

SATURN STAGE S-1-8
FINAL STATIC TEST REPORT

by

J. K. Crawford

August 5, 1964

SYSTEMS STATIC TEST BRANCH

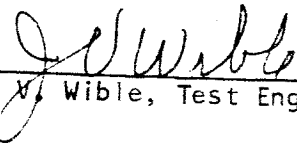

J. W. Wible, Test Engineering

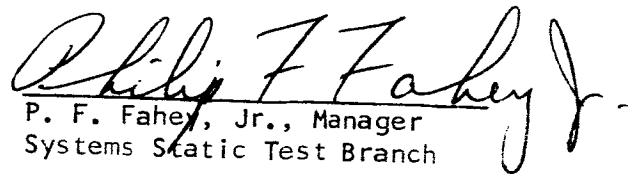

R. D. Cox, Test Operations

Approved by: 

P. F. Fahey, Jr., Manager
Systems Static Test Branch

Chrysler Corporation Space Division
Huntsville, Alabama

ABSTRACT

This report describes the acceptance test firing of the Saturn flight stage S-1-8 conducted at the Static Test Tower East, Marshall Space Flight Center (MSFC), Huntsville, Alabama.

TABLE OF CONTENTS

| | Page |
|--|------|
| ABSTRACT..... | ii |
| FOREWORD..... | 1 |
| SUMMARY..... | 3 |
| SECTION 1, INTRODUCTION..... | 5 |
| SECTION 2, ENGINE SYSTEMS..... | 7 |
| SECTION 3, ENGINE HYDRAULIC SYSTEMS..... | 49 |
| SECTION 4, PROPELLANT AND PNEUMATIC SYSTEMS..... | 53 |
| SECTION 5, ENGINE COMPARTMENT ENVIRONMENT..... | 77 |
| SECTION 6, VIBRATION AND SPECIAL INSTRUMENTATION..... | 85 |
| SECTION 7, ELECTRICAL CONTROL SYSTEMS..... | 87 |
| SECTION 8, TELEMETRY SYSTEMS..... | 93 |
| SECTION 9, CONCLUSIONS..... | 97 |
| SECTION 10, RECOMMENDATIONS..... | 103 |
| DISTRIBUTION LIST..... | 141 |
| APPENDIX | |
| A SYSTEMS STATIC TEST PROCEDURES..... | 105 |
| B REFERENCES..... | 113 |
| C REDLINE VALUES FOR STAGE S-1-8..... | 115 |
| D TEST DATA SHEET, TESTS SA-20 AND SA-21..... | 119 |
| E METEOROLOGICAL DATA, TEST SA-21..... | 125 |
| F CRITICAL COMPONENTS TIME/CYCLE HISTORY OF STAGE S-1-8 WHILE AT STATIC TEST..... | 127 |
| G UNSATISFACTORY CONDITION REPORTS LIST..... | 133 |

LIST OF ILLUSTRATIONS

| Figure | | Page |
|--------|---|------|
| 2-1 | RECOVERED PORTIONS OF THE 1-B SEAL RETAINER RING..... | 16 |
| 2-2 | PUNCTURED FIRST STAGE TURBINE HOUSING..... | 17 |
| 2-3 | H-1 ENGINE PURGE SYSTEM..... | 18 |
| 2-4 | H-1 ENGINE SCHEMATIC..... | 19 |
| 3-1 | ENGINE 1 HYDRAULIC SYSTEM..... | 50 |
| 4-1 | LOX TANKS SUPPLY SYSTEM..... | 59 |
| 4-2 | LOX PRESSURIZATION SYSTEM..... | 60 |
| 4-3 | FUEL PROPELLANT AND PRESSURIZATION SYSTEMS..... | 61 |
| 4-4 | LOX-SOX SYSTEM..... | 62 |
| 4-5 | GN ₂ CONTROL PRESSURE SYSTEM..... | 63 |
| 5-1 | TYPICAL HONEYCOMB PANEL EDGE CONSTRUCTION..... | 78 |
| 5-2 | TEST SA-21, HEAT SHIELD DAMAGE..... | 79 |
| 5-3 | STAINLESS STEEL HONEYCOMB HEAT SHIELD PANEL (BEFORE TEST SA-21)..... | 80 |
| 5-4 | STAINLESS STEEL HONEYCOMB HEAT SHIELD PANEL (AFTER TEST SA-21)..... | 81 |
| 7-1 | FIRING COMMAND TO IGNITION COMMAND (TEST SA-21)..... | 89 |
| 7-2 | IGNITION COMMAND TO COMMIT (TEST SA-21)..... | 90 |
| 7-3 | COMMIT TO INBOARD CUTOFF (TEST SA-21)..... | 91 |
| 7-4 | INBOARD CUTOFF TO RESET (TEST SA-21)..... | 92 |

LIST OF TABLES

| Table | | Page |
|-------|---|------|
| 2-1 | ENGINE STATIC TEST DATA (TEST SA-20)..... | 20 |
| 2-2 | ENGINE STATIC TEST DATA (TEST SA-21)..... | 24 |

LIST OF TABLES (CONTINUED)

| Table | | Page |
|-------|--|------|
| 2-3 | IGNITION AND CUTOFF SEQUENCE TIMES (TEST SA-20)..... | 28 |
| 2-4 | IGNITION AND CUTOFF SEQUENCE TIMES (TEST SA-21)..... | 30 |
| 3-1 | GIMBAL PROGRAM, TEST SA-20, ENGINES 1, 2, 3, AND 4..... | 51 |
| 3-2 | GIMBAL PROGRAM, TEST SA-21, ENGINES 1, 2, 3, AND 4..... | 52 |
| 4-1 | PROPELLANT LOADING AND PRESSURIZATION DATA..... | 64 |
| 4-2 | DISCRETE PROBE ACTUATION TIMES..... | 65 |
| 4-3 | VOLUME BELOW DISCRETE PROBES FOR STAGE S-1-8..... | 67 |
| 4-4 | PREVALVE CLOSING TIMES - TEST SA-20..... | 69 |
| 4-5 | PREVALVE CLOSING TIMES - TEST SA-21..... | 70 |
| 5-1 | HEAT SHIELD DAMAGE..... | 82 |
| 8-1 | COMPARISON OF TELEMETRY AND HARDWIRE DATA (TEST SA-21)..... | 95 |

LIST OF GRAPHS

| Graph | | Page |
|-------|---|------|
| 2-1 | ENGINE 1 IGNITION TRANSITION, MAIN OSCILLOGRAPH AND GG OSCILLOGRAPH..... | 32 |
| 2-2 | ENGINE 1 CUTOFF TRANSITION, MAIN OSCILLOGRAPH AND GG OSCILLOGRAPH..... | 33 |
| 2-3 | ENGINE 2 IGNITION TRANSITION, MAIN OSCILLOGRAPH AND GG OSCILLOGRAPH..... | 34 |
| 2-4 | ENGINE 2 CUTOFF TRANSITION, MAIN OSCILLOGRAPH AND GG OSCILLOGRAPH..... | 35 |
| 2-5 | ENGINE 3 IGNITION TRANSITION, MAIN OSCILLOGRAPH AND GG OSCILLOGRAPH..... | 36 |

LIST OF GRAPHS (CONTINUED)

| Graph | | Page |
|-------|---|------|
| 2-6 | ENGINE 3 CUTOFF TRANSITION, MAIN OSCILLOGRAPH AND GG OSCILLOGRAPH..... | 37 |
| 2-7 | ENGINE 4 IGNITION TRANSITION, MAIN OSCILLOGRAPH AND GG OSCILLOGRAPH..... | 38 |
| 2-8 | ENGINE 4 CUTOFF TRANSITION, MAIN OSCILLOGRAPH AND GG OSCILLOGRAPH..... | 39 |
| 2-9 | ENGINE 5 IGNITION TRANSITION, MAIN OSCILLOGRAPH AND GG OSCILLOGRAPH..... | 40 |
| 2-10 | ENGINE 5 CUTOFF TRANSITION, MAIN OSCILLOGRAPH AND GG OSCILLOGRAPH..... | 41 |
| 2-11 | ENGINE 6 IGNITION TRANSITION, MAIN OSCILLOGRAPH AND GG OSCILLOGRAPH..... | 42 |
| 2-12 | ENGINE 6 CUTOFF TRANSITION, MAIN OSCILLOGRAPH AND GG OSCILLOGRAPH..... | 43 |
| 2-13 | ENGINE 7 IGNITION TRANSITION, MAIN OSCILLOGRAPH AND GG OSCILLOGRAPH..... | 44 |
| 2-14 | ENGINE 7 CUTOFF TRANSITION, MAIN OSCILLOGRAPH AND GG OSCILLOGRAPH..... | 45 |
| 2-15 | ENGINE 8 IGNITION TRANSITION, MAIN OSCILLOGRAPH AND GG OSCILLOGRAPH..... | 46 |
| 2-16 | ENGINE 8 CUTOFF TRANSITION, MAIN OSCILLOGRAPH AND GG OSCILLOGRAPH..... | 47 |
| 4-1 | CENTER LOX TANK PRESSURE VS. TIME..... | 71 |
| 4-2 | GOX FLOW CONTROL VALVE POSITION VS. TIME..... | 72 |
| 4-3 | FUEL SYSTEM PRESSURIZATION CHARACTERISTICS VS. TIME..... | 73 |
| 4-4 | PRESSURES RELATED TO LOX-SOX SYSTEM VS. TIME..... | 74 |

LIST OF GRAPHS (CONTINUED)

| Graph | | Page |
|-------|---|------|
| 4-5 | TEMPERATURES RELATED TO LOX-SOX SYSTEM VS. TIME..... | 75 |
| 4-6 | CONTROL SPHERES PRESSURE VS. TIME..... | 76 |

SUMMARY

This report describes the acceptance test firings of the Saturn flight stage S-1-8, conducted at the Static Test Tower East, Marshall Space Flight Center, Huntsville, Alabama, during the period, April 27, 1964, to June 23, 1964.

Static test firings SA-20 and SA-21 were successfully conducted on May 26 and June 11, 1964, respectively. Test SA-20 duration was 48.94 seconds from ignition command signal to inboard engine cutoff signal with the cutoff signal being initiated by the firing panel operator. Test SA-21 duration was 139.92 seconds from ignition command signal to inboard engine cutoff signal, with LOX depletion cutoff of the outboard engines being initiated 5.69 seconds later, when the Thrust OK pressure switch on engine 4 dropped out.

Engine operation during test SA-20 was satisfactory; however, only engines 1 and 5 produced thrust within the specified limits of $188K \pm 3$ percent. The thrust of the other six engines exceeded the maximum limit of 193,640 pounds. All engines except 1 and 5 were reorificed prior to test SA-21.

Engine performance during test SA-21 was satisfactory with the exception of engines 6 and 8. The thrust produced by engine 6 was slightly above the specified limits of $188K \pm 3$ percent, and all parameters for engine 8, except consisphere temperature, indicated two abnormal downward performance shifts during the test.

Both engines, 6 and 8, were removed from the stage following evaluation of test data. Engine S/N H-2032 will replace S/N H-2017 at position 6. Engine S/N H-2029 was replaced by engine S/N H-2031 at position 8. Replacement engines S/N H-2032 and H-2031 produced thrust values within the specified limits of $188K \pm 3$ percent during static test firings at the Power Plant Test Stand, MSFC.

The LOX pressurization system functioned satisfactorily during both tests SA-20 and SA-21, although the LOX tank pressure exceeded the specified limits of 50 ± 2.5 psia. This discrepancy also occurred during static tests SA-18 and SA-19 of stage S-1-9. Unsatisfactory Condition Report CSD-S-00091 has been written documenting this discrepancy.

The acceptance firing test requirements for stage S-1-8, as specified in the Test Plan, were successfully achieved, with the exception of the pretest objective of topping LOX to a flight ullage of 2.2 percent immediately prior to ignition. The problems encountered which were peculiar to the small LOX tank ullage have been investigated by Systems Static Test Branch, and the results are presented in engineering test reports, Propellant Loading and Sub-Systems Special Test Report, and Special LOX Loading Test Report.

With the reinstallation of correctly performing engines at positions 6 and 8, the performance of all booster systems will be considered acceptable for launch.

Upon successful completion of the acceptance test firings, the Saturn stage S-1-8 was removed from Static Test Tower East on June 23, 1964, and returned by barge to the Chrysler Corporation Manufacturing Facility at Michoud, Louisiana for post-test modifications, repairs, installation of engine S/N H-2032 at position 6, and prelaunch hardware installation.

SECTION I. INTRODUCTION

The short and full duration firings, tests SA-20 and SA-21, on Saturn stage S-1-8, were performed by Chrysler Corporation Systems Static Test Branch, on May 26 and June 11, 1964, respectively, at the Static Test Tower East, Marshall Space Flight Center, Huntsville, Alabama.

Stage S-1-8 is the first of the Saturn S-1/S-1B booster stages to be manufactured by the Chrysler Corporation Space Division. The stage was shipped by barge from the CCSD manufacturing facility, at Michoud, Louisiana, on April 17, 1964, and arrived at the Marshall Space Flight Center dock on April 25, 1964. Installation of stage S-1-8 in STTE was accomplished on April 27, 1964. The stage was removed from STTE on June 23, 1964, upon completion of the long duration firing. Stage S-1-8 was loaded on the barge and departed Huntsville enroute to Michoud on June 24, 1964.

The primary objective of the static firing tests is to demonstrate the correct functional performance and operation of the airborne systems. To meet this requirement, the short duration test and the full duration acceptance test were performed with flight conditions simulated as closely as possible. The short duration firing constitutes a confidence test to verify airborne/ground control system compatibility, to checkout instrumentation, and to obtain engine thrust level data. The test objectives are further delineated as follows:

Short Duration Firing

1. Verification of airborne/ground control systems compatibility.
2. Determine propellant tank draining rates.
3. Check performance of the gimbal control system.
4. Verify reliability and performance of the telemetry system.
5. Verification of engine performance.
6. Verify the facility LOX liquid level measuring equipment capability for loading to a 2.2 percent ullage.
7. Obtain LOX and fuel pressurizing transients at ignition with reduced flight ullages.

Long Duration Firing

1. Determine propellant tank draining rates and terminal LOX draining characteristics.
2. Check performance of the gimbal control system.

3. Verify reliability and performance of the telemetry system.
4. Verification of engine performance.

The static test configuration of stage S-1-8 is defined by drawing 10M10016, Revision A. Deletions from the flight configuration include the following: stabilizer fins, stage interface fairing, adapter portions of the hydrogen chilldown ducts, forward compartment cover plates and instrumentation canister doors, LOX replenishing valve, and the LOX-SOX dispersal rings. Hardware additions include: upper stage deluge fire ring, inboard turbine exhaust duct extensions, auxiliary LOX dome purge manifold, and three LOX and three fuel fill and drain valves. Flight-type static test heat shield panels and engine flame curtains were used in place of the actual flight hardware. An uninstrumented, rectangular, S-1B stainless steel honeycomb heat shield panel (P/N 60C30555-1) was installed at fin line II adjacent to inboard engine 6 during test SA-20, and at fin line IV adjacent to inboard engine 8 during test SA-21. A peripheral tail skirt radiation shield is also incorporated in the static test configuration.

Reduced thrust levels experienced during test SA-18 of stage S-1-9, indicated that the lower LOX pump inlet pressure of 65 psia (formerly 80 psia), more than offset the thrust bias normally experienced between Rocketdyne acceptance test firings, and the Saturn stage firings. To compensate for the effect of the reduced LOX pump inlet pressure on stage S-1-8, the Rocketdyne recommended GG LOX orifices were installed in all engines, except engines 1 and 5, prior to test SA-20. Gas generator LOX orifices on engines 1 and 5 were increased, but not to the full Rocketdyne recommended dimensions. The Rocketdyne orifice size calculations for engines 1 and 5 had included an additional compensation for the main LOX diverter lip removal, which has subsequently been determined as unnecessary. Consequently, the GG LOX orifices that were installed on engines 1 and 5 corrected for the reduced LOX pump inlet pressure only.

The performance of each system is discussed in sections 2 through 8 of this report. Sections 9 and 10 constitute summaries of conclusions and recommendations. Included in the appendices are the following: System Static Test Procedures; References; Redline Values for Stage S-1-8; Test Data Sheet, Tests SA-20 and SA-21; Meteorological Data, Test SA-21; Critical Components Time/Cycle History of Stage S-1-8 While at Static Test; and Unsatisfactory Condition Reports List. These items are listed as APPENDICES A through G, respectively.

SECTION 2
ENGINE SYSTEMS

All engines operated satisfactorily during tests SA-20 and SA-21 with the exception of engine 8 during test SA-21. The operational difficulties occurring on this engine will be discussed in subsequent paragraphs of this section. During test SA-20, only engines 1 and 5 produced thrust within the specified limits of $188K \pm 3$ percent. The other engines produced thrust in excess of 193,640 pounds. These engines were reorificed prior to test SA-21. The performance of all engines, except engine 6, was within tolerance during test SA-21. This engine did not respond to reorificing as expected; consequently, it was removed from the stage for further testing at the Power Plant Test Stand. Engine S/N H-2032 will be installed in position 6 during post static checkout at Michoud.

The sea level thrust values and turbopump speeds are presented in the following table. All values were read at a slice time of X+29 to 32 seconds and were obtained by utilizing sea level reduction computer program CU0004.

| ENGINE | SEA LEVEL THRUST (KIPS) | | SEA LEVEL PUMP SPEED (RPM) | |
|--------|-------------------------|-------|----------------------------|-------|
| | SA-20 | SA-21 | SA-20 | SA-21 |
| 1 | 187.5 | 185.0 | 6504 | 6461 |
| 2* | 198.6 | 191.3 | 6712 | 6613 |
| 3* | 194.6 | 191.3 | 6710 | 6639 |
| 4* | 199.4 | 189.4 | 6825 | 6551 |
| 5 | 188.8 | 187.4 | 6567 | 6520 |
| 6* | 200.7 | 196.8 | 6834 | 6720 |
| 7* | 198.0 | 193.6 | 6778 | 6664 |
| 8* | 194.5 | 191.6 | 6675 | 6618 |

* Engine reorificed (GG LOX orifice only) prior to test SA-21.

During test SA-21, all engine 8 parameters except consisphere temperature indicated that a decrease in performance occurred at X+48.9 seconds and at X+127.8 seconds. Combustion chamber pressure decreased from 645.5 psig to 629.5 psig at X+48.9 seconds, and from 620.7 psig to 604.0 psig at X+127.8 seconds. In an effort to determine the cause of these performance shifts, the turbine exhaust hood was removed and the second stage turbine blades were inspected for possible erosion or damage. No discrepancies were found. The gas generator, the LOX and fuel wraparound manifolds, and the gearcase lube drain line were also removed for inspection. No contamination or discrepancies were noted. Engine 8 (S/N H-2029) was removed from the stage and replaced by engine (S/N H-2031). Engine S/N H-2029 was transported to the NASA engine shop where disassembly of the turbine was performed. Upon

disassembly, it was discovered that the four No. 4 screws that secure the I-B seal retainer ring to the seal housing had vibrated loose which allowed the retainer ring to rotate and eventually break up. These broken segments were thrown radially outward passing between the first stage nozzle and turbine wheel causing rubbing and eventual puncture of the first stage housing in two locations approximately 160 degrees apart. The damaged area circumscribed an area of approximately 15 degrees at each location. The first stage blades were chipped and worn due to metal particles from the retainer ring passing between the first stage nozzles and the turbine wheel. Photographs of the broken retainer ring and punctured first stage housing are included as FIGURES 2-1 and 2-2.

The replacement engines for positions 6 and 8 (S/N H-2032 and H-2031, respectively) were calibrated during static tests at the Power Plant Test Stand. The following table presents the sea level performance data from these tests. The sea level values were obtained using the H-1 engine sea level reduction computer program CU0004.

| ENGINE S/N | TEST NUMBER | SEA LEVEL THRUST (kips) | SEA LEVEL PUMP SPEED (rpm) | SEA LEVEL CHAMBER PRESSURE (psia) |
|------------|-------------|-------------------------|----------------------------|-----------------------------------|
| H-2031 | PI-435 | 187.9 | Meas. lost | 648.6 |
| H-2032 | PI-436 | 192.5 | 6671 | 662.6 |
| H-2032 | PI-437 | 190.2 | 6619 | 665.6 |

The performance of engines H-2031 and H-2032 was satisfactory during the static test at the Power Plant Test Stand. No malfunctions were noted.

In an attempt to alleviate the problem of contamination on the inboard engine LOX domes and injectors, a separate purge manifold identical to the one that was installed on stage S-1-9, was incorporated on stage S-1-8. This purge manifold has two supply lines, one for the regular 250 psig LOX dome purge, and a second supply line for the auxiliary 650 psig LOX dome purge. The auxiliary LOX dome purge supply solenoid is programmed to open at inboard engine cutoff signal and remain active until reset (reference FIGURE 2-3).

Prior to test SA-20, a special test was performed to determine if a change in the auxiliary LOX dome purge manifold plumbing would produce a higher pressure in the LOX domes of the inboard engines. For this test, the one-half inch diameter LOX dome purge tubing was disconnected at the purge manifold end and replaced with three-quarter inch diameter tubing connecting the purge manifold to LOX dome port C02A of each inboard engine. Also, to measure the pressure in the LOX dome, a water manometer was connected to LOX dome port C02C on engine 8. With both the LOX dome purge and the auxiliary LOX dome purge systems activated, the pressure in the LOX dome was 0.20 psig. In comparison, the pressure in the LOX dome of engine 8 was 0.10 psig with the original plumbing

configuration installed and both purges active. The complete results of this special test are presented in Systems Static Test Branch Memorandum T-367, LOX Dome Purge Investigation.

Millisadic data for test SA-20 indicated a sharp increase in all engine pressure parameters for engines 3 and 6. This shift, which occurred at X+10 seconds on engine 3 and X+12 seconds on engine 6, amounted to 8 psig and 3 psig in chamber pressure for engines 3 and 6, respectively. From past experience, a shift in all engine parameters, such as that observed on engines 3 and 6, is an indication of possible gas generator (GG) contamination. Consequently, the GG on engine 3 was removed, disassembled, and inspected. No contamination was noted in the GG or control valve. The control valve was functionally checked and the GG assembly was reinstalled on the engine. These abnormalities were not noted during test SA-21.

The turbopump No. 8 bearing temperature trace (measurement 15.08) indicated irregular fluctuations for all engines during tests SA-20 and SA-21. This condition, which is characteristic of outer race rotation, has been noted previously and is not considered detrimental to engine operation.

The No. 1 bearing pressure (measurement 2.54) increased sharply approximately 8 psig at X+9 seconds on engine 4, and 7 psig at X+16 seconds on engine 5 during test SA-21. The maximum pressures attained were 124 psig and 108 psig for engines 4 and 5, respectively. These pressures are not considered excessive. This variation resembles results from test SA-17 on stage S-1-7. The condition has been encountered frequently in past MSFC and Rocketdyne tests with no subsequent damage. The bearing pressure step is not considered detrimental to engine operation.

During test SA-20, the following discrepancies occurred to the engine instrumentation:

1. Measurement 15.08 - The conisphere temperature trace for engine 7 did not indicate. Post-test inspection of the thermocouple revealed that one of the two lead wires was broken. All conisphere thermocouples are normally replaced prior to each firing.

2. Measurement 19.01 - The LOX pump inlet temperature traces for engines 3 and 6 indicated an instrumentation failure after X+30.9 seconds and X+2.4 seconds, respectively. Post-test investigation revealed that in each case the malfunction was due to failure of the temperature sensors (P/N 50M10412). These temperature sensors were replaced prior to test SA-21.

3. Measurements 52.06 and 52.07 - The fuel pump inlet pressure trace for engine 6 and the LOX pump inlet pressure trace for engines 2

and 4 indicated instrumentation failure during test SA-20. These three traces indicated a constant pressure throughout the run duration. A similar problem existed during the static tests of stage S-1-9. At that time the problem was believed to be caused by moisture in the electrical connectors of these transducers. Post-test checks of these electrical connectors revealed no moisture was present. The continued loss of these measurements indicates that a problem still exists and that further investigation is required.

During test SA-21, the following discrepancies occurred to the engine instrumentation:

1. Hypergol Detect Light - The hypergol detect light on the Firing Preparation Panel remained illuminated after ignition command. Review of the sequence of event records showed that the switch, which indicates installation of an unspent hypergol cartridge, dropped out momentarily after ignition command. Post-test inspection revealed that the magnetically operated reed switch (P/N NA5-27189 TI) was sticking in the contracted position. After operating the switch probe several times, satisfactory operation was obtained, and replacement is not advised.

2. Measurement 52.07 - The LOX pump inlet pressure trace for engine 6 was erratic during test SA-21. The cause of this problem was traced to a faulty electrical connector at the transducer and was corrected. Also, the response of the LOX pump inlet pressure trace for engine 7 was slow during ignition transition. This condition has occurred during previous static tests. In an effort to isolate the cause of this recurring problem, the transducer for measurement 52.07-7 was removed from the stage and tested during a static firing at the Power Plant Test Stand. Results of this test were the same as test SA-21. Further investigation is in progress to determine the cause of this problem.

An engine system schematic is shown in FIGURE 2-4. Engine static test data for tests SA-20 and SA-21 are presented in TABLES 2-1 and 2-2. TABLES 2-3 and 2-4 present the ignition and cutoff sequence times. GRAPHS 2-1 through 2-16 show the oscillogram traces during the ignition and cutoff transitions of each engine during test SA-21. The engine pressure switch settings, regulator pressure settings, orifice sizes and the accumulated engine run times are contained in APPENDIX D, TEST DATA SHEETS - STTE.

Additional pertinent data, which is classified, are contained in the Confidential Supplement, Stage S-1-8. The data included in this Supplement are as follows: table of chamber pressures, plots of site and sea level chamber pressure versus turbopump speeds, and a table which presents a comparison of the hardwired chamber pressure values (measurements 4.51) with the telemetered chamber pressure values (measurement D-1).

Pretest SA-20 leak and hardware checks were conducted on the engine systems with the following results:

1. During installation of the Conax valve manifold test adapter assembly (P/N C-SSTB-2012) on engine 8, an attaching bolt was sheared. To provide adequate working access, it was necessary to remove the fuel control hose assembly (P/N 10605) before the sheared bolt could be extricated. After the bolt was removed, the hole was retapped and the Conax valve mounting face was resurfaced to remove several small scratches which were incurred during the bolt removal. The fuel control hose assembly was reinstalled and leak checked. No leakage was observed (reference QC Squawk S00103-2, UCR CSD-S-00008, and DMN H00103).

2. While performing the gas generator and turbine exhaust system leak checks, leakage was noted at the jam nut on the fuel igniter valve outlet elbow (P/N MC165C4). A new O-ring (P/N MS 29512-4) was installed under the jam nut, thus eliminating the leakage (reference QC Squawk S00109-5).

3. During a visual inspection of the thrust chambers, two dents were noted inside the thrust chamber of engine 7. These dents are located on adjacent tubes 1-3/4 inches above the return manifold and 90 degrees counterclockwise from the fuel inlet manifold. The depth of the dents are approximately 0.035 inch and 0.080 inch. No action was taken because the dents are less than the maximum allowable limit of 0.125 inch. Neither of these dents had been previously recorded in the Engine Log Book.

4. While checking for clearance around the solid propellant gas generator (SPGG), it was noted that on engines 5 and 6, tube assembly P/N 20M51296-1 came in contact with the SPGG housing and prevented proper alignment of the SPGG on the mounting flange. The tube assembly was repositioned by moving an Adel clamp.

5. During the tanking of fuel for the propellant loading test, leakage was noted at engine 6. It was found that the swivel elbow B-nut (P/N 4C68X-SS) on the fuel wraparound line was loose and that the B-nut on the high pressure bleed system tube assembly (P/N 10M10002-11) was also loose. Both fittings were torqued to maximum limit, and no further leakage was observed (reference QC Squawk S000109-6).

6. While removing the LOX and fuel pump inlet screens after the propellant loading tests, a nick was observed on the lower edge of the LOX inducer blade of engine 2. NASA turbopump shop personnel burnished and iridited the damaged area without removing the inducer (reference QC Squawk S00105-6 and UCR CSD-S-00034).

7. During removal of the fuel pump inlet screens, extreme difficulty was encountered in removing the bolts (NAS 1006-11H) which secure the wraparound ducts to the fuel pump inlet adapters. During reinstallation of the wraparound ducts, one bolt on engine 5 galled and one bolt on engine 6 twisted off. After removing the sheared bolt from

engine 6, a new insert (P/N KN HL 624) was installed. All other fuel pump inlet inserts were cleaned with a thread tap. Examination of the inserts indicated that excessive Molykote had been applied during the original assembly. To prevent a recurrence of this problem, it is recommended that limited amounts of Molykote be applied during manufacturing (reference UCR CSD-S-00032).

8. While performing thrust chamber gaseous leak checks, slight "fuzz" leakage was observed coming from the tapped hole in the LOX dome outer bolt circle on engines 1 and 3. The function of the tapped hole is for the attachment of a LOX dome removal tool. Since the leakage rate is slight, no action was taken prior to test SA-20 (reference QC Squawk S00104-13, S99106-8).

9. During the installation of the autoigniters, the one (S/N 116) at engine 6 required an excessive number of turns before obtaining the correct torque of 240 ± 24 in.-lbs. The autoigniter was removed and inspected. This inspection revealed that a crack existed between the threads and the wrench head and that the shank of the autoigniter had necked down as though it had been subjected to a tension load. It was determined that the use of the thread antiseize compound cut down on the thread friction and thus increased the stress on the autoignitier housing. All autoigniters were removed and checked for overstress. Six were found to be stretched and were replaced with new ones. All antiseize compound was removed from the threads, and the autoigniters were installed and torqued to 200 in.-lbs (reference QC Squawk S00103-4 and UCR CSD-S-00038).

10. During fuel lube blowdown, smoke was noted coming from the FABU heater blanket (P/N 4004) on engine 6. Further investigation revealed that the bottom of the blanket was blistered and saturated with fuel. The blanket was replaced, and no further problems were encountered (reference QC Squawk S00109-12 and UCR CSD-S-00039).

11. The engine thrust chambers were filled with 14 gallons of fuel and leak checked prior to test SA-20. The leak check revealed one slight seep leak on engine 5 located 1 inch above the return manifold and 50 degrees clockwise from the fuel inlet manifold, aft looking forward.

12. A visual inspection of engine 6 revealed that the band assembly (P/N 30M03322), which secures the inboard engine thrust chambers to the center access chute, was loose. The turnbuckle (P/N 30M03323) on the band assembly was torqued to the specified range of 35 to 40 in.-lbs. However, a piece of asbestos in the turnbuckle threads caused the specified torque to be attained without tightening the band assembly sufficiently. After removing the piece of asbestos, the turnbuckle was torqued to 40 in.-lbs and safety wired (reference QC Squawk S00109-3 and UCR CSD-S-00033).

Post-test SA-20 hardware inspection and leak checks were conducted on the engines with the following results:

| ENGINE | LEAKAGE RATE | LEAKAGE ELEVATION | LEAKAGE LOCATION IN DEGREES, COUNTERCLOCKWISE FROM FUEL INLET, AFT LOOKING FORWARD |
|--------|------------------|---------------------------------|--|
| 2 | Very slight seep | 12 inches above return manifold | 90° & 100° (2 leaks) |
| 5 | Very slight seep | 3 inches above return manifold | 80° |
| 8 | Very slight seep | 10 inches above return manifold | 90° |

4. A visual inspection of the LOX domes was performed on engines 3, 5, 6, 7, and 8. Entry into the LOX dome cavity was gained through LOX dome port C02A. Contamination observed is as follows: engines 3, 6, and 8 were clean; engine 5 had 1 particle per square inch; and engine 7 had approximately 15 particles per square inch. No attempt was made to clean the inboard engine LOX domes while the stage was in the test tower.



FIGURE 2-1
RECOVERED PORTIONS OF
THE I-B SEAL RETAINER RING

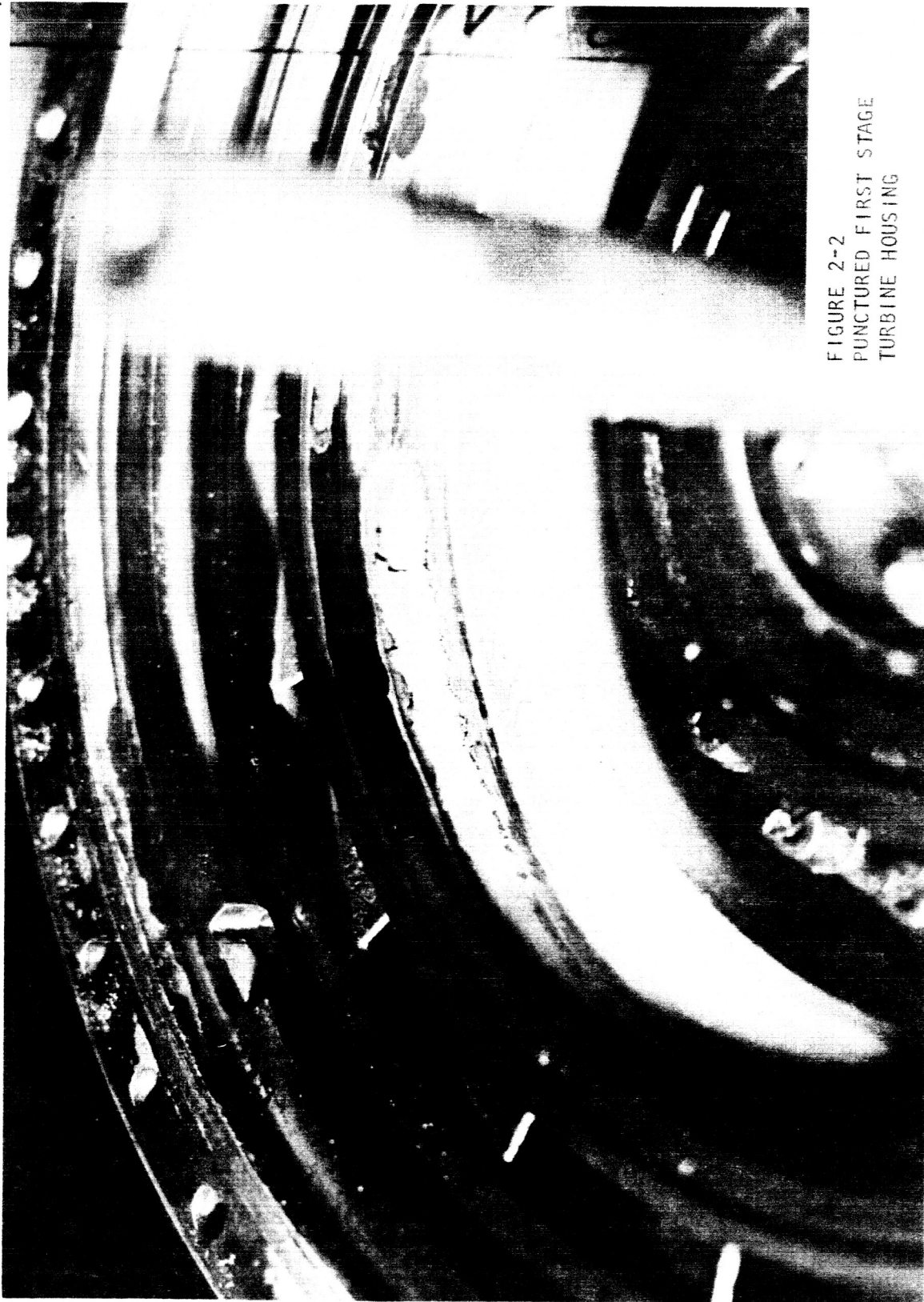
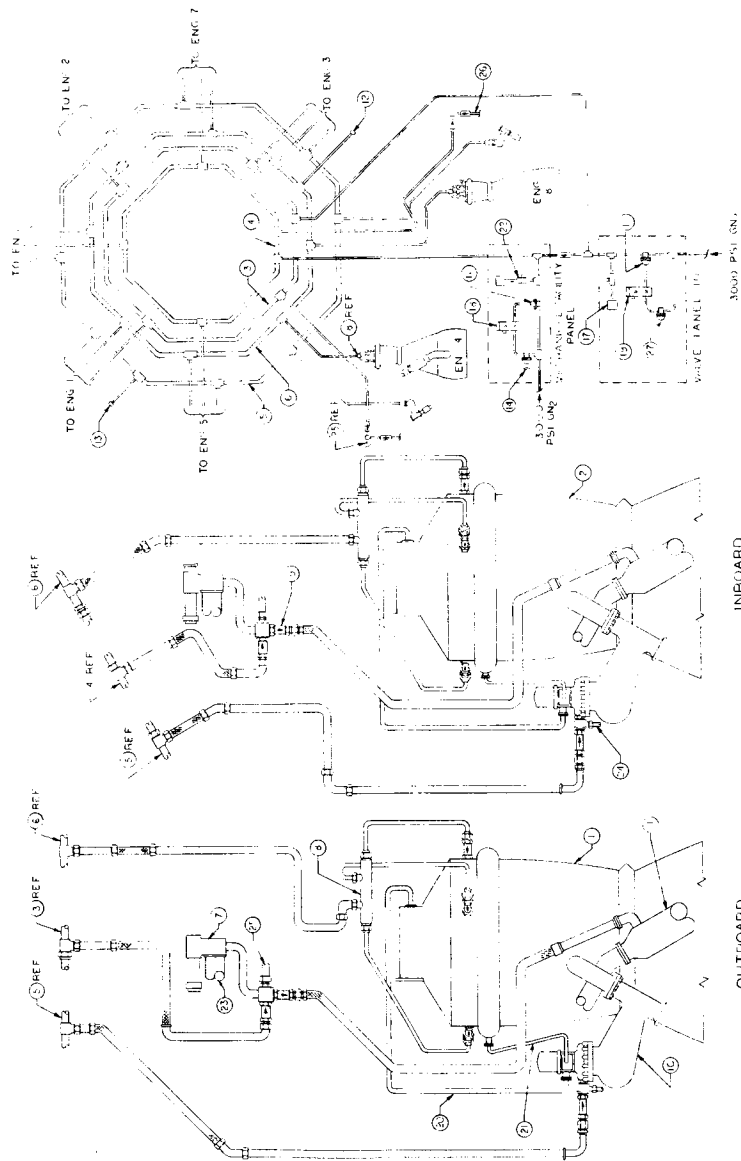

FIGURE 2-2
PUNCTURED FIRST STAGE
TURBINE HOUSING

- FINDING ITEM
- 1) ENGINES 1, 2, 3, 4
 - 2) LOX DOME PURGE MANIFOLD, OUTBOARD ENGINE
 - 3) LOX DOME PURGE MANIFOLD, INBOARD ENGINE
 - 4) GAS GENERATOR INJECTOR TURRET MANIFOLD (TYPICAL ALL ENGINES)
 - 5) FUEL INJECTOR TURRET (TYPICAL ALL ENGINES)
 - 6) MAIN LOX VALVE (TYPICAL ALL ENGINES)
 - 7) PURGE MANIFOLD (TYPICAL ALL ENGINES)
 - 8) CHECK VALVE (TYPICAL ALL ENGINES)
 - 9) LIQUID PROPellant GAS EXTRACTOR (TYPICAL ALL ENGINES)
 - 10) HEAT EXCHANGER (TYPICAL ALL ENGINES)
 - 11) PURGE SUPPLY, LOWER UMBRICAL, FIN II
 - 12) PURGE SUPPLY, LOWER UMBRICAL, FIN IV
 - 13) MAIN AFFINATE REGULATOR
 - 14) DUMP REGULATOR - 270 PSI
 - 15) PUMP REGULATOR - 650 PSI
 - 16) FIRE-SURE SWITCH (TYPICAL 2 PLACES)
 - 17) AUXILIARY LOX DOME PURGE SOLENOID
 - 18) LOX DOME PURGE SOLENOID
 - 19) LOX BOOTSTRAP LINE (TYPICAL ALL ENGINES)
 - 20) FUEL BOOTSTRAP LINE (TYPICAL ALL ENGINES)
 - 21) CALIBRATION VALVE (TYPICAL 2 PLACES)
 - 22) HIGH PRESSURE LOX DUCT
 - 23) TO MEASUREMENT 400 PSI PRESSURE GAS GENERATOR LOX INJECTOR MANIFOLD (TYPICAL ALL ENGINES)
 - 24) TO MEASUREMENT DITH (TYPICAL ENGINES 3 & 4)
 - 25) TO HEAT EXCHANGER (TYPICAL ALL ENGINES)
 - 26) FIELD REGULATOR



H-1 ENGINE PURGE SYSTEM FIGURE 2-3

- | ITEM NO | ITEM |
|---------|-------------------------------------|
| 1 | LOX SUCTION LINE |
| 2 | LOX BLEED LINE |
| 3 | TURBO PUMP |
| 4 | FUEL SUCTION LINE |
| 5 | LUBE DRAIN DRAIN |
| 6 | LOX SEAL DRAIN |
| 7 | GEAR BOX PRESS |
| 8 | LOX SEAL PURGE |
| 9 | LOX HIGH PRESS DUCT |
| 10 | MAIN LOX VALVE |
| 11 | IGNITER FUEL VALVE |
| 12 | LOX DOME |
| 13 | HYPERGOL CONTAINER |
| 14 | IGNITION MONITOR VALVE |
| 15 | MAIN FUEL VALVE |
| 16 | FUEL HIGH PRESS DUCT |
| 17 | T/P LUBE LINE |
| 18 | FABU |
| 19 | CONAX VALVE |
| 20 | MAIN LOX VALVE CLOSING CONTROL LINE |
| 21 | FUEL CONTROL CROSS |
| 22 | 2-STAGE TURBINE |
| 23 | FUEL BLEED LINE |
| 24 | SOLID PROPELLANT GAS GENERATOR |
| 25 | SPGG INITIATORS |
| 26 | LIQUID PROPELLANT GAS GENERATOR |
| 27 | GG LOX INJECTOR PURGE |
| 28 | GG AUTO IGNITERS |
| 29 | HEAT EXCHANGER |
| 30 | TURBINE EXHAUST DUCT |
| 31 | LOX BOOTSTRAP LINE |
| 32 | CONTROL LINE |
| 33 | FUEL BOOTSTRAP LINE |
| 34 | LOX INJECTOR |
| 35 | FUEL INJECTOR |
| 36 | FUEL MANIFOLD |
| 37 | COMBUSTION CHAMBER |

ORIFICES

- ▲ MAIN LOX
- ▲ MAIN FUEL
- ▲ GG LOX
- ▲ GG FUEL
- ▲ MLV CONTROL
- ▲ MFV CONTROL
- ▲ HEAT EXCHANGER (TYP 3 PLACES)

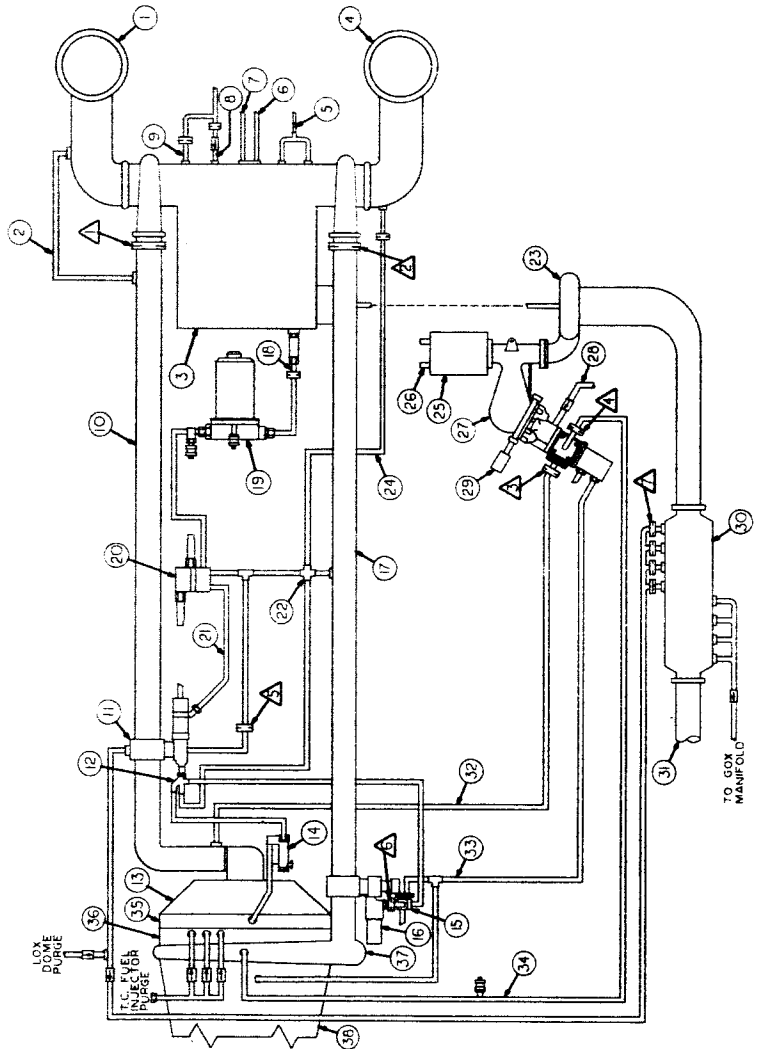

H-1 ENGINE SCHEMATIC FIGURE 2-4

TABLE 2-1
ENGINE STATIC TEST DATA

| | |
|--------------------------|------|
| Ambient Pressure (psia) | 14.4 |
| Ambient Temperature (°F) | 90 |

TEST SA-20

| STATIC MEASUREMENT NUMBER | MEASUREMENT DESCRIPTION | ENGINE | VALUES AT | | |
|---------------------------|---|--------|-----------|---------------------|---------|
| | | | IGNITION | AVERAGE X+29-32 sec | CUTOFF |
| 2.06 | Pressure Fuel Pump Inlet (psig) | 1 | 39.1 | 29.8 | 23.75 |
| | | 2 | 39.2 | 29.4 | 23.90 |
| | | 3 | 38.4 | 29.3 | 23.75 |
| | | 4 | 39.7 | 29.5 | 23.40 |
| | | 5 | 38.4 | 29.5 | 24.50 |
| | | 6 | 39.1 | 29.5 | 23.75 |
| | | 7 | 38.8 | 29.3 | 23.75 |
| | | 8 | 38.5 | 29.4 | 24.0 |
| 13.01 | Temperature Fuel Pump Inlet (°F) | 8 | 66.5 | 68.5 | 66.0 |
| | Density of Fuel at pump inlet (lbs/cu ft) | 8 | | 50.22 | |
| 5.51 | Pressure Fuel Pump Outlet (psig) | 1 | | 906.9 | 906.5 |
| | | 2 | | 971.0 | 970.2 |
| | | 3 | | 981.5 | 975.0 |
| | | 4 | | 985.9 | 980.6 |
| | | 5 | | 948.6 | 946.3 |
| | | 6 | | 1006.2 | 1000.0 |
| | | 7 | | 957.1 | 949.5 |
| | | 8 | | 956.7 | 947.8 |
| 2.07 | Pressure LOX Pump Inlet (psig) | 1 | 75.5 | 55.5 | 52.4 |
| | | 2 | 76.0 | 55.5 | 51.0 |
| | | 3 | 75.8 | 55.0 | 51.4 |
| | | 4 | 75.4 | 53.9 | 50.5 |
| | | 5 | 75.5 | 57.0 | 53.5 |
| | | 6 | 75.5 | 54.5 | 50.9 |
| | | 7 | 76.0 | 55.0 | 51.5 |
| | | 8 | 75.5 | 56.4 | 51.2 |
| 19.01 | Temperature LOX Pump Inlet (°F) | 1 | -282.7 | -293.5 | -293.45 |
| | | 2 | -282.2 | -293.3 | -293.40 |
| | | 3 | -282.0 | -293.1 | * |
| | | 4 | -282.3 | -294.0 | -293.9 |
| | | 5 | -281.3 | -293.7 | -293.65 |
| | | 6 | -281.3 | ** | ** |
| | | 7 | -280.6 | -292.6 | -292.75 |
| | | 8 | -284.1 | -294.4 | -294.45 |

* Measurement lost at X+34 seconds

** Measurement lost at X+6 seconds

TABLE 2-1 (CONTINUED)

| STATIC MEASUREMENT NUMBER | MEASUREMENT DESCRIPTION | ENGINE | VALUES AT | | |
|---------------------------|---|--------|-----------|---------------------|--------|
| | | | IGNITION | AVERAGE X+29-32 sec | CUTOFF |
| 2.01 | Pressure Gear Case (psig) | 1 | | 3.7 | |
| | | 2 | | 3.8 | |
| | | 3 | | 4.0 | |
| | | 4 | | 4.1 | |
| | | 5 | | 4.3 | |
| | | 6 | | 4.6 | |
| | | 7 | | 3.4 | |
| | | 8 | | 4.1 | |
| 92.01 | Turbopump Speed (rpm) | 1 | | 6538 | 6512 |
| | | 2 | | 6745 | 6722 |
| | | 3 | | 6739 | 6721 |
| | | 4 | | 6862 | * |
| | | 5 | | 6610 | ** |
| | | 6 | | 6864 | 6844 |
| | | 7 | | 6813 | 6770 |
| | | 8 | | 6727 | 6702 |
| 14.03 | Temperature Oronite (°F) | 1 | 121.4 | | |
| | | 2 | 131.5 | | |
| | | 3 | 132.0 | | |
| | | 4 | 131.5 | | |
| | | 5 | 127.5 | | |
| | | 6 | 121.9 | | |
| | | 7 | 126.0 | | |
| | | 8 | 122.4 | | |
| 2.54 | Pressure Lube Oil No. 1 Bearing | 1 | | 104.1 | |
| | | 2 | | 122.1 | |
| | | 3 | | 129.0 | |
| | | 4 | | 127.0 | |
| | | 5 | | 106.0 | |
| | | 6 | | 129.0 | |
| | | 7 | | 108.2 | |
| | | 8 | | 112.0 | |
| 14.01 | Temperature LOX Pump No. 1 Bearing (°F) | 1 | 106.0 | 136.0 | 156.0 |
| | | 2 | 92.5 | 119.8 | 139.0 |
| | | 3 | 102.4 | 119.8 | 140.0 |
| | | 4 | 99.0 | 129.9 | 153.0 |
| | | 5 | 102.0 | 131.0 | 154.0 |
| | | 6 | 109.0 | 122.0 | 145.0 |
| | | 7 | 101.8 | 135.5 | 160.0 |
| | | 8 | 124.0 | 136.0 | 155.0 |

* Measurement Lost - Oscillograph magazine jammed.

** Measurement Lost

TABLE 2-1 (CONTINUED)

| STATIC MEASUREMENT NUMBER | MEASUREMENT DESCRIPTION | ENGINE | VALUES AT | | |
|---------------------------|--|--------|-----------|---------------------|--------|
| | | | IGNITION | AVERAGE X+29-32 sec | CUTOFF |
| 15.02 | Temperature Turbopump No. 2 Bearing (°F) | 1 | 87.8 | 113.5 | 128.3 |
| | | 2 | 84.9 | 112.4 | 127.3 |
| | | 3 | 95.4 | 115.5 | 130.2 |
| | | 4 | 78.0 | 100.8 | 113.5 |
| | | 5 | 92.9 | 120.3 | 138.6 |
| | | 6 | 93.4 | 119.5 | 133.1 |
| | | 7 | 89.0 | 116.9 | 132.9 |
| | | 8 | 104.2 | 133.5 | 150.5 |
| 15.04 | Temperature Turbopump No. 4 Bearing (°F) | 1 | 112.1 | 151.0 | 170.4 |
| | | 2 | 107.0 | 141.8 | 156.0 |
| | | 3 | 110.4 | 149.1 | 166.3 |
| | | 4 | 112.9 | 154.9 | 172.5 |
| | | 5 | 109.5 | 147.2 | 165 |
| | | 6 | *56.8 | *96.5 | *114 |
| | | 7 | 113.0 | 157.5 | 179.5 |
| | | 8 | 115.3 | 151.0 | 167.5 |
| 15.08 | Temperature Turbopump No. 8 Bearing (°F) | 1 | 70.0 | 144.3 | 218.0 |
| | | 2 | 61.0 | 159.1 | 208.0 |
| | | 3 | 68.0 | 191.0 | 228.0 |
| | | 4 | 66.0 | 147.5 | 236.0 |
| | | 5 | 69.9 | 168.0 | 256.0 |
| | | 6 | 72.1 | 176.0 | 228.0 |
| | | 7 | 67.9 | 150.4 | 214.0 |
| | | 8 | 75.0 | 171.0 | 236.0 |
| 5.52 | Pressure LOX Pump Outlet (psig) | 1 | | 777.9 | 776.7 |
| | | 2 | | 819.9 | 820.0 |
| | | 3 | | 794.7 | 796.8 |
| | | 4 | | 838.5 | 839.6 |
| | | 5 | | 792.4 | 795.7 |
| | | 6 | | 833.0 | 831.4 |
| | | 7 | | 823.2 | 819.5 |
| | | 8 | | 816.0 | 816.7 |
| 13.11 | Temperature SPGG Surface (°F) | 1 | 67.0 | | |
| | | 2 | 60.2 | | |
| | | 3 | 62.3 | | |
| | | 4 | 63.5 | | |
| | | 5 | 66.3 | | |
| | | 6 | 65.6 | | |
| | | 7 | 64.5 | | |
| | | 8 | 62.0 | | |

* Doubtful measurement

TABLE 2-1 (CONTINUED)

| STATIC MEASUREMENT NUMBER | MEASUREMENT DESCRIPTION | ENGINE | VALUES AT | | |
|---------------------------|--|--------|-----------|----------------------------|-------|
| | | | IGNITION | AVERAGE X+29-32 sec CUTOFF | |
| 16.01 | Temperature Conisphere (°F) | 1 | | 1208 | 1130 |
| | | 2 | | 1245 | 1250 |
| | | 3 | | 1263 | 1265 |
| | | 4 | | 1268 | 1260 |
| | | 5 | | 1212 | 1220 |
| | | 6 | | 1287 | 1290 |
| | | 7 | | * | * |
| | | 8 | | 1263 | 1260 |
| 4.02 | Pressure GG LOX Injector Manifold (psig) | 1 | | 671.8 | |
| | | 2 | | 711.3 | |
| | | 3 | | 689.2 | |
| | | 4 | | 739.0 | |
| | | 5 | | 763.2 | |
| | | 6 | | 705.3 | |
| | | 7 | | 720.3 | |
| | | 8 | | 717.9 | |
| 4.04 | Pressure Turbine Inlet (psig) | 1 | | 477.8 | 478.5 |
| | | 2 | | 495.9 | 497.5 |
| | | 3 | | 490.7 | 491.0 |
| | | 4 | | 518.9 | 521.0 |
| | | 5 | | 491.0 | 493.0 |
| | | 6 | | 499.8 | 489.6 |
| | | 7 | | 519.5 | 516.7 |
| | | 8 | | 491.3 | 495.6 |

* Measurement lost

TABLE 2-2
ENGINE STATIC TEST DATA

| | |
|--------------------------|------|
| Ambient Pressure (psia) | 14.4 |
| Ambient Temperature (°F) | 87 |

TEST SA-21

| STATIC MEASUREMENT NUMBER | MEASUREMENT DESCRIPTION | ENGINE | VALUES AT | | |
|---------------------------|---|--------|-----------|---------------------|--------|
| | | | IGNITION | AVERAGE X+29-32 sec | CUTOFF |
| 2.06 | Pressure Fuel Pump Inlet (psig) | 1 | 38.5 | 30.3 | 14.8 |
| | | 2 | 36.7 | 30.5 | 14.7 |
| | | 3 | 37.2 | 30.7 | 14.5 |
| | | 4 | 37.8 | 30.0 | 14.6 |
| | | 5 | 38.9 | 30.5 | 16.0 |
| | | 6 | 38.8 | 30.3 | 15.7 |
| | | 7 | 38.9 | 29.9 | 15.8 |
| | | 8 | 37.2 | 30.5 | 16.0 |
| 13.01 | Temperature Fuel Pump Inlet (°F) | 8 | 71.0 | 75.7 | 77.5 |
| | Density of Fuel at pump inlet (lbs/cu ft) | 8 | | 50.07 | |
| 5.51 | Pressure Fuel Pump Outlet (psig) | 1 | | 942.6 | 921.9 |
| | | 2 | | 932.0 | 908.1 |
| | | 3 | | 951.9 | 923.9 |
| | | 4 | | 910.6 | 886.4 |
| | | 5 | | 922.3 | 893.2 |
| | | 6 | | 964.7 | 938.8 |
| | | 7 | | 906.2 | 880.9 |
| | | 8 | | 918.1 | 845.1 |
| 2.07 | Pressure LOX Pump Inlet (psig) | 1 | 74.3 | 56.0 | 32.3 |
| | | 2 | 74.0 | 54.3 | 31.2 |
| | | 3 | 74.2 | 54.0 | 31.0 |
| | | 4 | 75.0 | 54.0 | 31.8 |
| | | 5 | 73.7 | 54.8 | 33.5 |
| | | 6 | 74.3 | 54.0 | 32.0 |
| | | 7 | 74.5 | 53.8 | 31.5 |
| | | 8 | 74.1 | 55.2 | 34.0 |
| 19.01 | Temperature LOX Pump Inlet (°F) | 1 | -281.7 | -292.4 | -291.4 |
| | | 2 | -281.2 | -292.7 | -292.1 |
| | | 3 | -281.2 | -292.8 | -291.3 |
| | | 4 | -281.3 | -292.5 | -290.8 |
| | | 5 | -280.7 | -292.7 | -291.2 |
| | | 6 | -281.2 | -292.9 | -291.7 |
| | | 7 | -280.5 | -293.1 | -292.1 |
| | | 8 | -280.3 | -293.0 | -291.5 |

TABLE 2-2 (CONTINUED)

| STATIC MEASUREMENT NUMBER | MEASUREMENT DESCRIPTION | ENGINE | VALUES AT | | |
|---------------------------|---|--------|-----------|---------------------|--------|
| | | | IGNITION | AVERAGE X+29-32 sec | CUTOFF |
| 2.01 | Pressure Gear Case (psig) | 1 | | 3.1 | |
| | | 2 | | 3.8 | |
| | | 3 | | 4.0 | |
| | | 4 | | 4.2 | |
| | | 5 | | 4.3 | |
| | | 6 | | 4.1 | |
| | | 7 | | 3.4 | |
| | | 8 | | 4.3 | |
| 92.01 | Turbopump Speed (rpm) | 1 | | 6493 | 6452 |
| | | 2 | | 6643 | 6588 |
| | | 3 | | 6669 | 6600 |
| | | 4 | | 6579 | 6485 |
| | | 5 | | 6551 | 6461 |
| | | 6 | | 6753 | 6714 |
| | | 7 | | 6700 | 6655 |
| | | 8 | | 6654 | 6504 |
| 14.03 | Temperature Oronite (°F) | 1 | 132.0 | | |
| | | 2 | 133.0 | | |
| | | 3 | 127.0 | | |
| | | 4 | 125.5 | | |
| | | 5 | 121.5 | | |
| | | 6 | 121.5 | | |
| | | 7 | 130.0 | | |
| | | 8 | 124.7 | | |
| 2.54 | Pressure Lube Oil No. 1 Bearing | 1 | | 103.0 | |
| | | 2 | | 125.5 | |
| | | 3 | | 123.5 | |
| | | 4 | | 126.5 | |
| | | 5 | | 108.0 | |
| | | 6 | | 124.7 | |
| | | 7 | | 117.7 | |
| | | 8 | | 109.5 | |
| 14.01 | Temperature LOX Pump No. 1 Bearing (°F) | 1 | 102 | 143 | 220 |
| | | 2 | 78 | 116 | 197 |
| | | 3 | 100 | 122 | 202 |
| | | 4 | 97 | 125 | 217 |
| | | 5 | 104 | 126 | 212 |
| | | 6 | 118 | 124 | 219 |
| | | 7 | 103 | 136 | 226 |
| | | 8 | 124 | 138 | 211 |

TABLE 2-2 (CONTINUED)

| STATIC MEASUREMENT NUMBER | MEASUREMENT DESCRIPTION | ENGINE | VALUES AT | | |
|---------------------------|--|--------|-----------|---------------------|--------|
| | | | IGNITION | AVERAGE X+29-32 sec | CUTOFF |
| 15.02 | Temperature Turbopump No. 2 Bearing (°F) | 1 | 87.4 | | 187.2 |
| | | 2 | 79.0 | | 190.5 |
| | | 3 | 89.8 | | 193.4 |
| | | 4 | 77.6 | | 166.0 |
| | | 5 | 88.3 | | 193.9 |
| | | 6 | 94.9 | | 203.4 |
| | | 7 | 89.9 | | 200.9 |
| | | 8 | 103.9 | | 202.1 |
| 15.04 | Temperature Turbopump No. 4 Bearing (°F) | 1 | 113.6 | | 236.1 |
| | | 2 | 99.3 | | 203.3 |
| | | 3 | 111.5 | | 229.4 |
| | | 4 | 106.2 | | 221.3 |
| | | 5 | 111.5 | | 221.6 |
| | | 6 | 112.4 | | 219.7 |
| | | 7 | 113.3 | | 234.8 |
| | | 8 | 115.6 | | 215.2 |
| 15.08 | Temperature Turbopump No. 8 Bearing (°F) | 1 | 70.0 | 152 | 406 |
| | | 2 | 60.5 | 148 | 401 |
| | | 3 | 69.5 | 164 | 410 |
| | | 4 | 67.5 | 161 | 412 |
| | | 5 | 71.0 | 170 | 430 |
| | | 6 | 75.0 | 179 | 423 |
| | | 7 | 68.5 | 155 | 415 |
| | | 8 | 75.5 | 176 | 441 |
| 5.52 | Pressure LOX Pump Outlet (psig) | 1 | | 768.8 | 746.0 |
| | | 2 | | 790.9 | 768.6 |
| | | 3 | | 774.9 | 748.6 |
| | | 4 | | 786.8 | 760.6 |
| | | 5 | | 772.8 | 743.7 |
| | | 6 | | 805.0 | 785.0 |
| | | 7 | | 801.4 | 776.0 |
| | | 8 | | 803.0 | 742.7 |
| 13.11 | Temperature SPGG Surface (°F) | 1 | 64.8 | | |
| | | 2 | 57.8 | | |
| | | 3 | 60.5 | | |
| | | 4 | 60.0 | | |
| | | 5 | 63.7 | | |
| | | 6 | 63.0 | | |
| | | 7 | 58.5 | | |
| | | 8 | 62.3 | | |

TABLE 2-2 (CONTINUED)

| STATIC MEASUREMENT NUMBER | MEASUREMENT DESCRIPTION | ENGINE | VALUES AT | | |
|---------------------------|--|--------|-----------|----------------------------|-------|
| | | | IGNITION | AVERAGE X+29-32 sec CUTOFF | |
| 16.01 | Temperature Conisphere (°F) | 1 | | 1195 | 1177 |
| | | 2 | | 1222 | 1210 |
| | | 3 | | 1265 | 1248 |
| | | 4 | | 1210 | 1195 |
| | | 5 | | 1213 | 1193 |
| | | 6 | | 1253 | 1234 |
| | | 7 | | 1222 | 1210 |
| | | 8 | | 1310 | 1282 |
| 4.02 | Pressure GG LOX Injector Manifold (psig) | 1 | | 658.1 | |
| | | 2 | | 675.5 | |
| | | 3 | | 667.4 | |
| | | 4 | | 683.2 | |
| | | 5 | | 673.3 | |
| | | 6 | | 676.2 | |
| | | 7 | | 690.7 | |
| | | 8 | | 695.9 | |
| 4.04 | Pressure Turbine Inlet (psig) | 1 | | 462.0 | 454.2 |
| | | 2 | | 475.6 | 469.4 |
| | | 3 | | 474.9 | 467.6 |
| | | 4 | | 474.8 | 465.1 |
| | | 5 | | 477.1 | 462.4 |
| | | 6 | | 472.8 | 468.1 |
| | | 7 | | 494.4 | 483.8 |
| | | 8 | | 472.3 | 435.7 |

TABLE 2-3
IGNITION AND CUTOFF SEQUENCE TIMES

TEST SA-20

| ENGINE | TIMES FROM THE IGNITION SIGNAL OF EACH ENGINE IN MILLISECONDS | | | | | | | |
|--|---|--------|--------|--------|--------|--------|--------|--------|
| | 1 | 2 | 3 | 4 | 5 | 6 | 7 | 8 |
| IGNITION SIGNAL FROM IGNITION COMMAND (MILLISECONDS) | 327 | 226 | 327 | 226 | 26 | 126 | 27 | 126 |
| MLV Starts Opening | 235 | 215 | 230 | 220 | 215 | 215 | 230 | 205 |
| MLV Full Open | 470 | 470 | 485 | 460 | 470 | 485 | 455 | 495 |
| MLV Opening Time | 235 | 255 | 255 | 240 | 255 | 270 | 225 | 290 |
| MFV Starts Opening | 590 | 585 | 600 | 575 | 570 | 595 | 570 | 595 |
| MFV Full Open | 1225 | 1200 | 1200 | 1195 | 1170 | 1170 | 1255 | 1175 |
| MFV Opening Time | 635 | 615 | 600 | 620 | 600 | 575 | 685 | 580 |
| Thrust Chamber Ignition | 505 | 500 | 515 | 485 | 485 | 505 | 480 | 505 |
| Pc Prime | 820 | 810 | 820 | 810 | 790 | 810 | 805 | 810 |
| Pc Reaches 90% | 1015 | 1020 | 1075 | 1025 | 1020 | 1025 | 1065 | 1005 |
| // | | | | | | | | |
| Turbopump Prime Speed (RPM) | 5353 | 5345 | 5353 | 5263 | * | 5460 | 5460 | 5353 |
| Conax Firing Signal, (Seconds From Commit) | 46.070 | 46.071 | 46.071 | 46.071 | 45.952 | 45.952 | 45.952 | 45.952 |

* Measurement Lost

TABLE 2-3 (CONTINUED)

| ENGINE | 1 | 2 | 3 | 4 | 5 | 6 | 7 | 8 |
|---------------------|--|------|------|-----|------|------|------|------|
| | TIMES FROM CONAX FIRING SIGNAL IN MILLISECONDS | | | | | | | |
| MLV Starts Closing | 85 | 85 | 85 | * | 85 | 85 | 85 | 85 |
| MLV Full Closed | 420 | 395 | 390 | * | 355 | 385 | 360 | 370 |
| MLV Closing Time | 335 | 310 | 305 | * | 270 | 300 | 275 | 285 |
| MFV Starts Closing | 335 | 330 | 320 | * | 320 | 300 | 305 | 330 |
| MFV Full Closed | 1460 | 1430 | 1430 | * | 1340 | 1370 | 1440 | 1350 |
| MFV Closing Time | 1125 | 1100 | 1110 | * | 1020 | 1070 | 1135 | 1020 |
| Pc Leaves Mainstage | 110 | 115 | 115 | 110 | 115 | 105 | 100 | 110 |
| Pc Decays to 90% | 165 | 165 | 165 | 160 | 175 | 160 | 160 | 165 |
| Pc Decays to 10% | 370 | 360 | 370 | 350 | 350 | 350 | 345 | 350 |

* Measurements lost - oscillograph magazine jammed.

TABLE 2-4
IGNITION AND CUTOFF SEQUENCE TIMES

TEST SA-21

| ENGINE | 1 | 2 | 3 | 4 | 5 | 6 | 7 | 8 |
|---|---------|---------|---------|---------|---------|---------|---------|---------|
| IGNITION SIGNAL FROM IGNITION COMMAND (MILLISECONDS) | 325 | 225 | 326 | 225 | 26 | 125 | 25 | 125 |
| TIMES FROM THE IGNITION SIGNAL OF EACH ENGINE IN MILLISECONDS | | | | | | | | |
| MLV Starts Opening | 210 | 215 | 200 | 220 | 220 | 210 | 205 | 205 |
| MLV Full Open | 475 | 460 | 450 | 475 | 470 | 470 | 445 | 500 |
| MLV Opening Time | 265 | 245 | 250 | 255 | 250 | 260 | 240 | 295 |
| MFV Starts Opening | 575 | 575 | 550 | 575 | 580 | 575 | 575 | 605 |
| MFV Full Open | 1210 | 1175 | 1140 | 1200 | 1170 | 1155 | 1260 | 1195 |
| MFV Opening Time | 635 | 600 | 590 | 625 | 590 | 580 | 685 | 590 |
| Thrust Chamber Ignition | 500 | 485 | 485 | 490 | 470 | 490 | 475 | 520 |
| Pc Prime | 810 | 795 | 780 | 810 | 800 | 800 | 810 | 825 |
| Pc Reaches 90% | 995 | 985 | 1000 | 1000 | 1010 | 995 | 1025 | 1015 |
| ===== | | | | | | | | |
| Turbopump Prime Speed (RPM) | 5713 | 5544 | 5410 | 5396 | 5519 | 5539 | 5494 | 5425 |
| Conax Firing Signal, (Seconds From Commit) | 142.631 | 142.628 | 142.630 | 142.617 | 136.924 | 136.922 | 136.922 | 135.924 |

TABLE 2-4 (CONTINUED)

| ENGINE | 1 | 2 | 3 | 4 | 5 | 6 | 7 | 8 |
|---------------------|------|------|-------|-------|------|------|------|------|
| | | | | | | | | |
| MLV Starts Closing | 80 | 85 | 95 | 100 | 95 | 80 | 85 | 85 |
| MLV Full Closed | 415 | 390 | 405 | 400 | 370 | 380 | 360 | 370 |
| MLV Closing Time | 335 | 305 | 310 | 300 | 275 | 300 | 275 | 285 |
| MFV Starts Closing | 360 | 320 | 365 | 350 | 330 | 310 | 330 | 335 |
| MFV Full Closed | 1460 | 1420 | 1485 | 1530 | 1345 | 1350 | 1440 | 1365 |
| MFV Closing Time | 1100 | 1100 | 1120 | 1180 | 1015 | 1040 | 1100 | 1030 |
| Pc Leaves Mainstage | 90 | 120 | -133* | -370* | 125 | 110 | 110 | 115 |
| Pc Decays to 90% | 160 | 170 | -41* | -33* | 180 | 160 | 165 | 165 |
| Pc Decays to 10% | 380 | 360 | 487 | 460 | 355 | 355 | 345 | 360 |

* Trace dropped before conax signal.

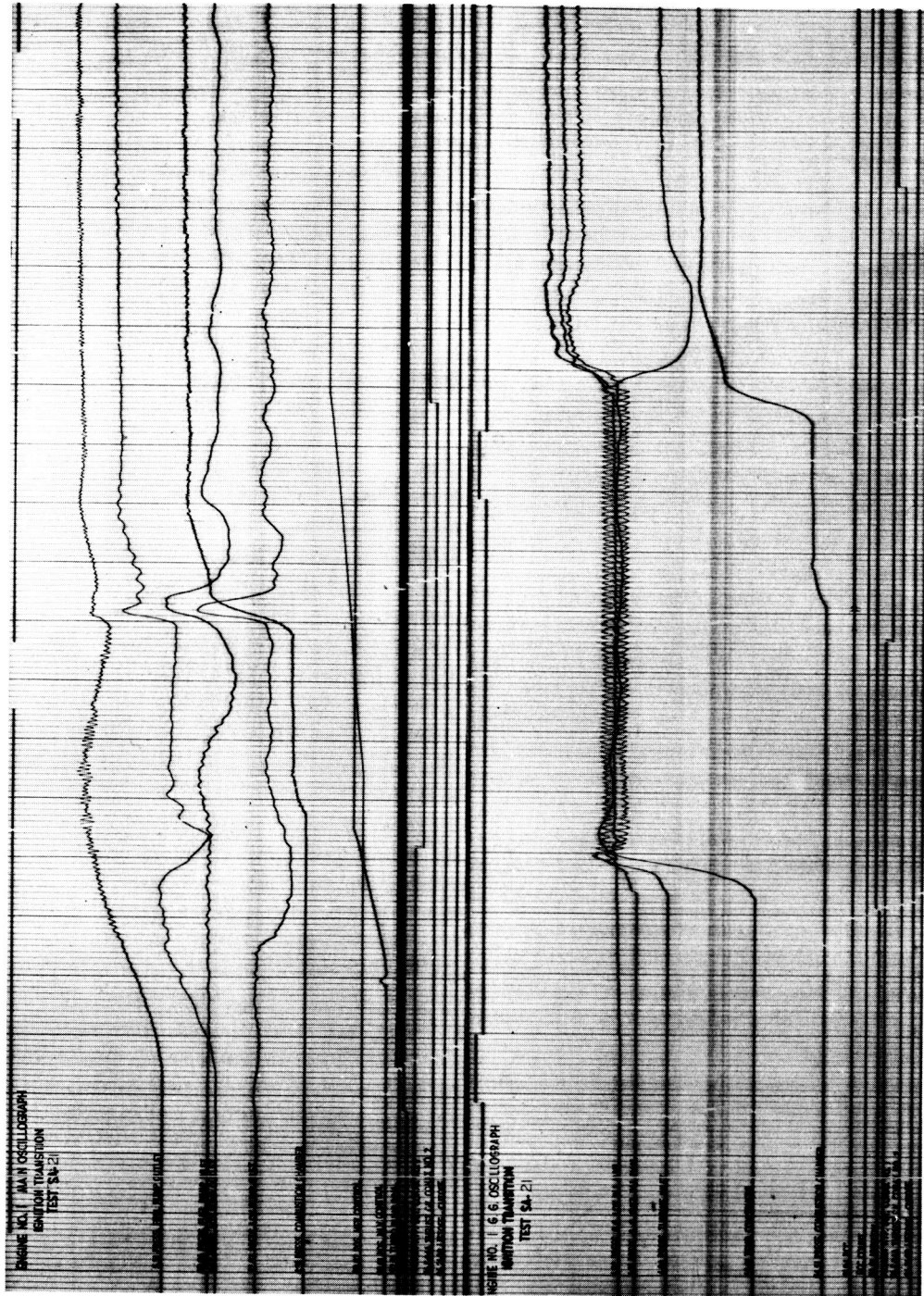

GRAPH 2-1

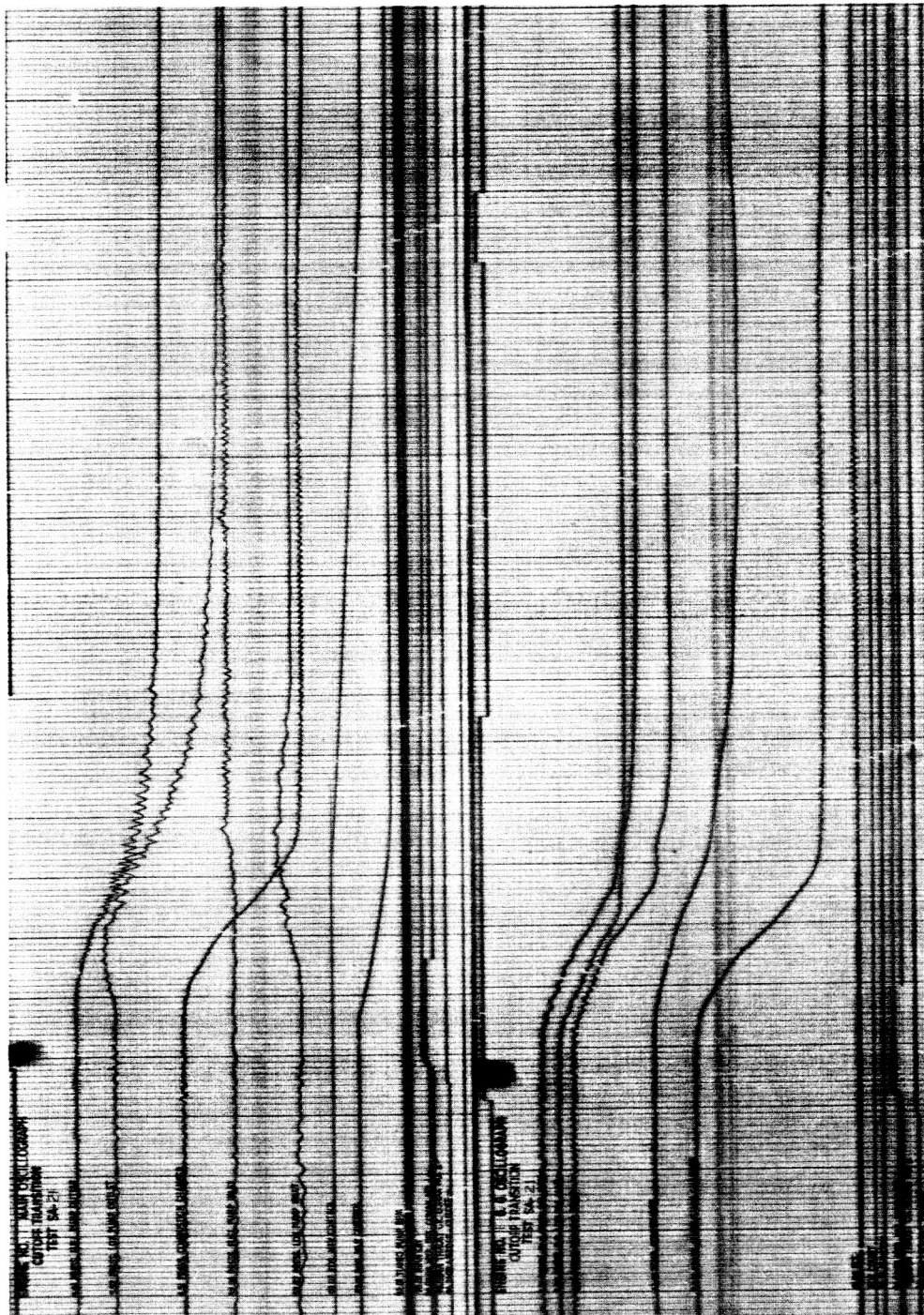

GRAPH 2-2

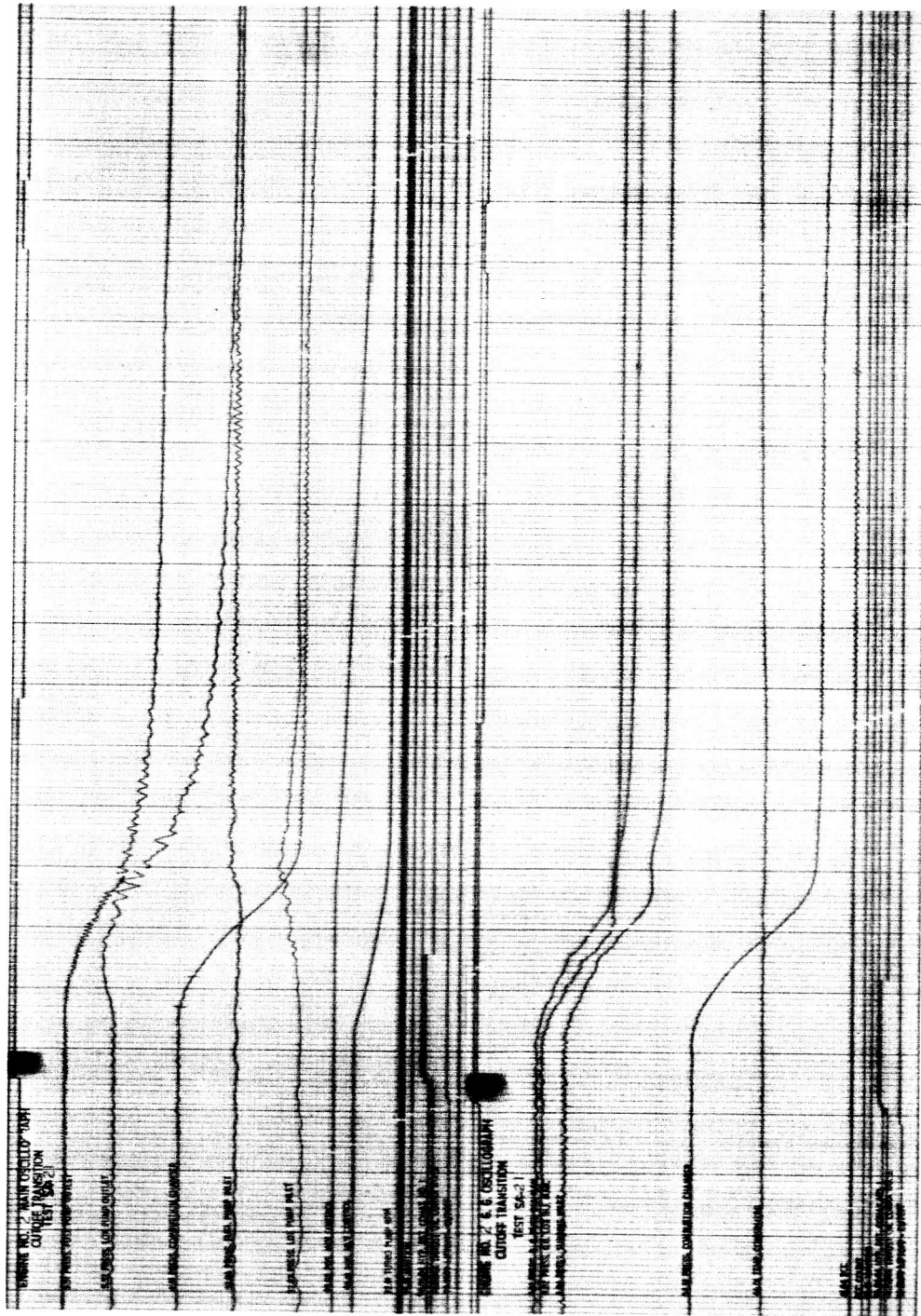

GRAPH 2-4

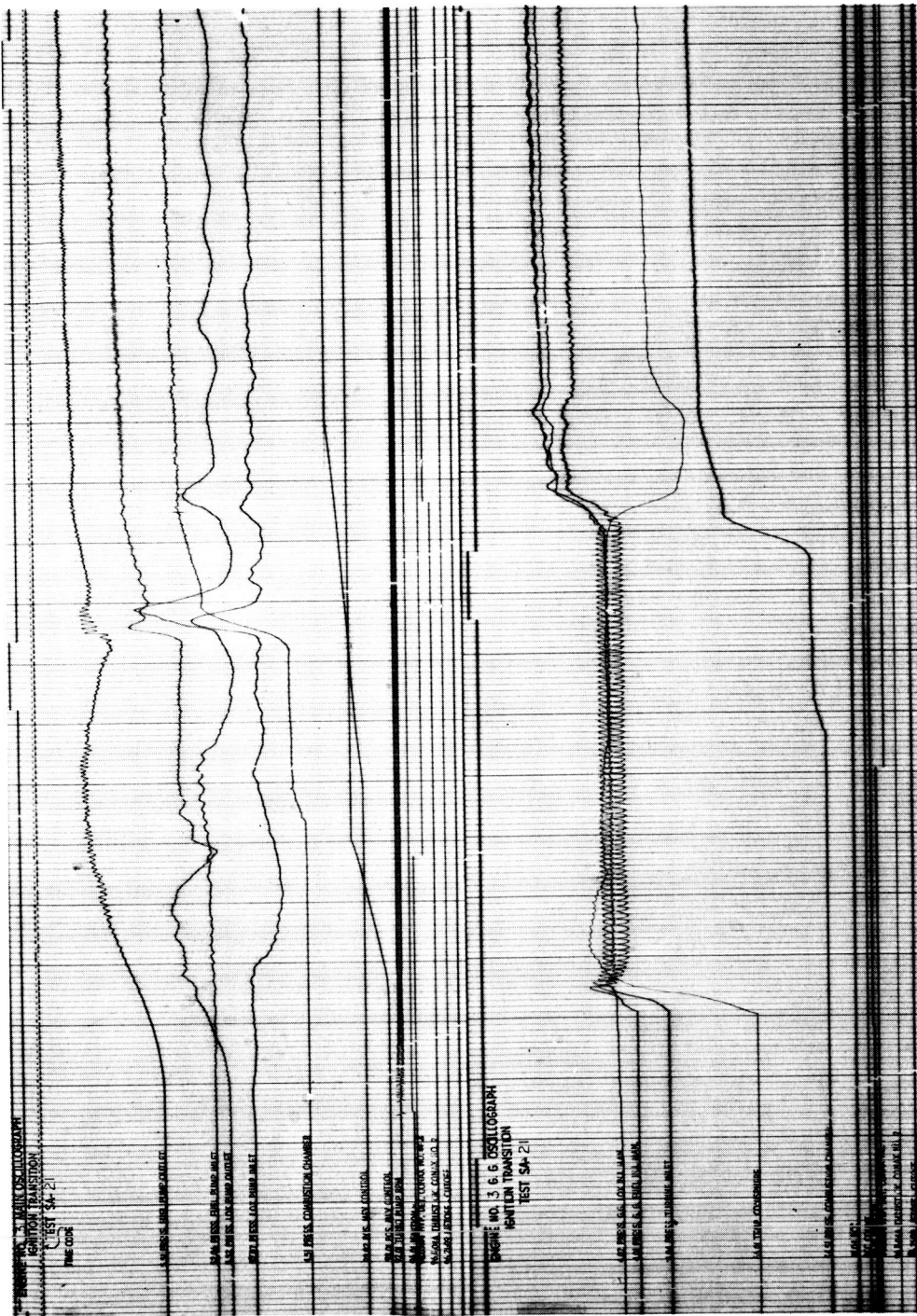

GRAPH 2-5

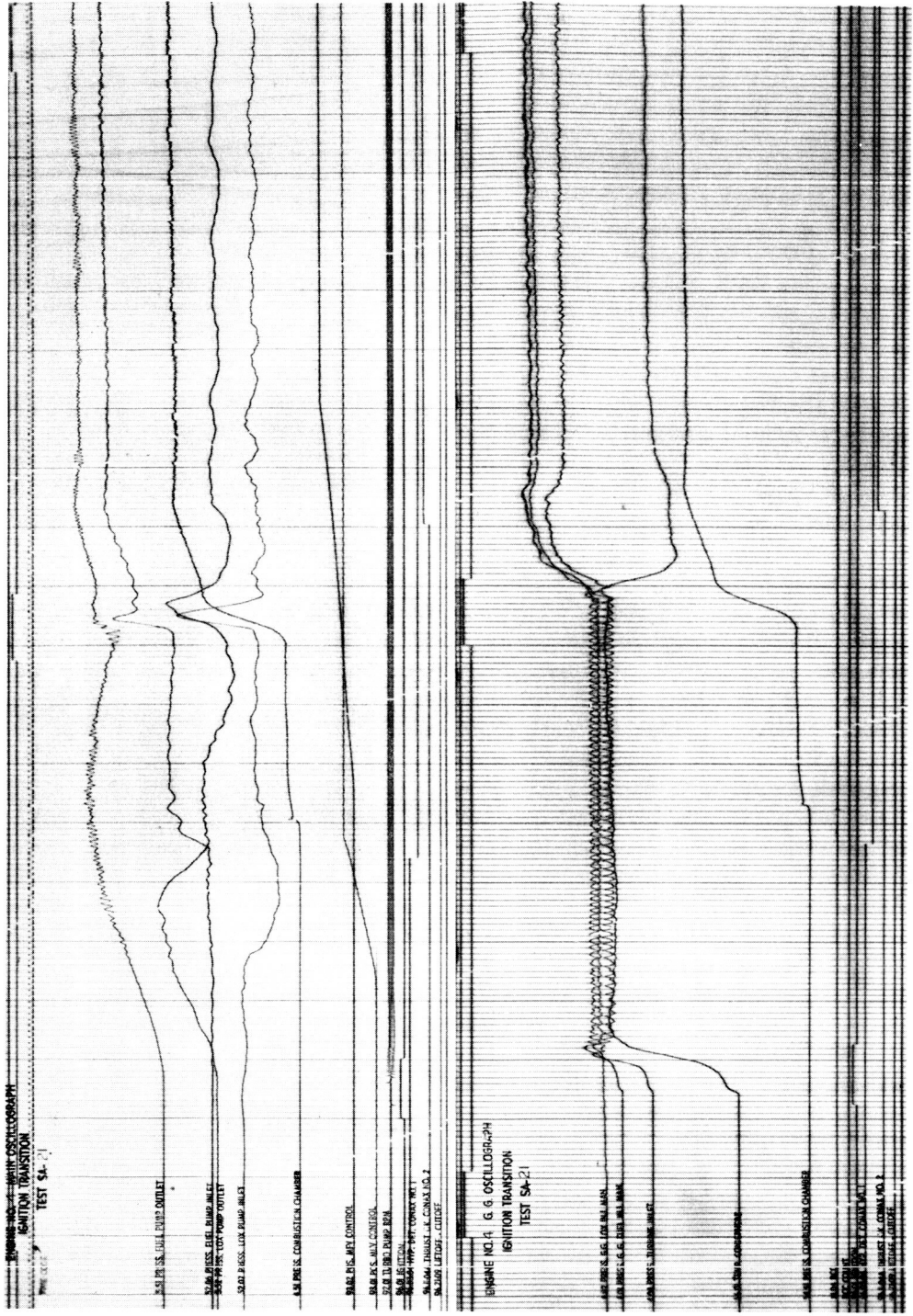

GRAPH 2-7

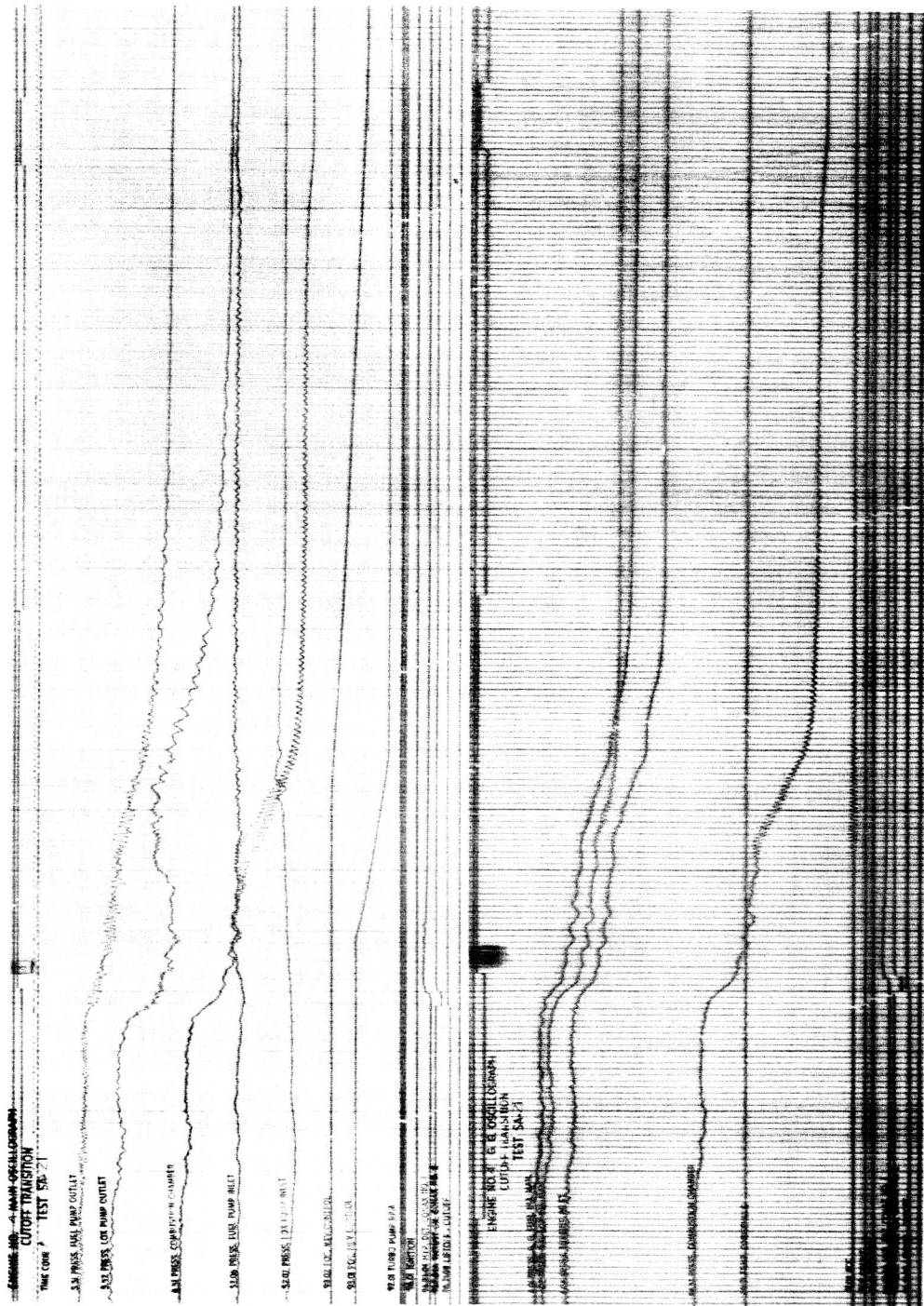

GRAPH 2-8

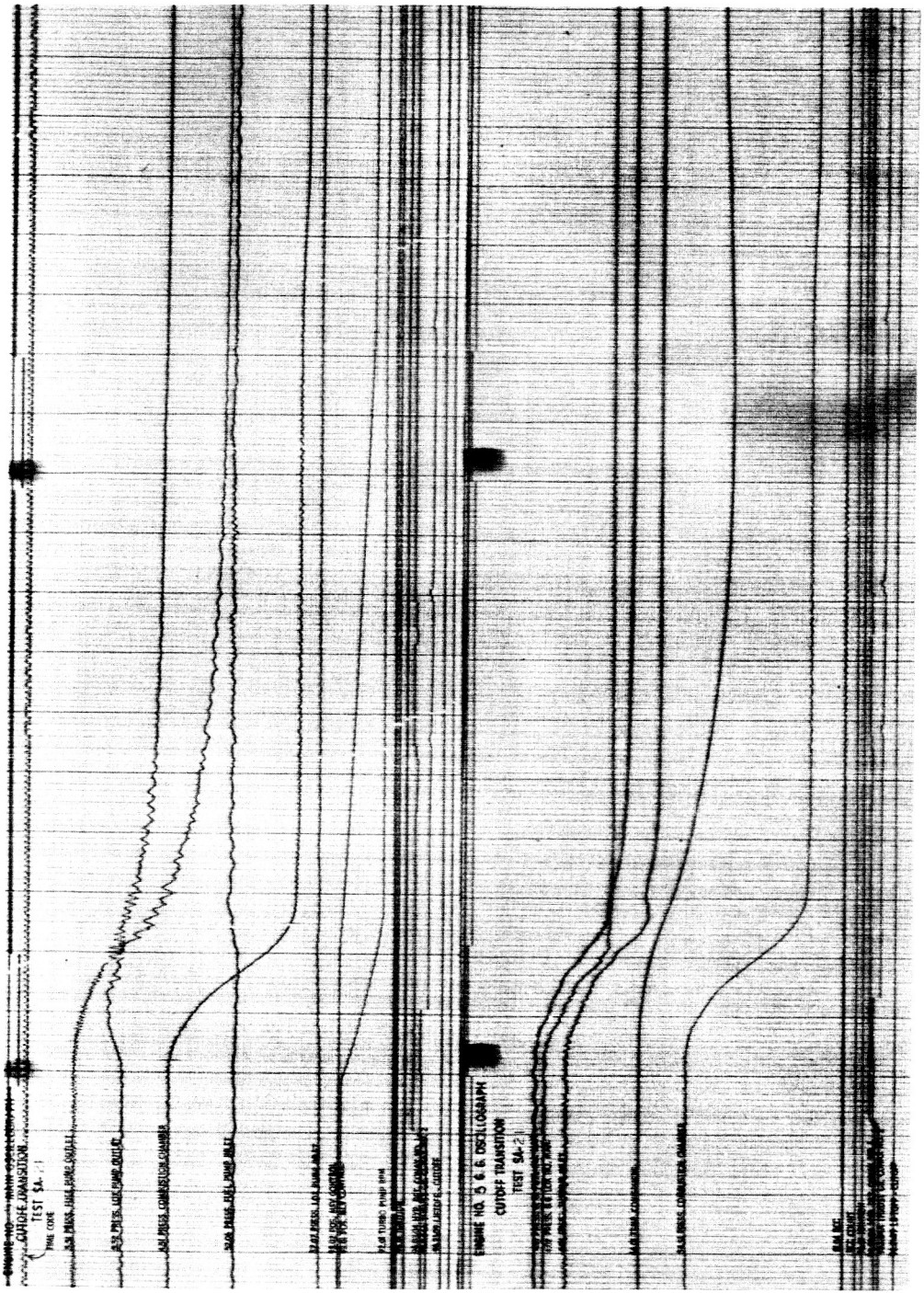

GRAPH 2-10

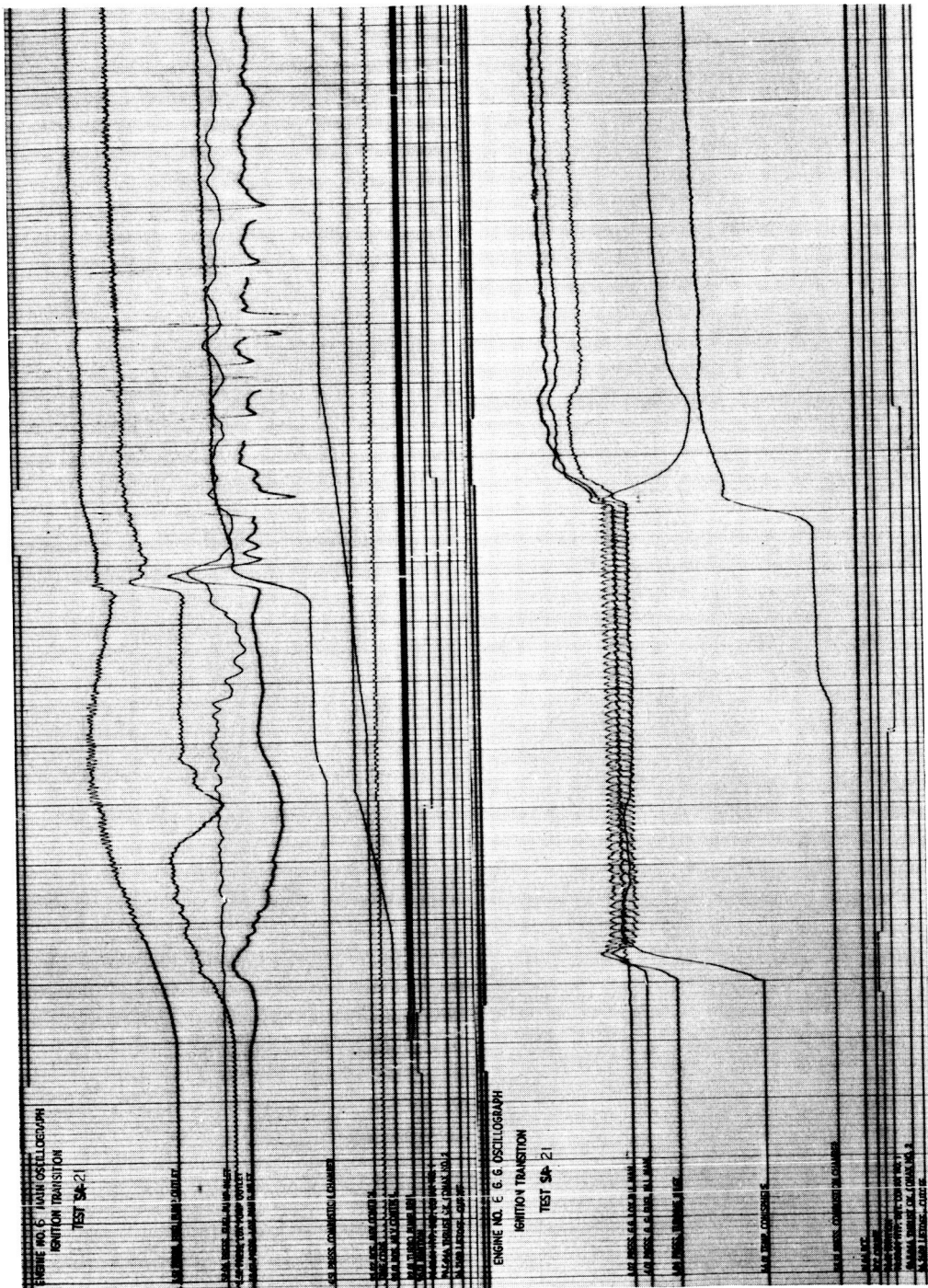

GRAPH 2-11

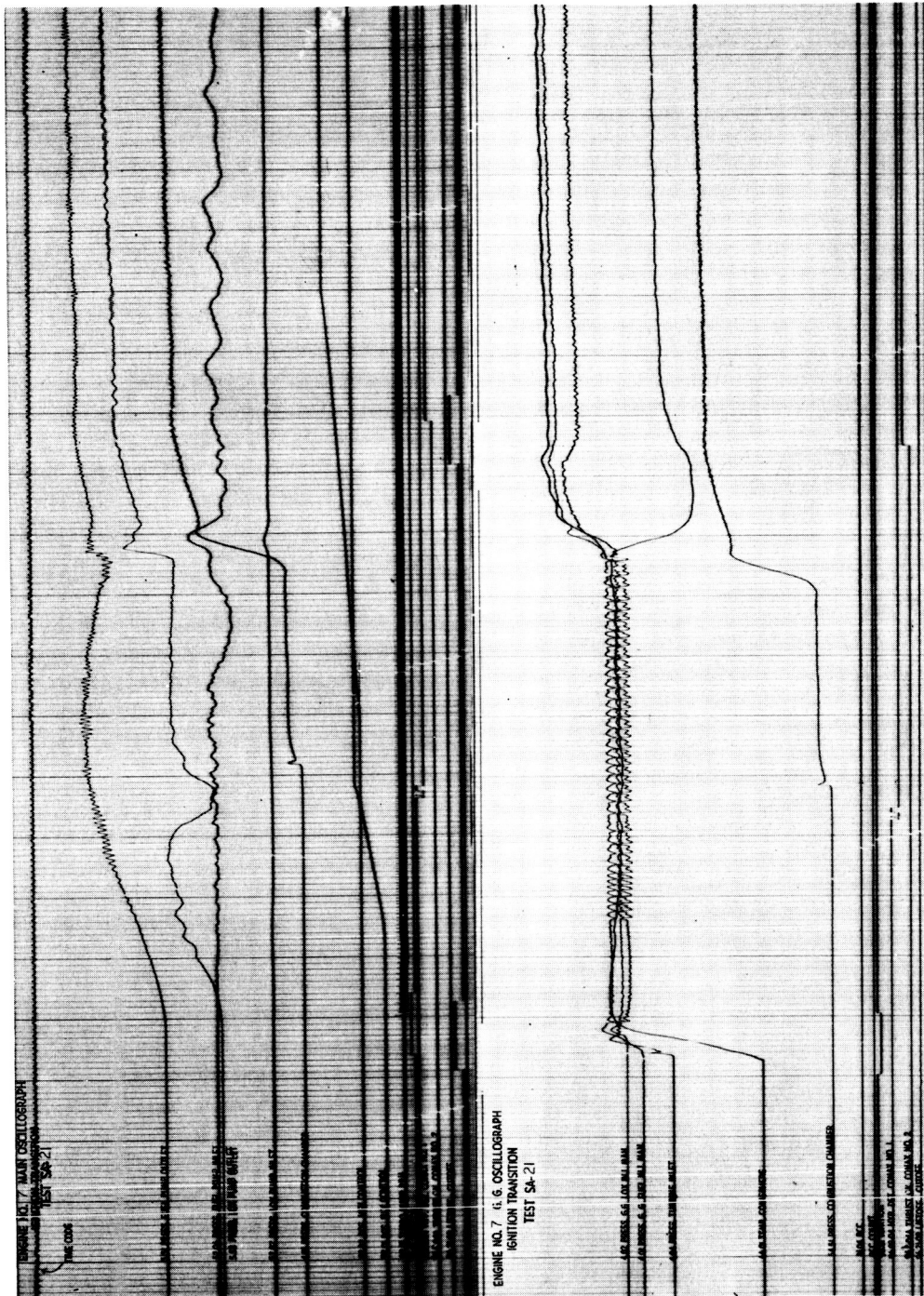

GRAPH 2-13

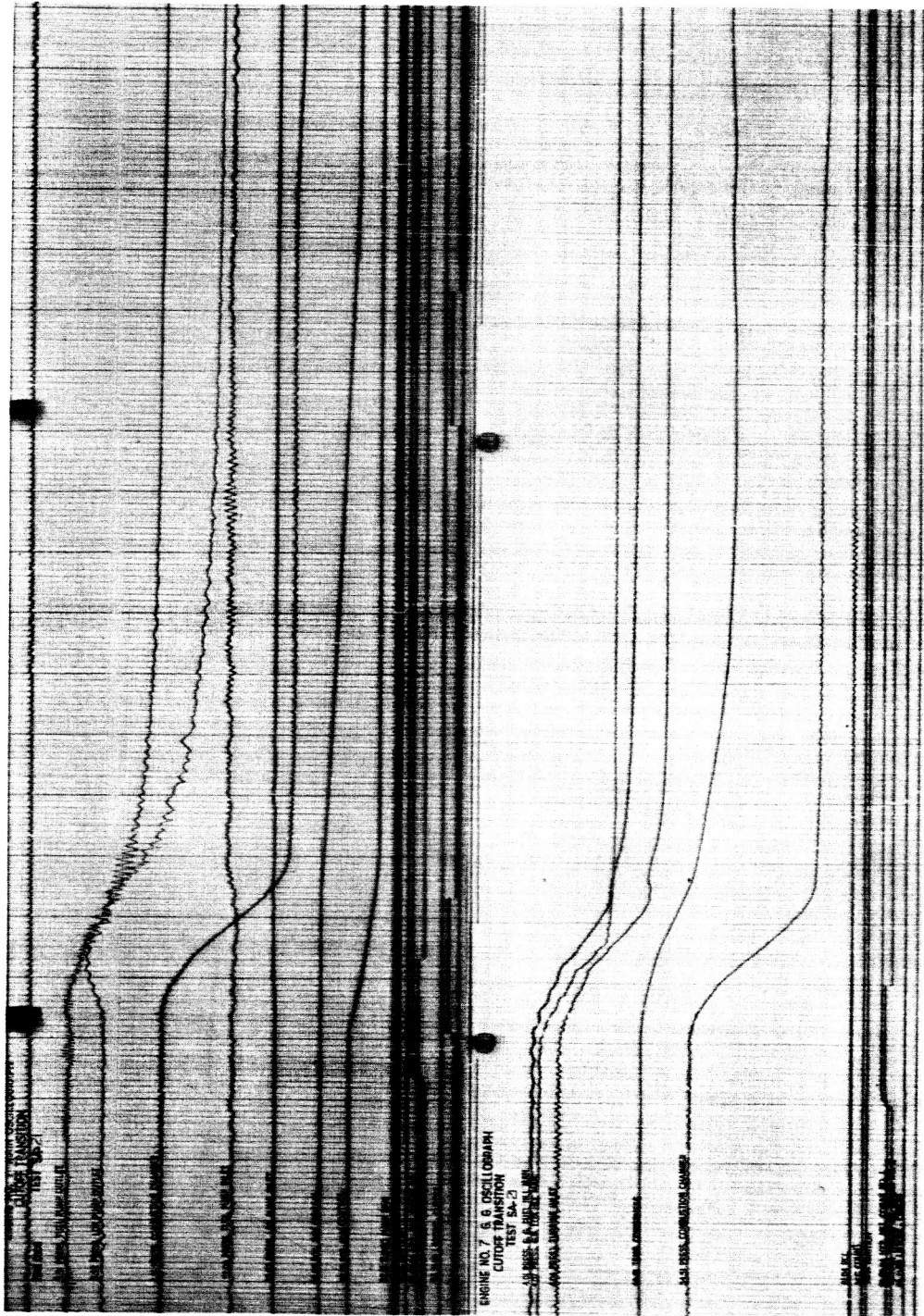

GRAPH 2-14

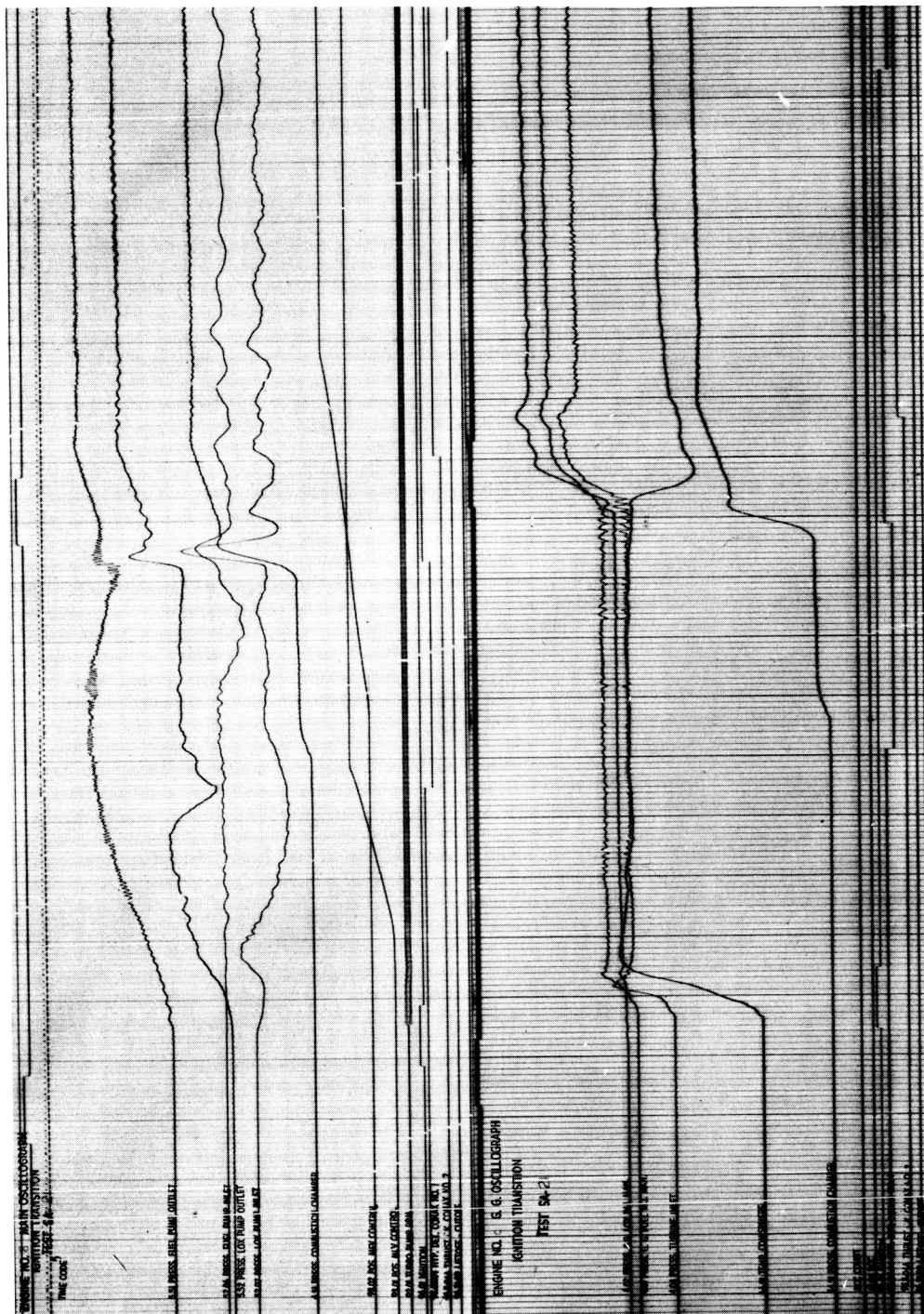

GRAPH 2-15

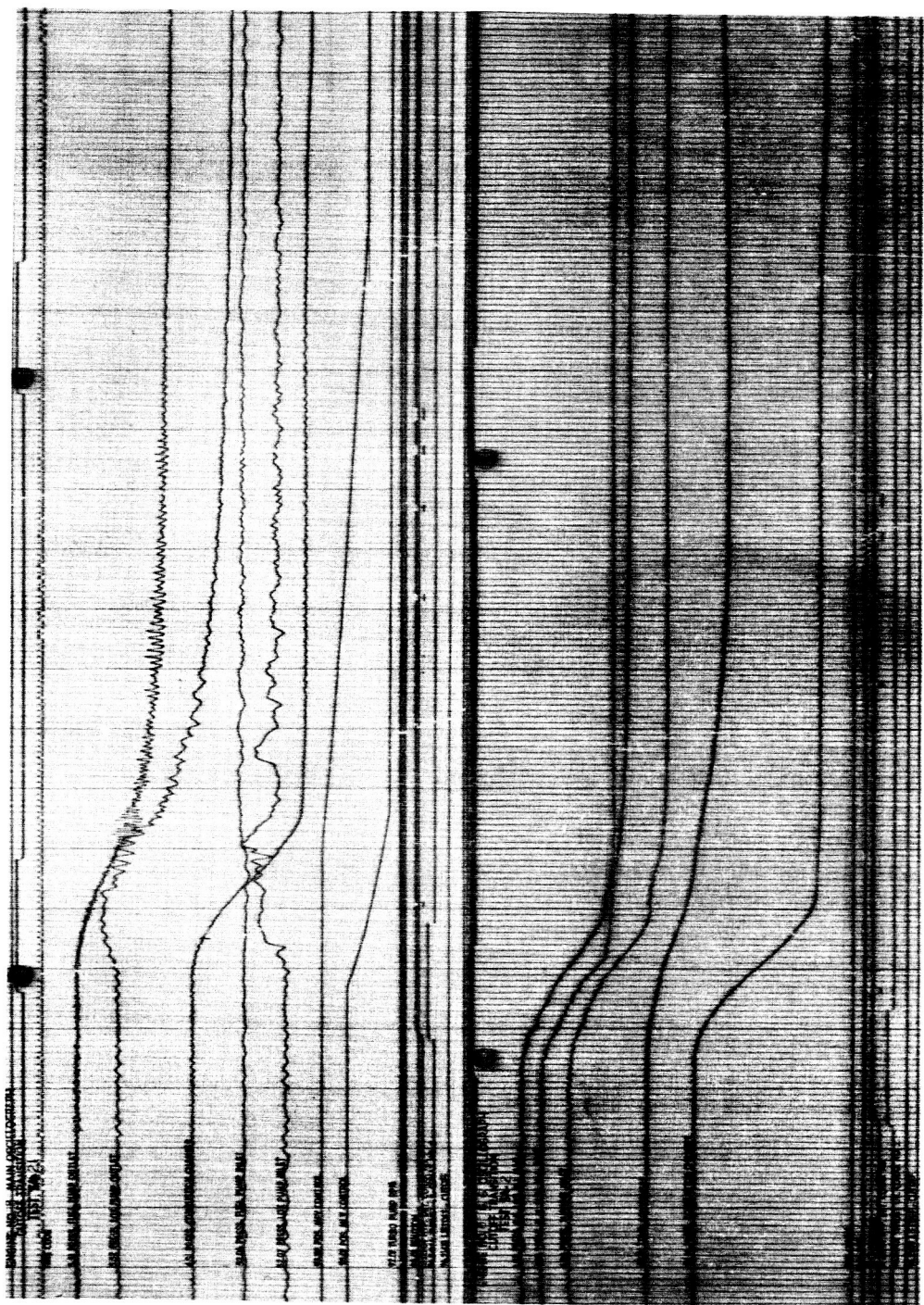

GRAPH 2-16

SECTION 3 ENGINE HYDRAULIC SYSTEMS

The engine hydraulic systems operated satisfactorily during static tests SA-20 and SA-21 of stage S-1-8, with all engine hydraulic system static test requirements accomplished as outlined in the gimbal program for each test. The gimbal program for the two static tests are included in TABLE 3-1 and TABLE 3-2. A system schematic is shown in FIGURE 3-1.

Pretest SA-20 inspections resulted in the replacement of a defective thermocouple and four defective pressure transducers. These replacements necessitated the cleaning and purging of the hydraulic systems on engines 2 and 3 prior to test SA-20.

A review of the records for test SA-20 revealed an erratic hydraulic oil supply pressure trace for engine 4 (measurement 56.01). This problem was traced to a defective transducer (P/N 20M85079). This transducer was replaced, and engine 4 was cleaned and purged prior to test SA-21. Post-test inspections revealed no evidence of hydraulic leakage or damage to system components.

A review of the test SA-21 oscillograph records revealed large fluctuations in engine 3 hydraulic oil supply pressure (measurement 56.01). The cause for these fluctuations was traced to an abnormally low GN₂ precharge of 800 psig instead of the normal 1600 psig. Post-test leak checks were performed and no evidence of leakage was observed at engine 3. The low GN₂ precharge at this engine position is attributed to human error during precharge operations. Tighter control will be maintained during future precharge operations.

Post-test SA-21 inspections revealed slight leakage at the connection between the main pump high-pressure flex hose (P/N 20M85096) and the check valve (P/N 20M85080-3) on the Accumulator-Reservoir Assembly on engines 2 and 3. A torque check of these connections revealed that they were below the minimum specified value of 450 to 525 inch-pounds. The measured torque on these connections for engines 2 and 3 was 260 inch-pounds, and 420 inch-pounds, respectively. Both connections were torqued to the maximum specified value.

For further details pertaining to the operation of the engine hydraulic system, refer to the tables and graphs contained in the Preliminary Static Test Reports for tests SA-20 and SA-21.

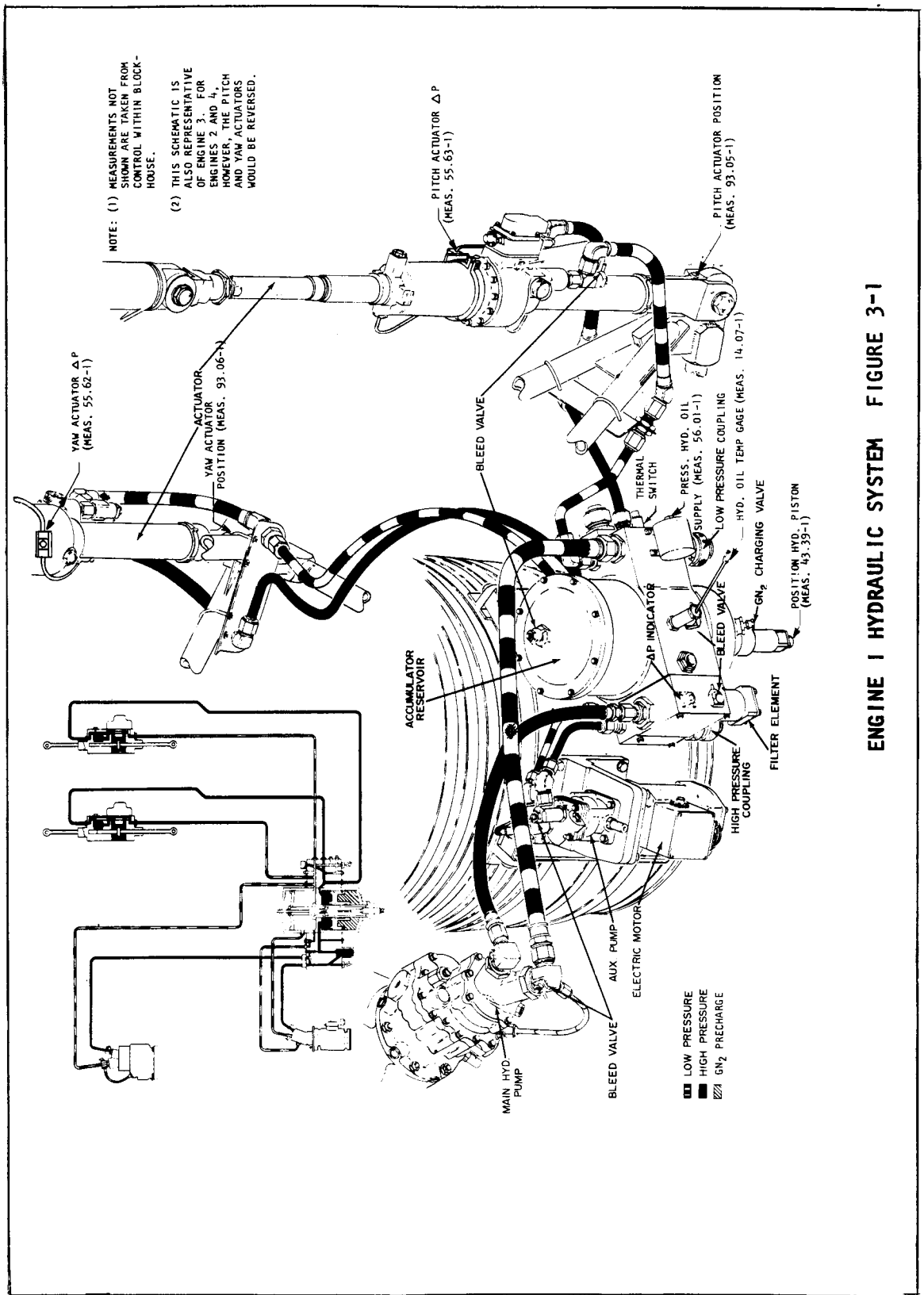

NOTE: (1) MEASUREMENTS NOT SHOWN ARE TAKEN FROM CONTROL WITHIN BLOCK-HOUSE.

(2) THIS SCHEMATIC IS ALSO REPRESENTATIVE OF ENGINE 3. FOR ENGINES 2 AND 4, HOWEVER, THE PITCH AND YAW ACTUATORS WOULD BE REVERSED.

ENGINE 1 HYDRAULIC SYSTEM FIGURE 3-1

TABLE 3-1
 GIMBAL PROGRAM, TEST SA-20
 ENGINES 1, 2, 3, AND 4

| TIME* (sec) | FUNCTION | DEGREES ON ACTUATOR | FREQUENCY (cps) |
|----------------|-------------|------------------------|--------------------|
| 0 - 3 | - | Null | - |
| 3 - 5.5 | Pitch & Yaw | $\pm 2^{\circ}$ | 2.0 |
| 5.5 - 7 | - | Null | - |
| 7 - 12 | Yaw | $\pm 3^{\circ}$ | 1.0 |
| 12 - 14 | - | Null | - |
| 14 - 19 | Pitch | $\pm 3^{\circ}$ | 1.0 |
| 19 - 21 | - | Null | - |
| 21 - 22 | Yaw | $+2^{\circ}$ | Step |
| 22 - 23 | - | Null | - |
| 23 - 24 | Yaw | -2° | Step |
| 24 - 25 | - | Null | - |
| 25 - 26 | Pitch | $+2^{\circ}$ | Step |
| 26 - 27 | - | Null | - |
| 27 - 28 | Pitch | -2° | Step |
| 28 - Cutoff | - | Null | - |

* All times measured from "SIMULATE LIFTOFF" X+00.34.

TABLE 3-2
 GIMBAL PROGRAM, TEST SA-21
 ENGINES 1, 2, 3, AND 4

| TIME* (sec) | FUNCTION | DEGREES ON ACTUATOR | FREQUENCY (cps) |
|----------------|-------------|---------------------------|--------------------|
| 0.0 - 5.0 | - | Null | 0 |
| 5.0 - 35.5 | Pitch | $\pm \frac{1}{2}^{\circ}$ | 1 thru 20 |
| 35.5 - 71.0 | Yaw | $\pm \frac{1}{2}^{\circ}$ | 1 thru 20 |
| 71.0 - 76.0 | - | Null | - |
| 76.0 - 77.0 | Pitch | $+2^{\circ}$ | Step |
| 77.0 - 81.0 | - | Null | - |
| 81.0 - 82.0 | Pitch | -2° | Step |
| 82.0 - 86.0 | - | Null | - |
| 86.0 - 87.0 | Yaw | $+2^{\circ}$ | Step |
| 87.0 - 91.0 | - | Null | - |
| 91.0 - 92.0 | Yaw | -2° | Step |
| 92.0 - 100 | - | Null | |
| 100 - 130 | Pitch & Yaw | $\pm 2^{\circ}$ | 1.5 |

* All times measured from "SIMULATE LIFTOFF" (X+00.34).

SECTION 4
PROPELLANT AND PNEUMATIC SYSTEMS

SYSTEM CONFIGURATION. The system configuration (i.e., purge settings, pressure switch settings, orifice sizes, etc.) is defined in APPENDIX D, Test Data Sheets, Tests SA-20 and SA-21. The fuel and LOX continuous level probes and the fuel depletion probes were not available for stage S-1-8.

PROPELLANT LOADING, SUBSYSTEMS TESTS, AND SPECIAL PROPELLANT TESTS. In order to accomplish the mission of injecting the micro-meteoroid satellites into the required orbit, it has been deemed necessary to load LOX to a 2.2 percent ullage and fuel to a 2.0 percent ullage in booster stages S-1-8, S-1-9, and S-1-10 which are designated for this purpose. Accordingly, a pretest objective in static testing stage S-1-8 was to load LOX to a 2.2 percent ullage*. Seven LOX loadings were performed on stage S-1-8, and six of these loadings were to the small ullages. Included in these LOX loadings was an additional special LOX loading test which was conducted following completion of the acceptance firing test series.

The major problems that have been encountered during these propellant loadings and the problems peculiar to the small ullages are itemized as follows:

1. Failure of a LOX prevalve to relieve properly.
2. Slow LOX prevalve closing times.
3. LOX leak at center LOX tank manhole cover.
4. LOX in the GOX standpipe.
5. LOX draining from the 7-inch vent and the LOX relief No. 1 vent extensions.

Items 1 and 2 were corrected by replacing the discrepant LOX prevalves. The prevalves are discussed in the following paragraphs.

Item 3 was corrected by replacing the center LOX tank manhole cover gasket.

Items 4 and 5 are peculiar to the small LOX tank ullage. LOX in the GOX standpipe is characterized by heavy frost on the GOX line beneath LOX tank 0-C. LOX was observed emitting from the 7-inch vent and LOX relief No. 1 vent extensions, which increased when LOX bubbling was initiated. These problems were investigated by Systems Static Test

*This was subsequently changed by verbal agreement between Chrysler's P&VE Mechanical Engineering Section and Systems Static Test Branch to a 2.3 percent ullage.

Branch and the results are presented in detail in engineering test reports, Propellant Loading and Subsystems Special Test Report, dated June 15, 1964, and Special LOX Loading Test Report, dated July 9, 1964.

The special LOX loading test was conducted on stage S-1-8, June 17, 1964, to further investigate the reasons for LOX overflowing into the GOX standpipe and LOX draining from the vents at the small ullages. From the analysis of the test records and motion pictures of the special LOX loading test, the following conclusions were made:

1. There is a greater height of liquid in the center LOX tank than there is in the outer LOX tanks when the LOX vents are open. The height of LOX in the center tank increases because of the differential pressure of GOX between the center LOX tank and the outer LOX tanks, and the differential pressure is due to the direct venting of the center LOX tank.
2. Venting of the LOX tanks at small ullages causes the LOX level in the center tank to rise and flow out the vents and overflow into the GOX line.
3. Helium bubbling causes liquid level disturbance and increases the height differential between the center LOX tank and the outer LOX tanks. Helium bubbling at the small ullages also causes LOX to flow out the vents and overflow into the GOX line.
4. LOX topping and bubbling with the vents closed minimizes the LOX height differential and suppresses the liquid level disturbance.
5. The liquid level in the center tank and outer tanks equalizes when the tanks are pressurized.
6. LOX bubbling with the vents closed brings the LOX temperature at the pump inlets within the specified redline values.

As a result of the special LOX loading test, it was recommended that the LOX tank vents should be closed during the final stages of LOX topoff and should remain closed until the conclusion of the test firing.

A special LOX loading to a 2.2 percent ullage is scheduled to be performed on stage S-1-10 with similar parameters and test conditions as were imposed on stage S-1-8. The purpose of this test will be as follows:

1. To verify the results of the special LOX loading test performed on stage S-1-8.
2. To verify the feasibility of changing the sequence to close the LOX vents during final topping of LOX with the vents remaining closed until conclusion of the test firing.

3. To obtain camera coverage of the center LOX tank.

LOX SYSTEM. The LOX system functioned satisfactorily during the acceptance test firings. FIGURES 4-1 and 4-2 show the LOX system schematic. TABLE 4-1 presents LOX tanking and pressurization data for tests SA-20 and SA-21.

LOX tank ullage at ignition command for test SA-20 was 362 cubic feet (2,706 gallons) or 3.88 percent; preignition pressurization of the system was accomplished in 67 seconds. The LOX tank ullage at ignition command for test SA-21 was 927 cubic feet (6,934 gallons) or 10.2 percent; preignition pressurization of the LOX system was accomplished in 97.5 seconds and required a 31-second hold in the automatic sequence.

LOX tank pressure exceeded the specified limits of 50 ± 2.5 psia during tests SA-20 and SA-21 as it did during tests SA-18 and SA-19 of stage S-1-9. After test SA-20 ignition, LOX tank pressure decayed to 51.1 psia at X+9 seconds, then gradually increased and reached a maximum of 54 psia at X+30 seconds, after which time it slowly decayed to 52.7 psia at cutoff. Following ignition on test SA-21, LOX tank pressure dropped to 53.9 psia at X+9 seconds, then gradually increased to a maximum of 54.4 psia at X+28 seconds, after which time it slowly decayed to 49.9 psia at outboard engine cutoff signal. A plot of center LOX tank pressure (measurement 2.05-C) versus time for tests SA-20 and SA-21 is shown in GRAPH 4-1. Due to this recurring problem of LOX tank overpressurization, UCR CSD-S-00091 was written. This UCR recommends that further studies be initiated to determine whether the LOX-to-heat-exchanger orifices are too large, whether the closed stop setting on the GOX flow control valve (GFCV) is improper, or whether LOX tank overpressurization is caused by a combination of these factors. If this study indicates that the LOX pressurization system performance is satisfactory, it is recommended that the LOX system pressure specification be changed to comply with system performance. An additional factor to consider is that the GFCV did not go fully closed. This problem is discussed in the following paragraph.

The GFCV position trace (measurement 43.49A) did not indicate that the GFCV reached the fully closed position during either test SA-20 or SA-21. The GFCV reached 98 percent closed and 96 percent closed during tests SA-20 and SA-21, respectively, and since the LOX tank pressure was above 52.5 psia, the GFCV should have been 100 percent closed (reference GRAPH 4-2). No cyclic movement of the GFCV gate was noted during either test. Similar indications of the GFCV not going fully closed were observed during the static tests for stages S-1-7 and S-1-9. During post-static checkout of both of these stages, the GFCV thrust bearings were inspected and found to be damaged. The indication of the GFCV not going fully closed tends to substantiate the theory that the thrust bearing of the valve is damaged. It was recommended in the Preliminary Static Test Reports for tests SA-20 and SA-21 that the GFCV on stage S-1-8 be inspected for thrust bearing damage during post-static

checkout.

To simulate flight LOX depletion characteristics, a 20.0-inch diameter orifice was installed in the center LOX tank sump. This orifice was intended to retain the LOX level in the center LOX tank 6 inches higher than the LOX level in the outer tanks at the start of the cutoff sequence (actuation of the LOX cutoff sensor in either LOX tank 0-2 or 0-4). Evaluation of the LOX discrete probe data indicates that the specified height differential was attained. At the start of the cutoff sequence, the height differential between the center LOX tank and LOX tank 0-4 was 5.5 inches. Discrete probe data from LOX tanks 0-1, 0-2, and 0-3 indicated that the LOX level in these tanks was approximately the same as in tank 0-4. The LOX and fuel discrete probe actuation times are shown in TABLE 4-2, and the corresponding LOX and fuel volumes below the discrete probes are presented in TABLE 4-3. Since the LOX and fuel continuous level probes were not installed, the LOX height differential between the center tank and outer tanks could not be verified from this source.

PREVALVES. After stage S-1-8 was installed in STTE, the LOX prevalves were removed and modified in accordance with engineering order EO 10C100003-119. This engineering order brings the prevalve part number up from 20C30042 to 60C20844-1 and modifies the lip seal to provide relief in the reverse flow direction.

Prevalve relieving pressure tests and closing time tests were accomplished as part of the test objectives for a special LOX tanking conducted May 18, 1964. Engine 7 prevalve did not relieve, and pressure increased to approximately 75 psig in engine 7 LOX suction line during this test. Engine 2 LOX prevalve closed after engine 2 fuel prevalve. The engines 2 and 7 LOX prevalves were replaced on May 23, 1964.

During the special LOX tanking conducted May 25, 1964, prevalve relief tests and timing tests were performed. It was found that all LOX prevalves relieved properly (the highest LOX pump inlet pressure attained was 43.5 psig), and that the prevalve closing times were satisfactory.

The LOX prevalves were slow to close at cutoff of test SA-20 (reference TABLE 4-4). The exposure time of the prevalves to LOX was 4.5 hours. The fuel prevalves indicated closed prior to the LOX prevalves on engines 2, 6, and 7. The closing times for both LOX and fuel prevalves had been verified to be within specification at ambient temperature during pretest checkout.

Special instrumentation installed on the LOX prevalves (reference Propellant Loading and Sub-Systems Special Test Report) indicated that the temperature of the prevalve actuator cylinder is on the order of -100° F with LOX on board as opposed to the prevalve design criteria of -65° F. Because of the slower closing rates of the LOX prevalves

after extended exposure to cryogenic temperature, Engineering Change Proposal ECP ED-20072, "Rework Kit for Actuator Used on Parker Valve No. F61C0017M1 [Chrysler P/N 60C20844]," was issued in conjunction with Configuration Change Action CCA 939C. Effectivity for this rework is stage S-1-10, and prevalve closing time tests and relieving tests are scheduled to be conducted on this stage.

Prevalve closing times for test SA-21 were acceptable (reference TABLE 4-5). It is probable that the prevalves functioned satisfactorily during this test because the prevalve exposure time in this instance was 3.5 hours, and therefore did not get as cold as during the previous test.

FUEL SYSTEM. The fuel system functioned satisfactorily during the acceptance test firings. The system configuration for the test is shown in FIGURE 4-3. TABLE 4-1 presents fuel tanking and pressurization data for tests SA-20 and SA-21.

Test SA-20 fuel tank ullage at ignition command was 182 cubic feet (1,365 gallons) or 3.18 percent. The pretest objective of loading fuel to a 2.0 percent ullage was not accomplished because of a malfunction of the primary fuel measuring device, fuel differential pressure transducer (measurement 2.11). The system was pre-pressurized to 16.7 psig in 2.05 seconds.

During post-test SA-20 inspection immediately following the firing, fuel was observed leaking from the heat shield panels around engine 4. The source of this leakage was traced to a calibration valve (P/N 10414076) in the sensing line leading to the Fuel Differential Step Pressure Switch (P/N 20M30154), located under fuel tank 4. The gland nut, which retains the valve stem in the valve body, vibrated loose and fuel pressure forced the valve stem out of the valve body. The valve stem was reinstalled in the valve body and the leakage stopped. Further inspection revealed that the calibration valve and mounting bracket had been drilled for safety wire, but that it had not been safety wired for this test. All stage calibration valve gland nuts were safety wired prior to test SA-21.

Test SA-21 fuel tank ullage at ignition was 244 cubic feet (1,828 gallons) or 4.3 percent. The system was pre-pressurized to 17.7 psig in 2.11 seconds. System pressurization from the stage spheres was normal. At X+66 seconds, the Emergency Fuel Pressurizing Pressure Switch closed when the fuel tank pressure dropped below 6 psig, and initiated Facility Fuel Tank Pressurizing. At X+70 seconds, system pressurization from the stage spheres was terminated by the flight sequencer. After this time, fuel tank pressure was maintained by Facility Fuel Pressurizing. GRAPH 4-3 shows a plot of the fuel system pressurization versus time for the full duration test, SA-21. Also shown on this graph is the pressure versus time for the fuel tank pressurization spheres.

LOX-SOX DISPOSAL SYSTEM. The LOX-SOX system functioned properly during test SA-21 (reference GRAPHS 4-4 and 4-5). The system was not activated during test SA-20. The disposal ring manifolds were not included as a part of the test configuration, and the flow rate from the system was controlled with 0.875-inch diameter orifices located in each of the plenum chamber outlets. The LOX-SOX system configuration is shown in FIGURE 4-4.

CONTROL PRESSURE SYSTEM. The control pressure system functioned satisfactorily during tests SA-20 and SA-21. GRAPH 4-6 shows the control spheres pressure decay versus time for test SA-21. One calorimeter was purged using the vehicle 750 GN₂ control pressure system. The remainder of the vehicle calorimeter purge lines were capped for both the tests. A schematic of the complete control pressure system is shown in FIGURE 4-5.

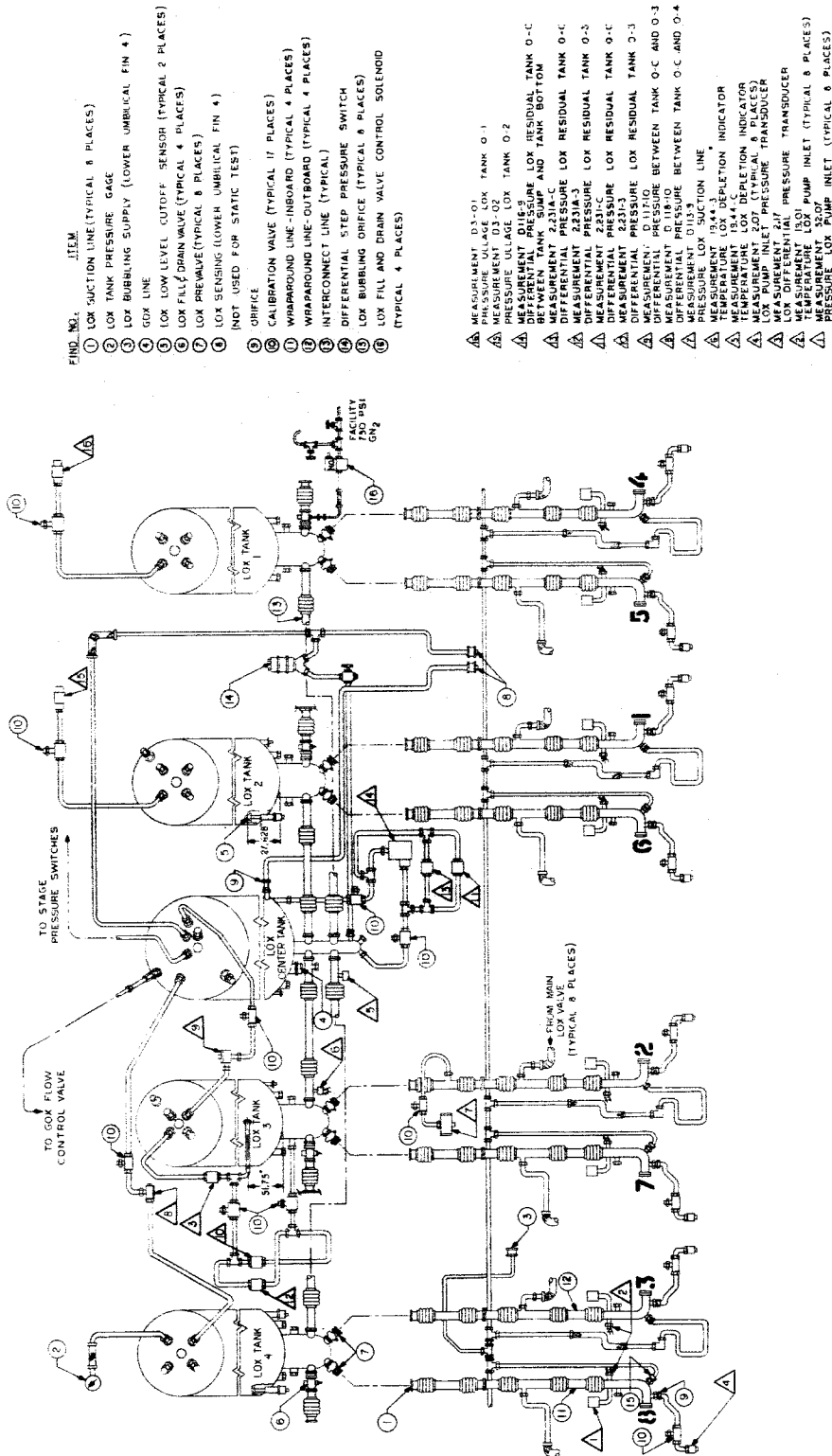

LOX TANKS SUPPLY SYSTEM FIGURE 4-1

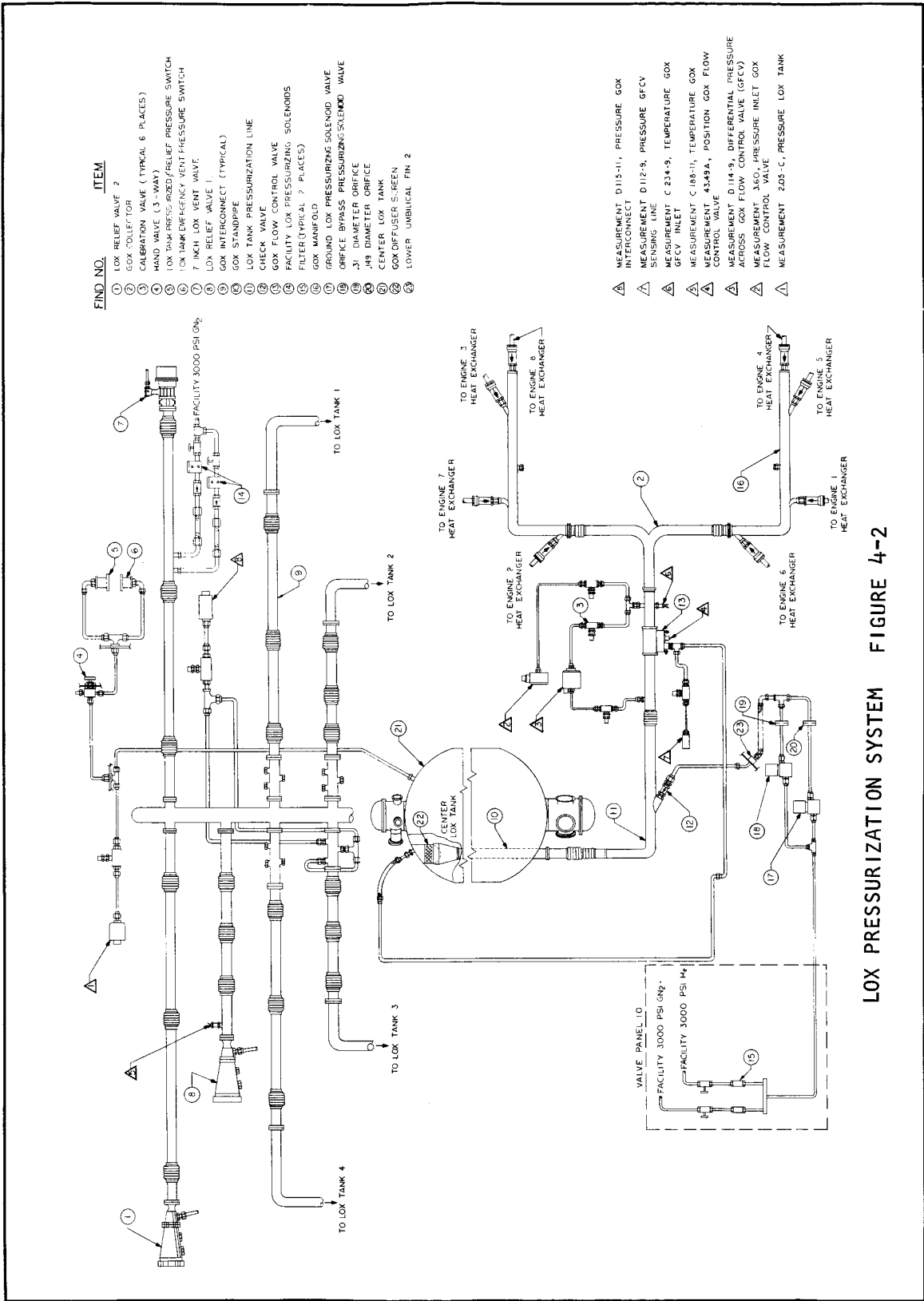

FIND NO. ITEM

- ① LOX RELIEF VALVE 2
- ② GOX COLLECTOR
- ③ CALIBRATION VALVE (TYPICAL 6 PLACES)
- ④ HAND VALVE (3-WAY)
- ⑤ LOX TANK REFERENCE/RELIEF PRESSURE SWITCH
- ⑥ LOX TANK EMERGENCY VENT PRESSURE SWITCH
- ⑦ 7 INCH LOX VENT VALVE
- ⑧ LOX RELIEF VALVE 1
- ⑨ GOX INTERCONNECT (TYPICAL)
- ⑩ GOX STANDPIPE
- ⑪ LOX TANK PRESSURIZATION LINE
- ⑫ CHECK VALVE
- ⑬ GOX FLOW CONTROL VALVE
- ⑭ FACILITY LOX PRESSURIZING SOLENOIDS
- ⑮ FILTER (TYPICAL 7 PLACES)
- ⑯ GOX MANIFOLD
- ⑰ GROUND LOX PRESSURIZING SOLENOID VALVE
- ⑱ ORIFICE BYPASS PRESSURIZING SOLENOID VALVE
- ⑲ .31 DIAMETER ORIFICE
- ⑳ .49 DIAMETER ORIFICE
- ㉑ CENTER LOX TANK
- ㉒ GOX DIFFUSER SCREEN
- ㉓ LOWER UMBILICAL PIN 2

- △ MEASUREMENT D112-11, PRESSURE GOX INTERCONNECT
- △ MEASUREMENT D112-9, PRESSURE GFCV SENSING LINE
- △ MEASUREMENT C 234-9, TEMPERATURE GOX GFCV INLET
- △ MEASUREMENT C 188-11, TEMPERATURE GOX
- △ MEASUREMENT 43-A9A, POSITION GOX FLOW CONTROL VALVE
- △ MEASUREMENT D114-9, DIFFERENTIAL PRESSURE ACROSS GOX FLOW CONTROL VALVE (GFCV)
- △ MEASUREMENT 360, PRESSURE INLET GOX FLOW CONTROL VALVE
- △ MEASUREMENT 205-C, PRESSURE LOX TANK

LOX PRESSURIZATION SYSTEM FIGURE 4-2

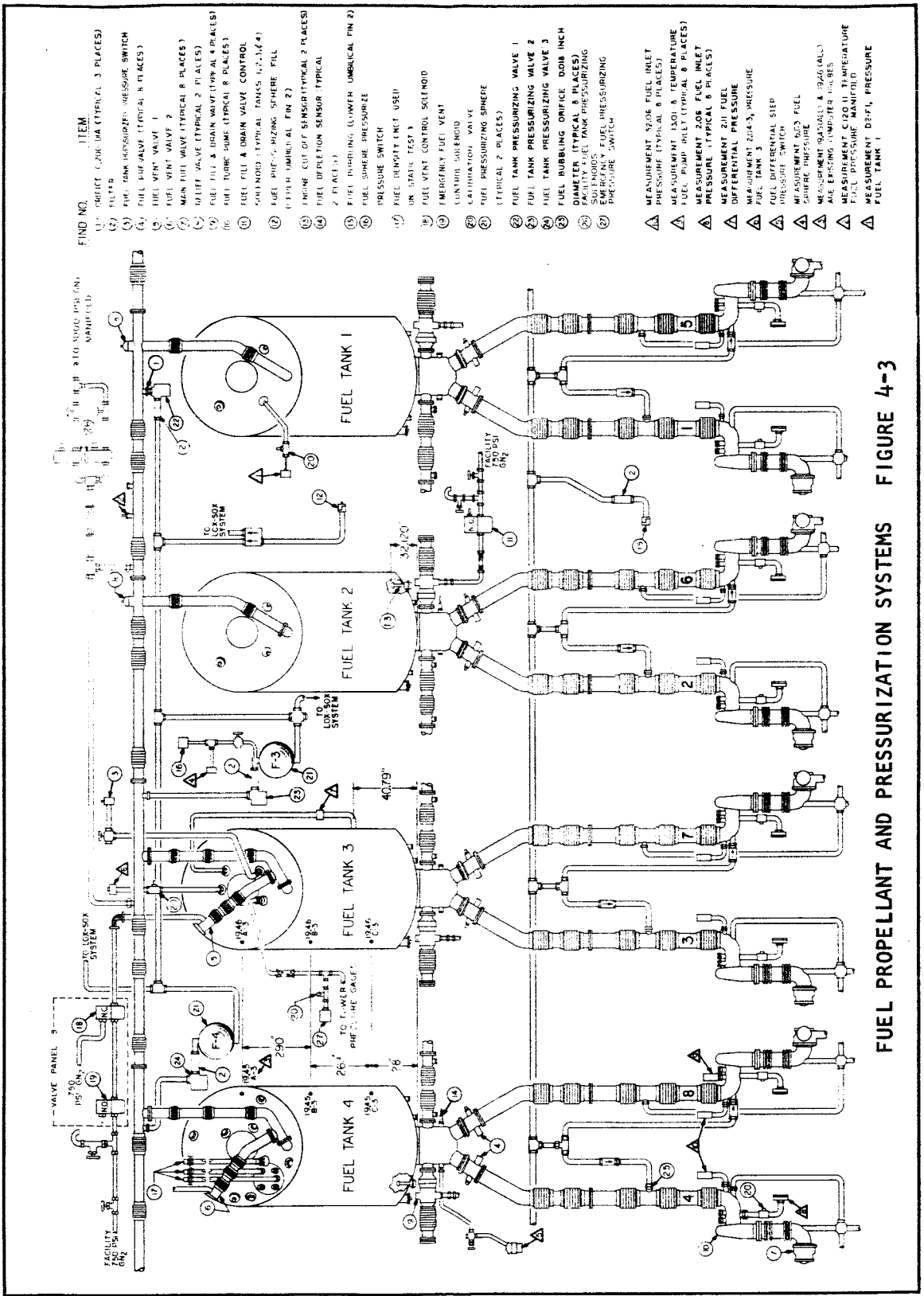

- | FIND NO. | ITEM |
|----------|---|
| (1) | ORIFICE (TYPICAL 3 PLACES) |
| (2) | FUEL TANK PRESSURIZING MEASURE SWITCH |
| (3) | FUEL SUPPLY VALVE (TYPICAL 8 PLACES) |
| (4) | FUEL VENT VALVE 1 |
| (5) | FUEL VENT VALVE 2 |
| (6) | MAIN FUEL VALVE (TYPICAL 8 PLACES) |
| (7) | RELIEF VALVE (TYPICAL 2 PLACES) |
| (8) | FUEL FILL & DRAIN MANIFOLD (TYPICAL 4 PLACES) |
| (9) | FUEL TURBO PUMP (TYPICAL 8 PLACES) |
| (10) | FUEL FILL & DRAIN VALVE CONTROL |
| (11) | SOLENOID (TYPICAL TANKS 1, 2, 3, 4) |
| (12) | FUEL PNEUMATIZING SPHERE FULL (TYPICAL 2 PLACES) |
| (13) | TRIMMING CUT OFF SENSOR (TYPICAL 2 PLACES) (2 PLACES) |
| (14) | FUEL DEFLECTION SENSOR (TYPICAL 2 PLACES) |
| (15) | FUEL BUBBLING (LOWWER UMBRICAL FIN 2) |
| (16) | FUEL SPHERE PRESSURIZE |
| (17) | PRESSURE SWITCH |
| (18) | FUEL DENSITY INLET USED ON STATION TEST |
| (19) | FUEL VENT CONTROL SOLENOID |
| (20) | EMERGENCY FUEL VENT CONTROL SOLENOID |
| (21) | FUEL PRESSURIZING SPHERE (TYPICAL 2 PLACES) |
| (22) | FUEL TANK PRESSURIZING VALVE 1 |
| (23) | FUEL TANK PRESSURIZING VALVE 2 |
| (24) | FUEL TANK PRESSURIZING VALVE 3 |
| (25) | FUEL BUBBLING ORIFICE 0.008 INCH DIAMETER (TYPICAL 8 PLACES) |
| (26) | FACILITY FUEL TANK PRESSURIZING EMERGENCY FUEL PRESSURIZING PRESSURE SWITCH |
| (27) | MEASUREMENT 5206 FUEL INLET PRESSURE (TYPICAL 8 PLACES) |
| ▲ | MEASUREMENT 1301 8 TEMPERATURE FUEL PUMP INLET (TYPICAL 8 PLACES) |
| ▲ | MEASUREMENT 2008 FUEL INLET PRESSURE (TYPICAL 8 PLACES) |
| ▲ | MEASUREMENT 2011 FUEL DIFFERENTIAL PRESSURE |
| ▲ | MEASUREMENT 2043 PRESSURE FUEL TANK 3 |
| ▲ | FUEL DIFFERENTIAL STEP MEASUREMENT |
| ▲ | MEASUREMENT 1057 FUEL GASTRIC PRESSURE |
| ▲ | MEASUREMENT 1040 1 & 1040 1 100 AIR EXPOSING TEMPERATURE PROBES |
| ▲ | MEASUREMENT 1050 11 TEMPERATURE FUEL PRESSURE MANIFOLD |
| ▲ | MEASUREMENT 1057 11 PRESSURE FUEL TANK 1 |

FUEL PROPELLANT AND PRESSURIZATION SYSTEMS FIGURE 4-3

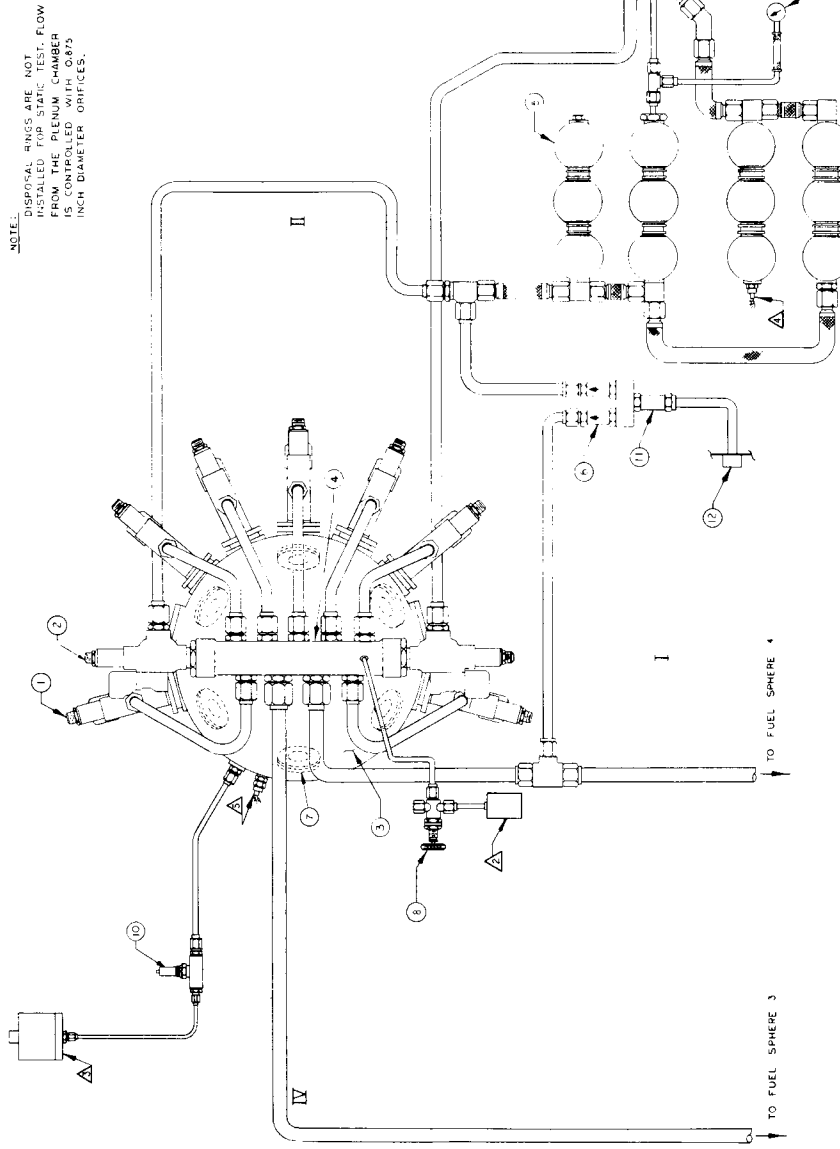

NOTE:
DISPOSAL RINGS ARE NOT
TO BE REMOVED FROM THE
PLENUM CHAMBER IS
CONTROLLED WITH 0.875
INCH DIAMETER ORIFICES.

FIG. NO. ITEM

- ① LOX-SOX PURGE SOLENOID VALVE (TYPICAL 7 PLACES)
- ② LOX-SOX EQUALIZATION VALVES (TYPICAL 2 PLACES)
- ③ PLENUM CHAMBER
- ④ MANIFOLD
- ⑤ LOX-SOX SPHERE (TYPICAL 12 PLACES)
- ⑥ CHECK VALVE
- ⑦ 0.875 INCH DIAMETER ORIFICES (TYPICAL 6 PLACES)
- ⑧ HAND VALVE, 3-WAY (TYPICAL 2 PLACES)
- ⑨ PRESSURE GAGE (LOCATED ON TOWER WALL)
- ⑩ CALIBRATION VALVE
- ⑪ FILTER
- ⑫ UPPER UMBILICAL PIN 2

- △ MEASUREMENT C 105-11 TEMPERATURE PLENUM CHAMBER
- △ MEASUREMENT C 237 II TEMPERATURE LOX-SOX SPHERE
- △ MEASUREMENT D 100-11 TEMPERATURE LOX-SOX SPHERE
- △ MEASUREMENT P-1 PRESSURE TRANSDUCER P-1 GR2 MANIFOLD
- △ MEASUREMENT P-2 PRESSURE TRANSDUCER I FT3 SPHERE

LOX-SOX SYSTEM FIGURE 4-4

FIND NO. ITEM

- 1 LOX RELIEF NO. 1 (O-3)
- 2 LOX RELIEF NO. 2 (O-4)
- 3 HIGH PRESSURE SPHERES
- 4 LOX VENT (O-1)
- 5 750 CONTROL REGULATOR
- 6 750 PSIG PRESSURE SWITCH
- 7 VENT PLATE
- 8 CHECK VALVE
- 9 0N2 CONTROL (UMH III) FILL (UMBILICAL FIN IX)
- 10 0N2 SPHERE PRESSURE SWITCH
- 11 LOX REPLENISH VALVE CONTROL SOLENOID
- 12 FILL AND VENT VALVE
- 13 PREVALVE CONTROL SOLENOID (TYPICAL B PLACES)
- 14 FUEL PREVALVE (TYPICAL B PLACES)
- 15 LOX PREVALVE (TYPICAL B PLACES)
- 16 GEAR CASE AND LOX SEAL PURGE (ONE SHOWN TYPICAL B PLACES)
- 17 PREVALVE BLOCKING MANIFOLD
- 18 EMERGENCY LOX VENT SOLENOID
- 19 CALORIMETER (ONLY ONE INSTALLED) FOR STATIC TEST
- 20 CALORIMETER PURGE CONTROL SOLENOID
- 21 LOX VENT CONTROL SOLENOID
- 22 LOX VENT NO. 2 CONTROL SOLENOID
- 23 FILTER
- 24 TURBO PUMP (ONE SHOWN, TYPICAL A PLACES)
- 25 CALIBRATION VALVE

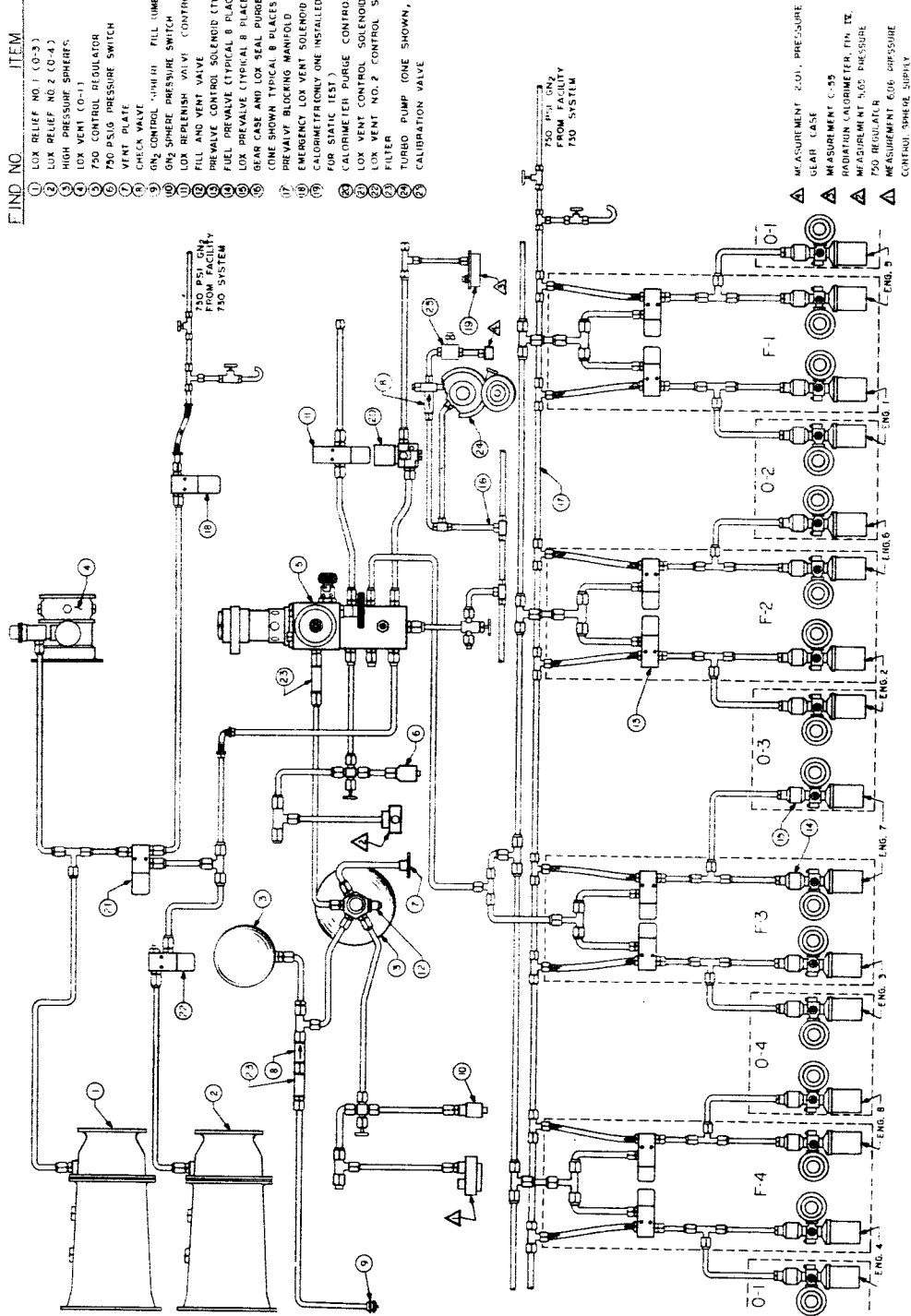

- ▲ MEASUREMENT 2.01, PRESSURE
- ▲ GEAR CASE
- ▲ MEASUREMENT C-35
- ▲ RADIATION CALORIMETER, FIN IX
- ▲ MEASUREMENT 5.00, PRESSURE
- ▲ 750 REGULATOR
- ▲ MEASUREMENT 6.00, SUPPLY
- ▲ CONTROL SPHERE SUPPLY

GN₂ CONTROL PRESSURE SYSTEM FIGURE 4-5

TABLE 4-1
PROPELLANT LOADING AND PRESSURIZATION DATA

LOX

| | <u>Test SA-20</u> | <u>Test SA-21</u> |
|---|-------------------|-------------------|
| 1. Tank pressurant..... | Helium | Helium |
| 2. Pressurizing orifice diameter (inches). | 0.149 | 0.149 |
| 3. Pressurizing time (seconds)..... | 67 | 97.5 |
| 4. Height from tank bottom of ignition command (inches)..... | 638 | 596 |
| 5. Ullage volume at ignition (gallons).... | 2.706 | 6.932 |
| 6. Ullage volume at ignition (percent).... | 3.88% | 10.2% |
| 7. Volume at ignition (gallons)..... | 65,270 | 61,042 |
| 8. Volume at cutoff (gallons)..... | 43,087 | Depleted |
| 9. Average boiloff rate (gallons/hour).... | 2,635 | 3,650 |

FUEL

| | | |
|--|----------|----------|
| 1. Tank pressurant..... | Nitrogen | Nitrogen |
| 2. Pressurizing time (seconds)..... | 2.05 | 2.11 |
| 3. Height from tank bottom at ignition command (seconds)..... | 627 | 620 |
| 4. Ullage at ignition (gallons)..... | 1,365 | 1,828 |
| 5. Ullage at ignition (percent)..... | 3.18% | 4.3% |
| 6. Volume at ignition (gallons)..... | 41,590 | 41,127 |
| 7. Volume at cutoff (gallons)..... | 27,911 | 3,061 |

TABLE 4-2
DISCRETE PROBE ACTUATION TIMES*

TEST SA-21

LOX PROBES

| TIME FROM* (SECONDS) | 0-C | 0-1 | 0-2 | 0-3 | 0-4 |
|-------------------------|-------|-------|-------|-------|----------|
| Ignition to P2 | 9.80 | 7.93 | 7.92 | 8.22 | 8.02 |
| P2 to P3 | 10.02 | 9.78 | 9.87 | 9.78 | 9.75 |
| P3 to P4 | 9.95 | 9.83 | 9.96 | 10.05 | 9.88 |
| P4 to P5 | 9.83 | 9.95 | 9.98 | 10.00 | ** |
| P5 to P6 | 9.83 | 10.07 | 9.98 | 10.10 | 19.81*** |
| P6 to P7 | 9.85 | 10.03 | 9.93 | 10.26 | 10.08 |
| P7 to P8 | 10.02 | 9.99 | 10.14 | 9.78 | 10.01 |
| P8 to P9 | 9.90 | 10.05 | 10.05 | 9.96 | 10.12 |
| P9 to P10 | 10.10 | 10.05 | 10.19 | 9.92 | ** |
| P10 to P11 | 9.89 | 10.08 | 10.13 | 10.43 | 20.28*** |
| P11 to P12 | 10.02 | 10.11 | 10.10 | 9.88 | 10.18 |
| P12 to P13 | 10.14 | 10.12 | 10.19 | 10.12 | 10.31 |
| P13 to P14 | 10.04 | ** | 10.21 | 9.99 | ** |
| P14 to P15 | 9.87 | ** | 10.21 | 10.13 | 20.22*** |

* Times shown are periods in seconds between probe actuations.

** Pulse Lost

*** Accumulative time between probes.

TABLE 4-2 (CONTINUED)

FUEL PROBES

| TIME FROM* (SECONDS) | F1 | F2 | F3 | F4 |
|-------------------------|-------|-------|-------|-------|
| Ignition to P1 | 12.73 | 12.43 | 12.72 | 12.88 |
| P1 to P2 | 9.45 | 9.51 | 9.59 | 9.74 |
| P2 to P3 | 9.62 | 9.51 | 9.54 | 9.75 |
| P3 to P4 | 9.81 | 9.68 | 9.53 | 9.73 |
| P4 to P5 | 10.03 | 9.65 | 10.01 | 8.90 |
| P5 to P6 | 9.72 | 9.76 | 9.95 | 9.29 |
| P6 to P7 | 9.35 | 9.86 | 9.86 | 10.01 |
| P7 to P8 | 9.81 | 10.07 | 9.16 | 9.79 |
| P8 to P9 | 9.83 | 10.16 | 9.39 | 9.61 |
| P9 to P10 | 9.73 | 10.02 | 9.55 | 9.56 |
| P10 to P11 | 9.85 | 10.00 | 9.63 | 9.72 |
| P11 to P12 | 9.70 | 9.87 | 9.60 | 9.60 |
| P12 to P13 | 8.83 | 9.90 | 9.76 | 9.72 |
| P13 to P14 | 10.76 | 9.88 | 9.77 | 9.65 |

* Times shown are periods in seconds between probe actuations.

TABLE 4-3
 VOLUME BELOW DISCRETE
 PROBES FOR STAGE S-1-8

LOX
 (GALLONS)

| PROBE | TANK 0-C | TANK 0-1 | TANK 0-2 | TANK 0-3 | TANK 0-4 |
|-------|-------------|-------------|-------------|-------------|-------------|
| P1 | 22,182 | 9,963 | 9,960 | 9,969 | 9,965 |
| P2 | 20,654 | 9,276 | 9,270 | 9,279 | 9,275 |
| P3 | 19,100 | 8,578 | 8,576 | 8,601 | 8,583 |
| P4 | 17,541 | 7,886 | 7,889 | 7,899 | 7,894 |
| P5 | 15,981 | 7,204 | 7,200 | 7,207 | 7,203 |
| P6 | 14,421 | 6,505 | 6,501 | 6,515 | 6,511 |
| P7 | 12,852 | 5,820 | 5,815 | 5,821 | 5,821 |
| P8 | 11,295 | 5,131 | 5,127 | 5,134 | 5,130 |
| P9 | 9,740 | 4,441 | 4,435 | 4,442 | 4,439 |
| P10 | 8,184 | 3,745 | 3,741 | 3,749 | 3,747 |
| P11 | 6,638 | 3,058 | 3,053 | 3,060 | 3,057 |
| P12 | 5,079 | 2,368 | 2,362 | 2,370 | 2,365 |
| P13 | 3,526 | 1,669 | 1,665 | 1,677 | 1,673 |
| P14 | 1,980 | 985 | 978 | 985 | 982 |
| P15 | 473 | 303 | 299 | 304 | 299 |

TABLE 4-3 (CONTINUED)

FUEL
(GALLONS)

| PROBE | TANK F-1 | TANK F-2 | TANK F-3 | TANK F-4 |
|-------|-------------|-------------|-------------|-------------|
| P1 | 9,479 | 9,480 | 9,481 | 9,478 |
| P2 | 8,816 | 8,805 | 8,822 | 8,814 |
| P3 | 8,162 | 8,163 | 8,165 | 8,160 |
| P4 | 7,506 | 7,507 | 7,510 | 7,503 |
| P5 | 6,849 | 6,851 | 6,852 | 6,847 |
| P6 | 6,185 | 6,187 | 6,190 | 6,183 |
| P7 | 5,530 | 5,531 | 5,534 | 5,529 |
| P8 | 4,872 | 4,874 | 4,877 | 4,871 |
| P9 | 4,207 | 4,213 | 4,217 | 4,206 |
| P10 | 3,554 | 3,558 | 3,560 | 3,553 |
| P11 | 2,899 | 2,902 | 2,903 | 2,897 |
| P12 | 2,241 | 2,247 | 2,245 | 2,239 |
| P13 | 1,577 | 1,581 | 1,587 | 1,575 |
| P14 | 925 | 927 | 930 | 921 |
| P15 | 274 | 279 | 279 | 272 |

TABLE 4-4
PREVALVE CLOSING TIMES - TEST SA-20

($4\frac{1}{2}$ Hour Exposure to LOX)

| Prevalve | Signal-to-Switch (seconds) | Switch-to-Switch (seconds) |
|-------------------------|-------------------------------|-------------------------------|
| LOX No. 1 Fuel No. 1 | 1.19 1.72 | 0.58 0.96 |
| LOX No. 2 Fuel No. 2 | 2.26 2.00 | 0.08 1.13 |
| LOX No. 3 Fuel No. 3 | 1.07 1.74 | 0.50 0.96 |
| LOX No. 4 Fuel No. 4 | 1.20 1.76 | 0.62 0.92 |
| LOX No. 5 Fuel No. 5 | 1.21 1.89 | 0.63 1.10 |
| LOX No. 6 Fuel No. 6 | 1.70 1.69 | 1.10 0.92 |
| LOX No. 7 Fuel No. 7 | 1.91 1.77 | 1.05 0.99 |
| LOX No. 8 Fuel No. 8 | 1.49 1.80 | 0.82 1.01 |

TABLE 4-5
PREVALVE CLOSING TIME - TEST SA-21

(4½ Hour Exposure to LOX)

| Prevalve | Signal-to-Switch (seconds) | Switch-to-Switch (seconds) |
|-------------------------|-------------------------------|-------------------------------|
| LOX No. 1 Fuel No. 1 | 0.87 1.64 | 0.41 0.87 |
| LOX No. 2 Fuel No. 2 | 1.43 1.91 | 0.60 1.11 |
| LOX No. 3 Fuel No. 3 | 0.93 1.66 | 0.43 0.90 |
| LOX No. 4 Fuel No. 4 | 0.79 1.65 | 0.32 0.87 |
| LOX No. 5 Fuel No. 5 | 0.80 1.79 | 0.39 1.04 |
| LOX No. 6 Fuel No. 6 | 0.95 1.59 | 0.50 0.88 |
| LOX No. 7 Fuel No. 7 | 1.00 1.68 | 0.41 0.95 |
| LOX No. 8 Fuel No. 8 | 1.08 1.68 | 0.58 0.94 |

GRAPH 4-1
 CENTER LOX TANK PRESSURE VS. TIME
 MEASUREMENT 2.05-C
 TEST SA-20 AND SA-21

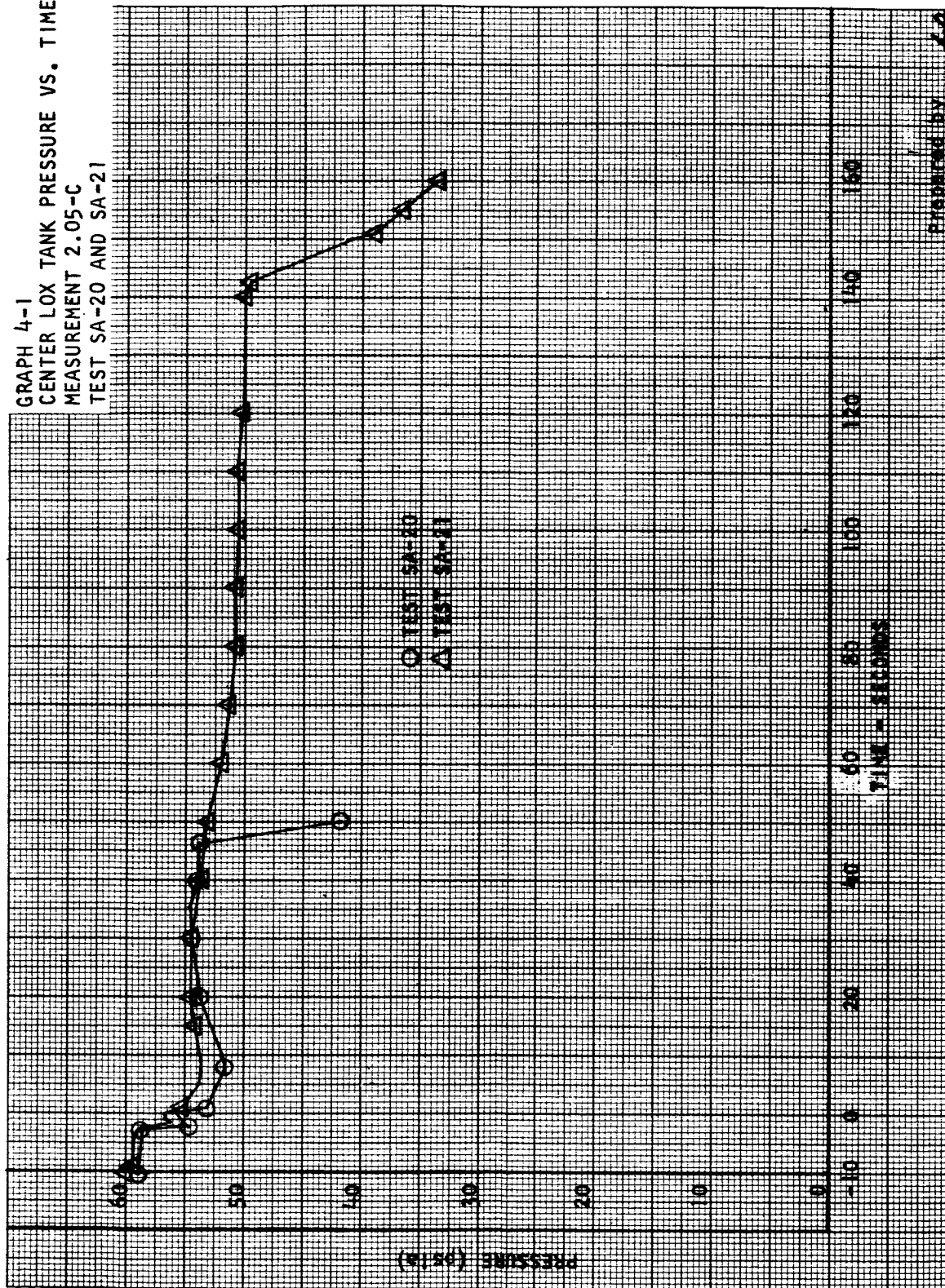

Prepared by 4-2

GRAPH 4-2
GOX FLOW CONTROL VALVE
POSITION VS. TIME
MEASUREMENT 43.49A
TEST SA-21

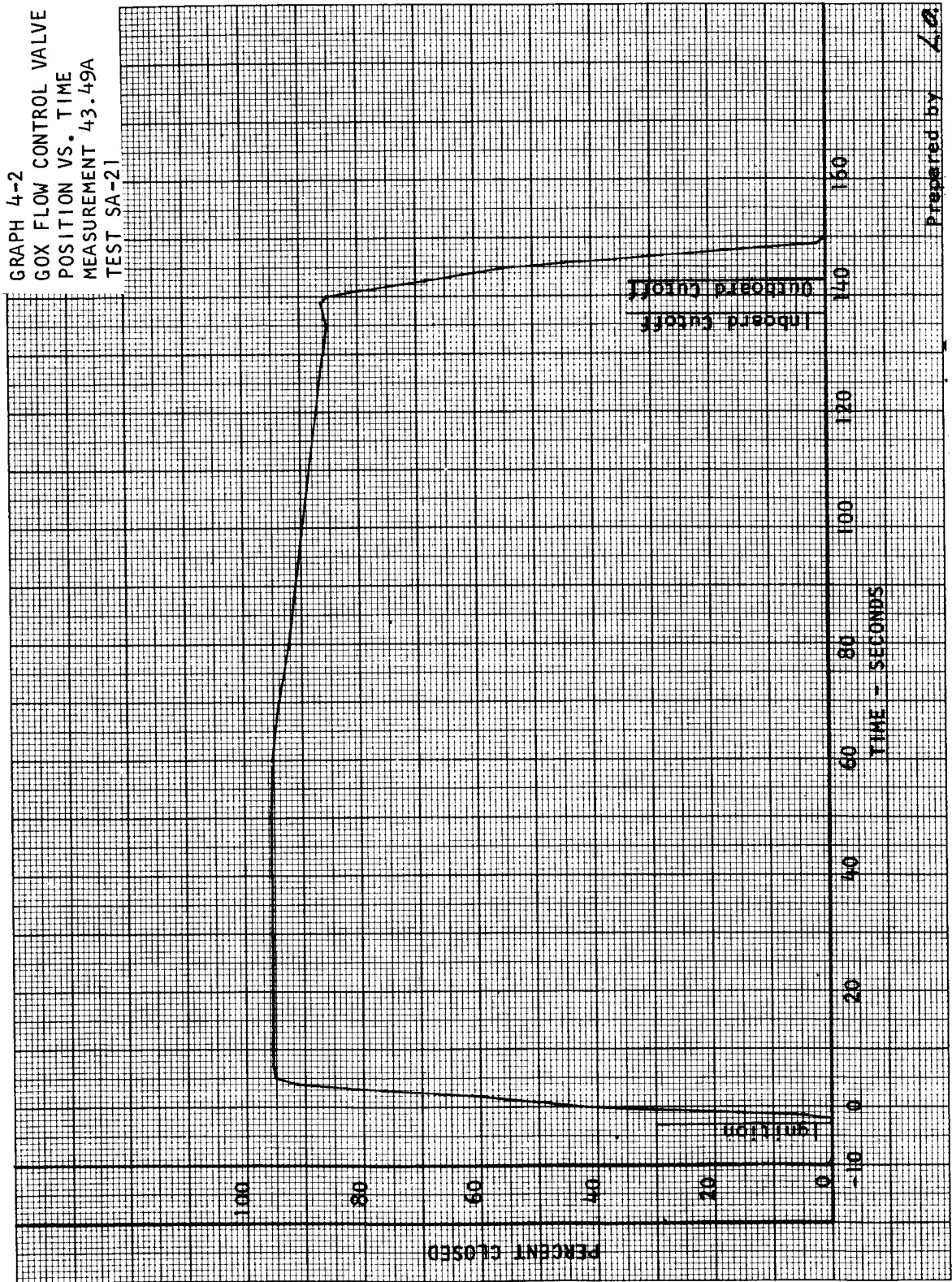

Prepared by LA

GRAPH 4-3
 FUEL SYSTEM PRESSURIZATION
 CHARACTERISTICS VS. TIME
 MEASUREMENTS 2.04-3 AND 6.03
 TEST SA-21

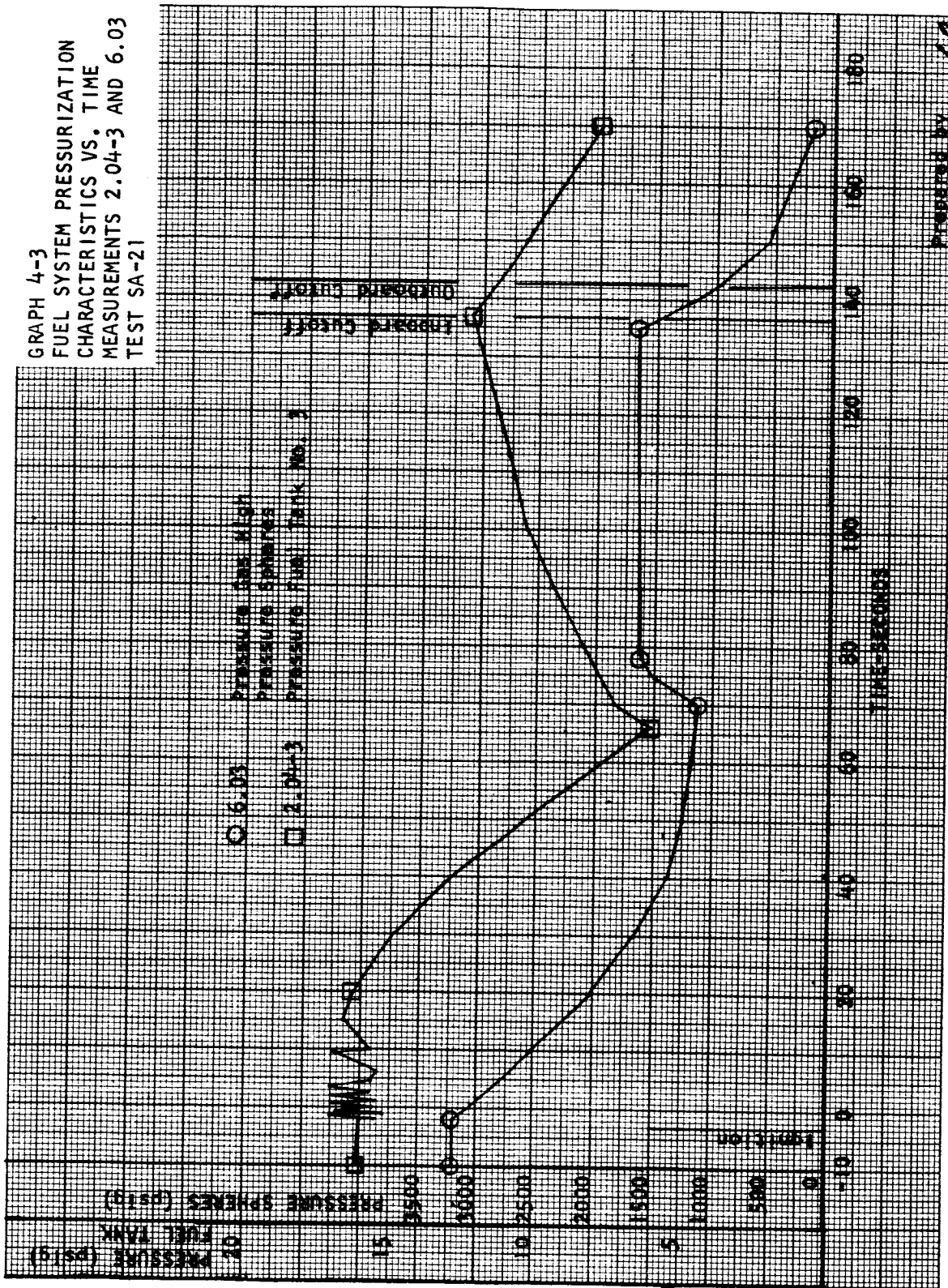

Prepared by L.A.

GRAPH 4-4
 PRESSURES RELATED TO LOX-SOX
 SYSTEM VS. TIME
 MEASUREMENTS P2, P3, 6.03,
 AND D120-111
 TEST SA-21

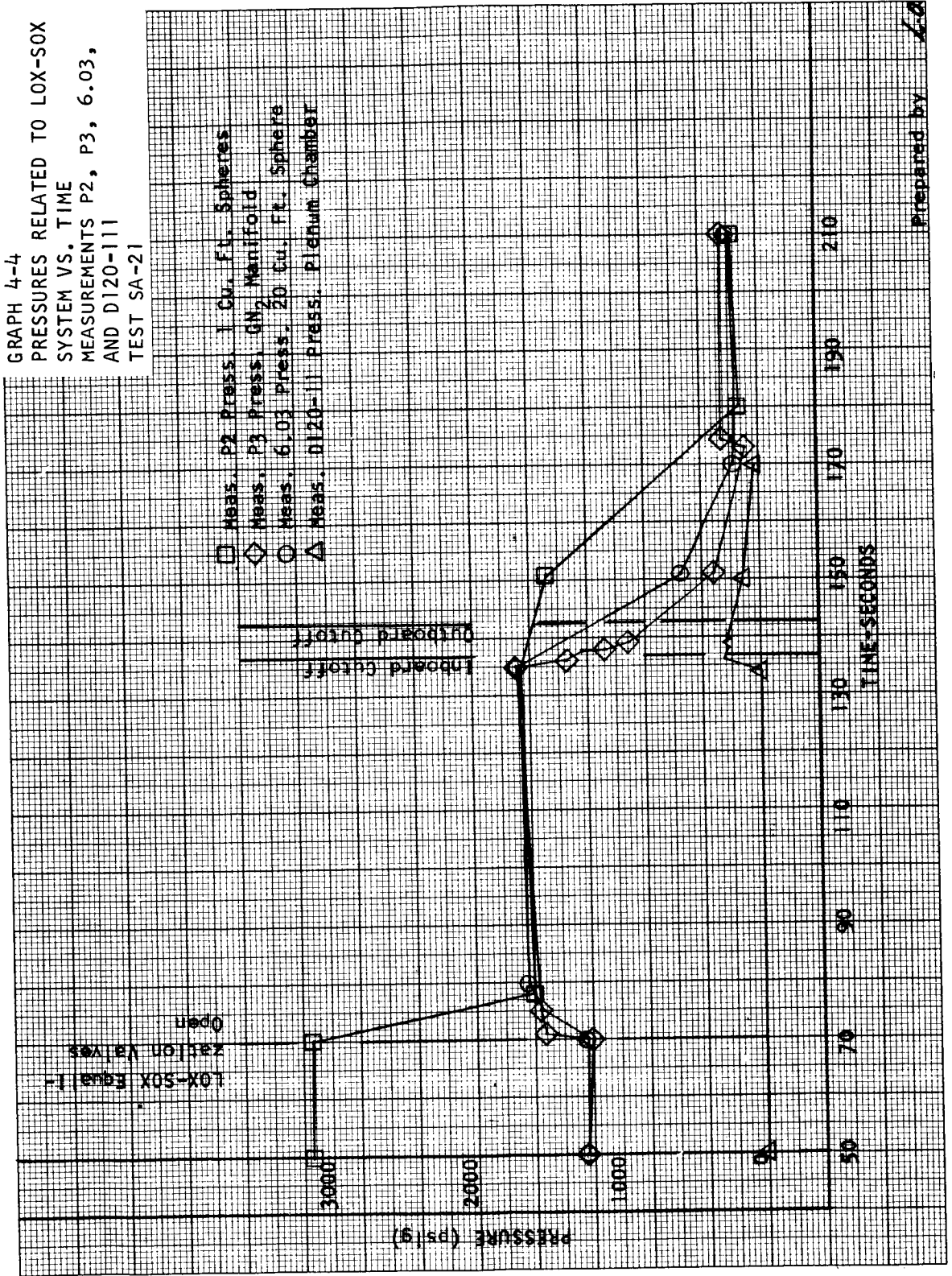

Prepared by *LA*

GRAPH 4-5
 TEMPERATURES RELATED TO LOX-
 SOX SYSTEM VS. TIME
 MEASUREMENTS C-236-11 AND C237-11
 TEST SA-21

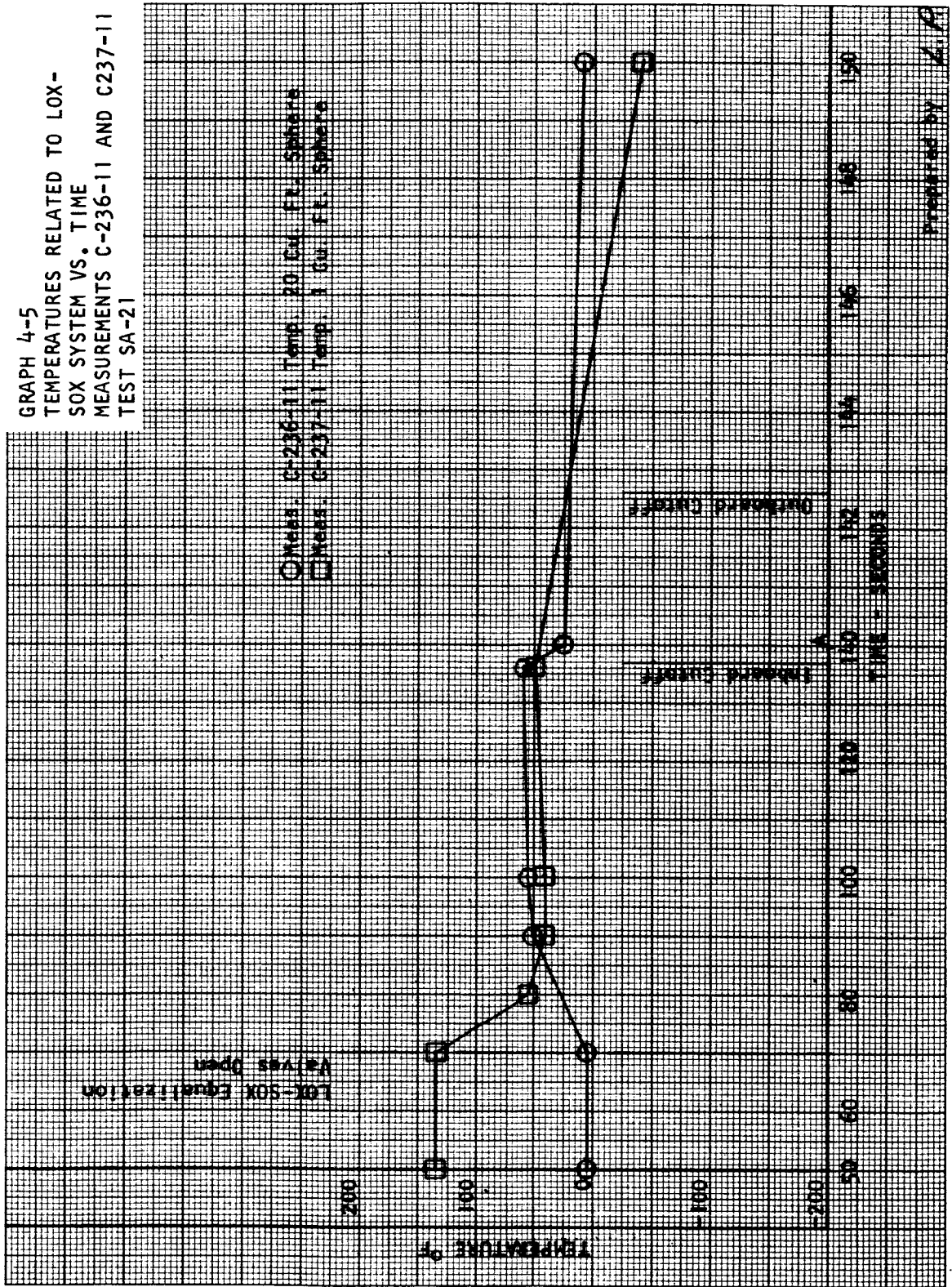

Prepared by L.P.

GRAPH 4-6
CONTROL SPHERES PRESSURE VS. TIME
MEASUREMENT 6.06
TEST SA-21

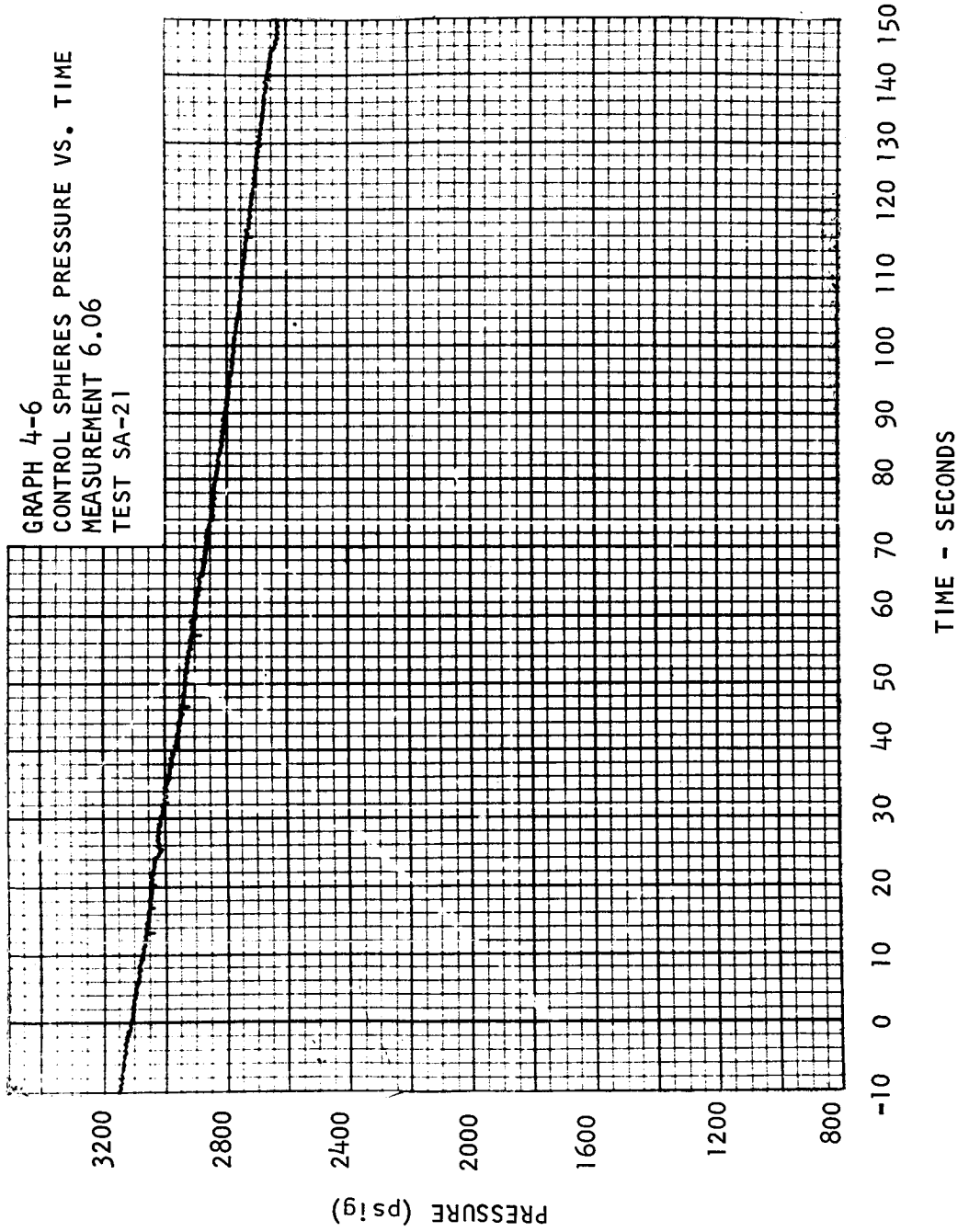

SECTION 5 ENGINE COMPARTMENT ENVIRONMENT

Post-test inspection of the engine compartment and lower stage structure revealed no visible evidence of overheating during test SA-20. Engine curtain and aspirator cover damage was negligible. There was no damage to the stage heat shield. An uninstrumented, rectangular, S-1B stainless steel, honeycomb heat shield panel (P/N 60C30555-1), installed adjacent to engine 6 on fin line II, was also undamaged. This heat shield consists of a crushed honeycomb matrix which is then filled and covered with M-31 insulating material. A sketch of the honeycomb heat shield panel is shown in FIGURE 5-1. The purpose of including this panel on stage S-1-8 was to evaluate this bonding technique under actual firing conditions.

Post-test inspection, following test SA-21, revealed moderate damage to the heat shield. Approximately 900 square inches of M-31 insulating material separated from the stage panels. Insulation material which remained was cracked in many places. The post-test status of the individual panels is shown in FIGURE 5-2 and TABLE 5-1.

The stainless steel honeycomb heat shield panel used in test SA-20 was reinstalled adjacent to engine 8 on fin line IV for test SA-21. This location is subjected to the most vibration and heating during a static firing. Damage to this panel consisted of one hairline crack in the insulation material, 15 inches long, and parallel to the inboard bolt line (see FIGURE 5-3 and FIGURE 5-4).

Slight engine curtain and aspirator cover damage was noted on the inboard quadrant of all outboard engines.

Turbine spinner surface temperatures were maintained within the specified limits (40° F to 75° F) by the boattail conditioning system, for tests SA-20 and SA-21.

There was no evidence of fire or hot gas leaks in the engine compartment during tests SA-20 and SA-21.

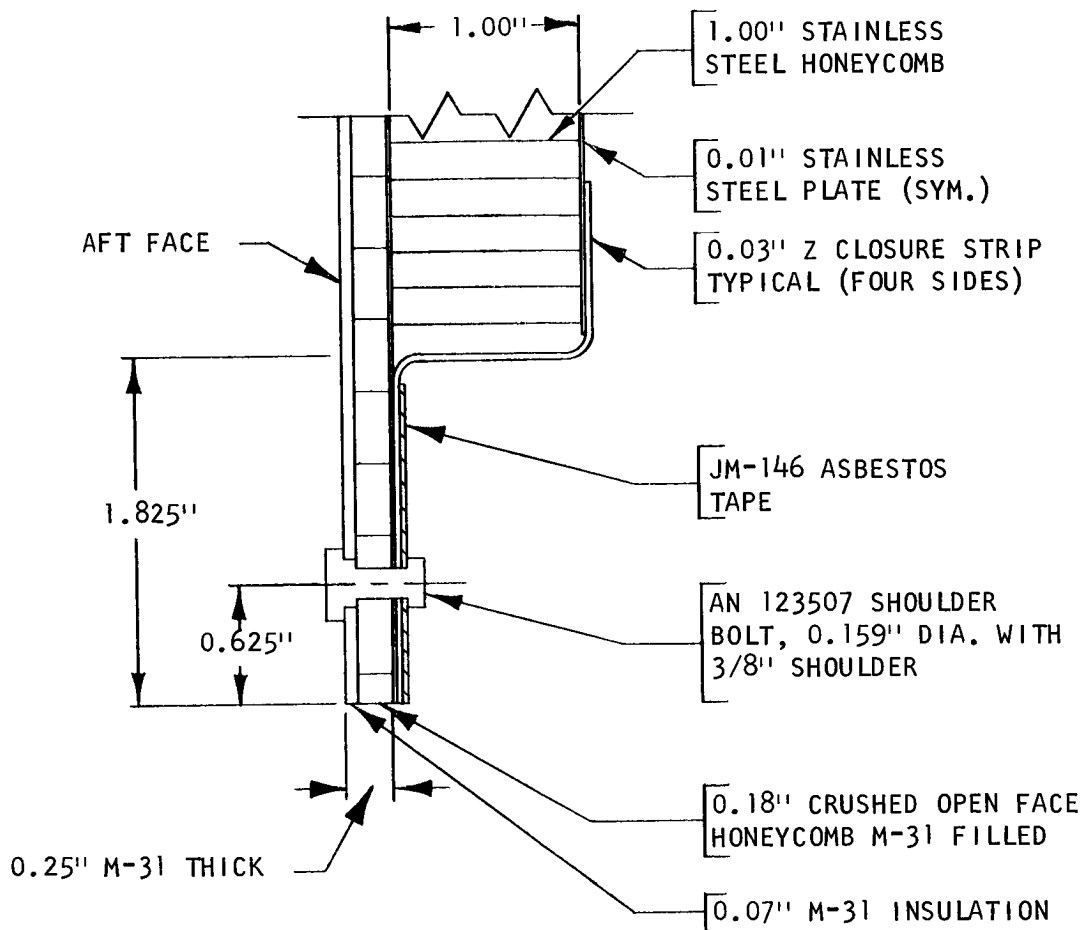

TYPICAL HONEYCOMB PANEL

EDGE CONSTRUCTION

FIGURE 5-1

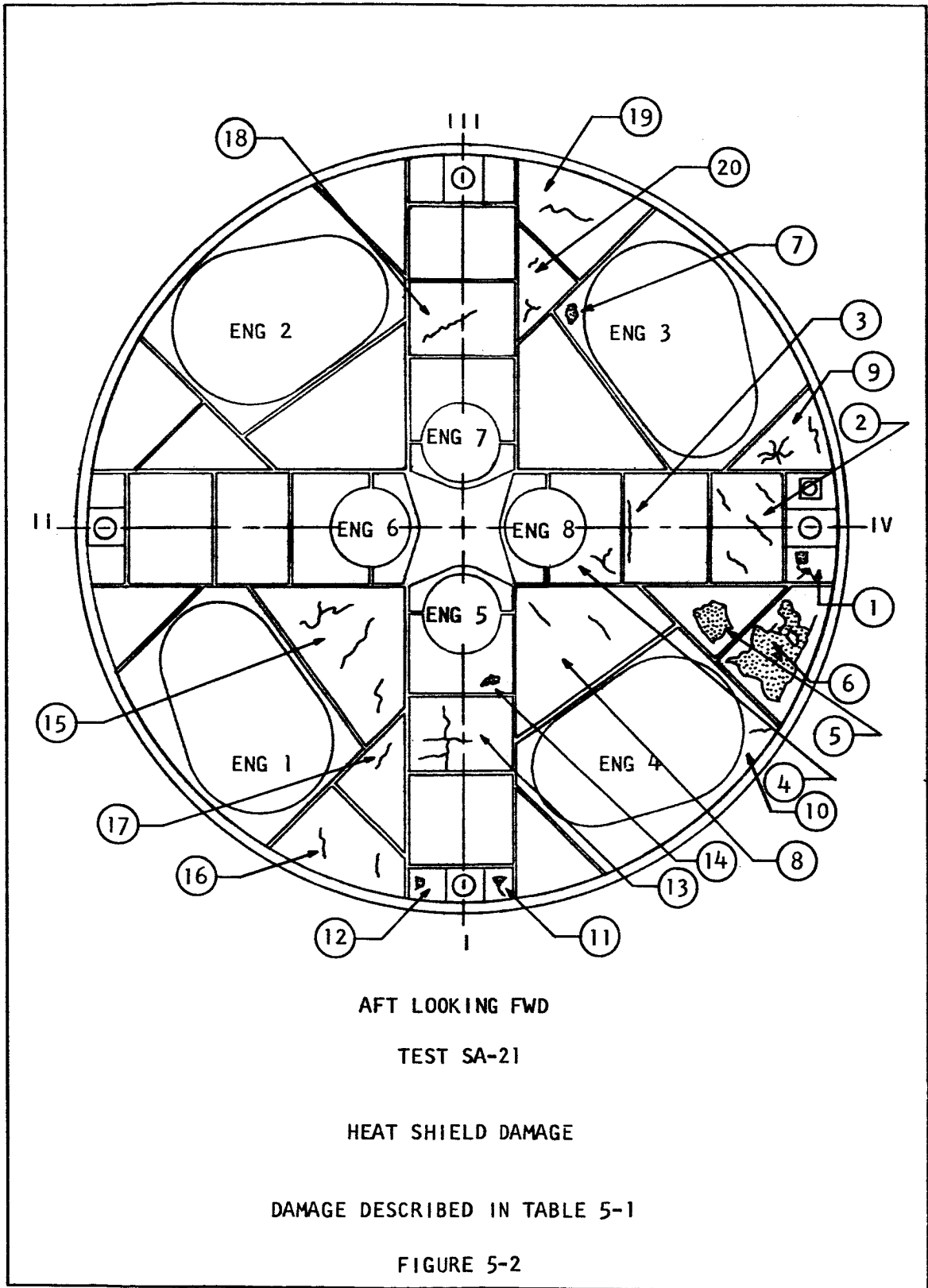

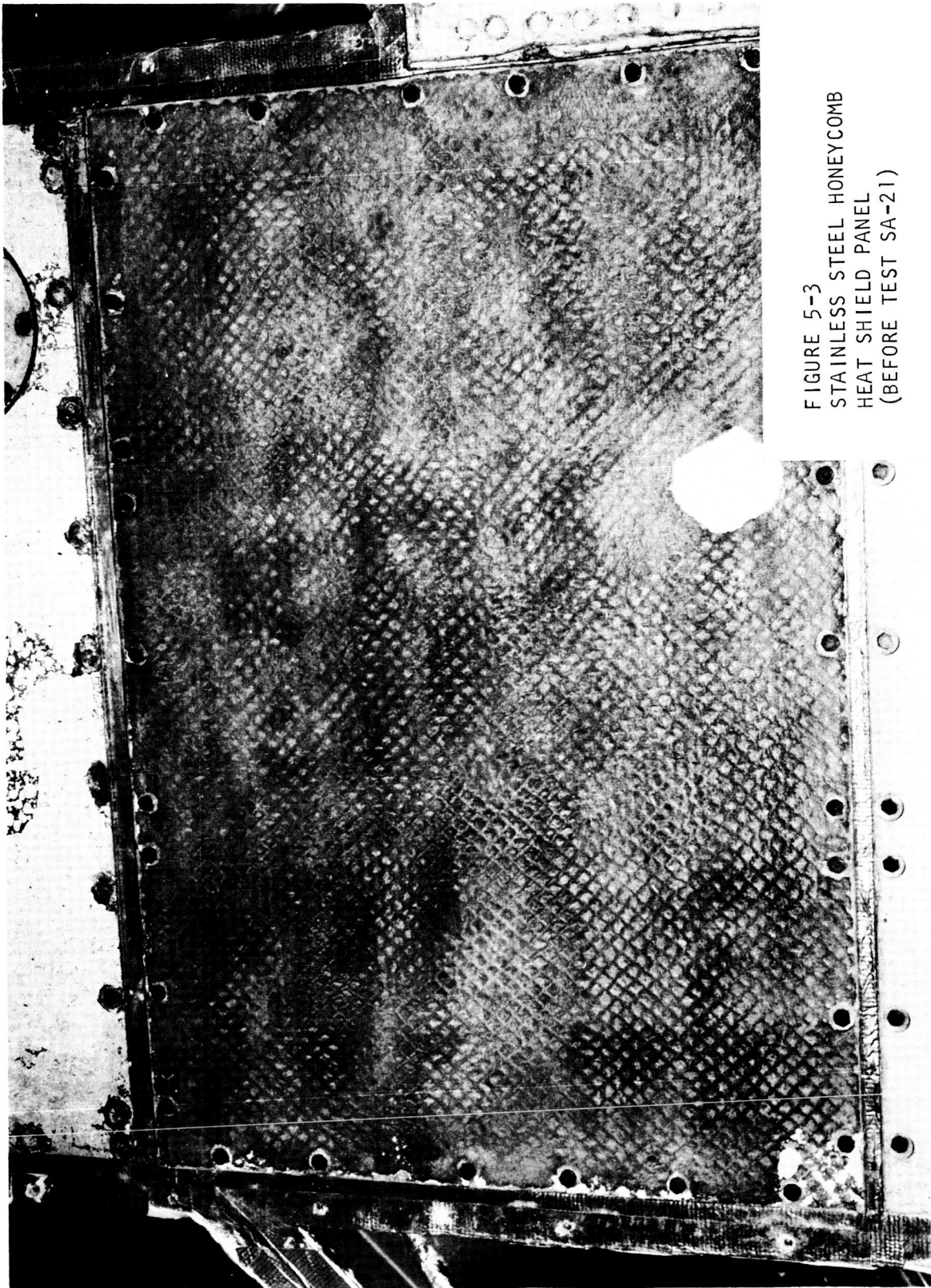

FIGURE 5-3
STAINLESS STEEL HONEYCOMB
HEAT SHIELD PANEL
(BEFORE TEST SA-21)

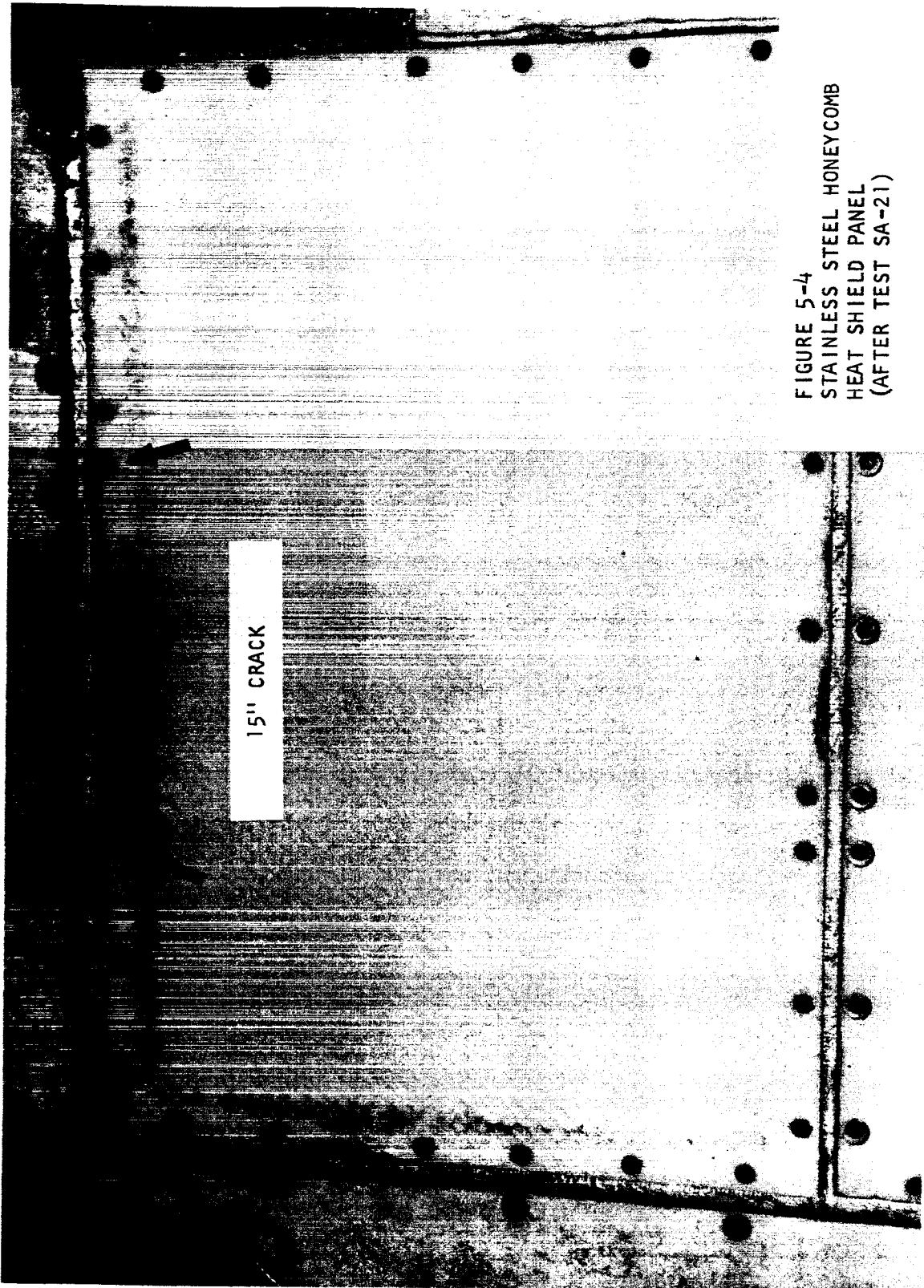

FIGURE 5-4
STAINLESS STEEL HONEYCOMB
HEAT SHIELD PANEL
(AFTER TEST SA-21)

TABLE 5-1
HEAT SHIELD DAMAGE

| REF. FIG. 5-1 | EXTENT OF DAMAGE |
|------------------|---|
| 1 | 30 square inches separated, remainder of panel is cracked and loose. |
| 2 | 4 cracks located as shown, each approximately 10 inches long. |
| 3 | Special S-1B honeycomb panel, 1 crack located as shown 15 inches long. |
| 4 | Network of cracks as shown, each 6 inches long. |
| 5 | 120 square inches separated. |
| 6 | 720 square inches separated. |
| 7 | 15 square inches separated. |
| 8 | 2 cracks located as shown, each 15 inches long. Remainder of panel is loose. |
| 9 | Entire panel is badly cracked and loose. |
| 10 | Crack located as shown, 6 inches long. Rest of panel is loose. |
| 11 | 5 square inches separated. |
| 12 | 5 square inches separated. |
| 13 | Network of cracks located as shown, all 20 inches long. |
| 14 | 5 square inches separated. |
| 15 | Entire panel is badly cracked and loose. |
| 16 | 2 cracks located as shown, each 6 inches long. All panel insulation is loose. |

TABLE 5-1 (CONTINUED)

| REF. FIG. 5-1 | EXTENT OF DAMAGE |
|------------------|--|
| 17 | Crack located as shown, 8 inches long. |
| 18 | Crack located as shown, 18 inches long. |
| 19 | Crack located as shown, 18 inches long. |
| 20 | Cracks located as shown, all cracks 6 inches long. |

SECTION 6 VIBRATION AND SPECIAL INSTRUMENTATION

Vibration and acoustic measurement data obtained during tests SA-20 and SA-21 are presented and discussed in the Vibration and Acoustic Evaluation Report, Stage S-1-8, which is published by Systems Static Test Branch. A discussion of the rough combustion cutoff (RCC) systems is included in that report.

The fire detection system functioned as required during tests SA-20 and SA-21, and no abnormal temperatures were detected. The fire detection system configuration was the same for tests SA-20 and SA-21. The system consisted of 12 Test Laboratory harnesses and 4 flight harnesses. Each rise rate indicator was set at 5 chart scales per second (3.0 mv) with a time delay of 1 second for the Test Laboratory harnesses and a time delay of one-half second for the flight harnesses. All 16 rise rate indicators were active in the cutoff circuit.

As requested in NASA memorandum R-P&VE-VF-234-63, radiation calorimeters were installed on the test tower to measure the radiant energy of the exhaust plume during tests SA-20 and SA-21. No usable data were obtained from these measurements during test SA-21. The results from these measurements for test SA-20 are presented in the PSTR for that test.

The special instrumentation requested by the various MSFC and CCSD groups is documented in the Static Test Hardwire Measurement Locations for Saturn Stage S-1-8, July 6, 1964. Included in this document are the hardwire measurements on the stage, test tower, GSE, and facilities, except those measurements which have been previously shown on released engineering documentation or flight measuring documentation.

SECTION 7
ELECTRICAL CONTROL SYSTEMS

Saturn stage S-1-8 underwent electrical system verification during prestatic testing and static firing while at Static Test.

Test SA-20 was terminated by the Firing Panel operator. Test SA-21 was terminated as planned, with inboard engine cutoff signal initiated by the flight sequencer 2 seconds after closure of the LOX low level sensor in tank 0-4. Outboard engine cutoff signal was initiated 5.67 seconds later when the Thrust OK pressure switch on engine 4 dropped out. The following table gives the time of commit and test duration times for tests SA-20 and SA-21.

| TEST | TIME OF COMMIT (X=0) | TEST DURATION FROM IGNITION COMMAND (X-3), TO CUTOFF SIGNAL | |
|-------|----------------------|---|------------------|
| | | INBOARD ENGINES | OUTBOARD ENGINES |
| SA-20 | 16:42:23.38 CST | 48.94 seconds | 49.06 seconds |
| SA-21 | 16:39:55.42 CST | 139.92 seconds | 145.61 seconds |

A 31 second hold in the automatic sequence was initiated 30 seconds prior to ignition command on test SA-21, to allow sufficient time for LOX tank pressurization.

Commencing with test SA-20, zero time on millisadic records, pulse override on the strip charts, and pulse override on the oscillograph records, occurs at commit. Zero time on all telemetry records occurs at commit, and is accurate to the nearest whole second.

All operations performed normally during test SA-20, with the exception that the oscillograph trace for hydraulic supply pressure, (measurement 56.01), on engine 4, was erratic. The supply pressure transducer was replaced prior to test SA-21, and no further difficulty was experienced.

The explosive bridge wire destruct system did not receive the transmitted cutoff and destruct signals during test SA-21. This problem was determined to be caused by RF interference. A complete description of this problem is presented in the TELEMETRY SYSTEMS section of this report.

The hypergol detector indicator for engine 8 malfunctioned during test SA-21. The problem was traced to faulty switch operation. A description of this problem is presented in the ENGINE SECTION of this report.

Operating times for major functions on test SA-21 are included on the enclosed bar charts (FIGURES 7-1 through 7-4).

A record of vehicle component operating times while in the Static Test area can be found in APPENDIX F.

TEST SA-21

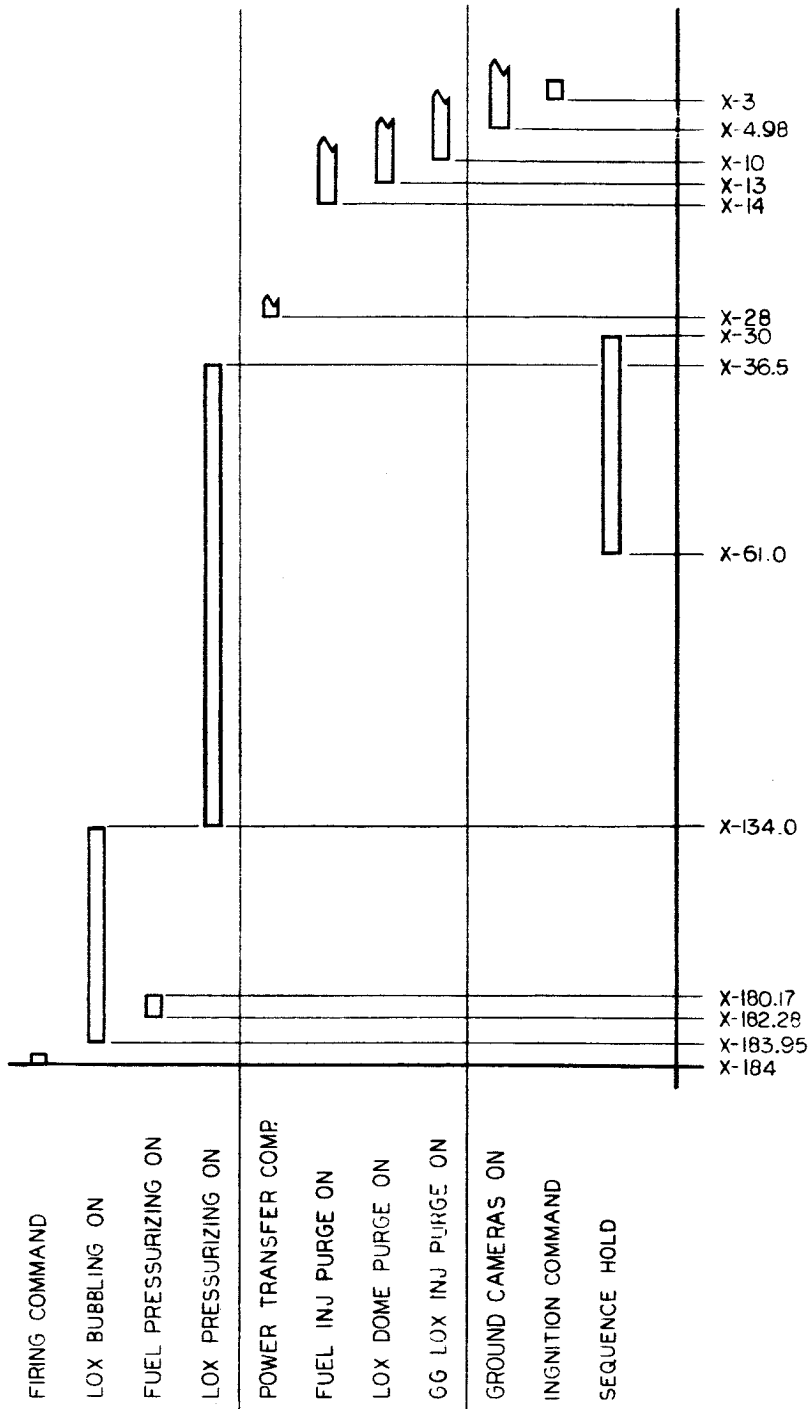

FIRING COMMAND TO IGNITION COMMAND

FIGURE 7-1

TEST SA-21

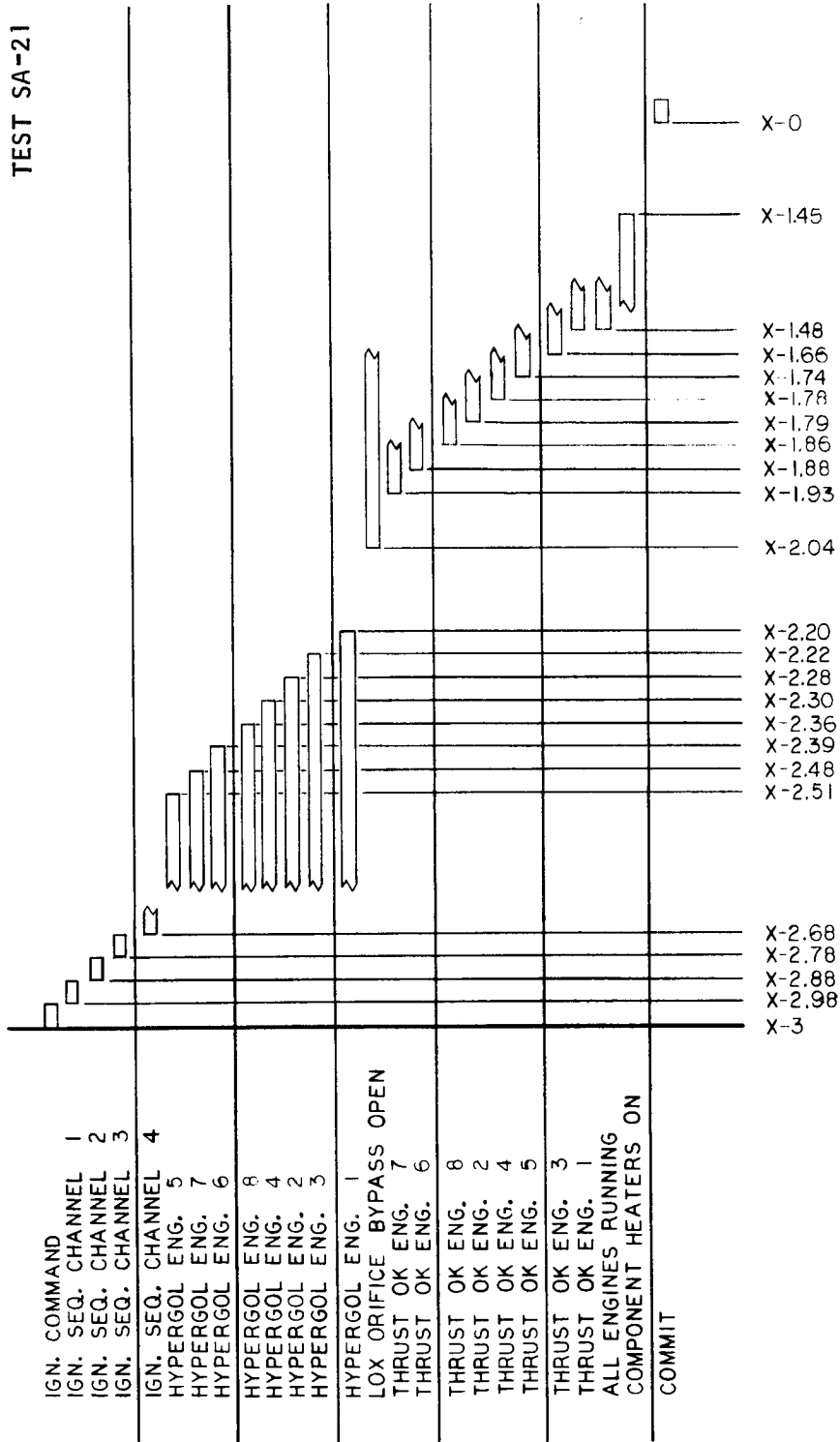

IGNITION COMMAND TO COMMIT
FIGURE 7-2

TEST SA-21

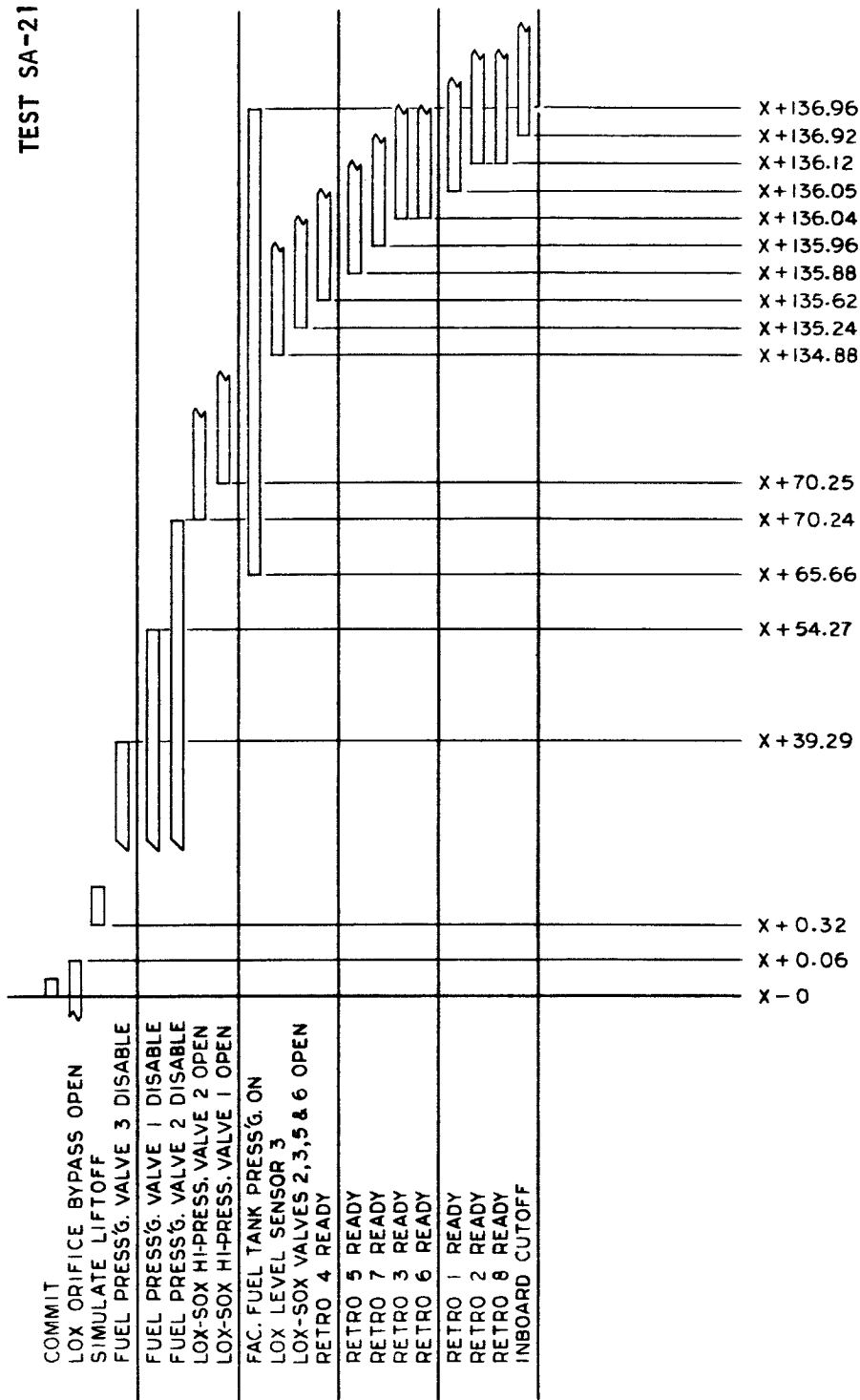

COMMIT TO INBOARD CUTOFF
FIGURE 7-3

TEST SA-21

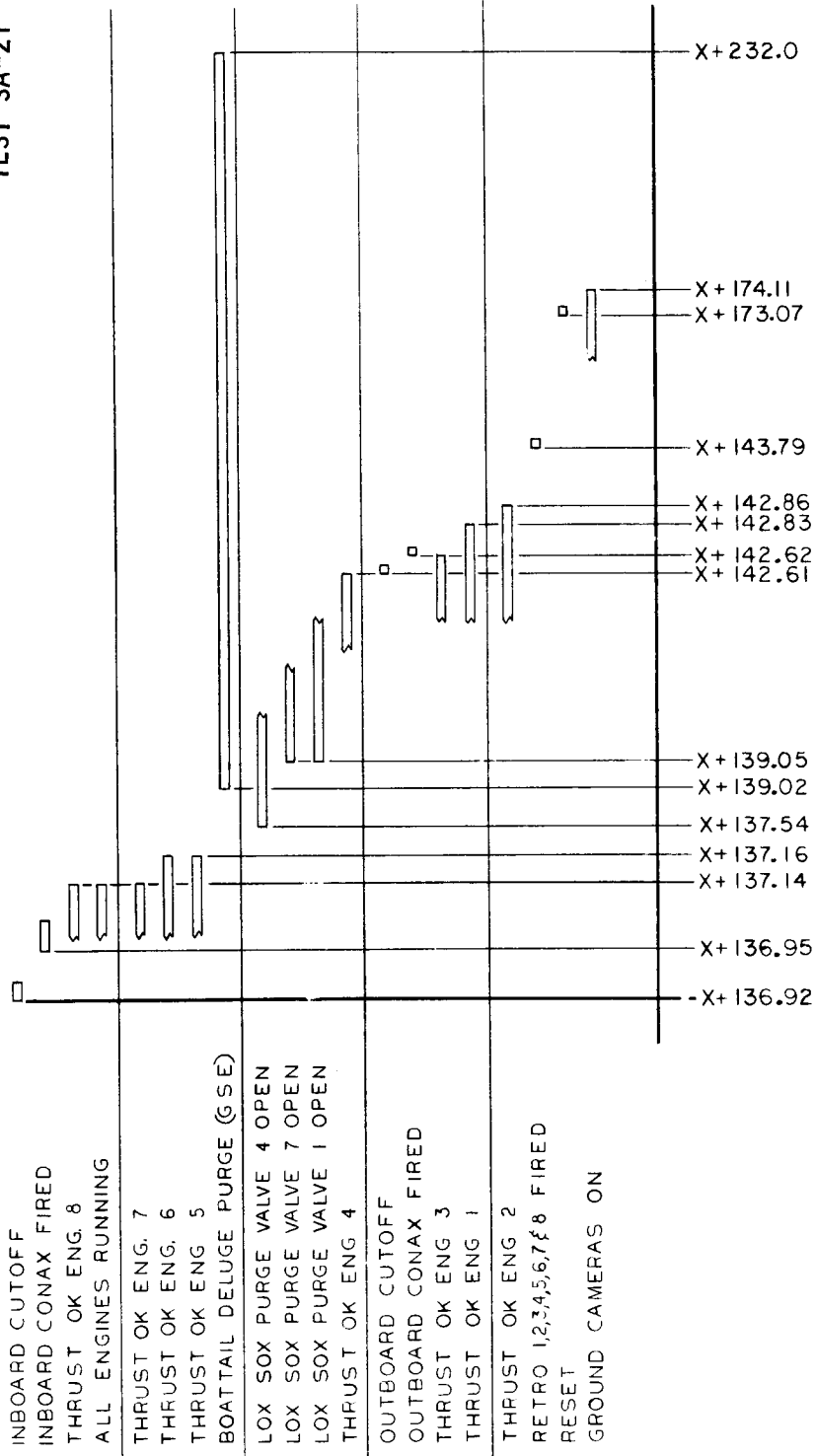

INBOARD CUTOFF TO RESET

FIGURE 7-4

SECTION 8 TELEMETRY SYSTEMS

The telemeter systems operated satisfactorily during both tests with the exception of the discrepancies noted in the Preliminary Static Test Report, Tests SA-20 and SA-21. During both tests, satisfactory results were obtained on 97 percent of the telemetered measurements. In the PSTR for test SA-19, stage S-1-9, it was noted that 31 measurement discrepancies occurred due to a malfunction of an input diode in three Universal Measuring Adapter (UMA) rack power supplies. Prior to test SA-20, this diode was replaced in 15 of the 17 UMA rack power supplies (which utilize the 22.5 volt power supply) in accordance with Engineering Order A11140-1. No malfunction of any UMA power supply occurred during either test SA-20 or SA-21. The two power supplies for UMA racks 9A522 and 9A528, which were not modified because of insufficient time prior to static firings of stage S-1-8, were properly modified and installed after test SA-21.

The stage S-1-8 F1 FM/FM package multiplexer has demonstrated a history of generating marginal calibrations under control of the program device located in the blockhouse. The rising edge of the F1 output calibrate command is discrepant (rising edges of commands other than F1 are satisfactory). Two spare relay drivers exist within the telemetering calibrator, and a calibrate command from either of these two relay drivers would be satisfactory. It is recommended that the F1 calibrate command signal be reassigned to one of the spare relay drivers, thereby eliminating use of the marginal "Relay 1" F1 calibrate command signal. Unsatisfactory Condition Reports CSD-S-00051 and CSD-S-00057 document this problem and state the preceding recommendation.

The two command destruct receivers (CDR 1 and CDR 2) did not indicate receipt of the destruct command signals which were broadcast at X+117 seconds from a transmitter located at Quality and Reliability Assurance Laboratory. Investigation revealed that the acoustic section of Test Laboratory used their voice communications channel during the time of test SA-21. The frequency of this communications channel (408.125 mc) is very near that of the CDR frequency (408.000 mc). Post static experiments disclosed that cutoff and destruct commands could not be received while the Acoustics Test Laboratory communications link was energized. This discrepancy should not occur on future static tests as the Acoustics Test Laboratory now utilize telephone communications.

During test SA-21, power supply 9A4A1 malfunctioned at outboard engine cutoff plus 1.1 seconds following the test. There were 14 simulated measurements and 1 flight measurement that depended upon this 5 volts for operation. All of these measurements operated normally until the power supply failed. This power supply was forwarded to Astrionics Laboratory after test SA-21 where an intensive investigation of the component failed to reveal any discrepancy. The power supply will be replaced.

Power supply 12A38, which supplies the +1089 5 volt dc bus, malfunctioned during test SA-21. The power supply generated ripples in its output voltage which changed the 5 volt output by as much as one-half volt. Tests made before and after the firing revealed that the power supply operated correctly at these times. Vibrations which occurred during the firing are the apparent cause of the malfunction. This power supply was not removed prior to shipment of the stage to Chrysler Michoud Operations. A thorough investigation of the power supply will be conducted at Michoud.

A specific breakdown of discrepancies according to measurement numbers, measurement names, and telemeter channel is given in the Telemetry Systems Section of the PSTR for Tests SA-20 and SA-21. All measurements not contained in these discrepancy lists operated satisfactorily.

A comparison of hardwire and telemetry data for combustion chamber pressure, measurements 4.51 and D1, respectively, is tabulated in the Confidential Supplement, Tests SA-20 and SA-21. A comparison of hardwire and telemetry data for LOX pump inlet temperature, measurements 19.01 and C54, respectively, for test SA-21 is presented in TABLE 8-1. These tables indicate that good agreement was obtained between hardwire and telemetered data for these measurements.

TABLE 8-1
COMPARISON OF TELEMETRY AND HARDWIRE DATA
TEST SA-21

| ENGINE | LOX PUMP INLET TEMPERATURE (°F) | | PER CENT DIFFERENCE |
|--------|---------------------------------|-----------|---------------------|
| | HARDWIRE | TELEMETRY | |
| 1 | -292.4 | -292.5 | 0.03 |
| 2 | -292.7 | -292.2 | -0.17 |
| 3 | -292.8 | -292.7 | -0.03 |
| 4 | -292.5 | -293.1 | 0.21 |
| 5 | -292.7 | -292.5 | -0.07 |
| 6 | -292.9 | * | * |
| 7 | -293.1 | -292.8 | -0.10 |
| 8 | -293.0 | -293.9 | 0.31 |

* This measurement was not connected to telemetry.

SECTION 9 CONCLUSIONS

ENGINE SYSTEMS. All engines operated satisfactorily during tests SA-20 and SA-21 with the exception of engine 8 during test SA-21. The performance of all engines, except engine 6, was within tolerance during test SA-21. This engine did not respond to reorificing as expected. With the reinstallation of correctly performing engines at positions 6 and 8, the performance of all booster systems will be considered acceptable for launch.

The investigation of the operational difficulties encountered on engine 8 (S/N H-2029) during test SA-21 revealed that the four No. 4 screws that secure the I-B seal retainer ring to the seal housing had vibrated loose which allowed the retainer ring to rotate and eventually break up. These fragments were thrown radially outward passing between the first stage nozzle and turbine wheel causing rubbing and eventual puncture of the first stage housing. The operational difficulties were attributed to this failure. The fix will consist of staking the four screws and will be effective on stages S-1-7, S-1-8, S-1-9 and S-1-10. The 200K engines that will be installed on stages S-1B-1 and subsequent will have this feature incorporated.

The replacement engines for positions 6 and 8 (S/N H-2032 and H-2031, respectively) were calibrated during static tests at the Power Plant Test Stand. The performance of these engines was satisfactory, and no malfunctions were noted.

The special auxiliary LOX dome purge test performed prior to test SA-20 indicated that a higher purge pressure can be obtained by plumbing a larger purge line directly into the LOX dome of each inboard engine. The LOX domes of engines 3, 5, 6, 7, and 8 were inspected for contamination following test SA-21; engine 5 had 1 particle per square inch, engine 7 had approximately 15 particles per square inch, and the remaining engines were clean. No attempt was made to clean the inboard engine LOX domes.

The turbopump No. 8 bearing on all engines showed evidence of outer race rotation. This condition has been experienced previously and is not considered detrimental to engine operation.

Steps occurring in the No. 1 bearing pressure were in evidence on engines 4 and 5 during test SA-21. This condition has been observed frequently in past MSFC and Rocketdyne tests and is not considered detrimental to engine operation.

Continued instrumentation failures occurring on the LOX and fuel pump inlet pressure measurements 52.06 and 52.07 indicate that a problem still exists, and further investigation is in progress to determine the cause of this problem.

During removal of the fuel pump inlet screens, extreme difficulty was encountered in removing the bolts which secure the wraparound ducts to the fuel pump inlet adapters. Examination of the inserts indicated that excessive Molykote had been applied during the original assembly.

Six autoigniters were found to be damaged during installation of the autoigniters prior to test SA-20. It was determined that the use of the thread antiseize compound reduced the thread friction and increased the stress on the autoigniter housing. All antiseize compound was removed from the threads, and the autoigniters were installed with the torque value reduced from 240 ± 24 in.-lbs. to 200 in.-lbs.

Initial high breakaway torques recorded on the turbopumps of engines 2, 7, and 8 following test SA-21 returned to normal after the shafts had been rotated. The high breakaway torques are attributed to carbon deposits between the carbon seal and the turbine shaft.

ENGINE HYDRAULIC SYSTEMS. The engine hydraulic systems operated satisfactorily during static test of stage S-1-8 with all engine hydraulic system static test requirements accomplished as outlined in the gimbal programs for each test.

A defective hydraulic oil supply pressure transducer (measurement 56.01, P/N 20M85079) was replaced on engine 4 following test SA-20.

Large fluctuations in the engine 3 hydraulic oil supply pressure (measurement 56.01) occurred during test SA-21. The cause for these fluctuations was traced to an abnormally low GN₂ precharge of 800 psig instead of the normal 1,600 psig. The low GN₂ precharge at this engine position is attributed to human error during precharge operations. Tighter control will be maintained in the future.

PROPELLANT AND PNEUMATIC SYSTEMS.

1. Propellant Loading, Subsystems Tests, and Special Propellant Tests. Six of seven LOX loadings performed on stage S-1-8 were to the small ullages required as a pretest objective. The major problems that have been encountered during these propellant loadings and the problems peculiar to the small ullages are itemized as follows:

- a. Failure of a LOX prevalve to relieve properly.
- b. Slow LOX prevalve closing times.
- c. LOX leak at center LOX tank manhole cover.
- d. LOX in the GOX standpipe.
- e. LOX draining from the 7-inch vent and the LOX relief No. 1 vent extensions.

Items a. and b. were corrected by replacing the discrepant LOX prevalues. Item c. was corrected by replacing the center LOX tank manhole cover gasket. Items d. and e. are peculiar to the small LOX tank ullage.

LOX in the GOX standpipe is characterized by heavy frost on the GOX line beneath LOX tank O-C. LOX was observed emitting from the 7-inch vent and LOX relief No. 1 vent extensions. The flow of LOX out the vents increased when LOX bubbling was initiated. A special LOX loading test was performed on stage S-1-8 following completion of the acceptance firing test series. The purpose of this test was to further investigate these problems associated with the small LOX tank ullages. From the analysis of the test records and motion pictures of the special LOX loading test, the following conclusions were made:

a. There is a greater height of liquid in the center LOX tank than there is in the outer LOX tanks when the LOX vents are open. This is caused by the differential pressure of GOX between the center LOX tank and the outer LOX tanks, and the differential pressure is due to the direct venting of the center LOX tank.

b. Venting of the LOX tanks at small ullages causes the LOX level in the center tank to rise and flow out the vents and overflow into the GOX line.

c. Helium bubbling causes liquid level disturbance and increases the height differential between the center LOX tank and the outer LOX tanks. Helium bubbling at the small ullages also causes LOX to flow out the vents and overflow into the GOX line.

d. LOX topping and bubbling with the vents closed minimizes the LOX height differential and suppresses the liquid level disturbance.

e. The liquid level in the center tank and outer tanks equalizes when the tanks are pressurized.

f. LOX bubbling with the vents closed lowers the LOX temperature at the pump inlets sufficiently.

2. LOX System. The LOX system functioned satisfactorily during tests SA-20 and SA-21, although the LOX tank pressure exceeded the specified limits of 50 ± 2.5 psia as it did during tests SA-18 and SA-19 of stage S-1-9. The maximum LOX tank pressures attained were 54 psia and 54.4 psia during tests SA-20 and SA-21, respectively. Due to this recurring problem of LOX tank overpressurization, UCR CSD-S-00091 was written documenting this discrepancy.

The GFCV position trace did not indicate that the GFCV reached the fully closed position during either test SA-20 or SA-21. No cyclic movement of the GFCV gate was noted during either test. Similar indications of the GFCV not going fully closed were observed during the

static tests for stages S-1-7 and S-1-9. During post-static checkout of these stages, the GFCV thrust bearings were inspected and found to be damaged. The indication of the GFCV not going fully closed tends to substantiate the theory that the thrust bearing of the valve is damaged.

To simulate flight LOX depletion characteristics, a 20.0-inch diameter orifice was installed in the center LOX tank sump. This orifice was intended to retain the LOX level in the center LOX tank 6 inches higher than the LOX level in the outer tanks at the start of the cutoff sequence. Evaluation of the LOX discrete probe data indicates that the specified height differential was attained.

3. Prevalves. The LOX prevalves have demonstrated a history of slow closing times after extended exposure to cryogenic temperatures. Special instrumentation installed on the LOX prevalves indicated that the temperature of the pre valve actuator cylinder is on the order of -100° F with LOX on board as opposed to the pre valve design criteria of -65° F. Because of this problem, Engineering Change Proposal ECP ED-20072 has been issued in conjunction with Configuration Change Action CCA 939C. These two documents authorize rework of the LOX pre valves which should alleviate the slow closing times.

Pre valve relief tests were performed during the special LOX tankings to evaluate the relief capabilities of the modified prevalves. The tests indicated that the prevalves were relieving properly. In the one instance where a LOX pre valve failed to relieve, the problem was corrected by replacing the discrepant pre valve.

4. Fuel System. The fuel system functioned satisfactorily during the acceptance test firings.

A pretest objective of tanking fuel to a 2.0 percent ullage was not accomplished because of a malfunction of the primary fuel measuring device, fuel differential pressure transducer (measurement 2.11).

Post-test SA-20 inspection immediately following the firing revealed fuel leakage which was traced to a calibration valve. The gland nut, which retains the valve stem in the valve body, vibrated loose and fuel pressure forced the valve stem out of the valve body. All stage calibration valve gland nuts were safety wired prior to test SA-21.

5. LOX-SOX Disposal System. The LOX-SOX disposal system functioned properly during test SA-21 (the system was not activated during test SA-20).

6. Control Pressure System. The control pressure system functioned satisfactorily during tests SA-20 and SA-21.

ENGINE COMPARTMENT ENVIRONMENT. The boattail temperatures and turbine spinner surface temperatures were satisfactorily maintained by the boattail heating system during the standby period of each test.

There was no evidence of fire or hot gas leaks in the engine compartment during either test SA-20 or SA-21.

Engine curtain and aspirator cover damage was negligible. Post-test inspection following test SA-21 revealed moderate damage to the heat shield. All engine curtains, aspirator covers, and heat shield panels will be replaced prior to flight.

Damage to the S-1B stainless steel honeycomb heat shield panel (P/N 60C30555-1) at the conclusion of the long duration test firing consisted of one hairline crack in the insulation material, 15 inches long and parallel to the inboard bolt line. It is concluded that the adherence of the M-31 insulating material on this panel during the static tests was satisfactory.

VIBRATION AND SPECIAL INSTRUMENTATION. A detailed discussion of the vibration and acoustic measurement data for tests SA-20 and SA-21 is published in the Vibration and Acoustic Evaluation Report dated July 13, 1964. Also included in this report is a discussion of the rough combustion cutoff (RCC) systems.

The fire detection system functioned as required during tests SA-20 and SA-21, and no abnormal temperatures were detected.

Special radiation calorimeters were installed on the test tower to measure the radiant energy of the exhaust plume during tests SA-20 and SA-21. The results from these measurements for test SA-20 are presented in the PSTR for that test. No usable data were obtained from these measurements during test SA-21.

ELECTRICAL CONTROL SYSTEMS. Saturn stage S-1-8 underwent electrical system verification during prestatic testing and static firing while at Static Test. Electrical problems which occurred on stage S-1-8 were corrected prior to each test. No major problems were encountered during either firing.

TELEMETRY SYSTEMS. The telemeter systems operated satisfactorily during both tests with the exception of the discrepancies noted in the Preliminary Static Test Report, Tests SA-20 and SA-21. During both tests, satisfactory results were obtained on 97 percent of the telemetered measurements. No malfunction of any UMA rack power supply occurred during either test SA-20 or SA-21.

During test SA-21, power supply 9A4A1 malfunctioned at outboard engine cutoff plus 1.1 seconds following the test. An investigation of the component failed to reveal any discrepancy. This power supply will be replaced.

Power supply 12A38 malfunctioned during test SA-21. The power supply generated ripples in its output voltage. Vibrations which occurred during the firing are the apparent cause of the malfunction. An investigation of this power supply will be conducted at Michoud.

Because of RF interference, the two command destruct receivers (CDR 1 and CDR 2) did not indicate receipt of the destruct command signals which were broadcast at X+117 seconds. The source of the RF interference was located and the problem has been corrected.

SECTION 10
RECOMMENDATIONS

ENGINE SYSTEMS.

1. Engine Thrust. Thrust of each engine was within specification including that of engine S/N H-2032 which is scheduled to be installed on stage S-1-8 at the Chrysler Corporation Manufacturing Facility. No further reorificing is recommended.
2. Auxiliary LOX Dome Purge. It is recommended that the static test auxiliary LOX dome purge configuration be modified by plumbing a larger purge line directly into the LOX dome of each inboard engine. The modification would consist of replacing the one-half inch diameter LOX dome purge tubing with three-quarter inch diameter tubing connecting the purge manifold to the inboard engine LOX dome ports.
3. Turbopump No. 8 Bearing Outer Race Rotation. No corrective action is recommended.
4. Steps in the No. 1 Bearing Pressure (measurement 2.54). No corrective action is recommended.
5. LOX and Fuel Pump Inlet Pressure Transducers (measurement 52.06 and 52.7). The continued loss of these measurements indicates that a problem still exists and further investigation is recommended.
6. Hypergol Detect Switch Probe (P/N NA5-27189 T1). After manually operating the switch probe, satisfactory operation was obtained, and replacement is not advised.
7. Excessive Application of Molykote on Fuel Pump Inlet Inserts and Bolts (NAS 1006-11H). To prevent a recurrence of the problem of extricating the bolts, it is recommended that controlled amounts of Molykote be applied during manufacturing.
8. Leakage Observed at the LOX Dome Outer Bolt Circle on Engines 1 and 3. Since the leakage rate is slight, no corrective action is recommended.
9. Overstressed Autoigniters. It is recommended that the use of thread antiseize compound on the autoigniters be discontinued and that the torque applied to the autoigniters be reduced from 240 ± 24 in.-lbs to 200 in.-lbs with a suitable tolerance.
10. Thrust Chamber Tube Leaks. None of the leakage in evidence is sufficient to warrant corrective action.

11. Turbopump Torques. Since the initial high breakaway torques recorded on the turbopumps of engines 2, 7, and 8 following test SA-21 returned to normal after the shafts had been rotated, no corrective action is recommended.

12. Inboard Engine LOX Dome and Injector Contamination. No corrective action is recommended.

PROPELLANT AND PNEUMATIC SYSTEMS.

1. Problems Associated with the Small LOX Tank Ullage. It is recommended that the LOX tank vents be closed during the final stages of LOX toff and remain closed until the conclusion of the test firing. This will be further proved out during special tests scheduled to be performed on stage S-1-10.

2. LOX System Overpressurization. Because of the recurring problem of LOX tank overpressurization, UCR CSD-S-00091 was written which recommends that further studies be initiated to determine whether the LOX-to-heat-exchanger orifices are too large, whether the closed stop setting on the GFCV is improper, or whether LOX tank overpressurization is caused by a combination of these factors. If this study indicates that the LOX pressurization system performance is satisfactory, it is recommended that the LOX system pressure specification be changed to comply with system performance.

3. GOX Flow Control Valve. It is recommended that the GFCV on stage S-1-8 be inspected for thrust bearing damage during post-static checkout.

4. Fuel Leakage at Calibration Hand Valve (P/N 10414076). It is recommended that it become standard practice to safety wire all such hand valves prior to static tests in the future.

TELEMETRY SYSTEMS.

1. F1 Calibrate Command Signal. It is recommended that on stages S-1-8, S-1-10, and S-1B vehicles the F1 calibrate command signal be reassigned to one of the spare relay drivers, thereby eliminating use of the marginal "Relay 1" F1 calibrate command signal.

2. Malfunctioning Power Supply 12A38. It is recommended that a thorough investigation of the power supply be conducted at the Chrysler Corporation Manufacturing Facility.

APPENDIX A

SYSTEMS STATIC TEST PROCEDURES

The following is a list of the applicable systems static test procedures used by Chrysler Corporation personnel in static testing Saturn stage S-1-8:

Stage Handling and Facility System

| <u>Procedure No.</u> | <u>Title</u> |
|----------------------|--|
| 6-CHSI-100 | S-1 Stage Installation Procedure |
| 6-CHSI-101 | Crane-Proof Loading Procedure |
| 6-CHSI-102 | Transporter Operation |
| 6-CHSI-103 | Transporter Maintenance |
| 6-CHSI-104 | Barge Loading and Unloading - S-1 Stage |
| 6-CHSI-105 | Retainer Rod Adjustment Procedure |
| 6-CHSI-110 | Upper and Lower Horizontal Stabilizer Rod Adjustment Procedure |
| 6-CHSI-120 | Equalizing Dead Load on Vertical Load Cells Procedure |
| 6-CHSI-125 | S-1 Stage Alignment Procedure |
| 6-CHSI-130 | S-1 Stage Removal Procedure |
| 6-CHSI-140 | Deflector Checkout Procedure |
| 6-CHSI-145 | Firex System Priming Procedure |
| 6-CHSI-150 | Firex Panels Checkout Procedure |
| 6-CHSI-155 | Boattail Conditioner Operation Procedure |
| 6-CHSI-165 | Instrument Compartment Air Conditioning System Operating Procedure |

APPENDIX A (CONTINUED)

Pneumatic and Propellant Systems

| <u>Procedure No.</u> | <u>Title</u> |
|----------------------|--|
| 6-CHSI-200 | Tower to Stage Interconnect Procedure |
| 6-CHSI-205 | Control System Leak Check |
| 6-CHSI-210 | Pressure Switch Functional Checkout |
| 6-CHSI-220 | Components Test |
| 6-CHSI-225 | GOX Flow Control Valve Checkout |
| 6-CHSI-230 | Fuel Transfer |
| 6-CHSI-235 | LOX Transfer |
| 6-CHSI-240 | Pneumatic System Preparation for Static Firing |
| 6-CHSI-245 | Pneumatic Systems Verification of Cleanliness |
| 6-CHSI-250 | Pneumatic Systems Securing Procedure |
| 6-CHSI-260 | LOX & Fuel System Leak Check |
| 6-CHSI-265 | GOX System Leak Check |
| 6-CHSI-270 | High Pressure System Leak Check |

Propulsion System

| <u>Procedure No.</u> | <u>Title</u> |
|----------------------|---|
| 6-CHSI-301 | Engine Pressure Switch Functional Checks |
| 6-CHSI-304 | Gas Generator and Exhaust System Leak Check |
| 6-CHSI-305 | Thrust Chamber Leak Check |
| 6-CHSI-306 | Ground Hydraulic Service Unit Operating Procedure |
| 6-CHSI-307 | Engine Hydraulic System Preparation |
| 6-CHSI-308 | Hydraulic System Calibration and Checkout |

APPENDIX A (CONTINUED)

| <u>Procedure No.</u> | <u>Title</u> |
|----------------------|---|
| 6-CHSI-309 | Pretest Gimbal Control and Hydraulic Systems Functional Check |
| 6-CHSI-310 | LOX Pump Seal Cavity Contamination Check |
| 6-CHSI-311 | Fuel Lube Blowdown |
| 6-CHSI-312 | Main Fuel Valve and Ignition Monitor Valve Leakage and Functional Test |
| 6-CHSI-313 | Gas Generator Control Valve Functional Test |
| 6-CHSI-314 | Fuel Control System Leak Test |
| 6-CHSI-317 | Engine Shipping Equipment Removal and Static Test Equipment Installation |
| 6-CHSI-318 | Engine Static Test Equipment Removal and Shipping Equipment Installation |
| 6-CHSI-340 | Fuel Additive Blending Unit Filling Procedure |
| 6-CHSI-341 | Handling and Installation of Hypergolic Igniter |
| 6-CHSI-342 | Handling and Installation of Solid Propellant Gas Generators, Initiators and GG Igniters. |
| 6-CHSI-343 | Conax Valve Installation |
| 6-CHSI-344 | Procedure for Greasing Gimbal Bearings |
| 6-CHSI-345 | Thrust Chamber Filling Procedure |
| 6-CHSI-346 | Main Fuel Valve Leak Check |
| 6-CHSI-354 | Post Static Pyrotechnic Removal |
| 6-CHSI-355 | Turbopump Preservation |
| 6-CHSI-356 | Removal of Residual Fuel from the Stage |
| 6-CHSI-357 | Thrust Chamber Jacket Flushing |
| 6-CHSI-370 | LOX Dome Flush and Purge Procedure (Single Engine) |
| 6-CHSI-371 | H-1 Engine Change and Checkout |
| 6-CHSI-372 | H-1 Engine Removal and Installation Procedure |

APPENDIX A (CONTINUED)

Electrical Controls

| <u>Procedure No.</u> | <u>Title</u> |
|----------------------|--|
| 1-CHSI-407 | Vehicle Cable Connections |
| 1-CHSI-408 | Routine Removal of Power |
| 1-CHSI-409 | Routine Application of Power |
| 1-CHSI-410 | Initial Application of Power |
| 1-CHSI-411 | Power Transfer Test |
| 1-CHSI-412 | Observer Cutoff |
| 1-CHSI-413 | Voltage Failure Cutoff |
| 1-CHSI-414 | Premature Commit Cutoff |
| 1-CHSI-415 | Fire Detection Cutoff |
| 1-CHSI-416 | Rough Combustion Cutoff |
| 1-CHSI-417 | Sequence Test, Part I |
| 1-CHSI-418 | Sequence Test Part II |
| 1-CHSI-419 | Sequence Test, Cycle |
| 1-CHSI-420 | Sequence Test, Shutdown |
| 1-CHSI-421 | Sequence Failure Cutoff |
| 1-CHSI-422 | Thrust Failure Cutoff Test |
| 1-CHSI-423 | Propellant Level Cutoff |
| 1-CHSI-424 | LOX Depletion Cutoff |
| 1-CHSI-425 | Ordnance Checkout with Launch Failure Cutoff |
| 1-CHSI-426 | Conax Valves Pre-Installation Checkout |
| 1-CHSI-427 | Engine Component Heater Check |
| 1-CHSI-428 | Electrical Checkout of SPGG Initiators and Initiator Harnesses |

APPENDIX A (CONTINUED)

| <u>Procedure No.</u> | <u>Title</u> |
|----------------------|--|
| 1-CHSI-429 | Safety Wiring of Connectors |
| 1-CHSI-430 | TSPS Cutoff |
| 5-CHSI-451 | SITS Power Up |
| 5-CHSI-452 | Booster Hydraulic System Preparation |
| 5-CHSI-453 | Control System Calibration |
| 5-CHSI-454 | Control Accelerometer Checkout and Calibration |
| 5-CHSI-455 | Rate Gyro Checkout and Calibration |
| 5-CHSI-456 | Program Device Checkout |
| 5-CHSI-457 | Gimbal Programmer Calibration |
| 5-CHSI-458 | Gimbal System Dry Run and Functional Checkout |
| 5-CHSI-460 | Program Device Propellant Level Cutoff |
| 5-CHSI-461 | Engine Interference Check |
| 5-CHSI-462 | X-15 Countdown (Gimbal Supplement) |
| 5-CHSI-463 | X-15 Countdown (SITS Supplement) |
| 5-CHSI-464 | SITS Sequence Test |
| 5-CHSI-465 | SITS Cutoff Test |
| 5-CHSI-466 | Pre-Static Gimbal Test |

R.F. & Telemetry

| <u>Procedure No.</u> | <u>Title</u> |
|----------------------|---|
| 3-CHSI-506 | Manual Checkout of Temperature Measurements |
| 3-CHSI-510 | Manual Checkout of Pressure Measurements |
| 3-CHSI-515 | Manual Checkout of Strain Gage Measurements |

APPENDIX A (CONTINUED)

| <u>Procedure No.</u> | <u>Title</u> |
|----------------------|--|
| 3-CHSI-518 | Manual Checkout of Vibration Measurements |
| 3-CHSI-520 | Dial Code Operations |
| 3-CHSI-525 | Telemeter System Calibration |
| 3-CHSI-526 | Oscillator Calibration, Eleven Point |
| 3-CHSI-527 | Discriminator Calibration |
| 3-CHSI-528 | Tape Speed Compensation Adjustment and Recorder Set-Up |
| 3-CHSI-529 | T/M Receiver Adjustment |
| 3-CHSI-531 | CEC Recording Oscillograph Set-Up |
| 3-CHSI-532 | SS Band Ground Station Alignment |
| 3-CHSI-533 | PCM Ground Station Alignment |
| 3-CHSI-534 | Solid State Decommutator Checkout and Set-Up |
| 3-CHSI-540 | Telemetry Monitoring of Liquid Level Measuring System |
| 3-CHSI-550 | Test Cable Removal |

Instrumentation

| <u>Procedure No.</u> | <u>Title</u> |
|----------------------|--|
| 2-CHSI-551 | Pressure Transducer Calibration by Application of Pressure |
| 2-CHSI-552 | Pressure Transducer Calibration by Simulation |
| 2-CHSI-553 | Temperature Calibrations |
| 2-CHSI-554 | Strain Gage Calibration, One Active Arm |
| 2-CHSI-555 | Strain Gage Calibration, Four Active Arms |
| 2-CHSI-556 | Vibration Transducer Calibration |

APPENDIX A (CONTINUED)

| <u>Procedure No.</u> | <u>Title</u> |
|----------------------|--|
| 2-CHSI-557 | Rough Combustion Cutoff System Calibration |
| 2-CHSI-558 | Displacement Transducer Calibration |
| 2-CHSI-559 | Gearcase Vibration Test |
| 2-CHSI-560 | Acoustic Transducer Calibration |
| 2-CHSI-561 | Commutated Tension Rod Calibration |
| 2-CHSI-562 | Standardization of Wiancko Calibrator and Calibration Test Gages |

Integrated System Operations

| <u>Procedure No.</u> | <u>Title</u> |
|----------------------|--|
| 7-CHSI-601 | L-1 Day Countdown Checklist |
| 7-CHSI-602 | Firing Day Countdown |
| 7-CHSI-604 | Post-Firing Shut Down |
| 7-CHSI-609 | Propellant Loading Test |
| 7-CHSI-610 | Simulated Flight Test |
| 7-CHSI-611 | X-15 Minute Countdown (Short Duration) |
| 7-CHSI-612 | X-15 Minute Countdown (Long Duration) |

APPENDIX B

REFERENCES

1. Memo, R-P&VE-VF-234-63 "Static Test Measurements for S-1-9", December 13, 1963.
2. Memo, Chrysler ICC Memorandum T-367, "LOX Dome Purge Investigation", June 16, 1964.
3. PSTR, Test SA-19, "Preliminary Static Test Report", April 20, 1964.
4. PSTR, Test SA-20, "Preliminary Static Test Report", June 10, 1964.
5. PSTR, Test SA-21, "Preliminary Static Test Report", June 26, 1964.
6. Report, "Confidential Supplement, Stage S-1-8, Tests SA-20 and SA-21", June 17, 1964.
7. Report, "Propellant Loading and Subsystems Special Test Report", June 15, 1964.
8. Report, "Special LOX Loading Test Report", July 19, 1964.
9. Report, "Vibration and Acoustic Evaluation Report, Stage S-1-8", July 13, 1964.
10. Report, "Static Test Hardwire Measurement Locations for Saturn Stage S-1-8", July 6, 1964.
11. Engineering Order A-11140-1, "Component Part Failure Under Vehicle Static Test Condition (Diode)", April 24, 1964.

APPENDIX C

REDLINE VALUES FOR STAGE S-1-8

Values for parameters which will be monitored to assure vehicle safety are specified below. Pre-run checks are made to verify satisfactory engine compartment conditions prior to clearing the stand. Parameters monitored after start of the "automatic countdown" as well as mainstage redline are listed. If any redline value exceeds its tolerance, cutoff shall be initiated unless otherwise specified by special instruction. The person giving cutoff shall indicate over the operating headset channel the reason for cutoff. Blockhouse personnel are warned that the duration test will have the 6-second delayed cutoff and therefore, monitors of the inboard engines should be alerted to expect their parameters to decay prior to cutoff.

PRE-RUN VERIFICATIONS

MAXIMUM

MINIMUM

After LOX tanking has begun, the following parameters will be monitored to assure that the values are not exceeded:

- | | | |
|--|--------|--------|
| 1. Turbopump Bearing No. 1 Temperature | | 0° F |
| 2. Oronite Temperature | 145° F | 105° F |
| 3. Turbine Spinner Surface Temperature | 75° F | 40° F |

PRE-IGNITION

- | | | |
|---|----------|-------------------|
| 1. GG LOX Injector Manifold Pressure (Monitor until X-20 minutes) | 185 psig | 165 psig |
| 2. Turbine Spinner Surface Temperature (Monitor until start of automatic sequencer) | 75° F | 40° F |
| *3. Hydraulic Oil Temperature | 210° F | 40° F |
| *4. Hydraulic Reservoir Piston Position | | 18% (360 ohms) |
| *5. Gearcase Pressure | 7 psig | 2 psig |

* Blueline only

APPENDIX C (CONTINUED)

| | <u>MAXIMUM</u> | <u>MINIMUM</u> |
|---|----------------|----------------|
| *6. Turbopump Bearing No. 1 Temperature | | 0° F |
| 7. LOX Pump Inlet Temperature (Immediately prior to ignition) | -275° F | -300° F |
| 8. LOX Pump Inlet Pressure | | 60 psig |
| 9. LOX Tank Ullage Pressure | 60 psig | |
| 10. Fuel Pump Inlet Temperature | | 0° F |
| 11. Fuel Pump Inlet Pressure | | 25 psig |
| 12. Fuel Tank Ullage Pressure | 25 psig | |
| *13. High Pressure Spheres Pressure | 3200 psig | 2700 psig |
| *14. Control Spheres Pressure | 3200 psig | 2700 psig |

MAINSTAGE

- | | |
|--------------------------------|----------|
| 1. Combustion Chamber Pressure | 678 psig |
|--------------------------------|----------|

NOTE: After mainstage equilibrium has been established, any change in either P_C or GG Temperature must be accompanied by a similar change in the other parameter before cutoff is to be given.

- | | |
|------------------------------|----------------------|
| 2. GG Conisphere Temperature | 1400° F Steady State |
|------------------------------|----------------------|

NOTE: After mainstage equilibrium has been established, any change in either P_C or GG Temperature must be accompanied by a similar change in the other parameter before cutoff is to be given.

- | | |
|-------------------------------|--------|
| *3. Hydraulic Oil Temperature | 275° F |
|-------------------------------|--------|

* Blueline only

APPENDIX C (CONTINUED)

| | <u>MAXIMUM</u> | <u>MINIMUM</u> |
|--|----------------|-------------------|
| *4. Hydraulic Reservoir Piston Position | | 10% (200 ohms) |
| 5. Gearcase Pressure | 10 psig | |
| <p><u>NOTE:</u> Cutoff to be initiated only if the corresponding pressure switch pick up indication is obtained.</p> | | |
| 6. LOX Tank Ullage Pressure | 60 psig | |
| 7. Fuel Tank Ullage Pressure | 25 psig | 2 psig |
| 8. Turbopump Bearing No. 1 Lube Jet Pressure (Within 10 seconds after ignition) | | 75 psig |
| 9. Turbopump Bearing No. 1 Temperature | | 0° F |
| 10. Turbopump Bearing No. 8 Temperature | 600° F | |
| 11. LOX Pump Inlet Pressure | | 25 psig |

NOTE: If the recorder pegs down-scale at maximum rate, cutoff shall not be initiated unless the corresponding prevalve closed indication is obtained. For a gradual decrease in pressure below the redline value, cutoff shall be initiated without regard to the prevalve position indicator.

| | | |
|--|--|--------|
| **12. Fuel Pump Inlet Pressure (Facility Fuel Tank Pressurization switch to "ON" at 10 psig) | | 5 psig |
|--|--|--------|

NOTE: If the recorder pegs down-scale at maximum rate, cutoff shall not be initiated

* Blueline only

** Facility fuel tank pressurizing ON at 10 psig, redline cutoff at 5 psig instead of 10 psig.

APPENDIX C (CONTINUED)

MAXIMUM

MINIMUM

unless the corresponding prevalve closed indication is obtained. For a gradual decrease in pressure below the redline value, cutoff shall be initiated without regard to the prevalve position indicator.

13. Deflector Water Pressure WP-3 & 4

65 psig

(Cutoff to be initiated only if corresponding pressure switch indication is obtained)

14. Rough Combustion Cutoff Device

The RCC device shall initiate cutoff after accumulation of 100 msec. equal to or greater than 100 g rms in the frequency range of 960 to 6000 cps.

15. Fire Detection System

The automatic rise rate cutoff device will be set to initiate cutoff if the temperature rise rate is 2.5 MV/sec or greater for a duration of 0.5 second for the flight harness, and 1.0 second for the static test harness.

For observer monitoring, the redline is an increase of five major chart divisions (2.5 MV) in one second.

General instructions for fire detection chart watchers are as follows:

1. If any one fire detection harness pegs upscale - no action.
2. If two or more fire detection harnesses peg upscale - initiate cutoff.
3. If static test LOX or flight harness pegs downscale - no action.
4. If static test fuel harness pegs downscale - initiate cutoff if recorder does not return within five seconds.

APPENDIX D

STAGE AND GROUND SUPPORT
TEST DATA SHEET
STAGE S-1-8

1. TEST NUMBER..... SA-20
2. TIME AND DATE.....16:42:23.38 CST (Commit)... May 26, 1964
3. DURATION (referenced from ignition command signal to inboard engine cutoff signal)..... 48.94 Seconds

4. ENGINE NUMBERS:

| | | | |
|--------------------------|--------------------------|--------------------------|--------------------------|
| Position No. 1 H-5019 | Position No. 2 H-5020 | Position No. 3 H-5021 | Position No. 4 H-5022 |
| Position No. 5 H-2016 | Position No. 6 H-2017 | Position No. 7 H-2018 | Position No. 8 H-2029 |

5. TEST OBJECTIVES:

- a. Verification of airborne/ground control systems compatibility.
- b. Determine propellant tank draining rates.
- c. Check performance of gimbal control system.
- d. Verify reliability and performance of telemetry equipment.
- e. Verification of engine performance.
- f. Verify the facility LOX liquid level measuring equipment capability for loading to a 2.3 percent ullage.

6. TEST CONDITIONS:

- a. Cutoff initiated by firing panel operator.
- b. Center LOX tank orifice diameter - 20.0 inches.
- c. Engines to be gimballed as outlined in the gimbal program (see TABLE 3-1, GIMBAL PROGRAM, TEST SA-20).
- d. LOX to be loaded to a 2.3 percent ullage.
- e. Fuel to be loaded to a 2.0 percent ullage.
- f. The 650 psig auxiliary LOX dome purge is to be actuated at cutoff.

7. STAGE PRESSURE SWITCHES AND RELIEF VALVE SETTINGS:

- a. LOX Tank Pressure Switch..... *60.0±1.5 psia
- b. LOX Tank Relief Valve No. 1 and
Emergency Vent Switch..... *67.5±1.5 psia
- c. Fuel Tank Pressure Switch..... *17.0±0.6 psig

* Tolerances revised from Saturn S-1 Static Test Plan, S-1-8 to operational range.

APPENDIX D (CONTINUED)

| | | |
|---|-------------------------------------|------|
| d. Fuel Tank Pressurizing Spheres Switch..... | <u>2835±100</u> | psig |
| e. Control Spheres Switch..... | <u>2835±100</u> | psig |
| f. Engine Control Pressure OK Switch..... | <u>625±25</u> | psig |
| g. Thrust OK Pressure Switch..... | <u>*810±12</u> | psia |
| h. LOX Relief Valves No. 1 & 2 (Relief Setting)..... | <u>*60±⁵₀</u> | psig |
| i. Fuel Vent Valves No. 1 & 2 (Relief Setting)..... | <u>19.0±0.5</u> | psig |
| j. Fuel Tank Safety Valve (Relief Setting)... | <u>23.0±0.5</u> | psig |
| k. Stage Helium..... | <u>2835±100</u> | psig |

8. GROUND SUPPORT PRESSURE SWITCHES:

| | | |
|---|----------------|------|
| a. Fuel Bubbling (GN ₂)..... | <u>110±15</u> | psig |
| b. LOX Bubbling (Helium)..... | <u>315±15</u> | psig |
| c. LOX Dome Purge..... | <u>195±15</u> | psig |
| d. GG LOX Injector Purge..... | <u>270±15</u> | psig |
| e. Fuel Injector Purge..... | <u>375±15</u> | psig |
| f. Turbine Spinner (Facility Safety Switch).. | <u>40±10</u> | psig |
| g. Gearcase..... | <u>12</u> | psig |
| h. Facility Helium..... | <u>3000±50</u> | psig |
| i. Facility GN ₂ | <u>3000±50</u> | psig |

9. TANKAGE AND PURGE ORIFICES:

| | | |
|---|---------------|---------|
| a. Ground LOX Pressurizing (Helium).....(1) | <u>0.149</u> | in. dia |
| b. LOX Tank Facility Pressurizing (GN ₂).....(2) | <u>0.386</u> | in. dia |
| c. Fuel Tank Pressurizing (GN ₂).....(3) | <u>0.2374</u> | in. dia |
| d. Fuel Tank Auxiliary Pressurizing (GN ₂)..... | <u>None</u> | in. dia |
| e. Fuel Sphere Supply.....(1) | <u>0.200</u> | in. dia |
| f. Control Spheres Supply.....(1) | <u>0.063</u> | in. dia |
| g. Fuel Bubbling.....(8) | <u>0.018</u> | in. dia |
| h. LOX Bubbling.....(8) | <u>0.102</u> | in. dia |
| i. Fuel Jacket Fill Line.....(1) | <u>0.189</u> | in. dia |
| j. Ground LOX Bypass Orifice.....(1) | <u>0.310</u> | in. dia |
| k. 105-Inch LOX Tank Sump.....(1) | <u>20.0</u> | in. dia |

10. REGULATOR PRESSURES:

| | | |
|--|------------|------|
| a. LOX Dome Purge..... | <u>250</u> | psig |
| b. GG LOX Purge..... | <u>300</u> | psig |
| c. Fuel Injector Purge..... | <u>490</u> | psig |
| d. LOX Bubbling..... | <u>392</u> | psig |
| e. Fuel Bubbling..... | <u>140</u> | psig |
| f. LOX Dome Purge Bypass..... | <u>250</u> | psig |
| g. Auxiliary Inboard LOX Dome Purge..... | <u>650</u> | psig |

* Tolerances revised from Saturn S-1 Static Test Plan, S-1-8 to operational range.

APPENDIX D (CONTINUED)

TEST SA-20

11. ENGINE DATA:

| ENGINE POSITION | ENGINE NUMBER | ENGINE ORIFICES (INCHES DIAMETER) | | | | | | | | ENGINE ACCUMULATED TIME* (seconds) |
|-----------------|---------------|-----------------------------------|---------|-----------------|-------------|-------------|----------|-----------|-------------|------------------------------------|
| | | GG LOX | GG FUEL | TURBINE SPINNER | MLV CONTROL | MFV CONTROL | MAIN LOX | MAIN FUEL | LOX TO H.E. | |
| 1 | H-5019 | 0.320 | 0.610 | 0.870 | 0.116 | 0.073 | None | 2.798 | 0.102 (3) | 298.3 |
| 2 | H-5020 | 0.312 | 0.593 | 0.870 | 0.116 | 0.073 | None | 2.801 | 0.102 (3) | 296.8 |
| 3 | H-5021 | 0.315 | 0.593 | 0.870 | 0.116 | 0.073 | None | 2.616 | 0.102 (3) | 296.3 |
| 4 | H-5022 | 0.326 | 0.600 | 0.870 | 0.116 | 0.073 | None | 2.815 | 0.102 (3) | 297.2 |
| 5 | H-2016 | 0.321 | 0.597 | 0.870 | 0.116 | 0.073 | None | 2.684 | 0.102 (3) | 337.3 |
| 6 | H-2017 | 0.308 | 0.568 | 0.870 | 0.116 | 0.073 | None | 2.733 | 0.102 (3) | 379.1 |
| 7 | H-2018 | 0.319 | 0.611 | 0.870 | 0.116 | 0.073 | None | 2.804 | 0.102 (3) | 502.2 |
| 8 | H-2029 | 0.321 | 0.600 | 0.870 | 0.116 | 0.073 | None | 2.750 | 0.102 (3) | 341.9 |

* Time through test SA-20, measured from Pc reaches 90% until Pc decays to 90%.

APPENDIX D (CONTINUED)

STAGE AND GROUND SUPPORT
TEST DATA SHEET
STAGE S-1-8

1. TEST NUMBER..... SA-21
2. TIME AND DATE.....16:39:55.418 CST (Commit). June 11, 1964
3. DURATION (referenced from ignition command signal to inboard engine cutoff signal)..... 139.92 Seconds

4. ENGINE NUMBERS:

| | | | |
|--------------------------|--------------------------|--------------------------|--------------------------|
| Position No. 1 H-5019 | Position No. 2 H-5020 | Position No. 3 H-5021 | Position No. 4 H-5022 |
| Position No. 5 H-2016 | Position No. 6 H-2017 | Position No. 7 H-2018 | Position No. 8 H-2029 |

5. TEST OBJECTIVES:

- a. Verification of airborne/ground control systems compatibility.
- b. Determine propellant tank draining rates and thermal LOX draining characteristics.
- c. Check performance of gimbal control system.
- d. Verify reliability and performance of telemetry equipment.
- e. Verification of engine performance.

6. TEST CONDITIONS:

- a. Cutoff will be initiated by LOX low level sensor, which is set for 27.63 inches above the theoretical tank bottom.
- b. The fuel low level sensor is set at 32.43 inches above the theoretical tank bottom.
- c. Center LOX tank orifice diameter - 20.0 inches.
- d. Engines to be gimballed as outlined in the gimbal program (see TABLE 3-2, GIMBAL PROGRAM, TEST SA-21).
- e. LOX to be loaded to 602.2 inches, 61,600 gallons, fuel to be loaded to 614.1 inches, 40,750 gallons (see TABLE 4-1, PROPELLANT LOADING AND PRESSURIZATION DATA).
- f. The 650 psig auxiliary LOX dome purge is to be activated at inboard engine cutoff.

7. STAGE PRESSURE SWITCHES AND RELIEF VALVE SETTINGS:

- a. LOX Tank Pressure Switch..... *59.5±.5 psia
- b. LOX Tank Relief Valve No. 1 and
Emergency Vent Switch..... *68.0±.5 psia

* Tolerances revised from Saturn S-1 Static Test Plan, S-1-8 to operational range.

APPENDIX D (CONTINUED)

| | | |
|---|--------------------------------------|------|
| c. Fuel Tank Pressure Switch..... | <u>*17.0±0.6</u> | psig |
| d. Fuel Tank Pressurizing Spheres Switch..... | <u>2835±100</u> | psig |
| e. Control Spheres Switch..... | <u>2835±100</u> | psig |
| f. Engine Control Pressure OK Switch..... | <u>625±25</u> | psig |
| g. Thrust OK Pressure Switch..... | <u>*810±12</u> | psia |
| h. LOX Relief Valves No. 1 & 2 (Relief Setting)..... | <u>*60⁺⁵₋₀</u> | psig |
| i. Fuel Vent Valves No. 1 & 2 (Relief Setting)..... | <u>19.0±0.5</u> | psig |
| j. Fuel Tank Safety Valve (Relief Setting)..... | <u>23.0±0.5</u> | psig |
| k. Stage Helium..... | <u>2835±100</u> | psig |

8. GROUND SUPPORT PRESSURE SWITCHES:

| | | |
|---|------------------------------------|------|
| a. Fuel Bubbling (GN ₂)..... | <u>110±15</u> | psig |
| b. LOX Bubbling (Helium)..... | <u>315±15</u> | psig |
| c. LOX Dome Purge..... | <u>195±15</u> | psig |
| d. GG LOX Injector Purge..... | <u>270±15</u> | psig |
| e. Fuel Injector Purge..... | <u>375±15</u> | psig |
| **f. Emergency Fuel Pressurizing..... | <u>5⁺³₋₀</u> | psig |
| g. Turbine Spinner (Facility Safety Switch).... | <u>40±10</u> | psig |
| h. Gearcase..... | <u>12</u> | psig |
| i. Facility Helium..... | <u>3000±50</u> | psig |
| j. Facility GN ₂ | <u>3000±50</u> | psig |

9. TANKAGE AND PURGE ORIFICES:

| | | |
|---|---------------|---------|
| a. Ground LOX Pressurizing (Helium).....(1) | <u>0.149</u> | in. dia |
| b. LOX Tank Facility Pressurizing (GN ₂).....(2) | <u>0.386</u> | in. dia |
| c. Fuel Tank Pressurizing (GN ₂).....(3) | <u>0.2374</u> | in. dia |
| d. Fuel Tank Auxiliary Pressurizing (GN ₂)..... | <u>None</u> | in. dia |
| e. Fuel Sphere Supply.....(1) | <u>0.200</u> | in. dia |
| f. Control Spheres Supply.....(1) | <u>0.063</u> | in. dia |
| g. Fuel Bubbling.....(8) | <u>0.018</u> | in. dia |
| h. LOX Bubbling.....(8) | <u>0.102</u> | in. dia |
| i. Fuel Jacket Fill Line.....(1) | <u>0.189</u> | in. dia |
| j. Ground LOX Bypass Orifice.....(1) | <u>0.310</u> | in. dia |
| k. 105-Inch LOX Tank Sump.....(1) | <u>20.0</u> | in. dia |

10. REGULATOR PRESSURES:

| | | |
|--|------------|------|
| a. LOX Dome Purge..... | <u>250</u> | psig |
| b. GG LOX Purge..... | <u>300</u> | psig |
| c. Fuel Injector Purge..... | <u>490</u> | psig |
| d. LOX Bubbling..... | <u>392</u> | psig |
| e. Fuel Bubbling..... | <u>140</u> | psig |
| f. LOX Dome Purge Bypass..... | <u>250</u> | psig |
| g. Auxiliary Inboard LOX Dome Purge..... | <u>650</u> | psig |

* Tolerances revised from Saturn S-1 Static Test Plan, S-1-8 to operational range.

** New System

APPENDIX D (CONTINUED)

11. ENGINE DATA:

TEST SA-21

| ENGINE POSITION | ENGINE NUMBER | ENGINE ORIFICES (INCHES DIAMETER) | | | | | | | LOX TO H.E. | ENGINE ACCUMULATED TIME* (seconds) |
|-----------------|---------------|-----------------------------------|---------|-----------------|-------------|-------------|----------|-----------|-------------|------------------------------------|
| | | GG LOX | GG FUEL | TURBINE SPINNER | MLV CONTROL | MFV CONTROL | MAIN LOX | MAIN FUEL | | |
| 1 | H-5019 | 0.320 | 0.610 | 0.870 | 0.116 | 0.073 | None | 2.798 | 0.102 (3) | 442.8 |
| 2 | H-5020 | 0.307 | 0.593 | 0.870 | 0.116 | 0.073 | None | 2.801 | 0.102 (3) | 441.4 |
| 3 | H-5021 | 0.311 | 0.593 | 0.870 | 0.116 | 0.073 | None | 2.616 | 0.102 (3) | 440.6 |
| 4 | H-5022 | 0.316 | 0.600 | 0.870 | 0.116 | 0.073 | None | 2.815 | 0.102 (3) | 441.5 |
| 5 | H-2016 | 0.321 | 0.597 | 0.870 | 0.116 | 0.073 | None | 2.684 | 0.102 (3) | 476.3 |
| 6 | H-2017 | 0.300 | 0.568 | 0.870 | 0.116 | 0.073 | None | 2.733 | 0.102 (3) | 518.0 |
| 7 | H-2018 | 0.311 | 0.611 | 0.870 | 0.116 | 0.073 | None | 2.804 | 0.102 (3) | 641.3 |
| 8 | H-2029 | 0.316 | 0.600 | 0.870 | 0.116 | 0.073 | None | 2.750 | 0.102 (3) | 479.8 |

* Time through test SA-21, measured from Pc reaches 90% until Pc decays to 90%.

APPENDIX E

METEOROLOGICAL DATA
 TEST SA-21
 JUNE 11, 1964

| LOCATION | BLOCKHOUSE | | | TOP STATIC TEST TOWER | |
|-------------|---------------|---------------------------|----------------------------|-----------------------|-------------------------|
| TIME OF DAY | TEMP. (°F) | BAROM. PRESS. (In. Hg) | REL. HUMIDITY (percent) | WIND VEL. (mph) | WIND DIR. (degrees)* |
| 10:00 a.m. | 92 | 29.069 | 61 | 0.5 | 295 |
| 10:30 a.m. | 94 | 29.069 | 56 | 5 | 265 |
| 11:00 a.m. | 95 | 29.069 | 49 | 0.5 | 280 |
| 11:30 a.m. | 96 | 29.068 | 49 | 2 | 240 |
| 12:00 m. | 96.5 | 29.067 | 49 | 3 | 280 |
| 12:30 p.m. | 97 | 29.066 | 47 | 7 | 275 |
| 1:00 p.m. | 97 | 29.065 | 44 | 1 | 255 |
| 1:30 p.m. | 98 | 29.064 | 41 | 4 | 295 |
| 2:00 p.m. | 98.5 | 29.063 | 41 | 2.5 | 235 |
| 2:30 p.m. | 98.5 | 29.062 | 42 | 5.5 | 285 |
| 3:00 p.m. | 98 | 29.062 | 48 | 5 | 285 |
| 3:30 p.m. | 94 | 29.063 | 68 | 9 | 280 |
| 4:00 p.m. | 90 | 29.063 | 78 | 10 | 310 |
| 4:30 p.m. | 87 | 29.063 | 82 | 11 | 320 |
| 5:00 p.m. | 85 | 29.063 | 86 | 6 | 350 |

* Wind direction is given in degrees starting north going clockwise.

APPENDIX F

CRITICAL COMPONENTS TIME/CYCLE HISTORY
OF STAGE S-1-8 WHILE AT STATIC TEST

| <u>ITEM</u> | <u>SERIAL NUMBER</u> | <u>TIME OR CYCLES</u> |
|---|----------------------|-----------------------|
| Engine 1 | H-5019 | 192.364 Seconds |
| Engine 2 | H-5020 | 192.578 Seconds |
| Engine 3 | H-5021 | 192.097 Seconds |
| Engine 4 | H-5022 | 192.339 Seconds |
| Engine 5 | H-2016 | 187.149 Seconds |
| Engine 6 | H-2017 | 186.923 Seconds |
| Engine 7 | H-2018 | 187.057 Seconds |
| Engine 8 | H-2029 | 185.935 Seconds |
| Auxiliary Hydraulic Pump Engine 1 | MX 80883 | 72.6 Minutes |
| Auxiliary Hydraulic Pump Engine 2 | MX 74058 | 75.1 Minutes |
| Auxiliary Hydraulic Pump Engine 3 | MX 80884 | 73.0 Minutes |
| Auxiliary Hydraulic Pump Engine 4 | MX 74062 | 61.8 Minutes |
| Auxiliary Hydraulic Pump Motor Engine 1 | 1297655 | 72.6 Minutes |
| Auxiliary Hydraulic Pump Motor Engine 2 | 1297576 | 75.1 Minutes |
| Auxiliary Hydraulic Pump Motor Engine 3 | 1297659 | 73.0 Minutes |
| Auxiliary Hydraulic Pump Motor Engine 4 | 1297573 | 61.8 Minutes |
| Accumulator Reservoir Engine 1 | 104 | 72.6 Minutes |
| Accumulator Reservoir Engine 2 | 105 | 75.1 Minutes |
| Accumulator Reservoir Engine 3 | 107 | 73.0 Minutes |
| Accumulator Reservoir Engine 4 | 107 | 61.8 Minutes |
| Turbine Exhaust Duct Engine 1 | 8255447 | 192.364 Seconds |

APPENDIX F (CONTINUED)

| <u>ITEM</u> | <u>SERIAL NUMBER</u> | <u>TIME OR CYCLES</u> |
|-------------------------------|----------------------|-----------------------|
| Turbine Exhaust Duct Engine 2 | 8255448 | 192.578 Seconds |
| Turbine Exhaust Duct Engine 3 | 8255450 | 192.097 Seconds |
| Turbine Exhaust Duct Engine 4 | 8255451 | 192.339 Seconds |
| Turbine Exhaust Duct Engine 5 | 43B5666 | 187.149 Seconds |
| Turbine Exhaust Duct Engine 6 | 43B5668 | 186.923 Seconds |
| Turbine Exhaust Duct Engine 7 | 43B5672 | 187.057 Seconds |
| Turbine Exhaust Duct Engine 8 | 43B5507 | 185.935 Seconds |
| Turbine Assembly Engine 1 | RN0228 | 192.364 Seconds |
| Turbine Assembly Engine 2 | RN024R | 192.578 Seconds |
| Turbine Assembly Engine 3 | RN026R | 192.097 Seconds |
| Turbine Assembly Engine 4 | RN027R | 192.339 Seconds |
| Turbine Assembly Engine 5 | RN019R | 187.149 Seconds |
| Turbine Assembly Engine 6 | RN020R | 186.923 Seconds |
| Turbine Assembly Engine 7 | RN023R | 187.057 Seconds |
| Turbine Assembly Engine 8 | 6313106 | 185.935 Seconds |
| Turbopump Engine 1 | RN022R | 192.364 Seconds |
| Turbopump Engine 2 | RN024R | 192.578 Seconds |
| Turbopump Engine 3 | RN026R | 192.097 Seconds |
| Turbopump Engine 4 | RN027R | 192.339 Seconds |
| Turbopump Engine 5 | RN018R | 187.149 Seconds |
| Turbopump Engine 6 | RN020R | 187.923 Seconds |
| Turbopump Engine 7 | RN023R | 187.057 Seconds |
| Turbopump Engine 8 | RN045R | 185.935 Seconds |

APPENDIX F (CONTINUED)

| <u>ITEM</u> | <u>SERIAL NUMBER</u> | <u>TIME OR CYCLES</u> |
|------------------------------------|----------------------|-----------------------|
| Ignition Monitor Valve Engine 1 | RN017R | 6 Cycles |
| Ignition Monitor Valve Engine 2 | RN012T | 6 Cycles |
| Ignition Monitor Valve Engine 3 | RN013T | 6 Cycles |
| Ignition Monitor Valve Engine 4 | RN010T | 6 Cycles |
| Ignition Monitor Valve Engine 5 | RN008T | 6 Cycles |
| Ignition Monitor Valve Engine 6 | RN009T | 6 Cycles |
| Ignition Monitor Valve Engine 7 | RN015T | 6 Cycles |
| Ignition Monitor Valve Engine 8 | 6302753 | 6 Cycles |
| Igniter Fuel Valve Engine 1 | RN010V | 6 Cycles |
| Igniter Fuel Valve Engine 2 | RN038V | 6 Cycles |
| Igniter Fuel Valve Engine 3 | RN027V | 6 Cycles |
| Igniter Fuel Valve Engine 4 | RN015V | 6 Cycles |
| Igniter Fuel Valve Engine 5 | RN021V | 6 Cycles |
| Igniter Fuel Valve Engine 6 | RN022V | 6 Cycles |
| Igniter Fuel Valve Engine 7 | RN026V | 6 Cycles |
| Igniter Fuel Valve Engine 8 | RN018V | 6 Cycles |
| Thrust OK Pressure Switch Engine 1 | 174 | 25 Cycles |
| Thrust OK Pressure Switch Engine 2 | 167 | 25 Cycles |
| Thrust OK Pressure Switch Engine 3 | 171 | 24 Cycles |
| Thrust OK Pressure Switch Engine 4 | 163 | 24 Cycles |
| Thrust OK Pressure Switch Engine 5 | 179 | 26 Cycles |
| Thrust OK Pressure Switch Engine 6 | 181 | 26 Cycles |
| Thrust OK Pressure Switch Engine 7 | 177 | 26 Cycles |

APPENDIX F (CONTINUED)

| <u>ITEM</u> | <u>SERIAL NUMBER</u> | <u>TIME OR CYCLES</u> |
|------------------------------------|----------------------|-----------------------|
| Thrust OK Pressure Switch Engine 8 | 173 | 23 Cycles |
| Calorimeter Purge Control Valve | 422 | 38 Cycles |
| LOX Fill and Drain Valve Tank 0-3 | 201 | 74 Cycles |
| Fuel Fill and Drain Valve Tank F-1 | 267 | 164 Cycles |
| Prevalve Control Valve Engine 1 | 695 | 127 Cycles |
| Prevalve Control Valve Engine 2 | 677 | 130 Cycles |
| Prevalve Control Valve Engine 3 | 676 | 122 Cycles |
| Prevalve Control Valve Engine 4 | 673 | 128 Cycles |
| Prevalve Control Valve Engine 5 | 694 | 131 Cycles |
| Prevalve Control Valve Engine 6 | 674 | 128 Cycles |
| Prevalve Control Valve Engine 7 | 679 | 124 Cycles |
| Prevalve Control Valve Engine 8 | 703 | 125 Cycles |
| Fuel Prevalve Engine 1 | 269 | 126 Cycles |
| Fuel Prevalve Engine 2 | 262 | 130 Cycles |
| Fuel Prevalve Engine 3 | 268 | 122 Cycles |
| Fuel Prevalve Engine 4 | 270 | 128 Cycles |
| Fuel Prevalve Engine 5 | 263 | 123 Cycles |
| Fuel Prevalve Engine 6 | 264 | 128 Cycles |
| Fuel Prevalve Engine 7 | 265 | 124 Cycles |
| Fuel Prevalve Engine 8 | 260 | 124 Cycles |
| LOX Prevalve Engine 1 | 212 | 127 Cycles |
| LOX Prevalve Engine 2 | 262 | 128 Cycles |
| LOX Prevalve Engine 3 | 207 | 122 Cycles |

APPENDIX F (CONTINUED)

| <u>ITEM</u> | <u>SERIAL NUMBER</u> | <u>TIME OR CYCLES</u> |
|---|----------------------|-----------------------|
| LOX Prevalve Engine 4 | 163 | 128 Cycles |
| LOX Prevalve Engine 5 | 162 | 121 Cycles |
| LOX Prevalve Engine 6 | 164 | 126 Cycles |
| LOX Prevalve Engine 7 | 203 | 123 Cycles |
| LOX Prevalve Engine 8 | 213 | 125 Cycles |
| Control Sphere Fill and Vent Valve | 148 | 26 Cycles |
| Control Sphere High Pressure Oil Pressure Switch | 25437 | 32 Cycles |
| Fuel Vent Valve 1 | CM205 | 266 Cycles |
| Fuel Vent Valve 2 | CM207 | 246 Cycles |
| Fuel Pressurizing Valve 1 | 218 | 85 Cycles |
| Fuel Pressurizing Valve 2 | 208 | 83 Cycles |
| Fuel Pressurizing Valve 3 | 209 | 82 Cycles |
| Fuel Tank Pressurized Pressure Switch | 25252 | 47 Cycles |
| Fuel Spheres Pressure OK Pressure Switch | 25437 | 31 Cycles |
| LOX Tank Relief Valve 1 | C0001 | 58 Cycles |
| LOX Tank Relief Valve 2 | C0002 | 261 Cycles |
| LOX Tank 7 Inch Vent Valve | R142V | 58 Cycles |
| Control Valve LOX Vent 1 and 7 Inch Vent | 670 | 58 Cycles |
| Control Valve LOX Vent 2 | 671 | 261 Cycles |
| LOX Emergency Vent Pressure Switch | 107 | 10 Cycles |
| LOX Tank Pressurized Pressure Switch | 138 | 51 Cycles |

APPENDIX F (CONTINUED)

| <u>ITEM</u> | <u>SERIAL NUMBER</u> | <u>TIME OR CYCLES</u> |
|-------------------------------|----------------------|-----------------------|
| LOX/SOX High Pressure Valve 1 | 234 | 57 Cycles |
| LOX/SOX High Pressure Valve 2 | 236 | 46 Cycles |
| LOX/SOX Purge Valve 1 | 230 | 15 Cycles |
| LOX/SOX Purge Valve 2 | 231 | 15 Cycles |
| LOX/SOX Purge Valve 3 | 232 | 15 Cycles |
| LOX/SOX Purge Valve 4 | 233 | 15 Cycles |
| LOX/SOX Purge Valve 5 | 235 | 15 Cycles |
| LOX/SOX Purge Valve 6 | 237 | 15 Cycles |
| LOX/SOX Purge Valve 7 | 238 | 15 Cycles |
| Inverter, 450 Volt | SAM010 | 15679.2 Minutes |
| Measuring Voltage Supply | SA113 | 16570.1 Minutes |
| Telemeter F-1 | 108 | 3010.0 Minutes |
| Telemeter F-2 | 106 | 2496.6 Minutes |
| Telemeter F-3 | 105 | 2315.4 Minutes |
| Telemeter S-1 | 127 | 1931.3 Minutes |
| Telemeter S-2 | 119 | 1842.4 Minutes |
| D.D.A.S. Assembly P-2 | 3 | 1922.8 Minutes |

APPENDIX G
UNSATISFACTORY CONDITION REPORT

| UCR NUMBER | PART NAME AND NUMBER | SERIAL NUMBER | DISCREPANCY | ACTION |
|-------------|---|---------------|---|--|
| CSD-S-00001 | Electrical Cable 40C30387 | 1W7/P2 | The control computer output meter, yaw position No. 1, did not deflect in the minus direction due to a broken wire going to pin B on the plug connector of cable 1W7/P2. | The cable was repaired by replacing the plug. |
| CSD-S-00002 | Thermocouple Probe C59-3 50M10322 | 0012 | The circuit of thermocouple probe C59-3 was discovered open during continuity check. | Replaced with same type thermocouple S/N 196.4. |
| CSD-S-00003 | Pressure Transducer 50M10305 | 3-8383 | An error of +7.6% was discovered in the output of pressure measurement D117-10, differential pressure between tanks 0C and 03. Maximum acceptable tolerance is $\pm 1.0\%$. | The defective transducer was replaced with one of a similar type S/N 3-9354. |
| CSD-S-00004 | Pressure Transducer 50M10306 | 3-8374 | An error of -4.2% was discovered in the output of pressure measurement D124-10, differential pressure, 60 degree tank fairing. Maximum acceptable tolerance is $\pm 1.0\%$. | The defective transducer was replaced with one of a similar type S/N 3-9350. |
| CSD-S-00005 | Fitting, Captive Firing 30M02329 | N/A | The facility holddown arms would not fit into the stage captive firing fitting, P/N 30M02329, at Fins I, III, and IV. | The installation of the adjustment blocks in the captive firing fittings at Fins 1, 3, and 4 was corrected and the hold-down arms installed without further difficulty. |
| CSD-S-00006 | Bracket, Hold-down, Test Stand AFA-496-3004-1 | N/A | Interference existed between the test stand holddown bracket, P/N AFA-496-3004-1, and the lower horizontal stabilizer rod clevises, P/N 8926477-6, which are located midway between Fins II and III. | The test stand hold-down bracket could not be modified without removing it from the stage, therefore, the interference problem was eliminated by chamfering the corners of the lower horizontal stabilizer rod clevis fingers. |
| CSD-S-00007 | Fitting, Captive Firing 30M02329 | N/A | Difficulty was encountered when removing the retainer rod attachment bolts from the captive firing fittings because the attachment rod bolts had been painted. | None |
| CSD-S-00008 | Hose Assembly, Fuel Control NAS-26823-1B | 045A | During installation of the conax valve test adapter on the fuel control hose assembly at engine B, one of the bolts sheared off. | After removing the fuel control hose assembly from the engine, the sheared bolt was removed and the threads were found to be galled. Also, a small scratch was noted in the conax valve sealing surface of the fuel control hose assembly. After chasing the damaged threads with a tap and machining the conax valve sealing surface down to remove the scratch, the fuel control hose assembly was inspected per NAS-26823-1B and reinstalled on the engine. |
| CSD-S-00009 | Cable Assembly 1W22P7 40C30371 | N/A | Cable assembly 1W22P7 was found to have a $\frac{1}{8}$ -inch hole in the shield and insulation, $\frac{1}{4}$ -inch above the plug connector. | The damaged portion of the cable was removed and a new P7 connector was installed. |
| CSD-S-00010 | Pressure Transducer 50M10262 | M-1958 | An error of -3.0% was discovered in the output of pressure measurement D125-9. Maximum acceptable tolerance is $\pm 1.0\%$. | The defective transducer was replaced with one of a similar type S/N 2019. |
| CSD-S-00011 | Pressure Transducer 50M10262 | M-1959 | An error of -1.6% was discovered in the output of pressure measurement D130-11. Maximum acceptable tolerance is $\pm 1.0\%$. | The defective transducer was replaced with one of a similar type S/N 2022. |
| CSD-S-00012 | Pressure Transducer 50M10262 | M-1950 | An error of -6.4% was discovered in the output of pressure measurement D28-9. Maximum acceptable allowance is $\pm 1.0\%$. | The defective transducer was replaced with one of a similar type S/N 2014. |
| CSD-S-00013 | Differential Pressure Transducer 50C10304 | 3-5845 | The output of pressure measurement D116-9 was erratic. | The transducer was replaced by a different type transducer for static test. |
| CSD-S-00014 | Fuel Tank Sliding Pins 30M00427 | N/A | Fuel tank sliding pins lacked lubricant as called out by EO 69-10C0003. Fuel tank 1 sliding pin, next to LOX tank 1, was slightly galled during removal of the bearing plate for inspection of the pin. | The galled pin was smoothed with crocus cloth. The exposed area of the eight pins was lubricated with MIL-G-3288 grease prior to LOX loading. While LOX was onboard, the lower exposed portion of the pins was lubricated. |

APPENDIX G (CONTINUED)
UNSATISFACTORY CONDITION REPORT

| UCR NUMBER | PART NAME AND NUMBER | SERIAL NUMBER | DISCREPANCY | ACTION |
|-------------|--|----------------|---|--|
| CSD-S-00015 | Check Valve 20C30132 | 907 | The LOX-SOX sphere assembly check valve failed to reseal upon completion of pressurization. | Valve was replaced with a like item, S/N 1039. |
| CSD-S-00016 | Check Valve 20C30132 | 905 | The fuel pressurizing sphere check valve failed to reseal upon completion of pressurization. | Valve was replaced with a like item, S/N 1038. |
| CSD-S-00017 | Valve, Ball Rotor 20C30043 | 266 | Fuel seepage was noted at the flange between the fuel tank 3 ball rotor valve body and the valve extension to the fuel tank sump. | Valve was replaced with a like item, S/N 289. |
| CSD-S-00018 | Zone Box 50C10403-1 | 1793 | The voltage output of measurement C192-2 was zero due to an open condition between pins B and C in the temperature zone box. | The defective zone box was replaced and the measurement was recalibrated. |
| CSD-S-00019 | Connector PT06P24-61P | N/A | The voltage output of the amplifier of measurement C220-9 was low due to pins W, Z, G, B, R, and U, in cable 9W16, at distributor 9A6-J13, being bent. | The pins W, Z, G, B, R, and U were straightened, checked, and the cable was reinstalled. |
| CSD-S-00020 | Amplifier Assembly, D. C. 50C10394-7 | 0829 | The output voltage of the amplifier of measurement C2-2 was high and drifting. The amplifier did not meet tolerance specifications. | The defective amplifier was replaced with a new amplifier module and calibrated. |
| CSD-S-00021 | 1.7 KC Sub-Carrier Oscillator 3131290-6G | 31132 | The operation of the 1.7 kc subcarrier oscillator on the F-1 (FM/FM) package was defective. | The subcarrier oscillator could not be adjusted to specifications, so it was replaced with a new unit. |
| CSD-S-00022 | Cable Assembly 40C30366 40C30366 | — | Transducer signals indicated zero output voltage due to reversed connection of two cable assemblies. | The cables were connected to the proper plugs. |
| CSD-S-00023 | Cable 18W5 40C30365 | N/A | The output voltage of the amplifier for measurements C216-18 through C219-18 was zero due to the absence of cable assembly 18W5. | A cable was fabricated by static test telemetry personnel for checkout of S-1-8. |
| CSD-S-00024 | Edcliff Pressure Transducer 20C85079 | 14792 | The output of the hydraulic supply transducer, measurement 56.01-2, D29-2, was erratic. | The defective transducer was replaced with a transducer of the same model. |
| CSD-S-00025 | Gage, Temperature 50C10405-1 | 0043 | The output voltage of the amplifier of measurement C220-9 was erratic due to an intermittent short between the thermocouple leads and the shield. | The defective thermocouple assembly was removed and replaced with a new unit. |
| CSD-S-00026 | Connector PT06P24-61P | N/A | The output voltage of the amplifier for measurements C180-11 through C185-11 was zero due to a misconnected cable. | The cable was connected as per the reference designator tag on the cable. |
| CSD-S-00027 | Marotta Valve N/A | 719 | During calibration a pressure transducer output read zero due to a teflon plug being left in the Marotta valve calibration port. | The Marotta valve was replaced with another of the same model. |
| CSD-S-00028 | Fuel Drain Line Tube Assembly 10M10002-5 | N/A | The fuel manifold drain line, 10M10002-5, makes an undesirable loop below the elevation of flex hose drain line, 10413270. | Following each firing, the tube will be removed to drain any fuel which is trapped. |
| CSD-S-00029 | Tube Assembly 10M10002-7 | N/A | The LOX manifold drain line, 10M10002-7 makes an undesirable loop below the elevation of the flex hose drain line. | None |
| CSD-S-00030 | Pressure Transducer 50M10305 | 3-9354 | Evaluation of the data from the replacement transducer installed for pressure measurement D117-10 revealed a linear error of +9%. Maximum acceptable tolerance is $\pm 1.0\%$. | The defective transducer was replaced with a similar transducer S/N 9341. |
| CSD-S-00031 | Wiancko Differential Pressure Transducer N/A | 65441 65443 | Transducers for differential pressure 2.11 and 2.17 were plumbed in reverse order. | A LOX-clean transducer was installed for measurement 2.17 and both LOX and fuel transducers were recalibrated. |

APPENDIX G (CONTINUED)
UNSATISFACTORY CONDITION REPORT

| UCR NUMBER | PART NAME AND NUMBER | SERIAL NUMBER | DISCREPANCY | ACTION |
|---------------|--|---------------|--|---|
| CSD-S-00032 | S-1 Stage Assembly 10M10002, Sheet 3 | S-1-8 | Extreme difficulty was encountered when removing the NAS1006-11H bolts which secure the wrap-around ducts to the fuel pump inlet adapters because excessive molykote was used during initial assembly. | All fuel pump inlet inserts were cleaned with a thread tap. |
| CSD-S-00033 | Band Assembly 30M03322 | N/A | The band assembly, P/N 30M03322, which secures the inboard chambers to the access chute was loose at engine 6. | The turnbuckle was torqued to 40 inch-pounds and safety wired. |
| CSD-S-00034 | Tapered, Inducer, Oxidizer 455538 | N/A | A small nick was noted in the outer edge of one of the LOX pump inducer blades at engine 2. | NASA turbopump shop personnel dressed and iridited the damaged inducer blade. |
| CSD-S-00035 | Power Supply 50M10363-1 | 022 | During functional test, a power supply shorted at +70° C. | The power supply was replaced with a spare modified per E.O. A11140-1. |
| CSD-S-00036 | Power Supply 50M10363-1 | 028 | During functional test, a power supply shorted at +70° C. | The power supply was replaced with a spare modified per E.O. A11140-1. |
| CSD-S-00037 | Edcliff Pressure Transducer 20C85079 | 13041 | The output of the hydraulic supply transducer, measurement 56.01-2, D29-2, was erratic. | The defective transducer was replaced by transducer of the same model. |
| CSD-S-00038 | Igniters, Gas Generator, Squibless 651139 | N/A | Void | This UCR was canceled before distribution and was superseded by UCR No. CSD-S-00058. |
| CSD-S-00039 | Heater Assembly, Fuel Dilutive Blender 4004 | 043 | The FABU heater blanket on engine 6 had several holes in it, and the rubber coating was blistered. | Replaced heater blanket with heater blanket P/N 10-142, S/N 069. |
| CSD-S-00040 | Power Supply 50M10363-1 | 019 | During functional test, a power supply failed at -20° C. | The power supply was replaced with a spare modified per E.O. A11140-1. |
| CSD-S-00041 | Circuit Breaker, 200 Amp. 75M03837 | N/A | Electrical power failure occurred in the circuit breaker mounted in the transporter rear dolly battery box during transportation of the S-1-8 stage causing loss of steering and communications. | Circuit breaker switch was re-activated and power was restored. It was necessary to tape both front and rear dolly power switches in the ON position to maintain power. |
| CSD-S-00042 | Gasket, Center LOX Tank Sump 30C00383 | N/A | LOX leakage was observed between the flanges of the rear manhole cover and the center LOX tank manhole. | The subject gasket was replaced with a like item and the center LOX tank sump flange bolts were torqued per drawing 10M10515. |
| CSD-S-00042-1 | Gasket, Center LOX Tank Sump 30C00383 | N/A | This UCR amends paragraph A of UCR CSD-S-00042. | N/A |
| CSD-S-00043 | Temperature Probe 50M10412 | 44166 | The temperature probe for measurement C54-2 read approximately 30% high during LOX loading test. | The defective probe was replaced with the same type, S/N 45889. |
| CSD-S-00044 | Temperature Probe 50M10412 | 45889 | No output was obtained from temperature probe C54-2 during LOX loading test. A continuity check revealed that the probe was open. | The defective probe was replaced with same type, S/N 45888. |
| CSD-S-00045 | Temperature Probe 50M10412 | 45888 | A continuity check of temperature probe C54-2 revealed that the probe was open. | A Rosemont probe S/N 4448 was installed for this measurement. |
| CSD-S-00046 | Cable Assembly 9W30 40C30366 | N/A | During capacitance checks, a discrepant resistance reading was obtained in the circuit of vibration measurement XE57-1. | Cable 9W30 was disconnected from the system and a GSE coaxial cable was installed for use during the remainder of static testing. |
| CSD-S-00047 | Tube Assembly 20M51083 (Inboard) 20M51099 (Outboard) | N/A | Extreme difficulty was encountered when installing and safety wiring the conax valve electrical cables due to the location of the turbine inlet pressure sensing lines. | None |
| CSD-S-00048 | Pressure Gauge 50C10101 | 3-9624 | Pressure transducer D20-4 indicated a 7% zero shift prior to test SA-20. | The defective transducer was replaced by a transducer of the same type, S/N 4-7475. |

APPENDIX G (CONTINUED)
UNSATISFACTORY CONDITION REPORT

| UCR NUMBER | PART NAME AND NUMBER | SERIAL NUMBER | DISCREPANCY | ACTION |
|-------------|--|---------------|--|---|
| CSD-S-00049 | Gulton Battery Charger EMB-103A | N/A | When the batteries were placed in the "LOAD" condition for generator backup, the voltage was insufficient to operate the necessary relays for placing the battery system in a load state. | Replaced R-23, trickle charge limiting circuit, and recharged the batteries. |
| CSD-S-00050 | Tube Assembly (LOX Bubbling Lines) 10M10002-15 | N/A | Engine 2 LOX bubbling line is slightly crimped near the B-nut that attaches to the fitting on the LOX wrap around manifold. | No action was taken. |
| CSD-S-00051 | Telemetrying Calibrator 50M10427 | 0003 | The F-1 telemeter package failed to generate inflight calibrations on the 270 channel wave train due to a defective telemetrying calibrator. | A spare telemetrying calibrator, S/N 003 was installed |
| CSD-S-00052 | Power Supply 50M10363-1 | 038 | Upon incorporation of E.O. A1140-1 into the power supply (50M10363-1, S/N 038) the power supply did not perform normally at -20° C. | This power supply was reinstalled for use during static firing SA-20 and was replaced with a properly functioning unit prior to test SA-21. |
| CSD-S-00053 | Power Supply 50M10363-1 | 025 | Upon completion of E.O. A1140-1 into the power supply (50M10363-1, S/N 025) the power supply did not perform normally at -20° C. | This power supply was reinstalled for use during static firing SA-20 and was replaced with a properly functioning unit prior to test SA-21. |
| CSD-S-00054 | Power Supply 50M10363-1 | 027 | Upon completion of E.O. A1140-1 into the power supply (50M10363-1, S/N 027) the power supply did not perform normally at -20° C. | This power supply was reinstalled for use during static firing SA-21 and was replaced with a properly functioning unit after test SA-21. |
| CSD-S-00055 | Valve, Ball Rotor Shutoff, LOX 60C27830 | 152 | The LOX prevalve, LOX Tank 3, had a slow closing time. | The LOX prevalve was replaced by a similar item, S/N 164. |
| CSD-S-00056 | Valve, Ball Rotor, Shutoff LOX 60C27830 | 134 | The LOX prevalve to engine 7 did not relieve and pressure below the valve built up to approximately 74.5 psig before the valve opened. | The LOX prevalve for engine 7 was replaced by a similar item, S/N 143 |
| CSD-S-00057 | Telemetrying Calibrator 50M10427 | 007 | The F-1 telemeter package failed to generate inflight calibrations. | No corrective action was taken. |
| CSD-S-00058 | Static Test Configuration, S-1 Stage 10M10016 | N/A | No pyrotechnic installation drawing exists for static test. | Drawing 20M51047, "Pyrotechnic Devices Installation", has been employed at Static Test in the past. |
| CSD-S-00059 | Static Test Configuration, S-1 Stage 10M10016 | N/A | The inboard engine overboard drain line extensions are extremely difficult to install. | Engineering Change Proposal SSTB-4 was written concerning this problem. |
| CSD-S-00060 | N/A | N/A | This UCR No. was not assigned to any report and will be left blank. | N/A |
| CSD-S-00061 | Temperature Gage 50M10412 | 44164 | Output from the temperature probe, C54-3, dropped to zero at approximately 5 seconds after ignition. A continuity check revealed that the transducer was open. | The defective transducer was replaced with same type S/N 48171. |
| CSD-S-00062 | Temperature Gage 50M10412 | 44162 | Output from the temperature probe, C54-6, dropped to zero at approximately 32 seconds after ignition. A continuity check revealed that the transducer was open. | The defective transducer was replaced with same type S/N 48162. |
| CSD-S-00063 | Rocket Engine Assembly 20M51051 Through 20M51054 | N/A | Gasket sealant was coming out of all outboard engine turbine exhaust duct flange connections. | Cleaned exposed areas with Freon. |
| CSD-S-00064 | S-1 Stage Assembly 10M10002 | S-1-8 | Gasket sealant (plastiseal "F") was coming out of all of the inboard engine turbine exhaust duct flange connections. | Cleaned exposed areas with Freon. |
| CSD-S-00065 | Static Test Configuration, S-1 Stage 10M10016 | N/A | Upon receiving stage S-1-8 at STTE, the radiation shield (P/N 30C03934-1) was only partially installed and the inboard engine drain line extension brackets were shipped as loose equipment. | Stage S-1-8 was removed from Static Test Tower East with the radiation shield and drain line brackets installed. No difficulty was encountered. |
| CSD-S-00066 | Servonic Pressure Transducer 20C85079 | 1023 | The output of the hydraulic oil system pressure transducer was erratic and intermittent on engine 4. | The defective transducer was replaced by another transducer of the same model, S/N 1019. |
| CSD-S-00067 | Plates, Duct Support 30M03823 30M03824 | N/A | The existing configuration makes it necessary to remove both the upper and lower duct support plates in order to install the turbine exhaust duct extensions. | None |

APPENDIX G (CONTINUED)
UNSATISFACTORY CONDITION REPORT

| UCR NUMBER | PART NAME AND NUMBER | SERIAL NUMBER | DISCREPANCY | ACTION |
|-------------|---|---------------|--|---|
| CSD-S-00068 | Receptacle, dual-T011W79P2 50C10203 | N/A | Evaluation of oscillograph records on test SA-20 revealed that the telemetry fuel discrete measurement A20-F3 was very noisy with erratic pulses. | The plug and plate and the 11W47P2 cable connector were replaced. |
| CSD-S-00069 | Access Door 30C00167 | N/A | Compartment access doors are not interchangeable. | No action has been started at this time. |
| CSD-S-00070 | Amplifier 50C10394-2 | 528 | The amplifier low calibrate output voltage was higher by 0.4 volt than the indicated voltage on its associated calibration curve. | The amplifier was replaced with a spare amplifier, S/N 847. |
| CSD-S-00071 | Pyrotechnic Devices Installation 20M51047 | N/A | Difficulty was encountered when installing the conax valves on the engines. | Installed conax valves using MS9088-13 bolts in place of MS35458-14 bolts as specified on flight pyrotechnic drawing. |
| CSD-S-00072 | Pyrotechnic Devices Installation 20M51047 | N/A | Difficulty was encountered when installing the solid propellant gas generator on the H-1 engines. | Installed SPGG using AK 10-524 nuts in place of H 34-5 nuts as specified in the flight pyrotechnic drawing. |
| CSD-S-00073 | 7 inch LOX Vent Valve 20M30122 | 142V | The 7 inch LOX vent failed to give a closed indication. | No action was taken. |
| CSD-S-00074 | Accelerometer 50C10395 | 282 | During checkout and calibration it was noted that the voltage output of the amplifier of E12-3 was 0.2 volt peak-to-peak. Investigation revealed that the accelerometer output signal was of insufficient amplitude. | The defective accelerometer was replaced as part of Kit No. 60C00028 and the measurement was recalibrated. |
| CSD-S-00075 | Zone Box 50C10402-1 | 1847 | The output of the zone box, 50C10402-1, was intermittent causing the amplitude to jump from 0.5 volt to 770 volts D.C. | The defective zone box was replaced and the measurement was recalibrated. |
| CSD-S-00076 | Master Measuring Supply 40M20002 | SA-113 | Measurements that obtained 5 volts from the +1089 buss had poor regulation during static firing. | No action taken. |
| CSD-S-00077 | Cable, Accelerometer 50C03756 | N/A | On the vibration, heat exchanger, Pitch, transducer the voltage output of the associated amplifier was reading zero when vibration input was applied to the accelerometer. Investigation revealed that the accelerometer cable read 25,000 ohms from center conductor to shield. | The defective accelerometer cable was removed and a new cable was apparent. |
| CSD-S-00078 | Emitter Follower 50C10401-1 Rev. 1 | 003 | The output of the associated amplifier (measurement E33.3) was 100 mv rms. The associated emitter follower was defective. | The defective emitter follower was changed as a kit and the measurement recalibrated. |
| CSD-S-00079 | Gage, Temperature 50M012203 | 5800 | The output voltage of the associated amplifier (measurement C120-11) was reading greater than 5 volts. It was discovered that the sensing element circuit of the temperature gage was open. | The defective probe was removed and replaced with a new unit. |
| CSD-S-00080 | Gage, Temperature 50M010412-1 | 44169 | An open temperature gage, C186-11, caused the output voltage of the associated amplifier to be greater than 5 volts. | The defective probe was removed and was replaced as part of a measurement kit. |
| CSD-S-00081 | Liquid-Level Rack (11A548) 50C10204 | 302034 | Number 5 probe on liquid level rack 11A548 was open and a defective amplifier for pulse 12 was evidenced. | Removed the defective liquid level rack and replaced with a new unit. |
| CSD-S-00082 | Connector (11W470P6) 10A491 | N/A | Pin "B" on cable 11W47-16 was bent. | The defective connector was removed and replaced with a new connector. |
| CSD-S-00083 | Temperature Probe 50M10412 | 44176 | During LOX loading test an erroneous reading was recorded on a temperature probe, 50M10412, due to a faulty transducer. | The defective transducer was replaced with same type, S/N 48163. |
| CSD-S-00084 | Pressure Plug MCI79D12W | N/A | At the LOX suction line on engine 6, the 3/4 inch bleeder pressure plug P/N MCI79D12W began to gall during removal. The plug was backed out approximately 1/8 inch. | The pressure plug was tightened and leak checked. No leakage was noted and measurement number 52.07-6 was relocated to another available instrumentation port for test SA-21. |

APPENDIX G (CONTINUED)
UNSATISFACTORY CONDITION REPORT

| UCR NUMBER | PART NAME AND NUMBER | SERIAL NUMBER | DISCREPANCY | ACTION |
|-------------|---|---------------|---|--|
| CSD-S-00085 | Temperature Probe 50C10410 | 42650 | The amplifier voltage was not of the correct value. The temperature probe, 50C10410, was open, and it is believed that the probe malfunctioned during the time of a static firing. | The defective transducer was replaced by a spare transducer. |
| CSD-S-00086 | Gage, Temperature 50C10412 | 44159 | Temperature probe 50C10412 was open. | The defective temperature gage was removed and replaced with a new unit. |
| CSD-S-00087 | Accelerometer Cable 50C10659-1 | N/A | The output was low and voltage was erratic for measurement E116-6. Investigation revealed that the accelerometer cable had an impedance of 35,000 ohms from the center conductor to shield. | The defective accelerometer cable was removed and replaced. |
| CSD-S-00088 | Measuring Rack (9A531) 60C50049-1 | N/A | Investigations showed water in measuring rack 9A531. Further investigation indicated water in the measurement calibrator P/A 50M10285 connector. | Rack 9A531 was disconnected and all modules removed and cleaned using freon 113 and dry air. Rack and modules will be shipped to CCSD Michoud for functional checkout. |
| CSD-S-00089 | Power Supply (9A4A1) 40C20053 | N/A | The +10B2 measuring supply of 9A9A2 failed. | No action taken. |
| CSD-S-00090 | Gage, Temperature 60C00013 | 44180 | An open temperature probe, 60C00013, caused a high output of the amplifier for the temperature plenum chamber measurement. | The defective temperature probe was removed and replaced with a new unit. |
| CSD-S-00091 | Saturn, S-1-8 10M10016 | N/A | LOX tank pressure too high. | No action was taken. |
| CSD-S-00092 | Accelerometer 50C01141-1 | N/A | The difference between the actual and predicted outputs of the bending mode accelerometer (E170-10) did not meet the required 2% accuracy. | No action was taken. |
| CSD-S-00093 | D. C. Amplifier 50C10394-17 | 1141 | The amplifier for measurement C94-7 had a "low" calibration of 0.52 V.D.C. The low calibration should be 0.82 V.D.C. according to the calibration curve submitted with the amplifier. | The amplifier was replaced with a spare amplifier. |
| CSD-S-00094 | Extension Cable 50C10225 | C0004 | An open conductor of the extension cable (P/N 50C10225) caused a reading of zero during checkout and calibration on measurement C61-3. | The defective cable was replaced with a new cable. |
| CSD-S-00095 | Cable, Extension N/A | N/A | The measurement L28-9 (sound intensity) had no output due to a damaged connector at the microphone on the extension cable between the microphone and emitter follower. | The cable was replaced as part of Kit No. 60C00035 and the measurement was then recalibrated. |
| CSD-S-00096 | Cable, Accelerometer 50C03753-3 | N/A | During calibration of measurement E130-9 an output from the accelerometer was not received in the "HI Cal" condition due to the open Pin "C" conductor of the accelerometer cable. | The cable was replaced. |
| CSD-S-00097 | Pyrotechnic Devices Installation 20M51047 | N/A | Rocketdyne requests that no lubricant be used while installing initiators in the SPGG, since the torque of 350±10 inch-pounds pertains to the condition where no lubricant is employed. | Initiators were installed with no lubricant applied to the threads. |
| CSD-S-00098 | Cable, Extension 50C12265 | N/A | The erratic output of measurement E33-7 was due to an extension cable between the accelerometer and emitter follower being pulled tight and under strain. Also, the cable had an intermittent open condition. | The cable was replaced and the measurement recalibrated. |

APPENDIX G (CONTINUED)
UNSATISFACTORY CONDITION REPORT

| UCR NUMBER | PART NAME AND NUMBER | SERIAL NUMBER | DISCREPANCY | ACTION |
|-------------|---|----------------|--|---|
| CSD-S-00099 | Cable, Accelerometer 50C03754-1 | N/A | Measurement E226-11 had no output signal from the amplifier module due to the accelerometer cable being open. | The cable was replaced and the measurement calibrated |
| CSD-S-00100 | Liquid Level Rack 50C10204 | 302030 | Measurement A19-04 (pulse B) was erratic due to a defective amplifier. | The defective amplifier was replaced with a similar unit. |
| CSD-S-00101 | Temperature Gage 50C10410 | 46117 | An open-circuited transducer, (S/N 46117), caused an erroneous reading on measurement C118-11 before LOX loading was complete. | The defective transducer was replaced by a spare transducer S/N 46120. |
| CSD-S-00102 | Liquid Level Probes 50M10205 | N/A | An investigation was initiated to determine the output of each individual liquid discrete probe because of intermittent and erratic operation during test SA-20. The data on probes 5, 10, and 14 revealed open indication, low output 24 mv, and zero output, respectively. | No action was taken because the discrete probes are inaccessible. |
| CSD-S-00103 | Liquid Level Probes 50M10205 | N/A | The same investigation as CSD-S-00102 revealed probes 1 and 11 of measurement A20-F1 to have an output of 42 mv. | No action was taken because the discrete probes are inaccessible. |
| CSD-S-00104 | Liquid Level Probes 50M10205 | N/A | The same investigation as CSD-S-00102 revealed that probe B of measurement A19-01 had a high forward resistance and probe 11, had an intermittent output voltage. | No action was taken because the discrete probes are inaccessible. |
| CSD-S-00105 | Multiplexer Assembly S-1 Vibration 50C10270-3 | 115 | During a prestatic firing, telemeter operational checks, the telemeter ground station reported no data being received on commutated channels 11 through 15. | Replaced vibration multiplexer with a spare unit. |
| CSD-S-00106 | Temperature Gage 50C10410 | 42649 | An open circuited transducer, (S/N 42649), caused an erroneous reading on measurement C188-11 before LOX loading was complete. | The defective transducer was replaced by a spare transducer, S/N 46117. |
| CSD-S-00107 | Temperature Gage 50C10410 | 46120- S1-8 | An open circuited transducer, (S/N 46120), caused an erroneous reading on measurement C188-11 before LOX loading was complete. | The defective transducer was removed and LOX clean plug has been installed in its place. |
| CSD-S-00108 | Temperature Probe 50C10412 | 48163 | Measurement C54-7 did not function properly because the temperature probe was open. | The defective temperature probe was replaced with a new unit. |
| CSD-S-00109 | Accelerometer 50C0114101 | N/A | The difference between the actual and predicted outputs of the bending mode accelerometer E169-10 did not meet the required specification of 2 percent accuracy. | No action was taken because of the inaccessible location of this accelerometer. |
| CSD-S-00110 | Accelerometer 50C01141-1 | N/A | The difference between the actual and predicted outputs of the bending mode accelerometer E168-10 did not meet the required specification of 2 percent accuracy. | No action was taken because of the inaccessible location of this accelerometer. |
| CSD-S-00111 | Temperature Probe 50C10410 | 42652 | An open circuited probe caused measurement C80-7 to rise sharply to 7 volts at ignition command and drop to 0.5 volt at commit plus 31.4 seconds. | The defective probe was replaced by a spare probe, S/N 42650. |
| CSD-S-00112 | Emitter Follower 50C10401-1 | 12 | Measurement E33-3 was noisy and erratic due to a defective emitter follower. | The defective emitter follower was replaced in kit form and recalibrated. |
| CSD-S-00113 | Vibrotion Pressure Transducer 50M10134 | 6004 | A frequency shift differing from the associated calibration curve occurred on D1-7. The frequency deviation from the curve varied and ranged from 11 to 14 cps. | The faulty transducer was replaced with a similar transducer. |
| CSD-S-00114 | Pressure Transducer 50M10134 | 5987 | The spare stock transducer for measurement D1-7 has a zero frequency shift of 22 cps from the calibration curve. | No spares were available; therefore, a complete calibration of the transducer was performed and a new calibration curve plotted for static firing only. |

APPENDIX G (CONTINUED)
UNSATISFACTORY CONDITION REPORT

| UCR NUMBER | PART NAME AND NUMBER | SERIAL NUMBER | DISCREPANCY | ACTION |
|-------------|---|--------------------------------------|--|---|
| CSD-S-00115 | Measurement Kit 60C00029 | N/A | Measurement EI29-9 voltage output was low in amplitude and erratic. This was due to a defective emitter follower. | The defective emitter follower was removed and replaced with a new measurement kit. |
| CSD-S-00116 | Accelerometer 50C10395 | 2951 | Measurement EI29-9 was indicating a low output. The signal from the accelerometer was of insufficient amplitude and was erratic. | The accelerometer and amplifier were replaced as part of Kit No. 60C00029 and calibrated. |
| CSD-S-00117 | Accelerometer 50C10395 | 254 | Measurement EI1-6 was indicating a low output. The signal from the accelerometer was of insufficient amplitude and was erratic. | The accelerometer and amplifier were replaced as part of Kit No. 60C00028 and calibrated. |
| CSD-S-00118 | Power Supply (9A4A1) 40C20053 | N/A | Measurement M2-9 dropped to zero at 1.1 seconds after outboard cutoff. The power supply (9A4A1) malfunctioned at this time, with its output voltage dropping to zero volts. Measurement M2-9 was operating correctly by indicating zero volts. | No action taken. |
| CSD-S-00119 | Temperature Probe 50C10412 | 1002 | An open temperature probe caused measurement C54-7 to function improperly during test SA-21. | The defective temperature probe was removed and replaced with a new unit. |
| CSD-S-00120 | Thrust Chamber Assembly 206078, Engine 1 205198, Engine 4 | RN004R, Engine 1 RN006R, Engine 4 | Films of test SA-21 indicated the possibility of hot gas leakage from the aspirators of engines 1 and 4 under the radiation blankets. Post-test leak checks were made whereby static pressure was applied to the turbine exhaust system. No loss of pressure nor leaks were noted. As a result, the radiation covers were not removed for further investigation. | None. Stage removal was in process when motion pictures were being reviewed. |
| CSD-S-00121 | Temperature Probe 50M10412 | 48162 | During a special LOX tanking test measurement C54-6 gave an incorrect temperature indication. The indication was approximately 8% higher than the true temperature of LOX. | The defective temperature probe was not replaced. |
| CSD-S-00122 | Telemeter Multiplexer P-2 50M10420 | N/A | Evaluation of the P2 multiplexer (test SA-21) revealed that telemeter channels P2B1-02-03 and P2B1-02-08 do not have measurements assigned, but were reading 2.0 volts prior to liftoff. At liftoff, when rack and channel power (XPI) was removed the readings decreased to zero within 6 seconds, and remained there until reset, at which time, XPI power was returned. Within 6 seconds after XPI power was returned, the readings increased to 2.0 volts. The two channels are assigned to a sub-multiplexer card (P/N 410336-3) within the P2 multiplexer. | No action was taken. |
| CSD-S-00123 | Valve Assembly Fuel Container Vent 20M3000 | CM205 | During the components checkout, the fuel vent valves were closed but the closed position indicator for fuel vent (CM205) did not indicate closed. Further checkout proved that the valve was closed, but did not give a closed indication. | Fuel vent valve CM205 was replaced by a spare valve CM309. |
| CSD-S-00124 | Valve Assembly Fuel Container Vent 20M3000 | CM207 | During the components checkout, the fuel vent valves were closed but the closed position indicator for fuel vent (CM207) did not indicate closed. Further checkout proved that the valve was closed, but did not give a closed indication. | Fuel vent valve CM207 was replaced by a spare, valve CM211. |
| CSD-S-00125 | Valve Assembly Fuel Container Vent 20M3000 | CM211 | During components checkout, the fuel vent valve was opened but the closed position indicator did not drop out. Further checkout verified that the fuel vent was open and that only a closed indication was received. Replacement of fuel vent valve CM211 was necessary. | Fuel vent valve CM211 was replaced by a spare, valve CM201. |
| CSD-S-00126 | Turbine Assembly 454204 | 6313106 | During test SA-21 on stage S-1-8, combustion chamber pressure shifts of 645.5-629.5 psig and 620.7-604.0 psig were indicated by engine 8 (S/N H-2029) at X=48.9 and X=127.8 seconds, respectively. These performance shifts were also reflected in all related parameters except conisphere temperature. | Spare engine S/N H-2031 was installed at position 8 on stage S-1-8 after calibration testing at the Power Plant Test Stand. Engine S/N H-2029, will be reallocated as a spare after being repaired by the Engine Prep Shop. |
| CSD-S-00127 | Rocket Engine Assembly, Inboard 20C51056-1 | H-2017 | The thrust produced by engine 6 (S/N H-2017, 200.7 K-lbs) during test SA-20 was above the specified limits of 188K ± 3 percent. Therefore, the GG LOX bootstrap orifice at engine 6 was changed (0.308" out 0.300" in) in order to bring the thrust within the specified limits. Test SA-21, however, revealed that the proper reduction in thrust was not obtained (196.8K, Test SA-21). | Engine S/N H-2032 will be installed at engine position 6 on stage S-1-8 after calibration testing at the Power Plant Test Stand. |

DISTRIBUTION

CCSD

D. N. Buell
W. Cannizzo
T. R. Cotter
R. D. Cox
E. J. Dofter
P. F. Fahey
C. C. Gage
D. E. Gero
R. F. Gompertz
J. M. Landon
R. W. Loomis
H. D. Lowrey
B. J. Meldrum
J. Pakis
W. S. Parker
J. F. Patrick
R. H. Ross
M. Rehburg
L. T. Scherer
E. M. Scranton (2)
R. C. Toward
R. A. Trahern (2)
F. M. Van Sickle
V. J. Vehko
R. C. Vile
J. V. Wible
R. L. Wiltse
J. H. Wood, Jr.
L. H. Yount (Cape Kennedy)
Library HIC (2)
Library Michoud (2)

DIR

Dr. W. von Braun
Dr. E. Rees

R-DIR

H. K. Weidner

R-P&VE

F. B. Cline, R-P&VE-DIR
J. O. Aberg, R-P&VE-V
J. F. Blumrich, R-P&VE-SA
T. Bullock, R-P&VE-SLR

W. A. Cobb, R-P&VE-PPF
J. H. Farrow, R-P&VE-SV
P. W. Frederick, R-P&VE-SS
R. P. Garcia, R-P&VE-PPE
L. F. Grant, R-P&VE-SVM
Dr. W. R. Lucas, R-P&VE-M
R. Pitts, R-P&VE-SVM
R. W. Rothe, R-P&VE-VF
W. A. Schulze, R-P&VE-VS (2)
J. Thomson/K. Reed, R-P&VE-PA
D. T. Westrope, R-P&VE-PAB
C. C. Wood, R-P&VE-PT

R-QUAL

C. O. Brooks, Jr., R-QUAL-P
O. Cerny, R-QUAL-AE (2)
W. E. Crews, R-QUAL-J
A. Urbanski, R-QUAL-A
C. T. Peigler, R-QUAL-RA

R-ASTR

J. D. Avery, R-ASTR-IMD
W. L. Howard, R-ASTR-NFS
M. A. Kalange, R-ASTR-NF
C. H. Mandel, R-ASTR-G
H. B. Meeks, R-ASTR-EA

EX-DIR

H. H. Maus

I-E-DIR

L. F. Belew

I-E-H

T. P. Smith

R-ME

W. R. Kuers, R-ME-DIR
M. E. Nowak, R-ME-RA
F. Weckwarth, R-ME-DA

M-WDZR

Col. Newman

DISTRIBUTION (CONTINUED)

LVO

R. L. Body, PA6
L. E. Fannin, VM22
T. A. Poppel, D
A. Zeiler, V

AST-S

O. H. Lange

R-AERO-FF

J. R. Eady

R-TEST

P. E. Cates, R-TEST-IE
W. L. Grafton, R-TEST-C
E. K. Kaschig, R-TEST-SBT
J. H. Kastanakis, R-TEST-II
R. H. Rivers, R-TEST-DIR
J. E. Shirey, R-TEST-IE
Dr. W. H. Sieber, R-TEST-I

SATURN I/IB PROJECT OFFICE

L. B. James, Dir.
A. W. Thompson
G. B. Hardy

ROCKETDYNE

R. J. Jolicoeur

MS-IPL (8)

MS-IP

MS-H

CC-P

M-HME-P

EXTERNAL

Scientific and Technical Information Facility (2)
Attn: NASA Representative (S-AK/RKT)
P. O. Box 5700
Bethesda, Maryland