

# GRAVITY GRADIENT STABILIZATION SYSTEM for the

DOCUMENT NO. 65SD4464  
20 OCTOBER 1965

APPLICATIONS  
TECHNOLOGY  
SATELLITE

FACILITY FORM NO. 2

N 66 24503

CR-44572

(NASA CR OR TRAC OR AD NUMBER)

1  
31

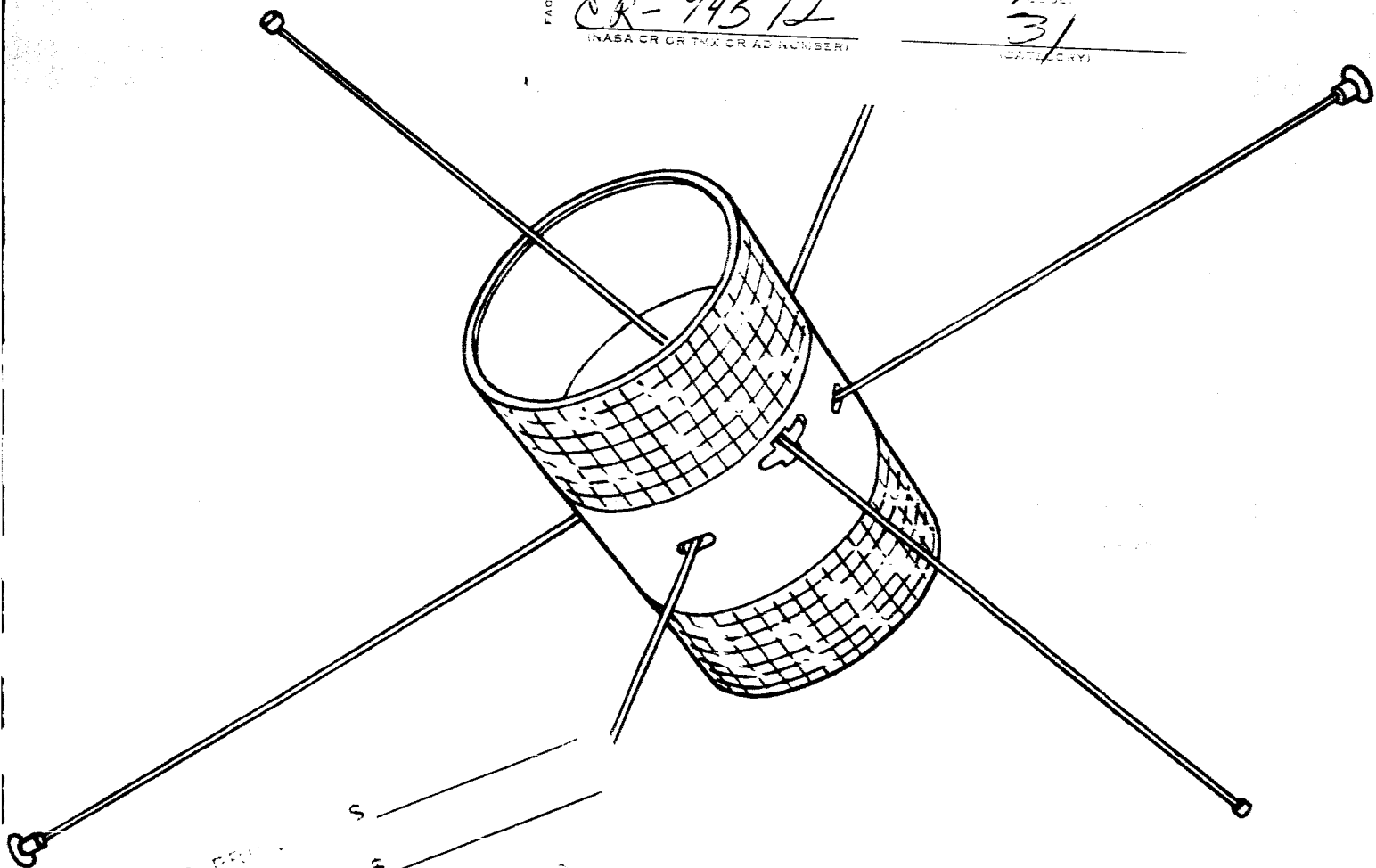

GPO REVENUE \_\_\_\_\_  
CFSTI PROGRAMS \_\_\_\_\_  
HONORARIUM \$ 5.00  
MAILING \$ 1.25  
# 652 244

## FIFTH QUARTERLY PROGRESS REPORT

NASA CONTRACT NAS 5-9042

GENERAL  ELECTRIC  
SPACECRAFT DEPARTMENT



DOCUMENT NO. 65SD4464

20 October 1965

GRAVITY GRADIENT STABILIZATION SYSTEM  
FOR THE  
APPLICATIONS TECHNOLOGY SATELLITE  
FIFTH QUARTERLY PROGRESS REPORT

1 July through 30 September 1965

CONTRACT NO. NAS 5-9042

for the  
NATIONAL AERONAUTICS AND SPACE ADMINISTRATION  
WENDELL SUNDERLIN  
ATS TECHNICAL OFFICER

APPROVED BY



---

R. J. Katucki, Manager  
Passive Attitude Control Programs

**GENERAL  ELECTRIC**

**SPACECRAFT DEPARTMENT**

*A Department of the Missile and Space Division*  
**Valley Forge Space Technology Center**  
P.O. Box 8555 • Philadelphia 1, Penna.

## TABLE OF CONTENTS

Section		Page
	ABSTRACT . . . . .	xiii
1	INTRODUCTION . . . . .	1-1
	1.1 Purpose . . . . .	1-1
	1.2 Program Contract Scope . . . . .	1-1
	1.3 Progress Summary . . . . .	1-1
2	SYSTEMS ANALYSIS AND INTEGRATION . . . . .	2-1
	2.1 Event Summary . . . . .	2-1
	2.2 ATS Mathematical Model . . . . .	2-2
	2.3 Attitude Determination Program . . . . .	2-3
	2.3.1 Data Reduction Computer Program . . . . .	2-4
	2.3.2 Attitude Determination Program . . . . .	2-6
	2.4 Orbit Test Plan . . . . .	2-6
	2.5 Flight Evaluation Plan . . . . .	2-7
	2.6 GE Data System Checkout . . . . .	2-11
	2.6.1 Vehicle Input Simulator Summary Description . . . . .	2-13
	2.6.2 Areas of Emphasis in Developing Plan for Data System Checkout . . . . .	2-14
	2.7 Analytical Studies and Results . . . . .	2-15
	2.7.1 Attitude Errors Caused by Spacecraft System Magnetic Dipole Moment . . . . .	2-15
	2.7.2 Response of TM-2 System to Pulsing Thrustor . . . . .	2-15
	2.8 Boom Thermal Bending Analysis . . . . .	2-19
	2.8.1 Numerical Solution of Shell Equations . . . . .	2-19
	2.8.2 Boom Thermal Bending Test . . . . .	2-19
	2.9 Boom Dynamics - Orbital Excitations . . . . .	2-19
3	BOOM SUBSYSTEM . . . . .	3-1
	3.1 Key Events . . . . .	3-1
	3.2 Damper Boom Release Mechanism Problem . . . . .	3-1
	3.3 Engineering Units . . . . .	3-3
	3.3.1 T1A Primary Boom Assembly . . . . .	3-3
	3.3.2 Damper Boom (Engineering Unit T1) . . . . .	3-7
	3.4 Thermal and Dynamic Models. . . . .	3-8
	3.5 Interface Tooling . . . . .	3-8
	3.6 Test Equipment . . . . .	3-9
	3.7 Interface Connectors . . . . .	3-9

## TABLE OF CONTENTS (Cont'd)

Section		Page
4	COMBINATION PASSIVE DAMPER . . . . .	4-1
4.1	Introduction . . . . .	4-1
4.1.1	Summary of Major Events During Reporting Period . . . . .	4-1
4.1.2	CPD Specification Status . . . . .	4-2
4.2	Design Development Effort . . . . .	4-2
4.2.1	General . . . . .	4-2
4.2.2	Combination Passive Damper (CPD) Package . . . . .	4-3
4.2.3	Thermal Model . . . . .	4-12
4.2.4	Dynamic Model . . . . .	4-12
4.2.5	Solenoid . . . . .	4-16
4.2.6	Eddy Current Damper . . . . .	4-19
4.2.7	Passive Hysteresis Damper . . . . .	4-21
4.2.8	Damper Boom Angle Indicates . . . . .	4-30
4.2.9	Subcontract Activities . . . . .	4-35
4.3	Test Equipment . . . . .	4-35
4.3.1	Low Order Force Fixtures (LOFF) . . . . .	4-35
4.3.2	Advanced Damping Test Fixture (ADTF) . . . . .	4-36
4.3.3	Dipole Measurement Facility . . . . .	4-36
4.3.4	Test Console Cables . . . . .	4-36
5	ATTITUDE SENSOR SUBSYSTEM . . . . .	5-1
5.1	Subsystem Description . . . . .	5-1
5.2	TV Camera Subsystem . . . . .	5-1
5.2.1	TV Camera Optics . . . . .	5-1
5.2.2	Materials in Standard 0431C Camera . . . . .	5-7
5.2.3	Telemetry Circuit Design . . . . .	5-7
5.2.4	Resolutions Testing . . . . .	5-7
5.3	Power Control Unit . . . . .	5-8
5.3.1	Electrical Design . . . . .	5-8
5.3.2	Mechanical Design . . . . .	5-11
5.3.3	Testing Activities . . . . .	5-11
5.4	Solar Aspect Sensor, Engineering Functional Tests and Results . . . . .	5-12
6	GROUND TESTING . . . . .	6-1
6.1	Engineering Evaluation Tests . . . . .	6-1
6.1.1	Special Tests . . . . .	6-1

TABLE OF CONTENTS (Cont'd)

Section		Page
	6.1.2 Component Evaluation Tests . . . . .	6-2
	6.1.3 System Evaluation Test . . . . .	6-3
	6.1.4 Aerospace Ground Equipment . . . . .	6-3
	6.1.5 System Thermal Tests at HAC . . . . .	6-3
	6.1.6 System Thermal Tests at HAC . . . . .	6-8
	6.1.7 System Dynamic Tests at HAC . . . . .	6-12
6.2	Qualification Tests . . . . .	6-13
	6.2.1 Parts Qualification Program . . . . .	6-13
	6.2.2 Component Qualification . . . . .	6-18
6.3	Flight Acceptance Tests . . . . .	6-19
6.4	Test Equipment . . . . .	6-19
7	QUALITY CONTROL . . . . .	7-1
	7.1 Quality Control Engineering . . . . .	7-1
	7.1.1 Boom Subsystem . . . . .	7-1
	7.1.2 Combination Passive Damper . . . . .	7-1
	7.1.3 Television Camera Subsystem . . . . .	7-2
	7.1.4 Solar Aspect Sensor . . . . .	7-3
	7.1.5 Power Control Unit . . . . .	7-3
7.2	Test Equipment Engineering . . . . .	7-4
	7.2.1 Boom Subsystem . . . . .	7-4
	7.2.2 Combination Passive Damper . . . . .	7-5
	7.2.3 Television Camera Subsystem . . . . .	7-5
	7.2.4 Solar Aspect Sensor . . . . .	7-6
	7.2.5 Power Control Unit . . . . .	7-6
7.3	Inspection and Test . . . . .	7-6
	7.3.1 Boom Subsystem . . . . .	7-6
	7.3.2 Combination Passive Damper . . . . .	7-7
	7.3.3 Television Camera Subsystem . . . . .	7-8
	7.3.4 Solar Aspect Sensor . . . . .	7-9
	7.3.5 Power Control Unit . . . . .	7-9
7.4	General . . . . .	7-10
8	MATERIALS AND PROCESSES . . . . .	8-1

## TABLE OF CONTENTS (Cont'd)

<u>Section</u>		<u>Page</u>
9	MANUFACTURING . . . . .	9-1
	9.1 Thermal Units . . . . .	9-1
	9.2 Dynamic Units . . . . .	9-1
	9.3 Engineering Unit 1 . . . . .	9-1
	9.4 Engineering Unit 2 . . . . .	9-2
	9.5 Prototype Units 1 and 2 . . . . .	9-2
	9.6 Flight Units . . . . .	9-2
	9.7 Tooling . . . . .	9-2
10	RELIABILITY AND PARTS AND STANDARDS . . . . .	10-1
	10.1 Reliability . . . . .	10-1
	10.1.1 Combination Passive Damper Clutch and Solenoid Transient Suppression Circuit . . . . .	10- 10-1
	10.1.2 Switch-Contact Redundancy in Boom clutch Solenoid . . . . .	10-4
	10.1.3 Primary Boom Assembly Wiring . . . . .	10-5
	10.1.4 ATS Parts Failure Rates . . . . .	10-7
	10.1.5 Power Control Unit Analysis . . . . .	10-11
	10.1.6 Improper Command Sequence . . . . .	10-16
	10.2 Parts and Standards . . . . .	10-16
	10.2.1 Introduction . . . . .	10-16
	10.2.2 Parts Drawings and Parts Lists . . . . .	10-18
	10.2.3 Parts Qualification Program . . . . .	10-19
	10.2.4 Degradation Analysis . . . . .	10-19
11	NEW TECHNOLOGIES . . . . .	11-1
12	GLOSSARY . . . . .	12-1
APPENDIX A	CABLE CUTTING MALFUNCTION ANALYSIS . . . . .	A-1
APPENDIX B	VIBRATION TEST PLAN FOR CPD DYNAMIC MODEL . . . . .	B-1
APPENDIX C	LIMIT SWITCH CONFIGURATION ANALYSIS . . . . .	C-1

## LIST OF ILLUSTRATIONS

Figure		Page
2-1	Data System Checkout . . . . .	2-12
2-2	Spacecraft Input Simulator . . . . .	2-12
3-1	Engineering Unit T1A Primary Boom Package . . . . .	3-4
3-2	Erections Unit, Booms, and Scissors Directions . . . . .	3-6
3-3	Test Track and Console for Boom System Evaluation at GE. . . . .	3-10
3-4	Test Trolley and Arrangement for Primary Boom Evaluation . . . . .	3-10
4-1	Combination Passive Damper Package . . . . .	4-4
4-2	Caging Cable Calibration Results . . . . .	4-9
4-3	Caging Pin Torque Fixture . . . . .	4-10
4-4	Eddy Current Caging Torque Test Results . . . . .	4-11
4-5	CPD Dynamic Model . . . . .	4-13
4-6	Force vs. Travel Test Results for Engineering Unit . . . . .	4-18
4-7	Energy Dissipated by Eddy Currents and Hysteresis in Torsional Restraint vs. Amplitude of Oscillation (ATS-A Eddy Current Damper) . . . . .	4-19
4-8	PHD Suspension System ATS-D/E Configuration . . . . .	4-27
4-9	Angle Indicator Evaluation Test Elements . . . . .	4-32
5-1	GE/HAC Electrical Interface (GE Dwg. 47E207151) . . . . .	5-2
5-2	Lens Data . . . . .	5-3
5-3	Radial Energy Distribution . . . . .	5-4
5-4	Special Frequency vs. Response . . . . .	5-4
5-5	Ray Trace Diagram . . . . .	5-5
5-6	Effect of Neutral Density Filter on Effective f/number . . . . .	5-6
5-7	Emergency Power Reset Command Buffer, Schematic Diagram . . . . .	5-10
5-8	Motor Driver Command Buffer, Schematic Diagram . . . . .	5-10
5-9	Digit Size as a Function of Incident Angle . . . . .	5-13
5-10	SAS Detector Alignment Geometry . . . . .	5-13
5-11	Analog Output of Least Significant Bit Cell and AGE Cell . . . . .	5-14
5-12	Transition Edge Error vs True Transition (Reticle 1, Bit 1) . . . . .	5-17
5-13	Transition Edge Error vs True Transition (Reticle 1, Bit 2) . . . . .	5-18
5-14	Transition Edge Error vs True Transition (Reticle 1, Bits 3&4) . . . . .	5-19
5-15	Transition Edge Error vs True Transition (Reticle 1, Bits 5, 6, 7 & 8) . . . . .	5-20
5-16	Transition Edge Error vs True Transition (Reticle 2, Bit 1) . . . . .	5-21
5-17	Transition Edge Error vs True Transition (Reticle 2, Bit 2) . . . . .	5-22
5-18	Transition Edge Error vs True Transition (Reticle 2, Bits 3&4) . . . . .	5-23
5-19	Transition Edge Error vs True Transition (Reticle 2, Bits 5, 6, 7 & 8). . . . .	5-24
6-1	CPD with Damper Boom in Stowed Position-Thermal Model . . . . .	6-9
6-2	Primary Boom Package and TV Target-Thermal Models . . . . .	6-10
6-3	TV Camera (Left) and Control Unit-Thermal Models . . . . .	6-10
6-4	Solar Aspect Sensor with Sun Sensor Detector-Thermal Model . . . . .	6-11
6-5	Power Control Unit - Thermal Model . . . . .	6-11

## LIST OF TABLES

Table		Page
2-1	Altitude Errors Resulting from Vehicle Dipole Moment, ATS-A . . . . .	2-16
2-2	Altitude Errors Resulting from Vehicle Dipole Moments, ATS-D/E . . . . .	2-16
2-3	Performance Comparison Chart, TM-2 Configuration (Including Pulse Thrustor Performance . . . . .	2-17
4-1	Specification Summary . . . . .	4-3
4-2	Combination Passive Damper Parts and Functions . . . . .	4-7
4-3	Sinusoidal Vibration Schedule, PHD Design Qualification per SVS 7331. . . . .	4-24
4-4	PHD Vibration Test Data . . . . .	4-25
4-5	Angle Indicator Test Summary . . . . .	4-33
6-1	Group A - Parts Requiring Qualification Testing . . . . .	6-15
6-2	Group B - Parts for Tear-Down and Analysis . . . . .	6-16
6-3	Status of Parts Qualification Program - 9 September 1965 . . . . .	6-17
10-1	Failure Rate Comparison . . . . .	10-3
10-2	Part Failure Rate for ATS Reliability Estimates . . . . .	10-9
10-3	Power Control Unit Failure Mode/Effects Summary . . . . .	10-12
10-4	Failure-Mode Failure Rates ("Hi-Rel" Parts) . . . . .	10-14
10-5	Degradation Analysis Summary . . . . .	10-20



## ABSTRACT

An outline for updating the Flight Evaluation Plan has been established in conjunction with the results of a meeting held at NASA/GSFC on 19 July 1965. The areas to receive special attention are defined in Section 2.5.

Results of two analytical studies are given in Section 2.7. These results include vehicle attitude errors resulting from vehicle magnetic dipole, and the TM-2 system response to pulsing thruster. This latter result was prepared to fulfill a request by NASA.

The pacing problem in the development of the Boom Subsystem has been the malfunction of the damper boom bolt cutter, and the subsequent search for a reliable alternate to replace the original Conax cutter. Two such alternates were investigated. The first design employs a Hi-Shear explosive nut in conjunction with a clevis-type tip mass tie bar. The second alternate utilizes an Avdel ball-lock tip mass release and a Horex (or Hi-Shear) explosive nut.

The 150-foot test track and Boom Subsystem test console were set up at GE. The test facility, pictured in Section 3, will be used during the next quarter for scheduled engineering evaluation of the Boom Subsystem.

Results of the TV camera optics analysis, completed by Wollensak Optical Division of the 3M Company, are included in Section 5, together with the ray trace diagrams of the lens systems.

Two modifications were made to the Power Control Unit. The first is an emergency power reset for all relays in the event the regulated power bus is not energized. The second modification is a command decoder failure inhibit circuit. Both schematics are included in the report.

Current and future ground testing is described in Section 6. Information is given for engineering evaluation tests which will be conducted by GE during the next reporting period. Plans are detailed for qualification and flight acceptance tests, together with the status of the required test equipment.

Results of reliability analyses which were completed during the quarter include a comparison of an RC circuit with a proposed diode in the CPD clutch solenoid transmission suppression circuit. An analysis was prepared of a proposed limit switch circuit for extending and scissoring the booms. A comparison of the piece parts failure rates currently used to prepare reliability estimates of the ATS components is listed in Section 8.1.4. A detailed part-by-part analysis of the PCU circuitry is presented together with a PCU Failure Mode/Effects summary.

ATS parts drawings and the parts list status are discussed in Section 8.2. A degradation analysis, which is based on the parts screening program reported in the Fourth Quarterly Progress Report, is included for the ATS parts that have been evaluated to date.

## SECTION 1 INTRODUCTION

### 1.1 PURPOSE

This report documents the technical progress made during the period from 1 July 1965 to 30 September 1965, toward the design and development of Gravity Gradient Stabilization Systems for the Applications Technology Satellites.

### 1.2 PROGRAM CONTRACT SCOPE

Under Contract NAS 5-9042, the Spacecraft Department of the General Electric Company has been contracted to provide gravity gradient stabilization systems for three Applications Technology Satellites: one to be orbited at 6000 nautical miles (ATS-A), and two to be orbited at synchronous altitude (ATS-D and ATS-E). Each system will consist of primary booms, damper boom, damper, attitude sensors and the power conditioning unit. In addition to the flight systems, GE will provide a thermal model, a dynamic model, engineering unit and two prototype units. GE will also supply two sets of aerospace ground equipment.

### 1.3 PROGRESS SUMMARY

Two groups of hardware, which are representative of the ATS passive stabilization system, were assembled by GE in accordance with program schedule and accepted by NASA/GSFC during the past quarter. The first group included all the thermal units. These units were designed to simulate the thermal conditions of the Gravity Gradient Stabilization flight system. They are intended for use in the ATS system thermal test scheduled to be conducted at the Hughes Aircraft Company.

The second group of hardware included the Gravity Gradient Stabilization System dynamic models. These units are intended to simulate the weight, mass and center of gravity of the Gravity Gradient Stabilization System; they will be used in the ATS system dynamic evaluation which is scheduled to be conducted by HAC.

Evaluation of the engineering units was begun during the reporting period. The object of these engineering tests is to confirm the specification requirements for each component and to establish design margins. To date, evaluation has begun on the Solar Aspect Sensor and the Power Control Unit. It is anticipated that significant data will be available as a result of these engineering tests to report in the forthcoming quarterly progress report.

A two-day design review was held at GE (21-22 September 1965) with the NASA/GSFC ATS Project Office representatives. The design review was comprehensive; all areas of the program were discussed, including hardware and systems analysis areas. Informal presentations were made by each cognizant engineer for his particular item. The meeting was considered to be informative and worthwhile.

SECTION 2  
SYSTEM ANALYSIS AND INTEGRATION

2.1 EVENT SUMMARY

Events having a significant bearing on the course and direction of ATS systems analysis efforts during the past quarter are summarized as follows:

18 JULY 1965

GE submitted (to NASA/GSFC) 5 copies each of the following documents:

- ATS Preliminary Flight Evaluation Plan
- ATS Data Processing System Preliminary Design Specification

19 JULY 1965

NASA/GE working session to review GE's Data Processing and Flight Evaluations Plans. A decision was made to use the NASA/GSFC orbit model in the GE Attitude Determination Program. This will eliminate any uncertainties (due to orbit) in the ultimate merger (by NASA) of GE-supplied attitude data and NASA-generated world map data. The session also produced a number of action items, some against GE and others against NASA.

26 JULY - 9 AUGUST 1965

GE vacation plant shutdown.

9 AUGUST 1965

The NASA orbit model was received ("A Mutual Visibility Computer Program for Communication Satellites" by G. Repass and R. Chaplick, NASA/GSFC) for incorporation into the GE Attitude Determination Program. Separate routines are required for singular conditions at zero inclination and zero eccentricity. NASA will provide at a later date.

11 AUGUST 1965

Revised estimates of central body moments of inertia were received from HAC; new inertia levels make upright capture on ATS-A marginal.

12 AUGUST 1965

GE letter to NASA/GSFC delineating GE's system responsibility relative to magnetic dipole design goals was submitted.

31 AUGUST 1965

GE submitted response to action items established at 19 July working session on data processing and flight evaluation.

3 SEPTEMBER 1965

First draft of the Gravity Gradient System Requirements Specification was completed.

21 SEPTEMBER 1965

NASA/GSFC design review, including an examination of progress in the systems area, took place.

2.2 ATS MATHEMATICAL MODEL

Four sections of the engineering report on the ATS mathematical model have been written. The report will contain ten sections and two appendices.

A technical revision in the attitude differential equations became necessary. It had originally been planned to integrate the time derivatives of the components of the angular momentum. This has the considerable advantage of saving about 20% of the arithmetic, but requires that certain integrated quantities satisfy algebraic constraints. The scheme for accomplishing this proved to be unworkable and so the method was abandoned in favor

of the conventional practice of integrating the angular accelerations. The revised equations have been derived but not yet programmed.

An error was discovered in the equation for the deflection of a thermally bent rod. The error was basic and was propagated through the center of mass, moment of inertia, and solar torque equations. The derivation of all of these equations must therefore be reviewed. The consequent delay is estimated to be two to four weeks for reviewing the equations, four weeks for programming, and four to eight weeks for checking. Meanwhile, work on programming and checking other modules continues.

### 2.3 ATTITUDE DETERMINATION PROGRAM

Since the issue of the last quarterly report, the total effort involved in Attitude Determination has been re-evaluated and has culminated in a time-task schedule delineated on the GE PERT Drawing No. 47D207482.

Briefly, the schedule consists of the developmental generation of two major computer programs:

- Data Reduction Computer Program
- Attitude Determination Program

The Data Reduction Program will process the telemetry data received from NASA, perform diagnostic processing, and format attitude sensing data for input to the Attitude Determination Program.

The Attitude Determination Program computes spacecraft attitude from all available sensing sources, i.e., solar aspect sensors, infrared earth sensors, and antenna polarization.

Prior to the realization of the Attitude Determination Program, two computer programs will be written for the analytical investigations required. The Data Simulation Program (which is completed) generates simulated attitude sensor data from the three sensing sources. These simulated data are required as input to the Attitude Determination Investigation Program (ADIP), which is 80% completed. ADIP will be utilized to determine:

- a. The effects on attitude computation accuracy when redundant means of sensing are available.
- b. A weighting criteria for each attitude computation scheme for correlating several redundancies.
- c. The effects on accuracy of attitude determination due to orbital model perturbations.

After these studies are performed, the ADIP will be modified as required into the Attitude Determination Computer Program.

### 2.3.1 DATA REDUCTION COMPUTER PROGRAM

The subroutines which perform the diagnostic processing within the Data Reduction Program were described in Sections 2.3.1, 2.3.2 and 2.3.3 of the Fourth Quarterly Progress Report.

The telemetry data fed to the program is separated into sensor outputs (where more than one transducer or sensor readout is coupled together in a telemetry word) and then functionalized into engineering units. Temperature, pressure, current, voltage, and event data are then diagnosed and outputted from the program via a presentation media (print or plot) established by evaluation criteria. Attitude sensing data are separated from the above diagnostic data and outputted for the computations within the Attitude Determination Program.



One of the prime requirements of the data reduction program is the description of the telemetry data being fed to it. For the telemetry words assigned to GE, these descriptions are garnered from test specifications and calibration data generated in the acceptance testing for these components. This information is presently being collected for all transducers that are the responsibility of GE.

For the total task of stabilization subsystem evaluation, GE also requires other spacecraft measurements which are under the responsibilities of other contractors. These measurements are:

- a. Temperatures - to obtain a thorough picture of thermal environment.
- b. Power source voltages and currents - to obtain (indirectly) an historic presentation of gravity gradient subsystem power consumption and for failure analysis.
- c. On-board tape recorder operations - to determine the effects, if any, of the tape recorder operation on the stabilization subsystem.
- d. Infrared earth sensor data - to obtain vehicle attitude.
- e. Telemetry subsystem data - to determine the noise content evaluation from the synchronization words, to determine subcommutator frame identification, and to obtain the calibration of the 5-volt power source which powers the majority of the GE sensors.

The sensor descriptions delineated for the five requirements above are necessary inputs for the generation of the Data Reduction Program.

### 2.3.2 ATTITUDE DETERMINATION PROGRAM

Results of some test runs made on the simulation program are now being used to aid in the detailed checking of the Attitude Determination Investigation Program.

It is currently planned to use the simulation program in studying the effects of satellite position and attitude geometry on the sensor outputs in conjunction with mathematical model outputs.

### 2.4 ORBIT TEST PLAN

Work has been initiated on a definitive ATS Gravity Gradient Orbit Test Plan. In response to a NASA/GSFC request, preliminary efforts are being concentrated on the first 30 days of the ATS-A mission. In addition, a separate document which outlines the basic orbit test philosophy is being generated to facilitate a better understanding of overall gravity gradient mission objectives and to provide the perspective of planned tests that may not be readily apparent from an examination of the test details.

Mission objectives and associated orbit tests may be categorized as follows:

- a. Demonstrate the operational feasibility of ATS-type gravity gradient systems at medium and synchronous altitudes; associated tests include initial capture and settling times, steady-state performance (including isolation of effects due to solar eclipse, orbit and seasonal effects) inversion by subliming rocket thrusters and inversion by primary boom retraction and re-extension.
- b. Demonstrate compatibility with mission requirements of long-life applications satellites; associated tests include system response to impulse functions, operational tests by experimenters in meteorological and communications fields and life tests (steady-state status monitoring at periodic intervals for 3 years).

- c. Obtain parametric flight data for application to post-ATS gravity gradient satellite design; associated tests include performance sensitivities to inertia ratios and magnitudes (obtained by "scissoring" and changing the nominal length of the primary booms) and establishing orbital conditions which precipitate yaw inversion.
- d. Establish the adequacy of the ATS Mathematical Model as a gravity gradient design tool; associated tests include measurement of primary boom thermal bending (using the television camera subsystem) and measurement of attitude dynamics using the ATS attitude measurement system. Both types of measurements will be evaluated in terms of performance predictions from the ATS Mathematical Model.

The sequencing of tests associated with the above objectives will be based on tradeoffs between test data value and probability of test success (including the effects of a test failure on the success of the remaining tests).

## 2.5 FLIGHT EVALUATION PLAN

A preliminary version of the ATS Flight Evaluation Plan was distributed for comment and review in July, 1965. An outline for updating the plan has been established in conjunction with results of a subsequent meeting held at NASA/GSFC 19 July 1965. Areas to receive special attention as to further definition and specification include:

### a. Antenna Polarization

- 1. Definition - a detailed description of the antenna polarization technique to be used on ATS is necessary in order to establish attitude determination procedures. In this respect, requirements concerning accuracy and rate of data to be obtained are being established, in order to provide sufficient information for vehicle attitude calculations.

2. Format - Specification of the format to be used in transferring antenna polarization data between the tracking station network, NASA/GSFC, and GE/SD is being completed so that the ATS information system may be firmly defined in integrated form.

b. Supplementary Data

1. Telemetry calibration information - Detailed calibration information and curves must be provided in order to further specify the data reduction functions to be used in the ATS program.
  - (a) Engineering Units/T/M volts - Calibration data on each individual sensor is being determined to show the functional relationship, and associated deviations, between input units (degrees, feet, psia, etc.) and output telemetry volts.
  - (b) T/M volts/ PCM bits - Information on the telemetry equipment used in converting from sensor output voltages to PCM coded bits suitable for transmission is necessary in meeting calibration data requirements.
2. Operational on-orbit status - Further specification of operational information to be provided during on-orbit periods will be established. This includes definition of command information required by GE/SD, and any associated communications information necessary to fully supplement records of on-orbit status of the vehicle.
3. Scientific data - Investigation and requirements establishment should be completed on any applicable scientific data which might be available and useful in flight evaluation efforts. This would include not only

experiment data from the ATS vehicle, but also any other data which might assist in attitude performance evaluation, or any diagnostic analysis to be completed.

c. Quick-Look Information System

A comprehensive overall description of the quick-look information system is being generated in order to provide a framework for specification of detailed requirements. Areas of particular emphasis (due to need for further specification) include:

1. Format - To indicate quantity, rate and time interval, and turn-around time capabilities and limitations;
2. Availability - To indicate limitations imposed through integration into the NASA-TWX network, or other means of data transmission used;
3. Scheduling - To indicate requirements placed on the quick-loop system in order to satisfactorily supplement the long-term information system in providing data for particular analysis efforts (capture) and on-orbit operations (inversion).

d. Flight Analysis Techniques

Expansion of the Flight Analysis and Evaluation section (Section 6, Preliminary Flight Evaluation Plan) is underway in an attempt to more clearly define and specify details of the ATS flight evaluation philosophy.

1. Techniques - A weekly plan of evaluation efforts to be applied is being established, indicating the handling of various flight data inputs. Particular emphasis will be given to methods of evaluation, such as:

- (a) Direct correlation, through comparison of curve amplitude excursions, frequency components, and transient decay characteristics;
- (b) Statistical correlation, through mean value/standard deviation comparison between predicted and actual data values, or through spectral density plot comparison of various functions;
- (c) Incipient failure monitoring, by performing a limit-checking operation on certain diagnostic data, such as controlled temperature monitors;
- (d) Operational performance evaluation, in particular covering possible effects of on-orbit operations on subsequent vehicle system and/or subsystem performance; this would be accomplished through monitoring of primary and secondary system status indicators and operational monitors.

More specific definition of duties of the evaluation team in conjunction with the weekly schedule is also to be included.

- 2. Formats - A detailed requirement specification of data and information formats for the data processing activity is being developed, indicating required plots, listings, and any calculations (mean value calculation, automatic limit check, etc.) to be performed prior to regular flight evaluation efforts. Plot specification will cover range, scaling, and unit requirements. Print-out specifications will include time interval requirements, and any limit-check "flags" to be used.

e. GE On-Orbit Consultant Schedule

Expansion of the GE Consultant Schedule - On-Orbit Support (Table 2.1, page 7 of the Preliminary Flight Evaluation Plan) is also underway, in an

attempt to more clearly define duties of GE/SD personnel at NASA/GSFC and the tracking stations. This schedule will list detailed requirements to be met by the consultant team members, in conjunction with the operational orbit test plan, and will indicate the support schedule to be followed at each location.

f. Data System Checkout

(See Section 2.6.)

Publication of a revised version of the ATS Flight Evaluation Plan is scheduled for the first quarter of 1966, pending completion of updating efforts according to the outline above.

2.6 GE DATA SYSTEM CHECKOUT

Capability for internal checkout of the GE portion of the ATS data system will be implemented. Such a checkout will enable:

- Verification of data processing programs prior to flight;
- Determination of processing and analysis turn-around times;
- Operational rehearsal for cognizant in-house personnel.

In addition, experience will be gained in actual flight analysis techniques in working with realistic data.

Each component of the GE data system will have previously undergone individual checkout; thus, this system checkout is primarily concerned with the overall functioning of the integrated system including the integrated use of the ATS Mathematical Model in conjunction with reduced flight data. A flow diagram for the Data System Checkout is shown in Figure 2-1 with additional definition of the Spacecraft Input Simulator in Figure 2-2.

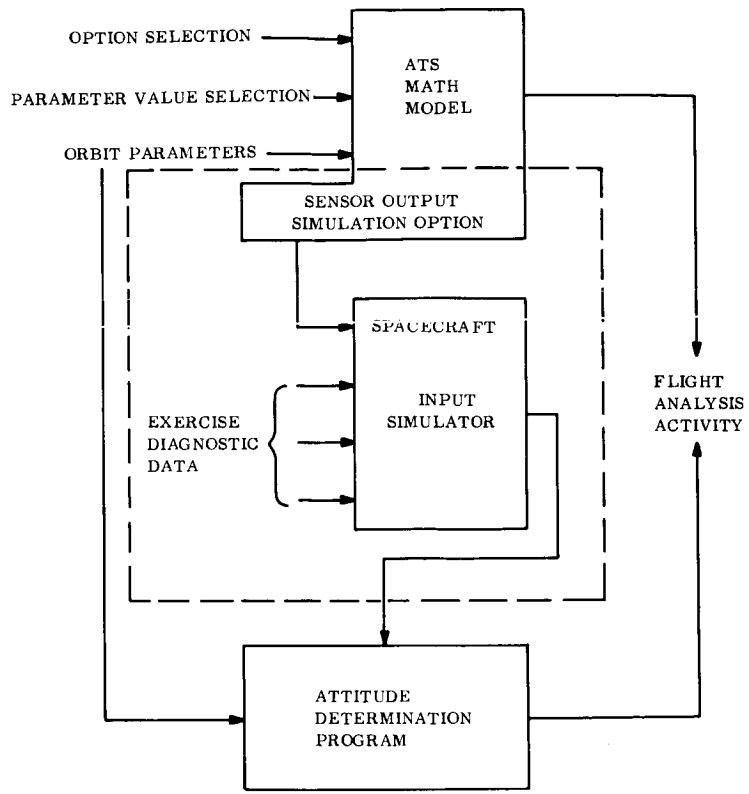

Figure 2-1. Data System Checkout

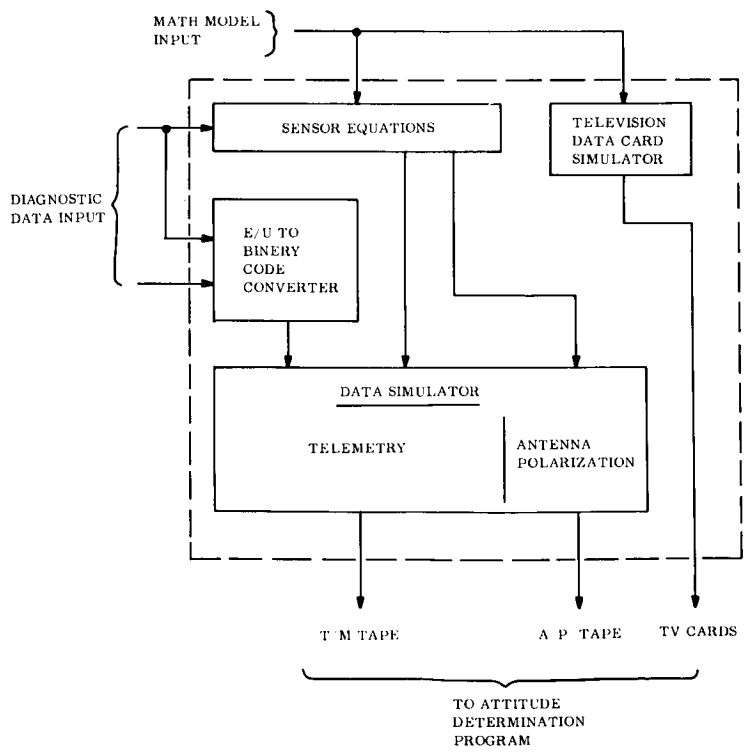

Figure 2-2. Spacecraft Input Simulator



## 2.6.1 VEHICLE INPUT SIMULATOR SUMMARY DESCRIPTION

The Vehicle Input Simulator Summary Description follows:

### a. Inputs required

1. Math Model - Solar aspect, earth sensor, antenna polarization, and damper (angular) outputs corresponding to mathematical-model-generated vehicle attitude/orbital performance.

Gravity gradient boom tip mass position(x and y displacements from vehicle yaw axis) in TV camera coordinate system.

2. Diagnostic Data - Critical temperatures, voltages, etc. pertinent to sensor output interpretation within the Attitude Determination Program calculation routines.

Simulated diagnostic data (temperatures, voltages, currents, pressures, lengths, angles, etc.) generated to exercise data processing software fully through the function operating range, and then simulate normal operating modes through the remainder of checkout.

### b. Outputs generated

1. Telemetry Tape - Telemetry input (to ADP) tape similar in format to planned weekly T/M tape input during on-orbit operation, containing complete simulated T/M data for processing.
2. Antenna Polarization Tape - Antenna polarization data input (to ADP) in on-orbit operation format containing any antenna polarization data available as stipulated by orbit geometry and vehicle attitude.

3. Television Cards - Hollerith cards containing data simulating that obtained from television pictures during the simulation period.

c. Functional Operation

1. Sensor Equations - Software operating on mathematical model-calculated sensor outputs, in conjunction with pertinent diagnostic data. This routine will employ inverted telemetry calibration curves in order to produce binary code outputs identical to that received from the Goddard Space Flight Center ground station during on-orbit operations.
2. Engineering Unit/Binary Code Converter - Software similar to the sensor equation block, converting all diagnostic data to binary code, simulating output from GSFC during on-orbit operations.
3. Television Data Card Simulator - Soft/hardware producing Hollerith cards containing vehicle pointing angle and tip mass deflection data, properly formatted as derived from the mathematical model-calculated earth sensor angular output and tip mass position values.
4. Data Simulator - Converter producing properly formatted and coded T/M data tape, and antenna polarization tape for input to the ADP, containing all simulated data.

## 2.6.2 AREAS OF EMPHASIS IN DEVELOPING PLAN FOR DATA SYSTEM CHECKOUT

a. Emphasis:

- Option/parameter selection - which are most critical for checkout satisfaction and analysis technique exercise.

- Diagnostic data - actual data form for complete checkout and exercise of each channel (requires T/M sensors study results)
- Analysis activity participation - definition and planning; technique development
- Input simulator - integration into data processing loop

b. Plus:

Format definition for information input during on-orbit operations

c. Then:

Operational planning required to implement the checkout operation for personnel and scheduling

## 2.7 ANALYTICAL STUDIES AND RESULTS

### 2.7.1 ATTITUDE ERRORS CAUSED BY SPACECRAFT SYSTEM MAGNETIC DIPOLE MOMENT

Attitude errors of the ATS-A and ATS-D vehicles resulting from vehicle magnetic dipole moments are shown in Tables 2-1 and 2-2.

### 2.7.2 RESPONSE OF TM-2 SYSTEM TO PULSING THRUSTER

In the TM-2 error budget of the Third Quarterly Progress Report (Page 2.1-38), the performance of the TM-2 configuration with a pulsed thruster was omitted. In response to a NASA/GSFC request, the performance of the TM-2 configuration was checked and the results are given in the error budget (Table 2-3) along with the previously stated errors.

TABLE 2-1. ATTITUDE ERRORS RESULTING FROM VEHICLE DIPOLE MOMENT  
ATS-A

Magnetic Dipole Moment (Pole/cm)	Dipole Orientation	Pitch (deg)		Roll (deg)		Yaw (deg)	
		Bias	Osc	Bias	Osc	Bias	Osc
1000	X <sub>1</sub>	0	0.1	0	0	0	0
5000	X <sub>1</sub>	-0.05	0.45	-0.2	0	-0.05	0.55
10,000	X <sub>1</sub>	-0.05	0.85	-0.4	0.1	-0.05	1.05
1000	Y <sub>1</sub>	0	0.2	0	0	0.55	0.25
5000	Y <sub>1</sub>	0	0.8	0	0.1	2.65	1.45
10,000	Y <sub>1</sub>	-0.15	1.45	0	0.2	5.25	2.85
1000	Z <sub>1</sub>	0	0.1	0	0	0	1.1
5000	Z <sub>1</sub>	-0.05	0.55	0	0.2	-0.25	5.25
10,000	Z <sub>1</sub>	-0.1	1.1	0	0.4	-0.6	10.0

TABLE 2-2. ATTITUDE ERRORS RESULTING FROM VEHICLE DIPOLE MOMENT  
ATS-D/E\*

Magnetic Dipole Moment (Pole/cm)	Dipole Orientation	Pitch (deg)	Roll (deg)	Yaw (deg)
1000	X <sub>1</sub>	0	0	0
5000	X <sub>1</sub>	0	-0.1	0
10,000	X <sub>1</sub>	0	-0.2	0
1000	Y <sub>1</sub>	0	0	0.3
5000	Y <sub>1</sub>	0	0	1.5
10,000	Y <sub>1</sub>	-0.1	0	2.9
1000	Z <sub>1</sub>	0	0	0
5000	Z <sub>1</sub>	0	0	-0.2
10,000	Z <sub>1</sub>	0	0.1	-0.3

\*These errors are constant. Oscillations do not occur because the vehicle is stationary with respect to the magnetic field of the earth.

TABLE 2-3. PERFORMANCE COMPARISON CHART, TM-2 CONFIGURATION  
( Including Pulse Thruster Performance)

TM-2 Configuration ATS-D	Sun 23.45° to Orbit Plane						Sun in Orbit Plane					
	Pitch (deg)		Roll (deg)		Yaw (deg)		Pitch (deg)		Roll (deg)		Yaw (deg)	
	Bias	Osc	Bias	Osc	Bias	Osc	Bias	Osc	Bias	Osc	Bias	Osc
Thermal Bending and Solar Torque	0	1.0	0	0.7	0.3	1.6	0.1	1.0	0	1.1	0.4	3.6
Magnetics	0	0	0	0	0.4	0	0	0	0	0	0.4	0
Central Body Solar Torque	0.2	0	0.2	0	0.4	0	0.2	0	0.2	0	0.4	0
Rod Alignment												
Curved Booms												
Principal Axis Shift	0.2	0	0.2	0	0.5	0	0.2	0	0.2	0	0.5	0
Solar Torque	0	0.1	0	0.1	0.3	0.3	0	0.1	0	0.1	0	0.4
Total Performance												
Without Thruster	0	1.4	0	0.5	0.4	1.1	0.1	1.4	0	0.8	0.4	2.5
With Pulsed Thruster	0	1.9	0	1.0	7.5	2.6						
With Constant Thruster	0	1.3	0	0.7	3.7	1.2	0	1.3	0	0.9	1.7	2.9

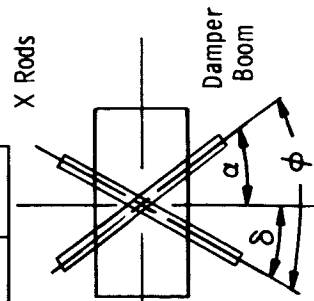

$b/I_D \omega_0$	$K/I_D \omega_0^2$	$I_y/I_R$	$I_D/I_R$	$\phi$	$\alpha$	$\delta$	$\xi$
1.0588	5.1504	0.04	0.2308	58.2	53.4	4.8	25.65

It is convenient at this time to clear up some of the confusion surrounding these error budgets and other performance estimates given subsequent to the Third Quarterly Progress Report. The error budgets (Pages 2.1-30 to 2.1-39 inclusive) represent the ideal performance of the appropriate system with a standard set of configuration and disturbance parameters, and are used solely to compare one system against another. For these studies, such things as rod misalignments, center of mass uncertainties, thruster offsets, and other inaccuracies of satellite manufacture and assembly have not been considered in detail, or, in many cases, were omitted entirely. This was done in the interest of speed and economy of system selections and was felt to be adequate for the basic selection of the non-dimensional parameters of the system. To study the performance, computer runs were made for each set of non-dimensional parameters with a standard set of rod lengths, tip weights, etc. The resultant runs, therefore, represent ideal performance only and are not necessarily representative of the actual or optimum for any given set of parameters.

Following selection of the non-dimensional parameters (designated TM-2) the optimum rod lengths, tip weights, etc. were determined. For this study, manufacturing and installation tolerances were included. Optimization of the configuration reduces the effect of these tolerances, but in general, they will degrade the overall performance. This results in differences between actual performance estimates and the estimates given in the charts. Further differences between the charts and actual performance result from optimization itself, which while improving the overall performance will increase some errors, while decreasing others. Performance estimates of the final configuration are, therefore, likely to be higher (both individually and collectively) than those of the error budgets, not because of an inferior system, but because of a more realistic evaluation of performance. When in doubt, the most recent error estimates are the most reliable.

## 2.8 BOOM THERMAL BENDING ANALYSIS

### 2.8.1 NUMERICAL SOLUTION OF SHELL EQUATIONS

The revised solution to the shell equations, using the exact roots of the differential equations, has been completed and programmed for the IBM 7094 computer. Results, to date, reveal an extreme sensitivity of the matrix of coefficients to the length of rod element. As rod element length is increased, this matrix of coefficients becomes strongly singular. It is suspected that this result is a measure of the effect of not satisfying the boundary conditions along the overlapped edge of the boom.

Numerical results are currently being obtained and interpreted.

### 2.8.2 BOOM THERMAL BENDING TESTS

A test plan has been written establishing technique and procedure for the setup, instrumentation control and data acquisition necessary for running a valid thermal bending test on gravity gradient rods. Test fixturing layout drawings have been started.

The test setup will be evaluated by first testing an instrumented seamless tube.

## 2.9 BOOM DYNAMICS - ORBITAL EXCITATIONS

In order to compute the dynamic action of the gravity gradient booms, it is necessary to establish the motion in absolute inertial coordinates so that inertial loadings are complete. However, it is most convenient to describe the vehicle in its own coordinate system. The methods used are described below. The complete development will be published in a forthcoming PIR.

Three coordinate systems are established:

- a. An absolute coordinate system
- b. An orbital coordinate system described by the tip of a moving vector from inertial reference and with one axis directed along the describing vector
- c. A body coordinate system whose origin lies at the tip of the inertial vector but which has (or may have) an angular displacement from the orbital reference system.

Additional local coordinate systems are also used within the vehicle, but these systems are transformed into vehicle coordinates prior to consideration of the overall body dynamics action.

An inertial center is defined with origin at 0 and terminus at R. Define a coordinate set with an R-axis coincident with  $\overline{OR}$ , a P-axis perpendicular to  $\overline{OR}$  and in a plane which contains the velocity vector and a Q-axis which is orthogonal to R and P.

The body axes are defined as orthogonal axes X, Y, and Z whose orientation with R, P, Q is described by Euleran Transformation.

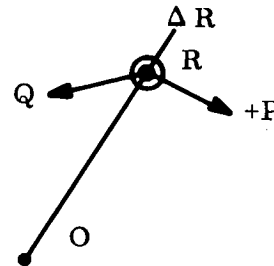

Letting  $r$  represent the vector of generalized coordinates in the inertia coordinate set, the kinetic and potential energy and the energy dissipated in damping can be written:

$$KE = 1/2 \dot{r}^T M_R \dot{r}$$

$$U = 1/2 r^T K_R r$$

$$D = 1/2 \dot{r}^T C_R \dot{r}$$



where  $M_R$ ,  $K_R$  and  $C_R$  are the mass, stiffness and damper matrices expressed with reference to the inertial coordinate system using Lagranges equations and the transformation relations

$$P = TX$$

$$r = \tau P$$

so that  $r = \tau TX$

$$X = T^{-1} \tau^{-1} r = T^T \tau^T r$$

$$M_R = \tau T M_X T^T \tau^T$$

$$C_R = \tau T C_X T^T \tau^T$$

$$K_R = \tau T K_X T^T \tau^T$$

The dynamic equation reduces to the following form

$$\begin{aligned} M_X T^T \ddot{R} + 2 M_X T^T \tau^T \dot{\tau} \dot{R} + M_X T^T \tau^T \ddot{\tau} R \\ + M_X T^T \tau^T \left\{ \tau \ddot{T} + 2 \dot{\tau} \dot{T} + \ddot{\tau} T \right\} X \\ + 2 M_X T^T \tau^T \left\{ \tau \dot{T} + \dot{\tau} T \right\} \dot{X} \\ + M_X \ddot{X} + C_X \dot{X} + K_X X = \text{Applied Forces} \end{aligned}$$

Where  $\ddot{R}$ ,  $\dot{R}$ , and  $R$  are the acceleration, velocity, and distance respectively of the body coordinate system origin from the inertial reference point.

Noting that the X term can be expressed as

$$\mathbf{X} = \bar{\mathbf{X}} + \delta$$

where  $\bar{\mathbf{X}}$  is the rigid body coordinate and  $\delta$  is the elastic deformation coordinate.

The last three terms on the left side of the above equation can be reduced further to

$$\mathbf{M}_X \ddot{\mathbf{X}} + \mathbf{C}_X \dot{\mathbf{X}} + \mathbf{K}_X \mathbf{X} = \mathbf{M}_X \ddot{\bar{\mathbf{X}}} + \mathbf{M}_X \ddot{\delta} + \mathbf{C}_X \dot{\delta} + \mathbf{K}_X \delta$$

since

$$\mathbf{C} \dot{\bar{\mathbf{X}}} = \mathbf{K} \bar{\mathbf{X}} = 0$$

The system is represented by 42 coordinates for present computational purposes. Present effort is devoted to checking the transformation matrices. Each of these is a 42 x 42 matrix of a tridiagonal form.

The (3 x 3) basic submatrix of  $\tau$  is

$$\tau_{(3 \times 3)} = \begin{bmatrix} -\sin \omega t & 0 & \cos \omega t \\ \cos \omega t & 0 & \sin \omega t \\ 0 & 1 & 0 \end{bmatrix}$$

where  $\omega$  is the angular velocity of the R vector.

$$\dot{\tau}_{(3 \times 3)} = \omega \begin{bmatrix} -\cos \omega t & 0 & -\sin \omega t \\ -\sin \omega t & 0 & \cos \omega t \\ 0 & 0 & 0 \end{bmatrix}$$

$$\ddot{\tau}_{(3 \times 3)} = \dot{\omega} \begin{bmatrix} -\cos \omega t & 0 & -\sin \omega t \\ -\sin \omega t & 0 & \cos \omega t \\ 0 & 0 & 0 \end{bmatrix}$$

$$+ \omega^2 \begin{bmatrix} \sin \omega t & 0 & -\cos \omega t \\ -\cos \omega t & 0 & -\sin \omega t \\ 0 & 0 & 0 \end{bmatrix}$$

The T matrix is expressed as

$$T = T_{\theta_z} T_{\theta_y} T_{\theta_x}$$

where

$$T_{\theta_z (3 \times 3)} = \begin{bmatrix} \cos \theta_z & -\sin \theta_z & 0 \\ \sin \theta_z & \cos \theta_z & 0 \\ 0 & 0 & 1 \end{bmatrix}$$

$$T_{\theta_y (3 \times 3)} = \begin{bmatrix} \cos \theta_y & 0 & \sin \theta_y \\ 0 & 1 & 0 \\ -\sin \theta_y & 0 & \cos \theta_y \end{bmatrix}$$

$$T_{\theta_x (3 \times 3)} = \begin{bmatrix} 1 & 0 & 0 \\ 0 & \cos \theta_x & -\sin \theta_x \\ 0 & \sin \theta_x & \cos \theta_x \end{bmatrix}$$

so that

$$\dot{T} = \dot{T}_{\theta_z} T_{\theta_y} T_{\theta_x} + T_{\theta_z} \dot{T}_{\theta_y} T_{\theta_x} + T_{\theta_z} T_{\theta_y} \dot{T}_{\theta_x}$$

and

$$\begin{aligned} \ddot{T} = & \ddot{T}_{\theta_z} T_{\theta_y} T_{\theta_x} + T_{\theta_z} \ddot{T}_{\theta_y} T_{\theta_x} + T_{\theta_z} T_{\theta_y} \ddot{T}_{\theta_x} \\ & + 2\dot{T}_{\theta_z} \dot{T}_{\theta_y} T_{\theta_x} + 2\dot{T}_{\theta_z} T_{\theta_y} \dot{T}_{\theta_x} + T_{\theta_z} \dot{T}_{\theta_y} \dot{T}_{\theta_x} \end{aligned}$$

with the derivatives of  $T_{\theta_z}$ ,  $T_{\theta_y}$  and  $T_{\theta_x}$  being of similar form to those of  $\tau$ .

The forcing function of the right-hand side of the equation is:

Forcing Function = Gravity Force + Applied Forces.

The gravity forces parallel with the R-axis are:

$$F_{g_R} = -M_P g \frac{R_e^2}{R^2} + 2 M_P g \frac{R_e^2}{R^3} r$$

where  $R_e$  is the earth radius,  $R$  is orbital radius and  $g$  is the acceleration of gravity at the earth surface.

The component of gravity force parallel with the P-axis is:

$$F_{g_P} = -M_P g \left( \frac{R_e}{R} \right)^2 \frac{P}{R}$$

The gravity force vector then is the sum:

$$\begin{bmatrix} F_{gr} \\ F_{gp} \\ F_{gq} \end{bmatrix} = g \left( \frac{R_e}{R} \right)^2 M_P \left\{ \begin{bmatrix} -1 \\ 0 \\ 0 \end{bmatrix} + \begin{bmatrix} 2 \frac{r}{R} \\ \frac{p}{R} \\ \frac{q}{r} \end{bmatrix} \right\}$$

These are transformed into body axes by:

$$\begin{aligned} \begin{bmatrix} F_{gx} \\ F_{gy} \\ F_{gz} \end{bmatrix} &= T^T \begin{bmatrix} F_{gr} \\ F_{gp} \\ F_{gq} \end{bmatrix} = g \left( \frac{R_e}{R} \right)^2 T^T T M_X T^T \left\{ \begin{bmatrix} -1 \\ 0 \\ 0 \end{bmatrix} + \frac{1}{R} \begin{bmatrix} 2 & 0 & 0 \\ 0 & 1 & 0 \\ 0 & 0 & 1 \end{bmatrix} P \right\} \\ &= g \left( \frac{R_e}{R} \right)^2 M_X T^T \left\{ \begin{bmatrix} -1 \\ 0 \\ 0 \end{bmatrix} + \frac{1}{R} \begin{bmatrix} 2 & 0 & 0 \\ 0 & 1 & 0 \\ 0 & 0 & 1 \end{bmatrix} T X \right\} \end{aligned}$$

SECTION 3  
BOOM SUBSYSTEM

3.1 KEY EVENTS

The key events which took place during this quarter were:

28 June 1965	Mockup delivered to GE from deHavilland. The test trolleys were included in the same delivery.
3 August 1965	Thermal and dynamic models of the primary and damper booms received by GE from deHavilland.
3 September 1965	Thermal units of the Boom Subsystem accepted by NASA/GSFC together with the other subsystems of the ATS stabilization system.
13 September 1965	Thermal models shipped to Hughes Aircraft Company for inclusion in the ATS System Thermal Test.
17 September 1965	Engineering Unit T1A primary boom shipped to GE.
19 September 1965	Dynamic model of primary boom package shipped to HAC for ATS System Dynamic tests. Damper boom retained at GE for instrumented vibration test in conjunction with CPD.
23 September 1965	Engineering Unit T1 damper boom received by GE.

3.2 DAMPER BOOM RELEASE MECHANISM PROBLEM

The Conax bolt cutter developed for the damper boom release operation employs dual redundant squibs firing into the same explosion chamber. The primary function of the bolt cutter is to sever the solid cylindrical tie bar which maintains the tip masses in intimate contact with the center body. Its secondary function is to shear the primer leads when the bolt cutting has been accomplished.

On 9 July 1965 a malfunction occurred at deHavilland during a deployment test of the T1 engineering damper boom assembly. When the Conax bolt cutter was fired, the tip mass tie

bar was not severed but the primer leads were sheared and no deployment resulted. Prior to returning the failed bolt cutter to Conax, the firing circuit utilized by deHavilland in the test was suspected to be the cause of the malfunction. However, the Conax failure analysis report (PAR 2100 reprinted as Appendix A) suggested that the most likely cause of the malfunction was lack of proper confinement of the potting compound due to voids in the primer cavity.

Investigation of the redundant squib circuits which actuate the bolt cutter revealed that the connector ram shears the primer leads within 100 microseconds after the first primer fires, thus cutting off power to the second primer. Since primers have in excess of one millisecond variation in firing time, redundancy cannot be guaranteed. The Conax failure analysis report stated that reliability cannot be guaranteed without testing a fairly large number of cutter operations under varying environmental conditions.

A test program, to determine design adequacy, was negotiated between Conax, deHavilland and GE. However, this test program was not implemented. After further review, it was decided to drop the bolt cutter design approach because of the pyro device development problems. Several alternate boom release designs were investigated for possible replacement of the Conax cutter; two have been examined in detail.

The first alternate design employed a Hi-Shear explosive nut in conjunction with a clevis-type tip mass tie bar. On 13 September 1965, this concept was tested at deHavilland in a makeshift set up on a tensile tester. A severed explosive nut base resulting from this test was subsequently attributed to improper base support during testing. According to Hi-Shear, frequent failures of this type in industry have prompted them to strengthen the base of this design for future units, although they state that this failure will not occur if the mounting is proper. On 15 September 1965, two additional tests on this first alternate design were conducted at deHavilland in the same test setup but with proper base support. The nut base remained intact, but in both tests the bolt did not move to separate the clevis tie rod. These failures were attributed to the lack of margin between the basic variations to be expected from the power cartridges and the force required to separate the clevis

mechanism. Therefore, this approach has also been dropped.

The second alternate design, now undergoing development, will utilize an Avdel ball-lock device for holding and releasing the top masses. This ball-lock release mechanism will be actuated by either a Horex explosive thruster or a Hi-Shear explosive nut. Negotiations now underway with Avdel, Horex and Hi-Shear will determine which combination will best suit the application.

Other tie rod and release device combinations were given consideration in selecting alternate designs for actual testing. All combinations contained merit but in discarding each one the main consideration was that of reliability of operation.

### 3.3 ENGINEERING UNITS

#### 3.3.1 T1A PRIMARY BOOM ASSEMBLY

The first deployment tests on the T1A primary boom (Figure 3-1) at deHavilland gave indications of binding and excessive motor current during extension and retraction. Adjustment of the guides on the trolleys eliminated the binding. Application of teflon tape to the surface of the test track where the booms lay during deployment as well as the addition of a bearing on the extension output shaft reduced the drag that was causing the excessive motor currents.

Test equipment failure at deHavilland resulted in erection units being driven against mechanical scissor stops. Resultant damage necessitated unit tear down and subsequent replacement of gears in the scissor gear train.

After rebuilding, the T1A was tested to the requirements of SVS 7316 and work statement 9770-GGEP, bought off, and shipped to GE on 17 September 1965. The unit was bought off with the boom lengths, scissor angle, clutch solenoid operational voltage and pressurization not conforming to the requirements. Buy off of the pressurization "out-of-spec" conditions was on stipulation that GE would locate source of leak and deHavilland would retrofit to correct leakage problem at a later date. Buy off test data is as follows:



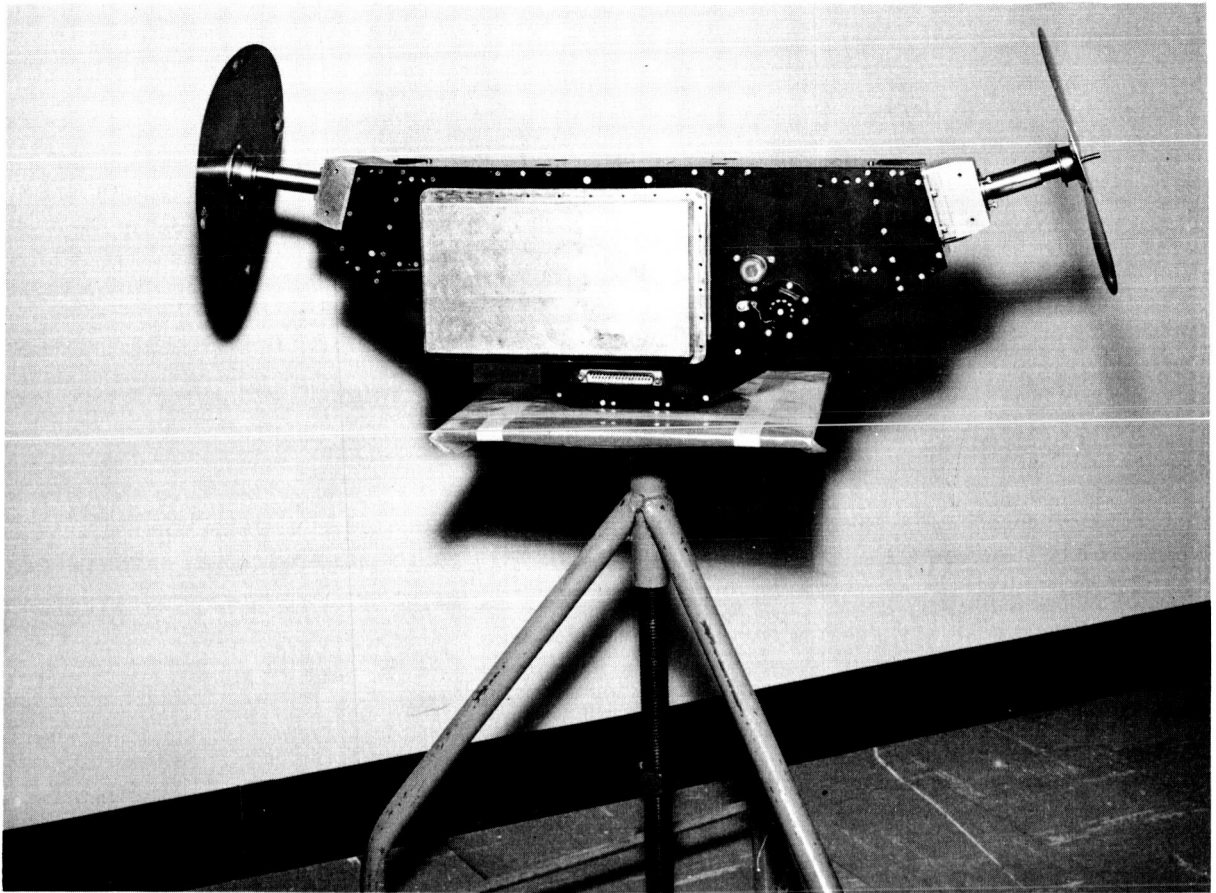

Figure 3-1. Engineering Unit T1A Primary Boom Package

a. Scissoring Angle

The required nominal acute half angle between the primary booms is 19 degrees. The actual measurements were: Boom 1,  $19^{\circ} 20'$  and Boom 2,  $19^{\circ} 0'$ .

The scissors mechanisms are to be capable of varying from the nominal angle to plus 12 degrees and minus 8 degrees simultaneously on both booms of a pair for a total of 20 degrees. The actual measurements were: Boom 1, plus  $11^{\circ} 45'$  minus  $6^{\circ}$ ; Boom 2, plus  $11^{\circ} 45'$  minus  $5^{\circ} 55'$  for a total of  $17^{\circ} 45'$  and  $17^{\circ} 40'$  respectively. This was a deficiency of  $2^{\circ} 15'$ . Design corrections will be made by SPAR Engineering to assure the scissoring mechanism will vary the required degrees and will be effective on Engineering Unit T1B. These angles were measured with respect to the theoretical centerline of the boom straightness envelope. An adjustable vernier protractor was used to check the angles. An inclinometer was suggested as a means of measurement but was not available, but will be used to check angles on Engineering Unit T1B.

Normal Scissor

From	To	Volts (dc)	Arm (amp)	Time		Field (amp)
				(min)	(sec)	
Out	In	22	0.110	3	39.4	0.100
In	Out	31	0.92	3	21.1	0.138
Out	In	31	0.89	3	15.5	0.132

Scissor Rate

Required/Sec		Actual		Volts (dc)
Min	Max	In	Out	
0.062	0.187	0.088	0.091	31 22

Emergency Scissor

From	To	Volts (dc)	Pulses	Pulse Width
In	Out	22	141	40
Out	In	22	133	40
In	Out	31	20	40
Out	In	31	24	40

b. Development Tests - Rate Required 1.5 Minutes, 3.0 Maximum feet/second

No. 1 Boom Assembly

Direction	Volts (dc)	Time		Distance Travel		Feet/Sec
		Min	Sec	Ft	In.	
Extend	22	1	25.7	134	10-3/8	1.88
Retract	22	1	40.5	135	2-1/2	1.62
Extend	31	1	11.5	135	2-1/2	2.30
Retract	31	1	17.0	135	7-7/8	2.00

No. 2 Boom Assembly

Direction	Volts (dc)	Time		Distance Travel		Feet/Sec
		Min	Sec	Ft	In.	
Extend	22	1	17.9	126	10-1/4	1.98
Retract	22	1	34.9	126	5	1.60
Extend	31	1	6.0	126	5	2.30
Retract	31	1	14.3	125	13-3/4	2.04

Boom Length

<u>Requirement</u>		<u>Actual</u>	
<u>Minimum</u>	<u>Maximum</u>	<u>No. 1 Element</u>	<u>No. 2 Element</u>
132 ft. 0.09 in.	132 ft. 0.59 in.	138 ft.	130 ft 2-1/4 in.

Room Diameter

<u>Minimum</u>	<u>Maximum</u>	<u>No. 1 Element</u>	<u>No. 2 Element</u>
0.480	0.520	Within requirements	Within requirements

Silver Plate Elements -- No straightness required.

c. Clutch Test

Operational at -35v dc only

Requirement - 22 to 35v dc

d. Leak Test

Unit was pressurized to 7 psia (compressed air) 22 psia registered on test equipment dial. Unit leak rate was 7 psia in 11 minutes 30 seconds.

Identification of erection unit and booms and scissor directions is shown in Figure 3-2. Since receipt of T1A at GE, the leak has been located in the center of the stainless steel scissor bellows, located on the Boom 2 side (LH) of the unit. This type of bellows will be utilized in engineering units only. Future units will employ CeCu bellows stressed to a lower lever.

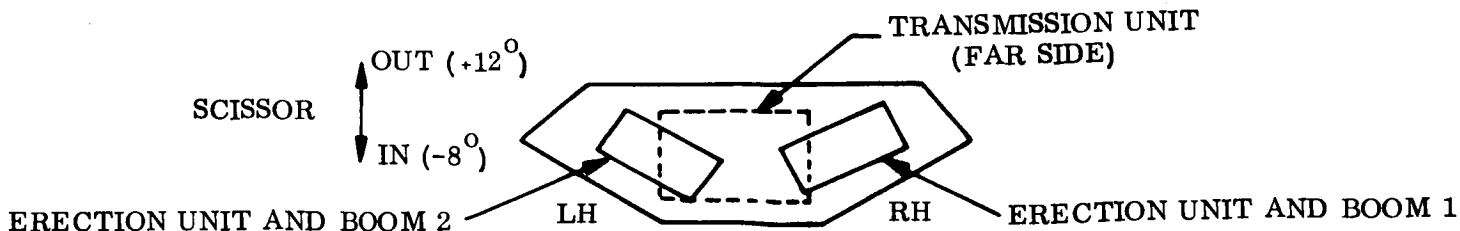

Figure 3-2. Erection Unit, Booms, and Scissors Directions

A complete circuit isolation, continuity and dc resistance check conducted at GE revealed that the -5v dc was shorted to the chassis. Subsequent trouble shooting traced the cause of short to an extension potentiometer hold-down-strap which was cutting through the insulation on the limit switch common lead wire. Redesign of transmisssion unit eliminates routing of wires near this strap in future units.

### 3.3.2 DAMPER BOOM (ENGINEERING UNIT T1)

The damper boom was deployed mechanically in a test conducted at deHavilland, but both ends of the boom did not deploy at the same rate. The problem was attributed to a change in friction on the copper brake shoe. The brake shoe was nickel plated, and additional tests were scheduled in which an actual bolt cutter and a replacement boom tape were to be used. However, the continuing difficulty with the squib-actuated bolt cutters resulted in a postponement in the planned testing with the bolt cutter.

An agreement was reached which enabled deHavilland to deliver the damper boom engineering model with a mechanical release rather than the pyrotechnic device. Plans included a retrofit to incorporate the new release mechanism after it is developed. Engineering Unit T1 of the damper boom was received by GE on 23 September 1965. The unit was tested at GE in ambient conditions. Faulty brake operation during GE tests caused one boom to "hang up" after it moved 3/4 inch away from the central body, but the other damper boom deployed properly.

The hangup was traced to a high spot on the brake lining of the centrifugal governor. The high spot was directly over a screw hold which is used to attach a cover plate. The hang up caused the bonding under the brake lining to break away from the housing in this area. Since this unit was successfully deployed five times at deHavilland with GE representatives observing the tests, it was theorized that a screw was subsequently inserted into this hole and forced the brake lining away from the housing.

The unit was reworked which included injecting adhesive behind the brake lining, and machining the ID of the lining to remove the high spot. The damper boom unit was retested and the deployment time occurred within one second of the time to full deployment which had been measured at deHavilland. The design will be changed to make the offending screw holes blind.

### 3.4 THERMAL AND DYNAMIC MODELS

The thermal units of the primary boom package and damper boom were received by GE from deHavilland on 3 August 1965. The units were retrofitted with resistances to simulate the anticipated thermal characteristics of the ultimate flight units (as further described in Section 6), and were accepted by NASA/GSFC on 3 September.

The dynamic models of the primary boom package and the damper boom were delivered to GE from deHavilland on 3 August. They were subjected to a vibration test to qualification levels. The dynamic models were accepted by NASA/GSFC on 13 September. The primary boom package was shipped to the Hughes Aircraft Company on 19 September, but the damper boom was retained with the permission of NASA, for an instrumented vibration evaluation in conjunction with the dynamic model of the Combination Passive Damper. Results of these detailed vibration tests are described in Section 4.2.4(B).

### 3.5 INTERFACE TOOLING

It was decided that the Hughes Aircraft Company will accept the interface tooling which was recommended by GE for installing the primary boom package into the spacecraft. The tool will enable HAC to drill mounting holes in the spacecraft to match the predrilled holes in the primary boom package. The tools are described in three GE drawings

101T103MP	Master Plate
101T104DJ	Drill Jig for deHavilland Use
101T105DJ	Drill Jig for HAC Use

These drawings were completed on 18 September. The 101T104DJ was hand carried to deHavilland and signed off 30 September. GE is awaiting approval by NASA/GSFC of the 101T105DJ before initiating manufacture of the jig for HAC.

### 3.6 TEST EQUIPMENT

The boom system test console and the test track will be used by GE for evaluation of both the primary and damper booms. The test console, shown at the right in Figure 3-3, simulates inputs from the Power Control Unit to initiate primary boom functions such as boom extension/retraction and scissoring. Damper boom deployment can also be initiated from the test console. Boom system performance is read from meters provided on the console or a 36-channel recording oscillograph.

The test track, shown at the left of Figure 3-3, consists of a 150-foot main section and a 10-foot section that is canted from the main track. During test of a primary boom pair, one of the rods is extended for its full length (132 feet for ATS-A booms). The rod is guided along the track by the test trolley (Figure 3-4) which rides along the rails. The second rod of the boom pair is extended at the same rate as the first, but it is reeled onto the spool of a take-up mechanism on the 10-foot track. The take-up mechanism is electrically operated from a power supply that is independent of the test console.

The damper boom is deployed from the center of the 150-foot test track to permit both ends of the boom to extend their full length.

### 3.7 INTERFACE CONNECTORS

GE was asked by NASA/GSFC to stop work on the connector location changes on the primary boom package. GE investigated the possibility of moving the boom major connector and the rf connector (for the rf experiment) to another location on the package. DeHavilland was directed to deliver the thermal unit as the connector had been originally designed, but the new connector location was included in the dynamic model.

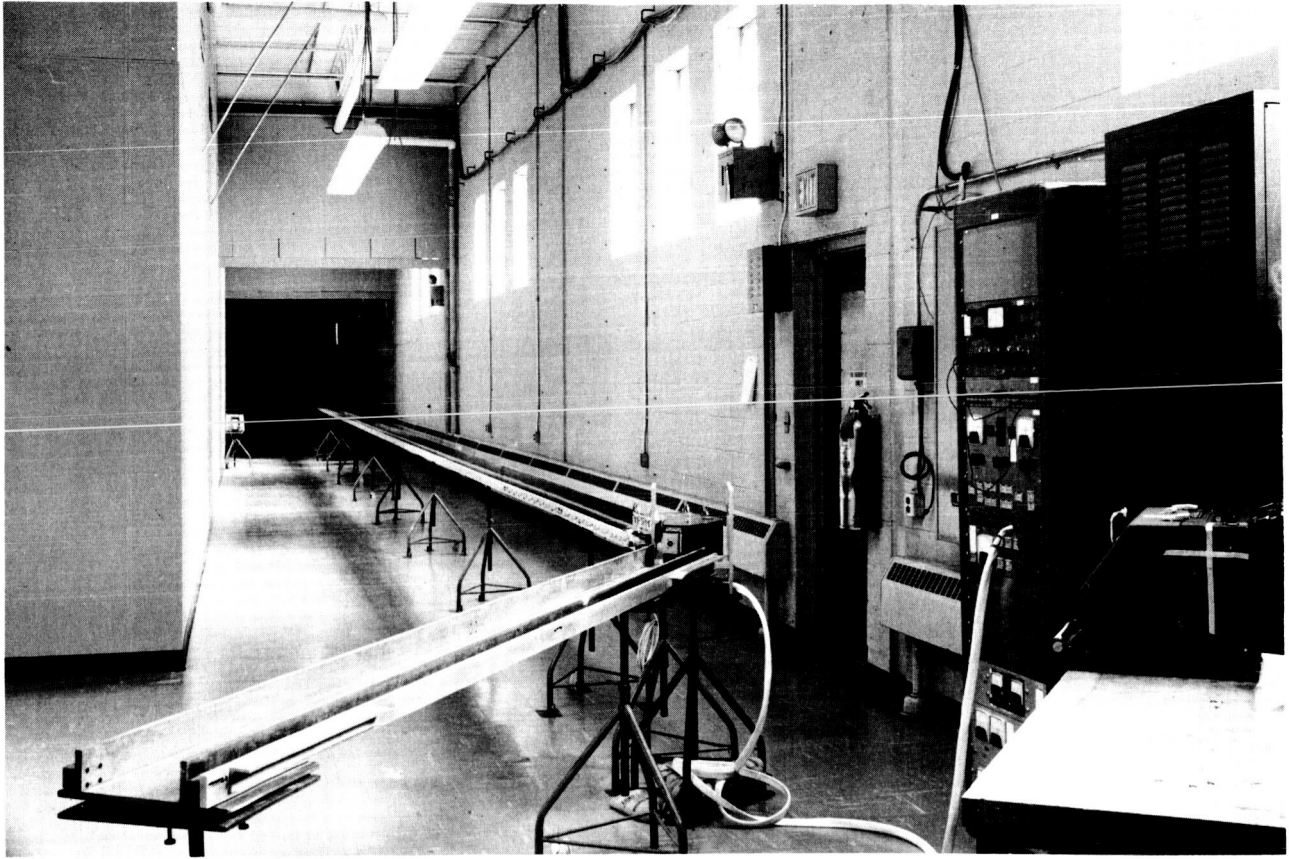

Figure 3-3. Test Track and Console for Boom System Evaluation at GE

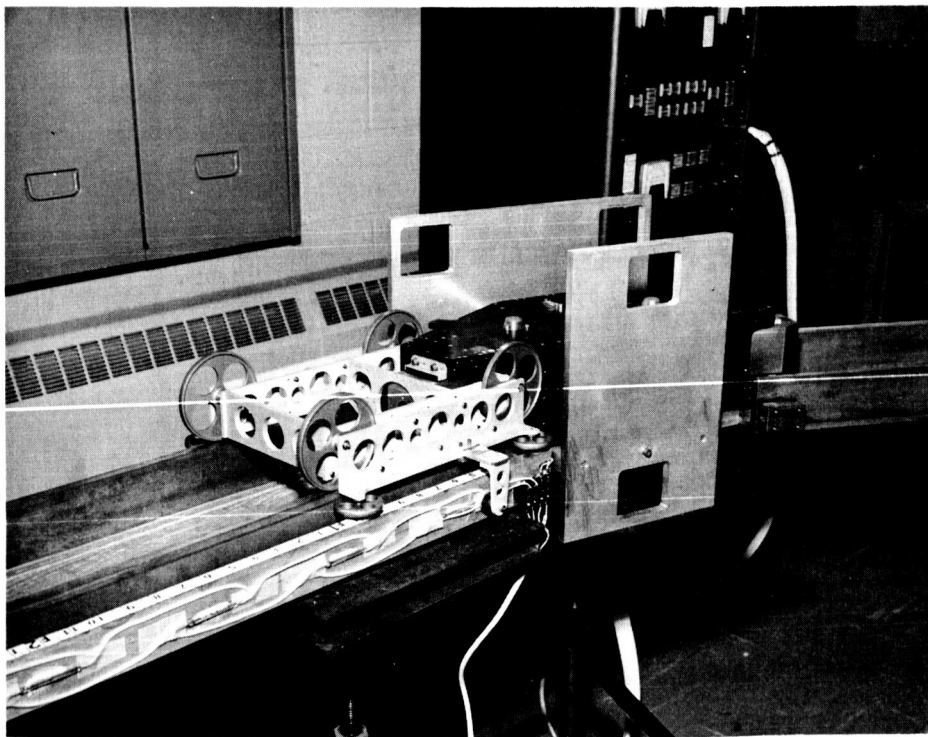

Figure 3-4. Test Trolley and Arrangement for Primary Boom Evaluation

SECTION 4  
COMBINATION PASSIVE DAMPER

4.1 INTRODUCTION

4.1.1 SUMMARY OF MAJOR EVENTS DURING REPORTING PERIOD

- 12 July 1965      A thermal shield design for the Combination Passive Damper was completed and given to NASA for coordination with HAC. No requirements or interface data had been received from HAC, and the thermal shield design was a "best guess" effort on GE's part in order to have a shield design and parts available for the Thermal Unit delivery.
- 17 July 1965      TRW, Inc. reported problems during vibration tests with the ATS-D/E torsion wire
- 27/28 July 1965      GE personnel visited TRW, Inc. to witness vibration tests of PHD Engineering Unit No. 2 which utilized the ATS-D/E torsion wire fix
- 30 July 1965      Vibration tests at GE on the CPD Solenoid proved conclusively that the solenoid must be caged to withstand the launch environment
- 3 August 1965      TRW, Inc. shipped PHD Engineering Unit No. 2 (ATS-D/E configuration)
- 11 August 1965      Completed assembly of the CPD Thermal Unit except for the revised resistors (heaters) which were installed 18 August
- 3 Sept. 1965      TRW, Inc. shipped PHD Prototype No. 1 (ATS-A configuration)
- 6 Sept. 1965      Started fixture survey tests on shaker in preparation for dynamic tests on the CPD Dynamic Unit



- 9 Sept. 1965 CPD Dynamic Unit assembled and delivered to be tested on the MB-210 Shaker Facility at GE
- CPD Thermal Unit shipped to HAC
- 12 Sept. 1965 Successfully completed vibration tests on CPD Dynamic Unit with no failures
- 16 Sept. 1965 Delivered corrected and signed CPD Interface Drawing to NASA for further coordination with HAC. This drawing included a revised thermal shield envelope as verbally requested by NASA and HAC.
- 21 Sept. 1965 Presented an informal design review of the CPD and associated components to NASA personnel at GE
- 27 Sept. 1965 GE personnel visited Bausch and Lomb to discuss fiber optics (used in the angle indicator) performance problems and methods by which the performance could be improved

#### 4.1.2 CPD SPECIFICATION STATUS

Table 4-1 lists the status of specifications directly applicable to and generated for the CPD.

#### 4.2 DESIGN DEVELOPMENT EFFORT

##### 4.2.1 GENERAL

During this reporting period, the detailed drawings were completed for the thermal model, dynamic model and engineering units. It was decided that the drawings used in the manufacture of the engineering units would be used, with a few minor exceptions, for the prototype and flight units. The changes could, in general, be limited to those required to incorporate high reliability electronic parts and to correct or eliminate errors made in initial

TABLE 4-1. SPECIFICATION SUMMARY

<u>Specification Title</u>	<u>Specification No.</u>	<u>Status</u>
Combination Passive Damper	SVS-7314	Issued 4 June 1965
Passive Hysteresis Damper	SVS-7331	Issued 5 March 1965
Electroexplosive Pressure Cartridge and Cable Cutter	SVS-5292	Issued 10 May 1965
Solenoid	R4612	Issued 14 May 1965, Revised 7 July 1965 to incorporate changes in design and testing requirements
Semi-Conductor Photo-Transistor, Silicon, NPN	R4615	Issued 10 July 1965
Pryolytic Graphite Simple and Complex Shapes	171A4211	Revised to reflect CPD requirements on 22 January 1965
Flexible Epoxy Adhesive	171A4402	Issued 17 September 1965; used for bonding pyrolytic graphite to aluminum support.

design or manufacturing obstacles discovered during the fabrication of the early models. The various activities associated with the engineering design effort are summarized below. The details of the fabrication and assembly of the first deliverable CPD units (thermal and dynamic models are also discussed briefly.

#### 4.2.2 COMBINATION PASSIVE DAMPER (CPD) PACKAGE

A detailed description of the CPD was published in the "Fourth Quarterly Progress Report" (pages 4-4 through 4-10). The CPD package is reprinted as Figure 4-1 of this report; the baseplate is shown on Sheet 1, the damper envelope on Sheet 2 and the details of the Passive Hystersis Damper on Sheet 3. A summary of the parts and their functions is given in Table 4-2.





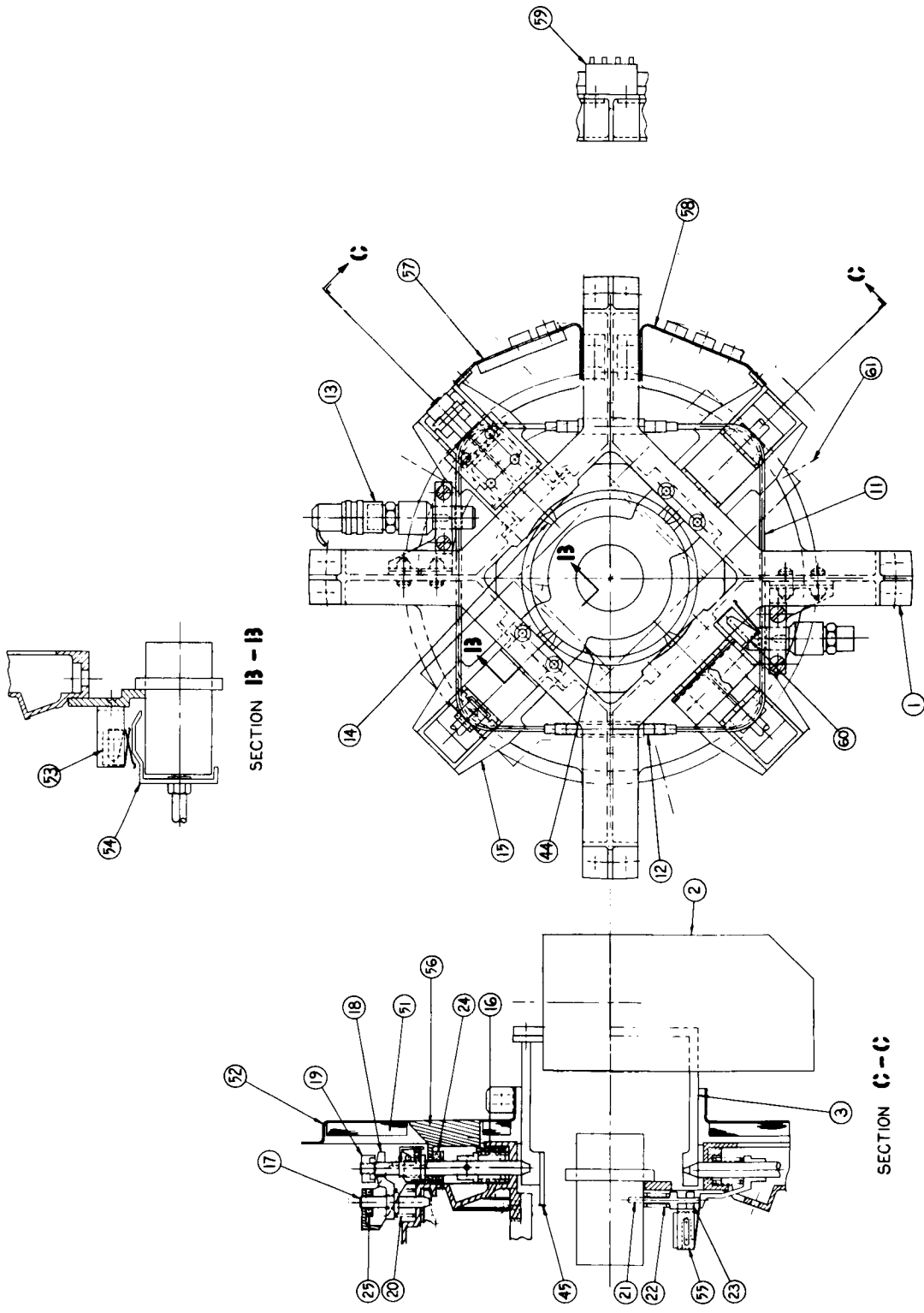

VIEW D-D  
(WITHOUT INSULATION BLANKETS,  
BOOM SHIRT & SOLENOID)

FIG. 4-1

Figure 4-1. Combination Passive Damper Package (Sheet 3 of 3)

TABLE 4-2. COMBINATION PASSIVE DAMPER PARTS AND FUNCTIONS

COMPONENT	FUNCTION	COMPONENT	FUNCTION
1. Base plate	Main structural member	31. Arm	Attaches eddy-current rotor to clutch plate
2. Damper boom package	Shown in stowed position. Stores the 90-foot damper boom	32} Suspension Magnets (20)	Supports eddy-current rotor
3. Damper boom shaft	Couples clutch housing to damper boom	33}	
4. Clutch housing	Clutches between damper boom and selected damping element	34. Pyrolytic Graphite rings	Diamagnetic material used in conjunction with suspension magnets to support eddy-current rotor
5. Hysteresis damper	Hysteresis damping mode	35. Pyrolytic Graphite rings	
6. Eddy-current damper	Eddy-current damping mode	36. Eddy-current damping ring	Actual eddy-current damping element
7. Inboard plate	Inboard suspension magnets	37. Eddy-current Magnets	Energy storage elements for eddy-current damper
8. Posts	Connects Inboard & Base plates Internally	38. Brackets	Attaches eddy-current magnets
9. Cover	Connects Inboard & Base plates Externally	39. Magnets	Provides torsional restraint element for eddy-current damper
10. Solenoid core	Used to actuate clutch on command	40. Torsional Restraint Pattern	
11. Cable, 0.125-in. diameter	Retains caging pins	41. Cylindrical Flange Extension	Provides read-out of angular relationship between damper boom and framework of the CPD (i.e., the spacecraft)
12. Turnbuckle	Provides tension to cable	42. Angle indicator head	
13. Gulliotine	Shears cable to uncage dampers. Squib actuated	43. Angle indicator discs	Constitutes "hard" stop on rotation of damper boom
14. Main Caging Pins	Cages damper boom to CPD framework	44. Faces (on solenoid support bracket)	
15. Pin Bracket	Supports caging pins	45. Arms	Fixed portion of soft stop
16. 49-pound Spring	Retracts boom caging pins in base plate	46. Pins (2)	
17. Pin	Cages eddy-current damper to framework	47. Spider	Supports insulation pad and rotating part of soft stop
18. Fork	Restrains eddy-current caging pin	48. Torsion Wire	Contracts pins and provides required restraining torque for soft stop
19. Nut	Loads boom caging pin	49. Crossbar	
20. 25-pound Spring	Retracts eddy-current pin	50} Insulation Blanket (2)	Provide thermal shield for CPD
21. Pin	Cages solenoid core	51}	
22. 10-pound Spring	Retracts solenoid caging pin	52. Aluminum Sheet	Signals position or solenoid (i.e., damping mode in use)
23. Guide	For solenoid caging pin	53. Switches (2)	
24. Buna-S Rubber Cushions	Absorb energy of boom and eddy-current caging pins, respectively	54. Ramp	Indicates uncaging of damper
25. Buna-S Rubber Cushions		55. Switch	
26. Eddy-Current Clutch Plate	Couples eddy-current damper to boom	56. Bracket	Mounting for catcher bracket from damper boom
27. Coned Diaphragm	Holds selected clutch plate in contact with clutch housing	57. Bracket	Holds electrical connectors for catcher gulliotine
28. Pivot Ring	Absorbs reaction of force holding clutch faces in engagement and acts as pivot for coned diaphragm	58. Bracket	Mounting for all other connectors
29. Hysteresis Clutch Plate	Couples hysteresis damper to boom	59. Electronic Module	
30. Activator Spool	Pushes diaphragm over center when activated by solenoid	60. Switches (2)	Indicate when damper booms have extended
		61. Pin	

## A. Design Effort

Work during this quarter was directed toward detailed design and construction. The final assembly drawing of the CPD (GE Dwg 47E207100) was issued on 3 August. The thermal shield was redesigned upon the verbal request of NASA to meet interface requirements of the spacecraft. This redesign will be effective on Prototype No. 1. The CPD envelope drawing (GE Dwg 47D207098) has been updated.

The CPD handling tool (GE Dwg 47E207487) was designed, and the drawings were released. The first handling tool was fabricated in time to be included with the shipment of the Thermal Units to NASA early in September.

A mockup of the CPD (GE Dwg SK56152-142) was designed, and the drawing was released for fabrication estimates on 9 September. However, a later decision cancelled plans to build the mockup.

## B. Testing

Three Belleville springs, one of which is used in the CPD clutch, were tested for force versus deflection with a molybdenum pivot ring. The pivot ring had been given an oxide treatment for corrosion protection. The springs were fabricated with the use of regular manufacturing tools. These springs produced more uniform results than the experimental springs which were previously tested. Results have not been fully analyzed, but indications are that the springs will be satisfactory for use in the Engineering Model and that the design can be used in prime hardware. The molybdenum ring showed much better resistance to wear from the action of the spring than the stainless steel rings which had been used in previous tests.

The cable (GE Dwg 47C207134 G2), to be used in caging the dynamic model of the CPD was calibrated on 18 September. The cable is of 1/8-inch diameter, made of stainless steel with seven bundles of 19 strands each. The length was measured with a vernier caliper over reference blocks which were clamped to the cable. The distance over the blocks was set at

approximately 4.25 inches, the length which was to be used to adjust the cable on the damper. The design load of the cable is 800 pounds. As a result of the test, the cable on the Dynamic Model was stretched 0.032 inch over the initial 4.25-inch measurement, by the design load. The cable performed satisfactorily in the test; Figure 4-2 is the calibration curve obtained from the test.

A test was made on 7 September to determine the torque required for setting the eddy current caging pins. The test fixture (shown in Figure 4-3) was set up in the testing machine with an actual caging pin, adjusting nut, and guide installed. A sketch of the test arrangement is shown in Figure 4-4 together with the torque versus load results.

The end of the three studs rested against a steel plate which was, in turn, cushioned by a thick piece of foam material resting on the platen of the universal load testing machine. The foam was used to produce more "give" in the system so that the load would not change appreciably with slight changes in adjustment of the nut. The holes in the plates of the test fixture had the same diameter and tolerance, and the bearing length of the holes was the same as in the

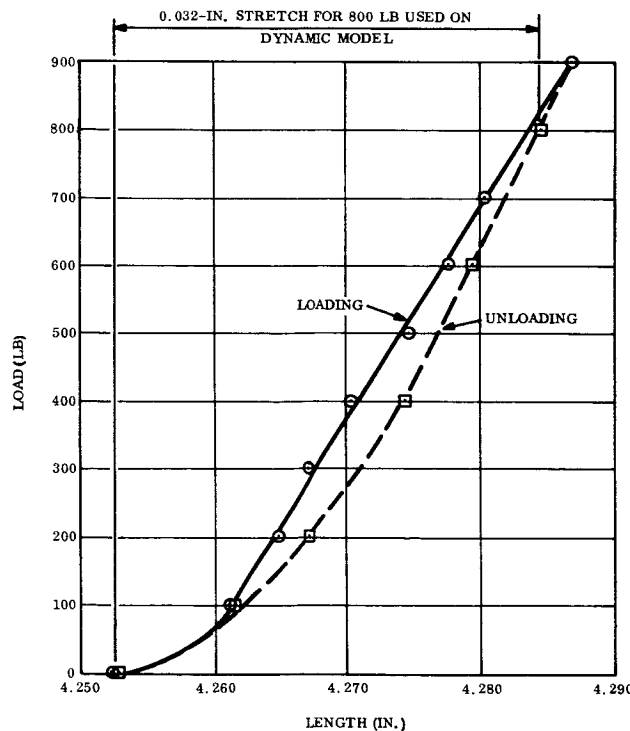

Figure 4-2. Caging Cable Calibration Results



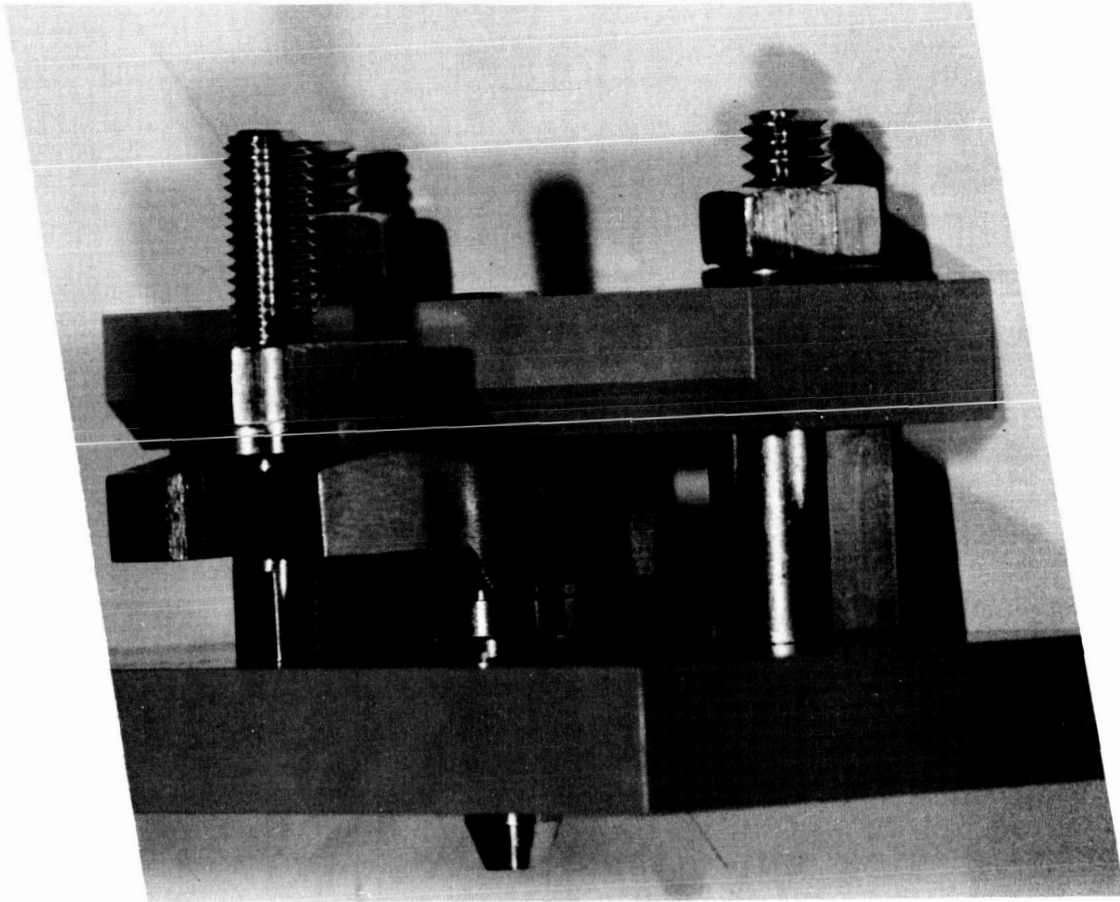

Figure 4-3. Caging Pin Torque Fixture

actual parts of the CPD which were being simulated. The holes were anodized, as in the actual parts. The torque readings were taken with a torque wrench having a calibrated 7-inch torque arm. This wrench was used with a 1-inch-long open end extension to fit the adjusting nut to give a total torque arm of 8 inches. This combination gives a true torque which is  $8/7$  times the torque read from the wrench; the reading was recorded. The torque action was rather erratic and is plotted as a range rather than a single value. Two tests were run with the nut turned 90 degrees between tests to present a new surface to the guide. Both the nut and guide showed some local deformation at the higher loads. The design load on the eddy current caging pin is 300 pounds. To give this load, the adjusting nuts on the Dynamic Model were tightened to 25-inch pound reading on the wrench. They performed satisfactorily on the vibration tests. The nuts showed less local deformation than in the test (the load was less). The local deformation probably helps prevent loss of adjustment.

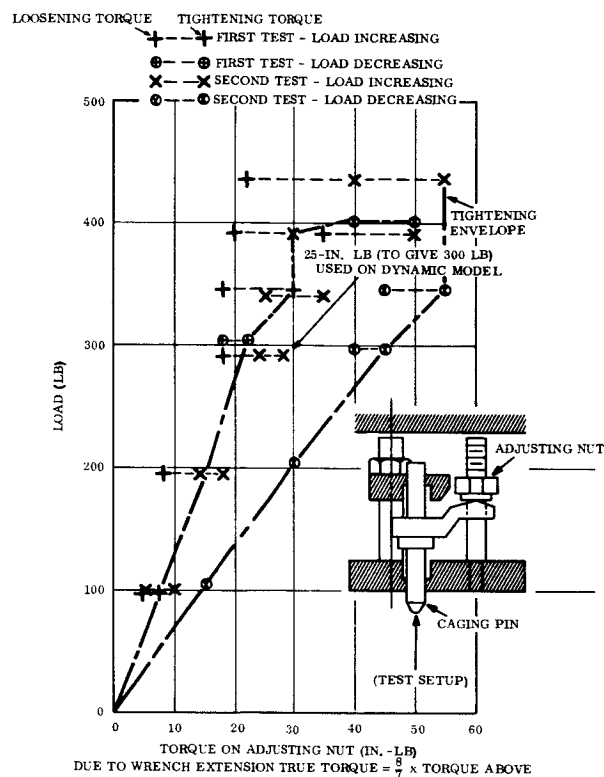

Figure 4-4. Eddy Current Caging Torque Test Results

### C. Magnetic Dipole Tests

It is specified that the magnetic dipole of the CPD not exceed 100 pole-centimeters; i. e., the torque on the CPD due to interaction with an ambient magnetic field should not exceed 100 dyne-centimeters per oersted of ambient field.

In order to evaluate the magnetic dipole characteristics of the CPD, a magnetic mockup was constructed to simulate the magnetics of the final design. This mockup contains all the magnets and magnetic materials used in the CPD. The mockup was suspended from a torsion wire in a known magnetic field and the resulting torques were measured for all three axes.

In this series of tests, various combinations of magnet polarities were tried in an attempt to minimize the net torque. The net magnetic dipole vector, for the polarity configuration chosen for the CPD, was determined from these tests to be approximately 450 pole-centimeters, or 4.5 times greater than the specified maximum of 100 pole-centimeters.

In a future series of tests, compensation magnets will be added to the CPD, in order to reduce the magnetic dipole to the specified value.

#### 4.2.3 THERMAL MODEL

Manufacture, assembly, and test of the CPD Thermal Model was completed during this reporting period. This unit, shown in Section 6, was successfully subjected to temperature cycling between  $-37^{\circ}\text{F}$  and  $+177^{\circ}\text{F}$  in order to confirm the quality of the thermal coatings, and to check the performance of the heater and thermocouple circuits under temperature extremes.

#### 4.2.4 DYNAMIC MODEL

##### A. Design Effort

The final assembly drawing for the CPD Dynamic Model (GE Dwg 47E207390) was issued on 17 August. The model was assembled under engineering supervision and vibration tested as reported in Section 4.2.4(B). Following vibration the model was disassembled and inspected; re-assembly was completed by 22 September. The model is shown in Figure 4-5 with the damper boom mounted in the stowed position.

The Dynamic Model is intended to serve two basic purposes: 1) use by HAC in the ATS system vibration test and 2) use as a design adjunct by GE to provide data on:

- Dynamic integrity of the CPD through in-house testing in advance of such testing on Engineering Unit No. 1
- CPD/Boom interface dynamic environment
- Vehicle/CPD interface dynamic environment as a result of HAC tests.

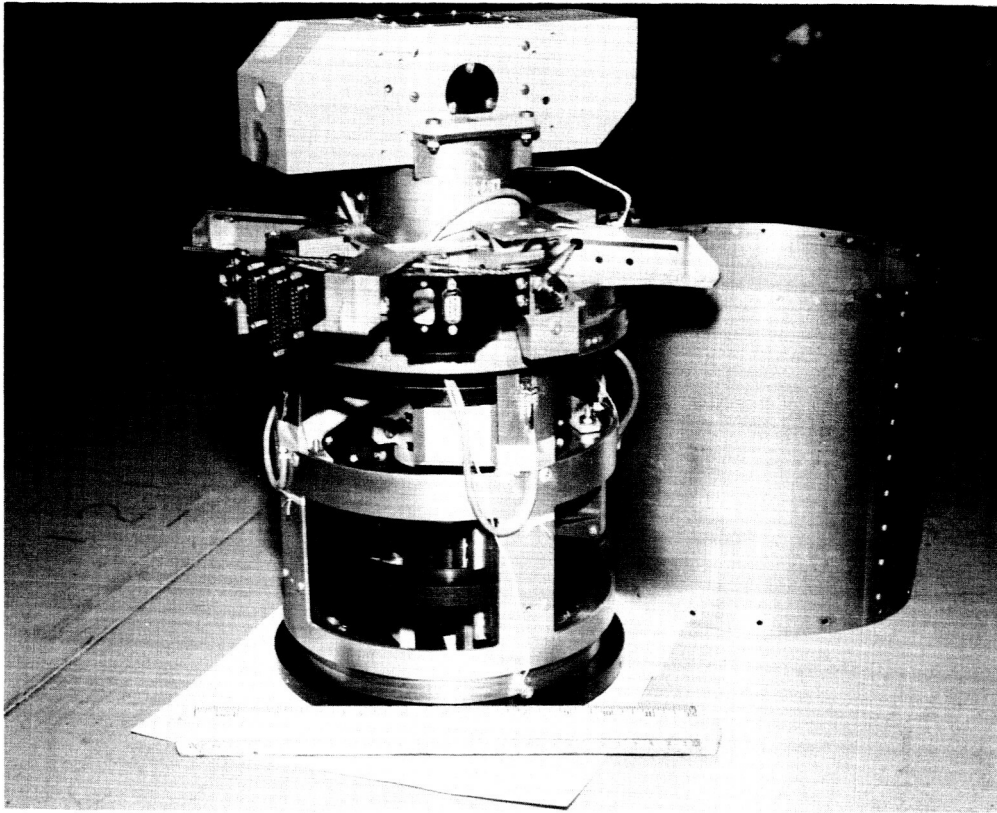

During Inspection

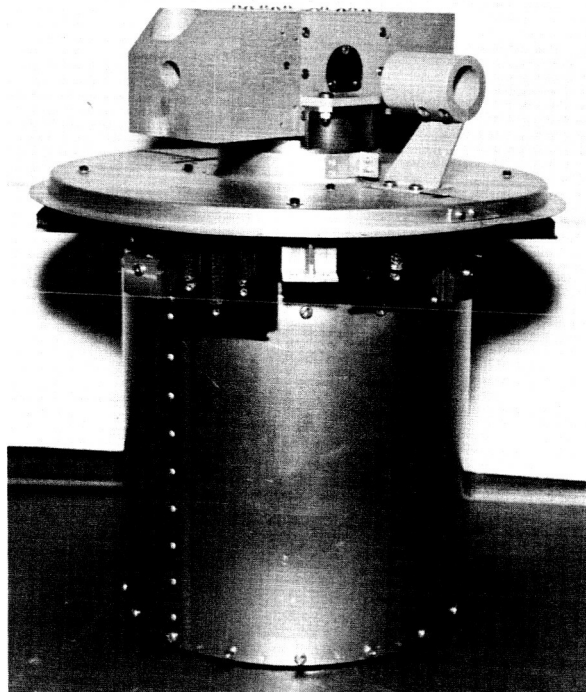

After Re-Assembly

Figure 4-5. CPD Dynamic Model

To meet these objectives, all parts which have a significant effect on the dynamic response to the CPD were incorporated into the model. Most of the parts used were made to reduce cost of manufacture without compromising design integrity. Fastening substitutions which are not likely to affect the dynamic response were made in order to meet the delivery schedule. The drawings were changed to reflect these substitutions. Ballast was added to replace some parts which had to be omitted so that the schedule would be met. This ballast simulated actual loading and resulted in the same total weight and center of gravity as had been calculated for the engineering model.

During the vibration test, described in Section 4.2.4(B) the alodine finish in both the straight and tapered caging pin holes were partially worn off. Anodized finish will be used in these holes for the engineering, prototype and flight models. In addition, a finer machine finish will be specified on both holes and pins. Plain anodizing was used on the clutch faces in the Dynamic Model. The wear marks resulting from the vibration test verified that hard anodize, as specified for engineering and future units, is desirable. The caging cable tension was checked after the vibration test, and it showed no change. The torque on the eddy current caging pin adjusting nut and on a number of the more critical fastenings was checked after the test; none of these showed significant change. No scraped finish or other indication that parts had moved during the test was observed.

The experience gained in manufacture and assembly of the Dynamic Model will be applied to the fabrication of future models.

The CPD Dynamic Model Interface drawing (GE Dwg 47C207929) was issued on 22 September.

#### B. Dynamic Model Vibration Test Summary

A sinusoidal vibration test of the CPD Dynamic Model and its fixturing was performed by GE during the week of 6 September on the C-210 Shaker Facility at the Valley Forge Space Technology Center. The test resulted in the acquisition of useful engineering data and a demonstration of the ability of the ATS-A Combination Passive Damper configuration to

withstand qualification-level vibration without structural failure. The test plan is given in Appendix B.

Test data were recorded on two reels of magnetic tape. Recorded test data has been reduced to X-Y plots. Following the vibration test, the Dynamic Model was inspected as described in Section 4.2.4(A).

### 1. Model Description

The CPD Dynamic Model is a non-functioning component which properly represents the geometric, inertia and stiffness properties of the prototype CPD. It was mated with a non-functioning model of the self-erecting boom package with ATS-A tip weights. Four additional tip weights were provided for ballasting this configuration to the ATS-D/E configuration.

### 2. Test Fixturing, Instrumentation and Vibration Test

Instrumentation on vibration model consisted of 16 accelerometers and 10 strain gages (as specified in Appendix B), a tri-axial input accelerometer for monitoring the fixture control point motion, and a control accelerometer.

Testing proceeded as specified and an additional scope test was performed to determine the low level response characteristics of the CPD in the ATS-D/E configuration.

### 3. Examination of Specimen

At the conclusion of all test runs the component was unfixtured, disassembled and examined as described in Section 4.2.4(A). No structural failures were found.

#### 4. Data Release

X-Y plots were gathered into six reports and released during the week ending 26 September. A final test report is scheduled for release during the week ending 10 October.

#### 5. Results of Fixture Survey

From the fixture surveys it was determined that the fixturing is controllable in the Y-axis direction, uncontrollable, for random, in the X and Z directions. As a result of conversations with design personnel, the "cannon" fixture has been modified, a slab for horizontal testing is being designed, and damping tape is being obtained for use in attenuating fixture high-frequency response.

#### 6. Results of Component Test

Principal resonances of the vibration model were found to agree with analytic predictions. Damping was found to increase with amplitude. Response amplitude at five times the low-level input were about twice as great as obtained at low level. Strain gage readings showed that stresses were less than 6000 psi at qualification levels. Amplification factors were generally less than 4; a few spikes ranged as high as 9.

##### 4.2.5 SOLENOID

###### A. Vendor Activity

Koontz-Wagner delivered Engineering Units 1 and 2 of the solenoid during this quarter. Delivery of Engineering Unit 2 was late because of difficulty in obtaining good quality wire for the solenoid. Koontz-Wagner has completed all basic parts for the prototype, qualification and spare units. They are presently in the process of winding the coils and assembling the units prior to final testing. Delivery of the prototype and spare units is scheduled for 1 October. Qualification tests are scheduled to begin at Koontz-Wagner on 4 October.

All materials and processes used by Koontz-Wagner has been approved by GE, as well as test procedures, testing equipment, flow plans and other software.

#### B. In-House Testing

Testing of Engineering Unit 1 has been completed and the unit will be installed into the CPD.

Testing of the unit was accomplished in accordance with the engineering test plan except that the spring actuation test was omitted (no springs were available) and vibration and dipole tests were added. Figure 4-6 shows the force versus travel characteristics for the solenoid with temperature and voltages at the extremes. All functional testing was done at room temperature. The voltage and temperature extremes were simulated by controlling the coil current in the solenoid.

Figure 4-6 also shows a curve for an input to the solenoid of 18.6 volts at a temperature of 66<sup>o</sup>C. It fails, by a very slight margin, to meet the force required at 0.2 inch of travel (16-pounds required, 15.5 pounds measured.) This test was performed to determine the minimum voltage the solenoid could tolerate at its maximum temperature and still meet the force versus travel requirements.

Present indications, based on the testing of two solenoids (one at Koontz-Wagner and one at both Koontz-Wagner and GE), are that the minimum allowable solenoid voltage to meet the force versus travel requirement is 18.78 volts. This value is based on:

- Maximum solenoid temperature: 60<sup>o</sup>C (latest input from thermo-analysis)
- Maximum push coil resistance at 24<sup>o</sup>C: 2.660 ohms
- Minimum coil current: 6.20 amperes.



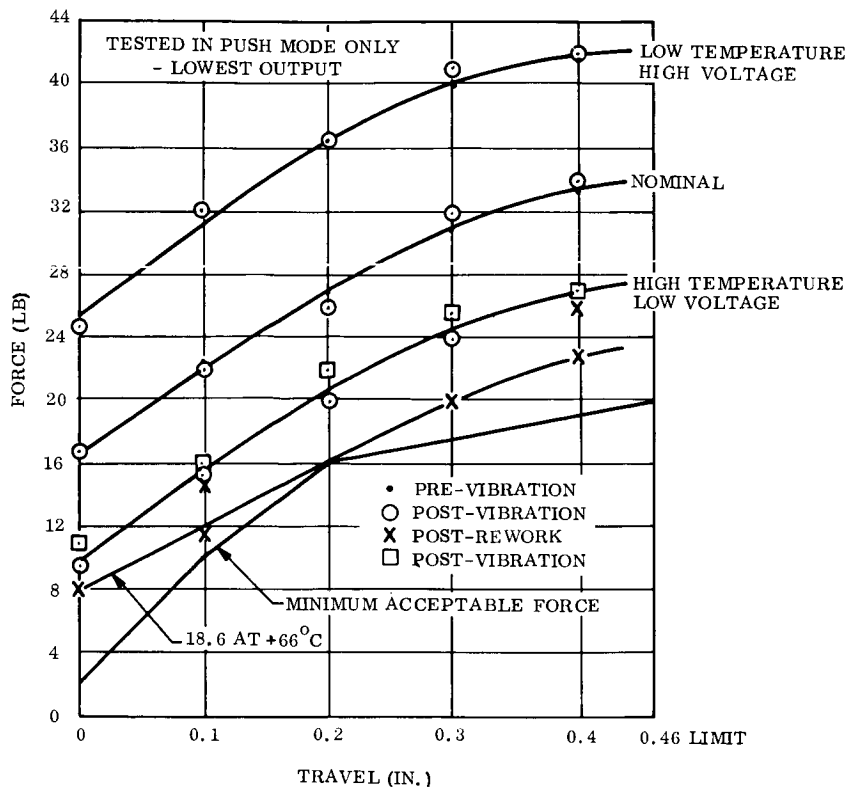

Figure 4-6. Force Versus Travel Test Results for Engineering Unit 1 Solenoid

The above information seems very reasonable based on test results to date. If this information is assumed to be correct, a voltage drop of 5.32v dc exists between the unregulated voltage bus and the solenoid (when the solenoid is at + 60°C, the push mode winding is at a maximum resistance, and the unregulated bus is at a minimum of -24.3v dc), and the solenoid would actuate the clutch mechanism.

The solenoid lower voltage limit is presently specified at -22.3 v dc.

As noted in the Monthly Progress Report for August, the solenoid passed the vibration testing with no degradation in functional performance. At the completion of the vibration test with the solenoid caged (designed configuration) another vibration test was attempted in the uncaged mode. The solenoid was damaged at the beginning of this test (pole faces loosened when plunger impacted on them) and the test was halted. It has been decided to cage the solenoid as initially planned, since this impacting could damage the clutching mechanism as well as the solenoid.

#### 4.2.6 EDDY CURRENT DAMPER

##### A. Magnetic Torsional Restraint Materials Investigation

As stated on page 4-13 of the Fourth Quarterly Progress Report, the material selected for the torsional restraint pattern is Eastman Sound Recording Tape, Type A303. The hysteresis characteristics of this pattern for ATS-A have been measured for various oscillation amplitudes. These characteristics are shown in Figure 4-7. Also shown are the energy dissipation characteristics of the eddy-current damper for ATS-A. The data show that, for oscillation amplitudes below 15 degrees, more energy is dissipated by hysteresis in the torsional restraint pattern than by eddy currents in the eddy-current damper. It is clear that a pattern material with much lower hysteresis would permit a much improved evaluation of eddy-current damping.

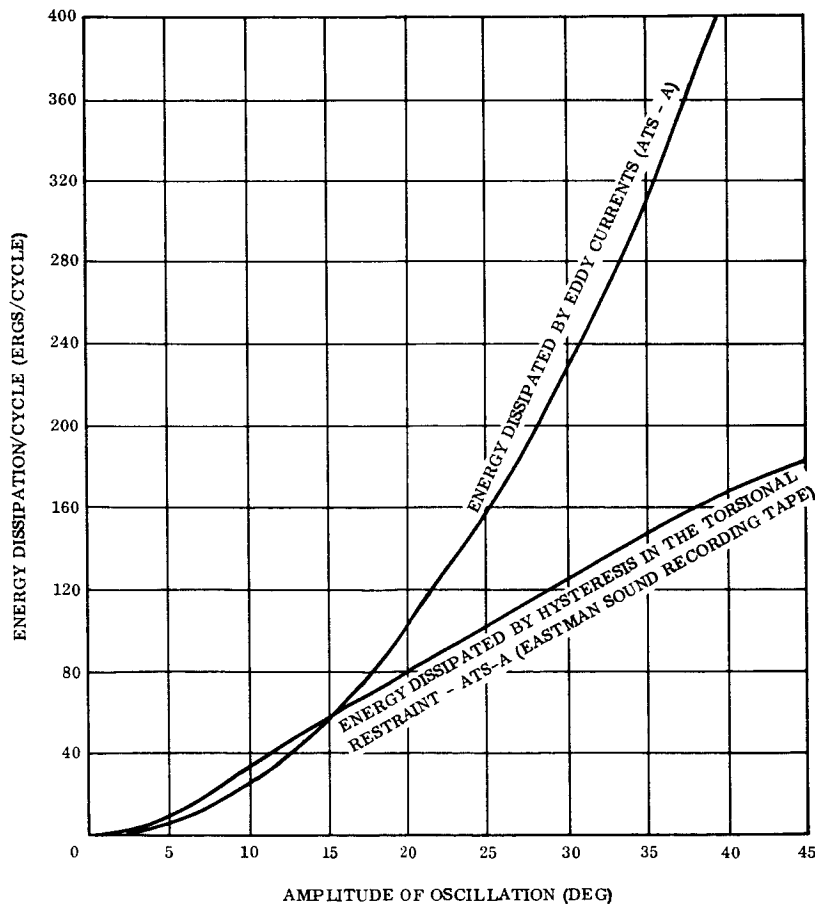

Figure 4-7. Energy Dissipated by Eddy Currents and Hysteresis in Torsional Restraint Versus Amplitude of Oscillation (ATS-A Eddy-Current Damper)

The investigation of low-hysteresis materials for the Eddy-Current Damper magnetic torsional restraint device has been concentrated in the area of testing laboratory samples of magnetic powder dispersions in epoxy resin. This type of material provides the most flexibility in design because specimen thickness and the concentration of magnetic powder can be varied as well as the type of powder to provide the desired performance characteristics.

The main difficulty to be overcome with the dispersion-type materials has been non-linearity due to voids and non-uniformity of the dispersion. The formulation technique has been improved with successive laboratory samples such that acceptable linearity is now being obtained.

Samples of nickel, cobalt, electrolytic-grade iron and carbonyl-iron-powder dispersion have been formulated. Of these, only the iron powders produced less hysteresis than the presently specified magnetic tape. Carbonyl iron is vastly superior because it produces negligible hysteresis.

Initial tests of carbonyl-iron-powder dispersions indicated a characteristic of relatively strong lateral force but subsequent tests with variations in thickness of specimen, percentage of iron, and magnetic flux have produced sufficient data so that it now appears possible to hold the lateral force to an acceptable level.

Preliminary indications are that the hysteresis produced by carbonyl iron is negligible for small as well as large angles and that the magnetic performance is unaffected by temperature changes over the CPD operating temperature ranges. Both temperature and small angle tests will be evaluated further during the coming reporting period.

Tests to date have utilized crescent-shaped specimens mounted on a flat disc. The parabolic shaped pattern mounted on a cylindrical rotor will be used for future tests to specifically define the torsional restraint pattern requirements for both ATS-A and ATS-D/E. Material and process specifications for the carbonyl-iron-powder/epoxy dispersion material will also be prepared during the next reporting period. It is anticipated that the carbonyl-iron-

torsional restraint pattern will be available in time to replace the magnetic tape during the early phases of testing of the engineering units.

#### B. Diamagnetic Suspension

The pyrolytic graphite rings for the engineering units were received and tested. The repulsion forces between the pyrolytic graphite and a suspension magnet were found to agree with the specified nominal force within about 5 percent. The nominal force characteristic was shown in Figure 7 of Appendix A of the Fourth Quarterly Progress Report.

#### 4.2.7 PASSIVE HYSTERESIS DAMPER

##### A. Subcontract Activities

TRW delivered Engineering Unit 2 and Prototype 1 of the Passive Hysteresis Damper during the quarter. All software and materials and processes were updated by TRW and approved by GE. TRW engaged in an extensive development program on the ATS-D suspension system since wire breakage occurred during vibration testing when the ATS-A suspension system was used. The problem was solved by redesigning the suspension system and a series of vibration tests were performed to confirm the reliability and integrity of the design. (See TRW Report 65-9711-51 Section 4.2.7.3 in appendix.) TRW is presently running functional tests on Prototype 2 prior to early October delivery to GE and are also beginning the ATS/D wire qualification tests.

##### B. In-House Testing

Engineering Units 1 and 2 have been subjected to dipole tests. Results of these tests indicate that the Armco Iron cover is the major contributor to the dipole of the damper. The damper without the cover exhibits an unsymmetrical quadrupole; however, with the cover installed, the dipole is dominant. The value of the dipole can be reduced to values between

5 to 10 pole-centimeters if the cover is demagnetized. This procedure will be accomplished prior to installing the passive hysteresis damper into the CPD.

A short radial force test was performed on the LOFF. Data indicated less than 0.002-inch displacement of the hysteresis damper rotor with 1288 dynes applied. This brief test confirmed the basic suspension calculations and no further tests were performed on the LOFF. The stiffness of the hysteresis damper suspension is very adequate since the specified force to bottom the damper in the radial direction is a minimum of 100 dynes.

Damping and torsional restraint tests were begun; however, instability in the electronic measuring system prevented acquisition of precise data. Modifications will be made to the system to provide for acquisition of reliable data.

#### C. 'Bow-Tie' Development

The development of a 'Bow-Tie' hysteresis damper which has a damping characteristic that more closely approaches the optimum damping times of the spacecraft was discontinued on 7 July by direction from NASA.

#### D. Passive Hysteresis Damper (PHD) Development Vibration Testing (ATS-D/E Configuration)\*

##### 1. Introduction and Objective

Development tests have been conducted on the PHD in the ATS-D/E configuration to ensure that the unit will survive qualification vibration test levels (Ref. 1) and also not exhibit a large null position shift due to this vibration.

Early during the PHD project the Development Model had survived a full qualification level test along all three axes in this configuration. Results of this test led to the elimination of the caging mechanism from the damper design. Subsequent tests on the Development Model to explore null position shifts due to vibration, however, resulted in failures of the 0.003-inch

\*TRW Report 65-9711-51, dated 17 August 1965

wire used for ATS-D/E. When Engineering Unit 2 also had a wire failure during vibration, a new development program was initiated for the suspension system.

The development tests were conducted on the PHD Development Model and Engineering Unit 2. The test procedure used was that specified in Reference 2, with minor changes due to intermediate results. The standard air-melted, 0.003-inch 302 cres wire was used throughout the tests. Most of the wire had been qualified per Reference 3 but samples were also used that came both before and after the qualified section of wire on the spool. Properties of the recently obtained vacuum-melt wire will be studied during some additional testing for the flight units.

## 2. Summary of Results

Thirty-three vibration tests were performed on the two units. The input used was the worst axis (Z-Z) of the Qualification Sinusoidal Vibration Schedule (Table 4-3) at a one-octave-per-second sweep rate instead of the two-octaves-per-second prescribed in Reference 1. The results of the tests are tabulated in Table 4-4.

All broken wires were examined (discussed in detail in Reference 4) to determine the nature or cause of the failure. These results are summarized in Table 4-4. Their conclusion was that, for all but one of the failures, the wire failed in a brittle manner. Several failures were identified as resulting from fatigue, but no conclusion could be reached as to whether a material defect in the wire was the cause of any of the failures.

Various means of reducing the stress levels in the wires were investigated that would also help minimize the rotational null shifts. Items that were investigated included: soft rotor stops, flexure end stops, reduced wire tension, reduced rotor stop distances, a revised flexure design with reduced tip mass, epoxy attachment of the wire, Silastic attachment of the wire, and clamps instead of mandrels on the rotor.

TABLE 4-3. SINUSOIDAL VIBRATION SCHEDULE PHD  
DESIGN QUALIFICATION, PER SVS-7331

FREQUENCY (cps)	AXIS	LEVEL (0-peak g)
10-36.5	Thrust Z-Z	0.5
36.5-250		34.5
250-400		18.5
400-2000		7.5
10-29.5	Lateral	0.5
29.5-250		22.5
250-400		15.0
400-2000		7.5

The results of the early tests on the Development Model and Engineering Unit 2 are shown as Tests 1 through 3 in Table 4-4. The development program started with Test 4. Most of the early configurations explored resulted in either wire failures or excessive null position shift. As seen in Table 4-4, failures occurred in Tests 4 through 8 as some of the previously mentioned items were investigated.

When the hook flexures were installed (Test 9 to 32) the wire was able to survive the qualification test environment. One set of wires successfully passed through qualification levels four times (Tests 10, 10A, 11, and 12) without failure but had null shifts on the order of 10 to 15 degrees. A test-to-failure was run on this configuration and the wire failed at 40g and 350 cps (the prescribed input at this frequency is 18.5g). An apparent correlation was found between the direction in which the rotor was oriented during the latter stages of the vibration test and the direction of the null position shift. When the rotor was rotated clockwise onto the stop it nearly always resulted in a shift to the left on the chart and vice-versa for a counter-clockwise rotation.

TABLE 4-4. PASSIVE HYSTERESIS DAMPER VIBRATION TEST DATA

Test No.	Date	Time	Model	Location	Item Investigated	Number Failures	Wire Tension (lb)	Adapter	Wire Source	Type Flexure	Flexure Spring Rate (lb/in.)	Rotor Attachment	Flexure Attachment	Point of Failure	Frequency at Failure (cps)	Type of Failure	Null Shift & Direction (deg)	Remarks
1	2 June	4:00p	Dev-elop-ment Model	FTT	-	0	0.7+	Dummy	Before Quali-fied Section	Double	10	Steel mandrel	Steel mandrel	-	-	-	-	-
2	16 July	4:00p	Model	EML	-	2	0.7	Dummy	After Quali-fied Section	Double	10	Steel mandrel	Steel mandrel	Flexure (1) Rotor (1)	60-80	7	-	-
3	17 July	8:00a	EU 2	FTT	-	1	0.7	Actual	Quali-fied	Double	20	Titanium mandrel	Titanium mandrel	Flexure (v-end) Rotor	< 500	5	-	PHD adapter only
4	17 July	3:00p	EU 2	EML	Teflon rotor stops	1	0.7	Actual	Quali-fied	Double	20	Titanium mandrel	Titanium mandrel	Rotor	220	1	-	-
5	19 July	3:30p	Dev-elop-ment Model	EML	End stops on flexures	1	0.7	Dummy	After Quali-fied	Double	10	Steel mandrel	Steel mandrel	Rotor (anodized end)	320	7	-	One stop bent out during test
6	19 July	4:30p	EU 2	EML	Repeat of 5	1	0.7	Actual	Quali-fied	Double	20	Titanium mandrel	Titanium mandrel	Rotor (v-end)	210	2a	-	-
7	19 July	8:15p	EU 2	EML	Repeat of 6, reduced tension	1	0.6	Dummy	Quali-fied	Double	20	Titanium mandrel	Titanium mandrel	Rotor (v-end)	110	2a	-	-
8	21 July	10:00a	EU 2	EML	Same as 6, reduced rotor stop distri-bution	1	0.7	Dummy	Quali-fied	Double	20	Titanium mandrel	Titanium mandrel	Rotor (v-end)	250	2b	-	Rotor stops 0.006-in. axial & 0.008-in. radial
9	21 July	2:30p	EU 2	EML	Hook flexure(1) (no end stops)	0	0.7	Actual	Quali-fied	Single(1) Double(1)	12 20	Titanium mandrel	Hook (1) Titanium mandrel(1)	-	-	-	-	Double flexure with Titanium mandrel & 0.005-in. wire on other end (no stop)
10	22 July	2:00p	EU 2	EML	Hook flexure(2) (no end stops)	0	0.7	Actual	Quali-fied	Single	12	Titanium mandrel	Hook	-	-	-	-	Filter installed for input. Used for



10A	22 July	2:10p	EU 2	EML	Repeat of 10, same wire	0	0.7	Actual	Qualified	Single	12	Titanium mandrel	Hook	-	-	15 (R)	Null shift due to both 10 & 10A. Mechanical hysteresis 2% before & after 10 & 10A. Rotor ccw Rotor cw
11	22 July	3:00p	EU 2	EML	Repeat of 10, & 10A, same wire	0	0.7	Actual	Qualified	Single	12	Titanium mandrel	Hook	-	-	13 (L)	
12	22 July	4:00p	EU 2	EML	Repeat of 10, 10A, & 11, same wire	0	0.7	Actual	Qualified	Single	12	Titanium mandrel	Hook	-	-	11 (R)	
13	22 July	5:30p	EU 2	EML	Same wire as 10 & 12, high level input	1	0.7	Actual	Qualified	Single	12	Titanium mandrel	Hook	Rotor (v-end)	350	3b	40g input at failure
14	24 July	8:30a	EU 2	EML	Wire clamps on rotor, epoxy on flexure	3	0.55	Actual	Qualified	Single	12	Steel clamp	Hook	Flexure(2) Rotor (v-end)	180	Rotor(2a) Flexure (4c) Flexure (3c)	Mechanical hysteresis 1% before test
15	24 July	2:30p	EU 2	EML	No epoxy on flexure reduced tension	1	0.55	Actual	Qualified	Single	12	Steel clamp	Hook	Rotor anodized end	200	2b	
16	26 July	9:15a	EU 2	EML	Silastic on flexure tip, epoxy on back	0	0.55	Actual	Qualified	Single	12	Steel clamp	Hook	-	-	2.2 (R)	
17	26 July	10:00a	EU 2	EML	Repeat of 16 same wire	0	0.55	Actual	Qualified	Single	12	Steel clamp	Hook	-	-	8 (L)	
18	26 July	10:30a	EU 2	EML	Repeat of 16, & 17, same wire	0	0.55	Actual	Qualified	Single	12	Steel clamp	Hook	-	-	2.6 (L)	Rotor cw
19	26 July	1:30p	EU 2	EML	Increased tension same wire	0	0.7	Actual	Qualified	Single	12	Steel clamp	Hook	-	-	2.2 (R)	Rotor cw
20	26 July	2:00p	EU 2	EML	Repeat of 19, same wire	0	0.7	Actual	Qualified	Single	12	Steel clamp	Hook	-	-	12.3 (R)	Rotor ccw
21	26 July	2:30p	EU 2	EML	Same wire at 18 & 19, high level input	2	0.7	Actual	Qualified	Single	12	Steel clamp	Hook	Middle of wire (2)	50	v-end (2b) anodized end (3c)	38g input at failure
22	27 July	11:00a	EU 2	EML	Dow 92-018 on flexure tip & clamp	0	0.5	Actual	Qualified	Single	12	Steel clamp	Hook	-	-	1.0 (R)	Rotor cw, epoxy on back of flexure.
23	27 July	11:40a	EU 2	EML	Repeat of 22, same wire	1	0.5	Actual	Qualified	Single	12	Steel clamp	Hook	Rotor anodized end	50	7	
24	28 July	10:20a	EU 2	EML	New hook flexure	0	0.5	Actual	Qualified	Single	6.4 & 8.13	Steel clamp	Hook	-	-	-	Rotor ccw, null shift unknown.

2

25	28 July	11:30a	EU 2	EML	Repeat of 24, same wire	0	0.5	Actual	Qualified	Single	6.4 & 12.8	Steel clamp	Hook	-	2 (L)	Rotor cw
26	28 July	1:15p	EU 2	EML	Repeat of 24 & 25, same wire	0	0.5	Actual	Qualified	Single	6.4 & 12.8	Steel clamp	Hook	-	0	Rotor ccw, slight reduction in torsional restraint
27	28 July	2:30p	EU 2	EML	Repeat of 24 & 25, same wire	1	0.5	Actual	Qualified	Single	6.4 & 12.8	Steel clamp	Hook	50	2a	(Reduced torsional restraint observed before test)
28	28 July	10:20p	EU 2	EML	Same configuration as 24-27, new wire, proof loaded	0	0.5	Actual	Qualified	Single	6.4 & 12.8	Steel clamp	Hook	-	-	Went down to 185g at 220 cps, rotor ccw, slight reduction in torsional restraint
29	28 July	11:10a	EU 2	EML	Repeat of 28, same wire	0	0.5	Actual	Qualified	Single	6.4 & 12.8	Steel clamp	Hook	-	0.5 (L)	Rotor cw, proof loaded before and after test
30	29 July	11:45a	EU 2	EML	Repeat of 28 & 29, same wire	0	0.5	Actual	Qualified	Single	6.4 & 12.8	Steel clamp	Hook	-	-	Null shift not measured, proof loaded before test
31	29 July	11:55a	EU 2	EML	Same wire as 28-30, high level input	1	0.5	Actual	Qualified	Single	6.4 & 12.8	Steel clamp	Hook	50	6	40g input at failure
32	31 July	3:30p	EU 2	FYT	Fully assembled, full qualification test	0	0.5	Actual	Qualified	Single	6.4 & 12.8	Steel clamp	Hook	-	1	Tape on rotational stops, proof loaded before and after test

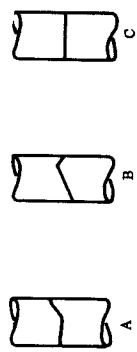

**NOTES**

- (1) All wire from same spool of 302 cres. Part of this spool has been qualified per Spec PT-1-12, Revision A. During qualification approximately 50 feet of wire was discarded due to failures during static loading tests.
- (2) All tests but 1 and 32 conducted to qualification levels along 2-axis only. Tests 1 and 32 conducted through full 3-axis sine and random qualification test schedule.
- (3) All tests but 3 and 32 conducted with magnet circuit and both covers removed.
- (4) All tests but 4 conducted with hard-anodized rotor stops.
- (5) Types of failure:

**PREFIX**

1. "Cup-come" - ductile
2. Brittle "A"
3. Brittle "B"
4. Brittle "C"
5. Brittle - No observation recorded as to 2, 3, 4.
6. Brittle "B" - No observation recorded as to A, B, C.
7. Wire not examined

**SUFFIX**

- a = Fatigue progression lines
- b = Vague indication of fatigue progression lines
- c = No indication of fatigue progression lines

3

Since the magnitude of the null shifts with this configuration was unacceptable, means of holding the wire more securely at its ends were explored. The first thing tried, epoxy bond, was apparently too rigid and caused the wires to break (Test 14). Removal of the epoxy and reducing the wire tension also resulted in wire failure (Test 15).

Starting with Test 16 the most successful configuration was examined. This configuration, which has been incorporated into Engineering Unit 2 for delivery to GE is shown in Figure 4-8. It consists of:

- a. Single-blade hook-end flexures with the wire restrained by clamps at the base and by epoxy on the back of flexures. A small amount of viscoelastic sealing material, Dow 92-018, is located near the tip of the flexure for cushioning.
- b. Clamps of 302 CRES to hold the wire on the rotor, with additional Dow 92-018 for cushioning at the edge of the clamp.

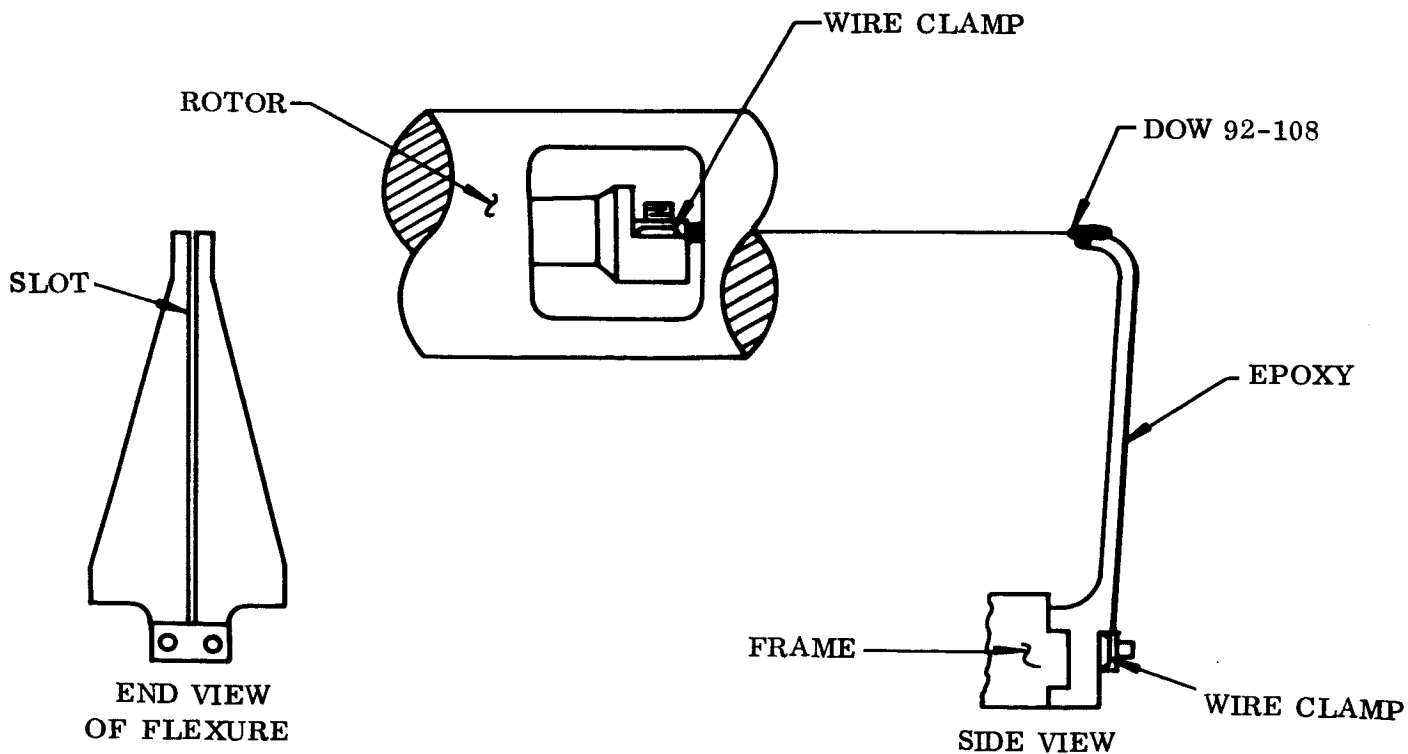

Figure 4-8. Passive Hysteresis Damper Suspension System ATS-D/E Configuration

Engineering Unit 2 was subjected to repeated qualification level tests in this configuration with null shifts less than 1 degree. In Tests 16 through 21 Silastic was used as the viscoelastic material but this is an unacceptable material for flight units due to outgassing. The results of these tests were so promising, however, that a similar viscoelastic material which does not outgas (Dow 92-018) was obtained. With Silastic on the tip of the flexure and clamp, the unit successfully passed three tests with 0.55 pound tension and another two after the tension had been increased to 0.7 pound (Tests 16-20). Test 21 was a test at increased levels and each of the two wires broke in its middle. This was an encouraging result since it indicated that the ends were no longer the most critical points. All previous failures had occurred on the mandrels or clamps.

The model was then reassembled in the final configuration with Dow 92-018. The first time the model was assembled in this configuration it passed one such test (Test 22) but failed on a second test (Test 23). The model was then restrung in the same configuration and survived three qualification level runs (Tests 24-26). After Test 26 a small reduction was observed in the torsional restraint of the damper. During Test 27 one of the wires broke in the middle. It is felt that the reduction in torsional restraint was due to a local failure of the wire and that this is the spot where it broke on the next test.

Engineering Unit 2 was restrung again in the same configuration and successfully passed through three more qualification-level tests (Test 28-30). A proof load of 0.5 pound was added to each flexure before each of these tests to check the wire condition. This doubled the design preload of 0.5 pound. A slight reduction in torsional restraint was noted after Test 28 but no failures occurred during Tests 29 and 30. Any local failure that caused the reduction in torsional restraint was apparently not large enough to cause a failure. A test-to-failure was then conducted on this model (Test 31) and failure occurred at 40g and 50 cps, (the prescribed qualification test level at this frequency is 34.5).

The final vibration test of this configuration was a full qualification-level run along all three axes conducted on the fully-assembled Engineering Unit 2 before delivery (Test 32). This test showed no breaks in the wire or decrease in the torsional restraint.

### 3. Conclusions and Design Changes to PHD

From the results of these tests it can be concluded that the new suspension system configuration is adequate to survive the worst input vibration environment prescribed and limit the null position shift to 1 degree or less. The following changes are to be implemented into the PHD (ATS-D/E) design, assembly, and test procedures:

- a. The ATS-D/E configuration will be modified to include the new flexures and clamping devices.
- b. Epoxy and Dow 92-018 will be applied as part of the assembly procedure.
- c. A more thorough examination will be made of the wire samples during wire qualification.
- d. Certain samples of the wire will be subjected to repeated qualification-level vibration tests in a damper model before their cyclic fatigue testing.
- e. A proof load of 0.5 pound shall be applied to each flexure after each vibration test.

The ATS-A configuration is not affected by these changes. It will still have the double flexures and mandrels.

Vibration levels used to evaluate the PHD wire suspension are shown in Table 4-3. These requirements are derived from Specification SVS-7331 for the CPD, Figure 4-8 shows the PHD suspension system.

### 4. References

1. General Electric Specification SVS-7331, "Passive Hysteresis Damper", 23 February 1965, including Alteration Notices 1 through 4.

2. Memo 65-9711-27, "Development-Test Plan, Torsional Restraint Characteristics, PHD," J. J. Conway, 18 June 1965.
3. Specification PT-1-12, Revision A, "Lot Qualification of Wire, Passive Hysteresis Damper Suspension," 18 June 1965.
4. Memo 9714.2-3, "PHD Wire Failure Analysis," Materials Engineering Department, 6 August 1965.
5. Memo 65-9711-39, "Vibration Test Report, Development Model PHD, Revised ATS-D and E Configuration," J. J. Conway, dated 18 June 1965.

#### 4.2.8 DAMPER BOOM ANGLE INDICATOR

##### A. General Design Status

The design of the angle indicator assembly is the same as reported in the Fourth Quarterly Progress Report with the exception that the lamp has been moved to directly in front of the fiber optic assembly, thereby removing the condensing lens set. The principal reason for this redesign was to increase the amount of energy available to the detectors. This resulted in a gain of approximately 100 percent. Besides substantially increasing the amount of energy, it was observed that a more uniform distribution of energy from the five exit ends of the fiber optic pipes was obtained (improving from 9.2/1 to 3.1/1). A problem has existed with the fiber optic assemblies because randomization of the fibers between the input and exit end has not been achieved as desired. A non-uniform distribution of energy has resulted at the exit ends because the lamp filament image, although blurred on the input surface of the fibers, is a non-uniform source of energy. The scrambling of the fibers was intended to make it appear as a uniform source on the exit end. The vendor has been contacted on this problem and is reworking several parts using a number of different approaches to solve the problems. One model prepared has shown a very marked improvement in the randomizing aspect. Previously the image of each exit pipe (when illuminated from the exit end) could

be clearly seen as a compact cluster in the entrance of the fiber optic. The new design effectively scattered the light from any one exit element over the entire face of the entrance. Existing parts will be used for engineering units. It is planned that the system can be made to function properly with them.

A second area of concern has been the inability to focus the energy from the exit end of the fiber pipes onto the detectors. With the system set up as initially designed, the size of the light spot was approximately 50 percent higher than required. After conducting several tests with different lenses and different lens positions, it was possible to reduce the spot size to the design value.

#### B. Testing Activity and Results

Three lamps were potted in a fixture to simulate the actual design mounting, and the lamps were put through the vibration test levels of SVS-7331 (PHD), which are the same levels that the angle indicator is expected to experience. All lamps passed the vibration test with no damage. Lighted lamps were then mounted on the combination passive damper solenoid and the solenoid was actuated 125 times with no damage to the lamps. After stripping the lamps from the fixture, two bulbs were broken; subsequent tests determined that breakage was due to potting and not vibration. Potting technique has been revised and lamps tested with no further problems. Phototransistors were temperature cycled to determine temperature characteristics; results show that, over the presently expected orbit temperature range, the light current will decrease approximately 50 percent at low temperature and dark current will increase to approximately 100 milliamps at high temperature. Both variations are within design limits. A test was performed to determine the relationship of the optical axis to the mechanical axis of the phototransistor due to the lens cap on the phototransistor. The results showed that, in general, peak sensitivity is not on the mechanical axis but the effects of this are not considered detrimental to the system.

Several miscellaneous tests have been performed such as outgassing studies of the fiber optic potting and epoxy compounds. These tests showed that no problem exists. Bonding of the encoder disc to the support ring utilizes material which has been proven to have no adverse effects from the space environment.

Tests were conducted on the system as a whole to determine that enough energy is available at each phototransistor. Incident energy on the phototransistor must be such that the minimum output current is 1.5 milliamps. Figure 4-9 shows the schematic arrangement of the major elements used in the test and Table 4-5 summarizes the results obtained for different test conditions.

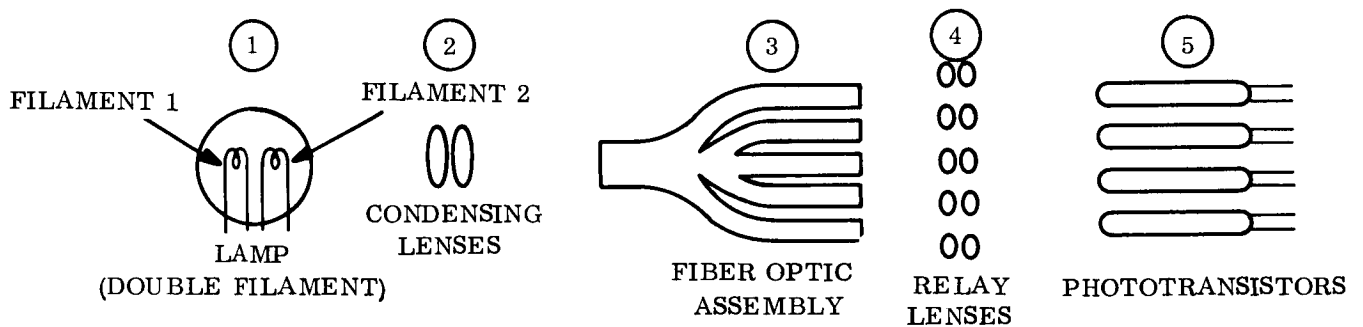

Figure 4-9. Angle Indicator Evaluation Test Elements

Test results up to this point indicated that the system was more efficient without the condensing lenses **2** from both energy and uniformity consideration.

Subsequent test showed that ample energy was at the pipe exit (equivalent to approximately 8 milliamps from the phototransistor) but too much energy was being lost in the relay lens system. Consequently additional tests were conducted in this area. The relay lenses were repositioned, which brought the output up to about 2 milliamps. A new single lens was used which further increased the output to 3.7 milliamps. All tests mentioned above were conducted with a phototransistor with average sensitivity and at room ambient.



TABLE 4-5. ANGLE INDICATOR TEST SUMMARY

IA Initial tests were started to determine uniformity and energy levels using elements (1), (2) and (3) with a linear detector directly against the exit ends of (3). Results were:

Total output = 0.04465 volt lamp filament 1  
 Variation pipe-to-pipe = 5.23/1

Total output = 0.03513 volt lamp filament 2  
 Variation pipe-to-pipe = 9.22/1

IB Element (2) was removed and element (1) was located next to (3).

Total output = 0.0908 volt lamp filament 1  
 Variation pipe-to-pipe = 2.43/1

Total output = 0.0653 volt lamp filament 2  
 Variation pipe-to-pipe = 3.11/1

IIA The following tests was used to determine if in fact enough energy was available to the phototransistors, using the system as designed, i.e., elements (1)(2)(3)(4)(5).

Total output = 1.8 ma lamp filament 1  
 Max. pipe = 0.62 ma  
 Min. pipe = 0.2 ma

Total output = 1.1 ma lamp filament 2  
 Max. pipe = 0.46 ma  
 Min. pipe = 0.04 ma

Eliminating element (2) as in IB

IIIB Total output = 4.42 ma lamp filament 1  
 Max. pipe = 1.09 ma  
 Min. pipe = 0.65 ma

Total output = 5.27 ma lamp filament 2  
 Max. pipe = 2.04 ma  
 Min. pipe = 0.72 ma

Phototransistor system requirements were:

Digital Signal	Telemetry Voltage (volts)	Current required ( $\mu$ amp)
1	> -5.5	* $\approx$ 20
0	< -2.0	$\approx$ 25

Light current requirements

	Available Current ( $\mu$ amps)
Initial	1500
Temperature Degradation (50%)	750
Radiation & Degradation (20%)	600
Loss due to Lamp Degradation (50%)	300

End of Life based on a design minimum of 40  $\mu$  amps = 7.5/1

Dark current requirements

Initial	0.005 $\mu$ a
Temperature Degradation	0.100 $\mu$ a
Radiation and Degradation	1.000 $\mu$ a

End of Life based on a design maximum of 10  $\mu$  amps = 10/1

\*Actual measurements at room ambient averaged 25.4 and 27.5  $\mu$ amps respectively.

#### 4.2.9 SUBCONTRACT ACTIVITIES (HOLEX CABLE CUTTER)

Horex, Incorporated has successfully completed the testing of the Horex Model 5402 Cable Cutter assemblies used in the CPD caging mechanism. These tests were conducted in accordance with GE Specification SVS-5292 "Electroexplosive Pressure Cartridge and Cable Cutter"; results are presented in Horex Test Report TR-378902, dated 27 August. Load Level Determination Tests are reported in Horex Test Report TR-3789, dated 25 August.

During the acceptance testing, 20 cable cutter assemblies were fired in a test set-up which included a length of 1/8-inch cable which was severed in each instance. These assemblies had been subjected to environmental conditions GE Specified in SVS-5292 prior to firing. In the load level determination tests to determine the proper propellant load, eight assemblies were fired with a length of 1/8-inch diameter cable inserted (and severed) in each unit tested. Charges tested varied from 20 to 100 milligrams. The charge selected was 50 milligrams of Horex No. 72 Propellant.

#### 4.3 TEST EQUIPMENT

##### 4.3.1 LOW ORDER FORCE FIXTURES (LOFF)

Both LOFF fixtures have been in continuous use throughout the quarter. LOFF 1 is presently being overhauled in preparation for CPD in-process and final component testing. LOFF 2 is being used for in-process piece part testing.

All CPD fixtures have been completed with the exception of the overturning-torque fixture and the thermal enclosure. These parts are presently in manufacturing. The completion dates on these parts are scheduled not to delay the CPD testing.

#### 4.3.2 ADVANCED DAMPING TEST FIXTURE (ADTF)

The ADTF has been in use throughout the quarter and is presently being used for CPD Engineering Unit 1 in-process eddy-current damping tests.

All test fixtures have been completed with the exception of the thermal box. This part is presently in manufacturing and will be ready when required.

A modification to the hysteresis damping mode electronics is being made to increase the system stability. At the present time the system is unstable and measurements of the hysteresis damping characteristics are inaccurate.

#### 4.3.3 DIPOLE MEASUREMENT FACILITY

The dipole facility has been completed. All fixtures are completed for mounting the CPD. The facility has been used throughout the quarter for dipole testing many CPD and other ATS components and piece parts.

#### 4.3.4 TEST CONSOLE CABLES

Test Console No. 1 is completely built, checked out and operating. It is presently being used to test angle indicator modules. Test Console 2 is about 90 percent completed. All cables for CPD testing are completed.

## SECTION 5

### ATTITUDE SENSOR SUBSYSTEM

#### 5.1 SUBSYSTEM DESCRIPTION

The latest electrical configuration of the ATS Gravity Gradient Stabilization System is shown in Figure 5-1. Since there have been no major conceptual changes in the last quarter, it is identical with the configuration shown in the Fourth Quarterly Report, GE/MSD Document 65SD4381, dated 20 July 1965, with the minor exception that two connectors in the TV Camera Control Units have been redesignated. Although no changes to the general block diagram of the ATS Gravity Gradient Stabilization System are contemplated, the latest electrical configuration can be obtained during the interim between quarterly progress reports by consulting the interface documents for ATS published monthly by GE.

#### 5.2 TV CAMERA SUBSYSTEM

##### 5.2.1 TV CAMERA OPTICS

The design of a Raptar  $f/2.8$  lens and sun-shutter assembly was completed by the sub-vendor, Wollensak Optical Division of the 3M Company. A computer analysis was made and results are reported in the graphs of Figures 5-2 to 5-4. Ray trace diagrams for the TV camera optics are shown in Figure 5-5. An automatic operation of the sun shutter has been provided. The shutter is designed to close automatically when the sun is less than 41 degrees (+4 degrees, -0 degrees) from the optical axis. A cross hair is provided on the protective quartz window by applying a thin coating of neutral density material through a mask. This process develops a reflective coating that has a reflectance of 25% and a transmission equal to or somewhat greater than 28%. A curve of effective  $f$ /number versus lens setting is shown in Figure 5-6. The transmission loss results in an effective lens speed of  $f/5.3$  when the lens is fully open.

This is more than adequate for the lens opening. A study was made of the range of  $f$ -stops that might be required. The earthward looking camera could utilize an effective  $f/22$  lens

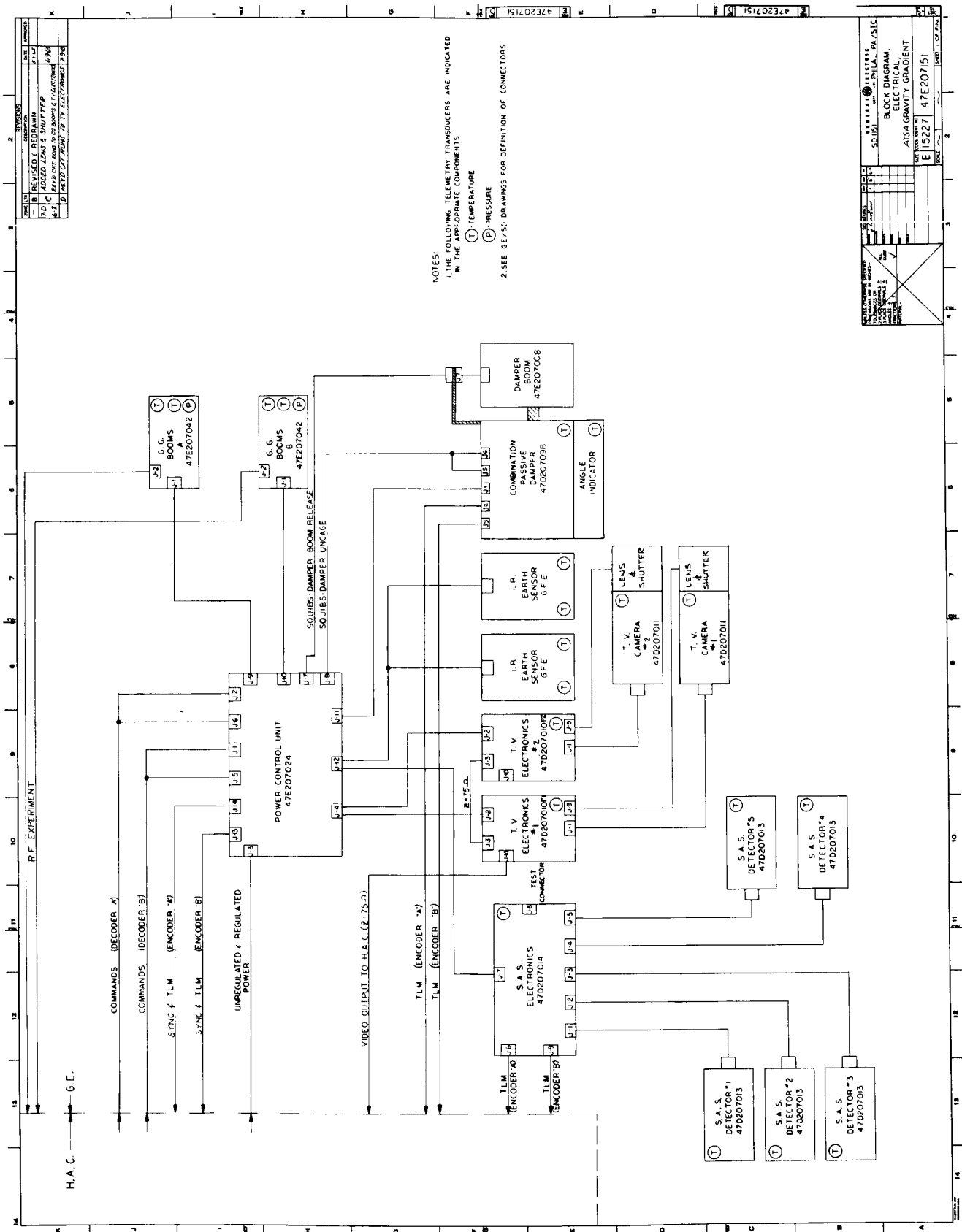

NOTES:  
 1. THE FOLLOWING TELEMETRY TRANSDUCERS ARE INDICATED IN THE APPROPRIATE COMPONENTS  
 (T) TEMPERATURE  
 (P) PRESSURE  
 2. SEE GE/51 DRAWINGS FOR DEFINITION OF CONNECTORS

REV	DATE	BY	CHKD	APP'D
1				
2				
3				
4				
5				
6				
7				
8				
9				
10				
11				
12				
13				
14				
15				
16				
17				
18				
19				
20				
21				
22				
23				
24				
25				
26				
27				
28				
29				
30				

BLOCK DIAGRAM,  
 ELECTRICAL,  
 ATLAS GRAVITY GRADIENT  
 47E207015  
 115227 47E207151  
 SHEET 7 OF 24

Figure 5-1. GE/HAC Electrical Interface (GE Dwg. 47E207151)

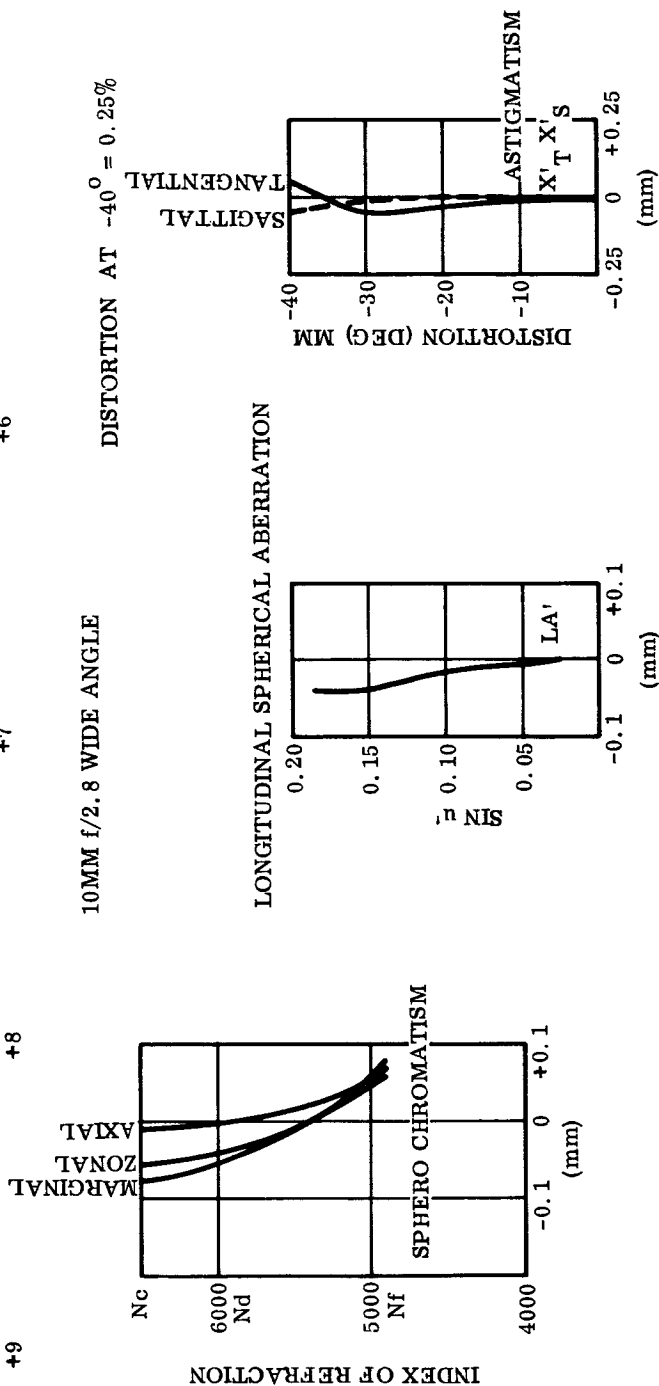
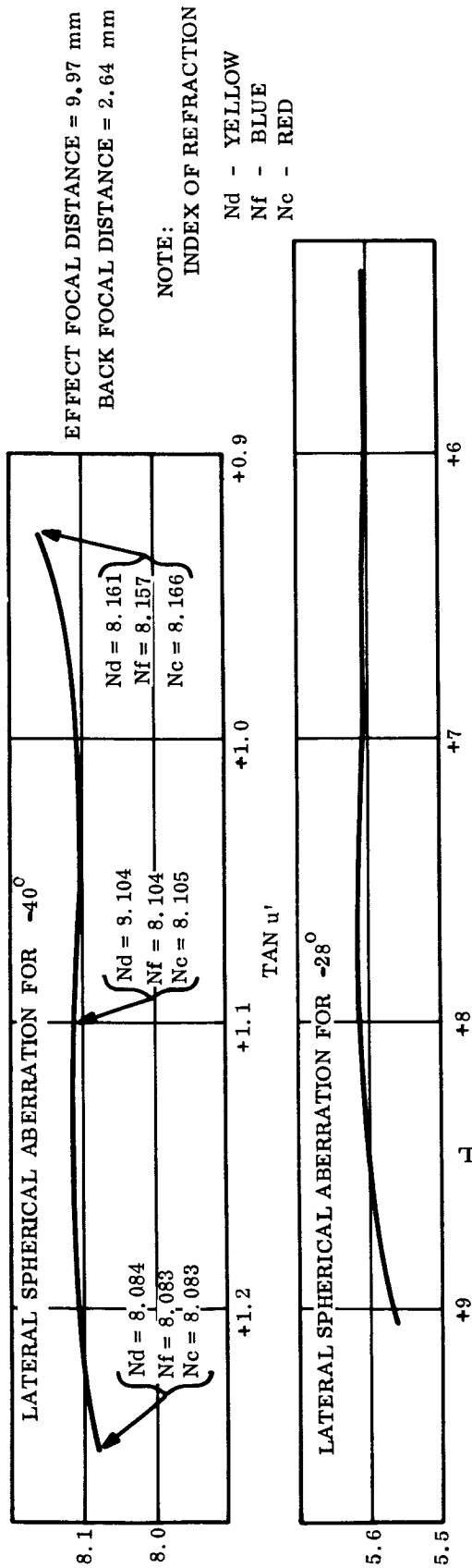

Figure 5-2. Lens Data

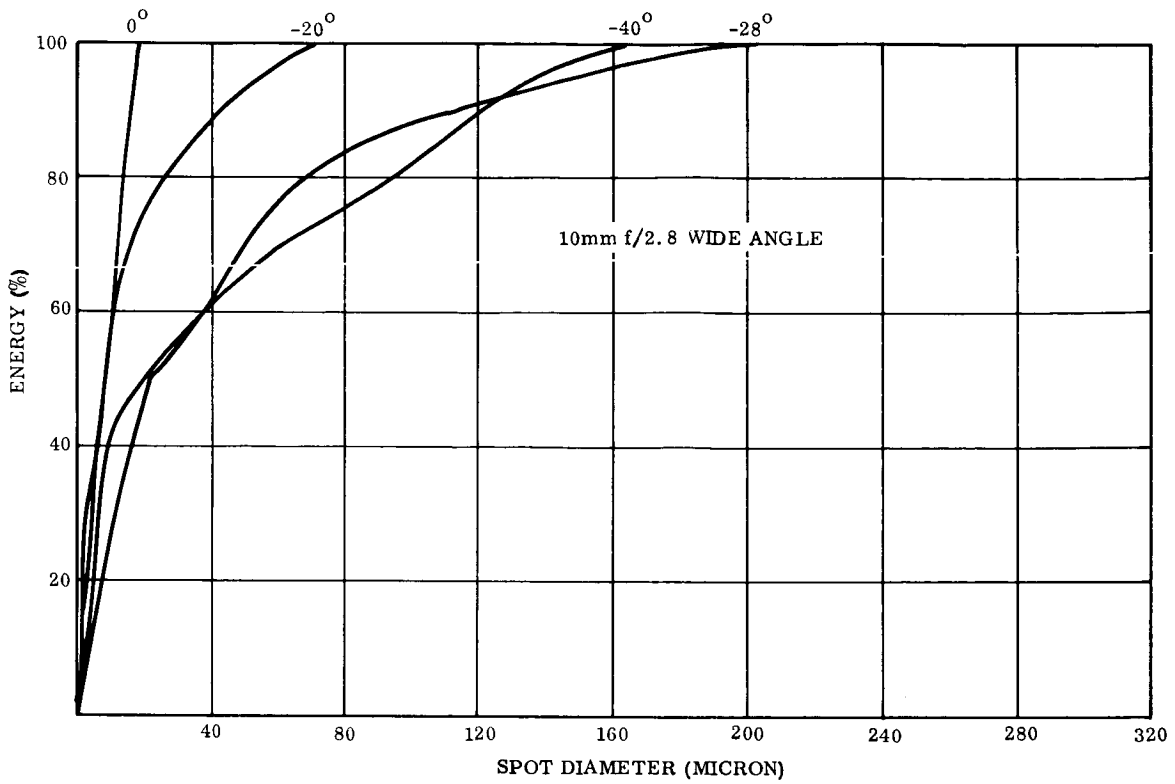

Figure 5-3. Radial Energy Distribution

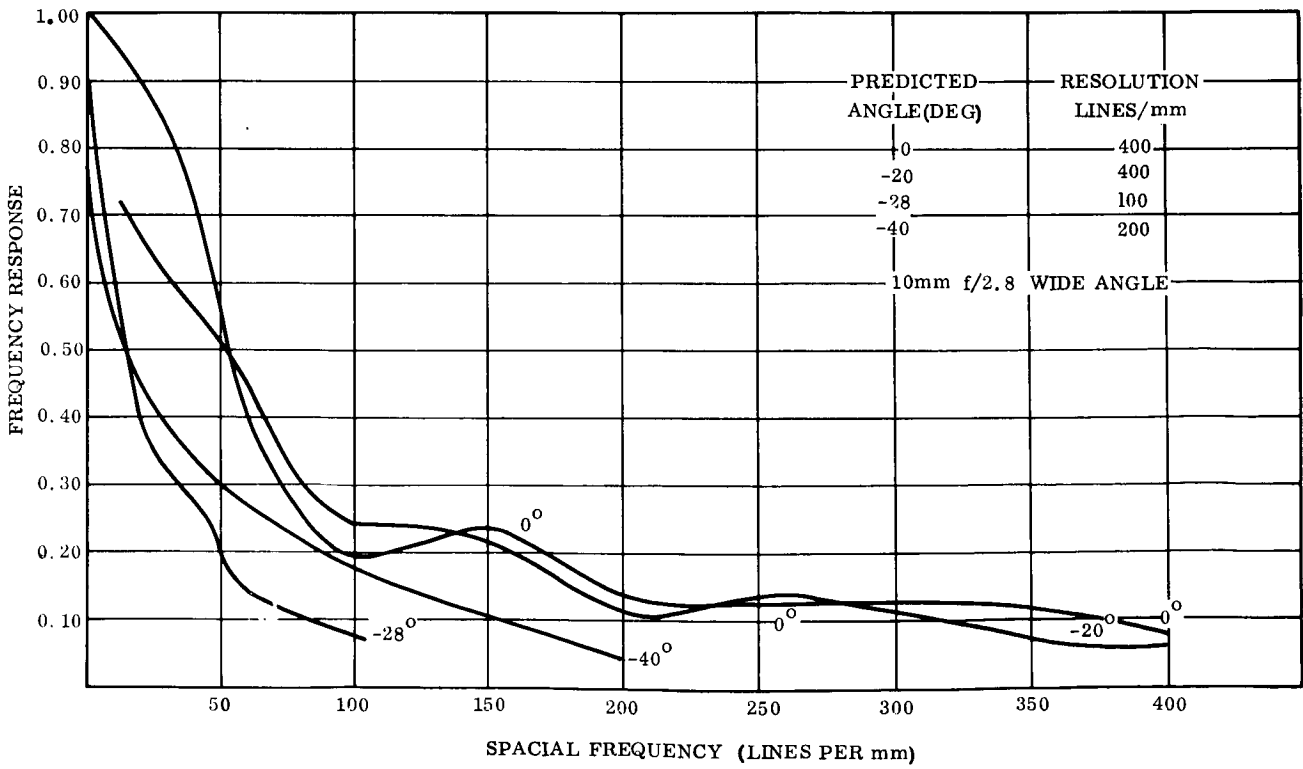
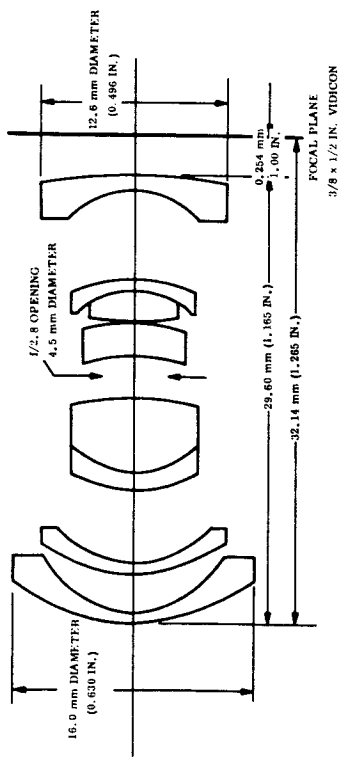

Figure 5-4. Spatial Frequency vs. Response



SCALE: 5X



A

10 mm (1/2.8)

EFFECTIVE FOCAL DISTANCE - 10.00 mm  
BACK FOCAL DISTANCE - 2.54 mm

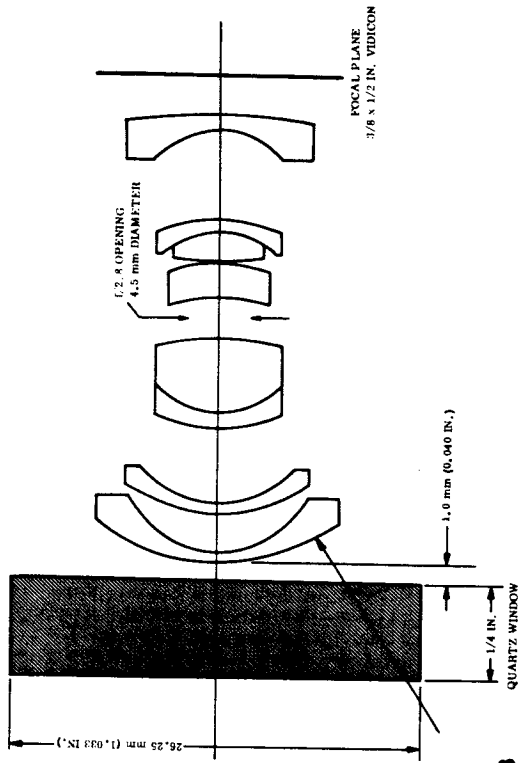

B

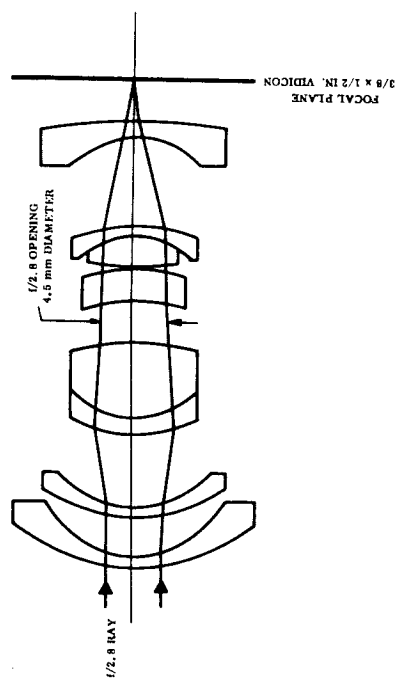

C

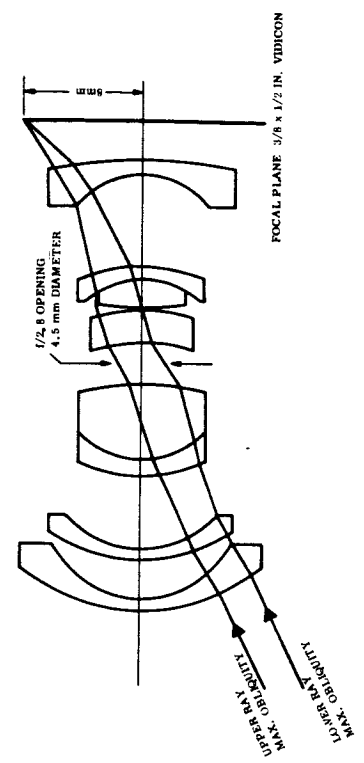

D

Figure 5-5. Ray Trace Diagram

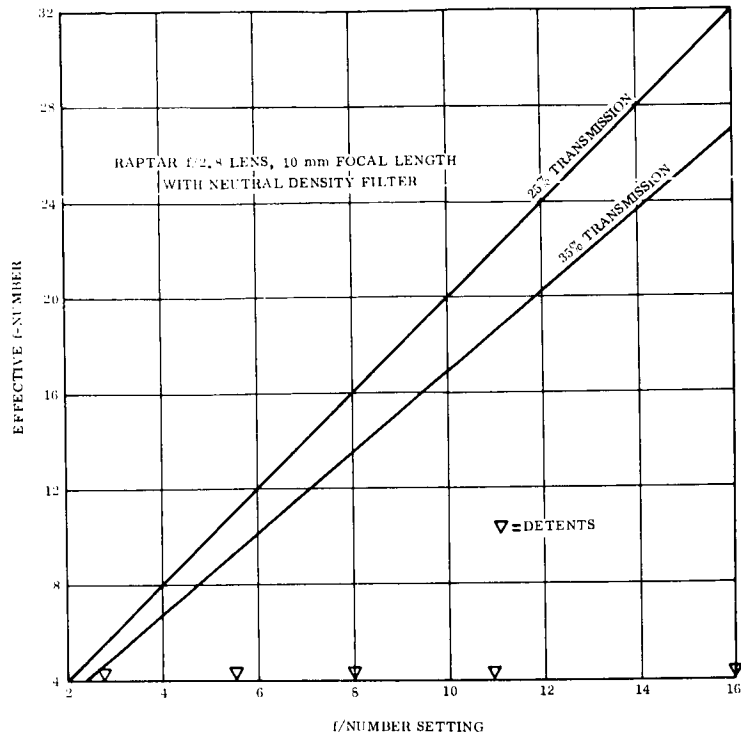

Figure 5-6. Effect of Neutral Density Filter on Effective f/ number.

stop and still require that the vidicon operate in its medium sensitivity mode. The spaceward looking camera could utilize an effective f/ 8 setting and still saturate the vidicon with the target response. The automatic target feature of the camera is reported capable of operating over at least two f-stops. Hence, a lens opening of approximately f/16 (effective) should enable camera performance in either earthward or spaceward orientation. At the present time, an f-stop of f/ 16 is considered to be compromising. If planned testing supports this view, the earthward looking camera will probably be set at f/ 16 (effective) and the spaceward looking camera will probably be set between f/ 5.3 and f/ 8 (effective).

### 5.2.2 MATERIALS IN STANDARD 0431C CAMERA

The design information supplied by Lear-Siegler indicated the standard camera design uses some materials of questionable suitability for use in space. Among these are a varnish used for impregnating r-f coils and power transformers, fishpaper insulation, plastic sleeving for wire, and cadmium plating for hardware. In addition, some materials are used too close to maximum rating, e. g., using wire with 600-volt insulation in circuits carrying 500 volts. These things were examined with respect to the corona problem and the vendor was asked to consider using substitute materials which have been specified by GE. This was done in order to minimize any problems which might occur when the control unit and camera are vented to space, since LSI has had no experience with this camera system in an unpressurized enclosure.

### 5.2.3 TELEMETRY CIRCUIT DESIGN

In complying with the component specification for telemetry of the vidicon faceplate temperature, the vendor was unable to locate a thermistor bead on the vidicon target ring without introducing objectionable noise into the video signal. The presence of the thermistor at this point of lowest signal level introduces some unavoidable feedback at the highest video frequencies (megacycle range) resulting in a picture with a rough vertical edge and random white response (snow). Bypassing the thermistor leads helps, but does not eliminate the problem. Rather than run the risk of deteriorating the video response, the vendor has been allowed to place the thermistor lead on the cylindrical chassis that immediately surrounds the vidicon target ring.

### 5.2.4 RESOLUTION TESTING

Considerable testing has been done to determine the closest useable working distance of the camera for making resolution measurements. The calculated hyperfocal distance of

the Raptar lens was reported to be 112.6 inches at f/2.8. Tests with the first available lens have indicated approximately 400 TV lines can still be resolved at approximately 19 inches, but the camera used was not the ATS camera and it was not considered to be in good alignment. However, it was capable of the full 8 mc video output response. Other tests were made both at GE and by the vendor. Based on these results, it has been decided that environmental tests in the test chambers would utilize an 18 x 24 inch resolution chart, 18 inches from the camera, with sufficient lighting to allow use of an f/8 stop. The primary check of resolution will be made on an approximate 5 by 7 foot chart, of GE design, at a working distance of 5 feet with f-number as required for simulating any operating requirement.

### 5.3 POWER CONTROL UNIT

During the report period, the Thermal, Dynamic, and Engineering Units were completed. In-process electrical testing of the subassemblies of the Engineering Unit was performed and recorded during the manufacturing process. Testing of the Engineering Unit was started. Updating of drawings for construction of the prime units is approximately 50% complete. Design changes have been incorporated as dictated by producibility, system performance requirements, compatibility testing, and engineering test results.

#### 5.3.1 ELECTRICAL DESIGN

The electronic design of the Power Control Unit was basically completed during the previous quarter; however, a few modifications are presently being incorporated in order to improve the overall system performance capability. These modifications are described in Sections 5.3.1(A) through 5.3.1(C).

A. Emergency Power Reset (See Figure 5-7)

This command buffer amplifier will be used in conjunction with the unregulated voltage bus in order to provide a "reset" capability for all relays in the event the regulated power bus is not energized.

B. Command Decoder Failure Inhibit Circuit

An inhibit feature in the command buffer amplifiers for the Primary Boom Subsystem control motors is being incorporated to prevent simultaneous input commands from shorting the voltage bus, and in the process, destroying transistor switches. This feature was incorporated by insertion of R1 and CR1 in the motor driver command buffer module (see Figure 5-8). It will give the boom "extension" commands, an over-ride on the boom "retraction" commands and will give the boom scissoring "expansion" commands, an over-ride on the "contraction" commands.

C. Motor Driver Module

Additional transistor buffer amplifiers (Q1 and Q2 in Figure 5-8) were added in the motor driver module to provide additional isolation between the armature and field driver output stages. This change was considered necessary after testing of the motors of the primary boom package with the PCU breadboard showed that there was feedback to the former common amplifier point in conjunction with some transformer action in the motor. The combination of these characteristics gave a possible instability upon motor turnoff, and could keep the motor going when the command pulse was removed if certain conditions were satisfied.



### 5.3.2 MECHANICAL DESIGN

The design activities necessary for definition and construction of the Thermal, Dynamic, and Engineering Units were supplied during the period. The manufacturing of the engineering unit was monitored and design changes were incorporated into prototype drawings for producibility reasons as well as eliminating possible trouble spots.

Review of materials useage in the unit has been performed to assure their compatibility with the ATS vehicle. Use of silicon grease, previously used to facilitate heat transfer, was eliminated as a result of this survey.

Additional vibration testing of the Engineering Unit is scheduled within the next few weeks so that the packaging design suitability will be further verified from the stress standpoint. The Engineering Unit has successfully passed both random and sinusoidal vibration at the acceptance levels without being totally foamed.

### 5.3.3 TESTING ACTIVITIES

#### A. Module Testing

In-process and post-assembly tests were made on all modules constructed for the Engineering Unit and test data was recorded by serial number for later reference. The tests were designed to give some data on the design margin initially present in each functional block of the Engineering Unit.

#### B. Printed Circuit Board Testing

These subassemblies for the Engineering Unit were given a functional check to verify wiring, connector, and printed circuit connections.

### C. Engineering Unit

Tests to check out the wiring of the unit were performed during the assembly process. The engineering tests were begun and as of the present time, the high and low temperature tests have been completed.

#### 5.4 SOLAR ASPECT SENSOR, ENGINEERING FUNCTION TESTS AND RESULTS

As previously described in the Second Quarterly Progress Report, the accuracy of the ATS Solar Aspect Sensor is determined if the position of the transition edge of each digit is known. The accuracy of the transitions was specified as  $\pm 1/2$  digit from its true position determined by the transfer function. The digit size, however, is dependent on the angle of incidence. This is evident from Figure 5-9, which is a parametric plot of the digit illuminated on reticle 1 as a function of both angle A and angle B. Angle A and B are defined as the angles the projected light beam makes with the face of the detector in the planes of the two slits and normal to the face of the detector, as shown in Figure 5-10.

Determination of the transition edges in the normal planes (A or B = 90 degrees) determines the performance of the detectors alone in all planes according to the geometric relationships given in the error analysis. Examination of Figure 5-11, which shows the analog output of the least significant bit cell and the AGC cell, will confirm this, since, if the flux delivered to the cells decreases due to variation in angle of incidence, all three factors determining the transition accuracy decrease proportionately. The "on" to "off" slope, the midpoint of the bitcell and the AGC cell output are lower by the same proportion.

When the Solar Aspect Sensor is operated as a system, however, the electronics unit introduces a fixed amount of threshold error, which is divided by the "on" to "off" slope to obtain the corresponding angular error. If the bit slope decreases, the angular error increases, for a constant current offset.



DIGIT SIZE AS A FUNCTION OF INCIDENT ANGLE.

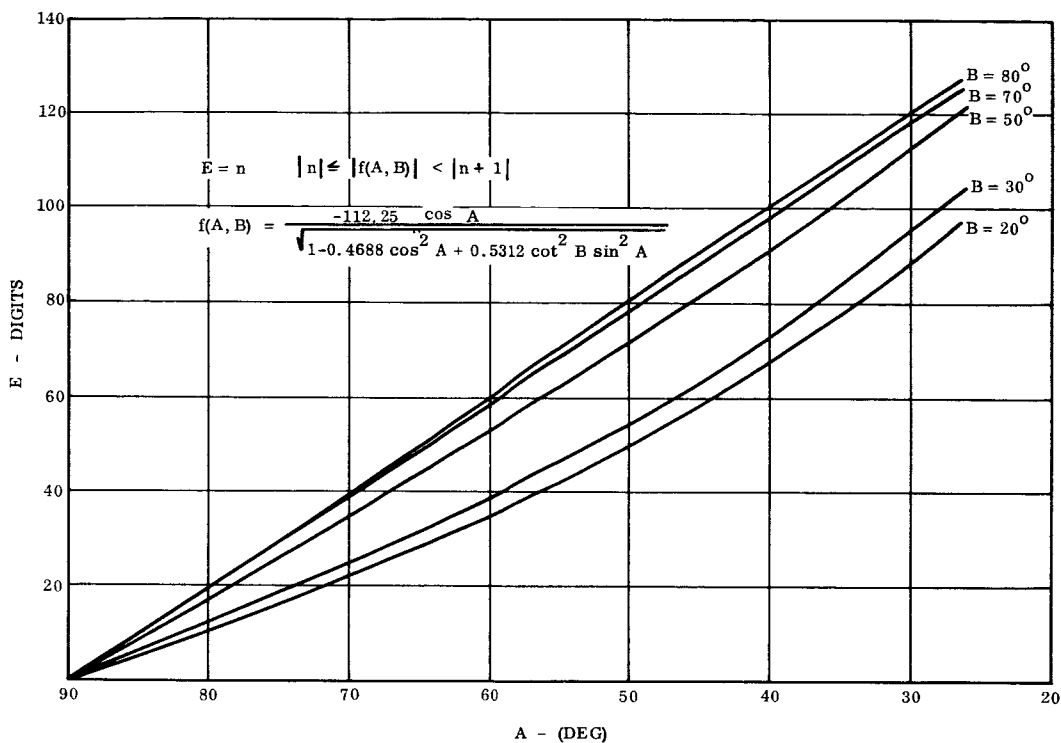
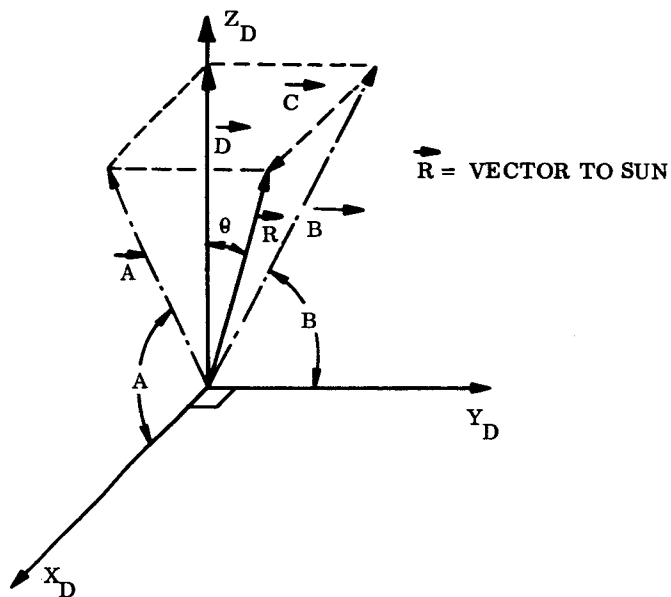

Figure 5-9. Digit Size as a Function of Incident Angle



EYE 1 MEASURES ANGLE A  
EYE 2 MEASURES ANGLE B

$X_D, Y_D, Z_D$  SHALL BE THE REFERENCE COORDINATE SYSTEM FOR MEASUREMENT

THE  $Z_D$  - AXIS SHALL BE DEFINED BY THE NORMAL TO SURFACE A

Figure 5-10. SAS Detector Alignment Geometry

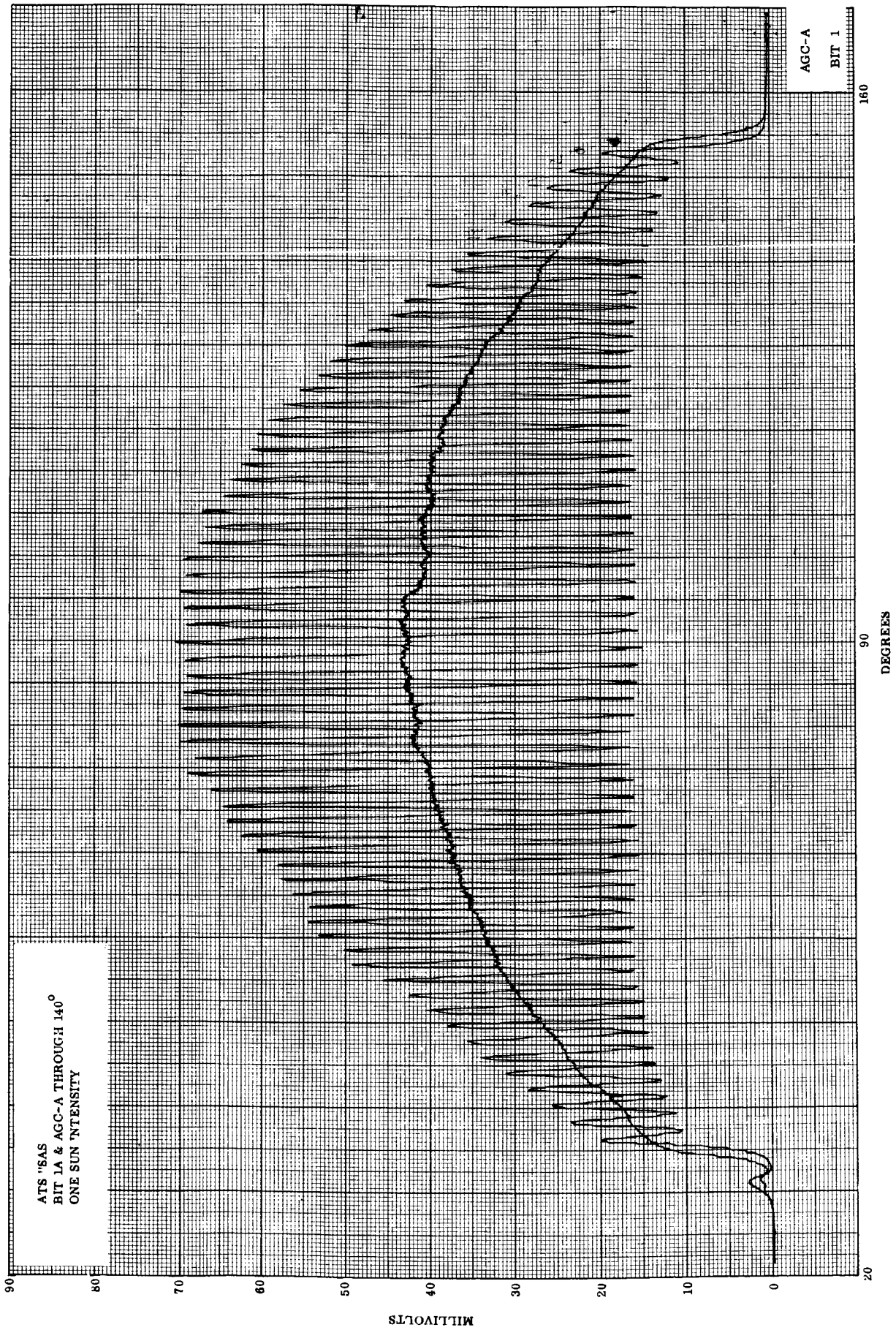

Figure 5-11. Analog Output of Least Significant Bit Cell and AGC Cell

Two measurements in the normal planes are, therefore, necessary to determine the accuracy of the Solar Aspect Sensor: 1) the position of the transition edges with each detector alone and 2) the position of the transition edges using the whole system. All readings must be within an error band of  $\pm 1/2$  digit from their ideal values. Also, if the difference is taken between the two measurements, that is, the offset due the electronics unit is established, the worst-condition performance can be calculated. In fact, if the test is performed with a solar intensity of less than one solar constant by the proportion corresponding to the worst-condition angle of incidence, the sensor performance can be checked directly.

The worst-condition illumination exists when angle  $\theta$  in Figure 5-10 is largest. This occurs at the extreme edge of the field of view, that is - angle A = angle B = 26.5 degrees. From Figure 5-10, it is evident that

$$\vec{R} = \vec{B} + \vec{C}$$

$$|\vec{D}| = \frac{\vec{R} \cdot \vec{D}}{|\vec{D}|} = |\vec{R}| \cos \theta$$

$$\cos \theta = \frac{|\vec{D}|}{|\vec{R}|} = \frac{|\vec{A}| \sin A}{|\vec{A} + \vec{C}|}$$

$$|\vec{C}| = |\vec{A}| \cos A$$

$$|\vec{A} + \vec{C}| = \sqrt{|\vec{A}|^2 + |\vec{C}|^2}$$

$|\vec{A}| = |\vec{B}|$  and they are arbitrary. Therefore, we assume

$$|\vec{A}| = |\vec{B}| = 1$$

then

$$|\vec{R}| = \sqrt{1 + \cos^2 A} = \sqrt{1.801}$$

$$|\vec{R}| = 1.341$$

$$\cos \theta = \frac{\sin A}{1.341}$$

We are interested in the fractional reduction in flux in the worst case condition, which is:

$$\frac{\cos \theta}{\sin A} = \frac{\sin A}{\sin A \times 1.341} = 746$$

Figures 5-12 through 5-19 are plots of the transition edge errors versus true position of the transitions in degrees from the normal to the face of the detector, angles (90-A) and (90-B). The intensity of the solar simulator was 0.75 solar constant. It is clear from the graphs that the sensor data are well within the specified accuracy limits.

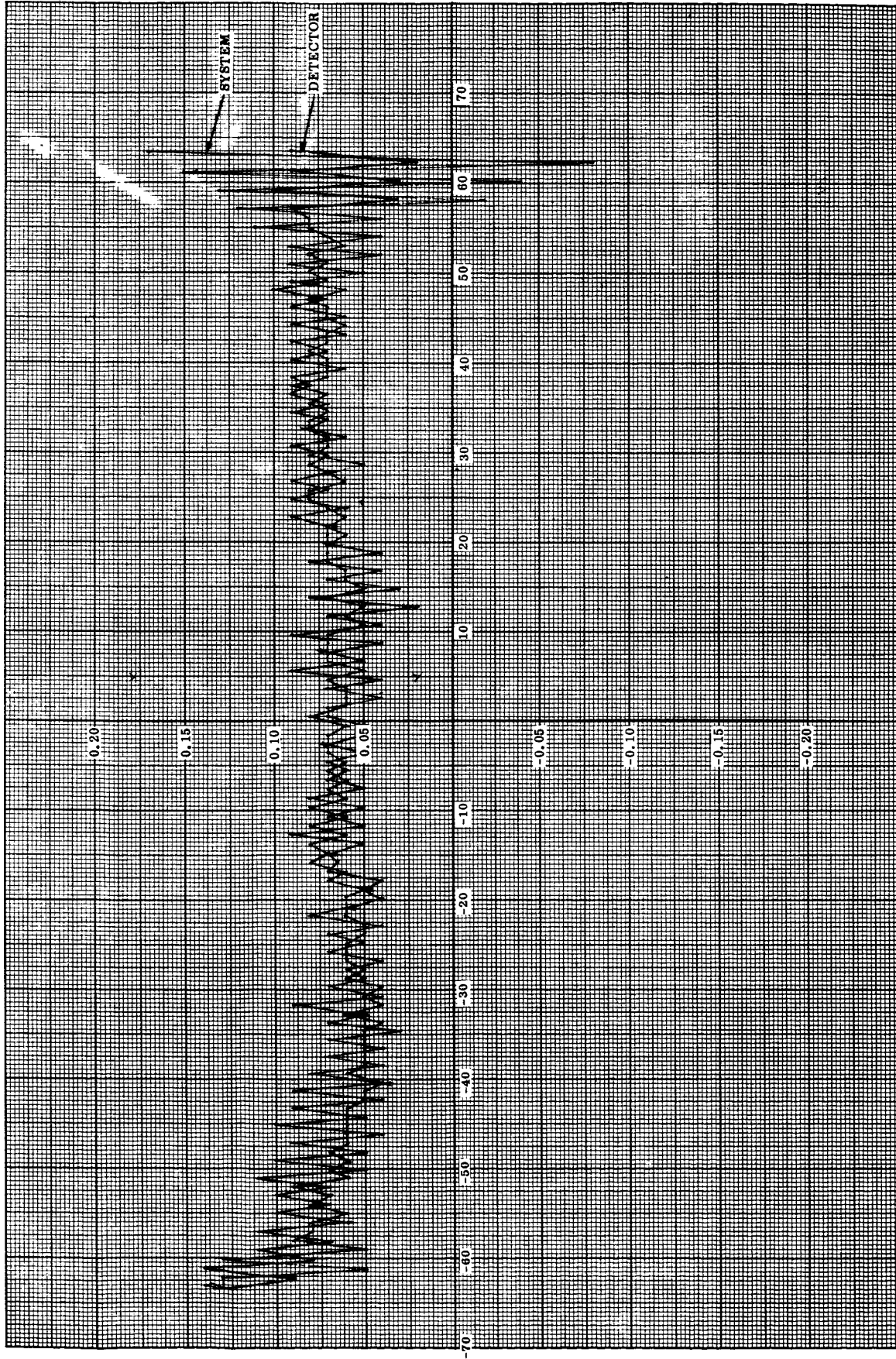

Figure 5-12. Transition Edge Error vs True Transition Position (Reticle 1, Bit 1)

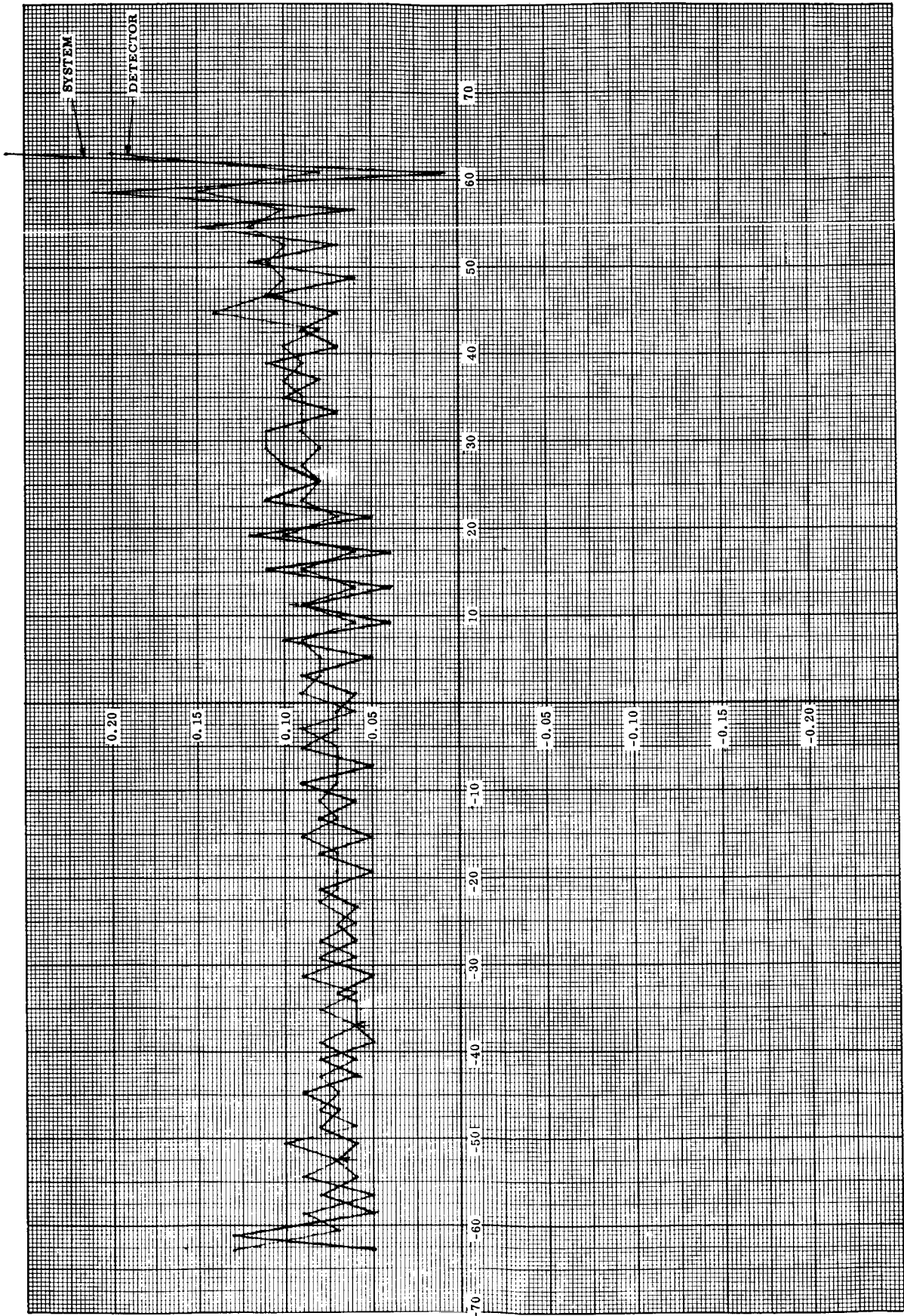

Figure 5-13. Transition Edge Error vs True Transition Position (Reticle 1, Bit 2)

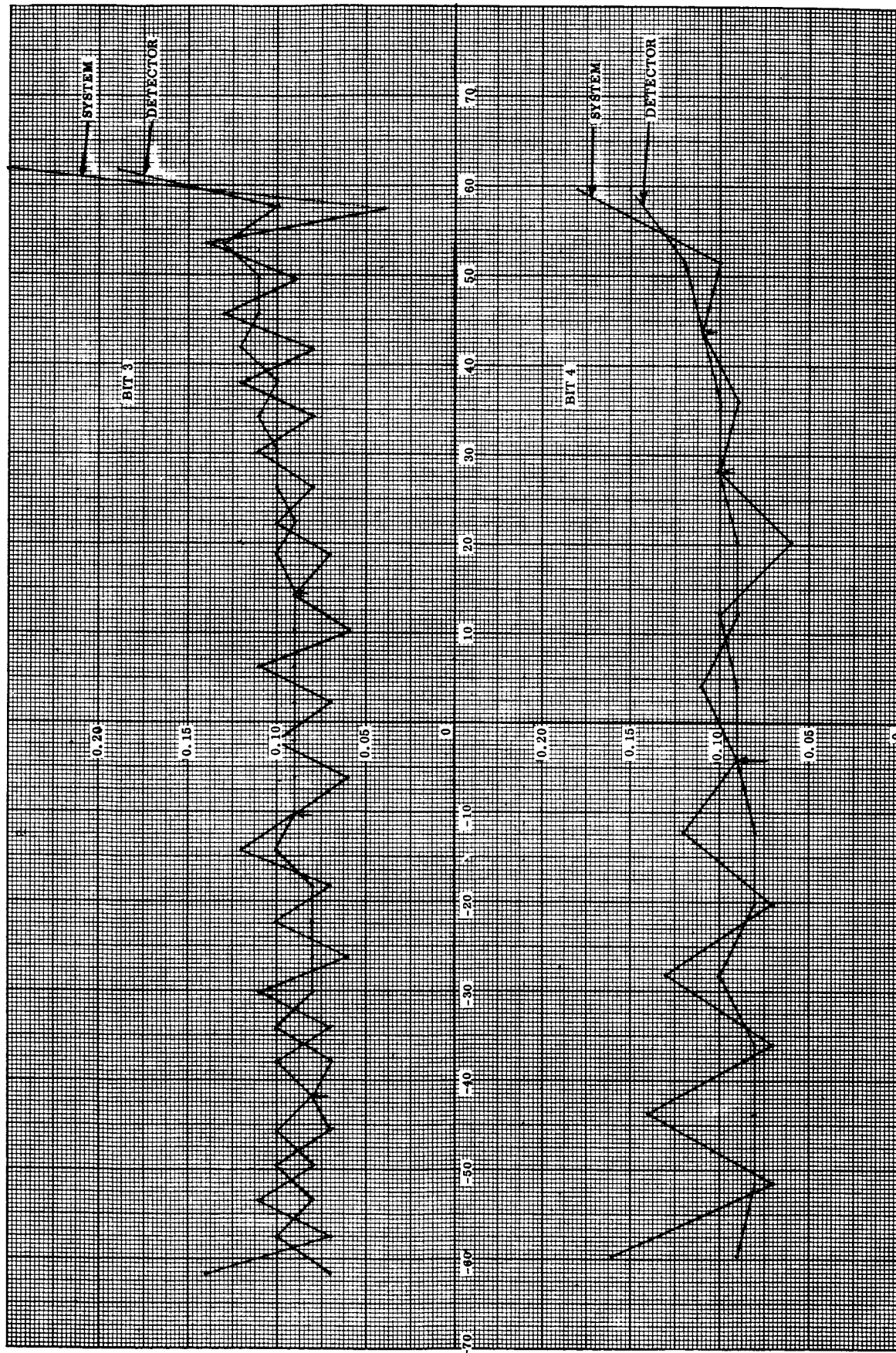

Figure 5-14. Transition Edge Error vs True Transition Position (Reticle 1, Bits 3 & 4)

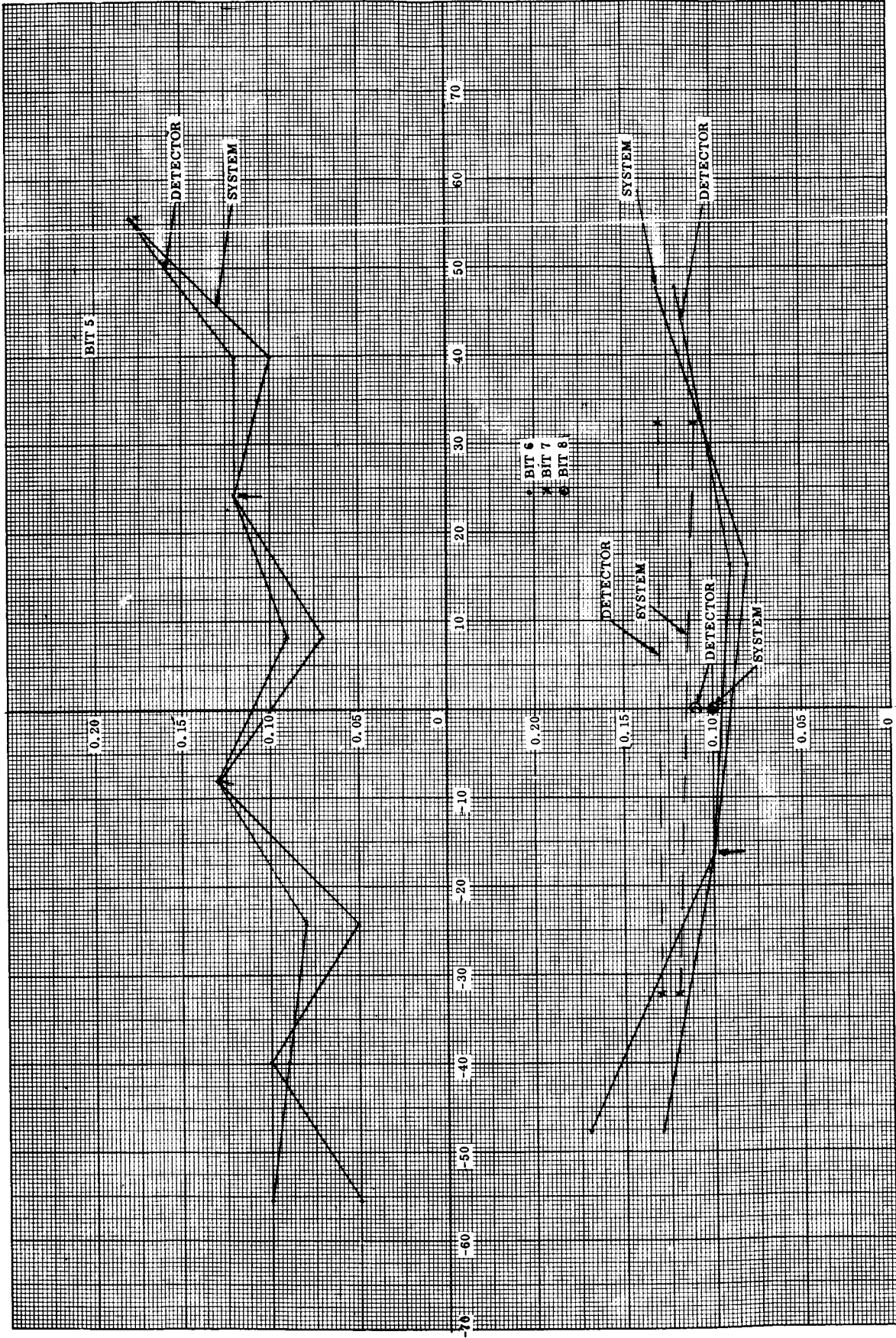

Figure 5-15. Transition Edge Error vs True Transition Position (Reticle 1, Bits 5, 6, 7 & 8)



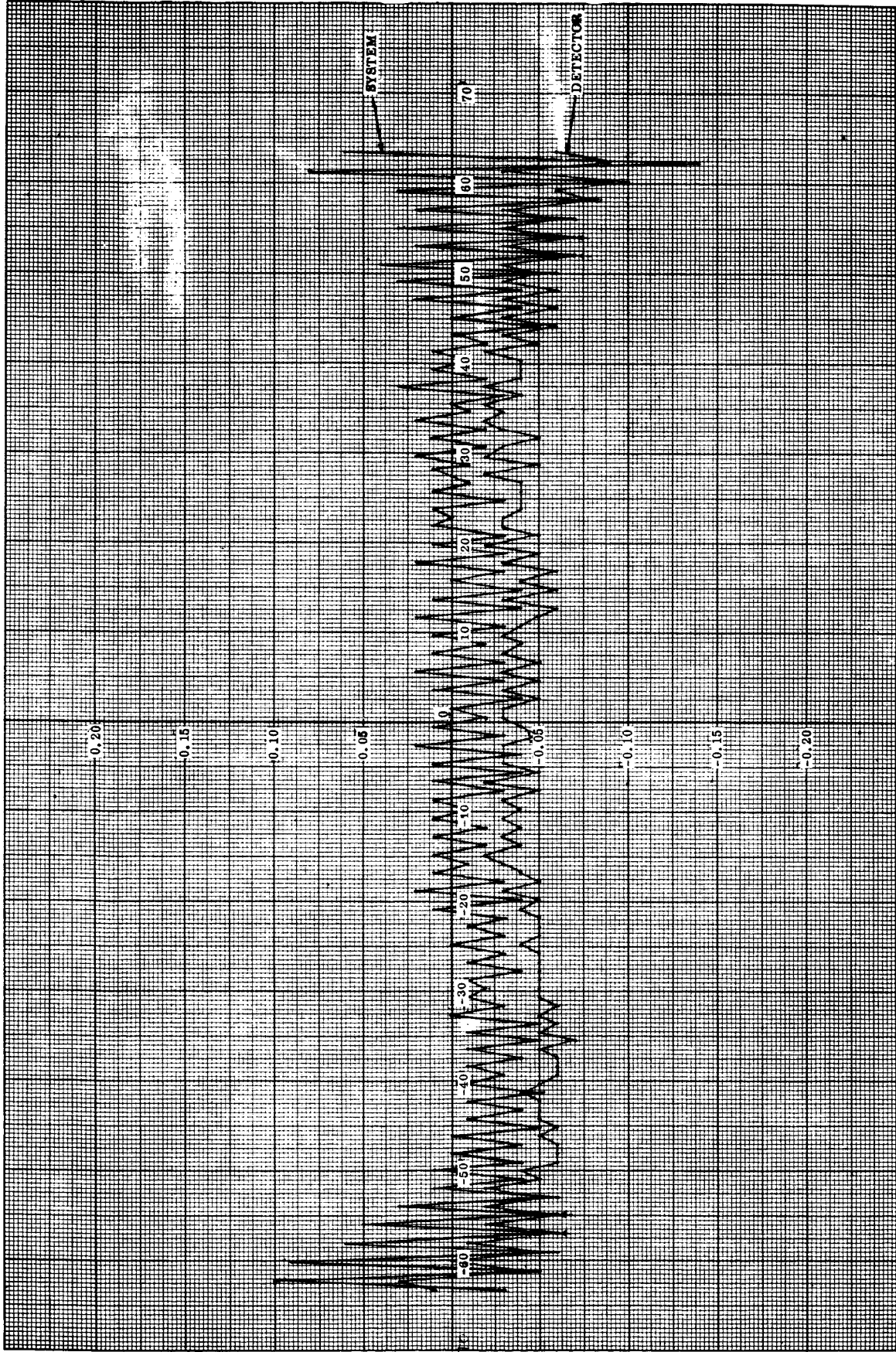

Figure 5-16. Transition Edge Error vs True Transition Position (Reticle 2, Bit 1)

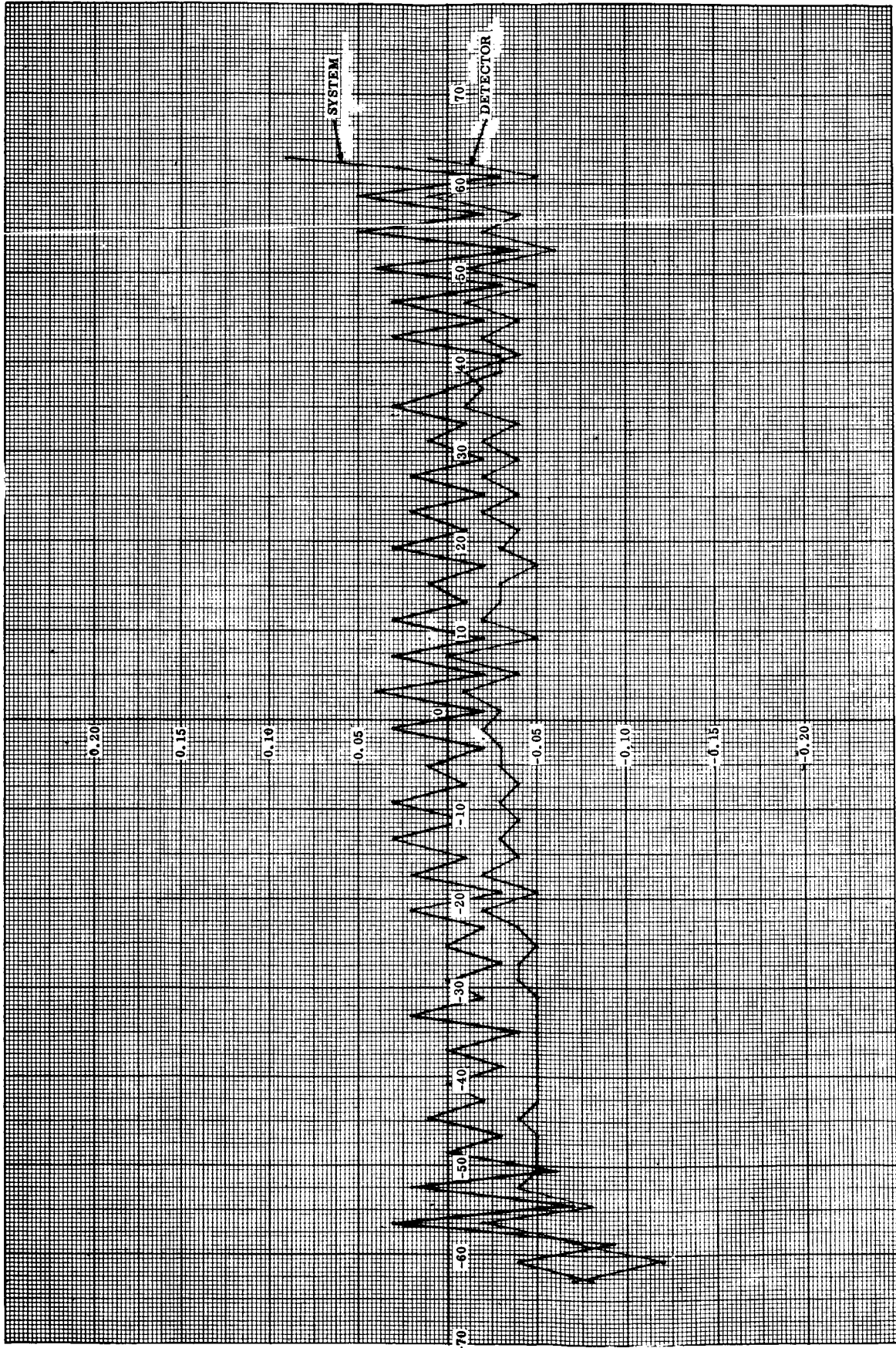

Figure 5-17. Transition Edge Error vs True Transition Position (Reticle 2, Bit 2)

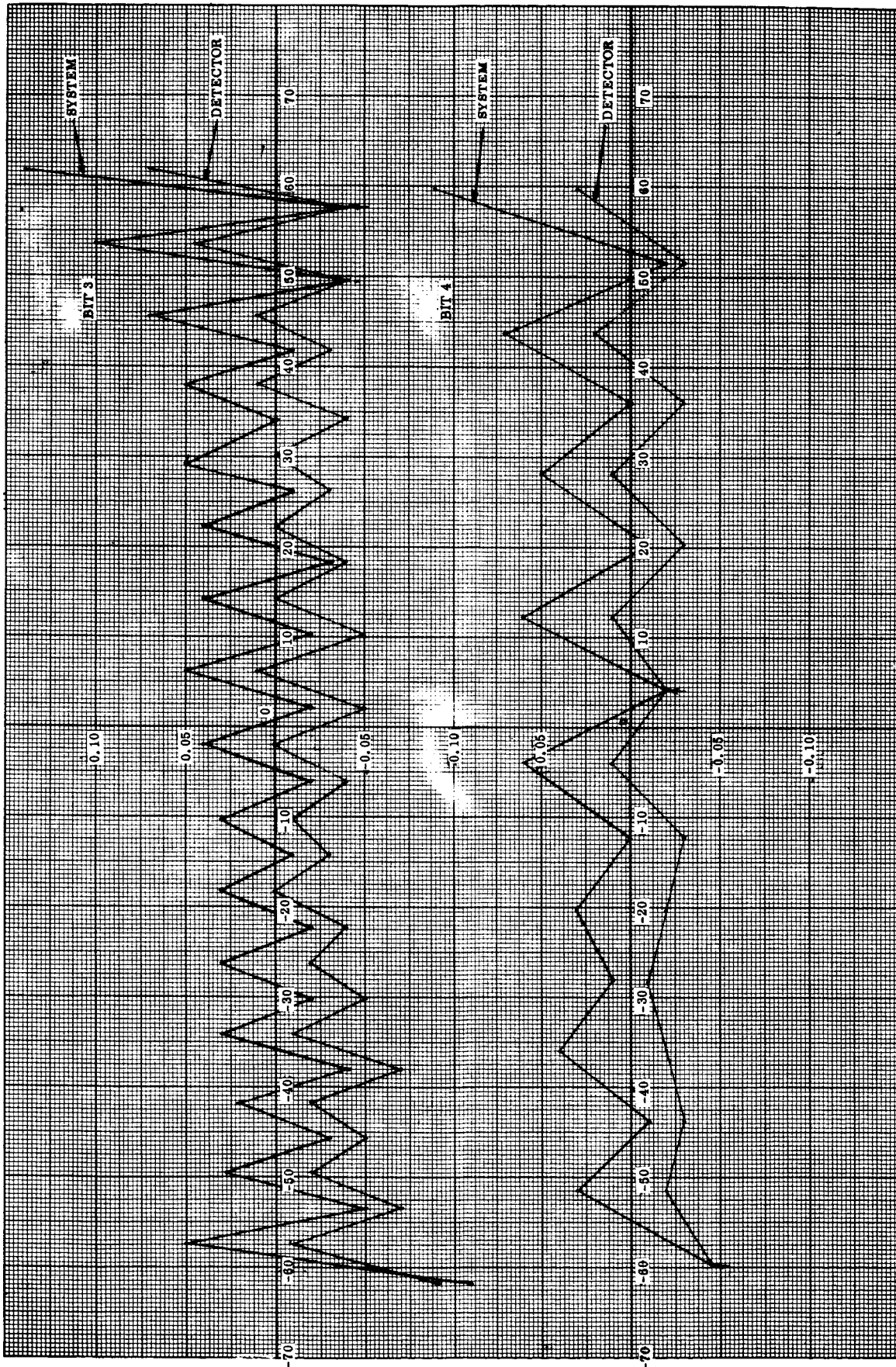

Figure 5-18. Transition Edge Error vs True Transition Position (Reticle 2, Bits 3 & 4)

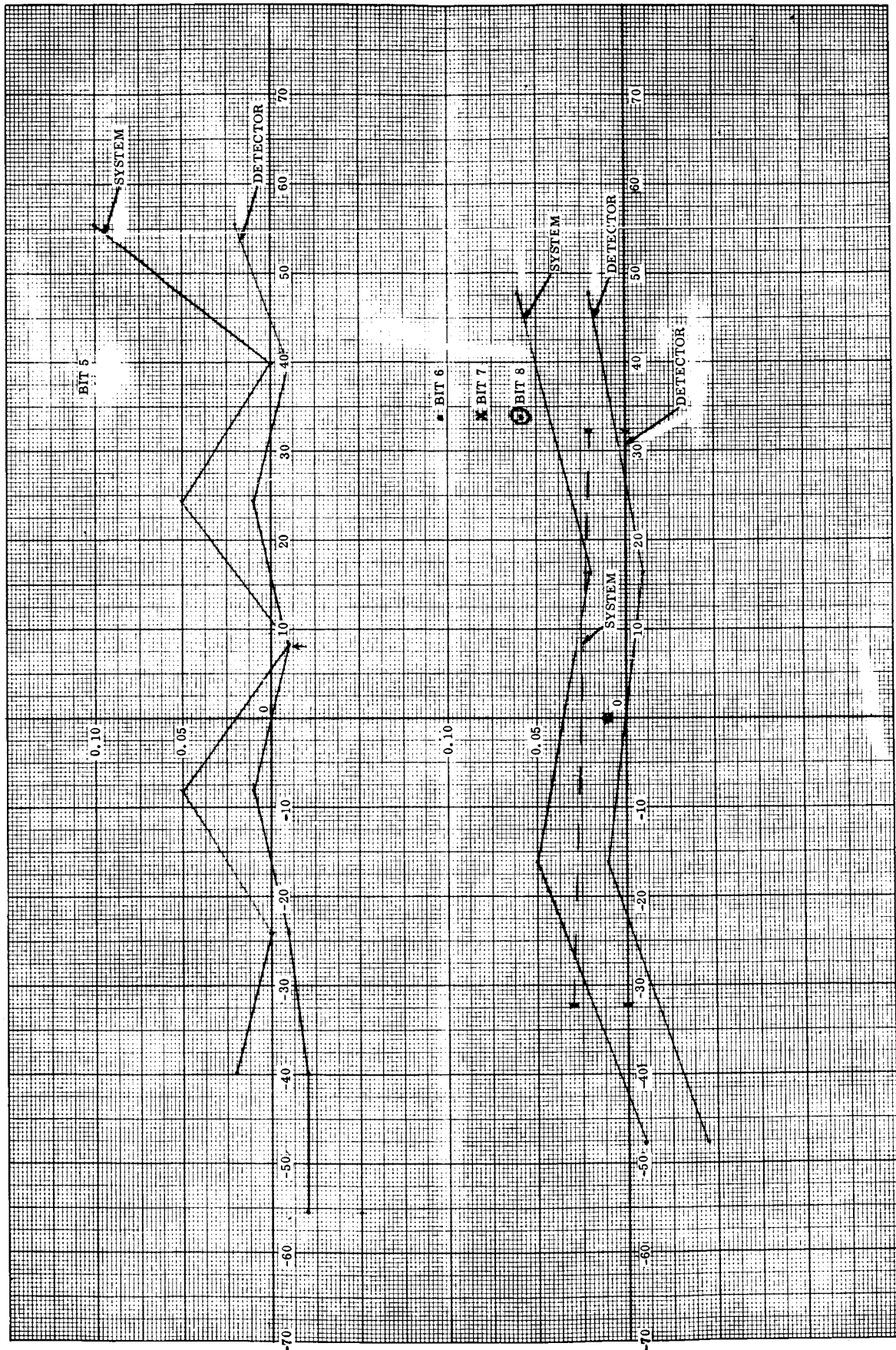

Figure 5-19. Transition Edge Error vs True Transition Position (Reticle 2, Bits 5, 6, 7 & 8)

SECTION 6  
GROUND TESTING

6.1 ENGINEERING EVALUATION TESTS

6.1.1 SPECIAL TESTS

A. ATS Cold Welding Study

This study program consists of experimentation to determine whether cold welding of certain space vehicle components will occur. Special apparatus has been developed to evaluate the extent of cold welding in the ATS boom under ultra-high vacuum. The ultra-high vacuum device is unique in that it is used in conjunction with a conventional vacuum chamber. The cold weld evaluation device employs D'Arsonval's principle, to introduce oscillatory motion to the test sample. Extent of cold welding is monitored using strain gage techniques.

Checkout of the cold weld and the ultra-high vacuum devices are complete. The two have been put together and final checkout is underway. Modifications on the liquid helium cooling system in the 5 by 5-foot chamber are underway. Completion date for chamber is estimated as 4 to 6 October.

B. Micrometeroid Damage Study

Hypervelocity acceleration of cast iron particles at velocities of 31,000 ft/sec and impingement upon samples of bare and silver plated beryllium-copper have been achieved. Particle size ranged from less than 3 to 75 microns, with 90% of the particles being the 3 micron size or less. Cratering and extensive perforation of both types of specimens occurred from particles over the entire size range. Some of the smallest particles only caused craters without any perforation. The density of impact was approximately  $4 \times 10^4$ /meter<sup>2</sup>.

Measurement of the solar absorbtivity was made difficult because of the carbonaceous material resulting from the explosive charge which was deposited on the surface. Methods for removing this deposit have been unsuccessful.

#### 6.1.2 COMPONENT EVALUATION TESTS

Engineering evaluation testing was started on the Solar Aspect Sensor and the Power Control Unit. Testing of both components was performed to prescribed test plans.

##### A. Solar Aspect Sensor Testing

Evaluation of the SAS Engineering Unit 1 was started during the last week of July. The objectives of the tests are to determine:

- a. Soundness of design under extreme environmental conditions.
- b. Instrumented performance versus theoretically predicted performance.
- c. Compatibility of vendor and GE test equipment.
- d. Performance in solar vacuum.

All major test equipment for the SAS engineering evaluation was installed and checked out. The unit was tested with the electronics unit and one detector at temperatures of  $-105^{\circ}\text{C}$ ,  $-55^{\circ}\text{C}$ ,  $+25^{\circ}\text{C}$  and  $+85^{\circ}\text{C}$ . The data taken in these temperature tests are in process of conversion for computer evaluation.

##### B. Power Control Unit Testing

The purpose of this engineering evaluation is to establish a high confidence level that the PCU will meet all the requirements of the applicable specification, SVS-7307. The evaluation will define the testing considered most useful in obtaining design margin information on the internal functions of the component. The engineering testing is further described in Section 5. Results of these tests will be compiled and issued as a test report during the next reporting period.

### 6.1.3 SOLAR VACUUM TESTING

A fixture has been designed which will permit one, or all five SAS sensor heads to be illuminated by one sun under vacuum conditions. The fixture is at GE and is ready to be assembled and checked out. The associated cables have also been received and checked.

An automatic feed carbon arc has been purchased and installed adjacent to the chamber. Chamber modifications are complete except for the installation of a liquid-nitrogen valve outside the chamber. It is anticipated that this valve will be installed early in October. Special brackets to be attached to the chamber are in fabrication and will be available by the middle of October. Assembly and checkout of the SAS fixture and carbon arc are expected to be complete by mid-October.

### 6.1.4 SYSTEM EVALUATION TEST

An ATS gravity gradient set of engineering hardware will be electrically interconnected at GE and evaluated using the AGE. Later the AGE will be shipped to HAC for use on prototype and flight hardware prior to system assembly. In the system evaluation tests at GE, a simulated HAC spacecraft will be used for the mounting of the gravity gradient components. Key objectives of the system evaluation testing are:

- a. Component - to - component compatibility.
- b. AGE - to - system compatibility.
- c. System EMI evaluation.

### 6.1.5 AEROSPACE GROUND EQUIPMENT

The AGE for the gravity gradient system is composed of:

- a. ATS gravity gradient test set rack
- b. Combination passive damper simulator

- c. Solar aspect sensor stimulator
- d. TV target
- e. Interconnection cables and breakout boxes

A. ATS Test Set Rack

The Test Set Rack is a two-bay rack. The left side of the rack is designated the A-side, and the right side of the rack is designated the B-side. Components of each side include:

- a. TV Monitor Panel (1A1) - Provide visual display of the field of view of either TV Camera 1 or 2.
- b. TV Monitor Panel (1A2) - Provides mounting for TV 1 and TV 2 ON/OFF; and provides choice of analog signals for display on DVM.
- c. CPD Panel (1A3) - Provides mounting for damper simulator or damper hardware plug-in; indicators for hysteresis or eddy current damper engaged (Boom 1 and Boom 2); damper engaged angle indicator ON/OFF (primary or redundant bulbs); digital output of angle indicator; and selection of all analog signals for display on DVM.
- d. SAS Panel (1A4) - Monitor for internal pulse A or B encoder and SAS ON/OFF; and digital display of SAS readout and selection of all analog signals for display on DVM.
- e. IR Earth Sensor (1A5) - Indicator for Sensor 1 and 2 ON/OFF and Sun in view; and selection of all analog signals for display on DVM.



- f. Rack Power Panel (1A6) - ON/OFF switch for all power in rack; and indicators for blower, rack power, and vehicle regulated and unregulated buses.
- g. Digital Volt Meter (DVM) (1B1) - Contains a Model NLS 5005M.
- h. DVM Panel (1B2) - Allows DVM to be connected to IRES, SAS, CPD, TVCS, PRI, BOOMS, PCU and two special positions (test points in back of rack); and an external set of jacks on face of panel.
- i. Primary Boom Panel (1B3) - Indicators for the state of both motors on both packages; meter display of boom length and scissor angle; and selection of analog signals for DVM display.
- j. PCU Panel (1B4) - Panel meters to monitor regulated and unregulated bus voltage and current; and DVM display of actual regulated and unregulated bus voltage, and telemetry of regulated and unregulated bus voltage and +5 volts.
  - 1. Unregulated bus voltage adjustable
    - (a) Monitor for A and B encoder and decoder, and emergency sensor power use
    - (b) 26 discrete commands and two spares
    - (c) 12 proportional commands (0.1 second to 2 or 3 minutes  $\pm$  10% of setting) can be preset or operated manually

## 2. Safety Fixture

- (a) Squib fire interlock - key switch necessary to give squib fire command unless damper simulator is plugged in
  - (b) Tip mass interlock - key switch necessary to give any proportional commands
  - (c) Boom initiate commands automatically limited to preset length
  - (d) Command switch interlocked so only one command can be given at one time
- k. Power Supply Panel (1B6) - Contains a -24 volt power supply for rack; a + 18 volt power supply for rack; and a - 24 volt power supply for vehicle (regulated bus).
- l. Power Supply for Vehicle Unregulated Bus (1B7)
- m. Power Relay Panel (1B5) - Controls the application of power to rack, vehicle and blowers.
- n. Interface Panel (1A7) - Contains the interface with the system. All signals are brought to terminal boards where they are available for troubleshooting. Panel also houses the multiple interface relays for the A and B encoders and decoders; these relays have been converted to plug-in units for easy replacement.

Test Set Rack Status: Primary Boom Panel (1B3) is complete, except for the meters. PCU Panel (1B4) is being modified to provide the 300-millisecond command required for the RV shutters. Interface Panel (1A7) will be complete in mid-October. All other panels are complete and awaiting the start of the rack checkout.

#### B. CPD Simulator

The CPD simulator provides all functions of dampers.

- a. Simulated squib loads
- b. Angle indicator loads
- c. Four different angle indicator loads
- d. Temperature sensor loads and outputs
- e. Angle indicator lamp loads
- f. Hysteresis and eddy current shift load and outputs

CPD Simulator Status: The CPD simulator is complete.

#### C. SAS Simulator

Allows for simulation of all bits simultaneously or one at a time.

SAS Simulator Status: Solar Aspect Sensor simulator development is awaiting return of quotes from subcontractors.

#### D. TV Target

The TV target will be a standard 18-inch by 24-inch resolution chart which is supported on an adjustable stand. Lighting will be provided by two, 500-watt lamps.

TV Target Status: The TV target is expected to be ordered during mid-October.

### E. Interconnection Cables and Breakout Boxes

The interconnection cables and breakout boxes allow monitoring of all lines between the PCU and all other components. All lines from rack to components are available at the interface panel. The panel is provided with the following connectors: 25-pin male, 15-pin male, 50-pin male, 25-pin female, and 9-pin female.

**Interconnection Cables and Breakout Boxes Status:** The breakout boxes are complete and awaiting cables which are currently being fabricated by GE at Burlington, Vermont.

#### 6.1.6 SYSTEMS THERMAL TESTS AT HAC

The GGSS thermal models were prepared for acceptance by NASA during August and shipped to the Hughes Aircraft Company on 9 September 1965. These components are intended for use by the HAC system thermal test. The hardware consists of:

- a. Combination Passive Damper and Damper Boom (Figure 6-1)
- b. Primary Boom Package (Figure 6-2)
- c. TV Camera with Lens and Camera Control Unit (Figure 6-3)
- d. Solar Aspect Sensor Electronics Unit and Five Sun Sensor Detectors (Figure 6-4)
- e. Power Control Unit (Figure 6-5)

Each thermal model has been fabricated to dissipate the same nominal power to within 10% of the predicted flight units when an input of 21.2 volts is applied. Several power dissipating resistors have been mounted in most of the units to distribute the power dissipation within each unit. In addition, the primary boom package contains separate resistors for the "extension" and "scissor" motors to allow them to be energized separately. Resistors have been selected which are capable of dissipating twice the predicted nominal power. Thermocouples of No. 30 copper-constantan wire with 50-foot-long leads have been used on all components.

Aluminum has been used freely in the thermal models to replace the mass of transformers, motors, magnets and other mass-contributing components and, in some cases, to replace more exotic structural materials (e.g., the SAS electronic package where aluminum is used to replace a magnesium-lithium package). In such cases, the weight of the thermal models has been calculated to simulate the thermal mass of the flight units.

The external configuration of each component has been held as closely as possible to the ATS-A configuration. The units are not intended to be used for mock-up purposes to establish clearance or connector locations on the vehicle. The finishes used on the thermal models have been selected to be representative of the flight hardware.

A "Thermal Interface Information" report (GE Document No. 65SD4421) was prepared by GE for use in the system thermal test. The document contains information relating to the thermal models and includes handling instruction, thermocouple installation locations and a drawing of each unit.



Figure 6-1. CPD with Damper Boom in Stowed Position - Thermal Models

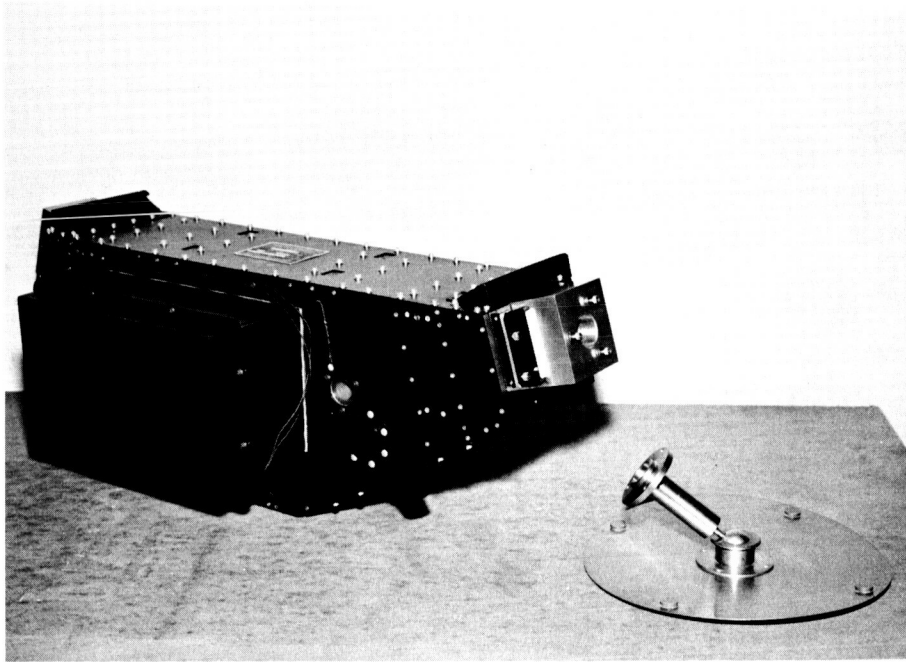

Figure 6-2. Primary Boom Package and TV Target - Thermal Models

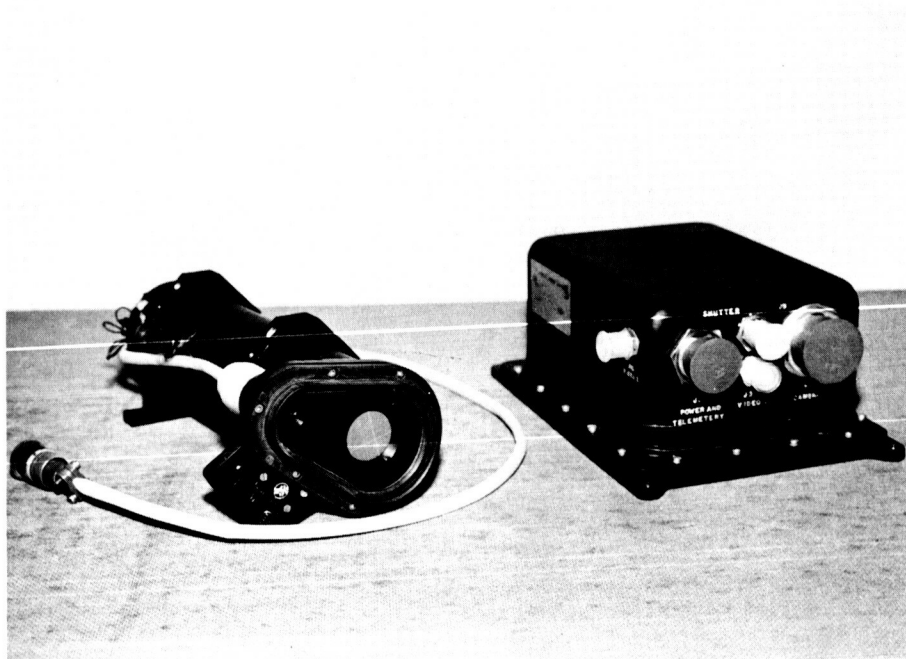

Figure 6-3. TV Camera (left) and Control Unit - Thermal Model

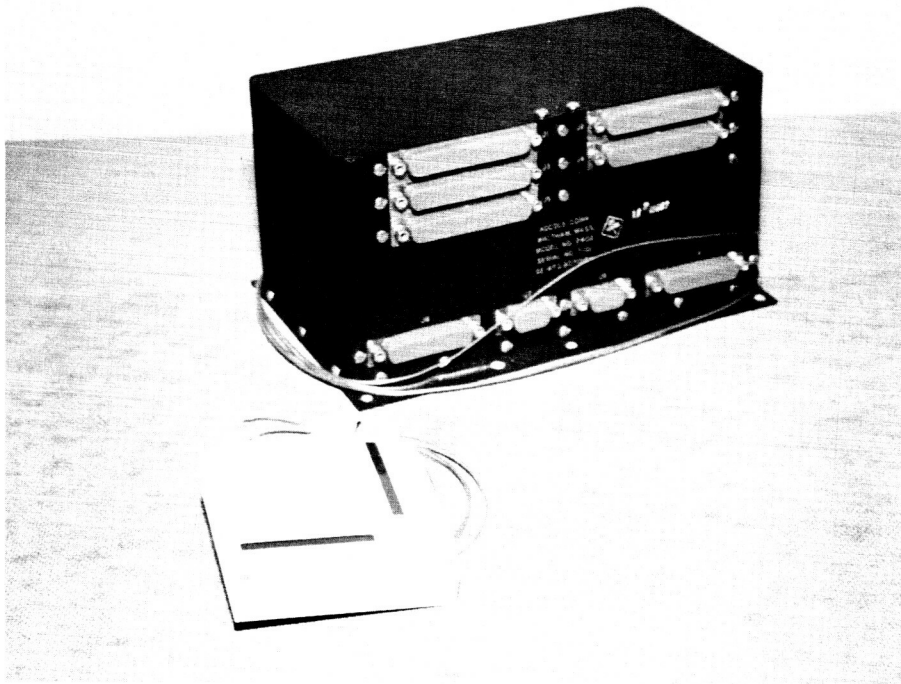

Figure 6-4. Solar Aspect Sensor with Sun Sensor Detector - Thermal Model

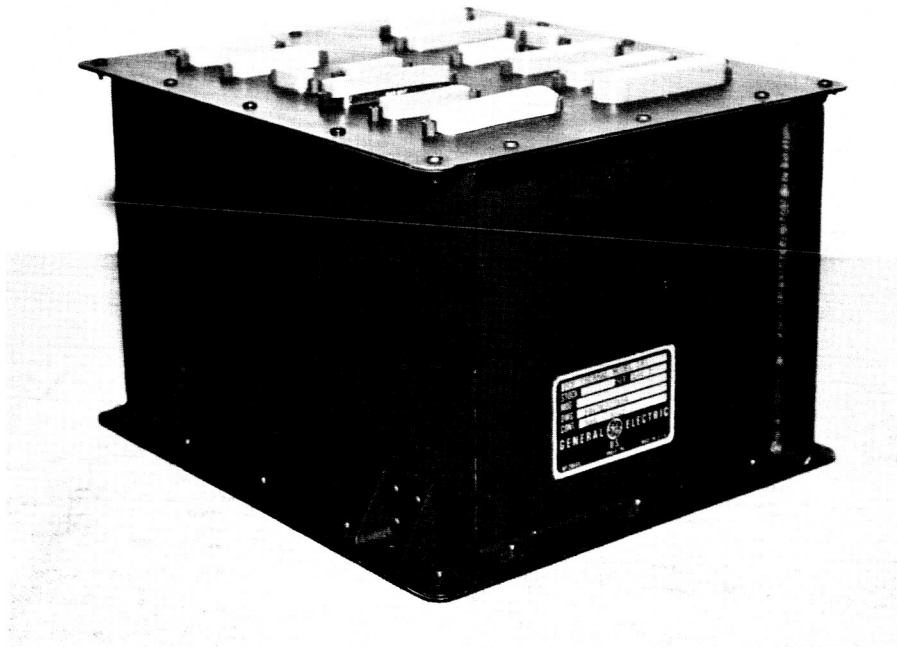

Figure 6-5. Power Control Unit - Thermal Model

#### 6.1.7 SYSTEM DYNAMIC TESTS AT HAC

As part of the ATS development program, the Hughes Aircraft Company is scheduled to conduct a series of dynamic tests on an ATS structural model. The objective of these dynamic tests will be to obtain spacecraft structural loading criteria and data for establishing fatigue spectra. A secondary objective will be to obtain realistic vibration levels at the component/structure interface to confirm component qualification vibration specifications.

GE has fabricated structural components for this system dynamic test which approximate flight hardware in mass, center of gravity, dimensional envelope and material. These models were successfully vibration tested and displayed for acceptance by NASA/GSFC representatives on 3 September. With exception of the combination passive damper, and the damper boom assembly all models were shipped from GE to NASA on 13 September 1965. The CPD and damper boom assembly were retained with NASA's concurrence for instrumented vibration tests to obtain early vibration data. Results of these tests are summarized in Section 4.2.4. The CPD and damper boom dynamic model were inspected and reassembled following the vibration environment, and the models are ready for shipment at NASA's convenience.

A list of the hardware which was supplied for the system dynamic tests includes:

- a. Primary Boom Assemblies (2)
- b. Damper/Damper Boom Assembly (including handling fixture) (1)
- c. Power Control Unit (1)
- d. SAS Electronics Unit (1)
- e. SAS Detectors (5)
- f. TV Cameras (2)
- g. TV/Control Units (2)



The dynamic models are similar to the thermal units shown in Figures 6-1 through 6-5.

Electrical connectors have been added to the dynamic models which are not included in the thermal units; and the finishes on the dynamic units are different, in some cases, from those of the thermal units.

A "Dynamic Interface Information" report (GE Document No. 65SD4430) was prepared by GE for use in the system dynamic tests. The document defines the hardware, and lists instrumentation requirements. A drawing of each dynamic model is included in the report.

## 6.2 QUALIFICATION TESTS

### 6.2.1 PARTS QUALIFICATION PROGRAM

#### A. Definition

The Parts Qualification Program is presented in Tables 6-1 and 6-2. Table 6-1 lists the parts assigned to Group A which, in turn, contains the parts and assemblies that are to be subjected to qualification testing per the applicable specifications. Table 6-2 lists the parts assigned to Group B which, in turn, contains the parts for which a favorable history of reliability already exists. The latter group is to be subjected to tear-down and analysis for evaluation of design features, workmanship, and identification of risk characteristics.

#### B. Revisions to the Program

1. Conax Bolt Cutter - This device (Item 6 in Table 6-1) has been deleted from use in the boom system. Upon completion of design engineering, the new device will be reviewed for addition to the parts qualification program.

2. Angle Indicator Head Assembly - The quantity of units to be tested (Item 4 in Table 6-1) was changed from five to three. This adjustment was a part of the package which also added the life-testing of 100 lamps. This was a tradeoff to accentuate the testing of the lamps, which were considered the highest risk elements in the assembly.

3. Lamps - Item 15 was added to Table 6-1. A quantity of 100 lamps will be subjected to an extended life test. This will provide reliability data on the life of the lamps used in the angle indicator.

4. Solenoid - The test site for the solenoid was changed from GE to the vendor's plant, Koontz-Wagner.

5. Transformers - Items 2 and 3 in Table 6-2 have been deleted. These parts are transformers which were no longer used in the final PCU design.

#### C. Status

The status of each item contained in the parts qualification program is given in Table 6-3.

#### D. Holex Cable Cutter

The testing of the cable cutter (Item 5 in Table 6-1) has been completed by the vendor, Holex. Results of the test are satisfactory, and will be published in a complete qualification report on the device.

TABLE 6-1. GROUP A - PARTS REQUIRING QUALIFICATION TESTING

Item	Part	Part No.	Vendor	Component	Quantity	Where Tested
1	Transformer, Inverter	R4610P1	Edgerton	SAS	5	GE-SD
2	Solar Cell Assembly	R4611P1	Hoffman Edgerton	SAS	5	Adcole
3	Solenoid	R4612P1	Koontz- Wagner	CPD	5	Koontz- Wagner
4	Angle Indicator Head Assembly	47E207350	GE-SD	CPD	3	GE-SD
5	Cable Cutter	115C7516 895D724	Holex	CPD	20	Holex
6	<del>Belt Cutter</del>	<del>5825-14</del> <del>(deHavilland)</del>	<del>Genax</del>	<del>Booms</del>	<del>18</del>	-
7	Pressure Transducer	-	C. I. C.	Booms	5	-
8	Potentiometer, Scissoring	TSPR10K(2)L2	Helipot	Booms	5	-
9	Potentiometer, Extension	T223R10K(1)L2	Helipot	Booms	5	-
10	Limit Switch, Extension	2HM1-3	Minn. Honey.	Booms	10	-
11	Limit Switch, Scissoring	6HM1-1	Minn. Honey.	Booms	10	-
12	Motor, Boom Drive	-	Globe Ind.	Booms	15	-
13	Motors, Scissoring	-	Globe Ind.	Booms	15	-
14	Sealed Drive Unit	-	deHavilland	Booms	2	GE-SD
15	Lamps, Double Filament	47C207314P1	Chicago Miniature	CPD	100	-

TABLE 6-2. GROUP B - PARTS FOR TEAR-DOWN AND ANALYSIS

Item	Part	Vendor	Component	Number To Be Purchased
1	Transistor	TI 2N2432	SAS	5
2	<del>Transformer</del>	<del>Treeco</del>	<del>PCU</del>	<del>5</del>
3	<del>Transformer</del>	<del>Raytheon</del>	<del>PCU</del>	<del>5</del>
4	Relay	R2313	PCU	5
5	Temp. Sensors	-	All	5
6	Thermistor	Fenwal	Booms	5
7	Solenoid, Rotary	Ledex	Booms	5
8	Switch - 1HM1	M. H.	Booms	5
9	Switch - 12SM4T	M. H.	Booms	5
10	Bellows	-	Booms	5
11	Capacitor	Sprague	Booms	5
12	Connector	Cannon DEM	Booms	5
13	Connector	Cannon DCM	Booms	5
14	Connector	Cannon DBH	Booms	5

TABLE 6-3. STATUS OF PARTS QUALIFICATION PROGRAM - 9 SEPTEMBER 1965

Item No.	Description	Status
<u>Group A</u>		
1	Transformer	Parts on order
2	Solar Cell Assembly	Drawing revisions being negotiated with vendor
3	Solenoid	Parts on order. Testing was scheduled to start 9 September 1965. Vendor is slipping date due to plating problems
4	Angle Indicator Head Assembly	Parts are being procured
5	Cable Cutter	Testing completed. See paragraph 6.2.1 (A)
6	(deleted)	-
7 thru 13		
14	Sealed Drive Unit	Need drawings from subcontractor
15	Lamps	Need definition of flight configuration from subcontractor
<u>Group B</u>		Order for parts is in process
1	Transistor	Parts on hand
2 and 3	(deleted)	-
4	Relay	Parts on order
5	Temp. Sensors	Parts are being procured
6 thru 14		Need drawings from subcontractor

## 6.2.2 COMPONENT QUALIFICATION

The following waivers to specification S2-0102 have been approved by NASA:

- a. Functional tests of the damper can be conducted when the relative humidity is over 55%, however every reasonable effort should be made to keep the relative humidity to a minimum.
- b. The temperature stabilization requirement in S2-0102 can be relaxed to  $\pm 2^{\circ}\text{C}$ .
- c. The performance test during the humidity environment (Section 4.4) is no longer required.
- d. The thermal operating test may be deleted from the qualification program for those components, and only those, on which a performance test can be conducted during the thermal vacuum test. If, however, the component does not successfully pass the initial thermal vacuum test, a complete qualification test program, as described in the Environmental Qualification and Acceptance Test Specification, S2-0102, must be conducted on the component.
- e. The non-operating thermal storage test may be deleted from the qualification program of only those components whose storage test temperature are contained within the thermal vacuum test temperature range.
- f. The relative humidity requirement of Section 4.4 is  $90\% \pm 5\%$  instead of  $90\% \pm 3\%$ .
- g. The averaging time (Section 4.5.2 (B)) of 25 seconds is an acceptable substitute for the three seconds called out in the specification.

### 6.3 FLIGHT ACCEPTANCE TESTS

Flight hardware will undergo testing in the following sequence:

- a. Component Acceptance Test - The component will be tested to ensure that it satisfies the component performance specification and will be subjected to the vibration and thermal vacuum requirements of NASA Specification S2-0102.
- b. System Functional Test at GE - All components of a flight system will be electrically interconnected at GE and a functional test will be conducted. Each command will be operated and all telemetry will be verified prior to shipment to HAC.
- c. System Tests at HAC - After assembly to the spacecraft a system test will be conducted which will include a functional test on all gravity gradient components with the exception of the squib actuated components.

### 6.4 TEST EQUIPMENT

- a. Solar Aspect Sensor - All major test equipment for SAS engineering and development testing are complete. The solar simulator (xenon lamp) is operative and ready for SAS testing. Various means of improving the beam uniformity are under investigation.
- b. Power Control Unit - All test equipment required for PCU engineering and development testing is complete. This includes test console and cabling, shock-vibration-acceleration test fixtures, dipole and thermal-vacuum test fixture, and the thermal-vacuum chamber penetration plate and cabling.

- c. Primary Boom Subsystem - Modifications are being made to the dipole and acceleration test fixtures; completion is scheduled for 10 October. All other outstanding test equipment required for engineering and development testing is scheduled for completion 17 October.
  
- d. TV Camera System - The test console and SVA, dipole and vacuum-thermal fixtures required for engineering and development testing of the TV camera are complete. The TV target and illuminator, and the camera holding fixture are scheduled for completion 3 October. The sun shutter stimulator will be complete 10 October. The TV monitor was checked out and calibrated.
  
- e. Combination Passive Damper - Test Console 1 is complete, and Test Console 2 is about 80% complete, with scheduled completion 17 October. Detail drawings for the LOFF and ADTF ovens have been released. The ovens are scheduled for completion 31 October. Modifications are being made to the Angle Indicator Calibration fixture and the acceleration fixture.
  
- f. Damper Boom - All test equipment needed for engineering tests is complete, with exception of the acceleration fixture. This fixture was returned to the vendor for repairs, but should not affect the presently planned test schedule.
  
- g. Dipole Test Facility - This test facility is complete and ready for the performance of dipole tests.
  
- h. Solar Vacuum Facility - The test chamber and arc light are ready for test use, and a quartz window is available for installation in the chamber. The facility will be complete to meet the latest test schedule for engineering units.
  
- i. Boom Test Facility - This facility is complete and ready for the testing of either the primary or damper boom systems.



SECTION 7  
QUALITY CONTROL

7.1 QUALITY CONTROL ENGINEERING

7.1.1 BOOM SUBSYSTEM

The Boom Subsystem Component Test Plan was completed and distributed internally.

A letter delegating certain Material Review Board authority to deHavilland has been prepared. The proposed deHavilland members' resumes were reviewed prior to preparation of the letter.

Test Requirements were issued for testing both the thermal and dynamic primary and secondary boom units.

Testing of Engineering Unit 1 damper boom was witnessed at deHavilland. The unit was handcarried to GE by the Quality Control Engineer to ensure the maintenance of the program schedule in view of the labor strike at deHavilland.

The Quality Control Plan submitted by deHavilland was reviewed and accepted by Quality Control and Test. Notification of acceptance was forwarded to purchasing for transmittal.

7.1.2 COMBINATION PASSIVE DAMPER

Work on the Component Test Plan is in process which will include subassembly testing.

Members of Quality Control participated in a design review of the CPD Angle Indicator.

Close contact was maintained with Thompson-Ramo-Woolridge concerning their progress and how they administer their quality control effort. The final performance tests and

dimensional inspections on the Engineering Unit 1 of the Passive Hysteresis Damper were witnessed by the Quality Control Engineer and the unit was accepted.

Quality Control requirements for the other major parts of the CPD (such as the fiber optics, explosive devices, angle indicator head, etc.) were established.

A Test Requirement (TR 11023) was written for the testing of the thermal unit.

### 7.1.3 TELEVISION CAMERA SUBSYSTEM

A Test Requirement (TR 11036) was issued for providing equipment to be used for corona testing at GE rather than at Lear-Siegler, Inc.

Test Requirement 11032 was issued describing the testing for the dynamic model TVCS and TR 11026 for the thermal model testing.

Copies of Lear Siegler's "Production Alignment and Checkout Procedure" and "Acceptance Test Procedure" were received for review. A letter was forwarded through Purchasing stating that the "Acceptance Test Procedure" is acceptable provided a number of changes are made.

A review of the quality problems encountered on the thermal and dynamic units and the corrective actions taken to prevent recurrence are presented in GE internal document PIR 4323-FM-134.

TR 11028 gives instructions for the bake-out of the cable assemblies and TR 11035 defines the requirements for equipment and fixtures to perform vibration testing on subsequent units.

#### 7.1.4 SOLAR ASPECT SENSOR

A GE internal document, PIR 4323-FM-106, was written to Purchasing to inform them that Adcole Corporation has taken the necessary corrective actions and now conforms to NPC 200-3 requirements.

PIR 4323-FM-124 presents the status of Adcole Corporation in meeting the quality requirements of the purchase order as defined by GE Standing Instruction SI 217,260. In addition, this document includes a detailed GE surveillance plan delineating the source inspection requirements in the Adcole Corporation manufacturing process.

TR 11021-1 and TR 11018-1 were written for the testing of the Dynamic and Thermal units respectively.

A document has been written outlining the changes necessary in GE drawings, specifications, and work statements in order to update these items to agree with the latest agreements with vendors and eliminate the possibility of ambiguous interpretations by the vendor.

Engineering Test Report 4323-FM-006 was issued for the thermal model solar aspect sensor and gives assurance that the unit was satisfactory for its intended purpose.

The status of testing at Adcole Corporation is discussed in GE internal document, PIR 4323-FM-039.

The draft Qualification and acceptance test plan for the solar aspect sensor was distributed for comments.

#### 7.1.5 POWER CONTROL UNIT

Test Requirement 11034 was issued describing the vibration testing to be performed on the Dynamic Unit.

Wire Dress meetings were held for the printed circuit board assemblies in the PCU.

PIR 4384-EAG-059 "Process Control Review of Printed Circuit Board Assemblies for ATS Power Control Unit 47E207222G1" was issued. A review of all of the boards was made to: 1) establish process control points during fabrication, 2) review a problem of lifted circuits, and 3) make recommendations to eliminate problems associated with manufacturing and inspection which had occurred in the past on boards of similar design. The findings were discussed with the responsible design engineer and design changes were initiated.

## 7.2 TEST EQUIPMENT ENGINEERING

### 7.2.1 BOOM SUBSYSTEM

Attempts to deploy the booms at deHavilland were witnessed by the GE Test Equipment Engineer during visits to the Canadian facility. One of the trips revealed the need for a redesign of the trolley mechanism and a requirement for a take-up mechanism console.

Modifications were made to the boom electrical console and power supplies were ordered.

The scissor calibration fixture drawings and the primary and secondary boom holding fixture drawings were completed.

Cable designs for the dipole and thermal vacuum testing were completed.

The boom take-up mechanism control panel drafting and the trolley modification drafting were completed.

Checkout of the test console was completed, and the test track facility completed for damper boom testing. The damper boom was mechanically fired indicating that the track facility and instrumentation worked satisfactorily.

The primary boom fixturing was modified to accept the latest change in connector position.

#### 7.2.2 COMBINATION PASSIVE DAMPER

The vibration fixture was completed, inspected and used for testing the dynamic unit.

All presently known special inspection tools and/or gages were completed through design and are in various stages of fabrication.

The LOFF and ATDF thermal enclosures were designed; however, later engineering inputs indicate a redesign effort which has been started.

The drafting effort on the angle indicator calibration fixture was completed and the fabrication was initiated.

#### 7.2.3 TELEVISION CAMERA SUBSYSTEM

The problem of testing the camera in the thermal vacuum environment was discussed and the method resolved.

All test cables were completed.

The sun shutter fixture design was completed and detail drafting is in process.

The holding and lighting fixture design and fabrication was completed.

The vibration fixture was used for the dynamic model but requires modification for subsequent testing.

The electrical test console was designed, fabricated and calibrated.

#### 7.2.4 SOLAR ASPECT SENSOR

The electrical test console was completed and checked out prior to use on the engineering units.

The alignment fixture was completed and is ready for use.

The solar simulator was checked out after installation and at present only one reticle on a detector can be tested at a time instead of testing two as planned. Further evaluation of the facility is in process.

A special fixture was made to bake the detectors in a thermal-vacuum environment.

#### 7.2.5 POWER CONTROL UNIT

The vibration fixture was completed and used for testing of the dynamic unit.

Design has been initiated for the card, module and component test equipment for testing the prototype and flight units.

The engineering test equipment has been modified for the latest PCU design changes.

Test cables for ambient temperatures and thermal-vacuum are being fabricated.

### 7.3 INSPECTION AND TEST

#### 7.3.1 BOOM SUBSYSTEM

Vendor surveillance activity was provided at deHavilland throughout the reporting period. Some detail part inspections were performed by the GE representative because of the strike at deHavilland. The wood mockup thermal and dynamic units were accepted at deHavilland.

The engineering units, consisting of both the damper boom and primary boom, were accepted with a number of deviations from specification.

Trip reports were issued weekly on the status of deHavilland furnished items with particular emphasis on quality. Many quality problems were reported and a review between GE and deHavilland personnel is planned.

The thermal and dynamic units were tested at GE during the reporting period; no problems encountered.

Engineering testing of the damper boom was started at GE at the new test track facility with quality control personnel supporting the tests.

#### 7.3.2 COMBINATION PASSIVE DAMPER

Surveillance inspection was performed at Chicago Miniature Lamp Works where the double-filament lamps for the angle indicator were accepted based on the acceptance test results and inspection data.

Testing of Engineering Unit 1 and Prototype Unit 1 were witnessed on the Passive Hysteresis Damper at Thompson-Ramo-Wooldridge - Space Technology Laboratories. Their manufacturing flow plan was reviewed. Test records, inspection records, and manufacturing shop travellers were audited.

Vendor surveillance personnel worked closely with Bausch and Lomb, Inc. prior to and during the fabrication of the fiber optics assemblies.

Ultrasonic inspection of aluminum forgings was witnessed at Universal Technical Testing Laboratories, Inc.

Although a number of discrepancies were apparent on the engineering solenoid, it was accepted at Koontz-Wagner with concurrence of the responsible design engineer.

In-process and final inspection of the guillotine and electro-explosive pressure cartridge order was performed at Horex, Inc. The guillotines were fired and each unit cut the GE furnished cables cleanly, thus meeting all specification requirements.

Visual and mechanical inspections were performed by GE vendor surveillance personnel on the angle indicator head at Ehresmann Machine Company. The pieces met all drawing requirements and were accepted.

The dynamic and thermal CPD units were inspected and tested in accordance with engineering instructions and were accepted for their intended use. Many of the engineering development tests are being performed by quality control technicians.

All inspections of damper parts for the engineering units are being performed the same as they would for prime hardware utilization inspection planning. Crab sheets are written on all discrepancies which are dispositioned by representatives of Engineering and Quality Control.

### 7.3.3 TELEVISION CAMERA SUBSYSTEM

A review of Lear-Siegler, Inc. performance revealed that they were not satisfying some of the requirements of the GE Standing Instruction SI 217,260. A letter was written by the vendor quality assurance engineer concerning these quality requirements. The vendor manufacturing flow plan was approved by GE and our surveillance inspection points were identified. Surveillance of the TVCS Engineering Units 1 and 2 revealed a number of discrepancies which were bought off by GE at the vendor. The unit was received at GE and testing was started with the support of Quality Control and Test technicians.



Testing of the thermal and dynamic models was conducted by quality control and test personnel. The dynamic unit testing was stopped when the lens and shutter assembly worked loose from the camera body. Repairs were made at GE but Lear-Siegler has been directed to redesign the method of attachment.

#### 7.3.4 SOLAR ASPECT SENSOR

Vendor surveillance participated in the complete dimensional inspection of a solar aspect sensor reticle and approved the master.

Testing of the thermal and dynamic units was performed by quality control and test personnel. Some discoloration of the detectors was noted in the temperature environment and the units were repaired.

Functional testing was witnessed at Adcole Corporation. Control of their Hi-Rel parts was discussed in addition to the quality requirements of SI 217,260.

#### 7.3.5 POWER CONTROL UNIT

Two trips were made to Melpar, Inc., concerning the GE printed circuit boards for the PCU. Problems involving vendor interpretation of our engineering requirements were resolved during the visit. Final inspection and acceptance was accomplished on the second trip and the units were handcarried to GE.

Several Hi-Rel parts suppliers were contacted by vendor surveillance personnel to assure that they understand our requirements. Trip reports for National Semiconductor Corporation and Mepco, Inc., were issued indicating that they are able to satisfy the specification requirements.

#### 7.4 GENERAL

The GE internal document PIR 4326-523 was issued which defines the "Drawing Control Procedure for Test Equipment Engineering - ATS Equipment" making the Supervisor of Drafting responsible for control.

Meetings were held with AFQC personnel regarding the updating of the Government Source Inspection List. PIR 4364-012 was published giving a listing of ATS items requiring source inspection from which the formal listing was revised.

The Gravity Gradient Stabilization System Quality Control Program Plan was revised and forwarded to NASA/GSFC for approval.

## SECTION 8

### MATERIALS AND PROCESSES

During the past quarter, major effort in the materials area has been devoted to the selection of materials in the CPD. These chief areas have included adhesives, which have been limited to epoxy resin systems, and selection of surface finishes. Surface finishes have been limited to anodic coatings, chromate conversion coatings, and epoxy paints. These materials were selected because they have the lowest outgassing of volatiles and are highly stable.

The tarnishing of silver in the plated boom has been investigated. Data for plated booms stored 6 months in a coiled condition in a paper box indicates that the solar alpha is 0.15 or less. Investigations of the likelihood of silver sulfide to decompose in orbit have yielded a negative result in two trials where vacuum, but not ultraviolet radiation, was employed. A test employing an ion-pump vacuum chamber and solar ultraviolet simulation is now underway.

Another significant investigation has been the development of a zero-hysteresis magnetic material for the torsional restraint of the eddy-current damper. The material consists of a dispersion of high purity iron in an epoxy matrix. The zero hysteresis feature is dependent upon the homogeneity and uniformity of the dispersion.

"Materials Report No. 2," GE Document No. 65SD4442, was published during the reporting period. The document contains detailed analyses of materials investigations for all subsystems.

**SECTION 9  
MANUFACTURING**

**9.1 THERMAL UNITS**

The thermal units for the Combination Passive Damper and the Power Control Unit were manufactured by GE. All thermal units were retrofitted with appropriate heat dissipating resistances and assembled for acceptance by NASA/GSFC. The thermal units of the ATS stabilization system and corresponding GE drawing numbers are:

<u>Thermal Unit</u>	<u>GE Drawing No.</u>
Combination Passive Damper	47C207493
Power Control Unit	47C207494
Solar Aspect Sensor Detector	47C207498
Solar Aspect Sensor	47C207499
TV Camera	47C207491
TV Camera Control Unit	47C207492
Primary Boom Package	47D207490
CPD Handling Fixture	47E207487

**9.2 DYNAMIC UNITS**

The dynamic models of the CPD and PCU were fabricated at GE. Metal weights were added to the PCU to simulate the specified weight and cg location. Foam was added to the unit to ensure that these weights would not shift position under the anticipated dynamic environments.

**9.3 ENGINEERING UNIT 1**

Except for the CPD and TV camera, all engineering units have been delivered for engineering testing. Fabrication of the CPD is approximately 80% complete.

#### 9.4 ENGINEERING UNIT 2

Manufacturing of the CPD is approximately 65% complete. Delivery of all other units will meet the program schedule.

#### 9.5 PROTOTYPE UNITS 1 AND 2

Parts for the PCU have been ordered or are in the process of being ordered. Subcontract items are ordered with delivery promised to meet program schedule.

#### 9.6 FLIGHT UNITS

Advanced orders have been placed for those components which have been defined for use in the flight units. Additional orders will be placed as further parts definitions are made.

Component test fixtures and system test equipment is approximately 85% complete.

#### 9.7 TOOLING

The manufacture of all major tooling for the CPD has been completed. These tools are available for use on the engineering units.

Tooling for the primary boom/spacecraft and CPD/spacecraft interfaces have been defined and the drawings were completed.

These interface tools will be fabricated upon receipt of concurrence from the Hughes Aircraft Company.

SECTION 10  
RELIABILITY AND PARTS & STANDARDS

10.1 RELIABILITY

10.1.1 COMBINATION PASSIVE DAMPER CLUTCH SOLENOID TRANSIENT SUPPRESSION CIRCUIT

As a result of a request from NASA/GSFC, GE investigated the desirability of replacing the transient suppression diode across the CPD clutch solenoid with an RC circuit (See Figure 10-1). NASA's concern is that an open failure of this diode would allow a transient spike to occur on de-energizing the solenoid that could conceivably damage the HAC Payload Power Switch. Opinion has been expressed that an RC circuit in this application is less likely to fail in the open mode.

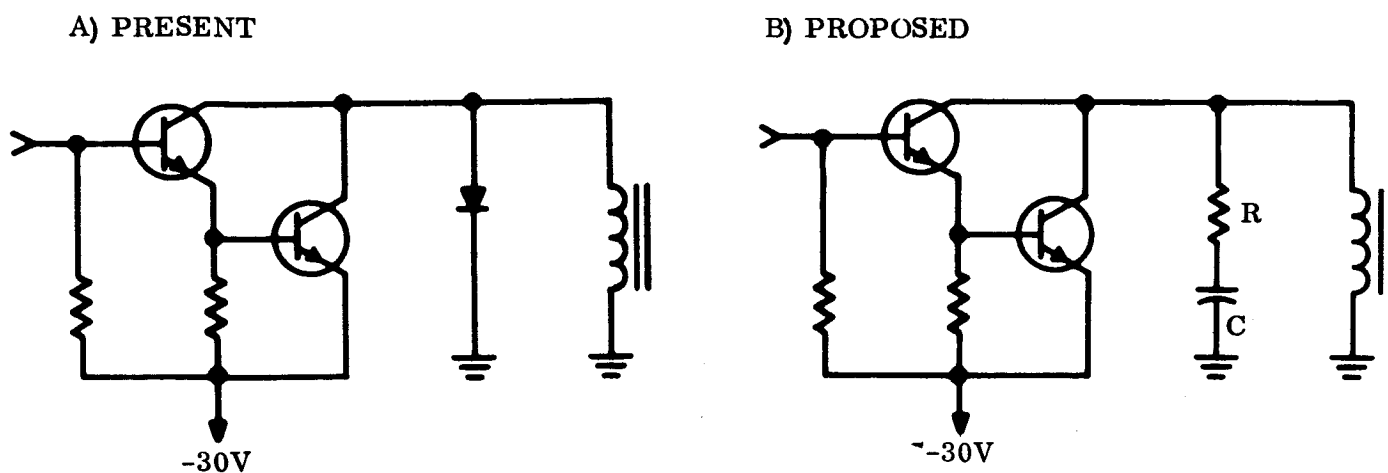

Figure 10-1. Combination Passive Damper Clutch Solenoid Suppression Circuit

Conversations with design engineering and parts specialists have led to the following considerations:

- a. A maximum size for the resistor (See Figure 10-1,B) is established by the requirement that the collector to emitter voltage across the output transistor (the voltage drop across R) should not exceed 60 volts. As a maximum current of 15 amps can flow in the solenoid, and as this current would flow through R the instant after output transistor is cut off,

$$R_{\max} = \frac{60V}{15A} = 4 \Omega$$

For critical damping in the RLC circuit (no oscillation), the following condition must exist:

$$\frac{4L}{R^2C} = 1$$

where R in this case is the total circuit resistance. The solenoid inductance is approximately 10 millihenries (max.) and its d-c resistance is approximately 2 ohms. To establish the optimum value of C, therefore, we have

$$C = \frac{4L}{R^2} = 1100 \mu f.$$

For a discussion, see "Reference Data for Radio Engineers," ITT '56, pages 154-7.

- b. Two RC circuits would be required (for the two windings of the clutch solenoid). The installation of two capacitors of the physical size indicated above (a voltage rating of at least 60v would be required) is obviously impractical. Use of a smaller capacitor would result in ringing oscillations that could lead to Electro Magnetic Interference (EMI) problems. For example, a 100  $\mu f$  capacitor would oscillate at about 160 cps, a 15  $\mu f$  capacitor at about 410 cps.

c. If the risk of EMI were accepted and a decision made to use, for example, a 15  $\mu$ f 75v capacitor (the largest ATS-qualified capacitor), there would still remain the question of relative reliabilities. Failure rates of the two configurations were compared, using the best available data. The results are tabulated in Table 10-1, and show no essential difference between the two configurations. Such a comparison is essentially meaningless, however, as the failure rate data employed represent averages over a large number of applications, and certainly do not necessarily reflect behavior under the transient conditions being considered here. A more pertinent comparison might be between the extensive GE history of successful employment of diodes in similar applications versus the almost complete absence of reliability data on capacitors subjected to large current transients.

The following conclusions were reached as a result of this investigation:

- a. The capacitor required for an optimized RC transient suppression circuit would be impractically large in this application. Use of a smaller capacitor involves the risk of EMI problems.
- b. There is no evidence to indicate that an RC circuit would be significantly more reliable than a diode in this application.

TABLE 10-1. FAILURE RATE COMPARISON

PART TYPE	$\lambda$ *	% OPEN	% SHORT	$\lambda$ OPEN	$\lambda$ SHORT
Diode, Power (35A)	0.005	40	20	0.002	0.001
Resistor, Carbon Composition (2W)	0.0005	30	0	0.00015	0
Capacitor, Solid Tantalum (15 $\mu$ f 75v)	0.008	10	15	0.0008 0.00095	0.0012 0.0012

\* Failure rates in %/1000 hr



### 10.1.2 SWITCH-CONTACT REDUNDANCY IN BOOM CLUTCH SOLENOID

At a boom-system design review held earlier in the program, GE agreed to a suggestion by NASA/GSFC that a redundant stepping switch wafer be added to the boom clutch solenoid; deHavilland recently informed GE that the addition of the redundant wafer would require extending one side of the gearbox penthouse by approximately 0.125 inch. As this change would result in an increase in the overall envelope, the original decision to provide redundancy was re-evaluated.

A switch was disassembled at deHavilland recently, and the following information was obtained:

- a. There are two sets of contacts and wipers on each wafer, providing a measure of electrical redundancy.
- b. The possible failure modes of the switch assembly would be:
  1. Contact failure (corrosion or dirt),
  2. Wiper-arm failure (breakage, etc.),
  3. Failure to index (detent failure),
  4. High temperature degradation of the wafer dielectric.

The following conclusions were reached:

- a. The likelihood of failure caused by contact or wiper-arm failure is small, due to the existing redundancy of these elements. Of the four failure modes listed, these two are the only ones that would be affected by adding another wafer.
- b. The likelihood of improper detenting is small, and the probability of failure in this mode would not be reduced by the addition of another wafer.

- c. The high-temperature degradation risk will probably be eliminated by a new wafer dielectric material now being specified by deHavilland.

On the basis of the foregoing, it was mutually agreed that there would be negligible advantage to be gained by the addition of a redundant wafer, and deHavilland was instructed to eliminate the requirement.

### 10.1.3 PRIMARY BOOM ASSEMBLY WIRING

#### A. Wiring Redundancy

DeHavilland has proposed "doubling-up" on 13 presently unused connector pins, providing parallel harness connections for primary mission functions. A numerical evaluation of this modification is not feasible due to the number of unknowns involved, but the following qualitative information is thought to be significant:

- a. Incorporation of this change would involve a 35% increase in the number of harness conductors required for mating the boom assembly to the Power Control Unit (PCU) with the associated penalties in size, stiffness, and weight. Similar internal wiring changes would be required at each corresponding connector of the PCU. Experience has shown that the majority of harness failures occur at the connector; experience further indicates that the reliability of a properly-designed harness connection depends to a large degree on human errors occurring during its fabrication and on the handling stresses to which it is subsequently exposed, e.g., increasing the number of active pins on a connector (in this case from 74% to 100% utilization) tends to aggravate both degrading influences.
- b. The theoretical gain in reliability obtained through redundancy is realized only if the redundant elements have independent failure rates (this is not the case when functional conducting paths are duplicated in a single harness connector) mechanical loads are borne to some extent by all conductors, and breakage of one increases the

load on those remaining. (This latter condition is especially true in the present instance, where "redundancy" is achieved in most cases by using adjacent pins for the same function.)

- c. Lastly, the base reliability of the harness in its present configuration is probably at least two orders of magnitude greater than that of some other elements in the system, such as the motors. The slight improvement obtained through partial harness redundancy would therefore not result in a significant change in system reliability. On the basis of these considerations, deHavilland's harness redundancy approach is not recommended.

This topic of wire redundancy was discussed with deHavilland personnel in a meeting held on 30 August. The position taken by deHavilland favored redundancy. They cited instances of failures which were due to broken wires, particularly in internal connections to motors. It was noted that joints inside motor cases could have been weakened (by handling, for example) and not be detected by visual or electrical inspection. It was agreed that the original GE decision against wire redundancy would stand with respect to the GE interface with deHavilland. However, it was also agreed that deHavilland could employ redundancy in selected areas within the primary boom package, subject to review and approval by GE.

#### B. Limit-Switch Wiring Change

DeHavilland has also proposed a change in the extension and scissoring motor limit switch wiring from a two-switch, series arrangement in each armature and field circuit to a single, series-parallel circuit for each motor. In the present configuration, failure to "make" in any of the four switches would result in loss of extension capability. DeHavilland's modification would reduce this hazard to a negligible level. Therefore, it was recommended that this change be incorporated into the primary boom assembly.

Four normally-closed limit switches are associated with each motor in the primary boom assembly for control purposes. At present these are wired so that extension-motor field

excitation passes through two of them in series; the remaining pair on the extension motor are also wired in series to carry the command pulse to the armature driver circuit. This arrangement was intended to guard against over-extension of the booms and the resulting loss in retraction capability. DeHavilland proposes to wire all four switches on the extension motor in a series-parallel configuration, carrying the command signal to both field and armature drivers (see Figure 10-2). This modification will require a minor circuit change in the PCU, but will result in a significant improvement in reliability. In the present configuration, failure to "make" in any of the four switches would result in loss of extension capability; deHavilland's modification would reduce this hazard to a negligible level. As the probability of an "open" switch failure is higher than that of a "short" failure, a further improvement in reliability can be realized by adding a jumper (shown dotted in Figure 10-2) between the two pairs of switches. An analogous change is proposed for the scissoring motor (see Figure 10-2), involving fewer switches but yielding benefits of a similar nature.

DeHavilland questioned the addition of the cross jumper wired to their proposed series-parallel limit switch configuration. GE accepted an action item to justify the recommendation with a supporting analysis. The analysis is included in this report as Appendix C.

#### 10.1.4 ATS PART FAILURE RATES

A compilation of the piece-part failure rates currently used to prepare reliability estimates on ATS components is listed in Table 10-2. This data represents the best presently available for burned-in and screened high-reliability parts in long-life space applications. Electrical stress levels are assumed to be below 25%, except for capacitors, where the assumed maximum level is 50%. Ambient temperatures are assumed to lie between 25 and 40°C.

The listing resulted from the continuation and expansion of a similar study prepared for the Voyager Program. Data from many sources has been evaluated in consultation with GE parts specialists. A "best estimate" has been derived; this is essentially an average weighted by confidence in the source. Note that failure rates derived in this manner represent an average for a large number of parts over a wide range of applications and

PRESENT EXTENSION MOTOR WIRING

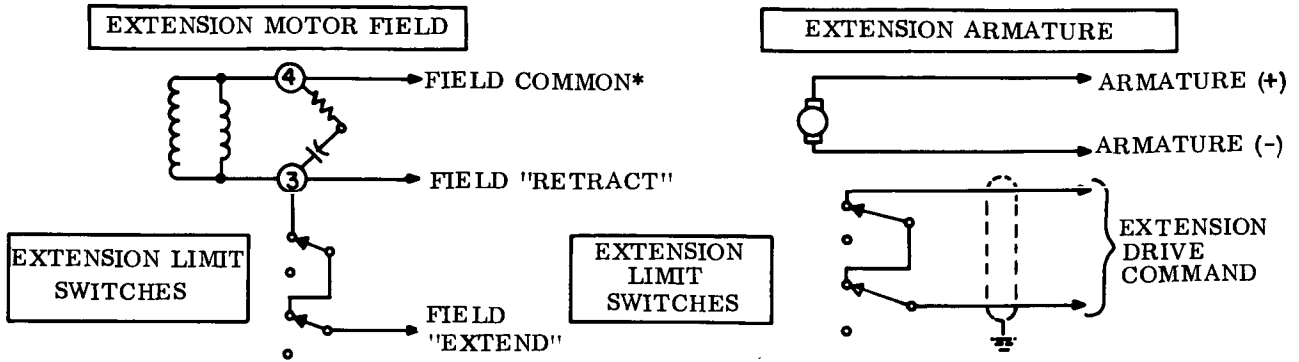

PROPOSED (& RECOMMENDED) EXTENSION MOTOR WIRING

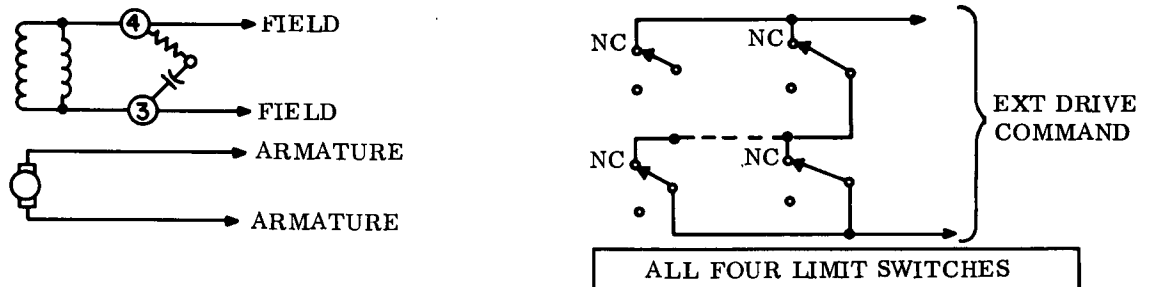

PRESENT SCISSOR MOTOR WIRING

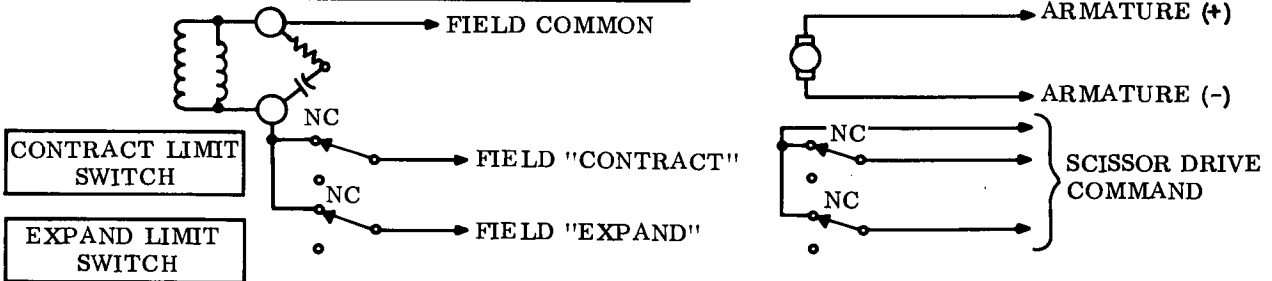

PROPOSED (& RECOMMENDED) SCISSOR MOTOR WIRING

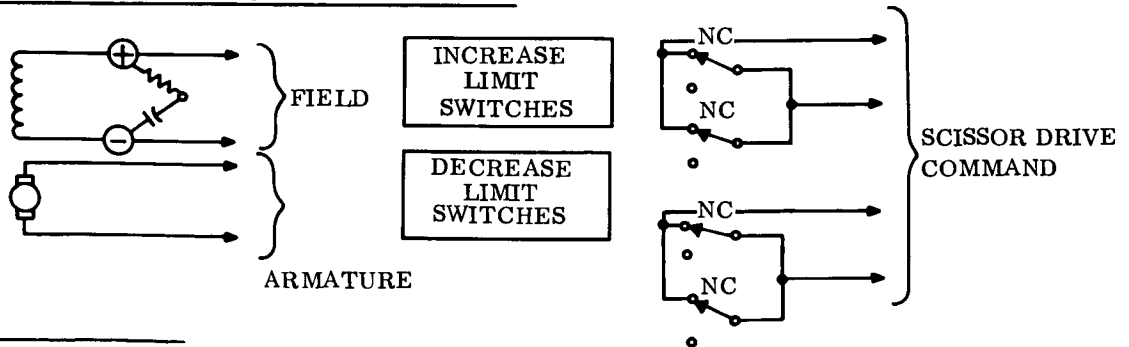

\*FUNCTIONS INDICATED BY ARROWS REFER TO POWER CONTROL UNIT OUTPUTS OR COMMAND FUNCTIONS

Figure 10-2. Proposed Change of Limit Switch Wiring for Extension and Scissor Motors

TABLE 10-2. PART FAILURE RATES FOR ATS RELIABILITY ESTIMATES

<u>PART TYPE</u>		<u>FAILURE RATE (X 10<sup>-5</sup>/HR)</u>	
Transistors	Switching	0.001	
	Analog	0.003	
	Power	0.006	
Diodes	Switching	0.0005	
	General Purpose & Rectifiers (< 50 mw)	0.001	
	Power Rectifier	0.005	
	Zener, Low-Power		
	Reference	0.002	
	Zener, Power Regulator	0.010	
	RF/Microwave	0.005	
	Tunnel	0.010	
Capacitors	Tantalum, Solid	0.008	
	Ceramic	0.002	
	Glass	0.001	
	Mica	0.001	
	Mylar	0.005	
	Paper	0.005	
	Variable (Glass/Ceramic)	0.050	
Resistors	Composition	0.0005	
	Fixed Film	0.0005	
	Wire Wound (Power)	0.005	
	Wire Wound (Accurate)	0.005	
Inductors	Transformers (Power) } Chokes (Power) }	0.01	
	Transformers (Signal) } Chokes (Audio) }	0.01	
	Chokes (RF) } Coils (RF) }	0.005	
	Integrated Circuits	Digital	0.005
		Analog	0.010
Relays		0.020	

operating conditions, and should therefore be applied with caution to individual piece-parts in any given set of circumstances. It is interesting to note that the failure rates presented here differ from those on similar listings, Advent, MACS, Voyager, etc., primarily in a more detailed breakdown of part categories, however absolute magnitudes for generic part types are comparable.

An attempt was made to expand this listing to include a breakdown of failure-mode percentages within each failure rate (See Section 8.1.5), but data is too limited and variations with application too wide to permit such a compilation at this time. Effort is continuing in this area.

The following is a partial listing of the data sources consulted during the preparation of the attached failure-rate compilation:

- a. TRA-873-74, "Reliability Analysis Data for Systems and Component Design Engineers," (Rev. 1 May 1965).
- b. MIL-HDBK-217, "Reliability Stress and Failure Rate Data for Electronic Equipment," August 1962.
- c. Earles & Edding, Generic Failure Rate Compilation in Proc 9th Symposium on Reliability & QC, 1963.
- d. Redler, W. M., "NASA Pad and Flight Experience: Parts Reliability Problems in Aerospace Systems," NASA Office of Reliability and Quality Assurance.
- e. LMED Experience 1964.
- f. Air Weapons Control System 412L, GE-MCD, 1964.
- g. Polaris MU 84 Fire Control System, GE-OD, 1964.

### 10.1.5 POWER CONTROL UNIT ANALYSIS

A detailed part-by-part analysis was conducted on the Power Control Unit circuitry. Each potential piece-part failure mode was examined for the effect a failure would have on the inter-relationship of the module, PCU and system performance. The probability of occurrence of a particular module failure mode was considered as the sum of the probabilities of all the piece-part failure modes that could lead to the outcome. In computing the failure modes, a duty cycles of a three-year mission operating time was assumed for telemetry and power switching functions, squib drivers were based on a duty cycle of 100 hours, and gravity gradient experiments, such as boom maneuvers, were based on a mission life of 200 days.

#### A. Interpretation of Failure - Mode Probabilities

The failure-mode probabilities listed in Table 10-3 are in percent per mission per module (or per module output channel, as applicable). For example: the probability of "no output" from the Voltage Monitor Module (A3) is 0.012% mission per channel: the probability of "incorrect output" (due to resistor drift or open in voltage divider) is 0.014% mission per channel. A3 has three output channels, so the total probability of failure (unreliability) for this module is:

$$Q = 3 (0.012 + 0.014) (10^{-2}) \approx 8 \times 10^{-4}$$

The module reliability is then:

$$R = 1 - Q = 1 - (8 \times 10^{-4}) = 0.9992 \text{ (3-year mission)}$$

By this method, the total unreliability of the PCU was found to be approximately 0.028. Adding a 50% safety factor, to allow for error and uncertainty in the failure-rates employed, yields an overall mission reliability estimate of 0.96.



TABLE 10-3. POWER CONTROL UNIT FAILURE MODE EFFECTS SUMMARY

MODULE	TYPE DRAWING NO.	SYSTEM FUNCTION(S)	FAILURE MODES	PROBABILITIES	FAILURE EFFECTS	BACKUP	REMARKS	
A1	T/M Power Supply PR47E207047G1	-5v dc excitation to T/M Sensors	No, or very low, output	0.17	Loss of T/M Data (Power drain in some cases)	None	Loss of Boom Position Information	
			Instability	0.013	Loss of T/M Data	None	Loss of Boom Position Information	
			Output voltage shift (reg.)	0.17	incorrect T/M Data	Monitor A3 may detect	Some data recoverable (?)	
			Output -24v (unregulated)	0.29	Loss of T/M Data	None		
A2	Pulse Shaping Module PR47E207050G1	Frame-sync pulse to solar aspect sensor	No output	0.06	Loss of SAS Data	None		
A3	Voltage Monitor Module PR47E207054G1	-5v, -24v, -30v Monitor (T/M)	No output	0.012	Loss of T/M Data	None	Loss of A1 backup. Loss of A1 backup.	
Incorrect output			0.014	Loss of T/M Data	None			
A4	Resistor Ladder Module PR47E207059G1	T/M D/A Converter (event encoding)	Incorrect level	0.05	Erroneous Event Data	None		
A5	Digital Event Module PR47E207064G1	T/M Signal conditioning (split signal)	No output	0.012	Loss of Event T/M	None		
A6 } A9 }	Squib Driver Module PR47E207057G1	Fire squibs to uncage ECD and Damper Boom Shaft (A6, A9 redundant)	No, or very low output	0.0035	No squib fire (loss of damper)	Redundancy in drivers	Probability negligible with redundancy	
A10 } A23 }			Premature out- put (100 hour)	0.0008	Premature squib fire	None		
A10 } A23 }	Squib Driver Module	Fire squibs to release self-erecting damper boom	No, or very low, output	0.0035	No squib fire (loss damper)	Redundancy in drivers	Probability negligible with Redundancy	
			Premature out- put	0.0008	Premature squib fire	None		
A7	Solenoid Driver Module PR47E207056G1 (typical)	Actuate CPD Clutch	None, or very low output	0.08	No clutch actuation- loss of damper switch- ing capability	None	Commits use of damper clutched in at time of failure	
			Premature output	0.01	Dampers may be switched when off null - loss of data (1)	None	Failure irreversible-i.e., clutch cannot be commanded to other state. (1) Failure may be catastrophic if it occurs when boom is far off null.	
A8 } A11 }	Solenoid Driver Module	Actuate clutch mechanism in Primary Boom Assemblies "A" (A8) and "B" (A11)	None, or very low output	0.08	No clutch actuation- loss of motor redundancy.	None	Commits use of motor clutched in at time of failure.	
			Premature output	0.01	See (2)	None	Failure irreversible-i.e., clutch cannot be commanded to other state. (2) Failure catastrophic if it occurs while motor is running (gear strip)	
A12 } A15 }	Armature Driver PR47E207049G1	Excitation to armature of extension motors in "A" (12) and "B" (15) Primary Boom Assemblies	None, or very low output	0.07	Loss of boom extension (and or retraction) capability.	Switch to scissoring motor(s).	See also A13, A14 below	
			Premature output	0.009	Continuous output to armature, with no field excitation, with result in steady 100° with motor dissipation	None if high motor temperature damages boom.	Output transistor will probably not burn open before motor. There is no way to remove power from this circuit.	
A17 A19	Armature Driver	Excitation to armatures of scissoring motors in "A" (A17) and "B" (A19) Primary Boom Assemblies	None, or very low output	0.07	Loss of boom scis- soring capability	Switch to extension motor(s)	See also A13, A14 below.	
			Premature output	0.009	See same mode A12, A15	See same mode A12, A15	See same mode A12, A15	
A13 A14	Field Driver PR47E207061G1 (typical)	Excitation to fields of extension motors in "A" (A13) and "B" (A14) Primary Boom Assemblies	On "extend" no output	0.008	Loss of boom exten- sion capability	Switch to scissoring motor(s)		
			Command -30v shorted	0.001	Loss of -30v power if payload power switch turns off be- fore transistor burn- out.	None		
			On "retract" no output	0.008	Loss of boom re- traction capability	Switch to scissoring motor(s)		
			Command -30v shorted	0.001	Loss of -30v power if payload power switch turns off be- fore transistor burn- out.	None		
			-30v short due to CR7 (CR1D) short in armature driver	0.001	Loss of -30v power if payload power switch turns off before tran- sistor burnout will occur only in presence of command	None	Secondary failure mode included due to criticality	
A16 } A18 }	Field Driver	Excitation to fields of scissoring motors in "A" (A16) and "B" (A18) Primary Boom System	Modes, Probabilities, Effects, etc., analogous to A13, A14 above except "extend" and "retract"					
A20 } A21 } A22 }	Relay Driver PR47E207048G1 (typical)	Power switching between TV systems (A20), IR scanners (A21), SAS, Angle Indicator, and Angle Indicator bulbs (A22)	None, or very low output	0.06	Loss of switching capability for failed command channel	HAC "reset" if failure in power "off" channel		
			Premature output	0.005	Affected relay held in position correspon- ding to command on failed channel.	None	Irreversible-cannot be "reset" by HAC if failure is in "on" channel.	

## B. Duty Cycles

In computing failure mode probabilities, the following duty cycles were assumed:

<u>Functional Category</u>	<u>Module Numbers</u>	<u>Mission Operating Time</u>
Telemetry and Power Switching	A1, A2, A3, A4, A20, A21, A22	3 Years
Squib Drivers	A6, A9, A10, A23	100 Hours
GG Experiment (Boom Maneuver, etc.)	A7, A8, A11, A12 A13, A14, A15, A16 A17, A18, A19	200 Days

## C. Failure Rates

The failure rates employed in computing the failure mode probabilities given in Table 10-3 were based on a study performed for the Voyager Program. "Hi-Rel" part rates from several programs, including Minuteman, MACS, and Advent, were evaluated, and "weighted averages", based on confidence in the source, were derived. A similar process was used to obtain the relative frequency of failure modes within the overall part failure rates. The results, as used in the present analysis, are listed in Table 10-4.

## D. Comments on Results

The most likely mode of failure in the PCU is loss of regulation in the 5v Telemetry Power Supply (Module A1), resulting in the telemetry reference voltage output approaching 24v. This would result in the loss of all boom position telemetry data (as well as other less critical information). A 5.6v Zener diode across the output of this supply would permit recovery of some data, as the shift in reference could be noted (via A3) and the degraded regulation would still provide usable information. The desirability of this backup, if feasible,

must be weighted against the risk of a "short" failure of the backup zener. The failure rates used in this study would indicate a risk (Q) of approximately  $5 \times 10^{-4}$  (per mission). This failure rate is probably quite pessimistic, however, for a Zener operated below its breakdown voltage. The risk of short might be essentially eliminated by placing two diodes in series, but difficulty may be encountered in obtaining units at this low voltage rating that would provide a satisfactory level of regulation.

TABLE 10-4. FAILURE - MODE FAILURE RATES ("HI-REL" PARTS)

<u>Part Type</u>	<u>Drift</u>	<u>Open</u>	<u>Short</u>
Transistor, Switching SI, Planar	0.3	0.5	0.2
Transistor, Analog, SI, Planar	0.6	1.0	0.4
Transistor, Power, SI, Planar	2.4	4.0	1.6
Diode, General Purpose, SI, Planar	0.7	1.0	0.3
Diode, Zener, SI, Planar	4.0	4.0	2.0
Capacitor, TA, Solid	3.8	0.5	0.7
Resistor, General Purpose, Fixed Film	0.05	0.45	—
Resistor, Power, Wirewound	1.0	9.0	—

NOTE: All failure rates  $\times 10^{-8}$  /hr

Particular attention is directed to the effects of "premature output" failure in several of the motor and clutch control circuits, especially the armature driver modules A12, A15, A7, and A19.

#### E. PCU Interface Review

A review of the PCU interface with HAC and other GE-ATS subsystems has been conducted. No discrepancies other than those noted below were encountered.

- a. The start current characteristics of the deHavilland extension scissoring motor may be a problem. Early tests by deHavilland indicated start currents of 5.7 to 6.4 amperes decaying with a time constant of approximately 50 milliseconds. These results were subsequently reported to be in error and the tests are to be rerun by deHavilland. If the starting current is as high as the early tests have indicated, a problem area could be the output transistor supplying motor armature current which is rated at 5 amperes maximum collector current.
  
- b. The cabling voltage drops to the GE subsystems need to be determined. A potential problem area is the damper clutch solenoid whose minimum coil voltage is specified as 22.3 vdc. The HAC unregulated bus voltage is reported to be between -24.3 and -32v dc.\* Assuming the PCU to contribute 0.221 ohms resistance\*\* and assuming a 3-foot cable length of No. 20 avg copper wire for the damper engage and power ground power/ground leads (thus adding a lead resistance of 0.061 ohms) the voltage applied to the coil can be as low as 21.3v dc. Other marginal areas are the primary boom clutch, solenoid, extension motors and scissors motors.

---

\*Per GE's conversation with HAC on 4 August 1965, the payload power switch will be a series transistor switch-type and can be expected to contribute a further voltage drop, thus reducing the lower limit of the unregulated power to the PCU below 24.3v dc.

\*\*Paragraph 3.4.6.3.4 of GE Specification SVS-7307, "Power Control Unit" indicates a 0 to 2.2 volt drop when terminated in resistive loads greater than 3 ohms. The solenoid coil resistance can be as low as 30v/15a or 2 ohms. Assuming that the PCU voltage drop is resistive in nature, this resistance would have to be 0.221 ohms to develop a 2.2 volt drop with an input supply voltage of 32v and a load of 3 ohms

The review did not include a study of the power required by each subsystem.

#### 10.1.6 IMPROPER COMMAND SEQUENCE

Improper command sequences (so called 'Idiot Modes') that could be expected to result in damage to the gravity gradient equipment while in flight were published in PIR 4144-238, dated 8 August 1965; copies were delivered to NASA/GSFC. This initial investigation into the topic of improper commands will be extended to include a malfunction analysis.

### 10.2 PARTS AND STANDARDS

#### 10.2.1 INTRODUCTION

The activities in Parts and Standards during the quarter are summarized below:

- a. Parts selection (as required)
- b. Parts application analysis and review
- c. Generation of parts drawings
- d. Revision and updating of parts drawings
- e. Selection of sources
- f. Resolution of procurement problems
- g. Review and critique of parts lists
- h. Updating the Approved Parts List

- i. Generation of individual qualification plans
- j. Ordering of parts for qualification
- k. Initiation and monitor of qualification testing
- l. Consultation services
- m. Computer processing of parts data received
- n. Degradation analysis of processed data

The tasks listed above are continuing.

Two areas that required considerable effort, but for which accomplishments are not readily measurable are:

- a. Item (f) (resolution of procurement problems). Procurement problems developed on almost every order for parts. Some of these problems were typical of those commonly found with normal part-procurement. Many others were problems arising from the use of specification documents which were written and controlled by a co-contractor.
- b. Item (l) consultation services were provided to Design and Reliability Engineering, Quality Control, and subcontractors on interpretation of standards, on performance characteristics and applications of parts, and on test conditions and limits.

## 10.2.2 PARTS DRAWINGS AND PARTS LISTS

### A. Parts Drawings

New drawings released for the program and added to the Approved Parts List 490L106 during the reporting period are:

R4615      Semiconductor, Phototransistor, Silicon, NPN

R2206      Connector, Plug, Bayonet Coupling, Solder-Type Contacts

47C207314 Lamp, Double Filament

GE drawings revised and updated are as follows:

R4505, Rev. A

R4506, Rev. A

R4507, Rev. A

R4508, Rev. A

R4509, Rev. A

R4511, Rev. B

R4512, Rev. B

R4514, Rev. B

R4516, Rev. B

R4523, Rev. B

R4524, Rev. A

R4527, Rev. A

R4529, Rev. A

R4530, Rev. A

R4541, Rev. A

R4545, Rev. A

R4549, Rev. A

R4583, Rev. A

R4604, Rev. A

R4610, Rev. A

R4612, Rev. A

490L106, Rev. C and D

In addition, the HAC drawings referenced in the above GE drawings were updated.

#### B. Review and Critique of Parts Lists

The parts lists submitted by Adcole Corporation for the solar aspect sensor were subjected to a detailed review. In general, it was noted that most parts listed are approved parts and are properly documented. Recommendations were made to bring the parts lists into full conformance with the Approved Parts List 490L106, and to align material selections to the Approved Materials and Processes List 490L107. Such detailed analyses will be continued on other components.

#### 10.2.3 PARTS QUALIFICATION PROGRAM

Details of the Parts Qualification are discussed in Paragraph 6.2.1.

#### 10.2.4 DEGRADATION ANALYSIS

Programming of the IBM 7094 Computer is completed, as previously reported. Power aging data are processed to calculate the average, standard deviation, and skewness of parameter distributions, and to rank them by order of magnitude to facilitate the selection of stable parts for flight use.

A listing of the data received and processed to date is given in Table 10-5. It is of interest to note that every lot of data received so far has given rise to at least one question relating to test conditions, the parameters measured, units of measurement, quantities, serialization, etc. In every case, contact with the vendor was necessary to clarify the point in question.

The processing of all items except the R4548-2 and R4579-2 has been completed. The most stable parts have been selected by degradation analysis, and the quantities required by the program for flight use have been identified and are in storage in a controlled stock area.



TABLE 10-5. DEGRADATION ANALYSIS SUMMARY

Part No.	HAC Specification	Description	Vendor & Type	Quantity	Parameter Measurements (at hours noted)	Parameter Data Submitted	Comments
R4534-193	988623	Resistor	Electra HRM	13	0, 168	Noise; $\Delta R$ from nominal nominal	
R4534-222	988623	Resistor	Electra HRM	13	0, 168		
R4534-289	988623	Resistor	Electra HRM	35	0, 168		
R4534-260	988623	Resistor	Electra HRM	34	0, 168		
R4534-318	988623	Resistor	Electra HRM	35	0, 168		
R4534-342	988623	Resistor	Electra HRM	19	0, 168		
R4534-347	988623	Resistor	Electra HRM	35	0, 168		
R4534-385	988623	Resistor	Electra HRM	13	0, 168		
R4549-1	988716	Diode	GE 1N1184	30	0, 240, 750, 1500	$V_F I_R$	
R4548-2	988713	Diode	Fairchild FD300	308	—	$V_F I_R$	Received from Fairchild via Adcole Corporation
R4585-1	988855	Transistor	National 2N2484	72	—	$h_{fe}, I_{cbo}$	
R4579-2	988846	Transistor	Solitron	112	0, 240, 750, ..	$h_{fe}, I_{ces}$	Further data pending

**SECTION 11**  
**NEW TECHNOLOGIES**

There were no new technologies uncovered during the past quarter. The General Electric Company will continue to monitor all design and fabrication areas that are associated with the ATS program and report any new technologies uncovered.

## SECTION 12

### GLOSSARY

The following is a list of abbreviations and definitions for terms used throughout this report:

<b>ADTF</b>	<b>Advanced Damping Test Fixture (used for CPD testing)</b>
<b>ATS-A</b>	<b>Medium Altitude Gravity Gradient Experiment (6000-nautical mile orbit flight)</b>
<b>ATS-D/E</b>	<b>Synchronous Altitude Gravity Gradient Experiment (24-hour orbit flight)</b>
<b>CPD</b>	<b>Combination Passive Damper</b>
<b>Crab Angle</b>	<b>Out-of-orbit angle flight caused by changes in X-rod angle</b>
<b>DME</b>	<b>Dynamic Mission Equivalent (Accelerated Functional Program)</b>
<b>GE-MSD</b>	<b>General Electric Company Missile and Space Division</b>
<b>GG/ATS</b>	<b>Gravity Gradient System/Applications Technology Satellite</b>
<b>HAC</b>	<b>Hughes Aircraft Company</b>
<b>ITPB</b>	<b>Integrated Test Program Board</b>
<b>Local Vertical</b>	<b>Imaginary line extending from the satellite center of mass to the center of mass of the earth</b>
<b>LOFF</b>	<b>Low Order Force Fixture (used for CPD testing)</b>
<b>MTBF</b>	<b>Mean Time Before Failure</b>
<b>MTTF</b>	<b>Mean Time to Failure</b>
<b>PCU</b>	<b>Power Control Unit</b>
<b>PIR</b>	<b>Program Information Request/Release, GE documentation</b>
<b>SAS</b>	<b>Solar Aspect Sensor</b>
<b>Scissoring</b>	<b>Changing the angle included between the primary booms in a manner that maintains a symmetrical configuration about the satellite yaw axis</b>
<b>STEM</b>	<b>Storable Tubular Extendable Member</b>
<b>Stiction Torque</b>	<b>That amount of torque required to overcome the initial effects of friction</b>
<b>SVA Fixture</b>	<b>Shock and Vibration Attachment Fixture</b>
<b>Thermal Twang</b>	<b>Sudden thermal bending which the booms experience in passing from a region of total eclipse into a region of continuous sunlight or vice versa</b>
<b>TR</b>	<b>Torsional restraint</b>
<b>TVCS</b>	<b>TV Camera Subsystem</b>

## APPENDICES

## APPENDIX A

### CABLE CUTTER MALFUNCTION ANALYSIS

The Conox Corporation completed an analysis on bolt cutter performance of the type used in a deployment test of the damper boom at deHavilland. Details of the malfunction are given in Section 3.2. The Conox report (PAR 2100) is reprinted in this appendix.

#### A.1 DETAILS OF FAILURE

In a test at deHavilland, Bolt Cutter Assembly, Part No. 1810-011-01, Serial No. 4700002 was utilized. The two primers of this device were connected in a parallel circuit. An attempt was made to operate the unit using a rectified power source adjusted to a 5-volt output. Upon application of power the output voltage immediately fell to 1 volt. The unit did not function.

The output voltage was then increased to 10 volts and applied to the cutter. Partial operation was achieved. The leadwire shearing device functioned but the bolt cutter ram did not move.

#### A.2 INVESTIGATION

The faulty unit was returned to Conox for examination. By observation there was nothing to indicate the cause of failure.

A resistance check was made on the primers. One showed an open circuit; the other, a bridgewire circuit resistance of 0.9 ohms (requirement is 0.9 to 1.2 ohms) indicating the possibility that this primer had not fired. This value incidentally, was approximately 0.2 ohms less (considering correction for external leads) than the customer measured for this primer prior to his attempt to operate.

It was verified that this primer was still "live" by the application of a 5-amp current to it. It actuated in 5 milliseconds. A vibration pickup was used to verify actuation. The bolt cutter ram did not move.

Following actuation of the primer, the bolt cutter was sectioned and examined. It was evident that no movement whatsoever of the bolt shearing ram had occurred. There was a deposit which resembled rust on a 180 degree segment of the rear shoulder of this ram.

It could not be determined positively whether or not the epoxy in the primer chamber cavity was void free. Appearances were such, however, as to cause us to doubt that this cavity was completely potted.

The inspection records for this unit were examined. They indicated that all parts were within tolerance and assembled and tested in accordance with applicable drawings and specifications. This unit was unique in that it was assembled individually, not as one of a lot and contained primers from a different lot than that used in the assembly of later units. The primer lot from which these two primers were selected was of 500-piece size. Review of the extensive tests run on sample primers from this lot indicated everything satisfactory.

The conditions under which current was applied to the primers by the customer were cause for suspicion. If either of the primers had been subjected to a 5-volt input it should have fired. Still neither fired until the source output was increased to 10 volts. Obviously something was wrong with the firing circuit. The firing circuitry drawing was reviewed and some conjecture made as to possible fault in this area. Security restrictions at the customer's installation made it impossible to directly investigate this circuitry. It appears that the probability of this being the cause of failure is remote, however, so further investigation along this course was discontinued.

Development test firing data was reviewed. The results are given in Table A-1.

CC-63 primers were used in the above development tests since the CC-91 primers specified for use in the unit were not available at the time these tests were run. The CC-91 and CC-63 primers are equivalent in output. The CC-65 primers utilized in Test 2 contain twice the amount of base charge as the CC-91 and CC-63 primers.

TABLE A-1. TEST FIRING DATA

Test	Primers	Firing Current	Results	Remarks
1	2 - CC63	5 amps to one primer	Incomplete operation	Initial design having high ram interference. Not comparable to following units.
2	2 - CC65	5 amps to each primer	Full Actuation	Evident excess power by considerable deformation of cutter body
3	2 - CC63	5 amps to each	Full Actuation	In each case there appeared to be adequate power as judged by the rams embedding approximately 1/8 inch into the stainless steel anvil after shearing rod.
4	2 - CC63	5 amps to one	Full Actuation	
5	2 - CC63	5 amps to one	Full Actuation	
6	1 - CC63 & 1 inert	5 amps to live primer	Full Actuation	

Two additional units were functioned at Conax after the failure of unit Serial No. 4700002 at deHavilland was reported. The first of these was a unit randomly sampled from the production lot of 21 pieces. A 5-amp current was applied to each primer. Operation was equivalent to that obtained in Development Tests 3, 4, 5 and 6.

The second firing was conducted on a unit purposely assembled with a complete epoxy void in the primer chamber cavity. A 5-amp current was applied to one primer only. Operation was incomplete. The bolt cutter ram only partially sheared the rod. This was a slightly better performance than that realized by deHavilland on the unit fired by them.

The unit fired by deHavilland, incidentally, was the second device assembled by production personnel. The first unit assembled by them (Serial No. 4700001) resulted in a dielectric failure. Both of these units were being used to finalize assembly procedures at the point following installation of the primers into the primer cavity. This dielectric failure unit was sectioned at a point immediately behind the primer cavity at the interface of the lead shearing ram. A very large epoxy void was evident.

At this stage of the investigation, the assembly procedures for potting the primers into their cavities were again reviewed. Initially it had appeared that the established procedure should give adequate assurance of a void free epoxy fill. This second review with the operators who had assembled the units brought to light difficulties that could have and most likely did result in epoxy voids of considerable but unpredictable sizes.

The cutter design itself was reviewed. A misunderstanding was apparent here in that all concerned either did not recognize or did not realize that the unit must operate with only one primer. The leadwire shearing ram will complete its travel in something less than 100 microseconds. Individual primers will have a firing time differential with a 5-amp applied current in excess of one millisecond. Only by the application of a very high firing current or preferably through condenser discharge could simultaneous firing of the primers be assured.

The CC-91 primers containing the HES 6394 explosive cannot be relied upon to autodetonate one another. On the basis of the tests run to date on this unit it appears that in one case out of three (the deHavilland failure versus Conax Tests 4 and 5) autodetonation was not achieved. Actually, in the case of Conax Tests 4 and 5 while the explosive of the second primers had been consumed it could not be determined if a high order detonation had been achieved. It is more probable that the primer cases had been ruptured by operation of the first primer and merely low order burning of the second primer achieved.

### A. 3 CONCLUSIONS

The actual cause of failure has not be determined. The most likely appears to be voids in the potting of the primer cavity. Past experience with primers, particularly those containing high temperature capability explosives such as Hercules Hi-Temp or HES 6394, has shown the necessity for complete containment of them in order to reliably achieve the high order detonation required for a shock wave operable device.

A total of eight firings have been made on this unit to date. Two of these were proven one primer only actuations. The one at deHavilland was this failure; the other at Conax was a



complete success. An epoxy void condition is the suspected difference between these two units.

Of the remaining six units, current was applied to both primers of three and to one only of the balance. Since these primers have an operating time differential averaging better than 1 millisecond with a 5-amp firing current and complete operation of the leadwire shearing device occurs in less than 100 microseconds from primer ignition it is most likely that even when current was applied to both primers only one was ignited electrically. The question then becomes what happened to the second primer and what, if anything, did it contribute to unit operation? Our experience indicates that they were not autodetonated. At best, their cases were ruptured and only low order burning took place which contributed little if anything to the unit operation.

It should be emphasized that even assurance of a void free epoxy potting of the primers will not permit a guarantee of any appreciable degree of operable reliability at this stage of the unit development. Reliability can only be guaranteed by a fairly large number of cutter operations under varying environmental conditions or by a complete investigation of tolerance conditions exceeding maximum/minimum allowances. The location of the primers with respect to the ram heads does not permit the most efficient utilization of primer power output. This design permits too much power to be absorbed by the cutter body rather than utilized in moving the rams. This means that variables in primer power output would be more critical since only a small portion of the output is used to perform useful work.

There is no satisfactory explanation as to why there was not any movement whatsoever of the bolt shearing ram. The rusty looking deposit on the one side of the ram head appears to be the result of exhaust gas blowby. We can only assume that incomplete potting was in some manner responsible for this condition.

The possibility of a defective primer being the cause of this failure cannot be ignored. Such a condition would be almost impossible to prove but fortunately, the probability of such an occurrence is extremely slight.

Hindsight indicates that greater assurance of operating reliability could have been achieved with less difficulty through the use of a dual bridge, single primer configuration. Initially, the problems involved with the development of the dual bridge primer appeared more formidable than the dual primer configuration problem.

In summation we are of the opinion that all cutter firings to date were essentially single primer operations. Units properly assembled with complete potting of the primer cavity should perform in accordance with requirements.

#### A.4 RECOMMENDATIONS

Twenty units have been assembled by the same potting method now determined to be unsatisfactory for assurance of a void free epoxy potting of the primer cavity. We do not know of any method by which the adequacy of the potting of these assembled units can be determined. Accordingly, they should be reworked if possible, by the removal of one primer. This primer would be replaced and repotted by a changed procedure which could give adequate assurance of a void-free potting.

In this regard Conax Production Engineering should consider changing to a method that will permit vacuum evacuation of the potting in the cavity after assembly of the primer end plug into the cutter body. The procedure should also be changed to specify the application of epoxy to the threads of the leadwire shearing ram and plug subassembly upon their assembly to the cutter body thus assuring an effective seal at this point.

Before Conax could assure any high numerical degree of reliability for this unit a more extensive development or evaluation test program should be conducted. Special bomb tests could be conducted to determine the consistency of primer output from this particular design configuration. These bomb tests should provide verification as to whether or not the second primer is autodedonated by the first or is merely ignited and burns with appreciable output.

It would also be desirable to test operation of this unit using primers with double shells. The additional confinement of the explosive provided by a second (or heavier) casing has been found effective in achieving a more consistent and higher order detonation with units such as explosive actuated nuts where it was not possible to confine the primers in any other manner. Use of a double shell primer could possibly eliminate the necessity for completely potting the primer cavity of this unit.

The customer has proposed a test program which would provide him with a limited degree of assurance as to the reliability of this cutter. He has suggested that ten cutters be assembled under completely recorded and controlled conditions. Eight of these units would be with one live and one dummy primer and two with two primers. In all cases, current would be applied to only one primer. Three of the eight units containing only one primer would be fired at  $-65^{\circ}\text{F}$ , three at  $+225^{\circ}\text{F}$  and two at room ambient. The two cutters with two live primers each would be fired primarily to determine autoignition of the second primer.

The eight single-primer unit firings appear reasonable; but it is suggested that if this test program is pursued the two units containing two primers each should be fired with a voltage source high enough to assure simultaneous ignition of the primers electrically. A condenser discharge firing or elimination of the leadwire shearing function would ensure simultaneous ignition of the primers electrically. This would ensure that the cutter body is capable of withstanding a simultaneous primer firing.

**APPENDIX B**  
**VIBRATION TEST PLAN FOR CPD DYNAMIC MODEL**

The following test plan was prepared in advance of the vibration test of the CPD Dynamic Model that is described in Section 4.2.4(B). The purpose of this test was to acquire sufficient data to provide the following information.

- a. A sinusoidal vibration survey of the CPD fixture demonstrating its adequacy.
- b. A definition of the response characteristics of the CPD under sinusoidal vibration.
- c. A measure of the vibratory levels at the boom/damper interface.
- d. Gain assurance at as early a date as possible that the engineering and prototype models will survive qualification test levels.
- e. Obtain dynamic response levels of CPD for comparison with results of HAC tests.

**B.1 DESCRIPTION OF MODEL**

The CPD vibration model is a non-functioning component which properly represents the geometric, inertia and stiffness properties of the prototype CPD. It will be delivered for testing with a non-functioning model of the self-erecting boom package with attached tip weights. The CPD/boom package constitutes the component to be tested.

**B.2 TEST FIXTURING**

A stiff fixture will be delivered for testing which provides an attachment of the CPD to the vibration generator. The attachment of the CPD to the fixture simulates the attachment of

the CPD to the satellite structure. The vibration fixture is drilled for the C-125 shaker head. It will be necessary to provide an adapter plate for attaching the fixture to the C-210 shaker for exciting in the shaker longitudinal axis. For lateral excitation the fixture will be attached to the C-210 shaker via a plate which will be supported on two Team Model 1-914 oil bearings.

### B.3 SIGN CONVENTION

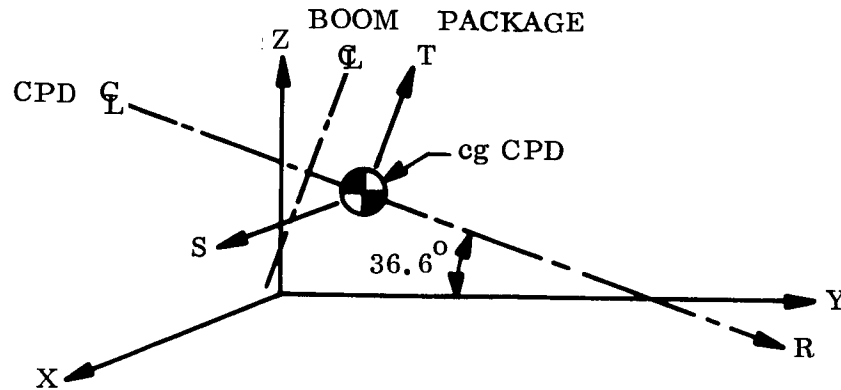

Spacecraft axis are X, Y, Z. Component axis are S, T, R. The S-axis is parallel to X-axis and the T, R axis are rotated approximately 40 degrees clockwise from the Z axis about the S axis. Center line of the boom package lies in the Z, Y plane.

Longitudinal direction of the fixture corresponds to minus Y-axis direction.

### B.4 INSTRUMENTATION

Component instrumentation will require 16 accelerometers and 10 strain gages. General location of required instrumentation is given in Table B-1. Specific locations have been provided in the form of marked drawings.

TABLE B-1. INSTRUMENTATION TYPES AND LOCATIONS

No.	Accelerometers Description	Location
3	1 Triaxial	Damper Boom Tip Mass
3	1 Triaxial	Damper Boom Interface
3	1 Triaxial	CPD Base Plate
3	1 Triaxial	STL Damper
2	Lateral 90° Apart	Eddy Current Rotor (Top)
2	Lateral 90° Apart	Upper Magnet Plate
	<u>Strain Gages</u>	
4	Max. Fiber Strain	CPD Base Plate Over Pins
2	Max. Fiber Strain	Clutch Adapter Straps
4	Max. Fiber Strain	Eddy Current Rotor Straps

Actual transducer location, sense direction and identification will be logged before starting test. Instrumentation must have current calibration, such calibration to be traceable to the Bureau of Standards. The vibration requirements are shown in Table B-2.

TABLE B-2. SINUSOIDAL VIBRATION SCHEDULE  
CPD DESIGN QUALIFICATION

Frequency (cps)	Axis	Level (0-peak g) Sweep Rate 2 octaves/ min
10-25	Thrust Z-Z	+ 2.3
25-250		+ 11.5
250-400		+ 18.5
400-2000		+ 7.5
10-17	Lateral	0.50 in. double amplitude
17-250		+ 7.5
250-400		+ 15.0
400-2000		+ 7.5

## B.5 FIXTURE SURVEY

A 30-pound dummy weight will be furnished for checking out the CPD fixturing and proving the force capability of the shaker. Three triaxial accelerometers will be mounted 120 degrees apart near the fixture/component interface. A triaxial accelerometer will be mounted at the fixture control point. A low-level sinusoidal sweep will be made to determine proper attenuation settings for recording transducer signals on magnetic tape. A sinusoidal vibration sweep will be made at a 2.0 g (o-p)\* level from 10 to 2000 cps. The sweep rate shall be low enough to develop at least 95% peak resonant response. The 12 signals will be recorded and reduced to X-Y plots.

The X-Y plots will be reviewed to determine if the motion of the fixture/component interface is consistent with the motion of the fixture control point. If not, a new control point will be selected. The fixture with dummy weight will then be excited at qualification test levels, the signals recorded and reduced to X-Y plots for incorporation into a fixture survey report. This procedure is to be performed for each of the three axes of excitation.

## B.6 COMPONENT TEST

At the satisfactory conclusion of the fixture survey in one axis, the component may be tested in that axis configuration. A low-level sinusoidal sweep from 10 to 2000 cps will be performed in order to determine proper attenuation settings for recording signals on magnetic tape. A sinusoidal sweep will then be performed at a 1.5 g (o-p) level from 10 to 2000 cps. The sweep rate to be low enough to develop at least 95% peak resonant response. The sweep to be performed sufficient number of times such that all 26 transducer signals and the control signal are recorded. The control signal will be recorded on each sweep.

Recorded signals will be reduced to X-Y plots and, if satisfactory, the component will be excited to qualification test level. Signals to be recorded during qualification level test will be determined by GE test directors. At the conclusion of the qualification level test,

---

\*zero to peak

a low-level sinusoidal survey will be made to see if a resonant frequency shift occurs which would indicate that the component was damaged. Recorded signals will be reduced to X-Y plots. It may be desirable to view certain data channels on an oscilloscope to determine if impacting between parts occurred.

The above procedure is to be performed for each of three axis of excitation. However, it will not be necessary to perform the 1.5 g sweep in both the Y and Z axis directions. One axis will give sufficient information. Attenuation setting runs may be waived at the decision of the test director.

#### B.7 MISCELLANEOUS

A record will be made of the weight, cg, of damper boom, eddy current rotor, and damper for inclusion in the test report.

A running log will be maintained during the test.

Permanent records shall be made and properly identified for future reference.

#### B.8 EXAMINATION OF SPECIMEN

At the conclusion of the test, or in the event of a premature failure, the CPD will be disassembled and an inspection performed to determine the extent and nature of any damage.

#### B.9 TEST REPORT

The test will be reported in PIR form presenting information in support of the five points test objectives. Copies of the results will be made available to NASA/GSFC.



APPENDIX C  
LIMIT SWITCH CONFIGURATION ANALYSIS

DeHavilland has proposed the following configuration for boom extension limit switches:

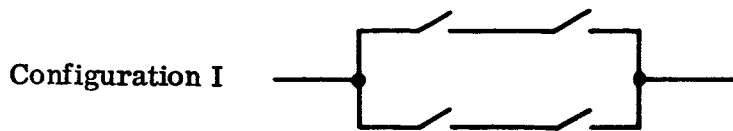

GE has recommended the addition of a jumper wire as indicated:



This suggested change is based on the consideration that an "open" failure of one of the limit switches is more likely than a short. Data sources consulted here indicate a failure-frequency ratio ranging from 2:1 to 10:1. That Configuration II is preferable in this circumstance can be demonstrated as follows:

If  $R$  = the probability that a single switch will operate successfully

$Q_o$  = the probability that a single switch will fail "open"

$Q_s$  = the probability that a single switch will fail shorted

and if, for simplicity, it is assumed that these are the only events that can occur, then

$$R + Q_o + Q_s = 1$$

For four switches, we can write

$$(R + Q_o + Q_s)^4 = 1$$

Expanding:

$$\begin{aligned}
 & R^4 + 4R^3Q_O + 4R^3Q_S + 6R^2Q_O^2 + 6R^2Q_S^2 + 12R^2Q_OQ_S \\
 & + 12RQ_O^2Q_S + 12RQ_OQ_S^2 + 4RQ_O^3 + 4RQ_S^3 + 4Q_O^3Q_S \\
 & + 4Q_OQ_S^3 + 6Q_O^2Q_S^2 + Q_O^4 + Q_S^4 = 1
 \end{aligned}$$

This expression contains all possible combinations of success and two modes of failure among four switches. The coefficient of each term indicates the number of ways (independent of switch configuration) that each combination can occur. Each of the terms must now be examined to determine whether it represents success or failure in a given configuration. For example, the first three terms represent success in both configuration I and II; in the fourth term, two of the six ways that this combination can occur represent success in Configuration I, while four of the six ways are successful in Configuration II. Continuing this process leads to the following expressions for the reliability of the two configurations:

$$\begin{aligned}
 R_I &= R^4 + 4R^3Q_O + 4R^3Q_S + 2R^2Q_O^2 + 4R^2Q_S^2 + 12R^2Q_OQ_S \\
 &+ 4RQ_O^2Q_S + 8RQ_OQ_S^2 \\
 R_{II} &= R^4 + 4R^3Q_O + 4R^3Q_S + 4R^2Q_O^2 + 2R^2Q_S^2 + 12R^2Q_OQ_S \\
 &+ 8RQ_O^2Q_S + 4RQ_OQ_S^2
 \end{aligned}$$

Examination of these two expressions will show that  $R_{II} > R_I$  when  $Q_O > Q_S$ .