

NASA TECHNICAL NOTE



NASA TN D-3485

NASA TN D-3485

LOAN COPY; RET
AFWL (WLEA)
KIRTLAND AFB,



EFFECT OF ORIENTATION ON
FRICTION CHARACTERISTICS OF
SINGLE-CRYSTAL BERYLLIUM
IN VACUUM (10^{-10} TORR)

by Donald H. Buckley
Lewis Research Center
Cleveland, Ohio

NATIONAL AERONAUTICS AND SPACE ADMINISTRATION • WASHINGTON, D. C. • JULY 1966

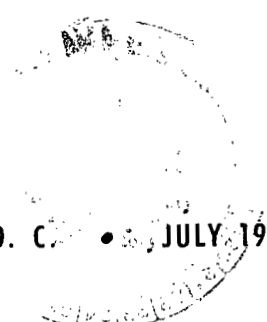



EFFECT OF ORIENTATION ON FRICTION CHARACTERISTICS OF
SINGLE-CRYSTAL BERYLLIUM IN VACUUM (10^{-10} TORR)

By Donald H. Buckley

Lewis Research Center
Cleveland, Ohio

NATIONAL AERONAUTICS AND SPACE ADMINISTRATION

For sale by the Clearinghouse for Federal Scientific and Technical Information
Springfield, Virginia 22151 - Price \$1.00

EFFECT OF ORIENTATION ON FRICTION CHARACTERISTICS OF SINGLE-CRYSTAL BERYLLIUM IN VACUUM (10^{-10} TORR)

by Donald H. Buckley

Lewis Research Center

SUMMARY

Studies were conducted to determine the influences of the crystallographic orientation of single-crystal beryllium on its friction characteristics when in sliding contact with sapphire and polycrystalline beryllium and aluminum oxide. Experiments were conducted in a vacuum of 10^{-10} torr with a 3/16-inch hemispherical-radius beryllium crystal sliding on a flat of beryllium and aluminum oxide. The rider was loaded against the flat with various loads from 100 to 1500 grams and the flat disk was rotated to give a sliding speed of 0.013 centimeter per second.

The results of the investigation showed that the basal plane exhibited lower friction than the prismatic slip plane. With the basal plane parallel to the interface, lower friction coefficients were observed in the $\langle 11\bar{2}0 \rangle$ than in the $\langle 10\bar{1}0 \rangle$ directions. The lowest friction coefficient for basal orientation was obtained with the basal plane inclined 135° to the sliding interface. The friction coefficient of single-crystal beryllium sliding on sapphire was lower than that of single-crystal beryllium sliding on polycrystalline aluminum oxide. With sapphire, brittle fracture of sapphire was observed, while with polycrystalline aluminum oxide, shear of beryllium was observed.

INTRODUCTION

The desirable friction and wear characteristics of hexagonal metals that exhibit basal slip were discussed in references 1 and 2. Complete welding was observed of cubic metals such as nickel and copper in vacuum sliding friction experiments (ref. 1). No evidence of welding has been observed with the metal cobalt in its hexagonal form. These differences in the behavior of cubic and hexagonal metals are related to the differences in crystallographic-slip behavior during plastic deformation of metals at the sliding interface. With hexagonal metals such as cobalt, the preferred orientation of crystallites

at the interface results in a basal shear mechanism. With a single slip mechanism operating, the forces required to shear metallic junctions at the sliding interface are markedly less than those required for cubic metals where multiple slip systems can operate. Multiple-slip-plane interactions result in the generation of immobile (sessile) dislocations that inhibit the motion of other slip-plane dislocations. The shear strengths of the junctions formed with cubic metals are, therefore, markedly increased at the metallic interface of sliding metals. Titanium metal is an exceptional case, because, although it has a hexagonal crystal structure, it slips primarily on prismatic and pyramidal planes.

The hexagonal metal beryllium, because of its good properties (basal slip behavior under deformation, excellent rigidity, good strength and light weight), appears very attractive as a material for space lubrication systems. Beryllium, however, has a serious limitation because it has poor ductility (ability to undergo plastic deformation), which makes fabrication difficult. This poor ductility in beryllium has been attributed to a number of factors (refs. 3 to 5): the grain size, the purity, and most markedly, the preferred orientation of crystallites in the fabricated forms (with the basal planes nearly parallel to the worked surface). Furthermore, it has been stated that if beryllium is stressed in compression perpendicular to the worked surface (parallel to the C-axis of the hexagonal cell), it will deform elastically to high stresses (to 280 000 psi) at which time it will fracture or explode with no evidence of plastic deformation (refs. 6 and 7).

Preferred orientation of crystallites in beryllium metal occurs with deformation, therefore, it can be anticipated that the resultant orientations will influence the frictional properties of the components of lubrication systems made from beryllium. The study of single-crystal beryllium of known orientations may then do much to elucidate the friction characteristics of the metal. Furthermore, it would be of interest to know what effect the preferred orientation in beryllium has on its friction characteristics when it is in contact with materials other than beryllium.

This investigation was conducted to determine the influence of crystallographic orientation in single-crystal beryllium on its friction characteristics in contact with (1) polycrystalline beryllium and (2) single and polycrystalline aluminum oxide.

The experiments of this investigation were conducted with oriented single-crystal beryllium riders sliding on polycrystalline beryllium disks and on aluminum oxide (both single crystal (0001) and polycrystalline) disks. A hemispherically tipped rider specimen contacted the flat of a rotating disk specimen. The rider was loaded against the disk at 100 to 1500 grams, and the disk rotation was such that a low speed (0.013 cm/sec) was produced. All friction experiments were conducted in a vacuum of 10^{-10} torr to minimize the influence of surface contaminants (such as beryllium oxide). Furthermore, electron bombardment was employed in vacuum to remove residual oxides.

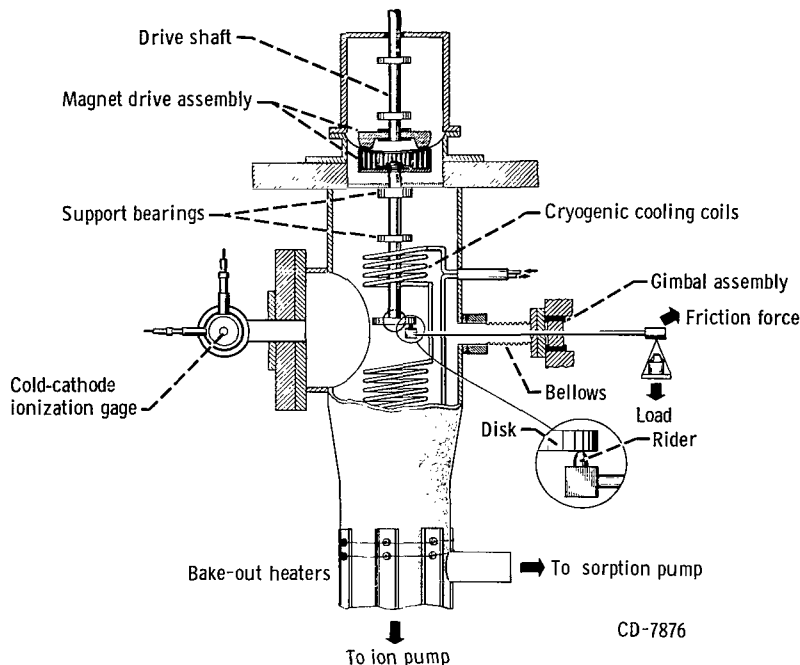

Figure 1. - High-vacuum friction and wear apparatus.

APPARATUS AND PROCEDURE

The apparatus used in this investigation is shown in figure 1. The basic elements of the apparatus were the specimens (a $2\frac{1}{2}$ -in. -diam flat disk and a $\frac{3}{16}$ -in. -hemispherical-rad. rider) that were mounted in a vacuum chamber. The disk specimen was driven with a magnetic drive coupling. The coupling had two 20-pole magnets 0.150 inch apart with a 0.030-inch diaphragm between magnet faces. The driver magnet, outside the vacuum system, was coupled to a hydraulic motor. The second magnet was completely covered with a nickel-alloy housing and was mounted on one end of the shaft within the chamber (fig. 1). The end of the shaft opposite the magnet contained the disk specimen.

The rider specimen was supported in the specimen chamber by an arm mounted by gimbals and bellows sealed to the chamber. A linkage (not shown in fig. 1) at the end of the retaining arm, away from the rider specimen, was connected to a strain-gage assembly. The assembly was used to measure frictional force. Load was applied through a dead-weight loading system.

Attached to the lower end of the specimen chamber was a 500-liter-per-second ionization pump and a sorption forepump. The pressure in the chamber was measured adjacent to the specimen with a cold-cathode ionization gage. In the same plane as the specimens and the ionization gage was a diatron-type mass spectrometer (not shown in fig. 1)

for determination of gases present in the vacuum system. A 20-foot-long coil of 5/16-inch-diameter stainless-steel tubing was used for liquid-nitrogen and liquid-helium cryopumping of the vacuum system. Electron bombardment was employed as a standard surface cleaning procedure in all experiments. A wire-wound thoriated-tungsten electron gun element was located 1 inch from the disk-specimen surface for the electron bombardment of the specimens.

Prior to placing the specimens in the vacuum chamber, the specimen surfaces were thoroughly washed with the solvents acetone and alcohol. The specimens were mounted in the chamber. The chamber was purged with dry nitrogen, evacuated, and pumped to bakeout pressure. After overnight bakeout, the specimens were cleaned by electron bombardments for 40 minutes and then cooled. The experiment started after a pressure of 10^{-10} millimeter of mercury was achieved with liquid-helium pumping. A mass spectrometer, which was used to monitor the gaseous species present in the system, indicated the presence of hydrogen as the residual gas present after liquid-helium cryopumping.

The speed used in this study was selected to be slow to avoid surface recrystallization. The particular speed value is, however, an arbitrary value resulting from the drive mechanism. Initial loads were kept light for the same reason. The total number of passes of the rider over the same disk area (duration of the run) was three.

Materials

The single-crystal beryllium used in this investigation was three-pass, zone-refined material (ref. 4). Crystals that received eight to twelve passes in zone refining were examined for comparative purposes. These specimens were prepared from the procedure cited in reference 8. The specimen material was obtained from the authors of reference 8. The hemispherical radius was machined on the end of each rider specimen by using spark-discharge machining. The specimens were then electropolished with an orthophosphoric acid reagent to remove any worked surface layer. The orientations were determined by the crystal supplier and were checked again at Lewis after they had been mounted in the apparatus specimen holder by using the X-ray Laue back-reflection technique. The basal plane was 0° from the rod axis for the first orientation, and the prismatic plane was 2° from the rod axis for the second orientation.

The polycrystalline beryllium used in this study was of commercial purity (as described in ref. 4); the principal impurity was beryllium oxide (nuclear-grade metal).

The single-crystal sapphire was annealed with an impurity content of less than 100 parts per million, as indicated by the crystal supplier. The basal plane for the sapphire disk specimens was within 6° of being parallel to the sliding interface, as deter-

mined by the Laue back-reflection technique. The polycrystalline aluminum oxide was high purity with a 99.9 percent density and an average grain diameter of 0.023 millimeter.

RESULTS AND DISCUSSION

Effect of Plane on Friction

The lattice parameters of the hexagonal metal beryllium are such that the lattice ratio c/a deviates considerably from that normally associated with ideal atomic close

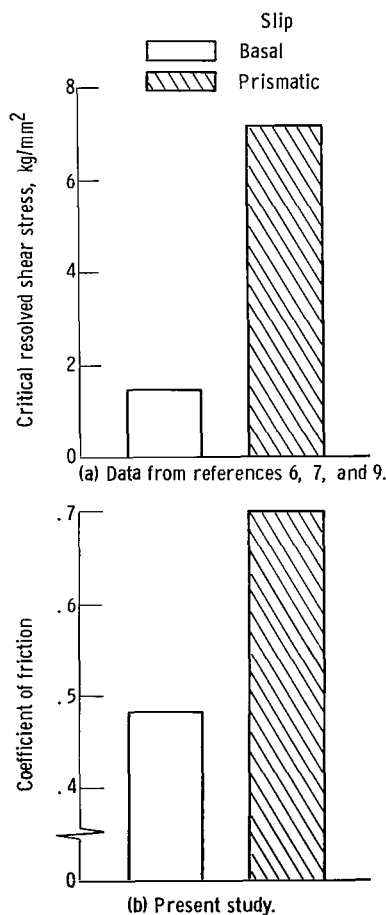

Figure 2. - Critical resolved shear stress and friction coefficient for beryllium metal. Friction experiments in vacuum (10^{-10} mm Hg); load, 250 grams; sliding velocity, 0.013 centimeter per second; mating surface, polycrystalline beryllium; no external heating of specimens.

packing. Despite this deviation, beryllium slips under plastic deformation primarily on the basal plane (refs. 6, 7, and 9). The measured shear stresses for single-crystal beryllium oriented for basal and prismatic slip are presented in figure 2. The coefficient of friction for single-crystal beryllium, which was oriented for basal and prismatic planes parallel to the sliding interface, is also presented in figure 2. The friction data were obtained with single crystals sliding on polycrystalline beryllium. The friction coefficient was lower for the basal orientation of the single crystals. These results correlate with the shear-stress data as did the data obtained with single-crystal cobalt (ref. 1). Knoop hardness (KHN) measurements made on the two planes indicated a KHN of 190 on the basal plane (0001) and a KHN of 87 for the prismatic plane ($10\bar{1}0$).

Effect of Direction on Basal Plane

The friction data of the beryllium crystal oriented with the basal plane parallel to the sliding interface were obtained with the crystal sliding in the $\langle 10\bar{1}0 \rangle$ crystallographic direction. For metals that exhibited basal slip, $\langle 11\bar{2}0 \rangle$ was observed to be the normal direction. A difference in the friction data might be anticipated with a change in the crystallographic direction of sliding. In order to determine if such a difference does exist, friction experiments were conducted with the basal plane of single-crystal beryllium parallel to the sliding interface. The specimen was initially

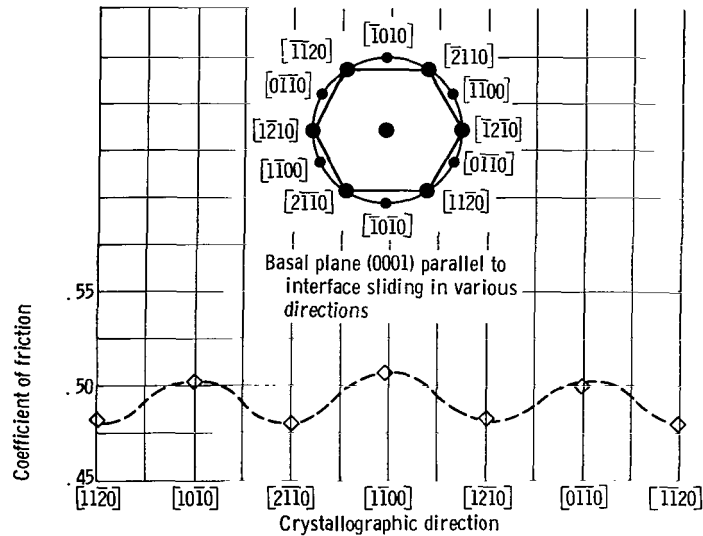

Figure 3. - Coefficient of friction for single-crystal beryllium rider sliding on polycrystalline disk with basal plane of rider in various crystallographic directions. Load, 250 grams; sliding velocity, 0.013 centimeter per second; ambient pressure, 10^{-10} millimeter of mercury; no external heating of specimens.

oriented to slide in the $\langle 11\bar{2}0 \rangle$ crystallographic direction. The specimen was then rotated 30° , and the friction coefficient was again determined. Friction data were obtained every 30° over a 180° arc. Only half the directions of the hexagonal basal plane were examined, because the friction should theoretically repeat itself every 60° , and the remaining 180° in the (0001) plane would only repeat the results of the first half.

The results of friction experiments obtained by sliding the basal plane of a beryllium rider in different crystallographic directions are presented in figure 3. Examination of these data indicates that, as theory predicts, the friction coefficient repeats every 60° . The minimum in friction coefficient is obtained when the specimen is sliding in the $\langle 11\bar{2}0 \rangle$ directions, and the maximum, when the specimen is sliding in the $\langle 10\bar{1}0 \rangle$ directions. The $\langle 11\bar{2}0 \rangle$ directions are, as stated earlier, the preferred slip directions and also the directions of greatest atomic density in the basal planes.

The friction differences of figure 3 are not great, but this is not surprising since the changes in structural orientation that bring about these differences are not great. However, in light of the periodicity and repetition of the data in a theoretically predictable manner, these differences can be considered real. The difference in friction between the points of the two orientations was 0.04 with a mean deviation of ± 0.005 .

Effect of Basal-Plane Orientation

In conventional stress-strain determinations with single crystals, the basal plane of

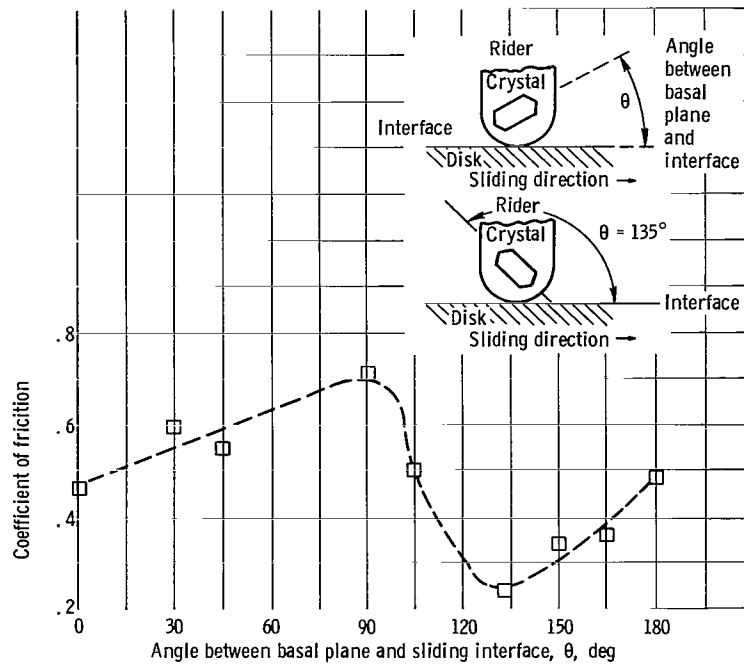

Figure 4. - Coefficient of friction for single-crystal beryllium sliding on polycrystalline beryllium in vacuum with various basal-plane orientations with respect to sliding interface. Load, 250 grams; sliding velocity, 0.013 centimeter per second; ambient pressure, 10^{-10} millimeter of mercury; no external heating of specimens.

the hexagonal metal does not lie normal to the direction of applied tensile or compressive force, but rather at an angle of 45° to the normal (ref. 10). With metals in sliding or rolling contact, the preferred orientation of the crystallites parallel, or nearly parallel, to the surface usually occurs. Then under such conditions, the normal applied load does little or nothing in contributing to the process of shearing between basal planes (fig. 2), and the friction force represents, in essence, the shear stress required to produce basal shear.

In order to determine if differences in friction might exist with changes in orientation of the basal plane with respect to the sliding surface, experiments were conducted by changing the orientation of the basal plane. The results are presented in figure 4. Data were obtained by rotating the basal plane through 180° with respect to the sliding direction. At 0° the friction coefficient is approximately 0.46, and, as the basal plane is tilted in the sliding direction, the friction coefficient increases to a maximum at a position 90° from the basal orientation. The sliding direction of the basal plane was the $\langle 11\bar{2}0 \rangle$ direction. With increasing tilt angle from 0° , it is much like the blade of a wood plane cutting into wood where the greatest resistance to motion (friction force) is observed with the blade tilted into the wood. Just beyond 90° , the friction coefficient decreases reaching a minimum at 135° .

When the basal plane of beryllium is oriented parallel to the sliding interface, the normal applied load (250 g in these experiments) does not contribute to the shearing force. At any orientation of a plane other than parallel to the sliding interface, the resultant shearing force will consist of two component forces: the shear force and the force resulting from the applied load. The force to shear basal planes (the friction force) will be at a minimum when the basal plane is inclined 135° to the interface.

Work-Hardening in Beryllium

Hexagonal, metal, single crystals that exhibit basal slip mechanism predominantly show very little tendency to work-harden. In sliding friction, the tendency to work-harden is very important. If a metal, such as cubic metal copper, will work-harden readily, the shear strength of the welding contacting asperities will increase. Shear must then occur either across junctions that have a higher shear strength and will therefore exhibit a larger frictional force, or in the undeformed metal removed from the contacting interface where a larger area must be sheared. In either event, the resultant frictional force is going to be greater than it was for the unworked metal.

Beryllium, like most hexagonal metals when oriented for basal slip, exhibits little tendency to work-harden, as indicated by the stress-strain data for beryllium obtained from reference 8 and presented in figure 5. Examination of figure 5 indicates that, for a 200-percent strain, the shear stress is only 4 to 5 kilograms per square millimeter, while, for the prismatic orientation, a 100-percent strain results in a shear stress of about 17.0 kilograms per square millimeter. The data of reference 8 were divided into stages by the author: stage I or easy glide and stage II or strain hardening. The curve for prismatic slip of beryllium appears very similar to the three-stage curve for face-centered cubic metals, such as copper, with the notable exception that, for beryllium, stage III has a sharper slope than stage II, which is somewhat unlike that of copper. Electron photomicrographs of thin sections obtained from the two crystal orientations after straining are included in figure 5. The differences in dislocations are clear. With the prismatic deformation, complex tangles of dislocations were observed; with the basal orientation, however, markedly less concentration of edge pairs was observed. A relation between dislocation density and shear stress for materials, such as copper, has been known for some time.

In reference 2, relatively moderate loads on single-crystal titanium resulted in the surface recrystallization of titanium with the formation of a highly textured interface. In order to determine if similar effects might be observed with beryllium, friction experiments were conducted at various loads with the prismatic orientation of beryllium. The

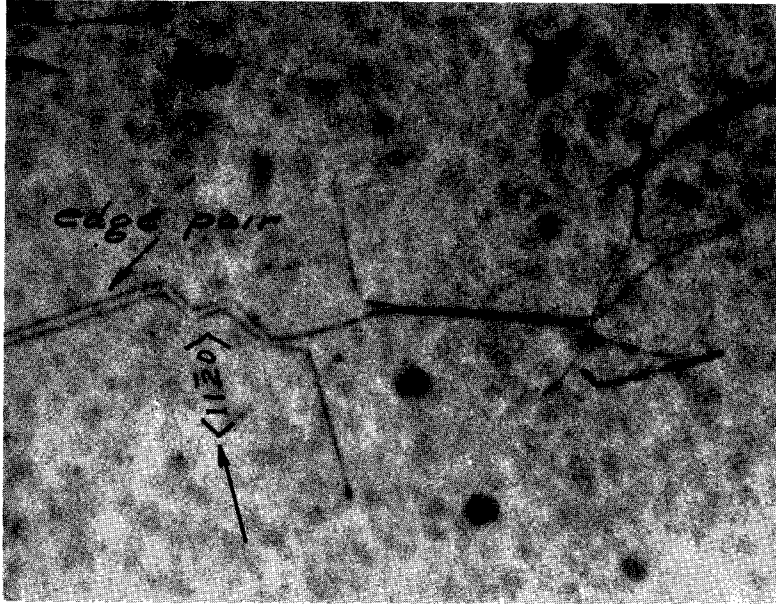

Edge of dislocations observed in foil cut from bulk crystal deformed by basal slip (stage I); X40 000.

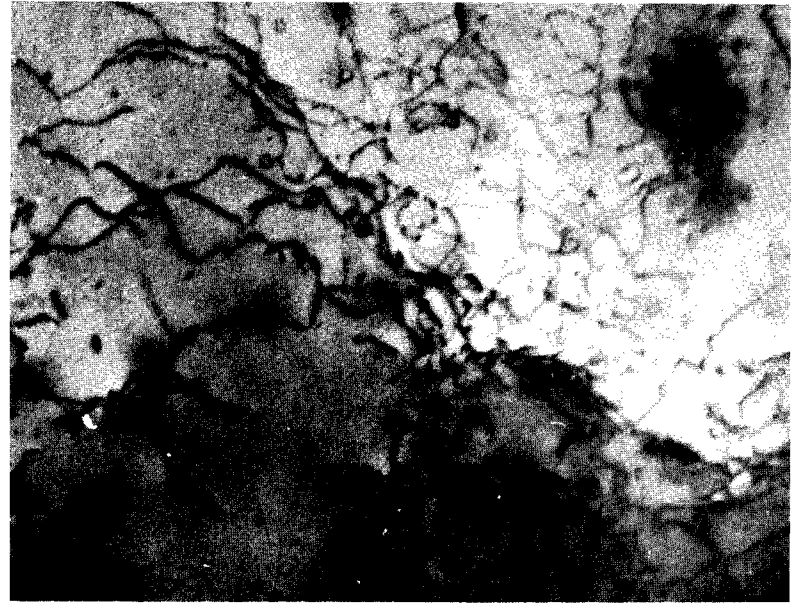

Complete tangle of dislocation observed in foil cut from bulk crystal deformed by prismatic slip (stage II); X40 000.

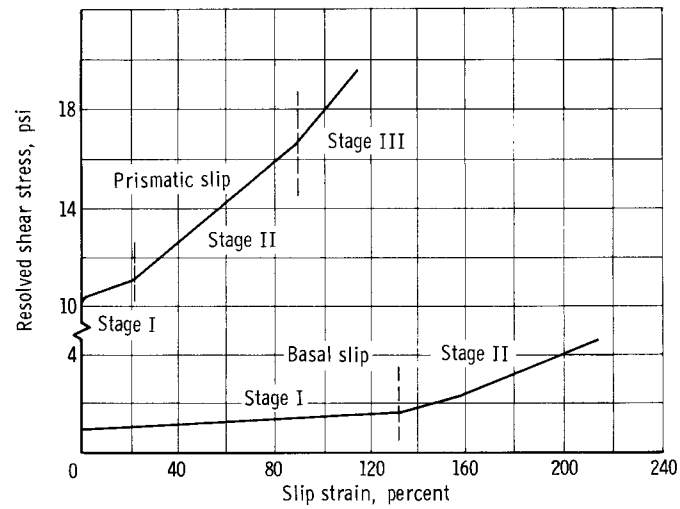

Figure 5. - Stress-strain data obtained for high-purity single-crystal beryllium (from ref. 5).

results are presented in figure 6. Increasing the load did not affect the friction coefficient over the range of 100 to 1500 grams. If an interfacial change such as recrystallization were to occur, a corresponding change could be anticipated for friction. With recrystallization, preferred orientation of the crystallites would occur with the basal planes parallel to the interface exhibiting a friction coefficient (0.46) similar to that in reference 1 for polycrystalline beryllium. Since a change did not occur, it is reasonable to assume that recrystallization of beryllium at the sliding interface did not occur in the load range covered in figure 6.

Beryllium Sliding on Aluminum Oxide

Of interest is the contact of metals, not only with other metals, but also with nonmetals, such as metal oxides. For example, little is known about the adhesion and friction characteristics of metals in contact with nonmetals such as aluminum oxide. Such systems may be worthy of consideration for space lubrication devices where cubic metals weld very readily. Some friction experiments were therefore conducted with single-crystal beryllium (basal and prismatic orientations) sliding on single and on polycrystalline aluminum oxide. The sapphire crystals had the basal plane (0001) oriented parallel to the sliding interface. The friction results are presented in figure 7.

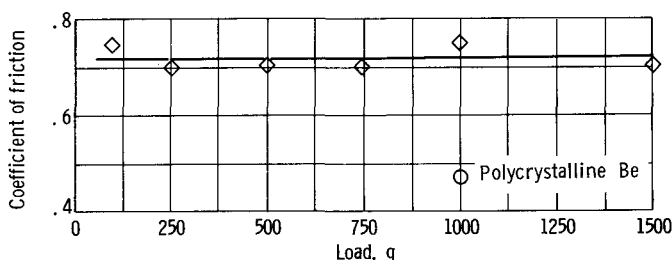

Figure 6. - Coefficient of friction with load for beryllium crystal sliding on (1010) plane in [0001] direction on polycrystalline beryllium. Sliding velocity, 0.013 centimeter per second; 10^{-10} millimeter of mercury; no external heating of specimens.

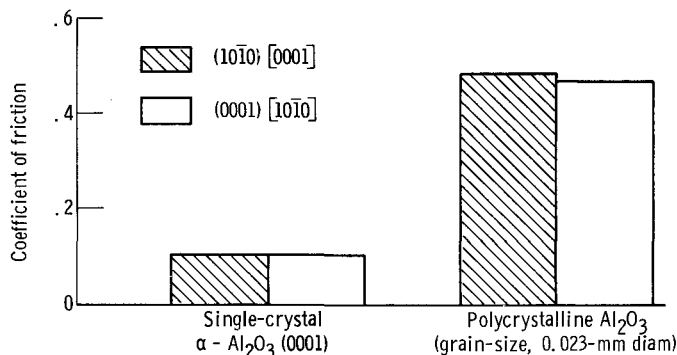
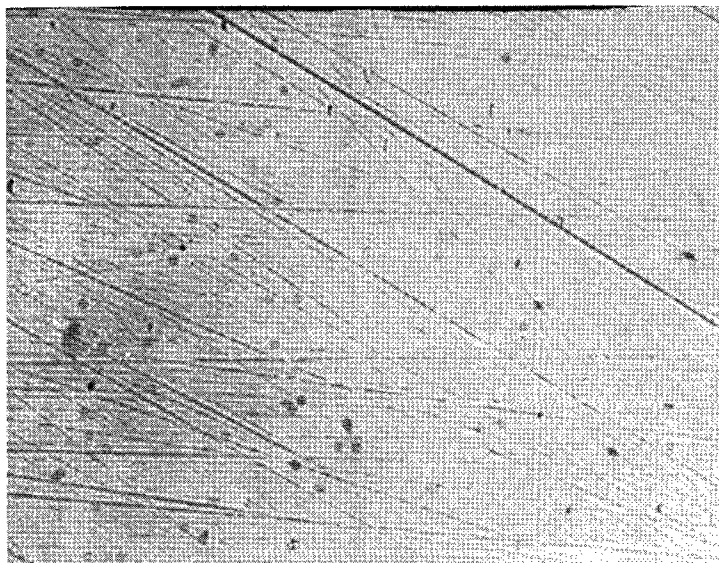

Figure 7. - Coefficient of friction for single-crystal beryllium sliding on single and polycrystalline α -aluminum oxide. Load, 1000 grams; sliding velocity, 0.013 centimeter per second; no external heating of specimens; run duration, 1 hour.

line aluminum oxide. The sapphire crystals had the basal plane (0001) oriented parallel to the sliding interface. The friction results are presented in figure 7.

Examination of figure 7 indicates that the orientation of beryllium exhibits essentially no influence on the friction data for either single or polycrystalline aluminum oxide. The reason for this is understood if the photomicrographs of figure 8 are examined. If an area of the sapphire disk from the wear track is examined (fig. 8(a)), an essentially smooth surface is seen, with the exception of some polishing scratches. In figures 8(b) and (c), where areas in the wear track are shown for the (0001) and the (1010) plane orientations parallel to the sliding interface, a considerable con-



(a) Surface outside wear area.

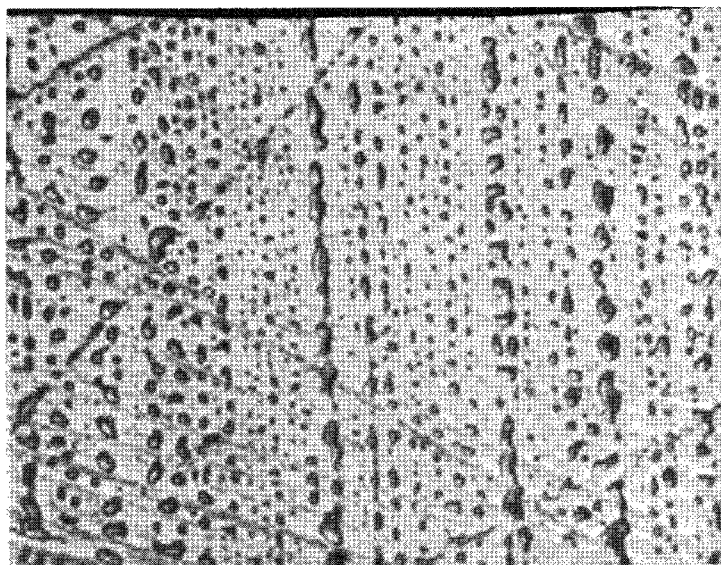

(b) Wear area with (0001)[1120] beryllium sliding on surface.

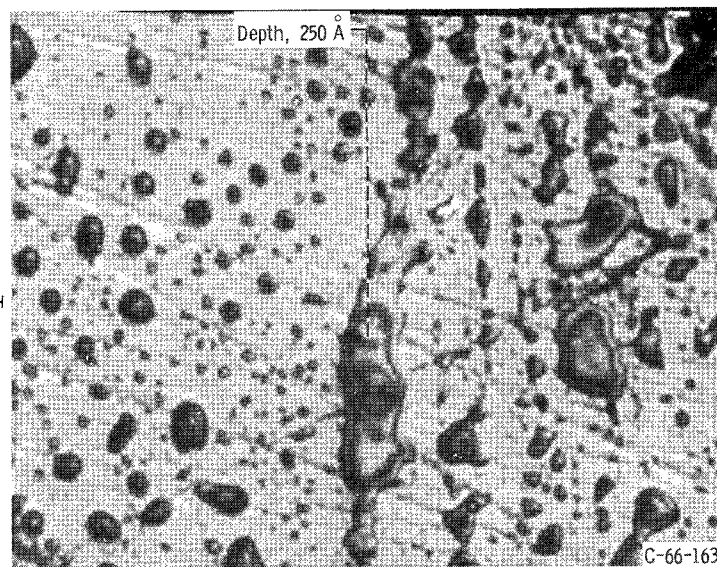

(c) Wear area with (1010)[0001] beryllium sliding on surface.

Figure 8. - Photomicrographs of sapphire disk surfaces (0001).

centration of surface pits is observed. Note particularly that, although pits are observed for both orientations, a much higher concentration (but of a smaller size) is observed with the beryllium basal plane sliding on sapphire. With the prismatic plane, the pits were deeper (as much as 250 Å) and larger. The surface distress represents the results of three passes of the beryllium rider over the same area. The friction data of figure 7 represent not the friction force required to shear beryllium-aluminum oxide bonds, but, rather, the force required to produce brittle fracture or cleavage for the basal orientation of sapphire. This being the case, the similarity of the friction data of figure 7 is understandable. It is not the shear strength in beryllium, but, rather, the fracture strength in aluminum oxide that is the friction force determinant.

The friction data for the crystallographic orientations of beryllium sliding on polycrystalline aluminum oxide are also presented in figure 7. The friction coefficient for polycrystalline aluminum oxide was 0.46 to 0.48 or more than four and one-half times the value obtained with single-crystal aluminum oxide. It is interesting to note that the friction value is the same for the basal orientation of beryllium (fig. 2, p. 5) sliding on polycrystalline beryllium. The reason for this is better understood with an examination of figure 9 which reveals that a large quantity of beryllium metal was transferred to the aluminum oxide surface. The friction force may now be represented by shearing the beryllium metal rather than by fracturing the aluminum oxide.

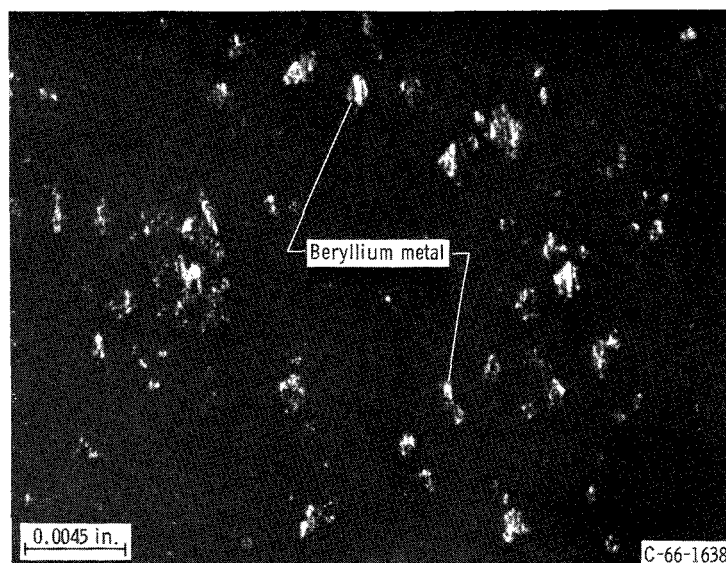
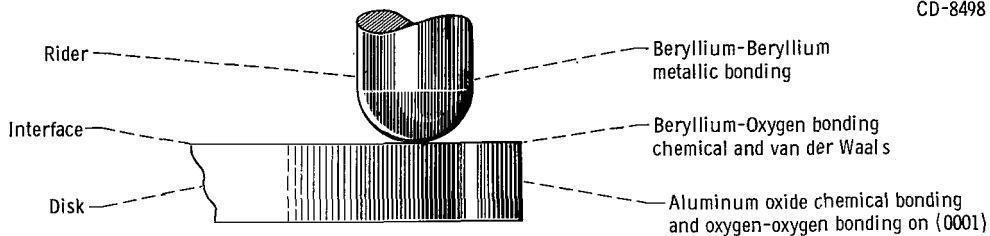
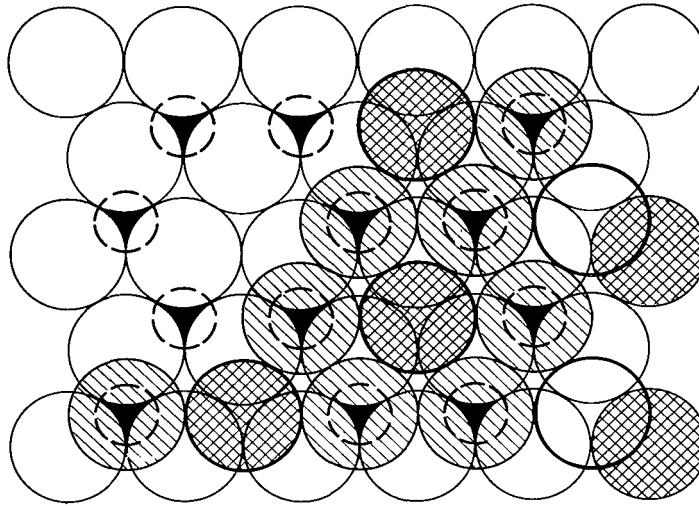

Figure 9. - Photomicrograph of polycrystalline aluminum oxide (0.023-mm average grain diam) wear surface with transferred beryllium metal present. Beryllium single crystal sliding on surface (0001)[1120].

- Aluminum ions on aluminum-oxide second layer
- Oxygen ions on aluminum oxide surface
- ⊘ Beryllium on A sites; chemical bonding
- ⊗ Beryllium on B sites; van der Waals interaction



CD-8498

Figure 10. - Nature of surface interaction and bonding of beryllium to sapphire (0001) plane.

Nature of Sliding Interface

The interface of the beryllium rider with aluminum oxide, as well as the atomic structure of sapphire, may be represented as shown in figure 10. The surface of sapphire with the basal plane parallel to the surface is represented by a layer of oxygen ions on the surface and in the second layer, or by aluminum ions (first subsurface layer) in a hexagonal array (ref. 11). For beryllium metal sliding on sapphire, some beryllium atoms may take up sites in oxygen interstices where an aluminum ion lies in the subsurface. At such points, only van der Waals interaction of beryllium with sapphire may occur. Where beryllium atoms take up sites on the oxygen atoms and a vacancy of aluminum ions exists, a surface chemical bonding of beryllium to oxygen occurs. Such bonding is discussed in reference 11.

When the sliding interface of beryllium with sapphire is examined in the light of sliding-friction studies, three types of bonds or bonding must be considered: (1) beryllium metal-to-metal bonding in the rider of beryllium, (2) chemical bonding of beryllium to oxygen of aluminum oxide, and (3) bonding in aluminum oxide (fig. 10). In sliding-friction experiments, it is reasonable to assume that the friction force will be represented by the weakest of the bonds near the interface. For single-crystal beryllium sliding on aluminum oxide (figs. 7 and 8), the weakest bond appears to be the oxygen-oxygen bonding in aluminum oxide since brittle fracture or cleavage of the sapphire occurs (fig. 8).

With beryllium sliding on polycrystalline aluminum oxide (figs. 7 and 9), the weakest bond appears to be the beryllium metal-to-metal bond, since in figure 9 a transfer of beryllium to aluminum oxide is shown. The fact that brittle fracture did not occur within the polycrystalline aluminum oxide is not surprising because cleavage along planes of proper orientation in a grain may be arrested by the presence of grain boundaries.

The data of figure 7 for the two orientations of beryllium indicate that the transferred beryllium exhibited basal slip. Recrystallization of the metal may have occurred at the interface. X-ray Laue back-reflection patterns revealed a highly deformed surface layer on the rider specimen.

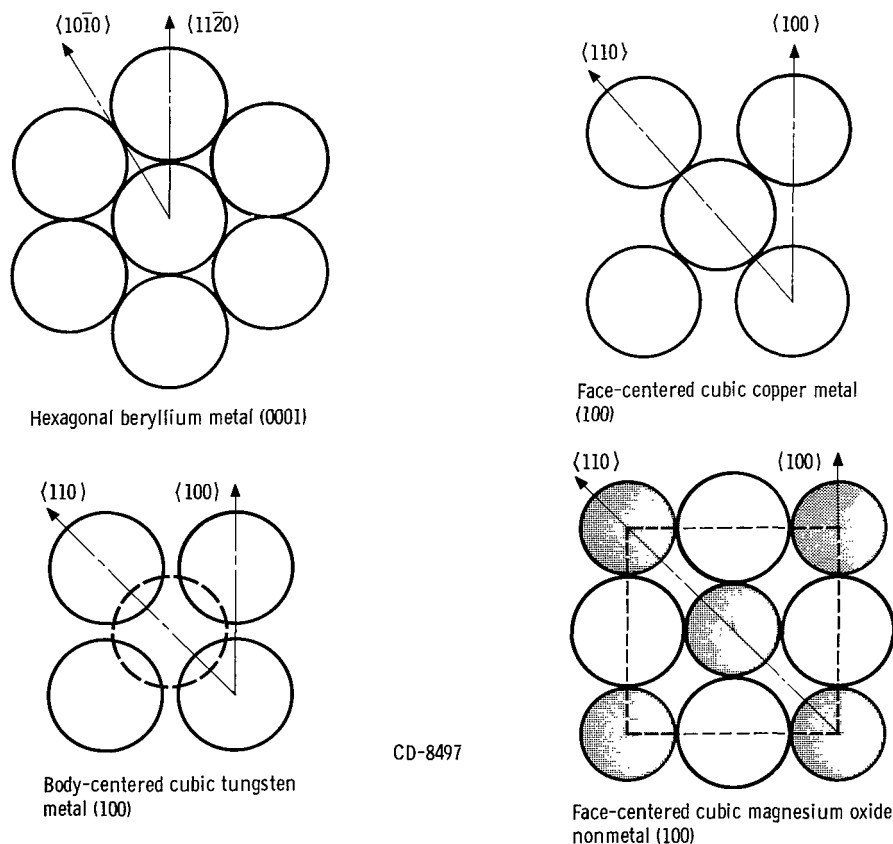

Figure 11. - Geometric arrangement of atoms in various structures.

TABLE I. - FRICTION PROPERTIES FOR VARIOUS
CRYSTALLOGRAPHIC ORIENTATIONS
OF MATERIALS

Material	Plane	Direction	^a Coefficient of friction	Reference
Beryllium (hexagonal)	(0001)	$\langle 11\bar{2}0 \rangle$	0.48	---
	(0001)	$\langle 1010 \rangle$.51	---
	(1010)	$\langle 0001 \rangle$.70	---
Tungsten (body-centered cubic)	(100)	$\langle 100 \rangle$	0.85	13
	(100)	$\langle 110 \rangle$	1.25	13
Copper (face-centered cubic)	(100)	$\langle 100 \rangle$	0.85	17
			1.14 (static)	12
	(100)	$\langle 110 \rangle$	0.65	17
			.56 (static)	12
Magnesium oxide (face-centered cubic)	(100)	$\langle 100 \rangle$	0.60	11
	(100)	$\langle 110 \rangle$.20	11

^aDynamic friction coefficient, unless otherwise noted.

Atomic Density

The data of this investigation indicate that, for beryllium (much the same as cobalt, ref. 1), the lowest friction coefficients are observed with the greatest atomic density planes slipping under deformation. Friction coefficients were obtained when the plane was oriented for sliding in the preferred slip direction or in the direction of greatest atomic density, namely, the $\langle 11\bar{2}0 \rangle$ direction (see fig. 11, table I).

Friction data were obtained for the face-centered cubic metal copper in static friction measurements (ref. 12) and dynamic friction experiments (ref. 13). These data indicate that, on the {100} planes of copper, the friction coefficient is greater in the $\langle 100 \rangle$ than in the $\langle 110 \rangle$ directions, as indicated in table I. Figure 11 indicates that, for the {100} planes of copper, atomic density is greater in the $\langle 110 \rangle$ than in the $\langle 100 \rangle$ directions.

The data in reference 14 for sapphire sliding on the surface of the body-centered cubic metal tungsten indicate that friction was lowest and that hardness was greatest in the direction of the greatest atomic density. On the {100} plane of tungsten, friction was lower and hardness higher in the $\langle 100 \rangle$ than in the $\langle 110 \rangle$ directions (see table I). Fig-

ure 11 indicates the $\langle 100 \rangle$ directions on the $\{100\}$ plane to have a higher atomic density than the $\langle 110 \rangle$ directions.

In addition to the correlation of friction with atomic density for hexagonal, face-centered, and body-centered cubic metals, similar relations may exist for other inorganic crystalline materials. The data for magnesium oxide (ref. 15) and for diamond (ref. 16) indicate that, for these structures, the friction coefficient is lowest in the direction of greatest atomic density. With magnesium oxide (shown in fig. 11 as a sodium chloride type structure) on the $\{100\}$ plane, friction was lowest and hardness greatest in the $\langle 110 \rangle$ directions.

SUMMARY OF RESULTS

The results obtained from an investigation of the effect of orientation on the friction characteristics of single-crystal beryllium in vacuum are summarized as follows:

1. The friction characteristics of single-crystal beryllium are anisotropic.
2. The friction coefficient of beryllium is lower for basal than for prismatic slip; that is, friction is lower in the preferred slip system.
3. On the basal plane, changes in the sliding direction result in a periodic repetition of the friction coefficient every 60° . Maximum in friction is observed in the $\langle 10\bar{1}0 \rangle$ and minimum in the $\langle 11\bar{2}0 \rangle$ directions.
4. The minimum friction coefficient for single-crystal beryllium is obtained when the basal plane is inclined 135° to the sliding direction.
5. The coefficient of friction was higher for beryllium sliding on polycrystalline aluminum oxide than on single-crystal (0001) sapphire. With polycrystalline aluminum oxide, a transfer of beryllium to the aluminum oxide surface was observed; thus, the friction coefficient represented that of beryllium sliding on itself. On single-crystal sapphire, cleavage of the single-crystal surface occurred. The adhesion of beryllium to aluminum oxide occurred with both single-crystal and polycrystalline samples; with the single crystal, however, the stress for aluminum oxide cleavage was less than that for shear of basal planes in beryllium.

Lewis Research Center,
National Aeronautics and Space Administration,
Cleveland, Ohio, March 22, 1966.

REFERENCES

1. Buckley, D. H. ; and Johnson, R. L. : Influence of Crystal Structure on Friction Characteristics of Rare Earth and Related Metals in Vacuum to 10^{-10} mm Hg. ASLE Trans. vol. 8, no. 2, pp. 123-132, 1965.
2. Buckley, D. H. : Influence of Crystal Orientation on Friction Characteristics of Titanium Single Crystals in Vacuum. NASA TN D-2988, 1965.
3. Gross, A. G. , Jr. : The Crystallography of Beryllium Sheet. Paper Presented at the Second International Conference on Beryllium Technology, Phila. (Penn.), Oct. 15-17, 1964.
4. Stonehouse, A. J. ; Carrabine, J. A. ; and Beaver, W. W. : The Effect of Purification, Agglomeration and Heat Treatment on the Properties of Beryllium Single Crystals. Paper Presented at the Second International Conference on Beryllium Technology, Phila. (Penn.), Oct. 15-17, 1964.
5. Bunshah, R. F. : Effect of Purification on Some Mechanical Properties of Beryllium. Metals Eng. Quart. , vol. 4, no. 4, Nov. 1964, pp. 8-17.
6. Lee, H. T. ; and Brick, R. M. : Slip and Twinning in Single Crystals of Beryllium. J. Metals, vol. 4, no. 2, Feb. 1952, pp. 147-148.
7. Tuer, G. L. ; and Kaufman, A. R. : Ductility of Beryllium as Related to Single Crystal Deformation and Fracture. The Metal Beryllium, ASM, 1955, pp. 372-424.
8. Damiano, V. V. ; and Herman, M. : Dislocations in Deformed Beryllium Single Crystals. Paper Presented at the Second International Conference on Beryllium Technology, Phila. (Penn.), Oct. 15-17, 1964.
9. Tarnopol, Lester: Hexagonal Slip in Beryllium Crystal. Metal Prog. , vol. 52, no. 3, Sept. 1947, p. 391.
10. Barrett, C. S. : Structure of Metals. Metallurgy and Metallurgical Engineering Series. McGraw-Hill Book Co. , Inc. , 1943.
11. McDonald, J. E. ; and Eberhart, J. G. : Adhesion in Aluminum Oxide-Metal Systems. Trans. AIME, vol. 233, no. 3, Mar. 1965, pp. 512-517.
12. Takagi, R. ; and Tsuya, Y. : Static Friction Between Clean Copper Single-Crystal Surfaces. Wear, vol. 4, 1961, pp. 216-227.
13. Bailey, John M. ; and Gwathmey, Allan T. : Friction and Surface Deformation During Sliding on a Single Crystal of Copper. ASLE Trans. , vol. 5, no. 1, Apr. 1962, pp. 45-56.

14. Buckley, Donald H. : Influence of Orientation of Grains in Tungsten on Its Friction Characteristics. NASA TN D-3238, 1966.
15. Bowden, F. P. ; Brookes, C. A. ; and Hanwell, A. E. : Anisotropy of Friction in Crystals. Nature, vol. 203, no. 4940, July 4, 1964, pp. 27-30.
16. Bowden, F. P. ; and Hanwell, A. E. : Friction and Wear of Diamond in High Vacuum. Nature, vol. 201, no. 4926, Mar. 1964, pp. 1279-1281.
17. Low, J. R. : Dislocations and Brittle Fracture in Metals. Deformation and Flow of Solids, R. Grammel, ed., Springer-Verlag (Berlin), 1956.

"The aeronautical and space activities of the United States shall be conducted so as to contribute . . . to the expansion of human knowledge of phenomena in the atmosphere and space. The Administration shall provide for the widest practicable and appropriate dissemination of information concerning its activities and the results thereof."

—NATIONAL AERONAUTICS AND SPACE ACT OF 1958

NASA SCIENTIFIC AND TECHNICAL PUBLICATIONS

TECHNICAL REPORTS: Scientific and technical information considered important, complete, and a lasting contribution to existing knowledge.

TECHNICAL NOTES: Information less broad in scope but nevertheless of importance as a contribution to existing knowledge.

TECHNICAL MEMORANDUMS: Information receiving limited distribution because of preliminary data, security classification, or other reasons.

CONTRACTOR REPORTS: Technical information generated in connection with a NASA contract or grant and released under NASA auspices.

TECHNICAL TRANSLATIONS: Information published in a foreign language considered to merit NASA distribution in English.

TECHNICAL REPRINTS: Information derived from NASA activities and initially published in the form of journal articles.

SPECIAL PUBLICATIONS: Information derived from or of value to NASA activities but not necessarily reporting the results of individual NASA-programmed scientific efforts. Publications include conference proceedings, monographs, data compilations, handbooks, sourcebooks, and special bibliographies.

Details on the availability of these publications may be obtained from:

SCIENTIFIC AND TECHNICAL INFORMATION DIVISION
NATIONAL AERONAUTICS AND SPACE ADMINISTRATION
Washington, D.C. 20546