

**NASA CONTRACTOR
REPORT**

NASA CR-563

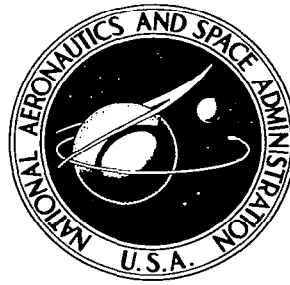

NASA GR-56

col

**LOAN COPY: RETURN TO
AFWL (WLIL-2)
KIRTLAND AFB, N MEX**

**VISUAL DETECTION OF
POINT SOURCE TARGETS**

by R. A. Shea and L. G. Summers

*Prepared by
TRW SYSTEMS
Redondo Beach, Calif.
for Ames Research Center*

NATIONAL AERONAUTICS AND SPACE ADMINISTRATION • WASHINGTON, D. C. • SEPTEMBER 1966

TECH LIBRARY KAFB, NM

0099480

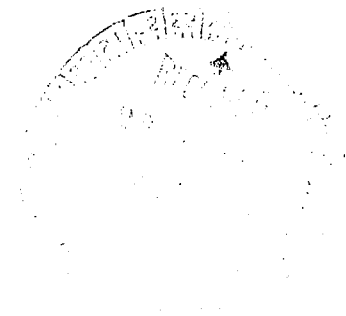
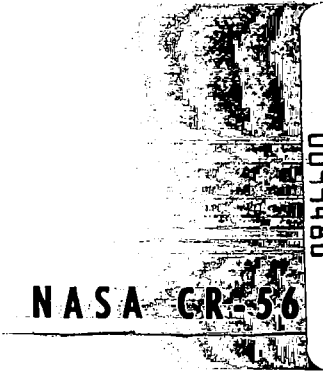



VISUAL DETECTION OF POINT SOURCE TARGETS

By R. A. Shea and L. G. Summers

Distribution of this report is provided in the interest of information exchange. Responsibility for the contents resides in the author or organization that prepared it.

Prepared under Contract No. NAS 2-2742 by
TRW SYSTEMS
Redondo Beach, Calif.

for Ames Research Center

NATIONAL AERONAUTICS AND SPACE ADMINISTRATION

ACKNOWLEDGMENT

The authors wish to thank Mr. Kenneth Ziedman for his review and comments throughout the course of this study.

TABLE OF CONTENTS

	<u>Page</u>
1.0 SUMMARY	1
2.0 INTRODUCTION	3
2.1 The Applied Problem	3
2.2 Related Investigations	4
3.0 EXPERIMENTAL DESIGN	7
3.1 Experiment I	7
3.2 Experiment II	8
4.0 EXPERIMENT APPARATUS AND PROCEDURE	11
4.1 Apparatus	11
4.2 Procedure	15
5.0 RESULTS AND INTERPRETATION	19
5.1 Experiment I	19
5.1.1 Analysis	19
5.1.2 Interpretation	28
5.2 Experiment II	31
5.2.1 Analysis	31
5.2.2 Interpretation	43
6.0 CONCLUSIONS	44
REFERENCES	47
APPENDIX A - Analysis of Variance and Probability Tables	48
APPENDIX B - Calibration Procedure	61
APPENDIX C - Subjects' Instructions	63
APPENDIX D - Representative Electro-oculograph Recordings for the V _{1.2} , I ₃ Condition Showing the Starfield Presentation Group Differences	65

LIST OF FIGURES

<u>No.</u>	<u>Title</u>	<u>Page</u>
1	Experimental Design for Experiment II	9
2	Experimental Room	12
3	Sequence of Trial Events Provided by Control Circuitry	14
4	Detection Time Curves for Field-of-View, Starfield Density and Target Velocity of Experiment I	21
5	Detection Time Curves for Session-Velocity, Starfield Density-Velocity, Field-of-View- Starfield Density and Field-of-View-Velocity Relationships of Experiment I	23
6	Detection Time Curves for Intensity versus Velocity versus Session of Experiment I	24
7	Detection Time Divided into Two Phases for Field-of-View	26
8	Number of Training Sessions per Subject for Experiment I	32
9	Detection Time Curves for Starfield Presentation Group, Session, Target Velocity and Target Intensity of Block A, Experiment II	34
10	Detection Time Curves for Replication- Session-Starfield Presentation Group and Target Intensity-Velocity-Group Relationships of Block A, Experiment II	35
11	Detection Time Curves for Target Velocity, Target Intensity and Starfield Presentation Group of Block B, Experiment II	37
12	Detection Curves Showing (a) Group- Intensity and (b) Group-Velocity Relationships for Block B, Experiment II	38
13	Detection Curves Showing the Group- Session-Intensity Relationships for Block B, Experiment II	40

LIST OF FIGURES (continued)

<u>No.</u>	<u>Title</u>	<u>Page</u>
14	Distributions of Eye Fixation Data for the Conditions of Experiment I	42

LIST OF TABLES

<u>No.</u>	<u>Title</u>	<u>Page</u>
I	Number of Stars and the Range of Magnitudes 1-5 for the Starfields	13
II	Summary of Analysis of Variance of Detection Times for Experiment I	20
III	Number of Training Sessions per Subject for Experiment I	32
IV	Summary of Analysis of Variance for the Detection Times of Block B, Experiment II	39

1.0 SUMMARY

This study presents the results of an experimental investigation of an observer's ability to detect, with the unaided eye, a target satellite in a rendezvous mission. The target was represented by a point source of light moving in a simulated starfield background. Specifically the study sought: 1) to determine for a variety of experimental conditions the time taken and the accuracy attained by an observer to detect this target; and 2) to delineate the search techniques used by the observer in performing this task.

Two experiments were conducted. The first (I) examined the effects of target velocity, target intensity, starfield density, field-of-view and practice upon detection time and accuracy using a unique starfield on each trial. The second (II) studied the differences in detection time and accuracy between two groups, one exposed to a unique and the other to the same starfield background on each trial. After training, half of each group was transferred to the other mode of starfield presentation to assess the effects of transfer.

Experiment I showed that detection time depends upon target velocity, starfield density and field-of-view. Differences in target velocity produced the greatest variability in performance with an average detection time of 220 sec for 0.1 mrad/sec rate and 45 sec for 2.4 mrad/sec rate. Experiment II showed that there is an appreciable difference in mean detection time between the two modes of starfield presentation -- 15 sec for the same starfield background contrasted with 150 sec for the unique. Detection time for the unique starfield group depended on target velocity and target intensity but for the group exposed to the same starfield became independent of these variables after a number of trials. There was no positive or negative transfer of training from one type of starfield presentation to the other.

On the basis of these results two models are proposed to explain the observer's search strategy, one for each type of presentation:

1) Unique Starfield

- o Initially the observer, using brief fixations, rapidly scans the starfield to detect the moving target. If this strategy fails he then fixates on specific clusters of stars and memorizes their pattern, later returning to each cluster to determine if a change in the pattern has occurred.
- o When the observer detects a change he identifies the target by ascertaining the change in a relative position of one of three or four stars forming a pattern.

2) Same Starfield

- o The observer, using only two or three fixations, detects the new object by comparing the memorized pattern with the presented pattern.

2.0 INTRODUCTION

Visual detection, from another spacecraft, of a satellite moving against a starfield background has obvious operational importance. For example, in any rendezvous mission, the target satellite must be detected and located to effect terminal guidance. Although radar will be included in the vehicle, the range for visual detection may actually exceed that of currently used radars, and the use of an active system may be unwise in engagement with a hostile satellite. The operator may be required to act as a backup system in the event of radar or other failure. (Lineberry, et al, (7) have shown that a pilot can accomplish rendezvous using only visual sighting of the target position.) Also an accurate knowledge of visual detection ranges can aid in planning launch time to obtain favorable illumination during acquisition phases. The purpose of this study was to assess the ability of the observer to detect a target satellite in rendezvous mission, to simulate these conditions a point source target moving slowly in a starfield was employed.

It should be noted that the search problem of this investigation differs from those traditionally studied. In other search studies (e.g., a target against a homogeneous or terrain background) detection depends in part on the distinguishability of the target from other objects in the field; that is, the target contrasts in appearance with the other objects in the field (e.g., size and shape, etc). Although in such studies target velocity or pattern variation may play a role in detection, variables involving contrast are generally the major factors. In the present study, however, these latter variables do not influence detection because the target is identical in appearance to the other objects from which it is to be distinguished. The only distinguishing aspect of the target is its change of position perceived as motion if its velocity is above the motion threshold as a pattern change if it is below.

2.1 THE APPLIED PROBLEM

The problem in this study was restricted to the detection of a visual point source (i.e., less than $10'$ arc). A satellite target may be distinguished from the fixed stars by relative motion, and its presence as a new

object in a known starfield. If the satellite is illuminated by solar or Earth light and the target intensity is within the range of visible stellar intensities, only its motion relative to the fixed stars and actual presence can serve as cues to the observer. (An asymmetrical rotating satellite may produce a variation of intensity with time.) The surface characteristics of a given target, the viewing angle and the direction of incident light are needed to determine its photometric intensity.

The field-of-view, background luminance, adaptation level of the observer and allowable search time will influence an observer's detection performance. During the 45 minute period of a typical transfer orbit a change in illumination geometry and line-of-sight angular motion will occur. Even if the terminal phase occurs in solar illumination, the target may be less visible than it was before the terminal phase, if, for example, the target moves between the chaser and the sun.*

2.2 RELATED INVESTIGATIONS

Several studies have been published on detection of a moving point source against a starfield. Baird et al (1) compared unaided visual search with search aided by a finely ruled reticle in a telescope. The reticle caused the target to blink as it moved across the field. A $22^{\circ} 38'$ starfield was used with the target always appearing in the central 12° . An average density starfield (not stated) was used with a range of stellar magnitudes from +0.5 to +6.0. The target intensity was +3.0 magnitude. The subjects were given two trials with and two trials without the reticle. For a target velocity of 0.1 mrad/sec, the mean detection time was 169 sec without the reticle and about 40 sec with the reticle. The number of misses and incorrect identifications, if any, were not reported.

Brissenden (2) examined the effects of target angular velocity and of initial separation from a reference point on the time to identify direction of motion of a point source. The starfield background consisted

* The variation in intensity as a function of time is specific to particular orbits and should be studied in the context of a given mission. This study is concerned only with the case of time-invariant intensity which may serve as a basis for predicting or studying specific time-varying cases.

of 106 stars in a 22° field with random separation angles. Stellar intensities were not given but the moving spot was slightly brighter than the background. The target was centered in a 3 star triangle or a 4 star square and different directions of motion were used. Initial separations from a reference star ranged from 12.5 to 60 mrad (.71 to 3.4 degrees). The subjects knew the location of the target so that search and detection were not required. The subject's task was only to report the direction of motion. Target velocities were varied from 0.1 mrad/sec ($.057^\circ$ /sec) to 2.0 mrad/sec (1.14° /sec). The time to detect the target varied from 2 sec to 35 sec for rates from 0.1 to 2.0 mrad/sec. With increases in separation and in uncertainty of the direction of motion, detection time increased. Errors in reporting the direction of motion increased from 2% for the target initially superimposed on a star to about 25% for 34 mrad of initial separation. It was not stated whether or not the detection times included incorrect responses.

Woodhull and Bauerschmidt (11) investigated the effect of angular velocity and number of background stars on detection performance. Angular velocities from 0 to 3.2 mrad/sec (0.18°) were used and the number of stars varied from one to six in a visual field of 10° . The subjects were required to indicate the direction of movement out of five possibilities (i.e., toward each corner and zero). Response times varied from about 2.5 sec to 40 sec over the range of velocities. Significant first order interactions were found among all combinations of subjects, number of stars, and velocities. For fields composed of one, two and three stars, the subjects reported an inability to establish a reference for determining the direction of motion. Errors in reporting direction increased with a decreasing target rate.

Summers et al (10) investigated the effects of target intensity and velocity on the subjects ability to detect a point source target when a different starfield was used on each trial. The range of conditions included photopic and mesopic targets (+2 to +5 magnitude). As part of the same study a second experiment was conducted to investigate the effects of target intensity, velocity and practice on detection performance when the same starfield was used on repeated trials. Both experiments showed

that target angular rate strongly affected detection time, but this dependence decreased with practice. Memory for the starfield played an important role in target detection. By the last session of the second experiment, differences in detection time between different conditions of target velocity and intensity had decreased. Variations in target intensity produced a variation in search time for the initial sessions in both experiments, but the magnitude of variation decreased with practice. In terms of detection time, there was apparently little difference in time for a mesopic target as compared to that for a photopic target.

The purpose of the present investigation was twofold: (1) to determine, under a variety of experimental conditions, the time that it takes an observer to detect a moving point source target and the accuracy with which he detects it, and (2) to examine the search techniques used by the observer in performing this task. The study was divided into two experiments:

- 1) A factorial study of the effects of target velocity, target intensity, starfield density, and practice upon detection time and accuracy using a different starfield on each trial.

- 2) A study of the relationships of detection time and accuracy to two modes of starfield presentation, one case in which the starfield was changed from trial to trial and another in which a simple starfield was used for all trials.

3.0 EXPERIMENTAL DESIGN

3.1 EXPERIMENT I

The independent variables of Experiment I were target velocity and intensity, starfield density, and field-of-view. The levels of the variables are given below:

- | | | | |
|----|-----------------------|----------------------------------------------------------------------------------------------------------|--------------------------------------------------------------------------------------------------------------------------------------------------------------------------------------------------|
| 1) | Velocity (V) | $V_{0.1} = 0.1 \text{ mrad/sec}$
$V_{1.2} = 1.2 \text{ mrad/sec}$
$V_{2.4} = 2.4 \text{ mrad/sec}$ | |
| 2) | Intensity (I) | $I_3 = 3\text{rd magnitude}$
$I_5 = 5\text{th magnitude}$ | |
| 3) | Starfield Density (D) | $D_0 = 0$
$D_L = \bar{x} - \sigma$
$D_H = \bar{x} + \sigma$ | where \bar{x} = the average number of stars/
field-of-view in
the real sky and
σ is the standard
deviation (x and
σ determined from
counts of star
maps) |
| 4) | Field-of-View (F) | $F_{27} = 27^\circ$
$F_{17} = 17^\circ$
$F_8 = 8^\circ$ | |

A split plot design was utilized with field-of-view as the between group variable. This was selected on the basis that an interaction between subject and field-of-view would be less than likely to occur than with the other variable. The within group variables were target velocity, target intensity, and starfield density. There were four replicates of the 18 experiment conditions (i.e., $V \times I \times D$) per subject with each subject receiving a total of 72 trials. Each group was composed of four subjects. Field-of-view, target velocity and intensity, starfield density and training were treated as fixed and subjects as a random variable.

3.2 EXPERIMENT II

The independent variables were mode of starfield presentation, target intensity and velocity, and transfer of training. A previous study (10) indicated that if the target velocity was below motion threshold, detection depended on the perception of change in target location and, therefore, memorization of the starfield played an important role in detection. The present experiment examined the effects of two types of memory on target detection performance, long term memory and short term memory. Long term memory in this experiment refers to the memory of the star patterns that develop with the repeated exposure to the same starfield whereas short term memory refers to the memory of the star patterns that develop during the exposure to a unique starfield on a single trial. Two procedures of starfield presentation were used to separate, in part, the two forms of memory: presentation of the same starfield for all trials (short term memory) and the presentation of a unique starfield for each trial (long term memory).

The following levels of variables were used:

- | | | |
|----|----------------------------|-----------------------------------------------------------------------------|
| 1) | Starfield Presentation (G) | GI = same starfield for each trial
GII = unique starfield for each trial |
| 2) | Target Velocity (B) | $V_{0.1}$ = 0.1 mrad/sec
$V_{1.2}$ = 1.2 mrad/sec |
| 3) | Target Intensity (I) | I_3 = 3rd magnitude
I_4 = 4th magnitude
I_5 = 5th magnitude |

A field-of-view of 27° and a high starfield density ($\bar{x} + \sigma$) was used throughout this experiment.

A split plot design was chosen for this experiment with starfield presentation as the between group variable. The within group variables were target velocity, target intensity and training session (S). A session for a subject consisted of 3 replicates of the 6 combinations of V and I for a total of 18 trials. The number of training sessions administered to a

subject depended on his learning curve. The subjects were divided into two groups of four, each receiving a different starfield presentation. After training was completed each of the two groups was split into two subgroups, one subgroup remained on the same mode of presentation and the other transferred to the other mode. As before, the number of sessions for a subject depended on the individual's learning curve. This design is shown in Figure 1. Subject was treated as a random variable, all others as fixed.

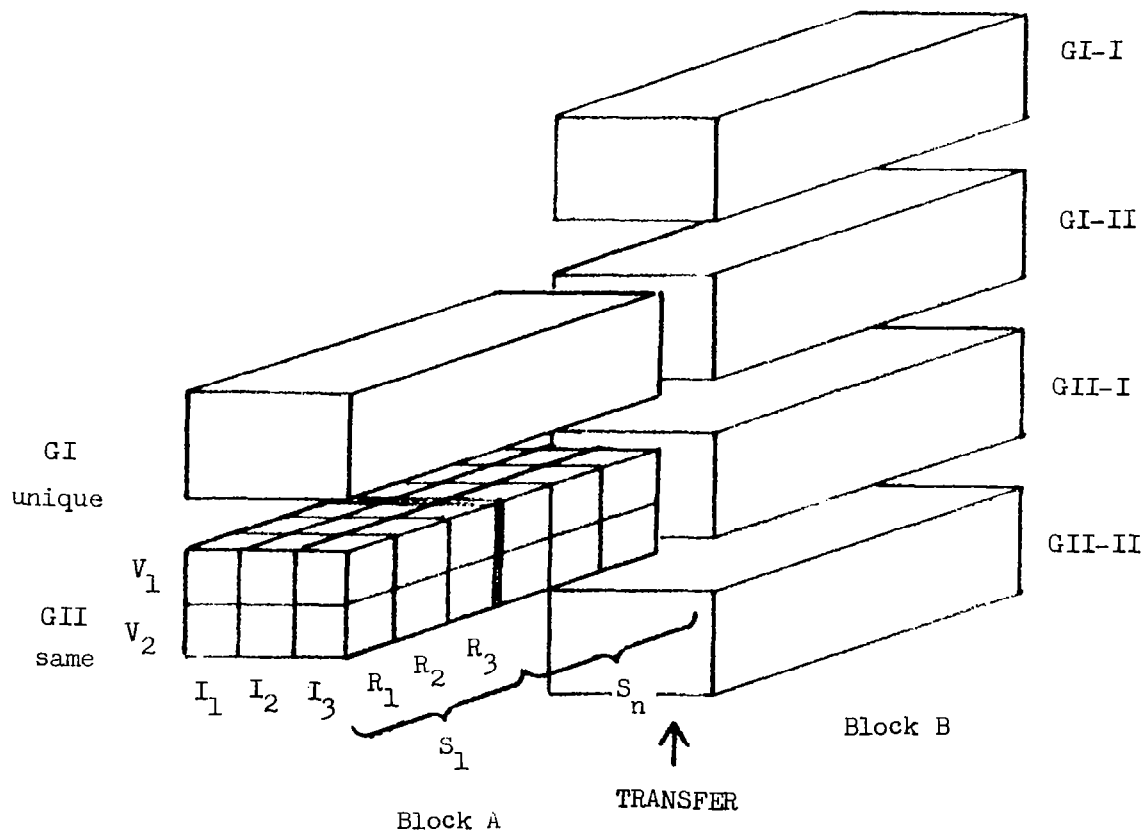

Figure 1: Experimental Design for Experiment II

In Figure 1, block A occurs before transfer of training, GI represents the unique and GII the same starfield presentation. Block B occurs after transfer of training. Subgroups GI-I and GII-I receive the unique and GI-II and GII-II the same starfield presentation

4.0 EXPERIMENT APPARATUS AND PROCEDURE

4.1 APPARATUS

Figure 2 shows a line drawing of the experiment room. The target projector was mounted in a three axis gimbal unit. The roll axis was deactivated and the pitch and yaw axes provided slow angular ranges for the target projector. Above the subject's box was the target projector and to the side the starfield projector. The subject seated in a box viewed the screen through a cutout which was fitted with a mechanical shutter to isolate him during the intertrial period. The room was light tight and black to minimize reflectance of light on the screen from the surrounding objects and walls.

The output of the target projector's high energy concentrated arc lamp, Sylvania C10, was focused through a double convex lens onto a pinhole aperture and imaged on the screen by an achromat. An image size of $\frac{1}{4}$ " diameter was projected on the screen 18 feet away. A filter placed between the pinhole and achromat corrected the color temperature of the target to within 50°K of the star images produced by the starfield projector. An iris diaphragm provided intensity control of the target and was calibrated in integral steps from 0 to 6th magnitude.

The two axis gimbal system allowed positioning and motion of the target in both vertical and horizontal axes with a maximum displacement of $\pm 15^{\circ}$ for both axes. The dynamic velocity range provided by the gimbals was 0.1 to 10 mrad/sec. Analog voltages set on two integrating amplifiers provided the target's motion. The final position of the target was recorded by switching the amplifiers to hold and reading the analog voltages with a digital voltmeter. Starfield projection was accomplished by using specially fabricated starfield slides with a lantern slide projector. The slides were fabricated by drilling .005" pinholes through brass shim stock. Neutral density filters placed over each pinhole attenuated the energy to provide the proper relative magnitude. The slide projector had an objective lens of $6\frac{1}{2}$ " focal length which provided a 27° field when viewed at a distance of 18 feet. The star images were $\frac{1}{4}$ " in diameter. An iris diaphragm was mounted on the front of the objective lens for intensity attenuation and image sharpening.

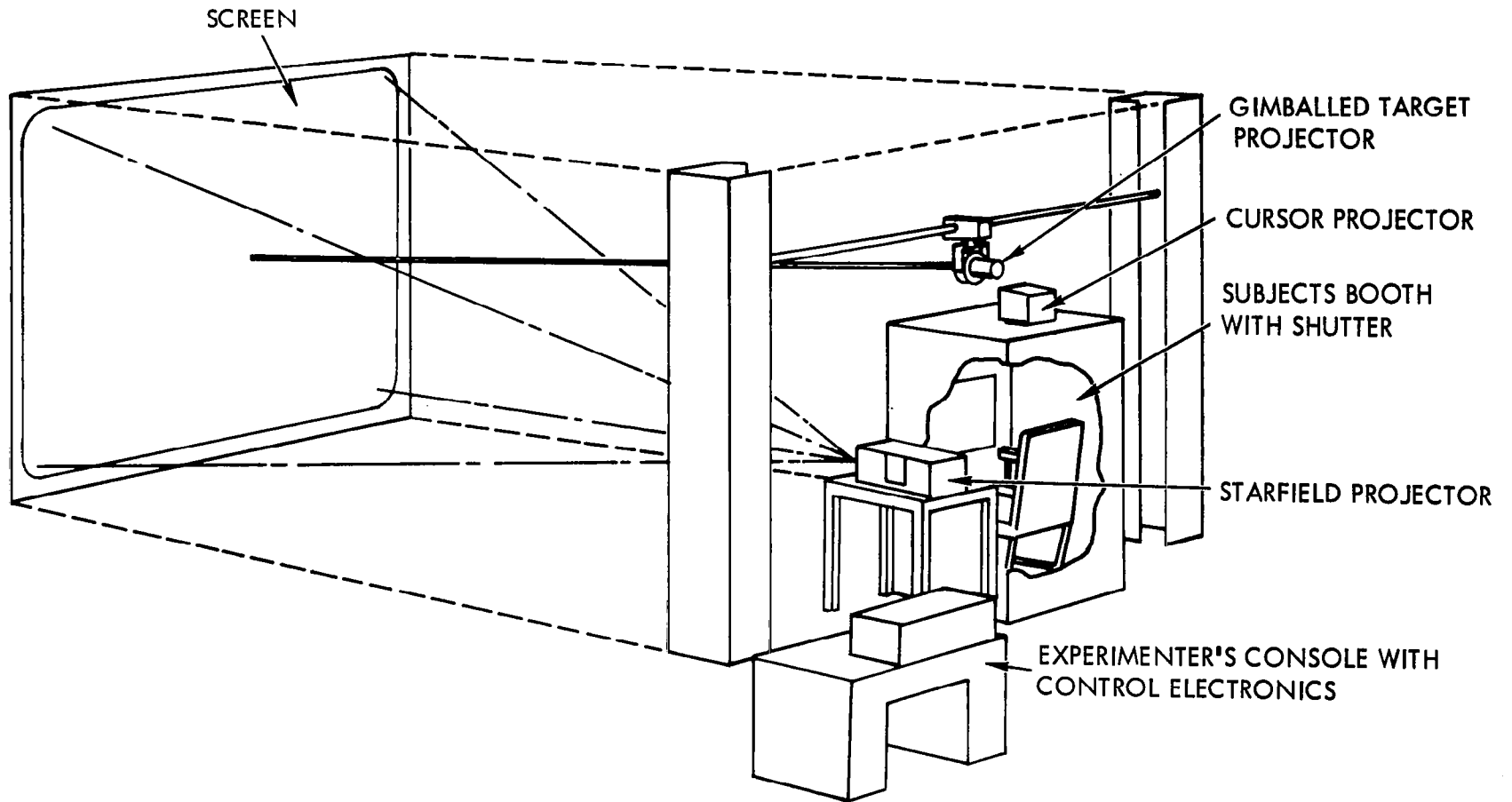

Figure 2: Experimental Room

For the first experiment 72 slides were used with 6 different fields-of-view, 24 slides were used for each field-of-view (12 for D_L , 12 for D_H with a blank slide used for D_0). Each starfield slide was presented twice (normal position and upside down) to each subject to obtain 48 starfield presentations. For the second experiment, 12 starfield slides of a single density/field-of-view combination were used. These slides were repeated according to a schedule described in Section 4.2. The relative magnitude and number of stars were determined from astronomical data. Frequencies of first through fifth magnitude stars for the three fields-of-view were obtained (9). The average and standard deviation were calculated for each frequency distribution. From this information the number and relative proportions of stars of each magnitude were determined for each field-of-view/density combination. These values are given in Table I. The positioning of each star on a slide was determined by using a random number table.

Table I

Number of Stars and the Range of Magnitudes 1-5 for the Starfields

Field-of-View	Density	Total N per Slide	Range Magnitude				
			1	2	3	4	5
8°	low	2	0-1	0-1	0-1	0-1	0-2
	high	5	0-1	0-1	0-2	0-3	1-5
17°	low	8	0-1	0-1	0-2	0-7	0-8
	high	17	0-1	0-2	0-3	1-6	7-13
27°	low	18	0-1	0-1	0-4	2-10	4-15
	high	35	0-2	0-4	1-6	0-20	11-31

The intensity of star and target images was calibrated at three intervals during the experimental trials to measure the change in intensity values. A Spectra Brightness Spot Meter was used to measure the luminance of each spot (refer to Appendix B). Background luminance of the screen was $.96 \times 10^{-9}$ ft-L.

The subject's response control was a formation stick located on the right-hand side of his seat. The trigger switch on the formation stick was used as the detection response switch and the bomb release to indicate completion of acquisition. The formation stick was used to control the rate of a cursor-image in the vertical and horizontal axes for acquisition.

A switching box provided control over the computer, timer and the optical cursor. The sequence of events generated by this unit is shown in Figure 3. This sequence was activated by opening the shutter. The experimenter's console was provided with potentiometers and switching logic so that he could select the initial position, rate and direction of movement for each new trial. These controls were connected to the analog computer.

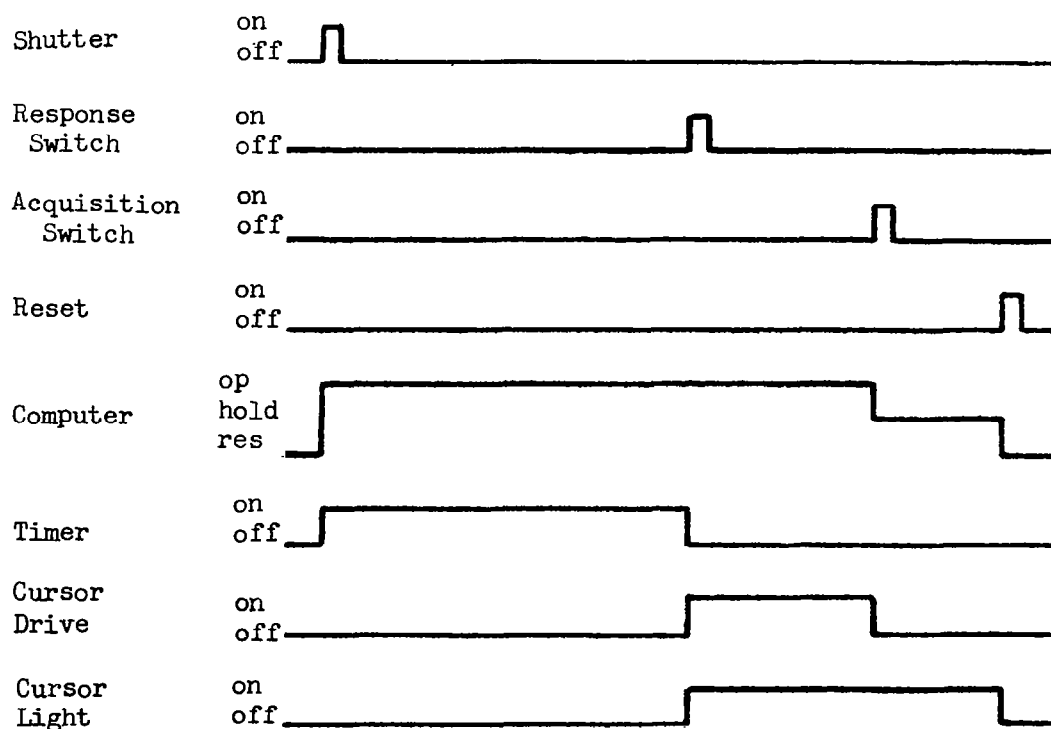

Figure 3: Sequence of Trial Events Provided by Control Circuitry

Electro-oculograph recordings were made by placing thin silver electrodes on the skin surrounding the eyeballs. The electrodes were held in place by a thin layer of Eastman 910 cement around their periphery. The electrodes were placed above and below the left eye for vertical movements and laterally of the right and left eyes for horizontal movements. Two Sanborn Model No. 350 low level preamplifiers with EEG/EKG plug-in units connected to a multichannel pen recorder were used to amplify the vertical and horizontal signals. The signals were processed through bandpass RC filters. The low frequency cutoff was 0.35 cps and the high frequency cutoff was -6db/oct at 5.5 cps. This AC recording method eliminated the drift problems usually inherent in DC EOG recording but allowed determination of the number and duration of area fixations and the direction of eye movements. That is, large movements between fairly widely displaced areas of the field can be distinguished from small movements concentrated in a given area.

4.2 PROCEDURE

Subjects were drawn from a population of male undergraduate students from the University of California at Los Angeles and El Camino Junior College. The experimenter randomly assigned the subjects to the experiment groups with the exception that the groups be composed as equally as possible of students from both schools.

The subjects visual acuity was measured with a Snellen Eye Chart. Only those subjects with 20/20 uncorrected vision were used in the experiments. Before conducting the first session the experimenter informed the subject about the general nature of the experiment and the task he was to perform.*

In the succeeding sessions the experimenter informed the subject that his task was identical to that of the previous sessions. The subject was dark adapted in the experimental booth for a period of 15-20 minutes at which time a 5th magnitude target was placed in various positions on the screen for the subject to identify. When the subject performed this task with 100% accuracy, the experimenter considered him dark adapted.

* The instructions are contained in Appendix C.

Before each trial the experimenter set up the experimental conditions of target rate, target position and direction, target intensity and type of starfield. Target rate, position and direction were determined by appropriate settings on the analog computer pots and function switches. The x and y components of target rate which determined target direction of motion were randomly selected from a table of approximately thirty-five sets of x, y values for each rate condition. In addition the experimenter assigned the targets an initial position in x and y with the use of a random number table. The experimenter adjusted the opening of the target projector aperture to obtain the target intensity value for that trial and then selected the appropriate starfield slide and inserted it into the starfield projector.

He then determined if the subject was ready and opened the shutter. The shutter closed a whisker switch initiated the timer and changed the computer mode to compute thereby initiating target motion (refer to Figure 3).

The experimenter recorded the subject's comments on a data sheet. A very dim red lamp was used to supply the required illumination. The experimenter also measured, using a stopwatch, the time taken by the subject to detect a pattern change.

The subject pressed the trigger switch on the control stick to indicate target detection. The closing of this switch stopped the timer. This action also turned on the cursor projector. By moving the formation control stick the subject superimposed the cursor on the object he decided was the target and then depressed the acquisition switch. If the subject did not respond by 600 seconds the experimenter told him he had 100 seconds left to select the target; when 10 seconds of this period were left the subject was instructed to select the object which he thought was the target. The subject was always informed as to whether he was correct or incorrect; if incorrect, the subject was shown the location of the target. The experimenter then closed the shutter.

The experimenter recorded detection time, correct or type of incorrect detection, and the x, y voltage values of the final position of the target. The latter was measured on the digital voltmeter. An incorrect detection

was classified in three categories: (1) identification of a pattern containing the target; (2) use of the target as a stationary reference; and (3) a complete miss.

For Experiment I each session consisted of 18 experimental trials. Each trial was defined by a combination of the values of the experimental variables; starfield density, target velocity and target intensity. The order of presentation of the 18 combinations for each session was determined using a random number table.

In Experiment II starfield presentation was as follows: for GII the same starfield slide was used for each trial, for GI a different slide was used for trials 1-12 and then the first six were repeated. In the subsequent sessions the six slides not repeated in the prior session were presented on the first and last six trials of the session. The experimenter employed the following order of slide orientation for the experimental session: upright, inverted, upright but left and right reversed, and inverted plus left and right reversed.

Those subjects receiving nominally a unique starfield on each trial were required to judge their degree of familiarity with the starfield. As in the first experiment, the subject received eighteen trials per session; within each session three replications consisting of the six combinations of target intensity and velocity were administered to the subject. The experimenter defined the order of presentation of these combinations with the use of a random number table.

The criterion used for determining whether a subject had reached a performance asymptote was: for the same starfield group, that the detection time scores for an entire session be less than 25 sec; and for the unique starfield group the following test was applied:

- 1) Determine the mean detection times for each level of target velocity and intensity for the prior session.
- 2) Compare the detection time scores for each value of the experimental variables of the present session with the appropriate mean values of (1) and determine the number of scores that exceeded this mean value.

3) Consider the subject as having reached an asymptote if the number obtained in (2) for each intensity level is three and for each rate value is four or five.*

If this condition was met the subject was then transferred to Block B or the same test was applied to the subject after transfer to determine performance stability. The experimenter randomly assigned four subjects to Group I and Group II. After asymptoting, two subjects from Group I were randomly assigned to Group I-I and two to Group I-II as were 2 subjects from Group II to Group II-I and two to Group II-II.

* In any session there were six scores for each intensity value and nine scores for each velocity value.

5.0 RESULTS AND INTERPRETATION

The data analyzed in this experiment include the detection response times, the probabilities of correct detection, the subjects' verbal responses during the trial and post trial comments on the detection responses by the subjects. In addition, electro-oculographic recordings were taken on two subjects from Experiment II to determine if a difference in the number of eye movements and fixations is related to the experimental conditions. Because the study was chiefly interested in detection time, the subjects were allowed a substantial amount of search time in order to insure a high number of correct detections. Detection times were evaluated statistically by an analysis-of-variance test.* Two detection probability values were calculated: one (P_1) based on only the number of correct detections, the other (P_2) based on the number of correct detections plus those incorrect ones which identifies at least the stargroup that included the target. The most frequent type of response falling in the latter category was the selection of the wrong member of a pair. Tables presenting detection probability data for the various combinations of experimental factors appear in Appendix A. This section presents, correlates and interprets the data outlined above.

5.1 EXPERIMENT I

5.1.1 Results and Interpretation

The independent variables of this experiment were, it may be recalled (c.f. 3.1), target velocity (V), target intensity (I), field-of-view (F), starfield density (D) and sessions (S). Table II shows the summary of the significant differences obtained from the analysis of variance test applied to the detection times; the complete analysis is given in Appendix A.

* The analysis of variance was considered to be the most robust test for the detection time results even though all assumptions (normal, independent samples with homogeneity of variance) might not have been met.

Table II

Summary of Analysis of Variance of Detection Times for Experiment I

Source	Degrees of Freedom	F Ratio	Significance Level
Between groups			
F	2/9	106.66	.001
Within groups			
V	2/6	137.54	.001
D	2/6	226.23	.001
S x V	6/18	2.70	.05
F x V	4/12	5.14	.05
F x D	4/12	8.51	.01
V x D	4/12	3.78	.001
I x S x V	6/18	6.62	.001
I x S x F x D	12/40	2.82	.01
I x F x V x D	8/24	2.95	.05

This analysis indicates that F, D and V significantly affect detection time. Duncan's Multiple Range Test was applied to ascertain the significant differences in detection time caused by the different levels of these factors. The results are listed below ($\alpha \leq .05$):

- field-of-view $F_{17} > F_{28}$
- starfield density $D_H > D_L > D_0$
- velocity $V_{0.1} > V_{1.2} > V_{2.4}$

Figure 4 illustrates the dependency of detection time upon these factors. P_1 values are indicated for each point of these curves. Detection time for $V_{0.1}$ is approximately three times greater than that for the other two velocity conditions and for F_{17} is greater than F_8 and F_{27} . The large time differences for density can be explained in part by the D_0 condition, however, there still remains a substantial difference between D_L and D_H . The probability of a correct response presented on these curves varies with the different levels of intensity, velocity and session but does not vary for different levels of density (except for D_0) or for field-of-view.

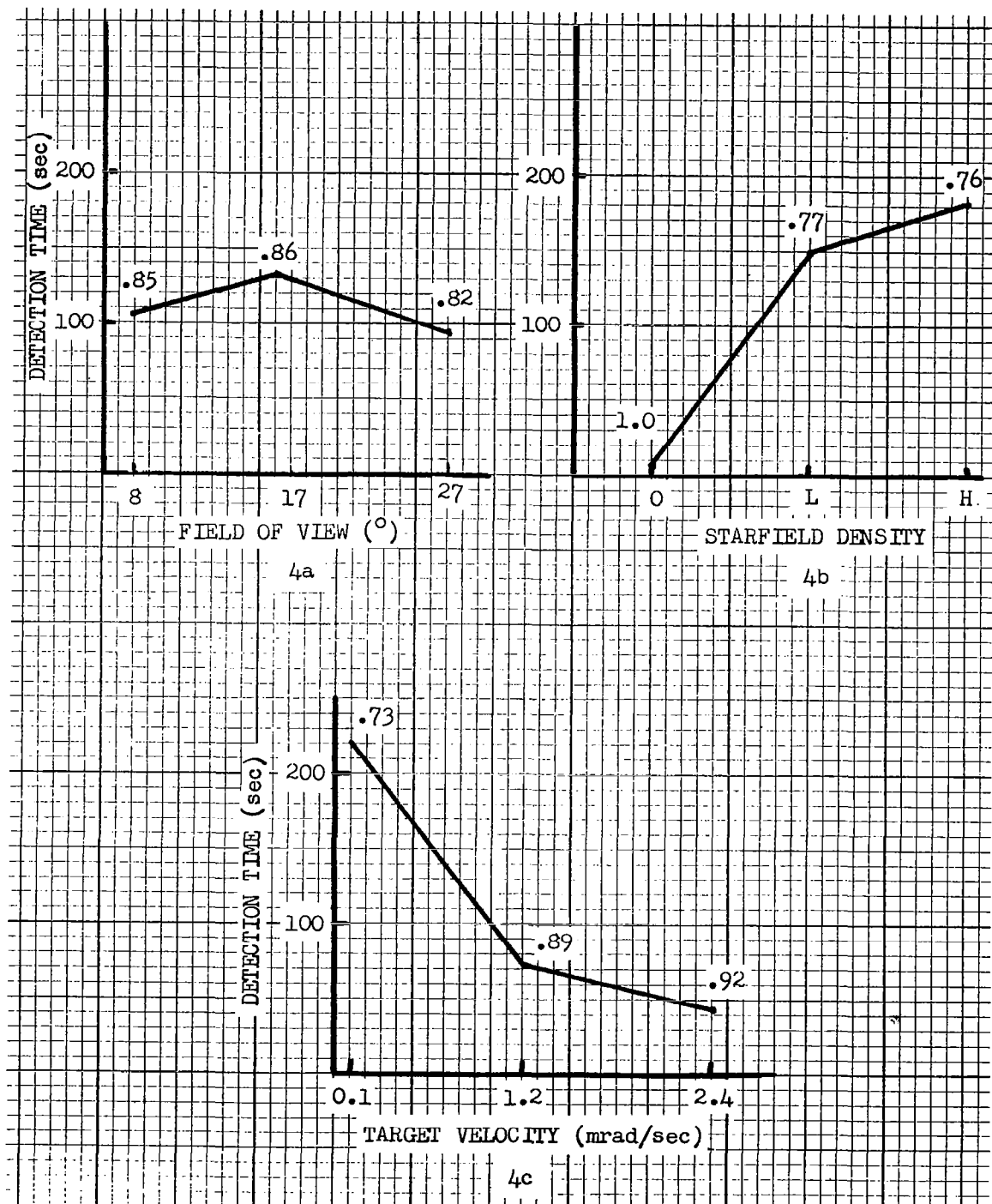

Figure 4: Detection Time Curves for Field-of-View, Starfield Density and Target Velocity of Experiment I (Probabilities of correct response (P_1) are given on the curves.)

Figure 5a shows that detection time was not significantly affected by the number of sessions for target velocities above the motion threshold (i.e., $V_{1.2}$ and $V_{2.4}$) but pronouncedly increased from session one to session two then leveled off for the target velocity below the motion threshold (i.e., $V_{0.1}$). Although the probability of correct response (P_1) for $V_{0.1}$ is lower than that for the two higher velocities the largest increase in P_1 between session one and four occurred for $V_{0.1}$. The sharp initial increase in detection time for $V_{0.1}$ suggests that the subject quickly learned to exercise more caution when target motion was too slow to be perceived as such; and although there was a lag between the increase in P_1 and detection time the two are obviously related.

Figure 5b indicates the joint effects of velocity and density on detection time and probability, the difference in detection time between the low and high density starfield for $V_{0.1}$ is greater than that for the other two velocities. Detection probability does not materially change between D_L and D_H for any velocity values. Once again, there is a sizeable difference in P_1 between velocities above and below the motion threshold however for any one velocity there is little variation in P_1 between the high and low density starfields. But if density has little effect on probability for any given velocity it does affect detection time -- the slower the target speed the greater the increase in detection time.

In Figure 5c P_1 does not differ between D_L and D_H for the various fields-of-view, however, a difference in detection time occurs between D_L and D_H , this difference being the largest for F_8 and smallest for F_{27} . This suggests that if the field contains a number of objects exceeding some minimal number, detection time is not materially affected by difference in number of objects. Different levels of intensity, as depicted in Figure 5d, produced a difference in mean detection time though this difference did not depend, except for the $V_{0.1} \times F_{17}$ condition, on the specific value of the field-of-view. The interaction effects of $V_{0.1} \times F_{17}$ arose, presumably, due to a sampling error. Figure 6 demonstrates the complex relationship between the effects of V , I and S on detection time. This significant interaction appears to depend primarily upon the variability of the effect $V_{0.1}$ and I_3 and I_5 for sessions one through four.

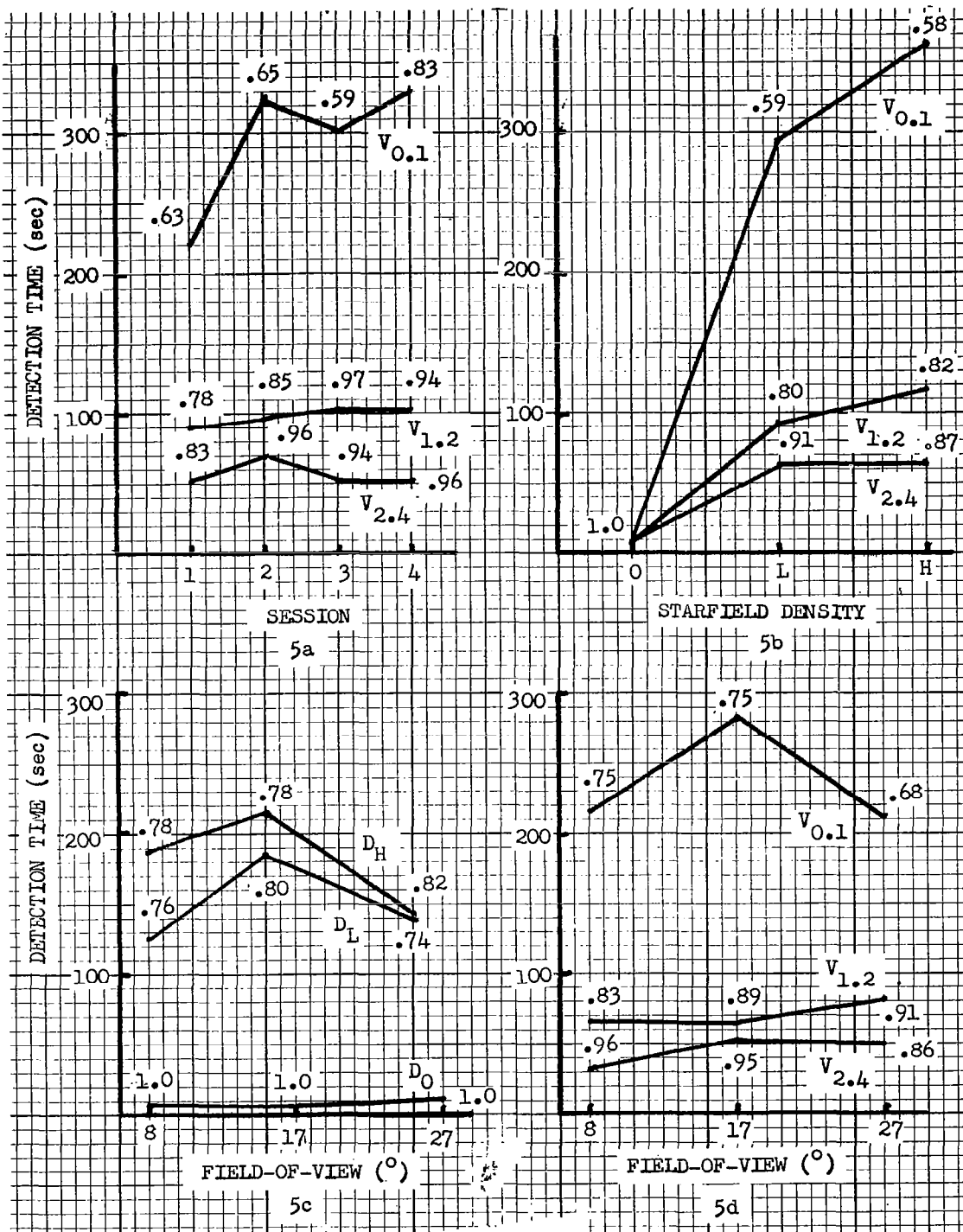

Figure 5: Detection Time Curves for Session-Velocity, Starfield Density-Velocity, Field-of-View-Starfield Density and Field-of-View-Velocity Relationships of Experiment I (Probabilities of correct response (P_1) are given on the curves.)

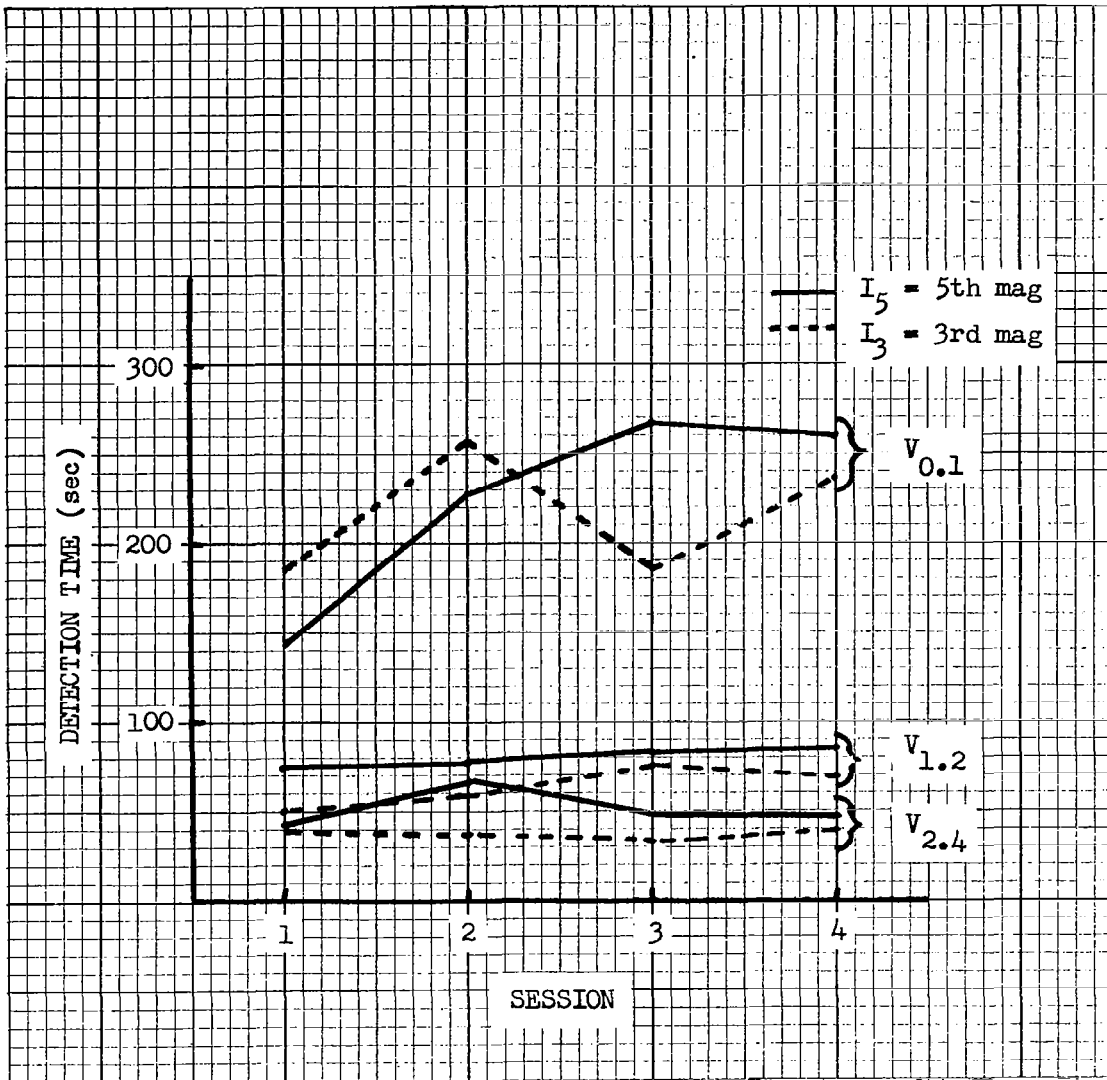

Figure 6: Detection Time Curves for Intensity versus Velocity versus Session of Experiment I

Table II indicates the presence of a number of significant third or higher order interactions. If the complex relationship actually exists then there would be no simple interpretation of the effects of the lower order interaction or of the main effects. Several ad hoc hypotheses are, therefore, advanced to account for these complex relationships:

- The presence of a zero density condition which eliminated the effects of the other factors.
- The presence of a group effect (F_2) which transcended the effect of field-of-view.
- The action of radically different processes such as motion perception vs perception of change.
- The increase in response time for I = 5th mag with sessions.

The times at which the subjects initially detected a change in the starfield pattern were recorded for those trials in which correct target identification occurred. The subjects' response times were divided into two categories; the time to detect a change (t_1) and the time to verify or locate the target after the perceived change (t_2). These two time intervals are shown for each field-of-view in Figure 7. The results indicated that the difference in response time between t_1 and t_2 remains approximately constant for different levels of density, intensity and velocity. T_1 is approximately 50% of t_2 indicating that it takes slightly more time to verify the target than to detect the pattern change.

The subject's verbal reports were recorded during and after each test trial and his search strategies, at the completion of the experiment. Considerable variation existed between subjects' verbal output, for example some subjects provided a continuous description of their behavior while others provided no verbal descriptions. This variability was due, in part, to the task instructions which required the subject to describe his search procedures but not to allow this response to interrupt the search process.

The following is a summary of a general search strategy that was reported by the subjects after the first session:

- An initial period of random scanning of the field to locate a fast moving target.

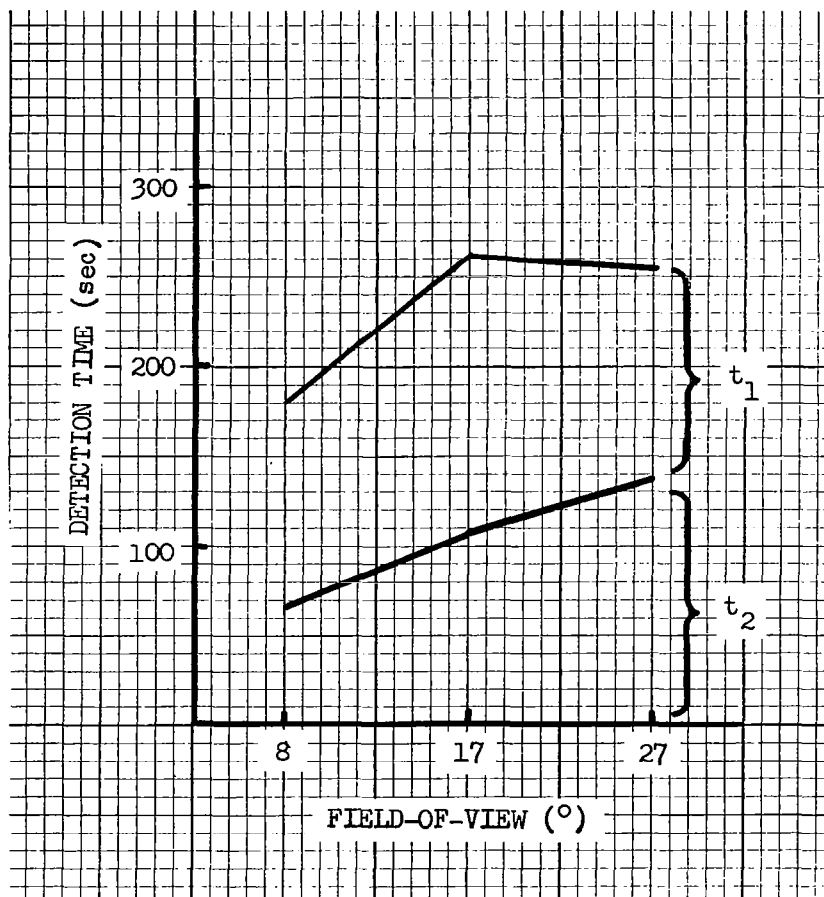

Figure 7: Detection Time Divided into Two Phases for Field-of-View (t_1 = detection of change in pattern and t_2 = verification time. Only those responses where the subject reported that he saw a change are shown.)

- A period of pattern recognition and retention.
- A period of checking the various patterns to detect pattern changes.
- A period of verification.

These periods, except for the first, overlapped to a certain extent.

Almost all the subjects reported that they initially scanned the field in a non-systematic fashion for a fast moving target; the duration of this phase remained relatively constant for all replications. After assuring themselves that the target velocity was below the "motion threshold" the subjects reported perceiving the field as a whole, then they divided this whole pattern into a number of smaller patterns; other subjects reported just the opposite procedure. Most of the subjects saw the patterns as geometric figures but some saw them as other forms. As would be expected from the random assignment of star position, some fields were reported to be easier to organize than others. For example, there were a few fields that most subjects experienced considerable difficulty in perceiving either whole or part forms because of the relative homogeneous distribution of stars.

The interval during which the subjects checked the various patterns was typically described as "just sitting back and looking" until a change was noticed. During the initial learning period a few subjects attempted to systematically check every object in the field; this approach invariably produced high detection times and low detection probabilities. When these subjects changed their strategy to that used by the others, their detection performance increased markedly. Many of the subjects shut their eyes for a period of time, then opened them and determined if a change had occurred. Another frequent response was "letting the field go out of focus".

In the verification period the subjects systematically analyzed the various objects belonging to the changed pattern. All subjects reported aligning the stars in a straight line with other stars that were assumed stationary. Another method used was to establish triangles that included both stationary and hypothesized targets and determine distance changes between them. The subjects reported having considerable difficulty using distance as a criterion when the distance between the various objects was greater.

Another condition that caused difficulty occurred when the geometric pattern containing the target appeared not to be changed although the distance relations had changed. This indicates that distance information was not as well remembered as pattern information.

The subjects described certain conditions that increased the difficulty of the task. These were fields that appeared homogeneous in star distribution and stars separated by "great" distances from the bulk of the stars. For fields that appeared homogeneous the subject experienced difficulty in perceiving the field as a whole or as composed of a number of smaller patterns. The subjects also experienced difficulty in determining whether an object had changed position when it was separated by a sizeable distance from other objects in the field. The most frequent error occurred when the target was unwittingly included in a reference pattern used to check on another object hypothesized as the target; the change in the reference pattern caused by the motion of the target was then incorrectly attributed to the hypothesized object. (This generally occurred when the reference pattern contained only a few objects.) The subjects sometimes realized this error almost immediately and this caused them to be more cautious on subsequent trials.

The explanation most frequently offered by the subjects to account for their failure to detect the high velocity target was their fixed attention on a particular star pattern to the exclusion of the remainder of the field. The explanation was used to account for their failure to detect rather obvious pattern changes that occurred for the low velocity condition.

The subjects receiving F_8 reported substantial difficulty in target identification but not in detection of the pattern change. This occurred, presumably, because the few objects present in the field do not supply an adequate reference for distance judgments.

5.1.2 Interpretation

Other visual search studies have investigated the effects of target size and contrast upon detection (8). The present study introduced a new factor, a group of objects identical to the target. As a result, detection time depended, not on the contrast between the target and the

background, but on target velocity. Above a given velocity the motion of the target can be perceived; below this velocity, only displacement can be perceived. Both types of perception require a pattern of stars for use as a visual-space reference.* But when displacement perception is involved, the observer must memorize and recall the stellar pattern in order to compare what he sees with what he has seen. As discussed previously, two types of memory are involved, short-term memory for the immediate past and long-term memory of the total field structure. In Experiment I the subject could use only short-term memory due to the presentation of a unique starfield on each trial.

Since no difference was found between $V = 1.2$ and $V = 2.4$ mrad/sec it may be assumed that they both were near or above the motion perception threshold. However, there might be a distinction between the rate of pattern change that is detectable and the rate at which an object is seen as moving.

Other motion studies have found a threshold value of \approx mrad/sec (3, 5) However in these studies the threshold was dependent upon target size, shape and luminance as well as the availability of stationary references and it is not clear whether these threshold values apply to the present study. In this study the motion threshold depended on the distance between the target and surrounding stars. Brissenden (2) found this effect in his studies and his results indicated that the motion threshold varied between 1.0 and 2.0 mrad/sec.

The detection of a change in pattern depends on the distance between the target and surrounding stars, the velocity of the target and the amount of structure in the pattern. It may be concluded that the detection time depends on velocity, i.e., the lower the velocity the longer the detection time. The interaction of velocity with density and field-of-view also indicates that the amount of structure (i.e., stellar density)

* It is difficult to determine which of two points is moving in a structureless field. Any point source, even if imbedded in a starfield, is subject to the autokinetic effect. A visual space reference, although difficult to define precisely, depends on starfield organization, density, distance of the target from the closest stars or stellar configurations, and ways in which the subject structures the field. In this context it should be emphasized that starfields constructed to some random rule will

in the field will affect the detection time. The 27° field-of-view produced a lower detection time than the 17° field-of-view primarily due to the 0.1 mrad/sec velocity condition (Figure 5d). This suggests that for low velocity targets the more highly structured the field is the shorter detection time.

The relationship of density and field-of-view, as shown in Figure 5c indicates the D_L for $F = 8^\circ$ and 17° had lowered detection times but for F_{27} there was no difference between D_L and D_H . This indicates that for small field-of-view with low densities, i.e., 3 or 4 objects, the observer can detect the changing object in less time than if he has to distinguish between a larger number of objects. Above a certain number of objects this factor no longer aids his detection.

Since no difference was obtained between target intensities it may be assumed that there is no difference with respect to photopic or mesopic vision.

From these results the following conceptual model is assumed for the detection processes. This model is a sequential decision process. Initially the observer explores the field for high velocity target using short fixations and rapid scan patterns. Target detection and verification occur almost simultaneously for targets with velocities above the motion threshold. If he is unable to detect a rapidly changing target, he proceeds to search the field attending in succession to particular areas in order to memorize specific patterns of stars. At some time he returns to each pattern of stars and ascertains if any change in the geometric pattern has taken place. He continues to do this until he detects a change in pattern. This search may be systematic, that is, a scan of the various patterns in some definite order, or it may be random with independent location of successive fixations. When the subject detects a change in a cluster of stars he then attends to this one area until he determines which of the stars has changed position by referencing it to the immediate surrounding stars.

If the whole starfield forms a specific geometric pattern or the field-of-view is small instead of looking at an individual cluster of stars the subject may look at the whole field at one time. For short-term memory

it would appear that the time to memorize a cluster or retain the configuration of a cluster depends upon the number of stars in that particular cluster. One factor to consider is that a large number of stars may form a very specific geometric pattern which may be easily retained, especially if the subject associates this pattern with a known geometric shape. This latter condition may explain the better detection performance for the highly structured large field-of-view.

5.2 EXPERIMENT II

5.2.1 Analysis

The data of this experiment were analyzed in two parts, one corresponding to Block A and one for B, the experimental design is depicted in Figure 1 in Section 3. Block A consists of the starfield presentation groups before transfer of training and Block B consists of the starfield presentation groups after transfer of training, i.e., GI = unique starfield group and GII = same starfield group (Block A); in Block B, GI-I and GII-I receive the unique starfield and subgroups GI-II and GII-II the same starfield. The other independent variables are velocity, intensity and training.

Because the number of training sessions depended on the individuals (training was continued until each subject reached an asymptote) only the data from the first two sessions and the last session of Block A were statistically analyzed. The first and last sessions of Block B were used in that analysis. The actual number of training sessions is presented in Figure 8.

A summary of the analysis of variance for the detection times for Block A is shown in Table III. This table lists significant effects with the associated probability level. For Block A all the main effects except replications within a session were significant. Application of the Duncan's Multiple Range Test to the intensity and session main effects indicated that the following differences were significant ($\alpha \leq 0.5$):

$$I_5 > I_3$$

$$S_1 > S_3$$

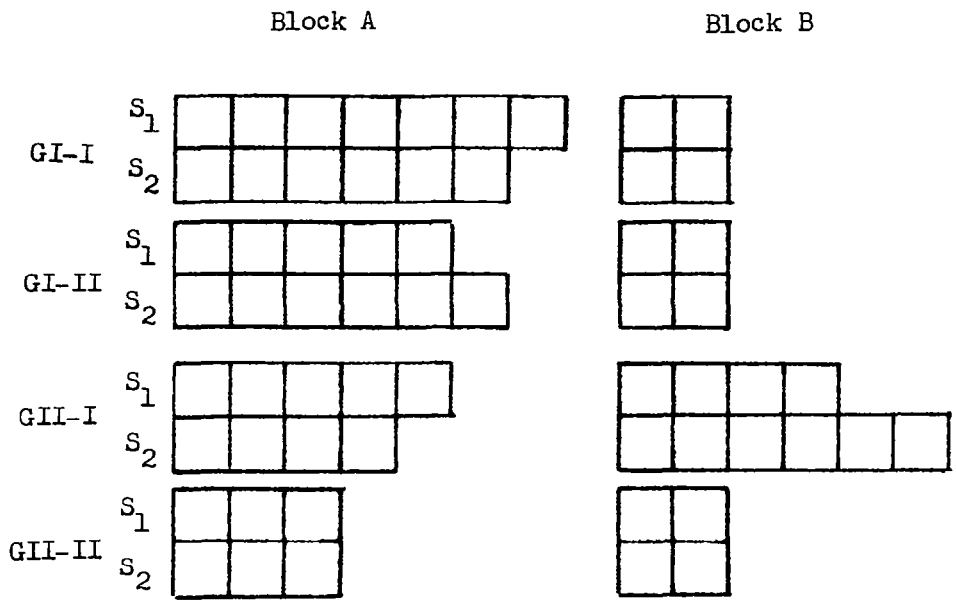

Figure 8: Number of Training Sessions per Subject for Experiment I

Table III

Summary of Analysis of Variance of Detection Times for Block A, Experiment II

Source	Degrees of Freedom	F Ratio	Significance Level
Between Groups			
G	1/3	115.61	.01
Within Groups			
V	1/3	57.59	.01
I	2/6	8.40	.05
S	2/6	5.50	.05
G x S	2/6	101.12	.001
G x R	2/6	19.75	.01
R x S	4/12	4.41	.05
G x R x I	4/12	3.87	.05
G x R x V	2/6	7.39	.05
G x I x V	2/6	10.45	.05
G x R x S x I x V	8/24	13.73	.0001

Figure 9a illustrates the relation between the detection time and the mode of starfield presentation for Block A. The average time required to detect the target was four times greater for GI than GII. This difference became even more pronounced when session is taken into account. For example, Figure 10a indicates that the average detection time for GI is approximately 30 times greater than that of GII for the last session. This figure also indicates the difference in detection time that occurred between replications within each session. The GI detection time remains relatively constant for both sessions and replications. For GII a considerable reduction in detection time occurs, between replications one and three for session one and two but by the last session this effect is no longer present. This represents a confounding of the effects of long and short-term memory while in the last session only the effect of long-term memory is present. It should be noted that unlike the previous findings the very low detection times for GII in the last session were accompanied by a detection probability close to unity. The degree of reduction in detection time for GII between session and between replications differentially depended upon the joint effect of a specific level of velocity and intensity. The probability of correct detection increased for both groups from the first to the last session. For GI this is accompanied by an increase in detection time.

Figure 10b illustrates the joint effects of intensity and velocity acting on GI's and GII's average detection times. The magnitude of the time differences between target intensities differentially depended on the mode of starfield presentation; that is the difference between I_3 and I_5 were greater for GI (unique) than GII (same). Similarly velocity affected detection time in a rather complex manner. The magnitude of the average detection time as affected by $V_{0.1}$ depended upon the specific values of intensity and the mode of starfield presentation. In summary the data

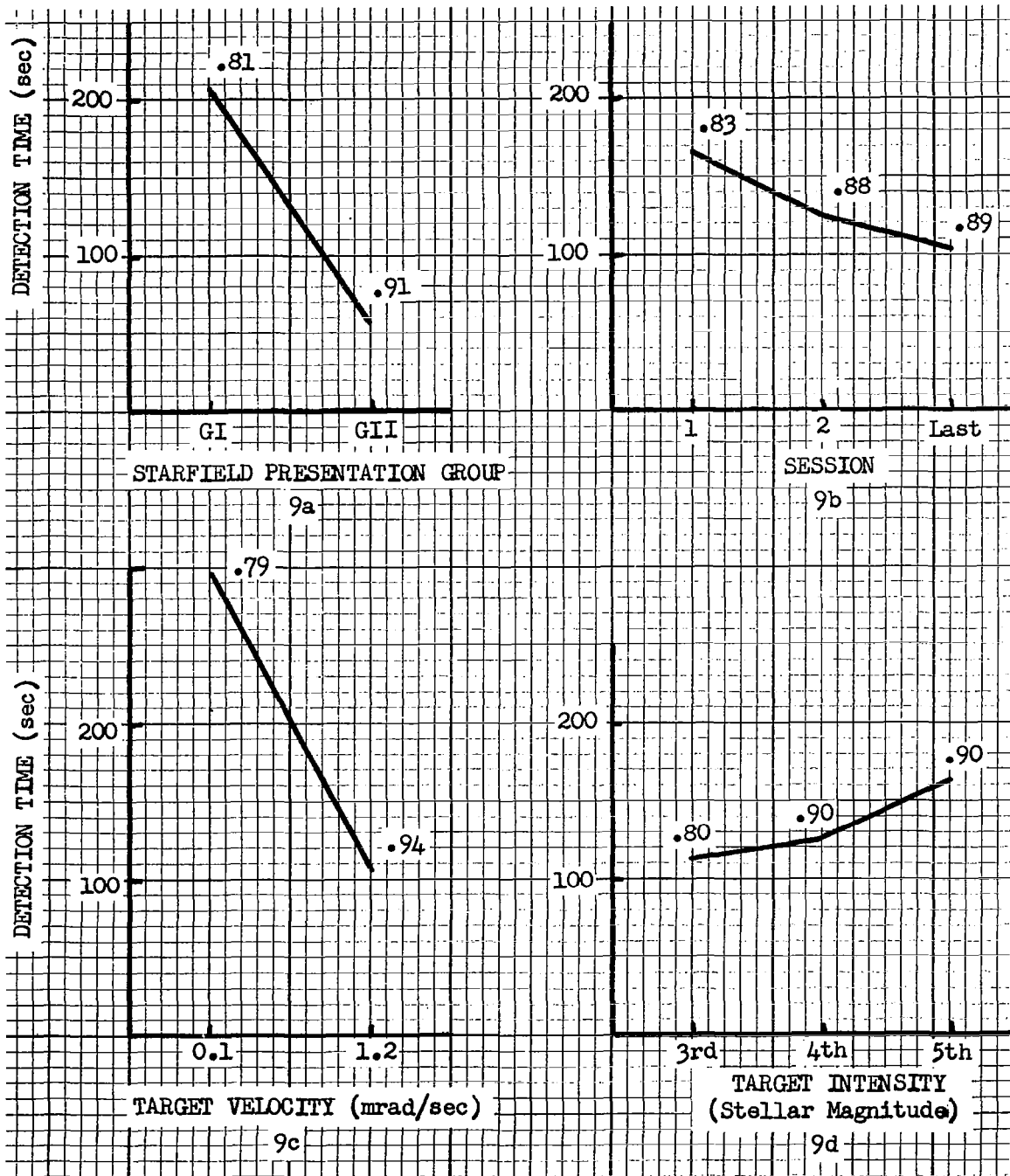

Figure 9: Detection Time Curves for Starfield Presentation Group, Session, Target Velocity and Target Intensity of Block A, Experiment II (Probabilities of correct response (P_1) are given on the curves.)

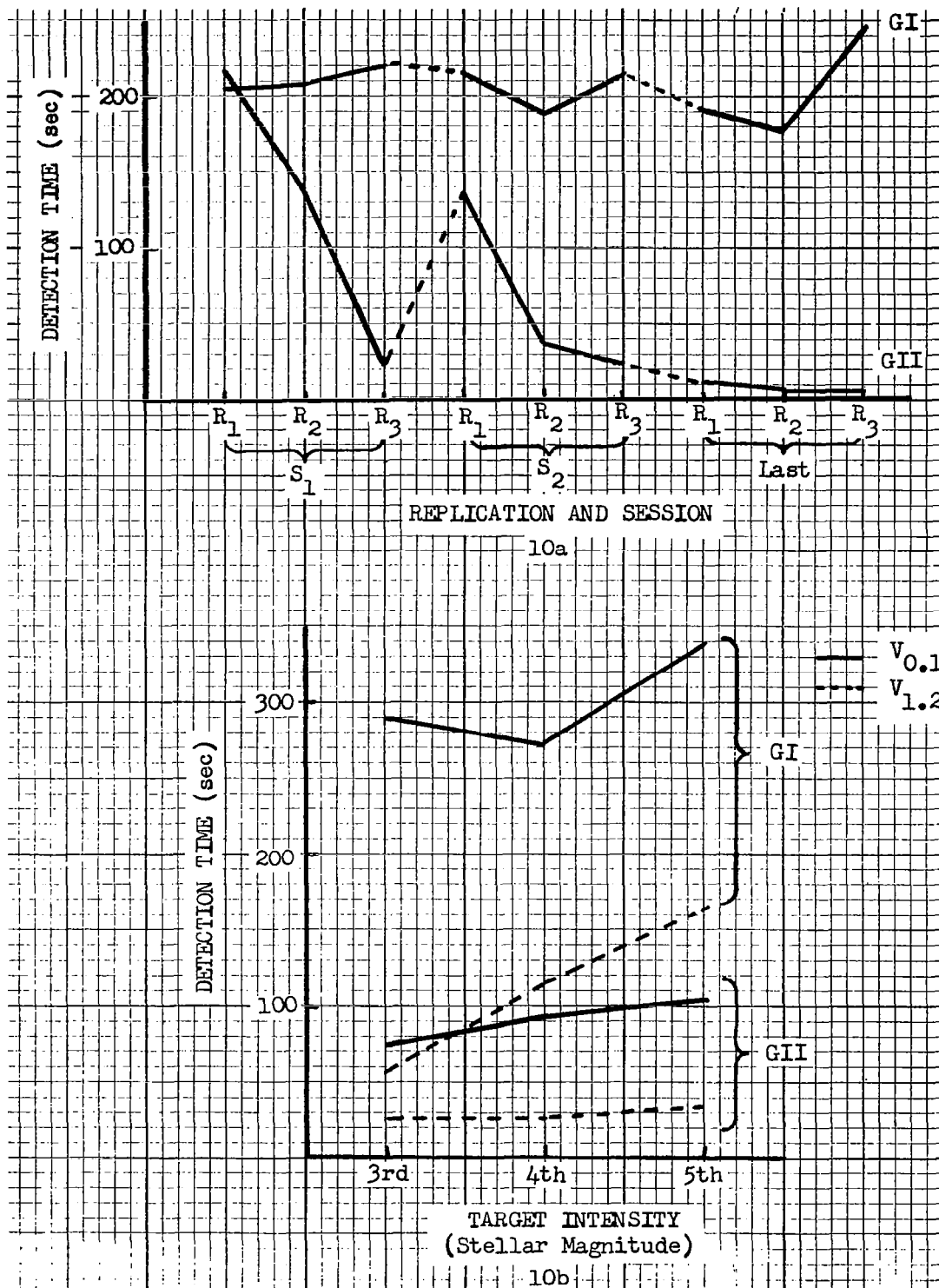

Figure 10: Detection Time Curves for Replication-Session-Starfield Presentation Group and Target Intensity-Velocity-Group Relationships of Block A, Experiment II

depicted in Figure 10b indicate that the effect of any one variable on average detection time for GI and GII depends upon their specific values.

The summary of the analysis of variance of detection times for Block B is shown in Table IV. (It should be noted that there are now four groups, two of which receive the unique starfield (GI-I and GII-I) and two which receive the same starfield (GI-II, GII-II).) To determine the difference between the levels of the significant variables, Duncan's Multiple Range Test was applied. As would be expected the average detection time of Groups I-I and II-I considerably exceed that for Groups I-II and II-II. These affects are shown graphically in Figure 11c. Each point on these curves has the probability value (P_1) associated with that condition. This figure also indicates a slight negative effect of prior training on the average detection times for the groups that were transferred from one condition to another, specifically GII-I times are greater than GI-I as are GI-II compared to GII-II. This difference, however, is considerably less than that caused by the model of starfield presentation. P_1 does not appear to be detrimentally affected by this transfer effect.

The significant first order interactions, group x intensity and group x velocity are graphically depicted in Figure 12. These graphs indicate that intensity and velocity only influenced the performance of the group receiving the unique starfield. As expected the probability of correct response was lowest for $V_{0.1}$ for GI-I and GII-I. Unlike the other groups GI-I average detection time was adversely affected by I_5 .

Figures 11a and 11b respectively depict the overall effects of target velocity and intensity. Both factors are seen as affecting detection time and probability, however, as in Block A the magnitude of these effects is highly dependent on the specific values of the other variables.

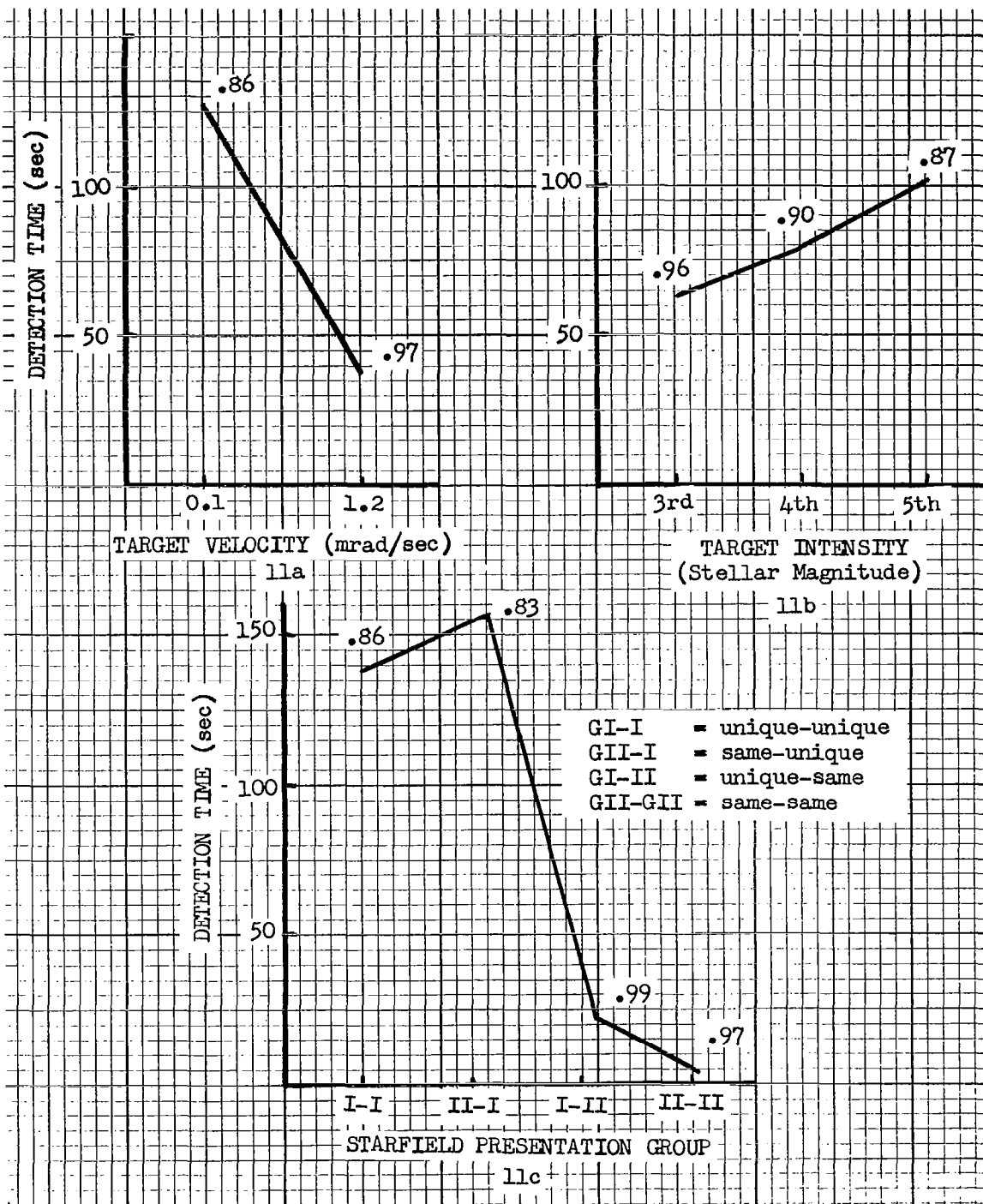

Figure 11: Detection Time Curves for Target Velocity, Target Intensity and Starfield Presentation Group of Block B, Experiment II (Probabilities of correct response (P_1) are given on the curves.)

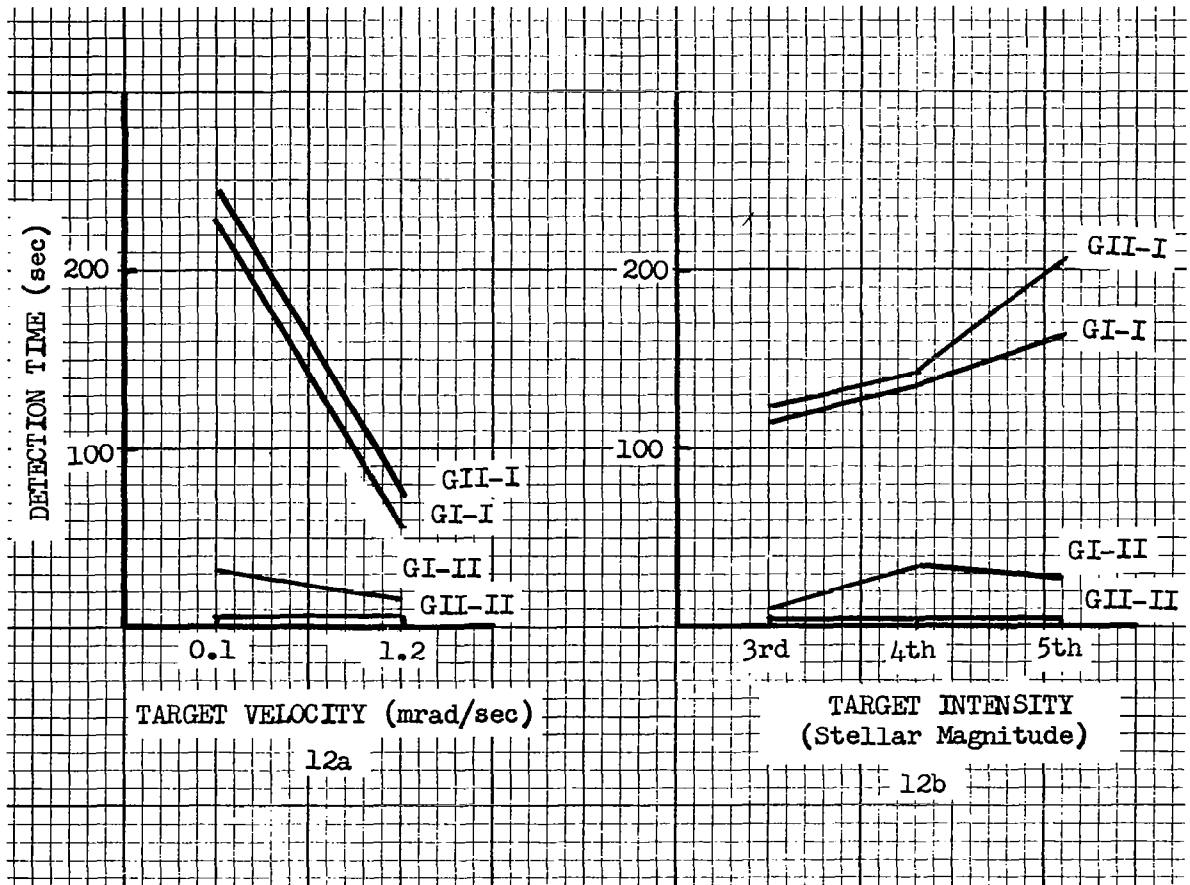

Figure 12: Detection Curves Showing (a) Group-Intensity and (b) Group-Velocity Relationships for Block B, Experiment II

Table IV

Summary of Analysis of Variance for the Detection
Times of Block B, Experiment II

Source	Degrees of Freedom	F Ratio	Significance Level
Between Groups			
G	3/4	51.15	.01
Within Groups			
I	2/6	8.14	.05
V	1/3	106.07	.01
G x I	6/6	4.57	.05
G x V	3/3	11.90	.05
G x S x I	6/6	6.16	.05
G x S x I x V	6/6	29.64	.001

The curves in Figure 13 indicate that the difference in average detection time for the various groups depended upon specific values of session and intensity (e.g., GI-I for I_4 , the detection time increased for the second session while in the other groups it decreased). Sessions obviously do not affect GII-II because their performance had stabilized by the end of Block A. In addition the increase in detection time for the second session of GI-I differentially depended upon specific velocity values.

The subjects receiving the same starfield reported that if they did not respond to their first impression but waited to verify their hypothesis (i.e., using the target's change of position) the confidence that they had detected the target markedly decreased and they began to consider other objects as potential targets. By the last session, however, all subjects in this group had learned to respond to this "first impression" because of the high probability of success and short detection time. The subjects were unable to report with any detail what processes were involved in detecting the target. They responded only that the target "just didn't belong." The subjects in this group

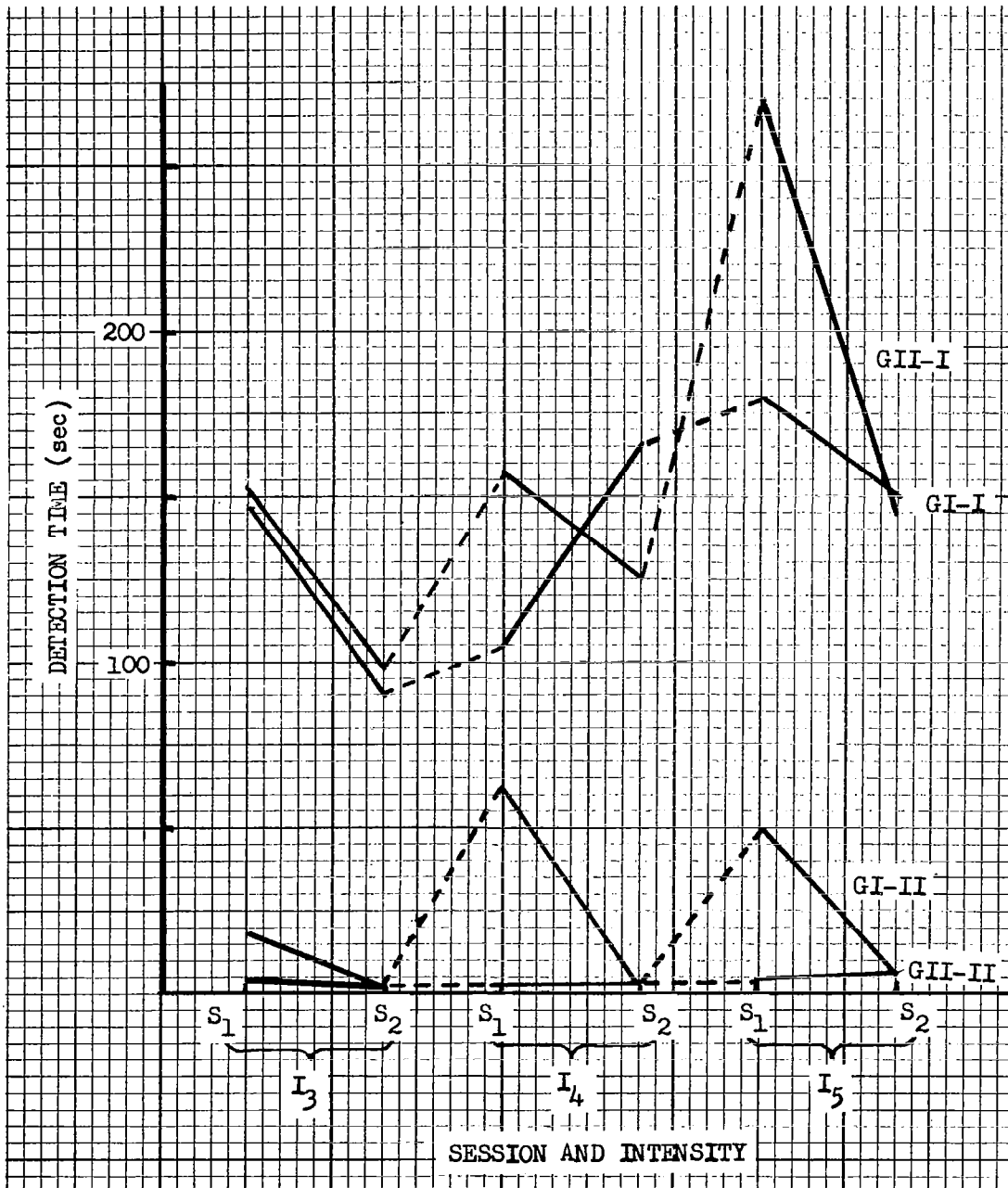

Figure 13: Detection Curves Showing the Group-Session-Intensity Relationships for Block B, Experiment II

reported that this task was not as interesting or as challenging as that with the unique starfield presentation. It is to be noted that the subjects who received the unique starfield reported some fields as highly familiar nevertheless their response depended primarily on target velocity.

Electro-oculograph recordings were made on trials run after the completion of Block B for two subjects who were both from GI-II. Two replications of four conditions (i.e., $V_{0.1}, I_3$; $V_{0.1}, I_5$; $V_{1.2}, I_3$ and $V_{1.2}, I_5$) were made on each subject. One subject received the same starfield presentation and the other subject received the unique starfield presentation.

The AC record of the eye movements indicated the point in time when gross movements occur. The data was thus interpreted in terms of fixations on a particular area.* For each trial the data was analyzed in terms of the number of fixations/sec and the distribution of the fixation periods. These data are presented in Table 14. Only tentative conclusions can be presented from this analysis. For the second replication of the unique presentation the distribution of the fixation period appears to change from a predominance of 2 sec periods to a predominance of shorter periods which counterbalance longer fixation periods. The frequency of fixations do not show any consistent trends.

During the trials on the unique starfield presentation the data showed that there were rapid eye movements followed by a longer fixation period (3 sec or greater). This long period always preceded the subjects' detection response. For the subject receiving the same starfield, this was not the case. Often times he responded immediately on fixation at a particular area. Usually there were only two or three fixations before he responded.

* Fixation in this context refers to looking at a restricted area and should not be confused with eye fixation times which are only 1/3 to 1/2 sec long.

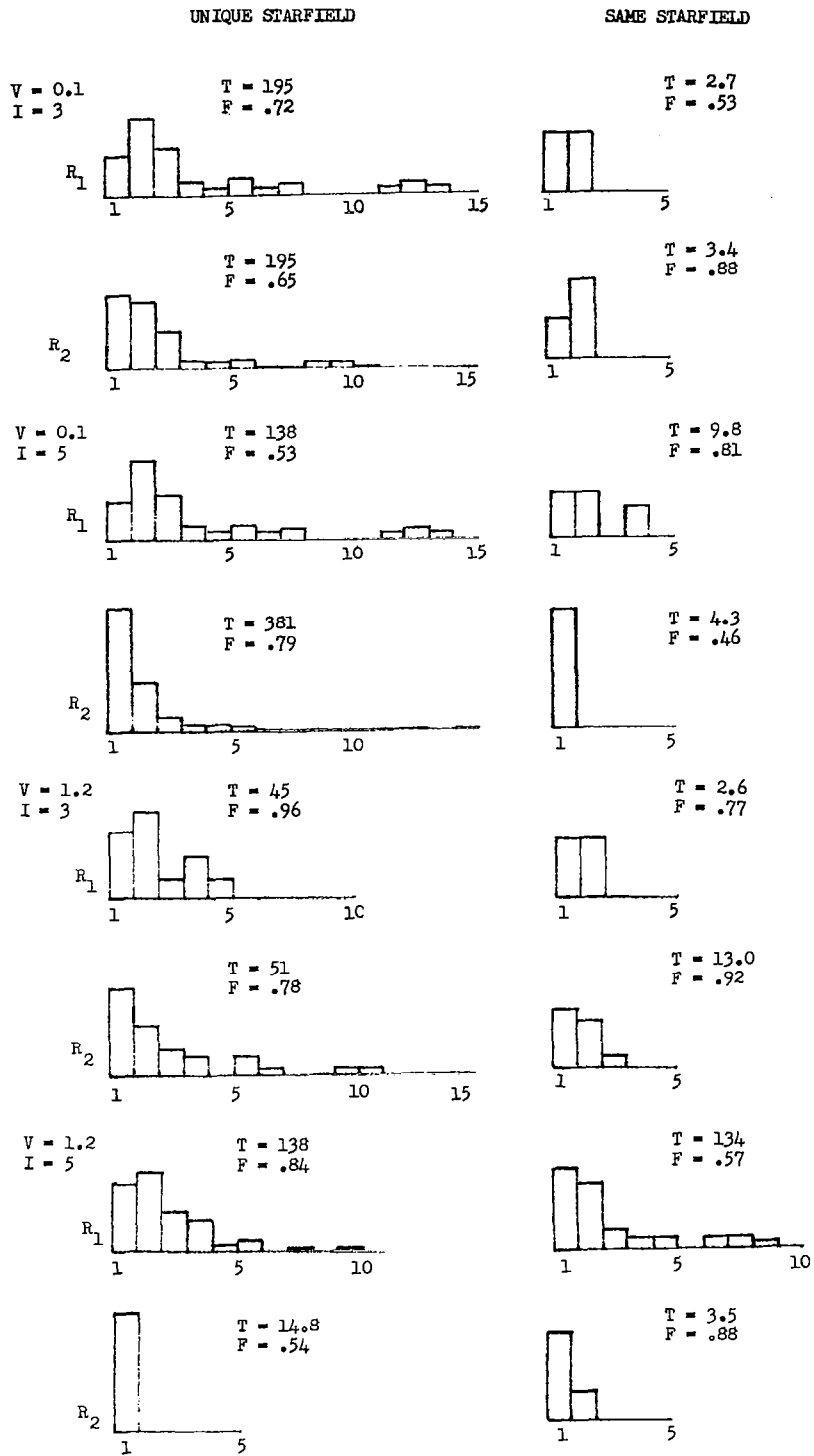

Figure 14: Distributions of Eye Fixation Data for the Conditions of Experiment I (Response times (T) are given in seconds and eye fixation frequencies (F) are given in no/sec)

5.2.2 Interpretation

Memorization of the starfield pattern was shown previously to reduce the subject's detection time (10). This memorization effect is illustrated by the learning curves for GII in Figure 12. In the same figure the graph for GI shows no learning at all.* Also with memory of the starfield, detection time no longer depended on target velocity or intensity (Block A results show an effect due to velocity for GII but Block B results indicate no difference in detection times; refer to Figs 4, 12). In this case no time is spent on target verification by watching for a change in pattern.

From these results it appears that a totally different detection model is needed to describe the data when the subject has memorized the starfield. The model required for this case is one in which the subject compares the whole field with his stored replica and ascertains the location of a new object in the field. In this case no time is spent on target verification by watching for a change in pattern.

The eye movement data taken on Experiment II, appears to confirm these two different conceptual models. The unique starfield presentation subject showed rapid scans followed by a longer duration fixation period before each response. This was repeated several times dependent upon his response time during one trial. Verification time is usually noted by a long fixation period on one area before the subject responded. Eye movement data by Enoch (4) supports these findings. He found an initial orienting series of movements which was constant for a given observer over different fields. He also reported that observers with shorter fixation times were more efficient. This corresponds to the difference between the first and second replications as shown in Table 14. The eye movements for the same starfield presentation subject showed as little as two fixation periods (one vertical and one horizontal) before the subject responded. This would indicate that he detects the target on the first or second look.

* The increase in detection time due to replication is attributed to fatigue effect since the average session duration for GI was $2\frac{1}{2}$ hrs compared to $1\frac{1}{2}$ hrs for GII.

6.0 CONCLUSIONS

The first part of this section relates the experimental findings to the applied problem of the visual detection of a satellite, the second suggests directions that future research might take.

1) That it is feasible to use the astronaut to detect a satellite is the most important conclusion to be drawn from this study. However, he should be specially trained for this task if he is to perform it with maximum accuracy and efficiency. The necessity for adequate training cannot be overemphasized.

Experiment I suggests that even were the astronaut trained on starfields dissimilar to those he is going to search he would learn with practice techniques of search and verification that would increase his chances of detecting the satellite, if not decrease his detection time. Experiment II, however, indicates that training will be most effective if the astronaut is presented with fields identical to those he will actually encounter; trained under these conditions, he will always be able to detect the satellite almost instantaneously and with almost absolute accuracy. His degree of familiarity with the field enables him to detect immediately any foreign object irrespective of its speed and intensity; it is precisely because the effects of these variables, which largely determined variations in detection time and probability throughout Experiment I, are eliminated by the end of Experiment II that the astronaut can achieve a uniformly high level of performance.

2) Future research on the problem of visual detection might proceed along two general lines: studies involving other astral conditions that will affect performance and studies of the perceptual processes themselves.

To the former category belong the two following experiments, both of which bear directly on the applied problem. The first would determine the capacity of an observer to memorize the total celestial sphere. Experiment II showed that a thorough familiarity with a starfield enables the observer to detect the target quickly and accurately. However, this finding is limited by the condition of the experiment: the subject had only one relatively small field to memorize. An astronaut, on the other hand, if he is to perform his detection task with equal efficiency, will

have to be familiar with the total night sky as it would appear from various vantage points. To determine whether this is possible, the proposed study would present sequentially a number of stationary starfields which in toto would represent the entire visible universe.

Even if the observer is able to memorize all the starfields, however, another problem must be considered: when the spacecraft is moving, the starfield will not appear stationary; the total pattern will be continuously changing as some stars disappear from view while others enter the visible field. To examine the effect of this phenomenon upon the detection performance of subjects previously trained on the stationary fields is the purpose of the second experiment.

The other line of research, a follow-up to the preliminary study of search strategies conducted at the end of Experiment II concerns itself with the perceptual processes underlying the detection and subsequent identification of a moving target. Since search processes are most directly reflected in the observer's eye movements and fixations, these must be recorded. Although such recordings have been made in detection studies involving homogeneous or highly complex backgrounds, in neither case has the effect of variation of the background structure been systematically analyzed. The starfield background lends itself particularly well to the study of the effects of structural changes: Because all the objects in the background are identical, such complicating variables as size and contrast are eliminated; hence the effects of structure can be examined in relative isolation. The information gained from such a study would be used to develop the search models tentatively constructed from the results of Experiments I and II. But it would also provide valuable insight into the processes involved in pattern perception generally.

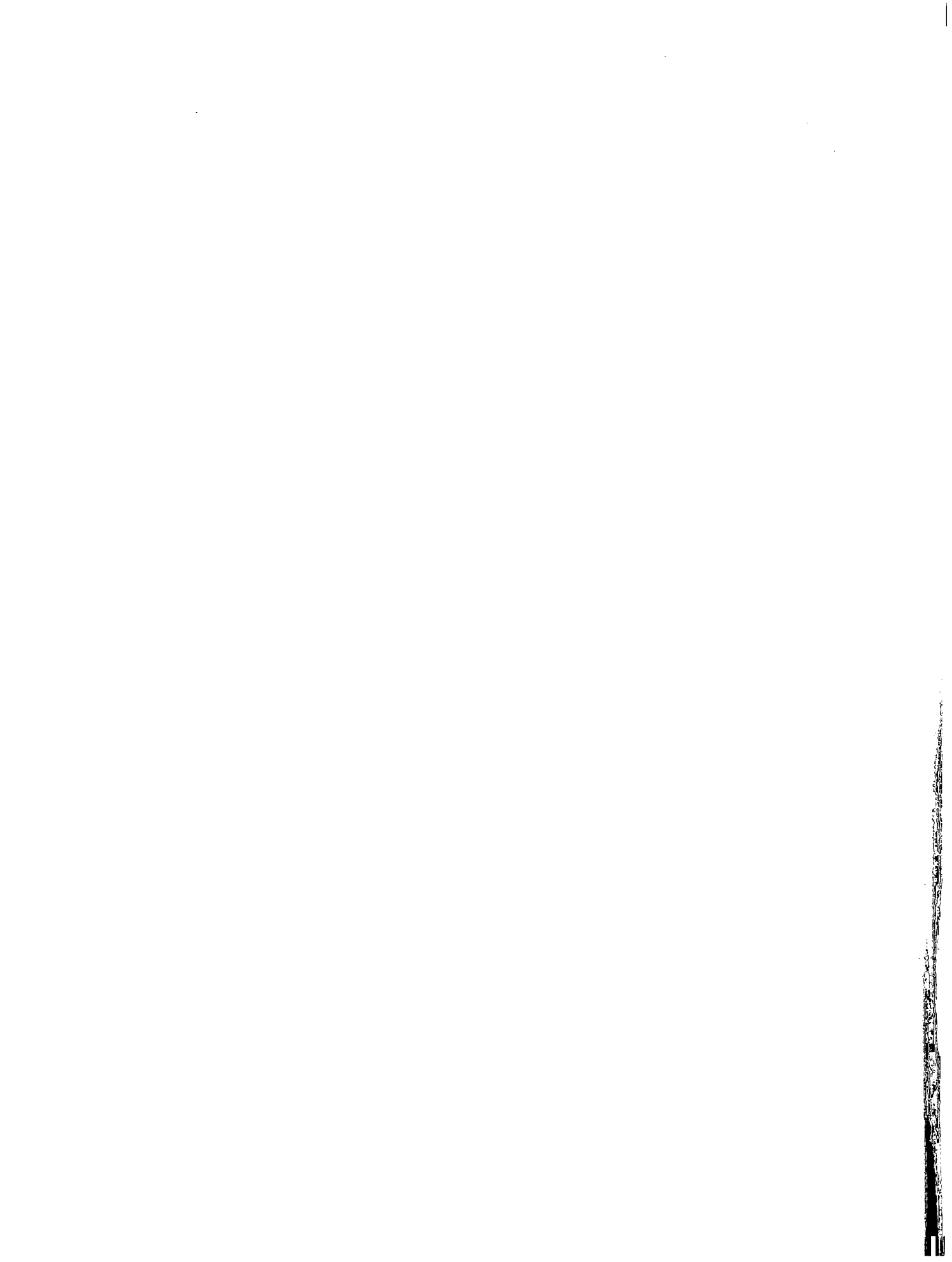

REFERENCES

1. Baird, F. E., Schindler, R. A. and Smith, R. N. "An optical aid for manual acquisition and tracking of a target satellite during a rendezvous mission," Advances in Astronautical Sciences, 16, 585-598 (1963)
2. Brissenden, R. F. "A study of human pilot ability to detect angular motion with application to control of space rendezvous," NASA TN-D-1498 (December 1962)
3. Brown, R. H. "Visual sensitivity to differences in velocity," Psychol. Bull., 58, 89-104 (1961)
4. Enoch, J. M. "Effect of the size of a complex display on visual search," J. of the Opt. Soc. of Am., 49, 280-286 (1959)
5. Graham, C. H. "Visual perception," In Stevens S. S. (Ed). Handbook of Experimental Psychology. New York: Wiley, 895-897 (1951)
6. Lazaar, E. S. "Visual detection," In B. O. Koopman, Search and Screening, OEG Rpt. No. 56, Navy Department (1946)
7. Lineberry, E. C., Brissenden, R. F. and Kurbjun, M. C. "Analytical and preliminary simulation study of a pilot's ability to control the terminal phase of a rendezvous with simple optical devices and a timer," NASA TN-D-965 (October 1961)
8. Morris, A. and Horne, E. P. (Eds) "Visual search techniques," NAS-NRC Pub. 712 (1960)
9. Norton, A. P. A Star Atlas and Reference Handbook (EPOC 1950) for Students and Amateurs, Edinburgh, 1-55 (1959)
10. Summers, L. G., Shea, R. A. and Ziedman, K. "Unaided visual detection of target satellites," J. Spacecraft, 3, 76-79 (1966)
11. Woodhull, J. G. and Bauerschmidt, D. K. "Human perception of line-of-sight rates," Hughes Aircraft Co., Culver City, Calif. Ref. 2732.20/135 (1962)

APPENDIX A

ANALYSIS OF VARIANCE AND PROBABILITY TABLES

		<u>Page</u>
Table I	ANOVA Detection Time Scores for Experiment II. . . .	49
Table II	Detection Probabilities for Experiment I	51
Table III	ANOVA of Time Scores for Experiment II	53
Table IV	Probability Values for Experiment II, Block A . . .	55
Table V	ANOVA of Time Scores for Experiment II, Block B . .	57
Table VI	Probability Values for Experiment II, Block B . . .	59

APPENDIX A

Table I. Analysis of Variance of Detection Time for Experiment I.

Source	df	SS	ms	F
Field of View (F)	2	791,199,677	395,559,838	106.7
F error	9	33,377,036	3,708,560	-
Subject(s)	3	109,627	36,542	-
Intensity (I)	1	38,513	38,513	5.73
Replication (R)	3	160,179	53,393	1.83
Velocity (V)	2	5,202,280	2,601,140	137.54
Density (D)	2	4,980,156	2,490,078	226.23
SD	6	66,040	11,007	-
SI	3	20,154	6,718	-
SR	9	262,044	29,116	-
SV	6	113,470	18,912	-
IR	3	46,695	15,565	2.61
IF	2	34,042	17,021	1.40
IV	2	2,255	1,128	0.132
ID	2	20,411	10,206	1.15
RF	6	105,885	17,648	0.834
RV	6	180,941	30,157	2.70
RD	6	129,534	21,589	1.47
FV	4	553,539	138,385	5.14
FD	4	257,265	64,316	8.51
VD	4	2,736,562	684,140	43.78
SIR	9	53,593	5,955	-
SIF	6	72,819	12,136	-
SIV	6	51,090	8,515	-
SID	6	53,172	8,862	-
SRF	18	380,784	21,155	-
SRV	18	201,056	11,170	-
SRD	18	263,634	14,646	-
SFV	12	322,957	26,913	-
SFD	12	90,718	7,560	-
SVD	12	187,521	15,627	-
IRF	6	59,429	9,905	2.11
IRV	6	132,782	22,130	6.62
IRD	6	66,079	11,013	2.11
IFV	4	37,740	9,435	0.731
IFD	4	60,486	15,122	0.981
IVD	4	7,579	1,895	0.128
RFV	12	159,085	13,257	1.42
RFD	12	150,356	12,530	0.834
RVD	12	192,243	16,020	1.13
FVD	8	342,574	42,822	2.18
SIRF	18	84,556	4,698	-
SIRV	18	60,209	3,345	-
SIRD	18	93,941	5,219	-
SIFV	12	154,804	12,900	-
SIFD	12	184,926	15,410	-
SIVD	12	177,800	14,817	-

APPENDIX A (continued)

Table I - Continued

Source	df	ss	ms	F
SRFV	36	335,051	9,307	-
SRFD	36	540,521	15,014	-
SRVD	36	511,973	14,221	-
SFVD	24	471,921	19,663	-
IRFV	12	89,721	7,477	0.785
IRFD	12	130,602	10,884	2.82
IRVD	12	76,212	6,351	1.68
IFVD	8	91,465	11,433	2.95
RFVD	24	297,267	12,386	1.58
SIRFV	36	342,830	9,523	-
SIRFD	36	139,140	3,865	-
SIRVD	36	136,416	3,789	-
SIFVD	24	92,996	3,875	-
SRFVD	72	565,648	7,856	-
IRFVD	24	75,347	3,139	0.246
SIRFVD	72	920,407	12,783	-

Table II Detection Probability for Experiment I

		FXV			
		V ₁	V ₂	V ₃	
F ₁		.75*	.83	.90	.85
		.80	.83	1.00	.86
F ₂		.75	.89	.95	.86
		.86	.96	.95	.92
F ₃		.68	.91	.86	.82
		.99	.98	.91	.88
		.73	.89	.92	N = 96
		.81	.93	.96	

		FXI		
		I ₁	I ₂	
F ₁		.79	.90	
		.84	.94	
F ₂		.83	.89	
		.90	.94	
F ₃		.76	.87	
		.85	.92	
		.80	.86	N = 144
		.96	.93	

		FXD			
		D ₁	D ₂	D ₃	
F ₁		1.00	.76	.78	
		1.00	.82	.84	
F ₂		1.00	.80	.78	
		1.00	.90	.86	
F ₃		1.00	.74	.82	
		1.00	.82	.82	
		1.00	.77	.78	N = 96
		1.00	.85	.84	

		FXR				
		R ₁	R ₂	R ₃	R ₄	
F ₁		.58	.82	.79	.94	
		.82	.86	.94	.97	
F ₂		.76	.86	.90	.93	
		.83	.94	.94	.99	
F ₃		.76	.82	.83	.86	
		.78	.94	.90	.90	
		.72	.86	.88	.91	N = 72
		.79	.91	.93	.95	

F₁ = 8° F₂ = 17°, F₃ = 27°

V₁ = 0.1 m rad/sec, V₂ = 1.2 m rad/sec, V₃ = 2.4 m rad/sec

D₁ = zero density, D₂ = low density, D₃ = high density

I₁ = 5th mag., I₂ = 3rd mag.

R₁ = replication one, etc.

N = number on which the probability values are based

* Each cell contains two P values, the upper is based on only the correct detection, the lower on at least the correct identification of the group containing the target.

APPENDIX A (continued)

Table II Detection Probability for Experiment I

	DXV		
	V ₁	V ₂	V ₃
D ₁	1.0	1.0	1.0
	1.0	1.0	1.0
D ₂	.59	.80	.91
	.73	.85	.96
D ₃	.58	.82	.87
	.69	.93	.92

N = 96

	DXI (continued)	
	I ₁	I ₂
D ₁	1.0	1.0
	1.0	1.0
D ₂	.71	.83
	.81	.89
D ₃	.68	.83
	.78	.91

N = 144

	VXI		
	V ₁	V ₂	V ₃
I ₁	.66	.84	.89
	.75	.91	.92
I ₂	.79	.94	.96
	.86	.94	.99

N = 144

	DXR			
	R ₁	R ₂	R ₃	R ₄
D ₁	1.0	1.0	1.0	1.0
	1.0	1.0	1.0	1.0
D ₂	.61	.81	.63	.90
	.68	.90	.85	.96
D ₃	.63	.70	.89	.83
	.69	.85	.93	.90

N = 72

	RXI	
	I ₁	I ₂
R ₁	.68	.79
	.74	.84
R ₂	.76	.92
	.88	.95
R ₃	.86	.91
	.89	.96
R ₄	.86	.96
	.94	.97

N = 144

	RXV		
	V ₁	V ₂	V ₃
R ₁	.63	.78	.83
	.64	.83	.90
R ₂	.65	.85	.96
	.83	.93	.99
R ₃	.59	.97	.94
	.85	.93	.96
R ₄	.83	.94	.96
	.90	.97	.99

N = 72

APPENDIX A (continued)

Table III. Analysis of Variance of Time Scores for Experiment II - Block A

Source	df	ss	ms	F
Group (G)	1	533,797,961	533,797,961	115.6
G error	6	27,702,307	4,617,051	-
Subjects (M)	3	207,755	69,252	-
Replication (R)	2	291,977	145,988	5.50
Sessions (S)	2	72,978	36,489	1.95
Intensity (I)	2	186,614	93,307	8.40
Velocity (V)	1	1,696,762	1,696,762	57.59
GM	3	164,066	54,689	-
GR	2	232,995	116,498	10.12
GI	2	88,992	44,496	3.74
GV	1	415,251	415,251	8.06
MR	6	159,345	26,558	-
MS	6	112,066	18,678	-
MI	6	66,636	11,106	-
MV	3	88,385	29,462	-
RS	4	171,292	42,823	4.41
RI	4	25,899	6,475	0.683
RV	2	33,139	16,570	1.18
SI	4	13,672	3,418	0.16
SV	2	62,401	31,201	1.67
IV	2	13,293	6,654	2.17
GMR	6	69,071	11,512	-
GMS	6	34,266	5,711	-
GMI	6	71,497	11,914	-
GMV	3	154,459	51,486	-
GRS	4	103,464	25,866	2.98
GRI	4	74,519	18,626	2.36
GRV	2	200,213	100,106	2.86
GSI	4	26,937	6,730	3.87
GSV	2	84,745	42,372	7.39
GIV	2	45,381	22,682	10.45
MRS	12	116,588	9,716	-
MRI	12	113,802	9,482	-
MRV	6	84,490	14,082	-
MSI	12	257,151	21,428	-
MSV	6	112,308	18,718	-
MIV	6	18,438	3,070	-
RSI	8	81,867	10,231	0.56
RSV	4	127,646	31,912	2.65
RIV	4	17,212	4,299	0.46
SIV	4	52,554	13,134	0.519
GMRS	12	104,198	8,683	-
GMRI	12	94,652	7,889	-
GMSI	12	20,830	1,737	-
GRSI	8	199,323	24,917	1.29
MRSI	24	435,687	18,154	-

APPENDIX A (continued)

Table III - Continued

Source	df	ss	ms	F
GMRV	6	209,851	34,975	-
GMSV	6	34,414	5,736	-
GRSV	4	112,095	28,024	2.55
MRSV	12	144,454	12,038	-
GMIV	6	13,001	2,170	-
GRIV	4	28,778	7,195	1.19
MRIV	12	112,341	9,363	-
GSIV	4	49,193	12,302	.405
MSIV	12	303,624	25,302	-
RSIV	8	126,309	15,791	0.79
GMRSI	24	464,564	19,356	-
GMRSV	12	131,931	10,994	-
GMRIV	12	72,639	6,053	-
GMSIV	12	364,661	30,387	-
GRSIV	8	201,971	25,244	13.73
MRSIV	24	479,569	19,981	-
GMRIV	24	44,114	1,838	-

Table IV P Values for Experiment II - Block A

	GXS		
	G ₁	G ₂	
S ₁	.74*	.85	.79
	.83	.88	.84
S ₂	.79	.93	.85
	.92	.96	.96
S ₃	.90	.99	.94
	.99	1.0	.99
	.81	.91	N = 72
	.92	.94	

	GXR		
	G ₁	G ₂	
R ₁	.82	.83	.83
	.90	.88	.90
R ₂	.82	.93	.88
	.90	.97	.93
R ₃	.79	.99	.89
	.93	.99	.96
			N = 72

	GX1		
	G ₁	G ₂	
V ₁	.70	.89	.79
	.86	.92	.89
V ₂	.93	.93	.93
	.96	.97	.97
			N = 108

	GX1		
	G ₁	G ₂	
I ₁	.75	.85	.80
	.92	.92	.92
I ₂	.83	.94	.90
	.90	.96	.93
I ₃	.83	.96	.90
	.90	.96	.93
			N = 72

	IXV		
	V ₁	V ₂	
I ₁	.71	.90	
	.86	.96	
I ₂	.82	.97	
	.89	.99	
I ₃	.85	.94	
	.90	.96	
			N = 72

G₁ = unique starfield, G₂ = different starfield

R₁ = replication 1 etc.

S₁ = session 1 etc.

I₁ = 5th mag, I₂ = 4th mag, I₃ = 3rd mag

V₁ = 0.1 m rad/sec, V₂ = 1.2 m rad/sec

N = number of scores per cell

* Each cell contains two P values, the upper is based on only the correct detections, the lower on at least the correct identification of the group containing the target.

Table IV P Values for Experiment II - Block A
(continued)

		IXR		
		S ₁	S ₂	S ₃
R ₁		.75	.81	.85
		.90	.90	.96
R ₂		.83	.92	.94
		.88	.96	.98
R ₃		.90	.90	.90
		.92	.94	.94
				N = 48

		IXS		
		R ₁	R ₂	R ₃
S ₁		.77	.77	.85
		.83	.88	.98
S ₂		.81	.88	1.0
		.87	.94	1.0
S ₃		.79	.92	.98
		.85	.94	1.0
				N = 48

		SXR		
		R ₁	R ₂	R ₃
S ₁		.77	.81	.79
		.81	.83	.92
S ₂		.79	.85	.92
		.90	.96	.96
S ₃		.92	.96	.98
		.98	.98	1.0
				N = 48

		SXV	
		V ₁	V ₂
S ₁		.68	.90
		.83	.90
S ₂		.75	.96
		.96	.99
S ₃		.94	.94
		1.0	.99
			N = 72

		RXV	
		V ₁	V ₂
R ₁		.69	.96
		.83	.96
R ₂		.86	.89
		.90	.96
R ₃		.81	.96
		.93	.99
			N = 72

APPENDIX A (continued)

Table V

Analysis of Variance Detection Time Series for Experiment II - Block B

Source	df	ss	ms	F
Groups G	3	115,172,774	38,390,925	51.15
G _{error}		3,002,356	750,589	
Subjects (M)	1	932	932	-
Replication (R)	1	62,023	62,023	8.80
Sessions (s)	2	9,620	4,810	3.31
Intensity (I)	2	68,462	34,231	8.14
Velocity (V)	1	576,792	576,792	106.07
GR	3	58,031	19,344	2.25
GS	6	35,436	5,906	0.372
GI	6	56,113	9,352	4.57
GV	3	482,276	160,759	11.90
MR	1	7,049	7,049	-
MS	2	2,905	1,452	-
MI	2	8,408	4,204	-
MV	1	5,438	5,438	-
RS	2	8,597	4,298	0.161
RI	2	20,952	10,476	5.04
RV	1	20,099	20,099	2.94
SI	4	7,277	1,819	0.106
SV	2	595	298	1.73
IV	2	10,026	5,013	1.94
GMR	3	25,787	8,596	-
GMS	6	95,146	15,858	-
GMI	6	12,288	2,048	-
GMV	3	40,532	13,511	-
GRS	6	10,120	1,687	0.384
GRI	6	57,067	9,511	6.16
GRV	3	22,629	7,543	0.95
GSI	12	30,590	2,549	0.233
GSV	6	65,634	10,939	1.03
GIV	6	24,421	4,070	0.893
MRS	2	53,482	26,741	-
MRI	2	4,155	2,078	-
MRV	1	6,848	6,848	-
MSI	4	68,547	17,137	-
MSV	2	343	172	-
MIV	2	5,155	2,578	-
RSI	4	16,315	4,079	0.539
RSV	2	3,238	1,619	0.470
RIV	2	43,998	21,999	6.28
SIV	4	7,746	1,936	0.132

APPENDIX A (continued)

Table V - continued

Source	df	ss	ms	F
GMRS	6	26,378	4,396	-
GMRI	6	9,266	1,544	-
GMSI	12	130,986	10,916	-
GRSI	12	103,425	8,619	1.16
MRSI	4	30,256	7,564	-
GMRV	3	23,813	7,938	-
GMSV	6	63,600	10,600	-
GRSV	6	17,985	2,998	0.262
MRSV	2	6,893	3,446	-
GMIV	6	27,342	4,557	-
GRIV	6	63,143	10,524	29.64
MRIV	2	7,003	3,502	-
GSIV	12	36,125	3,010	0.378
MSIV	4	58,723	14,681	-
RSIV	4	54,987	13,747	0.973
GMRSI	12	89,058	7,422	-
GMRSV	6	68,510	11,418	-
GMRIV	6	2,131	355	-
GMSIV	12	95,622	7,968	-
GRSIV	12	74,302	6,192	0.954
MRSIV	4	56,513	14,128	-
GMRSIV	12	77,855	6,488	-

Table VI P Values for Experiment II - Block B

GXV			
	V ₁	V ₂	
G ₁	.97*	.97	.97
	1.0	.97	.98
G ₂	.67	1.0	.83
	.89	1.0	.94
G ₃	.83	.89	.86
	.89	.97	.93
G ₄	.97	1.0	.99
	1.0	1.0	1.0
	.86	.97	N = 36
	.94	.99	

GXV			
	V ₁	V ₂	
G ₁	.92	1.0	1.0
	1.0	1.0	1.0
G ₂	.92	.75	.83
	1.0	.88	.96
G ₃	.71	.88	1.0
	.83	.96	1.0
G ₄	1.0	.96	1.0
	1.0	1.0	1.0
	.89	.90	N = 24
	.96	.96	

GXV		
	S ₁	S ₂
G ₁	1.0	.94
	1.0	1.0
G ₂	.78	.89
	.92	.97
G ₃	.89	.83
	.97	.89
G ₄	.97	1.0
	1.0	1.0
	.91	.92
	.97	.97

GXR			
	R ₁	R ₂	R ₃
G ₁	1.0	.96	.96
	1.0	1.0	1.0
G ₂	.83	.75	.92
	.88	.96	1.0
G ₃	.96	.79	.83
	.96	.92	.92
G ₄	.96	1.0	1.0
	1.0	1.0	1.0
	.94	.88	.93
	.98	.97	.98

G₁ = same → same G₂ = same → unique G₃ = unique → unique

G₄ = unique → same

S₁ = session 1 etc.

R₁ = replication 1 etc.

I₁ = 5th mag, I₂ = 4th mag, I₃ = 3rd mag.

V₁ = 0.1 m rad/sec, V₂ = 1.2 m rad/sec

* Each cell contains two P values, the upper is based on only the correct detection, the lower on at least the correct identification of the group containing the target.

Table VI P Values for Experiment II - Block B
(continued)

IXV		
	V ₁	V ₂
I ₁	.85	.98
	.94	1.0
I ₂	.81	.94
	.92	.98
I ₃	.92	1.0
	.98	1.0
N = 36		

IXS		
	S ₁	S ₂
I ₁	.85	.79
	.94	.94
I ₂	.90	.98
	.96	1.0
I ₃	.94	.96
	.98	1.0
N = 36		

IXR			
	R ₁	R ₂	R ₃
I ₁	.97	.78	.84
	.97	.97	.94
I ₂	.88	.94	.94
	.94	.97	1.0
I ₃	.97	.91	1.0
	.97	1.0	1.0
N = 24			

RXV		
	V ₁	V ₂
R ₁	.85	.78
	.94	1.0
R ₂	.79	.94
	.94	.98
R ₃	.90	.96
	.96	1.0
N = 36		

RXS		
	S ₁	S ₂
R ₁	.92	.92
	.96	.96
R ₂	.90	.90
	.98	.98
R ₃	.96	.85
	1.0	.98
N = 36		

VXS		
	S ₁	S ₂
V ₁	.85	.88
	.97	.94
V ₂	.96	.94
	.99	.99
N = 72		

APPENDIX B

CALIBRATION PROCEDURE

The illumination from the target and star images was measured using a Spectra Brightness Spot Meter, Model UB-1 $\frac{1}{2}$ ⁰ at various intervals during the course of the experiment. Before measuring the image the photometer was calibrated against a 100 ft-L standard source. After calibration of the photometer an aperture was mounted on the front of the lens. The aperture and photometer had been calibrated by the manufacturer so that the photometer could be used to measure illumination in ft-C. The experimenter mounted the photometer on a tripod and positioned it three feet from and normal to the image to be measured. All measurements were made under normal conditions. The values of illumination falling on the observer, who was located 17.5' from the source, was calculated using the inverse square law. The curves in Figure B1 illustrate the fall-off in illumination that occurred with use.

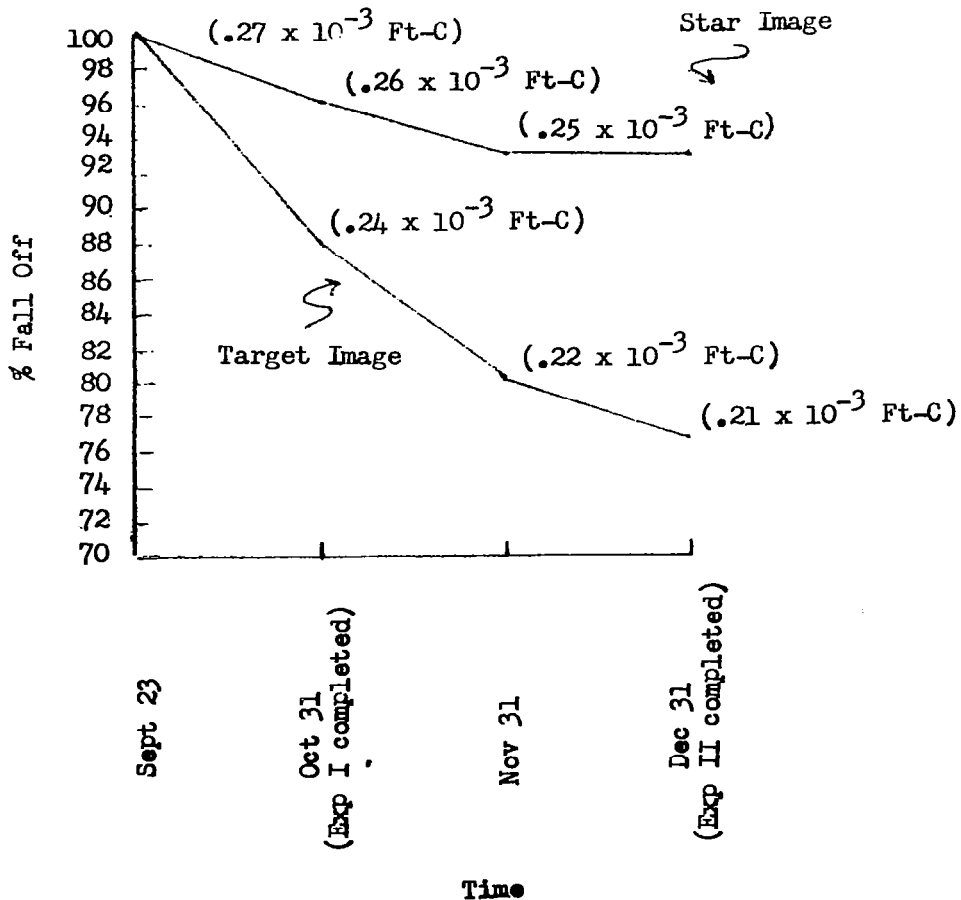

Figure B1: Illumination Falloff vs Use

As is evident from the curves the illumination from the star image did not materially decrease; this resulted from running the starfield projector lamp approximately one-half of the normal voltage.

APPENDIX C

SUBJECTS' INSTRUCTIONS

Your task in this experiment is the detection and identification of a satellite that appears in a starfield. The characteristic that distinguishes the satellite from the stars in the field is the relative motion of the satellite with respect to stars in the field. On some trials the satellite's velocity will be sufficiently great as to be apparent to the human observer however, on other trials the velocity will be below the motion threshold for the human observer. For this latter condition you will have to infer motion from the displacement of the satellite; to do this you will establish a reference, such as a star pattern, and compare this remembered pattern with that which you see at a later time. If a change in the pattern has occurred this establishes that the satellite "belongs" to that pattern but generally will not establish which star of the pattern is the satellite. To accomplish the latter you will probably have to align those objects which are potentially the satellite with surrounding stars you assume to be stationary. A frequent type of error that the observer commits is that of assuming the satellite is a stationary star and consequently identifying one of the stars as the satellite. This error can generally be avoided by using multiple references to check a hypothesis. Also the satellite's intensities will not necessarily be the same from trial to trial. On some trials the satellite's intensity will be above the cone threshold and consequently can be perceived using central or foveal vision; however on some trials the satellite's intensity will be below the cone threshold and thus can only be perceived using the peripheral portion of the visual field (e.g., if foveal vision is used the satellite will disappear from view).

Each trial will begin with the raising of the shutter exposing the starfield to your view. You will then search the starfield for the satellite. When you have detected the satellite press the trigger switch on the control stick. This action causes a cursor (i.e., ring) to appear on the screen. Encircle the satellite with this ring using the stick to control the cursor. During this interval do not continue to search the field but identify, as quickly as possible, what you thought was the target. After encircling the satellite press the bomb release switch, the top switch on the stick. The

shutter will then close ending the trial. On any particular trial the combination of satellite intensity, velocity, initial position and direction of motion has been determined using a random number table thus preventing you from being able to guess at a better than chance level what the conditions will be for any given trial. One satellite will be present on each trial.

You also should be aware of the autokinetic effect. This refers to the following: in a relatively unstructured field the human observer when looking at a point source of light will at times report that the source appears to be moving even though the source is stationary. This impression can be very compelling, however this effect as a source of error can be eliminated by checking the perceived motion relative to other stationary objects.

During the time you are searching the field for the satellite, would you describe the search strategy you are employing and indicate when you perceive a pattern change. Because this is supplementary data do not disrupt the search process to supply this information.

I want you to employ a stringent criterion for target detection. That is, I want you to have a high degree of certainty that what you identify as the as the target will be correct. Also please perform the task as rapidly as possible within the restriction imposed by a criterion of a high degree of certainty.

Are there any questions?

APPENDIX D

REPRESENTATIVE ELECTRO-
OCULOGRAPH RECORDINGS
FOR THE V_{1.2} I₃ CONDITION
SHOWING THE
STARFIELD PRESENTATION
GROUP DIFFERENCES

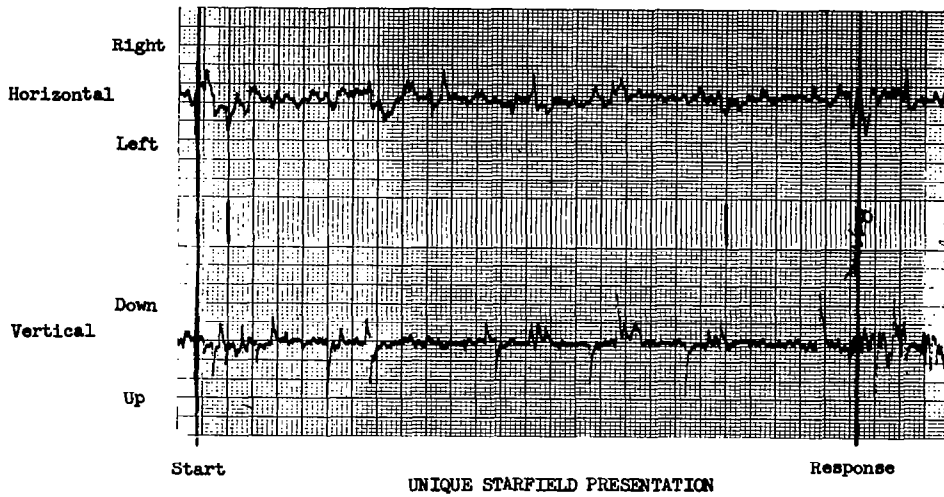

UNIQUE STARFIELD PRESENTATION

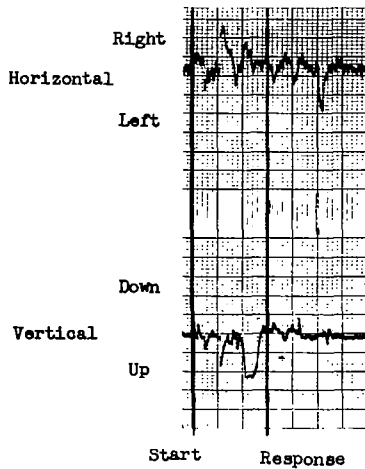

SAME STARFIELD PRESENTATION

"The aeronautical and space activities of the United States shall be conducted so as to contribute . . . to the expansion of human knowledge of phenomena in the atmosphere and space. The Administration shall provide for the widest practicable and appropriate dissemination of information concerning its activities and the results thereof."

—NATIONAL AERONAUTICS AND SPACE ACT OF 1958

NASA SCIENTIFIC AND TECHNICAL PUBLICATIONS

TECHNICAL REPORTS: Scientific and technical information considered important, complete, and a lasting contribution to existing knowledge.

TECHNICAL NOTES: Information less broad in scope but nevertheless of importance as a contribution to existing knowledge.

TECHNICAL MEMORANDUMS: Information receiving limited distribution because of preliminary data, security classification, or other reasons.

CONTRACTOR REPORTS: Technical information generated in connection with a NASA contract or grant and released under NASA auspices.

TECHNICAL TRANSLATIONS: Information published in a foreign language considered to merit NASA distribution in English.

TECHNICAL REPRINTS: Information derived from NASA activities and initially published in the form of journal articles.

SPECIAL PUBLICATIONS: Information derived from or of value to NASA activities but not necessarily reporting the results of individual NASA-programmed scientific efforts. Publications include conference proceedings, monographs, data compilations, handbooks, sourcebooks, and special bibliographies.

Details on the availability of these publications may be obtained from:

SCIENTIFIC AND TECHNICAL INFORMATION DIVISION
NATIONAL AERONAUTICS AND SPACE ADMINISTRATION

Washington, D.C. 20546