

**NASA CONTRACTOR
REPORT**

NASA CR-564



NASA CR

0099481



SEP 1966
NATIONAL AERONAUTICS AND SPACE ADMINISTRATION
WASHINGTON, D.C.

VISUAL AND CONTROL ASPECTS OF SACCADIC EYE MOVEMENTS

by Laurence R. Young, Bert L. Zuber, and Lawrence Stark

Prepared by
BIOSYSTEMS, INC.
Cambridge, Mass.
for Ames Research Center



VISUAL AND CONTROL ASPECTS OF SACCADIC EYE MOVEMENTS

By Laurence R. Young, Bert L. Zuber,
and Lawrence Stark

Distribution of this report is provided in the interest of information exchange. Responsibility for the contents resides in the author or organization that prepared it.

Prepared under Contract No. NAS 2-1328 by
BIOSYSTEMS, INC.
Cambridge, Mass.

for Ames Research Center

NATIONAL AERONAUTICS AND SPACE ADMINISTRATION

For sale by the Clearinghouse for Federal Scientific and Technical Information
Springfield, Virginia 22151 - Price \$3.00

Table of Contents

	<u>Page</u>
Preface	v
 Part One - CONTROL ASPECTS OF HUMAN SACCADIC EYE MOVEMENTS	
Summary	1
I. Introduction	2
II. Anatomy of the Extraocular System	6
III. Description of Saccadic Eye Movements	10
IV. Proprioception in Extraocular Muscles	28
V. Control Models for the Saccadic Eye Movement	35
Bibliography	54
Figures	57
 Part Two - THE EFFECT OF EYE MOVEMENT ON VISION	
Summary	70
I. Characteristics of Involuntary Miniature Eye Movements	73
II. The Effect of Eye Movement on Visual Acuity	83
III. Saccadic Suppression: the Elevation of Visual Threshold Associated with Saccadic Eye Movements	94
Bibliography	122
Figures	126

VISUAL AND CONTROL ASPECTS OF SACCADIC EYE MOVEMENTS

Preface

The research related in this report represents part of a continuing effort to study the physiology of the visual system in man using the experimental and analytic techniques of control engineering. Recent reports have dealt with the dynamics of the vergence and version tracking loops, emphasizing the intermittent characteristics of the latter, and some consideration of intraocular pressure regulation. This report consists of two studies related to saccadic eye movements - those rapid conjugate eye movements which jump the eyes about voluntarily and involuntarily. These saccades form the position correcting loop for visual tracking to keep the eyes "on target".

Part One of the report, by Dr. L. R. Young, investigates the control aspects of saccades, considering the information used, the feedback available, and the observed mechanical dynamic performance of this fast "slewing" control. Some new experimental results on the saccadic dead zone lead to a simple statistical theory for the time of occurrence of small corrective eye movements. The question of eye movement proprioception is discussed and a variety of saccadic

control models are critically reviewed.

Part Two of the report, by Drs. B. L. Zuber and L. Stark, concentrates on the information acquisition associated with eye movements, rather than the mechanical characteristics. The miniature involuntary eye movements occurring during fixation are reexamined from the point of view of their effect on visual acuity. Results are presented on saccadic suppression, or the elevation of visual acuity thresholds associated with microsaccades and voluntary saccadic movements. Considered together with suppression of vision during the fast phase of vestibular nystagmus and pupillary response suppression during saccades, these results bear directly on overall models of information processing in the visual control system.

This work was performed under NASA Contract NAS2-1328, monitored by Mr. D. Baty of Ames Research Center.

Part One

CONTROL ASPECTS OF HUMAN SACCADIC EYE MOVEMENTS

by
Laurence R. Young

Summary

The mechanism by which humans move their eyes in rapid saccadic jumps is examined from the physiological, behavioral and control points of view. The anatomy of the extraocular system is reviewed to present the special control problem involved in saccadic eye movements. Behavioral data describing the nonlinear and nonsymmetric characteristics of individual saccadic eye movements are assessed and new experimental data are provided to evaluate the timing of information received by the eye. Experiments were conducted on the effective dead zone of the eye and a simple probabilistic model proposed to describe this dead zone. The question of proprioceptive feedback in the extraocular muscles is considered in some detail. A number of control models for the mechanism of the saccadic eye movements are presented and evaluated.

I. Introduction

The human eye movement control system has previously been compared, by analogy, to the system for controlling the line of sight of a tracking radar antenna (22). A radar system might well be designed with a fast slewing mode for rapidly acquiring a target, and a smooth, slower tracking mode for keeping up with target motions. Similarly human eye movement control in response to visual targets consists of a rapid and a smooth mode. The fast jumps or saccadic eye movements, serve to "acquire the target" and place its image in the high resolution central area of the retina. Smooth "pursuit" movements are used for tracking moderate target velocities and serve to keep the target image approximately stationary on the retina.

In the event the radar tracking system is mounted on board a moving vehicle, an active stabilization system might normally be used to eliminate tracking errors due

to vehicle motion. For example, base motion isolation might be achieved by sensing vehicle rotations with gyroscopes and compensating through rate commands to the radar antenna gimbals. The analogous stabilization problem exists in eye movement control, where visual fixation errors might result from motion of the head or body. The "base motion isolation" is accomplished through "compensatory" eye movements. Head movement is sensed by the vestibular apparatus of the inner ear (28), or motion of the neck by neck proprioceptors (17).

The "miniature eye movements" (flicks, drift and tremor) may also be compared with drift and quantitation noise in a radar control system, and will be more fully explored in a forthcoming report.

Previous reports and papers have shown that the human eye movement control system tracking unpredictable visual targets may be described as a sampled data system comprising two parallel paths in the forward loop; the pursuit path acting as a discrete velocity servomechanism and the saccadic path serving as a sampled position control system. Since the duration of each individual saccadic jump is short relative to the sampling period of the model, the overall system behavior was adequately described by treating the jumps as instantaneous steps of eye position. In this report, however, it is the very nature of these rapid

eye movements which will be investigated from a control point of view. Returning to the radar analogy, the investigation relates to the mechanism and control logic for the rapid slewing necessary to acquire a new target. Among the questions to be considered are the following: (1) what is the information upon which the magnitude and direction of the saccadic step is based; (2) what feedback (visual or proprioceptive) if any, is used in the control; (3) what is the nature of the load being rotated; (4) what are the specifications on the system in terms of speed and accuracy; (5) over what range of steps is the system linear; (6) what asymmetry if any is present in the system; (7) is the control continuous or discrete; (8) what is the control law employed in saccadic eye movements.

Although definitive answers cannot be supplied to all of these questions at the present time, this report represents progress on research in this field and includes reinterpretation of some older data and indicates the need for several experiments.

Section II presents a brief review of the relevant anatomy of the extraocular system which is necessary for an appreciation of the special control problem involved in saccadic eye movements.

Section III is a collection and distillation of the data describing the quantitative nature of the saccadic

jump and the effects of a number of parameters on it.

In Section IV the important question of proprioception or non-visual position feedback is considered in some detail.

Section V critically reviews the models proposed for saccadic eye movement experiments.

II. Anatomy of the Extraocular System

The eyeball is a globular structure approximately 27 mm in diameter seated in a socket lined with a cushion of fat. Its orientation with respect to the head is controlled by the six extraocular muscles, which cause it to rotate about a point approximately at its geometrical center (29,4,8, 18, 27). It is filled with a viscous fluid called the vitreous humor. Its hard outer shell, the sclera or "white" of the eye, is broken only at the very front, where the transparent cornea protrudes. The cornea, a lens with a front radius of curvature of 8 mm, and a power of 42 diopters, is the first image forming element of the eye. Behind it is located the iris, a collection of muscles which can contract or relax to vary the diameter of the eye's aperture --the pupil. Located just in back of the iris is the lens, whose curvature can be controlled to accommodate or focus on near or far objects. An image is finally formed on the retina at the back surface of the eye. The two photosensitive elements in the retina, rods and cones, are distributed with rods predominating at the periphery and cones near the center. The rods, with a sensitivity to lower levels of illumination, are active in night vision, whereas the cones contribute color vision and a higher resolution. The central area of the retina, called the fovea, contains only cones, and yields the highest acuity. The fovea is

about 60 microns in diameter, corresponding to a visual angle of about 1° .

The six extrinsic muscles of the eye are admirably suited for their task of rotating the eyeball. They are arranged in three pairs of muscles as shown in the dissection view of Figure 1. In any eye movement one of the muscles of any pair (the agonist) contracts to pull on the eyeball while its opposite member (the antagonist) relaxes but opposes the motion. The movements of the eyeball are generally defined in terms of primary axes of rotation of the eyeball about its center. In rotations about the vertical axis the cornea moves laterally, away from the nose (abduction), or medially, toward the nose (adduction). Rotations about the transverse axis running horizontally right to left, move the cornea up (elevation) or down (depression). The third axis, the sagittal axis, is defined as the primary line of vision, and rotations about it rotate the top of the cornea nasally (intorsion) or laterally (extorsion). The axes of rotation determined by the individual muscle pairs, however, are nonorthogonal, and do not line up with the primary axes. As a result, the muscles have subsidiary actions as well as main actions. The possible actions of the muscles are shown schematically in Fig. 2, for the eyes looking straight forward. The lateral and medial recti. thus are an opposing pair used for adduction and abduction only, regardless of eye position. The

superior rectus, on the other hand, has a main action in elevation, which increases as the eye turns out and decreases as the eye turns in, and also subsidiary actions of adduction and intorsion which become increasingly important as the eye turns nasally.

The normal muscle fields permit the eyes to rotate about 45° left or right, 40° up and 60° down, and 30° in extorsion or intorsion. Since the muscle pairs are attached approximately at ends of diameters of the eyeball, their action is enhanced by a mechanical advantage not generally found in other muscles of the body. The extrinsic muscles are about 40 mm long and about 100 square millimeters in cross section. Their maximum force is calculated to be nearly one kilogram weight, whereas the actual force required to initiate a moderate saccadic movement has been calculated as less than 100 grams weight. This large reserve force means that only some of the individual fibers need contract at any one time, allowing the others to rest. The observation of Lion and Brockhurst (14) that no change in saccadic acceleration occurs during a prolonged series of saccadic movements under stress, bears out the theory that the extrinsic muscles do not normally fatigue.

Finally it should be noted that the nerves which transmit commands from the brain to the extraocular muscles contain a great many fibers in proportion to the size of the

muscles they control, thus permitting very fine control over these muscles. The reaction time of the extrinsic muscles, less than 10 msec, is the shortest of any muscle in the body (7).

III. Description of Saccadic Eye Movements

Saccadic eye movements refer to the rapid conjugate jumping motion of the eye in moving from one succession point to another. It has been demonstrated that the pattern of movements of typical saccades, produced in tracking a moving target or in reading a line of print, are identical to the fast phase, or "fly back", of vestibular nystagmus and optokinetic nystagmus. Furthermore, Zuber has recently shown, (31) that the miniature flicks or "microsaccades" of several minutes of arc magnitude belong to the same class of eye movements as larger saccades, covering a range of amplitudes of 10^3 , from 0.05° up to 50° . Consequently the descriptive material and control models discussed in this report are intended to apply to this entire family of eye movements.

The term saccade stems from an old French word referring to the rapid turning of a horse's head in response to a pull on the reins, and indeed brings to mind the rapid angular jerks of the eye in response to the net pull of the agonist-antagonist extraocular muscle pairs. A typical record of saccadic movements is shown in Fig. 3. The time course of the movement following a visual stimulus may be described as a response time of 120 to 250 msec followed by a short period of acceleration up to a relatively constant velocity, a longer deceleration to slow down the

motion and often a second brief acceleration before coming to rest. The response often, but not always, exhibits some overshoot before reaching its final value. The maximum velocity attained increases nonlinearly with the amplitude of the saccade up to approximately $600^{\circ}/\text{sec}$ for very large excursions. The total time duration of these saccades increases with its amplitude, and is approximately 100 msec for a 10° saccade. The nonlinear aspects of the movement will be treated in some detail below. When the undershoot or overshoot exceeds approximately 0.5° , a second corrective saccade generally follows after a "psychological refractory period" of approximately 200 to 300 msec.

Required Accuracy of Saccades -The Dead Zone

The occurrence of a secondary corrective saccade depends primarily upon the steady state error remaining after the completion of the first saccade. Errors of the order of 0.25 to 0.5° are often not corrected, which is consistent with the ability of the visual system to fuse disparate binocular images. The existence of uncorrected steady state errors indicates an accuracy specification on saccadic eye movements of some sizable fraction of a degree. In addition a threshold of response of the eye to target steps of small magnitudes was pointed out by Rashbass and others (19). The data and interpretations on the saccadic threshold or dead zone presented below represents further

analysis of experimental data taken by the author in 1962 and a new set of experiments performed in 1965 under different conditions.

The experiment consisted of a random series of small horizontal target steps, all of magnitude less than 1° , presented to a subject. The time of occurrence of the saccadic eye movement or the failure of such a response to occur within one second following the stimulus were recorded. The data for this experiment as shown in Fig. 4 clearly indicates the tendency toward delayed response or no response at all for decreasing magnitude of the target step, and confirms the existence of a dead zone of sorts. The 1962 experiments were performed with a single thin vertical line of light projected on a screen in a dark room. The 1965 experiments were performed in a lighted room using displacement of a line on an oscilloscope. The 1965 experiments were performed with and without oscilloscope grid lines, but always with a rich visual field to eliminate the possibility of "no response" because the target step was not perceived as moving relative to the background. The data shows no apparent difference between the two sets of experiments.

The existence of a sizeable dead zone in the saccadic mechanism is paradoxical at first. The two point resolution threshold for humans corresponds to the diameter of an

individual cone on the retina. The cone diameter is about 1 micron, corresponding to a resolution limit of 1 arc min in the visual field, which is also approximately the diffraction limit imposed by the pupil aperture. Thus a target step of 0.1 to 0.25° is certainly observed by the subject, and furthermore microsaccades of less than 0.25° are frequently observed to occur spontaneously in correction of drifts, so that the quantization of saccadic corrections by the motor mechanism does not account for the observed threshold. It must be recalled, however, that the purpose of the eye movement control system is to position the eye so that the target image lies on the fovea, but not necessarily in the center of this high resolution area of the retina. The fovea diameter is about 50 microns, corresponding to less than 1° in the visual field. Thus if the point target were initially at the center of the fovea a step of less than half the foveal diameter would induce no immediate saccadic correction. Since the initial position of the image on the fovea is uncertain, it is seen that the occurrence of a response to any target step less than the foveal diameter can only be described statistically depending upon the magnitude of the steps. Furthermore small random drifts always present during fixation are superposed on the image displacement due to the target step, and statistically might move the image off the fovea after some time and

yield a delayed saccadic response. Thus for any given magnitude small target step, the likelihood of a correction occurring should increase with time following the stimulus, and by any given time exceeding one reaction time following the stimulus, the probability of a corrective saccade occurring should increase with the amplitude of the step.

A simple statistical theory has been worked out to describe this phenomenon. Assume that the initial fixation error (x degrees) before the stimulus is uniformly distributed between the limits of the effective dead zone on the fovea ($\pm e$). Its probability density function is

$$f(x) = \begin{cases} \frac{1}{2e} & \text{for } |x| \leq e \\ 0 & \text{for } |x| > e \end{cases}$$

Let the magnitude of the target step be y degrees. Assume the eye drift rate is constant during the period under consideration (D°/sec). The fixation error (z) at any time following the stimulus, assuming no corrective saccade has been made is given by

$$z(t) = x + y + Dt$$

where the stimulus occurs at $t = 0$.

Now consider the probability density function of eye error immediately following the target step. The uniform distribution of x will merely be shifted by the magnitude of the target step, and the error will be uniformly distributed between $y - e$ and $y + e$.

$$f(z) = \begin{cases} \frac{1}{2e} & \text{for } (y - e) < z < (y + e) \\ 0 & \text{for } z < (y - e) \text{ or } z > (y + e). \end{cases}$$

Assume further that a corrective saccade can occur one reaction time following the stimulus only if the post-stimulus error $[z(0)]$ exceeds the dead zone $|z(0)| > e$. The probability of $z(0)$ exceeding e depends upon the step stimulus y , and is given by

$$P [z(0)] > e = \begin{cases} \frac{y}{2e} [P_{nt}(t_0)] & \text{for } y < 2e \\ P_{nt}(t_0) & \text{for } y > 2e. \end{cases}$$

(The factor $P_{nt}(t_0)$ represents the non-threshold-connected probability of eliciting a corrective saccade in a minimum reaction time t_0 . Even with a large target step a number of delayed responses are observed, and this factor is introduced to avoid confusion with the threshold phenomenon.) The probability density curve given by the above equation is the solid line in Fig. 5. The probability of a corrective saccade occurring in one reaction time (approximately 250 msec) varies linearly with the amplitude of the target step

from 0 up to a target step of $2e$, or twice the dead zone angle, reaching a threshold probability $P_{nt}(t_0)$ for large target steps.

By waiting longer than 1 reaction time to observe a corrective saccade, one may include the statistical effects of the random drift. Assuming that a corrective saccade will be triggered if the error $[z(t)]$ ever exceeds the dead zone e , it is clear that the effect of a constant velocity drift can only be to increase the probability of a corrective saccade by drifting the eye across the dead zone, but can never eliminate a corrective saccade by drifting the eye back into the dead zone once the error e had been exceeded. If the drift were always in the direction of increasing fixation error at D^0/sec , then the effect of waiting an additional Δt seconds to observe a corrective saccade would be the same as adding a bias angle $D\Delta t$ to the target step. If the simple assumption is made that half the time the drift is in the direction of increasing error than this bias is $0.5D\Delta t^0$, as is shown by the dashed line in Fig. 5. An additional correction is necessitated by the fact that the non-threshold probability of corrective saccade occurrence is increased with increasing time after the stimulus.

To check this formulation, the data of Fig. 4 was replotted in terms of the probability of corrective

saccades versus target step amplitude, as shown in Fig. 6. Notice first the data represented by the solid circles over the single horizontal lines, representing for each target step amplitude range the probability of observing a corrective saccade within 250 msec following the stimulus. This might be called the one reaction time probability density, although it is considerably longer than the minimum reaction time which can be observed. The data follows roughly the form predicted by the simple statistical model illustrated in Fig. 5, with the probability of a corrective saccade increasing linearly with target amplitude up to a certain angle and then leveling off. The straight line approximation to this data can be used to estimate the threshold level or extent of the saccadic dead zone. The parameters describing this straight line approximation are:

$$P_{nt}(0.25 \text{ sec}) = 0.82$$

$$\text{Probability density slope} = 1.35 \text{ (degrees}^{-1}\text{)}$$

The theory predicts:

$$\text{Probability density} = P_{nt}(t) \left[\frac{V}{2e} \right]_{\text{slope}}$$

This data approximation yields a dead zone amplitude of

$$e \approx 0.3 \text{ degrees}$$

Alternatively, if e is estimated from the 50% of asymptotic probability point, the curve yields

$$e \approx 0.26 \text{ degrees.}$$

The fact that the straight line approximation does not pass through the origin may be accounted for by the distribution of reaction times. Since reaction times shorter than 250 msec allow for the favorable influence of eye drift, the entire curve might be shifted upward slightly from the predicted curve.

Figure 6 also indicates the probability of a corrective saccade occurring in longer than one reaction time following the target step. The lines indicated by open squares and those denoted by open triangles represent the probability of corrective saccades occurring within 500 and 750 msec respectively following the target step. As predicted by the simple theory the probability density

curve is shifted to the left by waiting over increased intervals following the target step, and the non-threshold probability also increases when longer time is permitted to observe a corrective saccade. This data is not sufficiently complete to make accurate quantitative estimates of accurate high drift rate to check the statistical model; however, an approximate calculation may be made as follows. Assume that the data of Fig. 6 yields an average shift of the probability density curve to the left of approximately 0.1 degree for every 0.25 sec of additional time following one reaction time. Using the equation

$$\text{Bias} = 0.5d\Delta t$$

one calculates $d = 0.8$ degrees/sec for the eye drift rate, which is quite consistent with the drift rate observed under normal fixation conditions.

In summary, these experiments on saccadic eye movement dead zone confirm our simple statistical theories for the probability of corrective saccades as a function of time and amplitude. The accuracy specification on saccades, therefore, must be to keep the eye positioned within a dead zone of approximately ± 0.3 degrees, with corrective saccades occurring when ever the combination of initial fixation error, target movement, and eye drift move the eye out of the dead zone.

Visual Input Information for the Saccadic Eye Movement

It has been established that the saccadic eye movements are triggered by visual information taken in some 100 to 200 millisecc prior to the beginning of the saccade. For simplicity of analysis on the sampled data eye movement model, the sampling was treated as instantaneous impulse modulation, with timing of the sampler clock synchronized to the first large target movement following a period of rest. Further investigation has yielded a refinement of the notions of the timing of the visual information sample. It is known that the saccadic eye motion must be triggered by a response to a visual signal occurring at least 150 milliseconds prior to the initiation of the saccade for visual tracking. Experiments by Young and Stark (30) and more recently by Horrocks and Stark (12) have demonstrated that new visual information can be used to modify the course of a saccade only if it occurs prior to 80 milliseconds before the saccade. Furthermore, the phenomenon of saccadic suppression, or elevation of the visual threshold associated with a saccadic eye movement, has been more fully explored by Latour (13) and Zuber (31). They show that the visual threshold rises sharply starting approximately 80 milliseconds prior to the initiation of the saccade and does not return to its normal level until the termination of the saccadic eye movement. Finally, it must be recalled that the histogram of response times to

an unpredictable visual target step is not a single line but rather an assymmetric distribution with mode approximately 0.2 sec, minimum value approximately 0.15 sec and some long reaction times larger than 0.5 sec (23). The shape of the histogram indicates that the signal triggering these saccadic eye movements is not synchronized with the target step, which would lead to a single reaction time, nor is it characteristic of a free-running clock completely unsynchronized with the input, which would lead to a uniform distribution of reaction time. Rather it lends plausibility to the notion that the sampling is related to both a clock and the observation of the input, with the occurrence of saccades prior to the input resulting in delayed visual sampling. These results lead to our current notion of the timing of sampling of visual position information associated with saccadic eye movements illustrated schematically in Fig. 7.

The occurrence of the saccade trigger which is the beginning of the possible visual sampling period, may occur any time up to 200 msec following the target step depending among other things on the time of the previous saccade and the attention level. During the next 50 to 100 msec, the visual information is taken in, which may modify the time course of the saccade, but will not, in general prevent its occurrence or change its direction. (The eye responds to a 50 msec pulse by a 200 msec pulse.

The nature of the finite period sampling therefore must be such as to weight more heavily the information received at the beginning of the sample. At the end of this period of visual sampling, and approximately 80 msec prior to the initiation of the saccadic jump, saccadic suppression begins and effectively all further visual information on positioning the eye is removed until the saccade is completed.

Characteristics of the Saccadic Eye Movement Wave Form

In a number of human control systems, particularly those involving voluntary effort, the nature of the individual control movement varies over a considerable range, depending upon effort, fatigue, nature of the input, load on the moving limb, required accuracy, and learning experience. Thus the manner in which a man moves his hand to pick up a pencil depends upon among other things, the distance to the pencil and the original posture of his arm, the size and orientation of the pencil, the kind of clothing he is wearing and his anxiousness to attain his goal. In the case of saccadic eye movements, however, the nature of the task is quite constant (fixate the principle features of the target quickly to an accuracy of ± 0.5 degrees), the mechanical load of the eyeball and extraocular muscles remains constant, while fatigue and voluntary effort appear not to change the basic waveform.

To a reasonably good approximation the waveform of each saccadic depends only upon the total amplitude of that movement, with the peak velocity rising less rapidly than the amplitude to result in an increasing response time for increasing saccadic amplitude. This observation has led Gurevich to postulate a "universal law" of eye sensation reflexes (10). This universal law declares that the eye movement average speed depends upon angle of the saccade, but is independent of the initial and final positions of the eye in the orbit, the number and size of jumps in the movement preceding or following the saccade in question, and direction of the jump (left-right). This universal curve including its one and two standard deviation limits is shown in Fig. 8, in terms of log average velocity versus log saccadic amplitude. Gurevich further states that this universal curve is independent of whether the saccade is a "fixation saccade" to a target point or a random eye movement in the dark, and furthermore that it is independent of the plane of the eye movement, being equally valid for horizontal, vertical and diagonal saccades. The extrapolation of the curve down to the region of foveal "flicks" as shown by the broken line below 1.0 degrees has been experimentally verified by Zuber and will be treated in a subsequent report.

These curves indicate a pronounced amplitude dependent nonlinearity of the saccadic eye movement system, with

large amplitude eye movements taking longer than small amplitude eye movements. Certainly the source of this nonlinear behavior, be it a force limitation, velocity saturation, nonlinear damping or other mechanism, must finally be considered in the control descriptions of the saccadic eye movement system. In addition to the major amplitude-dependent nonlinearity some other interesting asymmetrical behavioral characteristics have been reported.

Primary-Secondary, Secondary-Primary Asymmetry

Some insight into the nature of the nonlinearity noted in saccadic eye movements can be gained by comparison of the waveforms of saccadic eye movements of identical amplitude, but differing initial and final positions in the orbit. If the waveforms were independent of initial and final orbit position, one would be inclined to attribute the nonlinearity to the velocity saturation or force limitation rather than a nonlinear damping, spring restraint or force limiting term dependent upon position of the eye in the orbit. On the other hand, differences between eye movements of identical amplitude, but varying initial and final positions would indicate a position dependent nonlinearity. Unfortunately the data taken by various investigators on these measurements is not in agreement. As mentioned above, Gurevich finds all eye movement average velocities independent of initial orbit

position. However, it must be noted that by recording average velocities rather than peak velocities considerable sensitivity to changes in waveform is sacrificed. Mackenson, using electro-oculographic recording, compared eye movements from the central position to either side (primary-primary) and from the side to the center (secondary-primary). He finds no essential difference in the waveform or peak velocities between these two conditions as shown in Fig. 9. Figure 9a is a family of curves of average saccadic eye movements starting from the origin and going to designated secondary positions, all plotted versus time from initiation of the saccade. In Fig. 9b the eye movements are all from the secondary position to the primary. These findings are in agreement with the older results of Burkner (32). In contradiction to these findings, however, an investigation by Brockhurst and Lion (2) showed that the velocity of eye movements toward the periphery was markedly less than the eye movements of equal amplitude from the periphery toward the center. Their results, shown in Fig. 10 are in agreement with the early reports of Dodge and Cline (9).

Primary-Secondary versus Secondary-Secondary Saccades.

A further interesting comparison relating to the source of the eye movement nonlinearity is the comparison of equal amplitude saccades originating or terminating in the

primary position with saccades passing from one secondary position through the origin to another secondary position. Mackenson's data shown in Fig. 11 clearly indicates that for a given total amplitude of swing the secondary-secondary eye movement reaches higher maximum velocities and is completed in a shorter time than the comparable primary-secondary movement. For example, the top curve in Fig. 11a representing the velocity versus time of the average waveform of the saccadic eye movement from the primary position to 30° left, shows a peak velocity of approximately $410^{\circ}/\text{sec}$ and a total duration of approximately 0.145 sec. The corresponding amplitude saccade in Fig. 11b is the second from the top, going from 15° left of center to 15° right. This movement reaches a peak velocity of approximately $550^{\circ}/\text{sec}$ and takes place over a time duration of only 0.120 sec approximately. One simple interpretation based just on this data, would be that a passive (fluid viscosity) or active (muscle feedback) damping term is dependent upon the position of the eye in the orbit and furthermore is lower in the primary position than it is to either side.

Nasal versus Temporal Saccades

A final comparison of symmetry may be made on the basis of the direction of the saccade, toward the nose (nasal) or away from the nose (temporal). Looking at one eye only, Robinson found a consistently longer duration of eye

movements when moving nasally than when moving temporally, with nasal saccades having on the average approximately 5 msec longer duration than temporal ones (20). Note that a binocular versional saccade will necessarily be temporal for one eye and nasal for the other, and therefore the asynchrony resulting from the different time durations will lead to some image disparity during the eye movement. Because of the elevated visual threshold during saccadic eye movements, this disparity will of course not be seen by the subject. Robinson calculates the disparity between the two eyes as much as 2.5° for a conjugate 15° saccade. In analysis of combined version and vergence movements, one must therefore be careful not to confuse this effect with a true vergence tracking movement.

IV. Proprioception in Extraocular Muscles

A question which has raised considerable interest among physiologists and psychologists for many years, is the presence and possible role of proprioception in eye muscles. Roughly speaking proprioception refers to the feedback of the position of some limb or body member to the brain by means of "displacement transducers". The "transducers" are muscle spindles which provide afferent nerve signals indicating muscle stretch to the brain. A considerable amount of confusion has existed because of misunderstanding of the word proprioception. Strictly speaking, proprioception refers to a negative feedback mechanism controlling motor discharge, based on measurement of muscle tension by the muscle spindle. The conscious awareness of the muscle stretch or "position sense" may be related to, but is not necessarily associated with proprioception.

Control Theory Implications of Proprioception

From a servomechanism point of view, proprioception provides continuous feedback of muscle tension and consequently eye position since the load is normally invariant. Whenever a rapid accurate movement of a mechanical or physiological member is required it is certainly desirable to provide instantaneous position feedback to the forward loop control of this movement.

Referring back to the radar analogy, proprioception is analogous to feedback of radar mount angle with respect to the base, and would be used in rapid slewing of the radar mount in response to a command signal. Furthermore position feedback would be useful in maintaining eye position constant in space during intermittent or long duration disappearances of the visual target. This would be analogous to the "hold" mode of a radar system which has temporarily lost the target it was tracking. Finally position feedback would be useful in interpreting the position of the eye center line, so that the relation of the field of view imaged on the retina could be related to the orientation of the head of the observer. In the tracking radar analogy this corresponds to the calculation of target angle with respect to the radar and radar center line angle with respect to the base as measured by the radar gimbal resolver.

Continuing from a strictly servomechanisms point of view, and ignoring physiological and psychological evidence for the moment, one can also find reasons why proprioception should not be necessary in the eye movement control system. Since carefully graded motor innervation to the extraocular muscles is presumably available, the requirement for sufficient feedback in mediating eye movements is questionable. The requirement for position feedback to prevent output drift is in a sense obviated by the

existence of the slower visual feedback loop which indicates clearly whether or not the eye is looking at the target of interest. Thus at best a proprioceptive feedback loop would be an inner path loop within the overall visual feedback system. Finally, consider the nonchanging nature of the task of the eye movement control system. Under normal conditions the dynamic load presented by the eye ball and the force available from the extraocular muscles do not change , consequently open loop control, once perfectly programmed for each saccadic step amplitude should be perfectly adequate. The ability of position feedback to overcoming the effects of disturbance torques or changes in open loop characteristics is not required in the eye movement control system. Finally the use of position feedback for interpreting the angle of the field of view may be obviated by the ability of humans to, in some manner, calculate the position of the eye on the basis of the effort that was expended in moving the eye from the primary position. Thus arguments on purely servomechanism theory grounds are ~~inconclusive~~ as to the desirability of having proprioceptive position feedback in the eye movement control system. Consequently an examination of the evidence as to the actual state of affairs becomes even more interesting to the investigator concerned with the logic of biological control systems.

Behavioral Experiments

The concept of proprioception and sense of position of the eyeball was introduced by Sherrington in 1918 (21). His theory of conscious position sense based on afferent nerve signals from the extraocular muscles has generally been disproved by a series of behavioral experiments. The simplest experiment contrary to the position sense theory involves the correction of visual impression when the eye is displaced passively. During an active voluntary saccadic eye movement the image of the outside visual field moves on the retina, yet the visual impression is of a stationary outside field. However, when the eye is passively displaced the impression is of a moving outside field, indicating that feedback of eye position is not used to correct the visual impression. Note that this experiment does not eliminate the possibility of feedback of active extraocular muscle tension to correct visual field impression, since the tension of extraocular muscles is obviously different when the eye is passively displaced than when it is actively displaced by means of those muscles. Further experimental evidence along the same line was summarized by Brindley and Merton in 1960 (1). They show that in the absence of visual or tactile cues subjects cannot detect passive movement of one or both eyes, and when the eyes are occasionally

mechanically restrained from moving the subject cannot tell whether he has successfully completed an attempted eye movement or not. Finally they show that passive movement of one eye causes no reflex movement of the other eye. The experiments were interpreted as supporting Helmholtz's view that nonvisual knowledge of eye position depends exclusively on judgement of "the effort of will in attempting to move the eyes". In all of these experiments, however, an external force was introduced in addition to the force of the extraocular muscles on the eyeball, either to passively displace the eye or to prevent active displacement. Thus the mechanical impedance of the eyeball as seen from the muscles was changed from the normal value, and the stretch-tension relation of the extraocular muscles was altered. Consequently these experiments do not eliminate the possibility of "position sense" stemming from sensation of tension in the extraocular muscles, where under normal conditions this tension bears a unique if nonlinear relationship to eyeball position. By simply investigating the ability of subjects to identify the direction of gaze of their unencumbered eyes when fixating a target having no visual reference field, Ludvigh demonstrated that the eye indeed has position sense, but that it is gross in comparison to the accuracy of eye stabilization and the accuracy of other proprioception in the body (15). He estimated the accuracy of the proprioceptive sense as no better than 10° , which is exceedingly gross compared to

the visual detection of direction of gaze, and is far less accurate than the position sensitivity of the hip joint, for example, where passive movements of 0.2° are perceptible. Ludvigh admits the possibility of the position sensing he observed resulting from the "feel" of the eye movements resulting from sensations from the eyelids. Finally, a recent paper by Christman and Kupfer presents anatomical evidence showing why the extraocular muscles, which do have a well developed proprioceptive stretch reflex system, cannot lead to conscious position sense. They point out that awareness of position arises from joint receptors and not from muscle or tendon organs, and that since eyeball movements involve no joints, there cannot be any position sense associated with them (3).

Physiological Evidence

While the possibility of conscious position sense through spindle receptors has been eliminated, the evidence for nonconscious proprioception has been strengthened in recent years. The existence of muscle spindles necessary for proprioceptive feedback has been found in the extraocular muscles of goats and other animals, but not until recently in the eye muscles of man as described by Cooper, Daniel and Whitteridge (6). In addition to identifying the muscle spindles they found fibers running up to the brain clearly indicating the existence of proprioceptive feedback. Breinin has presented electromyographic evidence to show

the role of the muscle spindles in regulating the tension of the extraocular muscles. The smoothly graded reciprocal innervation of the agonist-antagonist pair of eye muscles is lost when the normal feedback mechanism is lost by detaching the muscles from the globe. The resulting pull-on pull-off muscle forces are what would be expected when force feedback was eliminated and a control loop driven to its force limits. The role of the muscle spindles which seems to emerge is one of force sensing rather than position transducers, used to regulate the carefully programmed force levels required to perform accurate saccadic eye movements.

V. Control Models for the Saccadic Eye Movement

A number of investigators have attempted to describe the mechanics of the saccadic eye movement control system using a variety of simplified assumptions and hypotheses concerning the physiological mechanisms. This section will examine a number of possible control schemes which might be proposed a priori for the rapid rotation of the eyeball, and will review critically those attempts which have been published.

Westheimer's Model

The first, and conceptually simplest model, assumes that the eyeball is restrained by linear springs, and that it comes to rest at a position where the active force exerted by the muscles just balances the spring force. The first simple approximation to the form of the saccadic eye movement based on a model of this type was proposed by Westheimer in 1954 (25). Westheimer's model is open loop in nature and assumes that for a given amplitude saccade a certain change in torque is applied by the extraocular muscles, and that the resulting eye motion is determined solely by the restraining forces on the eye. He suggested the motion can be described in terms of a second order linear differential equation:

$$A_2 \ddot{\theta} + A_1 \dot{\theta} + A_0 (\theta - \theta_c) = f(t)$$

A_2 is identified as the eyeball moment of inertia; A_1 , the coefficient of friction; and A_0 the elastic restraint exerted by the relaxed antagonist muscle as the eye's position is changed. θ is eye position; θ_c , some central stable position; and $f(t)$, the forcing function applied by the agonist muscle. Notice that the restraining torque exerted by the antagonist muscle is assumed to be passive, a function only of $\theta - \theta_c$, and not a programmed force.

By assuming that $f(t)$ is a step increase in torque for a saccadic step, one can determine the values of the natural frequency and damping constant which best fit a typical saccadic response. The determination of the natural frequency depends somewhat on the criteria of evaluating the transient response and approximation to a second order response (26). The values are:

$$\omega_n = 240 \text{ radians/sec}$$

$$\xi = 0.7$$

Westheimer noted that this assumption of a step forcing function is inexact and furthermore pointed out the existence of nonlinearities of the viscous term and in the tension vs. extension relationship of the opposing muscle.

Vossius' Model

A basically different description of the nature of the individual saccadic mechanism has been proposed by

Vossius (24). He assumed that the saccadic mechanism is not a ballistic movement within an overall visual feedback loop, but that the individual saccadic jump itself is controlled by an inner loop proprioceptive feedback mechanism for muscle spindles on the extraocular muscles. As support for this theory he reports the existence of five different classes of the time course of saccadic movements and argues that the existence of all of these classes of responses is inconsistent with the assumption that the mechanism is of the open loop variety.

The model proposed by Vossius is drawn in Fig. 12. The reaction time is divided into a long brain delay ($t_1 = 130$ msec) and a shorter transport delay inside the proprioceptive loop ($t_0 = 5 - 10$ msec). The muscle transfer function is given as a constant. The eyeball dynamics are assumed to consist of its inertia and friction but no spring restraining torque, leading to a time constant τ_1 (15 msec). The proprioceptive feedback from eye position back to muscle command by way of the muscle spindles, is assumed to include rate as well as position feedback. The open loop transfer function for the inner loop is

$$TF_{OL} = \left[\frac{K_1}{s(1 + \tau_1 s)} + \frac{K_0}{(1 + \tau_1 s)(1 + \tau_2 s)} \right] e^{-st_0}$$

Vossius indicates by taking the step response of the closed loop transfer function any of the five classes of saccadic response will be produced through adjusting the relative magnitudes of the constants K_1 and K_0 .

The behavioral and electromyographic data against position feedback proprioception discussed in the previous section argue against the Vossius model. It would not, however, eliminate the possibility of muscle spindle feedback from the muscle force exerted on the eye, and would require that the feedback path of Fig. 12 be taken from a point between the muscle and the eye, following the muscle constant K_A .

Both the Westheimer and Vossius models are linear, and make no explicit allowance for the observed nonlinearity of eye velocity vs. saccadic amplitude, or the smooth reciprocal innervation and force limitation of the agonist-antagonist muscle pairs. The nonlinear relationships mentioned above, as well as the approximate "velocity triangle" shape of the individual saccadic movements suggest the consideration of several simple non-linear models. One obvious model is the force-limited bang-bang model. In its simplest form this model would call for an initial maximum acceleration force exerted by the agonist muscle until the eye had reached the midpoint of the desired rotation, followed by complete relaxation of the agonist and maximum force "braking" tension

by the antagonist to bring the eye to a stop at the desired new position. If the accelerating and decelerating forces are constant, at their maximum values, then the only parameter which can be varied is the time at which the reversal takes place. Assuming that the eyeball is primarily an inertial load, the time duration of each saccade should be proportional to the square root of the saccadic amplitude. Such a relationship does not yield a particularly good fit to the experimental data. Furthermore, the patterns of velocity and acceleration during a typical saccadic eye movement are decidedly not symmetric about the midpoint, as seen clearly in Fig. 13. Finally the electromyographic data taken during saccadic eye movements, although not terribly clear, does show some smooth reciprocal innervation rather than on-off behavior of the agonist-antagonist pair. This simple full acceleration - full deceleration, variable timing model must therefore be rejected.

A logical extension of the full forward - full back model mentioned above is a "pulse pair" forcing function concept. If one assumes a constant impulse starting and stopping force, with a constant velocity coast time separating the two, the control law could be visualized as regulation of the coast period as a function of desired saccadic step amplitude. If the eyeball dynamics are assumed to consist of only mass and a viscous term, but no spring constant, then the eyeball velocity does not reach its

maximum value after the cessation of the accelerating impulse, but rather rises to this velocity with a first order response. This could explain the observed data discussed earlier on maximum velocity vs. saccade amplitude, in which the velocity increases with amplitude for small amplitudes, and levels out at 500 to 600°/sec for amplitudes larger than 20°. Large amplitude saccades do indeed exhibit a fairly long constant velocity coast phase. Once again the lack of symmetry in the saccadic response curves leads to the rejection of this simple bang-bang model which does not contribute any active or passive spring constant to the eyeball dynamics.

Robinson Model

The variety of possible control models for the saccadic eye movement mechanism discussed above is a direct consequence of the limited amount of experimental data to check any model. In fact, in addition to the estimates of the physical parameters of the physiological components, the investigators had only one set of data to match, namely, the normal saccadic eye movement responses over a variety of amplitudes. This situation was recognized by Robinson who performed an elegant series of controlled experiments designed to examine the saccadic eye movement system under abnormal conditions (20).

One of the problems with analysis of the model discussed above was that there was no simple way of determining the force program or forcing function on the right hand side of the equation, since any given eye movement pattern could be attributed either to the eyeball dynamics (mass, friction and spring constant) or the muscle force program. In measurements on isometric saccades Robinson determined the force program applied to the eye in the absence of any eye movement. Experimentally he restrained the left eye from moving through a contact lens and measured the force applied by the eye to the restraint, while the unencumbered right eye made a normal saccade. The results of these experiments for a variety of saccadic movement amplitudes, are shown in Fig. 14. Forces are measured in grams at the edge of the eyeball. Notice that the peak force is not a linear function of saccadic eye movement amplitude, reflecting the nonlinear relationship between eye movement velocity and amplitude. It is particularly interesting to notice that the muscle force remains above the steady-state value for almost 200 msec after the completion of the saccadic movement. Robinson points out the importance of this long duration exponential decay as indicating that the mechanical events of the eye movement system are not completed when the eye comes to rest, but rather that active force from the muscle is continuing to counteract the long time constant visco-elastic elements in the orbit.

Since the force measurements of Fig. 14 are measured at the eyeball, they are not the active-state tension but rather represent the force commands as filtered through the visco-elastic elements between the muscle and the eye. Finally the steady-state tension revealed in this figure, as a function of saccadic amplitude, yields a mean ratio of steady-state force to saccadic magnitude of approximately 1.5 grams/degree when the correction for the spring constant of the restraining mechanism is included.

As a complementary experiment to the isometric saccades, Robinson also experimented with isotonic movements. In an isotonic movement, the time course of eye movement is measured when a passive constant force is applied. Constant forces were applied to the eye through application and removal of a series of weights connected to the eye through levers attached to the contact lens. If visual or proprioceptive inputs are ignored for the moment, these experiments may be considered as demonstrations of the step response of the eye to force inputs. The observed responses, as shown in Fig. 15, are not the rapid eye movements typical of saccades but rather represent rather long sluggish responses which Robinson has described as the sum of two exponentials. He attributes the slow part of the time course to the eyeball visco-elastic elements, and argues that they are not observed in normal unrestrained saccades because they are just canceled by

the net active state tension applied to the eyeball. The average steady-state displacement for each of the isotonic experiments reveals an independent estimate of the passive elastic restraint coefficient. The mean spring stiffness obtained from the isotonic experiments is 1.43 grams/degree, which is in good agreement with the 1.54 grams/degree obtained from measuring the active force in the isometric experiments.

As an additional test of the saccadic eye movement system under abnormal conditions Robinson artificially increased the moment of inertia of the eye by a factor of nearly 100. The saccadic eye movements obtained with this greatly increased moment of inertia showed only an 18% overshoot. These experiments are consistent with the heavily overdamped passive system discovered in the course of the isotonic eye movement experiments, and indicate clearly that the rapid eye movements of apparent low damping constant ($\xi = 0.7$) discussed by Westheimer, are in reality representations of a highly overdamped system controlled by a carefully compensated "fast acting" force program.

Robinson supplemented his experiments on normal and abnormal saccadic eye movements with a summary of the length tension relationships in the cat lateral rectus muscles. By plotting families of length tension curves with the

passive and active elasticity components were separated.

With the experimental evidence afforded by the isometric, isotonic and high inertia investigations of the saccadic eye movement system, Robinson proposed a simple configuration of the mechanical elements of the orbit as a model for the system. The force velocity and stress-strain curves of the extraocular muscles were linearized for the model, and the parameters were all assumed independent of the position of the eye in the orbit. Robinson's model is shown in Fig. 16. The mass of the globe is assumed acted on by muscle force (F_m), passive restraining forces (F_p), and possible external forces exerted on the eye during isotonic experiments (F_a). The moment of inertia of the eye may be artificially increased by the mass, M ; and the passive structure used to restrain the eye during isometric experiments is represented by the mass and spring system K_1 and m_1 . The passive restraining forces on the eye are assumed to be generated by a pair of visco-elastic elements (K_1, R_1 and K_2, R_2), one of which accounts for the long time constant and other for the short time constant as observed in the isotonic eye movements. Muscle force stems from active state tension (F_0) filtered through a damping of coefficient R_m , and a series elastic element of stiffness K_e . The parameters of the model are based on both physiological data and iterative approximations to yield the best match with experimental data.

The table shown below summarizes all the coefficients used by Robinson in the final model.

Table 1

<u>Parameter</u>	<u>Symbol</u>	<u>Value</u>
Net muscle series elastic stiffness	K_e	3.6 g/deg
Net muscle force-velocity slope	R_m	0.072 g.sec/deg
Muscle time constant	T_m	0.02 sec
Fast passive visco-elastic elements	Spring stiffness K_1	2.06 g/deg
	Viscosity R_1	0.025 g.sec/deg
	Time constant T_1	0.012 sec
Slow Passive visco-elastic elements	Spring stiffness K_2	6.36 g/deg
	Viscosity R_2	1.81 g.sec/deg
	Time constant T_2	0.285 sec
Combined passive spring stiffness	$\frac{K_1 K_2}{K_1 + K_2}$	1.5 g/deg
Isometric beam stiffness	K_1	15.0 g/deg
Moments of inertia	Eye & Lens m	$0.677 \times 10^{-4} \text{ g.sec}^2/\text{deg}$
	With isometric beam $m + m_1$	$2.16 \times 10^{-4} \text{ g.sec}^2/\text{deg}$
	With sled load $m + M$	$28.9 \times 10^{-4} \text{ g.sec}^2/\text{deg}$

Figure 17 shows the comparison of model and experimental data after iteration for best fit of the model parameters, matching eye movement force or position for the isometric,

isotonic, high inertia and normal saccadic eye movements of 10° magnitude. In addition, the lower half of the figure shows the active state tension (F_0) which had to be assumed as the programmed input to the eye movement system to achieve the normal 10° eye movement saccade. Notice that the active state tension has a brief large magnitude value for the first 40 msec followed by a slow decay to a final resting level. It is this large initial jump which accounts for the rapid onset of the overdamped eye movement system. In considering other amplitude saccades, Robinson varied the form of the active state tension to best match the eye movement response for saccades from 5° to 40° amplitudes. He reported that the strength of the early excess force was relatively constant --about 25 grams, but that its duration increased nonlinearly with the saccadic magnitude, thereby leading to the non-linear system behavior with amplitude.

In summary, Robinson's model successfully accounts for the approximate time course of normal saccadic eye movements over a wide range of amplitudes as well as the variety of abnormal test situations to which he subjected it. He showed that the eye is driven in a saccade by a rapid brief burst of force followed by a decreasing active tension in the muscles to overcome the visco-elastic forces in the eye, with steady-state restraining forces of 1.5 grams/degree. His estimation of active tension was

based on a best fit of the output of his model with the experimental data and is open to some question since it is heavily dependent upon the form assumed for the net muscle elastic stiffness and force velocity relationship, as well as the linear approximations to these parameters. Nevertheless, Robinson's model clearly is more successful in accounting for the basic saccadic eye movement mechanism, than the simple open-loop or closed-loop linear approaches described above. It remains only to determine by physiological experiments the parametric values which he chose on the basis of matching his model to the experimental data.

Cook's Model

The final model of the saccadic eye movement control system to be considered is one recently developed by Cook (5), and in some ways may be considered a refinement of the approach used by Robinson. The basic approach taken by Cook was to assume the dynamic characteristics of the "plant" or muscle-eyeball combination, based on available physiological data. By measuring output position velocity and acceleration during saccadic eye movements, he was able to work backwards to determine what the control variables must have been in terms of nerve signals. In building up a model of the mechanical configuration of the eye

movement mechanism, Cook followed much the same path as Robinson, with two important refinements. Rather than treating the net muscle force on the eye, Cook considered the forces generated by the agonist and antagonist muscles separately, thereby accounting for the difference in characteristics of muscles when they are shortening (agonist) and when they are lengthening (antagonist). The differing rise times associated with muscle tension following stimulation, known to depend upon whether the muscle is shortening or lengthening, are included in his description. The second major refinement included by Cook is the addition of nonlinear active damping in the agonist and antagonist muscles. As mentioned previously, Robinson estimated his active damping coefficient as a linear approximation to the net muscle force-velocity slope. Cook relied upon the data of Katz showing that damping in the muscle being lengthened is quite different than that for a muscle being shortened, and adapted Hill's analytic description of shortening active muscle behavior (11). Based on these physiological considerations, the composite model for eye movement mechanisms proposed by Cook is shown in Figure 18. The mass of the eyeball is shown as subject to forces from the antagonist and agonist muscles, as well as passive elastic and viscous forces. Cook assumed the equivalent inertia seen by the muscle at the edge of the

eyeball as

$$J = 0.43 \times 10^{-4} \text{ g.sec}^2/\text{deg}$$

using the same system of mixed units as Robinson.

(Robinson's final parameter for "mass" of the eye and lens is $0.677 \times 10^{-4} \text{ g.sec}^2/\text{deg}$, but he also mentions that the functional moment of inertia owing to the non-rigid nature of the body might be closer to $0.3 \times 10^{-4} \text{ g.sec}^2/\text{deg}$.) Cook's original estimate of the passive elastic coefficient is

$$K_p = 1.9 \text{ g/deg,}$$

but later modification to match experimental results yields

$$K_p = 1.5 \text{ g/deg}$$

which is exactly the combined passive spring stiffness used by Robinson. The major differences between Robinson's and Cook's models lie in the viscous components. Using Robinson's isotonic experimental data interpreted in terms of his own model, Cook calculated the passive damping coefficient to be

$$B_p = 0.019 \text{ g.sec/deg}$$

This quantity is considerably lower than either of the passive viscosity elements in Robinson's model, and similarly is only about one fifth of the active damping viscosity which Cook's model would attribute to the muscles for this case. (Cook's final adjusted value of this parameter is $B_p = 0.018$ g.sec/deg.) The muscle series elastic element was originally estimated as

$$K_a = 6 \text{ gm/deg}$$

and later adjusted on the basis of experimental matching to be

$$K_a = 1.8 \text{ gm/deg}$$

(Robinson's net muscle series elastic stiffness is 3.6 gm/deg, which exactly matches the effect of two muscles acting, each with 1.8 gm/deg stiffness.)

The active damping in the agonist muscle (B_{ag}) and antagonist muscle (B_{ant}) depends not only upon the difference between the two muscles, but on the values of antagonist tension ($T_{s_{ant}}$) and agonist tension ($T_{s_{ag}}$). Furthermore as mentioned before, the expressions for the damping depend upon whether the muscle is lengthening or shortening. The relationships used to describe these parameters are:

$$B_{ag} = \left[\frac{1.25 s_{ag} (N)}{1500 + \dot{\theta}_2} \right] \text{ gm sec/deg; } \dot{\theta}_2 \geq 0.$$

$$B_{ag} = \left[\frac{3T_{sag}(N)}{1500} \right] \text{ gm sec/deg; } \dot{\theta}_2 < 0.$$

$$B_{ant} = \left[\frac{1.25T_{sant}(N)}{1500 - \dot{\theta}_3} \right] \text{ gm sec/deg; } \dot{\theta}_3 \leq 0.$$

$$B_{ant} = \left[\frac{3T_{sant}(N)}{1500} \right] \text{ gm sec/deg; } \dot{\theta}_3 > 0.$$

Using these assumptions and the data on eye movement position and velocity during saccades it was possible to go back and compute the tension in the antagonist and agonist muscles. To go one step further back and compute the neural activation to the agonist and antagonist muscles (C_{ag} and C_{ant}) requires an assumption about the activation and de-activation process which translates neural signals to tension level. A simple form for the antagonist vs. time was based on its electromyogram, and C_{ag} was later computed. Cook applied his program to calculation of the agonist and antagonist tension levels and theoretical activation time courses for a variety of saccadic movement amplitudes. Some of these results are shown in Figure 19. It is not possible at the present state of the art of electromyography to either confirm or disprove these models. However, the

evidence does seem to show that the activation and de-activation time courses have smooth onset as indicated by Cook rather than the very sharp rise times predicted by Robinson. Cook's model requires a steady-state resting tension at 0° of 37.5 grams. The peak value of the agonist activation computed through Cook's model on the basis of variety of saccadic amplitudes and initial positions, shows a fairly consistent behavior as a function of size of saccadic jump and initial position. This relation is shown in Fig. 20 and the straight lines may be described by the equation

$$\text{Max } \{ C_{ag} \} \approx 37.5 + 3.5(\theta_{1_{\text{final}}} - \theta_{1_{\text{initial}}}) + 2\theta_{1_{\text{initial}}}$$

Cook's model was also successful in matching the isotonic experiment performed by Robinson, although parts of this experimental data were used in developing the passive-damping parameter of the model. The isometric experiment was also successfully simulated by Cook's model, which serves as an important check on the model since the data was not used in its development.

In summary the Robinson and Cook models appear to account for the major characteristics of saccadic eye movement behavior, showing clearly that some type of programmed active tension and both passive and active visco-elastic elements are involved in the system.

The exact nature of the program force calculated depends upon the forms assumed for the active impedance of the muscle, and until more accurate and repeatable electromyographic data is available, no independent checks of these neural signals appear to be possible. As a final note it should be pointed out that in neither of these models does proprioceptive feedback of extraocular muscle stretch or force appear explicitly. However, the active muscle damping and/or series elastic restraint could conceivably be mediated by feedback of muscle tension.

Bibliography

1. Brindley, G.S. and P.A. Merton. J. Physiol. 153: 127-130, 1960.
2. Brockhurst, R.J. and K.S. Lion. Analysis of ocular movement by means of an electrical method. AMA Arch. Ophth. 46:311-314, 1951.
3. Christman, E. and C. Kupfer. Proprioception in extra-ocular muscle. AMA Arch. Ophth. 69:184, 1963.
4. Cogan, D.G. Neurology of the Ocular Muscles. Charles C. Thomas Co., Springfield, Ill. 1948.
5. Cook, G. Control system study of the saccadic eye movement system. Sc.D. Thesis, M.I.T., E.E., June 1965.
6. Cooper, S., P. Daniel and D. Whitteridge. Muscle spindles and other sensory endings in the extrinsic eye muscles: the physiology and anatomy of these receptors and their connections with the brainstem. Brain 78:564, 1955.
7. Cooper, S. and J.C. Eccles. Isometric responses of mammalian muscles. J. Physiol. 69:377, 1930.
8. Davson, Hugh, ed. The Eye. Academic Press, N.Y. 1962.
9. Dodge, R. and C.W. Cline. in Psycholog. Rev. 8: 145, 1901.
10. Gurevich, B.Kh. Universal characteristics of fixation reflexes of the eye. Biofizika 6:377 (Trans. from Biophysica, page 95), 1961.
11. Hill, A.V. Energy liberation and "viscosity" in muscle. J. Physiol. 93:4, 1938.
12. Horrocks, A. and L. Stark. Experiments on error as a function of response time in horizontal eye movements. Q.P.R. 72, Res. Lab. Elec., M.I.T., pp. 267-269, Jan. 15, 1964.
13. Latour, P.L. Visual threshold during eye movements. Vision Res. 2:261-262, 1962.
14. Lion and R.J. Brockhurst. Study of ocular movements under stress. AMA Arch. Ophth. 46:315, 1951.

15. Ludvigh, E. Possible role of proprioception in the extraocular muscles. AMA Arch. Ophth. 48:436-441, 1952.
16. Mackensen, G. Die Geschwindigkeit horizontaler Blickbewegungen untersuchungen mit Hilfe der Electrooculographie. Gr. Arch. Ophth. 160:47-64, 1958.
17. Meiry, Jacob. The vestibular system and human dynamic space orientation. Sc.D. Thesis, M.I.T. June 1965.
18. Park, R.S. and G.E. Park. The center of ocular rotation in the horizontal plane. Am.J. Physiol. 104:545, 1933.
19. Rashbass, C. The relationship between saccadic and smooth tracking eye movements. J. Physiol. 159:326, 1961.
20. Robinson, D.A. The mechanics of human saccadic eye movements. J Physiol. 174:245-264, 1964.
21. Sherrington, C.S. Observations on the sensual role of the proprioceptive nerve supply of the extrinsic ocular muscles. Brain 41:332-343, 1918.
22. Stark, L., C. Kupfer and L.R. Young. Physiology of the visual control system. NASA CR-238, June 1965.
23. Stark, L., L. Young and G. Vossius. Predictive eye movement control. Inst. of Radio Engineer's Trans. on Human Factors in Electronics. Vol. HFE-3:52-57, 1962.
24. Vossius, G. Das system der Augenbewegung. Ztschr. Biol. 112:27, 1960.
25. Westheimer, G. Mechanism of saccadic eye movements. AMA Arch. Ophth. 52:710-724, 1954.
26. Westheimer, G. Personal communication with G. Westheimer, 1962.
27. Wolff, E. Anatomy of the Eye and Orbit. 5th ed. W.B. Saunders Co., Philadelphia & London, 1961.
28. Young, LR. Biological Control Systems -A Critical Review and Evaluation: Vestibular Control System. Contract NAS 2-1372, National Aeronautics & Space Administration, Ames Research Center, Moffett Field Calif. Nov., 1963.

29. Young, L.R. A sampled data model for eye tracking movements. Sc.D. Thesis, M.I.T. June 1962.
30. Young, L.R. and L. Stark. Dependence on accuracy of eye movements on prediction. Q.P.R. 67, Res. Lab. Elec. M.I.T. Oct. 15, 1962. pp.212-214.
31. Zuber, B.L. Physiological control of eye movements in humans. Ph.D. thesis, M.I.T., 1965.
32. Bruckner, A. Uber die Anfangsgeschwindigkeit der Augenbewegungen. Pflug. Arch. ges. Physiol. 90: 73-93,1902.

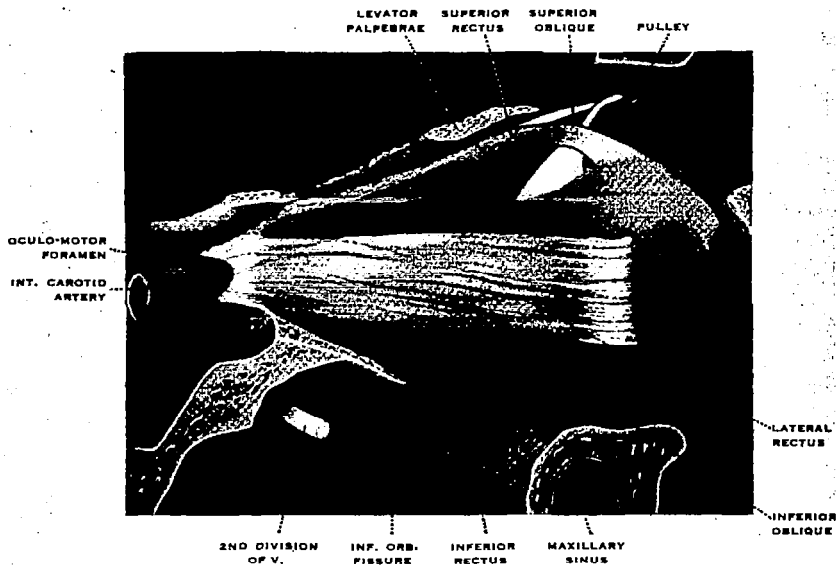

Fig. 1. Dissection view of the eyeball & extrinsic muscles. (27)

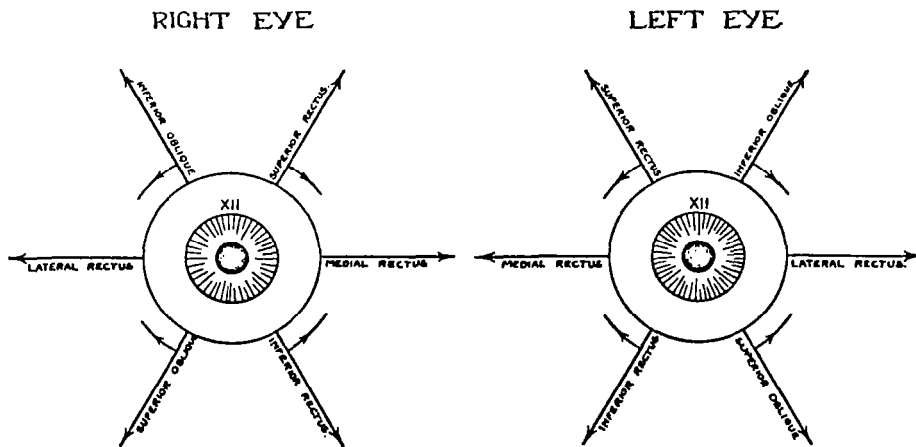

Fig. 2. Schematic diagram of extraocular muscle actions. (27)

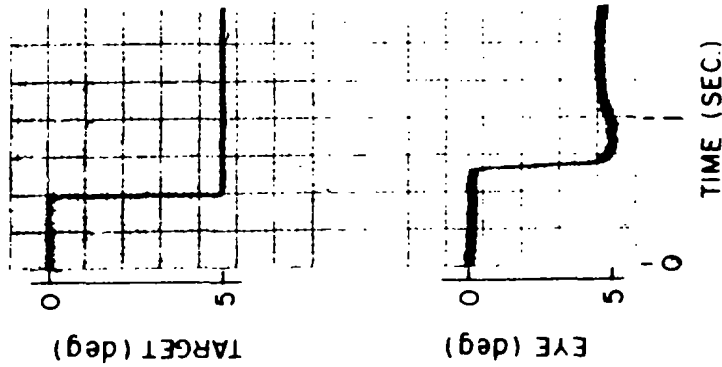
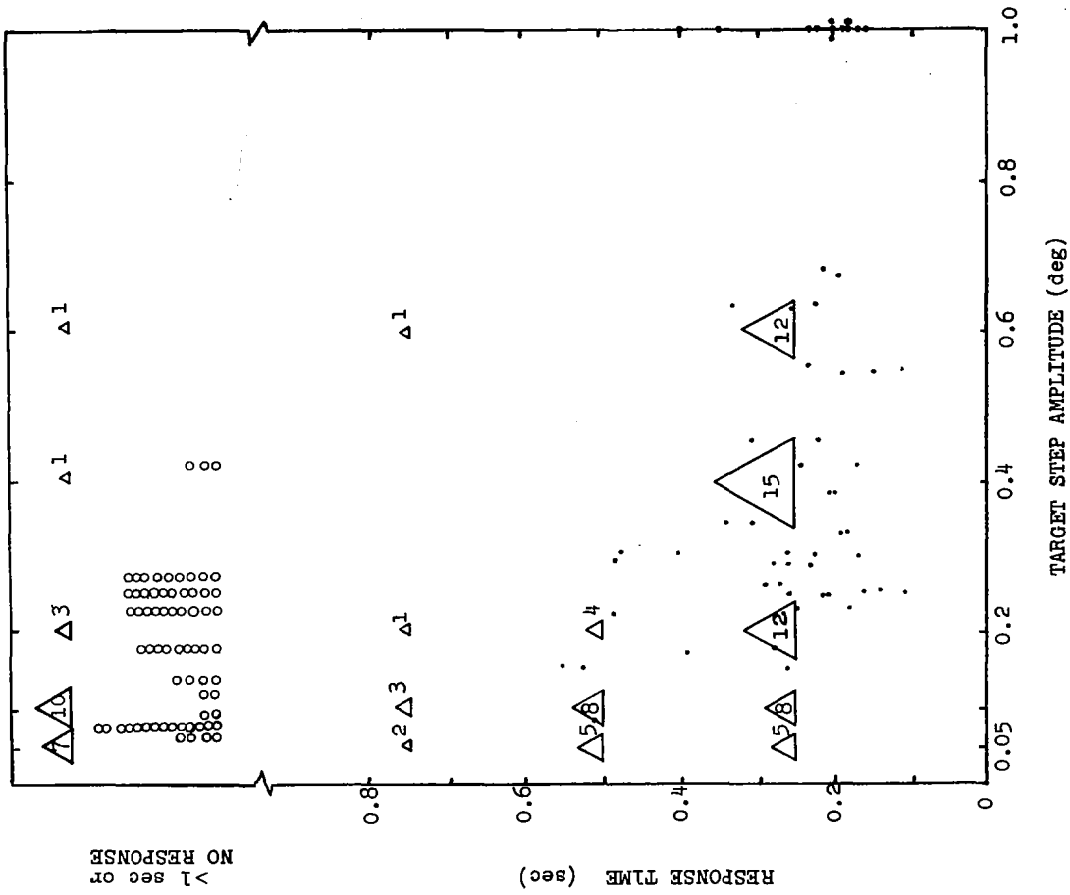

Fig. 3. Typical record of a 5 degree saccadic eye movement in response to a step of target position. (29)



O • Young (1962).
 Δ Biosystems Data, Young (1965).
 - Numerals represent No. of data points.

Fig. 4. Response time as a function of target step size. (29)

Probability of Corrective Saccade in Time t

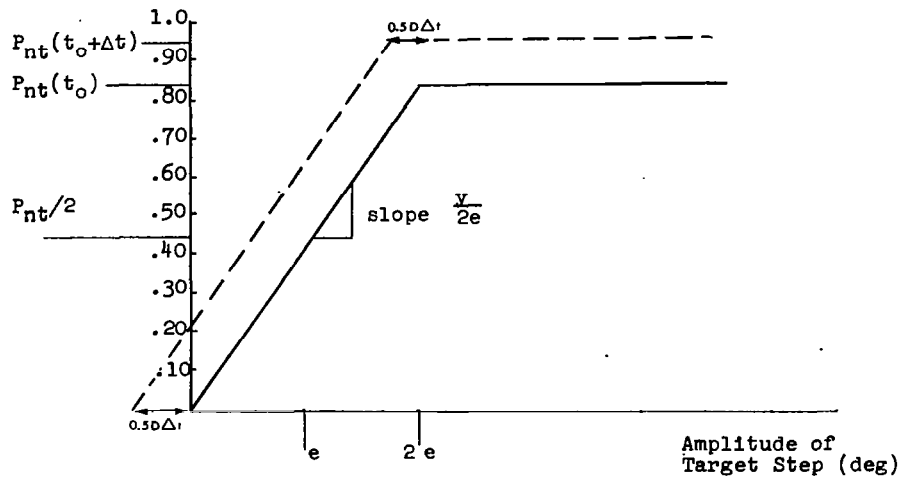

Fig. 5. Statistical model predictions of probability of corrective saccade. Solid line: predicted probability density of corrective saccade occurring in one reaction time. Dashed line: predicted probability density of corrective saccade occurring in one reaction time plus Δt sec. Slope: $y/2e$

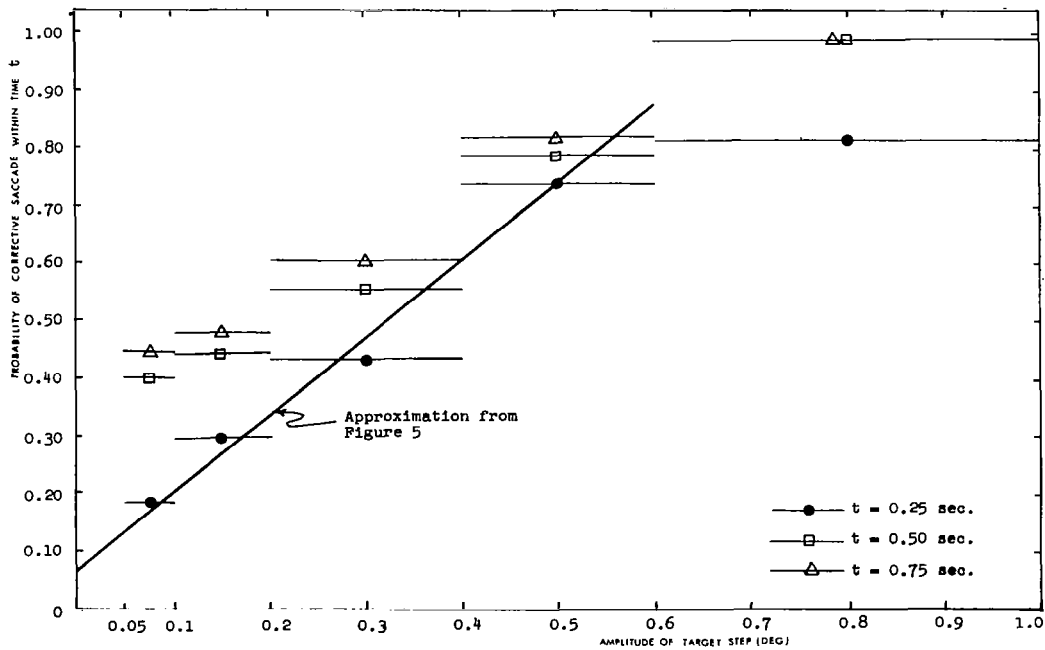
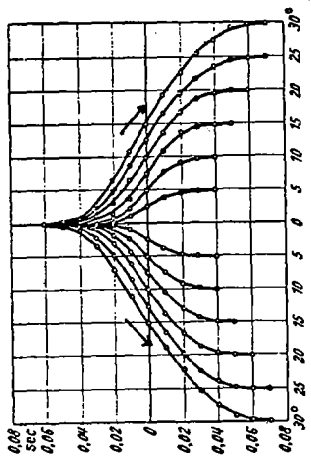
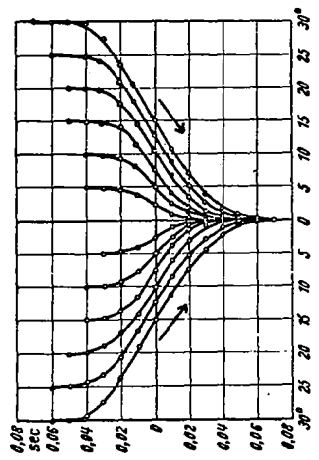

Fig. 6. Probability of corrective saccade within time t versus target step amplitude.



(a)



(b)

Fig. 9 (a) Eye movements from the primary position to a secondary position. Average curves based on 10 normal eye movements. (b) Eye movements from a secondary to the primary position. (16)

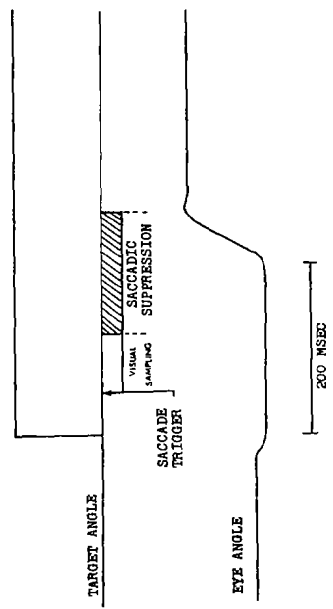

Fig. 7. Timing of sampling and suppression of visual information.

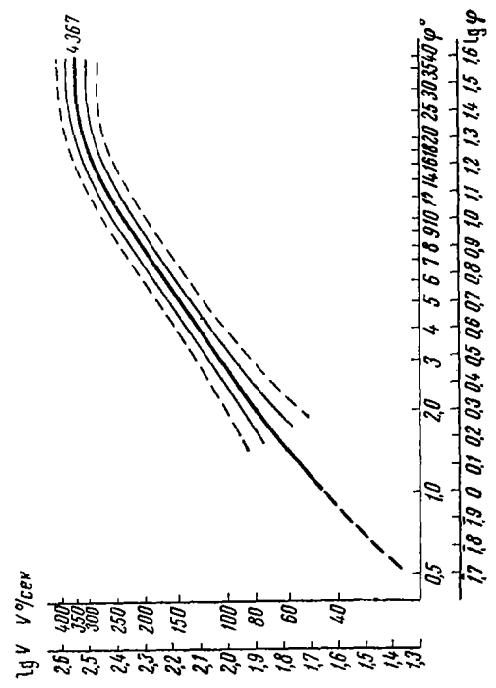

Fig. 8. "Universal" curve of the speed of jumps in movements along the horizontal (averaged data for 3 subjects). Heavy solid line - average speeds; thin lines - scatter (std. deviation); broken line - total scatter (two std. deviations); heavy broken line - extrapolation in the region of small jumps. Number on the curve - number of observations. (10)

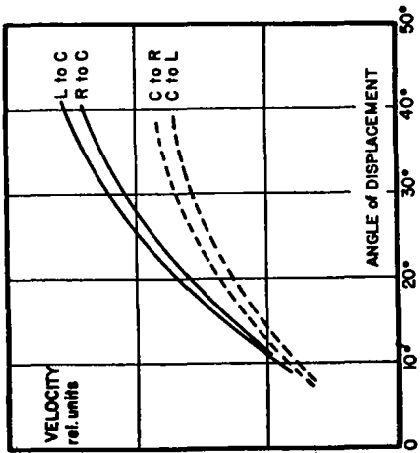
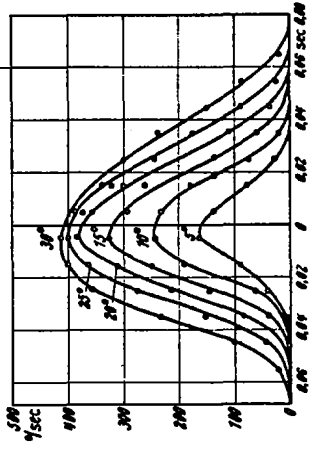
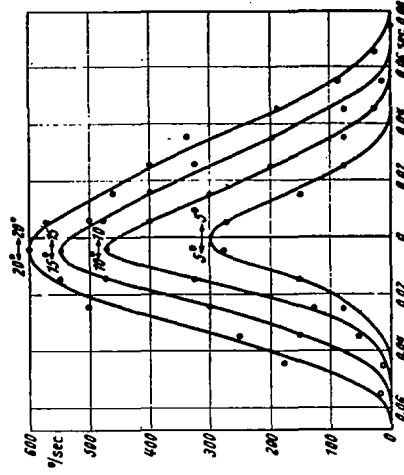

Fig. 10. Eye velocity of a movement toward the periphery and that of a movement toward the center. (2)



(A)



(B)

Figure 11. (A) Change of velocity in the course of eye movements of various sizes. All deviations were carried out from the primary position to the left.

(B) Changes of velocity of eye movements of various magnitude, which have been carried out from the left to the right half visual field (secondary-secondary).

(16)

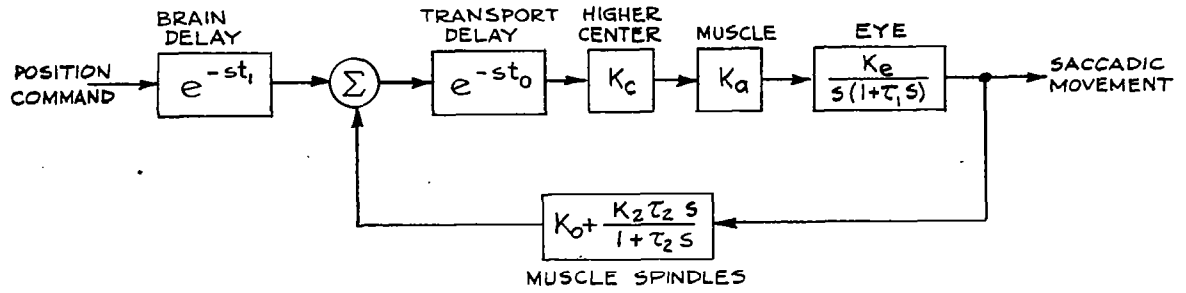

Fig. 12. Vossius' model for saccadic mechanisms. (29)

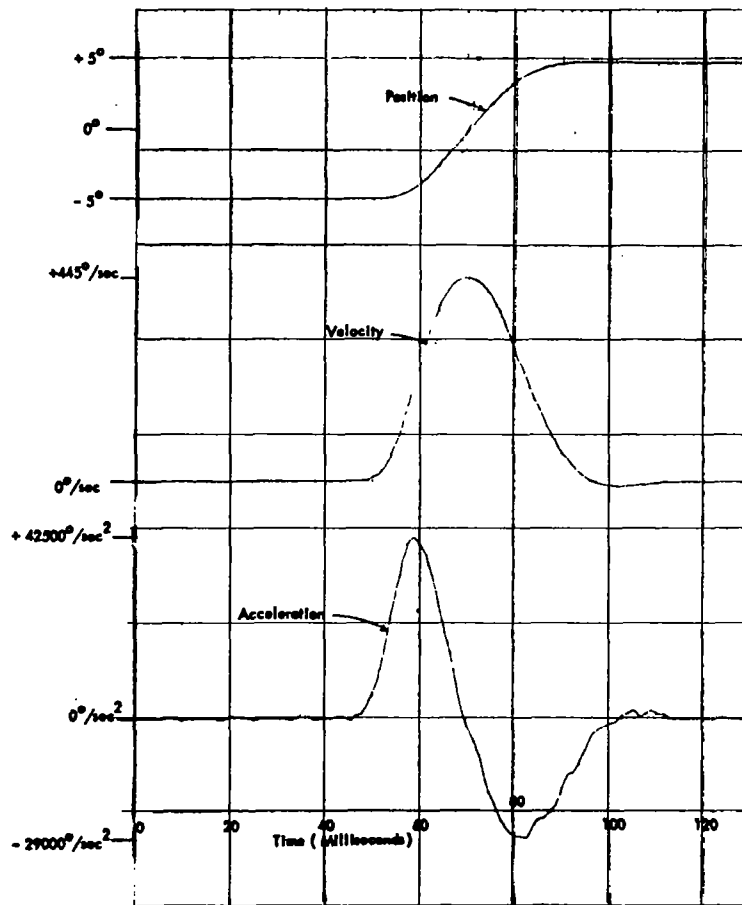

Fig. 13. Position, velocity and acceleration for a 10° saccadic movement, averaged from 65 samples. (5)

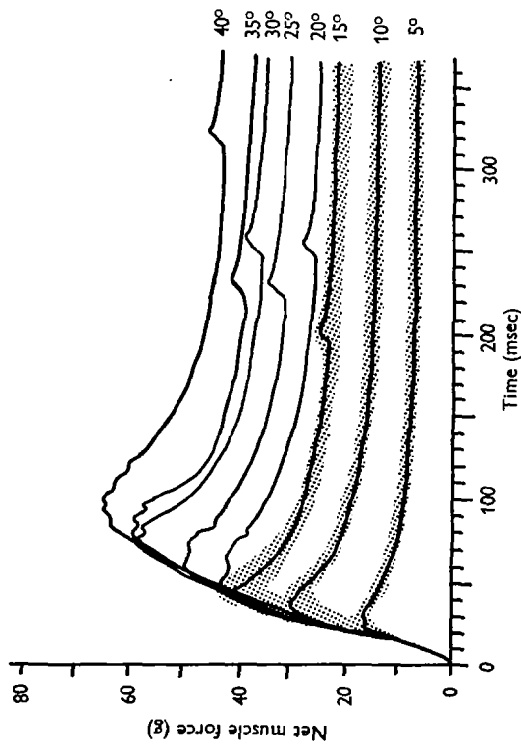

Fig. 14. Superimposed tracings of tension recorded from an isometric rod which restrains the eye from moving for various saccadic movements (5° - 40°) of the free eye. Ordinate is scaled to show net muscle force at the moment arm of the radius of the eyeball (12mm). Shading on the first three records represent the range of 18 records over 3 subjects. (20)

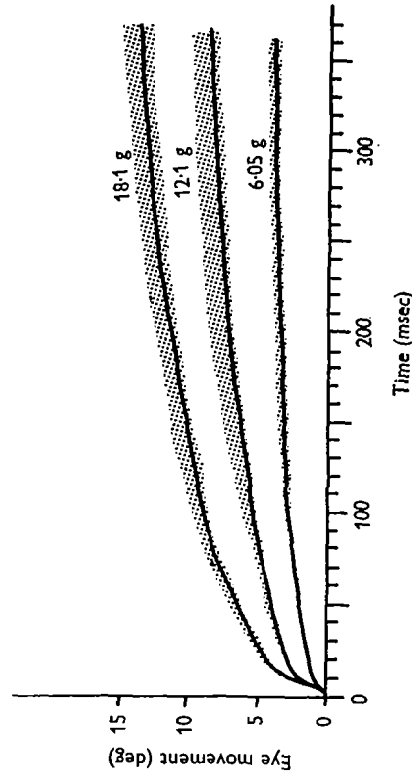

Fig. 15. Superimposed tracings of isotonic eye movement after being released from the application of the three forces shown. Shaded areas represent the range of nine records over 3 subjects. (20)

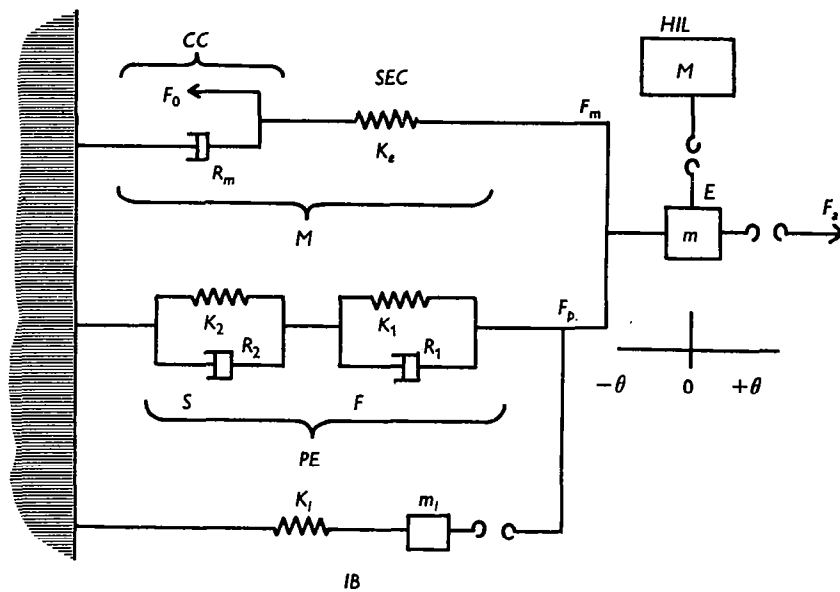

Fig. 16. Robinson's model for the mechanical elements of the extraocular system. (20)

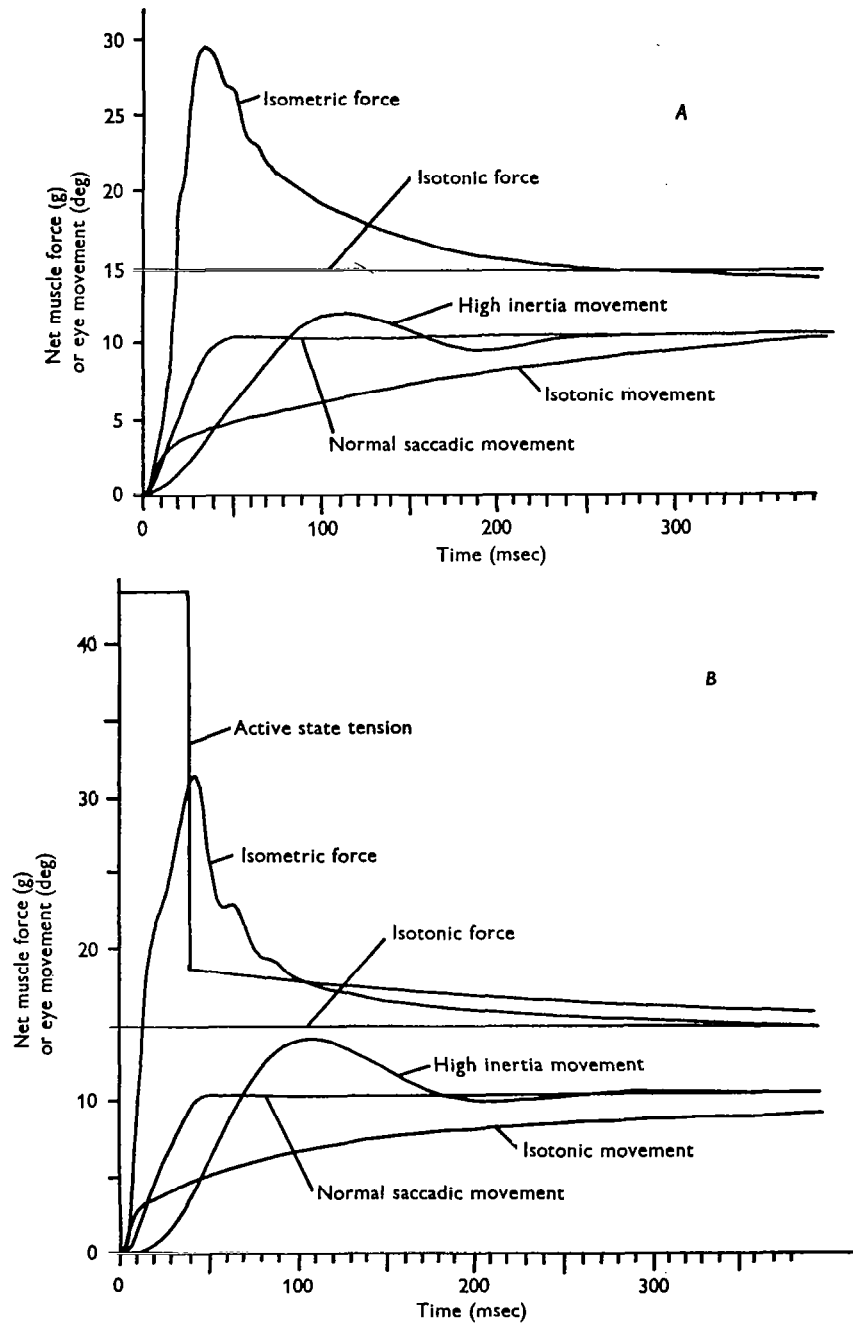

Fig. 17. A. The typical time courses of normal, isometric, isotonic and high inertia force or position for a 10° saccade. B. The same time course as calculated by Robinson's model. (20)

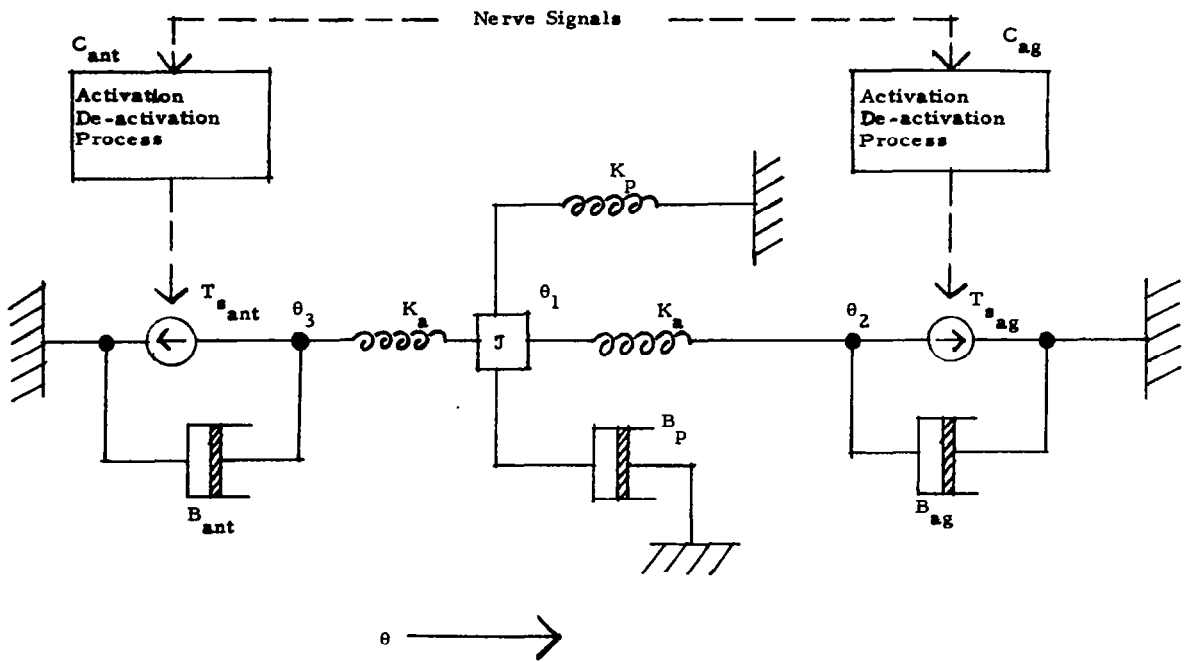

Fig. 18. Cook's composite model for eye movement mechanism. (5)

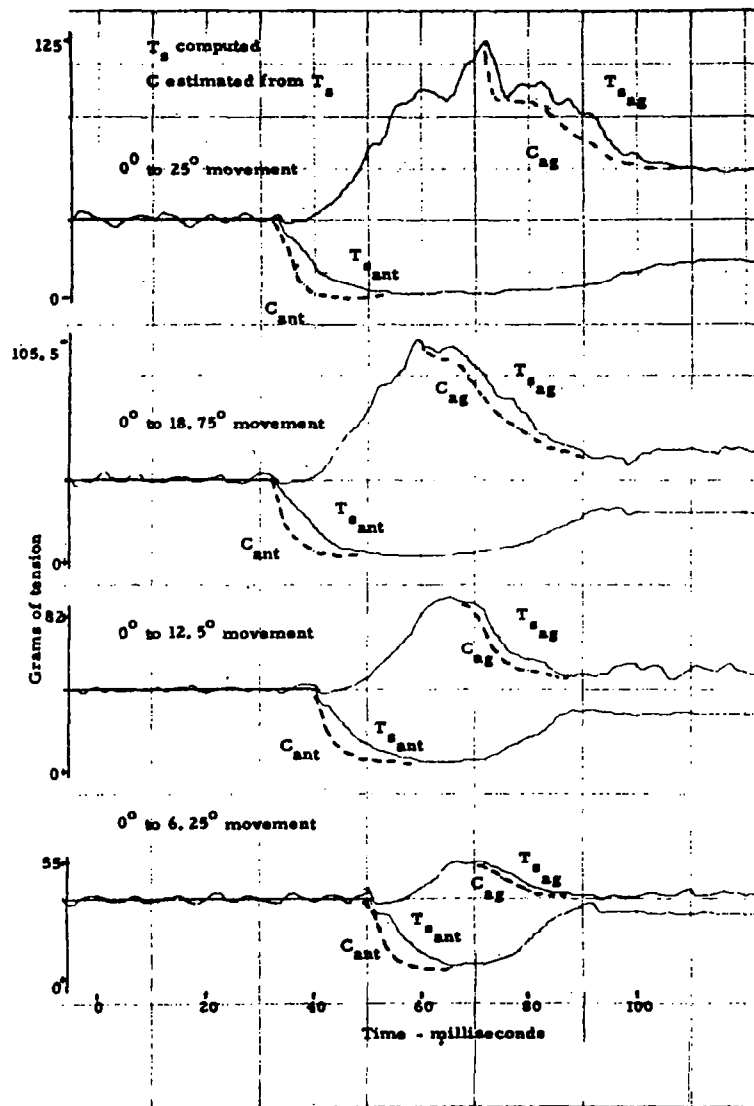

Fig. 19. Tension and activation control functions for saccadic movements, calculated by Cook. (5)

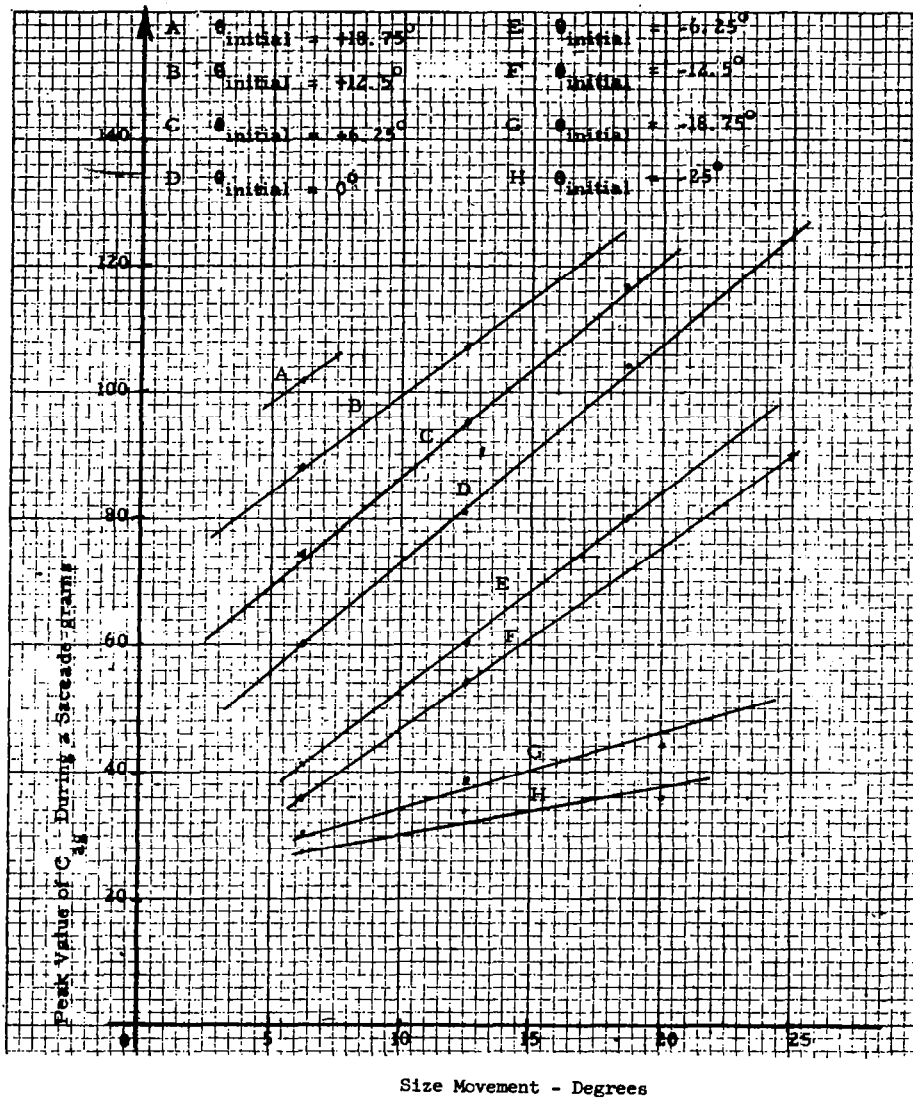

Fig. 20. Peak value of agonist activation as a function of size movement and initial position. (5)

Part Two

THE EFFECT OF EYE MOVEMENT ON VISION

Part Two

THE EFFECT OF EYE MOVEMENT ON VISION

by
Bert L. Zuber and Lawrence Stark

Summary

This report deals with various aspects of the interactions between the oculomotor and visual systems. Crucial to an understanding of the subject is the realization that the function of the oculomotor system is not so much to accurately move the eye to reduce tracking errors --as if it were a simple feedback control device --but rather, to position the eye so as to maximize the amount of information input.

Of central importance to the subject of this report was the early hypothesis, and later experimental verification, of the relativity of the term "steady fixation". When it was established that during steady fixation the eye was actually undergoing several different types of characteristic motions, a whole new area of research developed which included studies of the characteristic movements for their own sake, as well as efforts to determine the degree to which such movements have a role in establishing visual acuity.

The multi-input - multi-output eye movement control system includes versional voluntary tracking, vergence

movements, and unocular responses, as well as associated movements together with lens and pupillary responses. In addition to the direct effect on vision in positioning the eyes, eye movements have more subtle indirect effects on vision.

Section I discusses the small involuntary continual movements during fixation. Tremor is a noise-like fine oscillation, perhaps correlated with unocular motor activity. Drift is a slow erratic wandering of the eye apparently mainly away from optimum fixation. Microsaccades are fast position changes, and seem to correct for errors in fixation position in a complex stochastic fashion. They are generated by mechanisms related to the generation of saccades of all sizes. These three movements have been discussed in terms of the servoanalytical approach to the oculomotor system.

Section II reviews the effect of eye movements on vision and visual acuity. The microsaccades maintain vision: the eye "blacks out" with experimental procedures to oblivate the effect of microsaccades on retinal image position. However, once a test target is seen, the visual acuity with which that target pattern is perceived is not affected by these flicks. Tremor and drift have no appreciable effect on vision or visual acuity. Large constant velocity movements decrease visual acuity by apparently "smearing" the

retinal image. Large saccades decrease visual acuity independent of and in addition to any smearing effect.

Section III reviews the suppression phenomenon associated with saccades. This is an increased threshold occurring with a variety of saccades; voluntary saccades, reflex vestibular nystagmus flicks (but not the constant velocity segments), and even microsaccades produce saccadic suppression.

A model serves to focus a discussion of the oculomotor system generating three types of computations: 1) a command signal to the binocular oculomotor mechanism, 2) a corollary discharge computing an anticipated change of reference frame for visual orientation, and 3) the suppression signal.

Optimal processing of visual information must be thought of as the design criteria rather than a simple-minded tracking mean-squared error minimization. Reflex compensatory movements in unnatural physical environments may deteriorate visual function considerably.

I. Characteristics of Involuntary Miniature Eye Movements

General

Adler and Fliegelman (1934) were among the first investigators to measure and classify the types of eye movements occurring during steady fixation. In recording eye movements by means of a small mirror attached to the cornea, they were able to distinguish basically three distinct types of movement: 1) rapid shifts, which have since been called "flicks" or microsaccades; 2) waves which are now termed drift; and 3) fine vibratory movements, or tremor. Most subsequent investigations have confirmed the observations of Adler and Fliegelman (1934). A schematic representation of the movement of the retinal image within a circle of 50 microns during fixation is shown in Fig. 1. In this figure drifts are represented by dashed lines, microsaccades by solid lines. Ratliff and Riggs (1950) described microsaccades of 5.6 minutes of arc average amplitude (five subjects) with a range of 2.2 to 25.8 minutes of arc. One of their recordings of a microsaccade is shown in Fig. 2. In Fig. 3 some recordings of microsaccades obtained by Zuber, Stark and Cook (1965) are shown. Note that in the latter figure, recording of eye velocity as a function of time is also

shown. In the subjects of Ratliff and Riggs (1950) drifts and oscillations generally less than 5 minutes of arc in amplitude were observed. These authors observed fine tremor occurring in the frequency range of 30 to 70 cps and with median amplitude of 17.5 seconds of arc, but with an amplitude range of just perceptible (10 seconds of arc) to one minute of arc. It is worth noting that Ratliff and Riggs (1950) recorded eye position by means of a small mirror mounted on a stalk which projected from a contact lens worn by the subject, and were able to record both horizontal and vertical movements. Ditchburn and Ginsborg (1953) also recorded both horizontal and vertical components of movement using a contact lens with a mirror worked into the lens surface. Their results are in agreement with those of Ratliff and Riggs (1950). Adler and Fliegelman (1934) recorded only horizontal eye movements. A good summary of the characteristics of miniature eye movements up to 1953 appears in table form in Ditchburn and Ginsborg (1953). An abstract of that table appears in Table 1. Finally, Ratliff and Riggs (1950) made the important observation that the microsaccades often compensated for the effect of drift, tending to restore the target image to the foveal region.

Microsaccades

An important study of the cause and effect of microsaccades was made by Cornsweet (1956). On the basis of his

observations Cornsweet concluded that the drift which occurs during fixation is the result of instabilities in oculomotor control. While he showed that the probability of occurrence, direction and magnitude of microsaccades were strongly dependent on location of the retinal image on the retina, he was not able to demonstrate such a relationship for the drift. Clearly then, Cornsweet's results indicate that microsaccades tend to maintain a fixed position of the retinal image and serve to correct for the drift, which may be random noise within the system. This is a confirmation of the observation of Ratliff and Riggs (1950) mentioned above. It is interesting that Cornsweet observed a slight discrepancy between the position to which microsaccades tended to return the retinal image when the direction of movements was analyzed, and that observed when the magnitude was measured. These two positions, which were referred to as positions of minimum error, were, furthermore, on opposite sides of the mean ocular position during a run, which was the reference position taken by Cornsweet. These observations led to the speculation that there may be more than one physiological control mechanism for saccadic eye movements.

An important study of the detailed nature of the two-dimensional retinal image motion resulting from eye movements during fixation was made by Nachmias (1954). Using a measuring technique similar to that of Ratliff and Riggs (1950)

and digital computer analysis, Nachmias analyzed the directional preponderance of movement parallel to eight retinal meridians. Records from both of his subjects indicated that eye movements occur predominately in a small range of directions, each subject having a different preferred direction. As might be expected, drift and microsaccades occur in directions differing by roughly 180° . Nachmias also concluded that, while microsaccades clearly compensate for the displacement of the retinal image away from some retinal locus, the probability of occurrence of a microsaccade might increase with time since the last microsaccade, rather than with displacement. This conclusion was based on the observation that the frequency of microsaccades was constant whether the subject accommodated for infinity, when the drift rate was relatively low, or whether he accommodated for 30 cm, where the drift rate was higher. These results are in contradiction to those of Cornsweet (1956) who found the probability of occurrence of a microsaccade to be dependent upon eye position.

Krauskopf, Cornsweet and Riggs (1960) were the first investigators to record miniature involuntary eye movements under binocular viewing conditions. In recording horizontal components of motion only, they found that variations in vergence occurred which were the same order of magnitude as the variations occurring in the positions of the individual eyes. While it appeared that there was some correlation between the lateral positions of the eyes during these

experiments under steady fixation conditions, these investigators were led to conclude that the drift of the two eyes was uncorrelated, and that the major source of correlation was microsaccades. In their results between 95 and 99% of the saccades moved both eyes in the same direction. These authors propose a model for the control of fixation in which saccades are triggered by the error signal sensed in one eye (the eye with the greater error). Of course, in order for saccades to effectively correct for vergence errors the saccades for each eye must be of different magnitudes. Krauskopf, Cornsweet and Riggs (1960) found, however, that the magnitude of saccades in each eye were highly correlated.

One is tempted to wonder whether the control of fixation occurs by the same mechanism as has been described by Yarbus (1957) for the change of fixation between any two fixation points in space. According to Yarbus the eyes always move in such a way as to produce a combined pattern of equal versional movements and equal but opposite vergence movements. Experiments should be undertaken to ascertain whether these patterns do, in fact, exist during steady fixation. Such experiments would not only elucidate the mechanism of the control of fixation, but would also indicate the extent to which common physiological mechanisms are used for control of fixation and for control of larger voluntary eye movements.

Recent evidence of Zuber, Stark and Cook (1965) reveals that the peak velocities of microsaccades fall on the extrapolation of the curve of peak velocity versus amplitude for larger voluntary and involuntary saccadic eye movements. Figure 4 shows a plot of peak velocity versus amplitude for microsaccades, secondary corrective saccades and larger voluntary saccades. The data points showing amplitudes below 20 minutes of arc represent microsaccades. This result is taken to indicate that all saccades are produced by a common physiological system. Finally, it is possible that the vergence errors noted by Krauskopf, Cornsweet and Riggs (1960) are corrected by some type of unocular eye movement. The accommodative vergence mechanism has been suggested as a possibility for providing such movements in the case of binocular parallax (Zuber, 1965).

Drift

While the rate of drift has been mentioned above, this subject deserves a slightly more detailed discussion. It will be remembered that Cornsweet (1956) concluded that the drift resulted from oculomotor instability. This conclusion was based on several experimental results: 1) that there was no correlation between the rate of drift during 0.5 sec samples and the initial position of the retinal image with respect to the mean ocular position; 2) in general drift

tended to carry the retinal image away from the mean ocular position; 3) there was no significant difference between the ratio of drift toward and away from the mean ocular position. Finally, Cornsweet found no significant difference between rates of drift measured with the subject fixating a point or with the subject in total darkness.

Quite a different picture of the role of drift is presented by Nachmias (1959). Most important, perhaps, is his observation that along certain retinal meridia, namely, those along which compensation by saccades is poor, compensation by drift may be important. Thus, along these meridia he found a definite correlation between components of retinal image motion and projections of retinal image position at the beginning of 0.2 sec drift samples. In still a later study Nachmias (1960) presents further information on the nature of drift. One of his conclusions, again in contradiction to that of Cornsweet (1956), was that extinguishing the fixation point leads to an increase in drift rate. As mentioned above he also found that drift rate was greater for near accommodation (30 cm) than for accommodation at infinity. Finally Nachmias found that the preferred direction of drift could be systematically affected by changing the position of the eye in the head.

It is not unlikely that the differences between the results of Cornsweet (1956) and Nachmias (1959, 1960) are explainable on the basis of the differences in measuring techniques used by the two investigators. While both techniques involve the use of contact lenses, Cornsweet was only able to record horizontal components of eye movement, while Nachmias was able to record both horizontal and vertical components, and with the use of the computer was able to transform the data to obtain information about motion along eight retinal meridians. The contradictions between the results of these two investigators need not be overstressed. It is perhaps more accurate to consider the results of Nachmias as an extension of those of Cornsweet, which result from more recent analytical methods.

One further point regarding drift is of interest. Nachmias (1960, 1961) has shown that the drift rate is a function of accommodative level, increasing with increasing accommodation. This represents an effect of visual factors on eye movement. It would be interesting to determine whether the increased drift rate is related to the 2 cps oscillations of the lens which are known to occur (Campbell, Robson and Westheimer, 1959) and which must cause oscillations in image sharpness. Interestingly enough, these oscillations predominate during near accommodation and tend to disappear during far accommodation (Campbell, Robson and Westheimer, 1959), suggesting that there may

be some relationship between the increased drift rate and the lens oscillations which are both observed during near accommodation. It is also possible that the linkage between accommodation and vergence plays a part in this phenomenon. The 2 cps oscillations may show up as slight vergence oscillations which result from transmission over the normal accommodative-vergence pathways.

Tremor

The role of the fine tremor observed during fixation is still an unresolved question. Most authors agree that it occurs in the frequency range of 30 to 110 cps with amplitudes sometimes approaching one minute of arc (Ratliff and Riggs, 1950; Ditchburn and Ginsborg, 1953; Riggs, Armington and Ratliff, 1954; also see Table 1). Ratliff and Riggs (1950) point out that during a given experimental run the frequency of tremor may vary significantly within the range mentioned above. Riggs and Ratliff (1950) have stated that the tremor movements are uncoordinated, that is, each eye has its own characteristic tremor.

Summary

In this section we have discussed the experimental evidence for the continual movement of the eye during fixation. These motions have been seen to be of three

types: 1) microsaccades; 2) drift; and 3) fine tremor. The physiological role of the tremor is questionable, and this type of movement may be noise originating in the extraocular muscles. The consensus seems to be that drift results from instabilities in the oculomotor system, although drift may, in some cases, be compensatory. Microsaccades appear to serve primarily in a compensatory role, in most cases causing the return of the retinal image to some optimum retinal locus after drift has displaced the image from this locus.

The mechanism of the control of fixation has been discussed in light of earlier theories as well as later observations of complex patterns of versional and vergence eye movements, and the possibility of the utilization of unocular eye movements. Evidence is presented for a common physiological mechanism for the production of all saccadic eye movements.

II. The Effect of Eye Movement on Visual Acuity

The Role of Miniature Eye Movements

Experimental proof of the continuous motion of the retinal image caused by eye movements during steady fixation led to hypotheses regarding the role of miniature eye movements in establishing visual acuity. Principal among these hypotheses was that of Marshall and Talbot (1942), which held that advantage is taken of the small eye movements occurring during fixation in order to scan contours, and thus, to help in establishing an acuity greater than would be expected from considerations of a stationary retinal image on the known geometrical arrangement of retinal receptors. It should be pointed out at the outset that little evidence has been accumulated in support of such so-called "dynamic theories". Testing such hypotheses would logically involve attempts to measure acuity during periods when all eye movement has been stopped. As this is a rather difficult condition to achieve more indirect methods have been utilized.

The Short Exposure. Ratliff (1950) measured visual acuity in three subjects by means of parallel bar tests during brief exposures (75 msec). During these experiments eye movements were recorded so that acuity determinations could be correlated with amount of eye movement. Results

indicated that the presence of drift clearly hindered visual acuity, but that tremor was "less obviously related to acuity".

Stabilized Image Experiments. A second indirect technique for determining the role of eye movement in establishing visual acuity involves an optical system whereby the retinal image is caused to follow the movements of the eye. In such stabilized image techniques eye movement is not stopped, but movement of the retinal image with respect to the retina is prevented, thereby cancelling the effect of eye movement on the retinal image. Image stabilization may be brought about by reflecting the image of a target from a small mirror mounted on a contact lens worn by the subject. This reflected image appears on a screen viewed by the subject. In practice compensating optical pathways may be required in order to equalize extent of eye movement and extent of reflected image motion. Such an optical system, devised by Riggs, Ratliff, Cornsweet and Cornsweet (1953), is shown in Fig. 5.

Another ingenious method of stabilizing the retinal image was developed by Yarbus (1957). This method also involves a contact lens, but in this case the lens carries its own "projector" and is a completely self contained unit requiring no external optical pathways. Yarbus also developed the method of adhering the contact lens to the

eye by means of negative pressure. Such contact lenses weigh as little as 0.1 g. Two variations of the Yarus lens are shown in Fig. 6 with the original description of the author.

Ditchburn and Ginsborg (1952) also appear to have early stabilized the retinal image with some degree of success. Their optical system was similar to that shown in Fig. 5. In their experiments only horizontal components of retinal image motion were stabilized while the subject viewed a circular field divided vertically into halves. When the two halves of the field differed in brightness it was found that, during stabilization, the line demarcating the halves of the field disappeared intermittently, and that during such periods of disappearance the field appeared to be uniformly illuminated.

The observation of the disappearance of stabilized images has led to many detailed investigations concerning the nature of such disappearances and the implications of such phenomena for visual physiology. Only those aspects of stabilized image experimentation directly concerned with the effects of eye movements and visual acuity will be dealt with here.

Riggs, Ratliff, Cornsweet and Cornsweet (1953) performed experiments using varying degrees of retinal stabilization and measured visual acuity by testing for

perception of vertical line targets of various widths. They used three different degrees of stabilization: 1) normal viewing, i.e. no stabilization; 2) full stabilization; 3) reversal of movement, i.e. the retinal image was made to move by an amount equal to that of eye movement, but in the opposite direction. Stabilization was only for horizontal components of eye motion. For exposure times of one minute greatest values of acuity were measured under the conditions of reversal of image movement. Poorest acuity values were obtained under conditions of complete stabilization, and those values measured under normal viewing conditions were intermediate. These results are partially illustrated in Fig. 7. For target exposures less than 100 msec, these relationships were reversed, indicating that acuity is a decreasing function of the amount of retinal image movement allowed. This latter result was taken as confirmation of the findings of Ratliff (1950). In summary, these authors state that "eye movements are bad for acuity but good for overcoming the loss of vision due to uniform stimulation of the retinal receptors".

Attempts have been made to obtain more detailed information regarding the effects of specific types of eye movement on vision. Ditchburn, Fender and Mayne (1958) superimposed target movement on stabilized retinal fields in an attempt to determine which type of eye movement is responsible for the maintenance of vision. They simulated

drift, microsaccades and tremor using slow sinusoidal movements for drift, and movements of an Eindhoven string galvanometer for microsaccades and tremor. Imposed "drift" of frequency 0.55 cps and varying amplitude between 5 and 60 minutes of arc had little effect on the fade-out tendency of the field except when the larger amplitudes were used. These authors conclude that drift has little or no role in maintaining vision, since the amplitudes of imposed drift required to improve visibility are considerably greater than those observed during normal viewing. Imposed "microsaccades", on the other hand, served to improve visibility by a factor of about 2.5 over that observed during complete stabilization. This was true over the entire range of imposed "microsaccade" amplitudes used (2.5 to 25 minutes of arc), and is shown in Fig. 8. Subjects reported that image regeneration always followed a flick and that the regenerated image was of higher quality than that observed after spontaneous regenerations. "Tremor" imposed on the stabilized field was between 0.05 and 1.10 minutes of arc in amplitude and between 4 and 20 cps in frequency. Below 0.3 minutes of arc "tremor" generally caused a depression of visibility, while intermediate amplitudes led to improved visibility, but larger amplitudes (0.8 minutes of arc) often caused decreased visibility. This appears to be a complex multidimensional situation, not amenable to a simple solution.

These authors conclude that while the microsaccade may play an important role in maintaining vision, some other mechanism must also be operative. Calculations based on the visibility observed during complete stabilization and the normal interval between microsaccades for their subject led to the prediction that he should observe fading of the visual field during normal vision.

Riggs and Tulunay (1959) used a bipartite field, each part having different luminance, to test for visibility or percent of time seen, during varying degrees of stabilization of the field. The ratio of the luminance levels of the two parts of the field was a parameter in their experiments. Their results indicated that the vertical line dividing the field was seen a minimum amount of time during complete stabilization, i.e. when there was no motion of the image relative to the retina. If the angular extent of retinal image motion was more or less than that of the eye movement, visibility was significantly improved. These results are illustrated in Fig. 9. Here it can be seen that visibility is greater for higher levels of the luminance ratio. This is in agreement with the results of Ditchburn and Ginsborg (1952) and Riggs, Ratliff, Cornsweet and Cornsweet (1953).

Keesey (1960) has performed a crucial series of experiments in which she measured visual acuity under stabilized image and normal viewing conditions. Three

separate tests for visual acuity were used: 1) displacement of vernier; 2) visibility of a fine line; and 3) orientation of a grating. Under both conditions mentioned above acuity was measured as a function of exposure time of the acuity test target. The results of these experiments may be very simply summarized: in both stabilized and normal viewing conditions acuity was found to increase with increasing exposure time up to 0.2 sec, but acuity is unaffected by the involuntary eye movements that occur during normal viewing. One of Keesey's figures showing acuity (threshold angle) as a function of exposure time appears in Fig. 10. It is clear that acuity is the same whether viewing is normal or with the stabilized image (stopped). Keesey's results are, in a special sense, very important. In all of the previous work described above acuity was not, in fact, truly the measured variable, even though acuity targets were often used, c.f. Riggs, Ratliff, Cornsweet and Cornsweet (1953). Inevitably the subject's response is reported in terms of visibility, or percent of time seen. Keesey's results firmly establish that the motion of the retinal image relative to the retina caused by involuntary miniature eye movements has little to do with establishing visual acuity.

The Role of Larger Voluntary Eye Movements.

Velocity Tracking. Although a great deal of attention has been focused on the effect of miniature eye movements on vision, some work involving the effects of larger voluntary movements has been done. Mackworth and Kaplan (1962) measured visual acuity as a function of target velocity during eye movements brought about by tracking of the target. As a measure of acuity they used minimum resolvable stripe width for horizontal and vertical stripe test patterns presented for 99 msec. For target velocities between 0 and 120 degrees/ sec they found that acuity was an increasing function of test pattern luminance, and that acuity was greater for horizontal test patterns as opposed to vertical test patterns at any given luminance level. The difference between acuity measurements for horizontal and vertical stripe patterns was not evident when the test pattern was briefly illuminated by a stroboscope. They concluded, therefore, that the dependence of acuity on stripe orientation results from more smear of the retinal image in the case of vertically oriented stripes.

A major deficiency of the studies of Mackworth and Kaplan (1962) is that they failed to measure the velocity of the eye. Their plots of acuity as a function of velocity are thus based on target velocity, not eye velocity. As they point out, pursuit, or velocity tracking eye movements

are limited to velocities of less than about 30 degrees per second. For targets moving with greater than this velocity eye movements are usually saccadic, as has been shown by Young and Stark (1963). As can be seen from Fig. 4 the velocity of a saccadic eye movement is a function of its amplitude and can be as high as 300-400 degrees per second. Thus, over about three quarters of the range of target velocities used by Mackworth and Kaplan, responses were probably saccadic rather than smooth pursuit. Future experimentation on the effect of velocity tracking eye movements on acuity should be controlled to take into account the above facts.

Saccadic Eye Movements. Volkmann (1962) has investigated the effect of saccadic eye movement on visual acuity. Since Section III of this report deals with the effect of saccadic eye movements on visual threshold, her results serve as an appropriate transition between sections II and III.

Volkmann (1962) measured acuity at fixed times before, during and after voluntary 6 degree saccadic eye movements. Test targets were illuminated for 20 msec and were superimposed on a bright fixation field. She used three different tests for visual function: 1) detection thresholds for dot patterns; 2) recognition thresholds for words, and 3) minimum angles for grating resolutions. Results of experiments performed on three subjects indicated that

dot pattern detection thresholds and word recognition thresholds were both elevated by about 0.5 log units when targets were presented during saccades as compared to target presentations during steady fixation. Experiments with resolution grating tests showed similar results, although differences were smaller and less consistent. Typical results obtained by Volkman (1962) are shown in Figure 11. Here dot detection percentage as a function of log relative luminance is plotted.

Summary

At the risk of oversimplification the "visual" role of involuntary miniature eye movements during fixation may be summarized as follows: Their primary importance seems to be in the maintenance of vision, perhaps by causing intermittent stimulation of individual retinal receptors or receptive fields. The fact that they have no effect on visual acuity seems to prove that "dynamic" theories of visual acuity are without basis.

Little experimentation on the role of velocity tracking eye movements in establishing visual acuity has been done. Existing results seem to indicate that smearing of the retinal image during movement may cause a decrement in visual acuity. In general, better-controlled experiments are needed in this area.

Existing results on the effects of saccadic eye movements on acuity indicate that these movements cause a decrease in visual acuity independent of any image smearing effect.

III. Saccadic Suppression: the Elevation of Visual Threshold Associated with Saccadic Eye Movements

Introduction

This section covers material related to the effect of saccadic eye movements on visual threshold, an area of research which has been of interest in the past and which has been the subject of a number of recent investigations. The material below begins with a brief review of the literature and follows with an account of recent experimental work.

Historical Review and Implications of the Phenomenon

It was at the turn of the present century that several investigators discovered that vision is suppressed just before and during saccadic eye movements (Dodge, 1900, 1904; Holt 1903). More recent investigators have not only confirmed the earlier observations (Zuber, Crider and Stark 1964; Zuber, Michael and Stark, 1964; Latour 1962, 1963; Volkmann 1962; Ditchburn 1955; Lettvin 1960; Zuber, Horrocks, Lorber and Stark 1964), but have also attempted to quantify the phenomenon (Volkmann 1962). Also based on the earlier observations of Ditchburn (1955) and Holt (1906) attempts have been made to determine the

generality of this transient elevation of visual threshold (Zuber, Crider and Stark 1964; Zuber, Horrocks, Lorber and Stark 1964) which has been called saccadic suppression (Zuber, Crider and Stark 1964). Volkman (1962) studied saccadic suppression using three different tests for visual acuity. Her results have been summarized above.

The experiments described below were carried out for the purpose of determining the degree to which saccadic suppression is associated with saccadic eye movements in general, regardless of their origin. Attempts have also been made to establish the degree to which visual threshold is elevated during saccadic suppression, i.e., the magnitude or amount of suppression. The former experiments allow a dissection of the mechanism causing the suppression by the familiar "black box" approach. The latter experiments allow some judgement regarding the possible importance of the phenomenon.

The results of such experiments and, indeed, the bare existence of saccadic suppression, provide important evidence relating to several recent hypotheses regarding the interaction of visual and oculomotor function (Holst and Mittelstaedt 1950). One of these hypotheses is that of Holst and Mittelstaedt (1950) involving the principle of reafference. This principle basically predicts the modification of sensory inputs by means of feedback paths from motor to sensory areas. In independent studies

leading to the hypothesis of a reafferent mechanism, Sperry (1950) has called this feedback a corollary discharge. Teuber (1960, 1961) discussed the phenomenon of the corollary discharge in several publications. A corollary discharge has been invoked to explain the constancy of the spatial environment during eye movements (Holst and Mittelstaedt, 1950). During a saccadic eye movement the image of the environment is shifted on the retina with considerable amplitude and speed. Yet the observer notices no blur and, in fact, no movement whatsoever. On the other hand, if the eye is moved passively with the finger the environment is seen to jump in concert with the movement of the eye. Obviously, in the latter case there is no motor activity associated with the eye movement, while in the former case motor activity is normal. These observations seem to indicate that normal motor activity results in a corollary discharge which, in turn, somehow provides for constancy of the environment during eye movement. If a subject with paralyzed extraocular muscles attempts a voluntary eye movement he observes that the environment jumps in the direction opposite to that in which the eye movement was attempted. In this case motor activity, which is presumably normal at least down to the level of the brainstem ocular motor nuclei, has caused a corollary discharge. The signals which this discharge was to "cancel" were, however, not generated

since the eye did not move, and there was no movement of the image over the retina. Clearly, saccadic suppression, which may well involve a motor-to-sensory feedback mechanism, might in some way be related to this corollary discharge, but it remains to be seen to what extent this relationship exists. Such a relationship will be discussed in light of the results of the experiments presented below.

A second hypothesis for which saccadic suppression might have important implications is that of the intermittency operator proposed by Stark (1963). Experiments have shown (Young and Stark, 1963) that an adequate description of the system controlling versional eye movements requires a sampled data model. In this model the system is assumed to be connected only at discrete times, samples being taken no more often than about once every 200 milliseconds. The intermittency operator is the mechanism accounting for this sampling at discrete intervals, intermittency implying the opposite of sampling, namely, the cessation of activity for a specified period. Since saccadic suppression seems intimately associated with oculomotor activity, and since change in threshold could conceivably be linked to sampling, it is possible that studies of saccadic suppression could yield some useful information with respect to the intermittency operator. At the moment, however, the cause and effect relationships between the two phenomena are unclear.

Voluntary Saccades

The experiments described in this section are basically similar to those carried out by Latour (1962,1963). In these experiments the subject alternately shifted his fixation between two points by means of saccadic eye movements. Brief (10 microsec) test flashes were presented at various times before, during and after the eye movement. The subject's eye movements were recorded, as were the occurrence of the test flash and whether or not it was perceived by the subject. From these data the chance of perception of the test flash could be determined for any given time of its occurrence with respect to the beginning of the eye movement.

The intensity of the test flash was adjusted so that it was just suprathreshold when its image was approximately ten degrees off the fovea during steady fixation. This test flash was positioned midway between the two fixation lights, and subtended about one degree of visual angle.

The results of a typical experiment for a dark adapted subject are presented in Fig. 12. The center ordinate represents the chance of perception of the flash (per cent seen) and the abscissa represents the time in milliseconds between the beginning of the eye movement and the time of occurrence of the test flash. Superimposed on this plot is a schematic plot of eye position against

time. Eye position in degrees is found at the extreme right of the plot. Each point on the plot represents about ten separate test flash presentations on the average.

Briefly the results may be summarized as follows: In this experiment saccadic suppression began approximately fifty to eighty milliseconds before the eye began to move; vision then remained suppressed until about thirty to fifty milliseconds after the beginning of the eye movement. The suppression effect was maximal for a period of about twenty to forty milliseconds before the beginning of the eye movement. The portion of the saccadic suppression phenomenon that followed the onset of the eye movement had a time course roughly similar to that of the eye movement. Thus the chance of perception had returned to 100 percent at approximately the same time that the eye movement had terminated. These results roughly confirm those published by Latour (1962, 1963).

It is clear that much of the visual suppression observed in these experiments occurred well before the beginning of eye movement. This obviously rules out the possibility that the observed elevation of threshold occurs as a result of an effective smear of the test flash energy over the retina.

The shape of the saccadic suppression curve seems to be parametrically determined by the test flash intensity. This is shown schematically in Fig. 13. As the intensity of the test flash decreases, the dip in sensitivity becomes broader, expanding from right to left only, and deeper. These three curves are the smoothed results from experiments exactly the same as the one described above. Only the test flash intensities were different. More quantitative data on the effect of test flash intensity are presented in the following paragraph. It seems clear, however, that the time course of saccadic suppression is definitely a function of test flash intensity.

In determining the amount or extent of saccadic suppression the same experimental setup was used as described above. Two fixed times of flash presentation were used, and these were set in such a way that the test flash was always presented either just after the beginning of the eye movement (10.6 msec) or after the completion of the eye movement (91.0 msec). With each time of presentation test flash intensity was varied by changing neutral density filters through which the test flash was passed. At each intensity setting an average of about twenty test flashes was presented to the dark-adapted subject, and chance of perception was determined in the usual way. The results of such an experiment are shown in Fig. 14. From this figure it is clear that the elevation

of threshold is relatively much greater at the beginning of the eye movement (crosses) than at the end (circles). This is as predicted from Fig. 12. The amount of suppression is measured as the distance along the abscissa between the points on each curve corresponding to the same chance of perception. This distance, then, represents the difference in test flash intensities required to produce the same chance of perception at the beginning and at the end of the eye movement. At 50 percent chance of perception this difference corresponds to about one log unit, perhaps slightly more.

Microsaccades

Ditchburn (1955) has reported that subjects are unable to see the displacement of an oscilloscope trace when the displacement occurs simultaneously with the subject's microsaccades. Experiments were, therefore, designed to determine whether saccadic suppression is associated with microsaccades. The demonstration of such a phenomenon would extend the generality of saccadic suppression to the smallest involuntary saccadic eye movements.

The subject viewed a 4 degree transilluminated field on which the test flash appeared. The fixation point consisted of the intersection of two fine wires within the field. Viewing was monocular with the left eye. Eye movement, test flash occurrence and subject's indication of perception were recorded.

Test flash presentation was synchronized with microsaccadic eye movements by using the differentiated eye position signal to trigger a delayed pulse which caused the test flash. Horizontal microsaccades in one direction only caused the presentation of the test flash. With long delays the test flash occurred during the period following the microsaccade, or, on some occasions just before or during a following microsaccade. When the test flash was presented periodically with no synchronization with the eye movement it was clearly visible every time. Without anticipating the results of the experiment, it might be predicted that a small number of these control flashes might not be seen by the subject if microsaccades have an associated saccadic suppression. Thus even if the flashes are not synchronized with the microsaccades, a small number of test flashes will occur with close temporal proximity to the microsaccade, although the probability of this is small. The results of the experiment are, in fact, so dramatic, that these control flashes are, for all intents and purposes, seen "every time".

The results of an experiment are presented in Table 2. Test flash presentations are classified (horizontally) as seen, unseen, total, and percent seen; and (vertically) as those occurring within \pm 25 msec of the beginning of a saccade, those occurring within the interval of 25 to 50 msec before or after the beginning of a microsaccade, and

those occurring outside the latter range, i.e., $50 < t < -50$ msec. It should be pointed out that the necessity for synchronization of test flash and eye movement results in many more test flashes occurring in the time categories following the eye movement than in those preceding the eye movement. The results are obvious from Table 2. A flash is not seen if it occurs as much as 25 msec before or after the beginning of a microsaccade. Flashes occurring more than 50 msec before or after a microsaccade are seen 90 percent of the time. A fourth category in Table 2 accounts for stimulus presentations in which the temporal relationship between test flash and microsaccades was questionable. In such cases the test flash may have been triggered by small eyelid movements, rapid drift or rapid drift with a superimposed microsaccade. The present recordings do not allow choice among these possibilities. It is clearly unlikely that these 32 responses could significantly alter the striking results illustrated in the other categories.

It seems clear that saccadic suppression is associated with horizontal microsaccadic eye movement; thus the generality of this phenomenon is extended to the smallest involuntary saccadic eye movements.

Vestibular Nystagmus

One of the first allusions to visual suppression during the fast phase of vestibular nystagmus was made by Holt (1906). It is of particular importance to establish whether or not saccadic suppression is associated with the involuntary, saccadic fast phase of vestibular nystagmus. The reason for this is that the sensory end of the reflex mechanism is not visual in nature. It is known, however, that the pathways involved in vestibular nystagmus include certain parts of the oculomotor system, namely, the oculomotor nuclei and the extraocular muscles (Szentagothai, 1950).

The subject was seated on a swivel stool which could be manually rotated by a second person for the purpose of inducing post-rotary vestibular nystagmus. Angular acceleration was brought about by vigorous rotation. Once the subject was rotating with roughly constant angular velocity he was stopped rather suddenly and post-rotary nystagmus ensued. Movements of the subject's left eye were monitored by means of a pair of spectacle frames bearing light sensors, and which the subject wore at all times while seated on the stool. The apparatus and electronics are schematized in Fig. 15. As in the micro-saccade experiment, the differentiated eye position signal was used to trigger the delayed pulse, thereby causing

presentation of the test flash. Since the nystagmus is quasi-periodic, the use of suitably delayed pulses should allow test flash presentations occurring before the saccades.

When the subject was in position for testing he faced a field consisting of a sheet of white paper at a distance of about five feet, and which was provided with hidden fixation lights for static calibration. The test flash appeared in the center of this field and subtended about 2° of visual angle. Test flash intensity was established at that level where every flash was just visible when the subject fixated a point 5° distant from the test flash.

During an experiment the subject indicated perception of the test flash by activating the subject's indicator (push button), as described above. This indication, along with the delayed pulse causing the test flash and, in some experiments, differentiated eye position, was recorded on one channel of the recorder. On the second channel eye position was recorded.

In order to get some idea of the time course of the saccadic suppression associated with the nystagmus, experiments were carried out in which the delay was varied so as to present the test flash at various times with respect to the saccadic fast phase of the nystagmus. The composite results from four experiments appear in Fig. 16.

Percent seen (ordinate) as a function of time of flash presentation (abscissa) is plotted. The points in Fig. 16 were determined by classifying the data into 20 msec time bins. Thus the number of flashes occurring, for example, within the interval +40 to +60 msec which were reported seen was divided by the total number of flash presentations occurring within that interval. The resulting number (x100) is plotted at +60. The primary reason for classifying the data in this manner is that during an experimental run only a limited number of test flashes could be presented. This limitation results from the inability of the subject to sustain prolonged experimental runs. Rotation is often accompanied by the uncomfortable side effects of dizziness and nausea.

The apparent noisiness of the data in Fig. 16 may be the result of a certain degree of mental confusion on the part of the subject, causing his responses to be somewhat inconsistent. A second possible explanation might be found in the time course of the nystagmus. The initial portion of the nystagmus is characterized by a relatively high frequency of nystagmic beats. Thus the saccadic fast phases occur fairly close to one another in time. It is, therefore, possible that the perception of a flash presented after a given fast phase could be affected by the zone of suppression associated with the next fast phase. The cause of this noisiness is not clear

at this time. The results clearly indicate that saccadic suppression is associated with the saccadic fast phase of post-rotary vestibular nystagmus. The saccadic suppression observed in these experiments is similar to that observed in association with other types of horizontal saccades, in that a significant portion of the suppression occurs before the saccadic eye movement.

Summary of Experimental Results and Discussion

The results of the above-described experiments show that visual saccadic suppression is associated with a wide variety of horizontal saccadic eye movements, whether they be voluntary or involuntary, or whether the sensory system initiating the eye movement be visual or non-visual in nature. Thus the generality of the saccadic suppression phenomenon seems to be fairly well established. Wherever the suppression phenomenon has been observed a significant elevation of threshold has occurred before the eye movement. The magnitude of the elevation of visual threshold during saccadic suppression has been determined to be on the order of one to two log units for a dark-adapted subject making voluntary saccadic eye movements.

Other studies related to saccadic suppression, but not covered in this report indicate that the pupillary light reflex exhibits a pupillary saccadic suppression

which occurs concurrently with visual saccadic suppression (Lorber, 1964; Zuber, Stark and Lorber, 1965; Lorber, Zuber and Stark, 1965). Pupillary saccadic suppression seems to be a temporally more extensive phenomenon than visual saccadic suppression. When pupillary saccadic suppression is maximal the average pupillary response to a test flash is only 10 percent of the average response to the same flash presented during steady fixation.

The experimental results summarized above afford a reasonably secure position for speculation regarding the mechanisms underlying saccadic suppression. It is still impossible, however, to provide a precise neurophysiological model for the mechanism. While the model described below is preliminary in nature, and is provided mainly as a framework in which the experimental observations may be cast, it will be seen that certain other observations seem conveniently to fit into that framework.

The fact that the observed suppression is unquestionably linked to eye movements suggests a motor origin. Since much of the suppression occurs before the eye moves, the extraocular muscles and their proprioceptive sensory organs may surely be ruled out as a possible locus for this motor site. Since saccadic suppression has been observed in association with a wide variety of horizontal saccades, it is possible that the motor mechanism in the

brainstem (e.g., nucleus of Nerve III) might be involved in the origin of the inhibition process which feeds back to sensory or perceptual centers in the visual system. The argument for a brainstem origin is strengthened by the fact that saccadic suppression is observed during the fast phase of vestibular nystagmus. This type of movement is classically thought to be brought about by a simple reflex arc involving only the sensory organs in the semicircular canals, the vestibular nuclei, and the IIIrd nerve nuclei in the brainstem (Szentagothai, 1950). Thus the IIIrd nerve nuclei are the only sites common to the motor pathways involving both vestibular nystagmus and the other types of horizontal saccades.

Such arguments do not positively preclude, however, the existence of a more centrally located motor site of origin. On the one hand, it has been reported (Kornhuber and Da Fonseca, 1964) that electrophysiological correlates resulting from stimulation of the vestibular apparatus leading to vestibular nystagmus cannot be recorded in areas of the cortex dealing with visual and oculomotor function. Dumont-Tyc and Dell (1962) have reported that stimulation of the ampular nerve results in rhythmic activity of the nystagmoid type in the motor nerve to the lateral rectus muscle. These investigators further stated, however, that the rhythmicity of the discharge was abolished

after removal of the anterior part of the brain (diencephalic section) and the posterior part of the bulb (retrotrapezoidal section). They concluded that these two parts of the brain are responsible for an inhibitory effect leading to the rhythmicity in the vestibulo-ocular reflex arc. While certain details of experimental procedure are missing due to the brevity of the report, it must be concluded that the influences of higher centers on the vestibulo-ocular arc are not yet well defined. Consequently, it cannot be said with any certainty that the motor site of origin for saccadic suppression is not located in the brainstem. In the discussion below it will be assumed that an undefined upper motor center is the locus for such a site. This uncertainty will, furthermore, be of the utmost importance in attempts to localize the intermittency operator (Stark, 1963) and to define its relationship to saccadic suppression.

Before turning to the site of action of the saccadic suppression mechanism it will be necessary to introduce some experimental results dealing with the phenomenon of binocular rivalry, and which relate significantly to this discussion. When a subject is presented with separate and different fields for each eye, say, one containing vertical stripes, the other containing horizontal stripes, then it will be found that most of the time the subject sees only horizontal, or only vertical stripes. Under

such conditions the fields for each eye will be seen alternately and periodically, the periodicity of alternation depending on the viewing conditions. Binocular rivalry, then, is the alternate suppression of vision in each eye occurring when the retinal images for each eye are grossly different. The viewing or non-suppressed eye, the eye whose field is seen at any given time, is referred to as the dominant eye. The suppressed eye is called the non-dominant eye. Barany and Hallden (1948) have reported that the pupillary response to a flash presented to the non-dominant eye of a subject experiencing binocular rivalry was smaller than the response to the same flash presented to the dominant eye. These results have been confirmed in experiments using the objective methods of the direct-recording pupillometer (Lorber, 1964; Lorber, Zuber and Stark, 1965; Richards, 1964).

It is generally believed that binocular rivalry is a cortical phenomenon. Experiments have shown that the cortically evoked response to flicker presented to the non-dominant eye in rivalry is considerably decreased in amplitude, while the electroretinogram (measure of retinal activity due to light stimulation) evoked by the same stimulus is virtually unaffected (Balen, 1964). In summary, binocular rivalry is a monocular suppression of vision, probably cortical in nature, which has associated with it

a suppression of the pupillary light reflex.

In discussing the site of action of the saccadic suppression mechanism two assumptions will be made in an attempt to simplify the arguments that follow. The first assumption is that the visual and pupillary suppression observed during binocular rivalry are mediated by the same basic mechanism as are visual and pupillary saccadic suppression. The second assumption involves the "monocular" nature of binocular rivalry. That is, in binocular rivalry it is always one eye which becomes non-dominant, not the two corresponding hemi-retinas in the left and right eyes. In view of this it is assumed that the site of action of the suppression mechanism resides in some portion of the visual system or perceptual centers where the eyes are represented separately. Possible loci for such sites are thus limited to the retinas and higher perceptual centers, excluding everything between the optic chiasm and the output from the visual cortex. If the site of the suppression mechanism were in the visual cortex or lateral geniculate body then this mechanism would have to selectively affect the information flow on both sides of the brain (in the case of non-dominance of either eye in binocular rivalry). If nothing else this is teleologically unsatisfying. In the course of the following discussion the reason for this second

assumption will be clarified.

If the two limiting assumptions above are accepted a model to account for the experimental observations can now be devised. Basic to this model is a pathway from the upper motor center to an area which shall be called an inhibitory center (see Fig. 17). This inhibitory center does not necessarily imply a specific or defined anatomical entity, but more of a conceptual or operational entity. In the model this inhibitory center feeds back to a higher perceptual center where the two eyes are separately represented. The justification for such a perceptual center is based on observation. Namely, if one eye is occluded a well integrated environmental percept is still observed by the subject. In other words, information which had been spread out into both visual cortices has been reintegrated into a perfect percept of the environment. This center receives an input from both visual cortices, but the fibers are "uncrossed" so that fibers from one eye are separated from those of the other eye. The need for such a center is further emphasized when one considers the means whereby the motor commands for vergence eye movements are computed. Consider, for example, the case of asymmetrical convergence. If a target moves in such a way that its distance from the subject decreases, and this movement is in any plane

other than the median plane, then the error (i.e., distance from target image to fovea) on each retina is different. Thus, motor commands must be computed for each eye which are based on unequal errors and which will relocalize the image of the target on both foveas. This argument is justification for the pathway (Fig. 17) from higher perceptual center to upper motor center to Nerve III nucleus. As indicated, this pathway may carry vergence motor signals.

Given the model in Fig. 17 not only the above experimental results, but many other phenomena which have been reported may be accounted for. In saccadic suppression the unique pattern for firing resulting in a saccadic eye movement which arrives at the upper motor center causes a signal to be fed back to the inhibitory center. This inhibitory center then has two outputs: one to the higher perceptual centers causing suppression of vision; and another output causing pupillary saccadic suppression. The site of action of this second output might possibly be at the Edinger-Westphal nucleus. It is thought that the pupil system receives other inputs (sensory, emotional, psychological) at this level. One might object to this argument on the basis that the latency of the pupillary response (250 msec.) is so much greater than that of the visual response (perception) to a given stimulus. It has been shown, however, that about ninety percent of the

latency of the pupillary response may be attributed to the output neuromuscular elements of the pupillary system (Baker, 1959). Thus, the fact that pupillary saccadic suppression and saccadic suppression might have different sites of action is not contradictory to the concurrent occurrence of these phenomena. Two sites of action may, in fact, be evidenced by the different time courses of the two phenomena.

In binocular rivalry two disparate sets of information arrive at the higher perceptual centers. Presumably some sort of comparison is made to indicate this disparity and a signal is sent to the inhibitory center (via one of the pathways from higher perceptual centers to inhibitory center) indicating that the percept for one eye should be disregarded. Inhibition of this percept is accomplished by means of the feedback paths from inhibitory center to higher perceptual center. Pupillary suppression during rivalry is accomplished by the same mechanism as is used during pupillary saccadic suppression, except that in the case of rivalry the suppression is initiated in the inhibitory center rather than in the brainstem. It is not clear from the model how the alternation in dominance of the eyes is accomplished. It is interesting to note the similarity in the initiating signals for computation of motor commands for vergence eye movements on the one

hand, and for initiation of suppression in rivalry on the other hand. In both cases action from the higher perceptual centers arises from the existence of binocular disparity. That is, one important function for these centers might be first the recognition of binocular disparity, and second, the decision as to what to do to correct the disparity.

A phenomenon probably related to the above is that of amblyopia as seen in persons having strabismus (an ocular deviation leading to a lack of equal amounts of vergence in each eye). Some of these people alternate in the use of the left or right eye, the amblyopia always being observed in the eye opposite to the one in use. The model in Fig. 17 also accounts for this phenomenon, the initiation mechanisms probably being quite similar to those in rivalry. Here again note the close interaction of vergence commands, binocular disparity and suppression of vision. It has further been shown that people with strabismus exhibit diminished responses when the eye showing amblyopia is stimulated (Harms, 1937). This is further evidence that the operative mechanisms in amblyopic suppression are similar to those in binocular rivalry.

It has been noted that most normal people have a dominant eye. The model clearly indicates the means whereby this dominance might be brought about, although the initiation mechanism is less clear. Perhaps this is

another manifestation of the vergence-binocular disparity-suppression interaction.

As mentioned above a phenomenon considered relevant to the model is that of the corollary discharge. This idea has been invoked to explain the spatial constancy of the environment during eye movements (Holst and Mittelstaedt, 1950; Sperry, 1950). It is generally formulated as a feedback mechanism from the oculomotor system to perceptual centers. Thus, when the eye moves, perceptual centers are told to ignore the resulting movement of the image of the environment over the retina. When the eye is moved passively the environment is seen to move because there has been no motor outflow and hence no corollary discharge to account for the image movement. An important aspect of the corollary discharge is that it is monocular in the same sense that binocular rivalry is monocular. That is, it involves a single retina rather than two corresponding half retinas. If one eye is pressed firmly so as to impede its movement, and an eye movement is made, the result is that only one visual field (that seen by the restricted eye) appears to move. The corollary discharge, then, would seem to require separate representation of the two eyes for its explanation. The model in Fig. 17 might well account for the corollary discharge since central aspects of this model include feedback from

motor to perceptual centers as well as perceptual centers where the eyes are separately represented. It is undoubtedly true that the interaction between the inhibitory center and the perceptual centers is more complex in the case of the corollary discharge than in the case of the various types of suppression we have discussed. The corollary discharge and saccadic suppression may well be related phenomena, but it is difficult to see how the latter could account for the former. The corollary discharge obviously involves more than a simple blanking out of vision, and at any rate the blanking that occurs in saccadic suppression seems hardly sufficient to do the required job.

It is certainly true that the suppression phenomena discussed above could be accounted for by a model involving feedback to the retina from an inhibitory center via centrifugal fibers. Such a model involves no higher perceptual centers with separate ocular representations. In the case of this model, suppression is accomplished by attenuation at the input. Balen's (1964) evidence regarding the constancy of the ERG during rivalry is strong presumptive evidence against the involvement of part of the retina in this type of suppression. This evidence would be much stronger if it were shown that all cellular levels in the retina are unchanged during rivalry, not just the one

where the ERG originates. A review of the pros and cons of centrifugal fibers will not be given here. Such a review has been made by Brindley (1960). While a model involving centrifugal fibers offers a certain attractive simplicity, it is not clear how it might account for some of the phenomena which have been discussed. Where, for example, might the input to the inhibitory center arise in binocular rivalry? It is also most difficult to understand how the effects of the corollary discharge could be brought about at the retina when one considers the enormous complexity that must be required.

It is, perhaps, true that a mistake has been made in attempting to unify too many phenomena. One is sorely tempted to do so, however, when one considers the close interactions between binocular disparity and monocular visual suppression, binocular disparity and the computation of motor commands for vergence eye movements, and monocular visual suppression and the need to suppress vision under any circumstances.

Unfortunately the results of the saccadic suppression experiments and the above-described model yield little information about, or insight into, the localization of the intermittency operator (Stark, 1963). The same arguments set forth above regarding the site of origin of saccadic suppression apply equally to the intermittency

operator. Specifically, because the ocular motor nuclei of the brainstem are the only common motor stations for vestibular-initiated and all other saccades, it seems inescapable that these nuclei must be importantly related to the operation of the intermittency operator. It remains to be explained, however, why vergence and other types of eye movements which utilize these nuclei do not exhibit intermittency. Perhaps the answer is to be found in the cytoarchitecture of these brainstem areas. Particular attention should be paid to results such as those reported by Dumont-Tyc and Dell (1962), which could imply that the basis for the intermittency operator may, in fact, be a rhythmic inhibitory influence of higher centers. Such an explanation would not require any duality at the level of the ocular motor nuclei.

It does seem clear that the intermittency operator resides somewhere in the oculomotor system, that is, that it is not a sensory or visual phenomenon. If such were the case one would expect to consistently find what Latour referred to as "holes in visual perception" (Latour, 1963). Such is not the case. It seems most likely, therefore, that saccadic suppression is not the cause of intermittent operation, but merely one effect of it.

The above discussion clearly emphasizes that crucial data from pertinent neurophysiological experiments are

required in order to get more information regarding the pathways responsible for saccadic suppression and the intermittency operator.

Summary

In this section we have discussed saccadic suppression, the elevation of visual threshold prior to and during saccadic eye movements. The experimental results presented indicate that such an elevation of visual threshold is associated with a number of types of saccadic eye movement including microsaccades, voluntary saccades and the saccadic fast phase of vestibular nystagmus.

A preliminary model has been described which accounts for saccadic suppression as well as a number of related phenomena. It is apparent that more experimental work is required in order to elucidate the mechanisms of this important interaction between the oculomotor and visual systems.

BIBLIOGRAPHY

1. Baker, F.H. Unpublished experiments 1959.
2. Balen, A.T.N. van The Influence of Suppression on the Flicker ERG Doc. Ophthalm., XVIII:440, 1964.
3. Barany, E.H. and U. Hallden Phasic Inhibition of the Light Reflex of the Pupil During Retinal Rivalry. J. Neurophysiol., 11:25, 1948.
4. Brindley, G.S. Physiology of the Retina and the Visual Pathways. Ed. Arnold, Ltd., London, 1960 p.107.
5. Campbell, F.W., J.G. Robson and G. Westheimer Fluctuations of Accommodation Under Steady Viewing Conditions. J. Physiol., 145:579, 1959.
6. Cornsweet, T.N. Determination of the Stimuli for Involuntary Drifts and Saccadic Eye Movements. J.O.S.A., 46:987, 1956.
7. Ditchburn, R.W. Eye Movements in Relation to Retinal Action. Optica Acta 1:171, 1955.
8. Ditchburn, R.W. and B.L. Ginsborg Involuntary Eye Movements During Fixation. J. Physiol., 119:1, 1953.
9. Ditchburn, R.W. and B.L. Ginsborg Vision with a Stabilized Retinal Image Nature 17:36, 1952.
10. Dodge, R. The Illusion of Clear Vision During Eye Movement Psychol.Bull. II:193, 1905.
11. Dodge, R. Visual Perception During Eye Movement Psychol. Rev. 7:454, 1900.
12. Dumont-Tyc, S. and P. Dell Composantes Facilitatrices et Inhibitrices du Reflexe Vestibulo-oculaire J. Physiol., Paris, 54:331, 1962.
13. Harms, H. Ort und Wissen der Bildhemmung bei Schielenden Graefes Arch., 138:149, 1937 cited in Teuber, H.-L. and M.B. Bender Neuroophthalmology: The Oculomotor System Prog. in Neurol. and Psychiat., VI:148, 1951.
14. Holst, E.v. and H. Mittelslaedt Das Reafferenzprinzip: Wechselwirkungen Zwischen Zentralnervensystem und Peripherie Die Naturwissenschaften 37:464, 1950.

15. Holt, E.B. Eye Movement and Central Anesthesia Harvard Psychol. Studies, I:3, 1903.
16. Holt, E.B. Vision During Dizziness Psychol. Bull., 3:68, 1906.
17. Keeseey, U.T. Effects of Involuntary Eye Movement on Visual Acuity J.O.S.A. 50:769, 1960.
18. Kornhuber, H.H. and J.S. Da Fonseca Optovestibular Integration in the Cat's Cortex: A Study of Sensory Convergence on Cortical Neurons in The Oculomotor System, M.B. Bender, Ed., Harper and Row, New York, 1964 p.239.
19. Krauskopf, J., T.N. Cornsweet and L.A. Riggs Analysis of Eye Movements During Monocular and Binocular Fixation J.O.S.A., 50:572, 1960.
20. Latour, P.L. The Neuron as a Synchronous Unit in Nerve, Brain and Memory Models, N. Wiener and P. Schade, Eds., Elsevier Co., New York, 1963 p. 30.
21. Latour, P.L. Visual Threshold During Eye Movements Vision Res., 2:261, 1962.
22. Lettvin, J.Y. Student research QPR 58, RLE Massachusetts Institute of Technology 1960, p. 254.
23. Lorber, M. Pupillary Suppression During Eye Movements S.M. Thesis MIT 1964.
24. Lorber, M., B.L Zuber, and L. Stark Suppression of the Pupillary Light Reflex in Binocular Rivalry and Saccadic Suppression Nature (submitted 1965).
25. Lord, M.P. Measurements of Binocular Eye Movements of Subjects in the Sitting Position Brit. J. Ophthal., 35:21, 1951.
26. Lord, M.P. and W.D. Wright Eye Movements During Monocular Fixation Nature 162:25, 1948.
27. Mackworth, N.H. and I.T. Kaplan Visual Acuity When Eyes are Pursuing Moving Targets Science 136:387, 1962.
28. Marshall, W.M. and S.A. Talbot Recent Evidence for Neural Mechanisms in Vision Leading to a General Theory of Sensory Acuity Biol. Symposia 7:117, 1942.

29. Nachmias, J. Determiners of the Drift of the Eye During Monocular Fixation J.O.S.A., 51:761, 1961.
30. Nachmias, J. Meridional Variations in Visual Acuity and Eye Movements During Fixation J.O.S.A., 50:569, 1960.
31. Nachmias, J. Two-dimensional Motion of the Retinal Image During Monocular Fixation J.O.S.A., 49:901, 1959.
32. Ratliff, F. The Role of Physiological Nystagmus in Visual Acuity Am. Psychol., 5:260, 1950.
33. Ratliff, F. and L.A. Riggs Involuntary Motions of the Eye During Monocular Fixation J. Exp. Psychol., 40:687, 1950.
34. Richards, W. Unpublished data 1964.
35. Riggs, L.A., J.C. Armington and F. Ratliff Motions of the Retinal Image During Fixation J.O.S.A. 44:315, 1954.
36. Riggs, L.A. and Ratliff, F. Coordination of the Eyes in maintaining fixation. Am. Psychol. 5:260, 1950.
37. Riggs, L.A., Ratliff, F., Cornsweet, J.C. and Cornsweet, F.N. The disappearance of steadily fixated visual test object. J.O.S.A., 43:495, 1953.
38. Riggs, L.A. and S.U. Tulunay Visual effects of varying the extent of compensation for eye movements J.O.S.A., 49:741, 1959.
39. Sperry, R.W. Neural basis of the spontaneous optokinetic response produced by visual inversion J. Comp. Physiol. Psychol., 43:482, 1950.
40. Stark, L. Physiology of the visual control system: The intermittency operator in the control system for eye movements. NASA Progress Report No. 2 on Contract NAS 2-1328, 1963.
41. Szentagothai, J. The elementary vestibulo-ocular reflex arc J. Neurophysiol. 13:395, 1950.
42. Teuber, H.-L. Perception in Handbook of Physiology, Section I: Neurophysiology, Vol. III. J. Field, H.W. Magoun and V.E. Hall, Eds. (American Physiological Soc. Washington, D.C. 1960) p. 1647.

43. Teuber, H.-L. Sensory Deprivation, Sensory Suppression and Agnosia: Notes for a Neurologic Theory. J. Nerv. Men. Dis., 132:32, 1961.
44. Volkman, F.C. Vision During Voluntary Saccadic Eye Movements, J.O.S.A. 52:571, 1962.
45. Yarbus, A.L. Motion of the Eye on Interchanging Fixation Points. Biofizika, 2:698, 1957.
46. Yarbus, A.L. The Perception of an Image Fixed with Respect to the Retina. Biofizika, 2:703, 1957.
47. Young, L.R. and L. Stark. A Discrete Model for Eye Tracking Movements. IEEE Trans. Mil. Elec. MIL 7:113, 1963.
48. Zuber, B.L. Physiological Control of Eye Movements in Humans. Ph.D. thesis, M.I.T., 1965.
49. Zuber, B.L., A. Crider and L. Stark. Saccadic Suppression Associated with Microsaccades. QPR 74:244 Res. Lab. Elec. MIT 1964.
50. Zuber, B.L., A. Horrocks, M. Lorber and L. Stark. Visual Suppression During the Fast Phase of Vestibular Nystagmus. QPR 73:221, Res. Lab. Elec. MIT 1964.
51. Zuber, B.L., J.A. Michael and L. Stark. Visual Suppression During Voluntary Saccadic Eye Movements. QPR 73:217, Res. Lab. Elec. MIT 1964.
52. Zuber, B.L., L. Stark and G. Cook. Microsaccades and the Velocity-Amplitude Relationship for Saccadic Eye Movements (Submitted to Science).
53. Zuber, B.L., L. Stark and M. Lorber. Suppression of the Direct Light Reflex of the Pupil Associated with Saccadic Suppression.

Movements found

Investigation	Flicks		Method
	High frequency	'Interflick'	
(1) Adler & Fliegelman	Mean value: 1' arc at 50-100 c/s*	Mean values: 'Waves', 2' arc at 5 c/s; drifts frequency 1/sec	Horizontal component of deflexion of mirror placed on eye; monocular fixation; 1 subject
(2) Lord & Wright (1948) Lord (1951)	_____	Excursion 2-25' arc of duration 0.02-0.03 sec; mean interval between flicks for different subjects, 0.86-1.2 sec	Photo-electric recording of corneal reflexion using u.v. light; horizontal and vertical components; 6 subjects
(3) Ratliff & Riggs (1950)	Median values: 17.7" arc at 30-70 c/s; range of excursions 0-2' arc; >1' arc rare	Excursion, 2.2-25.8' arc of 0.02 sec duration; interval between flicks 0.2-4.0 sec	Horizontal and vertical components of deflexion of mirror attached to contact lens; monocular fixation; 5 subjects
(4) Ditchburn & Ginsborg (this paper)	10-30" arc at 30-80 c/s	1-20' arc of 0.025 sec duration; interval between flicks 0.03-5.0 sec to 6' arc	Horizontal and vertical component of deflexions of contact lens flat; 2 subjects

* Value for magnitude reported in original paper 2' 14" arc. This appears to have been incorrectly calculated and the value quoted here is as recalculated by Ratliff & Riggs (1950) from the data given.

Table 1. A summary of the results of studies on the In-voluntary Miniature Movements of the Eyes During Steady Fixation. Abstracted from Ditchburn and Ginsborg (1953)

POSITION OF FLASH	SEEN	UNSEEN	TOTAL	% SEEN
(A) $-25 < t < 25$	0	89	89	0
(B) $25 < t < 50$ $-50 < t < -25$	1	7	8	12.5
(C) $50 < t < -50$	61	7	68	90
QUESTIONABLE	8	24	32	25

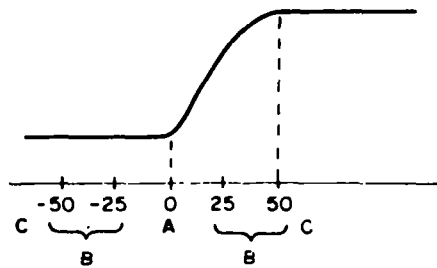

Table 2.

Percent of test flashes seen as a function of the temporal relationship of the flash to the microsaccade. From Zuber (1965)

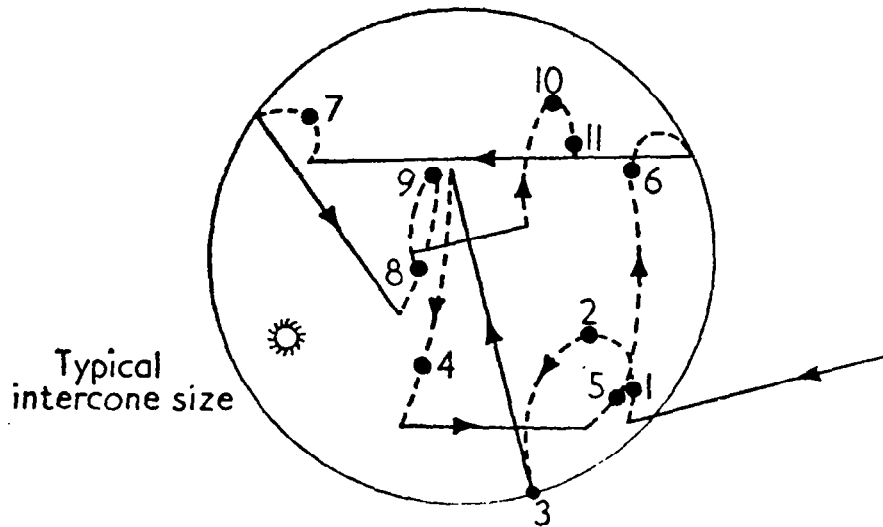

Figure 1. Movement of the retinal image during fixation. Dashed lines are drifts, solid lines are microsaccades. From Ditchburn (1955).



Figure 2. A microsaccade recorded by the contact lens technique. From Ratliff and Riggs (1950)

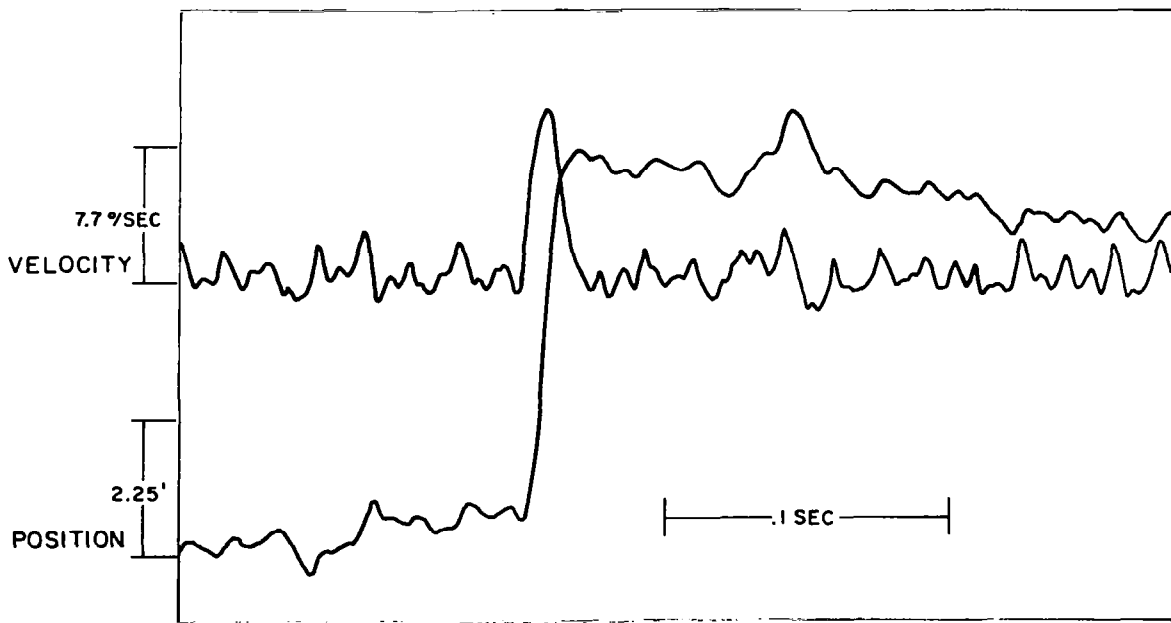
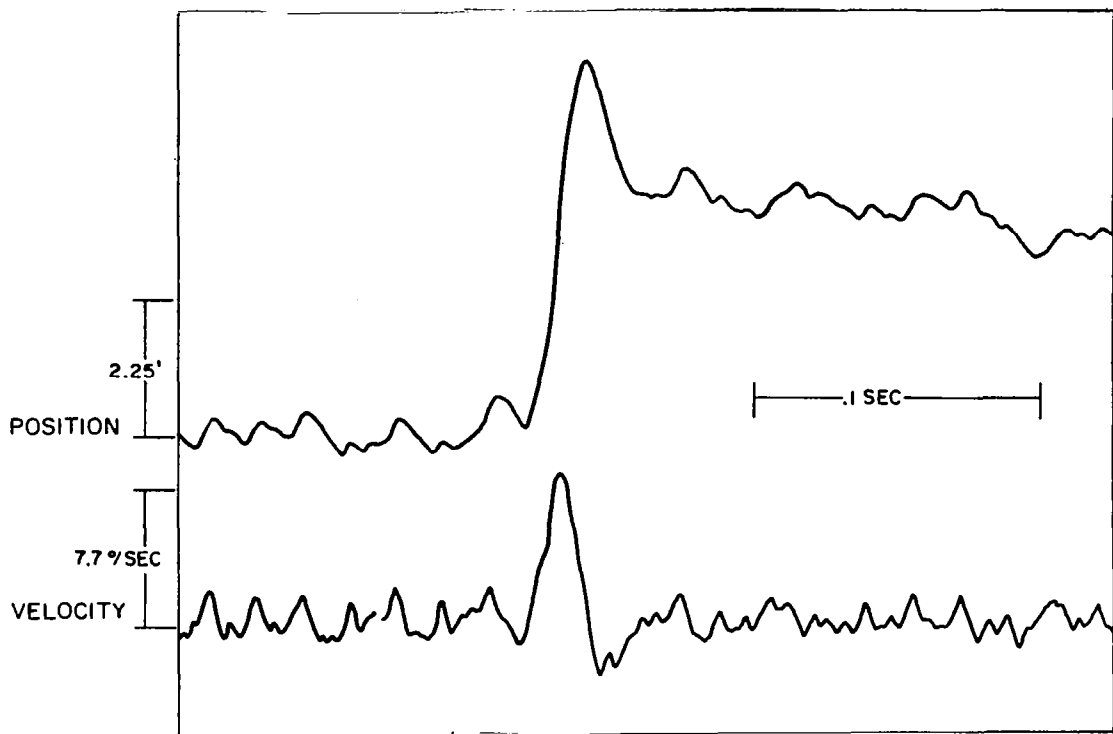

Figure 3. Recordings of two microsaccades and their velocity traces. From Zuber, Cook and Stark (1965)

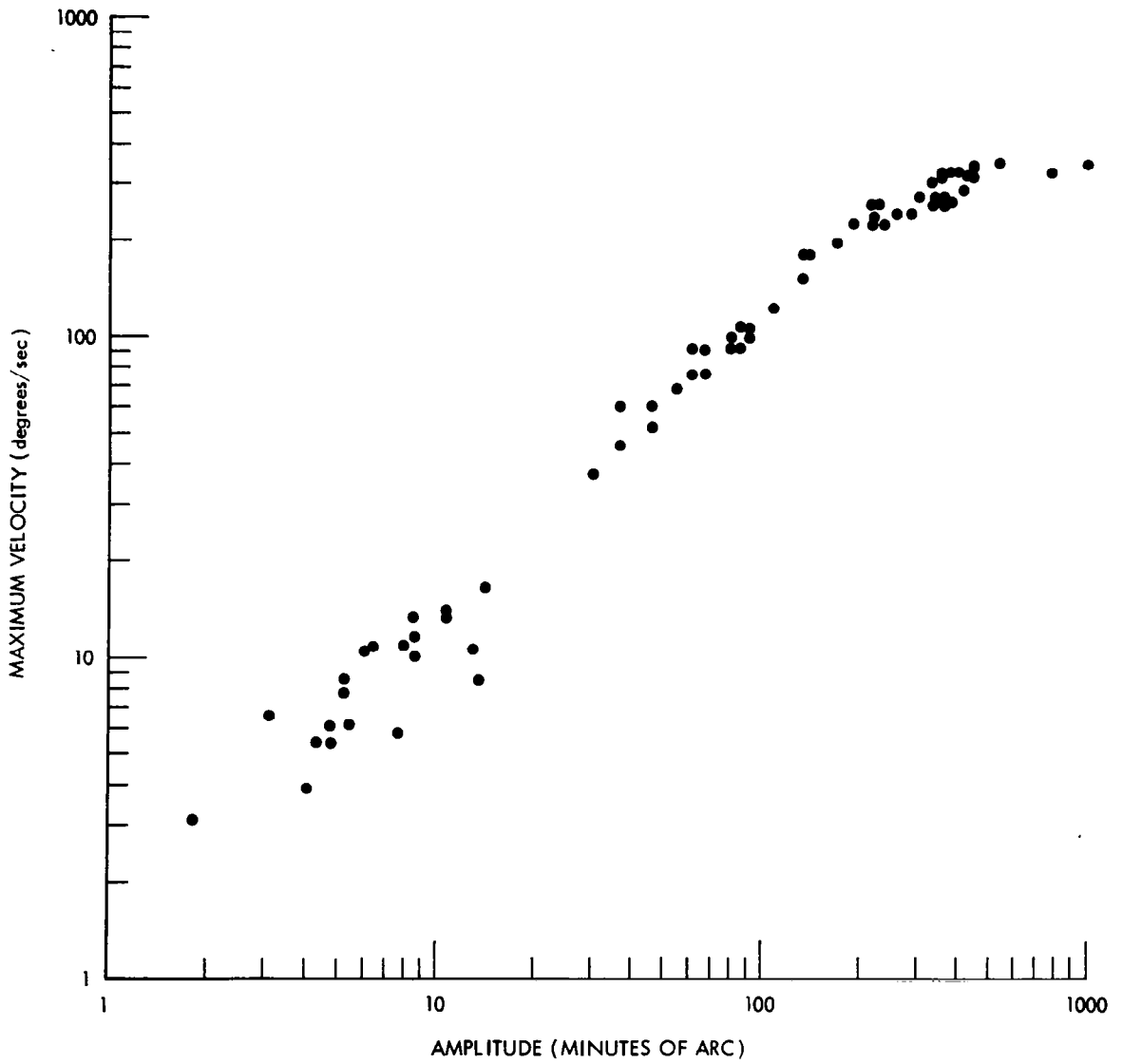

Figure 4. Maximum velocity ($^{\circ}/\text{sec}$) vs. amplitude (minutes of arc) for microsaccades and voluntary saccades. From Zuber, Cook and Stark (1965)

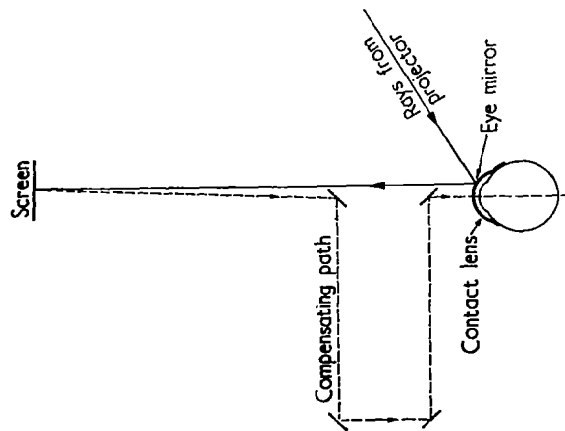

Figure 5. One method of optically stabilizing the retinal image. From Riggs, Ratliff, Cornsweet and Cornsweet (1953)

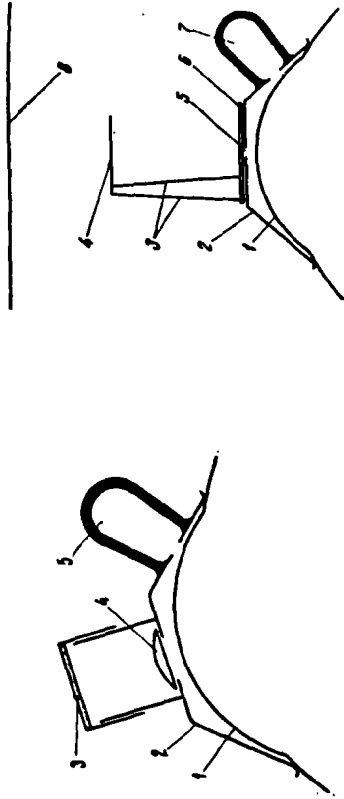

FIG. 1.

FIG. 1. The Type 1 cap, which gives a stationary retinal image over the whole field of view. (1) cornea, (2) body of cap, (3) opal glass, (4) lens, (5) rubber bulb. This bulb is used to reduce the air pressure in the space between cornea and cap. The atmospheric pressure causes the cap to adhere tightly to the eye and remain fixed relative to it (and hence to the retina). The lens enables the subject to see objects on the opal glass background clearly, the glass being illuminated by the coloured light in use in the test.

FIG. 2.

FIG. 2. The Type 2 cap, which gives a stationary retinal image over part of the field of view. (1) cornea, (2) body of cap, (3) steel braces for attaching the stop rigidly to the cap, (4) stop to shut off part of the field of view, (5) diaphragm, (6) glass plate, (7) rubber bulb, (8) background. Cap attached to the eye as in Fig. 1. The diaphragm enables the subject to see the stop clearly, the stop moving with the eye and thus remaining stationary relative to the retina, and also to see the background, which, though objectively motionless, moves relative to the retina.

Figure 6. The method of retinal image stabilization according to Yarbus (1957)

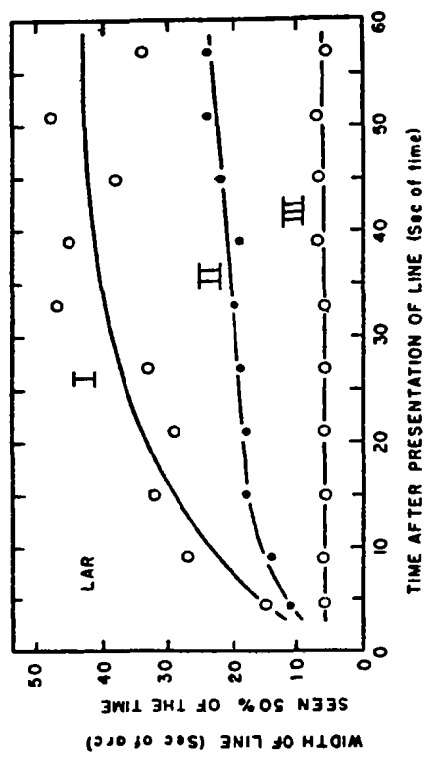

Figure 7. Width of line seen 50 percent of time during successive sections of a one-minute interval under viewing conditions: (I) complete image stabilization; (II) normal viewing, no stabilization; (III) reversal of image motion, i.e. exaggerated motion. From Riggs, Ratliff, Cornsweet and Cornsweet (1953)

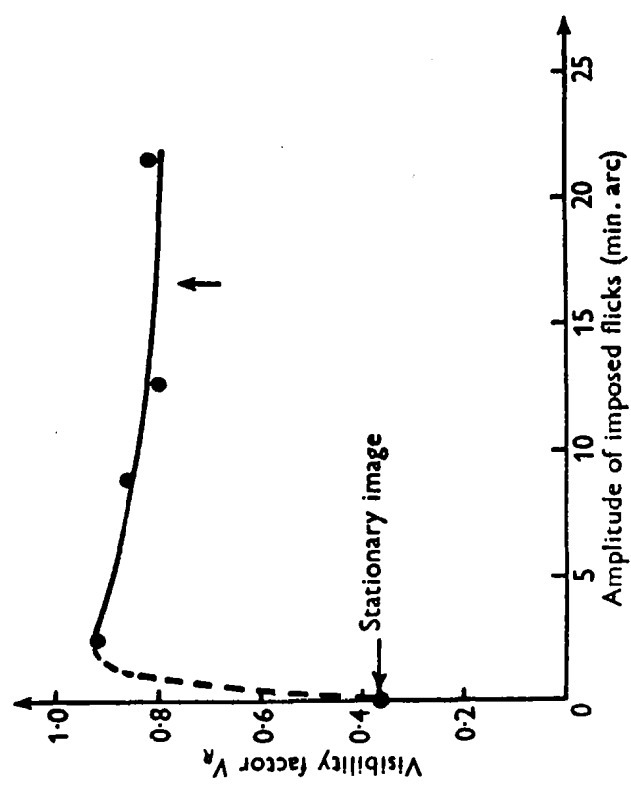

Figure 8. Improvement of visibility with the stabilized image by imposing "microsaccades" of varying amplitudes. From Ditchburn, Fender and Mayne (1958)

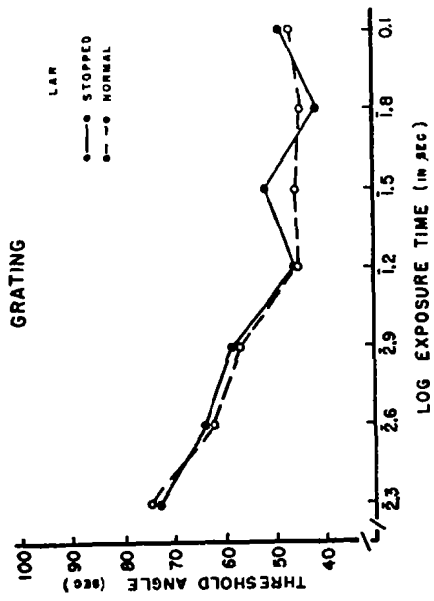

Figure 9. Visibility as a function of degree of image stabilization. Negative values along the abscissa indicate image movement less than eye movement, positive values indicate more image movement than eye movement. From Riggs and Tulunay (1959)

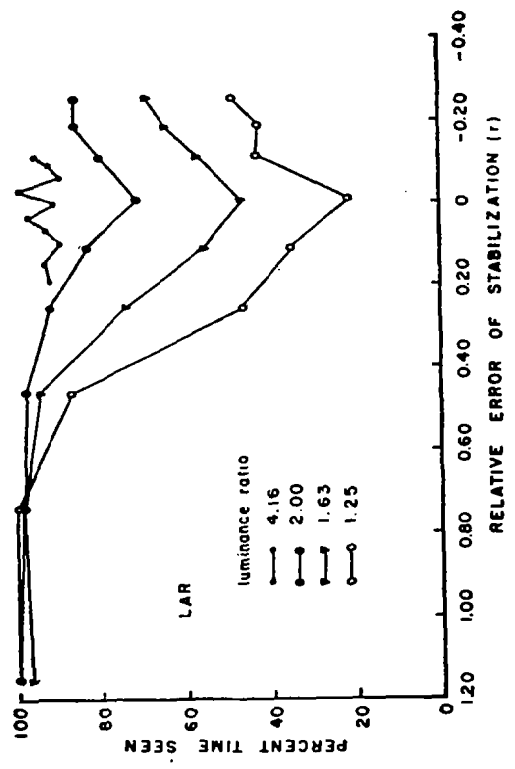

Figure 10. Results of Keesey (1960) showing that true visual acuity is the same with stabilized and unstabilized retinal images.

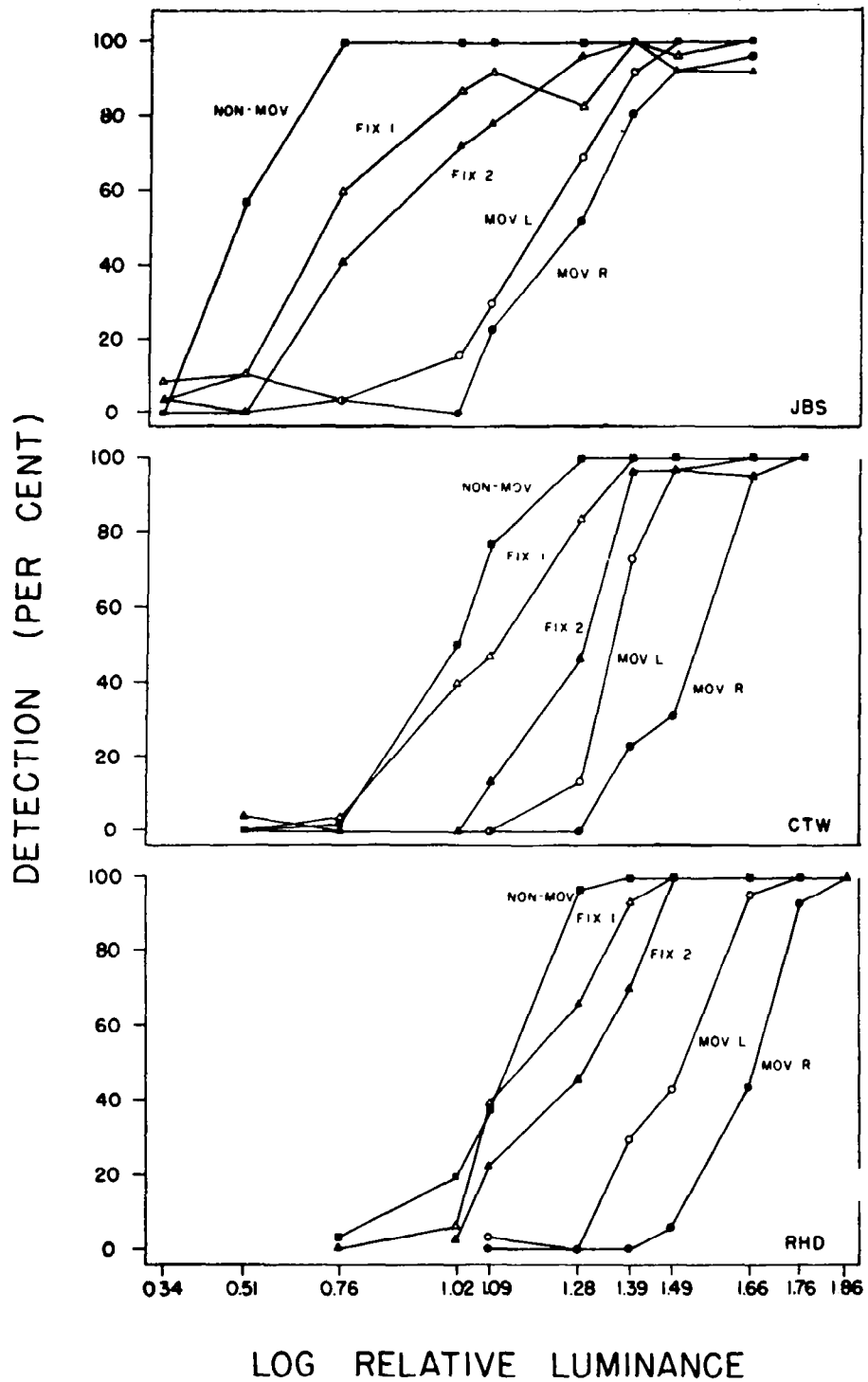

Figure 11. Percentage of light flashes detected, as a function of the log relative luminance of the flash for each subject in each experimental condition. From Volkman (1962)

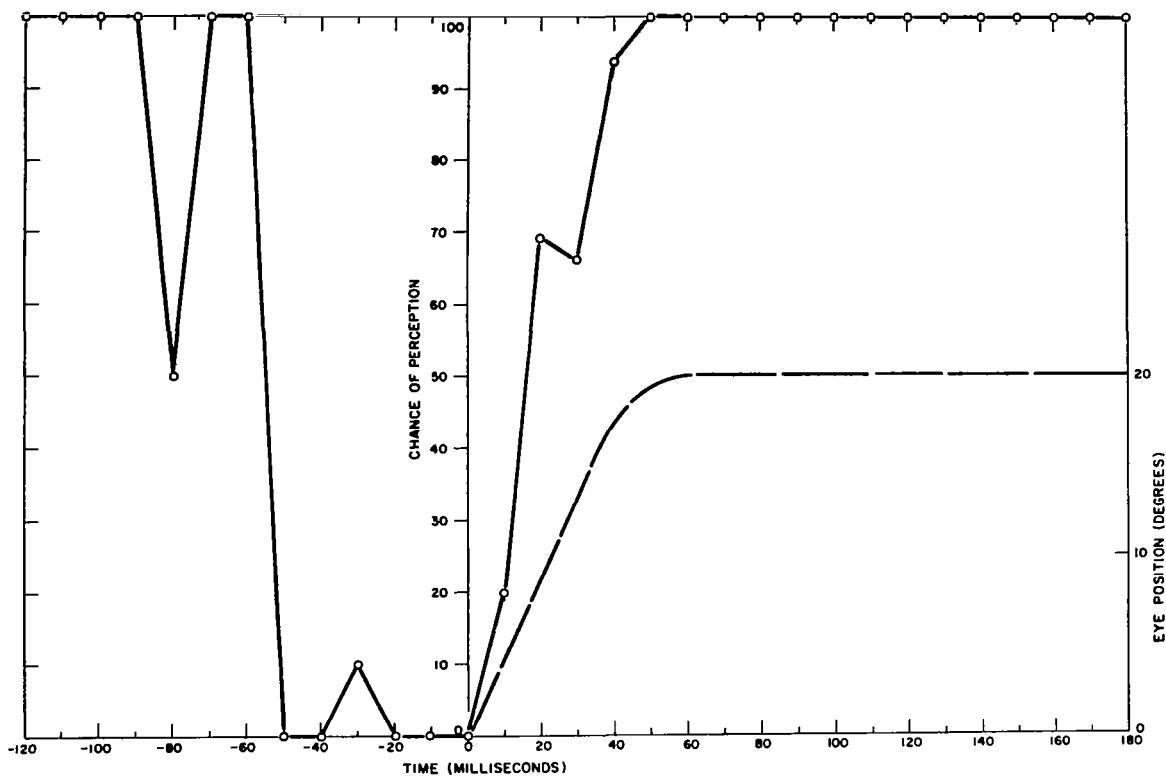

Figure 12. Saccadic suppression as determined with 20° saccadic eye movements. From Zuber (1965)

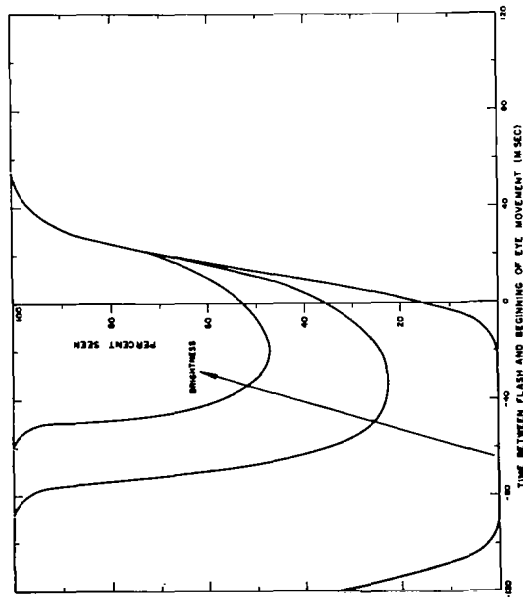

Figure 13. Schematic representation of the effect of test flash intensity on the saccadic suppression curve. From Zuber (1965)

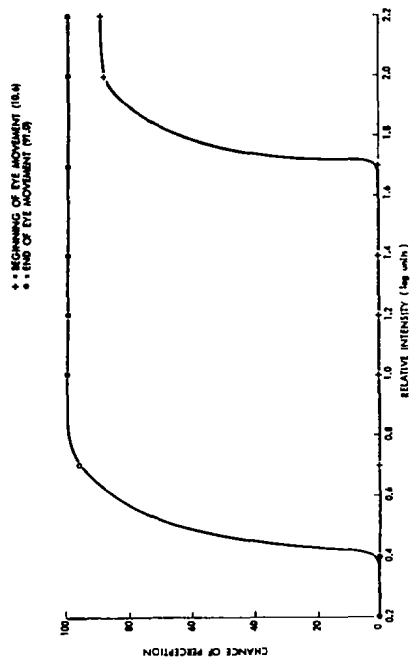

Figure 14. Chance of perception as a function of relative intensity of test flashes presented at two fixed times with respect to the eye movement. From Zuber (1965)

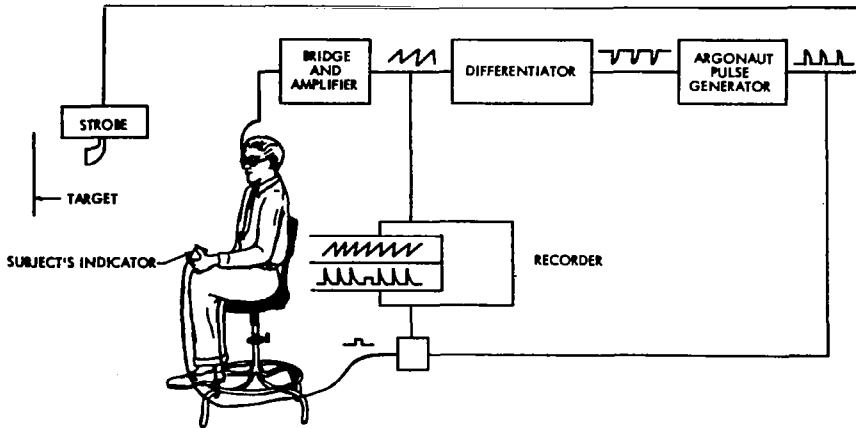

Figure 15. Representation of the apparatus used in measuring saccadic suppression associated with vestibular nystagmus. (From Zuber, 1965)

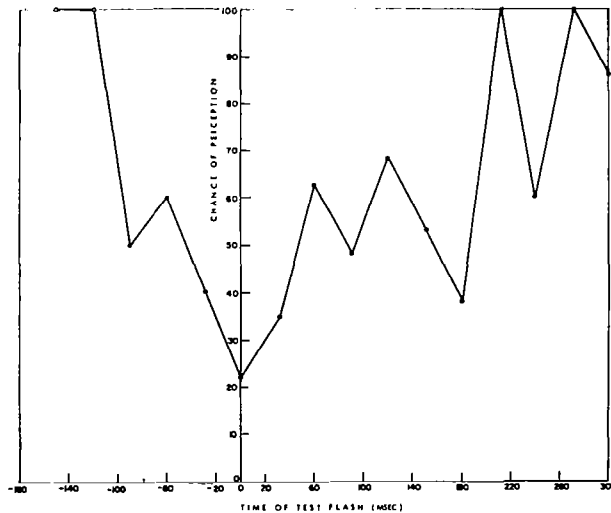

Figure 16. Saccadic suppression associated with the fast phase of post-rotary vestibular nystagmus. From Zuber (1965)

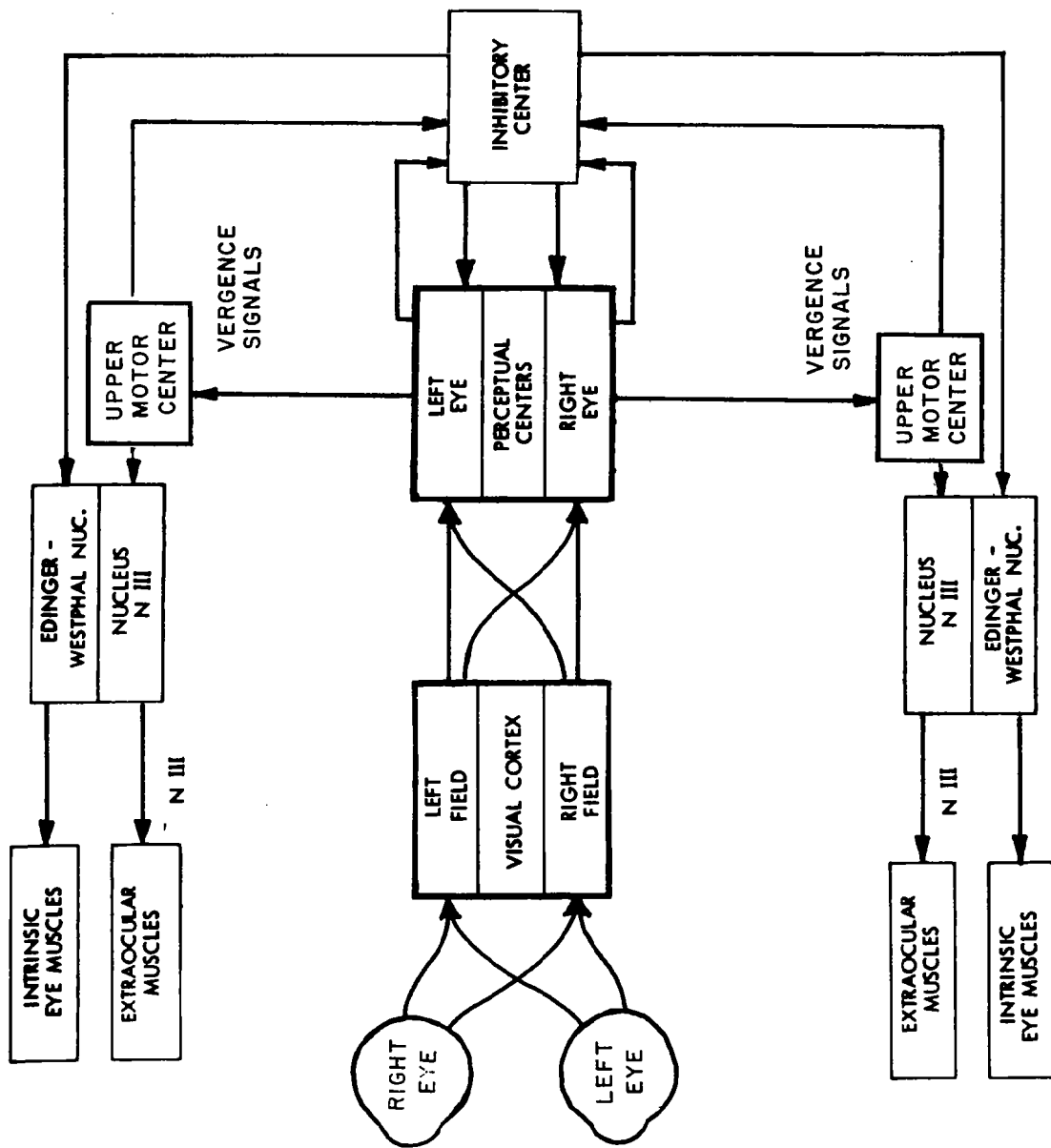

Figure 17. A model which could account for saccadic suppression and related phenomena.

"The aeronautical and space activities of the United States shall be conducted so as to contribute . . . to the expansion of human knowledge of phenomena in the atmosphere and space. The Administration shall provide for the widest practicable and appropriate dissemination of information concerning its activities and the results thereof."

—NATIONAL AERONAUTICS AND SPACE ACT OF 1958

NASA SCIENTIFIC AND TECHNICAL PUBLICATIONS

TECHNICAL REPORTS: Scientific and technical information considered important, complete, and a lasting contribution to existing knowledge.

TECHNICAL NOTES: Information less broad in scope but nevertheless of importance as a contribution to existing knowledge.

TECHNICAL MEMORANDUMS: Information receiving limited distribution because of preliminary data, security classification, or other reasons.

CONTRACTOR REPORTS: Technical information generated in connection with a NASA contract or grant and released under NASA auspices.

TECHNICAL TRANSLATIONS: Information published in a foreign language considered to merit NASA distribution in English.

SPECIAL PUBLICATIONS: Information derived from or of value to NASA activities. Publications include conference proceedings, monographs, data compilations, handbooks, sourcebooks, and special bibliographies.

TECHNOLOGY UTILIZATION PUBLICATIONS: Information on technology used by NASA that may be of particular interest in commercial and other nonaerospace applications. Publications include Tech Briefs; Technology Utilization Reports and Notes; and Technology Surveys.

Details on the availability of these publications may be obtained from:

SCIENTIFIC AND TECHNICAL INFORMATION DIVISION
NATIONAL AERONAUTICS AND SPACE ADMINISTRATION

Washington, D.C. 20546