

NASA CONTRACTOR
REPORT

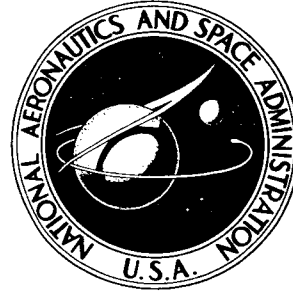

NASA CR-675

NASA CR-675

FACILITY FORM 602

N 67-17359

(ACCESSION NUMBER)

55

(PAGES)

NASA CR-675

(NASA CR OR TMX OR AD NUMBER)

(THRU)

1

(CODE)

20

(CATEGORY)

PROJECT FOG DROPS

INVESTIGATION OF WARM FOG PROPERTIES
AND FOG MODIFICATION CONCEPTS, VOL. III

by R. J. Pilié and W. C. Kocmond

Prepared by
CORNELL AERONAUTICAL LABORATORY, INC.
Buffalo, N. Y.
for

GPO PRICE \$ _____

CFSTI PRICE(S) \$ 3.00

Hard copy (HC) _____

Microfiche (MF) .65

ff 653 July 65

PROJECT FOG DROPS
INVESTIGATION OF WARM FOG PROPERTIES AND FOG
MODIFICATION CONCEPTS, VOL. III

By R. J. Pilić and W. C. Kocmond

Distribution of this report is provided in the interest of information exchange. Responsibility for the contents resides in the author or organization that prepared it.

Prepared under Contract No. NASr-156 by
CORNELL AERONAUTICAL LABORATORY, INC.
Buffalo, N.Y.

for

NATIONAL AERONAUTICS AND SPACE ADMINISTRATION

For sale by the Clearinghouse for Federal Scientific and Technical Information
Springfield, Virginia 22151 - Price \$2.50

TABLE OF CONTENTS

<u>Section</u>	<u>Page</u>
LIST OF ILLUSTRATIONS	v
LIST OF TABLES	vi
ABSTRACT	vii
I. INTRODUCTION	1
II. SUMMARY OF ACCOMPLISHMENTS TO DATE . .	2
A. Definition of the Problem	2
B. Investigation of Condensation Nuclei	2
C. Investigation of Methods for Altering Diffusional Growth Rates of Droplets	3
D. Investigation of Effects of Ionic-Surfactants on Coalescence.	3
E. Investigation of a Possible Method for Preventing Dense Radiation Fog	3
F. Investigation of Electrical Means of Fog Dispersal	4
III. TECHNICAL DISCUSSION	6
A. Characteristics of Natural Fog	6
1. Drop-Size Distribution	6
2. Liquid Water Content	10
3. Nuclei Measurements	11
B. Measurements of Cloud Nuclei	11
1. Buffalo, N. Y. Data	11
2. Hawaii Data	15
3. Philipsburg, Penn. Data	18
4. Conclusions	21

TABLE OF CONTENTS (Cont'd.)

<u>Section</u>	<u>Page</u>
III	
C. Investigation of Possible Techniques for Preventing Dense Radiation Fog	22
1. Theoretical Considerations.	23
2. Laboratory Experiments	27
3. Discussion of Results	32
4. Recommendation for Continued Effort to Suppress Radiation Fog	36
D. Investigation of Electrical Means of Fog Dispersal	36
1. Determination of Charge Per Droplet	37
2. Estimates of Electrical Forces on Droplets Due to Drop Charge.	41
3. Summary of Conclusions.	43
REFERENCES	46

LIST OF ILLUSTRATIONS

<u>Figure No.</u>		<u>Page</u>
1	Frontal Fog Droplet Impressions	7
2	Stratus Cloud Droplet Impressions	7
3	Average Drop Size Distribution for Three Frontal Fogs	9
4	Average Drop Size Distribution for Two Radia- tion Fogs (1 Ground and 1 Valley Fog)	9
5	Average Drop Size Distribution for Three Stratus Cloud Cases	9
6	Variation of Nucleus Concentration at 3.0% Supersaturation as a Function of Wind Direction.	13
7	Variation of Nucleus Concentration at 0.1% Supersaturation as a Function of Wind Direction.	13
8	Nucleus Concentration Measurements - Hilo Campus, Univ. of Hawaii	16
9	Nucleus Concentration Measurements - Ocean- side - Hilo, Hawaii	17
10	Nucleus Concentration Measurements, Ocean- side - Hilo, Hawaii, 24 August 1965.	19
11	Apparatus for Testing Fog Seeding Technique	28
12	Photomicrographs of NaCl nuclei produced by aerosol spray for seeding experiments	30
13	Comparison of Seeded and Unseeded Fogs	33
14	Degradation of Visibility Due to Improper Seeding.	34
15a	Experimental Configuration for Drop Charge Measurements	39
15b	Block Diagram of Pulsed High Voltage Source	39

LIST OF TABLES

<u>Table No.</u>		<u>Page</u>
I	Drop Size Data	8
II	Average Values of LWC for Two Frontal Fogs and Associated Visibility	11
III	Nucleus Concentration in Buffalo, N. Y.	12
IV	Nucleus Concentration Before and After a Frontal Passage- 2 August 1966, Buffalo, N. Y.	14
V	Average Nucleus Concentration at Three Locations	20
VI	Growth Time and Mass of Water Required to Produce Drop of Diameter (d) from an 8 μ Diameter NaCL Nucleus	25

ABSTRACT

Surface measurements of drop size distribution and liquid water content made in advection fogs are shown to agree with characteristics of the fog model presented in earlier work. Comparisons are made of cloud and fog nucleus concentrations measured in Buffalo, Hawaii and Central Pennsylvania.

Analytic and experimental data show that the basic concept for minimizing visibility degradation in radiation fog by preseeding with small concentrations of large hygroscopic nuclei is sound. Visibility improvements greater than a factor of two over unseeded fogs have been produced in the laboratory. The concept appears to have applicability only for radiation fog situations.

Analytic and experimental investigations show that it is impractical to attempt to suppress fog at an airport by placing electric charge on fog droplets. Electrical forces that can be established by this means when practical droplet charging equipment is used are far too small to have significant influence on fog dissipation rate.

PROJECT FOG DROPS
INVESTIGATION OF WARM FOG PROPERTIES
AND FOG MODIFICATION CONCEPTS
VOL. III

I. INTRODUCTION

The purpose of Project Fog Drops, conducted by Cornell Aeronautical Laboratory under Contract NASr-156, is to investigate basic fog properties and dynamics and to suggest and evaluate possible techniques for fog suppression. The principal accomplishments thus far are summarized in the next section. During the program's third year, emphasis was placed on obtaining measurements of various parameters in natural fog, learning more about the concentration and variability of cloud and fog nuclei and evaluating two suggested concepts for fog suppression. One of the concepts, involving seeding of the atmosphere prior to fog formation, appears to have applicability for the suppression of dense radiation fog. An electrical means of fog dispersal, is shown to be impractical for large scale application. The results of these investigations are reported herein.

* This is the third annual summary report published under the same title. The other two were designated NASA CR-72 and NASA CR-368, respectively.

II. SUMMARY OF ACCOMPLISHMENTS TO DATE

A. Definition of the Problem

A generalized fog classification system has been evolved. Structural models have been established for the micro- and macroscopic properties of advection and radiation fogs. Dynamic models have been formulated for advection and radiation fogs and for "sea smoke." A fog climatology has been established for the Continental United States. Results of these studies were presented in the first two annual reports.

B. Investigation of Condensation Nuclei

Using a thermal diffusion chamber developed on this program, measurements have been (and are being) made of the concentration of condensation nuclei active at supersaturations characteristic of natural clouds and originally thought to be characteristic of natural fog. An important conclusion of this investigation drawn at the end of the second year is that the maximum supersaturation existing in urban fog is probably substantially less than 0.1%. This observation, combined with results of experiments conducted during development of the diffusion chamber, led to the concept for seeding the atmosphere prior to fog formation to minimize the degradation in visibility.

These measurements were continued during the third year of the program at Buffalo, and Springville, New York, at the Philipsburg Airport in Central Pennsylvania and (as part of a field trip conducted on another project) on the Island of Hawaii. The results obtained indicate that even in rural regions of New York and Pennsylvania the maximum supersaturation achieved in natural fog is usually less than 0.1%. Measurements made in Hawaii, on the other hand, show that at the ocean surface (actually 50 meters from the water's edge) supersaturations of a few tenths would be required to activate sufficient nuclei to produce the droplet concentrations found in dense sea fogs. Two

miles inland the concentration of nuclei activated at one percent supersaturation had doubled so that typical advection-fog droplets concentrations could be produced at supersaturations as low as 0.1% to 0.2%. The source of these nuclei, although associated with the land mass, has not been established.

C. Investigation of Methods for Altering Diffusional Growth Rates of Droplets

The validity of the droplet growth-rate expression given by Eisner, Quince and Slack (1960) was demonstrated experimentally. On the basis of this expression we predicted that growth rates of droplets could be decreased by treatment of droplets with surface active monolayers such as hexadecanol and octadecanol and verified this prediction experimentally. We further demonstrated that treatment of nuclei prior to droplet formation did not prevent activation of the nuclei but did inhibit continued growth of droplets that formed on the nuclei. We have suggested that the drop size distribution in fog could be favorably altered (to improve visibility and cause more rapid precipitation) by treating a portion of the droplet population (or nucleus population) with selected monolayers to minimize competition for available water and thereby promote more rapid growth of untreated droplets. We have not, however, developed a practical method for treating drops in a natural fog.

D. Investigation of Effects of Ionic-Surfactants on Coalescence

Several investigators have considered the use of ionic surfactants to promote coalescence of droplets. Experiments conducted on this program showed that surface layers of such materials inhibit rather than promote coalescence.

E. Investigation of a Possible Method for Preventing Dense Radiation Fog.

The fact that radiation fog consists of large numbers of very small droplets accounts for the extreme stability of the fog and the poor visibility associated with it. Our search for techniques to suppress radiation fog, therefore, has been aimed at causing a redistribution of fog liquid water so that fogs consist of a few large drops rather than the natural distribution which is characterized by many small drops.

We have reasoned that if a portion of the atmosphere could be seeded with extremely hygroscopic nuclei prior to fog formation, the artificial nuclei might remove enough excess water from the atmosphere to prevent activation of most natural nuclei. This would result in a fog consisting of a small number of large drops that would scatter less light (improve visibility) and precipitate more rapidly.

Calculations made during the past year indicate that this reasoning is valid. To check these hypotheses and calculations in the laboratory we have conducted a series of experiments in which the visibility in seeded and unseeded fogs was measured. Results of tests conducted thus far indicate that visibility improvements of greater than a factor of 2 can be expected in dense fog if proper separation and insertion of nuclei are achieved. On those occasions when visibility in unseeded fog was greater than 1.5 miles, seeding provided no improvement in visibility. It appears therefore that the basic hypothesis on which the experiments are based is sound. A detailed discussion of the concept is given in Section III, Part C of the text.

F. Investigation of Electrical Means of Fog Dispersal

Since a majority of droplets in natural fog are less than 20μ radius the incidence of coalescence is very small. It has been suggested in the past that droplet coalescence might be enhanced by placing sufficient charge on droplets to cause attraction of neighboring drops. After reviewing various proposed methods of fog suppression by electrical means we suggested that the maximum electrical effect might be achieved by charging alternate adjacent regions of the fog positively and negatively. By so doing, we reasoned, substantial electric fields might be produced to promote rapid mixing of droplets charged to opposite polarities. Once mixed, the droplets might exert sufficient attractive forces on one another to promote coalescence.

From a thorough analytical and experimental investigation of this concept we have concluded that it is impractical to attempt to disperse fog by placing electrical charge on the droplets. We have been able to demonstrate, both theoretically and in the laboratory that, when practical equipment is used,

the average attractive force between oppositely charged, 10μ diameter droplets is approximately eight orders of magnitude less than gravitational forces. Such forces are truly negligible. We recommend that no further effort be devoted to fog suppression concepts based on artificial charging of fog droplets. Details of this investigation are given in Section III, Part D of the text.

III. TECHNICAL DISCUSSION

A. Characteristics of Natural Fog

During the latter part of October and early November of 1965, we participated with personnel of the Department of Meteorology, Penn State University, in a field program in Central Pennsylvania to obtain additional data about the characteristics of natural fog. In particular, data were sought about the drop-size distribution, nucleus concentration, liquid water content and vertical temperature variation in fog. Such information is necessary both for experimental verification of physical and dynamic fog models and for a better understanding of the mechanisms of fog formation.

During the period involved, measurements were made in three frontal fogs, two radiation fogs and three stratus clouds (encountered on mountain ridges). On two dates, during periods of pre-frontal fog, we were able to obtain measurements of all the desired fog parameters except vertical temperature profiles. Daily measurements of the concentration of condensation nuclei were made with a thermal diffusion chamber and a GE small particle detector.

1. Drop-Size Distribution

To obtain measurements of drop-size distribution, a modified Bausch and Lomb slide projector was used to expose gelatin coated slides to a stream of foggy air. Droplets in the airstream were impacted on treated slides to leave permanent, well defined replicas that could be accurately measured under a microscope. Sample photographs illustrating the droplet impressions in the gelatin layers are presented in Figures 1 and 2. From previous work, (Jiusto, 1960, 1965) we have found that true droplet diameters are very nearly equal to one-half the crater-like impressions left in the gelatin.

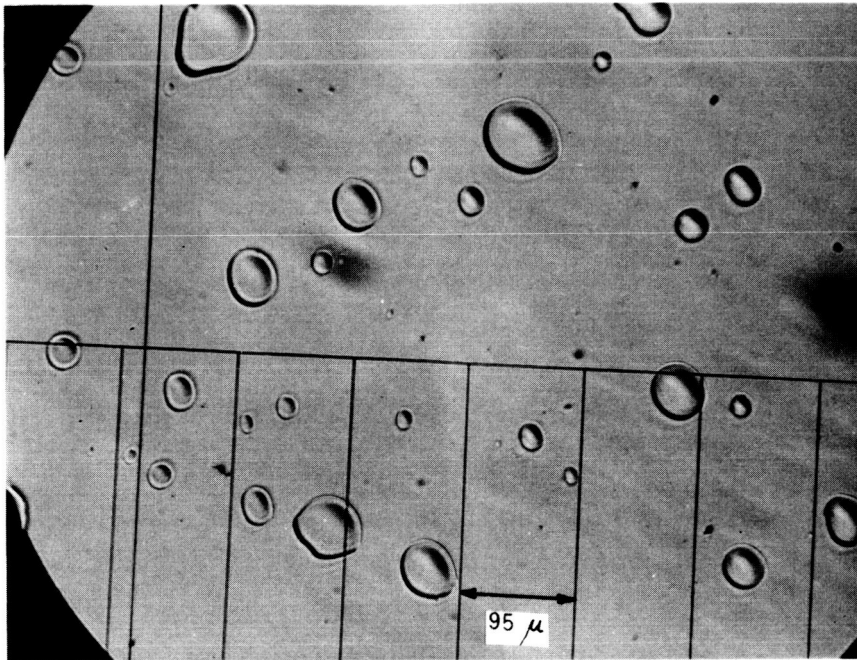

Figure 1 FRONTAL FOG DROPLET IMPRESSIONS

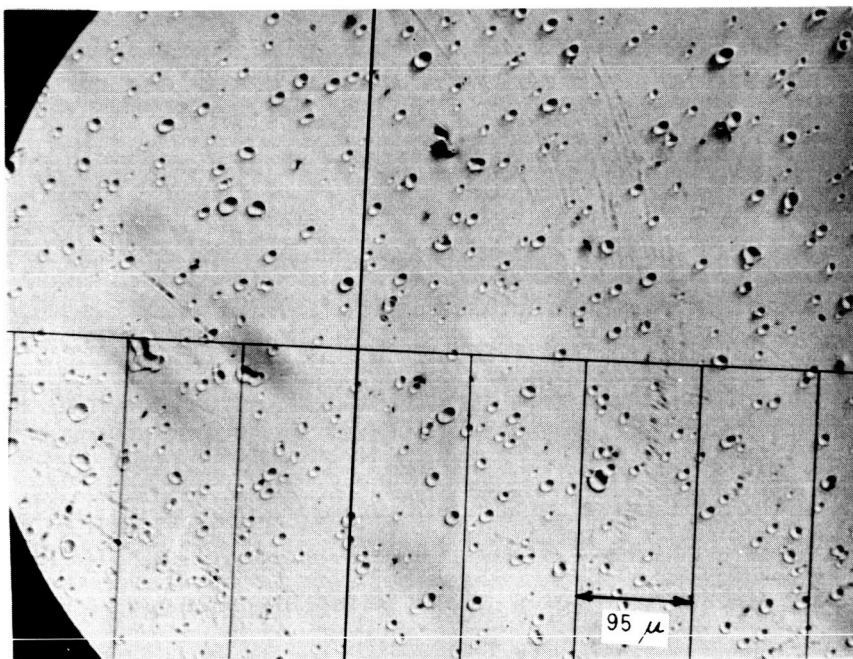

Figure 2 STRATUS CLOUD DROPLET IMPRESSIONS

The droplet replicas in Figure 1 were made during a pre-frontal fog. Visibility was about 1/8 mile with some light drizzle in the area. The drop-size range was typical for frontal fog, i. e. 2 to 50 μ diameter, although in this portion of the photograph the largest impression shown was made by a droplet of 34 μ diameter. In contrast, Figure 2 illustrates the craters made by droplets from a stratus cloud, which typically average 6 to 8 μ diameter and have a size range of 1 to 20 μ . Visibility within the cloud, which had obscured the nearby mountain sides, was less than 1/8 mile with some light drizzle falling.

From the results of numerous samples taken in clouds and fog the following drop size information was obtained

TABLE I
Drop Size Data

<u>Fog or Cloud Type</u>	<u>Drop Dia. Range (Avg.)</u>	<u>Mean Diameter</u>	<u>Vol. Mean Diameter</u>
Frontal	2-50 μ	7.8 μ	14.2 μ
Stratus	1.5-43	4.9	9.6
Radiation	1.5-39	3.5	7.5

In Figures 3, 4 and 5 average drop-size distributions are given for frontal fog, radiation fog and stratus clouds, respectively. A logarithmic scale of drop diameter intervals was chosen since a preponderance of drop sizes were clustered around 2 to 10 μ with only a few drops in the 30 μ , 40 μ and 50 μ range. Also shown in each figure are the data normalized to drop diameter increments of 1 μ .

The results of these measurements are in good agreement with the data given by Pedersen and Todsén (1960) for stratus clouds and fog. As expected, the use of narrow slides in our sampling apparatus not only improved our measuring capability but also revealed smaller average drop sizes than have been indicated by most previous measurements. The measured drop sizes are somewhat smaller than those indicated in our radiation fog model

Figure 3
AVERAGE DROP SIZE DISTRIBUTION FOR THREE FRONTAL FOGS

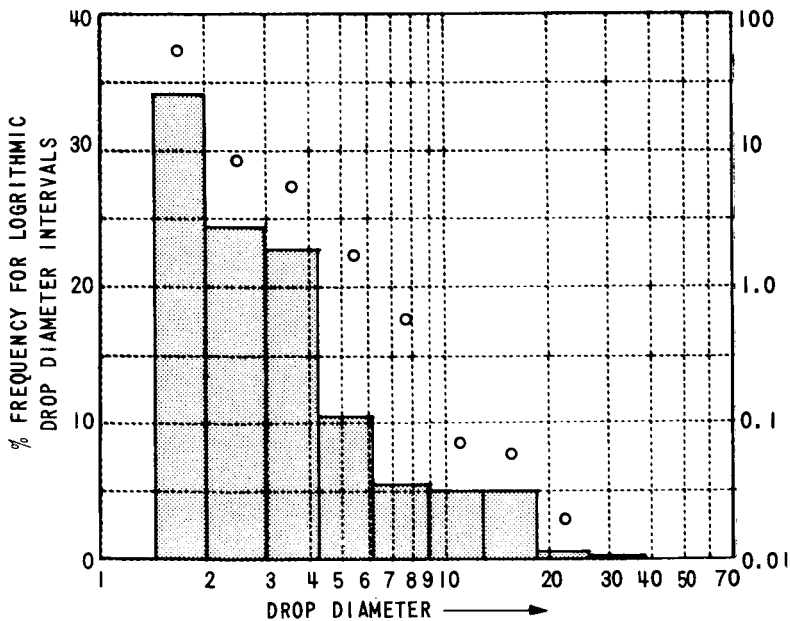
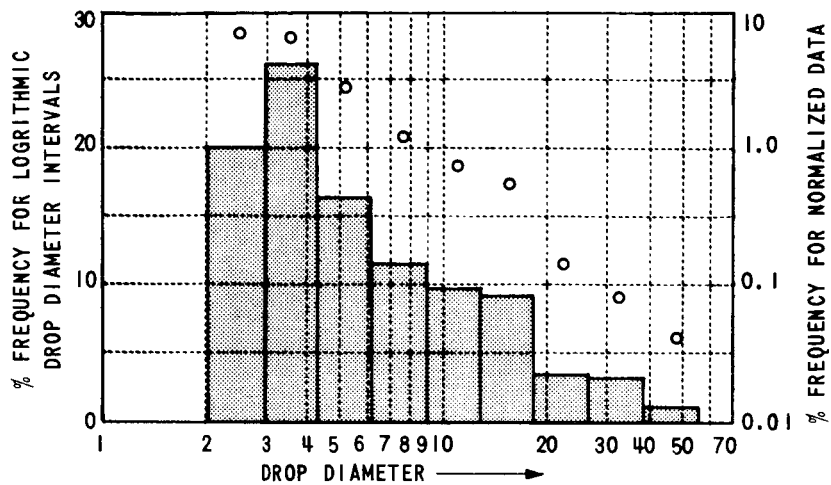
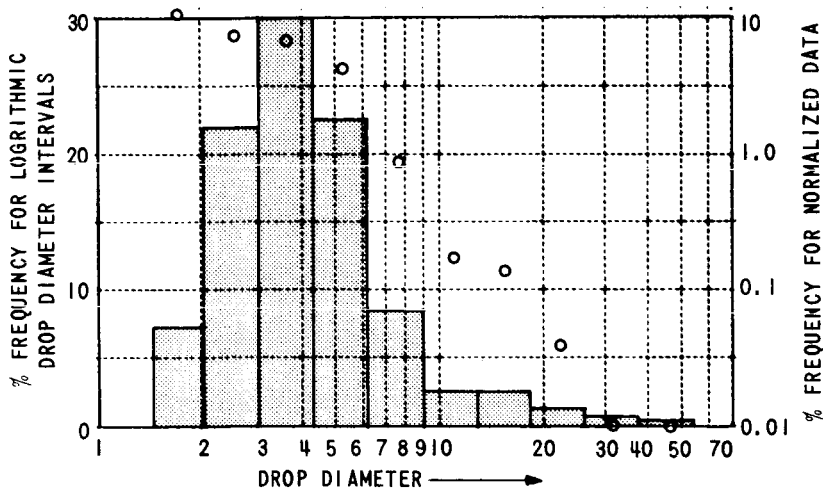

Figure 4
AVERAGE DROP SIZE DISTRIBUTION FOR TWO RADIATION FOGS (1 GROUND AND 1 VALLEY FOG)

NOTE:

Left scale is to be used for Histograms. Right scale is to be used for o in which data are normalized to drop diameter increments of 1 μ.

Figure 5
AVERAGE DROP SIZE DISTRIBUTION FOR THREE STRATUS CLOUD CASES



(First Annual Summary Report); however we do not consider the results of so few measurements sufficient to warrant modification of the model at this time.

As part of the program conducted by Penn State, Jiusto and Mack (1965) made a case study of an advection fog that occurred at the field site on 12 November 1965. This study is particularly interesting in that it illustrates the importance of drop size distribution on visibility. Detailed droplet spectra were obtained from 2 samples taken an hour apart during the fog. Horizontal visibility, as indicated by the transmissometer, was 1/8 mile for Sample A and 1/2 mile for Sample B. The difference in the individual drop-size distributions was striking. Sample A (1/8 mile visibility) revealed a high amplitude peak of small droplets ($\sim 5\mu$ diameter) while Sample B (1/2 mile visibility) indicated a broader and lower amplitude spectrum of larger droplets ($\sim 10\mu$ diameter). The relative concentration of droplets in the 1/8 mile case was estimated to be approximately an order of magnitude greater than in the less dense fog. Liquid water content in the two fogs was, therefore, about equal. This comparison illustrates exactly the effect that we are attempting to produce artificially by preseeding radiation fog (Section III, Part C).

2. Liquid Water Content

Because observations of liquid water content are extremely scarce we have, in the past, relied on developing analytic expressions to describe the distribution of liquid water in fog, Pilić (1965). These expressions have been valuable in formulating mathematical fog models and in assessing the general fog problem, but the requirement for additional measurements still exists. To help satisfy this requirement we obtained a few additional liquid water measurements while at Philipsburg, Pa. A Johnston-Williams hot wire liquid water meter was used for the measurements.

During the four weeks of operation in Central Pennsylvania we were able to obtain data about fog liquid water on the two occasions in which widespread frontal fog occurred. Measurements were taken approximately 5 meters above the ground, atop our laboratory van. Table II shows average

measured values of liquid water content and associated visibility in the two fogs. Estimates of visibility were made from the airport transmissometer located alongside our apparatus.

TABLE II
Average Values of LWC for Two Frontal Fogs
And Associated Visibility

<u>Visibility</u>	<u>Average LWC</u>
100 meters	0.22 g/cc ³
200 meters	0.12
300 meters	0.05

These averages are in quite good agreement with the value of 0.17 gm/cm³ used in our physical fog models, Jiusto (1964).

3. Nuclei Measurements

The concentrations of cloud and fog nuclei were measured on a daily basis at our field site using the CAL thermal diffusion chamber. Results of these measurements are presented in the next section, together with the data from Buffalo, N. Y. and Hilo, Hawaii.

B. Measurements of Cloud Nuclei

During the past year we have continued our investigation of cloud and fog nuclei and have gathered additional data in maritime (Hawaii) and continental (Buffalo, N. Y., Philipsburg, Penn.) climates. Measurements in the vicinity of Hilo, Hawaii were undertaken to obtain more data on maritime nucleus concentrations, and to assess their role in local cloud microphysics. Cloud nucleus measurements at Philipsburg Airport, Penn. were made during a 4 week field program in which data were sought about the characteristics of natural fog.

1. Buffalo, N. Y. Data

The cloud nucleus measurements obtained in Buffalo, N. Y. represent

data from approximately a 2 year period. These data are summarized in Table III together with a comparison of this years (1965-66) and last years (1964-65) observations.

TABLE III
Nucleus Concentrations in Buffalo, N. Y.

<u>Supersaturation</u>	<u>Average Data for 1964-65</u>	<u>Average Data for 1965-66</u>	<u>Average of all Data</u>
3.0%	5300	4100	4750
0.9%	3450	2600	3050
0.3%	1000	1000	1000
0.1%	495	490	495

As indicated by the figures in Table III average counts obtained for the current year (1965-1966) are somewhat lower ($\sim 25\%$) at 3.0% and 0.9% than counts taken during the period 1964-1965. Average nucleus measurements at lower supersaturations (e.g. 0.3% and 0.1%), however, are nearly identical for both years. The lower average numbers at high supersaturations during the past year are primarily due to lower concentrations that were observed when the wind was coming from the west. The data may reflect recent efforts by industry to reduce the particulate matter discharged into the atmosphere. This, of course, can only be hypothesized at the present time since no quantitative data are available on industrial effluent control. Continued measurements should reveal this trend if it actually exists.

Updated values of nucleus concentration in Buffalo, N. Y. as a function of wind direction are shown in Figures 6 and 7. The statistics are similar to previous measurements except for the somewhat lower average counts found at 3.0% supersaturation during periods of westerly wind and the somewhat higher counts at 0.1% supersaturation during periods of SW and SE wind. Again a fairly poor correlation was found between urban pollution and active nuclei near 0.1% supersaturation. An interesting, but as yet unexplained result of these statistics is the fact that cloud nucleus measurements at 0.1% supersaturation are generally very high when the wind direction is from the

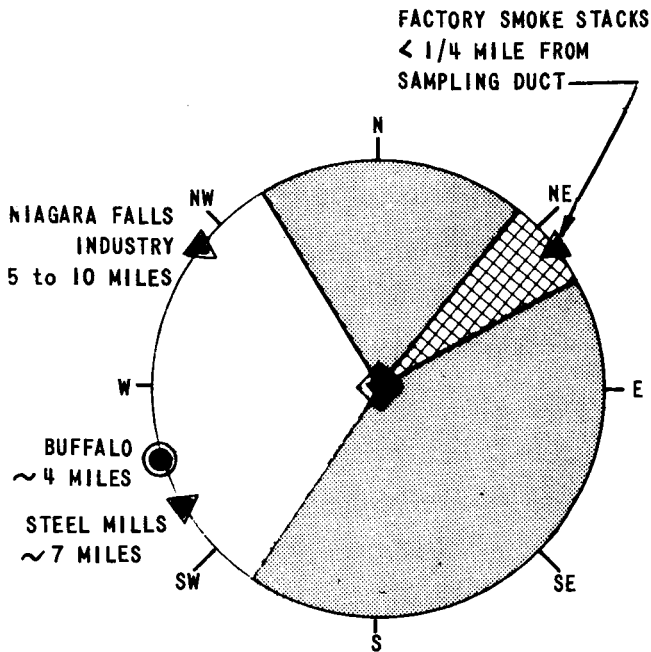







Figure 6
 VARIATION OF NUCLEUS CONCENTRATION
 AT 3.0% SUPERSATURATION AS A
 FUNCTION OF WIND DIRECTION

-  AIR INTAKE DUCT AT CAL
-  $\pm 20\%$ OF AVERAGE
-  $>50\%$ ABOVE AVERAGE
-  20% TO 50% ABOVE AVERAGE
-  20% TO 50% BELOW AVERAGE

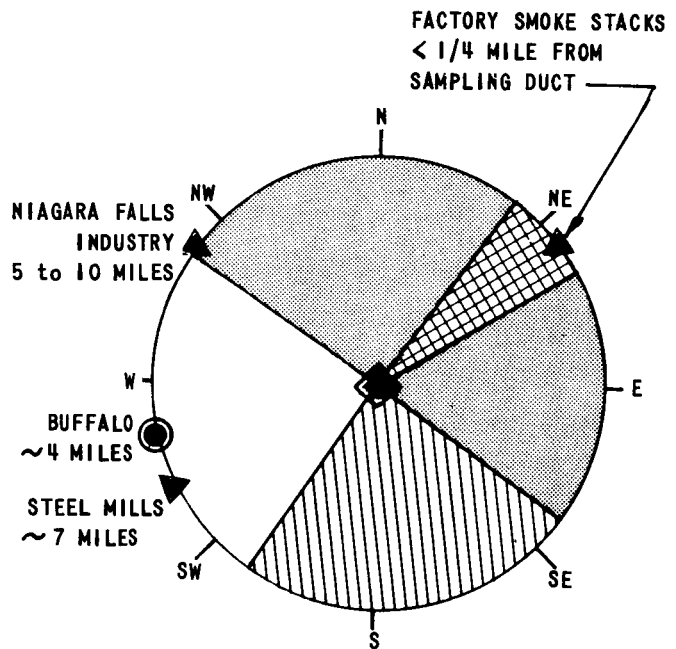

Figure 7
 VARIATION OF NUCLEUS CONCENTRATION
 AT 0.1% SUPERSATURATION AS A
 FUNCTION OF WIND DIRECTION

south (a region of very little industrial activity) even though the counts at 3.0% are consistently below average.

In our studies of nuclei we have found that, in general, a change of air mass (frontal passage) will produce the greatest change in the concentration of nuclei active at very low supersaturations (i. e. $\leq 1.0\%$). At higher supersaturations ($\sim 3.0\%$), sources of local pollution readily alter the numbers of active nuclei and often mask the effect of the frontal passage. Two sets of observations, one before and one after a cold front, serve to illustrate this point. The data are shown in Table IV.

TABLE IV
Nucleus Concentrations Before and After a
Frontal Passage
2 August 1966 - Buffalo, N. Y.

<u>Supersaturation</u>	<u>11 AM Wind S 18</u>	<u>2 PM Wind NW 13</u>	<u>1964-66 Averages</u>
3.0%	2550	4900	4750
1.0%	2100	1750	3050
0.3%	1600	730	1000
0.1%	700	150	495
0.02%	700	85	405

Prior to the frontal passage counts at 3.0% and 1.0% were below average as is usually the case when winds are from the south. Note, however, that at 0.3%, 0.1% and 0.02% the counts were substantially above average. With the passage of the front the wind direction abruptly changed to NW. The effect of industry to the NW immediately became apparent by the above average counts at 3.0% supersaturation. Note, on the other hand, the dramatic decrease in cloud nuclei concentration at 0.1% and 0.02% supersaturation. Evidently the basic characteristics of the existing air mass were most important in determining the concentration of nuclei that were active at low supersaturations. The case also illustrates how quickly changes in the spectrum of cloud and fog nuclei can occur.

2. Hawaii Data*

For about an eight week period during the summer of 1965 the CAL thermal diffusion chamber was operated (principally) at two sites, (a) the University of Hawaii, Hilo Campus (UHHC), located about 2 miles from the ocean and (b) on the shore of Hilo Bay, 50 meters from the water's edge. The latter location emphasized on-shore trade wind flow with a minimum source of land nuclei.

The results of these measurements are shown in Figures 8 and 9 where number concentrations, N , are plotted as a function of supersaturation, S . Each straight line represents a least-squares fit to the data resulting in the empirical relations:

$$N = 105 S^{0.63} \text{ (UHHC - two miles inland)}$$

and

$$N = 53 S^{0.46} \text{ (ocean edge)}$$

Note that these straight line relations are only considered valid for the indicated supersaturation range and cannot be extrapolated indiscriminately. Obviously as S approaches large values, N tends toward a limiting value. Departures from linearity are also expected at lower supersaturation.

The factor of two difference in nucleus concentrations at the two sites separated by only a few miles is rather impressive. Even more impressive are the comparisons between these data and those obtained with the same apparatus at Buffalo, N. Y. and at Philipsburg, Penn; average Buffalo and Philipsburg nucleus concentrations are shown for comparison in Figure 8. It is apparent that nucleus concentrations over populated continental areas exceed those of the Hawaiian maritime environment by 1 to 2 orders of magnitude.

* Results presented in this section were obtained by James E. Jiusto during a cloud physics investigation in Hawaii sponsored jointly by the National Science Foundation and Cornell Aeronautical Laboratory.

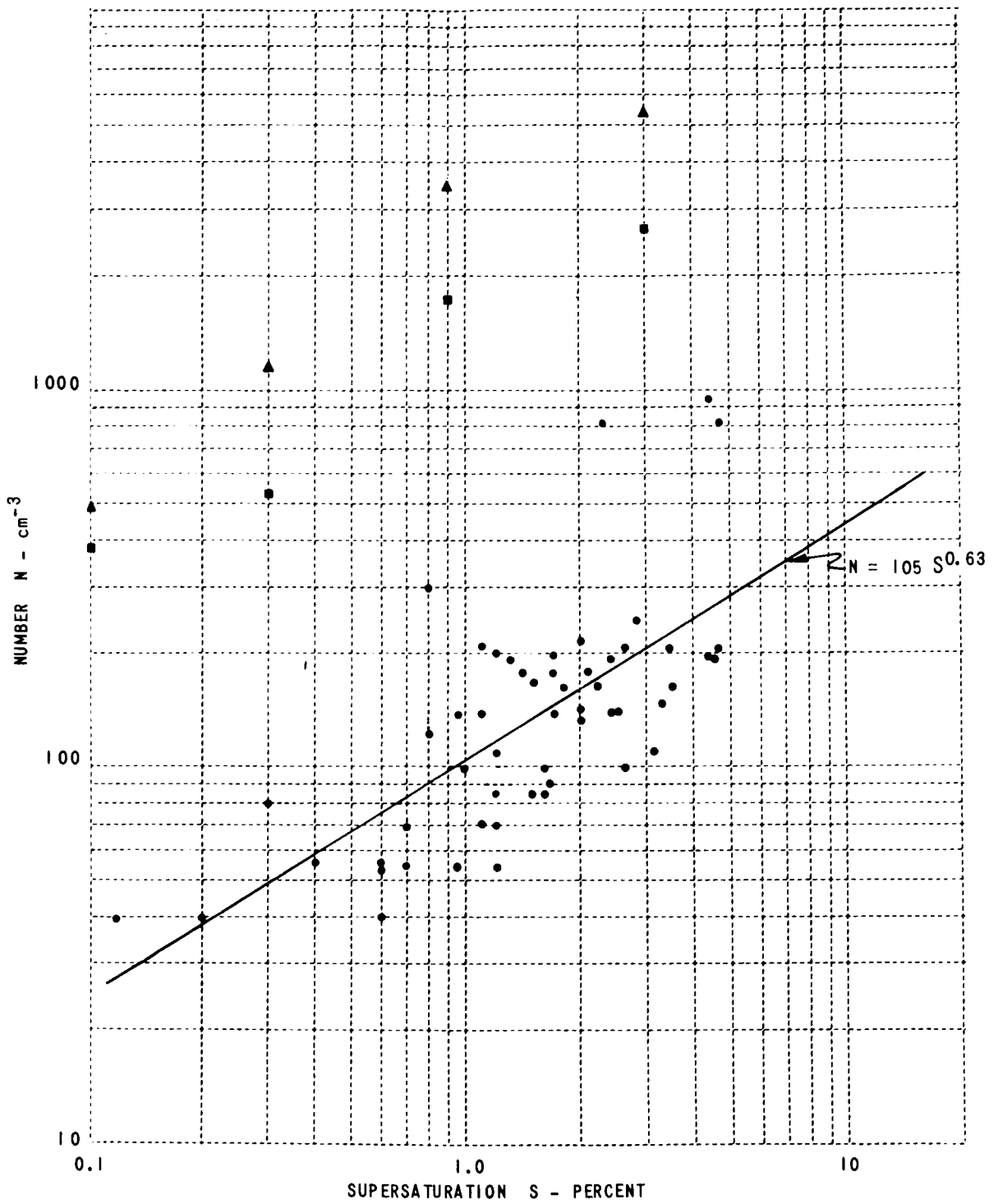

Figure 8 NUCLEUS CONCENTRATION MEASUREMENTS - HILO CAMPUS, UNIV. OF HAWAII (●)
 BUFFALO, N.Y. (▲) AND PHILIPSBURG, PA. (■)

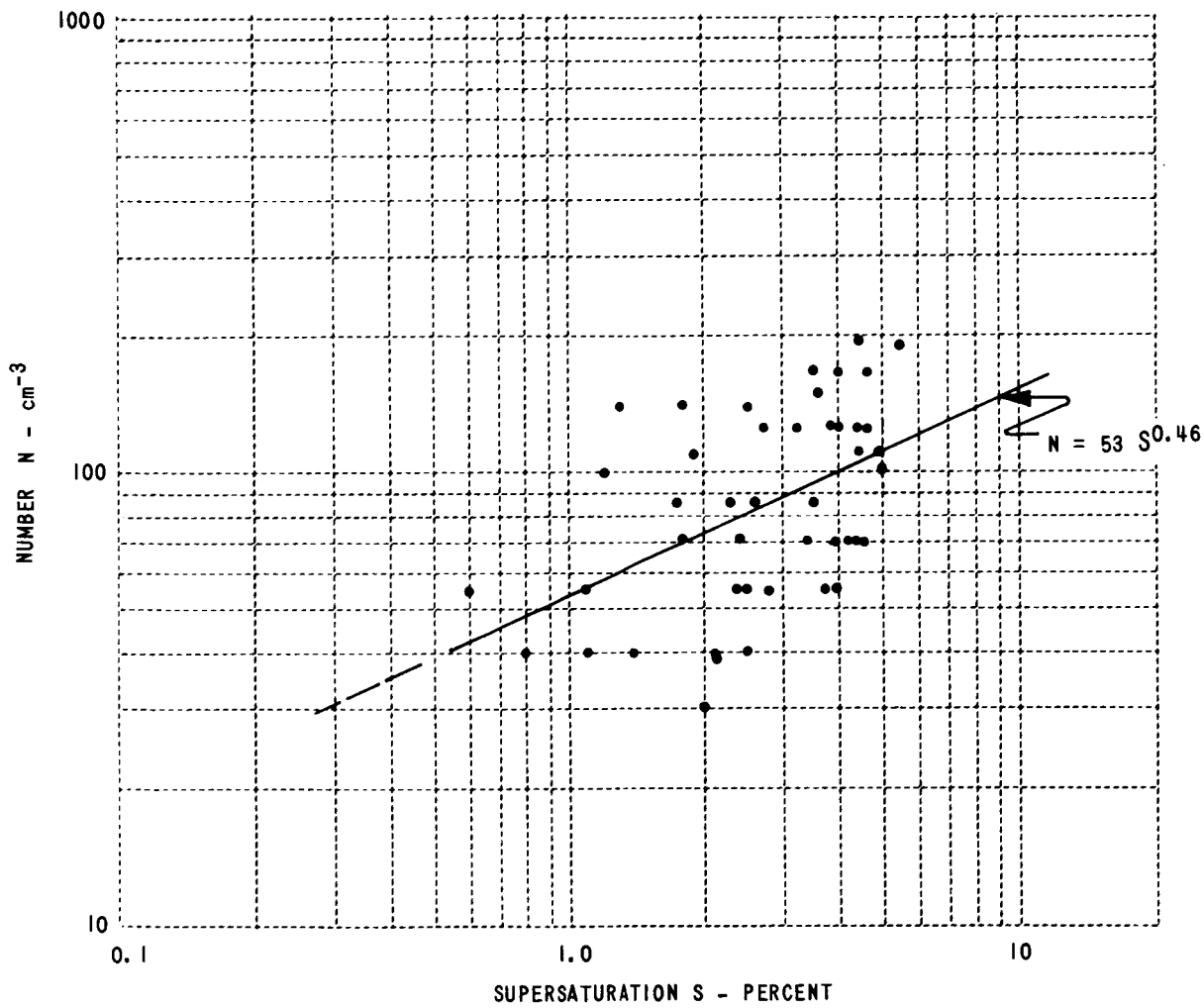

Figure 9 NUCLEUS CONCENTRATION MEASUREMENTS - OCEANSIDE - HILO, HAWAII

Figure 8 shows that at supersaturations between 0.1% and 1%, the nucleus concentrations vary from a few tens to a few hundred per cm^3 . Such numbers correspond quite well with observed droplet concentrations in maritime clouds and sea fogs. The almost immediate influence of land mass on cloud and fog nucleus concentrations is shown by the higher counts found just two miles inland. Under these conditions, typical advection fog droplet concentrations could be produced at supersaturations as low as 0.1% or 0.2%. The source of these nuclei, although associated with the land mass, has not been established.

Two individual runs made within five hours of one another at the oceanside site are interesting in that they represent, respectively, the highest and lowest nucleus concentrations obtained during the summer. (See Figure 10.) The high concentrations measured between 0950 and 1050L (local time) were associated with a NW flow of air from the Hilo industrial area; sugar refining plants and cane fires lay in the upwind direction. By 1430-1530L, the NE trade wind had established itself, and the resultant oceanic air trajectory produced extremely low nucleus concentrations. It is noteworthy that the two sets of data tend to converge at low supersaturation; hence these observations strengthen the conclusion of Twomey, 1963 and Kocmond, 1965, that local contamination appears less influential at low supersaturations.

3. Philipsburg, Penn. Data

As part of our fog research program in Central Pennsylvania, measurements of cloud and fog nucleus concentrations were obtained on a daily basis. From these measurements we expected to gather additional information about (a) the concentration of fog nuclei in areas relatively free of pollution but known to have frequent occurrences of natural fog and (b) the correlation between the total nucleus content and the concentration of fog nuclei.

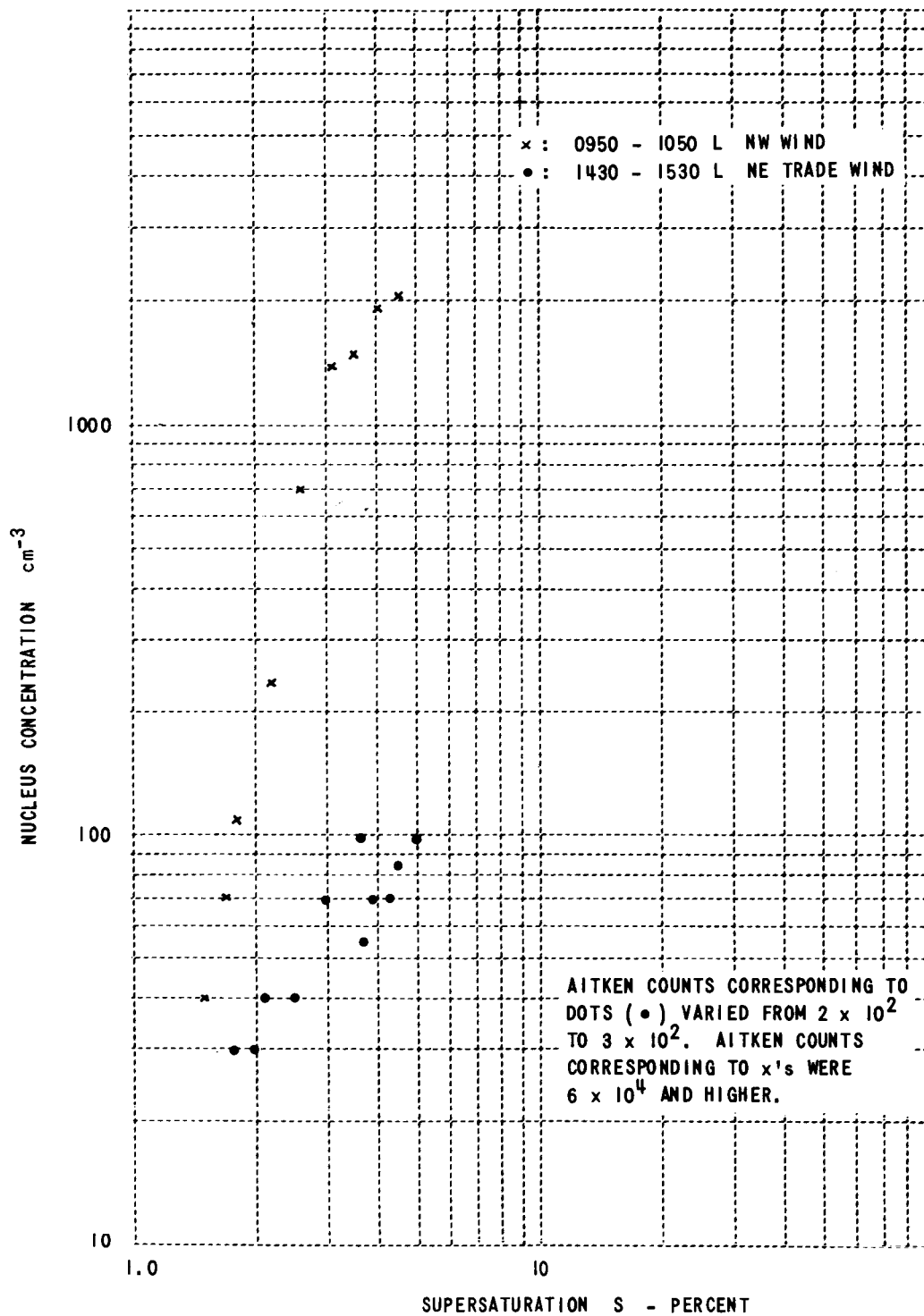

Figure 10 NUCLEUS CONCENTRATION MEASUREMENTS, OCEANSIDE - HILO, HAWAII
 24 AUGUST 1965

In Table V the results of Pennsylvania data are compared with observations taken at Buffalo and Springville, N. Y.

TABLE V
Average Nucleus Concentrations at Three Locations

<u>Supersaturation</u>	<u>Avg. No. Nuclei (Buffalo, N. Y.)</u>	<u>Avg. No. Nuclei (Springville, N. Y.)</u>	<u>Avg. No. Nuclei (Philipsburg, Pa.)</u>
3.0%	4750	3075	2600
0.9%	3050	1725	1720
0.1%	495	415	410
0.02%	400	335	380

At high supersaturations the observations in Central Pennsylvania follow the same general trend that was observed in Springville. For instance, at 3.0% supersaturation the average concentration of nuclei at our field site was nearly 45% less than in Buffalo and almost 15% less than in Springville, N. Y. This trend toward lower numbers in regions of low atmospheric pollution was discussed in the Second Annual Summary Report. Briefly, however, the effects of atmospheric pollution become less obvious at low supersaturations since most contaminants are in the Aitken size range (10^{-5} to 10^{-6} cm) which are not large enough to grow to fog droplet sizes at very low supersaturation. Many of these nuclei, however, are very hygroscopic and do contribute to industrial haze. Of particular interest in this comparison is the fact that at 0.02% supersaturation the average concentration of fog nuclei at Philipsburg was nearly the same as in the highly contaminated atmosphere of Buffalo.

At low supersaturations the Philipsburg data were strongly influenced by the measurements made on four separate days in which the nucleus concentration averaged between 750 and 900 nuclei/cm³. On three of these days the wind was S to SW and was accompanied by a penetrating odor (indicative of mercaptans; chemicals containing sulfur that are released in wood pulp processing). One such mill is located in a town about 22 miles S-SW of our field location. Evidently, a prolific source of fog nuclei is provided by the

chemicals used in these mills. We suspect that this source of fog nuclei plays an important role in the drop size distribution and visibility characteristics, as well as the formation, of some fogs in the area. On all occasions on which we noticed the odor, there was a substantial amount of haze, even though conditions were not good for the formation of natural fog.

The data obtained in Pennsylvania indicate that very little correlation exists between the concentration of fog nuclei and the total nucleus content. It is not uncommon to find as few as 150 nuclei/cm³ active at 0.1% supersaturation even though the total nucleus content (as measured by the expansion chamber) may be as high as 95,000/cm³ or as low as 2500/cm³. Hourly measurements sometimes show the fog nucleus count to be steadily increasing while the total nucleus count is falling. For example, at 0200 EST, on the morning of 3 November, the concentration of fog nuclei measured at 0.1% supersaturation numbered 225/cm³ while the total nucleus count stood at 6000/cm³. By 0600 EST the measured fog nucleus concentration had nearly tripled to 650 nuclei/cm³ and the total nucleus count fell to 4500/cm³.

4. Conclusions

The conclusions drawn from our investigation of fog and cloud nuclei thus far may be summarized as follows.

In continental air masses in the northeast United States, the concentration of nuclei active at 0.1% supersaturation usually exceeds the concentration of fog drops in dense natural fog. Maximum supersaturation in most inland fogs must therefore be substantially smaller than 0.1%. In a maritime atmosphere (Hawaii) the concentrations of nuclei active at 0.1% to 1.0% supersaturation are consistent with observed maritime cloud and fog droplet concentrations.

Nucleus concentrations in Hawaii are one to two orders of magnitude lower than in urban and rural areas of New York and Pennsylvania.

Industrial effluents and most other man made pollutants may not be particularly effective sources of fog nuclei in either continental or maritime atmospheres but are prolific sources of Aitken nuclei. One possible exception

is the effluent from pulp mills observed in Central Pennsylvania.

Air mass changes produce the most dramatic changes in cloud and fog nucleus concentrations. At high supersaturations industrial contamination often masks the effect of air mass changes.

Our measurements are consistent with the fact that precipitation is effective in scavenging nuclei from the atmosphere. Scavenging appears to be most effective for those nuclei that are active at supersaturation less than 1.0%.

C. Investigation of Possible Techniques for Preventing Dense Radiation Fog

In a fog, visibility restriction is due to light scattering by droplets in the optical path. Any procedure that reduces the amount of light scattered can therefore be expected to improve visibility. For water droplets the scattered light per droplet is proportional to the square of the droplet radius and, for constant liquid water content and a given size interval, the number of droplets is inversely proportional to radius cubed. It follows that if the total liquid water content can be concentrated in a few large drops rather than a large number of small drops, improvements in visibility would result.

Mathematically, the concept may be expressed as follows: For a drop size distribution $N(r)$ the total scattered light L is

$$L \sim \int_0^R N(r) r^2 dr \equiv N r_{rms}^2$$

The liquid water content W in the fog is

$$W \sim \int_0^R N(r) r^3 dr \equiv N r_{mvr}^3$$

where r_{rms} indicates root mean square droplet radius and r_{mvr} indicates mean volume radius. The light scattered per unit volume of liquid water is therefore

$$\frac{L}{W} \sim \frac{r_{rms}^2}{r_{mvr}^3}$$

We suggested that the desired changes in drop size distribution could be produced by seeding the atmosphere before natural fog forms with a relatively few giant hygroscopic nuclei. During the past year this concept was examined analytically and in laboratory experiments. Results, which are promising, may be summarized as follows.

Analytical results indicate that with monodispersed, eight micron diameter nuclei, visibility improvements approaching a factor of five as an upper limit might be possible.

Experimentally we have achieved visibility improvements of greater than a factor of two by preseeding an atmosphere suitable for formation of dense fog. When visibility of the natural fog exceeds approximately 1.5 miles we have not been able to cause further improvement. Intermediate improvements that have been achieved were no doubt due to a combination of improper seeding and variations in the natural properties of the atmosphere. Intentional overseeding with small nuclei invariably lowered visibility.

1. Theoretical Considerations

In the process of natural fog formation, droplets grow first on those nuclei that are both large and very hygroscopic. As the humidity increases, other nuclei of less hygroscopic substances deliquesce, but generally these nuclei do not promote growth to fog droplet sizes since they require a greater supersaturation than is normally found in fog. The number of nuclei that do participate in the ensuing fog is determined by 1) the distribution of sizes and hygroscopicities of the nuclei and 2) the rate at which excess water vapor is made available for droplet growth.

From a review of Weather Bureau records, we estimate that in relatively dry air prior to fog formation, the maximum cooling rate likely to be encountered is of the order of $3^{\circ}\text{C}/\text{hr}$. Without condensation, the rate of heat loss by the atmosphere is:

$$\frac{dH}{dt} = \rho C_p \frac{dT}{dt} = 2.4 \times 10^{-7} \text{ cal}/\text{cm}^3 \text{ sec} \quad (1)$$

where H = the heat loss per unit volume

ρ = air density

C_p = specific heat at constant pressure

$\frac{dT}{dt} = 3^\circ\text{C/hr} = 0.83^\circ\text{C/hr}$

Assuming that this heat transfer rate persists during the early stages of condensation and accounting for the latent heat of condensation L , the rate of temperature change is:

$$\frac{dT}{dt} = \left(\frac{dH}{dt} - L \frac{dM}{dt} \right) / \rho C_p \quad (2)$$

where $\frac{dM}{dt}$ is the condensation rate. If condensation occurs at such a rate, as to maintain a constant relative humidity, $\frac{dM}{dt}$ will be equal to the rate at which saturation absolute humidity W_s , decreases:

$$\frac{dM}{dt} = - \frac{dW_s}{dT} \frac{dT}{dt} \quad (3)$$

dW_s/dT was approximated from tabular values and equations (2) and (3) solved simultaneously to show that the rate of temperature change during the initial stages of condensation is approximately $0.93^\circ\text{C/hr} \approx 1^\circ\text{C/hr}$. At this rate of temperature change water is made available for condensation at $2.6 \times 10^{-10} \text{ gm/cm}^3 \text{ sec}$.

Once fog has formed the heat loss through radiation is reduced so that the rate of temperature change is of the order of 0.1°C/hr . At this rate additional water vapor is made available at approximately $2.8 \times 10^{-11} \text{ gm/cm}^3 \text{ sec}$.

One way to estimate the potential of the proposed preseeding concept is to compare the above rates with rates at which large, extremely hygroscopic nuclei can extract water from the atmosphere. To make this comparison, we have computed the amount of water that would be condensed out of a saturated atmosphere onto an 8μ diameter dry salt nucleus. We have also computed the relative humidity at which the growing solution drop would be at equilibrium with the environment. Expressions developed by Keith and

Arons (1954) were used to determine the time required for the dry salt nucleus to grow to the indicated diameter. Results are presented in Table VI. Similar calculations were made for LiCl and MgCl₂ nuclei; except for differences at low relative humidities the results were very similar.

TABLE VI

Growth time and mass of water required to produce drop of diameter (d) from an 8 μ diameter NaCl nucleus
(MASS = 5.8×10^{-10} gm)

<u>Size of solution drop(μ)</u>	<u>Mass H₂O(gm)</u>	<u>Time required to grow to (d) at 100% RH (sec)</u>	<u>Equilibrium relative humidity</u>
14.8	1.6×10^{-9}	0.25	76%
17.2	2.5×10^{-9}	0.7	85.2
21.4	5×10^{-9}	2.5	92.7
32.1	17×10^{-9}	23.0	98.3
36.2	25×10^{-9}	44.0	98.7
57.6	100×10^{-9}	450.0	99.7

Let us suppose that two nuclei of this type are introduced into each cm³ of air at a time when the relative humidity has reached a value between 85 and 90%. Because these nuclei are hygroscopic, condensation begins on them immediately and reduces the relative humidity from its initial value. By the time the initial humidity has been re-established - by continued air cooling - the equilibrium droplet diameters are between 17 and 21 μ . Once condensation has begun, the cooling rate of the air is limited to approximately 1°C/hr so that the maximum rate at which water can be made available for condensation is 2.6×10^{-10} gm/cm³ sec. During this initial growth period, when the heat loss rate by radiation is still high, the equilibrium relative humidity is expected to remain substantially below 100%. (If the atmosphere became saturated, the amount of water extracted by the two growing 21 μ diameter solution drops would exceed 40×10^{-10} gm/cm³ sec, a value 16 times greater than water would be made available even at the maximum cooling rate. Obviously the equilibrium humidity in the cooling atmosphere

will be between saturation relative to the solution drop and 100% relative humidity.) It seems, therefore, that the drops will grow at such a rate that they remain in approximate equilibrium with the ambient relative humidity at any time.

At this point in the fog formation we must consider the reduced cooling rate, which is not expected to exceed approximately 0.1°C/hr . At the newly established cooling rate, water is made available at only $0.093 \text{ gm/m}^3 \text{ hr}$ or $2.6 \times 10^{-11} \text{ gm/cm}^3 \text{ sec}$. During the next hour therefore, the total liquid water content will rise to approximately 0.14 gm/m^3 . If all water were condensed on the two nuclei, the droplets would achieve a diameter of 51μ by the end of the hour.

Three important features of the fog must now be recognized for comparison with the fog that would have formed had it not been seeded.

(a) According to our fog models, a radiation fog of liquid water content equal to 0.14 gm/m^3 would consist of $200 \text{ droplets/cm}^3$ having a volume mean diameter of 11.2μ . The extinction coefficient for such a fog would be $3.9 \times 10^{-4} (\text{cm}^{-1})$ whereas the extinction coefficient for the seeded fog would be $0.79 \times 10^{-4} (\text{cm}^{-1})$. Since the extinction coefficient is inversely proportional to visibility we can conclude that visibility in the seeded fog would be 4.9 times greater than what would have occurred without seeding.

(b) The fall velocity of an 11.2μ particle is approximately 0.35 cm/sec , which is negligible. The 56μ diameter particle on the other hand has a terminal fall speed of 9.3 cm/sec . At this velocity a solution drop at the top of a 100 meter fog would fall to the surface in 18 minutes.

(c) The relative humidity in the fog at the end of an hour would still be between 99 and 100%.

Since some of the natural nuclei would certainly be activated at a relative humidity of 99%, the model used is not completely realistic. (To construct a realistic model requires information on the hygroscopic nature and size of all natural nuclei: such information does not yet exist.) The

model therefore predicts a visibility improvement that is greater than can ever be expected in the field. Nevertheless the drop size distribution is certainly altered in the proper direction and a visibility improvement must occur. The amount of material required to treat a hypothetical zone of $2 \times 10^8 \text{ m}^3$ (2 km x 1 km x 0.1 km) would be about 230 kgm, a value that is not unreasonable. According to our model, once the artificial fog is formed, repeated seeding would be required about once every 20 minutes. Wind velocities other than near zero will be deleterious to the experiment. It is apparent that prohibitively large amounts of material would be required to treat the atmosphere in advection fog situations.

2. Laboratory Experiments

To provide a more realistic estimate of the visibility improvement that might be obtained in the field we have initiated a series of laboratory experiments in which fog can be formed in both seeded and unseeded samples of air drawn from outside the laboratory. The apparatus is arranged so that nuclei of the proper size (4μ to 10μ diameter) can be introduced into the air sample before entering an eight foot tall test chamber. Moisture for forming fog is supplied by wet blotting paper on the walls of the chamber. Fog density (visibility) is computed from transmissivity measurements made over the eight foot length of the chamber.

In a typical series of measurements fog is allowed to form in three successive samples of unseeded air and, if the light transmission measurements indicate that the 'natural' fogs are similar, a fourth air sample into which artificial nuclei have been introduced, is drawn into the chamber. The fog is allowed to develop and visibility of the seeded fog is compared with that of the three unseeded fogs. On some occasions a fourth natural fog is produced to provide additional comparisons. The experiment thus provides a measure of the effectiveness of our seeding procedures in suppressing the formation of dense natural fog. In an attempt to avoid the difficulties of producing properly sized hygroscopic nuclei for laboratory experiments we designed the apparatus shown schematically in Figure 11. This apparatus permits both gravitational separation of nuclei according to size and insertion of nuclei of proper size

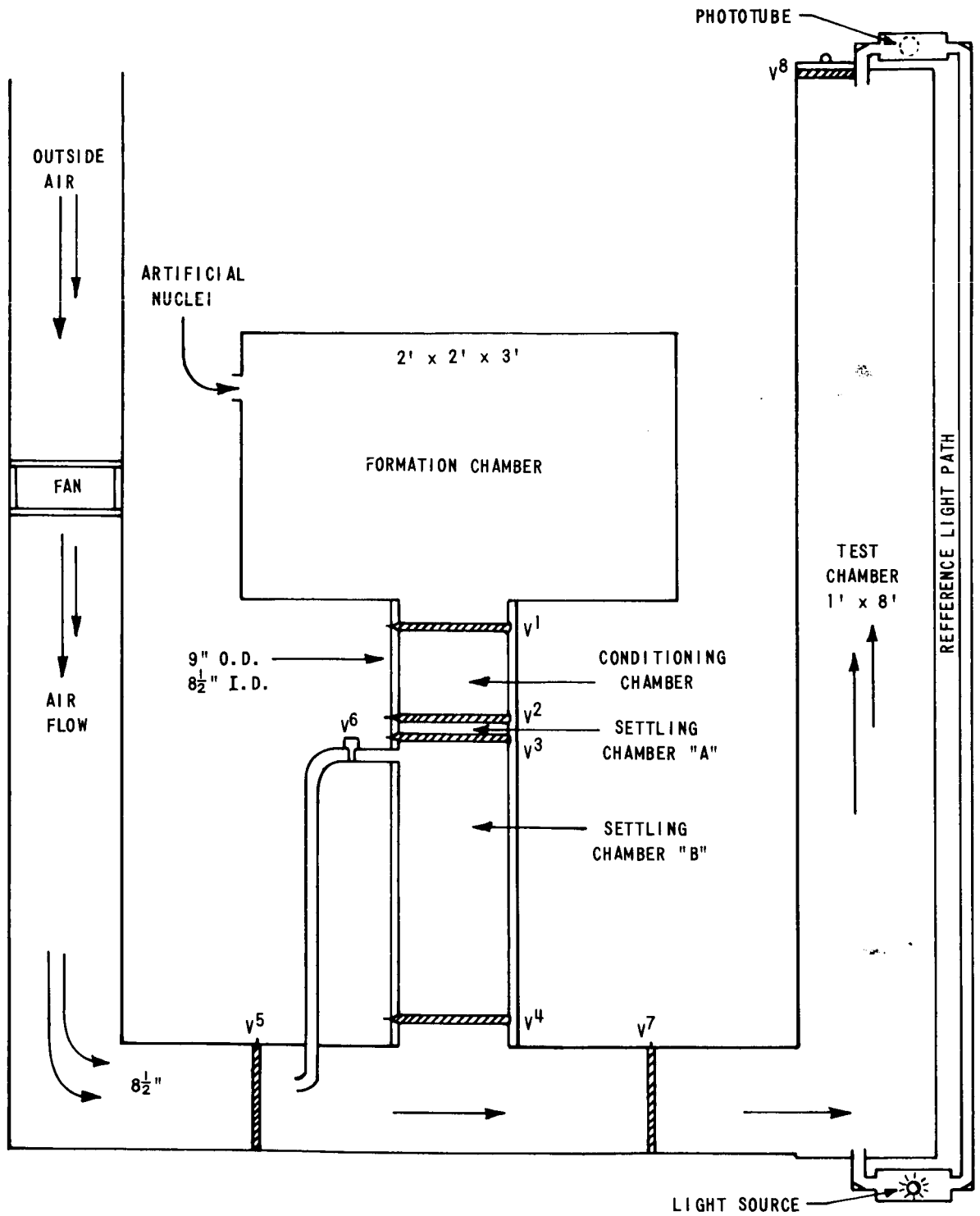

Figure 11 APPARATUS FOR TESTING FOG SEEDING TECHNIQUE

into the test chamber. Nuclei are produced by spraying a saturated salt solution into the 12 ft³ formation chamber which is heated by an infra-red lamp. The solution drops quickly evaporate in the dry atmosphere leaving very high concentrations of dry salt crystals. Measurements made with an electron microscope show that the size range of these crystals varies between 0.1 μ and 19 μ diameter. The problem is to separate those particles that have diameters of approximately 4 to 10 μ from the others and insert the desired particles into the atmosphere in which the fog will form.

To prepare the nuclei for separation, circular disk V₁ in Figure 11 is first removed to permit the nuclei to circulate into the conditioning chamber. Disk V₁ is then heated to approximately 80°C and replaced. A temperature inversion is thus established in the conditioning chamber helping to stabilize the air. Disks V₂ and V₃ are next removed to permit the nuclei to settle at their terminal fall velocities into settling chambers A and B. The settling chamber's dimensions were selected so that in approximately 100 seconds all nuclei greater than 10 μ diameter settle on Disk V₄ and those smaller than 4 μ diameter remain in or above chamber A. After 100 seconds Disk V₃ is replaced and, ideally, only nuclei in the 4-10 μ diameter range remain in settling chamber B. By means of appropriate valving, these nuclei are forced into the test chamber and the fog allowed to develop. Light transmission through the seeded fog is recorded on a Sanborn chart recorder for comparison with measurements made previously in unseeded fogs.

In Figure 12, photomicrographs are presented which show typical NaCl particles produced by the aerosol spray. The microscope grids and nuclei were shadowed with gold to facilitate identification of very small particles. Such photographs were used to obtain size distributions of the nuclei before and after passing through the settling chamber. It was determined that prior to separation only 6% of the total number of nuclei were in the size range 4 μ to 10 μ diameter. After separation, between 20% and 40% of the nuclei were of the proper size; the remaining particles were smaller than desired and limited the visibility improvement that could be achieved through seeding.

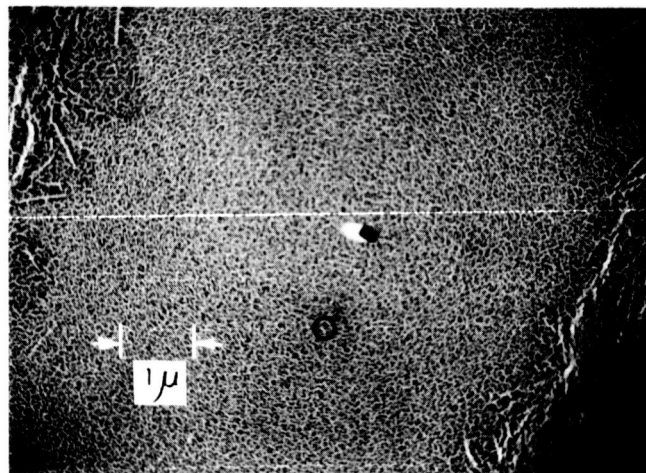
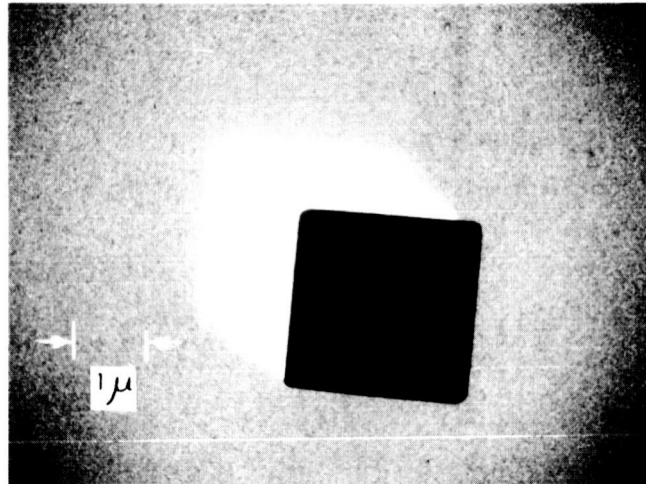
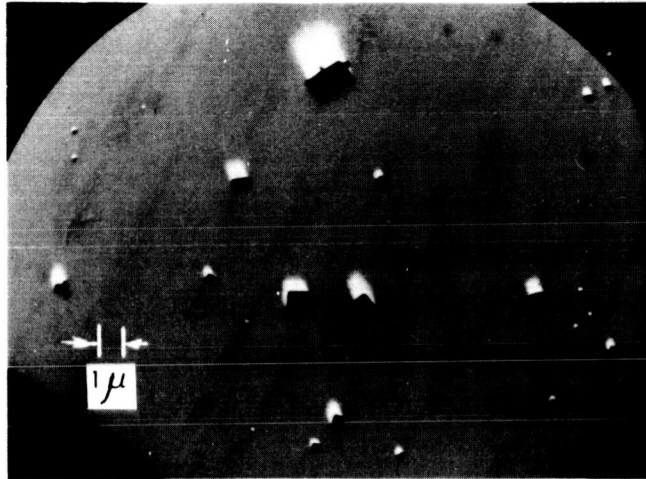

Figure 12 PHOTOMICROGRAPHS OF NaCl NUCLEI PRODUCED BY AEROSOL SPRAY FOR SEEDING EXPERIMENTS

The transmissometer used in the experiments consisted of a stabilized light source mounted under the fog chamber and photomultiplier detector mounted on top of the chamber. To assure stability of the equipment, light was transmitted from the stabilized light source to the detector alternately through the fog chamber and through a dehumidified reference tube. Alternating the light path from one chamber to the other was accomplished with a rotating mirror and several fixed mirrors. To avoid error due to condensation or droplets settling on optical surfaces, all optical elements exposed to the fog were maintained at slightly elevated temperatures throughout the experiments. To further avoid difficulties that might occur due to long term drifts, a standard data taking procedure was established in which a) the final transmission measurement through each fog was made, b) the chamber was flushed for 15 seconds and c) the transmission through the clear air was measured immediately. Visibility improvements discussed in this section are based on these two sets of measurements. Comparative measurements made during the period of fog formation are useful in developing an understanding of the processes taking place but are probably less accurate. These aforementioned precautions were necessary because with only an eight foot path through the chamber the difference between the amount of light transmitted through clear air and through a dense fog (1/4 to 1/8 mile visibility) is of the order of only three to six percent.

The manner in which visual range (visibility) was computed in seeded and unseeded fogs was as follows: a parallel beam of light having an initial intensity I_0 , and traversing a distance x through a scattering medium, has an intensity I given by

$$I = I_0 e^{-\beta x} \quad (4)$$

where β is the generalized extinction coefficient. Normally, β is represented by a combination of Rayleigh scattering, Mie scattering and an absorption coefficient. In fog, nearly all of the droplets are larger than 10^{-4} cm and only Mie scattering is important.

In our experiments, measurements were made of light intensity I_0 before the formation of fog, where there was no scattering, and again after

fog formation (I). From these measurements, and from the fact that the path length of the light is eight feet, we can compute the scattering coefficient

$$\beta = \frac{\ln I_0/I}{x} \quad (5)$$

The visual range can then be determined from the formula: (Duntley, 1948)

$$V = \frac{3.912}{\beta} \quad (6)$$

where the units of distance are those used in determining β .

3. Discussion of Results

To date we have run 21 experiments. Sixteen of the cases resulted in a measurable improvement in fog visibility. Of the five remaining cases two showed no improvement, although on both occasions natural fog visibility was in excess of 1.5 miles. Three other cases were unsuccessful due to improper seeding; in one of the cases overseeding resulted in a fog having poorer visibility characteristics than the natural fog.

The general trends of fog development for both seeded and unseeded fogs are shown in Figure 13. The data shown are characteristic of the sequence of events that occur when substantial visibility improvement is achieved.

Note that two minutes after seeding the visibility in the seeded fog is significantly less than the unseeded cases. This is to be expected since artificial nuclei that are admitted into the test chamber, being large and hygroscopic, quickly form solution drops several microns in diameter. It is important to note that in the process of forming fog the artificial nuclei use most of the water available for condensation and retard diffusional growth of natural nuclei. As the solution drops continue to grow and settle out of the chamber, fog visibility remains essentially unchanged. After all of the artificial nuclei have settled out of the chamber diffusional growth on natural nuclei proceeds and visibility deteriorates in a manner similar to that shown for the natural fog. This process required more than ten minutes and is not shown in the figure. In this example an 88% improvement in visibility resulted from seeding the atmosphere prior to fog formation.

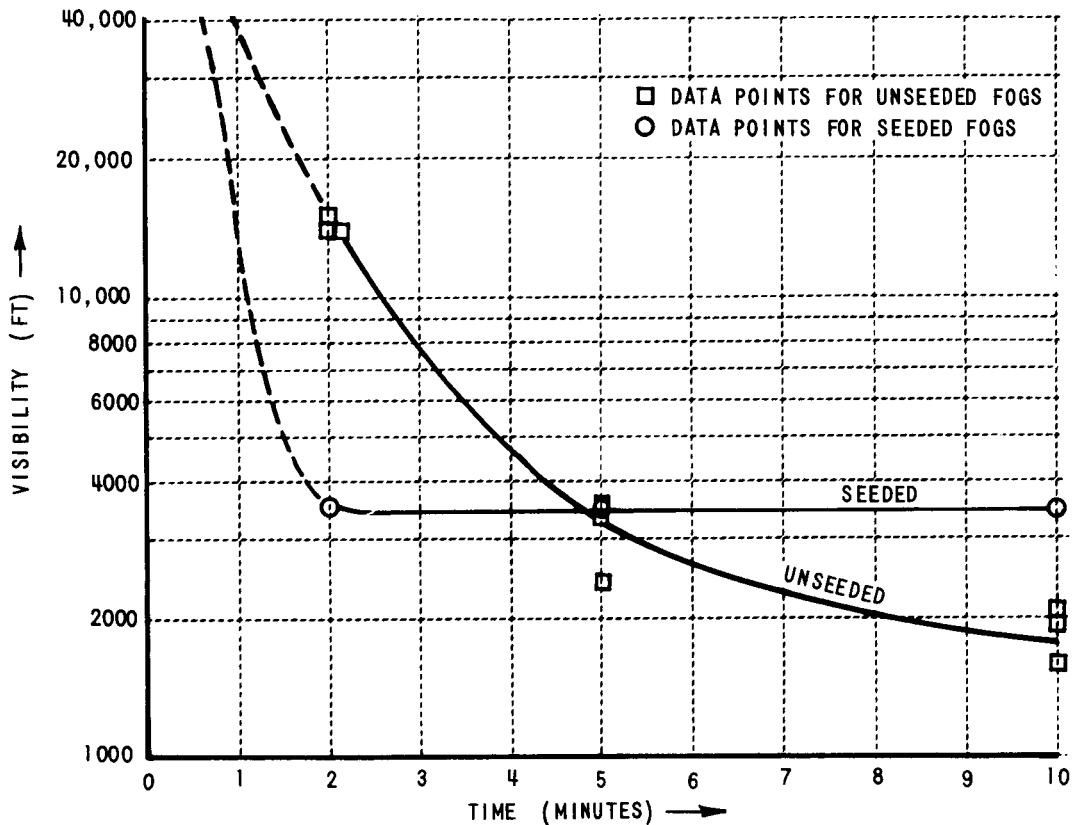

Figure 13 COMPARISON OF SEEDED AND UNSEEDED FOGS

In Figure 14 another example is presented which demonstrates how improper seeding can produce fogs of greater density than unseeded fogs. Slight overseeding was accomplished by allowing many very small salt nuclei ($< 1\mu$ diameter) to enter the test chamber along with nuclei of the proper size (4μ to 10μ diameter).

Again, as in the previous example, rapid deterioration of visibility occurred in the seeded case within two minutes. However, in this example visibility continued to deteriorate, and after 10 minutes was reduced to only 1200 ft compared to a visual range of 2000 ft in the unseeded fog. Such results can be expected whenever the atmosphere is preseeded with large numbers of small nuclei. On one occasion we purposely overseeded with high numbers of small nuclei and were able to decrease visibility to the extent that visibility was less than the length of the eight foot chamber.

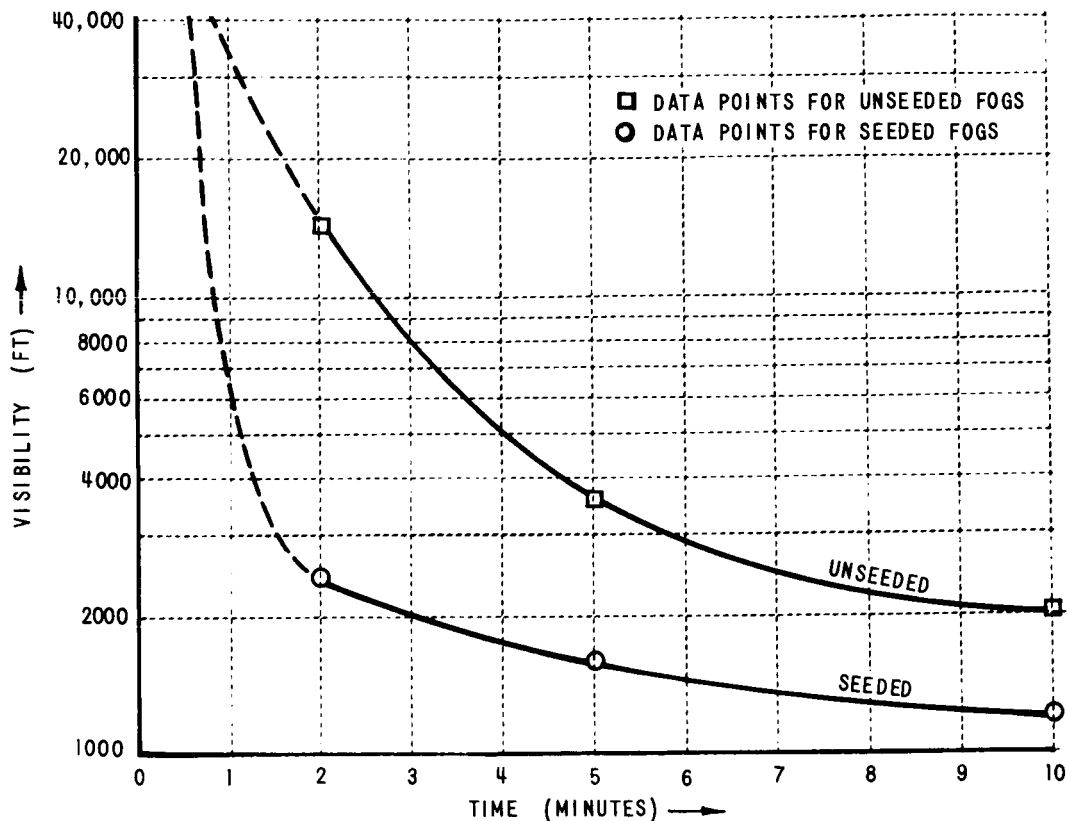

Figure 14 DEGRADATION IN VISIBILITY DUE TO IMPROPER SEEDING

The results of these experiments clearly demonstrate the need for careful control of the size and number of nuclei used in seeding. Undoubtedly the variability of our results is partially due to the variability in the effectiveness of our separation techniques (20% to 40% of the nuclei are in the proper size range).

For this reason we have been searching for more effective means of producing nuclei of the right size. Recent experiments have been aimed at developing methods for producing solution drops which, after evaporation, form nuclei that conform more nearly to the desired size distribution. Best results thus far have been achieved by forming the solution droplets with

an atomizer* which increases the percentage of usable nuclei (4μ to 10μ diameter) to 40% prior to separation. We have also begun testing commercial sieves which are available for separating particles in the size range from 1 to 20μ and are certified by the manufacturer to $\pm 2\mu$ of the nominal value. Significant results have not yet been obtained using sieves.

We recognize other refinements in the operational procedure and experimental technique that will be incorporated in future experiments. Basic among these is the need for a chamber of greater vertical depth. Because the existing chamber is only eight feet tall, droplets formed on large hygroscopic nuclei settle out of the fog in less than 10 minutes. While this is a desirable result for operations in the field, it limits our evaluation of the concept to unrealistically short times. To overcome this problem we are planning experiments in the 30 x 30 foot cylindrical settling chamber in the recently completed CAL Ordinance Laboratory. The cylinder is equipped with 23 sidewall ports so that instrumentation for visibility measurements in seeded and unseeded fogs can be made. We will also experiment with other hygroscopic materials (e.g., $MgCl_2$, $CaCl_2$, $LiCl$, urea) to determine the most effective nucleant for fog suppression. Finally, accurate measurements of the drop size distribution in seeded and unseeded fogs will be made to verify the results obtained through light transmission measurements.

* Manufactured by Air-Shields, Inc., Hatboro, Pa.

4. Recommendation for Continued Effort to Suppress Radiation Fog

In view of the above findings we are recommending that finalized laboratory tests be conducted to determine the maximum improvement in visibility that can be expected from preseeding. The results of our measurements to date are sufficiently encouraging to warrant further investigation of this concept. Items of particular importance are:

a. Devise improved techniques for producing nuclei of the proper size (4μ to 10μ diameter) for insertion into the atmosphere prior to fog formation.

b. Determine, in the laboratory, the best nucleating materials and the optimum size and concentration of nuclei to be used for seeding. The most important considerations in this study will be the handling qualities of the material.

c. Devise, if possible, methods for re-seeding laboratory produced fogs to determine whether, and to what extent, the effects of seeding can be prolonged.

d. Design and conduct experiments that will permit droplets formed on artificial nuclei to fall a minimum of 30 feet through the fog. These experiments are necessary to extend the period over which we can determine the visibility improvement achieved in fog. Such equipment will extend the transmissometer path length.

e. Based on the findings of items a through d, develop methods for preparing and disseminating sufficient quantities of the nucleating material for field experiments and formulate detailed plans for conducting such experiments.

D. Investigation of Electrical Means of Fog Dispersal

Numerous investigators have suggested that the presence of an ambient electric field and/or charge on droplets might form the basis for fog suppression (i.e. use electrical forces to enhance droplet coalescence and cause precipitation of the fog drops). We suggested that the maximum electrical effect

might be obtained by charging alternate adjacent regions of the fog positively and negatively. By so doing, we reasoned, substantial electric fields might be produced between the adjacent regions to promote rapid mixing of droplets charged to opposite polarities. Once mixed, the droplets of opposite polarities might exert substantial mutually attractive forces to promote coalescence.

During the past year we have tested this concept experimentally and have concluded that no significant increase in fog dispersal rate can be produced by electrical means using practical system configurations. The experiments that were conducted, their theoretical interpretation and detailed conclusions are described in the following paragraphs.

1. Determination of Charge per Droplet

In order to estimate the effect that artificial droplet electrification might have on fog it is necessary to calculate the electrical forces produced by the charge placed on droplets. It is therefore necessary to determine the amount of charge that can be placed on the droplets. To obtain this information we set up the following experiment.

A Faraday Cage, 0.91 x 0.91 x 0.45 m in dimension was constructed of aluminum and separated from ground by large polystyrene insulators. A corona wire was mounted in its center as shown in Figure 15a. To supply water for fog formation the inside of the cube was lined with blotting paper soaked with tap water. To accelerate fog formation and to create a stabilizing temperature gradient within the chamber, crushed ice was scattered over the chamber bottom. Dense fog formed within one half to 1 hour after admitting normal laboratory air into the chamber.

Fog droplet concentration was measured using a photographic arrangement similar to that used in the thermal diffusion chamber. A Mercury arc lamp and collimator were mounted near one corner of the chamber to illuminate droplets in a narrow region of space. Scattered light (90°) from droplets in a well defined volume was detected photographically with a Polaroid camera. Droplet "images" were then counted from the photograph.

To obtain an estimate of mean drop size the fog was drawn through a 3.5 cm diameter tube at a velocity of 45 meters per second while a modified Bausch and Lomb slide projector was used to expose gelatin coated slides to the airstream. Droplets impinging on the slides would form permanent replicas which later could be examined under a microscope. While only a few such measurements were made, mean drop diameters were consistently observed to be in the eight to ten micron range.

To provide charging current for the droplets, a corona discharge was produced at the wire by applying a high voltage. The equipment, shown in block diagram form in Figure 15b, produced 14,000 volt pulses 5.5 milliseconds long, of either polarity, at a rate of five per second.

The experimental procedure was as follows. Once the fog had formed, the high voltage was applied to the corona wire to produce a discharge. While the discharge was taking place the current to the chamber walls was observed with the vacuum tube volt meter. The high voltage was then removed and the chamber permitted to discharge through the VTVM. To be certain that the chamber was completely discharged the VTVM was switched to a voltage measuring mode and retained in the circuit until zero volts were indicated. The net charge on the capacitance between the chamber and ground (i. e. the charge in the box plus that on the box) was, therefore, zero. The droplet concentration measurement was made at this time. S_2 was then opened to remove the VTVM from the circuit and S_1 closed to place the electrometer between the cage and ground. The exhaust fan was turned on to remove all drops (and the charge on them) from the chamber, a process that required about one minute. (The time constant between chamber and ground was determined to be in excess of 1/2 hour.) With the droplets removed the net charge remaining across the capacitance, C , was equal and opposite in polarity to the charge Q removed from the chamber (i. e. that on the fog droplets). Voltage observed by the electrometer was therefore equal to

$$V = - \frac{Q}{C} = \frac{Ng V_o}{C} \quad (7)$$

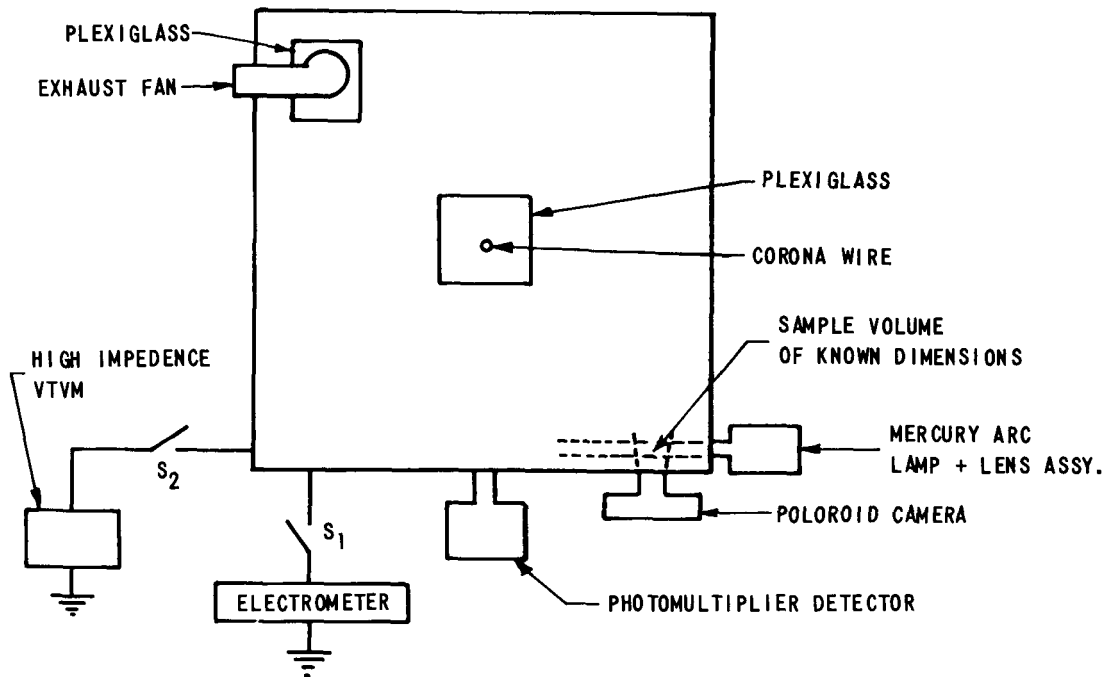

Figure 15a EXPERIMENTAL CONFIGURATION FOR DROP-CHARGE MEASUREMENTS

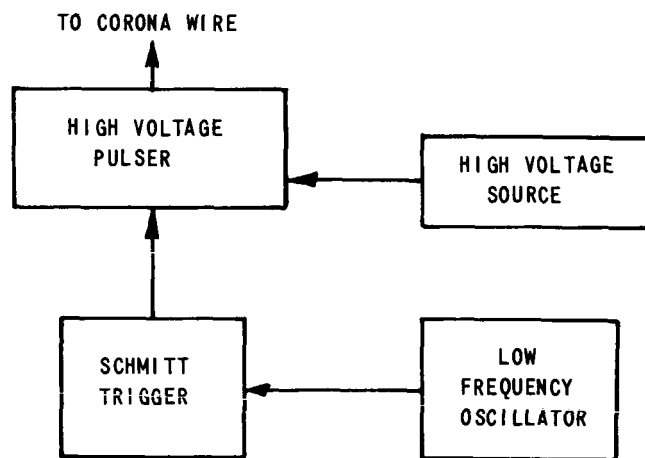

Figure 15b BLOCK DIAGRAM OF PULSED HIGH VOLTAGE SOURCE

From knowledge of the droplet concentration N , the volume of the chamber V_0 , the average charge per droplet q could be computed. The equipment was quite stable and results were repeatable from one experiment to the next. Typical experimental values were

$$N = 200 \text{ to } 300 \text{ droplets per cm}^3$$

$$V_0 = 0.388 \text{ m}^3$$

$$C = 290 \times 10^{-12} \text{ fds}$$

$$V = 30 \text{ to } 50 \text{ volts}$$

The average charge per droplet determined from many experiments was $q \approx 1.2 \times 10^{-16}$ coulombs or ~ 700 electronic charges. There was no difference observed between the amount of positive or negative charge that could be placed on a droplet.

The physical processes governing droplet charging may be viewed as follows. The electron-positive ion pairs formed near the corona wire quickly separate under the influence of the electric field associated with the discharge. Electrons attach to oxygen molecules to form O_2^- ions, which - in wet air - quickly become attached to water molecules. For a negative polarity wire the N_2^+ and O_2^+ ions produced in the discharge are collected at the wire and small negative ions are forced toward the walls. Enroute some are intercepted by droplets to cause a net negative electrification of the fog. For a positive-polarity wire both the electrons and O_2^- ions are collected by the wire and the positive ions move toward the chamber walls. Again some are trapped by droplets, this time to form a fog with net positive charge.

The maximum amount of charge that can be collected by a droplet was shown by Pauthenier (1932) to be that amount which produces an electric field at the droplet surface which is equal and opposite to the distorted ambient electric field that tends to drive charges toward the droplet. For a spherical droplet imbedded in an otherwise uniform electric field E_0 , the electric field at the droplet surface is given by

$$E = \left(1 + 2 \frac{K-1}{K+2}\right) E_0 \approx 3E_0 \quad (8)$$

where K is the dielectric constant of water. The electric field due to the maximum charge q_{\max} that can be placed on the droplet of radius r is

$$E = \frac{q_{\max}}{4\pi\epsilon_0 r^2} \quad (9)$$

Combining equations (8) and (9), q_{\max} may be expressed as

$$q_{\max} = 12\pi \epsilon E_0 r^2 \quad (10)$$

To obtain an order of magnitude estimate of E_0 we used the expression for the electric field under space charge limited conditions in a cylindrically symmetric chamber:

$$E = \sqrt{\frac{I}{2\pi\epsilon_0 K}} \approx 10^4 \quad (11)$$

where I = peak current per unit cylinder length ($\sim 2 \times 10^{-6}$ amps m^{-1} peak for our experiment) and K = ion mobility, $\sim 2 \times 10^{-4}$ in air. Assuming 10μ diameter drops, q_{\max} can be calculated from equation (10).

$$q_{\max} \approx 10^{16} \text{ coulombs} \approx 600 \text{ electronic charges}$$

This value is in reasonable agreement with the value of ≈ 700 electrons per drop found experimentally.

2. Estimates of Electrical Forces on Droplets Due to Drop Charge

With a quantitative understanding of the maximum charge that can be placed on a droplet it is possible to compute the electrical forces that might be experienced by droplets that have been treated in natural fogs. Let us assume first that a charging mechanism, e.g. a long horizontal corona wire and suitable grounded grids, is established at an airport to enable us to place an amount of charge equal to q_{\max} on all droplets within a distance R from the wire without placing any charge on those droplets outside of the cylinder with radius R . After this region of the fog has been charged, let the wind displace it by a distance $2R$ from its initial position and then repeat

the charging process, this time placing $-q_{\max}$ on every drop within meters of the wire. The result would be two adjacent cylinders containing in one cylinder all positively and in the other all negatively charged drops. Using parameters of the physical fog model (Jiusto, 1964) and reasonable characteristics for the charging device, we can estimate the forces tending to cause mixing of the drops in the two charged regions.

After the two charged regions drift away from the wire the electric field at the point of contact of the two regions will be

$$E = \frac{Q}{\pi \epsilon_0 R} = \frac{R n q_{\max}}{\epsilon_0} \quad (12)$$

where $Q = \pi R^2 n q_{\max}$ and n is the number of droplets per cubic meter. Assume that $R = 1$ meter, $n = 200 \text{ cm}^{-3} = 2 \times 10^8 \text{ m}^{-3}$, $\epsilon = 8.85 \times 10^{-12} \text{ coul/volt meter}$, and $q_{\max} = 10^{-16} \text{ coulombs}$, which is consistent with application of 10^4 volts between a corona wire and the set of grids that define R and 10 micron diameter droplets. The electric field will be

$$E \approx 2 \text{ kilovolts/meter}$$

The force exerted on one droplet at the edge of region 1 tending to push it into region 2 will be

$$F = E q_{\max} \approx 2 \times 10^{-13} \text{ newtons}$$

This value may be compared with the gravitational force of 5×10^{-12} newtons on the same droplet. The terminal velocity of the droplet under the influence of the electrical forces will therefore be only 0.04 of the terminal velocity of a 10 micron particle under the force of gravity, which, of course, is negligible.

The only way that electrical forces can be increased is to increase the maximum amount of charge on the droplets, which would require an increase in electric field during the charging cycle, or to increase the radius of both charged regions. To increase the electrical forces even to the extent that they equal gravitational forces, whether by increasing R or q_{\max} , would

require use of a power supply capable of delivering over a million volts to a corona wire that is perhaps as long as a runway. Such equipment in a field situation is clearly impractical.

The conclusion can be drawn, therefore, that use of electric forces to stimulate mixing of positively and negatively charged particles is not practical.

It should be pointed out that the source of charge is not an important consideration in these calculations. Provided sufficient charge is available, only the droplet radius and the electric field to which the droplets are exposed during the charging process are important.

Let us consider the effect that the opposite charges on droplets might have on the fog if mixing were accomplished by some means other than with electrical forces. For this purpose it is necessary to compute the average force that the electric field due to charge $+q_{\max}$ on one droplet exerts on another droplet of charge $-q_{\max}$. In a fog having droplet concentration of $200/\text{cm}^3$, the average separation, α , between droplets is approximately one millimeter.

The force exerted on one drop by the charge on the other is

$$F = E_{\text{drop}} q_{\max} = -\frac{q_{\max}}{4\pi\epsilon_0\alpha} \approx 10^{-19} \text{ newtons}$$

for 10 micron diameter droplets charged in a field of 10^4 volts/meter. This force is eight orders of magnitude smaller than the gravitational forces on the same droplets. Certainly, then, relative terminal velocities will be completely negligible.

3. Summary of Conclusions

a. The amount of charge that can be placed on a droplet is directly proportional to the electric field that exists during the charging process and directly proportional to the square of the droplet radius. For electric fields of the order of 10^4 volts per meter and typical fog-droplet radii of 5 microns the maximum amount of charge that can be placed on a droplet is of the order

of 10^{-16} coulombs, (600 electronic charges). Such electric fields can easily be produced in the field over distances of one meter from the charge source but with great difficulty over distances of 10 meters. It is completely impractical to produce of 10^5 volts per meter over ten meter distances.

b. If (during the droplet charging cycle) the electric field is maintained at 10^4 V/meter over distances of one meter from a linear charge source in a fog of high droplet concentration ($200/\text{cm}^3$), the electric field at the surface of the charged region due to charge on the droplets will be approximately two kilovolts per meter. The electric forces on individual droplets due to this field will be an order of magnitude smaller than the gravitational forces on the drop. Certainly no mixing of adjacent regions would be produced. To increase the electric forces by an order of magnitude, voltage sources capable of producing more than a million volts would be required. This is clearly impractical.

Since typical values for the earth's electric field are of the order of 100 volts per meter, forces exerted by the natural field will be an order of magnitude smaller than under the conditions described above.

c. If mixing of adjacent regions of the fog is accomplished by some means other than electrical forces, the mutual attraction between positive and negative particles would still exist. The average separation between droplets in a fog of $200/\text{cm}^3$ would be of the order of 1 mm. At this separation the mutual attraction between oppositely charged droplets would be approximately eight orders of magnitude smaller than gravitational forces. If droplets approach to within 100 microns the attractive force would still be six orders of magnitude smaller than gravitational forces. Such forces are truly negligible.

If under the influence of forces other than electrical forces droplets happen to collide, the charge of opposite polarity may enhance coalescence. The probability of collision between two droplets, both less than 18μ radius, is extremely small. With droplets of 5μ radius the probability of collision is essentially zero. Enhancement of coalescence upon collision is therefore meaningless.

On the basis of these results it may be concluded that it is impractical to attempt to modify fog by placing electric charge on the fog droplets. This conclusion should not be interpreted as indicating that electric forces are not important in the coalescence of droplets. In thunderstorms for example, where the electric fields may exceed those that can be applied artificially at an airport by more than three orders of magnitude and where drops are more than 10 times larger than fog droplets, the electric forces between drops can be ten orders of magnitude greater than those that can be applied artificially in fog. Such forces are truly significant.

Acknowledgements

We wish to express our gratitude to the personnel of Penn State University who assisted in our experiments and to the Department of Meteorology for their cooperation in this program. We also owe thanks to the personnel of the FAA, Philipsburg, Penn. Airport, who secured weather records and transmissometer data for us.

REFERENCES

- Duntley, S. Q., 1948: The Reduction of Apparent Contrast by the Atmosphere, J. Opt. Soc. Am., Vol. 38, No. 2.
- Justo, J. E., 1960: Greenland Whiteout Experiments - Summer 1960, Summary Report, Cornell Aeronautical Laboratory, Inc., Rept. No. RM-1430-P-2.
- _____, 1965: Cloud Particle Sampling, Pennsylvania State University, Department of Meteorology, Report No. 6, NSF G-24850.
- _____, 1964: Project Fog Drops, First Annual Summary Report, Cornell Aeronautical Laboratory, Inc., NASA CR-72.
- _____, and E. J. Mack, 1966: Fog Characteristics and Modification Concepts, Pennsylvania State University, Department of Meteorology, Interim Technical Note, Coal Research Laboratory Grant CR 63.
- Keith, C. H. and A. B. Arons, 1953: The Growth of Sea Salt Particles by Condensation of Atmospheric Water Vapor, Woods Hole Oceanog. Inst., Tech. Report No. 5.
- Kocmond, W. C., 1965: Project Fog Drops, Second Annual Summary Report (Pilić, R. J.), Cornell Aeronautical Laboratory, Inc., Report No. RM-1788-P-9.
- Pauthenier, M. M., et M. Moreau-Hanot, 1932: La Charge des Particles Sphériques Dans un Chamo Ionisé, Le Journal de Physique et le Radium, Série 7, 3.

Pedersen, K., and M. Todsén, 1960: Some Measurements of the Micro-Structure of Fog and Stratus Clouds in the Oslo Area, Norske Vindenskaps-Akad., Geofys. Pub., Vol. 21, No. 7.

Pilić, R. J., 1965: Project Fog Drops, Second Annual Summary Report, Cornell Aeronautical Laboratory, Inc., NASA CR-368.

Twomey, S., 1959: The Nuclei of Natural Cloud Formation - Parts I and II Geof. Pur. E. Appl., Vol. 43.

03327
224 copy
21-2-67

"The aeronautical and space activities of the United States shall be conducted so as to contribute . . . to the expansion of human knowledge of phenomena in the atmosphere and space. The Administration shall provide for the widest practicable and appropriate dissemination of information concerning its activities and the results thereof."

—NATIONAL AERONAUTICS AND SPACE ACT OF 1958

NASA SCIENTIFIC AND TECHNICAL PUBLICATIONS

TECHNICAL REPORTS: Scientific and technical information considered important, complete, and a lasting contribution to existing knowledge.

TECHNICAL NOTES: Information less broad in scope but nevertheless of importance as a contribution to existing knowledge.

TECHNICAL MEMORANDUMS: Information receiving limited distribution because of preliminary data, security classification, or other reasons.

CONTRACTOR REPORTS: Technical information generated in connection with a NASA contract or grant and released under NASA auspices.

TECHNICAL TRANSLATIONS: Information published in a foreign language considered to merit NASA distribution in English.

TECHNICAL REPRINTS: Information derived from NASA activities and initially published in the form of journal articles.

SPECIAL PUBLICATIONS: Information derived from or of value to NASA activities but not necessarily reporting the results of individual NASA-programmed scientific efforts. Publications include conference proceedings, monographs, data compilations, handbooks, sourcebooks, and special bibliographies.

Details on the availability of these publications may be obtained from:

SCIENTIFIC AND TECHNICAL INFORMATION DIVISION
NATIONAL AERONAUTICS AND SPACE ADMINISTRATION
Washington, D.C. 20546