

~~7167-1876~~

NASA TM X-55700

NIKE APACHE PERFORMANCE HANDBOOK

FACILITY FORM 402	7-25089	(ACCESSION NUMBER)	
	10/10/62	(PAGES)	22-29A
	TM-X-55700 29B	(NASA CR OR TMX OR AD NUMBER)	
			31
		(THRU)	
		(CODE)	
		(CATEGORY)	

DECEMBER 1966



GODDARD SPACE FLIGHT CENTER
GREENBELT, MARYLAND

3 NIKE A PACH E PERFORMANCE HANDBOOK 6

6 Howard L. Galloway, Jr.
Sounding Rocket Branch
Spacecraft Integration and Sounding Rocket Division, GSFC
and
Ruth Ann Crough 11
Fairchild Hiller Corporation

9 December 1966 1001

1 NASA

GODDARD SPACE FLIGHT CENTER
Greenbelt, Maryland 3

SYMBOLS

In the illustrations appearing here, the symbol L/A signifies "launch angle"; the symbol P/W signifies "payload weight ."

NIKE APACHE PERFORMANCE HANDBOOK

Howard L. Galloway, Jr.
Sounding Rocket Branch
Spacecraft Integration and Sounding Rocket Division, GSFC
and
Ruth Ann Crough
Fairchild Hiller Corporation

SUMMARY

Aerodynamic and performance data on the Nike Apache two-stage solid-propellant sounding rocket system are presented for the various configurations commonly flown. Calculations of vehicle stability and of speed, altitude, and range versus time and payload weight are presented graphically, together with flight-test data on lateral and longitudinal accelerations during the boost phases, for use in determining maximum performance of any given configuration as a function of various parameters.

The information in this document updates performance data presented in a previous handbook (issued as TN-D-1699) in that it contains revised calculations of the above parameters and additional information, both graphs and tables, for rockets flown from sea level and from 3986 feet above sea level; the results of a dispersion study of impact range; and the results of a postflight program-verification study.

PRECEDING PAGE BLANK NOT FILMED.

CONTENTS

	<u>Page</u>
INTRODUCTION	1
VEHICLE DESCRIPTION	1
AERODYNAMIC CHARACTERISTICS	8
PERFORMANCE CALCULATIONS	20
VERIFICATION	60
REFERENCES	61
APPENDIXES:	
A. Inputs to GE Mass Program Simulating Sounding-Rocket Trajectories	63
B. Trajectory Calculations for Standard Nike Apache Drag Cases	69
C. Postflight Verifications of Nike Apache Performance Using Actual Data	103

ILLUSTRATIONS

<u>Figure</u>		<u>Page</u>
1	Nike Apache on Launcher	2
2	Nozzle Extensions	3
3	Apache Pyrogen Igniter	4
4a	Apache Fin Assembly Unattached	4
4b	Apache Fin Assembly Attached	5
5	Nike Apache Dimensions	7
6	Apache Clean Flight Configuration	9
7	Drag Coefficient vs Mach Number for the Nike Apache . . .	10
8	Standard Apache Drag Cases	11
9	Drag Coefficients vs Mach Numbers for Standard Apache Drag Cases	12
10	DOVAP and Turnstile Antennas	13
11	Lift Coefficient vs Mach Number	14
12	Center of Pressure vs Mach Number (Short and Long Configurations)	15
13	Center of Gravity vs Payload Weight, Maximum- and Minimum-Length Apaches	17
14	Centers of Pressure and Gravity, Short Configuration . . .	18
15	Centers of Pressure and Gravity, Long Configuration . . .	19
16	Typical Apache Roll Rate and Natural Pitching Frequency vs Time	20
17	Maximum Longitudinal Acceleration vs Payload Weight (Sea-Level Launch, 80-Degree Launch Angle, Clean and Pitot-Static Configurations)	21
18	Typical First-Stage Boost Environment	22
19	Apogee vs Launch Angle for Four Drag Configurations (Sea-Level Launch)	24-25
20	Apogee vs Launch Angle for Four Drag Configurations (Launch at 3986 Feet Above Sea Level)	26-27

ILLUSTRATIONS (Continued)

<u>Figure</u>		<u>Page</u>
21	Effect on Apogee of Varying Second-Stage Ignition Time (Sea-Level Launch, 80-Degree Launch Angle, 50-lb Payload, Clean Configuration)	29
22	Effect on Impact Range of Varying Second-Stage Ignition Time (Sea-Level Launch, 80-Degree Launch Angle, 50-lb Payload, Clean Configuration)	30
23	Variation in Apogee with Launch Altitude (85-Degree Launch Angle, 50-lb Payload, Clean and Pitot-Static Configurations)	31
24	Burnout Speed vs Payload Weight (Sea-Level Launch, 20-second Second-Stage Ignition)	32
25	Burnout Speed vs Payload Weight (Launch 3986 Feet Above Sea Level, 20-second Second-Stage Ignition)	33
26	Dynamic Pressure vs Altitude (Sea-Level Launch and Launch 3986 Feet Above Sea Level, 80-Degree Launch Angle, 80-lb Payload, Clean Configuration)	35
27	Speed vs Time (Sea-Level Launch, 80-Degree Launch Angle)	36-37
28	Speed vs Altitude (Sea-Level Launch, 80-Degree Launch Angle, 80-lb Payload, Clean Configuration)	38
29	Altitude vs Time (Sea-Level Launch, 80-Degree Launch Angle)	39-40
30	Altitude vs Range (Sea-Level Launch, 80-Degree Launch Angle)	41-42
31	Speed vs Time (Launch 3986 Feet Above Sea Level, 80-Degree Launch Angle)	43-44
32	Speed vs Altitude (Launch 3986 Feet Above Sea Level, 80-Degree Launch Angle, 80-lb Payload, Clean Configuration)	45
33	Altitude vs Time (Launch 3986 Feet Above Sea Level, 80-Degree Launch Angle)	46-47
34	Altitude vs Range (Launch 3986 Feet Above Sea Level, 80-Degree Launch Angle)	48-49

ILLUSTRATIONS (Continued)

<u>Figure</u>		<u>Page</u>
35	Impact Range vs Launch Angle (Sea-Level Launch)	50-51
36	Impact Range vs Launch Angle (Launch 3986 Feet Above Sea Level)	52-53
37	Apogee vs Impact Range (Sea-Level Launch)	55-56
38	Apogee vs Impact Range (Launch 3986 Feet Above Sea Level)	57-58

TABLES

<u>Table</u>		<u>Page</u>
1	Impact Dispersion Values for Significant Parameters	59
2	Nike Apache 2-Sigma Dispersions	60

NIKE APACHE PERFORMANCE HANDBOOK

INTRODUCTION

Since 1963, the Nike Apache has been the rocket most widely used in NASA's international sounding-rocket program. This vehicle, consisting of a Nike M5-E1 first stage and a Thiokol TE-307 Mod II (Apache) second stage, is capable of lifting payloads in the 50- to 100-pound range to altitudes in the region of 100 to 130 statute miles (160 to 210 kilometers) when launched at an elevation angle of 80 degrees from a sea-level missile test facility.

This report contains performance data for use by scientific experimenters, vehicle managers, and range safety personnel, subject to limitations noted in the report and to revision in case of weight or configurational changes.

VEHICLE DESCRIPTION

The Nike Apache (Figure 1) is a two-stage solid-propellant unguided sounding rocket stabilized by four fins (on each of the two stages) in a cruciform configuration. The stages are connected by a conical transition section that is bolted to the first stage and slip-fits into the nozzle of the second stage. Separation is achieved at burnout of the first stage by differential drag forces. There is no mechanical restraint between the second stage and the transition assembly in the axial direction.

Ignition of the second stage is normally delayed for 16.5 seconds after burnout of the first stage to reduce aerodynamic heating and drag in the low-altitude high-density region of the atmosphere.

The first-stage motor is the standard Nike M5-E1 booster currently used by NASA in several vehicles.

The Apache TE-307 motor developed by Thiokol Chemical Corporation for use as a single-stage (Mod I) or an upper stage (Mod II) solid-propellant rocket booster is almost identical in appearance to the Cajun; in fact, most of the hardware used is identical and interchangeable. The external difference is the nozzle extension (Figure 2) which is fabricated of steel on the Cajun. As steel is not satisfactory with the higher exhaust-gas temperature of the Apache, the Apache extension is a steel can with a phenolic liner bonded to the steel and secured from rotation or expulsion by three roll pins. Although bulkier in dimension, the Apache extension is somewhat lighter than the Cajun extension.

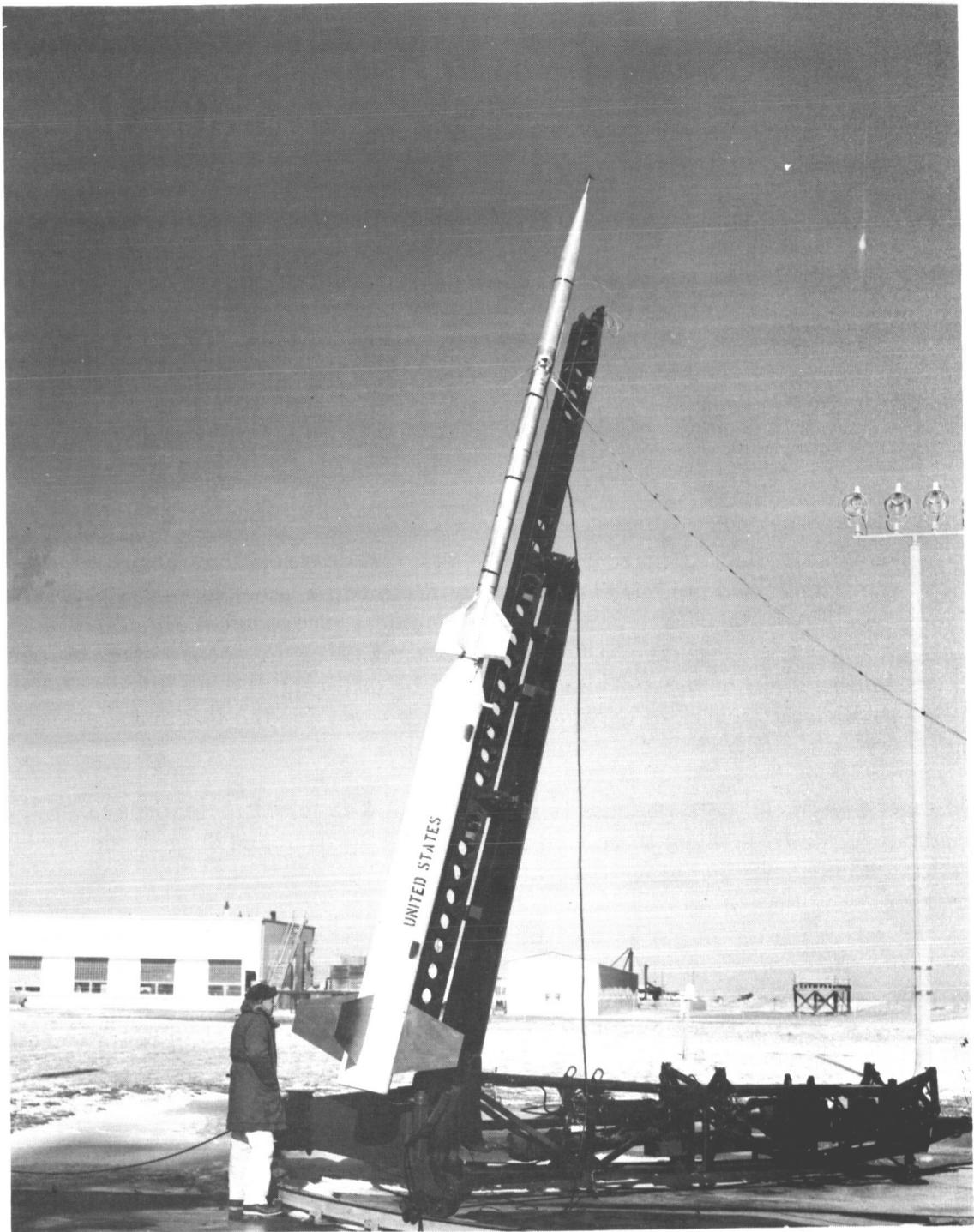

Figure 1. Nike Apache on Launcher

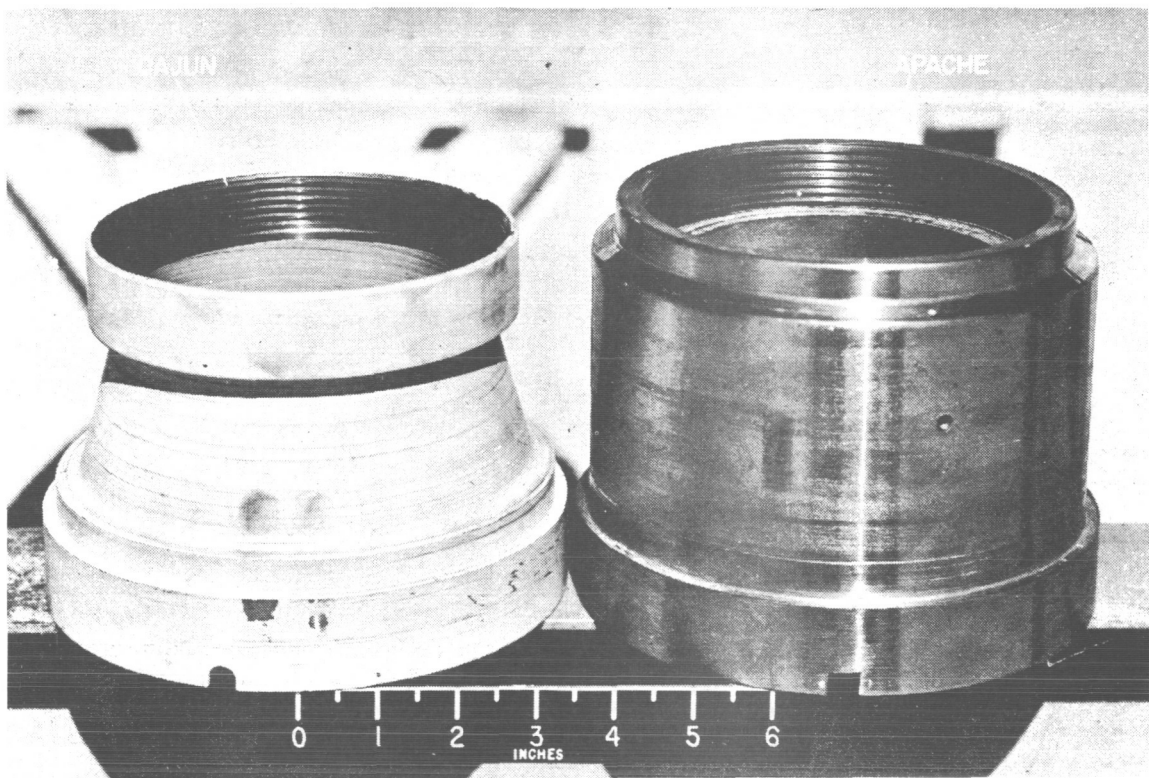

Figure 2. Nozzle Extensions

The primary internal difference between the Cajun and the Apache is the propellant. The Apache is loaded with an aluminized polyurethane propellant that has a higher specific impulse and a longer burning time than that powering the Cajun. Besides having a considerable performance improvement over the Cajun, the Apache should prove to be more reliable than the Cajun in terms of lower probability of motor failure; the operating pressure of the Apache is about 300 psi below that of the Cajun, although the case thicknesses are the same. (Higher reliability is theoretical rather than actual, as NASA has had no known Cajun failure due to case rupture.)

A second internal variation is the igniter. The Apache uses a pyrogen igniter (Figure 3) developed by Thiokol for use on certain propellants to achieve unpressurized altitude ignition. The pyrogen igniter, actually a small rocket motor that operates for about 100 milliseconds, provides both the temperature and pressure required to ignite the grain. Each propellant requires a certain threshold temperature and pressure below which ignition will not occur. The standard Cajun igniter cannot provide these threshold conditions for the Apache propellant at high altitudes.

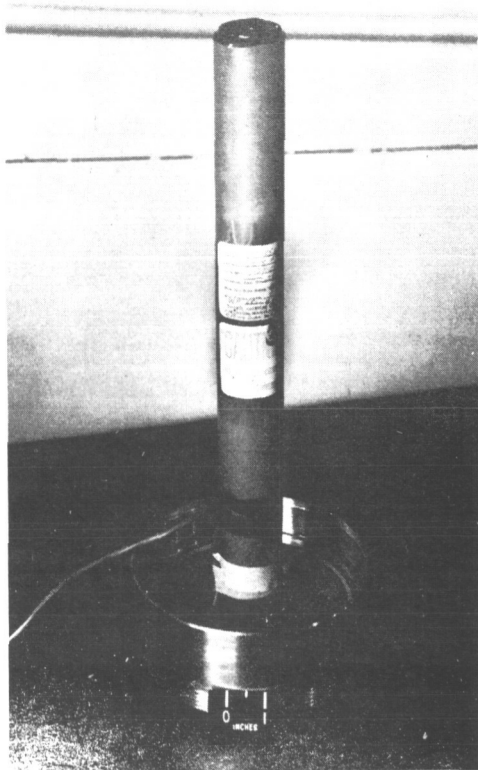

Figure 3. Apache Pyrogen Igniter

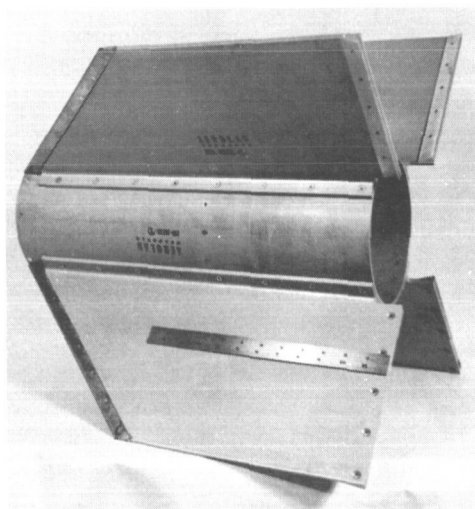

Figure 4a. Apache Fin Assembly Unattached

A pyrotechnic delay squib similar to that used on the Cajun is fired at launch and burns for a predetermined time before firing the pyrogen igniter. Because of the necessity for housing the igniter in a steel case and the length of the delay squib, a penalty of about 5 pounds is imposed on the vehicle burnout weight. Although this could be avoided by deleting the squib and firing the Apache with a timer housed in the payload section, the weight penalty is not serious enough to warrant the change for current NASA applications.

The Nike-to-Apache adapter and the fin assembly are identical to those used on the Cajun and are now interchangeable. The fin assembly has been modified to accommodate the increased dimensions of the Apache nozzle extension. All assemblies now being procured are interchangeable (Figure 4).

The Apache motor and fin assemblies are fabricated of aluminum except for the following components, which are fabricated of steel:

- Nozzle and nozzle extension (liner is graphite)
- Igniter housing (attached to head cap)
- Fin leading-edge cuffs

Because of the relatively small amount of ferrous metals it contains, the Apache, like the Cajun, can be used for boosting payloads carrying scientific instrumentation that cannot be flown on steel-cased motors.

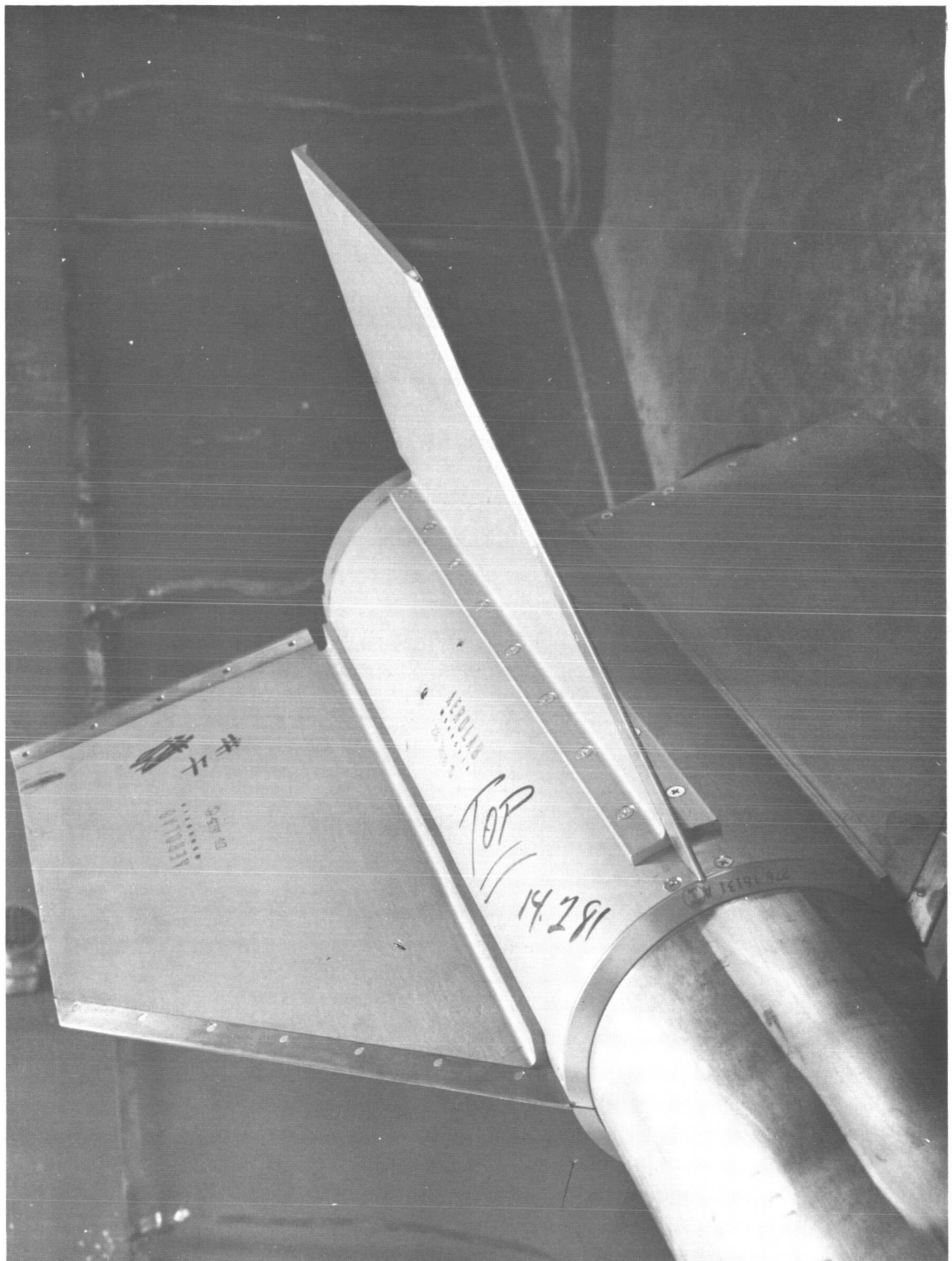

Figure 4b. Apache Fin Assembly Attached

Figure 5 shows the Nike Apache vehicle and gives the overall dimensions.

The system's weights and centers-of-gravity given here are approximate and vary slightly from round to round because of casting and extrusion techniques used in propellant and case manufacture. The variations do not significantly affect the flight characteristics of the system.

Weights (lb)	Centers-of-Gravity (in.)*
Apache Motor (empty, with head cap and igniter)	Apache Motor (no fins)
58.75	Full 54.8
Propellant	Empty 51.1
131.00	
Loaded Weight (no payload)	
189.75	
Fin Assembly	Apache Motor (with fins)
27.25	Full 49.2
Flight Weight (less payload)	Empty 38.1
217.0	
Nike Motor (empty)	
460.0	
Propellant (mass consumed)	
755.0	
Loaded Weight	
1215.0	
Fins	Nike Motor 67.5
75.0	Propellant 83.5
Nike Apache Adapter	Fins 18.4
27.0	Adapter 162.0
Flight Weight	
1317.0	
Launch Weight (less payload)	
1534.0	

*Dimensions given in inches from base of motor concerned

General physical characteristics of the Apache are:

Apache Weight . . . (as given above)	Propellant	Aluminized Polyurethane
Dimensions (in.)	Average Thrust (lb)	~ 5,130
Motor Length	Average P_c (psi)	700
107.0	Burning Time (sec)	~ 6.4
Diameters:	Total Impulse (lb-sec)	~ 32,800
Motor		
6.5		
Head Cap		
6.75		
Maximum		
(nozzle extension)		
7.135		

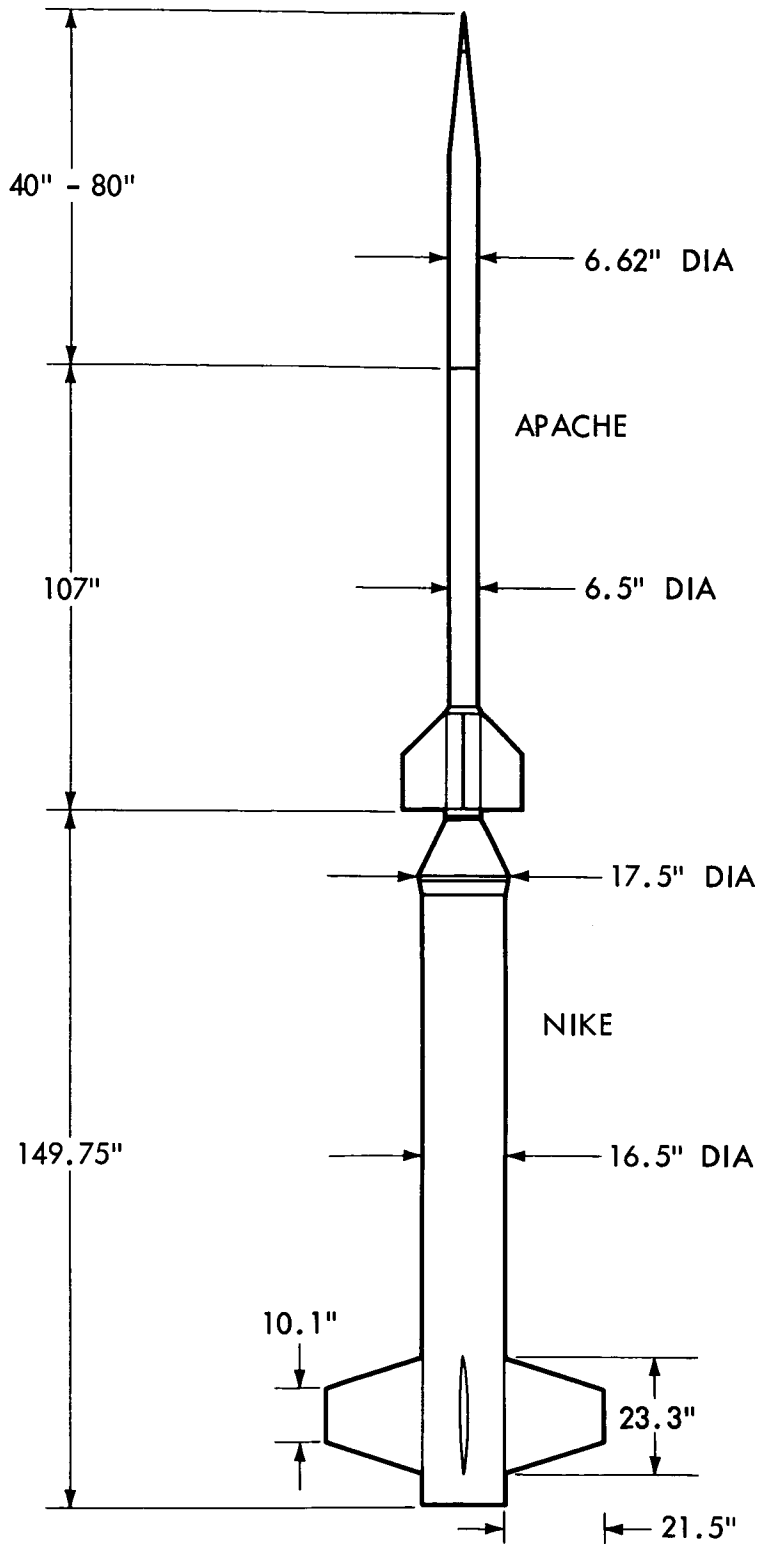

Figure 5. Nike Apache Dimensions

Figure 6 shows the Apache in a clean flight configuration with the approximate maximum and minimum payload lengths expected to be flown. Payload volume inside the cylindrical sections for the 6-inch and 46-inch extensions is 174 and 1340 cubic inches, respectively. Volume inside the standard cone is about 330 cubic inches. In actual practice, only about half the cone volume may be conveniently used for instrumentation; thus, the available payload volume for the Apache can be considered to lie between 340 and 1500 cubic inches, with a maximum internal diameter of about 6.1 inches.

Oversized and nonstandard configurations may be flown; however, each should be analyzed thoroughly to ensure compatibility with the flight environment to which it will be subjected. Special care should be taken to avoid the possibility of structural divergence of the Apache-plus-payload during the Nike boost phase.

AERODYNAMIC CHARACTERISTICS

Figure 7 shows the drag coefficient vs Mach number for the Nike Apache.

Most of the aerodynamic data on the Cajun hold true for the Apache, as the external configuration of both vehicles (exclusive of payload) is identical. Reference 1 is the most widely used source of Cajun data; however, several modifications of the drag and lift data have been made recently (References 2 and 3). Figure 8 shows the four standard drag configurations. Figure 9 gives the drag coefficients for the Apache for these various configurations. Transonic drag is estimated because the second-stage Apache normally does not fly at Mach numbers below 1.5, except at extreme altitudes where drag forces are negligible because of the low density of the atmosphere.

To estimate drag, certain assumptions as to external configuration are necessary. The cone chosen for analysis has an 11-degree total angle and a 6.62-inch-diameter base. The 11-degree cone is preferable to the blunter cones sometimes flown on Cajuns for two reasons: first, the 11-degree cone has less drag and thus gives slightly better performance; second, the more slender cone has a lower lift coefficient and a center of lift further aft for the same total payload length (Reference 3). This tends to improve the static stability of the vehicle and also results in lower bending moments on the Apache motor during first-stage boost. All the curves in Figure 9 except those for the pitot-static experiment (drag case 4) are based on this cone.

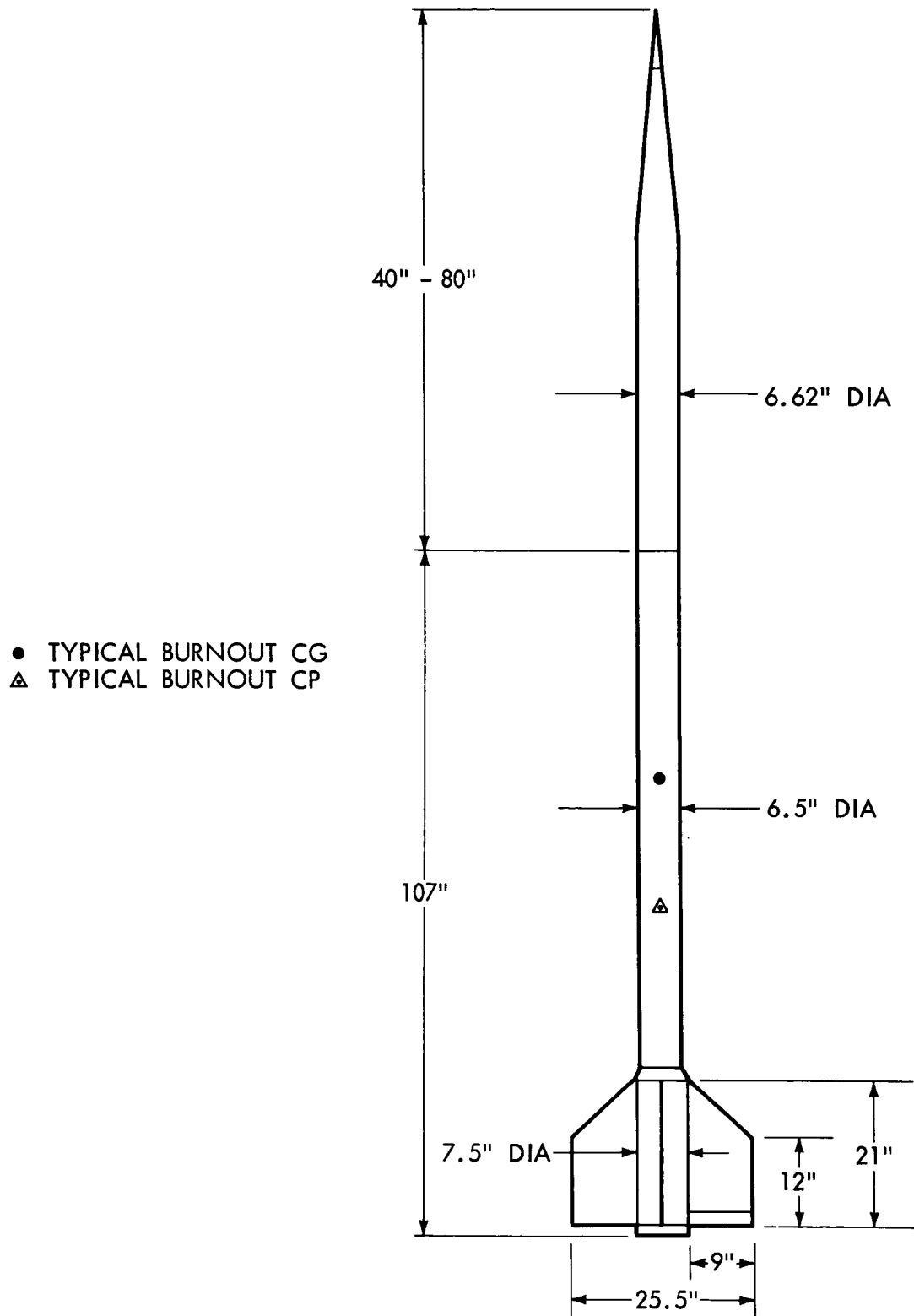

Figure 6. Apache Clean Flight Configuration

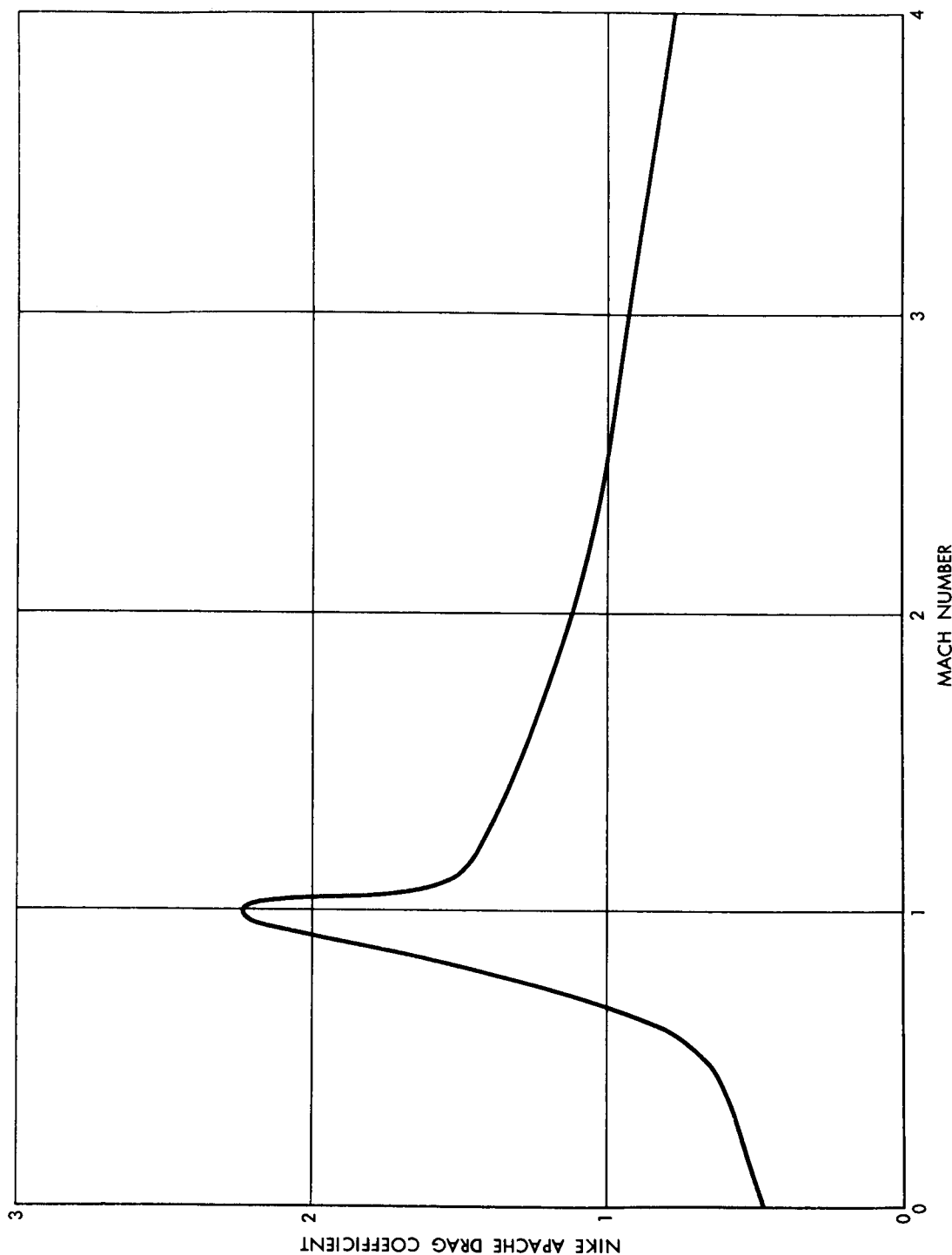

Figure 7. Drag Coefficient vs Mach Number for the Nike Apache

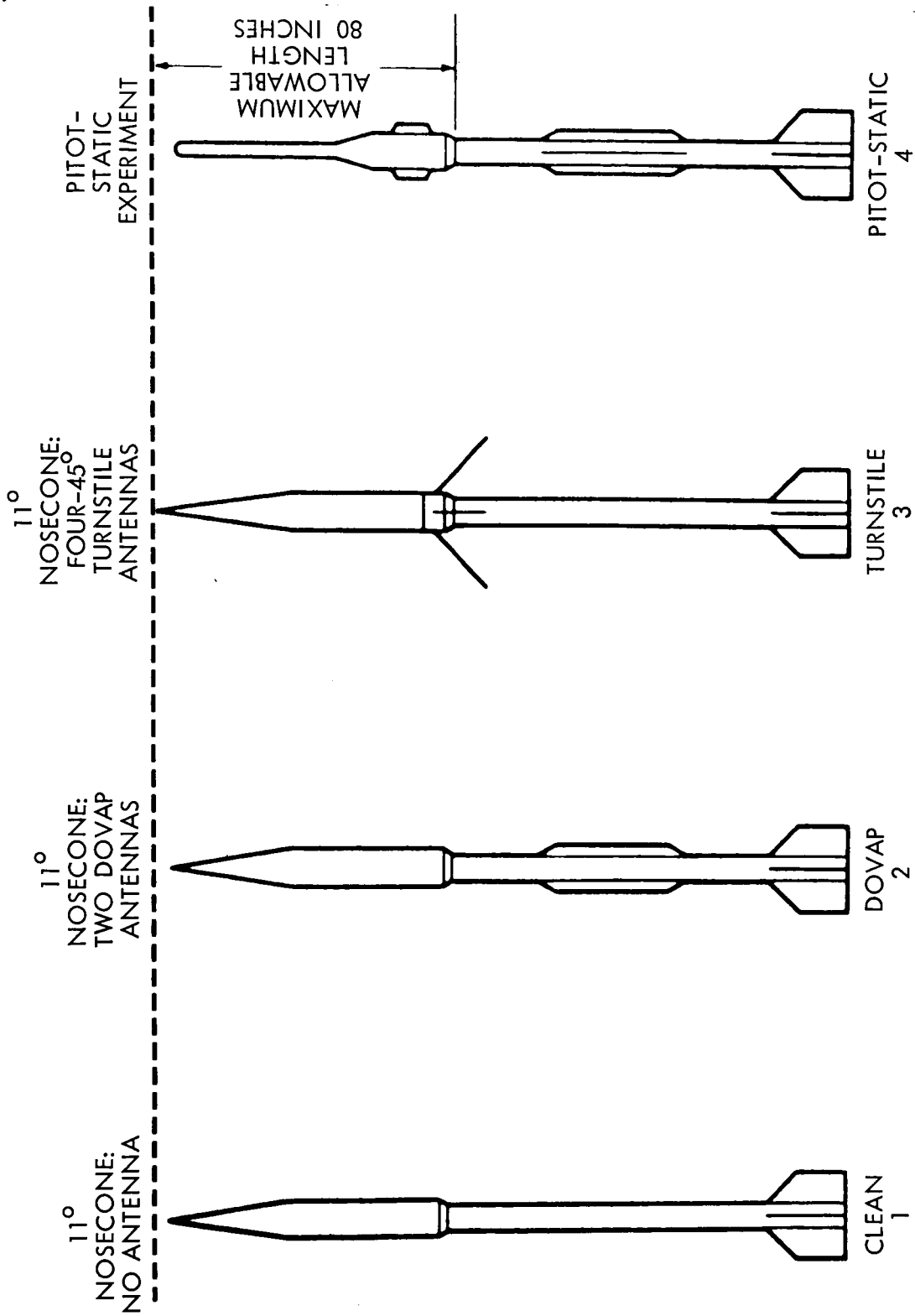
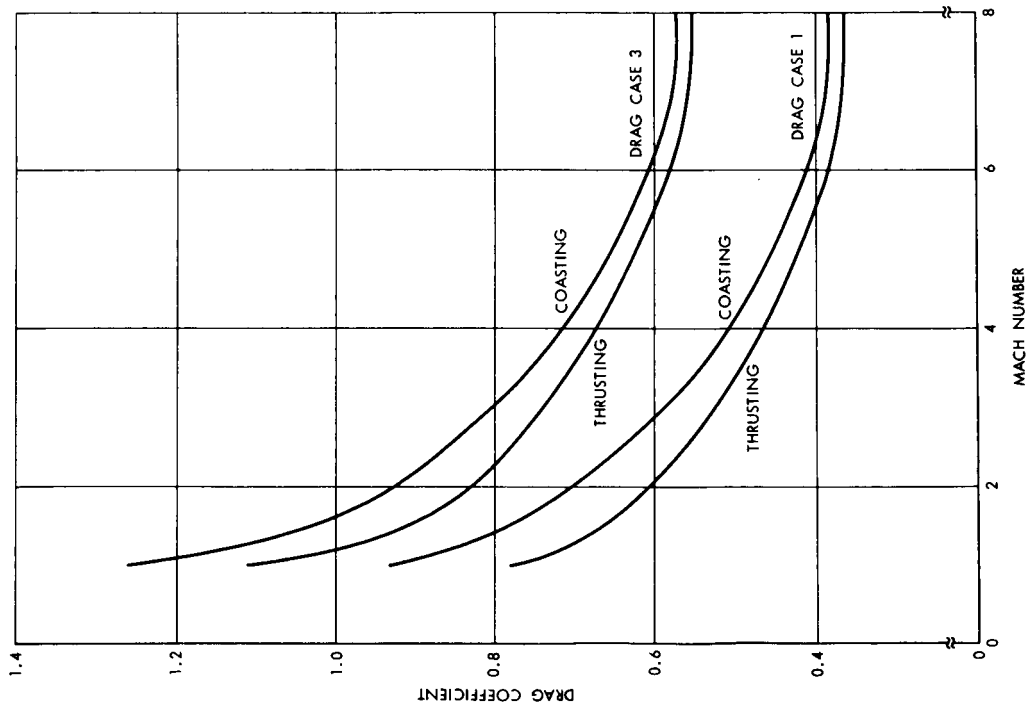
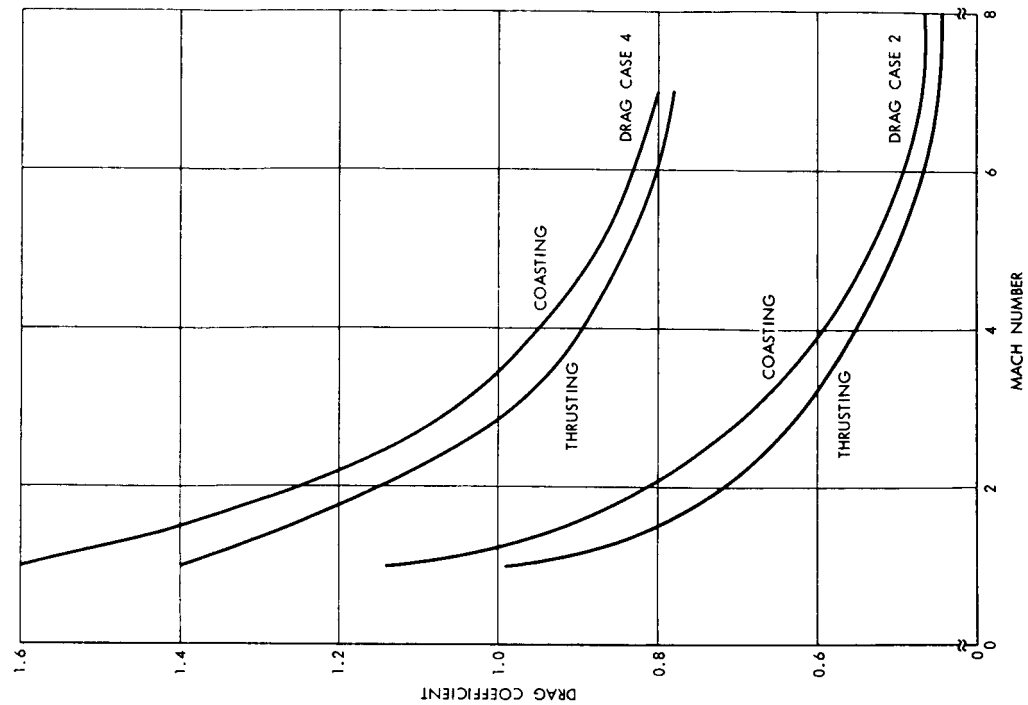

Figure 8. Standard Apache Drag Cases



Drag Cases 1 and 3



Drag Cases 2 and 4

Figure 9. Drag Coefficients vs Mach Numbers for Standard Apache Drag Cases

Drag-coefficient contributions are based on two types of antennas flown on the Nike Cajun:* two DOVAP and four turnstile (Figure 10). Drag contributions of other types of antennas flown are calculated individually. The DOVAP antennas are strapped to the motor case 180 degrees apart, and the turnstile antennas are usually swept at 45 degrees. One other configuration was considered: the Pitot-static probe, consisting of a Pitot-static tube and two quadraloops mounted on the payload. Two DOVAPs are mounted in their usual position. The drag coefficient penalty for each of these configurations has been computed and is reflected in the curves of Figure 9.

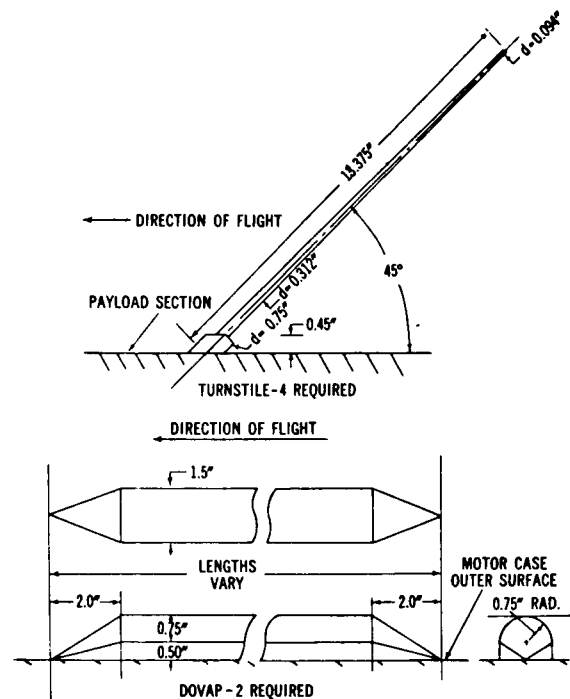

Figure 10. DOVAP and Turnstile Antennas

The lift and the center-of-pressure, calculated by the method of Reference 4, are shown in Figures 11 and 12, respectively. The lift coefficient is approximately true for all payload lengths (with 11-degree cone attached) normally flown. Center-of-pressure, however, is a function of total length. Maximum and minimum payload lengths were assumed in order to establish a range of centers-of-pressure covering most circumstances under which the Apache would be flown. A 6-inch cylindrical section yielding a minimum payload length of 40 inches was added to the standard 34-inch-long 11-degree nose cone, and a 46-inch cylindrical extension was added for a maximum length of 80 inches (Figure 6). The majority of the payloads to be flown on the Apache should fall within these limits. Payloads longer than 80 inches should not be flown because experience with the Apache and the Cajun has revealed a high probability of vehicle failure with long payloads because of structural divergence during first-stage boost.

Figure 12 shows the centers-of-pressure calculated for the maximum- and minimum-length Apaches. A linear interpolation may be employed to estimate the center-of-pressure for any length other than the extremes. Likewise, the

*Lane, John H. "Unpublished Data on Nike Cajun Sounding Rocket System." NASA-GSFC, 1961.

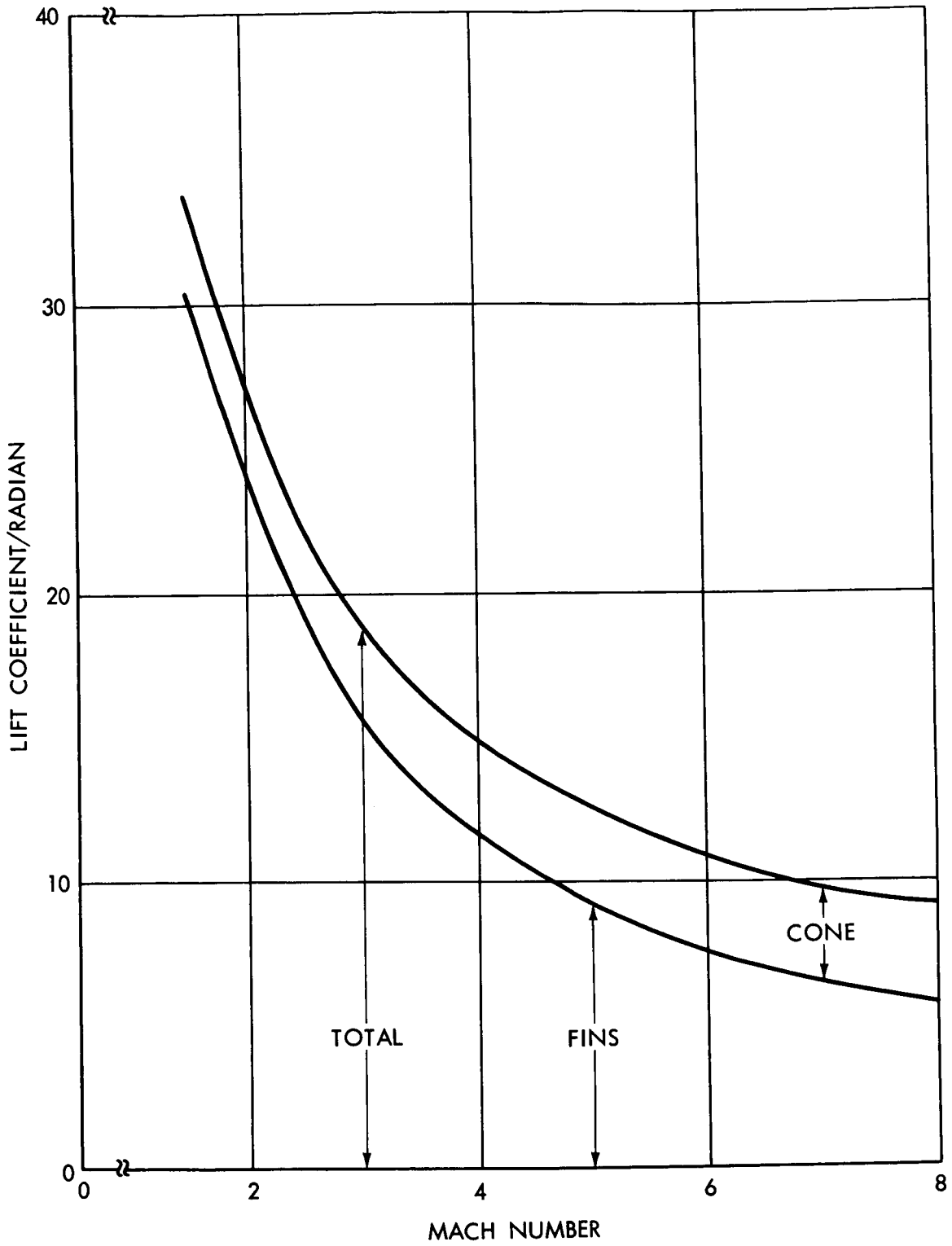

Figure 11. Lift Coefficient vs Mach Number

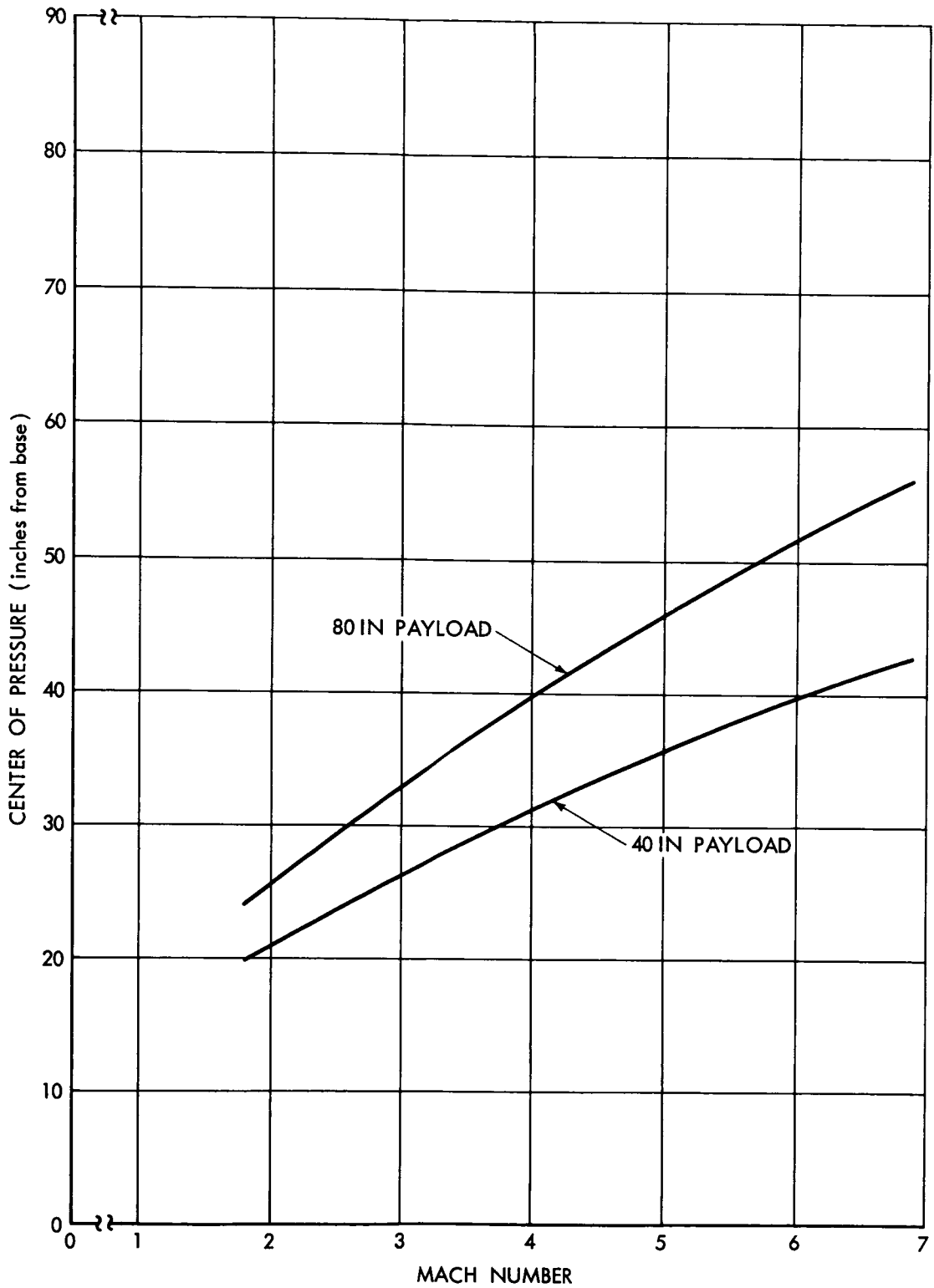

Figure 12. Center of Pressure vs Mach Number (Short and Long Configurations)

center-of-gravity for any given payload weight and length may be obtained from Figure 13.

Figures 14 and 15 combine the center-of-pressure and center-of-gravity data for convenience in estimating the aerodynamic static margin (or the weathercock stability) for any particular flight. Note that the Apache has considerable static stability for any of the payload lengths and weights considered. Although insufficient static stability might result from flying light payloads (i. e. , ≈ 40 lb) in very long payload compartments, this is unlikely to occur in practice.

Dynamic stability of the Apache can be maintained by spinning the vehicle at a relatively high roll rate, 5 rps at burnout of the Apache stage. Roll is obtained either by canting the fins, or by installing wedges on the trailing edges of the fins; NASA uses the latter method on the Apache. Figure 4 is an example of installed wedges. Excellent stability in the atmosphere and in space has been demonstrated by Apache flights which achieved a 5-rps roll rate at Apache burnout.

Figure 16 shows the actual roll-time history for a flight in which the maximum roll rate was 10 rps. Shown on the same figure is the natural pitching frequency of this typical Nike Apache. Flights having an Apache-burnout roll rate lower than 5 rps have exhibited large coning motions and/or tumbling of the vehicle as it exits from the atmosphere. If experimental considerations preclude the use of a rolling vehicle, then every effort should be made to keep the spin rate as low as possible. The fin-assembly manufacturer provides alignment and warp data on each set of fins, and these data should be considered in selecting fins for a no-roll vehicle; however, the experimenter should be aware that, without roll, the vehicles will probably perform poorly. In no case should the vehicle be intentionally rolled to rates in the vicinity of 1 to 3 rps at second-stage burnout, as pitch-roll resonance will occur and may result in vehicle breakup and/or poor attitude in space. Reference 5 describes the phenomenon of pitch-roll resonance, and Reference 6 is a report on the effect of payload length and configuration on static margin and natural pitching frequency.

The acceleration environment encountered by the payload in the Nike Apache is no more severe than that of the Nike Cajun. Figure 17 compares the maximum longitudinal accelerations imposed by the first- and second-stage boost phases. Since the Apache operates at a lower thrust level than does the Cajun, the loading during second-stage burn is less. Lateral accelerometers flown on the Apache indicate that no significant vibrations are transmitted to the payload during Apache boost. Remember, however, that the Nike boost phase does subject the payload to severe lateral and longitudinal loads. Figure 18 is a playback of the actual loads recorded during a typical Nike boost. The longitudinal

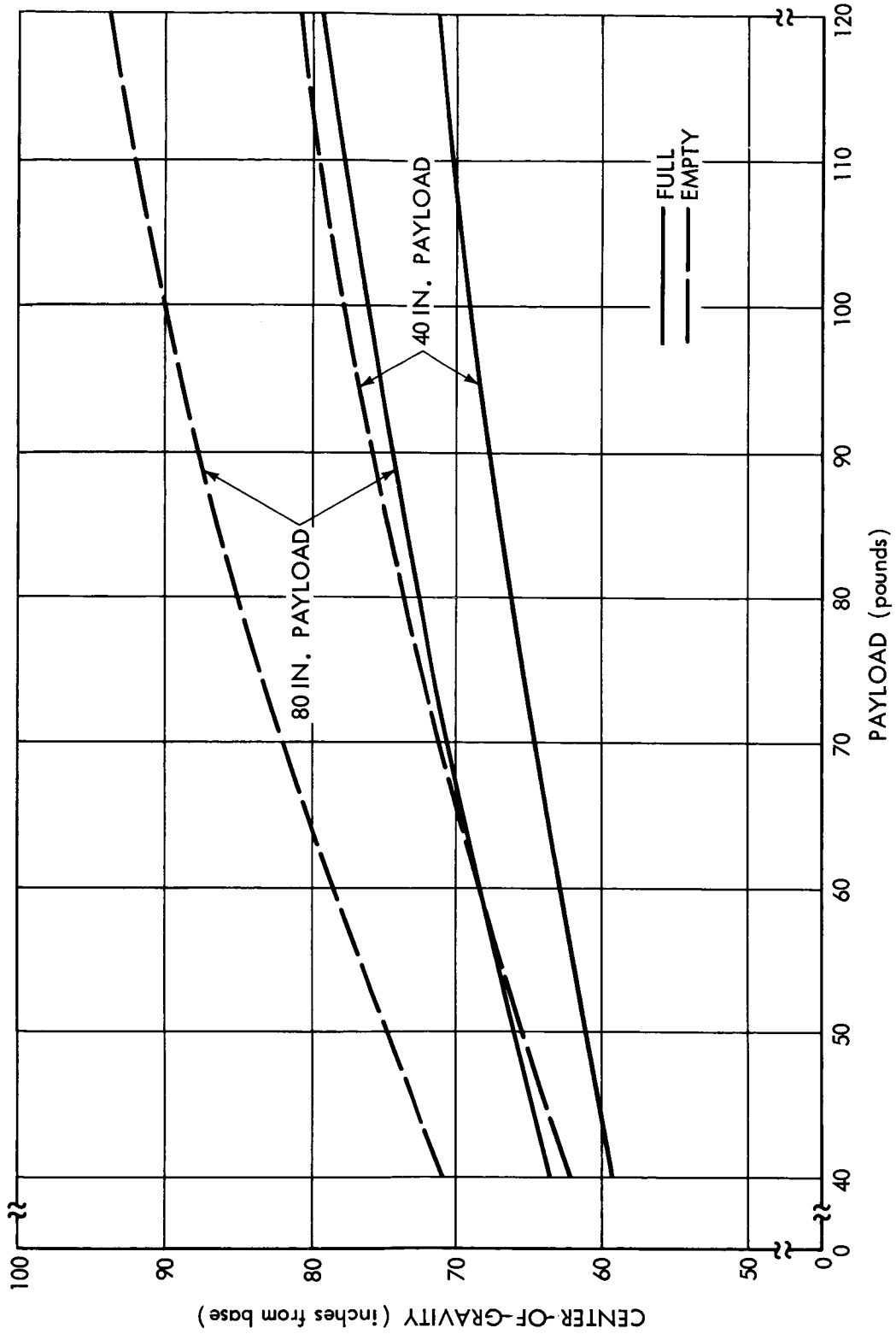

Figure 13. Center-of-Gravity vs Payload Weight, Maximum- and Minimum-Length Apaches

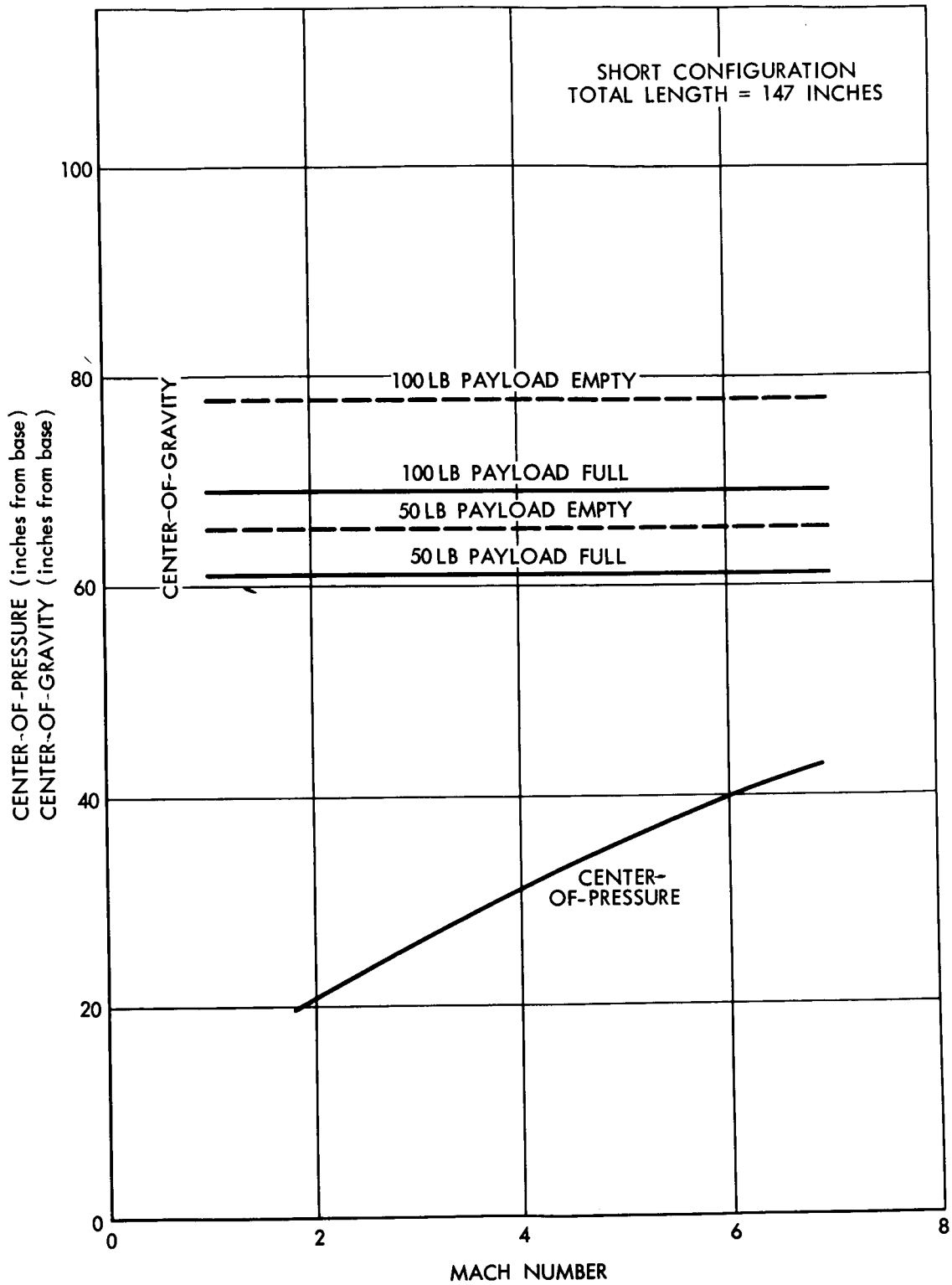

Figure 14. Centers of Pressure and Gravity, Short Configuration

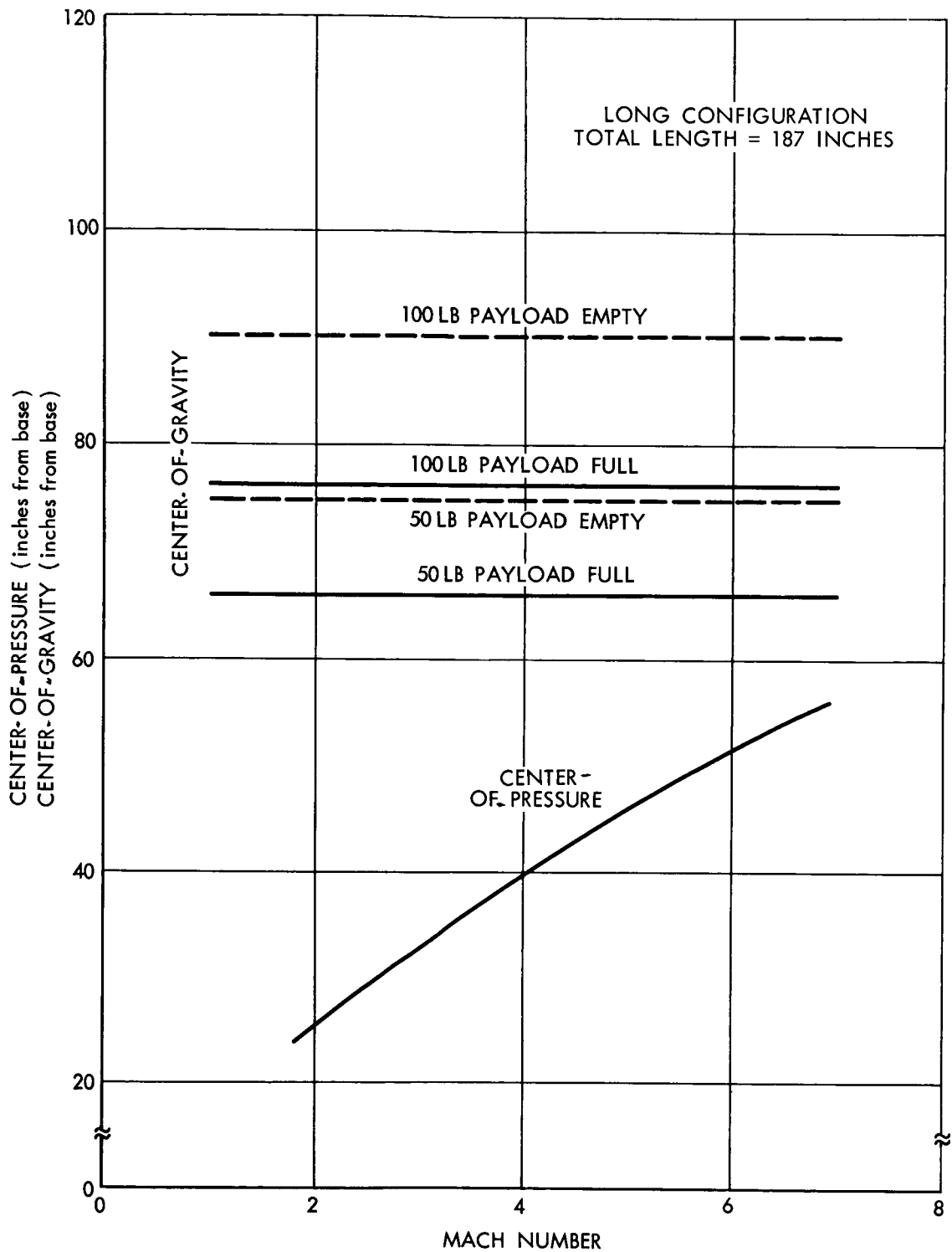

Figure 15. Centers of Pressure and Gravity, Long Configuration

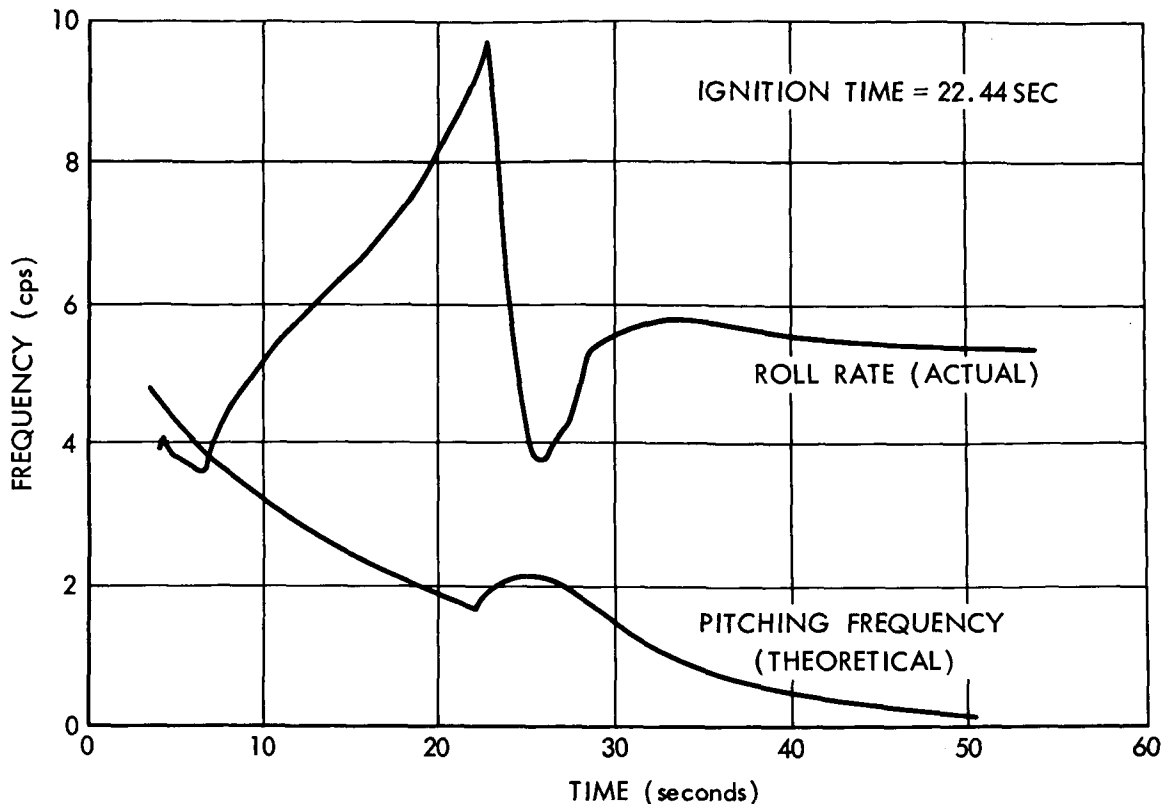

Figure 16. Typical Apache Roll Rate and Natural Pitching Frequency vs Time

accelerometer was a ± 100 g instrument; the lateral accelerometer range was ± 25 g. Data are shown only through Apache separation, as vibrations are not significant after this time. The environment shown in Figure 18 can be considered typical for the Nike Apache vehicle. Reference 7 contains results of a study of the longitudinal, lateral, and vibrational accelerations measured on a flight-performance rocket.

PERFORMANCE CALCULATIONS

All the trajectory data contained in this report were computed on an IBM 7094 digital computer using a three-dimensional n-stage particle-trajectory program originally developed by GE as the Missile and Satellite System (MASS) program modified to simulate trajectories for sounding-rocket vehicles. These trajectories, computed for a rotating oblate earth, include Coriolis effects.

Appendix A describes and gives examples of the inputs used in this program.

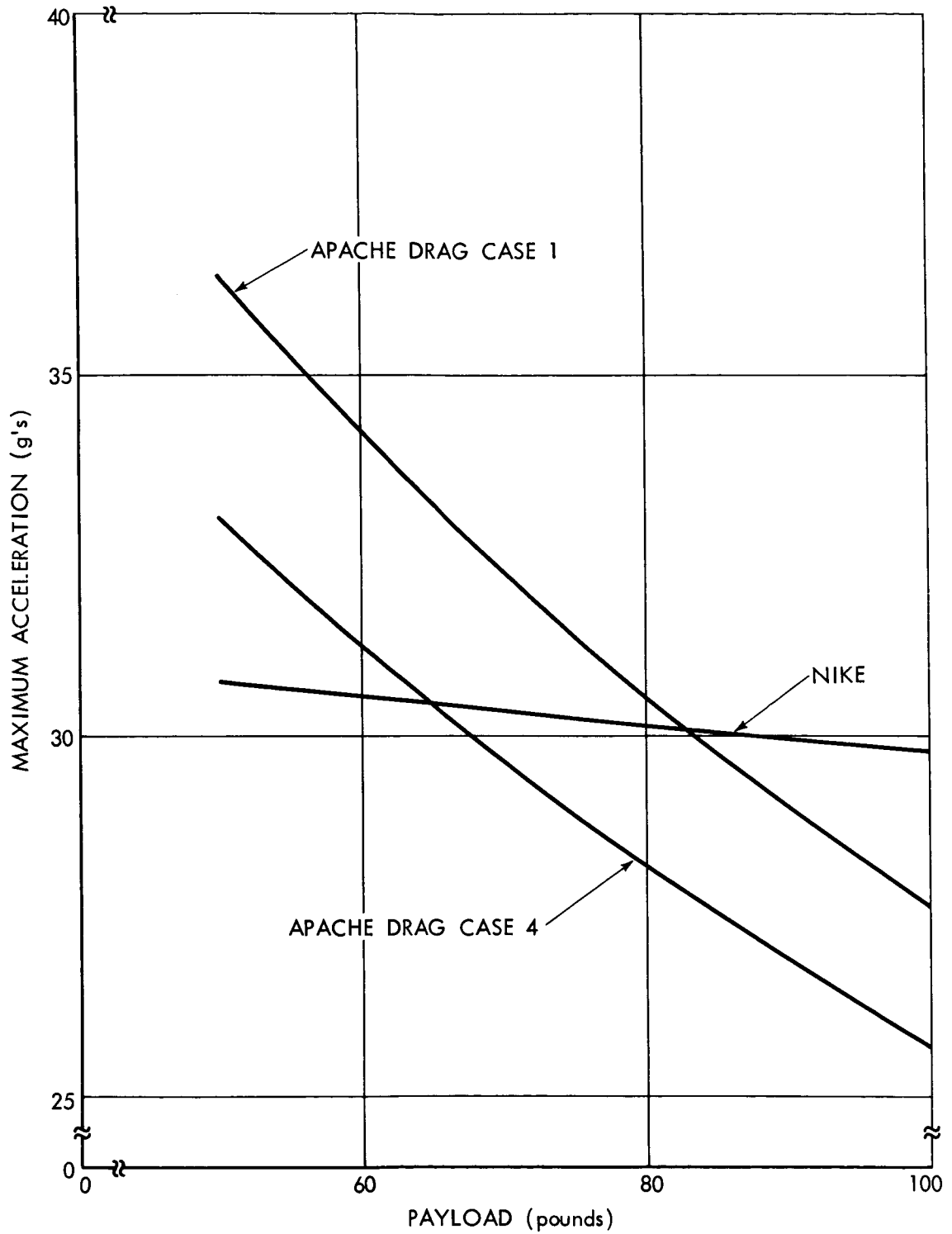

Figure 17. Maximum Longitudinal Acceleration vs Payload Weight (Sea-Level Launch, 80-Degree Launch Angle, Clean and Pitot-Static Configurations)

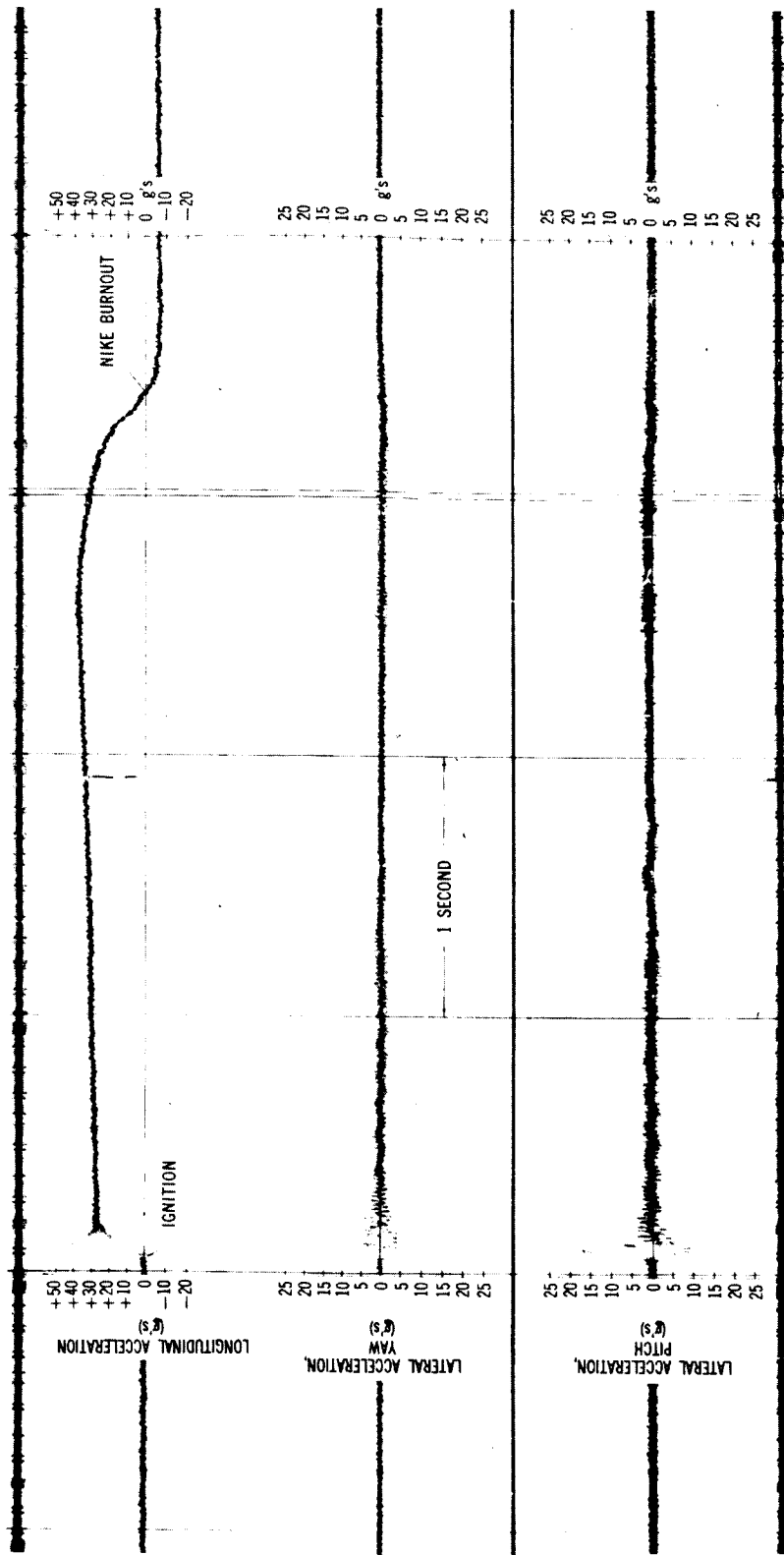

Figure 18. Typical First-Stage Boost Environment

The trajectory data appear here to indicate to the vehicle user the general range of performance obtainable from the Nike Apache vehicle under various conditions of payload weight, launch angle, and launch elevation. An attempt has been made for purposes of comparison to include altitude results from trajectories that would be representative of conditions found at the various missile test ranges used by NASA. Not all trajectories have been run for each case, but a sampling has been made to indicate the effects of launch altitude and launch angle on maximum altitude. Most launches of the Nike Apache will take place at the NASA Wallops Island facility, or at White Sands Missile Range Launch Complex 33, so that the bulk of the data presented is for conditions representative of these facilities: from a sea-level elevation at a launch angle of 80 degrees, or from a point 3986 feet above sea level.

Figure 19 summarizes maximum altitude performance for the Nike Apache launched from Wallops Island, for the four drag configurations most commonly flown: the basic vehicle with an 11-degree cone and (1) no antennas (clean); (2) two DOVAP antennas (of any length); (3) four turnstile antennas swept at 45 degrees; or (4) the Pitot-static probe.

In all accompanying figures, these configurations are referred to as "clean, drag case 1," "DOVAP, drag case 2," "turnstile, drag case 3" and "Pitot-static, drag case 4," respectively (see Figure 8).

Figure 20 summarizes maximum altitude performance of Nike Apaches launched from White Sands Missile Range, for launch angles up to 90 degrees (vertical). The normal angle for a Wallops Island firing is 80 degrees; normal angle for a White Sands Missile Range firing is 85 degrees. Except in special circumstances, these are the maximum launch angles (Q_e) permitted by range safety regulations for this type of vehicle.

The illustrations show the severe effect of drag on the performance of this system. For instance, a 23-statute-mile altitude penalty results from flying the four 45-degree turnstile antennas on a 50-pound payload at 80 degrees (Q_e) from a sea-level launch. Adding these antennas increases the drag coefficient 40 to 50 percent over that for the clean vehicle. If the four 45-degree turnstiles were swept back to 60 degrees, peak altitude for the case cited would increase by 15 statute miles. Two DOVAP antennas add somewhat less drag than the four turnstiles used, but still impose a significant penalty. If users of this system ever require maximum altitude performance, flush antennas must be developed.

A second-stage ignition time of 20 seconds from liftoff, used in all the trajectories providing the data in Figures 19 and 20, was chosen on the basis of an

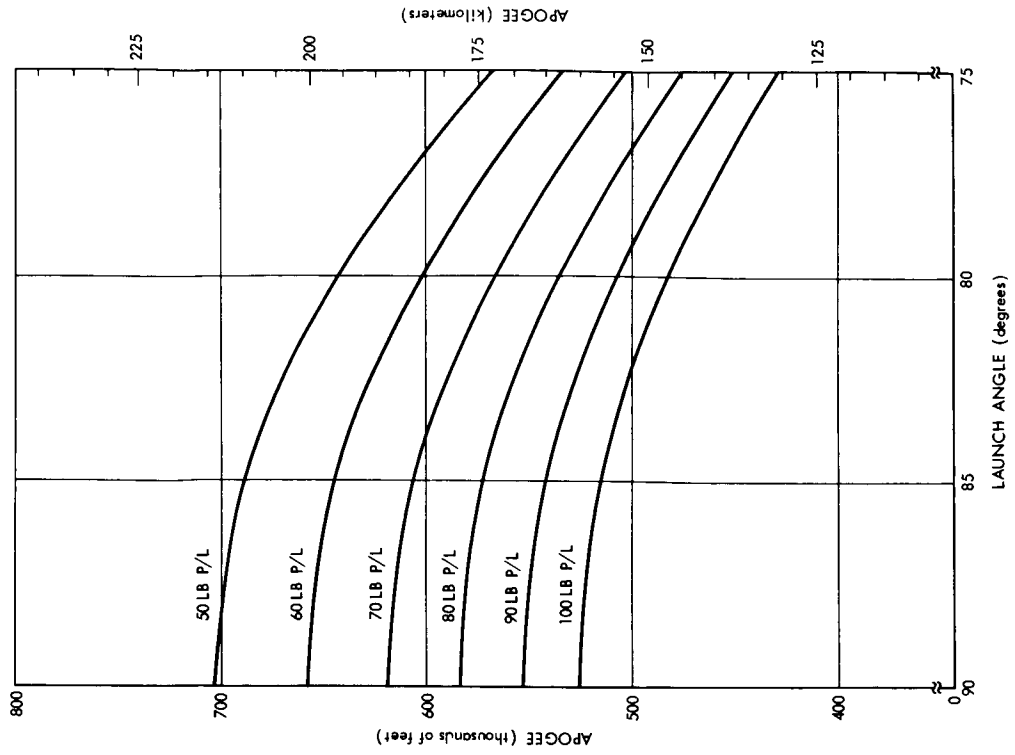
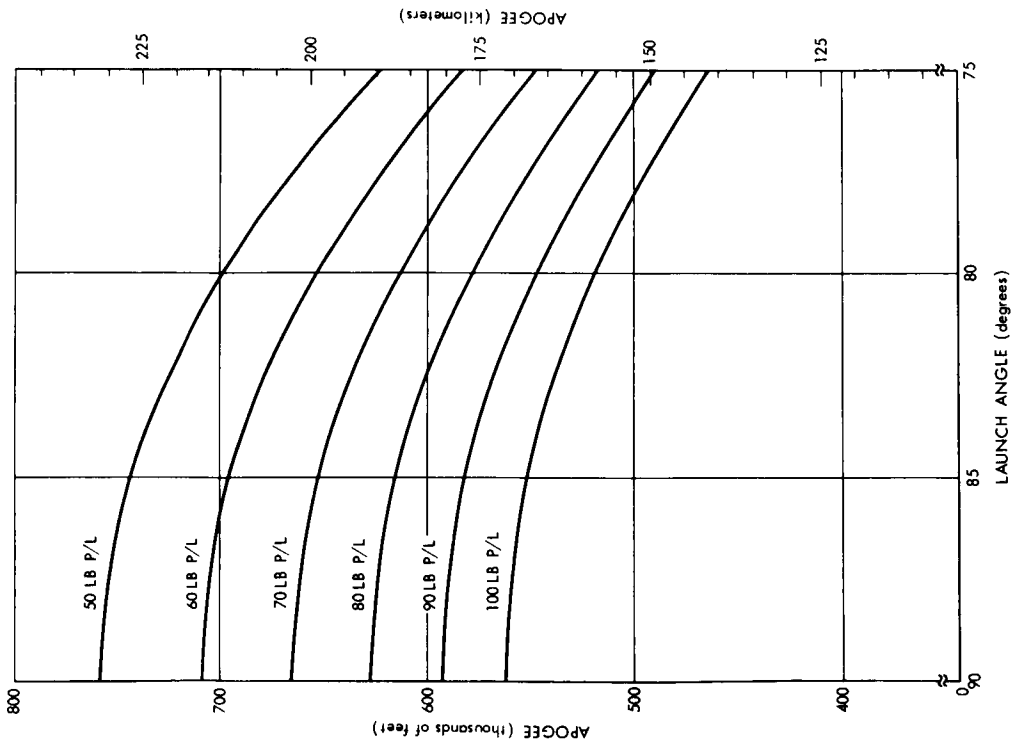
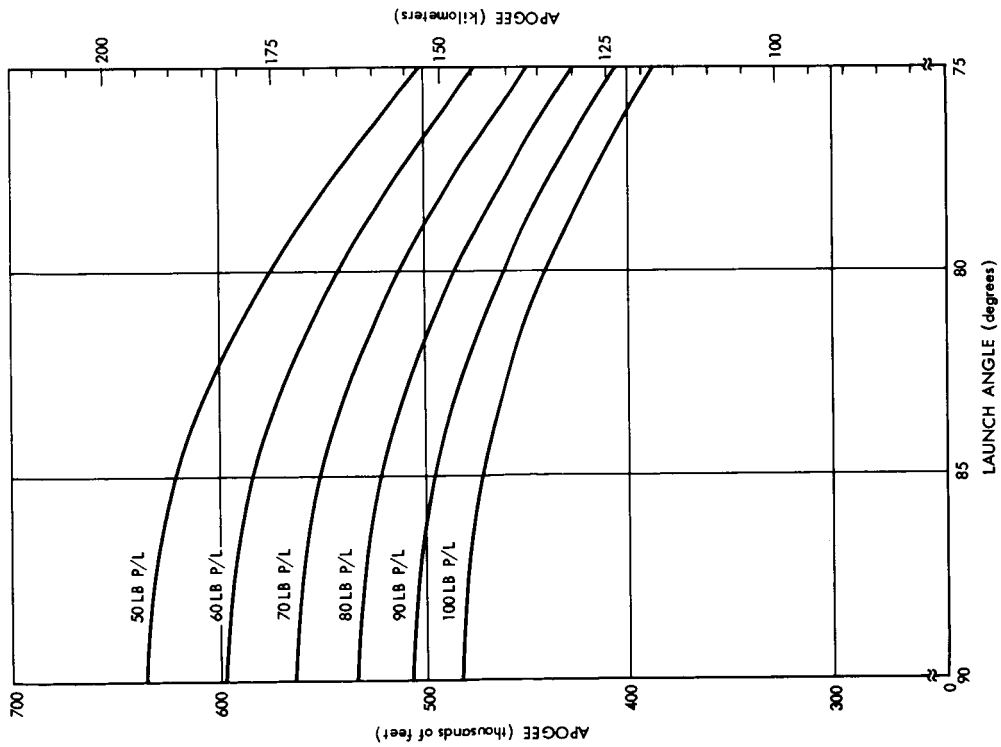
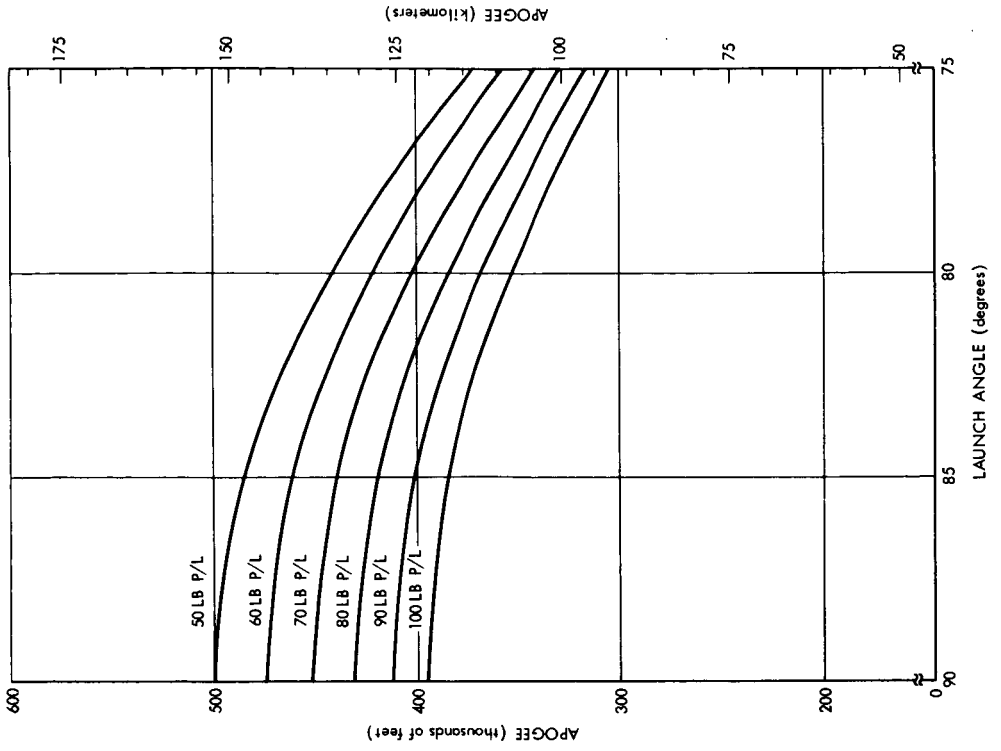

Figure 19. Apogee vs Launch Angle for Four Drag Configurations (Sea-Level Launch)



Drag Case 3



Drag Case 4

Figure 19. Apogee vs Launch Angle for Four Drag Configurations (Sea-Level Launch)

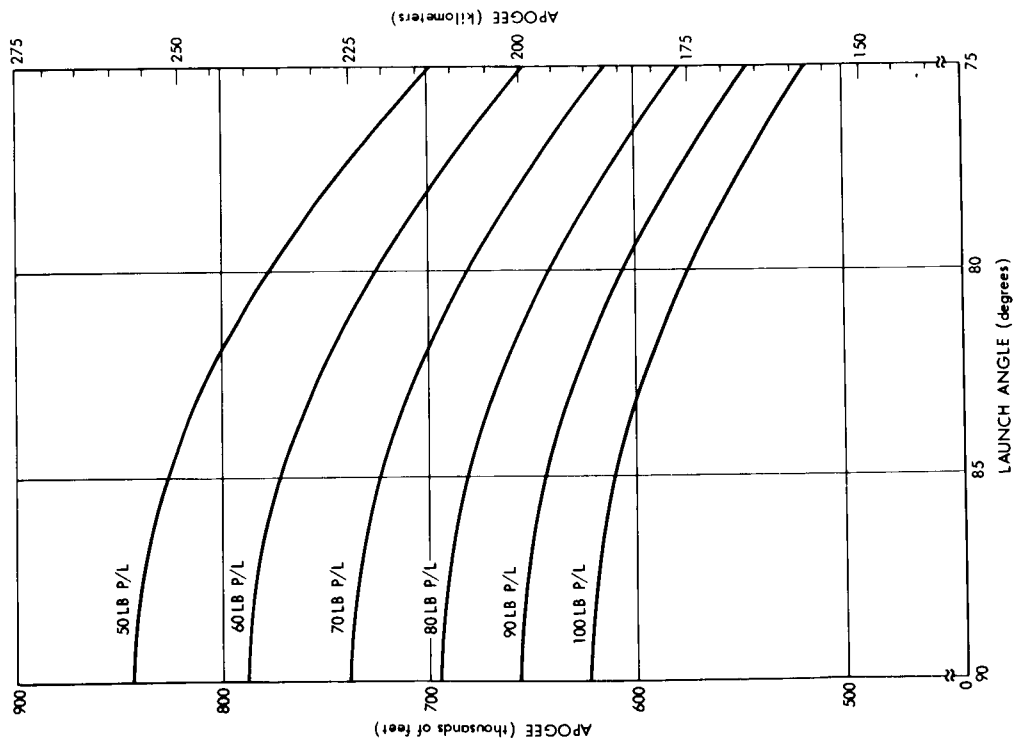

Drag Case 1

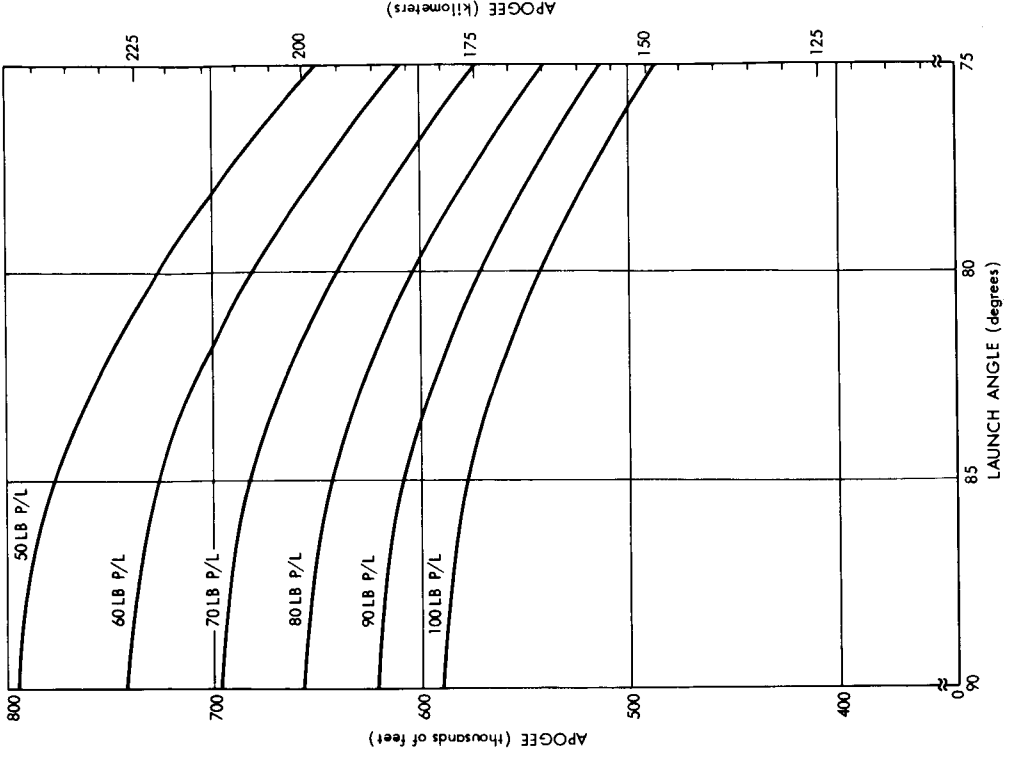

Drag Case 2

Figure 20. Apogee vs Launch Angle for Four Drag Configurations (Launch at 3986 Feet Above Sea Level)

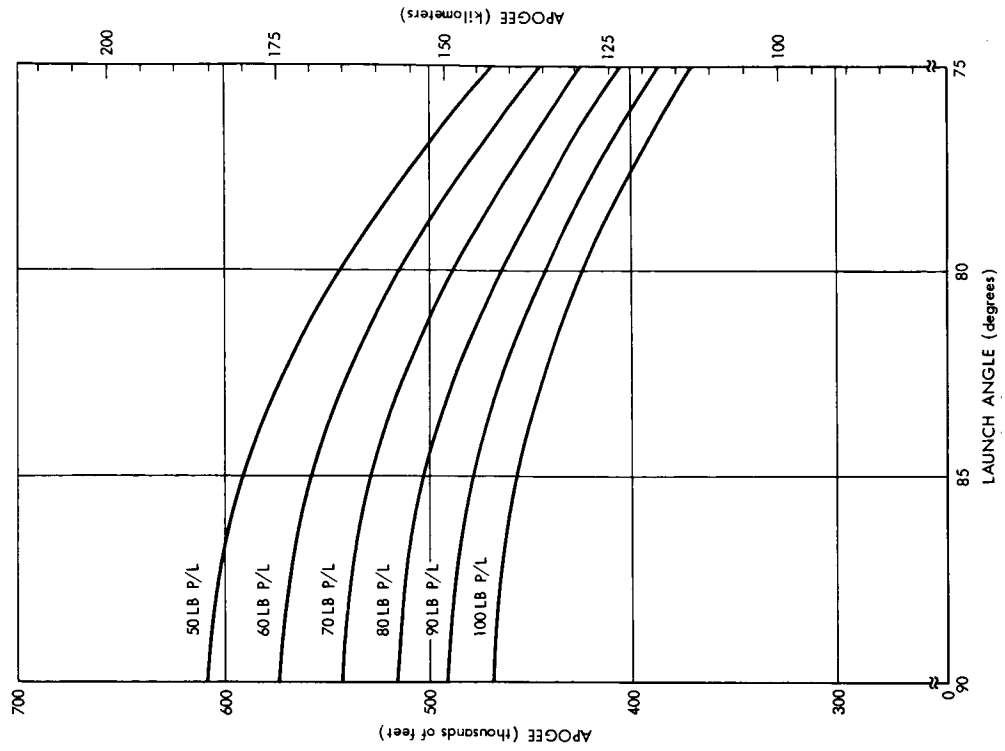
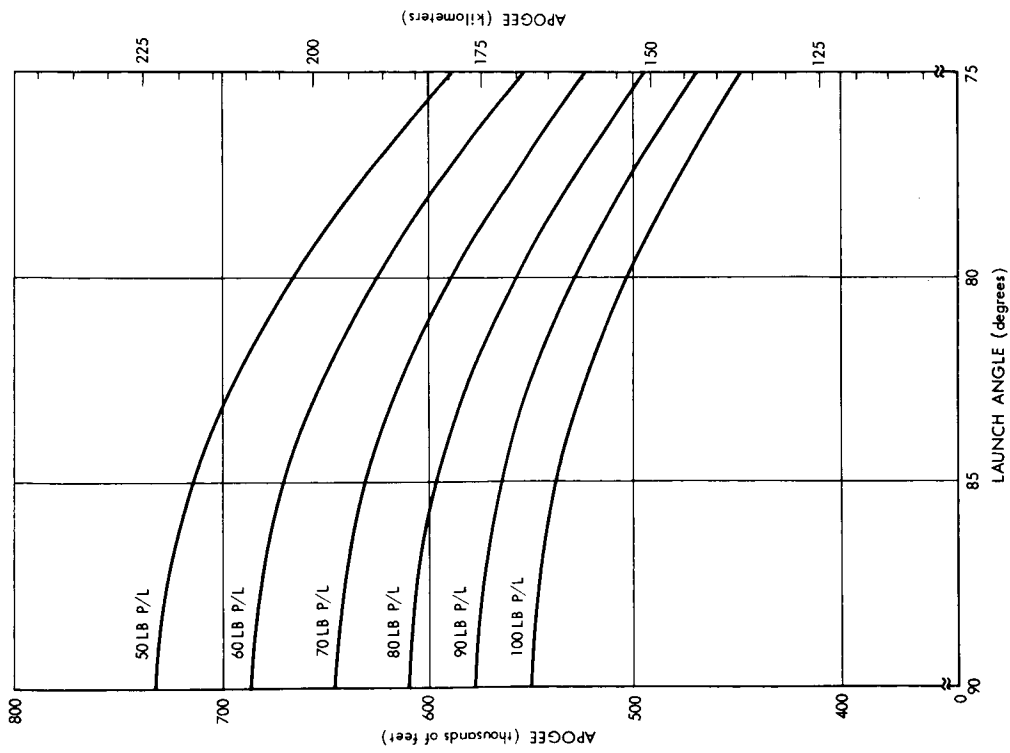

Figure 20. Apogee vs Launch Angle for Four Drag Configurations (Launch at 3986 Feet Above Sea Level)

optimization study, whose results appear in Figure 21. Actually, variation of the coast time seems to have little effect on maximum altitude. The optimum is about 19.5 seconds; however, trajectories calculated with second-stage ignition times between 16 and 24 seconds differ only about 1.3 statute miles in theoretical apogee. Ignition of the second stage at any time between these should not cause significant deterioration of performance. Figure 22 shows that the variation in horizontal impact range is 20 statute miles for the same values of ignition time. Very short coast phases should be avoided because heating effects on the fins (and possibly the payload) may become critical.

The drag on a rocket moving through the atmosphere is given by

$$D = C_D \frac{\rho V^2}{2} A$$

where D = drag (lbs.)

C_D = drag coefficient (dimensionless)

ρ = atmospheric density (slug/ft³)

V = speed of rocket (ft/sec)

A = drag reference area (ft²)

also $\frac{\rho V^2}{2}$ = dynamic pressure (lb/ft²)

If the launch site is above sea level, the lower value of ρ at the increased altitude causes a decrease in the drag acting on the vehicle.

Figure 23 illustrates the performance bonus resulting from launch from missile test ranges located significantly above sea level. The use of White Sands Missile Range, about 4000 feet above sea level, for the launch site, will increase attainable altitude more than 15.5 statute miles for any given flight configuration.

The burnout speed of the second stage varies from about 5000 to 6700 feet per second for the configurations launched from sea level (Figure 24). This variation is from 5300 to 7000 ft/sec for a launch from 3986 feet above sea level (Figure 25). The effects of drag are again apparent. Variation of the second-stage ignition time will have an effect on these speeds; however, the resulting change in the altitude-speed profile will essentially even out the drag-impulse losses, and the total altitude performance will not be seriously affected.

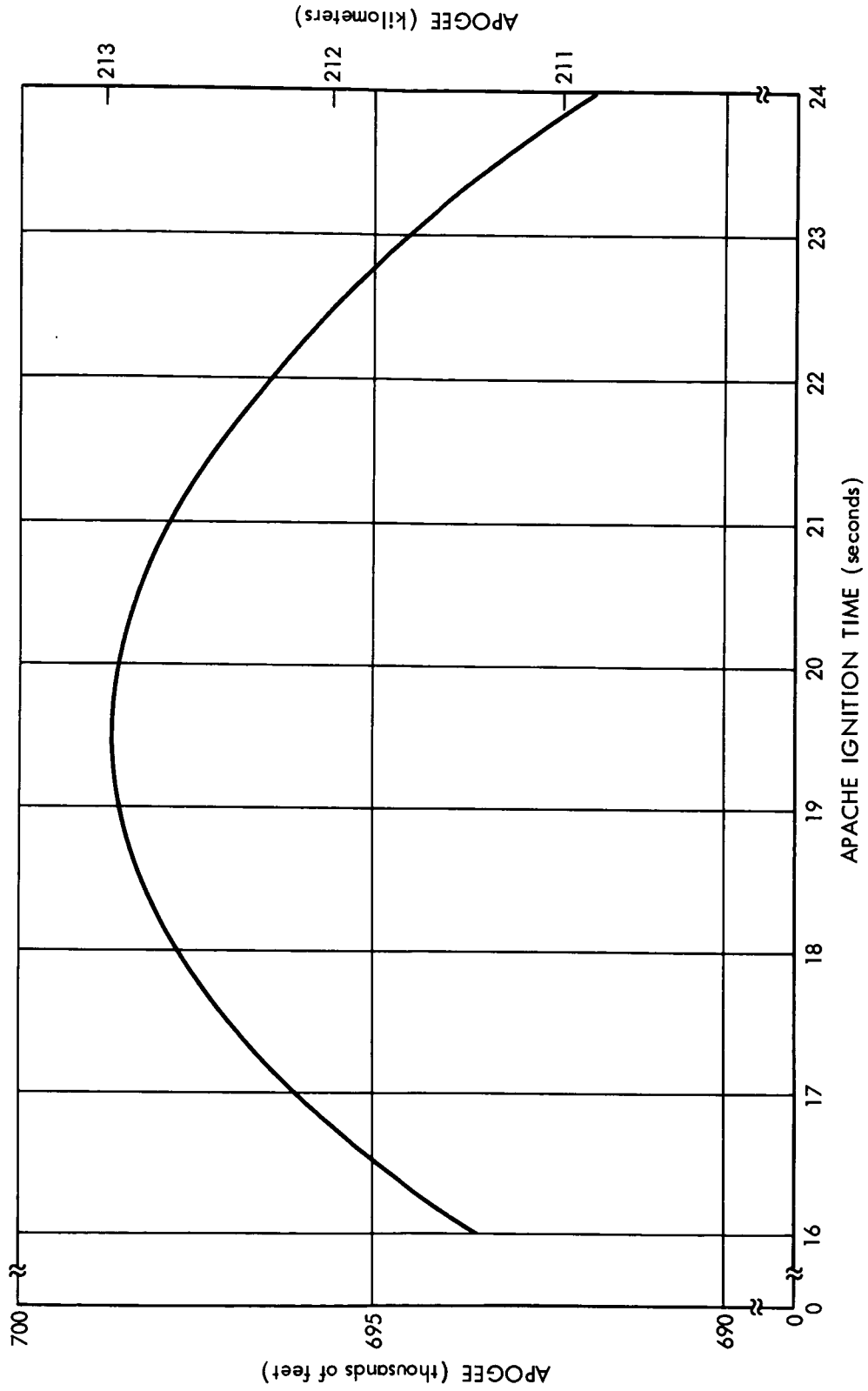

Figure 21. Effect on Apogee of Varying Second-Stage Ignition Time (Sea-Level Launch, 80-Degree Launch Angle, 50-Lb Payload, Clean Configuration)

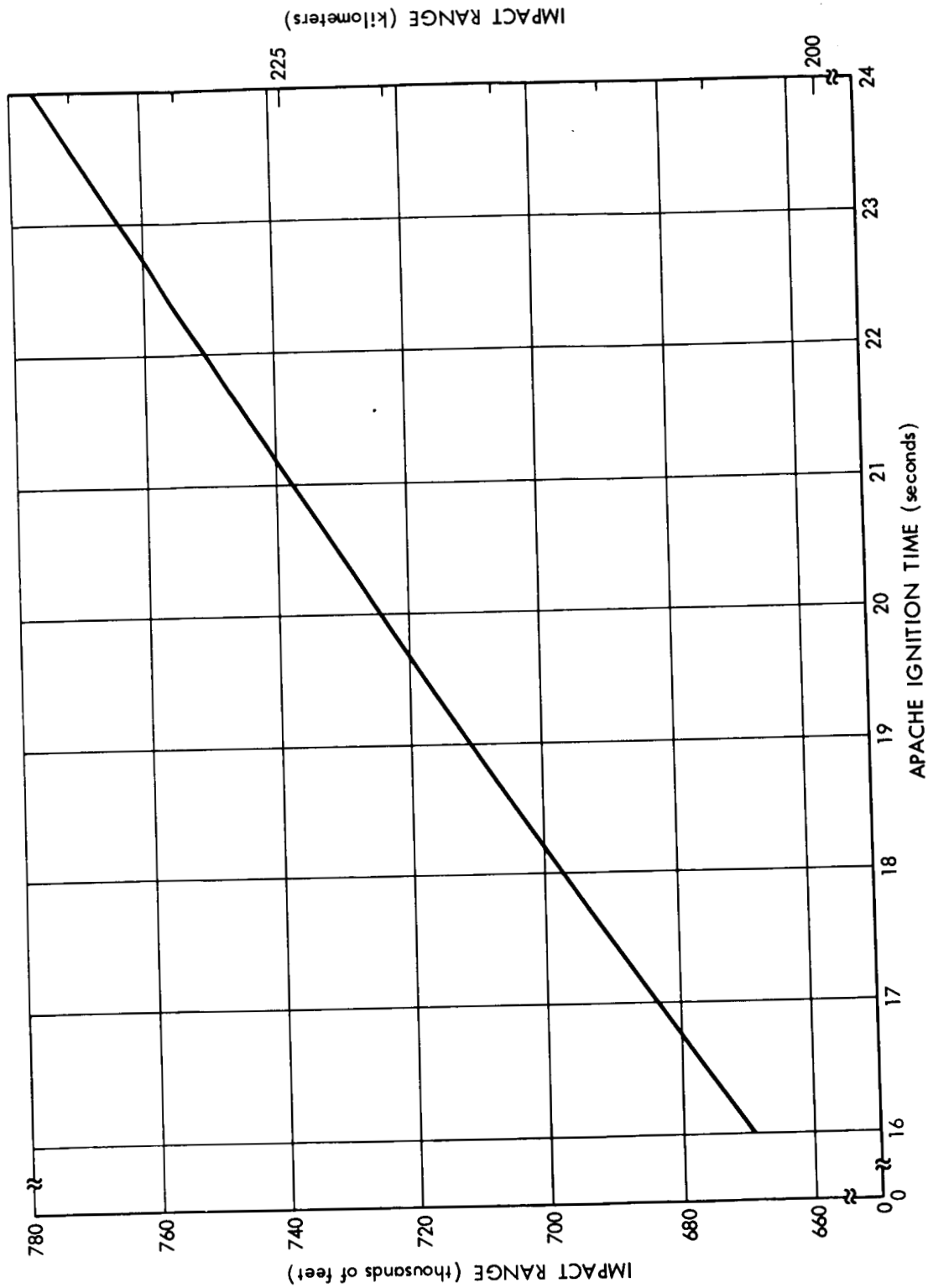

Figure 22. Effect on Impact Range of Varying Second-Stage Ignition Time
(Sea-Level Launch, 80-Degree Launch Angle, 50-Lb Payload, Clean Configuration)

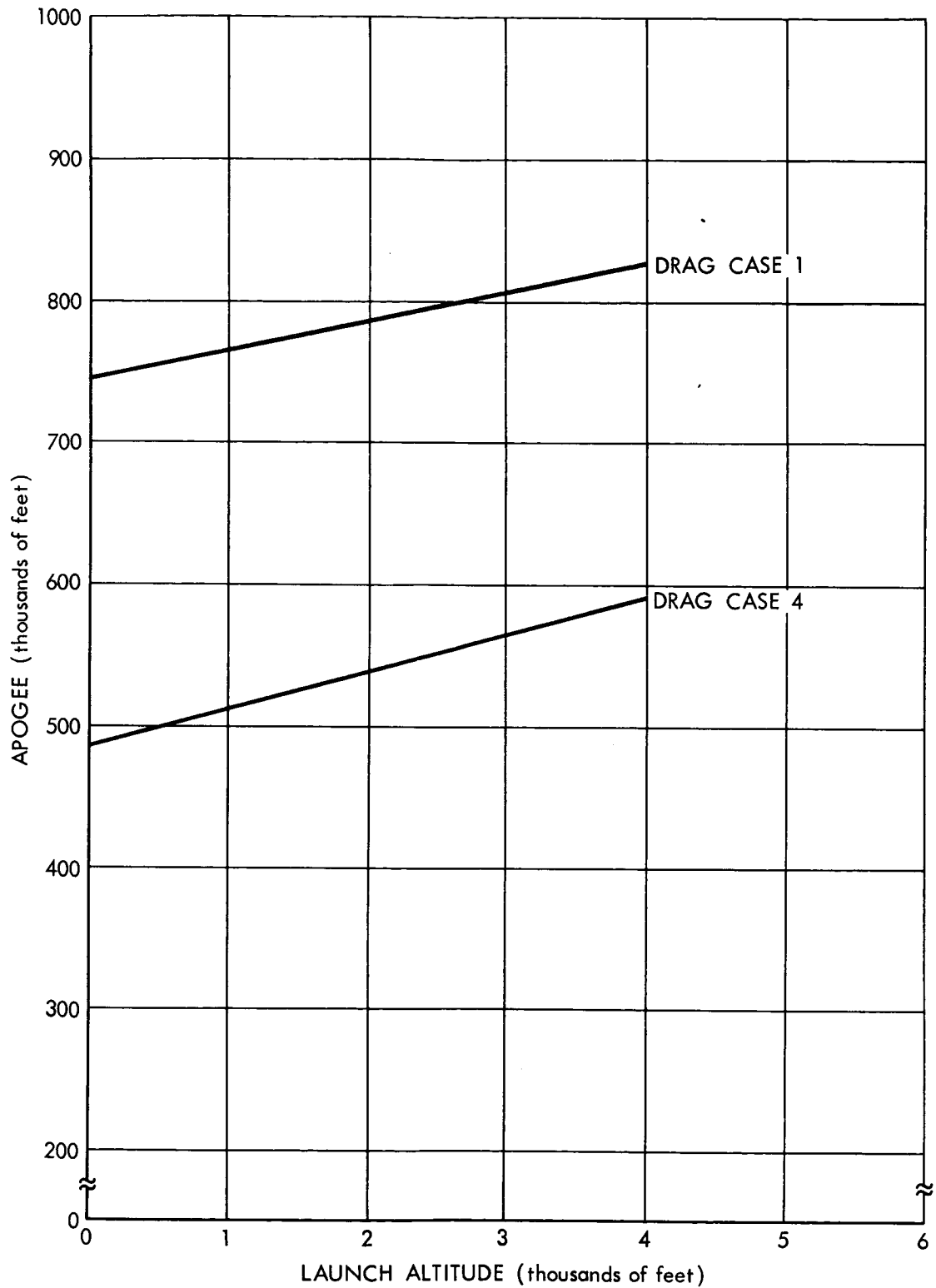
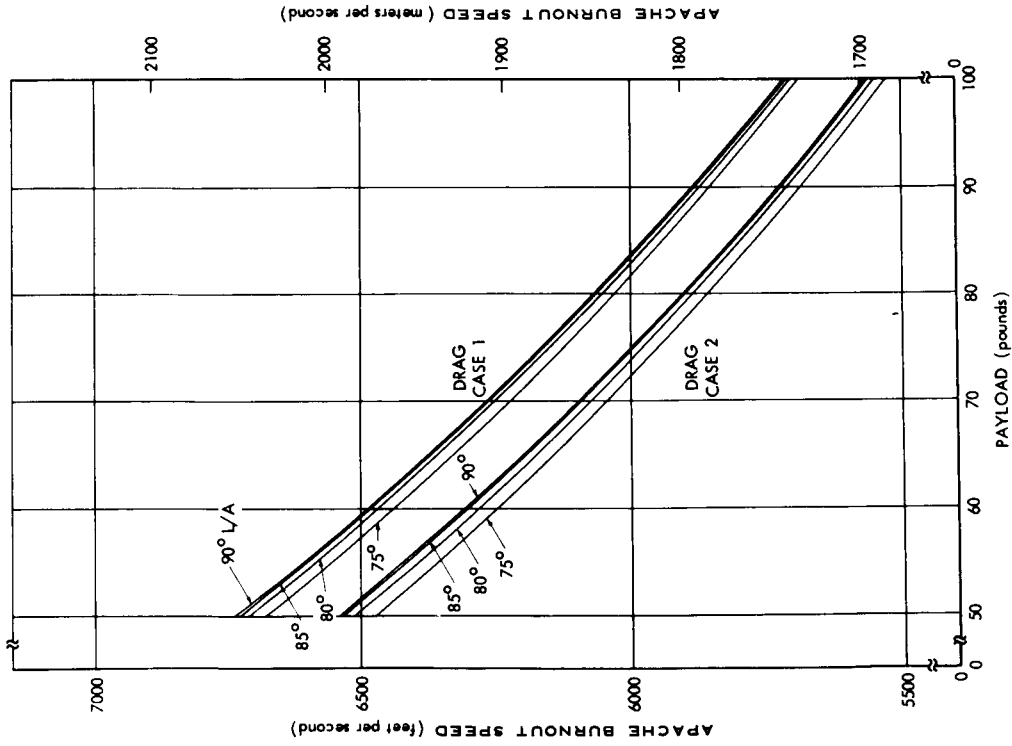
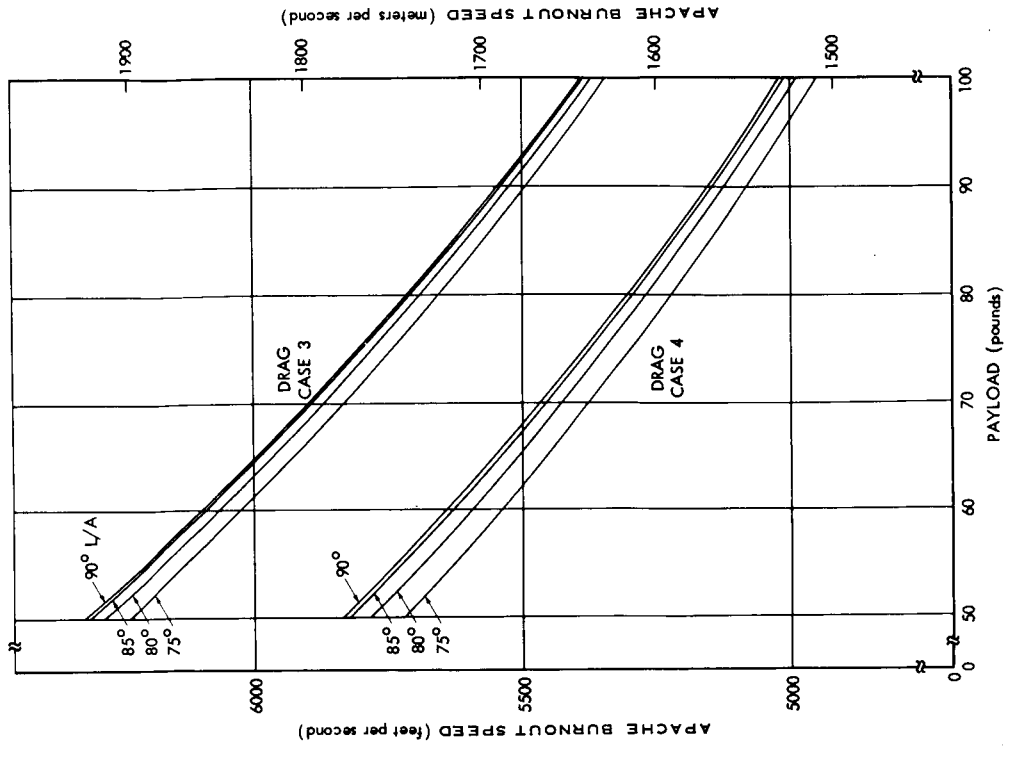

Figure 23. Variation in Apogee with Launch Altitude (85-Degree Launch Angle, 50-Lb Payload, Clean and Pitot-Static Configurations)



Cases 1 and 2



Cases 3 and 4

Figure 24. Burnout Speed vs Payload Weight (Sea-Level Launch, 20-Second Second-Stage Ignition)

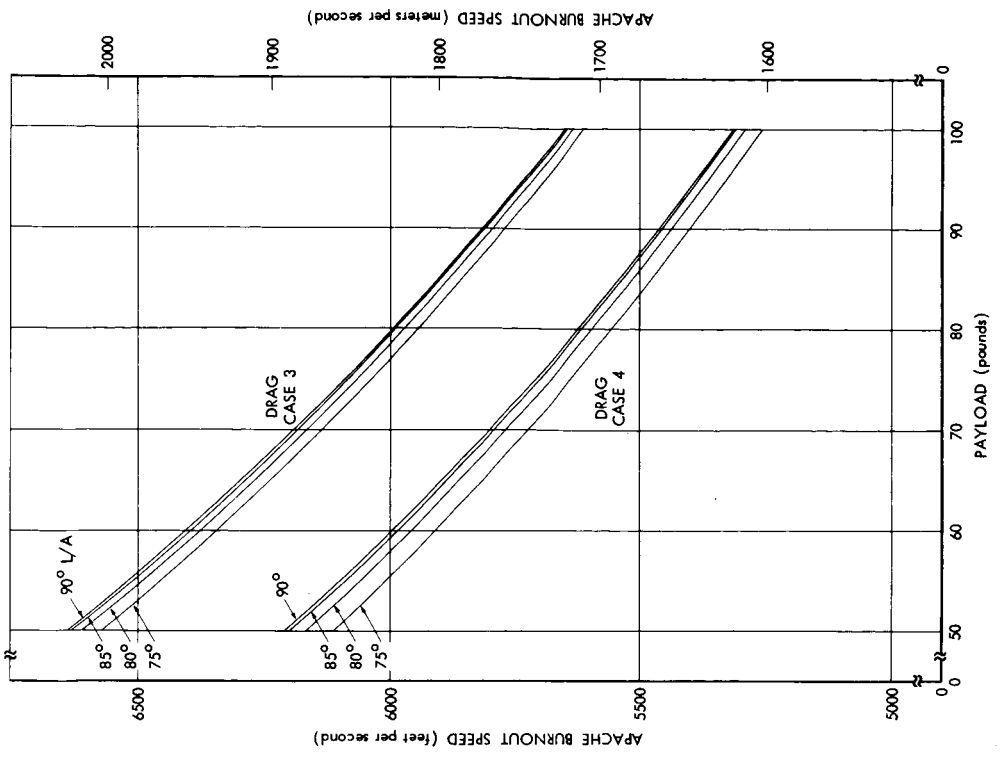

Cases 3 and 4

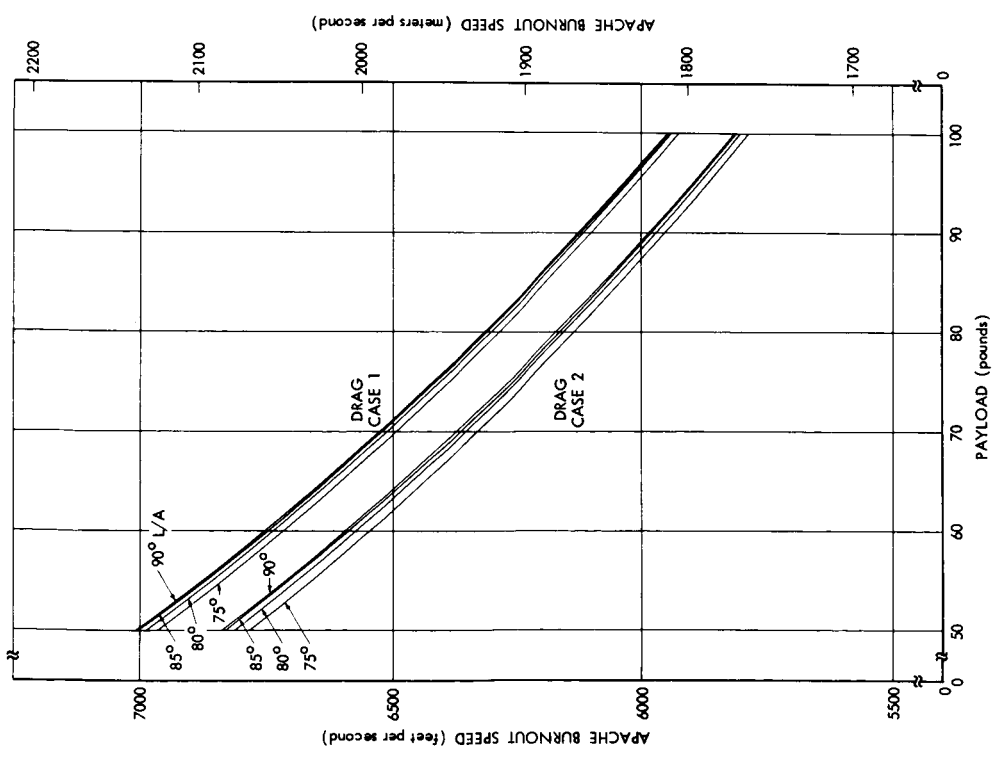

Cases 1 and 2

Figure 25. Burnout Speed vs Payload Weight
(Launch 3986 Feet Above Sea Level, 20-Second Second-Stage Ignition)

Figure 26 shows dynamic pressure as a function of altitude for a typical sea-level launch and a launch from 3986 feet above sea level.

The series of curves presented in Figures 24, 27, 28, 29 and 30 represent the general altitude, speed, range, and time characteristics of the Nike Apache for sea-level launch at 80 degrees Q_e (Wallops Island). Significant coordinates for any given flight may be found by cross reference and plotting, and by interpolation.

The series of curves presented in Figures 25 and 31 through 34 represent the same parameters for a Nike Apache launched from a site 3986 feet above sea level (White Sands Missile Range LC-33).

Figures 27 and 31 present speed versus time for the clean and DOVAP configurations fired from Wallops Island and White Sands Missile Range, respectively, as well as the same data for turnstile and Pitot-static configurations. Data are plotted through 50 seconds; after this time, the only significant force retarding the missile is gravity. During the first coasting phase, the vehicle with the higher payload weight loses less speed than that with the lesser weight; this is the effect of the "ballistic factor," $W/C_D A$, where W is the weight of the missile, C_D is the drag coefficient, and A is the cross-sectional area of the rocket. Figures 28 and 32 give speed as a function of altitude through 200,000 feet for a sea-level launch and launch from 3986 feet above sea level, respectively.

Figures 29 and 30, for a sea-level launch, and 33 and 34 for a launch from 3986 feet above sea level, give altitude versus time and altitude versus range respectively.

By interpolation and reasonable extrapolation from these data, range-altitude-time can be calculated for a wide variety of actual payload weights. Again, these data are computed for the clean, DOVAP, turnstile, and Pitot-static drag cases, launched from sea level and from 3986 feet above sea level. Use of the curves presented here should minimize the necessity of individually calculating trajectories for specific payload weights using any of the standard aerodynamic configurations.

Figures 35 and 36 show the variation in impact range with launch angle. These data are given for range safety personnel concerned with the effects on

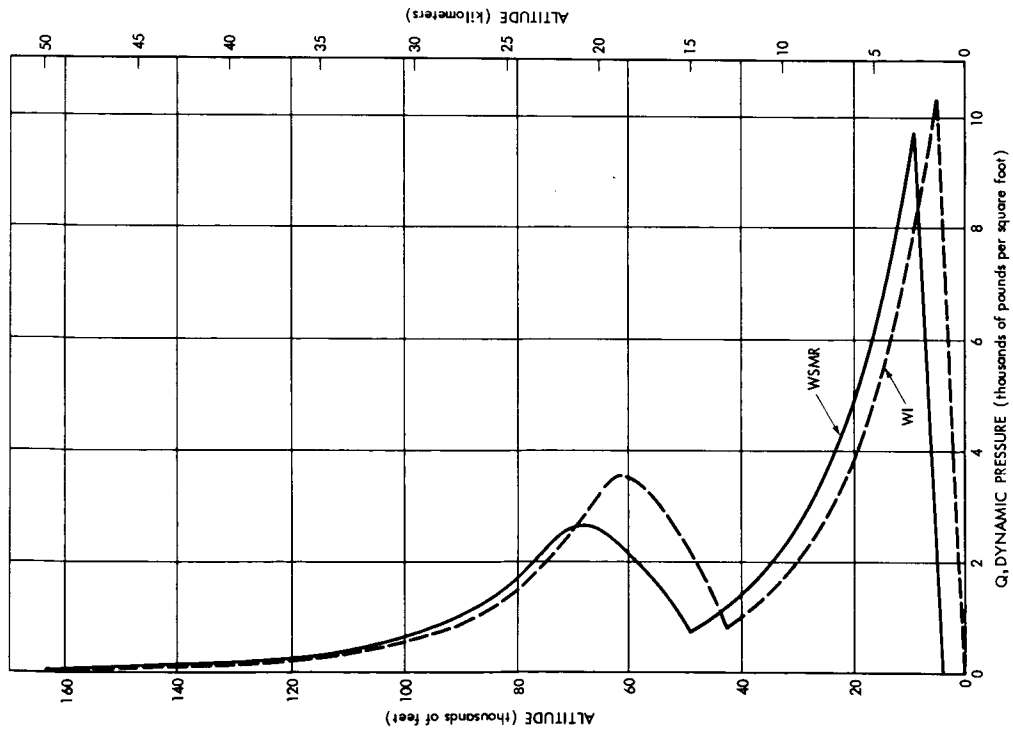

0 to 160 Thousand Feet

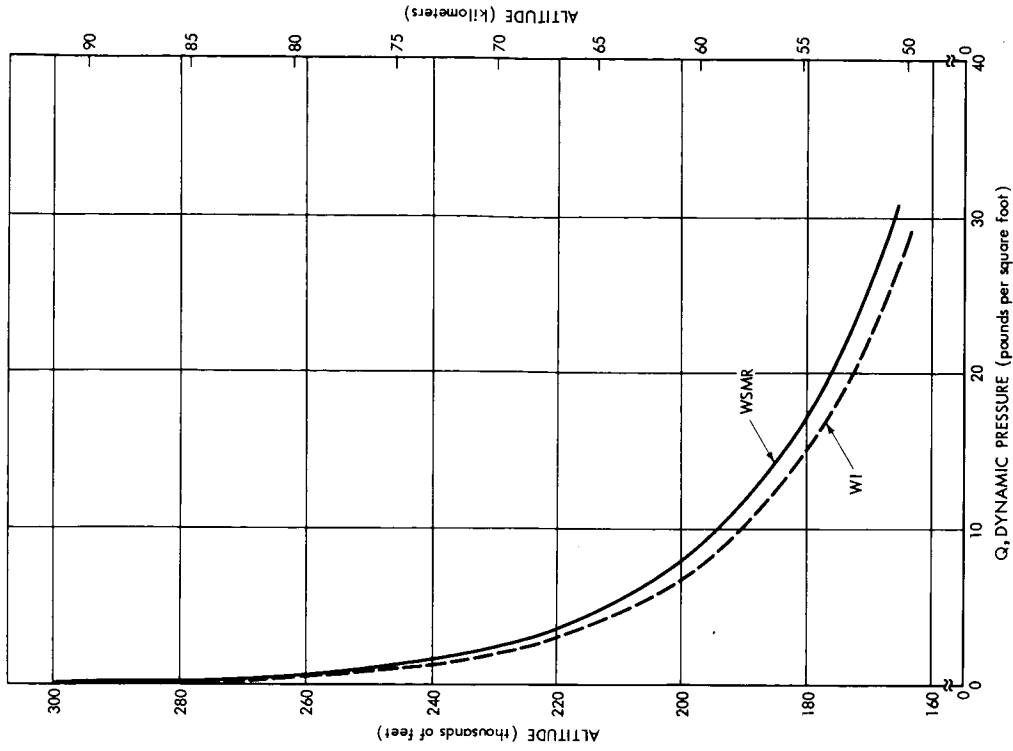

160 to 300 Thousand Feet

Figure 26. Dynamic Pressure vs Altitude (Sea-Level Launch & Launch 3986 Feet Above Sea Level, 80-Degree Launch Angle, 80-Lb Payload, Clean Configuration)

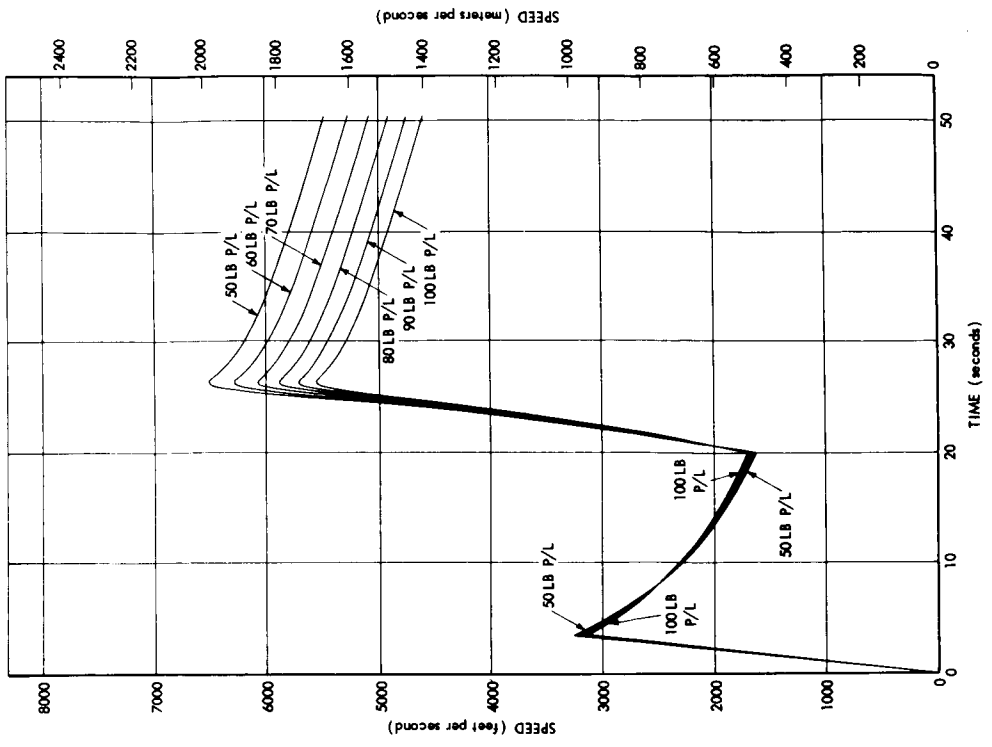

Drag Case 2

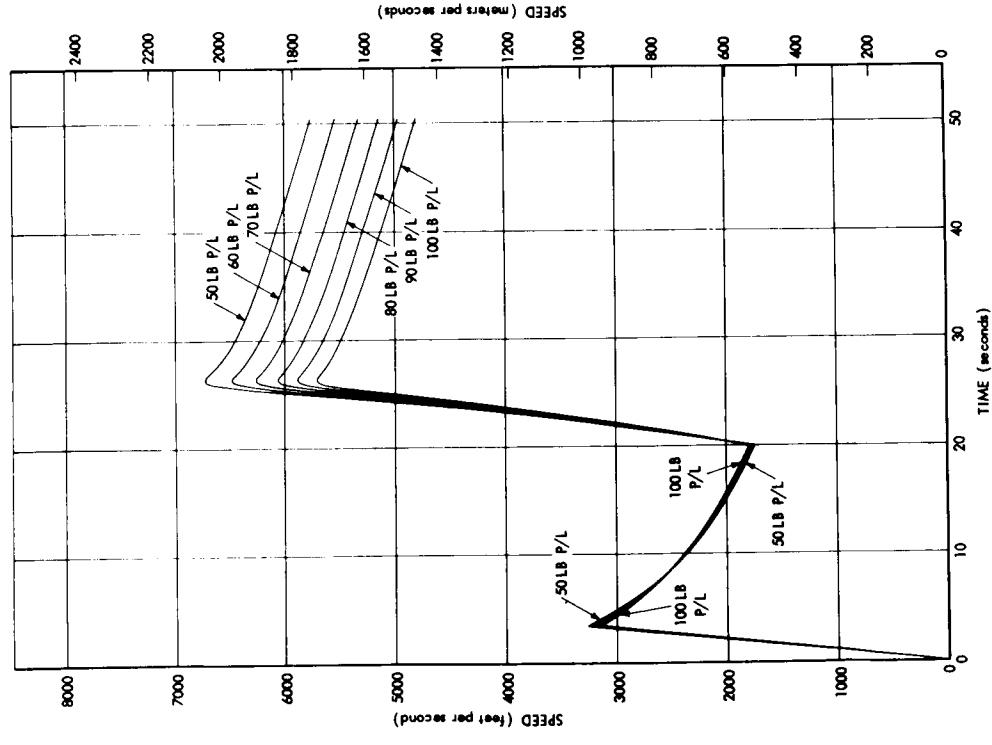

Drag Case 1

Figure 27. Speed vs Time (Sea-Level Launch, 80-Degree Launch Angle)

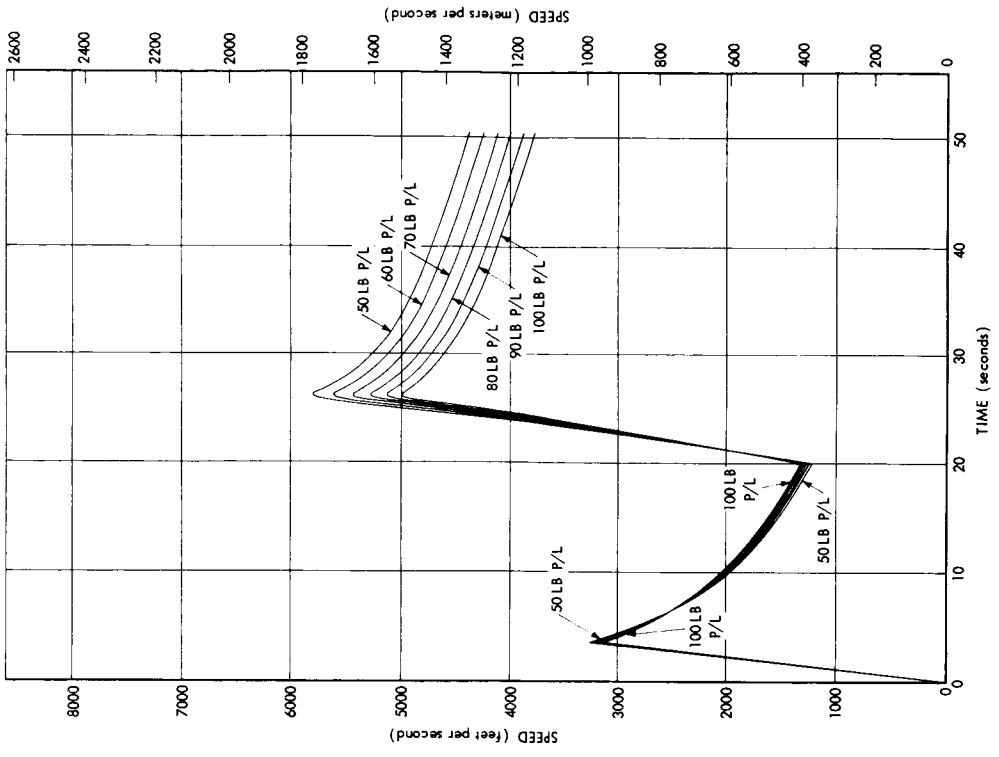

Drag Case 4

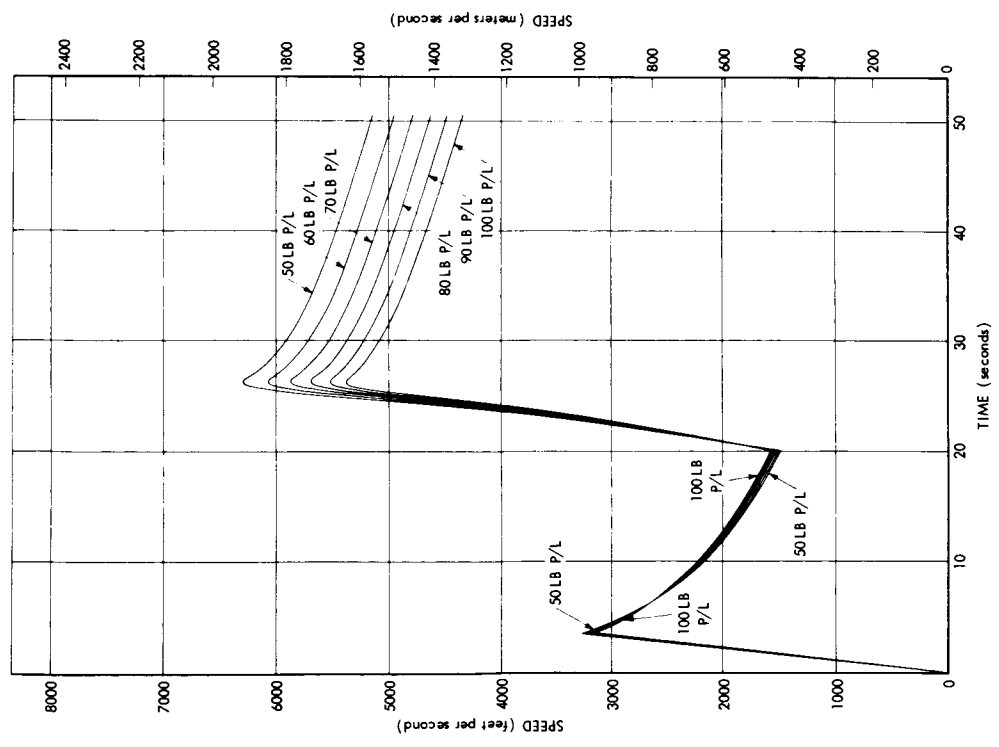

Drag Case 3

Figure 27. Speed vs Time (Sea-Level Launch, 80-Degree Launch Angle)

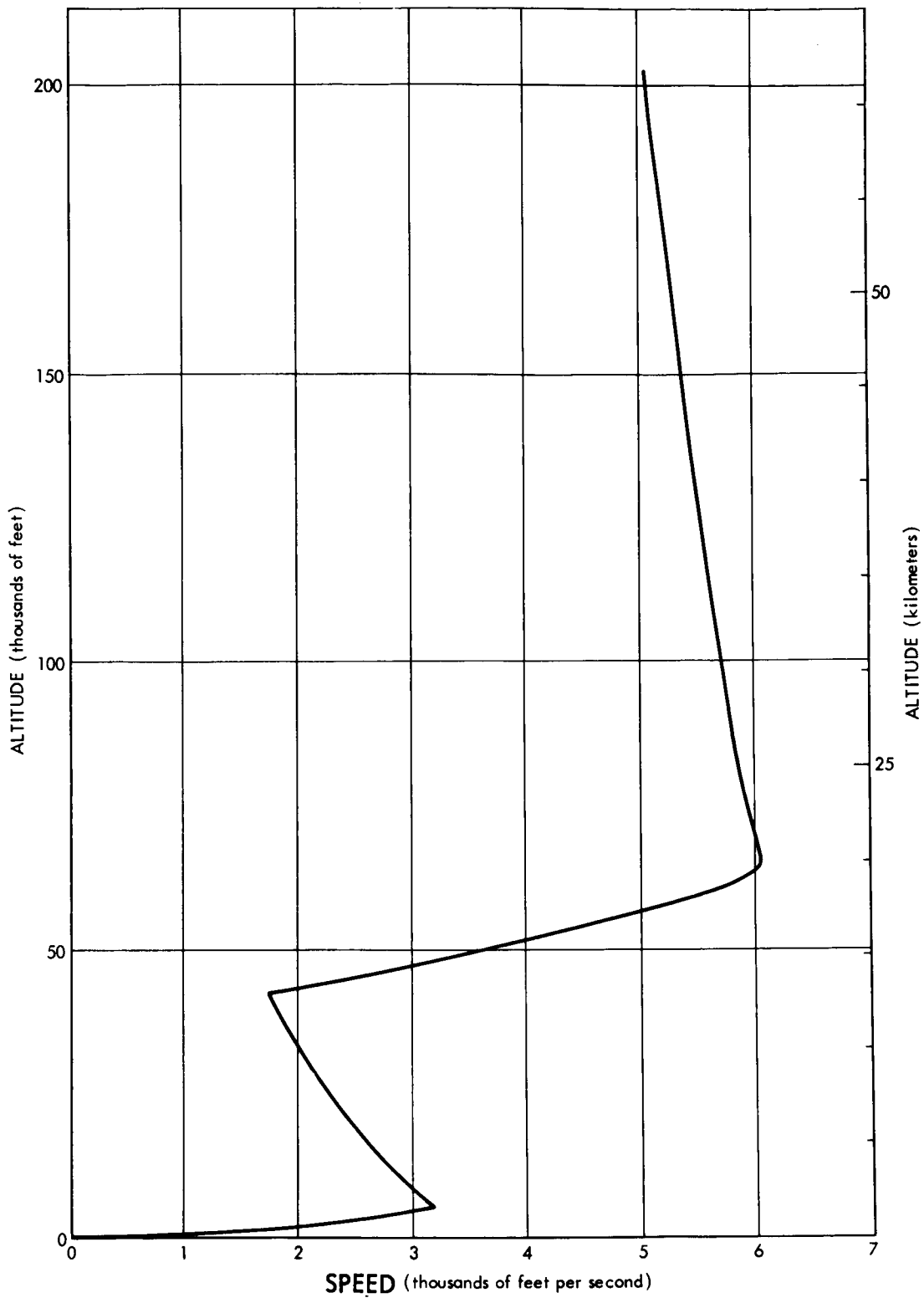
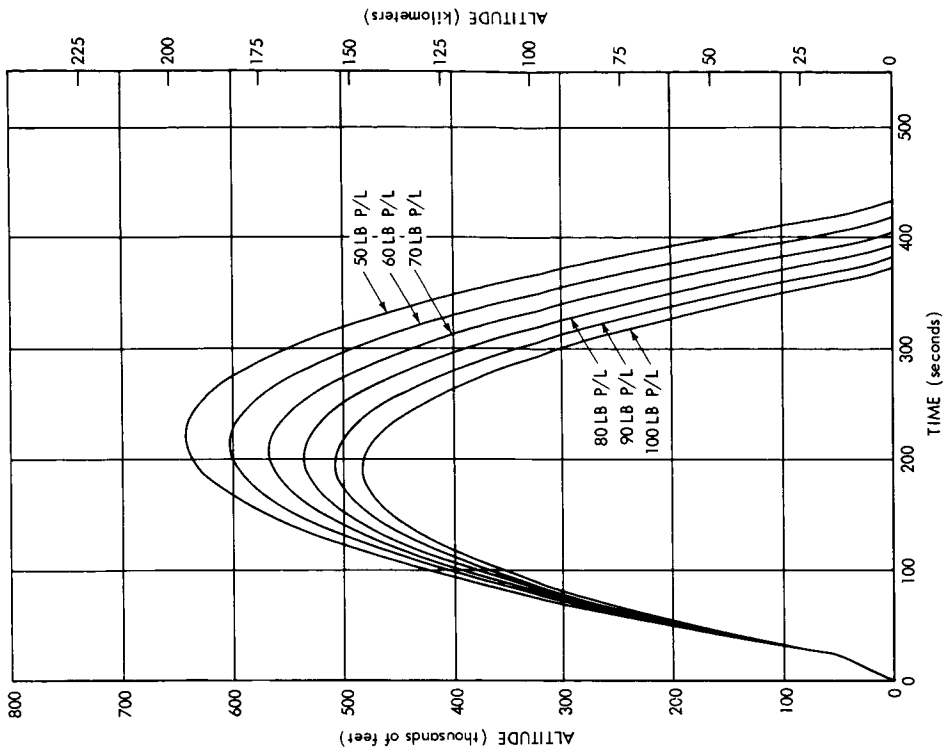
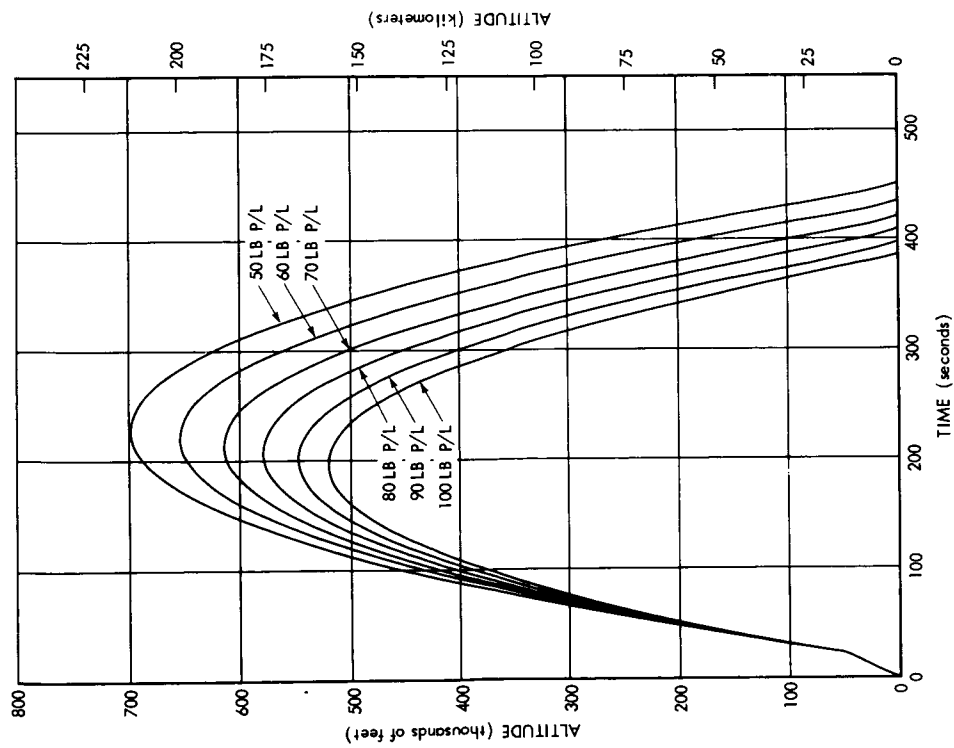

Figure 28. Speed vs Altitude (Sea-Level Launch, 80-Degree Launch Angle, 80-Lb Payload, Clean Configuration)



Drag Case 2



Drag Case 1

Figure 29. Altitude vs Time (Sea-Level Launch, 80-Degree Launch Angle)

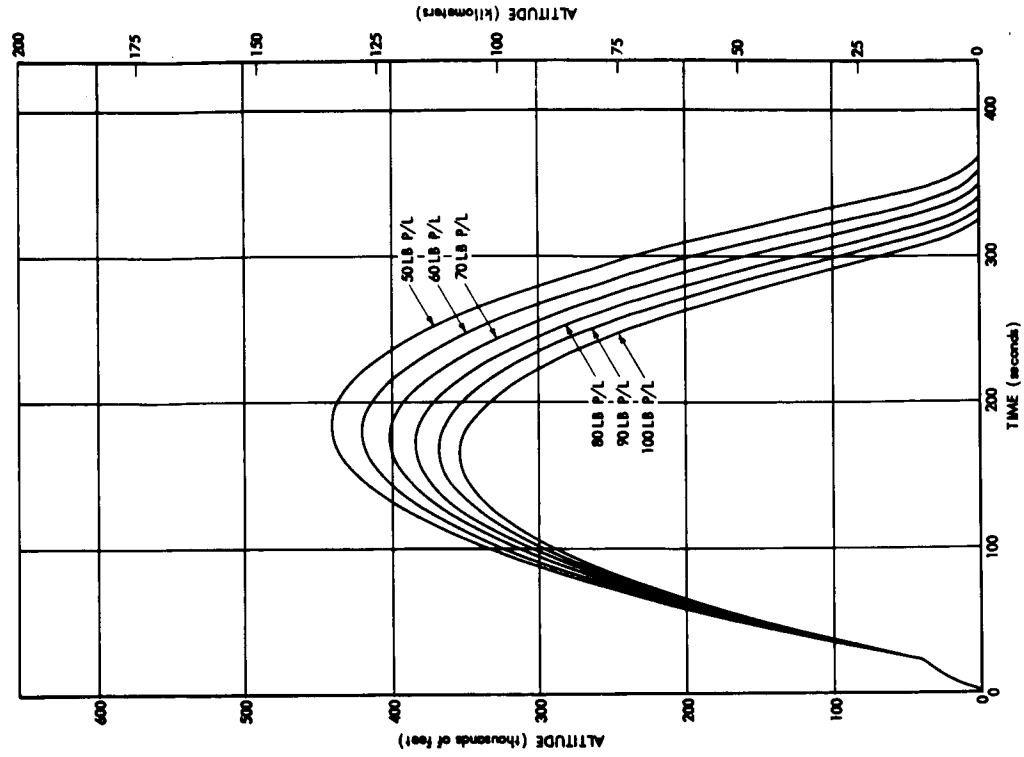

Drag Case 4

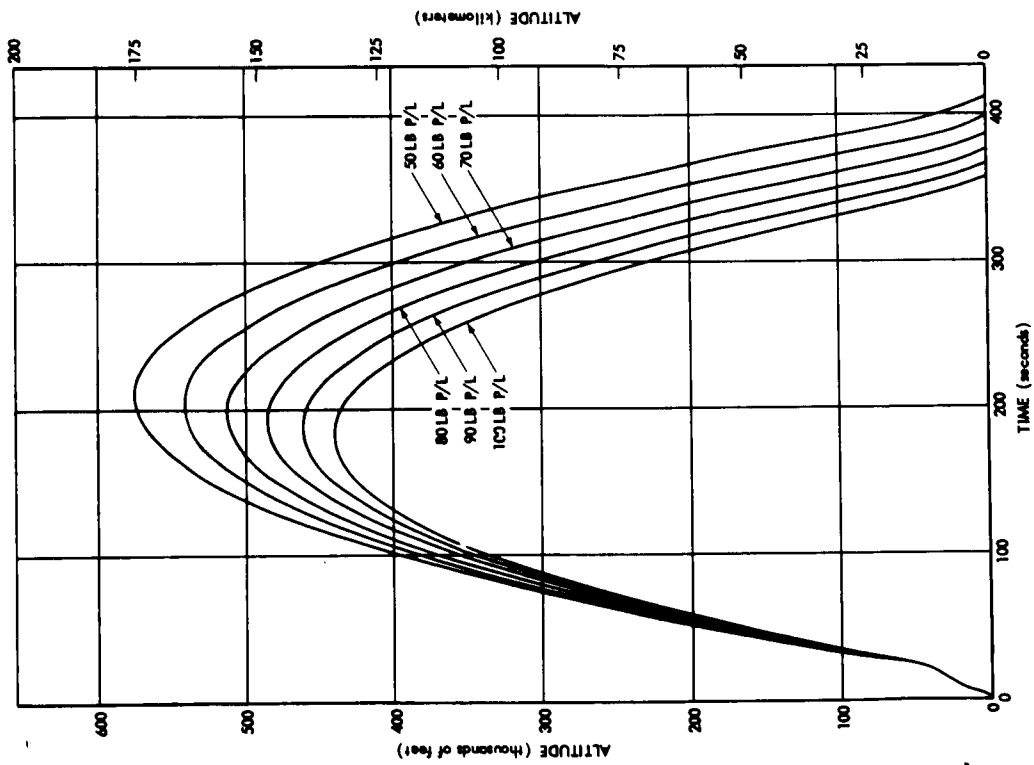

Drag Case 3

Figure 29. Altitude vs Time (Sea-Level Launch, 80-Degree Launch Angle)

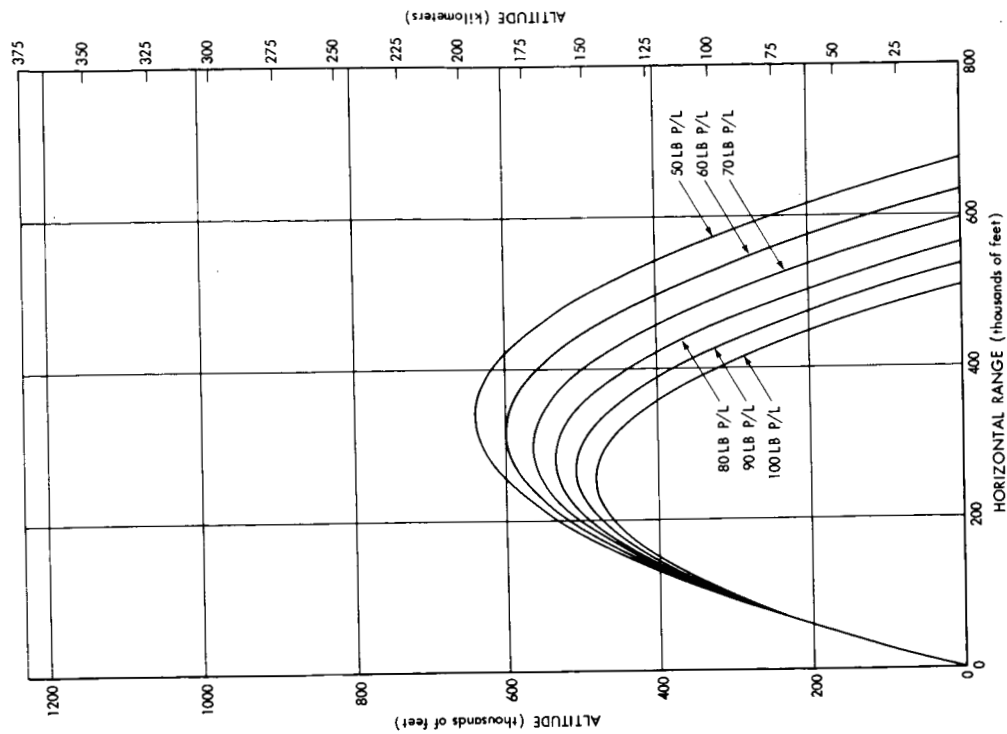

Drag Case 2

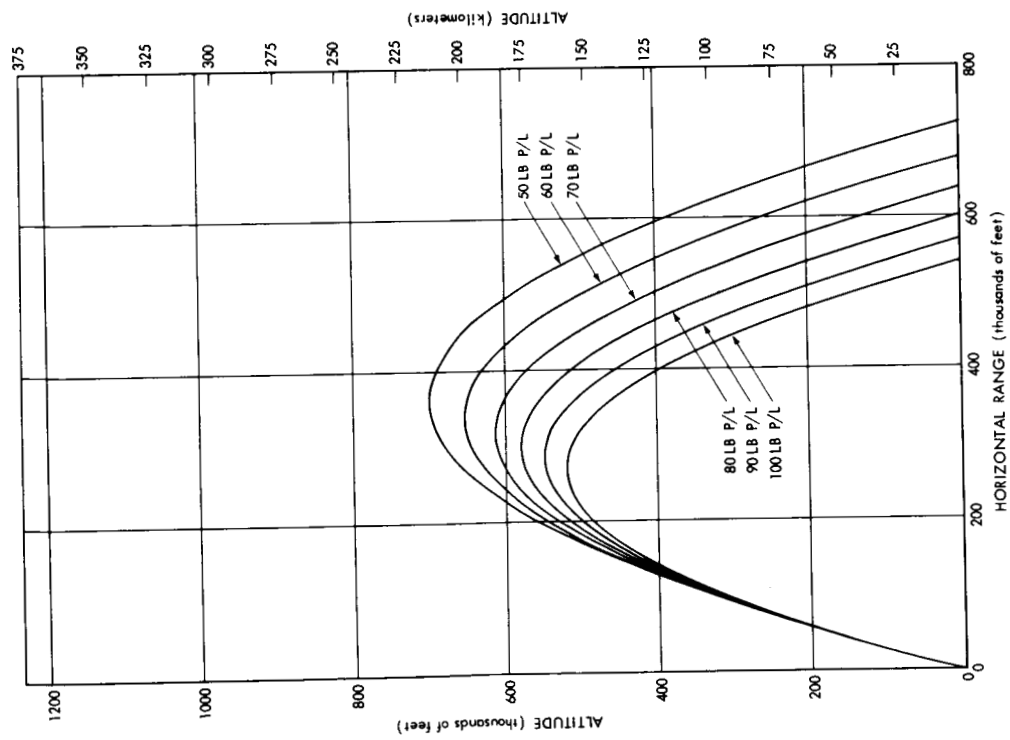

Drag Case 1

Figure 30. Altitude vs Range (Sea-Level Launch, 80-Degree Launch Angle)

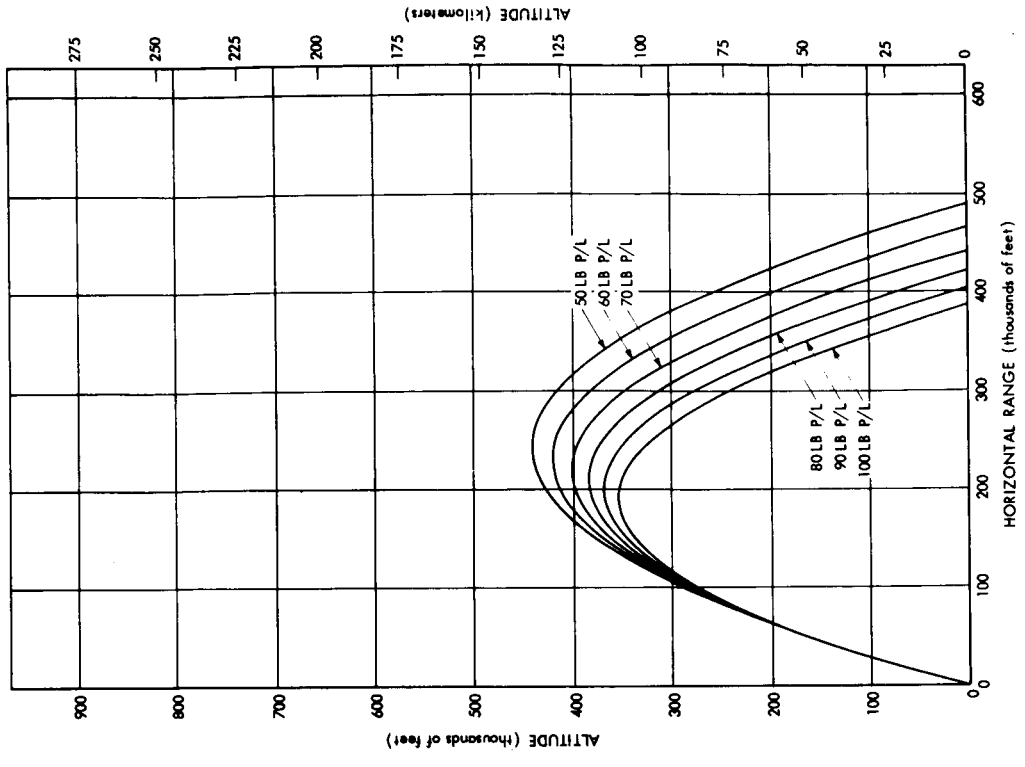

Drag Case 4

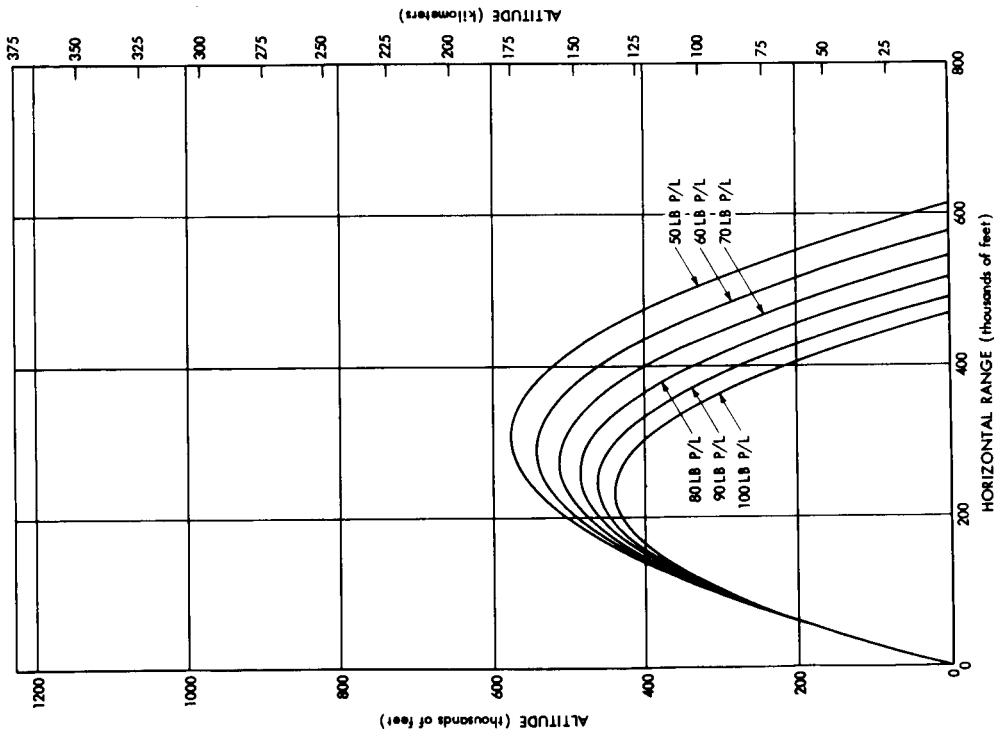

Drag Case 3

Figure 30. Altitude vs Range (Sea-Level Launch, 80-Degree Launch Angle)

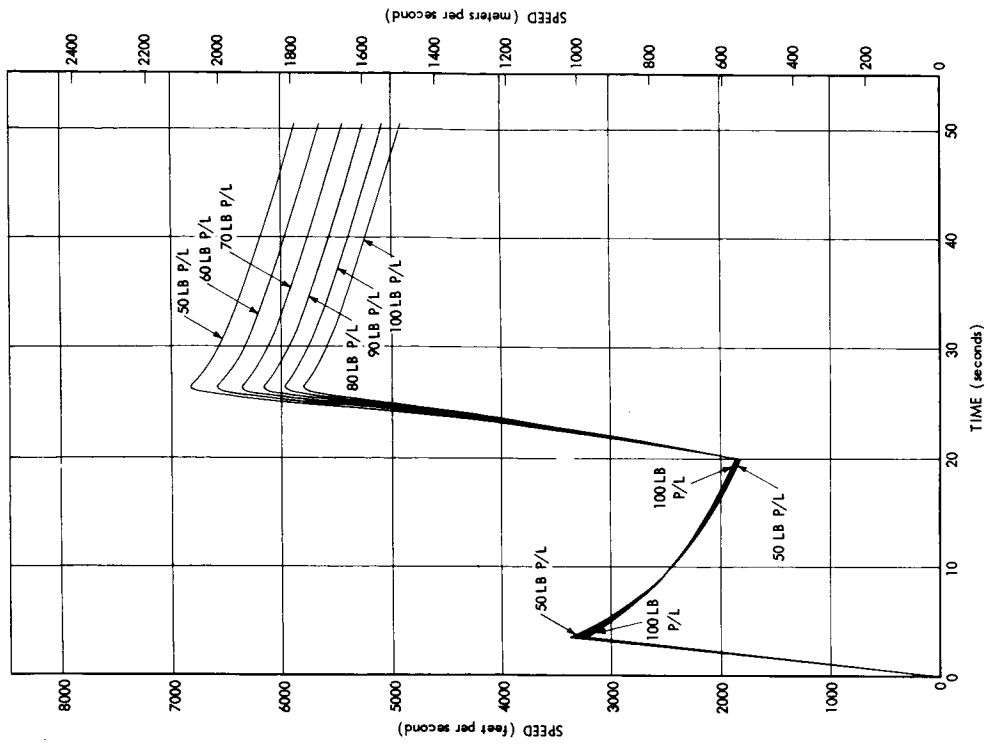

Drag Case 2

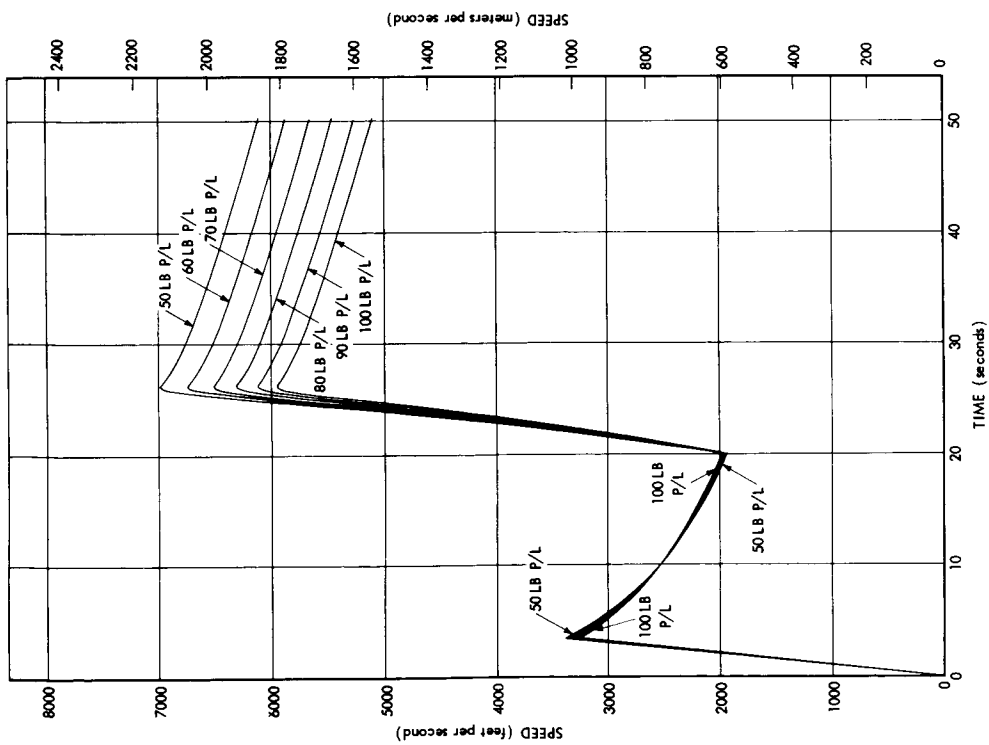

Drag Case 1

Figure 31. Speed vs Time (Launch 3986 Feet Above Sea Level, 80-Degree Launch Angle)

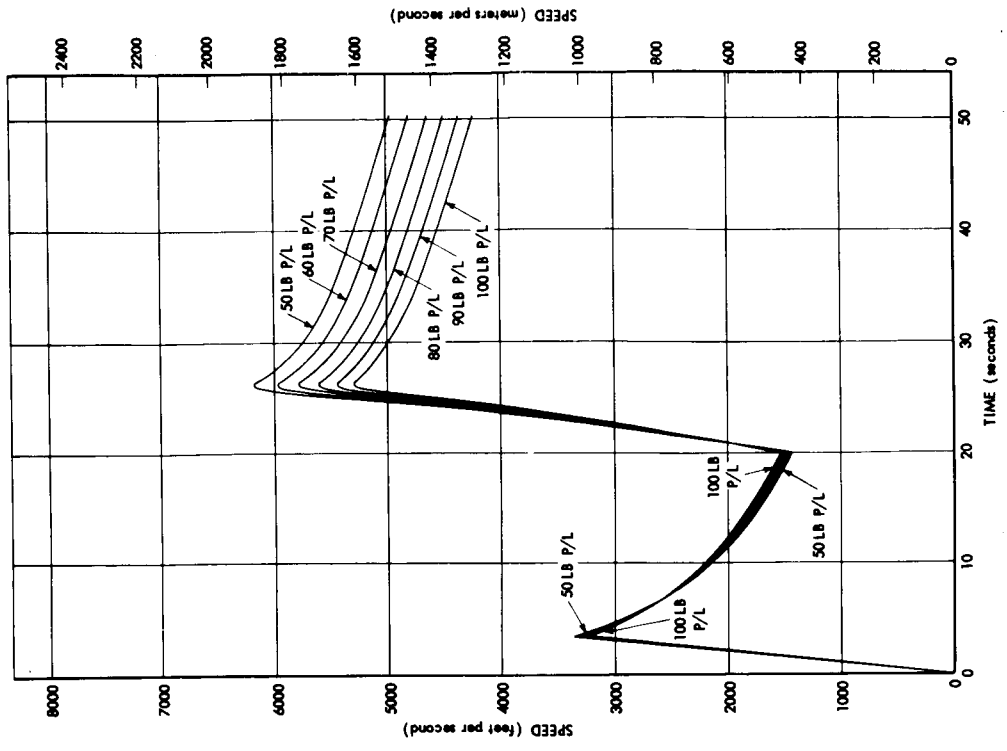

Drag Case 4

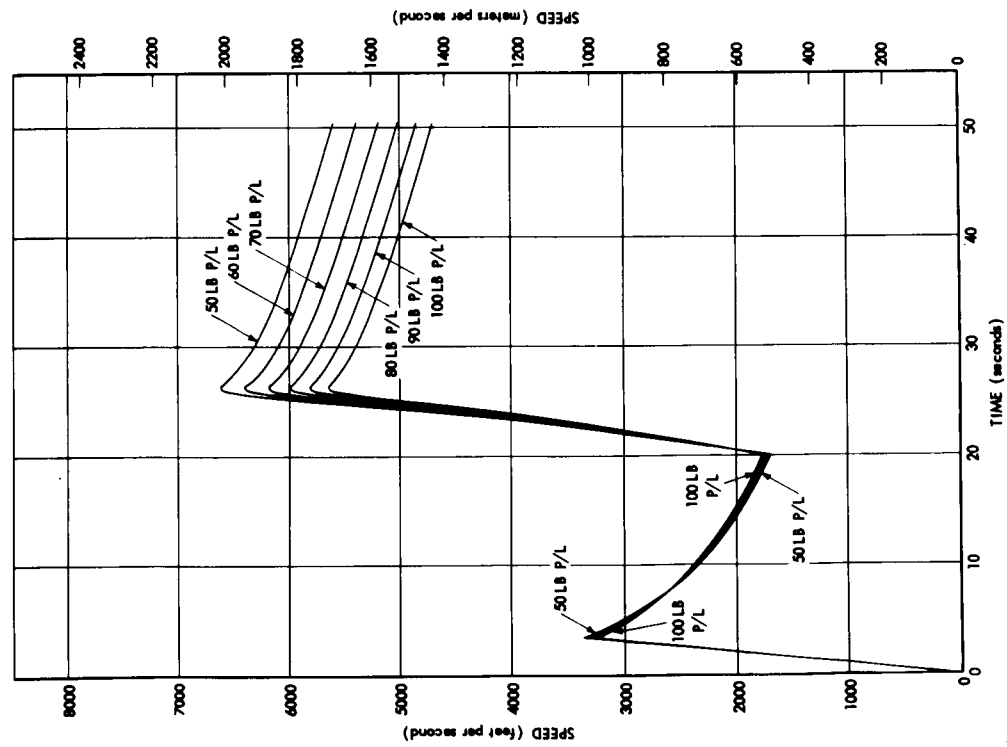

Drag Case 3

Figure 31. Speed vs Time (Launch 3986 Feet Above Sea Level, 80-Degree Launch Angle)

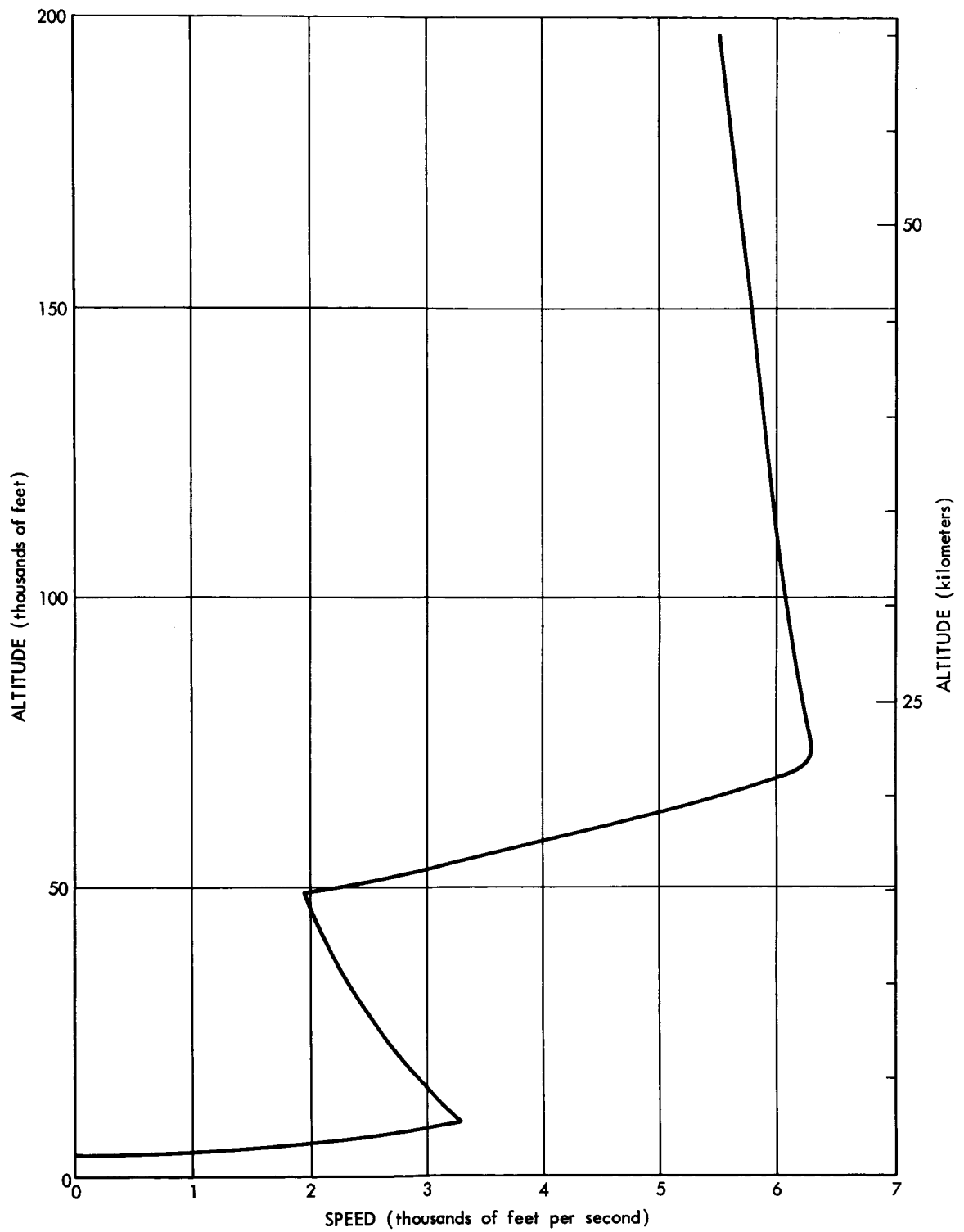

Figure 32. Speed vs Altitude (Launch 3986 Feet Above Sea Level, 80-Degree Launch Angle, 80-Lb Payload, Clean Configuration)

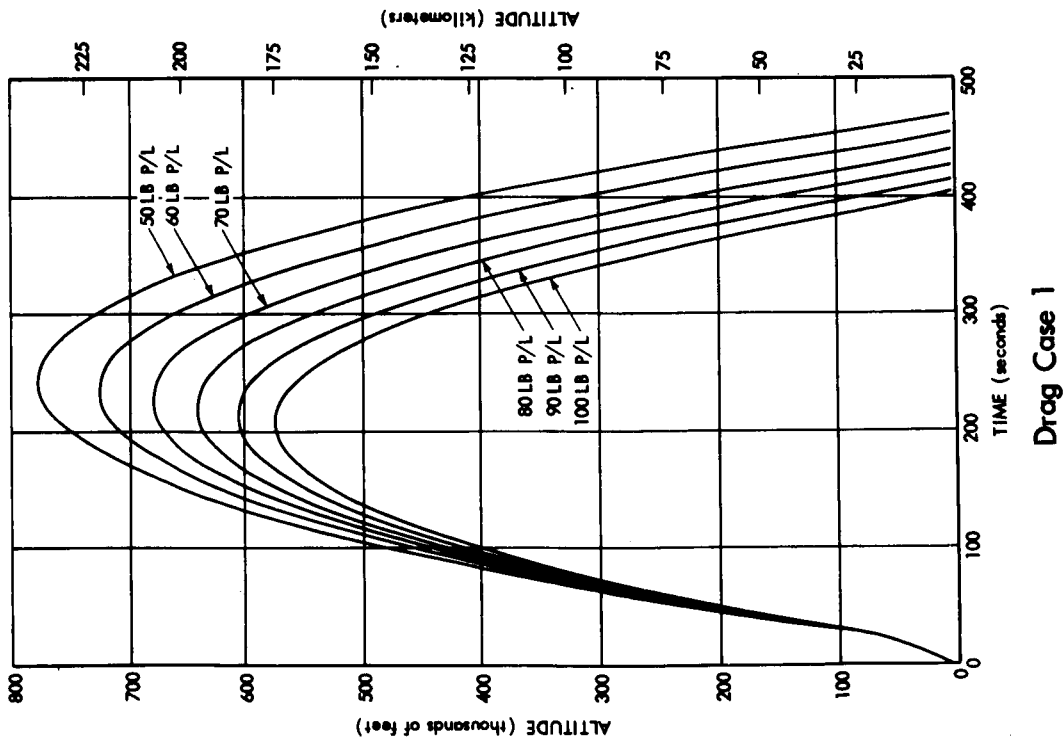
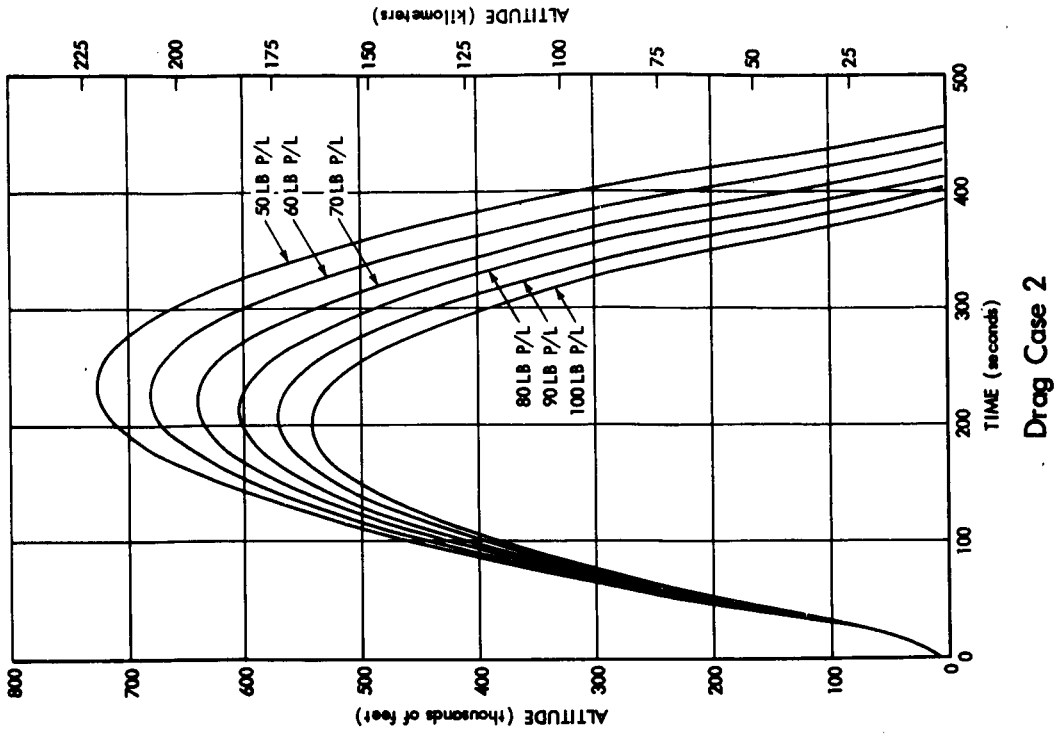
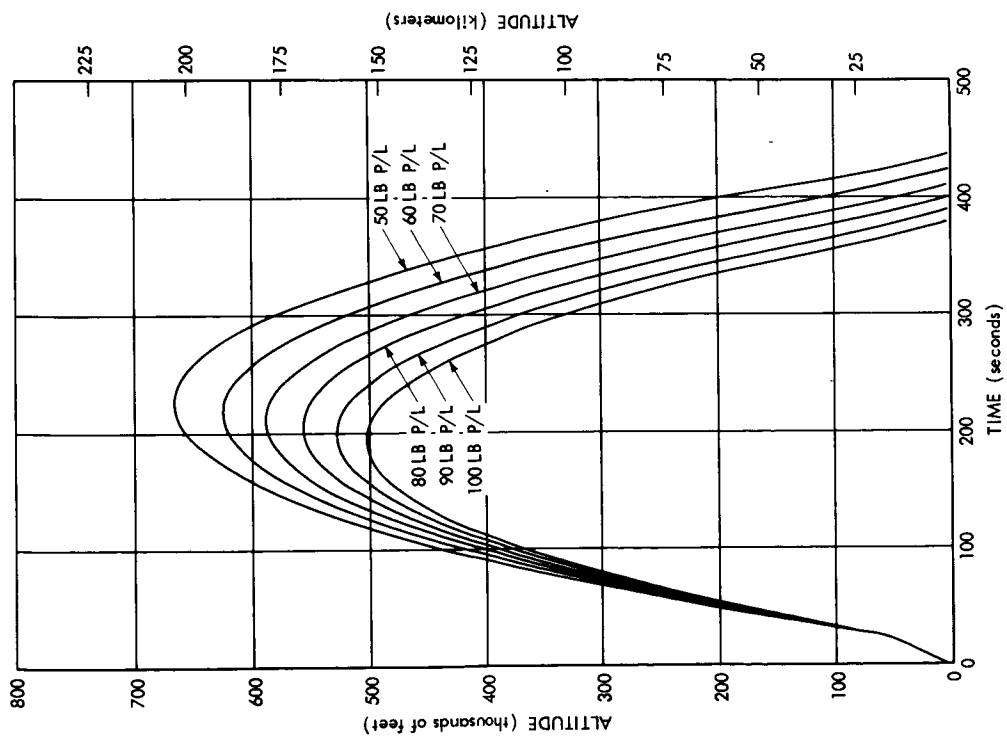
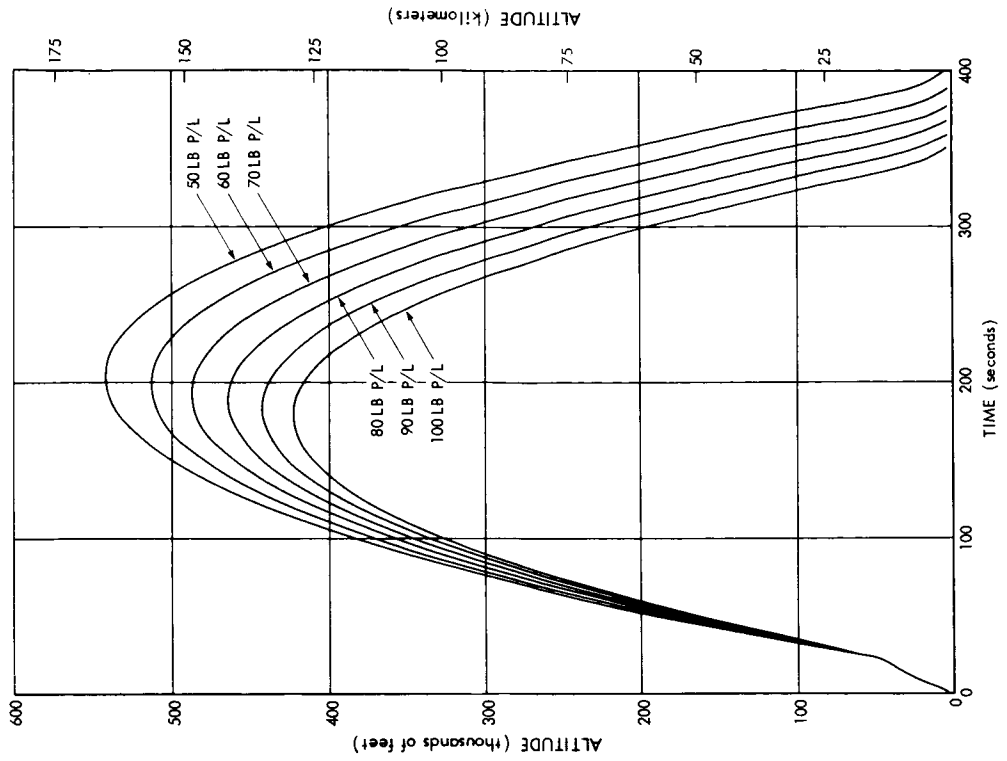

Figure 33. Altitude vs Time (Launch 3986 Feet Above Sea Level, 80-Degree Launch Angle)



Drag Case 3



Drag Case 4

Figure 33. Altitude vs Time (Launch 3986 Feet Above Sea Level, 80-Degree Launch Angle)

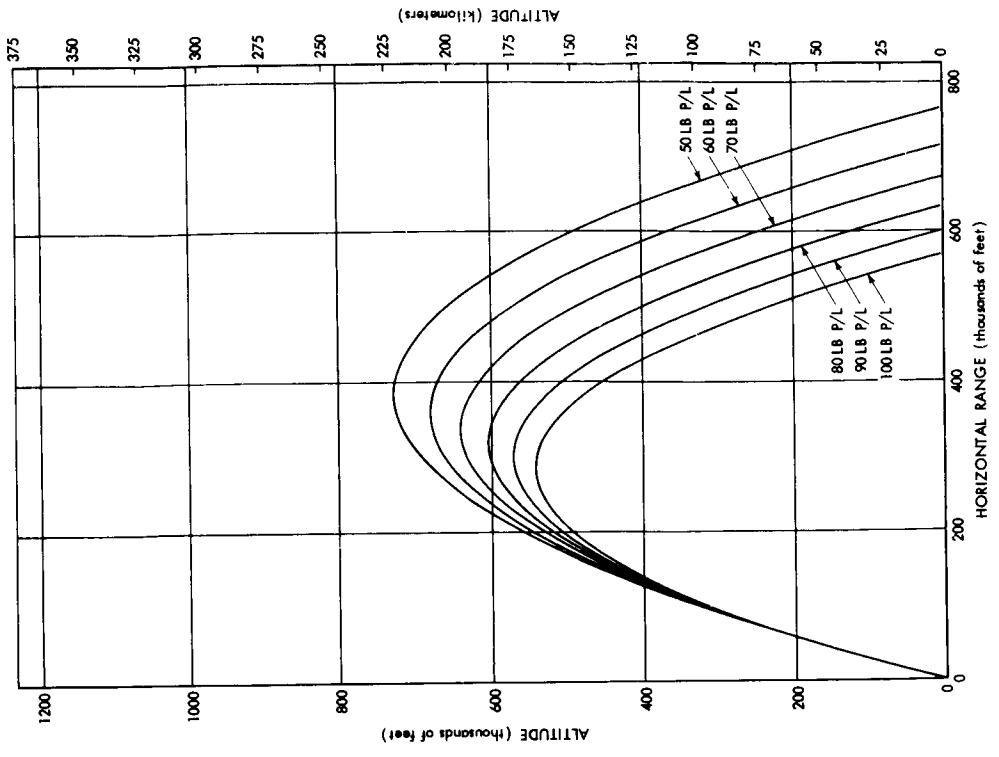

Drag Case 2

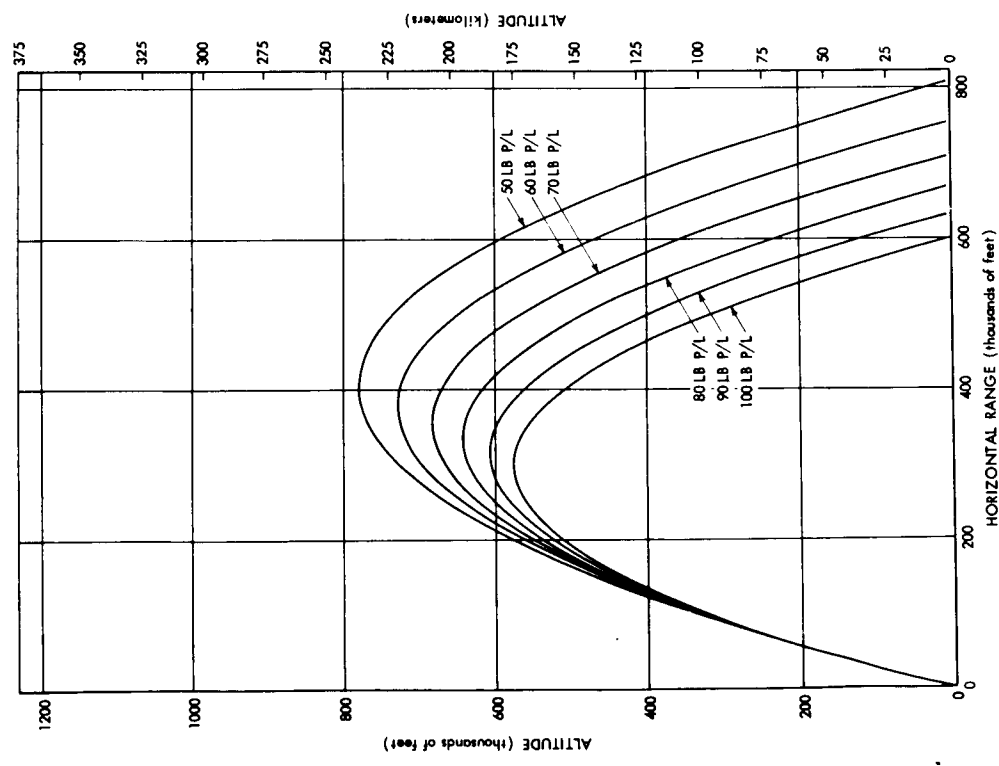

Drag Case 1

Figure 34. Altitude vs Range (Launch 3986 Feet Above Sea Level, 80-Degree Launch Angle)

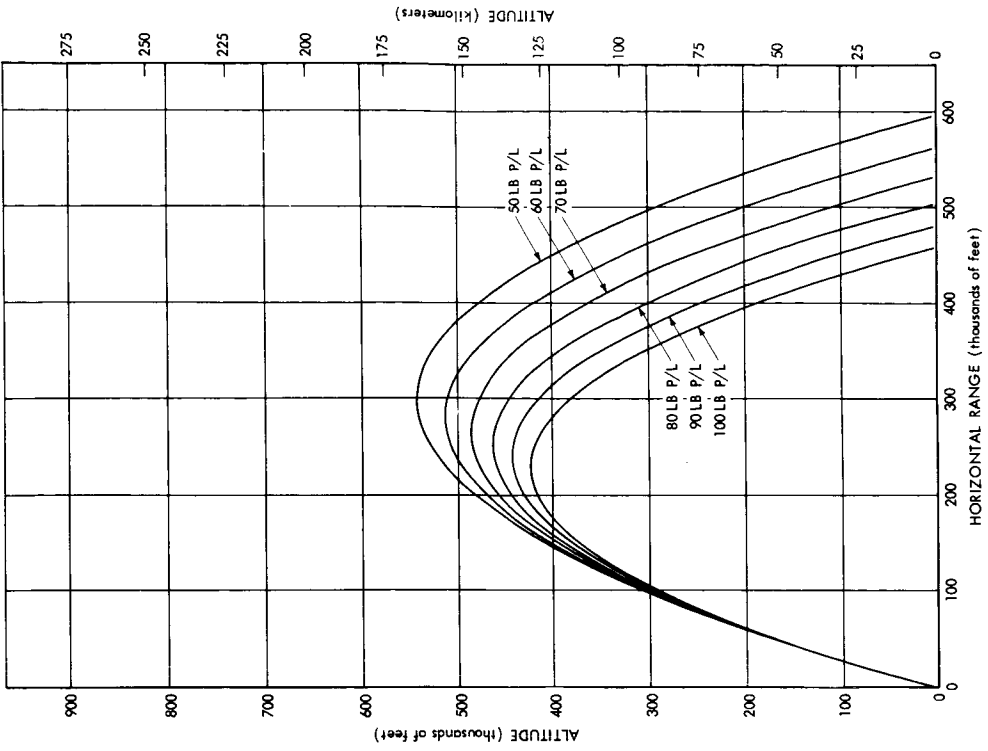

Drag Case 4

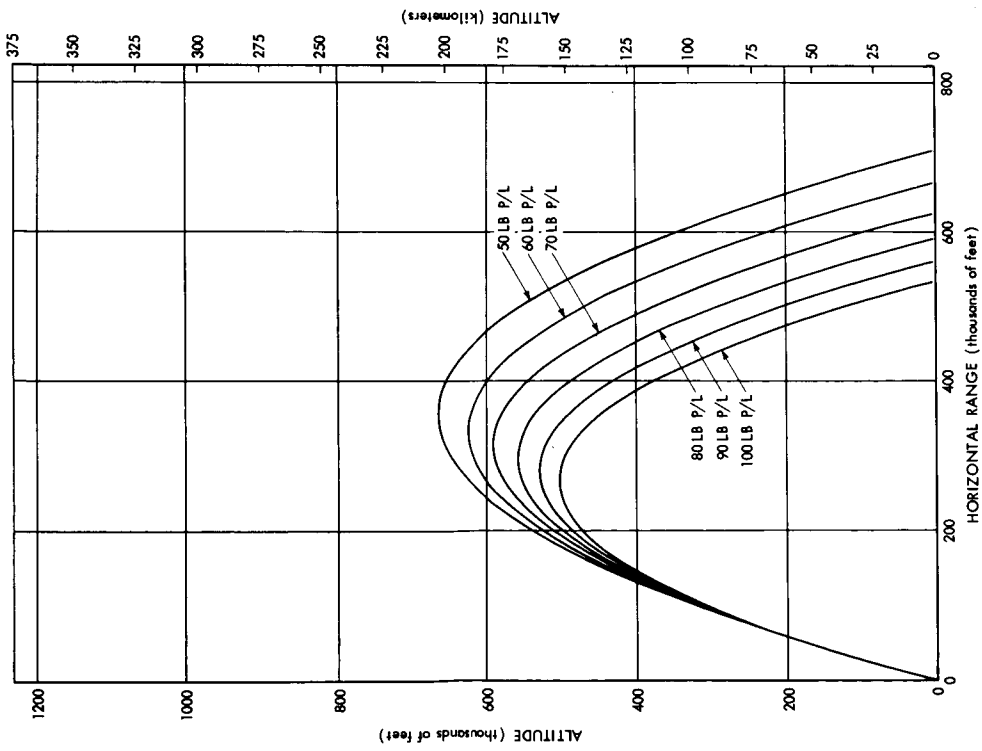

Drag Case 3

Figure 34. Altitude vs Range (Launch 3986 Feet Above Sea Level, 80-Degree Launch Angle)

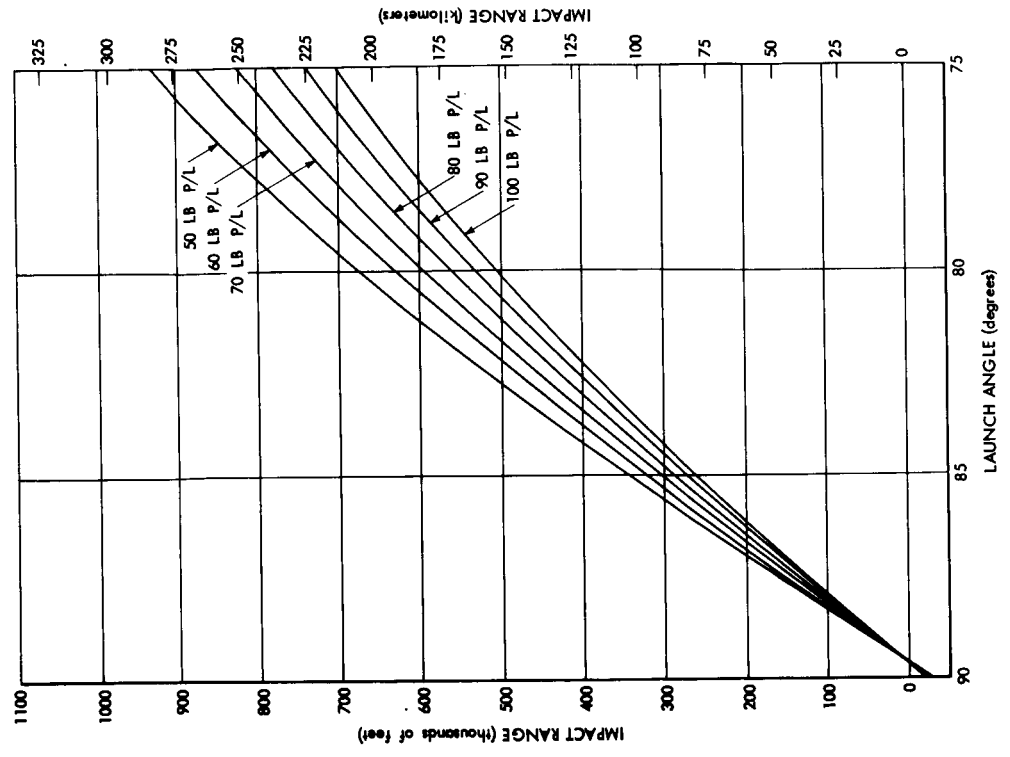
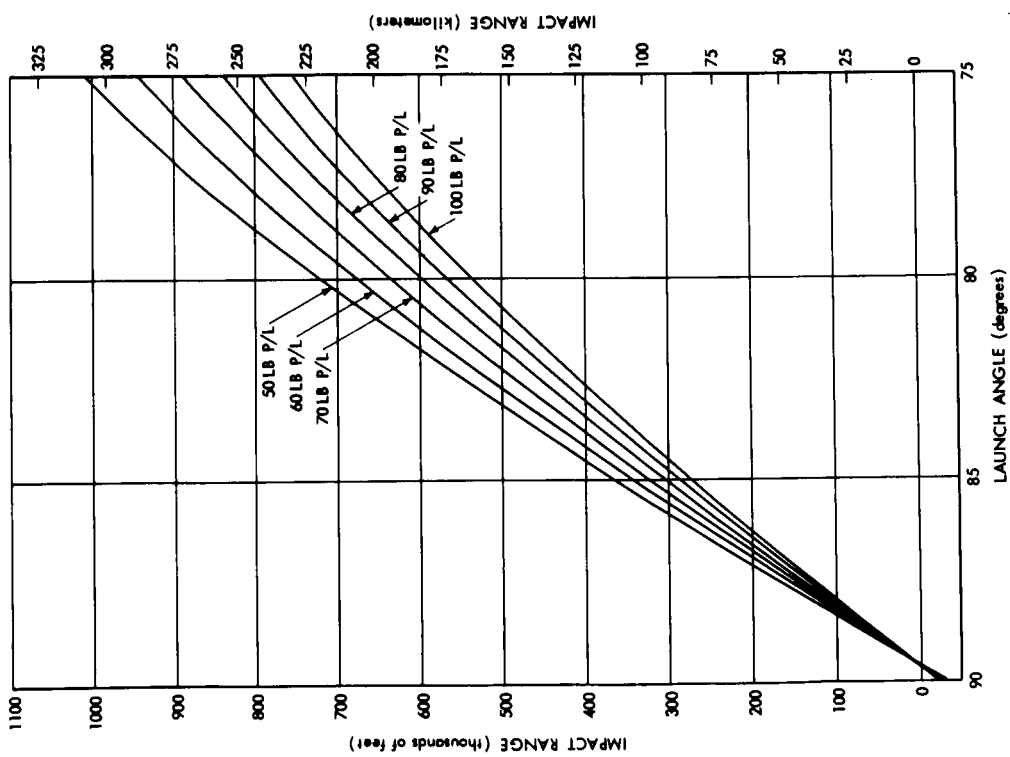

Figure 35. Impact Range vs Launch Angle (Sea-Level Launch)

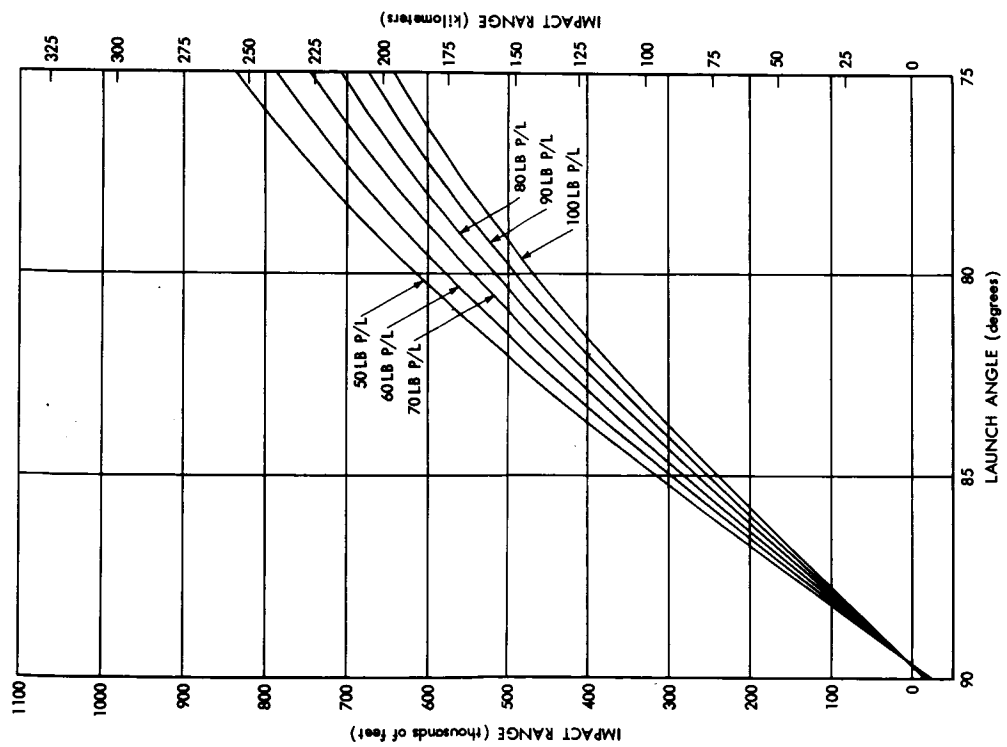
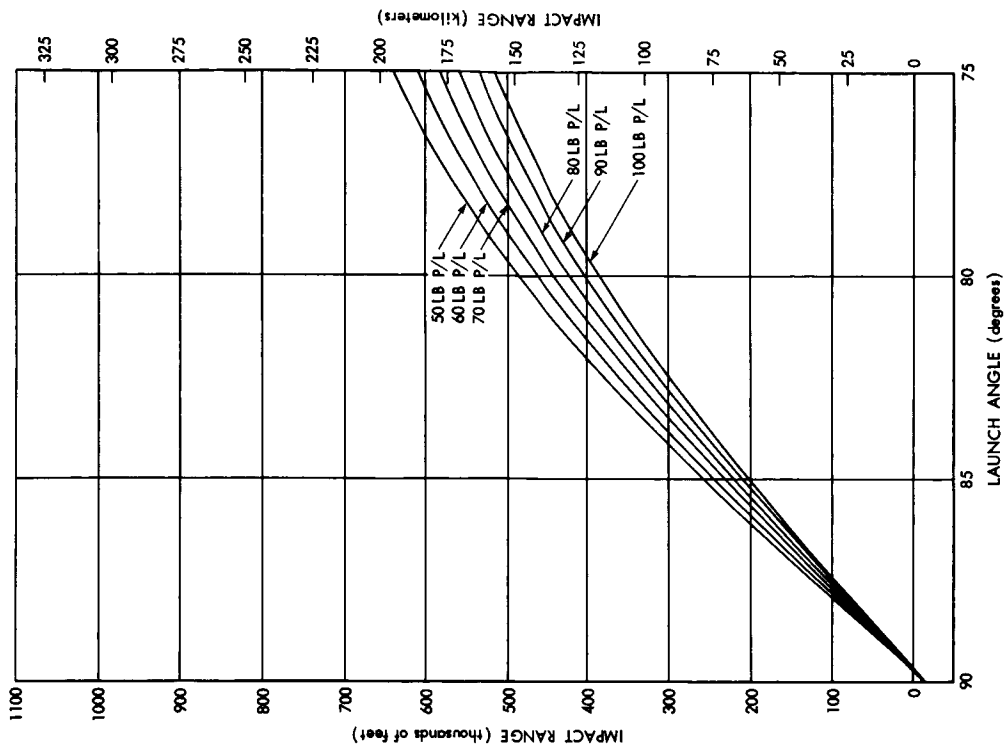

Figure 35. Impact Range vs Launch Angle (Sea-Level Launch)

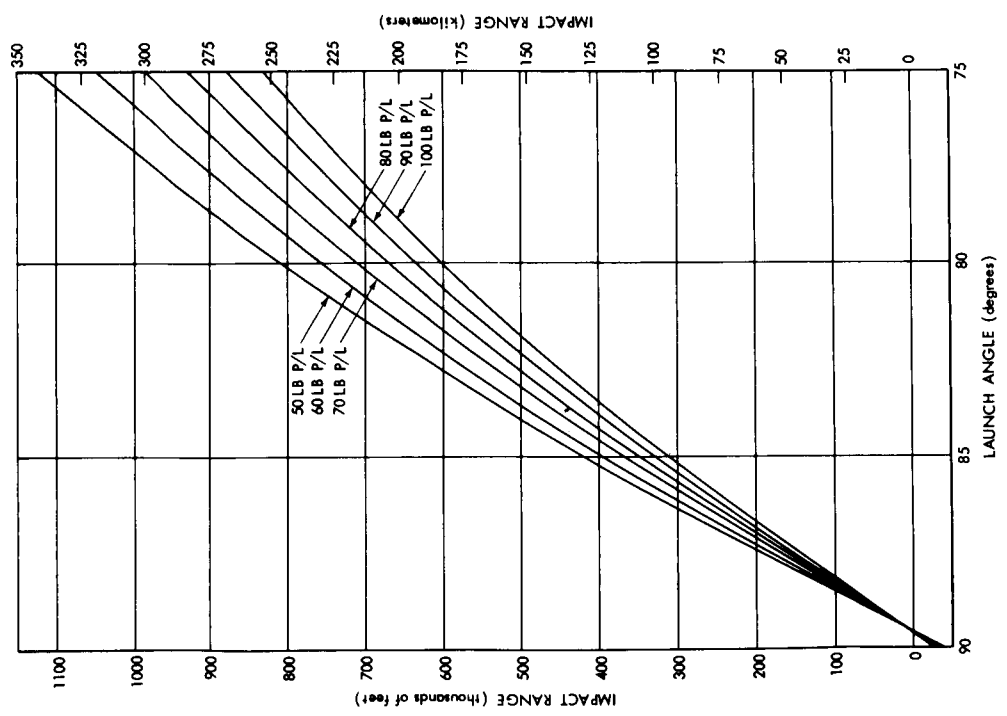
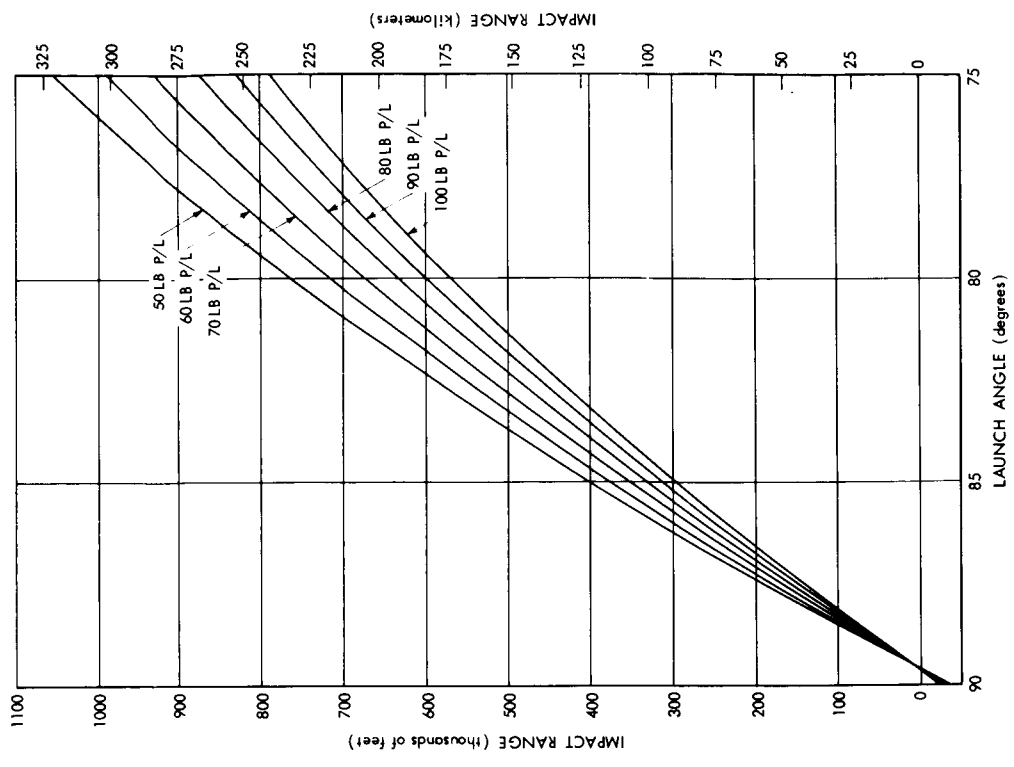
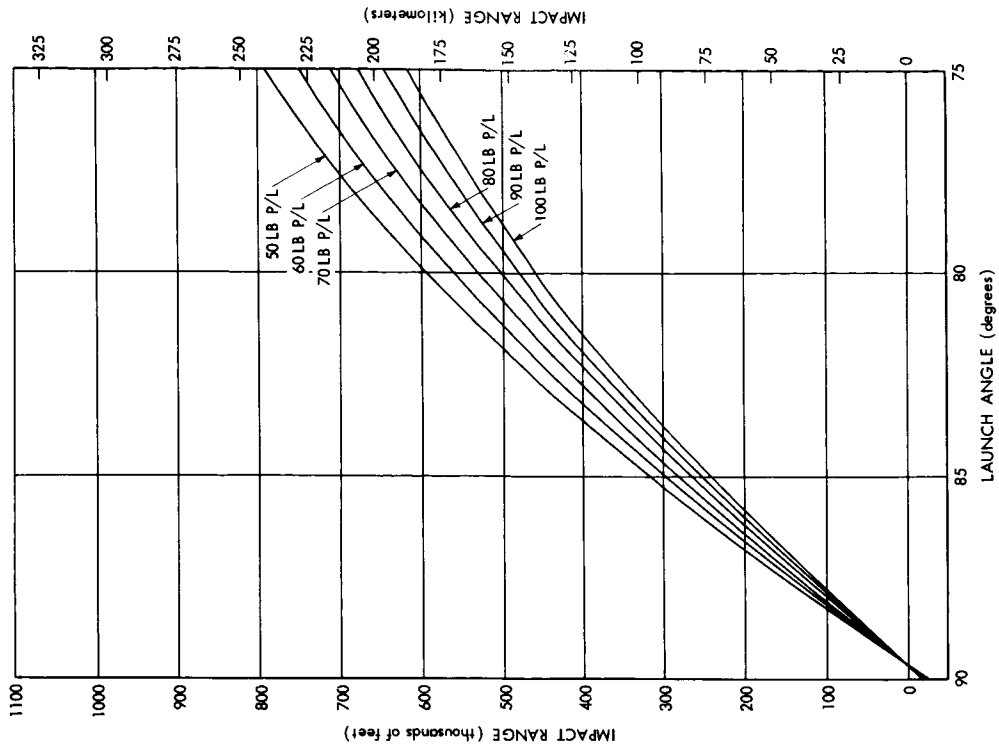
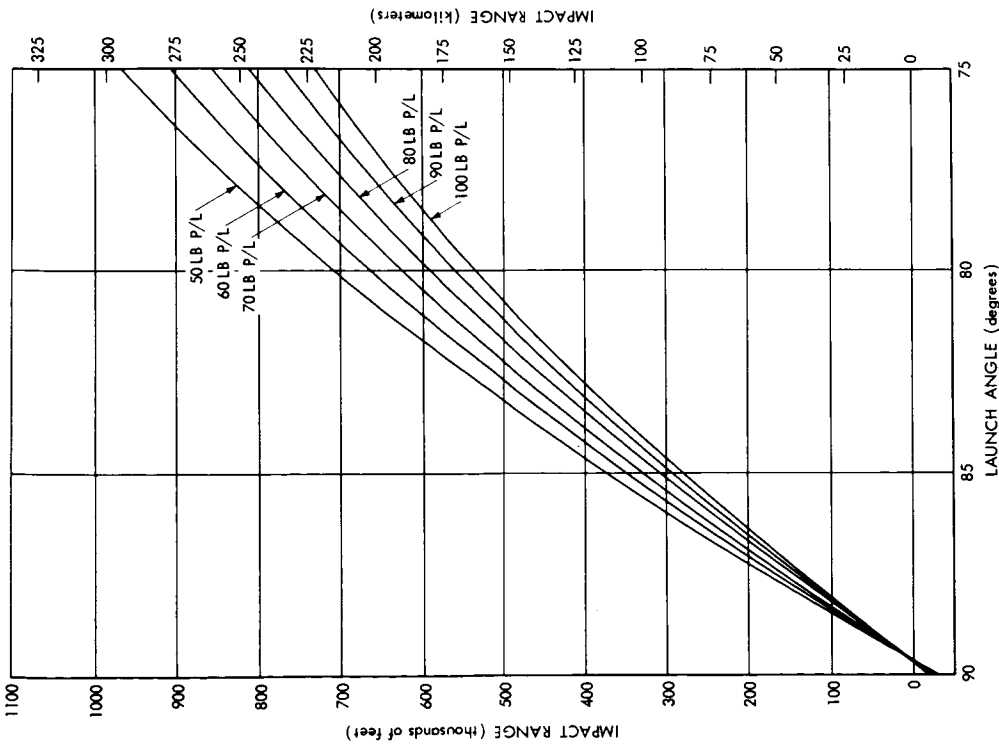

Figure 36. Impact Range vs Launch Angle (Launch 3986 Feet Above Sea Level)



Drag Case 4



Drag Case 3

Figure 36. Impact Range vs Launch Angle (Launch 3986 Feet Above Sea Level)

range resulting from under- or over-correction of the rocket to winds. Once the vehicle is launched and the actual flight path known, this chart can be used to confirm that the impact error due to pitch up (or down) is within specified dispersion limits.

Appendix B contains Nike Apache trajectory calculations for the four standard drag cases with various payload and launch-angle combinations, using both the Wallops Island (sea-level) and the White Sands Missile Range LC-33 (3986 feet above sea level).

Figures 37 and 38 are "carpet plots" of the four most common drag configurations launched from Wallops Island (sea level) and from White Sands Missile Range LC-33 (3986 feet above sea level). These plots will permit calculations of the apogee and impact range for any given payload and launch angle. Conversely, the approximate effective launch angle can be determined by knowing the apogee, impact range, and payload; this method is only approximate, because altitude can be affected by variables not considered in the basic computation. An example of this is the compromise in maximum altitude and range caused by excessive coning motion resulting from roll resonance.

The performance predictions may be considered accurate to within ± 5 miles in maximum altitude providing the payload weight is known to within 5 pounds. These data are based on particle-trajectory calculations that do not account for performance-disturbing influences such as variation in motor performance, or for aerodynamic asymmetries and appendages, each of which may have a noticeable effect on the observed performance of any given flight. Maximum altitude may vary as a result of deviation of the effective launch angle, due to wind correction. The launcher is set to compensate for wind; nevertheless, variations in effective launch angle of ± 2 degrees are not uncommon. From Figures 19 and 20, altitude effects of this variation may be found to be on the order of ± 5 statute miles. Launch-angle influence on impact range is of much greater magnitude; Figures 35 and 36 show that this can be as high as ± 20 statute miles per degree. Range and cross range uncertainties due to all effects (i. e., dispersion) are considered in Reference 8, which may be used for wind-weighting and dispersion for the Nike Apache.

Tables 1 and 2 summarize the results of a Nike Apache dispersion study conducted by New Mexico State University. Although NMSU used inputs slightly different from those contained in Appendix A of this report, the results show the magnitude of the perturbation value and the resulting dispersion effect on range.

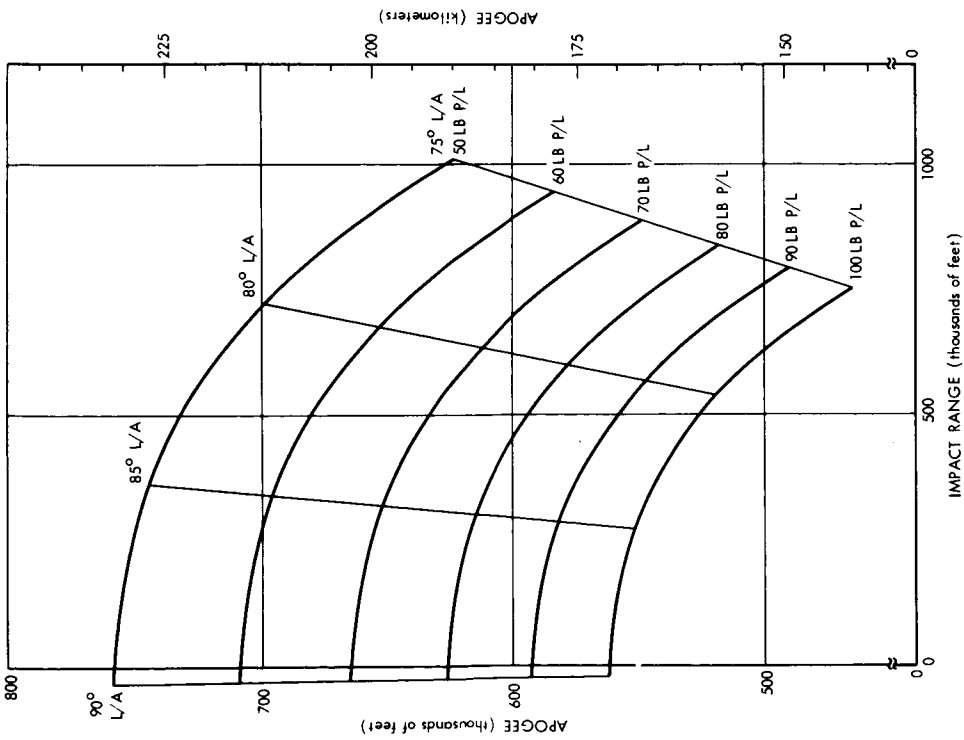

Drag Case 1

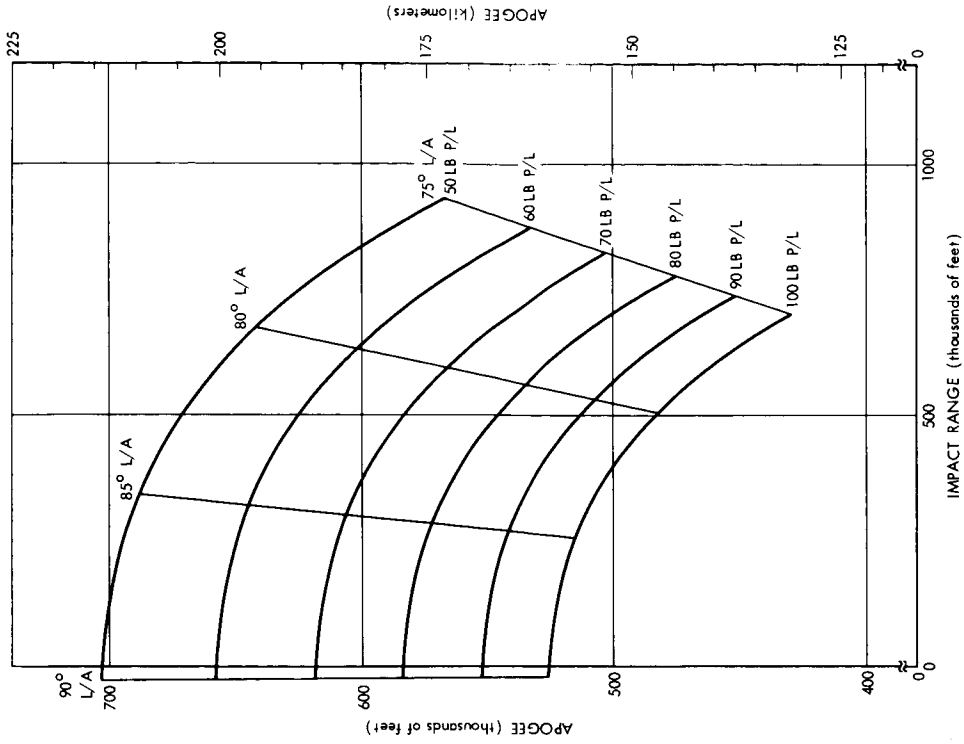

Drag Case 2

Figure 37. Apogee vs Impact Range (Sea-Level Launch)

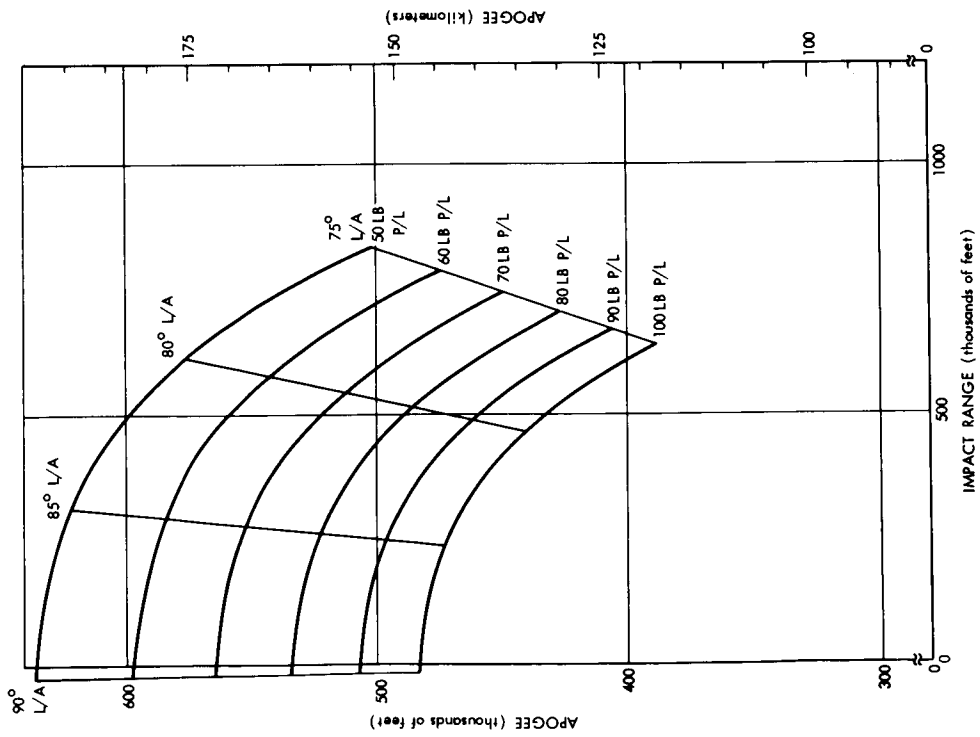

Drag Case 3

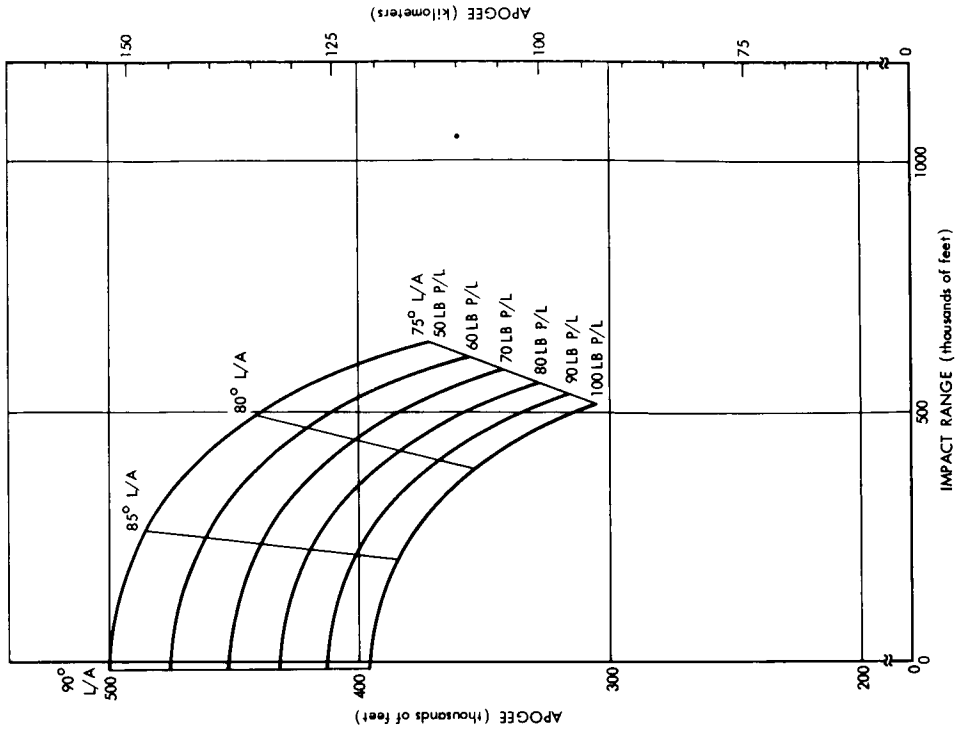

Drag Case 4

Figure 37. Apogee vs Impact Range (Sea-Level Launch)

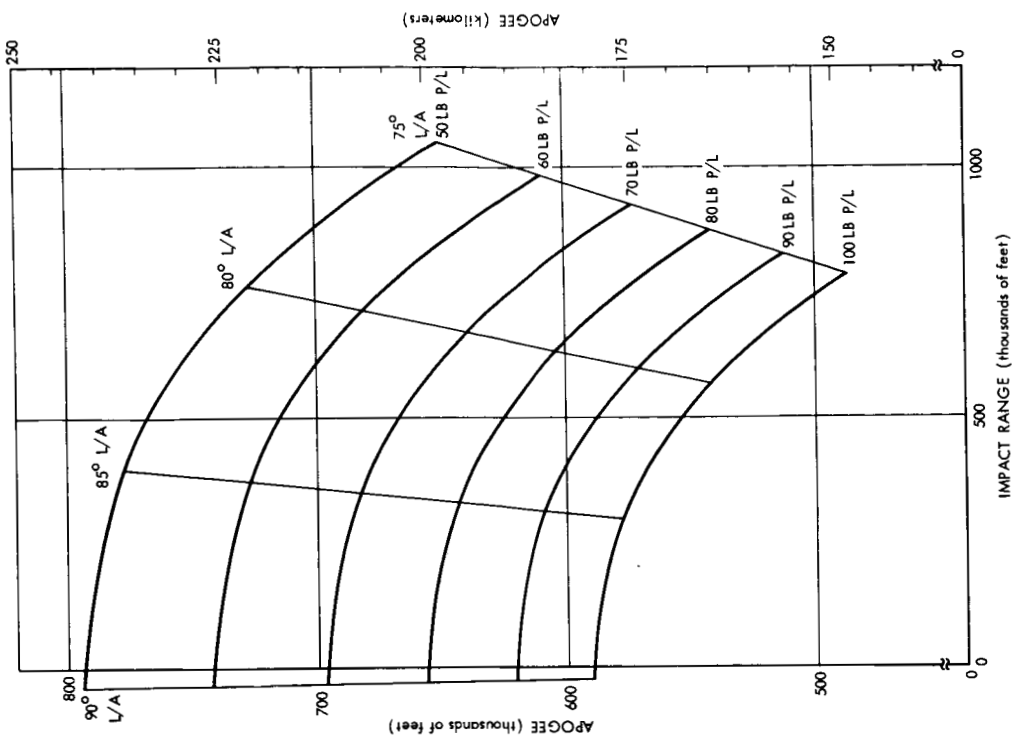

Drag Case 2

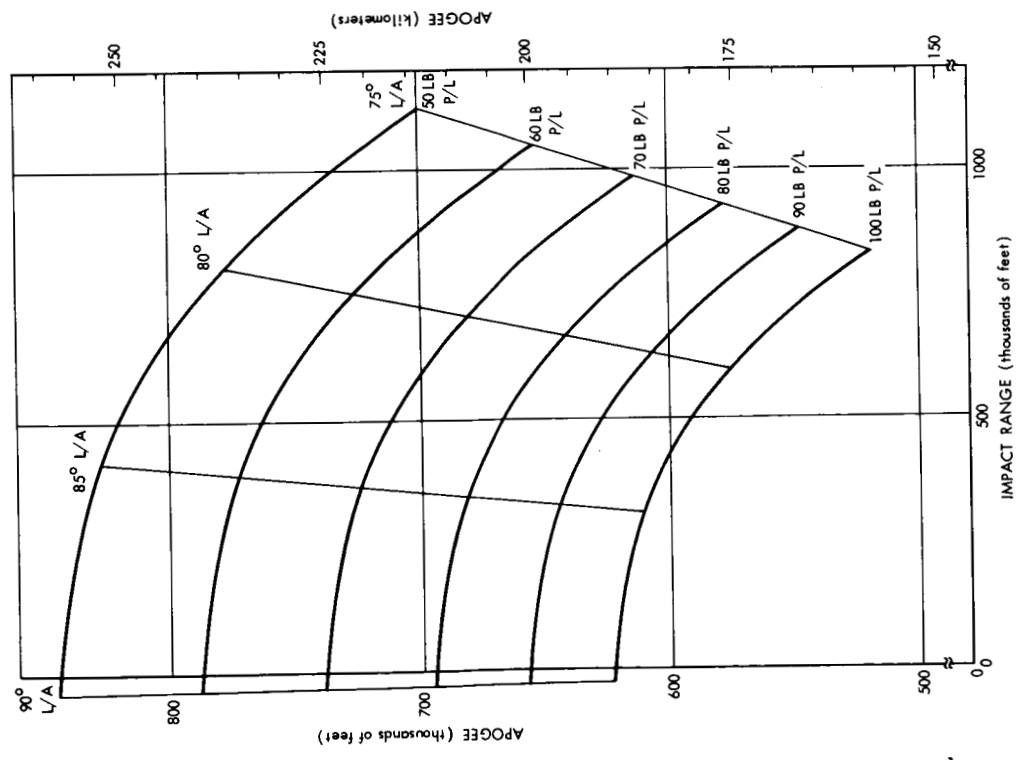

Drag Case 1

Figure 38. Apogee vs Impact Range (Launch 3986 Feet Above Sea Level)

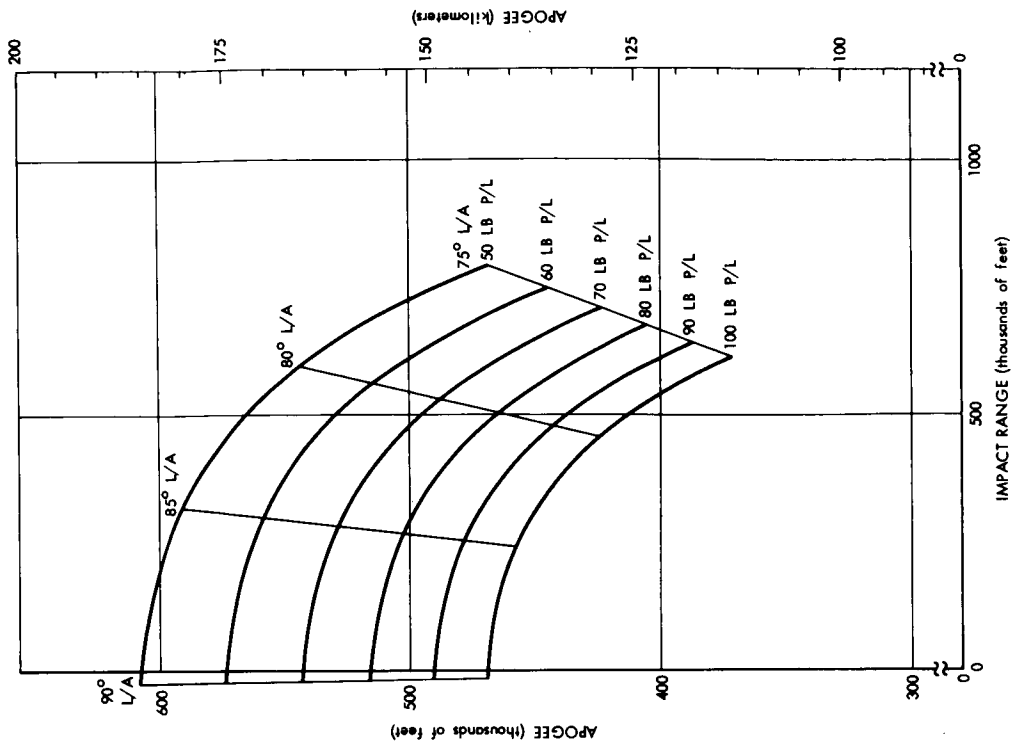

Drag Case 4

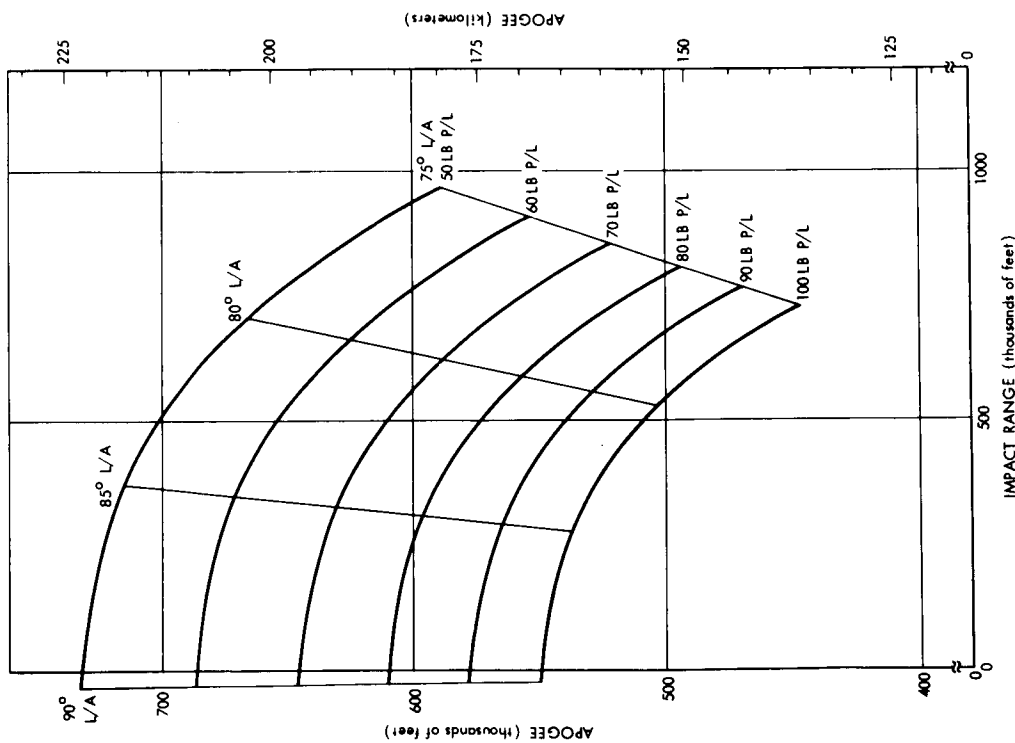

Drag Case 3

Figure 38. Apogee vs Impact Range (Launch 3986 Feet Above Sea Level)

Table 1
Impact Dispersion Values for Significant Parameters
(Nike Apache, Wallops Island)

Perturbing Parameter	Perturbing Values (2σ Estimates)	Dispersion Effect Due to Parameter (Nautical Miles)		Unit Dispersion Effect
		Range Effect	Cross Range Effect	
Initial Pitch Rate	-5 Deg/Sec	11.827	11.827	2.365
Nike Thrust Misalignment	0.1 Degree	9.350	9.350	93.500
Apache Thrust Variation	+5%	6.460		1.292
Apache Ignition Time*	+6 Sec	+13.308		2.218
Apache Ignition Time*	-3 Sec	-6.654		2.218
Apache-plus-Payload* Weight Variation	± 10 Lb	± 4.742		0.474
Wind Uncertainty	5 Ft/Sec	6.080	6.080	1.216
Nike Thrust Variation	+5%	3.861		0.772
Apache Coasting Drag Variation	-10%	3.471		0.347
Boost Phase Drag Variation	-10%	1.532		0.153
Nike Fin Misalignment	0.1 Degree			
Apache Powered Drag Variation	-10%	0.868		0.087
Tower Tilt Uncertainty	0.1 Degree	0.793		7.93
Tower Azimuth Uncertainty	0.5 Degree		0.779	1.558
Apache Fin Misalignment	0.1 Degree			
Apache Thrust Misalignment	0.1 Degree			

$Q_e = 80^\circ$

Payload = 80 lb

Drag Case 2

Zero-length launcher

*Not Included By NMSU

Table 2
 Nike Apache 2-Sigma Dispersion
 (Wallops Island)

Drag Case	Payload	Q _e	Launcher Length (Feet)	Standard Peak Altitude (1000's ft)	Standard Impact Range (Nautical Miles)	Range Dispersion (Nautical Miles)	Cross Section Dispersion (Nautical Miles)
	(lbs)	(deg)					
I	40	88	0.25	814.6	26.751	31.355	27.854
I	40	80	0.25	754.7	125.812	29.545	23.156
I	40	80	21.0	756.7	123.983	22.560	13.255
I	120	80	0.25	474.5	77.219	21.070	14.188
II	80	80	0.25	538.5	89.298	23.157	16.275
III	40	80	0.25	617.3	105.123	26.136	18.729
III	80	80	21.0	490.0	80.538	18.534	8.287

VERIFICATION

Appendix C contains the results of a postflight study of Nike Apache flights, using the following inputs:

- The G. E. MASS input data as given in Appendix A
- Actual payload weight as given in the vehicle manager's postflight summary
- Actual second-stage ignition time as determined by the speed/time history from radar
- The effective launch angle as determined by examining the flight path angle given by radar.

REFERENCES

1. Royall, J. F., Jr., and Garland, B. J.: "Characteristics of the Nike Cajun (Can) Rocket System and Flight Investigation of its Performance." NACA RM L57D26. 1957
2. Cooper, E., and Mamone, R.: "Feasibility Study, Nike Apache Rocket System with Fiberglass Payload." Atlantic Research Corp.-Space Vehicles Group Report 7903-2-01. April 30, 1961
3. Syverston, C. A., and Dennis, D. H.: "A Second-Order Shock Expansion Method Applicable to Bodies of Revolution Near Zero Lift." NACA Report 1328. 1957
4. Pitts, W. C., Nielsen, J. N., and Kaatari, George E.: "Lift and Center of Pressure of Wing-Body-Tail Combination at Subsonic, Transonic, and Supersonic Speeds." NACA Technical Report 1307. 1959
5. Galloway, Howard L.: "The Effect of a Fin Trailing-Edge Wedge on the Roll History of a Nike Apache." NASA X-721-66-85. February 1966
6. Mayo, Edward E.: "Effects of Payload Weight and Length on the Mass and Aerodynamic Characteristic of the Apache and Cajun Sounding Rocket (Apache)." NASA X-721-66-91. March 1966
7. Sterhardt, J. A.: "Environmental Test of Nike Apache Rocket NASA 14.111 GT." NASA X-671-65-236. June 1965
8. Hennigh, Keith E., and Otteson, Jon E.: "Unpublished Data from Dispersion Study of the Nike Apache." New Mexico State University (for NASA/GSFC). 1963

PRECEDING PAGE BLANK NOT FILMED.

APPENDIX A

Inputs to GE Mass Program for Simulating
Sounding-Rocket Trajectories

NIKE INPUTS

TIME (sec)	THRUST (lbs)	PROPELLANT WEIGHT (lbs)
0	42500	755.0
3.5	42500	0
3.5	0	0

NIKE DRAG COEFFICIENT WITH APACHE

MACH NO.	CD	MACH NO.	CD
0.00	0.47	1.10	1.53
0.38	0.59	1.16	1.46
0.46	0.63	1.20	1.44
0.50	0.66	1.26	1.40
0.54	0.71	1.38	1.35
0.60	0.80	1.40	1.34
0.66	0.95	1.60	1.255
0.70	1.08	1.80	1.18
0.76	1.27	2.00	1.12
0.79	1.40	2.20	1.07
0.84	1.60	2.40	1.02
0.90	1.90	2.60	0.99
0.96	2.20	2.80	0.96
0.99	2.23	3.00	0.93
1.02	2.20	6.00	0.48
1.04	2.00	30.00	0.48
1.06	1.68		

STANDARD APACHE THRUST
 APACHE THRUST DATA USED IN G.E. MASS (APTH2)

TIME - THRUST DATA FROM THIOKOL TEST CURVES
 TE - 307 2506 - BP15 - 316 - 8
 6 FEBRUARY 1961

TIME	THRUST	TIME	THRUST
0.00	0	3.56	5,360
0.06	5,250	4.06	5,550
0.13	6,400	4.56	5,740
0.16	6,050	4.74	5,796
0.21	5,460	4.86	5,710
0.26	5,320	5.06	5,400
0.36	5,210	5.48	4,100
0.56	5,000	5.73	3,250
1.06	4,780	5.86	1,950
1.56	4,750	6.06	650
2.06	4,930	6.14	340
2.56	5,200	6.36	0
3.06	5,200		

APACHE DRAG COEFFICIENTS

MACH NUMBER	CASE 1		CASE 2	
	COASTING	THRUSTING	COASTING	THRUSTING
1.00	0.930	0.780	1.140	0.990
1.25	0.841	0.707	0.997	0.863
1.50	0.785	0.665	0.918	0.798
1.75	0.740	0.634	0.860	0.754
2.00	0.704	0.607	0.815	0.718
2.50	0.643	0.564	0.741	0.662
3.00	0.590	0.527	0.681	0.618
3.50	0.544	0.496	0.631	0.583
4.00	0.507	0.467	0.591	0.551
4.50	0.479	0.444	0.562	0.527
5.00	0.454	0.423	0.536	0.505
5.50	0.432	0.402	0.512	0.482
6.00	0.412	0.384	0.492	0.464
6.50	0.396	0.374	0.476	0.454
7.00	0.388	0.368	0.468	0.448
7.50	0.384	0.364	0.464	0.444
8.00	0.384	0.364	0.464	0.444

APACHE PROPELLANT WEIGHT INPUTS

TIME (SEC)	PROPELLANT WEIGHT (LBS)	TIME (SEC)	PROPELLANT WEIGHT (LBS)
0.00	131.0	3.56	52.57
0.06	130.31	4.06	40.61
0.13	128.52	4.56	28.23
0.16	127.7	4.74	23.67
0.21	126.44	4.86	20.64
0.26	125.26	5.06	15.77
0.36	122.95	5.48	7.02
0.56	118.47	5.73	2.99
1.06	107.74	5.86	1.50
1.56	97.29	6.06	0.36
2.06	86.67	6.14	0.19
2.56	75.56	6.36	0.00
3.06	64.16		

APACHE DRAG COEFFICIENTS

MACH NUMBER	CASE 3		CASE 4	
	COASTING	THRUSTING	COASTING	THRUSTING
1.00	1.260	1.110	1.600	1.400
1.25	1.116	0.982	1.490	1.329
1.50	1.028	0.908	1.400	1.260
1.75	0.966	0.860	1.318	1.204
2.00	0.924	0.827	1.250	1.150
2.50	0.860	0.781	1.132	1.052
3.00	0.803	0.740	1.050	0.980
3.50	0.754	0.706	0.995	0.933
4.00	0.714	0.674	0.950	0.895
4.50	0.684	0.649	0.907	0.865
5.00	0.656	0.625	0.872	0.840
5.50	0.631	0.601	0.848	0.818
6.00	0.608	0.580	0.830	0.800
6.50	0.590	0.568	0.813	0.789
7.00	0.578	0.558	0.800	0.780
7.50	0.574	0.554	0.800	0.780
8.00	0.574	0.554	0.800	0.780

Launch Site	Altitude (Ft. above sea level)	Latitude (deg)	Longitude (deg)	Azimuth (deg)
Ascension Is.	0	-7.976(S)	-14.415(W)	200
Ft. Churchill	0	58.7345(N)	-93.819(W)	111
Sweden (Kronogard)	1430	66.22(N)	19.78(E)	270
Wallops Is.	0	37.8385(N)	-75.4827(W)	110
WSMR-				
(ALA-1) LC33	3986	32.5666(N)	-106.5666(W)	0
Sulf Site	4821.23	33.7233(N)	-106.7483(W)	152
Karachi	0	25.1939(N)	66.7464(E)	180

PRECEDING PAGE BLANK NOT FILMED.

APPENDIX B

Trajectory Calculations for Standard
Nike Apache Drag Cases

NIKE APACHE DRAG CASE 1
WALLOPS ISLAND 110° AZIMUTH
REAL EARTH 20 SEC APACHE IGNITION

	Time (sec)	P/L Wt. (lbs)	Computer Run Number	L/A (deg)	Speed (ft/sec)	Altitude (ft)	Horizontal Range (ft)	Flight Path Angle (deg)
Nike Burnout	3.5	50	320	75	3254	5292	1714	71.70
		60	321		3233	5256	1704	71.68
		70	322		3212	5221	1695	71.66
		80	323		3190	5186	1685	71.64
		90	324		3170	5152	1676	71.62
		100	325		3149	5117	1667	71.59
Apache Ignition	20.0	50			1729	40984	14740	67.08
		60			1742	41005	14769	67.07
		70			1755	41008	14794	67.06
		80			1765	40993	14813	67.04
		90			1774	40962	14826	67.02
		100			1782	40914	14833	67.00
Apache Burnout	26.36	50			6678	65069	25320	65.83
		60			6442	64519	25108	65.80
		70			6227	63996	24911	65.76
		80			6031	63494	24727	65.73
		90			5851	63010	24554	65.69
		100			5685	62539	24389	65.64
Apogee	219.08	50			2489	623386	502990	0
	211.82	60			2413	583661	470982	0
	205.23	70			2344	548682	442753	0
	199.24	80			2281	517724	417742	0
	193.76	90			2222	490157	395950	0
	188.72	100			2168	465414	375460	0
Impact	427.07	50			2634	0	1010587	-68.15
	412.61	60			2720	0	946398	-68.14
	399.53	70			2789	0	889780	-68.14
	387.65	80			2844	0	839616	-68.14
	376.80	90			2889	0	794922	-68.15
	366.84	100			2924	0	754800	-68.16

NIKE APACHE DRAG CASE 1
WALLOPS ISLAND 110° AZIMUTH
REAL EARTH 20 SEC APACHE IGNITION

	Time (sec)	P/L Wt. (lbs)	Computer Run Number	L/A (deg)	Speed (ft/sec)	Altitude (ft)	Horizontal Range (ft)	Flight Path Angle (deg)
Nike Burnout	3.5	50	320	80	3254	5439	1152	77.79
		60	321		3233	5403	1146	77.77
		70	322		3212	5367	1139	77.76
		80	323		3190	5332	1133	77.74
		90	324		3170	5296	1127	77.73
		100	325		3149	5261	1120	77.72
Apache Ignition	20.0	50			1732	42447	9955	74.71
		60			1745	42467	9975	74.70
		70			1757	42468	9990	74.69
		80			1767	42453	10002	74.68
		90			1775	42418	10010	74.66
		100			1782	42368	10014	74.64
Apache Burnout	26.36	50			6709	67840	17141	73.87
		60			6469	67251	16995	73.85
		70			6251	66693	16860	73.83
		80			6052	66160	16732	73.80
		90			5869	65645	16612	73.77
		100			5701	65147	16498	73.74
Apogee	231.02	50			1678	698613	360071	0
	223.21	60			1627	653217	337017	0
	216.16	70			1581	613360	316719	0
	209.75	80			1539	578160	298751	0
	203.89	90			1500	546850	282746	0
	198.51	100			1464	518815	268397	0
Impact	450.17	50			2826	0	724183	-75.26
	434.66	60			2902	0	677890	-75.26
	420.66	70			2962	0	637128	-75.27
	407.97	80			3009	0	601043	-75.27
	396.39	90			3045	0	568899	-75.28
	385.77	100			3073	0	540083	-75.29

NIKE APACHE DRAG CASE 1
WALLOPS ISLAND 110° AZIMUTH
REAL EARTH 20 SEC APACHE IGNITION

	Time (sec)	P/L Wt. (lbs)	Computer Run Number	L/A (deg)	Speed (ft/sec)	Altitude (ft)	Horizontal Range (ft)	Flight Path Angle (deg)
Nike Burnout	3.5	50	320	85	3254	5529	576	83.90
		60	321		3233	5492	573	83.89
		70	322		3212	5456	570	83.88
		80	323		3190	5420	567	83.88
		90	324		3170	5384	564	83.87
		100	325		3149	5349	560	83.86
Apache Ignition	20.0	50			1734	43338	4998	82.41
		60			1746	43358	5007	82.40
		70			1758	43358	5015	82.40
		80			1767	43340	5020	82.39
		90			1775	43306	5024	82.38
		100			1782	43254	5026	82.37
Apache Burnout	26.36	50			6726	69532	8586	82.01
		60			6484	68920	8512	82.00
		70			6264	68340	8444	81.98
		80			6063	67786	8380	81.97
		90			5879	67254	8320	81.96
		100			5710	66738	8262	81.94
Apogee	237.91	50			806	745280	181011	0
	229.81	60			783	696416	169580	0
	222.49	70			762	653570	159506	0
	215.84	80			743	615746	150576	0
	209.78	90			725	582153	142618	0
	204.22	100			708	552083	135475	0
Impact	463.53	50			2938	0	365433	-82.62
	447.45	60			3008	0	342375	-82.63
	432.95	70			3063	0	322056	-82.63
	419.80	80			3104	0	304042	-82.63
	407.82	90			3136	0	287991	-82.64
	396.83	100			3160	0	273583	-82.64

NIKE APACHE DRAG CASE 1
WALLOPS ISLAND 110° AZIMUTH
REAL EARTH 20 SEC APACHE IGNITION

	Time (sec)	P/L Wt. (lbs)	Computer Run Number	L/A (deg)	Speed (ft/sec)	Altitude (ft)	Horizontal Range (ft)	Flight Path Angle (deg)
Nike Burnout	3.5	50	320	90	3254	5559	-18	89.98
		60	321		3233	5522	-18	89.98
		70	322		3212	5486	-18	89.98
		80	323		3190	5450	-17	89.98
		90	324		3170	5414	-17	89.98
		100	325		3149	5378	-17	89.98
Apache Ignition	20.0	50			1734	43635	-45	89.86
		60			1747	43653	-45	89.86
		70			1758	43653	-45	89.86
		80			1767	43635	-45	89.86
		90			1775	43599	-45	89.86
		100			1782	43548	-46	89.86
Apache Burnout	26.36	50			6732	70091	-150	89.80
		60			6488	69471	-148	89.80
		70			6268	68884	-145	89.80
		80			6067	68324	-143	89.80
		90			5882	67784	-140	89.80
		100			5712	67264	-139	89.80
Apogee	239.68	50			99	759306	-15630	0
	231.51	60			93	709439	-14175	0
	224.14	70			88	665723	-12934	0
	217.44	80			83	627155	-11867	0
	211.34	90			78	592889	-10941	0
	205.73	100			75	562238	-10130	0
Impact	466.94	50			2974	0	-31047	-89.91
	450.74	60			3043	0	-28152	-89.91
	436.13	70			3095	0	-25681	-89.91
	422.89	80			3135	0	-23556	-89.91
	410.82	90			3165	0	-21716	-89.91
	399.75	100			3187	0	-20106	-89.92

NIKE APACHE DRAG CASE 2
WALLOPS ISLAND 110° AZIMUTH
REAL EARTH 20 SEC APACHE IGNITION

	Time (sec)	P/L Wt. (lbs)	Computer Run Number	L/A (deg)	Speed (ft/sec)	Altitude (ft)	Horizontal Range (ft)	Flight Path Angle (deg)
Nike Burnout	3.5	50	326	75	3254	5292	1714	71.70
		60	327		3233	5256	1704	71.68
		70	328		3212	5221	1695	71.66
		80	329		3190	5186	1685	71.64
		90	330		3170	5152	1676	71.62
		100	331		3149	5117	1667	71.59
Apache Ignition	20.0	50			1609	39644	14278	66.84
		60			1626	39704	14320	66.83
		70			1641	39745	14358	66.83
		80			1654	39766	14388	66.82
		90			1666	39769	14412	66.81
		100			1676	39755	14431	66.79
Apache Burnout	26.36	50			6474	62814	24607	65.51
		60			6249	62336	24414	65.48
		70			6044	61882	24236	65.46
		80			5857	61446	24069	65.43
		90			5684	61025	23913	65.40
		100			5526	60612	23762	65.36
Apogee	209.03	50			2415	567524	464242	0
	202.46	60			2343	533116	435740	0
	196.50	70			2277	502705	410541	0
	191.04	80			2216	475677	388151	0
	186.04	90			2160	451467	368105	0
	181.42	100			2108	429674	350083	0
Impact	408.78	50			2020	0	932761	-68.63
	395.57	60			2130	0	875605	-68.57
	383.60	70			2222	0	825073	-68.52
	372.70	80			2301	0	780165	-68.49
	362.71	90			2368	0	739958	-68.47
	353.52	100			2425	0	703802	-68.46

NIKE APACHE DRAG CASE 2
WALLOPS ISLAND 110° AZIMUTH
REAL EARTH 20 SEC APACHE IGNITION

	Time (sec)	P/L Wt. (lbs)	Computer Run Number	L/A (deg)	Speed (ft/sec)	Altitude (ft)	Horizontal Range (ft)	Flight Path Angle (deg)
Nike Burnout	3.5	50	326	80	3254	5439	1152	77.79
		60	327		3233	5403	1146	77.77
		70	328		3212	5367	1139	77.76
		80	329		3190	5332	1133	77.74
		90	330		3170	5296	1127	77.73
		100	331		3149	5261	1120	77.72
Apache Ignition	20.0	50			1614	41077	9646	74.54
		60			1630	41138	9675	74.54
		70			1644	41178	9699	74.53
		80			1657	41198	9719	74.53
		90			1668	41200	9734	74.52
		100			1678	41184	9746	74.50
Apache Burnout	26.36	50			6513	65559	16672	73.65
		60			6283	65046	16538	73.64
		70			6074	64556	16414	73.62
		80			5884	64088	16299	73.60
		90			5709	63635	16190	73.58
		100			5547	63196	16086	73.55
Apogee	221.51	50			1636	642181	335792	0
	214.35	60			1588	602114	314874	0
	207.86	70			1543	566794	296408	0
	201.95	80			1502	535508	280034	0
	196.53	90			1464	507554	265398	0
	191.54	100			1430	482470	252264	0
Impact	432.64	50			2206	0	675373	-75.48
	418.32	60			2310	0	633374	-75.46
	405.35	70			2396	0	596294	-75.44
	393.58	80			2468	0	563413	-75.43
	382.80	90			2529	0	534021	-75.43
	372.91	100			2580	0	507642	-75.42

NIKE APACHE DRAG CASE 2
WALLOPS ISLAND 110° AZIMUTH
REAL EARTH 20 SEC APACHE IGNITION

	Time (sec)	P/L Wt. (lbs)	Computer Run Number	L/A (deg)	Speed (ft/sec)	Altitude (ft)	Horizontal Range (ft)	Flight Path Angle (deg)
Nike Burnout	3.5	50	326	85	3254	5529	576	83.90
		60	327		3233	5492	573	83.89
		70	328		3212	5456	570	83.88
		80	329		3190	5420	567	83.88
		90	330		3170	5384	564	83.87
		100	331		3149	5349	560	83.86
Apache Ignition	20.0	50			1616	41950	4844	82.32
		60			1632	42011	4858	82.32
		70			1646	42051	4870	82.32
		80			1658	42071	4879	82.32
		90			1669	42072	4887	82.31
		100			1679	42055	4892	82.30
Apache Burnout	26.36	50			6534	67238	8355	81.90
		60			6302	66699	8287	81.89
		70			6091	66190	8225	81.88
		80			5899	65702	8167	81.87
		90			5722	65232	8112	81.86
		100			5559	64774	8059	81.85
Apogee	228.74	50			790	688813	170011	0
	221.26	60			768	645221	159504	0
	214.47	70			747	606873	150227	0
	208.30	80			728	572940	141995	0
	202.66	90			711	542679	134639	0
	197.46	100			695	515542	128031	0
Impact	446.54	50			2317	0	343209	-82.71
	431.58	60			2417	0	322018	-82.70
	418.07	70			2499	0	303311	-82.69
	405.80	80			2568	0	286710	-82.69
	394.58	90			2624	0	271874	-82.69
	384.29	100			2671	0	258546	-82.69

NIKE APACHE DRAG CASE 2
WALLOPS ISLAND 110° AZIMUTH
REAL EARTH 20 SEC APACHE IGNITION

	Time (sec)	P/L Wt. (lbs)	Computer Run Number	L/A (deg)	Speed (ft/sec)	Altitude (ft)	Horizontal Range (ft)	Flight Path Angle (deg)
Nike Burnout	3.5	50	326	90	3254	5559	-18	89.98
		60	327		3233	5522	-18	89.98
		70	328		3212	5486	-18	89.98
		80	329		3190	5450	-17	89.98
		90	330		3170	5414	-17	89.98
		100	331		3149	5378	-17	89.98
Apache Ignition	20.0	50			1617	42241	-43	89.86
		60			1632	42301	-43	89.86
		70			1646	42340	-43	89.86
		80			1659	42361	-43	89.86
		90			1670	42361	-43	89.86
		100			1679	42345	-43	89.86
Apache Burnout	26.36	50			6541	67792	-146	89.80
		60			6308	67246	-143	89.80
		70			6096	66729	-140	89.80
		80			5903	66235	-138	89.80
		90			5726	65758	-136	89.80
		100			5563	65296	-134	89.80
Apogee	230.65	50			93	703014	-14061	0
	223.09	60			87	658385	-12794	0
	216.24	70			82	619132	-11707	0
	210.01	80			78	584427	-10770	0
	204.31	90			74	553476	-9952	0
	199.07	100			70	525743	-9237	0
Impact	450.19	50			2354	0	-27921	-89.92
	435.09	60			2452	0	-25397	-89.92
	421.45	70			2533	0	-23237	-89.92
	409.07	80			2599	0	-21372	-89.92
	397.75	90			2655	0	-19749	-89.92
	387.37	100			2700	0	-18326	-89.92

NIKE APACHE DRAG CASE 3
WALLOPS ISLAND 110° AZIMUTH
REAL EARTH 20 SEC APACHE IGNITION

	Time (sec)	P/L Wt. (lbs)	Computer Run Number	L/A (deg)	Speed (ft/sec)	Altitude (ft)	Horizontal Range (ft)	Flight Path Angle (deg)
Nike Burnout	3.5	50	332	75	3254	5292	1714	71.70
		60	333		3233	5256	1704	71.68
		70	334		3212	5221	1695	71.66
		80	335		3190	5186	1685	71.64
		90	336		3170	5152	1676	71.62
		100	337		3149	5117	1667	71.59
Apache Ignition	20.0	50			1488	38176	13773	66.53
		60			1507	38277	13830	66.54
		70			1525	38356	13879	66.55
		80			1541	38416	13922	66.55
		90			1555	38456	13958	66.55
		100			1568	38478	13988	66.54
Apache Burnout	26.36	50			6235	60357	23837	65.11
		60			6023	59959	23664	65.10
		70			5831	59579	23505	65.09
		80			5655	59212	23356	65.07
		90			5492	58859	23217	65.05
		100			5343	58510	23086	65.02
Apogee	196.52	50			2312	501781	416466	0
	190.86	60			2246	473781	392485	0
	185.68	70			2185	448826	371143	0
	180.92	80			2129	426437	352031	0
	176.53	90			2077	406302	334877	0
	172.46	100			2029	388062	319374	0
Impact	386.94	50			1435	0	836622	-69.89
	375.25	60			1552	0	788556	-69.65
	364.63	70			1656	0	745775	-69.47
	354.90	80			1748	0	707452	-69.34
	345.98	90			1829	0	673054	-69.24
	337.75	100			1901	0	641962	-69.17

NIKE APACHE DRAGE CASE 3
WALLOPS ISLAND 110° AZIMUTH
REAL EARTH 20 SEC APACHE IGNITION

	Time (sec)	P/L Wt. (lbs)	Computer Run Number	L/A (deg)	Speed (ft/sec)	Altitude (ft)	Horizontal Range (ft)	Flight Path Angle (deg)
Nike Burnout	3.5	50	332	80	3254	5439	1152	77.79
		60	333		3233	5403	1146	77.77
		70	334		3212	5367	1139	77.76
		80	335		3190	5332	1133	77.74
		90	336		3170	5296	1127	77.73
		100	337		3149	5261	1120	77.72
Apache Ignition	20.0	50			1492	39570	9309	74.34
		60			1511	39673	9346	74.34
		70			1528	39754	9379	74.35
		80			1544	39814	9407	74.35
		90			1557	39854	9431	74.34
		100			1570	39876	9450	74.34
Apache Burnout	26.36	50			6282	63067	16164	73.39
		60			6066	62631	16043	73.38
		70			5869	62218	15932	73.37
		80			5689	61821	15828	73.36
		90			5523	61436	15731	73.34
		100			5370	61061	15639	73.32
Apogee	209.67	50			1579	575393	305701	0
	203.36	60			1533	541752	287543	0
	197.60	70			1492	511958	271464	0
	192.33	80			1453	485346	257112	0
	187.48	90			1417	461496	244261	0
	183.01	100			1384	439993	232688	0
Impact	411.62	50			1594	0	614799	-76.11
	398.73	60			1709	0	578354	-76.00
	387.06	70			1811	0	546077	-75.92
	376.40	80			1899	0	517259	-75.86
	366.64	90			1977	0	491456	-75.82
	357.65	100			2045	0	468218	-75.78

NIKE APACHE DRAG CASE 3
WALLOPS ISLAND 110° AZIMUTH
REAL EARTH 20 SEC APACHE IGNITION

	Time (sec)	P/L Wt. (lbs)	Computer Run Number	L/A (deg)	Speed (ft/sec)	Altitude (ft)	Horizontal Range (ft)	Flight Path Angle (deg)
Nike Burnout	3.5	50	332	85	3254	5529	576	83.90
		60	333		3233	5492	573	83.89
		70	334		3212	5456	570	83.88
		80	335		3190	5420	567	83.88
		90	336		3170	5384	564	83.87
		100	337		3149	5349	560	83.86
Apache Ignition	20.0	50			1495	40420	4676	82.22
		60			1513	40524	4694	82.22
		70			1530	40606	4711	82.23
		80			1545	40665	4724	82.22
		90			1559	40706	4736	82.22
		100			1571	40727	4745	82.22
Apache Burnout	26.36	50			6309	64723	8105	81.77
		60			6090	64266	8044	81.76
		70			5890	63832	7988	81.76
		80			5708	63414	7935	81.75
		90			5540	63012	7886	81.74
		100			5386	62621	7839	81.73
Apogee	217.35	50			768	621779	156291	0
	210.66	60			746	584596	146997	0
	204.58	70			726	551745	138774	0
	199.01	80			708	522471	131436	0
	193.91	90			692	496294	124871	0
	189.20	100			676	472742	118962	0
Impact	426.11	50			1692	0	315461	-82.96
	412.55	60			1805	0	296726	-82.92
	400.27	70			1905	0	280149	-82.89
	389.07	80			1991	0	265356	-82.86
	378.82	90			2066	0	252120	-82.85
	369.40	100			2132	0	240207	-82.84

NIKE APACHE DRAG CASE 3
WALLOPS ISLAND 110° AZIMUTH
REAL EARTH 20 SEC APACHE IGNITION

	Time (sec)	P/L Wt. (lbs)	Computer Run Number	L/A (deg)	Speed (ft/sec)	Altitude (ft)	Horizontal Range (ft)	Flight Path Angle (deg)
Nike Burnout	3.5	50	332	90	3254	5559	-18	89.98
		60	333		3233	5522	-18	89.98
		70	334		3212	5486	-18	89.98
		80	335		3190	5450	-17	89.98
		90	336		3170	5414	-17	89.98
		100	337		3149	5378	-17	89.98
Apache Ignition	20.0	50			1496	40703	-41	89.85
		60			1514	40807	-41	89.85
		70			1531	40887	-41	89.85
		80			1546	40949	-42	89.86
		90			1559	40988	-42	89.86
		100			1571	41010	-42	89.86
Apache Ignition	26.36	50			6318	65273	-140	89.80
		60			6097	64806	-137	89.80
		70			5897	64364	-136	89.80
		80			5714	63942	-134	89.80
		90			5546	63533	-131	89.80
		100			5391	63138	-129	89.80
Apogee	219.45	50			85	636142	-12245	0
	212.66	60			80	597877	-11055	0
	206.49	70			76	564084	-10291	0
	200.86	80			72	534026	-9504	0
	195.69	90			68	507132	-8816	0
	190.93	100			65	482964	-8211	0
Impact	430.04	50			1724	0	-24301	-89.94
	416.31	60			1837	0	-22213	-89.94
	403.88	70			1935	0	-20414	-89.93
	392.55	80			2021	0	-18851	-89.93
	382.18	90			2095	0	-17484	-89.93
	372.66	100			2160	0	-16282	-89.93

NIKE APACHE DRAG CASE 4
WALLOPS ISLAND 110° AZIMUTH
REAL EARTH 20 SEC APACHE IGNITION

	Time (sec)	P/L Wt. (lbs)	Computer Run Number	L/A (deg)	Speed (ft/sec)	Altitude (ft)	Horizontal Range (ft)	Flight Path Angle (deg)
Nike Burnout	3.5	50	338	75	3254	5292	1714	71.70
		60	339		3233	5256	1704	71.68
		70	340		3212	5221	1695	71.66
		80	341		3190	5186	1685	71.64
		90	342		3170	5152	1676	71.62
		100	343		3149	5117	1667	71.59
Apache Ignition	20.0	50			1220	35040	12688	65.71
		60			1244	35215	12768	65.76
		70			1266	35368	12843	65.80
		80			1286	35497	12908	65.83
		90			1305	35606	12966	65.85
		100			1322	35694	13018	65.87
Apache Burnout	26.36	50			5722	55063	22208	64.04
		60			5540	54814	22067	64.07
		70			5374	54574	21940	64.10
		80			5221	54342	21821	64.11
		90			5079	54114	21712	64.12
		100			4947	53886	21610	64.12
Apogee	169.33	50			2074	372669	319481	0
	165.70	60			2024	357003	304788	0
	162.26	70			1977	342512	291294	0
	159.01	80			1932	329087	278875	0
	155.93	90			1891	316655	267448	0
	153.02	100			1852	305102	256898	0
Impact	342.42	50			749	0	640690	-75.63
	333.71	60			820	0	611408	-74.54
	325.68	70			893	0	584478	-73.68
	318.25	80			967	0	559668	-73.00
	311.36	90			1040	0	536824	-72.46
	304.92	100			1112	0	515713	-72.03

NIKE APACHE DRAG CASE 4
WALLOPS ISLAND 110° AZIMUTH
REAL EARTH 20 SEC APACHE IGNITION

	Time (sec)	P/L Wt. (lbs)	Computer Run Number	L/A (deg)	Speed (ft/sec)	Altitude (ft)	Horizontal Range (ft)	Flight Path Angle (deg)
Nike Burnout	3.5	50	338	80	3254	5439	1152	77.79
		60	339		3233	5403	1146	77.77
		70	340		3212	5367	1139	77.76
		80	341		3190	5332	1133	77.74
		90	342		3170	5296	1127	77.73
		100	343		3149	5261	1120	77.72
Apache Ignition	20.0	50			1226	36355	8583	73.79
		60			1249	36535	8637	73.82
		70			1271	36690	8686	73.84
		80			1291	36824	8729	73.86
		90			1309	36934	8768	73.88
		100			1326	37024	8802	73.89
Apache Burnout	26.36	50			5786	57703	15091	72.67
		60			5598	57417	14990	72.69
		70			5426	57144	14900	72.70
		80			5268	56882	14816	72.71
		90			5122	56624	14738	72.72
		100			4986	56373	14666	72.72
Apogee	183.79	50			1447	441565	243456	0
	179.37	60			1409	420788	231207	0
	175.26	70			1374	401856	220103	0
	171.41	80			1342	384554	210004	0
	167.80	90			1311	368677	200785	0
	164.41	100			1283	354097	192358	0
Impact	368.02	50			818	0	489178	-79.17
	358.03	60			901	0	464670	-78.55
	348.89	70			985	0	442437	-78.09
	340.47	80			1068	0	422205	-77.73
	332.69	90			1149	0	403725	-77.45
	325.46	100			1225	0	386826	-77.24

NIKE APACHE DRAG CASE 4
WALLOPS ISLAND 110° AZIMUTH
REAL EARTH 20 SEC APACHE IGNITION

	Time (sec)	P/L Wt. (lbs)	Computer Run Number	L/A (deg)	Speed (ft/sec)	Altitude (ft)	Horizontal Range (ft)	Flight Path Angle (deg)
Nike Burnout	3.5	50	338	85	3254	5529	576	83.90
		60	339		3233	5492	573	83.89
		70	340		3212	5456	570	83.88
		80	341		3190	5420	567	83.88
		90	342		3170	5384	564	83.87
		100	343		3149	5349	560	83.86
Apache Ignition	20.0	50			1229	37158	4314	81.95
		60			1252	37340	4341	81.96
		70			1274	37498	4365	81.98
		80			1293	37632	4387	81.98
		90			1312	37745	4406	81.99
		100			1328	37836	4422	82.00
Apache Burnout	26.36	50			5822	59325	7577	81.41
		60			5631	59014	7526	81.42
		70			5455	58722	7480	81.42
		80			5294	58438	7437	81.43
		90			5146	58165	7397	81.43
		100			5008	57894	7360	81.43
Apogee	192.35	50			715	486134	127527	0
	187.48	60			696	461957	120893	0
	182.96	70			679	440115	114921	0
	178.75	80			663	420243	109507	0
	174.83	90			648	402139	104592	0
	171.16	100			634	385563	100108	0
Impact	383.37	50			869	0	257190	-84.24
	372.62	60			960	0	243856	-83.98
	362.81	70			1050	0	231844	-83.78
	353.80	80			1138	0	220948	-83.63
	345.49	90			1222	0	211055	-83.52
	337.79	100			1299	0	202026	-83.43

NIKE APACHE DRAG CASE 4
WALLOPS ISLAND 110° AZIMUTH
REAL EARTH 20 SEC APACHE IGNITION

	Time (sec)	P/L Wt. (lbs)	Computer Run Number	L/A (deg)	Speed (ft/sec)	Altitude (ft)	Horizontal Range (ft)	Flight Path Angle (deg)
Nike Burnout	3.5	50	338	90	3254	5559	-18	89.98
		60	339		3233	5522	-18	89.98
		70	340		3212	5486	-18	89.98
		80	341		3190	5450	-17	89.98
		90	342		3170	5414	-17	89.98
		100	343		3149	5378	-17	89.98
Apache Ignition	20.0	50			1230	37425	-36	89.85
		60			1253	37608	-37	89.85
		70			1274	37766	-37	89.85
		80			1294	37902	-37	89.85
		90			1312	38014	-37	89.85
		100			1329	38107	-38	89.85
Apache Burnout	26.36	50			5834	59861	-128	89.80
		60			5641	59544	-127	89.80
		70			5465	59242	-124	89.80
		80			5303	58955	-123	89.80
		90			5153	58673	-121	89.80
		100			5015	58400	-120	89.80
Apogee	194.83	50			68	500378	-8785	0
	189.82	60			65	475122	-8147	0
	185.19	70			62	452322	-7582	0
	180.89	80			59	431666	-7079	0
	176.87	90			56	412828	-6631	0
	173.13	100			54	395639	-6228	0
Impact	387.76	50			888	0	-17405	-89.99
	376.80	60			981	0	-16137	-89.98
	366.81	70			1073	0	-15016	-89.98
	357.64	80			1162	0	-14020	-89.97
	349.18	90			1246	0	-13130	-89.97
	341.35	100			1324	0	-12332	-89.97

NIKE APACHE DRAG CASE 1
WSMR - LC33
REAL EARTH 20 SEC APACHE IGNITION

	Time (sec)	P/L Wt. (lbs)	Computer Run Number	L/A (deg)	Speed (ft/sec)	Altitude (ft)	Horizontal Range (ft)	Flight Path Angle (deg)
Nike Burnout	3.5	50	380	75	3359	9394	1770	71.72
		60	384		3336	9357	1760	71.70
		70	388		3313	9320	1750	71.68
		80	392		3291	9284	1740	71.66
		90	396		3268	9248	1730	71.64
		100	400		3247	9213	1721	71.62
Apache Ignition	20.0	50			1920	47598	15626	67.38
		60			1931	47570	15642	67.36
		70			1940	47526	15651	67.34
		80			1947	47464	15655	67.31
		90			1952	47387	15652	67.28
		100			1957	47299	15646	67.25
Apache Burnout	26.36	50			6970	73084	26734	66.19
		60			6721	72446	26497	66.15
		70			6495	71839	26276	66.11
		80			6290	71255	26069	66.06
		90			6101	70693	25871	66.01
		100			5928	70152	25684	65.96
Apogee	230.41	50			2652	699428	562786	0
	222.54	60			2569	653905	526110	0
	215.44	70			2494	614033	493927	0
	208.99	80			2424	578762	465431	0
	203.10	90			2360	547398	440067	0
	197.70	100			2301	519372	417390	0
Impact	448.51	50			3328	3986	1122269	-68.04
	432.91	60			3386	3986	1049300	-68.05
	418.87	70			3427	3986	985268	-68.06
	406.12	80			3456	3986	928560	-68.07
	394.49	90			3475	3986	878087	-68.09
	383.84	100			348689	3986	832955	-68.10

NIKE APACHE DRAG CASE 1
WSMR - LC33
REAL EARTH 20 SEC APACHE IGNITION

	Time (sec)	P/L Wt. (lbs)	Computer Run Number	L/A (deg)	Speed (ft/sec)	Altitude (ft)	Horizontal Range (ft)	Flight Path Angle (deg)
Nike Burnout	3.5	50	380	80	3359	9544	1198	77.80
		60	384		3336	9506	1191	77.78
		70	388		3313	9469	1184	77.77
		80	392		3290	9432	1178	77.75
		90	396		3268	9396	1171	77.74
		100	400		3246	9360	1164	77.72
Apache Ignition	20.0	50			1924	49140	10569	74.86
		60			1934	49109	10579	74.84
		70			1942	49062	10583	74.83
		80			1948	48996	10585	74.81
		90			1953	48916	10582	74.79
		100			1957	48824	10579	74.77
Apache Burnout	26.36	50			6993	75946	18169	74.05
		60			6742	75268	18005	74.02
		70			6513	74625	17850	73.99
		80			6305	74007	17706	73.96
		90			6115	73415	17570	73.93
		100			5939	72844	17441	73.90
Apogee	242.40	50			1816	777693	406669	0
	234.00	60			1758	726341	379958	0
	226.44	70			1706	681456	356552	0
	219.57	80			1659	641806	335845	0
	213.31	90			1615	606607	317436	0
	207.57	100			1574	575180	300983	0
Impact	471.95	50			3507	3986	808457	-75.22
	455.31	60			3554	3986	755482	-75.22
	440.36	70			3586	3986	709058	-75.23
	426.79	80			3606	3986	667983	-75.24
	414.43	90			3618	3986	631465	-75.25
	403.13	100			3623	3986	598824	-75.26

NIKE APACHE DRAG CASE 1
WSMR - LC33
REAL EARTH 20 SEC APACHE IGNITION

	Time (sec)	P/L Wt. (lbs)	Computer Run Number	L/A (deg)	Speed (ft/sec)	Altitude (ft)	Horizontal Range (ft)	Flight Path Angle (deg)
Nike Burnout	3.5	50	380	85	3359	9636	611	83.89
		60	384		3336	9597	608	83.88
		70	388		3313	9560	604	83.88
		80	392		3290	9522	601	83.87
		90	396		3268	9485	597	83.86
		100	400		3246	9449	593	83.85
Apache Ignition	20.0	50			1926	50082	5329	82.41
		60			1935	50050	5334	82.40
		70			1943	50000	5335	82.39
		80			1949	49932	5336	82.38
		90			1954	49849	5335	82.38
		100			1957	49754	5332	82.36
Apache Burnout	26.36	50			7006	77698	9223	82.00
		60			6753	76995	9138	81.99
		70			6523	76330	9059	81.97
		80			6313	75692	8984	81.96
		90			6122	75081	8914	81.94
		100			5945	74492	8846	81.92
Apogee	249.68	50			926	827410	214482	0
	240.96	60			897	772380	200314	0
	233.12	70			870	724311	187907	0
	226.01	80			845	681905	176942	0
	219.52	90			823	644266	167196	0
	213.59	100			802	610687	158491	0
Impact	486.21	50			3610	3986	422809	-82.56
	468.96	60			3652	3986	394957	-82.57
	453.45	70			3678	3986	370564	-82.57
	439.40	80			3694	3986	349005	-82.58
	426.60	90			3700	3986	329842	-82.58
	414.90	100			3701	3986	312722	-82.59

NIKE APACHE DRAG CASE 1
WSMR - LC33
REAL EARTH 20 SEC APACHE IGNITION

	Time (sec)	P/L Wt. (lbs)	Computer Run Number	L/A (deg)	Speed (ft/sec)	Altitude (ft)	Horizontal Range (ft)	Flight Path Angle (deg)
Nike Burnout	3.5	50	380	90	3359	9667	16.9	89.98
		60	384		3336	9628	16.9	89.98
		70	388		3313	9590	16.9	89.98
		80	392		3290	9553	16.4	89.98
		90	396		3268	9516	16.4	89.98
		100	400		3246	9478	16.7	89.98
Apache Ignition	20.0	50			1926	50400	55.4	89.85
		60			1936	50367	55.6	89.85
		70			1943	50316	55.9	89.85
		80			1949	50247	55.9	89.85
		90			1954	50165	55.8	89.85
		100			1957	50066	55.8	89.85
Apache Burnout	26.36	50			7010	78288	166.0	89.79
		60			6756	77579	164.0	89.79
		70			6526	76906	162.0	89.79
		80			6316	76262	159.0	89.79
		90			6124	75643	157.0	89.79
		100			5947	75046	154.0	89.79
Apogee	252.12	50			116	844467	19115.0	0
	243.30	60			109	788186	17301.0	0
	235.37	70			102	739025	15768.0	0
	228.17	80			97	695667	14444.0	0
	221.62	90			92	657204	13298.0	0
	215.61	100			87	622868	12298.0	0
Impact	491.01	50			3644	3986	-38053.0	-89.90
	473.54	60			3684	3986	-34436.0	-89.90
	457.85	70			3709	3986	-31383.0	-89.90
	443.64	80			3722	3986	-28743.0	-89.90
	430.70	90			3727	3986	-26459.0	-89.90
	418.86	100			3726	3986	-24468.0	-89.90

NIKE APACHE DRAG CASE 2
WSMR - LC33
REAL EARTH 20 SEC APACHE IGNITION

	Time (sec)	P/L Wt. (lbs)	Computer Run Number	L/A (deg)	Speed (ft/sec)	Altitude (ft)	Horizontal Range (ft)	Flight Path Angle (deg)
Nike Burnout	3.5	50	381	75	3359	9394	1770	71.72
		60	385		3336	9357	1760	71.70
		70	389		3313	9320	1750	71.68
		80	393		3291	9284	1740	71.66
		90	397		3268	9248	1730	71.64
		100	401		3247	9213	1721	71.62
Apache Ignition	20.0	50			1805	46319	15186	67.18
		60			1819	46332	15215	67.17
		70			1831	46326	15236	67.15
		80			1841	46300	15253	67.13
		90			1849	46258	15262	67.11
		100			1857	46203	15267	67.09
Apache Burnout	26.36	50			6789	70957	26052	65.93
		60			6550	70392	25834	65.90
		70			6333	69852	25632	65.86
		80			6135	69332	25442	65.82
		90			5953	68831	25263	65.78
		100			5786	68347	25091	65.74
Apogee	222.04	50			2589	649786	528398	0
	214.74	60			2509	608929	494782	0
	208.12	70			2436	572980	465180	0
	202.10	80			2369	541088	438912	0
	196.59	90			2307	512684	415517	0
	191.52	100			2250	487223	394547	0
Impact	432.92	50			2689	3986	1053886	-68.24
	418.38	60			2779	3986	986994	-68.23
	405.25	70			2852	3986	928084	-68.22
	393.29	80			2910	3986	875808	-68.22
	382.38	90			2956	3986	829242	-68.23
	372.37	100			2994	3986	787501	-68.23

NIKE APACHE DRAG CASE 2
WSMR - LC33
REAL EARTH 20 SEC APACHE IGNITION

	Time (sec)	P/L Wt. (lbs)	Computer Run Number	L/A (deg)	Speed (ft/sec)	Altitude (ft)	Horizontal Range (ft)	Flight Path Angle (deg)
Nike Burnout	3.5	50	381	80	3359	9544	1198	77.80
		60	385		3336	9506	1191	77.78
		70	389		3313	9469	1184	77.77
		80	393		3290	9432	1178	77.75
		90	397		3268	9396	1171	77.74
		100	401		3246	9360	1164	77.72
Apache Ignition	20.0	50			1810	47835	10274	74.73
		60			1823	47846	10294	74.72
		70			1834	47838	10307	74.71
		80			1844	47809	10317	74.69
		90			1852	47765	10323	74.68
		100			1858	47708	10325	74.66
Apache Burnout	26.36	50			6820	73796	17717	73.88
		60			6577	73192	17565	73.86
		70			6357	72618	17424	73.83
		80			6156	72064	17292	73.80
		90			5972	71532	17167	73.77
		100			5802	71020	17048	73.74
Apogee	234.42	50			1778	727593	384503	0
	226.55	60			1722	680889	359718	0
	219.45	70			1672	639912	337937	0
	212.98	80			1625	603630	318638	0
	207.07	90			1583	571382	301473	0
	201.65	100			1543	542522	286106	0
Impact	456.96	50			2875	3986	764558	-75.30
	441.32	60			2956	3986	715390	-75.30
	427.22	70			3020	3986	672180	-75.30
	414.40	80			3070	3986	633890	-75.31
	402.72	90			3110	3986	599831	-75.31
	392.02	100			3140	3986	569337	-75.32

NIKE APACHE DRAG CASE 2
WSMR - LC33
REAL EARTH 20 SEC APACHE IGNITION

	Time (sec)	P/L Wt. (lbs)	Computer Run Number	L/A (deg)	Speed (ft/sec)	Altitude (ft)	Horizontal Range (ft)	Flight Path Angle (deg)
Nike Burnout	3.5	50	381	85	3359	9636	611	83.89
		60	385		3336	9597	608	83.88
		70	389		3313	9560	604	83.88
		80	393		3290	9522	601	83.87
		90	397		3268	9485	597	83.86
		100	401		3246	9449	594	83.85
Apache Ignition	20.0	50			1813	48761	5182	82.34
		60			1826	48772	5190	82.34
		70			1836	48762	5197	82.33
		80			1845	48732	5202	82.32
		90			1853	48685	5205	82.32
		100			1859	48626	5205	82.31
Apache Burnout	26.36	50			6837	75537	8993	81.91
		60			6592	74909	8919	81.90
		70			6370	74312	8845	81.89
		80			6167	73739	8777	81.88
		90			5982	73187	8713	81.86
		100			5811	72657	8650	81.84
Apogee	241.94	50			908	777176	203540	0
	233.74	60			880	726762	190309	0
	226.33	70			853	682586	178696	0
	219.59	80			829	643519	168418	0
	213.45	90			807	608817	159281	0
	207.82	100			787	577795	151106	0
Impact	471.61	50			2985	3986	401362	-82.59
	455.31	60			3060	3986	375344	-82.59
	440.63	70			3119	3986	352505	-82.60
	427.30	80			3164	3986	332287	-82.60
	415.15	90			3199	3986	314314	-82.60
	404.02	100			3225	3986	298231	-82.61

NIKE APACHE DRAG CASE 2
 WSMR - LC33
 REAL EARTH 20 SEC APACHE IGNITION

	Time (sec)	P/L Wt. (lbs)	Computer Run Number	L/A (deg)	Speed (ft/sec)	Altitude (ft)	Horizontal Range (ft)	Flight Path Angle (deg)
Nike Burnout	3.5	50	381	90	3359	9667	-17	89.98
		60	385		3336	9628	-17	89.98
		70	389		3313	9590	-17	89.98
		80	393		3290	9553	-16	89.98
		90	397		3268	9516	-16	89.98
		100	401		3246	9478	-17	89.98
Apache Ignition	20.0	50			1814	49074	-54	89.85
		60			1826	49084	-54	89.85
		70			1837	49073	-54	89.85
		80			1846	49042	-54	89.85
		90			1853	48996	-54	89.85
		100			1860	48932	-54	89.85
Apache Burnout	26.36	50			6842	76125	-162	89.79
		60			6597	75489	-159	89.79
		70			6374	74884	-157	89.79
		80			6171	74303	-155	89.79
		90			5985	73747	-152	89.79
		100			5813	73207	-151	89.79
Apogee	244.46	50			110	794209	-17565	0
	236.15	60			103	742530	-15935	0
	228.64	70			97	697248	-14553	0
	221.82	80			92	657219	-13354	0
	215.60	90			87	621695	-12316	0
	209.89	100			83	589905	-11409	0
Impact	476.53	50			3020	3986	-34961	-89.90
	460.02	60			3094	3986	-31712	-89.90
	445.14	70			3151	3986	-28957	-89.90
	431.63	80			3195	3986	-26570	-89.91
	419.33	90			3228	3986	-24501	-89.91
	408.06	100			3253	3986	-22693	-89.91

NIKE APACHE DRAG CASE 3
WSMR - LC33
REAL EARTH 20 SEC APACHE IGNITION

	Time (sec)	P/L Wt. (lbs)	Computer Run Number	L/A (deg)	Speed (ft/sec)	Altitude (ft)	Horizontal Range (ft)	Flight Path Angle (deg)
Nike Burnout	3.5	50	382	75	3359	9394	1770	71.72
		60	386		3336	9357	1760	71.70
		70	390		3313	9320	1750	71.68
		80	394		3291	9284	1740	71.66
		90	398		3268	9248	1730	71.64
		100	402		3247	9213	1721	71.62
Apache Ignition	20.0	50			1679	44832	14676	66.93
		60			1696	44890	14719	66.92
		70			1711	44928	14755	66.92
		80			1724	44944	14785	66.91
		90			1736	44942	14808	66.89
		100			1746	44926	14824	66.88
Apache Burnout	26.36	50			6571	68503	25270	65.60
		60			6344	68020	25074	65.58
		70			6137	67557	24892	65.56
		80			5948	67110	24723	65.52
		90			5775	66679	24562	65.49
		100			5616	66262	24410	65.46
Apogee	211.39	50			2503	589333	485147	0
	204.82	60			2427	554154	455419	0
	198.84	70			2358	523050	429146	0
	193.38	80			2294	495376	405795	0
	188.37	90			2236	470610	384916	0
	183.75	100			2182	448338	366157	0
Impact	413.67	50			2002	3986	967760	-68.81
	400.42	60			2114	3986	908602	-68.73
	388.42	70			2209	3986	856314	-68.68
	377.49	80			2291	3986	809833	-68.64
	367.48	90			2361	3986	768268	-68.61
	358.28	100			2422	3986	730922	-68.59

NIKE APACHE DRAG CASE 3
WSMR - LC33
REAL EARTH 20 SEC APACHE IGNITION

	Time (sec)	P/L Wt. (lbs)	Computer Run Number	L/A (deg)	Speed (ft/sec)	Altitude (ft)	Horizontal Range (ft)	Flight Path Angle (deg)
Nike Burnout	3.5	50	382	80	3359	9544	1198	77.79
		60	386		3336	9506	1191	77.78
		70	390		3313	9469	1184	77.77
		80	394		3290	9432	1178	77.75
		90	398		3268	9396	1171	77.74
		100	402		3246	9360	1164	77.72
Apache Ignition	20.0	50			1685	46312	9932	74.56
		60			1701	46369	9961	74.55
		70			1716	46407	9983	74.55
		80			1728	46422	10002	74.54
		90			1739	46419	10017	74.53
		100			1749	46402	10029	74.52
Apache Burnout	26.36	50			6610	71308	17197	73.66
		60			6378	70785	17061	73.64
		70			6168	70290	16933	73.62
		80			5976	69811	16814	73.60
		90			5800	69351	16702	73.58
		100			5638	68906	16596	73.55
Apogee	224.30	50			1727	666392	356602	0
	217.10	60			1674	625360	334263	0
	210.59	70			1625	589241	314591	0
	204.65	80			1581	557189	297140	0
	199.21	90			1540	528594	281574	0
	194.21	100			1502	502932	267611	0
Impact	438.42	50			2175	3986	709234	-75.58
	424.00	60			2282	3986	664912	-75.54
	410.97	70			2372	3986	625875	-75.52
	399.13	80			2449	3986	591244	-75.51
	388.30	90			2514	3986	560352	-75.50
	378.36	100			2569	3986	532638	-75.50

NIKE APACHE DRAG CASE 3
 WSMR - LC33
 REAL EARTH 20 SEC APACHE IGNITION

	Time (sec)	P/L Wt. (lbs)	Computer Run Number	L/A (deg)	Speed (ft/sec)	Altitude (ft)	Horizontal Range (ft)	Flight Path Angle (deg)
Nike Burnout	3.5	50	382	85	3359	9636	611	83.89
		60	386		3336	9597	608	83.88
		70	390		3313	9560	604	83.88
		80	394		3290	9522	601	83.87
		90	398		3268	9485	597	83.86
		100	402		3246	9449	594	83.85
Apache Ignition	20.0	50			1688	47216	5010	82.26
		60			1704	47274	5024	82.26
		70			1718	47310	5036	82.25
		80			1730	47324	5045	82.25
		90			1741	47320	5052	82.24
		100			1750	47301	5057	82.24
Apache Burnout	26.36	50			6631	73028	8737	81.80
		60			6397	72483	8666	81.80
		70			6185	71965	8600	81.78
		80			5991	71467	8538	81.77
		90			5814	70987	8480	81.76
		100			5650	70524	8424	81.75
Apogee	232.13	50			884	715691	189766	0
	224.57	60			856	670933	177730	0
	217.73	70			831	631584	167142	0
	211.50	80			808	596749	157770	0
	205.80	90			787	565690	149414	0
	200.57	100			768	537856	141926	0
Impact	453.52	50			2279	3986	374331	-82.70
	438.40	60			2383	3986	350653	-82.69
	424.75	70			2470	3986	329822	-82.69
	412.36	80			2543	3986	311378	-82.68
	401.03	90			2604	3986	294934	-82.68
	390.65	100			2656	3986	280200	-82.68

NIKE APACHE DRAG CASE 3
WSMR - LC33
REAL EARTH 20 SEC APACHE IGNITION

	Time (sec)	P/L Wt. (lbs)	Computer Run Number	L/A (deg)	Speed (ft/sec)	Altitude (ft)	Horizontal Range (ft)	Flight Path Angle (deg)
Nike Burnout	3.5	50	382	90	3359	9667	-17	89.98
		60	386		3336	9628	-17	89.98
		70	390		3313	9590	-17	89.98
		80	394		3290	9553	-16	89.98
		90	398		3268	9516	-16	89.98
		100	402		3246	9478	-17	89.98
Apache Ignition	20.0	50			1689	47522	-51	89.85
		60			1705	47579	-51	89.85
		70			1719	47615	-52	89.85
		80			1731	47628	-52	89.85
		90			1741	47624	-52	89.85
		100			1750	47603	-52	89.85
Apache Burnout	26.36	50			6638	73610	-156	89.79
		60			6404	73056	-154	89.79
		70			6191	72531	-151	89.79
		80			5996	72026	-150	89.79
		90			5818	71540	-147	89.79
		100			5653	71069	-146	89.79
Apogee	234.76	50			102	732671	-15710	0
	227.08	60			96	686632	-14297	0
	220.13	70			91	646171	-13096	0
	213.80	80			86	610366	-12053	0
	208.02	90			81	578471	-11143	0
	202.71	100			78	549873	-10347	0
Impact	458.60	50			2315	3986	-31258	-89.91
	443.25	60			2417	3986	-28445	-89.92
	429.39	70			2502	3986	-26052	-89.92
	416.81	80			2574	3986	-23972	-89.92
	405.32	90			2634	3986	-22162	-89.92
	394.78	100			2685	3986	-20577	-89.92

NIKE APACHE DRAG CASE 4
WSMR - LC33
REAL EARTH 20 SEC APACHE IGNITION

	Time (sec)	P/L Wt. (lbs)	Computer Run Number	L/A (deg)	Speed (ft/sec)	Altitude (ft)	Horizontal Range (ft)	Flight Path Angle (deg)
Nike Burnout	3.5	50	383	75	3359	9394	1770	71.72
		60	387		3336	9357	1760	71.70
		70	391		3313	9320	1750	71.68
		80	395		3290	9284	1740	71.66
		90	399		3268	9248	1730	71.64
		100	403		3247	9213	1721	71.62
Apache Ignition	20.0	50			1415	41818	13633	66.30
		60			1437	41955	13703	66.32
		70			1458	42070	13764	66.34
		80			1476	42160	13819	66.35
		90			1493	42231	13866	66.36
		100			1509	42284	13906	66.36
Apache Burnout	26.36	50			6113	63459	23678	64.78
		60			5912	63128	23520	64.79
		70			5728	62810	23375	64.79
		80			5559	62499	23239	64.78
		90			5403	62196	23112	64.77
		100			5260	61900	22993	64.75
Apogee	188.54	50			2308	469200	396662	0
	183.63	60			2244	445565	375336	0
	179.09	70			2185	424269	356191	0
	174.88	80			2131	404953	338900	0
	170.96	90			2080	387399	323242	0
	167.30	100			2033	371370	308995	0
Impact	373.92	50			1064	3986	791215	-71.53
	363.36	60			1176	3986	748816	-71.00
	353.73	70			1281	3986	710738	-70.61
	344.88	80			1377	3986	676335	-70.33
	336.72	90			1466	3986	645173	-70.11
	329.16	100			1546	3986	616811	-69.95

NIKE APACHE DRAG CASE 4
WSMR - LC33
REAL EARTH 20 SEC APACHE IGNITION

	Time (sec)	P/L Wt. (lbs)	Computer Run Number	L/A (deg)	Speed (ft/sec)	Altitude (ft)	Horizontal Range (ft)	Flight Path Angle (deg)
Nike Burnout	3.5	50	383	80	3359	9544	1198	77.80
		60	387		3336	9506	1191	77.78
		70	391		3313	9469	1184	77.77
		80	395		3290	9432	1178	77.75
		90	399		3268	9396	1171	77.74
		100	403		3246	9360	1164	77.72
Apache Ignition	20.0	50			1423	43227	9234	74.14
		60			1445	43366	9282	74.15
		70			1465	43483	9322	74.16
		80			1483	43576	9356	74.17
		90			1499	43647	9388	74.17
		100			1514	43700	9414	74.17
Apache Burnout	26.36	50			6168	66204	16144	73.10
		60			5961	65833	16032	73.11
		70			5772	65482	15928	73.11
		80			5599	65141	15831	73.10
		90			5440	64810	15741	73.09
		100			5292	64488	15657	73.08
Apogee	202.52	50			1612	543328	298987	0
	196.88	60			1566	514054	282030	0
	191.70	70			1523	487916	266925	0
	186.93	80			1484	464379	253366	0
	182.52	90			1447	443115	241153	0
	178.42	100			1413	423821	230102	0
Impact	399.71	50			1194	3986	594825	76.92
	387.90	60			1313	3986	561183	76.66
	377.16	70			1421	3986	531214	76.48
	367.33	80			1519	3986	504305	76.34
	358.28	90			1608	3986	480060	76.24
	349.93	100			1687	3986	458118	76.17

NIKE APACHE DRAG CASE 4
WSMR - LC33
REAL EARTH 20 SEC APACHE IGNITION

	Time (sec)	P/L Wt. (lbs)	Computer Run Number	L/A (deg)	Speed (ft/sec)	Altitude (ft)	Horizontal Range (ft)	Flight Path Angle (deg)
Nike Burnout	3.5	50	383	85	3359	9636	611	83.89
		60	387		3336	9597	608	83.88
		70	391		3313	9560	604	83.88
		80	395		3290	9522	601	83.87
		90	399		3268	9485	597	83.86
		100	403		3246	9449	594	83.85
Apache Ignition	20.0	50			1428	44090	4661	82.05
		60			1449	44231	4684	82.05
		70			1469	44348	4703	82.06
		80			1486	44441	4722	82.06
		90			1502	44512	4737	82.06
		100			1517	44565	4750	82.06
Apache Burnout	26.36	50			6199	67892	8211	81.53
		60			5989	67498	8152	81.53
		70			5797	67125	8096	81.53
		80			5621	66763	8046	81.52
		90			5460	66413	7998	81.52
		100			5311	66075	7954	81.51
Apogee	211.02	50			830	591410	161240	0
	204.94	60			806	558457	151842	0
	199.39	70			783	529130	143492	0
	194.28	80			762	502826	136025	0
	189.56	90			743	479136	129315	0
	185.20	100			725	457719	123261	0
Impact	415.60	50			1280	3986	318273	-83.26
	403.01	60			1401	3986	299770	-83.16
	391.59	70			1510	3986	283334	-83.08
	381.14	80			1608	3986	268630	-83.03
	371.55	90			1696	3986	255419	-82.99
	362.71	100			1774	3986	243498	-82.96

NIKE APACHE DRAG CASE 4
WSMR - LC33
REAL EARTH 20 SEC APACHE IGNITION

	Time (sec)	P/L Wt. (lbs)	Computer Run Number	L/A (deg)	Speed (ft/sec)	Altitude (ft)	Horizontal Range (ft)	Flight Path Angle (deg)
Nike Burnout	3.5	50	383	90	3359	9667	-17	89.98
		60	387		3336	9628	-17	89.98
		70	391		3313	9590	-17	89.98
		80	395		3290	9553	-16	89.98
		90	399		3268	9516	-16	89.98
		100	403		3246	9478	-17	89.98
Apache Ignition	20.0	50			1429	44381	-46	89.84
		60			1450	44524	-46	89.84
		70			1470	44640	-47	89.84
		80			1488	44732	-48	89.84
		90			1504	44806	-48	89.84
		100			1518	44856	-48	89.84
Apache Burnout	26.36	50			6209	68462	-145	89.79
		60			5998	68062	-143	89.79
		70			5805	67680	-141	89.79
		80			5628	67312	-139	89.79
		90			5466	66957	-138	89.79
		100			5317	66609	-136	89.79
Apogee	213.88	50			86	608062	-12134	0
	207.66	60			82	573838	-11150	0
	201.97	70			77	543398	-10301	0
	196.75	80			74	516130	-9551	0
	191.94	90			70	491622	-8891	0
	187.48	100			67	469432	-8306	0
Impact	420.96	50			1310	3986	-24123	-89.95
	408.12	60			1431	3986	-22164	-89.94
	396.46	70			1540	3986	-20475	-89.94
	385.80	80			1638	3986	-18983	-89.94
	376.04	90			1726	3986	-17670	-89.94
	376.02	100			1803	3986	-16505	-89.94

PRECEDING PAGE BLANK NOT FILMED.

APPENDIX C

Postflight Verification of Nike Apache
Performance Using Actual Data

APPENDIX C

As a means of checking the validity of preflight computer predictions of rocket trajectory results, a postflight verification study was made by computer, using the following inputs:

- The GE MASS input data as given in Appendix A
- Actual payload weights as given in the vehicle manager's postflight summary
- Actual second-stage ignition time as determined by the speed/time history from radar
- The effective launch angle as determined by examining the flight path angle given by radar

The figure shows the difference between actual and theoretical apogee versus the difference in actual and theoretical impact range.

Note that the points are not randomly scattered, but rather lie within a sector that suggests an over- or under-performance rather than an error in launch angle.

Superimposed on this plot are two lines which together form the envelope of apogee and impact range dispersion caused by the deviation in second-stage weight.

The distance along the line represents the change in dispersion with a change in weight. The line with the greater slope represents Drag Case 1, flown at a launch angle of 85 degrees. The line with the lesser slope represents Drag Case 4, flown at a launch angle of 80 degrees.

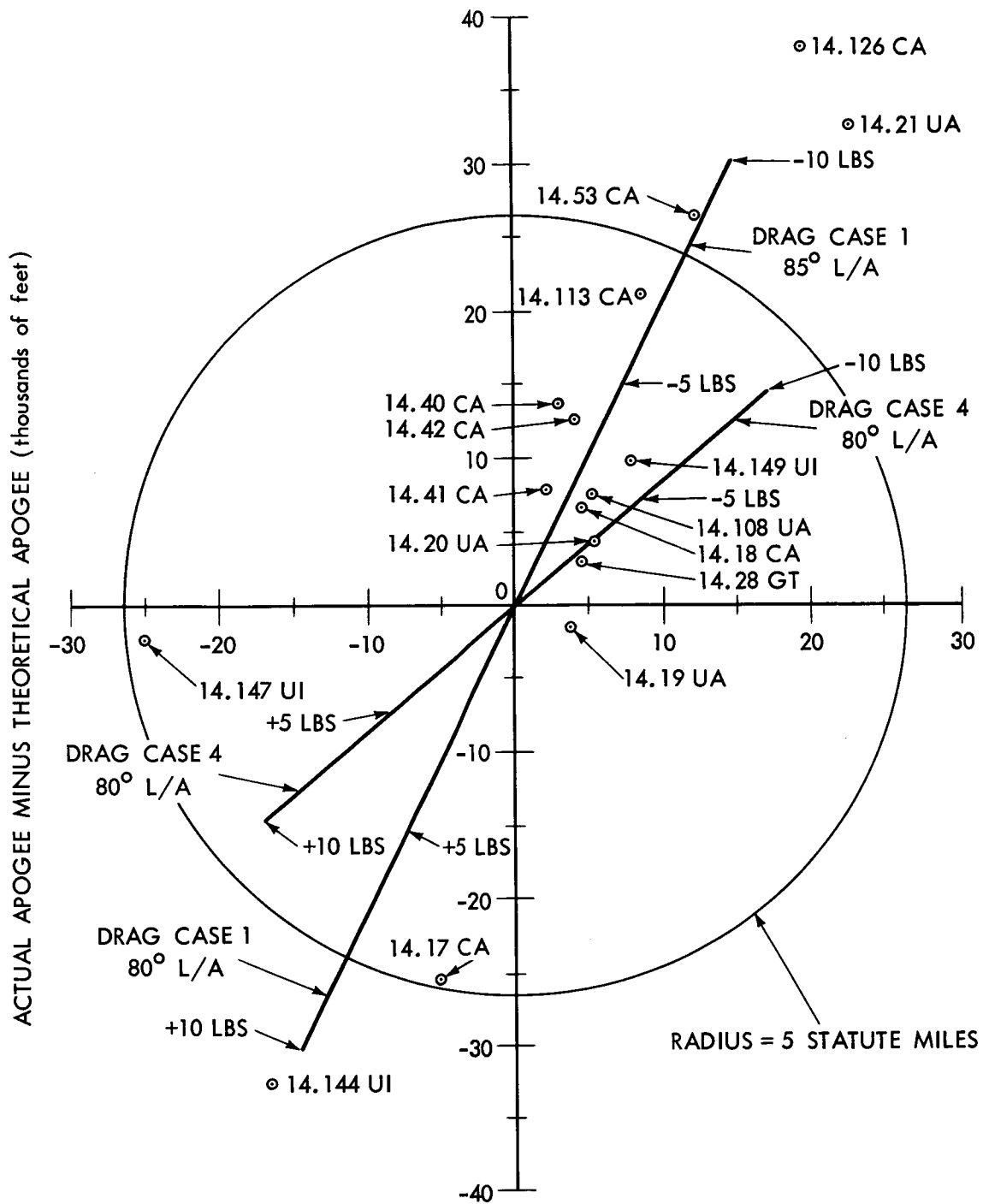

ACTUAL APOGEE MINUS THEORETICAL APOGEE (thousands of feet)

ACTUAL IMPACT RANGE MINUS THEORETICAL IMPACT RANGE (thousands of feet)