

G. T. Schjeldahl Company
Northfield, Minnesota
14 July 1967

NASA CR-66589

PEPP REPORT
PR25-32
B/L - 2

DESIGN REPORT

65 FOOT DIAMETER D-G-B PARACHUTE

PLANETARY ENTRY PARACHUTE PROGRAM

FACILITY FORM 602

(THRU) 1
(CODE) 02
(CATEGORY) 02

(ACCESSION NUMBER) 77
(PAGES) 77
(NASA CR OR TMX OR AD NUMBER) CR-66589

N68-20319

GPO PRICE \$ _____

CSFTI PRICE(S) \$ _____

Submitted to:

Hard copy (HC) 300

Martin-Marietta Corporation
Denver, Colorado

Microfiche (MF) 65

ff 653 July 65

Contract No. RC7-709020

NA51-6703

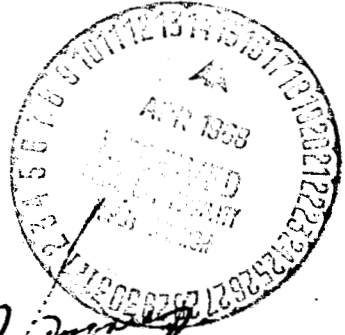

Prepared by:

Reinhold A. Lemke
Reinhold A. Lemke
Project Engineer

Richard D. Moroney
Richard D. Moroney
Program Manager

Ronald J. Niccum
Ronald J. Niccum
Staff Scientist

Theo. J. Neuhaus
Theodore J. Neuhaus
Report Editor

Distribution of this report is provided in the interest of information exchange. Responsibility for its contents resides in the author or organization that prepared it.

ABSTRACT

The design presented describes a 65-foot nominal diameter Disk-Gap-Band parachute tested as a candidate in the Planetary Entry Parachute Program. This report includes design requirements, estimates of maximum expected loads on the parachute, parachute configuration, stress analysis, moment of inertia, and component structural test data.

TABLE OF CONTENTS

List of Figures	ii
Table of Symbols	iii
1.0 Introduction	1
2.0 Design Specification	2
3.0 Design Data	5
4.0 Gore Layout and Parachute Configuration	6
5.0 Snatch Force	9
6.0 Opening Force	11
7.0 Parachute Sizing	13
8.0 Stress Analysis	23
9.0 Center of Gravity	34
10.0 Moments of Inertia	36
11.0 Fabrication and Packing	44

Appendices

- A GTSC Specification P-444**
- B Simplified Cloth Stress Analysis**
- C Component Structural Test Reports**

LIST OF FIGURES

1.	DGB Parachute System	4
2.	Inflated versus Constructed Shape	8
3.	Opening Force versus Diameter	15
4.	Opening Force versus Suspension Line Requirement	16
5.	Canopy Weight versus D_o	17
6.	Line Weight versus $\frac{D_o}{z}$	18
7.	Line Weight versus $\frac{D_o}{z}$	19
8.	Tape Weight versus $\frac{D_o}{z}$	20
9.	Tape Weight versus $\frac{D_o}{z}$	21
10.	Skirt Weight versus Band Tape	22
11.	Margin of Safety at Critical Points	32
12.	Parachute Folded	45
13.	Suspension Lines Folded	46
14.	Disc Portion Packed	47

TABLE OF SYMBOLS

<u>Symbol</u>	<u>Meaning</u>	<u>Units</u>
V_o	Deployment Velocity	ft/sec
V_e	Ejection Velocity	ft/sec
V_{op}	Parachute Velocity at ejection	ft/sec
V_s	Parachute Velocity at snatch	ft/sec
M	Mach Number	
q	Dynamic Pressure	Psf
P	Snatch Force	lbs
M_c	Mass of Canopy	slugs
Z	No. of suspension lines	
P'	Suspension line strength	lbs
L_s	Suspension line length	ft
L_r	Riser length	ft
ρ	Density	slugs/ft ³
ξ'	Break elongation	in/in
C_D	Drag Coefficient	
S_o	Nominal Canopy Area	ft ²
F_o	Opening shock load	lbs
Pult	Ultimate strength	lbs
Pall	Allowable load	lbs
M.S.	Margin of safety	
fd	Design Factor	
P_{sl}	Suspension line load	lbs
P_H	Horizontal suspension line load	lb

<u>Symbol</u>	<u>Meaning</u>	<u>Units</u>
P_{vb}	Vent band load	lb
P	Skirt band load	lb
r_b	Gore bulge radius	in
S_{od}	Nominal disc area	ft ²

1.0 INTRODUCTION

The design presented herein describes completely a 65-foot nominal diameter Disc-Gap-Band parachute to be tested as a candidate in the Planetary Entry Parachute Program. This report includes design requirements, estimates of maximum expected loads on the parachute, parachute configuration, stress analysis, moment of inertia, and component structural test data.

2.0 DESIGN SPECIFICATIONS

2.1 The parachute is a disc-gap-band type with a constructed geometric shape in accordance with LRC drawing LA-151, 822.

The nominal surface area of the parachute (S_o) is equal to the sum of the surface areas of the disc, gap, and band.

The parachute is designed in such a manner that S_o is as large as possible within the limits of these specifications. The minimum S_o is 3315 feet².

The disc is a regular polygon with an even number of sides. The maximum length of each side is 3 feet. There is a vent in the center of the disc and the area of the vent is equal to 0.5 percent of S_o . The surface area of the disc, including the vent area, is 53.0 percent of S_o .

The band is a right cylinder circumscribing the disc. The surface area of the band is 35 percent of S_o .

The area of the gap is 12.0 percent of S_o .

The number of suspension lines is equal to the number of sides on the disc. The length of each suspension is $1.128 (S_o)^{\frac{1}{2}}$ ~~1.128~~.

2.2 The riser, bridle, and deployment bag are in accordance with LRC drawing LC-151, 821.

2.3 The weight of the canopy and suspension lines is less than 80 pounds. The maximum weight of the parachute system, as supplied by the parachute supplier, is 86 pounds.

2.4 The parachute is designed to be capable of withstanding the following deployment conditions without structural failure:

- (a) 600 pounds load suspended on parachute
- (b) Mach number 1.6 at a dynamic pressure of 12 pounds/square foot.
- (c) Mortar ejection velocity of 130 feet/second.

2.5 All structural fabric material chosen for the parachute system is dacron. All lines, tapes, webbing, and threads are of a hi-tenacity type dacron material.

2.6 The complete parachute system is capable of withstanding 125° C for 91 hours while packed and is designed to be able to withstand deployment and opening loads without structural failure.

2.7 The canopy is white with a blue stripe on the inside of the canopy from the vent to the bottom of the band. Width of the stripe is 6 inches, tapering toward the vent. On the skirt there are 3-inch by 12-inch stripes at each suspension line and mid-gore location. The substance used to stripe the canopy will not structurally degrade or impair the flexibility of the canopy material.

2.8 The parachute system (excluding deployment bag) is shown in Figure 1.

DGB PARACHUTE SYSTEM

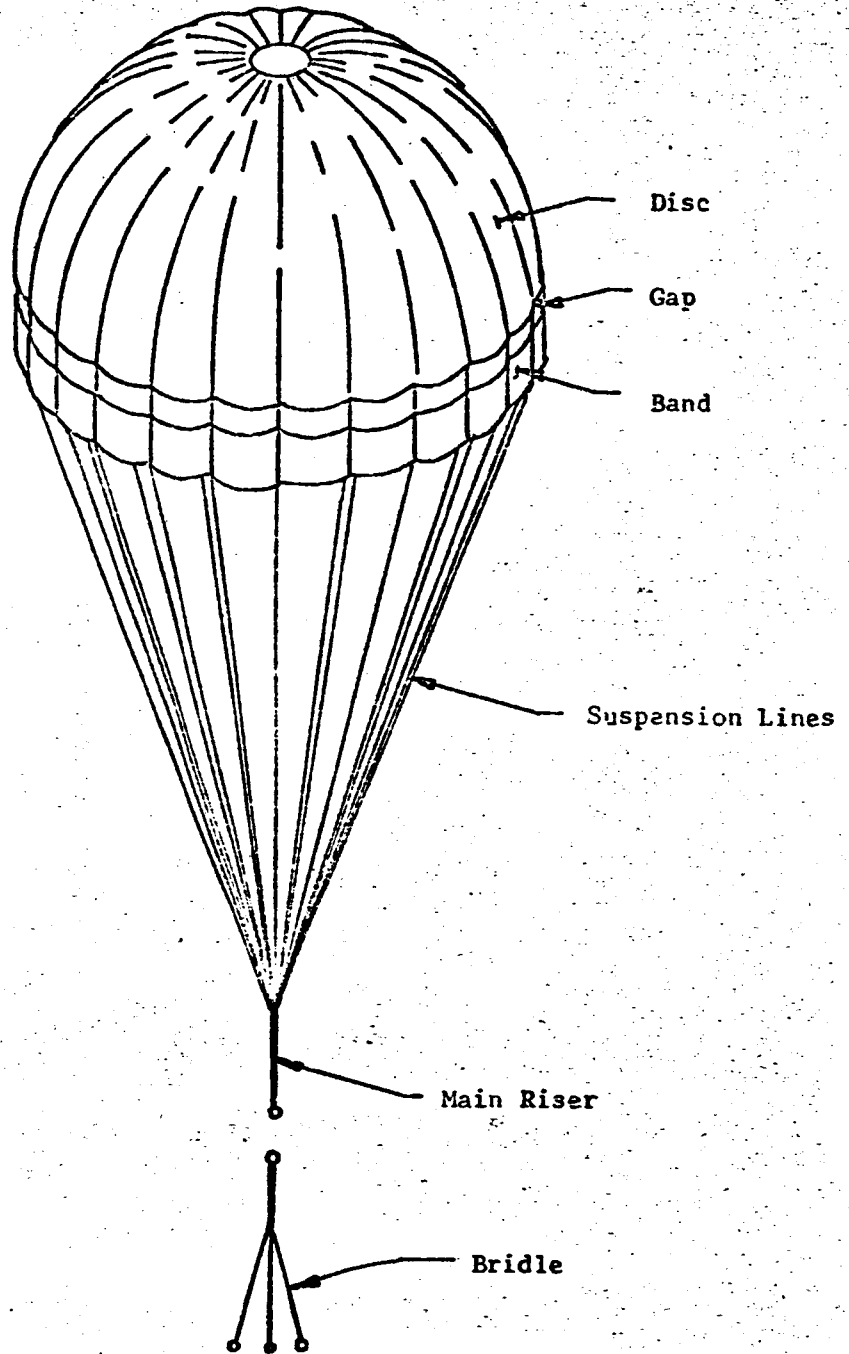

FIGURE I

3.0 DESIGN DATA

(65 FT D_o DGB)

Nominal Diameter (D_o)	65 ft.
Geometric Porosity (λg)	12.5 percent
Total Area (S_o)	3318.30 ft ²
Disc Area (.53 S_o)	1758.70 ft ²
Disc Diameter	47.65 ft.
Disc Circumference	152.84 ft.
Gap Area (.12 S_o)	398.20 ft ²
Gap Width	2.605 ft.
Band Area (.35 S_o)	1161.41 ft ²
Band Width	7.599 ft.
Vent Area (.005 S_o)	17.592 ft ²
Vent Diameter	4.732 ft.
No. of suspension lines	72
Length of suspension lines	65 ft/

4.0 GORE LAYOUT AND PARACHUTE CONFIGURATION

Based on a geometric porosity of 12.5 percent, the gore layout is calculated as follows:

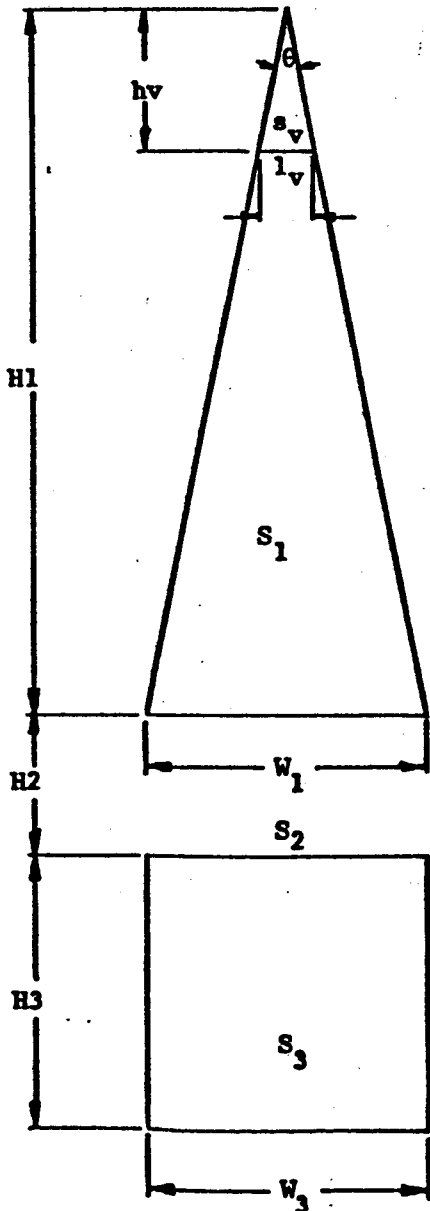

$$S_o = \frac{\pi}{4} D_o^2$$

$$Z = 72$$

$$\theta = \frac{360}{72} = 5^\circ$$

$$S_o = \frac{3318.30}{72} \times 144 \text{ in}^2 = 6636.60 \text{ in}^2$$

$$S_1 = 0.53 S_o = 3517.40 \text{ in}^2$$

$$S_2 = 0.12 S_o = 796.39 \text{ in}^2$$

$$S_3 = 0.35 S_o = 2322.81 \text{ in}^2$$

$$s_v = .005 S_o = 33.18 \text{ in}^2$$

$$H_1 = \sqrt{\frac{3517.40}{0.04366}} = 283.9 \text{ in.}$$

$$W_1 = W_3 = \frac{2 \times 3517.4}{283.9} = 24.78 \text{ in.}$$

$$H_2 = \frac{S_2}{W_1} = \frac{796.39}{24.78} = 32.14 \text{ in.}$$

$$H_3 = \frac{S_3}{W_1} = \frac{2322.81}{24.78} = 93.73 \text{ in.}$$

$$h_v = \sqrt{\frac{33.18}{0.04366}} = 27.57 \text{ in.}$$

$$l_v = \frac{2 \times s_v}{n_v} = 2.41 \text{ in.}$$

To allow stress relief at vent, add 10 percent fullness at vent

$$l_v' = \frac{l_v}{0.9} = 2.68 \text{ in.}$$

New apex angle θ_1

$$\tan \theta_{1/2} = \frac{24.78 - 2.68}{2} = \frac{11.05}{256.33} = .0431$$

New construction height of disc

$$\tan \theta_{1/2} = \frac{24.78}{\text{height}}$$

$$\text{Height} = \frac{12.39}{\tan \theta_{1/2}} = \frac{12.39}{0.0431} = 287.47 \text{ in.}$$

With this gore layout, the constructed shape as well as the expected inflated shape is as shown in Figure 2.

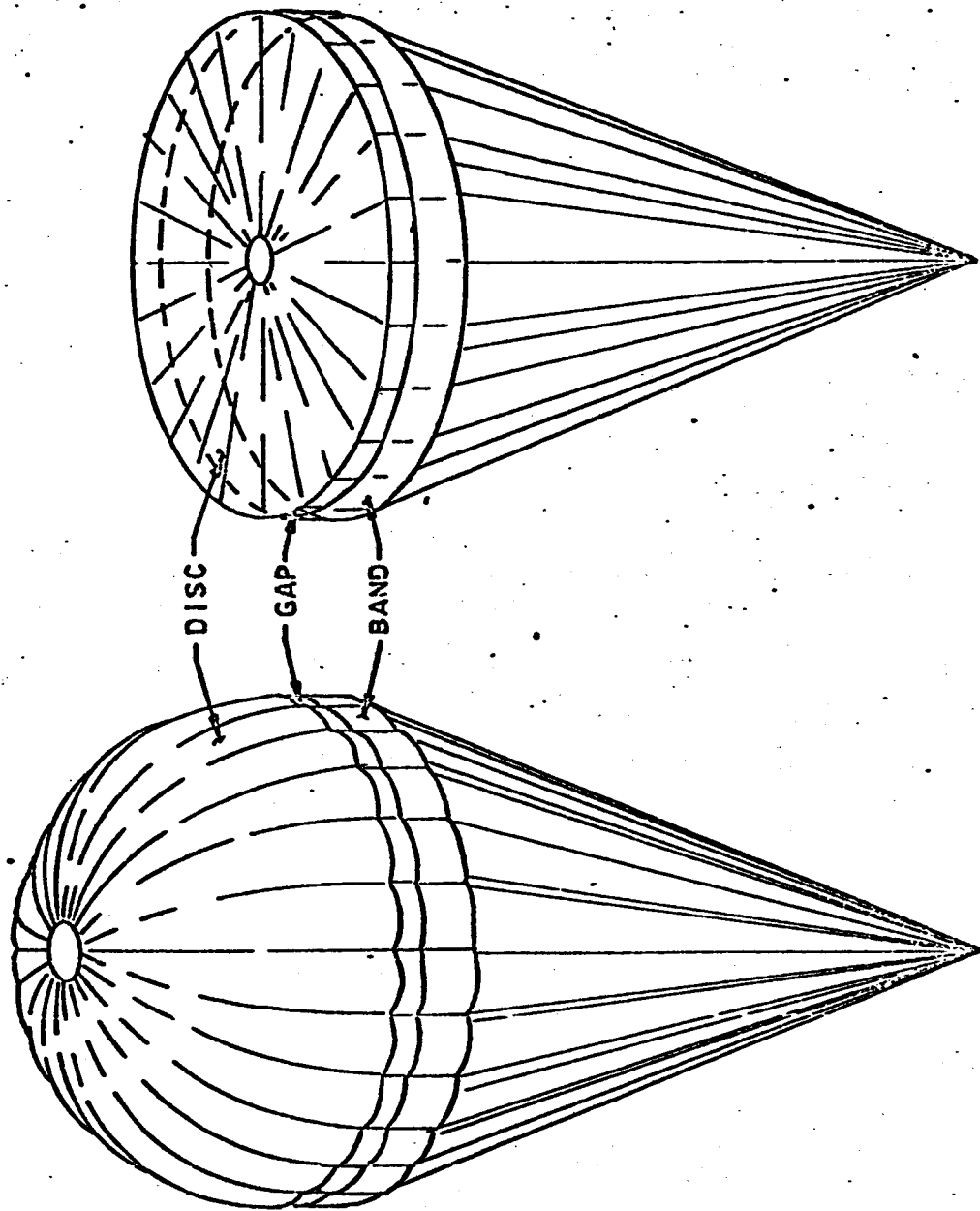

CONSTRUCTED SHAPE

EXPECTED INFLATED SHAPE

FIGURE 2

5.0 SNATCH FORCE

The parachute deployment bag is ejected rearward by means of a mortar and may, therefore, be treated in the classical manner as presented in reference 1.

Thus from equation 4-26

$$P = \sqrt{\frac{Mc(\Delta V)^2 Z P'}{L_s \xi'}}$$

Where: $Z = 72$
 $P' = 550 \text{ lbs}$
 $\xi' = 20 \%$
 $L_s = 65 \text{ ft}$

and with the design conditions defined as

$$M = 1.6 @ q = 12 \text{ psf}, V_o = 1665 \text{ fps}$$

which for the worst case can be assumed constant throughout the period of deployment.

Next the velocity of the deployment bag mass may be determined by considering the following:

For a cylinder of $l/d = 2.5$ with blunt end forward, $C_D = 0.85$

(reference 2) and since the bag diameter = 1 ft., $C_D S = 0.67 \text{ ft}^2$

Also the time from mortar ejection to line stretch may be computed assuming a mortar ejection velocity, $V_e = 130 \text{ fps}$ and

$$t = \frac{L_s + L_r}{V_e} = 0.582$$

hence defining initial parachute velocity as

$$V_{op} = V_o - V_e \text{ or } V_{op} = 1535 \text{ fps}$$

Thus velocity of the deployment bag system at line stretch is

$$V_s = \frac{V_{op}}{\rho/2 \frac{C_D S}{Mc} V_{op} t + 1} \approx 1525 \text{ fps}$$

and the velocity of the bag and canopy relative to the payload is

$$V_r = \Delta V = 1665 - 1525 = 140 \text{ fps}$$

and the snatch force is $P = 8900 \text{ lbs.}$

6.0 OPENING FORCE

The results of an earlier experiment with a 30-foot diameter DGB at essentially the same design conditions ($q=11.4$ psf, $M=1.56$) showed a maximum opening force of approximately 4000 lbs. Further, the opening process was of the so-called infinite mass type.

Calculating a shock factor for this case

$$X = \frac{F_o}{F_{s.s.}} = \frac{4000}{4200} = 0.94$$

which is considerably below what would normally be expected for this type canopy. (reference 1 and 3).

However, since the process is an essentially infinite mass type, calculations using finite mass approaches yield extraneous results.

Therefore, it was decided to simply scale the expected maximum force on the basis of area ratios from the smaller canopy to this:

$$F_o = F_o)_{30'} \times \frac{D_o^2}{D_o^2} \frac{65}{30}$$

$$F_o = 18,800 \text{ lbs}$$

Interestingly, Pioneer Parachute Company computed the expected opening shock by means of a computer with the filling time as a parameter. The results yielded 18,522 lb. assuming $t_f = 0.4$ secs and 16,980 lbs. assuming $t_f = 0.5$ sec. The variation in filling time comes from extending the $C_D S_o$ vs. time plot from the 30-ft test data to reach $C_D S_o$ maximum for the 65-ft canopy. This slope is so steep that an accurate value can not be attained. Therefore, two reasonable slopes have been chosen.

Because of the close agreement of the computer results to our calculations, it is felt that the maximum force expected is predicted with a high degree of confidence.

7.0 PARACHUTE SIZING

As previously shown, the maximum expected force was computed as a function of the area ratio of a given size canopy relative to the 30-ft DGB. This allows a rough computation of weight versus diameter to be made by using the graphs, Figures 3 - 10.

With the restrictions of a maximum allowable weight and minimum $S_o = 3315$ ft., an iteration process was made to provide a canopy which satisfied these requirements.

For the initially determined configuration which was $D_o = 65$ ft., 80 gores with 550 lb. suspension lines, yields an estimated weight of 70.2 lbs. (This did not include seam allowance.)

Conversations with Pioneer indicated that a four group arrangement of suspension lines with 20 per riser was not practical from a fabrication standpoint and that a six group arrangement was more reasonable. This point together with the fact that the suspension line material tests out at approximately 600 lbs., ultimate strength led to the reduction in number of suspension lines from 80 to 72.

Using the revised design $D_o = 65$ ft., $Z = 72$, and an exact gore layout Pioneer gave a weight estimate of $w = 72.73$ lbs. excluding thread (~ 1.5 lbs) and risers.

Gore layout is based on 41.5 wide material (1.5 oz/yd²) in the disc and 45 inch wide 1.0 oz/yd² material in the band with 10% fullness in vent area tapering to zero at skirt of disc.

Weight Estimate

<u>Item</u>	<u>Qty (yds)</u>	<u>Units Wt.</u>	<u>Total Wt. (lbs)</u>
1. Disc	235.41	1.5 oz/yd ²	22.28
2. Band	140.43	1.0 oz/yd	9.28
3. Cross seam reinforcement	143.5	0.158 oz/yd ²	2.27
4. Gap reinforcement	101.65	0.2535 oz/yd	1.67
5. Vent reinforcement	4.96	0.2535 oz/yd	0.79
6. Radial tapes	832.86	0.2535 oz/yd	13.55
7. Radial gap reinforcement	94.02	0.1580 oz/yd	0.79
8. Skirt reinforcement	50.82	0.2535 oz/yd	0.81
9. Suspension lines	1583.52	74.25 yd/lb	21.33

Total Excluding Thread & Riser 72.73 lbs.

OPENING FORCE VS DIAMETER

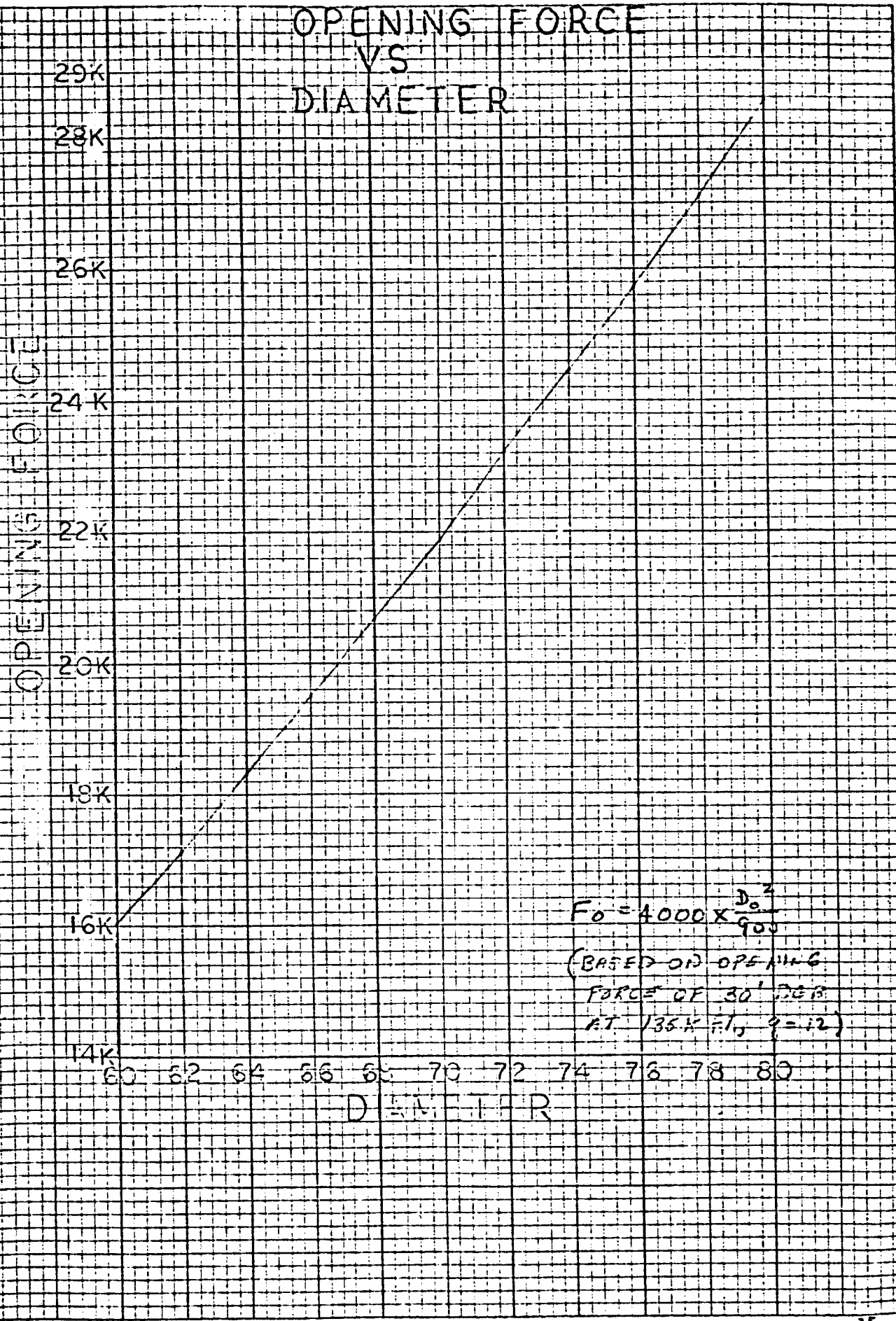

EUGENE DIETZGEN CO.
MADE IN U. S. A.

NO. 340-10 DIETZGEN GRAPH PAPER
10 X 10 PER INCH

FIGURE 3

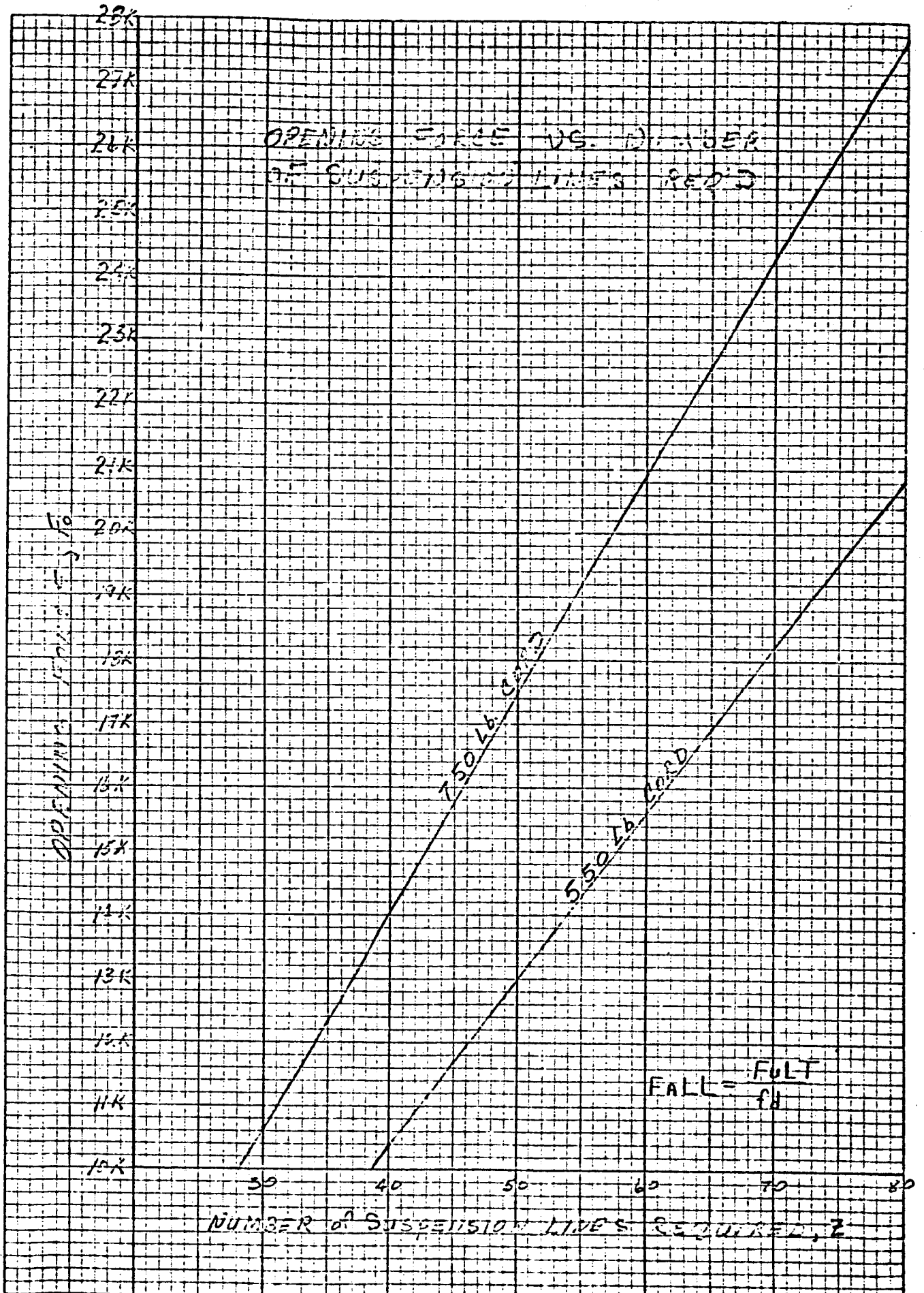

FIGURE 4

MADE IN U. S. A.
 COMPANY OF TERRY N. CO.
 10 X 10 PER INCH

NO. 340-10 DIETZGEN GRAPH PAPER
 10 X 10 PER INCH
 EUGENE DIETZGEN CO.
 MADE IN U. S. A.

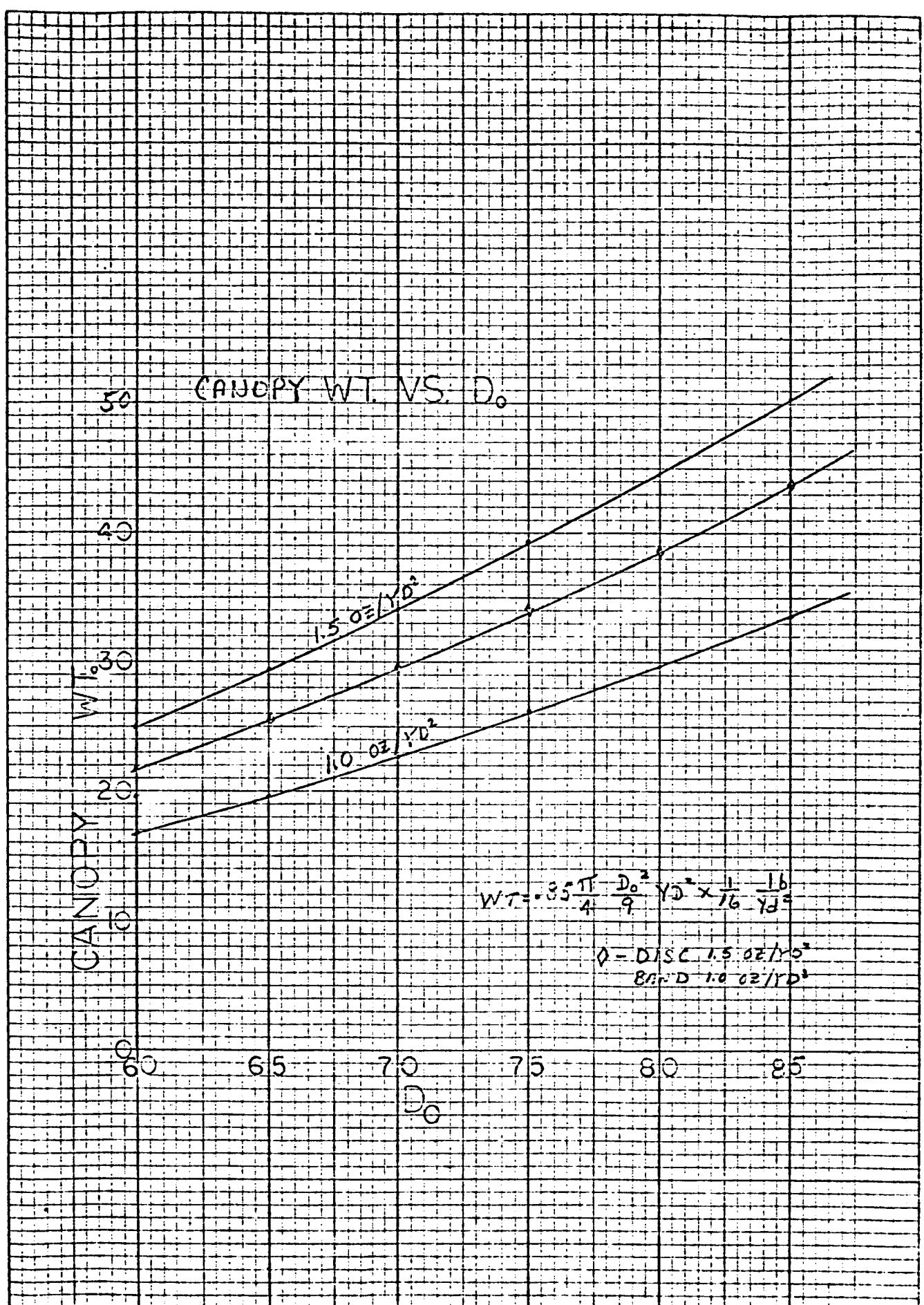

FIGURE 5

EUGENE DIETZGEN CO.
MADE IN U. S. A.

NO. 340-10 DILIZEN GRAPH PAPER
10 X 10 PER INCH

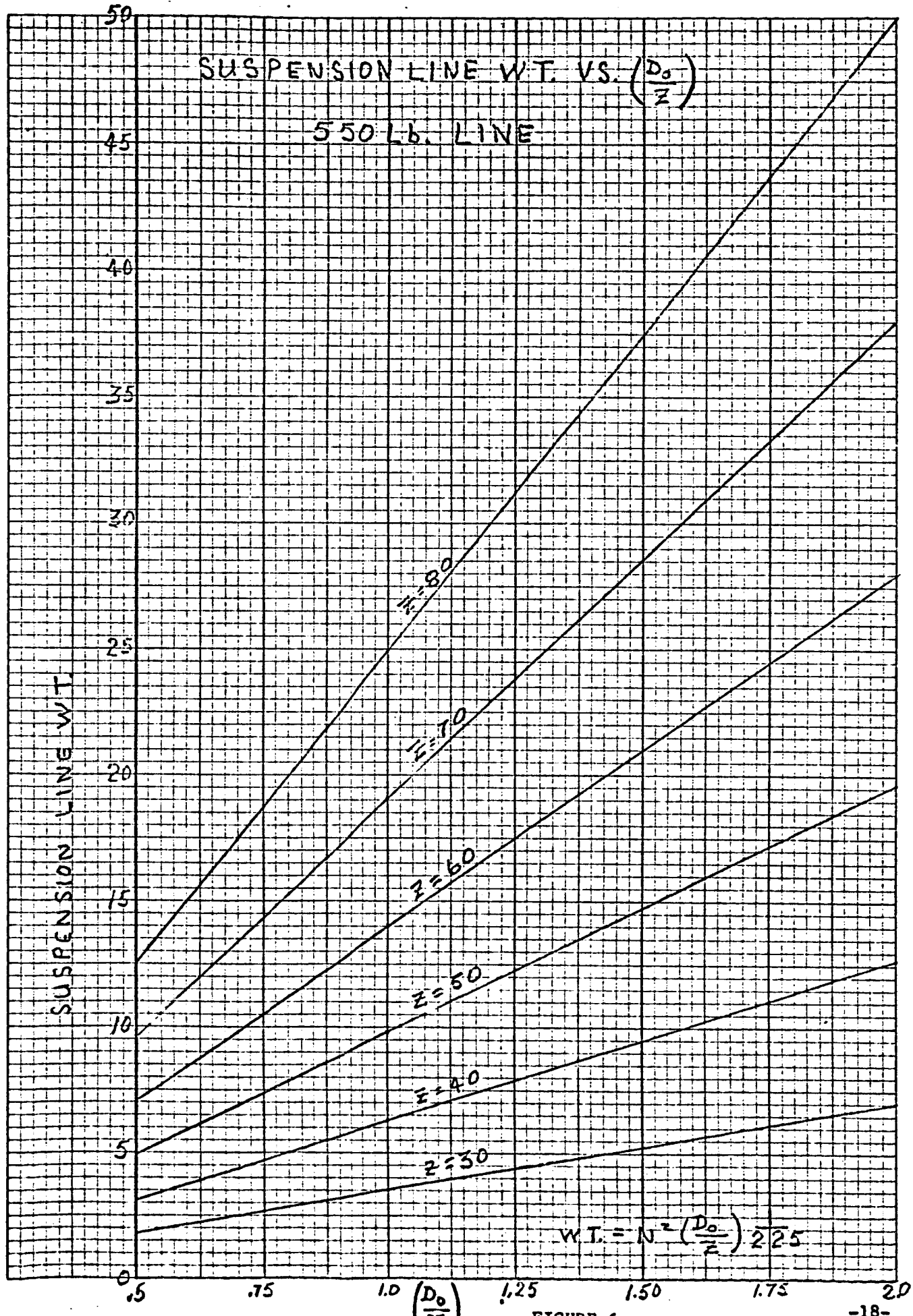

FIGURE 6

NO. 100-10 DIETZGEN GRAPH PAPER
 10 X 10 PER INCH
 EUGENE DIETZGEN CO.
 MADE IN U. S. A.

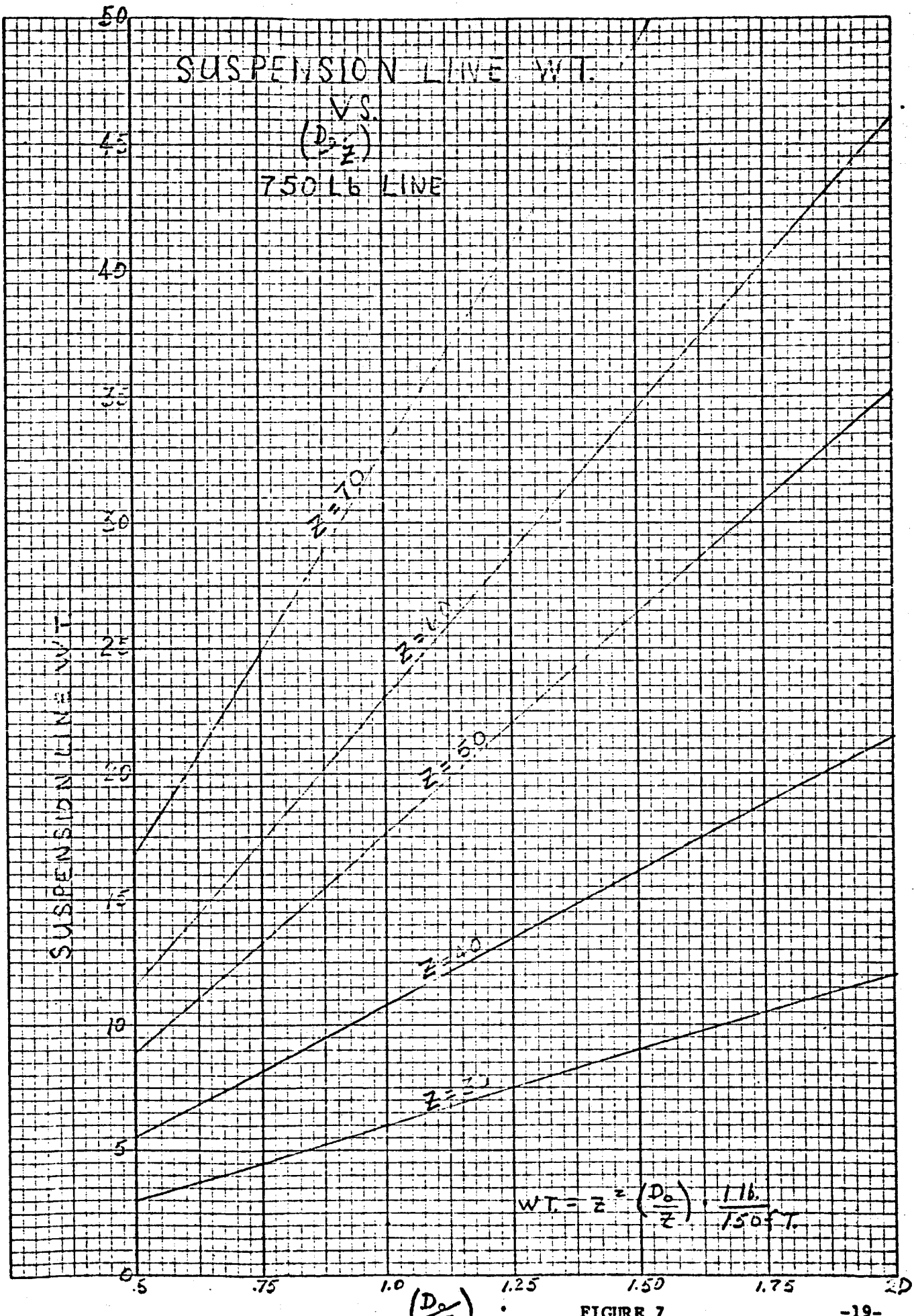

FIGURE 7



EUMEN DIE CASTING CO.
MADE IN U. S. A.

NO. 10 PLESEN GRAPH PAPER
10 X 10 PER INCH

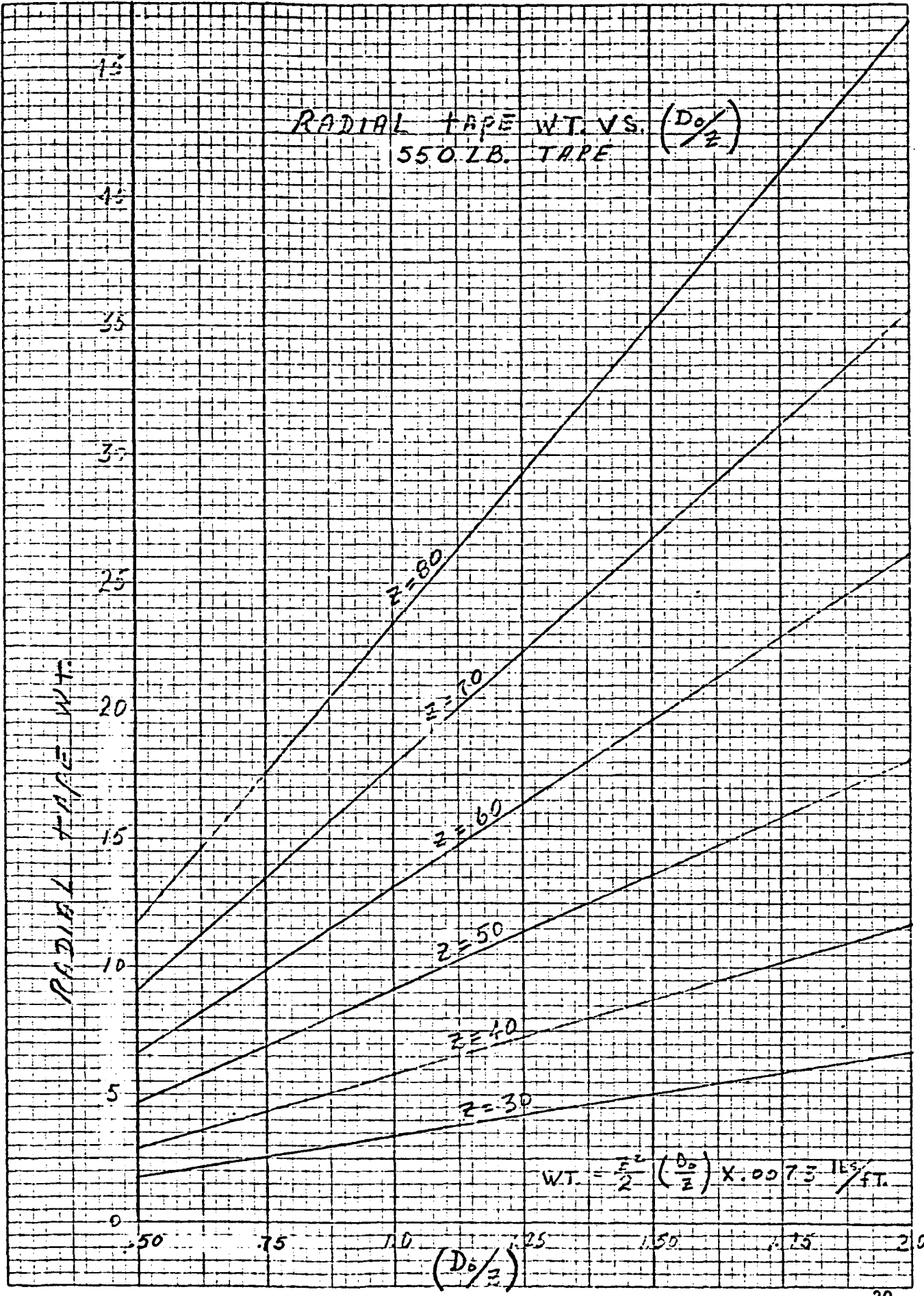

FIGURE 8

EUGENE DIEZEL CO.
MADE IN U. S. A.

NO. 34B-10 UTILIZING GRAPH PAPER
10 X 10 PER INCH

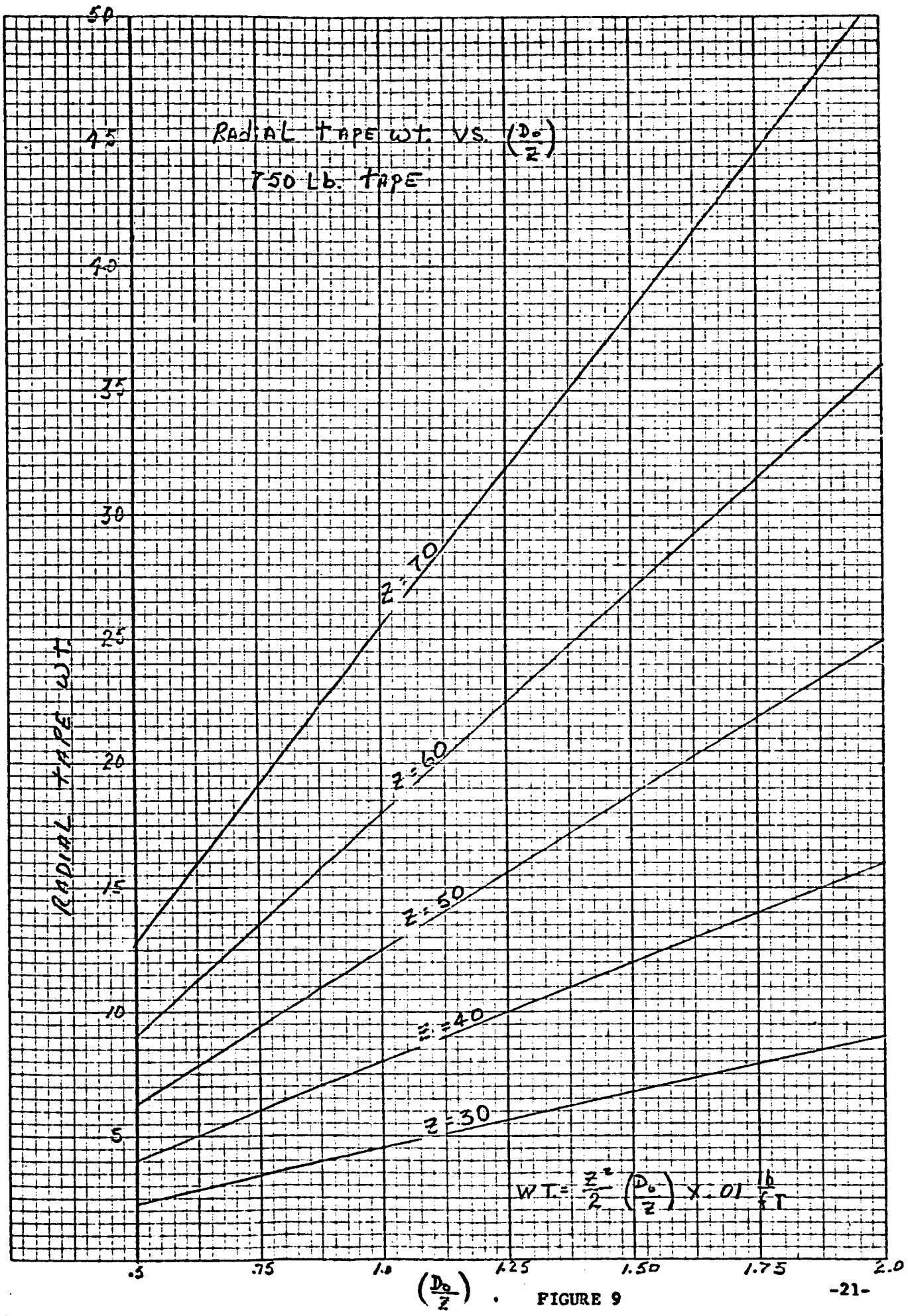

FIGURE 9

WT. OF SKIRT AND BAND TAPES
VS.
 D_o

WT. OF SKIRT AND BAND TAPES

4.0
3.5
3.0
2.5
2.0
1.5
1.0
.5

30 40 50 60 70 80
 D_o

550 LB.
330 LB.

$$WT = 3\pi D_o \sqrt{.525 \times \frac{WT}{\pi}} = 6.8 D_o \times \frac{WT}{\pi}$$

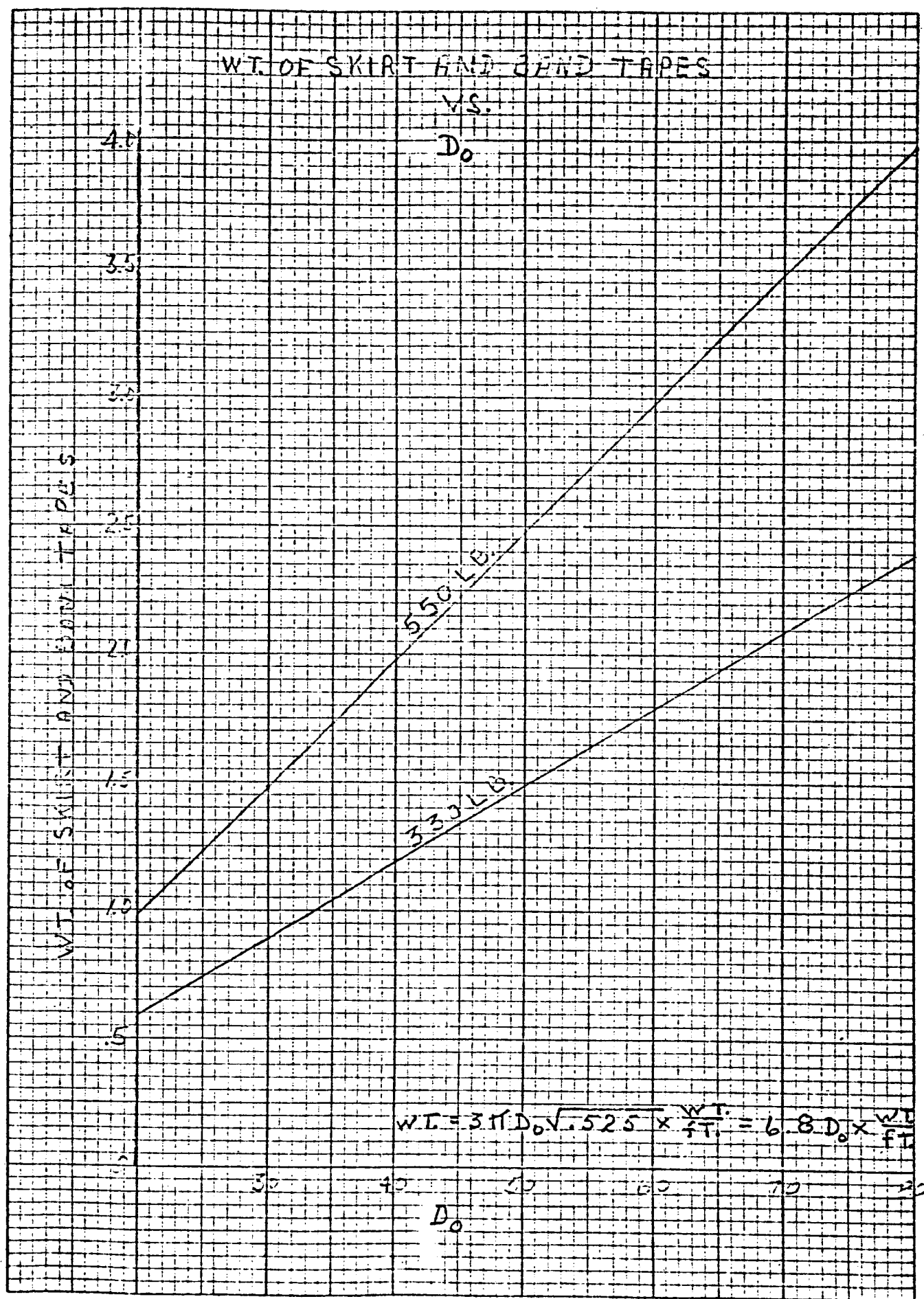

LUCINI DIEZEL CO.
MADE IN U. S. A.

NO. 300 10 DIEZEL ENGINE PUMP
10 X 10 PER INCH

8.0 STRESS ANALYSIS

8.1 Suspension lines (580 lb. minimum strength)

$$\frac{F_o}{Z} = \frac{18,800}{72} = 261 \text{ lb.}$$

Using a design factor of 2.13 for suspension lines,

$$P_{all} = \frac{580}{2.13} = 272 \text{ lb.}$$

$$\text{Margin of Safety (M.S.)} = \frac{P_{all}}{P_{dev}} - 1.0$$

$$\text{M.S.} = \frac{272}{261} - 1 = 1.04 - 1 = .04$$

$$\text{M.S.} = + 4\%$$

8.2 Radial tapes (570 lbs. minimum strength)

$$\frac{F_o}{Z} = \frac{18,800}{72} = 261 \text{ lb.}$$

Design factor = 1.95

$$P_{all} = \frac{570}{1.95} = 293 \text{ lbs.}$$

$$\text{M.S.} = \frac{293}{261} - 1 = 1.12 - 1 = .12$$

$$\text{M.S.} = + 12\%$$

8.3 Skirt, Gap, or Disc Band (Single 570 lb. tape)

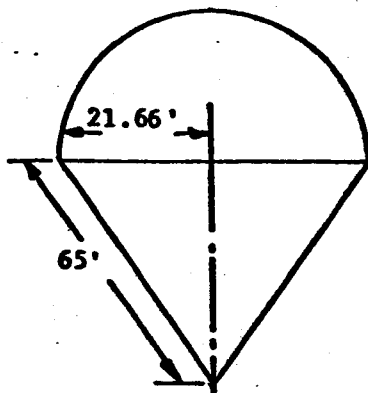

$$P_H = P_{S.L.} \times \frac{21.66}{65} = 87 \text{ lbs.}$$

Looking at the cross-section at the skirt

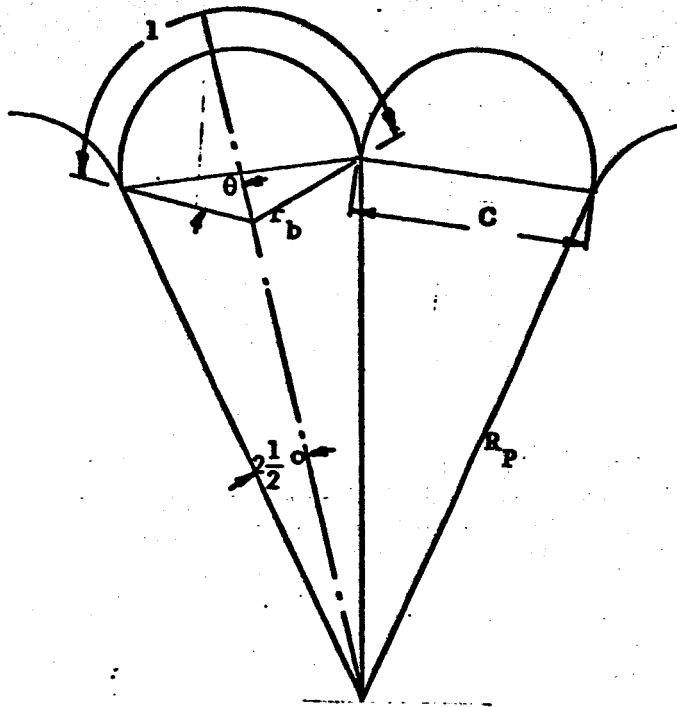

$$l = 2.1227'$$

$$c = 1.8913'$$

Assuming the projected diameter is $\frac{2}{3} D_o$, the gore bulge radius at the skirt is found from ratio,

$$\frac{l}{c} = 1.12235$$

$$2\theta = 95^\circ$$

$$\theta = 47\frac{1}{2}^\circ$$

$$r_b = \frac{c}{2 \sin \theta} = \frac{22.6956}{2 \times 0.737}$$

$$r_b \approx 15.4 \text{ in.}$$

By geometry:

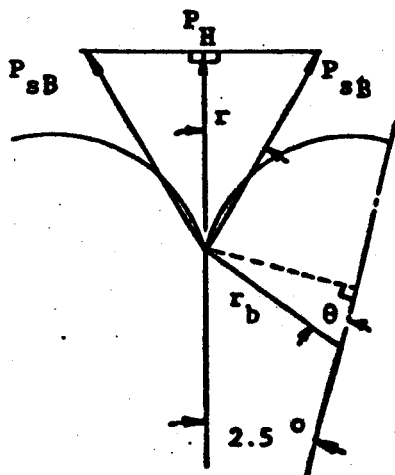

$$\theta = 47\frac{1}{2}^\circ$$

$$r = 45^\circ$$

Then:

$$P_{sB} = \frac{P_h}{2} \frac{1}{\cos r} = \frac{87}{2} \times \frac{1}{0.707}$$

$$P_{sB} \approx 61.5 \text{ lbs.}$$

The skirt band consists of a single 570 lb. tape.

Using a design factor of 1.95,

$$P_{all} = \frac{570}{1.95} = 292 \text{ lbs.}$$

$$P_{dev} = 61.5 \text{ lbs.}$$

$$M.S. = \frac{292}{61.5} - 1.0$$

$$M.S. = 3.75$$

$$M.S. = + 375\%$$

8.4 Canopy Cloth Stress

The stress in the canopy cloth is evaluated for a condition where the total opening load is assumed to be absorbed by the disc portion of the canopy. This is a reasonable assumption based on the constructed shape of the parachute.

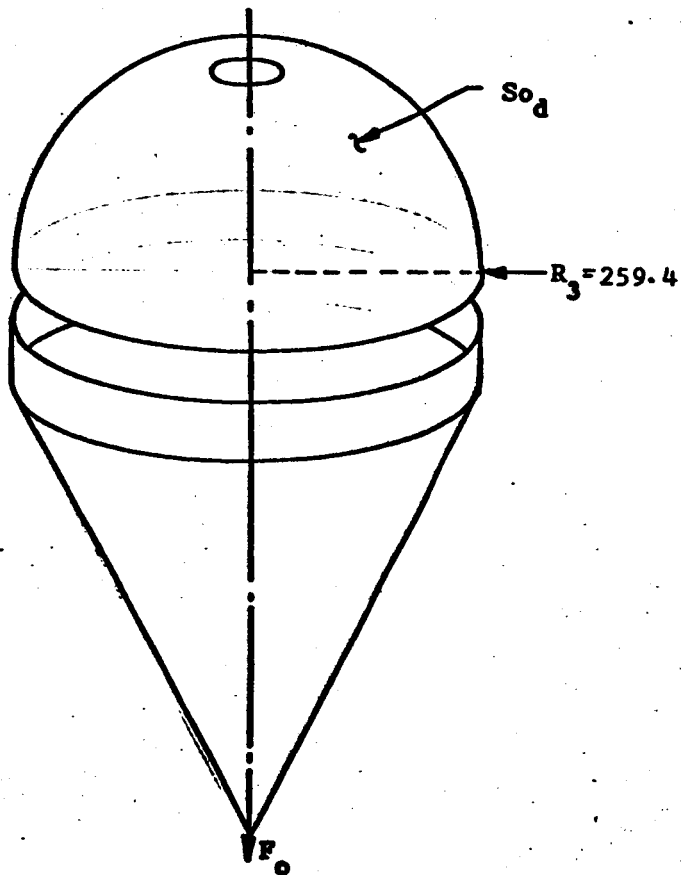

$$\Delta P = \frac{F_o}{S_{od}} = \frac{18,800}{1758.7} \times \frac{1}{144}$$

$$\Delta P = 0.074 \text{ lb/in}^2$$

Cloth tension:

$$\sigma t = \Delta P r$$

$$\sigma t = 0.074 \frac{\text{lb}}{\text{in}^2} \times 260 \text{ in.}$$

$$\sigma t = 19.2 \text{ lb/in.}$$

$P_{ult} = 46 \text{ lb/in}$ minimum based on tensile tests of the 1.50 oz/yd^2 dacron fabric used in the disc.

$$P_{all} = \frac{46}{1.75} = 26.25 \text{ lb/in}$$

$$P_{dev} = 19.2 \text{ lb/in}$$

$$\text{M.S.} = \frac{26.25}{19.2} - 1.0 = 0.37$$

$$\text{M.S.} = + 37\%$$

Accounting for the gore bulge radius, a more realistic load can be calculated as shown in Appendix A.

$$P_{dev} = \frac{\Delta P C}{2 \sin \theta} = \Delta P r_b = 0.96 \text{ lb/in}$$

$$\text{M.S.} = \frac{26.25}{0.96} - 1.0 = 26.3$$

$$\text{M.S.} = 2630\%$$

8.5 Main Seams

a. Disc

Worst case is when F_o is absorbed by the disc area portion of canopy,
then Disc Load = $\frac{18,800}{S_{od}} \times R_{P \text{ Disc}}$

P_{disc} (assuming thin shell with no bulge) = ~~18.7~~^{19.2} lb/in.

$$P_{all} = \frac{46 \text{ lb/in}}{2.17} = 21.2$$

$$M.S. = \frac{21.2}{19.2} - 1.0 = 0.104$$

$$M.S. = + 10.4\%$$

b. Band

$$P_{all} = \frac{34 \text{ lb/in}}{3.16} = 10.7 \text{ lb/in}$$

Developed load in band:

The most severe case in the band is if the total force F_o is absorbed by complete canopy uniformly. Thus,

$$P_{dev} = \frac{18,800 \text{ lb}}{477,792 \text{ in}^2} \times 260 \text{ in} = 10.3 \text{ lb/in}$$

$$M.S. = \frac{10.7}{10.3} - 1.0 = 0.039$$

$$M.S. = + 3.9\%$$

8.6 Cross Seams

a. Disc Area

With the same assumptions as used for the main seam analysis.

$$P_{all\ disc} = \frac{46\ lb/in}{3.16} = 14.6\ lb/in$$

$$P_{dev} = P_{dev\ radially} \times \sin \alpha = 19.2 \times .707 = 13.57\ lb/in.$$

$$M.S. = \frac{14.6}{13.57} - 1.0 = 0.075 = +7.5\%$$

b. Band Area

$$P_{all} = 10.7\ lb$$

$$P_{dev} = 10.30 \times .707 = 7.28\ lb$$

$$M.S. = \frac{10.7}{7.28} - 1.0 = 1.47 - 1.0$$

$$M.S. = +47\%$$

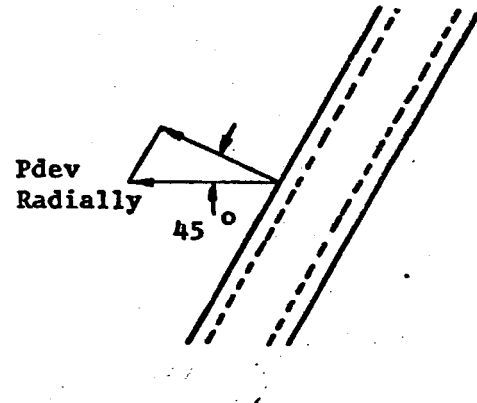

8.7 Vent Band

From the geometry of the vent, the tension in the vent tape can be determined

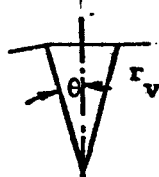

$$\theta = \frac{360}{22} = 2.5^\circ$$

Taking into consideration the fact that the constructed length of the vent band is longer than the circumference of the vent band based on the vent radial tapes, the vent band loading will be determined.

The vent band length between radial tapes is 1.797 inches, while the chord length based on vent radials is 1.656 inches.

From the ratio $\frac{1.797}{1.656} = 1.085$ the included angle between radial tapes and the bulge radius is found to be 80° .

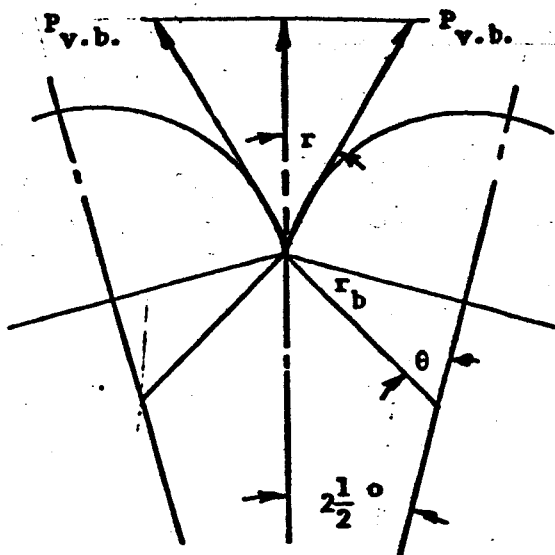

By Geometry:

$$r = 52 \frac{1}{2}^{\circ}$$

$$P_{v.b.} = \frac{P_s \cdot L}{2} \times \frac{1}{\cos 52 \frac{1}{2}^{\circ}}$$

$$P_{v.b.} = \frac{261}{2} \times \frac{1}{0.608}$$

$$P_{v.b.} = 215 \text{ lbs.}$$

The vent band consists of three 570 lbs. tapes,

$$P_{ult} = 3 \times 570 = 1710 \text{ lbs.}$$

$$P_{all} = \frac{1710}{1.95} = 878 \text{ lbs.}$$

$$P_{dev} = 215 \text{ lbs.}$$

$$M.S. = \frac{878}{215} - 1.0 = 3.08 = +308\%$$

This assumes vent band carries 100% of the opening load.

8.8 Vent Radial Tapes

Assuming the vent radials carry 100% of the load at the instant of opening,

$$P_{dev} = 261 \text{ lbs}$$

$$P_{ult} = 570 \text{ lbs}$$

$$P_{all} = \frac{570}{2.0} = 285 \text{ lbs}$$

Where $f_d = 2.0$ is used as a flutter factor

$$M.S. = \frac{285}{261} - 1.0 = 1.09 - 1.0$$

$$M.S. = +9\%$$

8.9 Riser to load cell junction

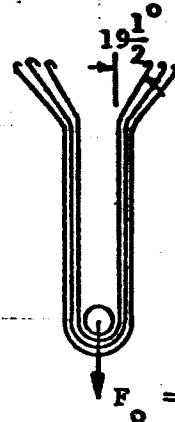

Allowable load

Assuming 6 ply MIL-W-25361 Type VIII webbing with an ultimate strength of 7000 lb/ply. (*rated, actual is > 7000*)

$$P_{all} = \frac{6 \times 7000}{2.12} = 19,811 \text{ lb}$$

$$M.S. = \frac{19,811}{18,800} - 1.0 = 0.054$$

$$M.S. = + 5.4\%$$

8.10 Lower Riser Bridle Ass'y

The bridle is designed such that any one leg is capable of withstanding 2/3 of the total opening shock load.

The bridle legs are fabricated from two layers of 10,000 lb. rated nylon webbing, MIL-W-4088, type XIX. The actual minimum tensile strength of this material is 11,500 pounds.

Using a design factor of 1.91 (eliminating heat loss efficiency) the margin of safety for the bridle legs is:

$$P_{ult} = 2 \times 11,500 = 23,000 \text{ lbs}$$

$$P_{dev} = \frac{2}{3} F_o = \frac{2}{3} \times 18,800 = 12,523 \text{ lbs}$$

$$P_{all} = \frac{P_{ult}}{fd} = \frac{23000}{1.91} = 12,042 \text{ lbs}$$

$$M.S. = \frac{12,042}{12,532} - 1.0 = -.004$$

$$M.S. = - 0.4\%$$

Although the Margin of Safety is negative, based on the assumption that each bridle leg must withstand two-thirds of the total opening shock load, the structural integrity of the bridle is not in jeopardy, since the design factor includes a 1.5 safety factor. The negative Margin of Safety indicates that the actual safety factor is slightly less than 1.5.

The locations of the calculated Margins of Safety are shown in Figure 11. Table I shows the design factors, and their determination, as used in the Margin of Safety calculations.

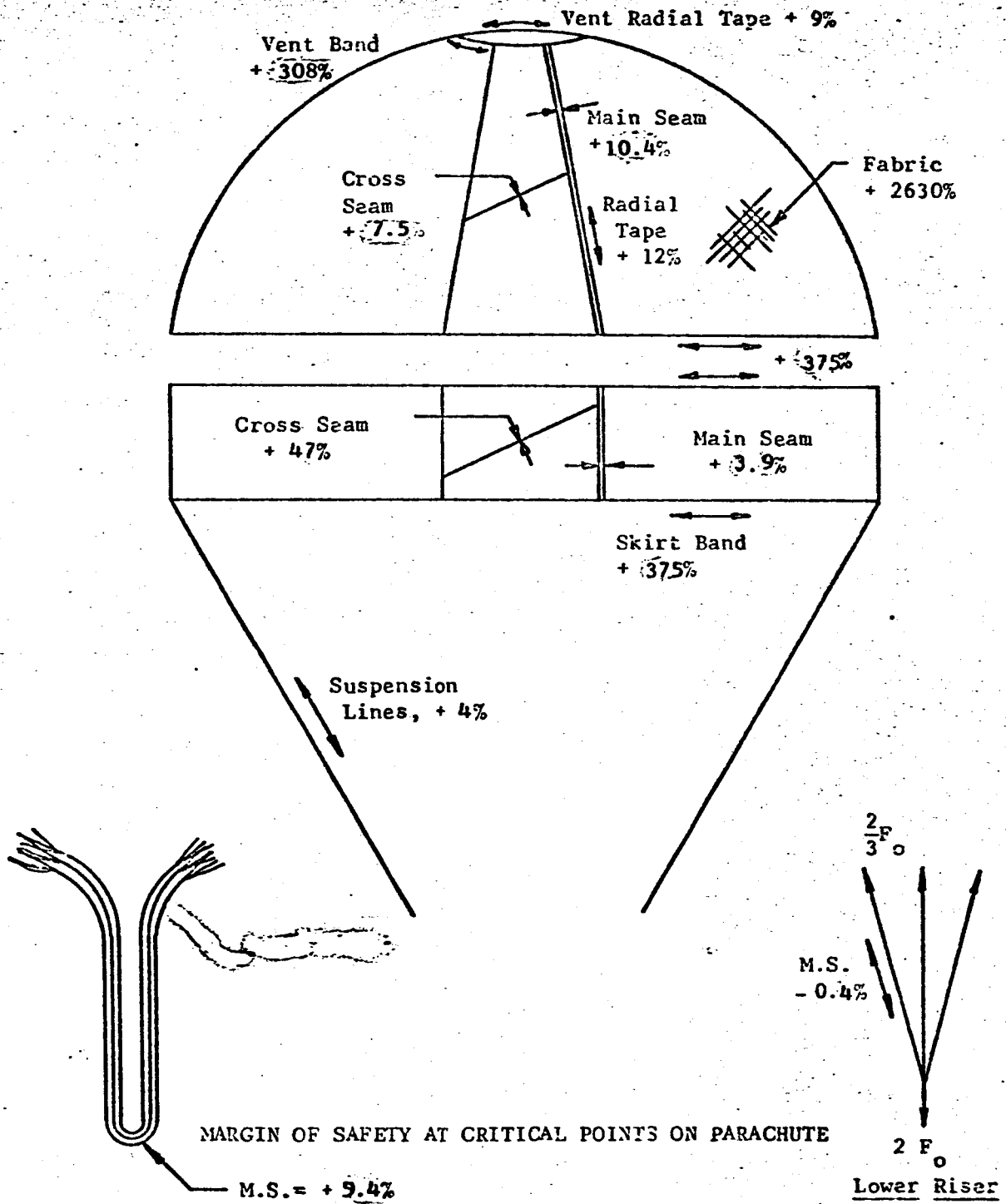

FIGURE II

TABLE I

STRENGTH-LOSS AND SAFETY FACTORS*

(a) Strength-loss factors

Symbol	Function	Canopy	Radials and skirt-vent tapes	Lines	Risers	Metal			Cross Seam
						Fittings	Main Seam	Disc Band	
b	joint efficiency	1.00	0.90	0.89	0.90	NA	0.80	0.55	0.55
n	heat-loss factors	0.90	0.90	0.90	1.00	1.00	0.90	0.90	0.90
l	abrasion	1.00	1.00	0.96	0.96	1.00	0.96	0.96	0.96

(b) Safety factors

j	safety factors	1.50	1.50	1.50	1.50	1.75	1.50	1.50	1.50
h	line convergence	NA	NA	1.04	NA	1.00	NA	NA	NA
f	Asymmetrical loading	1.05	1.05	1.05	1.10	1.00	NA	NA	NA
Design factor jhf/lmb		1.75	1.95	2.13	2.12**	1.75	2.17	3.16	3.16
					1.91				

* From Reference 1

** Includes Heat Loss Factor of 0.90

9.0 CENTER OF GRAVITY

9.1 Packed Parachute

The center of gravity location of the packed parachute is assumed to be at the center of the deployment bag.

9.2 Parachute in "strung-out" condition

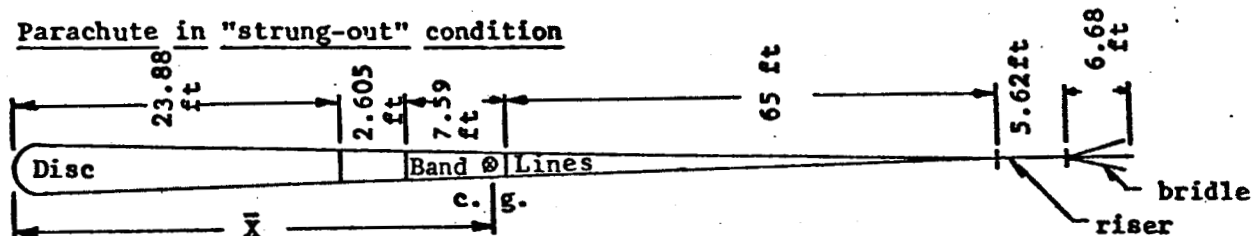

Because the parachute materials are homogenous, the center of gravity of each component is assumed to be at its center.

$$\begin{aligned} \sum Mc.g. = 0 = \bar{x} W_T - \frac{1d}{2} W_d - (1d + 1g + \frac{1b}{2}) (W_b) \\ - (1d + 1g + 1b + \frac{1e}{2}) W_l - (1d + 1g + 1b + 1e + \frac{1r}{2}) (W_r) \\ - (1d + 1g + 1b + 1e + 1r + \frac{1br}{2}) (W_{br}) - (1d + 1g + 1b)(W_{rad})/2 \end{aligned}$$

With the measured weights from Table II, the center of gravity is calculated as:

$$\begin{aligned} (1332.5)\bar{x} = \frac{23.88}{2} (267) + 30.28 (401) + 66.62(372) \\ + 101.93 (30.5) + 108.08 (46) + \frac{34.075}{2} (216) \end{aligned}$$

$$\bar{x} = 38.92 \text{ ft.}$$

TABLE II

MEASURED WEIGHT BREAKDOWN

<u>Item</u>	<u>Weight (oz)</u>
Disc	267
Band	401
Radial Tapes	216
Lines	372
Main Riser	30 $\frac{1}{2}$
Bridle	46
Deployment Bag	31

10.0 MOMENTS OF INERTIA

10.1 Roll Moment of Inertia

10.1.1 Disc

$$I_g = \int x^2 dA \quad \delta$$

$$dA = 2\pi x dy$$

$$\delta = \text{unit weight} = 0.0095 \text{ lb/ft}^2$$

$$x = \sqrt{r^2 - y^2}, \quad r = 21.66 \text{ ft}$$

$$I_g = 2\pi\delta \int (r^2 - y^2) \sqrt{r^2 - y^2} dy$$

Substituting $y = r \sin \theta$

$$I_g = 2\pi r^4 \delta \int_{\theta=0}^{\theta=90^\circ} \cos^3 \theta d\theta$$

$$I_g = 2\pi r^4 \delta \left. \frac{1}{3} \sin \theta (\cos^2 \theta + 2) \right|_{\theta=0}^{\theta=90^\circ}$$

$$I_g = 1900 \text{ lb-ft}^2$$

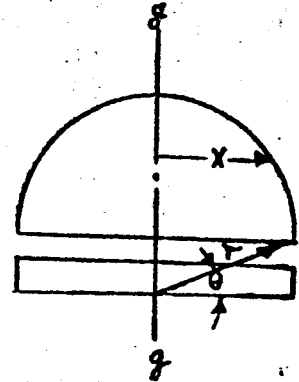

10.1.2 Band

$$I_g = Mr^2$$

$$M = 25 \text{ lb}$$

$$r = 21.66$$

$$I_g = 11,750 \text{ lb-ft}^2$$

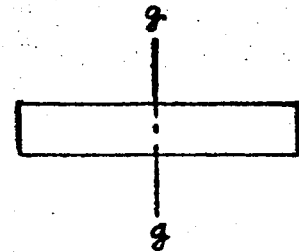

10.1.3 Radial Tapes

For thin rod bent into circular arc

$$I_g = \frac{Mr^2}{2} \left(1 + \frac{\sin \alpha \cos \alpha}{\alpha} \right)$$

$$\alpha = 90^\circ$$

$$I_g = \frac{Mr^2}{2}$$

$$M = 12.9 \text{ lb}, \quad r = 21.66 \text{ ft}$$

$$I_g = 3026 \text{ lb-ft}^2$$

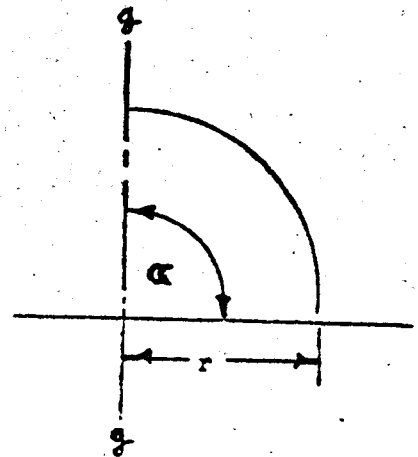

10.1.4 Suspension Lines

$$I_g = \frac{Ml^2 \sin^2 \alpha}{3}$$

$$M = 23.25 \text{ lb}$$

$$l = 65 \text{ ft}$$

$$\alpha = 19.5 \text{ deg}$$

$$\sin^2 \alpha = 0.11$$

$$I_g = 0.11 \times \frac{65}{3} \times 65 \times 23.25 = 3560 \text{ lb-ft}^2$$

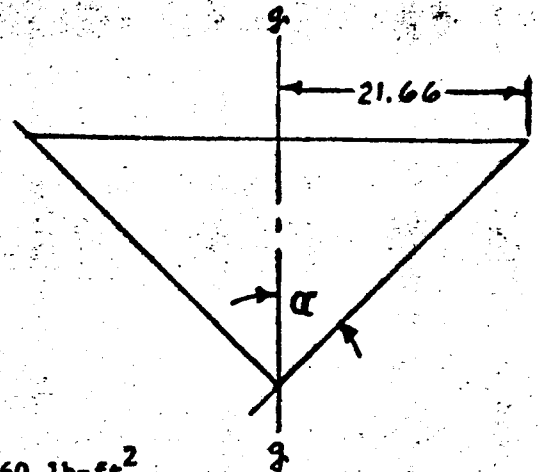

10.1.5 Included Air Mass

Assuming a hemispherical canopy, the moment of inertia of the included air mass is:

$$I_g = \frac{2}{5} Mr^2$$

Since the weight of the included air mass is a function of altitude, the moment of inertia of the included air mass will vary with altitude.

$$M_a = V \rho_0 \sigma$$

Where V = Canopy volume

ρ_0 = Sea level density

σ = Density ratio = ρ/ρ_0

$$M_a = 1596 \sigma \text{ lb}$$

$$I_g = 299,512 \sigma \text{ lb-ft}^2$$

AT 130,000 ft. altitude $I_g = 1033 \text{ lb-ft}^2$

AT Sea Level $I_g = 299,512 \text{ lb-ft}^2$

10.1.6 Total Roll Moment of Inertia

The roll moment of inertia of the riser and bridle are considered negligible and have not been included in the total roll moment.

$$I_{g \text{ total}} = 20236 + 299,512 \sigma \text{ lb-ft}^2$$

10.2 Pitch and Yaw Moments of Inertia-Inflated Canopy

10.2.1 Center of gravity-inflated canopy

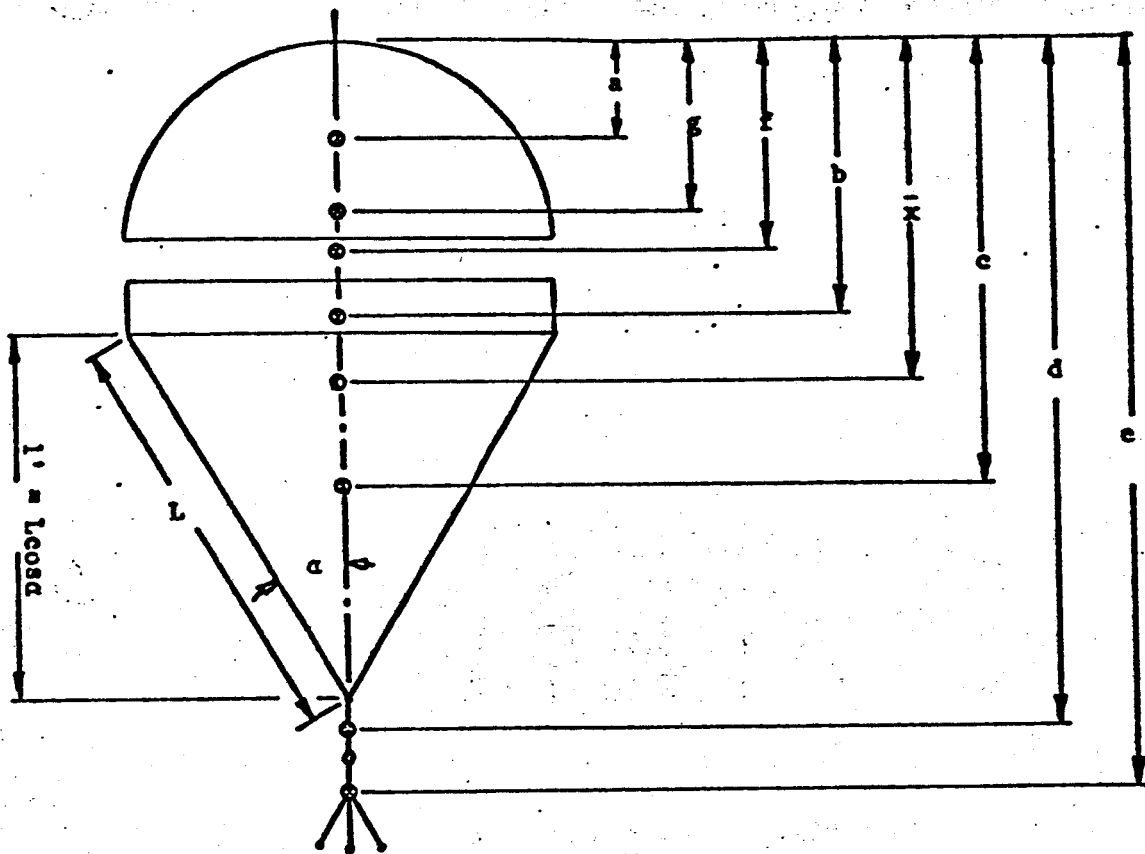

- a = c.g. of disc
- b = c.g. of band
- c = c.g. of lines
- d = c.g. of riser
- e = c.g. of bridle
- f = c.g. of air mass
- \bar{x} = c.g. of system
- g = c.g. of radial tapes

From flight photos, the inflated diameter is approximately $\frac{2}{3} D_0$

$$r = \frac{2}{3} \frac{D_0}{2} = \frac{D_0}{3}$$

$$r = 21.66'$$

$$h = r(1 - \sin\theta)$$

$$\theta = \frac{s}{r} = \frac{10.2}{21.66} \times 57.3 = 27 \text{ degrees}$$

$$\sin\theta = 0.454$$

$$h = 21.66 (1 - 0.454)$$

$$h = 11.80 \text{ ft}$$

Then; c.g of disc, $a = \frac{h}{2} = 5.90 \text{ ft.}$

$$b = 17.8 \text{ ft}$$

$$\text{c.g of lines, } c = r + \frac{1'}{2}$$

$$c = 21.66 + 30.45$$

$$c = 52.11 \text{ ft}$$

$$\text{c.g of riser, } d = r + 1' + \frac{5.62}{2}$$

$$d = 85.37 \text{ ft}$$

$$\text{c.g of bridle } e = 88.87 + \frac{6.67}{2}$$

$$e = 92.21 \text{ ft}$$

$$\text{c.g of included air mass, } f = r - \frac{3}{8} r$$

$$f = \frac{5}{8} r$$

$$f = 13.5 \text{ ft}$$

$$\text{c.g of radial tapes, } g = \frac{2r}{\pi} \left(\frac{\pi}{2} - 1 \right) = .363r$$

$$g = 7.86 \text{ ft}$$

$$\text{c.g of system, } \bar{X}, = \frac{\sum M_i X_i}{\sum M_i}$$

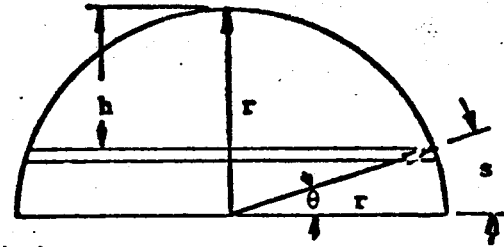

Where M_i = Weight of th component

X_i = c.g. of th component

Since the mass of the included air is a function of altitude, the c.g. of the system will change with altitude.

$$(1332.5 + M_a) \bar{X} = (5.90)(267) + (17.8)(401) + (52.11)(372) + (85.37)(30.5) \\ + (92.21)(46) + (7.86)(216) + (13.5)(M_a)$$

Where M_i is given in ounces

X_i is given in feet

M_a = mass of included air

$$\bar{X} = \frac{36,641.225 + 13.5 M_a}{1332.5 + M_a}$$

Evaluated at 130,000 ft. altitude, $M_a = 88$ oz

$$\bar{X} = \frac{37,829.225}{1420.5} = 26.63 \text{ ft}$$

10.2.2 Moment of inertia-disc

$$x^2 + y^2 = r^2$$

$$dm = 2\pi x dy$$

$$I_x = \int y^2 dm = \int 2\pi x y^2 dy$$

$$I_x = 2\pi \left[\frac{r^4}{8} \arcsin \frac{y}{r} - \frac{y}{8} (r^2 - 2y^2) \sqrt{r^2 - y^2} \right]_{-r}^r .442r$$

$$I_x = 2\pi r^4 \left[\frac{\pi}{16} - \frac{.442}{8} \left(\sqrt{1 - (.442)^2} \right) \right]$$

$$I_x = 2201.04 \text{ lb-ft}^2$$

$$I_{c.g. \text{ system}} = I_x + m \left[(\bar{x} - a)^2 - (r - a)^2 \right]$$

$$I_{c.g. \text{ system}} = 2201.04 + 16.7 \left[(20.73)^2 - (15.76)^2 \right]$$

$$I_{c.g. \text{ system}} = 5233.04 \text{ lb-ft}^2$$

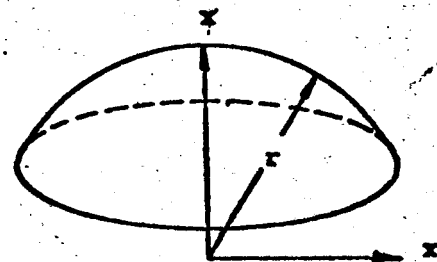

10.2.3 Moment of inertia - Band

$$I_g = \frac{m}{12}(6r^2 + h^2)$$

$$I_g = \frac{25}{12}(6 \times 21.6^2 + 7.6^2)$$

$$I_g = 6000 \text{ lb-ft}^2$$

$$I_{c.g. \text{ system}} = 6000 + 25(x - b)^2$$

$$I_{c.g. \text{ system}} = 6000 + 25(26.63 - 17.80)^2$$

$$I_{c.g. \text{ system}} = 7950 \text{ lb-ft}^2$$

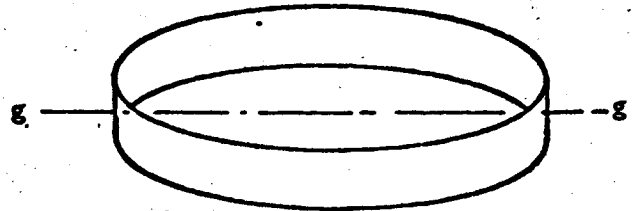

10.2.4 Moment of inertia - Radial Tapes

36 Semi-circular radial tapes

$$I_x = 36 (mr^2/2)$$

$$I_x = 3167 \text{ lb-ft}^2$$

$$I_{c.g. \text{ system}} = I_x + m \left[(x - g)^2 - (r - g)^2 \right]$$

$$I_{c.g. \text{ system}} = 3167 + 13.5 \left[(18.77)^2 - (13.80)^2 \right]$$

$$I_{c.g. \text{ system}} = 5115 \text{ lb-ft}^2$$

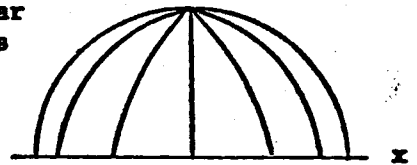

10.2.5 Moment of inertia-suspension lines

$$I_g = \frac{mL^2 \sin^2 \alpha}{12}$$

$$\alpha = 70.5^\circ$$

$$\sin \alpha = 0.94264$$

$$I_g = 7255 \text{ lb-ft}^2$$

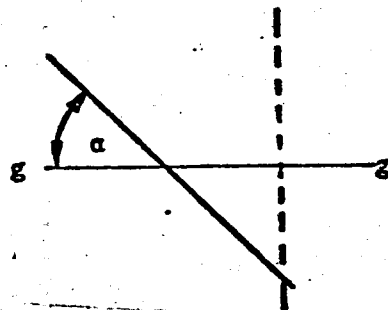

$$I_{\text{c.g. system}} = 7225 + m (c-x)^2$$

$$I_{\text{c.g. system}} = 7255 + 23.25 (52.11 - 26.63)^2$$

$$I_{\text{c.g. system}} = 22380 \text{ lb-ft}^2$$

10.2.6 Moment of inertia - Riser

$$I_g = \frac{mL^2}{12}$$

$$I_g = \frac{1.905}{12} (5.62)^2$$

$$I_g = 5.04 \text{ lb-ft}^2$$

$$I_{\text{c.g. system}} = 5.04 + 1.905 (d - \bar{x})^2$$

$$= 5.04 + 1.905 (85.37 - 26.63)^2$$

$$= 6580.04 \text{ lb-ft}^2$$

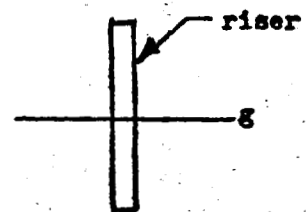

10.2.7 Moment of inertia - Bridle

$$I_g = \frac{1}{12} mL^2 \sin^2 \alpha$$

$$\alpha = 70^\circ$$

$$\sin \alpha = 0.94$$

$$I_g = 2.87/12 (6.67)^2 (0.885)$$

$$I_g = 9.45 \text{ lb-ft}^2$$

$$I_{\text{c.g. system}} = 9.45 + 2.87 (82.21 - 26.63)^2$$

$$I_{\text{c.g. system}} = 12369.45 \text{ lb-ft}^2$$

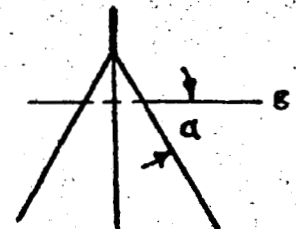

10.2.8 Moment of inertia - Included Air Mass

$$I_g = \frac{2}{5} mr^2 - m\left(\frac{3}{8}r\right)^2$$

$$I_g = .26 mr^2$$

$$I_g = .26 \times 5.9 \times 470$$

$$I_g = 719 \text{ lb-ft}^2$$

$$I_{\text{c.g. system}} = 719 + 5.9 (\bar{x} - f)^2$$

$$= 719 + 5.9 (26.63 - 13.52)^2$$

$$I_{\text{c.g. system}} = 1733 \text{ lb-ft}^2$$

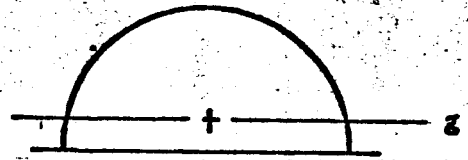

10.2.9 Total pitch and yaw moment of inertia

The total pitch and yaw moment of inertia at 130,000 ft. altitude:

$$I_{\text{c.g. Total}} = 61,360.53 \text{ lb-ft}^2$$

11.0 FABRICATION AND PACKING

The fabrication of the parachute system is completely described by G.T. Schjeldahl Company Drawings 1004659, 1004668, and 1004836.

The packing of the parachute is described in detail by G. T. Schjeldahl Company Specification P-444 (see Appendix A).

In order to assure that the packed parachute would fit into the mortar when removed from the shipping container, the parachute was packed in the deployment bag within a cylindrical shipping container which was 11.5 inches in diameter. Also, a dummy riser was placed in the riser protector flaps on the outside of the deployment bag, between the bag and the shipping container to assure that the maximum dimension of the packed parachute system would not exceed 11.5 inches diameter.

After sterilization, the parachute was transferred from the shipping container to the mortar with no problem.

Figures 12 thru 14 show the parachute during the packing operation. Figure 12 shows the parachute strung out and folded, Figure 13 shows the suspension lines as folded for packing, and Figure 14 shows the disc portion of the canopy packed in the bag.

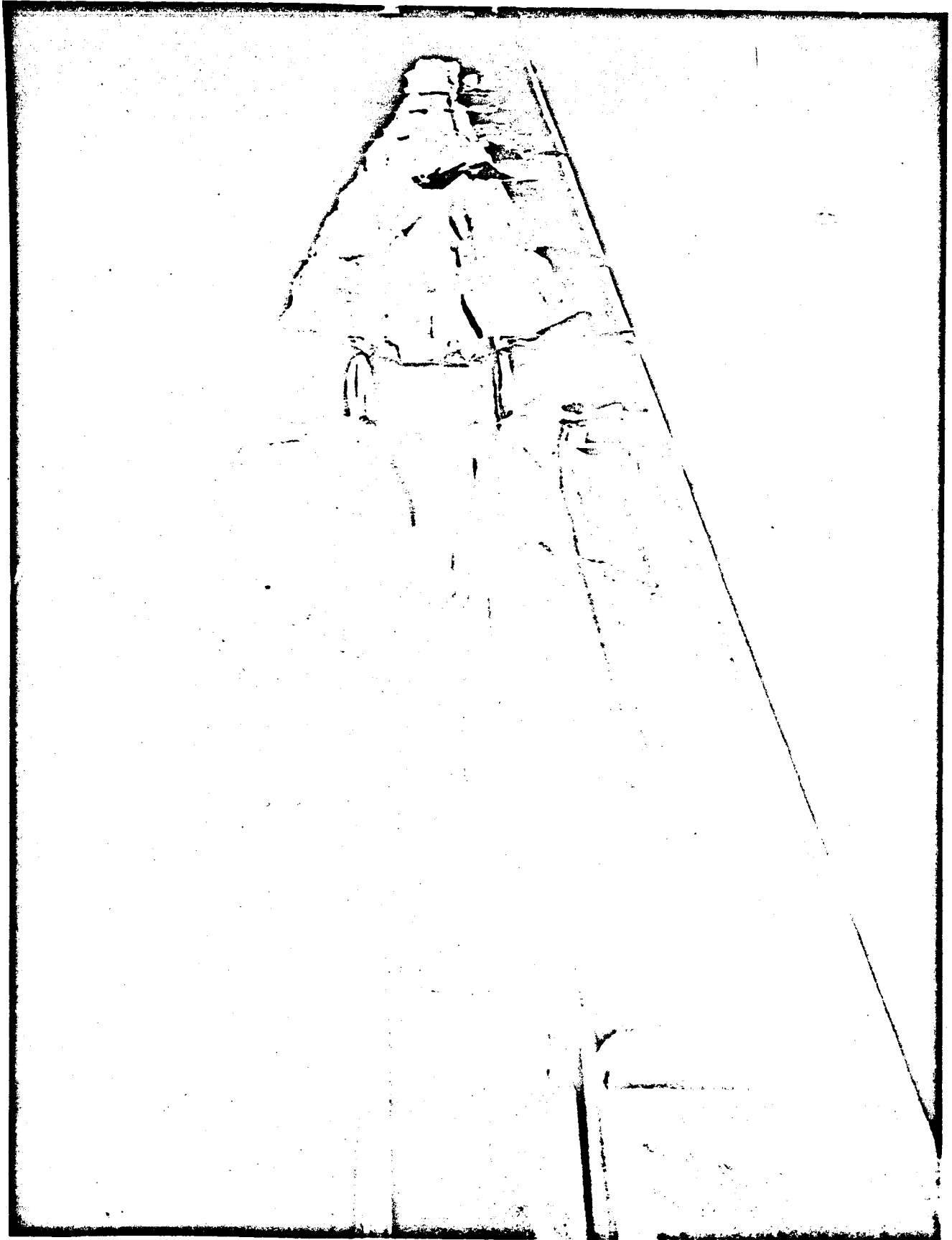

Figure 12

Parachute Folded



Figure 13

Suspension Lines Folded

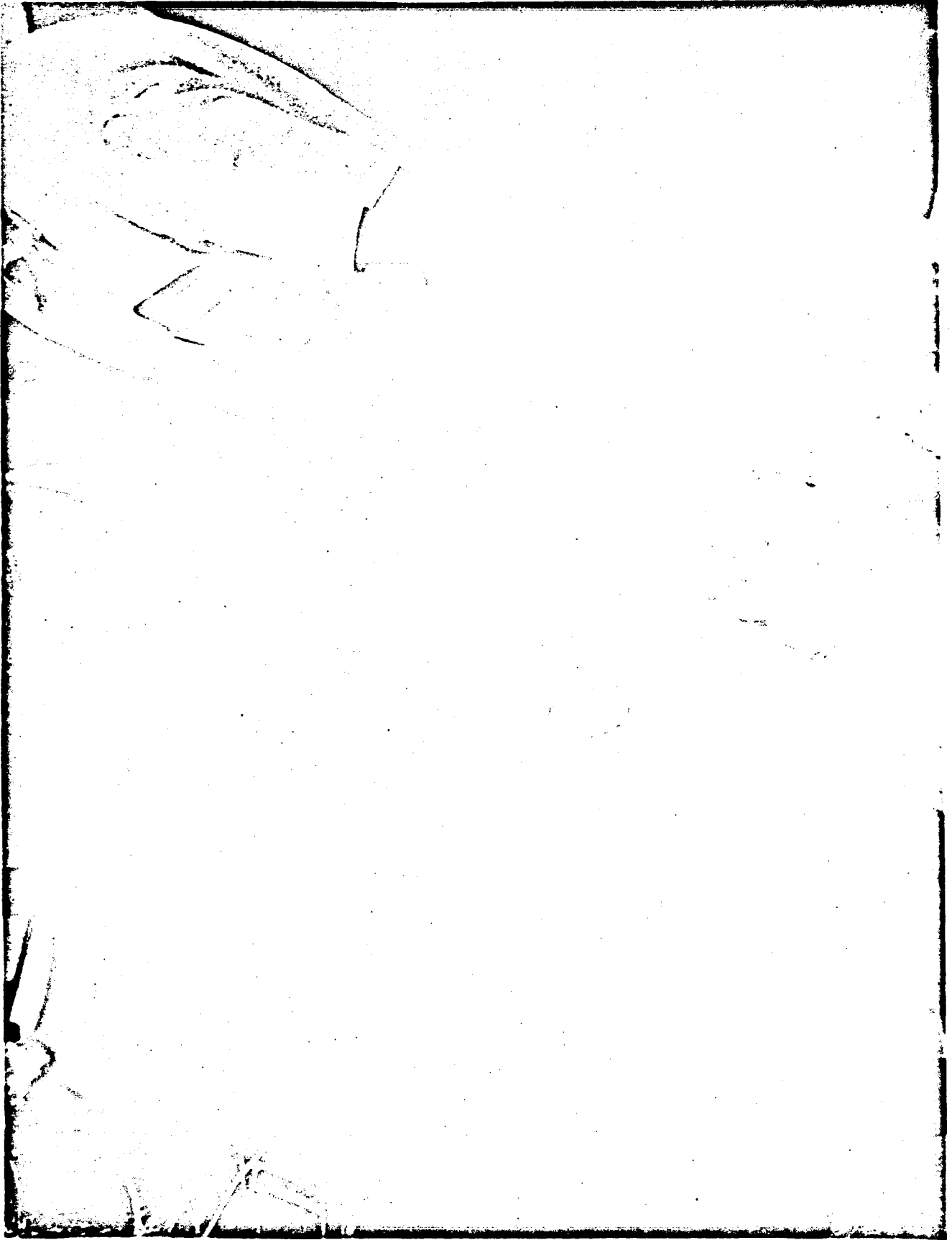

Disc Portion Packed

Figure 14

List of References

1. "Performance and Design Criteria for Deployment Aerodynamic Decelerators"
American Power Jet Company, Ridge Field, New Jersey, ASD-TR-61-579,
December, 1965
2. Hoerner, S. F., "Fluid Dynamic Drag", Midland Park, New Jersey
3. Eckstrom, C. V., "Design, Stress Analysis and Drawings for 30' diameter
Disc Gap Band Parachutes - Planetary Entry Parachute Program", G. T.
Schjeldahl Company, September, 1966

APPENDIX A

G.T.S.C. SPECIFICATION P-444



Schjeldahl Company

G.T. SCHJELDAHL COMPANY • NORTHFIELD, MINNESOTA 55057

SPECIFICATION

CLASSIFICATION

Page 1 of 4

Specification NO. P-444

Date Issued 3-21-67

Revision B

PACKING PROCEDURE 65° Do DGB

Prepared By: *Frank U. Jensen*
 Approved By: *Frank U. Jensen*
 Approved By: *Ronald C. Collins*
 Released By: *[Signature]*

REV.	ECO	CHANGED
A	8735	6-2-67 Revised & Retyped
B	8774	6-27-67

1. Lay the parachute on the packing table in the stretched out condition. Check the parachute to assure that the disc has not inverted through one of the gap openings.
2. Attach a tie cord from the parachute vent lines to the packing table. Working from the riser end, put the parachute under moderate tension (about 20#) and secure the riser to the packing table.
3. Check all suspension lines to assure that they are not knotted, twisted, or tangled.
4. Place all canopy material on one side of suspension lines. Then change to opposite side, one gore at a time in such a way that the material is laid neat and flat.
5. After each gore has been inspected and laid out, the gores are to be divided so that gores 1 to 36 are on one side, and gores 37-72 are on the other side.
6. Inspect each gore tape to assure that all are laid with the same side up, and that no twists are inserted in the tapes in the band and gap areas.
7. Because of the bulkiness of the canopy in the vent area, the gore edges at the vent cannot be folded the same as the main part of the gore. At the vent, every other gore is folded in on both sides of the stack, as illustrated in Figure 1.



Schjeldahl Company

G.T. SCHJELDAHL COMPANY • NORTHFIELD, MINNESOTA 55057

SPECIFICATION

CLASSIFICATION

Page 2 of 4

Specification NO. P-444

Date Issued 3-21-67

Revision 3

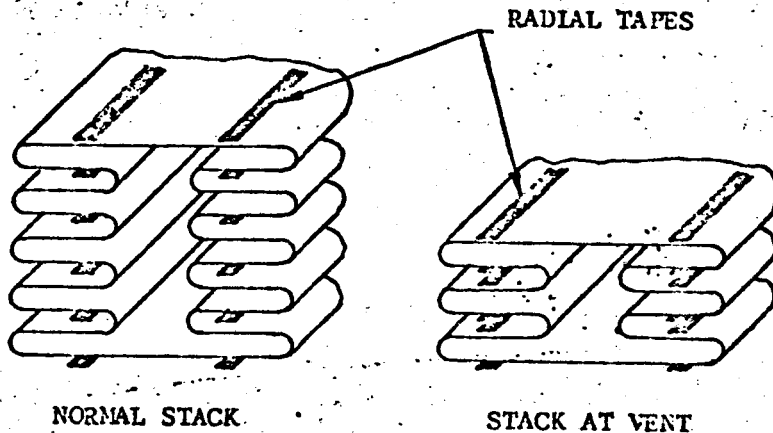

FIGURE 1

8. After the folding of the gore material is complete, place weights on the canopy to maintain the folds, and weight the upper riser to maintain tension in the suspension lines when the table tie cords are removed from the vent lines and riser.
9. Remove weights from the riser and fold the suspension lines (as a single unit) into ten-inch accordian fold loops, holding the ends of the loops in place with rubber bands. These rubber bands are to be removed when the parachute is placed in the deployment bag.
10. Two long strips of 10 mil mylar are to be used as a folding jig to make the lengthwise canopy folds. Only two folds are made lengthwise and these are one each five-inches out from the center-line of the canopy. One edge of the gore stack is folded up and laid over the top of the original stack. The other edge is folded down and under the original stack. As a result, the suspension lines go to the center of the folded parachute (See Figure 2)

REV. E C O CHANGED



Schjeldahl Company

G.T. SCHJELDAHL COMPANY • NORTHFIELD, MINNESOTA 55057

SPECIFICATION

CLASSIFICATION

Page 3 of 4

Specification NO. P-444

Date Issued 3-21-67

Revision B

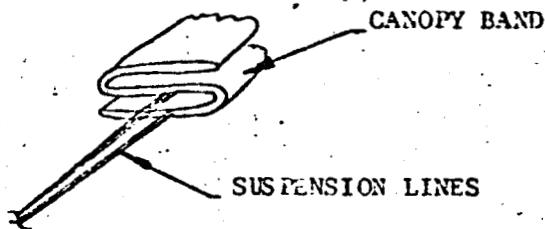

FIGURE 2

11. The canopy is now ready for insertion into the deployment bag. The loosely folded canopy will extend beyond the length of the deployment bag. Therefore, a 10 mil mylar liner is to be inserted in the deployment bag which is approximately 12 inches longer than the bag. Tie canopy apex to loop in bottom of deployment bag with 100 lb. dacron cord.
12. The canopy vent is placed in the bag first. The canopy is then accordion folded into the bag in such a way that the bag is completely filled. Care must be taken to assure that folds are neat, and long enough to fill all available space (See Figure 3).

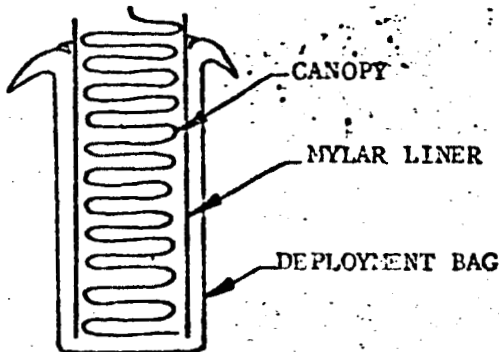

FIGURE 3

13. With the parachute partially packed in the deployment bag, place deployment bag in the shipping container.
14. Insert a 1-3/4 wide x 3/4 thick cloth webbing protector flaps to simulate the stowed riser.

REV. ECO CHANGED

B 5774 Added: Tie... cord

B 5774 Cloth webbing was metal bar.



Schjeldahl Company

G. T. SCHJELDAHL COMPANY • NORTHFIELD, MINNESOTA 55057

SPECIFICATION

CLASSIFICATION

Page 4 of 4
Specification NO. P-444
Date Issued 3-21-67
Revision B

	REV.	ECO	CHANGED
15. Continue packing the parachute into the deployment bag until the bag is completely filled. This should encompass all of disc portion of canopy.	B	5774	Add: This...canopy.
16. Place shipping container with deployment bag inside under the press and slowly press parachute into the bag. When more space is obtained by this method, continue packing remainder of parachute. Press as far into bag as possible and let stand 20 minutes under pressure.	B	5774	Add: Press....press
17. Fold the suspension lines into the bag in accordion fashion. Several layers of line will be required, and each layer shall be folded perpendicular to the preceding layer to prevent the possibility of line entanglement.			
18. The entire upper riser is then folded into the deployment bag. After pressure packing, a portion of this riser will be outside the bag when it is finally tied off.			
19. Using the packing press, slowly press parachute into the bag until it is below the bag mouth. Remove Mylar liner at this time.			
20. The deployment bag should now be fastened to the press to keep the bag from being pressed into the shipping container.			
21. The final pressing of the parachute into the bag shall be gradual to allow settling and escape of entrapped air. After the parachute is pressed completely into the bag, the system shall be allowed to set for about 1/2 hr.			
22. Bag Closure-String a 1000 pound line through the bag tie loops. Pull the upper riser out of the deployment bag until the knife is aligned with the bag loops. The bag mouth is then pulled closed using the 1000 pound line. (The packing press may be required to assist in the closing operation). When the bag mouth is pulled closed, tie off the 1000 pound line. Now string a 300 pound dacron line through the bag tie loops, and through the knife on the upper riser. Pull tight and tie off. Place a <u>"REMOVE BEFORE FLIGHT"</u> Tag on the 1000 pound line.			
23. Place cover on shipping container and bolt in place.			

APPENDIX B

SIMPLIFIED CLOTH STRESS ANALYSIS

SIMPLIFIED CLOTH STRESS ANALYSIS

The cloth stress, based on the gore bulge radius is determined as follows:

From the gore profile (Figure 2B) we obtain:

$$l = Sg \frac{2 \pi}{z}$$

Where l = cloth length between suspension lines

From Figure 1.0,

$$c = Xg \frac{2 \pi}{z} = \text{chord length between suspension lines, inflated canopy}$$

Then:

$$\frac{l}{c} = \frac{Sg}{Xg}$$

From the ratio of $\frac{l}{c}$, 2θ is determined from Table 1.B

From c and $\sin\theta$, the bulge radius r_b is determined.

Table IIB is a tabulation of the simplified cloth stress analysis for the 65 ft D-G-B with 10 percent fullness at the vent.

Figure IIIB shows the effect of fullness on the cloth stress for a triangular gore.

The ratio $f_1/f_{1\text{ref}}$ is a ratio of the stress at Sg to the minimum stress, which occurs when 2θ is 180 degrees, i.e., the gore bulge is a semi-circle.

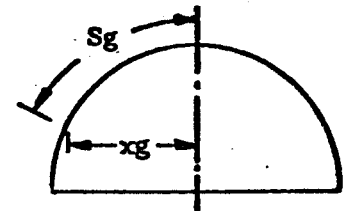

Figure 1B
Canopy Profile

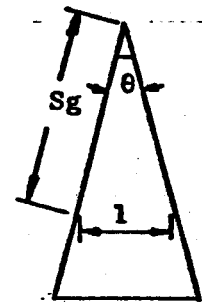
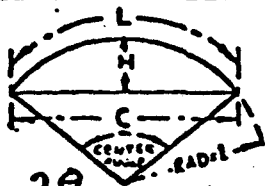

Figure 2B
Gore Profile

TABLE I B
(4 pages)



Length of Arc, Height of Segment, Length of Chord and Area of Segment for Angles from 1 to 180 degrees, and Radius = 1.--For other radii, multiply the values of L, H and C in the table by the given radius, and the values for areas, by the square of the radius.

Center Angle, Degrees	L . A	H . A	C . A	L/C	Area of Segment $\times R^2$
1	0.01745	0.00004	0.01745	1.00000	0.00000
2	0.03491	0.00015	0.03490	1.00028	0.00000
3	0.05236	0.00034	0.05235	1.00019	0.00001
4	0.06981	0.00061	0.06980	1.00014	0.00003
5	0.08727	0.00095	0.08724	1.00034	0.00006
6	0.10472	0.00137	0.10467	1.00047	0.00010
7	0.12217	0.00186	0.12210	1.00057	0.00015
8	0.13963	0.00243	0.13951	1.00086	0.00023
9	0.15708	0.00308	0.15692	1.00101	0.00032
10	0.17453	0.00380	0.17431	1.00126	0.00044
11	0.19199	0.00460	0.19169	1.00156	0.00059
12	0.20944	0.00548	0.20906	1.00181	0.00076
13	0.22689	0.00643	0.22641	1.00212	0.00097
14	0.24435	0.00745	0.24374	1.00250	0.00121
15	0.26180	0.00855	0.26105	1.00287	0.00149
16	0.27925	0.00973	0.27835	1.00323	0.00181
17	0.29671	0.01098	0.29562	1.00368	0.00217
18	0.31416	0.01231	0.31287	1.00412	0.00257
19	0.33161	0.01371	0.33010	1.00457	0.00302
20	0.34907	0.01519	0.34730	1.00509	0.00352
21	0.36652	0.01674	0.36447	1.00562	0.00408
22	0.38397	0.01837	0.38162	1.00615	0.00468
23	0.40143	0.02007	0.39873	1.00674	0.00535
24	0.41888	0.02185	0.41582	1.00735	0.00607
25	0.43633	0.02370	0.43288	1.00796	0.00686
26	0.45379	0.02563	0.44990	1.00864	0.00771
27	0.47124	0.02763	0.46689	1.00931	0.00862
28	0.48869	0.02970	0.48384	1.01002	0.00961
29	0.50615	0.03185	0.50076	1.01076	0.01067
30	0.52360	0.03407	0.51764	1.01151	0.01180
31	0.54105	0.03637	0.53448	1.01229	0.01301
32	0.55851	0.03874	0.55127	1.01313	0.01429
33	0.57596	0.04118	0.56803	1.01396	0.01566
34	0.59341	0.04369	0.58474	1.01482	0.01711
35	0.61087	0.04628	0.60141	1.01572	0.01864
36	0.62832	0.04894	0.61803	1.01664	0.02027
37	0.64577	0.05168	0.63461	1.01758	0.02198
38	0.66323	0.05448	0.65114	1.01856	0.02378
39	0.68068	0.05736	0.66761	1.01957	0.02568
40	0.69813	0.06031	0.68404	1.02059	0.02767
41	0.71559	0.06333	0.70041	1.02167	0.02976
42	0.73304	0.06642	0.71674	1.02274	0.03195
43	0.75049	0.06958	0.73300	1.02386	0.03425
44	0.76795	0.07282	0.74921	1.02501	0.03664
45	0.78540	0.07612	0.76537	1.02617	0.03915

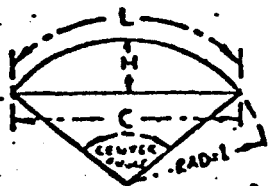

Length of Arc, Height of Segment, Length of Chord and Area of Segment for Angles from 1 to 180 degrees, and Radius = 1.--For other radii, multiply the values of L, H and C in the table by the given radius, and the values for areas, by the square of the radius.

Center Angle, Degrees	L	H	C	L/C	Area of Segment
46	0.80300	0.07950	0.78100	1.02816	0.04176
47	0.82000	0.08290	0.79700	1.02685	0.04448
48	0.83800	0.08650	0.81300	1.03075	0.04731
49	0.85500	0.09000	0.82900	1.03136	0.05025
50	0.87300	0.09370	0.84500	1.03313	0.05331
51	0.89000	0.09740	0.86100	1.03368	0.05649
52	0.90800	0.10120	0.87700	1.03534	0.05978
53	0.92500	0.10510	0.89200	1.03699	0.06319
54	0.94200	0.10900	0.90800	1.03744	0.06673
55	0.96000	0.11300	0.92300	1.04008	0.07039
56	0.97700	0.11710	0.93900	1.04046	0.07417
57	0.99500	0.12120	0.95400	1.04297	0.07808
58	1.01200	0.12540	0.97000	1.04329	0.08212
59	1.03000	0.12960	0.98500	1.04568	0.08629
60	1.04700	0.13400	1.00000	1.04700	0.09059
61	1.06500	0.13840	1.01500	1.04926	0.09502
62	1.08200	0.14280	1.03000	1.05048	0.09958
63	1.10000	0.14740	1.04500	1.05263	0.10428
64	1.11700	0.15200	1.06000	1.05377	0.10911
65	1.13400	0.15660	1.07500	1.05488	0.11408
66	1.15200	0.16130	1.08900	1.05785	0.11919
67	1.16900	0.16610	1.10400	1.05887	0.12443
68	1.18700	0.17100	1.11800	1.06171	0.12982
69	1.20400	0.17590	1.13300	1.06266	0.13535
70	1.22200	0.18080	1.14700	1.06536	0.14102
71	1.23900	0.18590	1.16100	1.06718	0.14683
72	1.25700	0.19100	1.17600	1.06887	0.15279
73	1.27400	0.19610	1.19000	1.07058	0.15889
74	1.29100	0.20140	1.20400	1.07225	0.16514
75	1.30900	0.20660	1.21700	1.07559	0.17154
76	1.32600	0.21200	1.23100	1.07717	0.17808
77	1.34400	0.21740	1.24500	1.07951	0.18477
78	1.36100	0.22290	1.25900	1.08101	0.19160
79	1.37900	0.22840	1.27200	1.08411	0.19859
80	1.39600	0.23400	1.28600	1.08553	0.20573
81	1.41400	0.23960	1.29900	1.08852	0.21301
82	1.43100	0.24530	1.31200	1.09071	0.22045
83	1.44900	0.25100	1.32500	1.09358	0.22804
84	1.46600	0.25690	1.33800	1.09566	0.23578
85	1.48300	0.26270	1.35100	1.09770	0.24367
86	1.50100	0.26860	1.36400	1.10043	0.25171
87	1.51800	0.27460	1.37700	1.10239	0.25990
88	1.53600	0.28070	1.38900	1.10583	0.26825
89	1.55300	0.28670	1.40200	1.10770	0.27677
90	1.57100	0.29290	1.41400	1.11103	0.28540

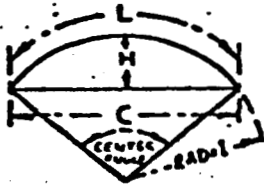

Length of Arc, Height of Segment, Length of Chord and Area of Segment for Angles from 1 to 180 degrees, and Radius = 1.--For other radii, multiply the values of L, H and C in the table by the given radius, and the values for areas, by the square of the radius.

Center Angle, Degrees	L	H	C	L/C	Area of Segment
91	1.58800	0.29910	1.42600	1.11360	0.29420
92	1.60600	0.30530	1.43900	1.11605	0.30320
93	1.62300	0.31160	1.45100	1.11853	0.31230
94	1.64100	0.31800	1.46300	1.12166	0.32150
95	1.65800	0.32440	1.47500	1.12406	0.33090
96	1.67500	0.33090	1.48600	1.12718	0.34050
97	1.69300	0.33740	1.49800	1.13017	0.35020
98	1.71000	0.34390	1.50900	1.13320	0.36010
99	1.72800	0.35060	1.52100	1.13609	0.37010
100	1.74500	0.35720	1.53200	1.13903	0.38030
101	1.76300	0.36390	1.54300	1.14257	0.39060
102	1.78000	0.37070	1.55400	1.14543	0.40100
103	1.79800	0.37750	1.56500	1.14888	0.41170
104	1.81500	0.38430	1.57600	1.15164	0.42240
105	1.83300	0.39120	1.58700	1.15500	0.43330
106	1.85000	0.39820	1.59700	1.15842	0.44440
107	1.86700	0.40520	1.60800	1.16106	0.45560
108	1.88500	0.41220	1.61800	1.16501	0.46690
109	1.90200	0.41930	1.62800	1.16830	0.47840
110	1.92000	0.42640	1.63800	1.17216	0.49010
111	1.93700	0.43360	1.64800	1.17536	0.50190
112	1.95500	0.44080	1.65800	1.17913	0.51380
113	1.97200	0.44810	1.66800	1.18225	0.52590
114	1.99000	0.45540	1.67700	1.18664	0.53810
115	2.00700	0.46270	1.68700	1.18968	0.55040
116	2.02500	0.47010	1.69600	1.19398	0.56290
117	2.04200	0.47750	1.70500	1.19765	0.57550
118	2.05900	0.48500	1.71400	1.20122	0.58830
119	2.07700	0.49250	1.72300	1.20545	0.60120
120	2.09400	0.50000	1.73200	1.20900	0.61420
121	2.11200	0.50760	1.74100	1.21309	0.62730
122	2.12900	0.51520	1.74900	1.21726	0.64060
123	2.14700	0.52280	1.75800	1.22127	0.65400
124	2.16400	0.53050	1.76600	1.22536	0.66760
125	2.18200	0.53830	1.77400	1.22998	0.68120
126	2.19900	0.54600	1.78200	1.23400	0.69500
127	2.21700	0.55380	1.79000	1.23854	0.70900
128	2.23400	0.56160	1.79800	1.24249	0.72300
129	2.25100	0.56950	1.80500	1.24709	0.73720
130	2.26900	0.57740	1.81300	1.25151	0.75140
131	2.28600	0.58530	1.82000	1.25604	0.76580
132	2.30400	0.59330	1.82700	1.26108	0.78030
133	2.32100	0.60130	1.83400	1.26553	0.79500
134	2.33900	0.60930	1.84100	1.27050	0.80970
135	2.35600	0.61730	1.84800	1.27489	0.82450

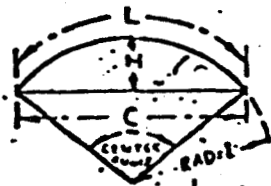

Length of Arc, Height of Segment, Length of Chord and Area of Segment for Angles from 1 to 180 degrees, and Radius = 1.--For other radii, multiply the values of L, H and C in the table by the given radius, and the values for areas, by the square of the radius.

Center Angle, Degrees	L	H	C	L/C	Area of Segment	C/H
136	2.37400	0.62540	1.85400	1.28047	0.83950	
137	2.39100	0.63350	1.86100	1.28479	0.85450	
138	2.40900	0.64160	1.86700	1.29030	0.86970	
139	2.42600	0.64980	1.87300	1.29524	0.88500	
140	2.44300	0.65800	1.87900	1.30015	0.90030	3.9216
141	2.46100	0.66620	1.88500	1.30557	0.91580	
142	2.47800	0.67440	1.89100	1.31041	0.93130	
143	2.49600	0.68270	1.89700	1.31576	0.94700	
144	2.51300	0.69100	1.90200	1.32124	0.96270	3.758
145	2.53100	0.69930	1.90700	1.32721	0.97860	3.716
146	2.54800	0.70760	1.91300	1.33193	0.99450	
147	2.56600	0.71600	1.91800	1.33785	1.01050	
148	2.58300	0.72440	1.92200	1.34391	1.02660	3.5994
149	2.60000	0.73280	1.92700	1.34924	1.04270	
150	2.61800	0.74120	1.93200	1.35507	1.05900	
151	2.63500	0.74960	1.93600	1.36105	1.07530	
152	2.65300	0.75810	1.94100	1.36682	1.09170	
153	2.67000	0.76660	1.94500	1.37275	1.10820	
154	2.68800	0.77500	1.94900	1.37916	1.12470	
155	2.70500	0.78360	1.95300	1.38504	1.14130	
156	2.72300	0.79210	1.95600	1.39212	1.15800	
157	2.74000	0.80060	1.96000	1.39795	1.17470	
158	2.75800	0.80920	1.96300	1.40499	1.19150	
159	2.77500	0.81780	1.96600	1.41149	1.20830	
160	2.79200	0.82640	1.97000	1.41725	1.22520	
161	2.81000	0.83500	1.97300	1.42422	1.24220	
162	2.82700	0.84360	1.97500	1.43139	1.25920	
163	2.84500	0.85220	1.97800	1.43832	1.27630	
164	2.86200	0.86080	1.98000	1.44545	1.29330	
165	2.88000	0.86950	1.98300	1.45234	1.31050	
166	2.89700	0.87810	1.98500	1.45944	1.32770	
167	2.91500	0.88680	1.98700	1.46703	1.34490	
168	2.93200	0.89550	1.98900	1.47410	1.36210	
169	2.95000	0.90420	1.99100	1.48166	1.37940	
170	2.96700	0.91280	1.99200	1.48945	1.39670	
171	2.98400	0.92150	1.99400	1.49648	1.41400	
172	3.00200	0.93020	1.99500	1.50476	1.43140	
173	3.01900	0.93900	1.99600	1.51252	1.44880	
174	3.03700	0.94770	1.99700	1.52078	1.46620	
175	3.05400	0.95640	1.99800	1.52852	1.48360	
176	3.07200	0.96510	1.99900	1.53676	1.50100	
177	3.08900	0.97380	1.99900	1.54527	1.51850	
178	3.10700	0.98250	2.00000	1.55350	1.53590	
179	3.12400	0.99130	2.00000	1.56200	1.55330	
180	3.14200	1.00000	2.00000	1.57100	1.57080	

TABLE IIB

CLOTH STRESS ANALYSIS
65' Do DGB
10 Percent Fullness

C	$\frac{Sg}{D_0}$	$\frac{Sg \cdot 0.0045}{D_0}$	$\frac{1'}{1}$	1'	$\frac{1'}{C}$	2θ	θ	sinθ	$\frac{1}{\sin\theta}$	ΔP	$\frac{APC}{2 \sin\theta}$
1.898	.0279	.0324	1.1613	2.205	1.162	107	53-1/2	.8038	1.244	0.074	0.087
7.990	.1186	.1231	1.0379	8.378	1.048	60	30	.5000	2.000		0.59
10.127	.1512	.1557	1.0298	10.597	1.0464	59	29-1/2	.4924	2.0308		0.767
11.714	.1767	.1812	1.0254	12.332	1.0527	63	31-1/2	.5225	1.912		0.83
14.089	.2181	.2226	1.0206	15.150	1.0753	75	37-1/2	.6087	1.6429		0.85
16.150	.2516	.2561	1.0179	17.430	1.0792	77	38-1/2	.0226	1.064		0.969
17.567	.2833	.2878	1.0158	19.586	1.1149	91	45-1/2	.7132	1.4021		0.91
18.234	.2977	.3022	1.0151	20.564	1.1277	96	48	.7431	1.3457		0.90
19.058	.3116	.3161	1.0144	21.513	1.1288	96	48	.7431	1.3457		0.94
20.167	.3385	.3440	1.0132	23.411	1.1608	107	53-1/2	.8038	1.244		0.92

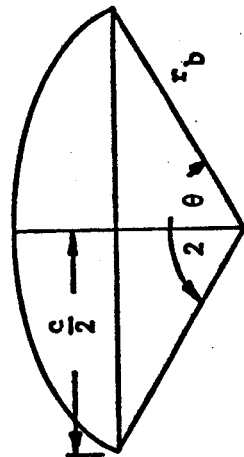

SIMPLIFIED CLOTH STRESS
 VERSUS CHORDLINE LENGTH
 FOR 12.5% TO DGB (BASED
 ON DGB PROFILE).

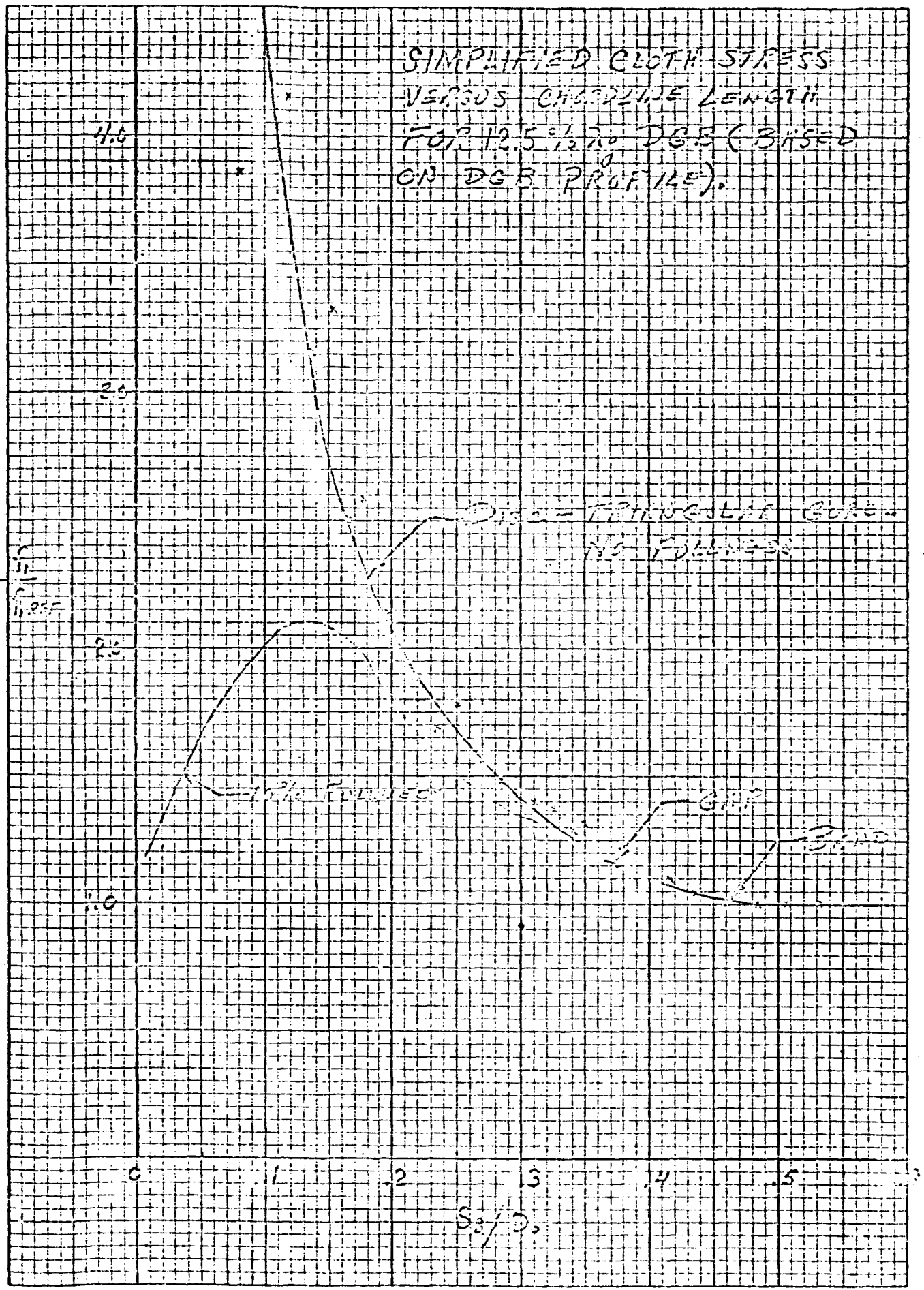

FIGURE III B

GENE ZUENGER
 MADE IN U. S. A.

10 X 10 PER INCH

APPENDIX C

COMPONENT STRUCTURAL TEST REPORTS

The joint efficiencies used in the Margin of Safety calculations are based on the average joint strength determined from component tests presented herein.

The Margin of Safety calculation used in the Stress Analysis section of this report are based on minimum material strengths and a design factor derived from a safety factor based on average test results.

This approach was taken to simplify ~~to~~ calculations somewhat. If one were to use actual minimum test values for material as well as joints, the number of threads per inch, as well as the strength of the thread in each joint, would have to be taken into consideration in the material strength. Unless the thread is considered, it is possible to calculate joint efficiencies of 1.0 or greater depending on the particular sample tested.

The test values presented here in confirm the joint efficiencies as being no worse than those used in the design factor calculations.

TITLE: SUSPENSION LINE TO RADIAL TAPE LOOP

PURPOSE: DETERMINE ULTIMATE STRENGTH OF JOINT

METHOD: TINIUS OLSEN TESTING MACHINE, 2400 lb. SCALE, 12 IN/MIN LOAD RATE, SAME AS FEDERAL SPECIFICATION CCC-T-1916, METHOD 4102. SAMPLE CONSTRUCTION SHOWN BELOW.

RESULTS:

<u>TEST NO.</u>	<u>BREAKING STRENGTH LBS.</u>
1	600
2	598
3	606
	AVG. 601

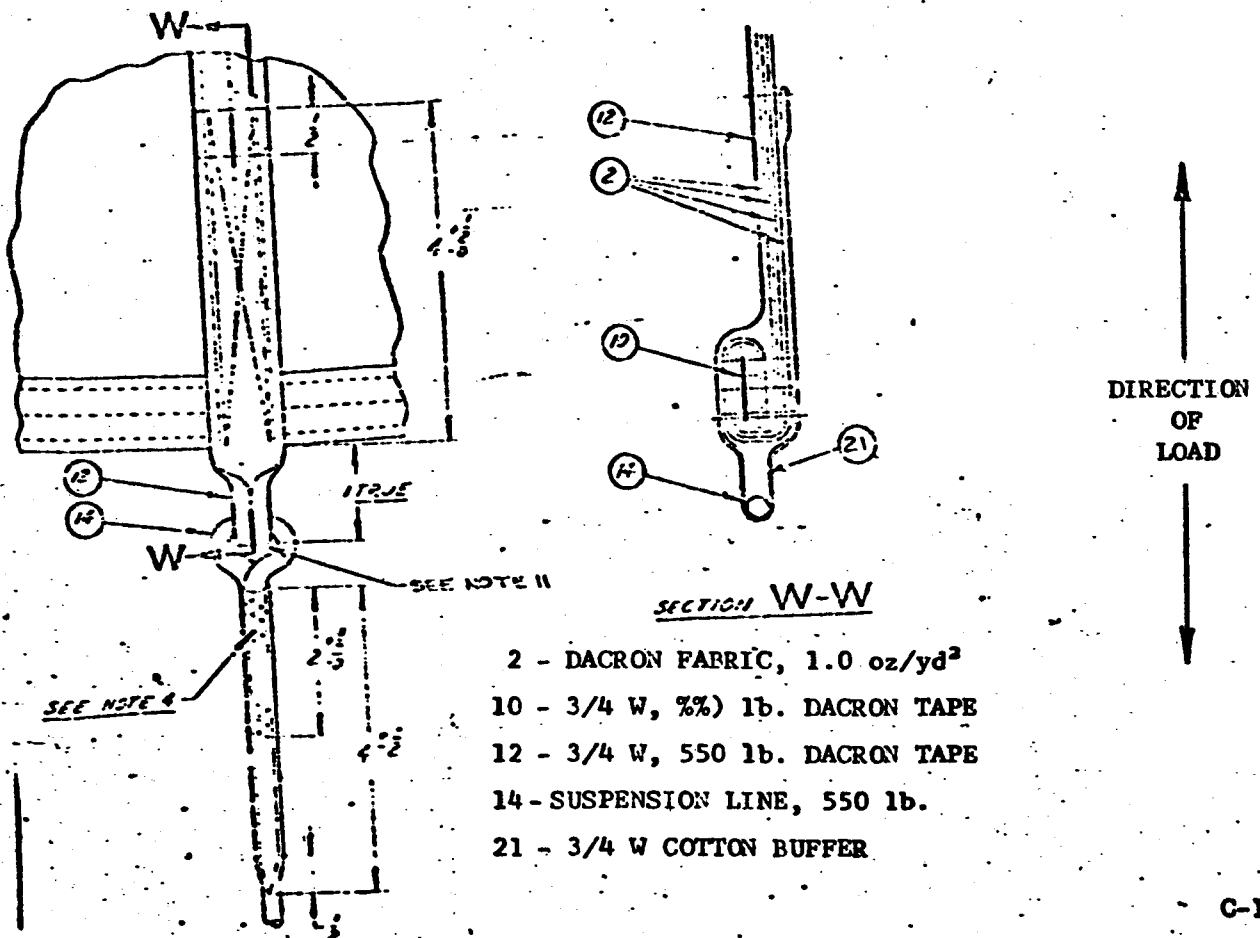

TITLE: TAPE, RADIAL, WITH REINFORCING MEMBER

PURPOSE: DETERMINE ULTIMATE TENSILE STRENGTH OF RADIAL TAPE TO REINFORCING MEMBER JUNCTION:

METHOD: TINIUS OLSEN TESTING MACHINE, 12 IN/MIN LOAD RATE, AND 3 INCH SPLIT DRUMS

RESULTS:

<u>TEST NO.</u>	<u>BREAKING STRENGTH LBS.</u>
1	572
2	568
3	572
AVG 570	

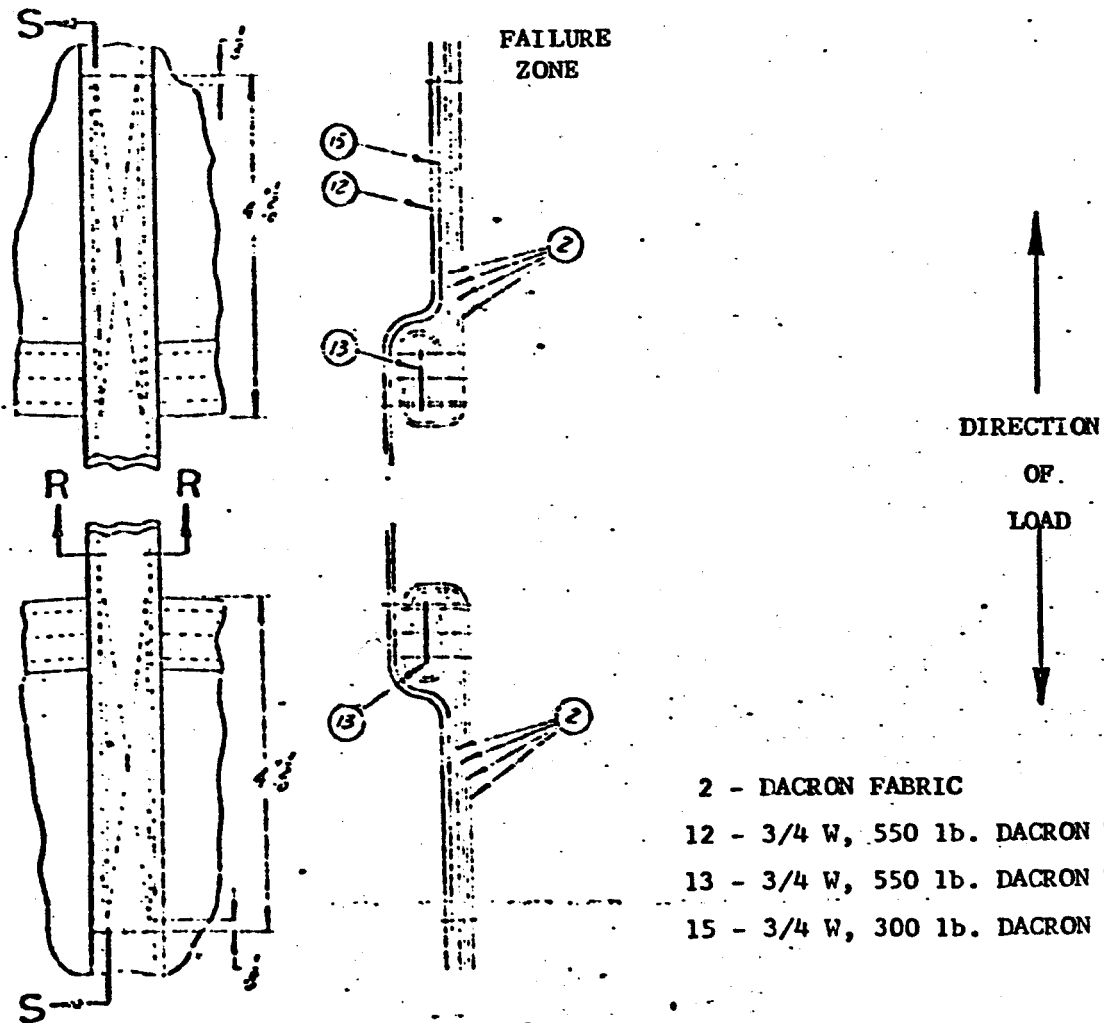

TITLE: CIRCUMFERENTIAL TAPE TO 1.0 oz/yd² DACRON FABRIC

PURPOSE: DETERMINE ULTIMATE LOAD THAT MAY BE APPLIED TO DACRON FABRIC AT THE CIRCUMFERENTIAL TAPE JUNCTION

METHOD: THE SAMPLES WERE TESTED ON A SCOTT TENSILE TESTING MACHINE WITH A JAW SEPARATION OF 4 INCHES, AND A JAW SEPARATION SPEED OF 12 INCHES PER MINUTE. SAMPLE CONSTRUCTION IS SHOWN BELOW

RESULTS:

TEST NO.	BREAKING STRENGTH LBS ₇ IN
1	50
2	53
3	53.5
4	50
AVG.	51.6

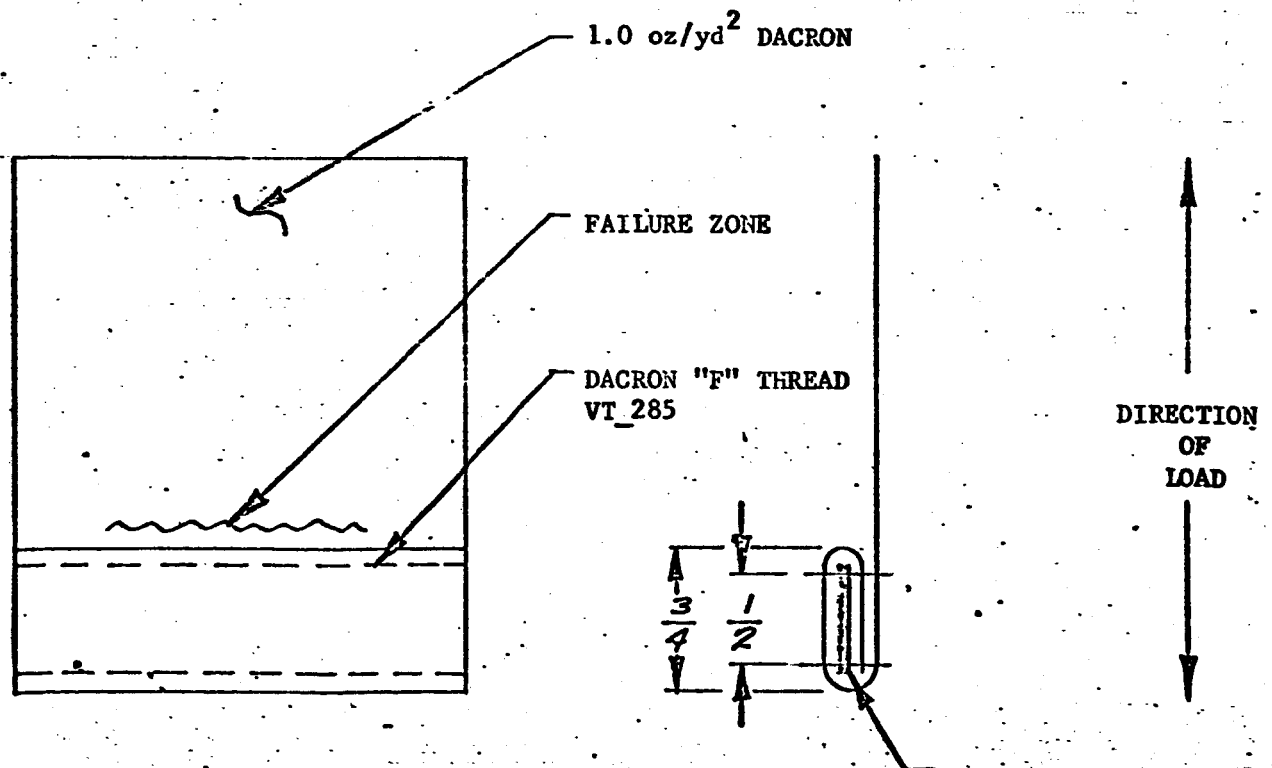

TITLE: CIRCUMFERENTIAL TAPE TO 1.5 oz/yd² DACRON FABRIC

PURPOSE:

DETERMINE ULTIMATE LOAD THAT MAY BE APPLIED TO DACRON FABRIC AT THE CIRCUMFERENTIAL TAPE JUNCTION.

METHOD:

THE SAMPLES WERE TESTED ON A SCOTT TENSILE TESTING MACHINE WITH A JAW SEPARATION OF 4 INCHES, AND A JAW SEPARATION SPEED OF 12 INCHES PER MINUTE. SAMPLE CONSTRUCTION IS SHOWN BELOW.

RESULTS:

<u>TEST NO.</u>	<u>BREAKING STRENGTH LBS.</u>
1	67.5
2	62.5
3	60.5
4	66.0
AVG.	64.1

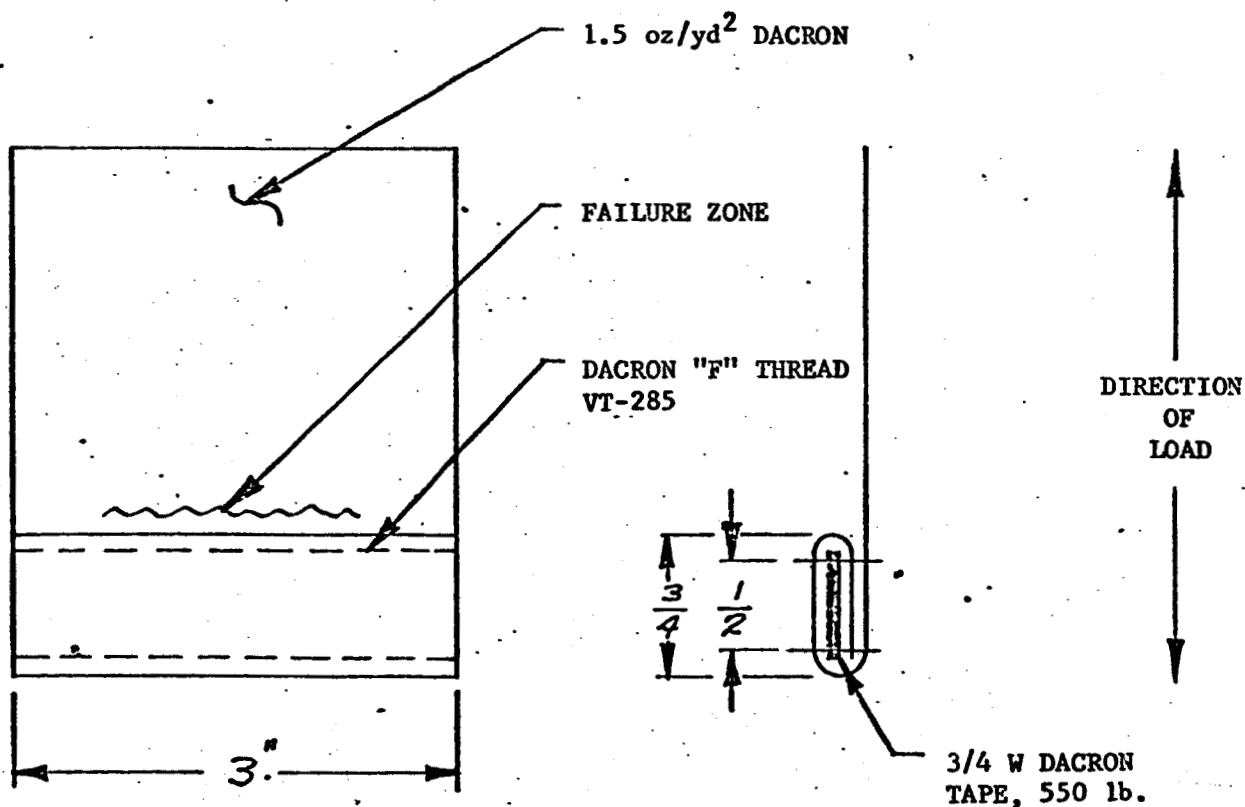

TITLE: MAIN SEAM - BAND

PURPOSE: DETERMINE ULTIMATE STRENGTH OF MAIN SEAM IN BAND.

METHOD: SAMPLES WERE TESTED ON A SCOTT TENSILE TESTING MACHINE, JAW SPEED OF 12 in/min., JAW SEPARATION OF 4 INCHES. SAMPLE CONSTRUCTION IS SHOWN BELOW.

RESULTS:

<u>TEST NO.</u>	<u>BREAKING STRENGTH LBS.</u>
1	24
2	20.5
3	28.5
4	25
AVG.	<u>24.5</u>

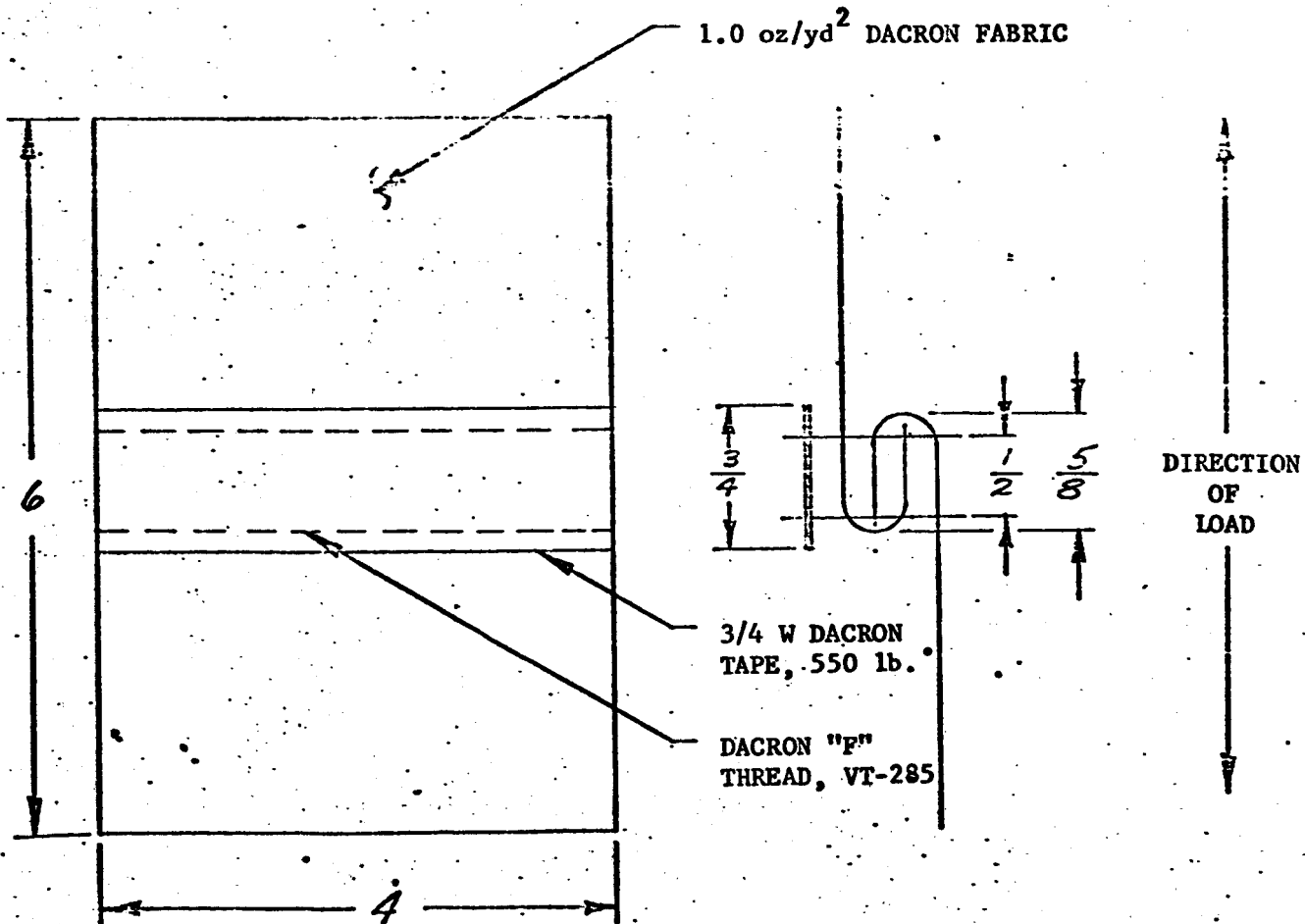

TITLE: CROSS SEAM - BAND

PURPOSE: DETERMINE ULTIMATE STRENGTH OF CROSS SEAM IN BAND.

METHOD: SAMPLES WERE TESTED ON A SCOTT TENSILE TESTING MACHINE, JAW SPEED OF 12 IN/MIN., JAW SEPARATION OF 4 INCHES. SAMPLE CONSTRUCTION IS SHOWN BELOW

RESULTS:

<u>TEST NO.</u>	<u>BREAKING STRENGTH LBS.</u>
1	38
2	36.5
3	43
4	37
5	46
AVG.	40.1

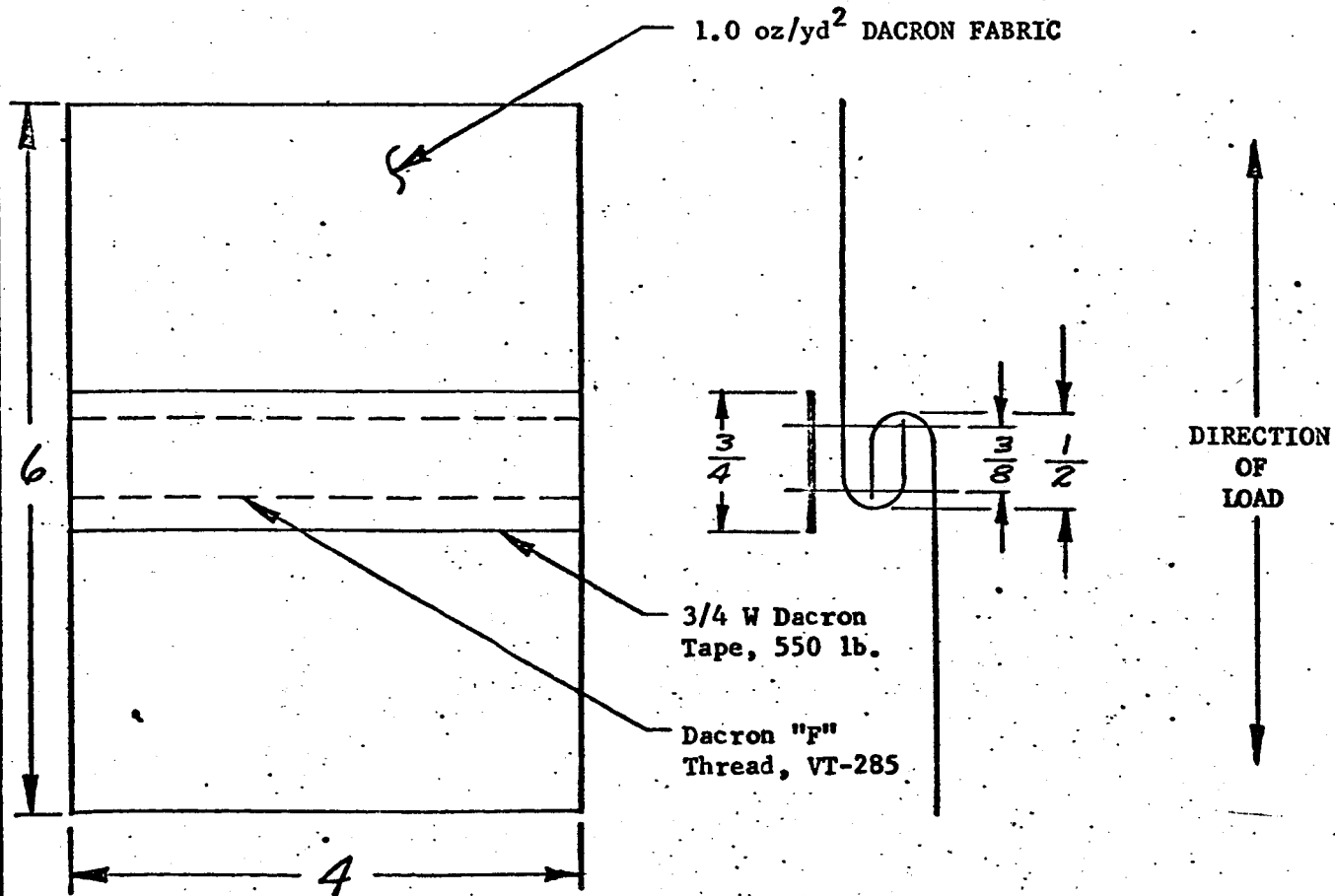

TITLE: MAIN SEAM - DISC

PURPOSE: DETERMINE ULTIMATE STRENGTH OF MAIN SEAM IN DISC

METHOD: SAMPLES WERE TESTED ON A SCOTT TENSILE TESTING MACHINE, JAW SPEED OF 12 IN/MIN., JAW SEPARATION OF 4 INCHES. SAMPLE CONSTRUCTION IS SHOWN BELOW

RESULTS:

<u>TEST NO.</u>	<u>BREAKING STRENGTH LBS.</u>
1	36.5
2	50.5
3	45.0
	AVG. 44.0

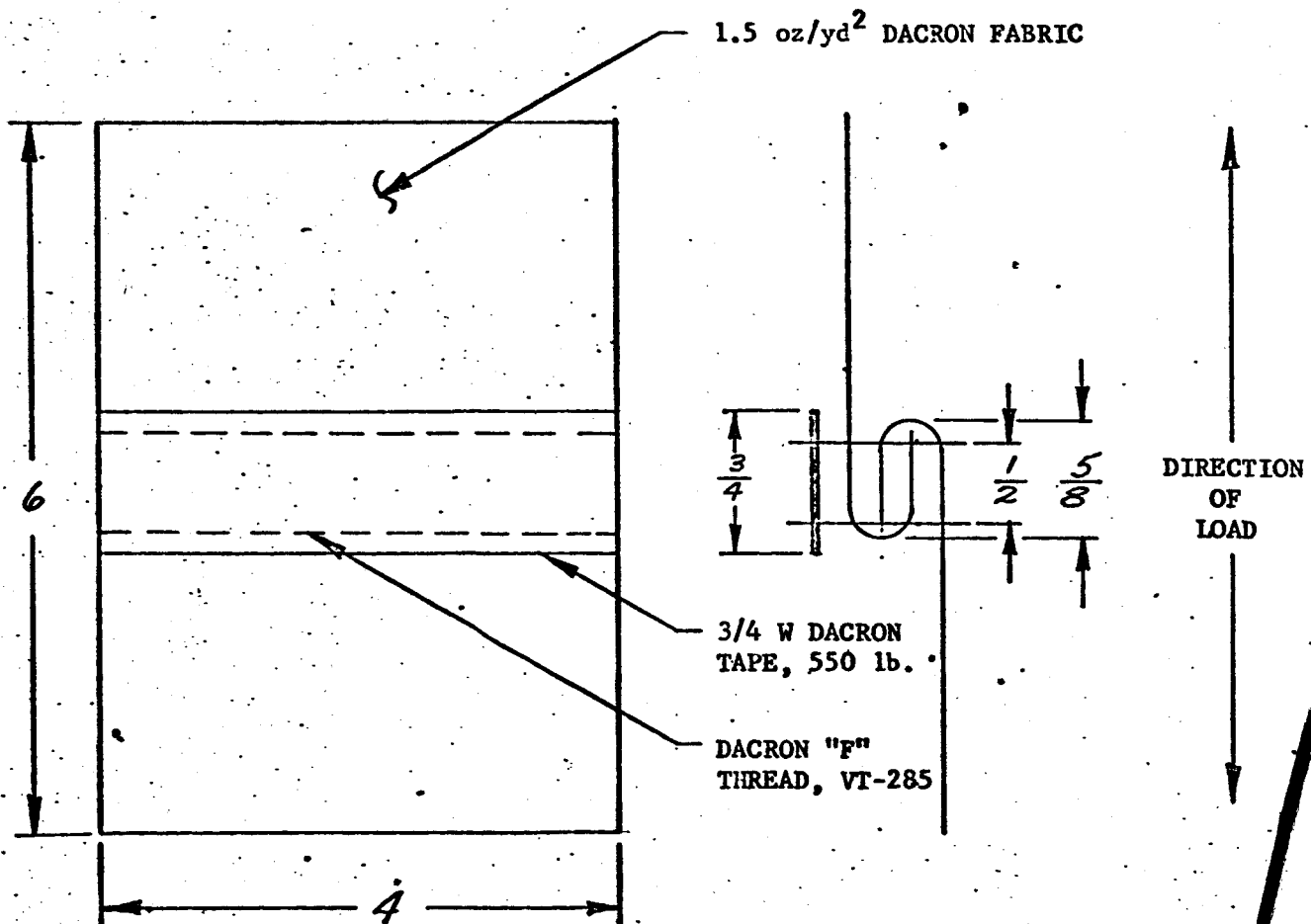

TITLE: CROSS SEAM - DISC

PURPOSE: DETERMINE ULTIMATE STRENGTH OF CROSS SEAM IN DISC.

METHOD: SAMPLES WERE TESTED ON A SCOTT TENSILE TESTING MACHINE, JAW SPEED OF 12 IN/MIN., JAW SEPARATION OF 4 INCHES. SAMPLE CONSTRUCTION IS SHOWN BELOW

RESULTS:

<u>TEST NO.</u>	<u>BREAKING STRENGTH LBS.</u>
1	39
2	42
3	48
	AVG. 43 lb/in.

