

N.T.

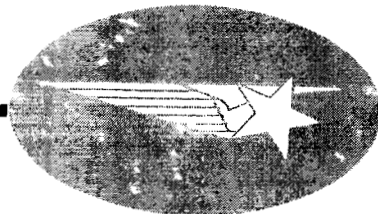

GPO PRICE \$ _____

CFSTI PRICE(S) \$ _____

Hard copy (HC) 3.00

Microfiche (MF) .65

ff 653 July 65

MISSION B EXPERIMENT
DATA STORAGE AND
RADIATION STUDIES

Augmentation Task 29

LMSC-A842321

5 September 1967



FACILITY FORM 602

N 68-25220
(ACCESSION NUMBER)

76
(PAGES)

CR 61822
(NASA CR OR TMX OR AD NUMBER)

(THRU)

1
(CODE)

14
(CATEGORY)

NG-25220

MISSION B EXPERIMENT
DATA STORAGE AND
RADIATION STUDIES

Augmentation Task 29

LMSC-A842321

5 September 1967

Prepared Under Contract No. NAS8-21003 by

LOCKHEED MISSILES & SPACE COMPANY
A Group Division of Lockheed Aircraft Corporation
Sunnyvale, California

for

NATIONAL AERONAUTICS AND SPACE ADMINISTRATION
GEORGE C. MARSHALL SPACE FLIGHT CENTER
Huntsville, Alabama

Prepared by:

W.C. Beckett
G.B. Holmes

Approved by:

R. Schuyler

PRECEDING PAGE BLANK NOT FILMED.

CONTENTS
(Part I)

Section		Page
	ILLUSTRATIONS	v
	TABLES	vii
1	INTRODUCTION	I-2
2	CLUSTER A GEOMETRIC CONSIDERATIONS	I-4
	2.1 Film Experiment Locations	I-4
	2.2 Film Storage Locations	I-6
3	EXPERIMENTS S052 AND S056 FILM DOSE ON ATM SPAR	I-9
	3.1 S052 Film Dose - Aft Mounted Camera	I-9
	3.2 S056 Film Dose	I-9
	3.3 Shield Material Comparison	I-12
	3.4 Radiation Streaming and Radiation Shutters	I-12
	3.5 Independent ATM-LM-CSM Operations	I-12
	3.6 S052 Side Mounted Camera Dose	I-14
	3.7 Interaction Between S052 and S056 Shields	I-14
	3.8 Film Self-Shielding Versus Time	I-14
	3.9 Shield Shaping	I-15
4	FILE DOSES DURING 42-DAY STORAGE PERIOD	I-17
	4.1 CM Film Storage	I-17
	4.2 MDA Film Storage	I-19
5	FILM RADIATION FOGGING	I-21
6	SHIELD WEIGHT ESTIMATES	I-28
7	SUMMARY OF STUDY RESULTS AND CONCLUSIONS	I-30
8	RECOMMENDATIONS	I-32
9	CLUSTER GEOMETRY SOURCE DATA REFERENCE MATERIAL	I-33
10	REFERENCES	I-35

CONTENTS
(Part II)

Section		Page
1	INTRODUCTION AND SUMMARY	II-2
	1.1 Introduction	II-2
	1.2 Summary	II-2
2	MISSION B EXPERIMENT DATA STORAGE REQUIREMENTS	II-5
	2.1 Ascent Experiment Storage Requirements	II-5
	2.2 Return Data Storage Requirements	II-6
3	MISSION B EXPERIMENT DATA STORAGE	II-8
	3.1 Ascent Data Storage	II-8
	3.1.1 Potential LM Data Storage Locations	II-8
	3.1.2 Ascent Experiment Locations	II-8
	3.1.3 LM Structural Effects	II-13
	3.1.4 Weight and Balance Conditions	II-13
	3.2 Return Data Storage	II-14
	3.2.1 Potential CM Data Return Locations	II-14
	3.2.2 Return Data Storage Installation	II-14
	3.2.3 Mission A-3 Data Return Weight and Balance- Command Module	II-19
	3.2.4 Additional CM Data Storage Potential	II-28
	3.2.5 CM Reentry Land Landing	II-32

ILLUSTRATIONS

(Part I)

Figure		Page
2-1	Cluster Configuration	I-5
2-2	AAP-3 CM Data Return Locations	I-7
2-3	CM Aft Bulkhead Data Storage Detail	I-8
3-1	Experiment S052 Film Exposure Vs. Shield Thickness and Weight Located on ATM Spar – Aft Mounted Camera	I-10
3-2	Experiment S056 Film Exposure Vs. Shield Thickness and Weight Located on ATM Spar	I-11
3-3	Experiment S052 Film Exposure Vs. Shield Weight for Three Different Shield Materials – Located on ATM Spar, Aft Mounted Camera	I-13
3-4	Experiment S052 Typical Internal and External Shielding Arrangement	I-16
4-1	Experiment Film Exposure Vs. Shield Thickness and Weight – Film Stored in CM	I-18
4-2	Experiment Film Exposure Vs. Shield Thickness and Weight – Film Stored in MDA	I-20
5-1	Plus-X Negative Fog Density Vs. Radiation Exposure	I-22
5-2	Film Type 103-0 Negative Fog Density Vs. Radiation Exposure	I-23
5-3	Panatomic-X Negative Fog Density Vs. Radiation Exposure	I-24
5-4	Film Type S0375 Negative Fog Density Vs. Radiation Exposure	I-25
5-5	Film Type SWR Negative Fog Density Vs. Radiation Exposure	I-26

(Part II)

3-1	LM Experiment Storage Potential	II-9
3-2	AAP-4 LM Experiment Storage Locations	II-10

Figure		Page
3-3	AAP-4 LM Experiment Storage Layout	II-11
3-4	CM Potential Data Return Locations	II-15
3-5	AAP-3 CM Data Return Locations	II-16
3-6	CM Aft Bulkhead Data Storage Layout	II-17
3-7	CM Container Utilization Layout	II-20
3-8	Reentry and Impact Conditions Plotted on Limit Diagram	II-29
3-9	Summary of Additional Containers	II-30
3-10	Land Landing Reentry Space	II-33

TABLES

(Part I)

Table		Page
1-1	Basic Requirement for 14 Days of Operation	I-3
5-1	Emulsion to Air Stopping Power Ratio	I-21
6-1	Shield Weight Estimates	I-29

(Part II)

2-1	AAP-4 Ascent Film Cassette Storage	II-5
2-2	Mission B Return Data Requirements	II-6
3-1	Derivation of A-3 CM Baseline Launch Weight and cg	II-22
3-2	AAP-4 Data Return	II-23
3-3	Off-Loaded Equipment	II-24
3-4	Reentry Mass Properties - CM Ballasted to Station 1040.0	II-25
3-5	Reentry Mass Properties Ballasted to Station 1040.5	II-26
3-6	Reentry Mass Properties - Unballasted	II-27
3-7	Comparative Weight Summary - Reentry Sequence of Events	II-31

TASK 29

PART I

I-1

Section 1
INTRODUCTION

For the Cluster A 56-day mission, it is required to protect experiment film from the effects of the space radiation environment. A preliminary investigation of this problem was completed during the month of June 1967; this was Augmentation Task 21, Film On-Orbit Storage Protection, completed under Contract NAS 8-21003. The results of this study are reported in Ref. 1. This study indicated that cluster shielding provides a significant increase in the shielding compared to assuming spherical geometry alone. This present study is an extension of the work to include a refinement of the spar-mounted experiment's internal geometry, particularly in the detail of the structural and experiment element shielding immediately surrounding the film used.

The influence of flux streaming upon total radiation damage to film on the spar was explored. In addition, it is desired to examine film storage in the Command Module (CM) as an alternate to storage within the Multiple Docking Adapter (MDA). The CM is considered a desirable area for film storage because of its superior shielding and the ready location for return of the data at mission completion (or in the event of an abort).

For the current study the assumed quantity of film is three 14-day camera and cassette loads for the ATM experiments. The initial film loading is accomplished before launch and two reloads are carried into orbit, stored within the LEM ascent stage. Because the LEM is lightly shielded, it is necessary to remove the film as soon as possible after ascent to orbital altitude and to place it in the storage container.

Based on the listing of films proposed for the individual ATM experiments, the films most sensitive to radiation damage are plus x film used with experiment S-052 and type 103-0 film used with experiment S-056. In this study the detailed investigations are directed towards protection for these two experiments.

As one of the Cluster A film protection study constraints, the ATM Experiment basic requirement data of Ref. 2 have been used. Some of the volume data have been updated based upon recent experiment design changes. The information on camera and canister weight, size, and volume for each of the experiments is summarized in Table 1-1.

Table 1-1

BASIC REQUIREMENT FOR 14 DAYS OF OPERATION

<u>Experiment</u>	<u>Unit</u>	<u>Weight/Unit (lb)</u>	<u>Size/Unit (in.)</u>	<u>Volume (ft³)</u>
S-052 (HAO)	Camera	15	14.3 × 3.5 × 9.8	0.28
S-053A (NRL)	Canister	50	6.5 × 16.3 × 14.3	0.88
S-053B (NRL)	Canister	50	6.5 × 16.3 × 14.3	0.88
S-054 (AS&E)	Canister	30	22 × 10 × 6	0.79
S-055B (HCO)	Camera	15	14.5 × 4.0 × 10.9	0.37
S-055C (Hα)	Canister	13	20 × 13 × 8	1.20
S-056 (GSFC)	Canister	<u>13</u>	14.5 × 10.9 × 4	<u>0.37</u>
		186		4.77

As seen from this table, the total return and storage requirement for a 14-day experimentation period is 186 lb and 4.77 ft³. The assumed storage volume required is for a 42-day period including three each of the above defined units.

The radiation environment of the earlier study is used in this present study. In addition, the effect of shielding weight distribution between on-the-spar exposures and storage container exposures is indicated. The problem of changes to radiation dose due to proton anisotropy (angular distribution effect) was started but results are not available at the time of this report submittal.

Section 2
CLUSTER A GEOMETRIC CONSIDERATIONS

The cluster geometry model used in the earlier study of Ref. 1 has been revised to include greater detail in critical regions. The major components of the model consist of the ATM/Rack, LM-A, MDA, Apollo CSM, MDA-SIV-B Airlock, and Saturn SIV-B converted to the OWS configuration (Fig. 2-1). The important components for film radiation considerations are the ATM/Rack, which contains the experiments, and the CSM and MDA, which are candidate film storage locations. The refinements in the geometric data for these components are discussed below.

2.1 FILM EXPERIMENT LOCATIONS

The present study is concerned with two experiments, S052 and S056, for which radiation sensitive films have been proposed. These experiment packages were simulated by hollow tubes, boxes, cameras, and film in the previous study. During the current effort, additional information became available and is incorporated into the model.

Two configurations of the S052 experiment are examined. These cases are labeled "Aft-mounted Camera," where the camera is located between the ATM spar and the LM-A, and "Side-Mounted Camera," where the camera is located beside the optical housing. The lenses, mirrors, mounts, shutters, electronic boxes, and other elements are simulated in sufficient detail for both cases. The optical house and camera wall thicknesses were not available at the time the aft mounted camera case was studied so these walls were conservatively assumed to be 1/16-in. aluminum. For the S052 side-mounted case, Ball Brothers Research Corporation furnished preliminary drawings specifying a 1/8-in. aluminum top plate for the optical housing and 3/16-in. aluminum sides and bottom except near the camera aperture face where it is 3/8 in. The side-mounted camera walls vary in thickness from 9/32 to one inch of aluminum. Several of the case-mounting pads are also included in the side mounted configuration.

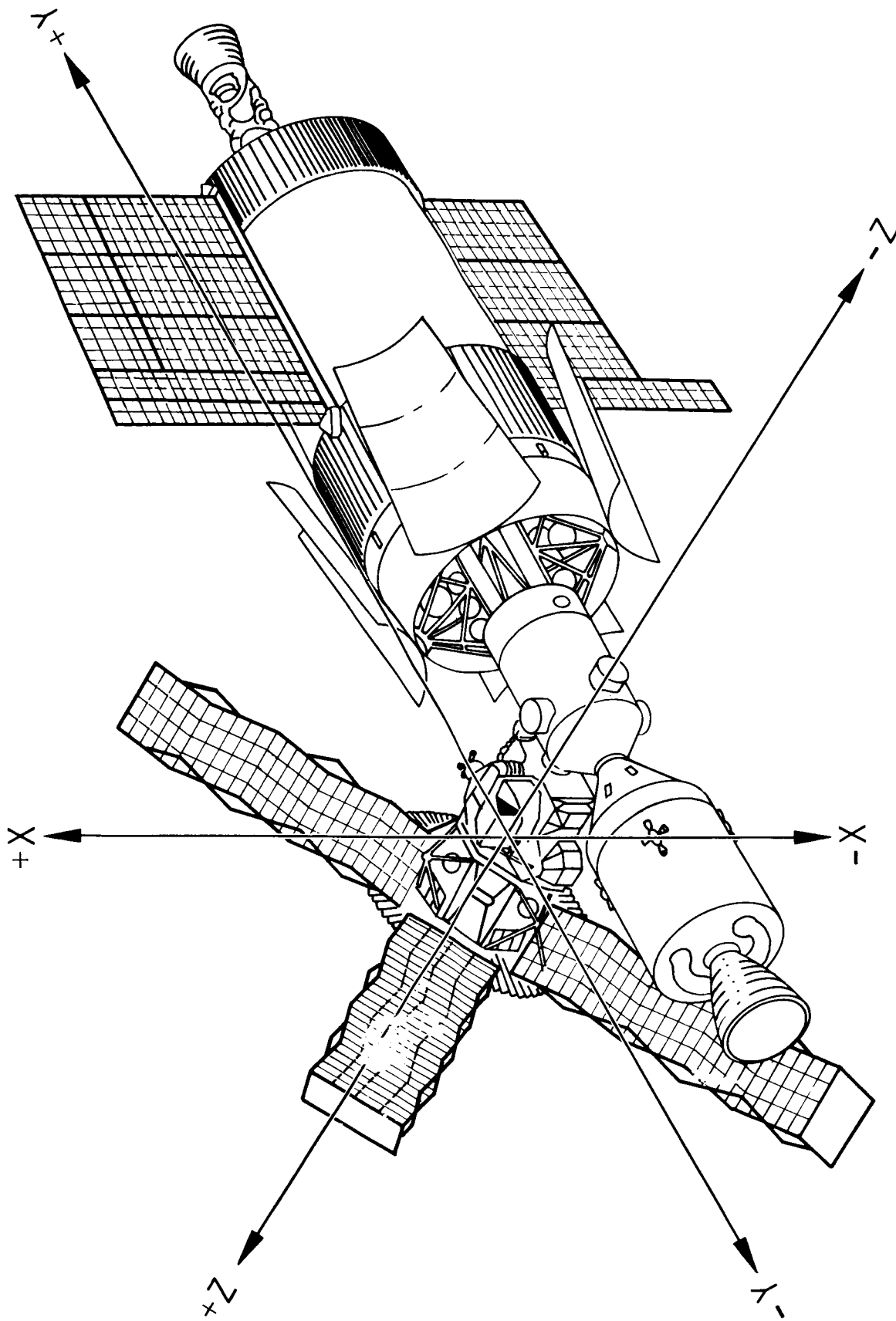



Fig. 2-1 Cluster Configuration

The S056 configuration is revised from a simple hollow tube (1/16-in. aluminum) to an adequately detailed representation. This improvement was made possible due to drawings furnished by the Astrionics Laboratory, MSFC, combined with measurements taken from the breadboard model at that laboratory. The aluminum instrument barrel is bounded by a cylinder on the inside and a cone on the outside such that the barrel wall thickness tapers from 1/4 in. at the camera end to 1/8 in. at the sun end. The beryllium mirror, aluminum or titanium diaphragms and aperture plates, support collar, and filter assembly motors are included inside the barrel. A layout drawing of the S056 camera permitted detailed simulation of this important component with internal fittings, drive motor, and other elements which provide significant shielding.

2.2 FILM STORAGE LOCATIONS

The MDA and CM appear to offer feasible locations for spare film storage. Doses to film stored in the MDA were estimated during a previous study. At that time the MDA configuration was represented with suitable wall thicknesses, radiator systems, docking ports, stiffening structure, and internal boxes and components. No revisions to the MDA configuration have been made during the present study.

The CM geometry model has been updated. Wall thicknesses and stowage bay contents are revised. The film locations specified in Figs. 2-2 and 2-3 are included in the present geometric model. Figure 2-2 shows the overall positioning of data return packages within the command module. Figure 2-3 indicates the detail storage positions of film in the command module aft bulkhead area assumed for this study. It will be noted that the S052 and S056 experiment packages have been placed adjacent to each other to permit a minimum shielding weight for these most sensitive films. However, only two thirds of the ATM film supply are placed in the CM. It is assumed that one of the three loads is on the ATM. Further, the other supplies of return data packages are omitted because they will be placed in the CM in the last few days of the mission. The S052 and S056 films are placed in an iron shielded box in place of boxes A4, A5, and A6 of Fig. 2-3.

 = AVAILABLE SPACE

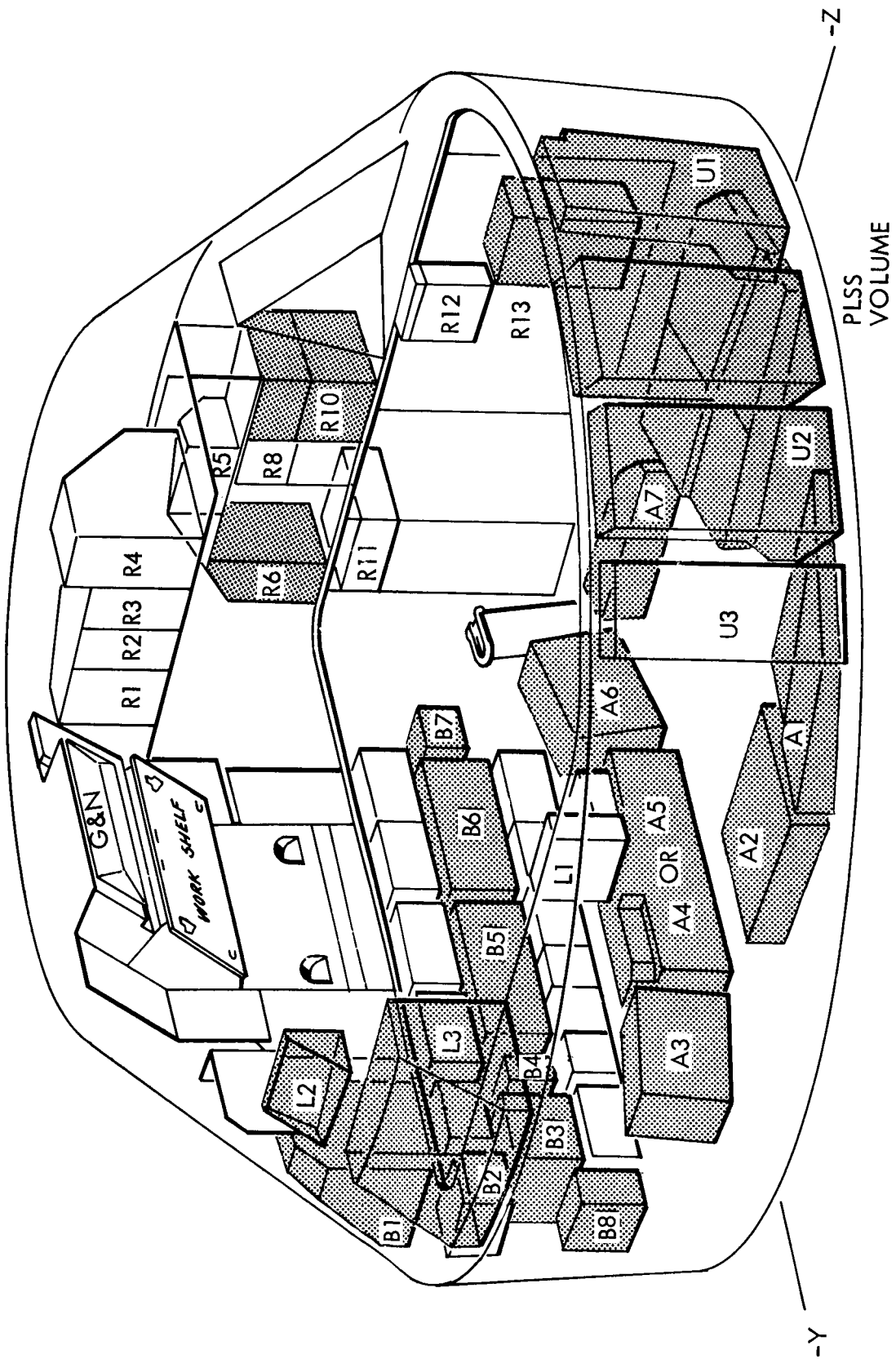
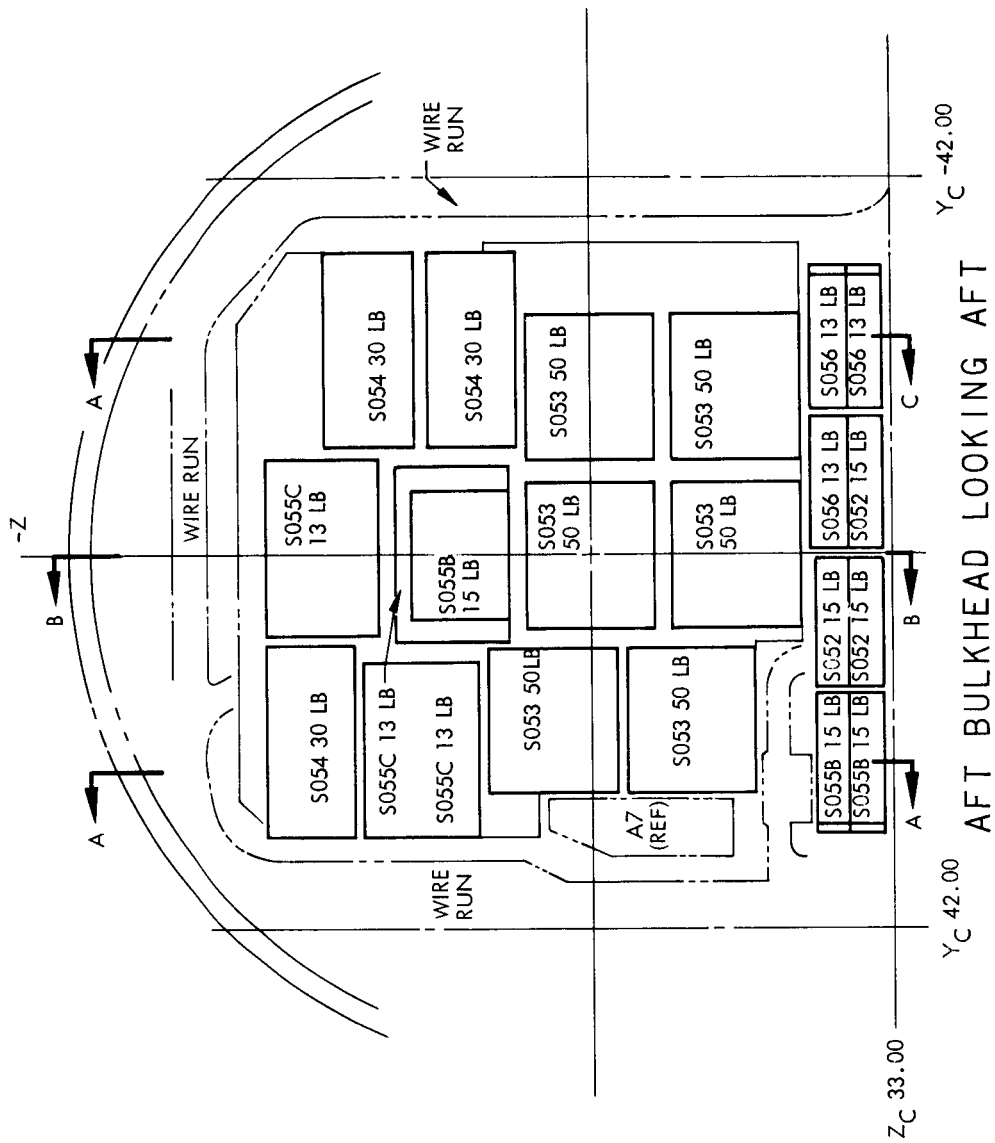

Fig. 2-2 AAP-3 CM Data Return Locations



AFT BULKHEAD LOOKING AFT

Fig. 2-3 CM Aft Bulkhead Data Storage Detail

Section 3

EXPERIMENTS S052 AND S056 FILM DOSE ON ATM SPAR

Dose estimates to S052 and S056 film are made for a variety of parametric conditions. Dose changes due to different shield materials and thicknesses, and to different detector locations are studied. The effect of film self-shielding while the film is winding and unwinding is investigated. The effect of streaming paths and the use of radiation shutters on dose estimates is explored. The interaction of the S056 camera shields on the S052 film is evaluated. Further, investigations of the doses resulting from independent LM/ATM/CSM operation and also operating the ATM/Rack alone are made. Finally, the S052 side mounted camera and special shielding for the aft mounted S052 camera configuration are studied. The results of these investigations are discussed in the following sub-sections.

3.1 S052 FILM DOSE - AFT MOUNTED CAMERA

The S052 film dose versus shield weight for 14 days exposure on the spar is shown in Fig. 3-1. The detector is chosen to be 0.1 in. from the edge of the film on the middle frame of the roll. An integration of dose rate versus time is performed as the film transfers to the takeup reel. Note that the curve is dashed beyond the 1-in. shield (iron) to indicate that the heavy shield values are obtained by ratioing aluminum shield data beyond this point. The choice of iron as a shield material is discussed in Section 3.3.

3.2 S056 FILM DOSE

The S056 film dose versus shield weight is shown in Fig. 3-2. Here, the time integration is omitted. Instead, the film is assumed to be at the halfway point (as shown in the inset) and two detector locations are selected. Detector A receives minimum self-shielding benefit, while detector B sees increased self-shielding but direct streaming paths through the 1.5×1.25 -in. rectangular aperture

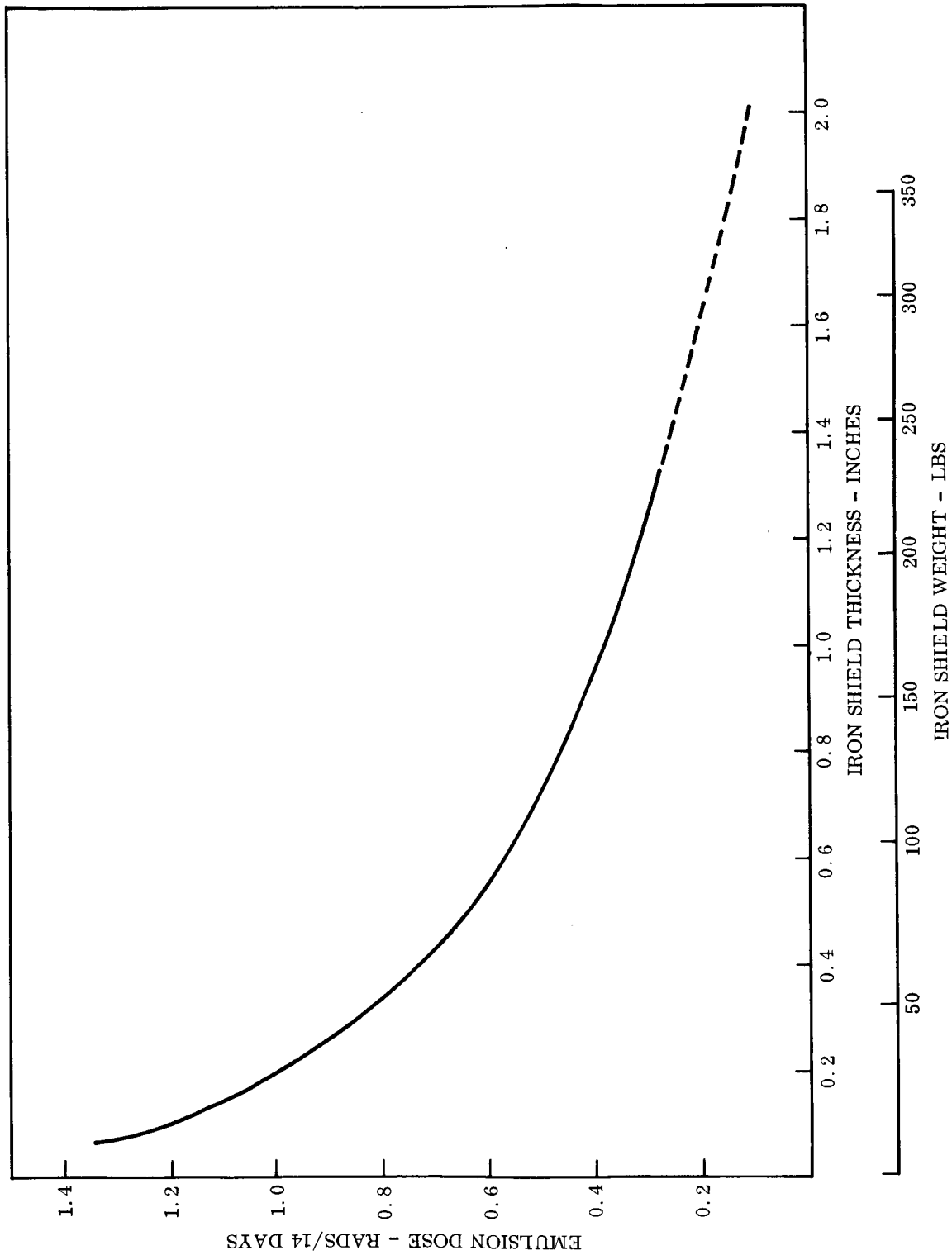

Fig. 3-1 Experiment S052 Film Exposure Vs. Shield Thickness and Weight
 Located on ATM Spar - Aft Mounted Camera

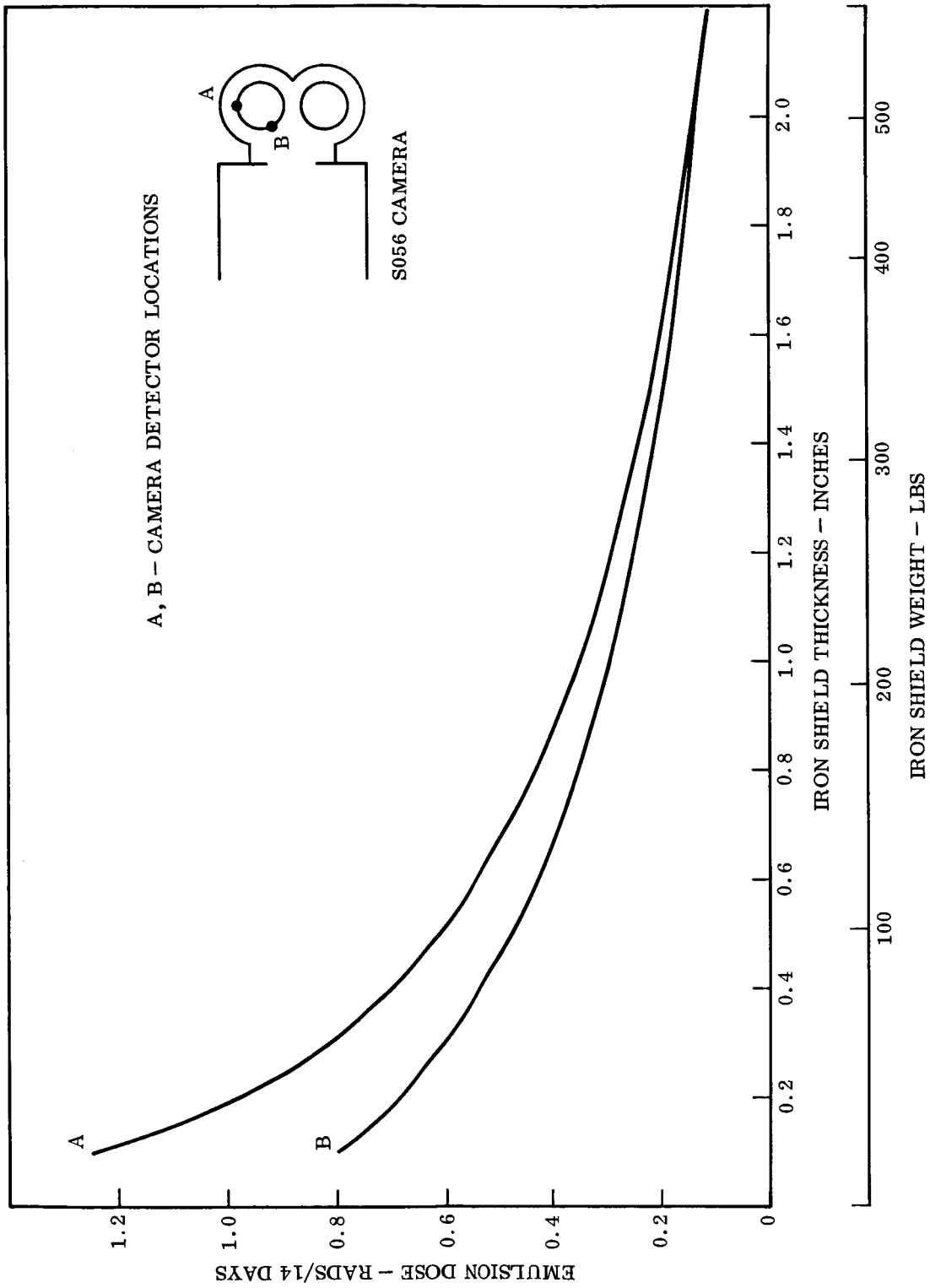

Fig. 3-2 Experiment S056 Film Exposure Vs. Shield Thickness and Weight Located on ATM Spar

in the 0.5-in. aluminum interface plates. For thin shields, film self-shielding is more significant than the effect of radiation streaming. As shield weight increases, the importance of self-shielding is reduced. The fact that curves A and B are very close at 2 in. of iron tends to indicate that streaming is not a dominant factor here.

3.3 SHIELD MATERIAL COMPARISON

A comparison of three shield materials for the S052 experiment (aft-mounted camera) is shown in Fig. 3-3. Aluminum is superior to iron and tungsten on a weight basis. However, space limitations on the ATM (and in the CM) dictate that a higher density material be chosen. Tungsten possesses a density of 19.3 compared to 2.7 for aluminum, but its low stopping power and high secondary production make it an inefficient shield. Iron, with a density of 7.8 appears to be a good compromise candidate. Iron is therefore chosen for most of the shield calculations in this study.

3.4 RADIATION STREAMING AND RADIATION SHUTTERS

During the course of the study, it was thought that a possible reduction in dose to the film located on the spar could be realized by employing radiation shielding shutters during passage through the anomaly while the vehicle is on the earth's dark side and no ATM photography is possible. However, Section 3.2 points out that streaming is not a critical problem for S056 (save possibly for electrons entering the aperture and striking the film at the focal plane). This conclusion is supported by a preliminary run on the S052 (aft mounted) experiment with no lens in the aperture. For a detector directly behind the aperture, the addition of a 1-in. tungsten radiation shutter reduces the dose by only 15 percent.

3.5 INDEPENDENT ATM-LM-CSM OPERATION

An independent ATM-LM-CSM configuration has been proposed as an alternate or backup to the Cluster A configuration. This reduced cluster affords less shielding to the ATM, and it was felt that this might increase shield requirements. The proposed

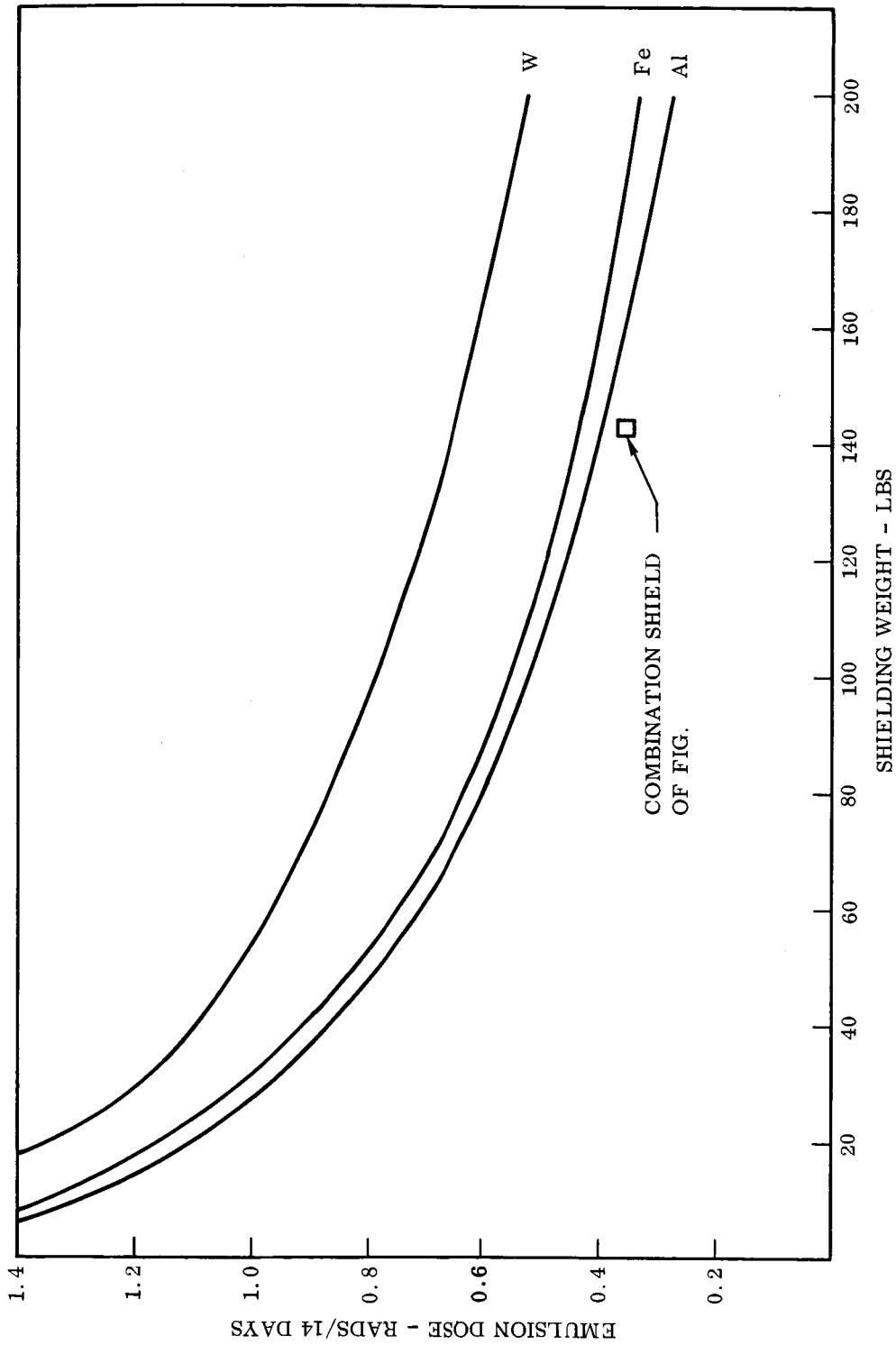

Fig. 3-3 Experiment S052 Film Exposure Vs. Shield Weight for Three Different Shield Materials - Located on ATM Spar, Aft Mounted Camera

configuration was investigated, and the dose to a detector on the surface of the S056 film located on the ATM is 3 percent higher for a thin (0.1-in. Fe) camera shield and 2 percent higher for a thick (2-in. Fe) camera shield when compared to Cluster A doses. The dose to S056 film stored in the CM is increased by 3 to 12 percent. As a further check, the LM and CSM were removed, leaving only the ATM. The S056 film dose is then 5 to 8 percent higher than the Cluster A dose. This result indicates that those elements in the immediate vicinity of the film provide the most significant radiation shielding.

3.6 S052 SIDE MOUNTED CAMERA DOSE

As stated in Section 2.1, two S052 configurations are considered. The aft-mounted camera dose results are given in Section 3.1. Late in the study, updated information was received for both cases. The side-mounted configuration was analyzed with no extra shielding. This dose is 40 percent lower than the aft-mounted case. It should be remembered (Section 2.1) that thin camera and optical housing walls are assumed for the aft mounted configuration. Therefore, the improvement in dose reduction achieved in going to the side-mounted camera is probably somewhat less than 40 percent.

3.7 INTERACTION BETWEEN S052 AND S056 SHIELDS

The inclusion of a shield for one experiment enhances the shield protection afforded other experiments. The magnitude of this interaction is determined for one case, the dose to the side-mounted S052 camera as the S056 camera shield is varied. The effect is less than one percent as the S056 shield changes from 0.1 in. to 2 in. of iron. Note that both cameras are in the same ATM quadrant but separated by about 3 ft. Further, the S056 camera is near the spar, which minimizes this interaction.

3.8 FILM SELF-SHIELDING VERSUS TIME

Film self-shielding is an important factor in determining radiation exposure. The variation of dose as a particular film frame is uncovered, transferred to the takeup

reel, then covered, is partially explored here. The magnitude of the variation is about the same for the first, middle, and last frames but is dependent upon shield thickness. The dose rate varies by 100 percent for a 1/16-in. iron S052 camera shield, 20 percent for a 0.5-in. shield, and 15 percent for a 1-in. shield. Figure 3-2 shows that the angular position of the reel causes changes of dose to a frame of at least 50 percent for a 0.1-in. iron shield around the S056 camera and 16 percent for a 1-in. iron shield.

3.9 SHIELD SHAPING

While no attempt was made to optimize the S052 (plus-x) aft mounted shield, one particular effort to reduce shield weight is shown by the isolated point in Fig. 3-3. The camera shield is illustrated in Fig. 3-4. A 0.4-in. tungsten case surrounds the reels. The camera wall is 0.3-in. aluminum. Reel-shaped, iron spot shields are placed on two sides of the camera. This arrangement reduces shield weight from 161 lb of aluminum or 184 lb of iron to 143 lb. Greater savings are possible. This approach will not be as effective if all shielding is constrained to be outside the camera case.

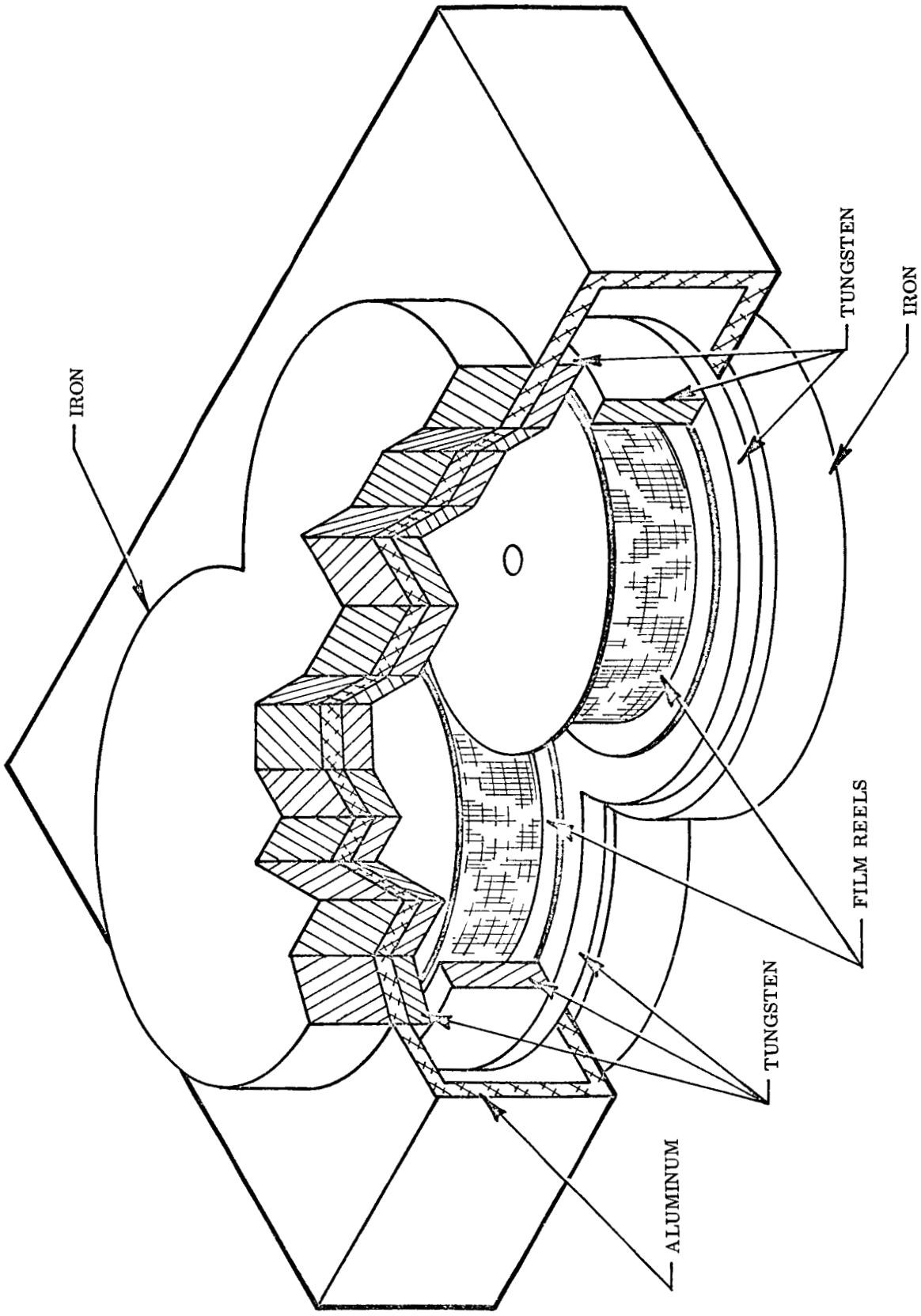

Fig. 3-4 Experiment S052 Typical Internal and External Shielding Arrangement

Section 4
FILM DOSES DURING 42-DAY STORAGE PERIOD

4.1 CM FILM STORAGE

The two spare sets of ATM experiment film may be stored in the CM in a manner depicted in Fig. 2-3 and outlined in the section describing film return locations. In this study, it is assumed that only S052 and S056 films require special shielding and that they are located in an iron box identified by positions A4, A5, and A6 in Fig. 2-2. Two S056 cameras are in A4, two S052 cameras are in A5, and A6 is empty. Although the film quantity considered here is for two loads in the shielded volume, the calculated shield weights assume that the box is large enough to contain all three film loads. The doses to these films are shown in Fig. 4-1. The dose curves apparently show that increasing shield thickness protects S052 film more than S056 film. However, these data should be interpreted carefully, as indicated below.

The S056 detector is located on the outer surface of a reel adjacent to an S052 camera. The S052 detector is located on the outer surface adjacent to the empty positions in the shielded box. As box wall thickness increases, the S052 detector dose should show a steeper slope because it has less shielding from other film than the S056 detector. The curves confirm this behavior. Had the S052 detector been adjacent to the S056 film, the dose curves should have possessed nearly equal slopes. The latter case is considered in Section 4.2, and the hypothesis is confirmed. The fact that both doses are nearly equal for a thin walled box in the CM, despite the larger mutual self-shielding afforded the S056 detector, must be ascribed to other causes such as proximity to the box walls and their position relative to other components.

This data and the data in section 3 emphasize that dose is not uniform over a single film reel nor between adjacent reels.

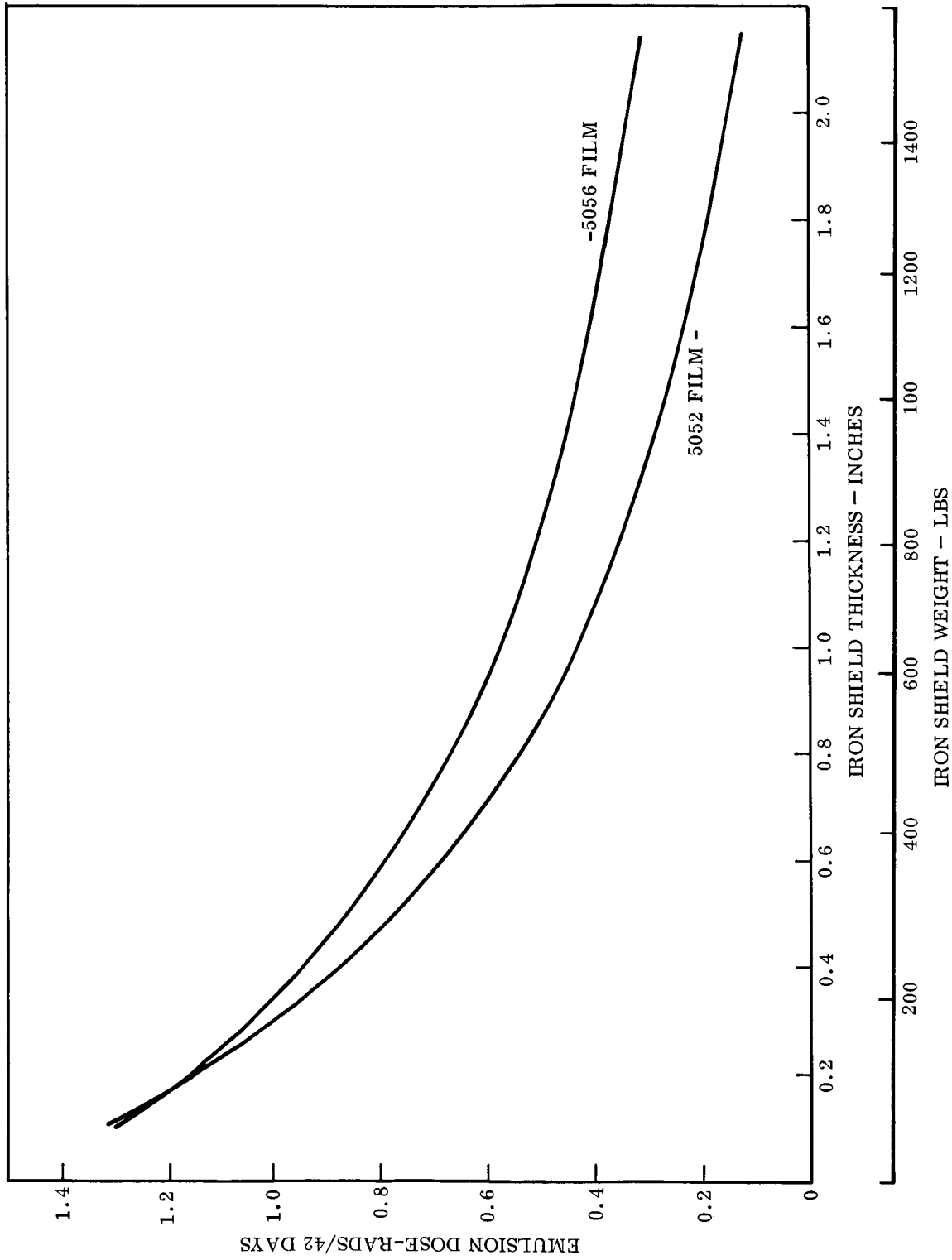

Fig. 4-1 Experiment Film Exposure Vs. Shield Thickness and Weight - Film Stored in CM

In addition to the S052 and S056 film doses, the dose to a detector on one of the S053A films was computed to be 1.23 rads over a 42 day period inside the CM but outside a 1-in. thick iron storage box. This dose level will not cause SWR film to exceed the negative fog density criterion of 0.2.

4.2 MDA FILM STORAGE

Dose estimates for films stored in the MDA are shown in Fig. 4-2. The considerations pointed out in Section 4.1 apply here. The doses are higher than in the CM, reflecting the thinner shielding offered by the MDA.

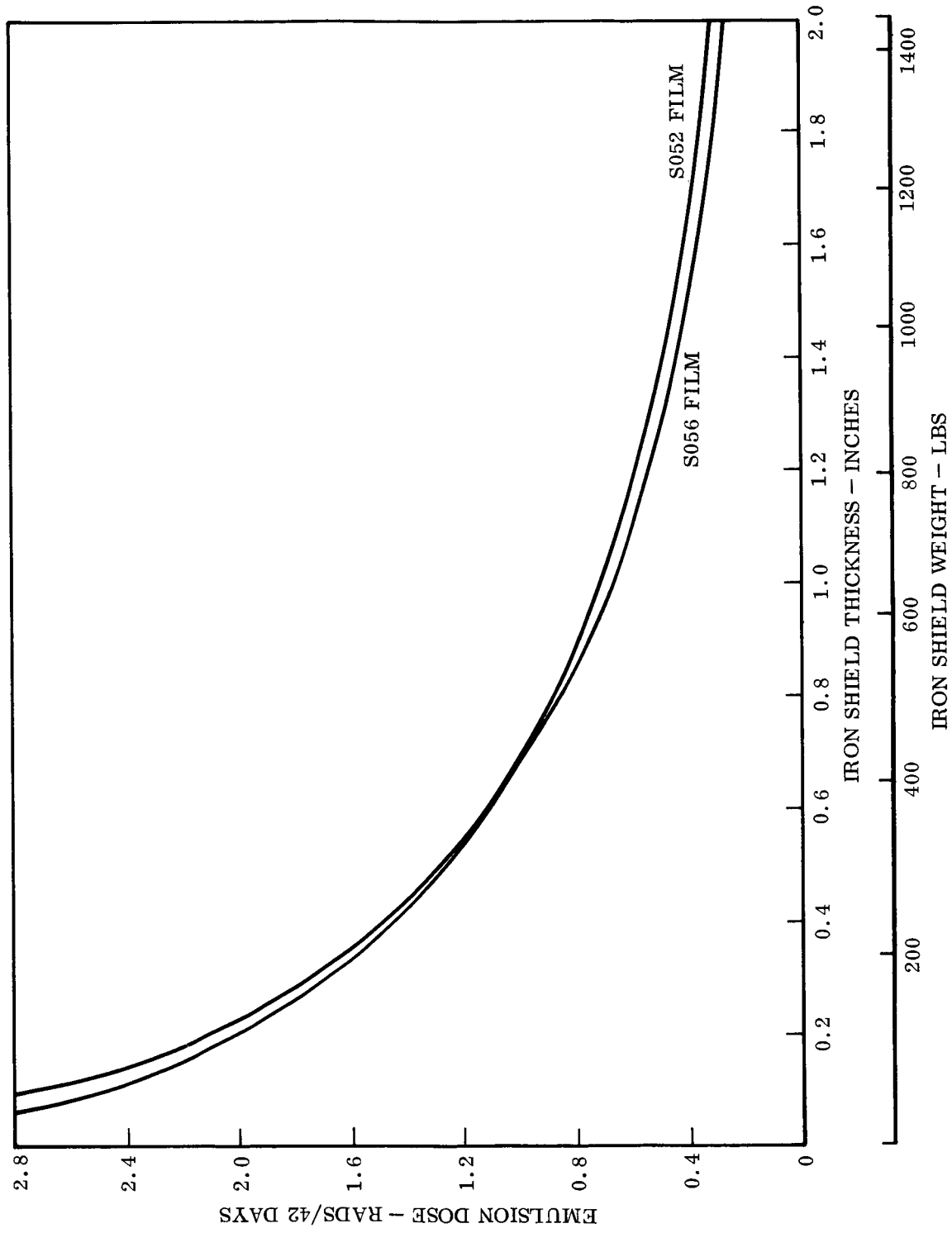

Fig. 4-2 Experiment Film Exposure Vs. Shield Thickness and Weight - Film Stored in MDA

Section 5
FILM RADIATION FOGGING

The response of several types of film to protons at five discrete energies are shown in Figs. 5-1 through 5-5 (Ref. 3). The experiments were performed by MSFC and Langley Research Center personnel at Harvard and Oak Ridge. These data show that the simple energy deposition doses computed in the present study are not adequate to predict radiation fog density accurately. A response function folded into the calculation is necessary.

A simple approximation based upon typical belt spectra penetrating a shield is used to convert to density versus air rads averaged over the penetrating proton spectrum. The air rad dose is converted to emulsion rad dose by multiplying air rads by 0.75. The justification for the latter approximation is that it is accurate within 7 percent over the energy range 10 to 1000 Mev (Ref. 4) as shown in Table 5-1.

Table 5-1

EMULSION TO AIR STOPPING POWER RATIO

<u>Energy (Mev)</u>	$\frac{S_{emul}}{S_{air}}$
1	0.574
10	0.693
30	0.734
50	0.748
100	0.764
200	0.777
500	0.790
1000	0.798

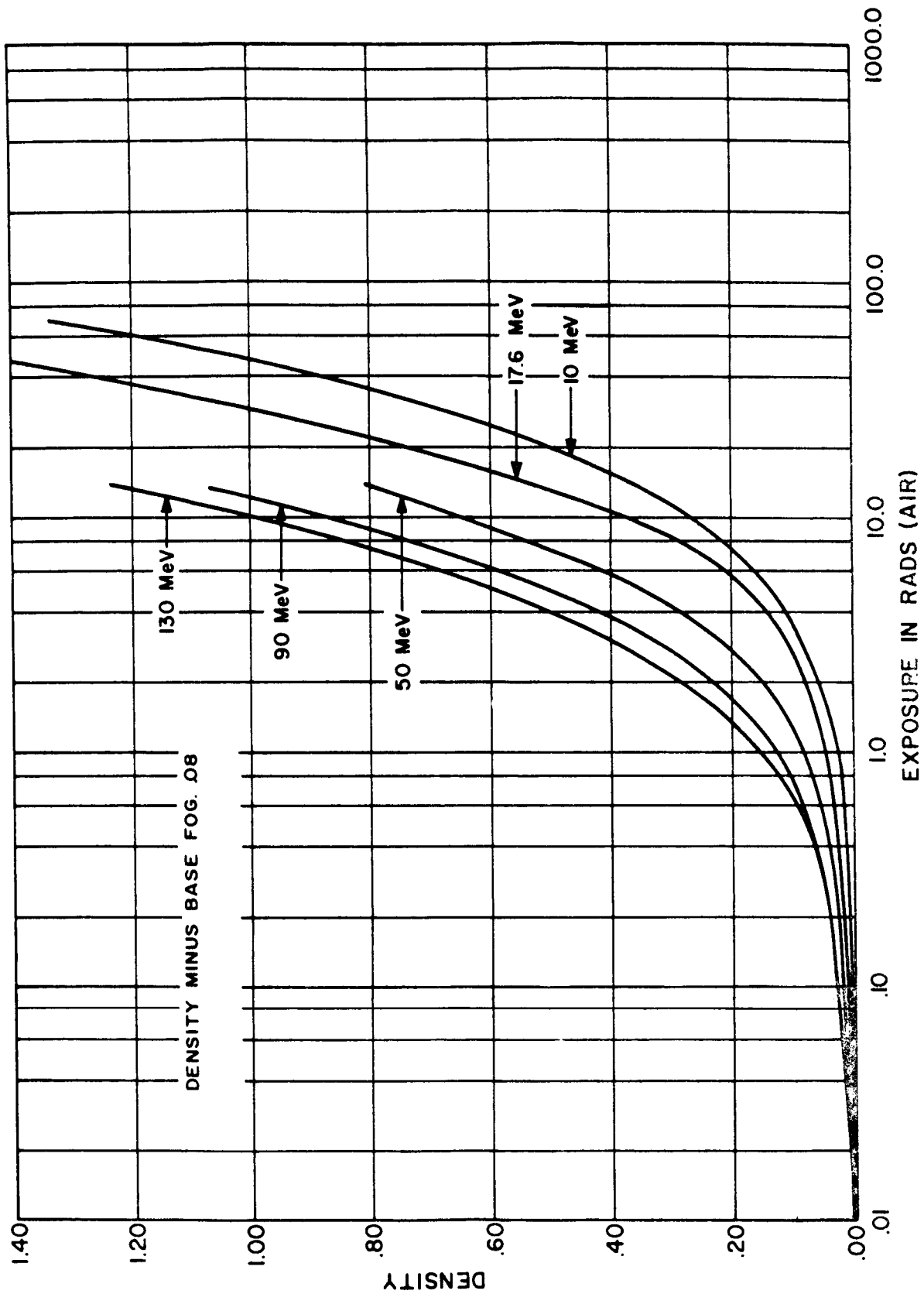

Fig. 5-1 Plus-X Negative Fog Density Vs. Radiation Exposure

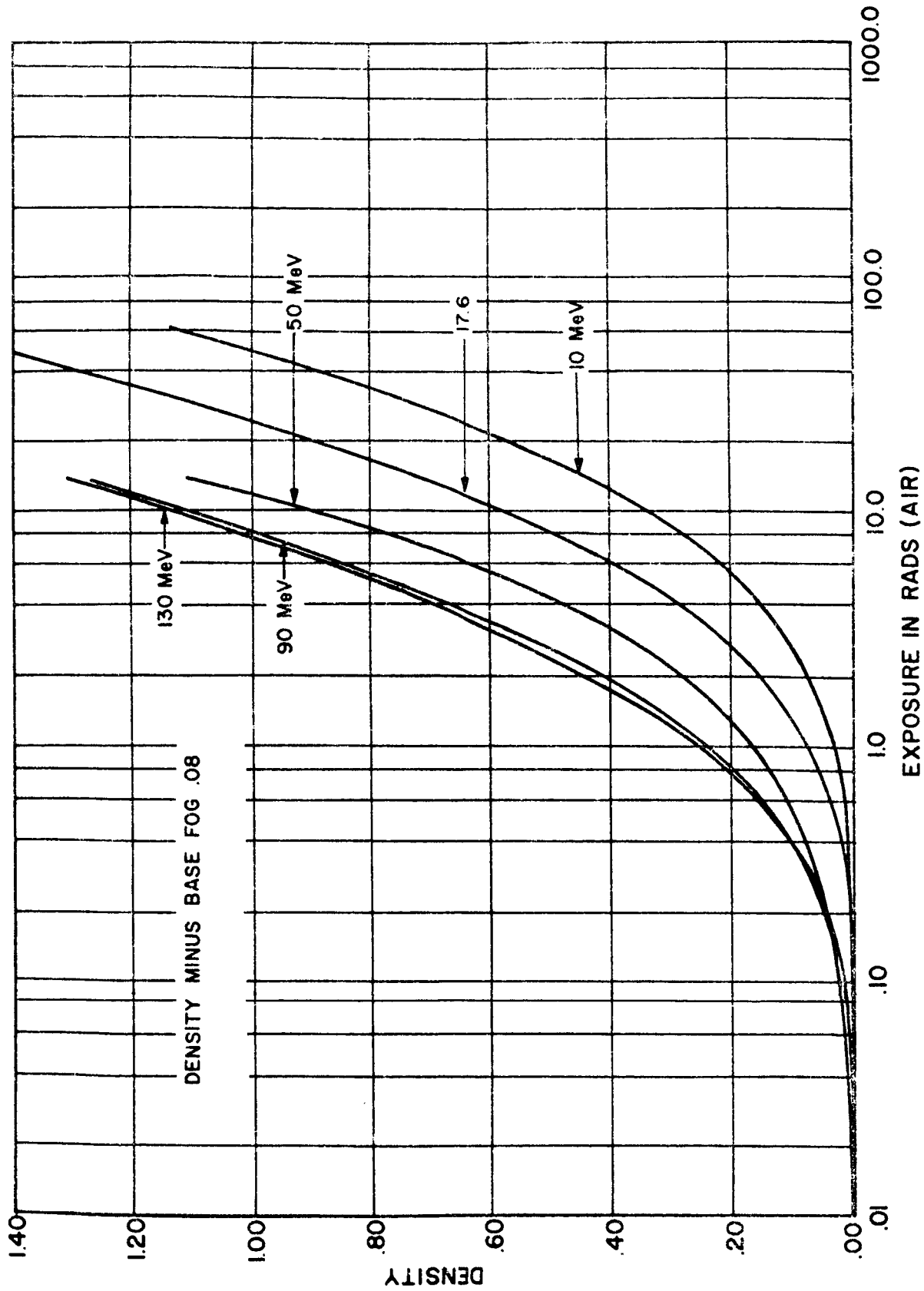

Fig. 5-2 Film Type 103-0 Negative Fog Density Vs. Radiation Exposure

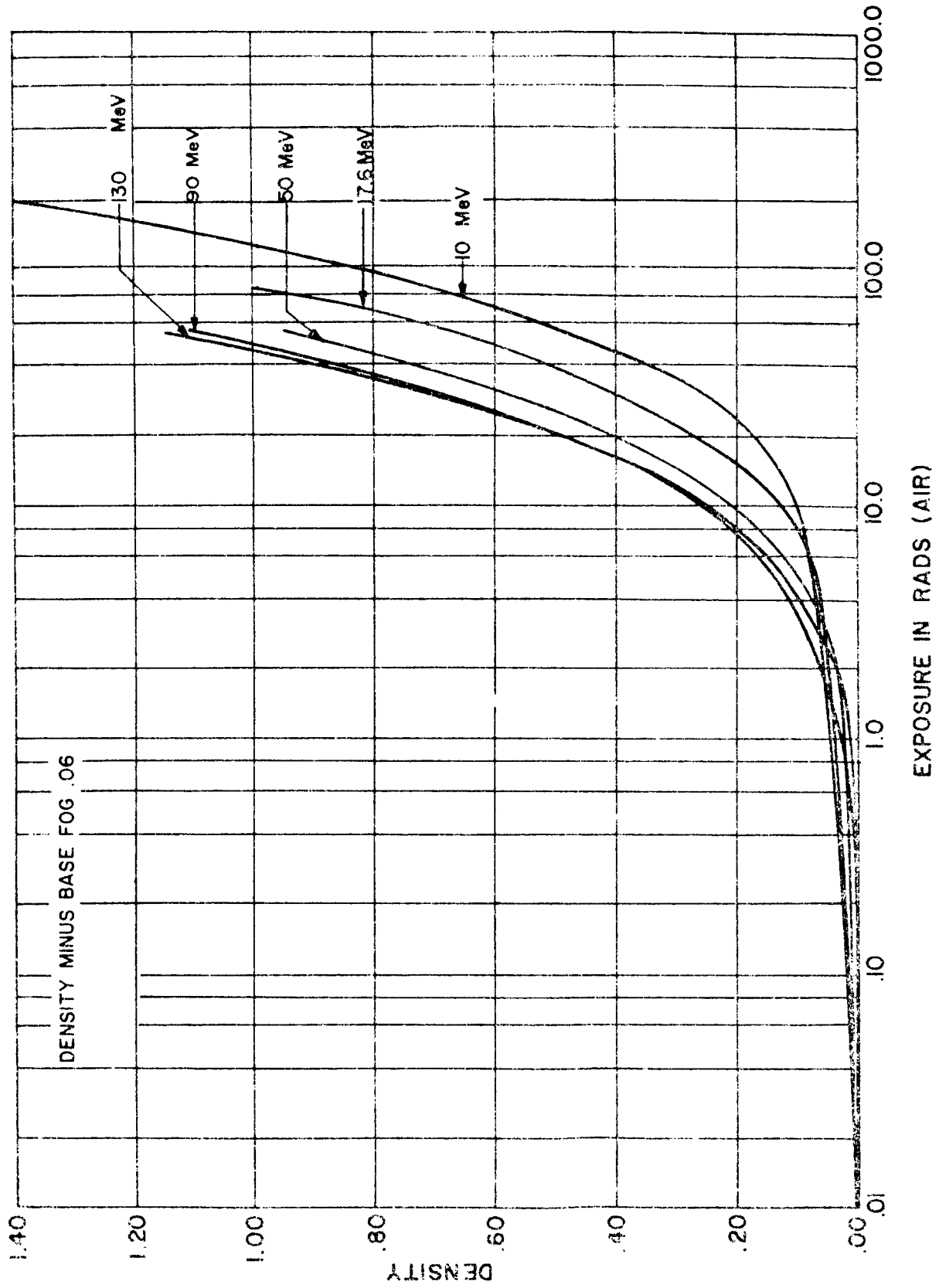

Fig. 5-3 Panatomic-X Negative Fog Density Vs. Radiation Exposure

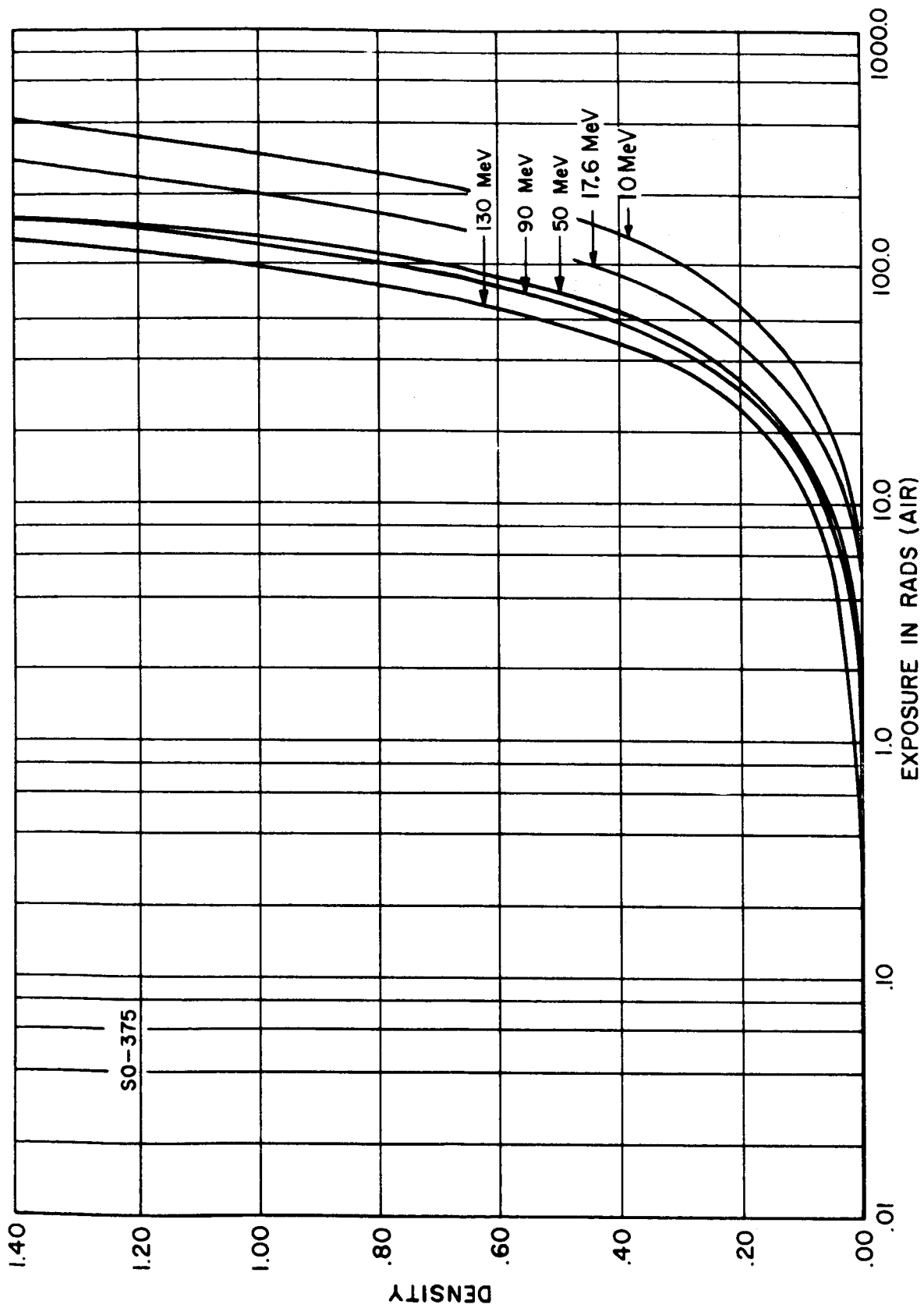

Fig. 5-4 Film Type S0375 Negative Fog Density Vs. Radiation Exposure

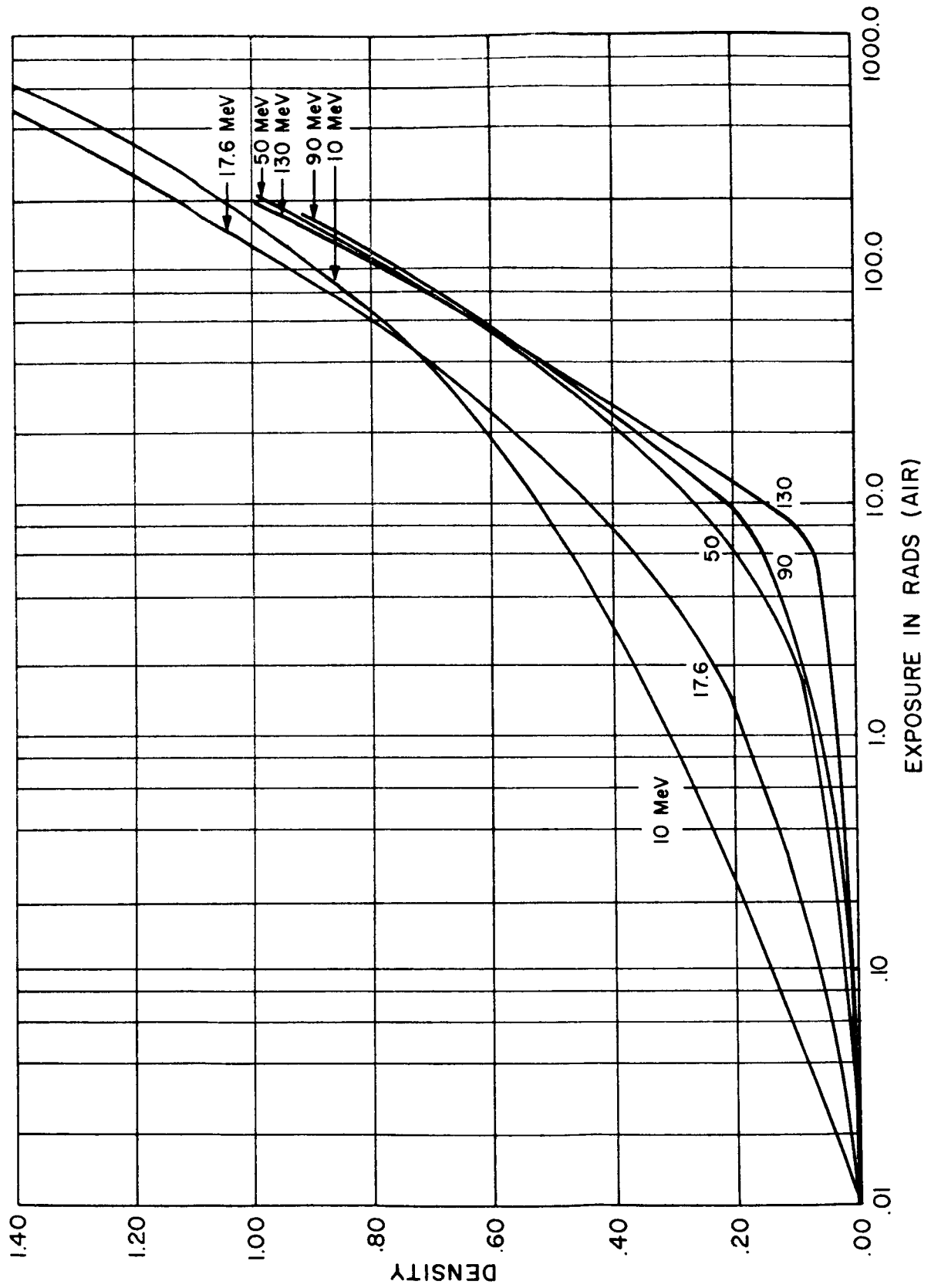

Fig. 5-5 Film Type SWR Negative Fog Density Vs. Radiation Exposure

The additional assumptions are made that S052 requires radiation fog density to be less than 0.1 and that all other experiments require radiation fog density to be less than 0.2. It is understood that Plus-X film is being considered only for S052. Under these conditions, shielding is required for Plus-X film to bring its total dose below 0.75 emulsion rads and for film type 103-0 to bring its total dose below 0.8 rads. All other film types in Figs. 5-1 through 5-5 will not exceed their radiation fog density constraint.

Section 6
SHIELD WEIGHT ESTIMATES

The dose and film dose tolerance data presented in Sections 3, 4, and 5 permit preliminary estimates of required shield weights to be made. The values should be used with caution because a number of uncertainties remain. For example, the number of experiments using radiation sensitive film may change. The radiation fog density tolerance may change. A more accurate integration over time and film orientation may change doses significantly. In addition, configuration changes and refinements are still possible. For these reasons and others, sizable uncertainties remain in shield weight calculations.

The present shield weight estimates are given in Table 6-1. The guidelines used in developing these estimates are:

- The maximum CM and MDA dose curves are used.
- The S052 configuration includes an aft mounted camera.
- The average of S056 curves A and B, Fig. 3-2, are used.
- The interaction between the S052 shield, the S056 shield, and the CM or MDA shield is small and is neglected.
- The conversion from emulsion rads to film fogging described in Section 5 is used.
- No significant dose is accumulated while the film is lightly shielded following ascent and preceding descent.

Table 6-1 shows shield weight estimates for the S052 and S056 experiments located on the spar as well as shield weight estimates required for storage locations in the CM or MDA for three assumed dose tolerance distributions. These assumed cases are:

- 40 percent of dose acquired in storage, 60 percent on the ATM spar
- 50 percent of dose acquired in storage, 50 percent on the ATM spar
- 60 percent of dose acquired in storage, 40 percent on the ATM spar

Table 6-1

SHIELD WEIGHT ESTIMATES*

Percent Dose Tolerance Distribution		Shield Weight (lb)				
CM	ATM	S052**	S056	ATM Total	CM	Total
40	60	140	120	260	1530	1790
50	50	170	160	330	1160	1490
60	40	215	210	425	875	1300
MDA	ATM	S052	S056	ATM Total	MDA	Total
40	60	140	120	260	1480	1740
50	50	170	160	330	1250	1580
60	40	215	210	425	1060	1485

*Assuming S052 uses three loads of Plus-X and S056 uses three loads of 103-0. If S052 uses Panatomic-X, the S052 shield weights go to zero and the CM and MDA shield weights are reduced 30 to 40 percent.

**Weights for the aft-mounted camera.

The total shield weight decreases as ATM shield weight increases. The minimum shielding weight realizable will be dependent upon such considerations as maximum weight permitted on the spar. In the weight and balance section of this report, main chute deployment weight margins (for the CM at reentry) of between 650 and 1100 lb were developed, indicating the feasibility of reentry with this extra shielding weight.

Section 7

SUMMARY OF STUDY RESULTS AND CONCLUSIONS

- Shield weight required on the ATM spar to protect Plus-X in S052 and type 103-0 film in S056 ranges from 260 lb for 6 percent of total dose tolerance accumulated on the spar to 425 lb for 40 percent dose accumulation.
- Panatomic-X film for S052 requires no spar shielding. Shield weight required on the ATM spar to protect type 103-0 film in S056 alone ranges from 120 to 210 lb for the same dose tolerance values.
- Shield weight required in the CM to protect Plus-X and 103-0 film ranges from 1530 lb for 40 percent dose tolerance accumulation to 875 lb for 60 percent accumulation.
- Shield weight required in the MDA to protect Plus-X and 103-0 film ranges from 1480 lb for 40 percent dose accumulation to 1060 lb for 60 percent accumulation.
- For cases investigated, minimum total shielding weight occurs for minimum dose accumulation on spar, i. e. , maximum spar shield weight.
- For experiment S-052 the dose to a detector inside the side mounted camera configuration is lower than for the corresponding detector in the aft-mounted camera configuration.
- Radiation streaming appears to be of minor importance for the two camera locations studied. Radiation shutters for "dark side" operation offer little radiation damage protection.
- Radiation dose rates for independent LM/ATM/CSM operation are 2-3 percent higher than Cluster A values.
- Mutual shield interactions studied affect dose rates by 1 percent or less.
- Variation in dose rate to a particular film frame can vary by a factor of 2 as the film is transferred from one reel to the other. Dose rate varies by a factor of 2 or more as the unit rotates one revolution. Dose rate varies by more than a factor of 2 within a reel.

- The elements in the immediate vicinity of the film are most important in determining dose rate. Elements which are farther away are usually of less or no importance.
- Film which is transported to orbit in the LM-A should be removed and placed in the radiation protection storage containers as soon as possible.

Section 8
RECOMMENDATIONS

- Incorporate film density response functions into the calculations.
- Recompute S052 film doses when camera details become available.
- Investigate further the variation of dose within the storage boxes to determine whether periodic "shuffles" would reduce the peak dose.
- Investigate the variation of film dose rate on the spar within a reel, as the reel rotates and as the film is transferred to the takeup reel.
- Revise shield estimates as astronaut "time line" charts become available.
- Optimize shield arrangement for the S052 folded optics side-mounted camera.
- Optimize shield arrangement within the CM.
- The problem of radiation flux anisotropy should be further examined.

Section 9
CLUSTER GEOMETRY SOURCE DATA
REFERENCE MATERIAL

DRAWINGS

1. MSFC R-ASTR-IM-SK1265, Magazine Assembly, ATM Camera, 2 Sheets, 5 Jun 1967
2. MSFC R-ASTR-IM-SK1105, Filter Assembly, ATM Camera, 25 Jul 1967
3. MSFC R-ASTR-IM-SK167, X-TR T-M Model Assembly Drwg. , 4 Apr 1967
4. BBRC 13993, Thermal Model Assembly - WLCE, ATM, 3 May 1967
5. BBRC 13993 23986, Optics Housing Layout. ATM Coronagraph (Side Mounted Camera), 24 Jun 1967
6. Brown Engineering Co. , SK10-7328, ATM Experiment Package Subassembly, No Date
7. NAA V34-000003, Command Module Inboard Profile - Apollo Complete, Sheets 1-12, 29 Apr 1966
8. NAA V36-933101, Equipment Arrangement CM Crew Compartment Block II, S/ C 101, Sheets 2 and 3, 20 Jan 1967
9. NAA 2743-116, CM Space Allocation and Equipment Storage Volume Capability, 1 Jun 1967
10. BBRC CP228-8, Fig. 3, ATM WLCE Configuration Isometric View of S 052 HAO WLCE, No Date, Received 14 Aug 1967
11. BBRC CP22876, Fig. 3-2, Optics Housing Detail of S 052 HAO WLCE, Isometric View, No Date, Received 14 Aug 1967
12. BBRC Fig. 3-3, ATM - WLCE Space Envelope for HAO S052, Preliminary Copy, No Date, Received 14 Aug 1967

13. BBRC, Isometric View of S 055-B, HCO ATM Ultraviolet Long Wave Spectrometer, Preliminary Copy, No Date, Received 14 Aug 1967
14. BBRC, Isometric View of S 053-A, NRL ATM Experiment A Spectroheliograph, Preliminary Copy, No Date, Received 14 Aug 1967
15. BBRC, Isometric View of S 053-B, NRL ATM Experiment B XUV Spectrograph, Preliminary Copy, No Date, Received 14 Aug 1967

REPORTS

1. MSFC Experiment Implementation Plan for the ATM Experiment S 056, X-Ray Telescope, 3 Apr 1967
2. MSFC Experiment Implementation Plan for the ATM Experiment S 052, HAO White Light Coronagraph, 3 Apr 1967

Section 10
REFERENCES

REPORTS

1. LMSC-A842261, Apollo Applications Program Film On-Orbit Storage Protection, Final Definition Phase C, Augmentation Task No. 21, 30 Jun 1967
2. MSFC Letter to MSC, ATM Payload Return Requirements, I-S/ AA Mgr. Signed by Leland F. Belew, 18 May 1967
3. MSFC, Experimental Investigations of Radiation Effects on ATM Photographic Film, Working Paper, W. L. Breazeale and R. A. Potter, Aug 1967
4. ER-7777, Volume I, Data Compilation and Evaluation of Space Shielding Problem - Range and Stopping Power Data, C. W. Hill, K. M. Simpson, Jr., and W. B. Ritchie; Jul 1965

TASK 29

PART II

II-1

Section 1
INTRODUCTION AND SUMMARY

1.1 INTRODUCTION

Storage of film, medical specimens, and other samples of materials for complete experiment performance is necessary to the success of Apollo Applications Program (AAP) experiments. An evaluation of the storage requirements and installation for the Mission B experiments was undertaken for both the ascent and return conditions. This report presents the results of this study.

The principal guidelines for the study were as follows:

- Satisfy all Mission B data storage requirements for both ascent and return.
- Minimize changes to AAP hardware.
- Use 42 days as a maximum time available for ATM operation by the astronaut.
- Utilize a water landing condition on CM reentry.
- Evaluate the LM and CM weight and cg effects.

1.2 SUMMARY

The AAP-4 LM/ATM is launched with one complete set of film cassettes (7) installed on the spar. Fourteen additional cassettes (2 per each ATM experiment) are required to obtain a total operating time capability of 42 days during the 56 day mission.

Sufficient space is available inside the AAP-4 LM ascent stage for storage of the 14 film cassettes. The following major areas have been utilized for data storage.

- Space vacated by the LM ascent stage main propulsion engine
- Left hand side wall vacated through removal of the rock boxes and miscellaneous storage shelves (sufficient space is available for four LiOH canisters and two food containers).

The modifications required are:

- Provide new data storage containers.
- Add additional secondary support structure.

A review of the weight and balance effects indicates the AAP-4 vehicle cg will not be altered significantly since the film cassettes are centrally located.

The packages to be returned to earth (664.3 lb) include the data resulting from each of the experiments performed prior to return of the AAP-3 CM.

A location for each of the ATM and Biomedical experiment data packages from Mission B being returned to earth is available in the AAP-3 CM. The CM return installation is based on a water landing reentry. Space is not available to locate the defined data packages if the CM reentry condition is restricted to a land landing. The following areas have been utilized for data storage:

- Aft Bulkhead. The space beneath the couches is used for most of the data return packages because of the large volume of available space needed due to the large volume of packages being returned. The aft bulkhead is made available by off-loading the emptied containers prior to reentry. Preliminary evaluation indicates the aft bulkhead is structurally adequate to support the data packages.
- Existing Container Utilization. Four out of 13 available storage containers have been utilized. The remaining nine are potentially available by off-loading equipment but their volume is not adequate to accept any of the data packages.

Weight and balance analyses were performed to determine if the required data return payload of 664 lb could be deorbited within the current Command Module weight and balance constraints which are:

- The total CM Descending Weight must not exceed the main parachute capability of 13,500 lbs.
- The cg at separation (reentry) must be located such that the hypersonic trim L/D is between values of .30 and .40. (Recent information indicates that the lower limit of .30 may be relaxed to .25.)

- The cg of the CM at water impact must fall with the current flotation limits.

Three reentry configurations were analyzed in the study:

- The CM with return payload is ballasted to the current Block II Command Module reentry c. g. of $X_a = 1040.0$ and $Z_a = 69$ (corresponding to a reentry L/D of .345). This configuration satisfies all of the above weight and balance constraints.
- The second configuration was designed to take advantage of the proposed lower L/D limit of .25 and is ballasted only to keep the impact condition within limits. This configuration also satisfies the parachute weight constraint and falls within the proposed reentry L/D range of .25 but outside the current limit of .30. A savings of 260 lbs in ballast is achieved.
- The third configuration, unballasted, is presented for comparison. An additional 207 lbs of ballast is removed, hence, this configuration shows the largest parachute weight margin. However, the flotation cg limits are exceeded and the reentry L/D is reduced to .26.

Section 2

MISSION B EXPERIMENT DATA STORAGE REQUIREMENTS

2.1 ASCENT EXPERIMENT STORAGE REQUIREMENTS

The ATM film cassettes to be used for resupply of the ATM experiments during the cluster mission have been studied from a volume and weight viewpoint and are presented in Table 2-1. Each ATM experiment on the Spar has one cassette installed at launch to provide the first 14 days of film. The additional cassettes (Table 2-1) to be used for resupply of the ATM experiments are carried on AAP-4, which results in sufficient film to operate the ATM experiments a total of 3 times (twice through resupply) at 14 days each. Recent astronaut time line studies indicate a maximum of 42 days is available for operation of the ATM experiments.

Table 2-1

AAP-4 ASCENT FILM CASSETTE STORAGE

<u>Expmt No.</u>	<u>Experiment Name</u>	<u>Qty Rqd</u>	<u>Dimensions (In.)</u>	<u>Wt Each (lb)</u>	<u>Total Wt (lb)</u>
S052	White Light Coronagraphy (HAO)	2	3.5 × 9.8 × 14.3	15	30
S053A	UV Coronal Spectographs (NRL)	2	6.5 × 14.25 × 16.35	50	100
S053B	UV Coronal Spectographs (NRL)	2	6.5 × 14.25 × 16.35	50	100
S054	X-ray Spectrographic Telescope (AS&E)	2	6.0 × 10.0 × 22.0	30	60
S055B	UV Spectrometer (HCO)	2	4.0 × 10.91 × 14.5	15	30
S055C	Hydrogen Alpha Telescope (H - α)	2	8.0 × 13.0 × 20.0	13	26
S056	X-ray Telescope (GSFC)	2	4.0 × 10.9 × 14.5	13	26
	TOTAL	14			372

The volume and weight of each package does not include provisions for radiation shielding. The ATM film cassettes used for resupply weigh 372 lb. An additional 186 lb of ATM film cassettes is located on the Spar.

2.2 RETURN DATA STORAGE REQUIREMENTS

The complete Data Return Requirements for Mission B (AAP-3/4) have been analyzed from weight and volume viewpoints. Table 2-2 presents the complete list of planned experiments for Mission B having return data and it notes the volume and weight to be returned to earth. The volume and weight of each package does not include provisions for radiation shielding. Mission B produced a total return weight of 664.3 lb.

Table 2-2
MISSION B RETURN DATA REQUIREMENTS

<u>Expmt No.</u>	<u>Experiment Name</u>	<u>Qty Rqd</u>	<u>Dimensions (In.)</u>	<u>Wt Each (lb)</u>	<u>Total Wt (lb)</u>
M018	Vectorcardiogram	1	8.0 Dia × 1.0	2.5	2.5
M050	Metabolic Cost of Space Tasks	1	4.0 × 5.0 × 8.0	2.5	2.5
M051	Cardiovascular Function	1	4.0 × 5.0 × 8.0	2.5	2.5
M052	Bone and Muscle Change	1	4.0 × 5.0 × 8.0	5.0	5.0
M053	Human Vestibular Function	1	4.0 × 5.0 × 8.0	3.1	3.1
M055	Time and Motion Studies	1	5.4 × 10.0 × 16.0	12.5	12.5
S052	White Light Coronagraphy (HAO)	3	3.5 × 9.8 × 14.3	15.0	45.0
S053A	UV Coronal Spectrographic Telescope (AS&E)	3	6.5 × 14.25 × 16.35	50.0	150.0
S053B	UV Coronal Spectrographic Telescope (AS&E)	3	6.5 × 14.25 × 16.35	50.0	150.0
S054	X-ray Spectrographic Telescope (AS&E)	3	6.0 × 10.0 × 22.0	30.0	90.0
S055B	UV Spectrometer (HCO)	3	4.0 × 10.91 × 14.5	15.0	45.0
S055C	Hydrogen Alpha Telescope (H - α)	3	8.0 × 13.0 × 20.0	13.0	39.0

S056	X-ray Telescope (GSFC)	3	$4.0 \times 10.9 \times 14.5$	13.0	39.0
S065	Multiband Terrain Photography	1	$7.0 \times 7.0 \times 21.0$	31.2	31.2
S069	X-ray Astronomy	1	$2.0 \times 8.0 \times 8.0$	3.0	3.0
S070	UV X-ray Solar Photographs	1	$7.25 \times 10.0 \times 10.5$	14.0	14.0
T017	Meteoroid Impact and Erosion	1	$4.0 \times 7.0 \times 17.0$	20.0	20.0
T021	Meteoroid Velocity	<u>1</u>	$2.0 \times 9.5 \times 13.0$	10.0	<u>10.0</u>
	TOTAL	32		TOTAL	664.3

Section 3
MISSION B EXPERIMENT DATA STORAGE

This section presents a summary of the AAP-4 LM and AAP-3 CM storage potential and a designated location for each ATM film cassette to be stored on ascent and each Mission B experiment package being returned to earth. Also included is a summary of the weight and balance effects on each mission.

3.1 ASCENT DATA STORAGE

3.1.1 Potential LM Data Storage Locations

Figure 3-1 summarizes the experiment data storage potential in the AAP-4 LM. The two largest areas available for storage inside of LM of data are the right hand wall and the engine well area.

3.1.2 Ascent Experiment Locations

Figures 3-2 and 3-3 present a potential location for each of the 14 ATM resupply film cassettes to be launched with AAP-4. Each of the packages have been located in vacant space on the inside of the LM to eliminate any need for EVA.

Eight cassettes are located in the area vacated by the LM ascent stage propulsion engine. These cassettes are located adjacent to the ATM TV monitors (relocated prior to ATM experiment operations). The astronaut has sufficient space to enter the LM through the hatch, transfer over the stored cassettes, and into the work station.

The remaining six cassettes have been located on the interior wall of the left side. Sufficient space has been allowed between the film cassettes and the LM floor for

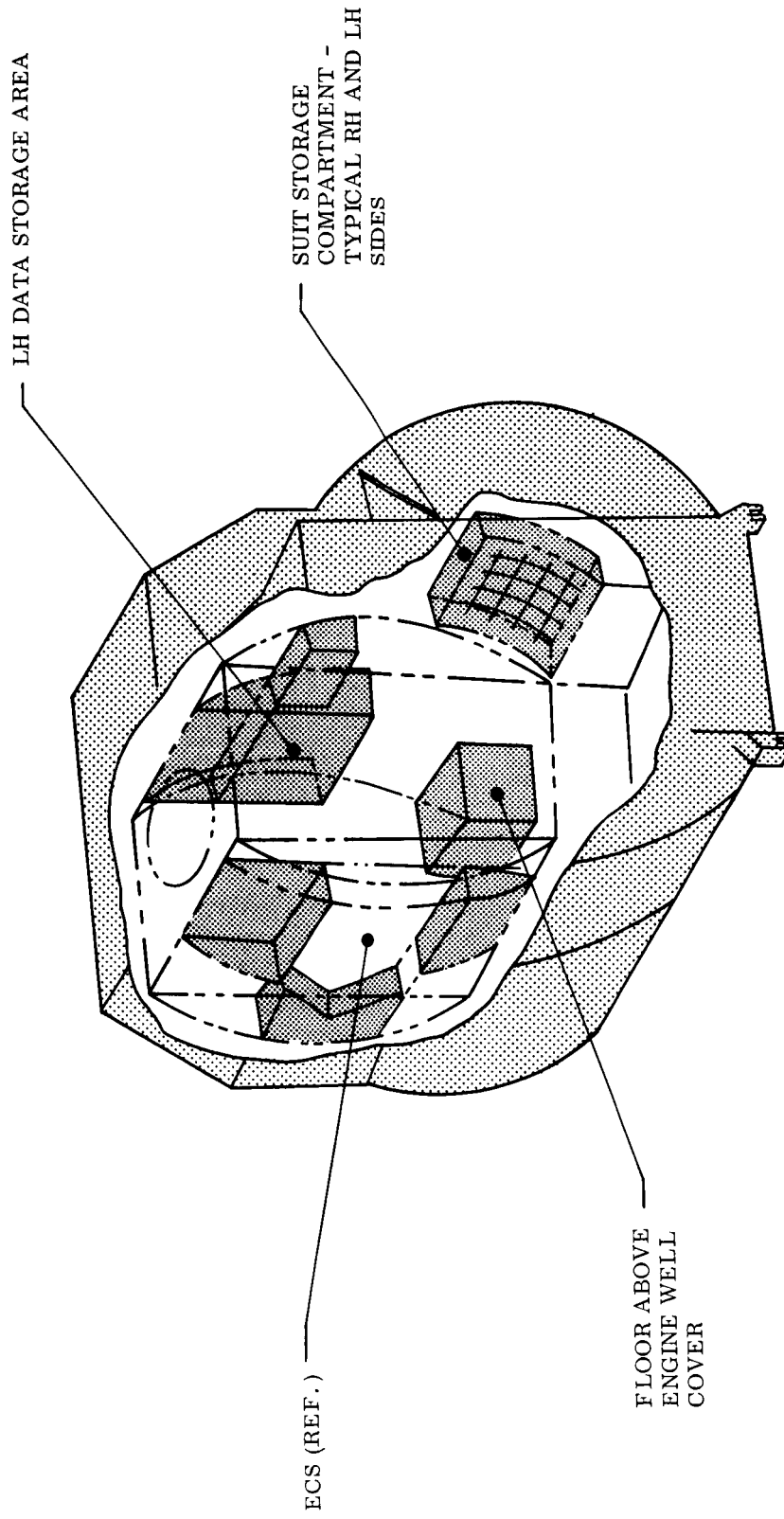

Fig. 3-1 LM Experiment Storage Potential

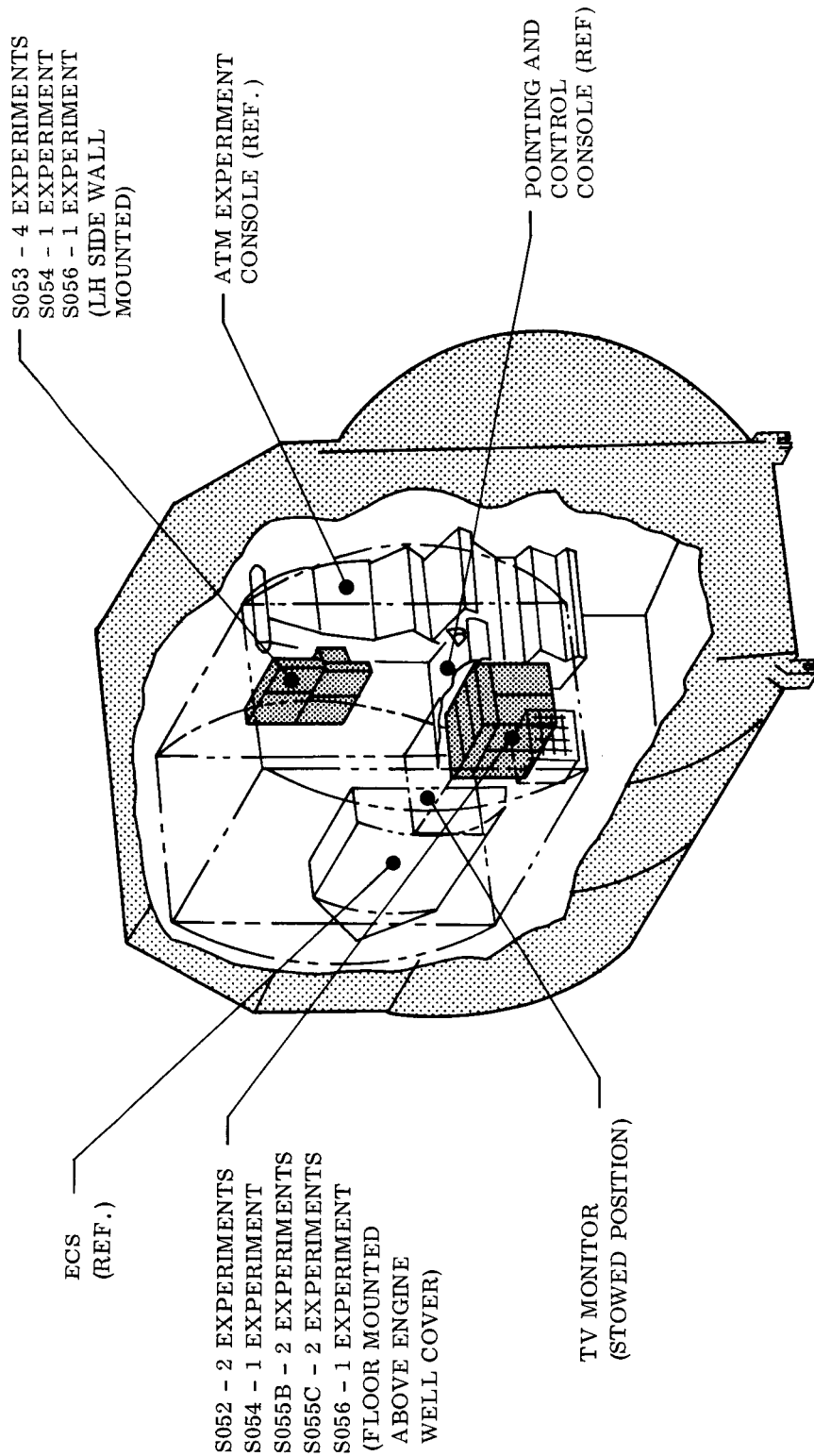
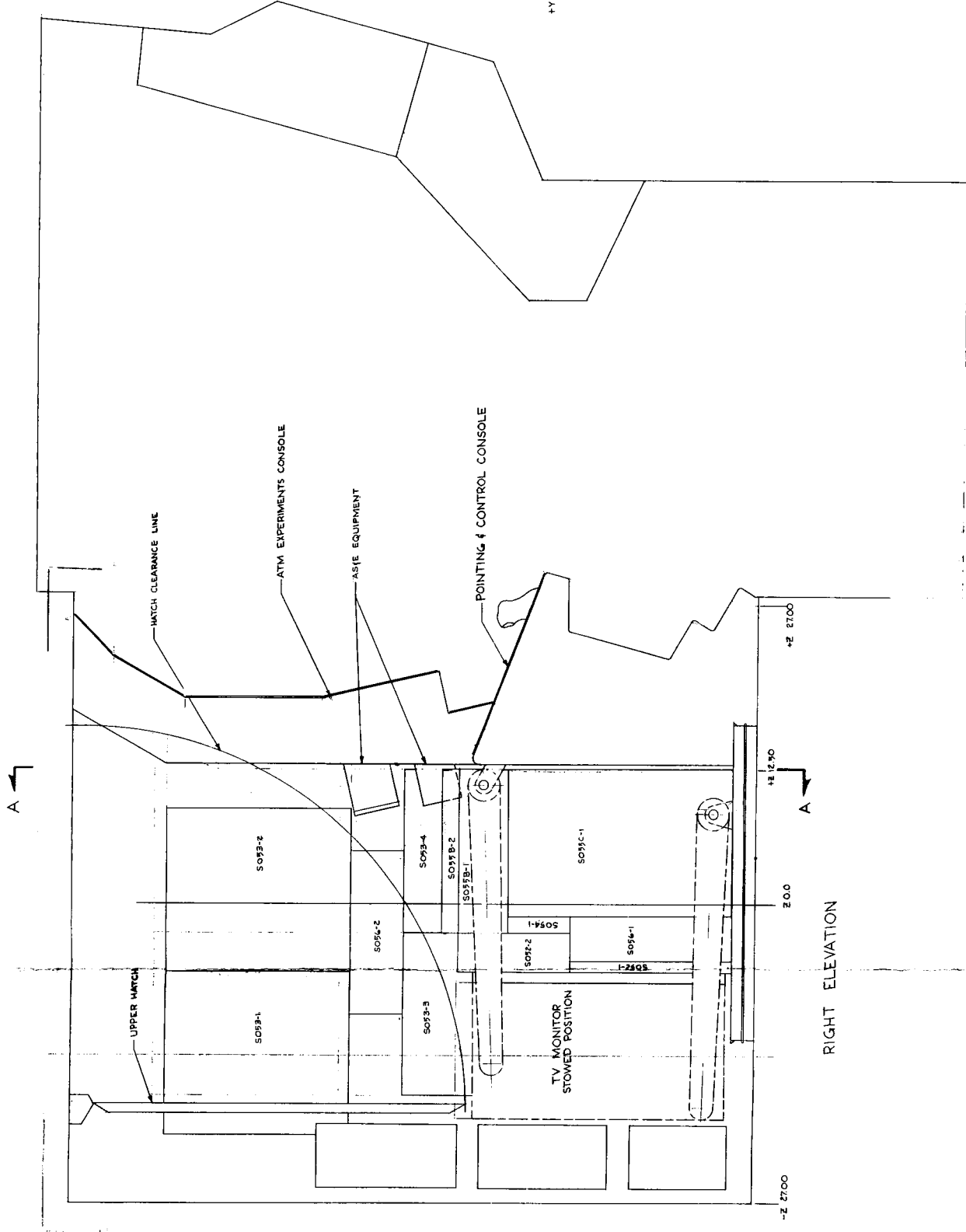
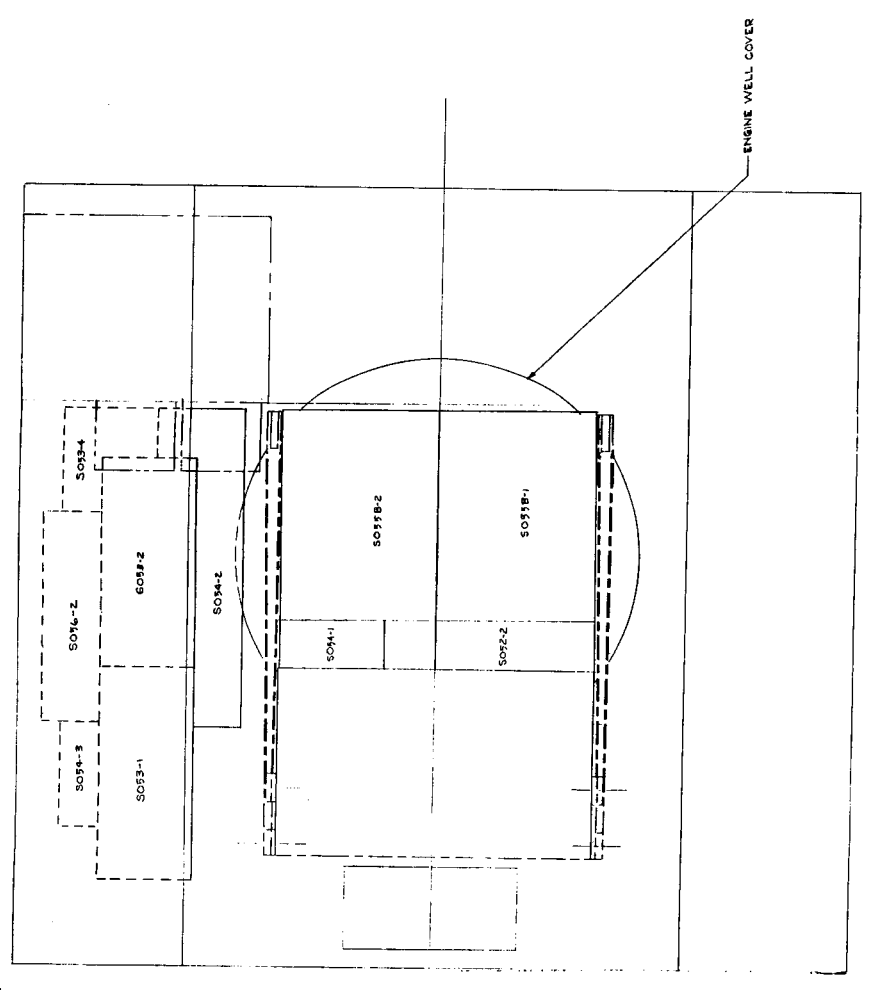

Fig. 3-2 AAP-4 LM Experiment Storage Locations



FOLDDOUT FRAME 2



FOLDDOUT FRAME 1

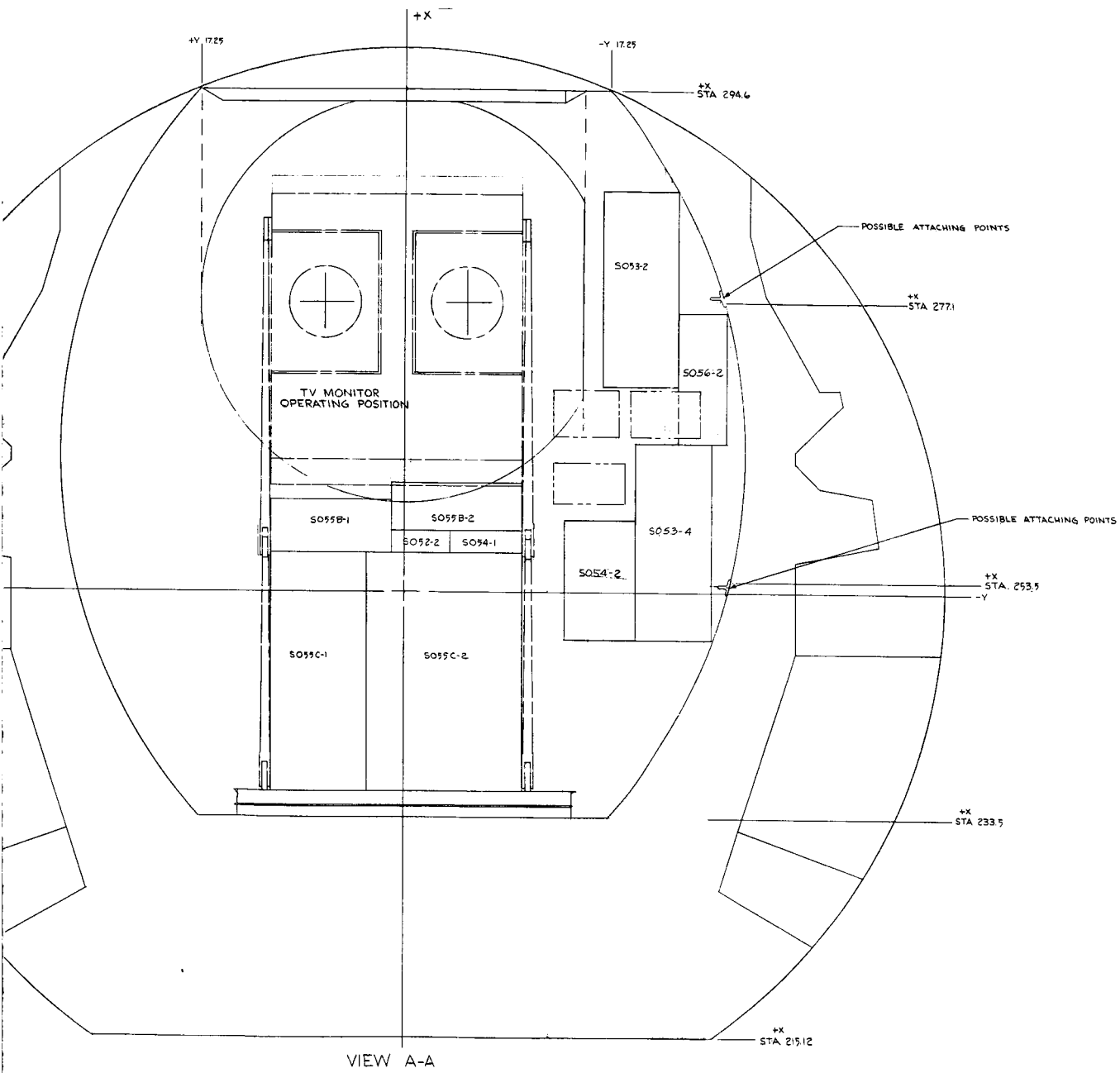

Fig. 3-3 AAP-4 LM Experiment Storage Layout

PRECEDING PAGE BLANK NOT FILMED.

4 LiOh canisters. Additional space is available above the film cassettes for two food containers.

All of the ATM film cassettes stored in the LM should be transferred to their permanent storage location as soon as possible after Cluster docking for the following reasons:

- The required radiation shielding after approximately one day's exposure (Refer to Part I) would increase the cassette volume and weight substantially thus reducing the available storage space.
- The ATM TV monitors cannot be erected into their operating position until the cassettes have been located.

3.1.3 LM Structural Effects

A preliminary review indicates that the steady-state load on the LM floor would be approximately 7 g, which is considerably less than the maximum steady-state loading (17-1/4 g) incurred during lunar landing. The packages located on the side wall area would be installed on shelves that are also supported from the floor to more equally distribute the loads.

3.1.4 Weight and Balance Conditions

It has been shown in Section 2 of this report that 372 lb of additional cassettes (plus about 56 lb of supporting structure) will be added to the Flight A-4 LM Ascent Stage. Except for the obvious requirement that the launch weight remain within booster capability, no weight and balance limits are in jeopardy from the additional payload. The payload items are installed in a generally central location and will not significantly alter the center of gravity of the A-4 vehicle.

3.2 RETURN DATA STORAGE

3.2.1 Potential CM Data Return Locations

Figure 3-4 summarizes all of the data storage potential in the AAP-3 CM, based on off-loading the maximum amount of equipment possible. The most significant volume available is beneath the couches. Each container on the aft bulkhead is secured with simple latches thus permitting maximum utilization of the aft bulkhead floor space by off-loading the necessary containers.

3.2.2 Return Data Storage Installation

Figure 3-5 presents a potential location for each of the experiment data packages to be returned in the AAP-3 CM. Most of the return data packages are located on the aft bulkhead because the volume of most data packages exceeds existing compartment capabilities.

The data packages containing the film most sensitive to radiation damage (S052 and S056) have been arranged adjacent to each other so that the most economical shielding usage can be utilized if the data is stored in the CM for extended periods of time.

Figure 3-6 presents a detailed layout of the packages located on the aft bulkhead. The following storage containers shown in Fig. 3-4 must be off-loaded prior to installation of the data packages and their containers:

- A1 - Miscellaneous expendables
- A2 through A6 - LiOH Containers
- A8 - Miscellaneous expendables

Container U3 can be utilized for storing any remaining expendables (mirror, tape, towels) prior to reentry.

 = AVAILABLE SPACE

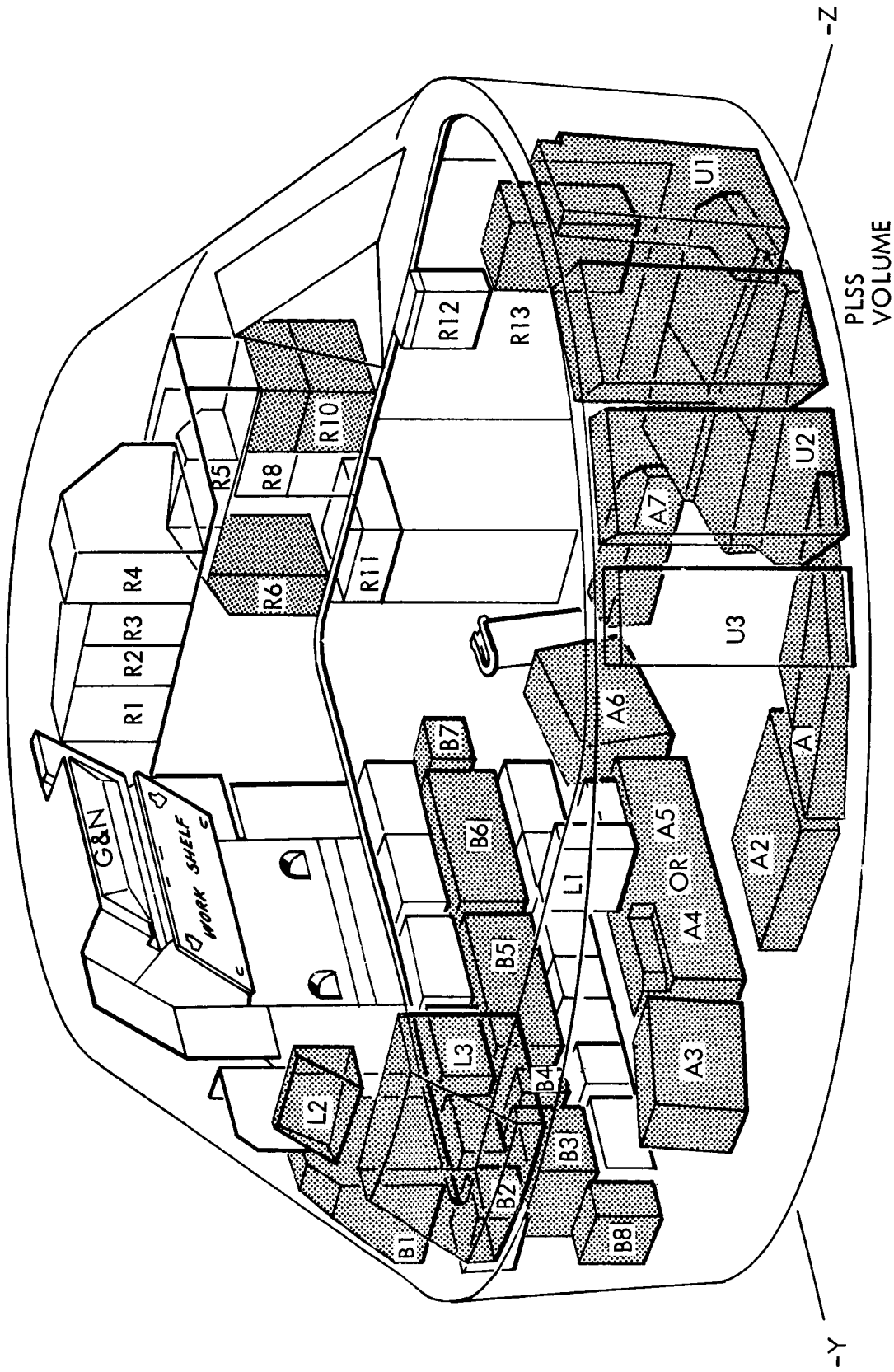

Fig. 3-4 CM Potential Data Return Locations

B3 - M018 (1)
 B5 - S070 (1)
 B6 - M055 (1)
 R13 - S069 (1)
 - T021 (1)

PLSS VOLUME:

- M050 (1)
 - M052 (1)
 - M053 (1)
 - T017 (1)
 - S065 (1)

AFT BHD FLOOR

1 - S052 (3)
 2 - S053 (6)
 3 - S054 (3)
 4 - S055 B (3)
 5 - S055 C (3)
 6 - S056 (3)

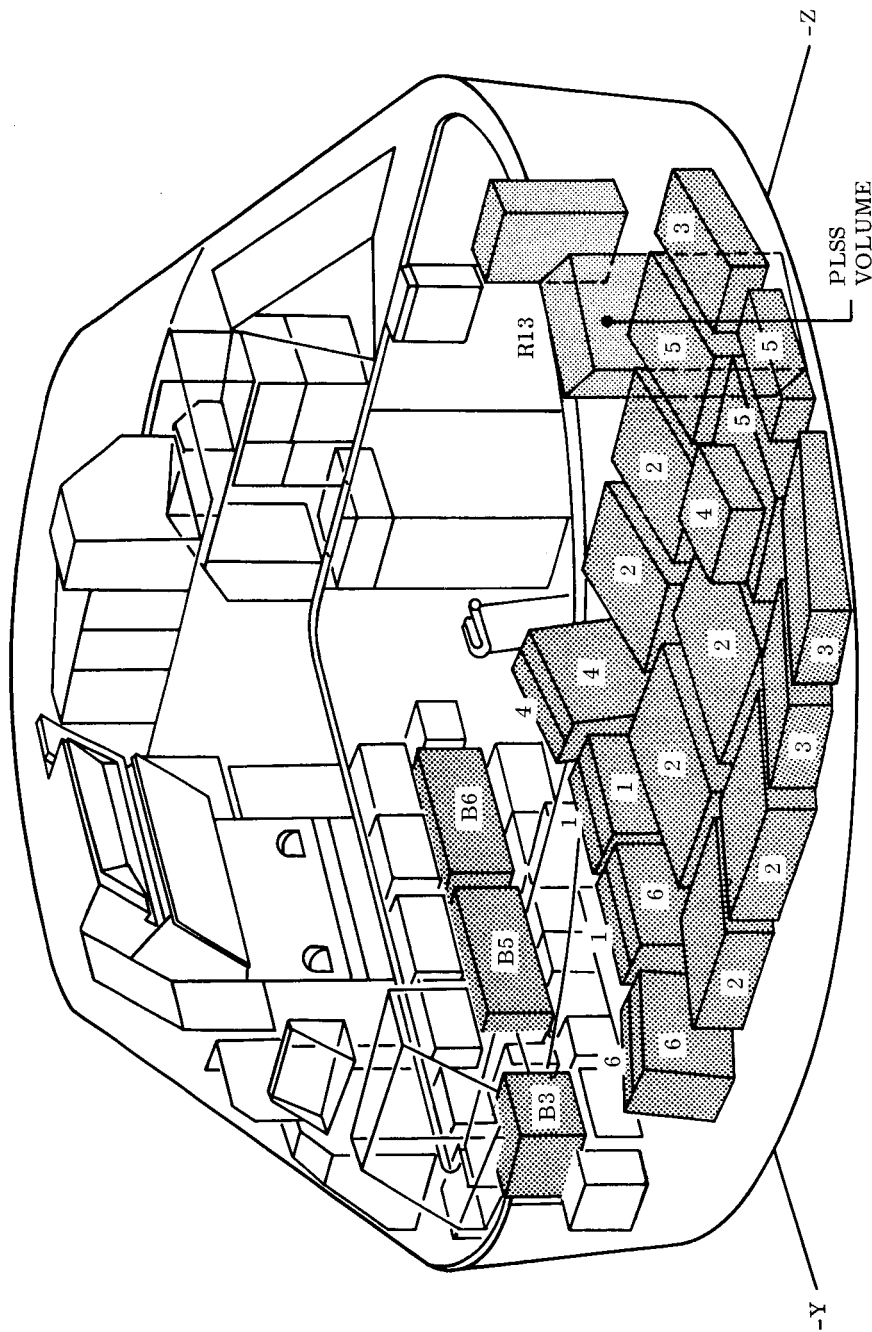
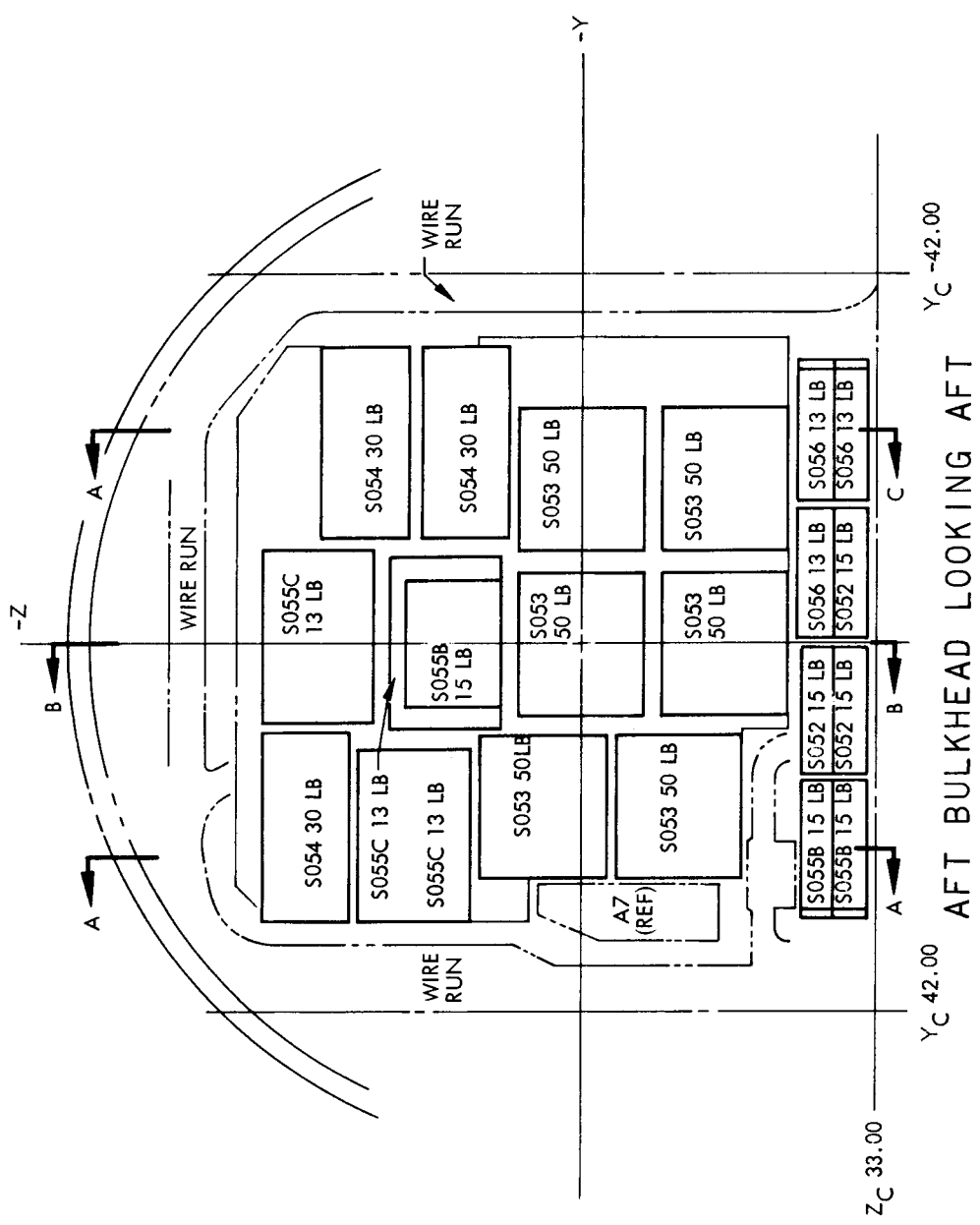
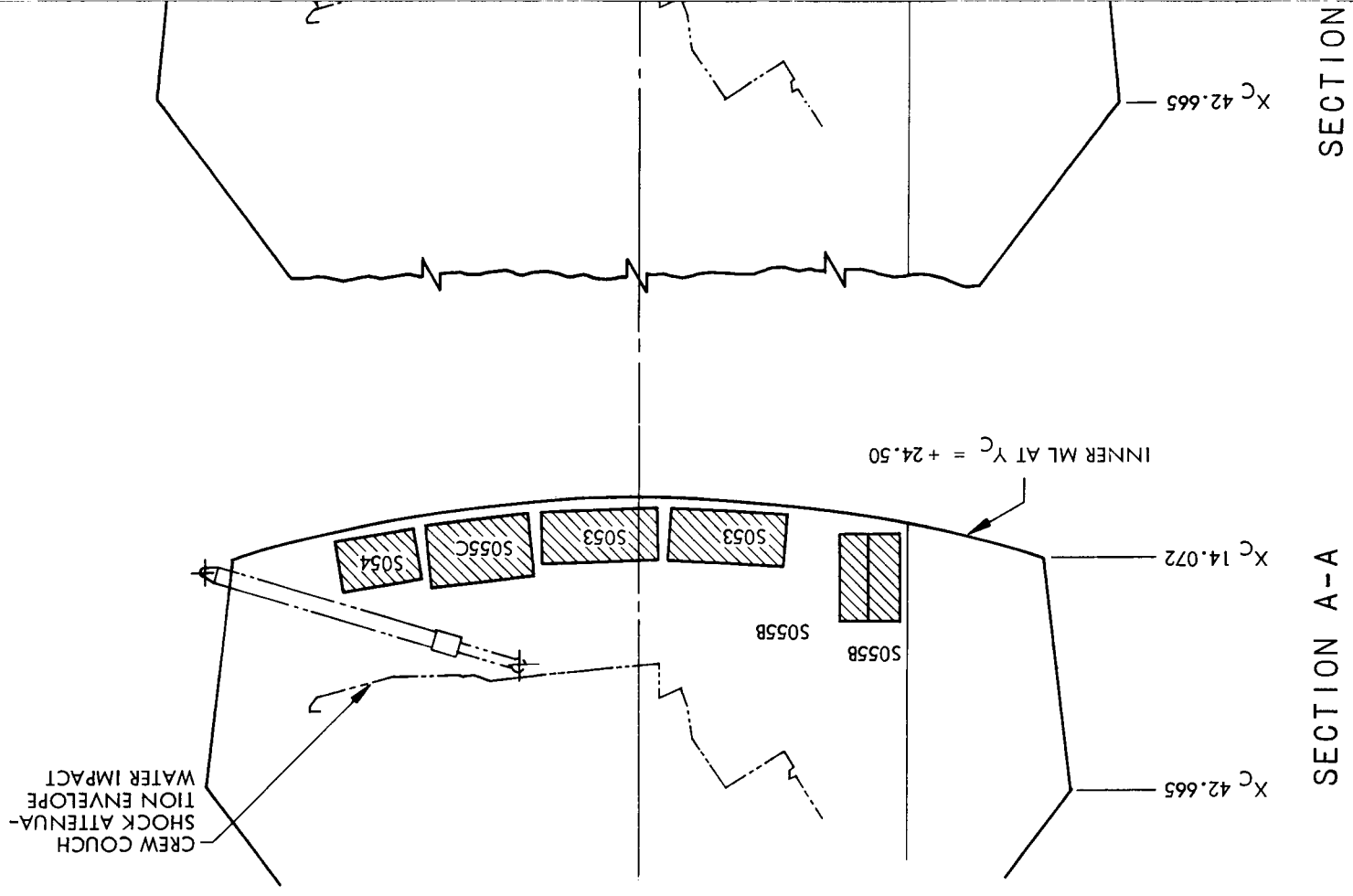

Fig. 3-5 AAP-3 CM Data Return Locations



SECTION

SECTION A-A

AFT BULKHEAD LOOKING AFT

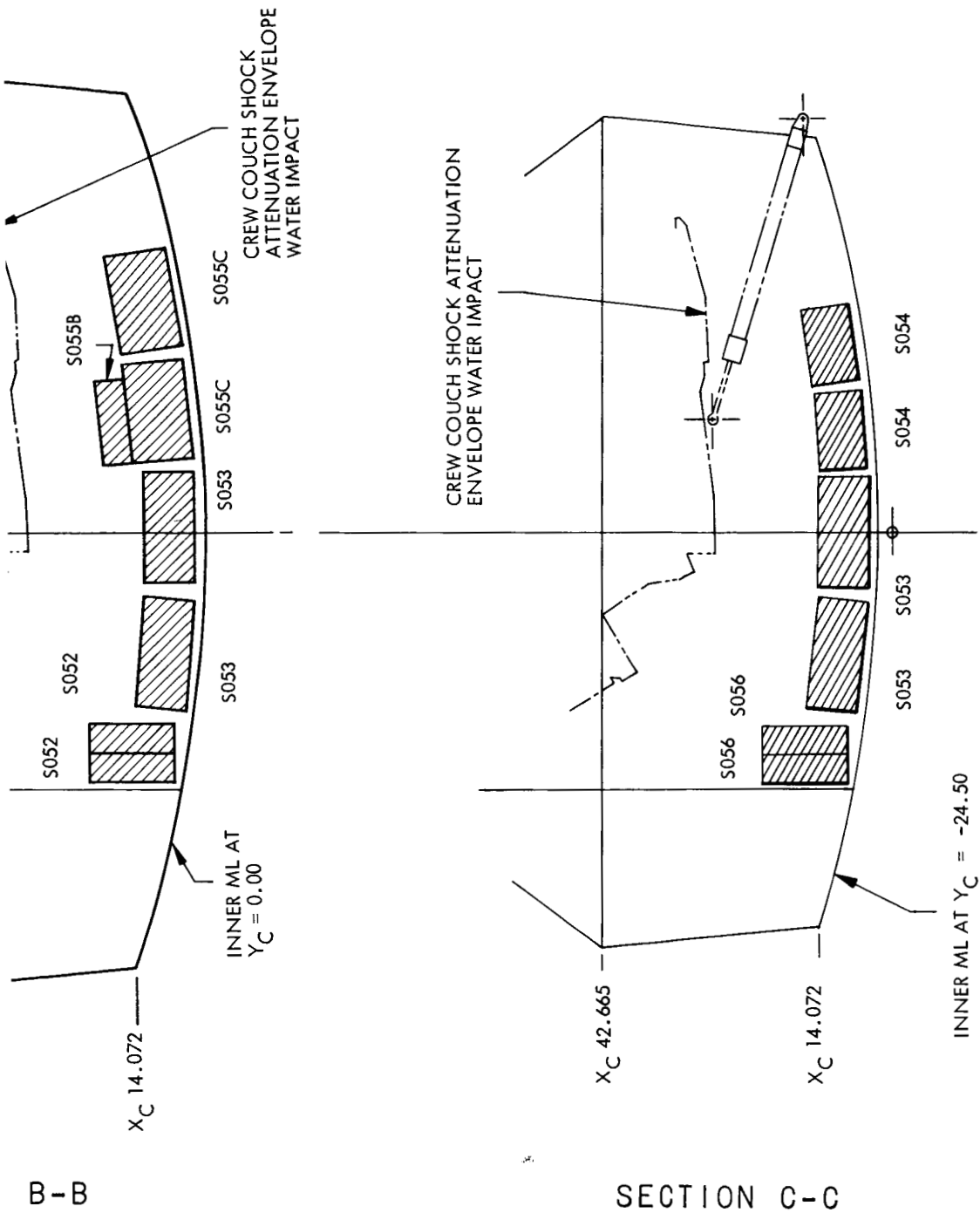

Fig. 3-6 CM Aft Bulkhead Data Storage Layout

II-17

OUT FRAME 2

FOLDOUT FRAME 3

PRECEDING PAGE BLANK NOT FILMED.

Figure 3-7 presents a detailed layout showing the data located in existing containers. These containers are also made available by off-loading the equipment stowed during the mission. Additional data packages are located on the CM sidewall (-Z axis) in an area made available by removal of the PLSS. Sufficient space is available on the aft bulkhead for these data packages if the PLSS is installed in this area.

CM Structural Effects. The complete data package installation was reviewed from a strength standpoint. Preliminary review indicates the data package installation on the aft bulkhead can be satisfactorily accomplished in the following manner:

- The packages are arranged to provide proper load distribution.
- The CM water landing condition is used during reentry.
- Provide simple quick-release latches, similar to existing designs for the package containers.

Thermal Environment. A preliminary review of the CM thermal environmental conditions and its effect on the return data was conducted. The data package containers may need thermal shielding to maintain the stored film at the desired temperature of 80° F.

CM Modification Summary. The modifications required to accommodate the recommended data return package installation are:

- Design new containers to accommodate the various data return packages.
- Add quick release fasteners to the CM aft bulkhead for attaching new data storage containers.
- Add attach fittings to the -Y axis CM interior wall for container attachment.

3.2.3 Mission A-3 Data Return Weight and Balance-Command Module.

Analyses presented in this section are based on the mass properties of the A-3 Command Module at launch in an unballasted condition without return data installed. To

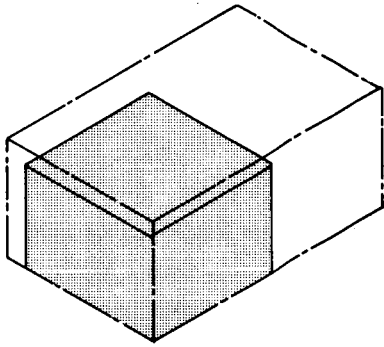

S070 = 14.0 LB
B5-ROCK BOX

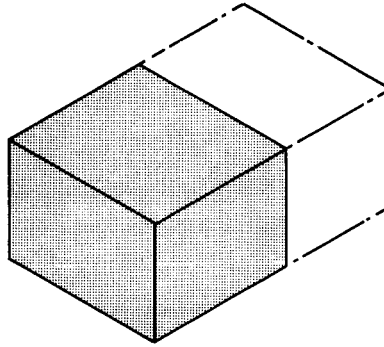

M055 = 12.5 LB
B6-ROCK BOX

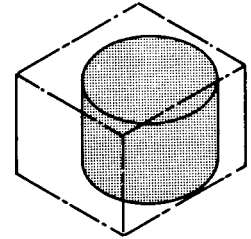

M018 = 2.5 LB
B3-STILL CAMERA

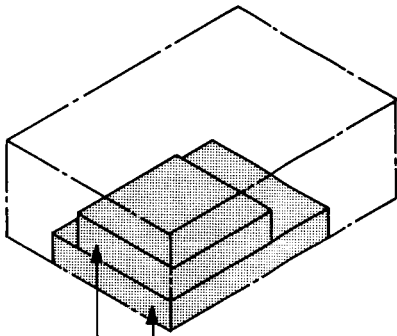

S069 = 3.0
 T021 = 10.0
WT. TOTAL = 13.0

R13-RH EQUIPMENT BAY

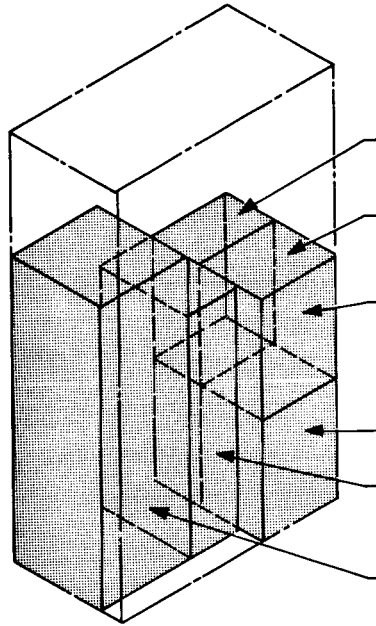

M052 = 5.0
 M053 = 3.1
 M050 = 2.5

 M051 = 2.5
 T017 = 20.0

 S065 = 31.2
Wt. TOTAL = 64.3

PLSS: -Z AXIS

Fig. 3-7 CM Container Utilization Layout

this baseline condition are added (1) the experiment data return items developed in Paragraph 2. 2, (2) weight changes resulting from preseparation transfer and jettison of consumables and equipment, (3) ballast to achieve the desired reentry condition. Weight and balance conditions occurring during the reentry phase are developed and compared with limiting values and constraints.

The A-3 Command Module weight model and mass property constraints used in this study are derived from the following sources:

- Summary and Detail Weight Statements – Command Module 104 Predicted, 1 June 1967 – Basic Block II CM data
- MSFC-R-P&VE-VAW-67-97, AAP Payload Weight Status Report, 14 July 1967 – Changes to the Block II CM for the A-3 mission
- SID 66-773, Command Module Return Payload Capability, 26 May 1966 – Flotation condition c. g. limits
- SID 64-183 (ARM-6), Structural Loads and Criteria, 31 Jan 1963, Rev. 9 Dec 1965 – Definition of Parachute Descending Weight

Table 3-1 presents the derivation of the A-3 Command Module mass properties in an unballasted condition and without return data installed. Ballast has been removed in this basic derivation since it will be shown that this item is highly dependent on data return weight and center of gravity limits.

Tables 3-2 and 3-3 list the weights and locations of experiment data to be returned and equipment and consumable items transferred to the cluster or jettisoned prior to separation. Not included in these tables are 1648 lb of Cluster B consumables launched on Flight A-3 (Ref. 2) which are transferred to the Cluster or otherwise expended before deorbit.

In Tables 3-4 through 3-6 the mass properties developed during the reentry sequence of events are shown for three balance conditions: (1) Ballasted to attain a separation c. g. of $\bar{X}_A = 1040.0$ and $\bar{Z} = 6.9$ corresponding to a hypersonic trim L/D of .345,

Table 3-1

DERIVATION OF A-3 CM BASELINE LAUNCH WEIGHT AND
CG (NO RETURN DATA OR BALLAST INSTALLED)

<u>Condition</u>	<u>Weight (lb)</u>	<u>Center of Gravity (In.)</u>		
		<u>\bar{X}_A</u>	<u>\bar{Y}_A</u>	<u>\bar{Z}_A</u>
Blk II CM Empty No. 104	(11,962)	(1042.1)	(-0.2)	(6.5)
Less Ballast	-510	1016.0	-1.4	45.3
Plus Mission-B Mods	75	1042.0	0.1	6.9
Mission-B CM Empty Weight	(11,527)	(1043.25)	(-0.14)	(4.79)
Useful Load	1,393	1037.25	-1.80	6.26
Mission B Cluster Consumables	1,648	1037.25	-1.80	6.26
Retro Rockets	1,271	990.0	0	0
Mission B CM Launch Weight	(15,839)	(1037.82)	(-0.45)	(4.69)

Table 3-2
AAP-3/4 DATA RETURN

Experiment	Weight (lb)	Center of Gravity (In.)		
		\bar{X}_A	\bar{Y}_A	\bar{Z}_A
M018	2.5	1031.0	-27.8	38.2
M050	2.5	1027.0	0	-51.0
M051	2.5	1027.0	0	-51.0
M052	5.0	1027.0	0	-51.0
M053	3.1	1027.0	0	-51.0
M055	12.5	1031.0	14.0	38.5
S052 (3)	45.0	1014.0	2.7	29.0
S053 (6)	300.0	1010.7	0	6.5
S054 (3)	90.0	1012.8	-8.3	-23.0
S055B (3)	45.0	1016.0	15.7	13.8
S055C (3)	39.0	1011.8	7.0	-21.5
S056 (3)	39.0	1015.3	-18.7	27.5
S065	31.2	1027.0	0	-51.0
S069	3.0	1025.0	49.0	-20.0
S070	14.0	1031.0	-7.4	38.5
T017	20.0	1027.0	0	-51.0
T021	10.0	1025.0	49.0	-20.0
Total Experiments	(664.3)	(1016.43)	(+0.39)	(+0.15)
15 Percent Support Structure	99.7			
Total Data Return	(764.0)	(1016.43)	(+0.39)	(+0.15)

Table 3-3
OFF-LOADED EQUIPMENT

<u>Item</u>	<u>Weight (lb)</u>	<u>Center of Gravity (in.)</u>		
		\bar{X}_A	\bar{Y}_A	\bar{Z}_A
Storage Container	23	1012	23	-51
Storage Container	23	1012	19	-17
Storage Container	23	1012	-26	-14
Still Camera B-3	15	1031	-28	43
Extra Food B-1	20	1028	39	-14
Rock Box	52	1031	14	45
CO ₂ Absorber No. 1	77	1012	18	5
CO ₂ Absorber No. 2	77	1012	-23	14
 AAP-3 Off-Loaded Equipment	 (31.0)	 (1017.14)	 (3.45)	 (7.36)
 Waste Management	 11.5	 1048.2	 48.1	 4.6
PLSS	93.5	1026.0	0	-52.5
TMG's	7.4	1013.9	-24.7	-12.6
Suit Spare Parts Kit	3.8	1041.5	24.5	11.2
Camera Misc.	8.2	1053.7	-3.9	19.0
Boost and Drinking Water	8.0	1022.6	-63.4	-16.4
EV Visor and Ladder	12.0	1028.0	38.5	-39.9
CWG	3.0	1030.0	21.3	-50.2
Emer. Oxygen	6.0	1042.7	-23.0	5.0
LEM Flight Plan	1.0	1061.0	-9.5	-10.5
Extra Food	35.0	1049.0	-38.5	25.7
Plus Water	+31.8	1022.6	-63.3	-16.4
 Total Transfer Weight	 158.0	 1035.6	 6.14	 -25.83

Table 3-4

REENTRY MASS PROPERTIES
CM BALLASTED TO STATION 1040.0 L/D = .345

<u>Condition</u>	<u>Weight (lb)</u>	<u>Center of Gravity (in.)</u>		
		<u>\bar{X}_A</u>	<u>\bar{Y}_A</u>	<u>\bar{Z}_A</u>
CM Launch Weight	(15,839)	(1037.82)	(-0.45)	(4.69)
Less Retro Rockets	-1,271	990.0	0	0
Less Off-Loaded Equipment	-310	1017.14	3.45	7.36
Plus Data Return	+764	1016.43	0.39	0.15
Less Docking Mech.	-172	1110.0	0	-2.5
Less CM Pre-Separation Transfer Items	-158	1035.6	6.14	-25.83
Less Mission B Useful Load	-1,648	1037.25	-1.8	6.26
Plus Ballast (1040/ .345)	+467	1016.0	0	57.74
CM Separation Weight (L/D Calc. at this point)	(13,511)	(1040.0)	(-0.44)	(6.90)
Less Ablator, Propellant and H ₂ O	-351	1015.9	-2.63	20.53
CM Recovery Threshold	(13,160)	(1040.6)	(-0.38)	(6.54)
Less Fwd Heat Shield	-303	1095.2	-0.10	1.9
Less Drogue Chute	-69	1090.3	0	-20.9
CM Main Chute Deployment	(12,788)	(1039.0)	(-0.39)	(6.80)
Less Main and Pilot Chutes	-451	1090.4	-1.2	7.5
Less RCS Propellant	-174	1022.6	-5.6	57.0
CM Impact	(12,163)	(1037.3)	(-0.28)	(6.05)

Table 3-5

REENTRY MASS PROPERTIES
BALLASTED TO STA. 1040.5, L/D = .28 (MIN. FOR FLOTATION C. G.)

<u>Condition</u>	<u>Weight (lb)</u>	<u>Center of Gravity (in.)</u>		
		\bar{X}_A	\bar{Y}_A	\bar{Z}_A
CM Launch Weight	(15,839)	(1037.82)	(-0.45)	(4.69)
Less Retro Rockets	-1,271	990.0	0	0
Less Off Loaded Equipment	-310	1017.14	3.45	7.36
Plus Data Return	+764	1016.43	0.39	0.15
Less Docking Mechanism	-172	1110.0	0	-2.50
Less Pre-Separation Transfer Items	-158	1035.6	6.14	-25.83
Less Mission B Useful Load	-1,648	1037.25	-1.80	6.26
Plus Ballast (Flotation)	+207	1016.0	0	45.3
CM Separation Weight (L/D Calc. at this point)	(13,251)	(1040.47)	(-0.44)	(5.71)
Less Ablator, Propellant and Water	-351	1015.9	-2.63	20.53
CM Recovery Threshold	(12,900)	(1041.14)	(-0.38)	(5.31)
Less Fwd Heat Shield	-303	1095.2	-0.10	1.90
Less Drogue Chutes	-69	1090.3	0	-20.90
CM Main Chute Deployment	(12,528)	(1039.56)	(-0.39)	(5.54)
Less Main and Pilot Chutes	-451	1090.4	-1.20	7.50
Less RCS Propellant	-174	1022.6	-5.60	57.00
CM Impact	(11,903)	(1037.88)	(-0.28)	(4.71)

Table 3-6

REENTRY MASS PROPERTIES
(UNBALLASTED)

<u>Configuration</u>	<u>Weight (lb)</u>	<u>Center of Gravity (in.)</u>		
		<u>\bar{X}_A</u>	<u>\bar{Y}_A</u>	<u>\bar{Z}_A</u>
CM Launch Weight	(15,839)	(1037.82)	(-0.45)	(4.69)
Less Retro Rockets	-1,271	990.0	0	0
Less Off Loaded Equipment	-310	1017.14	3.45	7.36
Plus Data Return	+764	1016.43	0.39	0.15
Less Docking Mechanism	-172	1110.0	0	-2.50
Less Pre-Separation Transfer Items	-158	1035.6	6.14	-25.83
Less Mission B Useful Load	-1,648	1037.25	-1.80	6.26
CM Separation Weight (L/D Calc. at this point)	(13,044)	(1040.86)	(-0.45)	(5.08)
Less Ablator, Propellant and Water	-351	1015.9	-2.63	20.53
CM Recovery Threshold	(12,693)	(1041.55)	(-0.39)	(4.65)
Less Fwd Heat Shield	-303	1095.2	-0.10	1.90
Less Drogue Chutes	-69	1090.3	0	-20.90
CM Main Chute Deployment	(12,321)	(1039.96)	(-0.40)	(4.86)
Less Main and Pilot Chutes	-451	1090.4	-1.20	7.50
Less RCS Propellant	-174	1022.6	-5.60	57.00
CM Impact	(11,696)	(1038.27)	(-0.29)	(3.98)

Section 6
SHIELD WEIGHT ESTIMATES

The dose and film dose tolerance data presented in Sections 3, 4, and 5 permit preliminary estimates of required shield weights to be made. The values should be used with caution because a number of uncertainties remain. For example, the number of experiments using radiation sensitive film may change. The radiation fog density tolerance may change. A more accurate integration over time and film orientation may change doses significantly. In addition, configuration changes and refinements are still possible. For these reasons and others, sizable uncertainties remain in shield weight calculations.

The present shield weight estimates are given in Table 6-1. The guidelines used in developing these estimates are:

- The maximum CM and MDA dose curves are used.
- The S052 configuration includes an aft mounted camera.
- The average of S056 curves A and B, Fig. 3-2, are used.
- The interaction between the S052 shield, the S056 shield, and the CM or MDA shield is small and is neglected.
- The conversion from emulsion rads to film fogging described in Section 5 is used.
- No significant dose is accumulated while the film is lightly shielded following ascent and preceding descent.

Table 6-1 shows shield weight estimates for the S052 and S056 experiments located on the spar as well as shield weight estimates required for storage locations in the CM or MDA for three assumed dose tolerance distributions. These assumed cases are:

- 40 percent of dose acquired in storage, 60 percent on the ATM spar
- 50 percent of dose acquired in storage, 50 percent on the ATM spar
- 60 percent of dose acquired in storage, 40 percent on the ATM spar

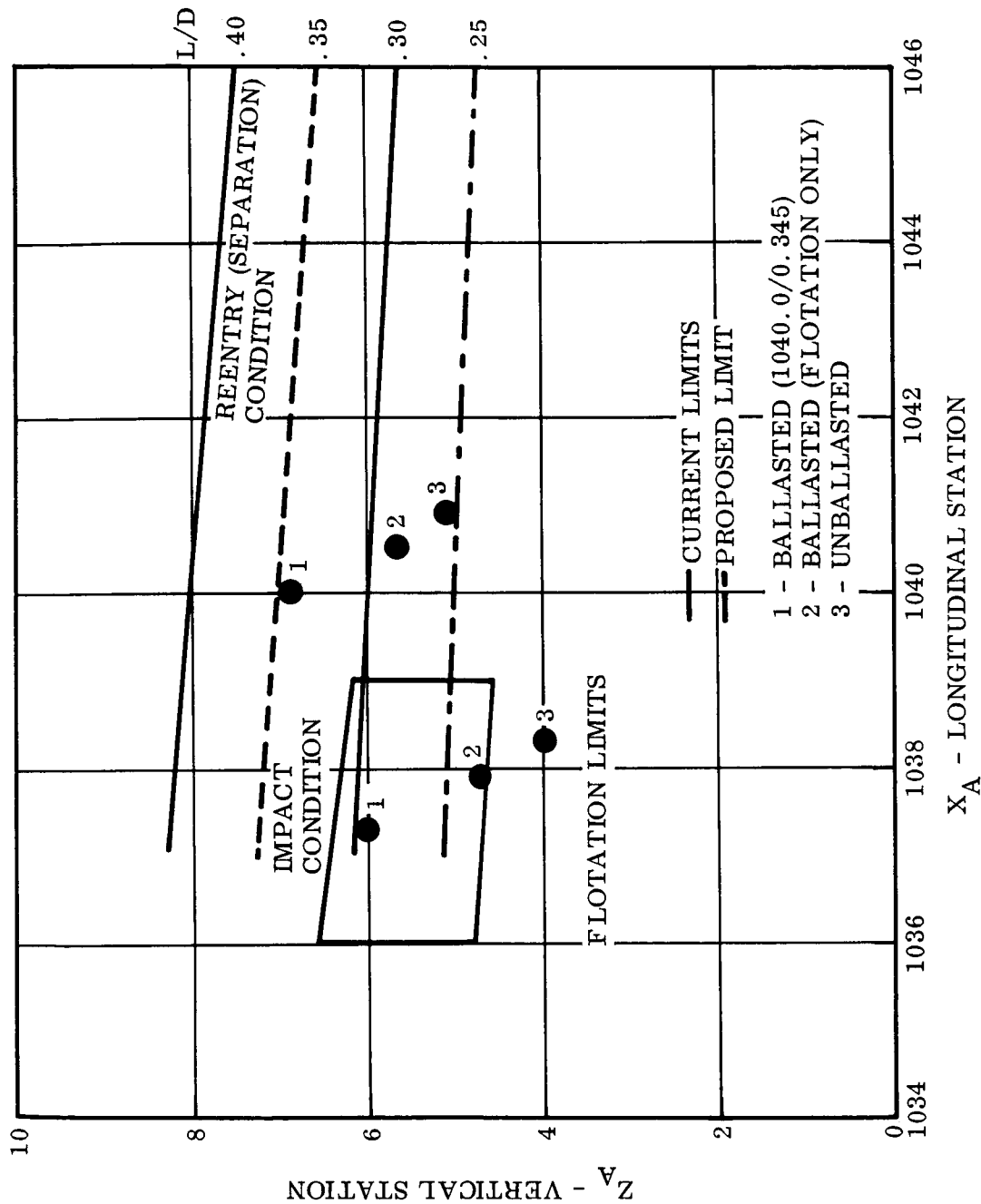

Fig. 3-8 Reentry and Impact Conditions Plotted on Limit Diagram

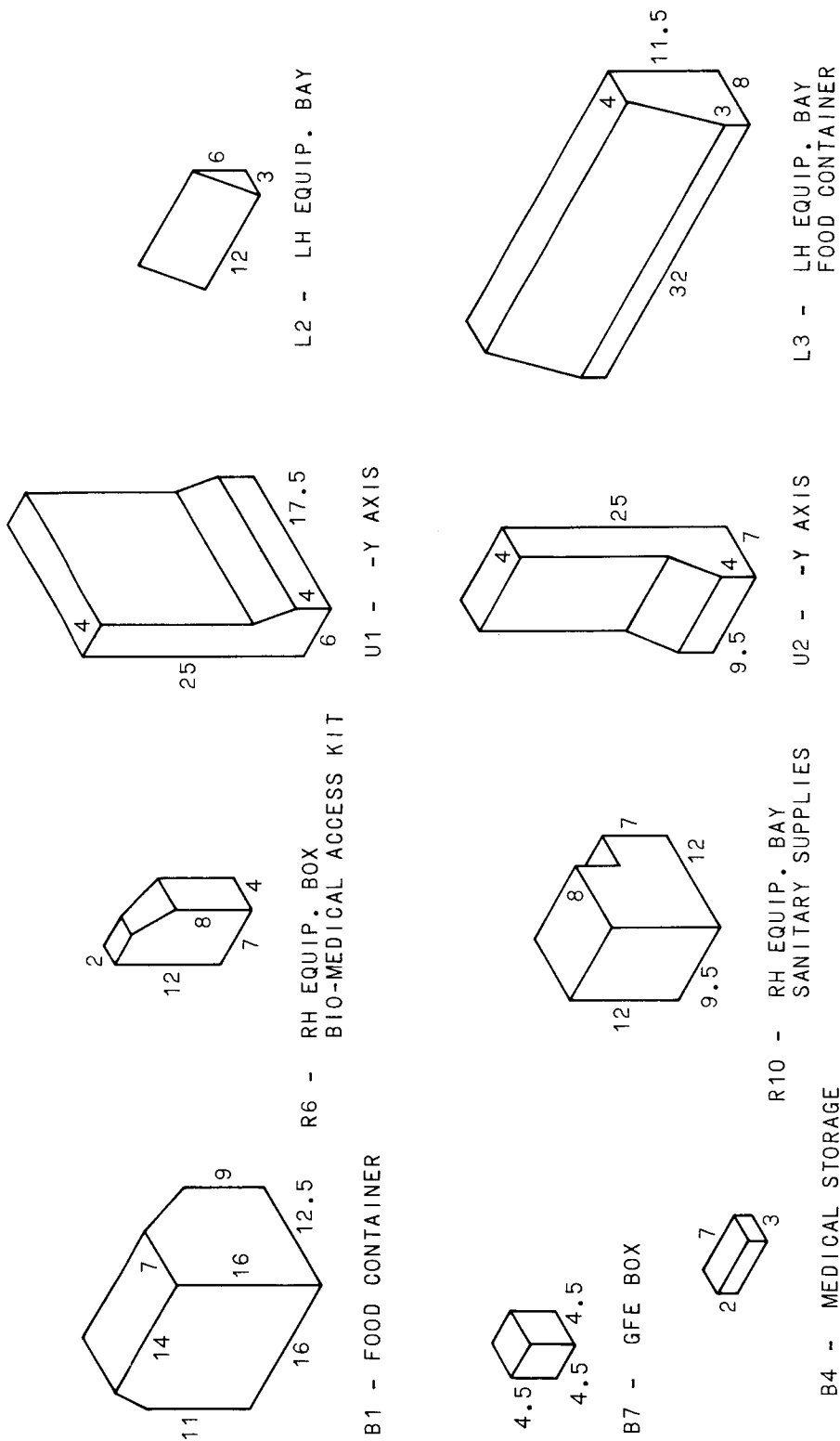

Fig. 3-9 Summary of Additional Containers

Table 3-7

COMPARATIVE WEIGHT SUMMARY - REENTRY SEQUENCE OF EVENTS

<u>Configuration</u>	<u>Weight (lb)</u>		
	<u>Ballasted</u> (1040.0/ .345)	<u>Ballasted</u> (Min for Flotation)	<u>Unballasted</u>
CM Launch Weight (Basic Unballasted)	(15,839)	(15,839)	(15,839)
Retro Rockets	-1,271	-1,271	-1,271
Mission B Useful Load and Equipment	-1,978	-1,978	-1,978
Off Loaded Equipment	-310	-310	-310
Data Return	+764	+764	+764
Ballast	+467	+207	0
CM Separation Weight	(13,511)	(13,251)	(13,044)
Ablator, Propellant and Water	-351	-351	-351
CM Recovery Threshold	(13,160)	(12,900)	(12,693)
Fwd Heat Shield	-303	-303	-303
CM Descending Weight	(12,857)	(12,597)	(12,390)
CM Main Chute Capability	13,500	13,500	13,500
Margin for Reentry	+643	+903	+1,110

3.2.5 CM Reentry Land Landing

Figure 3-10 shows how the amount of available space on the aft bulkhead is reduced when considering a land landing reentry condition. As noted some of the packages interfere with the couch stroke. Sufficient space is not available for all of the return data packages when considering a land landing reentry condition.

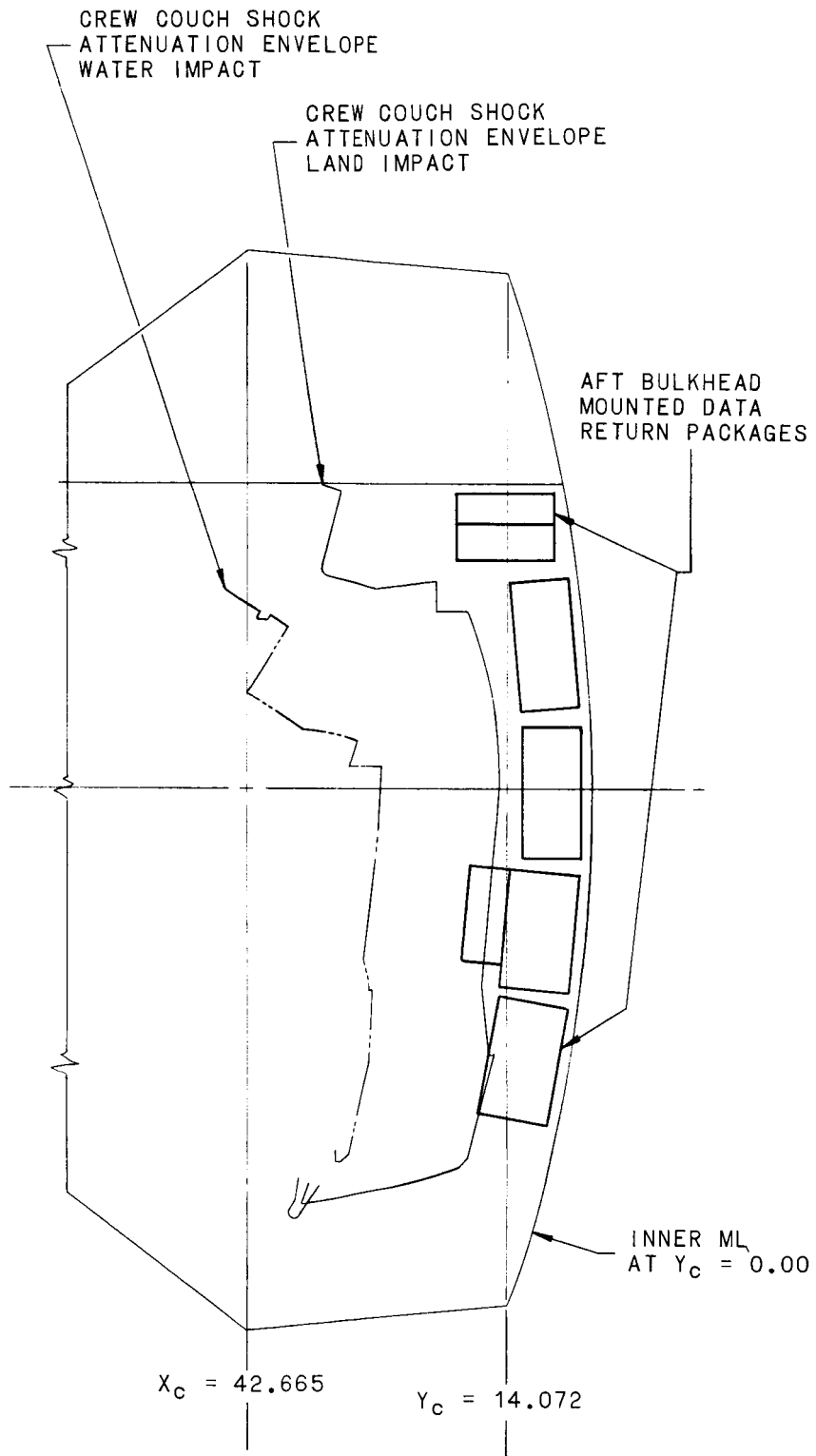

Fig. 3-10 Land Landing Reentry Space