

NASA TECHNICAL NOTE

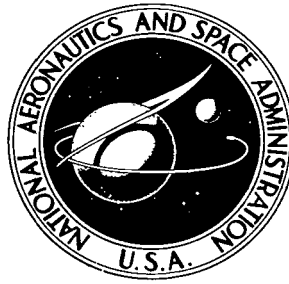

NASA TN D-4767

e.i

NASA TN D-4767



LOAN COPY: RETURN TO
AFWL (WLIL-2)
KIRTLAND AFB, N MEX

TESTS OF A SINGLE TUBE-IN-SHELL
WATER-BOILING HEAT EXCHANGER WITH
A HELICAL-WIRE INSERT AND SEVERAL
INLET FLOW-STABILIZING DEVICES

by James R. Stone and Nick J. Sekas

*Lewis Research Center
Cleveland, Ohio*

NATIONAL AERONAUTICS AND SPACE ADMINISTRATION • WASHINGTON, D. C. • AUGUST 1968



✓
TESTS OF A SINGLE TUBE-IN-SHELL WATER-BOILING HEAT EXCHANGER
WITH A HELICAL-WIRE INSERT AND SEVERAL INLET
FLOW-STABILIZING DEVICES

✓
By James R. Stone and Nick J. Sekas ✓

Lewis Research Center
Cleveland, Ohio

✓
NATIONAL AERONAUTICS AND SPACE ADMINISTRATION

For sale by the Clearinghouse for Federal Scientific and Technical Information
Springfield, Virginia 22151 - CFSTI price \$3.00

ABSTRACT

Experimental data were obtained on a vertical-upflow, single tube-in-shell, 0.436-in. - (1.11-cm) inside diameter by 60.5-in. - (1.54-m) long, water-boiling heat exchanger with a helical-wire insert (wire-pitch-to-inside-diameter ratio 1.90). Entrance-region plugs, inlet orifices, and a venturi-type inlet were tested at boiling-fluid flow rates from 60 to 100 lb_m/hr (0.0075 to 0.0125 kg/sec) and exit pressure ~17 psia (~115 kN/m²). Results are compared with those on a boiler with the same dimensions, but with no insert. Vapor superheat with heat-balance exit quality >1.0 was obtained. With no inlet device, with or without plugs the tendency for back-slugging instabilities was present. Orifices eliminated back-slugging, but exit quality of 1.0 was not obtained, although vapor superheat was indicated. The venturi eliminated back slugging and gave a heat-balance quality as high as 1.02; however, the flow range was limited.

CONTENTS

	Page
SUMMARY	1
INTRODUCTION	2
SYMBOLS	3
APPARATUS	4
Heat Supply Loop	4
Test Fluid Loop	5
Test Section	5
Inlet Region Modifications	5
Plugs	5
Orifices	6
Orifice and plug combination	6
Venturi-diffuser and plug combination	6
Instrumentation	6
PROCEDURE	7
RESULTS AND DISCUSSION	7
Nonboiling Runs	7
Boiling Results for the Various Inlet-Region Configurations	8
No plug or inlet device	8
Plug only	9
Single orifice only	9
Multiple-hole orifice only	10
Single orifice and plug	10
Venturi-diffuser and plug	10
Comparison of Inlet Region Devices	11
Exit quality and superheat	11
Pressure drop	11
Other considerations	12
SUMMARY OF RESULTS	12
APPENDIXES	
A - REDUCTION OF NONBOILING DATA	14
B - REDUCTION OF BOILING DATA	18
REFERENCES	19

TESTS OF A SINGLE TUBE-IN-SHELL WATER-BOILING HEAT EXCHANGER
WITH A HELICAL-WIRE INSERT AND SEVERAL INLET
FLOW-STABILIZING DEVICES

by James R. Stone and Nick J. Sekas
Lewis Research Center

SUMMARY

Experimental data were obtained on the performance of a vertical-upflow, single tube-in-shell, water-boiling heat exchanger with a helical-wire insert and several inlet flow-stabilizing devices. The boiler tube had an inner diameter of 0.436 inch (1.11 cm) and an effective length of 60.5 inches (1.54 m). The purpose of the wire helix was to separate the liquid and vapor phases, maintaining liquid on the heated surface and thus yielding efficient heat transfer up to high vapor quality. The ratio of wire pitch to tube inner diameter was 1.90. Velocity-increasing entrance-region plugs, inlet orifices and a venturi-type inlet were tested over a nominal range of boiling-fluid flow rates of 60 to 100 pounds (mass) per hour (0.0075 to 0.0125 kg/sec). Most of the data were taken with boiler exit pressure at about 17 pounds (force) per square inch (absolute) ($\sim 115 \text{ kN/m}^2$). The results are compared with experimental results obtained on the same test rig with a boiler of the same dimensions, but without the helical-wire insert.

Exit qualities (as determined by a heat balance) greater than 1.0 with vapor superheat were obtained, whereas such performance was not obtained with a plain tube. With no inlet pressure-drop device, with or without inlet-region plugs, the tendency for back-slugging instabilities was present. The orifices eliminated back-slugging, but exit qualities of 1.0 were not obtained, although vapor superheat was indicated. With a venturi-type inlet, back slugging was eliminated and exit quality greater than 1.0 was obtained. However, this device performed stably over a limited flow range.

INTRODUCTION

One of the major problem areas in the technology of Rankine-cycle space power systems has been the design of high-performance, dependable, compact boilers. The boilers must operate stably with a minimum of entrained liquid in the exit vapor stream. One approach to the stability problem has been to add a large pressure drop at the boiler inlet. This pressure drop has generally been obtained from orifices and area-reducing entrance-region plugs. In addition to increasing the pressure drop, the plugs induced increased heat-transfer coefficients in the nonboiling region. A common method used to reduce liquid entrainment has been to separate the liquid droplets from the vapor by swirling the two-phase mixture, thus centrifuging the liquid to the wall. This swirl has been obtained by inserting helical wires or twisted ribbons into the boiler tube, by coiling the tube, or by a combination of inserts and tube coiling. These approaches have resulted in varying degrees of improvement, as for example in the mercury boiler development program (refs. 1 to 4). Some other studies of the effect of swirling on boiler performance are described in references 5 to 7 for potassium boiling and references 8 to 10 for water boiling.

The beneficial effects of swirling the flow appear to be that a quality higher than that obtained in a plain, straight tube is reached before dry-wall boiling occurs, and that a higher heat-transfer coefficient is obtained in the dry-wall boiling regime (refs. 5, 6, and 9). These benefits are accompanied by a larger pressure drop across the boiler. Kreeger, et al. (ref. 4) reported that with twisted-ribbon inserts, liquid was found to accumulate on the ribbon, but with helical-wire inserts, good separation of the liquid from the vapor core was achieved. Even with the various swirl techniques, however, considerable amounts of vapor superheat with quality less than 1.0 (as determined by a heat balance) have been reported for the boiling of mercury (refs. 1 to 4) and water (ref. 10).

A series of experimental once-through heat-exchanger boiler studies have been conducted at Lewis Research Center. Plain-tube water-boiling experiments were reported in reference 11. Correlations were presented therein for boiling pressure drop and heat-transfer coefficients. In reference 11, it was found difficult to obtain high exit quality with stable flow. In the present experiments, results are reported on the performance of a boiler of the same dimensions as in reference 11 and on the same test rig, but with a helical-wire insert and several entrance-region modifications. The purpose of this study was to determine the effect of the helical wire and the entrance-region modifications on heat transfer and pressure drop. In addition, qualitative information on flow stability was sought.

The boiler tube used in this study was 60.5 inches (1.54 m) long and 0.436 inch (1.11 cm) in inside diameter. The full-length wire helix was brazed to the tube inside wall. Its diameter was 1/16 inch (1.6 mm), and its pitch (for 360° of coil) was 0.83

inch (2.1 cm). Several combinations of inlet pressure drop devices and area-reducing plugs were tested. Most of the data were obtained with boiling-fluid flow rates from about 60 to 100 pounds (mass) per hour (~ 0.0075 to 0.0125 kg/sec), heating-fluid (water) flow rate about 8000 pounds (mass) per hour (~ 1.0 kg/sec), and boiler exit pressure about 17 pounds (force) per square inch (absolute) (~ 115 kN/m²). Limited data were also obtained for other conditions.

SYMBOLS

c_p	liquid specific heat, Btu/(lb _m)(°F); J/(kg)(K)
D	diameter, in.; m
G	boiling-fluid superficial mass velocity, $4W_b/K\pi D_1^2$, lb _m /(hr)(ft ²); kg/(sec)(m ²)
g_c	conversion factor, 4.17×10^8 (lb _m)(ft)/(lb _f)(hr ²); 1.00 (kg)(m)/(N)(sec ²)
H	enthalpy, Btu/lb _m ; J/kg
J	heating-fluid flow parameter, $D_2/12k_h Re_h^{0.8} Pr_h^{0.5}$, (hr)(ft ²)(°F)/Btu; $D_2/k_h Re_h^{0.8} Pr_h^{0.5}$, (m ²)(K)/W
K	conversion factor, (1/144) ft ² /in. ² ; 1.00 m ² /m ²
k	liquid thermal conductivity, Btu/(hr)(ft)(°F); W/(m)(K)
Nu	Nusselt number, $D_1/12Rk$, dimensionless; D_1/Rk , dimensionless
P	pressure (absolute), psi; N/m ²
ΔP_B	boiler pressure drop, $P_{bi} - P_{be}$, psi; N/m ²
ΔP_G	calculated gravitational pressure drop, psi; N/m ²
ΔP_P	boiling-fluid pump pressure rise, psi; N/m ²
Pr	liquid Prandtl number, $c_p \mu/k$, dimensionless
Q	heating rate, Btu/hr; W
R	thermal resistance, (hr)(ft ²)(°F)/Btu; (m ²)(K)/W
R_o	combined resistance of wall and heating fluid, (hr)(ft ²)(°F)/Btu; (m ²)(K)/W
Re	Reynolds number, dimensionless
S	surface area, ft ² ; m ²
T	temperature, °F; K
W	mass flowrate, lb _m /hr; kg/sec

- x** vapor quality, dimensionless
- θ** temperature difference, $^{\circ}\text{F}$; K
- λ** enthalpy of evaporation, Btu/lb_m ; J/kg
- μ** liquid viscosity, $\text{lb}_m/(\text{ft})(\text{hr})$; $\text{kg}/(\text{m})(\text{sec})$
- ρ** density, lb_m/ft^3 ; kg/m^3

Subscripts:

- b** boiling fluid (test fluid)
- c** coolant (test fluid)
- e** exit
- h** heating-fluid
- i** inlet
- l** liquid property
- m** arithmetic mean
- p** exit plenum
- pt** plain tube
- s** boiling-fluid saturation
- 1** inner wall of boiler tube
- 2** outer wall of boiler tube
- 3** inner wall of shell tube

APPARATUS

A schematic diagram of the test rig is shown in figure 1. With the exception of the test section this is essentially the same rig as that used in reference 11. The various parts of the rig are described in the following sections.

Heat Supply Loop

The heat supply loop was designed for operation at temperatures up to 350°F (450 K) and pressures up to 200 pounds per square inch (absolute) ($1380\text{ kN}/\text{m}^2$). A cen-

trifugal pump circulated the heating water in the closed loop. The heating fluid was heated in a tank by immersion heaters.

Test Fluid Loop

A gear pump circulated the test fluid. The flow passed through a coiled, stainless-steel, electric preheater and then through a remotely-operated throttle valve to the test-section inlet plenum. From the test-section exit plenum the flow passed through a pipe to a spray condenser. A centrifugal pump recirculated cool liquid to the condenser from the test-fluid loop. From the condenser the flow passed into a multiple-tube heat exchanger cooled by water from an external cooling-water system. In most cases the condenser coolant recirculating pump was shut off, and the condensing was done in the heat exchanger.

Test Section

Figure 2 shows a schematic diagram of the test section. The test-fluid flow was vertically upward and the heating-fluid flow downward. The shell, or outer jacket, of the test section was a single stainless-steel tube. The inner (test-fluid) passage consisted of two lengths of stainless-steel tubing butt-welded together in such a manner that the internal wire helix was essentially continuous. The helical copper wire, 1/16 inch (1.6 mm) in diameter, had previously been brazed to the inner surface of the tubes. Heat transfer in the end sections was reduced by insulating the center tube as shown in figure 2. The effective length of the boiler was assumed to be limited to the 60.5-inch (1.54-m) uninsulated length. The outer shell of the test section was wrapped with a fiberglass insulating material.

Inlet Region Modifications

The various flow-stabilizing devices used in this study are described in this section. The same test section was used in all cases.

Plugs. - Figure 3 shows the inlet region of the test section with the 5-inch (0.127-m) long plug installed. A 10-inch (0.254-m) long plug was also used. These plugs were machined from brass rods and fit tightly against the helical wire, thus forming a helical flow passage. The plug fit tightly enough to be held in place; however, there were two small protruding rods at the upstream end to assure that the plug could not slide into the test section.

Orifices. - Two different single-hole orifices were used, one having a diameter of 0.025 inch (0.64 mm) and the other 0.0305 inch (0.77 mm). Both were located at the tube centerline. Two different multiple-hole orifices were also used. The first, having two 0.025-inch (0.64-mm) diameter holes is sketched in figure 4. The holes were angled to initiate swirling flow. The second multiple-hole orifice, having four 0.0135-inch (0.34-mm) diameter holes, is sketched in figure 5. These holes were also angled to initiate swirling flow. The holes, in addition, were angled outward toward the boiler-tube wall, instead of being parallel to it as with the first multiple-hole orifice. The orifice plates were all 0.080 inch (2.03 mm) thick and were soldered to the inlet end of the boiler tube.

Orifice and plug combination. - Figure 6 shows the inlet region of the test section with a 0.028-inch (0.71-mm) diameter orifice followed by a 10-inch (0.254-m) long plug. The plug was bonded to the 0.080-inch (2.03-mm) thick orifice plate, which was then soldered to the inlet end of the boiler tube. A slot passage was cut at the inlet end of the plug to provide a flow passage from the orifice into the boiler tube.

Venturi-diffuser and plug combination. - Figure 7 shows the inlet region of the test section with the venturi-type restrictor, the diffuser, and a 10-inch (0.254-m) long plug. A short length of stainless-steel tubing was rolled down to form the 0.0305-inch (0.78-mm) throat-diameter venturi; the rolling process left a small notch in the diffuser, as shown in the figure. The extension of the diffuser and the plug were brass. A 1/16-inch (1.6-mm) diameter copper wire with the same pitch (0.83 in. or 2.1 cm) as in the boiler tube was bonded to the tapered section of the plug. The upstream end of the wire was tapered down to minimize leading-edge bluntness.

Instrumentation

The flow rates for both loops were measured by turbine-type flowmeters.

The boiler inlet and exit pressures were measured with 0 to 150 pounds per square inch (0 to 1030 kN/m²) absolute Bourdon-type gages, with errors less than $\pm 1/4$ of 1 percent of full scale. The inlet pressure gage was always located downstream of all inlet orifices and the venturi. The smallest gage division was 1/2 pound per square inch (3.8 kN/m²), and the gage face was 8 inches (0.203 m) in diameter. The pressure taps were drilled through the test-section end plates and boiler-tube wall. The pressure gages were sufficiently damped to eliminate most high frequency oscillations. The test-fluid pump pressure rise was measured with a 6-inch (0.152-m) diameter differential gage having a 0 to 100 pound per square inch (0 to 690 kN/m²) scale. The pump pressure rise was not a precise measurement and is included only to show rough trends.

Copper-constantan thermocouples were installed in the boiling-fluid inlet and exit

plenum chambers and in the heating-fluid inlet and exit lines. These temperatures were read from multi-point strip-chart recorders having a range of 0° to 400° F (255.5 to 478 K), 2° F (1.1 K) smallest division, and an 11 inch (0.279 m) scale. After the tests were partially completed a chromel-alumel thermocouple was installed at the boiling-fluid exit, upstream of the plenum baffle plates, to measure the temperature as close as possible to the end of the boiler tube. This temperature was continuously recorded on a strip chart having a 6 inch (0.152 m) scale with a 10 millivolt range and 0.1 millivolt smallest division.

PROCEDURE

The sequence of testing was as follows: (1) no plug or inlet device, (2) plugs only, (3) the various orifice configurations, and (4) the venturi-diffuser and plug. Additional data on the 10-inch (0.254-m) plug with no inlet device were taken after partial completion of the orifice testing.

Generally the mode of operation was to maintain both flow rates and the boiling-fluid inlet temperature and exit pressure essentially constant, while increasing the heating-fluid inlet temperature. However, some series were run with variable boiling-fluid flow rate.

The conditions for each test run were established by adjusting the power to the main heater and preheater and setting pump speed, flow-control valve position and expansion tank pressures at selected values. When mean inlet and exit temperatures became constant with time, even if in some cases slightly oscillatory, the data for that run were taken.

The dissolved gas content was reduced and maintained at or below about 3 parts per million by weight by venting the top of the condenser while boiling in the test section. (Method of determining gas content is discussed in ref. 12.) This was done each day before data were taken.

RESULTS AND DISCUSSION

Nonboiling Runs

A series of nonboiling runs was made to check the instrumentation and to determine the heating-fluid and coolant (test fluid) thermal resistances. Table I contains the data for these runs. The analysis of these data is presented in appendix A. The rate of heat transfer in the test section was calculated for the heating fluid Q_h , and for the coolant

Q_b . The average disagreement was found to be 5 percent and the maximum disagreement was 11 percent, for heating-fluid temperature drops greater than 4.5° F (2.5 K). Mean coolant Nusselt numbers were determined for each nonboiling run and were plotted against mean coolant Reynolds number as shown in figure 8 (mean coolant Prandtl number essentially constant at 3.3). The plain-tube Nusselt number curve shown for comparison was determined as in reference 11. These data appear to be at least in qualitative agreement with the data of Sams (ref. 13) for air flowing in a tube with helical-wire inserts.

Boiling Results for the Various Inlet-Region Configurations

Data were obtained on the performance of the heat-exchanger boiler with helical-wire insert with each of the inlet-region configurations described in the APPARATUS section. These data are tabulated in tables II to X. The reduction of these data is described in appendix B.

Plots of exit quality and boiler pressure drop as a function of the boiler-exit temperature difference, $\theta_{se} = T_{hi} - T_{se}$, are presented for each configuration (figs. 9 to 22). For all configurations except the venturi, the nominal conditions were as follows: heating-fluid flow rate, 8000 pounds (mass) per hour (1.0 kg/sec); boiling-fluid flow rate, 60 pounds (mass) per hour (0.0075 kg/sec); boiling-fluid inlet temperature, 80° F ($\sim 300 \text{ K}$); and boiler exit pressure, 17 pounds (force) per square inch (absolute) ($\sim 115 \text{ kN/m}^2$). For the venturi-type inlet, the nominal boiling-fluid flow rate was 80 pounds (mass) per hour (0.010 kg/sec), with the other conditions the same. Calculated curves of exit quality or boiler pressure drop against θ_{se} for a plain-tube boiler of the same dimensions (ref. 11) and the same nominal conditions are shown in each figure for comparison. The choice of θ_{se} as the significant temperature difference is arbitrary; however, heating-fluid inlet temperature is the manipulated variable, while boiling-fluid exit saturation temperature and both flow rates are essentially constant, so that θ_{se} is a reasonable parameter. The exit quality at the onset of dry wall boiling for the plain tube (ref. 11) is also shown. Additional data, for conditions other than nominal, but all at about 17 pounds (force) per square inch (absolute) ($\sim 115 \text{ kN/m}^2$) boiler exit pressure, are presented in the tables. Comments on flow oscillations are based on the output of the turbine flowmeter, and are only qualitative.

No plug or inlet device. - Plots of exit quality and boiler pressure drop, respectively, are shown in figures 9 and 10, as a function of the boiler-exit temperature difference for the nominal conditions with no plug or inlet device. For exit qualities less than that at which dry-wall boiling occurs in the plain tube ($x_e \approx 0.82$), there is little effect of the wire helix on x_e for a given θ_{se} ; actually, the exit quality with the wire helix for a

given θ_{se} appears to be slightly less than for the plain tube. However, the rate of increase of x_e with θ_{se} remains unchanged up to $x_e \approx 1.0$ with the wire helix, indicating that there is no significant change in the overall heat-transfer coefficient, while for the plain tube (ref. 11) the performance beyond the onset of dry-wall boiling was very erratic and unpredictable. Even with the wire helix, however, exit quality of 1.0 was not reached without flow oscillations of at least ± 5 percent. These flow oscillations were usually accompanied by pulsating high temperature readings at the boiling-fluid inlet. These temperature rises were, at times, as much as 60° F ($\sim 35 \text{ K}$). Since the boiling-fluid inlet thermocouple was located just below the boiler-tube inlet end, these erratic high temperature readings may have been due to back slugging of vapor or hot liquid.

The pressure drop shown in figure 10 is considerably greater than that for the plain tube. It was generally found necessary to adjust the throttle valve to cause a fairly large total system pressure difference (given by the pump pressure rise ΔP_P in the tables), in order to maintain a reasonably steady boiling-fluid flow rate. (The throttle valve pressure drop is given approximately by $\Delta P_P - (P_{bi} - P_{be})$.) At high exit qualities the pressure drop across the throttle valve was about 13 pounds per square inch ($\sim 90 \text{ kN/m}^2$).

Data are also listed in table II for boiling-fluid flow rate about 100 pounds (mass) per hour (0.0125 kg/sec) with boiling-fluid inlet temperature of $\sim 80^\circ \text{ F}$ ($\sim 300 \text{ K}$) and in the range from 208° to 223° F (371 to 391 K). Otherwise the conditions were nominal. The highest exit quality obtained at this flow rate was 0.87.

Plug only. - Plots of exit quality and boiler pressure drop against the boiler-exit temperature difference for nominal conditions with plugs only are shown in figures 11 and 12, respectively. In these cases, no inlet device was used. The variations of x_e and ΔP_B with θ_{se} are essentially the same as for no plug or inlet device (figs. 9 and 10). But with the plugs, exit quality of 1.0 could be reached with flow oscillations less than ± 5 percent. However, the flow stability was not always repeatable, and when flow oscillations did occur they were generally accompanied by high and erratic boiling-fluid inlet temperature readings, as was the case with no plug. The throttle-valve pressure drops were about the same as for no plugs. It should be noted, however, that these were not necessarily the minimum values required for stability.

For the 5-inch (0.127-m) plug, table III also presents data for a boiling-fluid flow rate of about 100 pounds (mass) per hour ($\sim 0.0125 \text{ kg/sec}$) with otherwise nominal conditions. For the 10-inch (0.254-m) plug (table IV), data are also presented for two heating-fluid flow rates lower than nominal.

Single orifice only. - Plots of exit quality and boiler pressure drop against the boiler-exit temperature difference for nominal conditions with single orifices only are shown in figures 13 and 14, respectively. In these cases no plug was used. For exit

qualities less than about 0.7, the quality for a given θ_{se} is about the same as for the plain tube. With either orifice, however, increases in θ_{se} do not yield much increase in x_e , compared to the configurations with no inlet device (figs. 9 and 11); in addition, vapor superheat was indicated at exit qualities ranging from 0.72 to 0.93. However, with the orifices, no erratic boiling-fluid inlet temperature behavior occurred, like that seen without an orifice.

The orifice pressure drop at nominal conditions was about 35 pounds (force) per square inch ($\sim 240 \text{ kN/m}^2$) for the 0.025-inch (0.64-mm) orifice and about 15 pounds (force) per square inch ($\sim 103 \text{ kN/m}^2$) for the 0.0305-inch (0.78-mm) orifice. For the 0.025-inch (0.64-mm) orifice, data are also presented in table V for boiling-fluid flow rates from 52 to 73 pounds (mass) per hour (0.0065 to 0.0092 kg/sec) at otherwise nominal conditions.

Multiple-hole orifice only. - Plots of exit quality and boiler pressure drop against boiler-exit temperature difference for nominal conditions are shown in figures 15 and 16, respectively, for the multiple-hole orifices; one orifice plate had two 0.025-inch (0.64-mm) holes and the other had four 0.0135-inch (0.34-mm) holes. The holes were located at the tube-wall inside diameter and were angled to initiate swirling flow. The variation of x_e and ΔP_B with θ_{se} is about the same as for the single orifices, except that slightly higher exit qualities (0.85 to 0.93) were reached before superheat was observed. As with the single orifices, no erratic boiling-fluid inlet temperature behavior occurred. The orifice pressure drop at nominal conditions was about 20 pounds (force) per square inch ($\sim 138 \text{ kN/m}^2$) for the two-hole orifice and about 25 pounds (force) per square inch ($\sim 172 \text{ kN/m}^2$) for the four-hole orifice.

For the two-hole orifice, additional data are presented in table VII for boiling-fluid flow rates from 58 to 65 pounds (mass) per hour (0.0073 to 0.0082 kg/sec) with boiling fluid inlet temperatures from 223° to 251° F (379 to 395 K) at otherwise nominal conditions. Data are also included therein for boiling-fluid flow rate about 100 pounds (mass) per hour ($\sim 0.0125 \text{ kg/sec}$), boiling-fluid inlet temperatures from 227° to 258° F (381 to 399 K), and heating-fluid flow rate about 11 000 pounds (mass) per hour ($\sim 1.4 \text{ kg/sec}$) with essentially nominal boiler exit pressure.

Single orifice and plug. - Plots of exit quality and boiler pressure drop against the boiler-exit temperature difference for nominal conditions with the 0.028 inch (0.71 mm) orifice and 10 inch (0.025 m) plug are shown in figures 17 and 18, respectively. The variation of x_e and ΔP_B with θ_{se} is about the same as for the other orifice configurations. Exit superheat was indicated at qualities from 0.79 to 0.91. The orifice pressure drop at nominal conditions was about 25 pounds (force) per square inch ($\sim 172 \text{ kN/m}^2$). Considerable data are presented in table IX for conditions other than nominal but all at a boiler exit pressure about 17 pounds (force) per square inch (absolute) ($\sim 115 \text{ kN/m}^2$).

Venturi-diffuser and plug. - Plots of exit quality and boiler pressure drop against

the boiler-exit temperature difference for the venturi-diffuser and plug are shown in figures 19 and 20, respectively for boiling-fluid flow rate about 80 pounds (mass) per hour (~ 0.010 kg/sec) at otherwise nominal conditions. Stable operation was not obtained at a boiling-fluid flow rate of 60 pounds (mass) per hour (~ 0.0075 kg/sec). This was believed to be caused by unsteady cavitation. Superheat first was indicated at $x_e = 0.98$; flow oscillations in the range of ± 5 to 10 percent were observed at that point. No erratic boiling-fluid inlet temperature behavior as that seen without an inlet device, was observed. The pressure drop across the venturi and diffuser was about 25 pounds per square inch (~ 172 kN/m²) at 80 pounds (mass) per hour (0.0100 kg/sec) and 80^o F (300 K).

Another series of runs was made with the same flow rates and boiler exit pressure, but with boiling-fluid inlet temperature ranging from 210^o to 241^o F (371 to 389 K); the exit pressure and boiler pressure drop are plotted against θ_{se} , for this series, in figures 21 and 22, respectively. Superheat was observed at exit qualities from 0.96 to 1.02. No boiling-fluid flow oscillations as great as ± 5 percent were seen; however, additional pressure drop (up to 10 psi or 69 kN/m²) was required at the throttle valve for high exit quality.

Comparison of Inlet Region Devices

Exit quality and superheat. - The boiler performance with the various inlet devices, in terms of indicated superheat as a function of exit quality, is shown in figure 23(a) for no inlet device with or without plug (data of tables II to IV), figure 23(b) for all orifice configurations (data of tables V to IX), and figure 23(c) for the venturi-diffuser and plug combination (data of table X). All data listed in the tables are shown. For no inlet device, with or without plugs (fig. 23(a)), superheat is indicated over an exit quality range of 0.94 to 1.03. For the orifice configurations (fig. 23(b)), superheat is indicated over an exit quality range from 0.72 to 0.97; under no conditions used herein was $x_e = 1.0$ obtainable with orifices. For the venturi configuration (fig. 23(c)), superheat is indicated over an exit quality range from 0.96 to 1.02. The two thermocouples, T_{be} and T_{bp} , show the same trends although T_{be} is consistently higher in temperature.

Pressure drop. - A nondimensional boiler pressure-drop parameter, $(\Delta P_B - \Delta P_G)/(KG^2/\rho_l g_c)$, is plotted against exit quality in figure 24(a) for no inlet device with or without plug, figure 24(b) for all orifice configurations, and figure 24(c) for the venturi-diffuser and plug combination. (ΔP_G is calculated as in ref. 11.) Note that no inlet-device pressure drop is included in ΔP_B . Plain-tube values, calculated from reference 11, are shown for comparison. The data for all configurations normalize well except when exit vapor superheat is indicated; this is reasonable since the flow pattern in the high quality end of the boiler must then change.

Other considerations. - The orifices and the venturi configuration eliminated the boiling-fluid inlet temperature pulsations attributed to back slugging. However, with the orifice configurations, exit qualities of 1.0 or greater were not obtained. Without inlet pressure-drop devices, but with inlet-region plugs, exit qualities in excess of 1.0 (as determined by a heat balance) were obtained, but stability was not always repeatable. The venturi configuration showed good performance, but over a limited flow range. With $\sim 80^{\circ}$ F (~ 300 K) inlet temperature, flow oscillations as great as ± 5 to 10 percent were not seen with the venturi configuration until $x_e = 0.98$; with inlet temperature from 210° to 241° F (372 to 389 K), no flow oscillations as large as ± 5 percent were seen at exit qualities as high as 1.02.

SUMMARY OF RESULTS

The boiler tube with the wire-helix insert yielded more stable performance than did plain straight tubes of the same size; however, at exit qualities lower than about 0.8 the effect of the wire helix on heat transfer was slight. The boiler tube pressure drop was much greater with the wire helix than with the plain tube (2 to 3 times as great at high exit qualities).

Large inlet pressure drops were required to reduce boiling-fluid flow oscillations. With the wire helix alone or with entrance-region plugs most of the pressure drop occurred at the flow-control valve. The operation of the boiler became more stable when rod-shaped plugs were used in the entrance region of the boiler tube to reduce the net flow area; however, back slugging of vapor or hot liquid occasionally occurred.

Orifice-type boiler-tube inlets were found to be unsatisfactory, even though they eliminated the back slugging. The boiling-fluid exit temperature rose well above saturation temperature while the exit vapor quality was considerably less than unity.

A venturi-diffuser-plug boiler-tube inlet was found to perform well over a limited range. The minimum flow rate for stable operation was higher than 60 pounds (mass) per hour (0.0075 kg/sec), the nominal flow rate at which most of the data for other configurations were taken. With boiling-fluid inlet temperature only slightly below saturation, flow was steady (less than ± 5 percent oscillations), no back slugging occurred and heat-balance exit quality in excess of 1.0 was obtained with slight premature superheating, starting at 0.96 exit quality. At high exit qualities, additional pressure drop

was required at the throttle valve. With high inlet subcooling, no vapor superheating nor flow oscillations as great as ± 5 percent were seen until 0.98 exit quality was reached.

Lewis Research Center,
National Aeronautics and Space Administration,
Cleveland, Ohio, May 2, 1968,
120-27-02-03-22.

APPENDIX A

REDUCTION OF NONBOILING DATA

A series of nonboiling runs was made to check the instrumentation, and to determine the heating-fluid and coolant thermal resistances. The analysis of the data is discussed herein. Table I contains the data for these runs.

Check of Instrumentation by Heat Balance

The rate of heat transfer in the test section was calculated for the two streams independently. Equation (A1) was used for the heating fluid and equation (A2) for the coolant:

$$Q_h = W_h(H_{hi} - H_{he}) \quad (A1)$$

$$Q_b = W_b(H_{bp} - H_{bi}) \quad (A2)$$

Q_h is plotted against Q_b in figure 25. The average disagreement is 5 percent, and the maximum disagreement is 11 percent for heating-fluid temperature drops greater than 4.5° F (2.5 K). In further calculations for the nonboiling runs, Q_b was used, since the coolant temperature rise was greater than the heating-fluid temperature drop, and therefore is considered more accurate.

Determination of Heating-Fluid Thermal Resistance

The overall thermal resistance is the sum of the two fluid resistances and the wall resistance. It is necessary to know two of these resistances in order to determine the other from experimental data. In order to determine the heating-fluid thermal resistance, several runs were made wherein the coolant flow rate and inlet and exit temperatures were held constant, while the heating-fluid flow rate and temperature were varied. The mean overall thermal resistance, R , the inverse of the mean overall heat-transfer coefficient, was determined as follows for each run:

$$R = \frac{(T_{he} - T_{bi}) - (T_{hi} - T_{bp})}{\left(\frac{Q_b}{S_2}\right) \ln\left(\frac{T_{he} - T_{bi}}{T_{hi} - T_{bp}}\right)} \quad (\text{A3})$$

It was assumed that the wall and coolant thermal resistances were constant for each series. Since the heating-fluid flow was turbulent, it was assumed that the heating-fluid thermal resistance was directly proportional to J , where

$$J = \left(\frac{D_2}{12k_h}\right) \text{Re}_h^{-0.8} \text{Pr}_h^{-0.5} \quad (\text{hr})(\text{sq ft})(^\circ\text{F})/\text{Btu} \quad (\text{A4})$$

or

$$J = \left(\frac{D_2}{k_h}\right) \text{Re}_h^{-0.8} \text{Pr}_h^{-0.5} \quad (\text{m}^2)(\text{K})/\text{kW} \quad (\text{A4a})$$

Figure 26 shows a plot of R against J for four different series. The physical properties used are the square-root average of inlet and exit values. The $J = 0$ intercept on the R scale is assumed to be the sum of the wall and coolant thermal resistances. The slope of these lines defines the relation between the heating-fluid thermal resistance, R_h (the inverse of the mean heating-fluid heat transfer coefficient) and the parameter J . It is assumed that this slope is constant. In fairing these lines, the higher coolant flow rate data, having larger temperature differences, were more heavily weighted. The following relation was obtained:

$$R_h = 40J \quad (\text{A5})$$

Equation (A5) may be rewritten as follows. (Note that the diameter of the heated perimeter, D_2 and the hydraulic diameter of the annulus, $D_3 - D_2$, are equal.)

$$\frac{D_2}{12R_h k_h} = \text{Nu}_h = 0.025 \text{Re}_h^{0.8} \text{Pr}_h^{0.5} \quad (\text{U. S. customary units}) \quad (\text{A6})$$

or

$$\frac{D_2}{R_h k_h} = Nu_h = 0.025 Re_h^{0.8} Pr_h^{0.5} \quad (\text{SI units}) \quad (\text{A6a})$$

Effect of Wire Helix on Coolant Nusselt Number

Mean coolant Nusselt numbers were determined for each of the nonboiling runs, in order to determine the effect of the wire helix on single-phase heat transfer. The mean coolant thermal resistance R_c may be computed as follows:

$$R_c = R - R_o \quad (\text{A7})$$

where R_o is the combined thermal resistance of the wall and heating fluid. Assuming the wall thermal resistance of $0.30 \times 10^{-3} \text{ (hr)(ft}^2\text{)(}^\circ\text{F)/Btu}$ ($0.0053 \text{ (m}^2\text{)(K)/kW}$),

$$R_o = 0.00030 + 40J \quad (\text{hr)(ft}^2\text{)(}^\circ\text{F)/Btu} \quad (\text{A8})$$

or

$$R_o = 0.0053 + 40J \quad (\text{m}^2\text{)(K)/kW} \quad (\text{A8a})$$

Lumping the effects of swirl and the extended surface area provided by the wire helix, an effective mean coolant Nusselt number may be defined as follows:

$$Nu_c = \frac{D_1}{12R_c \left(\frac{D_1}{D_2} \right) k_c} \quad (\text{U. S. customary units}) \quad (\text{A9})$$

$$Nu_c = \frac{D_1}{R_c \left(\frac{D_1}{D_2} \right) k_c} \quad (\text{SI units}) \quad (\text{A9a})$$

The mean coolant Nusselt number is plotted against the mean coolant Reynolds number, $Re_c = (D_1 G / 12 \mu_c)$ (U. S. Customary Units) or $Re_c = D_1 G / \mu_c$ (SI Units), in figure 8. The mean coolant Prandtl number is essentially constant at 3.3. The plain-tube Nusselt number curve shown for comparison was determined as in reference 11; the following expression was used.

$$\text{Nu}_{\text{pt}} = 0.023 \text{Re}_c^{0.8} \text{Pr}_c^{0.5}$$

Sams (ref. 13) reported approximately a two-to-one increase in Nusselt numbers over plain-tube values for wire helices of the same wire-diameter-to-pitch ratio as used in this study. Sams' results are for air flowing in a 0.41-inch (1.04-cm) inside diameter tube with a Reynolds number of 30 000. (The effect of extended surface area was lumped with the effect of swirl.) The data of the present report appear to be approaching about $2\frac{1}{4}$ -to-one increase at Reynolds numbers over 10 000, thus indicating at least qualitative agreement with Sams' results.

APPENDIX B

REDUCTION OF BOILING DATA

The tabulated heating rate is calculated from the heating-fluid heat balance, equation (A1), except in some cases where the computed exit vapor quality was greater than 1.00. In these cases, assuming thermodynamic equilibrium, the boiling-fluid heat balance, equation (A2), may be used, where H_{be} is the enthalpy of the vapor at T_{bp} and P_{be} . When the tabulated x_e is equal to or greater than 1.00, the Q listed in the tables is the smaller of Q_h and Q_b .

The exit vapor quality is calculated from equation (B1). Thermodynamic equilibrium is assumed.

$$x_e = \frac{\left(\frac{Q}{W_b}\right) + H_{bi} - H_{lse}}{\lambda} \quad (B1)$$

REFERENCES

1. Wallerstedt, R. L.; and Miller, D. B.: Mercury Rankine Program Development Status and Multiple System Application. AIAA Specialists Conference on Rankine Space Power Systems. Vol. 1, AEC Rep. CONF-651026, vol. 1, 1965, pp. 3-51.
2. Gresho, P. M.; Poucher, F. W.; and Wimberly, F. C.: Mercury Rankine Program Test Experience. AIAA Specialists Conference on Rankine Space Power Systems. Vol. 1, AEC Rep. CONF-651026, vol. 1, 1965, pp. 52-102.
3. Gordon, R.; and Slone, H. O.: SNAP-8 Development Status - September 1965. AIAA Specialists Conference on Rankine Space Power Systems. Vol. 1, AEC Rep. CONF-651026, vol. 1, 1965, pp. 103-138.
4. Kreeger, A. H.; Hodgson, J. N.; and Sellers, A. J.: Development of the SNAP-8 Boiler. AIAA Specialists Conference on Rankine Space Power Systems. Vol. 1. AEC Rep. CONF-651026, vol. 1, 1965, pp. 285-306.
5. Peterson, J. R.: High-Performance "Once-Through" Boiling of Potassium in Single Tubes at Saturation Temperatures From 1500⁰ to 1750⁰ F. NASA CR-842, 1967.
6. Bond, J. A.; and Converse, G. L.: Vaporization of High-Temperature Potassium in Forced Convection at Saturation Temperatures From 1800⁰ to 2100⁰ F. NASA CR-843, 1967.
7. Boppart, J. A.; Parker, K. O.; and Berenson, P. J.: Multiple-Tube Potassium Boiler Performance. AIAA Specialists Conference on Rankine Space Power Systems. Vol. 1, AEC Rep. CONF-651026, vol. 1, 1965, pp. 327-356.
8. McAdams, W. H.; Woods, W. K.; and Bryan, R. L.: Vaporization Inside Horizontal Tubes. Trans. ASME, vol. 63, no. 6, Aug. 1941, pp. 545-552.
9. Carver, J. R.; Kakarala, C. R.; and Slotnik, J. S.: Heat Transfer in Coiled Tubes with Two-Phase Flow. Res. Rep. 4438, Babcock and Wilcox Co. (AEC Rep. TID-20983), July 31, 1964.
10. Owhadi, Ali: Boiling in Self-Induced Radial Acceleration Fields. Ph.D. Thesis, Oklahoma State Univ., 1966.
11. Stone, James R.; and Damman, Thomas M.: An Experimental Investigation of Pressure Drop and Heat Transfer for Water Boiling in a Vertical-Upflow Single-Tube Heat Exchanger. NASA TN D-4057, 1967.

12. Jeglic, Frank A.; Stone, James R.; and Gray, Vernon H.: Experimental Study of Subcooled Nucleate Boiling of Water Flowing in 1/4-Inch-Diameter Tubes at Low Pressures. NASA TN D-2626, 1965.
13. Sams, E. W.: Heat-Transfer and Pressure-Drop Characteristics of Wire-Coil-Type Turbulence Promoters. Reactor Heat Transfer Conference of 1956. John E. Viscardi, comp. AEC Rep. TID-7529, Pt. 1, Bk. 2, Nov. 1957.

TABLE I. - EXPERIMENTAL DATA FOR NONBOILING RUNS

(a) U. S. Customary Units

Run	Coolant				Heating fluid				Heating rate		Mean overall thermal resistance, R , $\frac{(\text{ft}^2)(\text{hr})(^\circ\text{F})}{\text{Btu}}$	Mean coolant Nusselt number, Nu_c
	Flow rate, W_b , lb mass/hr	Inlet temperature, T_{bi} , $^\circ\text{F}$	Exit plenum temperature, T_{bp} , $^\circ\text{F}$	Mean Reynolds number, Re_c	Flow rate, W_h , lb mass/hr	Inlet temperature, T_{hi} , $^\circ\text{F}$	Exit temperature, T_{he} , $^\circ\text{F}$	Flow parameter, J , $\frac{(\text{ft}^2)(\text{hr})(^\circ\text{F})}{\text{Btu}}$	Based on coolant temperature rise, Q_b , Btu/hr	Based on heating-fluid temperature drop, Q_h , Btu/hr		
1	428	78.5	210.5	12 500	1 200	336.5	292.0	26.8×10^{-6}	56.5×10^3	55.3×10^3	1.94×10^{-3}	201
2	429	79.0	210.0	12 800	1 690	310.0	280.0	20.9	56.2	52.2	1.70	199
3	427	79.5	210.5	12 700	2 390	291.5	269.7	16.3	55.9	53.3	1.50	204
4	↓	↓	210.5	↓	3 400	277.5	262.3	12.3	55.9	55.8	1.35	199
5	↓	↓	211.0	↓	4 690	268.0	257.0	9.17	56.1	52.5	1.24	196
6	↓	↓	211.0	↓	6 770	260.7	253.0	7.26	56.1	52.3	1.17	192
7	↓	↓	210.5	↓	12 800	251.7	247.4	4.39	55.9	55.9	1.06	198
8	58.7	70.0	210.5	1 610	1 250	219.0	212.0	29.9	8.30	8.8	3.80	49
9	58.7	70.7	210.5	1 630	3 480	214.5	212.5	13.4	8.21	7.0	2.95	53
10	58.7	71.0	210.7	1 650	5 300	213.5	212.6	9.55	8.21	4.8	2.62	58
11	80.0	72.0	211.0	2 250	1 240	224.8	215.8	29.8	11.1	11.3	3.50	56
12	80.0	72.0	211.0	2 250	3 460	216.7	213.8	13.1	11.1	10.1	2.50	66
13	80.0	72.0	210.3	2 240	5 300	214.7	213.0	9.53	11.1	9.1	2.27	70
14	99.5	70.3	211.0	2 740	1 230	232.7	220.3	30.0	14.0	15.4	3.17	66
15	↓	71.0	211.0	2 780	1 740	226.0	218.2	22.7	13.9	13.7	2.78	71
16	↓	69.5	210.7	2 730	2 450	222.2	216.7	17.6	13.9	13.6	2.56	72
17	↓	71.0	210.5	2 760	3 460	219.6	215.6	13.3	13.8	14.0	2.37	73
18	↓	71.7	210.7	2 800	11 600	215.6	214.4	5.10	13.9	13.9	1.90	80
19	173	73.7	210.3	4 850	1 230	253.8	235.5	29.1	23.6	22.8	2.52	105
20	173	73.5	210.5	4 860	1 720	243.0	231.0	22.4	23.7	20.9	2.21	114
21	175	74.0	210.8	4 930	2 460	236.0	227.0	17.1	24.0	22.4	1.97	113
22	173	74.5	210.0	4 880	3 640	230.7	223.7	12.5	23.4	25.6	1.84	110
23	↓	74.7	209.5	4 880	4 940	226.0	222.0	10.0	23.3	19.9	1.70	112
24	↓	78.0	210.5	4 990	6 880	225.5	222.5	7.59	22.9	21.3	1.66	105
25	↓	77.5	210.5	4 960	11 600	222.6	220.8	4.90	23.0	20.9	1.54	107
26	210	74.5	210.0	5 930	11 600	229.5	226.5	4.85	28.4	34.9	1.51	109
27	209	75.0	210.3	5 920	6 480	232.6	227.8	7.88	28.2	31.4	1.60	114
28	210	74.0	210.0	5 920	4 980	236.4	231.0	9.66	28.5	27.2	1.71	109
29	209	75.0	210.5	5 920	3 420	240.7	232.8	13.0	28.3	27.3	1.80	114
30	210	75.5	210.3	5 970	2 560	245.7	234.7	16.2	28.2	28.6	1.93	114
31	209	75.0	212.0	5 980	1 720	258.0	241.8	21.9	28.6	28.2	2.16	114
32	210	75.0	211.5	5 970	1 190	273.5	249.5	29.2	28.6	29.1	2.51	107

(b) SI Units

Run	Coolant				Heating fluid			Heating rate			Mean overall thermal resistance, R_r $\frac{(m^2)(K)}{W}$	Mean coolant Nusselt number, Nu_c
	Flow rate, W_b , kg/sec	Inlet temperature, T_{bi} , K	Exit plenum temperature, T_{bp} , K	Mean Reynolds number, Re_c	Flow rate, W_h , kg/sec	Inlet temperature, T_{hi} , K	Exit temperature, T_{he} , K	Flow parameter, J , $\frac{(m^2)(K)}{W}$	Based on coolant temperature rise, Q_b , kW	Based on heating-fluid temperature drop, Q_h , kW		
1	0.0539	299.0	372.3	12 500	0.151	442.3	417.6	4.72×10^{-6}	16.5	16.2	0.342×10^{-3}	201
2	.0540	299.3	372.0	12 800	.213	427.6	411.0	3.68	16.5	15.3	.300	199
3	.0538	299.5	372.3	12 700	.301	417.3	405.2	2.87	16.4	15.6	.264	204
4	↓	↓	372.3	↓	.428	409.5	401.1	2.17	↓	16.3	.238	199
5	↓	↓	372.6	↓	.591	404.2	398.2	1.62	↓	15.4	.219	196
6	↓	↓	372.6	↓	.853	400.2	395.9	1.26	↓	15.3	.206	192
7	↓	↓	372.3	↓	1.62	395.2	392.8	.773	↓	16.4	.187	198
8	.00740	294.3	372.3	1 610	.158	377.0	373.1	5.27	2.43	2.6	.670	49
9	.00740	294.6	372.3	1 630	.438	374.5	373.4	2.36	2.41	2.1	.520	53
10	.00740	294.8	372.4	1 650	.668	374.0	373.5	1.68	2.41	1.4	.462	58
11	.0101	295.4	372.6	2 250	.156	380.2	375.3	5.25	3.27	3.3	.617	56
12	.0101	295.4	372.6	2 250	.436	375.7	373.9	2.31	3.27	3.0	.440	66
13	.0101	295.4	372.2	2 240	.668	374.6	373.7	1.68	3.26	2.7	.400	70
14	.0125	294.4	372.6	2 740	.155	384.7	377.8	5.29	4.10	4.5	.560	66
15	↓	294.8	372.6	2 780	.219	380.9	376.6	4.00	4.08	4.0	.490	71
16	↓	294.0	372.4	2 730	.308	378.8	375.7	3.10	4.09	4.1	.451	72
17	↓	294.8	372.3	2 760	.437	377.4	375.2	2.35	4.06	4.0	.418	73
18	↓	294.9	372.4	2 800	1.46	375.2	374.5	.90	4.08	4.0	.335	80
19	.0218	296.3	372.2	4 850	.155	396.4	386.2	5.13	6.94	6.69	.444	105
20	.0218	296.2	372.3	4 860	.217	390.4	383.7	3.95	6.96	6.14	.390	114
21	.0221	296.5	372.5	4 930	.310	386.5	381.5	3.01	7.05	6.6	.347	113
22	.0218	296.8	372.0	4 880	.457	383.5	379.7	2.20	6.88	7.5	.324	110
23	↓	296.9	371.8	4 880	.622	380.9	378.7	1.76	6.85	5.9	.300	112
24	↓	298.7	372.3	4 990	.867	380.6	379.0	1.34	6.73	6.2	.292	105
25	↓	298.4	372.3	4 960	1.45	379.0	378.0	.862	6.75	6.1	.272	107
26	.0264	296.8	372.0	5 930	1.45	382.9	381.2	.854	8.34	10.2	.266	109
27	.0263	297.0	372.2	5 920	.816	384.6	381.9	1.39	8.29	9.2	.282	114
28	.0264	296.5	372.0	5 920	.628	386.7	383.7	1.68	8.36	8.0	.302	109
29	.0263	297.0	372.3	5 920	.431	389.1	384.7	2.29	8.30	8.0	.317	114
30	.0264	297.3	372.2	5 970	.323	391.8	385.7	2.86	8.29	8.40	.340	114
31	.0263	297.0	373.1	5 980	.216	398.7	389.7	3.86	8.39	8.29	.381	114
32	.0264	297.0	372.9	5 970	.150	407.3	394.0	5.15	8.40	8.53	.442	107

TABLE II. - EXPERIMENTAL DATA FOR TEST BOILER WITH NO PLUG OR INLET DEVICE

(a) U. S. Customary Units

Run	Boiling fluid								Heating rate, Q, Btu/hr	Heating fluid		
	Flow rate, W_b , lb mass/hr	Inlet temperature, T_{bi} , °F	Exit plenum temperature, T_{bp} , °F	Exit saturation temperature, T_{se} , °F	Pump pressure rise, ΔP_p , psi	Inlet pressure, P_{bi} , psia	Exit pressure, P_{be} , psia	Exit quality, x_e		Flow rate, W_h , lb mass/hr	Inlet temperature, T_{hi} , °F	Exit temperature, T_{he} , °F
1	59.5	81.5	220.0	219.7	13	18.6	17.0	0.16	18×10 ³	7950	251.5	249.3
2	59.0	81.5	220.0	219.0	14	19.2	16.8	.38	30	7850	271.7	268.0
3	^a 60	82.0	220.0	219.3	15	20.3	16.9	.60	43	7930	286.0	280.7
4	^a 60	^b 83	220.0	219.3	18	22.0	16.9	.77	52	8050	296.6	290.3
5	^c 59	^b 83	220.0	219.7	20	23	17.0	1.00	^d 65	8050	320.5	312.5
6	60.0	75.0	219.0	219.0	12	19.8	16.8	.48	37	7980	277.0	272.5
7	59.0	77.5	219.5	219.3	17	22.7	16.9	.92	61	8100	308.0	300.7
8	^a 59	^b 80	220.0	219.7	20	24.7	17.0	1.00	^d 65	7950	328.0	320.0
9	^c 60	^b 80	224	219.7	22	25.5	17.0	1.00	^d 66	8000	339.0	330.5
10	^c 61	^b 80	242	220.0	23	26	17.1	1.01	^d 68	8100	348.3	340.0
11	100	78.0	219.0	219.0	9	19.0	16.8	.08	22	7850	250.7	248.0
12	100	76.5	221.0	219.3	10	19.4	16.9	.18	32	7750	271.5	267.5
13	^a 100	78.0	220.0	219.3	16	22.0	16.9	.36	49	7680	295.6	289.4
14	^a 100	79.0	221.0	219.7	17	24.0	17.0	.43	55	7950	306.0	299.3
15	^a 100	79.0	219.5	219.7	19	25.5	17.0	.59	71	8030	321.0	312.5
16	^c 100	79.0	219.5	220.0	20	27.5	17.1	.67	79	8000	331.5	322.0
17	^c 100	^b 80	220.0	220.3	22	28.5	17.2	.75	87	7900	342.5	332.0
18	^a 100	^b 80	219.0	220.3	25	30	17.2	.81	92	8000	351.0	340.0
19	99.5	209.5	220.0	219.7	22	19.2	17.0	.14	14	7950	251.8	250.0
20	99.5	208.0	221.0	219.7	22	19.7	17.0	.21	21	8000	261.0	258.4
21	99.5	210.0	220.0	219.3	24	20.8	16.9	.29	27	7950	273.5	270.0
22	99.5	212.5	220.0	219.7	30	22.0	17.0	.41	40	8000	283.5	278.6
23	98.5	214.5	221.0	219.7	31	23.5	17.0	.43	41	8050	291.0	286.0
24	100	212.0	221.0	219.7	32	24.2	17.0	.49	48	8000	297.3	291.5
25	101	209.0	219.0	220.2	33	25.3	17.2	.53	53	7700	306.0	299.3
26	97.0	228.0	220.0	220.2	41	26.8	17.2	.68	64	8050	315.5	308.0
27	95.0	228.0	219.0	220.2	37	27.5	17.2	.76	69	8100	322.7	314.5
28	^a 101	222	220	220.2	37	29.0	17.2	.77	75	8050	330.3	321.3
29	^a 100	223	220	220.4	37	30.5	17.3	.82	79	8000	336.5	327.0
30	^a 102	223	221	220.4	39	31.5	17.3	.82	80	8050	341.5	332.0
31	^c 101	223	221	220.4	38	32	17.3	.87	84	8030	345.7	335.7

^aOscillations of ±5 to 10 percent in boiling-fluid flow rate.^bEstimated; thermocouple reading higher; believed due to back-slugging.^cOscillations greater than ±10 percent in boiling-fluid flow rate.^dBased on boiling-fluid heat balance, equation (A2); Q_h is greater.

(b) SI Units

Run	Boiling fluid								Heating rate, Q , kW	Heating fluid		
	Flow rate, W_b , kg/sec	Inlet temperature, T_{bi} , K	Exit plenum temperature, T_{bp} , K	Exit saturation temperature, T_{se} , K	Pump pressure rise, ΔP_p , kN/m ²	Inlet pressure, P_{bi} , kN/m ² abs	Exit pressure, P_{be} , kN/m ² abs	Exit quality, x_e		Flow rate, W_h , kg/sec	Inlet temperature, T_{hi} , K	Exit temperature, T_{he} , K
1	0.00750	300.6	377.6	377.4	90	128	117	0.16	5.2	1.00	395.0	393.8
2	.00745	300.6	↓	377.0	98	132	116	.38	8.7	.990	406.3	404.2
3	^a .0075	300.9	↓	377.2	100	140	116	.60	13	1.00	414.2	411.3
4	^a .0075	^b 301	↓	377.2	120	152	116	.77	15	1.01	421.2	417.7
5	^c .0074	^b 301	↓	377.4	140	159	117	1.00	^d 19	1.01	433.4	429.0
6	.00755	297.0	377.0	377.0	83	136	116	.48	11	1.00	409.3	406.8
7	.00745	298.4	377.3	377.2	120	156	116	.92	18	1.02	426.5	422.4
8	^a .0074	^b 300	376.3	377.4	140	170	117	1.00	^d 19	1.00	437.6	433.2
9	^c .0075	^b 300	379.8	377.4	150	176	117	1.00	^d 19	1.01	443.7	439.0
10	^c .0077	^b 300	389.8	377.6	160	179	118	1.01	^d 20	1.02	448.9	444.3
11	0.0126	298.7	377.0	377.0	63	131	116	.08	6.3	.990	394.6	393.2
12	.0126	297.9	378.1	377.2	69	134	116	.18	9.3	.977	406.2	404.0
13	^a .0126	298.7	377.6	377.2	110	152	116	.36	14	.970	419.6	416.1
14	^a .0126	299.3	378.1	377.4	120	165	117	.43	16	1.00	425.4	421.7
15	^a .0126	299.3	377.3	377.4	130	176	117	.59	21	1.01	433.7	429.0
16	^c .013	299.3	377.3	377.6	140	189	118	.67	23	1.01	439.5	434.3
17	^c .013	^b 300	377.6	377.8	150	196	118	.75	25	.996	445.6	439.8
18	^a .0126	^b 300	377.0	377.8	170	207	118	.81	27	1.01	450.4	444.2
19	0.0125	371.8	377.6	377.4	150	132	117	.14	4.3	1.00	395.3	394.2
20	↓	370.9	378.2	377.4	150	137	117	.21	6.2	1.01	404.2	398.9
21	↓	372.0	377.6	377.2	170	143	116	.29	8.3	1.00	407.3	405.4
22	↓	373.4	377.6	377.4	210	152	117	.41	12	1.01	412.9	410.2
23	.0124	374.5	378.2	377.4	210	162	117	.43	12	1.01	417.0	414.2
24	.0126	373.1	378.2	377.4	220	167	117	.49	14	1.01	420.5	417.3
25	.0127	371.5	377.0	377.7	230	174	119	.53	16	.970	425.4	421.7
26	.0122	382.0	377.6	↓	280	185	↓	.68	18	1.01	430.6	426.5
27	.0120	382.0	377.0	↓	260	189	↓	.76	20	1.02	434.6	430.1
28	^a .0127	378.7	377.6	↓	260	200	↓	.77	22	1.01	438.9	433.9
29	^a .0127	379.3	377.6	377.8	260	210	↓	.82	23	↓	442.3	437.1
30	^a .0128	379.3	378.2	377.8	270	217	↓	.82	23	↓	445.1	439.8
31	^c .013	379.3	378.2	377.8	260	221	↓	.87	25	↓	447.4	441.9

^aOscillations of ± 5 to 10 percent in boiling-fluid flow rate.

^bEstimated; thermocouple reading higher; believed due to back-slugging.

^cOscillations greater than ± 10 percent in boiling-fluid flow rate.

^dBased on boiling-fluid heat balance, equation (A2); Q_h is greater.

TABLE III. - EXPERIMENTAL DATA FOR TEST BOILER WITH 5-INCH (0.127-m) PLUG AND NO INLET DEVICE

(a) U. S. Customary Units

Run	Boiling fluid								Heating rate, Q , Btu/hr	Heating fluid		
	Flow rate, W_b , lb mass/hr	Inlet temperature, T_{bi} , °F	Exit plenum temperature, T_{bp} , °F	Exit saturation temperature, T_{se} , °F	Pump pressure rise, ΔP_p , psi	Inlet pressure, P_{bi} , psia	Exit pressure, P_{be} , psia	Exit quality, x_e		Flow rate, W_h , lb mass/hr	Inlet temperature, T_{hi} , °F	Exit temperature, T_{he} , °F
1	58.5	70.5	219.5	220.4	12	18.7	17.3	0.25	23×10^3	8150	256.3	253.5
2	58.8	72.5	219.0	220.4	13	20.1	17.3	.58	41	8000	278.5	273.5
3	58.8	77.0	222.5	224.0	26	23.1	18.5	.85	57	7950	301.7	294.7
4	58.8	77.5	223.0	223.8	18	24.5	18.4	1.00	^a 66	8000	322.0	314.0
5	58.5	79.0	246.5	223.8	19	25.4	18.4	1.01	^a 66	7970	333.5	325.5
6	^b 59	80.0	271.0	224.0	--	----	18.5	1.02	^a 67	8000	348.0	339.5
7	97.5	75.0	219.5	221.8	14	19.3	17.8	0.11	24	7950	253.3	250.3
8	100	78.0	222.5	224.0	17	22.1	18.5	.35	48	7880	287.5	281.5
9	101	83.0	222.5	224.3	21	25.5	18.6	.54	66	7830	315.5	307.3
10	^c 100	82.5	222.5	224.6	24	28.2	18.7	.66	77	8000	332.8	323.5

(b) SI Units

Run	Boiling fluid								Heating rate, Q , kW	Heating fluid		
	Flow rate, W_b , kg/sec	Inlet temperature, T_{bi} , K	Exit plenum temperature, T_{bp} , K	Exit saturation temperature, T_{se} , K	Pump pressure rise, ΔP_p , kN/m ²	Inlet pressure, P_{bi} , kN/m ² abs	Exit pressure, P_{be} , kN/m ² abs	Exit quality, x_e		Flow rate, W_h , kg/sec	Inlet temperature, T_{hi} , K	Exit temperature, T_{he} , K
1	0.00738	294.5	377.3	377.8	84	129	119	0.25	6.8	1.02	397.8	396.2
2	.00741	295.6	377.0	377.8	92	139	119	.58	12	1.01	410.1	407.3
3	.00741	298.1	379.0	379.8	180	159	128	.85	17	1.00	423.0	419.1
4	.00741	298.4	379.3	379.7	120	169	127	1.00	^a 19	1.01	434.3	429.8
5	.00738	299.3	392.3	379.7	130	175	127	1.01	^a 19	1.00	440.6	436.2
6	^b .0074	299.8	405.9	379.8	---	---	128	1.02	^a 20	1.01	448.7	444.0
7	0.0123	297.0	377.3	378.6	99	133	123	0.11	7.1	1.00	396.1	394.4
8	.0126	298.7	379.0	379.8	120	152	128	.35	14	.992	415.1	411.8
9	.0127	301.5	379.0	380.0	140	176	128	.54	19	.987	430.6	426.1
10	^c .0126	301.2	379.0	380.2	160	194	129	.66	23	1.01	440.3	435.1

^aBased on boiling-fluid heat balance (Q_h is higher).^bOscillation greater than ± 10 percent in boiling-fluid flow rate.^cOscillation of ± 5 to 10 percent in boiling-fluid flow rate.

TABLE IV. - EXPERIMENTAL DATA FOR TEST BOILER WITH 10-INCH (0.254-m) PLUG AND NO INLET DEVICE

(a) U. S. Customary Units

Run	Boiling fluid									Heating rate, Q, Btu/hr	Heating fluid		
	Flow rate, W _b , lb mass/hr	Inlet temperature, T _{bi} , °F	Exit temperature, T _{be} , °F	Exit plenum temperature, T _{bp} , °F	Exit saturation temperature, T _{se} , °F	Pump pressure rise, ΔP _P , psi	Inlet pressure, P _{bi} , psia	Exit pressure, P _{be} , psia	Exit quality, x _e		Flow rate, W _h , lb mass/hr	Inlet temperature, T _{hi} , °F	Exit temperature, T _{he} , °F
1	59.0	71.5	-----	219.5	219.7	13	18.5	17.0	0.25	23×10 ³	7910	255.5	252.6
2	59.0	70.0	-----	219.5	↓	14	19.4	↓	.41	32	7830	273.5	269.5
3	58.5	72.0	-----	220.0	↓	15	21.3	↓	.84	56	7900	299.4	292.5
4	59.2	72.0	-----	220.5	↓	16	22.2	↓	.88	59	7880	306.8	299.5
5	58.5	71.5	-----	220.0	220.0	17	23.2	17.1	1.00	^a 65	8000	320.2	312.0
6	58.5	71.5	-----	247.5	219.7	18	23.9	17.0	1.01	^a 66	8000	333.2	325.0
7	59.2	72.0	-----	277.0	219.7	19	25.0	17.0	1.03	^a 68	8000	352.0	343.7
8	59.5	72.0	-----	219.5	219.7	15	19.2	17.0	.40	32	8120	270.2	266.4
9	59.5	72.0	-----	219.8	219.7	17	21.4	17.0	.81	55	8010	298.5	291.8
10	^b 59	^c 73	-----	220.5	220.0	18	22	17.1	.90	62	8040	317.0	309.5
11	59.7	70.0	-----	220.0	220.0	12	18.5	17.1	.20	20	7940	252.0	249.5
12	59.2	73.0	221.5	219.0	219.0	20	20.2	16.8	.63	45	7950	279.0	273.5
13	59.2	74.0	222.0	↓	218.7	22	21.8	16.7	.83	56	8000	293.6	286.8
14	59.2	74.0	222.0	↓	218.7	23	22.4	16.7	.92	61	8060	300.0	292.6
15	59.5	74.0	222.0	↓	217.8	24	23.6	16.4	1.00	^a 66	8010	311.0	303.0
16	59.0	74.5	252.0	242.0	218.7	24	24.7	16.4	1.01	^a 66	7980	326.0	317.4
17	59.0	75.0	295.5	274.0	217.4	25	26.0	16.3	1.03	^a 67	7890	350.0	341.3
18	59.2	67.0	219.5	216.5	217.5	17	17.7	16.3	.06	12	4930	230.5	228.0
19	59.0	68.0	221.5	219.0	219.3	18	18.3	16.9	.14	17	4920	246.4	243.0
20	59.5	69.0	221.0	218.5	219.0	18	18.4	16.8	.24	23	4920	258.0	253.4
21	59.5	70.0	222.0	218.5	218.7	22	19.1	16.7	.38	31	4880	270.7	264.5
22	59.2	70.5	221.0	218.5	218.7	25	19.7	16.7	.48	36	4870	279.0	271.7
23	59.2	70.5	221.5	219.5	219.0	25	20.3	16.8	.58	42	4870	287.8	279.4
24	59.5	70.5	221.0	218.5	218.7	26	21.2	16.7	.68	48	4870	297.4	287.8
25	59.2	71.0	221.0	218.5	218.7	27	21.6	16.7	.78	53	4850	303.5	292.8
26	59.2	72.0	221.5	219.0	218.3	27	22.4	16.6	.85	57	4860	311.8	300.5
27	59.0	↓	222.0	219.0	218.3	28	22.8	16.6	.92	61	4840	318.0	305.8
28	↓	↓	227.0	218.5	218.0	28	23.5	16.5	.99	65	4820	325.5	312.5
29	↓	↓	240.5	219.0	↓	29	23.8	↓	.98	64	4750	332.0	319.0
30	↓	↓	259.5	249.5	↓	29	24.1	↓	.94	62	4780	339.5	327.5
31	↓	↓	278.5	267.5	↓	30	24.6	↓	1.02	67	4770	348.7	335.3
32	59.2	64.0	218.5	215.0	216.2	21	17.7	15.9	.05	12	2970	228.5	224.5
33	↓	64.5	220.0	217.0	218.3	22	18.1	16.6	.08	14	2960	240.6	236.0
34	↓	65.5	222.5	218.5	219.3	22	18.5	16.9	.16	18	3000	251.6	245.5
35	↓	67.5	221.5	↓	218.7	23	18.4	16.7	.27	24	2990	265.0	257.0
36	↓	69.0	221.5	↓	218.3	23	18.7	16.6	.40	32	2980	278.4	268.0
37	59.5	71.0	221.5	↓	↓	26	20.0	↓	.58	42	2980	298.0	284.3
38	59.2	72.0	221.0	↓	↓	27	21.6	↓	.80	54	2950	320.2	302.0
39	↓	72.0	221.0	↓	↓	28	22.2	↓	.91	61	2980	331.8	312.0
40	↓	72.0	221.0	218.0	217.8	28	22.8	16.4	1.00	66	2920	340.0	318.7
41	↓	73.0	229.0	218.5	217.4	28	23.4	16.3	1.00	^a 66	2910	350.0	328.3

^aBased on boiling-fluid heat balance (Q_h is higher).

^bOscillations of ±5 to 10 percent in boiling-fluid flow rate.

^cEstimated; thermocouple reading higher; believed due to back slugging.

TABLE IV. - Concluded. EXPERIMENTAL DATA FOR TEST BOILER WITH 10-INCH (0.254-m) PLUG AND NO INLET DEVICE

(b) SI Units

Run	Boiling fluid									Heating rate, Q, kW	Heating fluid		
	Flow rate, W_b , kg/sec	Inlet temperature, T_{bi} , K	Exit temperature, T_{be} , K	Exit plenum temperature, T_{bp} , K	Exit saturation temperature, T_{se} , K	Pump pressure rise, ΔP_p , kN/m ²	Inlet pressure, P_{bi} , $\frac{kN}{m^2}$ abs	Exit pressure, P_{be} , $\frac{kN}{m^2}$ abs	Exit quality, x_e		Flow rate, W_h , kg/sec	Inlet temperature, T_{hi} , K	Exit temperature, T_{he} , K
1	0.00743	295.1	-----	377.3	377.4	91	128	117	0.25	6.8	0.997	397.3	395.7
2	.00743	294.3	-----	377.3	↓	97	134	↓	.41	9.4	.987	407.3	405.6
3	.00737	295.4	-----	377.6	↓	110	147	↓	.84	16	.996	421.7	417.9
4	.00746	295.4	-----	377.9	↓	110	153	↓	.88	17	.992	425.8	421.8
5	.00737	295.1	-----	377.6	377.6	120	160	118	1.00	^a 19	1.01	433.2	428.7
6	.00737	295.1	-----	392.9	377.4	120	165	117	1.01	^a 19	1.01	440.5	435.9
7	.00746	295.4	-----	409.3	377.4	130	172	117	1.03	^a 20	1.01	450.9	446.3
8	.00750	295.4	-----	377.3	377.4	100	132	117	.40	9.2	1.02	405.4	403.4
9	.00750	295.4	-----	377.5	377.4	110	147	117	.81	16	1.01	421.5	417.5
10	^b .0074	^c 296	-----	377.9	377.6	120	152	118	.90	18	1.01	431.5	427.3
11	.00753	294.3	-----	377.6	377.6	85	128	118	.20	5.9	1.00	395.4	394.0
12	.00746	295.9	378.4	377.0	377.0	140	139	116	.63	13	1.00	410.4	407.3
13	.00746	296.5	378.7	↓	376.8	150	150	115	.83	16	1.01	418.5	414.7
14	.00746	296.5	378.7	↓	376.8	150	154	115	.92	18	1.02	422.0	417.9
15	.00750	296.5	378.7	↓	376.4	160	163	113	1.00	^a 19	1.01	428.2	423.7
16	.00743	296.8	395.4	389.8	376.4	170	170	113	1.01	^a 19	1.00	436.5	431.7
17	.00743	297.0	419.6	407.6	376.1	170	179	112	1.03	^a 20	.994	449.8	445.0
18	.00746	292.6	377.3	375.6	376.2	120	122	112	.06	3.6	.621	383.4	382.0
19	.00743	293.2	378.4	377.0	377.2	120	126	116	.14	5.0	.620	392.3	390.4
20	.00750	293.7	378.2	376.8	377.0	130	127	116	.24	6.7	.620	398.7	396.1
21	.00750	294.3	378.7	376.8	376.9	150	132	115	.38	9.0	.615	405.7	402.3
22	.00746	294.6	378.2	376.8	376.9	170	136	115	.48	11	.614	410.4	406.3
23	.00746	294.6	378.4	377.3	377.0	170	140	116	.58	12	.614	415.3	410.6
24	.00750	294.6	378.2	376.8	376.9	180	146	115	.68	14	.614	420.6	415.3
25	.00746	294.8	378.2	376.8	376.9	190	149	115	.78	15.6	.611	424.0	418.0
26	.00746	295.4	378.4	377.0	376.6	190	154	114	.85	16.5	.612	428.4	422.3
27	.00743	↓	378.7	377.0	376.6	190	157	↓	.92	17.8	.610	432.0	425.3
28	↓	↓	381.5	376.8	376.5	200	162	↓	.99	19.0	.607	436.2	429.0
29	↓	↓	389.0	377.0	↓	↓	164	↓	.98	18.8	.599	439.8	432.6
30	↓	↓	399.5	394.0	↓	↓	166	↓	.94	18.2	.602	444.0	437.1
31	↓	↓	410.1	404	↓	↓	170	↓	1.02	19.5	.601	449.1	441.6
32	.00746	290.9	376.8	374.7	375.5	150	122	110	.05	3.5	.374	382.3	380.1
33	↓	291.2	377.6	375.9	376.6	150	125	114	.08	4.0	.373	389.0	386.5
34	↓	291.8	379.0	376.8	377.2	150	128	116	.16	5.4	.378	395.2	391.8
35	↓	292.9	378.4	↓	376.9	160	127	115	.27	7.1	.377	402.6	398.2
36	↓	293.7	378.4	↓	376.6	160	129	114	.40	9.2	.375	410.0	404.2
37	.00750	294.8	378.4	↓	↓	180	138	↓	.58	12.3	.375	420.9	413.3
38	.00743	295.4	378.2	↓	↓	180	149	↓	.80	15.9	.372	433.2	423.2
39	↓	295.4	378.2	↓	↓	190	153	↓	.91	17.7	.375	439.7	428.7
40	↓	295.4	378.2	376.5	376.4	190	157	113	1.00	19.2	.368	444.3	432.4
41	↓	295.9	382.6	376.8	376.1	200	161	112	1.00	^a 19.2	.366	449.8	437.7

^aBased on boiling-fluid heat balance (Q_h is higher).

^bOscillations of ± 5 to 10 percent in boiling-fluid flow rate.

^cEstimated; thermocouple reading higher; believed due to backslugging.

TABLE V. - EXPERIMENTAL DATA FOR TEST BOILER WITH 0.025-INCH (0.64-mm) ORIFICE

(a) U. S. Customary Units

Run	Boiling fluid								Heating rate, Q , Btu/hr	Heating fluid		
	Flow rate, W_b , lb mass/hr	Inlet temperature, T_{bi} , °F	Exit plenum temperature, T_{bp} , °F	Exit saturation temperature, T_{se} , °F	Pump pressure rise, ΔP_p , psi	Inlet pressure, P_{bi} , psia	Exit pressure, P_{be} , psia	Exit quality, x_e		Flow rate, W_h , lb mass/hr	Inlet temperature, T_{hi} , °F	Exit temperature, T_{he} , °F
1	59.3	76.0	219.0	220.4	47	19.6	17.3	0.51	$\sim 38 \times 10^3$	7740	280.3	275.5
2	58.8	76.0	219.3	220.0	↓	22.0	17.1	.85	57	7680	310.3	303.0
3	59.3	76.0	258.0	220.0	↓	23.5	17.1	.93	62	7640	332.5	324.7
4	^a 59	79.0	281.0	220.2	↓	24.5	17.2	.91	60	7610	349.5	342.0
5	^b 56	80.0	285.5	220.2	46	24	17.2	.92	58	7610	349.5	342.3
6	^b 54	80.0	287.0	219.7	45	23	17.0	.91	55	7610	349.5	342.6
7	^b 52	80.0	287.0	220	40	23	17	.85	50	7610	348.3	342.0
8	66.6	79.0	219.5	220.2	50	22.7	17.2	.86	65	8020	309.5	301.8
9	70.4	80.0	219.5	220.2	49	22.7	17.2	.77	62	8020	309.7	302.2
10	59.5	79.5	233	220.2	36	21.2	17.2	.75	51	8020	309.5	303.3
11	^a 65	81.0	219.5	220.0	47	22.3	17.1	.78	58	8000	311.0	304.0
12	62.8	↓	261.5	220.4	47	23.5	17.3	.85	60	7950	332.3	325.0
13	^b 61	↓	282	220.2	47	23.8	17.2	.93	63	8050	347.5	340.0
14	66.6	↓	273.5	220.4	50	25.8	17.3	.96	71	8000	349.5	341.0
15	67.8	81.5	241.8	220.4	50	24.6	17.3	.93	70	8100	330.0	321.7
16	63.5	82.0	254.3	220.4	48	23.7	17.3	.91	65	↓	330.0	322.3
17	60.5	82.5	261.0	220.4	47	23.2	17.3	.87	59	↓	330.5	323.5
18	^a 58	83.0	263	220.2	45	22.8	17.2	.91	59	↓	329.5	322.5
19	^b 57	83.0	267	220.2	40	22.5	17.2	.82	52	↓	330.5	324.3
20	67.8	83.0	219.0	220.2	50	23.0	17.2	.84	64	8100	310.5	302.8
21	^a 59	83.5	236.0	220.4	41	21.6	17.3	.81	54	8100	311.0	304.5
22	^b 55	84.5	241.5	220.2	34	21.2	17.2	.81	50	8100	310.0	304.0
23	73.3	80.0	257	219.7	68	23.8	17.0	.78	66	7900	330.3	322.3
24	^a 62	81.0	265	219.7	46	23.0	17.0	.82	58	8000	332.0	325.0
25	59.0	80.5	218.5	219.3	40	18.2	16.9	.14	16	8050	241.5	239.5
26	59.0	80.5	↓	219.0	↓	18.5	16.8	.28	24	7950	254.4	251.5
27	59.0	81.5	↓	↓	↓	19.2	↓	.46	34	8050	267.0	262.8
28	59.3	82.5	↓	↓	↓	20.4	↓	.65	45	8070	278.5	273.0
29	59.3	83.0	218.0	↓	↓	21.3	↓	.75	51	8030	290.0	283.8
30	59.5	84.0	219.0	219.3	↓	21.9	16.9	.81	54	8000	300.3	293.7
31	58.8	85.0	241.0	219.3	37	22.2	16.9	.78	52	8000	309.0	302.7

^aOscillations of ±5 to 10 percent in boiling-fluid flow rate.

^bOscillations greater than ±10 percent in boiling-fluid flow rate.

(b) SI Units

Run	Boiling fluid								Heating rate, Q , kW	Heating fluid		
	Flow rate, W_b , kg/sec	Inlet temperature, T_{bi} , K	Exit plenum temperature, T_{bp} , K	Exit saturation temperature, T_{se} , K	Pump pressure rise, ΔP_p , kN/m ²	Inlet pressure, P_{bi} , kN/m ² abs	Exit pressure, P_{be} , kN/m ² abs	Exit quality, x_e		Flow rate, W_h , kg/sec	Inlet temperature, T_{hi} , K	Exit temperature, T_{he} , K
1	0.00746	297.6	377.0	377.8	320	135	119	0.51	11	0.975	411.1	408.4
2	.00741	297.6	377.2	377.6	↓	152	118	.85	17	.967	427.8	423.7
3	.00746	297.6	398.7	377.6	↓	162	118	.93	18	.962	440.1	435.5
4	^a .0074	299.3	411.5	377.8	↓	169	119	.91	18	.958	449.6	445.4
5	^b .0070	299.8	414.0	377.7	320	165	119	.92	17	.958	449.6	445.5
6	^b .0068	299.8	414.8	377.4	310	159	117	.91	16	.958	449.6	445.7
7	^b .0065	299.8	414.8	377.6	280	159	117	.85	15	.958	448.9	445.4
8	.00848	299.3	377.3	377.7	350	157	119	.86	19	1.01	427.3	423.0
9	.00885	299.8	377.3	377.7	340	157	119	.77	18	1.01	427.5	423.3
10	.00748	299.5	384.8	377.7	250	146	119	.75	15	1.01	427.3	423.9
11	^a .0082	300.4	377.3	377.6	320	154	118	.78	17	1.01	428.2	424.3
12	.00790	↓	400.6	377.8	320	162	119	.85	18	1.00	440.0	435.9
13	^b .0077	↓	412.0	377.7	320	164	119	.93	18	1.01	448.4	444.3
14	.00848	↓	407.3	377.8	350	178	119	.96	21	1.01	449.6	444.8
15	.00853	300.6	389.7	377.8	350	170	119	.93	21	1.02	438.7	434.1
16	.00798	300.9	396.7	377.8	330	163	↓	.91	19	↓	438.7	434.4
17	.00761	301.2	400.4	377.8	320	160	↓	.87	17	↓	439.0	435.1
18	^a .0073	301.5	401.5	377.7	310	157	↓	.91	17	↓	438.4	434.6
19	^b .0072	301.5	403.7	377.7	280	155	↓	.82	15	↓	439.0	435.5
20	.00853	301.5	377.0	377.7	350	159	119	.84	19	1.02	427.9	423.6
21	^a .0074	301.8	386.5	377.8	280	149	119	.81	16	1.02	428.2	424.6
22	^b .0069	302.3	389.6	377.7	230	146	119	.81	15	1.02	427.6	424.3
23	.00922	299.8	398.2	377.4	470	164	117	.78	19	1.01	438.9	434.4
24	^a .0078	300.4	402.6	377.4	320	159	117	.82	17	.995	439.8	435.9
25	.00743	300.1	376.8	377.2	280	125	116	.14	4.8	1.01	389.6	388.9
26	.00743	300.1	↓	377.0	↓	128	↓	.28	7.1	1.00	396.8	395.1
27	.00743	300.6	↓	↓	↓	132	↓	.46	10	1.01	403.7	401.3
28	.00746	301.2	↓	↓	↓	141	↓	.65	13	1.02	410.1	407.0
29	.00746	301.5	376.5	↓	↓	147	↓	.72	14	1.01	416.5	413.2
30	.00750	302.0	377.0	377.2	↓	151	↓	.81	16	1.01	422.2	418.5
31	.00741	302.6	389.3	377.2	250	153	↓	.78	15	1.01	427.1	423.5

^aOscillations of ±5 to 10 percent in boiling-fluid flow rate.^bOscillations greater than ±10 percent in boiling-fluid flow rate.

TABLE VI. - EXPERIMENTAL DATA FOR TEST BOILER WITH 0.0305-INCH (0.78-mm) ORIFICE

(a) U. S. Customary Units

Run	Boiling fluid								Heating rate, Q , Btu/hr	Heating fluid		
	Flow rate, W_b , lb mass/hr	Inlet temperature, T_{bi} , °F	Exit plenum temperature, T_{bp} , °F	Exit saturation temperature, T_{se} , °F	Pump pressure rise, ΔP_P , psi	Inlet pressure, P_{bi} , psia	Exit pressure, P_{be} , psia	Exit quality, x_e		Flow rate, W_h , lb mass/hr	Inlet temperature, T_{hi} , °F	Exit temperature, T_{he} , °F
1	^a 59	70.5	218.0	218.3	19	20.0	16.6	0.59	42×10^3	8000	275.5	270.3
2	^a 59	72.0	218.0	218.3	20	21.5	16.6	.79	53	7950	291.5	285.0
3	^a 59	74.0	228.0	219.3	20	22.5	16.9	.72	50	8020	307.5	301.5

(b) SI Units

Run	Boiling fluid								Heating rate, Q , kW	Heating fluid		
	Flow rate, W_b , kg/sec	Inlet temperature, T_{bi} , K	Exit plenum temperature, T_{bp} , K	Exit saturation temperature, T_{se} , K	Pump pressure rise, ΔP_P , kN/m ²	Inlet pressure, P_{bi} , kN/m ² abs	Exit pressure, P_{be} , kN/m ² abs	Exit quality, x_e		Flow rate, W_h , kg/sec	Inlet temperature, T_{hi} , K	Exit temperature, T_{he} , K
1	^a 0.0074	294.6	376.5	376.6	130	138	114	0.59	12	1.01	408.4	405.5
2	^a .0074	295.4	376.5	376.6	140	148	114	.79	16	1.00	417.3	413.7
3	^a .0074	296.5	382.0	377.2	140	155	116	.72	15	1.01	426.2	422.9

^aOscillations of ± 5 to 10 percent in boiling-fluid flow rate.

TABLE VII. - EXPERIMENTAL DATA FOR TEST BOILER WITH TWO-HOLE ORIFICE (0.025-IN. (0.64-mm) HOLES)

(a) U. S. Customary Units

Run	Boiling fluid									Heating rate, Q, Btu/hr	Heating fluid		
	Flow rate, W_b , lb mass/hr	Inlet temperature, T_{bi} , °F	Exit temperature, T_{be} , °F	Exit plenum temperature, T_{bp} , °F	Exit saturation temperature, T_{se} , °F	Pump pressure rise, ΔP_p , psi	Inlet pressure, P_{bi} , psia	Exit pressure, P_{be} , psia	Exit quality, x_e		Flow rate, W_h , lb mass/hr	Inlet temperature, T_{hi} , °F	Exit temperature, T_{he} , °F
1	59.2	70.0	221.5	217.0	217.8	32	18.2	16.4	0.06	12×10^3	8 000	237.3	235.8
2	59.2	71.5	223.0	218.0	218.3	32	18.8	16.6	.26	23	7 950	257.3	254.3
3	58.8	73.0	220.7	217.5	217.8	33	19.8	16.4	.52	37	8 000	275.2	270.5
4	59.2	73.5	220.7	217.5	218.0	34	20.9	16.5	.71	49	8 000	289.5	283.5
5	58.8	74.0	222.5	218.0	217.4	35	21.9	16.3	.86	58	8 000	301.3	294.3
6	^a 59	75.0	251.5	241.0	217.8	36	22.8	16.4	.85	57	8 070	313.6	306.8
7	^b 65	248.0	222.7	218.0	219.3	34	18.0	16.9	.15	7.7	7 680	237.5	236.5
8	^b 61	251.5	222.5	↓	219.0	↓	18.9	16.8	.41	22	8 000	254.5	251.8
9	^b 65	241.5	223.3	↓	219.0	↓	20.8	16.8	.61	37	7 900	275.8	271.2
10	^b 60	251.0	223.3	↓	218.7	↓	22.1	16.7	.93	52	7 950	296.3	290.0
11	62.7	223.0	222.5	217.5	219.7	36	18.0	17.0	.18	11	8 020	239.3	238.0
12	62.0	229.5	221.0	218.0	219.0	41	19.4	16.8	.44	26	7 990	264.5	261.3
13	61.0	232.5	223.3	218.0	219.3	↓	20.9	16.9	.71	41	8 000	280.2	275.2
14	60.0	237.0	224 to 231	218.0	218.7	↓	22.1	16.7	.88	50	8 070	296.5	290.5
15	59.2	234.5	239.7	241.0	218.7	↓	22.7	16.7	.94	53	7 980	308.6	302.2
16	57.8	239.0	291.5	278.5	219.0	42	23.3	16.8	.95	52	7 900	339.3	333.0
17	99.0	227.0	218.5	217.0	218.7	67	18.6	16.7	.12	11	11 000	243.5	242.5
18	96.4	235.5	221.0	217.0	218.0	67	21.2	16.5	.34	30	10 900	265.7	263.0
19	107	245.5	221.7	217.5	218.3	76	25.1	16.6	.46	44	10 800	288.4	284.4
20	100	247.0	222.0	217.5	218.3	72	28.4	16.6	.62	59	10 700	307.6	302.3
21	96.4	257.0	223.0	217.0	217.8	75	30.9	16.4	.86	76	10 700	327.7	320.5
22	96.4	258.0	243.5	241.0	216.3	78	33.0	16.0	.97	86	10 500	343.8	336.0

^aOscillations of ± 5 to 10 percent in boiling-fluid flow rate.^bOscillations greater than ± 10 percent in boiling-fluid flow rate.

(b) SI Units

Run	Boiling fluid									Heating rate, Q, kW	Heating fluid		
	Flow rate, W_b , kg/sec	Inlet temperature, T_{bi} , K	Exit temperature, T_{be} , K	Exit plenum temperature, T_{bp} , K	Exit saturation temperature, T_{se} , K	Pump pressure rise, ΔP_p , kN/m ²	Inlet pressure, P_{bi} , kN/m ² abs	Exit pressure, P_{be} , kN/m ² abs	Exit quality, x_e		Flow rate, W_h , kg/sec	Inlet temperature, T_{hi} , K	Exit temperature, T_{he} , K
1	0.00746	294.3	378.4	375.9	376.4	220	125	113	0.06	3.6	1.01	387.2	386.4
2	.00746	295.1	379.3	376.5	376.6	220	130	114	.26	6.8	1.00	398.3	396.7
3	.00740	295.9	378.0	376.2	376.4	230	136	113	.52	11	1.01	408.2	405.6
4	.00746	296.2	378.0	376.2	376.5	240	144	114	.71	14	1.01	416.2	412.9
5	.00740	296.5	379.0	376.5	376.1	240	151	112	.86	17	1.01	422.8	418.9
6	^a .0074	297.0	395.1	389.3	376.4	250	157	113	.85	17	1.02	429.6	425.8
7	^b .0082	393.2	379.1	376.5	377.2	230	124	117	.15	2.3	.966	387.3	386.8
8	^b .0077	395.1	379.0	↓	377.0	↓	130	116	.41	6.4	.994	396.8	395.8
9	^b .0082	389.6	378.9	↓	377.0	↓	143	116	.61	11	1.00	408.6	406.2
10	^b .0075	394.8	378.9	↓	376.9	↓	152	115	.93	15	1.01	420.0	416.5
11	.00788	379.3	379.0	376.2	377.4	250	124	117	.18	3.1	1.01	388.3	387.6
12	.00780	382.9	378.2	376.5	377.0	280	134	116	.44	7.6	1.00	402.3	400.5
13	.00767	384.5	378.9	376.5	377.2	↓	144	117	.71	12	1.01	411.0	408.3
14	.00755	387.0	380 to 384	376.5	376.9	↓	152	115	.88	15	1.02	420.1	416.8
15	.00746	385.6	388.0	389.3	376.9	↓	156	115	.94	15	1.00	426.8	423.3
16	.00726	388.2	417.3	410.1	377.0	290	161	116	.95	15	.994	443.9	440.4
17	.0125	381.5	376.8	375.9	376.9	460	128	115	.12	3.2	1.38	390.6	390.1
18	.0121	386.2	378.2	375.9	376.5	460	146	114	.34	8.8	1.37	403.0	401.5
19	.0134	391.8	378.5	376.2	376.7	520	173	114	.46	13	1.36	415.6	413.4
20	.0126	392.6	378.7	376.2	376.7	500	196	114	.62	17	1.35	426.3	423.3
21	.0121	398.2	379.3	375.9	376.4	520	213	113	.86	22	1.35	437.4	433.4
22	.0121	398.7	390.6	389.3	375.5	540	228	110	.97	25	1.32	446.4	442.0

^aOscillation of ± 5 to 10 percent in boiling-fluid flow rate.^bOscillation greater than ± 10 percent in boiling-fluid flow rate.

TABLE VIII. - EXPERIMENTAL DATA FOR TEST BOILER WITH FOUR-HOLE ORIFICE (0.0135-IN. (0.34-mm) HOLES)

(a) U. S Customary Units

Run	Boiling fluid									Heating rate, Q, Btu/hr	Heating fluid		
	Flow rate, W_b , lb mass/hr	Inlet temperature, T_{bi} , °F	Exit temperature, T_{be} , °F	Exit plenum temperature, T_{bp} , °F	Exit saturation temperature, T_{se} , °F	Pump pressure rise, ΔP_p , psi	Inlet pressure, P_{bi} , psia	Exit pressure, P_{be} , psia	Exit quality, x_e		Flow rate, W_h , lb mass/hr	Inlet temperature, T_{hi} , °F	Exit temperature, T_{he} , °F
1	58.8	72.0	222.0	218.5	219.0	31	18.4	16.8	0.09	14×10^3	7950	239.5	237.8
2	59.0	↓	222.5	218.0	219.0	31	18.6	16.8	.28	24	7900	254.0	251.0
3	59.2	↓	222.0	↓	218.7	32	19.7	16.7	.53	39	7950	274.2	269.4
4	59.0	↓	221.5	↓	218.0	32	21.2	16.5	.75	51	8050	291.7	285.5
5	59.0	↓	225.0	↓	218.0	33	22.2	16.5	.93	61	7950	304.0	296.5
6	58.8	↓	249.0	240.0	218.0	33	22.7	16.5	.87	58	8000	313.8	306.8

(b) SI Units

Run	Boiling fluid									Heating rate, Q, kW	Heating fluid		
	Flow rate, W_b , kg/sec	Inlet temperature, T_{bi} , K	Exit temperature, T_{be} , K	Exit plenum temperature, T_{bp} , K	Exit saturation temperature, T_{se} , K	Pump pressure rise, ΔP_p , kN/m ²	Inlet pressure, P_{bi} , kN/m ² abs	Exit pressure, P_{be} , kN/m ² abs	Exit quality, x_e		Flow rate, W_h , kg/sec	Inlet temperature, T_{hi} , K	Exit temperature, T_{he} , K
1	0.00741	295.4	378.7	376.8	377.0	210	127	116	0.09	4.0	1.00	388.4	387.5
2	.00744	↓	379.0	376.5	377.0	210	128	116	.28	7.1	.995	396.5	394.8
3	.00746	↓	378.7	↓	376.9	220	136	115	.53	11	1.00	407.7	405.0
4	.00744	↓	378.4	↓	376.5	220	146	114	.75	15	1.01	417.4	414.0
5	.00744	↓	380.4	↓	376.5	230	153	114	.93	18	1.00	424.3	420.1
6	.00741	↓	393.7	388.7	376.5	230	156	114	.87	17	1.01	429.7	425.8

TABLE IX. - EXPERIMENTAL DATA FOR TEST BOILER WITH 0.028-INCH (0.71-mm) ORIFICE AND 10-INCH (0.254-m) PLUG

(a) U. S. Customary Units

Run	Boiling fluid									Heating rate, Q, Btu/hr	Heating fluid		
	Flow rate, W _b , lb mass/hr	Inlet temperature, T _{bi} , °F	Exit temperature, T _{be} , °F	Exit plenum temperature, T _{bp} , °F	Exit saturation temperature, T _{se} , °F	Pump pressure rise, ΔP _p , psi	Inlet pressure, P _{bi} , psia	Exit pressure, P _{be} , psia	Exit quality, x _e		Flow rate, W _h , lb mass/hr	Inlet temperature, T _{hi} , °F	Exit temperature, T _{he} , °F
1	59.5	79.5	-----	219.5	219.0	30	18.6	16.8	0.28	24×10 ³	7 950	251.5	248.5
2	58.5	80.0	-----	221.0	219.3	30	20.3	16.9	.62	43	7 950	275.5	270.2
3	59.0	81.0	-----	219.5	219.3	31	21.8	16.9	.79	53	7 950	292.3	285.8
4	58.0	82.0	-----	237.0	219.0	34	22.7	16.8	.91	60	8 050	306.5	299.3
5	58.3	78.0	-----	219.0	219.3	34	21.6	16.9	.76	51	7 850	290.0	283.7
6	59.0	78.5	-----	228	219.3	37	23.0	16.9	.89	59	7 800	308.0	300.7
7	59.2	79.0	220.7	217.5	218.7	26	18.2	16.7	.25	24	8 000	252.0	249.0
8	58.8	79.5	221.5	217.0	218.3	26	19.1	16.6	.43	33	8 000	268.6	264.6
9	58.5	80.5	221.7	218.0	218.0	27	19.9	16.5	.64	44	8 050	280.0	274.6
10	58.0	81.0	224	217.5	218.0	27	20.8	16.5	.79	52	8 000	293.0	286.6
11	58.5	81.0	238.0	218.0	218.0	28	21.2	16.5	.84	56	8 050	298.7	292.0
12	58.0	81.5	254.7	239.5	217.8	↓	21.7	16.4	.80	53	8 000	304.2	297.8
13	58.8	82.0	286.0	270.0	217.8	↓	22.4	16.4	.80	53	8 050	322.8	316.5
14	58.2	83.0	327.0	302.5	217.8	↓	23.3	16.4	.86	56	8 000	350.4	343.7
15	58.2	83.0	317.5	296.5	217.8	28	22.7	16.4	.79	53	5 400	350.3	341.0
16	58.5	83.0	308.0	290.0	218.0	28	22.3	16.5	.75	50	4 000	350.0	338.0
17	60.0	78.5	218.7	216.5	216.3	26	17.4	16.0	.02	9.2	7 000	227.3	226.0
18	59.0	78.5	219.5	218.0	217.0	26	17.7	16.2	.04	11	7 000	230.5	229.0
19	59.0	78.5	222.7	220.0	217.0	26	18.3	16.2	.08	13	6 960	239.5	237.7
20	59.0	79.0	222.5	219.5	219.3	27	18.3	16.9	.23	21	6 930	252.5	249.5
21	58.5	79.5	221.3	218.5	219.0	↓	18.8	16.8	.35	28	6 900	262.3	258.3
22	59.2	80.0	222.0	219.5	219.3	↓	19.4	16.9	.42	32	6 900	270.6	266.0
23	59.0	80.5	222.5	↓	219.3	↓	20.0	16.9	.58	41	6 930	278.5	272.7
24	59.0	80.5	223.0	↓	219.3	↓	20.5	16.9	.64	45	6 840	287.6	281.2
25	59.5	82.0	221.5	↓	219.7	59	20.3	17.0	.66	46	6 900	283.0	276.5
26	59.0	208.5	-----	220.0	219.7	45	18.1	17.0	.16	10	8 070	239.7	238.5
27	59.5	208.0	-----	219.5	219.0	46	18.8	16.8	.31	18	7 870	254.5	252.5
28	59.2	209.5	-----	219.5	219.3	↓	20.3	16.9	.55	32	7 800	270.0	266.0
29	59.2	209.5	-----	219.5	↓	↓	21.7	↓	.71	41	7 800	283.0	277.8
30	59.0	209.0	-----	220.0	↓	↓	22.3	↓	.81	47	7 750	292.6	286.7
31	58.3	211.0	-----	246.0	↓	↓	23.0	↓	.86	49	7 620	303.2	297.0
32	59.3	206.0	-----	261.5	↓	51	24.0	↓	.88	51	7 580	316.0	309.5
33	^a 59	202	-----	282.0	↓	51	24.7	↓	.87	51	7 500	330.3	323.7
34	38.2	75.5	222.0	217.5	218.7	28	18.0	16.7	.26	15	1 240	264.0	252.0
35	^b 39	80.5	219 to 235	218.0	217.5	30	19.0	16.3	.79	35	1 240	330.0	303.0
36	^b 38	81.5	287.7	266.0	217.8	31	19.2	16.4	.81	35	1 240	349.5	322.5
37	67.6	76.5	221.3	218.0	217.5	45	22.2	16.3	.73	57	11 200	291.5	286.5
38	59.6	87.5	224	218.5	217.5	39	21.4	16.3	.80	54	11 200	292.0	287.3

^aOscillations greater than ±10 percent in boiling-fluid flow rate.

^bOscillations of ±5 to 10 percent in boiling-fluid flow rate.

TABLE IX. - Concluded. EXPERIMENTAL DATA FOR TEST BOILER WITH 0.028-INCH (0.71-mm) ORIFICE
AND 10-INCH (0.254-m) PLUG

(b) SI Units

Run	Boiling fluid										Heating rate, Q, kW	Heating fluid		
	Flow rate, W_b , kg/sec	Inlet temperature, T_{bi} , K	Exit temperature, T_{be} , K	Exit plenum temperature, T_{bp} , K	Exit saturation temperature, T_{se} , K	Pump pressure rise, ΔP_p , kN/m ²	Inlet pressure, P_{bi} , kN/m ² abs	Exit pressure, P_{be} , kN/m ² abs	Exit quality, x_e	Flow rate, W_h , kg/sec		Inlet temperature, T_{hi} , K	Exit temperature, T_{he} , K	
1	0.00748	299.6	-----	377.3	377.0	210	128	116	0.28	7.0	1.00	395.1	393.4	
2	.00736	299.8	-----	378.2	377.2	210	140	117	.62	13	1.00	408.4	405.4	
3	.00742	300.4	-----	377.3	377.2	210	150	116	.79	16	1.00	417.8	413.9	
4	.00730	300.9	-----	387.0	377.0	230	157	117	.91	18	1.01	425.6	421.7	
5	.00740	298.7	-----	377.0	377.2	230	149	117	.76	15	.990	416.5	413.0	
6	.00735	299.0	-----	382.0	377.2	250	159	117	.89	17	.983	426.5	422.4	
7	.00746	299.3	378.0	376.2	376.9	180	125	115	.25	7.1	1.01	395.4	393.7	
8	.00740	299.5	378.4	375.9	376.7	180	132	114	.43	9.6	.990	404.6	402.9	
9	.00737	300.1	378.5	376.5	376.5	180	137	↓	.64	13	1.01	410.9	407.9	
10	.00731	300.4	380	376.2	376.5	180	143	↓	.79	15	↓	418.2	414.6	
11	.00737	300.4	387.6	376.5	376.5	190	146	↓	.84	16	↓	421.3	417.6	
12	.00731	300.6	396.9	388.4	376.4	190	150	113	.80	16	↓	424.3	420.8	
13	.00740	300.9	414.3	405.4	376.4	190	154	113	.80	15	↓	434.7	431.2	
14	.00734	301.5	437.1	423.4	376.4	190	161	113	.86	16	↓	450.0	446.3	
15	.00734	301.5	431.8	420.1	376.4	190	157	113	.79	16	.670	450.0	444.8	
16	.00737	301.5	426.5	416.0	376.5	190	154	114	.75	15	.503	449.8	443.2	
17	.00755	299.0	376.9	375.6	375.5	180	120	110	.02	2.7	.880	381.5	380.9	
18	.00742	299.0	377.3	376.5	375.9	180	122	112	.04	3.2	.880	383.4	382.6	
19	.00742	299.0	379.1	377.6	375.9	180	126	112	.08	3.8	.875	388.4	387.4	
20	.00742	299.3	379.0	377.3	377.2	190	126	117	.23	6.2	.871	395.6	394.5	
21	.00736	299.5	378.4	376.8	377.0	↓	130	116	.35	8.2	.868	401.1	389.9	
22	.00746	299.8	378.7	377.3	377.2	↓	134	117	.42	9.4	.868	405.7	403.2	
23	.00742	300.1	379.0	↓	377.2	↓	138	↓	.58	12	.871	410.1	406.9	
24	.00742	300.1	379.3	↓	377.2	↓	141	↓	.64	13	.860	415.7	411.6	
25	.00748	300.9	378.4	↓	377.4	410	140	↓	.66	13	.868	412.6	409.0	
26	.00743	371.2	-----	377.6	377.4	310	125	117	.16	2.9	1.02	388.5	387.9	
27	.00750	370.9	-----	377.3	377.0	320	130	116	.31	5.4	.992	396.8	395.4	
28	.00746	371.8	-----	377.3	377.2	↓	140	117	.55	9.3	.983	405.4	403.1	
29	.00746	371.8	-----	377.3	↓	↓	150	↓	.71	12	.983	412.6	409.7	
30	.00743	371.5	-----	377.6	↓	↓	154	↓	.81	14	.976	417.9	414.6	
31	.00735	372.6	-----	392.0	↓	↓	159	↓	.86	14	.960	423.8	420.4	
32	.00747	369.8	-----	400.6	↓	350	165	↓	.88	15	.955	430.9	427.3	
33	^a .0074	367.6	-----	412.0	↓	350	170	↓	.87	15	.945	438.9	435.2	
34	.00480	297.3	378.7	376.2	376.9	190	124	115	.26	4.4	.156	402.0	395.4	
35	^b .0049	300.1	377 to 386	376.5	376.2	210	131	113	.79	10	.156	438.7	423.7	
36	^b .0048	300.6	415.2	403.2	376.4	210	132	113	.81	10	.156	449.6	434.6	
37	.00850	297.9	378.3	376.5	376.2	310	153	113	.73	17	1.41	417.3	414.6	
38	.00750	304.0	379.8	376.8	376.2	270	148	113	.80	16	1.41	417.6	415.0	

^aOscillations greater than ±10 percent in boiling-fluid flow rate.

^bOscillations of ±5 to 10 percent in boiling-fluid flow rate.

TABLE X. - EXPERIMENTAL DATA FOR TEST BOILER WITH VENTURI-DIFFUSER INLET AND 10-INCH (0.254-m) PLUG

(a) U. S. Customary Units

Run	Boiling fluid									Heating rate, Q, Btu/hr	Heating fluid		
	Flow rate, W_b , lb mass/hr	Inlet temperature, T_{bi} , °F	Exit temperature, T_{be} , °F	Exit plenum temperature, T_{bp} , °F	Exit saturation temperature, T_{se} , °F	Pump pressure rise, ΔP_p , psi	Inlet pressure, P_{bi} , psia	Exit pressure, P_{be} , psia	Exit quality, x_e		Flow rate, W_h , lb mass/hr	Inlet temperature, T_{hi} , °F	Exit temperature, T_{he} , °F
1	80.7	69.0	222.3	218.5	219.0	28	18.5	16.8	0.06	18×10 ³	7970	242.0	239.8
2	79.7	70.0	222.5	↓	218.7	28	18.7	16.7	.22	29	7990	259.4	255.7
3	80.4	71.0	221.5	↓	218.3	30	20.4	16.6	.39	42	7910	280.7	275.5
4	↓	72.5	220.0	↓	218.3	32	22.9	16.6	.64	61	7930	301.5	294.0
5	↓	73.5	222.5	↓	218.3	34	24.5	16.6	.74	69	7910	316.0	307.5
6	↓	74.5	223.0	↓	218.0	35	26.0	16.5	.88	80	7880	327.0	317.2
7	80.0	75.0	223.0	↓	217.8	36	27.1	16.4	.95	85	7920	336.0	325.7
8	^a 81	79.0	248.5	245.5	219.7	58	28.2	17.0	.98	88	7910	348.0	337.4
9	80.7	210.5	221.5	218.5	219.3	23	18.0	16.9	.09	8	7950	236.5	235.5
10	80.7	210.0	221.0	↓	219.3	23	18.8	16.9	.22	18	8030	248.7	246.5
11	79.7	214.0	222.0	↓	218.3	24	19.2	16.6	.30	24	8030	257.6	254.7
12	78.4	216.5	219.0	↓	218.3	30	21.1	16.6	.41	31	7900	273.4	269.5
13	82.0	229.0	221.0	↓	218.3	42	23.7	16.6	.57	44	8030	289.4	284.0
14	80.7	229.0	221.5	↓	218.0	46	25.2	16.5	.75	58	8000	304.0	297.0
15	78.4	235.0	221.0	↓	218.0	47	26.9	16.5	.87	65	7980	316.2	308.3
16	77.6	238.0	237.0	↓	217.8	48	28.1	16.4	.96	70	8020	329.0	320.5
17	76.7	240.0	262.0	254.5	217.8	49	28.7	16.4	1.00	72	8050	337.0	328.4
18	75.5	241.0	289.0	279.5	217.8	49	29.1	16.4	1.02	73	8000	349.7	341.0

(b) SI Units

Run	Boiling fluid									Heating rate, Q, kW	Heating fluid		
	Flow rate, W_b , kg/sec	Inlet temperature, T_{bi} , K	Exit temperature, T_{be} , K	Exit plenum temperature, T_{bp} , K	Exit saturation temperature, T_{se} , K	Pump pressure rise, ΔP_p , kN/m ²	Inlet pressure, P_{bi} , kN abs/m ²	Exit pressure, P_{be} , kN abs/m ²	Exit quality, x_e		Flow rate, W_h , kg/sec	Inlet temperature, T_{hi} , K	Exit temperature, T_{he} , K
1	0.0102	293.7	378.9	376.8	377.0	190	127	116	0.06	5.2	1.00	389.8	388.6
2	.0100	294.3	379.0	↓	376.9	190	129	115	.22	8.6	1.00	399.2	397.4
3	.0101	294.8	378.4	↓	376.3	210	140	114	.39	12	.993	411.3	408.4
4	↓	295.6	378.7	↓	376.3	220	158	↓	.64	18	.996	422.9	418.7
5	↓	296.2	379.0	↓	376.3	230	169	↓	.74	20	.993	430.9	426.2
6	↓	296.8	379.3	↓	376.5	240	179	↓	.88	24	.990	437.1	431.6
7	↓	297.0	379.3	↓	376.4	250	187	113	.95	25	.995	442.0	436.3
8	^a .0102	299.3	393.4	391.8	377.4	400	194	117	.98	26	.993	448.7	442.8
9	.0102	372.3	378.4	376.8	377.2	160	124	116	.09	2.3	1.01	386.8	386.2
10	.0102	372.0	378.2	↓	377.2	160	130	116	.22	5.2	1.01	393.5	392.3
11	.0100	374.3	378.7	↓	376.3	170	132	114	.30	6.9	1.01	398.5	396.8
12	.00988	375.6	377.0	↓	376.3	200	145	↓	.41	9.2	.996	407.3	405.1
13	.0103	382.6	378.2	↓	376.3	290	163	↓	.57	13	1.01	416.1	413.4
14	.0102	382.6	378.4	↓	376.5	320	174	↓	.75	17	↓	424.3	420.4
15	.00988	385.9	378.2	↓	376.5	320	185	↓	.87	19	↓	431.0	426.6
16	.00978	387.6	387.0	↓	376.4	330	194	113	.96	21	↓	438.2	433.4
17	.00966	388.7	400.9	396.8	376.4	340	198	113	1.00	21	↓	442.6	437.8
18	.00952	389.3	415.9	410.6	376.4	340	200	113	1.02	21	↓	449.6	444.8

^aOscillations of ±5 to 10 percent in boiling-fluid flow rate.

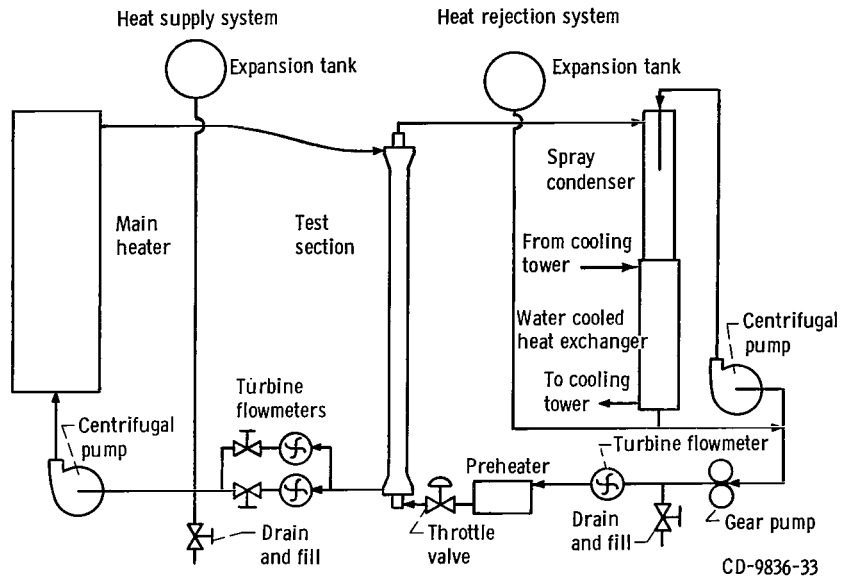

Figure 1. - Schematic diagram of test rig.

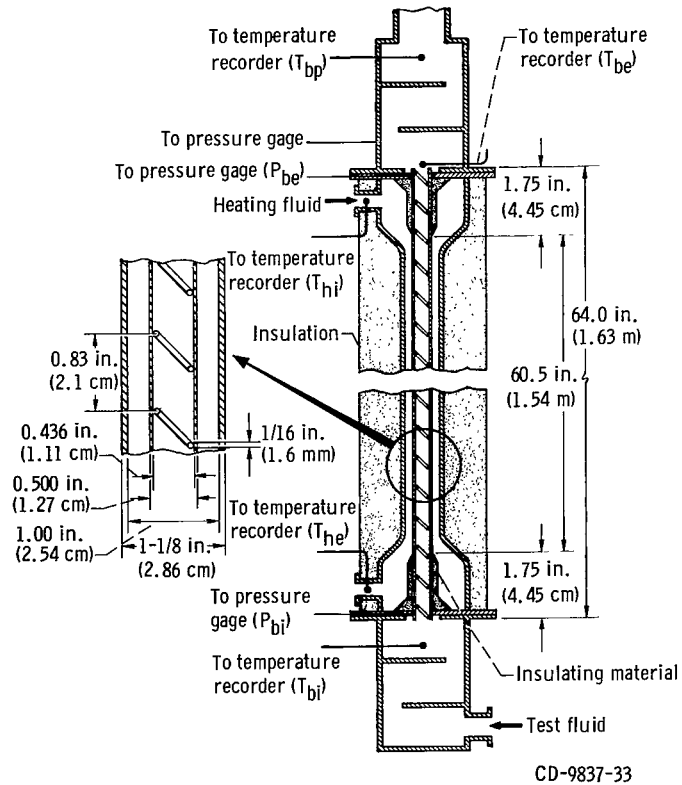

Figure 2. - Diagram of test section and plenum chambers with instrumentation.

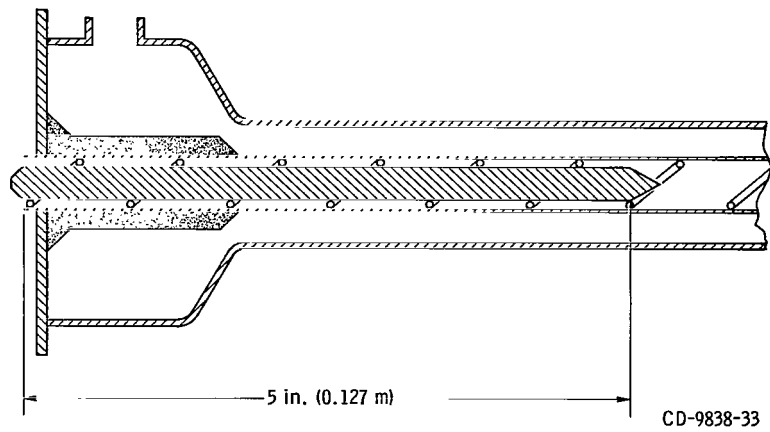

Figure 3. - Inlet end of test section with 5-inch (0.127-m) plug.

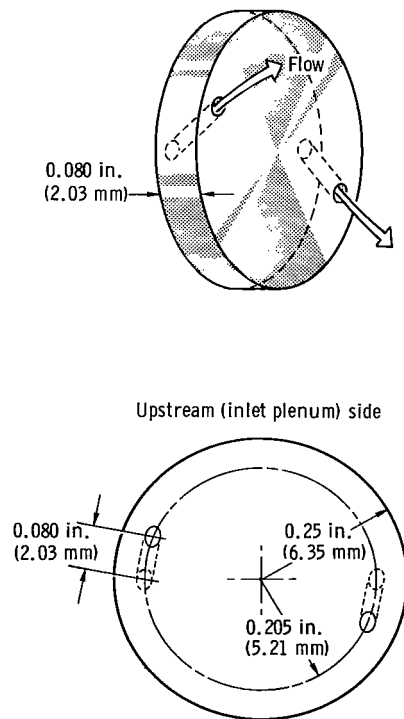

Figure 4. - Diagram of two-orifice inlet. Hole diameter, 0.025 inch (0.64 mm).

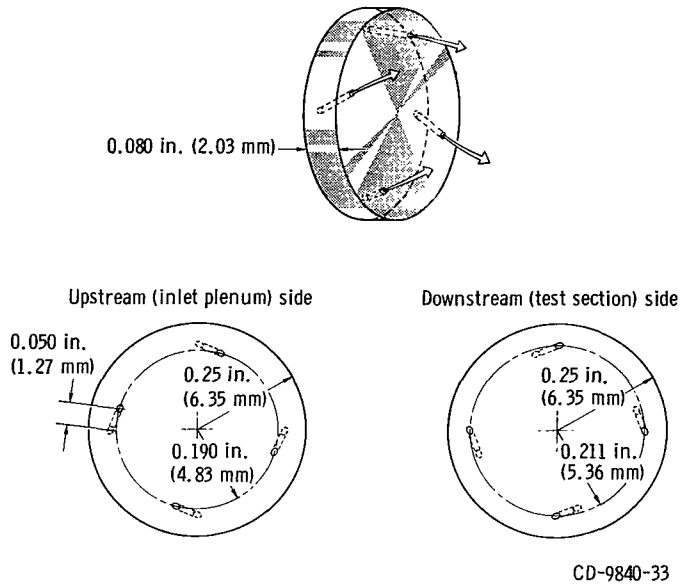

Figure 5. - Diagram of four-orifice inlet. Hole diameter, 0.0135 inch (0.34 mm).

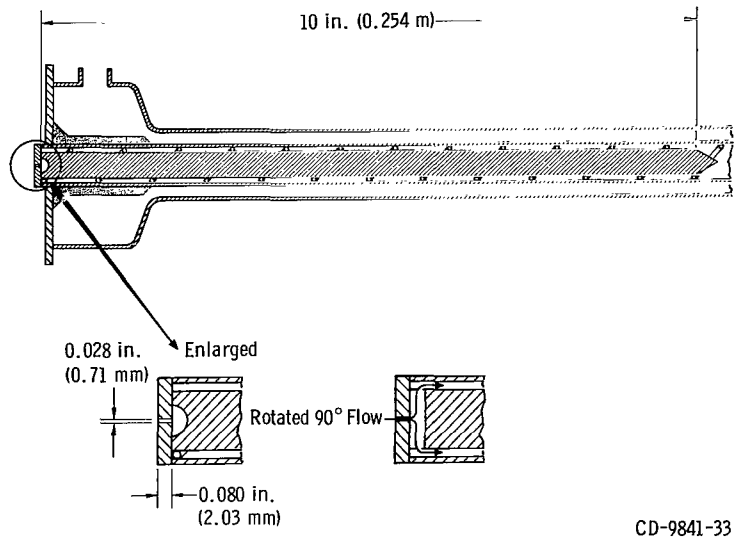

Figure 6. - Inlet end of test boiler with 0.028-inch (0.71-mm) orifice and 10-inch (0.254-m) plug.

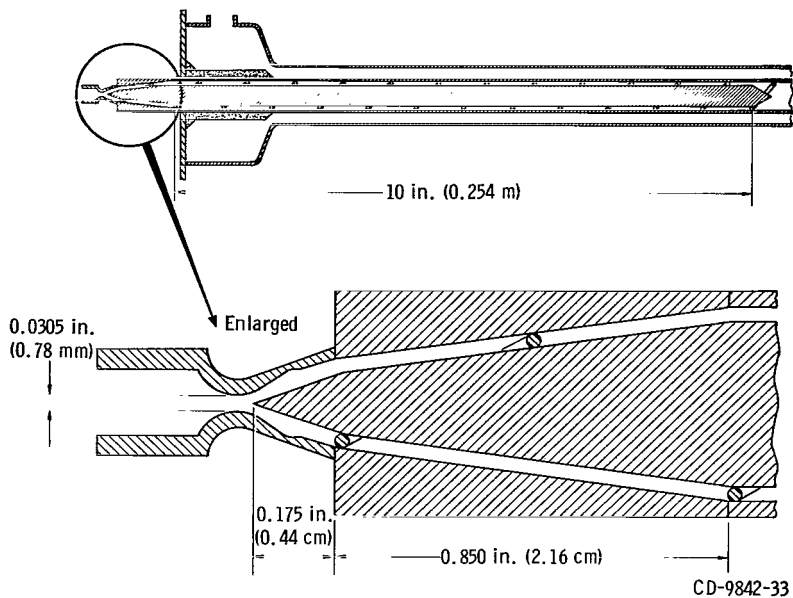

Figure 7. - Inlet end of test boiler with venturi-diffuser inlet and 10-inch (0.254-m) plug.

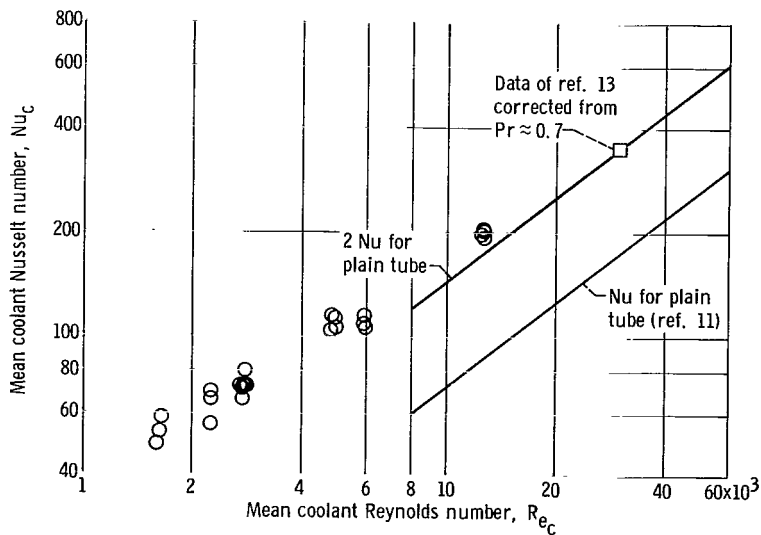

Figure 8. - Mean coolant Nusselt number as function of mean coolant Reynolds number for nonboiling runs with mean coolant Prandtl number about 3.3. (Data of ref. 13 shown for comparison.)

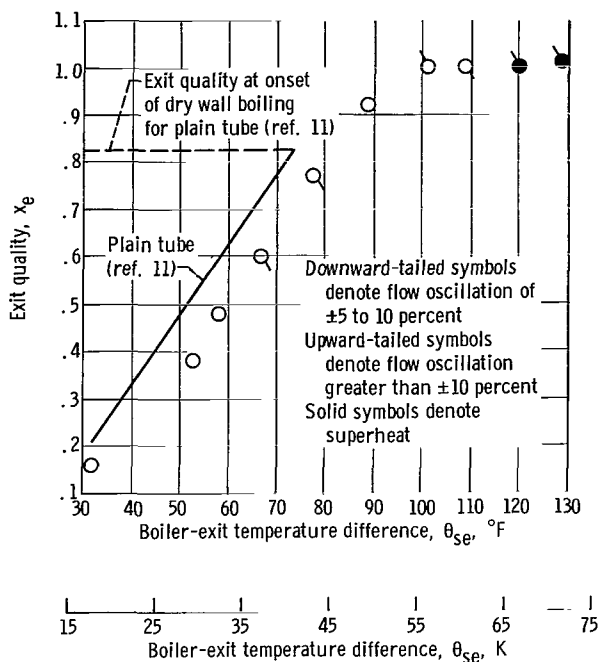

Figure 9. - Exit quality as function of boiler-exit temperature difference for test boiler with no plug or inlet device. Heating-fluid flow rate, ≈ 8000 pounds mass per hour (≈ 1.00 kg/sec); boiling-fluid flow rate, ≈ 60 pounds mass per hour (≈ 0.0075 kg/sec); inlet temperature, $\approx 80^\circ$ F (≈ 300 K); exit pressure, ≈ 17 psia (≈ 115 kN/m² abs).

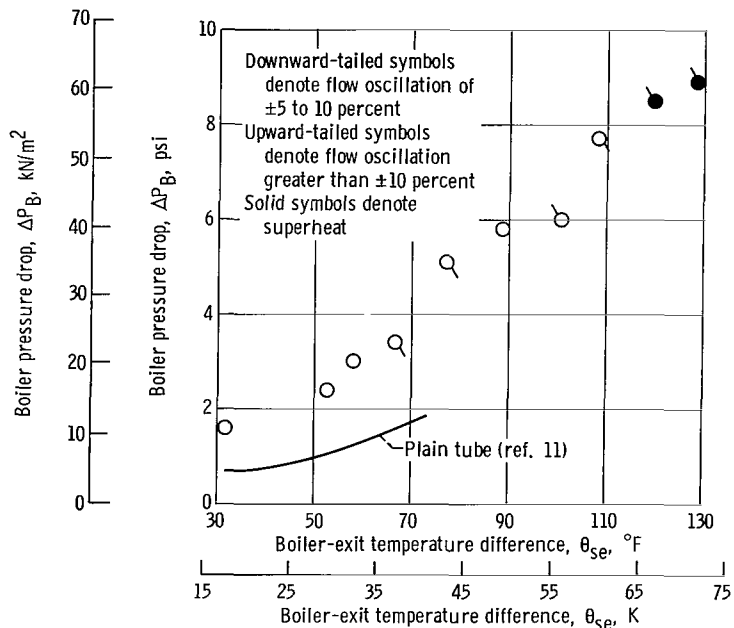

Figure 10. - Boiler pressure drop as function of boiler-exit temperature difference for test boiler with no plug or inlet device. Heating-fluid flow rate, ≈ 8000 pounds mass per hour (≈ 1.00 kg/sec); boiling-fluid flow rate, ≈ 60 pounds mass per hour (≈ 0.0075 kg/sec); inlet temperature, $\approx 80^\circ$ F (≈ 300 K); exit pressure, ≈ 17 psia (≈ 115 kN/m² abs).

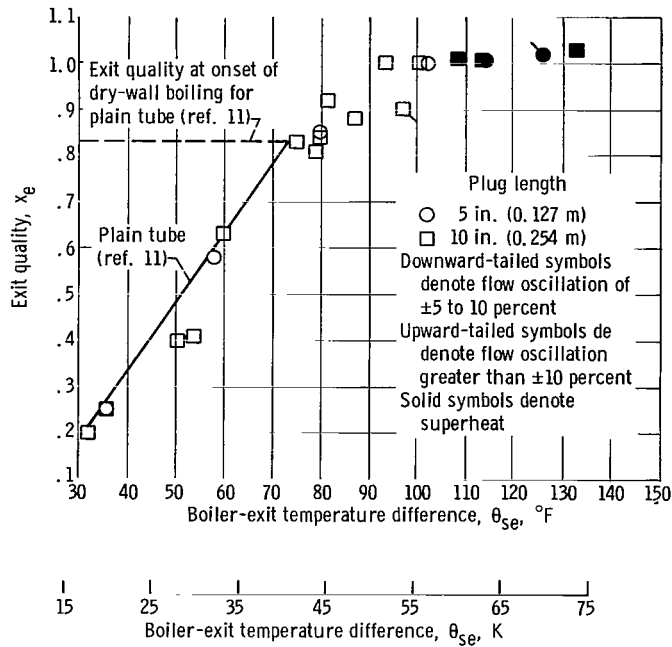

Figure 11. - Exit quality as function of boiler-exit temperature difference for test boiler with plug only. Heating-fluid flow rate, ≈ 8000 pounds mass per hour (≈ 1.00 kg/sec); boiling-fluid flow rate, ≈ 60 pounds mass per hour (≈ 0.0075 kg/sec); inlet temperature, $\approx 80^\circ$ F (≈ 300 K); exit pressure, ≈ 17 psia (≈ 115 kN/m² abs).

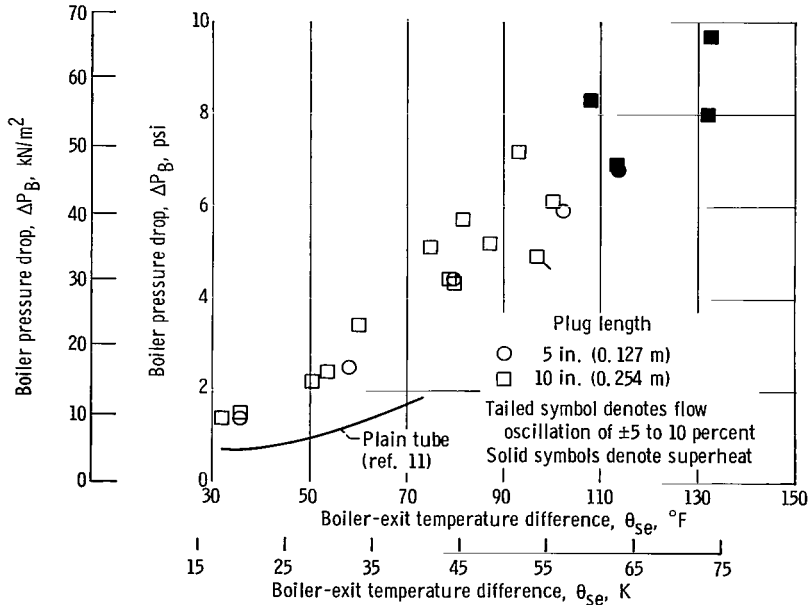

Figure 12. - Boiler pressure drop as function of boiler-exit temperature difference for test boiler with plug only. Heating-fluid flow rate, ≈ 8000 pounds mass per hour (≈ 1.00 kg/sec); boiling-fluid flow rate, ≈ 60 pounds mass per hour (≈ 0.0075 kg/sec); inlet temperature, $\approx 80^\circ$ F (≈ 300 K); exit pressure, ≈ 17 psia (≈ 115 kN/m² abs).

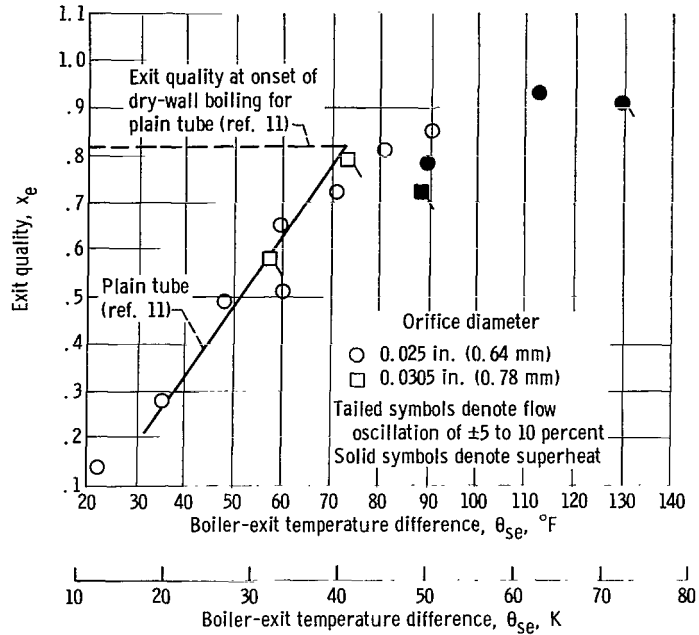

Figure 13. - Exit quality as function of boiler-exit temperature difference for test boiler with single orifice only. Heating-fluid flow rate, ≈ 8000 pounds mass per hour (≈ 1.00 kg/sec); boiling-fluid flow rate, ≈ 60 pounds mass per hour (≈ 0.0075 kg/sec); inlet temperature, $\approx 80^\circ\text{F}$ (≈ 300 K); exit pressure, ≈ 17 psia (≈ 115 kN/m² abs).

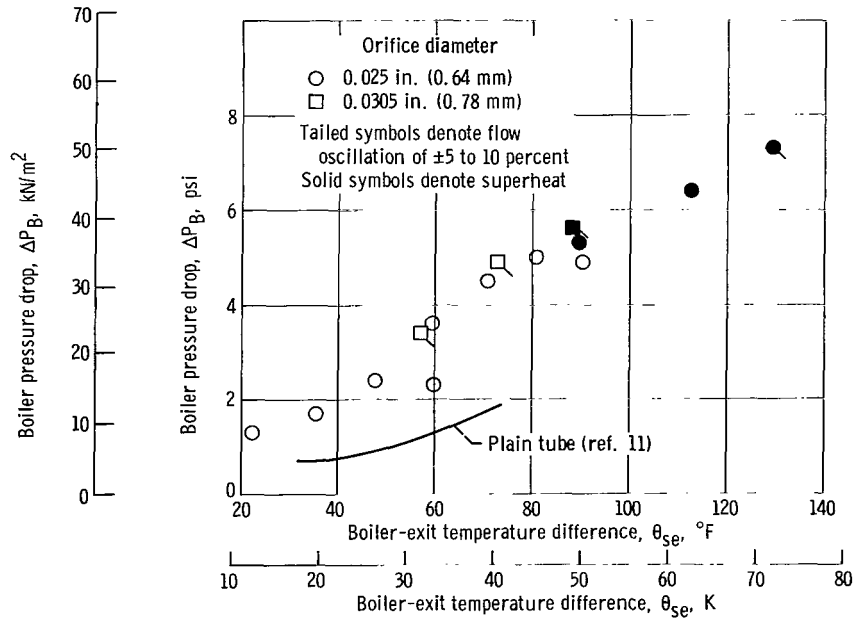

Figure 14. - Boiler pressure drop as function of boiler-exit temperature difference for test boiler with single orifice only. Heating-fluid flow rate, ≈ 8000 pounds mass per hour (≈ 1.00 kg/sec); boiling-fluid flow rate, ≈ 60 pounds mass per hour (≈ 0.0075 kg/sec); inlet temperature, $\approx 80^\circ\text{F}$ (≈ 300 K); exit pressure, ≈ 17 psia (≈ 115 kN/m² abs).

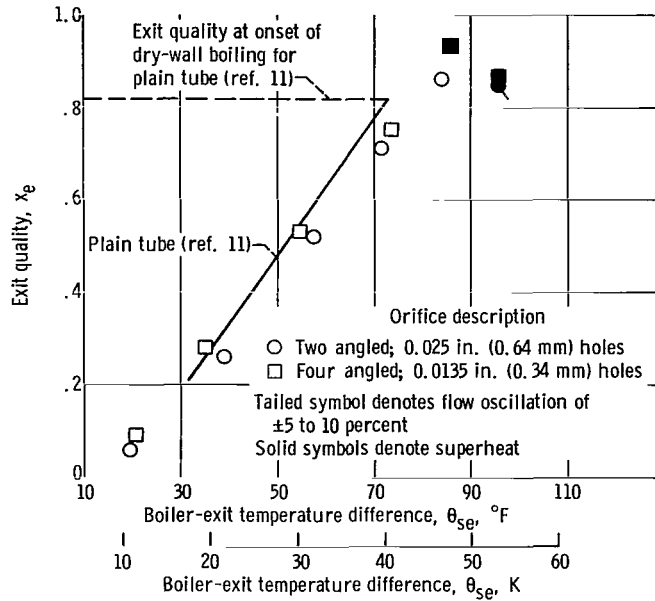

Figure 15. - Exit quality as function of boiler-exit temperature difference for test boiler with multiple-hole orifices only. Heating-fluid flow rate, ≈ 8000 pounds mass per hour (≈ 1.00 kg/sec); boiling-fluid flow rate, ≈ 60 pounds mass per hour (≈ 0.0075 kg/sec); inlet temperature, $\approx 80^\circ$ F (≈ 300 K); exit pressure, ≈ 17 psia (≈ 115 kN/m² abs).

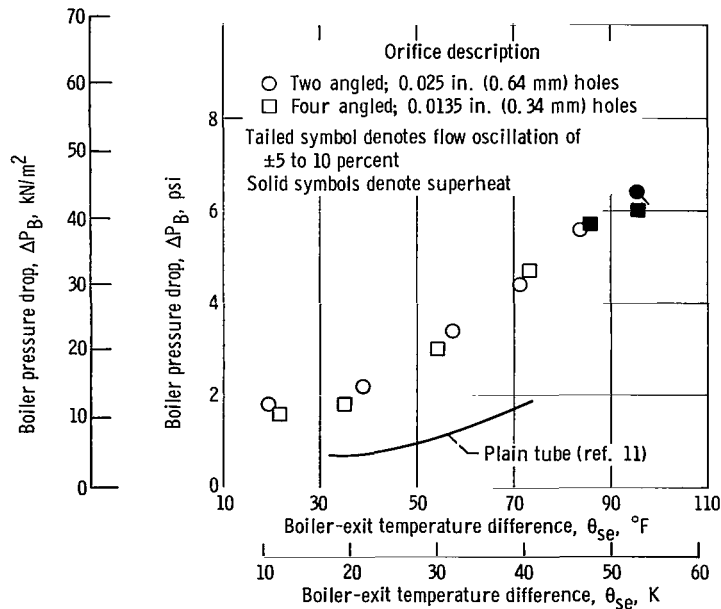

Figure 16. - Boiler pressure drop as function of boiler-exit temperature difference for test boiler with multiple-hole orifices only. Heating-fluid flow rate, ≈ 8000 pounds mass per hour (≈ 1.00 kg/sec); boiling-fluid flow rate, ≈ 60 pounds mass per hour (≈ 0.0075 kg/sec); inlet temperature, $\approx 80^\circ$ F (≈ 300 K); exit pressure, ≈ 17 psia (≈ 115 kN/m² abs).

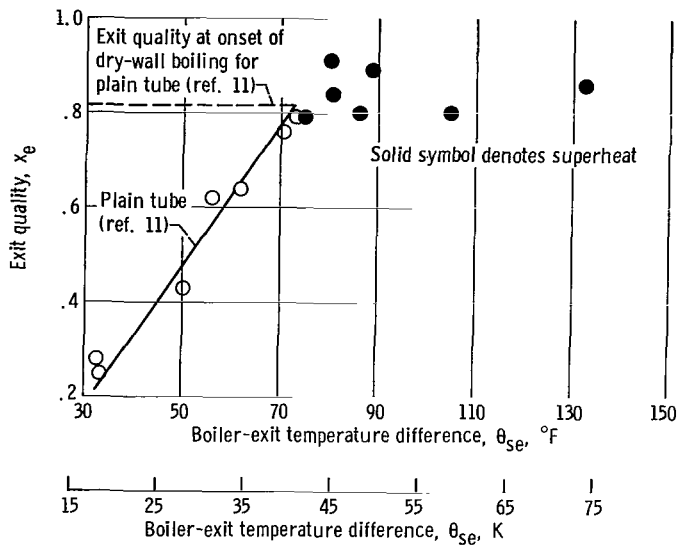

Figure 17. - Exit quality as a function of boiler exit temperature difference for test boiler with single 0.028-inch (0.71-mm) orifice and 10-inch (0.254-m) plug. Heating-fluid flow rate, ≈ 8000 pounds mass per hour (≈ 1.00 kg/sec); boiling-fluid flow rate, ≈ 60 pounds mass per hour (≈ 0.0075 kg/sec); inlet temperature, $\approx 80^\circ$ F (≈ 300 K); exit pressure, ≈ 17 psia (≈ 115 kN/m² abs).

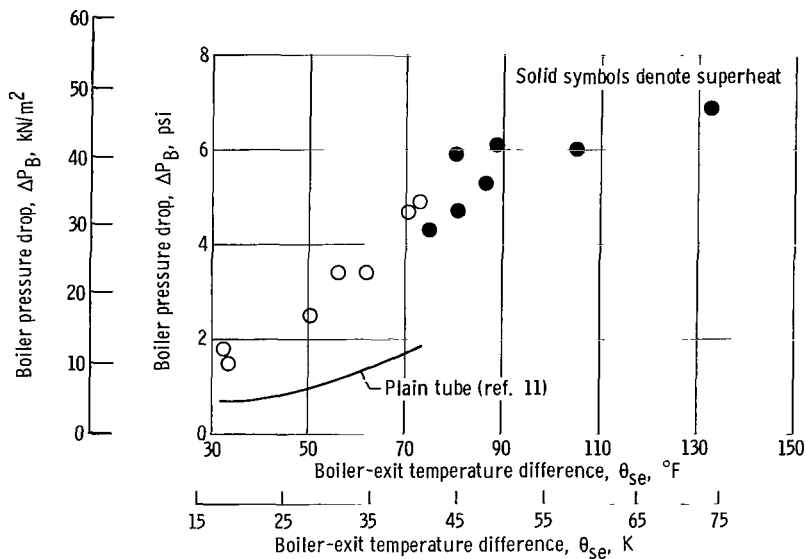

Figure 18. - Boiler pressure drop as function of boiler-exit temperature difference for test boiler with single 0.028-inch (0.71-mm) orifice and 10-inch (0.254-m) plug. Heating-fluid flow rate, ≈ 8000 pounds mass per hour (≈ 1.00 kg/sec); boiling-fluid flow rate, ≈ 60 pounds mass per hour (≈ 0.0075 kg/sec); inlet temperature, $\approx 80^\circ$ F (≈ 300 K); exit pressure, ≈ 17 psia (≈ 115 kN/m² abs).

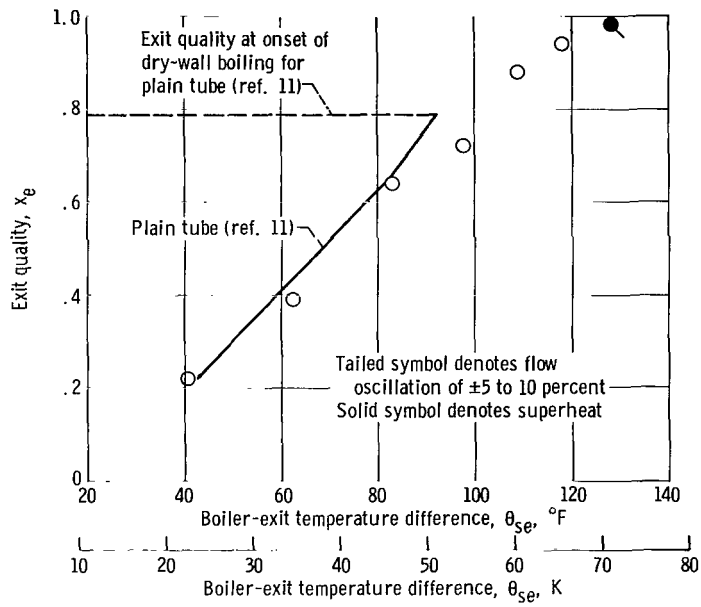

Figure 19. - Exit quality as function of boiler exit temperature difference for test boiler with venturi-diffuser inlet and plug. Heating-fluid flow rate, ≈ 8000 pounds mass per hour (≈ 1.00 kg/sec); boiling-fluid flow rate, ≈ 80 pounds mass per hour (≈ 0.0100 kg/sec); inlet temperature, $\approx 80^\circ$ F (≈ 300 K); exit pressure, ≈ 17 psia (≈ 115 kN/m² abs).

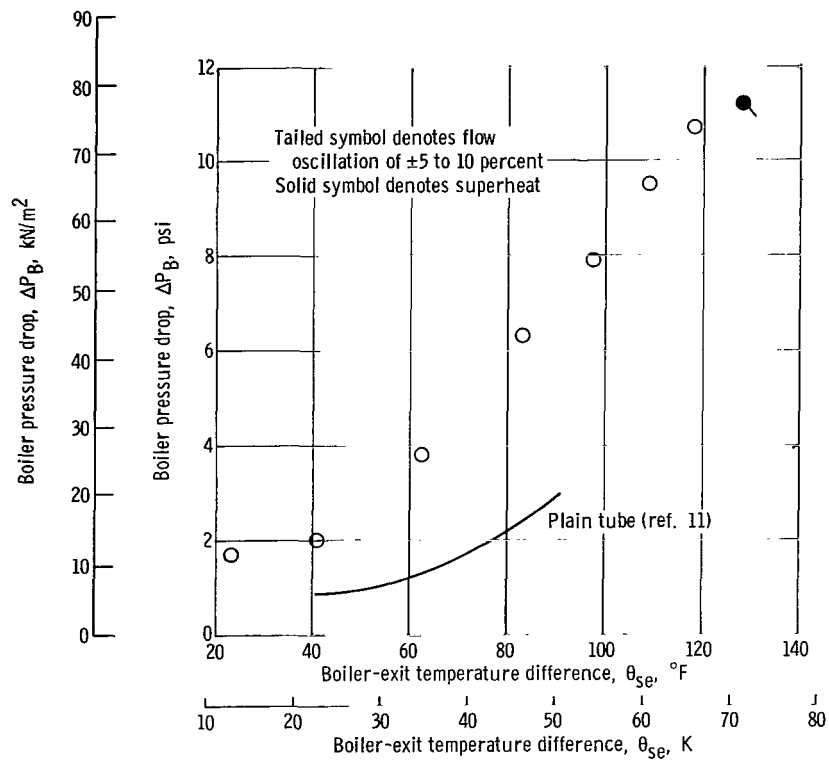

Figure 20. - Boiler pressure drop as function of boiler-exit temperature difference for test boiler with venturi-diffuser inlet and plug. Heating-fluid flow rate, ≈ 8000 pounds mass per hour (≈ 1.00 kg/sec); boiling-fluid flow rate, ≈ 80 pounds mass per hour (≈ 0.0100 kg/sec); inlet temperature, $\approx 80^{\circ}\text{F}$ (≈ 300 K); exit pressure, ≈ 17 psia (≈ 115 kN/m^2 abs).

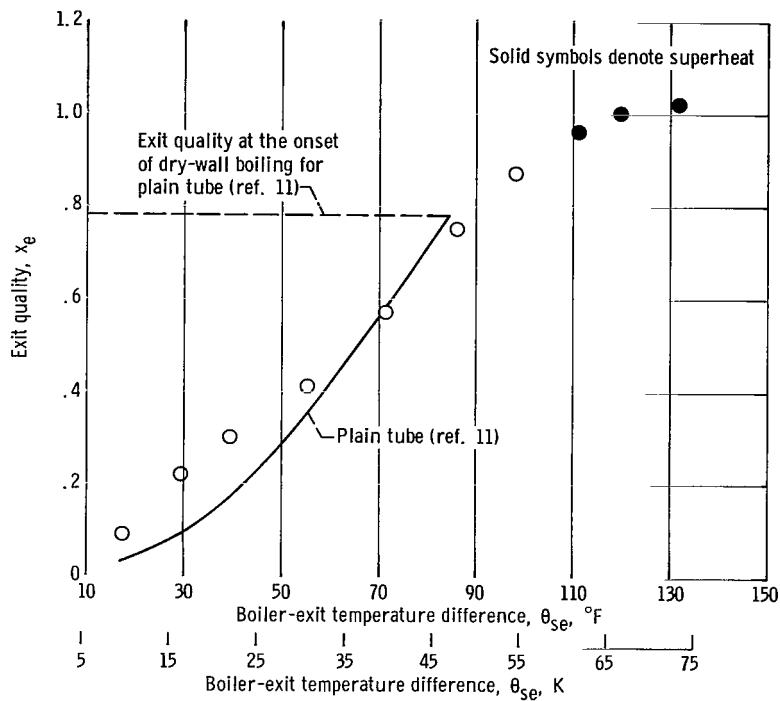

Figure 21. - Exit quality as function of boiler-exit temperature difference for test boiler with venturi-diffuser inlet and plug. Heating-fluid flow rate, ≈ 8000 pounds mass per hour (≈ 1.00 kg/sec); boiling-fluid flow rate, ≈ 80 pounds mass per hour (≈ 0.0100 kg/sec); inlet temperature, 210° to 241° F (372 to 389 K); exit pressure, ≈ 17 psia (≈ 115 kN/m² abs).

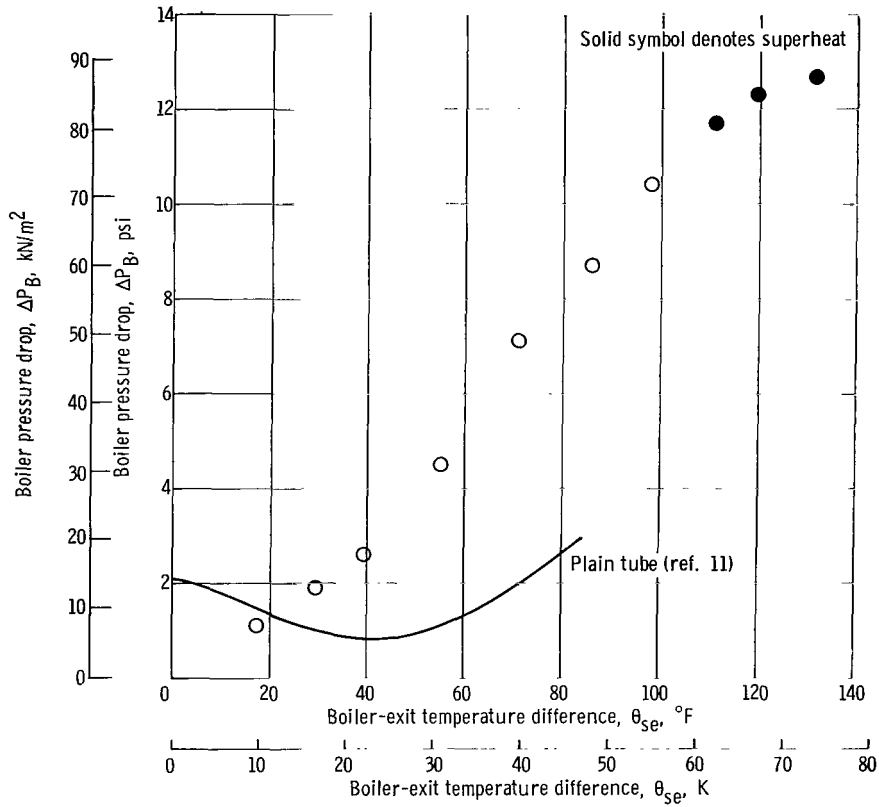
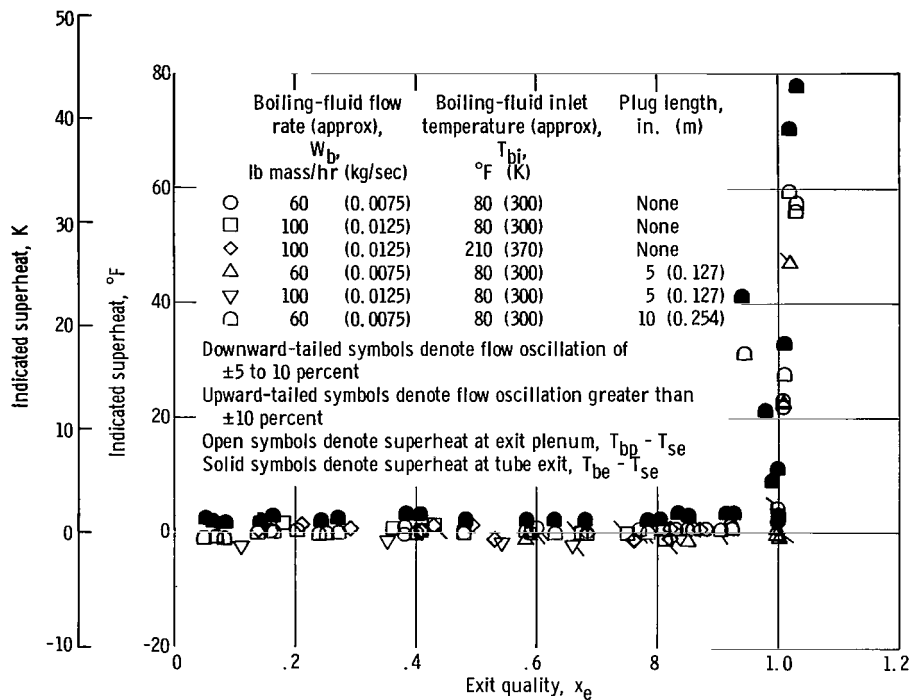
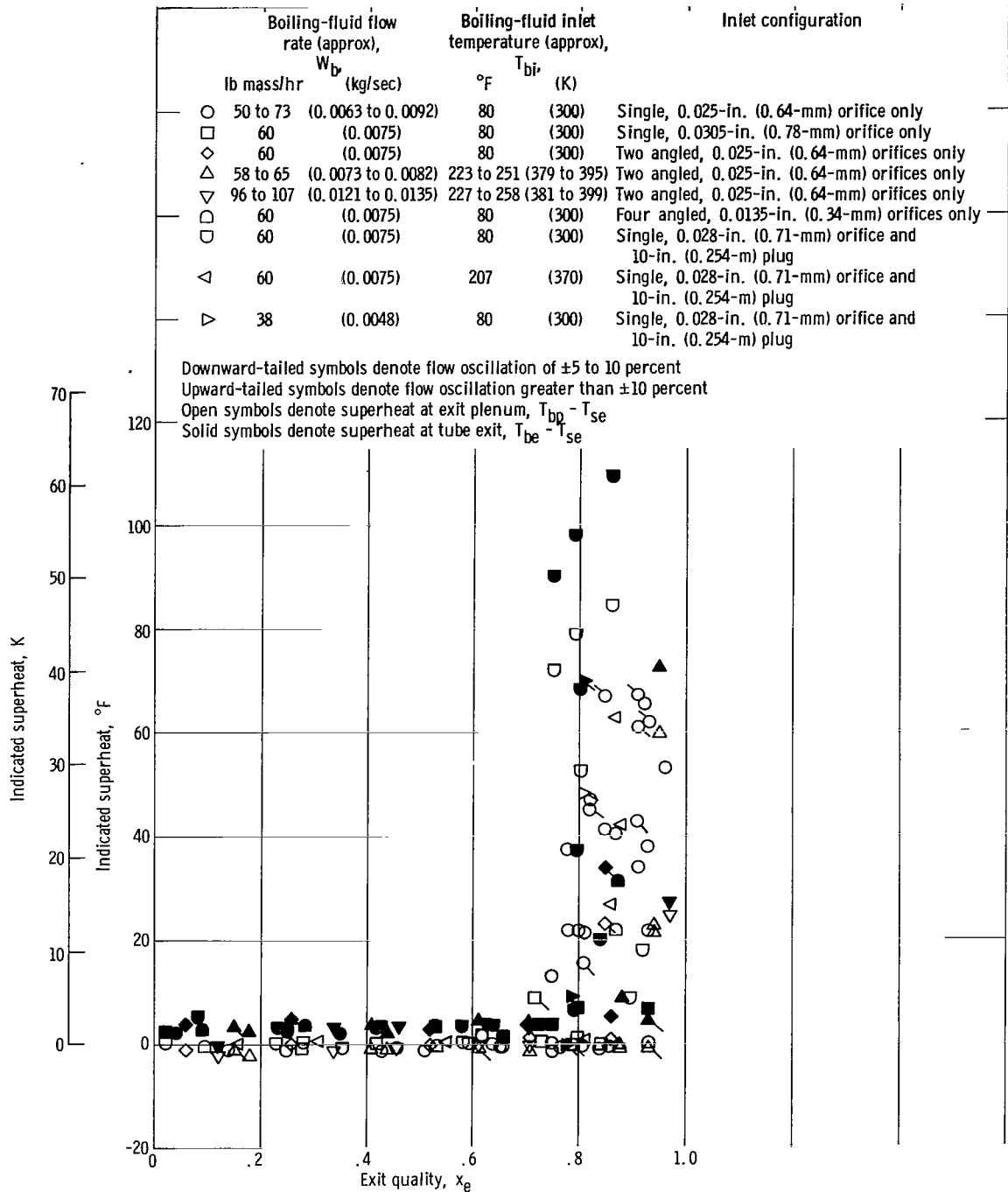

Figure 22. - Boiler pressure drop as function of boiler-exit temperature difference for test boiler with venturi-diffuser inlet and plug. Heating-fluid flow rate, ≈ 80 pounds mass per hour (≈ 0.0100 kg/sec); inlet temperature, 210° to 241° F (372 to 389 K); exit pressure, ≈ 17 psia (≈ 115 kN/m^2 abs).



(a) With no inlet device, with or without plug.

Figure 23. - Indicated superheat as function of exit quality.



(b) All configurations with orifice(s).

Figure 23. - Continued.

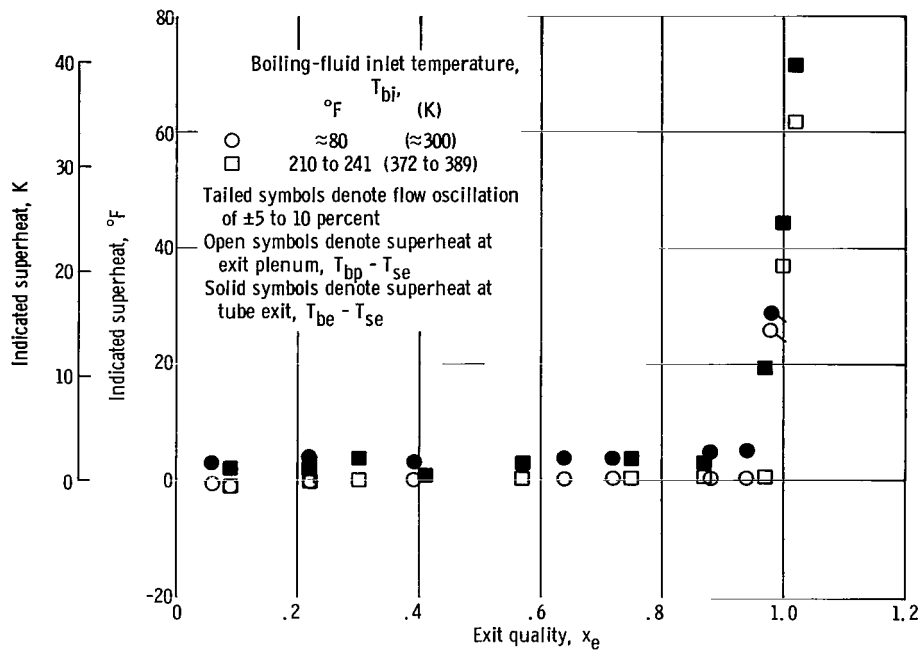

(c) With venturi-diffuser inlet and plug. Boiling-fluid flow rate, ≈ 80 pounds mass per hour (≈ 0.0100 kg/sec).

Figure 23. - Concluded.

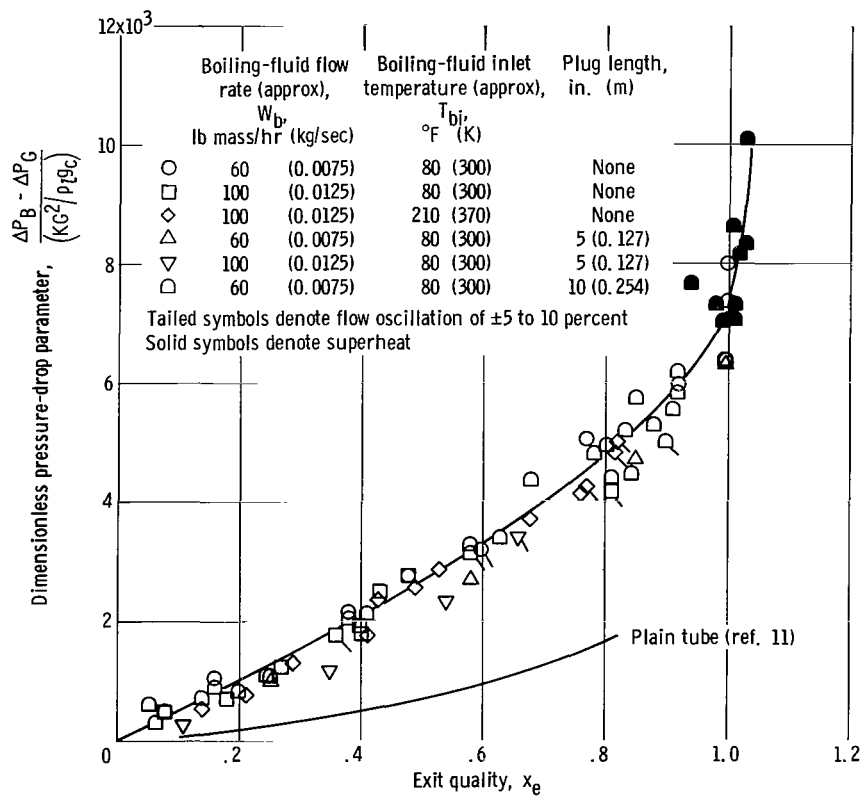

(a) With no inlet device, with or without plug.

Figure 24. - Dimensionless pressure-drop parameter as function of exit quality for test boiler with exit pressure of approximately 17 psia ($\approx 115 \text{ kN/m}^2 \text{ abs}$).

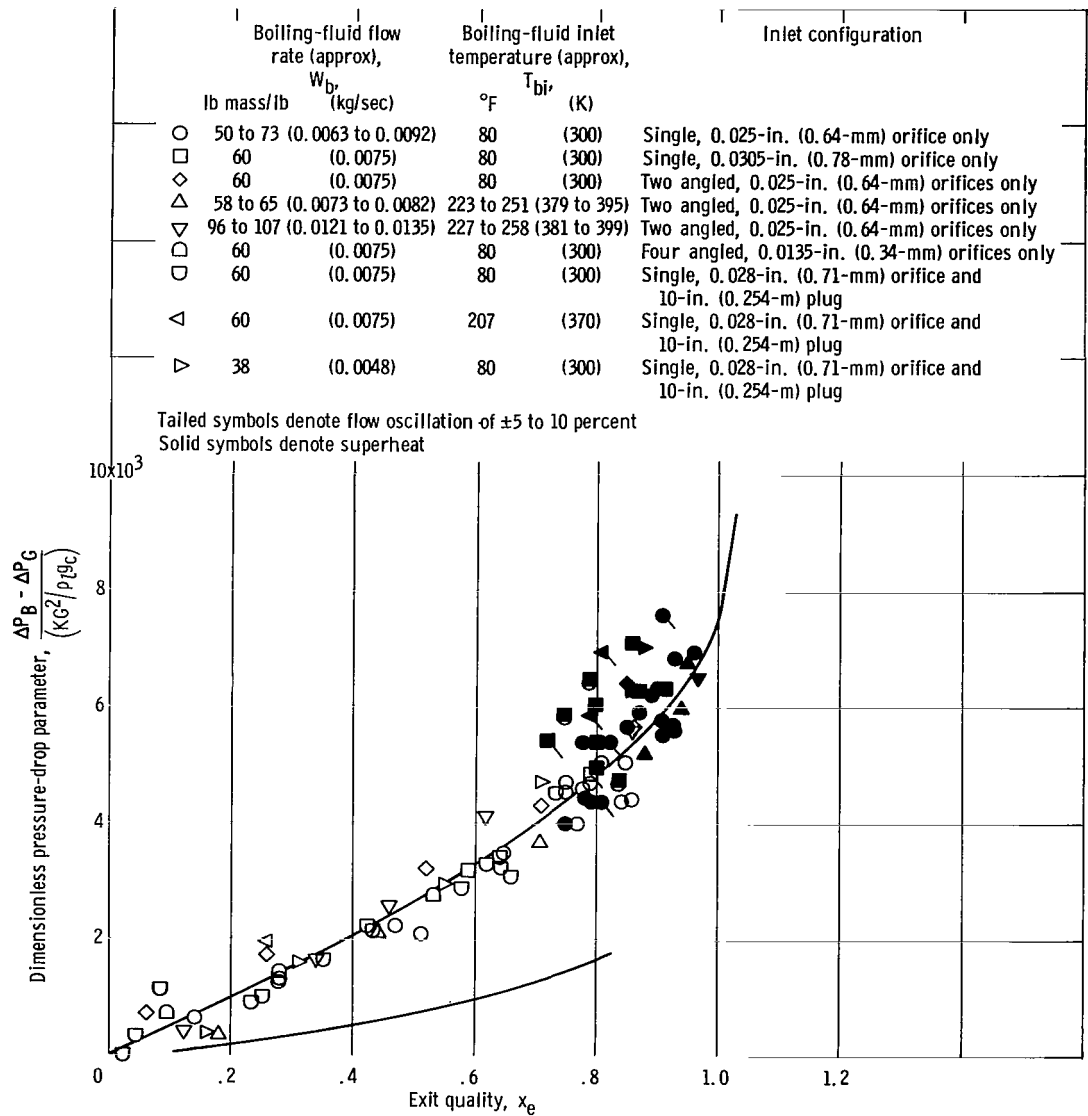

(b) All configurations with orifices.

Figure 24. - Continued.

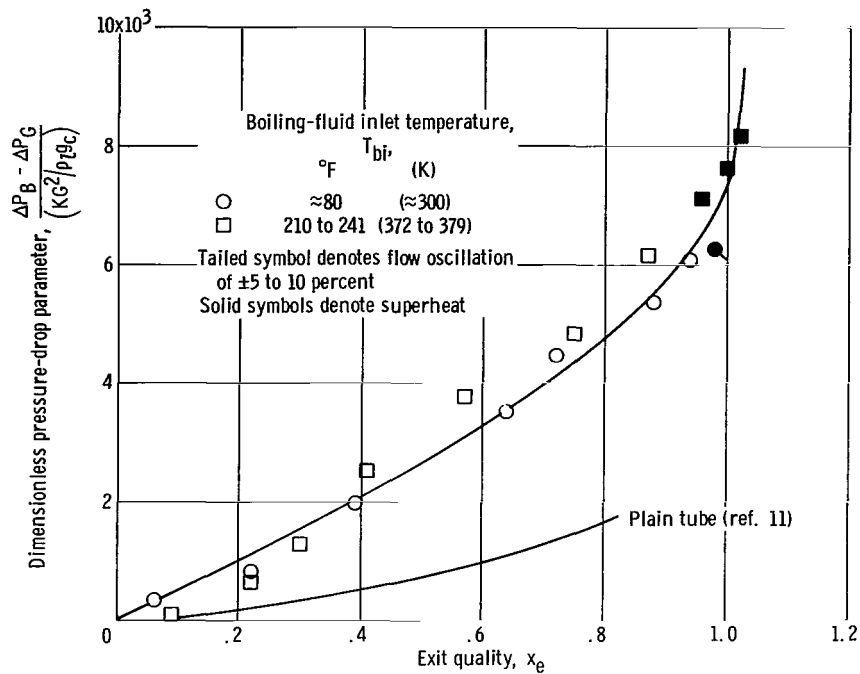

(c) With venturi-diffuser inlet and plug. Boiling-fluid flow rate, ≈ 80 pounds mass per hour (≈ 0.0100 kg/sec).

Figure 24. - Concluded.

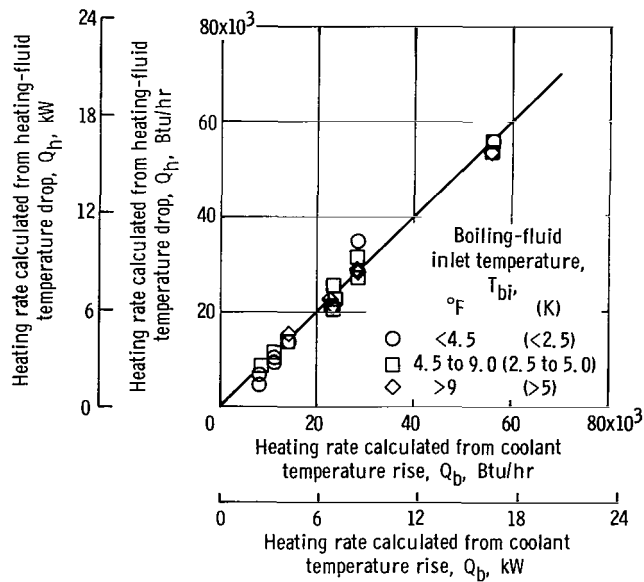

Figure 25. - Heating rate calculated from heating-fluid temperature drop compared with that calculated from coolant temperature rise for nonboiling runs.

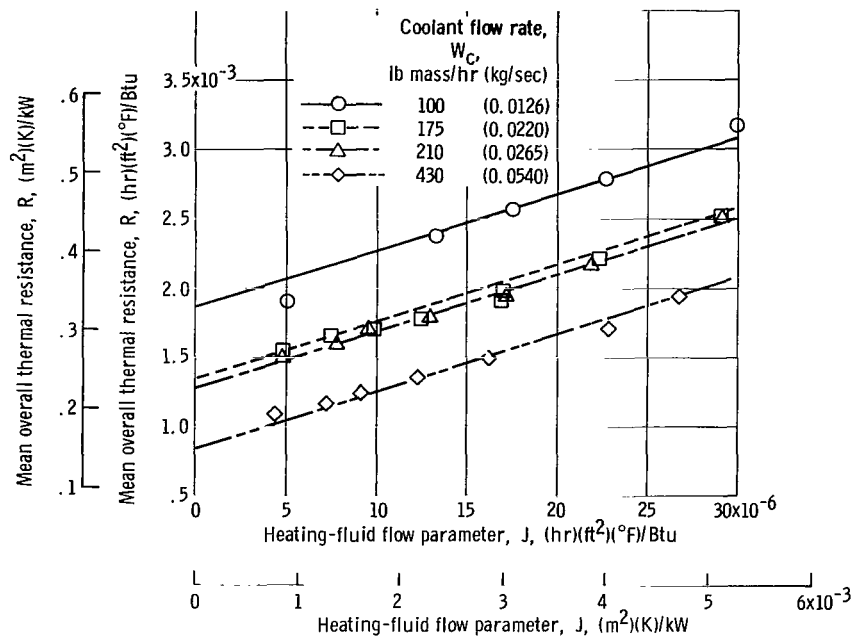

Figure 26. - Determination of heating-fluid thermal resistance. Mean overall thermal resistance plotted as function of heating-fluid flow parameter for constant inlet and exit coolant temperatures and various constant coolant flow rates; nonboiling runs.

NATIONAL AERONAUTICS AND SPACE ADMINISTRATION
WASHINGTON, D. C. 20546
OFFICIAL BUSINESS

POSTAGE AND FEES PAID
NATIONAL AERONAUTICS AND
SPACE ADMINISTRATION

FIRST CLASS MAIL

01 315 58276 00003
RESEARCH LABORATORY/AFWL/
WALLINGFORD FIELD STATION, NEW MEXICO 87117

POSTMASTER: If Undeliverable (Section 158
Postal Manual) Do Not Return

"The aeronautical and space activities of the United States shall be conducted so as to contribute . . . to the expansion of human knowledge of phenomena in the atmosphere and space. The Administration shall provide for the widest practicable and appropriate dissemination of information concerning its activities and the results thereof."

— NATIONAL AERONAUTICS AND SPACE ACT OF 1958

NASA SCIENTIFIC AND TECHNICAL PUBLICATIONS

TECHNICAL REPORTS: Scientific and technical information considered important, complete, and a lasting contribution to existing knowledge.

TECHNICAL NOTES: Information less broad in scope but nevertheless of importance as a contribution to existing knowledge.

TECHNICAL MEMORANDUMS: Information receiving limited distribution because of preliminary data, security classification, or other reasons.

CONTRACTOR REPORTS: Scientific and technical information generated under a NASA contract or grant and considered an important contribution to existing knowledge.

TECHNICAL TRANSLATIONS: Information published in a foreign language considered to merit NASA distribution in English.

SPECIAL PUBLICATIONS: Information derived from or of value to NASA activities. Publications include conference proceedings, monographs, data compilations, handbooks, sourcebooks, and special bibliographies.

TECHNOLOGY UTILIZATION PUBLICATIONS: Information on technology used by NASA that may be of particular interest in commercial and other non-aerospace applications. Publications include Tech Briefs, Technology Utilization Reports and Notes, and Technology Surveys.

Details on the availability of these publications may be obtained from:

SCIENTIFIC AND TECHNICAL INFORMATION DIVISION
NATIONAL AERONAUTICS AND SPACE ADMINISTRATION
Washington, D.C. 20546