

NASA TECHNICAL NOTE

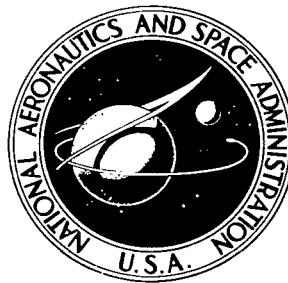

NASA TN D-5021

2.1

NASA TN D-5021



LOAN COPY: RETURN TO
AFWL (WLIL-2)
KIRTLAND AFB, N MEX

MITOTIC SYNCHRONIZATION OF L-STRAIN FIBROBLASTS WITH 5-AMINOURACIL AS DETERMINED BY TIME-LAPSE CINEPHOTOGRAPHY

by Clarence D. Cone, Jr., and Max Tongier, Jr.

Langley Research Center

Langley Station, Hampton, Va.



MITOTIC SYNCHRONIZATION OF L-STRAIN FIBROBLASTS
WITH 5-AMINOURACIL AS DETERMINED BY
TIME-LAPSE CINEPHOTOGRAPHY

By Clarence D. Cone, Jr., and Max Tongier, Jr.

Langley Research Center
Langley Station, Hampton, Va.

NATIONAL AERONAUTICS AND SPACE ADMINISTRATION

For sale by the Clearinghouse for Federal Scientific and Technical Information
Springfield, Virginia 22151 - CFSTI price \$3.00

CONTENTS

	Page
SUMMARY	1
INTRODUCTION	1
USE OF 5-AMINOOURACIL FOR MITOTIC SYNCHRONIZATION	2
MATERIALS AND METHODS	4
Synchronization Technique and Time-Lapse Recording Procedure	4
Synchronization technique	4
Time-lapse recording procedure	4
Method of Analysis of Time-Lapse Films	6
The rounding-up phenomenon	6
Film-analysis procedure	8
RESULTS AND DISCUSSION	10
Control Cultures	10
Synchronized Cultures	14
First mitotic wave synchronization	14
Second mitotic wave synchronization	14
Mitotic activity during continuous treatment	15
Advantages of Time-Lapse Recording	17
QUANTITATIVE EXPRESSION OF DEGREE OF SYNCHRONY	17
General Considerations	17
Experimental Errors Due to Imperfect Synchrony	18
The Mitotic Synchronization Index	20
CONCLUDING REMARKS	21
APPENDIX: BACKGROUND AND CHARACTERISTICS OF L-STRAIN MOUSE CELLS	23
REFERENCES	26

MITOTIC SYNCHRONIZATION OF L-STRAIN FIBROBLASTS
WITH 5-AMINOURACIL AS DETERMINED BY
TIME-LAPSE CINEPHOTOGRAPHY

By Clarence D. Cone, Jr., and Max Tongier, Jr.
Langley Research Center

SUMMARY

A technique for producing mitotically synchronous cultures of L-strain fibroblasts by treatment with 5-aminouracil (an analog of thymine) is presented along with a detailed description of a highly efficient procedure for determining the resulting degree of synchrony by use of time-lapse cinephotography. Particular advantages of the time-lapse recording procedure for synchrony determinations, as compared with the conventional colchicine-arrest or other histological methods, are cited. Several sets of representative experimental results illustrating the mitotic synchronization effectiveness of 5-aminouracil as determined by the time-lapse technique are presented and are interpreted on the basis of previous results for plant and animal cells. Basic effects on the validity of experimental results, caused by deviations of synchronized experimental cultures from ideal or perfect synchrony are also discussed, and a quantitative index for expressing the relative degree of synchrony attainable with various agents is defined. For completeness, a brief background discussion of previous uses of 5-aminouracil for cell synchronization is included.

INTRODUCTION

The Langley molecular biophysics laboratory (designated hereinafter as MBL) is presently engaged in a series of basic research investigations directed toward elucidation of the principal physicochemical mechanisms involved in the initiation of mammalian cell division. In these studies, which form part of a current research program on cellular damage mechanisms of ionizing space radiations, relatively large populations of mitotically synchronized cells are required for experimental purposes in the investigation of mitosis initiation phenomena. In order to evaluate the suitability of various cell systems for the experimental phases of this work, a preliminary investigation of several cell lines and synchronization agents and techniques has been carried out. This study resulted in the selection of the L-strain mouse fibroblast line (see appendix) for experimental purposes, using chemically induced synchronization obtained with 5-aminouracil (an analog

of thymine) as the synchronizing agent. The L-strain is a particularly hardy cell line and exhibits excellent morphological characteristics for mitosis observations. In addition this cell line has been cultured for many years and much information on its characteristics is available.

This paper discusses the particular technique which has been developed and which is now routinely used at the MBL for synchronization of experimental cultures of the L-strain cells for mitosis research, and presents a summary of representative experimental data indicating the degree of synchrony attainable with this method and the L-strain system. A particularly accurate and time-saving method which has been developed for determining the actual degree of synchrony, involving the use of time-lapse cinemography, is discussed in some detail. Also, to aid in comparisons of synchronization effectiveness, a brief consideration of the effects of deviations in experimental cultures from ideal synchrony is presented and a precise quantitative definition of the term "degree of synchrony" is developed.

USE OF 5-AMINOURACIL FOR MITOTIC SYNCHRONIZATION

Although few investigations appear to have been made of the usefulness of 5-aminouracil (denoted hereinafter as 5-AU) as a mitotic synchronizing agent for animal cells, its synchronizing effectiveness has been rather extensively investigated for various bacterial and plant-cell systems (refs. 1 to 5). However, some of the more general results for plant cells might be expected to apply in the case of animal cells, at least in a qualitative manner. In the mitotically active root meristems of such plants as Vicia faba and Allium cepa, 5-AU has been shown to be an effective synchronizing agent (ref. 5). In such plant systems, various studies have revealed that 5-AU acts primarily to retard metabolic progress of the cell through the S- and G₂-periods of interphase without producing any observable retardation of metabolic progress through the G₁-period.¹ The rate of deoxyribonucleic acid (DNA) synthesis during the S-period of the cell cycle is significantly reduced by the presence of 5-AU, thus greatly prolonging the duration of this period. Also, progress of cells which have fully completed DNA synthesis prior to 5-AU application is still greatly retarded during the G₂-period, or at least during the first part thereof. As a result of these metabolic retardations, cells in a treated population accumulate in the S- and G₂-periods during 5-AU exposure, and hence a substantial percentage of the population proceeds parasynchronously into division upon removal of the 5-AU block.

¹The conventional symbols G₁, S, G₂, and M of the generation cycle are used herein to designate the presynthetic, DNA synthetic, postsynthetic, and mitotic periods, respectively.

Despite the volume of work which has been carried out on plant-cell synchronization using 5-AU, the precise metabolic mechanisms by which this agent acts to retard progress through the S- and G₂-periods are still unknown. However, it appears that DNA synthesis is not actually prevented, but is only slowed by the presence of 5-AU, since continuously exposed cells ultimately pass on through the S- and G₂-periods and spontaneously enter apparently normal division. Vicia faba root cells spontaneously recover the ability to divide after some 26 hours of continuous exposure to 5-AU (ref. 5). Whatever the particular physiological mechanism or mechanisms underlying the 5-AU retardation of the S- and G₂-periods may be, they do not appear to produce any permanent alteration of the plant-cell metabolism, and the mitoses following 5-AU removal appear to be temporally typical and morphologically normal.

In animal cells, Chu has investigated the effects of 5-AU on both retardation of DNA synthesis and mitotic synchrony in cultures of Chinese hamster cells (results cited in ref. 5). It was found that following a 24-hour treatment of hamster cells with culture medium 0.003M (molar) in 5-AU, the time of peak mitoses occurred 8 hours after 5-AU removal. Tests with tritiated thymidine revealed that DNA synthesis was severely depressed by the presence of 5-AU, compared with the normal synthesis rate of hamster cells, but that, as in the case of plant cells, synthesis was not completely stopped. However, it is possible that DNA synthesis may have been proceeding by an alternate pathway not involving thymidine. Removal of the 5-AU resulted in a rapid increase in the apparent rate of DNA synthesis. In general, the wave of mitoses following 5-AU removal in the hamster cells appeared to be much sharper (that is, more highly synchronized) than in the case of the plant cells.

These results suggested that 5-AU may be an effective synchronizing agent for mammalian cells and that the action of this agent consists in the prolongation of the S-period and perhaps the G₂-period, for these cells. However, since the time of peak mitosis onset for such cells does not occur until some 8 hours after 5-AU removal, the cells presumably have ample time to resume and to complete DNA synthesis and associated metabolic preparations prior to prophase. Thus, the cells might be expected to enter mitosis in a relatively normal physiological state. The time-lapse observations of L-strain cells presented in this paper also indicate that the various aspects of division following 5-AU removal are essentially the same as for untreated cells, both morphologically and temporally. Furthermore, L-strain cells undergoing the second mitotic wave following 5-AU removal, and which have presumably fully recovered from all direct metabolic effects of the 5-AU treatment, behave in precisely the same manner as the cells undergoing the first mitotic wave. For these reasons, the use of 5-AU for the synchronization of mammalian cells such as the L-strain is presumed valid for experiments concerned with the elucidation of normal in vitro mitotic processes at least in the general vicinity of prophase and on through the mitotic period.

MATERIALS AND METHODS

Synchronization Technique and Time-Lapse Recording Procedure

The chemical-treatment procedure used to establish synchrony in L-strain populations is discussed in this section. Details of the time-lapse filming procedure used to record the history of mitotic activity needed for quantitatively ascertaining the degree of synchrony attained are also covered.

Synchronization technique.- The 5-AU synchronization technique presently used at the MBL for obtaining synchronized L-cell populations for various mitosis investigations consists in the application of Eagle's minimum essential medium, Hank's base, supplemented with 10-percent horse serum, and 0.003M in 5-AU (0.38 milligrams/milliliter of 5-AU) to cells growing on a suitable culturing surface, followed by incubation at 37° C for a period of 24 hours. The normal generation period of the L-strain in vitro at 37° C is approximately 20 hours (see appendix) for monolayer cultures²; thus the 24-hour treatment period allows essentially all cells in a monolayer population to accumulate in the blocked portion of the cycle (presumably in the S- and G₂-periods). (See ref. 5.) At the end of the treatment interval, the 5-AU medium is removed and the cells are washed once with normal (that is, 5-AU-free) culture medium, leaving the cells exposed to the wash medium for 4 minutes. The cells are then immersed in normal medium, and incubation is continued at 37° C. The time at which the cells of a given culture are transferred to the normal medium after washing is designated as time $t = 0$ for that culture and serves as a convenient reference point from which the time of the following peak of synchronous mitoses may be reckoned for experimental purposes. Cell populations intended for use in determining the basic degree of synchrony induced by 5-AU are usually grown and synchronized in modified Rose-type perfusion chambers, as described subsequently. Cells for other experimental uses are usually grown and synchronized directly in the particular experimental culturing vessels.

Time-lapse recording procedure.- For determining the synchronizing effectiveness of the 5-AU treatment procedure on the L-strain, the following photographic method is used to record the subsequent mitotic activity of the cells after 5-AU removal. This procedure was originally developed specifically for synchronization and allied mitotic studies and has proved to be much simpler and less time-consuming than the chemical colchicine metaphase-block technique conventionally used for determining mitotic-rate statistics. In addition, the time-lapse recordings give a continuous history of every individual cell and

²The basic procedure and results described in this paper are for monolayer cultures. The generation time of L-cells grown in spinner culture is greater than 20 hours and the cells require correspondingly longer 5-AU treatment periods.

its activities and condition following treatment, including viability and motility, and any occurrences of abnormal behavior can be readily detected.

Suitably dilute suspensions of nonsynchronous cells, obtained by mild trypsinization of stock monolayer cultures grown in Falcon-type plastic culture flasks are inoculated into modified Rose-type perfusion chambers (fig. 1) and allowed to settle and incubate for 4 to 6 hours. (The essential feature of the chamber modification consists in the provision of end spacers of precise dimensions so as to attain more uniform pressure over the cover-glass and gasket surfaces upon assembly, thereby preventing leakage and cover-glass breakage.) The concentration of the inoculating suspension is adjusted so that the resulting cell field on the chamber cover glass at the time of treatment has a nominal density of approximately 35 cells per square millimeter of surface. Treatment is initiated by drawing off the normal culture medium and replacing it with 5-AU medium as described in the foregoing section. Photographic recording of cell activities is usually commenced approximately 4 hours before the end of the treatment period. For this purpose, the test chamber is transferred to the recording system consisting of a Sage time-lapse unit (fig. 2) provided with a Zeiss Standard WL research microscope, and cell activity is recorded on 16-millimeter movie film at a rate of one frame per minute. The basic light source for this time-lapse unit is a very short duration flash so that the cells are exposed to a minimum of light during the experimental recording. Filming is usually accomplished by using a 2.5 \times Zeiss bright-field objective and 6 \times ocular which results in the recording of a field 2280 μ by 3170 μ containing approximately 250 cells. In some cases, however, where more clarity of morphological detail is desired during filming, a 10 \times Zeiss

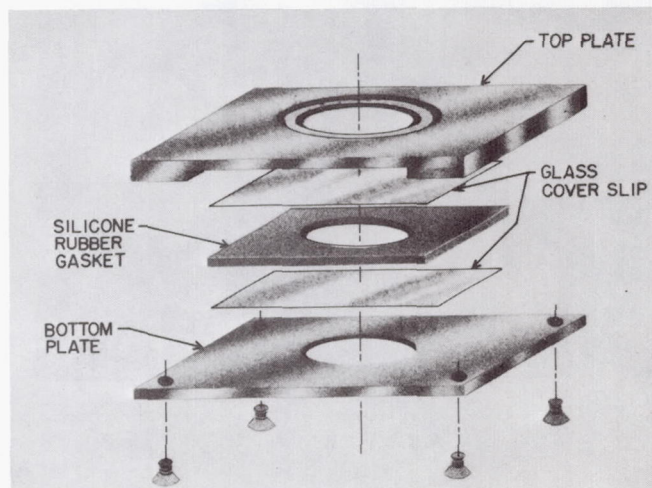

(a) Exploded view of chamber parts.

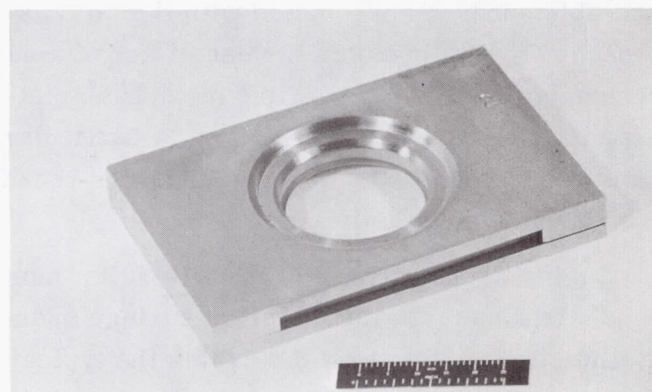

(b) Assembled chamber.

L-68-10,025

Figure 1.- Modified Rose-type culture chamber for time-lapse recording.

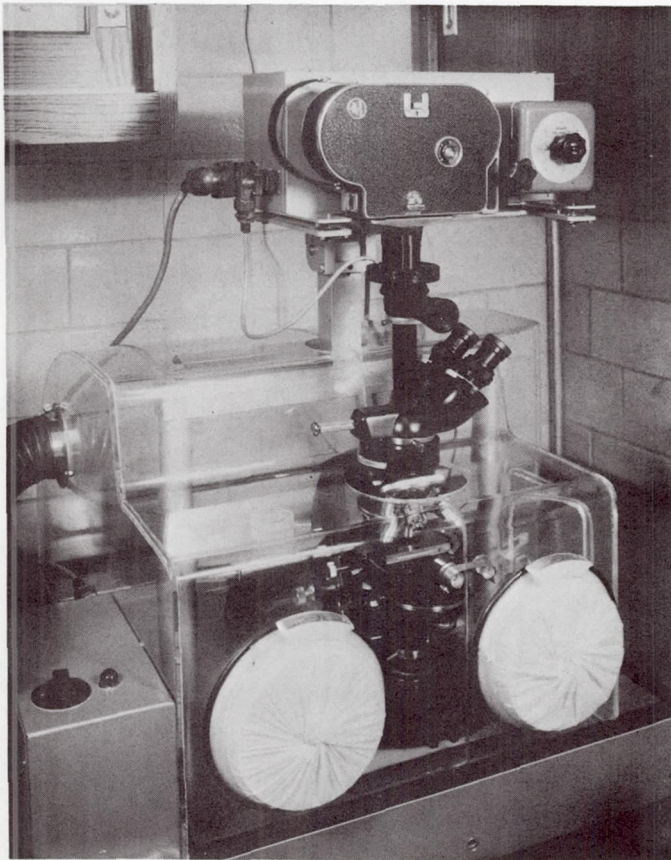

Figure 2.- Sage time-lapse recording unit used in tests. L-68-10,026

phase-contrast objective is used with a 6× ocular; this arrangement yields a film-frame record of an area 575μ by 802μ containing some 16 cells. At the end of the treatment period, the 5-AU medium is replaced and time-lapse filming of the same field continued for approximately 20 hours at the same rate of one frame per minute. This period is sufficient to cover the entire duration of the first sequence of synchronous mitoses. In many cases for the results reported herein, however, filming was continued for a period of approximately 28 hours after 5-AU removal in order to ascertain the time and degree of synchrony of the second mitotic sequence.

Method of Analysis of Time-Lapse Films

The rounding-up phenomenon.-

The use of time-lapse photography to determine the mitotic synchronizing efficiency of 5-AU is based upon the capability of establishing the precise time (relative to time $t = 0$) at which each cell of a population reaches a particular morphologically identifiable condition associated with the mitosis period. In principle, phase-contrast microscopy makes possible the use of any of a number of suitable observation criteria, for example, the formation of the metaphase plate, anaphase movement, telophase onset, and the like. There exists, however, a particularly convenient and useful indicator of mitosis onset in the form of the well-known rounding-up phenomenon accompanying division of monolayer cells in vitro.

During the interphase of in vitro cells, most types of mammalian cells in flask culture adhere closely to the culturing surface and assume the form of very thin flat sheets of stellate form. Figure 3 illustrates the typical interphase shape of L-strain fibroblasts in monolayer culture. As the cells approach the time for division, however, they slowly begin to thicken and the major pseudopods detach from the surface. This thickening continues until, ultimately, in late prophase the cell abruptly rounds up into a spherical form, detaching completely from the surface except at the point of "tangential" contact. Figure 4 illustrates this rounded-up condition for several L-strain fibroblasts. Time-lapse

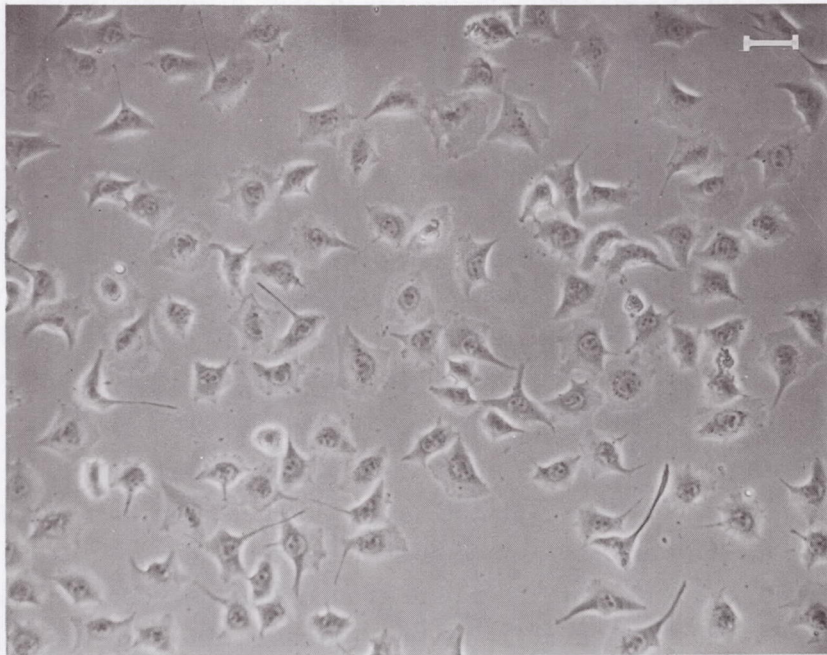

Figure 3.- Micrograph of L-cell field in interphase. Calibration: 20 μ . L-68-10,027

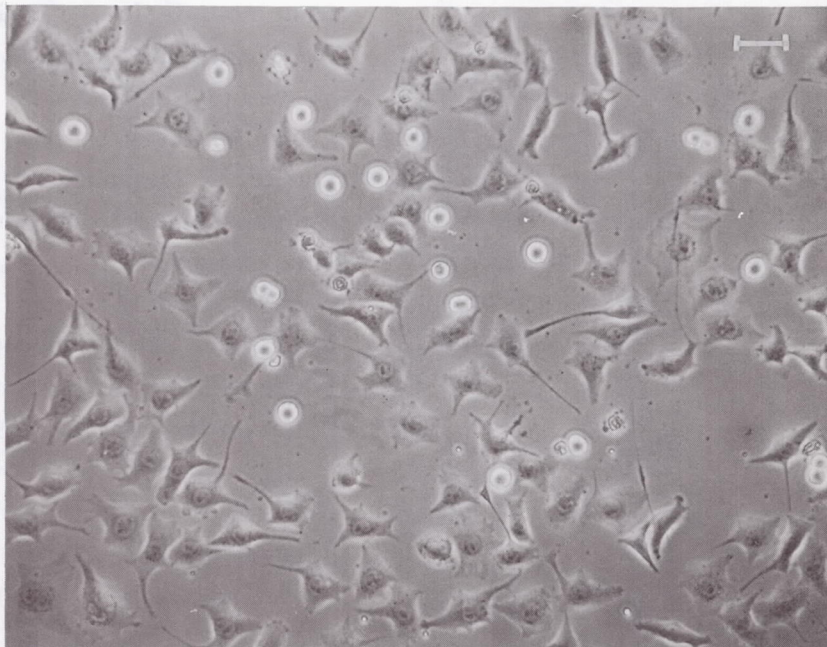
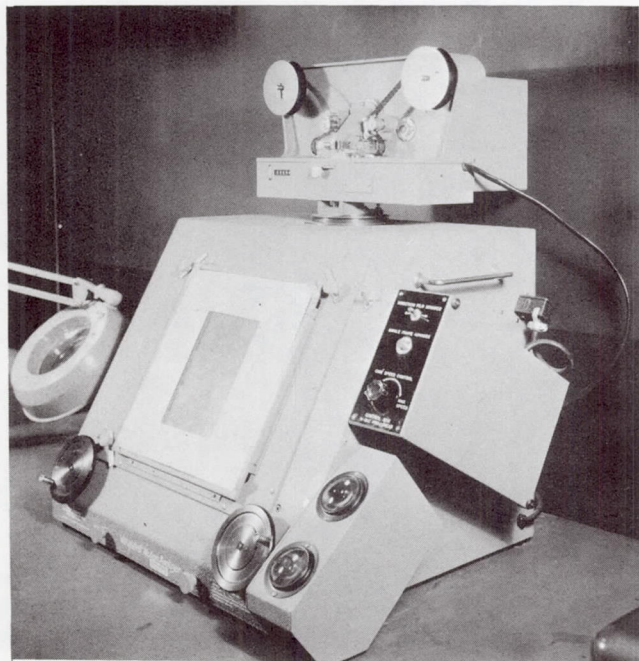

Figure 4.- Micrograph of L-cell field showing several cells in rounded state at onset of mitosis. Calibration: 20 μ . L-68-10,028

studies of the rounding-up process with phase-contrast optics at high magnification, where various cellular organelles and components (including chromosomes) are clearly visible, have indicated that the completion of the cell rounding up coincides essentially with the beginning of metaphase (spindle formation). In time-lapse film projections of cell rounding up, the morphological changes occur so rapidly at rounding up and are so striking, that the occurrence of rounding up serves as an excellent criterion for quickly and accurately establishing the time of mitosis onset for each cell in a recorded field. In effect, the rounding-up phenomenon in time-lapse recording identifies essentially the same point in the mitotic period as does the conventionally used colchicine metaphase block. With time-lapse recording, however, it is possible to establish the precise time of any desired point of metaphase (to within an accuracy of 1 minute or even less) for every dividing cell in the field.

Film-analysis procedure.- The time-lapse films are analyzed with the aid of a Vanguard Motion Analyzer with the M-16C projection head (fig. 5) to establish the time of maximum mitotic activity and the degree of synchrony induced by 5-AU. The film is mounted in the analyzer and projected on the ground-glass screen, which has been ruled in such a manner that the projected frame image (that is, the filmed cell field) is divided into six equal parts (fig. 6). The thin lines in this figure are movable crosshairs for further subdivision of the field. This figure is an actual-size reproduction of a typical 16-millimeter time-lapse frame as viewed on the analyzer. At the start of a film analysis, the five-digit frame counter of the analyzer is preset so that the subsequent frame number of each successive frame as it appears on the counter gives the actual time in minutes (from time $t = 0$) to which the frame corresponds. Starting with the first test frame of the film, a count is made of all cells in the first of the six ruled areas (that is, block I in fig. 6) on the viewing screen; the entire film is then run through, using the variable speed control of the analyzer, and the exact time of rounding-up completion is read from the counter and tabulated for each cell of the area. The process is then repeated in



L-68-10,029
Figure 5.- Vanguard Motion Analyzer used for determining degree of synchrony from time-lapse films.

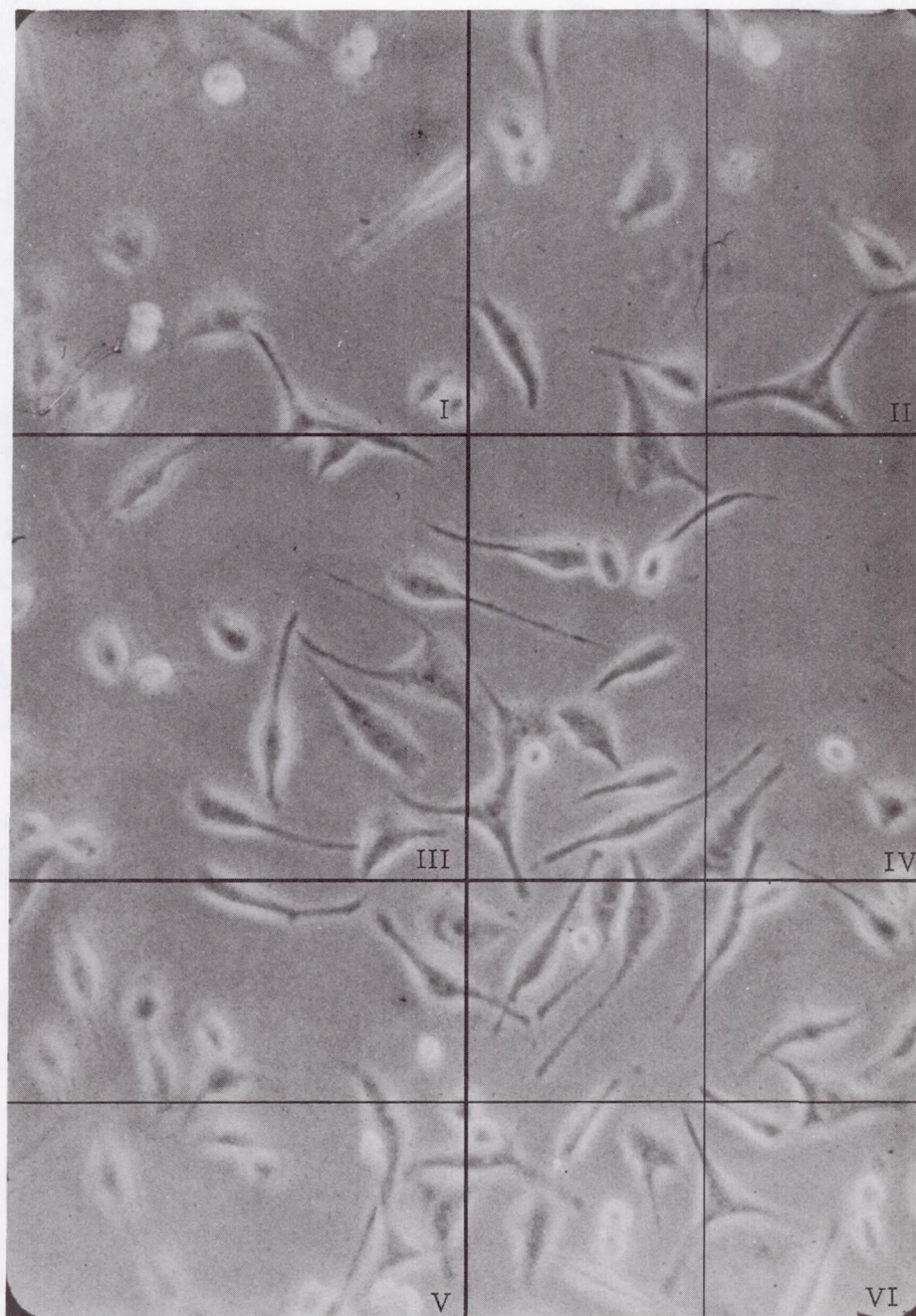

L-68-10,030
Figure 6.- Actual size screen image of time-lapse film frame. Thin lines are movable coordinates of Vanguard Motion Analyzer.

turn for each of the other five areas (blocks II to VI) to yield a complete tabulation for the entire field. In occasional cases, where cell density is heavy, the movable x,y coordinate lines of the analyzer (thin lines in fig. 6) are used to subdivide further the individual areas so as to facilitate the counting and tabulation procedure. Similarly, when the cell density is low, the x,y coordinate lines can be used alone to divide the field into four parts or less.

In practice, film readout can be accomplished quite rapidly when using cell rounding up as the criterion for division onset. The time-lapse process offers a considerable savings in time and simplification in procedure compared with the conventional colchicine metaphase-block technique for determining rates of mitotic activity, since only one test chamber of cells is required for an entire synchronization determination. Film readout is confined to the analysis of only one field of dividing cells, and experimental results can be quickly tabulated since only the cell round ups are scored and these are easily discernible. Working times for typical synchrony effectiveness tests by the time-lapse and fixation-stain techniques are 1.5 and 48 hours, respectively, as determined by actual experimental comparisons. In addition, the time-lapse technique has the advantage that precisely the same cell population is followed throughout the test, thus precluding spurious changes in culture conditions which may occur when using separate cultures for each time interval.

RESULTS AND DISCUSSION

Experimental data on the synchronization effectiveness of 5-AU on L-strain cells as determined by the time-lapse method discussed previously are presented in figures 7 to 9 in the form of mitotic frequency-distribution histograms. These histograms give the percentage of the total cell population dividing within each time interval Δt , as a function of time after removal of the 5-AU medium ($t = 0$). The ordinate values (percent of total cells dividing per interval) are given by

$$\frac{\Delta N_d}{N_0} \cdot 100$$

where ΔN_d is the number of cells dividing in the interval Δt , and N_0 is the total number of cells in the test field at time $t = 0$. For the purposes of this paper, the mitotic frequencies of all graphs have been averaged over a time interval $\Delta t = 1.0$ hour.

Control Cultures

The mitotic histograms for three representative tests with untreated (control) cultures of L-cells are presented in figure 7; the histogram resulting from the average of these three tests is shown at the bottom of the figure. The frequency values for hours 20 through 28 are based on the total cells in the field at time $t = 20$ hours, since the average cycle period of the L-strain used is 20 hours. (See appendix.) It should be noted that the

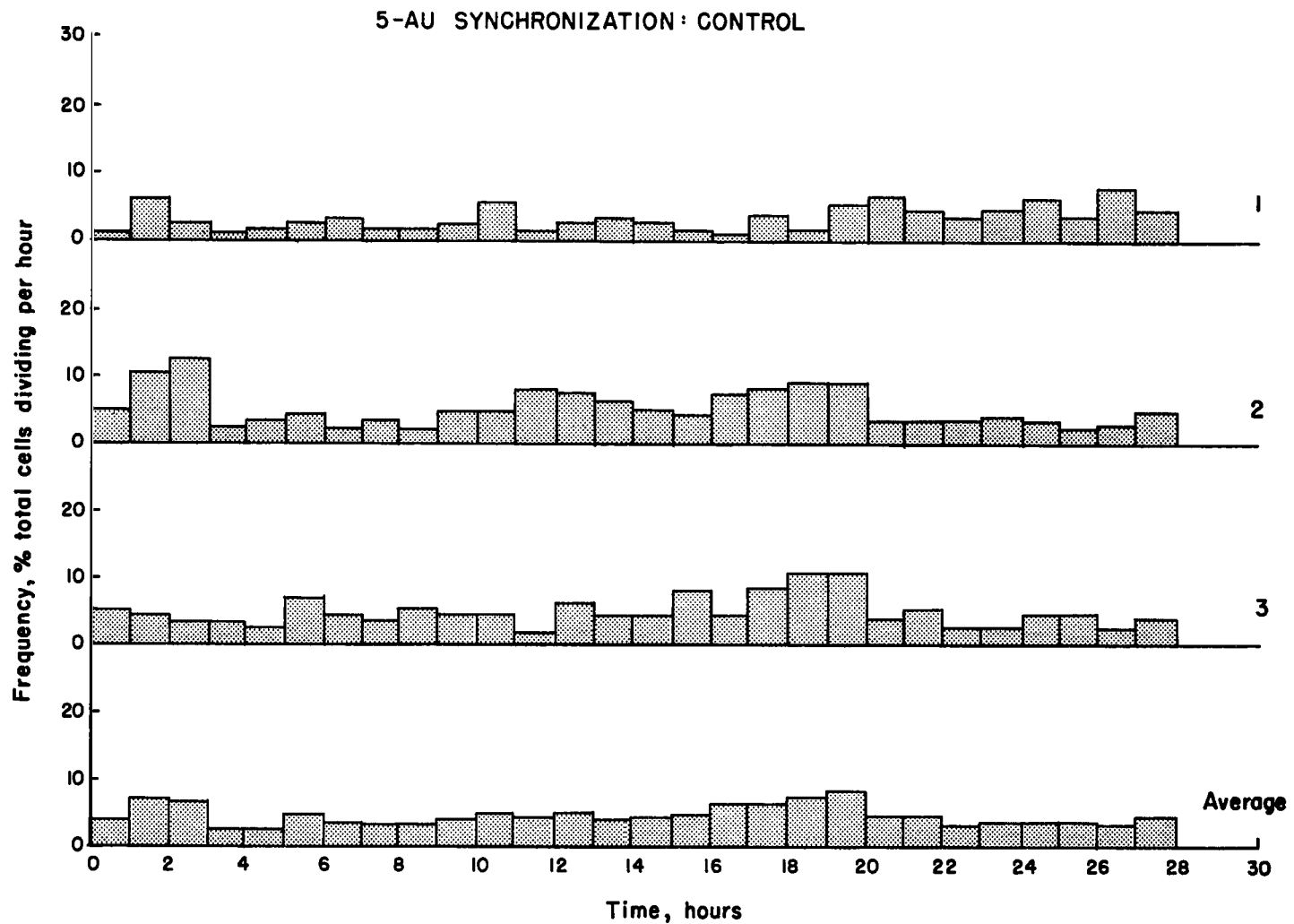

Figure 7.- Histograms of mitotic round-up frequency of unsynchronized control cultures. Numbers 1, 2, and 3 denote separate test cultures; average of three tests is given by bottom histogram. Average is based on analysis of 402 cells.

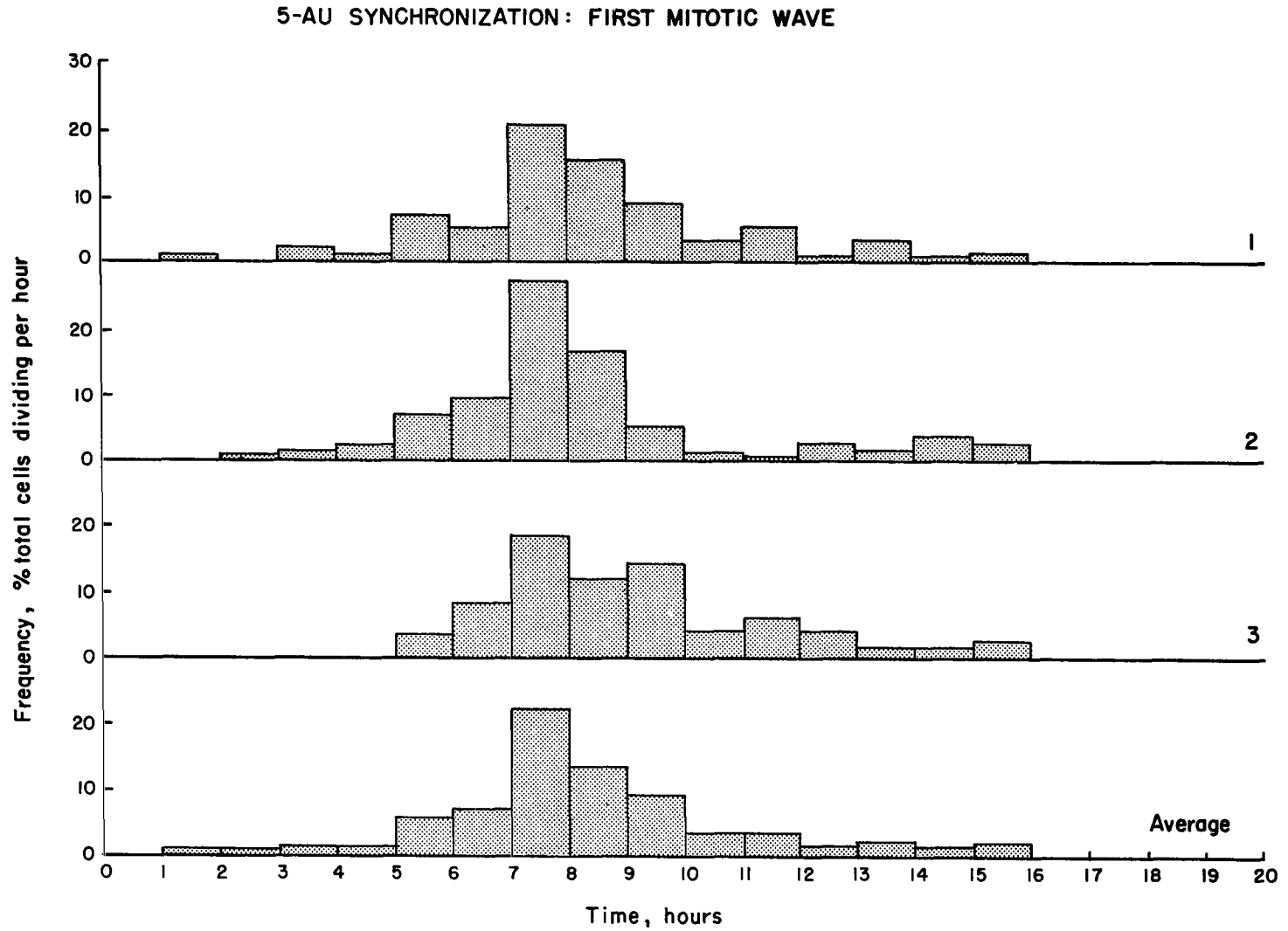

Figure 8.- Histograms of mitotic round-up frequency during first mitotic wave of 5-AU synchronized cells. Numbers 1, 2, and 3 denote separate test cultures; average of three tests is given by bottom histogram. Average is based on analysis of 485 cells.

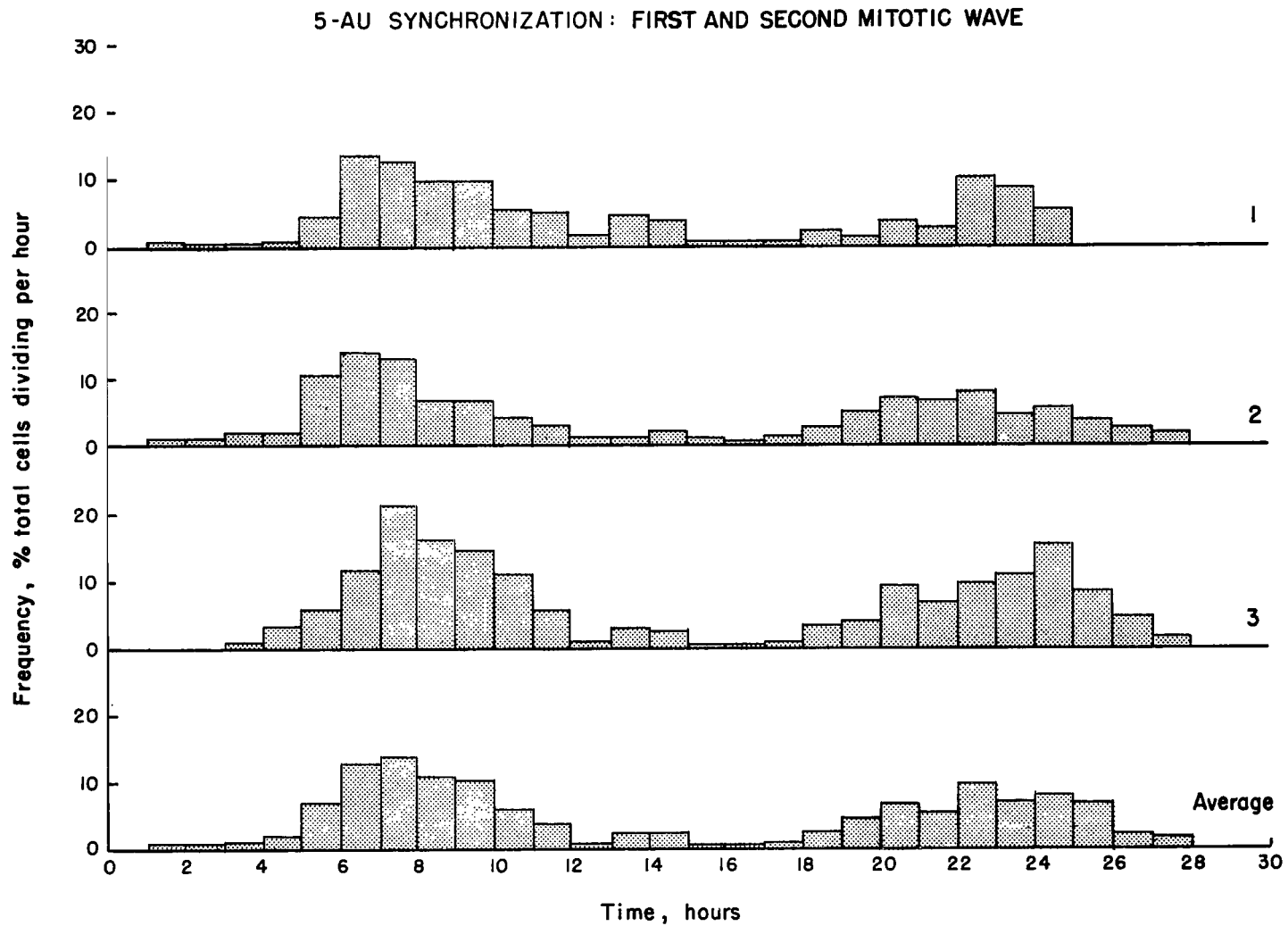

Figure 9.- Histograms of mitotic round-up frequency during first and second mitotic waves of 5-AU synchronized cells. Numbers 1, 2, and 3 denote separate test cultures; average of three tests is given by bottom histogram. Average of second wave is based on analysis of 860 cells.

cumulative mitosis percentage for the first 20-hour period is slightly more than 100 because a few cells divided twice during the interval, their period being somewhat less than the average of 20 hours. These representative results clearly indicate that mitoses proceed in an essentially random manner in large fields of untreated cultures. The expected value of $100 \Delta N_d / N_0$, averaged over 1-hour intervals for purely random division of L-cells (which have an average generation cycle period of 20 hours) is 5.0; the average experimental frequency value of 4.4 (fig. 7) agrees reasonably well with this theoretical value, especially when considering the finite numbers of cells upon which the experimental histograms are based.

Synchronized Cultures

First mitotic wave synchronization.- Figure 8 presents three representative histograms of the first mitotic wave for cells treated with 5-AU according to the foregoing synchrony procedure; the histogram average of these results is shown at the bottom of the figure. Since all tests were carried out in accordance with the same procedure, the results can be directly averaged. Hence the ensuing discussion relates to the characteristics of the average histogram of figure 8. Two features of the frequency distribution of this figure are of primary interest: the time of maximum mitosis onset t_d and the duration of the time interval over which division initiations occur. The second factor, as discussed in detail in the following section, serves as an especially appropriate criterion for quantitatively defining the "degree of synchrony" induced by the 5-AU treatment.

Figure 8 shows that the peak mitotic onset (that is, the modal value of the distribution) occurs at 7.5 hours after 5-AU removal. The individual curves of figure 8 show that each of these possesses essentially this same value of t_d , thus indicating that the time of maximum mitotic onset is quite reproducible. Because this period (0 to t_d) is less than the combined S- and G₂-period (9.0 hours) for the normal cycle of the L-strain (see fig. A-1 of appendix), some synthesis of DNA is perhaps proceeding during the period of 5-AU treatment in analogy with Chu's data for hamster cells and Mattingly's data for plant cells (ref. 5), or else the events of the S- and/or G₂-periods are accelerated.

In regard to the interval over which mitosis initiations occur, figure 8 shows that the first substantial number of mitoses begins at time $t = 5$ hours and continues for a period of 7 hours (up to $t = 12$ hours). The time interval for the first onset of mitoses (5 hours) is roughly equal to the normal G₂-period of 3 hours for L-cells, and hence the first divisions may be due to cells which were in the G₂-period during the treatment interval. In fact, a few random divisions occurred even between $t = 0$ and $t = 5$ hours; these divisions were possibly due to cells which had moved well into the G₂-period by the time of 5-AU removal. Alternately, the DNA synthetic rate may be increased above the normal rate following removal of the 5-AU blockage.

Second mitotic wave synchronization.- The results of a test series to determine the nature of the second wave of mitosis initiations of 5-AU synchronized cells are shown in

figure 9. In each test, the culture was observed continuously for a period of 28 hours after 5-AU removal, and thus figure 9 also includes additional data on the first mitotic wave. It is clear from this figure that not only does a second mitotic wave occur approximately 16 hours after the first wave of mitoses but also that a large amount of the original synchrony is preserved in this second wave. The occurrence of this second wave of mitoses for L-strain fibroblasts is contrary to Chu's observations (ref. 5) on hamster cells, wherein only one synchronous wave appeared following 5-AU treatment. The existence of a second synchronized peak in L-cells is a factor of special importance for certain mitotic studies since it provides a well-synchronized experimental population which has passed through at least one relatively normal cycle after the synchronization treatment. It is interesting to note, however, that the generation time of this second cycle, given by the interval between $t_{d1} = 7.5$ hours and $t_{d2} = 23.5$ hours of figure 9 (16 hours) is somewhat less than the normal cycle time of 20 hours for unsynchronized populations. This shortening of the generation time immediately following removal of a mitotic block has been observed in several cell systems, notably in Tetrahymena (ref. 6), and is attributable to the fact that various metabolic activities associated with cell growth are uninhibited by 5-AU and continue undiminished during the treatment period.

Mitotic activity during continuous treatment.- Mattingly (ref. 5) stated that plant cells under continuous exposure to 5-AU ultimately recovered the ability to divide. In order to determine whether this recovery was also possible for the present L-strain, two cultures were each continuously exposed to 5-AU for a period of 36 hours after the usual synchronization treatment. The 5-AU medium was changed at the end of the first 24-hour treatment period ($t = 0$) and replaced with fresh 5-AU medium to simulate the normal synchronization medium changes. The results of these tests are shown in figure 10. Only a few mitoses occur, and these are randomly distributed over the entire period. Although an attempt at synchronized division at $t = 15$ hours is suggested, no significant onset of mitoses comparable with that following 5-AU removal occurs.

Whereas DNA synthesis and chromosome replication might be surmised to take place even in the presence of 5-AU, thus eventually permitting mitosis to occur, such may not be the case. Although Mattingly refers to the observed divisions in plant cells under continuous treatment as mitotic recovery, it is possible (in view of the findings of Lindner (ref. 7)) that these mitoses were carried out at the expense of the splitting of chromosomes which had not replicated. Lindner (ref. 7) found that in continuous treatment of mouse ascites tumor cells with 5-fluorouracil, DNA synthesis was prevented but mitosis supposedly occurred by the splitting of unreplicated chromosomes. Those mitoses occurring in the present case for L-cells (fig. 10) could also possibly be an example of unreplicated chromosome splitting, although no explicit data are available on actual DNA synthesis during treatment. However, this possibility is made more plausible by the fact that nearly all divisions which did occur were tripolar divisions, indicating at least a splitting of the

5-AU SYNCHRONIZATION: CONTINUOUS TREATMENT

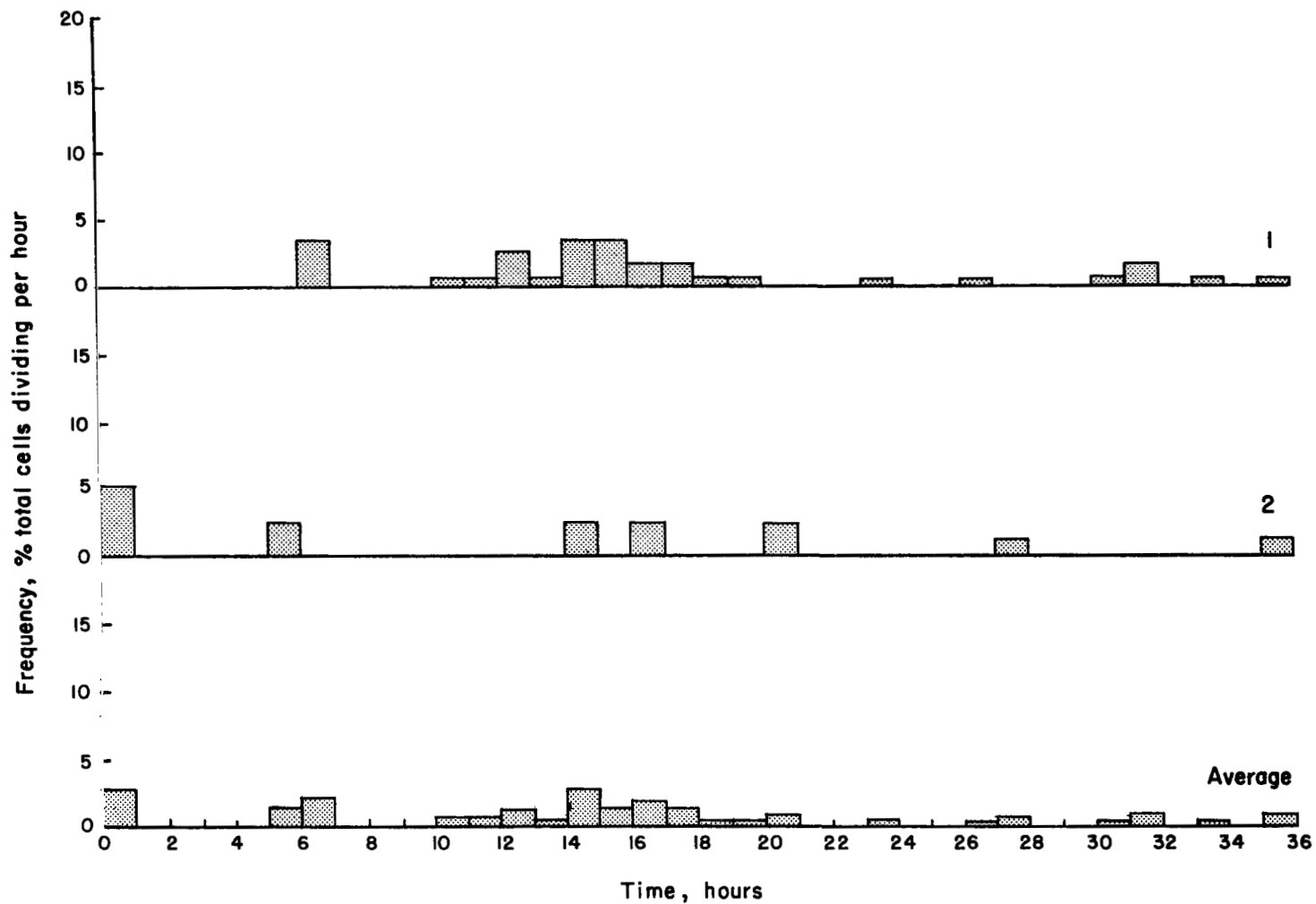

Figure 10.- Histograms of mitotic round-up frequency during continuous exposure to 5-AU. Numbers 1 and 2 denote separate test cultures; average of two tests is given by bottom histogram. Average is based on 227 cells.

cell centrioles during 5-AU treatment. As demonstrated by Mazia and others (ref. 8), tripolar and tetrapolar divisions can proceed without chromosome duplication after mercaptoethanol blockage of cells in metaphase because of centriole splitting, although this does not necessarily imply that the divisions involve chromosome splitting. In view of the apparent similarities between centrioles and centromeres, however, it is conceivable that the chromosomal centromeres also split in a manner similar to that of the centrioles during normal division blockage, and this splitting allows later division at the expense of a reduced DNA-ploidy of the form found by Lindner.

Advantages of Time-Lapse Recording

Since the time-lapse method of determining synchronization effectiveness allows the determination of the precise mitotic history of every cell in a given test field, it is possible to establish directly from the film records how many cells of the initial treated population actually divide following 5-AU removal and thus to discern any permanent or prolonged mitotic arrest effects which may have been induced in any portion of the population by the 5-AU treatment. Likewise, any abnormal or adverse mortality percentages associated with the treatment can also be determined. In some cases, because of unknown factors, untreated cell cultures have demonstrated a tendency to undergo "teloreduplication" (ref. 9) after failure to complete cytokinesis, although metaphase proceeded normally. The time-lapse analysis techniques described herein permit detection of such divisional abnormalities as may be induced by synchronization agents, quickly and quantitatively. In general, the time-lapse films of 5-AU synchronization reported herein for L-cells indicated that an average of 18.2 percent of a given initial cell field did not divide during the first mitotic wave (that is, during the first 16 hours) following 5-AU treatment; this percentage figure includes 2.2 percent of the initial cells which died during the period.³ The corresponding percentage figures for control cultures over a generation period (20 hours) are 2.0-percent total nondividing, all of which are due to cell death. Differentiation between living and dead nondividing cells generally cannot be readily discerned with the usual fixation-stain techniques.

QUANTITATIVE EXPRESSION OF DEGREE OF SYNCHRONY

General Considerations

Various indices have been used in the past to express the level of mitotic activity in cell populations. Two of the more commonly used ones, the mitotic index and the mitotic coefficient, are defined as follows:

³Cell death is easily detected in time-lapse recordings by the violent blebbing of the cell membrane followed by sudden collapse and cessation of all motion.

Mitotic index (MI)	Number of cells entering division in a stated time interval per 100 total cells
Mitotic coefficient (MC)	Number of cells in some stage of division per 100 total cells at a given instant of time

In general, these two indices have been used primarily for denoting the state of mitotic activity in tissues of various types, in vivo, and are determined from cell counts of fixed tissue sections. However, the mitotic index is also suitable for describing activity in cell cultures in vitro. The mitotic histogram presentations in this paper are in the form of the mitotic index of the test population (based on a 1-hour time interval) graphed as a function of time. The particular definition of the mitotic index stems, in part, from the conventional use of colchicine (or similar agents) to block dividing cells in metaphase by preventing spindle formation, and thereby allowing dividing cells to accumulate in this mitotic phase. By making the period of colchicine treatment correspond to the desired time interval in the definition of the mitotic index, a count of the number of metaphase cells per 100 total cells yields the mitotic index directly. Unfortunately, the mitotic index and the mitotic coefficient are often used interchangeably, with considerable resulting confusion. For purposes of this paper, the preceding definitions are strictly adhered to.

While the variation of the mitotic index with time gives a general indication of the relative degree of synchrony introduced in cell cultures by various agents, it is desirable for purposes of comparison to define a more explicit criterion which yields a quantitative numerical index for indicating relative synchronization effectiveness. By means of such an index, the sometimes ambiguous term "degree of synchrony" can be given a precise and useful meaning.

Experimental Errors Due to Imperfect Synchrony

The idealized goal of synchrony induction in vitro, by any means, is the production of a population, all cells of which upon release from the mitotic block: (1) proceed into division in a completely normal morphological and metabolic condition, and (2) approach mitosis in complete metabolic synchrony with subsequent simultaneous division. This second condition may be visualized as the limit denoted in figure 11, where the width of the mitotic-rate histogram (represented by a single bar) continually decreases ($\Delta t \rightarrow 0$) while the mitotic index $\frac{100 \Delta N_d / N_0}{\Delta t}$ increases, with $\Delta N_d / N_0$ approaching 1.0. In practical applications, the relative seriousness of deviations from either or both of these ideals depends on the particular experimental use which is intended for the resulting synchronized population. For studies involving elucidations of various normal metabolic and physical variations in cell properties associated with mitosis preparation and execution, it is desirable to approach ideal synchrony as closely as possible.

The effects of deviations from ideal synchrony in regard to the simultaneity of division are clearly evident from the hypothetical mitotic frequency distribution illustrated in figure 12. The time of maximum mitosis onset (that is, the modal value of the distribution) occurs at $t = t_d$ as shown. If it is desired to measure the value of a particular cell property (such as cell volume) at the state or condition corresponding to the time t_d , for example (that is, at the time of cell rounding up), such measurements made on a

population of synchronized cells at $t = t_d$ will include values not only for cells which are actually in the rounding-up stage, but also for numerous cells which have been rounded up for various lengths of time and for cells which are at various stages prior to round up. Thus, of all the cells measured at $t = t_d$ a portion will actually have already rounded up

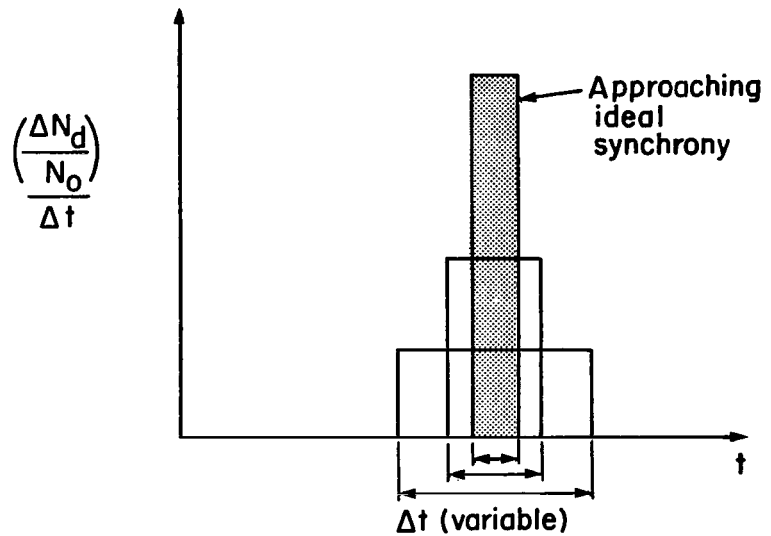

Figure 11.- Schematic illustration of approach to temporally ideal synchrony.

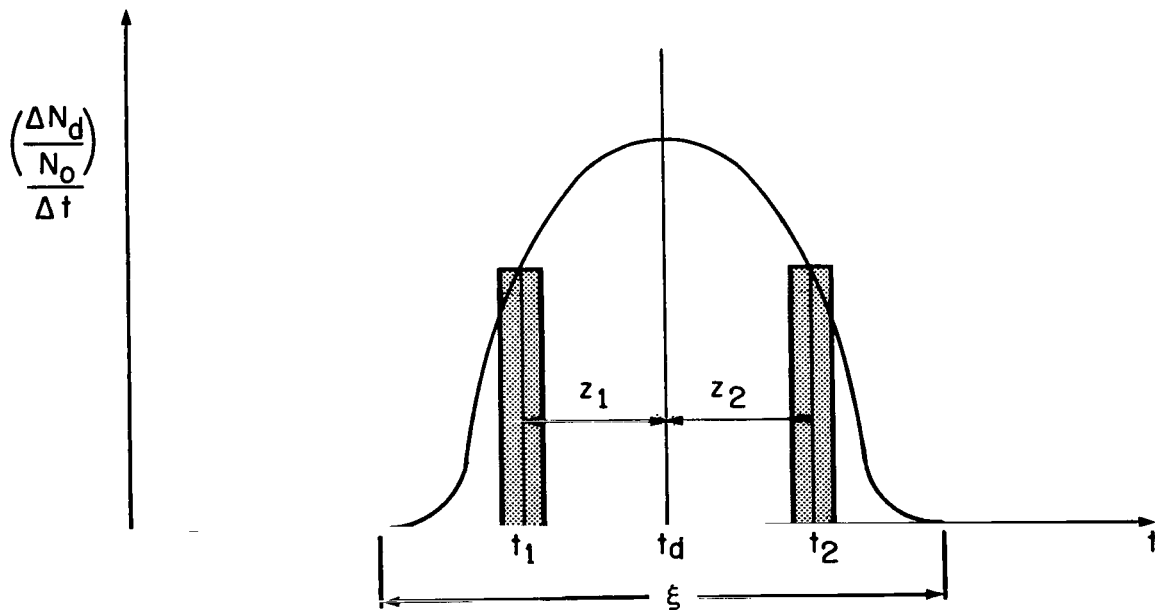

Figure 12.- Schematic illustration of sources of error accompanying deviation from temporally ideal synchrony.

at time t_1 and hence at time t_d are really in a state corresponding to a time z_1 -hours past round up. Likewise, another portion of the cells will be in a state corresponding to a time t_2 , or z_2 -hours prior to rounding up. An appreciable spread in the mitotic frequency distribution obviously results in a corresponding number of erroneous contributions to the overall measurements at condition t_d .

If the particular property being measured has a variation with time which is either increasing or decreasing linearly at time t_d , the erroneous contributions (that is, the high and low valued measurements) will tend to average out to the true value, provided the distribution is essentially symmetrical about $t = t_d$ and the linearity extends over a period of time approaching that of the frequency-distribution spread denoted in figure 12 by ξ . (For the present, ξ is assumed to be the total spread of the mitosis onset range.) If, however, the distribution is not symmetrical, or the variations are not linear, or if the distribution passes through a maximum or minimum in the interval ξ , values measured at t_d will be erroneous by an amount which increases continuously with increases in ξ . Hence, the degree of error to be expected in experimental measurements of various cell properties in the neighborhood of t_d depends upon the particular property being measured and the nature of its variation in the vicinity of t_d . If the mitotic frequency distribution is assumed to be also valid as a frequency distribution of the general metabolic synchrony of the cell, at least in the general neighborhood of the mitotic interval (that is, the population is locally cycle-synchronized as well as division-synchronized), then the same conditions on ξ as previously outlined for the cell state corresponding to time t_d apply equally well to conditions and states at any other time t in the neighborhood of t_d .

In general, the data of the present paper indicate that the mitotic frequency distribution obtained with 5-AU is roughly symmetrical about t_d , the time corresponding to maximum frequency of mitotic onset. Hence, the average or mean time for cell rounding up with 5-AU is also approximately the time of maximum rounding-up frequency t_d .

The Mitotic Synchronization Index

In view of the foregoing considerations, the magnitude of the mitotic frequency-distribution spread is clearly a criterion of considerable importance in determining the relative suitability of various synchronization methods for particular experimental studies, and can therefore serve as an effective index of the degree of synchrony. Hence, for purposes of quantitative comparison of the temporal aspect of synchronization effectiveness of various agents and treatments, the mitotic synchronization index is defined as

$$\text{Mitotic synchronization index (MSI)} = \frac{T}{\xi}$$

where

T normal cell generation period

ξ time spread of experimental mitotic frequency distribution

In practice, T could be any characteristic time period associated with the normal cell cycle, such as the durations of the G_1 - or S-periods, as long as the same period is used for all test comparisons in a given set. However, the cycle period T serves as a convenient standard for most comparisons and, when used in defining the MSI, gives a direct indication of the mitotic spread in terms of the cell cycle. The particular reason for defining the MSI as T/ξ instead of the reciprocal ξ/T is to obtain increasingly larger values of the index as the degree of synchrony increases. Thus an MSI value of 2 for a given synchronizing agent indicates that the mitotic synchronization wavelength extends over half a normal cycle and, hence, that this agent is not nearly as effective as one producing an MSI of 10. The MSI of an unsynchronized culture, of course, has the theoretical value of 1.0. Perfect synchrony is characterized by $MSI = \infty$.

Like the definition of T , that of ξ is also somewhat arbitrary provided the same definition is applied in all cases in a given set of tests. A convenient definition for ξ is the total spread of the experimental frequency distribution which includes all dividing cells. Since the total spread is difficult to determine in some cases because of the gradual dropoff of the distribution curve, some more definite criterion, such as the time difference between the fifth and ninety-fifth percentiles of the cumulative distribution $\xi = P_{95} - P_{05}$ is generally more convenient to use. In the case of symmetrical or near-symmetrical distributions, the standard deviation of the distribution serves as an excellent quantitative definition of ξ , and this definition is used as the criterion for expressing the MSI of the distributions in this paper. The MSI may be used not only for comparison of various synchronizing treatments on the same cell line, but for comparing the effects of a given treatment on different cell lines.

On the basis of the cycle period of 20 hours for L-strain cells, and by using the experimental value of the standard deviation for ξ , the MSI of the 5-AU synchronization procedure discussed herein (fig. 9) is 7.9 for the first mitotic wave and decreases to 6.3 for the second.

CONCLUDING REMARKS

The use of 5-AU as an agent for mitotic synchronization of L-strain fibroblasts appears to produce adequate synchronization for many experimental purposes, particularly

those involving morphological observations of premitotic and mitotic cells. The particular synchronization procedure employed results in the maintenance of a clearly distinguishable degree of synchrony through the second division period. The procedure described herein for utilization of time-lapse recording as a means of determining the synchronizing efficiency of various treatments offers a great savings of time over conventional cytological methods and has the additional advantage that a permanent time history is obtained for every cell in a test field.

Although the time-lapse recording and analysis procedures outlined in this paper are discussed in terms of their use for determining the effectiveness of various synchronization agents and techniques used in preparing synchronous cultures for experimental purposes, the method is also directly applicable to recording of experimental results from the actual mitotic studies. For example, the method has been found to be very useful for quantitative studies of the effectiveness of various mitotic inhibitors and for determining the specific times in the generation cycle where cells are most sensitive to the action of various toxicological agents, including ionizing radiations. The technique thus makes it possible to pinpoint quite accurately the state of maximum damage sensitivity and can lead to more rational and selective approaches to the study of mitotic damage mechanisms. For such uses, the time-lapse procedure offers several substantial advantages compared with conventional cytological techniques used for similar investigations.

Langley Research Center,
National Aeronautics and Space Administration,
Langley Station, Hampton, Va., November 13, 1968,
129-02-05-05-23.

APPENDIX

BACKGROUND AND CHARACTERISTICS OF L-STRAIN MOUSE CELLS

Historical Background

The L-strain of mouse fibroblasts was originally established by Earle and his coworkers at the National Cancer Institute (NCI) from connective tissue of C₃H mice in 1940, but was first announced in the literature in 1945 (ref. 10). This strain was one of several such lines originally initiated for use in studies of chemical carcinogenesis in vitro and was early converted to the malignant state by treatment with methylcholanthrene. Although most of the cell lines used in these initial studies at NCI were eventually discarded, the original L-strain was maintained until March 1948. At that time, a single clone (NCTC-929) was derived from the original L-strain, and the original cell line was discarded. The L-strain, clone 929, has been maintained continuously, and its descendant populations are now routinely used in many laboratories.

The particular population of L-cells covered in this paper has been maintained and utilized for research purposes at the MBL since 1965, when it was initiated as a clone derived directly from Earle's original clone NCTC-929 obtained from NCI.

Characteristics

Morphology.- L-strain cells exhibit characteristic fibroblastic morphology and are quite mobile in sparse cultures. The MBL cultures contain a small percentage of mononucleate and multinucleate giant cells which apparently are formed by teloreduplication. A discussion of some further morphological and behavioral characteristics of the L-strain as observed in time-lapse cinemography are given in references 11 to 13.

Generation cycle.- The generation period of the L-strain fibroblast is 20 hours (refs. 14 and 15). The duration of the cycle phases, as given by these same references, are illustrated graphically in figure A-1.

Figure A-2 presents a cycle-period frequency distribution for the MBL population of L-cells, as determined by time-lapse observations. The average period corresponds closely to the 20-hour period previously cited.

Chromosome number.- The modal chromosome number of the L-cell population covered by this paper is 67.

Culture medium.- The MBL stock population of L-cells is maintained continuously on Eagle's minimum essential medium, Hank's base, supplemented with 10-percent horse serum.

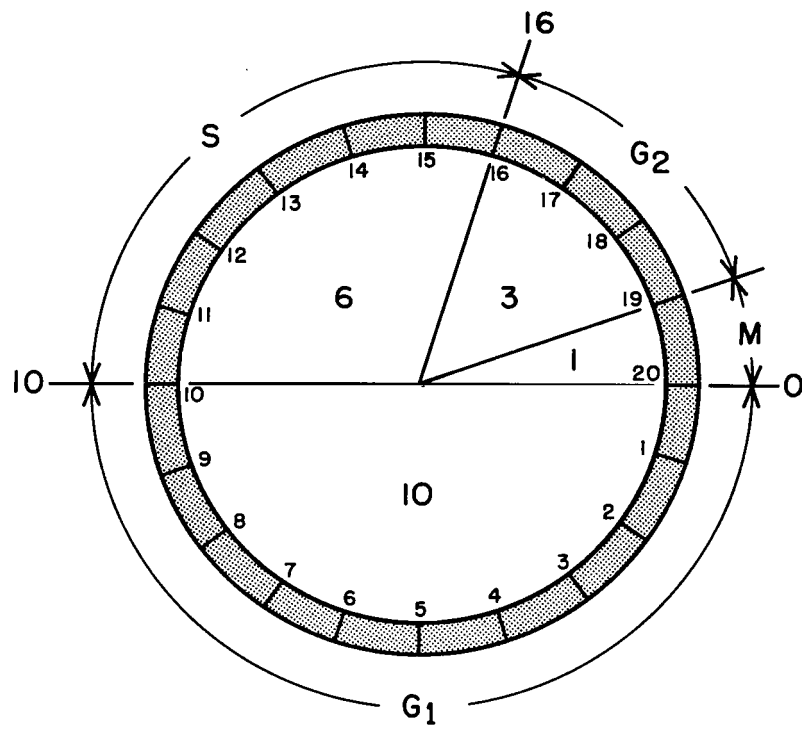

Figure A-1.- Phase-duration distribution of generation-cycle period of L-strain mouse fibroblast.

GENERATION CYCLE PERIOD DISTRIBUTION

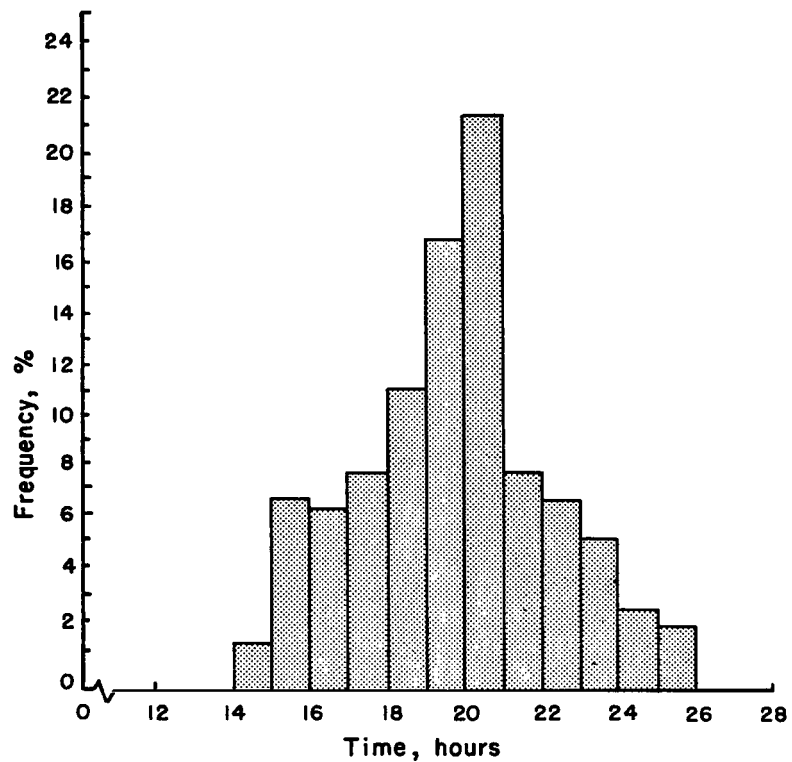

Figure A-2.- Generation-cycle-period distribution for MBL population of L-strain mouse fibroblasts. Taken from time-lapse observations.

REFERENCES

1. Dunn, D. B.; and Smith, J. D.: Occurrence of a New Base in the Deoxyribonucleic Acid of a Strain of Bacterium Coli. *Nature*, vol. 175, no. 4451, Feb. 19, 1955, pp. 336-337.
2. Duncan, Robert E.; and Woods, Philip S.: Some Cytological Aspects of Antagonism in Synthesis of Nucleic Acid. *Chromosoma*, Bd. 6, 1953, pp. 45-60.
3. Smith, Harold H.; Fussell, Catharine P.; and Kugelman, Bertha H.: Partial Synchronization of Nuclear Divisions in Root Meristems with 5-Aminouracil. *Science*, vol. 142, no. 3592, Nov. 1, 1963, pp. 595-596.
4. Jakob, K. M.; and Trosko, J. E.: The Relation Between 5-Amino Uracil-Induced Mitotic Synchronization and DNA Synthesis. *Exp. Cell Res.*, vol. 40, 1965, pp. 56-67.
5. Mattingly, Ellen: Synchrony of Cell Division in Root Meristems Following Treatment With 5-Aminouracil. *Cell Synchrony*, Ivan L. Cameron and George M. Padilla, eds., Academic Press, Inc., 1966, pp. 256-268.
6. Scherbaum, O.; and Zeuthen, E.: Induction of Synchronous Cell Division in Mass Cultures of Tetrahymena Piriformis. *Exp. Cell Res.*, vol. 6, 1954, pp. 221-227.
7. Lindner, Anton: Cytochemical Effects of 5-Fluorouracil on Sensitive and Resistant Ehrlich Ascites Tumor Cells. *Cancer Res.*, vol. 19, Feb. 1959, pp. 189-194.
8. Mazia, Daniel; Harris, Patricia J.; and Bibring, Thomas: The Multiplicity of the Mitotic Centers and the Time-Course of Their Duplication and Separation. *J. Biophys. Biochem. Cytol.*, vol. 7, no. 1, 1960, pp. 1-20.
9. Moorhead, Paul S.; and Hsu, T. C.: Cytologic Studies of HeLa, a Strain of Human Cervical Carcinoma. III. Durations and Characteristics of the Mitotic Phases. *J. Nat. Cancer Inst.*, vol. 16, no. 5, Apr. 1956, pp. 1047-1066.
10. Earle, Wilton R.: A Summary of Certain Data on the Production of Malignancy in Vitro. A.A.A.S. Research Conference on Cancer, Forest Ray Moulton, ed., Amer. Ass. Advance. Sci., 1945, pp. 139-153.
11. Cone, C. D., Jr.: Growth of Somatic Cell Clones in Micro Lagoons. *Exp. Cell Res.*, vol. 48, no. 1, Oct. 1967, pp. 212-216.
12. Cone, Clarence D., Jr.; and Peddrew, Kathryn H.: A Micro Lagoon Technique for the Culture and Observation of Isolated Mammalian Cells. NASA TN D-4906, 1968.
13. Cone, Clarence D., Jr.: Observations of Self-Induced Mitosis and Autosynchrony in Sarcoma Cell Networks. *Cancer Res.*, vol. 28, Oct. 1968, pp. 2155-2161.

14. Stanners, C. P.; and Till, J. E.: DNA Synthesis in Individual L-Strain Mouse Cells. *Biochim. Biophys. Acta.* vol. 37, 1960, pp. 406-419.
15. Whitmore, G. F.; Stanners, C. P.; Till, J. E.; and Gulyas, S.: Nucleic Acid Synthesis and the Division Cycle in X-Irradiated L-Strain Mouse Cells. *Biochim. Biophys. Acta*, vol. 47, 1961, pp. 66-77.