

69 27767

NASA CR98445



**DEPARTMENT
OF
ELECTRICAL ENGINEERING**

CONTRACT NAS8-20399

TECHNICAL REPORT

A COMPARATIVE ANALYSIS OF THE DECOUPLING EFFECTS
IN A
MAGNETIC FORMING BERYLLIUM COIL ASSEMBLY

**ENGINEERING AND
INDUSTRIAL RESEARCH STATION**

**CASE FILE
COPY**

**MISSISSIPPI STATE UNIVERSITY
STATE COLLEGE, MISSISSIPPI**

Contract NAS8-20399

A COMPARATIVE ANALYSIS OF THE DECOUPLING EFFECTS
IN A
MAGNETIC FORMING BERYLLIUM COIL ASSEMBLY

TECHNICAL REPORT

By

J. W. Rogers, D. D. Wier,

and L. D. Bennett

August, 1968

PRINCIPAL INVESTIGATOR

J. W. Rogers
Assistant Professor
Department of Electrical Engineering
Mississippi State University
Drawer EE, State College, Mississippi
Telephone: 601+323-4321, Ext. 396

Contract NAS8-20399

A COMPARATIVE ANALYSIS OF THE DECOUPLING EFFECTS
IN A
MAGNETIC FORMING BERYLLIUM COIL ASSEMBLY

By

J. W. Rogers, D. D. Wier,
and L. D. Bennett

Department of Electrical Engineering
Mississippi State University
State College, Mississippi

ABSTRACT

A beryllium coil assembly developed by the National Aeronautics and Space Administration, George C. Marshall Space Flight Center in Huntsville, Alabama, was analyzed. The purpose of the hammer coil is to reduce work hardening and metal fatigue.

The purpose of this study was to determine the currents and forces developed in a coil and plate assembly where the plate was stationary and moving.

The mutual coupling between hammer coil and plate was first determined by the aid of the digital computer. This was found to be a decaying exponential as a function of distance of separation. Next, the differential equations were written for a one, two, three, and

four ring hammer. Then the currents were determined by solving these equations by a Runge-Kutta digital computer program. Finally the forces were determined.

TABLE OF CONTENTS

Chapter	Page
PREFACE	iii
LIST OF TABLES	vi
LIST OF FIGURES	vii
I. INTRODUCTION	1
II. MODELING THE SYSTEM	3
III. ANALYSIS OF THE MODELED SYSTEM	8
A. Formulation of Voltage Equations	8
B. Determination of Model Parameters	11
C. Formulation of Force Equation	14
D. Method for Solving for Currents and Forces	15
IV. RESULTS AND CONCLUSIONS	18
ABSTRACT	36
APPENDICES	37
Appendix A--Calculation of k for Elliptic Integrals.	38
Appendix B--Calculation of Mutual Coupling	39
Appendix C--Calculation of Hammer Coil and Plate Currents	40
Appendix D--Function Statements for a One Ring Coil.	44
Appendix E--Function Statements for a Two Ring Coil.	46
Appendix F--Function Statements for a Three Ring Coil	50
Appendix G--Function Statements for a Four Ring Coil	57

TABLE OF CONTENTS (Continued)

	Page
Appendix H--Calculation of Forces	73
Appendix I--Plots of Mutual Coupling Versus Distance.	74
REFERENCE	93
BIBLIOGRAPHY	94

LIST OF TABLES

Table	Page
1. Calculated Values of the Mutual Coupling and Time Rate of Change of the Mutual Coupling Necessary to Determine the Currents of a One, Two, Three, and Four Ring Hammer Coil	19
2. Computed Values of Elliptic Integrals and the Constant Mutual Coupling for a Four Ring Hammer Coil	20
3. Tabulated Values of the Radius, Inductance, and Resistance of the Four Inner Rings of the Hammer Coil and the Resistance of the Corresponding Four Rings of the Plate. .	21

LIST OF FIGURES

Figure	Page
1. An Illustration of a Four Ring Hammer Coil and Plate Assembly	4
2. Equivalent Circuit of an N Turn Hammer Coil and Plate Assembly	6
3. Diagram of Two Concentric Rings Used to Calculate Mutual Coupling Between Hammer Coil and Plate	12
4. Diagram Illustrating the Force of Repulsion Between a Ring in the Hammer Coil and Plate	16
5. Computed Values of Currents Versus Time for a One Ring Hammer Coil and Moving Plate	23
6. Computed Values of Currents Versus Time for a One Ring Hammer Coil and Stationary Plate	24
7. Computed Values of Currents Versus Time for a Two Ring Hammer Coil and Moving Plate	25
8. Computed Values of Currents Versus Time for a Two Ring Hammer Coil and Stationary Plate	26
9. Computed Values of Currents Versus Time for a Three Ring Hammer Coil and Moving Plate	27
10. Computed Values of Currents Versus Time for a Three Ring Hammer Coil and Stationary Plate	28
11. Computed Values of Currents Versus Time for a Four Ring Hammer Coil and Moving Plate	29
12. Computed Values of Currents Versus Time for a Four Ring Hammer Coil and Stationary Plate	30
13. Plot of the Forces Developed in a One Ring Hammer Coil and Plate When the Plate is Both Stationary and Moving	32
14. Plot of the Forces Developed in a Two Ring Hammer Coil and Plate When the Plate is Both Stationary and Moving	33
15. Plot of the Forces Developed in a Three Ring Hammer Coil and Plate When the Plate is Both Stationary and Moving . .	34

LIST OF FIGURES (Continued)

Figure	Page
16. Plot of the Forces Developed in a Four Ring Hammer Coil and Plate When the Plate is Both Stationary and Moving for Ring Radii of $r_1 = 1.202$, $r_2 = 1.475$, $r_3 = 1.748$, and $r_4 = 2.021$ cm.	35
17. Plot of the Forces Developed in a Four Ring Hammer Coil and Plate When the Plate is Both Moving and Stationary for Ring Radii of $r_1 = 1.20$, $r_2 = 2.56$, $r_3 = 3.93$, and $r_4 = 5.29$ cm.	37
I-1. A Plot of the Mutual Coupling Between Ring One of the Hammer Coil and Ring One in the Plate and Approximate Fitted Curve as a Function of Distance of Separation . . .	74
I-2. A Plot of the Mutual Coupling Between Ring One of the Hammer Coil and Ring Two in the Plate as a Function of Distance of Separation	75
I-3. A Plot of the Mutual Coupling Between Ring One of the Hammer Coil and Ring Three in the Plate as a Function of Distance of Separation	76
I-4. A Plot of the Mutual Coupling Between Ring One of the Hammer Coil and Ring Four in the Plate as a Function of Distance of Separation	77
I-5. A Plot of the Mutual Coupling Between Ring Two of the Hammer Coil and Ring Two in the Plate as a Function of Distance of Separation	78
I-6. A Plot of the Mutual Coupling Between Ring Two of the Hammer Coil and Ring Three in the Plate as a Function of Distance of Separation	79
I-7. A Plot of the Mutual Coupling Between Ring Two of the Hammer Coil and Ring Four in the plate as a Function of Distance of Separation	80
I-8. A Plot of the Mutual Coupling Between Ring Three of the Hammer Coil and Ring Three in the Plate as a Function of Distance of Separation	81
I-9. A Plot of the Mutual Coupling Between Ring Three of the Hammer Coil and Ring Four in the Plate as a Function of Distance of Separation	82
I-10. A Plot of the Mutual Coupling Between Ring Four of the Hammer Coil and Ring Four in the plate as a Function of Distance of Separation	83

LIST OF FIGURES (Continued)

Figure	Page
I-11. A Plot of the Mutual Coupling $M_{11} + M_{12}$ as a Function of Distance Used to Analyze a Hammer Coil Consisting of Two Rings	84
I-12. A Plot of the Mutual Coupling $M_{12} + M_{22}$ as a Function of Distance Used to Analyze a Hammer Coil Consisting of Two Rings	85
I-13. A Plot of the Mutual Coupling $M_{11} + M_{12} + M_{13}$ as a Function of Distance Used to Analyze a Hammer Coil Consisting of Three Rings	86
I-14. A Plot of the Mutual Coupling $M_{12} + M_{22} + M_{23}$ as a Function of Distance Used to Analyze a Hammer Coil Consisting of Three Rings	87
I-15. A Plot of the Mutual Coupling $M_{13} + M_{23} + M_{33}$ as a Function of Distance Used to Analyze a Hammer Coil Consisting of Three Rings	88
I-16. A Plot of the Mutual Coupling $M_{11} + M_{12} + M_{13} + M_{14}$ as a Function of Distance Used to Analyze a Hammer Coil Consisting of Four Rings for Ring Radii of $r_1 = 1.202$, $r_2 = 1.475$, $r_3 = 1.748$, and $r_4 = 2.021$ cm.	89
I-17. A Plot of the Mutual Coupling $M_{12} + M_{22} + M_{23} + M_{24}$ as a Function of Distance Used to Analyze a Hammer Coil Consisting of Four Rings for Ring Radii of $r_1 = 1.202$, $r_2 = 1.475$, $r_3 = 1.748$, and $r_4 = 2.021$ cm.	90
I-18. A Plot of the Mutual Coupling $M_{13} + M_{23} + M_{33} + M_{34}$ as a Function of Distance Used to Analyze a Hammer Coil Consisting of Four Rings for Ring Radii of $r_1 = 1.202$, $r_2 = 1.475$, $r_3 = 1.748$, and $r_4 = 2.021$ cm.	91
I-19. A Plot of the Mutual Coupling $M_{14} + M_{24} + M_{34} + M_{44}$ as a Function of Distance Used to Analyze a Hammer Coil Consisting of Four Rings for Ring Radii of $r_1 = 1.202$, $r_2 = 1.475$, $r_3 = 1.748$, and $r_4 = 2.021$ cm.	92
I-20. A Plot of the Mutual Coupling $M_{11} + M_{12} + M_{13} + M_{14}$ as a Function of Distance Used to Analyze a Hammer Coil Consisting of Four Rings for Ring Radii of $r_1 = 1.20$, $r_2 = 2.56$, $r_3 = 3.93$, and $r_4 = 5.29$ cm	93
I-21. A Plot of the Mutual Coupling $M_{12} + M_{22} + M_{23} + M_{24}$ as a Function of Distance Used to Analyze a Hammer Coil Consisting of Four Rings for Ring Radii of $r_1 = 1.20$, $r_2 = 2.56$, $r_3 = 3.93$, and $r_4 = 5.29$ cm.	94

CHAPTER I

INTRODUCTION

The beryllium coil assembly is a device designed, built and utilized at the George C. Marshall Space Flight Center in Huntsville, Alabama. It is used in shaping and smoothing metal material with the advantages of reducing metal fatigue and work hardening as compared to other methods.

The beryllium coil assembly is a spiral shaped coil of wire which is potted in nylon for electrical insulation and strength. This coil is connected to a capacitor discharge unit. When this unit is discharged across the coil a time varying magnetic field will be created by the rapidly changing currents with respect to time. Now suppose that this coil is placed on a sheet of conducting material. Even though the sheet of material or plate is electrically insulated from the coil, a current will be produced in it due to the magnetic field created by the coil. Since the plate current is created by a voltage introduced by the hammer coil, the plate will have a magnetic field due to its current which is in opposition to the magnetic field in the hammer coil. The opposition of these fields causes a repulsion force between the hammer coil and the plate. This force causes rapid acceleration and motion of the plate away from the coil.

The purpose of this study is to calculate the force developed by the beryllium assembly and a metallic sheet of material. In this study this sheet of metallic material will be held stationary as well

as allowed to move. Therefore, the effect of decoupling can be observed. It is the goal of this study to present results that when coupled with previous studies will be beneficial in the development of future beryllium coil assemblies.

CHAPTER II

MODELING THE SYSTEM

Since the hammer coil is of spiral shape, it can be approximated by sixteen concentric rings with different radii. Likewise, it is assumed that the plate can be approximated by sixteen concentric rings which are mirror images of the hammer coil. Moreover, it is assumed that the rings of the coil and plate have radii approximately equal to the radii of the spiral in the actual hammer coil. However, in this study the assumption will be made that the hammer coil and plate is made up of one, two, three, and four rings. The radii of these four rings will be the same as the radii of the four innermost rings of the sixteen ring hammer coil. Figure 1 illustrates the four ring hammer coil and plate assembly.

Since the coil and plate are assumed to be concentric rings, these rings will possess a mutual coupling one with another. In other words, there will be a mutual coupling between each ring in the hammer coil and plate. This mutual coupling will be denoted by M_{nm} where n is the n th ring in the coil and m is the m th ring in the plate. Since the plate is allowed to move in part of this study, these mutual coupling terms will be a function of time. Therefore, the constant mutual coupling terms will be denoted by M'_{nm} where n is the n th ring and m is the m th ring in the coil or plate.

Each ring of the coil and plate will also have a self inductance and resistance. This resistance is actually the resistance of the

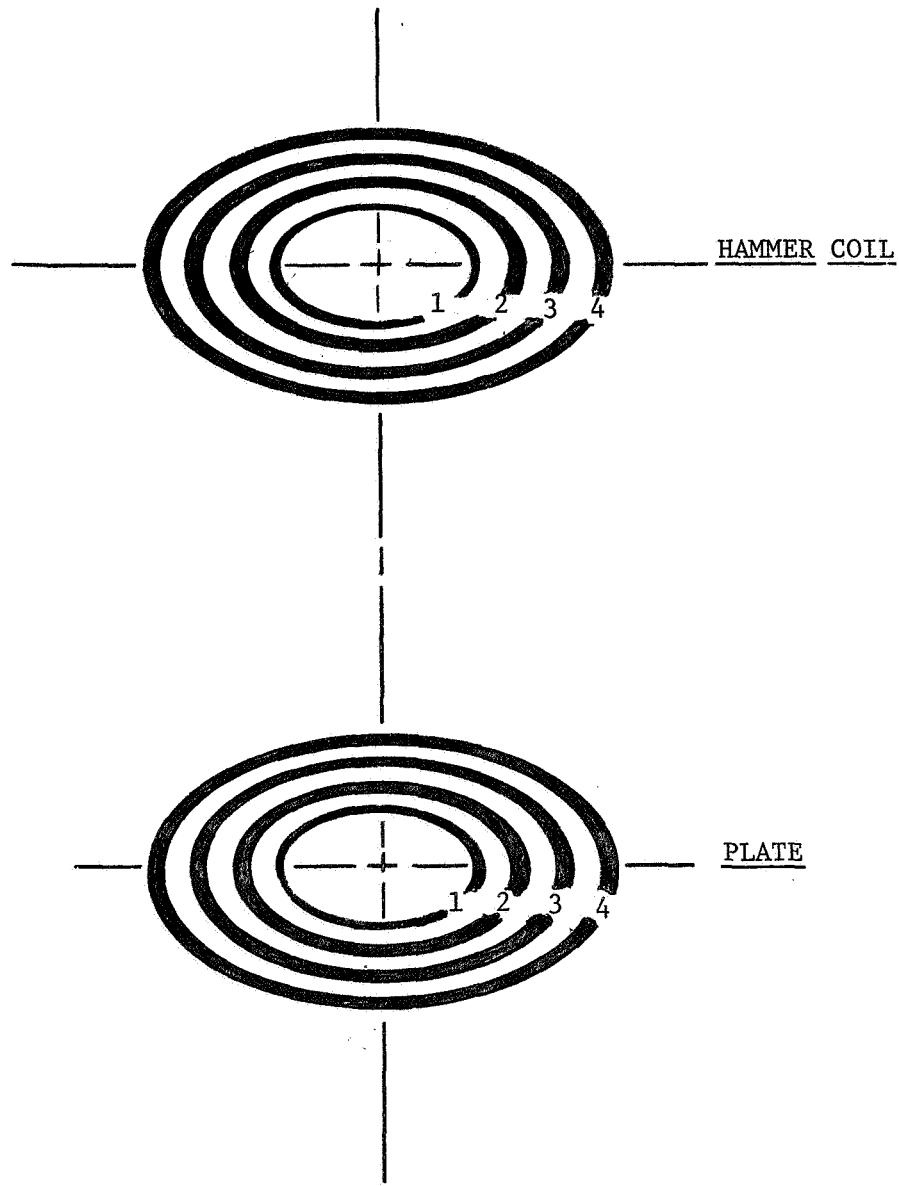

Figure 1. An Illustration of a Four Ring Hammer Coil and Plate Assembly.

conducting material which makes up the coil and plate. This resistance of the coil and plate along with the radii and self inductance for a four ring hammer coil and plate can be seen in Table 3 in Chapter IV.

Due to the mutual coupling, self inductance, and resistance of the coil and plate, and to the fact that the rings in the hammer coil are physically connected to each other, the hammer coil and plate will act like an N turn transformer, where N is the number of rings in the coil. Therefore, an equivalent circuit of the hammer coil and plate can be determined by drawing an N turn transformer where the secondary is allowed to move with a velocity that is a function of time. This equivalent circuit is shown in Figure 2. From this model of the coil and plate, it can be seen that R'_1 through R'_n are the resistances of the first through nth rings of the coil respectively. Likewise, R_1 through R_n are the resistances of the first through the nth rings of the plate. Also the inductance L_1 through L_n is the inductance of each ring in the coil and plate.

As discussed before, the plate will be allowed to move with a certain velocity. It is assumed that this velocity is as follows:

$$v = 100,000 \sin 2\pi f' t \quad \text{centimeters/second} \quad (1)$$

where $f' = 2f$ and $f = 3.3k$ hertz, the natural frequency of the hammer coil.¹ Therefore,

$$v = 100,000 \sin 41.4(10) t \quad \text{centimeters/second} \quad (2)$$

It should be pointed out that this velocity is valid only for $t < \frac{T}{4}$ where

$$T = \frac{1}{f} \quad (3)$$

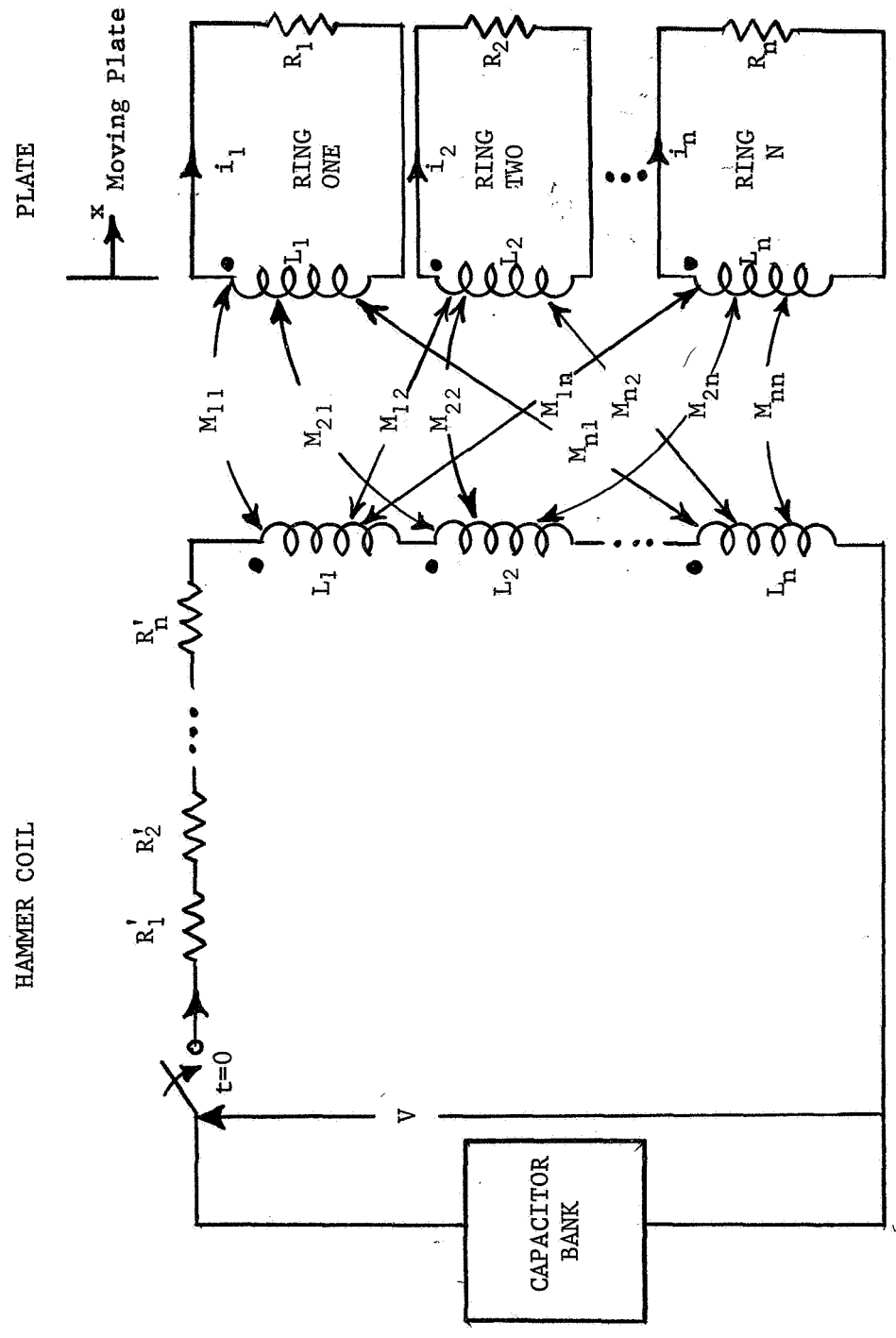

Figure 2. Equivalent Circuit of a N Turn Hammer Coil and Plate Assembly.

Therefore, the assumed velocity of the plate is approximately equal to the actual velocity only for $\frac{T}{4} < 75.7(10^{-6})$ seconds.

The input voltage from the discharge unit will be approximated by

$$V = 3000 \cos 20.7(10^{-3})t \text{ volts} \quad (4)$$

where 3000 volts is assumed to be the peak charge on the capacitor discharge unit. Likewise, this voltage equation will be valid only for $t < T/4$.

CHAPTER III

ANALYSIS OF MODELED SYSTEM

A. Formulation of Voltage Equations

From Figure 2, it can be seen that an N turn hammer coil and plate will generate N + 1 differential equations which have time varying coefficients due to the motion of the plate. Therefore, the five voltage equations for a four ring hammer coil can be written by the use of circuit theory. Since the mutual coupling is a function of time, the voltage drop due to the mutual coupling between coil and plate is given by $\pm \frac{d}{dt} (M_{nm} i)$.² Therefore, the voltage equation for the primary can be written as follows:

$$\begin{aligned} V = & (R'_1 + R'_2 + R'_3 + R'_4) i + (L_1 + L_2 + L_3 + L_4) \\ & + 2M'_{12} + 2M'_{13} + 2M'_{14} + 2N'_{23} + 2M'_{24} + 2M'_{34}) \frac{di}{dt} \\ & - M_{11} \frac{di_1}{dt} + i_1 \frac{dM_{11}}{dt} - M_{12} \frac{di_2}{dt} + i_2 \frac{dM_{12}}{dt} - M_{13} \frac{di_3}{dt} \\ & + i_3 \frac{dM_{13}}{dt} - M_{14} \frac{di_4}{dt} + i_4 \frac{dM_{14}}{dt} \\ & - M_{21} \frac{di_1}{dt} + i_1 \frac{dM_{21}}{dt} - M_{22} \frac{di_2}{dt} + i_2 \frac{dM_{22}}{dt} \\ & - M_{23} \frac{di_3}{dt} + i_3 \frac{dM_{23}}{dt} - M_{24} \frac{di_4}{dt} + i_4 \frac{dM_{24}}{dt} \\ & - M_{31} \frac{di_1}{dt} + i_1 \frac{dM_{31}}{dt} - M_{32} \frac{di_2}{dt} + i_2 \frac{dM_{32}}{dt} \end{aligned}$$

(Equation continued on following page)

$$\begin{aligned}
& - M_{33} \frac{di_3}{dt} + i_3 \frac{dM_{33}}{dt} - M_{34} \frac{di_4}{dt} + i_4 \frac{dM_{34}}{dt} \\
& - M_{41} \frac{di_1}{dt} + i_1 \frac{dM_{41}}{dt} - M_{42} \frac{di_2}{dt} + i_2 \frac{dM_{42}}{dt} \\
& - M_{43} \frac{di_3}{dt} + i_3 \frac{dM_{43}}{dt} - M_{44} \frac{di_4}{dt} + i_4 \frac{dM_{44}}{dt} \tag{5}
\end{aligned}$$

Now this equation for the coil or primary can be simplified by letting $\frac{dM_{nm}}{dt} = \dot{M}_{nm}$ and by noting that $M_{nm} = M_{mn}$. This will be shown later in the text. Also let $R_1' + R_2' + R_3' + R_4' = R_{14}$. Then Equation (5)

becomes:

$$\begin{aligned}
V - R_{14} i - (\dot{M}_{11} + \dot{M}_{12} + \dot{M}_{13} + \dot{M}_{14}) i_1 - (\dot{M}_{12} + \dot{M}_{22} + \dot{M}_{23} + \dot{M}_{24}) i_2 \\
- (\dot{M}_{13} + \dot{M}_{23} + \dot{M}_{33} + \dot{M}_{34}) i_3 - (\dot{M}_{14} + \dot{M}_{24} + \dot{M}_{34} + \dot{M}_{44}) i_4 \\
= (L_1 + L_2 + L_3 + L_4 + 2M_{12}' + 2M_{13}' + 2M_{14}' + 2M_{23}' + 2M_{24}' + 2M_{34}') \frac{di}{dt} \\
- (\dot{M}_{11} + \dot{M}_{12} + \dot{M}_{13} + \dot{M}_{14}) \frac{di_1}{dt} - (\dot{M}_{12} + \dot{M}_{22} + \dot{M}_{23} + \dot{M}_{24}) \frac{di_2}{dt} \\
- (\dot{M}_{13} + \dot{M}_{23} + \dot{M}_{33} + \dot{M}_{34}) \frac{di_3}{dt} - (\dot{M}_{14} + \dot{M}_{24} + \dot{M}_{34} + \dot{M}_{44}) \frac{di_4}{dt} . \tag{6}
\end{aligned}$$

Now the voltage equation for ring one in the plate can be written as follows:

$$\begin{aligned}
0 = R_1 + L_2 \frac{di_1}{dt} + M_{12}' \frac{di_2}{dt} + M_{13}' \frac{di_3}{dt} + M_{14}' \frac{di_4}{dt} \\
- M_{11} \frac{di}{dt} + i \frac{dM_{11}}{dt} - M_{12} \frac{di}{dt} + i \frac{dM_{12}}{dt} \\
- M_{13} \frac{di}{dt} + i \frac{dM_{13}}{dt} - M_{14} \frac{di}{dt} + i \frac{dM_{14}}{dt} \tag{7}
\end{aligned}$$

Now Equation (7) can be simplified to obtain the following:

$$\begin{aligned}
 & - (\dot{M}_{11} + \dot{M}_{12} + \dot{M}_{13} + \dot{M}_{14}) i - R_1 i_1 = \\
 & - (M_{11} + M_{12} + M_{13} + M_{14}) \frac{di}{dt} + L_1 \frac{di_1}{dt} + M'_{12} \frac{di_2}{dt} \\
 & + M'_{13} \frac{di_3}{dt} + M'_{14} \frac{di_4}{dt}
 \end{aligned} \tag{8}$$

Using the same procedure the equations for rings two, three, and four in the plate can be written as follows:

for Ring 2

$$\begin{aligned}
 & - (\dot{M}_{12} + \dot{M}_{22} + \dot{M}_{23} + \dot{M}_{24}) i - R_2 i_2 = \\
 & - (M_{12} + M_{22} + M_{23} + M_{24}) \frac{di}{dt} + M'_{12} \frac{di_1}{dt} \\
 & + L_2 \frac{di_2}{dt} + M'_{23} \frac{di_3}{dt} + M'_{24} \frac{di_4}{dt} ,
 \end{aligned} \tag{9}$$

for Ring 3

$$\begin{aligned}
 & - (\dot{M}_{13} + \dot{M}_{23} + \dot{M}_{33} + \dot{M}_{34}) i - R_3 i_3 = \\
 & - (M_{13} + M_{23} + M_{33} + M_{34}) \frac{di}{dt} + M'_{12} \frac{di_1}{dt} \\
 & + M'_{23} \frac{di_2}{dt} + L_3 \frac{di_3}{dt} + M'_{34} \frac{di_4}{dt}
 \end{aligned} \tag{10}$$

for Ring 4

$$\begin{aligned}
 & - (\dot{M}_{14} + \dot{M}_{24} + \dot{M}_{34} + \dot{M}_{44}) i - R_4 i_4 = \\
 & - (M_{14} + M_{24} + M_{34} + M_{44}) \frac{di}{dt} + M'_{14} \frac{di_1}{dt} \\
 & + M'_{24} \frac{di_2}{dt} + M'_{34} \frac{di_3}{dt} + L_4 \frac{di_4}{dt} .
 \end{aligned} \tag{11}$$

It should be noted here that Equations (6), (8), (9), (10), and (11) are for a four ring hammer coil. By setting the proper terms equal to zero in these equations, the equations for a one, two, or three ring coil can be determined very easily. Therefore, these equations will not be presented here.

B. Determination of Model Parameters

The mutual coupling previously discussed can be determined by using Figure 3 and the Neumann Form³ which is given by

$$M = u \sqrt{d^2 + (a+b)^2} [(1 - k^2/2) K(k) - E(k)] \quad (12)$$

where

$$k = 2 \sqrt{\frac{ab}{d^2 + (a+b)^2}} \quad (13)$$

and

$$E(k) = \int_0^{\pi/2} \sqrt{1 - k^2 \sin^2 \phi} \, d\phi \quad , \quad (14)$$

$$K(k) = \int_0^{\pi/2} \frac{d\phi}{(1 - k^2 \sin^2 \phi)^{1/2}} \quad . \quad (15)$$

As can be seen from Figure 3, there are two rings of radius "a" and "b" which are "d" distance apart. By using Equations (12) through (15) the mutual coupling can be calculated for these rings. The general procedure for doing this is to determine k of Equation (13) for a particular set of rings and different values of d. Then the next step is to evaluate the elliptic integrals of the first and second kind of Equations (14) and (15) from a complete book of tables.⁴ Now by substituting for k, E(k) and K(k) in Equation (12), the mutual coupling can be determined for various distances of separation.

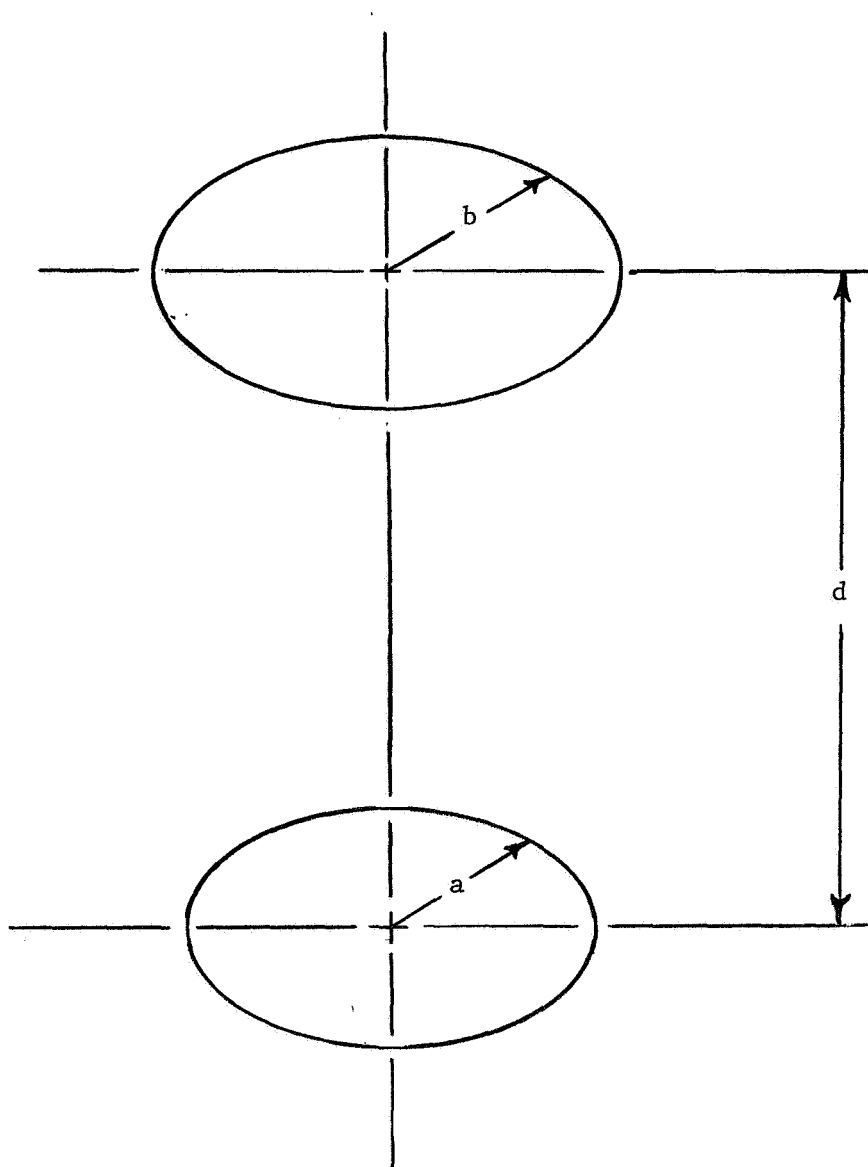

Figure 3. Diagram of Two Concentric Rings Used to Calculate Mutual Coupling Between Hammer Coil and Plate.

Appendix A and B give the computer programs used to determine k and M for various values of d . It should be noted here that due to the symmetrical nature of Equations (12) and (13), $M_{nm} = M_{mn}$.

As can be seen from the differential equations for a four ring hammer coil, some of the mutual terms add due to the addition property of an N turn transformer. Also, these mutual terms and their rate of change with respect to time need to be determined. This can be done by first determining an approximate curve for these mutual terms as a function of distance. These results can be seen in Figures I-1 and I-11 through I-19 for a one, two, three, and four ring hammer coil. Next, the distance of separation can be determined as follows by integration of Equation (2).

$$x = 2.42 [1 - \cos 41.4(10^3)t] \text{ centimeters} \quad (16)$$

Then by substituting Equation (16) the equations for the resultant mutual terms can be determined as a function of time. This result along with the rate of change of the resultant mutual terms is shown in Table 1 of Chapter IV.

Next, the constant mutual coupling terms between concentric ring in either the plate or hammer can be calculated by setting $d = 0$ in Equations (12) and (13). These constant terms are shown in Table 2 of Chapter IV for a one through four ring hammer coil.

The self inductance and resistance of each ring of the hammer coil and plate has been determined in previous studies.⁵ These values are listed in Table 3. It should be noted that the values of resistance of the rings in the plate are of approximate value because

neither the material of the plate nor the thickness of the plate has to be specified.

C. Formulation of Force Equation

A current-carrying conductor produces a magnetic field around the conductor. If a second current-carrying conductor is brought into the magnetic field of the first, then each wire is surrounded by two magnetic fields. If the currents in these two conductors are in opposite directions, the two conductors will repel each other with a force given by⁶

$$F = \frac{\mu_0 i i_r l_r}{2\pi R} \quad (17)$$

This is for the case where the two conductors are parallel. Here

$$\mu_0 = 4 (10^{-7}) \text{ henrys/meter,}$$

$$i = \text{current in conductor one in amperes,}$$

$$i_r = \text{current in conductor two in amperes,}$$

$$R = \text{distance between conductors one and two in meters,}$$

$$l_r = \text{length of conductor two in meters,}$$

$$F = \text{force of repulsion in R direction in newtons.}$$

From Figure 4, the force produced on ring r in the hammer can be determined by using Equation (17). However, F can be divided into two components, F_r and F_d . The F_r is exactly cancelled by a force F_r in the opposite direction as shown in Figure 4. Therefore, F_d is actually the force developed on the coil in the hammer. From Equation (17), F_d can be determined as follows:

$$F_d = F \cos \theta$$

or

$$F_d = \frac{u_o i i_r (2\pi a) \cos \theta}{2 \pi R} \quad (19)$$

However, from Figure 4,

$$\cos \theta = \frac{\Delta r}{R} \quad (20)$$

and

$$F = D^2 + (\Delta r)^2 \quad (21)$$

where

$$\Delta r = b - a \quad (22)$$

Therefore, Equation (18) becomes:

$$F_d = \frac{u_o i i_r (2\pi a)}{2\pi \sqrt{D^2 + (\Delta r)^2}} \frac{r}{\sqrt{D^2 + \Delta r^2}}$$

or

$$F_d = \frac{12.5664(10^{-7}) i i_r a}{D^2 + \Delta r^2} \quad (23)$$

This is the final equation that will be used to determine the forces produced in the hammer coil and plate assembly.

D. Method for Solving for Currents and Forces

The currents for the hammer coil and plate can be determined by using the Runge-Kutta⁷ computer program given in Appendix C. Appendix D through G gives the necessary FUNCTION statements which contain the differential equations of one, two, three, and four rings respectively. When placed at the end of the Runge-Kutta program, these FUNCTION statements complete the Fortran program necessary to compute the currents for either a one, two, three, or four ring hammer coil, depending on which appendix is used. The FUNCTION statements as they

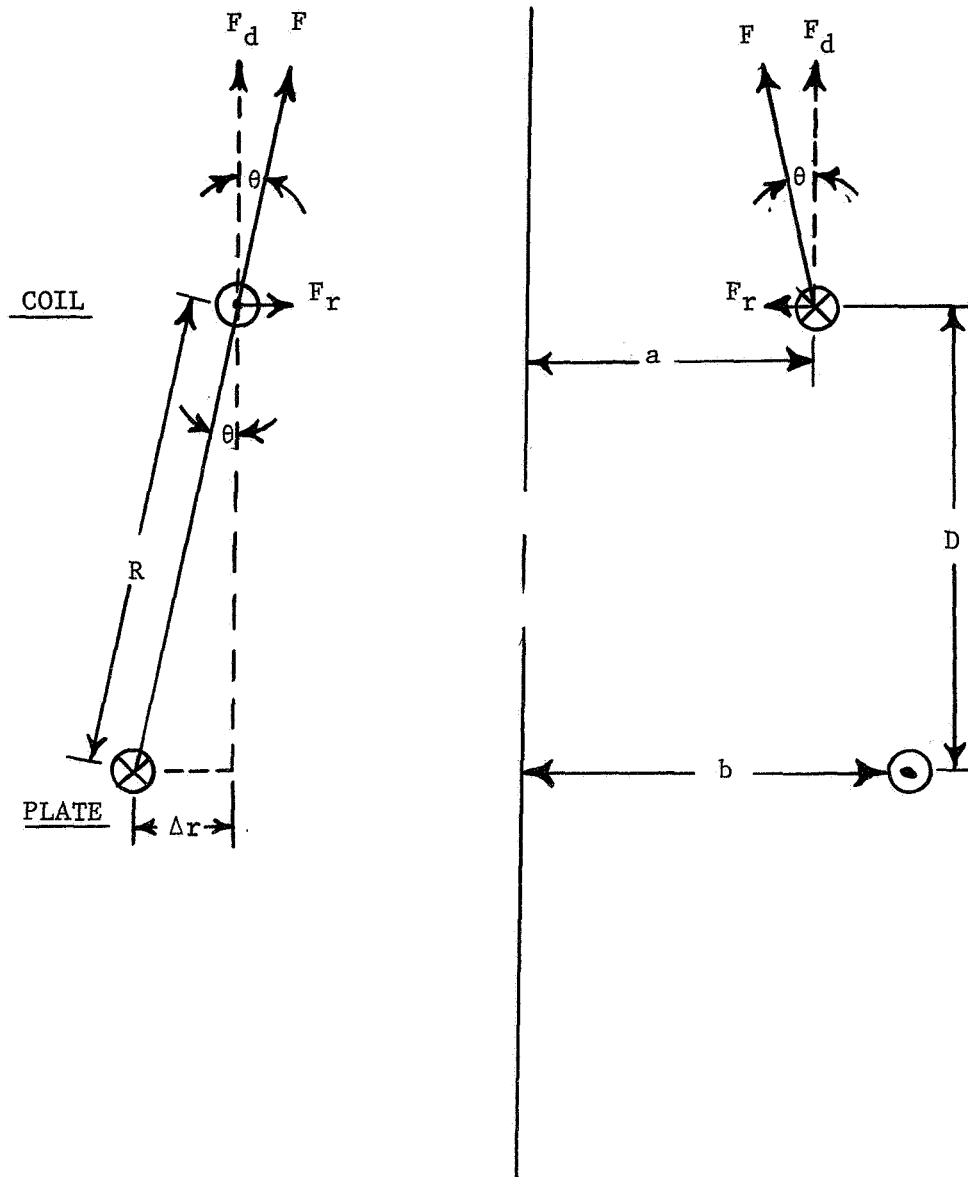

Figure 4. Diagram Illustrating the Force of Repulsion Between a Ring in the Hammer Coil and Plate.

are presented are for a moving plate. Only a few statements in each of Appendices D through G must be changed for the stationary plate. This is explained at the beginning of each appendix.

As an example, suppose that the currents for a two ring hammer coil with moving plate are to be determined. Then the FUNCTION statements of Appendix E would be placed at the end of the Runge-Kutta program of Appendix C. This then would be a complete computer program to determine these currents.

Figure 5 through 12 show the currents calculated for a stationary and moving plate by the above Runge-Kutta program and the corresponding FUNCTION statement. These currents were computed every 10^{-7} seconds for accuracy. However, values were printed only every 10^{-6} seconds for the first $75(10^{-6})$ seconds. This gave a set of currents up to approximately $\frac{T}{4}$ seconds.

The forces produced in the hammer coil were computed every 10^{-6} seconds by the use of Equations (23) and the computer program of Appendix H. Figures 13 through 16 give the values of these forces determined for a moving and a stationary plate.

CHAPTER IV

RESULTS AND CONCLUSIONS

The mutual coupling terms for a one through four ring hammer coil and plate are shown in Figures I-1 through I-10. These terms which are a function of distance of separation were computed by using the programs in Appendix A and B and the IBM 360 Model 40 Computer. It should be noted that the distance of separation ranges from .1 centimeters to 30 centimeters. The value of .1 centimeters as the smallest distance between the coil and plate is due to the potting of the coil in the head of the hammer. Noting the general shape of the curves for the mutual coupling terms, it can be seen that these curves have the approximate shape of a decaying exponential. This is not an unexpected result due to the physical structure of the coil and plate.

The constant mutual coupling of the rings in the hammer coil or plate are shown in Table 2. Here it can be seen that the coupling M'_{12} is larger than M'_{13} , which is in turn larger than M'_{14} . This can also be noted in the remaining terms. Therefore, one could conclude that as the difference in radius of two rings increases the mutual coupling decreases. This is also not an unexpected phenomenon.

As was seen in Chapter III, the coefficients of the differential equations for the hammer coil and plate are made up of the sum and time rate of change of the sum of different combinations of the mutual coupling terms. Figure I-1 and Figures I-11 through I-19 give these mutual terms and approximate curves as a function of distance of

Mutual Coupling Terms	Mutual Coupling as a Function of Time $\times 10^{-10}$ Henrys	Time Rate of Change of Mutual Coupling $\times 10^{-5}$ Henrys/Second
M_{11}	$2.85e^{5.08 \cos 41.4Kt}$	$- 6.0e^{5.08 \cos 41.4Kt} \sin 41.4Kt$
$M_{11} + M_{12}$	$17.5e^{3.36 \cos 41.4Kt}$	$- 26.3e^{3.63 \cos 41.4Kt} \sin 41.4Kt$
$M_{12} + M_{22}$	$16.8e^{3.87 \cos 41.4Kt}$	$- 26.9e^{3.87 \cos 41.4Kt} \sin 41.4Kt$
$M_{11} + M_{12} + M_{13}$	$37.3e^{3.15 \cos 41.4Kt}$	$- 48.7e^{3.15 \cos 41.4Kt} \sin 41.4Kt$
$M_{12} + M_{22} + M_{23}$	$49.8e^{3.15 \cos 41.4Kt}$	$- 65.0e^{3.15 \cos 41.4Kt} \sin 41.4Kt$
$M_{13} + M_{23} + M_{33}$	$67.6e^{2.9 \cos 41.4Kt}$	$- 81.2e^{2.9 \cos 41.4Kt} \sin 41.4Kt$
$M_{11} + M_{12} + M_{13} + M_{14}$	$63.9e^{2.78 \cos 41.4Kt}$	$- 73.5e^{2.78 \cos 41.4Kt} \sin 41.4Kt$
$M_{12} + M_{22} + M_{23} + M_{24}$	$89.3e^{2.78 \cos 41.4Kt}$	$- 102.5e^{2.78 \cos 41.4Kt} \sin 41.4Kt$
$M_{13} + M_{23} + M_{33} + M_{34}$	$118.7e^{2.66 \cos 41.4Kt}$	$- 130.5e^{2.66 \cos 41.4Kt} \sin 41.4Kt$
$M_{14} + M_{24} + M_{34} + M_{44}$	$133.5e^{2.54 \cos 41.4Kt}$	$- 140.0e^{2.54 \cos 41.4Kt} \sin 41.4Kt$

Table 1. Calculated Values of the Mutual Coupling and Time Rate of Change of the Mutual Coupling Necessary to Determine the Currents of a One, Two, Three, and Four Ring Hammer Coil.

M'_{mn}	Values of Elliptic Integral K(k)	Values of Elliptic Integral E(k)	Constant Mutual Coupling Between Concentric Rings $\times 10^{-8}$ Henrys
$M'_{12} = M'_{21}$	1.017	3.68	2.834
$M'_{13} = M'_{31}$	1.044	3.09	2.054
$M'_{14} = M'_{41}$	1.073	2.77	1.626
$M'_{23} = M'_{32}$	1.012	3.86	3.775
$M'_{24} = M'_{42}$	1.034	3.26	2.794
$M'_{34} = M'_{43}$	1.009	4.004	4.754

Table 2. Computed Values of Elliptic Integrals and the Constant Mutual Coupling for a Four Ring Hammer Coil.

Ring Segment	Radius in Centimeters	Inductance $\times 10^{-6}$ Henrys	Resistance (Hammer) $\times 10^{-4}$ Ohms	Resistance (Plate) $\times 10^{-4}$ Ohms
1	1.2027	.2070	2.0	3.0
2	1.4755	.2949	3.0	7.0
3	1.7483	.3866	4.0	9.0
4	2.0213	.4803	5.0	10.0

Table 3. Tabulated Values of the Radius, Inductance, and Resistance of the Four Inner Rings of the Hammer Coil and the Resistance of the Corresponding Four Rings of the Plate.

separation for a one, two, three, and four ring hammer coil. Moreover, Table 1 contains these terms and this rate of change.

The currents for a moving or a stationary plate can be seen in Figures 5 through 12 for a one through four ring hammer coil. Figure 5 shows the computed currents for a one ring hammer coil and moving plate. Comparing this with Figure 6 for the stationary plate, it can be seen that there is very little change in the coil currents. Both coil currents peak approximately at the same point with a slight increase in maximum for the stationary case. However, this is not true for the plate currents. Due to the decoupling of the coil and plate, the plate current for the moving plate peaks earlier with a much lower value, the peak value being $8.75(10^4)$ amperes at 43 microseconds as compared to $14.8(10^4)$ amperes at 74 microseconds for the stationary plate.

Observing Figures 7 through 12, it can be seen that for the decoupling or moving plate this phenomenon of lower and earlier peak plate currents persists for two, three, and four rings. Also, it can be seen that the coil current follows the same general pattern of not being effected to any great extent by the decoupling of the plate.

Observing the difference in the magnitude of the currents as the number of ring increase, it can be seen that this magnitude decreases. Also, the time at which the peak current occurs is increased as the number of rings increase. These two observations can be explained very easily by the following two reasons. First, the total resistance is increased as another ring is added, and second, the time constant is increased due to this increase in resistance. It should be noted that there is a pronounced difference in the magnitude of the coil and

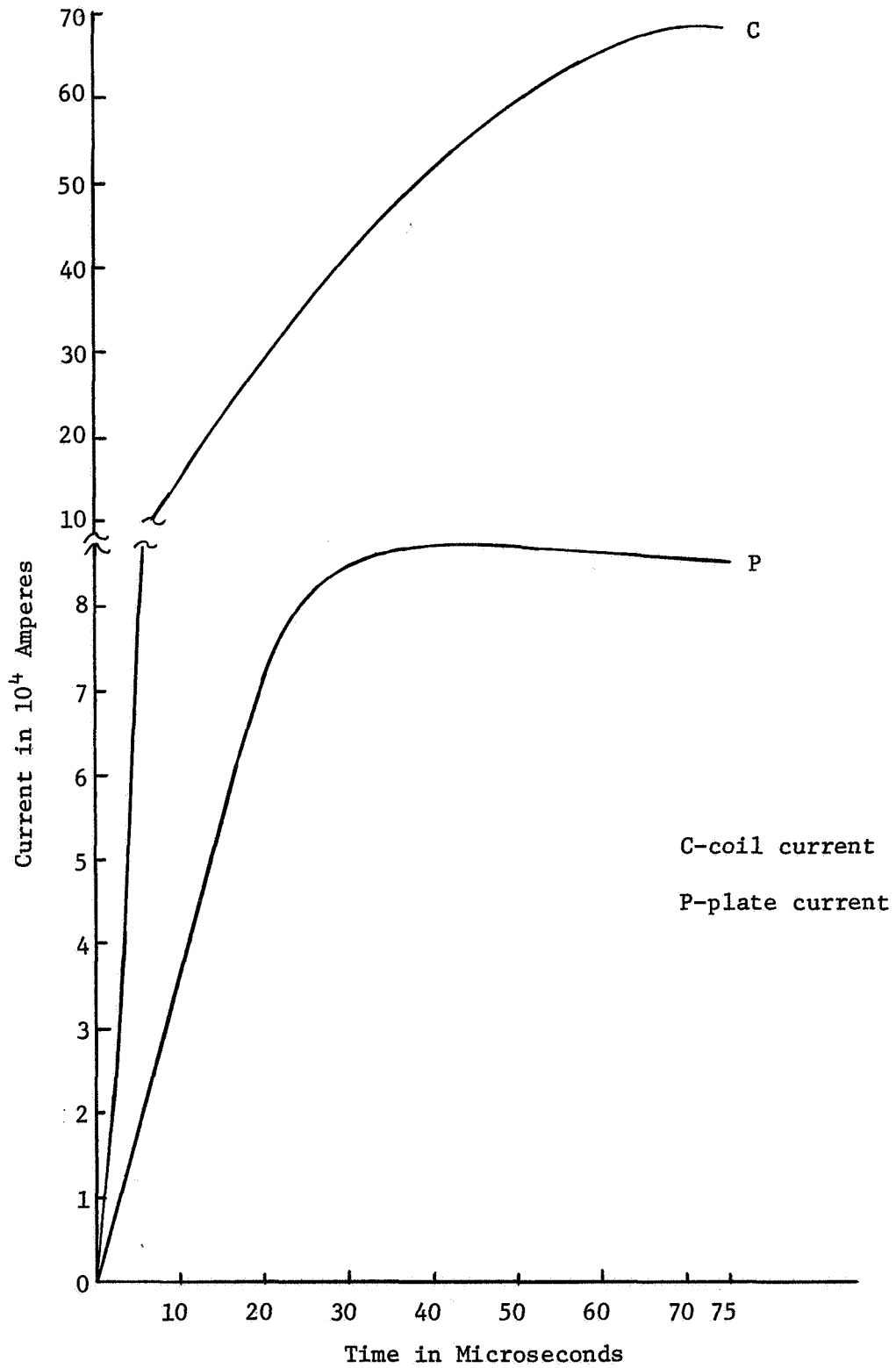

Figure 5. Computed Values of Currents Versus Time for a One Ring Hammer Coil and Moving Plate.

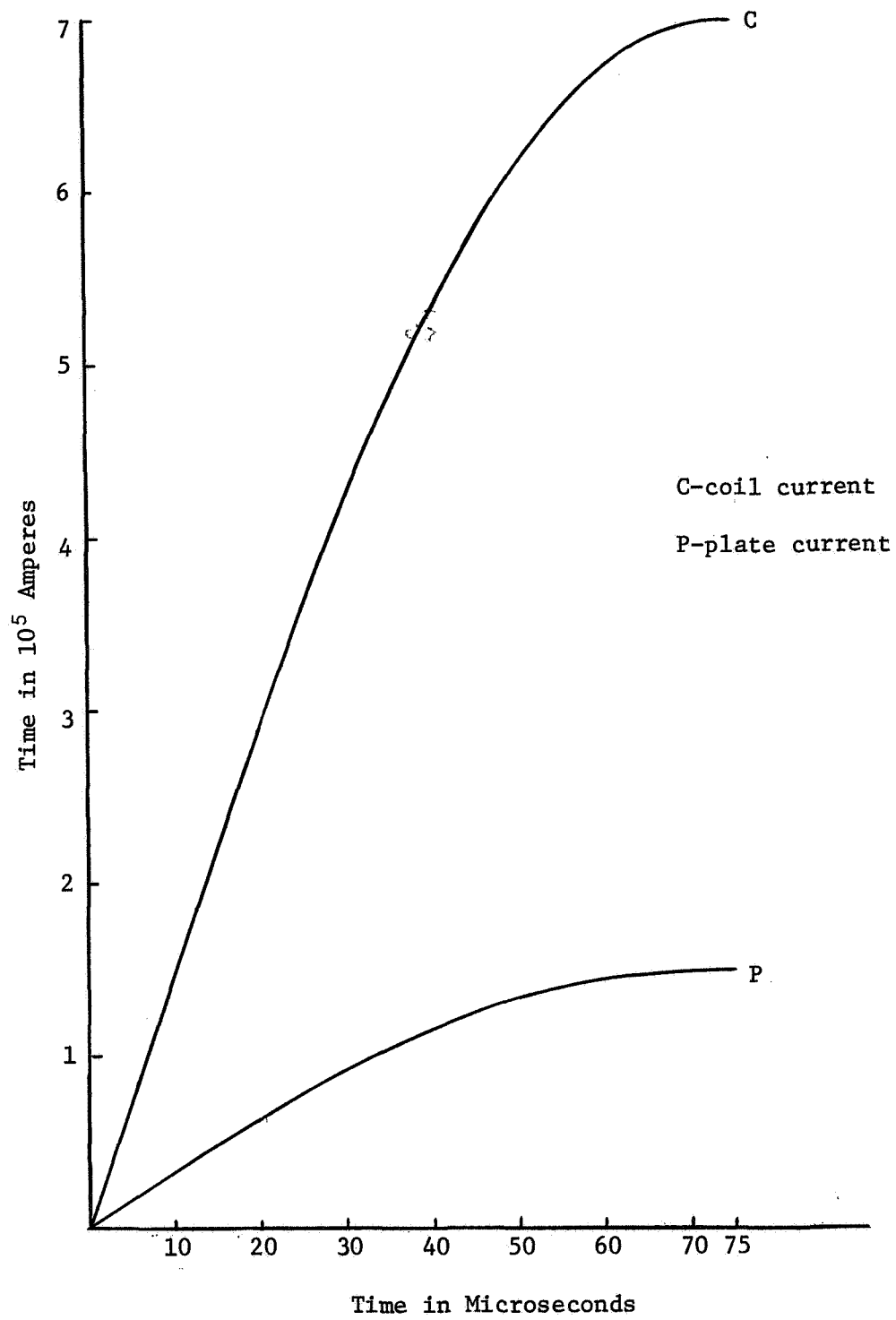

Figure 6. Computed values of Currents Versus Time for a One Ring Hammer Coil and Stationary Plate.

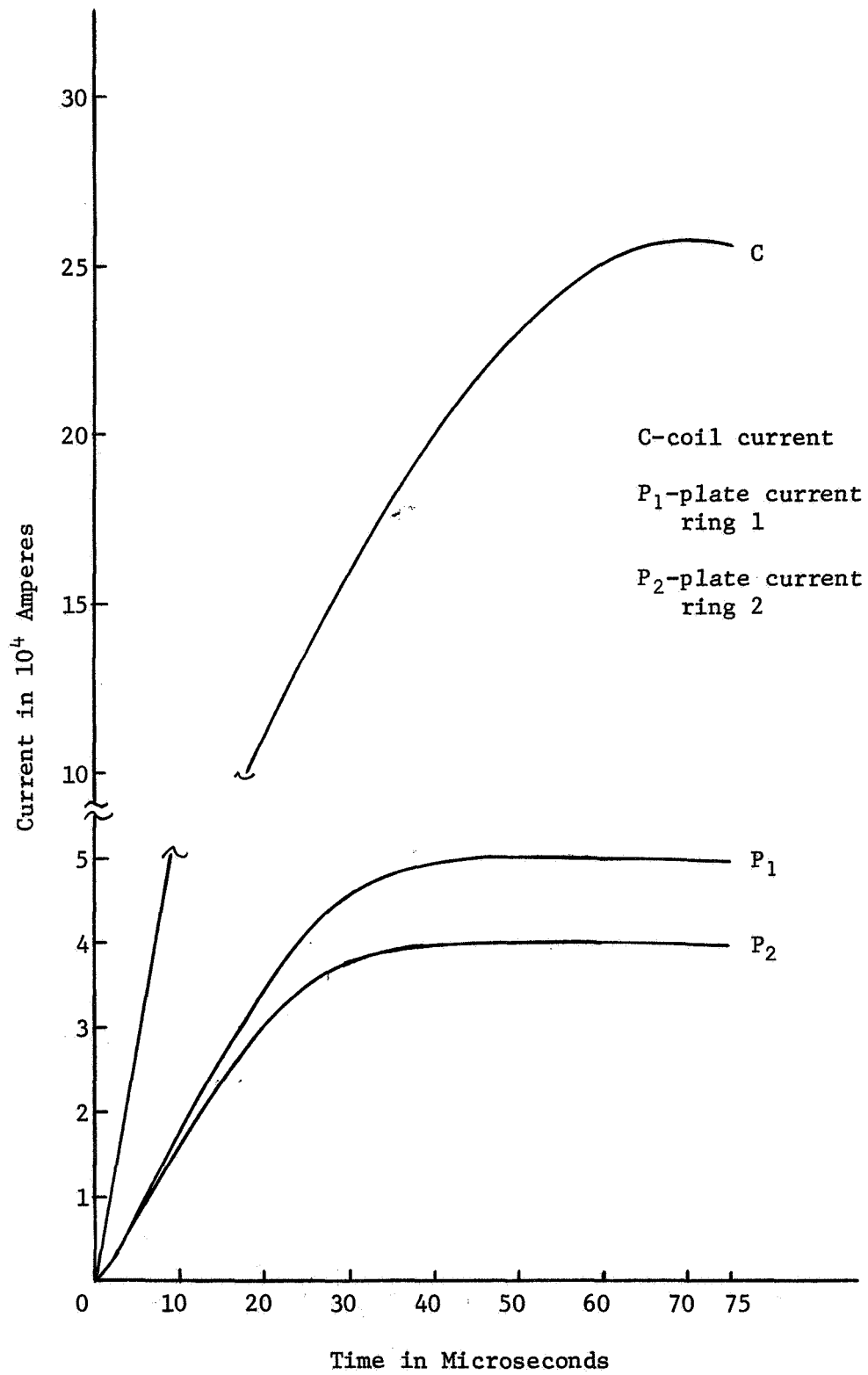

Figure 7. Computed Values of Currents Versus Time for a Two Ring Hammer Coil and Moving Plate.

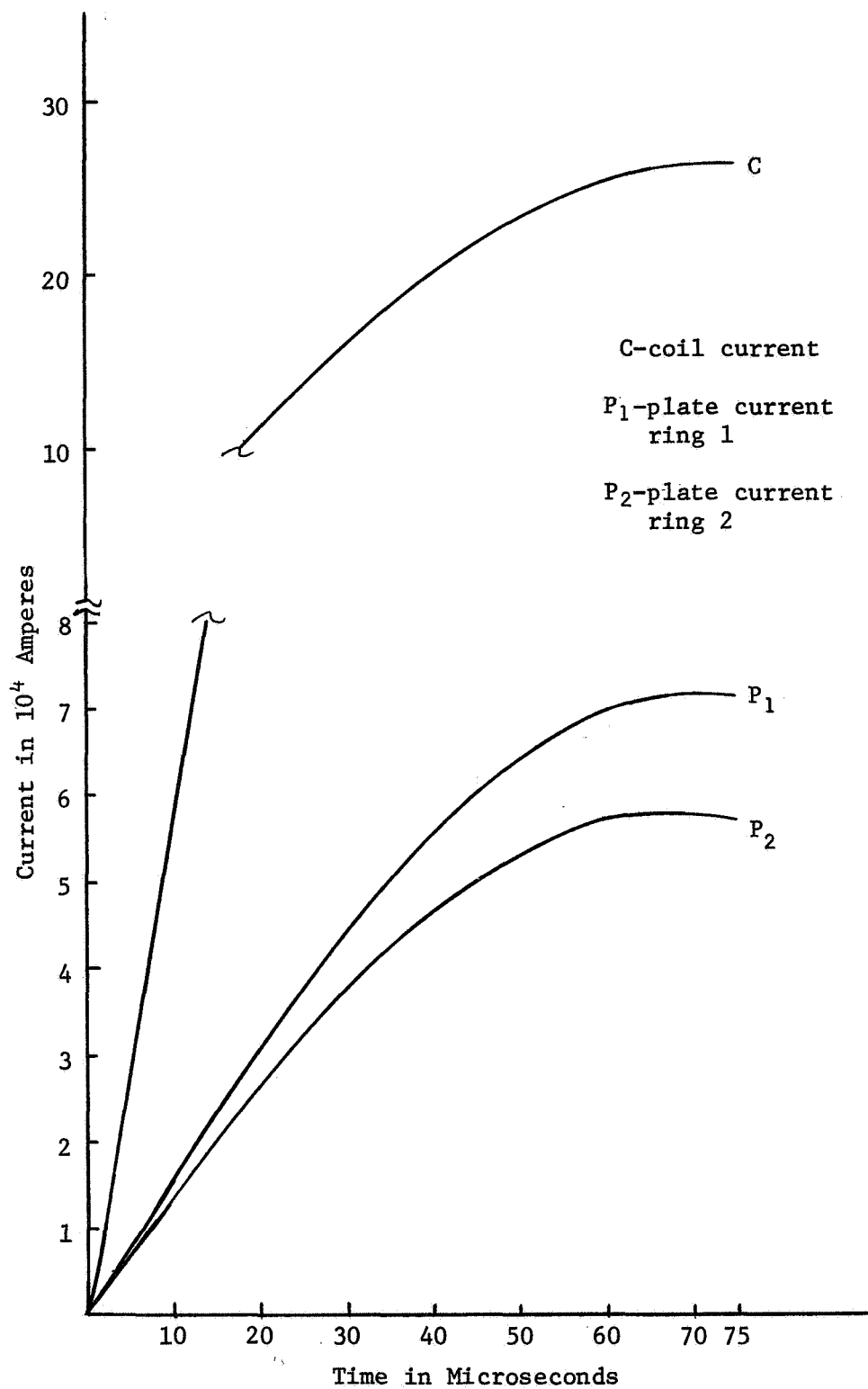

Figure 8: Computed Values of Currents Versus Time for a Two Ring Hammer Coil and Stationary Plate.

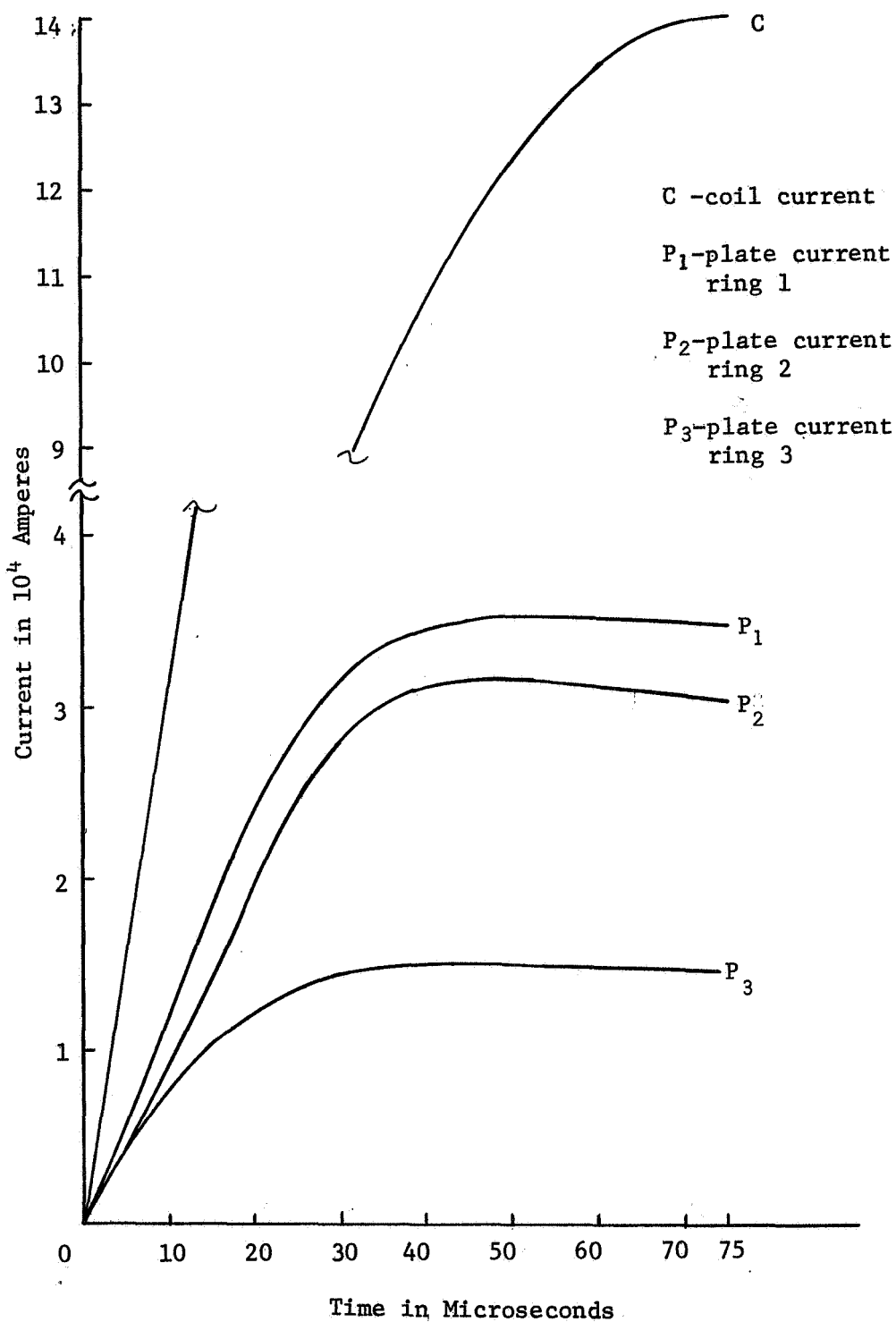

Figure 9. Computed Values of Currents Versus Time for a Three Ring Hammer Coil and Moving Plate.

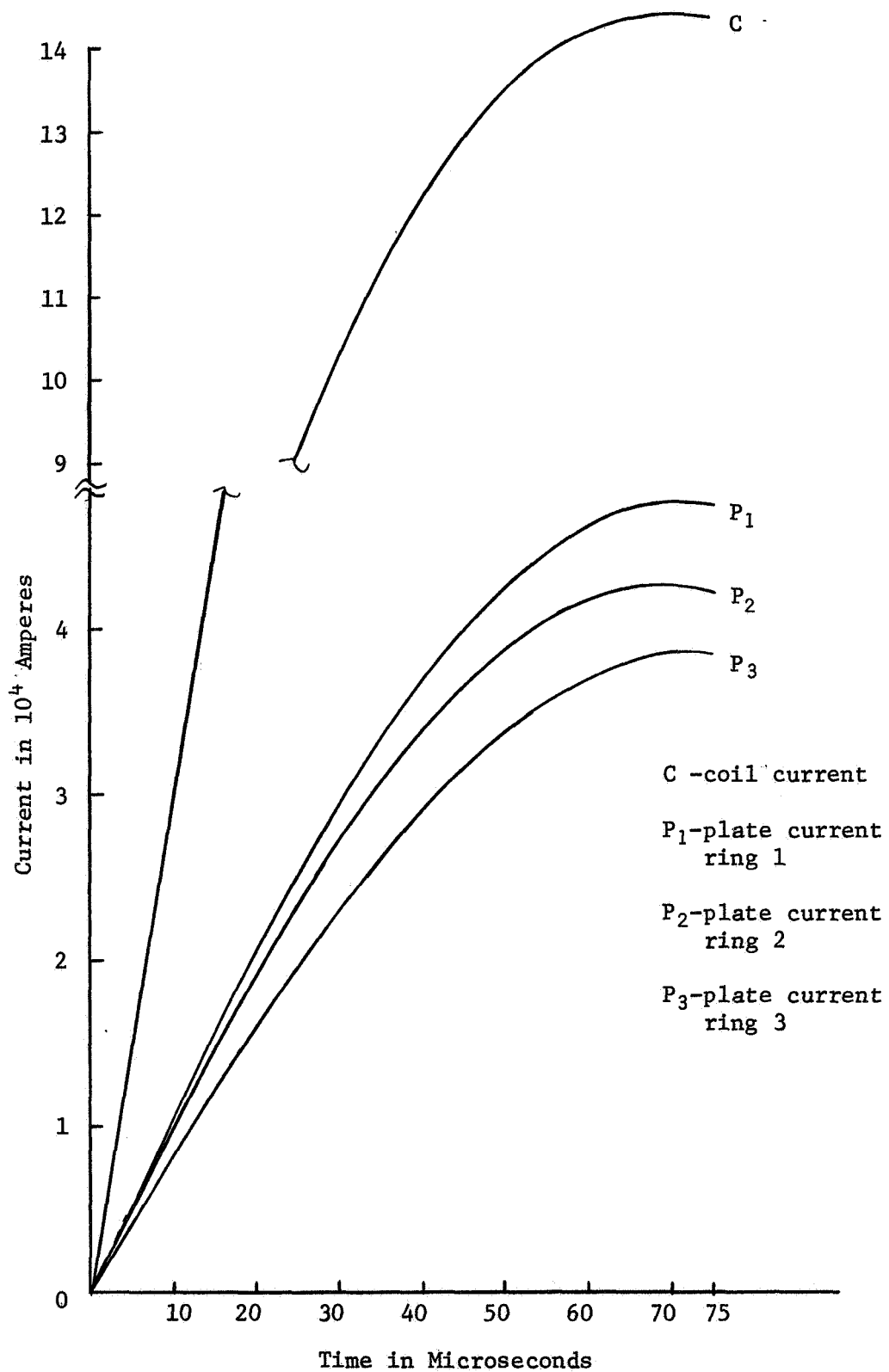

Figure 10. Computed Values of Currents Versus Time for a Three Ring Hammer Coil and Stationary Plate.

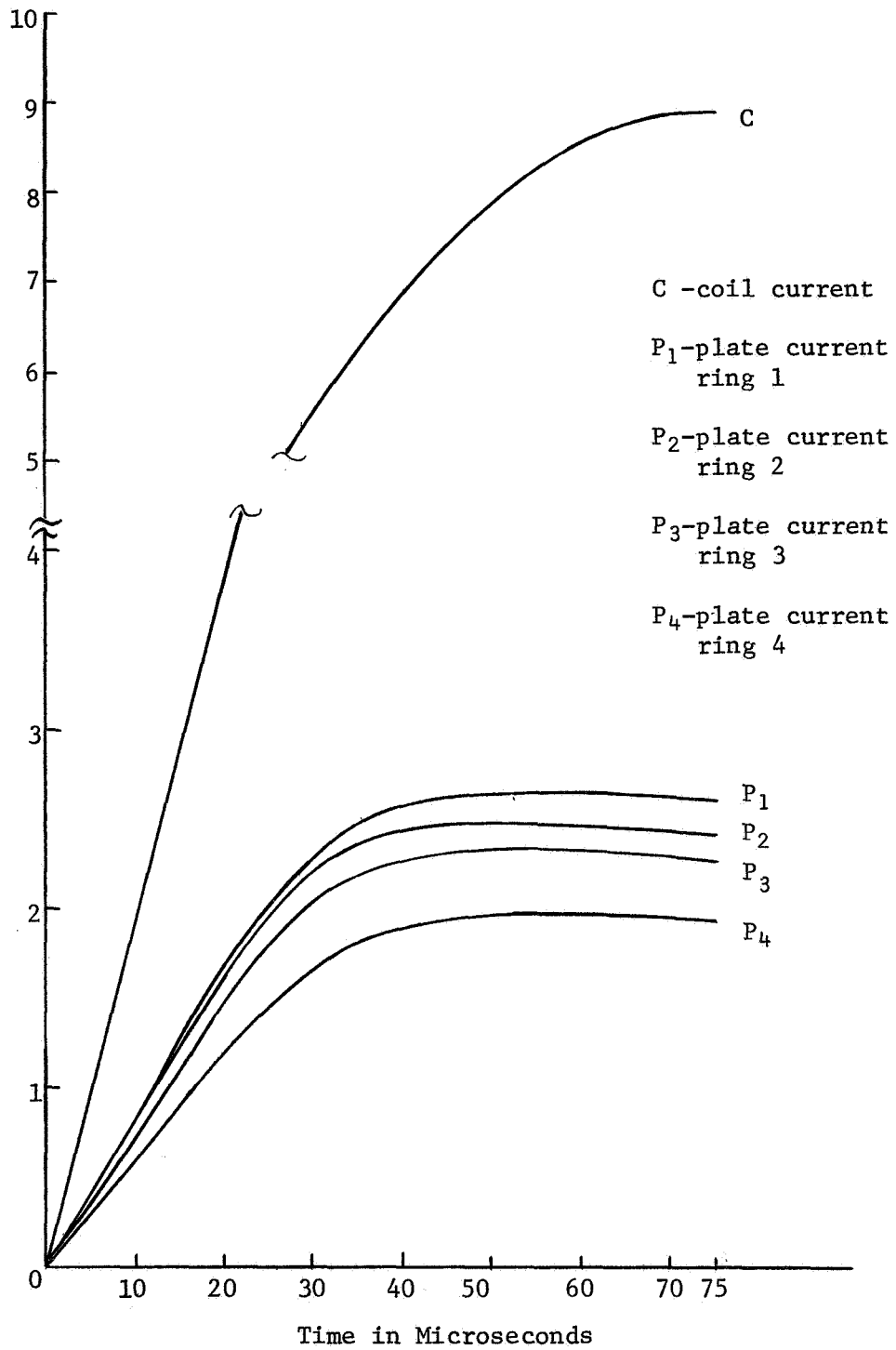

Figure 11. Computed Values of Currents Versus Time for a Four Ring Hammer Coil and Moving Plate.

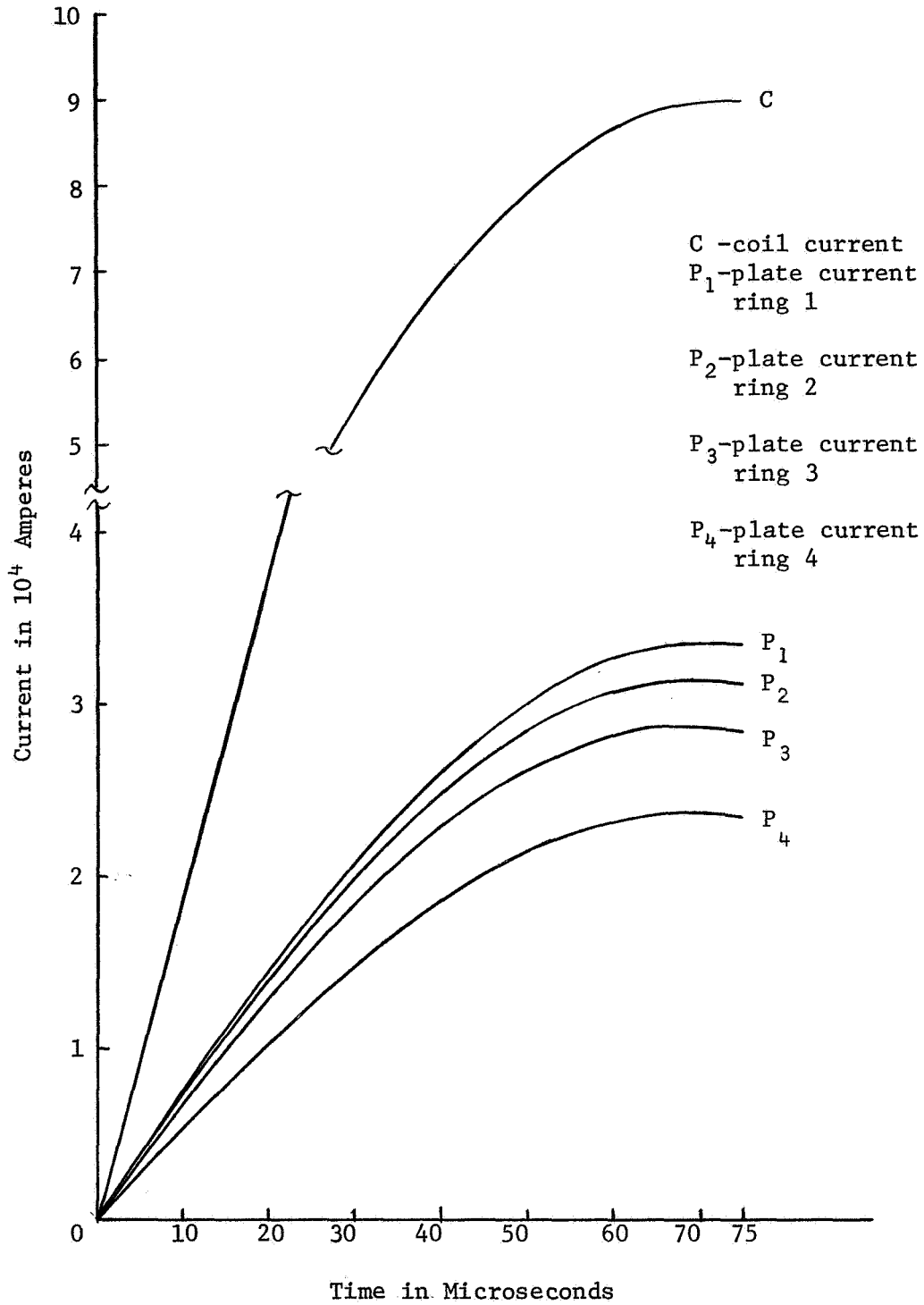

Figure 12. Computed Values of Currents Versus Time for a Four Ring Hammer Coil and Stationary Plate.

plate currents. This is the reason for the break-in scale for the currents. However, the coil current in all four different hammer coils is approximately linear up to a time of from 30 to 40 microseconds.

Next, the forces developed in the hammer coil and plate can be seen in Figure 13 through 16 for both the stationary and moving plate. Here the forces on the coil due to a stationary plate are from a factor of 10 to 40 higher than the forces for a moving plate. Since there was not that much of a pronounced change in the currents, this large difference in forces is due mostly to the force being inversely proportional to the distance between the coil and plate. Also, it can be seen that the force on a set of rings in the coil is less as the size of the rings decreases with the exception of ring four in Figure 16. In other words, the force is the largest on the outer ring. However, it should be noted that the force per unit length of the conductor is larger as one goes from the outside rings in. This would indicate that the center of the plate would deform more than the outside. Moreover, it should be noted that as the number of rings increases the maximum force decreases. Therefore, it is possible to estimate the value of the peak forces for a five ring hammer coil.

As can be seen, the peak forces for a moving plate occur from 20 to 30 microseconds with a rapid decrease after this point. However, the peak forces on the rings in the coil for a stationary plate occur at approximately 70 microseconds. Therefore, it can be concluded that decoupling of the plate has a very large effect on the force produced in the hammer coil assembly. Also, due to the rapid decrease in the

forces after the peak force is reached, it can be concluded that all of the useful work is accomplished in less than $\frac{T}{4}$ seconds.

In order to examine the effect that the spacing of the rings had on the forces produced, the four ring configuration was altered. For this calculation, the ring radii chosen were $r_1 = 1.20$, $r_2 = 2.56$, $r_3 = 3.93$ and $r_4 = 5.29$ cm. These radii correspond to the values one would measure by dividing the face of the actual hammer coil furnished to Mississippi State University into four equally spaced concentric rings.

The calculations were performed in the same manner as previously. The curves for the mutual coupling calculations are shown in Figures I-20 through I-24, and the results of the force calculation are shown in Figure 17. It will be noticed that the forces are somewhat lower than those shown in Figure 16, which is due primarily to the increased resistance of each ring. Otherwise, the form of the curve is much the same.

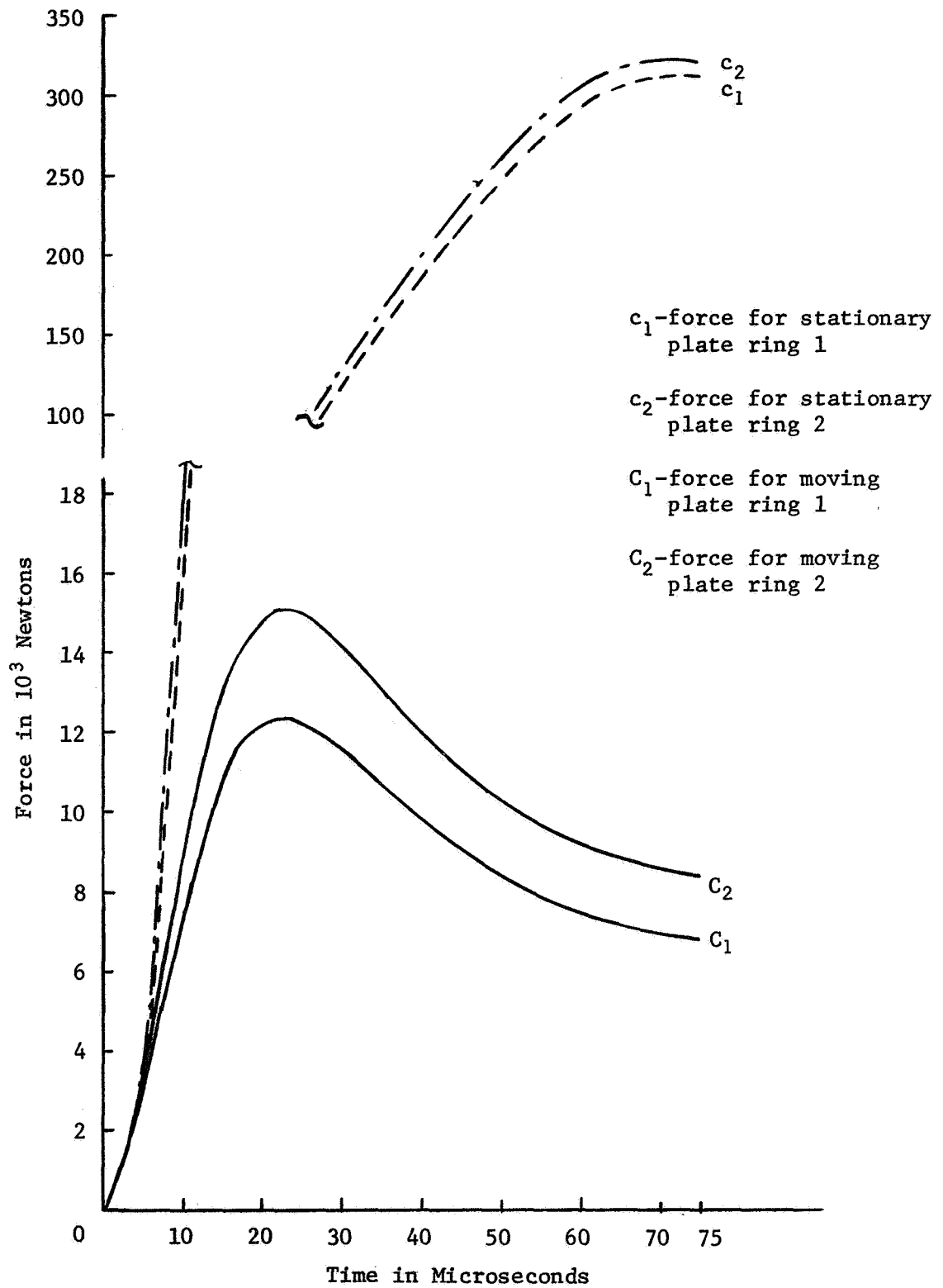

Figure 14. Plot of the Forces Developed in a Two Ring Hammer Coil and Plate When the Plate is Both Stationary and Moving.

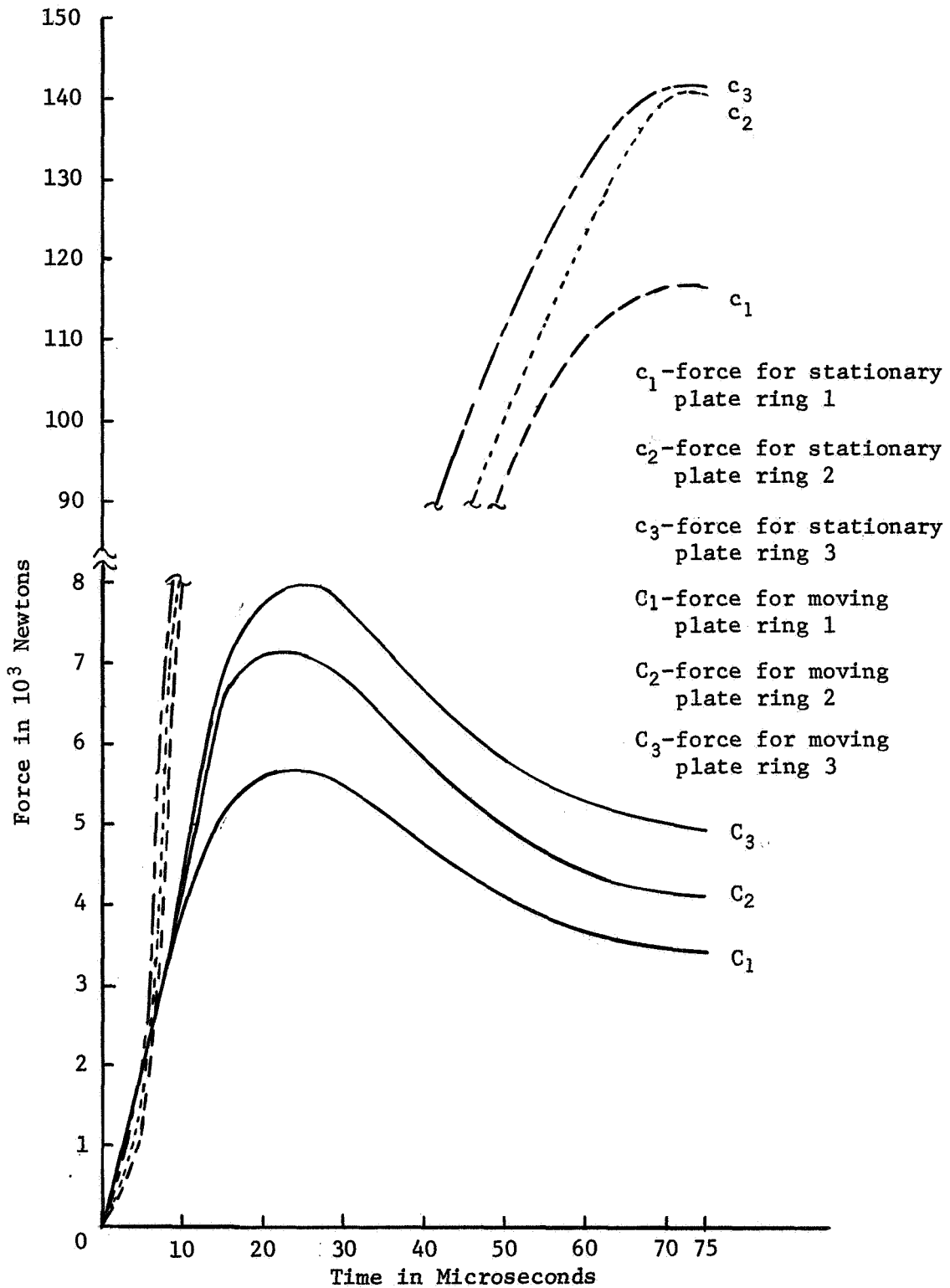

Figure 15. Plot of the Forces Developed in a Three Ring Hammer Coil and Plate When the Plate is Both Stationary and Moving.

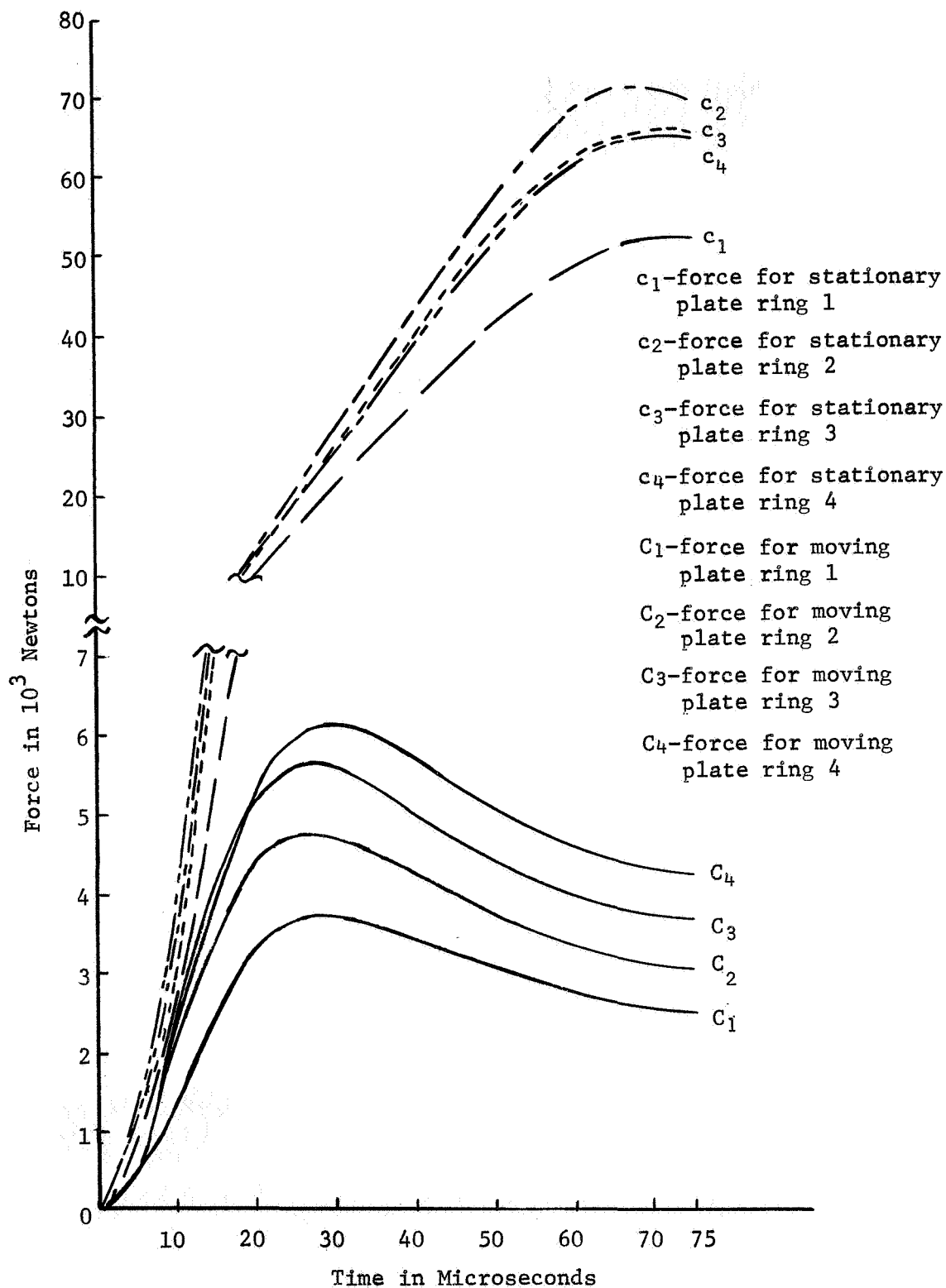

Figure 16. Plot of the Forces Developed in a Four Ring Hammer Coil and Plate When the Plate is Both Stationary and Moving for Ring Radii of $r_1 = 1.202$, $r_2 = 1.475$, $r_3 = 1.748$, and $r_4 = 2.021$ cm.

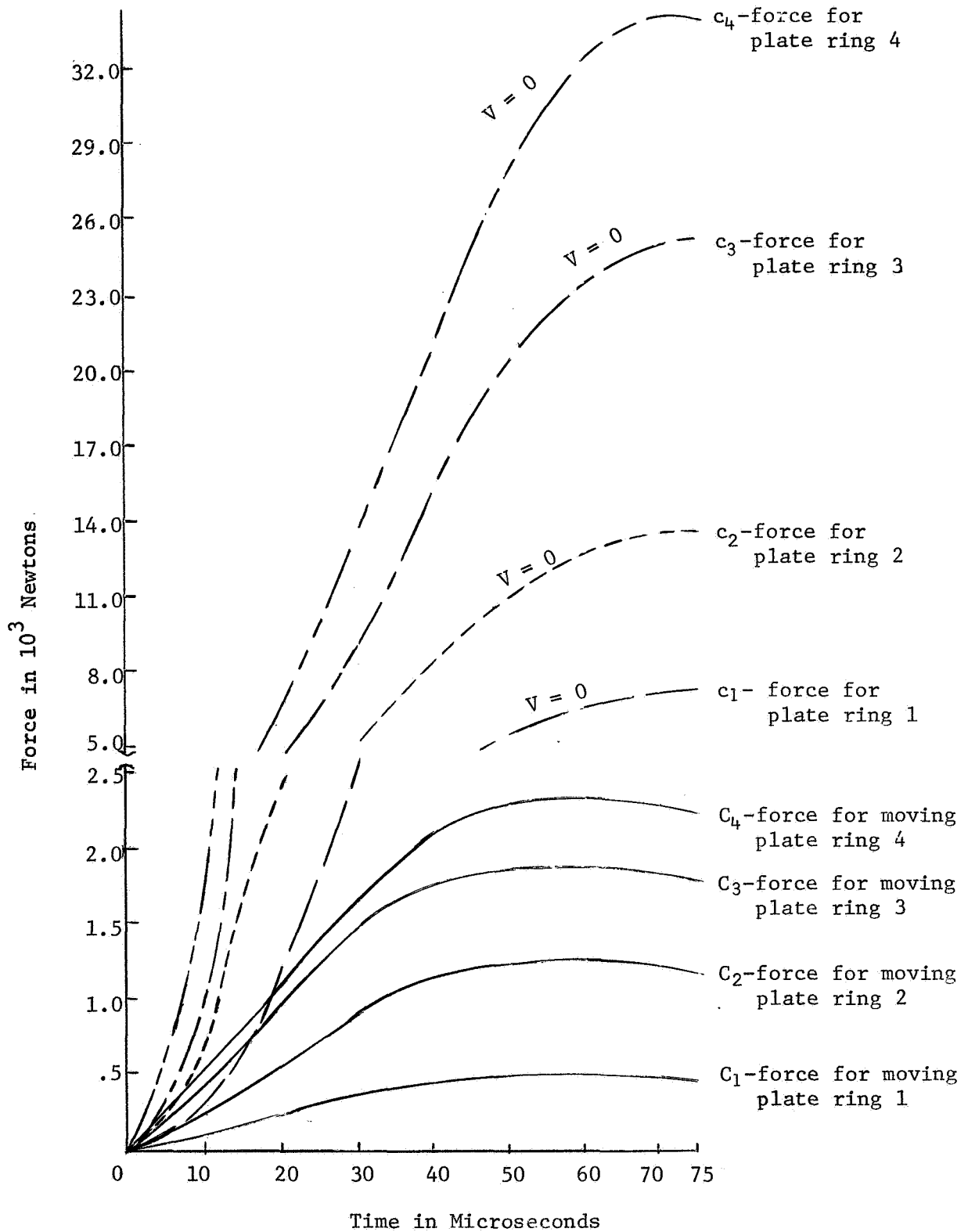

Figure 17. Plot of the Forces Developed in a Four Ring Hammer Coil and Plate When the Plate is Both Moving and stationary for Ring Radii of $r_1 = 1.20$, $r_2 = 2.56$, $r_3 = 3.93$, and $r_4 = 5.29$ cm.

APPENDICES

APPENDIX A

```
C C CALCULATION OF K FOR MUTUAL
DIMENSION P(16), D(100)
READ (1,10) R
WRITE (3,6)
6 FORMAT (14X1HA19X1HB19X1HD19X1HE19X1HF)
10 FORMAT (F10.0)
READ (1,2) I
2 FORMAT(I3)
DO 3 N=1, I
3 READ (1,10) D(N)
DO 4 L=1, I
DO 4 N=1, 16
K=N
DO 4 M=K, 16
F=2.*SQRT(R(N)*R(M)/(D(L)**2+(R(N)+R(M))**2))
F=57.2958*ATAN(E/(SQRT(1.0-E**2)))
4 WRITE (3,93) R(N), R(M), D(L), F, F
93 FORMAT (1X5F20.8)
STOP
END
```

APPENDIX B

```
C C. CALCULATION OF MUTUAL TERMS
  9 READ (1,10) A,B,D,E,F
 10 FORMAT (5F10.0)
    WRITE (3,6)
  6 FORMAT(13X1H A16X1H S16X1H D16X1H E16X1H F16X1H M)
    C=2.0*SQRT(A*B/(D*D+(A+B)**2))
    HAMER=12.567E-9*SQRT(D*D+(A+B)**2)*((1.-C*C/2.)*F-E)
    WRITE(3,4) A,B,D,E,F,HAMER
  4 FORMAT (1X6E17.8)
    GO TO 9
  STOP
  END
```



```

H2=H/2.
X=XI
DO 10 I=1,6
10 Y(I)=YI(I)
DO 70 LL=1,N
L=(LL-1)*6
DO 69 JJ=1,K
C
C      COMPUTE K SUR 0
C
DO 30 I=1,6
GO TO (21,22,23,24,25,26),I
21 T=FN1(X,Y(1),Y(2),Y(3),Y(4),Y(5),Y(6))
GO TO 30
22 T=FN2(X,Y(1),Y(2),Y(3),Y(4),Y(5),Y(6))
GO TO 30
23 T=FN3(X,Y(1),Y(2),Y(3),Y(4),Y(5),Y(6))
GO TO 30
24 T=FN4(X,Y(1),Y(2),Y(3),Y(4),Y(5),Y(6))
GO TO 30
25 T=FN5(X,Y(1),Y(2),Y(3),Y(4),Y(5),Y(6))
GO TO 30
26 T=FN6(X,Y(1),Y(2),Y(3),Y(4),Y(5),Y(6))
30 S1(I)=H*T
XA=X+H2
A1=Y(1)+S1(1)/2.
A2=Y(2)+S1(2)/2.
A3=Y(3)+S1(3)/2.
A4=Y(4)+S1(4)/2.
A5=Y(5)+S1(5)/2.
A6=Y(6)+S1(6)/2.
C
C      COMPUTE K SUB 1
C
DO 40 I=1,6

```

```

GO TO (31, 32, 33, 34, 35, 36), I
31 T=FN1(XA, A1, A2, A3, A4, A5, A6)
GO TO 40
32 T=FN2(XA, A1, A2, A3, A4, A5, A6)
GO TO 40
33 T=FN3(XA, A1, A2, A3, A4, A5, A6)
GO TO 40
34 T=FN4(XA, A1, A2, A3, A4, A5, A6)
GO TO 40
35 T=FN5(XA, A1, A2, A3, A4, A5, A6)
GO TO 40
36 T=FN6(XA, A1, A2, A3, A4, A5, A6)
40 S2(I)=H*T
A1=Y(1)+S2(1)/2.
A2=Y(2)+S2(2)/2.
A3=Y(3)+S2(3)/2.
A4=Y(4)+S2(4)/2.
A5=Y(5)+S2(5)/2.
A6=Y(6)+S2(6)/2.

```

C
C
C

COMPUTE K SUB 2

```

DO 50 I=1, 6
GO TO (41, 42, 43, 44, 45, 46), I
41 T=FN1(XA, A1, A2, A3, A4, A5, A6)
GO TO 50
42 T=FN2(XA, A1, A2, A3, A4, A5, A6)
GO TO 50
43 T=FN3(XA, A1, A2, A3, A4, A5, A6)
GO TO 50
44 T=FN4(XA, A1, A2, A3, A4, A5, A6)
GO TO 50
45 T=FN5(XA, A1, A2, A3, A4, A5, A6)
GO TO 50
46 T=FN6(XA, A1, A2, A3, A4, A5, A6)

```

```

50 S3(I)=H*T
   XA=X+H
   A1=Y(1)+S3(1)
   A2=Y(2)+S3(2)
   A3=Y(3)+S3(3)
   A4=Y(4)+S3(4)
   A5=Y(5)+S3(5)
   A6=Y(6)+S3(6)

```

```

C
C   COMPUTE K SUB 3
C

```

```

DO 65 I=1,6
GO TO (51,52,53,54,55,56),I
51 T=FN1(XA,A1,A2,A3,A4,A5,A6)
   GO TO 65
52 T=FN2(XA,A1,A2,A3,A4,A5,A6)
   GO TO 65
53 T=FN3(XA,A1,A2,A3,A4,A5,A6)
   GO TO 65
54 T=FN4(XA,A1,A2,A3,A4,A5,A6)
   GO TO 65
55 T=FN5(XA,A1,A2,A3,A4,A5,A6)
   GO TO 65
56 T=FN6(XA,A1,A2,A3,A4,A5,A6)
65 S4(I)=H*T
   X=X+H

```

```

C
C   COMPUTE NEW VALUES OF INTEGRALS
C

```

```

DO 69 I=1,6
69 Y(I)=Y(I)+(S1(I)+2.*S2(I)+2.*S3(I)+S4(I))/6.
   DO 70 I=1,6
   II=I+L
70 VAL(II)=Y(I)
   RETURN
   END

```

APPENDIX D

When placed at the end of the Runge-Kutta program of Appendix C, the following FUNCTION statements contain the necessary Fortran programming to compute currents for a hammer coil consisting of one concentric rings and a moving plate.

In order to calculate the currents for a stationary plate, the following Fortran statements need only to be placed in FUNCTION FN1 through FN6 and the corresponding cards removed.

$B=2.85E-10*EXP(5.08)$

$D=0.$

```
FUNCTION FN1(X,XX1,XX2,XX3,XX4,XX5,XX6)
A=20.7E-8
B=2.95E-10*EXP(5.08*CONS(41.4E3*X))
C=2.E-4
D=-6.E-5*EXP(5.08*CONS(41.4E3*X))*SIN(41.4E3*X)
E=3000.*COS(20.7E3*X)
FN1=(-(C*A+B*D)*XX1-(C*B+A*D)*XX2+A*E)/(A**2-B**2)
RETURN
END
FUNCTION FN2(X,XX1,XX2,XX3,XX4,XX5,XX6)
A=20.7E-8
B=2.85E-10*EXP(5.08*CONS(41.4E3*X))
C=2.E-4
D=-6.E-5*EXP(5.08*CONS(41.4E3*X))*SIN(41.4E3*X)
E=3000.*COS(20.7E3*X)
FN2=(-(C*B+A*D)*XX1-(C*A+B*D)*XX2+B*E)/(A**2-B**2)
RETURN
END
FUNCTION FN3(X,XX1,XX2,XX3,XX4,XX5,XX6)
FN3=0.0
RETURN
END
FUNCTION FN4(X,XX1,XX2,XX3,XX4,XX5,XX6)
FN4=0.0
RETURN
END
FUNCTION FN5(X,XX1,XX2,XX3,XX4,XX5,XX6)
FN5=0.0
RETURN
END
FUNCTION FN6(X,XX1,XX2,XX3,XX4,XX5,XX6)
FN6=0.0
RETURN
END
```

APPENDIX E

When placed at the end of the Runge-Kutta program of Appendix C, the following FUNCTION statements contain the necessary Fortran programming to compute currents for a hammer coil consisting of two concentric rings and a moving plate.

In order to calculate the currents for a stationary plate, the following Fortran statements need only to be placed in FUNCTION FN1 through FN6 and the corresponding cards removed.

A=1.75E-9*EXP(3.63)

AD=0.

B=1.68E-9*EXP(3.87)

BD=0

```

FUNCTION FN1(X,XX1,XX2,XX3,XX4,XX5,XX6)
R12=5.E-4
R1=3.F-4
R2=7.E-4
HL1=20.7F-8
HL2=29.49E-8
HL12=2.834E-8
A=1.75E-9*EXP(3.63*CDOS(41.4E3*X))
AD=-2.63E-4*EXP(3.63*CDOS(41.4E3*X))*SIN(41.4E3*X)
B=1.68E-9*EXP(3.87*CDOS(41.4E3*X))
BD=-2.69E-4*EXP(3.87*CDOS(41.4E3*X))*SIN(41.4E3*X)
V=3000*CDOS(20.7E3*X)
V1=V-R12*XX1-AD*XX2-BD*XX3
A1=HL1+HL2+2.*HL12
B1=-A
C1=-B
V2=-AD*XX1-R1*XX2
A2=-A
B2=HL1
C2=HL2
V3=-BD*XX1-R2*XX2
A3=-B
B3=HL2
C3=HL2
DELTA=A1*B2*C3+A2*B3*C1+A3*B1*C2-A3*B2*C1-A2*B1*C3-A1*B3*C2
FN1=(V1*B2*C3+V2*B3*C1+V3*B1*C2-V3*B2*C1-V2*B1*C3-V1*B3*C2)/DELTA
RETURN
END
FUNCTION FN2(X,XX1,XX2,XX3,XX4,XX5,XX6)
RETURN
R12=5.F-4
R1=3.E-4
R2=7.E-4

```

```

HL1=20.7E-8
HL2=29.49E-8
HI2=2.834E-8
A=1.75E-9*EXP(3.63*COS(41.4E3*X))
AD=-2.63E-4*EXP(3.63*COS(41.4E3*X))*SIN(41.4E3*X)
B=1.68E-9*EXP(3.87*COS(41.4E3*X))
BD=-2.69E-4*EXP(3.87*COS(41.4E3*X))*SIN(41.4E3*X)
V=3000*COS(20.7E3*X)
V1=V-R12*XX1-AD*XX2-BD*XX3
A1=HL1+HL2+2.*HI2
B1=-A
C1=-B
V2=-AD*XX1-R1*XX2
A2=-A
B2=HL1
C2=HI2
V3=-BD*XX1-R2*XX2
A3=-B
B3=HI2
C3=HL2
DELTA=A1*B2*C3+A2*B3*C1+A3*B1*C2-A3*B2*C1-A2*B1*C3-A1*B3*C2
FN2=(A1*V2*C3+A2*V3*C1+A3*V1*C2-A3*V2*C1-A2*V1*C3-A1*V3*C2)/DELTA
END
FUNCTION FN3(X,XX1,XX2,XX3,XX4,XX5,XX6)
R12=5.E-4
R1=3.E-4
R2=7.E-4
HL1=20.7E-8
HL2=29.49E-8
HI2=2.834E-8
A=1.75E-9*EXP(3.63*COS(41.4E3*X))
AD=-2.63E-4*EXP(3.63*COS(41.4E3*X))*SIN(41.4E3*X)
B=1.68E-9*EXP(3.87*COS(41.4E3*X))

```

```

BD=-2.69F-4*EXP(3.97*COS(41.4E3*X))*SIN(41.4E3*X)
V=3000*COS(20.7E3*X)
V1=V-R12*XX1-AD*XX2-8D*XX3
A1=HL1+HL2+2.*H12
B1=-A
C1=-B
V2=-AD*XX1-R1*XX2
A2=-A
B2=HL1
C2=H12
V3=-8D*XX1-R2*XX2
A3=-B
B3=H12
C3=HL2
DELTA=A1*B2*C3+A2*B3*C1+A3*B1*C2-A3*B2*C1-A2*B1*C3-A1*B3*C2
FN3=(A1*B2*V3+A2*B3*V1+A3*B1*V2-A3*B2*V1-A2*B1*V3-A1*B3*V2)/DELTA
RETURN
END
FUNCTION FN4(X,XX1,XX2,XX3,XX4,XX5,XX6)
FN4=0.0
RETURN
END
FUNCTION FN5(X,XX1,XX2,XX3,XX4,XX5,XX6)
FN5=0.0
RETURN
END
FUNCTION FN6(X,XX1,XX2,XX3,XX4,XX5,XX6)
FN6=0.0
RETURN
END

```

APPENDIX F

When placed at the end of the Runge-Kutta program of Appendix C, the following FUNCTION statements contain the necessary Fortran programming to compute currents for a hammer coil consisting of three concentric rings and a moving plate.

In order to calculate the currents for a stationary plate, the following Fortran statements need only to be placed in FUNCTION FN1 through FN6 and the corresponding cards removed.

A=3.73E-9*EXP(3.15)

AD=0.

B=4.98E-9*EXP(3.15)

BD=0

C=6.76E-9*EXP(2.9)

CD=0.

```
FUNCTION FN1(X,XX1,XX2,XX3,XX4,XX5,XX6)
V=3000* $\text{COS}(20.7\text{E}3*X)$ 
R13=9.E-4
R1=3.E-4
R2=7.E-4
R3=9.E-4
HL1=20.7E-8
HL2=29.49E-8
HL3=38.66E-8
H12=2.834E-8
H13=2.054E-8
H23=3.775E-8
A=3.73E-9* $\text{EXP}(3.15*\text{COS}(41.4\text{E}3*X))$ 
AD=-4.87E-4* $\text{EXP}(3.15*\text{COS}(41.4\text{E}3*X))*\text{SIN}(41.4\text{E}3*X)$ 
B=4.98E-9* $\text{EXP}(3.15*\text{COS}(41.4\text{E}3*X))$ 
BD=-6.5E-4* $\text{EXP}(3.15*\text{COS}(41.4\text{E}3*X))*\text{SIN}(41.4\text{E}3*X)$ 
C=6.76E-9* $\text{EXP}(2.9*\text{COS}(41.4\text{E}3*X))$ 
CD=-8.12E-4* $\text{EXP}(2.9*\text{COS}(41.4\text{E}3*X))*\text{SIN}(41.4\text{E}3*X)$ 
V1=V-R13*XX1-AD*XX2-BD*XX3-CD*XX4
A1=HL1+HL2+HL3+2.*H12+2.*H13+2.*H23
B1=-A
C1=-B
D1=-C
V2=-AD*XX1-R1*XX2
A2=-A
B2=HL1
C2=H12
D2=H13
V3=-BD*XX1-R2*XX3
A3=-B
B3=H12
C3=HL2
D3=H23
```

```

V4=-CD*XX1-P3*XX4
A4=-C
B4=H13
C4=H23
D4=HL3
DELTA=A1*(B2*C3*D4+B3*C4*D2+B4*C2*D3-B4*C3*D2-B2*C4*D3-B3*C2*D4)
8-R1*(A2*C3*D4+A3*C4*D2+A4*C2*D3-A4*C3*D2-A3*C2*D4-A2*C4*D3)
8+C1*(A2*B3*D4+A3*B4*D2+A4*B2*D3-A4*B3*D2-A3*B2*D4-A2*B4*D3)
8-D1*(A2*B3*C4+A3*B4*C2+A4*B2*C3-A4*B3*C2-A3*B2*C4-A2*B4*C3)
FNI=(V1*(B2*C3*D4+B3*C4*D2+B4*C2*D3-B4*C3*D2-B2*C4*D3)
8-R1*(V2*C3*D4+V3*C4*D2+V4*C2*D3-V4*C3*D2-V2*C4*D3-V3*C2*D4)
8+C1*(V2*B3*D4+V3*B4*D2+V4*B2*D3-V4*B3*D2-V2*B4*D3)
8-D1*(V2*B3*C4+V3*B4*C2+V4*B2*C4-V4*B3*C2-V2*B4*C3))/DELTA
RETURN
END
FUNCTION FN2(X,XX1,XX2,XX3,XX4,XX5,XX6)
V=3000*COS(20.7E3*X)
R13=9.E-4
R1=3.E-4
R2=7.E-4
R3=9.E-4
HL1=20.7E-8
HL2=29.49E-8
HL3=38.66E-8
H12=2.834E-8
H13=2.054E-8
H23=3.775E-8
A=3.73E-9*EXP(3.15*COS(41.4E3*X))
AD=-4.87E-4*EXP(3.15*COS(41.4E3*X))*SIN(41.4E3*X)
B=4.98E-9*EXP(3.15*COS(41.4E3*X))
BD=-6.5E-4*EXP(3.15*COS(41.4E3*X))*SIN(41.4E3*X)
C=6.76E-9*EXP(2.9*COS(41.4E3*X))
CD=-8.12E-4*EXP(2.9*COS(41.4E3*X))*SIN(41.4E3*X)

```

```

V1=V-R13*XX1-AD*XX2-BD*XX3-CD*XX4
A1=HL1+HL2+HL3+2.*H17+2.*H13+2.*H23
B1=-A
C1=-B
D1=-C
V2=-AD*XX1-R1*XX2
A2=-A
B2=HL1
C2=HL2
D2=HL3
V3=-BD*XX1-R2*XX3
A3=-B
B3=HL2
C3=HL2
D3=H23
V4=-CD*XX1-R3*XX4
A4=-C
B4=HL3
C4=H23
D4=HL3
DELTA=A1*(B2*C3*D4+B3*C4*D2+B4*C3*D2+B4*C3*D2-B2*C4*D3-B3*C2*D4)
8-B1*(A2*C3*D4+A3*C4*D2+A4*C2*D3-A4*C3*D2-A3*C2*D4-A2*C4*D3)
8+C1*(A2*B3*D4+A3*B4*D2+A4*B2*D3-A4*B3*D2-A3*B2*D4-A2*B4*D3)
8-D1*(A2*B3*C4+A3*B4*C2+A4*B2*C3-A4*B3*C2-A3*B2*C4-A2*B4*C3)
FN2=(A1*(V2*C3*D4+V4*C2*D3+V3*C4*D2-V4*C3*D2-V3*C2*D4-V2*C4*D3)
8-V1*(A2*C3*D4+A4*C2*D3+A3*C4*D2-A4*C3*D2-A2*C4*D3-A3*C2*D4)
8+C1*(A2*V3*D4+A3*V4*D2+A4*V2*D3-A4*V3*D2-A2*V4*D3-A3*V2*D4)
8-D1*(A2*V3*C4+A3*V4*C2+A4*V2*C3-A4*V3*C2-A2*V4*C3-A3*V2*C4))/DELTA
RETURN
END
FUNCTION FN3(X,XX1,XX2,XX3,XX4,XX5,XX6)
V=3000*COS(20.7E3*X)
R13=9.E-4

```

```

R1=3.F-4
R2=7.E-4
R3=9.E-4
HL1=20.7E-8
HL2=29.49E-8
HL3=38.66E-8
H12=2.834E-8
H13=2.054E-8
H23=3.775E-8
A=3.73E-9*EXP(3.15*COS(41.4E3*X))
AD=-4.87E-4*EXP(3.15*COS(41.4E3*X))*SIN(41.4E3*X)
B=4.98E-9*EXP(3.15*COS(41.4E3*X))
BD=-6.5E-4*EXP(3.15*COS(41.4E3*X))*SIN(41.4E3*X)
C=6.76E-9*EXP(2.9*COS(41.4E3*X))
CD=-8.12E-4*EXP(2.9*COS(41.4E3*X))*SIN(41.4E3*X)
V1=V-R13*XX1-AD*XX2-BD*XX3-CD*XX4
A1=HL1+HL2+HL3+2.*H12+2.*H13+2.*H23
B1=-A
C1=-B
D1=-C
V2=-AD*XX1-R1*XX2
A2=-A
B2=HL1
C2=H12
D2=H13
V3=-BD*XX1-R2*XX3
A3=-B
B3=H12
C3=HL2
D3=H23
V4=-CD*XX1-R3*XX4
A4=-C
B4=H13

```



```

C4=H23
D4=HL3
DELTA=A1*(B2*C3*D4+B3*C4*D2+B4*C2*D3-B4*C3*D2-B2*C4*D3-B3*C2*D4)
8-B1*(A2*C3*D4+A3*C4*D2+A4*C2*D3-A4*C3*D2-A3*C2*D4-A2*C4*D3)
8+C1*(A2*B3*D4+A3*B4*D2+A4*B2*D3-A4*B3*D2-A3*B2*D4-A2*B4*D3)
8-D1*(A2*B3*C4+A3*B4*C2+A4*B2*C3-A4*B3*C2-A3*B2*C4-A2*B4*C3)
FN3=(A1*(B2*V3*D4+B3*V4*D2+B4*V2*D3-B4*V3*D2-A2*V4*D3-A3*V2*D4)
8-B1*(A2*V3*D4+A3*V4*D2+A4*V2*D3-A4*V3*D2-A2*V4*D3-A3*V2*D4)
8+V1*(A2*B3*D4+A3*B4*D2+A4*B2*D3-A4*B3*D2-A2*B4*D3-A3*B2*D4)
8-D1*(A2*B3*V4+A3*B4*V2+A4*B2*V3-A4*B3*V2-A2*B4*V3-A3*B2*V4))/DELTA
RETURN
END
FUNCTION FN4(X,XX1,XX2,XX3,XX4,XX5,XX6)
V=3000*COS(20.7E3*X)
R13=9.E-4
R1=3.E-4
R2=7.E-4
R3=9.E-4
HL1=20.7E-8
HL2=29.49E-8
HL3=38.66E-8
H12=2.834E-8
H13=2.054E-8
H23=3.775E-8
A=3.73E-9*EXP(3.15*COS(41.4E3*X))
AD=-4.87E-4*EXP(3.15*COS(41.4E3*X))*SIN(41.4E3*X)
B=4.98E-9*EXP(3.15*COS(41.4E3*X))
BD=-6.5E-4*EXP(3.15*COS(41.4E3*X))*SIN(41.4E3*X)
C=6.76E-9*EXP(2.9*COS(41.4E3*X))
CD=-8.12E-4*EXP(2.9*COS(41.4E3*X))*SIN(41.4E3*X)
V1=V-R13*XX1-AD*XX2-BD*XX3-CD*XX4
A1=HL1+HL2+HL3+2.*H12+2.*H13+2.*H23
B1=-A

```

```

C1=-B
O1=-C
V2=-AD*XX1-RI*XX2
A2=-A
B2=HL1
C2=H12
D2=H13
V3=-RD*XX1-R2*XX3
A3=-B
B3=H12
C3=HL2
D3=H23
V4=-CD*XX1-R3*XX4
A4=-C
B4=H13
C4=H23
D4=HL3
DELTA=A1*(B2*C3*D4+B3*C4*D2+B4*C2*D3-B4*C3*D2-B2*C4*D3-B3*C2*D4)
8-B1*(A2*C3*D4+A3*C4*D2+A4*C2*D3-A4*C3*D2-A3*C2*D4-A2*C4*D3)
8+C1*(A2*B3*D4+A3*B4*D2+A4*B2*D3-A4*B3*D2-A3*B2*D4-A2*B4*D3)
8-D1*(A2*B3*C4+A3*B4*C2+A4*B2*C3-A4*B3*C2-A3*B2*C4-A2*B4*C3)
FN4=(A1*(A2*B3*C4+A3*B4*C2+A4*B2*C3-A4*B3*C2-A3*B2*C4-A2*B4*C3)
8-B1*(A2*C3*V4+A3*C4*V2+A4*C2*V3-A4*C3*V2-A2*C4*V3-A3*C2*V4)
8+C1*(A2*B3*V4+A3*B4*V2+A4*B2*V3-A4*B3*V2-A3*B2*V4-A2*B4*V3)
8-V1*(A2*B3*C4+A3*B4*C2+A4*B2*C3-A4*B3*C2-A3*B2*C4-A2*B4*C3)/DELTA
RETURN
END
FUNCTION FN5(X,XX1,XX2,XX3,XX4,XX5,XX6)
FN5=0.0
RETURN
END
FUNCTION FN6(X,XX1,XX2,XX3,XX4,XX5,XX6)
FN6=0.0
RETURN
END

```

APPENDIX G

When placed at the end of the Runge-Kutta program of Appendix C, the following FUNCTION statements contain the necessary Fortran programming to compute currents for a hammer coil consisting of four concentric rings and a moving plate.

In order to calculate the currents for a stationary plate, the following Fortran statements need only to be placed in FUNCTION FN1 through FN6 and the corresponding cards removed.

A=6.39E-9*EXP(2.78)

AD=0.

B=8.93E-9*EXP(2.78)

BD=0.

C=11.87E-9*EXP(2.66)

CD=0.

D=13.35E-9*EXP(2.54)

DD=0.

```

FUNCTION FN1(X,XX1,XX2,XX3,XX4,XX5,XX6)
R14=14.E-4
R1=3.E-4
R2=7.E-4
R3=9.E-4
R4=10.E-4
HL1=20.7E-8
HL2=29.49E-8
HL3=38.66F-8
HL4=48.03E-8
H12=2.834E-8
H13=2.054E-8
H14=1.626E-8
H23=3.775E-8
H24=2.794E-8
H34=4.754E-8
A=6.39E-9*EXP(2.78*COS(41.4E3*X))
AD=-7.35E-4*EXP(2.78*COS(41.4E3*X))*SIN(41.4E3*X)
B=8.93E-9*EXP(2.78*COS(41.4E3*X))
BD=-10.25E-4*EXP(2.78*COS(41.4E3*X))*SIN(41.4E3*X)
C=11.87E-9*EXP(2.66*COS(41.4E3*X))
CD=-13.05E-4*EXP(2.66*COS(41.4E3*X))*SIN(41.4E3*X)
D=13.35E-9*EXP(2.54*COS(41.4E3*X))
DD=-14.00E-4*EXP(2.54*COS(41.4E3*X))*SIN(41.4E3*X)
V=3000.*COS(20.7E3*X)
V1=V-R14*XX1-AD*XX2-BD*XX3-CD*XX4-DD*XX5
A1=HL1+HL2+HL3+HL4+2.*H12+2.*H13+2.*H14+2.*H23+2.*H24+2.*H34
B1=-A
C1=-B
D1=-C
E1=-D
V2=-AD*XX1-R1*XX2
A2=-A

```

B2=HL1
 C2=H12
 D2=H13
 E2=H14
 V3=-BD*XX1-R2*XX3
 A3=-B
 B3=H12
 C3=HL2
 D3=H23
 E3=H24
 V4=-CD*XX1-R3*XX4
 A4=-C
 B4=H13
 C4=H23
 D4=HL3
 E4=H34
 V5=-DD*XX1-R4*XX5
 A5=-D
 B5=H14
 C5=H24
 D5=H34
 E5=HL4
 A11=A1*(B2*(C3*D4*E5+C4*D5*E3+C5*D3*E4-C5*D4*E3-C4*D3*E5-C3*D5*E4)
 8-C2*(B3*D4*E5+B4*D5*E3+B5*D3*E4-B5*D4*E3-B4*D3*E5-B3*D5*E4)
 8+D2*(B3*C4*E5+B4*C5*E3+B5*C3*E4-B5*C4*E3-B4*C3*E5-B3*C5*E4)
 8-E2*(B3*C4*D5+B4*C5*D3+B5*C3*D4-B5*C4*D3-B4*C3*D5-B3*C5*D4))
 B11=B1*(A2*(C3*D4*E5+C4*D5*E3+C5*D3*E4-C5*D4*E3-C4*D3*E5-C3*D5*E4)
 8-C2*(A3*D4*E5+A4*D5*E3+A5*D3*E4-A5*D4*E3-A4*D3*E5-A3*D5*E4)
 8+D2*(A3*C4*E5+A4*C5*E3+A5*C3*E4-A5*C4*E3-A4*C3*E5-A3*C5*E4)
 8-E2*(A3*C4*D5+A4*C5*D3+A5*C3*D4-A5*C4*D3-A4*C3*D5-A3*C5*D4))
 C11=C1*(A2*(B3*D4*E5+B4*D5*E3+B5*D3*E4-B5*D4*E3-B4*D3*E5-B3*D5*E4)
 8-B2*(A3*D4*E5+A4*D5*E3+A5*D3*E4-A5*D4*E3-A4*D3*E5-A3*D5*E4)
 8+D2*(A3*B4*E5+A4*B5*E3+A5*B3*E4-A5*B4*E3-A4*B3*E5-A3*B5*E4)

```

8-E2*(A8*B4*D5+A4*B3*D3+A5*B3*D4-A5*B4*D3-A4*B3*D5-A3*B5*D4)
D11=D1*(A2*(B3*C4*E5+B4*C5*E3+B5*C3*E4-B5*C4*E3-B4*C3*E5-B3*C5*E4)
8-B2*(A3*C4*E5+A4*C5*E3+A5*C3*E4-A5*C4*E3-A4*C3*E5-A3*C5*E4)
8+C2*(A3*B4*E5+A4*B5*E3+A5*B3*E4-A5*B4*E3-A4*B3*E5-A3*B5*E4)
8-E2*(A3*B4*C5+A4*B5*C3+A5*B3*C4-A5*B4*C3-A4*B3*C5-A3*B5*C4)
E11=E1*(A2*(B3*C4*D5+B4*C5*D3+B5*C3*D4-A5*C4*D3-B4*C3*D5-B3*C5*D4)
8-B2*(A3*C4*D5+A4*C5*D3+A5*C3*D4-A5*C4*D3-A4*C3*D5-A3*C5*D4)
8+C2*(A3*B4*D5+A4*B5*D3+A5*B3*D4-A5*B4*D3-A4*B3*D5-A3*B5*D4)
8-D2*(A3*B4*C5+A4*B5*C3+A5*B3*C4-A5*B4*C3-A4*B3*C5-A3*B5*C4)
DELTA=A11-B11+C11-D11+E11
VA=V1*(R2*(C3*D4*E5+C4*D5*E3+C5*D3*E4-C5*D4*E3-C4*D3*E5-C3*D5*E4)
8-C2*(R3*D4*E5+B4*D5*E3+B5*D3*E4-B5*D4*E3-B4*D3*E5-B3*D5*E4)
8+D2*(R3*C4*E5+B4*C5*E3+B5*C3*E4-B5*C4*E3-B4*C3*E5-B3*C5*E4)
8-E2*(R3*C4*D5+B4*C5*D3+B5*C3*D4-B5*C4*D3-B4*C3*D5-B3*C5*D4)
BA=B1*(V2*(C3*D4*E5+C4*D5*E3+C5*D3*E4-C5*D4*E3-C4*D3*E5-C3*D5*E4)
8-C2*(V3*D4*E5+V4*D5*E3+V5*D3*E4-V5*D4*E3-V4*D3*E5-V3*D5*E4)
8+D2*(V3*C4*E5+V4*C5*E3+V5*C3*E4-V5*C4*E3-V4*C3*E5-V3*C5*E4)
8-E2*(V3*C4*D5+V4*C5*D3+V5*C3*D4-V5*C4*D3-V4*C3*D5-V3*C5*D4)
CA=C1*(V2*(R3*D4*E5+B4*D5*E3+B5*D3*E4-B5*D4*E3-B4*D3*E5-B3*D5*E4)
8-B2*(V3*D4*E5+V4*D5*E3+V5*D3*E4-V5*D4*E3-V4*D3*E5-V3*D5*E4)
8+D2*(V3*B4*E5+V4*B5*E3+V5*B3*E4-V5*B4*E3-V4*B3*E5-V3*B5*E4)
8-E2*(V3*B4*D5+V4*B5*D3+V5*B3*D4-V5*B4*D3-V4*B3*D5-V3*B5*D4)
DA=D1*(V2*(R3*C4*E5+B4*C5*E3+B5*C3*E4-B5*C4*E3-B4*C3*E5-B3*C5*E4)
8-B2*(V3*C4*E5+V4*C5*E3+V5*C3*E4-V5*C4*E3-V4*C3*E5-V3*C5*E4)
8+C2*(V3*B4*E5+V4*B5*E3+V5*B3*E4-V5*B4*E3-V4*B3*E5-V3*B5*E4)
8-E2*(V3*B4*C5+V4*B5*C3+V5*B3*C4-V5*B4*C3-V4*B3*C5-V3*B5*C4)
EA=E1*(V2*(R3*C4*D5+B4*C5*D3+B5*C3*D4-B5*C4*D3-B4*C3*D5-B3*C5*D4)
8-B2*(V3*C4*D5+V4*C5*D3+V5*C3*D4-V5*C4*D3-V4*C3*D5-V3*C5*D4)
8+C2*(V3*B4*D5+V4*B5*D3+V5*B3*D4-V5*B4*D3-V4*B3*D5-V3*B5*D4)
8-D2*(V3*B4*C5+V4*B5*C3+V5*B3*C4-V5*B4*C3-V4*B3*C5-V3*B5*C4)
FNL=(VA-BA+CA-DA+EA)/DELTA
RETURN
END

```

```

FUNCTION FN2(X,XX1,XX2,XX3,XX4,XX5,XX6)
R14=14.E-4
R1=3.E-4
R2=7.E-4
R3=9.E-4
R4=10.E-4
HL1=20.7E-8
HL2=29.49E-8
HL3=38.66E-8
HL4=48.03E-8
H12=2.834E-8
H13=2.054E-8
H14=1.626E-8
H23=3.775E-8
H24=2.794E-8
H34=4.754E-8
A=6.39E-9*EXP(2.78*COS(41.4E3*X))
AD=-7.35E-4*EXP(2.78*COS(41.4E3*X))*SIN(41.4E3*X)
R=8.93E-9*EXP(2.78*COS(41.4E3*X))
BD=-10.25E-4*EXP(2.78*COS(41.4E3*X))*SIN(41.4E3*X)
C=11.87E-9*EXP(2.66*COS(41.4E3*X))
CD=-13.05E-4*EXP(2.66*COS(41.4E3*X))*SIN(41.4E3*X)
D=13.35E-9*EXP(2.54*COS(41.4E3*X))
DD=-14.00E-4*EXP(2.54*COS(41.4E3*X))*SIN(41.4E3*X)
V=3000.*COS(20.7E3*X)
V1=V-R14*XX1-AD*XX2-BD*XX3-CD*XX4-DD*XX5
A1=HL1+HL2+HL3+HL4+2.*H12+2.*H13+2.*H14+2.*H23+2.*H24+2.*H34
B1=-A
C1=-B
D1=-C
E1=-D
V2=-AD*XX1-R1*XX2
A2=-A

```

B2=HL1
 C2=H12
 D2=H13
 E2=H14
 V3=-BD*XX1-R2*XX3
 A3=-B
 B3=H12
 C3=HL2
 D3=H23
 E3=H24
 V4=-CD*XX1-R3*XX4
 A4=-C
 B4=H13
 C4=H23
 D4=HL3
 E4=H34
 V5=-DD*XX1-R4*XX5
 A5=-D
 B5=H14
 C5=H24
 D5=H34
 E5=HL4
 A11=A1*(B2*(C3*D4*E5+C4*D5*E3+C5*D3*E4-C5*D4*E3-C4*D3*E5-C3*D5*E4)
 8-C2*(B3*D4*E5+B4*D5*E3+B5*D3*E4-85*D4*E3-84*D3*E5-83*D5*E4)
 8+D2*(B3*C4*E5+B4*C5*E3+B5*C3*E4-85*C4*E3-84*C3*E5-83*C5*E4)
 8-F2*(B3*C4*D5+R4*C5*D3+B5*C3*D4-B5*C4*D3-84*C3*D5-B3*C5*D4)
 8I1=81*(A2*(C3*D4*E5+C4*D5*E3+C5*D3*E4-C5*D4*E3-C4*D3*E5-C3*D5*E4)
 8-C2*(A3*D4*E5+A4*D5*E3+A5*D3*E4-A5*D4*E3-A4*D3*E5-A3*D5*E4)
 8+D2*(A3*C4*E5+A4*C5*E3+A5*C3*E4-A5*C4*E3-A4*C3*E5-A3*C5*E4)
 8-E2*(A3*C4*D5+A4*C5*D3+A5*C3*D4-A5*C4*D3-A4*C3*D5-A3*C5*D4)
 C11=C1*(A2*(B3*D4*E5+B4*D5*E3+B5*D3*E4-B5*D4*E3-B4*D3*E5-B3*D5*E4)
 8-B2*(A3*D4*E5+A4*D5*E3+A5*D3*E4-A5*D4*E3-A4*D3*E5-A3*D5*E4)
 8+D2*(A3*B4*E5+A4*B5*E3+A5*B3*E4-A5*B4*E3-A4*B3*E5-A3*B5*E4)

```

8-E2*(A3*B4*D5+A4*B5*D3+A5*B3*D4-A5*B4*D3-A4*B3*D5-A3*B5*D4))
D11=D1*(A2*(B3*C4*E5+A4*C5*E3+A5*C3*E4-B5*C4*E3-B4*C3*E5-B3*C5*E4)
8-B2*(A3*C4*E5+A4*C5*E3+A5*C3*E4-A5*C4*E3-A4*C3*E5-A3*C5*E4)
8+C2*(A3*B4*E5+A4*B5*E3+A5*B3*E4-A5*B4*E3-A4*B3*E5-A3*B5*E4)
8-E2*(A3*B4*C5+A4*B5*C3+A5*B3*C4-A5*B4*C3-A4*B3*C5-A3*B5*C4))
E11=F1*(A2*(B3*C4*D5+B4*C5*D3+A5*C3*D4-B5*C4*D3-B4*C3*D5-B3*C5*D4)
8-B2*(A3*C4*D5+A4*C5*D3+A5*C3*D4-A5*C4*D3-A4*C3*D5-A3*C5*D4)
8+C2*(A3*B4*D5+A4*B5*D3+A5*B3*D4-A5*B4*D3-A4*B3*D5-A3*B5*D4)
8-D2*(A3*B4*C5+A4*B5*C3+A5*B3*C4-A5*B4*C3-A4*B3*C5-A3*B5*C4))
DELTA=A11-B11+C11-D11+E11
AB=A1*(V2*(C3*D4*E5+C4*D5*E3+C5*D3*E4-C5*D4*E3-C4*D3*E5-C3*D5*E4)
8-C2*(V3*D4*E5+V4*D5*E3+V5*D3*E4-V5*D4*E3-V4*D3*E5-V3*D5*E4)
8+D2*(V3*C4*E5+V4*C5*E3+V5*C3*E4-V5*C4*E3-V4*C3*E5-V3*C5*E4)
8-E2*(V3*C4*D5+V4*C5*D3+V5*C3*D4-V5*C4*D3-V4*C3*D5-V3*C5*D4))
VB=V1*(A2*(C3*D4*E5+C4*D5*E3+C5*D3*E4-C5*D4*E3-C4*D3*E5-C3*D5*E4)
8-C2*(A3*D4*E5+A4*D5*E3+A5*D3*E4-A5*D4*E3-A4*D3*E5-A3*D5*E4)
8+D2*(A3*C4*E5+A4*C5*E3+A5*C3*E4-A5*C4*E3-A4*C3*E5-A3*C5*E4)
8-E2*(A3*C4*D5+A4*C5*D3+A5*C3*D4-A5*C4*D3-A4*C3*D5-A3*C5*D4))
CB=C1*(A2*(V3*D4*E5+V4*D5*E3+V5*D3*E4-V5*D4*E3-V4*D3*E5-V3*D5*E4)
8-V2*(A3*D4*E5+A4*D5*E3+A5*D3*E4-A5*D4*E3-A4*D3*E5-A3*D5*E4)
8+D2*(A3*V4*E5+A4*V5*E3+A5*V3*E4-A5*V4*E3-A4*V3*E5-A3*V5*E4)
8-E2*(A3*V4*D5+A4*V5*D3+A5*V3*D4-A5*V4*D3-A4*V3*D5-A3*V5*D4))
DB=D1*(A2*(V3*C4*E5+V4*C5*E3+V5*C3*E4-V5*C4*E3-V4*C3*E5-V3*C5*E4)
8-V2*(A3*C4*E5+A4*C5*E3+A5*C3*E4-A5*C4*E3-A4*C3*E5-A3*C5*E4)
8+C2*(A3*V4*E5+A4*V5*E3+A5*V3*E4-A5*V4*E3-A4*V3*E5-A3*V5*E4)
8-E2*(A3*V4*C5+A4*V5*C3+A5*V3*C4-A5*V4*C3-A4*V3*C5-A3*V5*C4))
EB=E1*(A2*(V3*C4*D5+V4*C5*D3+V5*C3*D4-V5*C4*D3-V4*C3*D5-V3*C5*D4)
8-V2*(A3*C4*D5+A4*C5*D3+A5*C3*D4-A5*C4*D3-A4*C3*D5-A3*C5*D4)
8+C2*(A3*V4*D5+A4*V5*D3+A5*V3*D4-A5*V4*D3-A4*V3*D5-A3*V5*D4)
8-D2*(A3*V4*C5+A4*V5*C3+A5*V3*C4-A5*V4*C3-A4*V3*C5-A3*V5*C4))
FN2=(AB-VB+CB-DB+EB)/DELTA
RETURN
END

```

```

FUNCTION FN3(X,XX1,XX2,XX3,XX4,XX5,XX6)
R14=14.E-4
R1=3.E-4
R2=7.E-4
R3=9.E-4
R4=10.E-4
HL1=20.7F-8
HL2=29.49E-8
HL3=38.66E-8
HL4=48.03E-8
H12=2.834E-8
H13=2.054E-8
H14=1.626E-8
H23=3.775E-8
H24=2.794E-8
H34=4.754E-8
A=6.39E-9*EXP(2.78* $\cos(41.4E3*X)$ )
AD=-7.35E-4*EXP(2.78* $\cos(41.4E3*X)$ )* $\sin(41.4E3*X)$ 
B=8.93E-9*EXP(2.78* $\cos(41.4E3*X)$ )
BD=-10.25E-4*EXP(2.78* $\cos(41.4E3*X)$ )* $\sin(41.4E3*X)$ 
C=11.87E-9*EXP(2.66* $\cos(41.4E3*X)$ )
CD=-13.05E-4*EXP(2.66* $\cos(41.4E3*X)$ )* $\sin(41.4E3*X)$ 
D=13.35E-9*EXP(2.54* $\cos(41.4E3*X)$ )
DD=-14.00E-4*EXP(2.54* $\cos(41.4E3*X)$ )* $\sin(41.4E3*X)$ 
V=3000.* $\cos(20.7E3*X)$ 
V1=V-R14*XX1-AD*XX2-BD*XX3-CD*XX4-DD*XX5
A1=HL1+HL2+HL3+HL4+2.*H12+2.*H13+2.*H14+2.*H23+2.*H24+2.*H34
B1=-A
C1=-B
D1=-C
E1=-D
V2=-AD*XX1-R1*XX2
A2=-A

```

B2=HL1
 C2=H12
 D2=H13
 E2=H14
 V3=-BD*XX1-R2*XX3
 A3=-B
 B3=H12
 C3=HL2
 D3=H23
 E3=H24
 V4=-CD*XX1-R3*XX4
 A4=-C
 B4=H13
 C4=H23
 D4=HL3
 E4=H34
 V5=-DD*XX1-R4*XX5
 A5=-D
 B5=H14
 C5=H24
 D5=H34
 E5=HL4
 A11=A1*(B2*(C3*D4*E5+C4*D5*E3+C5*D3*E4-C5*D4*E3-C4*D3*E5-C3*D5*E4)
 8-C2*(B3*D4*E5+84*D5*E3+85*D3*E4-85*D4*E3-84*D3*E5-83*D5*E4)
 8+D2*(B3*C4*E5+84*C5*E3+85*C3*E4-85*C4*E3-84*C3*E5-83*C5*E4)
 8-E2*(B3*C4*D5+84*C5*D3+85*C3*D4-85*C4*D3-84*C3*D5-83*C5*D4)
 B11=B1*(A2*(C3*D4*E5+C4*D5*E3+C5*D3*E4-C5*D4*E3-C4*D3*E5-C3*D5*E4)
 8-C2*(A3*D4*E5+A4*D5*E3+A5*D3*E4-A5*D4*E3-A4*D3*E5-A3*D5*E4)
 8+D2*(A3*C4*E5+A4*C5*E3+A5*C3*E4-A5*C4*E3-A4*C3*E5-A3*C5*E4)
 8-E2*(A3*C4*D5+A4*C5*D3+A5*C3*D4-A5*C4*D3-A4*C3*D5-A3*C5*D4)
 C11=C1*(A2*(B3*D4*E5+B4*D5*E3+B5*D3*E4-85*D4*E3-84*D3*E5-83*D5*E4)
 8-B2*(A3*D4*E5+A4*D5*E3+A5*D3*E4-A5*D4*E3-A4*D3*E5-A3*D5*E4)
 8+D2*(A3*B4*E5+A4*B5*E3+A5*B3*E4-A5*B4*E3-A4*B3*E5-A3*B5*E4)

```

8-E2*(A3*B4*D5+A4*B5*D3+A5*B3*D4-A5*B4*D3-A4*B3*D5-A3*B5*D4))
D11=D1*(A2*(B3*C4*E5+B4*C5*E3+B5*C3*E4-B5*C4*E3-B4*C3*E5-B3*C5*E4)
8-B2*(A3*C4*E5+A4*C5*E3+A5*C3*E4-A5*C4*E3-A4*C3*E5-A3*C5*E4)
8+C2*(A3*B4*E5+A4*B5*E3+A5*B3*E4-A5*B4*E3-A4*B3*E5-A3*B5*E4)
8-E2*(A3*B4*C5+A4*B5*C3+A5*B3*C4-A5*B4*C3-A4*B3*C5-A3*B5*C4)
E11=E1*(A2*(B3*C4*D5+B4*C5*D3+B5*C3*D4-B5*C4*D3-B4*C3*D5-B3*C5*D4)
8-B2*(A3*C4*D5+A4*C5*D3+A5*C3*D4-A5*C4*D3-A4*C3*D5-A3*C5*D4)
8+C2*(A3*B4*D5+A4*B5*D3+A5*B3*D4-A5*B4*D3-A4*B3*D5-A3*B5*D4)
8-D2*(A3*B4*C5+A4*B5*C3+A5*B3*C4-A5*B4*C3-A4*B3*C5-A3*B5*C4)
DELTA=A11-R11+C11-D11+E11
AC=A1*(B2*(V3*D4*E5+V4*D5*E3+V5*D3*E4-V5*D4*E3-V4*D3*E5-V3*D5*E4)
8-V2*(B3*D4*E5+B4*D5*E3+B5*D3*E4-B5*D4*E3-B4*D3*E5-B3*D5*E4)
8+D2*(B3*V4*E5+B4*V5*E3+B5*V3*E4-B5*V4*E3-B4*V3*E5-B3*V5*E4)
8-E2*(B3*V4*D5+B4*V5*D3+B5*V3*D4-B5*V4*D3-B4*V3*D5-B3*V5*D4))
BC=B1*(A2*(V3*D4*E5+V4*D5*E3+V5*D3*E4-V5*D4*E3-V4*D3*E5-V3*D5*E4)
8-V2*(A3*D4*E5+A4*D5*E3+A5*D3*E4-A5*D4*E3-A4*D3*E5-A3*D5*E4)
8+D2*(A3*V4*E5+A4*V5*E3+A5*V3*E4-A5*V4*E3-A4*V3*E5-A3*V5*E4)
8-E2*(A3*V4*D5+A4*V5*D3+A5*V3*D4-A5*V4*D3-A4*V3*D5-A3*V5*D4))
VC=V1*(A2*(B3*D4*E5+B4*D5*E3+B5*D3*E4-B5*D4*E3-B4*D3*E5-B3*D5*E4)
8-B2*(A3*D4*E5+A4*D5*E3+A5*D3*E4-A5*D4*E3-A4*D3*E5-A3*D5*E4)
8+D2*(A3*B4*E5+A4*B5*E3+A5*B3*E4-A5*B4*E3-A4*B3*E5-A3*B5*E4)
8-E2*(A3*B4*D5+A4*B5*D3+A5*B3*D4-A5*B4*D3-A4*B3*D5-A3*B5*D4))
DC=D1*(A2*(B3*V4*E5+B4*V5*E3+B5*V3*E4-B5*V4*E3-B4*V3*E5-B3*V5*E4)
8-B2*(A3*V4*E5+A4*V5*E3+A5*V3*E4-A5*V4*E3-A4*V3*E5-A3*V5*E4)
8+V2*(A3*B4*E5+A4*B5*E3+A5*B3*E4-A5*B4*E3-A4*B3*E5-A3*B5*E4)
8-E2*(A3*B4*V5+A4*B5*V3+A5*B3*V4-A5*B4*V3-A4*B3*V5-A3*B5*V4))
EC=E1*(A2*(B3*V4*D5+B4*V5*D3+B5*V3*D4-B5*V4*D3-B4*V3*D5-B3*V5*D4)
8-B2*(A3*V4*D5+A4*V5*D3+A5*V3*D4-A5*V4*D3-A4*V3*D5-A3*V5*D4)
8+V2*(A3*B4*D5+A4*B5*D3+A5*B3*D4-A5*B4*D3-A4*B3*D5-A3*B5*D4)
8-D2*(A3*B4*V5+A4*B5*V3+A5*B3*V4-A5*B4*V3-A4*B3*V5-A3*B5*V4))
FN3=(AC-BC+VC-DC+EC)/DELTA
RETURN
END
FUNCTION FN4(X,XX1,XX2,XX3,XX4,XX5,XX6)

```

```

R14=14.E-4
R1=3.E-4
R2=7.E-4
R3=9.E-4
R4=10.E-4
HL1=20.7E-8
HL2=29.49E-8
HL3=38.66E-8
HL4=48.03E-8
H12=2.834E-8
H13=2.054E-8
H14=1.626E-8
H23=3.775E-8
H24=2.794E-8
H34=4.754E-8
A=6.39E-9*EXP(2.78*COS(41.4E3*X))
AD=-7.35E-4*EXP(2.78*COS(41.4E3*X))*SIN(41.4E3*X)
B=8.93E-9*EXP(2.78*COS(41.4E3*X))
BD=-10.25E-4*EXP(2.78*COS(41.4E3*X))*SIN(41.4E3*X)
C=11.87E-9*EXP(2.66*COS(41.4E3*X))
CD=-13.05E-4*EXP(2.66*COS(41.4E3*X))*SIN(41.4E3*X)
D=13.35E-9*EXP(2.54*COS(41.4E3*X))
DD=-14.00E-4*EXP(2.54*COS(41.4E3*X))*SIN(41.4E3*X)
V=3000.*COS(20.7E3*X)
V1=V-R14*XX1-AD*XX2-BD*XX3-CD*XX4-DD*XX5
A1=HL1+HL2+HL3+HL4+2.*H12+2.*H13+2.*H14+2.*H23+2.*H24+2.*H34
B1=-A
C1=-B
D1=-C
E1=-D
V2=-AD*XX1-R1*XX2
A2=-A
B2=HL1

```

C2=H12
 D2=H13
 E2=H14
 V3=-BD*XX1-R2*XX3
 A3=-B
 B3=H12
 C3=HL2
 D3=H23
 E3=H24
 V4=-CD*XX1-R3*XX4
 A4=-C
 B4=H13
 C4=H23
 D4=HL3
 E4=H34
 V5=-DD*XX1-R4*XX5
 A5=-D
 B5=H14
 C5=H24
 D5=H34
 E5=HL4
 A11=A1*(B2*(C3*D4*E5+C4*D5*E3+C5*D3*E4-C5*D4*E3-C4*D3*E5-C3*D5*E4)
 8-C2*(B3*D4*E5+B4*05*E3+B5*D3*E4-B5*D4*E3-B4*D3*E5-B3*D5*E4)
 8+D2*(B3*C4*E5+B4*C5*E3+B5*C3*E4-B5*C4*E3-B4*C3*E5-B3*C5*E4)
 8-E2*(B3*C4*D5+B4*C5*D3+B5*C3*D4-B5*C4*D3-B4*C3*D5-B3*C5*D4))
 B11=B1*(A2*(C3*D4*E5+C4*D5*E3+C5*D3*E4-C5*D4*E3-C4*D3*E5-C3*D5*E4)
 8-C2*(A3*D4*E5+A4*D5*E3+A5*D3*E4-A5*D4*E3-A4*D3*E5-A3*D5*E4)
 8+D2*(A3*C4*E5+A4*C5*E3+A5*C3*E4-A5*C4*E3-A4*C3*E5-A3*C5*E4)
 8-E2*(A3*C4*D5+A4*C5*D3+A5*C3*D4-A5*C4*D3-A4*C3*D5-A3*C5*D4))
 C11=C1*(A2*(B3*D4*E5+B4*D5*E3+B5*D3*E4-B5*D4*E3-B4*D3*E5-B3*D5*E4)
 8-B2*(A3*D4*E5+A4*D5*E3+A5*D3*E4-A5*D4*E3-A4*D3*E5-A3*D5*E4)
 8+D2*(A3*B4*E5+A4*B5*E3+A5*B3*E4-A5*B4*E3-A4*B3*E5-A3*B5*E4)
 8-E2*(A3*B4*D5+A4*B5*D3+A5*B3*D4-A5*B4*D3-A4*B3*D5-A3*B5*D4))

```

D11=D1*(A2*(B3*C4*E5+B4*C5*E3+B5*C3*E4-B5*C4*E3-B4*C3*E5-B3*C5*E4)
8-R2*(A3*C4*E5+A4*C5*E3+A5*C3*E4-A5*C4*E3-A4*C3*E5-A3*C5*E4)
8+C2*(A3*R4*E5+A4*R5*E3+A5*R3*E4-A5*B4*E3-A4*R3*E5-A3*B5*E4)
8-E2*(A3*B4*C5+A4*B5*C3+A5*B3*C4-A5*B4*C3-A4*B3*C5-A3*B5*C4))
E11=E1*(A2*(B3*C4*D5+B4*C5*D3+B5*C3*D4-B5*C4*D3-B4*C3*D5-B3*C5*D4)
8-B2*(A3*C4*D5+A4*C5*D3+A5*C3*D4-A5*C4*D3-A4*C3*D5-A3*C5*D4)
8+C2*(A3*B4*D5+A4*B5*D3+A5*B3*D4-A5*B4*D3-A4*B3*D5-A3*B5*D4)
8-D2*(A3*B4*C5+A4*B5*C3+A5*B3*C4-A5*B4*C3-A4*B3*C5-A3*B5*C4))
DELTA=A11-B11+C11-D11+E11
AZ=A1*(B2*(C3*V4*E5+C4*V5*E3+C5*V3*E4-C5*V4*E3-C4*V3*E5-C3*V5*E4)
8-C2*(B3*V4*E5+B4*V5*E3+B5*V3*E4-R5*V4*E3-B4*V3*E5-B3*V5*E4)
8+V2*(B3*C4*E5+B4*C5*E3+B5*C3*E4-B5*C4*E3-B4*C3*E5-B3*C5*E4)
8-F2*(B3*C4*V5+B4*C5*V3+B5*C3*V4-B5*C4*V3-B4*C3*V5-B3*C5*V4))
BZ=B1*(A2*(C3*V4*E5+C4*V5*E3+C5*V3*E4-C5*V4*E3-C4*V3*E5-C3*V5*E4)
8-C2*(A3*V4*E5+A4*V5*E3+A5*V3*E4-A5*V4*E3-A4*V3*E5-A3*V5*E4)
8+V2*(A3*C4*E5+A4*C5*E3+A5*C3*E4-A5*C4*E3-A4*C3*E5-A3*C5*E4)
8-E2*(A3*C4*V5+A4*C5*V3+A5*C3*V4-A5*C4*V3-A4*C3*V5-A3*C5*V4))
CZ=C1*(A2*(B3*V4*E5+B4*V5*E3+B5*V3*E4-B5*V4*E3-B4*V3*E5-B3*V5*E4)
8-B2*(A3*V4*E5+A4*V5*E3+A5*V3*E4-A5*V4*E3-A4*V3*E5-A3*V5*E4)
8+V2*(A3*B4*E5+A4*B5*E3+A5*B3*E4-A5*B4*E3-A4*B3*E5-A3*B5*E4)
8-E2*(A3*B4*V5+A4*B5*V3+A5*B3*V4-A5*B4*V3-A4*B3*V5-A3*B5*V4))
VZ=V1*(A2*(B3*C4*E5+B4*C5*E3+B5*C3*E4-B5*C4*E3-B4*C3*E5-B3*C5*E4)
8-B2*(A3*C4*E5+A4*C5*E3+A5*C3*E4-A5*C4*E3-A4*C3*E5-A3*C5*E4)
8+C2*(A3*B4*E5+A4*B5*E3+A5*B3*E4-A5*B4*E3-A4*B3*E5-A3*B5*E4)
8-E2*(A3*B4*C5+A4*B5*C3+A5*B3*C4-A5*B4*C3-A4*B3*C5-A3*B5*C4))
EZ=E1*(A2*(B3*C4*V5+B4*C5*V3+B5*C3*V4-B5*C4*V3-B4*C3*V5-B3*C5*V4)
8-B2*(A3*C4*V5+A4*C5*V3+A5*C3*V4-A5*C4*V3-A4*C3*V5-A3*C5*V4)
8+C2*(A3*B4*V5+A4*B5*V3+A5*B3*V4-A5*B4*V3-A4*B3*V5-A3*B5*V4)
8-V2*(A3*B4*C5+A4*B5*C3+A5*B3*C4-A5*B4*C3-A4*B3*C5-A3*B5*C4))
FN4=(AZ-BZ+CZ-VZ+EZ)/DELTA
RETURN
END
FUNCTION FN5(X,XX1,XX2,XX3,XX4,XX5,XX6)

```

```

R14=14.E-4
R1=3.E-4
R2=7.E-4
R3=9.E-4
R4=10.E-4
HL1=20.7E-8
HL2=29.49E-8
HL3=38.66E-8
HL4=48.03E-8
H12=2.834E-8
H13=2.054E-8
H14=1.626E-8
H23=3.775E-8
H24=2.794E-8
H34=4.754E-8
A=6.39E-9*EXP(2.78* $\text{COS}(41.4\text{E}3^{\circ})$ )
AD=-7.35E-4*EXP(2.78* $\text{COS}(41.4\text{E}3^{\circ})$ )* $\text{SIN}(41.4\text{E}3^{\circ})$ 
B=8.93E-9*EXP(2.78* $\text{COS}(41.4\text{E}3^{\circ})$ )
BD=-10.25E-4*EXP(2.78* $\text{COS}(41.4\text{E}3^{\circ})$ )* $\text{SIN}(41.4\text{E}3^{\circ})$ 
C=11.87E-9*EXP(2.66* $\text{COS}(41.4\text{E}3^{\circ})$ )
CD=-13.05E-4*EXP(2.66* $\text{COS}(41.4\text{E}3^{\circ})$ )* $\text{SIN}(41.4\text{E}3^{\circ})$ 
D=13.35E-9*EXP(2.54* $\text{COS}(41.4\text{E}3^{\circ})$ )
DD=-14.00E-4*EXP(2.54* $\text{COS}(41.4\text{E}3^{\circ})$ )* $\text{SIN}(41.4\text{E}3^{\circ})$ 
V=3000.* $\text{COS}(20.7\text{E}3^{\circ})$ 
V1=V-R14*XX1-AD*XX2-BD*XX3-CD*XX4-DD*XX5
A1=HL1+HL2+HL3+HL4+2.*H12+2.*H13+2.*H14+2.*H23+2.*H24+2.*H34
B1=-A
C1=-B
D1=-C
E1=-D
V2=-AD*XX1-R1*XX2
A2=-A
B2=HL1

```

C2=H12
 D2=H13
 E2=H14
 V3=-BD*XX1-R2*XX3
 A3=-B
 B3=H12
 C3=HL2
 D3=H23
 E3=H24
 V4=-CD*XX1-R3*XX4
 A4=-C
 B4=H13
 C4=H23
 D4=HL3
 E4=H34
 V5=-DD*XX1-R4*XX5
 A5=-D
 B5=H14
 C5=H24
 D5=H34
 E5=HL4
 A11=A1*(B2*(C3*D4*E5+C4*D5*E3+C5*D3*E4-C5*D4*E3-C4*D3*E5-C3*D5*E4)
 8-C2*(B3*D4*E5+B4*D5*E3+B5*D3*E4-85*D4*E3-84*D3*E5-83*D5*E4)
 8+D2*(B3*C4*E5+B4*C5*E3+B5*C3*E4-85*C4*E3-84*C3*E5-83*C5*E4)
 8-E2*(B3*C4*D5+B4*C5*D3+B5*C3*D4-85*C4*D3-84*C3*D5-83*C5*D4))
 B11=B1*(A2*(C3*D4*E5+C4*D5*E3+C5*D3*E4-C5*D4*E3-C4*D3*E5-C3*D5*E4)
 8-C2*(A3*D4*E5+A4*D5*E3+A5*D3*E4-A5*D4*E3-A4*D3*E5-A3*D5*E4)
 8+D2*(A3*C4*E5+A4*C5*E3+A5*C3*E4-A5*C4*E3-A4*C3*E5-A3*C5*E4)
 8-E2*(A3*C4*D5+A4*C5*D3+A5*C3*D4-A5*C4*D3-A4*C3*D5-A3*C5*D4))
 C11=C1*(A2*(B3*D4*E5+B4*D5*E3+B5*D3*E4-85*D4*E3-84*D3*E5-83*D5*E4)
 8-B2*(A3*D4*E5+A4*D5*E3+A5*D3*E4-A5*D4*E3-A4*D3*E5-A3*D5*E4)
 8+D2*(A3*B4*E5+A4*B5*E3+A5*B3*E4-A5*B4*E3-A4*B3*E5-A3*B5*E4)
 8-E2*(A3*B4*D5+A4*B5*D3+A5*B3*D4-A5*B4*D3-A4*B3*D5-A3*B5*D4))
 D11=D1*(A2*(B3*C4*E5+B4*C5*E3+B5*C3*E4-85*C4*E3-84*C3*E5-83*C5*E4)

```

8-B2*(A3*C4*E5+A4*C5*E3+A5*C3*E4-A5*C4*E3-A4*C3*E5-A3*C5*E4)
8+C2*(A3*B4*E5+A4*B5*E3+A5*B3*E4-A5*B4*E3-A4*B3*E5-A3*B5*E4)
8-E2*(A3*B4*C5+A4*B5*C3+A5*B3*C4-A5*B4*C3-A4*B3*C5-A3*B5*C4))
E11=E1*(A2*(B3*C4*D5+B4*C5*D3+B5*C3*D4-B5*C4*D3-B4*C3*D5-B3*C5*D4)
8-B2*(A3*C4*D5+A4*C5*D3+A5*C3*D4-A5*C4*D3-A4*C3*D5-A3*C5*D4)
8+C2*(A3*B4*D5+A4*B5*D3+A5*B3*D4-A5*B4*D3-A4*B3*D5-A3*B5*D4)
8-D2*(A3*B4*C5+A4*B5*C3+A5*B3*C4-A5*B4*C3-A4*B3*C5-A3*B5*C4))
DELTA=A11-C11-D11+E11
AE=A1*(B2*(C3*D4*V5+C4*D5*V3+C5*D3*V4-C5*D4*V3-C4*D3*V5-C3*D5*V4)
8-C2*(B3*D4*V5+B4*D5*V3+B5*D3*V4-B5*D4*V3-B4*D3*V5-B3*D5*V4)
8+D2*(B3*C4*V5+B4*C5*V3+B5*C3*V4-B5*C4*V3-B4*C3*V5-B3*C5*V4)
8-V2*(B3*C4*D5+B4*C5*D3+B5*C3*D4-B5*C4*D3-B4*C3*D5-B3*C5*D4))
BE=B1*(A2*(C3*D4*V5+C4*D5*V3+C5*D3*V4-C5*D4*V3-C4*D3*V5-C3*D5*V4)
8-C2*(A3*D4*V5+A4*D5*V3+A5*D3*V4-A5*D4*V3-A4*D3*V5-A3*D5*V4)
8+D2*(A3*C4*V5+A4*C5*V3+A5*C3*V4-A5*C4*V3-A4*C3*V5-A3*C5*V4)
8-V2*(A3*C4*D5+A4*C5*D3+A5*C3*D4-A5*C4*D3-A4*C3*D5-A3*C5*D4))
CE=C1*(A2*(B3*D4*V5+B4*D5*V3+B5*D3*V4-B5*D4*V3-B4*D3*V5-B3*D5*V4)
8-B2*(A3*D4*V5+A4*D5*V3+A5*D3*V4-A5*D4*V3-A4*D3*V5-A3*D5*V4)
8+D2*(A3*B4*V5+A4*B5*V3+A5*B3*V4-A5*B4*V3-A4*B3*V5-A3*B5*V4)
8-V2*(A3*B4*D5+A4*B5*D3+A5*B3*D4-A5*B4*D3-A4*B3*D5-A3*B5*D4))
DE=D1*(A2*(B3*C4*V5+B4*C5*V3+B5*C3*V4-B5*C4*V3-A4*C3*V5-B3*C5*V4)
8-B2*(A3*C4*V5+A4*C5*V3+A5*C3*V4-A5*C4*V3-A4*C3*V5-A3*C5*V4)
8+C2*(A3*B4*V5+A4*B5*V3+A5*B3*V4-A5*B4*V3-A4*B3*V5-A3*B5*V4)
8-V2*(A3*B4*C5+A4*B5*C3+A5*B3*C4-A5*B4*C3-A4*B3*C5-A3*B5*C4))
VE=V1*(A2*(B3*C4*D5+B4*C5*D3+B5*C3*D4-B5*C4*D3-B4*C3*D5-B3*C5*D4)
8-B2*(A3*C4*D5+A4*C5*D3+A5*C3*D4-A5*C4*D3-A4*C3*D5-A3*C5*D4)
8+C2*(A3*B4*D5+A4*B5*D3+A5*B3*D4-A5*B4*D3-A4*B3*D5-A3*B5*D4)
8-D2*(A3*B4*C5+A4*B5*C3+A5*B3*C4-A5*B4*C3-A4*B3*C5-A3*B5*C4))
FN5=(AE-BE+CE+VE)/DELTA
RETURN
END
FUNCTION FN6(X,XX1,XX2,XX3,XX4,XX5,XX6)
FN6=0.0
RETURN
END

```

APPENDIX H

```
C C CALCULATION OF FORCE BY LARRY BENNETT
WRITE(3,6)
6 FORMAT (13X,Y,16X,RH,16X,RP,16X,YH,16X,YP,16X,FP)
9 READ(1,10)T,R3,R2,Y1,Y2
10 FORMAT(5F10.0)
X=2.42E-2*(1.-COS(41.4E3*T))+.001
R1=R3
DR=R2-R1
F=12.5664E-7*Y1*Y2*R1*X/(X**2+DR**2)
WRITE(3,4)T,R1,R2,Y1,Y2,F
4 FORMAT(1X6F17.6)
21 GO TO 9
20 STOP
END
```

APPENDIX I

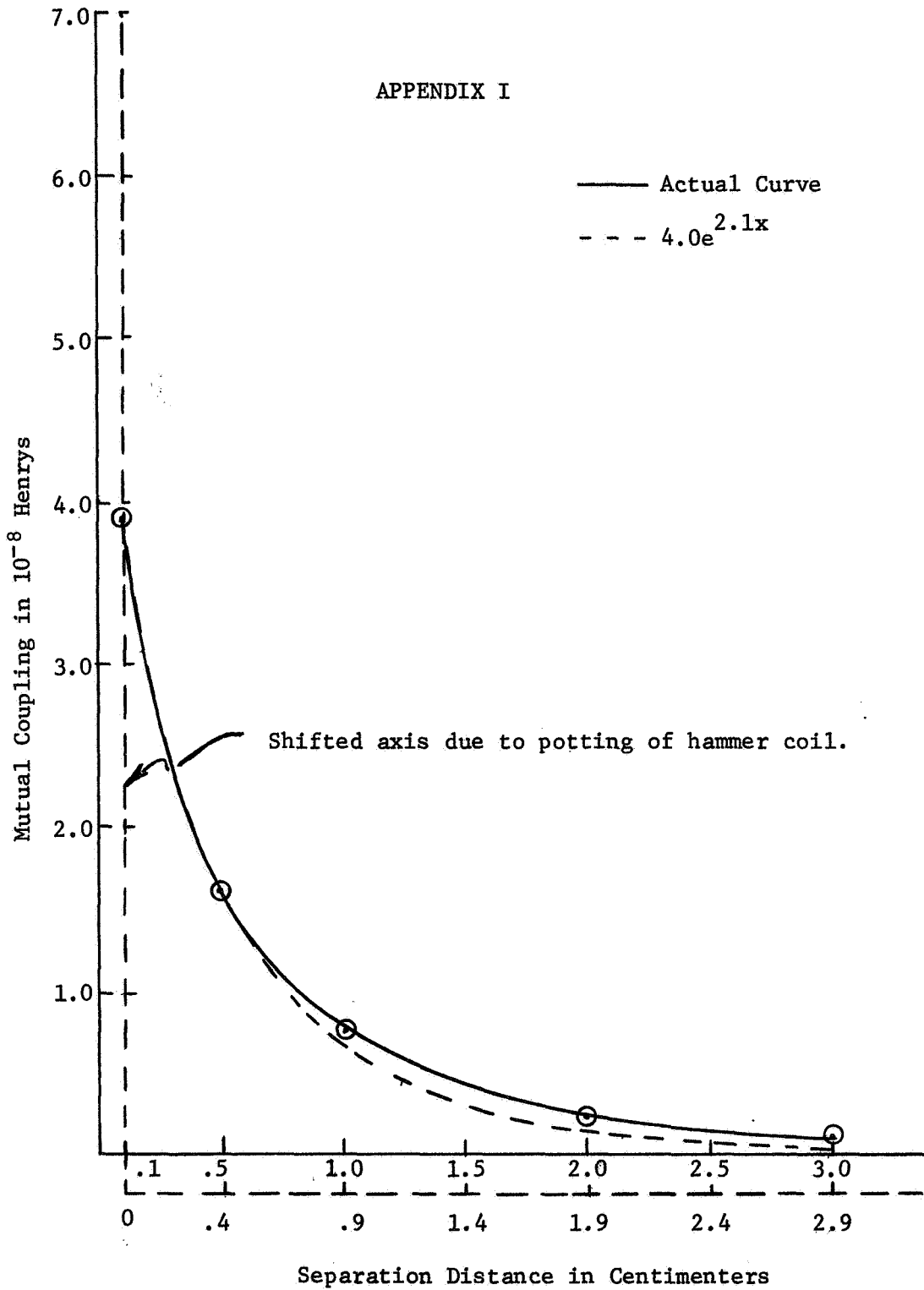

Figure I-1. A Plot of the Mutual Coupling Between Ring One of the Hammer Coil and Ring One in the Plate and Approximate Fitted Curve as a Function of Distance of Separation.

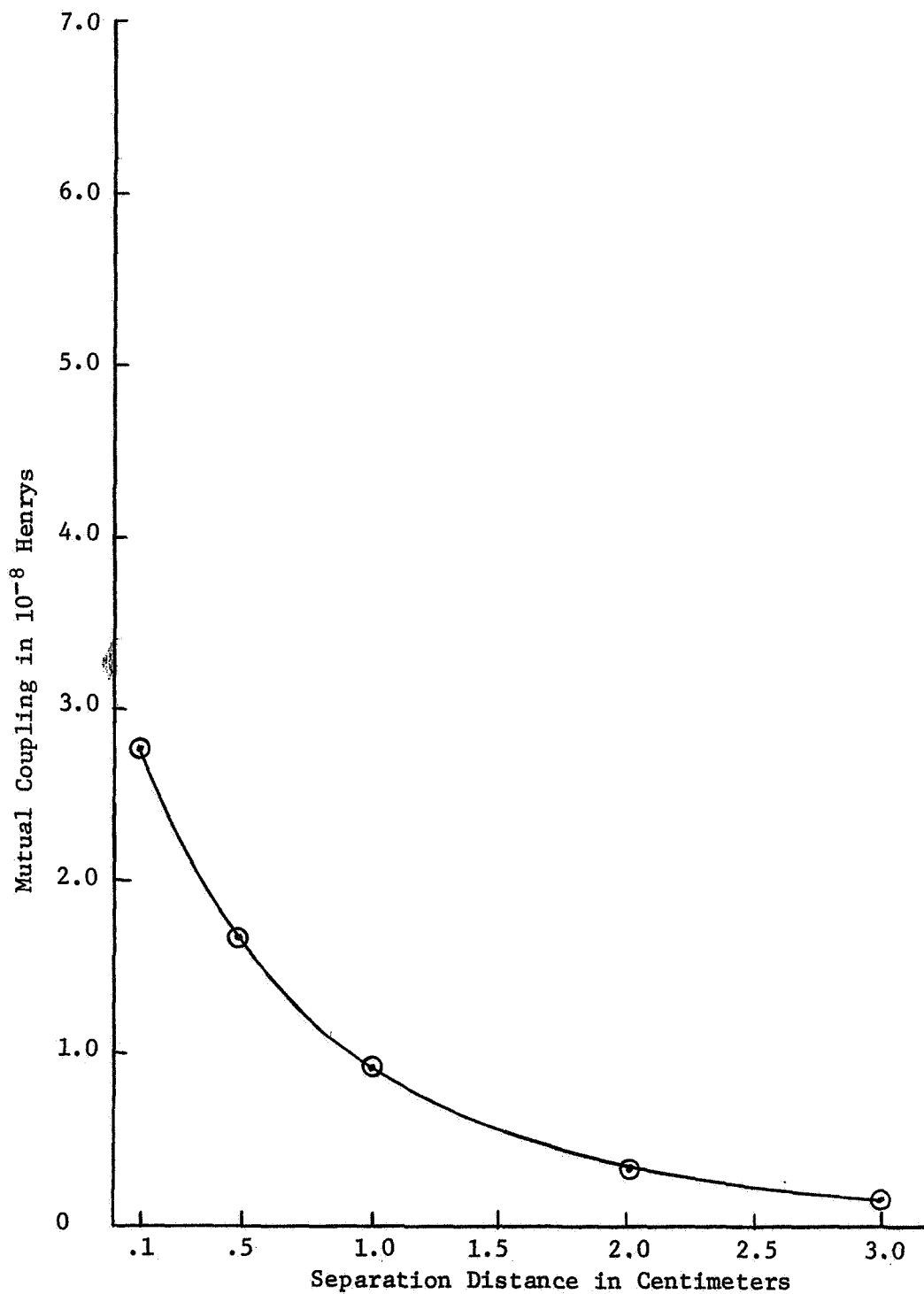

Figure I-2. A Plot of the Mutual Coupling Between Ring One of the Hammer Coil and Ring Two in the Plate as a Function of Distance of Separation.

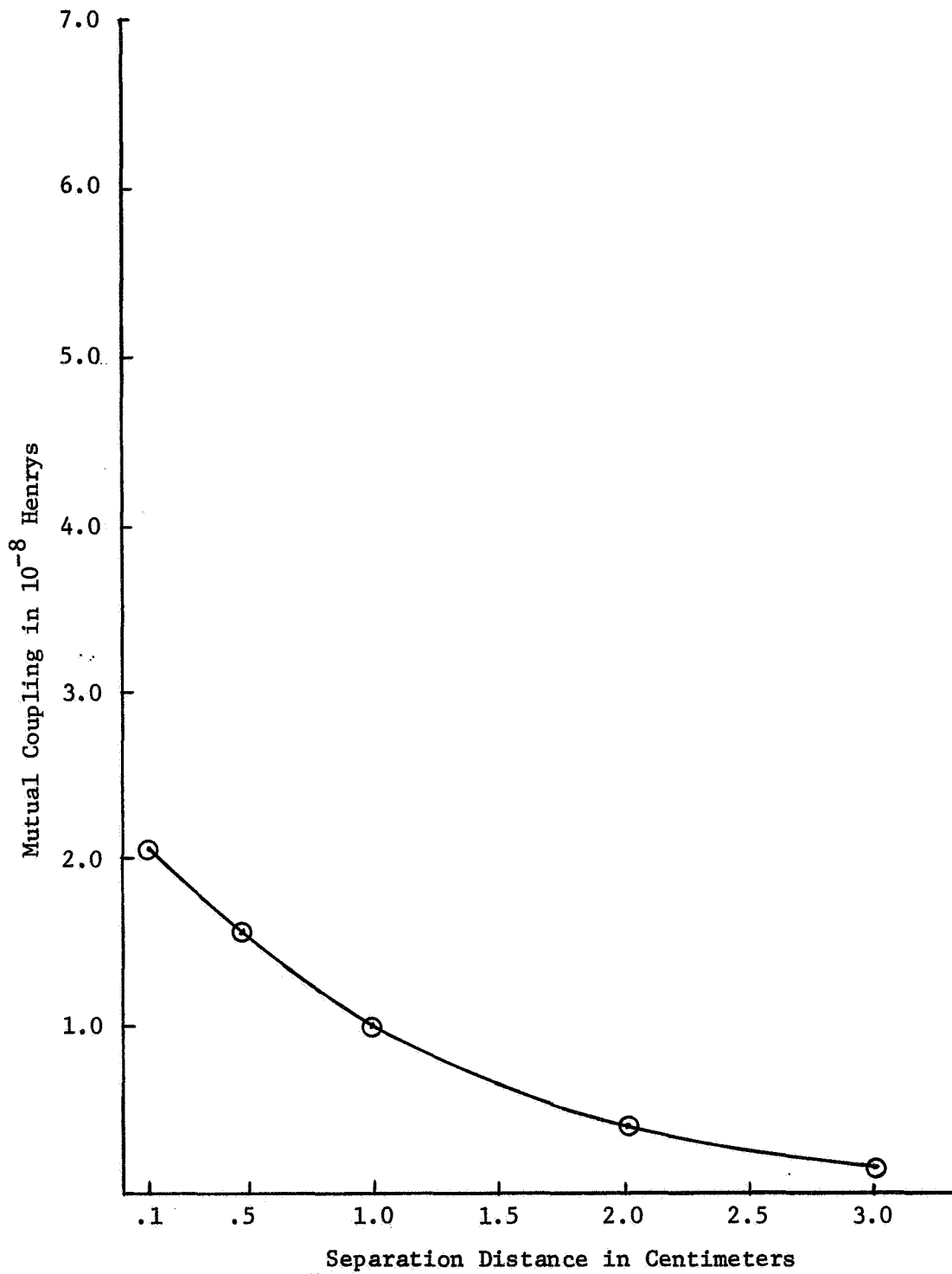

Figure I-3. A Plot of the Mutual Coupling Between Ring One of the Hammer Coil and Ring Three in the Plate as a Function of Distance of Separation.

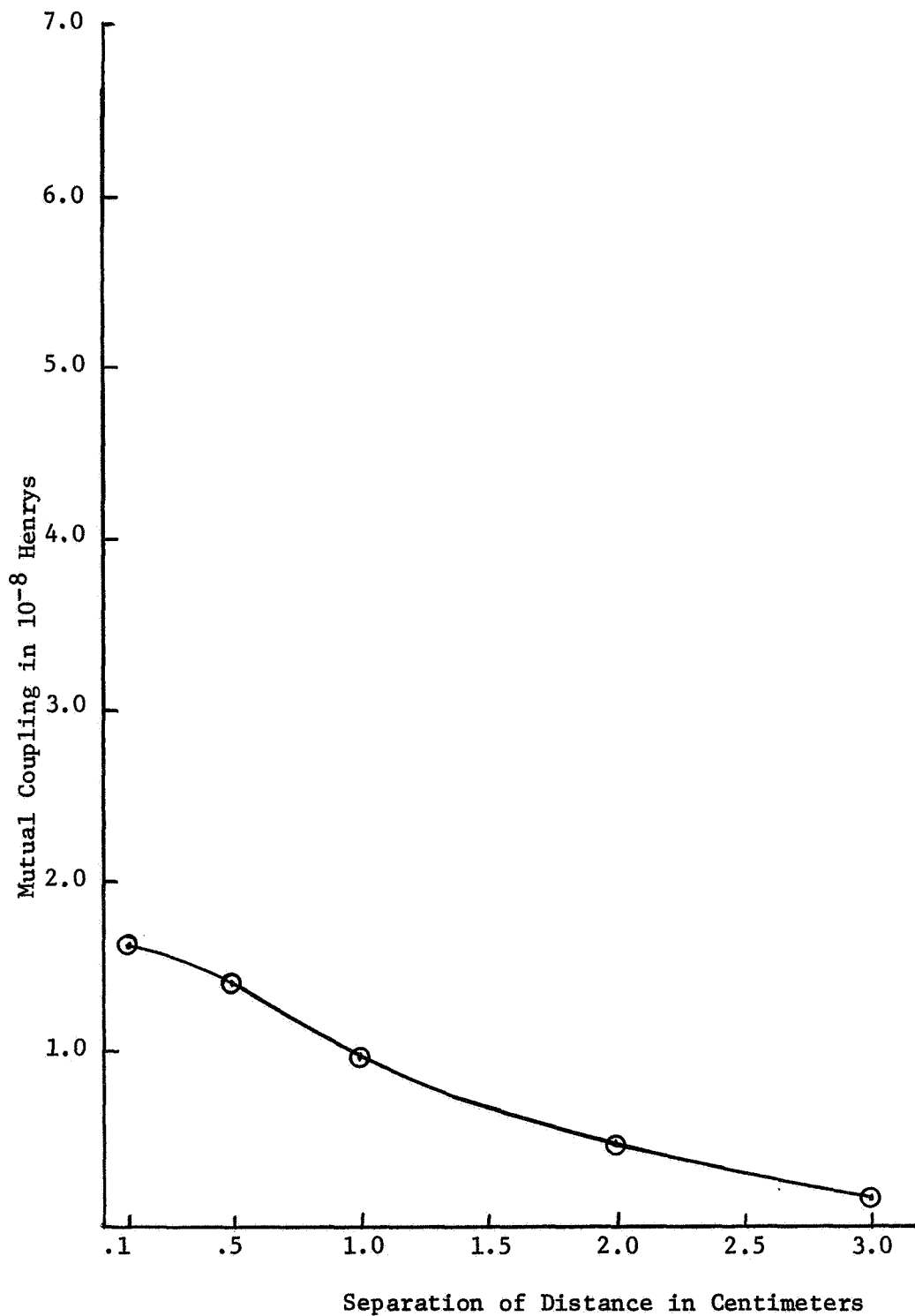

Figure I-4. A Plot of the Mutual Coupling Between Ring One of the Hammer Coil and Ring Four in the Plate as a Function of Distance of Separation.

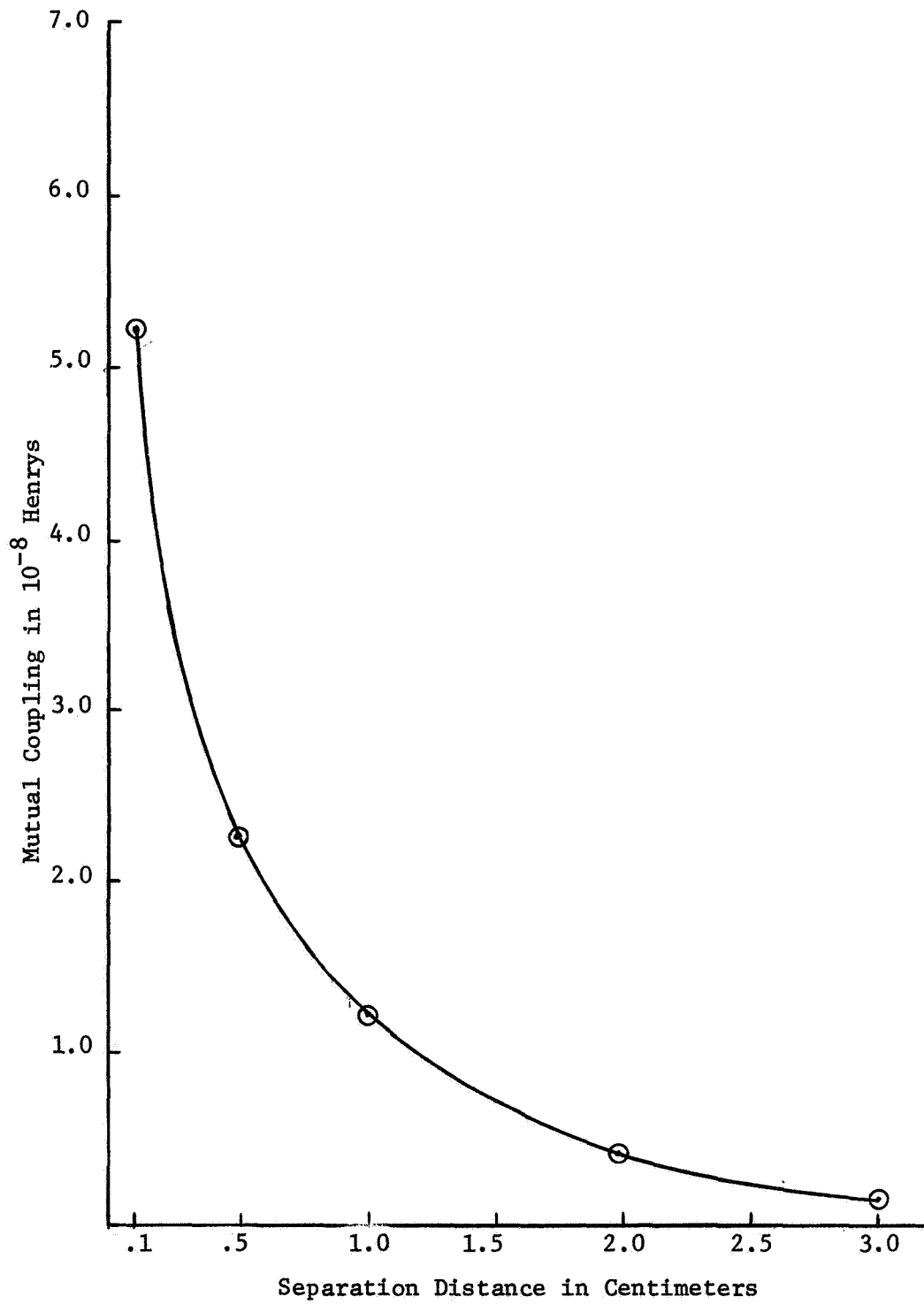

Figure I-5. A Plot of the Mutual Coupling Between Ring Two of the Hammer Coil and Ring Two in the Plate as a Function of Distance of Separation.

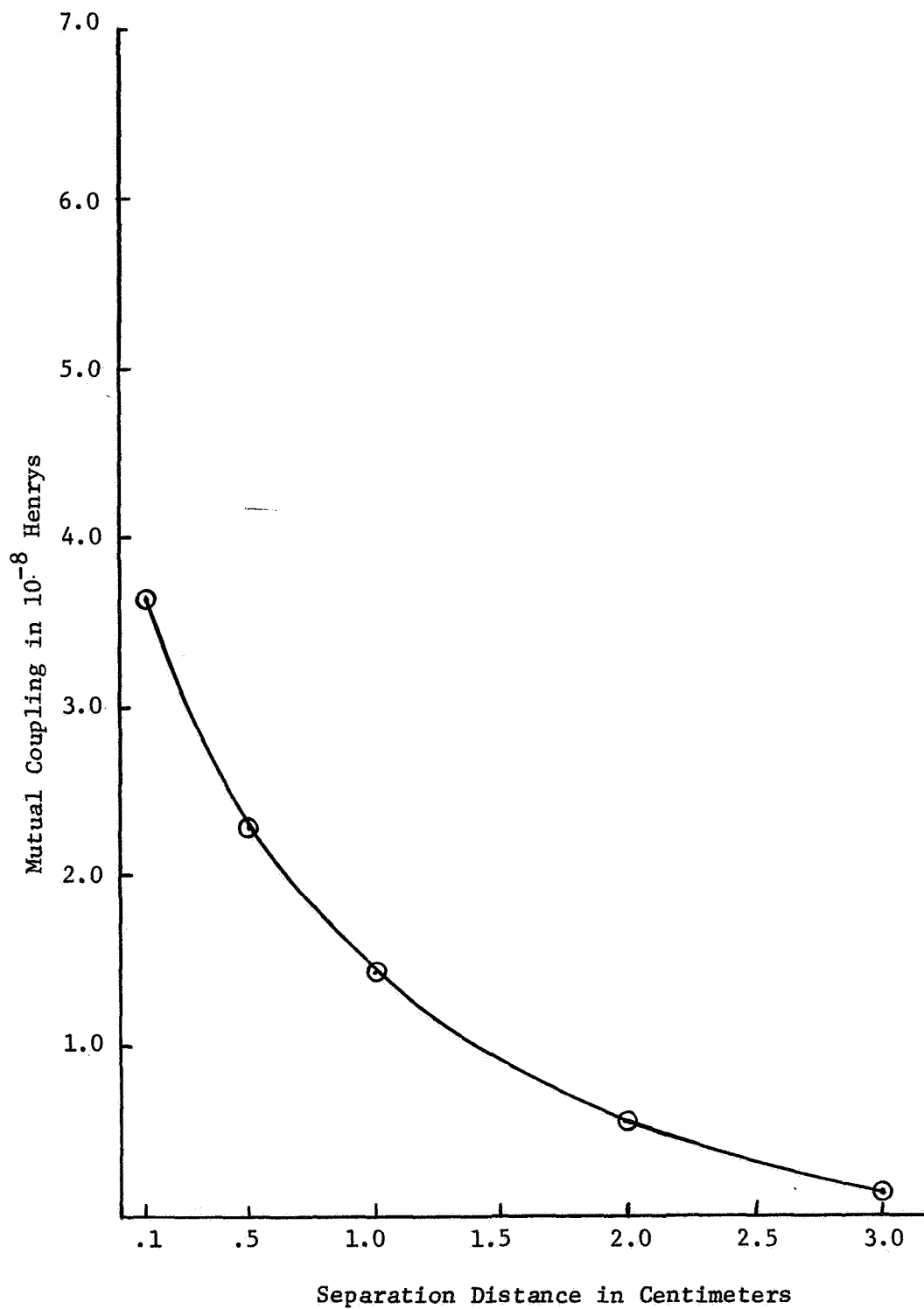

Figure I-6. A Plot of the Mutual Coupling Between Ring Two of the Hammer Coil and Ring Three in the Plate as a Function of Distance of Separation.

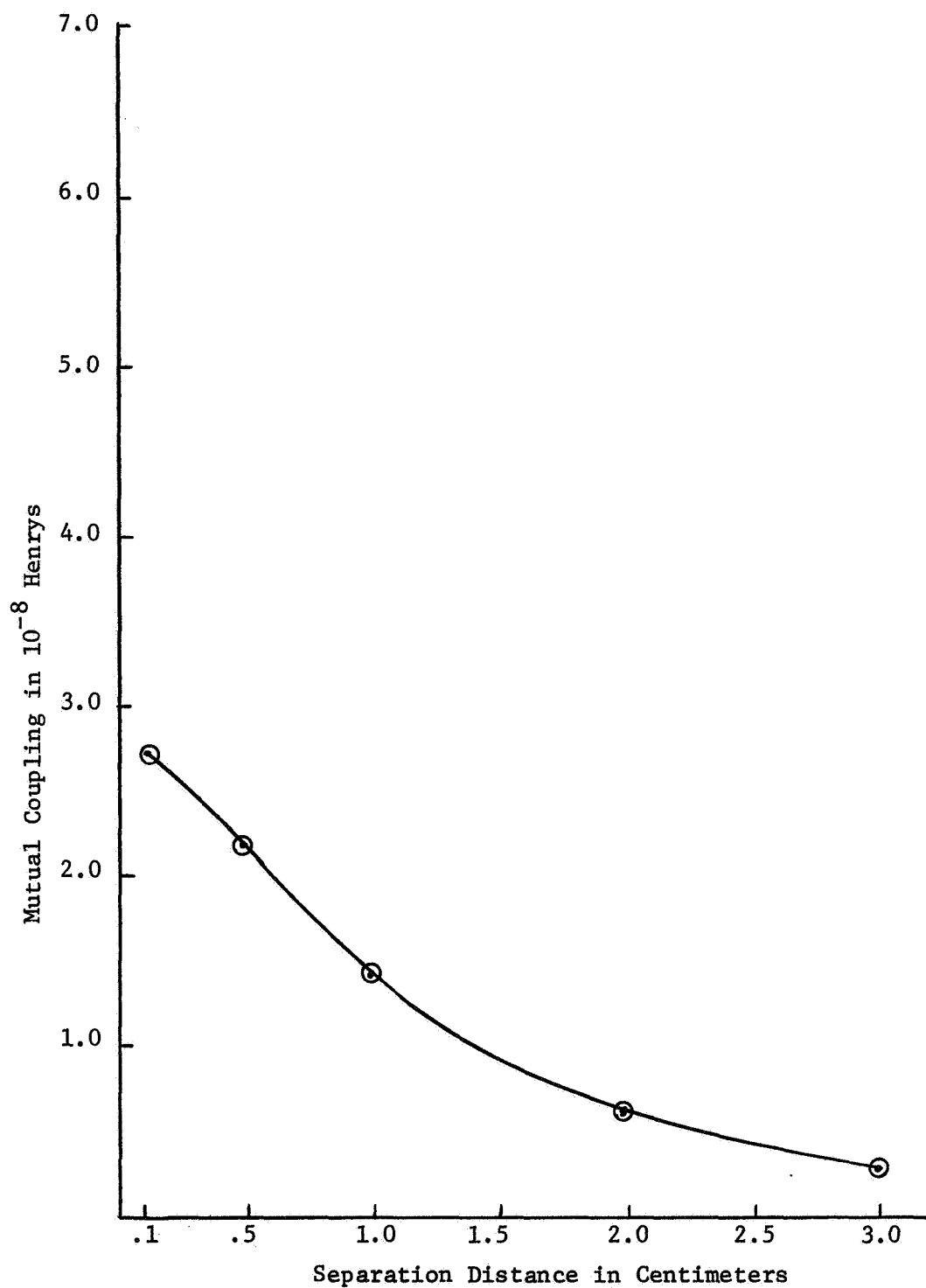

Figure I-7. A Plot of the Mutual Coupling Between Ring Two of the Hammer Coil and Ring Four in the Plate as a Function of Distance of Separation.

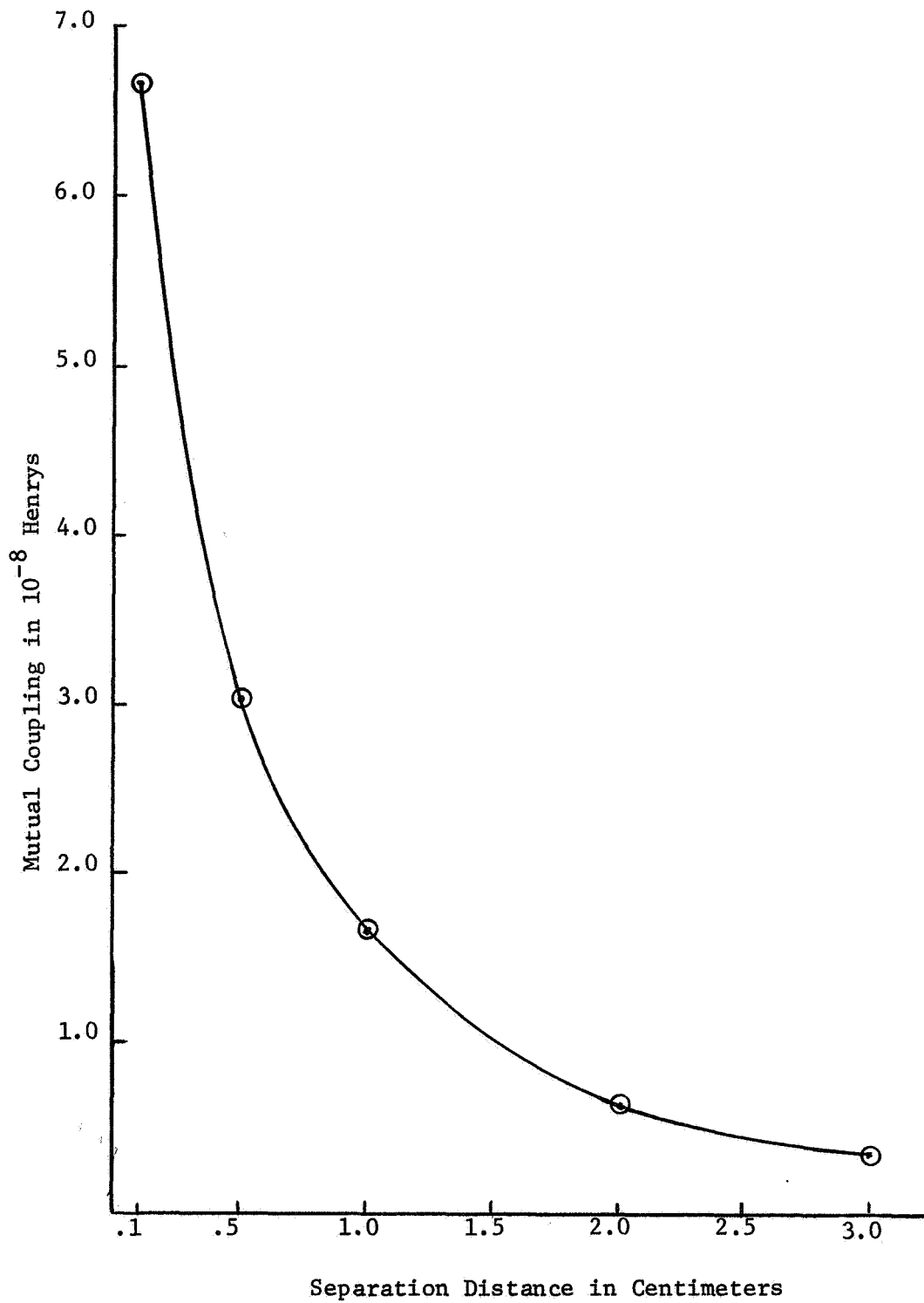

Figure I-8. A Plot of the Mutual Coupling Between Ring Two of the Hammer Coil and Ring Three in the Plate as a Function of Distance of Separation.

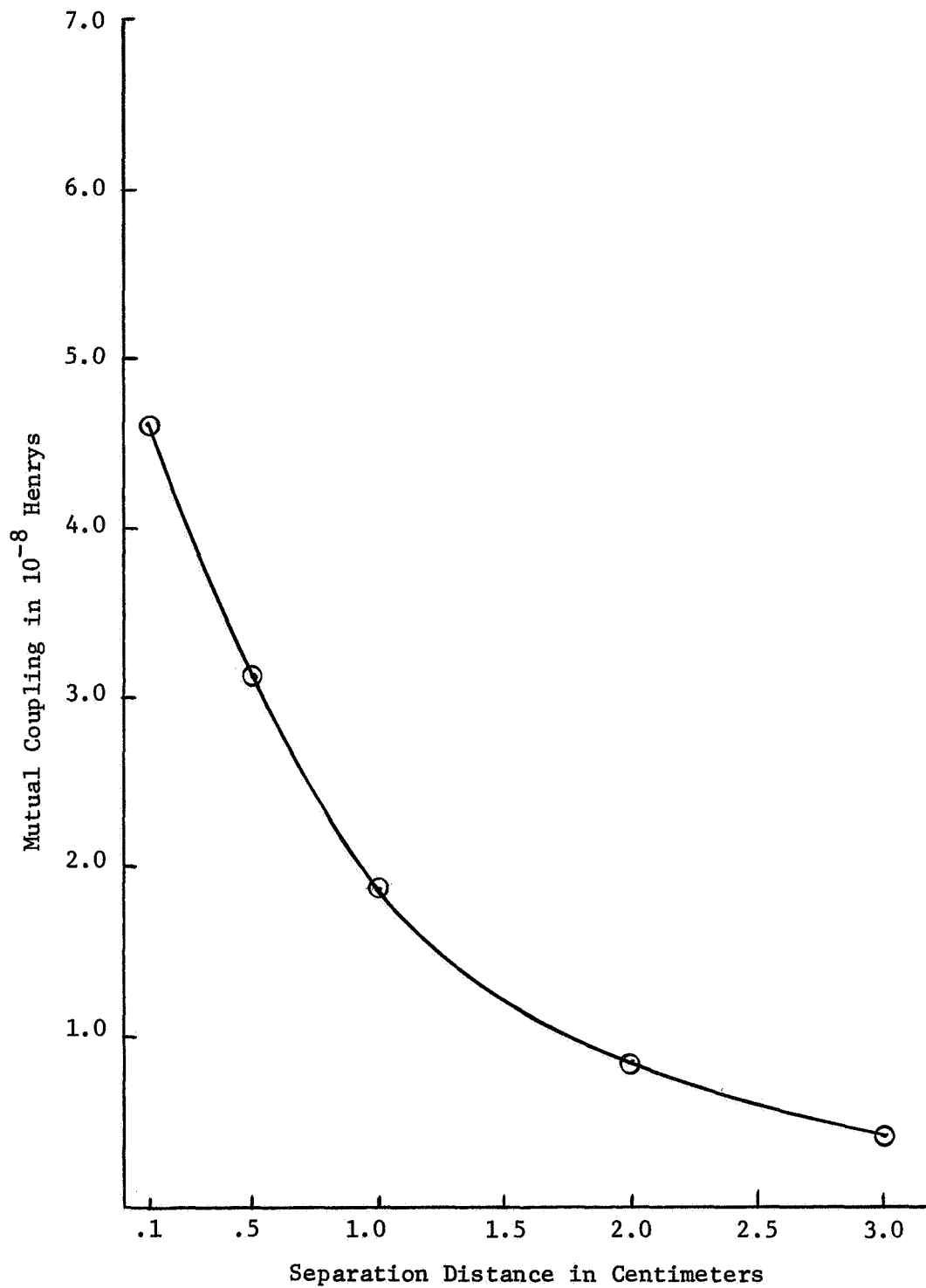

Figure 1-9. A Plot of the Mutual Coupling Between Ring Three of the Hammer Coil and Ring Four in the Plate as a Function of Distance of Separation.

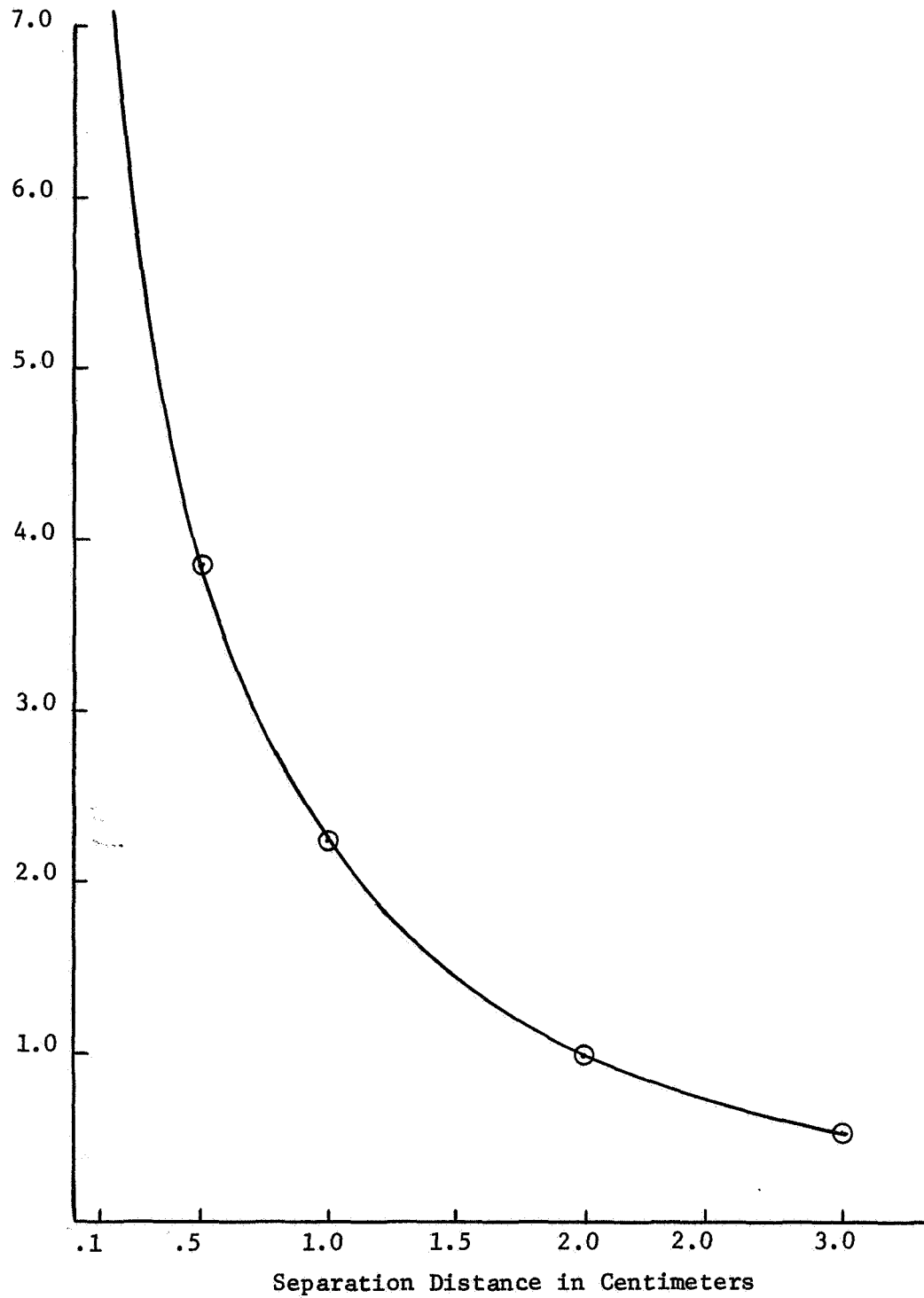

Figure I-10. A Plot of the Mutual Coupling Between Ring Four of the Hammer Coil and Ring Four in the Plate as a Function of Distance of Separation.

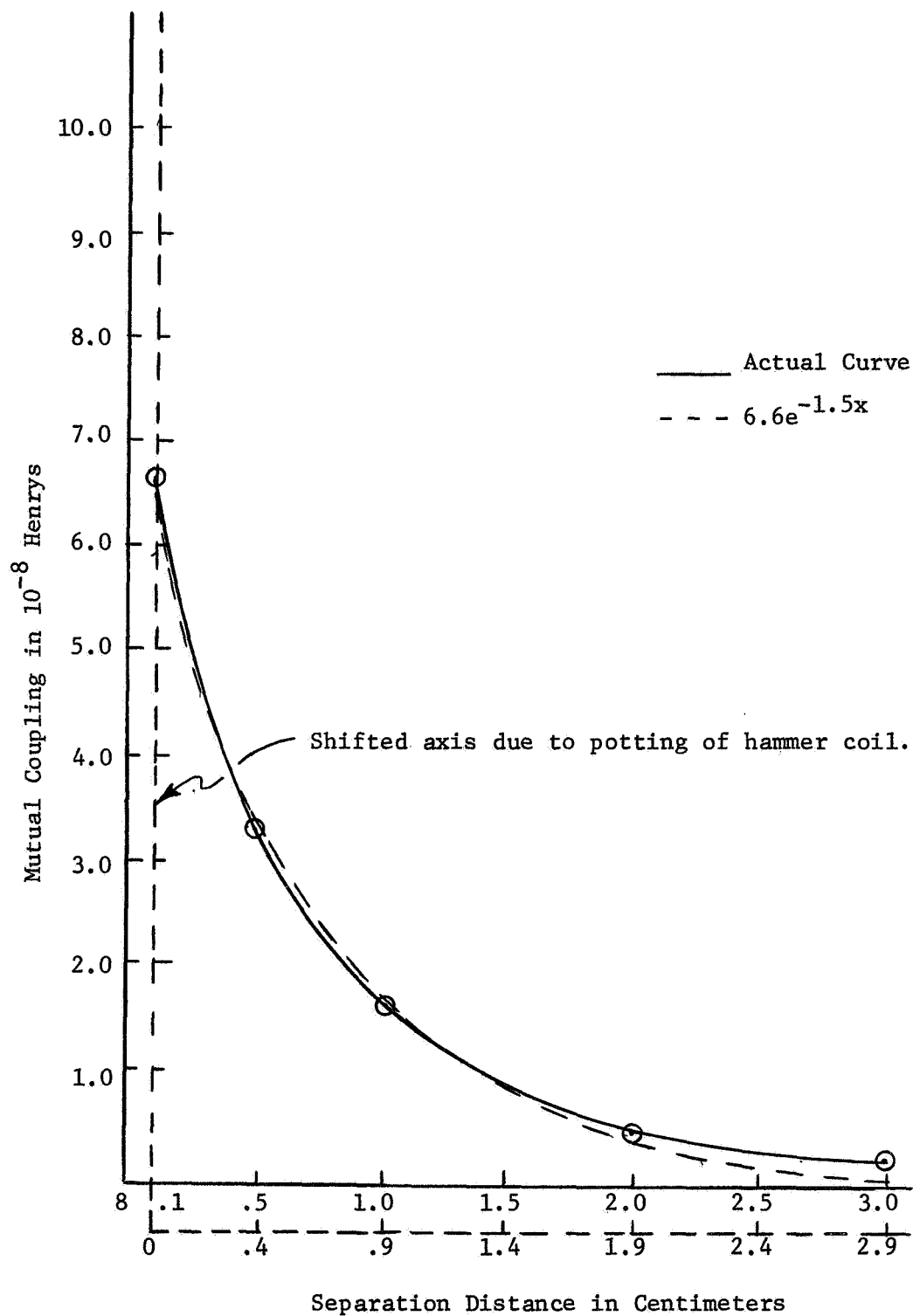

Figure I-11. A Plot of the Mutual Coupling $M_{11} + M_{12}$ as a Function of Distance Used to Analyze a Hammer Coil Consisting of Two Rings.

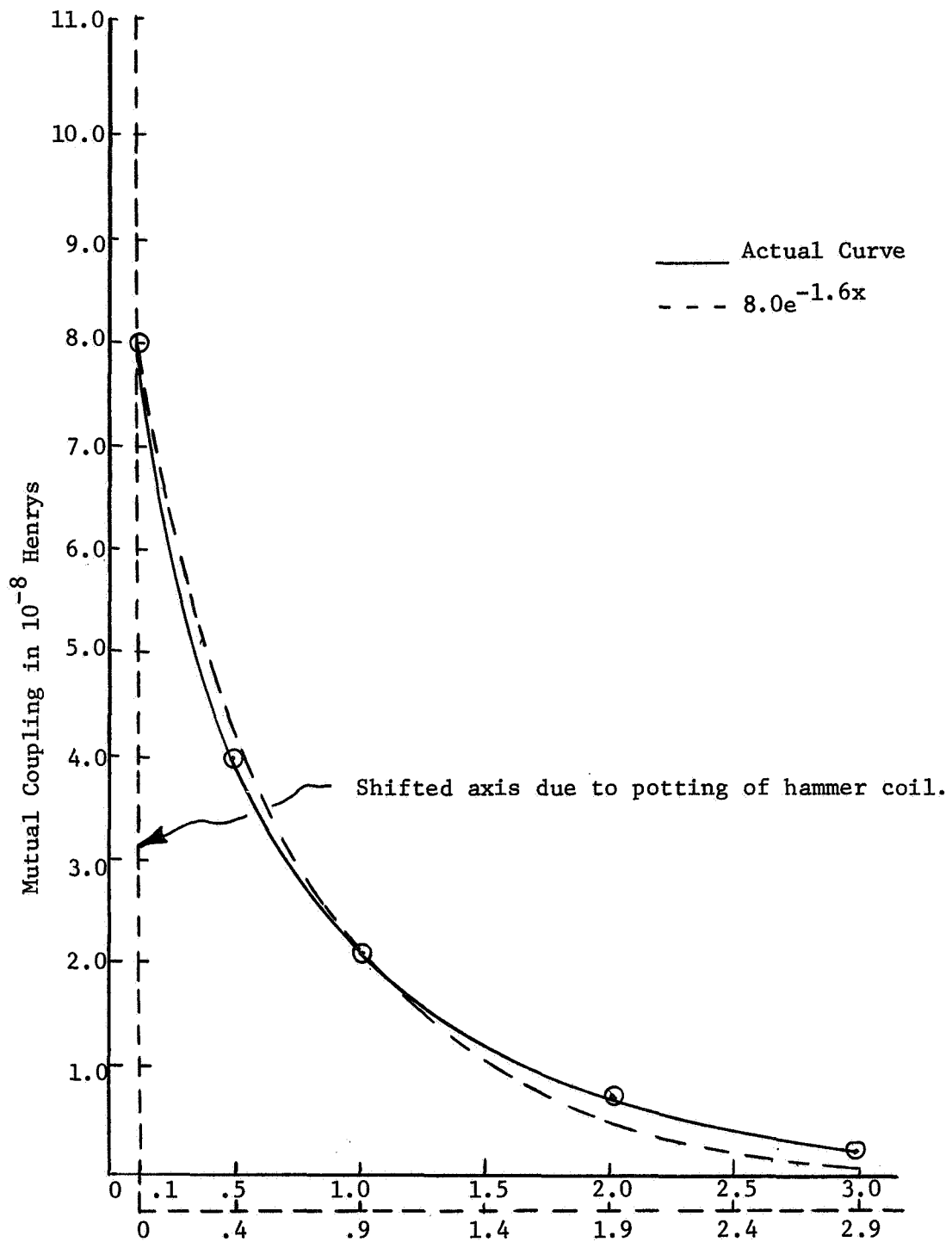

Figure I-12. A Plot of the Mutual Coupling $M_{12} + M_{22}$ as a Function of Distance Used to Analyze a Hammer Coil Consisting of Two Rings.

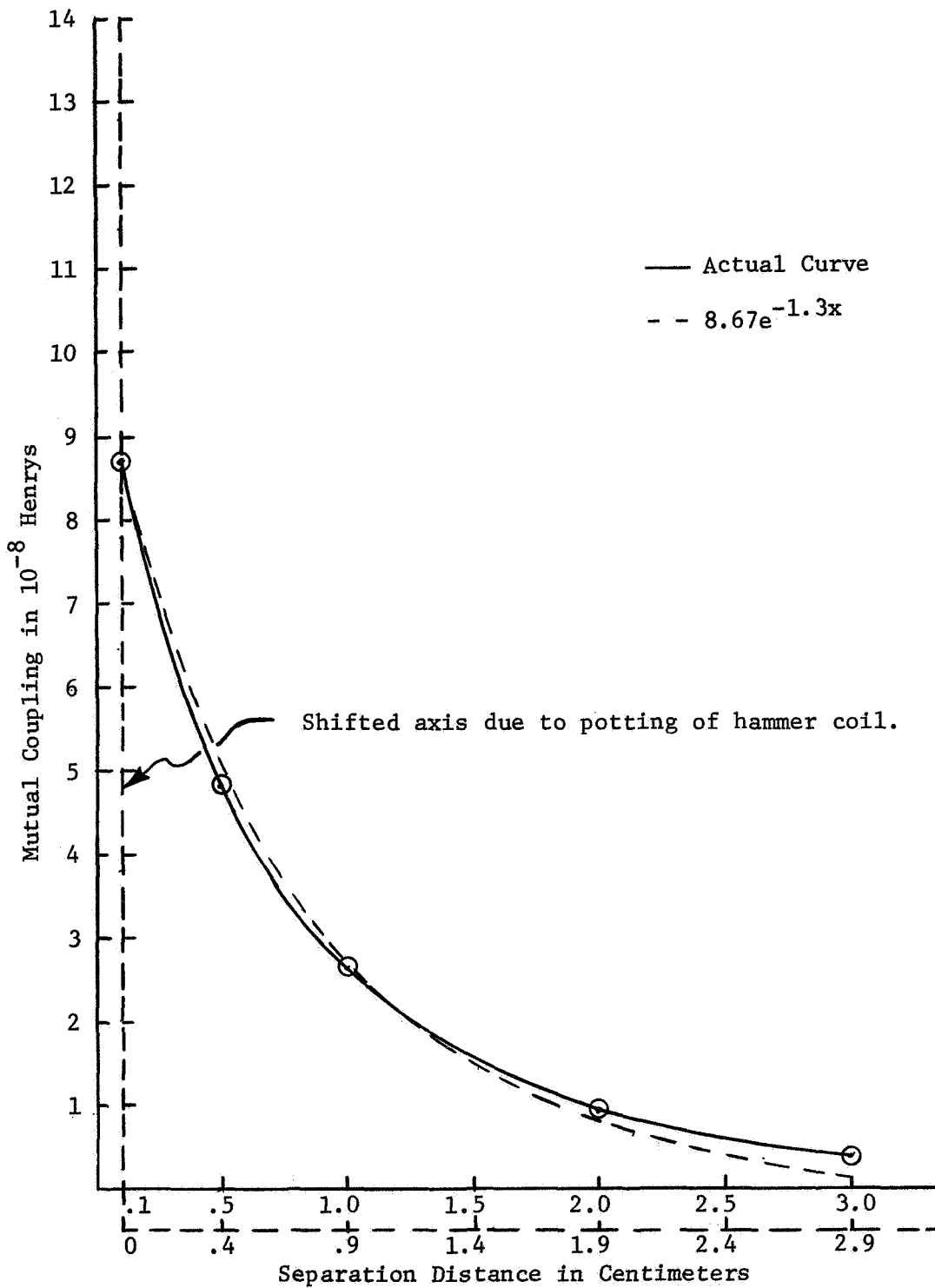

Figure I-13. A Plot of the Mutual Coupling $M_{11} + M_{12} + M_{13}$ as a Function of Distance Used to Analyze a Hammer Coil Consisting of Three Rings.

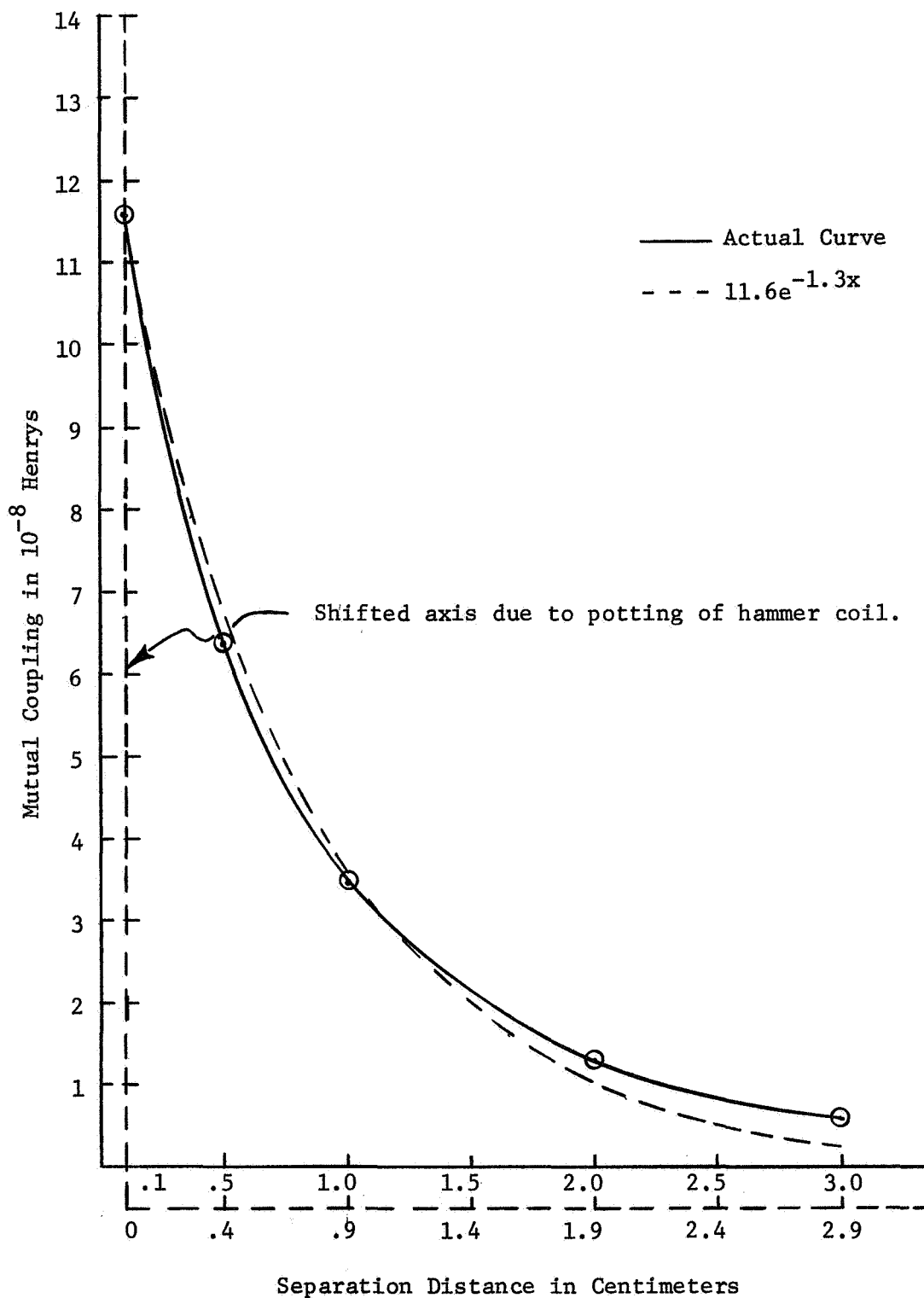

Figure I-14. A Plot of the Mutual Coupling $M_{12} + M_{22} + M_{23}$ as a Function of Distance Used to Analyze Hammer Coil Consisting of Three Rings.

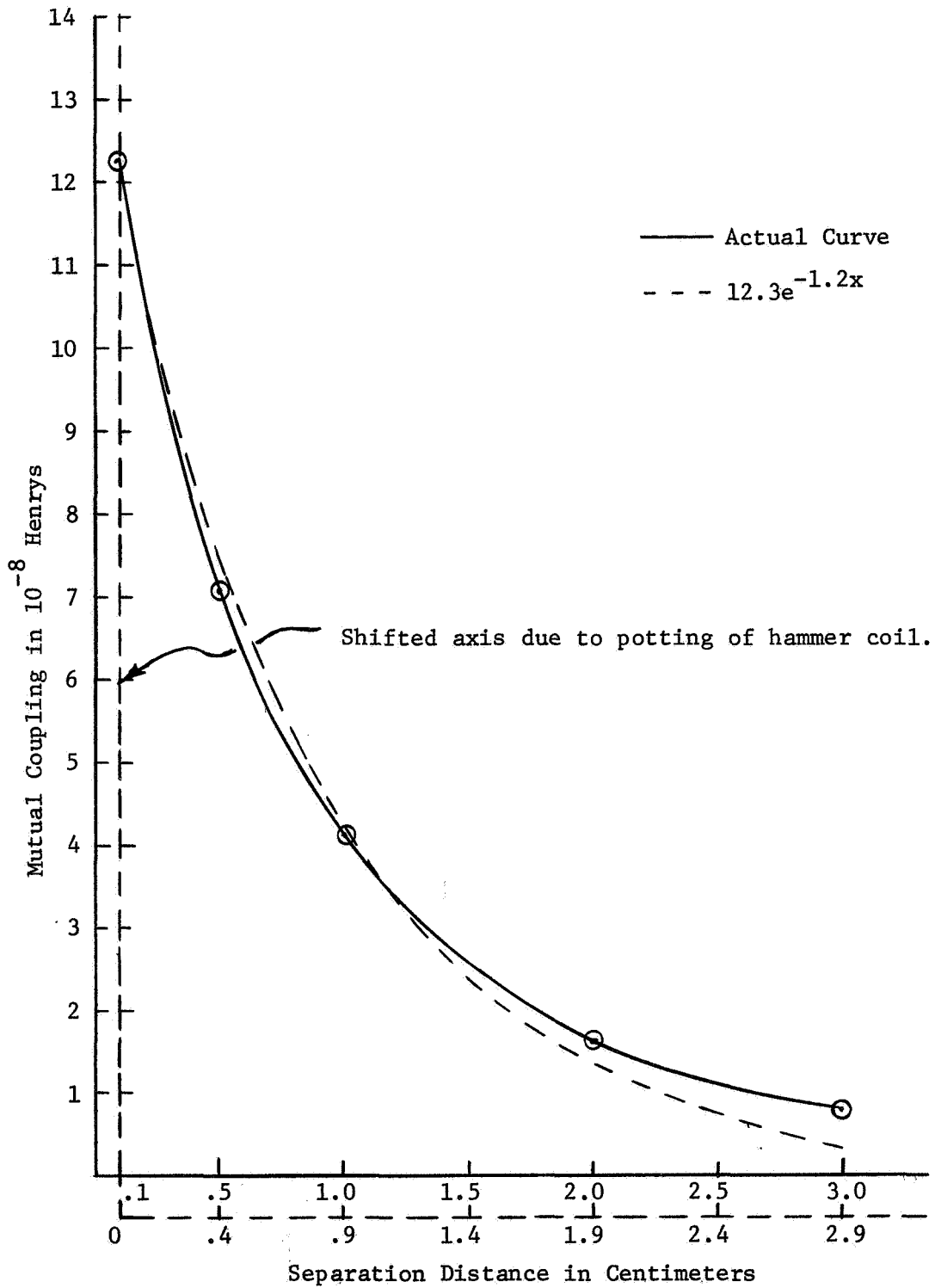

Figure I-15. A Plot of the Mutual Coupling $M_{13} + M_{23} + M_{33}$ as a Function of Distance Used to Analyze a Hammer Coil Consisting of Three Rings.

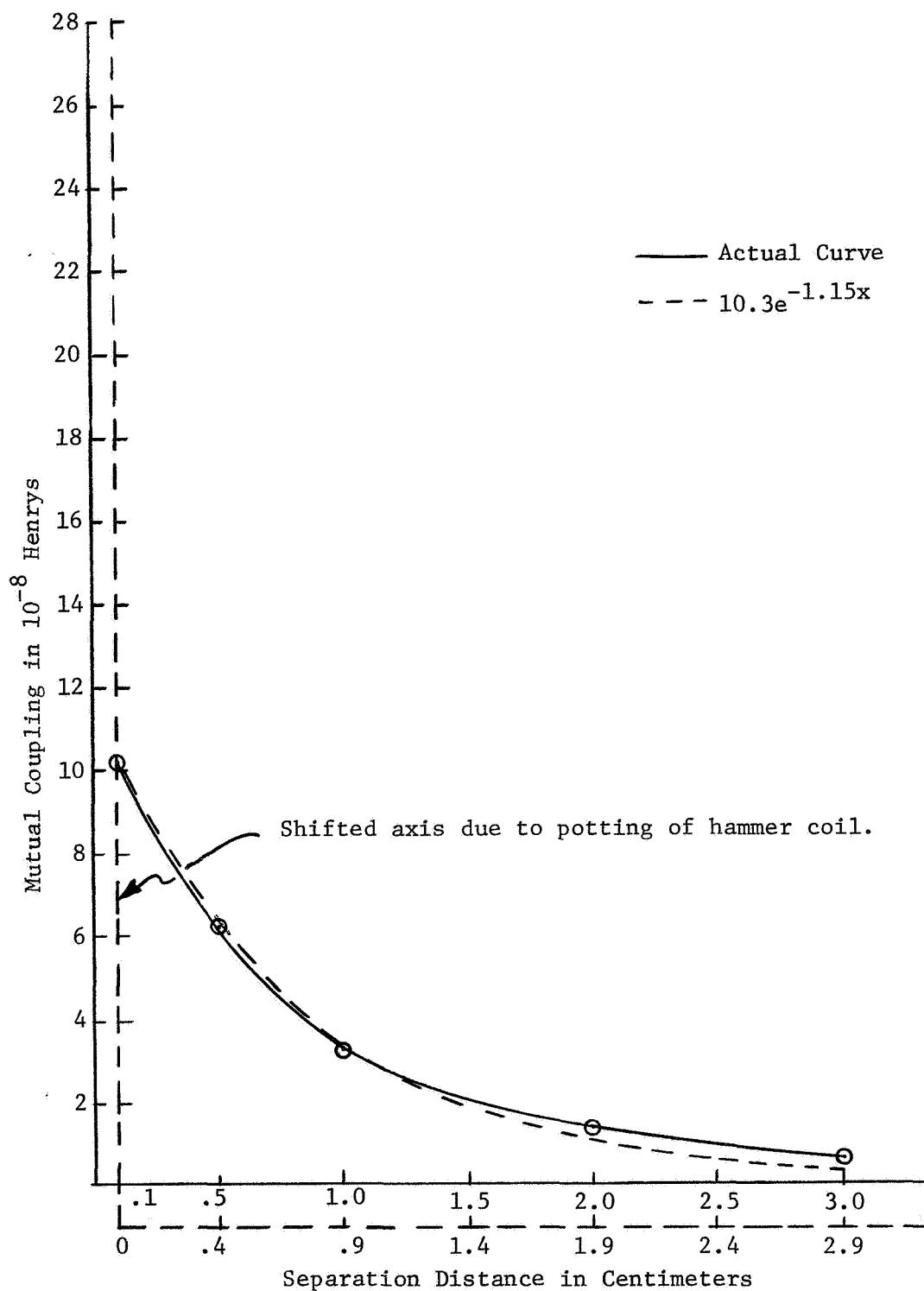

Figure I-16. A Plot of the Mutual Coupling $M_{11} + M_{12} + M_{13} + M_{14}$ as a Function of Distance Used to Analyze a Hammer Coil Consisting of Four Rings for Ring Radii of $r_1 = 1.202$, $r_2 = 1.475$, $r_3 = 1.748$, and $r_4 = 2.021$ cm.

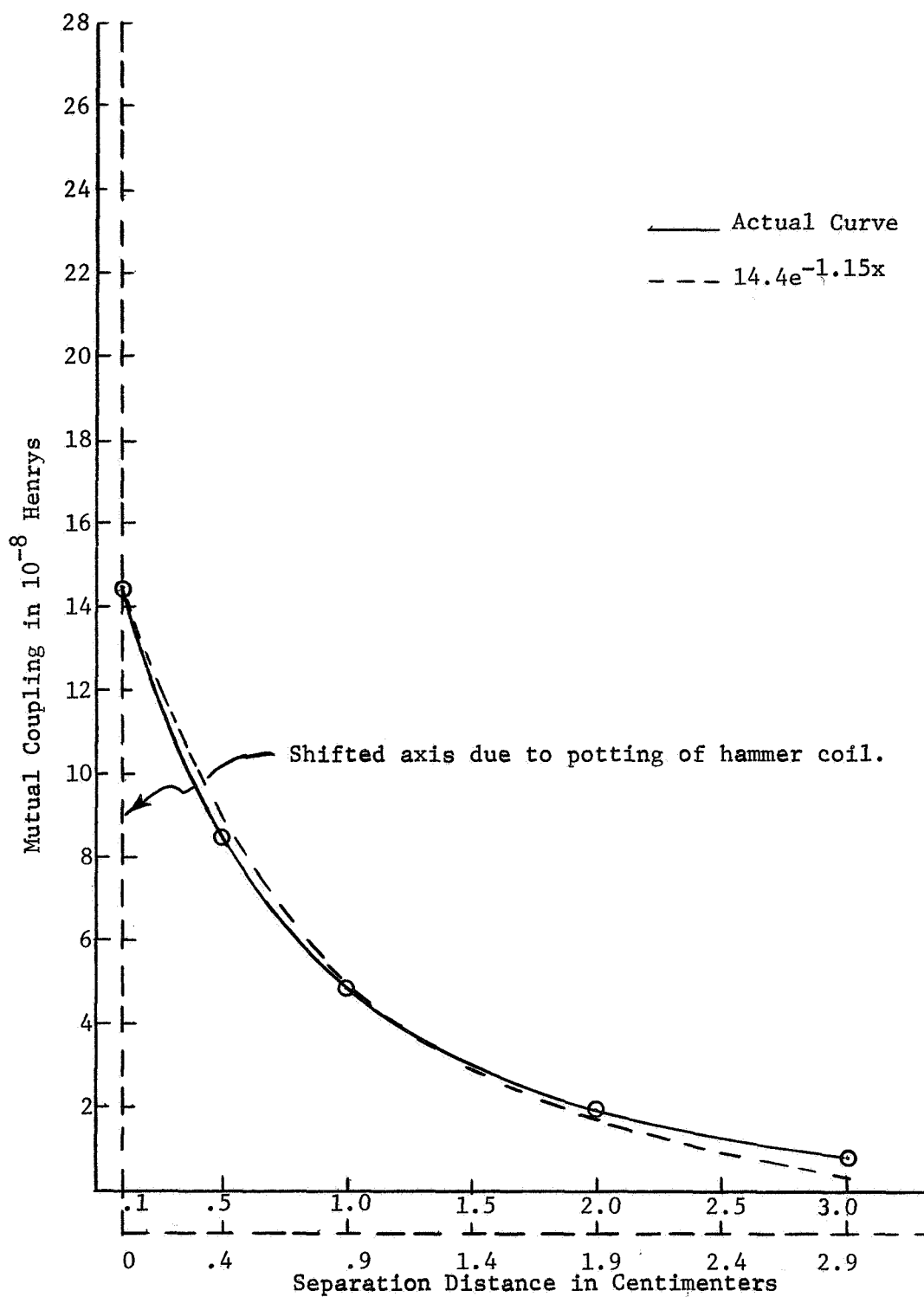

Figure I-17. A Plot of the Mutual Coupling $M_{12} + M_{22} + M_{23} + M_{24}$ as a Function of Distance Used to Analyze a Hammer Coil Consisting of Four Rings for Ring Radii of $r_1 = 1.202$, $r_2 = 1.475$, $r_3 = 1.748$, and $r_4 = 2.021$ cm.

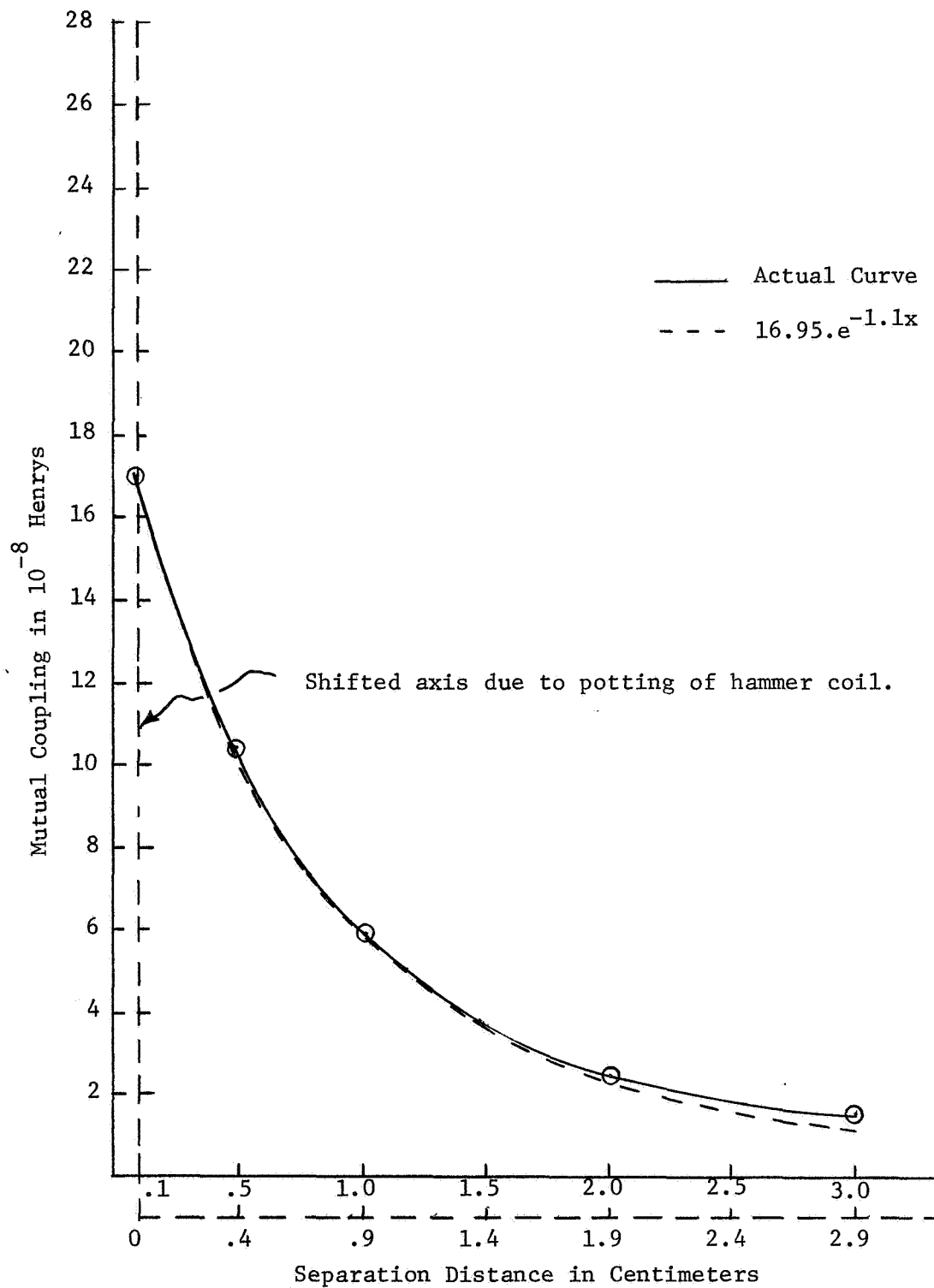

Figure I-18. A Plot of the Mutual Coupling $M_{13} + M_{23} + M_{33} + M_{34}$ as a Function of Distance Used to Analyze a Hammer Coil Consisting of Four Rings for Ring Radii of $r_1 = 1.202$, $r_2 = 1.475$, $r_3 = 1.748$, and $r_4 = 2.021$ cm.

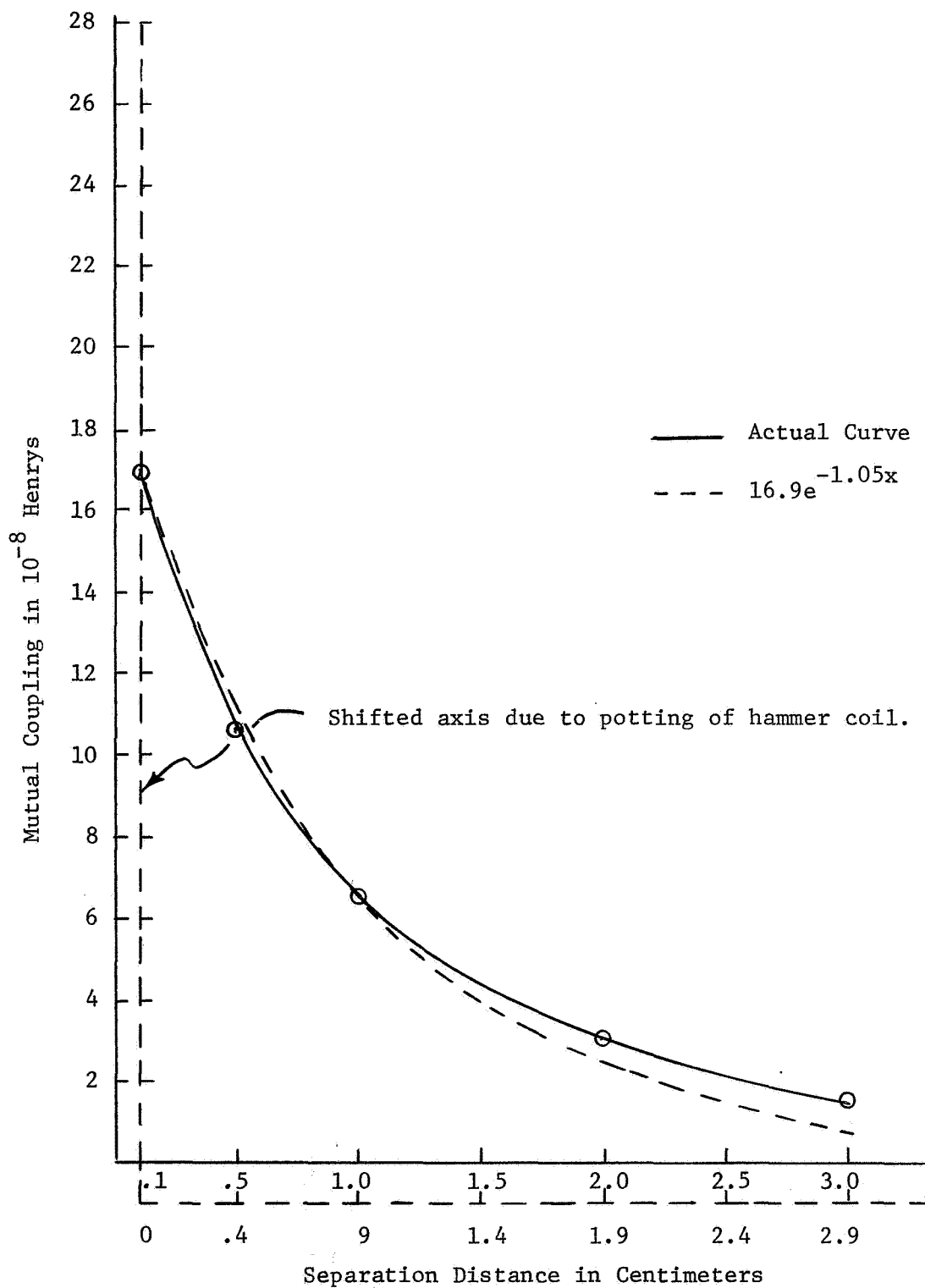

Figure I-19. A Plot of the Mutual Coupling $M_{14} + M_{24} + M_{34} + M_4$ as a Function of Distance Used to Analyze a Hammer Coil Consisting of Four Rings for Ring Radii of $r_1 = 1.202$, $r_2 = 1.475$, $r_3 = 1.748$, and $r_4 = 2.021$ cm.

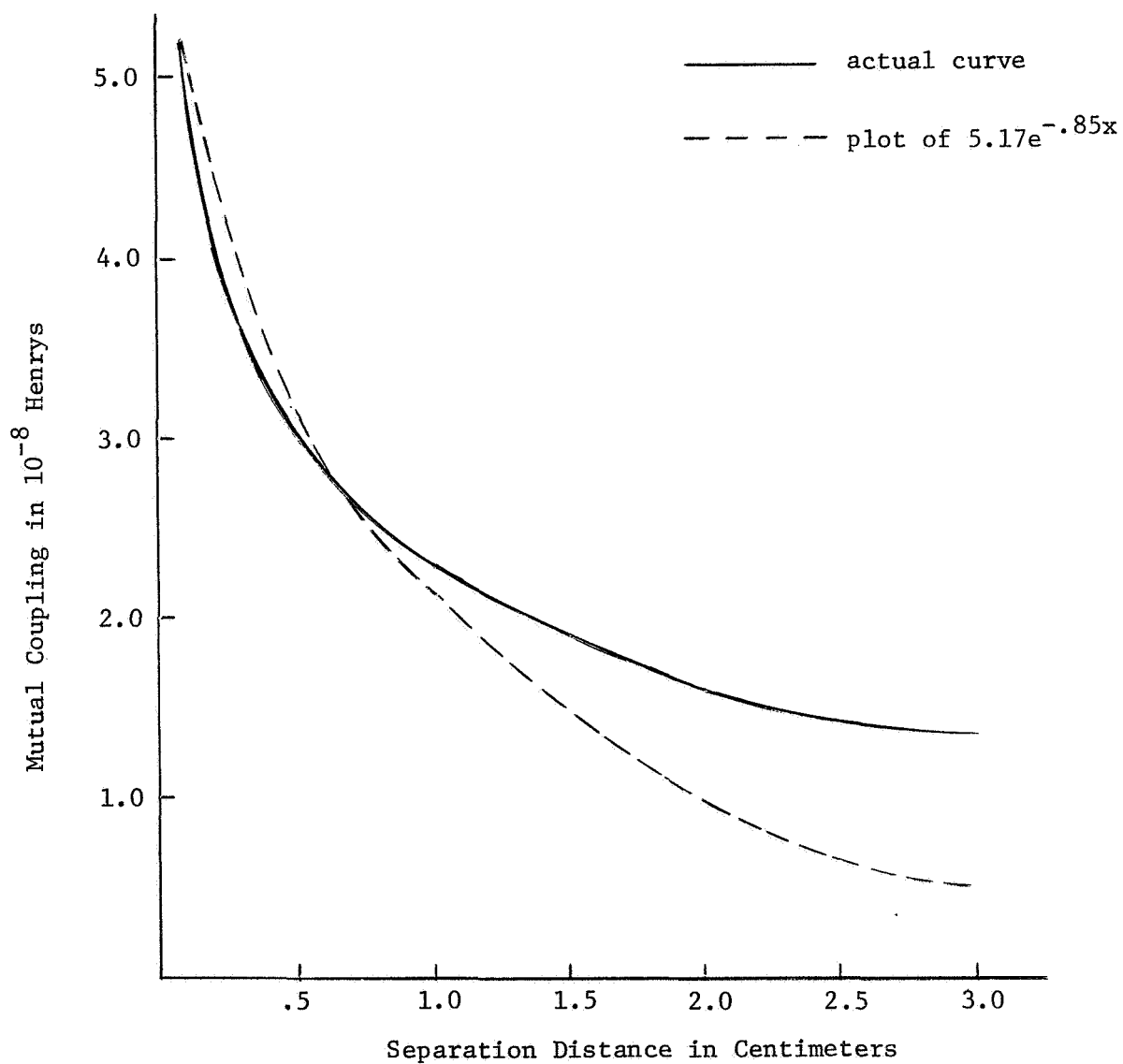

Figure I-20. A Plot of the Mutual Coupling $M_{11} + M_{12} + M_{13} + M_{14}$ Used to Analyze a Hammer Coil Consisting of Four Rings for Ring Radii of $r_1 = 1.20$, $r_2 = 2.56$, $r_3 = 3.93$, and $r_4 = 5.29$ cm.

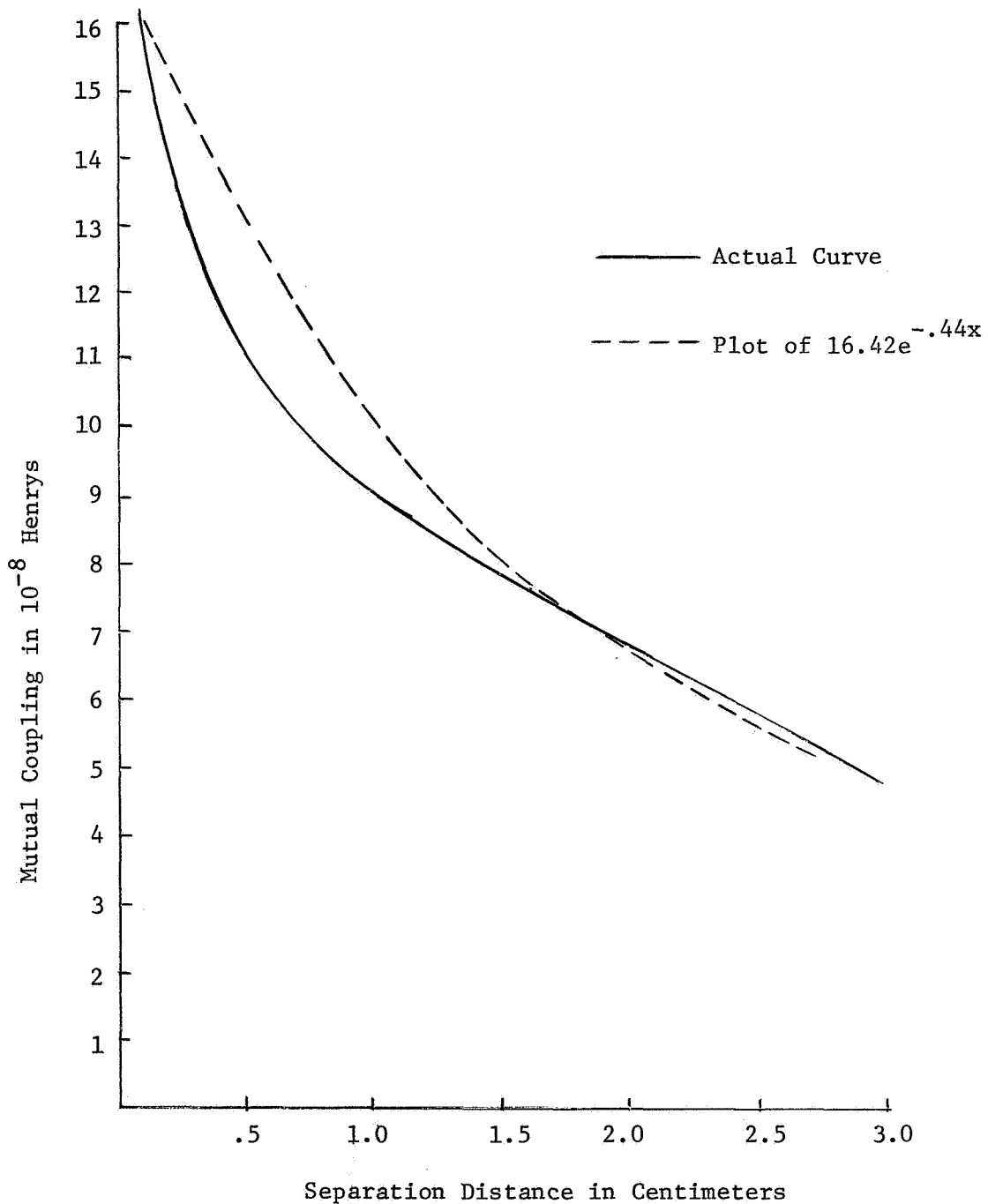

Figure I-21. A Plot of the Mutual Coupling $M_{12} + M_{22} + M_{23} + M_{24}$ as a Function of Distance Used to Analyze a Coil Consisting of Four Rings for Ring Radii of $r_1 = 1.20$, $r_2 = 2.56$, $r_3 = 3.93$, and $r_4 = 5.29$ cm.

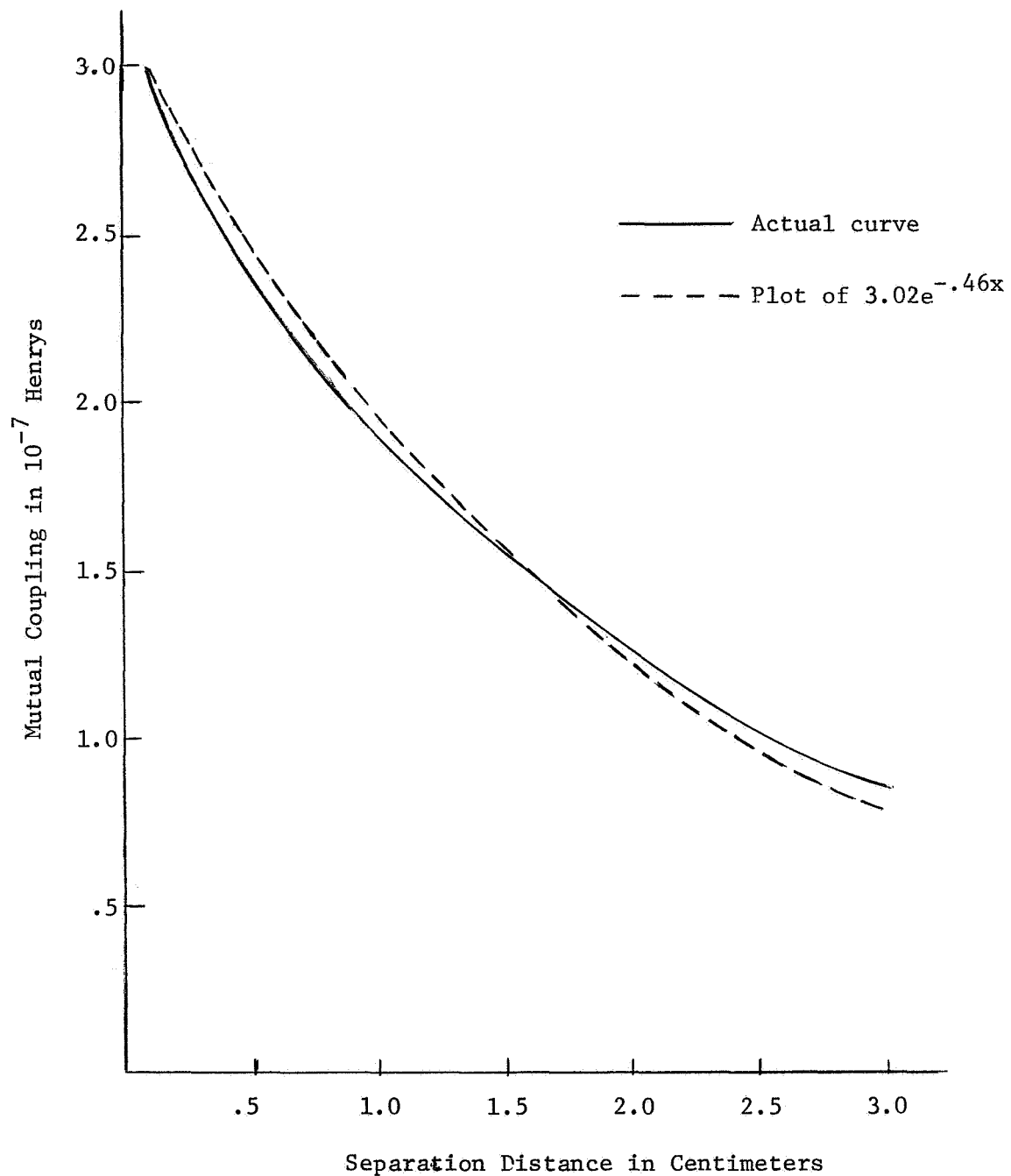

Figure I-22. A Plot of the Mutual Coupling $M_{13} + M_{23} + M_{33} + M_{34}$ as a Function of Distance used to Analyze a Hammer Consisting of Four Rings for Ring Radii of $r_1 = 1.20$, $r_2 = 2.56$, $r_3 = 3.93$, and $r_4 = 5.29$ cm.

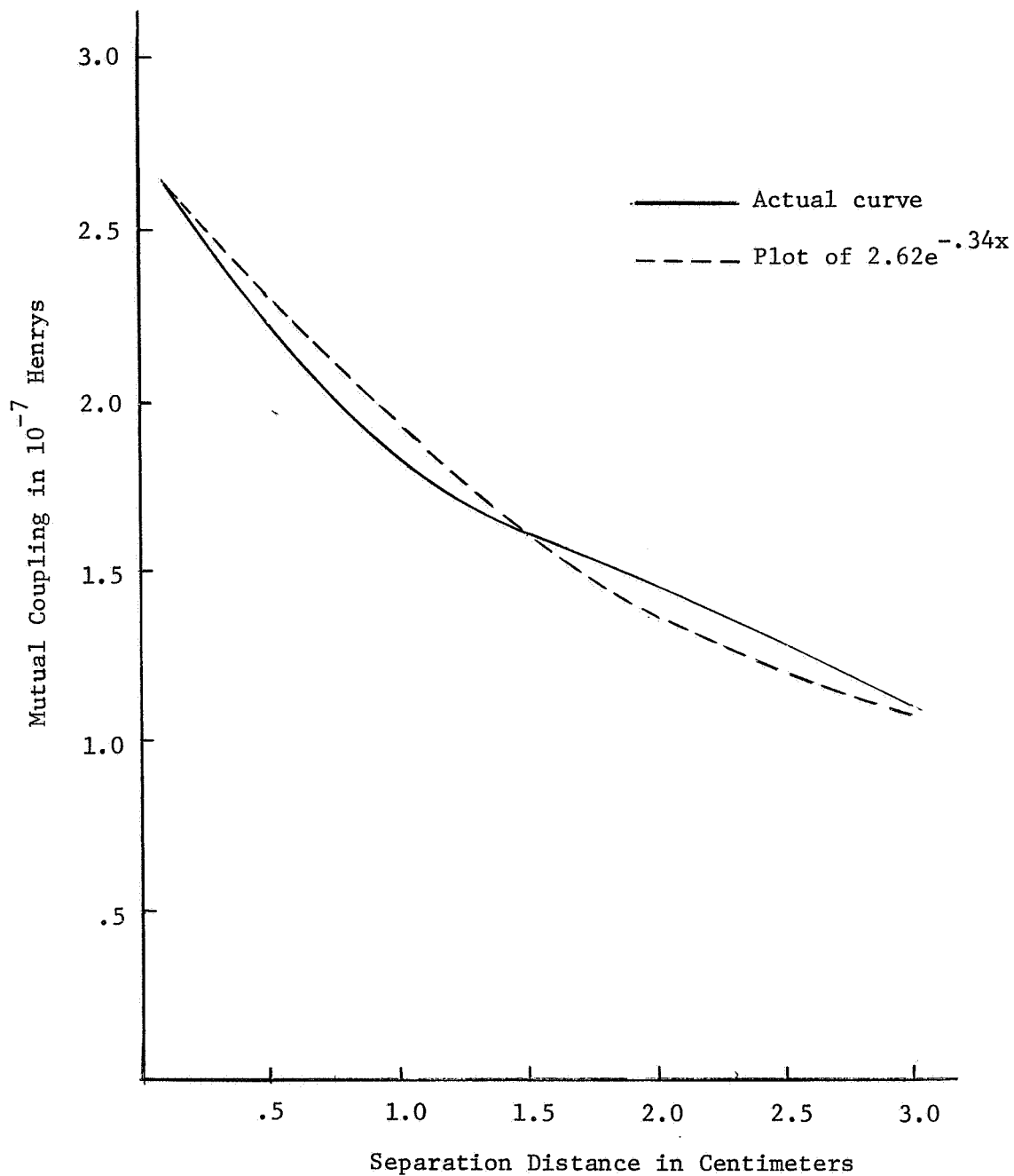

Figure I-23. A Plot of the Mutual Coupling $M_{14} + M_{24} + M_{34} + M_{44}$ as a Function of Distance Used to Analyze a Hammer Coil Consisting of Four rings for Ring Radii of $r_1 = 1.20$, $r_2 = 2.56$, $r_3 = 3.93$, and $r_4 = 5.29$ cm.

REFERENCES

1. George S. Hyde, Forces Produced On Aluminum Alloys Due to Magnetomotive Forming, Thesis, unpublished, Mississippi State University, 1967, p. 11.
2. John D. Kraus, Electromagnetics, (New York, 1953), pp. 308-310.
3. Simon Ramo and John R. Whinnery, Fields and Waves in Modern Radio, (New York, 1960), p. 258.
4. Samuel M. Selby, Standard Mathematical Tables, (Cleveland, 1965), pp. 279-281
5. D. D. Wier, B. J. Ball, C. G. Catledge, and L. J. Hill, Development of a Valid Mathematical Formula or Group of Formulas to Establish Within an Accuracy of 5% the Inductance Audio Range Resulting in Beryllium Coil Assemblies, Final Report, unpublished, Mississippi State University, 1966, p. 98.
6. Kraus, p. 152.
7. Kaj L. Nielsen, Methods in Numerical Analysis, (New York, 1961), pp. 232-242.

BIBLIOGRAPHY

- Hayt, William H. Jr., Engineering Electromagnetics. New York: McGraw-Hill, 1958.
- Hyde, George S., Forces Produced on Aluminum Alloys Due to Magnetomotive Forming. Thesis, Mississippi State University, 1967.
- Kraus, John D., Electromagnetics. New York: McGraw-Hill, 1953.
- Nielsen, Kaj L., Methods in Numerical Analysis. New York: Macmillan Company, 1961.
- Ramo, Simon and John R. Whinnery, Fields and Waves in Modern Radio. 2nd ed. New York: John Wiley & Sons, Inc., 1960.
- Selby, Samuel M., Standard Mathematical Tables. 14th ed. Cleveland: Chemical Rubber, 1965.
- Wier, D. D., B. J. Ball, C. G. Catledge, and L. J. Hill, Development of a Valid Mathematical Formula or Group of Formulas to Establish Within an Accuracy of 5% the Inductance Audio Range Resulting in Beryllium Coil Assemblies. Final Report, Mississippi State University, 1966.