

NASA TECHNICAL NOTE



NASA TN D-5373

c.1

NASA TN D-5373

LOAN COPY: RETURN  
AFWL (WLIL-2)  
KIRTLAND AFB, N MEX



# COMPUTER PROGRAM FOR VISCOUS, ISOTHERMAL COMPRESSIBLE FLOW ACROSS A SEALING DAM WITH SMALL TILT ANGLE

*by John Zuk and Patricia J. Smith*

*Lewis Research Center*

*Cleveland, Ohio*



COMPUTER PROGRAM FOR VISCOUS, ISOTHERMAL COMPRESSIBLE  
FLOW ACROSS A SEALING DAM WITH SMALL TILT ANGLE

By John Zuk and Patricia J. Smith

Lewis Research Center  
Cleveland, Ohio

NATIONAL AERONAUTICS AND SPACE ADMINISTRATION

---

For sale by the Clearinghouse for Federal Scientific and Technical Information  
Springfield, Virginia 22151 - CFSTI price \$3.00

## ABSTRACT

An analysis of the flow across a sealing dam of the type that appears in gas turbine seals was developed for steady, laminar, subsonic, isothermal compressible flow. The analysis is valid for both parallel sealing dam surfaces and surfaces separated by a small tilt angle. The computer program determines mass flow rate, pressure and velocity distributions, Mach number, force, center of pressure, axial film stiffness, rotational flow and pressure flow Reynolds numbers, power loss, and approximate temperature rise resulting from viscous shearing. The output is in both English units and the International System of Units. Some of the results can be automatically plotted.

# COMPUTER PROGRAM FOR VISCOUS, ISOTHERMAL COMPRESSIBLE FLOW ACROSS A SEALING DAM WITH SMALL TILT ANGLE

by John Zuk and Patricia J. Smith

Lewis Research Center

## SUMMARY

An analysis of the flow across a sealing dam of the type that appears in gas turbine seals was developed for steady, laminar, subsonic, isothermal compressible flow. Both parallel sealing dam surfaces and surfaces separated by a small tilt angle (e. g. , due to thermal distortion) are treated. The analysis is valid for plane pressure flow. When the sealing dam mean radius is much greater than the sealing dam radial width which, in turn, is much greater than the mean film thickness, the analysis is valid for hydrostatic radial flow. The analysis is also valid for relative rotation of the sealing dam surfaces if the circumferential shear flow has little effect on the radial pressure flow.

A computer program to carry out this analysis is also presented. Input variables include the dimensions of the seal, pressure boundary conditions, and molecular weight and physical properties of the gas. The output includes mass flow rate, pressure and velocity distributions, Mach number, force, axial film stiffness, center of pressure, rotational and pressure flow Reynolds numbers, Knudsen number, torque, power loss, and approximate temperature rise resulting from the viscous shearing for specified film thicknesses. The output units are in both the English and International Systems. Some of the results can be automatically plotted.

## INTRODUCTION

Some powerplants, such as advanced jet engines, exceed the operating limits for which face contact seals were designed (refs. 1 and 2). As a result, noncontact face seals have become necessary. A noncontact face seal which is pressure (force) balanced is shown in figure 1. In this seal, the pressure drop occurs across a narrowly spaced sealing dam, and the force due to this pressure drop is balanced by a predetermined hy-

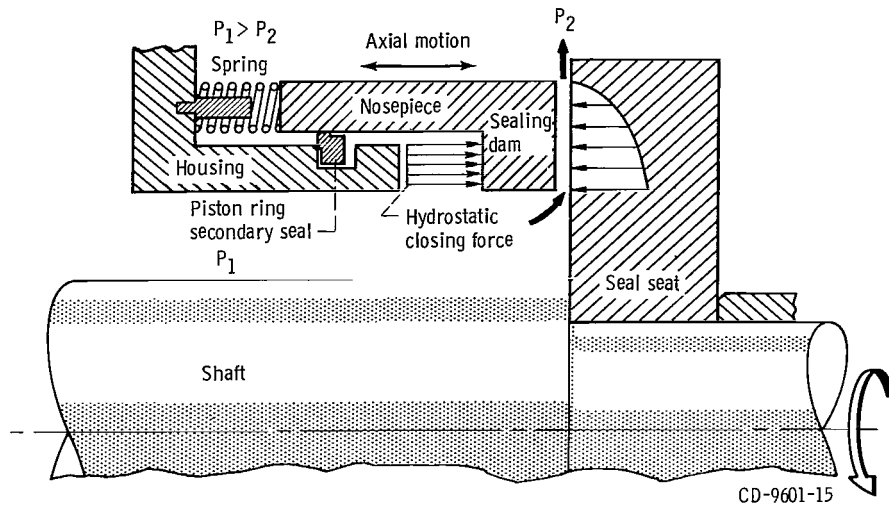

Figure 1. - Pressure-balanced face seal with no axial film stiffness.

drostatic closing force and a spring force. This configuration, however, has an inherent problem. For parallel sealing dam surfaces, there is a force caused by the pressure drop across the sealing dam, and this force is independent of film thickness; hence, there is no way of maintaining a preselected film thickness which will allow tolerable leakage and still have noncontact operation. Since the force is independent of film thickness, the design also lacks axial film stiffness for sufficient dynamic tracking of the stationary nosepiece with the rotating seal seat. The seal nosepiece must follow the seal seat surface under many conditions without surface contact or excessive increase in film thickness, which would yield high leakage. Some of these conditions are axial runout, misalignment, thermal distortion, coning, and dishing.

A promising method of maintaining a preselected film thickness and achieving axial film stiffness is to add a gas bearing, such as a shrouded Rayleigh step pad bearing, to the noncontact pressure-balanced seal (refs. 1 and 2). This is illustrated in figure 2. Both the sealing dam force due to the pressure drop across the sealing dam and the gas bearing force are balanced by the hydrostatic and spring closing forces. The gas bearing has a desirable characteristic whereby the force increases with decreasing film thickness. If the seal is perturbed in such a way as to decrease the gap, the additional force generated by the gas bearing will open the gap to the original equilibrium position. In a similar manner, if the gap becomes larger, the gas bearing force decreases, and the closing force will cause the seal gap to return to the equilibrium position.

Since a proper balance of the opening and closing forces must be found in order to determine a gap with a tolerable mass leakage, physical quantities of interest such as pressure distribution and mass leakage must be calculated for several gaps. The pressure distribution and mass leakage have been calculated for the parallel film hydrostatic

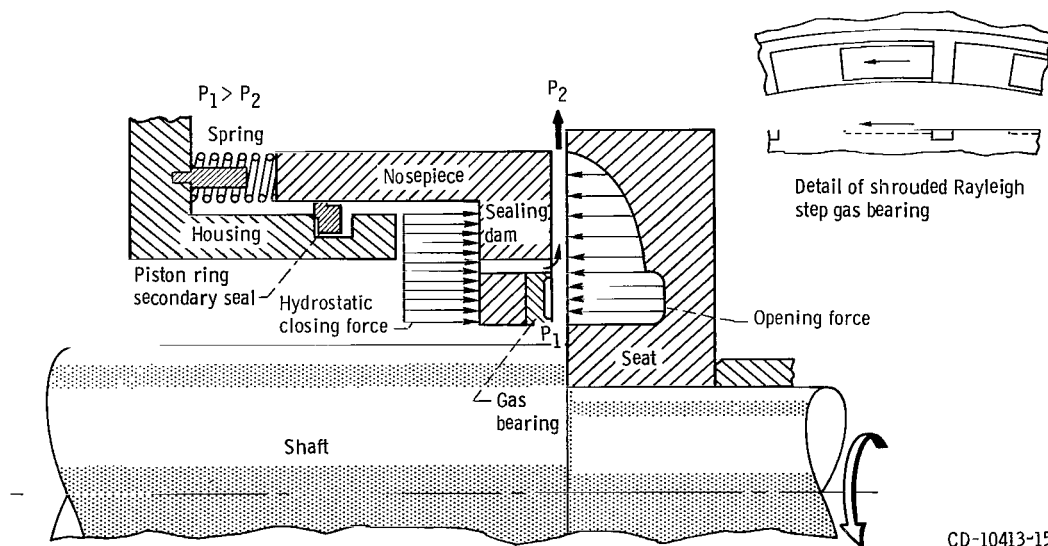

Figure 2. - Pressure-balanced face seal with a gas bearing added for axial film stiffness.

case. Mathematical solutions for the hydrostatic, isothermal, compressible, viscous flow sealing dam exist in the literature (e. g., see Gross (ref. 3)). Carothers (ref. 4) has conducted compressible flow experiments in thin films of air which are in radial flow between parallel plates. The pressure distribution was found for both subsonic and supersonic axial entrance flows. Grinnell (ref. 5) has theoretically and experimentally investigated compressible flow in a thin passage and has shown excellent agreement between theory and experiment.

An analysis for small tilts of the sealing dam surfaces does not exist in the literature. The tilts are caused by mechanical and thermal distortions of the seal, as stated in reference 1. To achieve a good design it is desirable to study the effect of the variation of a large number of parameters; thus, an automatic calculation and printout of physical variables would facilitate design.

This report presents a compressible flow sealing dam analysis that considers both parallel sealing dam surfaces and surfaces with small tilt angles. A computer program was developed to perform the calculations for the sealing dam design. Input variables include seal dimensions, pressure boundary conditions, and molecular weight and physical properties of the gas. Physical quantities such as mass flow rate, pressure and velocity distributions, Mach number, force, power, torque, and center of pressure are found for specified film thicknesses.

## BASIC MODEL AND EQUATIONS

The sealing dam model consists of two parallel, concentric, circular rings in relative rotation at a constant speed separated by a very narrow gap. A pressure differential exists between the rings' inner and outer radii (see fig. 3).

The model formulation is based on the following physical conditions:

- (1) The fluid is homogeneous, compressible, viscous, and Newtonian.
- (2) The flow is steady and laminar (continuum flow regime), and the body forces are negligible.
- (3) The bulk modulus is ignored ( $\lambda = -2/3 \mu$ ). This is Stokes idealization (ref. 3). This condition will be valid unless the gas is under high pressure, very dense (e.g., shock wave structure), or rarefied.
- (4) The fluid behaves as a perfect gas.
- (5) Since  $\Delta R$  is much greater than  $h$ , the entrance region effects are neglected; hence, the convective inertia forces are neglected. This means that the seal is treated as operating entirely in the viscous region.
- (6) The fluid film is isothermal. This means that all heat generated in the film is conducted away through the walls. This is a standard assumption of lubrication theory.

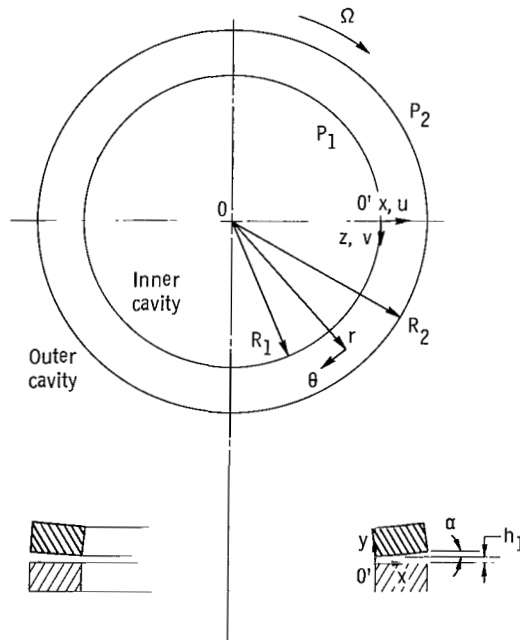

Figure 3. - Model of the sealing dam with a small tilt angle (not to scale). Rotating upper ring removed for clarity.

The validity of this assumption breaks down for cases of large thermal gradients in the sealing dam and when the frictional heating is high (e. g., small gap or high speed). However, thermal analysis of a seal (unpublished data by T. E. Russell of Lewis) shows that the sealing dam can be closely approximated by a constant temperature. In any case, the Mach number must be less than  $1/\sqrt{\gamma}$ . This is the limit of the validity of isothermal duct flow analyses as stated in most gas dynamics textbooks (e. g., Shapiro (ref. 6)).

(7) The entrance Mach number is close to zero. This means that there cannot be a large axial-flow source on one surface impinging on the radial surface, as is present in a hydrostatic bearing.

(8) The fluid velocity in the reservoir is considered to be negligible (stagnant) and thus its effects are neglected in this analysis.

(9) The radial pressure flow is uncoupled from the rotational shear flow. Reference 7 shows this assumption is valid under the following conditions:

(a) The ratio of the reference rotational velocity to the reference radial flow velocity must be less than  $1/\sqrt{Re_h(h/\Delta R)}$  (i. e.,  $\bar{R}\Omega/U_{ref} < 1/\sqrt{Re_h(h/\Delta R)}$ ).

(b) The mean radius  $\bar{R}$  must be much greater than  $h$ , and  $Re_h(h/\Delta R)$  must be much less than 1.

Using the above two conditions, reference 7 further shows

(c) The treatment of the radial flow as uncoupled from the rotational flow is a very good approximation for most applications where the radial pressure differential is large and the speeds are moderate.

(d) The circumferential and axial pressure variations are negligible.

(3) If  $\Delta R/R_1$  is much less than 1, a two-dimensional channel or narrow slot is valid.

The rotational flow, however, is important for power loss calculations due to viscous shear and transition to turbulent flow.

The governing flow equations for a compressible fluid with constant viscosity in vector notation are (ref. 8)

Conservation of mass:

$$\frac{D\rho}{Dt} + \rho \bar{\nabla} \cdot \bar{V} = 0$$

Conservation of momentum (Navier-Stokes equations):

$$\rho \frac{D\bar{V}}{Dt} = -\bar{\nabla}P - \mu \text{Curl}(\text{Curl} \bar{V}) + (\lambda + 2\mu) \bar{\nabla}(\bar{\nabla} \cdot \bar{V}) + \bar{F}$$

Isothermal equation of state:

$$P = P(\rho)$$



All symbols are defined in appendix A.

A rectilinear Cartesian coordinate system is used to describe the radial sealing dam flow (see fig. 3).

Applying the conditions assumed in the model reduces the above system of equations to the following set which can be solved:

Conservation of mass:

$$\frac{\partial(\rho u)}{\partial x} = 0 \quad (1)$$

This form of the continuity equation is not used but is replaced by the integrated form, which is shown to be the conservation of mass flow in the radial direction.

Conservation of momentum:

$$\frac{\partial^2 v}{\partial y^2} = 0 \quad \text{z-direction (circumferential)} \quad (2)$$

$$\frac{dP}{dx} = \mu \frac{\partial^2 u}{\partial y^2} \quad \text{x-direction (radial)} \quad (3)$$

Equation of state:

$$P = \rho R T = \frac{\rho P_1}{\rho_1} \quad (4)$$

Solving the circumferential direction momentum equation (eq. (2)) gives

$$v = C_1(r)y + C_2(r)$$

Applying the boundary conditions

$$v = 0 \rightarrow C_2 = 0 \quad \text{at } y = 0$$

$$v = r\Omega \rightarrow C_1 = \frac{r\Omega}{h} \quad \text{at } y = h$$

yields

$$v = \frac{r\Omega y}{h} \quad (5)$$

Since the azimuthal and axial pressure variations are neglected,  $P$  is a function of  $x$  only ( $P = P(x)$ ), and the radial momentum equation can be integrated twice with respect to  $y$

$$u = \frac{1}{2\mu} \frac{dP}{dx} y^2 + C_1' y + C_2'$$

Applying the boundary conditions

$$\begin{aligned} u = 0 &\rightarrow C_2' = 0 && \text{at } y = 0 \\ u = 0 &\rightarrow C_1' = -\frac{h(x)}{2\mu} \frac{dP}{dx} && \text{at } y = h(x) \end{aligned}$$

yields

$$u = \frac{1}{2\mu} \frac{dP}{dx} (y^2 - hy) \quad (6)$$

Now, the mass flow at any  $x$  per unit width is

$$\frac{\dot{M}}{L} = \rho \int_0^{h(x)} u \, dy = -\frac{h^3(x)\rho}{12\mu} \frac{dP}{dx} \quad (7)$$

Substituting the perfect gas law (eq. (4)) into equation (7) yields

$$\frac{\dot{M}}{L} = -\frac{h^3 \rho_1}{24\mu P_1} \frac{dP^2}{dx} \quad (8)$$

The mass flow does not change with  $x$ ; hence,

$$\frac{d\dot{M}}{dx} = 0 \quad (9)$$

(This equation replaces the continuity equation (1).) The boundary conditions for pressure are

$$\left. \begin{aligned} P = P_1, \text{ or } P^2 = P_1^2 && \text{at } x = 0 \\ P = P_2, \text{ or } P^2 = P_2^2 && \text{at } x = R_2 - R_1 \end{aligned} \right\} \quad (10)$$

An alternate formulation of this problem would have been to start with the compressible Reynolds' lubrication equation (ref. 3) for this model. Reynolds' equation is of the form of equation (9) with boundary conditions (10).

## Parallel Film Limiting Case

When the seal surfaces are parallel,  $h$  is constant, and equation (9) is readily solved by integrating twice and applying the boundary conditions (eq. (10)). The result is

$$P = P_1 \left[ 1 - \left( 1 - \frac{P_2^2}{P_1^2} \right) \frac{x}{R_2 - R_1} \right]^{1/2} \quad (11)$$

Hence,

$$\frac{dP^2}{dx} = P_1^2 \left[ \left( 1 - \frac{P_2^2}{P_1^2} \right) \frac{1}{R_2 - R_1} \right] \quad (12)$$

The mass leakage is found by substituting equation (12) into equation (8). This yields

$$\dot{M} = \frac{Lh^3 \rho_1 P_1}{24\mu(R_2 - R_1)} \left( 1 - \frac{P_2^2}{P_1^2} \right) \quad (13)$$

Equations (11) and (13) are reducible to the form found in reference 3. The total force per unit width is found from

$$\frac{F}{L} = \int_0^{R_2 - R_1} (P - P_{\min}) dx$$

which results in

$$\frac{F}{L} = \frac{2P_1(R_2 - R_1) \left[ 1 - \left( \frac{P_2}{P_1} \right)^3 \right]}{3 \left[ 1 - \left( \frac{P_2}{P_1} \right)^2 \right]} \quad (14)$$

Where  $P_{\min}$  is the smaller pressure of the two pressure boundary conditions. The center of pressure is

$$X_c = \frac{L \int_0^{R_2 - R_1} (P - P_{\min}) x \, dx}{F} \quad (15)$$

which results in

$$X_c = \frac{L(R_2 - R_1)^2}{F} \left\{ \frac{2P_1 \left[ \frac{2}{5} - \left( \frac{P_2}{P_1} \right)^3 \right]}{3 \left[ 1 - \left( \frac{P_2}{P_1} \right)^2 \right]} - \frac{P_{\min}}{2} \right\} \quad (16)$$

Since equation (14) does not depend on film thickness, there is no axial film stiffness for parallel sealing surfaces. This deficiency is overcome by adding a gas bearing to the sealing faces (fig. 2).

### Small-Tilt-Angle Case, $\alpha \neq 0$

For nonparallel sealing dam surfaces, the film thickness is no longer a constant; thus, equation (8) must be solved for the variable-film-thickness case. For a sealing dam with a small tilt (see fig. 4), the mean clearance is

$$h_m = \frac{h_1 + h_2}{2}$$

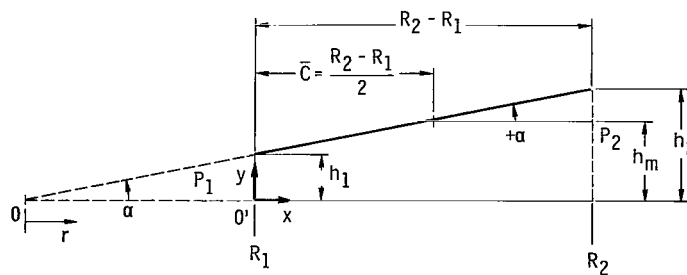

Figure 4. - Notation used for sealing dam with small tilt angle (not to scale).

For small tilts,

$$\sin \alpha = \frac{h(x) - h_m}{x - \bar{C}} \cong \alpha$$

where

$$\bar{C} = \frac{R_2 - R_1}{2}$$

Hence,  $h(x) = h_m + \alpha(x - \bar{C})$  or  $h(x) = B + \alpha x$  where  $B = h_m - \alpha\bar{C}$ . If

$$D = -\frac{24\mu P_1}{\rho_1 L}$$

equation (8) becomes

$$\frac{dP^2}{dx} = \frac{DM}{(\alpha x + B)^3}$$

Now the conservation of mass must be satisfied, that is,  $dM/dx = 0$  or

$$\frac{d^2P^2}{dx^2} = \frac{-3\alpha DM}{(\alpha x + B)^4} \quad (17)$$

Integrating equation (17) twice yields

$$P^2 = \frac{-DM}{2\alpha(\alpha x + B)^2} + C_1''x + C_2'' \quad (18)$$

When the following boundary conditions are applied,

$$\left. \begin{aligned}
 P = P_1 - C_2 &= P_1^2 + \frac{\dot{DM}}{2\alpha B^2} \quad \text{at } x = 0 \\
 P = P_2 - C_1 &= \frac{P_2^2 - P_1^2}{R_2 - R_1} - \frac{\dot{DM}h_m}{B^2(h_m + \alpha\bar{C})^2} \quad \text{at } x = 2\bar{C}
 \end{aligned} \right\} \quad (19)$$

equation (18) becomes

$$P^2 = \frac{\dot{DM}}{2\alpha} \left[ \frac{1}{B^2} - \frac{1}{(\alpha x + B)^2} \right] + P_1^2 \left[ 1 - \left( 1 - \frac{P_2^2}{P_1^2} \right) \left( \frac{1}{R_2 - R_1} \right) \right] - \frac{\dot{DM}h_m x}{B^2(h_m + \alpha\bar{C})^2} \quad (20)$$

or

$$P^2 = P_1^2 \left[ 1 - \left( 1 - \frac{P_2^2}{P_1^2} \right) \left( \frac{x}{R_2 - R_1} \right) \right] + \frac{\dot{DM}}{B^2} \left[ \frac{(\alpha x + B)^2 - B^2}{2\alpha(\alpha x + B)^2} - \frac{h_m x}{(h_m + \alpha\bar{C})^2} \right] \quad (21)$$

For small tilts of the sealing dam surfaces, the mass leakage is found from equation (13), where  $h$  is now  $h_{char}$ ; that is,

$$\dot{M} = \frac{Lh_{char}^3 \rho_1 P_1}{24\mu(R_2 - R_1)} \left( 1 - \frac{P_2^2}{P_1^2} \right) \quad (22)$$

where

$$h_{char} = \frac{h_1 h_2}{h_m}$$

Using equation (22) for the mass leakage in equation (21), the pressure distribution for small tilt angles becomes

$$\frac{P(x)}{P_1} = \left\{ \left[ 1 - \left( 1 - \frac{P_2^2}{P_1^2} \right) \left( \frac{x}{R_2 - R_1} \right) \right] - \frac{24\mu\dot{M}}{P_1\rho_1LB^2} \left[ \frac{(\alpha x + B)^2 - B^2}{2\alpha(\alpha x + B)^2} - \frac{h_m x}{(h_m + \alpha\bar{C})^2} \right] \right\}^{1/2} \quad (23)$$

The total force per unit width is found from

$$\frac{F}{L} = \int_0^{R_2 - R_1} (P - P_{\min}) dx \quad (24)$$

The center of pressure is found from

$$X_c = \frac{\int_0^{R_2 - R_1} (P - P_{\min}) x dx}{\frac{F}{L}} \quad (25)$$

In the computer program, the integrations in equations (24) and (25) are performed numerically.

The axial film stiffness is defined as

$$\text{STIFF} = - \frac{dF}{dh_m} \quad (26)$$

It can be seen from equation (23) that a sealing dam with nonparallel surfaces has an axial film stiffness. It can also be seen that this film stiffness can be positive or negative. In the computer program, the axial film stiffness is found numerically (see appendix B).

### Additional Parameters Calculated by Computer Program

The average radial velocity at any radial point  $x$  in the sealing dam gap is found from

$$u_{av}(x) = \frac{\dot{M}}{\rho(x)hL} = \frac{\dot{M}P_1}{L\rho_1P(x)h} \quad (27)$$

The local Mach number at any  $x$  is then

$$M = \frac{u_{av}(x)}{a} = \frac{u_{av}(x)}{\sqrt{\gamma RT}} \quad (28)$$

where  $a$  is the speed of sound.

The pressure flow Reynolds number is found by using the hydraulic radius  $2h$  as the characteristic length

$$Re_h = \frac{P_2 u_{av} 2h}{\mu RT} \quad (29)$$

The Knudsen number can be found from (ref. 9)

$$Kn = \frac{\text{Molecular mean free path}}{\text{Mean film thickness}} \cong \frac{1.48 M_{\max}}{\frac{Re_h}{2}} \quad (30)$$

Under conditions of very small film thicknesses, the Knudsen number may be greater than 0.01, and this continuum analysis would no longer be valid. (A slip flow regime analysis must be used.)

The total power is found by considering only the viscous shear caused by rotation.

$$\left. \begin{aligned} \text{Power} &= \bar{R}\Omega \cdot (\text{Shear force}) = \frac{\bar{R}^2 \Omega^2 \mu}{h} \int_A dA \\ &= \frac{\mu \bar{R}^2 \Omega^2 A}{h} \end{aligned} \right\} \quad (31)$$

where  $\bar{R}\Omega$  is the mean rotational velocity.

A very rough estimate of the film temperature rise due to the viscous shearing can be estimated by equating the heat generated by viscous shearing with heat transfer by convection. Thus,

$$T_{\text{film, av}} - T = \frac{\mu \bar{R}^2 \Omega^2 A}{h C_p \dot{M}} \quad (32)$$



This calculated film temperature rise will be higher than actual film temperatures. The predominant mode of heat transfer, conduction by the walls, is neglected.

## Computer Program Formulation

The previously derived equations, placed in the form used in the computer program, are shown in table I in the English system of units. A description of the program and flow charts is presented in appendix B. The program listing is given in appendix C. A sample problem with its input and output for parallel sealing dam surfaces and relative surface tilts of  $\pm 1$  milliradians is given in appendix D.

Lewis Research Center,  
National Aeronautics and Space Administration,  
Cleveland, Ohio, April 9, 1969,  
120-27-04-90-22.

TABLE I. - FORM OF PERTINENT EQUATIONS FOUND IN COMPUTER PROGRAM (IN SAME SEQUENCE AS EQUATIONS APPEAR IN PROGRAM)

$A = \pi (R_2^2 - R_1^2), \text{ in.}^2$	
$\bar{R} = \frac{Q}{M}, \frac{\text{ft-lb}}{(\text{lbm})(^\circ\text{R})} \text{ where } \bar{R} = 1545.4 \frac{\text{ft-lb}}{(\text{lb-mole})(^\circ\text{R})}$	$\text{Re}(P) = \frac{P_2 U_{av} 2h_{char} \left( \frac{12 \text{ in.}}{\text{ft}} \right)}{\left[ 32.174 \frac{(\text{lbm})(\text{ft})}{(\text{lb})(\text{sec}^2)} \right] \mu R (T + 460)}$
$\rho_1 = \frac{P_1 \left( \frac{144 \text{ in.}^2}{\text{ft}^2} \right)}{R(T + 460) \left[ 32.174 \frac{(\text{lbm})(\text{ft})}{(\text{lb})(\text{sec}^2)} \right]}, \frac{(\text{lb})(\text{sec}^2)}{\text{ft}^4}$	$Q = 13.083 \dot{M}, \text{ std cu ft/min}$ $\text{Power} = \left( \frac{\mu AV^2}{h_m} \right) \left( \frac{1 \text{ hp}}{550 \text{ ft-lb}} \right) \left( \frac{1}{\text{sec}} \right) \left( \frac{12 \text{ in.}}{\text{ft}} \right), \text{ hp}$
$a = \sqrt{\gamma} \bar{R} (T + 460) \left[ 32.174 \frac{(\text{lbm})(\text{ft})}{(\text{lb})(\text{sec}^2)} \right], \frac{\text{ft}}{\text{sec}}$	$\Delta T = \left[ 42.42 \frac{(\text{lb})(\text{min})}{\text{hp}} \right] \frac{(\text{Power})}{MC_p}, ^\circ\text{F}$
$\text{If } L = 0, L = 2\pi \frac{R_1 + R_2}{2}, \text{ in.}$	$H_{total} = 42.42(\text{Power}), \frac{\text{Btu}}{\text{min}}$
$\text{If } \rho_0 = 0, \rho_0 = \rho_1, \frac{(\text{lb})(\text{sec}^2)}{\text{ft}^4}$	$F = L \int_0^{R_2 - R_1} (P - P_0) dx, \text{ lb}$
$\text{If } N \neq 0, V = \left( \frac{\pi N}{12 \text{ in.}} \right) \left( \frac{R_1 + R_2}{2} \right) \left( \frac{\text{min}}{60 \text{ sec}} \right), \frac{\text{ft}}{\text{sec}}$	$X_c = \frac{L}{F} \int_0^{R_2 - R_1} (P - P_0) x dx, \text{ in.}$
$\text{If } N = 0 \text{ and } V = 0,$ $\Delta T = 0, ^\circ\text{R}$ $C_p = 0, \frac{\text{Btu}}{(\text{lbm})(^\circ\text{R})}$	$x = x_1 + n \Delta x, \text{ in.}$ $h = h_m + \alpha \left( x - \frac{R_1 - R_2}{2} \right), \text{ in.}$
$\text{Re}(\bar{R}) = \rho_0 \left( \frac{R_1 + R_2}{2} \right) \left( \frac{32}{60 \text{ sec}} \right) \left[ \frac{h}{\left( \frac{144 \text{ in.}^2}{\text{ft}^2} \right)} \right]$	$\text{If } \alpha = 0, \frac{P}{P_1} = \sqrt{1 - \left( 1 - \frac{P_2^2}{P_1^2} \right) \left( \frac{x}{R_2 - R_1} \right)}, \text{ in.}$
$\Delta x = \frac{R_2 - R_1}{\text{Number of steps}}, \text{ in.}$	$\text{If } \alpha \neq 0, \frac{P}{P_1} = \left\{ 1 - \left( 1 - \frac{P_2^2}{P_1^2} \right) \left( \frac{x}{R_2 - R_1} \right) + \frac{DM}{B^2 P_1^2} \left[ \frac{(o x + B)^2 - B^2}{2\alpha(o x + B)^2} - \frac{h_m x}{(h_m + \alpha C)^2} \right] \right\}^{1/2}$
$h_{char} = \frac{h_1 h_2}{h_m}, \text{ in.}$	$\text{STIFF} = - \frac{dF}{dh_m}, \frac{\text{lb}}{\text{in.}}$
$\dot{M} = \left[ 32.174 \frac{(\text{lbm})(\text{ft})}{(\text{lb})(\text{sec}^2)} \right] \left( \frac{60 \text{ sec}}{12 \text{ in.}} \right) \left[ \frac{h_{char}^3 \rho_1 P_1 L \left( 1 - \frac{P_2^2}{P_1^2} \right)}{24 \mu (R_2 - R_1)} \right], \frac{\text{lb}}{\text{min}}$	$\bar{F} = \frac{F}{ P_1 - P_2  (R_2 - R_1) L}$ $\bar{X}_c = \frac{X_c}{R_2 - R_1}$
$h_{min} = \text{smaller of } h_1 \text{ and } h_2, \text{ in.}$	$\text{Torque} = \left[ \frac{33\,000 (\text{Power})}{N} \right] \left( \frac{12 \text{ in.}}{\text{ft}} \right), \text{ ft-lb}$
$U_{av}(x) = \left[ 32.174 \frac{(\text{lbm})(\text{ft})}{(\text{lb})(\text{sec}^2)} \right] \left( \frac{60 \text{ sec}}{\text{min}} \right) L \rho_1 h_{min} P(x), \frac{\text{ft}}{\text{sec}}$	
$M = \frac{U_{av}}{a}$	

## APPENDIX A

### SYMBOLS

A	sealing dam surface area, in. <sup>2</sup> ; m <sup>2</sup>
a	speed of sound, ft/sec; m/sec
B	$h_m - \alpha \bar{C}$
C	constant of integration
$\bar{C}$	$(R_2 - R_1)/2$
$C_p$	specific heat at constant pressure, Btu/(lb)(°R); J/(kg)(K)
$C_v$	specific heat at constant volume, Btu/(lb)(°R); J/(kg)(K)
D	$-24\mu P_1/\rho_1 L$
F	sealing dam force, lb; N
$\bar{F}$	dimensionless force, $F/(P_2 - P_1)(R_2 - R_1)$
$\vec{F}$	body force vector
g	gravitational constant, 32.174 (lbm)(ft)/(lb)(sec <sup>2</sup> ); 9.81 m/sec <sup>2</sup>
h	film thickness, in.; m
K	$DM$
Kn	Knudsen number
L	sealing dam width, in.; m
M	Mach number
$\dot{M}$	mass flow, lb/min; kg/sec
m	molecular weight of gas, lbm/lb-mole; kg/kg-mole
n	an integer
P	static pressure, psi; N/m <sup>2</sup>
$P_{\min}$	smaller pressure of two pressure boundary conditions, psi; N/m <sup>2</sup>
Q	net volume flow rate, std cu ft/min; std cu m/sec
R	radius, in.; m
$\bar{R}$	mean radius, $(R_1 + R_2)/2$ , in.; m
$\Delta R$	sealing dam length, $R_2 - R_1$ , in.; m

$R$	gas constant, universal gas constant/molecular weight, ft-lb/(lbm)( $^{\circ}$ R); J/(kg)(K)
$\bar{R}$	universal gas constant, 1545.4 ft-lb/(lb-mole)( $^{\circ}$ R); 8.3143 J/(kg-mole)(K)
Re	Reynolds number
r	radial direction coordinate
STIFF	axial film stiffness = $-dF/dh_m$ , lb/in.; N/m
T	temperature, $^{\circ}$ F; K
U	pressure flow reference velocity, ft/sec; m/sec
u	velocity in r-direction or x-direction, ft/sec; m/sec
V	moving sealing dam surface speed (circumferential direction), ft/sec; m/sec
$\vec{V}$	fluid velocity vector
v	velocity in circumferential direction or z-direction, ft/sec; m/sec
$X_c$	center of pressure in radial or x-direction, in.; m
$\bar{X}_c$	dimensionless center of pressure, $X_c/(R_2 - R_1)$
x	coordinate in pressure gradient direction (x-direction)
y	coordinate across film thickness
z	shear flow coordinate in Cartesian system
$\alpha$	relative inclination angle of sealing dam surfaces, rad
$\gamma$	specific heat ratio, $C_p/C_v$
$\theta$	circumferential coordinate or azimuthal direction
$\lambda$	second viscosity coefficient or coefficient of bulk viscosity
$\mu$	absolute or dynamic viscosity, (lb-sec)/ft <sup>2</sup> ; N-sec/m <sup>2</sup>
$\rho$	density, (lb)(sec <sup>2</sup> )/ft <sup>4</sup> ; kg/m <sup>3</sup>
$\Omega$	angular rotation velocity, rad/sec
$\nabla$	Del operator, $\frac{\partial}{\partial x} \hat{i} + \frac{\partial}{\partial y} \hat{j} + \frac{\partial}{\partial z} \hat{k}$

Subscripts:

av	average
char	characteristic
h	based on film thickness
m	mean

max	maximum
min	minimum
r	based on radius
0	reference
1	inner radius or inlet
2	outer radius or outlet

## APPENDIX B

### COMPUTER PROGRAM

The program called SEAL performs an analysis of the flow across a gas film sealing dam with mean film thickness  $h_m$  and tilt angle  $\alpha$ . SEAL and its subprograms are written in FORTRAN IV. (The computer at the Lewis Research Center is an IBM 7094II/7044 or 7040 Direct Couple computer under IBSYS version 13 using ALTIO.)

Included in this appendix are lists of the input variables and program variables, along with their descriptions and English units; detailed descriptions of the subprograms; and a flow chart of the main program (fig. 5).

All input, calculations, and output are in English units. Printout of data in International Units is optional.

#### Main Program

The main program, SEAL, performs the primary flow analysis. Subroutines are used for secondary operations such as numerical integrations, numerical differentiation, and plotting data.

Input to SEAL is by punched cards in the following order:

- (1) Title card - alphanumeric identification of the data (format 12A6)
- (2) NJ card - number of mean film thicknesses to be analyzed in one running of the program (format I3)
- (3)  $h_m$  cards - mean film thicknesses, six per card (format F12.6)
- (4) Data cards - seal dimensions, pressure boundary conditions, physical properties of the gas, and logical variables (read by NAMELIST/INPT/)

Data are read by NAMELIST to minimize the number of cards required to run a second case with the same title and  $h_m$  cards. Input variables are initially set to zero. Consequently, variables which are not changed during the reading of the data cards will be calculated by the program. (See the list of input variables for their significance and for any restrictions on them.)

Output data are printed in English units in groups, in the following order:

- (1) Program identification - compressible sealing dam with small tilt angle
- (2) Data identification - as it appears on the title card

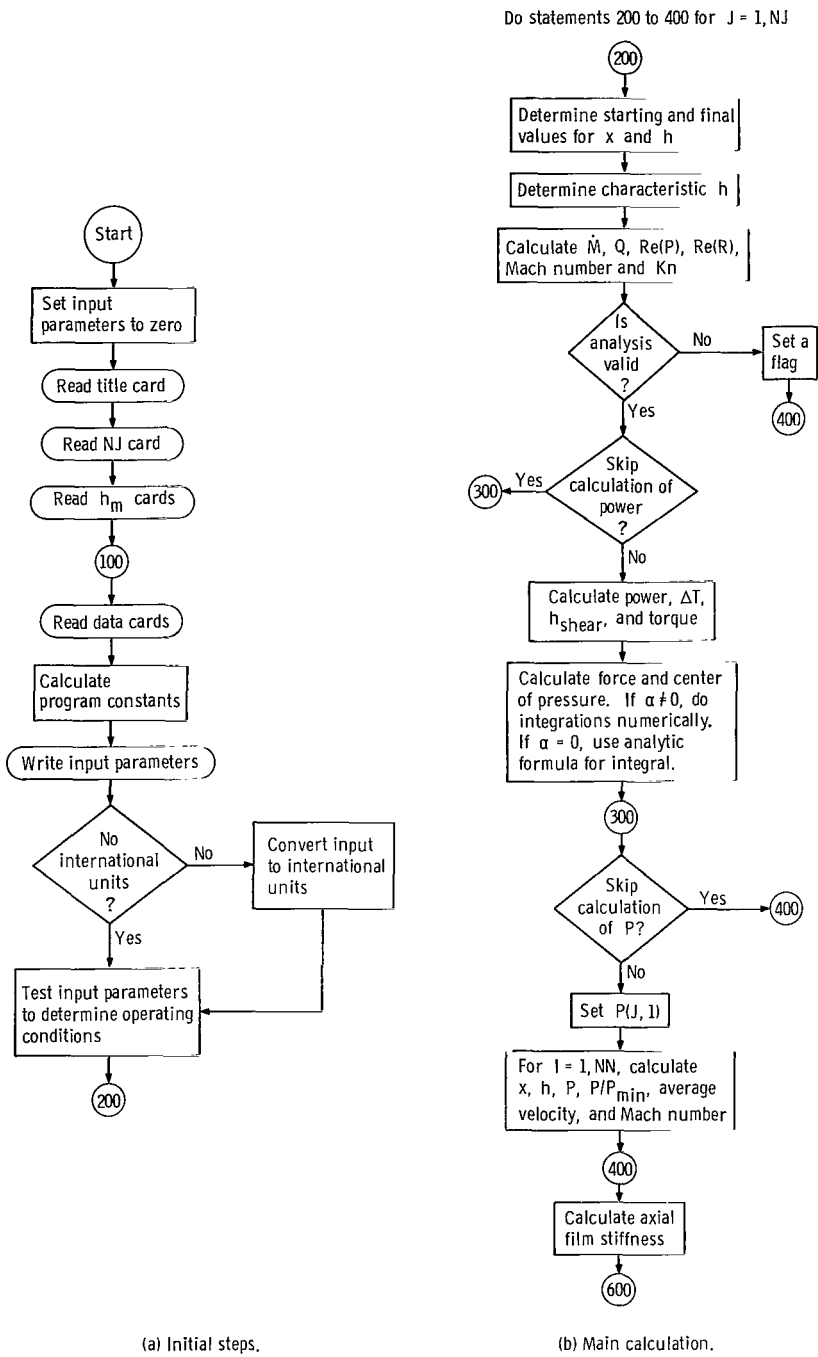

(a) Initial steps.

(b) Main calculation.

Figure 5. - Flow chart of main program (SEAL).

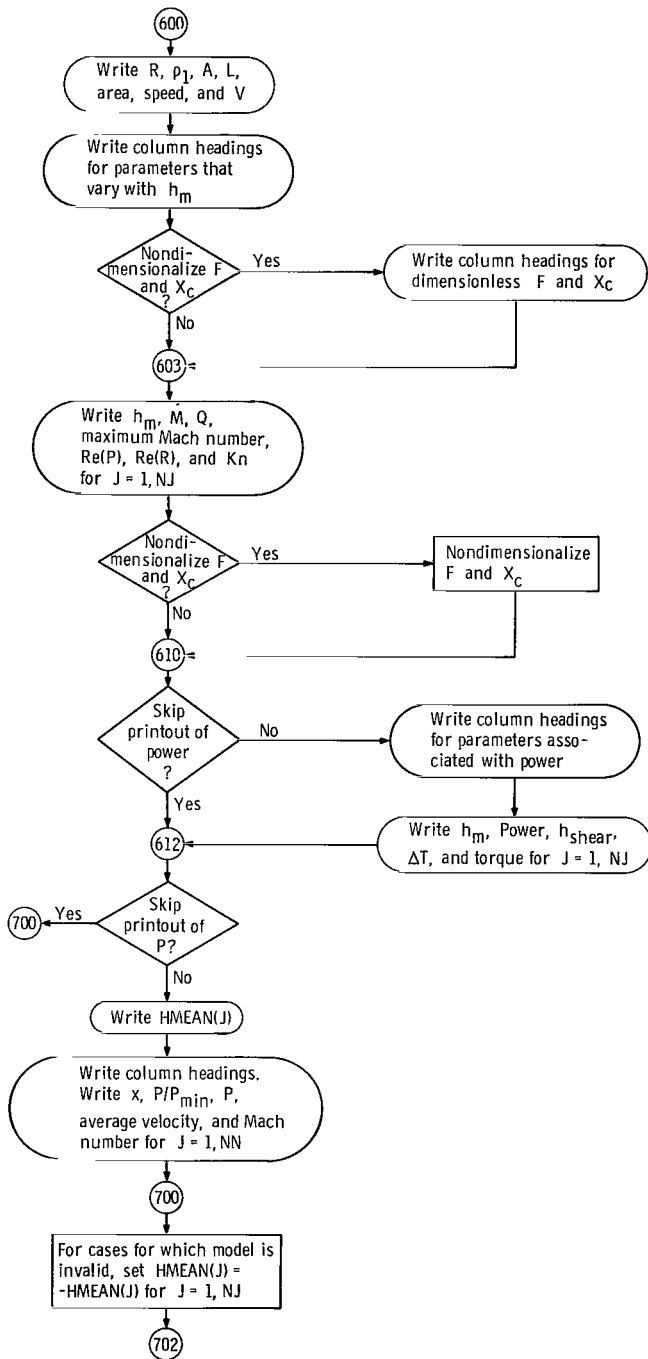

(c) Write routine.

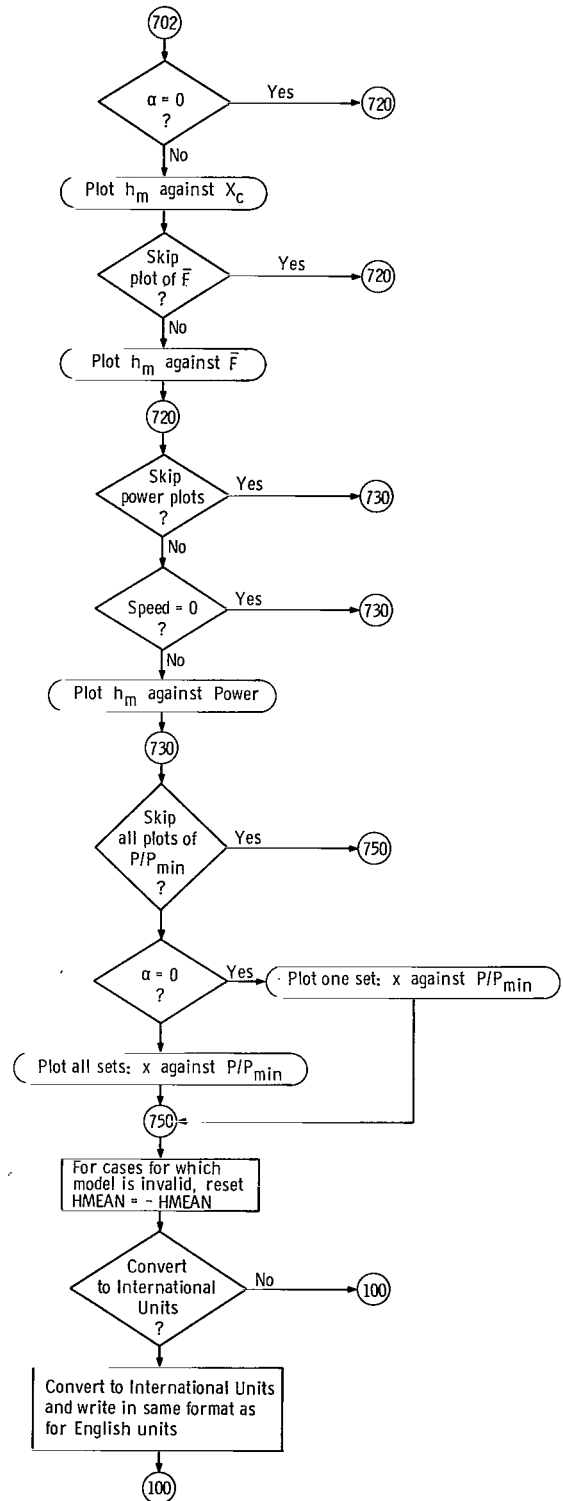

(d) Plot routine.

Figure 5. - Concluded.



- (3) Input data - as it appears on INPT cards
- (4) Calculated constants - rotational flow Reynolds number, reference density, density at inner radius of seal, speed of sound, gas constant, length of seal, and rotational velocity
- (5) Parameters that vary with  $h_m$  - mass flow rate, volume flow rate at standard conditions, maximum Mach number, pressure flow Reynolds number, rotational flow Reynolds number, sealing dam force, axial film stiffness, center of pressure, dimensionless sealing dam force, dimensionless center of pressure, and Knudsen number (Printout of dimensionless sealing dam force and dimensionless center of pressure may be suppressed by setting RSKIP to TRUE.)
- (6) Parameters associated with power dissipation - power, shear heat, apparent temperature rise, and torque (Printout of all parameters associated with power dissipation may be suppressed by setting TSKIP to TRUE.)
- (7) Parameters that vary across the sealing dam (one group for each  $h_m$ ) - distance across sealing dam, pressure, pressure ratio, average velocity, and Mach number (Printout of all data in group 7 may be suppressed by setting ASKIP to TRUE.)

Printout of data in English units is followed by plots of several parameters (see appendix D). Plots appear in standard form with minimum  $x$  and minimum  $y$  in the lower left corner of the plot. Legends at the bottom of the plots give conversion factors for International Units. The plots appear in the following order:

- (1) Center of pressure as a function of  $h_m$
- (2) Dimensionless sealing dam force as a function of  $h_m$  (Plots 1 and 2 are suppressed for  $\alpha = 0$  since center of pressure and sealing dam force do not change with  $h_m$ . For  $\alpha \neq 0$ , plot 2 may be suppressed by setting RSKIP to TRUE.)
- (3) Power as a function of  $h_m$  for nonzero speed (Plot 3 may be suppressed by setting TSKIP to TRUE.)
- (4) Pressure ratio as a function of distance across sealing dam for subsonic flow cases (If  $\alpha = 0$ , only one plot is made because the pressure distributions are identical for all  $h_m$ . All plots in group 4 may be suppressed by setting ASKIP to TRUE.)

Following the plots, data are printed in International Units. This printout may be suppressed by setting NOUI to TRUE.

SEAL is divided roughly into seven sections. The first section reads data and calculates program constants (cards 41 to 59).

The second section (cards 85 to 93) tests certain input variables. If they are zero, new values are calculated. If they are nonzero, the original values are used by the program. Since SPEED and CAPV both represent rotational velocity, they must be consistent. If SPEED is read as zero, CAPV must be examined. In the case that CAPV is not zero, SPEED is calculated from CAPV. If they are both zero, the system is considered to be static.

Section three (cards 99 to 146) is the first part of a loop which is done for each  $h_m$ . This section calculates starting values for  $x$  and  $h$ , mass flow rate, volume flow rate at standard conditions, pressure flow Reynolds number, rotational flow Reynolds number, maximum Mach number, and Knudsen number. If the maximum Mach number indicates that the flow analysis is no longer valid ( $M > 1/\sqrt{\gamma}$ ), IHTAG(J) is set equal to 1 as a trigger, and no further calculations are made. If the flow analysis remains valid, the program calculates power, shear heat, temperature rise due to power dissipation, torque, sealing dam force, and center of pressure. For  $\alpha \neq 0$ , the integrations in the force and center of pressure equations are done numerically by Simpson's rule. For  $\alpha = 0$ , the integrations are done analytically, and the resulting formulas are used in the program. The axial film stiffness is found numerically by Lagrange differentiation of force with respect to  $h_m$ .

Section four (cards 151 to 163) is the rest of the loop started in section three. Section four calculates film thickness, pressure, pressure ratio, average velocity, and Mach number at several points across the sealing dam. Section five (cards 168 to 211) writes data in English units. Section six (cards 215 to 257) plots the various parameters. And section seven (cards 261 to 319) writes data in International Units.

Numerical constants that appear in the program are for units conversion.

## Subprograms

SEAL uses six subroutines whose listings are given in appendix C. They are SIMPS1, PX, PXX, PRESS, STFNSS, and ARRNG. The last five are described in table II. SEAL also uses two subroutines that are not standard in IBSYS. These are SORTXY and PLOTXY.

SORTXY sorts two numerical arrays. A statement such as CALL SORTXY(X, Y, N) results in the array X being rearranged such that  $X(1) \leq X(2) \dots \leq X(N)$  with the Y array rearranged to preserve the X, Y pairs. N is the number of elements in the X and Y arrays.

TABLE II. - DESCRIPTION OF SUBROUTINES

Name	Call vector variables	COMMON block variables	Program variables	Description
PRESS (pressure function)	X	P1 P2 ALPHA C RDIF HM AK	YY Y AA Q	distance from inner radius of seal pressure at inner radius of seal smaller of P1 and P2 tilt angle $1 - P_1^2/P_2^2$ distance across seal mean film thickness constant distance from inner radius of seal pressure film thickness at outer radius of seal $P^2$ for $\alpha \neq 0$
PX (integrand in integral) $\int_0^{R_2-R_1} (P - P_{min}) dx$	Y	P1 PREF A, B, C, D, E	YY	distance from inner radius of seal pressure at inner radius of seal smaller of P1 and P2 dummy variables to fill common block distance from inner radius of seal
PXX (integrand in integral) $\int_0^{R_2-R_1} (P - P_{min}) x dx$	Y	P1 PREF A, B, C, D, E	YY	distance from inner radius of seal pressure at inner radius of seal smaller of P1 and P2 dummy variables to fill common block distance from inner radius of seal
STFNSS (numerical differentiation for film stiffness)	XX YY ITAG  DDY  MAX		X Y MM N K IST IN II, JJ A(5, 5) P1 S1 S2 P2 KY DY(50)	input array of independent variable input array of dependent variable input array of numerical flags (ITAG(J) $\neq 0$ implies flow became supersonic and case should be eliminated from calculation.) returned array of film stiffness DDY = -d(YY).d(XX) number of elements in XX, YY, and ITAG array of valid independent variables array of valid dependent variables number of valid points number of points used in the numerical differentiation, N = 5 index of point at which differentiation is made index of first point used in differentiation index of last point used in differentiation indices of points used in differentiation (II can be used as either the row index or the column index since the matrix A is square.) matrix whose elements A(I, J) = X(II) - X(JJ) product $(x_k - x_j) P_1(x_1)$ sum $\sum_{i=1}^n \frac{y_i}{D_{ik}}$ sum $\sum_{j=1}^n \frac{1}{(x_k - x_j)}$ product $\prod_{j=1}^n (x_k - x_j)$ integr value of derivative floating point array of derivatives
ARRNG (arranges arrays to be plotted)	X Y XP YP N I		T	input array of independent variable input array of dependent variable sorted array of new independent variable sorted array of new dependent variable number of elements in input arrays number of elements in sorted arrays temporary storage for sorting

PLOTXY plots two numerical arrays. A statement such as CALL PLOTXY (X, Y, KODE, P) produces an on-line plot of X against Y with the point X(1), Y(1) in the upper left corner. The plot appears with X increasing down the page and Y increasing across the page. KODE indicates which plotting options are used. For example, KODE = 6 gives a plot with most of the grid lines suppressed, \* as the plotting character, and the X and Y scales computed by the plotting routine. The array P contains information needed by the plotting routine, such as the number of points to be plotted, the X and Y scales if the programmer computes them, and the frequency of grid lines in the X and Y directions.

Special format statements are used to print plot titles and plot legends. A pair of statements such as

```
WRITE (6, 1)
1 FORMAT (2HPT, 10HPLOT TITLE)
```

will print the title PLOT TITLE above the plot. A pair of statements such as

```
WRITE (6, 2)
2 FORMAT (2HPL, 11HPLOT LEGEND)
```

will print the legend PLOT LEGEND immediately below the plot.

Listing of SORTXY and PLOTXY can be found in reference 10 or can be obtained from the Instrument and Computing Division of the Lewis Research Center.

SIMPS1 is a function subprogram used to perform a numerical integration by Simpson's rule. A statement such as F = SIMPS1 (XO, XF, G, K) gives F as the definite integral

$$F = \int_{XO}^{XF} G(X) dX$$

The integrand is evaluated at interior points by the external function G named in the calling vector. The interval of integration, XO to XF, is not divided uniformly. More subdivisions are made in regions where the integrand is changing rapidly. If two successive evaluations of the integral on a particular subinterval differ by more than  $3 \times 10^{-5}$  times the value of the integrand, the subinterval is divided into two subintervals and the integration is repeated. In the integration requires more than 200 subintervals, the integer K is raised by 1 to indicate that the returned value of the integral is incorrect.

PRESS is a function subprogram to evaluate the pressure at any distance X from the inner radius of the sealing dam. The distance appears in the calling vector. The

pressure differential equation is solved analytically, and the resulting formulas are used in the program. For  $\alpha = 0$ , the formula used is equation (11).

$$P = P_1 \sqrt{1 - \left(1 - \frac{P_2^2}{P_1^2}\right) \left(\frac{x}{R_2 - R_1}\right)} \quad (11)$$

For  $\alpha \neq 0$ , the formula used is equation (23)

$$P = P_1 \left\{ \left[ 1 - \left(1 - \frac{P_2^2}{P_1^2}\right) \left(\frac{x}{R_2 - R_1}\right) \right] - \frac{24\mu\dot{M}}{\rho_1 L B^2} \left[ \frac{(\alpha x + B)^2 - B^2}{2\alpha(\alpha x + B)^2} - \frac{h_m x}{(h_m + \alpha \bar{C})^2} \right] \right\}^{1/2} \quad (23)$$

PX is an external function subprogram to evaluate the integrand in the integral

$$\frac{F}{L} = \int_0^{R_2 - R_1} (P - P_{\min}) dx \quad (24)$$

Similarly, PXX is an external function subprogram to evaluate the integrand in the integral

$$X_c = \frac{\int_0^{R_2 - R_1} (P - P_{\min}) x dx}{\frac{F}{L}} \quad (25)$$

STFNSS is a subroutine subprogram to calculate the axial film stiffness (STIFF). It performs the numerical differentiation

$$STIFF = \frac{-dF}{dh_m}$$

by Lagrange's method (ref. 11). The general formula for Lagrange differentiation is

$$L'(x) = \sum_{i=0}^n L_i'(x) y_i$$

where

$$L'_i(x) = \frac{P_i(x)}{P_i(x_i)} \left( \sum_{\substack{j=0 \\ j \neq i}}^n \frac{1}{x - x_j} \right)$$

and

$$P_i(x) = (x - x_i)^{-1} \prod_{j=0}^n (x - x_j)$$

For the special case of the derivative at one of the tabulated points  $x_k$ ,

$$L'(x_k) = \prod_{\substack{j=0 \\ j \neq k}}^n (x_k - x_j) \left( \sum_{\substack{i=0 \\ i \neq k}}^n \frac{y_i}{D_{ik}} \right) + y_k \sum_{\substack{j=0 \\ j \neq k}}^n \frac{1}{x_k - x_j} \quad (34)$$

where  $D_{ik} = (x_k - x_i)P_i(x_i)$ ,  $i \neq k$ .

Subroutine STFNSS follows a computing scheme described in reference 11. A matrix is defined whose elements are

$$a_{ij} = x_i - x_j$$

The product of the off-diagonal elements of each row is multiplied by  $x_k - x_i$ , except for the  $k^{\text{th}}$  row. This defines  $D_{ik}$ . The sum

$$\sum_{\substack{i=0 \\ i \neq k}}^n \frac{y_i}{D_{ik}}$$

is formed and multiplied by the product of the negative of the off-diagonal elements in the  $j^{\text{th}}$  column. This gives the first term in the formula. The second term is formed by

summing the reciprocals of the off-diagonal elements in the  $k^{\text{th}}$  column and multiplying the sum by  $y_k$ .

The subroutine first eliminates cases for which the flow Mach number exceeds  $1/\sqrt{\gamma}$ . Then it arranges the data in order of ascending  $x$ . It chooses the five data points  $x_i, y_i$  ( $i = k - 2, k - 1, k, k + 1, k + 2$ ) for use in equation (34). If there are less than five data points in the set, all are used in the differentiation.

ARRNG is a subroutine subprogram used to arrange two arrays  $X$  and  $Y$  for plotting. The subroutine first eliminates cases for which the Mach number exceeds  $1/\sqrt{\gamma}$ . It sorts the remaining data in order of ascending  $X$ . It then inverts both arrays and interchanges them. The data are now in the form of ordered pairs  $(Y(N), X(N)), (Y(N-1), X(N-1)), \dots, (Y(1), X(1))$  where  $Y(N) \geq Y(N-1) \geq \dots \geq Y(1)$ . Arranging data in this form permits the  $Y$  array to be plotted as the independent variable in descending order. Consequently, the plots appear in standard form with minimum  $X$  and minimum  $Y$  in the lower left corner.

## Input Variables

Input variables to the program and their units are listed. Arrays are given with their dimensions.

FORTRAN symbol	Unit	Description	
TITLE(12)		alphanumeric identification of data	
NJ		number of mean film thicknesses ( $NJ \leq 50$ )	
HMEAN(J) J=1, NJ	in.	mean film thicknesses	
ALPHA	rad	tilt angle	
L	in.	width of mean circumference of sealing dam	
SPEED	rpm	rotational speed	} Only one of these needs to be set. If both are set, CAPV is calculated from SPEED.
CAPV	ft/sec	sealing dam surface speed	
MOLWT	lb/lb-mole	molecular weight of gas	
P1	psi	pressure at inner radius of seal	

FORTRAN symbol	Unit	Description
P2	psi	pressure at outer radius of seal
T	°F	isothermal reference temperature
R1	in.	inner radius of seal
R2	in.	outer radius of seal
RHORO	$(\text{lb})(\text{sec}^2)/\text{ft}^4$	reference density at inner radius of seal (If RHORO is read as zero, program calculates RHORO.)
RHORF	$(\text{lb})(\text{sec}^2)/\text{ft}^4$	density at mean radius used in calculating ro- tational Reynolds number (If RHORF is read as zero, program calculates RHORF.)
MU	$(\text{lb})(\text{sec})/\text{ft}^2$	absolute viscosity of gas
CP	Btu/(lb)(°R)	specific heat of gas
GAMMA		ratio of specific heats
NGRID		number of steps across seal (maximum, 20)
ASKIP		logical variable (If ASKIP = TRUE, program skips calculation and printout of x, pressure, average velocity, Mach number, and pres- sure ratio. It also skips plotting of x against pressure ratio.)
RSKIP		logical variable (If RSKIP = TRUE, program skips calculation and printout of dimensionless center of pressure and dimensionless force. It also skips plotting of FBAR.)
TSKIP		logical variable (If TSKIP = TRUE, program skips calculation, printout, and plotting of variables associated with power.)
NOUI		logical variable (If NOUI = TRUE, program makes no conversion to International Units.)



## Program Variables

The variables used in the program are listed in the approximate order of their appearance. Arrays are given with their dimensions. Variables marked with a \* are printed as output data.

FORTRAN symbol	Unit	Description
PI		$\pi = 3.1415927$
RUNIV	$\frac{\text{ft-lb}}{(\text{lb-mole})(^{\circ}\text{R})}$	universal gas constant
ZERO		input variables are equated to ZERO which is initially set equal to 0.0
PP1	psi	value of P1 in common block
PREF	psi	smaller of P1 and P2 in common block
AAA	rad	value of ALPHA in common block
MCUT		point at which mathematical model becomes invalid
NN		number of grid points ( $1 \leq \text{NN} \leq 21$ )
JMOD		number of pressure distributions that will fit evenly on one page
*AREA	$\text{in.}^2$	face surface area of seal
RDIF	in.	distance across seal, equal to $R2 - R1$
C		outside- to inside-pressure ratio, equal to $P2/P1$
CC		constant used in pressure calculation ( $\text{CC} = 1 - (P2^2/P1^2)$ )
PDIF	psi	total pressure drop across seal
*R	$\frac{\text{ft-lb}}{(\text{lbm})(^{\circ}\text{R})}$	gas constant
*RHO1	$(\text{lb})(\text{sec}^2)/\text{ft}^4$	calculated density at inner radius of seal
A	ft/sec	speed of sound

FORTRAN symbol	Unit	Description
IHTAG(J)		numerical flag: IHTAG(J) = 0 implies flow analysis is valid IHTAG(J) ≠ 0 implies flow analysis is not valid
HM	in.	current value of HMEAN (J) in common block
DELX	in.	distance between successive grid points
*X(J, I)	in.	distance from inner radius of seal
X(J, 1)	in.	first point in x distribution
X2	in.	last point in x distribution
H(J, I)	in.	film thickness at X(J, I)
H(J, 1)	in.	film thickness at X(J, I)
H2	in.	film thickness at X2
HCHAR	in.	characteristic film thickness
*MDOT(J)	lb/min	mass flow across seal
UAV	ft/sec	average velocity at outer radius of seal
*MACHMX(J)		maximum Mach number for given HMEAN(J)
*REP(J)		pressure Reynolds number
RHOREF	$(\text{lb})(\text{sec}^2)/\text{ft}^4$	calculated density at mean radius of seal
*RER(J)		rotational Reynolds number
*Q(J)	std cu ft/min	volume flow rate at standard conditions
*KN(J)		Knudsen number
*POWER(J)	hp	power dissipated by viscous shearing
*DELTJ(J)	$^{\circ}\text{R}$	apparent temperature rise due to power dissipation
*HTOTAL(J)	Btu/min	shear heat of system
*TORQUE(J)	ft-lb	torque
AK1	$(\text{psi})^2$	constant needed in pressure calculations

FORTRAN symbol	Unit	Description
K, KK		numerical flags which indicate whether or not the numerical integrations of $(P - P_{\min})$ and $(P - P_{\min})^x$ are accurate
*F(J)	lb	sealing dam force
*XC(J)	in.	center of pressure
*P(J, I)	psi	pressure at X(I, J)
*PRAT(J, I)		ratio of P to $P_{\min}$ at X(I, J)
*UAVRG(J, I)	ft/sec	average velocity at X(I, J)
*MACH(J, I)		Mach number at X(I, J)
*STIFF(J)	lb/in.	axial film stiffness, equal to $-dF/dh_m$
*FBAR(J)		dimensionless force
*XCBAR(J)		dimensionless center of pressure
JJ		counter for cases for which Mach number $< 1/\sqrt{\gamma}$ (If JJ = 1 modulo JMOD, the printer will skip to a new page.)
XPT, YPT, XPLOT, YPLOT		utility arrays used in sorting and plotting
PP		contains information needed by plotting subroutine(See ref. 10 for details.)
KODE		plotting code (See ref. 10 for details.)
NP		number of points in a plot ( $1 \leq NP \leq 50$ )
*UI		output variables in International Units
I		distance across sealing dam index
J		mean film thickness index

# APPENDIX C

## PROGRAM LISTING

```

$IBFTC SEAL 1
C 2
C COMPRESSIBLE FLOW SEALING DAM ANALYSIS WITH SMALL TILT ANGLE 3
C 4
C LOGICAL ASKIP,RSKIP,TSKIP,NOUI 5
REAL MDOT,MOLWT,MU,MACH,MACHMX,MCUT,KN,L 6
DIMENSION XPLOT(50),YPLOT(50),XPT(50),YPT(50),PP(61),ZERO(17), 7
1 UL(30),TITLE(12). 8
DIMENSION F(50),XC(50),MDOT(50),XCBAR(50),FBAR(50),Q(50), 9
1 POWER(50),HI(50),HTOTAL(50),DELTJ(50),TORQUE(50),HMEAN(50), 10
2 MACHMX(50),REP(50),STIFF(50),IHTAG(50),KN(50),RER(50) 11
DIMENSION H(50,21),X(50,21),P(50,21),UAVRG(50,21),PRAT(50,21), 12
1 MACH(50,21). 13
COMMON/INTGRL/PP1,PREF,AAA,CC,RDIF,HM,AK1 14
EXTERNAL PX,PXX 15
NAMELIST/INPT/ALPHA,L,SPEED,CAPV,MOLWT,P1,P2,T,R1,R2,RHOR0, 16
1 RHORF,MU,CP,GAMMA,NGRID,ASKIP,RSKIP,TSKIP,NOUI 17
DATA PI,RUNIV/3.1415927,1545.4/ 18
EQUIVALENCE (ZERO(1),MOLWT), (ZERO(6),P1), (ZERO(11),L), 19
1 (ZERO(2),ALPHA), (ZERO(7),P2), (ZERO(12),T), 20
2 (ZERO(3),SPEED), (ZERO(8),R1), (ZERO(13),MU), 21
3 (ZERO(4),RHOR0), (ZERO(9),R2), (ZERO(14),CAPV), 22
4 (ZERO(5),RHORF), (ZERO(10),CP), (ZERO(15),GAMMA) 23
DO 90 I=1,15 24
90 ZERO(I) = 0. 25
C 26
C READ INPUT DATA,CALCULATE PROGRAM CONSTANTS, AND WRITE INPUT 27
C CONDITIONS 28
C 29
C DATA CARDS 30
C TITLE - DATA IDENTIFICATION - 1 CARD (FORMAT 12A6) 31
C 32
C NJ - NUMBER OF FILM THICKNESSES (FORMAT I3) 33
C 34
C HMEAN - MEAN FILM THICKNESSES - 6 PER CARD (FORMAT 6F12.0) 35
C 36
C $INPT - SEAL DIMENSIONS, OPERATING CONDITIONS, PHYSICAL 37
C PROPERTIES OF GAS, LOGICAL VARIABLES 38
C (READ BY NAMELIST/INPT/) 39
C 40
C READ (5,3) TITLE 41
C READ (5,1) NJ 42
C READ (5,2) (HMEAN(J),J=1,NJ) 43
100 WRITE (6,10) 44
C READ (5,INPT) 45
C PP1 = P1 46
C PREF = AMLN1(P1,P2) 47
C AAA = ALPHA 48
C MCUT = 1./SQRT(GAMMA) 49
C NN = NGRID+1 50
C JMOD = 59/(4+NN) 51
C AREA = PI*(R2**2-R1**2) 52
C RDIF=R2-R1 53
C C=P2/P1 54
C CC=1.-C*C 55
C PDIF=ABS(P1-P2) 56
C R= RUNIV/MOLWT 57
C RHO1= P1/R/(T+460.)*4.4756636 58
C A= SQRT(GAMMA*R*(T+460.))*32.174) 59
C WRITE (6,54) TITLE 60

```

	WRITE(6,11) ALPHA,P2,P1,T,MU,MOLWT,GAMMA,R2,R1,L,RHORO,RHORF,NN,	61
	1 SPEED,CAPV,CP,ASKIP,RSKIP,TSKIP	62
	IF (NOUL) GO TO 110	63
C		64
C	CONVERT INPUT DATA TO INTERNATIONAL UNITS	65
C		66
	UI(1) = ALPHA	67
	UI(2) = P2*6.8947572E3	68
	UI(3) = P1*6.8947572E3	69
	UI(4) = (T+460.)/1.8	70
	UI(5) = MU*47.880258	71
	UI(6) = MOLWT	72
	UI(7) = GAMMA	73
	UI(8) = R2*2.54E-2	74
	UI(9) = R1*2.54E-2	75
	UI(10) = L*2.54E-2	76
	UI(11) = RHORO*517.2026	77
	UI(12) = RHORF*517.2026	78
	UI(13) = SPEED/60.	79
	UI(14) = CAPV*.3048	80
	UI(15) = CP*.41865783E4	81
C		82
C	TEST INPUT PARAMETERS AND DETERMINE OPERATING CONDITONS	83
C		84
	110 IF (L.EQ.0.) L=PI*(R1+R2)	85
	IF (RHORO.NE.0.) RHO1=RHORO	86
	IF (SPEED.EQ.0.) GO TO 120	87
	CAPV = P[*SPEED*(R1+R2)/720.	88
	GO TO 200	89
	120 IF (CAPV.NE.0.) GO TO 121	90
	TSKIP = .TRUE.	91
	CP=0.	92
	121 SPEED = CAPV*720./PI/(R1+R2)	93
C		94
C		98
	200 DD 400 J=1,NJ	99
	IHTAG(J) = 0	100
	HM = HMEAN(J)	101
	DELX = RDIF/FLOAT(NGRID)	102
	IF (ALPHA.GE.0.) GO TO 210	103
	X(J,1) = RDIF	104
	X2 = 0.	105
	DELX = -DELX	106
	GO TO 220	107
	210 X(J,1) = 0.	108
	X2 = RDIF	109
	220 H(J,1) = HMEAN(J)+ALPHA*(X(J,1)-RDIF/2.)	110
	H2 = HMEAN(J)+ALPHA*(X2-RDIF/2.)	111
	HCHAR = H(J,1)*H2/HMEAN(J)	112
	MDOT(J) = HCHAR**3*RHO1*P1*L*CC/MU/RDIF*6.7029167	113
	UAV = ABS(MDOT(J))*P1/L/RHO1/AMIN1(H(J,1),H2)/PREF/13.405833	114
	MACHMX(J) = UAV/A	115
	IF (MACHMX(J).LT.MCUT) GO TO 223	116
	IHTAG(J) = 1	117
	GO TO 400	118
	223 REP(J) = 2.*PREF*UAV*HCHAR/MU/R/(T+460.)/2.6811667	119
	IF (RHORF.NE.0.) GO TO 221	120

```

      IF (ALPHA.NE.0.) AK1=-12.*MDOT(J)*MU*PI/L/RH01/160.83333      121
      RHOREF = PRESS(RDIF/2.)/R/(T+460.)*4.4756636                    122
      GO TO 222                                                         123
221  RHOREF = RHOREF                                                  124
222  RER(J) = RHOREF*CAPV*HMEAN(J)/MU/12.                             125
      Q(J) = 13.083*MDOT(J)                                           126
      KN(J) = 2.96*MACHMX(J)/REP(J)                                    127
230  IF (TSKIP) GO TO 240                                             128
      POWER(J)= MU*AREA*CAPV**2/HMEAN(J)/6600.                       129
      DELTJ(J)=42.42*POWER(J)/ABS(MDOT(J))/CP                        130
      HTOTAL(J) = 42.42*POWER(J)                                       131
      TORQUE(J)= POWER(J)*3.3E4/SPEED                                  132
C      133
C      DETERMINE FORCE AND CENTER OF PRESSURE                          134
C      135
240  IF (ALPHA.EQ.0.) GO TO 250                                       136
      AK1 = -12.*MDOT(J)*MU*PI/L/RH01/160.83333                    137
      K = 0                                                            138
      KK = 0                                                            139
      F(J)= SIMPS1(0.,RDIF,PX,K)*L                                     140
      XC(J) = SIMPS1(0.,RDIF,PXX,KK)/F(J)*L                          141
      IF (K.NE.0) WRITE (6,21)HMEAN(J)                                142
      IF (KK.NE.0) WRITE (6,24) HMEAN(J)                               143
      GO TO 300                                                         144
250  F(J) = L*RDIF*(2.*PI*(1.-C**3)/CC/3.-PREF)                     145
      XC(J) = L*RDIF**2/F(J)*(2.*PI*(.4-C**3)/3./CC-PREF/2.)       146
C      147
C      DETERMINE PRESSURE, FILM THICKNESS, PRESSURE RATIO (P/P1),   148
C      AVERAGE VELOCITY, AND MACH NUMBER AT EACH GRID POINT        149
C      150
300  IF (ASKIP) GO TO 400                                             151
      P(J,1) = P1                                                      152
      IF (ALPHA.LT.0.) P(J,1)=P2                                       153
      DO 320 I=1,NN                                                    154
      IF (I.EQ.1) GO TO 310                                             155
      X(J,I) = FLOAT(I-1)*DELX*X(J,1)                                   156
      H(J,I) = HMEAN(J)+ALPHA*(X(J,I)-RDIF/2.)                        157
      P(J,I) = PRESS(X(J,I))                                           158
310  PRAT(J,I) = P(J,I)/PREF                                          159
      UAVRG(J,I) = ABS(MDOT(J))*PI/L/RH01/P(J,I)/HMEAN(J)/13.405833 160
      MACH(J,I) = UAVRG(J,I)/A                                         161
320  CONTINUE                                                         162
400  CONTINUE                                                         163
      CALL STFNSS(HMEAN,F,IHTAG,STIFF,NJ)                              164
C      165
C      WRITE ROUTINE                                                 166
C      167
600  WRITE (6,12) R,RH01,A,L,AREA,SPEED,CAPV                         168
      WRITE(6,13)                                                       169
      IF (.NOT.RSKIP) WRITE(6,14)                                       170
      WRITE (6,55)                                                       171
      IF (RSKIP) GO TO 603                                              172
      WRITE (6,56)                                                       173
C      174
603  DO 610 J=1, NJ                                                  175
      WRITE (6,23) HMEAN(J)                                             176
      IF (IHTAG(J).EQ.0) GO TO 609                                       177
      WRITE (6,20)                                                       178
      GO TO 610                                                         179
609  WRITE (6,15) MDOT(J),Q(J),MACHMX(J),REP(J),RER(J),KN(J),F(J),   180

```

	1 STIFF(J),XC(J)	181
	IF (RSKIP) GO TO 610	182
C		183
C	NORMALIZE F AND XC	184
C		185
	FBAR(J)=F(J)/PDIF/RDIF/L	186
	XCBAR(J)=XC(J)/RDIF	187
	WRITE(6,16) XCBAR(J),FBAR(J)	188
610	CONTINUE	189
	IF (TSKIP) GO TO 612	190
	WRITE (6,17):	191
	DO 611 J=1,NJ	192
	WRITE (6,23) HMEAN(J)	193
	IF(LHTAG(J).EQ.0) GO TO 613	194
	WRITE(6,20)	195
	GO TO 611	196
613	WRITE(6,22) POWER(J),HTOTAL(J),DELTJ(J),TORQUE(J)	197
611	CONTINUE	198
612	IF (ASKIP) GO TO 700	199
C		200
C	WRITE X AND PRESSURE DISTRIBUTIONS	201
C		202
	JJ = 0	203
	DO 620 J=1, NJ	204
	IF (LHTAG(J).NE.0) GO TO 620	205
	JJ = JJ+1	206
	IF (MOD(JJ,JMOD).EQ.1) WRITE (6,57)	207
	WRITE (6,18) HMEAN(J)	208
	WRITE (6,19): (X(J,I),PRAT(J,I),P(J,I),UAVRG(J,I),MACH(J,I),	209
	1 I=1,NN)	210
620	CONTINUE	211
C		212
C	PLOT ROUTINE	213
C		214
700	KODE = 6	215
	PP(3) = 0.	216
	PP(4) = 0.	217
	DO 701 J=1,NJ	218
	IF (IHTAG(J).NE.0) HMEAN(J)=-HMEAN(J)	219
701	CONTINUE	220
	IF (ALPHA.EQ.0.) GO TO 720	221
	CALL ARRNG(HMEAN,XC,XPLOT,YPLOT,NJ,NP)	222
	PP(1) = NP	223
	WRITE (6,32):	224
	CALL PLOTXY(XPLOT,YPLOT,KODE,PP)	225
	WRITE (6,40):	226
710	IF (RSKIP) GO TO 720	227
	IF (ALPHA.EQ.0.) GO TO 720	228
	CALL ARRNG(HMEAN,FBAR,XPLOT,YPLOT,NJ,NP):	229
	PP(1) = NP	230
	WRITE (6,38)	231
	CALL PLOTXY(XPLOT,YPLOT,KODE,PP)	232
	WRITE (6,42):	233
720	IF (TSKIP) GO TO 730	234
	IF (SPEED.EQ.0.) GO TO 730	235
	CALL ARRNG(HMEAN,POWER,XPLOT,YPLOT,NJ,NP)	236
	PP(1) = NP	237
	WRITE (6,34)	238
	CALL PLOTXY(XPLOT,YPLOT,KODE,PP)	239
	WRITE (6,43)	240

730	IF (ASKIP) GO TO 750	241
	DO 741 J=1,NJ	242
	IF (IHTAG(J).NE.0) GO TO 741	243
	WRITE (6,37) HMEAN(J)	244
	DO 740 I=1,NN	245
	XPT(I) = X(J,I)	246
	YPT(I) = PRAT(J,I)	247
740	CONTINUE	248
	CALL ARRNG (XPT,YPT,XPLOT,YPLOT,NN,NP)	249
	PP(1) = NP	250
	CALL PLOTXY(XPLOT,YPLOT,KCODE,PP)	251
	WRITE (6,46)	252
	IF (ALPHA.EQ.0.) GO TO 750	253
741	CONTINUE	254
750	DO 751 J=1,NJ	255
	IF (IHTAG(J).NE.0) HMEAN(J)=-HMEAN(J)	256
751	CONTINUE	257
C		258
C	CONVERT TO INTERNATIONAL UNITS AND PRINT	259
C		260
800	IF (NOUI) GO TO 100	261
	UI(21) = R*.38095	262
	UI(22) = RH01*517.2026	263
	UI(23) = A*.3048	264
	UI(24) = L*2.54E-2	265
	UI(25) = AREA*6.4516E-4	266
	UI(26) = SPEED/60.	267
	UI(27) = CAPV*.3048	268
	WRITE (6,10)	269
	WRITE (6,54) TITLE	270
	WRITE (6,50) (UI(I),I=1,12),NN,(UI(I),I=13,15),ASKIP,RSKIP,	271
	1 TSKIP,(UI(I),I=21,27)	272
	WRITE (6,13)	273
	IF (.NOT.RSKIP) WRITE (6,14)	274
	WRITE (6,51)	275
	IF (.NOT.RSKIP) WRITE (6,56)	276
	DO 810 J=1,NJ	277
	UH = HMEAN(J)*2.54E-2	278
	WRITE (6,23) UH	279
	IF (IHTAG(J).EQ.0) GO TO 809	280
	WRITE (6,20)	281
	GO TO 810	282
809	UM = MDOT(J)*.755987E-2	283
	UQ = Q(J)*.47194744E-3	284
	UF = F(J)*4.4482216	285
	US = STIFF(J)*1.7512683E2	286
	UXC = XC(J)*2.54E-2	287
	WRITE (6,15) UM,UQ,MACHMX(J),REP(J),RER(J),KN(J),UF,US,UXC	288
	IF (.NOT.RSKIP) WRITE(6,16) XCBAR(J),FBAR(J)	289
810	CONTINUE	290
	IF (TSKIP) GO TO 812	291
	WRITE (6,52)	292
	DO 811 J=1,NJ	293
	UH = HMEAN(J)*2.54E-2	294
	WRITE (6,23) UH	295
	IF(IHTAG(J).NE.0) GO TO 813	296
	UP = POWER(J)*7.4569987E2	297
	UHT = HTOTAL(J)*17.597833	298
	UT = DELTJ(J)/1.8	299
	UTRK = TORQUE(J)*1.3558179	300



WRITE(6,22) UP,UHT,UT,UTRK	301
GO TO 811	302
813 WRITE(6,20)	303
811 CONTINUE	304
812 IF (ASKIP) GO TO 100	305
JJ = 0	306
DO 821 J=1,NJ	307
IF (LHTAG(J).NE.0) GO TO 821	308
JJ = JJ+1	309
IF (MOD(JJ,JMOD).EQ.1) WRITE (6,57)	310
UH = HMEAN(J)*2.54E-2	311
WRITE (6,53) UH	312
DO 820 L=1,NN	313
UX = X(J,L)*2.54E-2	314
UP = P(J,L)*6.8947572E3	315
UV= UAVRG(J,L)*.3048	316
WRITE (6,19) UX,PRAT(J,L),UP,UV,MACH(J,I)	317
820 CONTINUE	318
821 CONTINUE	319
GO TO 100	320
C	321
1 FORMAT (I3)	322
2 FORMAT (6F12.6)	323
3 FORMAT (I2A6)	324
10 FORMAT (1H1,46HCOMPRESSIBLE SEALING DAM WITH SMALL TILT ANGLE)	325
11 FORMAT (1H0,12HINPUT DATA -,/,1H0,12HTILT ANGLE =,F8.4,	326
1 9H RADIANS,/,1H0,6X,7HP2,PSIA,10X,7HP1,PSIA,10X,7HT,DEG F,10X;	327
2 20HVISCOISITY,LB-SEC/FT2,10X,16HMOLECULAR WEIGHT,18X,5HCP/CV,/,	328
3 1H ,2G17.5,F13.0,G25.5,G31.5,G28.5,/,1H0,4X,9HR2,INCHES,8X;	329
4 9HR1,INCHES,9X,8HL,INCHES,10X,15HRHO,LB-SEC2/FT4,10X,	330
5 20HRHO(ROT),LB-SEC2/FT4,10X,17HNO OF GRID POINTS,/,1H ,3G17.5,	331
6 G21.5,G27.5,L22,/,1H0,6X,5HN,RPM,11X,8HV,FT/SEC,9X;	332
7 15HCP,BTU/LB-DEG R,13X,6HSKIP A,6X,6HSKIP R,6X,6HSKIP T,/,1H ,	333
8 2G17.5,G18.5,L19,2L12)	334
12 FORMAT (1H0,17HBEGIN OUTPUT DATA,/,1H0,3X,	335
1 30HGAS CONSTANT,FT-LB/LB(M)-DEG R,4X,18HRHO(I),LB-SEC2/FT4,6X,	336
2 21HA(SOUND SPEED),FT/SEC,/,1H ,G24.5,G30.5,G25.5,/,1H0,3X,	337
3 8HL,INCHES,14X,8HAREA,IN2,14X,9HSPFED,RPM,13X,8HV,FT/SEC,/,1H ,	338
4 G14.5,3G22.5)	339
13 FORMAT (1H0,2X,9HMEAN FILM,4X,6HMLDOT),6X,1HQ,8X,4HMACH,5X,	340
1 5HRE(P),6X,5HRE(R),5X,7HKNUDSEN,7X,1HF,7X,5HSTIFF,7X,2HXC)	341
14 FORMAT (1H+,110X,2HXC,8X,1HF)	342
15 FORMAT (1H+,11X,2G11.3,2F9.3,2F10.3,F12.3,2G11.3)	343
16 FORMAT (1H+,103X,2F10.3)	344
17 FORMAT (1H0,16HMEAN FILM,INCHES,8X,10HPOWER,H.P.,6X,	345
1 18HSHEAR HEAT,BTU/MIN,5X,12HDEL(T),DEG F,8X,12HTORQUE,FT-LB)	346
18 FORMAT (1H0,11HMEAN FILM =,G11.3,2X,6HINCHES,/,1H0,5X,8HX,INCHES,	347
1 4X,8HP/P(MIN),7X,5HP,PSI,6X,12HU(AV),FT/SEC,4X,7HMACH NO)	348
19 FORMAT (1H ,G14.3,4G14.5)	349
20 FORMAT (1H+,77X,18HANALYSIS NOT VALID)	350
21 FORMAT (1H0,26HFOR MEAN FILM THICKNESS =,G15.5,3X,	351
1 14HF IS INCORRECT)	352
22 FORMAT (1H+, 15X,4G20.5)	353
23 FORMAT (1H ,G11.3)	354
24 FORMAT (1H0,26HFOR MEAN FILM THICKNESS =,G15.5,3X,	355
1 15HXC IS INCORRECT)	356
30 FORMAT (2HPT,55HPLOT OF M(DOT) AND Q VS H(MEAN) WHERE Q = 13.083*M	357
1(DOT) )	358
32 FORMAT (2HPT,23HPLOT OF X(C) VS H(MEAN))	359
33 FORMAT (2HPT,28HPLOT OF MDOT(BAR) VS H(MEAN))	360

34	FORMAT (2HPT,24HPLOT OF POWER VS H(MEAN)).	361
37	FORMAT (2HPT,35HPLOT OF P/P(MIN); VS X FOR H(MBAN) =,G15.5)	362
38	FORMAT (2HPT,25HPLOT OF F(BAR) VS H(MEAN).)	363
40	FORMAT (2HPL,50HXC ON VERTICAL SCALE - H(MEAN) ON HORIZONTAL SCALE	364
	1 ,/,2HPL,/,2HPL,10X,56HXC IN INCHES - TO CONVERT TO METERS, MULTIP	365
	2LY BY 2.54E-2 ,/,2HPL,/,2HPL,10X,61HH(MEAN) IN INCHES - TO CONVER	366
	3T TO METERS, MULTIPLY BY 2.54E-2 )	367
41	FORMAT (2HPL,54HM(BAR) ON VERTICAL SCALE - H(MEAN) ON HORIZONTAL S	368
	1CALE,/,2HPL,/,2HPL,10X,23HM(BAR) IS DIMENSIONLESS,/,2HPL,/,2HPL;	369
	2 10X,61HH(MEAN) IN INCHES - TO CONVERT TO METERS; MULTIPLY BY 2.54	370
	3E-2)	371
42	FORMAT (2HPL,54HF(BAR) ON VERTICAL SCALE - H(MEAN) ON HORIZONTAL S	372
	1CALE,/,2HPL,/,2HPL,10X,23HF(BAR) IS DIMENSIONLESS,/,2HPL,/,2HPL;	373
	2 10X,61HH(MEAN) IN INCHES - TO CONVERT TO METERS, MULTIPLY BY 2.54	374
	3E-2)	375
43	FORMAT (2HPL,53HPOWER ON VERTICAL SCALE - H(MEAN) ON HORIZONTAL SC	376
	1ALE,/,2HPL,/,2HPL,10X,61HPOWER IN HORSE POWER - TO CONVERT TO WATT	377
	2S, MULTIPLY BY 745.7,/,2HPL,/,2HPL,10X,61HH(MEAN) IN INCHES - TO C	378
	3ONVERT TO METERS, MULTIPLY BY 2.54E-2,/,2HPL,/,2HPL,50HFOR SHEAR H	379
	4EAT IN BTU/MIN, MULTIPLY POWER BY 42.42)	380
46	FORMAT (2HPL,50HP/P(MIN) ON VERTICAL SCALE - X ON HORIZONTAL SCALE	381
	1,/,2HPL,/,2HPL,10X,25HP/P(MIN) IS DIMENSIONLESS,/,2HPL,/,2HPL,10X,	382
	2 55HX IN INCHES - TO CONVERT TO METERS, MULTIPLY BY 2.54E-2)	383
50	FORMAT (1H0,12HTILT ANGLE =,F8.4,9H RADIANS,/,1H0,5X,7HP2,N/M2,	384
	1 9X,7HP1,N/M2,10X,7HT,DEG K,10X,16HVISCOSITY,N-S/M2,10X,	385
	2 16HMOLECULAR WEIGHT,14X,5HCP/CV,/,1H ,G14.5,G17.5,F14.0,G24.5,	386
	3 G26.5,G27.5,/,1H0,4X,9HR2,METERS,7X,9HR1,METERS,9X,8HL,METERS;	387
	4 13X,9HRHO,KG/M3,12X,14HRHO(ROT),KG/M3,10X,	388
	5 17HNO OF GRID POINTS,/,1H ,G14.5,G17.5,G18.5,G21.5,G22.5,I21,/,;	389
	6 1H0,6X,5HN,RPS,12X,5HV,M/S,9X,13HCP,J/KG-DEG K,	390
	7 16X,6HSKIP A,6X,6HSKIP R,6X,6HSKIP T,/,1H ,G15.5,G17.5,	391
	8 G18.5,L20,2L12,/,1H0,17HBEGIN OUTPUT DATA,/,1H0,3X,	392
	9 23HGAS CONSTANT,J/KG-DEG K,10X,12HRHO(1),KG/M3,10X;	393
	X 18HA(SOUND SPEED),M/S,/,1H ,G20.5,G31.5,G23.5,/,1H0,3X,	394
	1 8HL,METERS,15X,7HAREA,M2,15X,9HSPEFD,RPS,15X,5HV,M/S,/,1H ,G14.5,	395
	2 3G23.5).	396
51	FORMAT (1H ,4X,6HMETERS,5X,6HKG/SEC,5X,4HSCMS,6X,5H(MAX),25X,	397
	1 6HNUMBER,5X,7HNEWTONS,4X,4HKG/M,6X,6HMETERS)	398
52	FORMAT (1H0,16HMEAN FILM,METERS,7X,11HPOWER,WATTS,8X,	399
	1 16HTOTAL HEAT,WATTS,6X,12HDEL(T),DEG K,8X,10HTORQUE,N-M)	400
53	FORMAT (1H0,11HMEAN FILM =,G14.5;2X,6HMETERS,/,1H0,5X,8HX,METERS,	401
	1 4X,8HP/P(MIN),7X,6HP,N/M2,6X,11HU(AV),M/SEC,5X,7HMACH NO)	402
54	FORMAT (1H0,12A6)	403
55	FORMAT (1H ,3X,6HINCHES,6X,6HLB/MIN,5X,4HSCFM,6X,5H(MAX),25X,	404
	1 6HNUMBER,8X,2HLB,6X,5HLB/IN,5X,6HINCHES)	405
56	FORMAT (.1H+,109X,3HBAR,7X,3HBAR)	406
57	FORMAT (1H1)	407
		408
		409

C

END

\$IBFTC PRESR	410
C	411
C     PRESSURE FUNCTION	412
C	413
FUNCTION PRESS(X)	414
COMMON/INTGRL/P1,P2,ALPHA,C,RDIF,HM,AK	415
C	416
YY = X	417
IF (ALPHA.NE.0.) GO TO 100	418
Y = P1*SQRT(1.-C*YY/RDIF)	419
GO TO 101	420
100 AA = HM-ALPHA*RDIF/2.	421
YDIF = YY/RDIF	422
Q = P1**2*(1.-YDIF*C)+AK/ALPHA*((1.-YDIF)/AA**2-(1./	423
I ALPHA*YY+AA)**2-YDIF/(ALPHA*RDIF+AA)**2))	424
Y = SQRT(Q)	425
101 PRESS = Y	426
RETURN	427
END	428

\$IBFTC FPD	429
C	430
C     EXTERNAL FUNCTION FOR INTEGRAL (P-P1) DX	431
C	432
FUNCTION PX(Y).	433
COMMON/INTGRL/P1,PREF,A,B,C,D,E	434
YY=Y	435
PX = PRESS(YY)-PREF	436
RETURN	437
END	438

\$IBFTC FPXD	439
C	440
C     EXTERNAL FUNCTION FOR INTEGRAL (P-P1)XDX	441
C	442
FUNCTION PXX(Y)	443
COMMON/INTGRL/P1,PREF,A,B,C,D,E	444
YY=Y	445
PXX = (PRESS(YY)-PREF)*YY	446
RETURN	447
END	448

\$IBFTC DERLV	449
C	450
C     LAGRANGE NUMERICAL DIFFERENTIATION OVER MAXIMUM OF 5 POINTS	451
C	452
SUBROUTINE STFNSS(XX,YY,ITAG,DDY,MAX)	453
DIMENSION XX(50),YY(50),ITAG(50),DDY(50),X(50),Y(50),DY(50),A(5,5)	454
C	455
C     ELIMINATE INVALID POINTS AND ARRANGE VALID POINTS IN ASCENDING	456
C     ORDER. IF THERE ARE LESS THAN 2 VALID POINTS, NO DIFFERENTIATION	457
C     IS POSSIBLE.	458
C	459
100 MM = 0	460
DO 110 M=1,MAX	461
IF (ITAG(M).NE.0) GO TO 110	462
MM = MM+1	463
X(MM) = XX(M)	464
Y(MM) = YY(M)	465
110 CONTINUE	466
IF (MM.GE.2) GO TO 130	467
DO 120 M=1,MAX	468
120 DDY(M) = 0.	469
RETURN	470
130 CALL SORTXY(X,Y,MM)	471
C	472
C     SET UP MATRIX OF X DIFFERENCES FOR EACH POINT X(K)	473
C	474
200 N = MINO(MM,5)	475
DEBUG N,MM	476
DEBUG (X(M), Y(M),M=1,MM)	477
DO 250 K=1,MM	478
IST = MAXO(K-2,1).	479
IST = MINO(MM-N+1,IST)	480
IN = IST+N-1	481
DEBUG K,IST,IN	482
DO 211 LI=IST,IN	483
I = LI-IST+1	484
DO 210 JJ=IST,IN	485
J = JJ-IST+1	486
A(I,J) = X(II)-X(JJ)	487
210 CONTINUE	488
DEBUG (A(L,JJ),JJ=1,N)	489
211 CONTINUE	490
C	491
C     FORM SUMS AND PRODUCTS FOR DERIVATIVE FORMULA	492
C	493
220 S1 = 0.	494
S2 = 0.	495
P2 = 1.	496
DO 231 LI=IST,IN	497
IF (LI.EQ.K) GO TO 231	498
I = LI-IST+1	499
P1 = X(LI)-X(K)	500
S2 = S2-1./P1	501
P2 = P2*P1	502
DO 230 JJ=1,N	503
IF (LI.NE.JJ) P1=P1*A(L,JJ)	504
230 CONTINUE	505
DEBUG P1,Y(LI)	506
S1 = S1+Y(LI)/P1	507
231 CONTINUE	508

```

        IF ((N/2)*2.NE.N) S2=-S2          509
        DEBUG S1,S2,P2                    510
C                                           511
C     DERIVATIVE                          512
C                                           513
        KY = S2*Y(K)+P2*S1                514
        DY(K) = KY                        515
250 CONTINUE                              516
C                                           517
C     PUT CALCULATED DERIVATIVES IN ORDER TO CORRESPOND TO INPUT XX 518
C     ARRAY                                519
C                                           520
300 DO 320 M=1,MAX                         521
        IF (ITAG(M).NE.0) GO TO 320       522
        DO 310 LI=1,MM                    523
        IF (XX(M).NE.X(LI)) GO TO 310     524
        IF ((N/2)*2.NE.N) GO TO 311      525
        DDY(M) = -DY(LI)                  526
        GO TO 320                          527
311 DDY(M) = DY(LI)                       528
        GO TO 320                          529
310 CONTINUE                              530
320 CONTINUE                              531
        DEBUG (X(M),DY(M),M=1,MM)        532
C                                           533
        RETURN                             534
        END                                535

```

```

$IBFTC SMPSR1                             536
C                                           537
C     NUMERICAL INTEGRATION BY SIMPSONS RULE 538
C                                           539
        FUNCTION SIMPS1(XMIN,XMAX,FUNCI,KER) 540
        DIMENSION V(200),H(200),A(200),B(200),C(200),P(200),E(200),NE(200) 541
        EQUIVALENCE (E,NE),(TEST,NTEST)    542
        T=3.0E-5                            543
        V(1)=XMIN                            544
        H(1)=0.5*(XMAX-XMIN)                 545
        A(1)=FUNCI(XMIN)                     546
        B(1)=FUNCI(XMIN+H(1))                547
        C(1)=FUNCI(XMAX)                     548
        P(1)=H(1)*(A(1)+4.0*B(1)+C(1))      549
        E(1)=P(1)                            550
        ANS=P(1)                              551
        N=1                                   552
        FRAC=2.0*T                            553
1     FRAC=0.5*FRAC                          554
2     TEST=ABS(FRAC*ANS)                     555
        K=N                                   556
3     DO 7 L=1,K                             557
4     IF (NTEST-IABS(NE(L))) 5,5,7          558
5     N = N+1                                559
        V(N)=V(L)+H(L)                       560
        H(N)=0.5*H(L)                        561
        A(N)=B(L)                            562

```

B(N)=FUNC1(V(N)+H(N))	563
C(N)=C(I)	564
P(N)=H(N)*(A(N)+4.0*B(N)+C(N))	565
Q=P(I)	566
H(I)=H(N)	567
B(I)=FUNC1(V(I)+H(I))	568
C(I)=A(N)	569
P(I)=H(I)*(A(I)+4.0*B(I)+C(I))	570
Q=P(L)+P(N)-Q	571
ANS=ANS+Q	572
E(I)=Q	573
E(N)=Q	574
6 IF (N-200) 7,13,13	575
7 CONTINUE	576
8 IF (N-K) 9,9,2	577
9 Q = 0.0	578
10 DO 11 I=1,N	579
11 Q=Q+E(I)	580
12 IF (ABS(Q)-T*ABS(ANS)) 14,14,1	581
13 KER=KER+1	582
14 ANS=0.0	583
15 DO 16 I=1,N	584
16 ANS=ANS+P(I)	585
SIMPS1=(ANS+Q/30.0)/3.0	586
17 RETURN	587
END	588

\$IBFTC RRANG	589
C	590
C    SUBROUTINE TO ARRANGE ARRAYS TO BE PLOTTED	591
C	592
SUBROUTINE ARRNG (X,Y,XP,YP,N,I):	593
DIMENSION X(25),Y(25),XP(25),YP(25)	594
I = 1	595
DO 100 J=1,N	596
IF (X(J).LT.0.) GO TO 100	597
XP(I) = Y(J)	598
YP(I) = X(J)	599
I = I+1	600
100 CONTINUE	601
I = I-1	602
CALL SORTXY (XP,YP,I)	603
LI = I/2	604
DO 101 J=1,LI	605
IJ = I-J+1	606
T = YP(J)	607
YP(J) = YP(IJ)	608
YP(IJ) = T	609
T = XP(J)	610
XP(J) = XP(IJ)	611
XP(IJ) = T	612
101 CONTINUE	613
RETURN	614
END	615

EO1\* UNIT05, EOF.

## APPENDIX D

### EXAMPLE PROBLEM

An example of the use of the computer program is given with the following conditions: Air, internally pressurized at 65 psia, is to be sealed from ambient air at 15 psia. The mean temperature is 100<sup>o</sup> F. The sealing dam outside diameter is 6.630 inches, inside diameter is 6.530 inches, and the design speed is 1398 rpm. Mean film thicknesses of 0.1 to 1.0 mil are to be investigated in increments of 0.1 mil for parallel surfaces and a positive and negative tilt angle of 1.0 milliradian. Thus,

Pressure at inner radius or inlet, $P_1$ , psia	65
Pressure at outer radius or outlet, $P_2$ , psia	15
Temperature, $T$ , <sup>o</sup> F	100
Inner radius, $R_1$ , in.	3.265
Outer radius, $R_2$ , in.	3.315
Mean film thickness in increments of 0.1 mil, $h_m$ , mils	0.1 to 1.0
Relative inclination angle of sealing dam surfaces, rad	$0, \pm 1.0 \times 10^{-3}$
Design speed, rpm	1398
Molecular weight of gas, $m$ , lbm/lb-mole	28.966
Absolute or dynamic viscosity, $\mu$ , lb-sec/ft <sup>2</sup>	$3.96 \times 10^{-7}$
Specific heat at constant pressure, $C_p$ , Btu/(lb)( <sup>o</sup> R)	0.24
Specific heat ratio, $C_p/C_v$	1.4

The data sheet for this sample problem is shown in table III. The sample output with all possible output options is shown in both English units and International System of Units. Note that the analysis is not valid for a mean film thickness of 0.4 mil and larger. The Mach number has exceeded  $1/\sqrt{\gamma} = 0.845$ . The execution time for this problem is about 0.39 minute on the Lewis computer.

**TABLE III. - DATA FOR SAMPLE PROBLEM**

TITLE												PROJECT NUMBER												ANALYST												SHEET _____ OF _____																																											
STATEMENT NUMBER												CONT												FORTRAN STATEMENT												IDENTIFICATION																																											
1	2	3	4	5	6	7	8	9	10	11	12	13	14	15	16	17	18	19	20	21	22	23	24	25	26	27	28	29	30	31	32	33	34	35	36	37	38	39	40	41	42	43	44	45	46	47	48	49	50	51	52	53	54	55	56	57	58	59	60	61	62	63	64	65	66	67	68	69	70	71	72	73	74	75	76	77	78	79	80
SAMPLE PROBLEM																																																																															
1.4																																																																															
0.0010            0.0009            0.0008            0.0007            0.0006            0.0005																																																																															
0.00045          0.0004            0.00035          0.0003            0.00025          0.0002																																																																															
0.00015          0.0001																																																																															
\$INPT ALPHA=0.0, L=0.0, SPEED=1.398, CAPV=0.0, MOLT=28.966, P1=65., P2=15., T=10C., R1=3.265, R2=3.315, RHOR=0.0, RHORF=0.0, MU=3.96E-7, CP=2.4, GAMMA=1.4, NGRID=10, ASKIP=F, RSKIP=F, TSKIP=F, NQUI=F \$																																																																															
\$INPT ALPHA=.001 \$ \$INPT ALPHA=-.001 \$																																																																															



## COMPRESSIBLE SEALING DAM WITH SMALL TILT ANGLE

## SAMPLE PROBLEM

## INPUT DATA -

TILT ANGLE = 0.      RADIANS									
P2, PSIA 15.0000	P1, PSIA 65.0000	T, DEG F 100.	VISCOSITY, LB-SEC/FT2 0.39600E-06	MOLECULAR WEIGHT 28.9660	CP/CV 1.43330				
R2, INCHES 3.31500	R1, INCHES 3.26500	L, INCHES 20.0000	RHO, LB-SEC2/FT4 0.93000E-02	RHO(ROT), LB-SEC2/FT4 0.60000E-02	ND OF GRID POINTS 11				
N, RPM 0	V, FT/SEC 40.0000	CP, BTU/LB-DEG R 0.24000	SKIP A T	SKIP R F	SKIP T F				

## BEGIN OUTPUT DATA

GAS CONSTANT, FI-LB/LB(M)-DEG R 53.3522		RHO(L), LB-SEC2/FT4 0.93000E-02		A(SOUND SPEED), FT/SEC 1160.08							
L, INCHES 20.0000	AREA, IN2 1.03358	SPEED, RPM 1393.21		V, FT/SEC 40.0000							
MEAN FILM INCHES	M(OUT) LB/MIN	Q SCFM	MACH (MAX)	RE(P)	RE(R)	KNUDSEN NUMBER	F LB	STIFF LB/IN	XC INCHES	XC BAR	F BAR
C.100E-02											
C.900E-03											
C.800E-03											
C.700E-03											
C.600E-03											
C.500E-03											
C.450E-03											
C.400E-03											
C.350E-03	0.166	2.174	0.711	273.048	17.677	0.008	30.208 -0		0.170E-01	0.339	0.604
C.300E-03	0.105	1.369	0.522	171.949	15.152	0.009	30.208 0		0.170E-01	0.339	0.504
C.250E-03	0.605E-01	0.792	0.363	99.507	12.626	0.011	30.208 0		0.170E-01	0.339	0.604
C.200E-03	0.310E-01	0.406	0.232	50.948	10.101	0.013	30.208 0		0.170E-01	0.339	0.604
C.150E-03	0.131E-01	0.171	0.131	21.494	7.576	0.018	30.208 0		0.170E-01	0.339	0.604
C.100E-03	0.387E-02	0.507E-01	0.058	6.368	5.051	0.027	30.208 0		0.170E-01	0.339	0.604
MEAN FILM, INCHES	POWER, H.P.	SHEAR HEAT, BTU/MIN		DEL(T), DEG F		TORQUE, FT-LB					
C.100E-02						ANALYSIS NOT VALID					
C.900E-03						ANALYSIS NOT VALID					
C.800E-03						ANALYSIS NOT VALID					
C.700E-03						ANALYSIS NOT VALID					
C.600E-03						ANALYSIS NOT VALID					
C.500E-03						ANALYSIS NOT VALID					
C.450E-03						ANALYSIS NOT VALID					
C.400E-03						ANALYSIS NOT VALID					
C.350E-03	0.26350E-03	0.12026E-01		0.30161		0.67150E-02					
C.300E-03	0.33075E-03	0.14030E-01		0.55877		0.78342E-02					
C.250E-03	0.39690E-03	0.16836E-01		1.15867		0.94010E-02					
C.200E-03	0.49612E-03	0.21045E-01		2.82878		0.11751E-01					
C.150E-03	0.66149E-03	0.28061E-01		8.94033		0.15668E-01					
C.100E-03	0.99224E-03	0.42091E-01		45.2604		0.23503E-01					

PLOT OF POWER VS H(MEAN)

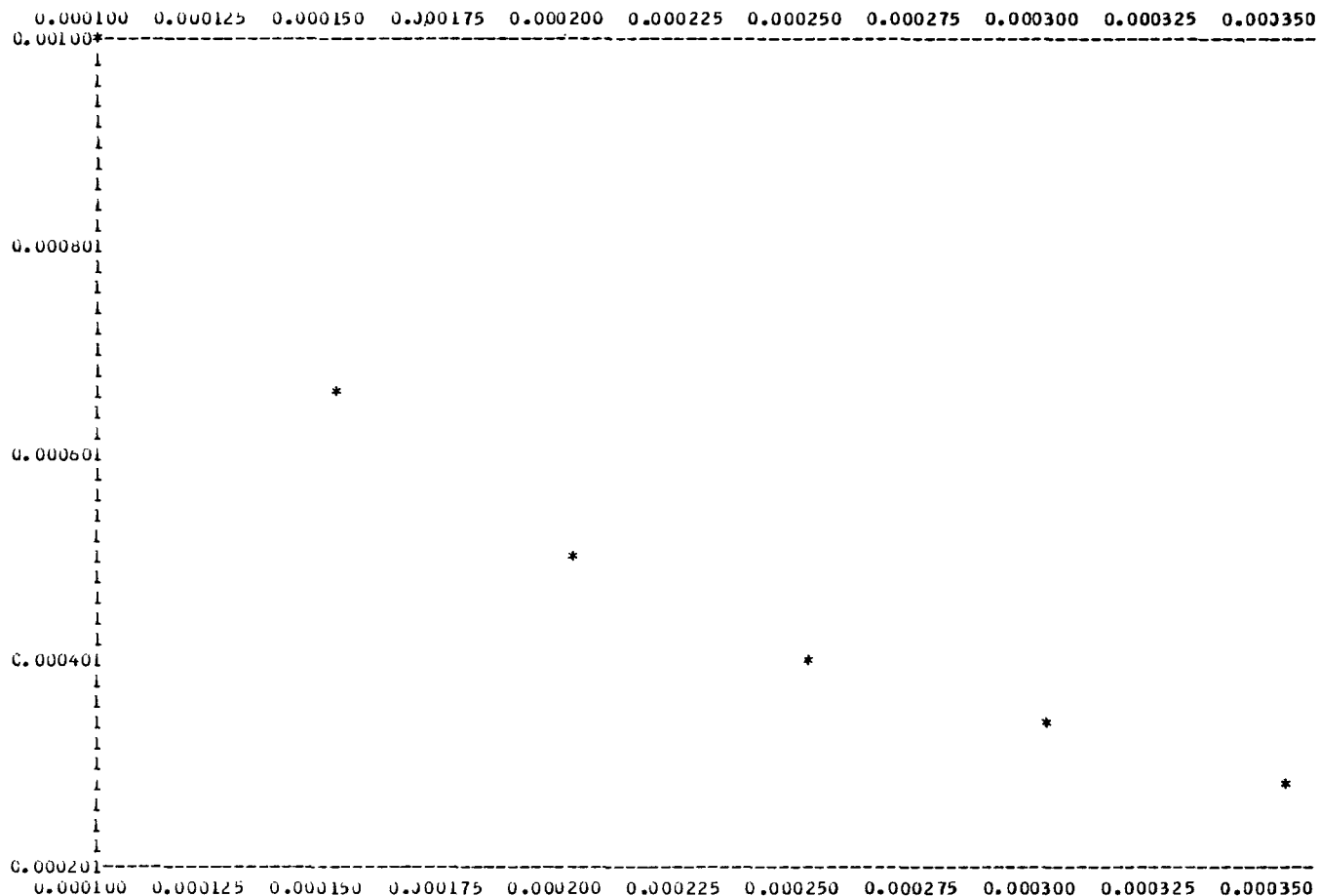

POWER ON VERTICAL SCALE - H(MEAN) ON HORIZONTAL SCALE

POWER IN HORSE POWER - TO CONVERT TO WATTS, MULTIPLY BY 745.7

H(MEAN) IN INCHES - TO CONVERT TO METERS, MULTIPLY BY 2.54E-2

FOR SHEAR HEAT IN BTU/MIN, MULTIPLY POWER BY 42.42

## COMPRESSIBLE SEALING DAM WITH SMALL TILT ANGLE

## SAMPLE PROBLEM

TILT ANGLE = 0. RADIANS

P2, N/M2 0.10342E C0	P1, N/M2 0.44810E 00	T, DEG K 311.	VISCOSITY, N-S/M2 0.18961E-04	MOLECULAR WEIGHT 28.9660	CP/CV 1.40000
R2, METERS 0.84201E-C1	R1, METERS 0.82931E-01	L, METERS 0.50800	RHO, KG/M3 4.80998	RHO (ROT), KG/M3 3.10322	NO OF GRID POINTS 11
N, RPS 0	V, M/S 12.1920	CP, J/KG-DEG K 1004.78	SKIP A T	SKIP R F	SKIP T F

## BEGIN OUTPUT DATA

GAS CONSTANT, J/KG-DEG K 287.000		RHU(1), KG/M3 4.80998		A(SOUND SPEED), M/S 353.591							
L, METERS 0.50800	AREA, M2 0.66083E-03	SPEED, RPS 23.2202		V, M/S 12.1920							
MEAN FILM METERS	M(OUT) KG/SEC	Q SC MS	MAX (MAX)	RE(P)	RE(R)	KNUDSEN NUMBER	F NEWTONS	STIFF KG/M	XC METERS	XC BAR	F BAR
0.254E-04							ANALYSIS NOT VALID				
0.229E-04							ANALYSIS NOT VALID				
0.203E-04							ANALYSIS NOT VALID				
0.178E-04							ANALYSIS NOT VALID				
0.152E-04							ANALYSIS NOT VALID				
0.127E-04							ANALYSIS NOT VALID				
0.114E-04							ANALYSIS NOT VALID				
0.102E-04							ANALYSIS NOT VALID				
0.889E-05	0.120E-C2	0.103E-02	0.711	273.048	17.677	0.008	134.373 -0		0.431E-03	0.339	0.604
0.762E-05	0.791E-03	0.046E-03	0.522	171.949	15.152	0.009	134.373 0		0.431E-03	0.339	0.604
0.635E-05	0.458E-C3	0.374E-03	0.363	99.507	12.626	0.011	134.373 0		0.431E-03	0.339	0.604
0.508E-05	0.234E-03	0.191E-03	0.232	50.948	10.101	0.013	134.373 0		0.431E-03	0.339	0.604
0.381E-05	0.989E-C4	0.007E-04	0.131	21.494	7.576	0.018	134.373 0		0.431E-03	0.339	0.604
0.254E-05	0.293E-04	0.239E-04	0.058	6.358	5.051	0.027	134.373 0		0.431E-03	0.339	0.604
MEAN FILM, METERS	POWER, WATTS	TOTAL HEAT, WATTS		DEL(T), DEG K		TORQUE, N-M					
0.254E-04							ANALYSIS NOT VALID				
0.229E-04							ANALYSIS NOT VALID				
0.203E-04							ANALYSIS NOT VALID				
0.178E-04							ANALYSIS NOT VALID				
0.152E-04							ANALYSIS NOT VALID				
0.127E-04							ANALYSIS NOT VALID				
0.114E-04							ANALYSIS NOT VALID				
0.102E-04							ANALYSIS NOT VALID				
0.889E-05	0.21140	0.21163		0.16756		0.91043E-02					
0.762E-05	0.24064	0.24690		0.31043		0.10622E-01					
0.635E-05	0.29597	0.29628		0.64370		0.12746E-01					
0.508E-05	0.36996	0.37035		1.57154		0.15933E-01					
0.381E-05	0.49328	0.49381		4.96685		0.21243E-01					
0.254E-05	0.73991	0.74071		25.1447		0.31865E-01					

COMPRESSIBLE SEALING DAM WITH SMALL TILT ANGLE

SAMPLE PROBLEM

INPUT DATA -

TILT ANGLE = 0. RADIANS

P2,PSIA 15.0000	P1,PSIA 05.0000	T,DEG F 100.	VISCOSITY, LB-SEC/FT2 0.39600E-06	MOLECULAR WEIGHT 28.9660	CP/CV 1.40000
K2, INCHES 3.31500	R1, INCHES 3.20500	L, INCHES 0	RHO, LB-SEC2/FT4 0	RHO(ROD), LB-SEC2/FT4 0	NO OF GRID POINTS 11
N, RPM 1398.00	V, FT/SEC 0	CP, BTU/LB-DEG R 0.24000	SKIP A F	SKIP R F	SKIP T F

BEGIN OUTPUT DATA-

GAS CONSTANT, FT-LB/LB(M)-DEG R 53.3522		RHO(1), LB-SEC2/FT4 0.97371E-02		A(SOUND SPEED), FT/SEC 1160.08							
L, INCHES 20.6717	AREA, IN2 1.05358	SPEED, RPM 1398.00		V, FT/SEC 40.1375							
MEAN FILM INCHES	M(DOT) LB/MIN	u SCFM	MACH (MAX)	RE(P)	RE(R)	KNUDSEN NUMBER	F LB	STIFF LB/IN	XC INCHES	XC BAR	F BAR
0.100E-02							ANALYSIS NOT VALID				
0.900E-03							ANALYSIS NOT VALID				
0.800E-03							ANALYSIS NOT VALID				
0.700E-03							ANALYSIS NOT VALID				
0.600E-03							ANALYSIS NOT VALID				
0.500E-03							ANALYSIS NOT VALID				
0.450E-03							ANALYSIS NOT VALID				
0.400E-03							ANALYSIS NOT VALID				
0.350E-03	0.180	2.352	0.711	273.048	20.889	0.008	31.223 -0		0.170E-01	0.339	0.604
0.300E-03	0.113	1.481	0.522	171.949	17.905	0.009	31.223 0		0.170E-01	0.339	0.604
0.250E-03	0.655E-01	0.827	0.363	99.507	14.921	0.011	31.223 0		0.170E-01	0.339	0.604
0.200E-03	0.335E-01	0.439	0.232	50.948	11.937	0.013	31.223 0		0.170E-01	0.339	0.604
0.150E-03	0.142E-01	0.185	0.131	21.494	8.953	0.018	31.223 0		0.170E-01	0.339	0.604
0.100E-03	0.419E-02	0.549E-01	0.058	6.368	5.968	0.027	31.223 -0		0.170E-01	0.339	0.604
MEAN FILM, INCHES	PDWEK, H.P.	SHEAR HEAT, BTU/MIN		DEL(T), DEG F		TORQUE, FT-LB					
0.100E-02						ANALYSIS NOT VALID					
0.900E-03						ANALYSIS NOT VALID					
0.800E-03						ANALYSIS NOT VALID					
0.700E-03						ANALYSIS NOT VALID					
0.600E-03						ANALYSIS NOT VALID					
0.500E-03						ANALYSIS NOT VALID					
0.450E-03						ANALYSIS NOT VALID					
0.400E-03						ANALYSIS NOT VALID					
0.350E-03	0.28545E-03	0.12109E-01		0.28063		0.67381E-02					
0.300E-03	0.33302E-03	0.14127E-01		0.51990		0.78611E-02					
0.250E-03	0.39903E-03	0.16952E-01		1.07807		0.94333E-02					
0.200E-03	0.49954E-03	0.21190E-01		2.63200		0.11792E-01					
0.150E-03	0.60605E-03	0.28254E-01		8.31843		0.15722E-01					
0.100E-03	0.99907E-03	0.42381E-01		42.1120		0.23583E-01					

MEAN FILM = 0.350E-03 INCHES

X, INCHES	P/P (MIN)	P, PSI	U (AV), FT/SEC	MACH NO
0	4.33333	65.0000	190.365	0.16410
0.500E-02	4.12311	61.8400	200.071	0.17246
0.100E-01	3.90157	58.5235	211.432	0.18226
0.150E-01	3.66667	55.0000	224.977	0.19393
0.200E-01	3.41505	51.2348	241.511	0.20818
0.250E-01	3.14466	47.1099	262.323	0.22613
0.300E-01	2.84800	42.7200	289.647	0.24968
0.350E-01	2.51661	37.7492	327.788	0.28256
0.400E-01	2.13437	32.0156	380.490	0.33316
0.450E-01	1.66667	25.0000	494.949	0.42665
0.500E-01	1.00000	15.0000	824.915	0.71109

MEAN FILM = 0.300E-03 INCHES

X, INCHES	P/P (MIN)	P, PSI	U (AV), FT/SEC	MACH NO
0	4.33333	65.0000	139.860	0.12056
0.500E-02	4.12311	61.8406	146.991	0.12671
0.100E-01	3.90157	58.5235	155.338	0.13390
0.150E-01	3.66667	55.0000	165.289	0.14248
0.200E-01	3.41505	51.2348	177.430	0.15295
0.250E-01	3.14466	47.1099	192.727	0.16613
0.300E-01	2.84800	42.7200	212.802	0.18344
0.350E-01	2.51661	37.7492	240.824	0.20759
0.400E-01	2.13437	32.0156	283.952	0.24477
0.450E-01	1.66667	25.0000	363.636	0.31346
0.500E-01	1.00000	15.0000	606.060	0.52243

MEAN FILM = 0.250E-03 INCHES

X, INCHES	P/P (MIN)	P, PSI	U (AV), FT/SEC	MACH NO
0	4.33333	65.0000	97.1251	0.83723E-01
0.500E-02	4.12311	61.8466	102.077	0.87992E-01
0.100E-01	3.90157	58.5235	107.873	0.92988E-01
0.150E-01	3.66667	55.0000	114.784	0.98945E-01
0.200E-01	3.41565	51.2348	123.220	0.10622
0.250E-01	3.14466	47.1099	133.838	0.11537
0.300E-01	2.84800	42.7200	147.779	0.12739
0.350E-01	2.51661	37.7492	167.239	0.14416
0.400E-01	2.13437	32.0156	197.189	0.16998
0.450E-01	1.66667	25.0000	252.525	0.21768
0.500E-01	1.00000	15.0000	420.875	0.36280

MEAN FILM = 0.200E-03 INCHES

X, INCHES	P/P (MIN)	P, PSI	U(AV), FT/SEC	MACH NO
0	4.33333	65.0000	62.1600	0.53583E-01
0.500E-C2	4.12311	61.8406	65.3294	0.56315E-01
0.100E-C1	3.90157	58.5235	69.0390	0.59512E-01
0.150E-C1	3.66667	55.0000	73.4619	0.63325E-01
0.200E-C1	3.41565	51.2348	78.8606	0.67979E-01
0.250E-C1	3.14466	47.1699	85.6564	0.73837E-01
0.300E-C1	2.84800	42.7200	94.5767	0.81528E-01
0.350E-C1	2.51661	37.7492	107.533	0.92264E-01
0.400E-C1	2.13437	32.0156	126.201	0.10879
0.450E-C1	1.66667	25.0000	161.616	0.13931
0.500E-C1	1.00000	15.0000	269.360	0.23219

MEAN FILM = 0.150E-03 INCHES

X, INCHES	P/P (MIN)	P, PSI	U(AV), FT/SEC	MACH NO
0	4.33333	65.0000	34.9550	0.30140E-01
0.500E-C2	4.12311	61.8406	36.7478	0.31677E-01
0.100E-C1	3.90157	58.5235	38.8344	0.33476E-01
0.150E-C1	3.66667	55.0000	41.3223	0.35620E-01
0.200E-C1	3.41565	51.2348	44.3591	0.38238E-01
0.250E-C1	3.14466	47.1699	48.1617	0.41533E-01
0.300E-C1	2.84800	42.7200	53.2005	0.45859E-01
0.350E-C1	2.51661	37.7492	60.2060	0.51898E-01
0.400E-C1	2.13437	32.0156	70.9880	0.61193E-01
0.450E-C1	1.66667	25.0000	90.9091	0.78365E-01
0.500E-C1	1.00000	15.0000	151.515	0.13061

MEAN FILM = 0.100E-03 INCHES

X, INCHES	P/P (MIN)	P, PSI	U(AV), FT/SEC	MACH NO
0	4.33333	65.0000	15.5400	0.13396E-01
0.500E-C2	4.12311	61.8406	16.3324	0.14079E-01
0.100E-C1	3.90157	58.5235	17.2597	0.14878E-01
0.150E-C1	3.66667	55.0000	18.3655	0.15831E-01
0.200E-C1	3.41565	51.2348	19.7151	0.16995E-01
0.250E-C1	3.14466	47.1699	21.4141	0.18459E-01
0.300E-C1	2.84800	42.7200	23.6447	0.20382E-01
0.350E-C1	2.51661	37.7492	26.7582	0.23066E-01
0.400E-C1	2.13437	32.0156	31.5502	0.27197E-01
0.450E-C1	1.66667	25.0000	40.4040	0.34829E-01
0.500E-C1	1.00000	15.0000	67.3400	0.58048E-01

## PLOT OF POWER VS H(MEAN)

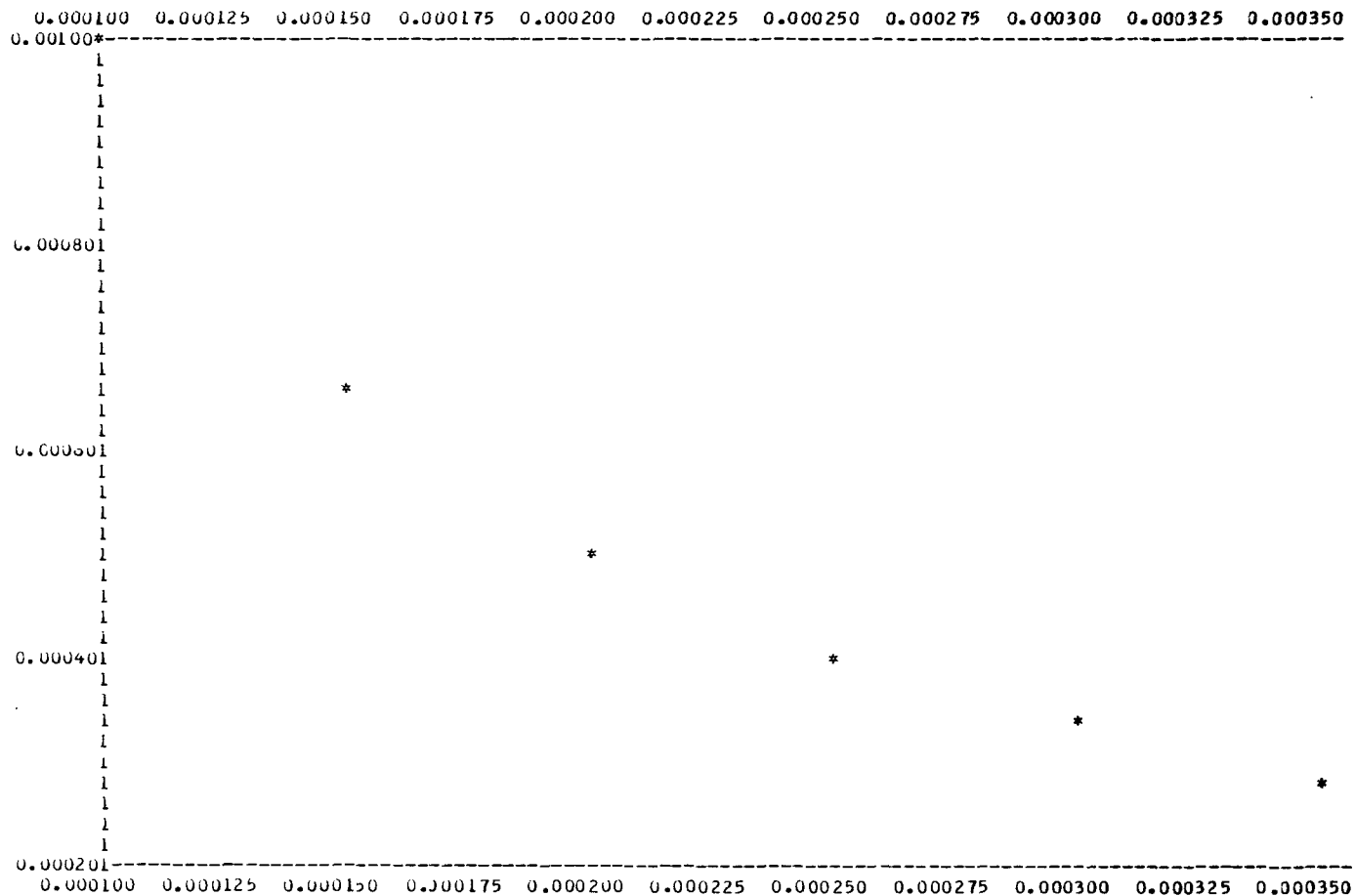

POWER ON VERTICAL SCALE - H(MEAN) ON HORIZONTAL SCALE

POWER IN HORSE POWER - TO CONVERT TO WATTS, MULTIPLY BY 745.7

H(MEAN) IN INCHES - TO CONVERT TO METERS, MULTIPLY BY 2.54E-2

FOR SHEAR HEAT IN BTU/MIN, MULTIPLY POWER BY 42.42

PLOT OF P/P(MIN) VS X FOR H(MEAN) = 0.35000E-03

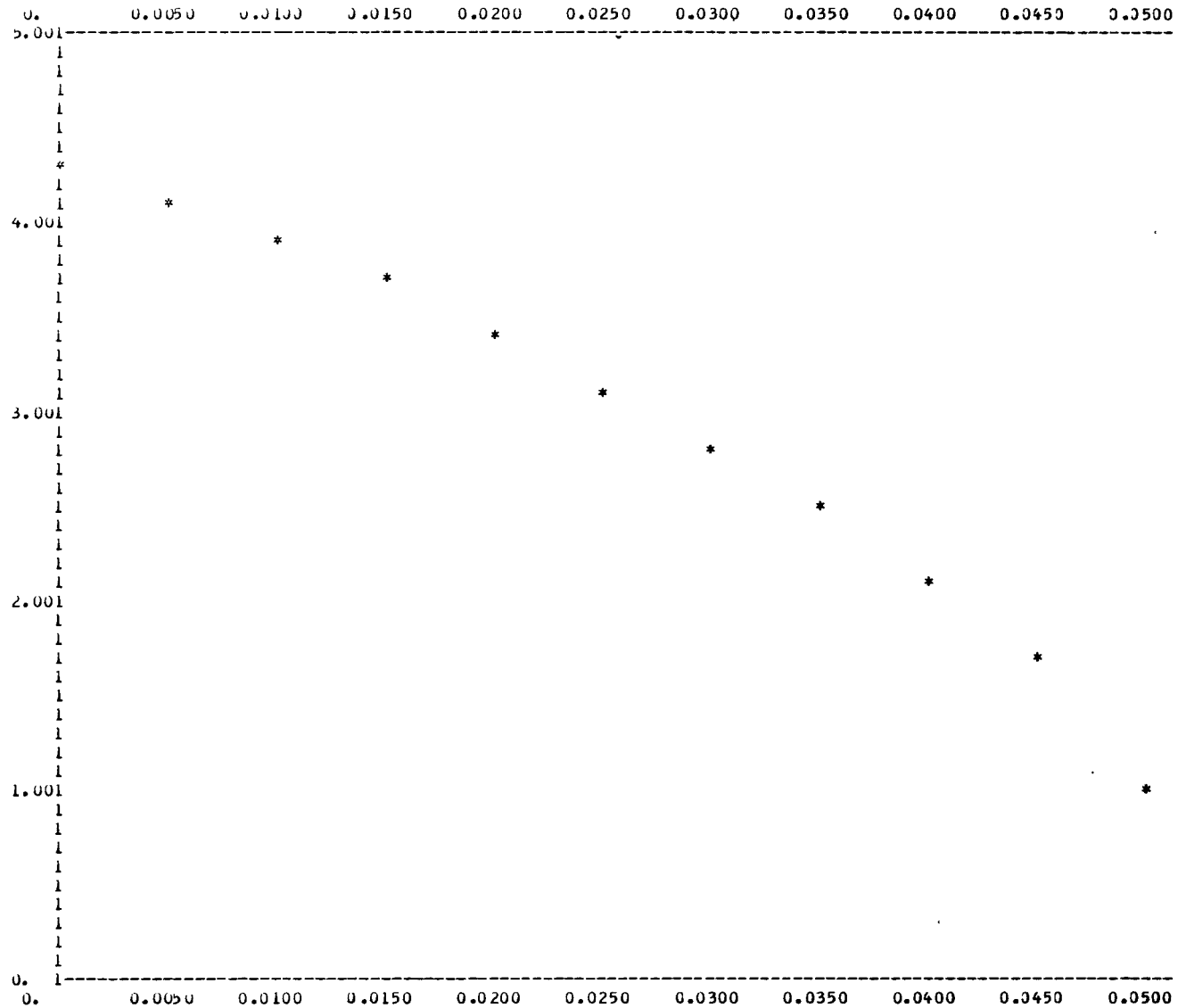

P/P(MIN) ON VERTICAL SCALE - X ON HORIZONTAL SCALE

P/P(MIN) IS DIMENSIONLESS

X IN INCHES - TO CONVERT TO METERS, MULTIPLY BY 2.54E-2



## COMPRESSIBLE SEALING DAM WITH SMALL TILT ANGLE

## SAMPLE PROBLEM

TILT ANGLE = 0. RADIAN

P2,N/M2 0.10342E-06	P1,N/M2 0.44816E-06	T,DEG K 311.	VISCOSITY,N-S/M2 0.18961E-04	MOLECULAR WEIGHT 28.9660	CP/CV 1.40000
R2,METERS 0.84201E-01	R1,METERS 0.82931E-01	L,METERS 0	RHO,KG/M3 0	RHO(RGT),KG/M3 0	NO OF GRID POINTS 11
N,RPS 23.3000	V,M/S 0	CP,J/KG-DEG K 1004.78	SKIP A F	SKIP R F	SKIP T F

## BEGIN OUTPUT DATA

GAS CONSTANT,J/KG-DEG K 287.086	RHC(1),KG/M3 5.03606	A(SOUND SPEED),M/S 353.591
------------------------------------	-------------------------	-------------------------------

L,METERS 0.52500	AREA,M2 0.66683E-03	SPEED,KPS 23.3000	V,M/S 12.2339
---------------------	------------------------	----------------------	------------------

MEAN FILM METERS	M(OUT) KG/SEC	Q SCMS	MACH (MAX)	RE(P)	RE(R)	KNUDSEN NUMBER	F NEWTONS	STIFF KG/M	XC METERS	XC BAR	F BAR
0.254E-04							ANALYSIS NOT VALID				
0.229E-04							ANALYSIS NOT VALID				
0.203E-04							ANALYSIS NOT VALID				
0.178E-04							ANALYSIS NOT VALID				
0.152E-04							ANALYSIS NOT VALID				
0.127E-04							ANALYSIS NOT VALID				
0.114E-04							ANALYSIS NOT VALID				
0.102E-04							ANALYSIS NOT VALID				
0.889E-05	0.130E-02	0.111E-02	0.711	273.048	20.889	0.008	138.886 -0		0.431E-03	0.339	0.604
0.762E-05	0.850E-03	0.699E-03	0.522	171.949	17.905	0.009	138.886 0		0.431E-03	0.339	0.604
0.635E-05	0.455E-03	0.405E-03	0.363	99.507	14.921	0.011	138.886 0		0.431E-03	0.339	0.604
0.508E-05	0.254E-03	0.207E-03	0.232	50.948	11.937	0.013	138.886 0		0.431E-03	0.339	0.604
0.381E-05	0.107E-03	0.874E-04	0.131	21.494	8.953	0.018	138.886 0		0.431E-03	0.339	0.604
0.254E-05	0.317E-04	0.259E-04	0.058	6.368	5.968	0.027	138.886 -0		0.431E-03	0.339	0.604

MEAN FILM, METERS	POWER,WATTS	TOTAL HEAT,WATTS	DEL(T),DEG K	TORQUE,N-M
0.254E-04				ANALYSIS NOT VALID
0.229E-04				ANALYSIS NOT VALID
0.203E-04				ANALYSIS NOT VALID
0.178E-04				ANALYSIS NOT VALID
0.152E-04				ANALYSIS NOT VALID
0.127E-04				ANALYSIS NOT VALID
0.114E-04				ANALYSIS NOT VALID
0.102E-04				ANALYSIS NOT VALID
0.889E-05	0.21286	0.21309	0.15591	0.91356E-02
0.762E-05	0.24834	0.24860	0.28883	0.10658E-01
0.635E-05	0.29800	0.29832	0.59893	0.12790E-01
0.508E-05	0.37251	0.37290	1.46222	0.15987E-01
0.381E-05	0.49067	0.49721	4.62135	0.21316E-01
0.254E-05	0.74501	0.74561	23.3956	0.31975E-01

MEAN FILM = 0.00500E-05 METERS

X, METERS	P/P (MIN)	P, N/M2	U (AV), M/SEC	MACH NO
0	4.33333	0.44816E 00	58.0233	0.16410
0.127E-C3	4.12311	0.42042E 06	00.9818	0.17246
0.254E-C3	3.90157	0.40351E 00	04.4444	0.18226
0.381E-C3	3.68667	0.37921E 00	08.5730	0.19393
0.508E-C3	3.41505	0.35325E 06	73.6124	0.20818
0.635E-C3	3.14400	0.32523E 06	79.9559	0.22613
0.762E-C3	2.84800	0.29454E 00	88.2845	0.24968
0.889E-C3	2.51601	0.26027E 06	99.9398	0.28256
0.102E-C2	2.13437	0.22074E 00	117.802	0.33316
0.114E-C2	1.66667	0.17237E 00	150.861	0.42665
0.127E-C2	1.00000	0.10342E 00	251.434	0.71109

MEAN FILM = 0.10200E-05 METERS

X, METERS	P/P (MIN)	P, N/M2	U (AV), M/SEC	MACH NO
0	4.33333	0.44816E 06	42.0294	0.12056
0.127E-C3	4.12311	0.42642E 00	44.8029	0.12671
0.254E-C3	3.90157	0.40351E 00	47.3469	0.13390
0.381E-C3	3.68667	0.37921E 00	50.3801	0.14248
0.508E-C3	3.41505	0.35325E 06	54.0826	0.15295
0.635E-C3	3.14400	0.32523E 06	58.7431	0.16613
0.762E-C3	2.84800	0.29454E 00	64.8021	0.18344
0.889E-C3	2.51601	0.26027E 00	73.4031	0.20759
0.102E-C2	2.13437	0.22074E 06	80.5480	0.24477
0.114E-C2	1.66667	0.17237E 06	110.836	0.31340
0.127E-C2	1.00000	0.10342E 06	184.727	0.52243

MEAN FILM = 0.63500E-05 METERS

X, METERS	P/P (MIN)	P, N/M2	U (AV), M/SEC	MACH NO
0	4.33333	0.44816E 00	29.6037	0.83723E-01
0.127E-C3	4.12311	0.42042E 06	31.1131	0.87992E-01
0.254E-C3	3.90157	0.40351E 06	32.8798	0.92988E-01
0.381E-C3	3.68667	0.37921E 06	34.9862	0.98945E-01
0.508E-C3	3.41505	0.35325E 00	37.5574	0.10622
0.635E-C3	3.14400	0.32523E 06	40.7938	0.11537
0.762E-C3	2.84800	0.29454E 00	45.0431	0.12739
0.889E-C3	2.51601	0.26027E 00	50.9744	0.14416
0.102E-C2	2.13437	0.22074E 06	60.1032	0.16998
0.114E-C2	1.66667	0.17237E 06	76.9697	0.21768
0.127E-C2	1.00000	0.10342E 06	128.283	0.36280

MEAN FILM = 0.50800E-05 METERS

X, METERS	P/P (MIN)	P, N/M2	U(AV), M/SEC	MACH NO
0	4.33333	0.44816E 06	18.9464	0.53583E-01
0.127E-C3	4.12311	0.42642E 06	19.9124	0.56315E-01
0.254E-C3	3.90157	0.40351E 06	21.0431	0.59512E-01
0.381E-C3	3.68007	0.37921E 06	22.3912	0.63325E-01
0.508E-C3	3.41505	0.35325E 06	24.0367	0.67979E-01
0.635E-C3	3.14460	0.32523E 06	26.1081	0.73837E-01
0.762E-C3	2.84800	0.29454E 06	28.8276	0.81528E-01
0.889E-C3	2.51661	0.26027E 06	32.6236	0.92264E-01
0.102E-C2	2.13437	0.22074E 06	38.4661	0.10879
0.114E-C2	1.68667	0.17237E 06	49.2606	0.13931
0.127E-C2	1.00000	0.10342E 06	82.1010	0.23219

MEAN FILM = 0.36100E-05 METERS

X, METERS	P/P (MIN)	P, N/M2	U(AV), M/SEC	MACH NO
0	4.33333	0.44816E 06	10.6573	0.30140E-01
0.127E-C3	4.12311	0.42642E 06	11.2007	0.31677E-01
0.254E-C3	3.90157	0.40351E 06	11.8367	0.33476E-01
0.381E-C3	3.68007	0.37921E 06	12.5950	0.35620E-01
0.508E-C3	3.41505	0.35325E 06	13.5206	0.38238E-01
0.635E-C3	3.14460	0.32523E 06	14.6858	0.41533E-01
0.762E-C3	2.84800	0.29454E 06	16.2155	0.45859E-01
0.889E-C3	2.51661	0.26027E 06	18.3508	0.51898E-01
0.102E-C2	2.13437	0.22074E 06	21.6372	0.61193E-01
0.114E-C2	1.68667	0.17237E 06	27.7091	0.78365E-01
0.127E-C2	1.00000	0.10342E 06	46.1818	0.13061

MEAN FILM = 0.25400E-05 METERS

X, METERS	P/P (MIN)	P, N/M2	U(AV), M/SEC	MACH NO
0	4.33333	0.44816E 06	4.73660	0.13396E-01
0.127E-C3	4.12311	0.42642E 06	4.97810	0.14079E-01
0.254E-C3	3.90157	0.40351E 06	5.26077	0.14878E-01
0.381E-C3	3.68007	0.37921E 06	5.59779	0.15831E-01
0.508E-C3	3.41505	0.35325E 06	6.00918	0.16995E-01
0.635E-C3	3.14460	0.32523E 06	6.52701	0.18459E-01
0.762E-C3	2.84800	0.29454E 06	7.20089	0.20382E-01
0.889E-C3	2.51661	0.26027E 06	8.15591	0.23066E-01
0.102E-C2	2.13437	0.22074E 06	9.61651	0.27197E-01
0.114E-C2	1.68667	0.17237E 06	12.3151	0.34829E-01
0.127E-C2	1.00000	0.10342E 06	20.5252	0.58048E-01

COMPRESSIBLE SEALING DAM WITH SMALL TILT ANGLE

SAMPLE PROBLEM

INPUT DATA -

TILT ANGLE = 0.0010 RADIANS

P2,PSIA 15.0000	P1,PSIA 65.0000	T,DEG F 100.	VISCOSITY, LB-SEC/FT2 0.39600E-06	MOLECULAR WEIGHT 28.9660	CP/CV 1.40000
R2, INCHES 3.31500	R1, INCHES 3.26500	L, INCHES 20.6717	RHO, LB-SEC2/FT4 0	RHO(ROT), LB-SEC2/FT4 0	NO OF GRID POINTS 11
N,RPM 1398.00	V, FT/SEC 40.1375	CP, BTU/LB-DEG R 0.24000	SKIP A F	SKIP R F	SKIP T F

BEGIN OUTPUT DATA

GAS CONSTANT, FT-LB/LB(M)-DEG R 53.3522	RHO(1), LB-SEC2/FT4 0.97371E-02	A(SOUND SPEED), FT/SEC 1160.08
--	------------------------------------	-----------------------------------

L, INCHES 20.6717	AREA, IN2 1.03358	SPEED, RPM 1398.00	V, FT/SEC 40.1375
----------------------	----------------------	-----------------------	----------------------

MEAN FILM INCHES	M(DUT) LB/MIN	Q SCFM	MACH (MAX)	RE(P)	RE(R)	KNUDSEN NUMBER	F LB	STIFF LB/IN	XC INCHES	XC BAR	F BAR
C.100E-02											
C.900E-03											
C.800E-03											
C.700E-03											
C.600E-03											
C.500E-03											
C.450E-03											
C.400E-03											
C.350E-03	0.177	2.310	0.754	288.097	19.865	0.008	29.507	-0.464E 04	0.181E-01	0.363	0.571
C.300E-03	0.111	1.451	0.558	182.424	16.879	0.009	29.220	-0.677E 04	0.180E-01	0.361	0.565
C.250E-03	0.636E-01	0.832	0.391	106.207	13.893	0.011	28.819	-0.954E C4	0.179E-01	0.359	0.558
C.200E-03	0.320E-01	0.419	0.253	54.671	10.907	0.014	28.221	-0.147E C5	0.177E-01	0.355	0.546
C.150E-03	0.130E-01	0.170	0.144	23.044	7.924	0.019	27.240	-0.262E 05	0.174E-01	0.349	0.527
C.100E-03	0.346E-02	0.452E-01	0.064	6.559	4.960	0.029	25.387	-0.506E 05	0.169E-01	0.338	0.491

MEAN FILM, INCHES	POWER, H.P.	SHEAR HEAT, BTU/MIN	DEL(T), DEG F	TORQUE, FT-LB
C.100E-02				ANALYSIS NOT VALID
C.900E-03				ANALYSIS NOT VALID
C.800E-03				ANALYSIS NOT VALID
C.700E-03				ANALYSIS NOT VALID
C.600E-03				ANALYSIS NOT VALID
C.500E-03				ANALYSIS NOT VALID
C.450E-03				ANALYSIS NOT VALID
C.400E-03				ANALYSIS NOT VALID
C.350E-03	0.28545E-03	0.12109E-01	0.28497	0.67381E-02
C.300E-03	0.33302E-03	0.14127E-01	0.53089	0.78611E-02
C.250E-03	0.39963E-03	0.16952E-01	1.11107	0.94333E-02
C.200E-03	0.49954E-03	0.21190E-01	2.75934	0.11792E-01
C.150E-03	0.66055E-03	0.28254E-01	9.05200	0.15722E-01
C.100E-03	0.99907E-03	0.42381E-01	51.1084	0.23583E-01

MEAN FILM = 0.350E-03 INCHES

X, INCHES	P/P (MIN)	P, PSI	U (AV), FT/SEC	MACH NO
0	4.33333	65.0000	187.466	0.16160
0.500E-C2	4.07817	61.1726	199.195	0.17171
0.100E-C1	3.81840	57.2760	212.747	0.18339
0.150E-C1	3.55223	53.2834	228.688	0.19713
0.200E-C1	3.27731	49.1597	247.872	0.21367
0.250E-C1	2.99045	44.8567	271.650	0.23417
0.300E-C1	2.68897	40.3046	302.331	0.26061
0.350E-C1	2.35962	35.3943	344.273	0.29677
0.400E-C1	1.99571	29.9356	407.050	0.35088
0.450E-C1	1.56888	23.5331	517.794	0.44634
0.500E-C1	1.00000	15.0000	812.354	0.70026

MEAN FILM = 0.300E-03 INCHES

X, INCHES	P/P (MIN)	P, PSI	U (AV), FT/SEC	MACH NO
0	4.33333	65.0000	136.967	0.11807
0.500E-C2	4.07004	61.0506	145.827	0.12570
0.100E-C1	3.80361	57.0542	156.041	0.13451
0.150E-C1	3.53224	52.9835	168.030	0.14484
0.200E-C1	3.25556	48.8034	182.422	0.15725
0.250E-C1	2.96442	44.4663	200.215	0.17259
0.300E-C1	2.66027	39.9041	223.106	0.19232
0.350E-C1	2.33406	35.0109	254.287	0.21920
0.400E-C1	1.97358	29.6037	300.734	0.25924
0.450E-C1	1.55366	23.3049	382.015	0.32930
0.500E-C1	1.00000	15.0000	593.522	0.51162

MEAN FILM = 0.250E-03 INCHES

X, INCHES	P/P (MIN)	P, PSI	U (AV), FT/SEC	MACH NO
0	4.33333	65.0000	94.2403	0.81236E-01
0.500E-C2	4.05836	60.8753	100.626	0.86741E-01
0.100E-C1	3.78251	56.7376	107.964	0.93066E-01
0.150E-C1	3.50388	52.5581	116.549	0.10047
0.200E-C1	3.22008	48.3012	126.821	0.10932
0.250E-C1	2.92797	43.9195	139.474	0.12023
0.300E-C1	2.62310	39.3465	155.684	0.13420
0.350E-C1	2.29870	34.4805	177.655	0.15314
0.400E-C1	1.94318	29.1477	210.158	0.18116
0.450E-C1	1.53294	22.9941	266.400	0.22964
0.500E-C1	1.00000	15.0000	408.375	0.35202

MEAN FILM = 0.200E-03 INCHES

X, INCHES	P/P (MIN)	P, PSI	U (AV), FT/SEC	MACH NO
0	4.33333	65.0000	59.2916	0.51110E-01
0.500E-C2	4.04018	60.6028	63.5937	0.54819E-01
0.100E-C1	3.75000	56.2501	68.5146	0.59060E-01
0.150E-C1	3.46063	51.9094	74.2438	0.63999E-01
0.200E-C1	3.16950	47.5425	81.0633	0.69878E-01
0.250E-C1	2.87340	43.1010	89.4167	0.77078E-01
0.300E-C1	2.56797	38.5196	100.352	0.86246E-01
0.350E-C1	2.24675	33.7012	114.356	0.98577E-01
0.400E-C1	1.89896	28.4844	135.301	0.11663
0.450E-C1	1.50318	22.5477	170.925	0.14734
0.500E-C1	1.00000	15.0000	256.930	0.22148

MEAN FILM = 0.150E-03 INCHES

X, INCHES	P/P (MIN)	P, PSI	U (AV), FT/SEC	MACH NO
0	4.33333	65.0000	32.1315	0.27698E-01
0.500E-C2	4.00823	60.1235	34.7376	0.29944E-01
0.100E-C1	3.69363	55.4075	37.6942	0.32493E-01
0.150E-C1	3.38711	50.8067	41.1076	0.35435E-01
0.200E-C1	3.08488	46.2732	45.1351	0.38907E-01
0.250E-C1	2.78351	41.7526	50.0219	0.43119E-01
0.300E-C1	2.47852	37.1778	56.1772	0.48425E-01
0.350E-C1	2.16374	32.4561	64.3498	0.55470E-01
0.400E-C1	1.82946	27.4420	76.1077	0.65606E-01
0.450E-C1	1.45735	21.8603	95.5406	0.82357E-01
0.500E-C1	1.00000	15.0000	139.236	0.12002

MEAN FILM = 0.100E-03 INCHES

X, INCHES	P/P (MIN)	P, PSI	U (AV), FT/SEC	MACH NO
0	4.33333	65.0000	12.8345	0.11038E-01
0.500E-C2	3.93663	59.0795	14.0877	0.12144E-01
0.100E-C1	3.57603	53.6404	15.5162	0.13375E-01
0.150E-C1	3.23850	48.5745	17.1344	0.14770E-01
0.200E-C1	2.91923	43.7885	19.0372	0.16384E-01
0.250E-C1	2.61310	39.1965	21.2340	0.18304E-01
0.300E-C1	2.31417	34.7125	23.9768	0.20668E-01
0.350E-C1	2.01593	30.2589	27.5240	0.23726E-01
0.400E-C1	1.70973	25.6459	32.4534	0.27975E-01
0.450E-C1	1.38146	20.7219	40.1650	0.34623E-01
0.500E-C1	1.00000	15.0000	55.4865	0.47830E-01

PLU1 OF X(C) VS H(MEAN)

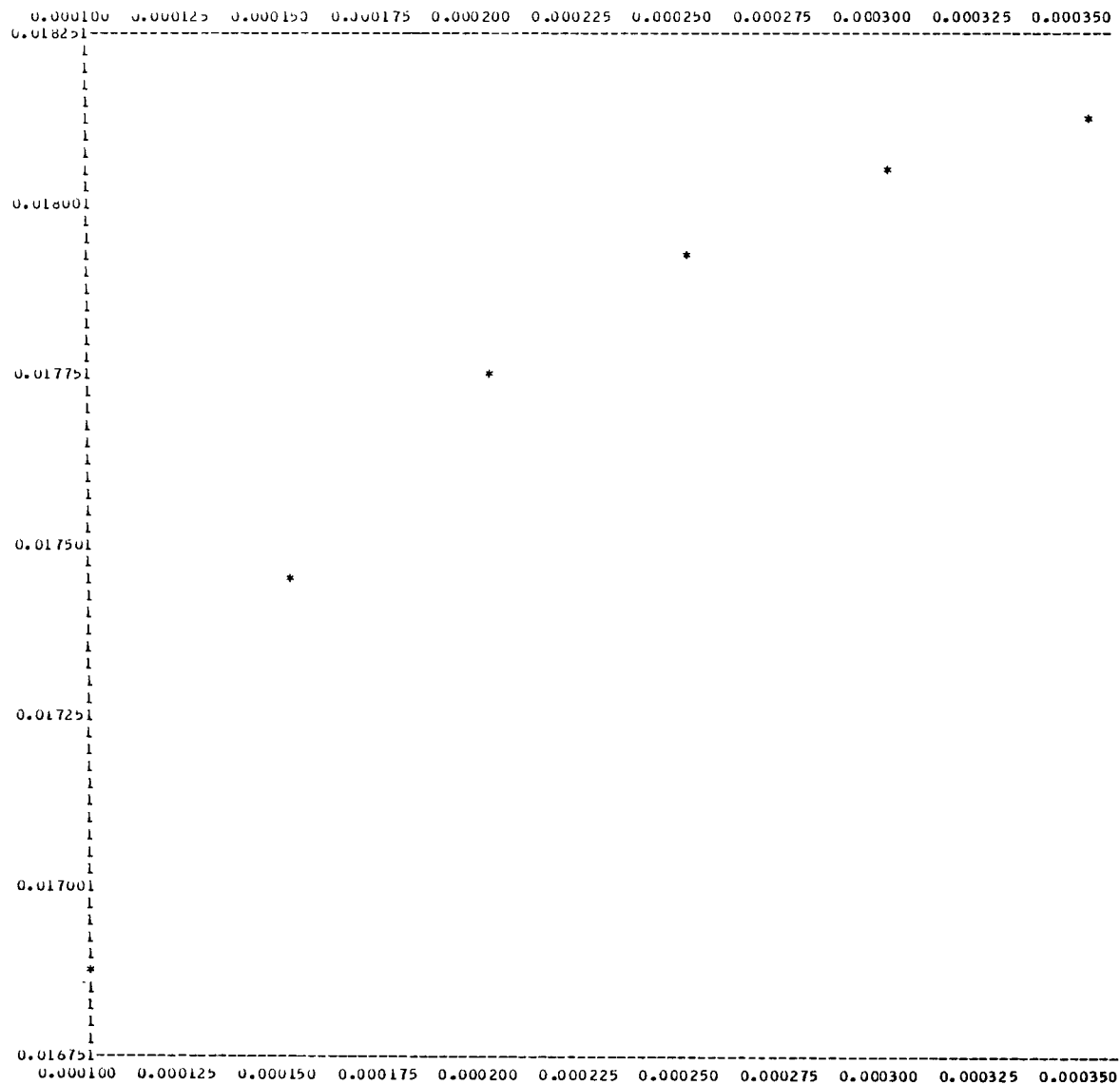

XC ON VERTICAL SCALE - H(MEAN) ON HORIZONTAL SCALE

XC IN INCHES - TO CONVERT TO METERS, MULTIPLY BY 2.54E-2

H(MEAN) IN INCHES - TO CONVERT TO METERS, MULTIPLY BY 2.54E-2

PLOT OF F(BAR) VS H(MEAN)

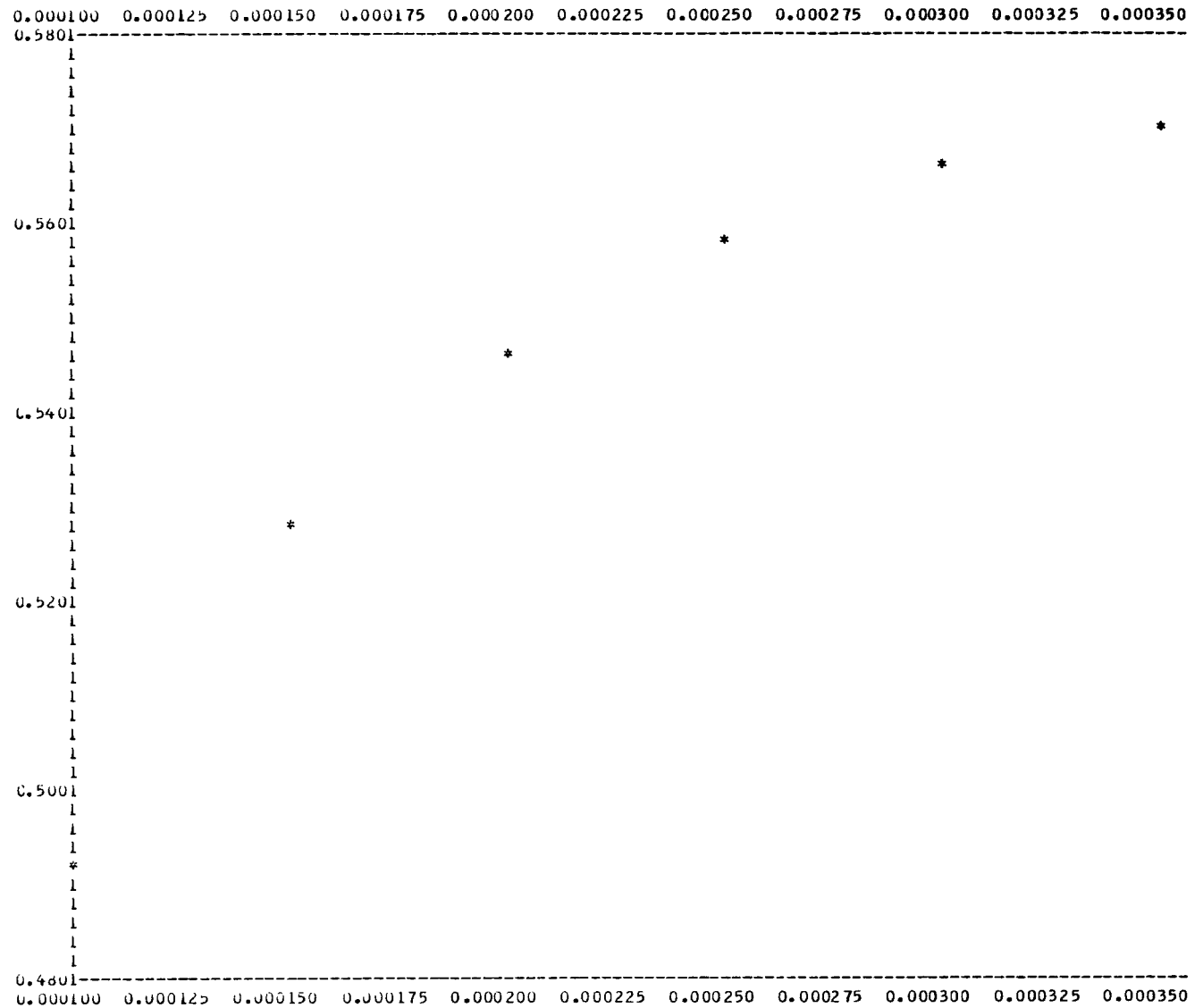

F(BAR) ON VERTICAL SCALE - H(MEAN) ON HORIZONTAL SCALE

F(BAR) IS DIMENSIONLESS

H(MEAN) IN INCHES - TO CONVERT TO METERS, MULTIPLY BY 2.54E-2



PLUT OF POWER VS H(MEAN)

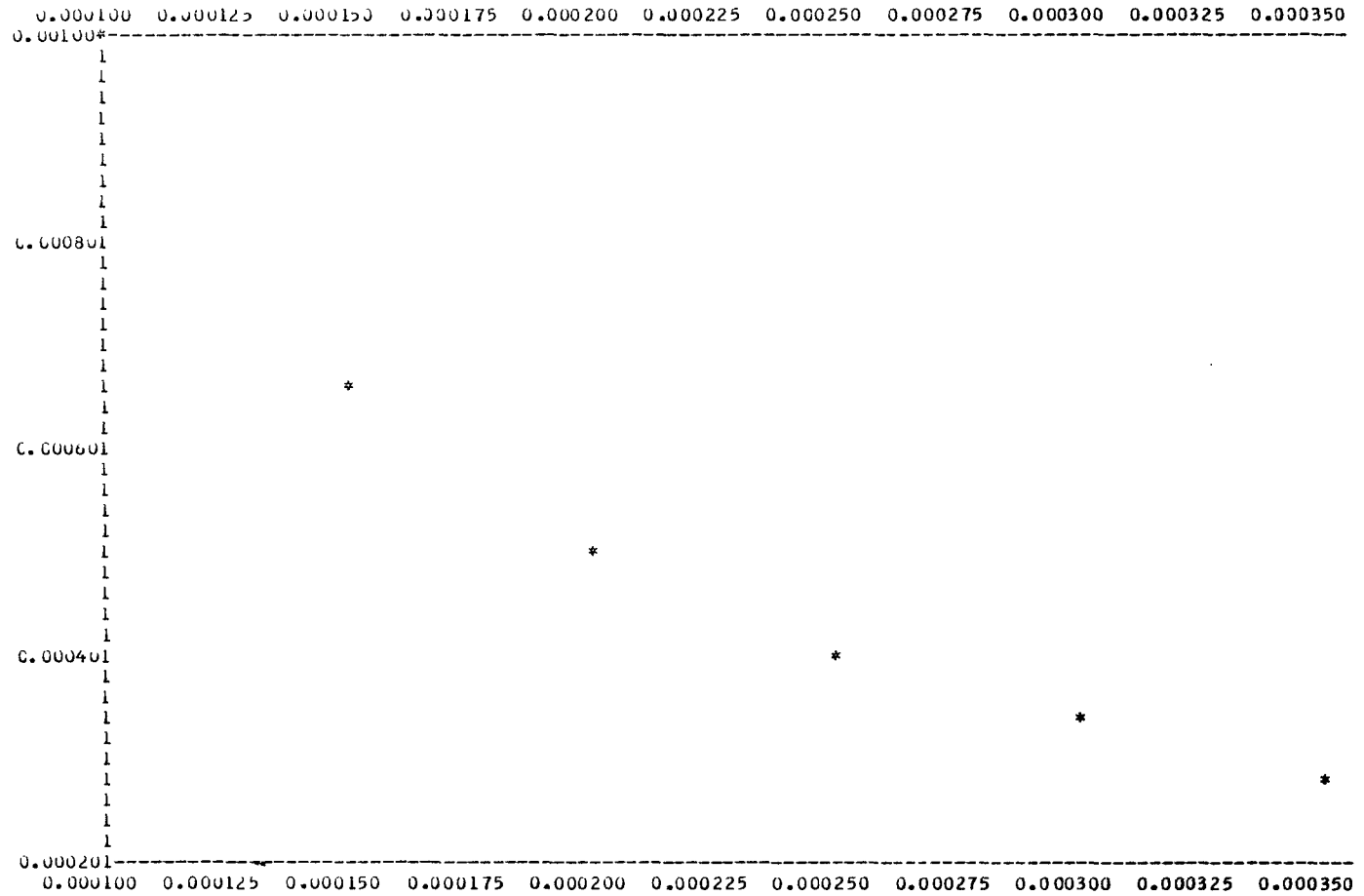

POWER ON VERTICAL SCALE - H(MEAN) ON HORIZONTAL SCALE

POWER IN HORSE POWER - TO CONVERT TO WATTS, MULTIPLY BY 745.7

H(MEAN) IN INCHES - TO CONVERT TO METERS, MULTIPLY BY 2.54E-2

FOR SHEAR HEAT IN BTU/MIN, MULTIPLY POWER BY 42.42

PLOT OF P/P(MIN) VS X FOR H(MEAN) = 0.35000E-03

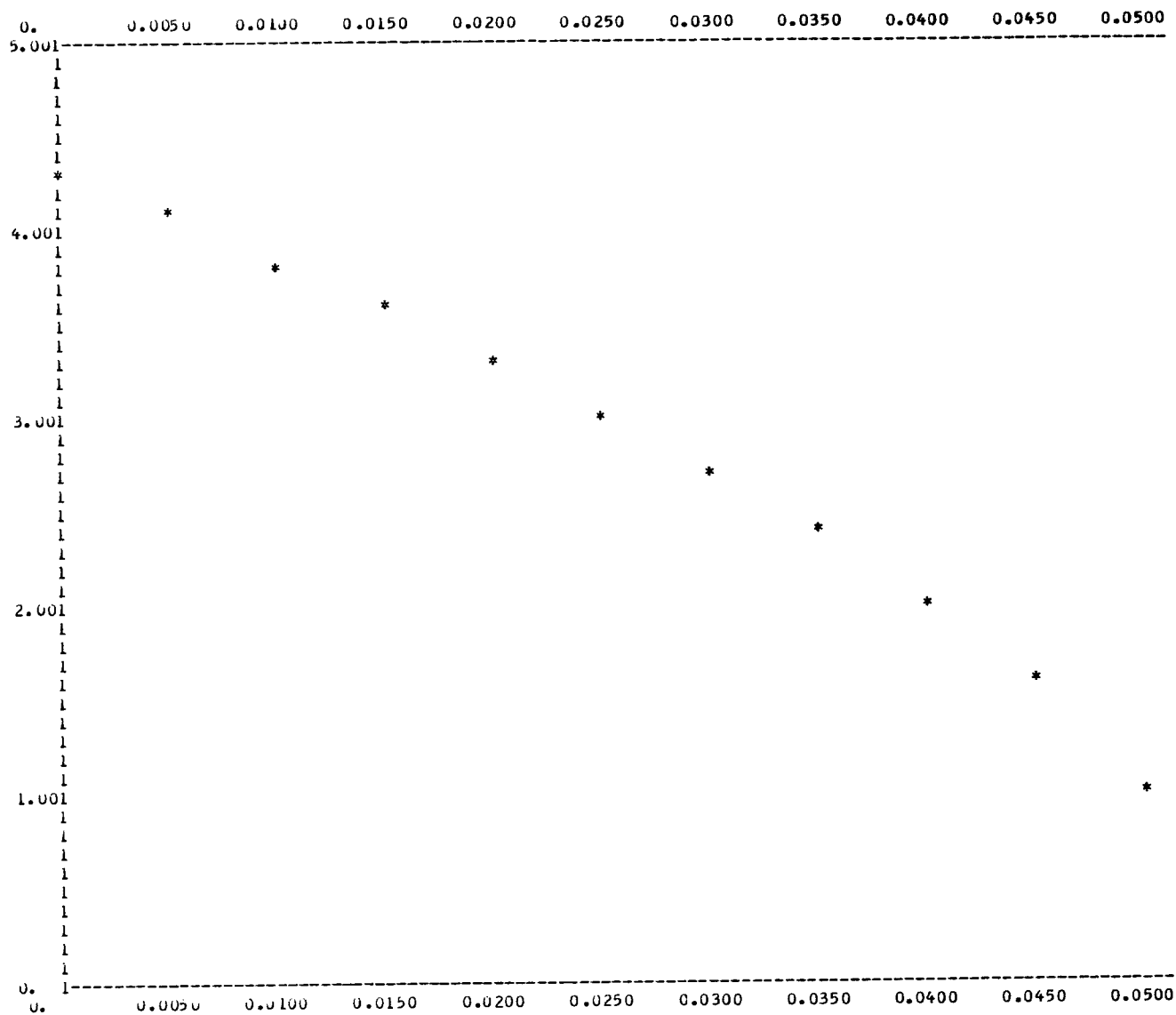

P/P(MIN) ON VERTICAL SCALE - X ON HORIZONTAL SCALE

P/P(MIN) IS DIMENSIONLESS

X IN INCHES - TO CONVERT TO METERS, MULTIPLY BY 2.54E-2

PLOT OF P/P(MIN) VS X FOR H(MEAN) = 0.30000E-03

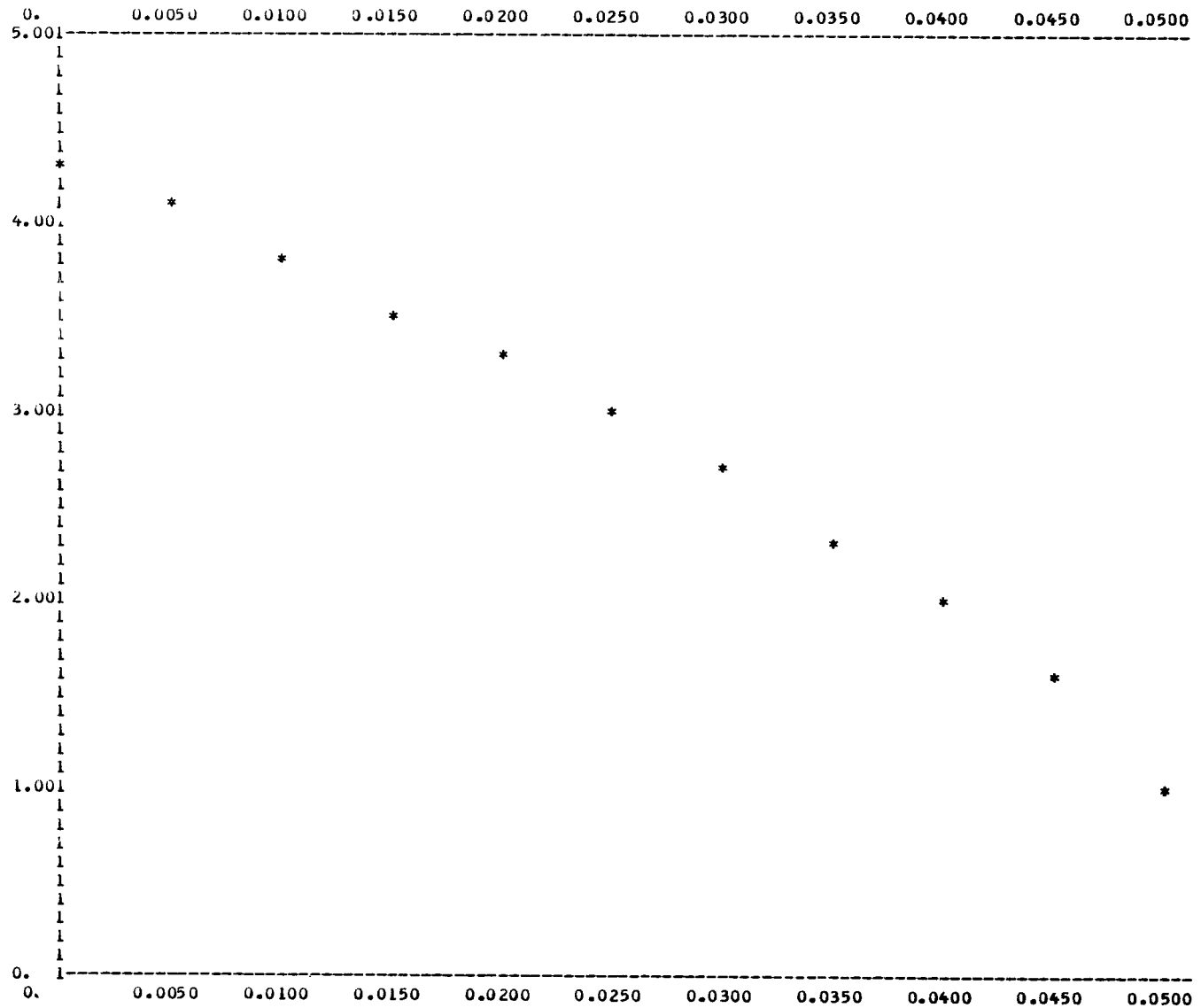

P/P(MIN) ON VERTICAL SCALE - X ON HORIZONTAL SCALE

P/P(MIN) IS DIMENSIONLESS

X IN INCHES - TO CONVERT TO METERS, MULTIPLY BY 2.54E-2

PL0T OF P/P(MIN) VS X FOR ...

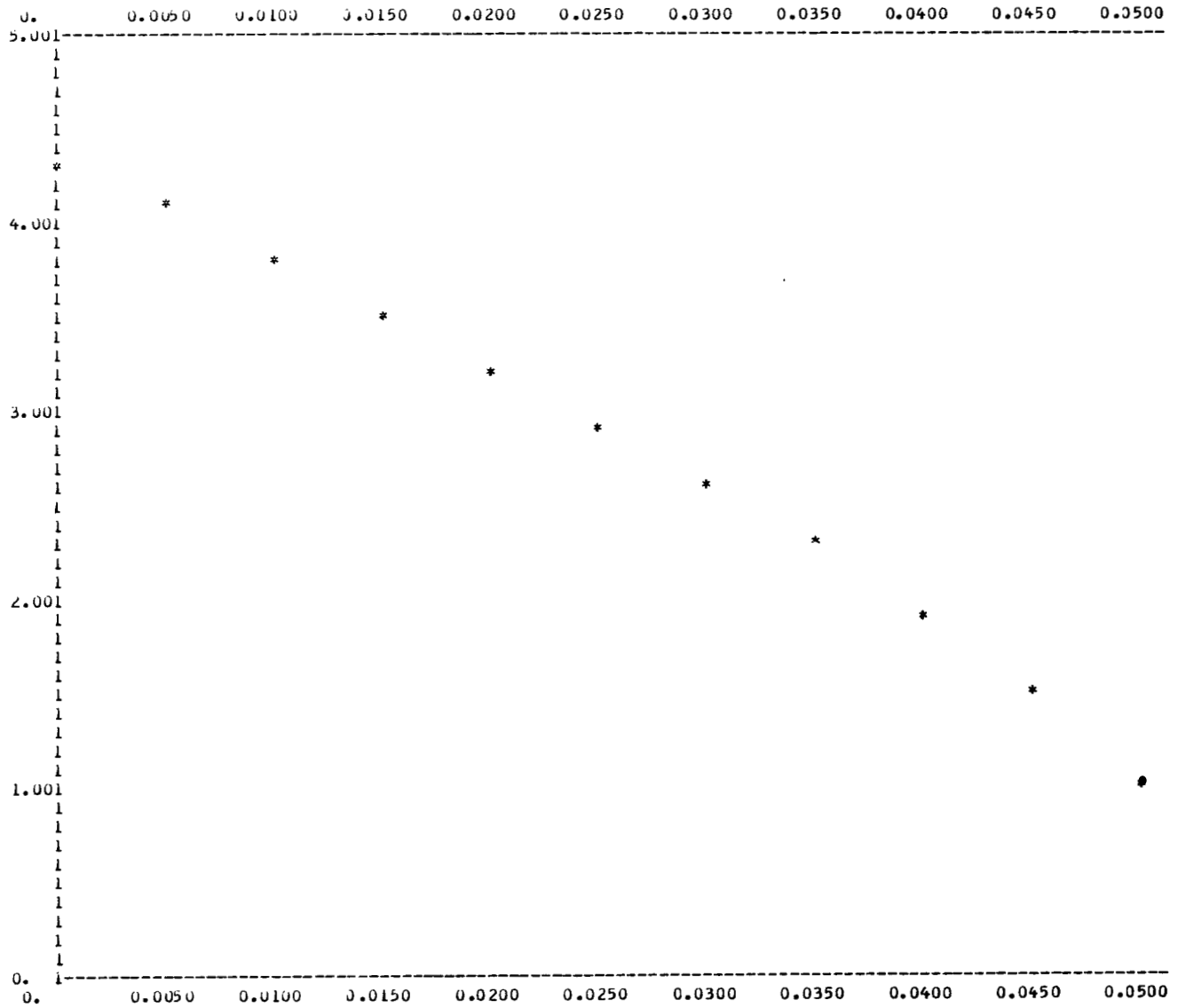

P/P(MIN) ON VERTICAL SCALE - X ON HORIZONTAL SCALE

P/P(MIN) IS DIMENSIONLESS

X IN INCHES - TO CONVERT TO METERS, MULTIPLY BY 2.54E-2

PLOT OF P/P(MIN) VS X FOR H(MEAN) = 0.20000E-03

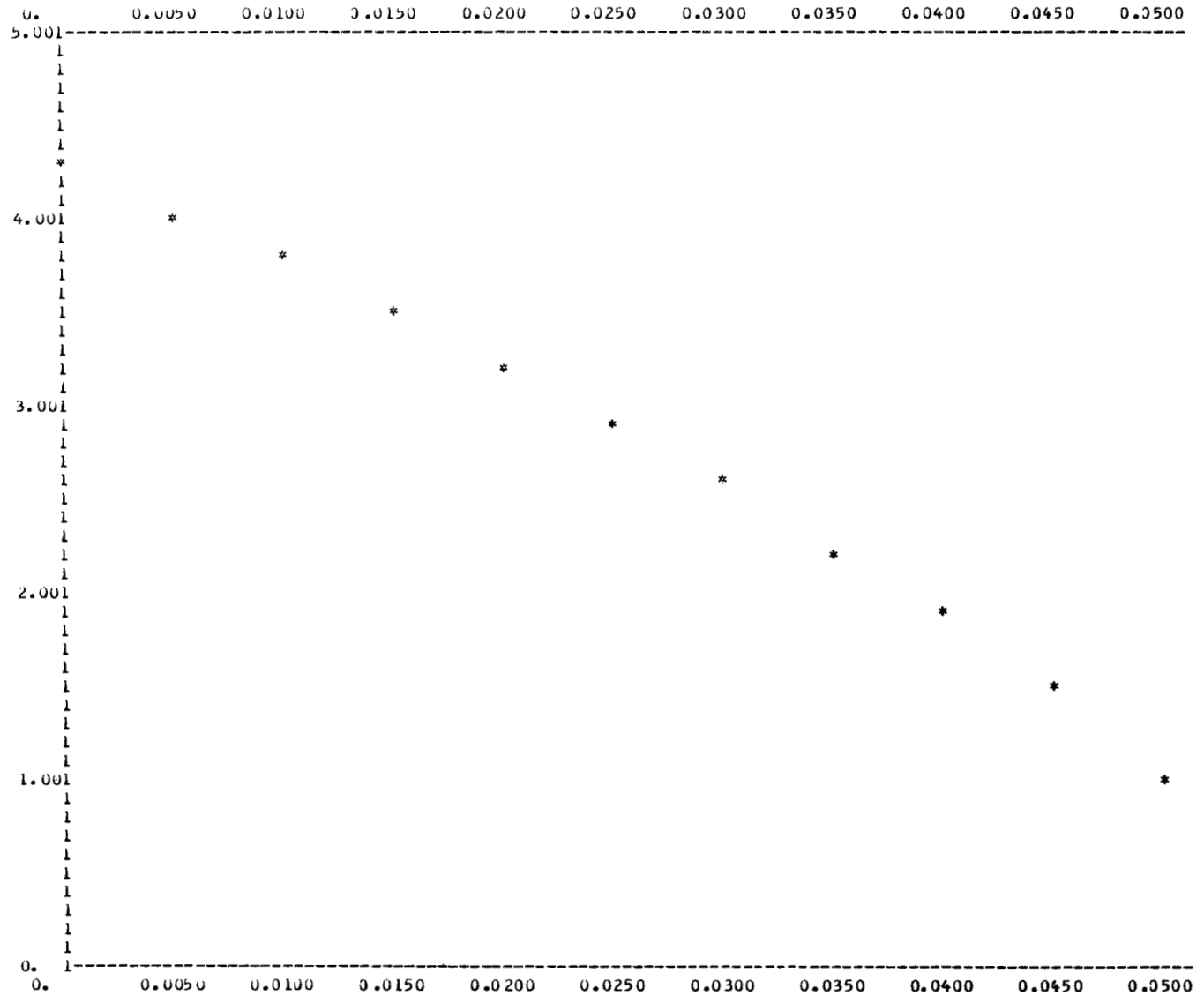

P/P(MIN) ON VERTICAL SCALE - X ON HORIZONTAL SCALE

P/P(MIN) IS DIMENSIONLESS

X IN INCHES - TO CONVERT TO METERS, MULTIPLY BY 2.54E-2

PLUT OF P/P(MIN) VS X FOR H(MEAN) = 0.15000E-03

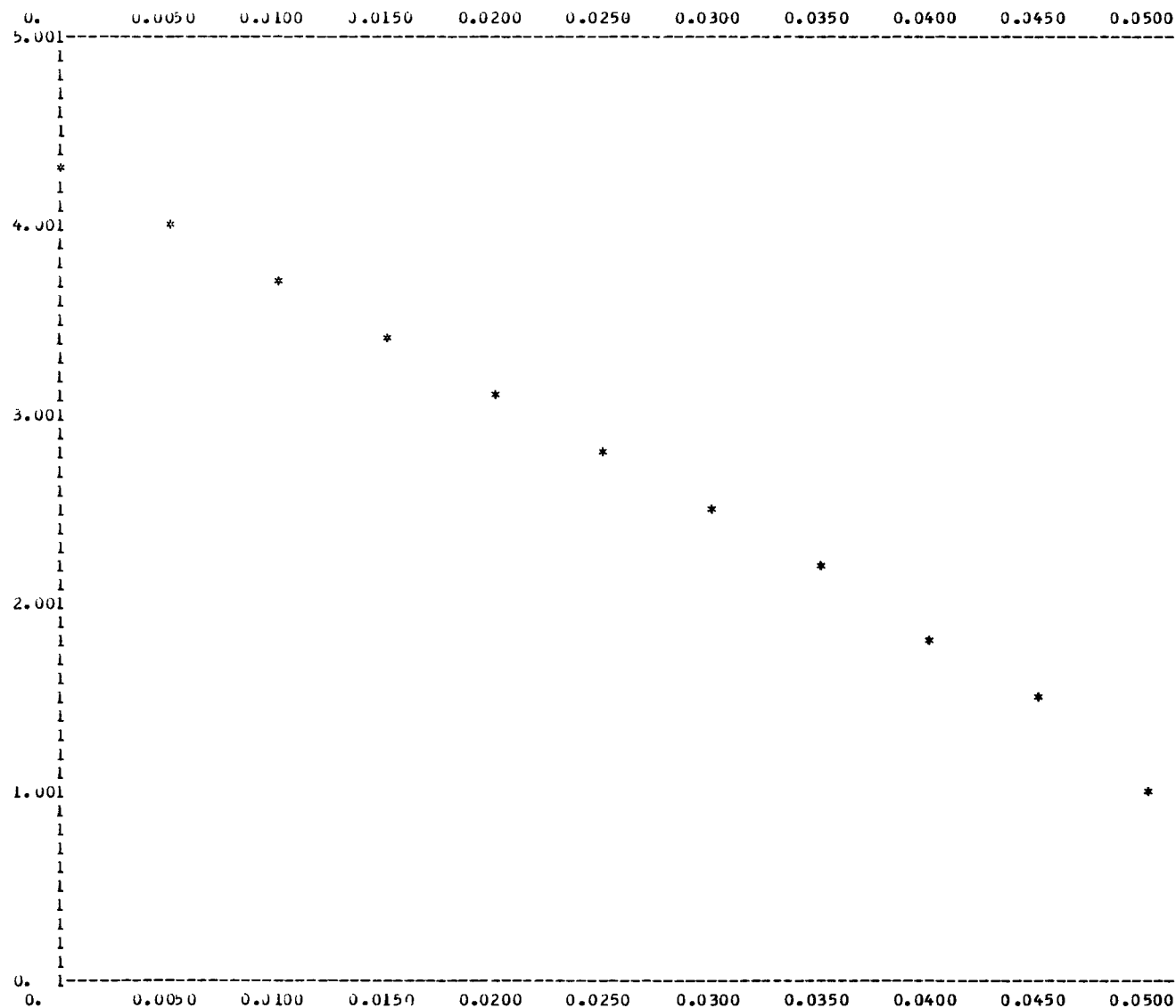

P/P(MIN) ON VERTICAL SCALE - X ON HORIZONTAL SCALE

P/P(MIN) IS DIMENSIONLESS

X IN INCHES - TO CONVERT TO METERS, MULTIPLY BY 2.54E-2

PLUT OF P/P(MIN) VS X FOR H(MEAN) = 0.10000E-03

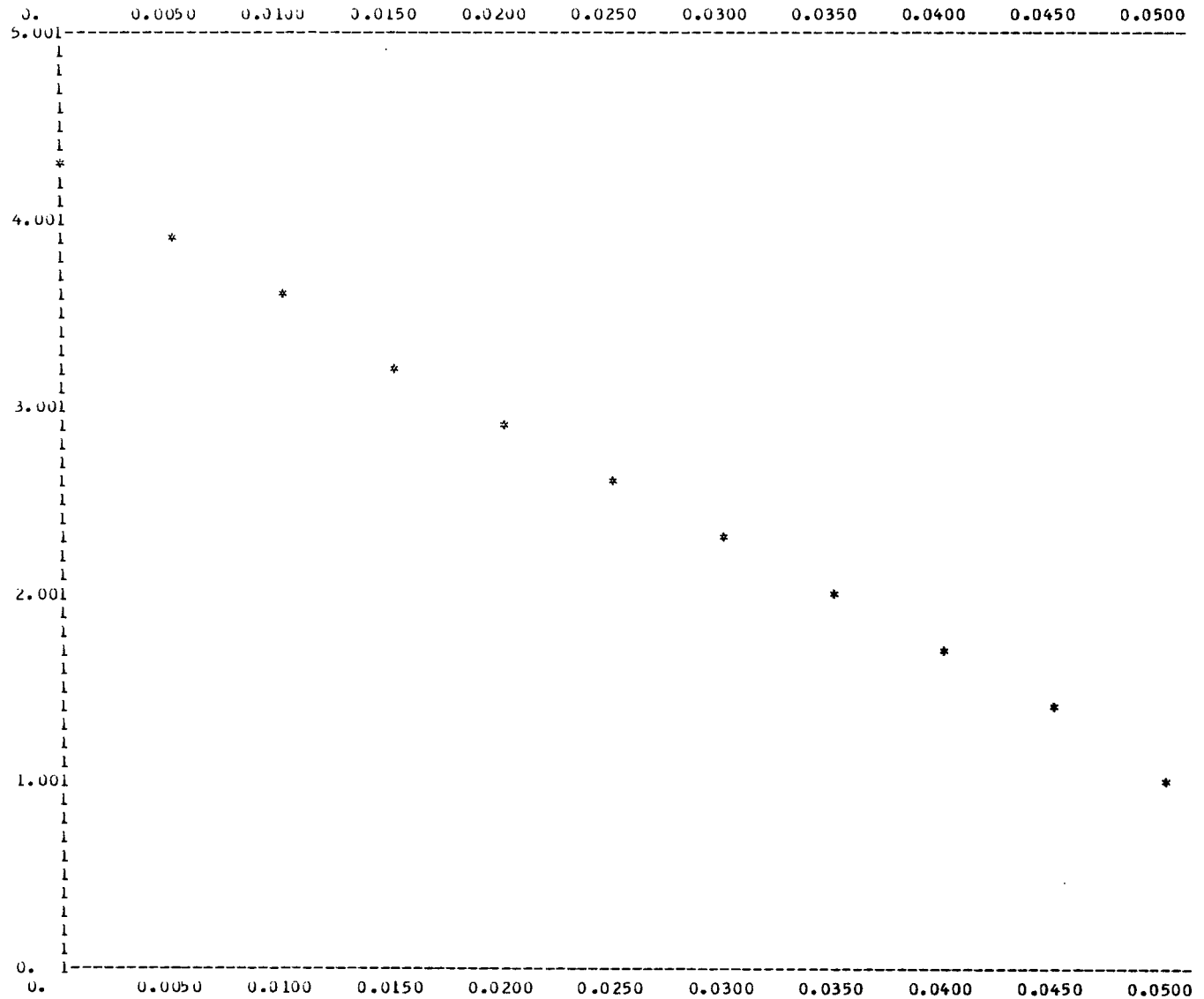

P/P(MIN) ON VERTICAL SCALE - X ON HORIZONTAL SCALE

P/P(MIN) IS DIMENSIONLESS

X IN INCHES - TO CONVERT TO METERS, MULTIPLY BY 2.54E-2

COMPRESSIBLE SEALING DAM WITH SMALL TILT ANGLE

SAMPLE PROBLEM

TILT ANGLE = 0.0010 RADIAN

P2,N/M2 0.10342E 06	P1,N/M2 0.44816E 06	I,DEG K 311.	VISCOSITY,N-S/M2 0.18961E-04	MOLECULAR WEIGHT 28.9660	CP/CV 1.40000
K2,METERS 0.84201E-01	K1,METERS 0.82931E-01	L,METERS 0.52506	RHO,KG/M3 0	RHO(ROT),KG/M3 0	NO OF GRID POINTS 11
N,KPS 23.3000	V,M/S 12.2339	CP,J/KG-DEG K 1004.76	SKIP A F	SKIP R F	SKIP T F

BEGIN OUTPUT DATA

GAS CONSTANT,J/KG-DEG K 287.086		RHO(I),KG/M3 5.03606		A(SOUND SPEED),M/S 353.591							
L,METERS 0.52506	AREA,M2 0.66683E-05	SPEED,KPS 23.3000		V,M/S 12.2339							
MEAN FILM METERS	M(DUT) KG/SEC	Q SCMS	MACH (MAX)	RE(P)	RE(R)	KNUDSEN NUMBER	F NEWTONS	STIFF KG/M	XC METERS	XC BAR	F BAR
0.254E-04							ANALYSIS NOT VALID				
0.229E-04							ANALYSIS NOT VALID				
0.203E-04							ANALYSIS NOT VALID				
0.178E-04							ANALYSIS NOT VALID				
0.152E-04							ANALYSIS NOT VALID				
0.127E-04							ANALYSIS NOT VALID				
0.114E-04							ANALYSIS NOT VALID				
0.102E-04							ANALYSIS NOT VALID				
0.889E-05	0.134E-02	0.109E-02	0.754	288.097	19.865	0.008	131.252 -0.812E 06		0.461E-03	0.363	0.571
0.762E-05	0.838E-03	0.685E-03	0.558	182.424	16.879	0.009	129.976 -0.119E 07		0.458E-03	0.361	0.565
0.635E-05	0.481E-03	0.393E-03	0.391	106.207	13.893	0.011	128.193 -0.167E 07		0.455E-03	0.359	0.558
0.568E-05	0.242E-03	0.198E-03	0.253	54.671	10.907	0.014	125.534 -0.257E 07		0.451E-03	0.355	0.546
0.381E-05	0.583E-04	0.803E-04	0.144	23.044	7.924	0.019	121.171 -0.459E 07		0.443E-03	0.349	0.527
0.254E-05	0.261E-04	0.213E-04	0.064	6.559	4.960	0.029	112.925 -0.886E 07		0.429E-03	0.338	0.491
MEAN FILM METERS	POWER,WATTS	TOTAL HEAT,WATTS		DEL(T),DEG K		TORQUE,N-M					
0.254E-04						ANALYSIS NOT VALID					
0.229E-04						ANALYSIS NOT VALID					
0.203E-04						ANALYSIS NOT VALID					
0.178E-04						ANALYSIS NOT VALID					
0.152E-04						ANALYSIS NOT VALID					
0.127E-04						ANALYSIS NOT VALID					
0.114E-04						ANALYSIS NOT VALID					
0.102E-04						ANALYSIS NOT VALID					
0.889E-05	0.21286	0.21309		0.15832		0.91356E-02					
0.762E-05	0.24834	0.24860		0.29494		0.10658E-01					
0.635E-05	0.29800	0.29832		0.61726		0.12790E-01					
0.568E-05	0.37251	0.37290		1.53296		0.15987E-01					
0.381E-05	0.49667	0.49721		5.02889		0.21316E-01					
0.254E-05	0.74501	0.74581		28.3936		0.31975E-01					



MEAN FILM = 0.88500E-05 METERS

X, METERS	P/P (MIN)	P, N/M2	U(AV), M/SEC	MACH NO
0	4.33333	0.44816E 06	57.1397	0.16160
0.127E-C3	4.07617	0.42177E 06	60.7146	0.17171
0.254E-C3	3.81840	0.39490E 06	64.8453	0.18339
0.381E-C3	3.55223	0.36738E 06	69.7042	0.19713
0.508E-C3	3.27751	0.33894E 06	75.5513	0.21367
0.635E-C3	2.99045	0.30928E 06	82.7988	0.23417
0.762E-C3	2.68697	0.27789E 06	92.1504	0.26061
0.889E-C3	2.35962	0.24403E 06	104.935	0.29677
0.102E-C2	1.99571	0.20640E 06	124.069	0.35088
0.114E-C2	1.58888	0.16226E 06	157.823	0.44634
0.127E-C2	1.00000	0.10342E 06	247.605	0.70026

MEAN FILM = 0.76200E-05 METERS

X, METERS	P/P (MIN)	P, N/M2	U(AV), M/SEC	MACH NO
0	4.33333	0.44816E 06	41.7474	0.11807
0.127E-C3	4.07004	0.42093E 06	44.4481	0.12570
0.254E-C3	3.80361	0.39337E 06	47.5614	0.13451
0.381E-C3	3.53224	0.36531E 06	51.2156	0.14464
0.508E-C3	3.25356	0.33649E 06	55.6023	0.15725
0.635E-C3	2.96442	0.30658E 06	61.0255	0.17259
0.762E-C3	2.66627	0.27513E 06	68.0026	0.19232
0.889E-C3	2.33406	0.24139E 06	77.5068	0.21920
0.102E-C2	1.97358	0.20411E 06	91.6636	0.25924
0.114E-C2	1.55360	0.16008E 06	116.438	0.32930
0.127E-C2	1.00000	0.10342E 06	180.905	0.51162

MEAN FILM = 0.63500E-05 METERS

X, METERS	P/P (MIN)	P, N/M2	U(AV), M/SEC	MACH NO
0	4.33333	0.44816E 06	28.7245	0.81236E-01
0.127E-C3	4.05836	0.41972E 06	30.6707	0.86741E-01
0.254E-C3	3.78251	0.39119E 06	32.9075	0.93066E-01
0.381E-C3	3.50388	0.36238E 06	35.5243	0.10047
0.508E-C3	3.22008	0.33303E 06	38.6551	0.10932
0.635E-C3	2.92797	0.30281E 06	42.5116	0.12023
0.762E-C3	2.62310	0.27128E 06	47.4525	0.13420
0.889E-C3	2.29870	0.23773E 06	54.1491	0.15314
0.102E-C2	1.94318	0.20097E 06	64.0562	0.18116
0.114E-C2	1.53294	0.15854E 06	81.1987	0.22964
0.127E-C2	1.00000	0.10342E 06	124.473	0.35202

MEAN FILM = 0.50600E-05 METERS

X, METERS	P/P (MIN)	P, N/M2	U(AV), M/SEC	MACH NO
0	4.33333	0.44810E 00	18.0721	0.51110E-01
0.127E-C3	4.04010	0.41784E 00	19.3834	0.54819E-01
0.254E-C3	3.75000	0.38783E 00	20.8833	0.59060E-01
0.381E-C3	3.46003	0.35790E 00	22.6295	0.63999E-01
0.508E-C3	3.16950	0.32779E 00	24.7361	0.69878E-01
0.635E-C3	2.87340	0.29717E 00	27.2542	0.77078E-01
0.762E-C3	2.58797	0.26558E 00	30.4958	0.86246E-01
0.889E-C3	2.24675	0.23230E 00	34.8558	0.98577E-01
0.102E-C2	1.89876	0.19839E 00	41.2396	0.11663
0.114E-C2	1.50318	0.15540E 00	52.0979	0.14734
0.127E-C2	1.00000	0.10342E 00	78.3123	0.22148

MEAN FILM = 0.38100E-05 METERS

X, METERS	P/P (MIN)	P, N/M2	U(AV), M/SEC	MACH NO
0	4.33333	0.44810E 00	9.79507	0.27698E-01
0.127E-C3	4.00823	0.41454E 00	10.5880	0.29944E-01
0.254E-C3	3.65383	0.38202E 00	11.4892	0.32493E-01
0.381E-C3	3.38711	0.35050E 00	12.5296	0.35435E-01
0.508E-C3	3.08488	0.31904E 00	13.7572	0.38907E-01
0.635E-C3	2.78351	0.28787E 00	15.2467	0.43119E-01
0.762E-C3	2.47852	0.25633E 00	17.1228	0.48425E-01
0.889E-C3	2.16374	0.22378E 00	19.6138	0.55470E-01
0.102E-C2	1.82946	0.18921E 00	23.1976	0.65606E-01
0.114E-C2	1.45735	0.15072E 00	29.1208	0.82357E-01
0.127E-C2	1.00000	0.10342E 00	42.4392	0.12002

MEAN FILM = 0.25400E-05 METERS

X, METERS	P/P (MIN)	P, N/M2	U(AV), M/SEC	MACH NO
0	4.33333	0.44810E 00	3.90283	0.11038E-01
0.127E-C3	3.93863	0.40734E 00	4.29394	0.12144E-01
0.254E-C3	3.57603	0.36984E 00	4.72935	0.13375E-01
0.381E-C3	3.25830	0.33491E 00	5.22258	0.14770E-01
0.508E-C3	2.91923	0.30191E 00	5.79340	0.16384E-01
0.635E-C3	2.61310	0.27025E 00	6.47211	0.18304E-01
0.762E-C3	2.31417	0.23933E 00	7.30814	0.20668E-01
0.889E-C3	2.01593	0.20849E 00	8.38933	0.23726E-01
0.102E-C2	1.70573	0.17882E 00	9.89179	0.27975E-01
0.114E-C2	1.38146	0.14287E 00	12.2423	0.34623E-01
0.127E-C2	1.00000	0.10342E 00	16.9123	0.47830E-01

## COMPRESSIBLE SEALING DAM WITH SMALL TILT ANGLE

SAMPLE PROBLEM

INPUT DATA -

TILT ANGLE = -0.0010 RADIANS

P2, PSIA 15.0000	P1, PSIA 05.0000	T, DEG F 100.	VISCOSITY, LB-SEC/FT2 0.39600E-06	MOLECULAR WEIGHT 28.9660	CP/CV 1.40000
K2, INCHES 3.31500	K1, INCHES 3.26500	L, INCHES 20.6717	RHO, LB-SEC2/FT4 0	RHO(RUT), LB-SEC2/FT4 0	NO OF GRID POINTS 11
N, RPM 1398.00	V, FT/SEC 40.1375	CP, BTU/LB-DEG R 0.24000	SKIP A F	SKIP R F	SKIP T F

BEGIN OUTPUT DATA

GAS CONSTANT, FT-LB/LB(M)-DEG R 53.3522		RHO(1), LB-SEC2/FT4 0.97371E-02		A(SOUND SPEED), FT/SEC 1160.08							
L, INCHES 20.6717	AREA, IN2 1.03338	SPEED, RPM 1398.00		V, FT/SEC 40.1375							
MEAN FILM INCHES	M(OUT) LB/MIN	Q SCFM	MACH (MAX)	RE(P)	RE(R)	KNUDSEN NUMBER	F LB	STIFF LB/IN	XC INCHES	XC BAR	F BAR
0.100E-02											ANALYSIS NOT VALID
0.900E-03											ANALYSIS NOT VALID
0.800E-03											ANALYSIS NOT VALID
0.700E-03											ANALYSIS NOT VALID
0.600E-03											ANALYSIS NOT VALID
0.500E-03											ANALYSIS NOT VALID
0.450E-03											ANALYSIS NOT VALID
0.400E-03											ANALYSIS NOT VALID
0.350E-03	0.177	2.310	0.754	208.097	21.866	0.008	32.894	0.444E 04	0.191E-01	0.383	0.637
0.300E-03	0.111	1.451	0.558	182.424	18.876	0.009	33.165	0.635E 04	0.192E-01	0.384	0.642
0.250E-03	0.030E-01	0.852	0.391	106.207	15.883	0.011	33.539	0.887E 04	0.193E-01	0.386	0.649
0.200E-03	0.320E-01	0.419	0.253	54.671	12.884	0.014	34.090	0.134E 05	0.195E-01	0.390	0.660
0.150E-03	0.130E-01	0.170	0.144	23.044	9.874	0.019	34.974	0.233E 05	0.197E-01	0.395	0.677
0.100E-03	0.340E-02	0.452E-01	0.004	6.559	6.830	0.029	36.590	0.435E 05	0.202E-01	0.404	0.708
MEAN FILM, INCHES	POWER, H.P.	SHEAR HEAT, BTU/MIN		DEL(T), DEG F		TORQUE, FT-LB					
0.100E-02											ANALYSIS NOT VALID
0.900E-03											ANALYSIS NOT VALID
0.800E-03											ANALYSIS NOT VALID
0.700E-03											ANALYSIS NOT VALID
0.600E-03											ANALYSIS NOT VALID
0.500E-03											ANALYSIS NOT VALID
0.450E-03											ANALYSIS NOT VALID
0.400E-03											ANALYSIS NOT VALID
0.350E-03	0.28545E-03	0.12109E-01		0.28497		0.67381E-02					
0.300E-03	0.33302E-03	0.14127E-01		0.53089		0.78611E-02					
0.250E-03	0.39963E-03	0.16952E-01		1.11107		0.94333E-02					
0.200E-03	0.49954E-03	0.21190E-01		2.75934		0.11792E-01					
0.150E-03	0.66005E-03	0.28254E-01		9.05200		0.15722E-01					
0.100E-03	0.99907E-03	0.42381E-01		51.1084		0.23583E-01					

MEAN FILM = 0.350E-03 INCHES

X, INCHES	P/P (MIN)	P, PSI	U(AV), FT/SEC	MACH NO
0.500E-C1	1.00000	15.0000	812.354	0.70026
0.450E-C1	1.77378	26.0067	457.978	0.39478
0.400E-C1	2.27982	34.1974	350.323	0.30715
0.350E-C1	2.67571	40.1357	303.002	0.26171
0.300E-C1	3.06616	45.0424	270.233	0.23294
0.250E-C1	3.25100	49.3749	246.792	0.21274
0.200E-C1	3.54372	53.1550	229.237	0.19761
0.150E-C1	3.76901	56.5442	215.501	0.18576
0.100E-C1	3.97428	59.0143	204.403	0.17620
0.500E-C2	4.10130	62.4195	195.216	0.16828
0.400E-C9	4.33333	65.0000	187.466	0.16160

MEAN FILM = 0.300E-03 INCHES

X, INCHES	P/P (MIN)	P, PSI	U(AV), FT/SEC	MACH NO
0.500E-C1	1.00000	15.0000	593.522	0.51162
0.450E-C1	1.79236	26.8854	331.140	0.28545
0.400E-C1	2.30441	34.5661	257.559	0.22202
0.350E-C1	2.70205	40.5308	219.656	0.18935
0.300E-C1	3.03185	45.4778	195.762	0.16875
0.250E-C1	3.31511	49.7267	179.035	0.15433
0.200E-C1	3.56381	53.4571	166.541	0.14356
0.150E-C1	3.78549	56.7824	156.789	0.13515
0.100E-C1	3.98552	59.7798	148.927	0.12838
0.500E-C2	4.16700	62.5050	142.434	0.12278
0.400E-C9	4.33333	65.0000	136.967	0.11807

MEAN FILM = 0.250E-03 INCHES

X, INCHES	P/P (MIN)	P, PSI	U(AV), FT/SEC	MACH NO
0.500E-C1	1.00000	15.0000	408.375	0.35202
0.450E-C1	1.81866	27.2799	224.547	0.19356
0.400E-C1	2.33689	35.0834	174.002	0.15051
0.350E-C1	2.73873	41.0809	149.111	0.12854
0.300E-C1	3.06739	46.0108	133.134	0.11476
0.250E-C1	3.34736	50.2103	121.999	0.10516
0.200E-C1	3.59126	53.8688	113.714	0.98023E-01
0.150E-C1	3.80707	57.1060	107.268	0.92466E-01
0.100E-C1	4.00023	60.0034	102.088	0.88001E-01
0.500E-C2	4.17407	62.6201	97.8221	0.84324E-01
0.400E-C9	4.33333	65.0000	94.2404	0.81236E-01

MEAN FILM = 0.200E-03 INCHES

X, INCHES	P/P (MIN)	P, PSI	U(AV), FT/SEC	MACH NO
0.500E-C1	1.00000	15.0000	256.930	0.22148
0.450E-C1	1.85868	27.8802	138.233	0.11916
0.400E-C1	2.39066	35.8599	107.473	0.92643E-01
0.350E-C1	2.79317	41.8976	91.9850	0.79292E-01
0.300E-C1	3.11962	46.7943	82.3594	0.70995E-01
0.250E-C1	3.35431	50.9147	75.6944	0.65249E-01
0.200E-C1	3.63088	54.4632	70.7625	0.60998E-01
0.150E-C1	3.83795	57.5693	66.9446	0.57707E-01
0.100E-C1	4.02141	60.3211	63.8906	0.55074E-01
0.500E-C2	4.18548	62.7822	61.3861	0.52916E-01
0.466E-C9	4.33333	65.0000	59.2916	0.51110E-01

MEAN FILM = 0.150E-03 INCHES

X, INCHES	P/P (MIN)	P, PSI	U(AV), FT/SEC	MACH NO
0.500E-C1	1.00000	15.0000	139.236	0.12002
0.450E-C1	1.92662	28.8993	72.2698	0.62297E-01
0.400E-C1	2.47056	37.1484	56.2216	0.48464E-01
0.350E-C1	2.88188	43.2282	48.3144	0.41648E-01
0.300E-C1	3.20333	48.0499	43.4562	0.37468E-01
0.250E-C1	3.46841	52.0261	40.1441	0.34605E-01
0.200E-C1	3.69252	55.3878	37.7076	0.32504E-01
0.150E-C1	3.88536	58.2803	35.8362	0.30891E-01
0.100E-C1	4.05350	60.8025	34.3497	0.29610E-01
0.500E-C2	4.20165	63.0248	33.1384	0.28566E-01
0.466E-C9	4.33333	65.0000	32.1315	0.27698E-01

MEAN FILM = 0.100E-03 INCHES

X, INCHES	P/P (MIN)	P, PSI	U(AV), FT/SEC	MACH NO
0.500E-C1	1.00000	15.0000	55.4865	0.47830E-01
0.450E-C1	2.06517	30.9776	26.8577	0.23160E-01
0.400E-C1	2.64382	39.6573	20.9872	0.18091E-01
0.350E-C1	3.04814	45.7222	18.2934	0.15692E-01
0.300E-C1	3.35498	50.3247	16.5386	0.14256E-01
0.250E-C1	3.59854	53.9781	15.4192	0.13292E-01
0.200E-C1	3.79168	56.9652	14.6106	0.12595E-01
0.150E-C1	3.96407	59.4610	13.9974	0.12066E-01
0.100E-C1	4.10544	61.5815	13.5154	0.11650E-01
0.500E-C2	4.22721	63.4082	13.1260	0.11315E-01
0.466E-C9	4.33333	65.0000	12.8046	0.11038E-01

PLUT OF X(L) VS H(MEAN)

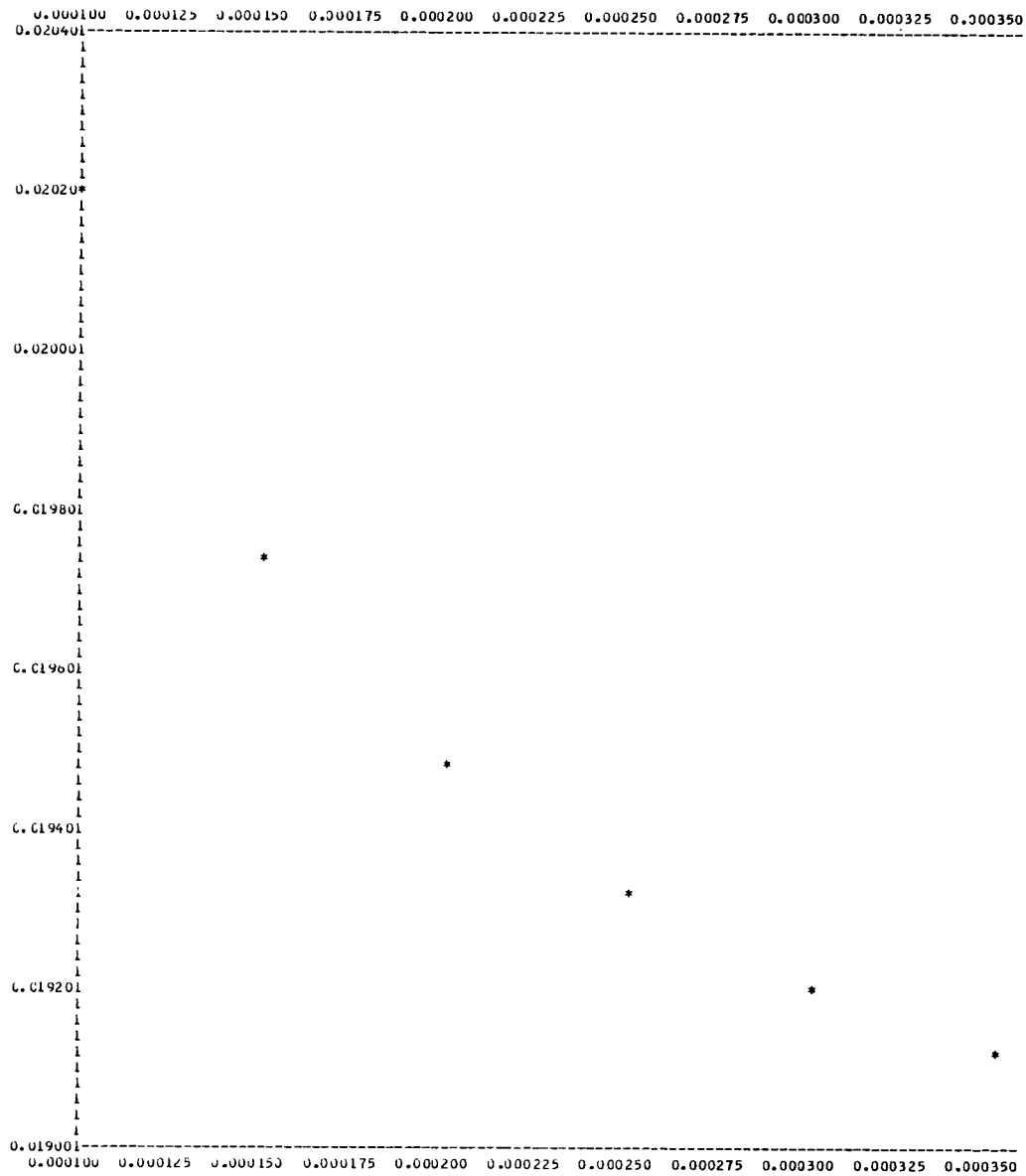

XC ON VERTICAL SCALE - H(MEAN) ON HORIZONTAL SCALE  
XC IN INCHES - TO CONVERT TO METERS, MULTIPLY BY 2.54E-2  
H(MEAN) IN INCHES - TO CONVERT TO METERS, MULTIPLY BY 2.54E-2

PLOT OF F(BAR) VS H(MEAN)

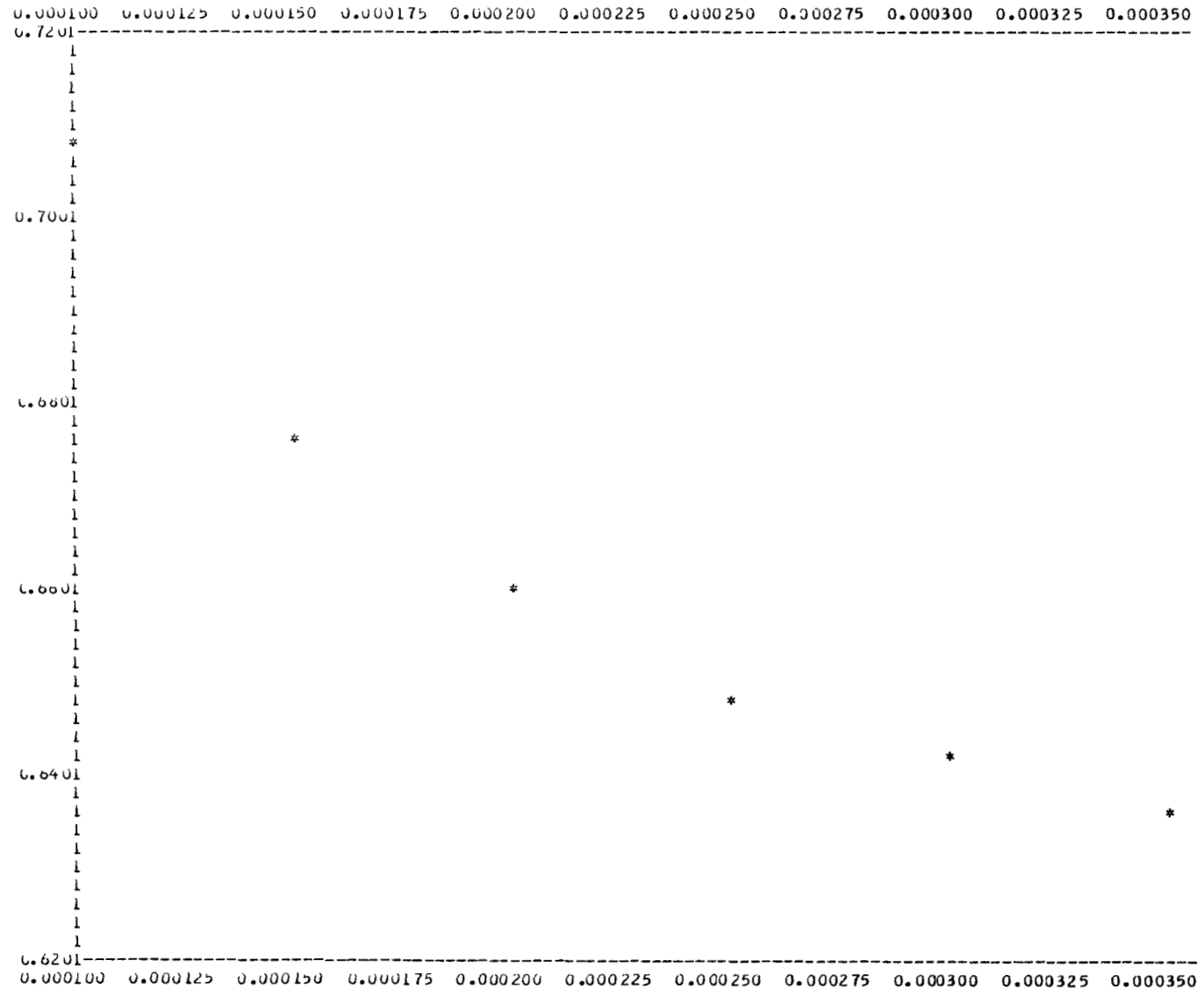

F(BAR) ON VERTICAL SCALE - H(MEAN) ON HORIZONTAL SCALE

F(BAR) IS DIMENSIONLESS

H(MEAN) IN INCHES - TO CONVERT TO METERS, MULTIPLY BY 2.54E-2

PLUT OF POWER VS H(MEAN)

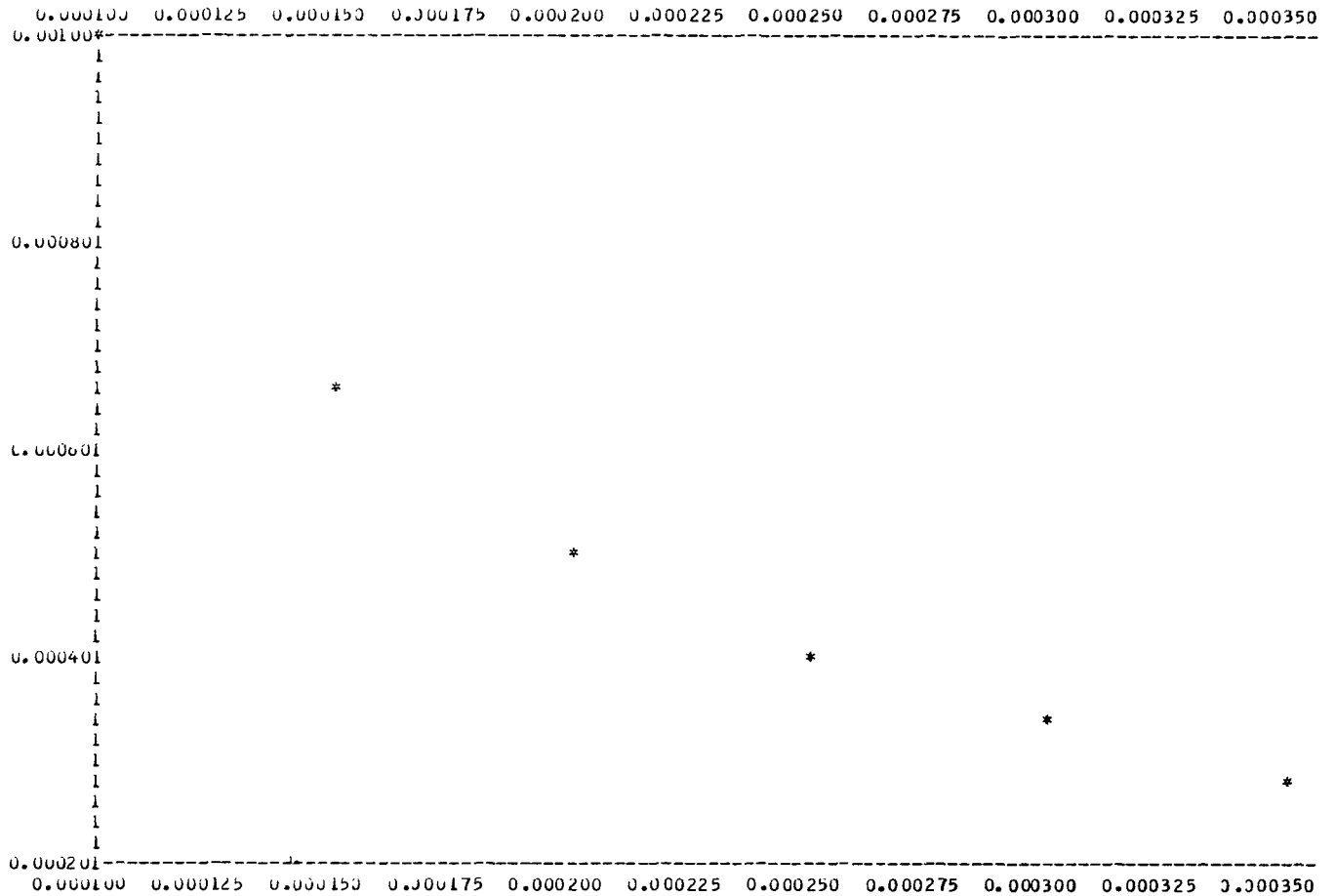

POWER ON VERTICAL SCALE - H(MEAN) ON HORIZONTAL SCALE

POWER IN HORSE POWER - TO CONVERT TO WATTS, MULTIPLY BY 745.7

H(MEAN) IN INCHES - TO CONVERT TO METERS, MULTIPLY BY 2.54E-2

FOR SHEAR HEAT IN BTU/MIN, MULTIPLY POWER BY 42.42



PLOT OF P/P(MIN) VS X FOR H(MEAN) = 0.35000E-03

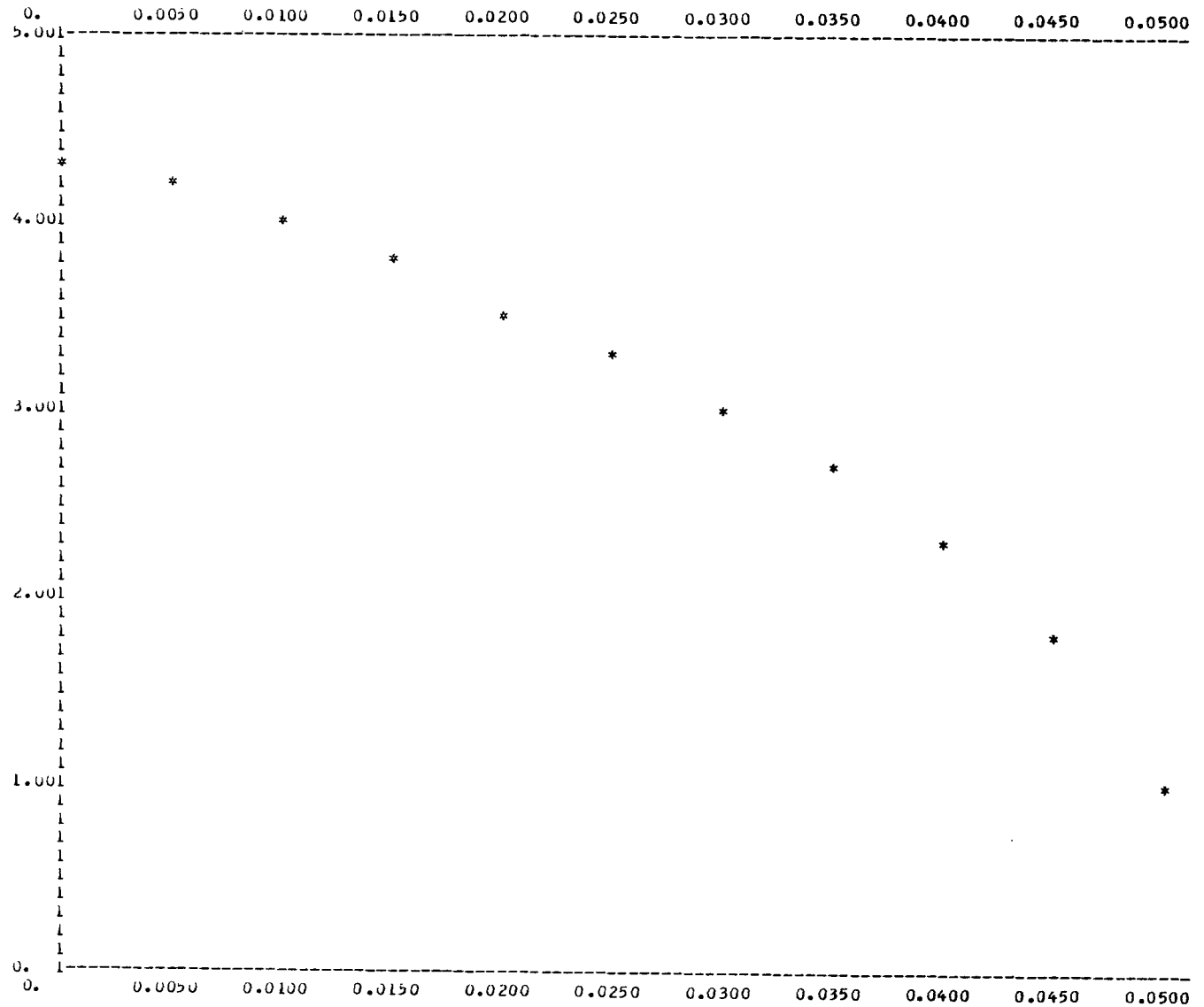

P/P(MIN) ON VERTICAL SCALE - X ON HORIZONTAL SCALE

P/P(MIN) IS DIMENSIONLESS

X IN INCHES - TO CONVERT TO METERS, MULTIPLY BY 2.54E-2

PLOT OF P/P(MIN) VS X FOR H(MEAN) = 0.30000E-03

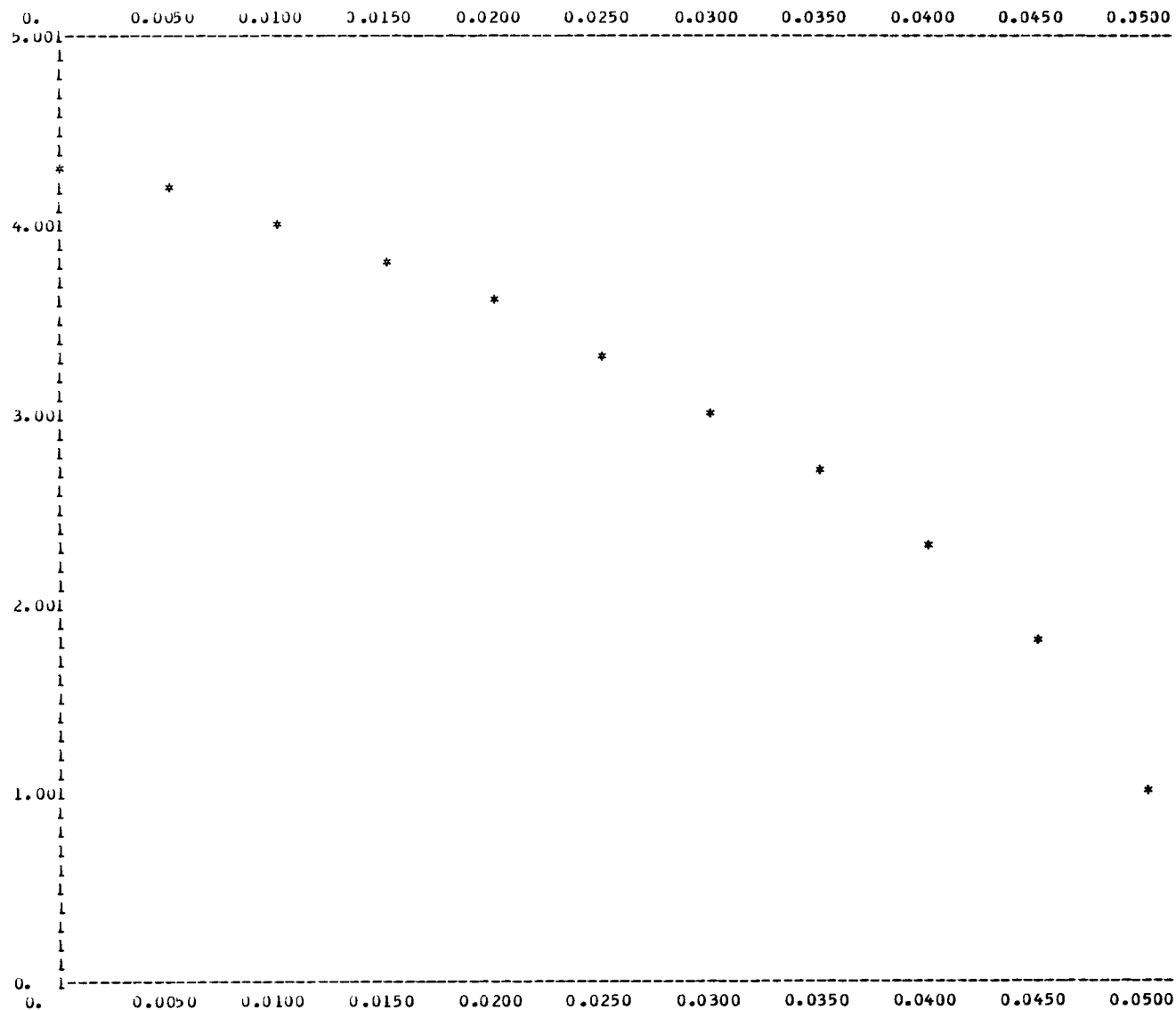

P/P(MIN) ON VERTICAL SCALE - X ON HORIZONTAL SCALE

P/P(MIN) IS DIMENSIONLESS

X IN INCHES - TO CONVERT TO METERS, MULTIPLY BY 2.54E-2

PLOT OF P/P(MIN) VS X FOR H(MEAN) = 0.25000E-03

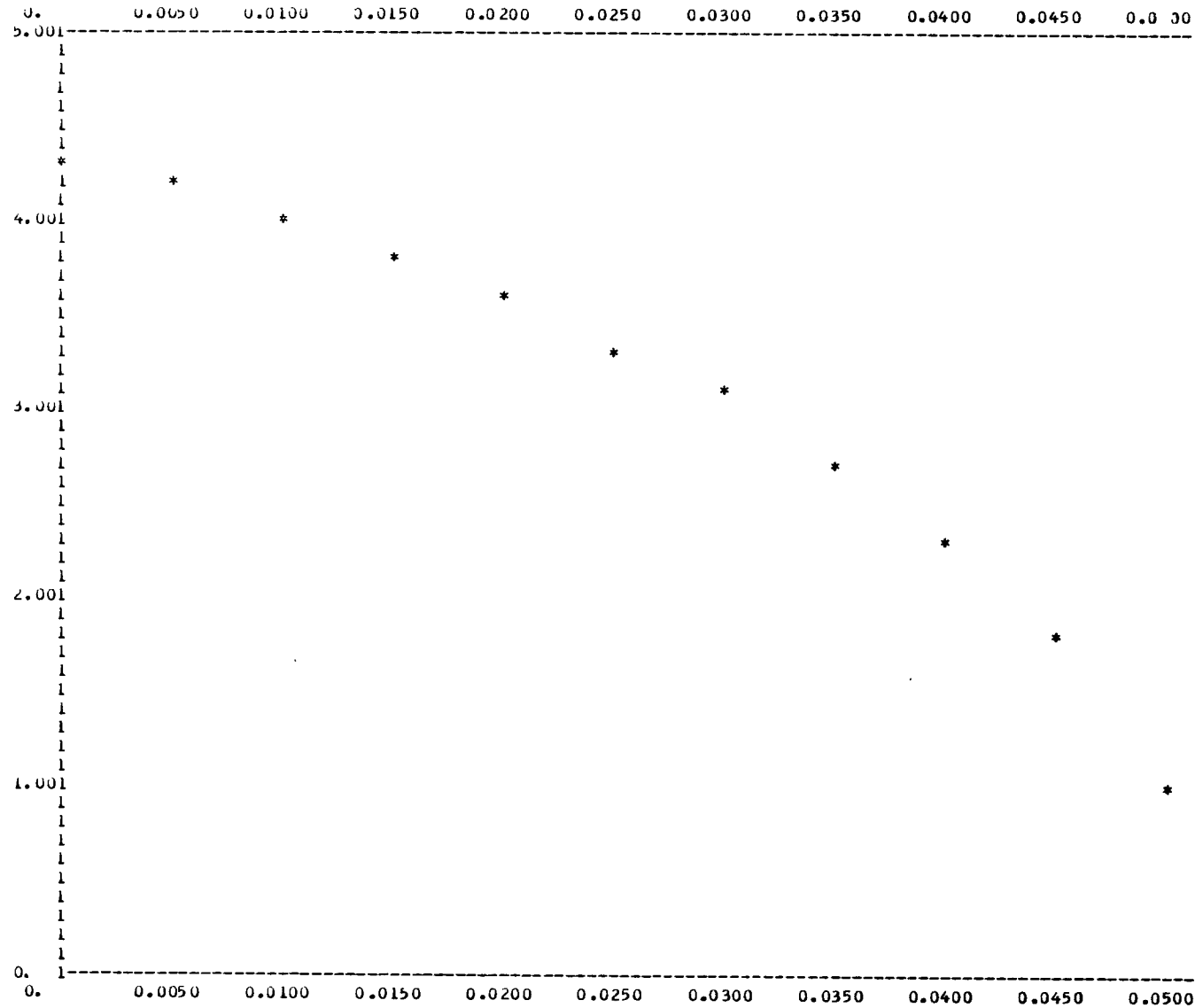

P/P(MIN) ON VERTICAL SCALE - X ON HORIZONTAL SCALE

P/P(MIN) IS DIMENSIONLESS

X IN INCHES - TO CONVERT TO METERS, MULTIPLY BY 2.54E-2

PLOT OF P/P(MIN) VS X FOR H(MEAN) = 0.20000E-03

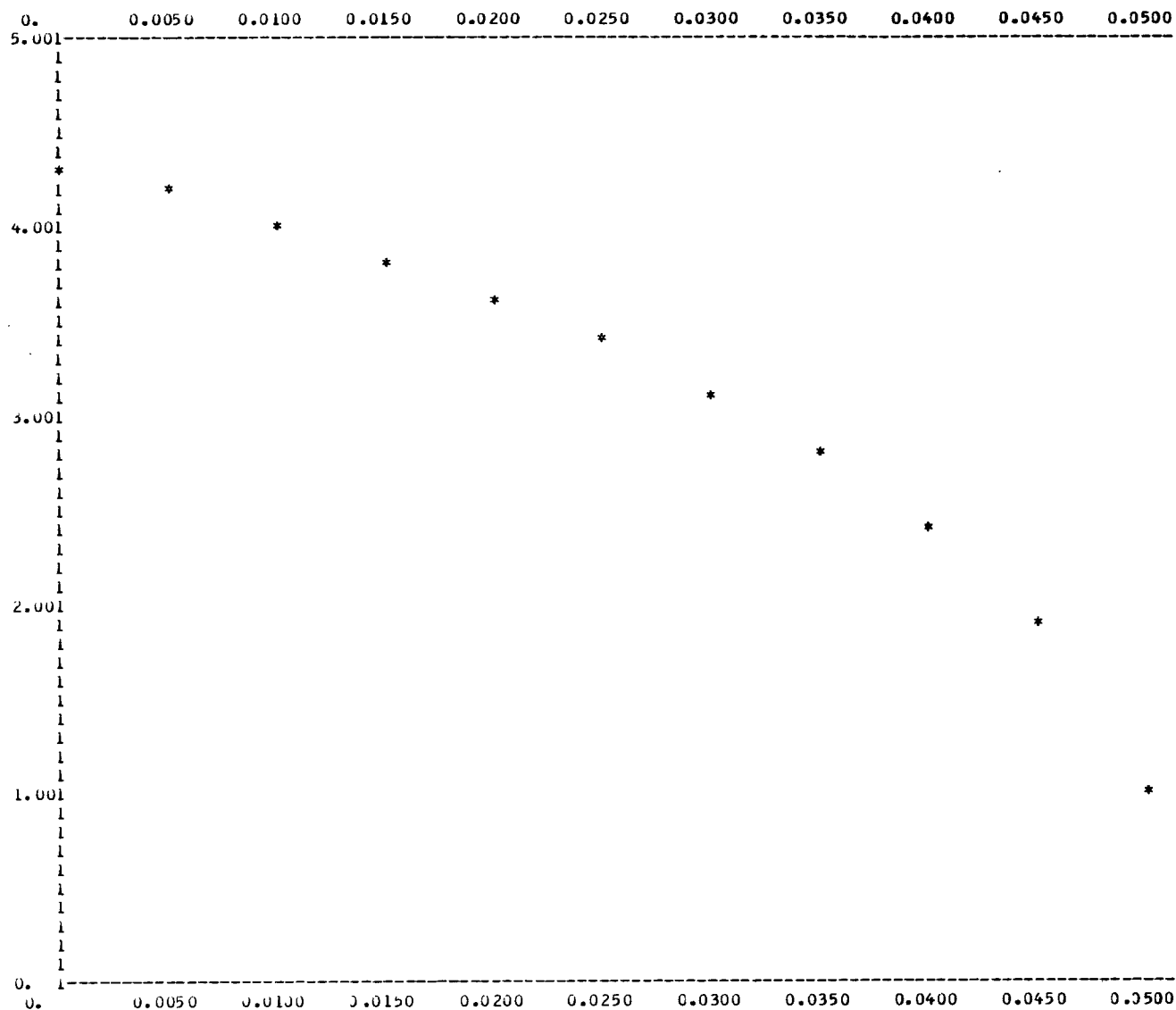

P/P(MIN) ON VERTICAL SCALE - X ON HORIZONTAL SCALE

P/P(MIN) IS DIMENSIONLESS

X IN INCHES - TO CONVERT TO METERS, MULTIPLY BY 2.54E-2

PLT OF P/P(MIN) VS X FOR H(MEAN) = 0.15000E-03

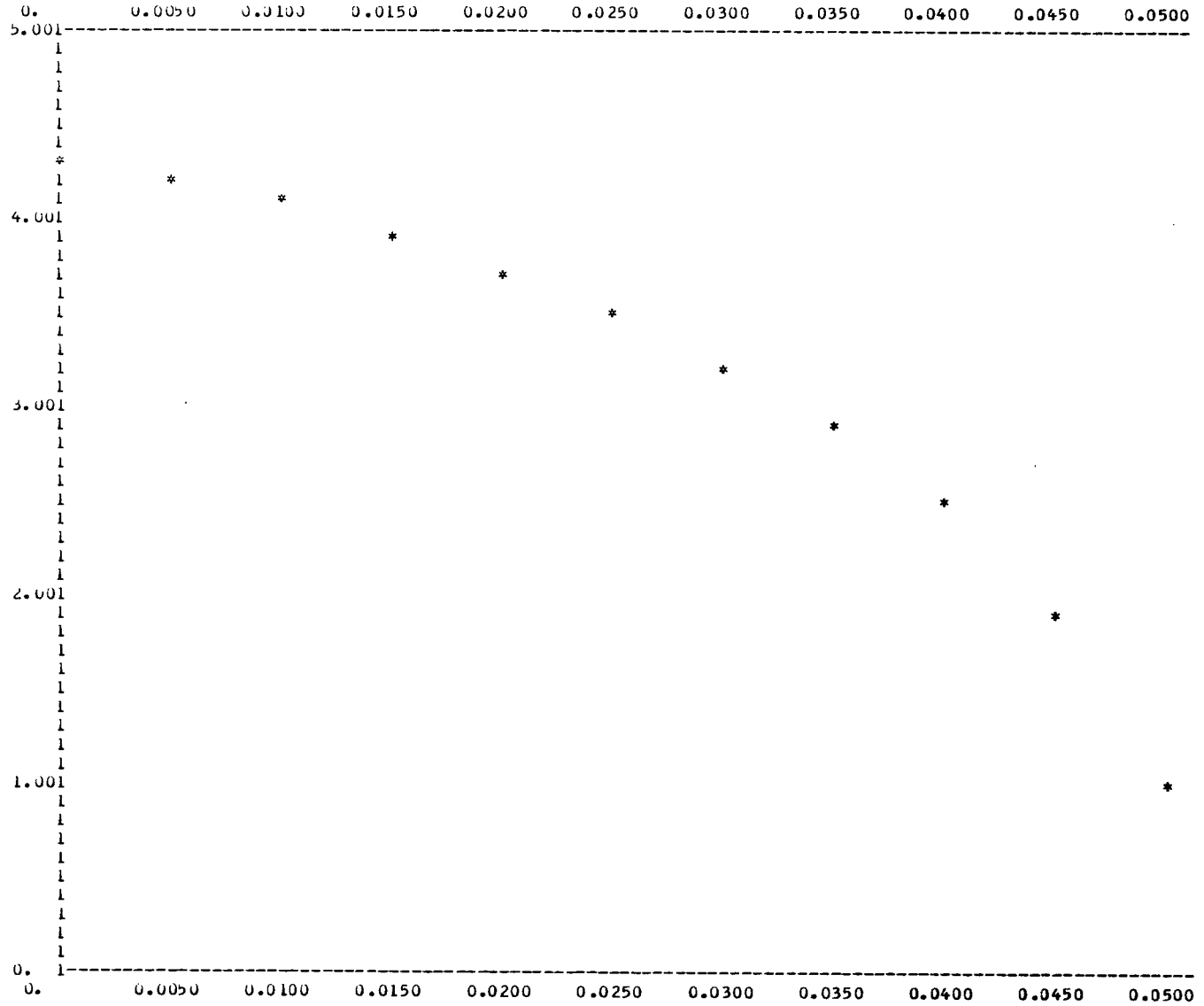

P/P(MIN) ON VERTICAL SCALE - X ON HORIZONTAL SCALE

P/P(MIN) IS DIMENSIONLESS

X IN INCHES - TO CONVERT TO METERS, MULTIPLY BY 2.54E-2

PLDT DF P/P(MIN) VS X FOR H(MEAN) = 0.10000E-03

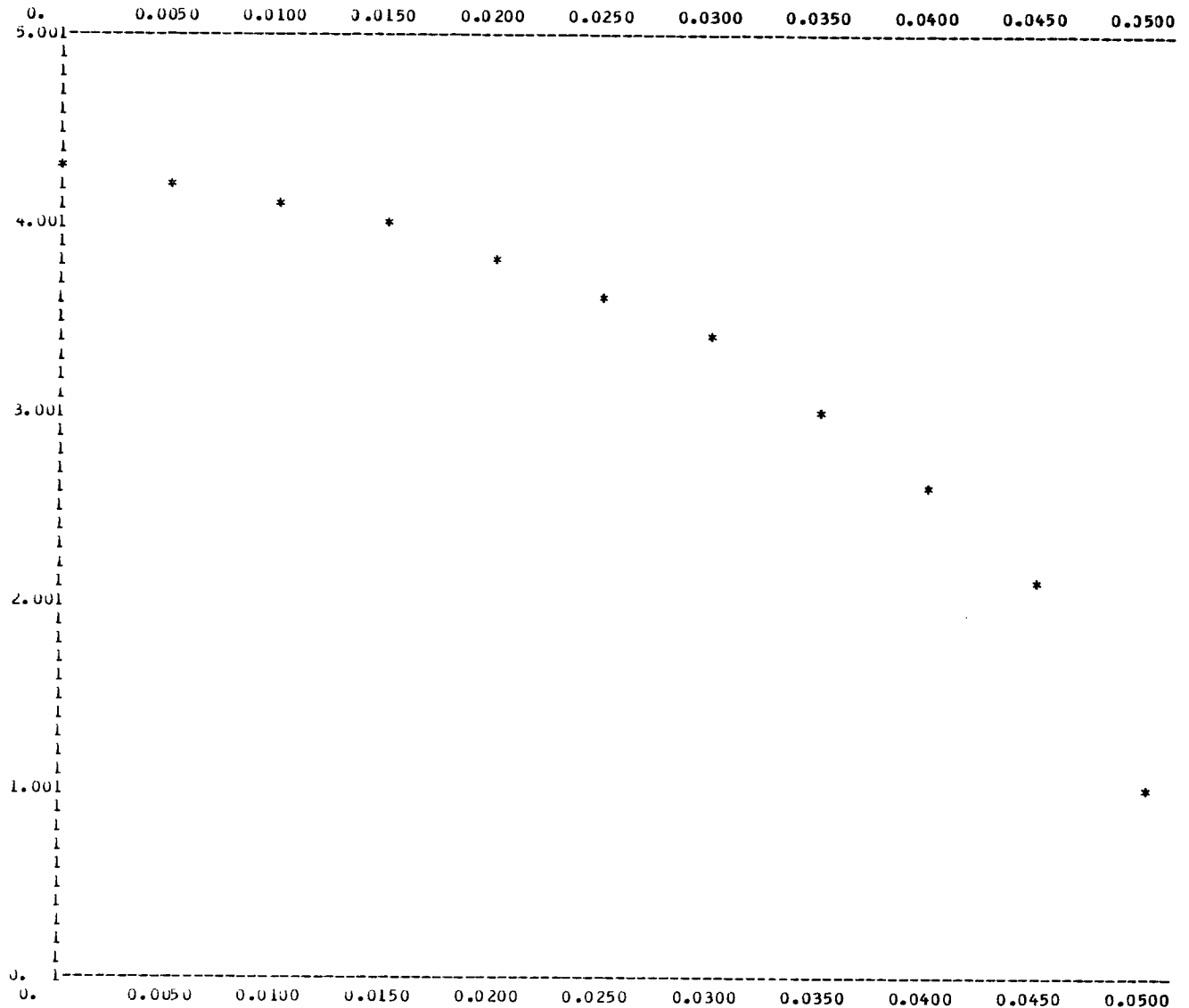

P/P(MIN) ON VERTICAL SCALE - X ON HGRIZUNTAL SCALE

P/P(MIN) IS DIMENSIONLESS

X IN INCHES - TO CONVERT TO METERS, MULTIPLY BY 2.54E-2

## COMPRESSIBLE SEALING DAM WITH SMALL TILT ANGLE

SAMPLE PROBLEM

TILT ANGLE = -0.0010 RADIANS

P2,N/M2 0.10342E C6	P1,N/M2 0.44816E 06	T,DEG K 311.	VISCOSITY,N-S/M2 0.18961E-04	MOLECULAR WEIGHT 28.9660	CP/CV 1.40000
K2,METERS 0.84201E-C1	K1,METERS 0.82931E-J1	L,METERS 0.52506	RHO,KG/M3 0	RHO(ROT),KG/M3 0	NO OF GRID POINTS 11
N,RPS 23.3000	V,M/S 12.2339	CP,J/KG-DEG K 1004.78	SKIP A F	SKIP R F	SKIP T F

BEGIN OUTPUT DATA

GAS CONSTANT,J/KG-DEG K 287.066		RHU(1),KG/M3 5.03606		A(SOUND SPEED),M/S 353.591							
L,METERS 0.52506	AREA,M2 0.66683E-03	SPEED,RPS 23.3000		V,M/S 12.2339							
MEAN FILM METERS	M(DUT) KG/SEC	Q SLMS	MACH (MAX)	RE(P)	RE(R)	KNUDSEN NUMBER	F NEWTONS	STIFF KG/M	XC METERS	XC BAR	F BAR
0.254E-04							ANALYSIS NOT VALID				
0.229E-04							ANALYSIS NOT VALID				
0.203E-04							ANALYSIS NOT VALID				
0.178E-04							ANALYSIS NOT VALID				
0.152E-04							ANALYSIS NOT VALID				
0.127E-04							ANALYSIS NOT VALID				
0.114E-04							ANALYSIS NOT VALID				
0.102E-04							ANALYSIS NOT VALID				
0.889E-05	0.134E-02	0.109E-02	0.754	288.097	21.866	0.008	146.320	0.777E 06	0.486E-03	0.383	0.637
0.762E-05	0.838E-C3	0.685E-03	0.558	182.424	18.876	0.009	147.525	0.111E C7	0.488E-03	0.384	0.642
0.635E-05	0.481E-C3	0.393E-03	0.391	106.207	15.883	0.011	149.191	0.155E C7	0.491E-03	0.386	0.649
0.508E-05	0.242E-03	0.198E-03	0.253	54.671	12.884	0.014	151.641	0.235E 07	0.495E-03	0.390	0.650
0.381E-05	0.983E-04	0.803E-04	0.144	23.044	9.874	0.019	155.574	0.408E 07	0.501E-03	0.395	0.677
0.254E-05	0.261E-04	0.213E-04	0.064	6.559	6.830	0.029	162.760	0.761E 07	0.513E-03	0.404	0.708
MEAN FILM,METERS	POWER,WATTS	TOTAL HEAT,WATTS		DEL(T),DEG K		TORQUE,N-M					
0.254E-04							ANALYSIS NOT VALID				
0.229E-04							ANALYSIS NOT VALID				
0.203E-04							ANALYSIS NOT VALID				
0.178E-04							ANALYSIS NOT VALID				
0.152E-04							ANALYSIS NOT VALID				
0.127E-04							ANALYSIS NOT VALID				
0.114E-04							ANALYSIS NOT VALID				
0.102E-04							ANALYSIS NOT VALID				
0.889E-05	0.21286	0.21309		0.15832		0.91356E-02					
0.762E-05	0.24834	0.24860		0.29494		0.10658E-01					
0.635E-05	0.29800	0.29832		0.61726		0.12790E-01					
0.508E-05	0.37251	0.37290		1.53296		0.15987E-01					
0.381E-05	0.49667	0.49721		5.02889		0.21316E-01					
0.254E-05	0.74501	0.74581		28.3936		0.31975E-01					

MEAN FILM = 0.88500E-05 METERS

X, METERS	P/P (MIN)	P, N/M2	U(AV), M/SEC	MACH NO
0.127E-C2	1.00000	0.10342E 06	247.605	0.70026
0.114E-C2	1.77378	0.18345E 06	139.592	0.39478
0.102E-C2	2.27982	0.23578E 06	108.607	0.30715
0.889E-C3	2.67571	0.27673E 06	92.5380	0.26171
0.762E-C3	3.00616	0.31090E 06	82.3660	0.23294
0.635E-C3	3.29166	0.34043E 06	75.2221	0.21274
0.508E-C3	3.54372	0.36650E 06	69.8716	0.19761
0.381E-C3	3.76961	0.38986E 06	65.6845	0.18576
0.254E-C3	3.97428	0.41103E 06	62.3019	0.17620
0.127E-C3	4.16130	0.43037E 06	59.5019	0.16828
0.118E-10	4.33333	0.44816E 06	57.1397	0.16160

MEAN FILM = 0.76200E-05 METERS

X, METERS	P/P (MIN)	P, N/M2	U(AV), M/SEC	MACH NO
0.127E-C2	1.00000	0.10342E 06	180.905	0.51162
0.114E-C2	1.79236	0.18537E 06	100.931	0.28545
0.102E-C2	2.30441	0.23833E 06	78.5041	0.22202
0.889E-C3	2.70205	0.27945E 06	66.9511	0.18935
0.762E-C3	3.03185	0.31356E 06	59.6683	0.16875
0.635E-C3	3.31511	0.34285E 06	54.5599	0.15433
0.508E-C3	3.56381	0.36857E 06	50.7618	0.14356
0.381E-C3	3.78549	0.39150E 06	47.7891	0.13515
0.254E-C3	3.98532	0.41217E 06	45.3930	0.12838
0.127E-C3	4.16700	0.43096E 06	43.4138	0.12278
0.118E-10	4.33333	0.44816E 06	41.7474	0.11807

MEAN FILM = 0.63500E-05 METERS

X, METERS	P/P (MIN)	P, N/M2	U(AV), M/SEC	MACH NO
0.127E-C2	1.00000	0.10342E 06	124.473	0.35202
0.114E-C2	1.81866	0.18809E 06	68.4420	0.19356
0.102E-C2	2.33889	0.24189E 06	53.2166	0.15051
0.889E-C3	2.73873	0.28324E 06	45.4491	0.12854
0.762E-C3	3.06739	0.31723E 06	40.5794	0.11476
0.635E-C3	3.34736	0.34619E 06	37.1854	0.10516
0.508E-C3	3.59126	0.37141E 06	34.6599	0.98023E-01
0.381E-C3	3.80707	0.39373E 06	32.0952	0.92466E-01
0.254E-C3	4.00023	0.41371E 06	31.1164	0.88001E-01
0.127E-C3	4.17407	0.43175E 06	29.8162	0.84324E-01
0.118E-10	4.33333	0.44816E 06	28.7245	0.81236E-01



MEAN FILM = 0.5000E-05 METERS

X, METERS	P/P (MIN)	P, N/M2	U(AV), M/SEC	MACH NO
0.127E-C2	1.00000	0.10342E 00	78.3123	0.22146
0.114E-C2	1.85888	0.19223E 06	42.1333	0.11916
0.102E-C2	2.59000	0.24725E 06	32.7576	0.92643E-01
0.889E-C3	2.75317	0.28687E 06	28.0370	0.79292E-01
0.702E-C3	3.11902	0.32204E 06	25.1031	0.70995E-01
0.635E-C3	3.59431	0.35104E 06	23.0715	0.65249E-01
0.508E-C3	3.03088	0.37551E 00	21.5684	0.60998E-01
0.381E-C3	3.03195	0.39093E 06	20.4047	0.57707E-01
0.254E-C3	4.02141	0.41590E 06	19.4738	0.55074E-01
0.127E-C3	4.18548	0.43287E 06	18.7105	0.52916E-01
0.118E-10	4.33333	0.44816E 06	18.0721	0.51110E-01

MEAN FILM = 0.33100E-05 METERS

X, METERS	P/P (MIN)	P, N/M2	U(AV), M/SEC	MACH NO
0.127E-C2	1.00000	0.10342E 05	42.4592	0.12002
0.114E-C2	1.92602	0.19925E 06	22.0278	0.62297E-01
0.102E-C2	2.47050	0.25013E 06	17.1363	0.48464E-01
0.889E-C3	2.88180	0.29805E 06	14.7202	0.41648E-01
0.702E-C3	3.26333	0.33129E 00	13.2485	0.37468E-01
0.635E-C3	3.40841	0.35871E 00	12.2359	0.34605E-01
0.508E-C3	3.69252	0.38189E 06	11.4933	0.32504E-01
0.381E-C3	3.88530	0.40183E 06	10.9229	0.30891E-01
0.254E-C3	4.05350	0.41922E 06	10.4698	0.29610E-01
0.127E-C3	4.20105	0.43454E 06	10.1006	0.28566E-01
0.118E-10	4.33333	0.44816E 06	9.79367	0.27698E-01

MEAN FILM = 0.25400E-05 METERS

X, METERS	P/P (MIN)	P, N/M2	U(AV), M/SEC	MACH NO
0.127E-C2	1.00000	0.10342E 06	10.9123	0.47830E-01
0.114E-C2	2.06517	0.21358E 06	8.18928	0.23160E-01
0.102E-C2	2.64382	0.27343E 06	6.39691	0.18091E-01
0.889E-C3	3.04814	0.31524E 00	5.54839	0.15692E-01
0.702E-C3	3.35498	0.34698E 00	5.04095	0.14256E-01
0.635E-C3	3.59854	0.37217E 06	4.69976	0.13292E-01
0.508E-C3	3.79708	0.39276E 06	4.45331	0.12595E-01
0.381E-C3	3.96407	0.40997E 06	4.26640	0.12066E-01
0.254E-C3	4.10544	0.42459E 06	4.11948	0.11650E-01
0.127E-C3	4.22721	0.43718E 06	4.00081	0.11315E-01
0.118E-10	4.33333	0.44816E 06	3.90283	0.11038E-01

## REFERENCES

1. Johnson, Robert L.; Loomis, William R.; and Ludwig, Lawrence P.: Performance and Analysis of Seals for Inerted Lubrication Systems of Turbine Engines. Presented at the ASME Gas Turbine Conference and Products Show, Washington, D. C., Mar. 17-21, 1968.
2. Johnson, R. L.; and Ludwig, L. P.: Shaft Face Seal with Self-Acting Lift Augmentation for Advanced Gas Turbine Engines. Presented at Fourth International Conference on Fluid Sealing, Philadelphia, May 1969 (FICFS-27).
3. Gross, William A.: Gas Film Lubrication. John Wiley & Sons, Inc., 1962.
4. Carothers, P. R., Jr.: An Experimental Investigation of the Pressure Distribution of Air in Radial Flow in Thin Films Between Parallel Plates. MS Thesis, U. S. Naval Post Grad. School, Monterey, Calif., 1961.
5. Grinnell, S. K.: Flow of a Compressible Fluid in a Thin Passage. Trans. ASME, vol. 78, no. 4, May 1956, pp. 765-771.
6. Shapiro, Ascher H.: The Dynamics and Thermodynamics of Compressible Fluid Flow. Vol. I. The Ronald Press Co., 1953.
7. Zuk, John; and Ludwig, L. P.: Investigation of Isothermal, Compressible Flow Across a Rotating Sealing Dam, I - Analysis. NASA TN D-5344, 1969.
8. Hughes, W. F.; and Gaylord, E. W.: Outline of Theory and Problems of Basic Equations of Engineering Science. Schaum Publishing Co., 1964.
9. Eckert, E. R. G.; and Drake Robert M., Jr.: Heat and Mass Transfer. Second ed., McGraw-Hill Book Co., Inc., 1959.
10. Dellner, Lois T.; and Moore, Betty Jo: An Optimized Printer Plotting System Consisting of Complementary 7090 (Fortran) and 1401 (SPS) Subroutines. Part I - Instructions for Users. NASA TN D-2174, 1964.
11. Nielsen, Kaj L.: Methods in Numerical Analysis. The Macmillan Co., 1956.

FIRST CLASS MAIL



POSTAGE AND FEES PAID  
NATIONAL AERONAUTICS AND  
SPACE ADMINISTRATION

150 001 47 51 305 69192 00903  
AIR FORCE WEAPONS LABORATORY/AFWL/  
KIRTLAND AIR FORCE BASE, NEW MEXICO 87117

ATTN: LUD BOWMAN, ACTING CHIEF TECH. LIAISON

POSTMASTER: If Undeliverable (Section 158  
Postal Manual) Do Not Return

*"The aeronautical and space activities of the United States shall be conducted so as to contribute . . . to the expansion of human knowledge of phenomena in the atmosphere and space. The Administration shall provide for the widest practicable and appropriate dissemination of information concerning its activities and the results thereof."*

— NATIONAL AERONAUTICS AND SPACE ACT OF 1958

## NASA SCIENTIFIC AND TECHNICAL PUBLICATIONS

**TECHNICAL REPORTS:** Scientific and technical information considered important, complete, and a lasting contribution to existing knowledge.

**TECHNICAL NOTES:** Information less broad in scope but nevertheless of importance as a contribution to existing knowledge.

**TECHNICAL MEMORANDUMS:** Information receiving limited distribution because of preliminary data, security classification, or other reasons.

**CONTRACTOR REPORTS:** Scientific and technical information generated under a NASA contract or grant and considered an important contribution to existing knowledge.

**TECHNICAL TRANSLATIONS:** Information published in a foreign language considered to merit NASA distribution in English.

**SPECIAL PUBLICATIONS:** Information derived from or of value to NASA activities. Publications include conference proceedings, monographs, data compilations, handbooks, sourcebooks, and special bibliographies.

**TECHNOLOGY UTILIZATION PUBLICATIONS:** Information on technology used by NASA that may be of particular interest in commercial and other non-aerospace applications. Publications include Tech Briefs, Technology Utilization Reports and Notes, and Technology Surveys.

*Details on the availability of these publications may be obtained from:*

SCIENTIFIC AND TECHNICAL INFORMATION DIVISION  
NATIONAL AERONAUTICS AND SPACE ADMINISTRATION  
Washington, D.C. 20546