

NASA TECHNICAL NOTE

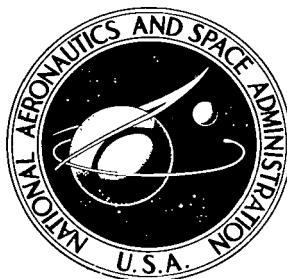

NASA TN D-5662

c. 1

NASA TN D-5662

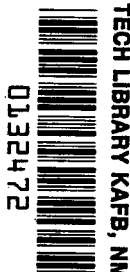

TECH LIBRARY KAFB, NM

**LOAN COPY: RETURN TO
AFWL (WLOL)
KIRTLAND AFB, N MEX**

**EFFECTS OF GROUND PROXIMITY
ON THE LONGITUDINAL AERODYNAMIC
CHARACTERISTICS OF AN UNSWEPT
ASPECT-RATIO-10 WING**

by Arthur W. Carter

Langley Research Center

Langley Station, Hampton, Va.

NATIONAL AERONAUTICS AND SPACE ADMINISTRATION • WASHINGTON, D. C. • FEBRUARY 1970



0132472

1. Report No. NASA TN D-5662	2. Government Accession No.	3. Recipient's Catalog No.	
4. Title and Subtitle EFFECTS OF GROUND PROXIMITY ON THE LONGITUDINAL AERODYNAMIC CHARACTERISTICS OF AN UNSWEPT ASPECT-RATIO-10 WING		5. Report Date February 1970	6. Performing Organization Code
7. Author(s) By Arthur W. Carter	8. Performing Organization Report No. L-6970		10. Work Unit No. 721-01-11-02-23
9. Performing Organization Name and Address NASA Langley Research Center Hampton, Va. 23365	11. Contract or Grant No.		13. Type of Report and Period Covered Technical Note
12. Sponsoring Agency Name and Address National Aeronautics and Space Administration Washington, D.C. 20546	14. Sponsoring Agency Code		
15. Supplementary Notes			
16. Abstract A wind-tunnel investigation has been made of the effects of ground proximity on the longitudinal aerodynamic characteristics of an unswept wing with an aspect ratio of 10 and a taper ratio of 0.3. Data were obtained throughout a range of heights of the wing above a stationary and moving-belt ground plane with flaps retracted and with full-span double-slotted flaps deflected 30° and 50°.			
17. Key Words Suggested by Author(s) Ground effect Longitudinal aerodynamic characteristics	18. Distribution Statement Unclassified - Unlimited		
19. Security Classif. (of this report) Unclassified	20. Security Classif. (of this page) Unclassified	21. No. of Pages 60	22. Price* \$3.00

EFFECTS OF GROUND PROXIMITY ON THE
LONGITUDINAL AERODYNAMIC CHARACTERISTICS OF AN
UNSWEPT ASPECT-RATIO-10 WING

By Arthur W. Carter
Langley Research Center

SUMMARY

A wind-tunnel investigation has been made of the effects of ground proximity on the longitudinal aerodynamic characteristics of an unswept wing with an aspect ratio of 10 and a taper ratio of 0.3. Data were obtained over a stationary and moving-belt ground plane with flaps retracted and with full-span double-slotted flaps deflected 30° and 50° . Ground-effect data were also obtained for the model with leading-edge slats on the wing with trailing-edge flaps deflected 50° . The results indicated the need for a moving-belt ground plane in order to remove the boundary-layer buildup and to predict the correct aerodynamic characteristics for a plain wing as well as for wings with trailing-edge flaps and leading-edge slats.

With flaps retracted, the results indicated that a decrease in height of the wing above the moving-belt ground plane produced an increase in the lift-curve slope, an increase in the angle of attack for zero lift, and a decrease in the pitching-moment-curve slope.

With flaps deflected, the results indicated that a decrease in height of the wing above the ground produced decreases in the maximum lift and in the negative or nose-down pitching moments. The principal effect of ground proximity was a reduction in induced drag which resulted in an increase in lift-drag ratios as the wing approached the ground.

INTRODUCTION

The aerodynamic characteristics of a wing are influenced by the proximity of the wing to the ground. Investigations of ground effects in wind tunnels normally are made with a fixed ground plane placed in the airstream below the model to simulate the ground. As pointed out in reference 1 for high-lift configurations at low heights above the ground, the fixed ground plane provided incorrect simulation of the effects of ground proximity because of the thick boundary layer which developed between the airstream and the ground plane. Although this boundary layer has not created serious problems in investigations of unpowered, low-lift configurations, the ground simulation is not strictly correct,

especially when the model is in close proximity to the ground. In order to provide an accurate means of simulating the ground in wind-tunnel investigations, a moving-belt ground plane was installed in the 17-foot (5.18-meter) test section of the Langley 300-MPH 7- by 10-foot tunnel as described in reference 2.

The purpose of the present report is to present the results of an investigation of an unswept aspect-ratio-10 wing over the moving-belt ground plane. The effects of ground proximity on the longitudinal aerodynamic characteristics were investigated for the wing with full-span double-slotted flaps deflected 30° and 50° and with the flaps retracted. Ground-effect data are also presented for the model with leading-edge slats on the wing with trailing-edge flaps deflected 50° .

SYMBOLS

The units used for the physical quantities in this paper are given both in U.S. Customary Units and in the International System of Units (SI). Factors relating these two systems of units are presented in reference 3.

b	wing span, feet (meters)
c	wing chord, inches (centimeters)
\bar{c}	wing mean aerodynamic chord, inches (centimeters)
c_f	flap chord, inches (centimeters)
C_D	drag coefficient, $\frac{D}{q_\infty S}$
C_L	lift coefficient, $\frac{L}{q_\infty S}$
$C_{L\alpha}$	lift-curve slope
$C_{L\alpha,0}$	lift-curve slope over stationary ground plane
$C_{L\alpha,1}$	lift-curve slope over moving-belt ground plane, $V_B = V_\infty$
C_m	pitching-moment coefficient, $\frac{\text{Pitching moment}}{q_\infty S \bar{c}}$
$C_{m\alpha}$	pitching-moment-curve slope

D	wing drag, pounds force (newtons)
h	height of lower surface of wing at $\bar{c}/4$ above ground plane at $\alpha = 0^\circ$ with wind off, feet (meters)
h_c	height of wing corrected for angle of attack and for sting and balance bending due to wing lift, feet (meters)
K_1	intercept of dC_D/dC_L^2 at zero lift
$K_2 = \frac{dC_D}{dC_L^2}$	
L	wing lift, pounds force (newtons)
q_∞	free-stream dynamic pressure, pounds force/foot ² (newtons/meter ²)
S	wing area, feet ² (meters ²)
V_B	linear velocity of moving-belt ground plane, feet/second (meters/second)
V_∞	free-stream velocity, feet/second (meters/second)
α	angle of attack of wing, degrees
δ_f	flap deflection (positive when deflected down), degrees

Subscripts:

max	maximum
∞	free stream

MODEL AND APPARATUS

A drawing of the model is shown in figure 1. The wing had an NACA 4415 airfoil section with an aspect ratio of 10 and a taper ratio of 0.3. The wing was mounted at the bottom of a cylindrical fuselage which had a faired nose section. Details of the full-span double-slotted trailing-edge flap arrangement and ordinates of the flap and vane are given in figure 2. The flap chord was 33.3 percent of the wing chord and the vane chord was

56.6 percent of the flap chord. The flap system was deflected about the hinge line indicated in figure 2, and the relative position of the vane with respect to the flap remained the same at flap deflections of 30° and 50° . Details of the leading-edge slat are given in figure 3. The leading-edge slats were used only with the 50° flap deflection.

The model was mounted on a sting-supported six-component strain-gage balance for direct measurement of the forces and moments on the model. The balance was located at the center of the fuselage with the moment center of the balance located at the 25-percent mean-aerodynamic-chord station of the wing. The pitching-moment data have been transferred vertically to a moment center located at the quarter chord on the lower surface of the wing as indicated in figure 1. An electronic clinometer was located in the fuselage for use in determining the geometric angle of attack of the wing during the investigation.

Photographs of the sting-supported model mounted above the moving-belt ground plane in the 17-foot (5.18-meter) test section of the Langley 300-MPH 7- by 10-foot tunnel are shown as figure 4. A description of the tunnel is given in reference 4. Details of the moving-belt ground-plane system and drawings of the model-support system are presented in reference 2.

TEST CONDITIONS

For this investigation, the Reynolds number based on the free-stream dynamic pressure of 5 pounds force/foot² (239 newtons/meter²) and wing mean aerodynamic chord of 1.0963 feet (0.3342 meter) was 0.45×10^6 .

The wing heights ranged from $\frac{h}{b} = 0.017$ to $\frac{h}{b} = 0.683$ which was the center line of the test section. This latter height was considered to be essentially out of ground effect for the present model. The heights of the model above the ground plane were measured relative to the lower surface of the model at $\bar{c}/4$ with $\alpha = 0^{\circ}$ for the wind-off condition. Changes in the measured heights of the wing above the ground occurred because of sting and balance deflections due to lift and because of translation of the wing reference point due to rotation of the angle-of-attack mechanism at the various heights investigated. For the purpose of the present paper, these variations in height do not affect the relative comparisons of the data and, consequently, the heights have not been corrected. However, the height changes were calculated for each model configuration and the corrected height-to-span ratios have been plotted against angle of attack in figure 5 for height-to-span ratios from 0.017 to 0.283. If height corrections are desired in close proximity to the ground, the data in this figure may be used. Above $\frac{h}{b} = 0.283$, height corrections should have no significance.

A suction slot at the belt leading edge was utilized to remove the boundary layer at that point, and the boundary layer was prevented from building up over the belt by the use of a belt linear speed equal to that of the tunnel airstream. Each model configuration was investigated at the lowest feasible height and at several additional heights over the moving belt. Data were also obtained at each of these heights with the ground belt stationary. When a height was reached for each configuration at which the influence of the moving belt on the data became negligible, the remaining heights were investigated only with the belt stationary.

RESULTS AND DISCUSSION

The basic results of the investigation are presented in figure 6. The variations of C_D , α , and C_m with C_L show the effects of the moving-belt ground plane on the longitudinal aerodynamic characteristics of the aspect-ratio-10 wing at several heights of the model above the ground plane.

The boundary condition requiring a moving-belt ground plane for full-span high-lift configurations was presented in figure 10 of reference 1. This boundary is reproduced in figure 7 of the present paper. By use of the method of reference 1, the combinations of height of the wing above the ground plane and lift coefficient which required use of the moving-belt ground plane were determined from the data of figure 6 and are shown in figure 7. These data indicate good agreement with the previously determined boundary. However, as shown in figure 7, the data for the wing with flaps retracted indicate the need for the moving-belt ground plane at all lift coefficients down to and including $C_L = 0$ in order to predict the correct lift coefficient and lift-curve slope for height-to-span ratios below 0.06.

In theory, the velocity of the belt must be the same as the velocity of the airstream. However, as concluded in reference 1, the slope of the lift-loss curve with moving-belt velocity for high lift coefficients is such that extreme precision is not required in setting the linear velocity of the belt. As shown in figure 8, the effect of variations in the belt velocity between 75 and 125 percent of the airstream velocity was negligible at low lift coefficients. However, the data of figure 8 illustrate the need for removal of some of the boundary layer on the ground plane, although considerable variation in the belt speed appears permissible at low lift coefficients.

Wing With Flaps Retracted

The effects of the height of the wing above the ground and of the moving-belt ground plane on the aspect-ratio-10 wing with flaps retracted are presented in figure 9. The

longitudinal aerodynamic characteristics over the moving-belt ground plane are shown in figure 9(a). The data at a height-to-span ratio of 0.683 which was essentially out of ground effect are shown also. These data indicate that the slope of the lift curve increased as the height of the wing above the ground decreased. The angle of attack for zero lift increased with decrease in height above the ground. The variation of lift-curve slope with height-to-span ratio is shown in figure 9(b) for the stationary and moving-belt ground planes. As shown in this figure, the data over the stationary ground plane incorrectly predicted the lift-curve slopes at height-to-span ratios below 0.07. At the minimum height investigated ($\frac{h}{b} = 0.017$), the stationary ground plane resulted in an error of 30 percent in the slope of the lift curve (fig. 9(c)). It should be pointed out that this height-to-span ratio, however, is below normal landing-gear height and would appear impractical for actual flight operations.

The lift-curve slope decreased rapidly with increase in height of the model above the moving-belt ground plane as shown in figure 9(b) and reached a constant value of 0.0833 at a height-to-span ratio of about 0.4. The lift-curve slope was calculated based on section lift data obtained from reference 5 and was corrected for aspect ratio and sweep of the 50-percent chord line in accordance with the method of reference 6. This calculated value was 0.0833 and was in agreement with the experimentally determined value.

As shown in figure 9(a), the slope of the pitching-moment curve with respect to C_L increased with increase in height of the wing above the ground plane. The variation of this pitching-moment-curve slope with height-to-span ratio is shown in figure 9(d). This slope increased rapidly from a value of 0.027 at a height-to-span ratio of 0.017 to a constant value of 0.076 at a height of about one-quarter wing span above the ground.

It should be pointed out that the model did not have tail surfaces. The effect of the change in downwash at the tail resulting from ground effect and the corresponding change in pitching moment is not present in the data of figure 9(a). For the wing with flaps retracted, this effect would not be expected to be large inasmuch as the change in lift due to ground effect is small. As shown in figure 9(d), the ratio dC_m/dC_L at a given height was the same for the stationary and moving ground planes, and, therefore, this pitching-moment-curve slope was independent of the velocity of the moving-belt ground plane.

The slope of the pitching-moment curve with respect to angle of attack is presented in figure 9(e) for the stationary and moving-belt ground planes. These data indicate that, at height-to-span ratios below 0.09 for this wing with flaps retracted, the use of the stationary ground plane resulted in an incorrect prediction of the pitching-moment-curve slope with respect to angle of attack. The discrepancy between the slopes with the stationary and moving-belt ground planes increased as the height of the wing above the ground decreased.

At positive lift coefficients, the effects of the moving-belt ground plane (fig. 6) and of the height of the wing above the ground (fig. 9(a)) on the total drag were negligible.

The effect of ground proximity on the lift-drag ratio of the wing with flaps retracted is shown in figure 9(f). The effect of the velocity of the moving-belt ground plane was negligible, and the data for the stationary ground plane are not presented. The maximum lift-drag ratio was 36 for the wing out of ground effect and occurred at a lift coefficient of 0.73 corresponding to an angle of attack of about 4.5° (fig. 9(a)). The lift-drag ratio increased as the height of the wing above the ground plane was decreased. The angle of attack for maximum lift-drag ratio remained at approximately 4.5° as the height above the ground plane decreased. The maximum lift-drag ratio was 39.5 at a height corresponding to 5 percent of the wing span which would be representative of the landing-gear height for a large low-wing aircraft.

Effects of Wing Flaps

Flaps deflected 30° .- Figure 10 presents the effects of height of the wing above the ground on the aspect-ratio-10 wing with flaps deflected 30° . The longitudinal aerodynamic characteristics are shown in figure 10(a). The effect of the ground on the wing lift was small except near maximum lift. The effect of the ground on the pitching moment was small, although the nose-down pitching moment was reduced at the higher lift coefficients as the wing approached the ground. As in the case with flaps retracted, it should be noted that this model did not have tail surfaces. The change in pitching moment resulting from changes in downwash at the tail as the wing is affected by the proximity of the ground would be expected to be larger than for the retracted-flap configuration, particularly at angles of attack near maximum lift.

Ground proximity reduced the drag of the wing with flaps deflected 30° . The total drag over the stationary and moving-belt ground planes is plotted against the square of the lift coefficient in figures 10(b) and 10(c), respectively. These data indicate that the change in drag over both stationary and moving-belt ground planes varied directly with the square of the lift coefficient. An extrapolation of the fairing of the drag data to zero lift indicated that a constant value of 0.06 occurred for all wing heights with both the stationary and moving-belt ground planes. These data, therefore, suggest that the drag may be calculated by the following equation:

$$C_D = K_1 + K_2 C_L^2 \quad (1)$$

where K_1 is equal to a constant value of 0.06 and where K_2 is a constant for the ratio dC_D/dC_L^2 . The constant K_2 varied with height above the ground, and values of K_2 for a range of height-to-span ratios from 0.033 to out of ground effect are presented in

figure 10(d). The fairing of the drag data in figure 10(a) was not arbitrary but was based on calculations by use of equation (1) for values of the lift coefficient prior to wing stall.

Lift-drag ratios are presented in figures 10(e) and 10(f) for the stationary and moving-belt ground planes, respectively. The maximum lift-drag ratio for the wing out of ground effect was about 12.2. The lift-drag ratio increased with decrease in height of the wing above the ground, primarily because of the reduction in the drag as the wing approached the ground. In close proximity to the ground ($\frac{h}{b} = 0.033$), the maximum lift-drag ratio was approximately 22. The variation of the lift-drag ratio with height above the ground for an angle of attack of approximately 0° and a lift coefficient of 2 is shown in figure 10(g). As shown in this figure the data over the stationary ground plane considerably underestimated the lift-drag ratios when the wing was in close proximity to the ground.

Flaps deflected 50° .- The longitudinal aerodynamic characteristics of the wing with flaps deflected 50° are shown in figure 11(a). The ground effect on the wing resulted in a loss in lift at all angles of attack above -10° . The negative or nose-down pitching moment was reduced at all lift coefficients as the wing approached the ground.

Ground proximity also reduced the drag of the wing with flaps deflected 50° . The total drag over the stationary and moving-belt ground planes is plotted against the square of the lift coefficient in figures 11(b) and 11(c), respectively. These data indicate that the value of 0.06 of the constant K_1 was the same as that obtained with the 30° flap deflection and that equation (1) may be used to calculate the total drag. Values of K_2 for a range of height-to-span ratios from 0.05 to those out of ground effect are presented in figure 11(d). Equation (1) was also used to calculate the drag for the fairing of the drag polars in figure 11(a).

The lift-drag ratios for the aspect-ratio-10 wing with flaps deflected 50° are presented in figures 11(e) and 11(f) for the stationary and moving-belt ground planes, respectively. The maximum lift-drag ratio obtained for the wing out of ground effect was about 9.4. The variation of the lift-drag ratio with height-to-span ratio for a lift coefficient of 2.2 and angles of attack near -6° is shown in figure 11(g). As shown in this figure, the data over the stationary ground board underestimated the lift-drag ratios when the wing was in close proximity to the ground.

Effects of Leading-Edge Slats

The effects of ground proximity on the aspect-ratio-10 wing with leading-edge slats and with trailing-edge flaps deflected 50° are presented in figure 12. Only one slat setting was used in the investigation, and as may be observed in figure 6, where data for the 50° flap deflection are shown with and without the leading-edge slats, the slat setting apparently was not at the optimum deflection. Nevertheless, the data show the effects of

the proximity of the moving-belt ground plane on a wing with a leading-edge slat. As shown in figure 12(a), the effect of the ground on the wing lift was small except near maximum lift. The nose-down pitching moment at lift coefficients above 2.0 was reduced as the wing approached the ground, but the effect of ground proximity was less pronounced than for the wing without the leading-edge slat.

The drag decreased with decrease in height of the wing above the ground, and the total drag over the stationary and moving-belt ground planes is presented in figures 12(b) and 12(c), respectively. These drag data indicate that the addition of leading-edge slats to the wing considerably increased the profile drag. The total drag for the wing with leading-edge slats and trailing-edge flaps deflected 50° may be calculated by the use of equation (1) with a value of K_1 of 0.15 and values of K_2 as presented in figure 12(d). The drag coefficients were calculated by using equation (1), and these calculated values were used in fairing the drag polars of figure 12(a).

The lift-drag ratios for the stationary and moving-belt ground planes are presented in figures 12(e) and 12(f), respectively. The maximum lift-drag ratio for the wing out of ground effect was about 7.0. The variation of the lift-drag ratio with height-to-span ratios for a lift coefficient of 2.2 and an angle of attack of approximately -2.5° is presented in figure 12(g). As was the case with the wing without the leading-edge slat, the data over the stationary ground plane underestimated the lift-drag ratios when the wing was in close proximity to the ground.

Comparison With Theory

As stated in reference 7, the agreement between experiment and Wieselsberger's lifting-line ground-effect theory (ref. 8) appeared to be generally good for aspect-ratio-1 airfoils. Reference 9 reported general agreement with this theory for rectangular airfoils with aspect ratios between 1 and 6. Results from the present investigation are compared with Wieselsberger's theory in figure 13.

Data for the wing with flaps retracted are in poor agreement with the theory. Wieselsberger's theory relies primarily on a reduction in the induced drag in close proximity to the ground, and as shown in figure 9(a) the small drag of the wing with flaps retracted was relatively unaffected by ground proximity. The small increases in lift-drag ratio resulted principally from the increase in lift-curve slope as the wing approached the ground. Apparently, this simple theory is not adequate for a wing with an aspect ratio of 10, a taper ratio of 0.3, and flaps retracted.

Data for the aspect-ratio-10 wing with flaps deflected and with leading-edge slats showed better agreement with the theory (fig. 13) than did the data for the flaps retracted. As shown in figures 10 to 13, the induced drag decreased as the wing approached the

ground and, therefore, better agreement with the theory could be expected. However, the theory does not appear adequate for these configurations either.

The more recent and sophisticated theories, such as those cited in reference 10 which used a discrete vortex digital computer program to determine the ground effect on flat wings of arbitrary plan form, possibly could provide better agreement between experiment and theory. However, inasmuch as the primary purpose of this paper was to present experimental data for the aspect-ratio-10 wing, no effort was made to compare the data with the more complicated theories.

CONCLUDING REMARKS

A wind-tunnel investigation has been made of the effects of ground proximity on the longitudinal aerodynamic characteristics of an unswept wing with an aspect ratio of 10 and a taper ratio of 0.3. The results indicated the need for a moving-belt ground plane in order to remove the boundary-layer buildup and to predict the correct aerodynamic characteristics for a plain wing as well as for wings with trailing-edge flaps and leading-edge slats.

With flaps retracted, a decrease in height of the wing above the moving-belt ground plane resulted in an increase in lift-curve slope, an increase in the angle of attack for zero lift, and a decrease in pitching-moment-curve slope.

With flaps deflected, a decrease in height of the wing above the ground resulted in decreases in maximum lift and in negative or nose-down pitching moments. The principal effect of ground proximity was a reduction in induced drag which resulted in an increase in lift-drag ratios as the wing approached the ground.

Langley Research Center,
National Aeronautics and Space Administration,
Langley Station, Hampton, Va., December 9, 1969.

REFERENCES

1. Turner, Thomas R.: Endless-Belt Technique for Ground Simulation. Conference on V/STOL and STOL Aircraft, NASA SP-116, 1966, pp. 435-446.
2. Turner, Thomas R.: A Moving-Belt Ground Plane for Wind-Tunnel Ground Simulation and Results for Two Jet-Flap Configurations. NASA TN D-4228, 1967.
3. Mechtly, E. A.: The International System of Units - Physical Constants and Conversion Factors. NASA SP-7012, 1964.
4. Kuhn, Richard E.; and Hayes, William C., Jr.: Wind-Tunnel Investigation of Longitudinal Aerodynamic Characteristics of Three Propeller-Driven VTOL Configurations in the Transition Speed Range, Including Effects of Ground Proximity. NASA TN D-55, 1960.
5. Abbott, Ira H.; and Von Doenhoff, Albert E.: Theory of Wing Sections. Dover Publ., Inc., 1959.
6. Lowry, John G.; and Polhamus, Edward C.: A Method for Predicting Lift Increments Due to Flap Deflection at Low Angles of Attack in Incompressible Flow. NACA TN 3911, 1957.
7. Carter, Arthur W.: Effect of Ground Proximity on the Aerodynamic Characteristics of Aspect-Ratio-1 Airfoils With and Without End Plates. NASA TN D-970, 1961.
8. Wieselsberger, C.: Wing Resistance Near the Ground. NACA TM 77, 1922.
9. Fink, Marvin P.; and Lastinger, James L.: Aerodynamic Characteristics of Low-Aspect-Ratio Wings in Close Proximity to the Ground. NASA TN D-926, 1961.
10. Saunders, G. H.: Aerodynamic Characteristics of Wings in Ground Proximity. Can. Aeronaut. Space J., vol. 11, no. 6, June 1965, pp. 185-192.

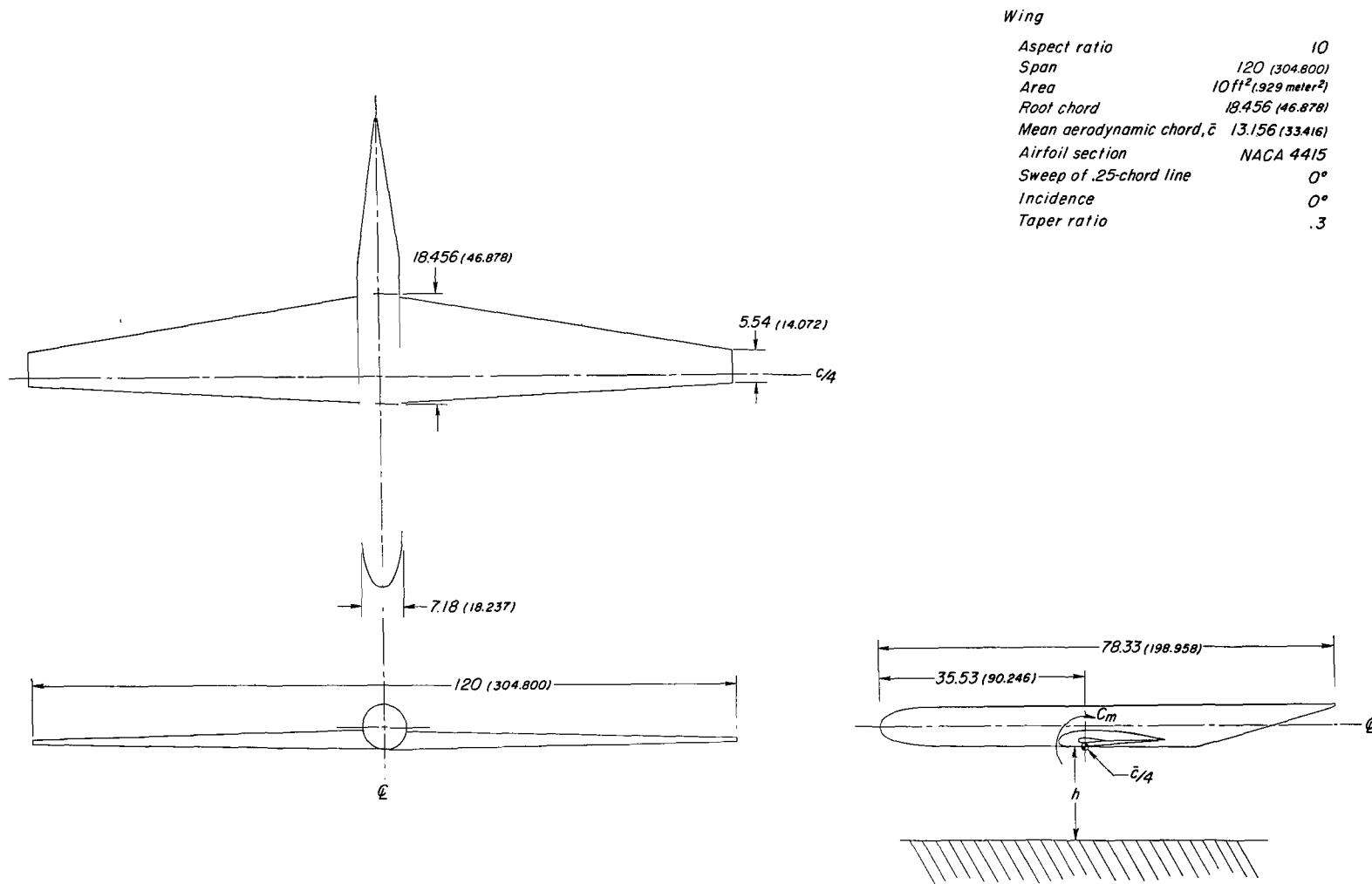

Figure 1.- Three-view drawing and geometric characteristics of model. Dimensions are given in inches and parenthetically in centimeters unless otherwise noted.

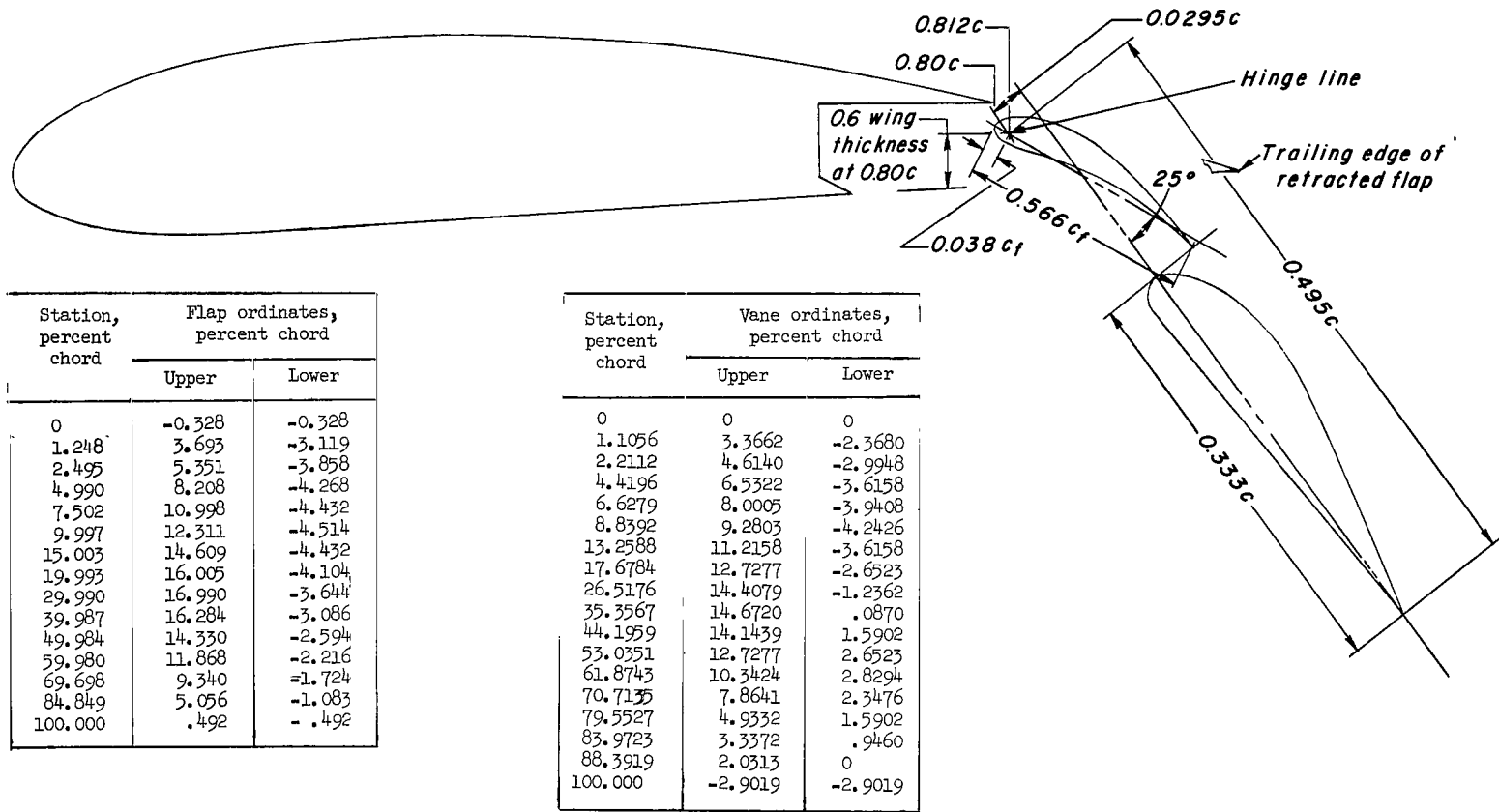

Figure 2.- Details of the double-slotted flap arrangement and ordinates of the flap and vane.

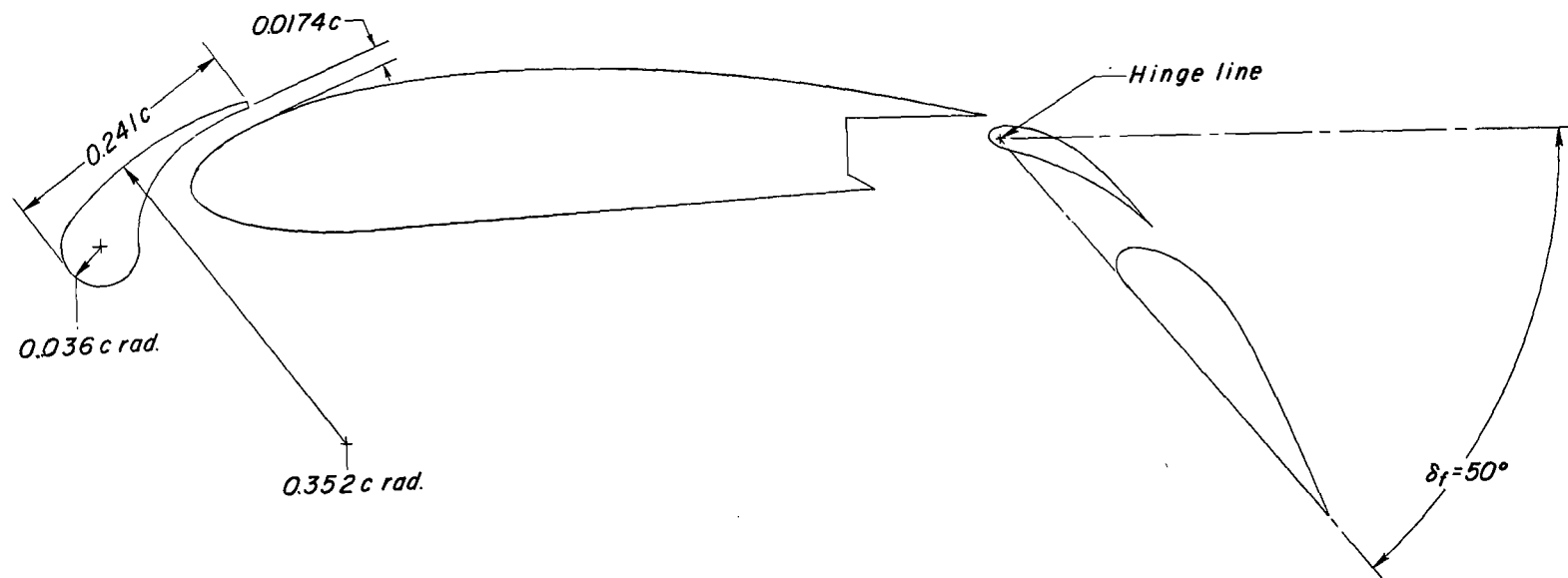
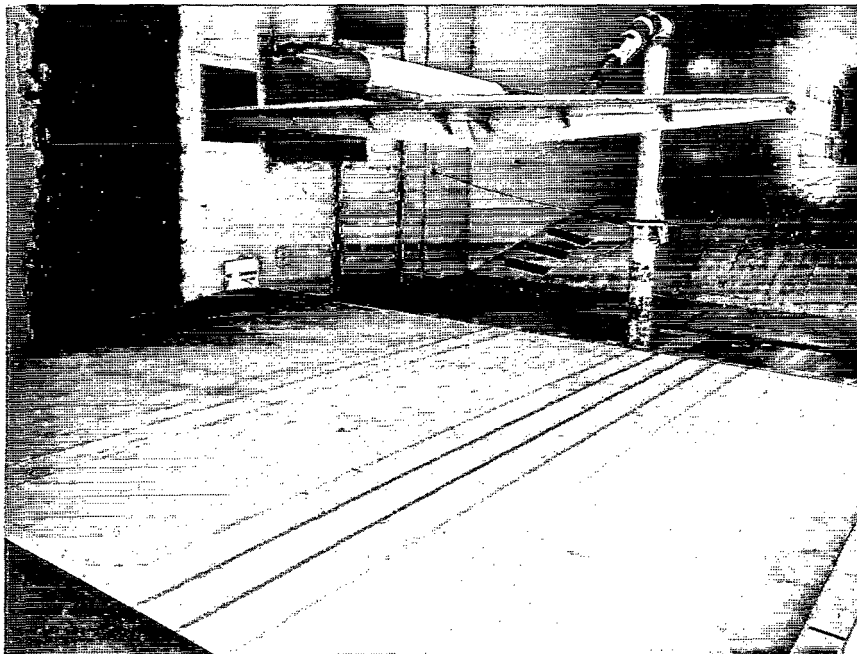
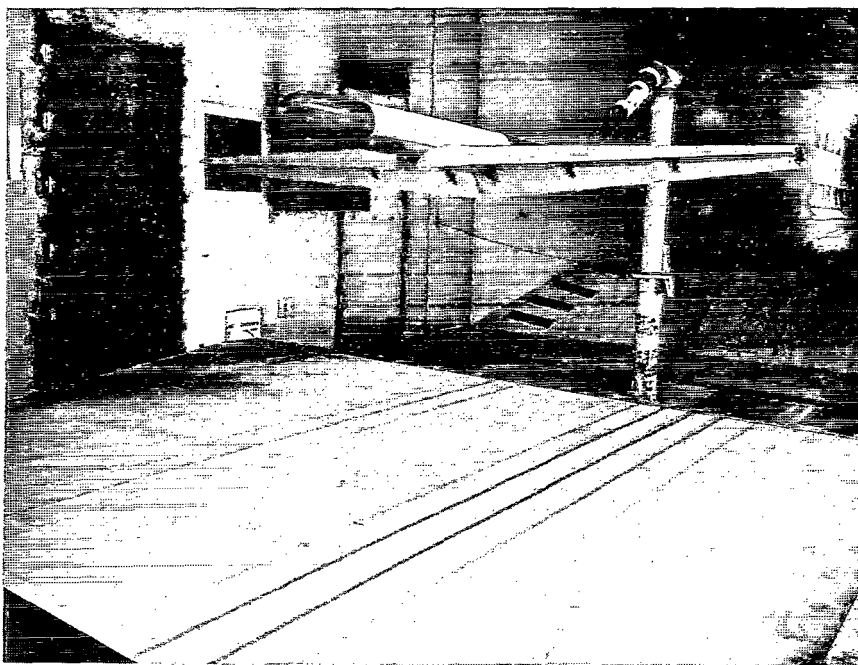

Figure 3.- Details of the leading-edge slat for the aspect-ratio-10 wing.



(a) $\delta_f = 50^\circ$.

L-64-9377



(b) $\delta_f = 50^\circ$ with leading-edge slats.

L-64-9376

Figure 4.- Photographs of the model above the moving-belt ground plane in the 17-foot (5.18-meter) test section of the Langley 300-MPH 7- by 10-foot tunnel.

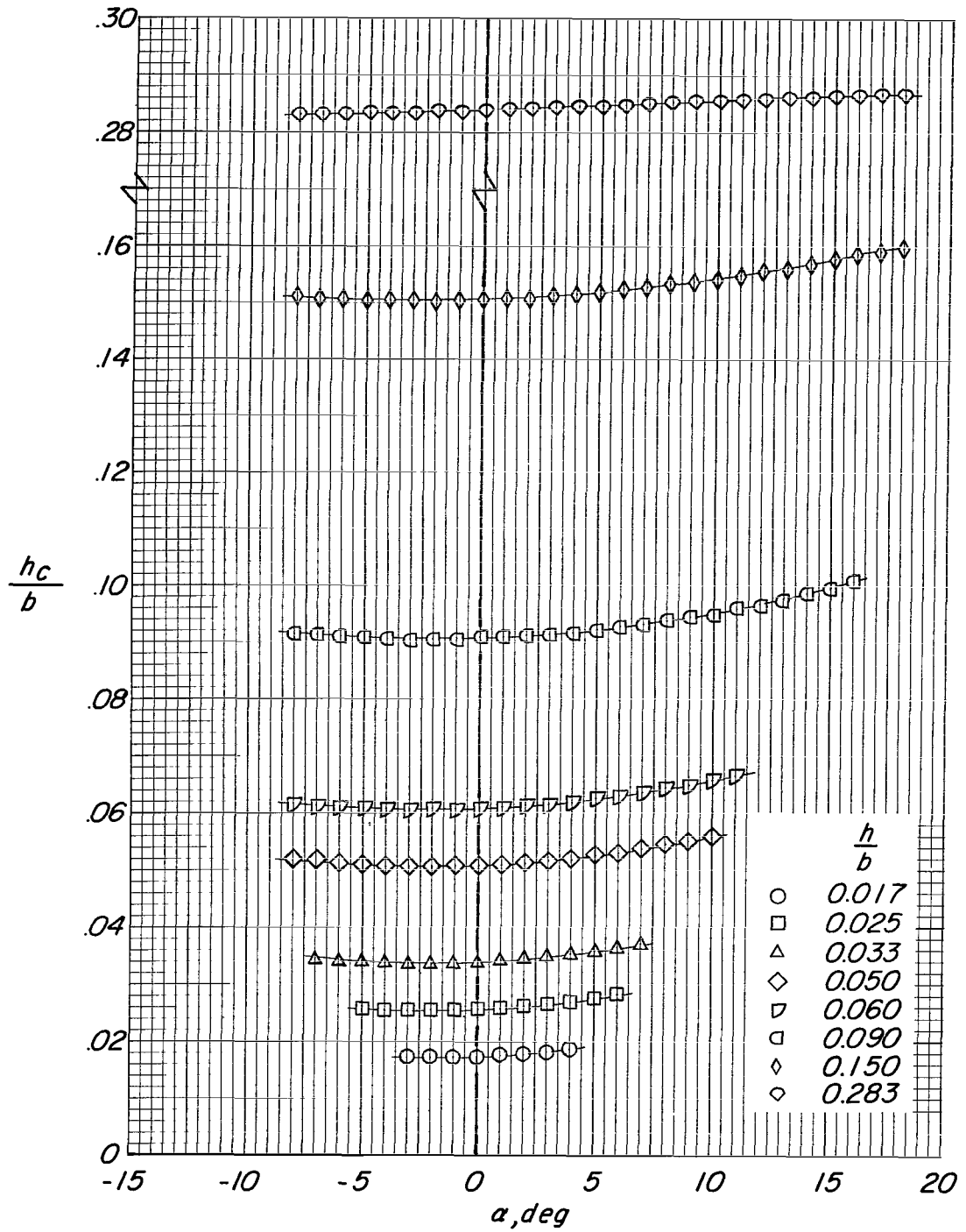

(a) $\delta_f = 0^\circ$.

Figure 5.- Corrected height-to-span ratios for the aspect-ratio-10 wing. $\frac{V_B}{V_\infty} = 1$.

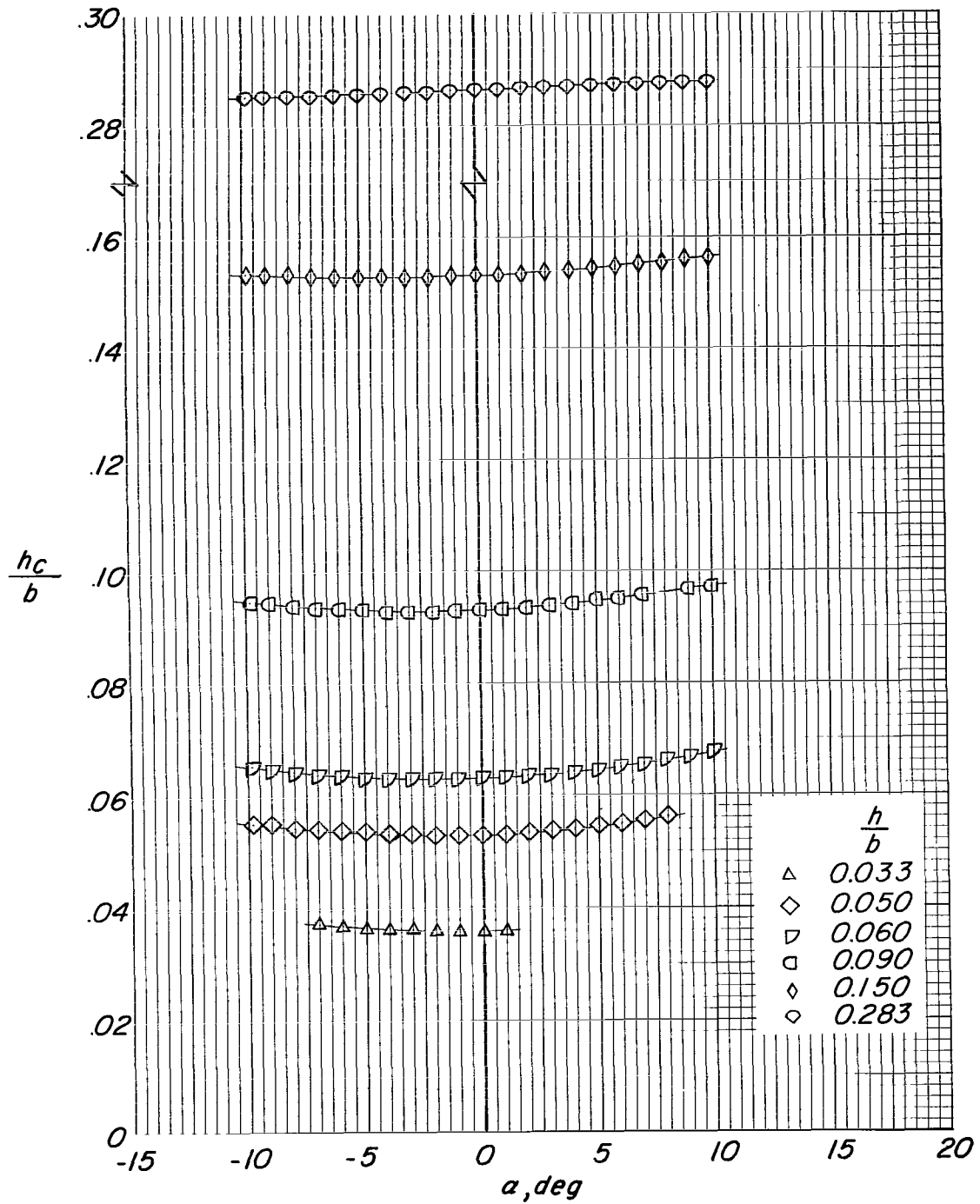

(b) $\delta_f = 30^\circ$.

Figure 5.- Continued.

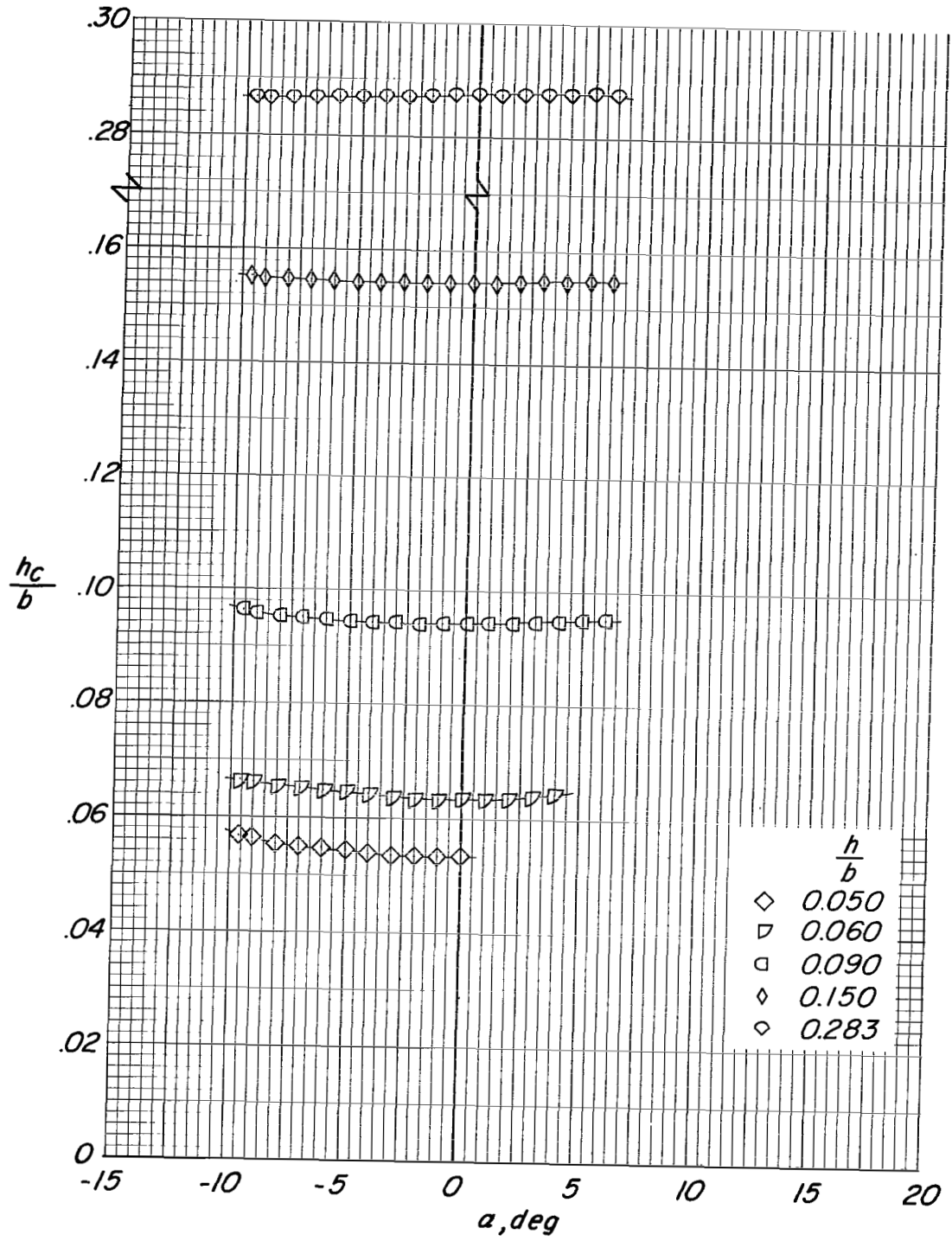

(c) $\delta_f = 50^\circ$.

Figure 5.- Continued.

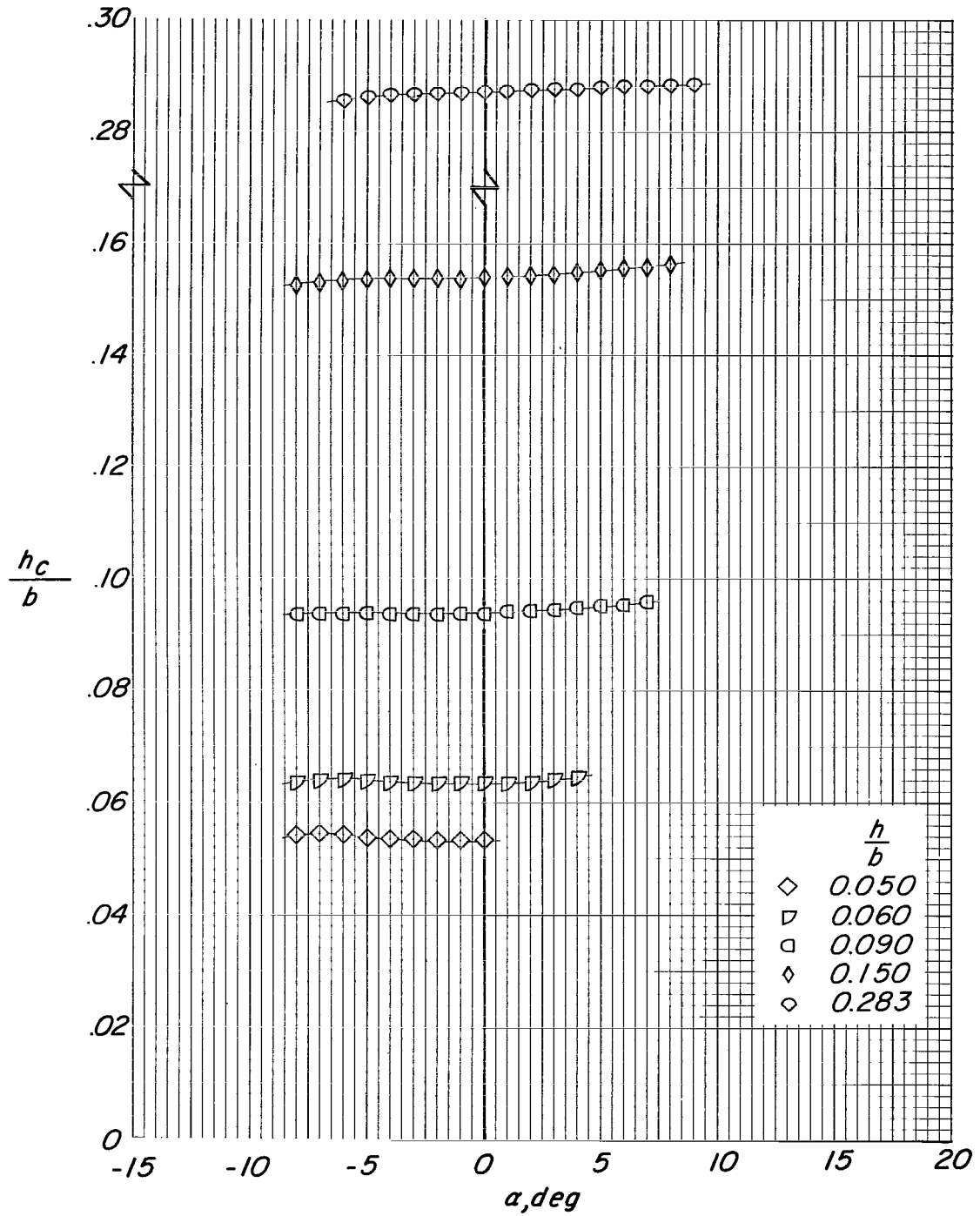

(d) $\delta_f = 50^\circ$ with leading-edge slats.

Figure 5.- Concluded.

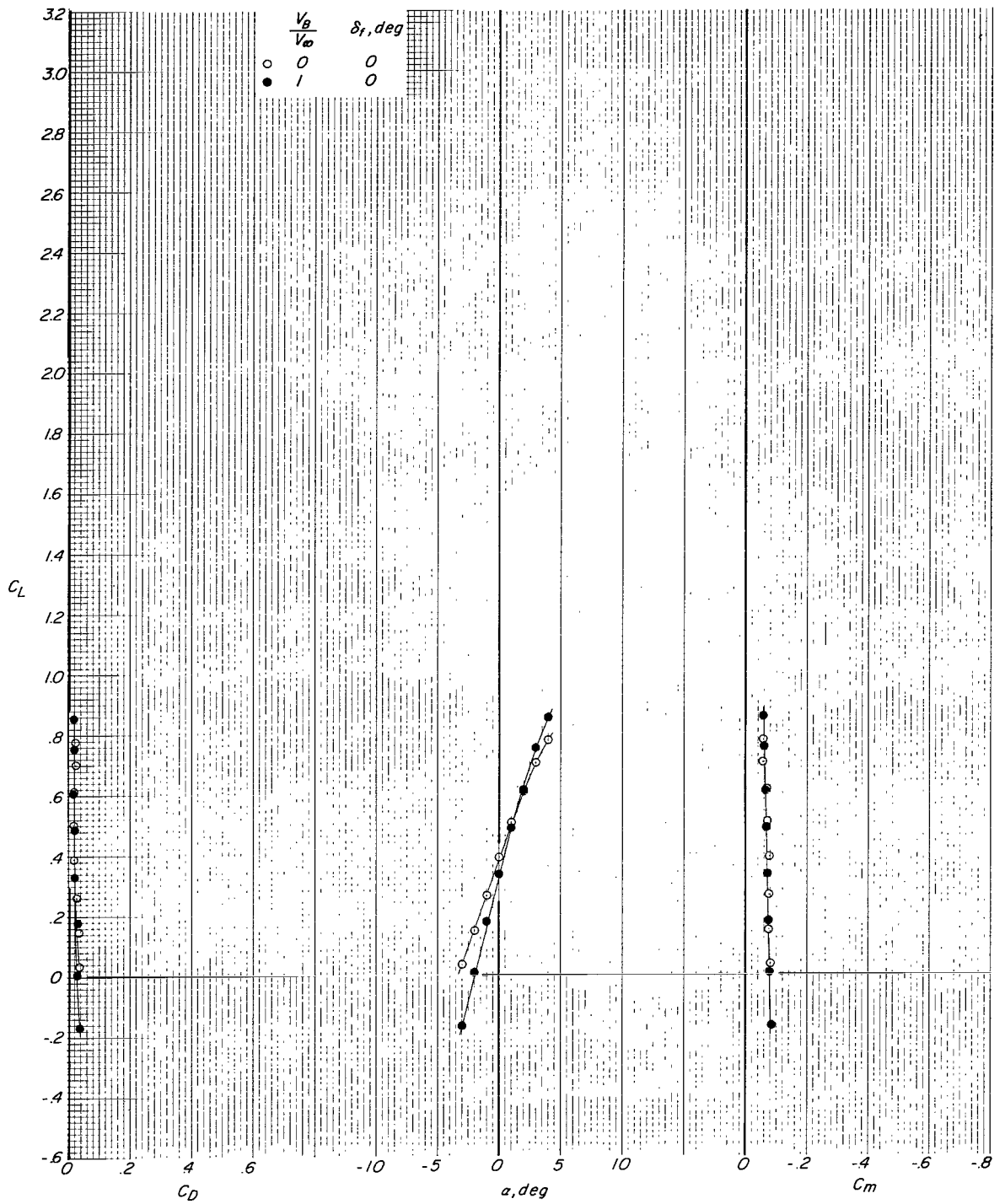

(a) $h/b = 0.017$.

Figure 6.- Effect of moving-belt ground plane on the longitudinal aerodynamic characteristics of the model.

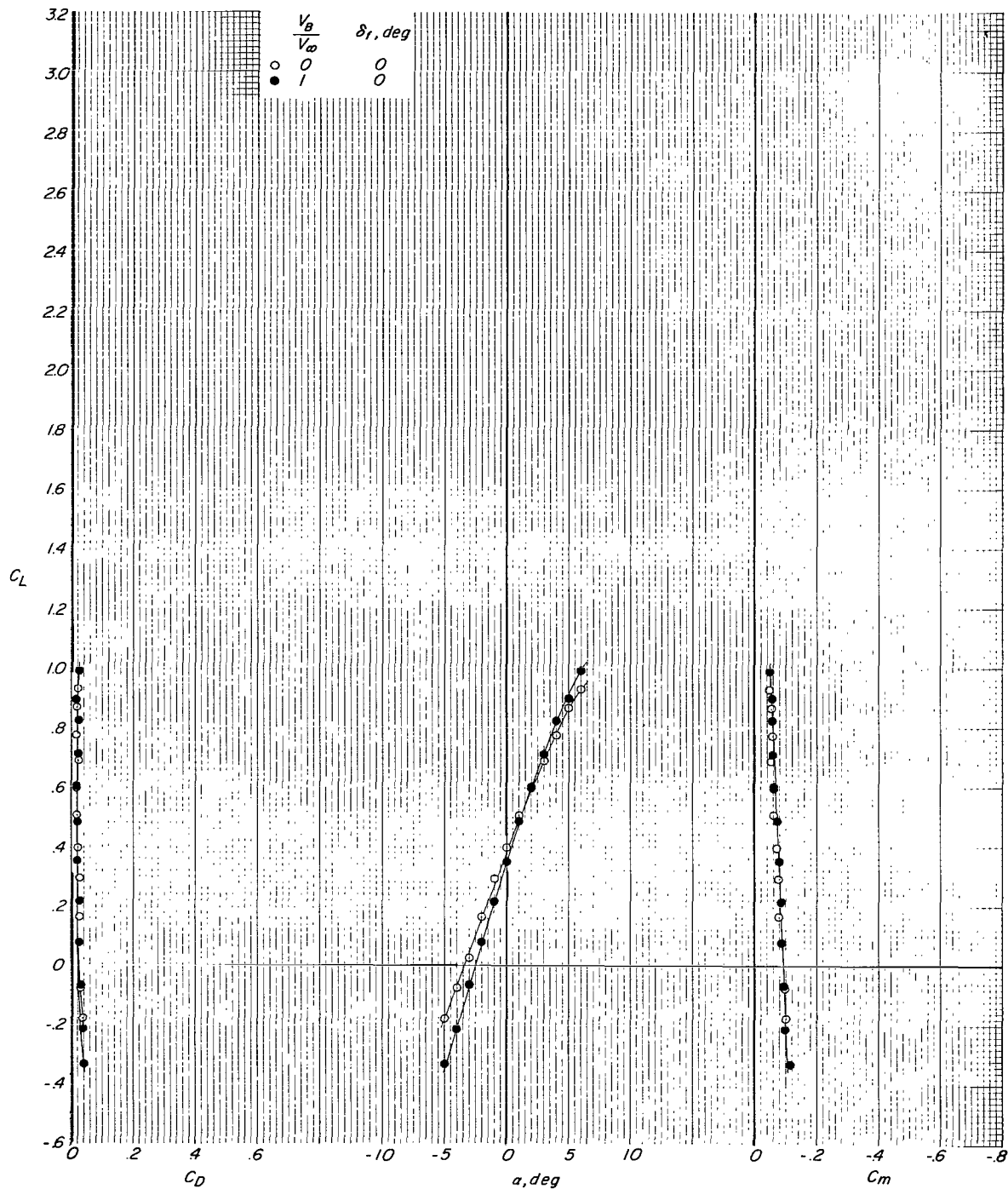

(b) $h/b = 0.025$.

Figure 6.- Continued.

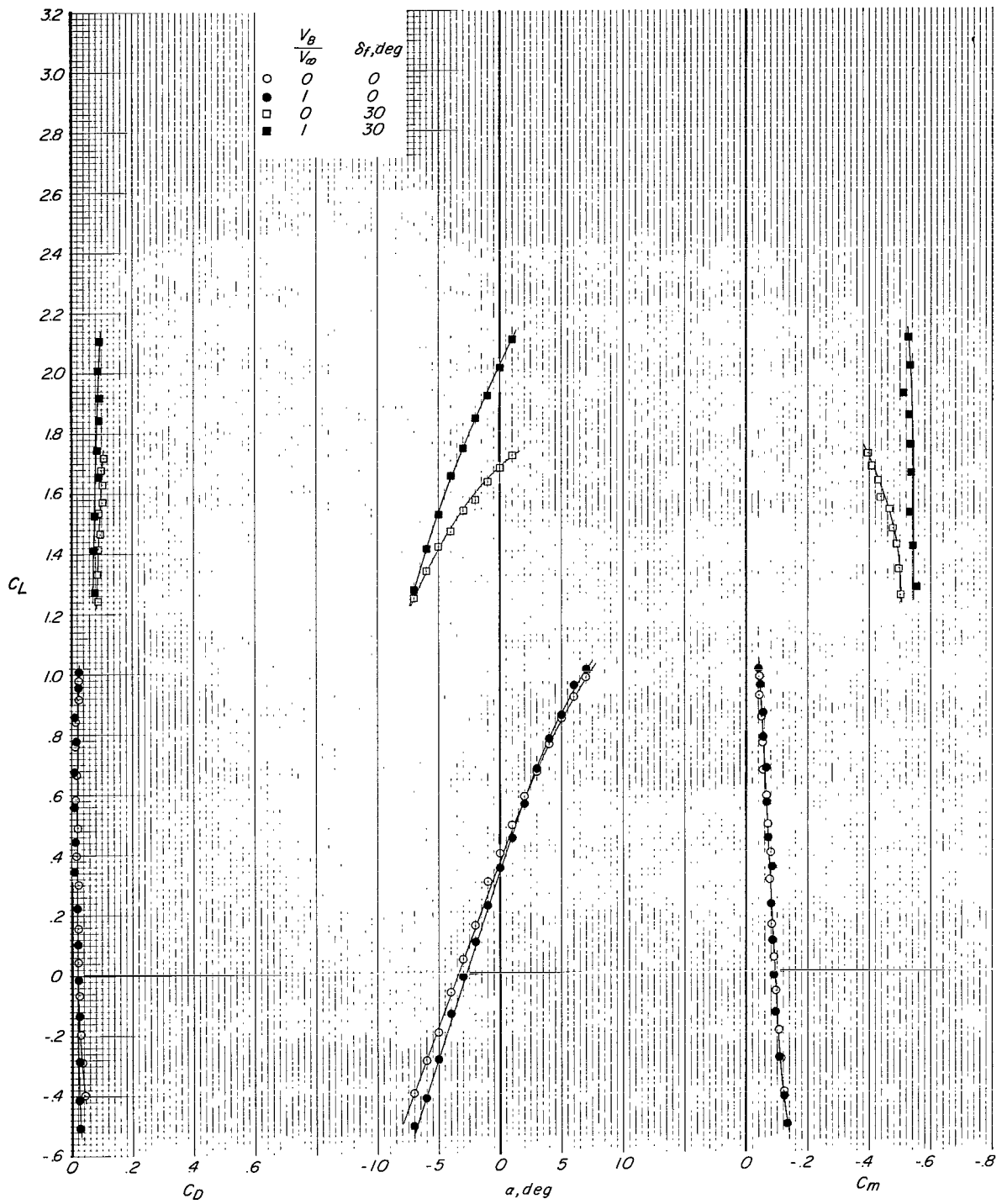

(c) $h/b = 0.033$.

Figure 6.- Continued.

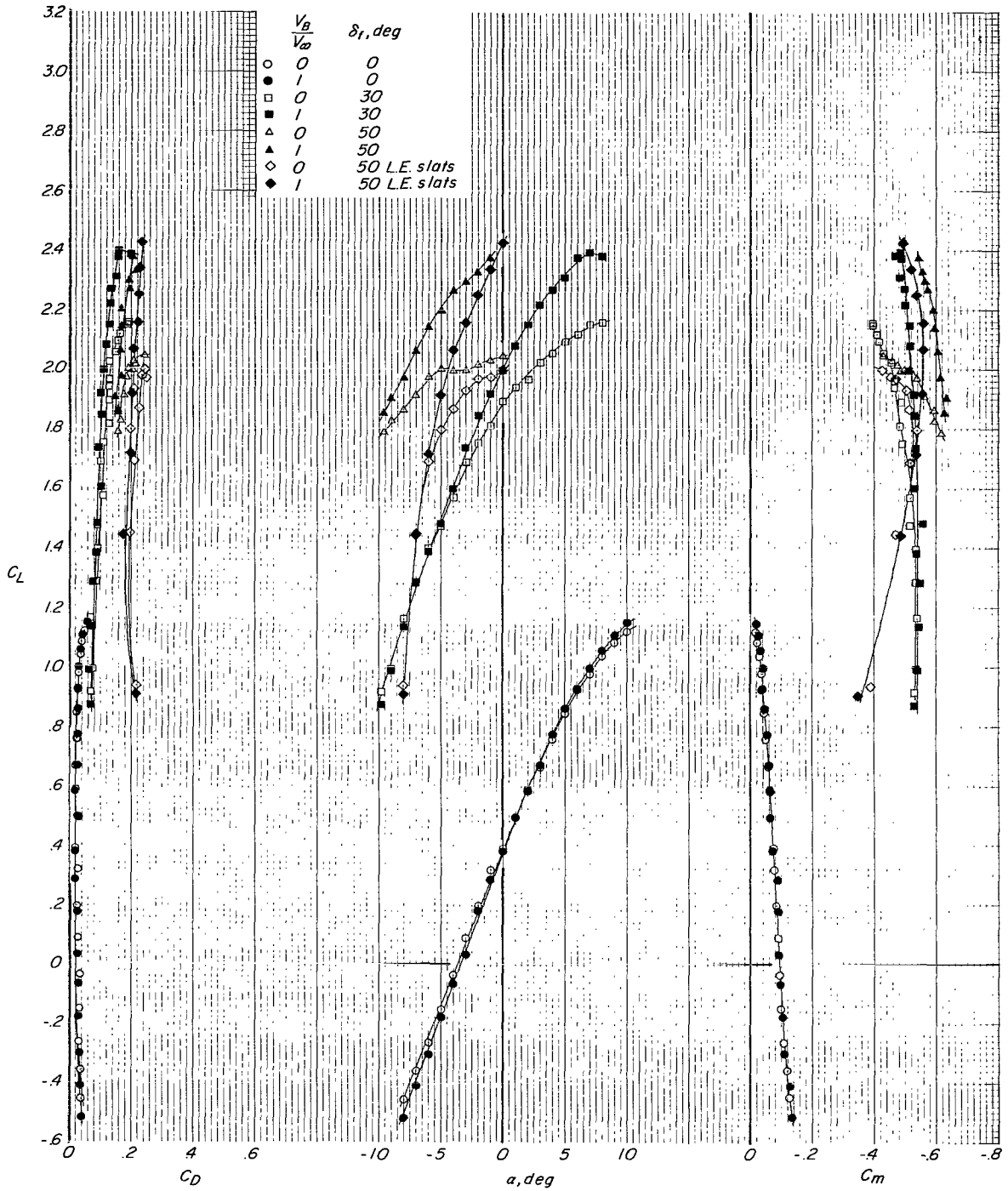

(d) $h/b = 0.050$.

Figure 6.- Continued.

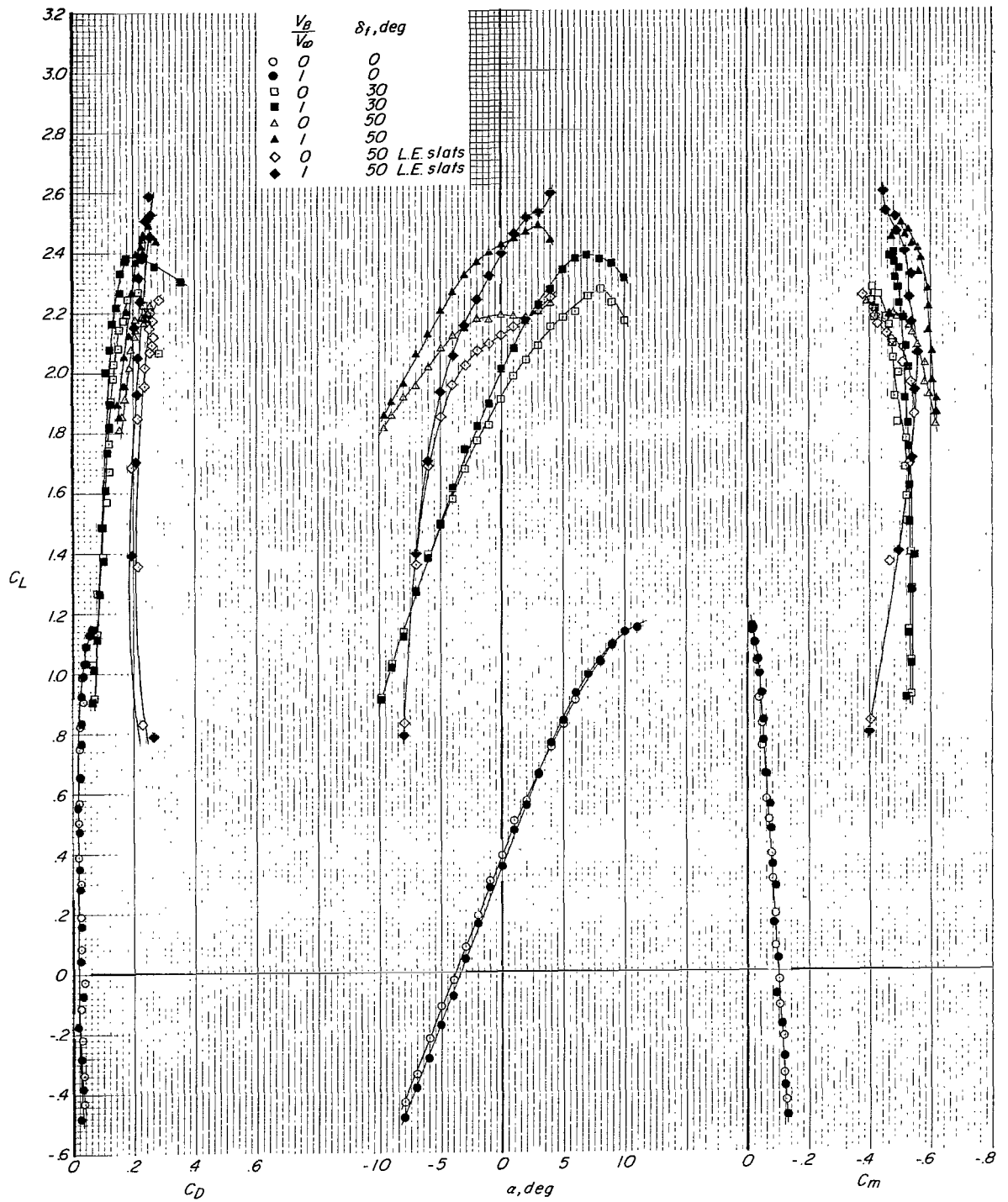

(e) $h/b = 0.060$.

Figure 6.- Continued.

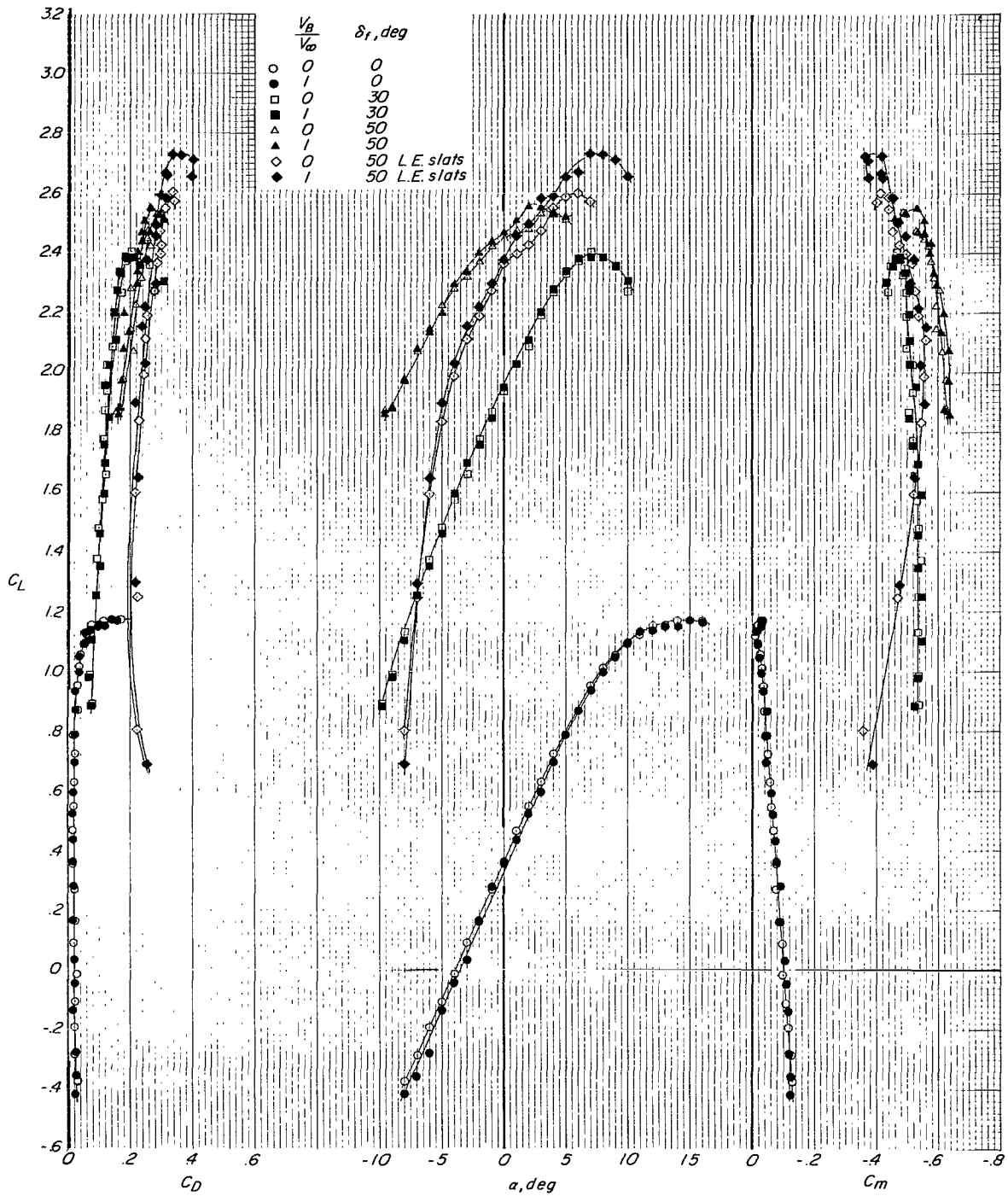

(f) $h/b = 0.090$.

Figure 6.- Continued.

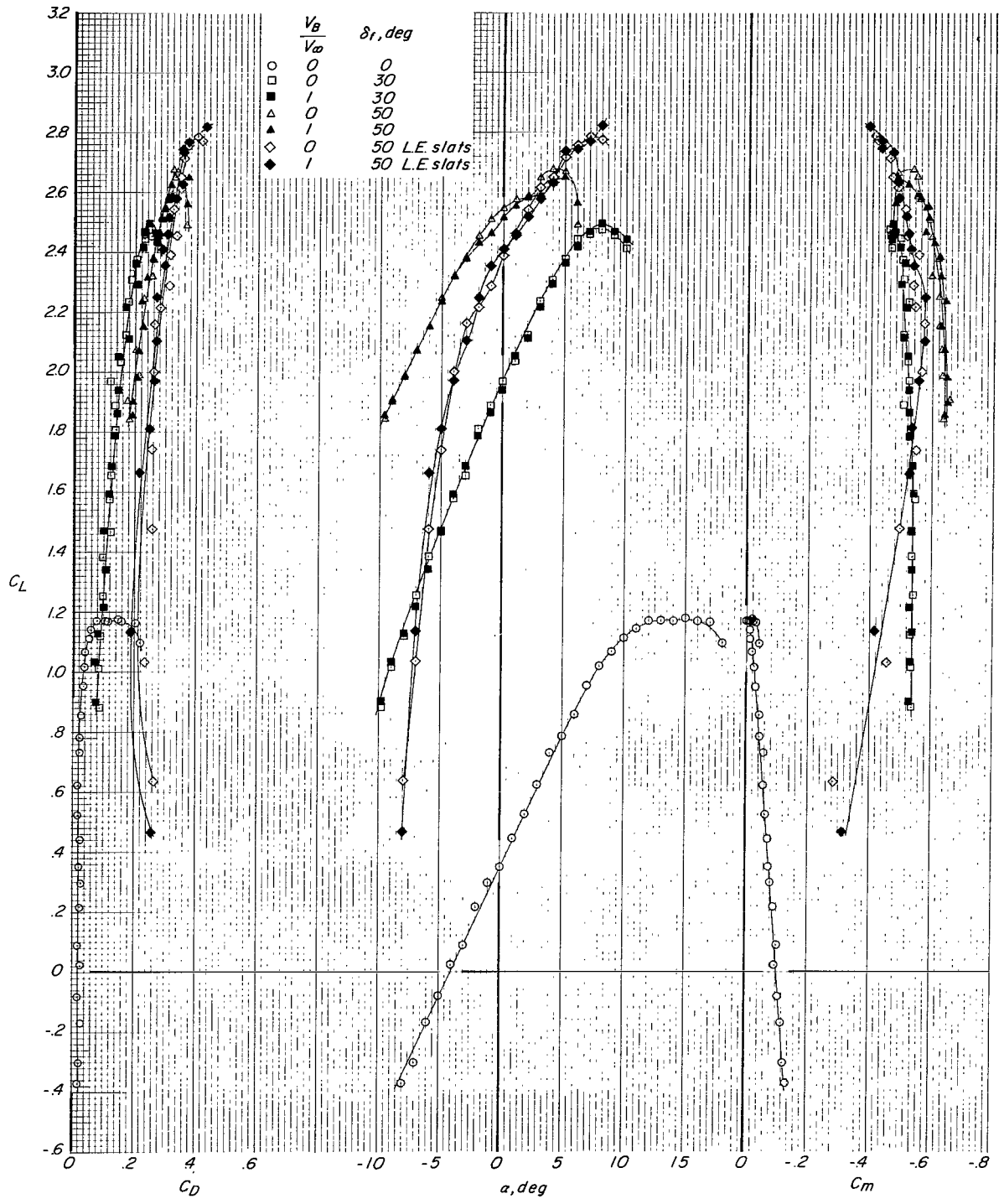

(g) $h/b = 0.150$.

Figure 6.- Continued.

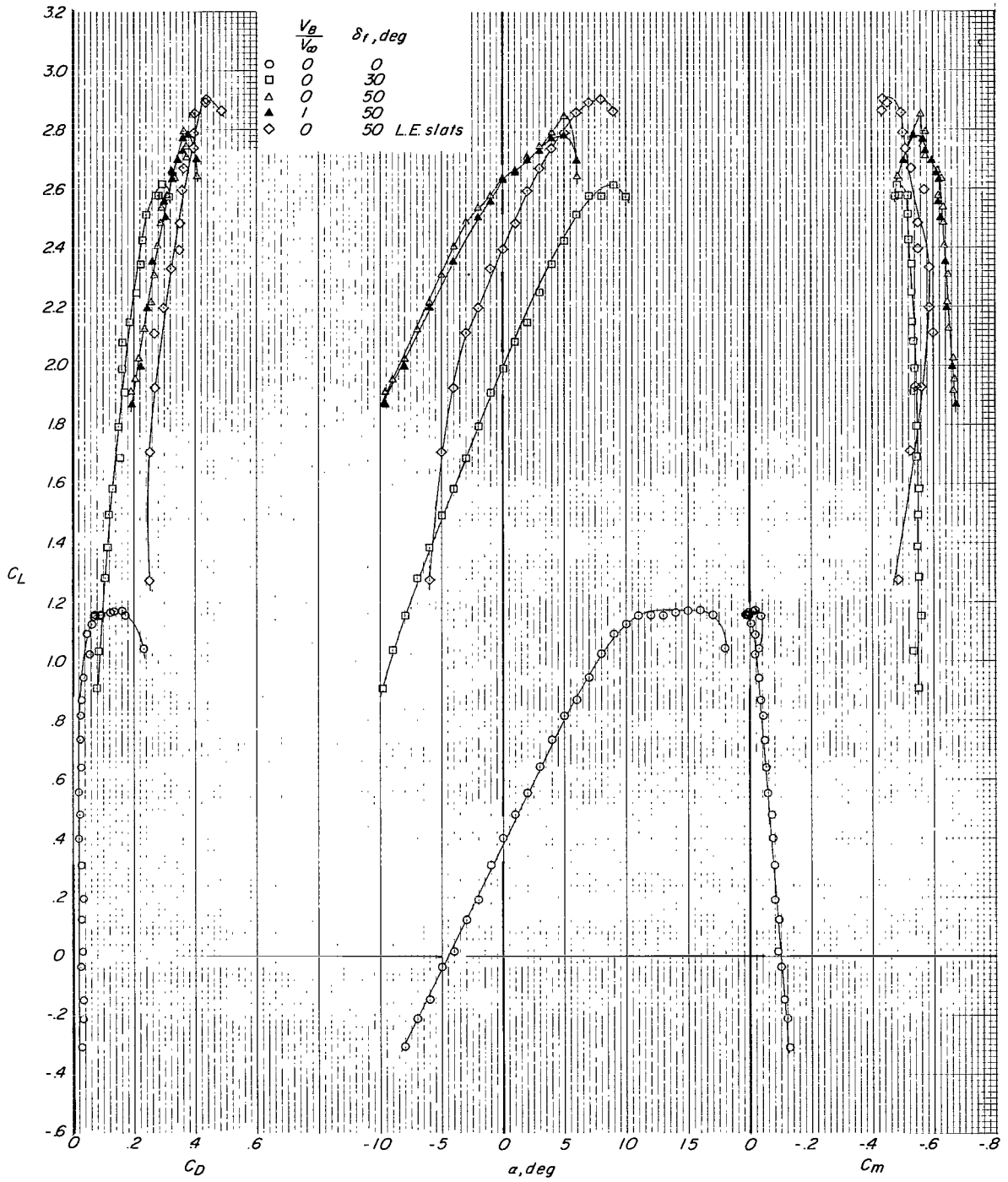

(h) $h/b = 0.283$.

Figure 6.- Continued.

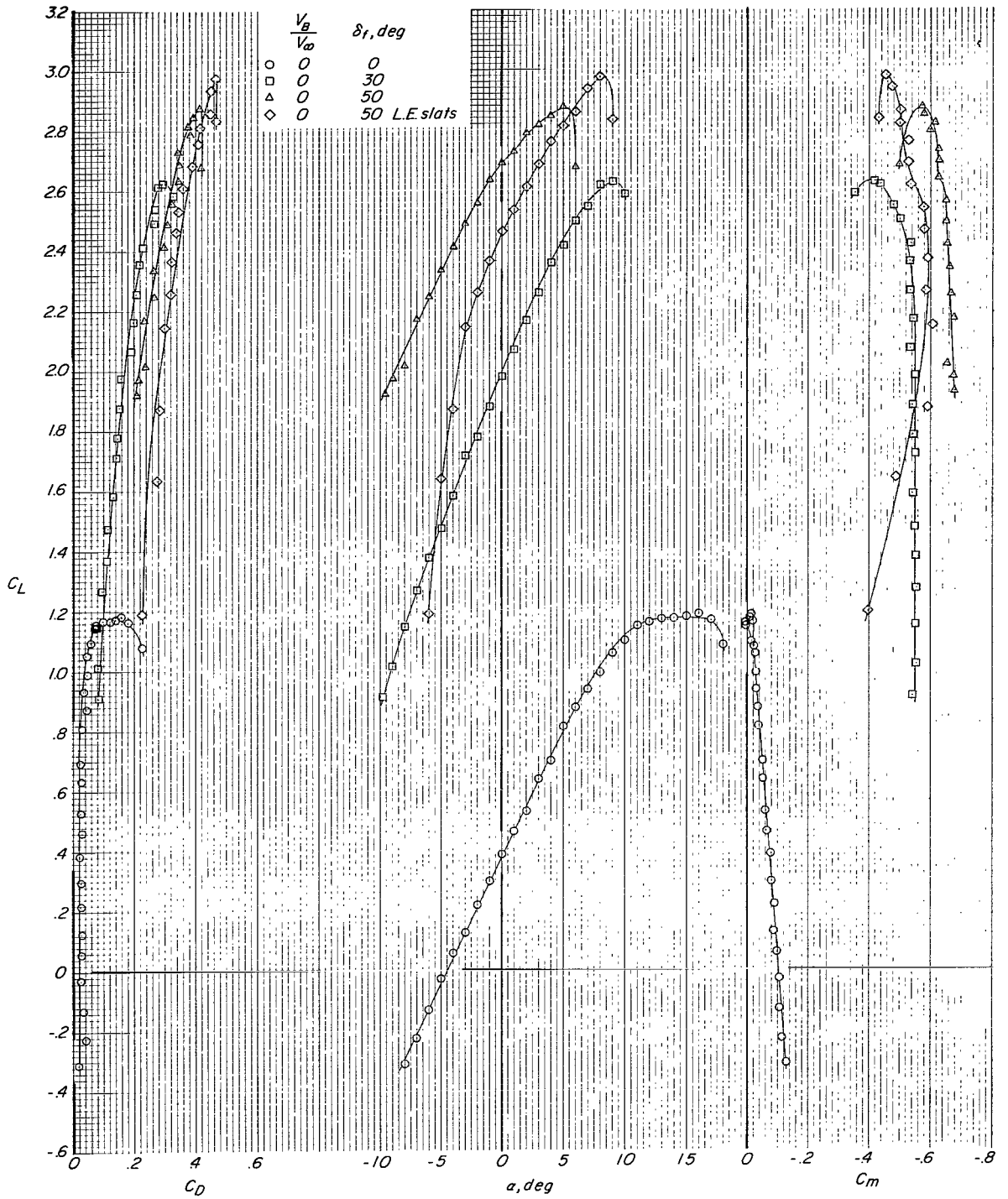

(i) $h/b = 0.400$.

Figure 6.- Continued.

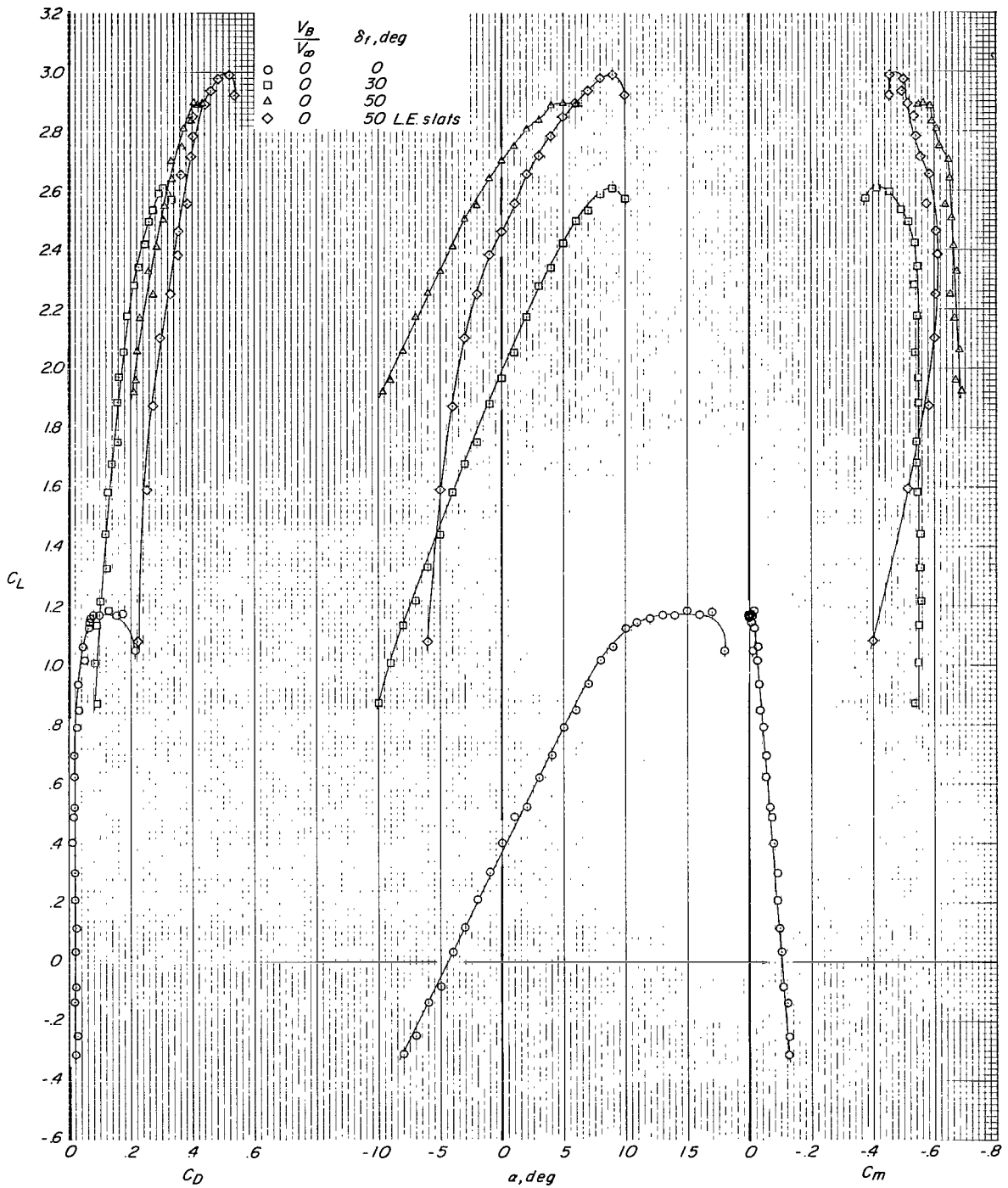

(j) $h/b = 0.500$.

Figure 6.- Continued.

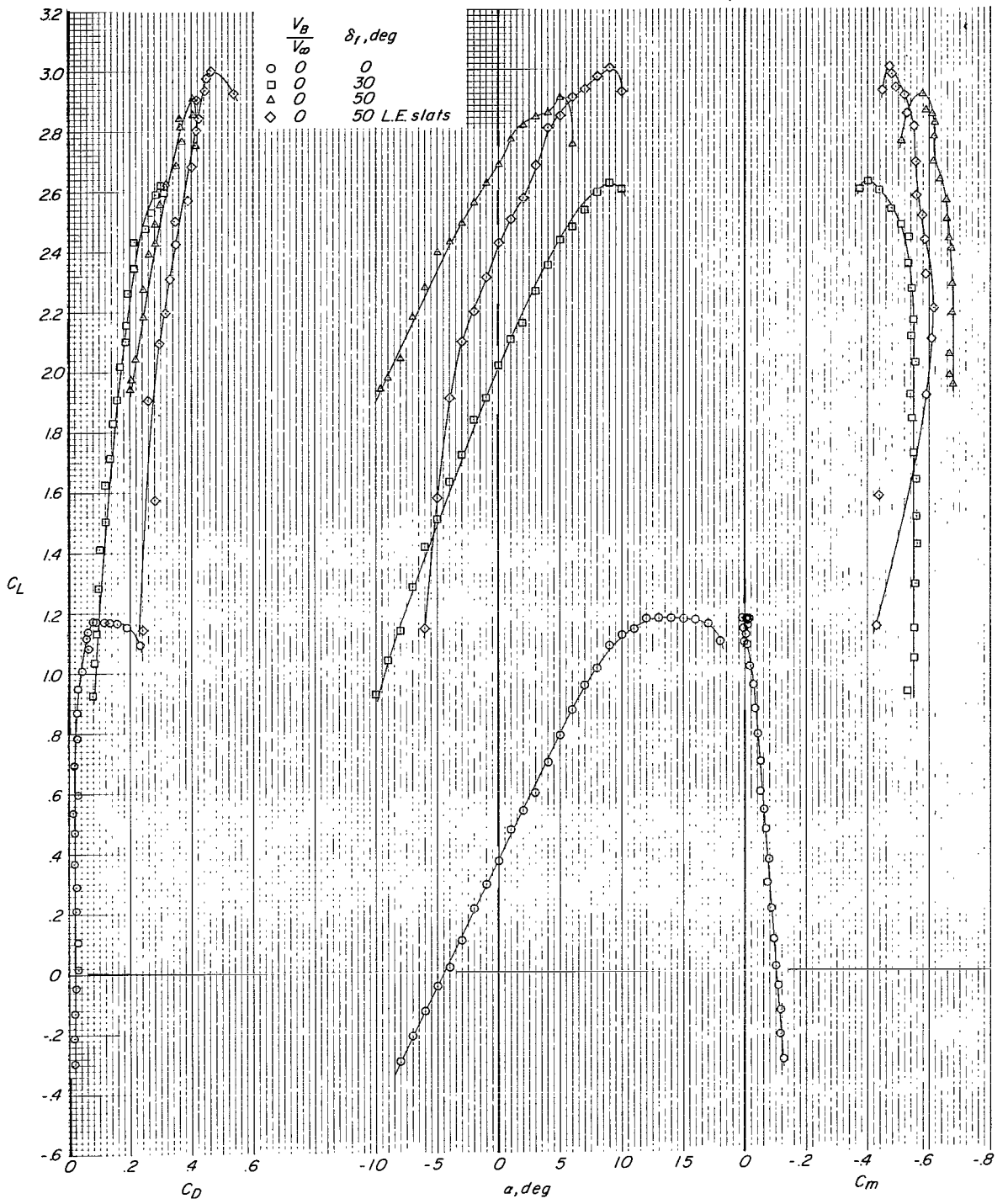

(k) $h/b = 0.683$.

Figure 6.- Concluded.

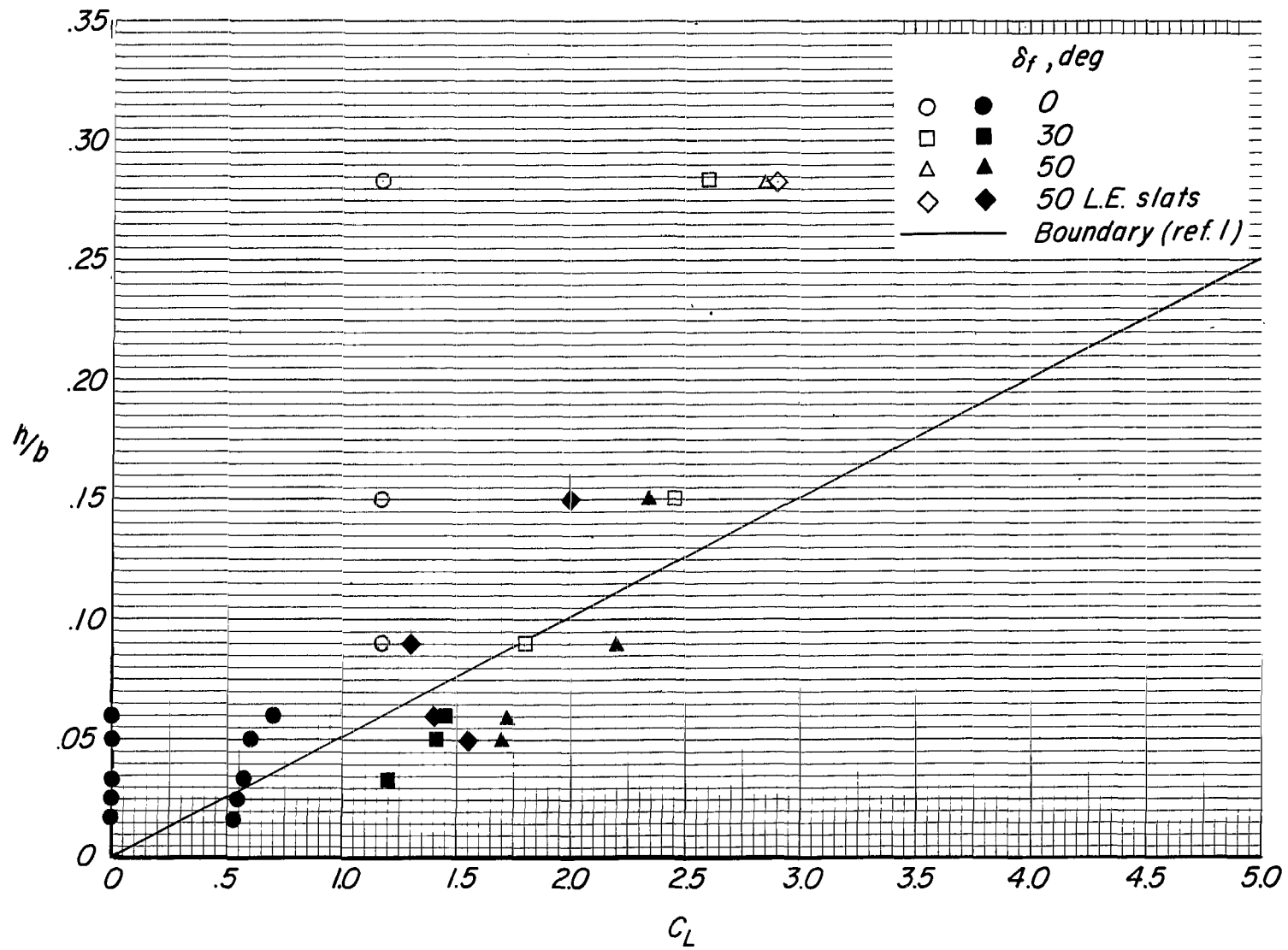

Figure 7.- Conditions requiring moving-belt ground plane. Open symbols indicate stationary ground board adequate; closed symbols indicate moving belt required.

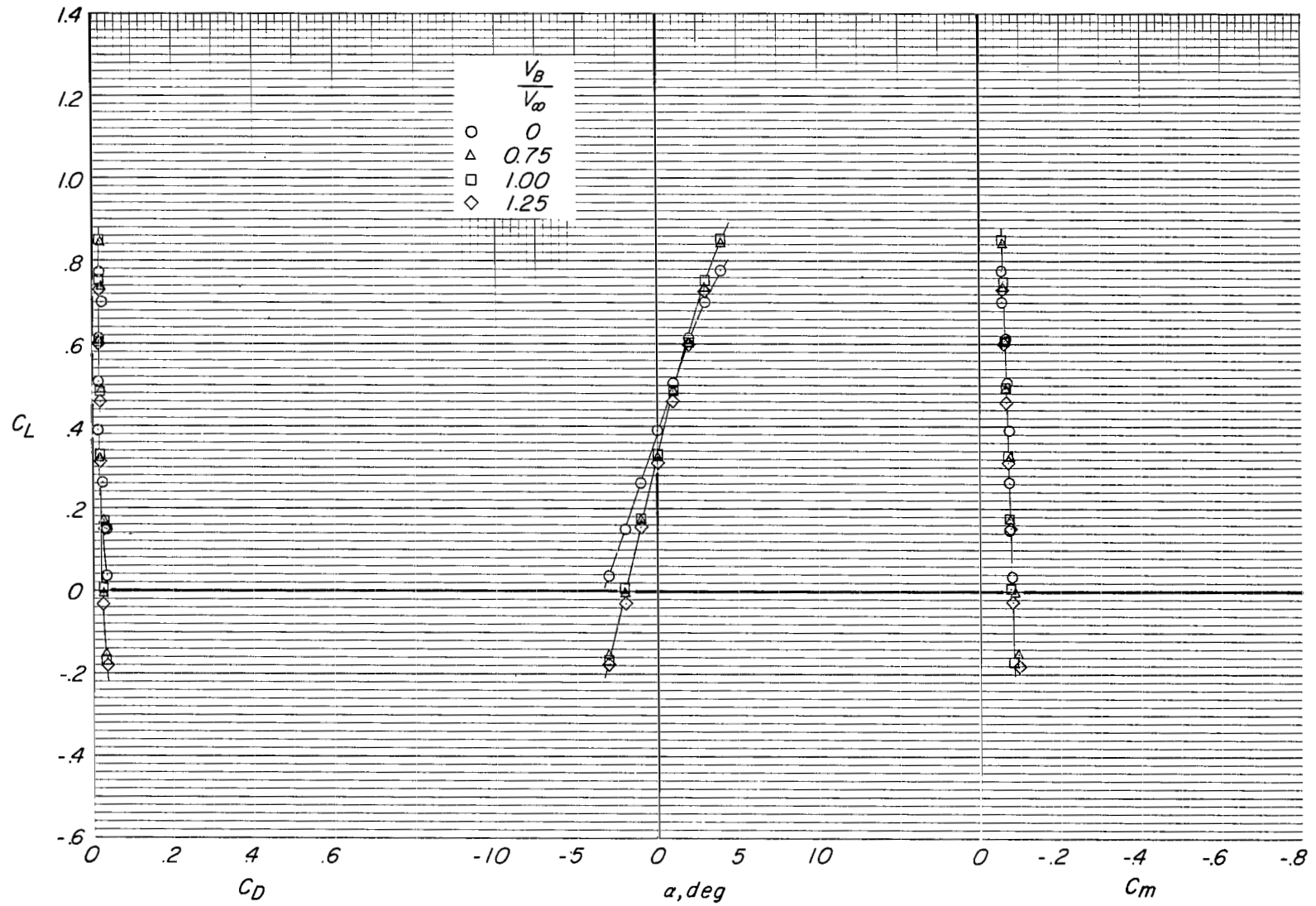
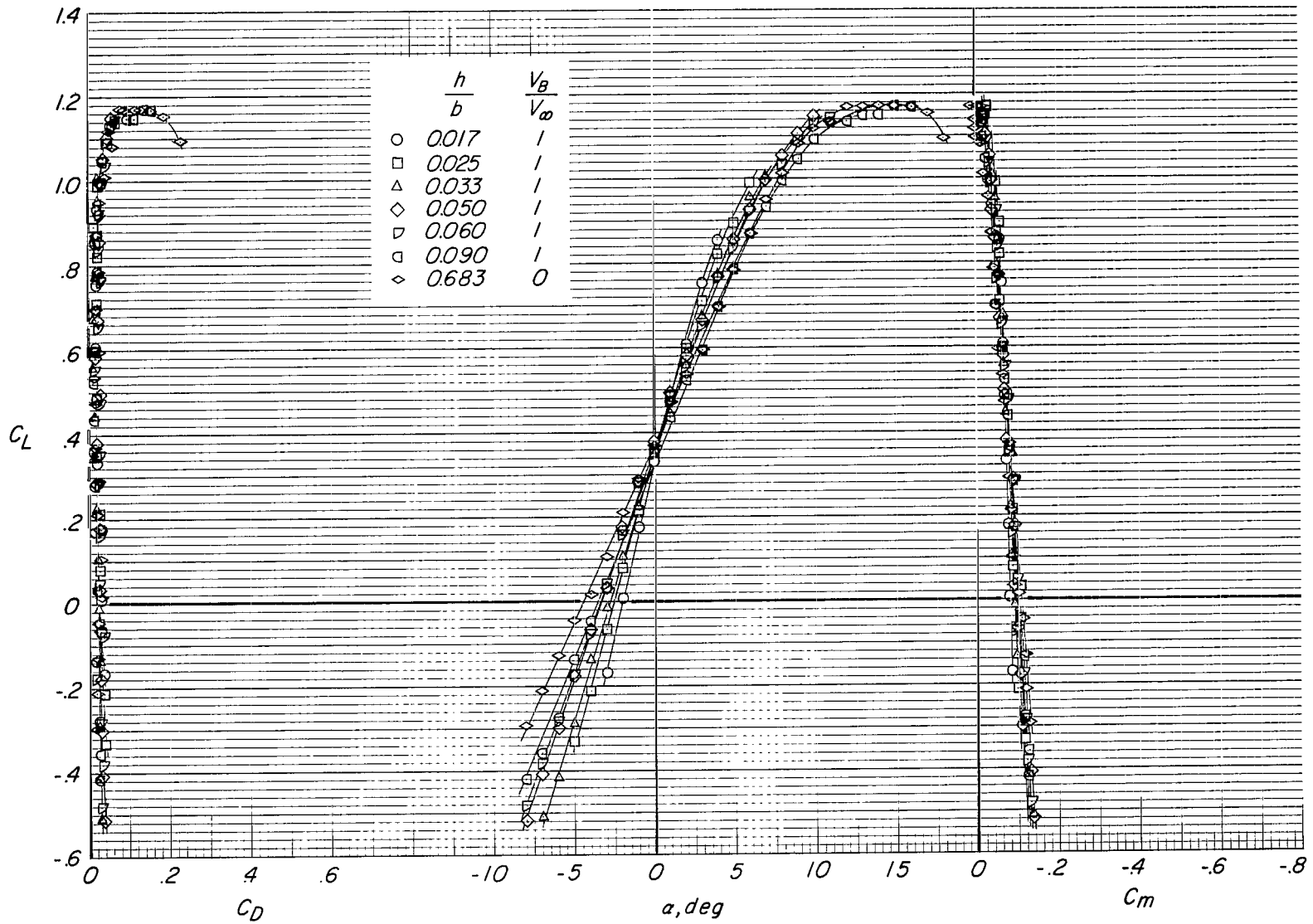
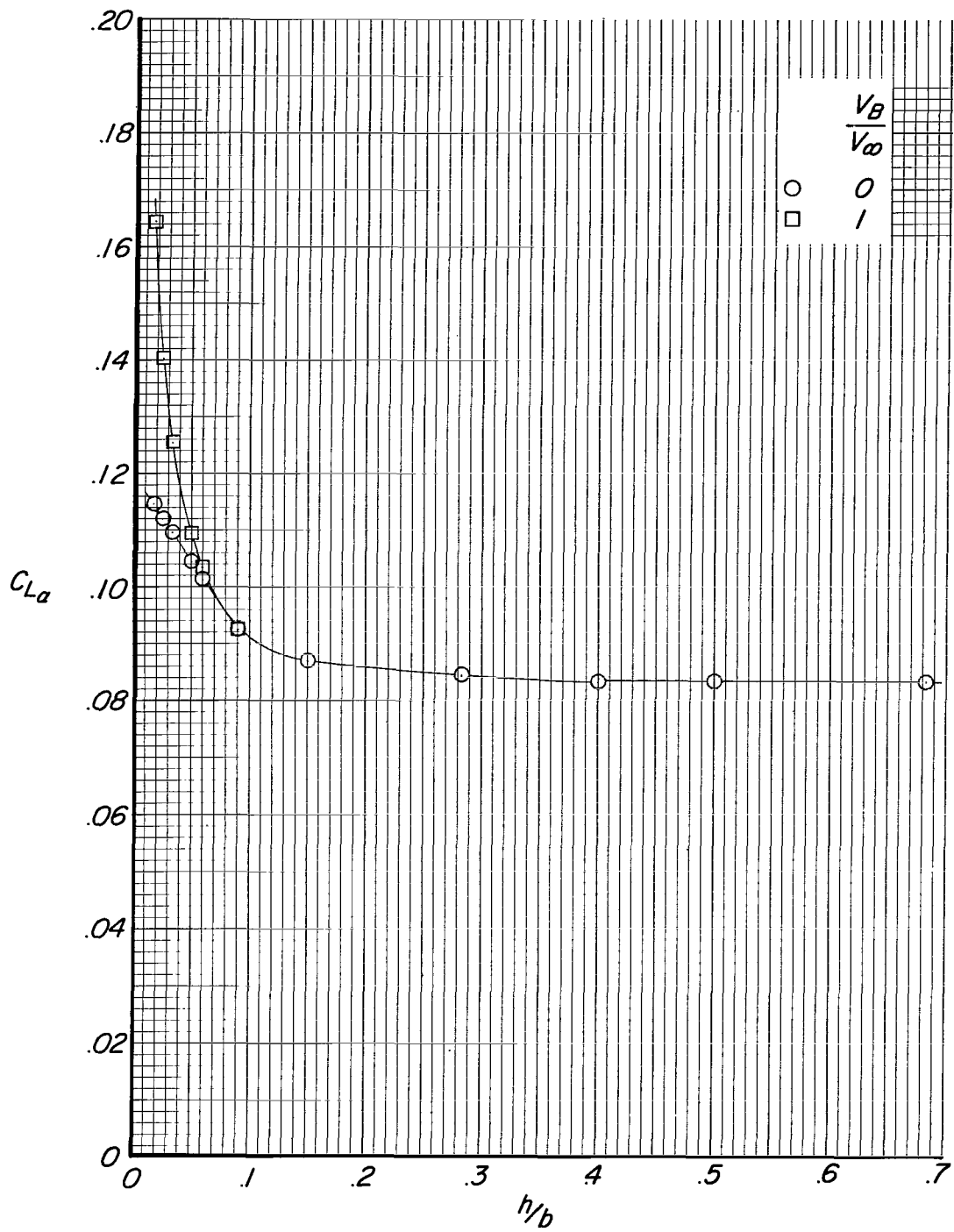

Figure 8.- Effect of variations in the velocity of the moving-belt ground plane on the longitudinal aerodynamic characteristics of the aspect-ratio-10 wing with flaps retracted and at a height-to-span ratio of 0.017.



(a) Longitudinal aerodynamic characteristics.

Figure 9.- Effects of height of the wing above the ground and of the moving-belt ground plane on the aspect-ratio-10 wing with flaps retracted.



(b) Variation of lift-curve slope with height-to-span ratio.

Figure 9.- Continued.

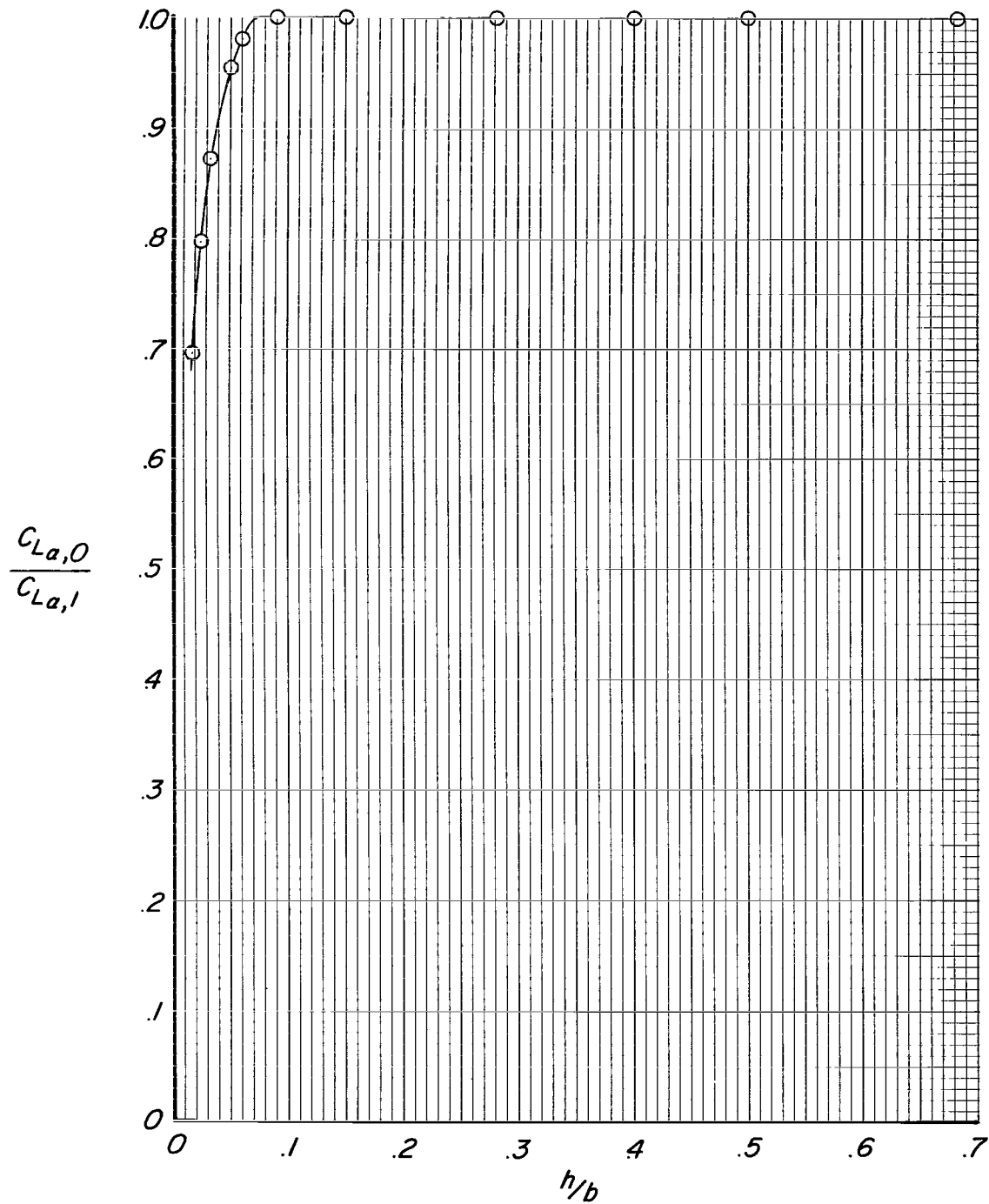

(c) Variation of $C_{L_{\alpha,0}}/C_{L_{\alpha,1}}$ with height-to-span ratio.

Figure 9.- Continued.

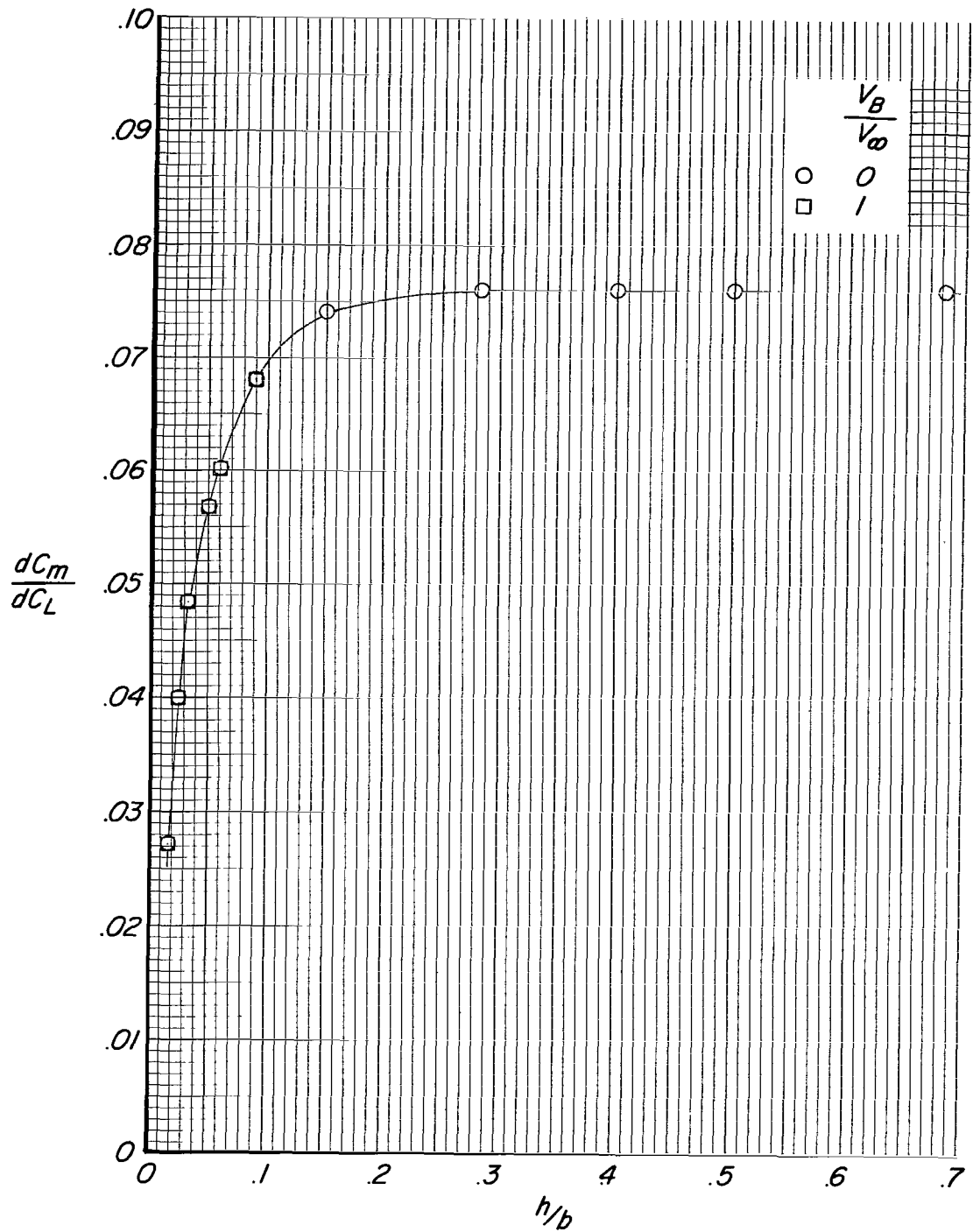

(d) Variation of dC_m/dC_L with height-to-span ratio.

Figure 9.- Continued.

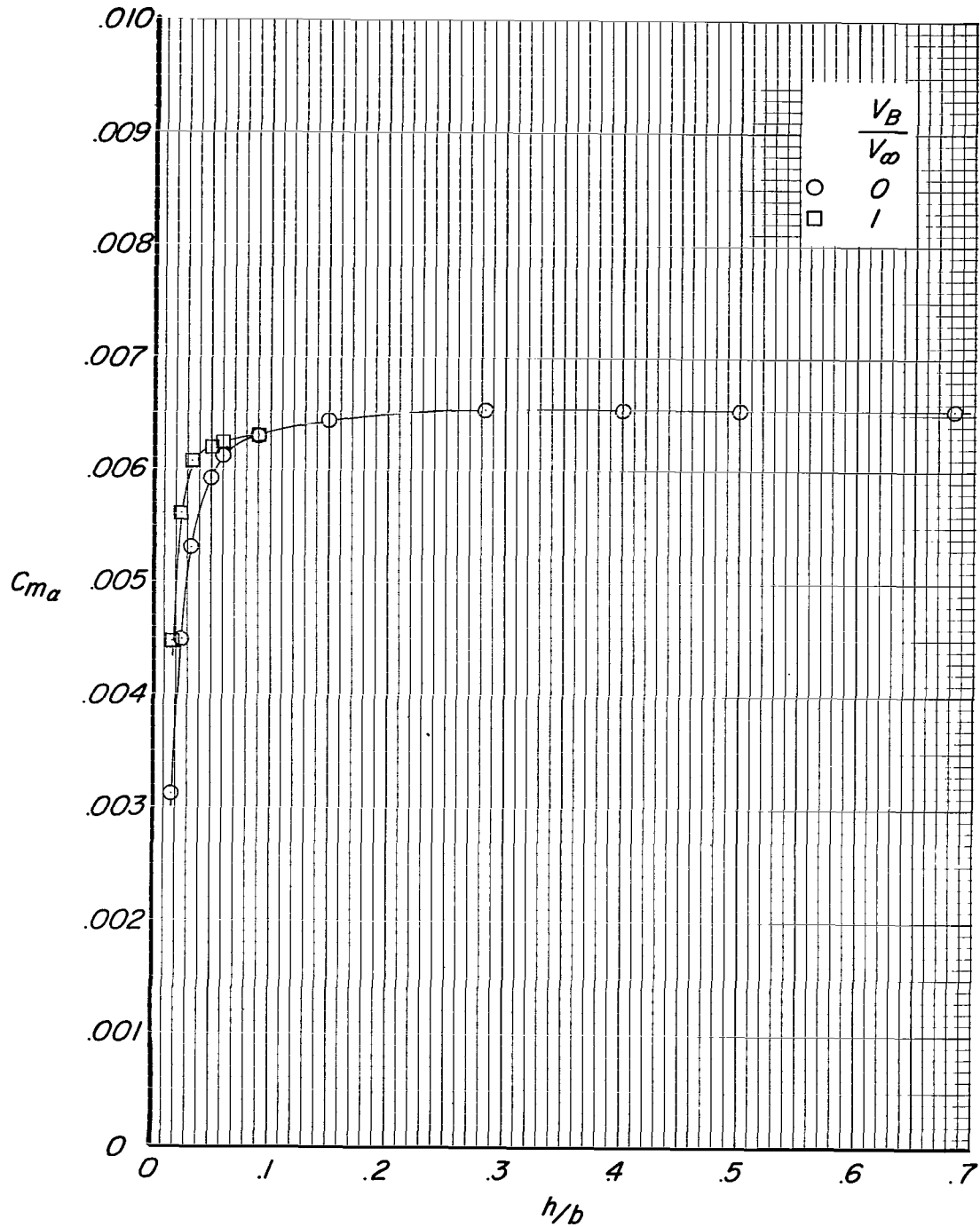

(e) Variation of pitching-moment-curve slope with height-to-span ratio.

Figure 9.- Continued.

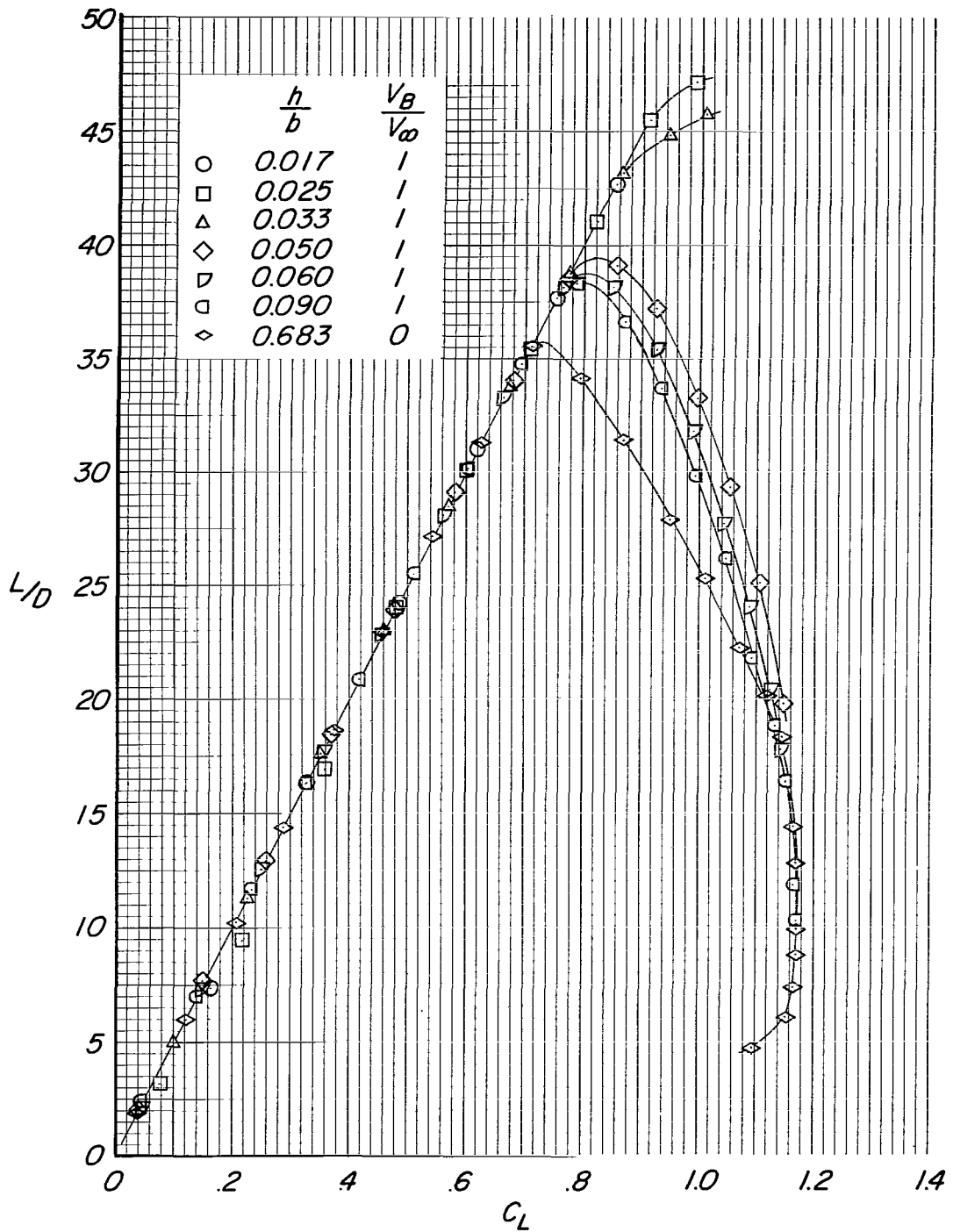

(f) Variation of lift-drag ratio with lift coefficient.

Figure 9.- Concluded.

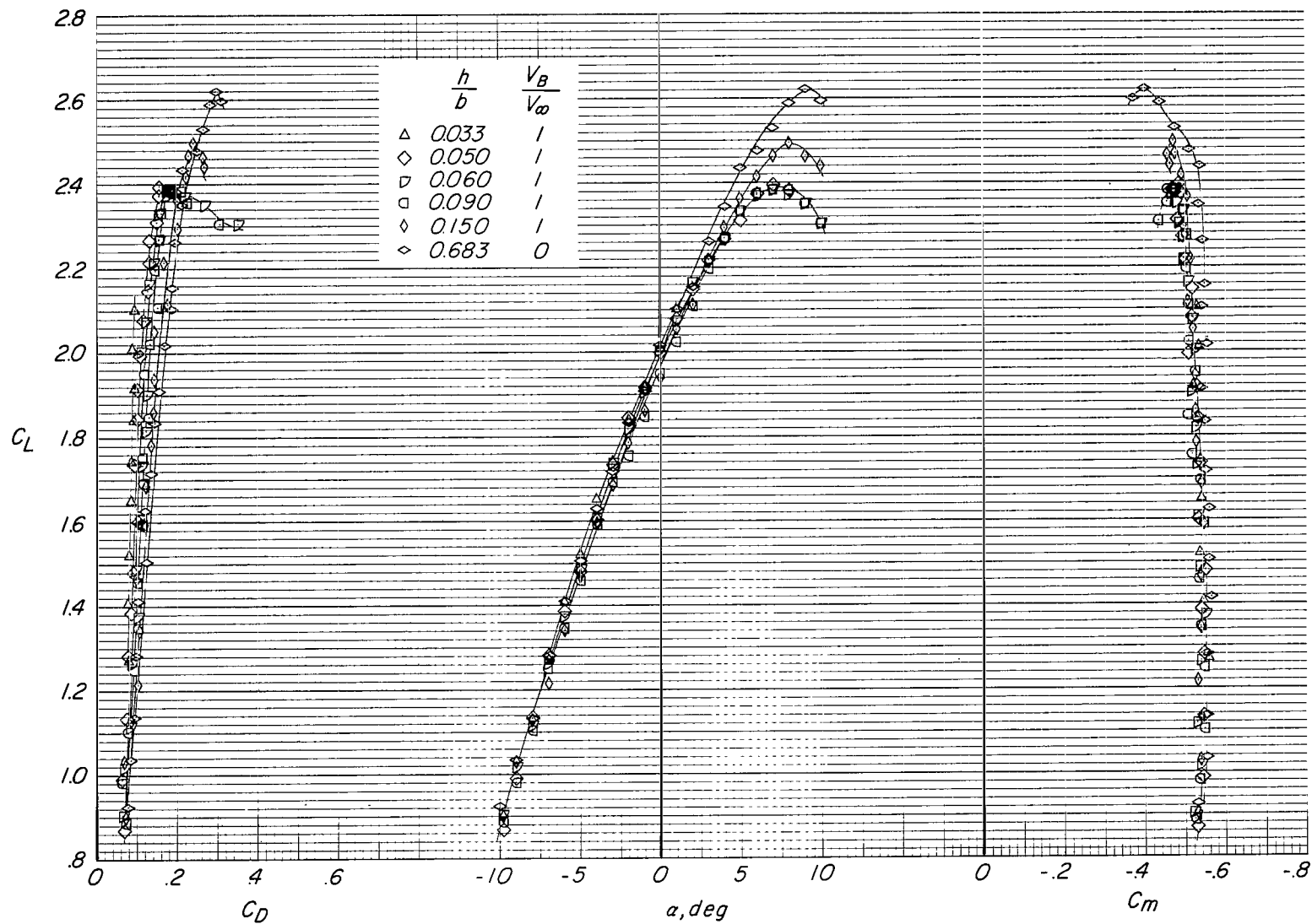

(a) Longitudinal aerodynamic characteristics.

Figure 10.- Effects of height of the wing above the ground and of the moving-belt ground plane on the aspect-ratio-10 wing with flaps deflected 30°.

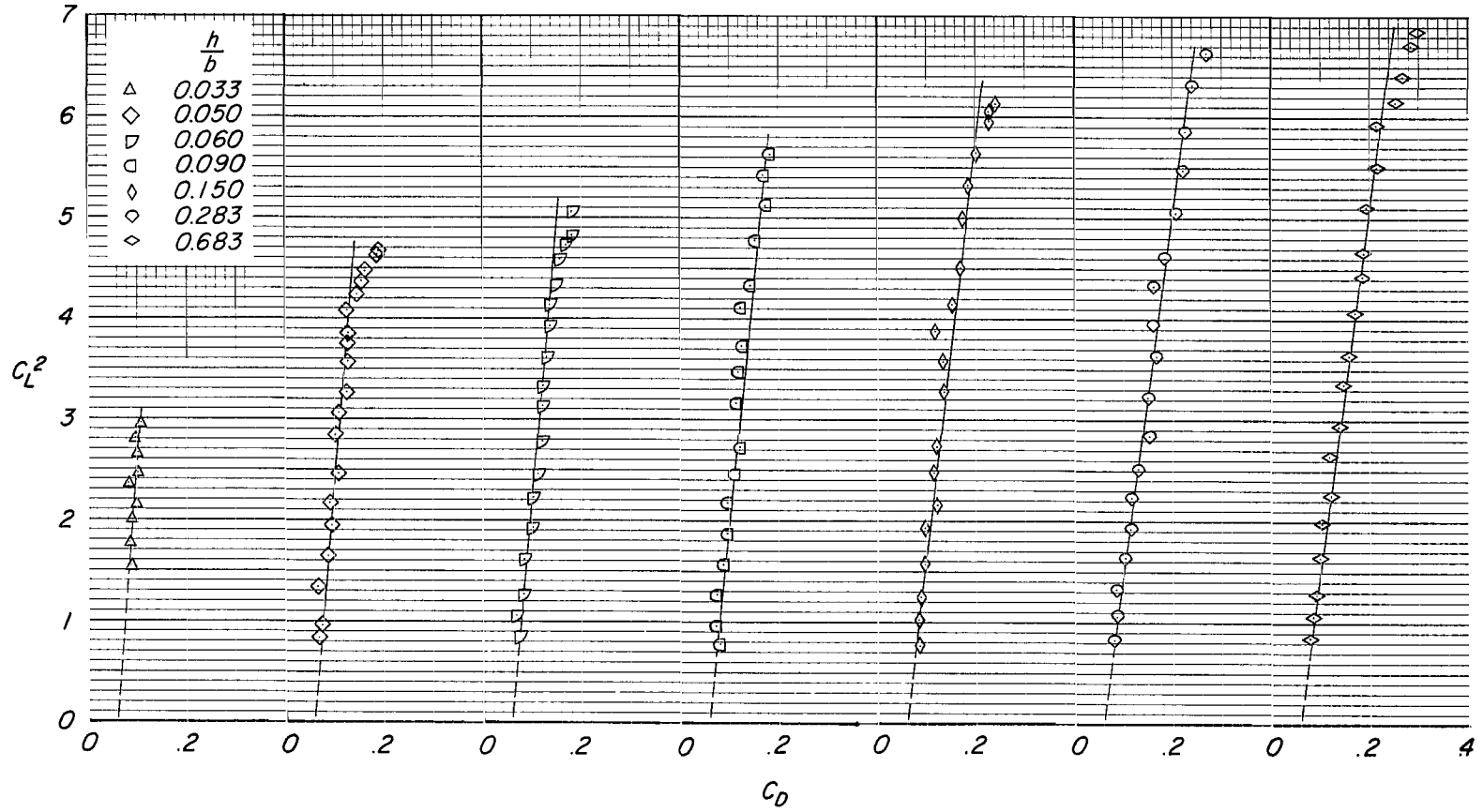

(b) Stationary ground plane. $\frac{V_B}{V_\infty} = 0$.

Figure 10.- Continued.

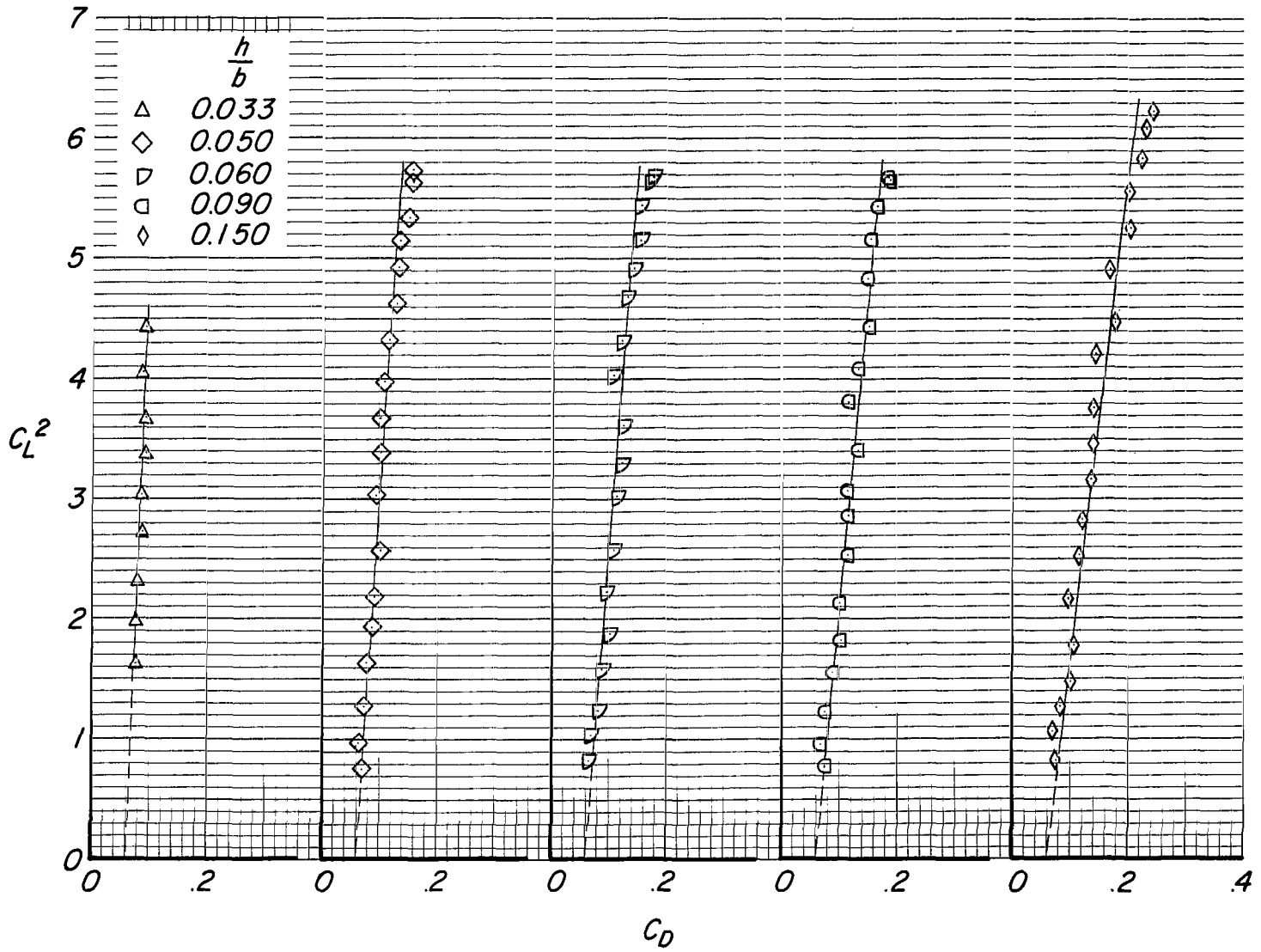

(c) Moving-belt ground plane. $\frac{V_B}{V_\infty} = 1$.

Figure 10.- Continued.

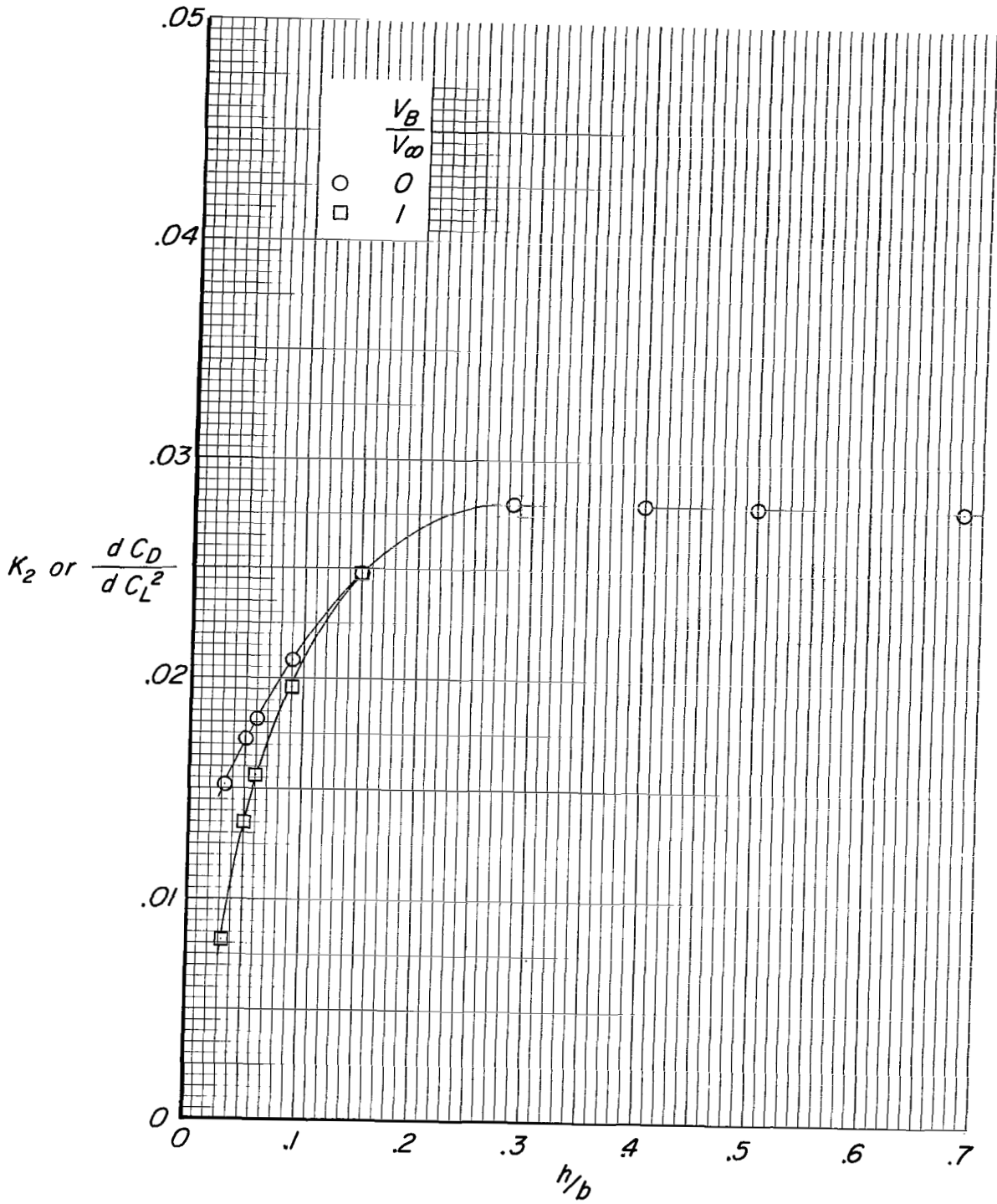

(d) Variation of K_2 or dC_D/dC_L^2 with height-to-span ratio.

Figure 10.- Continued.

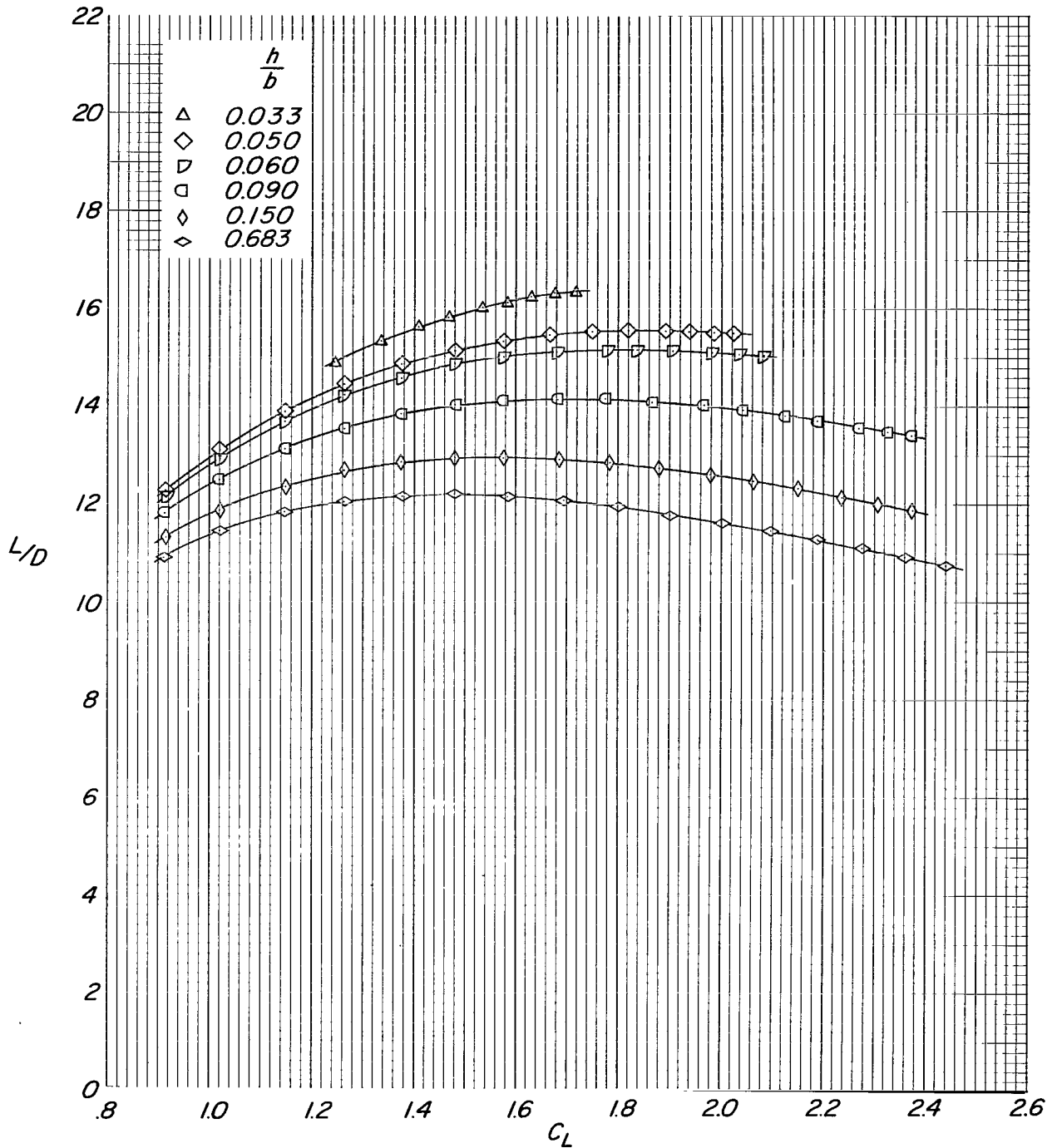

(e) Lift-drag ratio for stationary ground plane. $\frac{v_B}{v_\infty} = 0$.

Figure 10.- Continued.

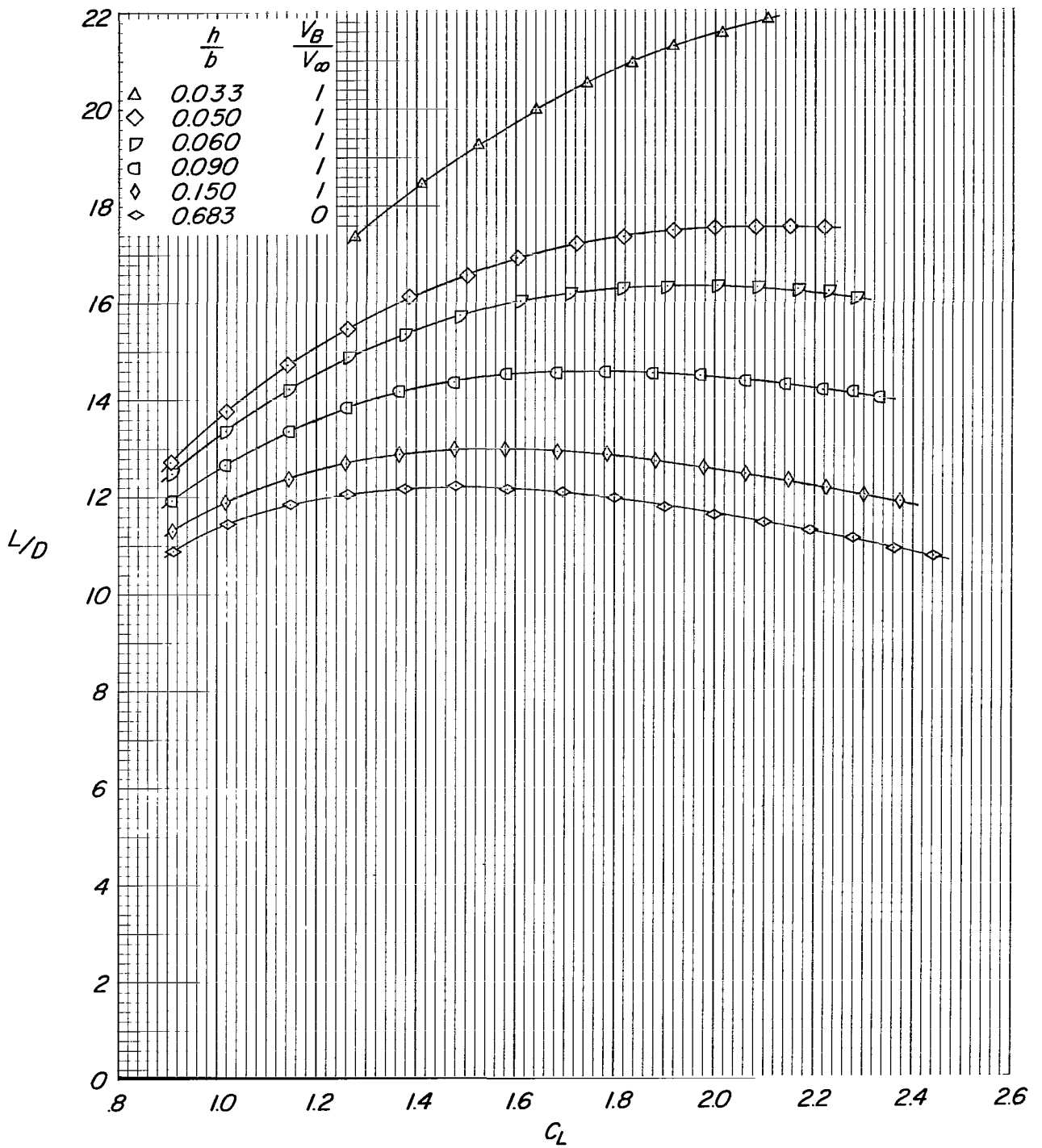

(f) Lift-drag ratio for moving-belt ground plane.

Figure 10.- Continued.

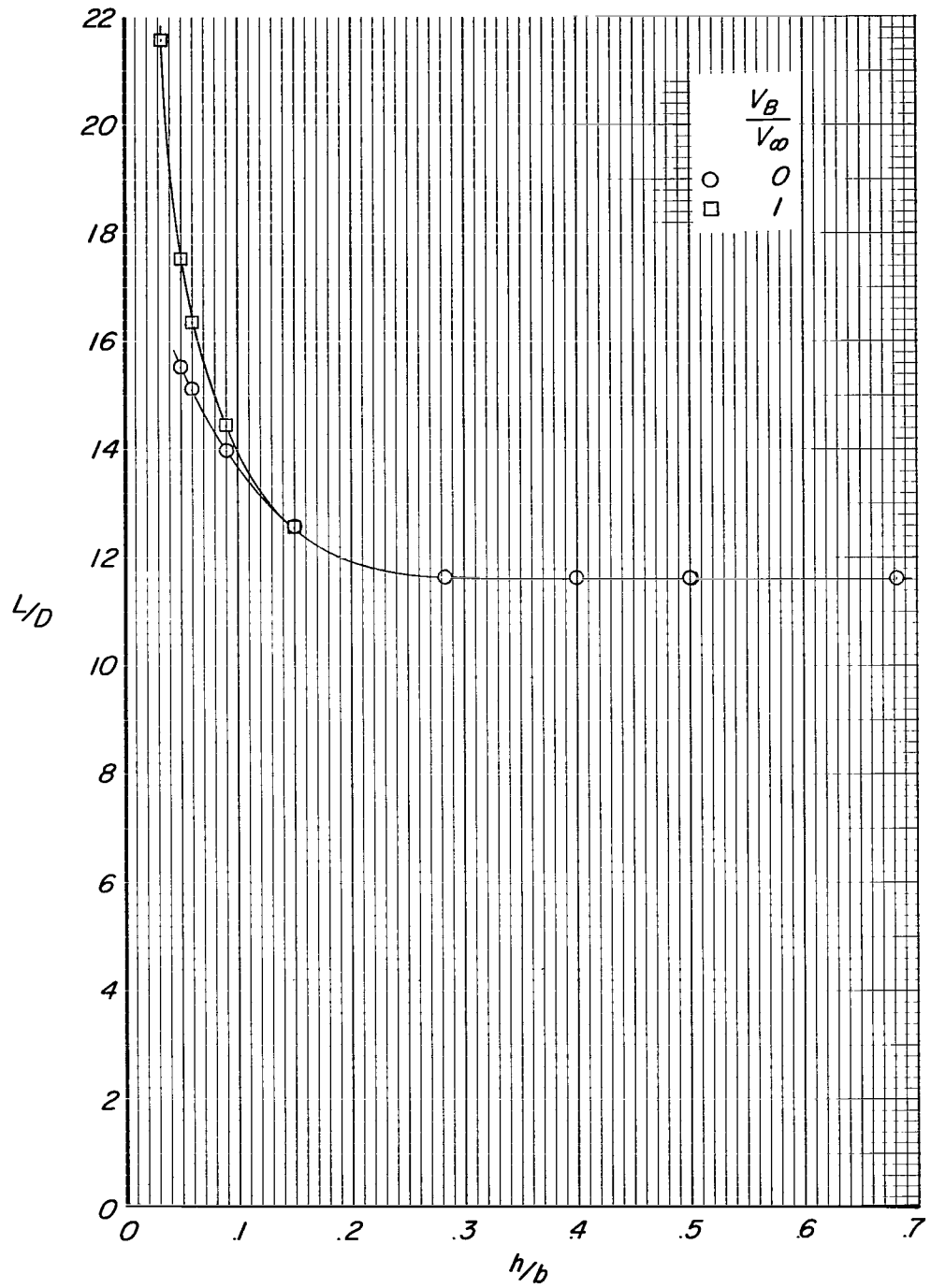

(g) Variation of lift-drag ratio with height-to-span ratio at $C_L = 2$.

Figure 10.- Concluded.

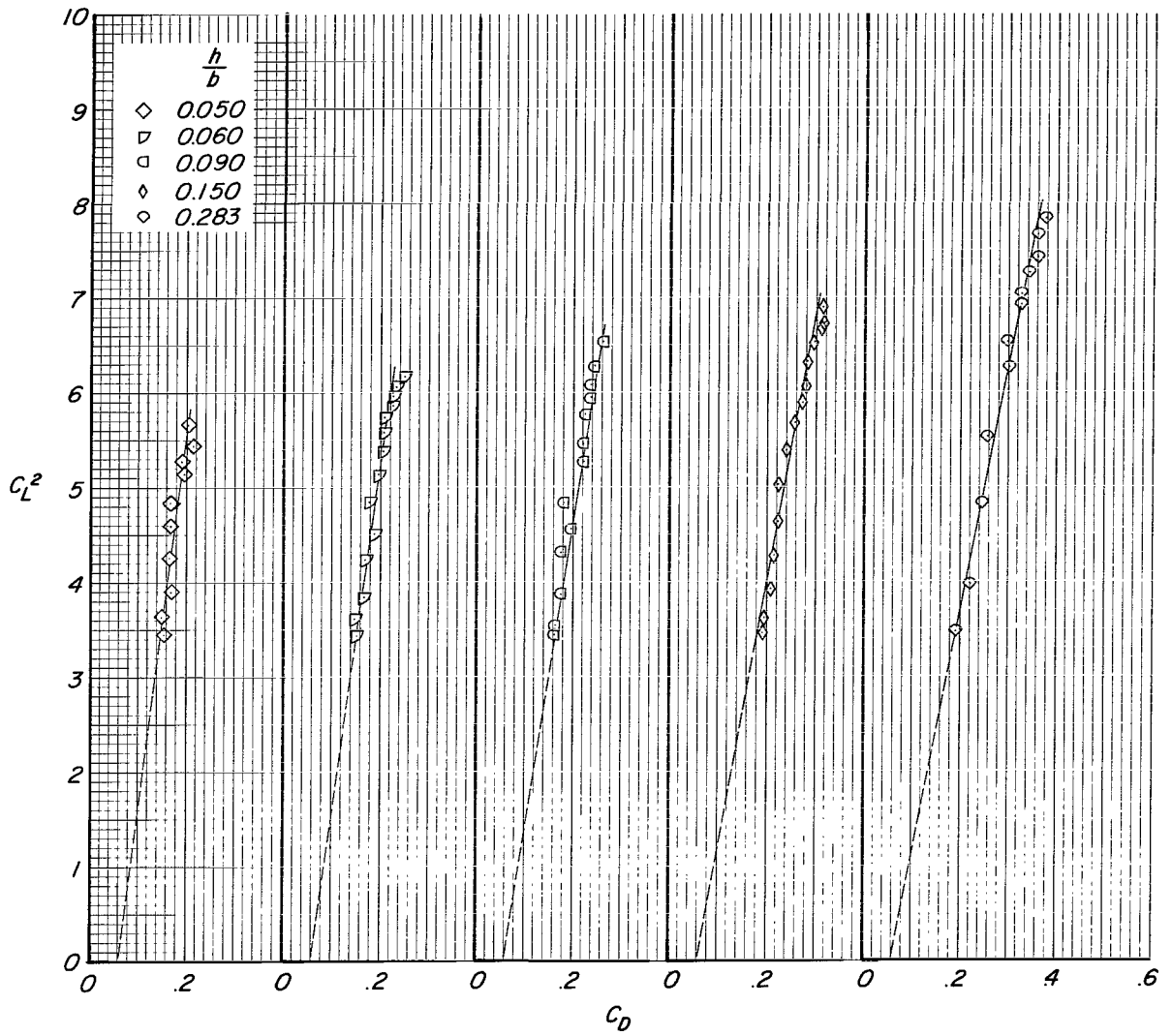

(c) Moving-belt ground plane. $\frac{V_B}{V_\infty} = 1$.

Figure 11.- Continued.

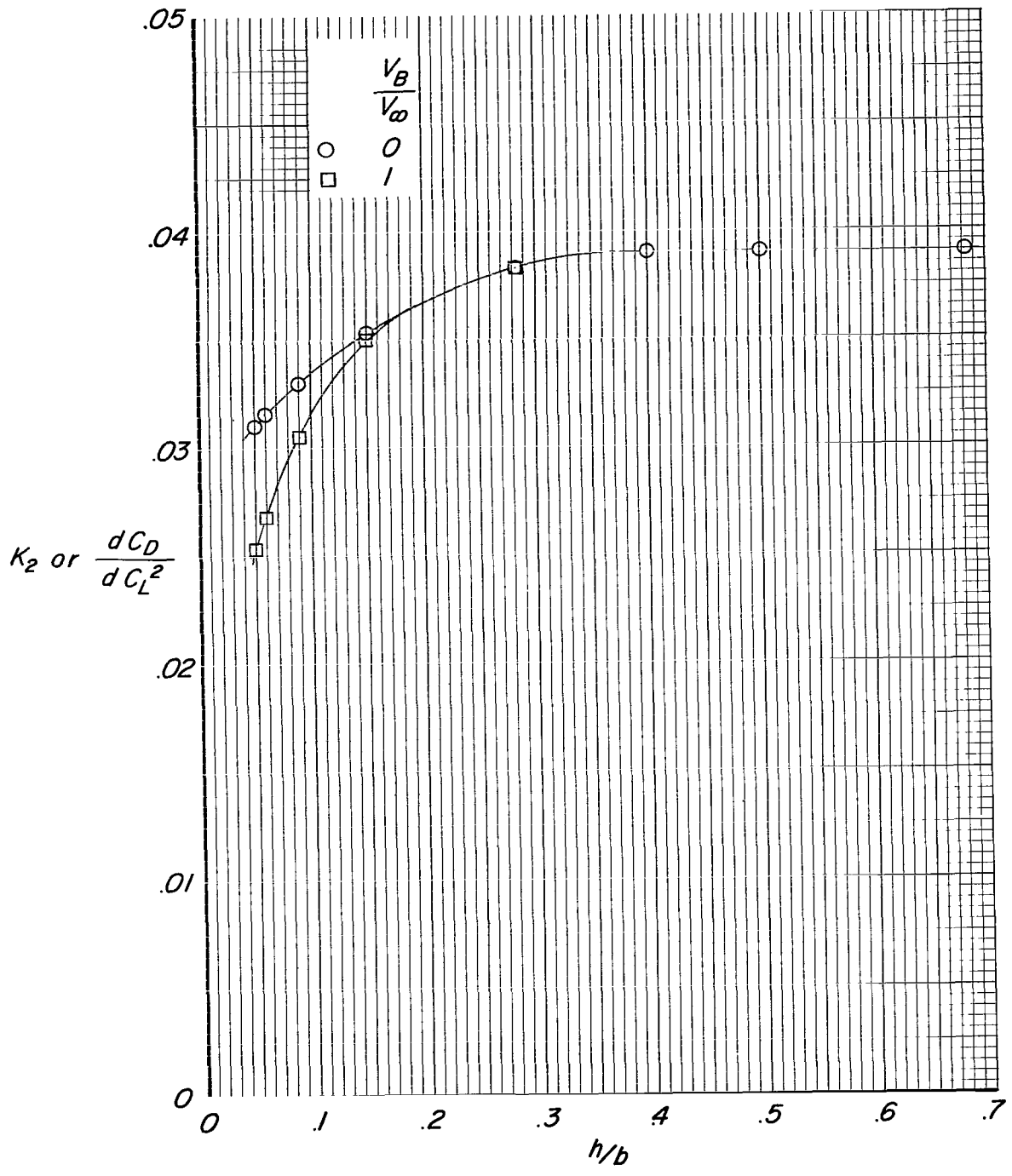

(d) Variation of K_2 or dC_D/dC_L^2 with height-to-span ratio.

Figure 11.- Continued.

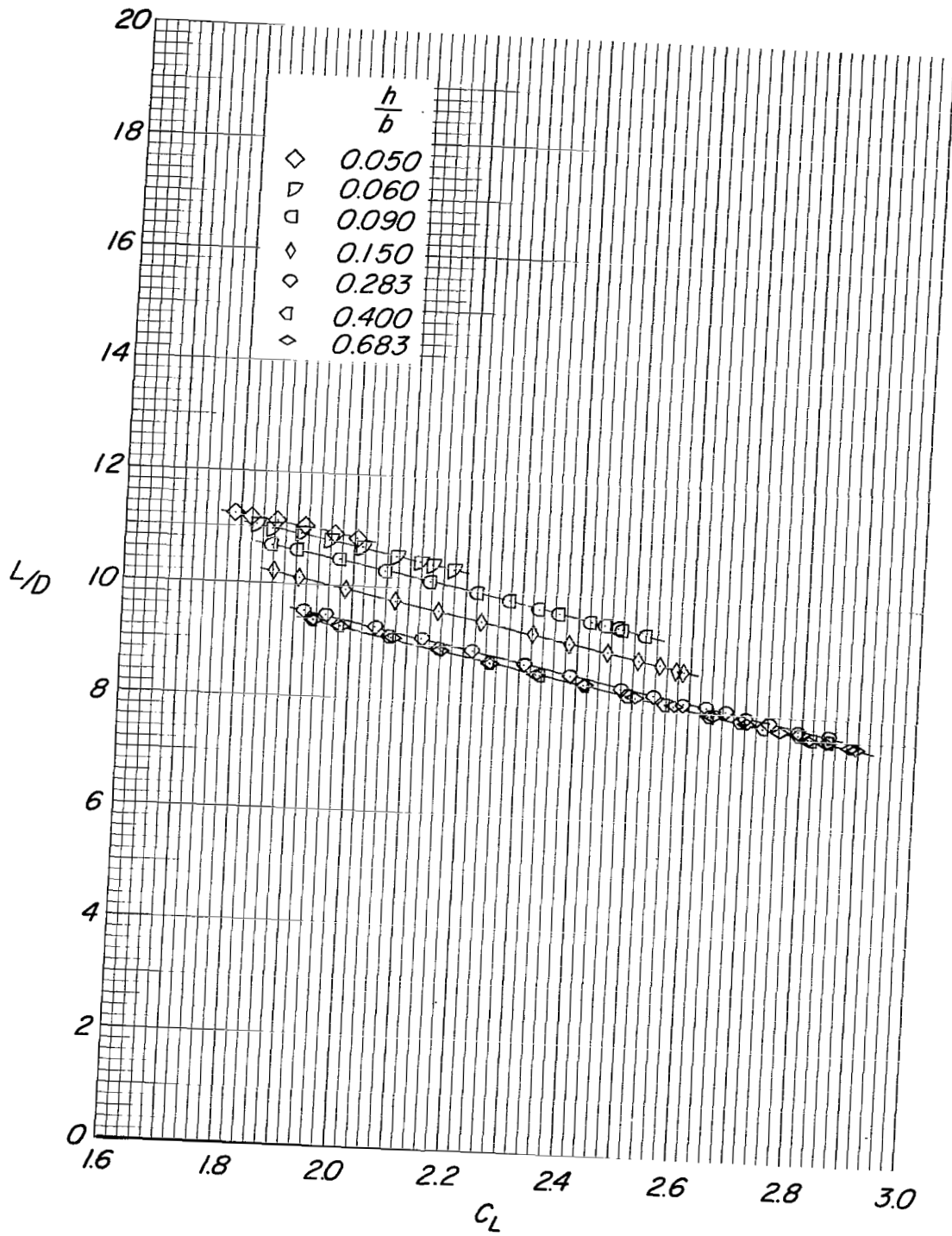

(e) Lift-drag ratio for stationary ground plane. $\frac{V_B}{V_\infty} = 0$.

Figure 11.- Continued.

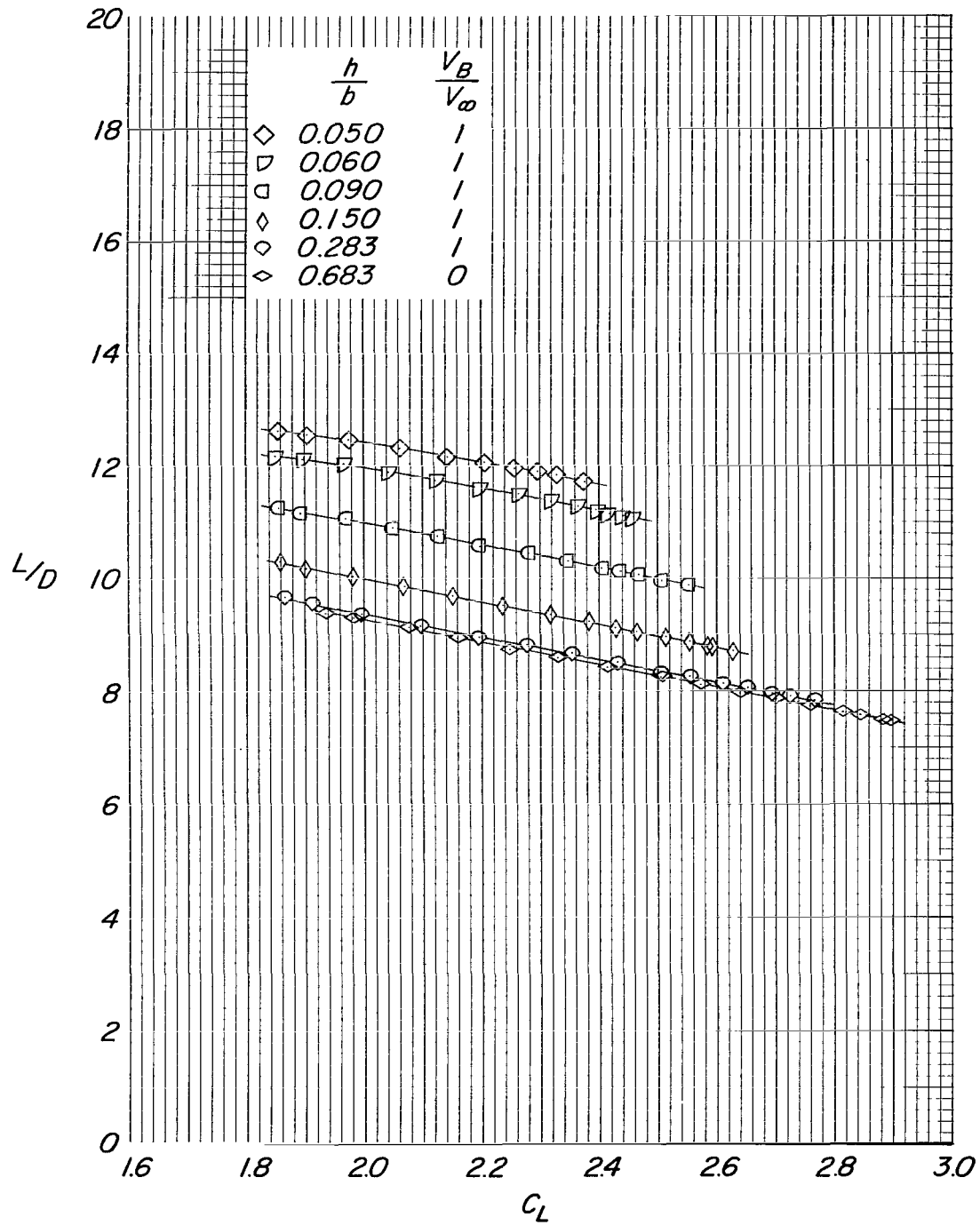

(f) Lift-drag ratio for moving-belt ground plane.

Figure 11.- Continued.

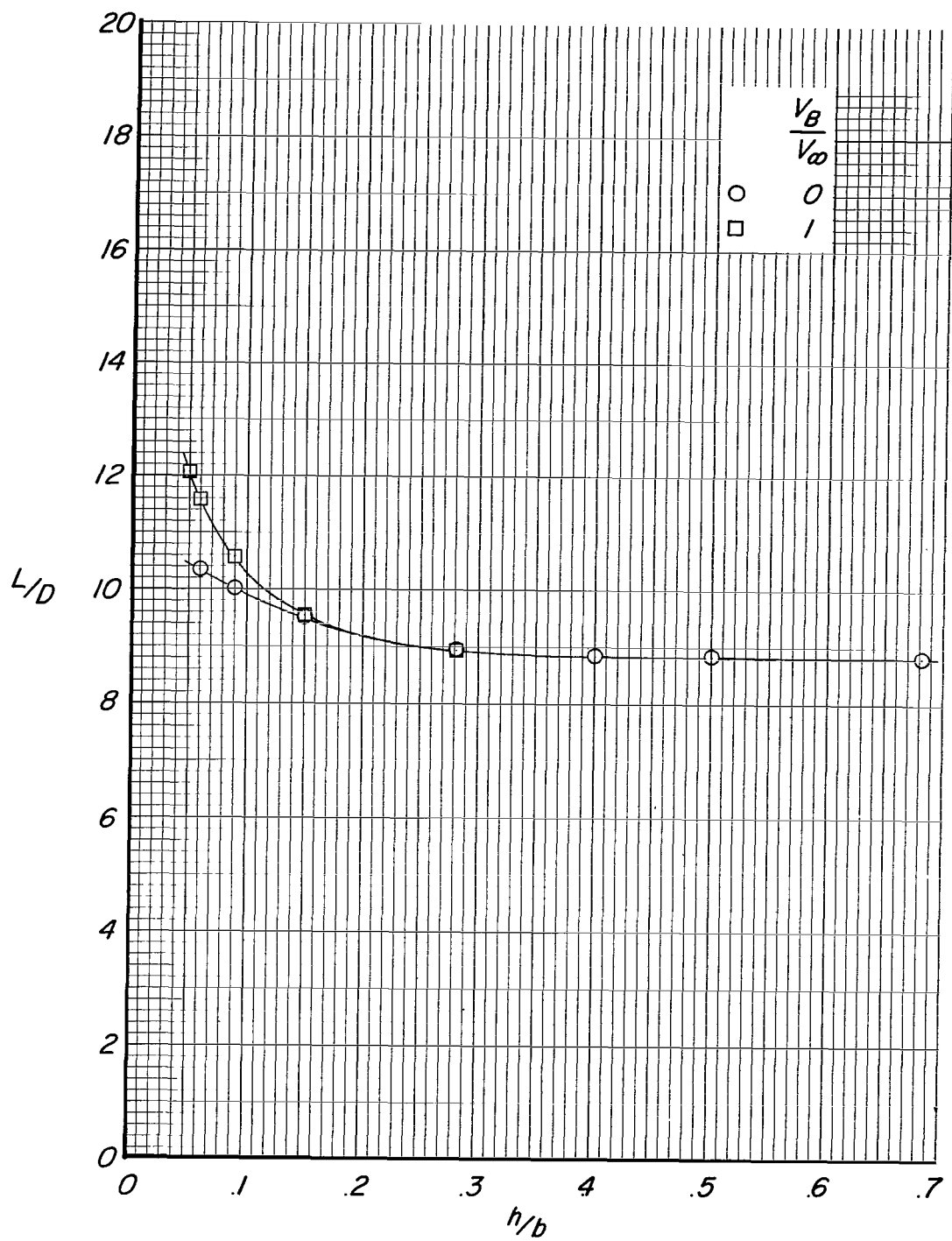

(g) Variation of lift-drag ratio with height-to-span ratio at $C_L = 2.2$ and $\alpha \approx -6^\circ$.

Figure 11.- Concluded.

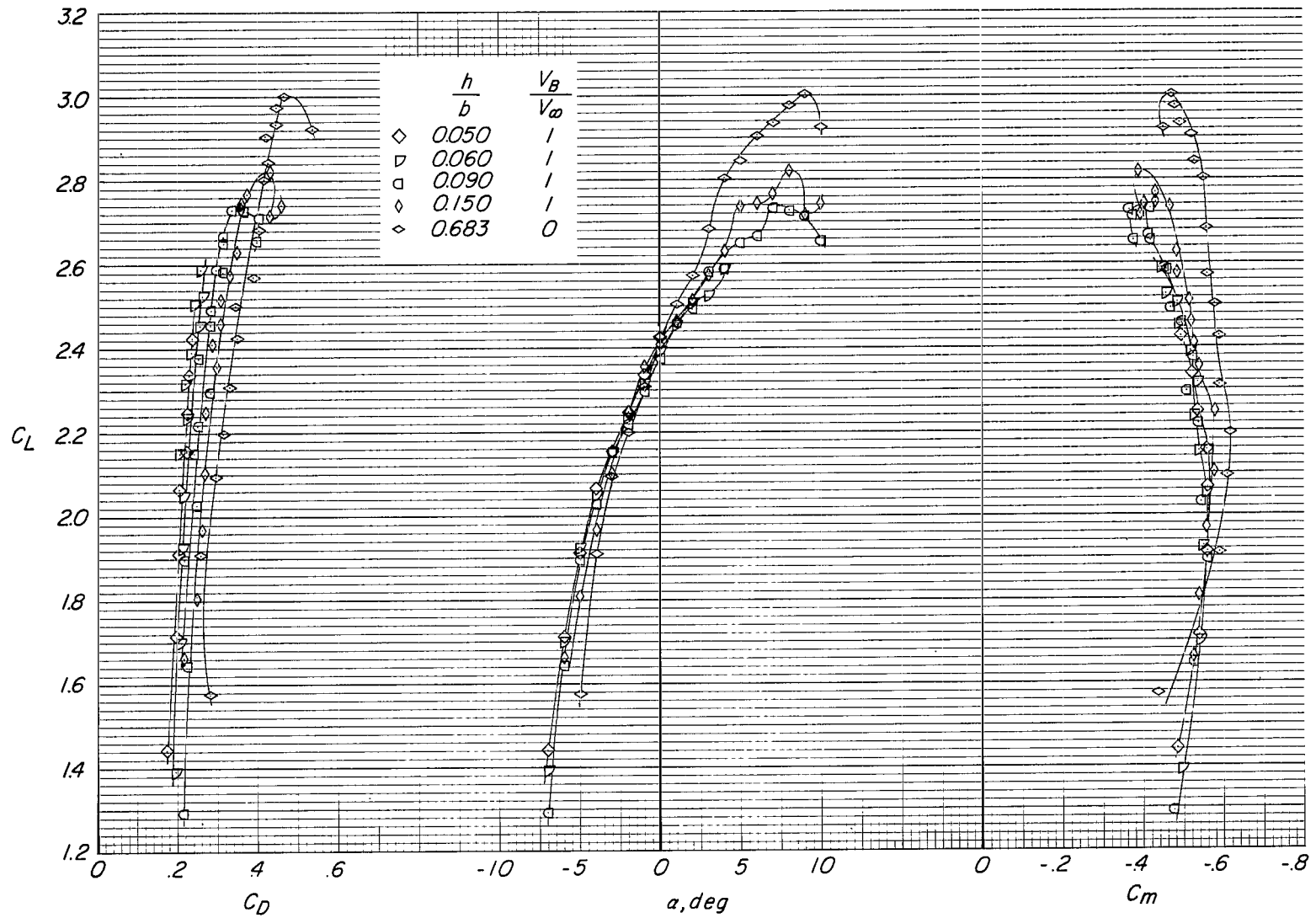

(a) Longitudinal aerodynamic characteristics.

Figure 12.- Effects of height of the wing above the ground and of the moving-belt ground plane on the aspect-ratio-10 wing with leading-edge slats and with trailing-edge flaps deflected 50° .

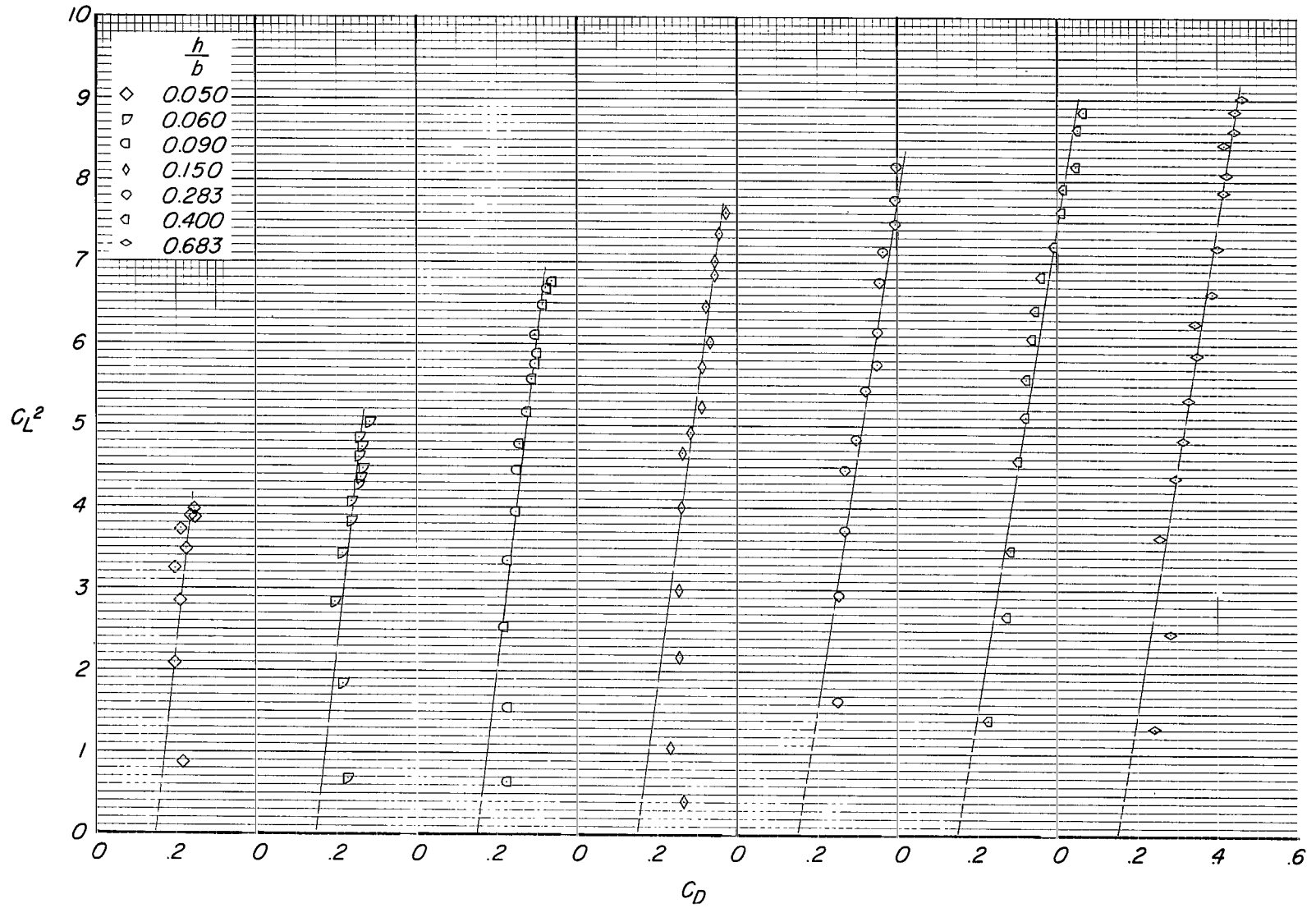

(b) Stationary ground plane. $\frac{V_B}{V_\infty} = 0$.

Figure 12.- Continued.

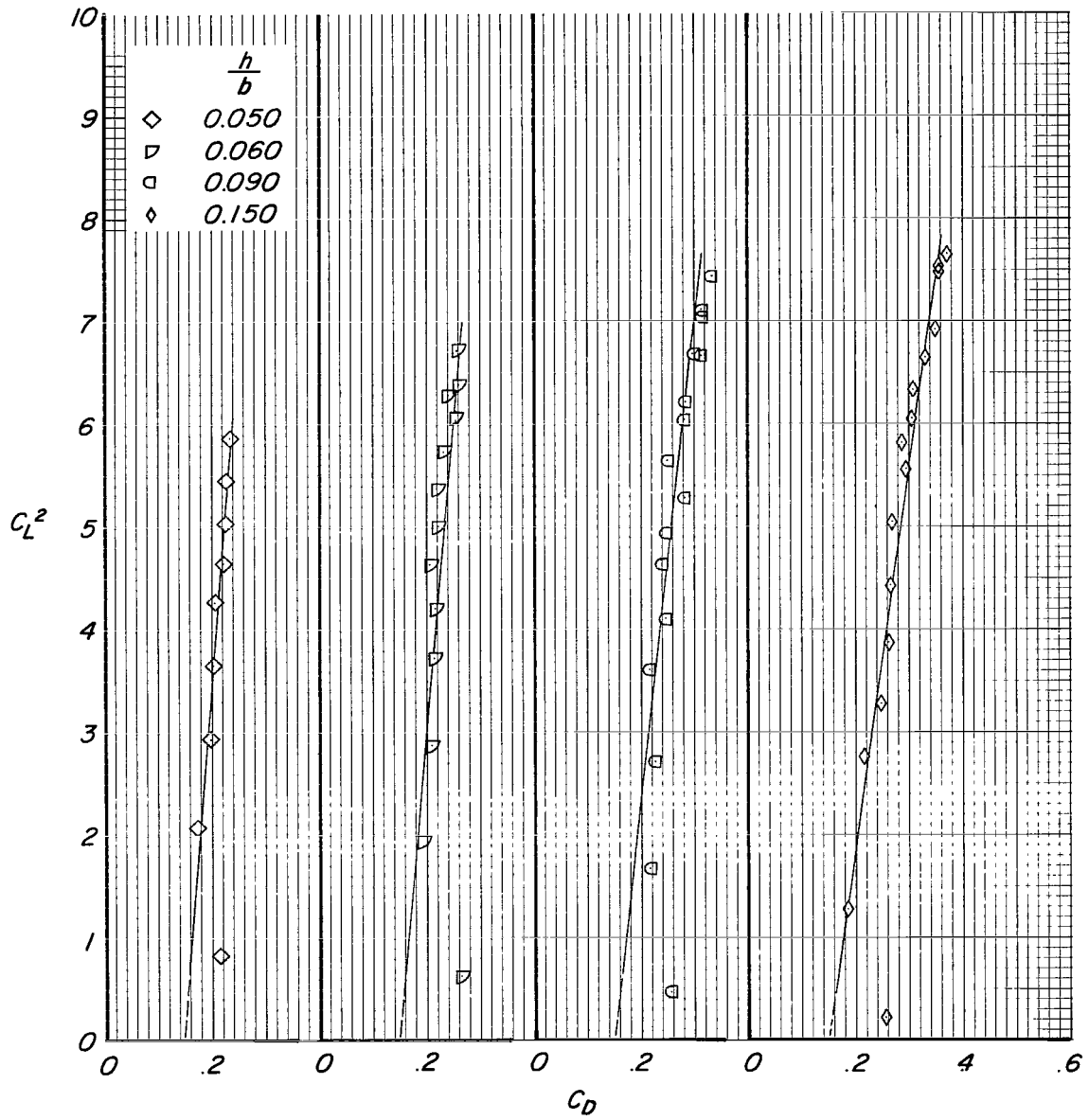

(c) Moving-belt ground plane. $\frac{V_B}{V_\infty} = 1$.

Figure 12.- Continued.

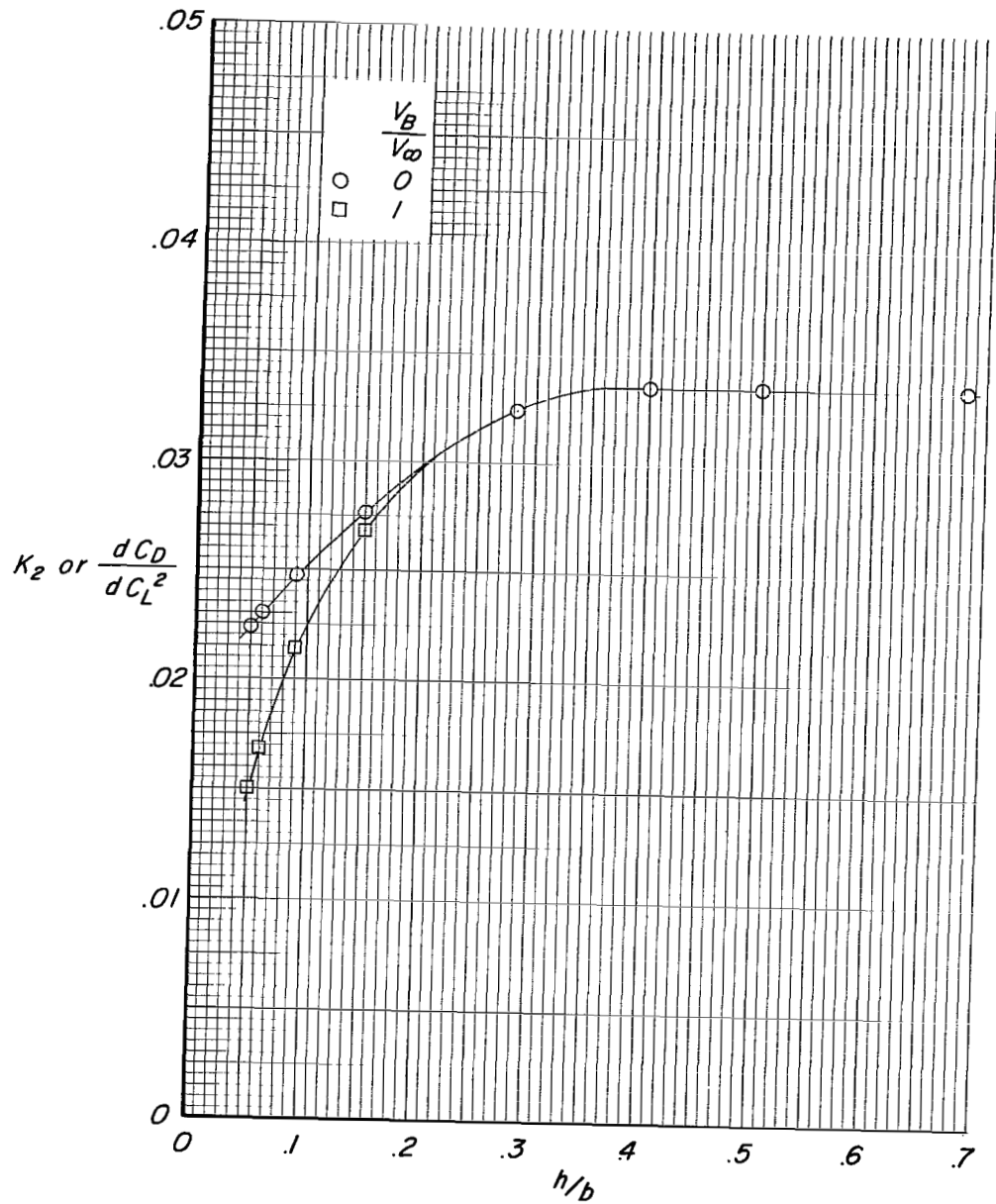

(d) Variation of K_2 or dC_D/dC_L^2 with height-to-span ratio.

Figure 12.- Continued.

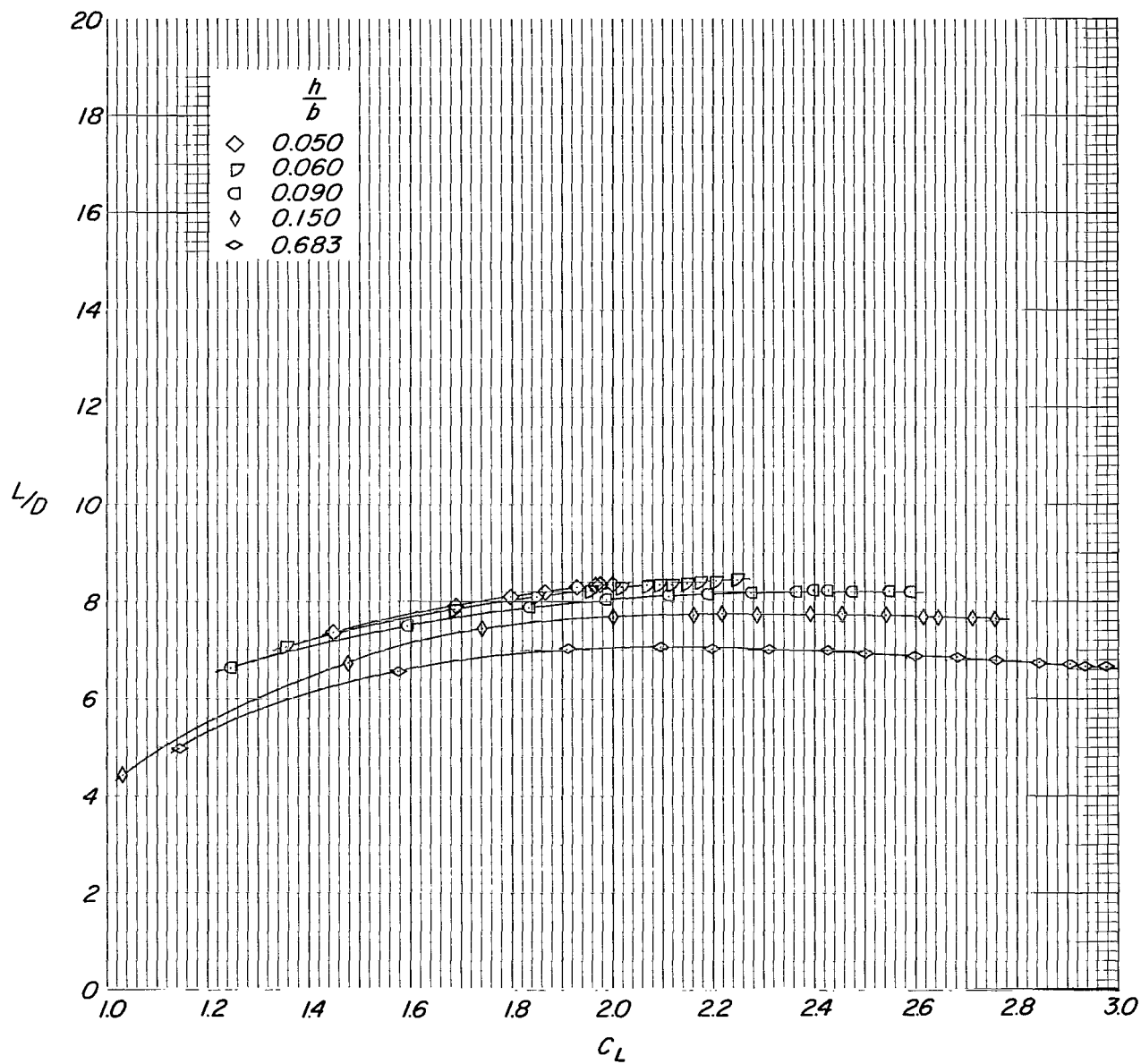

(e) Lift-drag ratio for stationary ground plane. $\frac{V_B}{V_\infty} = 0$.

Figure 12.- Continued.

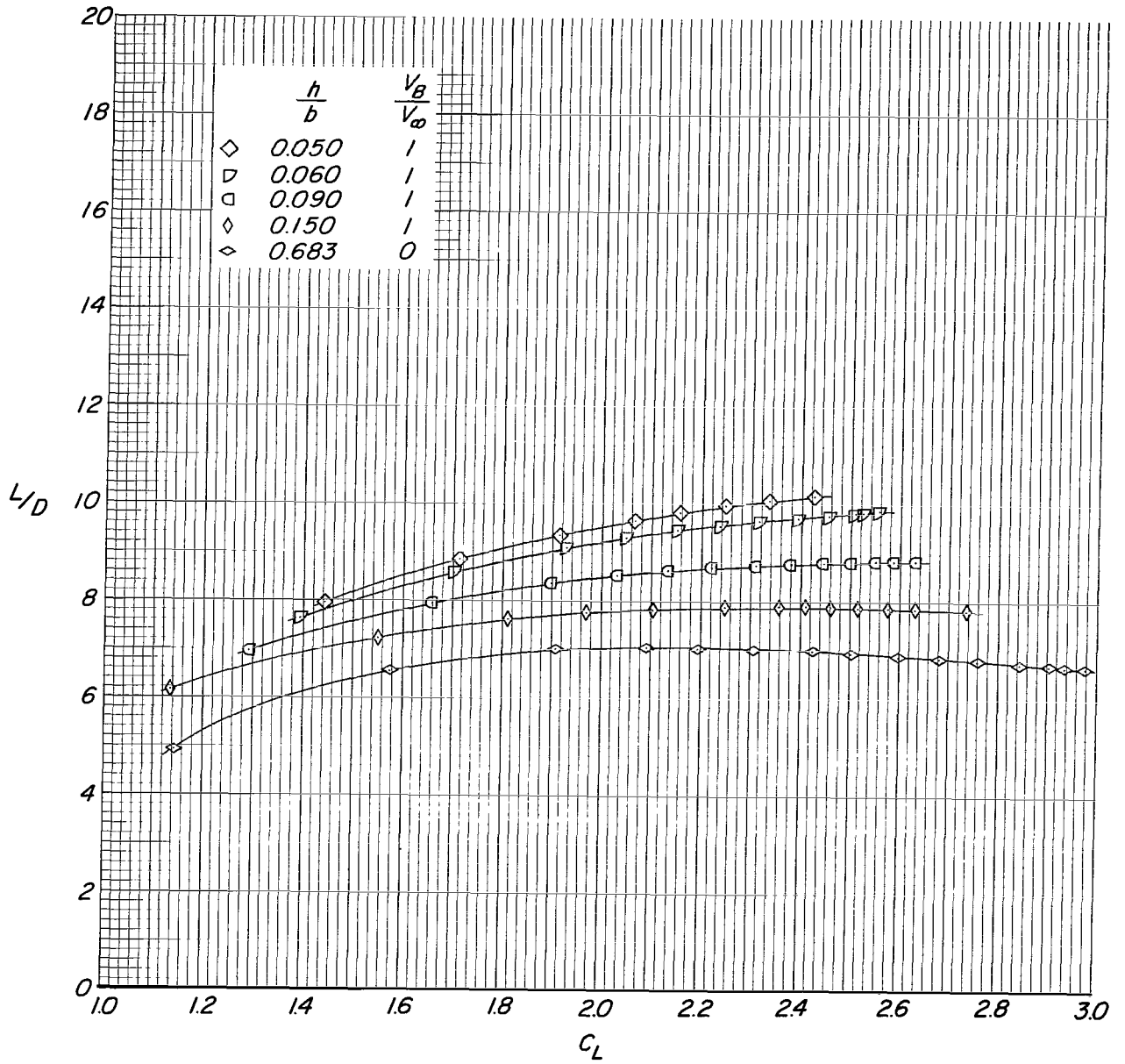

(f) Lift-drag ratio for moving-belt ground plane.

Figure 12.- Continued.

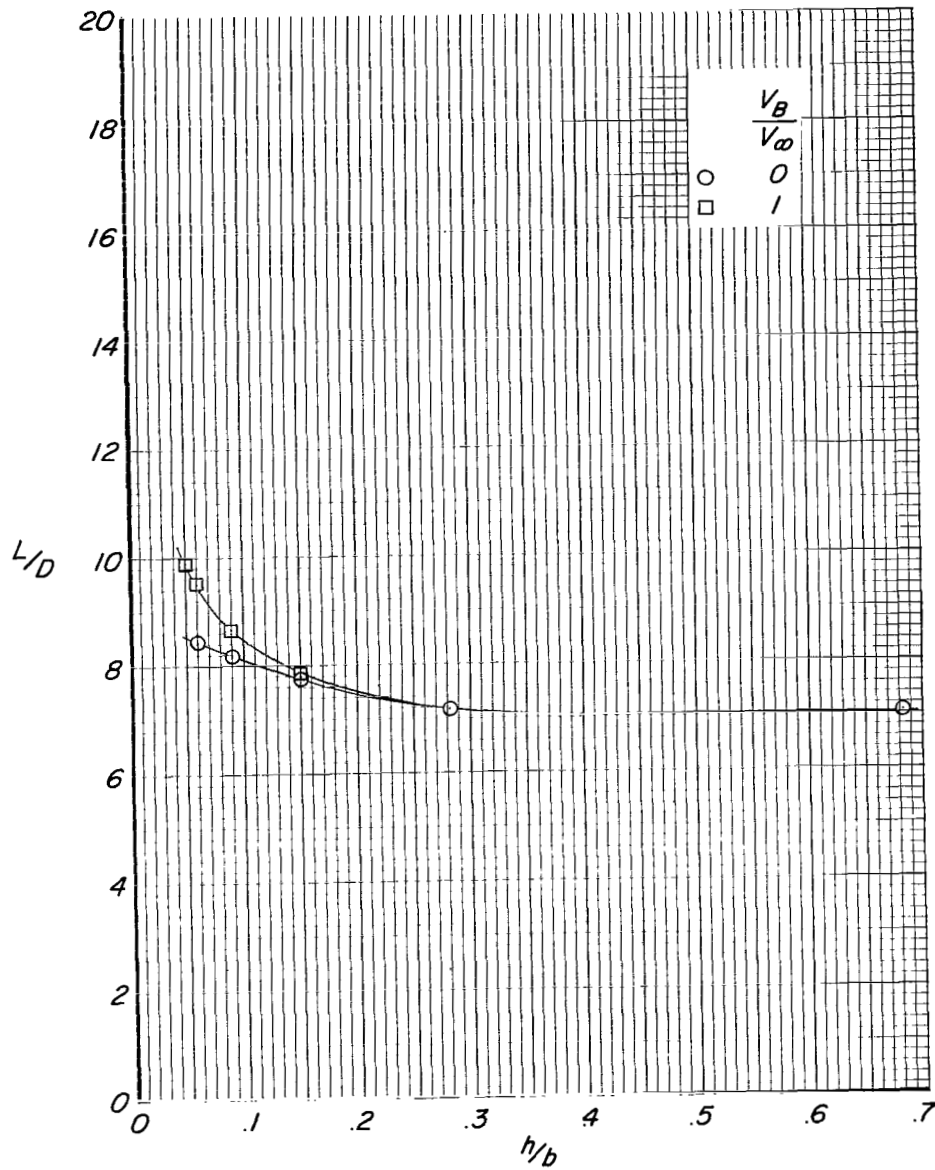

(g) Variation of lift-drag ratio with height-to-span ratio at $C_L = 2.2$ and $\alpha \approx -2.5^\circ$.

Figure 12.- Concluded.

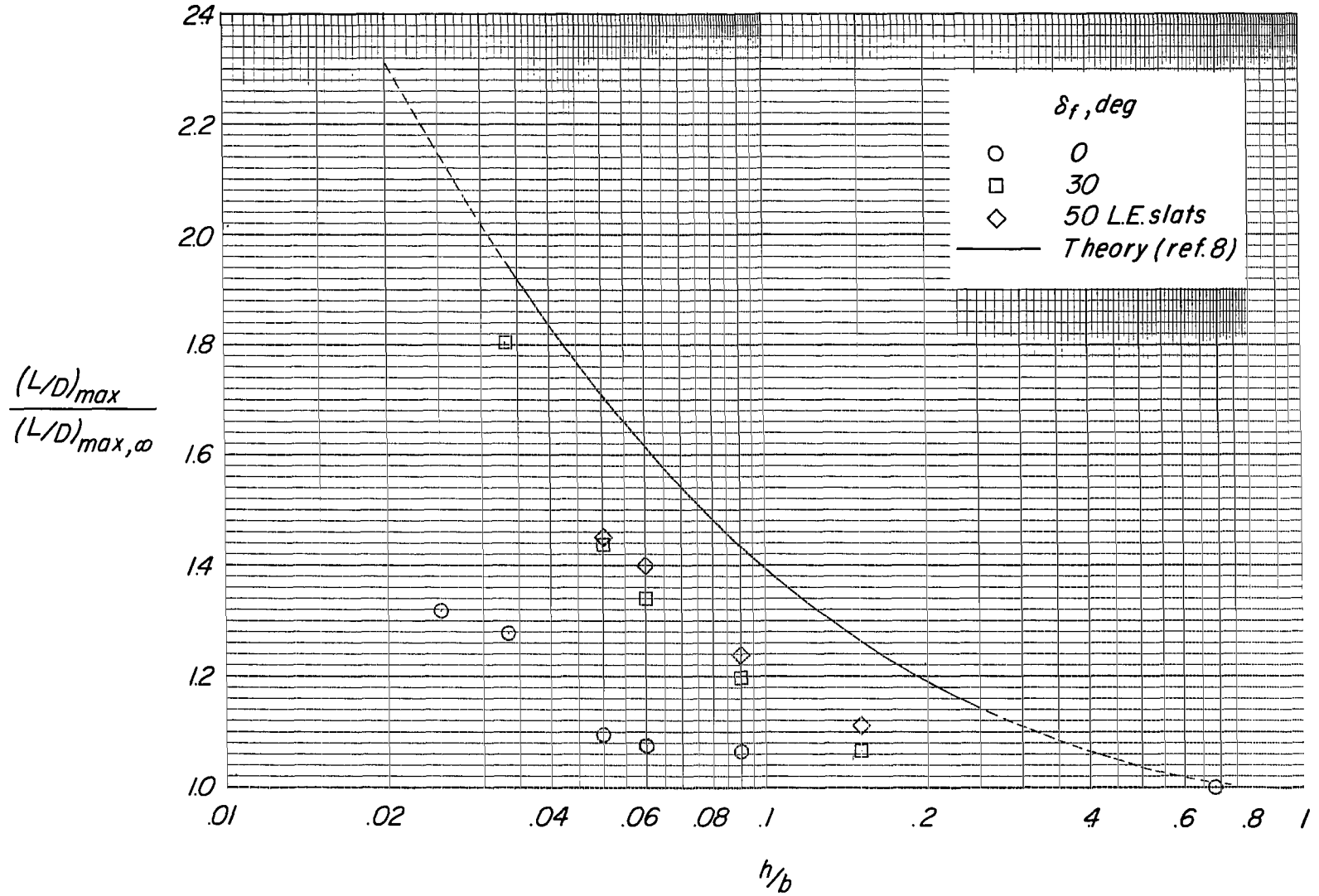

Figure 13.- Theoretical and experimental effects of ground proximity on the ratio of the maximum lift-drag ratio in ground effect to that out of ground effect.

FIRST CLASS MAIL



POSTAGE AND FEES PAID
NATIONAL AERONAUTICS AN
SPACE ADMINISTRATION

05U 001 26 51 3DS 70033 00903
AIR FORCE WEAPONS LABORATORY /WL0L/
KIRTLAND AFB, NEW MEXICO 87117

ATT E. LOU BOWMAN, CHIEF, TECH. LIBRARY

POSTMASTER: If Undeliverable (Section 158
Postal Manual) Do Not Return

"The aeronautical and space activities of the United States shall be conducted so as to contribute . . . to the expansion of human knowledge of phenomena in the atmosphere and space. The Administration shall provide for the widest practicable and appropriate dissemination of information concerning its activities and the results thereof."

— NATIONAL AERONAUTICS AND SPACE ACT OF 1958

NASA SCIENTIFIC AND TECHNICAL PUBLICATIONS

TECHNICAL REPORTS: Scientific and technical information considered important, complete, and a lasting contribution to existing knowledge.

TECHNICAL NOTES: Information less broad in scope but nevertheless of importance as a contribution to existing knowledge.

TECHNICAL MEMORANDUMS: Information receiving limited distribution because of preliminary data, security classification, or other reasons.

CONTRACTOR REPORTS: Scientific and technical information generated under a NASA contract or grant and considered an important contribution to existing knowledge.

TECHNICAL TRANSLATIONS: Information published in a foreign language considered to merit NASA distribution in English.

SPECIAL PUBLICATIONS: Information derived from or of value to NASA activities. Publications include conference proceedings, monographs, data compilations, handbooks, sourcebooks, and special bibliographies.

TECHNOLOGY UTILIZATION PUBLICATIONS: Information on technology used by NASA that may be of particular interest in commercial and other non-aerospace applications. Publications include Tech Briefs, Technology Utilization Reports and Notes, and Technology Surveys.

Details on the availability of these publications may be obtained from:

SCIENTIFIC AND TECHNICAL INFORMATION DIVISION
NATIONAL AERONAUTICS AND SPACE ADMINISTRATION
Washington, D.C. 20546