

FOURTH SYMPOSIUM ON
THE ROLE OF THE VESTIBULAR
ORGANS IN SPACE EXPLORATION

509806

**CASE FILE
COPY**

NAVAL AEROSPACE MEDICAL INSTITUTE
NAVAL AEROSPACE MEDICAL CENTER

Pensacola, Florida

September 24-26, 1968

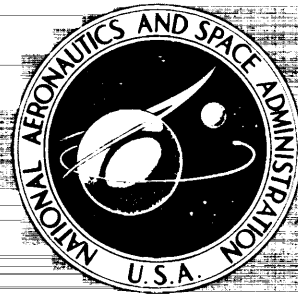

NATIONAL AERONAUTICS AND SPACE ADMINISTRATION



FOURTH SYMPOSIUM ON THE ROLE OF THE VESTIBULAR ORGANS IN SPACE EXPLORATION

Held under the auspices of the Committee on Hearing, Bioacoustics, and Biomechanics, National Academy of Sciences - National Research Council, and assisted by the Office of Advanced Research and Technology, National Aeronautics and Space Administration.

Naval Aerospace Medical Institute

Naval Aerospace Medical Center

Pensacola, Florida

September 24-26, 1968

General Chairman: ASHTON GRAYBIEL
NAVAL AEROSPACE MEDICAL INSTITUTE



Scientific and Technical Information Division
OFFICE OF TECHNOLOGY UTILIZATION
NATIONAL AERONAUTICS AND SPACE ADMINISTRATION
1970
Washington, D.C.

For sale by the Superintendent of Documents,
U.S. Government Printing Office, Washington, D.C. 20402
Price \$4.50
Library of Congress Catalog Card Number 66-60689

Foreword

Although the main topics chosen for presentation and discussion at this symposium were motion sickness and central vestibular mechanisms, the scope was broadened, as on previous occasions, by extending invitations to heads of NASA laboratories and to principal investigators of NASA-sponsored projects to report on any progress in related areas.

Sessions I through IV were designed to review the historical aspects, etiology, symptomatology, and treatment of motion sickness. But at the end of these sessions, despite many excellent presentations and much discussion, there was no escape from the conclusion that our limited knowledge of motion sickness represents a highly unsatisfactory state of affairs. It soon became evident that the use of the term "motion sickness" was not always restricted to its literal meaning and that even when it was, there were differences of opinion, either with regard to its definition or with regard to the criteria used in making a diagnosis. The effects of these differences became even more evident when the discussion centered on etiology, symptomatology, and the central mechanisms underlying motion sickness and its abolition through adaptation.

The situation we face is that there are too few facts known about motion sickness and that those available have not been structured conceptually. Moreover, we need to identify the precise role motion sickness plays in the total symptomatology evoked by exposure to unusual force environments, and to differentiate between these and other circumstances not involving "motion" but evoking similar symptoms.

It is pertinent to inquire why the challenge presented by such a frequently occurring fascinating constellation of symptoms has received so little attention. Some of the answers are probably contained in the following statements:

(1) Scientific studies must to a large extent be conducted under controlled laboratory conditions, and such studies are costly in terms of subjects, facilities, equipment, and the time required to carry them out.

(2) Motion sickness is a reversible illness which annoys but does not worry mankind and consequently holds little interest for the clinician whose services are not needed either to make the diagnosis or to prescribe treatment. But the clinical scientist should note the analogy between motion sickness and psychosomatic disorders involving the visceral nervous system. For example, the experimenter, through selection of subject and manipulation of vestibular input, can create conditions for studying influences of a psychological nature on physical symptoms.

(3) The study of motion sickness has held little interest for the physiologist or psychologist, partly because of the "cost" mentioned above but mostly because it is a problem in the area of operational or environmental medicine.

To regard motion sickness solely in this light is to ignore both its intrinsic theoretical interest and its relatedness to continuing areas of psychological and

physiological concern. The techniques which are currently used to study motion sickness in the laboratory offer an excellent means of investigating the central mechanisms of adaptation involved in accommodating to an "atypical" environment and subsequently reaccommodating to the "typical" environment once the atypical conditions have been removed. Moreover, the very large yet relatively consistent variability that is observed among individuals in the extent to which they are susceptible to motion sickness suggests the existence of some stable and enduring characteristic of the individual. Thus, these individual differences are likely to be of considerable interest to those investigators concerned with identifying the important parameters of psychophysiological variation.

The subsequent presentations by anatomists and electrophysiologists were outstanding and exemplified the widening growth of interest in vestibular mechanisms and the high degree of specialization required to obtain the information which one day will allow conceptualization of the roles of the semicircular canals and the otolith apparatus. At the moment, the anatomists seem to face fewer obstacles than the physiologists in that all of the powerful tools of the former can be brought to bear in revealing fine structural differences among receptor cells and properties of specialized synapses and by tracing pathways in the central nervous system and depicting communication channels and topographical arrangements. Their important accomplishments edge ever closer to "function," and some of their findings are of great significance for physiology.

In contrast to the anatomist, who can apply his techniques as well to the vestibular as to any other system, the electrophysiologist works under severe constraints in dealing with the vestibular system, especially when comparison is made with research on vision and hearing. His problem does not lie in recording electrical "responses" in the central nervous system but rather in presenting a normal stimulus to the end organ. Angular and rectilinear accelerations cannot be manipulated as can light and sound. Moreover, the employment of "releasing stimuli" evoking innate patterned responses, which accounts for recent major advances in our understanding of auditory and especially visual mechanisms, has scarcely been used in vestibular neurophysiology.

Difficulties with stimulation is only the beginning. The electrophysiologist has yet to distinguish sharply between canalicular and otolithic inputs which perforce must produce different effects. The physiologic inertial accelerative stimulus to the canals is gravity independent as is its resting discharge. The otolithic receptors, in addition to whatever gravity independent resting discharge might be exhibited in weightlessness, are never without the stimulus of gravity when properly positioned in the gravitational field. This stimulus pattern changes with changing position of the head and is complicated by whatever inertial acceleration transients are generated in the act of moving.

The electrophysiologists are the first to point out that, in stimulating electrically a vestibular branch or the whole vestibular nerve, the sensory input is preternaturally "strong" and always abnormal in its temporal and spatial patterning. It is important to recognize that in the intact organism, not only is a right-left imbalance a cause for "disturbance" in the vestibular system, but even an acceleration, normal in all respects save its patterning, usually causes a disturbance. This extreme sensitivity to abnormal patterning of inputs may well result from the fact that of all sensory nuclei, the vestibular, perhaps to the greatest extent, combine the functions of analysis and integration. The disturbances

caused by abnormal stimulation are manifested by many indicators which suggest that vestibular influences may reach cell assemblies never stimulated under natural circumstances. Until normal stimuli are applied, the physiologist will be studying not only the physiological pathways but also the polysynaptic "disturbance pathways" of the central nervous system. These constraints are pointed out only to demonstrate the great difficulty in conducting electrophysiological studies and to underscore the need for additional support in the long task ahead.

Recent progress, as indicated by the elegant studies reported in this symposium, emphasize the importance of the triadic interrelations of vestibular nuclei, cerebellum, and reticular formation together with their direct and indirect reciprocal connections with the brainstem, cord, and cerebral cortex.

ASHTON GRAYBIEL
Naval Aerospace Medical Institute
Naval Aerospace Medical Center

Contents

	PAGE
<i>WELCOME</i>	1
WALTON L. JONES	
SESSION I	
Chairman: W. J. McNally	
<i>EXPERIMENTAL STUDIES OF THE ELICITING MECHANISM OF MOTION SICKNESS</i>	7 (1)
ARNE SJÖBERG	
<i>EXPERIENCES WITH RESEARCH ON MOTION SICKNESS</i>	29 (2)
GEORGE RICHARD WENDT	
SESSION II	
Chairman: Martin P. Lansberg	
<i>NEURAL MECHANISMS UNDERLYING THE SYMPTOMATOLOGY OF MOTION SICKNESS</i>	35 (3)
K. E. MONEY AND J. D. WOOD	
<i>CONFLICTING SENSORY ORIENTATION CUES AS A FACTOR IN MOTION SICKNESS</i>	45 (4)
FRED E. GUEDRY, JR.	
<i>THE OTOLITH ORGANS AS A PRIMARY ETIOLOGICAL FACTOR IN MOTION SICKNESS: WITH A NOTE ON "OFF-VERTICAL" ROTATION</i>	53 (5)
ASHTON GRAYBIEL AND EARL F. MILLER II	
SESSION III	
Chairman: Thomas C. D. Whiteside	
<i>THE SEMICIRCULAR CANALS AS A PRIMARY ETIOLOGICAL FACTOR IN MOTION SICKNESS</i>	69 (6)
EARL F. MILLER II AND ASHTON GRAYBIEL	
<i>SECONDARY ETIOLOGICAL FACTORS IN THE CAUSATION OF MOTION SICKNESS</i>	83 (7)
WALTER H. JOHNSON	
<i>THE SYMPTOMATOLOGY OF MOTION SICKNESS</i>	89 (8)
JACK E. STEELE	

SESSION IV**Chairman: E. J. Baldes**

	PAGE
<i>USE OF DRUGS IN THE PREVENTION OF MOTION SICKNESS</i>	101 (9)
CHARLES D. WOOD	
<i>PREVENTION OF MOTION SICKNESS IN THE SLOW ROTATION ROOM BY INCREMENTAL INCREASES IN STRENGTH OF STIMULUS</i>	109 (10)
ASHTON GRAYBIEL	
<i>RÉSUMÉ OF SESSIONS ON MOTION SICKNESS</i>	117 (11)
HERBERT L. BORISON	

SESSION V**Chairman: Bo E. Gernandt**

<i>THE FIRST-ORDER VESTIBULAR NEURON</i>	123 (12)
HANS ENGSTRÖM	
<i>COMPUTER ANALYSIS OF SINGLE-UNIT DISCHARGES IN THE VESTIBULAR NERVE OF THE FROG</i>	137 (13)
JORGE HUERTAS AND RUTH S. CARPENTER	
<i>VESTIBULAR AND SOMATIC INPUTS TO CELLS OF THE LATERAL AND MEDIAL VESTIBULAR NUCLEI OF THE CAT</i>	145 (14)
VICTOR J. WILSON	

SESSION VI**Chairman: César Fernández**

<i>ELECTROPHYSIOLOGICAL EXPERIMENTS ON THE ISOLATED SURVIVING LABYRINTH OF ELASMOBRANCH FISH TO ANALYZE THE RESPONSES TO LINEAR ACCELERATIONS</i>	161 (15)
OTTO E. LOWENSTEIN	
<i>ANATOMICAL ASPECTS ON THE FUNCTIONAL ORGANIZATION OF THE VESTIBULOSPINAL PROJECTION, WITH SPECIAL REFERENCE TO THE SITES OF TERMINATION</i>	167 (16)
ROLF NYBERG-HANSEN	
<i>THE CEREBELLOVESTIBULAR INTERACTION IN THE CAT'S VESTIBULAR NUCLEI NEURONS</i>	183 (17)
MASAO ITO	

SESSION VII**Chairman: Wolfgang A. Precht**

<i>MULTISENSORY INFLUENCE UPON SINGLE UNITS IN THE VESTIBULAR NUCLEUS</i>	203 (18)
JOHN M. FREDRICKSON AND DIETRICH SCHWARZ	

<i>INTERACTION BETWEEN VESTIBULAR AND NONVESTIBULAR SENSORY INPUTS.....</i>	PAGE	(19)
OTTAVIO POMPEIANO	209	
<i>VESTIBULAR ACTIVITY IN THE DESCENDING MEDIAL LONGITUDINAL FASCICULUS.....</i>		(20)
BO E. GERNANDT	237	

SESSION VIII

Chairman: William D. Neff

<i>EVOKED POTENTIAL AND MICROELECTRICAL ANALYSIS OF SENSORY ACTIVITY WITHIN THE CEREBELLUM.....</i>	245	(21)
RAY S. SNIDER AND KARL LOWY		
<i>CORTICAL PROJECTION OF LABYRINTHINE IMPULSES: STUDY OF AVERAGED EVOKED RESPONSES.....</i>	259	(22)
E. A. SPIEGEL, E. G. SZEKELY, H. MOFFET, AND J. EGYED		

SESSION IX

Chairman: William E. Collins

<i>EXPERIMENTAL AND CLINICAL EXPERIENCES AND COMMENTS ON ULTRASONIC TREATMENT OF MENIÈRE'S DISEASE.....</i>	271	(23)
ARNE SJÖBERG		
<i>PATTERNS OF COCHLEAR HAIR-CELL LOSS IN GUINEA PIGS AFTER INTENSE STIMULATION BY SINUSOIDAL SOUND.....</i>	285	(24)
HARLOW W. ADES, CHARLES W. STOCKWELL, LYNN B. POCHE, AND HANS ENGSTRÖM		
<i>THRESHOLDS FOR THE PERCEPTION OF ANGULAR ACCELERATION ABOUT THE THREE MAJOR BODY AXES.....</i>	299	(25)
BRANT CLARK AND JOHN D. STEWART		
<i>EFFECT OF INSTABILITY DURING ROTATION ON PHYSIOLOGIC AND PERCEPTUAL-MOTOR FUNCTION.....</i>	307	(26)
BERNARD D. NEWSOM		

SESSION X

Chairman: Lawrence F. Dietlein

<i>CERTAIN ASPECTS OF ONBOARD CENTRIFUGES AND ARTIFICIAL GRAVITY.....</i>	331	(27)
RALPH W. STONE, JR., W. M. PILAND, AND WILLIAM LETKO		
<i>WALKING IN SIMULATED LUNAR GRAVITY.....</i>	347	(28)
WILLIAM LETKO AND AMOS A. SPADY, JR.		

	PAGE
<i>PROGRESS IN VESTIBULAR MODELING</i>	
<i>Part I: Response of Semicircular Canals to Constant Rotation in a Linear Acceleration Field.....</i>	353
ROBERT W. STEER, JR.	29
<i>Part II: A Model for Vestibular Adaptation to Horizontal Rotation.....</i>	363
LAURENCE R. YOUNG AND CHARLES M. OMAN	30
<i>Part III: A Quantitative Study of Vestibular Adaptation in Humans.....</i>	369
RICHARD MALCOLM	31
<i>PARTICIPANTS.....</i>	381

Welcome

WALTON L. JONES

Office of Advanced Research and Technology, NASA

For the National Aeronautics and Space Administration, I should like to welcome you once again to Pensacola and to the Fourth Symposium on the Role of the Vestibular Organs in Space Exploration. For some of you, this represents our fourth occasion to gather together to discuss our research findings; for others, this is the first meeting. I trust, however, that all of you will find the present meeting as productive and rewarding as those of the past.

I should like also to note the international flavor of our present conference. This year, we have representatives from many countries. It is agreed that the exchange of the latest research data among investigators such as these is having a stimulating effect on research in the field of vestibular physiology and, at the same time, is providing needed information for the space program.

As director of NASA's Biotechnology and Human Research Division, I have an opportunity to review NASA support of various research programs. From this vantage point, it has become clear to me that the United States is entering a new age of science and technology and that a substantial impetus for our entry into this new age is coming as a result of NASA research programs. From our examination of many of our specific research efforts, whether conducted at NASA centers, universities, Government laboratories, or contractor facilities, I have come to identify certain trends and characteristics which appear to be largely responsible for our rapid strides into this new era of technology. Obviously, in reviewing any research program, we give a heavy weighting to the extent to which the proposed effort

fits in with and will contribute to these trends of the times.

I should like to take a few moments this morning to review some of the trends of the present-day research and to examine this symposium in the light of these trends. The first concerns the increasing use of the multidiscipline approach to problems in science. NASA is quite convinced that most of the problems facing the agency and the world today are so complex that they will yield only to research-and-development efforts that transcend individual scientific disciplines. For this reason, a substantial part of the funding for the NASA University Program is in the form of grants to the university rather than to specific departments, and it is intended to encourage broad integrated attacks on problem areas by the university as a whole. I am pleased that this policy is quite in keeping with the structure of this symposium which, in addition to having representatives of many of the nations of the free world, also has in attendance investigators representing a number of the traditional disciplines. I see physicians, physiologists, engineers, psychologists, physicists, and others, all working toward the common goal of understanding the human vestibular system.

A second trend I should like to note concerns the increasing application by research scientists of space technology to basic scientific investigations. An example is a miniature blood-pressure sensor, less than 0.05 inch in diameter. It is small enough to be inserted through a hypodermic needle, and it is now being used to obtain pressure measurements inside the arteries and the heart without disturbing the flow of blood. In

this case, the sensor is based on transducers originally designed to measure pressures on flight models in NASA wind-tunnel tests.

Another significant point concerning the research of today, and one of which I am sure you all are aware, has to do with the use of high-speed digital computers as an integral tool within the research effort. These computers, so critical in the control and monitoring of space flights, now are being put to use in real-time analyses of physiological experiments. The increased utilization of computers for the immediate reduction of data is due in part to the recent development of time-sharing systems which allow a single computer to service several users simultaneously through telephone quality-data lines. The first time-sharing computer system was placed into operation early in the 1960's. Since then, a number of commercial organizations have begun to offer this service, including the provision of operating software. These systems, which are expanding at an incredible rate, allow any investigator to have what is almost an on-line computer capability with a rapid readout concerning the results of his investigation. The excellent computer facility at the Naval Aerospace Medical Institute provides on-line capability to research studies conducted here. The use of on-line services such as this, plus the expanding availability of time-sharing systems, should greatly increase the pace of progress in the physiological sciences in years to come.

Now I should like to turn to what I consider to be one of the most significant characteristics of modern research: the use of the systems-engineering approach. The systems-engineering approach, so important in the development of major aerospace equipment, now is being used in the study of physiological processes. One important phase in this approach involves the development of analytic models of system functions. These models, which in the case of dynamic systems draw heavily on control-engineering techniques, attempt to describe the interrelationships among the many components of a system and to predict the response of the system to any combination of stimulus forces. To quote a recent report of the Space Science Board of the National Academy of

Sciences, one that deals with physiology in the space environment:

Systems analysis, based on modeling of a system with known data on known factors, can provide significant extensions of our understanding. Moreover, this can be accomplished at remarkably less cost in time, effort, and resources than by any other method now available to us.

A word or two is in order, however, concerning both the hazards and the benefits of such efforts. First, it must be realized that the mathematical modeler deals essentially with input-output relationships. In describing these relationships, particularly when he is developing a model of some human physiological or behavioral system, the modeler draws largely upon the concepts of servomechanics or control engineering as explanatory devices for dealing with the adaptive character of these human systems. However, even if the model, once developed, is capable of describing perfectly the response of the system to any combination of stimulus forces, it does not mean that we understand the system from the biologist's point of view.

It is obvious that the basic structure of the human does not consist of a large number of integrators, differentiators, and servomotors—at least not in the sense in which the mathematician uses these terms. These terms simply are useful in describing the functional characteristics of biological systems. The biologist will want to examine the precise structure of these systems, frequently at the subcellular level, so that he can understand the manner in which such phenomena as learning and adaptation take place—phenomena which, incidentally, are not easily handled by the systems-engineering and mathematical-modeling techniques of today. The development of these models, however, can be of great value, since they offer an organized theoretical structure which is amenable to empirical testing and since they suggest reasonable explanations concerning the operation of component structures within the system. Thus, modeling should serve both as an incentive to research and as a framework for the integration of the results of different investigations.

There is one final feature of some of our current research which I feel is worthy of com-

ment. In this case, I would draw your attention to the unique opportunities for research which are presented with the advent of the space age. I believe it is incumbent on each investigator to recognize these opportunities and to exploit them as appropriate within the framework of his particular area of interest. As an example of these unique opportunities, consider the subject of our symposium today—"The Role of the Vestibular Organs in Space Exploration." Gravity exercises such a profound influence on the functioning of human postural mechanisms that many problems in basic vestibular physiology can be studied more effectively under weightlessness than in a normal gravitational field. One of the dividends of space flight will be the opportunity to carry out such experiments that are impossible on Earth.

It is obviously both difficult and expensive to program an experiment to be conducted during the course of a space flight. However, the information gained through such experiments

can be so dramatic and so important that I should not like to see any of us lose sight of these opportunities.

In conclusion, I believe there are a number of identifiable characteristics of what might be termed the mainstream of modern research programs. These programs draw on the talents of many disciplines and mount a broad attack on a given problem area. They exploit recent advances in technology and typically rely on high-speed computer analyses for data processing. They make good use of the techniques of systems analysis and are sensitive to the opportunities to conduct research in unique environmental settings. It seems to me that the current research in vestibular physiology, as exemplified by the totality of papers presented at these meetings, can be considered mainstream research in every respect. I am quite pleased that the National Aeronautics and Space Administration has played some part in the support of this program.

SESSION I

Chairman: W. J. McNALLY
Montreal, Canada

Experimental Studies of the Eliciting Mechanism of Motion Sickness

ARNE SJÖBERG

University of Uppsala, Sweden

SUMMARY

After an analysis of ship movements and calculation of the maximal acceleration values for a normal-sized passenger vessel on high seas, it is concluded that angular acceleration is unimportant in the elicitation of seasickness. The vertical up-and-down motions of a ship are the most important, and experimental motion sickness can easily be provoked in human beings and dogs exposed to vertical movements in rapid elevators or hoisting cranes. Deaf-mutes with reactionless labyrinths and dogs after labyrinthectomy have no symptoms of motion sickness after exposure to these rapid elevator movements.

On board a ship on a heavy sea, eye movements similar to nystagmus have been recorded by electronystagmography (ENG). Simultaneously, on the same direct-writing paper, the pitching and rolling motions of the ship have also been recorded with accelerometers.

Optical and proprioceptive impulses are not necessary for the appearance of symptoms of motion sickness. It is known from experience, however, that these impulses together facilitate and promote the appearance of the symptoms. The optical impulses facilitate the symptoms to a greater extent than do the proprioceptive ones.

Results of hydromechanical studies and experiments on labyrinth models and temporal bones have shown that, when a person is exposed to linearly accelerated horizontal and vertical movements or to the movements of a ship on a heavy sea, pressure variations with accompanying displacements and flows in both the perilymph and the endolymph must occur at every point in the contents of the labyrinth. These pressure variations affect both labyrinths at the same time, but the momentary pressure in the corresponding points of the two labyrinths will seldom be exactly the same during these varying motions. It seems very probable that these pressure variations in the fluids of the labyrinth are of such a magnitude that the transmitted excitatory effect will create manifest symptoms of motion sickness.

It thus seems justifiable to assume that the symptom complex of motion sickness arises from the two receptor systems of the labyrinth: the otoliths and the ampullar cristae.

The intermittent headache and some of the psychic symptoms accompanying motion sickness may be largely due to the intracranial pressure variations caused by the linear acceleration movements.

The results of some new hydromechanical experiments in the absence of gravity can be applied to the problems concerning weightlessness in prolonged space flights. The unfavorable vestibular reactions of the motion-sickness type after sharp movements of the head in Russian cosmonauts may probably have been due to the fact that, in the absence of gravity, as soon as a sudden horizontal acceleration takes place, the fluids of the labyrinth will be forced "outward" or flung toward the membranous and osseous walls of the labyrinth. The liquid in a vessel is forced toward the side away from the direction of the acceleration. The result will be a very rapid adequate excitation of the "deafferented" weightless receptor systems. These unexpected afferent impulses will suddenly produce symptoms of vertigo, motion sickness, and perhaps sensory illusions.

The hydromechanical hypotheses and experimental results may also plausibly explain the spatial illusion in weightlessness of the body being in an upside-down position.

INTRODUCTION

When I began my research 40 years ago on the fascinating problem of the mechanism eliciting seasickness, I hardly anticipated that this subject would be of such great topical interest in the world of today, in the space age with its studies of vestibular problems in manned space flights of long duration. It is of primary importance at the present time to prevent vestibular disturbances in weightlessness and perhaps to solve problems concerning artificial gravity. Because of the increase in sea and air travel by both civilian and military, the production of effective anti-motion-sickness drugs is equally important.

For centuries, intensive studies have been made of the symptom complex which has been generally called seasickness, better known today as motion sickness, vestibular sickness, or space sickness. It was at the end of the 19th century that motion sickness was first seriously related to the inner ear, and at an early date its resemblances to Ménière's disease were pointed out. Important support for this view was obtained by the observation that deaf-mutes seldom or never became seasick (refs. 1 to 3). In 1901, Butler Savory (ref. 4) considered that seasickness was provoked reflectively from the semicircular canals, and Corning in 1904 (ref. 5) pointed out the similarity between rotatory vertigo and seasickness. In 1903, Kreidl succeeded in inducing seasickness experimentally in animals subjected to artificial ship movements. Remarkably enough he does not seem to have published his results, but he is said to have shown "qu'après section bilaterale du nerf auditif, les animaux sont insensibles aux mouvements artificiels" (ref. 6). Bárány (ref. 7), Bruns (ref. 8), Byrne (ref. 9), and many others considered that it was the angular accelerations which provoked the symptoms and they therefore tested subjects in rotating chair experiments. It was Wojatschek (ref. 10) and Quix (ref. 6) who first suggested that it was probably the otoliths and not the semicircular canals which were stimulated by ship movements. In spite of intensive studies, however, no unequivocal explanation was given for the way in which the

excitatory process was primarily induced in the labyrinth.

My original aim was to study seasickness experimentally on dogs subjected to artificial ship movements.

ANALYSIS OF SHIP MOVEMENTS

Since ship movements on rough seas are extremely complex mathematically, an analysis of them was considered necessary (fig. 1). Three principal types of oscillations are involved:

- (1) Plunging—a purely vertical motion;
- (2) Pitching—a motion around the transverse axis of the ship; and
- (3) Rolling—a motion around the longitudinal axis of the ship.

Motions around the vertical axis of the ship—yawing—are due only to unsteady steering of the ship and probably have no actual influence on the induction of motion sickness.

Added to these is a continuous motion forward. The accelerations can vary here in either a positive or a negative direction, according to the size of the ship in relation to the dimensions of the waves.

In figure 1 we see that, from a mechanical point of view, a passenger undergoes the same

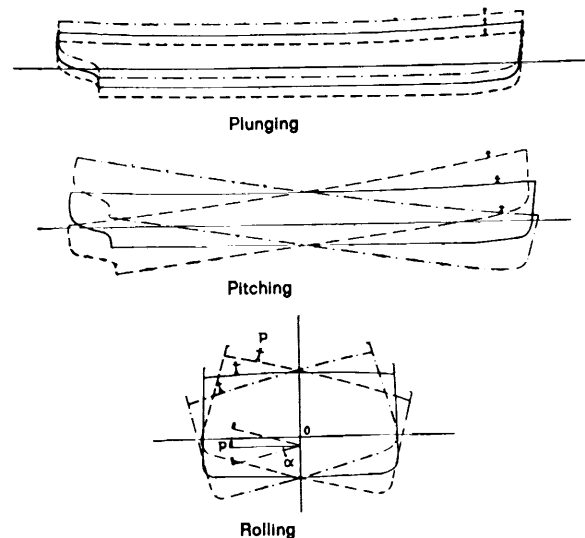
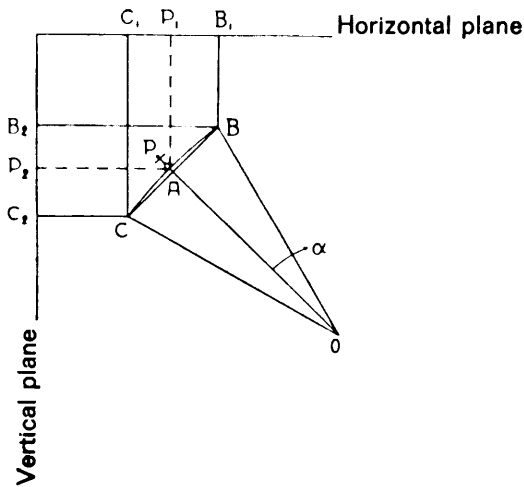

FIGURE 1.—Three types of oscillations of a ship's movements on rough seas.

movements on pitching and rolling. It may be said that these two movements are composed of a harmonic oscillatory motion and a rotatory motion.

Figure 2 corresponds to the longitudinal section of a vessel with regard to pitching and to the transverse section on rolling. It is imagined that the passenger (*P*) is placed at a supposed point *A* on the vessel. Both on pitch and on roll, *P* describes, with point *A* as the median position, a to-and-fro movement from *C* to *B*. If the angle is small enough (especially if the radius, as on a ship, is large), then the path of point *P* can be regarded as a straight line, and the projections of *P* on the vertical and horizontal planes, respectively, then describe approximately harmonic pendulous motions in the paths *C*₁ and *B*₁ and *C*₂ and *B*₂, with points *P*₁ and *P*₂, respectively, as median positions.

If the passenger is located right in the front of the prow of the ship, then on pitching and also on plunging of the ship he is subjected mainly to a vertical harmonic pendulous motion. If,



- α = Estimated angle of roll resp. pitching
- P* -- Passenger
- O* Axis of rotation
(Transverse resp. longitud axis of the vessel)

FIGURE 2.—Section of a vessel. The passenger *P* is placed at an imaginary point *A* on the vessel. The figure represents both pitch and roll.

on pitching, *P* is at the mast top or on the navigation bridge, he describes instead a harmonic pendulous motion in the horizontal plane, but now forward and backward. On rolling he describes instead a harmonic pendulous motion from side to side in the horizontal plane.

If our passenger changes his location on the ship, then naturally the amplitude of the harmonic pendulous motion on pitch and roll varies. The amplitude becomes progressively smaller as he comes closer to the axis of rotation *O*, and progressively greater the further his distance from *O* (fig. 2). It is a well-known fact that a horizontal body position close to the center of gravity of the ship lessens the symptoms produced by rough seas, but it should be noted that the value of the angle is the same whatever the location of *P*.

It is thus seen that the path of *P* consists approximately of harmonic pendulous motions in both the vertical and the horizontal plane and, in addition, of an angular motion.

The general motion to which a passenger is subjected takes place under varying axes and comprises a superposition of three pure sine curves with different amplitudes and numbers of oscillations. (See fig. 3 which illustrates conditionally selected sine curves.) To this supposed motion is then added the continuous accelerated motion. This general motion consists of—

- (1) A space motion (composed of plunging plus the harmonic pendulous motion in both the vertical and the horizontal plane on pitch and roll);
- (2) A combined rotatory motion which is the sum of the rotatory motions on pitch and on roll;
- (3) A continuous, possibly irregular, accelerated motion in the horizontal plane, which would seem to have special importance in small vessels.

Since the time period and also the angle of pitch and of roll are specific for every vessel and

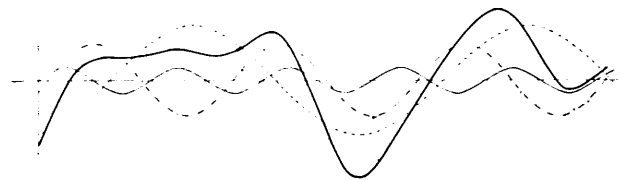

FIGURE 3.—Superposition of three pure sine curves representing motion axes to which a ship's passenger is subjected.

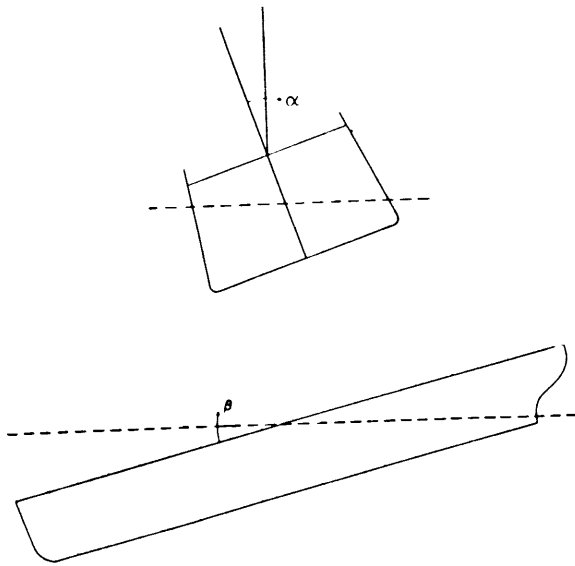

FIGURE 4.—Illustrating the angle of pitch (α) and of roll (β) of a vessel at sea.

are also dependent upon the nature of the wave movements, no mean values for these factors are to be found in the literature on shipbuilding.

Figure 4 illustrates rolling and pitching. Angle α in this figure is the angle on rolling; i.e., the inclination of the mast toward the vertical plane. The angle on pitching (β) represents the inclination of the vessel toward the horizontal plane. For passenger ships of normal size there are certain upper and lower limit values. The maximal value for roll is probably 15° and for pitch 5° . The time period (the time for a simple oscillation, T) can vary; for roll and pitch it probably varies between 5 and 40 seconds (ref. 1).

The greatest angular acceleration that can occur for a passenger ship of normal size (10 000 to 20 000 tons) is approximately $5^\circ/\text{sec}^2$. This corresponds on rolling to an angle of 15° and a time period of 5 seconds. Such heavy rolling seldom occurs and then only on a very choppy heavy sea. All other values for pitch and roll lie below $2^\circ/\text{sec}^2$ (refs. 4 and 11).

EYE MOVEMENTS ON LINEAR ACCELERATIONS

Now we come to a very important problem in seasickness. The vegetative explosion which

characterizes Ménière's disease comprises, among other things, vertigo and nystagmus. In seasickness, on the other hand, nystagmus in its usual sense is absent on macroscopic observation. In this connection it should be recalled that, in Ménière's disease, the labyrinthine excitation is induced on only one side and therefore nystagmus occurs. This has long been considered to support the assumption that seasickness is only induced from the one type of mechanoreceptors of the labyrinth, the otoliths, which react to linear acceleration. The ampullar cristae, on the other hand, are considered to respond only to angular accelerated movements.

The lowest value for the angular acceleration which in normal persons can induce an ocular movement in the direction of the slowest nystagmus phase is called its "minimum perceptible." The values obtained experimentally for minimum perceptible have varied in man from $1^\circ/\text{sec}^2$ up to 4° to $5^\circ/\text{sec}^2$ (refs. 6, 12, and 13). As mentioned previously, it is only on heavy rolling that the angular accelerations reach a value of $5^\circ/\text{sec}^2$. The Dutch investigator Nieuwenhuijsen (ref. 14), during journeys in 1958 across the Atlantic from New York to Rotterdam, and using an angular accelerometer, obtained a figure of $4.5^\circ/\text{sec}^2$ for angular speed as a maximal value which was maintained for only a short period. Usually the maximal angular acceleration was lower than $1.5^\circ/\text{sec}^2$. In other words, it is only in extreme cases that the angular accelerations exceed the values for minimum perceptible, and then only negligibly.

As I have just mentioned, it has been considered, generally, that these facts support the view that it is in the otoliths and not in the semi-circular canals that the cause of seasickness is to be found.

Before the introduction of electronystagmography, no nystagmus could be observed with the unaided eye. As early as in 1931, however, I was able to demonstrate, with Dohlman's photokymograph (ref. 12), despite all sources of error, reflectory eye movements on linear up-and-down vertical acceleration motion in rapidly moving elevators. The amplitudes were 4 meters to 6 meters and the maximal speed just over 1 m/sec.

The principle of Dohlman's recording method was that a beam of light was reflected in a small concave mirror fixed to the eye with a rubber arrangement. The spot of light was projected onto a light-sensitive paper to a curve, a nystagmogram.

In 1922, Fleisch (ref. 15) demonstrated on rabbits vertical eye movements of the nystagmus type on horizontal accelerations. Later Jongkees and Philipszoon (ref. 16), but especially Niven, Hixson, and Correia (ref. 17) and also Guedry (ref. 18), demonstrated eye movements of nystagmus type on linear accelerations.

During recent months my collaborators, C. Angelborg and R. Aust, and I have made recordings on persons on board ships belonging to the Swedish Navy and also on board large automobile ferries on the Stockholm-Gotland line. We have used a Mingograph 34 (Elema-Schönander, Sweden) which is a multichannel direct-writing electrocardiograph with four recording channels and a universal amplifier for recording of biological potentials; e.g., electronystagmograms (ENG). By this means it has been possible to record simultaneously both horizontal and vertical eye movements and, in addition, vertical and horizontal accelerations of the ship on one and the same recording paper. For recordings of pitching and rolling ship movements, we have used a small accelerometer with fine sensitivity. A thin wire of constantan is used as the detector element in these transmitters. The resistance of the wire is varied

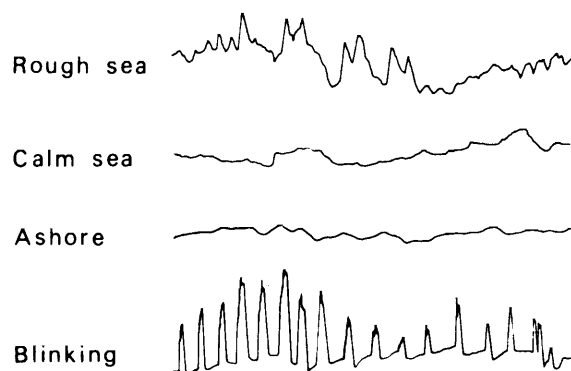

FIGURE 5.—Recording of vertical nystagmus-like eye movements on heavy seas.

according to its length. Extension of the wire is a linear function of the acceleration. In heavy seas we have so far succeeded in recording vertical nystagmus-like eye movements (fig. 5). These studies have not yet been published, and these results are preliminary ones.

It seems justifiable, then, to conclude that seasickness symptoms are most probably not induced by angular accelerations but by harmonic oscillatory space motions in the horizontal and vertical planes on pitching, rolling, and plunging. Of the different motion components, the up-and-down harmonic oscillatory movements would seem to play the principal role.

MAGNITUDE OF FORCES AT DIFFERENT LOCATIONS ON SHIPS

To give a better idea of the enormous forces to which our bodies are subjected on board a ship during heavy seas, we have calculated the magnitude of those movements to which a passenger is subjected by the different principal oscillations at varying locations on a passenger ship of normal size.

We assume that the ship has a displacement of 10 000 tons, with a length of 120 meters and a breadth of 16 meters. The maximum angle for pitching is assumed, as discussed above, to be 5° and for rolling 15° . In reality, the oscillatory motions of the ship naturally take place around varying diagonal axes. For the sake of simplicity, we may regard the principal oscillations here as isolated motions around the longitudinal and transverse axes through the center of gravity.

From these calculations (ref. 11), it is evident that—

(1) A person located at the prow of the ship is, on pitching, thrown up and down 10 to 11 meters, with a maximum acceleration at the turning points of approximately 2 m/sec^2 .

(2) When at the side of the ship on a level with the center of gravity, the passenger is raised and lowered 4 meters, with a maximum acceleration of just under 1 m/sec^2 .

(3) On plunging there are maximum vertical movements of 10 meters, and the acceleration is about 2 m/sec^2 .

(4) On the navigation bridge, the person is thrown instead, on pitching, forward and backward 3 to 4 meters, with an acceleration of 1 m/sec². On rolling he is thrown from side to side 10 meters, with a maximum acceleration of 2 m/sec².

(5) At the mast top the forward and backward movement on pitching can be 7 meters and the acceleration approximately 1.5 m/sec², but on rolling a person can be thrown 20 to 21 meters from side to side, with an acceleration at the turning point of 4 m/sec².

In some cases a person can be exposed to the sum of these vertical and horizontal accelerations.

EXPERIMENTAL MOTION SICKNESS

In Humans

If these acceleration values are now compared with the greatest accelerations which experience has shown to occur on railways, the latter values are lower; i.e., about 1 m/sec². This conforms also with the fact that motion sickness on train journeys is considerably milder than true seasickness on board a ship. For rapid passenger elevators, on the other hand, the accelerations on starting and retardation can vary from 1 to

3 m/sec². Experience has shown that sensitive persons subjected to elevator movements can easily have intense symptoms of motion sickness. Here the accelerations are of the same order of magnitude as in ship movements. By analysis of the ship movements, we concluded that the problem of inducing experimental motion sickness could be simplified by subjecting human beings and suitable animals—dogs or monkeys—to vertical harmonic pendulous motions.

The harmonic pendulous motions just mentioned can most easily be produced by an apparatus as shown in figure 6(a) and (b). A wheel rotating at different constant rates drives a frame up and down between two guide rails. The radius of the wheel can vary. This apparatus has been used in our hydromechanical experiments. The apparatus is ideal for inducing motion sickness experimentally. I originally intended that it should be constructed in larger dimensions, but for reasons of cost I had to use the apparatus already available.

The simplest way of testing motion sickness is in large hoisting cranes or in rapid passenger elevators that are driven up and down with amplitudes of 4 to 6 meters and accelerations of

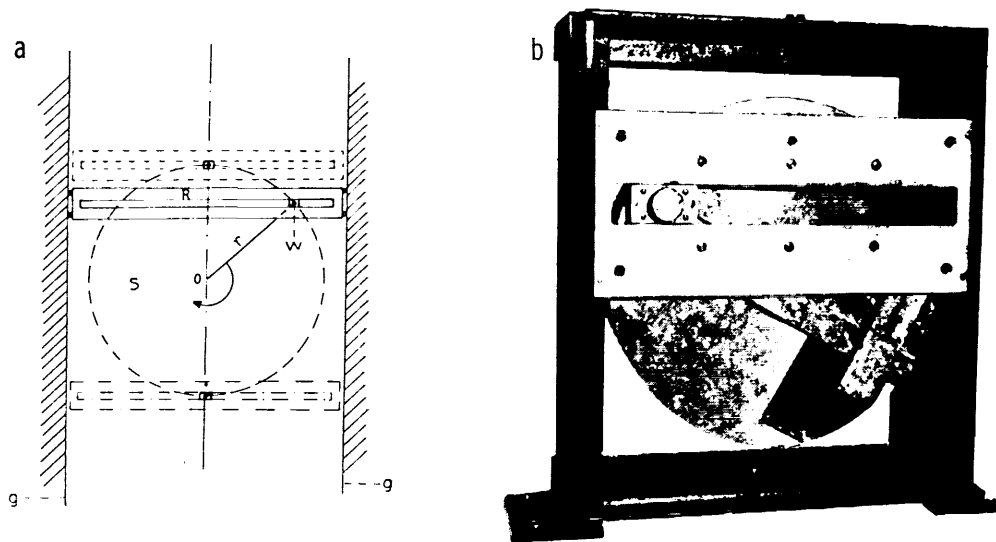

FIGURE 6.—Apparatus for producing vertical harmonic pendulous motion and inducing motion sickness experimentally. (a) Schematic of wheel shown in (b) that rotates at different constant rates and drives a frame up and down between two guide rails (b).

about 1 to 1.5 m/sec². The machinery of the elevators has to be suitably cooled in order to allow the heavy stress exerted by prolonged upward and downward movements with rapid braking. Persons who knew that they became easily seasick had pronounced symptoms of motion sickness after 15 to 30 minutes in these elevators. Even elevator conductors with many years of habituation easily became ill after these upward and downward movements with rapid braking and starting. However, deaf-mutes with intact tympanic membranes and reactionless labyrinths (on syringing with iced water) had not the slightest symptoms in moving elevators.

In Dogs

To elicit motion sickness in dogs, there has to be a more rapid change at the turning points for the up-and-down movement than is attained in elevators. This requirement could only be fulfilled in large hoisting cranes in Stockholm Harbor. The experiments were very time consuming. The machinery of the cranes was strained to such an extent that the resistances sometimes became red hot.

The animals were placed in cages with longitudinal sides made of wire netting, so that they could be observed easily. The maximum accelerations were 1.5 m/sec², and the amplitudes 3 to 4 meters.

Clinical Picture

To these up-and-down movements in hoisting cranes, adult dogs, varying in weight from 9 to 21 kilograms, reacted with typical symptoms of motion sickness after periods varying between 10 and 30 minutes. The symptom complexes occurred in two forms: agitated and asthenic. Most animals showed the agitated form. After a few minutes they became restless and ran about in the cage, howling and barking. Their respiration increased. A number of animals had diarrhea and pollakiuria. Their salivation was greatly increased, so that saliva ran from their noses. At first they followed the movements with their eyes. In the last few minutes before the first vomiting attack, the dogs instinctively avoided keeping their eyes open. They

crept together apathetically and appeared prostrate. After the first vomiting attack, they generally recovered rapidly, but after 30 to 60 minutes there was an exacerbation with further vomiting.

With the asthenic form, the animals did not reach the stage of vomiting. They showed clear symptoms, however, in the form of increased salivation, polypnea, diarrhea, and pollakiuria. They lay pressed to the bottom of the cage, avoiding all movement, and showed no reaction to external stimuli such as calling, whistling, or prodding, etc.

After 3 to 4 hours' "traveling," or after repeated trials, the animals often became habituated to the oscillations, and it took a rather longer time to induce symptoms. No definite eye movements were observed with the unaided eye.

Labyrinthectomy

Bilateral labyrinthectomy was performed on dogs that had previously been subjected to the elevator movements and had reacted with typical motion sickness, and microscopic examination of serial sections after the animal had been killed was made in order to establish that the removal of the labyrinth had been complete. Before the animal was killed, however, control tests were made in the hoisting cranes about a month after the operation. Even after up to 4 hours' traveling, the animals never showed any symptoms of motion sickness. They moved freely in their cages or lay quietly on the floor. They showed no caloric reaction after syringing with 500 to 600 ml of ice water.

These experiments demonstrated unequivocally that a well-functioning labyrinth must be present for symptoms of motion sickness to be elicited.

OPTICAL AND PROPRIOCEPTIVE IMPULSES

For control of our balance, our orientation in space, and our locomotion, we depend upon impulses from (1) the ocular system, (2) the vestibular system, and (3) from muscles, joints, viscera, and skin in the form of proprioceptive impulses. It is of extreme importance to remember that the predominant neuro-otological

symptoms are particularly referred to this principal triad of physiological equilibrium stimuli. We all know that it is the vestibular receptor system, the end organ of the labyrinth, that gives us true information on the linear and angular acceleration to which the head is subjected in relation to the ground.

As early as in 1922, Gertz (ref. 19) stressed in his studies that the efferent impulses which arise from muscle movements induce the sensory components in the reaction of the vestibular nerve and give a "propriozeptiven Schwindel" ("tactile vertigo"). This is induced most simply if, with the head and neck motionless, a person stands on a circular, rotatable plate and makes "right turns" or "left turns." When he steps down to the floor and walks forward with closed eyes, he deviates because of the proprioceptive impulses induced by the leg movements. Most persons have probably had similar sensations when first walking on land after a rough sea voyage. In German it is often said, "und dem Seemann schwankt nicht selten der Boden unter den Füßen." These are purely proprioceptive impulses which, so to speak, persist when the stimuli have ceased.

In this connection I want to emphasize the intimate relations between proprioceptive (cervical) impulses and the vestibular nuclei. Cervical receptors are found not only in the cervical and occipital muscles but also in the joints of the upper three cervical vertebrae. Spinovestibular communications, therefore, take place. Afferent fibers pass to the vestibular nucleus from the upper three cervical segments (refs. 20 and 21). After incision of the posterior roots to C1, C2, and C3 in cats, Cohen (ref. 22) demonstrated equilibrium disturbances closely resembling those seen following labyrinthectomy.

In spondylosis deformans in the cervical spine, the syndrome of Barré-Lieou (ref. 23) often occurs; it is also called cervical migraine or, briefly, the cervical syndrome. The main symptom here is vertigo of a transient type, an occasional feeling of uncertainty with a tendency to propulsion or lateropulsion. Pathogenetically it is considered that, on rotations of the head, the more or less arteriosclerotically changed vertebral artery can be compressed and ischemia in

the distribution area of the vestibular nuclei can occur.

But with regard to the origin of the vestibular symptoms after rotation of the head in the Barré-Lieou syndrome, consideration must also be taken of the tonic, cervical, occipital, and labyrinthine reflexes, which are probably provoked by the proprioceptive impulses from the receptors in the muscles of the back of the head and joints in the upper part of the cervical spine. Exostosis directed posteriolaterally can constrict the intervertebral foramina, and may compress the spinal roots and produce root symptoms in the form of pains and vertigo via the spinonuclear vestibular communications just mentioned.

To determine the importance of optical and proprioceptive impulses for the elicitation of motion-sickness symptoms, we made animal experiments in which these impulses were successively eliminated. The optical impulses were excluded by an occlusive bandage and by suturing the eyelids together. The surest way of eliminating the deep sensitivity would have been to incise the posterior roots or the spinal cord below the medulla oblongata. For technical reasons we limited ourselves to merely excluding the kinesthetic impulses by enclosing the entire body of the animal, including the neck, in plaster of paris. Only the head and a window over the abdomen and around the urogenital orifices were cut out. The dogs were suspended in an upright position in the cages.

First the normal "elevator time" prior to the first vomiting episode in elevators traveling up and down was determined, and then the elevator times prior to vomiting (1) without optical impulses, (2) with plaster bandage, and (3) with plaster bandage plus occlusive bandage were measured. To exclude some degree of habituation, control experiments were then performed. The results showed longer elevator times when the optical impulses had been eliminated. The longest times were obtained with the plaster bandage combined with the occlusive one on the eyes. By excluding optical impulses only, the elevator times became longer than after plaster bandaging alone.

From these animal experiments it is justifiable to conclude that optical and proprioceptive im-

pulses are not necessary for the elicitation of symptoms of motion sickness. But as experience has shown, these impulses facilitate the induction of the symptoms. The optical impulses have a stronger stimulatory effect than do the proprioceptive ones.

HYDROMECHANICAL STUDIES

The vestibular apparatus has, as is known, mechanoreceptors built into a system of fluid-filled spaces to which defined hydromechanical laws are applicable. The basic excitatory medium would seem to be the pressure changes, induced by external factors, which induce flows and displacements in the perilymph and which are transmitted homogeneously to the endolymph, whence the excitatory stimulus is transmitted to the sensory cells. The labyrinthine fluids are practically noncompressible. Thus, for labyrinthine excitation to occur, the surrounding vessel walls should not be completely closed but should allow movement of labyrinthine fluids. For the perilymphatic space, such protective arrangements against pressure increase include (1) the perilymphatic duct, (2) the oval window, and (3) the round window. For the endolymphatic space, the endolymphatic duct and sac serve as safety valves.

There seems to be good reason to suppose that, in the perilymphatic and endolymphatic spaces, similar pressure variations occur. On the basis of this supposition, it would seem suitable to use one single canal system when making a simple labyrinth model for analysis of the hydromechanical conditions in linear acceleration motions. We made a simple model of a labyrinth in the form of a water-filled glass tube bent at an angle, both ends of which were closed by thin rubber membranes or bags, which were to represent the "safety valves" of the labyrinth against pressure increase.

First I should like to give an example of the pressure distribution in a fluid, water, lying in a container at rest or in linear motion with a constant velocity or acceleration. This container can represent a model of a labyrinth.

Apparatus

Container in Vertical Motions

Open container:

1. The container at rest or in linear vertical motion at constant velocity (the acceleration thus being equal to zero).

If, over the open surface (∇) of the liquid, atmospheric pressure $= p_0$ is prevalent, then, according to the laws of hydromechanics, the

$$acc = 0$$

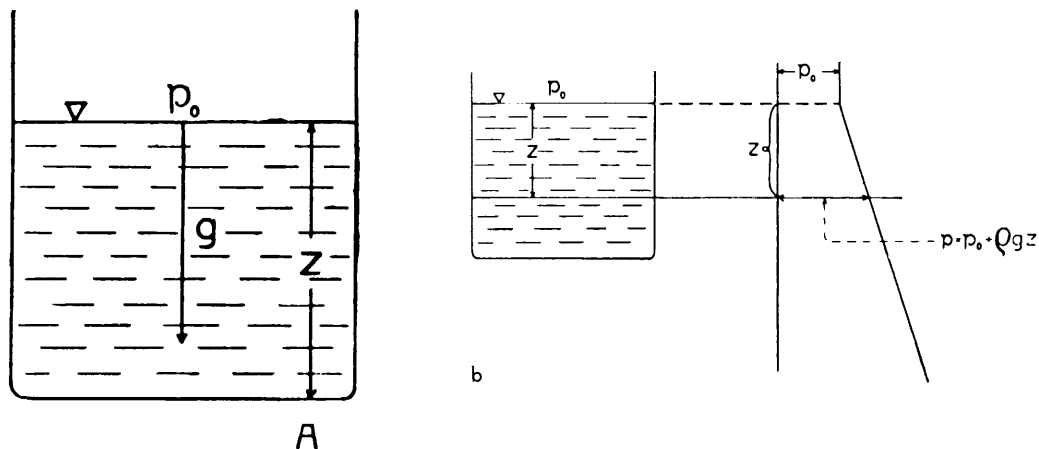

FIGURE 7.—A water-filled glass representing a model of a labyrinth. The pressure is linear to the depth. ∇ = open surface of the liquid; p_0 = atmospheric pressure; g = acceleration due to gravity; z = depth beneath surface of water; A = particular point at z ; ρ = mass of liquid per unit volume.

absolute pressure p at a particular point A at depth z beneath the surface of the water will be

$$p = p_0 + \rho g z$$

where ρ = the mass of the liquid per unit of volume = the density of the liquid, and g is the acceleration caused by the force of gravity.

From figure 7 we see, therefore, that the pressure is linear to the depth. The pressure curve appears as $p = p_0 + \rho g z$.

2. The container in linear vertical motion with constant downward acceleration a .

The pressure p on a particular point at a depth z below the surface of the water will be

$$p = p_0 + \rho(g - a)z$$

From figure 8 we see that the pressure in case (b) is lower than that in case (a).

A downwardly directed acceleration (toward the same side as the acceleration due to gravity) results also in a pressure reduction, and this reduction becomes greater with increase in acceleration.

3. The container in linear vertical motion with constant upward acceleration (fig. 9).

An upwardly directed acceleration (opposite to the acceleration due to gravity) results in an increased pressure, and we obtain the equation

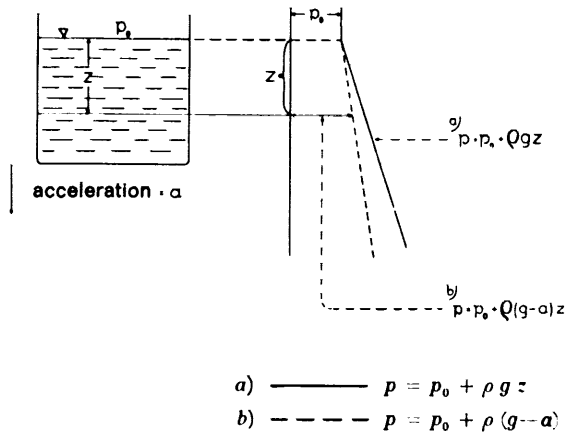

FIGURE 8.—Container in linear vertical motion with constant downward acceleration. Pressure at each point of walls of container is changed when the acceleration is changed on vertical motion. Acceleration directed downward results in pressure reduction.

$$p = p_0 + \rho(g + a)z$$

From this relationship, it must follow that, when on vertical motion the acceleration is changed, the pressure at each point of the walls of the container is changed.

4. Container in linear vertical motion with varying acceleration.

The motion of the container consists of a vertical harmonic pendulous oscillation, for example, between points A and B in figure 10; in other words, a motion with a variable acceleration. Above the middle point O in section OA where the acceleration is directed downward, a pressure reduction results. In section OB , on the other hand, a pressure increase is obtained since the acceleration is directed upward. (The direction of the acceleration is the same during the rising as during the falling phase.)

If the container is given a form with a right-angle bend as in our labyrinth model, this ob-

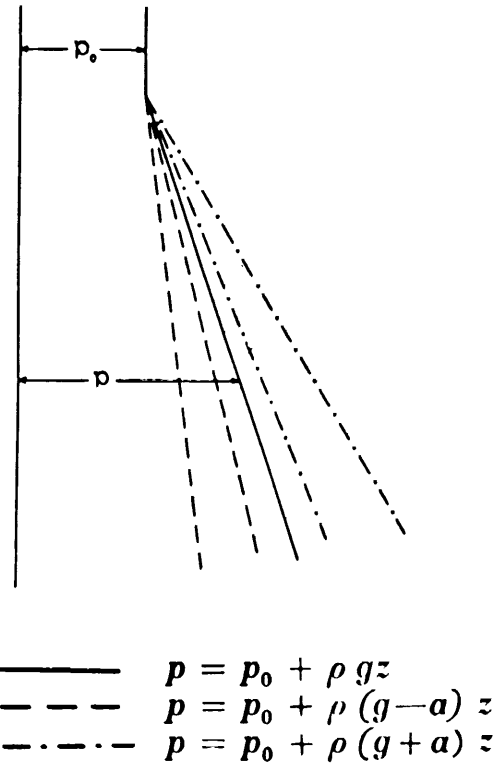

FIGURE 9.—Container in linear vertical motion with constant upward acceleration resulting in increased pressure.

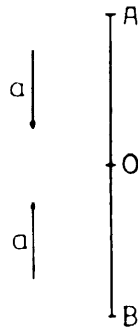

FIGURE 10.—Container in linear vertical motion with varying acceleration.

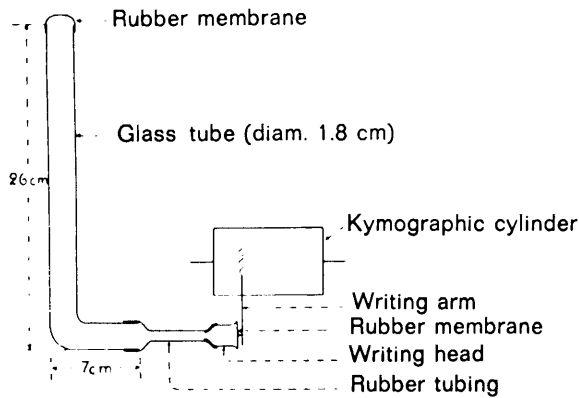

FIGURE 11.—Model of a labyrinth in form of a water-filled glass tube.

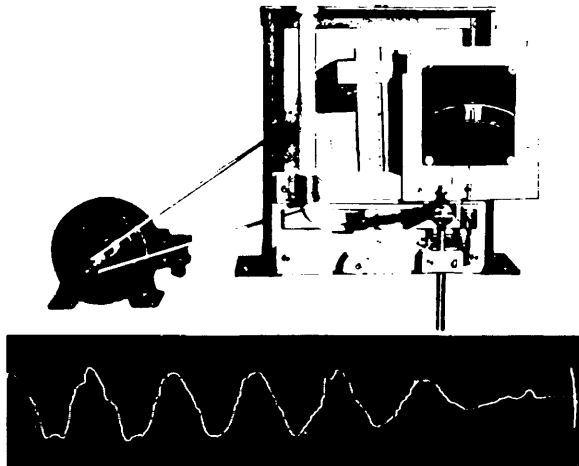

FIGURE 12.—The model (fig. 11) placed on the vertically moving platform (top). Type of pressure variations (bottom).

viously has no influence on the overlying pressure variations.

Closed container:

If the container is closed with rubber membranes as on our glass tube—the model of the labyrinth (fig. 11)—and set in a vertical harmonic pendulous motion, then qualitatively the same effect must be obtained on the pressure distribution within the container; quantitatively, on the other hand, the conditions are changed. Mathematically, this problem can only be solved with great difficulties. In this case, account must be taken of the elastic quality of the walls of the container, of the rubber tubings, and of the rubber membrane of the writing head (fig. 11).

To show that the above theoretical reasoning is also applicable to our closed model of the labyrinth, we have demonstrated with a graphic recording that such pressure variations can also occur in a closed container on vertical harmonic pendulous oscillations.

The model was filled with water and connected to the writing head where the movements were transmitted to the writing arm of a kymograph. The entire instrument was placed on the vertically moving platform of our harmonic oscillation apparatus (fig. 12). The pressure variations are of the type seen at the bottom of figure 12. The accelerations varied from 3.9 to 8.9 m/sec².

Container in Horizontal Motions

Open container:

1. The container at rest or in linear horizontal motion at constant velocity (the acceleration thus being equal to zero).

No alteration is seen in the position of the surface of the liquid. The same equation is valid as for the open container in vertical motion (fig. 7).

2. The container in linear horizontal motion with constant acceleration.

If the container is set in linear horizontal motion with constant acceleration a (cases II and III, fig. 13), the force and direction of which are depicted by the arrow, then the surface of the liquid, according to the laws of hydromechanics, will lie at right angles to the resultant of the value of the acceleration a drawn in the opposite direction and the acceleration due to the force of

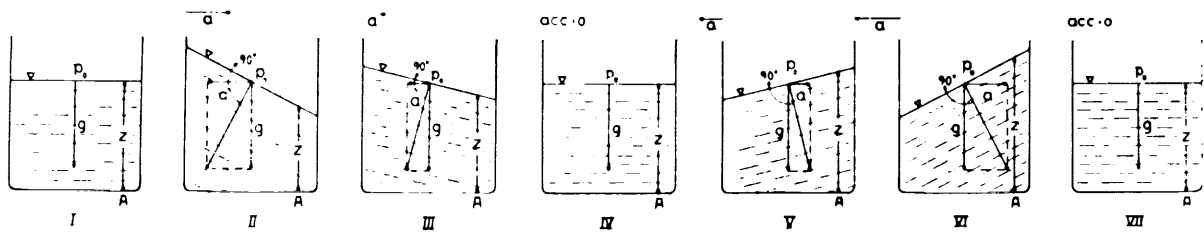

FIGURE 13.—Container in linear horizontal motion. I: At rest. II: In motion. III: Decreased acceleration. IV: Acceleration zero. V: Acceleration in opposite direction. VI: Increase in acceleration. VII: Acceleration zero. a = linear acceleration; g = force of gravity; ∇ = flat surface of the fluid; z = the depth of point A under the water's surface; P_0 = atmospheric pressure above the free surface of the water.

gravity. The pressure p at point A at depth z will vary with the value of z . In case II it will be smallest, and in case VI, greatest.

Thus with this motion, at each point of the container, and particularly on the walls of the container, pressure variations will occur and result in fluid flows and fluid displacements.

3. The container in linear horizontal motion with varying acceleration.

Figure 13 illustrates the pressure distribution in the fluid-filled container. In case I the container is at rest, and in case II it is set in motion. The surface of the liquid takes a sloping position and the value of z diminishes. When the acceleration then decreases, as in case III, the value of z increases slightly, since the positional angle of the surface of the liquid to the horizontal plane is slightly smaller. When the acceleration has declined to zero, then the velocity is constant. The surface of the liquid again is at rest (case IV); this applies both to the state of rest and to constant velocity.

If the acceleration is then again changed, either in a negative or a positive direction (cases V and VI), the position of the liquid changes correspondingly as it did in cases II and III, and the value of z is increased. In case VII, acceleration is again zero.

Figure 13 also illustrates the pressure distribution in a container moving in harmonic pendulous oscillation in the horizontal plane, with case IV as the middle position. We assume that the container moves from II to IV to VI, and back again the same way to II. The acceleration is greatest at the turning points II and VI and is equal to zero in the middle position. Accord-

ingly, it can be seen that also by varying horizontal accelerations, pressure variations and fluid displacements occur in a similar manner.

Closed container:

If this container, like the model of the labyrinth, is closed by an elastic rubber membrane, it may be assumed that qualitatively the same pressure variations with flows and displacements in the fluid will occur as were seen with the vertical motions.

We also found that our closed model of the labyrinth, when subjected to linear motions in the horizontal plane with varying accelerations, reacted distinctly with deviations of the writing arm.

One conclusion from our hydromechanical studies and experiments was, therefore, that, in the labyrinth model closed with an elastic rubber membrane and filled with fluid, pressure variations occur at each point of its contents and especially in its walls under harmonic oscillatory motions in both the vertical and the horizontal plane. The same applies to other horizontal and vertical motions with varying accelerations. The fluid pressure variations result in flows and displacements, which can be easily recorded graphically by the movements of a writing arm.

Most investigators of the vestibular system probably consider today that the ampullar cristae react only to angular accelerations, while it is the otoliths that respond to linear accelerations.

Fleisch (ref. 15) as early as 1922, and also Magnus in 1924 (ref. 24), showed that the semicircular canals probably reacted to linear acceleration motions.

Magnus and deKleyn used a glass model of a

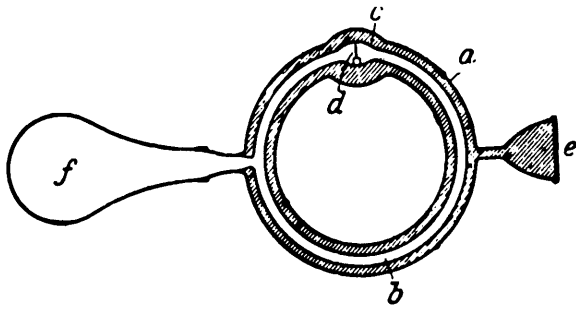

FIGURE 14.—The Magnus and deKleyn glass model of a labyrinth. (See text.)

labyrinth (fig. 14). In the ampulla there was an elastic cupula (*d*). The model was closed with an elastic window (*e*), and the inner sac—the “membranous semicircular canal”—communicated with the outer sac by means of a “pressure reservoir,” a rubber bag (*f*). This model reacted promptly to linear accelerations with cupula impulses both at the beginning and at the end of the movement.

The writing arm in our labyrinth model is analogous to this cupula and reacts, as we have seen above, to accelerated movements in the vertical and horizontal planes. It must then be asked whether these experimental results can be applied to living persons who have been subjected to accelerated linear motions that provoke motion sickness in its different forms, but especially in true seasickness.

It seems plausible to me that the hydro-mechanical results can, on the whole, be applied to the living labyrinth.

LABYRINTHINE PRESSURE VARIATIONS

We must thus consider that, in persons who are subjected to ship movements in rough seas, or at any rate to linear motions in a vertical or horizontal plane where the accelerations are of such magnitude as to correspond to those on rough seas, each point of the labyrinth and its contents is affected by pressure variations. Such pressure variations occur in the walls of the labyrinth and in the labyrinthine fluids, and must be followed by displacements and flows in both the perilymph and the endolymph.

As is known, one labyrinth in the human body is located on either side of the median plane of the body, the plane of symmetry. In relation to this plane the labyrinths are mirror images of each other (fig. 15). The pressure variations on linear acceleration motions discussed above must occur in the two labyrinths simultaneously.

That the momentary pressures at corresponding points on the labyrinths are not always the same is evident from figure 15, a labyrinth model. If the two liquid-filled containers (labyrinths), placed on either side of a plane of symmetry, are set in motion with an acceleration *a* (corresponding to the arrow in fig. 15, i.e., at right angles to the plane of symmetry), the surfaces of the liquids assume the positions as shown in this figure. Points *p*₁ and *p*₂ are corresponding points on the two containers. The momentary pressures at these points are not equal; *z*₂ is greater than *z*₁. If, on the other hand, the container is set in motion in the direction of the plane of symmetry, the momentary pressures at points *p*₁ and *p*₂ are always equal. If the movement has a component which is at right angles to the plane of symmetry, the pressures at corresponding points of the labyrinth models will never be equal, as we have seen.

A passenger on board a ship in rough seas will, at many locations on the ship, be moved

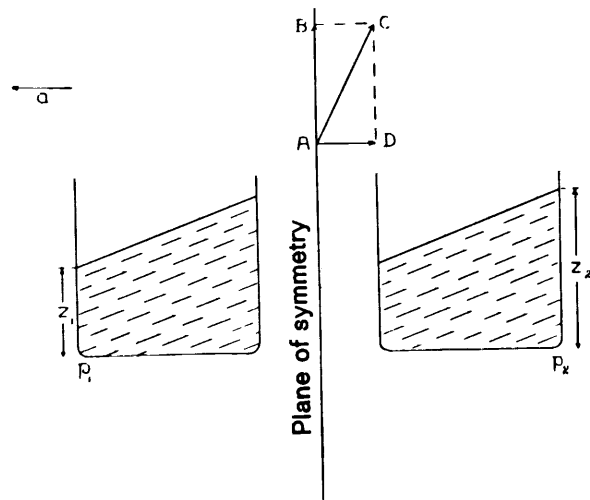

FIGURE 15.—The “labyrinths” in relation to the median plane of the body, the plane of symmetry. (See text.)

both up and down and thrown from side to side. With the intralabyrinthine pressure variations that will be induced, the momentary pressure at corresponding points of the two labyrinths will probably seldom be absolutely the same.

The question now is whether these intralabyrinthine pressure variations induced by elevator or ship movements are of such magnitude that the excitation of the sensory epithelium would be strong enough to elicit symptoms of motion sickness. In an attempt to answer this question to some extent, we made experiments on fresh autopsy human temporal bones, that had been stored in a refrigerator.

Since the labyrinthine fluids are practically noncompressible, the "safety valves," the labyrinth windows, have to be displaced outward as pressure increases inside the labyrinth.

In the same way as the writing arm in our labyrinth model illustrated the pressure variations which occur on up-and-down or side-to-side harmonic oscillatory motions, the outward displacement of the stapes should be able to serve as a norm, or be an approximate expression of the magnitude of the intralabyrinthine fluid displacement produced by such motions.

As a theoretical explanation for the caloric reaction, Bárány assumed, as is well known, that cooling gives a reduction and heating an increase in the specific weight of the endolymph. This results in endolymph flows which would seem to be the basic medium of excitation of the sensory epithelium in the cupulae. On heating of the labyrinth, the volume of the labyrinthine fluids must increase and the pressure rise. The coefficient of heat expansion for the fluid must be greater than for the labyrinthine capsule, and this must lead to an outward displacement of the stapes.

To make an acceptable comparison, the following measurements were made on each temporal bone preparation:

- (1) The maximal outward displacement of the stapes on vertical oscillatory movements
- (2) The outward displacement of the stapes after electrical heating of the preparation

Experimental Arrangement

The displacements of the stapes were measured electrically (figs. 16 and 17) by attaching a very small square platinum plate to the capitulum stapedis (weight 7 to 8 mg). Attached to the

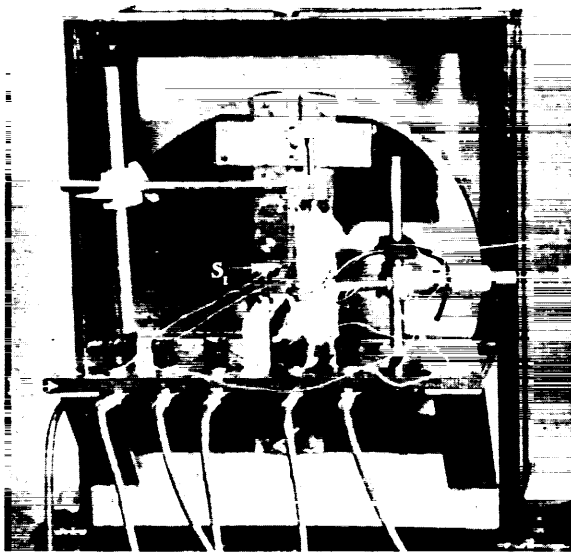

FIGURE 16.—The temporal bone preparation placed on the plate of the apparatus for vertical harmonic oscillations. E: ebonite plate; S and S₁: pole screws; T: thermocouple; M: micrometer screw.

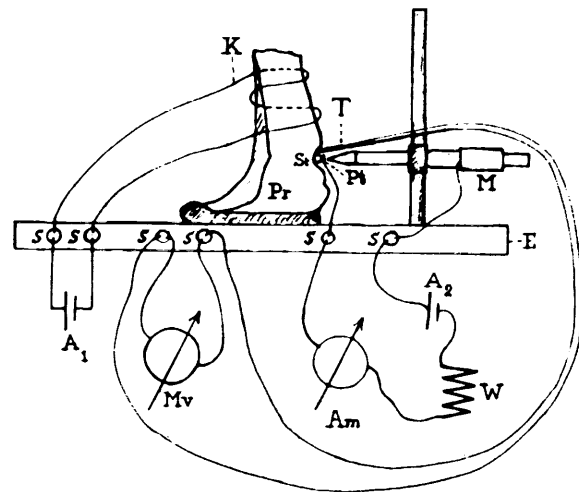

FIGURE 17.—The temporal bone preparation electrically heated. Mv = millivoltmeter; Am = ammeter; W = resistance of 2000 ohm; A₁ = storage battery, 18 volt; A₂ = storage battery, 2 volt; S = pole screw; K = constantan wire; Pr = preparation; St = stapes; Pt = platinum tip of the stapes; T = thermocouple; M = micrometer screw; E = ebonite plate.

platinum plate was a small piece of tinsel thread 0.6 mm long and 0.03 mm thick. The preparation was placed on the ebonite plate of our apparatus for vertical harmonic oscillations (fig. 16). The platinum plate was connected to an electric circuit. With the vertical motions the stapes plate was moved, the platinum plate came into contact with the tip of the micrometer screw, the circuit was closed, and the ammeter gave a signal. The greatest distance to contact was the measure of the maximum outward displacement of the stapes. On the average, this displacement was 0.01 mm. The maximum acceleration value for passenger ships of normal size and for the elevators which we used was about 3 m/sec². We used a maximum acceleration of 3.95 m/sec² for the temporal bones. The driving wheel of the apparatus rotated at 60 rpm. The time for a complete oscillation up and down was 1 second. The amplitude = the radius = 10 cm.

In the heating experiments the preparations were heated electrically by winding a constantan wire around the bone (fig. 17) (resistance, 12 to 15 ohms). Heat was produced by a storage battery. The temperature was measured with thermoelements of copper-constantan placed against the promontorium. In these experiments also, the outward displacement of the stapes was, on the average, 0.01 mm when the bone was heated 5° to 12° (measured against the wall of the labyrinth).

The up-and-down vertical oscillations thus elicited intralabyrinthine pressure variations of such magnitude that, in a living person, they would probably exert such a strong excitatory effect on the sensory epithelium of the vestibular apparatus that this could well be compared with a very strong caloric effect of the type which we see today; for example, in ultrasonic treatment of Ménière's disease.

The Eliciting Mechanism

We have seen from the foregoing that, on rough seas or in elevators where persons are subjected to linear acceleration movements in the vertical and horizontal planes, it can be expected that pressure variations will occur simultaneously in

the two labyrinths. But the momentary pressures at corresponding points within the two labyrinths are probably seldom of the same magnitude.

As a result of the pressure variations, flows and displacements are probably transmitted to the perilymph and endolymph. These are of such magnitude that an intensive excitation of the sensory epithelium is induced in the two receptor systems of the labyrinth, the otoliths and the ampullar cristae, resulting in manifest symptoms of motion sickness. It would seem reasonable to ask why vestibular nystagmus cannot be recorded even by electronystagmography (ENG). On the nystagmograms, as we have just seen, only typical nystagmus-like vertical eye movements are visible.

In my opinion, this may be due theoretically to the fact that the two labyrinths are stimulated simultaneously, and inhibitory impulses prevent the induction of a manifest vestibular nystagmus. Since the pressures at corresponding points of the labyrinths are not always equal, the impulses to eye movements, arising from each side, cannot completely eliminate one another, and only the small atypical nystagmic beats can occur, but not a fully developed vestibular nystagmus.

Also belonging to the clinical picture of motion sickness is intermittent headache, which may perhaps be due to intracranial pressure variations which are undoubtedly provoked by ship and elevator movements.

APPLICATION TO PROBLEMS OF WEIGHTLESSNESS

It now seems appropriate to ask whether these results of our experimental studies on the eliciting mechanism of motion sickness can possibly give a plausible explanation for part of the vestibular disturbances in weightlessness. Graybiel (refs. 25 and 26) said that the absence of the weight factor can probably explain the relative ease with which astronauts seem to manage their strenuous space journeys and science-fiction-like walks in space. There would be no otolith stimulation.

Transient weightlessness has been studied in parabolic flights with rapid jet planes, and Soviet

experimenters (refs. 27 to 29) have described the illusion of rotation in opposite directions and postrotational nystagmus. Two subjects (not professional airmen) had a sensation of being upside down during the period of weightlessness. Such spatial illusions have been observed by Soviet cosmonauts in orbital flight. These Soviets state that it is the change in afferent impulse activity that is responsible for the production of sensory reactions in weightlessness.

For studies of weightlessness of longer periods, we have to turn to prolonged orbital flights. The Soviet studies in the spaceship Voskhod are of special interest. The cosmonauts had undergone different degrees of vestibular training. "Komarov had had several years of vestibular training. Feoktistov and Yugarov only a few months." Komarov showed very high vestibular resistance before the flight, and during the flight he developed no unfavorable vestibular reactions. The other two, on the other hand, with less training and low vestibular resistance, developed "vestibuloautomatic reactions" of the motion-sickness type.

During orbital flight with a period of weightlessness lasting 24 hours, "Yugarov and Feoktistov developed illusory sensations that their bodies were upside down in space." These illusions appeared when their eyes were closed and when they were open. The sensations persisted throughout the whole period of weightlessness and remained until the onset of g -loading during the descent of the ship. The two also had unpleasant sensations of vertigo during sharp movements of the head and, consequently, "tried to move less and when performing their work they moved smoothly." After sleep, the vestibular syndrome improved, and they were able to carry out their program.

Earlier, in the spaceship Vostok II, Titov had also had similar feelings of the head being down or that he was in an inverted position. This type of illusion has been described by many cosmonauts when they were still lying on their backs, but oddly enough, not apparently by the American astronauts. During sharp movements of the head, Titov was also troubled by vertigo and manifest symptoms of motion sickness. The symptoms declined after a period of sleep

and disappeared altogether on descent and the return of g -forces.

New Hydromechanical Experiments

As far as I know, no acceptable explanation for these illusions has been given. Likewise, the question seems to be unanswered as to whether impulses pass to the vestibular nerve from the equilibrium apparatus in weightlessness or not. Graybiel's view seems to be the most plausible, that the otoliths are not stimulated in weightlessness and no afferent impulses are thus sent out to the brain.

How then can we explain that (1) in weightlessness, as a result of rapid movements of the head, i.e., linear accelerations, a sudden sensation of vertigo and symptoms of motion sickness occur?; and (2) even when the space pilot is lying on his back in the capsule, throughout the period of weightlessness he has the confusing illusion that he is upside down?

In this connection, Schock's experimental studies on cats (ref. 30) may be mentioned. Normal nonoperated animals became disorientated and confused in weightlessness. The symptoms increased when the eyes were covered. Animals that had undergone bilateral labyrinthectomy were unaffected, but when their optical impulses were excluded they also became disorientated in the state of weightlessness.

Intact vision is essential for space flights. In a state of weightlessness, when the proprioceptive impulses are also eliminated, the pilots have only their sense of vision to depend upon. I have been fascinated by this peculiar state when the sensation of weight is eliminated; therefore, I have continued my previous hydromechanical studies and experiments at the Stockholm College of Technology. In collaboration with H. Bergkvist, new model experiments are being carried out.

We will return now to figure 13 of the liquid-filled container, representing a model of a labyrinth. We will imagine that the container is subjected to a horizontal acceleration a . Two forces are acting on the liquid: first the force of gravity g , and second the horizontal force of inertia ma (mass times acceleration). The flat surface of the liquid will assume a position at right angles

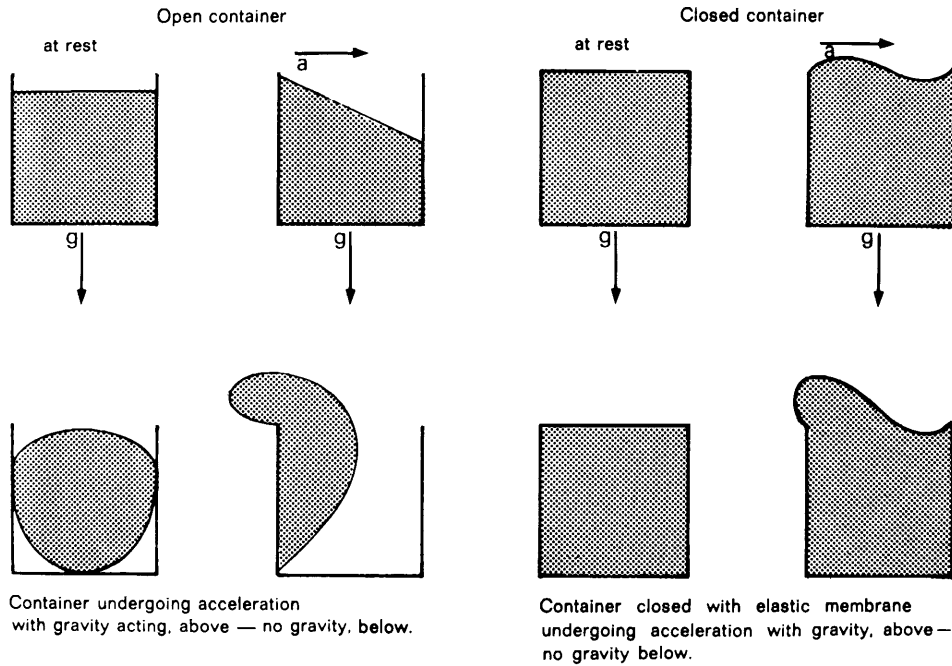

FIGURE 18.—The liquid-filled model of a labyrinth subjected to horizontal acceleration in a state of weightlessness. The liquid is thrown out of the container.

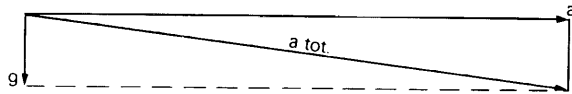

FIGURE 19.—Total acceleration ($a_{tot.}$), with large horizontal acceleration (a), representing state of weightlessness.

to the resultant of the two forces at the point in question. If a is increased or g decreased, the angle will increase and thereby the depth z at the “posterior wall” of the container (e.g., case VI). When z becomes greater than the wall of the container, the liquid will be thrown out. If the container is closed with an elastic membrane, this will be displaced outward.

With this reasoning, if the vertical acceleration is allowed to approach zero, the state of weightlessness is obtained. In the g -free space the liquid is thus thrown out of the open container (fig. 18). If the container is closed, the liquid remains in it. If the container is closed by an elastic membrane, its contents will tend to be forced against this membrane or will be flung outward or be keeled over.



FIGURE 20.—Open container in linear horizontal motion with 2-g centripetal acceleration.

Since, for technical reasons, it is difficult in these model experiments to eliminate g , we chose to simulate the state of weightlessness in linear acceleration by means of a large centripetal acceleration. As can be seen in figure 19, with a sufficiently large horizontal acceleration the total acceleration (a tot.) will represent the state of weightlessness, where, of course, g is nonexistent, with adequate accuracy.

Figures 18 to 21 from our new hydromechanical model experiments illustrate and summarize the problem. Figure 20 is an open container in linear horizontal motion with a centripetal acceleration of $2g$. In the next figure (fig. 21) this acceleration is $3g$, and the container is closed. In figure 22 the container is closed by an elastic membrane and is set in linear horizontal acceleration of $15g$; this figure, as I said, represents the state of weightlessness with adequate ac-



FIGURE 21.—Closed container in linear horizontal motion with 3-g centripetal acceleration.

curacy. The fluid will be forced against the membrane with a tendency to be keeled over. In figure 23(a) we see a closed rubber bag in a container at rest. In figure 23(b) the linear acceleration is $23g$ and the bag has this tendency to be keeled over.

Finally, in our opinion it seems plausible that these hydromechanical model data may explain why the cosmonaut in the resting state of weightlessness, when no afferent impulses are being sent from the otoliths, suddenly has vertigo when his head is turned rapidly; i.e., when he is subjected to a weak linear acceleration.

The weightless endolymph is as an effect of the force of mass inertia thrown against the walls of the labyrinth with its "deafferented" weightless receptor system. These new moderate, unexpected afferent impulses will suddenly produce a strong excitatory effect on the sensory epithelium of the vestibular apparatus, inducing manifest symptoms of vertigo and motion sickness.

Spatial Illusions

The extremely important question of the spatial illusion, in weightlessness, of the body being in an upside-down position can also be plausibly explained.

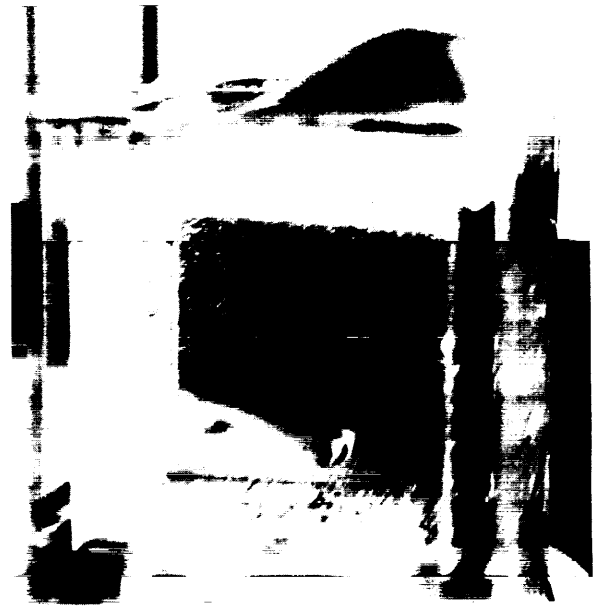

FIGURE 22.—Container closed by an elastic membrane. Linear horizontal 15-g acceleration.

As is well known, the statoconic membrane of the macula is considered to have approximately twice as high a specific weight as the

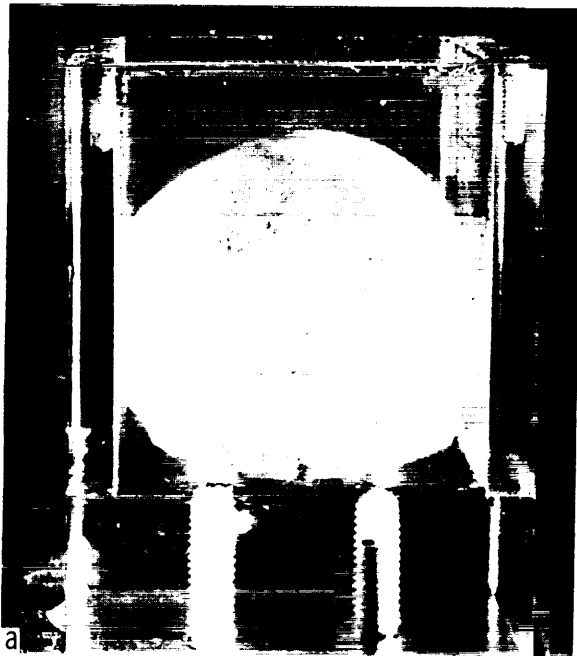

FIGURE 23.—(a) Closed rubber bag in container at rest. (b) With linear 23-g acceleration, the bag has a tendency to lean over.

endolymph. In other words, the membrane can easily change its position in relation to the sensory epithelium. By deviation of the sensory hairs in the viscous, gelatinous superficial mass, a mechanical transformation takes place, and the macula functions both as a position indicator and as an accelerometer.

The change in position of the otolith membrane can be caused by two types of forces: the force of inertia and an alteration of the relative direction of the force of gravity. If a person, and thus his macula, is subjected to an acceleration a , the layer subjacent to the otoconic membrane, the sensory cells, tends to move in a direction opposite to the acceleration, because of the inertia of the mass. This force, the force of mass inertia ($F = ma$), acts upon the macula and is oriented in a direction opposite to the acceleration. This force thus moves the otoconic membrane out of its equilibrium position, and the sensory hairs mediate a sensation of acceleration to the sensory cells. The macula is covered by a gelatinous or viscous mass, which surrounds the sensory hairs. This viscous mass probably has a fairly high frictional force, which will have an inhibitory effect on the movements of the otoconic membrane. The accelerations to which the head is normally subjected are small compared with the acceleration g due to gravity. The change in the total acceleration, acting upon the macula, will thus be relatively small when an "external" acceleration occurs.

In the state of weightlessness, on the other hand, the conditions are different. Since there is no effect of acceleration due to gravitation, the change in acceleration is equal to the "external" acceleration. A very moderate acceleration, e.g., a movement of the head, is now perceived instead as a large change in movement. The result may then be, as mentioned above, the pronounced and rapidly manifested attacks of motion sickness as experienced by the Soviet cosmonauts. If, on the other hand, there is influence by the force of gravity, and this has a component perpendicular to the nerve endings (e.g., when the head is bent forward), the otoconic membrane will be displaced from its position of equilibrium and the macula will function here as a position indicator. When an "external" ac-

celeration has ceased, the membrane, because of the acceleration due to gravity, will return to its position of rest.

In a condition of weightlessness, on the other hand, spatial illusions can occur, since there is no restoratory force to act on the membrane. There is no signal that the acceleration has ceased. If now the macula is subjected to an arbitrary small acceleration, the otoconic membrane will remain in its displaced equilibril position even when the acceleration has ceased to have any influence. The influence of the frictional force of the viscous superficial layer

on both the membrane and the sensory hairs will probably accentuate this condition. The macula will thus continue to indicate the presence of an acceleration which has, in fact, ceased.

After, for example, a posteriorly directed acceleration, the individual may well have a sensation of being in the face-downward position. In figure 24, finally, we attempt to visualize the mechanism of such a vestibular macular spatial illusion. In weightlessness the membrane remains in position and indicates an erroneous positional change. The individual will have an illusion of being in an inverted position.

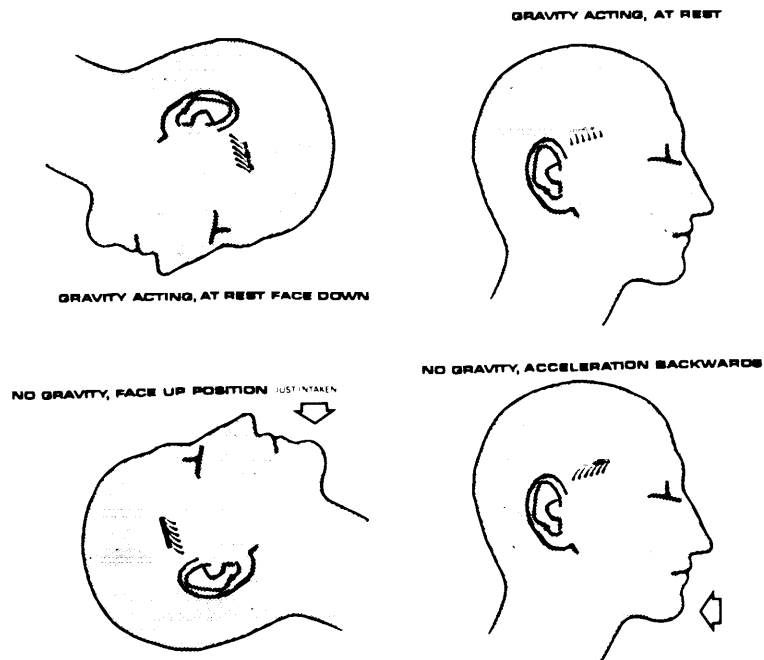

FIGURE 24.—Visualization of the macular spatial illusion.

REFERENCES

1. JAMES, J. A.: The Sense of Dizziness in Deaf Mutes. *Am. J. Otol.*, vol. 4, 1882, pp. 239-254.
2. REYNOLDS, T. T.: On the Nature and Treatment of Seasickness. *Lancet*, vol. 1, 1884, pp. 1161-1162.
3. MINOR, J. L.: Freedom of Deaf-Mutes from Sea-sickness. Its Bearing Upon the Theory of Sea-sickness and Its Treatment. *Memphis J. Med. Sci.*, vol. 1, 1889, pp. 252-254.
4. SJÖBERG, A.: Experimental Studies of the Eliciting Mechanism of Seasickness. *Acta Oto-Laryngol.*, vol. 13, 1929, pp. 343-347.
5. CORNING, J. L.: The Suppression of Rotary Vertigo; Its Bearing on the Prevention and Cure of Seasickness. *N.Y. Med. J.*, vol. 80, 1904, pp. 297-299.
6. QUIX, F. H.: Le Mal de Mer, le Mal des Aviateurs. *Monograph No. 8. Oto-Rhino-Laryngol. Intern.*, 1922, pp. 825-912.
7. BÁRÁNY, R. (translated by I. W. Voorhees): Functional Testing of the Vestibular Apparatus. *Ann. Otol.*, vol. 21, 1912, pp. 71-127.
8. BRUNS, O.: Wesen und Bekämpfung der Secund Luftkrankheit. *Münch. Med. Wschr.*, vol. 73, 1926, pp. 977-979.
9. BYRNE, J.: On the Physiology of the Semicircular Canals and Their Relation to Seasickness. *J. T. Dougherty*, New York, 1912, 569 pp.
10. WOJATSCHEK, W.: Einige neue Erwägungen über das Wesen der Seekrankheit. *Beitr. Anat. Physiol. Pathol. Therap. Ohres*, vol. 2, 1909, pp. 336-345.
11. SJÖBERG, A.: Experimentelle Studien über den Auslösungsmechanismus der Seekrankheit. *Acta Oto-Laryngol.*, suppl. 14, 1931, pp. 1-136.
12. DOHLMAN, G.: Physikalische und physiologische Studien zur Theorie des kalorischen Nystagmus. *Acta Oto-Laryngol.*, suppl. 5, 1925, pp. 1-96.
13. ASCHAN, G.; BERGSTEDT, M.; AND STAHL, J.: Nystagmographical Observations Illustrating the Cupular Mechanism in Rabbits and Pigeons. *Acta Soc. Med. Upsalienis*, vol. 60, 1955, pp. 89-98.
14. NIEUWENHUIJSEN, J. H.: Experimental Investigations in Seasickness. *Utrecht Acad. Proefschrift*, 1958.
15. FLEISCH, A.: Das Labyrinth als beschleunigungsempfindliches Organ. *Pfügers Arch. ges. Physiol.*, vol. 195, 1922, pp. 499-515.
16. JONGKEES, L. B. W.; AND PHILIPSOON, A. J.: Nystagmus Provoked by Linear Accelerations. *Acta Physiol. Pharmacol. Neerl.*, vol. 10, 1962, pp. 239-247.
17. NIVEN, J. I.; HIXSON, W. C.; AND CORREIA, M. J.: Elicitation of Horizontal Nystagmus by Periodic Linear Acceleration. *Acta Oto-Laryngol.*, vol. 62, 1966, pp. 429-441.
18. GUEDRY, F. E.: Influence of Linear and Angular Accelerations on Nystagmus. *Second Symposium on the Role of the Vestibular Organs in Space Exploration*, NASA SP-115, 1966, pp. 185-196.
19. GERTZ, H.: Action Motrice Induite. *Acta Med. Scand.*, vol. 57, 1922, p. 41.
20. KORNHUBER, H.: Physiologie und Klinik des zentral-vestibulären Systems. *Hals-Nas.-Ohrenheilk.*, vol. 3, 1966, pp. 2150-2350.
21. GERNANDT, B. E.; AND GILMAN, S.: Descending Vestibular Activity and Its Modulation by Proprioceptive, Cerebellar and Reticular Influences. *Exptl. Neurol.*, vol. 1, 1959, pp. 274-304.
22. COHEN, L. A.: Role of Eye and Neck Proprioceptive Mechanisms in Body Orientation and Motor Coordination. *J. Neurophysiol.*, vol. 24, 1961, pp. 1-11.
23. SANDSTRÖM, J.: Cervical Syndrome With Vestibular Symptoms. *Acta Oto-Laryngol.*, vol. 54, 1962, pp. 207-226.
24. MAGNUS, R.: Körperstellung. *Monographien aus dem Gesamtgebiet der Physiologie der Pflanzen und der Tiere*. Springer, Berlin, 1924, p. 740.
25. GRAYBIEL, A.: Vestibular Sickness and Some of Its Implications for Space Flight. *Neurological Aspects of Auditory and Vestibular Disorders*, W. S. Fields and B. R. Alford, eds., Charles C Thomas, 1964, pp. 248-270.
26. GRAYBIEL, A.: Vestibular Problems in Relation to Space Travel. *The Vestibular System and Its Diseases*, R. J. Wolfson, ed., Univ. Pennsylvania Press, 1966, pp. 443-458.
27. KAS'YAN, I. I.; KRASOVSKI, A. S.; KOLOSOV, I. A.; LOMOVA, M. A.; LEBEDEV, V. I.; AND YUROV, B. N.: Some Physiologic Reactions in Man During Short Periods of Weightlessness. *Federation Proc.*, vol. 25, pt. II, 1966, pp. 605-611.
28. YUGANOV, E. M.; GORSHKOV, A. I.; KAS'YAN, I. I.; BRYANOV, I. I.; KOLOSOV, I. A.; KOPANEV, V. I.; LEBEDEV, V. I.; POPOV, N. I.; AND SOLODOVNIK, F. A.: Vestibular Reactions of Cosmonauts During Flight in the Ship "Voskhod." *Federation Proc.*, vol. 25, pt. II, 1966, pp. 767-770.
29. YUGANOV, E. M.; GORSHKOV, A. I.; KAS'YAN, I. I.; BRYANOV, I. I.; KOLOSOV, I. A.; KOPANEV, V. I.; LEBEDEV, V. I.; POPOV, N. I.; AND SOLODOVNIK, F. A.: Vestibular Reactions of Cosmonauts During the Flight in the "Voskhod" Spaceship. *Aerospace Med.*, vol. 37, July 1966, pp. 691-694.
30. SCHOCK, G. J. D.: A Study of Animal Reflexes During Exposure to Subgravity and Weightlessness. *Aerospace Med.*, vol. 32, 1961, pp. 336-340.

DISCUSSION

McNally: I should like to pay tribute to Dr. Graybiel because he is pretty important to us all. You know that in science, as in everything else, there are styles, and at the present time vestibular physiology is in style. There was a time not so long ago when it was not, and cochlear physiology was the rage. Back in the 1915's and 1920's in the days of Bárány, Sherrington, Magnus, and DeKleyn, physiology of the vestibular system was very popular. Dr. Graybiel took up the study of vestibular physiology, persevered in it, trained his associates, and had them ready to respond to problems involved in the space program. We owe him a tremendous debt of gratitude for what he has been able to do for vestibular physiology.

It is rather interesting that our first speaker also brought us a link with these early physiologists, especially to Bárány who did his work in Uppsala and won his Nobel Prize there. It is most fitting that we had one of his successors at Uppsala, Professor Sjöberg, talk to us today. I can well remember when I first became interested in seasickness while reading articles by Professor Sjöberg back in the 1920's.

Money: Professor Sjöberg, do you think that the pressure changes in response to linear accelerations are more or less important than the direct effect of the linear acceleration on the otolithic membrane? Also, could you outline the evidence for the conclusion that the proprioceptors are not necessary for motion sickness?

Sjöberg: I believe that the pressure variations with flows and displacements probably are transmitted to the perilymph and endolymph, there inducing in the two receptor systems of the labyrinth, the otoliths and the ampullar cristae, a strong excitation of the sensory epithelium, resulting in manifest symptoms of motion sickness.

Money: I understood you to say that neither the impulses from the eyes nor from the proprioceptors was necessary.

Sjöberg: In my paper I said that, from the animal experiments, it is justifiable to conclude that optical and proprioceptive impulses are not necessary for the elicitation of symptoms, but these impulses stimulate and facilitate the induction of the symptoms. I agree with you that the optical is more important.

Money: More important than the proprioceptors?

Sjöberg: Yes, more important; the optical impulses have a stronger stimulatory effect than do the proprioceptive ones.

Money: That answers my second question.

Huertas: I should like to dwell a little bit more on the vibration-conducting mechanism. The labyrinth is contained in a nonelastic bony box, so to speak, which cannot be distended; therefore, any change in shape of the membranous labyrinth would be due to changes in buoyancy between the membranous membrane of the labyrinth and the fluids by which it is surrounded. Do you have any evidence of the differences in specific gravity between the three elements involved—the perilymph, membranous labyrinth, and endolymph—to back up your theory of displacement by vibra-

tion? It is accepted today that angular acceleration can produce motion sickness; therefore, the receptors for angular accelerations must play a role in motion sickness. You did not mention such receptors as active elements in the production of motion sickness. Is there an otolith response to accelerations in space during zero-*g* or not? Dr. Gualtierotti made a similar query at the last symposium. There are otolith fibers or linear-acceleration-responding units which are sensitive to 1 milli-*g*, to a thousandth of a *g*. The ballistic forces of the heart produce acceleration movements of the head much greater than that; therefore, even during weightlessness the otolith is constantly stimulated with each heartbeat.

Sjöberg: It is well known that, for the statoconic membrane of the macula, the specific weight is considered approximately twice as high as that of the endolymph.

On a very winding road, naturally the receptors for angular accelerations play a role in the elicitation of motion sickness.

Lansberg: I am very much impressed by the measurements you have made of the distance that the stapes moves out. Do you not think that, during ultrasonic therapy for Ménière's disease, there is more involved than just the heating of the labyrinth? Is it not the selective destruction of the epithelium in the horizontal canal that causes the symptoms, both in the irritative and in the paralytic phase?

Sjöberg: In my subsequent paper ("Experimental and Clinical Experiences and Comments on Ultrasonic Treatment of Ménière's Disease"), I go into the question of the thermal effect. In Uppsala we have experimented on rabbits and human beings during ultrasonic irradiation with the head in different positions. We have shown that the initial nystagmus of the irritative type brought about by ultrasonic treatment is probably a caloric reaction provoked by the endolymphatic flow caused by the thermal effect. The nystagmus of the destructive type does not change direction when the head position is altered from face up to face down.

Waite: During Gemini 7, Astronaut Frank Borman shook his head repeatedly and reported no untoward symptoms whatsoever. Has motion-sickness symptomatology been reported during vertical acceleration or linear acceleration with the head rigidly fixed so that no angular accelerations can take place?

Sjöberg: Symptoms of motion sickness can be elicited during up-and-down harmonic pendulous movements with the head fixed.

Barber: Have you any comments to make upon the incidence of motion sickness in bilateral otosclerosis, where each stapes is fixed?

Sjöberg: I have no experience with otosclerosis in relation to motion sickness.

McNally: Professor Sjöberg represents a line of very distinguished investigators as does Professor Wendt who brings to us the traditions of Parker and Maxwell and Dodge.

Experiences With Research on Motion Sickness¹

GEORGE RICHARD WENDT

University of Rochester

SUMMARY

The author's studies of motion sickness, conducted since before World War II, are briefly described. They included studies of the nature of susceptibility to motion sickness, of the effects of wave character on incidence of motion sickness, of other factors related to motion sickness, including preventive drugs, and of the effects of sickness on performance.

INTRODUCTION

I was invited to take part in this symposium to review the research on motion sickness for which I have been personally responsible. My associates and I have done several hundred separate researches of all degrees of magnitude from relatively small to very large. Most of these were done in the period 1939 to 1956, but some span the period from 1930 to the present. Relatively few are in normal publication channels, but nearly all are at least briefly described in technical reports and so-called final reports.

Let me briefly account for this state of affairs. In 1939 our involvement in war was easily predicted. I decided to direct my interests in the vestibule to an area of military consequence, motion sickness. Because there were then few people with either skills or interest in motion sickness, I allowed my interest and research to cover nearly the entire gamut of possible problems.

This paper will have served my purpose if it leads a few of you to seek copies of my unpublished reports and, hopefully, to do experiments

to answer the many questions I left unanswered or insufficiently proven. The reports which give access to most others are one to the National Research Council Committee on Selection and Training of Aircraft Pilots in 1944, a final report to the Office of Naval Research in 1954, and a progress report to the National Institute of Mental Health in 1956 (refs. 1 to 3). Most of our published papers are in the *Journal of Psychology*.

After Pearl Harbor, I was deluged by requests for answers to the problems of motion sickness. I did my best to answer these needs. From the perspective of 27 years later, my efforts do not seem to have been misleading on major issues. What follows is a selection of problems emphasizing those we did not solve and wish someone else would soon try to solve.

STUDIES OF NATURE OF SUSCEPTIBILITY TO MOTION SICKNESS

Our early wartime work, 1939 to 1942, was low-budget exploratory investigation, resulting in over 200 studies of human vestibular, autonomic, other physical and physiological, and psychological characteristics of those susceptible or nonsusceptible to motion sickness, as indicated by their life histories. In retrospect, I can say that most data on the nature of susceptibility were negative, i.e., of no predictive value, others were positive, but not feasible to use, and one,

¹In the 38 years during which I have engaged in this research, it has been supported by agencies and aided by individuals far too numerous to mention. Preparation of this paper is currently aided by the University of Rochester and by a contract with the Office of Naval Research. Neither sponsor should be held accountable for the views expressed.

on past history of vomiting and of motion sickness, had a moderate predictive value.

Studies of Vestibular Sensitivity

The magnitude and duration of vestibular nystagmus are probably not predictive of motion sickness according to a number of our studies. It is possible that visual inhibition of nystagmus is less effective in susceptibles. Habituation to rotation, with the subjects being rotated in the dark, is not related to motion-sickness susceptibility. This may not apply to the very different problem of habituation in the Pensacola Slow Rotation Room, where full vision is standard and sickness is common.

Studies of Autonomic Responses

About 50 studies of many aspects of the problem of autonomic responses gave negative results. Blood pressure; pulse rate and its changes; arrhythmia; cardiac response to vestibular stimulation; reaction to revolver shot or to apprehension; tilt-table response; cold-pressor reaction; vasomotor response to hyperventilation and to breath holding; injections of Adrenalin or of acetyl- β -methylcholine, and others, were not usefully predictive.

Other Physiological and Medical Studies

Motor coordination, the electroencephalogram, somatotype, and breathing rate were unrelated to susceptibility. On the other hand, susceptibles made health complaints and displayed symptoms much more often. Medical histories yielded no support for their complaints, nor did infirmary records.

Psychological Studies

A very large number of biographical data and psychological test scores were assembled on 630 men. The results are interesting but of little practical value. The susceptibles rated slightly higher on neuroticism. They took two to three times as many courses in religion, philosophy, art, and music, and only half as many in economics and chemistry. They were equal in athletics, but outstanding in individual sports such as track, wrestling, and boxing. They tended to avoid liquor, coffee, and tobacco.

Because almost all these data have little prac-

tical use, being so heavily culturally influenced, they should be used only for understanding rather than prediction. A set of predictive criteria based on our liberal-arts college population is virtually useless for a secondary school population that does not have the same choices of activities.

Predictive Value of History of Vomiting

We were able to account for 4 to 35 percent of the variance of motion sickness in actual practice, based on various predictions. A single test on a wave machine was least predictive. A good history of motion sickness by questionnaire or interview was dependable and could account for about 20 percent of the variance, while more elaborate biographical data, adapted to a particular population, could perhaps double these odds.

Unfortunately, this work was done in the days of the DC-3, the landing ship-tank, and lawn swings and may be much less useful for today's hardware. Changes in our culture require a frequent reassessment of biographical data.

STUDIES OF THE EFFECTS OF WAVE CHARACTER ON MOTION SICKNESS

The chances are that most of you know of my papers on the effects of wave characteristics on frequency of motion sickness. These studies became possible when more research money was available after Pearl Harbor.

I started with the general observation that magnitude of acceleration was not in direct relationship to sickness, e.g., in riding horseback, but that time between accelerations was. My first experimental proof was that wave frequency was very important. A medium-frequency wave of 16 to 22 cpm was most effective in making men sick. I then went on, in a series of seven more experiments, to show the role of other factors. I will quote from my sixth paper:

In general conclusion, then, it would appear that the capacity of a wave to induce sickness depends on wave-duration, acceleration-level, waveform, and energy per wave. It is clear that the effect of any one of these variables depends on its context with the others. We have obtained enormous differences in the nauseating properties of waves. The H-wave for instance (16 cpm, 0.25 g) is roughly 20 times as nauseating per unit of energy as the A-wave (32 cpm, 0.65 g).

I suggest a report by C. H. Baker (ref. 4) as a review of this work. (See also *J. Psychol.*, vols. 39 and 57.)

A general conclusion from these studies is that the human, exposed to wave action, reacts as a resonating system with a maximum output of sickness at about 20 cpm, followed by a sharp cutoff at higher frequencies. It was my hope and intention to find where in the brain or receptors this resonant action took place. Unhappily, in the late 1940's our electronic technology failed at both the receptor end and the cerebellum. We tried in six experiments to record from various elements of the vestibular system, but essentially failed in each. It is also possible that animals may not make good subjects. R. L. Cramer and I, in a behavioral experiment, exposed 126 cats to waves of different frequencies, but found them too variable to make suitable subjects. In these present days of implanted electrodes, J. W. Wolfe has worked with me and showed that the situation is much more hopeful for finding what the central nervous system is doing. I hope that he or others can supply the answers I failed to supply.

I should also mention that I failed to produce acceptable sinusoidal waves with my equipment, and used only constant acceleration waves. The problem of comparing these two wave types must eventually be done by someone who has available both types of waves.

I did a little work with what is now known as canal sickness, but, except for an impression that it is more uncomfortable and longer lasting than the reaction to vertical acceleration, made no contribution.

OTHER SELECTED ITEMS

Motion Sickness and Fear

On the basis of much behavioral evidence, I used to be unalterably opposed to the idea that motion sickness is caused by fear. I have softened my line on this, now believing that motion sickness may cause anxiety. I am still strongly opposed to the idea, popular in 1940, that people susceptible to motion sickness are cowards.

Relationship of Motion Sickness to Temperature and Posture

Contrary to my own expectations, we have not been able in three separate studies to show that high temperature facilitates motion sickness. Nor have we been able to establish an interaction of temperature, body or head orientation, and wave frequency, except that an uncomfortable posture (head 90° back) is accompanied by more sickness. Studies of airline passengers, requested to adopt head-up and head-back postures, were inconclusive.

Head Movement on the Vertical Accelerator

Motion pictures of head bobbing on the vertical accelerator, taken from 240 men, showed no relationship to development of motion sickness.

Motion Sickness and Efficiency of Performance

All our laboratory performance studies were done immediately before and after brief exposures to motion (20 minutes or less). A quote from a summary of all our studies of the effects of sickness on performance (ref. 5) follows:

It has now been shown that speed in code substitution, level of aspiration in rifle target fire, and speed on the Mashburn complex coordinator are slightly decreased; speed of mirror tracing, accuracy of code substitution, accuracy of rifle fire, accuracy of dart throwing, speed of obstacle running, and speed of dash showed statistically insignificant decreases.

[A] greater deficit in those nauseated as compared to those who vomited was present [in seven out of nine of these tests].

All deficits were trivial. On the other hand, interviews with chronically seasick or airsick personnel often show severe weight loss and motivational problems.

Laboratory Tests of Prevention of Sickness by Drugs

Sea trials and air trials of motion-sickness preventives are not replicable unless one uses hundreds of subjects. By contrast, we showed, by replicating the same procedure on five groups (total of 240 men), that findings were consistent with group sizes of 24 men. Laboratory testing seems to have advantages. It is regrettable that no facility exists for continuing such work (ref. 6).

Correlated Studies

Not included in this account are the results of 17 years of studies of vestibular function, eye

movements, and very numerous experiments on the effects of drugs on social behavior and on emotions and motivations. Many of the latter are basic to any advance in use of drugs for prevention and treatment of motion sickness (ref. 7).

CONCLUDING REMARKS

We believe that our multivariable experiments, planned so that each experiment included a replication of several previously used variables of a total of 14 or more, are an efficient way to obtain valid data. We have done two kinds of experiments. In motion-sickness studies on

the vertical accelerator, we normally used 14 variables with one subject for each possible combination of these 14. In drug studies we have used each subject one or more times on each drug variable, always using at least four variables (i.e., drug treatments) which were used in all of our previous experiments. The level of consistency of our results, in both motion-sickness and drug studies, has been very satisfying. In a laboratory at Trinity College, an attempt was made to replicate our drug studies exactly, and nearly identical results were obtained that showed high correlations of drug-induced changes, one as much as $r=+0.994$ when compared to our data.

REFERENCES

1. WENDT, G. R.: Motion Sickness in Aviation. Report to the National Research Council Committee on Selection and Training of Aircraft Pilots, 1944, pp. 1-41.
2. WENDT, G. R.: Studies of Motion Sickness, Vestibular Function and of Psychological and Physiological Effects of Drugs. Final report to the Office of Naval Research, 1954, pp. 1-36.
3. WENDT, G. R.; NOWLIS, H.; AND NOWLIS, V.: The Effects of Drugs on Social and Emotional Behavior. Progress report to the National Institute of Mental Health, Mar. 1, 1956.
4. BAKER, C. H.: Motion and Human Performance: A Review of the Literature. Technical Rept. 770-1, Human Factors Research, Inc., Goleta, Calif., Aug. 1966, pp. 1-188.
5. JOHNSON, C.; AND WENDT, G. R.: Studies of Motion Sickness: XX. Effects of Sickness on Performance in Code Substitution and Mirror Drawing. J. Psychol., vol. 57, 1964, pp. 81-84.
6. JOHNSON, C.; AND WENDT, G. R.: Studies of Motion Sickness: XIX. The Efficiency of Laboratory Tests of the Preventive Action of Drugs. J. Psychol., vol. 57, 1964, pp. 71-79.
7. CAMERON, J. G.; SPECHT, P. G.; AND WENDT, G. R.: Chemical Studies of Behavior: XIV. Effects of a Dramamine-Analgesic-Caffeine Combination on Moods, Emotions and Motivations. J. Psychol., vol. 67, 1967, pp. 263-270.

DISCUSSION

Money: Did all the subjects wear blindfolds in all your waveform studies?

Wendt: Yes.

SESSION II

***Chairman:* MARTIN P. LANSBERG
National Aeromedical Center
Soesterberg, Netherlands**

Neural Mechanisms Underlying the Symptomatology of Motion Sickness¹

K. E. MONEY

AND

J. D. WOOD

Defence Research Establishment Toronto

SUMMARY

A review of knowledge about the neural mechanisms of motion sickness is presented, and recent unpublished attempts to increase that knowledge are related. The participation of peripheral afferent nerves, peripheral efferent nerves, and central structures is described and the integrated action of these structures is discussed. The structures that are indispensable for the vomiting of motion sickness are the vestibular apparatus, the vestibular nerve, the vestibular nuclei, the uvula and nodulus of the cerebellum, the chemoceptive emetic trigger zone, the vomiting center, and the somatic peripheral nerves to the respiratory muscles and to the muscles of the abdominal wall.

PERIPHERAL AFFERENT NERVES

The Vestibular Nerve

It is well known that motion sickness does not occur in the absence of a functioning inner ear or after section of its nerve. James reported in 1882 (ref. 1) that none of a group of 15 deaf-mutes who were exposed to rough weather at sea became sick, and it was established in later studies of deaf-mutes (refs. 2 to 6) and in studies of animals subjected to experimental surgery (refs. 7 to 13) that destruction of the vestibular apparatus or section of its nerve confers immunity to motion sickness. It can be said, therefore, that the vestibular nerve is necessary for motion sickness.

More specifically, because it has been shown that discrete inactivation of the semicircular canals confers immunity to motion sickness in dogs (ref. 12), it seems likely that, in dogs at

least, the ampullary nerves are necessary for motion sickness. It is possible, of course, that the nerves to the otolith organs are also necessary for motion sickness.

Abdominal Afferents

Because some kinds of nauseating motions can be expected to cause movement of the viscera, it has been suggested that such movements contribute to the nausea and vomiting of motion sickness (refs. 14 to 17). In a study (ref. 18) of 21 dogs, however, denervation of the viscera did not markedly reduce susceptibility to motion sickness. To obtain a measure of their initial susceptibility to motion sickness, the dogs were exposed to swinging at intervals of 1 week or longer, and the duration of swinging required to cause vomiting was recorded. The animals with consistent susceptibility were then subjected to sympathectomy, vagotomy, or both, and the susceptibility was again measured by weekly swinging. None of the animals operated upon exhibited immunity to the vomiting of motion sickness, and a consistent increase in the dura-

¹DRET Review Paper No. 720. Technical services were provided by A. D. Nicholas and W. J. Watson. Statistical analysis was by Dr. D. M. Sweeney.

tion of swinging required to cause vomiting was found in only two of six sympathectomized dogs, in only two of six vagotomized dogs, and in only three of nine both sympathectomized and vagotomized. Because sympathectomy and vagotomy divide the visceral afferent route (as well as the autonomic supply) of most of the gastrointestinal tract, as revealed in the doubly operated dogs by markedly increased thresholds (doses and times) for vomiting to orally administered copper sulfate, it is reasonable to conclude that visceral afferent nerves are not necessary for motion sickness. In fact, it seems unlikely that they play any important role.

Afferents From Proprioceptors

The receptors of muscles, tendons, and joints have not been investigated for a possible role in motion sickness. These receptors are involved with posture and orientation, and it would be surprising if they were found to be without influence.

Afferents From the Eyes

The influence of vision on susceptibility to motion sickness can be very important. For example, in a two-pole swing experiment in which the subjects' heads were not fixed, the incidence of motion sickness was found to be 35 percent when the eyes were closed, but only 2 percent when the eyes were open (ref. 19). Vision can also increase the incidence of motion sickness, as shown by experiments in which the subjects were either blindfolded or permitted to view the inside walls of moving capsules (refs. 20 and 21). Indeed, movement of the visual field without any movement of the body can cause signs and symptoms of motion sickness (refs. 22 to 24). Because movement of the visual field has not been effective in persons lacking the peripheral vestibular receptors, it seems possible that vision influences motion sickness through an action on the vestibular system, possibly on the central vestibular structures.

Afferents from the retina are not necessary for motion sickness, however, because motion sickness can readily be produced in blindfolded subjects. Similarly, afferents from the external eye muscles were found not to be necessary for

motion sickness in three dogs that were swung after injection of Xylocaine behind the eyeballs. The dogs were swung four times at weekly intervals without treatment, to establish the duration of swinging required to cause vomiting. They were then swung after injection of 4 milliliters of 2 percent Xylocaine behind each eyeball. This treatment eliminated vestibular and optokinetic eye movements and caused the pupils to dilate fully, but it had no apparent influence on the duration of swinging required to cause vomiting (table 1). Although it seems clear that afferents from the eye muscles are not necessary for motion sickness, they might in some circumstances play an important role, as do afferents from the retina.

PERIPHERAL EFFERENT NERVES

The role of efferent nerves in motion sickness has not been investigated in any detail. It has been suggested (ref. 25) on theoretical grounds that the vestibular efferents, by sensitizing the vestibular end organs during motion involving sensory incongruity, increase the afferent activity to the vestibular nuclei and thereby promote the development of motion sickness. Similarly, it seems reasonable to expect that activity in the gamma efferents to muscle spindles would exert an influence, and in view of the importance of head movements in motion sickness (ref. 26), motor nerves which influence head movements probably play a role. The

TABLE 1.—*Durations of Swinging Required To Cause Vomiting, to Nearest Minute, With and Without Xylocaine Behind the Eyeballs*¹

Dog no.	Without treatment, min	With Xylocaine, min
62.....	9, 5, 6, 7	12
64.....	7, 12, 11, 13	7
76.....	23, 12, 14, 16	10

¹ Tests were conducted at intervals of 1 week or more. The 10-minute result with dog 76 was obtained after the 12-minute result and before the 14-minute result; otherwise the results are recorded in chronological order.

efferents to the retina are not necessary for motion sickness, as shown by the dogs that vomited to swinging after application of Xylocaine to the orbits, but they may play an important role in some situations. If vomiting is taken as the criterion of motion sickness, the motor efferents for vomiting are necessary for motion sickness.

The Autonomic Nervous System

The autonomic nervous system is the efferent nerve supply to smooth muscle and glands. Its role in motion sickness seems to have been grossly exaggerated.

Motion sickness, and especially the vomiting of motion sickness, have been described frequently as vegetative or autonomic phenomena (refs. 27 to 33). Vomiting, however, is the expulsion through the mouth of the contents of the stomach and (in some cases) upper intestine. It is accomplished in mammals primarily by an integrated action of the respiratory and somatic abdominal musculature, and not by the muscles of the gastrointestinal tract (ref. 34). The stomach is largely a passive sac during vomiting, and the force for expulsion is supplied by the diaphragm, the intercostal muscles, and the muscles of the abdominal wall. The important motor nerves for vomiting are therefore the phrenic nerve to the diaphragm and the spinal nerves to the intercostal and abdominal muscles. The autonomic supply to the stomach and upper intestine is also active during vomiting, but its contribution is dispensable, because "there is no essential difference in the vomiting act performed by normal and gut-denervated animals" (ref. 35).

The sensation of nausea, which can be experienced by human subjects after total gastrectomy (ref. 34), is probably the conscious awareness of unusual activity in the vomiting centers, and there is no reason to regard it as a result of autonomic activity. Therefore, the major parts of the motion-sickness syndrome, nausea and vomiting, cannot be described as autonomic phenomena. The pallor and cold sweating of motion sickness can reasonably be considered autonomic phenomena, but only because pallor and sweating are usually controlled by the autonomic nervous

system. It is possible, although not likely, that the pallor and sweating of motion sickness are caused by a circulating chemical unrelated to the autonomic mediators; the pharmacological dissection which could answer this question has apparently not been done.

In the experiment designed to investigate the role of abdominal afferents in motion sickness (ref. 18), nine susceptible dogs were prepared with sympathectomy and vagotomy. These dogs were, therefore, without the sympathetic division of the autonomic nervous system, and without the parasympathetic supply to the gastrointestinal tract down to the ileocolic valve. Only three of the nine animals were consistently less susceptible to motion sickness postoperatively, and even these three were not immune. It seems reasonable to conclude from this experiment not only that the visceral afferents play no vital role in the vomiting of motion sickness but also that the autonomic supply to the viscera plays no vital role. Theories of motion sickness that depend upon the proximity of the medial vestibular nucleus and the dorsal nucleus of the vagus nerve are scarcely tenable in the light of this experiment.

CENTRAL STRUCTURES

Vestibular Nuclei

Because most vestibular sensory fibers synapse in the vestibular nuclei, and because the vestibular nerve is necessary for motion sickness, the vestibular nuclei are probably necessary for motion sickness.

Vestibular Parts of the Cerebellum

In four dogs that had consistently vomited to swinging preoperatively, the uvula, nodulus, and pyramis were removed (ref. 36). Two of these dogs did not vomit in any postoperative test, and the other 2 vomited in only one of 9 or 10 postoperative tests. In a later experiment (ref. 11), nine dogs that had consistently vomited to swinging were subjected to partial or complete removal of the uvula and nodulus. Seven of these dogs did not vomit in any postoperative test, one dog vomited in only one postoperative test, and one dog with minimal damage to the

uvula and nodulus vomited in all of the four postoperative tests. Additional animals subjected to the removal of the pyramis and other nonvestibular parts of the cerebellum retained their preoperative susceptibility to motion sickness. It seems clear that the vestibular parts of the cerebellum are necessary for the vomiting of motion sickness in dogs.

Chemoceptive Emetic Trigger Zone

The chemoceptive emetic trigger zone is located superficially in the caudal part of the floor of the fourth ventricle, dorsolateral to the vagal nuclei (ref. 37). Central emetics such as apomorphine and the cardiac glycosides act, by way of the bloodstream, upon the chemoceptive trigger zone which in turn acts upon the "integrative vomiting center" (ref. 34) to cause vomiting. In 12 dogs that had regularly vomited to swinging preoperatively, the chemoceptive trigger zone was destroyed (ref. 37). Two of these dogs vomited in all the postoperative tests after durations of swinging comparable to the preoperative durations, but two of them vomited only during some of the postoperative tests and eight of them failed to vomit in all of the postoperative tests. The absence of the chemoceptive trigger zone was confirmed by failure to vomit to apomorphine and by histology, and the ability of the animals to vomit postoperatively was established by oral administration of copper sulfate. It seems likely that the chemoceptive emetic trigger zone is necessary for motion sickness.

Vomiting Center

The neural mechanisms responsible for the coordinated muscular contractions of vomiting are obviously necessary for vomiting. It is not known whether the required coordination is effected by a morphologically distinct "center" having only an integrating function.

Cerebrum

The cerebrum (telencephalon) does not play a vital role in motion sickness in dogs. One dog that had consistently vomited within 4 to 10 minutes of swinging was decerebrated by removing a wedge of tissue rostral to a plane joining the superior colliculi to a point just

behind the mammillary bodies (ref. 38). Its susceptibility was tested again between the 26th and 53d postoperative days, and it vomited in all of the five swing tests administered, within 3 to 9 minutes of swinging. In six other dogs with unilateral removal of the cerebral cortex, and in six additional dogs with bilateral removal of the cerebral cortex from temporal or occipital or parietal areas, no essential participation by a cortical structure was revealed (ref. 36). Motion sickness in a decorticate man has also been reported (ref. 39).

Because the cerebrum is not necessary for motion sickness, it is difficult to escape the conclusion that psychological factors are not necessary for motion sickness. Aside from the question of necessity, however, the cerebrum and psychological factors can undoubtedly influence the development of motion sickness in man.

THE INTEGRATED PICTURE

Figure 1 presents an integrated picture of the neural mechanisms of motion sickness. Appropriate motion acts on the vestibular apparatus, the proprioceptors, and the eyes. In some cases it also acts on the abdominal viscera, but this is probably not important in motion sickness. Afferents from the eyes are not necessary for motion sickness, but they are known to play an important role in some situations. The structures that can be considered indispensable for the vomiting of motion sickness (in dogs at least) are the vestibular apparatus, the vestibular nerve, the vestibular nuclei, the vestibular part of the cerebellum, the chemoceptive emetic trigger zone, the vomiting center, and the somatic motor nerves to the respiratory muscles and to the muscles of the abdominal wall. Structures that are dispensable are the nerves to the eyes, the nerves to the abdominal viscera, and the cerebral cortex.

Following the sequence of events between appropriate motion and vomiting, one can see a logical relationship among motion, the vestibular apparatus, the vestibular nerve, the vestibular nuclei, and the vestibular cerebellum; there is an equally logical and well-known relationship among the chemoceptive emetic trigger zone,

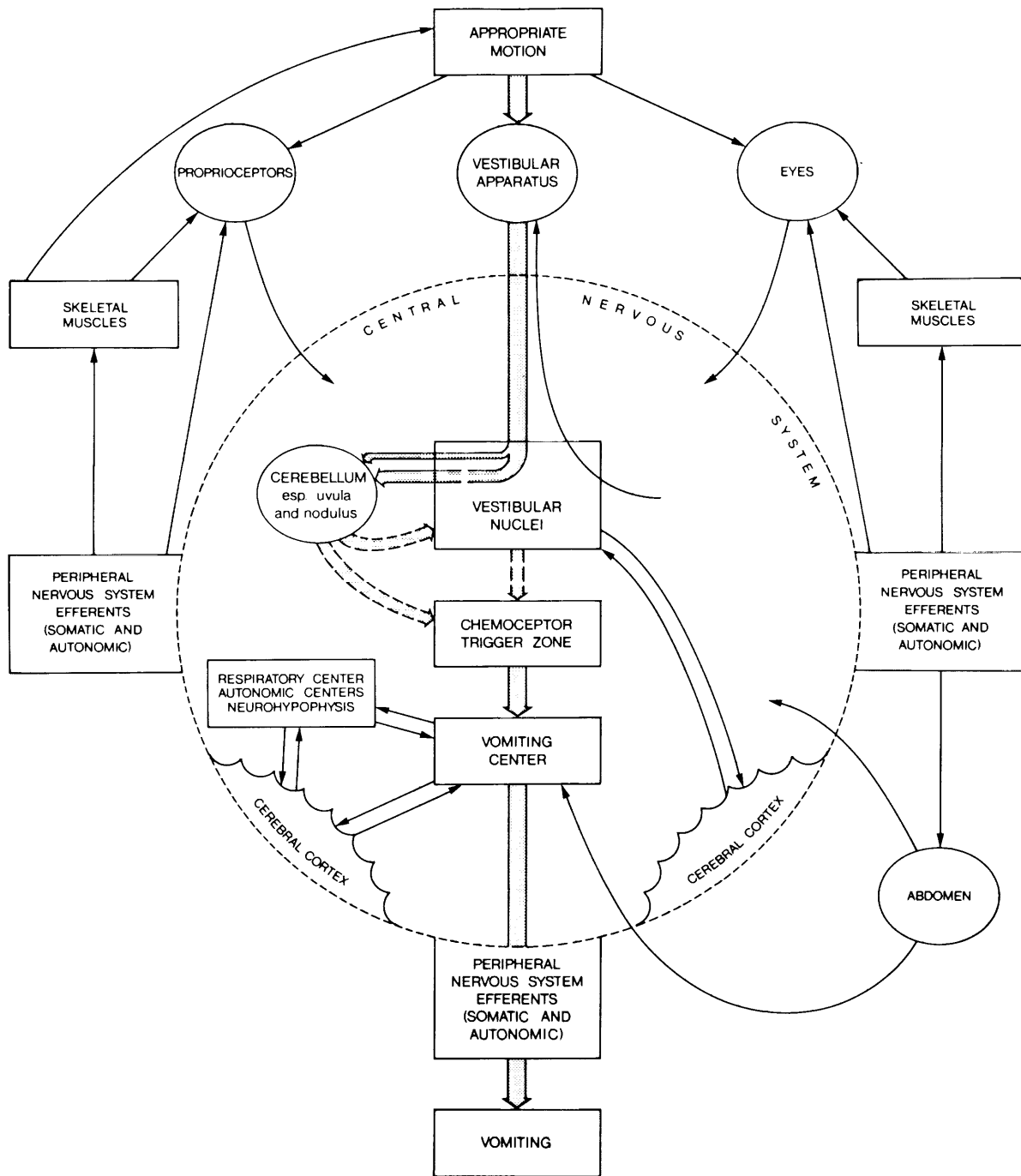

FIGURE 1.—Relationships among anatomical structures involved in motion sickness. Structures joined by the wide shaded lines are indispensable to the vomiting of motion sickness in dogs.

the vomiting center, the motor nerves for vomiting, and the muscles of vomiting. There is no known reason, however, why the vestibular cerebellum should influence the chemoceptive emetic trigger zone, and therefore the essence of motion sickness is probably to be found here, in the relationship between the vestibular cerebellum and the chemoceptive trigger zone. The mystery of why motion causes vomiting in a healthy animal is found reflected here in the brain.

Because the chemoceptive emetic trigger zone is sensitive to chemicals (ref. 40), and because motion sickness develops so slowly (usually repeated stimulation of the vestibular apparatus is required for a period of several minutes or even hours to cause vomiting), it seems likely that the cause of nausea and vomiting in motion sickness is an emetic chemical that accumulates under the influence of the vestibular cerebellum during motion. Babkin and his associates as early as 1943 (refs. 9, 41, and 42) investigated the possibility that circulating acetylcholine was responsible for motion sickness in dogs. They were unable, however, to demonstrate any increase in blood acetylcholine during motion sickness.

ATTEMPT TO ESTABLISH THE HYPOPHYSIS AS A LINK BETWEEN THE VESTIBULAR CEREBELLUM AND THE CHEMOCEPTIVE TRIGGER ZONE

Several observations suggest that the neurohypophysis secretes an emetic agent during appropriate motion: (1) posterior pituitary extract is an emetic agent (ref. 35); (2) a pituitary-type inhibition of water diuresis occurs with motion sickness, and an antidiuretic substance can be recovered from the urine of subjects who have been motion sick (ref. 43); (3) the cardiovascular response to nauseating motion resembles closely the response to Pitressin injection (ref. 44); (4) the centers which normally control pallor and sweating are intimately associated with the hypothalamic-hypophyseal system. Also, the adrenocortical response in motion sickness (refs. 45 to 47) suggests the possibility that the adenohypophysis plays an important role in

motion sickness. The susceptibility of hypophysectomized dogs to motion sickness is therefore of interest.

Normal mongrel dogs were tested for susceptibility to motion sickness on a motor-driven swing, and dogs that vomited within 20 minutes on the initial exposure were considered suitable for further testing and were subsequently swung at intervals of at least 1 week until they had demonstrated susceptibility at least four consecutive times. In most cases, more than four preoperative tests were carried out. After the initial test, the maximum duration of swinging was set arbitrarily at 60 minutes, and dogs that did not vomit within 60 minutes of swinging at any preoperative test were discarded from the experiment; postoperatively, swing tests were stopped after 60 minutes and failure to vomit by that time was taken as a negative response. After consistent susceptibility to motion sickness had been established, each dog was hypophysectomized by the transbuccal approach. In some cases, parts of the hypothalamus were also destroyed, by cautery. After recovery from the operation, the surviving animals were again tested for susceptibility to motion sickness at intervals of 1 week or longer, and they were observed for polyuria throughout the remainder of the experiment. No hormones were administered to the animals postoperatively.

Seven dogs survived the hypophysectomy and were tested postoperatively. The operations had no consistent effect on the durations of swinging required to produce vomiting (table 2). A Wilcoxon two-sample rank test showed no significant difference between the preoperative and postoperative vomiting times of the seven dogs. Five of the dogs exhibited polyuria following the operation, and in three of these the polyuria was permanent, continuing until the deaths of the animals 6 to 10 weeks postoperatively. Autopsy with an operating microscope confirmed that the pituitary glands had been removed.

In this experiment it was not established that either the adenohypophysis or the neurohypophysis was completely ablated in the dogs, but the pituitary glands were removed, and in three of the dogs the neurohypophysis was inactivated, according to the criterion of permanent polyuria

(ref. 48). A dog was considered to have polyuria if its postoperative daily urine output exceeded the preoperative output by more than 1 liter per 10 pounds of body weight. The operations did not have a large or consistent influence on susceptibility to motion sickness, and the results indicate that motion sickness is possible in the absence of the pituitary gland and in the presence of permanent polyuria. It therefore seems unlikely that the hypophysis plays any necessary role in motion sickness in the intact animal.

INVESTIGATION OF GAMMA-AMINO-BUTYRIC ACID IN MOTION SICKNESS

It has been suggested (ref. 49) that various unrelated drugs that are effective against motion sickness have a common action in increasing the level of γ -aminobutyric acid in the brain. In terms of the relationship between the vestibular cerebellum and the chemoceptive trigger zone, this would mean that during appropriate motion the vestibular cerebellum causes a decrease in

TABLE 2.—*Durations of Swinging Required To Produce Vomiting, to Nearest Minute, Before and After Hypophysectomy*¹

Dog no.	Preoperative, min	Postoperative, min	Postoperative polyuria
58.....	5, 6, 5, 5	15, 14, (died)	Transient.
15.....	9, 8, 7, 6, 8, ² 8	5, 5, 5, 5, 7	Permanent.
B200.....	18, 25, 21, 53, 19	x, ³ x, x, 19, x, 14	Transient.
B224.....	6, 5, 8, 9, 4	13, 17, 17, 14, 33	None.
15A.....	12, 14, 6, 5, 4,	5, 4, 5, 6, 8	Permanent.
B223.....	6, 7, 6, 4, 8	5, 4, 6, 5, 7	Permanent.
B334.....	4, 11, 11, 11	11, 15	None.

¹ Tests were conducted at intervals of 1 week or more and are recorded in chronological order.

² Nonstandard stimulus used inadvertently.

³ Values greater than 60 indicated by "x."

TABLE 3.—*Durations of Swinging To Cause Vomiting*

[In minutes and seconds]

Date	Medication	Interval between injection and swinging, hr	Dog no. 4	Dog no. 6	Dog no. 7
<i>1968</i>					
Jan. 23			17:30	13:02	8:35
31			15:15	8:50	8:07
Feb. 7			15:43	16:05	11:08
14			15:40	10:00	6:40
21	AOAA, 0.2 mg/kg ¹	6	7:25	16:40	9:22
28	AOAA, 0.5 mg/kg.....	6	6:15	15:54	³ 0:00
Mar. 27	Thio SC, 2 mg/kg ²	3		7:15	8:45
Apr. 4	Thio SC, 2 mg/kg.....	1		13:59	4:37

¹ AOAA means aminooxyacetic acid.

² Thio SC means thiosemicarbazide.

³ Dog vomited just before swinging started and again after 5:20 of swinging.

the level of γ -aminobutyric acid, or, alternatively, that the vestibular cerebellum is unable to exert its influence on the chemoceptive trigger zone in the presence of high concentrations of γ -aminobutyric acid. It was therefore of interest to investigate susceptibility to motion sickness in animals in whom the brain level of γ -aminobutyric acid had been artificially raised.

Three dogs were exposed to swinging motion once each week for 4 weeks to establish the duration of swinging required to induce vomiting. After a further 7-day interval, the dogs were swung again, 6 hours after subcutaneous injection of 0.2 mg/kg of aminooxyacetic acid. This drug is known to raise the level of γ -aminobutyric acid in the brain (ref. 50). As indicated in table 3, the injections had no significant effect on the durations of swinging required to cause vomiting. One week later the dogs were swung again, 6 hours after injection of 0.5 mg/kg of aminooxyacetic acid. As shown in table 3, this dose also had no strong influence, but possibly caused vomiting sooner than without medication. Larger doses of aminooxyacetic acid caused repeated vomiting without any swinging or other motion.

The original intention was to study more dogs with aminooxyacetic acid after these preliminary trials, but the results were so discouraging that the decision was made not to continue. Because raising the brain level of γ -aminobutyric acid caused vomiting and seemed to promote motion sickness, it was decided to test susceptibility to motion sickness after lowering the brain level of γ -aminobutyric acid, which can be accomplished with thiosemicarbazide (ref. 51). Two of the same dogs (one had become pregnant) were used. No strong influence of 2 mg/kg of thiosemicarbazide was found when testing the animals 3 hours after injection or, again 1 week later, 1 hour after injection (table 3). While the data from this experiment are scarcely conclusive, it seems unlikely that the level of γ -aminobutyric acid in the brain plays any essential or powerful role in the development of motion sickness, and it seems unlikely that anti-motion-sickness drugs act by raising the brain's concentration of γ -aminobutyric acid.

The link between the vestibular cerebellum and the chemoceptive trigger zone remains unilluminated.

REFERENCES

1. JAMES, WILLIAM: The Sense of Dizziness in Deaf Mutes. *Am. J. Otol.*, vol. 4, 1882, pp. 239-254.
2. MINOR, J. L.: Seasickness: Its Cause and Relief. *N.Y. Med. J.*, vol. 64, 1896, pp. 522-523.
3. REYNOLDS, T. T.: On the Nature and Treatment of Seasickness. *Lancet*, vol. 1, 1884, pp. 1161-1162.
4. SJÖBERG, A. A.: Experimental Studies of the Eliciting Mechanism of Sea-sickness. *Acta Oto-Laryngol.*, vol. 13, 1929, pp. 343-347.
5. BROWN, G. L.; MCARDLE, B.; AND MAGLADERY, J. W.: Interim Report on Clinical Investigations Into Air-sickness. FPRC Report 410(a), Research Unit, National Hospital, London, 1941.
6. GRAYBIEL, A.: Vestibular Sickness and Some of Its Implications for Space Flight. *Neurological Aspects of Auditory and Vestibular Disorders*, W. S. Fields and B. R. Alford, eds., Charles C Thomas, 1964, pp. 248-270.
7. SJÖBERG, A. A.: Experimentelle Studien Über Den Auslosungsmechanismus der Seckrankheit. *Acta Oto-Laryngol.*, suppl. 14, 1931, pp. 1-136.
8. McNALLY, W. J.; STUART, E. A.; AND MORTON, G.: Effect of Labyrinthectomy on Motion Sickness in Animals. Report C748. Appendix M. Proceedings of Conference on Motion Sickness, National Research Council of Canada, Aug. 28, 1942.
9. BABKIN, B. P.; AND BORNSTEIN, M. B.: The Effect of Swinging on the Motility of the Stomach in Dogs. Report C4030. Proceedings, Second Meeting, Association Committee, Naval Medical Research, National Research Council, Canada, Oct. 1943, pp. 1-8.
10. KURASHVILI, A. E.: Vestibular Reactivity During the Cumulative Action of Slow Centripetal Accelerations. FTD MT-63-179, TT 64 11970. Translation of *Zh. Ush.*, Nos., *Gorl. Bol.*, vol. 22, 1962, pp. 49-55.
11. WANG, S. C.; AND CHINN, H. I.: Experimental Motion Sickness in Dogs: Importance of Labyrinth and Vestibular Cerebellum. *Am. J. Physiol.*, vol. 185, 1956, pp. 617-623.
12. MONEY, K. E.; AND FRIEDBERG, J.: The Role of the Semicircular Canals in Causation of Motion Sickness and Nystagmus in the Dog. *Can. J. Physiol. Pharmacol.*, vol. 42, 1964, pp. 793-801.
13. JOHNSON, W. H.; MEEK, J. C.; AND GRAYBIEL, A.: Effects of Labyrinthectomy on Canal Sickness in Squirrel Monkey. *Ann. Otol.*, vol. 71, 1962, pp. 289-298.

14. IRWIN, J. A.: The Pathology of Sea-sickness. *Lancet*, vol. 1, Nov. 1881, pp. 907-909.
15. NUNN, P. W. G.: Seasickness: Its Causes and Treatments. *Lancet*, vol. 2, 1881, p. 1037.
16. DESNOES, P. H.: Seasickness. *J. Am. Med. Assoc.*, vol. 86, 1926, pp. 319-324.
17. CASTELLANI, A.: Sea-sickness: A Short General Account. *J. Trop. Med.*, vol. 43, 1940, pp. 63-66.
18. WANG, S. C.; CHINN, H. I.; AND RENZI, A. A.: Experimental Motion Sickness in Dogs: Role of Abdominal Visceral Afferents. *Am. J. Physiol.*, vol. 190, Sept. 1957, pp. 578-580.
19. JOHNSON, W. H.; AND TAYLOR, N. B. G.: Some Experiments on the Relative Effectiveness of Various Types of Accelerations on Motion Sickness. *Aerospace Med.*, vol. 32, 1961, pp. 205-208.
20. MANNING, G. W.; AND STEWART, W. G.: Effect of Body Position on Incidence of Motion Sickness. *J. Appl. Physiol.*, vol. 1, Mar. 1949, pp. 619-628.
21. BROWN, J. H.; AND CRAMPTON, G. H.: Concomitant Visual Stimulation Does Not Alter Habituation of Nystagmic, Oculogyral or Psychophysical Responses of Angular Acceleration. *Acta Oto-Laryngol.*, vol. 61, 1966, pp. 80-91.
22. WITKIN, H. A.: Perception of Body Position and of the Position of the Visual Field. *Psychol. Monogr.*, vol. 63, 1949, pp. 1-46.
23. CRAMPTON, G. H.; AND YOUNG, F. A.: The Differential Effects of a Rotary Visual Field on Susceptibles and Nonsusceptibles to Motion Sickness. *J. Comp. Physiol. Psychol.*, vol. 46, 1953, pp. 451-453.
24. MILLER, J. W.; AND GOODSON, J. E.: Motion Sickness in a Helicopter Simulator. *Aerospace Med.*, vol. 31, Mar. 1960, pp. 204-212.
25. GILLINGHAM, K. K.: Training the Vestibule for Aerospace Operations. Central Control of Vestibular Function. Review 8-65. USAF School of Aerospace Medicine, Brooks Air Force Base, Tex., 1965.
26. JOHNSON, W. H.; STUBBS, R. A.; KELK, G. F.; AND FRANKS, W. R.: Stimulus Required to Produce Motion Sickness. I. Preliminary Report Dealing With Importance of Head Movements. *J. Aviat. Med.*, vol. 22, 1951, pp. 365-374.
27. DE WIT, G.: Seasickness (Motion Sickness). A Labyrinthological Study. *Acta Oto-Laryngol.*, suppl. 108, 1953, pp. 1-56.
28. SPIEGEL, E. A.: Effect of Labyrinthine Reflexes on Vegetative Nervous System. *Arch. Otol.*, vol. 44, July 1946, pp. 61-72.
29. SPIEGEL, E. A.; AND SOMER, I.: Vestibular Mechanisms. *Medical Physics*, Otto Glaser, ed., Year Book Publishers, 1944, pp. 1638-1658.
30. VAN EGMOND, A. A. J.; GROEN, J. J.; AND DE WIT, G.: The Selection of Motion Sickness-Susceptible Individuals. *Intern. Record Med.*, vol. 167, 1954, pp. 651-660.
31. VARTBARONOV, R. A.: Some Vascular Reactions in Man Related to Coriolis Acceleration. *Space Flight Physiology*, *Izvest. Akad. Nauk, SSSR, Ser. B*, No. 1, 1965, pp. 21-26. (JPRS Translation: 29, 156.)
32. VOYACHEK, W.: *Fundamentals of Aviation Medicine*. Translated by I. Steiman, Univ. of Toronto Press, 1943.
33. WODAK, E.: Vestibulär ausgelöste vegetative Phänomene und ihre Dissoziationen mit den übrigen vestibulären Reaktionen. *Pract. Oto-Rhino-Laryngol.*, vol. 18, July 1956, pp. 225-239.
34. CUMMINS, A. J.: The Physiology of Symptoms. III. Nausea and Vomiting. *Am. J. Digest. Dis.*, vol. 3, Oct. 1958, pp. 710-721.
35. BORISON, H. L.; AND WANG, S. C.: Physiology and Pharmacology of Vomiting. *Pharmacol. Rev.*, vol. 5, June 1953, pp. 193-230.
36. BARD, PHILIP: Physiological Investigation of Causes and Nature of Motion Sickness. Report 485, National Research Council, Committee on Aviation Medicine, Sept. 1945.
37. WANG, S. C.; AND CHINN, H. I.: Experimental Motion Sickness in Dogs. Functional Importance of Chemoceptive Trigger Zone. *Am. J. Physiol.*, vol. 178, 1954, pp. 111-116.
38. BARD, P.; WOOLSEY, C. N.; SNIDER, R. S.; MOUNTCASTLE, V. B.; AND BROMILEY, R. B.: Delineation of Central Nervous Mechanisms Involved in Motion Sickness. *Fed. Proc.*, vol. 6, Mar. 1947, p. 72 (abstract).
39. DOIG, R. K.; WOLF, S.; AND WOLFF, H. G.: Study of Gastric Function in a "Decorticate" Man with Gastric Fistula. *Gastroenterol.*, vol. 23, 1953, pp. 40-44.
40. CHINN, H. I.; AND SMITH, P. K.: Motion Sickness. *Pharmacol. Rev.*, vol. 7, Mar. 1955, pp. 33-82.
41. BABKIN, B. P.; AND BORNSTEIN, M. B.: The Effect of Swinging and of Binaural Galvanic Stimulation on the Motility of the Stomach in Dogs. *Rev. Can. de Biol.*, vol. 2, 1943, pp. 336-349.
42. BABKIN, B. P.; DWORKIN, S.; AND SCHACHTER, M.: Experimental Motion Sickness and Attempts at Therapy. *Rev. Can. de Biol.*, vol. 5, 1946, pp. 72-85.
43. TAYLOR, N. B. G.; HUNTER, J.; AND JOHNSON, W. H.: Antidiuresis as a Measurement of Laboratory Induced Motion Sickness. *Can. J. Biochem. Physiol.*, vol. 35, 1957, pp. 1017-1027.
44. SUNAHARA, F. A.; JOHNSON, W. H.; AND TAYLOR, N. B. G.: Vestibular Stimulation and Forearm Blood Flow. *Can. J. Physiol. Biochem.*, vol. 42, 1964, pp. 199-207.
45. DAHL, E. V.; FRANKS, J. J.; PRIGMORE, J. R.; AND CRAMER, R. L.: Adrenal Cortical Response in Motion Sickness. *Arch. Environ. Health*, vol. 7, 1963, pp. 86-91.
46. COLEHOUR, J. K.: Stress Measurements in Normal and Labyrinthine Defective Subjects in Unusual Force Environments. The Role of the Vestibular Organs in the Exploration of Space, NASA SP-77, 1965, pp. 347-355.
47. COLEHOUR, J. K.; AND GRAYBIEL, A.: Biochemical Changes Occurring With Adaptation to Accelerative Forces During Rotation. *Aerospace Med.*, vol. 37, Apr. 1966, pp. 1205-1207.
48. HEINBECKER, P.; AND WHITE, H. L.: Hypothalamico-

- Hypophyseal System and Its Relation to Water Balance in the Dog. *Am. J. Physiol.*, vol. 133, 1941, pp. 582-593.
49. GIURGEA, C. E.; MOEYERSOONS, F. E.; AND EVRAERD, A. C.: A GABA-Related Hypothesis on the Mechanism of Action of the Antimotion Sickness Drugs. *Arch. Int. Pharmacodyn.*, vol. 166, 1967, pp. 238-251.
50. WOOD, J. D.; AND WATSON, W. J.: The Effect of Amino-Oxyacetic Acid and Hydroxylamine on Rats Breathing Oxygen at High Pressure. *J. Neurochem.*, vol. 12, 1965, pp. 663-669.
51. WOOD, J. D.; WATSON, W. J.; AND STACEY, N. E.: A Comparative Study of Hyperbaric Oxygen-Induced and Drug-Induced Convulsions With Particular Reference to γ -aminobutyric Acid Metabolism. *J. Neurochem.*, vol. 13, 1966, pp. 361-370.

Conflicting Sensory Orientation Cues as a Factor in Motion Sickness¹

FRED E. GUEDRY, JR.

Naval Aerospace Medical Institute

SUMMARY

Evidence is adduced to support the hypothesis that conflicting sensory data relating to spatial orientation from among visual, vestibular, and somatosensory systems can induce motion sickness in the absence of any strong, long, or periodic stimulus to the semicircular canals or otolith system.

During a number of years of conducting spinning, oscillating, and tilting experiments, I have never purposely conducted a motion-sickness experiment. However, in the course of various experiments, some stimulus conditions seemed much more conducive to motion sickness than others, and some individuals were much more susceptible to motion sickness than others.

One of the primary aims of the present paper is to point out that a vestibular stimulus of moderate magnitude, repeated several times but not with any particular periodicity, can produce a high incidence of the signs and symptoms of motion sickness. This stimulus, which has been variously named the Coriolis vestibular stimulus or the angular Coriolis stimulus, involves contradictory sensory input from within the labyrinth itself.

The kind of stimulus to which I refer is depicted in figure 1. The subject is rotating on a device about an Earth-vertical axis that has an angular velocity ω_1 , and his head tilt is made about a second axis, the ω_2 -axis, which is orthogonal to the axis of the turntable. During the head movement there are two angular acceleration components: (1) Angular accelerations about the

ω_2 -axis from starting and stopping the head movement, which would occur during any natural head movement even if the table were not rotating. These accelerations leave no residual effects. (2) The second component is constituted by angular accelerations about a third orthogonal axis, the $\omega_1\omega_2$ -axis, shown in figure 1. During the head movement, this stimulus changes in magnitude and direction relative to the canal system so that a complex pattern of stimulation of the canals is produced during the movement. The $\omega_1\omega_2$ acceleration would cause the canals to signal approximate angular velocity about the subject's y -axis, whereas the change in position relative to gravity signaled by the otolith organs during the movement would be about the subject's x -axis. The $\omega_1\omega_2$ stimulus shifts during the head movement but when averaged over time, the $\omega_1\omega_2$ stimulus is aligned with the subject's y -axis. When the movement is completed, the cupulae deflections would signal rotation which should be accompanied by change in orientation relative to gravity (if such rotation were really taking place), but the otoliths would signal constant position; i.e., no change in orientation relative to gravity. These patterns of sensory input from the canals and otoliths are clearly conflicting. This is in contrast to the normal synergy between canals and otoliths depicted schematically in the lower right portion of figure 1, where

¹I should like to acknowledge very helpful communications with K. E. Money and with J. T. Reason who have conducted independent reviews of motion-sickness literature and have provided me with their prepublication manuscripts.

the axis of change in orientation signaled by the otoliths and the axis of angular velocity signaled by the canals are one and the same; viz, the subject's x -axis.

In the past few years we have observed more than 500 student pilots while they made six 45° head tilts with their eyes closed during rotation at 15 rpm (refs. 1 and 2). These head movements were approximately 30 seconds apart, but there was no strict periodicity maintained. After six such head movements, only 5 percent of the student pilots were adjudged by observers

to have been unaffected by the head movements. By the students' own ratings, about 50 percent indicated some feelings of nausea and only 11 percent indicated no effect at all. The magnitude of the stimulus to the semicircular canals produced by each head movement can be duplicated by a simple angular acceleration to 11.5 rpm. Simple angular impulses of this magnitude seldom produce nausea in the absence of conflicting visual data. Moreover, during the initial angular acceleration to 15 rpm while the head was fixed relative to the turntable, there

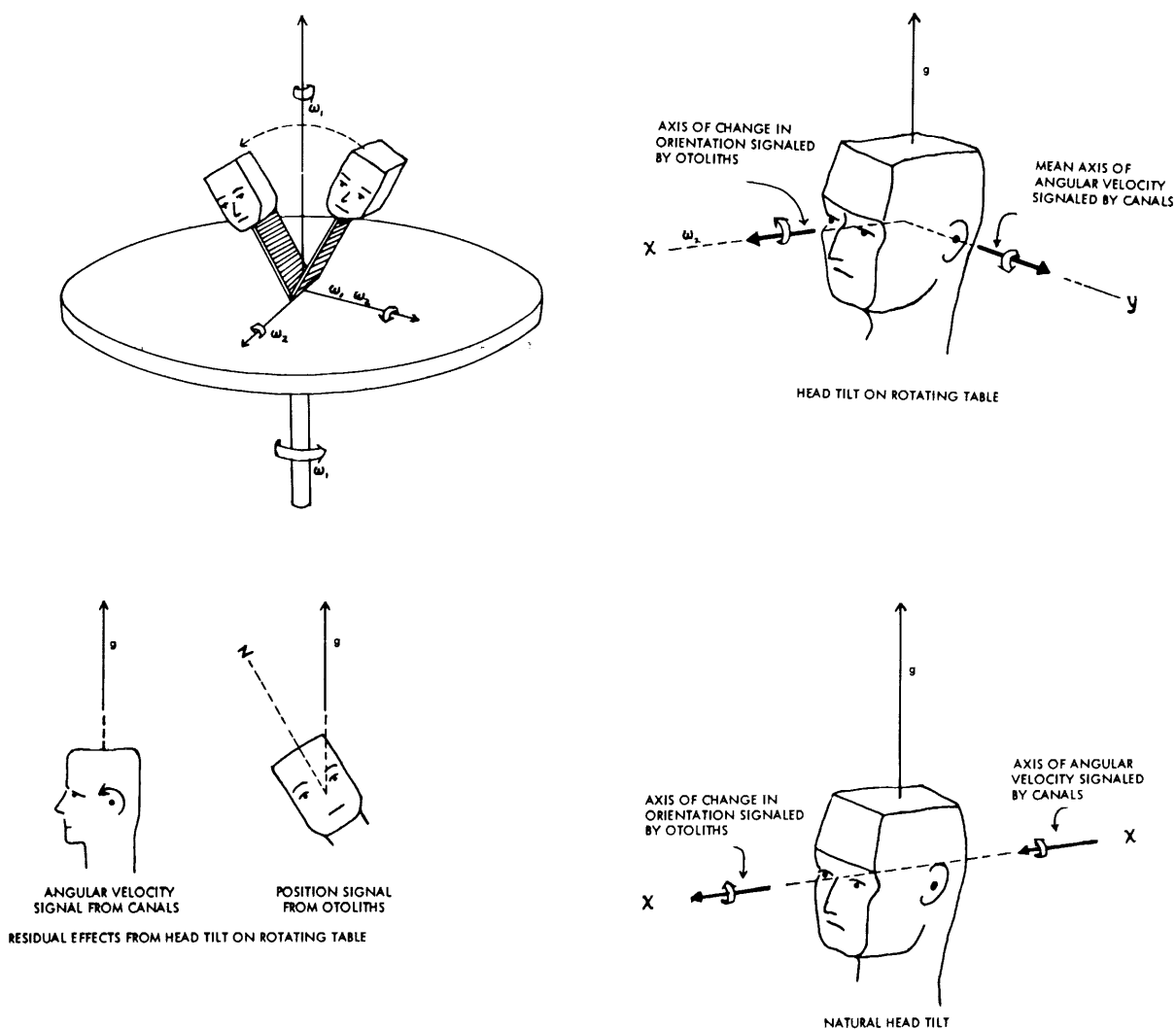

FIGURE 1.—Illustrating the directional conflict of sensory inputs from canals and otoliths during head tilt on a rotating table and the concordant sensory input during natural head tilt without concomitant whole-body rotation.

were no signs from these subjects of displeasure or surprise; yet, with the first head movement that actually produced a lesser angular impulse to the canal system, many subjects indicated displeasure and many exhibited pallor and sweating. All of those subjects who were adjudged to have been severely affected by the head-movement stimulus later dropped out of the flight program.

To illustrate the magnitude of this Coriolis vestibular stimulus, the situation shown in figure 2 was used. The configuration shown in *A* was selected because the residual stimulus as the head movement is completed is to the lateral canals that yield an easily recorded nystagmus. Subjects were positioned so as to locate the plane of the horizontal canals 30° from the axis of the turntable. The rotation device was set into rotation at 10 rpm ($\omega_1 = 10$ rpm). After 2 minutes of constant rotation at 10 rpm, the head was dorso-

flexed through 60° in 3 seconds from the initial position to the final position. In this particular head movement, it is primarily the lateral canals that are stimulated, and though there is some stimulation of the vertical canals, the net residual effect of the stimulus to the vertical canals is zero when the movement is complete. It can be shown that, under this particular condition as the head movement is just completed (*A* of fig. 2), the angular impulse delivered to the lateral canals by the head movement is equivalent in magnitude to the angular impulse delivered by angular acceleration to 10 rpm with the head fixed as shown in *B*.

Subjects placed in situations *A* and *B* of figure 2 produced results graphed in figure 3. The nystagmus produced by the head tilts (*A*) was usually of lower intensity, and it clearly declined more quickly than that produced by simple angular acceleration (*B*).

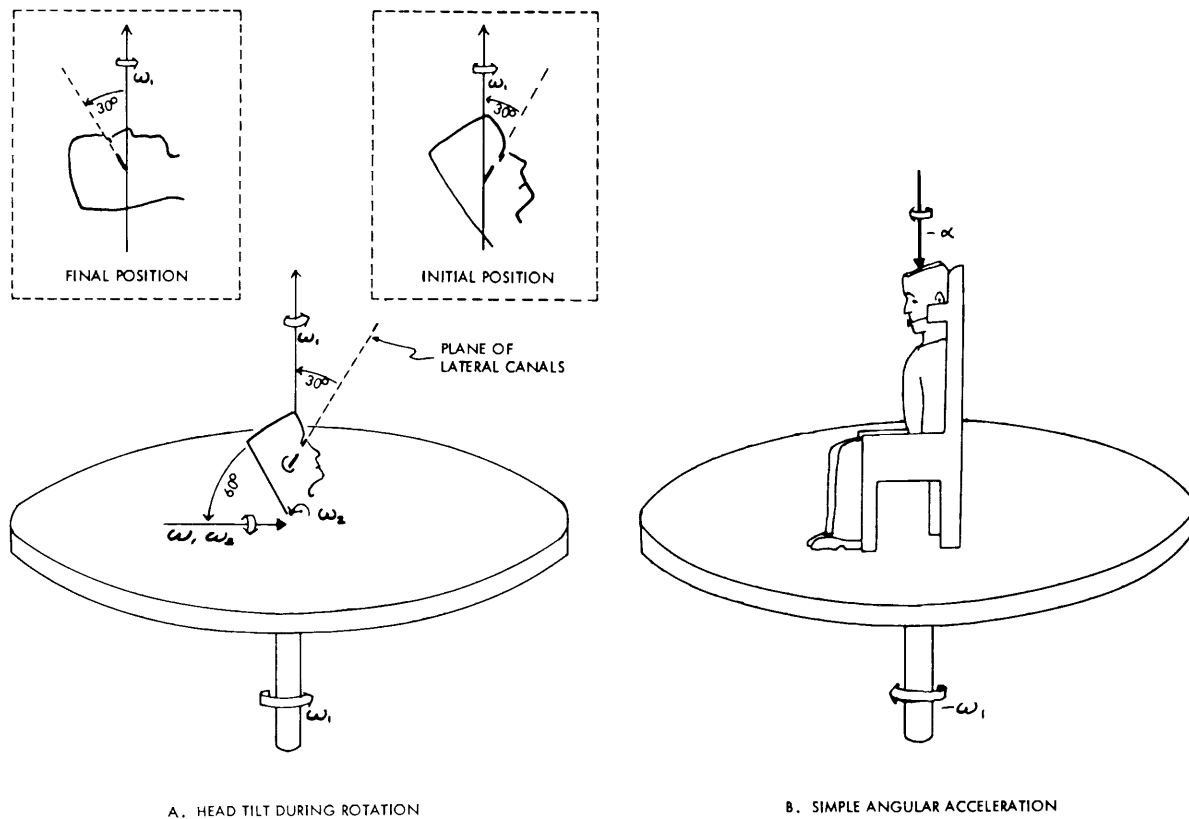

FIGURE 2. — Stimulus used to produce horizontal nystagmus (*A*) by head movement during 60°/sec angular velocity and (*B*) by simple angular acceleration to 60°/sec with head in fixed relation to the axis of rotation.

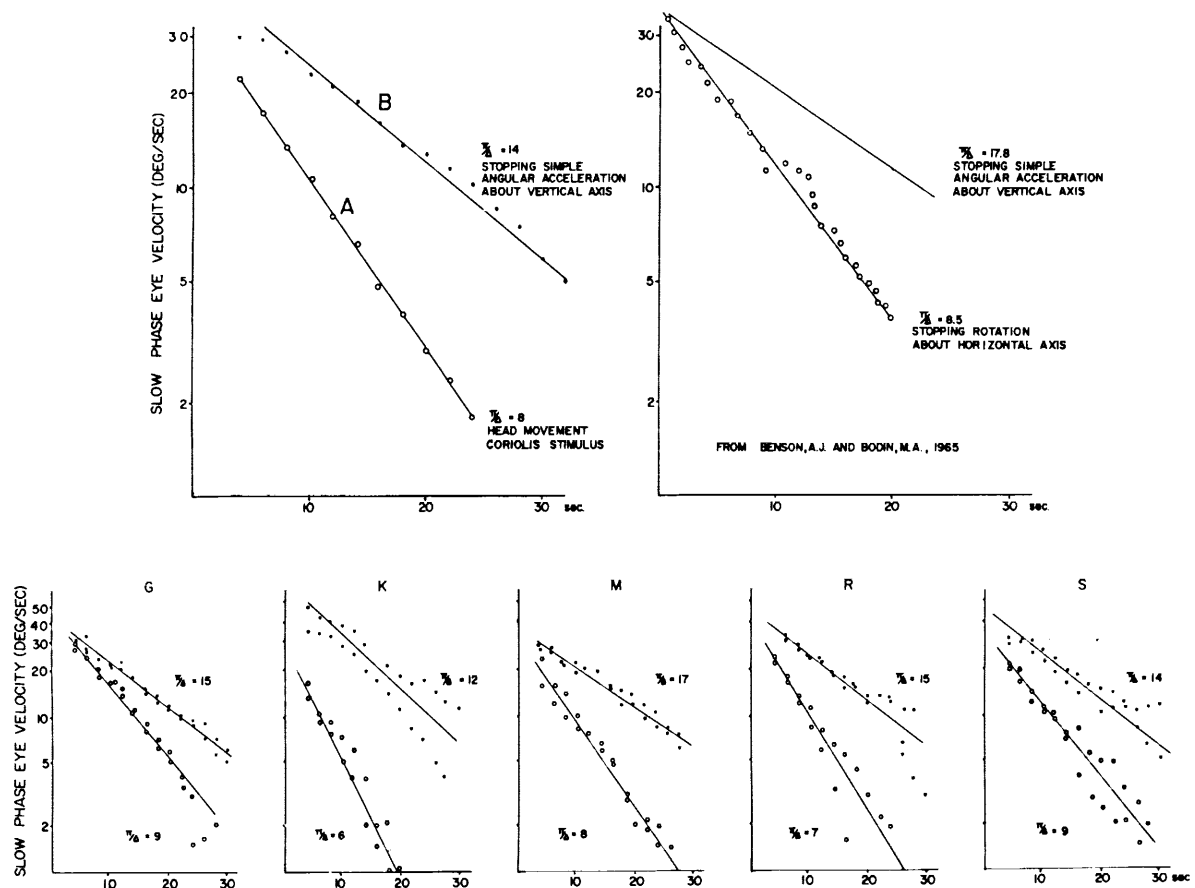

FIGURE 3.—Illustrating different decay rates (π/Δ) of nystagmus slow-phase velocity following different stimuli of equal magnitude to the lateral canals. Upper left panel is the average result from the individual responses (G through S) displayed in the five lower panels.

The rapid decline of nystagmus produced by the head movement is a sign of conflict between the canals, which signal rotation about an axis not aligned with gravity, and the otolith and somatosensory systems, which signal a constant orientation relative to gravity. This situation as the head movement is completed is closely analogous to the nystagmus and sensation produced by cessation of rotation about an Earth-horizontal axis; in the latter situation as well, the canals signal rotation while the other systems signal no rotation. As shown in the upper right graphs, the nystagmus decline following rotation about a horizontal axis is more rapid than the decline of nystagmus produced by simple angular acceleration about a vertical axis even though the angular impulses are equal in the two situations (ref. 3).

From considerations of the mechanics of the stimulus as well as the magnitude of the nystagmus responses, the stimulus in situation *A* is no greater in magnitude than that in situation *B*. Yet simple angular acceleration of the magnitude and duration used in *B* may be repeatedly administered without producing any of the signs of motion sickness, whereas head movements during rotation produce signs of motion sickness. For example, I conducted one experiment in which more than 100 men received 176 simple angular accelerations to 10 rpm within a 4-hour interval. There was not a single indication of motion sickness from these subjects. In another series of experiments (refs. 4 and 5) in which a total of 50 men made 45° head tilts during rotation at 7.5 rpm, approximately 70 percent of the subjects showed some sign of motion sick-

ness. Typically, signs of motion sickness appeared within the first 40 head movements. The angular impulses produced by the head movements were of less magnitude than the simple angular accelerations to 10 rpm, yet the head movements produced signs of sickness, whereas the stronger simple angular accelerations did not produce these signs.

When a person is permitted to move around within a rotating room, there is much more than an intralabyrinthine conflict. During body movement within the room, information fed back from the muscles and joints signal curvilinear motion relative to the Earth, while visual estimates that gage the intended movement do not register the curvilinear path. Movement in a straight line relative to the floor of the room is actually movement in a curved path relative to the Earth. Even in the absence of vision, the somatosensory system would feed back information indicating curvilinear movement of the hand or foot when the intended movement of the hand or foot is in a straight line. Coupled with these incongruities (between intended movements, somatosensory feedback, and visual feedback) is the intralabyrinthine conflict as described above.

The rearranged sensory input that occurs within the slow rotation room (SRR) is analogous to what happens in experiments in which lenses have been used to rearrange the visual input as subjects attempted to move about (ref. 6). The results within the rotating room have characteristics in common with other sensory rearrangements. At first, subjects experience difficulty in walking and in other voluntary motor activities, and most subjects experience nausea. With prolonged exposure, the psychomotor skills improve, while nausea, nystagmus, and illusions diminish. After adaptation to this situation, return to a natural environment reinstates many of these responses, including nausea (refs. 7 to 9). These new reactions in a natural environment offer inferential support for the "pattern copy" hypothesis proposed by Groen (ref. 10).

It may be significant that individuals without labyrinthine function, when exposed to this rotating-room environment, have all of the visual and somatosensory rearrangement encountered by normal subjects, yet they have not been made

sick (ref. 7 and A. Graybiel et al., "Comparative Effects of 12 Days' Rotation at 10 RPM on Four Normal Subjects and Four Persons With Bilateral Labyrinthine Defects," in preparation). The fact that these subjects showed psychomotor disturbance upon return to a normal stationary environment indicates that a central-nervous-system adjustment to sensory rearrangement had occurred, but no sickness was produced. This could be interpreted to indicate that the intralabyrinthine conflict is crucial to the motion sickness in this situation. However, other interpretations are clearly possible, and this is a debatable issue.

Many authors have pointed out experiments (refs. 11 to 17) that show that visual-sensed motion without concomitant vestibular stimulation can produce motion sickness. Especially interesting observations were made by Miller and Goodson (ref. 18) in connection with a helicopter simulator. The subject's control stick manipulated the motion of the visual field as though the subject had moved, but he actually remained stationary relative to the Earth. Experienced helicopter flight instructors were reported to be more susceptible to sickness in this situation than were inexperienced students.

There is in progress a closely related study by Sinacori (J. B. Sinacori, Northrup Norair Division, Hawthorne, Calif., personal communication), who is using a simulator similar to that used by Miller and Goodson. Some visual distortion present in the earlier device has been reduced, but even so, experienced helicopter pilots have become nauseated and have found the device difficult to control, whereas inexperienced personnel were less disturbed by nausea. The most interesting new development reported by Sinacori is that a motion base has been incorporated into the simulator which gives a vestibular signal as the visual simulation is commenced. These vestibular signals are limited by restricted angular displacement of about 10° in pitch, roll, and yaw; but the results indicate that when the signals are "washed out" gradually, i.e., by using a time constant of 2 seconds or longer in returning the subject to initial upright position, there is a greatly improved control of the simulator and a reduction in nausea among experienced pilots. This improvement

with the motion base has been present irrespective of whether the pilots have been exposed first to the motion-base or to the fixed-base condition. Recently, an inexperienced person was exposed to the motion base but with unfavorable washout characteristics, and he did not have nausea. He was then given a training session with favorable motion characteristics during which his performance became very good and nausea was absent. In a third session, he was reexposed to the unfavorable motion characteristics and he became sick and performed poorly, even though initially the same exposure did not produce nausea. The results imply that at least part of the nausea and lack of control with the fixed-base simulator used by Miller and Goodson and later by Sinacori was attributable to the absence of correlated vestibular input. These studies imply that conflicting data from the visual, vestibular, and somatosensory systems may be the important aspect of the stimulus relative to producing motion-sickness symptoms in these situations, and these situations certainly did not involve intense or periodic stimuli to either the otolith or semicircular canal systems. The results also stress the fact that training in a motion device sets up expected correlations between motor commands and expected patterns of sensory input pertaining to spatial orientation and motion. When these expected patterns do not match the incoming patterns, the probability of sickness is increased.

Several authors (refs. 19 to 22; ref. 23, p. 99) have emphasized intralabyrinthine conflict as an especially important factor in production of motion sickness. The invariant correlation between information from otoliths and canals in natural head movements leads me to speculate that unnatural stimuli that yield conflicting inputs from these two kinds of labyrinthine sense organs are especially potent in the production of motion sickness. The vestibular receptors work on an inertial principle and provide quantitative velocity and position data relative to an external fixed reference system which perceptually is the Earth. In a natural environment, the adequacy of reflex actions and perceptions depends upon the magnitude and direction of angular velocities and displacements signaled. Inherent in ves-

tibular sensations are both magnitude and direction. If an unnatural stimulus situation produces a magnitude mismatch or a directional mismatch in the sensory signals from the otoliths and canals, the individual's reflex actions and perceptions are inadequate to cope with his state of motion unless the central nervous system either disregards part of the vestibular input or develops new compensatory reflexes appropriate to the situation. In some individuals, motion sickness is a byproduct of the adjustment to such situations.

While I have been emphasizing the importance of intralabyrinthine conflict in the production of motion sickness, I should not discard the idea of "overstimulation" of the canals or otoliths completely. Motion sickness has been encountered in several experiments involving prolonged simple angular acceleration about a vertical axis (ref. 24, and personal observation). Angular impulses from a 40-rpm change in angular velocity produce pronounced dissociation between nystagmus and sensation in many subjects and strong secondary effects that interact with the effects of immediately following stimuli. There is reason to believe that these interactions increase the incidence of motion sickness that occurs with these particular stimuli (ref. 24, and personal observation), but the intensity of the interaction is partially determined by the length and strength of the preceding canal stimulus. Motion sickness has also been encountered occasionally in prolonged sinusoidal variation of angular acceleration, and it has been encountered frequently in sinusoidal variation of vertical linear acceleration (ref. 25). In some of these experiments, periodicity and intensity of stimulation both appear to be important to the motion sickness that occurs, and it is possible to raise arguments that intermodality conflicts were also present. Whether one chooses to call these situations cases of conflicting sensory inputs, unfavorable periodicity, or overstimulation appears somewhat arbitrary.

In summary, it has been my purpose to point out that conflicting sensory data relating to spatial orientation from among visual, vestibular, and somatosensory systems can produce a high incidence of motion sickness in the absence of

any strong, long, or periodic stimulus to the semicircular canals or otolith system. An argument has been presented for the proposition that intralabyrinthine conflict is especially potent in the production of motion sickness, perhaps more potent than intermodality conflicts between the visual, vestibular, and somatosensory systems. It is possible that a functional vestibular system is necessary to the motion sickness that

occurs when motion is sensed directly only by the visual system.

It has not been my purpose to imply that the idea of overstimulation of the canals or of the otoliths should be discarded as a factor in motion sickness. There are several forms of vestibular stimulation that produce motion sickness without obvious intralabyrinthine conflict or intermodality conflict.

REFERENCES

1. AMBLER, R. K.; AND GUEDRY, F. E.: The Validity of a Brief Vestibular Disorientation Test in Screening Pilot Trainees. *Aerospace Med.*, vol. 37, 1966, pp. 124-126.
2. AMBLER, R. K.; AND GUEDRY, F. E.: Cross-Validation of a Brief Vestibular Disorientation Test Administered by a Variety of Personnel. *Aerospace Med.*, vol. 39, 1968, pp. 603-605.
3. BENSON, A. J.; AND BODIN, M. A.: Effect of Orientation to the Gravitational Vertical on Nystagmus Following Rotation About a Horizontal Axis. IAM Rept. no. 338. RAF Institute of Aviation Medicine, Farnborough, England, 1965.
4. GUEDRY, F. E.; COLLINS, W. E.; AND GRAYBIEL, A.: Vestibular Habituation During Repetitive Complex Stimulation: A Study of Transfer Effects. *J. Appl. Physiol.*, vol. 19, 1964, pp. 1005-1115.
5. GUEDRY, F. E.: Visual Control of Habituation to Complex Vestibular Stimulation in Man. *Acta Oto-Laryngol.*, vol. 58, 1964, pp. 377-389.
6. HELD, R.: Exposure History as a Factor in Maintaining Stability of Perception and Coordination. *J. Nerv. Ment. Dis.*, vol. 132, 1961, pp. 26-39.
7. GRAYBIEL, A.; CLARK, B.; AND ZARRIELLO, J. J.: Observations on Human Subjects Living in a "Slow Rotation Room" for Periods of Two Days. *Arch. Neurol.*, vol. 3, 1960, pp. 55-73.
8. GUEDRY, F. E.; AND GRAYBIEL, A.: Compensatory Nystagmus Conditioned During Adaptation to Living in a Rotating Room. *J. Appl. Physiol.*, vol. 17, 1962, pp. 398-404.
9. GUEDRY, F. E.: Habituation to Complex Vestibular Stimulation in Man: Transfer and Retention of Effects From Twelve Days of Rotation at 10 RPM. *Percept. Mot. Skills*, vol. 21, monograph suppl. 1-V21, 1965, pp. 459-481.
10. GROEN, J. J.: Problems of the Semicircular Canal From a Mechano-physiological Point of View. *Acta Oto-Laryngol.*, suppl. 163, 1960, pp. 59-66.
11. CLAREMONT, C. A.: The Psychology of Sea-Sickness. *Psyche*, vol. 11, 1930, pp. 86-90.
12. CRAMPTON, G. H.; AND YOUNG, F. A.: The Differential Effect of a Rotary Visual Field on Susceptibles and Non-susceptibles to Motion Sickness. *J. Comp. Physiol. Psychol.*, vol. 45, 1953, pp. 451-453.
13. GILLINGHAM, K. K.: A Primer of Vestibular Function, Spatial Disorientation and Motion Sickness. Review 4-66. USAF School of Aerospace Medicine, Brooks Air Force Base, Tex. 1966.
14. STEELE, JACK E.: Motion Sickness and Spatial Perception. A Theoretical Study. ASD TR 61-530. Aeronautical Systems Division, Aerospace Medical Laboratory, Wright-Patterson Air Force Base, Ohio, 1961.
15. McEACHERN, D.; MORTON, G.; AND LEHMAN, P.: Seasickness and Other Forms of Motion Sickness. I. A General Review of the Literature. *War Med.*, 1942, pp. 410-428.
16. BENFARI, R. C.: Perceptual Vertigo: A Dimensional Study. *Percept. Mot. Skills*, vol. 18, 1964, pp. 633-639.
17. REASON, JAMES T.: Motion Sickness: Some Theoretical Considerations. *Intern. J. Man Machine Studies*, vol. 1, 1969, pp. 21-38.
18. MILLER, J. W.; AND GOODSON, J. E.: A Note Concerning "Motion Sickness" in the 2-FH-2 Hoover Trainer. NSAM-519. Naval School of Aviation Medicine, Pensacola, Fla., 1958.
19. LANSBERG, M. P.: A Primer of Space Medicine. Elsevier, Amsterdam, 1960.
20. LANSBERG, M. P.: Canal Sickness: Fact or Fiction? *Industr. Med. Surg.*, vol. 32, 1963, pp. 21-24.
21. ARSLAN, M.: Les Accélérations de Coriolis dans la Stimulation Vestibulaire (Recherches Electronystagmographiques). *Confin. Neurol.*, vol. 21, 1961, pp. 403-411.
22. GUEDRY, F. E.; AND MONTAGUE, E. K.: Quantitative Evaluation of the Vestibular Coriolis Reaction. *Aerospace Med.*, vol. 32, 1961, pp. 487-500.
23. GUEDRY, F. E.: Psychophysiological Studies of Vestibular Function. Contributions to Sensory Physiology, W. D. Neff, ed., Academic Press, 1965, pp. 63-135.
24. BROWN, J. H.: Interacting Vestibular Stimuli and Nystagmic Habituation. *Acta Oto-Laryngol.*, vol. 62, 1966, pp. 341-350.
25. ALEXANDER, S. J.; COTZIN, M.; KLEE, J. G.; AND WENDT, G. R.: Studies of Motion Sickness: XVI. The Effects upon Sickness Rates of Waves of Various Frequencies but Identical Acceleration. *J. Exptl. Psychol.*, vol. 37, 1947, pp. 440-448.

The Otolith Organs as a Primary Etiological Factor in Motion Sickness: With a Note on "Off-Vertical" Rotation

ASHTON GRAYBIEL

AND

EARL F. MILLER II

Naval Aerospace Medical Institute

SUMMARY

Among investigators who agree that the vestibular organs are essential in producing motion sickness, there is either uncertainty or disagreement as to the roles of the otolith organs and the semi-circular canals which, under natural living conditions, furnish different information in response, respectively, to linear and angular accelerations. The shifting emphasis on the essentiality of the two organs is briefly traced, leaving in doubt today the role of the otolith organs formerly regarded as essential in the causation of seasickness and airsickness. This doubt has arisen by the demonstration that nystagmus, easily evoked when the canals are stimulated by angular or Coriolis accelerations, also may be manifested when a person is exposed to rectilinear accelerations or to "rotating linear acceleration vectors" (RLAV) in the absence of angular or Coriolis accelerations.

Some experimental findings on man are reviewed. In one series, it was demonstrated that, in highly susceptible subjects, motion sickness may be experienced when the RLAV is within 4° of the physical upright. If the canals are indeed stimulated under these conditions, it implies a second highly effective means of stimulation inasmuch as, under the same circumstances, fluid in a model of the canals is not disturbed. In a second series of experiments, nystagmus was evoked in subjects regarded as possibly having residual otolith function, based on the ocular counterrolling test, but absent canalicular function, based on lack of response to high angular accelerations and to irrigation of the external canal with ice water.

Although there may be doubt regarding the essentiality of the otolith organs in the genesis of motion sickness, there is little doubt but that their "influence" has been demonstrated in weightlessness. Six subjects, symptom free while fixed in their seats during parabolic flight, manifested symptoms when required to carry out experimenter-paced head motions. Moreover, most subjects demonstrated a significant change in susceptibility when exposed to Coriolis accelerations under ground-based and weightless conditions, some manifesting an increase, others a decrease.

While making preparations to study the effect of g -loading on susceptibility to motion sickness, it was accidentally discovered that a susceptible person subjected to passive rotation with his long body axis tilted 10° from the gravitational upright readily became motion sick. This early opportunity was taken to describe the device and to present some preliminary findings illustrating its uses.

INTRODUCTION

The primary etiological role of the nonacoustic labyrinth in the genesis of motion sickness is declared by the fact that it is unique among sensory systems in conferring immunity after function is lost. This recognition of the essentiality of the labyrinth in no way minimizes the role of

secondary influences which always are present; specific secondary etiologic factors may increase or decrease susceptibility or, indeed, may be facultative in this respect.

Among investigators who agree that the non-acoustic labyrinth is essential in the causation of motion sickness, there is still either lack of agreement or uncertainty concerning the individual

and combined roles of the semicircular canals and the otolith organs. Until these roles have been elucidated, it may not be possible to predict with scientific accuracy the susceptibility to motion sickness in novel force environments. It is the purpose of this report and the one to follow to summarize our present position regarding the etiologic roles of the two vestibular organs in causing motion sickness; a third report (Walter H. Johnson, "Secondary Etiological Factors in the Causation of Motion Sickness," this symposium) will deal with secondary etiological factors.

BRIEF HISTORICAL REVIEW

Historically, the shipboard force environment was the first to receive serious attention, and the acceleration patterns of that environment, interpreted in the light of the Mach-Breuer-Brown theory (ref. 1), seemed to implicate the otolith apparatus. Thus, when motion sickness was experienced under mild sea conditions, the linear accelerations were above threshold value while the angular accelerations were below 2 to 4 deg/sec/sec which was then regarded as in the threshold range. Moreover, clinical observations revealed the absence of nystagmus, which was regarded as supporting evidence that the semicircular canals were either not implicated or, if they were, played a small etiological role. On the other hand, the early experimental studies using vertical oscillations (refs. 2 and 3) and later studies using horizontal oscillations (refs. 4 and 5) clearly proved that rectilinear accelerations could readily evoke frank motion sickness in susceptible human and animal subjects. De Wit (ref. 6) in his monograph on seasickness published in 1953 concluded, "Seasickness is caused by overstimulation of the otolith system."

The connection between the otoliths and seasickness was so strongly established that years elapsed before any doubt was expressed that, insofar as the etiological roles of the vestibular organs were concerned, there was any difference between seasickness and airsickness. In the early days of flight the etiological role of the force environment was often complicated by hypoxia, another cause of nausea and vomiting. That the majority opinion implicated the otolith apparatus

in causing airsickness is shown indirectly by the impact made by a report (ref. 7) of observations that motion sickness in flight could be reduced or prevented by fixation of the head, thus implicating the semicircular canals more than the otolith apparatus.

Motion-sickness studies using horizontal and vertical oscillators were reevaluated in the light of this finding. The angular component in horizontal swings and lack of head fixation in some experiments using vertical oscillations were underscored as generators of small angular accelerations (ref. 8). Observations on seasickness were also reevaluated in the light of studies proving that the thresholds of response of the semicircular canals were far lower (ref. 9) than they were formerly thought to be.

Although there was ample evidence that typical symptoms of motion sickness could be evoked in susceptible subjects by thermal stimulation and angular acceleration (ref. 10) involving the horizontal semicircular canals and by Coriolis acceleration (refs. 11 and 12), it was the observations in the slow rotation room (ref. 13) which strongly emphasized the predominant etiologic role of the semicircular canals in causing motion sickness, at least in this force environment.

Equally important was the evidence pointing away from the otolith apparatus by calling into question the validity of the Mach-Breuer-Brown theory under certain artificial stimulus conditions. The evidence consisted in the demonstration that nystagmus can be evoked when a person is exposed to (1) rectilinear accelerations (refs. 14 and 15), (2) constant angular velocity when rotated about a coplanar Earth-horizontal axis (ref. 16), and (3) a rotating linear acceleration vector in the absence of angular motion (in a counter-rotating room) (ref. 17).

In addition to studies on man, experiments using animal subjects with selective injury to the canalicular system showed reduced or abolished susceptibility to motion sickness (ref. 18), and electrophysiological studies revealed what appeared to be canalicular responses to linear accelerations (ref. 19).

In summarizing this brief review, it is evident that there has been a gradual shift in the majority opinion regarding the roles of the two vestibular

organs in the genesis of motion sickness. The early experimental studies interpreted in the light of the Mach-Breuer-Brown theory seemed to demonstrate the essentiality of the otolith organs. Today, the evidence suggests that the canals are essential organs in the genesis of motion sickness and, by implication, leave in doubt the role of the otolith apparatus.

EVIDENCE IMPLICATING THE OTOLITH APPARATUS IN THE CAUSATION OF MOTION SICKNESS

The Counterrotating Room

A counterrotating room (ref. 20) is chosen to typify the force environment in devices either not generating angular or Coriolis accelerations or at least not generating them at the time motion-sickness symptoms are evoked. Among 18 healthy subjects with normal function of the canals as revealed by the threshold caloric test and normal function of the otoliths as revealed by the oculogravic illusion test, 11 manifested symptoms of motion sickness in the counterrotating room (CRR), six did not, and in one the evidence was in doubt. Two experienced symptoms while rotating at 10 rpm, one after 14, and the other after 30 minutes. At the effective radius of 2 feet in the room, the rotating gravito-inertial vector deviated from the physical upright of the subject by less than 4°. Three other subjects experienced symptoms while rotating at 15 rpm for 30 minutes or less, with the rotating vector less than 9° from the physical upright.

There can be no question that, in these subjects, the otolith organs were stimulated in an unusual pattern, even at the lower stimulus level, inasmuch as the stimulus exceeded the threshold of response (ref. 21). It is equally certain that the cupula-endolymph system of the canals was not stimulated, at least in a normal manner; the fluid in a glass model was not even disturbed. If the canals were stimulated at the lower effective stimulus level, the rotating linear acceleration vector evoking symptoms would represent a second fairly efficient stimulus mechanism, inasmuch as the accelerative forces involved were small. If the canals were not stimulated, the question of the significance of their resting discharge arises and whether it was modulated by

the unusual input from the otolithic receptors, and, in this way, would give rise to symptoms.

The fact that nystagmus can be evoked at higher stimulus levels in the CRR (ref. 20) and in other devices when angular or Coriolis accelerations are absent is a matter of great and continuing interest and has been reviewed in NASA SP-115. Although the definitive experiment has not been performed, nystagmus evoked under the above conditions constitutes the best evidence that the canals may be stimulated at low as well as at high stimulus levels.

Experiments on Persons With Vestibular Defects

Labyrinthine-Defective Subjects

Eleven persons with severe bilateral labyrinthine defects (L-D subjects) have participated in many experiments for a period of over 10 years, and during this time functional tests have been conducted on several occasions (table 1) (ref. 22). None has experienced motion sickness in any of our laboratory devices (refs. 13 and 20) or in the air (ref. 23). During their exposure at sea they were free from symptoms characteristic of motion sickness; two occasions in this regard deserve comment. On one occasion (ref. 24) several of them had not recovered from a nauseating dose of sirup of ipecac at the time they were exposed to turbulent seas in a boat; recovery was uneventful despite the conditions. On the second occasion (ref. 25) during a severe Atlantic storm when living conditions aboard the ship were abnormal, one subject (HA) reported "slight nausea—not gastrointestinal"; other symptoms checked in the prepared questionnaire form were not remarkable under the circumstances.

Based on the clinical findings in these L-D subjects (table 1), it was concluded that some otolithic function might be left. In six of them the likelihood of residual canalicular function seemed to be nil in view of the lack of response both to ice-water irrigations and to exposure to high angular accelerations, yet they manifested nystagmus when exposed to Earth-horizontal rotation at 12 rpm (ref. 16). The conditions in the latter experiment were favorable for stimulation of any residuum of the otolithic apparatus, where differences in specific weight between the otoliths and surround were great, but not

TABLE 1.—*Clinical Findings in 11 Deaf Persons With Bilateral Labyrinthine Defects*

Subject	Age	Auricular defects		Hearing ¹		Threshold response, caloric test		Counterroll index, minutes of arc. ² maximum tilt ³	
		Etiology	Onset year, age	R	L	R	L	50°	75°
Domich.....	48	Meningitis.....	13	Nil	Nil	N.R., ⁴ 10° C, 3 min	N.R., 10° C, 3 min	74	74
Greenmun.....	48	Mastoiditis.....	12	Nil	160	N.R.....	N.R.....	60
Gulak.....	26		4½	≥ 145	≥ 145	10° C, 40 sec.....	10° C, 40 sec.....	76	89
Harper.....	29		13	Nil	Nil	N.R., 2.8° C, 10 min	N.R., 2.8° C, 10 min	47	53
Jordan.....	34		7½	Nil	Nil	N.R.....	N.R., 3.0° C, 3 min	126	176
Larson.....	29		6	≥ 115	≥ 110	10° C, 40 sec.....	N.R.(?).....	73	109
Myers.....	25	Meningitis.....	8	Nil	Nil	N.R., 2.8° C, 10 min	7.9° C, 40 sec.....	63	82
Peterson.....	33		12	Nil	Nil	N.R., 2.6° C, 3 min	N.R., 2.6° C, 3 min	21	30
Piper.....	26		3	Nil	Nil	9.8° C, 40 sec.....	Not tested (infection)	71	85
Steele.....	25		12½	≥ 130	≥ 135	10.0° C, 3 min....	11.0° C, 3 min....	110	117
Zakutney.....	25		3½	≥ 135	≥ 130	2.8° C, 10 min....	2.8° C, 10 min....	22	36

¹ Response to white noise up to 160 decibels.

² One-half the sum of maximum roll right and left (minutes of arc).

³ Angular displacement of body from vertical in frontal plane.

⁴ N.R.—No response.

for the sensory epithelium of the canals where differences in specific weight were very small. The dilemma is created by the fact that in a normal person, nystagmus is so easily evoked by an artificial stimulus to the canals, whereas in the otolith apparatus the typical response is a compensatory movement of the eyes. Henriks-son (personal communication) believes that on approaching a critical rate of cyclic stimulation of the otolith apparatus, compensatory movements might become nystagmic. In any event, the findings in these L-D subjects demonstrate a clear separation between evoking nystagmus and motion sickness.

Partial Loss of Vestibular Function

The fact that persons with loss of vestibular

function are insusceptible to motion sickness raises the problem of how much loss confers immunity. In table 2 are shown the relevant clinical findings in eight persons with abnormal values on the threshold caloric test (ref. 26) or ocular counterrolling test (ref. 27), or both. Interpretation of the findings is made difficult because of the great individual variance in susceptibility to motion sickness and in ocular counterrolling values among clinically normal persons. The first subject was "discovered" fortuitously, during a demonstration in the slow rotation room (SRR), when he failed to manifest any signs of motion sickness during a variety of activities when rotating at 10 rpm. At that time he was unable to stand more than a few seconds on one

TABLE 2.—*Clinical Findings and Susceptibility to Motion Sickness in Subjects With Labyrinthine Function Test Scores Outside the "Normal" Range*

Subject	Age and sex	Health	Etiological factor	Hearing		Caloric threshold, °C ¹		Ocular counterrolling		Rail test performance	Provocative tests and history of motion sickness			
				R	L	R	L	R-L symmetry	Index		rpm	Head movements	Motion sickness	Other
1	38; M	Excellent	Labyrinthitis after dive 3 years previous.	Decrease ² > 2000.	Decrease > 2000.	34.5	33.5			Significant decrease.	10	85	M III	2 years previously, no symptoms in SRR; ataxic. History of reduced susceptibility to motion sickness.
2	39; M	Good	Diver	Moderate high frequency loss.	Moderate high frequency loss.	35.8	30.0	Normal	290	Low average.	7.5	75	M III	
3	37; M	Good	Diver					Slightly abnor. mal.	93	Above average.				History > average susceptibility.
	41		Diver	Decrease > 2000.	Decrease > 2500.			Slightly abnor. mal.	155	Above average.				
	42	Coronary heart disease. Fair	Diver	Decrease > 2000.	Decrease > 2500.	36.0	36.2	Slightly abnor. mal.	148	Normal range.				R.T.C. ³ Average range. Hallpike: severe symptoms. Coriolis acceleration: average range. Never motion sick.
4	22; M	Good	Skull injury.	Decrease > 500 cps.	Normal	Nil I-W ⁴	34.7	Normal	164		20	300+	0	
5	50; M	Fair	Ménière's disease.		Normal	30.6	Nil I-W	Normal	305	Far below average.	10	125, and additional activities.	0	Insusceptible since strep treatment.

6	49; F	Fair.....	Ménière's disease.	Slight decrease low frequency high frequency.	Normal.....	Nil I-W	25.0	Abnormal.	137	Moderately below normal.	10	172, and additional activities.	0	Insusceptible since strep treatment.
7	56; M	Fair.....	Ménière's disease.	Normal range except high frequency.	Decrease except 2-3000	31.5 I-W	Nil	Normal.....	235	Moderately below normal.	10	100, and additional activities.	0	Insusceptible since strep treatment.
8	42; M	Fair.....	Ménière's disease.	Decrease > 1000.	Decrease > 2000.	Nil	Nil	Normal.....	149	Far below normal.	10	100, and additional activities.	0	Insusceptible since strep treatment.

¹ Minimal cooling of exit temperature of water (irrigation, 40 sec) causing nystagmus.

² Decrease over number of cps as indicated.

³ Rotating tilt chair.

⁴ Ice water.

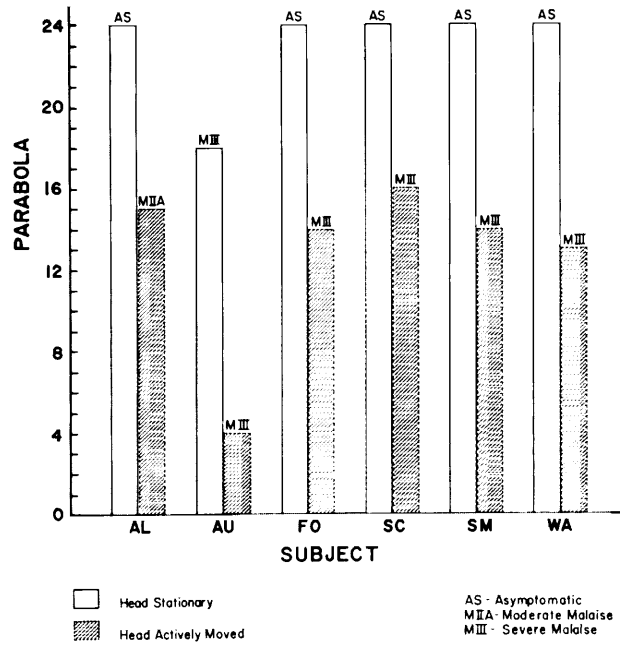

FIGURE 2.—Motion sickness susceptibility in zero g. Effect among six susceptible subjects of active head movements relative to the restrained condition upon motion-sickness susceptibility measured in terms of the number of parabolas required to provoke Malaise III. (From ref. 28).

while making head motions in the absence of rotation (fig. 2) not only adds to the validity of the findings indicating increased susceptibility but also demonstrates experimentally what had been reported by Soviet cosmonauts (refs. 29 and 30). It seemed reasonable to conclude that any significant changes in susceptibility during weightlessness were due very largely to changes in otolithic modulating influences resulting from the lifting of the gravitational load.

There is a large amount of other evidence that canalicular responses are modified by linear accelerations in man (refs. 31 to 33) and that susceptibility to motion sickness is affected by increased g-loading.

OFF-VERTICAL ROTATION

While making preparations to conduct experiments with the object of determining the influence of g-loading on susceptibility to motion sickness, it was found that symptoms were readily evoked in most normal persons when they were

passively rotated with the base of a chair device tilted 10° away from the gravitational upright. Although a full report is in preparation, it seemed worthwhile to make a brief account here inasmuch as the off-vertical rotation (OVR) affords an exceptionally precise means of controlling the stressful accelerations.

Exposure Device and Procedure

A Stille rotating chair, model RS-3, was modified (fig. 3) for use as a rotating tilted chair. It was mounted on a platform which could be tilted up to 20° , either by means of a hand crank or an electric motor, and the degree of tilt could be read from a large protractor. A rigid bracket was added with provision for supporting and adjusting both a dental appliance to fix the subject's head and a goggle device (ref. 34). The latter device included a monocular target, consisting of a dimly illuminated line of collimated light, which the subject could rotate about its center to indicate the upright or raise or lower to indicate the "horizon"; visual and automatic readouts were available.

Provision was made for centering the subject's head precisely over the center of rotation and

for proper counterbalancing to ensure smooth rotation at any degree of tilt. The rotation was programed on a time axis involving periods of acceleration at 0.5 deg/sec/sec for 30 seconds, followed by periods of constant velocity for 6 minutes until either the endpoint described below was reached or 6 minutes at 25 rpm were completed. In effect, this program represented unit increases of 2.5 rpm every 6.5 minutes after the initial step. Thus, the endpoint indicated that temporal summation of the disturbing effects had exceeded the capacity for homeostatic adjustment over a period of time, and this served as an index of susceptibility. The endpoint also could be expressed in elapsed time at terminal velocity.

With each revolution of the OVR device, the subject's head also rotated out of phase about the yaw and roll axes. Thus, while turning at constant velocity, the vestibular organs are exposed to a rotating linear acceleration vector. The effects on the paired maculae of utricle and saccula are unusual in that the horizontal component of this specific force with respect to the subject continually changes direction. The question whether the semicircular canals also are stimulated by a rotating linear acceleration vector has been discussed above.

The endpoint used in this series of observations, "moderate malaise" (M II A), has been described elsewhere in detail (ref. 35); the diagnostic criterion on which it is based is summarized in table 3 (ref. 35).

Subjects

Five of the deaf persons with bilateral labyrinthine defects mentioned in table 1 and 66 normal males participated. The five I-D subjects, 28 to 54 years of age (GR, GU, MY, PE, and ZA), were in good health, and each had participated in many similar experiments; hence, they were regarded as sophisticated subjects.

The control group of 66 subjects ranged in age from 19 to 33 years; 34 of them were in the Navy aviation officer training program, 30 were Navy enlisted men, and 2 were Navy medical externs. All had met the required Navy medical qualifications and were in good health.

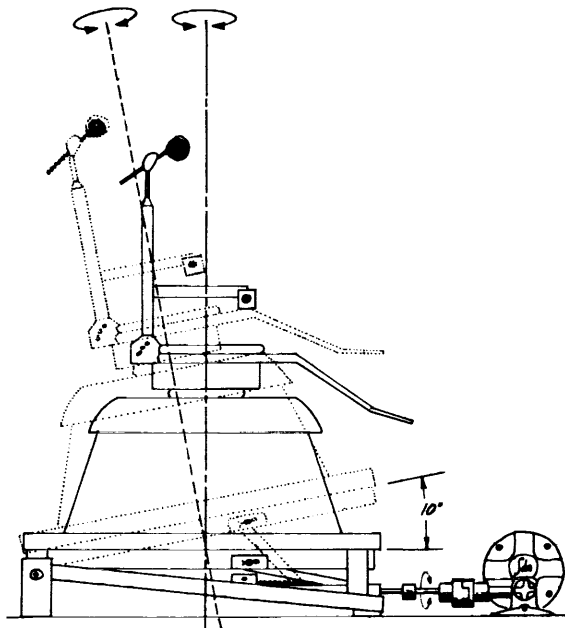

FIGURE 3.—Off-vertical rotating chair device; slide mechanisms for positioning subject not shown.

TABLE 3.—*Diagnostic Categorization of Different Levels of Severity of Acute Motion Sickness*

Category	Pathognomonic, 16 points	Major, 8 points	Minor, 4 points	Minimal, 2 points	AQS, ¹ 1 point
Nausea syndrome.....	Vomiting or retching.	Nausea II, ² III.	Nausea I.....	Epigastric discomfort.	Epigastric awareness.
Skin.....		Pallor III.....	Pallor II.....	Pallor I.....	Flushing, subjective warmth, ≥ II.
Cold sweating.....		III.....	II.....	I.....	
Increased salivation.....		III.....	II.....	I.....	
Drowsiness.....		III.....	II.....	I.....	
Pain.....					Headache, ≥ II.
Central nervous system.....					Dizziness: Eyes closed, ≥ II. Eyes open, III.

Levels of Severity Identified by Total Points Scored

Frank sickness (S) ≥ 16 points	Severe malaise (M III) 8-15 points	Moderate malaise A (M II A) 5-7 points	Moderate malaise B (M II B) 3-4 points	Slight malaise (M I) 1-2 points
-----------------------------------	---------------------------------------	---	---	------------------------------------

¹ Additional qualifying symptoms.

² III, severe or marked; II, moderate; I, slight.

General Procedure

Each subject was carefully instructed in the best manner of reporting the symptoms. This was important, not only for the observer to estimate the level of severity of the signs and symptoms but also to avoid overshooting the endpoint (M IIA) because of the rapid increase in severity of symptoms once they became definite.

Under the conditions of this test, the observer always had a good opportunity to note and record changes in facial color and expression and the onset of sweating. The subject was queried repeatedly and, with the onset of moderate malaise, the device was quickly tilted to the upright to abolish the stressful stimuli, and deceleration effected at the same rate as that of the acceleration.

In conducting susceptibility tests the subject's eyes were covered with a padded shield. Unless otherwise indicated, normal subjects were exposed to the programed accelerations described above while tilted 10° away from vertical. This program was altered for the group of L-D subjects. On one occasion all except ZA were

exposed for 6 minutes at terminal velocities of 10, 20, and 30 rpm, and all except GU were exposed on other occasions at 30 rpm for periods of 10 minutes or longer.

Results

Motion Sickness

Symptoms of all but 6 of the 66 control subjects reached the endpoint during the "standard" test, and the variance in their susceptibility is shown in figure 4. More than half reached the endpoint at the three velocities of 7.5, 10.0, and 12.5 rpm.

Of the six not reaching the endpoint, three were available for retesting. Of these, two experienced M IIA when the tilt was increased to 20°, as indicated by the dotted columns in figure 4. Under the test as programed, once symptoms appeared, they waxed rapidly, necessitating alertness on the part of subject and experimenter to avoid overshooting the endpoint, as illustrated in figure 5. This could be prevented by using another mode; e.g., selecting the velocity at which symptoms would be expected. None of

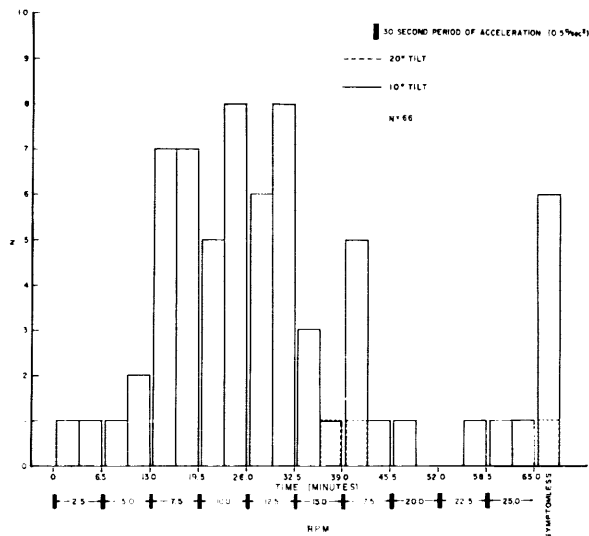

FIGURE 4.—Differences in susceptibility to motion sickness (endpoint, *M II A*) among 66 subjects exposed to off-vertical rotation according to the programed stress indicated on the abscissa; among the six not experiencing symptoms at 10° tilt, three were available for retesting at 20° tilt. Two of the three reached the endpoint as indicated by the dashed lines.

the five L-D subjects experienced symptoms of motion sickness.

Sensations During Rotation

There were more uniformities than differences between normal and L-D subjects in reporting their perceptions with eyes covered during rotation. During periods of constant velocity, both L-D and normal subjects sensed the motion not as rotation but as if they were revolving, and, except in a few instances, sensed the direction as being opposite to that in which the chair was turning. Although a detailed analysis has not been made of the cyclic variations in the subjects' experiences and the variations from one experience to another, they were reminiscent of those experienced in the counterrotating room (ref. 20). In general, there was a greater tendency for the L-D subjects to become disoriented than was the case for the normal controls, and there were greater individual differences among the L-D subjects in reporting their subjective impressions with regard to their orientation to the gravitational upright and in

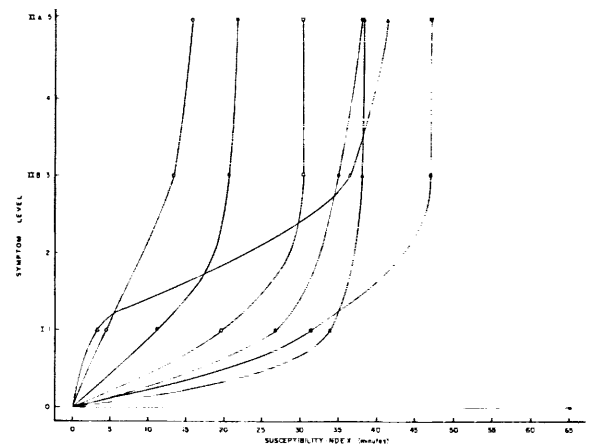

FIGURE 5.—Demonstrating relatively rapid increases in level of severity of symptoms among seven subjects varying in susceptibility to motion sickness when exposed to off-vertical rotation at 10° tilt.

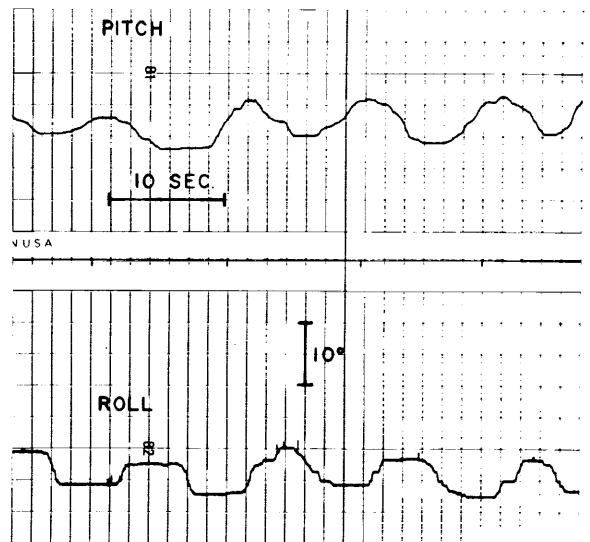

FIGURE 6.—Actual recording of a subject's dynamic settings of the visual target to the "horizon" (pitch) and the vertical (roll) during 10° off-vertical rotation at 5 rpm.

the shape of the "envelope" in which they revolved.

Estimations of Deviations From the Vertical and From the Horizon

A few recordings have been made of the subjects' settings using the goggle device described above. The subject's task was to maintain the

dim broken line of light in darkness at the vertical and the center gap at the level of the horizon. In figure 6 are shown typical settings of a normal subject. It is seen that this rather demanding task was accomplished quite well. A few normal subjects became "confused" or "disoriented," and a larger number performed poorly. The L-D subjects experienced much more difficulty than normal subjects in making the settings. One evidence of this was their need for a greater excursion of arc in setting the target to the "horizon"; they kept hitting the "stops."

Comment

The effectiveness of the provocative test just

described for motion sickness is shown by the small angle of tilt required to evoke symptoms in 90 percent of subjects available at an air station. The reliability, i.e., test-retest, was high. The passive character of the exposure minimized fatigue, as compared to that experienced when making active head movements. The scoring index accurately ranked the subjects inasmuch as a given value represented the same exposure history for all. Although only one programed mode was used, variations could be made to fit different purposes. The OVR device is useful in exploring further the visual and non-visual subjective experience, both in normal persons and in persons with labyrinthine defects.

REFERENCES

1. BORING, E.: Proprioception of the Inner Ear. Sensation and Perception in the History of Experimental Psychology, E. Boring, ed., Appleton-Century, 1941, pp. 535-544.
2. SJÖBERG, A.: Experimentelle Studien über den Auslösungsmechanismus der Seekrankheit. *Acta Oto-Laryngol.*, suppl. 14, 1931, pp. 1-136.
3. ALEXANDER, S. J.; COTZIN, M.; HILL, C. J., JR.; RICCIUTI, E. A.; AND WENDT, G. R.: Wesleyan University Studies of Motion Sickness: III. The Effects of Various Accelerations Upon Sickness Rates. *J. Psychol.*, vol. 20, 1945, pp. 3-8.
4. JOHNSON, W. H.; AND TAYLOR, N. B. G.: Some Experiments on the Relative Effectiveness of Various Types of Accelerations on Motion Sickness. *Aerospace Med.*, vol. 32, 1961, pp. 205-208.
5. MANNING, G. W.; AND STEWART, W. G.: Effect of Body Position on Incidence of Motion Sickness. *J. Appl. Physiol.*, vol. 1, 1949, pp. 619-628.
6. DE WIT, G.: Seasickness (Motion Sickness). *Acta Oto-Laryngol.*, suppl. 108, 1953, pp. 1-56.
7. JOHNSON, W. H.; STUBBS, R. A.; KELK, G. F.; AND FRANKS, W. R.: Stimulus Required to Produce Motion Sickness. I. Preliminary Report Dealing With Importance of Head Movements. *J. Aviat. Med.*, vol. 22, 1951, pp. 365-374.
8. KEIST, B. F.; SHEELEY, W. F.; BYERS, J. M., JR.; AND CHINN, H. I.: Relative Effects of Head Immobilization and Medication on the Incidence of Airsickness. Report 55-78. School of Aviation Medicine, USAF, Randolph AFB, Tex., 1955.
9. GRAYBIEL, A.; KERR, W. A.; AND BARTLEY, S. H.: Stimulus Thresholds of the Semicircular Canals as a Function of Angular Acceleration. *Am. J. Psychol.*, vol. 61, 1948, pp. 21-36.
10. BÁRÁNY, R.: Physiologie und Pathologie des Bogengangapparates beim Menschen. (Funktionsprüfung des Bogengangapparates.) *Klin. Studien*, Deuticke, Wien, 1907.
11. SCHUBERT, G.: Die physiologischen Auswirkungen der Coriolis-Beschleunigungen bei Flugzeugsteuerung. *z. Hals-Nas.- u. Ohrenheilk.*, vol. 30, 1932, pp. 595-604.
12. SPIEGEL, E. A.; OPPENHEIMER, M. J.; HENNY, G. C.; AND WYCIS, H. T.: Experimental Production of Motion Sickness. *War Med.*, vol. 6, 1944, pp. 283-290.
13. GRAYBIEL, A.; CLARK, B.; AND ZARRIELLO, J. J.: Observations on Human Subjects Living in a "Slow Rotation Room" for Periods of Two Days. *Arch. Neurol.*, vol. 3, 1960, pp. 55-73.
14. JONGKEES, L. B. J.; AND PHILIPSZON, A. J.: Nystagmus Provoked by Linear Accelerations. *Acta Physiol. Pharmacol. Neerl.*, vol. 10, 1962, pp. 239-247.
15. NIVEN, J. I.; HIXSON, W. C.; AND CORREIA, M. J.: Elicitation of Horizontal Nystagmus by Periodic Linear Acceleration. *Acta Oto-Laryngol.*, vol. 62, 1967, pp. 429-441.
16. GUEDRY, F. E., JR.: Orientation of the Rotation-Axis Relative to Gravity. *Acta Oto-Laryngol.*, vol. 60, 1965, pp. 30-48.
17. MONEY, K. E.: Discussion following paper by F. E. Guedry, Jr., Influence of Linear and Angular Accelerations on Nystagmus. Second Symposium on the Role of the Vestibular Organs in Space Exploration, NASA SP-115, 1966, pp. 196-198.
18. MONEY, K. E.; AND FRIEDBERG, J.: The Role of the Semicircular Canals in Causation of Motion Sickness and Nystagmus in the Dog. *Can. J. Physiol. Pharmacol.*, vol. 42, 1964, pp. 793-801.
19. BENSON, A. J.; GUEDRY, F. E., JR.; AND JONES, G. M.: Response of Lateral Semicircular Canal Units in Brain Stem to a Rotating Linear Acceleration Vector. *J. Physiol.*, vol. 191, 1967, pp. 26P-27P.

20. GRAYBIEL, A.; AND JOHNSON, W. H.: A Comparison of the Symptomatology Experienced by Healthy Persons and Subjects With Loss of Labyrinthine Function When Exposed to Unusual Patterns of Centripetal Force in a Counter-Rotating Room. *Ann. Otol.*, vol. 72, 1963, pp. 357-373.
21. GRAYBIEL, A.; AND PATTERSON, J. L., JR.: Thresholds of Stimulation of the Otolith Organs as Indicated by the Oculogravic Illusion. *J. Appl. Physiol.*, vol. 7, 1955, pp. 666-670.
22. GRAYBIEL, A.: Orientation in Aerospace Flight. Special Report 66-6. NASA Order R-93. Naval Aerospace Medical Institute, Pensacola, Fla., 1966.
23. COLEHOOR, J. K.; AND GRAYBIEL, A.: Excretion of 17-hydroxycorticosteroids, Catechol Amines, and Uropepsin in the Urine of Normal Persons and Deaf Subjects With Bilateral Vestibular Defects. *Aerospace Med.*, vol. 35, 1964, pp. 370-373.
24. GRAYBIEL, A.: Functional Disturbances of Vestibular Origin of Significance in Space Flight. Second International Symposium on Man in Space, Paris, 1965, Springer-Verlag, Wien and New York, 1967, pp. 8-32.
25. KENNEDY, R. S.; GRAYBIEL, A.; McDONOUGH, R. G.; AND BECKWITH, F. D.: Symptomatology Under Storm Conditions in the North Atlantic in Control Subjects and in Persons With Bilateral Labyrinthine Defects. *Acta Oto-Laryngol.*, vol. 66, 1968, pp. 533-540.
26. MCLEOD, M. E.; AND MEEK, J. C.: A Threshold Caloric Test: Results in Normal Subjects. NSAM-834. NASA Order R-47. Naval School of Aviation Medicine, Pensacola, Fla., 1962.
27. MILLER, E. F., II: Counterrolling of the Human Eyes Produced by Head Tilt With Respect to Gravity. *Acta Oto-Laryngol.*, vol. 54, 1961, pp. 479-501.
28. MILLER, E. F., II; GRAYBIEL, A.; KELLOGG, R. S.; AND O'DONNELL, R.: Motion Sickness Susceptibility Under Weightless and Hypergravity Conditions Generated by Parabolic Flight. *Aerospace Med.*, vol. 40, 1969, pp. 862-868.
29. KOMENDANTOV, G. L.; AND KOPANEV, V. I.: Motion Sickness as a Problem of Space Medicine. *Problems of Space Biology*, vol. 2, N. M. Sisakyan and V. I. Yazdovskiy, eds., JPRS TT18, 395. Joint Publications Research Service, 1963, pp. 84-89.
30. GAZENKO, O.: Medical Studies on Cosmic Spacecraft "Vostok" and "Voskhod." *Bioastronautics and the Exploration of Space*, T. C. Bedwell, Jr., and H. Strughold, eds., Air Force Systems Command, Brooks Air Force Base, Tex., 1965, pp. 357-384.
31. BENSON, A. J.; AND WHITESIDE, T. C. D.: The Effect of Linear Acceleration on the Response to Angular Acceleration in Man. *J. Physiol.*, vol. 156, 1961, pp. 6P-7P.
32. LANSBERG, M. P.; GUEDRY, F. E., JR.; AND GRAYBIEL, A.: Effect of Changing the Resultant Linear Acceleration Relative to the Subject on Nystagmus Generated by Angular Acceleration. *Aerospace Med.*, vol. 36, 1965, pp. 456-460.
33. BENSON, A. J.; AND BODIN, M. A.: Interaction of Linear and Angular Accelerations on Vestibular Receptors in Man. *Aerospace Med.*, vol. 37, 1966, pp. 144-154.
34. GRAYBIEL, A.; MILLER, E. F., II; BILLINGHAM, J.; WAITE, R.; BERRY, C. A.; AND DIETLEIN, L. F.: Vestibular Experiments in Gemini Flights V and VII. *Aerospace Med.*, vol. 38, 1967, pp. 360-370.
35. GRAYBIEL, A.; WOOD, C. D.; MILLER, E. F., II; AND CRAMER, D. B.: Diagnostic Criteria for Grading the Severity of Acute Motion Sickness. *Aerospace Med.*, vol. 39, 1968, pp. 453-455.

DISCUSSION FOLLOWING ALL OF SESSION II

Gernandt: What about the splanchnic nerve, Dr. Money?

Money: These nerves are present, but since the animals after operation failed to vomit to copper sulfate (rather, they did not fail, but the thresholds were markedly increased by a factor of 10), it was concluded that the drug was taking the blood route to the chemoreceptor trigger zone. It was concluded that the viscera was denervated, at least from the point of view of the vagus nerve and the sympathetic nerve. As Dr. Gernandt points out, there are other nerves to the viscera as well. We can take this as referring only to those which were in fact eliminated by Wang, Chinn, and Renzi.

(Postsymposium note: The sympathectomy as described by these authors, by removal of the sympathetic chain in one unbroken thread, would, in fact, divide the splanchnic nerve.)

Waite: Concerning the parabolic flight data presented early in Dr. Graybiel's paper, I should like to comment that a Soviet investigator, Yuganov, reported three groups, including subjects who demonstrated no change whatsoever. Does Dr. Graybiel think he might obtain such a group if he were to test a greater number of subjects?

Graybiel: I would think so. We did find a bimodal distribution, not a complete separation into two groups. These findings are suspect because in parabolic flight there is the high-g pullup and pullout which may influence susceptibility to motion sickness in the weightless phase. But we used subjects who were familiar with this maneuver and for the most part were not bothered in standard parabolic flights. They were rotated just during the weightless period. I believe that, qualitatively, our findings will stand up. I think the evidence that the nystagmus runs on for a much longer time in weightlessness also tends to indicate the influence probably of the otolith apparatus on the canal response.

Schiff: My comment is on Dr. Money's paper and relates to work done at the Army Chemical Research Center some time prior to my retirement from the Navy. We performed a series of experiments in which, in the first case, we injected diisopropyl fluorophosphate (DFP) or some analog which destroyed the acetylcholinesterase. As soon as this occurred, the animal would walk in circles, the so-called

adversive syndrome. In another cat we put cocaine next to the round window. The animal would again walk in circles. Then we put the G-agent or DFP against the round window. This substance permeates most tissues highly effectively. No circular motion occurred in the animal. The conclusion would seem to be that it was a central phenomenon, since the acetylcholinesterase exists in the brain portion. As far as in the peripheral labyrinth is concerned, acetylcholinesterase exists as a result of the efferent system, but we have no way of measuring efferent effect. From an afferent point of view, the animal did not walk in circles, which meant there was no acetylcholine involved.

Baldes: Dr. Graybiel, have you tilted your seat 10° forward from the vertical?

Graybiel: The base of the chair is 10° away from the vertical. As it rotates, a person in the chair changes his position all the time. We call it off-vertical rotation. I would like to ask Dr. Money a question regarding the use of vomiting as an endpoint or the guiding system in motion sickness. Vomiting is not an initial cardinal symptom of motion sickness; in my opinion it is a complication. By the time vomiting occurs, many preceding events have taken place. The initial cardinal symptoms are such manifestations as sweating, pallor, drowsiness, and stomach awareness. In another paper I have shown a hygrometer recording demonstrating that, as a result of one single head movement in the slow rotation room, there is a slight increase in sweating and a little change in finger temperature (ref. 9 of text). These changes occur very quickly indeed, whereas, vomiting, as Dr. Money pointed out, is usually a rather late symptom unless the stress is extremely severe.

Money: Of course, there are many other things besides vomiting that go with motion sickness. However, I meant to point out that I see motion sickness as basically a mystery. It is an anomaly, or what have you. It happens even in fish. It happens in man, monkeys, cows, horses, and dogs, and why should such an antiteleological phenomenon occur in so many different species? When that question is answered, the essence of motion sickness will be understood. Although there are more sensitive indicators than vomiting, I believe that vomiting is the only part of the motion-sickness syndrome that is common to all the species which have motion sickness. Therefore, to attack the problem of motion sickness, you have to consider the element common to all the species, and that is vomiting.

The autonomic effects that you mentioned, salivation and pallor, are normally controlled by the autonomic nervous system, but it has never been shown as far as I know that, in motion sickness, it is the autonomic nervous system which is effecting these changes. It might be, but it is just possible that the pallor, salivation, and sweating are caused by a circulating chemical that is not related to the autonomic transmitters.

Lowenstein: Dr. Guedry placed emphasis on internal labyrinthine conflict. Why do many people show minimum disturbance in weightlessness when semicircular canal and missing otolith effect seem to contradict each other in weight-

lessness; or is it that we have so far only tested people who are habituated?

Guedry: Probably I should say I cannot answer your question. It seems to me that we are not exactly sure how that otolith system is responding during weightlessness. We may be stimulating the canals and otoliths with head movements, but the otoliths would be stimulated differently than in a 1-g environment. However, their sensory input would not necessarily be in direct conflict with that of the canals. If the astronauts were in a rotating vehicle, head movement near the axis of rotation would not necessarily produce conflict of the kind I pointed out between the otoliths and the canals. This also applies to a weightless situation which does not involve a rotating vehicle. If the otolith effect is simply missing as you suggest, then the axis of rotation signaled by the canals during head movements is not in direct conflict with any specific information from the otoliths. In the rotation situations to which I referred in our experiments, head movements produced directional information from both the canals and the otoliths, and the directional information from these two sources was incompatible. However, we must also keep in mind that head movements during weightlessness do induce nausea in some individuals, as Billingham reported at the second symposium in 1966 (John Billingham: "Russian Experience of Problems on Vestibular Physiology Related to Space Environment," NASA SP-115, 1966, pp. 5-11).

Waite: Dr. Money, would you care to postulate a function for the somasomatic synaptic connections between the vestibular nuclei and the dorsal vagal nucleus which have been described variously over the past few years, especially by Malcolm Carpenter?

Money: No, I could not postulate a function; but, inasmuch as vagotomized dogs get sick as easily as most dogs, I do not think it is important for motion sickness.

Barber: Can you speculate, Dr. Money, as to a physiological or perhaps phylogenetic purpose for motion sickness? There may be one, since it occurs in so many orders of life. Secondly, can you reconcile your views of chemical stimulation of the chemoreceptive emetic trigger zone to variations in susceptibility to motion sickness?

Money: For whatever reason, there is individual variation in susceptibility. If it is a matter of direct neuronal mechanism or connection, there would be a variation of that kind, or a variation in the rate at which an emetic chemical is produced or destroyed. Why some individuals would have such a mechanism and others a different one, I have no idea. The basic philosophical notion of motion sickness is something I have given some thought to and have come up with nothing. There seems to be no survival value in vomiting in response to motion, and there is no survival value in becoming pale or sweating either. The only wild idea I had that was consistent with the fact is that it is just possible we had a sea-dwelling ancestor who did derive some survival value from a vomiting response to motion such as in shallow water or something like that; and we just inherited this, and it is therefore a vestigial mechanism. But that is just a speculation.

Whiteside: My question, perhaps rather a comment, is directed to Dr. Guedry in regard to the conflict situation which he refers to in the vestibular labyrinth itself. I would have thought that there were indications that the conflict would have to be between different modalities, because although you can produce a conflict in the visual sense alone, for example, by the waterfall illusion, that situation does not produce nausea, certainly not in me, and I think not in anyone else, nor does it produce any discomfort of any nature. I would have thought, therefore, that the internal intermodality concept was probably the better one.

Guedry: This is something that we will not settle today; but, certainly without any visual input and with simply a few head movements in darkness, you can make people pretty sick fairly quickly. I would argue, and this is nothing but an argument, that the vestibular system gives vectorlike information. We are given directional information as well as magnitude information. The canals seem to locate the angular velocity vector relative to the skull. Now, if the canals respond only to angular acceleration, as is generally believed, then the canals cannot possibly locate the axis of rotation relative to gravity, but the otolith system certainly could.

In the situations I described, the otolith system would indicate one axis of rotation relative to the skull, while the canals would indicate a different axis of rotation relative to the skull. The directions indicated would be incompatible. I do not want to say that is the only thing that produces motion sickness in all situations, but I think that an intralabyrinthine conflict of this kind may be a primary cause of motion sickness in the situation to which I referred.

Parker: Returning to the question of autonomic nervous system involvement in motion sickness, I would suggest that perhaps we can get at individual differences in susceptibility to motion sickness by studying the autonomic responses. Autonomic-response characteristics may indicate individual predispositions to respond to stress in general and to motion-sickness-inducing stimuli in particular. If this approach is valid, why have autonomic nervous system response measurements not given us any information previously? I think we are just beginning to get some understanding, through the work of people who identify themselves as psychophysicists, of some properties of the autonomic nervous system. I think we are seeing three or four concepts which might be valuable for investigating individual differences in motion sickness. These concepts include the autonomic balance which has been explored by Wenger. He has suggested some relation to motion sickness with this measure and has developed quite precise measuring techniques.

More interestingly, Lacey has developed a concept called response stereotypy; some people are very rigid in the manner in which they respond to various stresses, whereas other

people are quite random in the kinds of autonomic responses they give, even to the same stress.

Another concept might be autonomic precision. Here I refer to a sort of damping phenomenon. For example, you produce changes in heart rate as a function of exposure to a stress and, in some individuals, a great deal of rebound may be exhibited; i.e., they go from a high heart rate to well below their homeostatic level. We could suggest, perhaps, that individuals may be differentiated along a scale of precision. We could suggest that they may be differentiated along a scale of stereotypy. We could suggest that individuals may be differentiated along a scale of autonomic balance. By locating individuals within this hypothetical multifactor space, through appropriate testing, we might be able to predict some individual differences in motion sickness susceptibility.

Torok: Autonomic nervous responses to strong vestibular stimulation have been known for a long time. There is not much doubt that such reactions exist. As to the meaning, the reason, or the philosophy of these reactions, they may be considered to be alarm reactions to extreme stimulation or abuse. The parasympathetic system particularly is known to serve and function in such capacity in general physiology. Autonomic responses do not occur during physiological stimulation, but will be manifest only when the stimulation strength is above physiological level or when the receptors are abused. Such a totally unphysiological abuse occurs during motion sickness.

Dr. Money tries to prove that vomiting is not necessarily an autonomic nervous response in motion sickness. He speculates that it might be a direct vestibulomuscular response through intercostal nerve stimulations, for instance. Certainly, the intercostal musculature is involved along with the diaphragm and the abdominal muscles in vomiting, but these are rather secondary to the antiperistalsis which, in turn, is the autonomic effect elicited by vestibular abuse. This is not a unique phenomenon but rather the role of the autonomic nervous function in the entire general physiology.

Money: I disagree that the autonomic nervous system is important to the vomiting of motion sickness. Perhaps Dr. Borison can outline the evidence for this, but it is a matter of controversy whether there is any antiperistalsis whatever in vomiting. Certainly, vomiting occurs quite normally in animals essentially lacking the autonomic nervous system altogether. This is not to say that the autonomic nervous system cannot be used as a valuable index of something that is going on somewhere else in the body; but nevertheless, except in frogs and fishes, antiperistalsis is dispensable for vomiting and it is not the essential thing. The essential force for expulsion in mammals comes from the respiratory musculature and the abdominal-wall musculature. Perhaps we could submit this to Dr. Borison for mediation.

SESSION III

***Chairman:* THOMAS C. D. WHITESIDE
R.A.F. Institute of Aviation Medicine
Farnborough, England**

The Semicircular Canals as a Primary Etiological Factor in Motion Sickness¹

EARL F. MILLER II

AND

ASHTON GRAYBIEL

Naval Aerospace Medical Institute

SUMMARY

Data are presented which support the view that the semicircular canals can act as the essential factor for the production of motion sickness and the evocation of symptoms characteristic of this malady in the absence of "motion." Quantitative grading of acute symptoms demonstrated that motion sickness can be evoked by stimuli which are at once adequately provocative and unique for the canals. These results are compared with those of two provocative tests that introduce Coriolis forces and with one that generates a rotating linear acceleration vector when human subjects are exposed in rotating devices. Wide interindividual differences but only slight intraindividual differences among the six provocative test conditions are revealed. The pattern of symptoms manifested by the group of 10 subjects at the test endpoint, moderate malaise, is also similar among these tests.

The fact that typical symptoms of motion sickness (M IIA endpoint) were produced by bithermal irrigation as well as simple angular acceleration in several subjects representing a wide range of susceptibility adds to the evidence that the semicircular canals can act as the primary etiological factor in this malady.

INTRODUCTION

This report is intended to complement the preceding one by centering attention on the individual role of the semicircular canals in the etiology of motion sickness. The presentation falls into two main parts, the first demonstrating the essentiality of the canals and the second comparing susceptibility to symptoms characteristic of motion sickness in the same subjects when the canals only, the otoliths primarily, and when both organs of equilibrium are stimulated simultaneously.

Some evidence that the canals are the primary etiological factor in motion sickness has been

furnished by animal and human studies. Money and Friedberg (ref. 1) reported that confirmed inactivation of all six semicircular canals by plugging eliminates motion sickness in susceptible dogs, at least to the same extent as does bilateral labyrinthectomy of these animals. None of four patients treated for Ménière's disease with streptomycin sulfate experienced the nausea syndrome while carrying out the Dial test or during exercises to habituate them to the oculogyral illusion (ref. 2). The vestibulometric testing of these individuals revealed great suppression of semicircular canal function, but sparing of various amounts of otolith function. In two patients this was within normal range, although there was a probability that some loss of otolith function had nevertheless occurred. The history of motion sickness was not helpful; these patients had not experienced

¹This study was supported by Contract T-81633, Biomedical Research Office, Manned Spacecraft Center, and by Order R-93, Office of Advanced Research and Technology, NASA.

much motion sickness prior to the therapy, but, on the other hand, none had been exposed to very stressful force environments. Still the argument that motion sickness cannot occur without at least some residual function of the semicircular canals remains unchallenged.

Historically, several investigators have demonstrated, for the most part in an incidental manner, that specific stimulation of the canals by caloric irrigation and simple angular acceleration can evoke vegetative reactions in man. Schmiedekam and Hensen as early as 1868 (ref. 3) recorded that filling the external auditory canal with cold water produced dizziness, nausea, and vomiting, whereas water of near body temperature did not have this effect. Calorization has been employed by several investigators for determining motion sickness susceptibility (refs. 4 to 7).

Bárány (ref. 8) reported that his now classical clinical method of evoking nystagmus by rotating a patient 10 times in approximately 20 seconds, then suddenly stopping him, only infrequently provoked nausea. "Impulse" braking of lesser intensity used for example in certain cupulometric techniques can also evoke vegetative reactions (refs. 5 and 9), but this response would only be expected in individuals with fairly high susceptibility. Increasing the rate of angular acceleration, as was done in the present study, markedly increases the incidence of motion sickness and thus its adequacy as a test of susceptibility for general use. Rates within or above the range of this study have been employed in cupulometric studies but not repeatedly for the purpose of studying susceptibility. These observations illustrate that if a provocative type of motion is used as the stimulus, its effect in terms of motion-sickness production is dependent upon the strength of the forces involved, within definite limits and, of course, the level of the subject's susceptibility. The selection of an adequately provocative type of motion from among the wide variety available to the investigator who desires to develop a laboratory test of motion-sickness susceptibility is quite another matter. In most cases this process is either based upon information gained from "natural" environments or empiric data, since the major factor

is not the vestibular stimulus intensity but its pattern whose effectiveness is difficult to predict (ref. 10). For example, relatively small forces which, with a particular patterning may be well tolerated in one situation, with another, may be surprisingly provocative. Recently it has been shown that even ordinary head movements in near weightlessness can produce motion sickness (ref. 11).

Complex temporal and spatial patterns of vestibular stimulation can be generated by active or passive movement of the subject's head while he is being rotated at a constant velocity. This procedure has been shown by numerous investigators to be highly provocative, even at low rotational rates (refs. 12 to 15), but unlike the two general methods of canicular stimulation already described, it provides otolithic stimulation as well.

PROCEDURE

Subjects

The subjects used in the intertest comparisons were ten young Navy enlisted males, 19 or 20 years of age. Each had passed the standard medical examination required by the Navy Department and was in excellent health at the time of these tests. In addition, each manifested normal vestibular function as determined by specific tests of otolithic (refs. 16 and 17) and semicircular canal function (ref. 18). The additional subjects cited in this report have been described in other communications (preceding paper, this symposium, entitled "The Otolith Organs as a Primary Etiological Factor in Motion Sickness: With a Note on 'Off-Vertical' Rotation," by Graybiel and Miller; ref. 13; and Miller and Graybiel, unpublished data).

Methods

In each of the tests herein described, the vestibular stressor level was adjusted so that it was subjectively and objectively equivalent among all subjects as indicated by the common manifestation of a definitive level of moderate (M IIA) or severe (M III) malaise (ref. 19). The M IIA and M III endpoints as well as other diagnostic malaise levels were quantitatively determined by specific diagnostic criteria which

are outlined in table 1. This set of ground rules has placed the study of motion sickness in this laboratory on a highly workable, standardized, and quantitative basis. Moreover, it has permitted the reliable measurement of susceptibility using premonitory signs and symptoms without resorting to the classical pathognomonic endpoint of vomiting or retching. In fact, in this investigation as well as in others currently being conducted, M IIA, a condition in which even mild nausea is a rare occurrence, served successfully in defining susceptibility (E. F. Miller II and A. Graybiel, "Comparison of Five Levels of Motion Sickness Severity as the Basis for Grading Susceptibility," in preparation). A tally sheet (shown as an appendix) was used to score the specific signs and symptoms of motion sickness as they appeared in each test; this aid permits even an observer with minimal training to record the symptomatology, sum corresponding point values, and end the provocative stimulation upon reaching the desired criterion (ref. 13).

The order of testing varied among the subjects as listed in table 2; the time interval between tests of an individual was at least 24 hours. The first two methods to be described

were experimental probes; the others are used routinely in this laboratory.

Angular Acceleration Susceptibility (AAS) Test

The subject was rigidly fixed in an upright position with his head and neck held firmly by a fiberglass mold and centered approximately over the axis of rotation of a special motor-driven Bárány-type chair. The subject's eyes were open and uncovered. The test was initiated (time zero) by rapidly accelerating the chair within approximately 4 seconds (~90°/sec²) to a velocity of 30 or 60 rpm which was maintained until 150 seconds had elapsed. The choice of maximum chair velocity was dependent upon the subject's level of susceptibility. It was found that the more susceptible individuals could not sustain the initial acceleration to 60 rpm without manifesting very rapidly appearing and severe symptoms; these individuals were retested at 30 rpm (~45°/sec²) (table 2). Following the constant-velocity phase, the chair was decelerated to a stop within approximately 4 seconds. The chair remained stationary until the accumulative time totaled 300 seconds; this inactive phase was

TABLE 1.—*Diagnostic Categorization of Different Levels of Severity of Acute Motion Sickness*¹

Category	Pathognomonic, 16 points	Major, 8 points	Minor, 4 points	Minimal, 2 points	AQS, ² 1 point
Nausea syndrome	Vomiting or retching.	Nausea II, III ³ ..	Nausea I.....	Epigastric discomfort.	Epigastric awareness.
Skin.....		Pallor III.....	Pallor II.....	Pallor I.....	Flushing/subjective warmth ≥ II.
Cold sweating.....		III.....	II.....	I.....	
Increased salivation.....		III.....	II.....	I.....	
Drowsiness.....		III.....	II.....	I.....	
Pain.....					Headache ≥ II.
Central nervous system.....					Dizziness: Eyes closed, ≥ II. Eyes open, III.

Levels of Severity Identified by Total Points Scored

Frank sickness (S) ≥ 16 points	Severe malaise (M III) 8-15 points	Moderate malaise A (M IIA) 5-7 points	Moderate malaise B (M IIB) 3-4 points	Slight malaise (M I) 1-2 points
-----------------------------------	---------------------------------------	--	--	------------------------------------

¹ From ref. 19.

² Additional qualifying symptoms.

³ III, severe or marked; II, moderate; I, slight.

introduced to allow for any lag in the appearance or intensification of the diagnostic symptoms. The 300-second procedural cycle (acceleration, constant velocity; deceleration, static hold) was repeated up to 20 times or until the subject exhibited M IIA. If the test were terminated during a dynamic procedural phase, the chair was slowly decelerated ($0.5^\circ/\text{sec}^2$) to a stop. The accumulative test duration served as the index of susceptibility to motion which involved simple angular acceleration without any significant gravito-inertial force changes.

Concern has been expressed that rates near or above those provided by the Bárány method can damage the labyrinths (ref. 20). Arslan argued that such accelerations which can be greatly exceeded in ordinary head movements probably do not harm the cupula (ref. 21) and suggested the possibility of central adaptation in the decrease in the duration of nystagmus and sensation of rotation. There was no opportunity in the present study to test the after-effects, if any, of the multiple exposures to rapid angular acceleration in the AAS test which with the exception of one subject was the final one administered. Such a possibility should be

carefully explored before this method is employed routinely.

Bithermal Irrigation Susceptibility (BIS) Test

By strict definition, any test employing caloric irrigation does not, at least in any direct way, measure motion-sickness susceptibility since the subject remains stationary. However, cupular deflection is accomplished, and the effect in terms of subjective sensations and attendant symptoms closely resembles that which can be induced by accelerative forces.

A version of the Fitzgerald-Hallpike method (ref. 22) has been used as a provocative test. It has also been our experience that the stimulus conditions of this particular test are occasionally sufficient to elicit symptoms to the point of invalidating any subsequent test of susceptibility made on the same day. To increase its provocative effect for more subjects, we irrigated both ears simultaneously, one at the higher, the other at the lower temperature level. In this test the subject was seated upright in a stationary chair with his head firmly secured by straps and a head rest. He was instructed in the use of hand signals which the experimenter used to question

TABLE 2.—*Motion-Sickness Susceptibility as Measured by the 6 Experimental Conditions*

Subject	Angular acceleration		Bithermal irrigation, eyes open		Bithermal irrigation, eyes closed		Coriolis acceleration, rotating chair		Coriolis acceleration, slow rotation room		Off-vertical rotation		Test order
	Rank	Score, time/RPM, sec	Rank	Score, time, sec	Rank	Score, time, sec	Rank	Score, CSSI	Rank	Score, RPM/HM ¹	Rank	Score, time, sec	
SY.....	² 1	41/30	1	26	1	35	1	1.9	1	7.5/20	3	620	4-5-6-2-3-1
JE.....	2	240/30	6	156	2	89	7	9.0	9.5	20.0/40	1	325	4-5-6-2-3-1
JA.....	3	340/30 95/60	5	134	9	315	2	6.4	3	7.5/35	5	1280	5-4-6-2-3-1
HR.....	4	180/60	3	119	3	115	4	7.4	2	7.5/30	6	1755	5-4-2-6-3-1
HB.....	5	460/30 185/60	4	124	4	130	3	6.8	4	10.0/30	4	970	4-5-6-2-3-1
HE.....	6	187/60	8	180	6	200	8	9.4	7	15.0/30	7	1790	5-6-2-4-3-1
RO.....	7	374/60	9.5	360+	10	360+	5.5	8.2	5.5	10.0/50	2	550	4-5-6-1-3-2
HU.....	8	420/60	2	105	5	180	5.5	8.2	5.5	10.0/50	8	2075	5-6-4-2-3-1
DA.....	9	605/60	7	172	8	295	9.5	24.0	9.5	20.0/40	10	3720	4-5-6-3-2-1
DL.....	10	1080/60	9.5	360+	7	207	9.5	24.0	8	15.0/45	9	3675	4-5-6-3-2-1

¹ Head movements.

² Most susceptible.

the occurrence of specific diagnostic symptoms during the binaural irrigation. The test was initiated with the simultaneous introduction of a stream of warm water (44° C) into the right and cold water (30° C) into the left external auditory canal. A constant flow rate of 6 cc/sec into each ear was maintained until acute signs and symptoms indicated M IIA or an arbitrary time limit of 6 minutes was reached. The water temperature was maintained within $\pm 0.1^\circ$ C of the stated values. The procedure was varied by either having the subject's eyes closed (BIS E/C) or eyes open (BIS E/O), conditions which will also be described in the following text by eyes covered or eyes uncovered, respectively. The duration of the irrigation period in seconds served as a convenient index of motion-sickness susceptibility as measured by this method.

Coriolis Acceleration Susceptibility (CAS) Test

Chair

The experimental apparatus (Stille rotational chair) and procedure for a standardized and highly reliable laboratory test of susceptibility to Coriolis forces are diagrammed in figure 1 and described in detail in another report (ref. 13). It was found early in this test's developmental program that one rate of rotation could not be used to scale the wide range of individual differences in this susceptibility, and chair velocity had to be introduced as an additional parameter. The stressor effect of a standard head tilt as a function of chair velocity was measured in another study (Miller and Graybiel, unpublished data) by determining among several subjects the number of head tilts required to elicit a common malaise level (M IIA and M III) at each of several different chair velocities. Individually, the regularity of this function was limited to rotational rates above a critical amount. When the rpm was reduced below this amount, there was characteristically a sudden marked increase in the subject's capacity for making head movements without evoking symptoms, as would be predicted from the results of testing at higher velocities. These findings indicated the possible influence and the limits of physiological mechanisms for adjusting to motion stress which

are expressed as the individual's functional vestibular reserve (FVR) (ref. 23). One interpretation of the critical FVR value is that it represents a limit of an individual's ability to make homeostatic adjustments, perhaps in the form of inhibiting irradiation of vestibular activity to neural centers involved in the genesis of motion sickness. If the chair rpm were lower than indicated for the individual's FVR, neurovegetative symptoms apparently would not appear no matter how long this test were continued. The concept of FVR is of great practical significance in training and habituating astronauts for space flight (ref. 23), but in this and other tests of susceptibility it is important that the vestibular stressor level be in excess of the subject's FVR

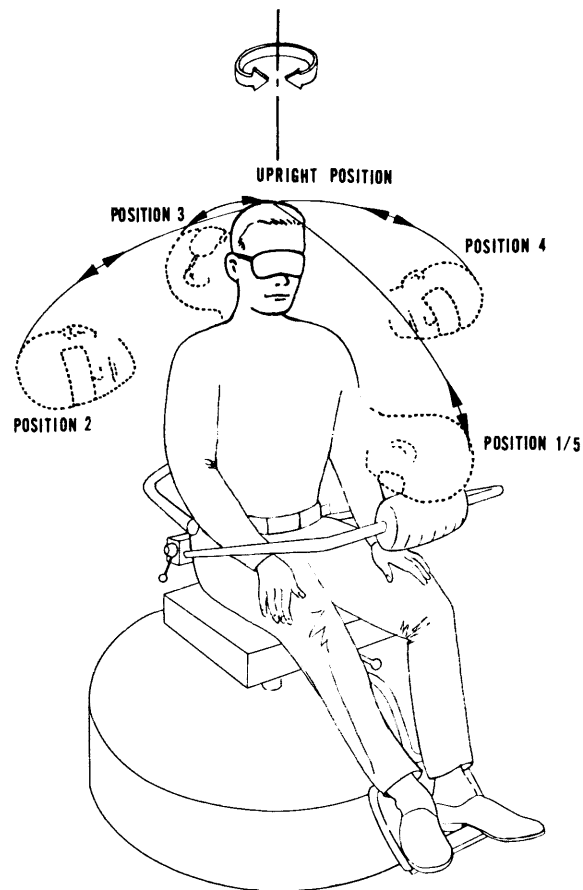

FIGURE 1.—Diagram of the standardized procedure for making each sequence of head movements to and from tilt positions 1 through 5 during clockwise and counterclockwise rotation of the chair.

in order to obtain a valid calibration of his susceptibility.

Attention was given in the design of this test to factors which reduce or, if possible, eliminate habituation. Moving the head in different directions for a limited number of times, covering the eyes, and if the test were repeated, reversing the direction of rotation (CW, CCW) were procedures introduced to increase the complexity of the stimulus, to decrease experiential factors and thereby reduce the subject's ability to habituate to the test conditions. Furthermore, a chair velocity which would stress the individual at a level above his functional vestibular reserve was carefully selected. These procedures probably contributed to its high test-retest reliability (refs. 11 and 13).

The subject was secured in the rotary chair and blindfolded. While stationary, he demonstrated the head-movement sequence. After the subject returned to an upright position, the chair was rotated clockwise or counterclockwise at an acceleration rate of $5^\circ/\text{sec}^2$ until one of the several programmed constant velocities (2.5, 5.0, 7.5, 10.0, 12.5, 15.0, 20.0, 25.0, 30.0 rpm) was reached. At no less than 60 seconds thereafter, the first head movement sequence was begun. Coriolis acceleration was then introduced by having the subject bend his neck and upper body as necessary to effect approximately 90° positive and negative movements of his head (and vestibular apparatus) from its upright position within the frontal and sagittal planes according to the following pattern: forward, upright, pause; rightward, upright, pause; backward, upright, pause; leftward, upright, pause; forward, upright, rest (fig. 1). Each of the movements to a new position or the return to upright was executed smoothly over a 1-second period. A taped recording directed and standardized the temporal sequence of head movements.

The pauses between movements were of the same (1-second) duration with the final pause (rest) lasting for 20 seconds. The rest duration was found to be short enough so that any appreciable recovery from previous stimulation did not occur. On the other hand, it was sufficiently long to query the subject fully and to observe closely for signs of malaise appearing on his face

as well as to allow for the lag in the appearance of motion-sickness symptoms after each exposure to the head movement sequence. Immediately upon reaching the M IIA level the head movements were terminated, the subject returned to his upright position, and the chair was slowly decelerated ($0.5^\circ/\text{sec}^2$) to a stop.

The level of motion stress imposed upon each subject had to be such that his symptoms would develop rather gradually in order that the observer could readily differentiate and sequentially register them; furthermore, it was of great practical importance to avoid overstimulating the subject to the point of extreme nausea or vomiting (frank sickness). For this reason, the "motion experience questionnaire" was developed as a guide for selecting the proper chair rotational rate for testing each subject (ref. 13). Table 3 lists the best estimate of the chair's rotational test rate (rpm) which we so far have been able to gain from the average level of experience X and intensity of symptoms S which the subject reports in this questionnaire. The table's usefulness is demonstrated by the fact that, in approximately 4 out of 5 cases among 250 subjects, it predicted an rpm which yielded the malaise criterion within the limits of 40 to 166 head movements on the first trial (ref. 13). Only one additional test was usually necessary to calibrate those individuals who were tested with an incorrect rotational rate.

It is our experience that when M IIA or M III occurs within a limited range of head movements (ref. 13), the signs and symptoms develop regularly and gradually without exceeding the chosen criterion level. If the number of head movements required falls outside this range, the test is considered invalid, and the subject is retested after at least 48 hours have elapsed, with the rpm adjusted in accordance with his initial response. If the M IIA criterion is not reached at this limit of 150 head movements when 30 rpm is used, the test is stopped and the results used as evidence that the individual was essentially immune to motion sickness.

With regard to the physical forces present, the amount of Coriolis stimulation with the set pattern of head movements was found to vary directly with the rotational rate of the chair (Miller and Graybiel, unpublished data). The average

TABLE 3.—Table of Rotary Chair Test Velocities Found To Be Most Often Associated With the Various Average Coded Experience X and Symptoms S Levels Reported in the Motion Experience Questionnaire

M III	Symptoms S										
	0.0	0.5	1.0	1.5	2.0	2.5	3.0	3.5	4.0	4.5	5.0
Experience X:											
0.5.....	10.0	10.0	10.0	10.0	10.0	10.0	10.0	7.5	5.0	5.0	5.0
1.0.....	12.5	12.5	10.0	10.0	10.0	10.0	10.0	7.5	5.0	5.0	5.0
1.5.....	12.5	12.5	12.5	10.0	10.0	10.0	10.0	7.5	7.5	5.0	5.0
2.0.....	12.5	12.5	12.5	12.5	12.5	10.0	10.0	10.0	7.5	5.0	5.0
2.5.....	12.5	12.5	12.5	12.5	12.5	12.5	12.5	10.0	7.5	5.0	5.0
3.0.....	15.0	15.0	12.5	12.5	12.5	12.5	12.5	12.5	10.0	7.5	7.5
3.5.....	20.0	15.0	15.0	15.0	12.5	12.5	12.5	12.5	10.0	7.5	7.5
4.0.....	25.0	20.0	15.0	15.0	15.0	15.0	12.5	12.5	10.0	7.5	7.5
4.5.....	30.0	25.0	20.0	20.0	20.0	15.0	15.0	12.5	10.0	7.5	7.5
5.0.....	30.0	30.0	25.0	25.0	25.0	20.0	15.0	12.5	10.0	7.5	7.5

¹ Rotary chair velocity (rpm).

stressor effect (*E*-factor) of a single head movement which was determined for each of the test velocities and malaise criteria (IIA and III) is presented in table 4 (Miller and Graybiel, unpublished data). With these values a measure of each individual's susceptibility, referred to as his Coriolis Sickness Susceptibility Index or CSSI, is simply calculated by multiplying the appropriate *E*-factor associated with the chair's test velocity and malaise criterion by the number of head movements *N* required to elicit the selected malaise criterion:

$$CSSI = E \times N$$

Slow Rotation Room

The dial test conducted on the Pensacola Slow Rotation Room (SRR) has been described elsewhere (ref. 14). Essentially, it involves dials which are positioned around the subject such that he is forced to make head movements, which are out of the plane of the slowly rotating room, when resetting these dials according to taped instructions. Twenty sequences of five head movements are made in a single successive series of trials at 5.0, 7.5, 10.0, 15.0, 20.0 rpm or until M III develops. Unlike the other tests, the patterning and progressive buildup of symptoms up to this endpoint were not recorded and therefore could not be compared. The test results are expressed in terms of the number of head movements executed at the rpm level which produced M III.

TABLE 4.—Average Stressor Effect (*E*-Factor) of a Single Head Movement for Each of the Test Velocities and Malaise IIA and III Criteria

Test velocity, rpm	M IIA ¹	M III ²
30.0.....	0.67	0.60
25.0.....	.48	.43
20.0.....	.33	.28
15.0.....	.205	.165
12.5.....	.150	.118
10.0.....	.105	.078
7.5.....	.064	.046
5.0.....	.032	.021
2.5.....	.010	.006
1.0.....	.002	.001

¹ 150 head movements at 30 rpm = 100.0.

² 166 head movements at 30 rpm = 100.0.

Off-Vertical Rotation (OVR) Susceptibility Test

This method was described in the preceding report (this symposium, Graybiel and Miller). The subject sat upright in a Stille rotary chair and his eyes were covered with a padded shield. The chair was tilted so that its rotational axis was displaced 10 degrees from the gravitational vertical (fig. 2), then accelerated slowly (0.5°/sec²) for 30 seconds to reach and maintain for a period of 6 minutes the constant velocity of 2.5 rpm. Continuing from this velocity level, the same sequence of slow acceleration, followed by 6 minutes of constant velocity, was repeated in

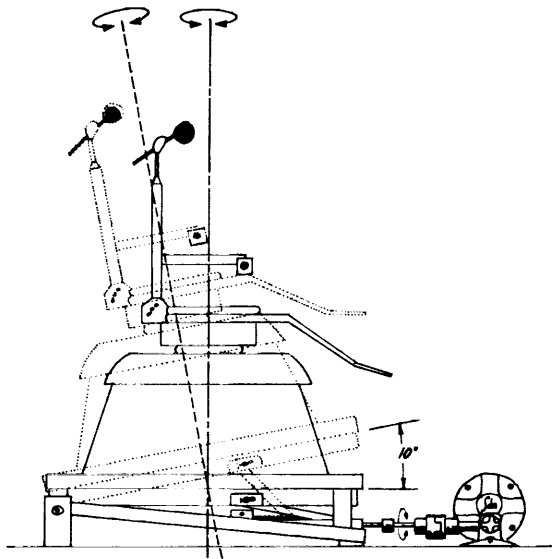

FIGURE 2.—Diagram of apparatus used in the off-vertical rotation test.

succession for levels of 5.0, 7.5, 10.0, 12.5, 15.0, 17.5, 20.0, 22.5, and 25.0 rpm. With the onset of M IIA the chair was quickly returned to its upright position, which ended all provocative stimulation, and then the rotation was slowly ($0.5^\circ/\text{sec}^2$) halted.

RESULTS AND DISCUSSION

The results are summarized in table 2 which lists each subject's score expressed in terms of magnitude of the stimulus and duration of its application and corresponding rank order of motion-sickness susceptibility as determined with each of the test procedures. As indicated in the table, the vestibular stimuli associated with each test were adequate to provoke M IIA (M III, for the dial test) in all subjects except RO and DI with eyes covered, and RO with eyes open during the bithermal irrigation test.

Intratest Subject Differences

All tests yielded a wide range of scores indicating that susceptibility varied considerably among the subjects. For example, susceptibility as measured by the angular acceleration test ranged from 41 seconds at 30 rpm to 1080 seconds at 60 rpm. All of the subjects tested at 30 rpm

ranked below those tested at 60 rpm, since the effective stimulus ratio as indicated by the dual test results of two subjects (table 2) greatly exceeded the 2:1 ratio based upon chair velocities.

In the bithermal irrigation tests, subject RO experienced only mild symptoms with 6 minutes of irrigation, whereas subject SY developed M IIA after only 26 seconds of irrigation; the rapid development and continuation in the build-up of his symptoms after M IIA was reached and irrigation stopped required several trials each on a separate day in which the duration of irrigation was progressively reduced in order to determine this threshold. The substantial lag between the caloric stimulus and the manifestation of symptoms was also revealed but to a lesser extent in the other subjects. As a result, the endpoint could not always be properly controlled and often exceeded the M IIA level, sometimes reaching severe malaise (M III). For this reason, the test protocol has been changed for future studies to include pauses in the irrigation throughout the test.

Susceptibility to Coriolis forces generated by active head movements in a rotating chair covered a wide range from what could be described as high (CSSI=1.9) to moderate (CSSI=24.0). This gross classification on an arbitrary scale of 0 to 100 is based upon data of a previous study (ref. 13) (fig. 3) which revealed marked skewness toward the high score (low susceptibility) end of the frequency distribution of Coriolis sickness susceptibility among 250 subjects. This graphic representation, the first to be expressed quantitatively on a single scale of values, indicates that the distribution of motion-sickness susceptibility is not Gaussian as has been suggested (ref. 24).

Under the dial test conditions, development of M III was well distributed throughout the range of scores from 20 head movements at 7.5 rpm (subject SY) to 40 head movements at 20 rpm (subjects JE, DA).

Susceptibility to simple rotation around an off-vertical axis varied about tenfold in terms of duration of exposure and terminal velocity level; viz, from 325 seconds, 2.5 rpm (subject JE) to 3720 seconds, 25 rpm (subject DA).

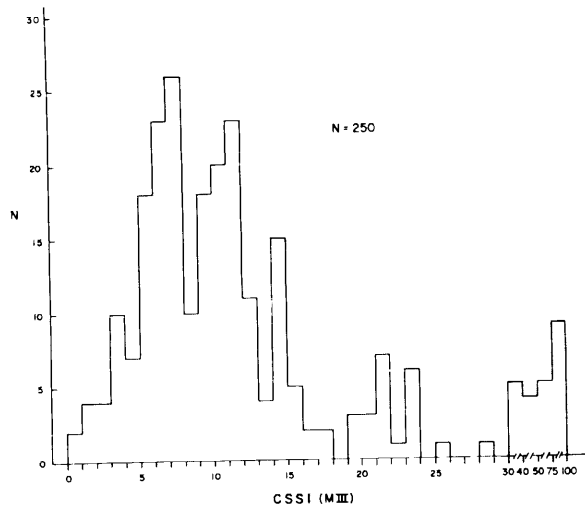

FIGURE 3.—Distribution of Coriolis sickness susceptibility index (CSSI) among 250 normal subjects.

Intertest Subject Differences

In addition to intratest individual differences, certain subjects did not always maintain their rank order among the several test conditions. Since the test sequence varied among subjects and each test was administered only once, no importance can be attached to small intraindividual differences in scores or rank order. However, some differences are so substantial that it must be considered that susceptibility may vary as a function of the type of vestibular stimulus and this variance in turn may be highly individualistic. For example, subject JE, who revealed high susceptibility to angular acceleration and off-vertical rotation, was relatively unsusceptible to Coriolis

forces encountered in the slow rotation room as well as in the rotating chair. The most apparent difference between the conditions of these two types of tests was the active or passive movements of the head in space which in this individual could have been the significant factor. Another example, subject RO, the least susceptible to bithermal bilabyrinthine calorization, ranked second in susceptibility to off-vertical rotation.

As a general rule, however, susceptibility to the various provocative tests followed a more or less regular order. The extent of this orderliness is expressed in the correlations among susceptibility rankings for the six provocative test conditions as presented in table 5. All correlations were positive in sign and substantial in amount; the highest ($\rho = 0.93$) was found between Coriolis susceptibility as measured by the rotating chair and the rotating room methods. This finding can be explained by the fact that the Coriolis forces used as the stimulus in these two situations were quite similar. Differences in the two procedures which were principally vision versus no vision, on-axis versus off-axis rotation evidently did not differentially affect the subjects' relative susceptibility. The high correlation indicates that the standardized rotating chair test (ref. 13) can be used as a valid substitute for the dial test when a centrifuge is not available. Furthermore, the data collected with the dial test (refs. 14 and 25) can serve as background for the new test.

The next highest correlation (0.75) existed between susceptibility as measured by bithermal

TABLE 5.—Correlations Among Susceptibility as Ranked by Several Tests of Motion Sickness

	Upright angular acceleration without head movements, eyes closed (AAS)	Upright bithermal irrigation, eyes closed, no movement (BIS E/C)	Upright bithermal irrigation, eyes open, no movement (BIS E/O)	Upright constant on-axis rotation with active head movements, eyes closed (CAS, chair)	Upright constant off-axis rotation with active head movements, eyes open (CAS, SRR)	Tilted off-vertical rotation, passive head movements, eyes closed (OVR)
AAS.....		0.60	0.57	0.71	0.56	0.75
BIS E/C.....			.69	.33	.31	.32
BIS E/O.....				.75	.74	.19
CAS, chair.....					.93	.55
CAS, SRR.....						.35
OVR.....						

irrigation (eyes open) and that measured with Coriolis force environments of the dial and rotary chair tests. Correlations between each of the Coriolis acceleration tests and the bithermal irrigation test dropped markedly ($\rho=0.31$ and 0.33) when the eyes were covered during irrigations, reflecting to a great extent the rank order difference of subject JA as already described.

An equally high correlation was found between angular acceleration and off-vertical rotation susceptibility measurements, while the latter correlated the least (0.19) with the bithermal irrigation test (eyes open) data. One significant difference which exists among these tests and bithermal irrigation tests probably lies in the presence or absence of motion which is also perceived by nonlabyrinthine receptors, a secondary factor in motion sickness. This might also explain the finding of only moderate (0.57 and 0.60) correlations between the two "pure" tests of susceptibility to semicircular canal stimulation. It must also be considered that the calorization technique stimulated mainly the vertical, whereas the angular acceleration stimulated mainly the lateral canals which may have had a differential influence upon susceptibility. The moderately high correlation between the eyes covered and uncovered conditions of the bithermal irrigation test indicates that visual cues generally had no appreciable effect upon the susceptibility of most subjects, but there were exceptions. A greater effect from irrigation was found with vision for subject JA and without for subjects JE and DI. Subject DI who experienced only mild dizziness during the 6 minutes of irrigation when he observed the laboratory environment, on the other hand, spontaneously noted and complained of the great increase in sensations and symptoms without vision, and he developed M IIA after 207 seconds. Subject JA, who ranked fifth in susceptibility with visual stimuli present, sustained greater than twice the duration of irrigation and ranked ninth without this influence. These results suggest that visual stimuli may in certain individuals tend either to suppress (ref. 15) or facilitate the effects of vestibular activity and indicate the complexity and variability in processing multiple sensory inputs. Since the subject's head was rigidly fixed in these studies, vision would ap-

pear to be a secondary but significant factor in motion sickness whose influence goes considerably beyond any aid it may provide for immobilization of the head in situations in which it is not restrained (ref. 26).

The substantial correlations found among all the various provocative tests of this study indicate that generally individuals possess an overall susceptibility to motion sickness which is relatively independent of the type of motion. However, it is well known and shown in this study that susceptibility measured in one motion environment may not always be a valid predictor of susceptibility in another (refs. 14 and 25). Other factors, including otolithic contributions which have been dramatically demonstrated when the normal g -load is counteracted (ref. 11), may markedly influence susceptibility.

The general agreement, but occasional wide discrepancy, between susceptibility to different motion environments is exemplified in the results shown in figure 4 which were obtained from a larger population tested by the Coriolis (rotary chair) and the off-vertical rotation methods. These two sets of data collected on 35 of 66 nor-

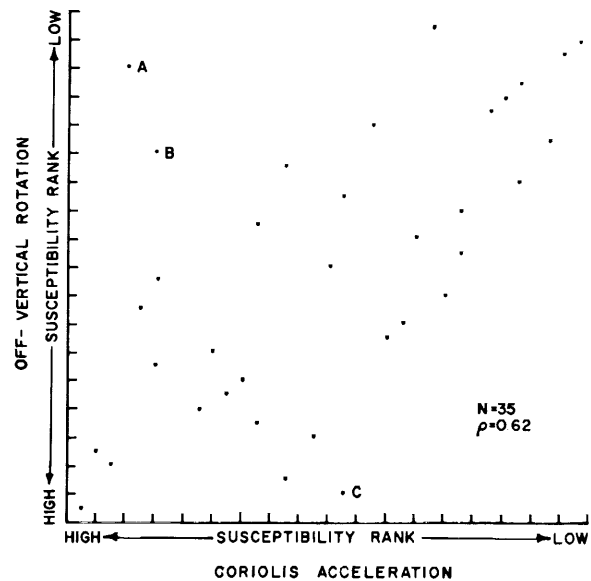

FIGURE 4.—Scattergram of 35 normal subjects showing the relationship between motion-sickness-susceptibility test by the Coriolis (rotary chair) and off-vertical rotation tests.

mal subjects, described in the preceding study (this symposium, Graybiel and Miller), correlate highly and at a level comparable to that reported for the smaller group of subjects of this study (table 5). Most cases fall at or near the regression line but there are notable exceptions, particularly those individuals denoted by letters A, B, and C in figure 4. In this small percentage of subjects, the factor of active or passive movement of the vestibular organs might have been influential, but the relative amounts of stimulation of the canals and otoliths in the two test situations must also be considered. In most cases, however, the two methods of measuring susceptibility yield quite similar results.

Symptomatology

The subjects' MIA symptomatological patterning found for the angular acceleration, Coriolis acceleration, the two bithermal irrigations, and off-vertical rotation conditions is summarized in figure 5. The patterning among these tests was similar with respect to frequency of incidence and grouping of symptoms, but some significant differences were revealed. Pallor and epigastric awareness or discomfort were the most significant symptoms for all provocative tests. Headache II, III, and nausea I were manifested infrequently at this endpoint level. Drowsiness I occurred most frequently (3 of the 10 subjects) during off-vertical

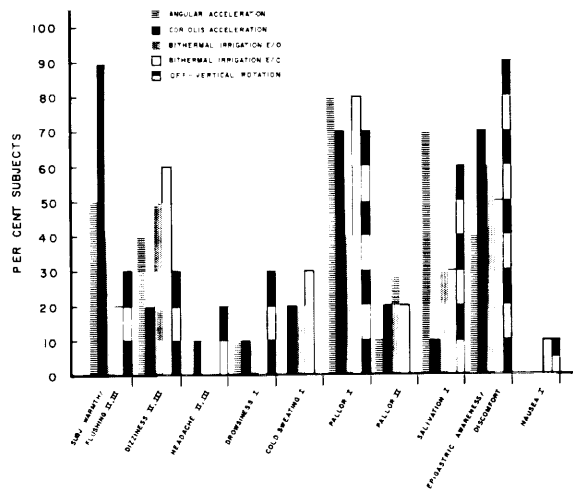

FIGURE 5.—Frequency of specific diagnostic symptoms manifested for each test condition.

rotation. Increased subjective warmth was experienced more frequently in the Coriolis test which required active head and body movements and thereby may have contributed to the manifestation of this symptom; this test provoked increased salivation in only one subject. Cold sweating was conspicuously absent in the off-vertical rotation and the angular acceleration tests which, on the other hand, featured increased salivation. Caloric irrigation elicited moderate to severe dizziness in about one-half the subjects. The similarities among the group's symptomatological patterns would be an indication that similar physiological mechanisms were involved. Comparison of symptomatology manifested by the group of 35 subjects during passive off-vertical rotation and active head movements with vertical rotation revealed that with the exception of the difference in subjective warmth, again influenced by exercise, no distinct differences were found (fig. 6).

With respect to rate of buildup of symptoms, there was a clear-cut difference between the off-vertical rotation and the Coriolis acceleration test which probably stems from a procedural difference. When the standardized test of susceptibility for Coriolis acceleration is properly

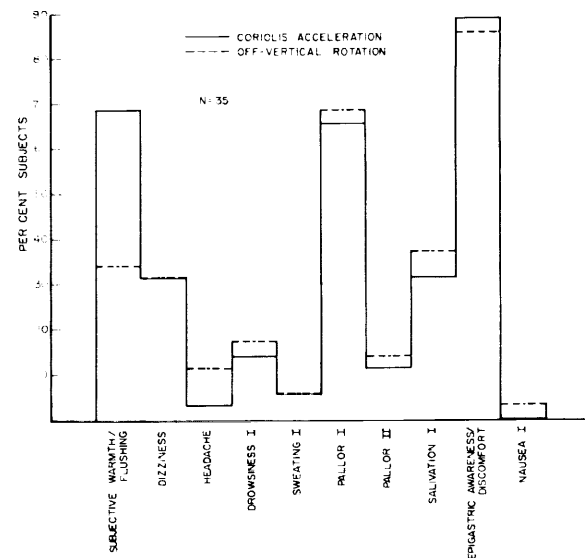

FIGURE 6.—Comparison of frequency of specific diagnostic symptoms manifested during off-vertical (10°) and vertical (with active head movements) rotations.

conducted, symptoms slowly appear and increase in intensity from M I up to the endpoint (fig. 7); whereas, in the case of off-vertical rotation they can appear suddenly and wax rapidly, passing through several malaise levels within several seconds' time (fig. 6, preceding paper this symposium, Graybiel and Miller). Much greater care and closer observation are therefore required in administering this test in order to avoid overshooting the selected malaise criterion. It is probable that exposure to longer durations at a velocity below the terminal one would be sufficiently provocative yet yield a slower symptom buildup pattern.

Among 250 subjects of a previous study (ref. 13), nausea I, epigastric discomfort, or epigastric awareness was the predominant feature of severe malaise (M III). However, a significant proportion of this test population (9.6 percent) failed to manifest even the mildest form of this syndrome at this malaise level. This finding is not in alignment with the classical viewpoint which, for the most part, equates motion sickness with a gastrointestinal reaction marked by nausea or vomiting, symptoms which have represented the endpoint in the vast majority of studies dealing with this topic and are still regarded by some investigators as the only ones having reliability (ref. 24). If M III as diagnosed by a nonnausea symptom complex is equivalent, in terms of the subject's well-being, his psychomotor efficiency, or some other indicator, to that involving the nausea syndrome, then the restricted "nausea syndrome" criterion of motion sickness must be reevaluated. In many of the cases in which the endpoint was reached without the nausea syndrome, the symptoms were for the most part effectively localized in the head region; e.g., moderate or severe levels of drowsiness to the point of being unable to follow instructions, headache, facial pallor, severe dizziness, and increased salivation. It is possible if not probable that if the motion stress had been continued, the nausea syndrome would have eventually appeared in most of these subjects. In any case it is questionable that the manifestation of the nausea syndrome is required for predicting susceptibility to frank motion sickness. As described in the methods section, the average relative stimulus effect of a single

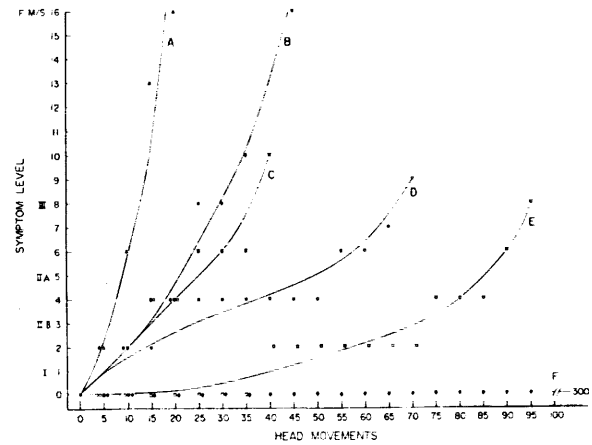

FIGURE 7.—Variations among six selected cases (subjects A through F) in the buildup rate of Coriolis-sickness symptoms.

head movement in the Coriolis acceleration (rotary chair) test could be expressed by the factor E , which directly related in logarithmic terms to chair velocity (table 4). It appears, therefore, when vestibular stressor conditions are appropriate, each head movement may act to release autonomic effects on an incremental and accumulative basis through a neural or humoral mechanism. The latter is suggested in the report of Wang and Chinn that insertion of plastic barriers in the fourth ventricle of several dogs removed their susceptibility even though their emetic thresholds to apomorphine were not raised (ref. 27). In any case the rate of release seems dependent on the stressor "step-size" taken with each head movement at a specific chair velocity. Six cases from a 250-subject group (A, B, C, D, E, F, fig. 7) illustrate the different rates in the buildup of symptoms. The ideal pattern of response is illustrated by cases D and E. As a rule, when a subject experienced M IIA and M III with only a few head movements (cases A, B, C) it was found extremely difficult if not impossible at times to prevent a skyrocketing of his symptoms up to the level of frank sickness (FS) as illustrated by cases A and B. These two cases show the typical response when the rpm is too high relative to their susceptibility level. If, on the other hand, the rpm selected is too low for the individual, head movements can be continued beyond a practical number

without any apparent effect, such as in case F in figure 7. In another case, not represented in the figure, in which the subject was rotated below his critical rpm value, 900 head movements were executed without provoking any increase in symptoms beyond that found in the initial head movements. In fact, there was a lessening and disappearance of his symptoms as the test progressed. However, when each of these subjects was retested at a properly adjusted rpm, the "normal" pattern of response (such as cases D and E) resulted.

In these studies the intensity and duration of the vestibular stimulus were individually con-

trolled so as to provide an equivalent stressor stimulus in terms of the response of each subject under each test condition as diagnosed by specific criteria (ref. 19). The physical dimensions of the stimulus therefore varied with the individual but in most cases they were small, approaching what commonly is regarded as physiological proportions, yet they proved highly effective in provoking motion sickness. As expressed by Lansberg (ref. 28), the opinion advanced by certain investigators (refs. 29 to 32) that motion sickness is simply the result of overstimulation of the otolith organs is untenable.

APPENDIX

Symptom level	Pt. val.	Principal symptoms								RPM	CW	CCW
		TMP ₁	DIZ ₂	HAC ₃	DRS ₄	SWT ₅	PAL ₆	SAL(+) ₇	NSA ₈			
Major	8				III	III	III	III	II, III			
Minor	4				II	II	II	II	I	I, II, III	II	III
Minimal	2				I	I	I	I	E.D. ₉			
AQS	1	II, III	II, III	II, III					E.A. ₁₀	Other sym.	HM ₁₁	
												5
												10
												15
												20
												25
												30
												35
												40
												45
												50
												55
												60
												65
												70
												75
												80
												85
												90
												95
												100

- 1. Subjective warmth
- 2. Dizziness
- 3. Headache
- 4. Drowsiness

- 5. Cold sweating
- 6. Pallor
- 7. Salivation increase
- 8. Nausea

- 9. Epigastric discomfort
- 10. Epigastric awareness
- 11. Head movements

REFERENCES

1. MONEY, K. E.; AND FRIEDBERG, J.: The Role of the Semicircular Canals in Causation of Motion Sickness and Nystagmus in the Dog. *Canad. J. Physiol. Pharmacol.*, vol. 42, 1964, pp. 793-801.
2. GRAYBIEL, A.; SCHUKNECHT, H. F.; FREGLY, A. R.; MILLER, E. F., II; AND MCLEOD, M. E.: Streptomycin in Ménière's Disease. Long Term Follow-up. *Arch. Otolaryngol.*, vol. 85, 1967, pp. 155-170.
3. SCHMIEDEKAM, D.; AND HENSEN, G. P.: Arbeiten des Kieler physiol. Institutes (Investigations of the Physiologic Institute of Kiel), 1868, pp. 48-49.
4. LIDVALL, H. F.: Mechanisms of Motion Sickness as Reflected in the Vertigo and Nystagmus Responses to Repeated Caloric Stimuli. *Acta Oto-Laryngol.*, vol. 55, 1962, pp. 527-536.
5. PREBER, L.: Vegetative Reactions in Caloric and Rotatory Tests. *Acta Oto-Laryngol.*, suppl. 144, 1958, pp. 1-119.
6. BEHR, K.; PREBER, L.; AND SILFVERSKIOLD, B. P.: Recording of the Skin Resistance in Thermal and Rotatory Stimulation of the Labyrinth. *Acta Psychiat. Neurol. Scand.*, vol. 30, 1955, pp. 741-748.
7. FISHER, L.: Seasickness and Internal Ear Stimulation. *New York J. Med.*, vol. 106, 1917, pp. 542-546.
8. BÁRÁNY, R.: Physiologie und Pathologie des Bogengangapparates beim Menschen. *Klin. Studien, Deuticke*, 1907, pp. 1-76.
9. KRIJGER, M. W. W.: De Betekenis van het evenwichtsorgaan voor de vlieger. *Diss., Utrecht*, 1954.
10. WENDT, G. R.: Vestibular Functions. *Handbook of Experimental Psychology*, S. S. Stevens, ed., John Wiley & Sons, 1965, pp. 1191-1223.
11. MILLER, E. F., II; GRAYBIEL, A.; KELLOGG, R. S.; AND O'DONNELL, R. D.: Motion Sickness Susceptibility under Weightless and Hypergravity Conditions Generated by Parabolic Flight. *Aerospace Med.*, vol. 40, 1969, pp. 862-868.
12. HARRIS, C. S.; AMBLER, R. K.; AND GUEDRY, F. E., JR.: A Brief Vestibular Disorientation Test. Report NSAM-856, Naval School of Aviation Medicine, Pensacola, Fla., 1963.
13. MILLER, E. F., II; AND GRAYBIEL, A.: A Simple Laboratory Means of Determining Susceptibility to Coriolis (Motion) Sickness. Report NAMI-1058, NASA T-81633, Naval Aerospace Medical Institute, Pensacola, Fla., 1969.
14. KENNEDY, R. S.; AND GRAYBIEL, A.: The Dial Test: A Standardized Procedure for the Experimental Production of Canal Sickness Symptomatology in a Rotating Environment. Report NSAM-930, Naval School of Aviation Medicine, Pensacola, Fla., 1965.
15. SPIEGEL, E. A.; OPPENHEIMER, M. J.; HENNY, G. C.; AND WYCIS, H. T.: Experimental Production of Motion Sickness. *War Med.*, vol. 6, 1944, pp. 283-290.
16. MILLER, E. F., II: Counterrolling of the Human Eyes Produced by Head Tilt With Respect to Gravity. *Acta Oto-Laryngol.*, vol. 54, 1961, pp. 479-501.
17. MILLER, E. F., II: Ocular Counterrolling. *The Vestibular System and Its Diseases*, R. J. Wolfson, ed., University of Pennsylvania Press, 1966, pp. 229-241.
18. MCLEOD, M. E.; AND MEEK, J. C.: A Threshold Caloric Test: Results in Normal Subjects. Report NSAM-834, Naval School of Aviation Medicine, Pensacola, Fla., 1962.
19. GRAYBIEL, A.; WOOD, C. D.; MILLER, E. F., II; AND CRAMER, D. B.: Diagnostic Criteria for Grading the Severity of Acute Motion Sickness. *Aerospace Med.*, vol. 39, 1968, pp. 453-455.
20. JONGKEES, L. B. W.: The Examination of the Vestibular Organ. *Sensory Mechanisms*, Y. Zotterman, ed., Elsevier, New York, 1967.
21. ARSLAN, M.: On the Renewing of the Methodology for the Stimulation of the Vestibular Apparatus. *Acta Oto-Laryngol.*, suppl. 122, 1955, pp. 1-97.
22. FITZGERALD, C.; AND HALLPIKE, C. S.: Studies in Human Vestibular Function: I. Observations on the Directional Preponderance ("Nystagmusbereitschaft") of Caloric Nystagmus, Resulting From Cerebral Lesions. *Brain*, vol. 65, 1942, pp. 115-131.
23. GRAYBIEL, A.: Vestibular Problems in Prolonged Manned Spaceflight. Presented to the Bárány Society Vestibular Symposium, Uppsala, Sweden, May 29-31, 1968.
24. BRAND, J. J.; AND PERRY, W. L. M.: Drugs Used in Motion Sickness. A Critical Review of the Methods Available for the Study of Drugs of Potential Value in Its Treatment and of the Information Which Has Been Derived by These Methods. *Pharmacol. Rev.*, vol. 18, 1966, pp. 895-924.
25. KENNEDY, R. S.; AND GRAYBIEL, A.: Validity of Tests of Canal Sickness in Predicting Susceptibility to Airsickness and Seasickness. *Aerospace Med.*, vol. 33, 1962, pp. 935-938.
26. JOHNSON, W. H.; AND TAYLOR, N. B. G.: Some Experiments on the Relative Effectiveness of Various Types of Accelerations on Motion Sickness. *Aerospace Med.*, vol. 32, 1961, pp. 205-208.
27. WANG, S. C.; AND CHINN, H. I.: Experimental Motion Sickness in Dogs. Importance of Labyrinth and Vestibular Cerebellum. *Am. J. Physiol.*, vol. 185, 1956, pp. 617-623.
28. LANSBERG, M. P.: Canal-Sickness—Fact or Fiction. *Rev. Med. Aeron.*, vol. 2, 1961, pp. 173-178.
29. QUIX, F. H.: Le Mal de Mer, le Mal des Aviateurs. *Monographies Oto-Rhino-Laryngol. Internat.* No. 8, Amédée Legrand, Paris.
30. VAN EGMOND, A. A. J.; GROEN, J. J.; AND DE WIT, G.: The Selection of Motion-Sickness-Susceptible Individuals. *Internat. Record Med.*, vol. 167, 1954, pp. 651-660.
31. NIEUWENHUYSEN, J. H.: Experimental Investigations on Sea-Sickness. Thesis, Utrecht, 1958.
32. DE WIT, G.: Sea-Sickness. *Acta Oto-Laryngol.*, suppl. 108, 1953, pp. 1-56.

Secondary Etiological Factors in the Causation of Motion Sickness

WALTER H. JOHNSON

University of Toronto

SUMMARY

It is well known that there are great variations in susceptibility to motion sickness; however, much remains to be determined as to the physiologic and psychologic reasons for such differences. Although individual differences in sensitivity of the nonauditory labyrinth undoubtedly constitute the primary factor involved, extralabyrinthine influences constitute secondary etiologic factors of importance under certain circumstances. Vision, cerebral activity, olfaction, food, ambient air temperature, sexual differences, age, and chemical toxicity including alcohol, illness, and adaptation are discussed in relation to their influence on motion-sickness susceptibility.

INTRODUCTION

As stated by Tyler and Bard (ref. 1), "Motion sickness is a specific disorder which is evoked in susceptible individuals and animals when they are subjected to movements which have certain characteristics."

Although it is well known that there are great variations among individuals in susceptibility to motion sickness, little is known as to the physiologic and psychologic reasons for such differences. As Tyler and Bard again so aptly concluded, "By way of summary about all that can be said is that susceptibility appears to depend on a rather specific constitutional capacity to respond to certain patterns of vestibular stimulation and thus it can be modified to some extent by several extralabyrinthine influences."

This last statement was made in 1949, and today, 19 years later, there still remains a dearth of knowledge as to just what these extralabyrinthine factors are, and this is largely because of lack of significant controlled documentation. When discussing the basic cause of variations in motion-sickness susceptibility under different conditions, it becomes difficult to separate the primary from secondary influencing factors, and the distinction between the two is hard to define.

VISION

A number of authors have attributed motion sickness to conflicting central effects brought on by conflicting visual, vestibular, and kinesthetic impressions. Sjöberg (ref. 2) noted that susceptibility to motion sickness is diminished when the eyes are closed. According to Desnoes (ref. 3), persons watching foam-crested waves or currents in the ship's wake are more likely to become seasick, vision here being considered only as a contributing factor.

The "witch's house," sometimes seen in amusement parks in which the walls and floor move independently of each other, results in confusion as to orientation in space (ref. 4); that is, there are conflicting impressions between one's field of vision and the remaining equilibrium senses, with resulting nausea and vomiting. Such conflict, it is said, can also produce nausea without movement of the subject (e.g., when a darkened floor is slanted but the visible walls are set normally).

It is a common experience among viewers of wide-screen motion pictures to experience nausea. This is especially effective when highly realistic sequences, such as bobsled runs and flight by low flying aircraft, are viewed. Similar ef-

fects have been reported in theater presentations of ships at sea (ref. 5).

A most interesting correlation between motion-sickness susceptibility and nausea induced by moving visual fields has been reported by Crampton and Young (ref. 6), who concluded, "Individuals susceptible to motion sickness are also susceptible to nausea in a rotary visual field situation, and conversely, nonsusceptibles are resistant."

Graybiel (ref. 7) and his associates have made the significant finding that moving visual fields do not cause sickness in the absence of a normal functioning vestibular system; this was established by exposing labyrinthine-defective humans to appropriate conditions, both in the laboratory and in aircraft aerobatics. The significance of this finding possibly merits further investigation, but it does suggest that moving visual fields cause sickness either by stimulating the vestibular system directly or through evoked head movements. Another possibility has been suggested by K. E. Money ("Motion Sickness," *Physiol. Rev.*, in press) who stated—

It seems likely that vision modifies vestibular responses normally, in the sense that olfaction modifies salivation, and it may be that a visual stimulus which is normally associated with a vestibular stimulus would give rise to a central vestibular activity in the absence of the vestibular stimulus. This then could explain how moving visual fields cause sickness, since the subjects would not be adapted to the vestibular activity provoked, and it would explain why labyrinthine-defective subjects are immune to such visual stimuli.

Vision, however, is not essential to motion sickness since blind subjects are susceptible.

It is significant to note that, in some circumstances, vision promotes sickness and in other conditions it suppresses sickness. In the latter case it may be that vision results in diminished vestibular stimulation by acting to control head movements.

Several authors (including Kottenhoff and Lindahl, ref. 8) have reported the nauseating effect of wearing spectacles that invert the visual field, especially when accompanied by some kind of motion, even walking. It is also known that disturbances such as refractive error or diplopia can cause nausea.

No matter what the conditions may be, then, it can be concluded that vision does influence susceptibility to motion sickness, either by increas-

ing or decreasing its incidence and severity. Available evidence suggests:

In humans visual information which is in agreement with information from the vestibular and other sensory receptors suppresses motion sickness, but only when the circumstances are such that the visual information can influence head movements. On the other hand, visual information which is not in agreement with information from the vestibular and other sensory receptors promotes motion sickness (K. E. Money, "Motion Sickness," in press).

CEREBRAL FACTORS

The outstanding neurosurgical work carried out by Tyler and Bard (ref. 1) showed that the motion-sickness syndrome can occur in decerebrate dogs, the nodulus and uvula of the cerebellum being the essential components of the central nervous system involved. Removal of the cortex resulted in essentially the same conclusions.

It could easily be concluded that no function dependent upon the cerebrum is necessary for motion sickness. However, there is ample evidence for believing that the cerebrum does exert considerable control over the brainstem concerned, with resulting suppression, on the one hand, or facilitation, on the other. Correia and Guedry (ref. 9) have recently shown that the nature of concomitant mental activity strongly affects the development of motion sickness; distracting unrelated tasks such as mental arithmetic have an inhibitory effect while closely associated cerebration facilitates its development.

Although anxiety and fear can induce nausea and vomiting, the consensus as the result of controlled experiments is that anxiety is not an influencing factor as reported by Graybiel (ref. 7) and probably does not promote its development very much. It has been reported that the incidence of motion sickness in aircrew is about five times higher during training than during combat (ref. 10).

Wendt (ref. 11) has made a particularly excellent study of psychological factors in relation to motion-sickness susceptibility and has concluded that although suggestion and conditioning do have some effects, "physical and physiological factors outweigh them in practical importance." He concluded that emotional states and personality defects have no important influ-

ence on the development of motion sickness. There is even a report of a decorticate man who exhibited facial pallor and vomiting during a turbulent aircraft flight (ref. 12).

OLFACTION

The effects of odors, insofar as bringing on the objective signs of motion sickness more readily, are, in a sense, confusing or perhaps surprising. It seems reasonable that odors that are normally considered as being unpleasant would precipitate the classical symptoms more readily than would be the case in their absence, the smell of vomitus being particularly effective. Odors like that of tobacco smoke, however, and even those of food which normally are considered pleasant ones, become the very opposite when some degree of motion sickness prevails; thus, they can be considered in this sense as contributing toward increased susceptibility.

FOOD

There are conflicting reports as to eating habits in inducing motion sickness. Manning and Stewart (ref. 13), for example, reported no relationship between susceptibility and time duration since eating the last meal, although Fields (ref. 14) reported a relationship, with susceptibility increasing with postmealtime. It is perhaps not surprising, therefore, that student pilots are given conflicting advice by their instructors in this regard. It may well be that the presence of food in the stomach can initiate a gastric awareness, especially during aircraft maneuvers involving positive *g*-forces, thereby contributing to a threshold stimulus causing vomiting. Traction on the mesentery during abdominal surgery has been reported to induce nausea (ref. 15) by stimulating visceral afferent nerves. A pertinent finding was reported by Johnson (ref. 16) when monkeys were made to regurgitate their stomach contents as the result of being exposed to quickly applied negative *g*-forces on a centrifuge. Similar experiences have been reported by pilots as the result of so-called Bunting aircraft maneuvers with resulting projectile expulsion of the gastric contents, but without any accompanying nausea. This response cannot be considered as true mo-

tion sickness, but it may well account for the difference of opinion that exists as to food in the stomach and susceptibility to motion sickness.

AMBIENT AIR TEMPERATURE

Uncomfortable heat has been considered to be a contributing factor (ref. 17), and sufferers are known to express a desire for cool fresh air. There is, however, insufficient evidence to substantiate a correlation between ambient air temperature and motion sickness susceptibility.

DIFFERENCES BETWEEN SEXES

As the result of recording the incidence of airsickness among airline passengers, Lederer (ref. 18), Reason (ref. 19), Hanada (ref. 20), and others have reported that women were more susceptible than men. Why this should be so is unknown, although a feeling of malaise during menstruation is possibly a contributing factor. There is no physiologic reason to believe that vestibular end-organ sensitivity is different between sexes, although endocrine changes may well affect the sensory and associated autonomic responses.

AGE

There is really no conclusive evidence to indicate any correlation between age and sensitivity to motion sickness, although it has been stated that infants and elderly persons are less susceptible (ref. 21). One should remember, however, that infants and elderly people are less active, and hence any nausea-inducing stimulus becomes less intense. Infants spend much of their time either supine or with the head well supported, conditions that render them less vulnerable (ref. 22). It is significant to note that vestibular responses can be demonstrated in infants within a few days after birth.

CHEMICAL

Although there may be two distinct nausea centers in the central nervous system which are triggered by different means—namely, chemical stimulus and motion—there is interdependence between these zones for the production of sick-

ness caused by motion. Wang and Chinn (ref. 23) showed that motion sickness required the integrity of both centers even though an emetic drug (apomorphine) required only one of these for its action, the chemoceptive trigger zone that is located in the superficial region of the floor of the fourth ventricle. It may be, as suggested by Chinn and Smith (ref. 10), that motion-sickness vomiting is triggered by "a chemical elaborated in significant amounts during motion." It is not surprising, then, to find that nauseating chemicals lower the resistance to motion sickness.

In the case of alcohol, there is undoubtedly a twofold effect that makes it particularly hazardous. First of all, it has been established that when the blood alcohol level reaches a significant amount, the threshold for stimulation of the vestibular receptors is significantly lowered, so that it readily responds to weaker stimulation. Also, the response to a normally effective stimulus lasts for a much longer period of time. These responses become further complex because of the fact that even in the absence of motion, the subject may experience marked subjective vertigo in certain head positions, a condition that has been called positional alcohol nystagmus (PAN). The initial onset of PAN has been called phase I by Aschan (ref. 24); in man this can be followed several hours later by phase II in which the vertigo and nystagmus return, but occur in the opposite direction, even when all traces of alcohol have left the blood. These effects have been considered as being central in origin, but because the peripheral vestibular receptors are essential at least for the nystagmus, the possibility remains that the effect may be on the end organ. In any case, the result is an increased sensitivity to nausea-inducing motion.

An additional effect that undoubtedly summates with such increased vestibular sensitivity comes from the effect of alcohol's inducing nausea and vomiting even in the absence of motion. These effects of alcohol can thus add up to a vicious long-lasting combination causing greatly increased sensitivity, the degree of which is dependent upon both the amount of alcohol involved and the subject's sensitivity to alcohol and motion.

ILLNESS

Certain pathologic disorders undoubtedly have effects similar to alcohol in changing sensitivity to motion sickness, although there is a scarcity of any pertinent measurements of this. Women are thought to be more susceptible to airsickness during the menstrual period, but one hesitates to call this an illness. Certain toxemia conditions, as occur with jaundice, kidney disease, and diabetes, can result in nausea and vertigo. Also, toxins produced by foreign bodies such as virus, bacteria, or allergens undoubtedly have both central and peripheral effects that alter susceptibility to motion sickness.

Two well-known disorders involving the vestibular system are Ménière's disease and vestibular neuronitis. Both are characterized by episodes of vertigo, sometimes accompanied by nausea and vomiting in spite of the fact that the involved labyrinth usually shows a hypoactive response to caloric stimulation. It would be interesting, therefore, to determine the sensitivity of such patients to motion sickness. It may well be that their threshold might be raised by decreased vestibular sensitivity, although the very opposite could be the case for psychogenic or other reasons. The author is unaware of any significant experiments on this.

Vertigo and nausea can, of course, be caused by many other pathologic changes that may well render the subject more susceptible to motion sickness, not only because of the above-mentioned factors, but also because of poor compensatory head responses resulting from lack of interest in the environment. On the other hand, if sufficiently ill, the subject may well assume a supine position, which in itself can result in a diminished vestibular stimulation; this is caused by decreased concomitant head movements or by the fact that the otolith receptors or even canals are in a less vulnerable position.

ADAPTATION

This author will not discuss adaptation in any detail because it has been well documented and studied by others. In fact, the most meritorious study on this subject has been carried out at Pensacola by Graybiel and his associates in the

slow rotation room. Adaptation should be mentioned, however, for the sake of completeness, as a factor affecting susceptibility to motion sickness, although it perhaps should be classified as a primary rather than a secondary factor in this regard. There is no doubt that this phe-

nomenon can effectively moderate the physiologic response to nauseating motion in most people. However, the physiologic basis for adaptation still awaits clarification, as is also the case for most, if not all, of the factors that have been mentioned.

REFERENCES

1. TYLER, D. B.; AND BARD, P.: Motion Sickness. *Physiol. Rev.*, vol. 29, Oct. 1949, pp. 311-369.
2. SJÖBERG, A.: Experimentelle Studien über den Auslösungsmechanismus der Seekrankheit. *Acta Oto-Laryngol.*, suppl. 14, 1931, pp. 1-136.
3. DESNOES, P. H.: Seasickness. *J. Am. Med. Assoc.*, vol. 86, 1926, pp. 319-324.
4. VON DIRINGSHOFEN, H.: Medical Guide for Flying Personnel. Translated by V. E. Henderson, Univ. of Toronto Press, 1940, 102 pp.
5. SCHWAB, R. S.: Chronic Seasickness. *Ann. Intern. Med.*, vol. 19, 1943, pp. 28-35.
6. CRAMPTON, G. H.; AND YOUNG, F. A.: The Differential Effects of a Rotary Visual Field on Susceptibles and Nonsusceptibles to Motion Sickness. *J. Comp. Physiol. Psychol.*, vol. 46, 1953, pp. 451-453.
7. GRAYBIEL, A.: Vestibular Sickness and Some of Its Implications for Space Flight. *Neurological Aspects of Auditory and Vestibular Disorders*, W. S. Fields and B. R. Alford, eds., Charles C Thomas, 1964, pp. 248-270.
8. KOTTENHOFF, H.; AND LINDAHL, L. E. H.: Visual and Emotional Factors in Motion Sickness: Preliminary Communication. *Percept. Mot. Skills*, vol. 8, 1958, pp. 173-174.
9. CORREIA, M. J.; AND GUEDRY, F. E., JR.: Modifications of Vestibular Responses as a Function of Rate of Rotation About an Earth Horizontal Axis. *Acta Oto-Laryngol.*, vol. 62, 1967, pp. 297-308.
10. CHINN, H. I.; AND SMITH, P. K.: Motion Sickness. *Pharmacol. Rev.*, vol. 7, 1955, pp. 33-82.
11. WENDT, G. R.: Of What Importance Are Psychological Factors in Motion Sickness? *J. Aviation Med.*, vol. 19, 1948, pp. 24-32.
12. DOIG, R. K.; WOLF, S.; AND WOLF, H. G.: Study of Gastric Function in a "Decorticate" Man With Gastric Fistula. *Gastroenterology*, vol. 23, 1953, pp. 40-44.
13. MANNING, G. W.; AND STEWART, W. G.: Effect of Body Position on Incidence of Motion Sickness. *J. Appl. Physiol.*, vol. 1, 1949, pp. 619-628.
14. FIELDS, W. S.: Induced Motion Sickness in Naval Ratings. *Proceedings Conference on Motion Sickness*, Report C 739, App. D, National Research Council, Canada, Aug. 1942.
15. McEACHERN, D.; MORTON, G.; AND LEHMAN, P.: Seasickness and Other Forms of Motion Sickness. *War Med.*, vol. 2, 1942, pp. 410-428.
16. LOWRY, R. H.; AND JOHNSON, W. H.: Pseudo Motion Sickness Due to Sudden Negative "G"; Its Relation to Airsickness. *J. Aviation Med.*, vol. 25, 1954, pp. 103-106.
17. BRUNER, J. M.: Seasickness in a Destroyer Escort Squadron. *U.S. Armed Forces Med. J.*, vol. 6, 1955, pp. 469-490.
18. LEDERER, L. G.; AND KIDERA, G. J.: Passenger Comfort in Commercial Air Travel With Reference to Motion Sickness. *Intern. Record Med.*, vol. 167, 1955, pp. 661-668.
19. REASON, J. T.: An Investigation of Some Factors Contributing to Individual Variation in Motion Sickness Susceptibility. *Flying Personnel Research Committee Rept. 1277*, Ministry of Defence (Air Force Department), London, 1968.
20. HANADA, T.: The Studies on Motion Sickness. *J. Oto-Rhino-Laryngol. Soc., Japan*, vol. 69, 1966, pp. 950-978.
21. HOWLETT, J. G.: Motion Sickness. *Can. Med. Assoc. J.*, vol. 76, 1957, pp. 871-873.
22. JOHNSON, W. H.; STUBBS, R. A.; KELK, G. F.; AND FRANKS, W. R.: Stimulus Required to Produce Motion Sickness. I. Preliminary Report Dealing With Importance of Head Movements. *J. Aviation Med.*, vol. 22, 1951, pp. 365-374.
23. WANG, S. C.; AND CHINN, H. I.: Experimental Motion Sickness in Dogs. *Am. J. Physiol.*, vol. 178, 1954, pp. 111-116.
24. ASCHAN, G.: Different Types of Alcohol Nystagmus. *Acta Oto-Laryngol.*, suppl. 140, 1958, pp. 69-78.

The Symptomatology of Motion Sickness

JACK E. STEELE

*6570th Aerospace Medical Laboratories
Wright-Patterson Air Force Base*

SUMMARY

Motion sickness is maladaptation to a dynamic environment. The major symptoms are caused by inadequate and inappropriate vascular and circulatory responses, resulting mainly from inadequate perception (integration and analysis of the pertinent sensory data) of the dynamic environment and consequent misestimation of the nature and degree of the threat involved.

INTRODUCTION

Motion sickness is essentially maladaptation to a novel inertial environment. The symptoms do not develop inevitably in the presence of motion, nor is motion inevitably present when the symptoms do develop (refs. 1 to 4). Motion-sickness symptoms occur only when there is a malfunction of the victim's orientation-perceiving mechanisms and his motion- and acceleration-compensating mechanisms. This is a complex system involving many subsystems. There are various ways in which it can fail or decompensate, depending on the specific nature of the load placed upon it and the individual variations in ability to handle the load.

The orienting system integrates and utilizes information from many sense organs, most notably the vestibular, the visual, and the tactile-proprioceptive-kinesthetic. There is much mutual interplay among these subsystems. The main systems utilizing the resulting integrated data are the visual, the musculoskeletal, and the cardiovascular. The system contributes to arousal as an important source of early warning of impending threat (danger of falling, being struck, etc.). It is also monitored for reliability. Both orientation information and an estimate of its reliability are available consciously. Either can warn of impending danger. The term "dis-

orientation" refers to the condition in which perceived orientation is incorrect. The term "vertigo" (originally meaning a false sense of rotation) now is used commonly to refer to conscious awareness of a failing or inadequate perception of motion and accelerative forces. Conscious fear is relatively unimportant in motion sickness. Unconscious estimate of the threat is most significant. Adaptation to motion consists mainly of learning to perceive it correctly and to make proper adjustment of antigravity compensatory reflexes, etc., and learning to evaluate the threat properly so that inappropriate defensive preparatory steps are not taken.

Symptoms arise as the result of failure to make adequate compensatory adjustments, as the result of inappropriate or incorrect adjustments and preparations, and as a result of the additional information-processing load imposed by incorrect perceptual data processing and the effort to correct it. Similar symptoms can be produced by bringing about these same conditions in various ways, other than by subjecting the victim to the motions typically associated with motion sickness.

The novelty of the environment need not be so great as we might expect. Even return to that most familiar condition, 1 *g* vertical and zero angular acceleration and total zero velocity, can

produce symptoms in one who has been thoroughly adapted to some other, such as a ship, a rotating room, or even that environment produced by the disassociation of the normal relationship between the visual and the vestibular sensory inputs induced by wearing inverting or reversing spectacles (refs. 1 to 6). Such a condition could be called "still sickness" if we persist in attempting to name the disease by the characteristics of the environment that are contributory to its production.

Concepts of diseases lead lives of their own. They evolve. As we learn more about them, originally different diseases may come to be considered as but different manifestations of the same underlying disease process, or a disease may fragment into many as we learn to differentiate between basically different entities that had but superficial resemblance. As an illustration, I offer a disease from antiquity, the "boat disease." This is not a disease of boats but one caused by riding in boats. In accordance with medical tradition, it was named after the old Greek word for boat, "naus," hence nausea. This disease grew to include similar conditions even when they were not caused by riding in boats. Ultimately it lost its status as a disease and reverted to being merely a symptom found as part of many syndromes.

We went through the cycle again with seasickness which became travel sickness, which then fragmented into mountain sickness, trainsickness, carsickness, airsickness, etc. With the advent of laboratory interest in the condition, we acquired rotating chair sickness, Coriolis sickness, elevator sickness, swing sickness, and even Cinemascope sickness, 2-FH-2 Hoover simulator sickness, and still sickness. Motion sickness provides a pertinent and insightful name for the syndrome occurring under all of these circumstances. Even though motion is neither a necessary nor sufficient cause (and in the case of 2-FH-2 hover simulator sickness can, when properly applied, actually reduce symptom formation, preceding paper by Fred E. Guedry, Jr., "Conflicting Sensory Orientation Cues as a Factor in Motion Sickness"), motion does indicate the general area in which the victims are maladapted, whether with regard to their perception

of the actual acceleration and motion environment or in the inadequacy of their compensatory physiological adjustments. "Maladaptation to inertial environment" more accurately (though awkwardly) designates the condition whose manifestations I am to discuss. For whether the subject is moving or not, whether his environs are moving or not, the inadequacy of his adaptation to the dynamic aspects of his environment is the one element that distinguishes the sick subject from the unaffected.

When examined closely, the borders separating one disease from another, one body malfunction from another, are not sharp. The blackout and unconsciousness that can result from high acceleration in the foot-to-head direction might not seem closely related to the usual symptoms of motion sickness. Yet the same symptoms would be felt every time we arose from a supine to an erect posture were it not for the cardiovascular compensatory adjustments that occur. Lesser derangements of these same adjustments can account for symptoms in many cases of motion sickness. The body is a complex system comprising many interrelated subsystems. Its malfunctions are better understood from this point of view than from attempts to sharply demarcate disease entities or to overemphasize the role of any one of the subsystems involved.

SYSTEMS INVOLVED IN MOTION SICKNESS

In motion sickness, the perceptual-sensory system dealing with inertia and motion, that part of the central nervous system that is alerted by and prepares for response against external threats, the cardiovascular system, and the neuromuscular system are involved. I offer a partial tracing of the vestibular signals as a rationale for dealing with a hypothetical central processor for dynamic inertial information rather than with detailed neural structures involved. The vestibular ganglia communicate with 14 specific neural structures having about 2 dozen mutual interconnections. These, in turn, communicate through approximately 120 identified channels to the next level consisting of 44 centers (ref. 7). Thus, going no farther than three steps from the

sense organ, and without even considering the visual, auditory, proprioceptive, and other inputs, the system becomes quite unwieldy.

Sense organs measure certain qualities of their environment and send signals to the central nervous system. To understand the subsequent chain of events, we must distinguish between the transmission of excitation and the transmission of messages. The distinction is particularly important in discussions of the vestibular system in which corresponding semicircular canals send the same message by shifting the intensity of their signals (repetition rate of their pulse outputs) in opposite directions. This is important in understanding how the reduced sensitivity found in Ménière's syndrome can lead to sensations of rotation, dizziness, and nausea. A reduced pulse output rate conveys the message of rotation as surely as does an increased output rate. A man who has recently lost all vestibular input on one side as a result of surgery is receiving from that side zero input pulses (i.e., zero excitation), but a message signifying very strong angular and linear acceleration. Analysis of the production of symptoms in motion sickness is analysis of changes occurring in the body as the result of all incoming messages concerning orientation, acceleration, and motion (or failing to occur in appropriate response to this information).

Sensory organs function normally in motion sickness. At least there is no evidence that they are not functioning normally, and indeed it is extremely difficult if not impossible to elicit motion-sickness symptoms in subjects lacking functional inertia-sensitive sense organs. The central processor is usually not working correctly. Perception of acceleration and motion is usually (though not necessarily always) incorrect. Symptoms arising directly from this malfunction are minimal, consisting mainly of such illusions as a tilting horizon. Failure of correct central interpretation of acceleration and motion data participates in the generation of major symptoms mainly through the inappropriate or inadequate adjustments of the other subsystems that require the information for their proper functioning and through the elicitation of attempts to correct the central perceptual processor.

The cardiovascular system is a major partici-

pant in symptom generation, first through failure to compensate adequately for acceleration loads placed directly on it, and, second, by its inability to handle the demands placed on it by the circulatory requirements of muscles inappropriately preparing for emergency action. The neuromuscular system participates by its inordinate demands on the circulatory system and manifests the inadequate central integration of inertial data by ataxia, tenseness, and fatigue. The central arousal system (reticular formation?) participates by triggering several alarm responses, including muscle hyperemia and, more appropriately, the reorganization of inertial perception. Many of the symptoms and other observable conditions of motion sickness are overdetermined. There are several causal chains leading to the same effect. Some of the changes observed are part of the problem, some part of the solution, and some are both. A change compensating for one disturbance may aggravate another.

Inadequate cerebral circulation is an old theory of motion sickness. It still has much to recommend it. There can be no doubt that nausea often accompanies decreasing blood pressure and falling cardiac output from any cause. Whether or not this nausea is secondary to embarrassed cerebral circulation is less certain. Two items are of cerebral significance in motion sickness. One is the known increased metabolic demands of the brain in arousal states (ref. 8), and the other is the high correlation between susceptibility to motion sickness and unusual lability of cerebral circulation (at least as reflected by central retinal artery changes) under conditions of minor longitudinal *g*-changes on a horizontal swing (ref. 9). There is some experimental evidence that cerebral circulation, or at least the quantity of blood in the head, decreases with vestibular stimulation (ref. 10). Decreased spontaneity, increased depression, and headache are mild indications of impaired cerebral function.

Compensation for longitudinal acceleration is about the simplest adjustment the vascular system must make. Yet it is of considerable magnitude. For even so simple a change as shifting from the supine to the erect posture, the hydrostatic pressure difference introduced between

head and foot is greater than the pressure difference that the heart maintains between its input and its output. To remain adequate, this adjustment requires practice and training. Light-headedness accompanies first arising after several days in bed. Symptoms may be caused simply by vascular compensatory inadequacy in spite of adequate correction data supplied by the central integrator of inertial data. The after-nausea following various types of motion sickness experiments is aggravated by standing, relieved by sitting or reclining. One of the mildest inputs, from the point of view of sensory stimulation, is capable of producing nausea in a few minutes. This is simple rotation in a vertical plane at a frequency of about 15 rpm while in the seated position (ref. 11). Elevator experiments have shown that g -changes at about this frequency are most effective in nausea production, though more time is required (ref. 12). Some have attributed this frequency sensitivity of the nausea-producing mechanism to an undiscovered resonance in the sense organs. I feel that this is a highly unlikely explanation, and far more significant is the fact that this is approximately the natural slosh frequency of the blood in the vascular system. Near this frequency the blood undergoes the greatest displacement, and the greatest compensatory shift in vessel tone is required.

In zero- g experiments, in which zero g alternates with increased g , the periods of increased g seem most responsible for the symptoms. In one series, subjects either became sick during the preweightless acceleration or they did not become sick at all (ref. 13). In another series in which 51 percent of the subjects vomited at one time or another, no one experienced nausea while prone during the accelerations. Two vomited in this position, but this occurred within 20 seconds of starting the maneuver and with no nausea (ref. 14). It appears that for production of nausea under these circumstances, increased loads on the cardiovascular system are of greatest importance. I participated in two such runs. Allowed to lie down during increased g and to float free during zero g , I experienced no symptoms. On the later run, confined to a seat, I became nauseated and experienced afternausea hours later while standing.

The cardiovascular changes considered up to this point could occur in the absence of any disorientation or errors in data processing relevant to motion and inertia. Errors in processing inertial information can only make matters worse. Even in that excellent angular overstimulation situation, Coriolis stimulation, linear-acceleration messages cannot be ignored. Angular acceleration about any axis not parallel to the direction of linear acceleration implies a change of direction of linear g . Central-nervous-system determination of direction of linear g (vertical) is a complex thing involving several separate inputs. In general, the short-term information is derived from semicircular-canal inputs, and the long-term information depends on integration of inputs from the otolith and other organs. With a time constant of only a few seconds for blood displacement caused by linear g , compensation, to be adequate, must utilize some of the implied g -change information based on semicircular-canal inputs. Experimental subjects report that they experience changes in linear g . They describe this as being in a climbing or diving spiral. Objective measurements on the same subjects show actual and different physical responses, depending on whether a climb or a dive is being experienced. Some subjects showed slowed and deepened respiration during the "dive," and breath holding during the "climb."

Neuromuscular Factors

To keep the cause-effect steps in proper sequence, I should like to discuss the neuromuscular changes before returning to more serious cardiovascular problems that occur secondarily to the muscle changes. The simplest neuromuscular effects are directly caused by improper central-nervous-system integration and interpretation of sensory messages dealing with acceleration and motion. The problem is made more difficult by the need to predict the inertial environment in order that intended movements and dynamic postural reflexes may be properly compensated in time to achieve their objectives. Correcting muscle tension after an arm or leg has been deflected by an improperly predicted force is not a satisfactory solution. We are

usually unaware of these unconscious compensatory contributions to our motions, though we may experience them as a heaviness on first emerging after some time in the water, or as a lightness when first dropping a heavy load. Without the correct sensing and utilization of acceleration data, we experience ataxia and clumsiness. This is somewhat inconvenient and potentially dangerous, but in most motion-sickness situations greater harm is caused by the body's reaction to what is only potentially dangerous. The part of the alarm reaction that prepares the muscles for anticipated strong action in the face of this implied environmental threat contributes greatly to severe motion sickness.

Immediate reflex response to acceleration and motion can contribute to tenseness and subsequent fatigue. Benson has found that the gastrocnemius and soleus reflexes in man are increased by angular acceleration (ref. 15). There is no compensatory decrease in the opposite leg, merely a lesser increase. This increase in 16 subjects was from 73 percent to 136 percent, always greater in the trailing leg and linearly related to the table velocity before deceleration over a range from 20° to 110°/sec. The reaction required the presence of a functioning labyrinth and was apparently mediated by the gamma efferent system, rather than directly via the alpha motoneurons. The monosynaptic reflexes were unaltered. There is indirect evidence for the involvement of the extrapyramidal system in motion sickness. Most antihistamine drugs effective in motion sickness are also effective in Parkinsonism, and a surprisingly large number of drugs primarily identified as effective in Parkinsonism have proven effective in motion sickness (ref. 16). The involvement of the system for dynamic postural reflexes seems evident in both cases.

The greatest contribution of the neuromuscular system to the generation of motion-sickness symptoms is probably through the part of the alarm reaction that prepares the muscles for vigorous activity. Increase in blood sugar appears to be part of the solution rather than a cause of symptoms (ref. 17; and Fields, Meakins, and MacEachern, cited in ref. 3, p. 1810). Reducing blood sugar by giving insulin increases the symp-

toms. Other indications of alarm response are increased blood and urine levels of catecholamines and 17-hydroxycorticosteroids (ref. 18). These changes also probably do not contribute to symptoms, but rather to their suppression. Sympatholytic drugs increase the symptom formation while sympathomimetic drugs tend to reduce symptoms (ref. 19). One phenothiazine derivative that might have been expected to be helpful turned out not to be, but it differed from the effective drugs in being sympatholytic. The most significant preparatory move by far, however, is the diversion of circulating blood to the muscles.

It has been shown that muscle volume increases in subjects who are becoming motion sick (ref. 10). This volume shift in preparation for exercise is quite sensitive to central neural control. Weber showed an increase in muscle mass as a response to merely thinking about exercise (refs. 20 and 21). Apparently, actually using the muscles tends to counteract some of the bad effects. Physical work and going about one's business tend to reduce the symptoms (ref. 17). Circulatory compensation for the mass of blood diverted to muscles is difficult. Skin blanching can compensate for only part of it (ref. 10). Other organs, mainly the intra-abdominal viscera, must also lose some of their blood supply.

Cardiovascular Factors

Having described the manner in which muscle preparation for vigorous action can place additional loads on the cardiovascular system, I should like to examine the evidence that such a load does actually occur and that failure to adjust to it correlates highly with development of symptoms.

The most severe motion-sickness symptoms seem to be caused by a decrease in circulating blood volume. In motion-susceptible individuals, pulse rate decreases, systolic pressure and minute volume decrease (refs. 10, 22, and 23). The common features are indicative of a pre-collapse state. This is indicated primarily by the sharp drop in systolic pressure and minute volumes in spite of increasing peripheral resistance of the arterial system. The body's own estimate of inadequate circulation is indicated by

increased output of antidiuretic hormone (ref. 24).

Stimulation of the VIIIth nerve, whether caloric, galvanic, or by angular acceleration, causes a fall in blood pressure (ref. 25). This fall in blood pressure can be blocked by cutting the vagus. Stimulation of the peripheral end of the cut vagus produces a similar fall in blood pressure. Lergigan, a phenothiazine derivative, can block the blood-pressure fall produced in either of these ways (ref. 19). It is an effective anti-motion-sickness drug. On the other hand, another phenothiazine derivative, chlorpromazine, a potent and specific antiemetic, is ineffective in motion sickness (ref. 26). This is probably because it lowers blood pressure and can, in large doses, cause vascular syncope. Measures that help combat circulatory collapse reduce motion-sickness symptoms. These are tight abdominal belts (ref. 27), anti-g-suits, intravenous dextran solution, and adrenergic drugs (ref. 19; and Enquist, cited in ref. 19). Other conditions that reduce cardiac output, such as cardiac tamponade or sudden congestive heart failure, tend to produce nausea.

Reduced cardiac output can produce symptoms in two ways: those secondary to attempts at compensation for the condition and those resulting from inadequate compensation. Blanching of skin and abdominal viscera appear to be compensatory. There is little evidence of increased acid production in motion sickness, but blanching would reduce mucosal resistance to that acid which is present. As high as 50 percent of chronic seasick subjects show anatomical changes in the gastric mucosa as a result of such irritation (ref. 28). Sweating, which commonly accompanies the blanching of the skin, could be compensatory for the skin's reduced effectiveness as a cooling organ. Sweating could also be part of the preparation for vigorous muscle action in anticipation of increased heat production. There are no reports on the actual body temperature of motion-sick subjects, though their common desire for cooler surroundings would indicate the impairment of heat-loss mechanisms.

It is not known for certain how decreased cardiac output and blood pressure produce nausea. There are several reasons to believe that it involves embarrassment of cerebral circulation

and metabolism. Decreased oxygen tension seems responsible for the nausea of mountain sickness. There is a higher incidence of motion sickness in unpressurized aircraft flying at higher altitudes. Vestibular stimulation has promptly reduced the volume of blood in the brains of dogs and monkeys (ref. 8). Measures that tend to improve cerebral circulation can reduce symptoms without necessarily improving the general level of cardiac output. Lowering the head, for example, in a maneuver similar to that employed for the prevention of vascular syncope, can relieve the nausea (ref. 23). Nausea is less on sitting than on standing, and still less on reclining. Subjects with poor regulation of cerebral circulation are more susceptible to motion sickness (ref. 9). Retching or vomiting does, at least momentarily, raise the intracranial blood pressure. This is the only compensatory value observable for such a reflex, other than removing irritants from the gastrointestinal tract. It is notable that nausea accompanies cerebral circulatory embarrassment produced by various other causes.

CONCLUSION

The human body is a very complex system. In attempting to understand some malfunction we should not delve so deeply into one subsystem that we lose sight of the others. Previously, seeking the cause of motion sickness, I have denigrated the role of the sensory systems and emphasized that of the perceptual or central integrative system, but of course without sensory input there is nothing to perceive or integrate (ref. 29). In preparing the present paper on symptomatology, I was impressed by the role of the extrapyramidal and vascular systems. Both Parkinsonism and increased susceptibility to motion sickness have been reported as after-effects of viral encephalitis. A large number of the same drugs are useful in both conditions. Dynamic postural reflexes are increased under conditions of acceleration. Muscle volume also increases.

The major symptoms seem to be caused by cardiovascular inadequacy, secondary to diversion of circulating blood to the muscles in response to a threatened need for vigorous

muscular action on the basis of inadequately perceived inertial and dynamic environment. The problem is aggravated in people with poor cerebral circulatory control. Vagotonic subjects are more susceptible. Cholinergic drugs aggravate and anticholinergic drugs ameliorate the symptoms. Two of the most effective anti-motion-sickness drugs, scopolamine and amphetamine, have little else in common except perhaps their usefulness in Parkinsonism. One blocks

the vagus-mediated fall in blood pressure and cardiac output. The other increases blood pressure and cardiac output. These effects are additive against motion sickness.

A disease that began in the stomach has moved through the ears, the brain, the musculature, the visual, the circulatory, the endocrine, the thermoregulatory, the urinary, and back to the upper intestine (increased serotonin content). What have we overlooked?

REFERENCES

- BRUNER, J. M.: Seasickness in a Destroyer Escort Squadron. *Armed Forces Med. J.*, vol. 6, Apr. 1955, pp. 469-490.
- MILLER, J. W.; AND GOODSON, J. E.: A Note Concerning "Motion Sickness" in the 2-FH-2 Hoover Trainer. *Naval School of Aviation Medicine Rept.* 519, Pensacola, Fla., 1956.
- MONNIER, D.: Le Mal de Mer; Pathogénie et Traitement. *Rev. Pathol. Gen.*, vol. 56, Dec. 1956, pp. 1800-1830.
- ANON.: The Concept of Motion Sensitivity. *Intern. Record Med.*, vol. 168, June 1955, pp. 371-376.
- KOHLER, I.: Experiments With Prolonged Optical Distortions. Presented at XIVth Intern. Congr. Psychol., Montreal, June 1954.
- GRAYBIEL, A.: Vestibular Sickness and Some of Its Implications for Space Flight. *Neurological Aspects of Auditory and Vestibular Disorders*, W. S. Fields and B. R. Alford, eds., Charles C Thomas, 1964, pp. 248-270.
- RAPOPORT, A.; HORVATH, W. J.; SMALL, R. B.; AND FOX, S. S.: The Mammalian Central Nervous as a Network. AMRL-TR-67-187, Aerospace Medical Research Laboratories, Wright-Patterson Air Force Base, Ohio, 1967.
- KETY, S. S.: Considerations of the Effects of Pharmacological Agents on the Over-all Circulation and Metabolism of the Brain. *Neuropharmacology*, H. A. Abramson, ed., Josiah Macy, Jr., Foundation, 1955, pp. 13-89.
- VAN EGMOND, A. A. J.; GROEN, J. J.; AND DEWIT, G.: Selection of Motion Sickness-Susceptible Individuals. *Intern. Record Med.*, vol. 167, Dec. 1954, pp. 651-660.
- JOHNSON, W. H.; SUNAHARA, F.; AND TAYLOR, W. J. R.: Some Physiologic Responses to Vestibular Stimulation. Third Symposium on the Role of the Vestibular Organs in Space Exploration, NASA SP-152, 1968, pp. 355-362.
- KELLOGG, R. S.: Dynamic Counterrolling of the Eye in Normal Subjects and in Persons With Bilateral Labyrinthine Defects. The Role of the Vestibular Organs in the Exploration of Space, NASA SP-77, 1965, pp. 195-202.
- ALEXANDER, S. J.; COTZIN, M.; HILL, C. J., JR.; RICCIUTI, E. A.; AND WENDT, G. R.: Studies of Motion Sickness. 1. The Effects of Variation of Time Intervals Between Accelerations Upon Sickness Rates. *J. Psychol.*, vol. 18, 1945, pp. 49-62.
- VON BECKH, J. J.: A Summary of Motion Sickness Experiences in Weightless Flights Conducted by the Aeromedical Field Laboratory. Symposium on Motion Sickness, With Special Reference to Weightlessness, AMRL-TDR-63-25, Aerospace Medical Research Laboratories, Wright-Patterson Air Force Base, Ohio, June 1963, pp. 67-72.
- LOFTUS, J. P.: Motion Sickness in the C-131 B. Symposium on Motion Sickness, With Special Reference to Weightlessness, AMRL-TDR-63-25, Aerospace Medical Research Laboratories, Wright-Patterson Air Force Base, Ohio, June 1963, pp. 3-5.
- BENSON, A. J.: Effect of Labyrinthine Stimulation on Reflex and Postural Activity in Gastrocnemius Soleus Muscle Group in Man. *J. Physiol.*, vol. 146, 1959, pp. 37-38.
- CHINN, H. I.: Evaluation of Drugs Effective Against Motion Sickness. USAF School of Aviation Medicine Rept. 55-144, Randolph Air Force Base, Tex., Oct. 1955.
- HARBERT, F.; AND SCHIFF, M.: Motion Sickness. *U.S. Armed Forces Med. J.*, vol. 1, Sept. 1950, pp. 979-984.
- COLEHOUR, J. K.; AND GRAYBIEL, A.: Urinary Excretion of Corticosteroids and Catechol Amines in Normal Persons and Deaf Subjects With Bilateral Vestibular Defects Following Acrobatic Flight Stress. *Aerospace Med.*, vol. 35, 1964, pp. 370-373.
- GERNANDT, B. E.; AND SCHMITERLÖW, C. G.: Some Observations Concerning the Mode of Action of the Antihistaminic Drug 'Lergigan' (N α -Methyl- β -dimethyl-Aminoethyl) phenothiazine hydrochloride) in Motion Sickness. *Brit. J. Pharmacol.*, vol. 8, June 1953, pp. 181-186.
- WEBER, E.: Ueber den Einfluss der Lebensweise und Fortbewegungsart auf die Beziehungen Zwischen Hirnrinde und Blutdruck. *Arch. Physiol.*, suppl., 1906, p. 309.

21. WEBER, E.: Ueber die Ursache der Blutverschiedbung im Korper bei verschiedenen physichen Zustanden. Arch. Physiol., 1907, p. 293.
22. POWELL, T. J.: Acute Motion Sickness Induced by Angular Acceleration. FPRC Rept. 865, Institute of Aviation Medicine, Farnborough, Hants, England, Feb. 1954.
23. BRIANOV, I. I.; DEGTIAREV, B. A.; LAPSHINA, N. A.; KALMYKOVA, N. D.; AND RASKATOVA, S. R.: Hemodynamics During Vestibular Stimulation. Voenno-Med. Zh., Moscow, no. 11, 1966, pp. 45-50.
24. TAYLOR, N. B. G.; HUNTER, J.; AND JOHNSON, W. H.: Antidiuresis as a Measurement of Laboratory Induced Motion Sickness. Can. J. Biochem. Physiol., vol. 35, 1957, pp. 1017-1027.
25. SPIEGEL, E. A.; AND DEMETRIADES, TH. D.: Contributions to the Study of the Vegetative Nervous System. Part III. The Influence of the Vestibular Apparatus on the Vascular System. Pflügers Arch. ges. Physiol., vol. 196, 1922, pp. 185-199.
26. GOODMAN, L. S.; AND GILLMAN, A.: The Pharmacological Basis of Therapeutics. Second ed. Macmillan Co., 1955.
27. POPPEN, J. R.: Seasickness: Etiology and Treatment. U.S. Naval Med. Bull., vol. 37, July 1939, pp. 463-469.
28. SCHWAB, R. S.: Chronic Seasickness: Neurological, Psychiatric, and Naval Aspects. U.S. Naval Med. Bull., vol. 40, Oct. 1942, pp. 923-936.
29. STEELE, J. E.: Motion Sickness and Spatial Perception. Symposium on Motion Sickness, With Special Reference to Weightlessness, AMRL-TDR-63-25, Aerospace Medical Research Laboratories, Wright-Patterson Air Force Base, Ohio, June 1963, pp. 43-65.

DISCUSSION FOLLOWING ALL OF SESSION III

Whiteside: Dr. Johnson has earned a reputation as being the man who really brought the subject of motion sickness onto a rather different level. It was his work in immobilizing the head of people who are flying which highlighted the importance of the factor of head mobility when angular accelerations are present and, therefore, of course, the associated development of the so-called Coriolis effects.

There is one big difficulty that we often have in this type of exercise. You cannot really understand the function and the mode of action of many of the symptoms leading up to a syndrome unless you step back and come out of the woods. I think we tend at this stage to be unable to see the trees because we are in the woods. Words like "conflict" and so forth have been mentioned. I personally think that this is a most promising line of approach, and, indeed, it forms the basis of the philosophy which Lieutenant Colonel Steele has toward this subject. I believe he is in effect doing this extremely useful step of taking us back, looking at the assembly of symptoms, and trying to interpret them in an integrative way. This is what we tend not to do. Inevitably, we must look at the bits and pieces, but we must also try to get an integrative view of this problem and see the integrative action of all these factors as they combine to give rise to this syndrome.

Blatt: This may be somewhat anecdotal, but I think it may be pertinent. Parenthetically, one might say that the theme of this meeting today might come from a chapter of the book of the great Greek historian, Herodotus. The name of that book was "Airs, Waters and Places." When I was a corpsman in the Army during World War II, we used to work about that beach in Hawaii where training was being given in landing for beach assault. This beach was next to a sugar mill. It was interesting that whenever the sugarcane was being processed, that is, the grinding occurred, there appeared to be an increase in the frequency of motion sickness, because of this sickening smell of sugar-cane processing. In southern Louisiana there are many many sugar mills, and grinding starts about the second week of October. It is very interesting that, at about that time, there is an increase in frequency of motion sickness in the immediate environment of the sugar mill. The odor of fresh sugar being processed apparently can cause this. In addition, some of the employees who are new to the sugar-grinding industry will complain of a sensation of whirling. It is also interesting that one such individual, who, at the beginning of each year of grinding would have a perennial episode of vertigo with nausea in association with this exposure, no longer complained of this after a laryngectomy for malignancy. Of course, this is subjective. Also, it is interesting that, during the month of October in Louisiana, people who go water skiing about the lakes and bayous next to the sugar mills, which are in operation 24 hours a day, also complain of this combination of nausea and vertigo when they are immediately exposed to that kind of environment.

Money: I should like to ask Dr. Steele what the evidence is for a blood-sugar increase in motion sickness. I saw one

negative report. I am wondering where his positive one was found.

Steele: This was reported by Monnier (ref. 3 of text) and by Harbert and Schiff (ref. 17). Incidentally, the increase is not necessarily in motion sickness, but to motion, being a compensatory change. As I did mention, the decrease in blood sugar was reported as augmenting the symptoms, whereas an increase tended to reduce symptoms.

Money: That explains the difference, because the negative report I saw compared two groups of subjects both of whom were exposed to motion. When they compared the blood sugar of the sick group to that of the nonsick group, there was no difference.

Miller: We have done a number of studies here in Pensacola on labyrinthine-defective subjects and have never really had any success in getting them motion sick. Are you suggesting that your head-over-heels procedure might elicit motion-sickness symptoms in these individuals?

Steele: I really wondered about that. Participants in this experiment at least admitted no symptoms. This would indicate that more of the problem is in the message, in its analysis, and in the adjustments made in response to that information rather than in an adjustment made to the actual displacement of blood. The exposure of 3 minutes is not really what I would consider a severe exposure. I wish more effort were made to nauseate these subjects in other ways than by putting stimuli through their nonexistent sensors. The problem of canal sickness is a little like the problem of the retinal disease which is manifested also by nausea and sometimes by fainting; it is well known that blind men do not faint at the sight of blood. But this does not really implicate too greatly the retina.

Whiteside: I really am intrigued at the way these factors of conflict keep coming up, perceptual conflict is really what I am referring to, and the way in which adaptation is referred to could be interpreted as adaptation to the conflict situation. To be a little more specific, when the conflict is one involving vision, the eyes are caused to move by a variety of involuntary stimuli, such as the vestibular stimuli which have been considered. One stimulus which has not been considered but which may play an important role is the tonic neck reflex. The eyes inevitably move a small amount as one is observing something, and one gets a visual sensation of movement. Some of that sensation may be suppressed or eliminated by a better control of the eye movement. This control in response to a specific type of deviation of the eyes from the target may well be a factor in the so-called adaptation which seems to take place to a particular type of motion. Control of eye fixation may play a part in the observation that a man becomes adapted to the motion of a specific ship of a certain tonnage and size. He then goes onto a different type of a ship and he becomes seasick once more.

Lansberg: My remark and question concern positional alcohol nystagmus and are directed to Dr. Johnson. I have done quite a few of these experiments, and perhaps it has been an unforgivable neglect on my part, but I am afraid I

did not notice much nausea. The subjects got nystagmus, but they did not get nausea or vertigo concurrent with the nystagmus. Is that right, or did I understand that you meant to say that vertigo accompanies the positional alcohol nystagmus, or do you feel that vertigo and positional alcohol nystagmus are quite separate?

Johnson: I did not mean to say that the positional alcohol nystagmus causes nausea, although we all know that nausea can result from too much alcohol. We know, however, that such nystagmus is dependent upon the presence of the vestibular end organ.

Lansberg: That is right.

Stone: Dr. Miller, in the seat rotation tests where the subject moved his head or body, did you measure the rate of motion of the head in these situations? If you did, as the

rate of the chair was increased did the subjects tend to reduce the rate of their head and body motions?

Miller: The velocity of the chair was held constant in any given test. The rate of head (body) motion was always essentially the same and independent of chair velocity; it was controlled by having the subject follow taped instructions which provided the temporal sequence as well as the direction of each head tilt. Monitoring by the experimenter further assured that the subject tilted his head approximately 90° and at the proper rate; i.e., 1 second to the tilted position, 1 second return to upright. Occasionally we have found that a subject might tend to restrict the magnitude of his head movements when he began to develop symptoms, but he was quickly admonished about this and always required to follow the standard procedure.

SESSION IV

***Chairman:* E. J. Baldes**

U.S. Army Aeromedical Research Laboratory

Use of Drugs in the Prevention of Motion Sickness

CHARLES D. WOOD
Shreveport Medical School
Louisiana State University

SUMMARY

The most potent drugs for the prevention of motion sickness are those with central autonomic activity. Drugs which block parasympathetic or stimulate sympathetic activity are most effective. Drugs such as the phenothiazines, phenoxybenzamine, or meprobamate, which reduce sympathetic activity, appear to increase susceptibility to motion sickness. Scopolamine was the most effective single drug, and when combined with *d*-amphetamine, it was even more effective in prevention of motion sickness. The antihistamines appeared to be more suitable for use with exposure to mild forms of motion. In highly susceptible individuals, or during exposure to more intense motion, the combination of scopolamine with *d*-amphetamine was the most effective preparation tested.

INTRODUCTION

A large number of anti-motion-sickness drugs are currently available, and these can be classified as belladonnas, antihistamines, phenothiazines, or as a large miscellaneous group (refs. 1 and 2). Based on reports in the literature, the various classes of drugs would appear to have approximately equal efficacy in preventing motion sickness. This impression seems to be due to the fact that the drugs were not tested under identical conditions or in a controlled environment (ref. 3).

The slow rotation room (SRR) at the Naval Aerospace Medical Institute has provided a laboratory setting in which to compare the effectiveness of drugs under controlled and reproducible conditions (refs. 4 and 5). Results obtained from laboratory experiments have been validated by comparing them with those obtained during field studies (unpublished observations). In this way a more exact comparison of the relative effectiveness of each individual drug and each class of drug could be made.

This report summarizes our data regarding the study of 16 drugs with 8 variations in dosage

and 3 different combinations of drugs; selection was based on the reported effectiveness of drugs in different categories as revealed by the review of the relevant literature (ref. 2).

PROCEDURE

Fifty Navy enlisted men 17 to 23 years of age were volunteer subjects. A comprehensive medical evaluation revealed that all were in good health. With regard to the sensory organs of the inner ear, none had any significant loss of (1) hearing as revealed by audiometry, (2) otolith function as revealed by ocular counter-rolling (ref. 6), or (3) canal function as revealed by the threshold caloric test (ref. 7). The Coriolis accelerations were generated by requiring the subject, while seated, to flex his head and upper part of the body out of the plane of the room's rotation. These "head movements" were standardized (ref. 8) by requiring the subject to set the needle of five dials to different locations according to taped instructions; the sequential order of the dial settings was varied in a random fashion. A series of five head movements followed by a pause was termed a "sequence" and required 30 seconds. Thus,

the duration of stress in minutes was equivalent to 10 head movements, or two sequences, and the severity of the stress increased as a function of the room's angular velocity.

By individualizing the level of stress, persons with varying susceptibility to motion sickness could serve as their own controls in an experiment. As part of the initial workup, subjects were "calibrated" in terms of the number of head movements at a given rpm necessary to produce a level of motion sickness termed "severe malaise" (M III). This endpoint has been precisely defined (ref. 9), and here it is sufficient to describe it as mild motion sickness to which subjects do not object. Independent estimates of the M III endpoint indicated close agreement among experimenters with previously shared experiences.

The double-blind technique was used. Drugs and placebo (lactose) were in matched oral capsules and administered using a Latin-square design. In each of 5 experiments, 7 drugs and 3 placebos (4 placebos on one occasion) were given to 10 subjects, each participating in 10 experimental trials. In all, the 50 subjects were exposed to stress on 500 occasions.

The capsules were given 1 to 2 hours prior to exposure in the SRR. Only one subject was exposed at a time. The number of head movements was recorded when the M III endpoint was reached, and then the room was brought to a stop. Habituation was taken into account by establishing the mean placebo level of susceptibility which was used as the baseline in measuring the effects of the drugs. It should be emphasized that the procedure made it possible to demonstrate increased as well as decreased susceptibility.

RESULTS

The results are summarized in figure 1 where the drugs and combinations of drugs are ranked according to their effectiveness in reducing susceptibility to acute SRR sickness.

Among drugs with either a sympatholytic action or a tranquilizing effect, some caused a slight decrease and others an increase in susceptibility to SRR sickness. Phenoxybenzamine HCl and thiethylperazine maleate in the usual doses, as well as a triple dose of the latter, were found to

reduce the subjects' tolerance to the stressful Coriolis accelerations. Trimethobenzamide HCl in a triple dose and meprobamate ranked just below the placebo level, while a single dose of the former was effective just above that level. A new drug known as Experimental 999 was the most effective, although its level of effectiveness was below that of all antihistaminic drugs tested with the exception of meclizine in the usual dose. When $2\frac{1}{2}$ times the usual dose of Exp 999 was administered, its effectiveness decreased.

All six of the antihistaminic agents tested caused a decrease in susceptibility to SRR sickness, although the difference between the least and most effective was large. The effectiveness of meclizine was not increased when given in combination with dextroamphetamine sulfate.

The effectiveness of the sympathomimetic drugs was a chance finding and is thus explained: Amphetamine was given to counter the drowsiness caused by *l*-scopolamine hydrobromide and then administered alone for purposes of experimental control. In a 10-mg dose it was found to rank in effectiveness near the middle of the antihistamine group. It was unique among drugs tested in that a larger than the "recommended" dose increased its effectiveness, but the side effect (nervousness) contraindicated this dose for routine use.

Scopolamine with a parasympatholytic action was the single most effective drug. When the usual dose of 0.6 mg was doubled, its effectiveness was not increased, the actual number of head movements decreasing slightly. Drowsiness and "dry mouth" were prominent side effects.

The combination of the sympathomimetic drugs and scopolamine, a parasympatholytic drug, was additive in case of ephedrine and synergistic in the case of amphetamine 20 mg plus scopolamine 1.2 mg. The only troublesome side effect was "dry mouth." The same combination in half the doses was nearly as effective.

DISCUSSION

It has been stated that all persons with normal vestibular and neural responses are susceptible to motion sickness. The level of this sus-

ceptibility varies greatly among individuals; some are highly susceptible while others are very resistant. If the stimulus is strong enough and lasts long enough, however, all normal persons apparently will respond. The anti-motion-sickness drugs raise this individual base line so that an increased percentage of persons are then able to withstand a given exposure to motion. None of the drugs is completely effective, being dependent on the individual's susceptibility and the strength and duration of the stimulus.

The medications with central autonomic activity appeared to have the greatest effect on susceptibility to motion sickness in the SRR. The drugs that blocked sympathetic activity

increased susceptibility to motion sickness. Preparations with sympathetic stimulating activity and those with parasympathetic blocking activity were most effective in preventing the development of motion sickness.

Phenoxylbenzamide, which is a sympathetic blocking agent with some central action, increased susceptibility to motion sickness. This drug was also reported to increase susceptibility in a large study at sea. In aerobic studies at Pensacola the tolerated motion with this drug was below that of the placebo trials. Meprobamate is another preparation with adrenolytic activity which reduced tolerance to motion.

Another group of drugs with sympathetic blocking activity is the phenothiazines. These

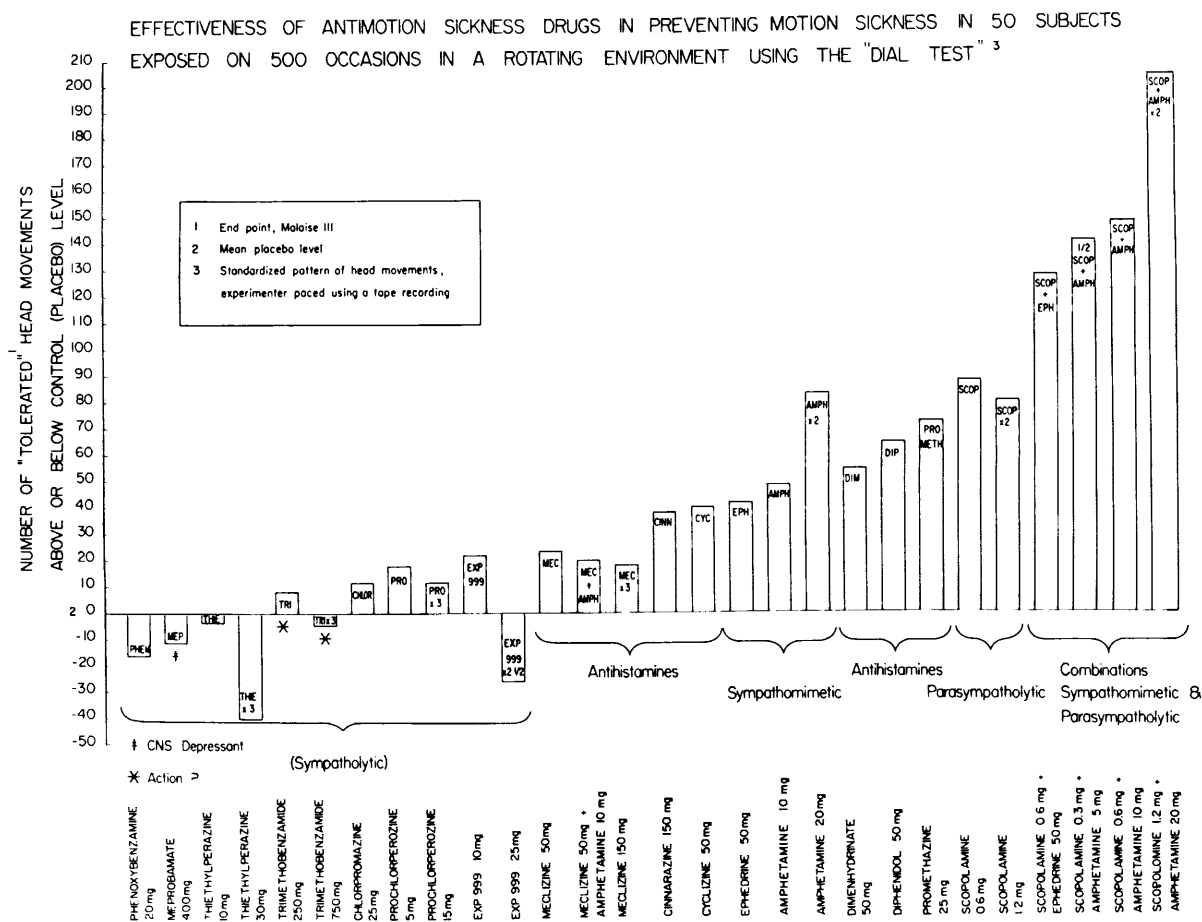

FIGURE 1.—Relative effectiveness of the drugs tested against motion sickness on the SRR. Drugs are arranged in order of effectiveness of the usually recommended dose, and increased doses and combinations are plotted adjacent to the recommended dose. Drug classification is indicated by brackets.

medications are very effective against chemically induced nausea; however, in the usually recommended dose they produced only a slight increase in tolerance to motion over the placebo level with all representatives tested. When the dose was increased, these preparations reduced the tolerance to motion below the placebo level. It would appear that any drug which reduces sympathetic activity will be ineffective or will increase susceptibility to motion sickness. These results further illustrate that drugs which protect against chemically induced nausea must act by a different mechanism from those which protect against motion sickness. Any recommendation of a drug as a motion-sickness preventative should be based on its efficacy in tests involving motion and not on its activity against other types of nausea.

Trimethobenzamide, which is reported to be an effective antinausant with little, if any, autonomic activity, was ineffective in our studies. In fact, even a triple dose did not produce a significant variation from the placebo level of susceptibility to motion sickness.

The antihistamines include a large number of effective anti-motion-sickness remedies; these have an "atropine-like effect" which is thought to be due to a central anticholinergic (parasympatholytic) action. All drugs in this classification were effective, to some extent, in preventing motion sickness. It appears that the antihistamines are quite useful during exposure to the mild types of motion. They have a longer duration of action and milder side effects than some of the other groups of anti-motion-sickness drugs. In exposure to more severe motion, the antihistamine types did not prove to be highly effective. The failure of the British investigators to find these drugs to be effective may have been due to the more severe stress to which they exposed their subjects (ref. 10).

The sympathomimetics represent another class of drugs found to be effective; they were first used to relieve the drowsiness caused by some of the other anti-motion-sickness drugs. The most effective representative of this class for this purpose was *d*-amphetamine. Tested alone in a 10-mg dose, it was found to rank in effectiveness

near the middle of the antihistamine group. Ephedrine was another representative of this class of drugs and it proved to be almost as effective as *d*-amphetamine in preventing motion sickness; it was effective when used in combination with scopolamine and when used alone. Ephedrine was not so effective in relieving the drowsiness produced by scopolamine as was *d*-amphetamine. The effectiveness of both of these drugs served to illustrate that medications which activate the sympathetic division of the autonomic nervous system also afford some protection against motion sickness. In searching the literature, it was found that *d*-amphetamine had been tested against motion sickness prior to World War II (refs. 11 and 12) and was found to be fairly effective by some British investigators; however, due to conflicting results in other studies it was not then adopted as a motion-sickness preventative.

The parasympatholytic class of anti-motion-sickness drugs is represented in this study by scopolamine. This preparation, also known as hyoscine by the British, has had extensive testing and has proven to be the most effective drug in this classification, which includes a number of synthetic preparations and atropine. The central action of scopolamine is known to be several times greater than that of atropine; therefore, it was chosen to represent this class of drugs. The antihistamines also have a central anticholinergic effect and are effective against motion sickness, but scopolamine has a much more pronounced action. Scopolamine was the single most effective drug in our series of studies, but the side effects of dry mouth and drowsiness are disturbing factors with its use.

Various combinations of drugs have been tried against motion sickness, usually with little if any increase in efficacy. In the present study, *d*-amphetamine was combined with scopolamine as well as with meclizine in an attempt to relieve the drowsiness produced by these drugs. When used alone, *d*-amphetamine was effective against motion sickness, as was previously mentioned, and combined with scopolamine, a potentiation of effectiveness was obtained; that is, the effect obtained was greater than the

sum of the effect of the two drugs when tested separately. The combination of *d*-amphetamine and meclizine failed to increase effectiveness, however. The increased protection afforded by the combination of a sympathomimetic (*d*-amphetamine) and a parasympatholytic (scopolamine) indicates a prominent role for the autonomic nervous system in motion sickness and its prevention.

As motion sickness develops, the involvement of the autonomic reactions is quite obvious. Earlier theories of motion sickness were based on autonomic activation, but the inability to demonstrate consistent changes in such areas as blood pressure, respiration, etc., which are responsive to alterations in autonomic activity, caused these theories to be discarded. However, when a subject in whom motion sickness is developing is observed in controlled experiments in the SRR, a waxing and waning of the various autonomic reactions can be seen. The face of the subject may flush, then become pale, only to return to normal color. Variations also can be seen in sweating, stomach awareness, etc., until motion sickness actually develops. In individuals who have a tolerance above the stress of the motion they are being exposed to, various reactions related to motion sickness can frequently be seen. This is also true of persons protected by medications. Such observations, along with the types of drugs which give protection against motion sickness, would suggest the action of competing systems in the central nervous system involving both divisions of the autonomic nervous system. The signs and symptoms associated with the sympathetic division would then appear to be protective, while those associated with the parasympathetic division would contribute to the ultimate vomiting of motion sickness. Therefore, as a person is exposed to the stresses of motion, the conflicting sensory stimuli, such as vestibular, visual, and proprioceptive, would activate both autonomic divisions. As the stress continues, either the protective sympathetic reactions would be sufficient to prevent motion sickness or the stress would override this protection and

the parasympathetic-somatic reactions would result in vomiting.

The results of our drug evaluation studies indicate that the effective drugs act by activating the central sympathetic activity or blocking the central parasympathetic activity. In this way, the autonomic activity during exposure to motion would be shifted toward the protective sympathetic reactions. Habituation to motion could be the result of conditioning these same protective mechanisms to a stronger reaction when exposed to motion. The diverse nature of the effective anti-motion-sickness drugs argues for a central action rather than a primary one on the receptors or on the effector organs through peripheral actions. The reticular activating system is known to have a marked influence on the autonomic activity; however, the presence of both stimulant and depressant drugs in the effective groups would indicate that this is not the primary site of action. It would appear, therefore, that higher systems directly involved with the autonomies are the critical ones involved in the motion sickness reaction. Motion sickness certainly involves not only the autonomic system, but rather a complex of higher systems, including the vestibular, cerebellum, somatic motor areas, hypothalamus, and possibly the reticular system.

The perfect anti-motion-sickness drug has not been found, but the results of our studies appear to indicate promising pharmacological areas for future exploration. The present drugs only increase an individual's resistance and do not make him immune to motion sickness. In addition, the most effective drugs have undesirable side effects. Therefore, much progress is still possible in this field. The studies reported here demonstrate that the combination of scopolamine with *d*-amphetamine is the most effective preparation now available. The superiority of this combination of drugs has been demonstrated in SRR studies as well as in aerobic and sea studies. For exposure to milder conditions, antihistamines such as cyclizine may be sufficient and more agreeable to the patient.

REFERENCES

1. WOOD, C. D.; KENNEDY, R. S.; AND GRAYBIEL, A.: Review of Antimotion Sickness Drugs From 1954-1964. *Aerospace Med.*, vol. 36, Jan. 1965, pp. 1-4.
2. WOOD, C. D.; KENNEDY, R. S.; GRAYBIEL, A.; WHERRY, R. J., JR.; AND TRUMBULL, R.: Clinical Effectiveness of Antimotion-Sickness Drugs. Computer Review of the Literature. *J. Am. Med. Assoc.*, vol. 198, Dec. 12, 1966, pp. 1155-1158.
3. CHINN, H. I.; AND SMITH, P. K.: Motion Sickness. *Pharmacol. Rev.*, vol. 7, Mar. 1955, pp. 33-82.
4. WOOD, C. D.; GRAYBIEL, A.; AND KENNEDY, R. S.: A Comparison of Effectiveness of Some Antimotion Sickness Drugs Using Recommended and Larger Than Recommended Doses as Tested in the Slow Rotation Room. *Aerospace Med.*, vol. 37, Mar. 1966, pp. 259-262.
5. WOOD, C. D.; GRAYBIEL, A.; McDONOUGH, R. G.; AND KENNEDY, R. S.: Human Centrifuge Studies on the Relative Effectiveness of Some Antimotion Sickness Drugs. *Aerospace Med.*, vol. 37, Feb. 1966, pp. 187-190.
6. MILLER, E. F., II: Counterrolling of the Human Eyes Produced by Head Tilt With Respect to Gravity. *Acta Oto-Laryngol.*, vol. 54, 1962, pp. 479-501.
7. MCLEOD, M. E.; AND MEEK, J. C.: A Threshold Caloric Test: Results in Normal Subjects. NSAM-834. NASA Order R-47. Naval School of Aviation Medicine, Pensacola, Fla., 1962.
8. GRAYBIEL, A.; CLARK, B.; AND ZARRIELLO, J. J.: Observations on Human Subjects Living in a "Slow Rotation Room" for Periods of Two Days. *Arch. Neurol.*, vol. 3, 1960, pp. 55-73.
9. GRAYBIEL, A.; WOOD, C. D.; MILLER, E. F., II; AND CRAMER, D. B.: Diagnostic Criteria for Grading the Severity of Acute Motion Sickness. *Aerospace Med.*, vol. 39, 1968, pp. 453-455.
10. GLASER, E. M.; AND MCCANCE, R. A.: Effect of Drugs on Motion Sickness Produced by Short Exposure to Artificial Waves. *Lancet*, vol. 1, Apr. 1959, pp. 853-856.
11. BLACKHAM, R. J.: Sea-sickness. *Brit. Med. J.*, vol. 2, July 22, 1939, pp. 163-167.
12. HILL, J.: Benzedrine in Seasickness. *Brit. Med. J.*, vol. 2, Dec. 4, 1937, pp. 1109-1112.

DISCUSSION

Baldes: As Dr. Jones pointed out in his introductory remarks, this symposium is devoted to the role of the vestibular organs in space exploration, but I am going to take you out of orbit and bring you down to some lap-of-the-Earth problems with which the Army is concerned. As you all must know, a few years ago competition was entered into by 12 aircraft companies for the development of an advanced aerial fire-support system. This competition was won by Lockheed which developed what is known as the compound helicopter; this is a most unusual aircraft called the Cheyenne. Ten of these prototypes have now been accepted by the Army for testing purposes. Regarding the maneuverability of this aircraft, it has the following capabilities: a diving speed of 264 knots, and an ordinary speed of about 220. It has the capability of turning around 180° in 8 seconds at a speed of 100 knots, the radius of turn being 435 feet. That means it is exposed to more than 2 radial *g*; it is stressed for 3½, actually. It can hold a 90° bank, and roll at the rate of 60°/sec. It is powered by 3400-horsepower gas turbine. It is called a compound helicopter because it has wings and a pusher prop tail.

The thing of interest which I think might be of concern to some of us is this: Remembering that this is a highly maneuverable aircraft, the problem concerns the gunner or the copilot who sits tandem with the pilot, but at a lower level. The gunner's seat is placed on a rotating table; this can rotate at a maximum rate of 100°/sec, the maximum excursion of the rotation being 210° from stop to stop. The maximum acceleration of the rotating table is 180°/sec². Assuming equal acceleration and deceleration rates of the

seat, the time for rotation of 210° from stop to stop may be less than 3 seconds. When this rotation is combined with maneuverability of the aircraft, I think there will be problems of a vestibular nature. In addition, may I point out that the gunner looks forward and downward through his telescope at the target. He does not sit upright and thus align the vertical through his head. This should bring up some very interesting problems in disorientation.

Dr. Wood, do you have a pill or capsule you can recommend that can be bought at a drugstore for motion sickness?

Wood: These, of course, have to be made up, but they have a few more side effects than the antihistamines. The antihistamines such as Marezine or Dramamine are usually effective for the usual type of motion sickness.

Licking: I have been working in Dr. Wang's laboratory and with Dr. Tokumasu of the University of Tokyo. We have tested scopolamine on several units in the vestibular nuclei of several cats, and scopolamine seems to have quite a dramatic effect, decreasing the capacity of motion-sensitive units responding to a specific movement. Were your subjects also tested as to their thresholds for perceiving motion, pitch, yaw, plunging, etc.?

Wood: No; but Dr. Miller may have done some other research in his area. He could probably answer that question because these same subjects were used in other Pensacola studies.

Miller: The semicircular canal threshold of most, if not all, the subjects used by Dr. Wood was determined by measuring the smallest angular acceleration for which the direction of apparent movement of a fixed target (oculogyral

illusion) could be correctly identified. The thresholds which covered a wide range of acceleration values showed no apparent correlation with motion-sickness susceptibility.

Johnson: I want to congratulate Dr. Wood for a very well-organized research program and his explanation of how these drugs act in relation to their chemistry. As he has pointed out, controversy does exist as to the relative effectiveness of such drugs. I think this is due to experimental design. The British, for instance, have long preferred hyoscine in the Royal Navy. I must point out that I have published an article (W. H. Johnson and P. E. Ireland, "Suppression of Motion Sickness by Thiethylperazine (Torecan)," *Aerospace Med.*, vol. 37, 1966, pp. 181-183) which disagrees with your conclusions as to the effectiveness of Torecan (a phenothiazine). We tested this compound in the Canadian Air Force on several search-and-rescue missions involving low flying in turbulent areas. The airmen experienced considerable airsickness until we used this compound. Possibly you used a different dose.

Wood: As shown in figure 1 of the text, we used 30 mg of thiethylperazine (Torecan) in one instance and 10 mg in

another. There was very little effect with 10 mg, and with 30 mg, the effectiveness fell below the baseline.

Johnson: We found Torecan effective only when using 40 mg.

Schiff: It was very interesting to see how effective Dramamine was. Dramamine is made of two molecules, one is a molecule of Benadryl and the other part is a chlorotheophyllin. The Benadryl is highly parasympatholytic, and the chlorotheophyllin is a preventive against sleepiness; so it is decidedly a sympathomimetic.

There is a question whether or not sweating and skin changes as occur with other parasympathetic, other cholinergic, phenomena, occur since all preganglionic fibers are cholinergic; some of the postganglionic fibers are adrenergic. If the level at which the acetylcholine was working was conceived to be acting on the preganglionic fiber, we would be able to explain all the phenomena without having to separate them into two categories. This appears to be what happens because the sympathomimetic also is antagonistic to the parasympathetic. So one is driven further toward a greater control. It is a very interesting study.

Prevention of Motion Sickness in the Slow Rotation Room by Incremental Increases in Strength of Stimulus

ASHTON GRAYBIEL

Naval Aerospace Medical Institute

SUMMARY

Two groups of experiments in the Pensacola slow rotation room demonstrated the possibility of preventing motion sickness in human subjects by incremental exposures to otherwise highly stressful Coriolis accelerations. These accelerations were generated by motions of the subject's head out of the plane of the room's rotation. In the first experiment, control of the accelerations was maintained principally through regulation of the room's velocity. In the second, the adaptation was speeded up by control over head motions made by the subjects as well as over the room's velocity.

The cardinal findings in these experiments have important theoretical and practical implications in adaptation to Coriolis accelerations, as well as in the prevention of motion sickness by "natural" means in a rotating spacecraft.

INTRODUCTION

This report deals with experiments in the Pensacola slow rotation room designed to prevent motion sickness by means of incremental increases to otherwise almost intolerable levels of Coriolis accelerations.

The primary etiological factor causing slow rotation room (SRR) sickness is stimulation of the vestibular organs, especially the semi-circular canals, by Coriolis accelerations generated by rotations of the subject's head out of the plane of the room's rotation. Thus, control of the stressor is exercised through regulation of the room's angular velocity, which is accomplished accurately and without difficulty, and control over head rotations, which is not so readily accomplished in the active subject. With regard to the latter, the experimenter exercises control by requesting the subject either to fixate his head, to carry out tasks involving stressful head rotation, or to execute standardized head motions. With head fixed, the stressor is "off"; adaptative processes come to a halt, and if motion is present, the oppor-

tunity for restoration is initiated. When assigned tasks of a general nature are carried out, it is difficult to measure the incidental stressful head motions involved. Only if the head motions are standardized and precisely carried out are quantitative data obtainable; obviously, however, the experimenter has only limited control over head motions even when subjects cooperate fully. Subjects left to their own devices differ in the number of stressful head rotations made whether or not motion sickness is present.

The experiments to be described fall into two groups. In the first, control of the stress was exercised mainly through regulation of the SRR angular velocity; and in the second, control over the subjects' head motions as well as the room's velocity was attempted. A terminal velocity of 10 rpm was chosen partly because of the small likelihood that rotating orbiting spacecraft would exceed this velocity and partly because, in our experience, normal subjects suddenly exposed in a room rotating at 10 rpm invariably became sick while carrying out assigned tasks and housekeeping activities (refs. 1 to 4). Under different conditions, how-

ever, susceptibility to motion sickness at rotational velocities of 10 rpm may not be so great (refs. 5 to 7).

ADAPTATION THROUGH CONTROL OVER VELOCITY OF THE SRR

Three initial probes were unsuccessful (ref. 8). Two involved three incremental steps to terminal velocity on the SRR (10 rpm) over a period of approximately 3 days, and the third a series of 40 incremental steps over a period of 40 hours. The subjects were free to follow their own interests except during testing periods of 4 hours in the morning and afternoon. Although all of the subjects experienced motion sickness, it was estimated that the severity was lessened as compared with that experienced by subjects suddenly exposed to such a velocity. It was concluded that none of the patterns of stepwise increases in velocity resulted in acceptable levels of adaptation to the stress.

In the next attempt, symptoms of motion sickness, with the probable exception of drowsiness, were prevented solely through control of the

SRR velocity (ref. 9). The initial speed of rotation was 2 rpm, after which there were nine unit increases in velocity, with dwell times of 2 days at each level except terminal velocity (10 rpm) where the subjects remained for nearly 9 days. Four male subjects, 17 to 19 years of age, participated. All were healthy, and semicircular canal and otolith organ function was normal as revealed by the threshold caloric (ref. 10) and ocular counterrolling (ref. 11) test procedures. The diagnostic categorization used in estimating levels of severity of acute motion sickness is summarized in table 1 (ref. 12).

After 3 days of familiarization with the test program, the subjects entered the SRR where they remained for about 32 days; the rotation period was nearly 25 days. They had a busy schedule except in the evening and at times made "experimenter-paced" head motions.

The stress profile and the symptomatology are summarized in figure 1 (ref. 13). With the exception of drowsiness, the subjects' symptoms were either trivial or explicable (due to power failure) in the perrotation period. Daily clinical evaluations by the onboard physician-experi-

TABLE 1.—*Diagnostic Categorization of Different Levels of Severity of Acute Motion Sickness*¹

[AQS = Additional qualifying symptoms. III = severe or marked, II = moderate, I = slight]

Category	Pathognomonic, 16 points	Major, 8 points	Minor, 4 points	Minimal, 2 points	AQS, 1 point
Nausea syndrome.....	Vomiting or retching.	Nausea II, III.	Nausea I.....	Epigastric dis- comfort.	Epigastric awareness.
Skin.....		Pallor III.....	Pallor II.....	Pallor I.....	Flushing/subjective warmth, ≥ II.
Cold sweating.....		III.....	II.....	I.....	
Increased salivation.....		III.....	II.....	I.....	
Drowsiness.....		III.....	II.....	I.....	
Pain.....					Headache.
Central nervous system.					Dizziness: eyes closed, ≥ II; eyes open, III.

Levels of Severity Identified by Total Points Scored

Frank sickness (S) ≥ 16 points	Severe malaise (M III) 8-15 points	Moderate malaise A (M IIA) 5-7 points	Moderate malaise B (M IIB) 3-4 points	Slight malaise (M I) 1-2 points
--------------------------------------	--	---	---	---------------------------------------

¹ From ref. 12.

menter, bolstered by routine hematological procedures, urinalysis, and other laboratory tests, revealed no definite variations from control values. The results of the analysis of the excretion rates for catechol amines and 17-hydroxycorticosteroids revealed no significant differences from baseline rates throughout the entire experimental period. On cessation of rotation, ataxia was the most prominent and lasting complaint, and symptoms of motion sickness were either absent or trivial.

ADAPTATION THROUGH CONTROL OF THE SUBJECT'S HEAD MOTIONS AND VELOCITY OF THE SRR

The experiments described in the preceding section demonstrated that adaptation would occur in the absence of overt symptoms of motion sickness, but that long periods were required when reliance was placed only on "incidental" stressful head motions. It became apparent that the adaptation process should be speeded

up by controlling the subject's head motions as well as the velocity of the SRR.

Two experiments were conducted (ref. 14) in which the dwell time at each incremental increase in velocity of the SRR was determined by the capacity of the subject to make a given number of standardized head motions generating

TABLE 2.—Susceptibility to Acute SRR Sickness (Dial Test)

Subject	Rotation, rpm	Head movements, number	Level of symptoms ¹
Experiment I:			
TA	7.5	60	M III
SC	15.0	35	M III
JE	20.0	70	M III
Experiment II:			
RO	20.0	300	M I
CA	20.0	300	M IIA
DA	20.0	75	M III

¹ See table 1.

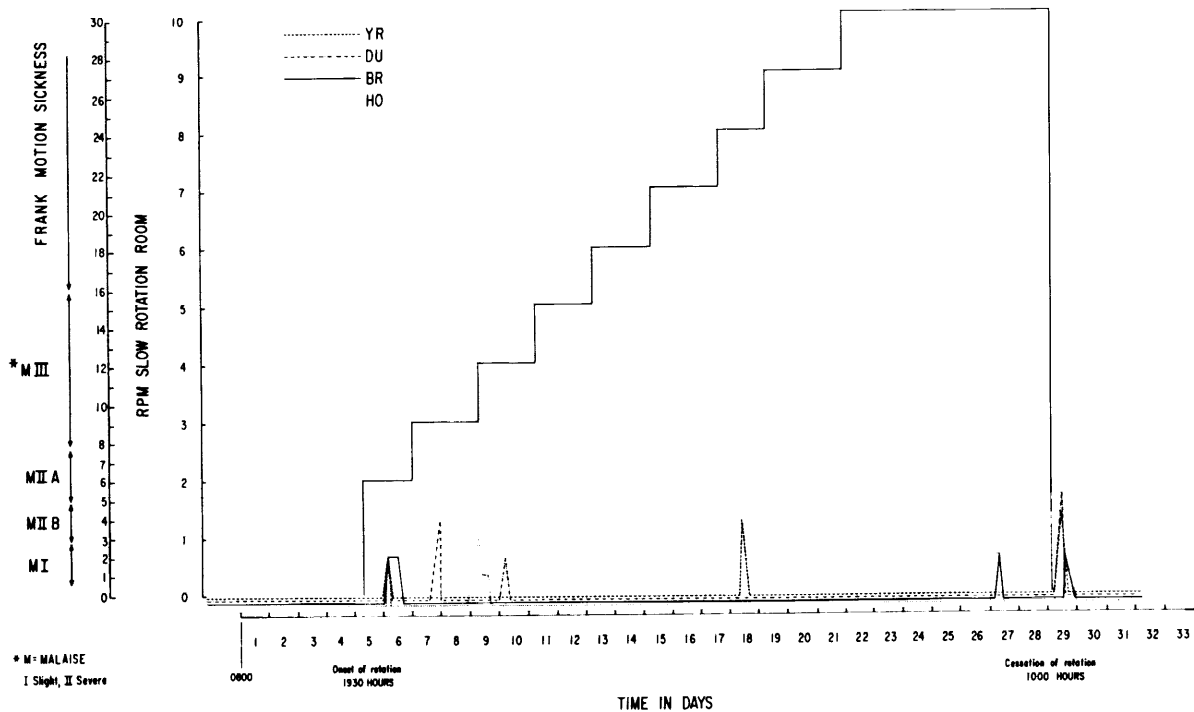

FIGURE 1.—The stress profile in the SRR and changes in level of motion sickness symptoms in four healthy subjects exposed to rotation over a period of nearly 25 days. (From ref. 13.)

Coriolis accelerations. The limiting factors were fatigue on the part of the subject and the periods required for sleep and other life-support activities. Three volunteer subjects participated in each experiment. All six were college students, 18 to 23 years of age, and were selected mainly on the basis of clinical fitness and not on the basis of susceptibility to motion sickness. None had any significant loss in hearing, all had normal threshold caloric tests responses and ocular counterrolling indices, and scores made on postural equilibrium tests (refs. 15 and 16) were within the normal range. Their susceptibility to acute SRR sickness as revealed by the dial test is shown in table 2; note that the endpoint, severe malaise (M III), was not reached by subjects RO and CA at the cutoff point; i.e., 300 head movements at 20 rpm.

Experiment I

The stress profile and summary of the findings in the first experiment are shown in figure 2. The subject's shoulders were restrained, and the movements consisted essentially of flexion

of the head from the upright and return: about 70° forward, about 35° backward, and 45° left and right, always in the same order. The head movements were paced with a metronome set for 2 seconds at velocities of 1 to 6 rpm, 4 seconds at 7 to 9 rpm, and 6 seconds at 10 rpm. Standardized tasks were used to test for the effectiveness of transfer of adaptation to omnidirectional motions at terminal velocity.

Individual differences in susceptibility to motion sickness and in rate of adaptation to the stressful accelerations were revealed. TA was by far the most susceptible of the three subjects. He became drowsy at a very low level of stress, and this was followed by more severe symptoms at higher angular velocities; indeed, he was not able always to make the required number of head motions. To insure prevention of symptoms at 10 rpm in his case, a different program for the incremental increases in stress would be required. There were small but significant differences between the other two subjects. SC manifested very mild symptoms at 8 rpm while both SC and JE, for the first time,

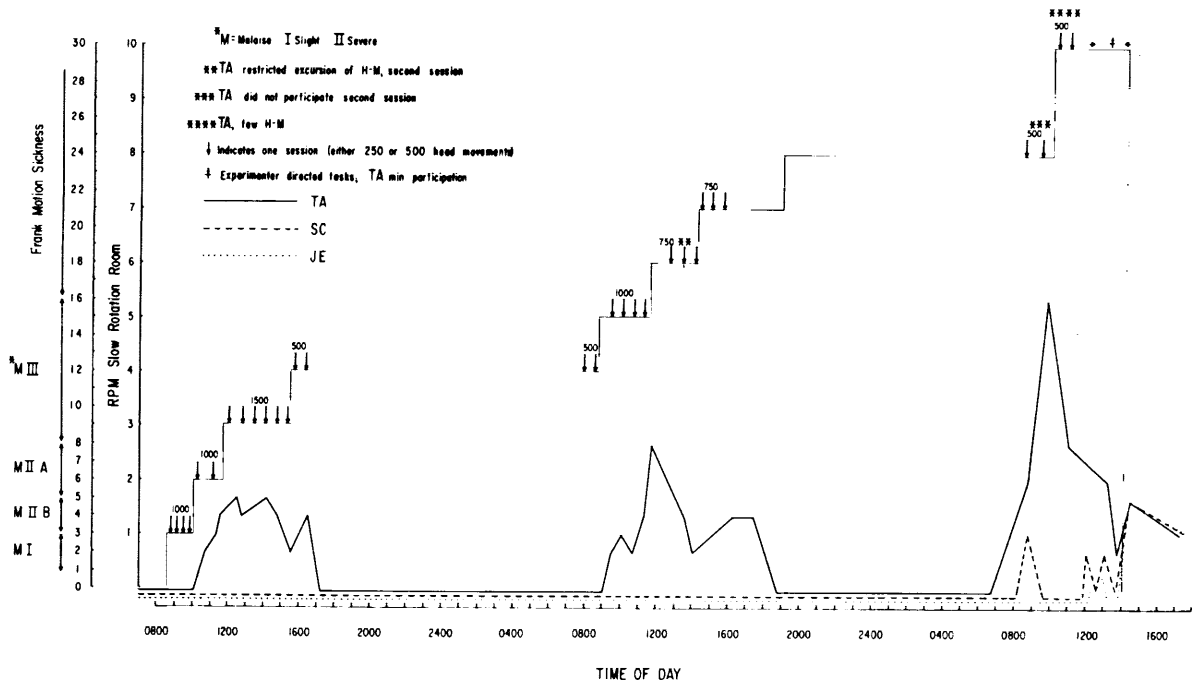

FIGURE 2.—The stress profile in the SRR and manifestations of motion sickness in three healthy subjects exposed to rotation for over 2 days. (From ref. 14.)

manifested symptoms when required to carry out the standardized tasks at terminal velocity, indicating that the adaptation acquired making the standardized (limited) head motions did not afford full protection (incomplete transfer) during activities involving omnidirectional head rotations of maximal excursion.

Experiment II

The stress profile of the second experiment, along with a summary of the findings, is shown in figure 3. The duration of rotation in the SRR was a little over 2 days, during which time the subjects made 1000 head movements at each one-unit increase in velocity, except at 10.0 rpm when they made 500 and then participated in generalized activities. These sessions occupied about 4 to 5 hours of each day, and there were no restrictions on the subject's moving about at other times. In this experiment the subjects were secured by means of a lap belt, and the movements involved not only flexion of head but also

movement of the trunk at the waist. The back of the chair limited backward motion to about 40° , but the movements sideways were about 70° and those forward, 90° .

The findings revealed that one subject, DA, did not manifest any overt symptoms of motion sickness either perrotation or during the post-rotation period, while in the other two the symptoms were either trivial (CA) or mild (RO). It is also noteworthy that all of the subjects were ataxic on attempting to walk after cessation of rotation.

DISCUSSION

The cardinal findings in these experiments have important theoretical and practical implications which are discussed below.

Theoretical Implications

The fact that adaptation to strong Coriolis accelerations can occur in the absence of overt symptoms of motion sickness is proof that the

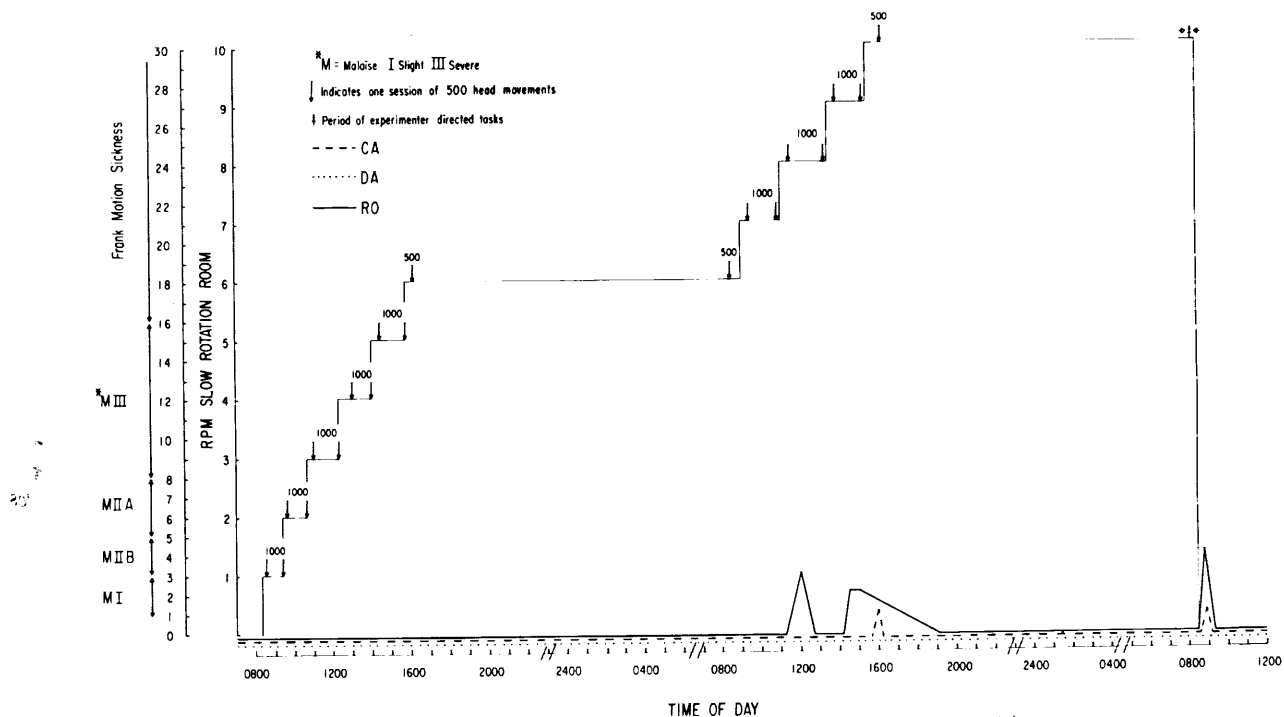

FIGURE 3.—The stress profile in the SRR and manifestations of motion sickness in three healthy subjects exposed to rotation for about 2 days. The large number of head motions accounted for the rapid adaptation. (From ref. 14.)

adaptive processes need not involve the neural processes and events immediately responsible for motion-sickness symptoms. In other words, by preventing symptoms it was demonstrated that what is sometimes referred to as "habituation of symptoms" did not occur and raised the question whether it ever occurs. Groen (ref. 17) has discussed both the nature and possible sites of the adaptation processes.

There was evidence of transfer of adaptation acquired at a given angular velocity of the SRR to a higher velocity; also, adaptation acquired through limited head excursions in two planes of arc transferred to omnidirectional head motions of unlimited excursion, provided a sufficient number of discrete motions had been made. There was some evidence in our studies that overadaptation at 10 rpm minimized or abolished the susceptibility to symptoms on cessation of rotation, suggesting a "general suppression" effect with the exception that it was direction specific; adaptation in a clockwise direction increased susceptibility to symptoms during exposure to a counterclockwise rotation. On cessation of rotation, after long exposure at 10 rpm, ataxia was prominent even when symptoms of motion sickness were absent, implicating non-vestibular and somatosensory systems.

Another implication, based on findings in present and previous experiments in the SRR (refs. 1 to 4), is that when symptoms do occur, they represent a "failure" in homeostatic processes. This failure is due to exposure to Coriolis accelerations, the stressor, which exceed the capacity of the organism to adapt. In other words, the "functional vestibular reserve" representing the adaptive capacity has been exceeded, and symptoms of failure appear. The strength of the stressor per se is not important, but its strength vis-a-vis the reserve is all important. Some of the characteristics of natural or innate reserve are shown by interindividual differences in susceptibility to motion sickness in persons with little or no previous exposure in unusual force environments. Going beyond the limits of the functional reserve or a failure of homeostasis presumably allows, through the processes of facilitation and inhibition, irradiation of vestibular activity to areas not stimulated

under natural conditions. The initial responses implicate the visceral nervous system, but these effects are followed by second- and third-order effects, some of which are in the nature of "complications" (refs. 18 to 20). Although it is well known that a person may be more susceptible to motion sickness in one force environment than another, there is no evidence that vestibular mechanisms underlying the symptomatology are not generally applicable.

Practical Implications

The findings in these experiments point the way toward the prevention of motion sickness by "natural" means if it is decided to generate artificial gravity by causing a spacecraft to rotate. Adaptation could be effected without evoking significant symptoms of motion sickness through control over the angular velocity of the spacecraft and through the astronauts' control over head rotations out of the plane of the spacecraft's rotation. Additional observations must be made to determine the best profiles, taking into account the number of stepwise increases to terminal velocity and individual adaptability, not only under terrestrial conditions but also at given subgravity levels. With regard to the former, it may be pointed out that all persons have some vestibular reserve in a rotating environment under terrestrial conditions, but that, for some persons, this reserve is nil in weightlessness even in the absence of rotation and even may be exceeded; i.e., symptoms may be evoked with head motions (ref. 21). Obviously, the incremental increases would be differently patterned in the case of astronauts selected for low susceptibility compared with an unselected group of astronauts. It is also essential to keep in mind that adaptation does not occur with head fixed, such as would be the case while astronauts were sleeping or while engaged in tasks not requiring head motions out of the plane of rotation of the spacecraft.

For a given pattern of changes in angular velocity and the accompanying changes in g -loading which would be a function of the effective radius, e.g., position of the astronaut, the remaining aspects in control of the vestibular stimulation would rest almost entirely with the individual. The greater the number of stressful accelerations,

the more rapid the adaptation, although additional guidelines are important. Overt symptoms of motion sickness should be avoided, although it is reasonable to believe that levels of stress just within the tolerance limits are the most effective. Some experience is needed to avoid summation or cumulation effects. Very mild acute symptoms quickly disappear with head fixation. Details concerning the most efficient way to effect adaptation need to

be worked out as well as the best means of avoiding symptoms while a susceptible astronaut is carrying out essential tasks.

Return to a stationary environment, or quick transfer back and forth between a rotating and stationary environment presents little or no problem from the standpoint of motion sickness but may with regard to ataxia which is, in very large degree, a separate problem (refs. 22 and 23).

REFERENCES

1. GRAYBIEL, A.; CLARK, B.; AND ZARRIELLO, J. J.: Observations on Human Subjects Living in a "Slow Rotation Room" for Periods of Two Days. *Arch. Neurol.*, vol. 3, 1960, pp. 55-73.
2. CLARK, B.; AND GRAYBIEL, A.: Human Performance During Adaptation to Stress in the Pensacola Slow Rotation Room. *Aerospace Med.*, vol. 32, 1961, pp. 93-106.
3. GRAYBIEL, A.; KENNEDY, R. S.; KNOBLOCK, E. C.; GUEDRY, F. E., JR.; MERTZ, W.; MCLEOD, M. E.; COLEHOUR, J. K.; MILLER, E. F., II; AND FREGLY, A. R.: The Effects of Exposure to a Rotating Environment (10 rpm) on Four Aviators for a Period of Twelve Days. *Aerospace Med.*, vol. 36, 1965, pp. 733-754.
4. GUEDRY, F. E., JR.: Habituation to Complex Vestibular Stimulation in Man: Transfer and Retention of Effects From Twelve Days of Rotation at 10 rpm. *Percept. Mot. Skills*, vol. 21, 1965, pp. 459-481.
5. STONE, R. W., JR.; AND LETKO, W.: Some Observations on the Stimulation of the Vestibular System of Man in a Rotating Environment. The Role of the Vestibular Organs in the Exploration of Space, NASA SP-77, 1965, pp. 279-292.
6. NEWSOM, B. D.; BRADY, J. F.; AND GOBLE, G. J.: Equilibrium and Walking Changes Observed at 5, 7½, 10, and 12 rpm in the Revolving Space Station Simulator. *Aerospace Med.*, vol. 36, 1965, pp. 322-326.
7. LETKO, W.; AND STONE, R. W., JR.: The Effects of the Plane of Vestibular Stimulation on Task Performance and Involuntary Eye Motion. Third Symposium on the Role of the Vestibular Organs in Space Exploration, NASA SP-152, 1968, pp. 49-55.
8. BERGSTEDT, J.: Stepwise Adaptation to a Velocity of 10 rpm in the Pensacola Slow Rotation Room. The Role of the Vestibular Organs in the Exploration of Space, NASA SP-77, 1965, pp. 339-344.
9. GRAYBIEL, A.; DEANE, F. R.; AND COLEHOUR, J. K.: Prevention of Overt Motion Sickness by Incremental Exposure to Otherwise Highly Stressful Coriolis Accelerations. *Aerospace Med.*, vol. 40, 1969, pp. 142-148.
10. MCLEOD, M. E.; AND MEEK, J. C.: A Threshold Caloric Test: Results in Normal Subjects. NSAM-834. NASA Order R-47. Naval School of Aviation Medicine, Pensacola, Fla., 1962.
11. MILLER, E. F., II: Counterrolling of the Human Eyes Produced by Head Tilt With Respect to Gravity. *Acta Oto-Laryngol.*, vol. 54, 1962, pp. 479-501.
12. GRAYBIEL, A.; WOOD, C. D.; MILLER, E. F., II; AND CRAMER, D. B.: Diagnostic Criteria for Grading the Severity of Acute Motion Sickness. *Aerospace Med.*, vol. 39, 1968, pp. 453-455.
13. GRAYBIEL, A.: Structural Elements in the Concept of Motion Sickness. *Aerospace Med.*, vol. 40, 1969, pp. 351-367.
14. GRAYBIEL, A.; AND WOOD, C. D.: Rapid Vestibular Adaptation in a Rotating Environment by Means of Controlled Head Movements. *Aerospace Med.*, vol. 40, 1969, pp. 638-643.
15. GRAYBIEL, A.; AND FREGLY, A. R.: A New Quantitative Ataxia Test Battery. *Acta Oto-Laryngol.*, vol. 61, 1966, pp. 292-312.
16. FREGLY, A. R.; AND GRAYBIEL, A.: An Ataxia Test Battery Not Requiring Rails. *Aerospace Med.*, vol. 39, 1968, pp. 277-282.
17. GROEN, J. J.: Adaptation. *Pract. Oto-Rhino-Laryngol.*, vol. 19, 1957, pp. 524-530.
18. McNALLY, W. J.; AND STUART, E. A.: Physiology of the Labyrinth Reviewed in Relation to Seasickness and Other Forms of Motion Sickness. *War Med.*, vol. 2, 1942, pp. 683-771.
19. TYLER, D. B.; AND BARD, P.: Motion Sickness. *Physiol. Rev.*, vol. 29, 1949, pp. 311-369.
20. TAYLOR, N. B. G.; HUNTER, J.; AND JOHNSON, W. H.: Antidiuresis as a Measurement of Laboratory Induced Motion Sickness. *Can. J. Biochem. Physiol.*, vol. 35, 1957, pp. 1017-1027.
21. MILLER, E. F., II; GRAYBIEL, A.; KELLOGG, R. S.; AND O'DONNELL, R. D.: Motion Sickness Susceptibility Under Weightless and Hypergravity Conditions Generated by Parabolic Flight. *Aerospace Med.*, vol. 40, 1969, pp. 862-868.
22. GRAYBIEL, A.: Vestibular Problems in Prolonged Manned Space Flight. Presented at the Vestibular Symposium Sponsored by the Bárány Society, Uppsala, Sweden, May 29-30, 1968.
23. GRAYBIEL, A.: Vestibular Mechanisms in Human Behavior. *Ann. Otol.*, vol. 77, 1968, pp. 772-786.

DISCUSSION

Lansberg: Do you think the effect will linger once the man has become habituated and he has left the rotating room after a month or after 6 weeks?

Graybiel: No, I do not. He loses this quite rapidly.

Lansberg: The habituation has to be rebuilt?

Graybiel: Yes. He remains habituated for a little while, but even within 48 hours it appears as though it is decreasing. However, the subject does seem to retain a little extra protection as compared to what was present before. We have not really studied this systematically.

Baldes: Have you tried any experiments on hypnosis in your rotating room?

Graybiel: We had one young medical officer who practiced autohypnosis. He was able to prevent motion sickness while making head movements at 20 rpm during the provocative dial test. This required considerable effort on his part. Prior to the exposure, I found him lying on a couch. I asked him if he was unwell. He said, "No," and that he was "just concentrating and getting set." We have precipitated one mild attack of petit mal. On two occasions we have precipitated a severe circulatory collapse in a highly susceptible person. Symptoms due to a fall in blood pressure are extremely rare in our experience.

Newsom: I am glad to see the confusion between our two studies has finally been cleared up. As you recall, we reported at the first symposium in 1965 (Newsom, Bernard D.; and Brady, James F.: "Observations on Subjects Exposed to

Prolonged Rotation in a Space Station Simulator," NASA SP-77, 1965, pp. 279-292) that there were no symptoms after stepwise adaptation. Even more surprising was that we had no postrotation effects. There were no postrotation effects providing the man kept his eyes open. Did you do any blind rail walking or blind balancing?

Graybiel: We have performed a number of experiments indicating that symptoms of motion sickness and manifestations of ataxia in the rotating room, though commonly associated, can be "uncoupled." This was clearly demonstrated in an experiment involving the use of air-bearing supports and articulated Fiberglas molds which permitted the subjects to carry out activities, including walking, when in the Earth-horizontal position. While rotating for 2 days in the "horizontal mode," they experienced symptoms of motion sickness which disappeared through the mechanisms of adaptation. Then they were taken out of the molds and exposed for an additional 2 days when upright. In this vertical mode they experienced ataxia but not motion sickness. When the first 2 days were spent upright, they experienced both ataxia and motion sickness which gradually disappeared. The last 2 days were spent in the molds without complaints, and they remained in the molds for a day and a half following cessation of rotation. Soon after rotation ceased, mild symptoms of motion sickness appeared on making head movements. On getting out of the molds they experienced ataxia as the result of adaptation to the rotating environment acquired 3½ days previously; obviously different mechanisms were involved.

Résumé of Sessions on Motion Sickness

HERBERT L. BORISON

Dartmouth Medical School

SUMMARY

This is a review of the neurological elements responsible for coordinating the vomiting sequence and a discussion of the input and output components of the emetic reflex. Questions are raised as to the nature of the reflex arc in the vomiting of motion sickness, the cause for the long onset of the effects of motion sickness, and the mechanism by which anti-motion-sickness drugs act.

REVIEW OF THE VOMITING MECHANISM

If we go back into medical history, we find the ancient Egyptians depicted vomiting in a painting decorating a wall in a tomb of Thebes (fig. 1). Presumably the lady is disgorging herself between courses at a banquet. Another early reference to vomiting is in the form of a quotation attributed to a Christian physician of Bagdad, one Elluchasem Elimithar, who died in 1063. He said, "Vomiting is to be preferred when the moon is north of the house in conjunction with a receding planet."

I have done some work in the footsteps of Dr. S. C. Wang on the vomiting mechanism. Figure 2 shows a specimen of the brainstem of the cat removed after *in situ* perfusion with formalin. Such an experimental preparation lacking both forebrain and cerebellum, but of course retaining its peripheral connections, is quite capable of executing the complete emetic process in response to appropriate stimuli—although certainly not to motion.

Figure 3 is a drawing of the same surface of the brainstem as photographed in figure 2. The arrows point to the limits of a lesion on the margin of the fourth ventricle that abolishes selectively the emetic effectiveness of a variety of chemical agents without in any way dis-

turbing the inherent control mechanism of vomiting. Wang and I described this phenomenon around 1948 and attributed the resulting emetic refractoriness to destruction of a specialized receptive site that we labeled the medullary emetic chemoreceptor trigger zone (CTZ). We came to this conclusion for two main reasons, namely, that other reflex-induced emetic responses were not attenuated and, most importantly, we had localized the vomiting center itself more deeply, in the reticular formation of the medulla oblongata. Figure 4 is a phantom view of the medulla showing the spatial orientation of various components of the neurological mechanism responsible for coordinating the complex sequential pattern of vomiting. I will not dwell on the experimental evidence for localization of the brainstem "centers." We have concluded from our studies that organization and integration of the emetic response must be accomplished in the reticular formation and that the CTZ on the medullary surface serves solely as a sensory organ—a chemical transducer, if you will—for specific agents in the bloodstream as well as in the cerebrospinal fluid.

Figure 5 is a photomicrograph of a section through the region of the fourth ventricle (IV) at the level of the superficial chemoreceptor trigger zone and the deeper vomiting center (VC). It was only after we had developed our

concept of the emetic chemoreceptor mechanism that we came to know about the vascular ependymal organ, area postrema (AP), which coincides morphologically with our localization of the CTZ.

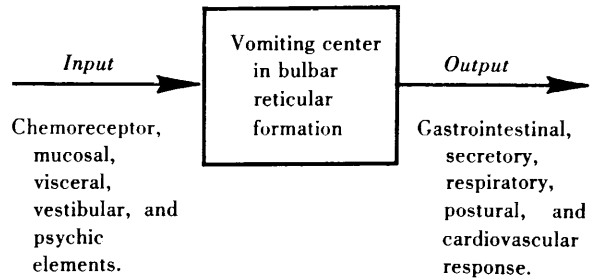

FIGURE 1.—*Egyptian lady vomiting.*



FIGURE 2.—*Lower brainstem of the cat with fourth ventricle exposed by removal of the cerebellum.*

A review of the input-output relations of the emetic reflex follows: The chemoreceptor trigger zone is an input component sensitive to emetic substances in blood and cerebrospinal fluid.



I call it "the" emetic reflex for all inputs because we can no longer accept the once-popular notion that the vomiting center itself could respond to emetic stimuli. Thus, by control-system analogy, we envisage a variety of inputs to the "controller" that, after suitable signal processing, delivers its commands to various outputs.

On the output side, multiple forms of expression are observed: gastrointestinal, secretory, respiratory, postural, and cardiovascular. There has been much discussion about the use of autonomic blockade in the treatment of motion sick-

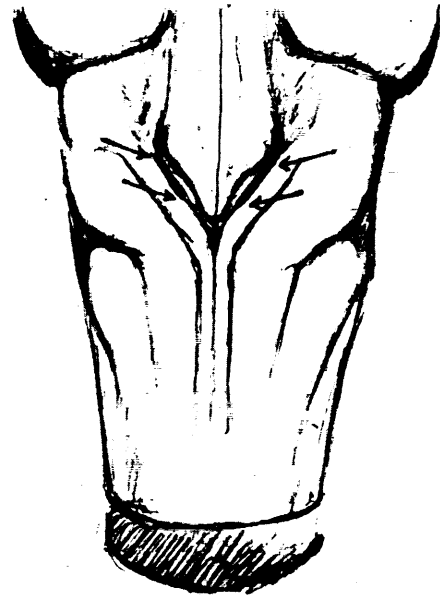

FIGURE 3.—*Region of area postrema at "writing point" of fourth ventricle. Arrows indicate the limits of a lesion sufficient to destroy the emetic chemoreceptor trigger zone.*

ness. It is, however, irrational to separate central autonomic from somatic coordination. Indeed, there is no justification for speaking of an autonomic center as such. That is to say, it is impossible to select those neuronal components in the central nervous system, particularly in the reticular formation, that are concerned with autonomic as opposed to somatic expression. For our immediate interest, somatic activity is no less important, if not more so, than is autonomic activity in the execution of vomiting. Thus, it is an unprofitable course to seek protection against motion sickness through attempts at autonomic drug blockade of controller and motor functions.

While I have had considerable experience with the physiology and pharmacology of vomiting per se, I must confess that my research contact with motion sickness has been strictly limited. In

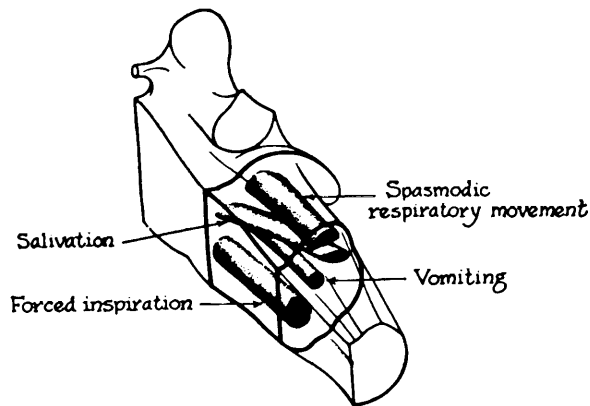

FIGURE 4.—Phantom view of hemi-medulla oblongata showing the location of the vomiting center and related integrative loci.

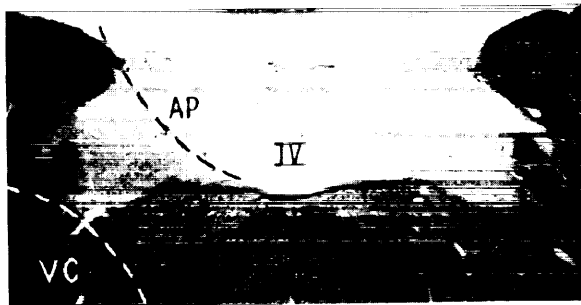

FIGURE 5.—Histologic cross section through area postrema (AP) on the surface of the fourth ventricle (IV). Vomiting center (VC) is situated ventrolaterally.

fact, I can tell you about the only really pertinent experiment, if you can call it that, which I have done on the problem. This relates to a cat that resided in my laboratory, which we took one day to visit a country school in the rolling hills of New Hampshire. I was going to show the children some simple reflex responses to enliven my talk on the subject, "Your Brain Protects You." On our way to the school the cat vomited in the back seat of the car, which is not a very unusual occurrence on the roads of New Hampshire, except that this cat was one of our experimental animals possessing a lesion of the chemoreceptor trigger zone. It had been with us for a long time and had been tested repeatedly in demonstrations to the medical students of its refractoriness to emetic drugs. This raises a real problem with regard to the suspected role of area postrema in motion sickness, as was so thoroughly analyzed by Dr. Money. It is easy to suggest that species difference may account for research discrepancies, but I would prefer to think that the role of the chemoreceptor trigger zone in the emetic pathway for motion sickness has still not been fully elucidated. Indeed, the larger question of the involvement of a humoral factor in motion-induced vomiting requires most serious consideration.

QUESTIONS REGARDING FURTHER STUDY

We have heard much discussion about a highly complex constellation of effects. If we are to make any further progress, we must make sure that we are all talking about the same thing. There must be no equivocation in communication. "Vomiting" is oftentimes avoided or simply implied in speaking about motion sickness. Yet it is the only all-or-none unmistakable concomitant, as well as the most incapacitating. We all know what vomiting means in relation to motion sickness, but if this is not explicitly stated as part of the response pattern, it cannot be an assumed criterion. The next question that must be raised is whether we are in fact dealing with a single spectrum of effects produced by different stimuli arising from the various types of motion capable of initiating

physiological disturbance. This is another source of difficulty in extrapolating laboratory experiments—these elegant laboratory experiments on humans—to the real thing that occurs in the field. We are also dealing, in human experimentation, with the same situation faced in clinical pharmacology; namely, with the ever-present hazard of subjective interpretation.

Going on to more specific questions: First, what is the essential reflex arc in the vomiting of motion sickness? We know that structures of primary importance include the labyrinthine apparatus and the cerebellum. The whole forebrain can be excluded, which takes care of a huge lineup of secondary effects that in good measure are mediated by the hypothalamus.

Second, what accounts for the long onset of effect? This suggests cumulation of a transmitter, a neurohumoral substance. In looking at Dr. Graybiel's work with stepwise adaptation, this might be explained by some process such as enzyme induction, which implies that the hypothetical transmitter is destroyed faster than it is being made. Something of this sort could possibly account for adaptation, but where does the process occur?

This is, of course, the key problem that poses our third question. At the present time, the two most likely sites of transmitter action for motion-induced vomiting, which should also be considered vulnerable points for therapeutic attack, are the labyrinth itself and the CTZ. Our lack of understanding of the discrete mechanism, however, is underscored by the empiric and largely ineffective therapy of motion sickness that has availed itself to date. As a result of extensive

investigative efforts we are faced with the fact that anti-motion-sickness drug efficacy bears no correlative relationship to other types of antiemetic drug activity. Thus, antiemetic drugs that are effective antagonists of substances that act on the CTZ are not effective in preventing motion sickness. So where are the anti-motion-sickness drugs acting? We observe many side effects of drug therapy that cast suspicion on actions unrelated to the specific neural pathways participating in motion sickness, at least for the vomiting component. To get to the root of the problem, I think it becomes necessary to work with the stripped animal, that is an animal without its forebrain—one that is free of the psychic complications that confound the underlying physiological disturbance.

Nothing I have said diminishes the marvelous work being done in humans, with its broad psychological implications. I wish only to inject a note of caution that we may lose sight of the forest because of the trees, and that both approaches are really required. We still have no means of making educated guesses on drug efficacy in motion sickness. The role of our chemoreceptor trigger zone remains an enigma. In the final analysis, it appears that we should be looking for agents that act directly on the labyrinth or, with less likelihood of success, in the cerebellovestibular circuit.

I have not spoken specifically of the fine critiques given today on such matters as sensory conflict and the dynamics of motion as a physiological stimulus. I hope, in any case, that I have touched most of the bases and beg to be excused for my oversights.

SESSION V

Chairman: BO E. GERNANDT
Naval Aerospace Medical Institute

The First-Order Vestibular Neuron¹

HANS ENGSTRÖM

Uppsala, Sweden

SUMMARY

The vestibular part of the statoacoustic nerve contains both afferent and efferent fibers, the former being much more numerous than the latter. The afferent neurons have bipolar ganglion cells located in one single ganglion cell in the inner meatus. The ganglion cells belonging to the vestibular nerve are considerably larger than those of the spiral ganglion and they also differ slightly in structure. Several of the vestibular fibers are thicker than the cochlear fibers. The majority of the vestibular ganglion cells are surrounded by a multilayered myelin sheath. In this sheath some regions are found where the myelin is very regular, but in most areas the myelin is quite irregular with alternating regions of loose and semicompact myelin. The majority of the ganglion cells are myelinated, but a small percentage (2 to 5 percent) have only a single or a double layer of Schwann-cell cytoplasm. These cells differ considerably from the myelinated ones, not only in structure for they are also much smaller. The way they are related to the sensory cells is not yet known, nor is their function known. Similar unmyelinated cells are found in about 10 percent of the spiral ganglion of the cochlea, and it has not yet been possible to certify their sensory-cell relation in the cochlea either. The efferent fibers are rather thin compared with the afferent ones. They have their ganglion cells in the brainstem. Their peripheral endings form a rich plexus in the vestibular epithelia where they form many en passant synapses with sensory cells, nerve calyces, and nerve fibers.

The vestibular nerve contains a large number of unmyelinated fibers found intermingled with the afferent and efferent nerve fibers.

During the last 10 to 15 years the fundamental principles of the structural organization of vestibular sensory regions have been described. In studies by Wersäll (ref. 1); by Wersäll and Flock (ref. 2); by Ades and Engström (ref. 3); by Engström, Lindeman, and Ades (ref. 4); by Smith (ref. 5); by Spoendlin (ref. 6), and others, it has been shown that all vestibular sensory epithelia have two kinds of sensory cells, called type I and type II. Their structural features have been repeatedly described in earlier symposia of this series (figs. 1 to 4).

In studies by Engström, Ades, and Hawkins (ref. 7), by Flock (ref. 8), and recently by Linde-

man (refs. 9 and 10), it has been shown that the sensory cells are organized in a very characteristic manner on each macula, and on each crista ampullaris. Because of this characteristic orientation of the sensory cells, we talk about a morphological polarization of the cells. Several authors have shown that the morphological polarization of the sensory cells is paralleled by a functional polarization. This means that two nearby regions in one macula utriculi, for instance, may give different responses to the same stimulus.

It is rather generally agreed upon that the otoliths or the statoconium membranes over the maculae (figs. 5 to 7) and the cupulae over the cristae act upon the sensory cells by shearing movements with respect to the surface of the sensory epithelium. It is also generally accepted that the semicircular canals act as integrating

¹This research has been sponsored in part by the Office of Naval Research, Washington D.C., through the European Office of Aerospace Research, OAR, U.S. Air Force under Contract F61052-68-C-0064.

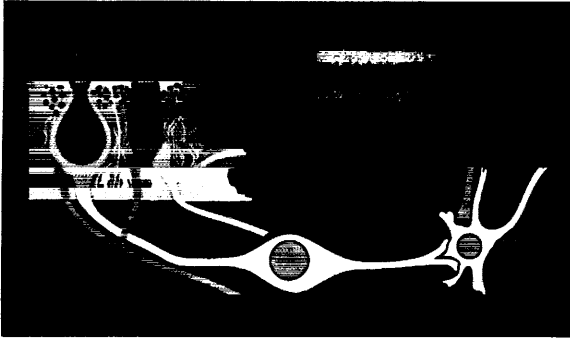

FIGURE 1.—Schematic drawing showing principles in innervation. The sensory cells are innervated by dendrites from bipolar ganglion cells (yellow). These form the afferent fibers, leading from the sensory cells to the secondary vestibular ganglion cells. The efferent fibers are red.

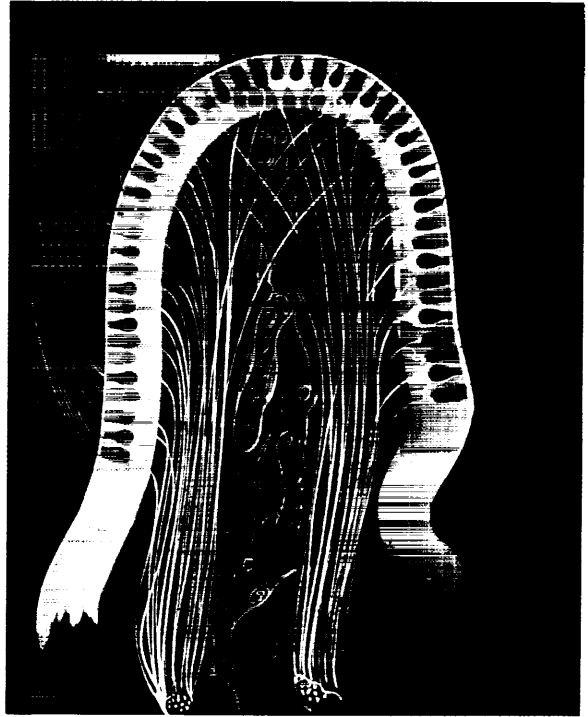

FIGURE 2.—Schematic drawing of the sensory cells over a crista ampullaris. Sensory cells of type I and type II are distributed over the surface of the crista.

FIGURE 4.—Schematic drawing of one sensory cell type I (left) and type II (right). They are both innervated by afferent fibers in direct contact with the sensory cells. Around the type I cell the afferent ending is shaped like a calyx. Efferent (red) fibers end at the surface of the type II cell, but at the surface of the calyx around the type I cell.

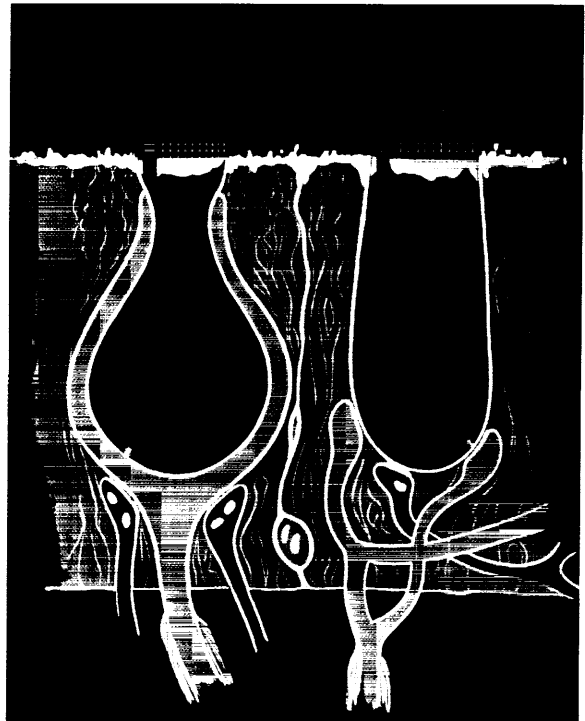

FIGURE 3.—Schematic drawing of sensory cells and statoconia from a macula.





FIGURE 5.—*Statoconia* from macula sacculi of a guinea pig. ♦ The hexagonal prisms are very distinct. They consist of calcite. This is a micrograph taken with a scanning electron microscope. This technique permits a study of unsectioned material. (Cf. also figs. 6 and 7.)



FIGURE 6.—Bundles of sensory hairs at the surface of macula utriculi of a guinea pig as seen in the scanning electron microscope. The different length of the hairs in each bundle on one cell can be very beautifully seen. In this case we have used a drying technique. If freeze-drying technique is used, the hairs will stand straight up. In this case the varying length can be better visualized through the drying technique.



FIGURE 7.—Detail from the previous figure showing the sensory hairs on one cell. The scanning electron microscope gives an excellent method for the study of the vestibular sensory regions, and we have also used it extensively now for a study of the cochlea. The technique permits a study of a whole macula and the magnification can be varied in a range between $20\times$ to $20\,000\times$.

accelerometers while the maculae are regarded, at least mainly, as linear integrating accelerometers. Information from these accelerometers is propagated through the vestibular nerve fibers from the peripheral sense organ over the vestibular ganglion cells to vestibular nuclei where synaptic contacts are established with the second-order neurons.

The stimulus response can be recorded as action potentials in the vestibular nerve. Even at rest these nerve fibers have a low-frequency activity with a rather steady firing rate. The stimulus acting upon the vestibular sensory regions thus in reality modifies the discharge, and the frequency change follows distinctive patterns as described by many authors and reported to this group a few years ago by Lowenstein (ref. 11).

The peripheral sensory cells and the contact between the peripheral terminations of the vestibular nerve fibers have been carefully studied with the aid of electron microscopy (figs. 8 to 11). The basic information regarding the vestibular nerve as a whole and its branches, however, has been long known. The early literature regarding the nerve can be found summarized in the beautiful publication by Retzius (ref. 12), but the most-referred-to publication concerning the vestibular nerve is Lorente

de Nó's paper of 1926 (ref. 13) in which he describes the distribution of both cochlear and vestibular nerve fibers. His findings have been discussed in a recent paper by Ballantyne and Engström (ref. 14).

It is quite evident that the rapid development of techniques for studying fine structure and the simultaneous development of microsurgery for both experimental and clinical purposes offer the opportunity to study the vestibular nerve further. Very little has been published in this field, and the present publication will describe some of the features of the first-order neurons of the vestibular nerve.

The acoustic nerve in man contains about 35 000 to 50 000 nerve fibers, while only 14 000 to 24 000 nerve fibers form the vestibular nerve. This nerve has two main subdivisions: the upper and lower vestibular branches. The superior vestibular nerve innervates the cristae of the

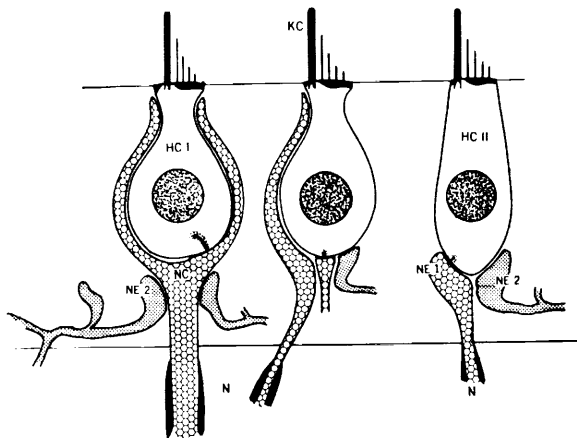

FIGURE 8.—Schematic drawing of different forms of contact between sensory cells and nerve endings. Some cells have a direct contact with the afferent endings (NE 1) and efferent endings (NE 2), while at type I cells the efferent endings contact the nerve calyx (NC) only. N: nerve fibers. KC: kinocelium.



FIGURE 9.—Synaptic region (Sy) between an afferent nerve ending (NE 1) and a hair cell, type II. At the synaptic junction many small invaginations look like prestages to synaptic bars.



FIGURE 10.—Two afferent nerve endings (NE I) at the base of a type II cell from macula utriculi of a squirrel monkey. Observe the large number of mitochondria in the nerve endings.

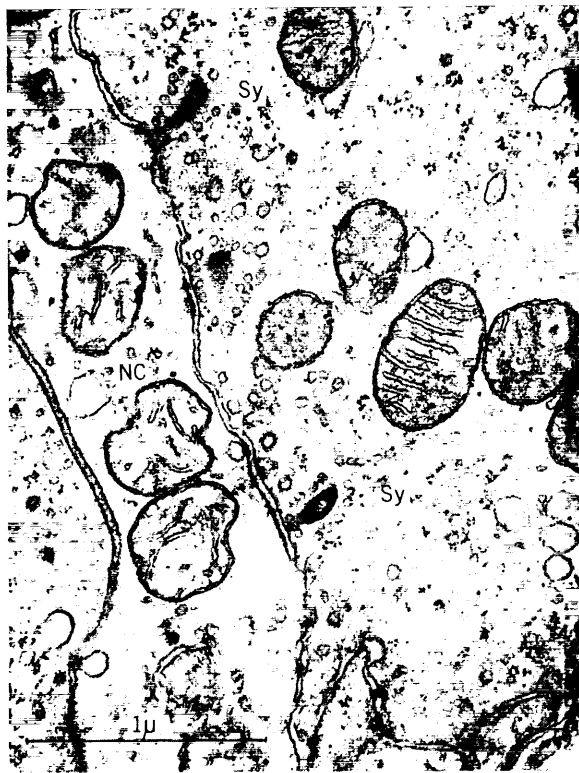

FIGURE 11.—Nerve calyx (NC) situated between a hair cell type I to the left and type II to the right. There are many synaptic regions (Sy) between the nerve calyx and the type II cell. Squirrel monkey, macula utriculi.

superior vertical and lateral ampullae, the utricular macula, and a small part of the macula sacculi. The inferior branch innervates the posterior vertical ampulla and the major portion of the macula sacculi.

The diameters of the nerve fibers vary considerably in the statoacoustic nerve. In general, many of the vestibular fibers are slightly thicker than the acoustic fibers. The cochlear fibers have a diameter varying between 1μ and 9μ (refs. 15 and 16). The vestibular fibers have a diameter between 1μ and 13μ , but only around 10 percent exceed 6μ in diameter. The vestibular nerve also contains a large number of non-myelinated fibers (refs. 1 and 17, figs. 12 and 13). These are intermingled with the myelinated fibers. There are different densities of these fibers in different parts of the nerve.

The major portion of the fibers in the vestibular nerve is of afferent nature, but it is well known that a small number of nerve fibers (according to Gacek, 400 fibers in the cat, ref. 18) carry efferent impulses. Gacek in 1961 (ref. 19) was able to demonstrate by experimental studies that there is a system of myelinated efferents with their origin in the lateral vestibular nucleus, and Carpenter (ref. 20) stated, "The medial, superior and parts of the descending vestibular nuclei on both sides project efferent fibers



FIGURE 12.—Nerve fiber of afferent nature (N) leaving the sensory epithelium of a macula utriculi in a squirrel monkey. Observe how the supporting cell forms a sheath around the unmyelinated nerve. This sheath ends when Schwann cells begin.



FIGURE 13.—Afferent nerve fiber at a macula utriculi below the epithelium. A few layers of irregular myelin can be seen. Squirrel monkey.



FIGURE 14.—Efferent, granulated ending (NE 2) forming a synapse to the sensory cell.



FIGURE 15.—Efferent, granulated nerve ending (NE 2) at a type II cell. The small white arrows indicate a subsynaptic cistern. The black arrow points to a synaptic bar close to an afferent ending. Macula utriculi, squirrel monkey.



FIGURE 16.—Hair cell type I completely surrounded by a nerve calyx (NC). Squirrel monkey, macula utriculi.

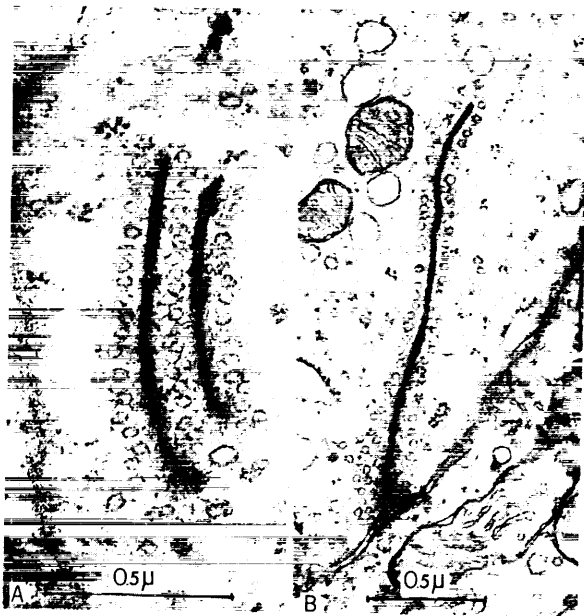

FIGURE 17.—Very long synaptic bars in type I cells from a macula sacculi of a squirrel monkey. These extended synaptic structures are sticking far into the sensory cell from the synaptic region. Synaptic vesicles in large numbers can be seen.

to the labyrinth via the vestibular nerve.” Studies by us and by Lindeman (refs. 9 and 10) indicate that these fibers form a very widespread network in the lower half of the vestibular sensory epithelia (figs. 14 to 16). At that level the nerve fibers make contact with several sensory cells. The nerve endings are of a typical presynaptic type. They contain large amounts of synaptic vesicles (figs. 17 and 18). Further reference to this system can be found in Lindeman’s papers (refs. 9 and 10).

The majority of the nerve fibers in the vestibular nerve, those forming the first-order neuron, are of afferent nature. It has just been stated that they vary considerably in size and it has been known for a long time that their ganglion cells also vary in size. This was carefully studied by Lorente de Nó (ref. 13) who separated groups of ganglion cells according to size and in relation to specific regions in the sensory epithelium. He wrote of magnocellular and parvicellular regions. The various sensory regions of the vestibular labyrinth, according to

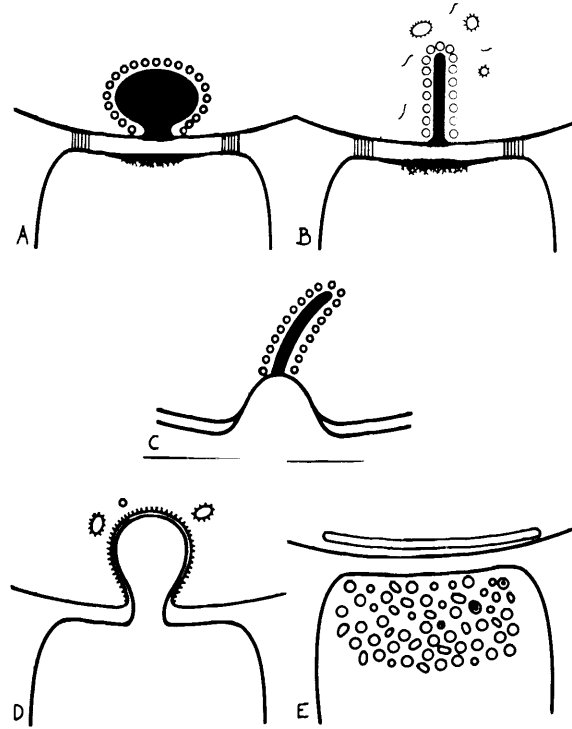

FIGURE 18.—A, B, C, and D are found between sensory cells and afferent nerve endings. In A, B, and C the synaptic vesicles are found inside the sensory cell. Type E is an efferent ending with large numbers of synaptic vesicles and a subsynaptic cisterna.

Lorente de Nó, were projected onto the different parts of the vestibular ganglion. A discussion of this problem can be found in the paper by Ballantyne and Engström (ref. 14). During recent years the tonotopical organization has been doubted by several authors, but as stated by Ballantyne and Engström, the fibers have a complicated course which is extremely difficult to follow.

In several recent publications (refs. 8 and 9), it has been shown that the vestibular sensory regions have a structural and functional subdivision which was not known earlier. The presence of these different regions and their different functional importance make it necessary to restudy the topographical arrangement of vestibular nerve fibers. In this relation, recent studies by Lindeman (ref. 10) are of great interest. He was able to show that the striola regions of

maculae and the central area of the cristae are especially vulnerable to ototoxic antibiotics. These areas as far as we know are innervated by the thickest fibers. We hope it will be possible to follow the chain of neural degeneration after a localized degeneration to the striolar region. Likewise, studies by Winther (ref. 21) are of interest. We knew before that the central area of the cristae is most vulnerable to ototoxic antibiotics. Winther has shown that X-rays, on the other hand, preferentially damage the

peripheral regions of the cristae. In this way we can get two sets of inverse degenerations. Another approach to this problem employs the laser technique. Stahle and collaborators (ref. 22) have now developed techniques by which it is possible to pinpoint damage to very minute regions in the labyrinth.

It has been stated that the afferent fibers of the vestibular nerve are myelinated and their bipolar ganglion cells are also surrounded by a myelin sheath. That cochlear and vestibular ganglion cells have a myelin coating has been known for a long time. In a recent publication, Kellerhals et al. (ref. 23) have surveyed this literature, and we refer the reader to that monograph. In this book and earlier studies by Rosenbluth (ref. 24), it has been shown that the cochlear ganglion contains two types of ganglion cells. Ballantyne and Engström (ref. 14) have recently shown that the vestibular ganglion cells have different sizes and that these ganglion cells are rather mixed.



FIGURE 19.—Afferent nerve fiber (N) at the region where myelin (MY) begins to appear. Observe that one Schwann cell forms very irregular myelin.

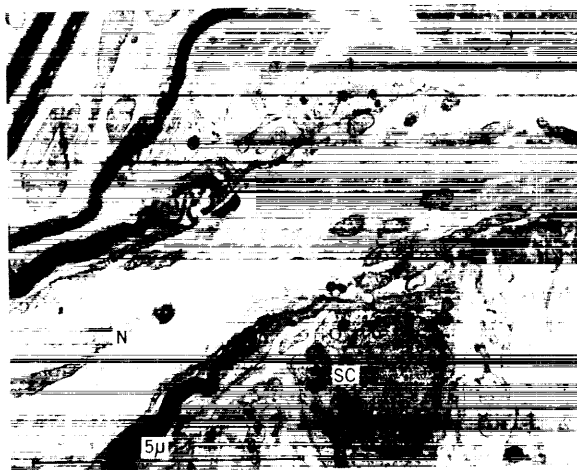

FIGURE 20.—Detail from figure 19 showing the myelin formation and a Schwann cell (SC) with irregular myelin.



FIGURE 21.—Two cross-sectioned nerve fibers immediately below the macula utriculi of a squirrel monkey.

It has been very difficult to verify any such subdivision as described by Lorente de N6 (ref. 13), but it is possible that it still exists. This matter is now being studied in embryological material. It is, however, quite clear that there exist two distinctly separate types of ganglion cells in the vestibular ganglion as has been found earlier in the cochlear ganglion. Of these, one variety has a thick myelin sheath, the other has no such multilayered myelin, only one thin Schwann-cell layer around the cell (figs. 19 to 25). We call the first type myelinated ganglion cell (figs. 26 to 28), the other unmyelinated. In the cochlea of the guinea pig, the latter type comprises about 10 percent. The number of unmyelinated cells is lower in the vestibular ganglion, approximately 2 to 5 percent as far as we have been able to find.

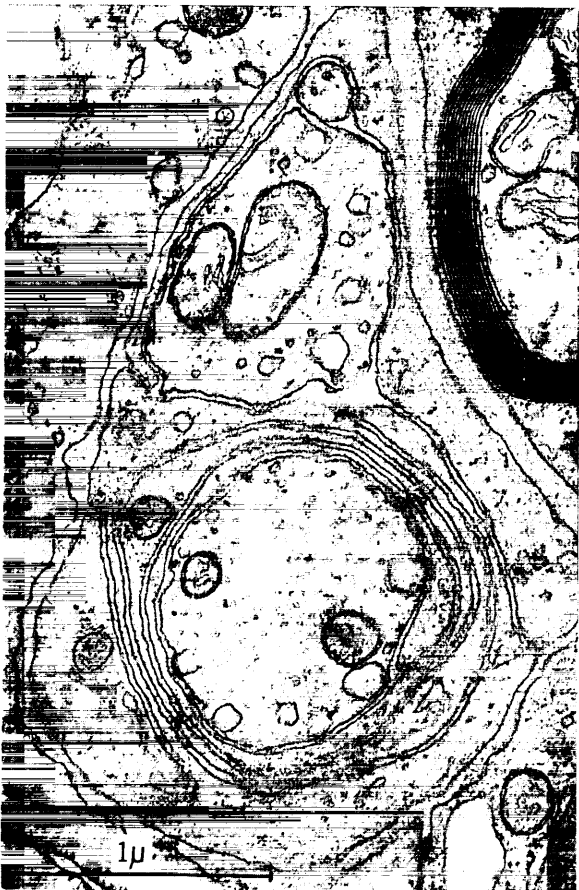

FIGURE 22.—Region below macula utriculi with myelin formation. Schwann-cell cytoplasm envelops the axon.



FIGURE 23.—Regular myelin has appeared.

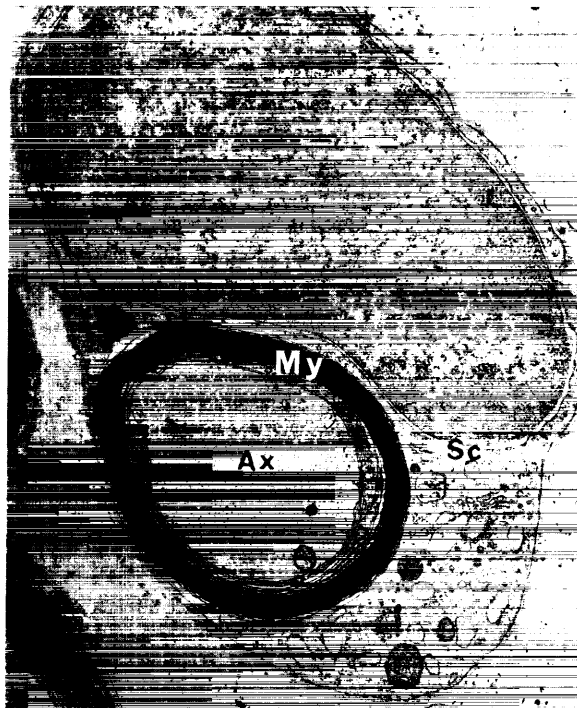

FIGURE 24.—Myelinated nerve (My) from guinea pig close to the vestibular ganglion. The Schwann cell surrounds and forms the myelin.



FIGURE 25.—Very thick myelin sheath around a vestibular nerve fiber. Macula utriculi nerve, squirrel monkey.

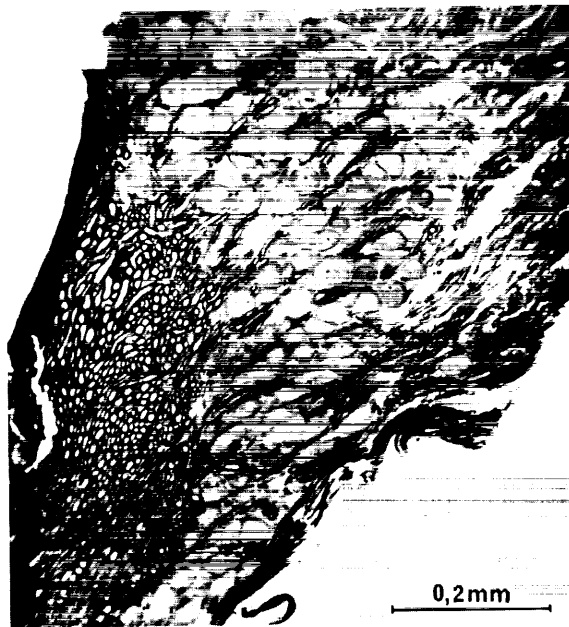

FIGURE 26.—Vestibular ganglion and nerve fibers from a cat.

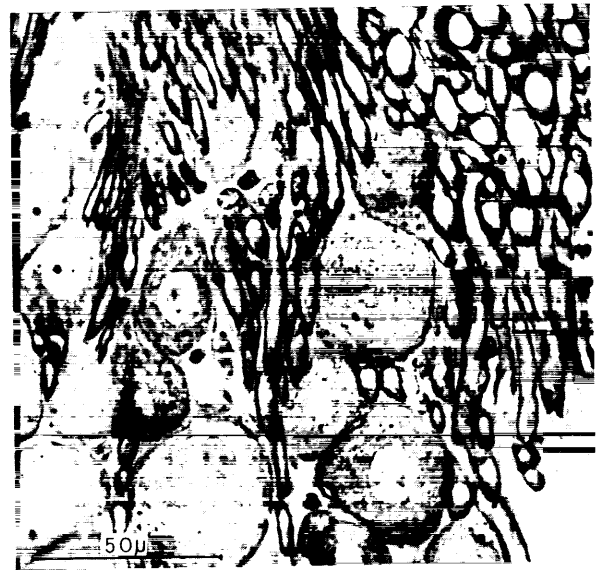

FIGURE 27.—Ganglion cells from the vestibular ganglion of a cat.

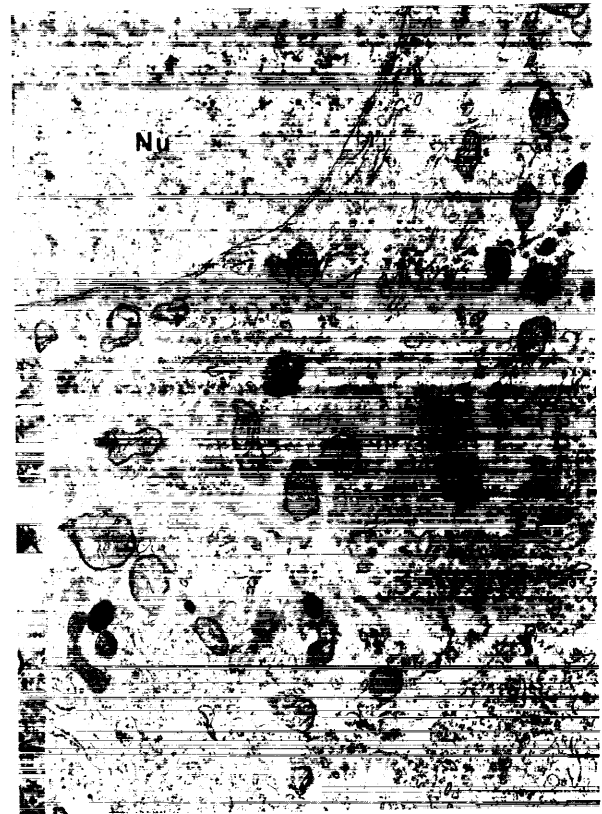

FIGURE 28.—Ganglion cell of rather fibrous type. The nucleus (Nu), mitochondria (M), and endoplasmic reticulum (Er) are seen. Guinea pig.

The myelin sheath has a very irregular appearance in certain areas; in others, the myelin is of a more normal, regular type. This arrangement has been discussed by Kellerhals et al. (ref. 23) for the cochlear ganglion, and the vestibular ganglion myelination has been described by Ballantyne and Engström (ref. 14). Both the peripheral dendrite and the central neurite are provided with a myelin sheath. This sheath, however, is quite regular and of the normal appearance seen in other nerves. It has just been said that the ganglion cell myelin sheath is very irregular, and it is of great clinical interest to remember that this region of irregular myelin seems to be the origin of acoustic neuromas. Such neuromas are generally found in a region corresponding to the vestibular ganglion and they often develop inside the vestibular nerve. A few neuromas are also found in the acoustic nerve and then generally close to the spiral ganglion or at the region of demyelination in the osseous spiral lamina.

Centrally to the ganglion cells the afferent fibers continue their course to the second-order neurons in the vestibular nuclei. We have made several attempts at a reconstruction of the course of the fibers, but we have found it extremely difficult to follow the fibers because of their tortuous course and the intermingling of fibers of different diameters.

In previous discussions concerning the distribution of the nerve fibers in the vestibular sensory regions, studies by several authors have shown that special parts of the epithelium are innervated by the thickest fibers. In general, these regions are the striolae on the maculae and the centers of the cristae. Recent studies by Lindeman have taken up this problem through numerical analysis and have shown that the density of sensory cells is higher at the slopes of the cristae than at the top and also that the density of type I sensory cells is higher per surface unit along the slopes. The distribution of nerve fibers seems to be such that the thick fibers mainly run to type I cells at the central



FIGURE 29.—Crista ampullaris with nerve fibers. The nerve calyces are also very distinct.

sensory regions. The medium-sized fibers, on the other hand, go mainly to peripheral regions where they may innervate several type I cells. They sometimes have a rather long intraepithelial course. Lindeman (ref. 9) has found 10 type I cells get ramifications from one single nerve fiber. Sometimes the same fiber may innervate both type I and type II cells. The innervation of type II cells seems to be mainly by medium-sized or thin fibers. Of great interest from a functional point of view is, of course, the high density of sensory cells and nerve fibers at the slopes of the cristae (fig. 29) and its functional implications. It may be that physiological interest has been too much focused at the top of the cristae instead of at the peripheral regions.

REFERENCES

1. WERSÄLL, J.: The Minute Structure of the Crista Ampullaris in the Guinea Pig as Revealed by the Electron Microscope. *Acta Oto-Laryngol.*, vol. 44, 1954, pp. 359-369.
2. WERSÄLL, J.; AND FLOCK, Å.: Functional Anatomy of the Vestibular and Lateral Line Organs. Contributions to Sensory Physiology, W. D. Neff, ed., Academic Press, 1965, pp. 39-61.
3. ADES, H. W.; AND ENGSTRÖM, H.: Form and Innervation of Vestibular Sensory Epithelia. The Role of the Vestibular Organs in the Exploration of Space, NASA SP-77, 1965, pp. 23-41.
4. ENGSTRÖM, H.; LINDEMAN, H. H.; AND ADES, H. W.: Anatomical Features of the Auricular Sensory Organs. Second Symposium on the Role of the Vestibular Organs in Space Exploration, NASA SP-115, 1966, pp. 33-44.
5. SMITH, C. A.: Microscopic Structure of the Utricle. *Ann. Otol.*, vol. 65, 1956, pp. 450-469.
6. SPOENDLIN, H. H.: Organization of the Sensory Hairs in the Gravity Receptors in Utricle and Sacculle of the Squirrel Monkey. *Z. Zellforsch.*, vol. 62, 1964, pp. 701-716.
7. ENGSTRÖM, H.; ADES, H. W.; AND HAWKINS, J. E., JR.: Structure and Function of the Sensory Hairs of the Inner Ear. *J. Acoust. Soc. Am.*, suppl. 34, 1962, pp. 1356-1362.
8. FLOCK, Å.: Electron Microscopic and Electrophysiological Studies on the Lateral Line Canal Organ. *Acta Oto-Laryngol.*, suppl. 199, 1965, pp. 1-90.
9. LINDEMAN, H.: Studies on the Morphology of the Sensory Regions of the Vestibular Apparatus. *Ergebn. Anat. Entwgesch.*, 1969.
10. LINDEMAN, H. H.: Regional Differences in Structure of the Vestibular Sensory Regions. *J. Laryngol.*, vol. 83, 1969, pp. 1-17.
11. LOWENSTEIN, OTTO: The Functional Significance of the Ultrastructure of the Vestibular End Organs. Second Symposium on the Role of the Vestibular Organs in Space Exploration, NASA SP-115, 1966, pp. 73-87.
12. RETZIUS, G.: Das Gehörorgan der Wirbelthiere. Das Gehörorgan der Reptilien, der Vögel, und der Säugethiere. Samson & Wallin (Stockholm), 1884.
13. LORENTE DE NÓ, R.: Études sur l'Anatomie et la Physiologie du Labyrinthe de l'Oreille et du VIII^e Nerf. *Trav. Lab. Rech. Biol. (Madr.)*, vol. 24, 1926, pp. 53-153.
14. BALLANTYNE, J.; AND ENGSTRÖM, H.: Morphology of the Vestibular Ganglion Cells. *J. Laryngol.*, vol. 83, 1969, pp. 19-42.
15. ENGSTRÖM, H.; AND REXED, B.: Über die Kaliberverhältnisse der Nervenfasern im N. stato-acusticus des Menschen. *Z. Mikr.-anat. Forsch.*, vol. 47, 1940, pp. 448-455.
16. GACEK, R. R.; AND RASMUSSEN, G. L.: Fiber Analysis of the Statoacoustic Nerve in Guinea Pig, Cat, and Monkey. *Anat. Record*, vol. 139, 1961, pp. 455-463.
17. PALUMBI, G.: Innervation of Human Inner Ear in Light of New Histomorphological Studies. *Sc. Med. Ital.*, vol. 3, 1954, pp. 351-367.
18. GACEK, R. R.: Efferent Component of the Vestibular Nerve. *Neural Mechanisms of the Auditory and Vestibular Systems*, G. L. Rasmussen and W. F. Windle, eds., Charles C Thomas, 1960, pp. 276-284.
19. GACEK, R. R.: The Efferent Cochlear Bundle in Man. *Arch. Otolaryngol.*, vol. 74, 1961, pp. 690-694.
20. CARPENTER, M. B.: Experimental Anatomical-Physiological Studies of the Vestibular Nerve and Cerebellar Connections. *Neural Mechanisms of the Auditory and Vestibular Systems*, G. L. Rasmussen and W. F. Windle, eds., Charles C Thomas, 1960, pp. 297-323.
21. WINTHER, F.: Acute Degenerative Changes in the Inner Ear Sensory Cells of the Guinea Pig Following Local X-Ray Irradiation. *Acta Oto-Laryngol.*, vol. 67, 1969, pp. 262-275.
22. STAHL, J.; AND HÖBERG, L.: Laser and the Labyrinth. Some Preliminary Experiments on Pigeons. *Acta Oto-Laryngol.*, vol. 60, 1965, pp. 367-374.
23. KELLERHALS, B.; ENGSTRÖM, H.; AND ADES, H. W.: Die Morphologie des Ganglion Spirale Cochleae. *Acta Oto-Laryngol.*, suppl. 226, 1968, pp. 1-78.
24. ROSENBLUTH, J.: The Fine Structure of Acoustic Ganglia in the Rat. *J. Cell Biol.*, vol. 12, 1962, pp. 329-359.

DISCUSSION

Lowenstein: Do you have any information about the posterior ampulla nerve? Where does this join the pars superior complex of the vestibular ganglions? It is due to developmental reasons that that nerve passes initially through the pars inferior nerve. It has always puzzled me how one can find the reunion of the three ampullary nerves in the vestibular ganglion.

Engström: We have dissected the vestibular nerve especially in the cat, but also in man and some other animals. We have also many serial-sectioned labyrinths. It is normal that the nerve fibers are twisted. The posterior ampullary nerve joins the saccular nerve to form the lower vestibular nerve. After a slight further twist this nerve meets the superior vestibular nerve. We have tried to dissect the vestibular branches free together with their ganglion cells, but due to the complicated course of the different components, it is extremely difficult to follow the nerve fibers during their whole length.

Steinberg: In one of your slides you seemed to show a progressive change in the structure of the ribbon synapse of the type II primary sensory cell. As you know, this type of synapse is also prominent in the vertebrate retina, at both the receptor and bipolar cells. Do you mean that this structure actually opens into the extracellular space?

Engström: I am not quite clear whether you mean the invagination shown in my schematic drawings. In the cochlea we have good evidence that invaginations form an intermediate stage in the formation of synaptic bars, but I admit that the evidence is not conclusive. Large numbers of similar invaginations of nerve-ending cytoplasm into infoldings of the sensory cells have been observed in vestibular and cochlear sensory regions. Some such formations can be found among our illustrations.

Precht: My question concerns the type I sensory cell. From your illustrations it appears that one fiber, one large fiber, supplies one sensory cell. Is that a simplification or is this a true one-to-one relation between this particular type I sensory cell and the primary fibers?

Engström: This is a simplification. In the text it states that, at the top of the crista, there is a low factor relation, approximately one to three or one to five. But down along the sides, Lindeman has counted up to 10 cells innervated

by one nerve fiber; therefore, one medium-sized nerve fiber at the slope of the crista is innervating 10 sensory cells of type I. I might mention also, as I have earlier, that a type I nerve fiber may innervate a type II cell. It might even be that a sensory cell of type I has a nerve calyx around itself, and that nerve calyx has a synaptic bar onto the type I cell and a synaptic bar to an adjacent cell of type II on the side. Thus, there must be an intermediate stage sometimes between these cells. And I guess there is a development from the type II cells. It has been stated, especially by Wersäll, that, in reality, it was a mistake when he named these type I and the other type II. It should have been the opposite way.

Lowy: You mentioned that the spike generation occurred at the beginning of the myelinated part of the vestibular nerve. Is that based on direct experimental evidence or an analogy with other systems like Pacinian corpuscles?

Engström: I was referring to other reports, not to my own experiments.

Newsom: Would you expand a little on the comment you made about the radiosensitivity of the particular portion of that cell?

Engström: These are experiments made by Winther who has published a paper (ref. 21 of text) on this problem. He studied irradiation of the inner ear and discovered that by irradiating the head of a guinea pig and giving a dosage to its inner ear. He then followed the degeneration taking place and found just the opposite to what we expected. The damage occurred mainly at the slopes of the crista; all other damage we have been able to cause has been at the top. Thus, ototoxic antibiotics are always acting upon the top of the crista, but irradiation is clearly mainly acting upon the sides. Thus, there is a kind of inverse situation in this case. At the same time he has shown that, by giving a high dosage of irradiation, he obtained a very clear damage to the base of the cochlea. So the region of the slopes of the cristae gets severe damage by irradiation, and it is much more than Winther expected at the beginning of his studies. We have been very amazed at both the extent of damage and the form the damage takes, but it is quite clear and indisputable absolutely that, with the high dosage, he obtained an inverse form of degeneration.



Computer Analysis of Single-Unit Discharges in the Vestibular Nerve of the Frog

JORGE HUERTAS

AND

RUTH S. CARPENTER

Ames Research Center, NASA

SUMMARY

Description is made of several computer methods to analyze single-nervous-unit discharges. Their applicability to the study of vestibular units during spontaneous and provoked activity is discussed. A computer window technique that analyzes the frequency, the shortest interval, the longest interval, and standard deviation is described. This technique seems to be particularly suited to describe the changes in activity of vestibular neurons. The results are discussed in light of present knowledge of neurophysiology and anatomy.

INTRODUCTION

During the previous four decades, one of the main activities of the neurophysiologist has been the study of the electrical potentials produced by neural structures. Much advancement in understanding the functions of the brain has been made by correlating electrical activity with the structural arrangement of the nervous system. On the other hand, as methods and technology have improved, understanding the performance at the subcellular level and at the level of the neuron and its neighboring cells has become a challenge.

Since the time of Ramon y Cajal, the neuron has been recognized as the functional unit of the nervous system (ref. 1). The neuron receives messages, elaborates messages, produces a response, and also serves as a conductor of the message unit from neural station to neural station. The neurophysiologist has been intrigued for a long time by the presence of discharges—equal in size and shape but occurring at different intervals—which express neuronal activity. As these discharges in some instances occur at

irregular intervals, an analysis of their relationship has been difficult, if not impossible, until the advent of the computer.

For the study of neuronal activity correlated with the sensory inputs that have a direct effect upon the electrical performance of the neurons, the vestibular nerve of the frog presents several advantages. These advantages arise from the following facts: Direct studies of the nerve can be performed in the intact unanesthetized animal (refs. 2 and 3); exposure of the vestibular nerve for microelectrode recording is accomplished with minimum surgery, which is nondestructive to the nerve, to the blood supply, or to the nervous system; and, most importantly, the nerve can be activated using physiological stimuli. These stimuli can be measured with accuracy by means of accelerometers.

There are many descriptions in the literature of computer analysis of neuronal spike patterns (refs. 4 to 7). Some of these methods demonstrated characteristic arrangement in the serial dependence of the intervals that can be described statistically. Most of the papers deal with the “spontaneous activity” resulting from stimulation of the neuron by natural means. The purpose of

this paper is to present a computer analysis of the performance of the vestibular units during stationary and acceleratory periods. These studies should then demonstrate—

1. How the single unit of the vestibular nerve behaves during periods in which the animal is not submitted to the influences (accelerations) which noticeably alter its performance. For the purpose of this paper, these periods will be referred to as “spontaneous.”

2. How the single unit performs when the animal is submitted to acceleratory influences (tilt or rotation).

3. Whether or not there is a constant relationship between prestimulus activity and post-stimulus activity.

4. What happens after the animal is returned to the initial prestimulus position.

MATERIALS AND METHODS

More than 100 single units in the *Rana catesbeiana* were studied. The frogs were anesthetized in a solution of tricaine methanesulfonate (Sandoz MS 222). Immediately thereafter, their brachial and lumbar plexuses were dissected and sectioned to prevent voluntary movements (accelerations) from the animal while recording. As the effects of this anesthesia tend to wear off in about 3 hours, this time of elapse was allowed between preliminary preparations and the actual collection of data. By using the technique of Gualtierotti and Gerathewohl (ref. 3), the vestibular nerves were exposed via the roof of the mouth, taking particular care not to damage the endolymphatic organ, the cerebral circulation, the bony labyrinth, or the neural structures. The animal was then placed on a rotating and tilting table. The electrocardiogram (EKG) was monitored constantly. The EKG is a good index of the general condition of the frog.

The position of the table in three-dimensional space was monitored by three accelerometers that measured accelerations (positive or negative) in the three spatial vectors x , y , and z (ref. 8). The microelectrodes (tungsten) or micropipets (average tip diameter, 0.5 micron; filled with 4 M NaCl) were driven slowly into the nerve by means of a hydraulic manipulator. The criteria for

determination of a stationary vestibular fiber were as follows: Pulses should appear with varying intervals; the minimum interval should not be shorter than 1.5 msec; the size and shape of the spikes should be very similar; and the discharge pattern of the unit must exhibit stability for at least a 20-second period before recording. Recording was achieved (fig. 1) through a sequence that began as the signal was picked up by an emitter follower with an input impedance of 40 megohms (G. Deboo, personal communication). Then the output of the emitter follower was amplified, displayed on a cathode-ray oscilloscope, and also monitored by means of a loudspeaker. The signals were recorded on magnetic tape for further analysis only when we were reasonably convinced that we were dealing with one fiber. Ancillary display systems consisted of an inkwriting oscillograph coupled with a ramp generator with an automatic reset, where the interspike interval is then represented by a sequence of saw teeth, the shorter ones corresponding to short intervals and the longer ones to long intervals. An Ampex analog magnetic tape recorded the activity of the unit under consideration, a fiducial mark that determined the beginning of a sequence, a time mark in real time, the frog's electrocardiogram, and the values expressed on the accelerometers.

The computer processing was divided into three steps: digitation of analog data, which for

EXPERIMENTAL ARRANGEMENT IN VESTIBULAR LABORATORY

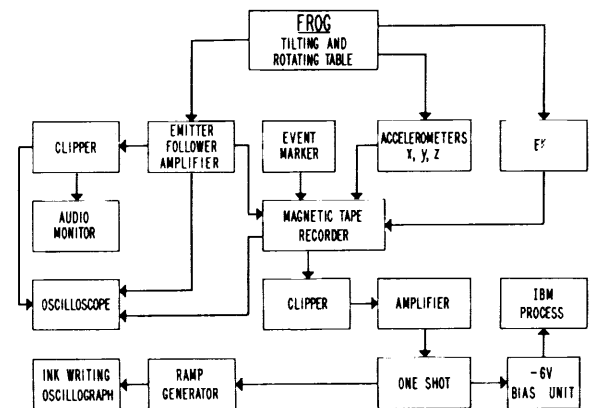

FIGURE 1.—Flow diagram demonstrating how the single nerve fiber potentials were processed for computer analysis.

the present purpose is the measurement of the interval between two spikes; statistical analysis of such intervals; and display of the results. This display is done either using the cathode-ray oscilloscope screen or an x - y plotter. This report is concerned with the findings in 90 single fibers.

RESULTS

Spontaneous Activity

Computer analysis revealed a great deal of variability in the range of the firing frequencies from unit to unit. Expressed in terms of the mean firing frequency, values ranged from under 1 per second to 46 per second. This analysis is limited to the slower firing units.

Figure 2 is representative of an interval histogram of spontaneous activity as described above. The histogram at the upper left shows a fast rise time and an exponential-like decay of frequency of intervals. It shows also that 60 percent of all intervals are contained in the 0- to 250-msec class. The histogram on the upper right represents the same data but with different bounds. It still shows the same pattern; however, as the bounds have been changed, the decay does not look so steep as it was in the first instance. The histogram in the lower left shows the distribution of intervals between 0 and 500 msec. This histogram contains essentially the same information as the first two classes of the first histogram. Finally, the histogram in the lower right shows the interval frequencies con-

tributing to the fast rise of the first histogram. This illustration shows very clearly how the same data plotted within different bounds have a seemingly different appearance. This must be kept in mind for statistical analysis of the data.

The histograms for all fibers studied were unimodal and were skewed to the right. The mean interval in these histograms changed with each unit; however, we noticed that the shortest interval, the longest interval, and the mean interval maintained a dynamic relationship. Other authors have found unit-specific stability (ref. 6), and our findings confirm this observation.

Provoked Activity

Analysis of the short-term provoked activity of the neurons of the vestibular system present special problems resulting from the physical characteristics of the system. Here the stimulating force is an acceleration that by definition involves a rate of change. This is in contraposition to other forms of stimuli acting upon other receptors in which the stimulus control can be maintained within set limits. When a neuron becomes activated by an acceleration, the firing pattern changes suddenly. Figure 3 shows how angular acceleration alters the pattern of interspike intervals. If the acceleratory force is applied in one direction, the intervals become shorter (facilitation); if the force acts in the opposite direction, the intervals become longer (inhibition). It has been found that, in the hearing organ, the same stimulus applied a second

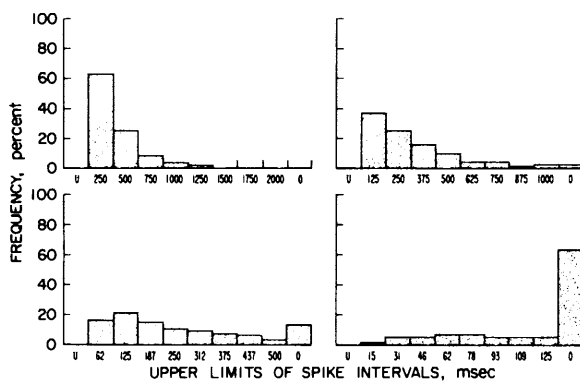

FIGURE 2.—Interval histograms of spontaneous activity of a frog vestibular unit using four different bounds.

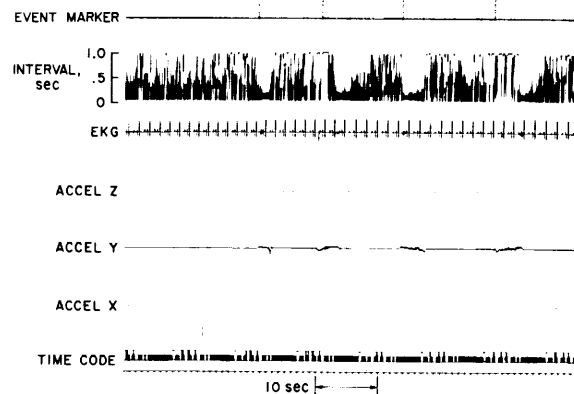

FIGURE 3.—Responses of a vestibular nerve fiber to horizontal angular acceleration.

time does not necessarily produce the same interval response (ref. 9). In the vestibular organ, it is far more difficult to repeat the same stimulus several times, and we are still in the process of making these comparative studies.

The statistical sample necessary to obtain an interval histogram from a single unit must be rather large. Yet, during the period in which the unit is being excited, it is undergoing a continuous change in performance. Therefore, it is difficult to obtain a large enough sample that can be compared statistically with the prestimulus period. We are dealing here with two seemingly different time series: the spontaneous activity time series and the stimulated activity time series. It has been suggested that the time patterns in spike discharges are influenced by both stimulus and refractory properties of the neurons. Therefore, the stimulus histograms should reflect the continued influence of these two factors, the "recovered probabilities" (ref. 10).

The question of how long a sample must be during a stimulus remains unanswered. Stimulation during 2 seconds of angular acceleration produces a response that is related to the vector of the stimulus. During the 2 seconds in which the acceleration is applied, the unit responds either in a facilitatory or an inhibitory pattern. During facilitation the intervals are very short and compressed in time. During inhibition the long intervals provide a very meager sample. Moreover, in the examples under consideration the acceleratory rate is continuously increased. No two spikes occur during the same acceleratory value.

There are two procedural routes that can be used for the analysis of intervals during short periods of stimulation. A set number of spikes may be taken as an index of activity and to establish a relationship between the number of spikes and the time during which they occur (fig. 4). The computer was programed to count a predetermined number of spikes and clock the time during which they occur. In this case, the spikes are grouped in sets of 25. The abscissa represents elapsed time. If the intervals are long, the unit of time in which they will occur is long; if the intervals are short, the predetermined number of spikes will occur in a

short period of time. If the effect of stimulation is facilitatory, the time lapse becomes short; if the effect is inhibitory, the time lapse becomes longer. The arithmetical mean for each group of 25 spikes is represented by the heavy line and the maximum and minimum intervals are represented in figure 4 by dots and dashes above and below the mean, respectively. The value of the mean is changed noticeably when the neuron is activated, a fact noted previously by Nakahama (ref. 11). Yet, regression analysis does not prove that there is a direct relationship between the mean values and a given stimulus.

The second procedure to be considered here involves the use of an arbitrary time window and observation of the behavior of the spike intervals during these time limits. As the angular acceleratory forces that were used in our experiments lasted for about 2 seconds, 2-second windows were selected to study neuronal activity. Figure 5 demonstrates such a window. The duration in real time for each event displayed here is 2 seconds. The number of intervals is expressed in percentage, and the bounds for the histograms have been established between 0 and 500 msec, subdivided into 50 classes of 10 msec each. During the spontaneous firing event represented in the first histogram, 13 spikes occurred in 2 seconds. The next 2 seconds were

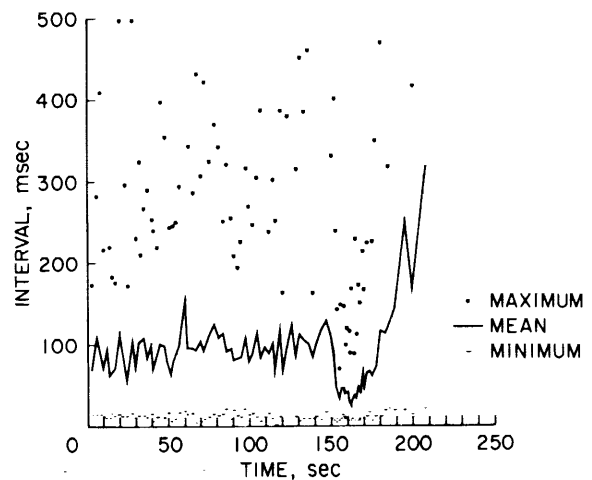

FIGURE 4.—Responses of a vestibular unit of the frog to horizontal angular acceleration. Each point represents the average of 25 intervals.

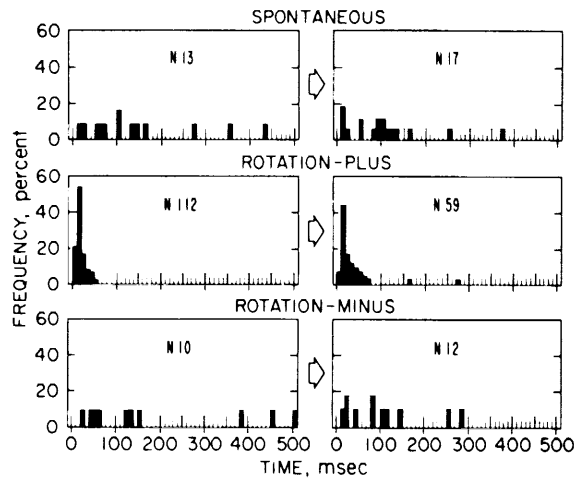

FIGURE 5.—Interval histograms of consecutive 2-second samples of a vestibular unit that responds to rotation.

populated by 17 spikes. In both histograms there is a relatively good spread of intervals among the different classes. These histograms can be described in terms of the arithmetic mean, standard deviation, largest interval, and shortest interval, together with the number of spikes occurring during each event. The second row of histograms in figure 5 shows the same windows during facilitatory stimulation. Here the number of spikes has been increased by a factor of 8.6, and all the intervals have shifted toward the shorter periods. When deceleration occurs, the neural unit becomes inhibited. This is expressed by longer intervals and a slight decrease in the number of spikes. The third row shows the distribution of intervals when the animal is rotated in the opposite direction. Here inhibition occurs, and the number of intervals diminishes.

The method that was selected and developed for the present study stresses the time sample, but it also takes into consideration the number of spikes. The program written for this purpose produces the following data: It divides the time events into consecutive 2-second epochs, counts the number of intervals within this period, and finds the longest and the shortest interval. It also calculates the mean, standard deviation, frequency distribution, and percentage frequency.

Figure 6 shows data similar to those displayed

in figure 5, but with values obtained by the window technique plotted on semilogarithmic paper. The abscissa represents real time, and the number of intervals counted for each 2 seconds are registered at the top. The values for each window, maximum interval, mean interval, standard deviation, and minimum interval, are plotted for each time period. The plot for spontaneous activity obtained in this manner shows how these four values remain within a limited range, and fluctuation of maximum and minimum intervals occurs proportionately without disorderly dispersion or conversion. The mean and the standard deviation remain within very close limits, and in a few instances we have seen them expressed by the same value.

When the unit is stimulated (in this case by rotation), all four values shift in the same direction. If there is facilitation, both the maximum and minimum intervals become shorter concomitantly. The parallelism observed during spontaneous activity is shifted, and the logarithmic differences between the maximum and minimum intervals remain seemingly unaltered. In the case of inhibition, there is a shift in minimum and maximum to longer intervals, which are clearly defined by the increase in value of the mean interval. The window technique allows the physiologist to observe four statistical parameters at the same time. This is in marked contrast to other displays such as

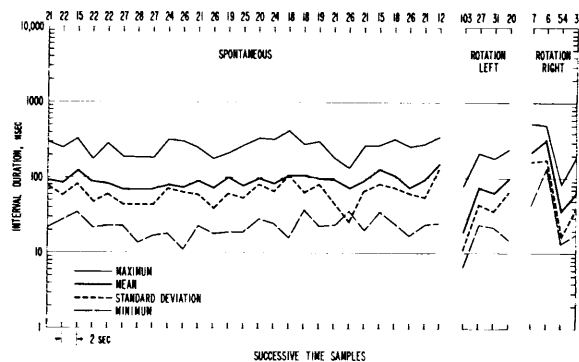

FIGURE 6.—Firing patterns of a vestibular unit at rest and during horizontal rotation. The numbers along the top represent the number of intervals that occurred during each 2-second period.

histograms in which only one parameter is observed and time dependencies are lost. The window technique also allows a comparison of the number of intervals that occur during a given period of time and serves as an index as to whether the vestibular unit is firing spontaneously or is being influenced by a stimulation.

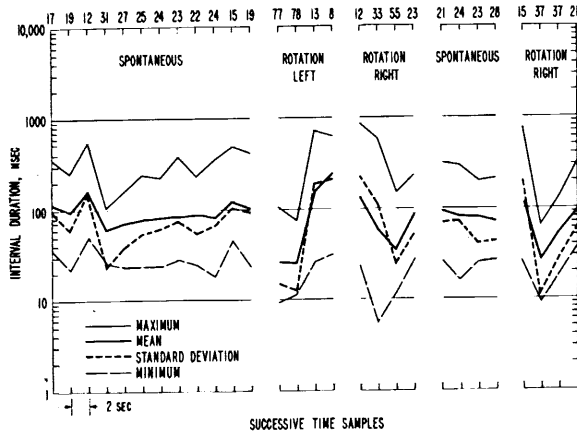

FIGURE 7.—Firing patterns of a vestibular unit at rest and during horizontal rotation. The numbers along the top represent the number of intervals that occurred during each 2-second period.

Figure 7 illustrates the behavior of another unit that is essentially the same as the one displayed in figure 6; however, the responses are more marked. It also exemplifies how the firing pattern returns to the prestimulus level. Figure

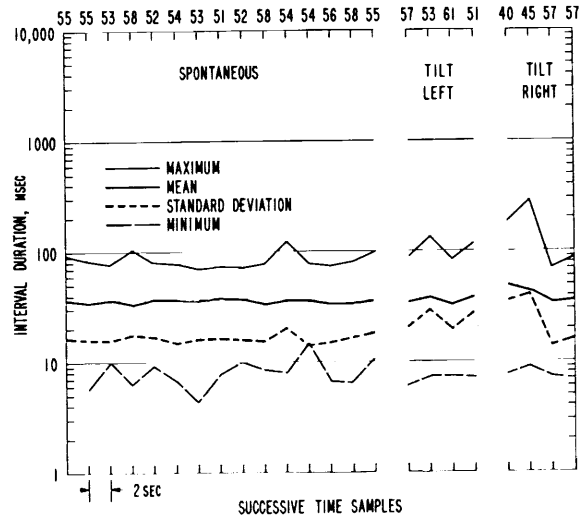

FIGURE 8.—Vestibular nerve unit that is not sensitive to tilt. Note how the values remain within the prestimulation limits during tilt.

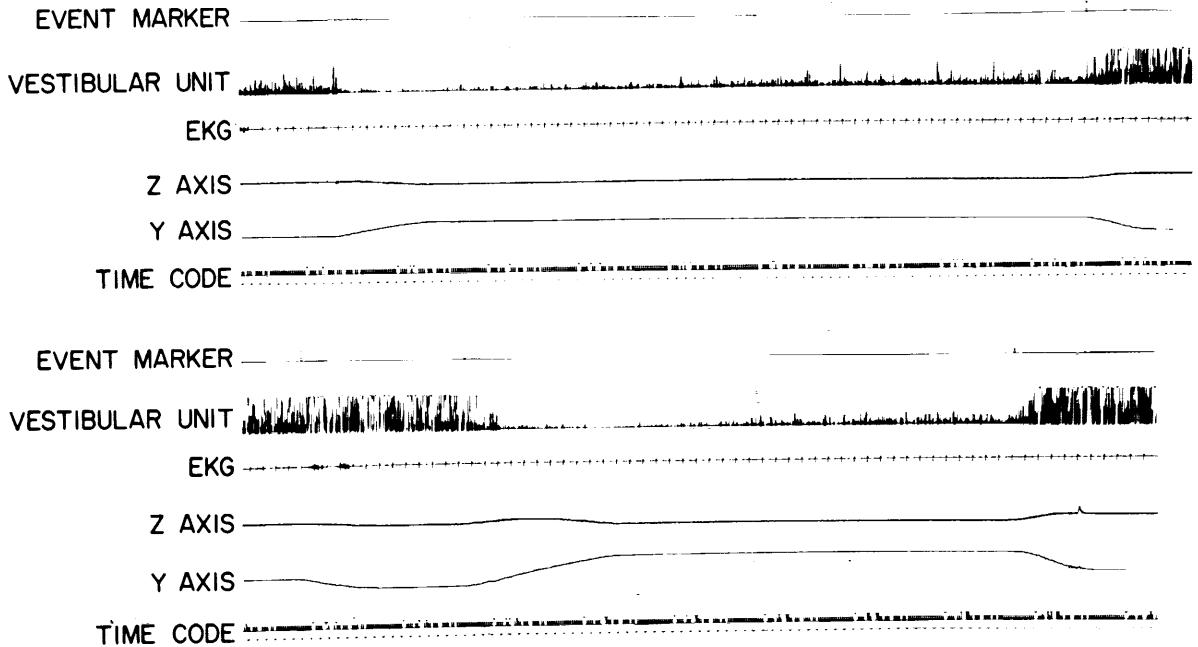

FIGURE 9.—Response of a vestibular nerve unit to linear acceleration.

8 is an example of a unit that is not sensitive to tilt. Notice how the values remain within the same range during stimulation.

In the case of vestibular units that respond to tilt, theoretically the situation should be different because tilt can be maintained at the same value for a long period of time. Therefore, a comparison of a spontaneous interval activity and an equivalently long sample obtained during tilt should be possible. Figure 9 shows the performance of a unit that responds to tilt. It is obvious that this is not a steady state and that with time there is a trend toward adaptation. Therefore, an interval histogram is not representative of the active process that is taking place. Because of this fact, the window technique is also better suited for the analysis of the behavior of these units that respond to tilt. Figure 10 exemplifies the sequence of events that characterize the performance of such a unit. By use of this method, the trend toward adaptation in time can be observed with accuracy during sustained tilt. In one instance a unit was followed with this trend for 80 seconds, and the unit did not return to the baseline values of spontaneous activity. At the present time we are in the process of studying more of these long-term shifts.

CONCLUSION

The vestibular units that have been found to date can be classified as follows: (1) units that respond directionally to rotation only, (2) units that respond to tilt only, (3) units that respond to tilt and rotation, and (4) units that do not respond to the acceleratory stimuli applied. The spontaneous activity for these types of units varies markedly in range. The different frequencies were represented in all four types; however, the faster frequencies were found in those units that responded to rotation. In spite of this variability, each fiber seems to conform to a typical firing pattern, and the values of the longest and the shortest intervals fluctuate about a characteristic mean. Despite this, the spontaneous discharges do not predict the degree of change during stimulation. The ratio of change can be greater in some of the slowest firing units. For other units, the pattern of the prolonged response to tilt is characterized

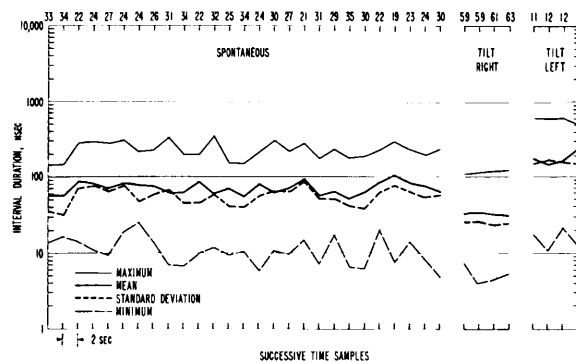

FIGURE 10.—Comparison of the spontaneous firing patterns of a vestibular unit and the pattern obtained during tilt. The numbers along the top represent the number of intervals that occurred during each 2-second period.

by increasingly longer intervals proportional to the length of time during which the unit remains constantly stimulated.

The shifts that we found in the values for the maximum interval, minimum interval, and standard deviation suggest that peripheral and/or central biasing mechanisms must exist, of which the dynamic range of the spontaneous discharge is an expression. This mechanism must involve a regulatory system that inhibits or releases the first-order neuron from its influence according to a pattern of information. Perhaps this originates at other sensory terminals of the same organ, as is the case in the retina, or at the level of the central nervous system, as is the case in the muscular sensory system. The long periods of inhibition during linear acceleration suggest the importance of inhibition for carrying information. Our findings are in agreement with what has been found in single-unit work of other sensory systems, particularly the visual and auditory systems.

To understand the performance of the first-order neuron of the vestibular system, a great amount of research is still needed. This research must be carried out at the cellular level using electron-microscopy techniques, at the end-organ level using histochemistry procedures, and at the level of the central nervous system using neurophysiological techniques. The computer analysis of these data will help in the progress of such an endeavor.

REFERENCES

1. RAMON Y CAJAL, S.: Ses Nouvelles Idées sur la Structure du Système Nerveux chez l'Homme et chez les Vertébrés. Deuxième tirage. Traduction de l'Espagnol par le Dr. L. Azoulay. C. Reinwald, Paris, 1895.
2. ROSS, M.: Electrical Studies of the Frog Labyrinth. *J. Physiol.*, vol. 86, 1936, pp. 117-146.
3. GUALTIEROTTI, T.; AND GERATHEWOHL, S. J.: Spontaneous Firing and Responses to Linear Acceleration of Single Otolith Units of the Frog During Short Periods of Weightlessness and During Parabolic Flight. The Role of the Vestibular Organs in the Exploration of Space, NASA SP-77, 1965, pp. 221-228.
4. KUFFLER, S. W.; FITZHUGH, R.; AND BARLOW, H. B.: Maintained Activity in the Cat's Retina in Light and Darkness. *J. Gen. Physiol.*, vol. 40, 1957, pp. 683-702.
5. WERNER, G.; AND MOUNTCASTLE, V. B.: The Variability of Central Neural Activity in a Sensory System, and Its Implications for the Central Reflection of Sensory Events. *J. Neurophysiol.*, vol. 26, 1963, pp. 958-977.
6. RODIECK, R. W.; KIANG, N. Y.; AND GERSTEIN, G. L.: Some Quantitative Methods for the Study of Spontaneous Activity of Single Neurons. *Biophys. J.*, vol. 2, July 1962, pp. 351-368.
7. MOORE, G. P.; PERKEL, D. H.; AND SEGUNDO, J. P.: Statistical Analysis and Functional Interpretation of Neuronal Spike Data. *Ann. Rev. Physiol.*, vol. 28, 1966, pp. 493-522.
8. ALLEN, WILLIAM H. (ED.): Dictionary of Technical Terms for Aerospace Use. NASA SP-7, 1965, table XI.
9. SIEBERT, W. M.: Some Implications of the Stochastic Behavior of the Primary Auditory Neurons. *Kybernetik*, vol. 2, June 1965, pp. 206-215.
10. GRAY, P. R.; KIANG, N. Y. S.; AND SHIPLEY, S. W.: Probabilities Associated With Spike Discharges in Auditory Nerve Fibers. *Proc. Am. Physiol. Soc.*, 17th Meeting, Aug. 1965.
11. NAKAHAMA, H.: Relation of Mean Impulse Frequency to Statistical Dependency Between Intervals in Neuronal Impulse Sequences. *J. Neurophysiol.*, vol. 29, 1960, pp. 935-941.

DISCUSSION

Lowenstein: How much hysteresis did you find on repeated stimulation with the same magnitude of stimulus, say in utricular preparations?

Huertas: Hysteresis was always found. It varied from case to case. I have no measurements on hand, but hysteresis is present.

Pompeiano: In your experiments was the vestibular nerve contralateral to the recorded side cut or not?

Huertas: No; I have not recorded that. It is very hard to get equivalent fibers. In my attempt to do so I kept getting two differently acting fibers all the time. To establish a mathematical order with one fiber is hard enough.

Precht: You mentioned that you got quite different responses when you tested the same unit more than one time with the same acceleration. The illustration makes the reason for this difference in response quite obvious; the stimulus was not the same in each test.

Huertas: No.

Precht: The second point is, Did you try to correlate the shortest spike intervals measured in a single unit during constant stimuli of various magnitude with the stimulus intensity; that is, did you try to get a stimulus-response relationship?

Huertas: Do you mean did I correlate the stimulus with the minimum interval only?

Precht: Yes.

Huertas: Yes, we measured automatically the minimum interval, and the minimum interval was different; it varied within a few milliseconds to a similar stimulus.

Precht: Is there any kind of a mathematical relation between the stimulus and the response, for instance, linear or logarithmic?

Huertas: Not if one uses only one parameter. We are attempting to find a definite answer to your question in the near future.

Graybiel: My comment is in regard to the behavioral aspect. If you tilt a person and measure ocular counter-rolling, the roll will remain about the same value for a period of hours. If you expose a person under conditions wherein he observes a change in direction of a line of light in response to a change in direction of the resultant vector with respect to the observer, there is a dynamic phase, followed by a static phase; there is no decay over a long period of time, at least up to 2½ hours.

Money: Did the height of the spikes vary with acceleration or did the height of the spikes remain constant?

Huertas: It remained constant. But one of the beliefs in neurophysiology is that the spikes of the same neuron are exactly alike. They are not. Therefore, other criteria for stationary are needed. Let me answer your question this way: They remain within the same patterns as before acceleration.

Vestibular and Somatic Inputs to Cells of the Lateral and Medial Vestibular Nuclei of the Cat¹

VICTOR J. WILSON

The Rockefeller University

SUMMARY

An important input to Deiters' cells is that from the labyrinth, which includes fibers from static receptors. The input from the labyrinth is seen in a larger fraction of the cells projecting to the cervical and thoracic cord than of the cells projecting to the lumbosacral cord. Both groups of cells can be facilitated by impulses ascending the spinal cord. These impulses are due to activity in a variety of peripheral nerves coming from different receptors, but apparently not from primary spindle endings or Golgi tendon organs. The cells of Deiters' nucleus, that influence the excitability of motoneurons at all levels of the spinal cord via the vestibulospinal tract, are therefore themselves impinged upon by a variety of inputs that share in the regulation of their excitability.

Some cells in the medial vestibular nucleus project to the spinal cord, but many more project rostrally. Both types of projecting cells are almost completely absent from the caudal region of the nucleus, as is the monosynaptic input from primary vestibular fibers. The vestibular input originates in the horizontal canal and utricle, and probably in other parts of the labyrinth. Electric stimulation of the labyrinth activates many projecting cells as well as many cells without long axons. There is also a somatic input to cells in the medial nucleus, and it is of particular interest that vestibular and somatic inputs, as well as commissural inputs and inputs from fibers descending from higher levels of the central nervous system, converge on many cells lacking long axons projecting rostrally or to the spinal cord. It is probable that among these cells there are interneurons that regulate the activity of projecting cells.

INTRODUCTION

In recent years a remarkable amount of detailed anatomical information has become available about the organization of the vestibular nuclei, the projection of their cells and the inputs to them, to a large extent through the investigations of Brodal and his collaborators in Oslo. It is profitable to attempt to relate this anatomical knowledge to the properties of neurons in the vestibular nuclei, as revealed by electrophysiological methods. Such studies have been undertaken in several laboratories, including ours. So far, we have concentrated our efforts on an

analysis of the organization of the lateral and medial vestibular nuclei of the cat, and of vestibular and somatic inputs to cells in these nuclei. All our experiments have emphasized study of cells identified by location and projection, since only in this way is it possible to relate physiological results to the anatomical data at our disposal. In this paper I will describe some of the results of experiments that have been presented in greater detail elsewhere (refs. 1 to 4).

All our experiments have been performed on acutely decerebellated cats, anesthetized by intraperitoneal injections of chloralose (40 mg/kg) and urethane (800 mg/kg) dissolved in polyethylene glycol, paralyzed by gallamine triethiodide (Flaxedil, American Cyanamid Co.), and artificially respired. A diagrammatic representation of the experimental arrangement is

¹Work in the author's laboratory was supported in part by grant 5R01 NB 02619 from the National Institute of Neurological Diseases and Blindness, USPHS.

shown in figure 1. Recording of the activity of single neurons in the vestibular nuclei was extracellular, by means of glass micropipets filled with 2 M NaCl saturated with Fast Green FCF. With such electrodes it is possible to eject a small amount of dye (refs. 5 and 6), which was frequently done at the bottom of electrode tracks. The dye marks were easily found in serial histological sections of the vestibular region prepared after each experiment, which made accurate localization of the tip of the recording electrode possible. During experiments, cells were sometimes found by the presence of spontaneous or synaptically evoked activity, more often by antidromic activation. Antidromic invasion of Deiters' cells resulted from stimulation of the vestibulospinal tract at various levels of the spinal cord; cells in the medial nucleus were activated antidromically either by

an electrode inserted near the descending medial longitudinal fasciculus at the level of the third or first cervical segment, or by an electrode placed in the medial longitudinal fasciculus about 2 mm rostral to Deiters' nucleus. Vestibular afferent fibers were activated by electrical stimulation by means of an electrode inserted in the scala vestibuli. In experiments on Deiters' nucleus, only the ipsilateral labyrinth was stimulated, but contralateral stimulation was added in many medial nucleus experiments. In one series of experiments, natural stimulation of static receptors was achieved by tilting (ref. 7). Somatic afferent fibers were activated by electrical stimulation of various muscle, cutaneous, and mixed limb nerves, as well as by stimulation of spinal tracts with the same electrodes used for antidromic stimulation of cells in the vestibular nuclei. Further details of experimental procedures can be found in the original publications (refs. 1 to 3).

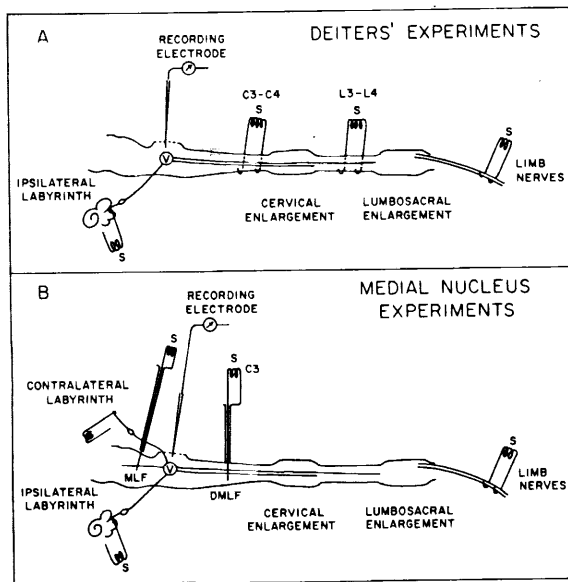

FIGURE 1.—Diagram of experimental arrangement. A, experiments on Deiters' nucleus. Stimulating electrodes (S) at C3-C4 and L3-L4 were used for antidromic activation of vestibular neurons. Cells activated by the lumbar and cervical electrodes were classified as L-cells, while cells stimulated only by the cervical electrodes were classified as C-cells. The other stimulating electrodes were used to stimulate various limb nerves, and the ipsilateral vestibular nerve. B, experiments on the medial nucleus. Electrodes for antidromic stimulation were placed in the medial longitudinal fasciculus rostral to Deiters' nucleus (MLF) and in the upper cervical cord (DMLF).

THE LATERAL VESTIBULAR NUCLEUS

Many cells in this nucleus project to the spinal cord in the vestibulospinal tract, ending at all levels from upper cervical to sacral (refs. 8 to 10). Electrical stimulation of Deiters' nucleus results in facilitation, monosynaptic or polysynaptic, of extensor motoneurons at all these levels of the spinal cord (refs. 11 and 12). Anatomical, as well as some physiological, investigations have suggested that the nucleus is somatotopically organized; specifically, cells projecting to the cervical cord are to be found predominantly in the rostroventral part of the nucleus while cells projecting to the lumbosacral cord are mainly located in its dorso-caudal region (ref. 13). To a certain extent this distribution has been confirmed by recent electrophysiological studies (refs. 2 and 14). Our experiments, however, show that there is considerable departure from the ideal somatotopic pattern. Localization of cells found in tracks marked by dye ejection indicates that the dorso-caudal part of the nucleus does contain mainly cells whose axons extend to the lumbosacral cord (henceforth designated L-cells). In the rest of the nucleus, L-cells and C-cells (the latter projecting to the fore-limb region and thoracic cord) are intermingled,

C-cells outnumbering L-cells by a relatively small margin (ref. 2). Such serious blurring of somatotopic organization must be taken into account when considering the functional meaning of the termination of different types of afferents in specific regions of the lateral vestibular nucleus.

It has been suggested previously that Deiters' nucleus can be divided into parts that are not equivalent functionally. Our findings on the distribution of spontaneous activity, which is much more prevalent dorsally than ventrally in the type of preparation we have used (ref. 2), and on the distribution of the vestibular input, together with the results of others on the location of cells inhibited by stimulation of the cerebellar cortex (ref. 15), indicate that the most meaningful dividing line is between the dorsal and ventral regions of the nucleus. As we shall see below, the ventral part of the nucleus receives a pronounced input from the labyrinth. The dorsal part, on the other hand, receives a strong inhibitory input from the cerebellar cortex. It is therefore reasonable to consider ventral Deiters' cells as relays between labyrinth and spinal cord, while dorsal Deiters' cells are part of the efferent system of the cerebellar cortex.

Vestibular Input to Cells in the Lateral Nucleus

It was shown by Walberg, Bowsher, and Brodal (ref. 16) that vestibular afferents terminate principally in the rostroventral part of Deiters' nucleus. This has recently been confirmed by Mugnaini, Walberg, and Brodal (ref. 17) who showed, in addition, that vestibular afferents terminate not only on small- and medium-size cells, but also on some giant neurons. In excellent agreement with these findings, Ito and his colleagues (ref. 15) have observed monosynaptic excitatory postsynaptic potentials (EPSP's) in Deiters' neurons on stimulation of the vestibular nerve, and our results (ref. 2) show that such monosynaptic excitation, illustrated in figure 2, is found almost exclusively in the ventral part of the nucleus.

Among the cells that we sampled, 31 of 61 C-cells (51 percent) and 18 of 80 L-cells (22 percent) could be fired monosynaptically by

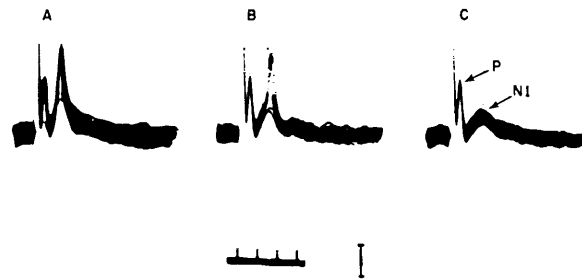

FIGURE 2.—Effect of stimulation of the labyrinth on a rostral L-cell in Deiters' nucleus. Each picture consists of several superimposed sweeps, recorded extracellularly. A: 1/sec. The cell is driven monosynaptically from the labyrinth and responds to every shock; there is a large P-wave, representing the incoming afferent volley, right after the stimulus artifact. B: 5/sec. Cell misses occasionally, revealing the underlying NI potential. This is a postsynaptic (monosynaptic) field potential. C: 20/sec. Cell no longer responds, but a sizable NI remains. Time mark, msec; voltage calibration, 500 μ V. Negative deflection upward in this and succeeding figures. (From ref. 3.)

stimulating the labyrinth with a single electric shock. Some of these cells had axons the conduction velocity of which exceeded 100 m/sec; these were giant cells. As shown in table 1, almost all cells that fired monosynaptically were located in the ventral part of the nucleus. In addition to cells fired monosynaptically, a few (16/141, or 11 percent) were fired polysynaptically with a longer latency. This relatively small number of cells fired polysynaptically is in contrast to the much greater number of medial nucleus cells so fired (ref. 4, and below).

TABLE 1.—Fraction of Cells Driven Monosynaptically by the Labyrinth in Different Part of Deiters' Nucleus

	Rostral	Middle	Caudal
Dorsal.....	1/3C 1/7L	0/8	0/4C 0/10L
Ventral.....	6/12C 9/11L	3/6	6/9C 2/6L

This table is based on 76 cells found in tracks containing a dye mark. Location of cells was determined from an analysis of serial frozen sections cut at 40 microns and stained with thionin. L, cell projecting to lumbosacral cord; C, cell projecting to cervicothoracic cord. Data from ref. 2 and from unpublished observations by B. W. Peterson.

Although stimulation of the labyrinth excites more C-cells than L-cells, in keeping with previous anatomical and physiological findings (ref. 13), the number of L-cells excited is far from negligible. A relatively direct pathway therefore exists between the labyrinth and segmental motor mechanisms at all levels of the spinal cord.

The question may be asked, What part or parts of the labyrinth give rise to the afferent fibers that reach the lateral vestibular nucleus? In 1933, Lorente de N6 (ref. 18; see also ref. 19) showed that while there is overlap between the projections of different parts of the labyrinth within the vestibular nuclei, there is a clear projection to Deiters' nucleus from the utricle, the receptor for position sense. Adrian (ref. 20) found that vestibular neurons in the cat were affected by tilt, and subsequently Duensing and Schaefer (ref. 21) studied this effect of tilt on various cells in the vestibular nuclei, some of them located in Deiters' nucleus. Recent detailed investigations by Peterson (ref. 7) have shown that the spontaneous activity of many lateral vestibular cells, including cells with axons in the vestibulo-spinal tract, can be increased or decreased by tilting (see also ref. 22). In agreement with the findings described above, Peterson observed that cells strongly affected by tilting were generally found in the ventral part of Deiters' nucleus; electrical stimulation revealed that most of the strongly affected cells received a monosynaptic input from the labyrinth. This monosynaptic input could come from various receptors, as there is evidence that canal and utricular receptors often converge on cells in the lateral nucleus, as well as in other nuclei (refs. 7, 21, and 23).

Somatic Input to Cells in the Lateral Vestibular Nucleus

It has been known for some time that fibers in the restiform body may give off collaterals to the vestibular nuclei (cf. ref. 24). These fibers may include dorsal spinocerebellar tract fibers, but at least some of the spinovestibular fibers that have been described recently (refs. 25 and 26) are not collaterals of the dorsal spinocerebellar tract. Spinovestibular fibers are scanty in numbers and terminate, among other places, in

the caudal part of Deiters' nucleus. In accord with these observations, short-latency excitatory postsynaptic potentials have been observed in some Deiters' cells following stimulation of the ventral and lateral funiculi of the cervical spinal cord (ref. 14). What the functional meaning of this pathway is remains to be determined. It is unlikely to play a very important role in regulating the activity of Deiters' cells; in our experiments, stimulation of the spinal cord or of peripheral nerves caused almost no short-latency modification of the activity of Deiters' cells (refs. 1 and 2).

We have observed that stimulation of various forelimb and hindlimb nerves can produce a relatively long-lasting facilitation of the firing of single units in Deiters' nucleus, as is shown in figure 3 (refs. 1 and 2); not unexpectedly, facilitation can also be evoked by stimulation of muscle and cutaneous afferents from the neck (unpublished observations by R. M. Wylie, M. Yoshida, and V. J. Wilson). Unlike stimulation of the labyrinth that could fire silent cells, stimulation of peripheral nerves usually was able only to facilitate cells with ongoing spontaneous activity, of which there were many. Some other characteristics of this peripheral activation of Deiters' cells are as follows (refs. 1 and 2): (1) It has a latency near 20 msec (on stimulation of hindlimb nerves), and the pathway that produces it has a spinal conduction velocity ranging from 10 to 80 m/sec, usually 40 m/sec or less; (2) the facilitation lasts 100 to 200 msec; (3) while

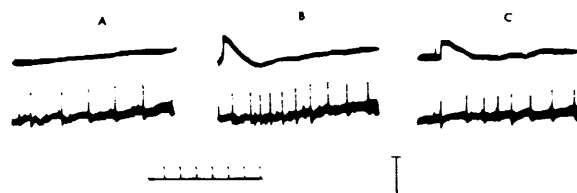

FIGURE 3.—Activation of a Deiters' L-cell by peripheral stimulation. Extracellularly recorded spikes are displayed on the lower beam while the afferent spike and cord potential, evoked by stimulation of hindlimb nerves and recorded at the cord-dorsal root junction, are displayed on the upper beam. A, spontaneous firing; B, effect of a strong shock to many ipsilateral nerves simultaneously; C, effect of a stimulus to the superficial peroneal nerve, strong enough to activate many delta fibers. Calibrations: time, 10 msec; amplitude for lower beam, 500 μV . Spikes retouched. (From ref. 1.)

single shocks to cutaneous or mixed nerves are effective in producing facilitation, multiple shocks to muscle nerves are usually required. An important result is that stimulation of ipsilateral and contralateral forelimb and hindlimb nerves often produces facilitation of the same Deiters' cells, and these may be cells projecting to the forelimb or hindlimb regions of the spinal cord. The facilitation is not organized somatotopically (ref. 2). Similar convergence was observed previously (refs. 27 and 28), but these earlier experiments were performed in animals with the cerebellum intact. Because of the localized distribution of spino-vestibular fibers, the extensive convergence was ascribed to passage of impulses through the cerebellum. Our experiments on decerebellate animals show that this convergence is characteristic of the spinal or bulbar components of the ascending pathway. The nature of the ascending pathway is apparently quite complex and it may include pathways through the reticular formation as well as collaterals of spino-olivary, spinocerebellar, and reticulocerebellar fibers (refs. 1, 15, and 29). Finally, in our experiments, just as in those of Pompeiano and his colleagues (refs. 27 and 28), the change in excitability of Deiters' cells due to peripheral stimulation was usually facilitatory and only infrequently inhibitory. Impulses reaching the cerebellar cortex could activate Purkinje cells, which are inhibitory cells (ref. 30) and which project directly onto dorsal Deiters' neurons. Of course, impulses relayed through the cerebellar cortex and deep nuclei can produce not only inhibition but also facilitation and disinhibition of Deiters' cells (ref. 15), and the net effect resulting from different peripheral stimuli remains to be determined. Nevertheless, it would be expected that stimulation of peripheral nerves in animals with the cerebellum intact should produce more inhibition of Deiters' cells than has so far been described, and systematic investigation of this matter seems to be required.

What kind of afferent fibers, when stimulated, produce facilitation of cells in the lateral vestibular nucleus? This question has been asked in experiments performed in animals with the cerebellum intact as well as in decerebellate animals,

and there is considerable agreement among the results obtained (refs. 1, 2, and 28). Facilitation results when cutaneous or mixed forelimb and hindlimb nerves are stimulated with very weak shocks, and increases as the shocks are strengthened to 20 or more times the threshold of the largest fibers in the nerve; impulses in large and small fibers can lead to facilitation of Deiters' cells. Evidently the large fibers that are effective in producing facilitation and that are found in mixed nerves are not muscle afferent fibers. Stimulation of hindlimb muscle nerves does not result in facilitation until the shocks are strong enough to stimulate fibers larger than group I, whether the cerebellum is in place or removed (fig. 4; see refs. 1, 2, and 28). The same is true for stimulation of forelimb muscle nerves in decerebellate animals (fig. 4; ref. 2); in animals with an intact cerebellum it is possible that stimulation of the smaller forelimb group I fibers may influence Deiters' cells (ref. 28), but the data presented so far are not sufficient for critical evaluation of this possibility. It is interesting that cells in the brainstem reticular formation also are not affected by stimulation of hindlimb, or forelimb, group I fibers (ref. 31). Group I fibers activate some types of spinocerebellar fibers (ref. 32), and stimulation of group I fibers from some hindlimb muscles, particularly quadriceps, evokes field potentials in the olive (ref. 33). As it is likely that collaterals of some spinocerebellar or olivocerebellar fibers terminate in Deiters' nucleus (see above), the possibility remains that searching by means of intracellular recording, or by means of extracellular excitability testing more exhaustive than so far employed might reveal, even in decerebellate animals, group Ia and Ib inputs to the cells of Deiters' nucleus that have so far escaped detection. This possibility is even stronger in animals with the cerebellum intact. A group Ia input from hindlimb nerves (gastrocnemius-soleus), activating Deiters' cells by disinhibition via the cerebellum, has recently been assumed in explaining long-latency facilitatory effects on H reflexes in human subjects (ref. 34).

Facilitation of Deiters' neurons can be produced by weaker stimuli when stimulating forelimb muscle nerves than when stimulating hind-

limb muscle nerves, as shown in figure 4. It is generally accepted that effects that first appear when the stimulus to a muscle nerve reaches

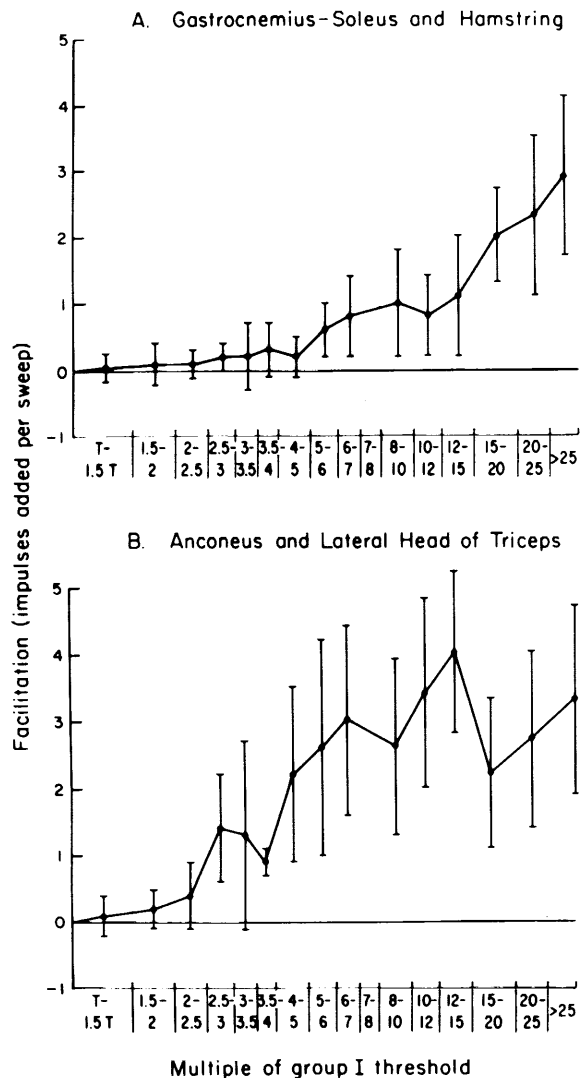

FIGURE 4.—Comparison of facilitating action on Deiters' cells of a triple shock (300/sec) to hindlimb (A) and forelimb (B) muscle nerves. Results of stimulation of two different hindlimb nerves were merged to construct graph A; of two forelimb nerves to construct graph B. Results from 12 cells were used for A, from 11 cells for B; three cells were common to both populations. T is the threshold of the largest fibers in the nerve; i.e., group I threshold. The bars show the standard deviation of each mean; n ranged from 5 to 50, and was usually 10 or more. For 20 of the cells, measurements were made from 100-msec sweeps; 200-msec sweeps were used for the other three cells. (From ref. 2.)

approximately two times the threshold of the largest fibers in the nerve are due to activation of group II fibers, while effects starting at 5 to 10 times threshold are due to activation of group III fibers. From this and figure 4 it is obvious that, in decerebellated cats, hindlimb fibers in the group III category must be stimulated for facilitation to appear, but that it is sufficient to stimulate group II fibers in the forelimbs to evoke facilitation. Apparently hindlimb group II fibers are effective in animals with an intact cerebellum (ref. 28), but this, as well as any possible contribution of group I fibers in such preparations, needs further investigation.

We have, therefore, a reasonable amount of information about the size of muscular and extramuscular afferent fibers that, when stimulated, can influence the excitability of Deiters' cells. There is also some information about the receptors these fibers supply. Most interesting is the fact, indicated by the ineffectiveness of electrical stimulation of group I fibers, that activation of the primary endings of muscle spindles, or of tendon organs, has little or no influence on cells of the lateral vestibular nucleus. Apparently the vestibulospinal system, closely involved in the regulation of posture and muscle tone, is little affected by information originating in the most important muscle receptors. Since group II fibers in muscle nerves do not necessarily innervate only the secondary endings of the spindles (ref. 35), and since some muscle nerves may be contaminated by joint afferents (cf. ref. 31), it is difficult to estimate the contribution of fibers from spindle secondary endings to the facilitation produced by stimulation of group II fibers.

As for other receptors, Pompeiano and Cotti (ref. 27) found that Deiters' units could be facilitated by manipulation of the limbs, tendon tapping, hair movement, and even by stimuli to the snout. In the experiments of Frederickson, Schwarz, and Kornhuber (ref. 36), deep somatic stimuli, particularly joint movement, were much more effective than exteroceptive stimuli in exciting vestibular cells. Most of the cells they studied, however, were located in the medial and descending nuclei, and a detailed investigation of the effect of different types of somatic stimuli on Deiters' cells still needs to be done.

Convergence of Vestibular and Somatic Inputs

Vestibular and somatic inputs converge on many Deiters' cells. For example, in our experiments (ref. 2) most of the cells that were driven by stimulation of the labyrinth, monosynaptically or polysynaptically, and that were spontaneously active (making detection of an ascending facilitatory input possible), were also facilitated by stimulation of leg nerves. While most of the facilitated cells studied in these experiments were located in the dorsal part of the nucleus, subsequent experiments have shown that ventrally placed cells can also be facilitated by impulses originating in the spinal cord, and these same experiments have shown that somatic and vestibular convergence takes place in cells whose activity is modified by static position changes (unpublished observations by B. W. Peterson). Convergence of vestibular and nonvestibular synaptic inputs (nonvestibular inputs include those transmitted via the cerebellum as well as direct ones) has also been observed by Ito and his collaborators (ref. 15). It should be noted that convergence is seen in cells whose axons project to many levels of the spinal cord in the vestibulospinal tract (ref. 2). Cells projecting to the level of neck motoneurons, which are particularly influenced by vestibular inputs (refs. 37 and 38) and by stimulation of Deiters' nucleus (ref. 12), have not yet been studied.

THE MEDIAL VESTIBULAR NUCLEUS

The axons of many medial nucleus cells project rostrally, mainly in the medial longitudinal fasciculus (MLF), and terminate predominantly in the extraocular nuclei (refs. 39 and 40). Other cells send their axons to the spinal cord in the descending medial longitudinal fasciculus (DMLF; refs. 8, 40, and 41), as do some cells in the descending vestibular nucleus (ref. 42). The fibers to the spinal cord appear to be small in number, do not descend below midthoracic levels, and terminate on cells of laminae 7 and 8 (refs. 10 and 41). There are in the medial nucleus not only cells with long axons, but also a significant number of cells with axons that arborize within the vestibular

nuclei (refs. 13 and 43). This is in contrast to Deiters' nucleus; most of its cells are believed to have long axons (ref. 13). I will refer to medial nucleus cells without long ascending or descending axons as interneurons, and will include among them commissural cells projecting to the contralateral vestibular nuclei (ref. 44). In discussing our work on the medial nucleus (refs. 3 and 4), I will limit myself to describing some vestibular and somatic inputs to the different types of cells in this nucleus. First, however, it is necessary to consider some aspects of the nucleus' organization.

For convenience, we have divided the nucleus into 10 areas equal in length. These areas are illustrated in figure 5; 1 is the most caudal and 10 the most rostral. The landmarks in these areas remained constant from one animal to another, making it possible to pool the data for cell location obtained in all experiments. Our findings on the relative number of units projecting rostrally (MLF cells) and caudally (DMLF cells), and on the location of these units,

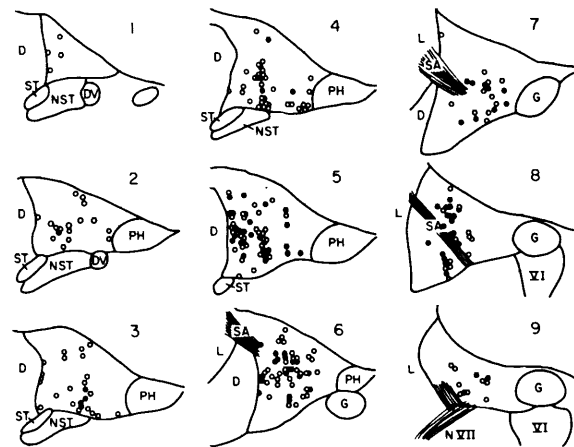

FIGURE 5.—Distribution in areas 1 to 9 of the medial vestibular nucleus of cells that were driven (filled circles) and were not driven (open circles) monosynaptically by stimulation of the labyrinth at a rate of 1/sec. Area 1 is the most caudal tenth of the nucleus; area 9 is very rostral. Abbreviations: D, descending vestibular nucleus; DV, dorsal nucleus of the vagus; G, genu of the facial nerve; L, lateral vestibular nucleus of Deiters'; N VII, facial nerve. NST, nucleus of the solitary tract; PH, nucleus prepositus hypoglossi; SA, stria acustica; ST, solitary tract; VI, nucleus of the abducens nerve. (From ref. 4.)

are shown in table 2, and can be summarized as follows: (1) 41 percent of medial nucleus cells tested projected rostrally in the MLF, while only 17 percent projected to the spinal cord in the DMLF. This is in agreement with the results of anatomical investigations, that also show the rostrally projecting axons greatly to outnumber caudally directed axons. (2) Contrary to our expectations, very few cells had long axons projecting both rostrally and caudally. Even though the number of dichotomizing cells revealed in our experiments is probably an underestimate, there are apparently fewer such cells than previously believed (ref. 13). (3) Most cells projecting rostrally and caudally were located in areas 4 to 10; i.e., in the rostral two-thirds of the nucleus. (4) A substantial number of cells seemed to lack long axons. Some of these cells undoubtedly had long axons that were not excited by our stimuli, either because their threshold was too high or because they projected to regions we did not stimulate (e.g., the cerebellum, ref. 13), but others were certainly interneurons.

TABLE 2.—*Fraction of Units Tested Projecting Into MLF AND DMLF*

Area	Projection into MLF	Projection into DMLF	Nonprojecting units
1.....	1/6	1/6	4/6
2.....	0/21	3/22	14/18
3.....	3/33	0/20	19/19
4.....	17/60	0/43	28/36
5.....	32/68	8/56	19/56
6.....	49/79	9/51	16/53
7.....	14/26	5/23	6/9
8.....	22/44	10/34	9/37
9.....	5/18	9/18	5/19
10.....	2/2	1/1	0/2
Total..	145/357 (41%)	46/274 (17%)	120/255 (47%)

This table is derived from units studied in experiments with the MLF stimulating electrode placed 1.5 to 2.0 mm rostral to Deiters' nucleus and the DMLF electrode at C3. Nonprojecting units include only those tested with both MLF and DMLF stimulation, and found lacking both. The sample thus tested is smaller than the samples tested for one or the other projection. (Data from ref. 3.)

Vestibular Input to Cells in the Medial Nucleus

Many cells in the medial nucleus can be fired monosynaptically or polysynaptically by electrical stimulation of the ipsilateral labyrinth (refs. 3, 4, 45, and 46), and it is this ipsilateral input that I will deal with primarily. Many cells in the medial nucleus receive inputs from the horizontal canals. Those cells excited by ipsilateral and inhibited by contralateral acceleration have been called type I cells; those inhibited by ipsilateral and excited by contralateral acceleration have been called type II cells (cf. ref. 46). Type I and type II cells are included in the sample of cells that we have studied by means of electrical stimulation. This sample undoubtedly also includes cells activated by fibers originating in parts of the labyrinth other than the horizontal canal. In our experiments with electrical stimulation, of 264 cells, 58 (22 percent) responded only monosynaptically, 86 (33 percent) only polysynaptically, 34 (13 percent) fired twice—monosynaptically and polysynaptically—while 86 (33 percent) were not driven at all by the stimulus. In agreement with anatomical results which show that after destruction of the labyrinth there is a little terminal degeneration in the caudal region of the medial nucleus (refs. 16 and 19), we found that in this region (areas 1 to 4) there were very few cells driven monosynaptically by electrical stimulation of the labyrinth (fig. 5). In contrast, cells fired polysynaptically were scattered throughout the nucleus, in approximately similar proportion in all areas.

It will be noticed that the distribution of cells driven monosynaptically is essentially the same as the distribution of cells with ascending or descending axons. In this region of overlap, cells of all types were fired by labyrinthine stimulation. Monosynaptic firing was observed in 32 of 40 DMLF cells, 37 of 99 MLF cells, and 27 of 106 cells lacking a long axon; polysynaptic activation was observed in 9 of 35 DMLF cells, 51 of 101 MLF cells, and 54 of 94 cells without long axons. There are several interesting aspects to these results. First, it is apparent that while all types of cells receive a monosynaptic input from the labyrinth, a particularly high proportion of DMLF cells receive such an input despite the fact that MLF and DMLF cells are inter-

mingled. This gives support to the suggestion (cf. ref. 47) that while the location of a cell is of great importance in determining its input, the function of the cell also plays a role in regulating this input. Second, since many fibers in the MLF are known to end in the motor nuclei of the eye muscles, labyrinthine activation of cells projecting rostrally provides a direct reflex pathway for deviation of the eyes following movement of the head. Labyrinthine activation of cells projecting caudally provides a direct pathway from labyrinth to cervicothoracic cord. What type of spinal cells these caudally projecting fibers end on, and what effect they have on those cells, is not known. Most investigations on the role of descending vestibular fibers have concentrated on the vestibulospinal tract, and the vestibular projection in the medial longitudinal fasciculus needs further attention. Third, many cells excited by stimulation of the ipsilateral labyrinth lack long axons, and, as stated above, there are probably many interneurons among them. In connection with these cells, it is necessary to discuss briefly the effects of stimulation of the contralateral labyrinth. These effects, excitatory and inhibitory, were described in some detail by Shimazu and Precht (ref. 48), and many of their findings were confirmed by ours (ref. 4). For purposes of the present discussion, it is sufficient to restate that some cells in the medial nucleus can be excited, others inhibited, by stimulation of the contralateral labyrinth, via commissural vestibular fibers (ref. 44); the latency of the inhibition is sometimes as short as 1.6 to 2.1 msec (ref. 4), and, as there are no crossed primary fibers (refs. 16 and 17), it seems that some of the commissural fibers are inhibitory, and that the simplest commissural inhibitory pathway consists of an inhibitory commissural cell, activated monosynaptically by vestibular afferents (refs. 4, 49, and 50). In other cases, however, the pathway probably consists of an excitatory commissural cell that in turn excites an inhibitory neuron (probably a type II cell) located on the contralateral side, near the cell to be inhibited. It is apparent that there are inhibitory, and probably excitatory, interneurons in the medial nucleus and these cells are undoubtedly included

in our sample of cells without long axons; type II cells excited by stimulation of the contralateral labyrinth usually lack long axons (refs. 4 and 51). It is reasonable to assume that the interneurons influence the activity of cells that receive ipsilateral excitatory vestibular inputs and that relay this input rostrally or caudally. It is therefore of interest that inputs from the ipsilateral and contralateral labyrinths often converge on cells without long axons and that, as we shall see below, the converging inputs also include some of nonvestibular origin.

As is the case with Deiters' nucleus, the medial nucleus receives inputs from more than one part of the labyrinth. It seems that all three semicircular canals, as well as the utricle, supply afferent fibers to the medial nucleus (refs. 18 and 19). In experiments utilizing natural stimulation, cells in the medial nucleus have so far been shown to be excited (or inhibited) by horizontal acceleration (refs. 46 and 52) and static tilting (refs. 7 and 21, and unpublished observations by B. W. Peterson). Our experiments do not indicate which vestibular receptors impinge on rostrally and caudally projecting cells. It is known, however, that many cells excited by horizontal acceleration have axons ascending in the MLF (ref. 53), while few have axons projecting to the spinal cord (ref. 51). So far there is little to indicate whether cells affected by tilting can be fired antidromically by spinal cord stimulation (unpublished observations by B. W. Peterson).

Somatic Input to Cells in the Medial Nucleus and Its Convergence With the Vestibular Input

There is much less information about the somatic input to medial nucleus cells than there is about this input to Deiters' cells. A few direct spinovestibular fibers end in the caudalmost part of the nucleus (refs. 25 and 26), and from the observations of Lorente de N6 (ref. 24), it appears that collaterals of some cerebellopetal fibers also terminate in the medial nucleus.

Many of the cells studied by Frederickson, Schwarz, and Kornhuber (ref. 36) were located in the medial nucleus and, as described above in the discussion of Deiters' cells, they could be activated by deep somatic stimuli, particularly

by joint movement. All these cells also responded to polarization of the labyrinth. In our experiments (ref. 4) synaptic activation from the spinal cord was often looked for only by stimulation through the same electrode (located in the cervical spinal cord near the midline) that was used for antidromic activation of medial nucleus cells; in some cases stimulation of peripheral nerves was also attempted. A number of cells were excited transsynaptically by the cord electrode and by strong shocks (above group III threshold) to peripheral nerves, in a manner similar to that shown in figure 6. As we did not search systematically for such activation in all cells, only limited conclusions can be drawn from the results. Most interesting is that of 38 cells in which spinal synaptic activation was seen, only 5 had long axons. Apparently somatic activation of cells in the medial nucleus is most common among interneurons. This result is similar to that of Precht and his collaborators (ref. 51), who

rarely found spinal synaptic activation of type I neurons receiving an excitatory input from the ipsilateral horizontal canal, but found it frequently among type II cells, excited from the contralateral horizontal canal. Few of these cells could be activated antidromically from the spinal cord, and it was presumed that there were inhibitory interneurons among them.

Not only somatic stimuli of spinal origin impinge on the group of cells we have been discussing. Cells in the medial nucleus can also be activated synaptically by fibers in the MLF (fig. 6), many of which originate in the interstitial nucleus of Cajal (refs. 53 and 54). The cells activated by this descending MLF input are type II cells, excited by contralateral horizontal acceleration (ref. 53). Cells excited by ipsilateral horizontal acceleration are inhibited by the descending fibers, and it has been suggested that the inhibition is mediated by type II cells (ref. 53). In our experiments we have observed synaptic activation of 40 medial nucleus cells as a result of stimulation of the MLF. Only two of these cells had long axons. Finally, 17 cells were activated synaptically from both MLF and spinal cord; none of these cells had long axons.

It is apparent from all of these results that vestibular and nonvestibular inputs converge on many cells in the medial vestibular nucleus. Most of these cells lack long axons, and it is likely that many are interneurons whose function it is to regulate the activity of those cells that relay information from labyrinth receptors to other levels of the central nervous system.

The functional role of the medial vestibular nucleus is not clear. Considerable evidence has accumulated, however, that this nucleus is involved in a variety of phenomena taking place during sleep, including presynaptic inhibition of different spinal pathways and of various supraspinal structures (ref. 55). Whatever the pathways by which these actions are carried out, further study of the regulation of activity within the medial and descending nuclei is clearly called for. A more detailed study of nonvestibular inputs should be part of such a study.

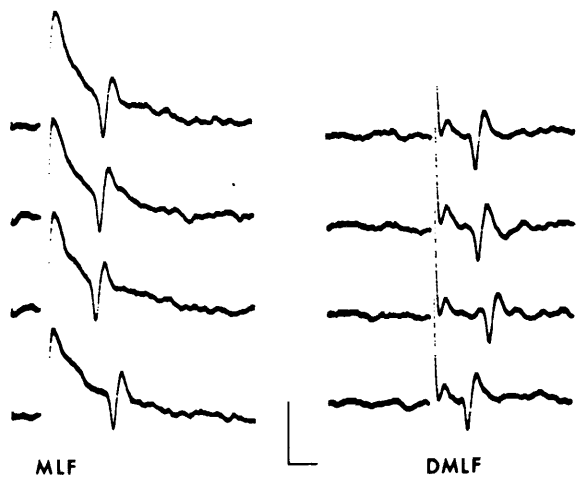

FIGURE 6.—Synaptic activation of a cell in area 3 of the medial nucleus. Extracellular recording. This cell could not be driven antidromically. Stimulation of the MLF (left) produced transsynaptic firing at a variable latency of 1.6 to 2.9 msec. Stimulation of the DMLF (right) caused firing at 1.1 to 1.7 msec. Calibrations: 500 μ V and 1 msec. (From ref. 4.)

REFERENCES

1. WILSON, V. J.; KATO, M.; THOMAS, R. C.; AND PETERSON, B. W.: Excitation of Lateral Vestibular Neurons by Peripheral Afferent Fibers. *J. Neurophysiol.*, vol. 29, 1966, pp. 508-529.
2. WILSON, V. J.; KATO, M.; PETERSON, B. W.; AND WYLIE, R. M.: A Single Unit Analysis of the Organization of Deiters' Nucleus. *J. Neurophysiol.*, vol. 30, 1967, pp. 603-619.
3. WILSON, V. J.; WYLIE, R. M.; AND MARCO, L. A.: Organization of the Medial Vestibular Nucleus. *J. Neurophysiol.*, vol. 31, 1968, pp. 166-175.
4. WILSON, V. J.; WYLIE, R. M.; AND MARCO, L. A.: Synaptic Inputs to Cells in the Medial Vestibular Nucleus. *J. Neurophysiol.*, vol. 31, 1968, pp. 176-185.
5. THOMAS, R. C.; AND WILSON, V. J.: Precise Localization of Renshaw Cells With a New Marking Technique. *Nature*, vol. 206, 1965, pp. 211-213.
6. THOMAS, R. C.; AND WILSON, V. J.: Marking Single Neurons by Staining With Intracellular Recording Microelectrodes. *Science*, vol. 151, 1966, pp. 1538-1539.
7. PETERSON, B. W.: Effect of Tilting on the Activity of Neurons in the Vestibular Nuclei of the Cat. *Brain Res.*, vol. 6, 1967, pp. 606-609.
8. POMPEIANO, O.; AND BRODAL, A.: The Origin of Vestibulospinal Fibres in the Cat. An Experimental-Anatomical Study, With Comments on the Descending Medial Longitudinal Fasciculus. *Arch. Ital. Biol.*, vol. 95, 1957, pp. 166-195.
9. NYBERG-HANSEN, R.; AND MASCITTI, T. A.: Sites and Mode of Termination of Fibers of the Vestibulospinal Tract in the Cat. An Experimental Study With Silver Impregnation Methods. *J. Comp. Neurol.*, vol. 122, 1964, pp. 369-387.
10. PETRAS, J. M.: Cortical, Tectal and Tegmental Fiber Connections in the Spinal Cord of the Cat. *Brain Res.*, vol. 6, 1967, pp. 275-324.
11. LUND, S.; AND POMPEIANO, O.: Descending Pathways With Monosynaptic Action on Motoneurons. *Experientia*, vol. 21, 1965, pp. 602-603.
12. WILSON, V. J.; AND YOSHIDA, M.: Vestibulospinal and Reticulospinal Effects on Hindlimb, Forelimb and Neck Alpha Motoneurons. *Proc. Nat. Acad. Sci.*, vol. 60, 1968, pp. 836-840.
13. BRODAL, A.; POMPEIANO, O.; AND WALBERG, F.: The Vestibular Nuclei and Their Connections, Anatomy and Functional Correlations (Ramsay Henderson Trust Lectures). Oliver & Boyd, Edinburgh, London, 1962.
14. ITO, M.; HONGO, T.; YOSHIDA, M.; OKADA, Y.; AND OBATA, K.: Antidromic and Transsynaptic Activation of Deiters' Neurons Induced From the Spinal Cord. *Jap. J. Physiol.*, vol. 14, 1964, pp. 638-658.
15. ECCLES, J. C.; ITO, M.; AND SZENTÁGOTHAJ, J.: The Cerebellum as a Neuronal Machine. Julius Springer (Berlin), 1967.
16. WALBERG, F.; BOWSER, D.; AND BRODAL, A.: The Termination of Primary Vestibular Fibers in the Vestibular Nuclei in the Cat. An Experimental Study With Silver Methods. *J. Comp. Neurol.*, vol. 110, 1958, pp. 391-419.
17. MUGNAINI, E.; WALBERG, F.; AND BRODAL, A.: Mode of Termination of Primary Vestibular Fibres in the Lateral Vestibular Nucleus. An Experimental Electron Microscopical Study in the Cat. *Exptl. Brain Res.*, vol. 4, 1967, pp. 187-211.
18. LORENTE DE NÓ, R.: Anatomy of the Eighth Nerve. The Central Projection of the Nerve Endings of the Internal Ear. *Laryngoscope*, vol. 43, 1933, pp. 1-38.
19. STEIN, B. M.; AND CARPENTER, M. B.: Central Projections of Portions of the Vestibular Ganglia Innervating Specific Parts of the Labyrinth in the Rhesus Monkey. *Am. J. Anat.*, vol. 120, 1967, pp. 281-318.
20. ADRIAN, E. D.: Discharge From Vestibular Receptors in the Cat. *J. Physiol.*, vol. 101, 1943, pp. 389-407.
21. DUENSING, F.; AND SCHAEFER, K. P.: Über die Konvergenz Verschiedener Labyrintharen Afferenzen auf Einzelne Neurone des Vestibulariskerngebietes. *Arch. Psychiat. Nervenkr.*, vol. 199, 1959, pp. 345-371.
22. FUJITA, Y.; ROSENBERG, J.; AND SEGUNDO, J. P.: Activity of Cells in the Lateral Vestibular Nucleus as a Function of Head Position. *J. Physiol.*, vol. 196, 1968, pp. 1-18.
23. HALLPIKE, C. S.: Some Types of Ocular Nystagmus and Their Neurological Mechanisms. *Proc. Roy. Soc. Med.*, vol. 60, 1967, pp. 1043-1055.
24. LORENTE DE NÓ, R.: Études sur le Cerveau Postérieur. III. Sur les Connexions Extracérébelleuses des Fascicules Afférents au Cerveau, et sur la Fonction de cet Organe. *Trav. Lab. Rech. Biol.*, vol. 22, 1924, pp. 51-65.
25. POMPEIANO, O.; AND BRODAL, A.: Spino-vestibular Fibers in the Cat. *J. Comp. Neurol.*, vol. 108, 1957, pp. 353-382.
26. BRODAL, A.; AND ANGAUT, P.: The Termination of Spino-vestibular Fibres in the Cat. *Brain Res.*, vol. 5, 1967, pp. 494-500.
27. POMPEIANO, O.; AND COTTI, E.: Analisi Microelettroica Delle Proiezioni Cerebellodeitersiane. *Arch. Sci. Biol. Bologna*, vol. 43, 1959, pp. 57-101.
28. GIAQUINTO, S.; POMPEIANO, O.; AND SANTINI, M.: Riposta de Unita Deitersiane a Stimolazione Graduata di Nervi Cutanei e Muscolari in Animali Decerebrati a Cerevelleto Integro. *Boll. Ital. Biol. Sper.*, vol. 39, 1963, pp. 524-527.
29. ITO, M.; OBATA, K.; AND OCHI, R.: The Origin of Cerebellar-Induced Inhibition of Deiters' Neurons. II. Temporal Correlation Between the Transsynaptic Activation of Purkinje Cells and the Inhibition of Deiters' Neurons. *Exptl. Brain Res.*, vol. 2, 1966, pp. 350-364.
30. ITO, M.; AND YOSHIDA, M.: The Origin of Cerebellar-Induced Inhibition of Deiters' Neurons. I. Monosynaptic Initiation of the Inhibitory Postsynaptic Potentials. *Exptl. Brain Res.*, vol. 2, 1966, pp. 330-349.

31. POMPEIANO, O.; AND SWETT, J. E.: Actions of Graded Cutaneous and Muscular Afferent Volleys in the Decerebrate, Cerebellectomized Cat. *Arch. Ital. Biol.*, vol. 101, 1963, pp. 552-583.
32. OSCARSSON, O.: Functional Organization of the Spino- and Cuneocerebellar Tracts. *Physiol. Rev.*, vol. 45, 1965, pp. 495-522.
33. ARMSTRONG, D. M.; ECCLES, J. C.; HARVEY, R. J.; AND MATTHEWS, P. B. C.: Responses in the Dorsal Accessory Olive of the Cat to Stimulation of Hind Limb Afferents. *J. Physiol.*, vol. 194, 1968, pp. 125-146.
34. ECCLES, J. C.: The Way in Which the Cerebellum Processes Sensory Information. *Neurophysiological Basis of Normal and Abnormal Motor Activities*, M. D. Yahr and D. P. Purpura, eds., Raven Press, 1967, pp. 379-406.
35. BARKER, D.; IP, C.; AND ADAL, M. N.: A Correlation Between the Receptor Population of the Cat's Soleus Muscle and the Afferent Fibre-Diameter Spectrum of the Nerve Supplying It. *Symposium on Muscle Receptors*, D. Barker, ed., Hong Kong University Press, 1962, pp. 257-262.
36. FREDERICKSON, J. M.; SCHWARZ, D.; AND KORNHUBER, H. H.: Convergence and Interaction of Vestibular and Deep Somatic Afferents Upon Neurons in the Vestibular Nuclei of the Cat. *Acta Oto-Laryngol.*, vol. 61, 1966, pp. 168-188.
37. MAGNUS, R.: Some Results of Studies in the Physiology of Posture, II. *Lancet*, vol. 211, 1926, pp. 585-588.
38. BATINI, C.; MORUZZI, G.; AND POMPEIANO, O.: Cerebellar Release Phenomena. *Arch. Ital. Biol.*, vol. 95, 1957, pp. 71-95.
39. BRODAL, A.; AND POMPEIANO, O.: The Origin of Ascending Fibres of the Medial Longitudinal Fasciculus From the Vestibular Nuclei. An Experimental Study in the Cat. *Acta Morphol. Neerl.-Scand.*, vol. 1, 1957, pp. 306-328.
40. McMASTERS, R. E.; WEISS, A. H.; AND CARPENTER, M. B.: Vestibular Projections to the Nuclei of the Extraocular Muscles. Degeneration Resulting From Discrete Partial Lesions of the Vestibular Nuclei in the Monkey. *Am. J. Anat.*, vol. 118, 1966, pp. 163-194.
41. NYBERG-HANSEN, R.: Origin and Termination of Fibers From the Vestibular Nuclei Descending in the Medial Longitudinal Fasciculus. An Experimental Study With Silver Impregnation Methods in the Cat. *J. Comp. Neurol.*, vol. 122, 1964, pp. 355-367.
42. WILSON, V. J.; WYLIE, R. M.; AND MARCO, L. A.: Projection to the Spinal Cord From the Medial and Descending Vestibular Nuclei of the Cat. *Nature*, vol. 215, 1967, pp. 429-430.
43. LORENTE DE NO, R.: Vestibulo-Ocular Reflex Arc. *Arch. Neurol. Psychiat.*, vol. 30, 1933, pp. 245-291.
44. LADPLI, R.; AND BRODAL, A.: Experimental Studies of Commissural and Reticular Formation Projections From the Vestibular Nuclei in the Cat. *Brain Res.*, vol. 8, 1968, pp. 65-96.
45. PRECHT, W.; AND SHIMAZU, H.: Functional Connections of Tonic and Kinetic Vestibular Neurons With Primary Vestibular Afferents. *J. Neurophysiol.*, vol. 28, 1965, pp. 1014-1028.
46. SHIMAZU, H.; AND PRECHT, W.: Tonic and Kinetic Responses of Cat's Vestibular Neurons to Horizontal Angular Acceleration. *J. Neurophysiol.*, vol. 28, 1965, pp. 991-1013.
47. THOMAS, R. C.; AND WILSON, V. J.: Recurrent Interactions Between Motoneurons of Known Location in the Cervical Cord of the Cat. *J. Neurophysiol.*, vol. 30, 1967, pp. 661-674.
48. SHIMAZU, H.; AND PRECHT, W.: Inhibition of Central Vestibular Neurons From the Contralateral Labyrinth and its Mediating Pathway. *J. Neurophysiol.*, vol. 29, 1966, pp. 467-492.
49. KASAHARA, M.; MANO, N.; OSHIMA, T.; OZAWA, S.; AND SHIMAZU, H.: Contralateral Short Latency Inhibition of Central Vestibular Neurons in the Horizontal Canal System. *Brain Res.*, vol. 8, 1968, pp. 376-378.
50. MANO, M.; OSHIMA, T.; AND SHIMAZU, H.: Inhibitory Commissural Fibers Interconnecting the Bilateral Vestibular Nuclei. *Brain Res.*, vol. 8, 1968, pp. 378-382.
51. PRECHT, W.; GRIPPO, J.; AND WAGNER, A.: Contribution of Different Types of Central Vestibular Neurons to the Vestibulospinal System. *Brain Res.*, vol. 4, 1967, pp. 119-123.
52. DUENSING, F.; AND SCHAEFER, K. P.: Die Aktivität Einzelner Neurone im Bereich der Vestibulariskerne bei Horizontalbeschleunigungen Unter Besonderer Berücksichtigung des Vestibulären Nystagmus. *Arch. Psychiat. Nervenkr.*, vol. 198, 1958, pp. 225-252.
53. MARKHAM, C. H.; PRECHT, W.; AND SHIMAZU, H.: Effect of Stimulation of Interstitial Nucleus of Cajal on Vestibular Unit Activity in the Cat. *J. Neurophysiol.*, vol. 29, 1966, pp. 493-507.
54. POMPEIANO, O.; AND WALBERG, F.: Descending Connections to the Vestibular Nuclei. An Experimental Study in the Cat. *J. Comp. Neurol.*, vol. 108, 1957, pp. 465-503.
55. POMPEIANO, O.: Sensory Inhibition During Motor Activity in Sleep. *Neurophysiological Basis of Normal and Abnormal Motor Activities*, M. D. Yahr and D. P. Purpura, eds., Raven Press, 1967, pp. 323-373.

DISCUSSION

Nyberg-Hansen: Concerning the medial nucleus, I noticed from one of your illustrations that there is little evidence of axons dichotomizing, sending one branch in the rostral and another in the caudal direction. However, we

know from the work of Cajal, and from Lorente de No, too, I think, of such dichotomizing axons from the medial nucleus. Do you have any comments on this?

Wilson: My first comment is that we did find far fewer

dichotomizing fibers than we expected. This may be accounted for to some extent by our missing some of the rostrally and caudally descending fibers. The other thing you must realize is that I am speaking about long dichotomizing axons which can be stimulated in the midline and in the spinal cord. Some of the axons may go up in some other direction where we fail to stimulate one of the branches. Also from my experience, looking back at Cajal's and Lorente's pictures, it seems that it is sometimes a little hard to know exactly where the cell bodies are. I am not completely sure what the main reason is for our finding relatively few dichotomous fibers. Perhaps there are just fewer of these than we expected.

Nyberg-Hansen: How far rostrally did you stimulate the medial longitudinal fasciculus?

Wilson: We put our electrode approximately 2 mm rostral to Deiters' nucleus. I think this would be rostral to the end of the medial nucleus.

Borison: Do you have any reason to exclude the forebrain from participation? That is to say, have the latencies of effects and the time courses given you reason to exclude pathways from distant sources reaching, say, the cerebral cortex? In this connection do you think your results might have been different in unanesthetized decerebrate animals? Finally, did you curarize your animals, and have you any reason to believe that there might not have been secondary effects due to reflex responses in the periphery?

Wilson: As far as curarization is concerned, of course the animals were Flaxedilized, and there has been no movement. Secondly, it is likely that, if I had done my experiments on animals that were not anesthetized and decerebrate, or under Nembutal, or under any one of many other possible conditions, some results would have been different. Concerning the results of the monosynaptic inputs from the labyrinth, the location of cells driven antidromically, and anything else of this type, there would be no difference whatsoever. One thing which you can consider is these long-latency and diffuse effects coming up from the spinal cord. They were similar in animals under Nembutal and under chloralose anesthesia. I suspect they would be reasonably similar under other conditions, but not exactly the same. Probably the patterns of activity would have been different under some conditions. As far as exclusion of effects going rostrally and then coming back is concerned, the latencies of the facilitation, for example from the forelimbs to Deiters' nucleus, are on the order of a few milliseconds. I really do not believe there is enough time for this to go all the way to the cortex and come back again, but certainly I cannot exclude that there is something going on rostrally to the vestibular nuclei. I do not think it is a major factor.

Ito: Relevant to your observation on the influence of group Ia muscle afferents upon Deiters' neurons, have you tested the effect of joint afferents which, in the previous work by Gernandt, Livingston, and Katsuki, seem to have a powerful action on Deiters' neurons?

Wilson: No. So far we have not specifically dissected out any joint nerves to stimulate them. Of course it is possible that some of the nerves that we stimulated there were contaminated by joint afferents. This is something I cannot

really discuss, but it is part of the work we are doing now. By the way, I still find it hard to believe that there is no Ia input, direct or indirect, to Deiters' nucleus.

Pompeiano: I should like to discuss briefly two problems which are relevant to the nice presentation made by Dr. Wilson. The first problem concerns the effects of stimulation of the primary afferents on Deiters' neurons. The second problem concerns the effects of stimulation of the vestibular nerve on the primary afferents in the spinal cord. With respect to the peripheral influences on Deiters' neurons, our observations made in unanesthetized decerebrate cats with the cerebellum intact clearly support the conclusion of Dr. Wilson. In particular, we were unable to find any change in the activity of the Deiters' neurons on repetitive stimulation of the group Ia afferents (Giaquinto, S.; Pompeiano, O.; and Santini, M.: Response of Deitersian Units to Graded Stimulation of Cutaneous and Muscular Nerves in Decerebrate Animals with Intact Cerebellum. *Boll. Soc. Ital. Biol. Sper.*, vol. 39, 1963, pp. 524-527). On the other hand, the cutaneous and the high-threshold muscular afferents exerted a clear-cut effect on Deiters' neurons. On the basis of these findings, it may be questioned whether Deiters' neurons receive collaterals from the dorsal spinocerebellar tract (DSCT), at least from that subdivision of the DSCT which transmits group Ia volleys to the cerebellum. In our experiments the response patterns of Deiters' neurons to stimulation of the cutaneous and high-threshold muscular afferents were generally characterized by a facilitation and in a few instances by inhibition; however, with an increase in stimulus intensity, the majority of the units responded in a complex fashion. The most common response was an initial short-latency discharge, followed by a silent period or a late discharge. It seems likely, at least in the preparation with the cerebellum intact, that some competition of facilitatory and inhibitory effects occurs at the level of the vestibular neurons from converging afferent volleys of different spatial and temporal dispersions.

With respect to the second problem, I should like to mention that stimulation of the vestibular nerve performed in decerebrate cats evokes dorsal-root potentials in the lumbar cord at the time that descending vestibular volleys elicit motoneuronal discharges (Cook, W. A., Jr.; Cangiano, A.; and Pompeiano, O.: Vestibular Influences on Primary Efferents in the Spinal Cord. *Pflügers Arch. ges., Physiol.*, vol. 299, 1968, pp. 334-338). The vestibular evoked primary afferent depolarization involved group I afferents from both extensor and flexor muscles and also large group II cutaneous afferents. These findings suggest that when spinal motoneurons are triggered by the vestibular apparatus, it may be functionally important to reduce the segmental afferent input to these motoneurons by the mechanism of presynaptic inhibition. This partial deafferentation may prevent instabilities in the motor system, which might occur when somatic sensory volleys elicited during movements are fed back into the spinal cord and interact with the discharging motoneurons.

Wilson: This, of course, is something I covered in mentioning the various interesting observations made by you.

Precht: Just a short comment on the function of the medial nucleus with respect to the spinal cord. We tried to activate

antidromically the vestibular neurons that responded to horizontal rotation, having in mind the idea that there is an effect of horizontal rotation on the spinal cord reflexes as Gernandt and Thulin showed many years ago. However, it is quite striking that almost none of the second-order neurons of the horizontal semicircular canal is activated antidromically by stimulating the spinal cord at C₃.

Wilson: Type I?

Precht: Type I is not activated; however, several of the type II and type III neurons were antidromically excited. The effect of horizontal rotation on spinal reflexes cannot be satisfactorily explained on the basis of these data. Probably vestibuloreticulospinal projections are also of great importance. So we are still in the functional "no-man's land" at this particular point. We know to some extent the synaptology of the vestibulospinal system, but we do not know what kind of sensory information is transmitted to the spinal cord via the vestibulospinal tracts.

Wilson: We have also been interested in this. Peterson has been looking to see whether any of the cells that he sees in the medial nucleus are influenced by tilting. Unfortunately, so far he has not had good tilting effects and good

antidromic driving in the same cat, but we are pursuing this also.

Precht: A short comment to the problem of monosynaptic and polysynaptic activation of the vestibular neurons in response to vestibular nerve stimulation. In talking about second-order neurons of the horizontal canal, it is quite surprising that, if one uses the adequate stimulus, the threshold of the monosynaptically activated neurons is much higher, significantly higher, than that of the ones that are polysynaptically activated. So it is quite important from the standpoint of a correlation between anatomy and physiology that a monosynaptic input is not necessarily powerful in terms of assuring a high sensitivity to a given sensory input.

Wilson: Absolutely. I should like to add right here that I think the same thing applies to the output side. Very often when we talk about the output, and the vestibulospinal tract is an example, we concentrate on the monosynaptic effect. It is my personal opinion that most of the effects that you see on the extensor tone are mediated polysynaptically. The monosynaptic action is a more discretely organized arrangement.

SESSION VI

Chairman: CÉSAR FERNÁNDEZ
University of Chicago

Electrophysiological Experiments on the Isolated Surviving Labyrinth of Elasmobranch Fish to Analyze the Responses to Linear Accelerations

OTTO E. LOWENSTEIN
University of Birmingham, England

SUMMARY

The classical assumption that semicircular canals respond exclusively to angular acceleration and cannot, therefore, be involved in the elicitation of responses to linear acceleration has recently been challenged by a number of observations.

Experiments are described in which the isolated surviving labyrinth of elasmobranch fishes (dogfish and ray) was subjected to linear acceleration. Recordings from horizontal and vertical canals as well as from the utricle and lagena indicate that semicircular canals—under these physiological conditions (interruption of blood supply and opening into the perilymphatic space)—do yield responses to tilting and to rotating vectors of linear acceleration which resemble those obtained from the otolith organs. As compared with the latter, however, the responses from the semicircular canal have a significantly higher threshold.

INTRODUCTION

There is no need for a detailed restatement of the classical concepts concerning the distribution of function between semicircular canals and otolith organs. Whereas it is generally assumed that the semicircular canal is stimulated exclusively by angular acceleration and provides the central nervous system with integrated information relating to angular velocity at any given moment, the otolith organ, although capable of being stimulated by changes in angular velocity, is chiefly concerned with the monitoring of linear accelerations in the form of gravitational, centrifugal, translatory, and oscillatory stimuli, the last belonging to the field of vibration and sound.

The assumption that semicircular canals are exclusively stimulated by angular acceleration, and not at all by linear acceleration, has been challenged in the past, but has recently come under renewed and serious scrutiny in the light of a number of experiments in which it was found

that responses to angular acceleration, i.e., perrotatory and postrotatory nystagmus, perrotatory and postrotatory impulse activity chiefly in second-order neurons in vestibular centers, as well as the subjective experience of human observers, are significantly modified by centrifugal effects and by simultaneous changes of head position in space. For detailed references and discussion, see references 1 to 7.

In a number of these cases the authors have quite rightly taken into account that these modifications in the canal responses could be accounted for by central integration of canal response with simultaneous information derived from otolith inputs with or without a contribution from vertical canals. Money, Graybiel, and Johnson (see ref. 2, pp. 196 and 197) and Benson (personal communication) have tried to deal with such ambiguities by an ingenious device which makes it possible to subject the horizontal semicircular canal to a rotating vector of linear acceleration without any concomitant positional change of the subject. However, here,

too, the possibility of interference by simultaneous signals from vertical canals cannot be excluded (refs. 1, 8, and 9). Nor can one be sure that kinesthetic information and otolith-derived responses to centrifugal effects may not have contributed to the observed modification of perrotatory and postrotatory responses of the horizontal canals.

If we are interested in the functional range of the peripheral organ as such, even if this may be considered of rather academic importance, the only conclusive method is to test and evaluate the responses of such peripheral structures in complete isolation.

Material and Methods

Preparations that would lend themselves to such a study in isolation are not easy to obtain. Attempts to record from first-order vestibular neurons or their nerve processes have only rarely been reliably successful, especially in birds and mammals. Gernandt (ref. 10) reports having recorded from the vestibular branch of the eighth nerve where it leaves the auditory meatus. The labyrinths of elasmobranch fishes (refs. 8, 9, and 11) and of the frog (ref. 12) have yielded much of the information on which our qualitative notions about the functional behavior of semicircular canals and otolith organs are at present based. When the emphasis is on quantitative aspects, the study of single units may be considered preferable, if not imperative, although useful results have been obtained by the analysis of the electronic integration of responses based on the recordings of massive multifiber response pictures.

Single-unit peripheral preparations are relatively easily obtainable from the dendritic branches of the primary sensory neurons innervating the ampullae of the horizontal and anterior vertical canals of the isolated surviving labyrinth of the dogfish, *Scyllium canicula*, and of the thornback ray, *Raja clavata*. Greater difficulties are encountered in attempts to obtain such preparations from a utricle, a sacculus, or lagena. Having developed the technique for the isolation of these recording sites, I felt it incumbent on me to try to contribute to the search for the site of origin of responses to

linear acceleration, especially of those that have been postulated to modify the basic response picture of the semicircular canals.

It is imperative at the outset to establish under what conditions the exposure of isolated units from a semicircular canal to linear accelerations is capable of yielding truly crucial results. The isolated labyrinth preparation, although eminently manageable, is cut off from the circulatory sources of oxygen and other metabolic materials. It is true that useful response pictures can be obtained from such a preparation from a cold-blooded animal for prolonged periods of time, in fact for an hour or more, if the ambient temperature and air humidity are kept within certain limits. When deterioration becomes recognizable in a canal preparation, it manifests itself in ways usually compatible with the assumption that it has its origin in a change in the turgor or elasticity of the cupula. The threshold to angular acceleration becomes lower, the preparation becomes highly sensitive to vibration of the substrate, and, finally, in excessively old preparations, say 3 to 4 hours after isolation from the animal, the strict directionality of the response may disappear before the final disappearance of discharge activity in the nerve. This well-known sequence of events yields useful signposts to the experimenter from which he learns when the further use of a certain preparation is inadvisable in accordance with this or that objective of the experiment, especially so far as its quantitative evaluation is concerned. It must be conceded here that ideally the use of the isolated preparation, as elsewhere in physiological experimentation, is inadvisable for the evaluation of absolute as opposed to relative quantitative parameters.

The second important consideration arises from the fact that access to the nerve strands innervating the individual labyrinthine end organs is gained by the removal of part, however small, of the cartilaginous wall of the labyrinth capsule. This results in the opening of the perilymphatic space and in a certain loss of perilymphatic fluid. As this fluid may be considered to act as a shock absorber and, together with anchoring strands of connective tissue, normally helps to keep the membranous labyrinth in place, such loss of support may easily con-

tribute to dislocations of canal and ampulla under the impact of linear accelerations. The relevance of this can be seen in the fact that experimenters observing effects which they feel might be due to canal responses to linear acceleration have suspected that they might be brought about by such dislocations within the perilymphatic space, even in the intact unopened bony labyrinth, especially when exposed to linear acceleration of high g -values outside the normal range with which the labyrinth is evolutionarily adapted to cope (ref. 13). Both circumstances might greatly impair the significance of results in which linear accelerations are seen either to modify the responses to simultaneously applied angular accelerations or to lead to a significant modulation of the resting discharge purely on linear acceleration, be this by gravity in positions deviating from the normal, during constant-speed rotations, or during rotations in which vectors of linear acceleration are made to sweep over the end organ. If, however, a canal preparation showing the full range of responses characteristically occurring during angular acceleration failed to respond to any of the above-mentioned types of linear acceleration, such behavior would have to be considered significant evidence against the susceptibility of canals to such stimuli.

The ideal solution would be if it were found possible to record single-unit first-order activity of definitely known origin from the anterior ramus of the eighth nerve just outside the foramen through which it leaves the labyrinth capsule. On their passage through the foramina of the elasmobranch labyrinth capsule, the branches of the eighth nerve are packed in a highly viscous jelly which obviously serves the purpose of establishing a leakproof barrier between perilymphatic space and the brain case. Centrally to this passage the nerve disperses into a brain-type tissue organization which makes it quite impossible to isolate strands containing recordable single units. Moreover, a scattered assembly of cell bodies of the first-order neurons are found here, and any record taken from here could not be held to be above suspicion with regard to possible synaptic cross-modification of responses originating in neighboring end organs.

The only reliable pickup that can be held for

protracted periods of time, especially under experimental conditions of the preparation's rapid displacement in space, is the attachment of small, whittled-down nerve twigs in a forceps electrode. The application of microelectrodes such as tungsten needles coated with insulating material up to the tip does not generally yield lasting pickup from single units, unless balanced floating microelectrodes of the type developed by Gualtierotti (personal communication) are used. These sophisticated electrodes may in fact provide the answer to the problem, but they are difficult to make and consequently very expensive.

These thoughts crystallized in part during a conversation with A. J. Benson and, with them in mind, I had the dual-purpose accelerator designed and built in my department by my chief technical officer, S. V. Hill, whose ingenuity has again, as on previous occasions, made a significant contribution to the work to be described.

Technique

The preparation can be mounted on the platforms in various orientations such as normal, upside-down, nose-up, nose-down, side-up, or side-down longitudinally or transversely to the direction of movement. The movement is monitored photoelectrically and transmitted via radio link to the second oscilloscope channel. The impulse discharges after preamplification are similarly transmitted to the first channel of the oscillograph and to a tape recorder or, if necessary, straight through an integrating frequency meter to a pen recorder. Platform I is rigidly fixed to a rotating arm at a distance of 30 cm from the center. Preparations mounted on it are stimulated by rotatory eccentric torque; i.e., angular acceleration at the beginning and end of prolonged periods of constant-speed rotations up to 90 rpm with a slowest useful constant speed of 2 rpm. Again the impulse discharge from a preparation is preamplified on the platform and transmitted by radio link to the first channel of the oscilloscope to tape recorder, frequency meter, and pen recorder. The rotation is monitored photoelectrically.

Platform II (cf. ref. 2, pp. 196 and 197) rotates freely on its central spindle at the end of the rotat-

ing arm. By means of a chain drive to the center spindle, it is made to counterrotate at the same angular velocity and consequently keeps facing in the same direction during the rotation of the arm. A preparation mounted on it will therefore not be subjected to torque but to vectors of linear acceleration which sweep over it once per full cycle rotation of the platform. Here transmission by radio link was found unnecessary and takes place by wire after preamplification on the platform. The machine is at present installed at the Marine Biological Laboratory at Plymouth, and I am only in a position to report on preliminary results gained during a period of 3 months' experimentation.

The first test to which a successful single- or few-fiber preparation of either the horizontal or vertical ampulla is subjected is a tilting test on a tilting gantry. Its responsiveness to swings in the plane of the canal and to swing about horizontal axes is tested and put on record.

Pickup of the nerve was in all cases by means of a forceps electrode through a minimal opening in the cartilaginous capsule as near as possible to where the nerve twig joins the anterior ramus and as far as possible from the ampullary wall itself. So far, attempts at picking up fibers after removal of the jelly outside the unopened capsule have not met with success.

During earlier work with this type of preparation, postional responses shown by the ampullae of the horizontal or anterior vertical canal were interpreted as signs of functional deterioration. In the present series of experiments, tilting tests were carried out as soon as possible after the isolation of the labyrinth, and clear static responses were found in both types of canals with disturbing regularity as early as 15 minutes after decapitation of the animal. The difference in frequency in the horizontal and in 90° head-up and head-down positions is striking, and we are dealing with a clear response of the organ to a gravitational stimulus; i.e., to linear acceleration (see also ref. 12). Whether this is entirely due to the interruption of the blood supply or to perilymph loss around the ampullae, or to both, cannot be ascertained. Maximum discharge frequencies are found near the 90° nose-down or side-down positions, with minimum in the nose-up

and side-up positions. The same holds, but to a much lesser extent, for the horizontal ampulla. There is a distinct possibility that these responses may be the result of a dislocation forward of the whole membranous labyrinth as a consequence of the disturbance in the anchorage and/or loss of perilymph associated with the opening made in the wall of the labyrinth capsule. On the other hand, I have recently observed similar static responses from the ampullae of the unopened cyclostome labyrinth.

PRELIMINARY RESULTS

The account of the preliminary findings in the first 3 months of the present series of experiments may conveniently start with the response picture obtained from otolith organs, i.e., utriculus and lagena, to stimulation with the rotating vector. The strong increases and decreases in the discharge activity are confined to a certain direction of the vector, each wave in the integrated total voltage occurring once per revolution of the stimulator and in a fixed sector in space. The utriculus preparation was mounted in the normal horizontal position; the lagena preparations were also mounted horizontally. Thresholds of such responses from otolith organs were found to vary, but in some instances were as low as 2 rpm or below 0.01 g. This then is what one has to look out for in search of a response to linear acceleration.

Turning now to the semicircular canals, we are faced with a puzzling situation. Although, with the preparative methods used so far, a large proportion of the vertical ampullae and somewhat fewer of the horizontal ones proved to be position-sensitive immediately after isolation and therefore to react to gravitational stimulation, only a small percentage have so far yielded significant responses to stimulation by a rotating linear vector. The threshold was high and only in one case did the response amount to much at 30 rpm (0.3 g). In the material analyzed so far, I have not found an impressive response of this kind from a vertical ampulla, despite their very strong positional responses. This is puzzling, especially as in a number of experiments the resultant between gravity and the linear vector ought to have

summed. I have to leave this question open at present.

There are, however, not a few instances of the total absence of a response to the rotating linear vector both in horizontal and vertical ampullae.

Finally, there is yet another type of situation in which linear acceleration has been claimed to have modified the response from the semicircular canal. This is claimed to happen on eccentric torque. Here the time constant of the decay of the perrotatory nystagmus is said to have been significantly altered, i.e., shortened (ref. 3), under the influence of the constant centrifugal effect on the semicircular canal during and after a period of constant acceleration followed by constant-velocity rotation. This situation too can be easily reproduced on platform I of the rotary stimulator. The decay of perrotatory and postrotatory responses appears to fall well within the decay periods found by Groen, Vendrik, and myself (ref. 14). I have had an opportunity to test one and the same preparation quantitatively during

centric and eccentric rotation. This would obviously be the necessary condition for an assessment of the significance levels of any differences in the time constant under these conditions of stimulation. As yet no significant difference has been observed at 45 rpm.

CONCLUSIONS¹

The important task now is to elaborate a technique of recording from the unopened labyrinth as soon as possible after its isolation from the animal. It will be seen whether under these conditions the rather puzzling effect of spatial orientation on the basic discharge level of semicircular canal units can be minimized or completely prevented. In such preparations, linear accelerations of any kind should be without effect, at least at *g*-values.

¹The results discussed in this paper are tentative and unpublished. The illustrations shown at its presentation are therefore not included in this publication.

REFERENCES

1. CRAMPTON, GEORGE H.: Does Linear Acceleration Modify Cupular Deflection? The Role of the Vestibular Organs in Space Exploration, NASA SP-115, 1966, pp. 169-184.
2. GUEDRY, FRED E., JR.: Influence of Linear and Angular Accelerations on Nystagmus. The Role of the Vestibular Organs in Space Exploration, NASA SP-115, 1966, pp. 185-196. Discussion, pp. 196-198.
3. BENSON, ALAN J.: Modification of Per- and Post-Rotational Responses by the Concomitant Linear Acceleration. The Role of the Vestibular Organs in Space Exploration, NASA SP-115, 1966, pp. 199-213.
4. LANSBERG, MARTIN P.; GUEDRY, FRED E., JR.; AND GRAYBIEL, ASHTON: The Effect of Changing the Resultant Linear Acceleration Relative to the Subject on Nystagmus Generated by Angular Acceleration. *Aerospace Med.*, vol. 36, 1965, pp. 456-460.
5. BENSON, ALAN J.; AND BODIN, M. A.: Interaction of Linear and Angular Accelerations on Vestibular Receptors in Man. FPRC Report 1243. Ministry of Defence (Air), London, 1965.
6. BENSON, ALAN J.; GUEDRY, FRED E., JR.; AND JONES, G. MELVILLE: Responses of Lateral Semicircular Canal Units in Brain Stem to a Rotating Linear Acceleration Vector. *J. Physiol.*, vol. 191, 1967, pp. 26P-27P.
7. BODIN, M. A.: The Effect of Gravity on Human Vestibular Responses During Rotation in Pitch. *J. Physiol.*, vol. 196, 1968, pp. 74P-75P.
8. LOWENSTEIN, O.; AND SAND, A.: The Individual and Integrated Activity of the Semicircular Canals of the Elasmobranch Labyrinth. *J. Physiol.*, vol. 99, 1940, pp. 89-101.
9. LOWENSTEIN, O.; AND SAND, A.: The Mechanism of the Semicircular Canal. A Study of the Responses of Single-Fibre Preparations to Angular Accelerations and to Rotation at Constant Speed. *Proc. Roy. Soc. Med. B*, vol. 129, 1940, pp. 256-275.
10. GERANDT, B.: The Effect of the Centrifugal Force Upon the Nerve Discharge from the Horizontal Canal. *Acta Physiol. Scand.*, vol. 21, 1950, pp. 61-72.
11. LOWENSTEIN, O.; AND ROBERTS, T. D. M.: The Equilibrium Function of the Otolith Organs of the Thornback Ray (*Raja clavata*). *J. Physiol.*, vol. 110, 1949, pp. 392-415.
12. LEDOUX, A.: Activité Electrique des Nerfs des Canaux Semicirculaires du Saccule et de l'Utricule chez la Grenouille. *Acta Oto-Rhino-Laryngol.*, vol. 3, 1949, pp. 335-349.
13. MONEY, K. E.; SOKOLOFF, M.; AND WEAVER, R. S.: Specific Gravity and Viscosity of Endolymph and Perilymph. The Role of the Vestibular Organs in Space Exploration, NASA SP-115, 1966, pp. 91-98.
14. GROEN, J. J.; LOWENSTEIN, O.; AND VENDRIK, A. J. H.: The Mechanical Analysis of the Responses From the End-Organs of the Horizontal Semicircular Canal in the Isolated Elasmobranch Labyrinth. *J. Physiol.*, vol. 117, 1952, pp. 329-346.

DISCUSSION

Money: Did I see what you called a torque response at the beginning of the counterrotating stimuli?

Lowenstein: The torque response was a control experiment. I wanted to see how the preparation responds to torque in the plane of the canal.

Money: I see. Then that was not part of the picture?

Lowenstein: No; it was not part of the picture.

Money: I thought it was the acceleration of the counterrotation.

Lowenstein: No.

Anliker: We are engaged in the mechanical analysis of the semicircular canals, and we predict that the semicircular canals not only respond to linear acceleration but also to circular translation or counterrotation. If we have time, I could show how this works.

Lowenstein: I was told about this by Dr. Anliker, and it sounded convincing at first hearing.

Anatomical Aspects on the Functional Organization of the Vestibulospinal Projection, With Special Reference to the Sites of Termination

ROLF NYBERG-HANSEN

University of Oslo, Norway

SUMMARY

A review is given of the functional organization of the vestibulospinal projection in the cat. Special emphasis is placed on the sites of termination of vestibulospinal fibers within the spinal gray matter.

The spinal projection from the vestibular nuclei can be separated into two different fiber systems: the classical vestibulospinal tract and the fibers descending in the medial longitudinal fasciculus. Because of their origin from the medial vestibular nucleus and their medial course in the brainstem and the spinal cord, the latter is called the medial vestibulospinal tract, and the more laterally coursing classical vestibulospinal fibers is called the lateral vestibulospinal tract.

The lateral tract comes from the lateral vestibular nucleus and descends in the ventrolateral funiculus organized in a somatotopical manner throughout the whole cord. The fibers terminate ipsilaterally in the entire lamina VIII and the neighboring parts of lamina VII of the spinal gray matter. No terminations are found among the perikarya of the motoneurons in lamina IX.

The medial tract descends bilaterally in the dorsomedial part of the ventral funiculus to the rostral half of the cord only. There is no evidence of a somatotopical organization within this tract. The fibers terminate bilaterally in the dorsal half of lamina VIII and the adjacent part of lamina VII. The fibers on the ipsilateral side outnumber those on the contralateral side.

Although the lateral and medial vestibulospinal tracts exhibit some striking mutual resemblances, they differ in other anatomical respects. This makes it likely that the two pathways also, at least to some extent, are functionally dissimilar. The lateral tract exerts a tonic facilitatory effect on postural tonus and spinal extensor mechanisms. This influence is mediated both on α - and γ -motoneurons, chiefly by way of spinal interneurons in laminae VII and VIII. There is some physiological evidence of minor direct monosynaptical connections to the motoneurons. The most likely anatomical explanation of this is the terminating of vestibulospinal fibers on dendrites of motoneurons extending beyond the confines of lamina IX, into laminae VII and VIII.

The medial vestibulospinal tract is concerned with movements of the head and neck and, according to recent physiological observations, also with presynaptic inhibition of primary afferents in the spinal cord.

Impulses of vestibular origin are also conveyed to the spinal cord indirectly by way of reticulospinal pathways. Pontine reticulospinal and lateral vestibulospinal pathways exhibit striking mutual resemblances anatomically as well as physiologically.

The anatomical observations on the vestibulospinal pathways presented in this review are in general agreement with conclusions reached in recent physiological investigations.

INTRODUCTION

The anatomical organization of the vestibular nuclear complex is rather intricate. This is already apparent when subdivision of the nuclear complex into specific nuclei on a cytoarchitectonic basis is performed, but the complexity is even more outstanding when the various afferent and efferent fiber connections of the vestibular nuclei are taken into account. Recent advances in the neurophysiology of the vestibular nuclei and their connections with other regions of the central nervous system have increased the demand for a detailed knowledge of their minute anatomy, among other things of the anatomical organization of the vestibulospinal projection, including the sites of termination within the spinal gray matter. Anatomical data of these kinds are indispensable for functional interpretations, and for the analysis of the vestibular influences on spinal mechanisms.

In the present account, anatomical aspects of the organization of the vestibular projection to the spinal cord will be presented with special emphasis on the sites of termination, which will be referred to the laminar organization of the spinal gray matter described by Rexed (refs. 1 and 2). Rexed's observations that the spinal gray matter may be subdivided on a cytoarchitectonic basis into 10 different laminae, representing at least in part functionally different regions, have in recent years provided a fruitful common basis of reference for the sites of termination of various afferent fiber systems to the cord. This has allowed more precise correlation to be made between anatomical and physiological observations and their functional interpretations, and thus unveiled functional aspects of the intrinsic organization of the spinal cord as well (see, for example, refs. 3 to 6).

In this presentation, attempts will likewise be made to correlate the anatomical observations with relevant physiological data in order to reveal aspects of the functional organization of the vestibulospinal projection.

The methods used for tracing the course and determining the sites of termination of vestibulospinal fibers following lesions of the various vestibular nuclei have been the silver impregnation

methods of Nauta (ref. 7) and Glees (ref. 8). The descending vestibulospinal fibers have been studied in transverse as well as in longitudinal sections of the cord, a procedure which allows much more detailed observations to be made than can be obtained in transverse sections alone, which are most commonly used.

THE VESTIBULOSPINAL PROJECTION

The fiber connections from the vestibular nuclei to the spinal cord can be separated into two different fiber systems: the classical vestibulospinal tract and the fibers descending in the medial longitudinal fasciculus. These two pathways should be called the lateral and the medial vestibulospinal tract, respectively, as proposed by Nyberg-Hansen (ref. 6).

The Lateral Vestibulospinal Tract

The experimental study in the cat by Pompeiano and Brodal (ref. 9), using the modified Gudden method (ref. 10), confirmed the results of some previous investigators that the lateral vestibulospinal tract originates exclusively from the lateral nucleus of Deiters. The lateral vestibular nucleus is defined as that part of the vestibular nuclear complex which contains the giant cells of Deiters (ref. 11). However, this nucleus also contains a considerable number of medium-sized and small neurons as well, and all types of cells project to the spinal cord. This was emphasized by Pompeiano and Brodal (ref. 9), and later confirmed physiologically (refs. 12 and 13). The anatomically demonstrated somatotopical organization within the lateral vestibulospinal tract has likewise been verified physiologically (refs. 12, 14, and 15). Figure 1 diagrammatically summarizes the findings of Pompeiano and Brodal (ref. 9) and shows how the rostroventral part of the lateral vestibular nucleus projects to the cervical cord, while the fibers to the lumbosacral cord take origin from the dorsocaudal part. Fibers to the thoracic cord come from intermediate regions. Abbreviations used in figures 1, 2, 3, 7, 8, and 11 are listed below. (Note that roman numerals are used in reference to the laminar organization of the spinal gray matter, while the numerals VI and VII are also used to indi-

cate the positions of the cranial nerves of those numbers. However, there should be no confusion as the former are used in conjunction with sectional views of the spinal cord, and the latter label the indicated nerves seen in cross section at the level of the fourth ventricle.)

B.c.....	brachium conjunctivum
C, with subscript.....	cervical
Cc.....	column of Clarke
C.r.....	corpus restiform
C.t.....	corpus trapezoideum
D.....	descending (inferior) vestibular nucleus
il.....	intermediolateral cell column
L.....	left
L, within drawing.....	lateral vestibular nucleus
L, with subscript.....	lumbar
M.....	medial vestibular nucleus
N.c.t.....	nucleus of the trapezoid body
N.cu.e.....	nucleus cuneatus externus
N.tr.sp.V.....	nucleus of spinal trigeminal tract
N.n.VI, N.n.VII.....	nuclei of cranial nerves VI and VII
N.VI, N.VII, N.VIII, VI, VII	cranial nerves
Oli.....	inferior olive
Ols.....	superior olive
p.h.....	nucleus praepositus hypoglossi
R.....	right
S.....	superior vestibular nucleus
Th, with subscript.....	thoracic
Tr.sp.V.....	spinal trigeminal tract
x.....	small-celled group x, lateral to the descending vestibular nucleus

In an experimental study with silver-impregnation methods, Nyberg-Hansen and Mascitti (ref. 16) confirmed the observation of Pompeiano and Brodal (ref. 9) that the lateral vestibulospinal tract takes its origin solely from the lateral vestibular nucleus. Following lesions of the superior, medial, and descending vestibular nuclei, they found no degeneration in the lateral vestibulospinal tract. Figure 2 shows the finding in one of their cases (cat B. St. L. 307, killed after 8 days) where the lesion is restricted to the lateral nucleus, which is completely destroyed.

The ensuing degenerating fibers of the lateral vestibulospinal tract descend purely ipsilaterally along the periphery of the ventrolateral funiculus.

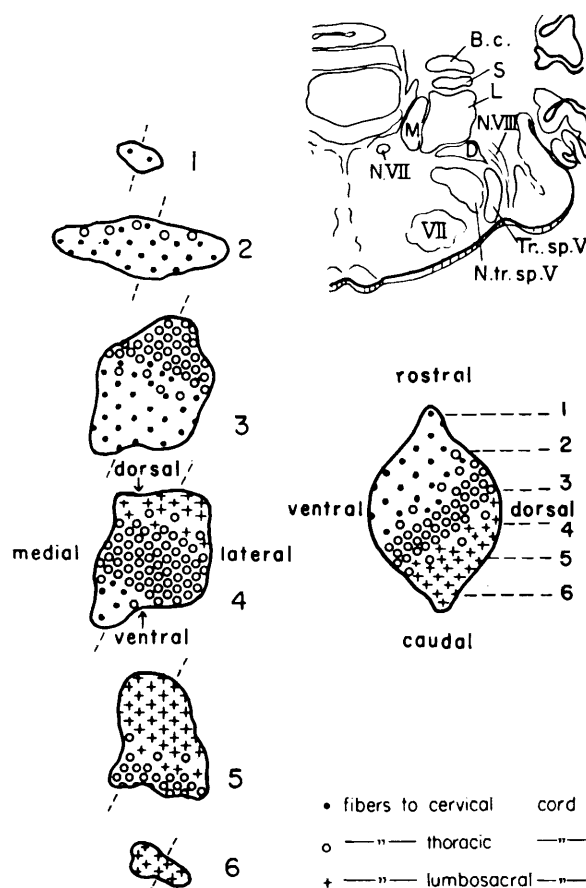

FIGURE 1.—Diagram showing the somatotopic pattern within the lateral vestibulospinal tract in the cat as demonstrated experimentally by Pompeiano and Brodal (ref. 9). To the left (1-6) a series of transverse sections through the lateral nucleus; to the right (1-6) a longitudinal reconstruction of the nucleus. (See text for explanation of abbreviations.)

The tract gradually decreases in size as more caudal levels are reached, but it can be followed throughout the whole cord. Its position changes during its descent in the cord. In the cervical enlargement the tract is located peripherally in the ventrolateral funiculus extending laterally to the most laterad emerging ventral root fibers, and does not extend into the dorsal three-fourths of the ventral funiculus where the medial longitudinal fasciculus is located along the anterior median fissure. During its descent in the thoracic cord, the lateral vestibulospinal tract is gradually displaced in a dorsomedial direction, and in the lumbosacral enlargement it is found

medially in the ventral funiculus along the anterior median fissure (fig. 2). This dorso-medial shift has previously been noticed by some authors (refs. 9 and 17 to 19) and is a feature of

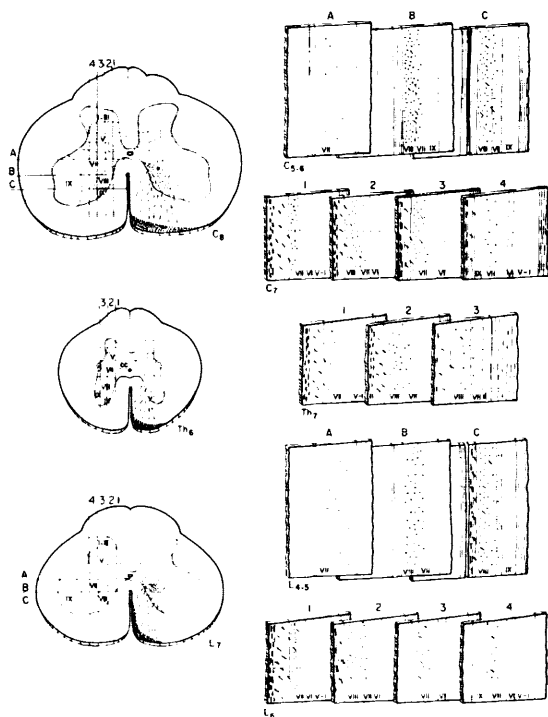
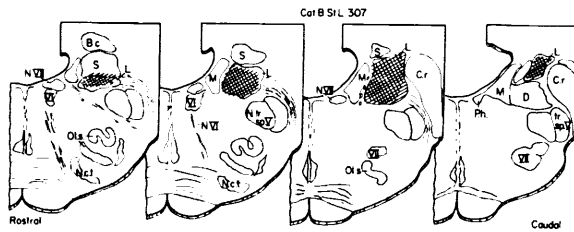

FIGURE 2.—Diagrammatic representation of the distribution of degenerating coarser (wavy lines) and terminal fibers (dots) within the spinal cord in a case with a total lesion (hatchings) of the lateral vestibular nucleus involving the origin of the lateral vestibulospinal tract. From the thoracic cord only transverse and sagittal sections are shown, while horizontal sections as well are shown from the cervical and lumbar enlargements. The positions of the longitudinal sections are indicated in the drawings of the transverse sections. The roman numerals refer to the laminae of Rexed. (From ref. 16.) (See text for explanation of abbreviations.)

practical importance in physiological studies of the lateral vestibulospinal tract. As will be further commented upon in the section on the medial vestibulospinal tract, it follows from this arrangement that the only conclusive way to identify fibers from the vestibular nuclei descending in the medial longitudinal fasciculus in the spinal cord is to observe them in the area allotted to the fascicle in the cervical cord.

From a quantitative point of view, it appears that the cervical and lumbosacral enlargements receive equal numbers of lateral vestibulospinal tract fibers, while a smaller number go to the thoracic cord. Although the precise diameter of degenerating fibers cannot be determined, it seems likely that the lateral vestibulospinal tract is composed of fibers of different size, but the majority of them are rather thick.

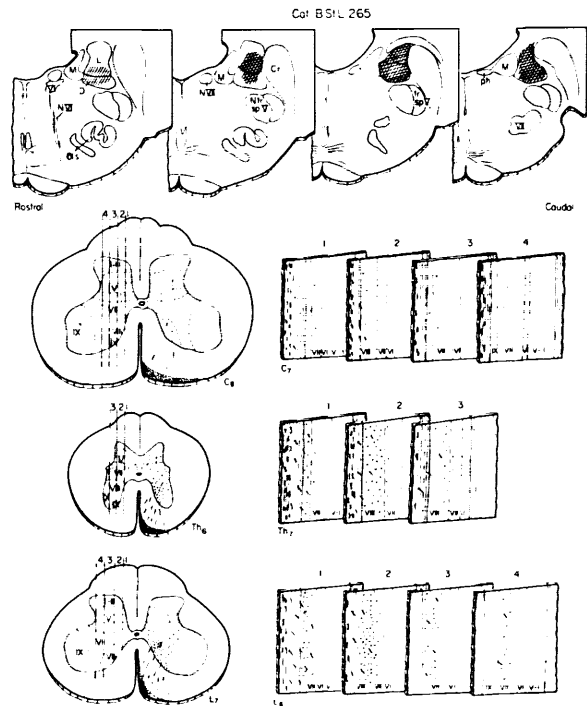

FIGURE 3.—Diagrammatic representation of the distribution of degenerating fibers of the lateral vestibulospinal tract within the spinal cord as seen in transverse and sagittal sections from the cervical, thoracic, and lumbar cord in a case with a lesion (hatchings) of the dorsocaudal, "hind-limb" region of the lateral vestibular nucleus (above). (From ref. 16.) (See text for explanation of abbreviations.)

Recently the conduction velocity of the fibers of the lateral vestibulospinal tract has been found to range from 20 to 140 m/sec (refs. 12 and 13), the majority having values between 50 and 120 m/sec (ref. 13).

Observations made by Nyberg-Hansen and Mascitti (ref. 16) in another case (cat B. St. L. 265, killed after 11 days) shown in figure 3 confirmed the somatotopic origin of the lateral vestibulospinal tract first demonstrated by Pompeiano and Brodal (ref. 9). In this case the lesion as concerns the lateral vestibular nucleus is restricted to the caudal, "hindlimb" region, and the ensuing degeneration in the cord is almost exclusively restricted to its lower half (fig. 3).

As to the sites of termination, fibers leave the lateral vestibulospinal tract and enter the spinal gray matter of the ventral horn corresponding to the medial aspect of lamina VIII and the extreme ventral aspect of lamina VII (figs. 2, 3, and 4A). They then radiate in a dorsolateral direction to terminate in the entire lamina VIII and the neighboring medial and central parts of lamina VII (figs. 2, 3, and 5). Occasionally a few fibers are seen in the ventral part of lamina VI and in lamina IX, but they are never seen in contact with nerve cells in these laminae.

Lateral vestibulospinal fibers bypass the ventromedial group of motoneurons. In the photomicrographs they are never seen to establish contact with the soma and proximal dendrites of these neurons, while a few contacts occur in the thoracic cord. No fibers terminate in the intermediolateral cell column or in the column of Clarke.

Within the laminae of termination, rows of minute black dots indicating the finest degenerating fibers, and fine isolated black fragments, in part presumably representing degenerating boutons (refs. 20 to 22) are found in the neuropil, but also in close contact with somata (fig. 4B) and particularly with dendrites (figs. 4C, 6A, and 6B).

Since, however, thin glial sheets, which can be seen only in the electron microscope, may be interposed between boutons and postsynaptic structures, all close contacts between terminal structures and somata and dendrites in silver-impregnated sections may not represent true synaptic contacts. However, since isolated

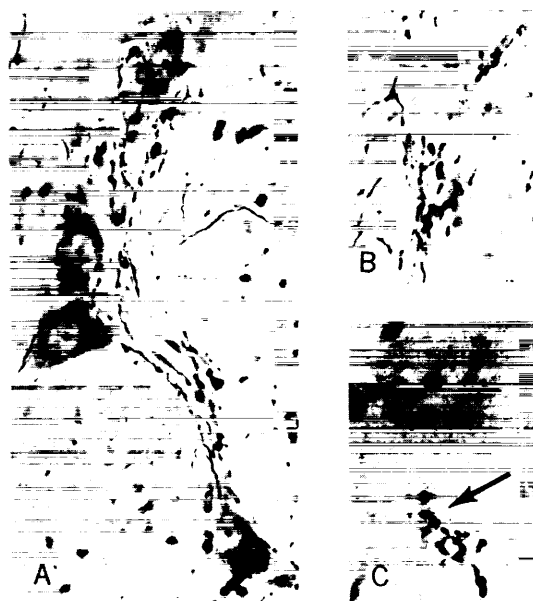

FIGURE 4.—Photomicrographs showing degeneration with the Nauta method. A: Degenerating lateral vestibulospinal fibers entering the spinal gray matter (to the left) along the dendrites of nerve cells medially in laminae VIII. B: Degeneration on the perikaryon and especially along a proximal dendrite of a small nerve cell in lamina VII. C: Degeneration on a proximal dendrite (arrow) of a nerve cell in lamina VIII in a case with a lesion of the medial vestibular nucleus involving the origin of the medial vestibulospinal tract. (From refs. 16 and 46.)

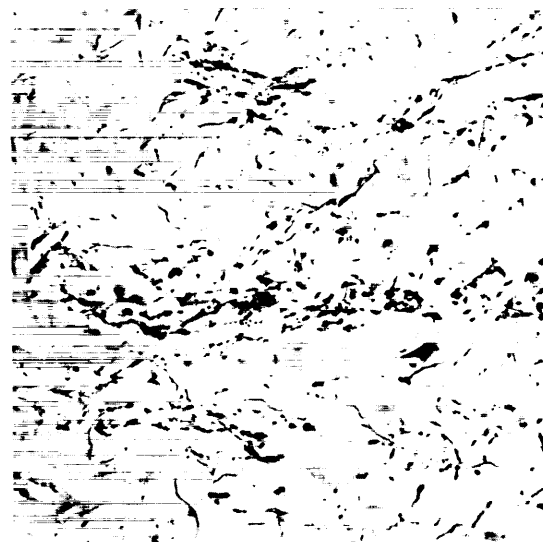

FIGURE 5.—A photomicrograph of degenerating lateral vestibulospinal fibers in the neuropil in lamina VIII. Nauta method. (From ref. 16.)

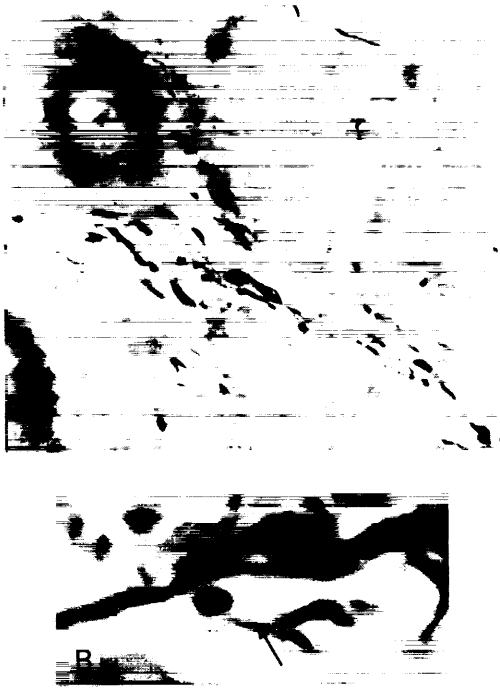

FIGURE 6.—Photomicrographs showing degeneration in silver sections. A: Degeneration along a proximal dendrite of a nerve cell in lamina VIII, Nauta method. B: Degenerating bouton with a terminal fiber leading up to it (arrow) in lamina VIII, Glees method. (From ref. 16.)

fragments tend to be more frequently observed around dendrites and in the neuropil than around the somata (figs. 4B, 6A, and 6B), the suggestion may be ventured that a relatively large number of the fibers of the lateral vestibulospinal tract terminate on dendrites. The final answer on this important point, however, can be obtained only in electron-microscopic studies.

The area of termination of the lateral vestibulospinal fibers reported by Shimert (ref. 23) appears to be in accordance with the findings outlined above. However, his statement that terminations are almost exclusively on medial motoneurons is scarcely tenable, since the majority of neurons in lamina VIII, interpreted by Shimert as medial motoneurons, most probably are spinal interneurons (refs. 1 and 24 to 29). The almost complete lack of terminations on motoneurons appears to be in accordance with the findings of some previous investigators (refs. 30 to 32), although their lesions have not been

restricted to the lateral vestibular nucleus. Recently Petras (ref. 33) has made observations similar to those of Nyberg-Hansen and Mascitti (ref. 16), although he does not correlate his observations with Rexed's laminae.

The considerations made above concerning the sites of termination, and particularly the lack of direct termination on the somata of motoneurons in lamina IX, are subject to the following qualification: It is well known that dendrites of spinal motoneurons extend for considerable distances from the perikarya beyond the confines of lamina IX, into the territories of laminae VII and VIII (refs. 4, 24, 27, 34, and 35). Some of the terminations in these laminae may thus actually be on dendrites of motoneurons extending into them. The demonstration by Lund and Pompeiano (ref. 36) of monosynaptic excitatory postsynaptic potentials (EPSP's) in spinal extensor motoneurons following stimulation of the lateral vestibular nucleus, indeed indicates that this really may be the case. However, in accordance with the anatomical observations outlined above, physiological studies as well leave no doubt that a large number, if not the majority of lateral vestibulospinal tract fibers terminate on interneurons in laminae VII and VIII, and not directly on motoneurons (ref. 37).

The heavy termination in lamina VIII deserves additional comment. Rexed (ref. 1) drew attention to the fact that several earlier authors had described the neurons in this region as commissural cells sending their axons across the midline in the anterior commissure (see refs. 1 and 16). In recent years this observation has repeatedly been confirmed (refs. 27 to 29 and 38). Since the lateral vestibulospinal tract is purely ipsilateral, the commissural nature of the neurons in lamina VIII may account for at least some of the contralateral effects on spinal mechanisms obtained on vestibular stimulation (refs. 14, 37, and 39 to 42). However, transmission of vestibular impulses to the brainstem reticular formation via vestibuloreticular fibers from the vestibular nuclei (ref. 43) and further relayed to the cord by way of the bilateral reticulospinal projection (refs. 44 and 45) may also account for some of the contralateral effects.

The Medial Vestibulospinal Tract

Using the modified Gudden method (ref. 10), Pompeiano and Brodal (ref. 9) found retrograde cellular changes only in the lateral vestibular nucleus giving origin to the lateral vestibulospinal tract. However, from a critical analysis of the pertinent literature, they concluded that fibers descending in the medial longitudinal fasciculus most probably are derived from the medial nucleus. Experimental evidence for this suggestion has later been given by this author (ref. 46). Following lesions of the medial vestibular nucleus, this author found fibers in the dorsal three-fourths of the ventral funiculus of the cervical cord, within the area along the anterior median fissure generally allotted to the medial longitudinal fasciculus in the cord. Because of this position it is often called fasciculus sulcomarginalis (fig. 7). The degenerating fibers do not extend as far ventrolaterad as the most dorsomedially localized lateral vestibulospinal fibers. On account of their origin in the medial vestibular nucleus and their more medial course in the brainstem and in the spinal cord, Nyberg-Hansen (ref. 6) proposed that these fibers should be called the medial vestibulospinal tract.

Figure 7 shows one case from Nyberg-Hansen's study (ref. 46) (cat B. St. L. 311, killed after 7 days) with a lesion localized to the medial nucleus. As can be seen, the medial vestibulospinal tract is confined to the upper half of the cord. Its fibers can be traced bilaterally to midthoracic levels in the dorsal part of the ventral funiculus along the anterior median fissure. The fibers on the ipsilateral side outnumber those on the contralateral one. These findings appear to be in accordance with some older investigations (refs. 47 to 49). The number of medial vestibulospinal fibers is very modest when compared with those in the lateral vestibulospinal tract, which is the major pathway from the vestibular nuclei to the spinal cord, as recently confirmed physiologically by Wilson, Wylie, and Marco (ref. 50). The fibers in the medial tract also have a smaller diameter than those in the lateral tract (ref. 46).

In cases with lesions in the superior, lateral,

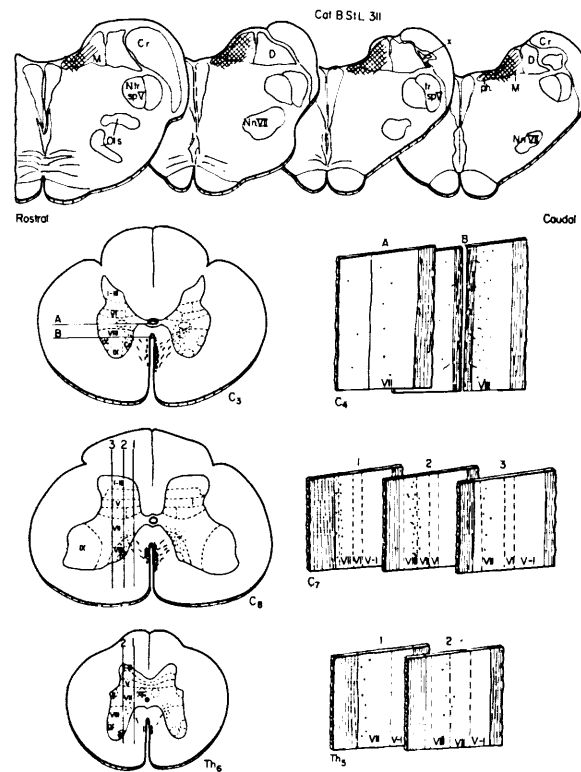

FIGURE 7.—Diagrammatic representation of the distribution of degenerating coarser (wavy lines) and terminal fibers (dots) within the spinal cord in a case with a lesion of the medial vestibular nucleus (above) involving the origin of the medial vestibulospinal tract. From the thoracic cord only transverse and sagittal sections are shown, while horizontal sections as well are shown from the cervical cord. (From ref. 46.) (See text for explanation of abbreviations.)

and descending vestibular nuclei, no degeneration has been found in the medial vestibulospinal tract. Figure 8 shows two cases (from Nyberg-Hansen's study, ref. 46) where there were lesions of the descending nucleus, in which no degeneration could be observed in the spinal cord. However, as is shown, the rostral and caudal parts of the descending nucleus are not destroyed. The observation that the descending nucleus does not project to the cord agrees with the anatomical findings of Carpenter (ref. 51) and of Carpenter, Alling, and Bard (ref. 52). Recently, however, Wilson, Wylie, and Marco (refs. 50 and 53) have presented physiological evidence for very modest contribution to the medial vestibulospinal tract from the medial as well as from the descending nucleus.

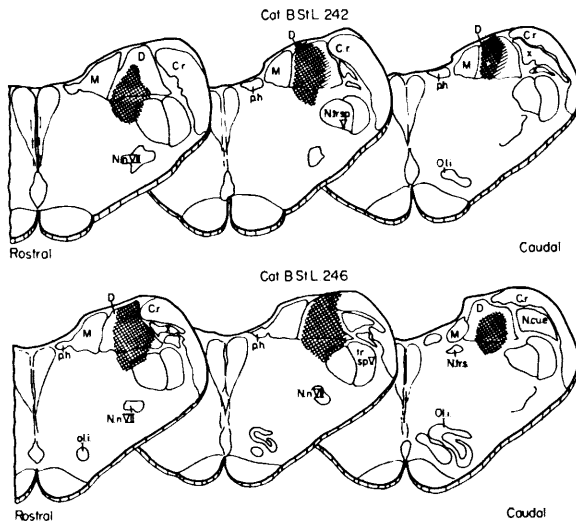

FIGURE 8.—Drawings of the lesions (hatchings) of the descending vestibular nucleus in two cases in which no degeneration is present in the spinal cord. The rostral and caudal parts of the descending nucleus are not destroyed. (From ref. 46.) (See text for explanation of abbreviations.)

Concerning the sites of termination of the fibers of the medial vestibulospinal tract, figure 7 shows that the majority of them terminate in the cervical cord. They enter the gray matter of the ventral horn corresponding to the dorso-medial aspect of lamina VIII, and terminate in the dorsal half of this lamina and the neighboring medial parts of lamina VII (figs. 4C and 7). No fibers terminate among the soma of the motoneurons in lamina IX, neither in the intermedio-lateral cell column nor in the column of Clarke. The area of termination is much less extensive than is that of the lateral vestibulospinal tract.

FUNCTIONAL CONSIDERATIONS

The lateral vestibular nucleus and the lateral vestibulospinal tract are known to exert a tonic facilitatory influence on postural tonus and spinal extensor mechanisms (for references, see ref. 54). In accordance with this, EPSP's have been recorded in spinal extensor α -motoneurons following stimulation of the lateral vestibular nucleus (refs. 36 and 55), some of them being the result of monosynaptic vestibulospinal connections to the motoneurons (ref. 36). However, in accordance with the anatomical observations outlined

above, there is in addition physiological evidence for ample vestibulospinal influence on spinal interneurons (refs. 37, 41, and 56). This arrangement provides a basis for a variable interplay at the interneuronal level among afferent impulses from other sources as well. Interaction and convergence of vestibulospinal, corticospinal, and propriospinal impulses at an interneuronal level in the cord have been reported (ref. 57), and recently a more precise localization of these particular interneurons has been attempted by Erulkar, Sprague, Whitsel, Dogan, and Janetta (ref. 37). Interneurons activated by vestibular nerve stimulation alone were located chiefly in lamina VIII, those responding in addition to dorsal root stimulation mainly centromedially in lamina VII, and finally interneurons activated by vestibular nerve and motor cortex stimulation appear to be situated laterally in laminae VI and VII (ref. 37). Furthermore, Grillner, Hongo, and Lund (ref. 56) reported that vestibulospinal impulses monosynaptically activated interneurons mediating the antagonistic extensor Ia inhibition to flexor α -motoneurons, and recently these particular interneurons have been localized to the ventral part of lamina VII, just mediad to lamina IX (ref. 58).

Vestibulospinal influences on the γ -motoneurons innervating the intrafusal muscle fibers are also well known. Thus, stimulation of the vestibular receptors (refs. 59 and 60) and the vestibular nerve (refs. 41, 61, and 62) as well as the lateral vestibular nucleus (refs. 62 to 64) have all been shown to activate the γ -motoneurons, especially to extensor muscles. Some evidence of a monosynaptic connection to extensor γ -motoneurons through the lateral vestibulospinal tract has also been reported (ref. 64), but there appears to be no doubt that the polysynaptic route is by far the largest (refs. 41 and 64). Since the γ -motoneurons supplying a particular muscle are located within the group of α -motoneurons innervating the same muscle (refs. 65 and 66), the importance of the polysynaptic route is in accordance with the anatomical observations reported above that the fibers of the lateral vestibulospinal tract chiefly terminate on interneurons in laminae VII and VIII (figs. 2 and 3).

Following stimulation of the vestibular nerve, the γ -motoneurons discharge at lower threshold and with higher frequencies than do the α -motoneurons (refs. 41 and 62). Furthermore, stimulation of the vestibular nerve is much more effective for γ -motoneuron activation than is stimulation of the lateral vestibular nucleus itself (ref. 62). The well-known activation of the reticular formation of the lower brainstem following vestibular stimulation (refs. 41 and 67), and the participation of reticulospinal pathways, in addition to vestibulospinal ones in conduction of vestibular impulses to the cord (refs. 41, 62, and 67), may be the possible explanation for these differences. Since there is no evidence of primary vestibular fibers to the reticular formation (ref. 68), the recently demonstrated heavy vestibuloreticular projection from the vestibular nuclei (ref. 43) may account for the transmission of vestibular impulses to the reticular formation. In this connection it is of great interest to notice

that reticulospinal pathways, thus being the final path for at least some vestibular impulses to the spinal cord, have been shown in part to course together with and terminate within the same laminae of the spinal gray matter as do the vestibulospinal pathways (ref. 45). Figure 9 shows the course and sites of termination of medullary and pontine reticulospinal fibers (ref. 45), and, as further shown in figure 10, which is from the study of Nyberg-Hansen (ref. 6), the anatomical similarities are most conspicuous as concern the pontine reticulospinal and lateral vestibulospinal fiber systems (refs. 6 and 45). These mutual anatomical resemblances presumably reflect common functional features as well, a suggestion indeed supported by physiological studies which show that pontine reticulospinal and lateral vestibulospinal pathways both facilitate spinal extensor motoneurons (see refs. 69 and 54, respectively). Both pathways appear, furthermore, to be engaged with monosynaptical activation of neurons of the ventral spinoreticular tract (bVFRT) (refs. 70 and 71) polysynaptically influenced by flexor reflex afferent (FRA) impulses (ref. 72). The neurons of the ventral spino-

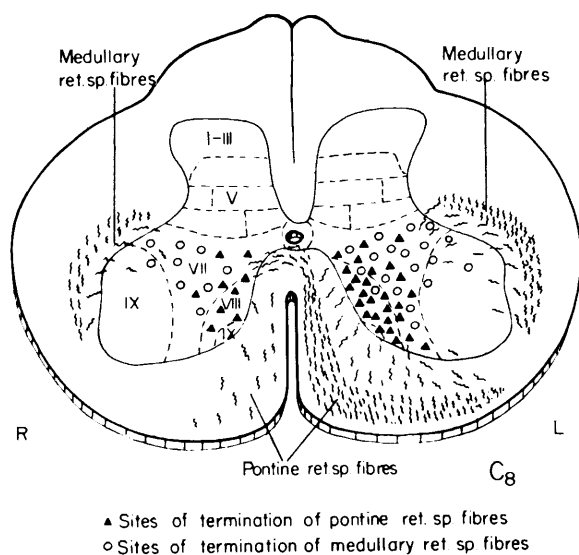

FIGURE 9.—Diagram of a transverse section of the spinal cord showing the location in the ventral and lateral funiculi and the sites of termination within the spinal gray matter of pontine and medullary reticulospinal fibers arising in the nucleus reticularis pontis caudalis and nucleus reticular gigantocellularis, respectively. Note the different location in the white matter, and the partially dissimilar areas of termination within the gray matter of the two contingents of reticulospinal fibers. Note, furthermore, the anatomical similarities between the pontine reticulospinal and vestibulospinal fibers. (From ref. 45.)

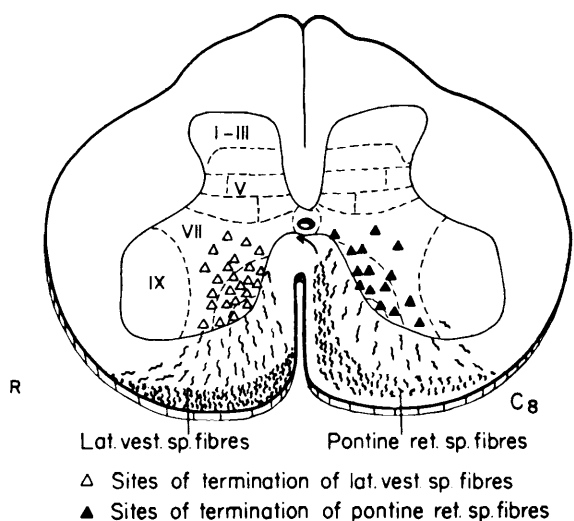

FIGURE 10.—Diagram of a transverse section of the spinal cord showing the location in the ventrolateral funiculus and the sites of termination within the spinal gray matter of pontine reticulospinal and lateral vestibulospinal fibers. Note the similarities between the two pathways with regard to the course and sites of termination. (From ref. 6.)

reticular tract are usually claimed to be located ventromedially in the spinal gray matter (ref. 73), where pontine reticulospinal as well as lateral vestibulospinal fibers terminate, as shown in figure 10. There appears thus to be a satisfactory anatomical substratum for the physiologically demonstrated monosynaptical activation.

Because of its restriction to the upper half of the spinal cord, and its origin from the medial vestibular nucleus, the medial vestibulospinal tract is generally assumed to be concerned with the adjustments of the tonus in the muscles of the head and neck and with movements of the head occurring simultaneously with conjugate deviation of the eyes, particularly in the horizontal plane (see refs. 46 and 54). Some recent physiological observations indicate that the medial vestibulospinal tract also may be engaged in the control of incoming sensory impulses in the cord. Thus, the phasic inhibition of monosynaptic and polysynaptic spinal reflexes which takes place during REM sleep (ref. 74) has been shown to be due to presynaptic inhibition of group 1a afferent fibers (ref. 75). Since bilateral lesions of the medial and descending vestibular nucleus abolished the rapid eye movements as well as the accompanying phasic inhibition of monosynaptic reflexes during REM sleep (ref. 76), Pompeiano (ref. 77) concluded that the medial and descending nuclei by way of the medial vestibulospinal tract exert a presynaptic inhibition of primary afferent fibers in the spinal cord. The observation by Carpenter, Engberg, and Lundberg (ref. 78) that presynaptic inhibition of group 1a, 1b, and FRA afferents occurs on stimulation of the region of the medial longitudinal fasciculus in the medulla oblongata and lower pons fits in with this line of reasoning. It should, however, be emphasized that in addition to medial vestibulospinal fibers, pontine reticulospinal (ref. 45) and interstitio-spinal fibers (ref. 79) as well course within the area of the medial longitudinal fasciculus at this level of the brainstem. Furthermore, since the medial vestibulospinal tract only can be traced to midthoracic levels, it follows that the effect on the lower half of the cord must be relayed farther down by way of descending propriospinal fibers.

CONCLUSION

It will appear from the foregoing account that the vestibular nuclear complex has at its disposal two different direct routes by which vestibulospinal impulses may be mediated to the spinal cord: the lateral and medial vestibulospinal tracts. In addition, impulses of vestibular origin are also conveyed to the spinal cord by

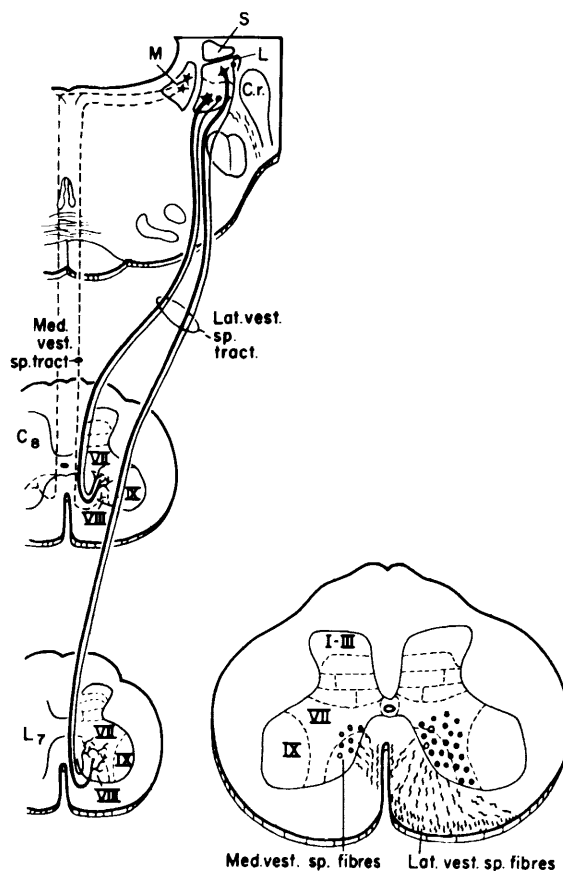

FIGURE 11.—A diagram showing the sites of origin, course, and sites of termination of the lateral and medial vestibulospinal tract as determined by Nyberg-Hansen and Mascitti (ref. 16) and Nyberg-Hansen (ref. 46). The medial tract arises from the medial vestibular nucleus and courses chiefly ipsilaterally within the descending medial longitudinal fasciculus to midthoracic levels of the cord. The lateral tract originates from the lateral nucleus and descends purely ipsilaterad to sacral levels, organized in a somatotopical manner. Both tracts terminate in laminae VII and VIII. The lateral vestibulospinal tract is the major spinal projection from the vestibular nuclei. (See text for explanation of abbreviations.)

way of reticulospinal fibers. There appear anatomically and physiologically to be mutual resemblances between the lateral vestibulospinal tract and the pontine reticulospinal fiber system. The two direct vestibulospinal pathways differ in some anatomical aspects, which make it likely that they, in part, are functionally dissimilar, also.

The lateral vestibulospinal tract originates solely from the lateral nucleus and descends ipsilaterally, organized in a somatotopical manner throughout the whole cord. The medial tract, on the other hand, comes from the medial (and possibly descending) vestibular nucleus and descends bilaterally to the rostral half of the cord only. Fibers of both pathways terminate in laminae VII and VIII of the spinal gray matter, chiefly on interneurons, those of the medial tract in more dorsal regions (fig. 11). The medial vestibulospinal tract is, furthermore, very modest when compared with the lateral one, which, by far, is the major pathway mediating vestibulospinal impulses to the cord. The differences between the two pathways are further emphasized when the origin of peripheral vestibular impulses to the lateral and medial vestibular nucleus is considered. While the utricular macula appears to be the main source of origin of primary vestibular fibers to the lateral nucleus, those to the medial nucleus are primarily derived from the cristae of the circular ducts (refs. 54 and 80 to 82).

It follows from this arrangement that the lateral nucleus and the lateral vestibulospinal tract are well qualified to exert the well-known facilita-

tory influence on postural tonus and spinal extensor mechanisms. This influence is exerted on α - as well as on γ -motoneurons, and available anatomical and physiological data point to the indirect route via interneurons in laminae VII and VIII as the most important one. There is, however, in addition, some physiological evidence in favor of a direct monosynaptic vestibulospinal route to both α - and γ -extensor motoneurons. This anatomical arrangement, with the majority of lateral vestibulospinal tract fibers terminating on spinal interneurons, and not directly on the motoneurons, is well suited to permit a large degree of plasticity and freedom of the motoneurons. It provides, furthermore, a basis for a variable interplay and integration of afferent impulses from several sources at an interneuronal level before the impulses finally converge upon the motoneurons.

In contrast to the lateral tract which may act on all spinal levels, the medial vestibulospinal tract is restricted to the rostral half of the cord. In concert with this, the medial vestibular nucleus and the medial tract are primarily assumed to be concerned with the control of proprioceptive mechanisms of the cervical cord and with movements of the head which may occur simultaneously with eye movements. However, recent physiological studies indicate that the medial and descending vestibular nucleus by way of the medial vestibulospinal tract exert a pre-synaptic inhibition of primary afferents in the spinal cord, and that this is the likely basis for the phasic inhibition of spinal reflexes occurring during REM sleep.

REFERENCES

1. REXED, B.: The Cytoarchitectonic Organization of the Spinal Cord in the Cat. *J. Comp. Neurol.*, vol. 96, 1952, pp. 415-496.
2. REXED, B.: A Cytoarchitectonic Atlas of the Spinal Cord in the Cat. *J. Comp. Neurol.*, vol. 100, 1954, pp. 297-379.
3. REXED, B.: Some Aspects of the Cytoarchitectonics and Synaptology of the Spinal Cord. *Progr. Brain Res.*, vol. 11, 1964, pp. 58-90.
4. SPRAGUE, J. M.; AND HA, H.: The Terminal Fields of Dorsal Root Fibers in the Lumbosacral Spinal Cord of the Cat, and the Dendritic Organization of the Motor Nuclei. *Progr. Brain Res.*, vol. 11, 1964, pp. 120-152.
5. LUNDBERG, A.: Integration in the Reflex Pathway. Muscular Afferents and Motor Control, R. Granit, ed., Almqvist & Wiksell, 1966, pp. 275-305.
6. NYBERG-HANSEN, R.: Functional Organization of Descending Supraspinal Fibre Systems to the Spinal Cord. Anatomical Observations and Physiological Correlations. *Ergebn. Anat. Entwickl.-Gesch.*, vol. 39, 1966, pp. 1-48.

7. NAUTA, W. J. H.: Silver Impregnation of Degenerating Axons. *New Research Techniques of Neuroanatomy*, W. F. Windle, ed., Charles C Thomas, 1957, pp. 17-26.
8. GLEES, P.: Terminal Degeneration Within the Central Nervous System as Studied by a New Silver Method. *J. Neuropathol. Exptl. Neurol.*, vol. 5, 1946, pp. 54-59.
9. POMPEIANO, O.; AND BRODAL, A.: The Origin of Vestibulospinal Fibres in the Cat. An Experimental-Anatomical Study, With Comments on the Descending Medial Longitudinal Fasciculus. *Arch. Ital. Biol.*, vol. 95, 1957, pp. 166-195.
10. BRODAL, A.: Modification of Gudden Method for Study of Cerebral Localization. *Arch. Neurol. Psychiat.*, vol. 43, 1940, pp. 46-58.
11. BRODAL, A.; AND POMPEIANO, O.: The Vestibular Nuclei in the Cat. *J. Anat. (London)*, vol. 91, 1957, pp. 438-454.
12. ITO, M.; HONGO, T.; YOSHIDA, M.; OKADA, Y.; AND OBATA, K.: Antidromic and Trans-synaptic Activation of Deiters' Neurons Induced from the Spinal Cord. *Jap. J. Physiol.*, vol. 14, 1964, pp. 638-658.
13. WILSON, V. J.; KATO, M.; THOMAS, R. C.; AND PETERSON, B. W.: Excitation of Lateral Vestibular Neurons by Peripheral Afferent Fibers. *J. Neurophysiol.*, vol. 29, 1966, pp. 508-529.
14. POMPEIANO, O.: Organizzazione Somatotopica delle Risposte Posturali alla Stimolazione Elettrica del Nucleo di Deiters nel Gatto Decerebrato. *Arch. Sci. Biol.*, vol. 44, 1960, pp. 497-511.
15. WILSON, V. J.; KATO, M.; PETERSON, B. W.; AND WYLIE, R. M.: A Single-Unit Analysis of the Organization of Deiters' Nucleus. *J. Neurophysiol.*, vol. 30, 1967, pp. 603-619.
16. NYBERG-HANSEN, R.; AND MASCITTI, T. A.: Sites and Mode of Termination of Fibers of the Vestibulospinal Tract in the Cat. An Experimental Study with Silver Impregnation Methods. *J. Comp. Neurol.*, vol. 122, 1964, pp. 369-387.
17. BIEDL, A.: Absteigende Kleinhirnbahnen. *Neur. Cbl.*, vol. 14, 1895, pp. 493-501, 434-448.
18. RUSSELL, J. S. R.: The Origin and Destination of Certain Afferent and Efferent Tracts in the Medulla Oblongata. *Brain*, vol. 20, 1897, pp. 409-440.
19. LEWANDOWSKY, M.: Untersuchungen über die Leitungsbahnen des Truncus cerebri und ihren Zusammenhang mit denen der Medulla spinalis und des Cortex cerebri. *Denkschr. med.-naturw. Ges. Jena, Neurobiol. Arb.*, ser. II, vol. 1, 1904, pp. 63-150.
20. WALBERG, F.: The Early Changes in Degenerating Boutons and the Problem of Argyrophilia. Light and Electron Microscopical Observation. *J. Comp. Neurol.*, vol. 122, 1964, pp. 113-137.
21. GUILLERY, R. W.; AND RALSTON, H. J.: Nerve Fibres and Terminals: Electron Microscopy After Nauta Staining. *Science*, vol. 143, 1964, pp. 1331-1332.
22. LUND, R. D.; AND WESTRUM, L. E.: Neurofibrils and the Nauta Method. *Science*, vol. 151, 1966, pp. 1397-1399.
23. SCHIMERT, J. S.: Die Endigung swise des Tractus vestibulospinalis. *Z. Anat. Entwickl. Gesch.*, vol. 108, 1938, pp. 761-767.
24. CAJAL, S. R.: *Histologie du Système Nerveux de l'homme et des Vertébrés*. Maloine (Paris), 1901-1911.
25. SPRAGUE, J. M.: A Study of Motor Cell Localization in the Spinal Cord of the Rhesus Monkey. *Am. J. Anat.*, vol. 82, 1948, pp. 1-26.
26. SPRAGUE, J. M.: Motor and Propriospinal Cells in the Thoracic and Lumbar Ventral Horn of the Rhesus Monkey. *J. Comp. Neurol.*, vol. 95, 1951, pp. 103-123.
27. SCHEIBEL, M. E.; AND SCHEIBEL, A. B.: Spinal Motoneurons, Interneurons and Renshaw Cells. A Golgi Study. *Arch. Ital. Biol.*, vol. 104, 1966, pp. 328-353.
28. WILLIS, W. D.; AND WILLIS, J. C.: Properties of Interneurons in the Ventral Spinal Cord. *Arch. Ital. Biol.*, vol. 104, 1966, pp. 354-386.
29. SZENTÁGOTHAL, J.: Synaptic Architecture of the Spinal Motoneuron Pool. *EEG & Clin. Neurophysiol.*, vol. 25 suppl., 1967, pp. 4-19.
30. RASDOLSKY, J.: Über die Endigung der extraspinalen Bewegungssysteme im Rückenmark. *Z. ges. Neurol. Psychiat.*, vol. 86, 1923, pp. 360-374.
31. STAAL, A.: Subcortical Projections on the Spinal Grey Matter of the Cat. Thesis, Koninklijke Drukkerijen Lankhout-Immig N.V.-S-Gravenhage, Leiden, 1961, pp. 1-164.
32. KUYPERS, H. G. J. M.; FLEMING, W. R.; AND FARINHOLT, J. W.: Subcortical Projections in the Rhesus Monkey. *J. Comp. Neurol.*, vol. 118, 1962, pp. 107-137.
33. PETRAS, J. M.: Cortical, Tectal and Tegmental Fiber Connections in the Spinal Cord of the Cat. *Brain Res.*, vol. 6, 1967, pp. 275-324.
34. LORENTE DE NO, R.: Synaptic Stimulation of Motoneurons as a Local Process. *J. Neurophysiol.*, vol. 1, 1938, pp. 195-206.
35. AITKEN, J. T.; AND BRIDGER, J. E.: Neuron Size and Neuron Population Density in the Lumbosacral Region of the Cat's Spinal Cord. *J. Anat. (London)*, vol. 95, 1961, pp. 38-53.
36. LUND, S.; AND POMPEIANO, O.: Monosynaptic Excitation of Alpha Motoneurons From Supraspinal Structures in the Cat. *Acta Physiol. Scand.*, vol. 73, 1968, pp. 1-21.
37. ERULKAR, S. D.; SPRAGUE, J. M.; WHITSEL, B. L.; DOGAN, S.; AND JANETTA, P. J.: Organization of the Vestibular Projection to the Spinal Cord of the Cat. *J. Neurophysiol.*, vol. 29, 1966, pp. 626-664.
38. SZENTÁGOTHAL, J.: Short Propriospinal Neurons and Intrinsic Connections of the Spinal Grey Matter. *Acta morph. Acad. Sci. Hung.*, vol. 1, 1951, pp. 81-94.
39. DE VITO, R. V.; BRUSA, A.; AND ARDUINI, A.: Cerebellar and Vestibular Influences on Deitersian Units. *J. Neurophysiol.*, vol. 19, 1956, pp. 241-253.
40. GERNANDT, B. E.; KATSUKI, Y.; AND LIVINGSTON, R. B.: Functional Organization of Descending Vestibular Influences. *J. Neurophysiol.*, vol. 20, 1957, pp. 453-469.
41. GERNANDT, B. E.; IRANYI, M.; AND LIVINGSTON, R. B.:

- Vestibular Influences on Spinal Mechanisms. *Exptl. Neurol.*, vol. 1, 1959, pp. 248-273.
42. MASSOPUST, L. C.: Some Descending Vestibular Projections in the Medulla Oblongata and Spinal Cord. *Neurology*, vol. 10, 1960, pp. 697-704.
 43. LADPLI, R.; AND BRODAL, A.: Experimental Studies of Commissural and Reticular Formation Projections From the Vestibular Nuclei in the Cat. *Brain Res.*, vol. 8, 1968, pp. 65-96.
 44. TORVIK, A.; AND BRODAL, A.: The Origin of Reticulo-spinal Fibers in the Cat. An Experimental Study. *Anat. Record*, vol. 128, 1957, pp. 113-138.
 45. NYBERG-HANSEN, R.: Sites and Mode of Termination of Reticulo-spinal Fibers in the Cat. An Experimental Study With Silver Impregnation Methods. *J. Comp. Neurol.*, vol. 124, 1965, pp. 71-100.
 46. NYBERG-HANSEN, R.: Origin and Termination of Fibers from the Vestibular Nuclei Descending in the Medial Longitudinal Fasciculus. An Experimental Study With Silver Impregnation Methods in the Cat. *J. Comp. Neurol.*, vol. 122, 1964, pp. 355-367.
 47. SCHUEREN, A. VAN DER: Étude Anatomique du Faisceau Longitudinal Postérieur. *Névraxe*, vol. 13, 1912, pp. 183-309.
 48. BUCHANAN, A. R.: The Course of the Secondary Vestibular Fibers in the Cat. *J. Comp. Neurol.*, vol. 67, 1937, pp. 183-204.
 49. FERRARO, A.; PACELLA, B. L.; AND BARRERA, S. E.: Effects of Lesions of the Medial Vestibular Nucleus. An Anatomical and Physiological Study in Macacus Rhesus Monkeys. *J. Comp. Neurol.*, vol. 73, 1940, pp. 7-36.
 50. WILSON, V. J.; WYLIE, R. M.; AND MARCO, L. A.: Organization of the Medial Vestibular Nucleus. *J. Neurophysiol.*, vol. 31, 1968, pp. 165-175.
 51. CARPENTER, M. B.: Fiber Projections From the Descending and Lateral Vestibular Nuclei in the Cat. *Am. J. Anat.*, vol. 107, 1960, pp. 1-21.
 52. CARPENTER, M. B.; ALLING, F. A.; AND BARD, D. S.: Lesions of the Descending Vestibular Nucleus in the Cat. *J. Comp. Neurol.*, vol. 114, 1960, pp. 39-50.
 53. WILSON, V. J.; WYLIE, R. M.; AND MARCO, L. A.: Projection to the Spinal Cord From the Medial and Descending Vestibular Nuclei of the Cat. *Nature*, vol. 215, 1967, pp. 429-430.
 54. BRODAL, A.; POMPEIANO, O.; AND WALBERG, F.: The Vestibular Nuclei and Their Connections. *Anatomy and Functional Correlations* (Ramsay Henderson Trust Lectures), Oliver & Boyd, Edinburgh, London, 1962.
 55. SASAKI, K.; TANAKA, T.; AND MORI, K.: Effects of Stimulation of Pontine and Bulbar Reticular Formation Upon Spinal Motoneurons of the Cat. *Jap. J. Physiol.*, vol. 12, 1962, pp. 45-62.
 56. GRILLNER, S.; HONGO, T.; AND LUND, S.: Interaction Between the Inhibitory Pathways From the Deiters' Nucleus and Ia Afferents to Flexor Motoneurons. *Acta Physiol. Scand.*, vol. 68, suppl. 277, 1966, pp. 1-61.
 57. GERNANDT, B. E.; AND GILMAN, S.: Vestibular and Propriospinal Interactions and Protracted Spinal Inhibition by Brain Stem Activation. *J. Neurophysiol.*, vol. 23, 1960, pp. 269-287.
 58. HULTBORN, H.; JANKOWSKA, E.; AND LINDSTRØM, S.: Recurrent Inhibition From Motor Axon Collaterals in Interneurons Monosynaptically Activated From Ia Afferents. *Brain Res.*, vol. 9, 1968, pp. 367-369.
 59. ELDRÉD, E.; GRANIT, R.; AND MERTON, P. A.: Supraspinal Control of the Muscle Spindles and Its Significance. *J. Physiol.*, vol. 122, 1953, pp. 498-523.
 60. GRANIT, R.; HOLMGREN, B.; AND MERTON, P. A.: The Two Routes for Excitation of Muscles and Their Subsistence in the Cerebellum. *J. Physiol.*, vol. 130, 1955, pp. 213-224.
 61. ANDERSSON, S.; AND GERNANDT, B. E.: Ventral Root Discharge in Response to Vestibular and Proprioceptive Stimulation. *J. Neurophysiol.*, vol. 19, 1956, pp. 524-543.
 62. DIETE-SPIFF, K.; CARLI, G.; AND POMPEIANO, O.: Comparison of the Effects of Stimulation of the VIIIth Cranial Nerve, the Vestibular Nuclei or the Reticular Formation on the Gastrocnemius Muscle and Its Spindles. *Arch. Ital. Biol.*, vol. 105, 1967, pp. 243-372.
 63. GRANIT, R.; POMPEIANO, O.; AND WALTMAN, B.: Fast Supraspinal Control of Mammalian Muscle Spindles: Extra- and Intrafusal Co-Activation. *J. Physiol.*, vol. 147, 1959, pp. 385-398.
 64. CARLI, G.; DIETE-SPIFF, K.; AND POMPEIANO, O.: Responses of the Muscle Spindles and of the Extrafusal Fibres in an Extensor Muscle to Stimulation of the Lateral Vestibular Nucleus in the Cat. *Arch. Ital. Biol.*, vol. 105, 1967, pp. 209-242.
 65. ECCLES, J. C.; ECCLES, R. M.; IGGO, A.; AND LUNDBERG, A.: Electrophysiological Studies on Gamma Motoneurons. *Acta Physiol. Scand.*, vol. 50, 1960, pp. 32-40.
 66. NYBERG-HANSEN, R.: Anatomical Demonstration of Gamma Motoneurons in the Cat's Spinal Cord. *Exptl. Neurol.*, vol. 13, 1965, pp. 71-81.
 67. GERNANDT, B. E.; AND THULIN, C.-A.: Vestibular Connections of the Brain Stem. *Am. J. Physiol.*, vol. 171, 1952, pp. 121-127.
 68. WALBERG, F.; BOWSHER, D.; AND BRODAL, A.: The Termination of Primary Vestibular Fibers in the Vestibular Nuclei in the Cat. An Experimental Study With Silver Methods. *J. Comp. Neurol.*, vol. 110, 1958, pp. 391-419.
 69. ROSSI, G. F.; AND ZANSCHEITTI, A.: The Brain Stem Reticular Formation. *Arch. Ital. Biol.*, vol. 95, 1957, pp. 199-435.
 70. HOLMQVIST, B.; LUNDBERG, A.; AND OSCARSSON, O.: A Supraspinal Control System Monosynaptically Connected With an Ascending Spinal Pathway. *Arch. Ital. Biol.*, vol. 98, 1960, pp. 402-422.
 71. GRILLNER, S.; HONGO, T.; AND LUND, S.: The Origin of Descending Fibres Monosynaptically Activating Spino-reticular Neurones. *Brain Res.*, vol. 10, 1968, pp. 259-262.

72. LUNDBERG, A.; AND OSCARSSON, O.: Two Ascending Spinal Pathways in the Ventral Part of the Cord. *Acta Physiol. Scand.*, vol. 54, 1962, pp. 270-286.
73. OSCARSSON, O.: Differential Course and Organization of Uncrossed and Crossed Long Ascending Spinal Tracts. *Progr. Brain Res.*, vol. 12, 1964, pp. 164-176.
74. GASSEL, M. M.; MARCHIAFAVA, P. L.; AND POMPEIANO, O.: Tonic and Phasic Inhibition of Spinal Reflexes During Deep, Desynchronized Sleep in Unrestrained Cats. *Arch. Ital. Biol.*, vol. 102, 1964, pp. 471-499.
75. MORRISON, A. R.; AND POMPEIANO, O.: Central Depolarization of Group Ia Afferent Fibers During Desynchronized Sleep. *Arch. Ital. Biol.*, vol. 103, 1965, pp. 517-537.
76. POMPEIANO, O.; AND MORRISON, A. R.: Vestibular Influences During Sleep. III. Dissociation of the Tonic and Phasic Inhibition of Spinal Reflexes During Desynchronized Sleep Following Vestibular Lesions. *Arch. Ital. Biol.*, vol. 104, 1966, pp. 213-246.
77. POMPEIANO, O.: Sensory Inhibition During Motor Activity in Sleep. *Neurophysiological Basis of Normal and Abnormal Motor Activities*, M. D. Yahr and D. P. Purpura, eds., Raven Press, 1967, pp. 323-372.
78. CARPENTER, D.; ENGBERG, I.; AND LUNDBERG, A.: Primary Afferent Depolarization Evoked From the Brain Stem and the Cerebellum. *Arch. Ital. Biol.*, vol. 104, 1966, pp. 73-85.
79. NYBERG-HANSEN, R.: Sites of Termination of Interstitiospinal Fibers in the Cat. An Experimental Study With Silver Impregnation Methods. *Arch. Ital. Biol.*, vol. 104, 1966, pp. 98-111.
80. LORENTE DE NÓ, R.: Anatomy of the Eighth Nerve. The Central Projection of the Nerve Endings of the Internal Ear. *Laryngoscope*, vol. 43, 1933, pp. 1-38.
81. ECKEL, W.: Elektrophysiologische und histologische Untersuchungen im Vestibulariskerngebiet bei Drehreizen. *Arch. Ohr., Nas., u. KehlkHeilk.*, vol. 164, 1954, pp. 487-513.
82. SHIMAZU, H.; AND PRECHT, W.: Tonic and Kinetic Responses of Cat's Vestibular Neurons to Horizontal Angular Acceleration. *J. Neurophysiol.*, vol. 28, 1965, pp. 991-1013.

DISCUSSION

Tang: How did you place the lesions and how do you determine the extent of your lesions?

Nyberg-Hansen: The lesions were made stereotaxically by an electrode going through the cerebellum in an oblique angle in order to avoid tentorium cerebelli. The lesions were checked histologically in serial sections at 15-micron stained thionine. Every fifth section was mounted and examined.

Tang: What electrode are you using, and are you using alternating or direct current to destroy the tissue?

Nyberg-Hansen: We used steel electrodes, and the lesions were made with direct current.

Tang: I asked because I found by using the Prussian blue staining method that the lesion is much more extensive than histologically shown because the ion diffusion goes way beyond the histologically identifiable big hole. The ion can diffuse way beyond the site of the lesion.

Nyberg-Hansen: I can say only that in our sections we got only a very small hole, and the lesion as depicted in my illustrations is not the hole which is made, but includes the glia reaction as well. I think that with weak current and small lesions, examined closely in thionine sections, you can outline the lesion very well.

Pompeiano: I should like to mention the results of some unpublished experiments made recently by Cook, Cangiano, and myself, indicating that the effects of vestibular nerve stimulation on the primary afferents in the lumbar cord are not mediated by the medial vestibulospinal tract nor by propriospinal descending pathways, but are transmitted to the spinal cord by collaterals from the vestibular nuclei to brainstem structures whose descending pathways course along the ventral quadrants.

The problem of the distribution of the vestibulospinal synapses within the somatodendritic complex of the extensor

α -motoneurons is also relevant to your anatomical findings. This problem needs further experimental data, but a few observations are available on this subject. It has been found recently (S. Lund and O. Pompeiano: Monosynaptic Excitation of Alpha Motoneurons From Supraspinal Structures in the Cat. *Acta Physiol. Scand.*, vol. 73, 1968, pp. 1-21) that the values for the "time to peak" and the decay of the monosynaptic EPSP induced in extensor motoneurons by single-shock stimulation of the Deiters' nucleus are well in accordance with the corresponding values for the homonymous group Ia EPSP's. This suggests that, in the cat, there is no difference in the average distance from the soma of the postsynaptic membrane for the two kinds of synapses, as has been found in the frog (E. Fadiga and J. M. Brookhart: Monosynaptic Activation of Different Portions of the Motor Neuron Membrane. *Am. J. Physiol.*, vol. 198, 1960, pp. 963-703).

Nyberg-Hansen: Yes. I want to stress that we have seen some very few fibers in lamina IX among the motoneurons, but it has been impossible to tell whether they have any relationship to these neurons. With present anatomical methods, it is only safe to conclude that there are no terminations on the soma. If there are any terminations on the motoneurons, as the physiologists have shown, it must be on the dendrites.

I may add that we have recently started doing electronmicroscopic studies with degeneration techniques on this fiber system. So far our results are only preliminary. Such studies may turn out to show synapses on the dendrites of motoneurons. But I think that with electronmicroscopic studies, this will not come out so much concerning the soma, because if you see few fibers among the soma in silver studies, it shall be very difficult to see them in electronmicroscopic studies.

Wilson: As far as the location of the terminals in the vestibulospinal tract is concerned, we found that the rise time of the EPSP's in the neck is quite slow. So there I would certainly look on the dendrites. The position of the people in your laboratory used to be that most of the cells or all of the cells in Deiters' nucleus project to the spinal cord. Does this still remain your viewpoint or do you think there might also be interneurons in Deiters' nucleus? Do you still think all the cells project to the spinal cord or would you consider there might be interneurons in there also?

Nyberg-Hansen: I have not personally done retrograde studies on this, but from the studies of Pompeiano and Brodal, it appears like all large, medium-sized cells and small neurons of the lateral nucleus project to the cord. But there may very well be axon collaterals going in a rostral direction, and as recently shown by Ladpli and Brodal, there is a heavy interconnection between the vestibular nuclei as well as a projection from the vestibular nuclei to the reticular formation. This may, of course, be collaterals of vestibulospinal tract fibers.

The Cerebellovestibular Interaction in the Cat's Vestibular Nuclei Neurons

MASAO ITO

University of Tokyo

SUMMARY

Postsynaptic effects of the vestibular and cerebellar impulses were investigated in the cat's vestibular nuclei neurons with intracellular recording techniques. These neurons were identified by their antidromic invasion from the spinal cord or the cerebellum and/or by their location determined with histologically controlled micromanipulation. The vestibular nerve impulses exert monosynaptically an excitatory effect upon many vestibular nuclei neurons, producing the excitatory postsynaptic potentials (EPSP's). Polysynaptic actions, however, involve both excitation and inhibition. In contrast, the cerebellar impulses along Purkinje axons evoke the inhibitory postsynaptic potentials (IPSP's) monosynaptically in any of their target neurons. These vestibular and cerebellar impulses converge upon vestibular nuclei neurons in the fashion that the cerebellum is superposed on the reflex arcs which are primarily formed between the vestibular nerve and certain vestibular nuclei cells. On the basis of these observations, an attempt is made to interpret the role of the cerebellum in terms of basic concepts of the control theory.

INTRODUCTION

The vestibular nuclear complex consists of four divisions: lateral (Deiters), medial, descending (inferior), and superior (see ref. 1). Synaptic organization in these nuclei has been the subject of extensive histological investigations (refs. 1 and 2). The vestibular nerve fibers supply synapses to all of the four nuclei ipsilaterally, though with certain regional predominance (refs. 3 and 4). Purkinje-cell axons mediating the output signals from the cerebellar cortex also impinge upon the vestibular nuclei ipsilaterally; those from the cortex of the vermis, predominantly of the anterior lobe and less of the posterior lobe, innervate the relatively dorsal parts of the nucleus of Deiters as well as of the other nuclei (refs. 5 and 6), while those from the so-called vestibulocerebellum cover almost the entire nuclei except for the nucleus of Deiters (ref. 7). Axons from fastigial nuclei form another cerebellar output and have abundant synapses with vestibular nuclei cells (ref. 8). Other inputs

are supplied from the spinal cord and medulla as well as from the supramedullary centers (ref. 1).

After integration of these input signals, the vestibular nuclei send their output message through the following five projection pathways: (1) descending through the lateral vestibulospinal tract, (2) descending through the medial longitudinal fasciculi, (3) cerebellopetal, (4) ascending through the medial longitudinal fasciculi, and (5) intranuclear and internuclear connections, the latter being either homolateral or between the right and left sides. The first type of projection is derived only from the nucleus of Deiters and the third one mainly from the descending nucleus. The second and the fifth arise from both the medial and descending nuclei, and the fourth from all of the four divisions (ref. 1).

A wealth of anatomical data has facilitated greatly the recent physiological investigations on vestibular nuclei neurons. With microelectrode techniques the nature and efficacy of transmission could be determined on each type of

synapse with histologically defined origin. Of particular importance is the finding that Purkinje cells exert solely inhibitory action upon their target neurons, while both vestibular nerve fibers and fastigial axons have direct excitatory action. These observations now reveal some essential features of the cerebello-vestibular interaction and facilitate conception of some general ideas about the cerebellar control mechanisms.

METHODS OF STUDY

Under Nembutal anesthesia, the cat's head was fixed in a supine position. Microelectrodes filled with solution containing 3 *M* KCl, 2 *M* NaCl, or 2 *M* K-citrate were inserted through the ventral surface of medullary pyramid in a ventrodorsal direction, usually on the right side (ref. 9). The vestibular nerve branches were exposed in the right vestibule by the method of Andersson and Gernandt (ref. 10). An acupuncture needle, insulated except for the very tip, was placed lightly on the vestibular nerve branches as a cathode. The anode was formed by another needle placed on the cochlear bone. The ventral surface of the spinal cord at the second or third (C2 or C3) cervical segment was exposed; upon this three needle electrodes were mounted, one on the anterior median fissure and the other two at 2 mm right and left, respectively, to the former. The needle or concentric electrodes were also inserted into the cerebellum stereotaxically.

Penetration of neuronal elements within vestibular nuclei was signaled by the sudden appearance of a membrane potential of -40 to -70 mV and also of spikes and postsynaptic potentials in response to stimulation of the spinal cord, cerebellum, and vestibular nerve. Localization of impaled neurons was determined by the following procedure (refs. 9, 11, and 12): After each experiment, the brain tissues were fixed by intracarotid injection of a 10-percent buffered formalin saline solution, with the microelectrode left buried in one of the tracks through vestibular nuclei. Frozen sections were then prepared from the medulla and cerebellum (transversely with a 40-micron thickness) on which the trace of the microelectrode track

was found. These sections were first stained with methylene blue, and the contour of their histological structures was traced under a photographic enlarger. The sections were then stained by the Klüver-Barrera method to reveal details of the cytoarchitecture of the vestibular nuclei. The position at which individual neurons were impaled was plotted on a lattice made up of the microelectrode tracks and lines equal to the depths of microelectrode insertion as measured on the scale of the micro-manipulator. The lattice was then fitted on the histological section by using as a guide the trace of the microelectrode track.

CELL IDENTIFICATION BY ANTIDROMIC ACTIVATION

Antidromic activation has been employed widely as the most reliable method of identifying certain neuron groups (ref. 9). This was successfully applied to the following three groups of vestibular nuclei neurons.

(1) *Deiters' neurons*.—When the C₂ or C₃ segment was stimulated with the needle electrode placed about 2 mm lateral from the anterior median fissure (C_i in fig. 1), conspicuous negative field potentials developed over the region of the nucleus of Deiters on the same side (ref. 9). These field potentials are produced by the antidromic invasion of Deiters' neurons through their vestibulospinal axons. In individual Deiters' neurons, the antidromic spikes show a marked inflection on their ascending phase as in motoneurons (ref. 13) (fig. 1A) and are followed by an afterhyperpolarization of several millivolts that lasts for about 50 msec (fig. 1B) (ref. 9). As confirmed by histological examination (ref. 14), the cells projecting onto cervicothoracic segments of the spinal cord were located relatively ventrad and those onto lumbosacral segments relatively dorsad, though with a considerable overlap (ref. 9). Unit analysis by Wilson et al. (ref. 15) further confirmed that the lumbosacral Deiters' neurons tend to be located caudally in relation to the cervicothoracic ones (ref. 14). The conduction velocity along the vestibulospinal tract fibers ranged from 25 to 140 m/sec, with the mode at 90 to 100 m/sec (refs. 9 and 15).

(2) *DMLF cells*.—Antidromic activation of these neurons was brought about most effectively with the C_m electrode placed on the anterior median fissure (fig. 1) (ref. 12). The difference in threshold for this activation between C_i and C_m or between C_c and C_m electrodes was usually more than fivefold; these cells should be sending axons through the descending medial longitudinal fasciculi (DMLF). Their action potentials were similar to those of Deiters' neurons in that they had an inflection on the ascending phase (fig. 1C). The DMLF cells presently studied were impaled mostly in the rostral pole of the descending vestibular nucleus which extrudes underneath the nucleus

of Deiters (cf. ref. 1). These cells were activated from the cervical cord with relatively short latencies (mean 0.82 msec from C_2), comparable to those for ventrally located Deiters' neurons (0.81 msec from C_3) (ref. 12). These neurons may have similar conduction velocities and so probably have similarly large-sized cell somata. On the basis of histology findings, the majority of DMLF cells appear to be located within the medial vestibular nucleus (ref. 16); this was confirmed recently by unit recording (ref. 17). These medial cells, however, were not particularly sought out in the present investigations.

(3) *Cerebellar-projecting cells*.—Cells in the descending nucleus often responded antidromically to the juxtafastigial stimulation by generating action potentials similar to those of Deiters' and DMLF neurons; spikes have an inflected ascending phase (fig. 1E) and are followed by an afterhyperpolarization (fig. 1F).

The other components of vestibular nuclei were less well identified. The cells impaled within the superior vestibular nucleus may be taken as representative of those cells sending axons cranially through the ascending medial longitudinal fasciculi (AMLF) and are grouped as type IV, since most of the cells in this region appear to be directed rostrally (ref. 1). A number of neurons impaled in the descending and medial vestibular nuclei could not be activated antidromically, either from the spinal cord or from the cerebellum. Such neurons may include those cells projecting rostrally through the AMLF, but at least a part of them may be serving as connections among vestibular nuclei and thus may be grouped as type V.

Axons were also often penetrated within vestibular nuclei. Some of them could be identified as the vestibular nerve fibers by their direct response to the vestibular nerve stimulation (fig. 1D). The evoked spike showed the steep ascending phase with no inflection and was followed by little afterpotential, features characteristic of axons (ref. 18). Some others were identified as Purkinje-cell axons of cerebellovestibular projection or cerebellar afferent fibers (or their collaterals) running through the vestibular nuclei (refs. 9 and 19).

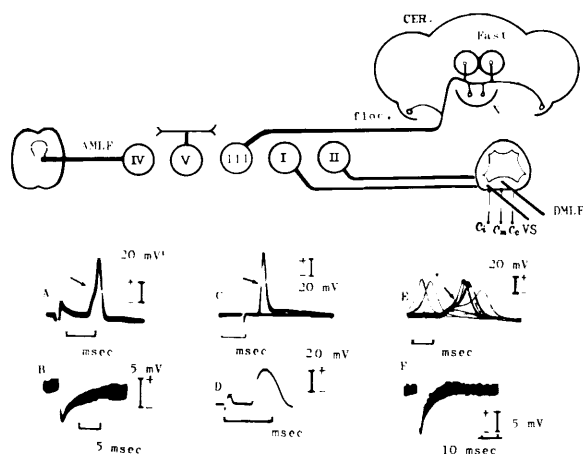

FIGURE 1.—Identification of vestibular nuclei neurons by their antidromic activation. The diagram on the top illustrates axonal projections for five types of neurons. I-V: Indicated in the text. CER: Cerebellum. Fast: Fastigial nucleus. floc.: Floccular lobe. N: Nodulus. VS: Vestibulospinal tract. A: Intracellular recording from a Deiters' neuron during antidromic invasion from C_3 level. Arrow marks the inflection on the spike ascending phase. B: Afterhyperpolarization following an antidromic spike (from ref. 9). C: Antidromic spike of a DMLF cell in response to C_2 stimulation; arrow mark similar to A; note that the stimulus intensity was set at threshold where antidromic invasion failed in about half the trials. D: Direct response of a vestibular nerve fiber to the vestibular nerve stimulation (from ref. 18). E: Antidromic invasion of a descending vestibular nucleus neuron to the juxtafastigial stimulation. Arrow indicates as in A and C. F: Afterhyperpolarization following an antidromic spike from juxtafastigial region (from refs. 9, 12, and 18).

STUDY WITH VESTIBULAR STIMULATION

Monosynaptic Action of Vestibular Nerve Volleys

The most conspicuous event which happens in many vestibular nuclei cells during stimulation of the ipsilateral vestibular nerve with brief electric pulses (0.1- to 0.2-msec duration) is initiation of excitatory postsynaptic potentials (EPSP's) with extremely short latencies. They are illustrated in figures 2*A* through *E* for a Deiters' neuron, in *F* through *H* for a cerebellar-projecting cell, and in *I* through *K* for a superior nucleus neuron (refs. 12 and 18), with various stimulus intensities. At two to five times the threshold of excitation of the vestibular nerve,

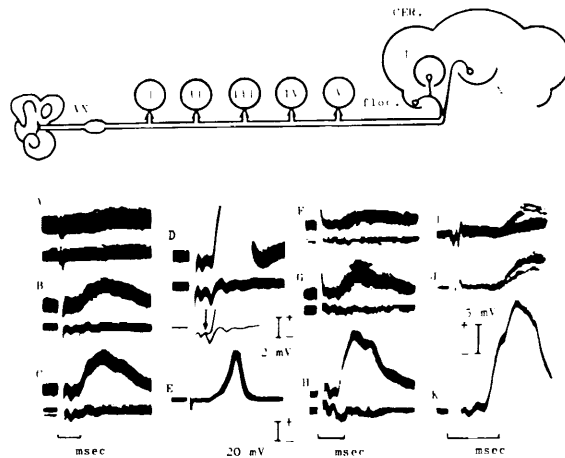

FIGURE 2.—Monosynaptic excitation of vestibular nuclei neurons by the vestibular nerve volley. Top diagram shows the direct innervation by the vestibular nerve fibers. L: Lateral nucleus. VN: Vestibular nerve. Intracellular recording from a Deiters' neuron (A through E), from a descending nucleus neuron (F through H), and from a superior nucleus neuron (I through K). Lower traces in A through C and F through H, and middle traces in D indicate extracellular control potentials. The bottom trace in D shows the upper and middle traces in superposition; the downward arrow indicates their diverging point. In A, the intensity of the vestibular nerve stimulation was just at threshold for the EPSP, and increased to 1.1 times in B, 1.5 times in C, and 3.8 times in D over that in A. E: Same as in the upper traces of D but taken with a low amplification. Similarly, the vestibular nerve stimulation is of threshold intensity in F and increased by a factor of 1.5 in G, by 5 in H, 1.03 in I, 1.06 in J, and 3.6 in K. Voltage scale of 2 mV applies to A through D and F through H and that of 5 mV to I through K. (From refs. 12 and 18.)

there was usually orthodromic firing of impaled cells (*E*).

The latency of the vestibular-evoked EPSP's distributes multimodally, with the earliest group at 0.6 to 1.0 msec and later ones at 1.0 to 1.8 msec. The earliest EPSP's have a mean latency of 0.76 msec (± 0.08 msec SD) in 44 Deiters' neurons and of 0.72 msec (± 0.08 msec SD) in 43 non-Deiters' vestibular nuclei cells (refs. 12 and 18). These EPSP's must be produced monosynaptically because their latencies are longer, just by a monosynaptic delay time, than the latency of arrival of the primary vestibular impulses at the vestibular nuclei. The latter latency is 0.33 msec (ref. 18) at the *P*-wave of the field potential (ref. 20); at the foot of spikes in individual vestibular nerve fibers it is 0.46 msec (ref. 18).

Distribution

The monosynaptic EPSP's were seen in 29 percent of the Deiters' neurons examined (44 of 151). These vestibular-excited cells are located relatively ventrad, as confirmed by histological data (ref. 4) and unit analysis (ref. 15). The monosynaptic EPSP's occurred in 6 of 7 DMLF cells examined, in 9 of 14 cerebellar-projecting ones, in 9 of 12 superior nuclei cells, and in 19 of 30 descending and medial nucleus neurons with identified projection. These frequencies of occurrence appear to be considerably higher than those given with unit analysis (36 percent for medial and 40 percent for descending nuclei, ref. 21), but the discrepancy may, at least partly, be due to the fact that the intracellular recording presently adopted reveals existence of the EPSP's even if they are subthreshold for orthodromic excitation that is detected only by the extracellular unit recording. It is also to be considered that the intracellular recording preferentially samples relatively large cells which might more commonly receive the monosynaptic EPSP's than do relatively small cells.

Unitary Composition

The gradation in size of the monosynaptic EPSP's, which varied according to the intensity of the vestibular nerve stimulation (fig. 2*A* through *K*), indicates that a number of vestibular

nerve fibers converge onto single vestibular nuclei neurons. In figure 3A the vestibular nerve stimulation was adjusted to a juxtathreshold intensity and was repeated every second. Small monosynaptic EPSP's onset at the left broken vertical line and show a considerable fluctuation in size. As indicated in figure 3C and D for two Deiters' neurons, respectively, the fluctuation in amplitude of these EPSP's occurs with the smallest unit of 0.2 to 0.3 mV. Similarly small amplitude EPSP's were usually seen to occur spontaneously as in figure 3B and E. It is probable that a part of these EPSP "noises" is caused by the vestibular impulses which arise spontaneously. In this way the monosynaptic transmission from the vestibular nerve fibers to Deiters' neurons resembles that from group Ia muscle afferents to spinal motoneurons (refs. 22 to 24); it is performed through convergence of a number of afferent fibers, each fiber making only a minute contribution. The action of single vestibular nerve fibers was evaluated approximately by measuring

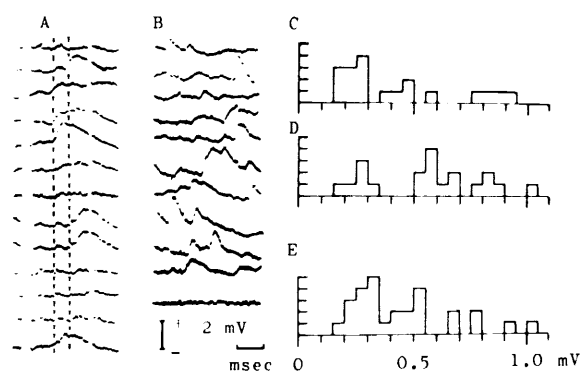

FIGURE 3.—Vestibular-evoked and spontaneous unitary EPSP's in Deiters' neurons. A, B: Intracellular recording from two Deiters' neurons; time constant, 0.02 sec. From the top to the bottom are single-sweep records taken every second. In A the vestibular nerve stimulation was at a juxtathreshold intensity. Left vertical broken line indicates the moment of onset of the monosynaptic EPSP's; the right one marks the moment when delayed small EPSP's were induced in some sweeps. In B no stimuli were given. C: Frequency distribution of amplitudes of the small EPSP's evoked monosynaptically by the juxtathreshold stimulation of the ipsilateral vestibular nerve, partly illustrated in A. D: Similar to C, but for another cell. E: Similar to C and D, but for spontaneous EPSP noises, partly illustrated in B. (From ref. 18.)

the least discernible EPSP's evoked with juxtathreshold stimulation and averaged over 20 to 40 sweeps at a repetition rate of 10 per second (fig. 3A). In 11 Deiters' neurons the mean smallest EPSP's have a peak amplitude of 0.25 to 0.67 mV (average, 0.46 mV), their maximum ascending slope being 0.3 to 2.5 V/sec (average, 1.1 V/sec). In these cells, the maximum ascending slope of the maximal EPSP's was 12 to 61 times (average, 25 times) as large as that of the mean smallest EPSP's (ref. 18). These figures will give a rough measure of the number of the vestibular nerve fibers converging on Deiters' neurons.

In non-Deiters' vestibular nucleus cells the size of the unitary EPSP's was often relatively large (see fig. 2F and I). In 12 non-Deiters' neurons the mean smallest EPSP's ranged from 0.27 to 2.0 mV (average, 0.76 mV) and their maximum ascending slopes from 0.6 to 3.6 V/sec (mean, 2.19 V/sec). The ratio of the maximum ascending slope of the mean smallest EPSP's to that of the maximal EPSP's was between 6 and 38, the average being 15 (ref. 12). Therefore, non-Deiters' vestibular nucleus neurons appear to receive a smaller number of vestibular nerve fibers, each of which has a higher efficacy of synaptic transmission than that of Deiters' neurons. Actually, Wilson et al. (ref. 25) reported that very little spatial summation is needed to produce monosynaptic firing of a medial nucleus unit by vestibular nerve impulses. It may be said that, in general, the transmission from the vestibular nerve to non-Deiters' neurons is less integrative and thus more of a relay than that to Deiters' neurons.

Repetitive Discharges in Vestibular Nerve Fibers

A rather peculiar observation with vestibular nerve stimulation is that the monosynaptic EPSP's are followed by prominent late EPSP's with a latency of 1.9 to 2.2 msec (fig. 4A to C) and further by those at 3.5 to 4.2 msec (D), there being characteristic multi-peaked depolarization. That this successive onset of EPSP's is caused by repetitive discharges in the vestibular nerve fibers is indicated by three lines of observations: First, when examined with double-shock stimulation of the vestibular nerve, the refractory curve for testing monosynaptic EPSP's falls down two

or three times, corresponding exactly to the peaks of EPSP's, as illustrated in figure 4E through J and plotted in K. Second, individual vestibular nerve fibers, as impaled within vestibular nuclei, often responded repeatedly (twice or three times, or even more) to single vestibular nerve stimulation (fig. 5A through C). At threshold stimulation, the whole train of these spikes behaved in an all-or-none manner (A, B). Therefore, the late spikes in a fiber appear to be triggered by the initial spike in that fiber. Sometimes the

burst of repeated spikes, similar to that evoked by stimulation, occurred spontaneously at a frequency of about 20 per second (fig. 5D). Third, the fact that such repetitive discharges as seen in figure 5A through C take place in many vestibular nerve fibers is demonstrated in figure 5E through I where the refractoriness is tested for the P-wave of the field potentials which represent the volley in the vestibular nerve. As plotted in J, the refractory curve shows inflections approximately corresponding to the onset of late EPSP's. When the vestibular organ was destroyed, the refractory curve of the P-wave became simpler, indicating that many vestibular nerve fibers ceased to discharge repeatedly. The cause of this multiple firing in vestibular nerve fibers is not clear at the present time. It

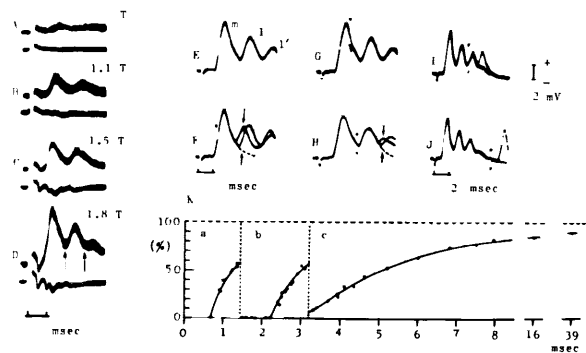

FIGURE 4.—*Multipeaked EPSP's built up in Deiters' neurons during stimulation of the vestibular nerve. A through D: Upper traces, intracellular recording from a Deiters' neuron. Lower traces, extracellular controls. Stimulus intensity is indicated in each record by the multiple of vestibular nerve excitation thresholds. Upward arrows in D point to the moments of late onset of depolarization. E through J: Double-shock vestibular nerve stimulation in another Deiters' neuron. E: Control obtained with conditioning stimuli with a supramaximal intensity for the monosynaptic EPSP. m, l, and l': Three peaks of EPSP's. In F through J, test stimuli of the same intensity as that of the conditioning ones were given at various intervals after conditioning at the moments indicated by dots. In each record, test stimuli were switched off in about half of the trials. In F and H, the descending phase of the m- and l-EPSP's is indicated by broken lines which were assumed to follow an exponential curve with time constant of 0.9 msec. Upward and downward arrows show how to measure the amplitudes of test EPSP's. In I and J, the test EPSP's were measured from the baseline provided by the conditioning stimuli alone. Time scale of msec (1.0) applies to E through H and that of 2 msec to I and J. K: Refractory curve for the test monosynaptic EPSP's. Ordinates: amplitude of the test EPSP relative to that of the m-EPSP which is indicated by horizontal broken line. Abscissae: time intervals between the conditioning and test stimuli. Vertical broken lines separate the phases a, b, c of the recovery curves of the test EPSP's, corresponding to the m, l, l' peaks of the conditioning EPSP's. (From ref. 18.)*

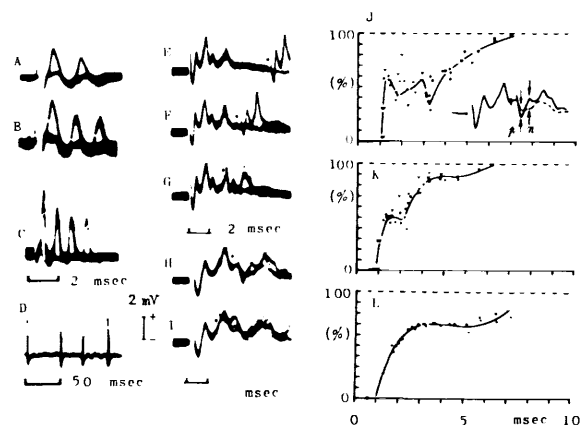

FIGURE 5.—*Multiple discharges in vestibular nerve fibers which occurred in response to single vestibular nerve stimulation. A through D: Partial intracellular recording from three vestibular nerve fibers (A, B, C, D) within the nucleus of Deiters. E through I: Extracellular recording from the nucleus of Deiters. Double-shock stimuli, each being supramaximal for P-wave, were given to the vestibular nerve at various intervals. The test stimuli were switched off in about half of the trials at the moments indicated by dots. J: Relates the amplitudes of the test P-wave in the records partly illustrated in E through I (ordinate) to the shock intervals (abscissa). Inset diagram in J indicates how to measure the size of the P-wave, which is the sum of the respective peak amplitudes of the positive (p) and negative (n) phases of P-wave as measured from the potential curves following the conditioning stimuli alone (broken line). K, L: Similar to J, but taken immediately after (K), and about 2 hours after (L), destruction of the vestibular organ. (From ref. 18.)*

can only be pointed out that this may be due to a kind of pseudoreflex at the peripheral end of nerve fibers which occurs in frog skin nerve under certain experimental conditions (ref. 26).

Polysynaptic Action of Vestibular Nerve Volleys

In some Deiters' neurons, the latency of the vestibular-evoked EPSP's exceeded 1 msec (fig. 6H). These EPSP's were usually of relatively small size even with maximal vestibular nerve stimulation (fig. 6A through C). The mean latency for these delayed EPSP's is 1.28 msec ($n=18$) and is longer by 0.52 msec than that of the monosynaptic EPSP's (0.76 msec; see above). The 0.52 msec is close to the 0.75-msec difference in latency between monosynaptic EPSP's and disynaptic IPSP's evoked by group Ia muscle afferents in spinal motoneurons (ref. 27). Therefore, it is assumed that the delayed EPSP's are produced disynaptically

through excitatory interneurons interposed between the vestibular nerve fibers and Deiters' neurons.

An alternate possibility that the delayed EPSP's are induced monosynaptically by impulses along relatively slow conducting fibers can be excluded for two reasons. First, the intensity range of the vestibular nerve stimulation effective for evoking the delayed EPSP's is quite similar to that for the monosynaptic EPSP's, indicating that both the monosynaptic and delayed EPSP's are evoked through the vestibular nerve fibers which have a similar excitability and hence presumably a similar conduction velocity. Second, delayed EPSP's were encountered widely within the nucleus of Deiters, even in its dorsal portion, as shown in figure 7Q (shaded), where no primary vestibular nerve fibers have appreciable synapses, according to histological observations (ref. 4). The delayed EPSP's, presumably of disynaptic origin, were seen also in some non-Deiters' neurons (fig. 6J).

The inhibitory postsynaptic potentials (IPSP's) were also sometimes observed either in isolation or in superposition upon the monosynaptic EPSP's (fig. 6D through G). The latency of these IPSP's falls within the range of from 1.2 to 1.8 msec, indicating that they have a polysynaptic (or at least a disynaptic) origin.

The neuronal connections between the vestibular nerve fibers and vestibular nucleus neurons are illustrated in the diagram at the bottom of figure 6. The cell V_2 receives monosynaptic EPSP's and in some cases also polysynaptic PSP's through interneurons V_e and V_i . They involve about one-third of Deiters' neurons and two-thirds of the non-Deiters' neurons examined. V_1 cells are activated only polysynaptically. They are common in the dorsal part of the nucleus of Deiters. V_3 cells, receiving inhibition only from the ipsilateral vestibular nerve, were found only in non-Deiters' nuclei. They may have other sources of excitatory input. The interneurons V_e and V_i should also be located in the vestibular nuclear complex, probably in the medial and/or descending nuclei where short-axoned cells of the interneuron type exist (ref. 1). Some cells impaled in these regions and

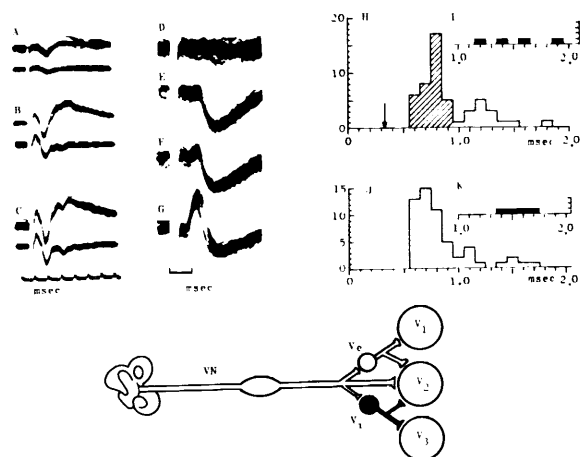

FIGURE 6.—Vestibular-evoked polysynaptic EPSP's. A through C: Intracellular recording from Deiters' neuron. D through G: From a DMLF cell. Intensity of vestibular nerve stimulation: 1.2T in A, 2.5T in B, 3.8T in C, 1.0T in D, 1.2T in E, 1.4T in F, and 1.8T in G. H: Frequency distribution of the latency for the vestibular-evoked EPSP's (abscissa) in Deiters' neurons. Downward arrow indicates latency of the P-wave. Shaded area represents the early group of EPSP's in the monosynaptic range. I: Similar to H but for IPSP's. J and K: Frequency distributions of vestibular-induced EPSP's and IPSP's, respectively, in non-Deiters' vestibular nucleus neurons. Bottom figure is a diagram of the synaptic connections from the vestibular nerve to vestibular nucleus neurons. Further explanation is in text. (From refs. 12 and 18.)

activated monosynaptically from the vestibular nerve might serve as interneurons as postulated here.

STUDY WITH CEREBELLAR STIMULATION

Inhibitory Action of Purkinje Cells

The inhibitory action of the cerebellar Purkinje cell was first noticed in the experiment where microelectrodes were inserted into dorsal Deiters' neurons. During stimulation of the anterior lobe of the cerebellum, IPSP's appeared with monosynaptic latencies (refs. 28 and 29) (fig. 7G through M). The monosynaptic inhibitory area for Deiters' neurons expanded longitudinally, mainly along the ipsilateral vermis cortex of the anterior lobe (ref. 30). The ipsilateral cortex of the posterior lobe was also effective in inhibiting Deiters' neurons, though less prominently than the anterior lobe. The inhibitory fibers could be stimulated in the white matter of the cerebellum, predominantly in the ipsilateral side at rostral regions of nuclei fastigii and interpositus. Further, the monosynaptic inhibition of the anterior and posterior lobes occurs chiefly in the dorsal portion of the nucleus of Deiters, as shown in figure 7N and O. These spatial patterns of distribution of the inhibitory fibers, in both the cerebellum and the nucleus of Deiters, conform to those of the Purkinje-cell axons of corticovestibular projection (refs. 5, 6, and 31). It is also demonstrated that transsynaptic activation of Purkinje cells through cerebellar afferent fibers produces IPSP's in Deiters' neurons with a delay of monosynaptic range (ref. 33).

Similar inhibitory action has been observed recently in the superior vestibular nucleus neurons (Ito, Fukuda, and Kaji, unpublished). In them, stimulation of the ipsilateral floccular lobe was very effective in producing monosynaptic IPSP's, in accordance with the flocculovestibular projection defined histologically (refs. 7 and 34).

The vestibular-evoked IPSP's show a fine gradation in their sizes, according to stimulus intensity (fig. 7A through M); there must be convergence of a number of Purkinje cell axons onto single vestibular nuclei cells. The

convergence number was calculated for Deiters' neurons as 20 to 50 (Ito et al., unpublished).

Histological data (refs. 5 to 7) indicate that Purkinje-cell axons from the cortex of the vermis project onto the dorsal part of the nucleus of Deiters as well as of the other non-Deiters' nuclei. The whole areas of the vestibular nuclei,

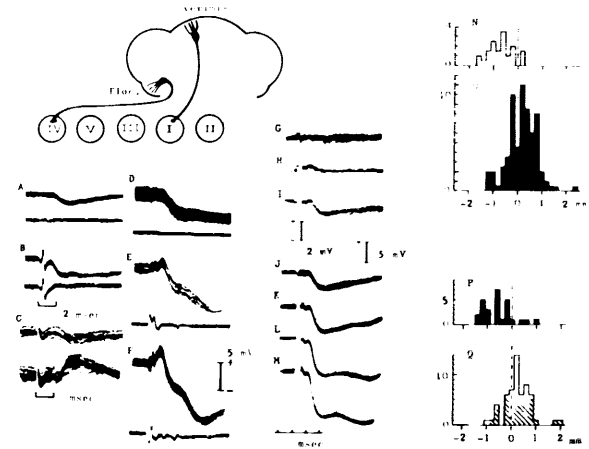

FIGURE 7.—Monosynaptic IPSP's induced in vestibular nucleus neurons during stimulation of the cerebellar cortex. Diagram at top shows the cerebellovestibular projections. A through F: Recorded from three superior vestibular nucleus neurons during stimulation of the floccular lobe. Upper traces: Intracellular records. Lower traces in A and B and D through F are extracellular controls, while those in C are intracellular but during passage of Cl⁻ injection hyperpolarizing currents. Intensity of floccular stimulation (0.2-msec duration) was 2 volts in A, 10 in B, 10 in C, 2 in D, 10 in E, and 20 in F. G through M: IPSP's induced in a Deiters' neuron during stimulation of vermis cortex of culmen. Stimulus intensity, 1.9 V in G, 2.1 in H, 3.2 in I, 5.0 in J, 10 in K, 20 in L, and 30 in M. Dotted lines in I and M indicate the time course of the potential changes similar to that in J. Note the different voltage scales for G through I (2 mV) and J through M (5 mV). N: Frequency distribution of the depths of penetration of those cells which did not receive monosynaptic inhibition from the cerebellar anterior lobe. O: Similar to N, but for those which received the inhibition. Zero on the abscissa and vertical broken line indicate the mean depth of all the Deiters' neurons in each preparation. Figures with minus sign represent ventral, and those with no sign dorsal deviations (from ref. 11). P, Q: Illustrating, similarly to N and O, the frequency distribution for those Deiters' neurons with (P) and without (Q) monosynaptic activation from the vestibular nerve. Shaded in Q are those cells activated only polysynaptically by the vestibular nerve volley. (From refs. 11 and 18.)

except for the nucleus of Deiters, are covered also by Purkinje-cell axons from the vestibulo-cerebellum (nodulus, flocculus, ventral uvula, and ventral paraflocculus). Peculiarly, the ventral part of the nucleus of Deiters receives little cerebellar corticofugal projection. Accordingly, monosynaptic IPSP's have not been evoked in ventral Deiters' neurons from any part of the cerebellum. Those Deiters' neurons receiving monosynaptic activation from the vestibular nerve showed no trace of the cerebellar inhibition except in a few cells in which both vestibular EPSP's and cerebellar IPSP's appeared monosynaptically (Ito et al., unpublished). Recent electron-microscopic study also indicates that some Deiters' neurons have synapses with both vestibular nerve and Purkinje-cell axons (Walberg, personal communication).

Dorsal Deiters' neurons may have direct connection with spinal motoneurons, though distinction between the dorsal and ventral Deiters is not clear in the experiment by Lund and Pompeiano (ref. 35). The superior vestibular nuclei neurons may connect with oculomotor neurons (ref. 1), but there is no direct physiological evidence. These possible three-neuron

chains from Purkinje cell to vestibular nuclei cell and then to motoneurons are illustrated in figure 8D and E.

With the cerebellar nuclei inserted, the connection from Purkinje cells to the final common motor path becomes multisteppered (fig. 8A through C). There is evidence indicating that the Purkinje cells exert solely inhibitory action upon cerebellar nuclei cells (ref. 36). To the contrary, the simplest arrangement has been found in oculomotor neurons of Japanese snake fish which Purkinje cells inhibit directly (fig. 8F) (ref. 37). Recently, Llinás et al. (ref. 38) found in the frog that the cerebellar Purkinje-cell axons pass out of the medulla and innervate the hair cells of the vestibular organ directly (fig. 8H). Here again the action of Purkinje cells seems to be inhibitory (ref. 39). It may also be mentioned that Purkinje cells inhibit basket and Golgi cells in the cerebellar cortex through their axon collaterals. There are no data available on the action of the Purkinje cells involved in the control of electric-organ discharges in electric fish (fig. 8G), but, since the electric plaque is a modification of musculature, it is highly possible that Purkinje cells have inhibitory action similar to that in the motor system.

Disinhibition

Electric stimulation of the cerebellar cortex usually produced a prolonged delayed depolarization lasting for 50 to 500 msec in dorsal Deiters' neurons (refs. 29 and 40). Evidence has been given to indicate that this slow depolarization is caused by depression of Purkinje cells which otherwise are firing spontaneously and so building up a steady hyperpolarization at the membrane of Deiters' neurons (ref. 40). This depression of Purkinje cells seems to be effected through the inhibitory neurons in the cerebellar cortex (basket, superficial stellate, and Golgi cells; ref. 41).

Disinhibitory slow depolarization in dorsal Deiters' neurons could also be produced by stimulating the spinocerebellar afferents at C2 level or in the inferior olive (ref. 40). In superior vestibular nucleus cells the stimulation of the vestibular nerve evoked similar disinhibition (Ito and Fukuda, unpublished).

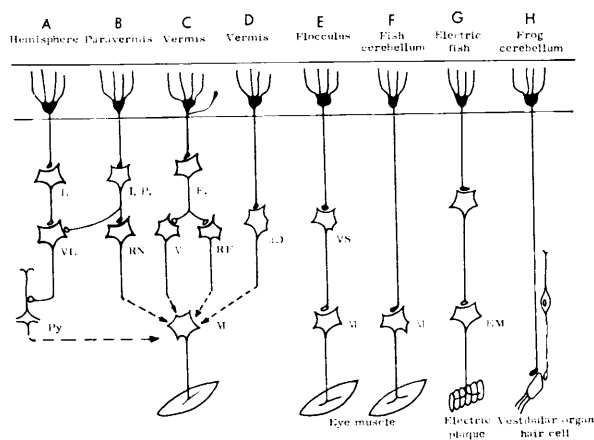

FIGURE 8.—Diagrammatic illustration of various types of cerebellar efferent connections. L: Lateral nucleus. I.P.: Interpositus nucleus. F: Fastigial nucleus. VL: Nucleus ventralis lateralis of thalamus. RN: Red nucleus. V: Vestibular nuclei in general. RF: Reticular formation. dD: Dorsal part of nucleus of Deiters. VS: Superior vestibular nucleus. Py: Pyramidal tract neurons. M: Motoneurons. EM: Electromotor neuron.

Disinhibition was seen also in cerebellar nuclei (Ito et al., unpublished). It appears to account, at least largely, for the facilitatory action produced by cerebellar stimulation upon muscle tone (refs. 42 and 43).

Axon Reflex

One of the most important aspects of the cerebellar organization in the cerebellar efferent system was revealed by the finding that the cerebellar stimulation evoked not only monosynaptic IPSP's in subcortical neurons but also monosynaptic EPSP's. In the superior vestibular nucleus cell of figure 7E and F such EPSP's as these are seen in superposition upon the IPSP's. It has already been suggested (ref. 11) that these

EPSP's are brought about through the cerebellar efferents which may have synapses with subcortical cells via their collaterals, as described previously by Lorente de N6 (ref. 44). Recently, sources have been identified for some of the excitatory fibers to vestibular nuclei (Ito, Kawai, Udo, and Mano, in preparation). One is the vestibular nerve fibers. In figure 9A stimulation of the floccular lobe evoked prominent EPSP's with monosynaptic latency in a ventral Deiters' neuron. In their time course and in their having a late peak superimposed, the floccular-induced EPSP's (A) greatly resemble those produced by vestibular nerve volleys (B). In fact, when evoked at short intervals, these EPSP's interacted with each other in the manner of impulse collision, as seen in figure 9C and plotted in F(O). It is obvious that the floccular stimulation evoked the EPSP's via the vestibular nerve fibers which, after synapsing with ventral Deiters' neurons, pass into the floccular nerve, as indicated histologically (ref. 45). In the cell of figure 9A through F, stimulation near the fastigial nucleus also produced EPSP's with monosynaptic latency (D), and these EPSP's again interacted with those from the vestibular nerve (E and F). Apparently the vestibular nerve fibers are giving off branches also to the juxtafastigial region, presumably innervating the nodules and ventral uvula (refs. 7 and 45).

The interference curves between the EPSP's from the flocculus (O) or juxtafastigial region (●) in figure 9F show a fall at 2- or 3-msec intervals. This indicates that the vestibular nerve fibers respond to floccular nerve or juxtafastigial stimulation with repetitive discharges, just as seen in vestibular nerve stimulation (see above). That the major portion of the vestibular nerve fibers is involved in this repetitive response is indicated in figure 9G through K where the P-wave evoked by the vestibular nerve stimulation is depressed by the floccular stimulation very effectively in the phase corresponding to the second fall in the interference curve of EPSP's (see I) (Ito, Fukuda, and Kaji, unpublished). Similar EPSP's of vestibular nerve origin were seen in the superior as well as descending vestibular nuclei cells.

Another type of excitatory fibers was found to

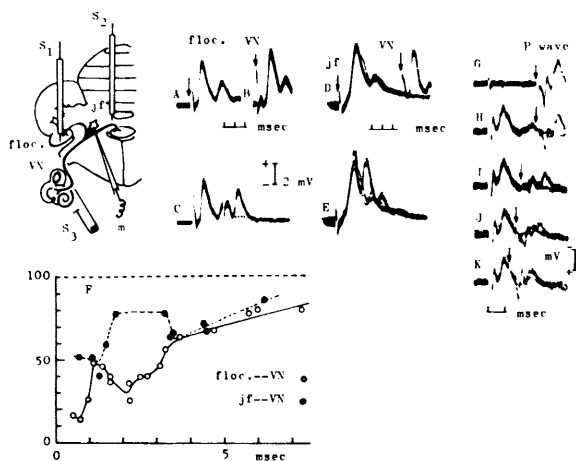

FIGURE 9.—Axon reflex from the floccular lobe to vestibular nucleus neurons through vestibular nerve fibers. Diagram on the left indicates the arrangement of recording (m) and stimulating (S₁, S₂, S₃) electrodes. jf: Juxtafastigial region. A through E: Intracellular recording from a ventral Deiters' neuron. A: EPSP from floccular lobe. B: EPSP from vestibular nerve. C: Combination of the floccular (conditioning) and vestibular nerve (test) stimuli. Dotted line indicates the time course under no test stimulation. D: Combination of jf. and VN stimuli, the latter being switched off in about half of the trials. E: Similar to D, but with a shorter stimulus interval. F: Ordinate plots the amplitudes of test VN-EPSP's relative to their control value as function of time intervals after conditioning at floc. or jf. Horizontal broken line indicates the 100-percent value. G through K: Extracellular recording within the descending vestibular nucleus. Conditioning stimuli were given to floccular lobe and test ones to the vestibular nerve at various intervals, the latter being switched off in about half the trials. Downward arrows indicate the moments of test stimulation.

be distributed widely within the anterior lobe of the cerebellum and to impinge onto both ventral and dorsal Deiters' neurons. By examining the occlusion due to impulse collision and refractoriness, the major source of these excitatory fibers was found to be in the dorsomedial portion of the lower medulla which involves the so-called perihypoglossal nuclei and also the dorsal part of paramedian reticular formation. Both the perihypoglossal nuclei and paramedian reticular formation project to the cerebellar anterior and posterior lobes bilaterally (refs. 46 to 48). It appears that the cerebellar afferents of these medullary origins have collateral innervation on Deiters' neurons.

Histologically, the dorsal spinocerebellar fibers are shown to synapse with Deiters' neurons (refs. 44 and 49). Actually, occlusion was seen between the EPSP's evoked from the cerebellar anterior lobe and those from C2 lateral funiculus (Ito et al., in preparation). The spinal ascending fibers appear to impinge only onto these Deiters' neurons located dorsocaudally (ref. 49).

The neuronal connections thus revealed are illustrated schematically in figure 10*A*, *B*, and *C* for dorsal Deiters', ventral Deiters', and superior vestibular neurons, respectively. Those connections via fastigial nucleus are omitted in

figure 10. It is known that fastigial axons have only excitatory action upon vestibular neurons and mediate the Purkinje-cell inhibition indirectly by withdrawal of the excitatory fastigial impulses (ref. 43). The cerebellofastigial influence may act upon dorsal Deiters' and superior vestibular neurons in parallel with the direct projection by Purkinje cells, while it is the only pathway for cerebellar control on ventral Deiters' neurons.

CEREBELLOVESTIBULAR INTERACTION

In figure 10 it will be realized that there are two different types of synaptic organizations concerned in cerebellovestibular interaction. Ventral Deiters' neurons (*B*) appear to form a reflex center driven by vestibular as well as medullary inputs, but there is no direct control from the cerebellar cortex. On the other hand, the excitatory signals to dorsal Deiters' neurons and superior vestibular nucleus cells are fed also into the cerebellar cortex and, after being processed there, are returned as inhibitory signals through Purkinje-cell axons that interact postsynaptically in vestibular nuclei cells with the original excitatory inputs (*A*, *C*). It seems that a certain region of the vestibular nuclei forms a reflex center by itself without direct interference from the relevant cerebellar cortex, as shown schematically in figure 11*B*. The cerebellum would be superimposed upon the other divisions of vestibular nuclei, as in *A*, which may be involved in relatively complex functions (see below).

The simplest reflex arc is the well-known two-neuron arc that serves as the followup length of servomechanism of muscles (ref. 13) (fig. 12*B*). A comparable two-neuron arc is composed of the vestibular nerve fibers and oculomotor neurons in Japanese snake fish (Kindokoro, personal communication) (fig. 12*A*). Histological data indicate that the vestibular nerve fibers innervate also the cerebellar cortex (ref. 50), and there is now evidence indicating that the cerebellar Purkinje cells pass down their axons directly onto oculomotor neurons (ref. 37). It appears that the cerebellar cortex is there superimposed on the two-neuron arc,

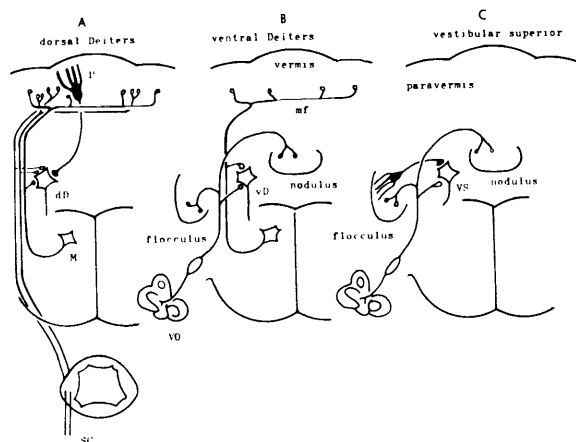

FIGURE 10.—Synaptic connections from the Purkinje-cell axons and cerebellar afferents to vestibular nuclei neurons. M: Medullary cell of origin of cerebellar afferents which have abundant synapses with Deiters' neurons. P: Purkinje cells. SC: Spinocerebellar fibers. VO: Vestibular organ. mf: Mossy fibers. VD: Ventral part of nucleus of Deiters.

corresponding to the fact that the system involves a complex control function, having the feedback loop completed from the eye to vestibular organ.

The three-neuron arc is formed with the vestibular nerve, ventral Deiters' neurons, and extensor motoneurons, particularly those for neck muscles (fig. 13B) (ref. 51). In this system the function may be relatively straightforward;

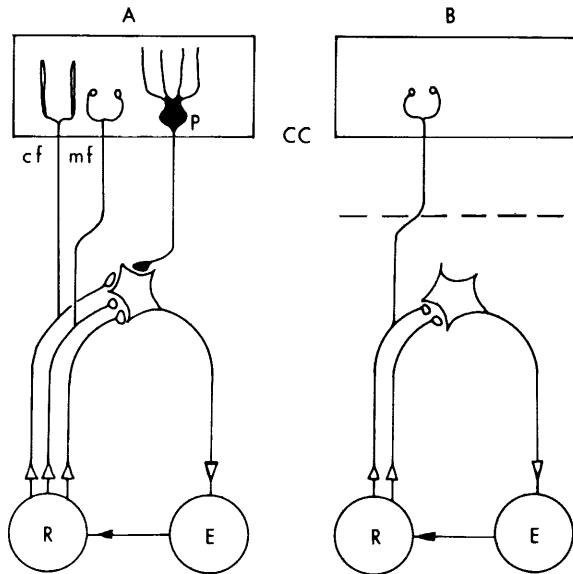

FIGURE 11.—Relation between the reflex center and the cerebellar cortex. cf: Climbing fiber. E: Effector part of the reflex system concerned. R: Its receptor part. CC: Cerebellar cortex. Explanation is in text.

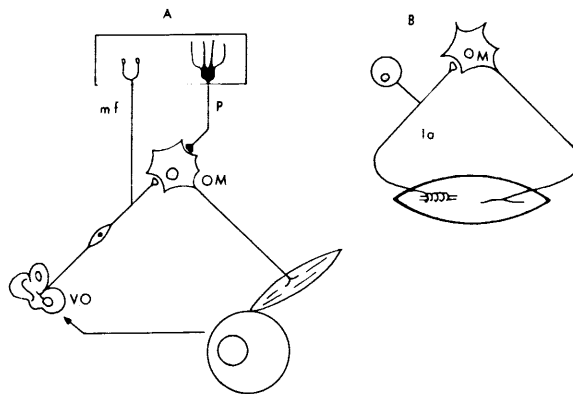

FIGURE 12.—Two-neuron arcs with (A) and without (B) cerebellar control. M: Motoneurons. OM: Oculomotor neuron. Ia: Group Ia muscle afferent. Explanation is in text.

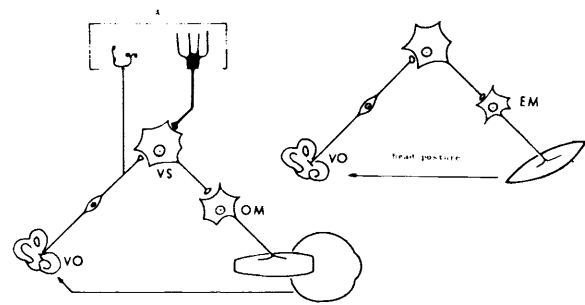

FIGURE 13.—Possible three-neuron arcs with (A) or without (B) cerebellar control. VS: Superior vestibular nucleus. EM: Extensor motoneuron. Explanation is in text.

neck muscles control the head position which is readily reflected in the activity of vestibular receptors. The superior vestibular nuclei cells, receiving the vestibular nerve, may innervate oculomotor neurons directly (ref. 1), though there is no direct evidence at the present time. With reservations because of this uncertainty, one may conceive a three-neuron arc on which the cerebellum is superimposed, corresponding to the complex task to be performed with this system. A general idea of this sort of origin and evolution of the cerebellum appeared in Herrick's article many years ago (ref. 52).

GENERAL CONSIDERATIONS ON THE ROLE OF THE CEREBELLAR CONTROL

On the basis of present knowledge of the cerebellovestibular system, one may consider a little further the role of the cerebellum in general.

Motoneurons in combination with certain receptors and a certain muscle or muscle group would form a simple control system with a negative feedback loop (fig. 14A). In an engineering control system, when the dynamic characteristics of the object to be controlled or of the feedback loop are relatively complex, a compensatory element ought to be inserted, usually in series with the object to be controlled. This element (for instance, a differentiator or an integrator) would improve the overall performance of the system. As illustrated schematically in figure 14B, certain supraspinal neurons, such as ventral

Deiters' neurons, may function in this way, at least to some extent. When the system has to carry out a more complex performance, a modern computer will be introduced instead of a relatively simple compensatory element. The cerebellum appears to be inserted in this way into certain motor control systems (fig. 14C). Examples are those which involve dorsal Deiters' and superior vestibular nuclei cells (figs. 10 and 13).

A piece of the cerebellar cortical sheath in combination with a brainstem motor center now appears to form a unit of the compensatory element in a very expanded sense (fig. 15A). Insertion of the cerebellar nuclei between the

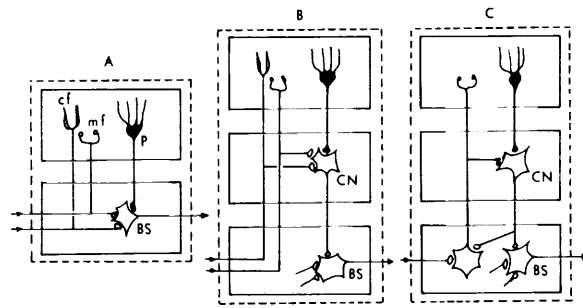

FIGURE 15.—Diagrammatic illustration of variation in cerebellar corticosubcortical connections. BS: Brainstem. CN: Cerebellar nuclei. Further explanation is in text.

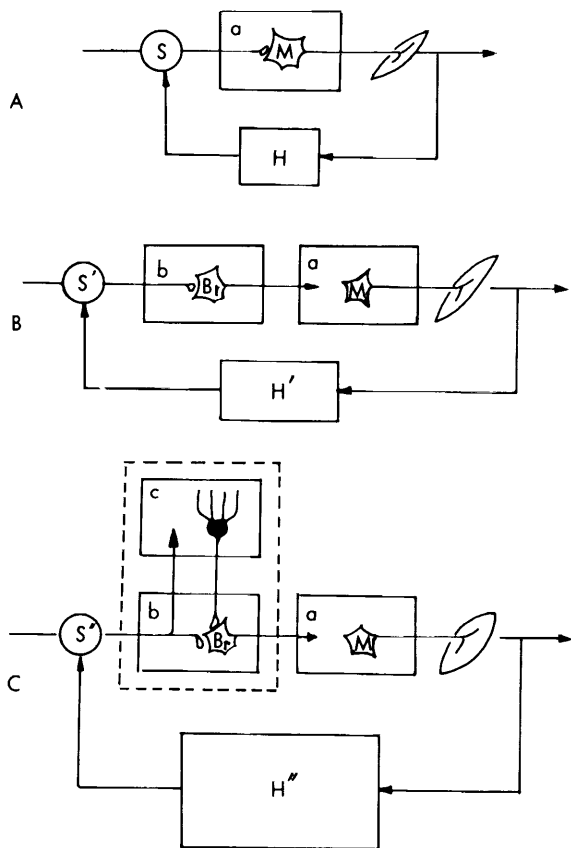

FIGURE 14.—Block diagrams illustrating the development of the motor control system. M: Motoneurons. S, S', S'': Sensory part of the system. H, H', H'': Feedback loop. B: Brainstem neuron. a: Motor nucleus as the object to be controlled. b: Brainstem center as a kind of compensator. c: Cerebellar cortex. Further explanation is in text.

cerebellar cortex and the brainstem may modify the ability of this unit in two respects. First, the integration of excitatory inputs with the inhibitory Purkinje-cell signals is performed at the cerebellar nuclei, allowing the brainstem centers to carry out more integration with other signals (fig. 15B). Second, a reverberating circuit may be formed between the cerebellar nucleus neurons and those originating in certain cerebellar afferents (fig. 15C). There is anatomical evidence to suggest a reverberating connection between the descending vestibular nucleus and fastigial nucleus (refs. 53 and 54), between the paramedian reticular formation and fastigial nucleus (refs. 1 and 48), and between the pontine nucleus and the intracerebellar lateral nucleus (ref. 55). These connections would favor the maintenance of a certain standard of activity in the cerebellum-brainstem system. Such activity as this would provide the bias around which the dynamic characteristics of the system may be optimum.

While the extrapyramidal centers in the brainstem, together with the phylogenetically older part of the cerebellum, are engaged in respective servo actions, the pyramidal system would carry out the voluntary movement. It would influence the extrapyramidal system by shifting equilibrium so as to fit its achievement (fig. 16). It is known that the fast-conducting pyramidal tract fibers have a disynaptic inhibitory and the slow-conducting ones a monosynaptic excitatory linkage with red nucleus neurons (fig. 16B) (ref. 56). The

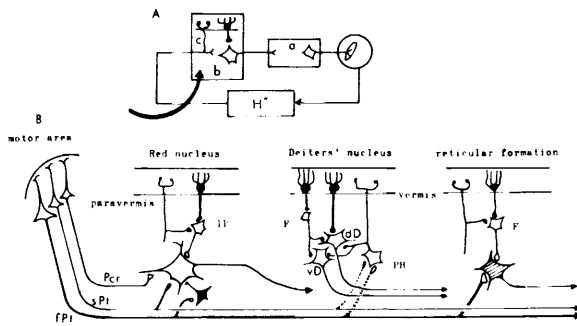

FIGURE 16.—The pathways through which pyramidal tract system influences the extrapyramidal one. A: Diagram similar to figure 14C. Thick curved arrow indicates the pyramidal tract signals. B: Connection from the cerebral motor cortex to brainstem centers. fPt: Fast-conducting pyramidal tract fibers. sPt: Slow-conducting pyramidal tract fibers. Per: Corticorubral projection fiber. IP: Interpositus nucleus. F: Fastigial nucleus. PH: Perihypoglossal nuclei. Possible connections from pyramidal tract fibers to PH are indicated by broken lines.

reticulospinal neurons, on the other hand, appear to receive monosynaptic excitation from fast-conducting pyramidal tract fibers (Mano, personal communication) (fig. 16B). There is no direct connection between the pyramidal tract fibers and Deiters' neurons (ref. 1). However, the perihypoglossal nuclei receive pyramidal tract fibers and so may mediate the cerebral influence onto Deiters' neurons (see above) (fig. 16B).

Besides modifying the extrapyramidal system, the pyramidal system appears to utilize the phylogenetically newer part of the cerebellum for its own achievement. In cats the pontine nucleus receives projection fibers from the cerebral sensorimotor area, a certain portion of which appears to be the collaterals of pyramidal tract fibers (ref. 57). The pontine nucleus neurons, in turn, project to the cerebellar cortex, chiefly to the hemisphere, having excitatory synapses with the lateral nucleus neurons (Ito et al., unpublished) and eventually terminating in the cerebellar cortex as mossy fibers. The lateral nucleus neurons, after receiving Purkinje-cell axons, project rostrally to the ventrolateral part of the thalamus which, in turn, innervates the fast-conducting pyramidal tract neurons monosynaptically (ref. 58). The functional significance of this loop has been discussed by Eccles (ref. 59). Here,

one might recall the way in which a feedback control system is converted into a feedforward one (ref. 60). This is done by replacing the original feedback loop with a side loop which involves in itself the "dummy" for the element skipped by this shortcut. In figure 17A, the original loop for a voluntary movement is closed through the external world. It is assumed that the voluntary action starts from the association cortex and is transferred through the motor cortex to lower motor centers. The effects would be checked through the sensory system and be fed back into the association area. An equivalent performance would be possible if the motor area is equipped with the cerebellar side loop in which all the elements in the control system except for the motor area are miniaturized, as diagrammatically illustrated in figure 17B. There the voluntary movement would be performed in the way programed in the cerebellum without referring to its actual end effect. This seems to be the case with learned, skilled movement.

Objection to the above view may arise from the fact that the neocerebellum receives signals not only from the motor cortex but also from other parts of the cerebral cortex through pontine nucleus and the lateral reticular nucleus as well as the inferior olive (refs. 61 to 63). The outputs from fastigial nucleus and rubrospinal tract fibers also enter the neocerebellum through the lateral reticular nucleus (ref. 61). Existence of these

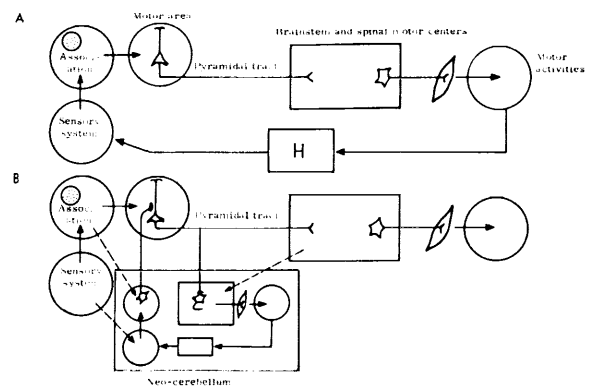

FIGURE 17.—Illustrating diagrammatically the possible control system activity involved in voluntary movements. Association: association cortex. Circles filled with dots indicate the origin of will. Further explanation is in text.

projections, however, may be understandable from the viewpoint of control theory as an arrangement required for a kind of adaptive control mechanism. To carry out a high-ordered function, the dynamic characteristics of the elements involved in a control system have to be examined on line to maintain adequate conditions. In a similar way, the miniaturized dummies in the

neocerebellum will always be modified by the signals coming in from the original elements (fig. 17*B*, indicated by broken lines and arrows). Of course, this may be nothing more than one of the many possible ways of thinking, but it seems to deserve consideration because the functional significance of the arrangement in the cerebellar control system still remains so obscure.

REFERENCES

1. BRODAL, A.; POMPEIANO, O.; AND WALBERG, F.: The Vestibular Nuclei and Their Connections. Anatomy and Functional Correlations (Ramsay Henderson Trust Lectures). Oliver & Boyd (Edinburgh, London), 1962.
2. BRODAL, A.: Anatomical Aspects on Functional Organization of the Vestibular Nuclei. Second Symposium on the Role of the Vestibular Organs in Space Exploration, NASA SP-115, 1966, pp. 119-139.
3. LORENTE DE NÓ, R.: Anatomy of the Eighth Nerve. The Central Projection of the Nerve Endings of the Internal Ear. Laryngoscope, vol. 43, 1933, pp. 1-38.
4. WALBERG, F.; BOWSER, D.; AND BRODAL, A.: The Termination of Primary Vestibular Fibers in the Vestibular Nuclei in the Cat. An Experimental Study with Silver Methods. J. Comp. Neurol., vol. 110, 1958, pp. 391-419.
5. WALBERG, F.; AND JANSEN, J.: Cerebellar Corticovestibular Fibers in the Cat. Exptl. Neurol., vol. 3, 1961, pp. 32-52.
6. WALBERG, F.; AND JANSEN, J.: Cerebellar Cortico-Nuclear Projection Studied Experimentally With Silver Impregnation Methods. J. Hirnforsch., vol. 6, 1964, pp. 338-354.
7. ANGAUT, P.; AND BRODAL, A.: The Projection of the "Vestibulocerebellum" Onto the Vestibular Nuclei in the Cat. Arch. Ital. Biol., vol. 105, 1967, pp. 441-479.
8. WALBERG, F.; POMPEIANO, O.; BRODAL, A.; AND JANSEN, J.: The Fastigiovestibular Projection in the Cat. An Experimental Study With Silver Impregnation Methods. J. Comp. Neurol., vol. 118, 1962, pp. 49-76.
9. ITO, M.; HONGO, T.; YOSHIDA, M.; OKADA, Y.; AND OBATA, K.: Antidromic and Trans-synaptic Activation of Deiters' Neurones Induced From the Spinal Cord. Jap. J. Physiol., vol. 14, 1964, pp. 638-658.
10. ANDERSSON, S.; AND GERNANDT, B. E.: Cortical Projection of Vestibular Nerve in Cat. Acta Oto-Laryngol., vol. 116, 1954, pp. 10-18.
11. ITO, M.; AND YOSHIDA, M.: The Origin of Cerebellar-Induced Inhibition of Deiters' Neurones. I. Monosynaptic Initiation of the Inhibitory Postsynaptic Potentials. Exptl. Brain Res., vol. 2, 1966, pp. 330-349.
12. KAWAI, N.; ITO, M.; AND NOZUE, M.: Postsynaptic Influences on the Vestibular Non-Deiters' Nuclei From the Primary Vestibular Nerve. Exptl. Brain Res., vol. 8, 1969, pp. 190-200.
13. ECCLES, J. C.: The Physiology of Synapses. Julius Springer (Berlin), 1964.
14. POMPEIANO, O.; AND BRODAL, A.: The Origin of Vestibulospinal Fibers in the Cat. An Experimental-Anatomical Study. With Comment on the Descending Medial Longitudinal Fasciculus. Arch. Ital. Biol., vol. 95, 1957, pp. 166-195.
15. WILSON, V. J.; KATO, M.; PETERSON, B. W.; AND WYLIE, R. M.: A Single-Unit Analysis of the Organization of Deiters' Nucleus. J. Neurophysiol., vol. 30, 1965, pp. 603-619.
16. NYBERG-HANSEN, R.: Origin and Termination of Fibers From the Vestibular Nuclei Descending in the Medial Longitudinal Fasciculus. An Experimental Study With Silver Impregnation Methods in the Cat. J. Comp. Neurol., vol. 122, 1964, pp. 355-367.
17. WILSON, V. J.; WYLIE, R. M.; AND MARCO, L. A.: Organization of the Medial Vestibular Nucleus. J. Neurophysiol., vol. 31, 1968, pp. 166-175.
18. ITO, M.; HONGO, T.; AND OKADA, Y.: Vestibular-Evoked Postsynaptic Potential in Deiters' Neurones. Exptl. Brain Res., vol. 7, 1969, pp. 214-230.
19. ITO, M.; KAWAI, N.; UDO, M.; AND SATO, N.: Cerebellar-Evoked Disinhibition in Dorsal Deiters' Neurones. Exptl. Brain Res., vol. 6, 1968, pp. 247-264.
20. PRECHT, W.; AND SHIMAZU, H.: Functional Connections of Tonic and Kinetic Vestibular Neurones With Primary Vestibular Afferents. J. Neurophysiol., vol. 28, 1965, pp. 1014-1028.
21. WILSON, V. J.; WYLIE, R. M.; AND MARCO, L. A.: Projection to the Spinal Cord From the Medial and Descending Vestibular Nuclei of the Cat. Nature, vol. 215, 1967, pp. 429-430.
22. ECCLES, R. M.; AND LUNDBERG, A.: Integrative Patterns of Ia Synaptic Action on Motoneurons of Hip and Knee Muscles. J. Physiol., vol. 144, 1958, pp. 271-298.
23. KUNO, M.: Quantal Components of Excitatory Synaptic Potentials in Spinal Motoneurons. J. Physiol., vol. 175, 1964, pp. 81-99.
24. BURKE, R. E.: Composite Nature of the Monosynaptic Excitatory Postsynaptic Potentials. J. Neurophysiol., vol. 30, 1967, pp. 1114-1137.
25. WILSON, V. J.; WYLIE, R. M.; AND MARCO, L. A.: Synap-

- tic Inputs to Cells in the Medial Vestibular Nucleus. *J. Neurophysiol.*, vol. 31, 1968, pp. 176-185.
26. SATO, M.: Pseudoreflex From End Plate and Sensory Nerve Ending. *J. Neurophysiol.*, vol. 16, 1953, pp. 101-115.
 27. ARAKI, T.; ECCLES, J. C.; AND ITO, M.: Correlation of the Inhibitory Postsynaptic Potential of Motoneurons With the Latency and Time Course of Inhibition of Monosynaptic Reflexes. *J. Physiol.*, vol. 154, 1960, pp. 354-377.
 28. ITO, M.; AND YOSHIDA, M.: The Cerebellar-Evoked Monosynaptic Inhibition of Deiters' Neurones. *Experientia*, vol. 20, 1964, p. 515.
 29. ITO, M.; AND KAWAI, N.: IPSP-Receptive Field in the Cerebellum for Deiters' Neurones. *Proc. Jap. Acad.*, vol. 40, 1964, pp. 762-764.
 30. ITO, M.; KAWAI, N.; AND UDO, M.: The Origin of Cerebellar-Induced Inhibition of Deiters' Neurones. III. Localization of the Inhibitory Zone. *Exptl. Brain Res.*, vol. 4, 1968, pp. 310-320.
 31. EAGER, R. P.: Efferent Cortico-Nuclear Pathways in the Cerebellum of the Cat. *J. Comp. Neurol.*, vol. 120, 1963, pp. 81-104.
 32. ITO, M.; OBATA, K.; AND OCHI, R.: Initiation of IPSP in Deiters' and Fastigial Neurones Associated With the Activity of Cerebellar Purkinje Cells. *Proc. Jap. Acad.*, vol. 40, 1964, pp. 765-768.
 33. ITO, M.; OBATA, K.; AND OCHI, R.: The Origin of Cerebellar-Induced Inhibition of Deiters' Neurones. II. Temporal Correlation Between the Trans-Synaptic Activation of Purkinje Cells and the Inhibition of Deiters' Neurones. *Exptl. Brain Res.*, vol. 2, 1966, pp. 350-364.
 34. DOW, R. S.: Efferent Connections of the Flocculo-Nodular Lobe in *Macaca mulata*. *J. Comp. Neurol.*, vol. 68, 1938, pp. 297-307.
 35. LUND, S.; AND POMPEIANO, O.: Descending Pathways With Monosynaptic Action on Motoneurons. *Experientia*, vol. 21, 1965, p. 602.
 36. ITO, M.; YOSHIDA, M.; AND OBATA, K.: Monosynaptic Inhibition of the Intracellular Nuclei Induced From the Cerebellar Cortex. *Experientia*, vol. 20, 1964, pp. 295-296.
 37. KIDOKORO, Y.: Direct Inhibitory Innervation to Teleost Oculomotor Neurones by Cerebellar Purkinje Cells. *Brain Res.*, vol. 10, 1968, pp. 453-456.
 38. LLINÁS, R.; PRECHT, W.; AND KITAI, S. T.: Cerebellar Purkinje Cell Projection to the Peripheral Vestibular Organ in the Frog. *Science*, vol. 158, 1967, pp. 1328-1330.
 39. LLINÁS, R.; PRECHT, W.; BRACHI, F.; AND HUERTAS, J.: The Inhibitory Cerebello-Vestibular System in the Frog. *Proc. Intern. Union Physiol. Sci.*, vol. 7, 1968, p. 269.
 40. ECCLES, J. C.; LLINÁS, R.; AND SASAKI, K.: The Mossy Fiber-Granule Cell Relay in the Cerebellum and Its Inhibition by Golgi Cells. *Exptl. Brain Res.*, vol. 1, 1966, pp. 82-101.
 41. ANDERSEN, P.; ECCLES, J. C.; LLINÁS, R.; AND VOORHOEVE, P. E.: Postsynaptic Inhibition of Cerebellar Purkinje Cells. *J. Neurophysiol.*, vol. 27, 1964, pp. 1138-1153.
 42. MORUZZI, G.: *Problems in Cerebellar Physiology*. Charles C Thomas, 1950.
 43. ECCLES, J. C.; ITO, M.; AND SZENTÁGOTHAJ, J.: *The Cerebellum as a Neuronal Machine*. Springer-Verlag, 1967.
 44. LORENTE DE NÓ, R.: Vestibulo-Ocular Reflex. *Arch. Neurol. Psychiat.*, vol. 30, 1933, pp. 245-291.
 45. BRODAL, A.; AND HØIVIK, B.: Site and Mode of Termination of Primary Vestibulocerebellar Fibers in the Cat. *Arch. Ital. Biol.*, vol. 102, 1964, pp. 1-21.
 46. BRODAL, A.: Experimental Demonstration of Cerebellar Connexions From the Peri-Hypoglossal Nuclei (Nucleus Intercalatus, Nucleus Praepositus Hypoglossi and Nucleus of Roller) in the Cat. *J. Anat.*, vol. 86, 1952, pp. 110-129.
 47. TORVIK, A.; AND BRODAL, A.: The Cerebellar Projection of the Perihypoglossal Nuclei (Nucleus Intercalatus, Nucleus Praepositus Hypoglossi and Nucleus of Roller) in the Cat. *J. Neuropath. Exptl. Neurol.*, vol. 13, 1954, pp. 515-527.
 48. BRODAL, A.; AND TORVIK, A.: Cerebellar Projection of Paramedian Reticular Nucleus of Medulla Oblongata in Cat. *J. Neurophysiol.*, vol. 17, 1954, pp. 483-495.
 49. POMPEIANO, O.; AND BRODAL, A.: Spino-Vestibular Fibers in the Cat. *An Experimental Study*. *J. Comp. Neurol.*, vol. 108, 1957, pp. 353-481.
 50. LARSELL, O.: *The Comparative Anatomy and Histology of the Cerebellum from Myxinoids Through Birds*. J. Jansen, ed., Univ. Minnesota Press, 1967.
 51. WILSON, V. J.; AND YOSHIDA, M.: Vestibulospinal and Reticulospinal Effects on Hindlimb, Forelimb, and Neck Alpha Motoneurons of the Cat. *Proc. Nat. Acad. Sci.*, vol. 60, 1968, pp. 836-840.
 52. HERRICK, C. P.: Origin and Evolution of the Cerebellum. *Arch. Neurol. Psychiat.*, vol. 11, 1924, pp. 621-652.
 53. BRODAL, A.; AND TORVIK, A.: Über den Ursprung der sekundären vestibulocerebellaren Fasern bei der Katze. Fine experimentell-anatomische Studie. *Arch. Psychiat. Nervenkr.*, vol. 195, 1957, pp. 550-567.
 54. WALBERG, F.; POMPEIANO, O.; BRODAL, A.; AND JANSEN, J.: The Fastigio-Vestibular Projection in the Cat. *An Experimental Study With Silver Impregnation Methods*. *J. Comp. Neurol.*, vol. 118, 1962, pp. 49-76.
 55. BRODAL, A.: *The Reticular Formation of the Brain Stem. Anatomical Aspects and Functional Correlation (Ramsey Henderson Trust Lectures)*. Oliver & Boyd (Edinburgh, London), 1957.
 56. TSUKAHARA, N.; FULLER, D. R. G.; AND BROOKS, V. B.: Influences From Pyramidal Collaterals on Cells of the Red Nucleus. *Proc. of XXIV Intern. Union Physiol. Sci.*, vol. 7, 1968, p. 441.
 57. BRODAL, P.: The Corticopontine Projection in the Cat. I. Demonstration of a Somatotopically Organized Projection From the Primary Sensorimotor Cortex. *Exptl. Brain Res.*, vol. 5, 1968, pp. 210-234.
 58. YOSHIDA, M.; YAJIMA, K.; AND UNO, M.: Different Activation of the Two Types of the Pyramidal Tract Neu-

- rones Through the Cerebello-Thalamocortical Pathway. *Experientia*, vol. 22, 1966, pp. 331-332.
59. ECCLES, J. C.: Circuit in the Cerebellar Control of Movement. *Proc. Nat. Acad. Sci.*, vol. 58, 1967, pp. 336-343.
60. FUJII, M.: *Control Engineering*. (In Japanese.) Iwanami (Tokyo), 1968.
61. BRODAL, P.; MARSALA, J.; AND BRODAL, A.: The Cerebral Cortical Projection to the Lateral Reticular Nucleus in the Cat, With Special Reference to the Sensorimotor Cortical Areas. *Brain Res.*, vol. 6, 1967, pp. 252-274.
62. WALBERG, F.: Descending Connections to the Inferior Olive. An Experimental Study in the Cat. *J. Comp. Neurol.*, vol. 104, 1956, pp. 77-173.
63. WALBERG, F.: Further Studies on the Descending Connections to the Inferior Olive; Reticulo-Olivary Fibers; An Experimental Study in the Cat. *J. Comp. Neurol.*, vol. 114, 1960, pp. 79-87.

DISCUSSION

Borison: One pathway which was not given much attention in your analysis is the one concerned in motion sickness. Do you think that Deiters' nucleus might be implicated in a cerebellovestibular pathway that has a feeder input to the reticular formation?

Ito: Actually, I cannot answer such a question because we are working on Nembutalized cats and never see motion sickness in them. However, my guess is perhaps that the cerebellovestibular system is involved in it.

Snider: I was particularly fascinated by your difficulty with handling the EPSP's which you picked up in Deiters' nucleus. I am curious to know how the explanation you gave negates the possibility that there might be Purkinje cells that are excitatory rather than inhibitory. I know this is of special interest to you and should be brought out.

Ito: Very strictly speaking, I have to say there is no evidence indicating that any Purkinje cells are excitatory.

When we see EPSP's in vestibular neurons during stimulation of the cerebral cortex, we can always show that these EPSP's are produced through axon collaterals, just using the impulse collision technique. This was so with the vestibular nerve, with the fibers originating from perihypoglossal nuclear regions and also with some spinocerebral fibers. Of course, it is necessary to do further experiments to exclude positively the possibility that you mentioned.

Nyberg-Hansen: Dr. Ito is quite correct concerning the contribution to the medial vestibulospinal tract from the descending nucleus. As I showed in my study, the lesions did not hit the rostral part of that nucleus. If they had, I would have destroyed vestibulospinal fibers from the lateral nucleus coursing through the rostral part of the descending nucleus. When you thus cannot demonstrate fibers with retrograde cellular changes, and you cannot do it with anterograde degeneration either, you have to do it physiologically, and you and Dr. Wilson have done it.

SESSION VII

Chairman: WOLFGANG A. PRECHT
Institute for Biomedical Research

Multisensory Influence Upon Single Units in the Vestibular Nucleus

JOHN M. FREDRICKSON
AND
DIETRICH SCHWARZ
University of Toronto

SUMMARY

Cells in the vestibular nucleus responsive to vestibular end-organ and joint stimulation have been studied by the method of single-unit analysis in the unanesthetized cat. Ninety-nine percent of the units responded to vestibular stimulation and 80 percent to joint movement. There were no responses to muscle pressure, or to optic or acoustic stimuli. The convergent pattern of the two effective sensory systems on single cells was usually summative. Cerebellectomy did not grossly alter the pattern of joint influence.

The vestibular cells responsive to joint movement function to detect the angular positions of joints, and through discharge patterns indicate the rate and direction of movement, as well as the steady position of joints.

The convergence of the two main position-sense receptors (joints and labyrinth) in the vestibular nucleus is discussed from the standpoint of its significance for rapid, reflex, postural adjustments and postural stability.

INTRODUCTION

Head-position information is provided by the vestibular labyrinth: The otolith organs signal the axis of rotation relative to gravity, whereas the axis of rotation relative to the head is monitored by the semicircular canals. To make rapid, reflex, postural adjustments, however, the central nervous system must receive position information concerning the relative position of the head upon the body. Logically, neck-position afferents must play an important role in informing the central nervous system where the body is in space relative to the head. In fact, it is known that severe disturbances of body equilibrium occur following ablation of C1, C2, and C3 dorsal roots in the cat (ref. 1) and monkeys (ref. 2). Other classic neurophysiological investigations (refs. 3 to 5) have demonstrated the need for integration of vestibular and deep somatosensory (proprioceptive) afferents in postural regulation;

however, the question remained as to where this positional information converged in the central nervous system to bring about the necessarily rapid, reflex, postural adjustments.

In this study, single units were sampled in the vestibular nucleus of cats in order to determine—

- (1) Whether convergence of deep somatosensory and vestibular input occurs, and if so, how frequently and in what way.
- (2) Whether acoustic or visual input has any influence.
- (3) Whether the pattern of responses is grossly altered following cerebellectomy.

METHOD

This single-unit study was carried out on 21 cats not under the influence of general anesthesia. These animals were immobilized during the experiment with gallamine triethiodide (Flaxedil). A long-acting local anesthetic was infiltrated into

incised and pressure-point areas. Two of these animals underwent cerebellectomy. (Further details as to methodology are available, ref. 6.)

Stimuli consisted of diffuse white light directed onto open eyes (both continuous illumination and intermittent illumination with light phases and dark phases of equal duration were used), hand-claps and whistles, galvanic stimulation (0.05 to 0.12 mA) delivered through round-window membrane electrodes, and, finally, somatosensory stimulation which included blowing on the fur, gently touching the skin, deep muscle pressure, and joint movement. The location of all of the neurons sampled with steel microelectrodes was verified histologically. One hundred and thirty-seven neurons were thoroughly analyzed; approximately 50 percent were located in the descending vestibular nucleus, 30 percent in the medial nucleus, and 20 percent in the lateral (Deiters') nucleus.

RESULTS

Some of the more pertinent details previously reported (ref. 6) for most of the units in this study will herein be summarized. New data, specifically concerning single-unit responses to joint movement, will be presented.

Optic and Acoustic Responses

There were no such responses, but it must be stressed that the analysis was visual. Thus a very subtle neuronal response, particularly if it had a very long latency, may have been missed.

Vestibular Responses

Ninety-nine percent of the neurons analyzed responded to labyrinthine polarization with short latencies. Approximately 10 percent of the units responded exclusively to ipsilateral stimulation, whereas 4 percent responded to contralateral stimulation alone. The most rapid responses ipsilaterally were monosynaptic, accounting for approximately 50 percent of the neurons analyzed with latencies of 0.5 to 0.7 msec. Fifteen percent of the units responding to contralateral labyrinthine polarization had latency values which were below 1.5 msec. A few of these units were analyzed on fast film and were found to respond between 0.7 and 0.9 msec. Thus it would appear that there is a small population of neurons in the vestibular nucleus served monosynaptically from the contralateral vestibular labyrinth.

Neuronal responses were broken down into direction-dependent and direction-independent types. The first term implies that the response changed with a reversal of the polarizing currents, whereas the second term implies a fixed response regardless of the direction of the polarizing current. The most common response, that is, activation with ipsilateral cathodic stimulation (fig. 1), is the same as that produced by stimulation of the lateral semicircular canal by ipsilateral rotational acceleration or hot calorization (refs. 7 to 9). This most common ipsilateral response occurred approximately 55 percent of the time. A more complete analysis of the responses to labyrinthine polarization has been reported (ref. 6).

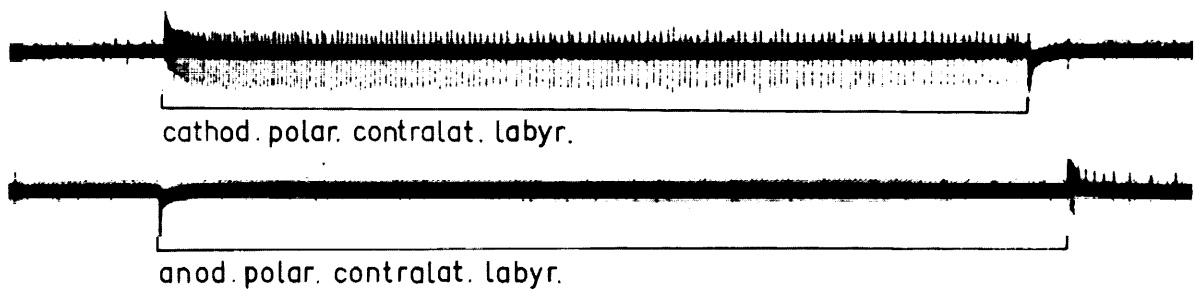

FIGURE 1.—Neuron located in the descending vestibular nucleus which responded monosynaptically to labyrinthine polarization. This particular response was preponderant and was termed "direction dependent" as there was a response reversal with a reversal of polarization.

Somatic Responses

Approximately 80 percent of the neurons analyzed responded to joint movement (proprioceptive or "deep" stimulation). Only three units responded to skin stimulation (exteroceptive or "superficial"). There were no responses to deep muscle pressure; this is in agreement with a previous study (ref. 10) demonstrating that there were no responsive Deiters' neurons upon electrically stimulating group Ia nerve fibers which arise exclusively from muscle spindles.

Exteroceptive responses, rarely noted in the vestibular nucleus, have a wider effect upon neurons in the reticular formation (refs. 11 to 14). The exteroceptive system, which is known to play an important role in skilled aimed movements, does not, from this study, appear to have much direct influence on rapid, reflex, postural adjustments.

The general distribution of responses from joints was 40 percent from the vertebral column alone, 40 percent from both vertebra and limbs, and 20 percent from the limbs alone. Approximately 45 percent of the total number of joint-responsive units responded to neck movement. Ipsilateral joint responses exceeded contralateral responses by 2 to 1, and proximal joint responses exceeded peripheral responses by almost 5 to 1. This preponderance of proximal joint influence upon the neurons was significant. It has been previously shown (ref. 15) that proximal joint-position sense is more acute than distal, both with respect to distance and rate-of-movement stimulus.

It appeared that all units affected by joint movement responded immediately, although exact latency times could not be measured. The great majority of the responses were excitatory in nature. A few neurons appeared to be inhibited by reciprocal joint movement. This was especially true for units influenced by neck movement. A more detailed analysis of joint responses is contained in a previous communication (ref. 6).

The maximum rate of neuronal discharge appeared to correspond with the maximum joint displacement; however, an exact evaluation of the joint angle versus neuronal discharge was not carried out. Thus, a further nine vestibular units, responsive to joints, have been studied more closely. The joints were moved by hand, but care was taken to move only the joint in question, which was generally the only activating source. Joint angles were measured with a standard orthopedic device.

None of these additional units were inhibited by the reciprocal joint movement which provoked activation. On this occasion, as well as noting that the neurons were activated maximally at an extreme range of joint movement, we also noted that successively smaller degrees of joint movement produced successively lower frequencies of discharge (fig. 2). Thus from a threshold position, if flexion was the activating joint movement, the neuron discharged at more rapid frequencies as the joint moved toward the maximal angle of flexion (fig. 3). It can be seen from figure 3 that, at each angle of excitation, there is a steady

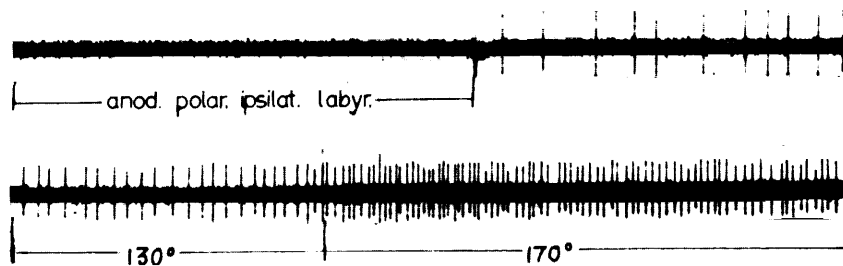

FIGURE 2.—Unit located in the lateral vestibular nucleus responsive to both vestibular and joint stimulation. The inhibition produced by ipsilateral anodic labyrinthine polarization is included in order that one may compare the "resting" activity following the vestibular stimulation with the discharge rate on the second line during extension of ipsilateral elbow. Unit activity at 130° of extension is less than that at 170°. Maximum joint extension resulted in the maximum discharge rate. Flexion did not influence the resting activity of the unit.

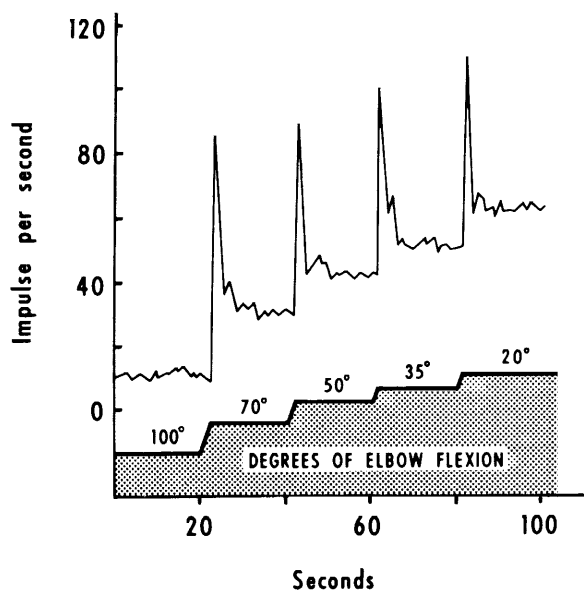

FIGURE 3.—Graphic illustration of the excitatory response pattern of a neuron located in the medial vestibular nucleus. Increasing angles of elbow flexion produced increasing levels of neuronal activity. Note the initially marked transient increase in discharge as the joint is moved to a new angle, followed by a steady discharge level peculiar to that angle.

state of discharge which appears to be specific to that angle. The angular range of joint movement producing activation was large, averaging approximately 100°. These characteristics have also been noted with joint-responsive neurons in the thalamus and cortex of the Rhesus monkey (refs. 16 and 17).

Convergence and Interaction

Approximately 80 percent of all the neurons responded to both labyrinthine and joint stimulation. Interaction was thoroughly investigated for approximately 40 units, and the results were almost invariably summative. On a few occasions a complex interaction was observed.

Cerebellectomy Preparations

Fourteen neurons were studied in two cerebellectomized animals. Eleven responded to both labyrinthine and joint stimulation, while three responded to labyrinthine stimulation alone. Thus, it appeared that the cerebellum did not, in any major way, alter the distribution of the effective stimuli.

DISCUSSION

Mechanism of Spinovestibular Influence

There is a great deal of evidence to support the view that somatic influence has a direct effect upon some units in the vestibular nucleus: (1) Spinovestibular fibers have been found to terminate directly in certain portions of the vestibular nucleus (refs. 18 and 19); (2) we found that large doses of barbiturates did not eliminate the effect of joint movements; and (3) cerebellectomy did not abolish or grossly alter the somatic influence upon vestibular units.

The possibility that some somatic impulses ascend via the reticular formation cannot be excluded; however, in a similarly constructed parallel study, Potthoff, Richter, and Burandt found far fewer neuronal responses to joint movement in the bulbar and pontine reticular formation (ref. 20). Other neurophysiological studies have also demonstrated very little in the way of joint responses in the reticular formation (refs. 11, 12, and 14).

Significance of Vestibular and Joint Interaction

These results, which have demonstrated an almost exclusive deep somatosensory influence upon vestibular neurons, correlates well with the known facts that reflex postural adjustment depends upon impulses from the vestibular labyrinth and deep sensory receptors. It is interesting that deep muscle pressure did not influence the single units recorded. Flaxedil does not appear to abolish muscle responses (H. D. Hentatsch, personal communication) and therefore cannot be implicated in explaining why muscle pressure was ineffective.

Certainly joint movement has been shown to be exquisitely sensitive as a postural indicator. Magnus and Storm van Leeuwen (ref. 1) produced a syndrome in cats somewhat resembling a bilateral labyrinthectomy by cutting the dorsal roots of C1, C2, and C3, and Cohen (ref. 2) noted an even more marked labyrinthine-like deficit in monkeys following section or local anesthetization of C1, C2, and C3 dorsal roots. McCouch, Deering, and Ling (ref. 21) demonstrated that the receptors for the tonic neck reflex appeared to be exclusively located within C1, C2, and C3 joints.

It would appear from this study that proximal limb and neck joints play an especially prominent role in supplying postural information to the vestibular nuclei. At this brainstem station, the information can be dealt with immediately, permitting essential, rapid, reflex, postural adjustments.

The receptor organs for joint movement impulses have been traced by dissection and appear to be located in the joint capsule and pericapsular connective tissue (ref. 16). The joint-position information noted in the vestibular nucleus must arrive via the spinovestibular tract (refs. 18 and 19).

The discharge patterns and frequencies of the units studied in the vestibular nucleus responding to joint movement provided information concerning the direction, rate of movement, and the steady position of the limbs. Mountcastle, Poggio, and Werner (ref. 17) made similar obser-

vations for single units in the ventrobasal nuclear complex of the Rhesus thalamus, and they have thoroughly discussed the possible significance. They also reviewed the variations in response patterns noted at stations other than the vestibular nuclei receiving position-sense information from the joints; that is, the first-order afferents, the thalamus, and the sensory cortex.

Position information from the joints and vestibular labyrinth appears to ascend together in the central nervous system. We have found (ref. 22) that the primary cortical vestibular receiving area in the Rhesus corresponds to that portion of the somatosensory cortex where Mountcastle noted such prominent joint input. Presumably, short-latency vestibular responses in the thalamus would also be located in the same areas as the joint input, that is, in the ventrobasal nuclear complex; however, this has not been proven.

REFERENCES

- MAGNUS, R.; AND STORM VAN LEEUWEN, W.: Die Akuten und die dauernden Folgen des Ausfalles der tonischen Hals und Labyrinthreflexe. *Plügers Arch. ges. Physiol.*, vol. 159, 1914, p. 157.
- COHEN, L. A.: Role of Eye and Neck Proprioceptive Mechanisms in Body Orientation and Motor Coordination. *J. Neurophysiol.*, vol. 24, 1961, pp. 1-11.
- MCNALLY, W. J.; AND TAIT, J.: Ablation Experiments on the Labyrinth of the Frog. *Am. J. Physiol.*, vol. 75, 1925, pp. 155-179.
- MAGNUS, R.: Körperstellung. Monographien aus dem Gesamtgebiet der Physiologie der Pflanzen und der Tiere. Julius Springer (Berlin), 1924.
- SHERRINGTON, C. S.: Decerebrate Rigidity and Reflex Co-ordination of Movements. *J. Physiol.*, vol. 22, 1898, p. 319.
- FREDRICKSON, J. M.; SCHWARZ, D.; AND KORNHUBER, H. H.: Convergence and Interaction of Vestibular and Deep Somatic Afferents Upon Neurons in Vestibular Nuclei of the Cat. *Acta Oto-Laryngol.*, vol. 61, 1966, pp. 168-188.
- DUENSING, F.; AND SCHAEFER, K.-P.: Die Aktivität einzelner Neurone im Bereich der Vestibulariskerne bei Horizontalbeschleunigungen unter besonderer Berücksichtigung des vestibulären Nystagmus. *Arch. Psychiat.*, vol. 198, 1958, pp. 225-252.
- ECKEL, W.: Elektrophysiologische und histologische Untersuchungen im Vestibulariskerngebiet bei Drehreizen. *Arch. Ohr., Nas., u. KehlkHeilk.*, vol. 164, 1954, pp. 487-513.
- GERNANDT, B. E.: Response of Mammalian Vestibular Neurons to Horizontal Rotation and Caloric Stimulation. *J. Neurophysiol.*, vol. 12, 1949, pp. 173-184.
- GIAQUINTO, S.; POMPEIANO, O.; AND SANTINI, M.: Risposte di Unità Deitersiane a Stimolazione Graduata di Nervi Cutanei e Muscolari in Animali Decerebrati a Cerevelletto Integro. *Boll. Soc. Ital. Biol. sper.*, vol. 39, 1963, pp. 524-527.
- BACH-Y-RITA, P.: Convergent and Long-Latency Unit Responses in the Reticular Formation of the Cat. *Exptl. Neurol.*, vol. 9, 1964, pp. 327-344.
- BELL, C.; SIERRA, G.; BUENDIA, N.; AND SEGUNDO, J. P.: Sensory Properties of Neurons in the Mesencephalic Reticular Formation. *J. Neurophysiol.*, vol. 27, 1964, pp. 961-987.
- POTTHOFF, P. C.; AND BURANDT, H. R.: Neuronale Antworten auf vestibuläre Reize im Tectum und pontomesencephalen Tagmentum der Katze und ihre Konvergenz mit optischen, akustischen und somatosensiblen Afferenzen. *Pflügers Arch. Ges. Physiol.*, vol. 281, 1964, p. 130.
- SCHEIBEL, M. E.; SCHEIBEL, A.; MOLLICA, A.; AND MORUZZI, G.: Convergence and Interaction of Afferent Impulses on Single Units of Reticular Formation. *J. Neurophysiol.*, vol. 18, 1955, pp. 309-311.
- GARDNER, E.: Physiology of Moveable Joints. *Physiol. Rev.*, vol. 30, 1950, pp. 127-176.
- MOUNTCASTLE, V. B.; AND POWELL, T. P. S.: Central Nervous Mechanisms Subserving Position Sense and Kinethesis. *Bull. Johns Hopkins Hospital*, vol. 105, 1959, pp. 173-200.
- MOUNTCASTLE, V. B.; POGGIO, G. F.; AND WERNER, G.:

- The Relation of Thalamic Cell Response to Peripheral Stimuli Varied Over an Intensive Continuum. *J. Neurophysiol.*, vol. 26, 1963, pp. 807-834.
18. MEHLER, W. R.; FEFERMAN, M. E.; AND NAUTA, W. J. H.: Ascending Axon Degeneration Following Anterolateral Chordotomy: An Experimental Study in the Monkey. *Brain*, vol. 83, 1960, pp. 718-750.
 19. POMPEIANO, O.; AND BRODAL, A.: Spino-vestibular Fibers in the Cat: An Experimental Study. *J. Comp. Neurol.*, vol. 108, 1957, pp. 353-382.
 20. POTTHOFF, P. C.; RICHTER, H. P.; AND BURANDT, H. R.: Multisensorische Konvergenzen an Hirnstammneuronen der Katze. *Arch. Psychiat. Nervenkr.*, vol. 210, 1967, p. 36.
 21. MCCOUCH, G. P.; DEERING, I. D.; AND LING, T. H.: Location of Receptors for Tonic Neck Reflexes. *J. Neurophysiol.*, vol. 14, 1951, pp. 190-195.
 22. FREDRICKSON, J. M.; FIGGE, U.; SCHEID, P.; AND KORNHUBER, H. H.: Vestibular Nerve Projection to the Cerebral Cortex of the Rhesus Monkey. *Exptl. Brain Res.*, vol. 2, 1966, pp. 318-327.

DISCUSSION

Precht: I think it has become clear by now that the vestibular nuclei and the neurons in this nucleus are by no means simple relay cells that lead to some reflex action, but rather very complicated centers for integration of various inputs.

Torok: I want to confirm a statement that Dr. Fredrickson made about whiplash injury and subsequent postural vertigo and nystagmus. We have seen recently several patients with a diagnosis of "whiplash injury." Dizziness was the complaint. The cochlear and vestibular sensitivity appeared to be normal and fully symmetrical. Upon postural stimulation, however, in certain head positions, short vertigo and nystagmus was repeatedly observed. Contrary to the more typical benign paroxysmal postural vertigo syndrome, the elicited postural dizziness and nystagmus showed no fatigue at all.

Precht: Did I understand you correctly that pressure on the muscle, even on the neck muscles, did not have any influence on the discharge frequency of vestibular neurons? Changes in frequency of firing did occur on passive head movements?

Fredrickson: That is right. We actually had to move the joint. This surprised us a great deal initially; therefore, we took great pains to stabilize the joint which was actually producing the effect, and then to retest the effect of deep muscle pressure. It was very clear that deep muscle pressure did not seem to have any effect. We wondered whether the Flaxedil was playing some role in preventing muscle influence,

but from the literature there is no evidence to suggest Flaxedil inhibits muscle spindle activity.

Waite: How many degrees of deviation in the cervical joints do you think you stimulated with, approximately?

Fredrickson: I would say approximately 60° was maximum.

Waite: Would you care to comment on the effect of 1° or 2°, or perhaps less than 1° of deviation?

Fredrickson: Yes; small degrees of deviation would also cause the effect. We did not closely study the effect of degrees of neck deviation versus neuronal activity. We did for a few of the limb joint neurons as it was much easier to more exactly ascertain the limb joint angle, but certainly small degrees of movement of the neck did cause activation.

Lowenstein: Presumably the whole of the vestibular nerve was polarized?

Fredrickson: Perhaps; however, the stimulating current was very small. In all likelihood we surely stimulated more than one portion of the vestibular end organ.

Lowenstein: I think you had 30 percent conforming to the picture I described. You must not forget that I polarized through the recording electrode directly at the ampullary sense ending; therefore, I am not surprised at the percentage. I think you were rather lucky to get consistent results.

Fredrickson: Yes; only 30 percent responded that way. There were several combinations of responses to polarization, so our results were really quite mixed.

Interaction Between Vestibular and Nonvestibular Sensory Inputs¹

OTTAVIO POMPEIANO

University of Pisa, Italy

SUMMARY

During the deep phase of sleep the activity of the second-order vestibular neurons increases phasically due to extralabyrinthine inputs to the vestibular nuclei. This activity leads to sudden contractions of somatic and extrinsic eye muscles (rapid eye movements, or REM sleep). Experiments have been performed to find out whether the increase in the vestibular discharge is also able to effect transmission of somatosensory volleys through the ascending lemniscal pathway.

The orthodromic lemniscal response recorded from the contralateral medial lemniscus on single-shock stimulation of the forelimb nerves is phasically depressed during the bursts of REM. This effect is still present after interruption of the spinocervical (Morin's) pathway, thus indicating that somatic afferent transmission through the cuneate nucleus is phasically depressed at this time.

The synaptic mechanisms responsible for this effect have been investigated. In particular, the antidromic group II cutaneous and group I muscular volleys led, respectively, from the superficial and the deep radial nerves on single-shock stimulation of the cuneate nucleus are phasically enhanced during the bursts of REM. This increased excitability of the central endings of the cuneate tract fibers is taken to indicate presynaptic depolarization of the terminals of the primary afferents within the cuneate nucleus, thus leading to presynaptic inhibition of synaptic transmission through the cuneate nucleus.

The excitability of the cuneate neurons has also been tested during sleep. It is shown that the direct excitability of the cuneothalamic relay neurons is depressed during REM, an effect which is attributed to postsynaptic inhibition of the cuneate neurons. This postsynaptic event, together with the presynaptic mechanism, contributes to the phasic depression of transmission of somatic afferent volleys through the cuneate nucleus at the time of the REM.

Lesion experiments indicate that the increase in the vestibular activity occurring during REM is able to block the transmission of somatic afferent volleys within the dorsal-column nuclei through the roundabout way of the sensory-motor cortex.

Contrary to the depressed transmission of somatic afferent volleys at dorsal-column level, the transmission of somatic volleys through the nucleus ventralis posterolateralis (VPL) is greatly facilitated during REM due to an increased postsynaptic responsiveness of the thalamic neurons.

It is postulated that some part of the efferent vestibular activity giving rise to contractions of the limb musculature during REM is fed into the somatic sensory system, particularly the VPL nucleus, where it interacts with the incoming somatic information filtered at dorsal-column level. The reduced amplitude of the orthodromic volley due to active inhibitory events within the cuneate nucleus has thus to be weighted against an increased excitability of the thalamocortical neurons. Further experiments are required to find out whether the vestibular control of somatic afferent transmission described during the deep phase of sleep is also operative during the motor activities produced by natural labyrinthine stimulations in the awake animal.

¹ This study was supported by PHS research grant NB 05695-03 from the National Institute of Neurological Diseases and Blindness, Public Health Service.

INTRODUCTION

It is well known that physiological sleep of mammals consists of a synchronized phase, or light sleep, characterized by large-amplitude slow waves in the electroencephalogram (EEG), frequently grouped in spindles (ref. 1); a desynchronized phase, or deep sleep, characterized by low-voltage, fast cortical waves (refs. 2 and 3); and by complete abolition of the postural muscle activity (refs. 4 and 5). One of the typical features of this desynchronized phase of sleep is the sudden appearance from time to time of bursts of rapid eye movements, REM (refs. 2 to 7), often associated with a typical motor pattern, characterized by the occurrence of quick muscular contractions (ref. 8). This phase of sleep is present in man also, where a striking relation has been found between eye movements and dream activity (refs. 3, 6, 7, 9, and 10).

In the attempt to investigate the central mechanisms responsible for the hypnic discharges of the oculomotor and spinal motoneurons, the observation was made that during this phase of sleep, the vestibular activity increases phasically (refs. 11 to 14). While during wakefulness the activity of the second-order vestibular neurons largely depends upon the discharge of different types of labyrinthine receptors, during desynchronized sleep the increase in the activity of the vestibular neurons, particularly those localized in the medial and descending vestibular nuclei, depends upon internal extralabyrinthine volleys. There is evidence that pontine structures, which are rhythmically active during desynchronized sleep (refs. 4 and 5), are at the origin of the outbursts of vestibular discharge (ref. 15). While most of the electrophysiological investigations so far performed on the vestibular system utilized anesthetized or decerebrate preparations, we have given thought to the possibility of using the REM periods of desynchronized sleep as a tool to study central vestibular mechanisms in unrestrained, unanesthetized animals with the whole brain intact.

It will be shown here that the vestibular discharge typical of the desynchronized phase of sleep is able to excite not only the oculomotor but also the spinal motoneurons (refs. 16 to 19). Muscle contractions which affect the somatic

musculature during the bursts of REM are actually associated with pyramidal discharges (refs. 20 to 22) which are triggered by ascending vestibular volleys (refs. 23 and 24).

After the demonstration that the motor pattern typical of the REM phase of sleep depends upon the activity of the vestibular nuclei, we decided also to study how sensory communication to the brain is processed during motor activities induced under strictly physiological conditions by vestibular volleys. The main result of these investigations is that during the REM phase of sleep, the centrally induced vestibular discharge is able to effect the transmission of sensory volleys at different relay stations of several sensory pathways (refs. 16 to 19).

Paradigmatic in this connection is the series of events which affects the ascending transmission of somatic sensory volleys through the dorsal-column medial lemniscal pathway. The result is that just at the time of the REM bursts, i.e., when the vestibular activity increases thus leading to motoneuronal excitation, the orthodromic transmission of somatosensory volleys along the lemniscal pathway is partially blocked by active inhibitory processes which operate at the level of the dorsal-column nuclei through both mechanisms of presynaptic and postsynaptic inhibition (refs. 25 to 32). On the contrary, a facilitation of the sensory-evoked responses occurs at the level of the specific thalamic nuclei (ref. 33).

RESULTS

Vestibular Influences on the Oculomotor Nuclei During REM

Experiments were performed in order to localize the structures responsible for REM. We have concentrated our attention on the vestibular complex, because the second-order vestibular neurons project directly or indirectly to the oculomotor nuclei, thus controlling their activity (ref. 34). It was then assumed that the vestibular nuclei which control eye movements were involved during the outbursts of REM of desynchronized sleep. A microelectrode analysis of the spontaneous activity of the vestibular nuclei

performed in the unrestrained, unanesthetized cat during natural sleep and wakefulness has shown that most of the neurons localized in the medial and descending vestibular nuclei, but not in the superior and lateral vestibular nuclei, increase their activity during desynchronized sleep (refs. 11 to 13). In particular, the pattern of discharge consists of bursts of rapid firing (80 to 160 spikes per second) which are invariably associated with the ocular movements typical of this phase of sleep.

The increased activity of the units localized in the medial and descending vestibular nuclei indicates that these structures are in some way related to REM occurring during desynchronized sleep. The crucial proof was provided by the lesion of vestibular nuclei (refs. 35 to 37). The most impressive finding of these experiments is the demonstration that after well-defined vestibular lesions, the episodes of desynchronized sleep are still characterized by typical

low-voltage, fast activity in the EEG and by complete electrical silence of the cervical antigravity muscles. However, the bursts of REM are completely abolished (fig. 1). The abolition of the typical bursts of REM lasted throughout the survival of the animal; i.e., up to 36 days after the lesion. Histologic control indicated that a complete and persistent abolition of REM occurs only when the lesion affects completely the medial and descending vestibular nuclei on both sides in their entire rostrocaudal extent. Bilateral and symmetrical lesions of either the superior or the lateral vestibular (Deiters') nucleus do not prevent the appearance of the bursts of REM.

The abolition of REM is due neither to interruption of primary vestibular fibers nor to lesion of cerebellofugal fibers which cross the area of the vestibular regions before reaching the brainstem (refs. 38 and 39). A regular occurrence of REM could still be observed after bilateral chronic

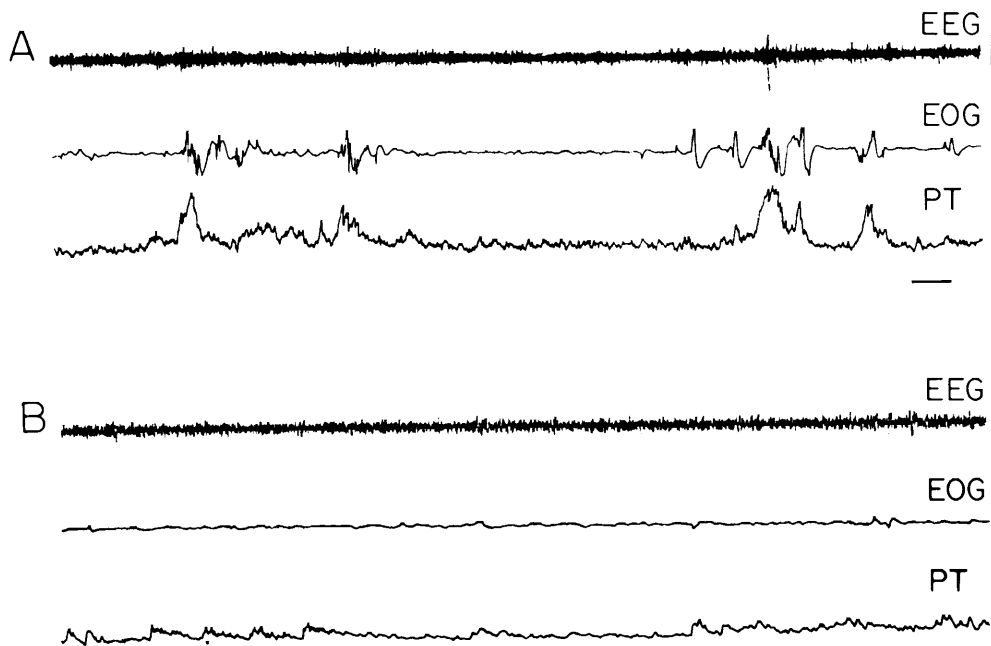

FIGURE 1.—Integrated pyramidal discharge during desynchronized sleep in the normal preparation or after bilateral destruction of the vestibular nuclei. A: Experiment made 4 days after the operation. Note the large phasic enhancements in the pyramidal activity during the REM periods of desynchronized sleep. B: Experiment made 2 days after chronic implantation of the electrodes and complete bilateral destruction of the medial and descending vestibular nuclei. Note the absence of the large bursts of REM and related phasic enhancements of pyramidal discharge. Desynchronized phases of sleep recorded from unrestrained, unanesthetized cats. Bipolar records. EEG: Electronencephalogram. EOG: Electro-oculogram. PT: Integrated activity of the pyramidal tract. Voltage calibrations: 0.2 mV (EEG) and 0.5 mV (EOG). Time calibration: 5 sec. (From ref. 24.)

section of the vestibular nerves or complete cerebellectomy (refs. 35 to 37). The conclusion is drawn that the medial and descending vestibular nuclei represent a necessary link in the causal chain of events leading to the activation of the oculomotor nuclei which is responsible for the REM outbursts.

Vestibular Influences on Spinal Motoneurons During REM

A typical phenomenon that occurs during desynchronized sleep is represented by the rapid muscle contractions which appear at the time of REM (ref. 8). The pattern and the organization of these muscular contractions have been studied in unrestrained cats by recording simultaneously the activity from flexor and extensor muscles of proximal and distal parts of both hindlimbs and from the posterior neck muscles (ref. 8). Muscular contractions have been found in all hindlimb muscles tested. They are generally more prominent in flexor than extensor muscles, and are more frequent in distal muscles than in proximal ones. The fact that section of the dorsal roots does not influence the frequency nor the pattern of the muscular contractions indicates that these are basically due to phasic excitatory influences acting directly upon the α -motoneurons. We are not going to describe here in detail the pathways responsible for the muscular twitches. Suffice it to say that the vestibular volleys may reach the spinal motoneurons, not only through pathways coursing along the ventral funiculus, where the descending efferent projections from the vestibular nuclei are located, but also particularly through pathways coursing along the dorsolateral funiculus. One of the main descending tracts located in this region is the corticospinal tract.

Evarts (refs. 40 to 42) was the first to record the discharge of single pyramidal-tract neurons in precentral gyri of unanesthetized monkeys during natural sleep and wakefulness. A similarity was found between wakefulness and desynchronized sleep with respect to the average unit activity in pyramidal-tract neurons. Striking differences, however, were found in the temporal patterns of discharge during the two experimental conditions. While relaxed wakefulness was associated with a regular discharge, bursts of

activity alternating with periods of silence appeared during synchronized sleep (ref. 43), which became much more intense and were separated by long intervals of complete inactivity during the desynchronized phase. The same result was also obtained by recording the pyramidal discharge from single fibers originating from the postcentral gyrus (refs. 44 and 45).

Further experiments devoted to an analysis of the integrated activity of the pyramidal discharge during desynchronized sleep have shown that the striking increase in the activity of the pyramidal tract originating from the precentral motor cortex is related in time to the outbursts of REM (refs. 20 to 22, 44, and 45). The muscular contractions, therefore, appear to be associated not only with the REM, as stated above, but also with outbursts of pyramidal discharges.

After the demonstration that the medial and descending vestibular nuclei are responsible for the oculomotor activity during the REM bursts, an attempt was made to find out (1) whether the increase in the pyramidal discharge related in time with the REM depends upon the integrity of the vestibular nuclei, and (2) whether the destruction of these nuclei also prevents the appearance of the muscular twitches (refs. 23 and 24).

The bilateral destruction of the vestibular nuclei did not abolish the modulation of the integrated pyramidal discharge during synchronized sleep. Only the phasic increase of the integrated pyramidal activity related in time with the large bursts of REM depends upon ascending vestibular volleys, since they disappeared following a bilateral destruction of the vestibular nuclei (fig. 1). It is of interest that even the large muscular contractions which occurred synchronously with the REM were abolished by the vestibular lesions (refs. 23 and 24).

Summing up, a complete, bilateral lesion of the medial and descending vestibular nuclei abolishes the typical bursts of REM. In this experimental condition the episodes of desynchronized sleep are simply characterized by the typical low-voltage, fast activity in the EEG and by complete abolition of the neck muscular activity. The integrity of the medial and descending vestibular nuclei is necessary not only

for the occurrence of the bursts of REM during desynchronized sleep, but also for the appearance of the phasic increases in the pyramidal discharge and the related muscular contractions.

Transmission of Sensory Volleys Through the Cuneate Nucleus During REM

A preliminary study was concerned with the modulation during sleep of synaptic transmission at the level of the dorsal column nuclei in the lemniscal system (refs. 25 and 30). Previous experiments had shown that the orthodromic lemniscal response elicited by cutaneous afferent volleys is not affected by sleep (refs. 46 and 47). In particular, neither the amplitude (refs. 46 and 47) nor the latency of this response (refs. 48 and 49) appeared to be modified during desynchronized sleep as compared with the synchronized phase. However, the electro-oculogram was not recorded in these experiments; the phasic effects that could be related in time with the REM were possibly missed.

Our experiments were performed in unrestrained, unanesthetized cats (refs. 25 and 30). The electroencephalogram (EEG), the electromyogram (EMG) of the posterior cervical muscles, and the electro-oculogram (EOG) were recorded through chronically implanted electrodes as described in a previous paper (ref. 50). To stimulate the left superficial or deep radial nerve, a bipolar collar-type electrode was applied to the nerve at the level of the elbow, while the lemniscal response was recorded from the contralateral side through a pair of stainless-steel electrodes (100 microns) completely insulated except at the tip (interelectrode distance less than 0.5 mm). All the electrode leads were then soldered on tube sockets held tightly on the skull by dental cement. The experiments started 36 to 48 hours after the end of the operation, when the effects of the anesthesia had worn off.

Depression of Orthodromic Lemniscal Response

Single-shock stimulation of the superficial radial nerve with rectangular pulses 0.05 msec in duration produces a large action potential in this preparation, which can be recorded from the contralateral medial lemniscus. It appears at a latency of about 3.7 msec (range 3.5 to 4.0 msec)

and increases with increasing stimulus strengths until it reaches a maximum amplitude for stimulus intensities corresponding to about 2.2 to 2.5 times the threshold (T) for the response. Observations in which the orthodromic lemniscal response was recorded simultaneously with the antidromic volley led from a branch of the superficial radial nerve, distally to the stimulating electrode, clearly showed that the threshold for the orthodromic lemniscal response corresponded to about 1.05 times the threshold for the antidromic group II volley (ref. 51). Since, with our recording technique, there was no further growth in both amplitude and duration of the lemniscal potential for intensities above 2.2 to 2.5 T , it is apparent that the orthodromic lemniscal response was exclusively a result of stimulation of group II cutaneous afferents. Excitation of group III cutaneous afferents generally occurs at stimulus strengths above 3.5 to 4.0 T times the threshold for group II cutaneous afferents.

At the beginning of the experiment the animal soon became accustomed to the volleys elicited by single-shock stimulation of group II afferent fibers of the superficial radial nerve. No EEG arousal was observed when the stimulation was carried out at the repetition rate of one every 1.6 to 2.0 seconds on a background of cortical synchronization. This can be easily understood since no collaterals are given off by the axons of the cuneothalamic relay neurons to the reticular formation (refs. 52 to 58). During transition from quiet-waking to synchronized sleep, there was no significant change in the amplitude of either the early or the late component of the orthodromic lemniscal response. Nor was any significant difference found in the amplitude of the evoked potentials by comparing the spindle periods with the interspindle lulls (fig. 24).

A distinction has been made previously between tonic manifestations, which occur throughout the desynchronized phase of sleep, and phasic phenomena, such as the rapid eye movements (REM) and the muscular twitches (ref. 8).

No tonic changes of the lemniscal response can be detected during transition from synchronized to desynchronized sleep, nor at the end of the episode, when the EMG activity reappears in

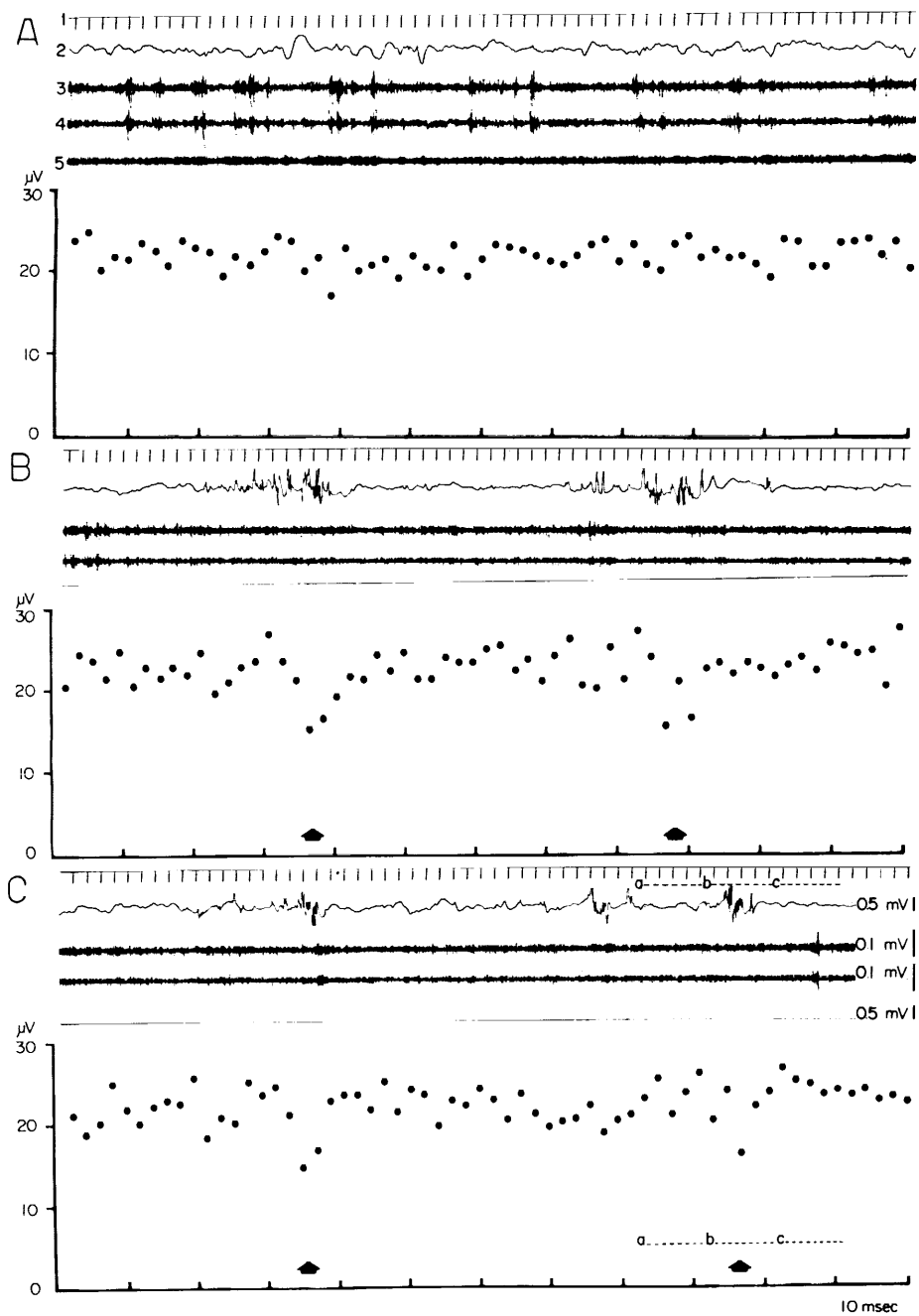

FIGURE 2.—Modulation of the orthodromic lemniscal response during a typical episode of desynchronized sleep. A: Synchronized sleep. B and C: Desynchronized sleep with large bursts of REM. There is a great stability of the lemniscal response during synchronized sleep and no tonic change in amplitude of the response appears during the desynchronized episode. A phasic depression of the evoked potential occurs only during the large bursts of REM, as indicated by the arrows. Note, however, the stability of the responses during isolated ocular jerks or during the small train of low frequency ocular movements in C. See figure 3 for explanation of dashed horizontal lines a through c. Unrestrained, unanesthetized cat. Experiment performed 2 days after chronic implantation of the electrodes. 1: Signals of the electrical shocks applied to the left superficial radial nerve (rectangular pulses: 1 every 1.9 seconds, 0.05-msec pulse duration, 3 times the threshold (T) for the lemniscal response). 2: Electro-oculogram (EOG); 3: Left parieto-occipital (EEG). 4: Right parieto-occipital (EEG). 5: Electromyogram (EMG) from posterior cervical muscles. The amplitude of the orthodromic response of the right medial lemniscus is represented by the dots. (From ref. 30.)

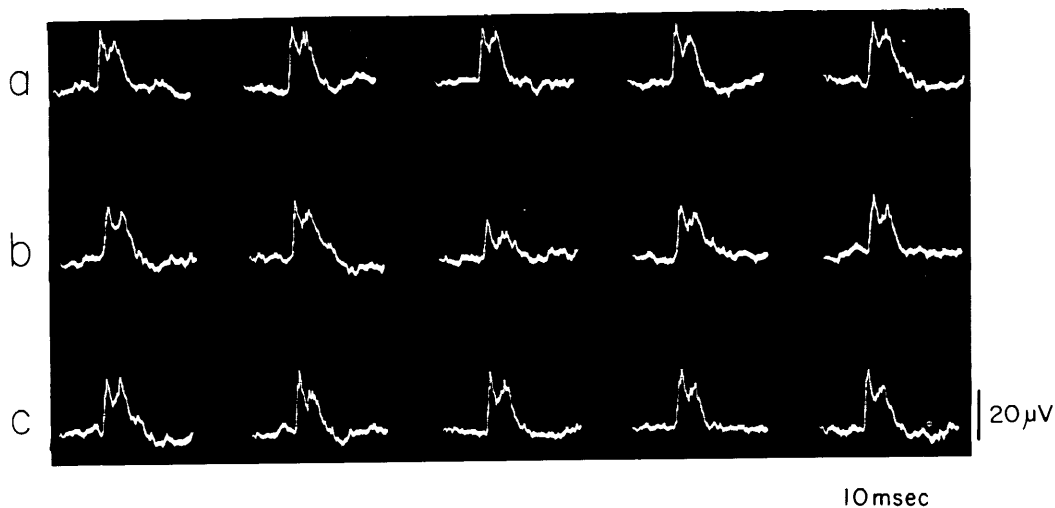

FIGURE 3.—Phasic depression of the orthodromic lemniscal response during a REM period of desynchronized sleep. Same animal and experiment as in figure 2. The records indicate the orthodromic lemniscal responses recorded from the right medial lemniscus following stimulation of the left superficial radial nerve before (a), during (b), and after (c) a burst of REM, as illustrated in figure 2 where the amplitudes of the responses are plotted diagrammatically. Note the large phasic depression of the lemniscal response which appears during a large burst of REM, particularly when the ocular movements reach a very high repetition rate (compare b in figs. 2 and 3). (From ref. 30.)

the cervical muscles. The orthodromic lemniscal responses, however, are phasically depressed during the bursts of REM. Figure 2B and C shows that the phasic depressions (arrows) are related in time with the large bursts of REM. The records a, b, and c, of figure 3 were taken at the moments labeled as a, b, and c in figure 2C. The third record from the left, in figure 3b, shows a striking reduction in amplitude. It is clearly related in time with a strong outburst of REM (see fig. 2C).

The average depression of the lemniscal response during the REM corresponds to about 15 to 20 percent of the average amplitude recorded during the intervals between the REM.

It should be noted, moreover, that not every burst of REM was associated with a depression of the orthodromic lemniscal response. Only when the REM bursts were strong and prolonged was the depression observed; it generally did not outlast the end of the outburst. A clear-cut relationship between intensity of the lemniscal depression and repetition rate of ocular movements within a burst of REM is shown by figure 4. This fact would suggest that mechanisms of temporal summation are

involved both in the production of the large bursts of REM and in the depression of the lemniscal responses.

The phasic depression of the lemniscal response is not due to interaction between the electrically induced volley and the proprioceptive afferent volleys related with the short-lasting contractions of the limb musculature, since it is observed also in the absence of these muscle contractions. The hypothesis of a phasic inhibition of synaptic transmission at the level of the dorsal-column nuclei is supported by experiments to be reported in the next section.

One might simply ask now which pathway contributing to the orthodromic lemniscal response is influenced during sleep. The classical scheme postulates that proprioceptive and exteroceptive volleys ascending along the dorsal column are relayed by the gracile and cuneate nuclei and project, through the medial lemniscus, onto the ventrobasal thalamic nuclei of the opposite side. There are, however, two subsidiary pathways to the sensory cortex; their primary relays are localized in the spinal cord, not far above the segmental level of the dorsal roots of entry. One pathway, discovered by Morin (ref. 59), ascends along the dorsolateral funiculus

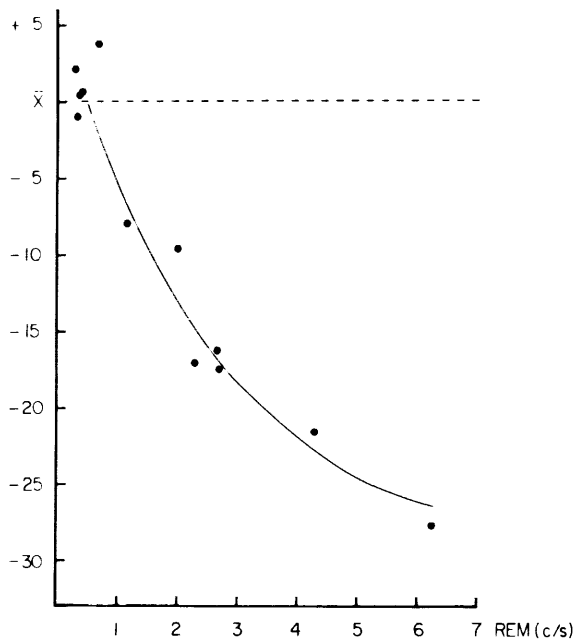

FIGURE 4.—Relation between repetition rate of ocular movements during the bursts of REM and the amplitude of the orthodromic lemniscal responses. Same animal as in figures 2 and 3; same experiment. The abscissa gives the repetition rate of the ocular movements (c/s) within each burst of REM. The ordinate gives the amplitude of the response of the right medial lemniscus to single-shock stimulation of the left superficial radial nerve during the trains of REM. The amplitude is calculated as percentage of the mean control value \bar{X} obtained during the intervals between the REM. Each point represents the average value of measurements taken during 3 bursts of REM. The greater the depressions of the orthodromic lemniscal responses, the higher the repetition rate of the ocular movements. (From ref. 30.)

of the same side to the lateral cervical nucleus, to relay thence to the thalamus and hence to the cortex. The other is the spinothalamic tract ascending contralaterally to the nuclei of the thalamus and hence to the cortex. It is generally stated, however, that there are few if any spinothalamic fibers in the cat. It has recently been shown, moreover, that the dorsal-column tracts contain not only primary afferents but also axons of spinal units synaptically driven by afferent fibers. These secondary fibers are located in the deep part of the dorsal funiculi and are influenced by cutaneous fibers and by high-threshold muscular afferents (refs. 60 and 61). Our experiments clearly show that the lemniscal

responses recorded from the right medial lemniscus on single-shock stimulation of the left superficial radial nerve and their sleep modulation were apparently unmodified after section of the dorsolateral funiculus, leading to interruption of the spinocervical pathway (ref. 62) as well as after interruption of the deep part of the dorsal funiculi.

The dorsal-column tracts (gracile and cuneate), which were spared by the lesion, were therefore responsible for the transmission of the cutaneous afferent volleys to the contralateral medial lemniscus. The results show that after that lesion, a phasic depression of the orthodromic lemniscal response occurred during the REM. On the other hand, after the section limited to the dorsal funiculi, thus sparing the spinocervical tract, the sleep changes of the lemniscal responses were no longer statistically significant.

Summing up, in the free-moving, unanesthetized cat, the orthodromic lemniscal response elicited by single-shock stimulation of the superficial radial nerve was not modified during relaxed wakefulness and synchronized sleep. Striking changes, however, were observed during the phase of desynchronized sleep. Although the orthodromic lemniscal responses were not altered tonically during the desynchronized phase of sleep, a phasic depression occurred synchronous with the large bursts of REM. Moreover, a depression of the orthodromic lemniscal response during the REM bursts was still present after interruption of the ipsilateral spinocervical pathway. It can be concluded that somatic afferent transmission through the dorsal-column system is greatly depressed during the REM periods of desynchronized sleep.

Presynaptic and Postsynaptic Inhibition of Transmission of Somatic Afferent Volleys Through the Cuneate Nucleus During REM

The experiments reported in the previous section have led to the conclusion that the sleep modulation of the orthodromic lemniscal response was mainly caused by reduced transmission of somatic afferent volleys through the dorsal-column pathway. It has been shown in acute experiments that a depression of synaptic transmission through the dorsal-column nuclei may be produced under several experimental condi-

tions through both mechanisms of presynaptic and postsynaptic inhibition (refs. 63 to 66). A presynaptic mechanism is indicated by the occurrence of depolarization of the terminals of primary afferent fibers within the cuneate nucleus (refs. 64 and 65), an effect exactly comparable to the depolarization of the intraspinal endings of primary afferent fibers (ref. 67).² The hypothesis of presynaptic inhibition is also supported by the fact that, in the cuneate nucleus, there are interneurons with properties similar to those interneurons in the spinal cord which are postulated to be interpolated as the presynaptic inhibitory pathway (ref. 66). Electron-microscopic observations have recently shown the existence of axo-axonic contacts in the cuneate nucleus (refs. 68 to 70). A postsynaptic inhibitory mechanism can be documented (1) by the appearance of inhibitory postsynaptic potentials (IPSP's) recorded intracellularly from the cuneothalamic relay cells, and (2) by a decrease in the excitability of cuneate cells to direct electrical stimulation.

Experiments were then performed in order to analyze whether these mechanisms of presynaptic and postsynaptic inhibition were involved in the modulation of synaptic transmission occurring at the level of the dorsal-column nuclei during physiological sleep (refs. 26 to 28 and 31). Since these experiments had to be performed in unrestrained, unanesthetized animals, no intracellular recording could be made. Indirect evidence to be presented in this paper leads to the conclusion that both mechanisms of presynaptic and postsynaptic inhibition are responsible for the phasic depression of the orthodromic lemniscal response occurring during the periods of REM. The presynaptic hypothesis was tested by studying sleep changes in the excitability of the cutaneous and muscular primary afferents to the cuneate nucleus close to their synaptic terminals. Antidromic volleys were elicited in the superficial and deep radial nerves by single-

shock stimulation of the cuneate nucleus, following Wall's method (ref. 71). The postsynaptic hypothesis was tested by studying the excitability changes of the cuneate cells, by recording the lemniscal responses to direct electrical stimulation of the cuneate nucleus.

For this purpose, a stimulating electrode was implanted chronically within the cuneate nucleus. This electrode was made from a steel wire, 100 microns in diameter, sharpened electrolytically until the tip reached a diameter of less than 5 microns. It was then completely insulated except at the tip and the resistance was usually of the order of 500 kilohms. The cuneate nucleus was stimulated monopolarly with single rectangular pulses, negative in polarity, 0.02 to 0.05 msec in duration. The intensity of the stimulus was expressed in multiples of the threshold (T) for the antidromic or the direct lemniscal response. It was then possible to study in the unrestrained, unanesthetized animal either the modulation during sleep of the antidromic responses, recorded monopolarly from the superficial or the deep radial nerve, or the modulation of the orthodromic lemniscal responses to direct stimulation of the cuneate nucleus. In some experiments both types of responses could be recorded simultaneously or separately during successive episodes of sleep.

Excitability Changes of Presynaptic Fibers in the Cuneate Nucleus

Figure 5 gives the anatomical localization of the tip of the stimulating microelectrode in the cuneate nucleus in one of our experiments. After unipolar stimulation of the cuneate nucleus, antidromically conducted impulses were recorded in the superficial or deep radial nerves. Figure 5 shows the antidromic responses led from the superficial (*a*) and the deep radial nerve (*b*) on single-shock stimulation of the ipsilateral cuneate nucleus in unanesthetized, free-moving animals. In figure 5*a* the antidromic volley recorded from the superficial radial nerve started with a latency of about 1.92 msec and had a total duration of about 1.70 msec. Since the conduction distance was 160 mm, the conclusion can be drawn that in this experiment, the conduction velocity of the fastest antidromically invaded fibers corresponded to 83 m/sec. The conduc-

² It is assumed that presynaptic depolarization leads to a reduction in the size of the orthodromic spikes at the presynaptic terminals and, hence, to a reduction in their effectiveness in exciting the postsynaptic membrane. At the same time presynaptic depolarization implies an increase in the antidromic response to direct stimulation of the terminals.

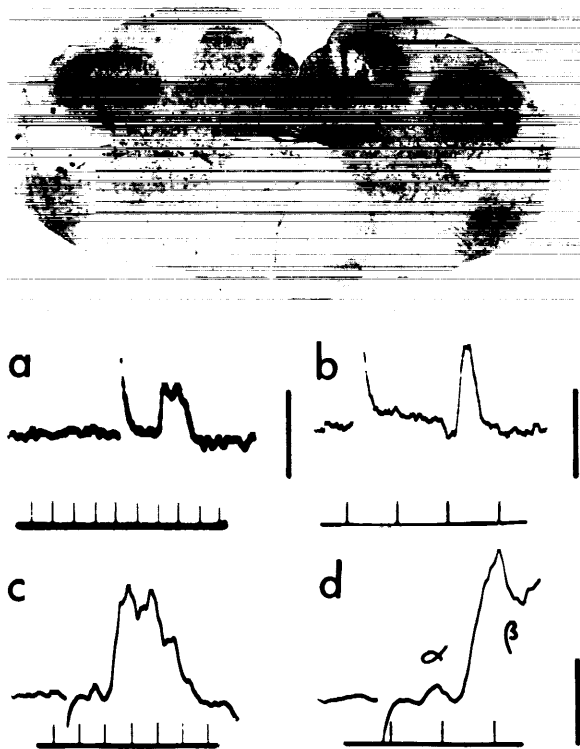

FIGURE 5.—Antidromic and orthodromic responses elicited by single-shock stimulation of the cuneate nucleus in unrestrained, unanesthetized cat. In the upper part of the figure a transverse section of the medulla, stained with Nissl's method, shows the localization of the tip of the stimulating electrode in the cuneate nucleus. a: Antidromic responses of the superficial radial nerve to single-shock stimulation of the ipsilateral cuneate nucleus with an electrical pulse of 0.02 msec, 2.0 times the threshold for the antidromic response (T). Time scale in msec. Voltage calibration: 10 μV . b: Antidromic responses of the deep radial nerve to single-shock stimulation (0.03 msec, 2.5 T) of the ipsilateral cuneate nucleus. Time scale in msec. Voltage calibration: 20 μV . c and d: Responses of the medial lemniscus to single-shock stimulation of the contralateral cuneate nucleus. Single electrical pulses (0.02 msec) at increasing stimulus strengths (from c to d) have been used. Time scales in msec. Voltage calibration: 100 μV . Note the higher sweep speed in d. In c and d the latency of the initial α -spike is 0.77 msec while the secondary, or β -spike, has a latency of 1.43 msec, i.e., 0.66 msec longer than the α -spike. Note the double configuration in c of the β -spike due to a second component beginning about 1.2 msec after the first and the presence on the decaying phase of this second β -spike of a third wavelet. (From ref. 31.)

tion velocities of the fastest group II cutaneous fibers in the dorsal columns and peripheral nerves are of the same order (ref. 51).

When recording was made from the deep radial nerve (fig. 5b), an antidromic volley started with a latency of about 1.85 msec and had a total duration of about 0.65 msec. Since in this experiment the conduction distance was 185 mm, the conduction velocity of the fastest antidromically invaded afferent fibers corresponded to 100 msec. This high conduction velocity indicates that group I afferent muscle fibers are involved in the antidromic response from the deep radial nerve.

The excitability changes of the intracuneate endings of group II (cutaneous) and group I (muscular) afferents were then studied during the different episodes of sleep and wakefulness. The size of the antidromic potential was taken as an approximate measure of the number of primary afferent fibers to the cuneate nucleus excited by the stimulus. Continuous recording started 10 to 20 minutes after the beginning of low-rate repetitive stimulation of the cuneate nucleus (1/1.5 to 2.0 seconds, 1.3 to 1.8 T). Movements were not elicited by the cuneate stimulation, nor was any EEG arousal produced when the stimulation was carried out on a background of behavioral drowsiness and cortical synchronization.

The antidromic potentials led from group II cutaneous fibers were rather constant during quiet wakefulness. Fluctuations in amplitude were of course detected, as shown by the fact that the standard deviation corresponded on the average to 10 percent of the mean amplitude.

During the transition from quiet waking to synchronized sleep, no significant changes in either mean amplitude or standard deviation of group II antidromic volleys were recorded from the superficial radial nerve, nor was there any clear-cut difference found between the periods characterized by trains of synchronous waves and the interspindle lull \acute{s} . The main changes in amplitude of the antidromic volley occurred during desynchronized sleep. In this stage of sleep there was a slight increase in the mean amplitude of the antidromic group II volley, which never exceeded the value of 5 to 8 percent with respect to that obtained during the synchronized phase.

A detailed analysis of the relation between

excitability changes of the intracuneate terminals of primary somatosensory fibers and phasic events occurring during desynchronized sleep indicates that the average size of the antidromic responses recorded during the REM corresponded to 125 percent of the mean value found during synchronized sleep. During these outbursts the standard deviation increased to reach 20 to 25 percent of the mean amplitude. On the contrary, the mean amplitude and the

standard deviation of the responses recorded during the same episodes of desynchronized sleep in the absence of REM closely corresponded to the values obtained during synchronized sleep. A correlation between increase in the antidromic group II cutaneous volley and ocular movements turned out to be particularly evident when the bursts of REM were composed of high-rate, large-amplitude movements (fig. 6). The phasic enhancement of the

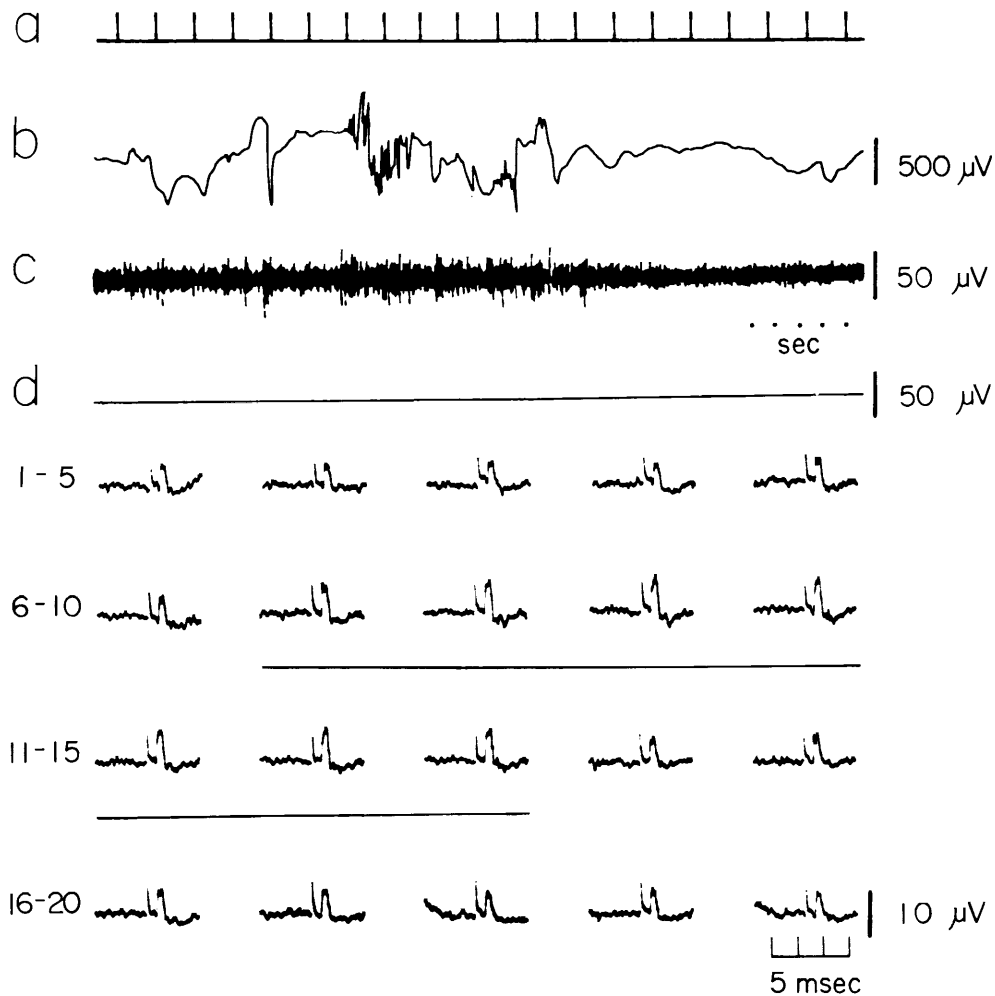

FIGURE 6.—Phasic increase in amplitude of the antidromic group II cutaneous volley during a REM period of desynchronized sleep. Unrestrained, unanesthetized cat. Experiment made 2 days after implantation of the electrodes. a: Signals of the electrical stimuli (0.02 msec, 2 T, 1 every 1.6 seconds) applied to the left cuneate nucleus. b: Electro-oculogram (EOG). c: Left parieto-occipital (EEG). d: Posterior cervical muscles (EMG). The cathode-ray oscilloscope records show 20 antidromic responses of group II cutaneous fibers of the left superficial radial nerve following single-shock stimulation of the cuneate nucleus before (1-6), during (7-13), and after (14-20) a burst of REM, as illustrated above. Note the enhancement of the antidromic response (7-13) that occurs during the REM burst. (From ref. 31.)

antidromic volley in most cases lasted throughout the duration of the outburst.

Although the correlation between bursts of REM and enhancement of the antidromic potentials is clear, we noted that not every ocular burst was associated with an enhancement of the antidromic potential. To explain this finding, a correlation was made between excitability changes of intracuneate endings of group II cutaneous fibers and repetition rate of the ocular movements within the REM. In particular, the average amplitudes of the antidromic responses recorded during bursts of REM in which the ocular movements occurred at the same repetition rate were compared with the average value obtained from the responses that occurred during the same episode of desynchronized sleep but in the absence of REM. Figure 7 shows that the higher the repetition rate of the ocular movements within the REM burst, the greater was the increase of the antidromic response. It had been previously shown that not only cutaneous but also group I muscle afferents from forelimb nerves project to the dorsal-column-medial-lemniscal system (refs. 72 to 80). It is of interest that the antidromic group I volley recorded from the deep radial nerve on single-shock stimulation of the ipsilateral cuneate nucleus also showed modulation during wakefulness and sleep similar in kind to that which affected the antidromic group II volley recorded from the superficial radial nerve.

Figure 8 shows the phasic enhancement of the antidromic group I volley during desynchronized sleep occurring at the time of a large burst of REM. The degree of enhancement was of the same order as that described for the group II cutaneous volley in the same experimental condition.

These results indicate that depolarization of presynaptic intracuneate endings of both cutaneous and muscular afferent fibers occurs during REM. It is well established that presynaptic inhibition acts by decreasing the amplitude of the presynaptic impulses, thus reducing their excitatory influence on the postsynaptic membrane (ref. 67). These observations fit the hypothesis that, synchronously with the REM

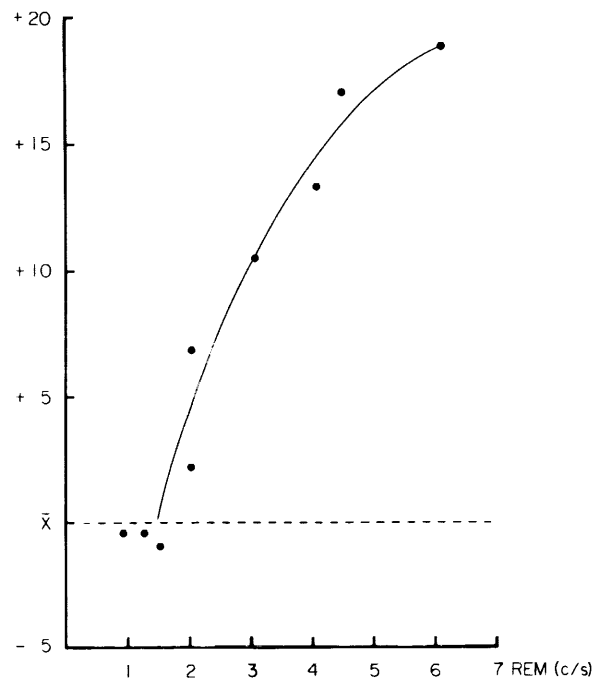

FIGURE 7.—Relationship between rate of ocular movements within bursts of REM and the enhancement of the antidromic group II cutaneous volley. Same animal and experiment as in figure 6. The dots represent the amplitudes of the antidromic group II cutaneous volley recorded from the left superficial radial nerve on single-shock stimulation of the ipsilateral cuneate nucleus during the REM periods of desynchronized sleep. The abscissa indicates the repetition rate (c/s) of ocular movements within the bursts of REM; the ordinate indicates the amplitude of the antidromic response during the trains of REM calculated as percentage of the mean control value \bar{X} obtained during the intervals between the REM. Each point represents the average value of measurements taken during 3 bursts of REM. The enhancement of the antidromic response is clearly related with the repetition rate of the ocular movements within the bursts of REM. (From ref. 31.)

outbursts, the synaptic transmission at the level of the relay neurons of the dorsal column nuclei is inhibited by a presynaptic mechanism. In fact, a phasic depression of the orthodromic medial lemniscal response to single-shock stimulation of the radial nerves always occurred during the REM phase of desynchronized sleep (refs. 25 and 30). This phasic depression of the lemniscal response, however, is not simply the consequence of a presynaptic inhibitory action. It will be shown in the next section that postsynaptic inhibition is likely to contribute to the

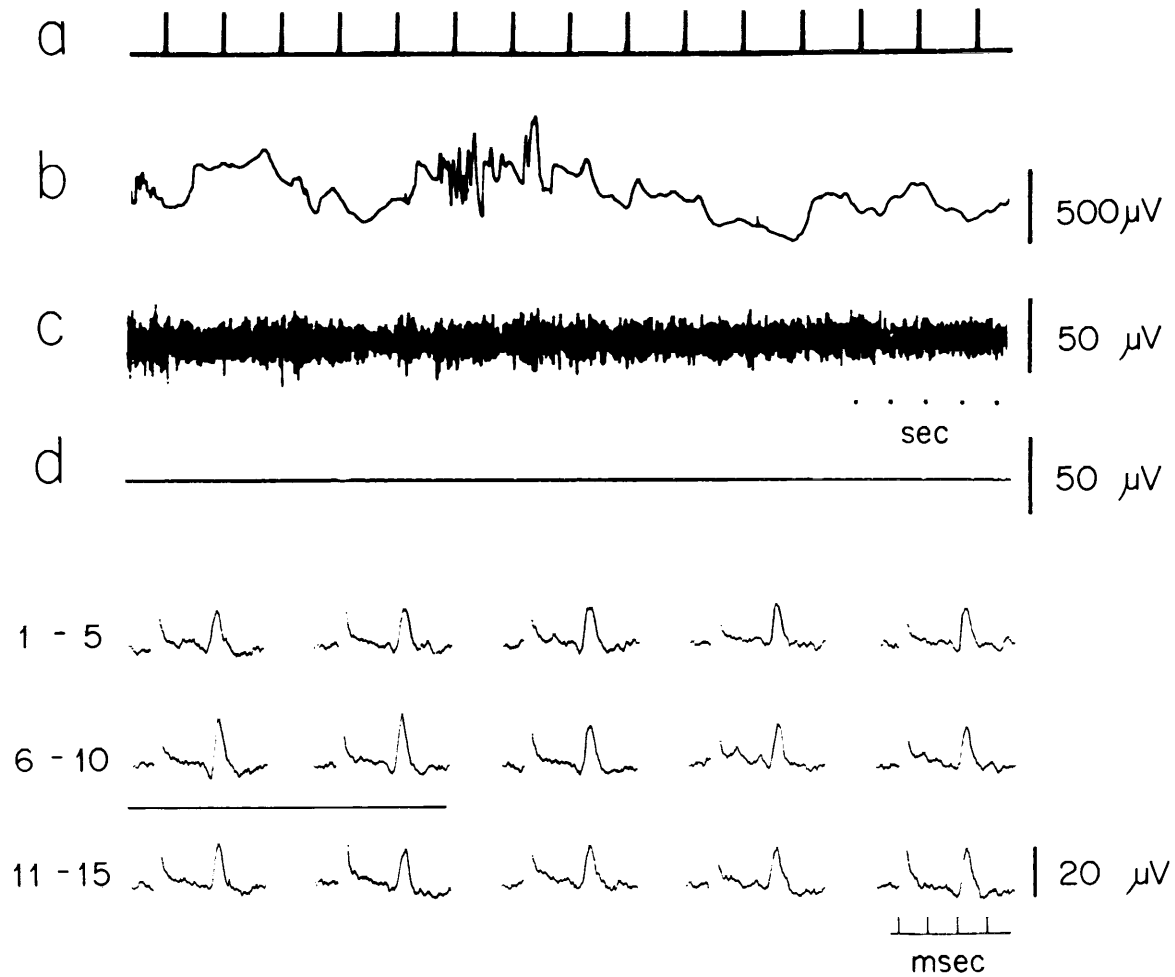

FIGURE 8.—Phasic increase in amplitude of the antidromic group I muscular volley during a period of REM of desynchronized sleep. Experimental arrangement same as in figure 6 (electrical pulses: 0.03 msec, 1.54 T). The records show 15 antidromic responses of group I muscular fibers led from the left deep radial nerve following single-shock stimulation of the cuneate nucleus before (1-5), during (6, 7), and after (8-15) a burst of REM. A clear-cut enhancement of the antidromic response (6, 7) occurs during the REM burst. (From ref. 31.)

phasic depression of the orthodromic responses during REM.

Excitability Changes of the Cuneothalamic Relay Neurons

It has been shown by previous authors (ref. 63) that when a brief current pulse is applied through a microelectrode to the cuneate nucleus of the anesthetized cat, an initial brief positive spike (α -spike), followed by a much more prolonged and complex positive potential (β -spike), can be recorded from the lemniscal axons in the contralateral ventrobasal complex of the thala-

mus. Similar potentials could be easily identified also in our experiments, where single-shock stimulation of the cuneate nucleus was made in the unanesthetized cat through an implanted microelectrode, while the evoked potential was recorded from the contralateral medial lemniscus with a narrow bipolar electrode (refs. 26 to 28 and 31). Figure 5c and d shows the kind of evoked potentials recorded in our experimental conditions at various sweep speeds.

In agreement with the finding of previous authors, we observed that the latency of the initial spike (α -spike) is so short (0.7 to 0.8 msec)

that it must be due to impulses generated by direct stimulation of cuneothalamic relay neurons or their axons. The secondary, or β -spike, had a latency of 0.7 to 0.8 msec longer than the α -spike, a time just adequate for monosynaptic transmission; it was attributed, therefore, to direct excitation of presynaptic fibers and consequent synaptic excitation of cuneate neurons (ref. 63). The β -spike may have a simple configuration, characterized by a rising phase, followed by a slow decay. It may have, however, a double configuration, the second wave beginning about 1.0 to 1.2 msec after the first (ref. 63).

This observation has been attributed to the fact that transsynaptic excitation evokes a double discharge from most of the cuneate neurons (ref. 66). In figure 5c, the decaying phase of the β -spike complex indicates that some cuneate neurons discharged three or even more impulses.

During relaxed wakefulness, both the α - and the β -spikes were produced by each stimulus. These responses were regular in amplitude and only slight fluctuations occurred. The standard deviation with respect to the mean amplitude was slightly higher for the α - than for the β -spike, and corresponded to 15 and 10 percent of the mean amplitude, respectively.

During the transition from quiet wakefulness to synchronized sleep, there were no significant changes in both mean amplitude and standard deviation of the α - and β -spikes, nor was there any clear-cut difference found between the periods characterized by trains of synchronous waves and interspindle lulls.

The main changes in cuneate cell excitability occurred during desynchronized sleep. In this phase of sleep there was a slight depression of both the α - and β -spikes; the mean amplitudes corresponded to 96 and 94 percent, respectively, of the value obtained during synchronized sleep. The decrease in the mean amplitude of the responses was accompanied only by slight changes in the standard deviation. A detailed analysis of the relation between cuneate neuron excitability and the events occurring during desynchronized sleep indicated that the depression of both the α - and β -spike was not a tonic phenomenon, since it did not occur during the inter-

vals between the large bursts of REM; it did not occur, moreover, when the ocular movements appeared to be isolated or grouped in small bursts. A depression of the lemniscal responses actually occurred only when large bursts of REM appeared in the electro-oculogram. At this time both α - and β -spikes were generally depressed. Figure 9 shows the changes in amplitude of both the lemniscal responses elicited by direct stimulation of the cuneate nucleus during desynchronized sleep and their depression at the time of the large bursts of REM, while figure 10 illustrates those responses plotted in figure 9 which occur at the time of two large bursts of REM.

To obtain a statistical evaluation of the relative depression affecting α - and β -spikes during REM, the mean amplitude of both the responses occurring during phasic bursts of ocular movements was compared with the mean amplitude of the responses that occurred during the same episodes of desynchronized sleep, but in the absence of REM. The α -depression was generally smaller than the β -depression. This finding is particularly evident in figure 11, where a correlation has been made between the frequency of the ocular movements within the bursts of REM and the depression of the responses. This analysis was performed since it had been found that not every ocular outburst was associated with a depression of the lemniscal responses. Figure 11 shows that the more frequent the ocular movements within the REM burst, the greater was the α - and β -depressions. However, the degree of depression was greater for the β -spike than for the α -spike. When this occurred, the β -depression was generally longer lasting than the α -depression. This different time course of the depression of α - and β -excitability during the REM episodes is particularly evident in figures 9b and 10b, where α -depression is limited to the larger amplitude, higher frequency ocular movements, associated and followed by a larger and more prolonged β -depression.

Whenever a depression of the lemniscal responses elicited by direct stimulation of the cuneate nucleus occurred at the time of the REM, there was also a phasic depression of the ortho-

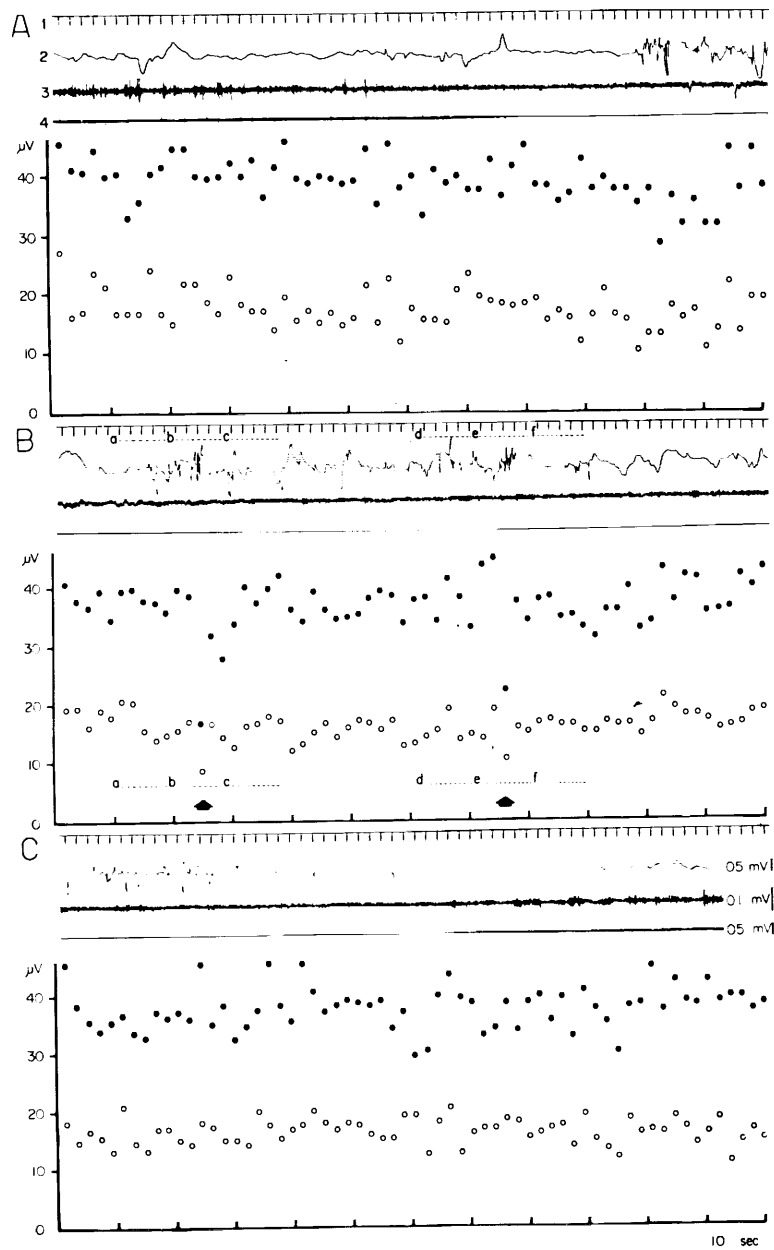

FIGURE 9.—Modulation of the lemniscal responses to direct stimulation of the cuneate nucleus during the large bursts of REM. Unrestrained, unanesthetized cat. Experiment made 5 days after implantation of the electrodes. Bipolar records. 1: Signals of the electrical shocks applied to the left cuneate nucleus (rectangular pulses: 1 every 2 sec, 0.05 msec, 2.15 times the threshold (T) for the direct lemniscal response); 2: Electro-oculogram (EOG); 3: Left parieto-occipital (EEG); 4: Posterior cervical muscles (EMG). The amplitudes of both the α -spike (empty circles) and the β -spike (filled circles) recorded from the right lemniscus on single-shock stimulation of the left cuneate nucleus have been plotted below. A, B, C: Episode of desynchronized sleep, during which time there are phasic depressions of the lemniscal responses. They are observed only synchronously with the largest bursts of REM. The early potentials (empty circles) are less depressed than the late potentials (filled circles). See figure 10 for explanation of dashed lines a through f. (From ref. 31.)

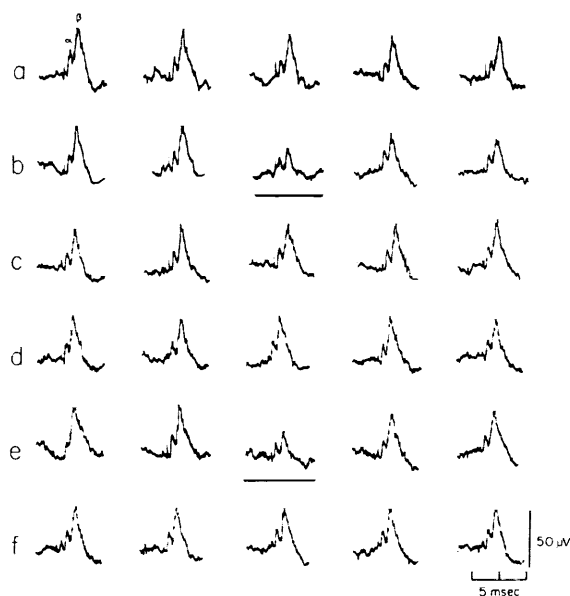

FIGURE 10.—Phasic depressions of the lemniscal responses to direct stimulation of the cuneate nucleus during REM periods of desynchronized sleep. Same animal and experiment as in figure 9. The records indicate the responses recorded before (a, d), during (b, e) and after (c, f) the bursts of REM, as illustrated in figure 9. In this same figure the amplitude of the cathode-ray oscilloscope responses has been plotted diagrammatically. Note the large phasic depression of the lemniscal responses that appears during two bursts of REM characterized by high repetition rate of ocular movements. Note also in b the quick recovery in the amplitude of the α -spike, as compared to some persistent depression of the β -spike, following the underlined response. (From ref. 31.)

dromic lemniscal response recorded from the medial lemniscus on single-shock stimulation of the superficial radial nerve. Also, this depression occurred during the REM periods. In figure 12 the mean amplitude and the standard deviations of such orthodromic and direct lemniscal responses recorded in the same experiment during different EEG backgrounds can be compared with the mean amplitude and the standard deviation of the antidromic group II cutaneous volley recorded in another experiment from the superficial radial nerve on single-shock stimulation of the cuneate nucleus during corresponding EEG backgrounds. It is clear from this figure that the depression of the α - and β -excitability during REM parallels that of the orthodromic lemniscal response, while the

enhancement of presynaptic excitability is virtually a mirror image of that depression.

The conclusion of our experiments is that excitability changes of the cuneothalamic relay neurons as tested by direct stimulation of the cuneate nucleus actually occur during a certain phase of sleep.

In agreement with previous findings (refs. 25 and 30) that the orthodromic lemniscal response

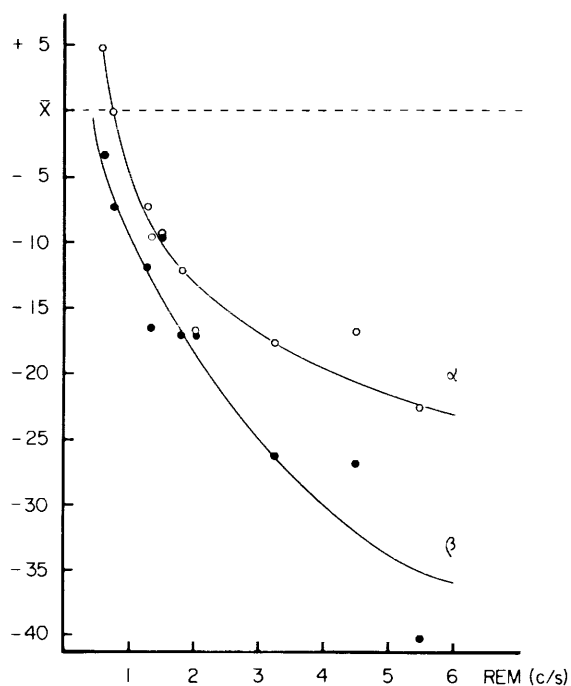

FIGURE 11.—Relationships between repetition rate of ocular movements within bursts of REM and the amplitude of the orthodromic lemniscal responses elicited by direct stimulation of the cuneate nucleus. Same animal as in figures 9 and 10; same experiment. The symbols represent the amplitudes of both the early potential (empty circles) and the late potential (filled circles) recorded from the right lemniscus on single-shock stimulation of the left cuneate nucleus, during bursts of REM. The abscissa indicates the repetition rates of the eye movements (c/s) within the REM; the ordinate indicates the amplitude of the two components of the lemniscal responses during the same trains of REM calculated as percentage of the mean control values \bar{x} obtained during desynchronized sleep, in the intervals between the REM. Each point represents the average value of measurements taken during 3 bursts of REM. Greater depression of the lemniscal responses occur with higher frequencies of ocular movements within the bursts of REM. Furthermore, for the same bursts of REM, depression is greater for the late potential than for the early potential. (From ref. 31.)

neurons (ref. 63). Therefore, the depression of the α -excitability during the desynchronized phase of sleep indicates that postsynaptic inhibition has an important depressant influence on many cuneothalamic relay neurons during REM.

The depression of the β -spike during the REM is more difficult to interpret. We have shown that the presynaptic depolarization of the primary afferents to the cuneate nucleus produced by REM results in a large increase in the number of presynaptic fibers being excited by the cuneate stimulus. This would tend to increase the size of the β -spike. This increase, however, has to be weighed against (1) the depression of synaptic excitation that results from the presynaptic depolarization, i.e., presynaptic inhibition, and (2) the depression that results from the postsynaptic hyperpolarization, i.e., postsynaptic inhibition.

Of course the effectiveness of the presynaptic inhibitory action during REM is indicated by the depression of synaptic transmission in cases in which β -depression is coupled with very little or no α -depression of cuneate neurons. However, as pointed out by previous authors (ref. 63), the β -depression of cuneate neurons does not give a simple index of synaptic excitation and its depression by presynaptic inhibition, since the β -depression is minimized by the large increase in presynaptic excitability.

Summing up, the structures which are responsible for the phasic depression of the orthodromic lemniscal response during desynchronized sleep must operate through both mechanisms of presynaptic and postsynaptic inhibition.

Transmission of Sensory Volleys Through the Nucleus Ventralis Posterolateralis During REM

Accumulated evidence indicates that during desynchronized sleep the transmission of somatic centripetal impulses elicited either by peripheral stimulation (refs. 47 and 81 to 84) or by central, lemniscal (refs. 47, 81, and 85 to 87), or thalamic (refs. 47, 81, 85, 86, 88, and 89), stimulation is constantly facilitated. This effect occurs at the level of the nucleus ventralis posterolateralis (VPL) and lasts throughout the episode of desynchronized sleep. There is also a constant parallelism between the facilitation of the

thalamic responses and those recorded from the cortex (ref. 90). Moreover, a further increase in the lemniscocortical (refs. 86, 87, and 91) and thalamocortical responses (ref. 86) has been found to occur synchronously with the REM.

We are not going to discuss here the tonic changes in somatic afferent transmission through the VPL nucleus, since they last throughout the desynchronized phase of sleep, and therefore are not vestibular in origin. We are interested mainly in the observation that during the desynchronized phase of sleep, the thalamic output resulting from stimulation of second-order somatosensory neurons shows sudden brief increases (ref. 92). These happen at the same time as REM's and deep-sleep waves (refs. 86 and 93). Suppression of proprioceptive oculomotor and/or retinal inputs does not prevent the occurrence of such phasic changes in thalamic transmission (refs. 87 and 94). Experiments were recently made (ref. 33) in order to investigate the synaptic changes occurring in the nucleus ventralis posterolateralis during desynchronized sleep, particularly at the time of the REM. Similar to the approach used in our previous experiments on the dorsal column nuclei (refs. 26 to 28 and 31), both presynaptic and postsynaptic events have been investigated at thalamic level (ref. 33). In particular, the responsiveness of the presynaptic and postsynaptic components of thalamic synapses was studied by implanting chronically bipolar electrodes in the medial lemniscus (ML), the nucleus ventralis posterolateralis (VPL), and the somesthetic radiations (SR). Each electrode could then be used either for stimulation or for recording.

Facilitation of the Orthodromic Thalamic Response

The orthodromic response evoked in the VPL nucleus by stimulation of the medial lemniscus consisted of a short-latency-positive-negative deflection followed by a slower positive wave. The first component of the response can be attributed to the action potential of the presynaptic terminals, while the second may be ascribed to the postsynaptic activity of thalamic neurons. It was found in particular that while the presynaptic component of the VPL response did not significantly change in amplitude during the

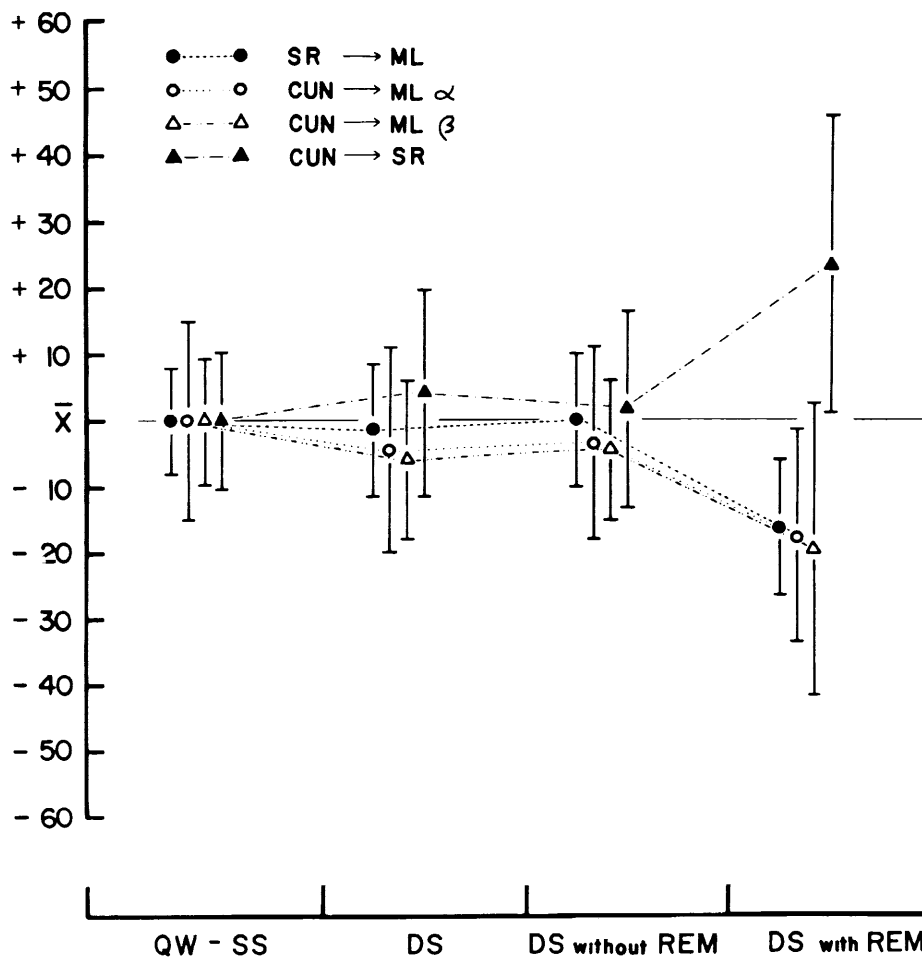

FIGURE 12.—Effects of sleep on the orthodromic lemniscal response and on the excitability both of cuneate neurons and of the presynaptic terminals in the cuneate nucleus. Filled circles: Orthodromic responses recorded from the right medial lemniscus (ML) on single-shock stimulation of the left superficial radial nerve (SR). Open circles and open triangles: Responses recorded from the right ML on single-shock stimulation of the left cuneate nucleus (CUN). The initial α -spike and the later β -spike due to direct and synaptic excitation of the cuneate neurons have been plotted with different symbols. Filled triangles: Antidromic responses recorded from the left SR on single-shock stimulation of the CUN. The average values of measurements during desynchronized sleep (DS) are calculated as percentage of the mean control values (\bar{X}) during quiet wakefulness-synchronized sleep (QW-SS). The vertical segments represent the standard deviations. The responses during DS have been further divided into two groups: (1) the responses recorded during the intervals between the REM (DS without REM) and (2) the responses recorded during the large bursts of REM (DS with REM). About 2000 responses for each experimental situation were statistically evaluated. (From ref. 31.)

elicited by peripheral nerve stimulation is unmodified during synchronized sleep, as compared with relaxed wakefulness, the present observations show that both α - and β -excitability of the cuneate nucleus are also unmodified in the same experimental conditions. A marked decrease of

α - and β -excitability occurs only during desynchronized sleep, at the time of the REM (refs. 26 to 28 and 31).

It has been clearly shown that the test for α -spike depression provides a direct assessment of postsynaptic inhibition of cuneothalamic relay

desynchronized phase of sleep, the mean amplitude of the postsynaptic component was significantly higher during REM than during non-REM periods (fig. 13, upper records). Only in some instances a slight decrease of the presynaptic component in the VPL occurred during the bursts of REM.

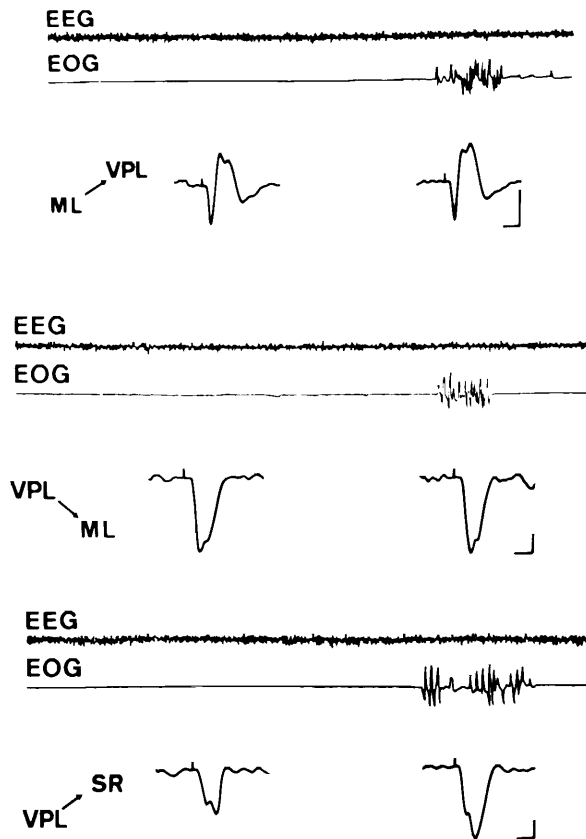

FIGURE 13.—Presynaptic and postsynaptic changes in the nucleus ventralis posterolateralis (VPL) during the REM periods of desynchronized sleep. Unrestrained, unanesthetized cats. Upper records: Changes in orthodromically evoked responses recorded from the VPL to medial lemniscus (ML) stimulation during a REM burst of desynchronized sleep. Middle records: Changes in antidromic responses recorded from ML to intrathalamic (VPL) stimulation during a REM burst of desynchronized sleep. Lower records: Changes in the excitability of thalamic neurons recorded from the somesthetic radiation (SR) by stimulating the VPL nucleus. EEG: Electroencephalogram; EOG: Electro-oculogram. Cathode-ray oscilloscope calibration for the evoked responses: 1 msec and 50 μ V. (From ref. 33.)

Excitability Changes of Presynaptic Fibers in the VPL Nucleus

Experiments were performed to test the excitability of presynaptic terminals of second-order sensory neurons by antidromic stimulation (ref. 71) of the VPL nucleus. The antidromic responses recorded from the medial lemniscus consisted of two positive components, probably due to excitation of two groups of nerve fibers with different conduction velocity. These antidromic responses did not show significant changes in amplitude during the REM periods (fig. 13, middle records). On some occasions, however, a slight increase of the antidromic response in the medial lemniscus was observed. This finding together with the observation that, during the same phase of sleep, the presynaptic component of the thalamic response evoked by stimulation of the medial lemniscus is sometimes slightly reduced in amplitude suggests that depolarization of the presynaptic terminals within the thalamus may occur at the time of the REM.

Excitability Changes of the VPL Neurons

The increase in amplitude of the postsynaptic component of the discharge evoked in the VPL nucleus by stimulation of the medial lemniscus during REM's suggests that the thalamic cells have become more responsive to incoming afferent impulses. Direct stimulation of the VPL nucleus evokes in the corresponding thalamocortical radiation a response consisting of an initial brief positive deflection (α -spike) followed by a second positive component of longer duration (β -spike). While the α -spike is due to direct excitation of thalamic relay cells, the β -spike, occurring one synaptic delay later, is produced by direct excitation of presynaptic fibers in the thalamic nucleus, with consequent synaptic activation of thalamic neurons (ref. 95). The α -spike is thus a suitable index for evaluating changes in excitability of thalamic neurons. The β -spike cannot be used for this purpose, however, because its amplitude is affected as well by changes in presynaptic terminals. The amplitude of the α -spike always increased during REM in the somesthetic radiation when VPL was stimulated (fig. 13, lower records). It is of interest that even the antidromic response recorded in

the VPL nucleus by stimulating the somesthetic thalamocortical radiations increased during the REM periods. The invariable increase in size of the postsynaptic component of the thalamic responses evoked by stimulation of the medial lemniscus as well as the increased discharge of the thalamic neurons produced by direct stimulation of the VPL nucleus or antidromic stimulation of the somesthetic radiations supports the conclusion that REM's are associated with a phasic enhancement of the responsiveness of thalamic cells in the VPL.

In summary, postsynaptic facilitation occurs in the VPL nucleus during REM. Only on some occasions this phenomenon is associated with depolarization of the presynaptic terminals within the thalamus. Reduced transmission of orthodromic volleys at the level of the presynaptic endings within the thalamus is apparently overwhelmed by increased postsynaptic responsiveness of thalamic cells.

Vestibular Control of Somatic Afferent Transmission in the Cuneate Nucleus and the VPL Nucleus

It has been shown that, during the REM, there is a phasic depression of the orthodromic lemniscal response (refs. 25 and 30) which is due to both mechanisms of presynaptic and postsynaptic inhibition (refs. 26 to 28 and 31). Experiments were performed to localize the structures which are responsible for the inhibitory control of synaptic transmission in the cuneate nucleus during desynchronized sleep (refs. 29 and 32). Attention was devoted to the vestibular nuclei which we have proved to be responsible not only for the REM (refs. 35 to 37) but also for the phasic enhancement of the pyramidal discharge, related in time with the REM (refs. 23 and 24).

Since stimulation of the sensory-motor cortex, performed in acute experiments, is able to inhibit the transmission of cutaneous afferent volleys through the cuneate nucleus by both mechanisms of presynaptic and postsynaptic inhibition (ref. 63), the possibility exists that excitation of the pyramidal neurons elicited by the ascending vestibular volleys during the REM periods of desynchronized sleep is responsible for the inhibition of synaptic transmission

in the cuneate nucleus which occurs at the time of the REM.

We have shown that bilateral destruction of the medial and descending vestibular nuclei abolishes not only the REM but also the related phasic depression of the orthodromic lemniscal response evoked by single-shock stimulation of the superficial radial nerve (fig. 14). The absence of any modulation, during sleep, of the lemniscal response following vestibular lesions is also duplicated by experiments of bilateral ablation of the sensory-motor cortex, which, on the other hand, does not prevent the appearance of the typical bursts of ocular movements.

Summing up, the depression of the orthodromic lemniscal response elicited by single-shock stimulation of the superficial radial nerve during the bursts of REM is abolished by a bilateral lesion of the vestibular nuclei, or by complete ablation of the sensory-motor cortex. It appears, therefore, that during REM, the vestibular nuclei depress the synaptic transmission at the level of the dorsal column nuclei through the roundabout way of the sensory-motor cortex and the pyramidal tract (fig. 15). Further experiments are required to find the pathways and structures which are responsible for the facilitation of sensory transmission through the VPL nucleus during the REM periods of desynchronized sleep. It may well be postulated, however, that the efferent discharge originating from the second-order vestibular neurons at the time of the REM represents the common triggering mechanism which is responsible not only for the depression in the orthodromic transmission of somatic afferent volleys through the dorsal-column nuclei (refs. 29 and 30) but also for the increased responsiveness of thalamic cells within the VPL nucleus during the REM bursts (refs. 33, 87, and 96).

CONCLUSION

An analysis of the central mechanisms responsible for the motor events occurring during desynchronized sleep, made by microelectrode recording of single vestibular neurons in unrestrained unanesthetized animals (refs. 11 to 13), as well as by lesion experiments, clearly indicates that the medial and descending vestibular nuclei

are responsible not only for REM (refs. 35 to 37), but also for the phasic excitation of spinal

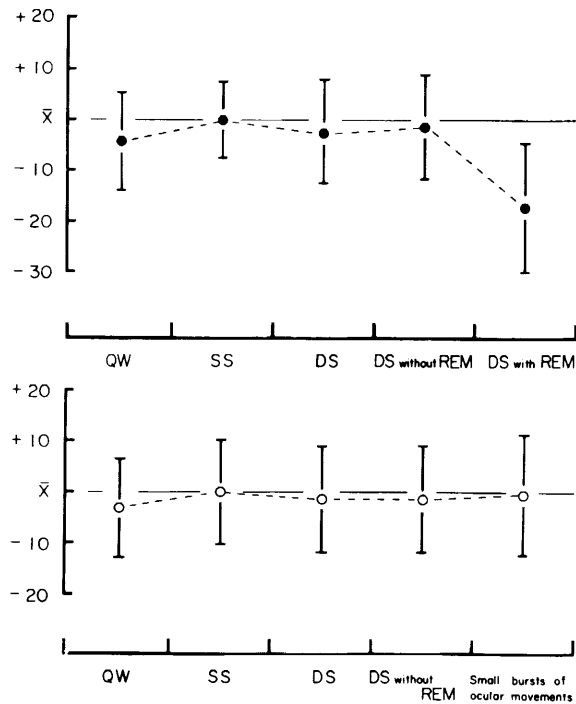

FIGURE 14.—Effects of different backgrounds of sleep on the orthodromic lemniscal responses recorded in the intact animal or after vestibular lesion. Unrestrained, un-anesthetized cats. Upper diagram: Intact preparation. Lower diagram: Animal submitted to bilateral electrolytic lesion of the vestibular nuclei, sparing only the ventral part of the medial and descending vestibular nuclei of both sides. In both instances the responses were recorded from the right medial lemniscus on single-shock stimulation of the left superficial radial nerve. The results obtained during several episodes of desynchronized sleep have been statistically evaluated. The average values of measurements during quiet wakefulness (QW) and desynchronized sleep (DS) are calculated as percentage of the mean control values (\bar{X}) during synchronized sleep (SS). The vertical segments represent the standard deviations. The responses during DS have been further divided in two groups: (1) the responses recorded during absence of ocular movements (DS without REM), and (2) the responses recorded during the large bursts of rapid eye movements (DS with REM). In the lower diagram this group contains only the responses recorded during the residual ocular movements which remained after the vestibular lesion (small bursts of ocular movements). Note the depression of the orthodromic lemniscal responses during the large bursts of REM (DS with REM) in the intact preparation and the absence of any significant change in the amplitude of the responses during the residual ocular movements after vestibular lesion. (From refs. 30 and 32.)

motoneurons (refs. 23 and 24). It is of interest that (1) during desynchronized sleep the pyramidal discharge increases during the bursts of REM, and (2) the abolition of the hypnic contractions following lesion of the vestibular nuclei is always associated with the abolition of the pyramidal discharges that occur synchronously with the periods of REM (refs. 23 and 24).

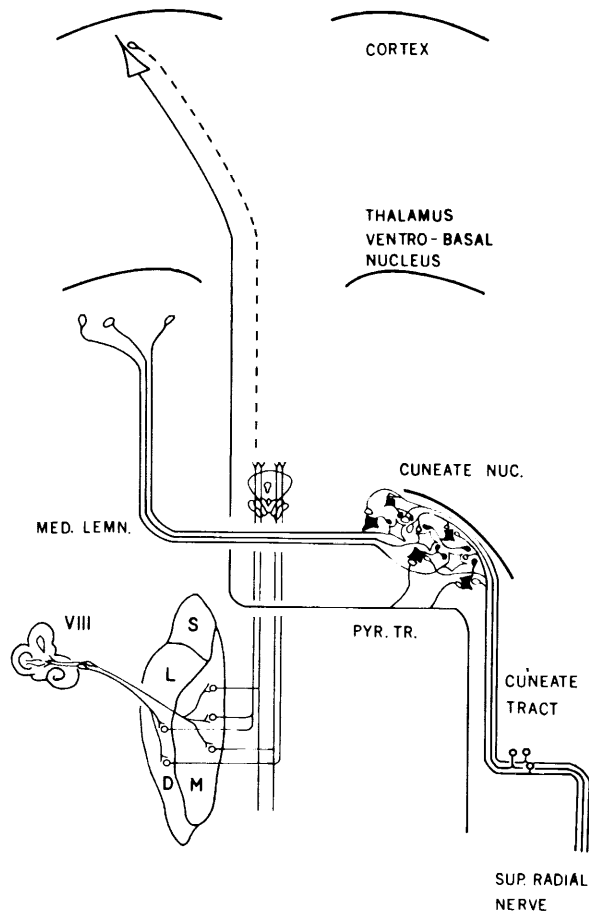

FIGURE 15.—Anatomical schema of the neural mechanisms involved in the sleep modulation of somatic afferent transmission through the cuneate nucleus. Synaptic transmission of cutaneous impulses (superficial radial nerve) to cuneothalamic relay neurons (white) is blocked by inhibitory cuneate interneurons (black) through presynaptic and postsynaptic mechanisms. The hypothesis is made that the inhibitory interneurons are driven by collaterals of the pyramidal tract, the corticospinal neurons being in turn excited by ascending vestibular volleys through unknown polysynaptic pathways (dotted line). D: Descending vestibular nucleus; L: Lateral vestibular nucleus (of Deiters); M: Medial vestibular nucleus; S: Superior vestibular nucleus. (From ref. 32.)

The demonstration that, during sleep, vestibular afferent volleys impinge upon the sensory-motor cortex is supported by the observation that in acute experiments, labyrinthine volleys are able to alter the pattern of discharge of some neurons localized in this cortical area (refs. 97 to 99). Moreover, a discharge of impulses can also be recorded from the bulbar pyramid on single-shock stimulation of the vestibular nerves performed under chloralose anesthesia (ref. 100).

In summary, a motor pattern is formed during desynchronized sleep due to increased activity of the vestibular neurons. It consists not only of REM, due to direct excitation of the oculomotor neurons, but also of muscular contractions related in time with REM. These phasic events are associated with reflex excitation of corticospinal neurons due to ascending vestibular volleys impinging upon the motor cortex. Other structures, however, also triggered by the ascending vestibular system, are likely to contribute to the phenomenon. For sake of simplicity they have not been considered in the present report.

Parallel to the phasic excitation of the extrinsic ocular and spinal motoneurons occurring during desynchronized sleep, phasic events influence the transmission of sensory inputs along the dorsal-column-medial-lemniscal system. In particular, the experimental evidence clearly indicates that the orthodromic lemniscal response is phasically depressed during REM due to mechanisms of presynaptic and postsynaptic inhibition occurring within the cuneate nucleus (refs. 25 to 28, 30, and 31). An analysis of the central structures responsible for the phasic depression of these lemniscal responses during REM shows that this effect is abolished after bilateral lesions localized to the medial and descending vestibular nuclei (refs. 29 and 32).

Bilateral destruction of the sensory-motor cortex also duplicates the effects of the vestibular lesions, although the appearance of the bursts of REM is not prevented by the cortical ablation. Both these lesions in fact abolish the phasic depression of somatic afferent transmission through the dorsal column nuclei during the REM. These observations suggest that volleys ascending from the vestibular nuclei are able to

excite neurons of the somatosensory cortex, whose efferent discharge is finally responsible for the depressed transmission at dorsal column level. It has been pointed out above that the phasic depression of transmission of somatic afferent volleys through the cuneate nucleus during the bursts of REM is due to both mechanisms of presynaptic and postsynaptic inhibition (refs. 26 to 28 and 31). It is of interest that the same mechanisms occurring during physiological sleep in unrestrained animals can also be elicited in acute experiments on repetitive stimulation of the sensory-motor cortex (refs. 63 to 66). We may conclude that the vestibular activity occurring during the REM periods of desynchronized sleep is able to block the transmission of somatic afferent volleys within the dorsal column nuclei through the roundabout way of the sensory-motor cortex (fig. 15).

It is quite surprising that, contrary to the depressed transmission of somatic afferent volleys at dorsal column level, the transmission of somatic volleys through the VPL nucleus is greatly facilitated during REM (refs. 33, 86, 87, and 91). Therefore, within the VPL nucleus the reduced amplitude of the orthodromic volleys has to be weighted against an increased excitability of the thalamocortical neurons.

It has been assumed by several authors that the sensory feedback dependent upon active movement plays an important role in motor coordination (refs. 101 to 103). It is of interest that, while during the movements associated with REM, the somatic sensory volleys are partially inhibited at medullary level, a postsynaptic facilitation occurs simultaneously within the specific thalamic nuclei. We can postulate, therefore, that some part of the efferent vestibular activity giving rise to contraction of the limb musculature is fed into the somatic sensory system, particularly the nucleus ventralis posterolateralis, where it interacts with the incoming somatic information filtered at dorsal-column level. The result is that external stimulation due to sensory feedback is partially substituted by internal stimulation which is incorporated at thalamic level and elaborated by the somatosensory cortex.

It has been assumed for years that the ves-

tibular nuclei represent a premotor center which controls the oculomotor and spinal motoneurons. The present experiments clearly indicate that the efferent discharge originating from the vestibular nuclei affects the transmission of somatic sensory volleys at the different relay stations of the medial lemniscal pathway simultaneously with the efferent discharges which give rise to the hypnic contractions of the limb musculature.

The existence of such "corollary" central discharges, i.e., discharges from motor to sensory structures, has been postulated in order to account for the perceptual constancy of the environment during movements (ref. 104).

Further experiments are required to find out whether the vestibular mechanisms described

during the deepest phase of sleep are also operative during the motor activities produced by natural labyrinthine stimulations. One may propose that also during the natural labyrinthine stimulations in the awake animal, the somatosensory volleys originated at the time of the muscle contractions are not simply transmitted without alteration through the ascending lemniscal pathways. Similar to what has been described in the sleeping preparation, vestibular volleys may well interact with exteroceptive and proprioceptive afferent impulses at different relay stations of the somatosensory pathway, thus leading to proper perception during body movements. Appropriate experiments, however, are required to test this hypothesis.

REFERENCES

- MORUZZI, G.: Active Processes in the Brain Stem During Sleep. Harvey Lectures, vol. 58, 1963, pp. 233-297.
- DEMENT, W.: The Occurrence of Low Voltage, Fast Electroencephalogram Patterns During Behavioral Sleep in the Cat. EEG Clin. Neurophysiol., vol. 10, 1958, pp. 291-296.
- DEMENT, W. C.: Eye Movements During Sleep. The Oculomotor System, M. B. Bender, ed., Hoeber Medical Division, Harper & Row, New York, 1964, pp. 366-416.
- JOUVET, M.: Recherches sur les Structures Nerveuses et les Mécanismes Responsables des Différentes Phases du Sommeil Physiologique. Arch. Ital. Biol., vol. 100, 1962, pp. 125-206.
- JOUVET, M.: Neurophysiology of the States of Sleep. Physiol. Rev., vol. 47, 1967, pp. 117-177.
- ASERINSKY, E.; AND KLEITMAN, N.: Regularly Occurring Periods of Eye Motility and Concomitant Phenomena, During Sleep. Science, vol. 118, 1953, pp. 273-274.
- ASERINSKY, E.; AND KLEITMAN, N.: Two Types of Ocular Motility Occurring in Sleep. J. Appl. Physiol., vol. 8, 1955, pp. 1-10.
- GASSEL, M. M.; MARCHIAFAVA, P. L.; AND POMPEIANO, O.: Phasic Changes in Muscular Activity During Desynchronized Sleep in Unrestrained Cats. An Analysis of the Pattern and Organization of Myoclonic Twitches. Arch. Ital. Biol., vol. 102, 1964, pp. 449-470.
- DEMENT, W. C.; AND KLEITMAN, N.: The Relation of Eye Movements During Sleep to Dream Activity: An Objective Method for the Study of Dreaming. J. Exptl. Psychol., vol. 53, 1957, pp. 339-346.
- DEMENT, W. C.; AND KLEITMAN, N.: Cyclic Variations in EEG During Sleep and Their Relation to Eye Movements, Body Motility and Dreaming. EEG Clin. Neurophysiol., vol. 9, 1957, pp. 673-690.
- BIZZI, E.; POMPEIANO, O.; AND SOMOGYI, I.: Attività Spontanea di Singole Unità Registrate dai Nuclei Vestibolari Nei Gatti Integri non Anestetizzati nel Corso del Sonno e della Veglia. Boll. Soc. Ital. Biol. sper., vol. 40, 1964, pp. 138-141.
- BIZZI, E.; POMPEIANO, O.; AND SOMOGYI, I.: Vestibular Nuclei: Activity of Single Neurons During Natural Sleep and Wakefulness. Science, vol. 145, 1964, pp. 414-415.
- BIZZI, E.; POMPEIANO, O.; AND SOMOGYI, I.: Spontaneous Activity of Single Vestibular Neurons of Unrestrained Cats During Sleep and Wakefulness. Arch. Ital. Biol., vol. 102, 1964, pp. 308-330.
- POMPEIANO, O.: Ascending and Descending Influences of Somatic Afferent Volleys in Unrestrained Cats: Supraspinal Inhibitory Control of Spinal Reflexes During Natural and Reflexly Induced Sleep. Aspects Anatomofonctionnels de la Physiologie du Sommeil, Editions du Centre National de la Recherche Scientifique, Paris, 1965, pp. 309-395.
- MORRISON, A. R.; AND POMPEIANO, O.: Vestibular Influences During Sleep. IV. Functional Relations Between Vestibular Nuclei and Lateral Geniculate Nucleus During Desynchronized Sleep. Arch. Ital. Biol., vol. 104, 1966, pp. 425-458.
- POMPEIANO, O.: Muscular Afferents and Motor Control During Sleep. Nobel Symposium I. Muscular Afferents and Motor Control, R. Granit, ed., Almqvist & Wiksell, Stockholm, 1966, pp. 415-436.
- POMPEIANO, O.: The Neurophysiological Mechanisms of the Postural and Motor Events During Desynchronized Sleep. Sleep and Altered States of Consciousness, S. S. Kety, E. V. Evarts, and H. L. Williams, eds.,

- Res. Publ. Ass. Nerv. Ment. Dis., vol. 45, 1967, pp. 351-423.
18. POMPEIANO, O.: Sensory Inhibition During Motor Activity in Sleep. *Neurophysiological Basis of Normal and Abnormal Motor Activities*, M. D. Yahr and D. P. Purpura, eds., Raven Press, Hewlett, N.Y., 1967, pp. 323-372.
 19. POMPEIANO, O.: Mechanisms of Sensory-Motor Integration During Sleep. *Progress in Physiological Psychology*, E. Stellar and J. M. Sprague, eds., Academic Press, 1968.
 20. MARCHIAFAVA, P. L.; AND POMPEIANO, O.: Scariche Cortico-Spinali e Inibizione di Risposte Motorie a Stimolazione Piramidale nel Sonno Desincronizzato. *Rend. Accad. Naz. Lincei, Cl. Sci. fis., mat. e nat., Serie VIII*, vol. 36, 1964, pp. 547-549.
 21. MARCHIAFAVA, P. L.; AND POMPEIANO, O.: Pyramidal Influences on Spinal Cord During Desynchronized Sleep. *Arch. Ital. Biol.*, vol. 102, 1964, pp. 500-529.
 22. MARCHIAFAVA, P. L.; AND POMPEIANO, O.: Attività Piramidale Durante il Sonno Desincronizzato. *Riv. Neurol.*, vol. 32, 1966, pp. 118-129.
 23. MORRISON, A. R.; AND POMPEIANO, O.: Influenze Vestibolari Sulla Attività Piramidale Durante i Movimenti Rapidi Oculari nel Sonno Desincronizzato. *Boll. Soc. Ital. Biol. sper.*, vol. 41, 1965, pp. 937-939.
 24. MORRISON, A. R.; AND POMPEIANO, O.: Vestibular Influences During Sleep. II. Effects of Vestibular Lesions on the Pyramidal Discharge During Desynchronized Sleep. *Arch. Ital. Biol.*, vol. 104, 1966, pp. 214-230.
 25. CARLI, G.; DIETE-SPIFF, K.; AND POMPEIANO, O.: Modulazione Ipnica della Risposta Lemnisciale alla Stimolazione Elettrica di Afferenze Cutanee. *Boll. Soc. Ital. Biol. sper.*, vol. 42, 1966, pp. 638-639.
 26. CARLI, G.; DIETE-SPIFF, K.; AND POMPEIANO, O.: Inibizione Presinaptica e Postsinaptica nel Nucleo Cuneato Durante il Sonno. *Boll. Soc. Ital. Biol. sper.*, vol. 42, 1966, pp. 640-641.
 27. CARLI, G.; DIETE-SPIFF, K.; AND POMPEIANO, O.: The Transfer of Sensory Information Through the Lemniscal Pathway During Sleep. *J. Physiol.*, vol. 184, 1966, pp. 19P-21P.
 28. CARLI, G.; DIETE-SPIFF, K.; AND POMPEIANO, O.: Presynaptic and Postsynaptic Inhibition on Transmission of Cutaneous Afferent Volleys Through the Cuneate Nucleus During Sleep. *Experientia*, vol. 22, 1966, pp. 239-240.
 29. CARLI, G.; DIETE-SPIFF, K.; AND POMPEIANO, O.: Influenze Vestibolari Sulla Trasmissione d'Impulsi Somatici Lungo la Via Lemnisciale. *Rend. Accad. Naz. Lincei, Cl. Sci. fis., mat. e nat.*, vol. 40, 1966, pp. 113-115.
 30. CARLI, G.; DIETE-SPIFF, K.; AND POMPEIANO, O.: Transmission of Sensory Information Through the Lemniscal Pathway During Sleep. *Arch. Ital. Biol.*, vol. 105, 1967, pp. 31-51.
 31. CARLI, G.; DIETE-SPIFF, K.; AND POMPEIANO, O.: Presynaptic and Postsynaptic Inhibition on Transmission of Somatic Afferent Volleys Through the Cuneate Nucleus During Sleep. *Arch. Ital. Biol.*, vol. 105, 1967, pp. 52-82.
 32. CARLI, G.; DIETE-SPIFF, K.; AND POMPEIANO, O.: Vestibular Influences During Sleep. V. Vestibular Control on Somatic Afferent Transmission in the Cuneate Nucleus During Desynchronized Sleep. *Arch. Ital. Biol.*, vol. 105, 1967, pp. 83-103.
 33. DAGNINO, N.; FAVALE, E.; LOEB, C.; MANFREDI, M.; AND SEITUN, A.: Presynaptic and Postsynaptic Changes in Specific Thalamic Nuclei During Deep Sleep. *Arch. Ital. Biol.*, vol. 107, 1969.
 34. BRODAL, A.; POMPEIANO, O.; AND WALBERG, F.: The Vestibular Nuclei and Their Connections. *Anatomy and Functional Correlations*. Oliver & Boyd, Edinburgh, 1962.
 35. POMPEIANO, O.; AND MORRISON, A. R.: Abolizione dei Movimenti Rapidi Oculari nel Sonno Desincronizzato Prodotta da Lesioni Vestibolari. *Boll. Soc. Ital. Biol. sper.*, vol. 41, 1965, pp. 935-937.
 36. POMPEIANO, O.; AND MORRISON, A. R.: Vestibular Influences During Sleep. I. Abolition of the Rapid Eye Movements During Desynchronized Sleep Following Vestibular Lesions. *Arch. Ital. Biol.*, vol. 103, 1965, pp. 569-595.
 37. POMPEIANO, O.; AND MORRISON, A. R.: Vestibular Origin of the Rapid Eye Movements During Desynchronized Sleep. *Experientia*, vol. 22, 1966, pp. 60-61.
 38. WALBERG, F.; POMPEIANO, O.; BRODAL, A.; AND JANSEN, J.: The Fastigiovestibular Projection in the Cat. An Experimental Study With Silver Impregnation Methods. *J. Comp. Neurol.*, vol. 118, 1962, pp. 49-75.
 39. WALBERG, F.; POMPEIANO, O.; WESTRUM, L. E.; AND HAUGLIE-HANSEN, E.: Fastigiotectular Fibers in the Cat. An Experimental Study With Silver Methods. *J. Comp. Neurol.*, vol. 119, 1962, pp. 187-199.
 40. EVARTS, E. V.: Temporal Patterns of Discharge of Pyramidal Tract Neurons During Sleep and Waking in the Monkey. *J. Neurophysiol.*, vol. 27, 1964, pp. 152-171.
 41. EVARTS, E. V.: Neural Activity in Visual and Motor Cortex During Sleep and Waking. *Aspects Anatomofonctionnels de la Physiologie du Sommeil*, Editions du Centre National de la Recherche Scientifique, Paris, 1965, pp. 189-212.
 42. EVARTS, E. V.: Activity of Individual Cerebral Neurons During Sleep and Arousal. *Sleep and Altered States of Consciousness*, S. S. Kety, R. V. Evarts, and H. L. Williams, eds., Res. Publ. Ass. Nerv. Ment. Dis., vol. 45, 1967, pp. 319-337.
 43. ADRIAN, E. D.; AND MORUZZI, G.: Impulses in the Pyramidal Tract. *J. Physiol.*, vol. 97, 1939, pp. 153-199.
 44. MORRISON, A. R.; AND POMPEIANO, O.: Corticospinal Influences on Primary Afferents During Sleep and Wakefulness. *Experientia*, vol. 21, 1965, pp. 660-661.

45. MORRISON, A. R.; AND POMPEIANO, O.: Pyramidal Discharge From Somatosensory Cortex and Cortical Control of Primary Afferents During Sleep. *Arch. Ital. Biol.*, vol. 103, 1965, pp. 538-568.
46. FAVALE, E.; LOEB, C.; AND MANFREDI, M.: Contributo alla Conoscenza dei Meccanismi della Facilitazione delle Risposte Corticali Evocate da Stimoli Somatici Periferici e Centrali Durante il Sonno Profondo. *Boll. Soc. Ital. Biol. sper.*, vol. 38, 1962, pp. 1151-1153.
47. FAVALE, E.; LOEB, C.; MANFREDI, M.; AND SACCO, G.: Somatic Afferent Transmission and Cortical Responsiveness During Natural Sleep and Arousal in the Cat. *EEG Clin. Neurophysiol.*, vol. 18, 1965, pp. 354-368.
48. DAGNINO, N.; FAVALE, E.; LOEB, C.; MANFREDI, M.; AND SEITUN, A.: Tempo di Trasmissione degli Impulsi Afferenti Attraverso i Nuclei di Goll e di Burdach e il Nucleo Ventro-Postero-Laterale del Talamo Durante il Sonno Spontaneo. *Boll. Soc. Ital. Biol. sper.*, vol. 41, 1965, pp. 550-552.
49. DAGNINO, N.; FAVALE, E.; LOEB, C.; MANFREDI, M.; AND SEITUN, A.: Accelerated Synaptic Transmission in Nucleus Ventralis-Postero-Lateralis During Deep Sleep. *Experientia*, vol. 22, 1966, pp. 329-330.
50. POMPEIANO, O.; AND SWETT, J. E.: EEG and Behavioral Manifestations of Sleep Induced by Cutaneous Nerve Stimulation in Normal Cats. *Arch. Ital. Biol.*, vol. 100, 1962, pp. 311-342.
51. HUNT, C. C.; AND MCINTYRE, A. K.: An Analysis of Fibre Diameter and Receptor Characteristics of Myelinated Cutaneous Afferent Fibres in Cat. *J. Physiol.*, vol. 153, 1960, pp. 99-112.
52. MATZKE, H. A.: Course of the Fibres Arising From Nucleus Gracilis and Cuneatus of the Cat. *Anat. Record*, vol. 103, 1949, p. 487.
53. MATZKE, H. A.: The Course of the Fibers Arising From the Nucleus Gracilis and Cuneatus of the Cat. *J. Comp. Neurol.*, vol. 94, 1951, pp. 439-452.
54. GLEES, P.; AND SOLER, J.: Fibre Content of the Posterior Column and Synaptic Connections of Nucleus Gracilis. *Z. Zellforsch.*, vol. 36, 1951, pp. 381-400.
55. TORVIK, A.: Afferent Connections of the Sensory Trigeminal Nuclei, the Nucleus of the Solitary Tract, and Adjacent Structures. An Experimental Study in the Rat. *J. Comp. Neurol.*, vol. 106, 1956, pp. 51-141.
56. ROSSI, G. F.; AND BRODAL, A.: Terminal Distribution of Spino-Reticular Fibers in the Cat. *Arch. Neurol. Psychiat.*, vol. 78, 1957, pp. 439-453.
57. BOWSHER, D.: Projection of the Gracile and Cuneate Nuclei in *Macaca mulatta*: An Experimental Degeneration Study. *J. Comp. Neurol.*, vol. 110, 1958, pp. 135-156.
58. SCHEIBEL, M. E.; AND SCHEIBEL, A. B.: Structural Substrates for Integrative Patterns in the Brain Stem Reticular Core. *Reticular Formation of the Brain*, H. H. Jasper et al., eds., Henry Ford Hospital International Symposium, Little, Brown & Co., 1958, pp. 31-55.
59. MORIN, F.: A New Spinal Pathway for Cutaneous Impulses. *Am. J. Physiol.*, vol. 183, 1955, pp. 245-252.
60. UDDENBERG, N.: Studies on Modality Segregation and Second Order Neurons in the Dorsal Funiculus. *Experientia*, vol. 22, 1966, pp. 441-442.
61. UDDENBERG, N.: Functional Organization of Long. Second-Order Afferents in the Dorsal Funiculus. *Exptl. Brain Res.*, vol. 4, 1968, pp. 377-382.
62. BRODAL, A.; AND REXED, B.: Spinal Afferents to the Lateral Cervical Nucleus in the Cat. An Experimental Study. *J. Comp. Neurol.*, vol. 98, 1953, pp. 179-212.
63. ANDERSEN, P.; ECCLES, J. C.; OSHIMA, T.; AND SCHMIDT, R. F.: Mechanisms of Synaptic Transmission in the Cuneate Nucleus. *J. Neurophysiol.*, vol. 27, 1964, pp. 1096-1116.
64. ANDERSEN, P.; ECCLES, J. C.; SCHMIDT, R. F.; AND YOKOTA, T.: Slow Potential Waves Produced in the Cuneate Nucleus by Cutaneous Volleys and by Cortical Stimulation. *J. Neurophysiol.*, vol. 27, 1964, pp. 78-91.
65. ANDERSEN, P.; ECCLES, J. C.; SCHMIDT, R. F.; AND YOKOTA, T.: Depolarization of Presynaptic Fibers in the Cuneate Nucleus. *J. Neurophysiol.*, vol. 27, 1964, pp. 92-106.
66. ANDERSEN, P.; ECCLES, J. C.; SCHMIDT, R. F.; AND YOKOTA, T.: Identification of Relay Cells and Interneurons in the Cuneate Nucleus. *J. Neurophysiol.*, vol. 27, 1964, pp. 1080-1095.
67. ECCLES, J. C.: *The Physiology of Synapses*. Springer-Verlag (Berlin), 1964.
68. VALVERDE, F.: The Posterior Column Nuclei and Adjacent Structures in Rodents: A Correlated Study by the Golgi Method and Electron Microscopy. *Anat. Record (Abstr.)*, vol. 151, 1965, p. 496.
69. VALVERDE, F.: The Pyramidal Tract in Rodents. A Study of Its Relations With the Posterior Column Nuclei, Dorsolateral Reticular Formation of the Medulla Oblongata, and Cervical Spinal Cord (Golgi and Electron Microscopic Observations). *Z. Zellforsch.*, vol. 71, 1966, pp. 297-363.
70. WALBERG, F.: Axoaxonic Contacts in the Cuneate Nucleus, Probable Basis of Presynaptic Depolarization. *Exptl. Neurol.*, vol. 13, 1965, pp. 218-231.
71. WALL, P. D.: Excitability Changes in Afferent Fibre Terminations and Their Relation to Slow Potentials. *J. Physiol.*, vol. 142, 1958, pp. 1-21.
72. AMASSIAN, V. E.; AND BERLIN, L.: Early Cortical Projection of Group I Afferent in the Forelimb Muscle Nerves of Cat. *J. Physiol.*, vol. 143, 1958, p. 61P.
73. AMASSIAN, V. E.; AND BERLIN, L.: Early Projection of Large Muscle Afferents From Forelimb of Cat to Somatosensory Cortex. *Fed. Proc.*, vol. 17, 1958, p. 3.
74. OSCARSSON, O., AND ROSÉN, I.: Projection to Cerebral Cortex of Large Muscle Spindle Afferents in Forelimb Nerves of the Cat. *J. Physiol.*, vol. 169, 1963, pp. 924-945.

75. OSCARSSON, O.; AND ROSÉN, I.: Short-Latency Projections to the Cat's Cerebral Cortex From Skin and Muscle Afferents in the Contralateral Forelimb. *J. Physiol.*, vol. 182, 1966, pp. 164-184.
76. OSCARSSON, O.; ROSÉN, I.; AND SULG, I.: Organization of Neurons in the Cat Cerebral Cortex That Are Influenced From Group I Muscle Afferents. *J. Physiol.*, vol. 183, 1966, pp. 189-210.
77. ANDERSSON, S. A.; LANDGREN, S.; AND WOLSK, D.: The Thalamic Relay and Cortical Projection of Group I Muscle Afferents From the Forelimb of the Cat. *J. Physiol.*, vol. 183, 1966, pp. 576-591.
78. LANDGREN, S.; SILFVENIUS, H.; AND WOLSK, D.: Somato-Sensory Paths to the Second Cortical Projection Area of the Group I Muscle Afferents. *J. Physiol.*, vol. 191, 1967, pp. 543-559.
79. ROSÉN, I.: Functional Organization of Group I Activated Neurons in the Cuneate Nucleus of the Cat. *Brain Res.*, vol. 6, 1967, pp. 770-772.
80. SWETT, J. E.; AND BOURASSA, C. M.: Short Latency Activation of Pyramidal Tract Cells by Group I Afferent Volleys in the Cat. *J. Physiol.*, vol. 189, 1967, pp. 101-117.
81. FAVALE, E.; LOEB, C.; AND MANFREDI, M.: Somatic Evoked Responses in Cats During Natural Sleep. *Experientia*, vol. 19, 1963, pp. 189-192.
82. ALBE-FESSARD, D.; MASSION, J.; HALL, R.; AND ROSENBLITH, W.: Modifications au Cours de la Veille et du Sommeil des Valeurs Moyennes de Réponses Nerveuses Centrales Induites par des Stimulations Somatique chez le Chat Libre. *C. R. Acad. Sci.*, vol. 258, 1964, pp. 353-356.
83. GUILBAND, G.; AND YAMAGUCHI, Y.: Evolution au Cours des Diverses Phases du Sommeil des Activités Évoquées des Différentes Régions du Cortex Somato-moteur du Chat. *J. Physiologie*, vol. 56, 1964, pp. 370-371.
84. GUILBAND, G.; AND KUMMER, J. L.: Comparaison de l'Évolution au Cours du Sommeil, des Activités Évoquées par Stimulation Somatique dans les Noyaux Ventral Postérieur et Ventral Latéral du Thalamus et au Niveau du Cortex Moteur Chez le Chat. *J. Physiologie*, vol. 57, 1965, pp. 617-618.
85. FAVALE, E.; LOEB, C.; AND MANFREDI, M.: Somatic Responses Evoked by Central Stimulation During Natural Sleep and During Arousal. *Arch. Int. Physiol.*, vol. 71, 1963, pp. 229-235.
86. ALLISON, T.: Cortical and Subcortical Evoked Responses to Central Stimuli During Wakefulness and Sleep. *EEG Clin. Neurophysiol.*, vol. 18, 1965, pp. 131-139.
87. DAGNINO, N.; FAVALE, E.; LOEB, C.; MANFREDI, M.; AND SEITUN, A.: Nervous Mechanisms Underlying Phasic Changes in Thalamic Transmission During Deep Sleep. *EEG Clin. Neurophysiol.*, suppl. 26, 1967, pp. 156-163.
88. PISANO, M.; ROSADINI, G.; AND ROSSI, G. F.: Risposte Corticali Evocate da Stimoli Dromici e Antidromici Durante il Sonno e la Veglia. *Riv. Neurobiol.*, vol. 8, 1962, pp. 414-426.
89. ROSSI, G. F.; PALESTINI, M.; PISANO, M.; AND ROSADINI, G.: An Experimental Study of the Cortical Reactivity During Sleep and Wakefulness. *Aspects Anatomico-fonctionnels de la Physiologie du Sommeil*, Éditions du Centre National de la Recherche Scientifique, Paris, 1965, pp. 509-532.
90. FAVALE, E.; LOEB, C.; AND MANFREDI, M.: Le Risposte Corticali Somatiche Durante il Sonno Profondo: Particolare Comportamento delle Risposte Radiato-Corticali. *Boll. Soc. Ital. Biol. sper.*, vol. 39, 1963, pp. 430-432.
91. DAGNINO, N.; FAVALE, E.; LOEB, C.; AND MANFREDI, M.: Trasmissione Talamica e Movimenti Oculari Durante il Sonno Profondo. *Boll. Soc. Ital. Biol. sper.*, vol. 41, 1965, pp. 1269-1271.
92. FAVALE, E.; LOEB, C.; AND MANFREDI, M.: Modificazioni delle Risposte Corticali Evocate da Stimole Centrali nelle Diverse Fasi del Sonno e al Risveglio. *Boll. Soc. Ital. Biol. sper.*, vol. 38, 1962, pp. 1146-1148.
93. DAGNINO, N.; FAVALE, E.; LOEB, C.; AND MANFREDI, M.: Thalamic Transmission Changes During the Rapid Eye Movements of Deep Sleep. *Arch. Int. Physiol.*, vol. 73, 1965, pp. 858-861.
94. DAGNINO, N.; FAVALE, E.; LOEB, C.; MANFREDI, M.; MASSAZZA, G.; AND SEITUN, A.: Afferenze Oculari (Retiniche e Proprioceptive) e Variazioni Fasiche della Trasmissione Talamica Durante il Sonno Profondo. *Boll. Soc. Ital. Biol. sper.*, vol. 42, 1966, pp. 1775-1777.
95. ANDERSEN, P.; BROOKS, C. McC.; ECCLES, J. C.; AND SEARS, T. A.: The Vento-Basal Nucleus of the Thalamus: Potential Fields, Synaptic Transmission and Post-Synaptic Components. *J. Physiol.*, vol. 174, 1964, pp. 348-369.
96. DAGNINO, N.; FAVALE, E.; LOEB, C.; MANFREDI, M.; AND SEITUN, A.: Pontine Triggering of Phasic Changes in Sensory Transmission During Deep Sleep. *Arch. Int. Physiol.*, vol. 74, 1966, pp. 889-894.
97. JUNG, R.; KORNHUBER, H. H.; AND DA FONSECA, J. S.: Multisensory Convergence on Cortical Neurons. Neuronal Effects of Visual, Acoustic and Vestibular Stimuli in the Superior Convolutions of the Cat's Cortex. *Progress in Brain Research*, Vol. 1, Brain Mechanisms, G. Moruzzi, A. Fessard, and H. H. Jasper, eds., Elsevier, Amsterdam, 1963, pp. 207-240.
98. KORNHUBER, H. H.; AND ASCHOFF, J. C.: Somatisch-vestibuläre Konvergenz und Interaktion an Neuronen des motorischen und des somatosensiblen Cortex der Katze. *Pflügers Arch. ges. Physiol.*, vol. 278, 1963, pp. 72-73.
99. KORNHUBER, H. H.; AND ASCHOFF, J. C.: Somatisch-vestibuläre Integration an Neuronen des motorischen Cortex. *Naturwissenschaften*, vol. 51, 1964, pp. 62-63.
100. MEGIRIAN, D.; AND TROTH, R.: Vestibular and Muscle Nerve Connections to Pyramidal Tract Neurons of Cat. *J. Neurophysiol.*, vol. 27, 1964, pp. 481-492.

101. HELD, R.: Plasticity in Sensory-Motor Systems. *Sci. Amer.*, vol. 213, 1965, pp. 84-94.
102. HELD, R.; AND FREEDMAN, S. J.: Plasticity in Human Sensorimotor Control. *Science*, vol. 142, 1963, pp. 455-462.
103. KOEZE, T. H.; PHILLIPS, C. G.; AND SHERIDAN, J. D.: Thresholds of Cortical Activation of Muscle Spindles and α -Motoneurons of the Baboon's Hand. *J. Physiol.*, vol. 195, 1968, pp. 419-449.
104. TEUBER, H. L.: The Riddle of Frontal Lobe Function in Man. *The Frontal Granular Cortex and Behavior*, J. M. Warren and K. Akert, eds., McGraw-Hill Book Co., Inc., 1964, pp. 410-444.

DISCUSSION

Tang: Do I understand correctly that, during rapid eye movements, there is a spinal block of the somatic afferent which provides for protection or for better sleeping? The somatic afferents would be blocked at the spinal level in order that the animal not be awakened by its own muscle contractions. On the other hand, the ventral posterior lateral nucleus increases the excitability. Would that not be a built-in protection? In other words, if the external stimuli could get through the spinal nuclei, this would automatically awaken the animal very rapidly because the sensitivity of the higher level is increased. Would that be a correct interpretation?

Pompeiano: It is true that just at the time of the motor contractions synchronous with the REM bursts, there is a depression of somatic afferent transmission not only to the spinal motoneurons but also to the dorsal-column nuclei. On the other hand, this effect is associated with a facilitation of the orthodromic response through the nucleus ventralis posterolateralis (VPL). The interpretation of our results that you gave may well be correct. I think, however, that the significance of our findings is more far reaching. It was found in our experiments that all the effects described depend upon vestibular discharges which are responsible not only for the rapid eye movements but also for the appearance of the related contractions of the limb musculature. One may propose that even during the motor contractions elicited by natural labyrinthine stimulation in the awake animal, vestibular volleys interact with proprioceptive afferent impulses at different relay stations of the somatosensory pathway.

It has been postulated by several authors that the sensory feedback dependent upon active movements plays an important role in motor coordination (R. Held: *Plasticity in Sensory-Motor Systems. Sci. Amer.*, vol. 213, 1965, pp. 84-94). Our experiments indicate that the integration of the somatosensory volleys during the muscular contractions related in time with the bursts of REM involves inhibitory events at the level of the dorsal-column nuclei as well as facilitatory events at the level of the specific thalamic nuclei. The result is that external stimulation due to somatic afferent volleys is partially substituted by internal stimulation due to vestibular afferent volleys which are incorporated at thalamic level and elaborated by the somatosensory cortex. It appears, therefore, as if a central discharge originating from the oculomotor centers in the brainstem reaches the VPL neurons simultaneously with the efferent discharge which gives rise to the limb and eye movements. The existence of such "corol-

lary" central discharges, i.e., discharges from motor to sensory structures, has been postulated in order to account for the perceptual constancy of the environment during body movements (H. L. Teuber: *In: The Frontal Granular Cortex and Behavior*, J. M. Warren and K. Akert, eds., McGraw-Hill, 1964, pp. 410-444).

Snider: Professor Pompeiano, that is a very fine presentation. No doubt we could spend the rest of the afternoon on some of the implications of this. It seems to me that one point I missed was which comes first, the eye movements or the vestibular discharges. As I see it, you have not eliminated the so-called trigger zones in the pontine region. What happens in these animals if the extraocular muscles are ablated acutely (i.e., the extraocular muscles are removed), thus removing the feedback into the pontine system or even into the cerebellum? What, for example, does the vestibule have to do with this? Your thesis, as I see it, is proposing spontaneous activity in the vestibular nuclei. Perhaps I am reading ahead of the data here.

In our subsequent paper on the cerebellum (Ray S. Snider and Karl Lowy, "Evoked Potential and Microelectrical Analysis of Sensory Activity Within the Cerebellum"), we believe the cerebellum is tied up with relating eye movements to some of these discharges. I would also like to know how you were relating the vestibular nuclei to the VPL. That is not a monosynaptic pathway. It must have been acting through the reticular formation. Do you not feel that the spontaneous activity, at least the trigger zones, is still in the reticular formation and the vestibular system is carrying out the dictates of it?

Pompeiano: Our experiments indicate that the bursts of REM as well as all the related events depend upon the activity of the medial and descending vestibular nuclei. This activity still occurs after cerebellectomy or bilateral section of the VIII nerves. The persistence of a rhythmic pontine activity in spite of the destruction of the vestibular nuclei suggests that the increase in the vestibular discharge during desynchronized sleep is triggered by central volleys originating from a pontine center. There is also evidence indicating that the phasic changes in sensory transmission during the bursts of REM do not depend upon retinofugal discharges nor can they be attributed to afferent discharge from eye muscle proprioceptors because the same effects were obtained also following enucleation of eyes or extraocular muscles.

So far, we have studied only the pathways responsible for the depression of the orthodromic lemniscal responses elicited

by single-shock stimulation of forelimb nerves during the bursts of REM. It appears that during these rapid eye movements, the vestibular nuclei depress the synaptic transmission at the level of the dorsal-column nuclei through the round-about way of the sensory-motor cortex and the pyramidal tract. The pathway responsible for the vestibular influences on the VPL has not been investigated yet.

Graybiel: Have you watched for REM sleep in persons who had lost all four limbs?

Pompeiano: Nobody has so far watched for REM sleep in subjects who had lost all four extremities. Our observation that the REM bursts depend upon the activity of the vestibular nuclei has been recently confirmed in man (O. Appenzeller and A. P. Fischer, Jr.: Disturbances of Rapid Eye Movements During Sleep in Patients With Lesions of the Nervous System. EEG Clin. Neurophysiol., vol. 25, 1968, pp. 29-35). These authors found that REM's were absent in patients with severe Wernicke-Korsakoff's disease, in whom the vestibular nuclei are known to be often affected.

One of the fields in which the investigations should be

directed in the future is that concerned with the relationship existing between REM sleep and vestibular function. It is well known that artificial interruption of REM sleep in humans is followed by a striking compensatory increase in amount and percentage of the REM time if the subjects are allowed uninterrupted sleep. It has been proposed that the REM mechanism is triggered by a neurochemical substance which accumulates to a critical threshold level within a pontine center and is then released. One may postulate that the sensitivity of the subjects to natural labyrinthine stimulation is inversely related to the amount of time previously spent in REM sleep and that the intensity of the labyrinthine responses increases during REM deprivation. In view of the possible relationship between REM sleep, REM deprivation, and intensity of labyrinthine reflexes, one may eventually begin to sort out ways in which drugs may alter the sensitivity to labyrinthine reaction via the mechanism of permanently altering the nature of REM sleep. Obviously all these hypotheses should be tested experimentally.

Vestibular Activity in the Descending Medial Longitudinal Fasciculus^{1,2}

BO E. GERNANDT

Naval Aerospace Medical Institute

SUMMARY

The functional importance of the medial longitudinal fasciculus (MLF) in carrying vestibular impulses into the spinal cord has been studied in cats. The amplitude, duration, and latency of the gross motor responses evoked by vestibular stimulation and recorded from cervical and lumbar levels do not show any significant or persistent changes after a selective bilateral disconnection of the descending MLF. Thus, in evaluating the hierarchical importance of the three descending vestibulofugal pathways, it becomes obvious that the MLF offers a much weaker link than the connections represented by the vestibulospinal and reticulospinal tracts. By sectioning all pathways other than the MLF in the brainstem at the cerebellopontine angle, this tract could be investigated in anatomical isolation from adjacent vestibular connections. Vestibular stimulation applied to this "MLF animal" preparation evoked motor responses which could be recorded as far down as midthoracic levels. No sign of activity was ever recorded from lumbosacral levels. Judged by the response, the MLF seems to have a homogeneous fiber spectrum, and the mean speed of conduction of the neurons is about 63 m/sec. Single MLF axon recordings demonstrated that the discharge frequency in response to vestibular stimulation may reach values that are more than twice the value of ventral-root α -fiber discharge in response to identical stimulation, and that the synaptic transmission across the vestibular nuclei occurs with a considerable safety factor. Excitatory and inhibitory postsynaptic potentials evoked by vestibular activity conducted in the MLF have been recorded intracellularly from flexor and extensor motoneurons at cervical levels, but the relative amounts of excitatory or inhibitory action on a test motoneuron are variable. Pure EPSP's or IPSP's can be recorded, but the majority of motoneurons showed EPSP's; the long latencies of each were approximately the same and indicate that spinal interneurons are involved in the transmission. These depolarizing and hyperpolarizing effects could be recorded in a random fashion from flexor and extensor neurons, as identified by antidromic stimulation, but no consistent sign of reciprocity was obtained when recording from neurons with antagonistic function.

INTRODUCTION

Among a multiplicity of descending pathways available for conducting impulses into the spinal cord are three tracts—the vestibulospinal, the reticulospinal, and the medial longitudinal fas-

ciculus (MLF)—which place spinal motor cells under the reflex control of the vestibular apparatus. The functional significance of the first two tracts has been studied extensively during the last decade (ref. 1), and the amount of neuro-anatomical work that has gone into the elucidation of the details of these pathways is considerable (ref. 2). However, some experimental attempts to obtain information about the importance of the descending portion of the MLF have not been successful, largely because of specific inherent limitations which preclude complete systematic investigation (ref. 3). The anatomical

¹ The animals used in this study were handled in accordance with the "Principles of Laboratory Animal Care" established by the Committee on the Guide for Laboratory Animal Resources, National Academy of Sciences-National Research Council.

² An expanded report appears in *Exptl. Neurol.*, vol. 22, 1968, pp. 326-342.

properties of the fiber groups which compose collectively the MLF have attracted attention as well as occasional disagreement. It is known that the fibers of the MLF originate in the medial, and probably the spinal, vestibular nuclei and descend in the homolateral as well as the contralateral fasciculus. The extent of the descending tract in the spinal cord and the manner by which the fibers articulate with the ventral horn cells have been studied (refs. 4 and 5), but to what degree this tract participates in spinal activity has been evaluated in various ways. A report describing primary vestibular fibers entering the MLF (ref. 6) was not verified in a more recent investigation (ref. 7).

METHODS

The experiments reported here were performed on decerebellate cats anesthetized with intravenously administered α -chloralose (60–70 mg/kg), immobilized by gallamine triethiodide, and maintained on artificial respiration. The peripheral branches of the left vestibular nerve were exposed and equipped with stimulating electrodes; for recording purposes, the deep radial, selected intercostal nerves, and lumbosacral ventral roots were exposed unilaterally or bilaterally and a peripheral neurotomy performed. To isolate the medial longitudinal fasciculus, visible through the floor of the fourth ventricle on each side of the median sulcus, a transection of the brainstem, sparing only the MLF, was carried out at the level of the cerebello-pontine angle under a Zeiss binocular dissecting microscope. The section was followed by suction with a fine pipet, inducing a discernible separation of the brainstem and with only the MLF spanning the gap. As a consequence, the preparations were essentially spinal. Histological controls upon Weil-Weigert stained microscopic sections cut from blocks that included the full extent of the operative lesion were carried out after each experiment in order to verify the extent and completeness of the separation.

The cervical spinal cord was exposed by laminectomy from the third to the seventh cervical vertebrae. In some of the experiments, the dorsal and ventral roots were left intact; in others,

the dural cuffs were opened and the dorsal roots sectioned extradurally in order to obtain maximal distance between the distal portion of the roots and the cord. The distal ends were gently gripped between the two Ag-AgCl wires of the stimulating electrodes and elevated to a vertical position. Exposed neural structures were bathed in mineral oil and maintained at body temperature by radiant heat.

Intracellular recordings from the motoneurons of the cervical cord were carried out with glass microelectrodes of approximately 0.5-micron tip diameter, filled with 3 M KCl, having a resistance of 5–20 megohms, and connected via a Bak unity-gain negative capacitance amplifier to a dc amplifying channel consisting of a Tektronix type D plug-in unit and a type 555 oscilloscope.

FINDINGS

Figure 1A shows the control response to single-shock suprathreshold vestibular stimulation recorded from the ipsilateral deep radial nerve (upper beam) and the ventral root L7. The illustration was obtained by superimposing 10 sweeps. Except for a small opening through the occipital bone over the region of the obex, the

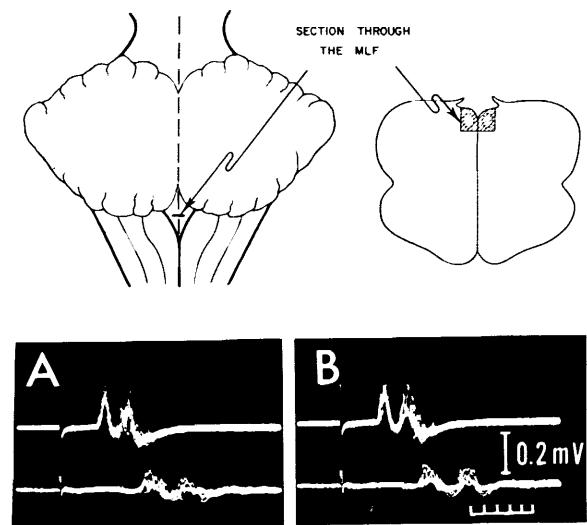

FIGURE 1.—Control responses to single-shock suprathreshold vestibular stimulation recorded from deep radial nerve (upper beam) and ventral root L7 before (A) and after (B) selective elimination of the descending medial longitudinal fasciculi as shown in schematic drawing. Time scale in msec.

cats were intact; i.e., the three descending vestibulofugal tracts were unimpaired. Between recordings *A* and *B*, a section through the MLF had been carried out as shown in the schematic drawing of figure 1. Because of some difficulties confining the MLF, particularly in the ventral direction, the section across the midline was made 3 mm wide and 3 mm deep in order to disrupt the majority of descending fibers (ref. 8). In spite of this rather extensive section beyond the main confinement of the tract, it has not been possible to demonstrate any significant or persistent difference in the responses after this disconnection, not even at the cervical level of motor output (fig. 1*B*) and no matter whether threshold, suprathreshold, or supramaximal strength of stimulation was applied.

To explore the importance of the MLF in transmitting vestibular impulses to different

segmental spinal motoneuron populations, the "MLF animal" preparation was employed in the present study (fig. 2*A*). By eliminating all other extrapyramidal and pyramidal tracts by a high lesion through the central neuraxis, a straight relay between primary and secondary vestibular fibers, exclusively represented by the medial longitudinal fasciculus, is offered in sufficient anatomical isolation from adjacent vestibulofugal connections to provide a favorable situation in which the functional significance of the tract can be evaluated without undue interference (figs. 2*B* and *C*). The response, then conducted through the isolated portion of the descending MLF, had a latency of 7 msec, a duration of 8 to 10 msec, and an amplitude of about 100 to 150 μ V. The findings appear to contribute to an understanding of the role played by the MLF, one of the phylogenetically oldest tracts, in the transmission of vestibular activity into the spinal cord. However, the extent to which it is permissible to interpret activities of the central nervous system in terms of properties of axons and synapses after making extensive sections through the structure may be open to discussion. In addition to a more or less transient depression of reflexes induced by transection of the brainstem, the vestibular facilitatory influx to the cord is reduced due to the elimination of the two other vestibulofugal pathways (refs. 9 to 13), and thus the excitability level of the motor pools is lowered when the cells are impinged upon by the evoked activity funneled through the MLF exclusively (figs. 2*D* to *F*). The isolated tract which is simple in the sense that it is easy to describe in anatomical terms may, when activated, evoke only a non-specific response, whereas the tract as a member of the descending vestibulofugal system may participate in reflex activity of much greater complexity. When the peripheral branches of the vestibular nerve were stimulated, after the bridge containing the MLF had been made, responses of gradually declining amplitude and increasing latency could be obtained as far down as the Th 5 and Th 6 intercostal nerves. The effect was strictly ipsilateral. No responses were recorded from ventral lumbosacral roots and no visible effects upon the local segmental reflexes were obtained.

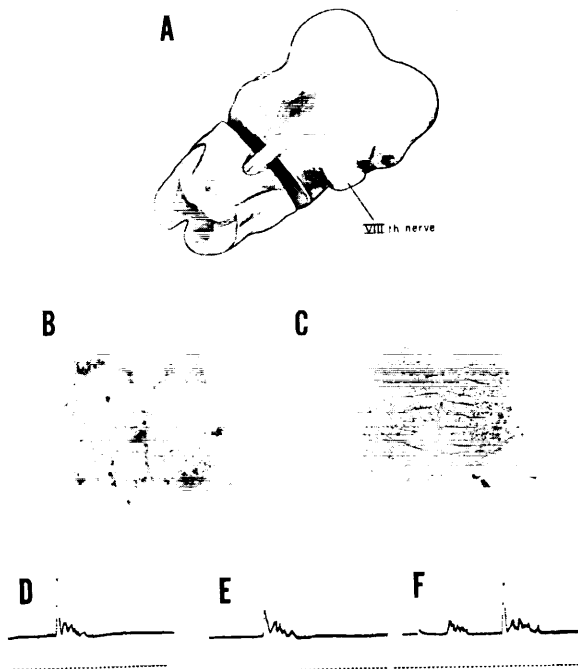

FIGURE 2.—Drawing of brainstem showing medial longitudinal fasciculi bridging gap (A). Histological controls upon hematoxylin-eosin (B) and Weil-Weigert (C) stained microscopic cross sections of bridge containing main group of fibers constituting medial longitudinal fasciculi. Amplification, 15 \times . Segmental response to dorsal root C5 (DRC5) stimulation and deep radial nerve recording before (D) and after (E) creating bridge according to drawing. Segmental response preceded by vestibular activity exclusively funneled through MLF (F). Time scale in msec.

In 42 instances intracellular recordings for several minutes permitted testing the effects of MLF activation on individual extensor and flexor motoneurons, as identified by antidromic stimulation of the deep radial and the musculocutaneous nerves. The cervical motoneurons showed both excitatory and inhibitory effects in response to single-shock vestibular stimulation. The majority of the neurons, however, displayed an excitatory postsynaptic potential. No significant differences in discharge characteristics as defined in terms of latency, magnitude, and duration of evoked EPSP's and IPSP's were found during MLF activation. Figure 3 demonstrates the arrival of the vestibulospinal volley recorded from the surface of the cord (upper beam) at the same level as the site of the microelectrode penetration. The latencies of these EPSP's, as measured from the onset of the cord surface potential, varied between 1.1 and 1.6 msec. These values indicate that the activation of cervical motoneurons by impulses conducted in the MLF occurs via interneurons. In many instances it was possible to shorten the latency by increasing the strength of vestibular stimulation and, therefore, the values given are the shortest measured. In about one-third of the neurons, the EPSP's were followed by a small but distinct hyperpolarizing phase which in some instances lasted as long as 75 msec.

In 10 of the impaled cells, the MLF volley evoked inhibitory postsynaptic potentials having latencies varying from 1.2 to 1.8 msec. The time course of these depolarizing and hyper-

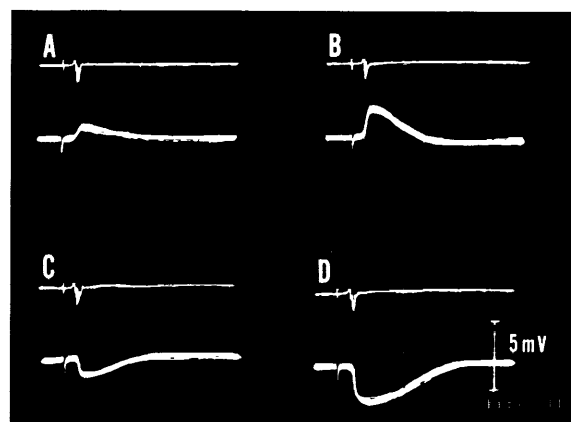

FIGURE 3.—Upper traces indicate arrival of MLF volley in spinal cord at the level of microelectrode penetration. Lower traces intracellular records of postsynaptic potentials in radial motoneurons. EPSP's evoked by 1 pulse/sec (A) and 50 pulses/sec (B) vestibular stimulation. IPSP's elicited by 1 pulse/sec (C) and 50 pulses/sec (D) vestibular stimulation. Time scale in 5-msec intervals.

polarizing effects was about 20 to 30 msec; i.e., longer than the duration of EPSP's and IPSP's evoked by stimulation of peripheral muscle afferents. With vestibular stimuli of subthreshold strength for spike discharge, the irregularly shaped EPSP and IPSP waves reached values of 1 to 2 mV, but with increase in the strength or frequency (50 to 200 pulses/sec) of stimulation, values of 4 to 6 mV were obtained. No pattern of reciprocity was encountered when recording from extensor or flexor motoneurons; the appearance of depolarization or hyperpolarization occurred in an unpredictable manner.

REFERENCES

1. GERNANDT, B. E.: Vestibular Influence Upon Spinal Reflex Activity. Myotatic, Kinesthetic and Vestibular Mechanisms, A. V. S. de Reuck and J. Knight, eds., Churchill, London, 1967, pp. 170-183.
2. BRODAL, A.; POMPEIANO, O.; AND WALBERG, F.: The Vestibular Nuclei and Their Connections, Anatomy and Functional Correlations. Oliver & Boyd, Edinburgh and London, 1962.
3. GERNANDT, B. E.; AND GILMAN, S.: Generation of Labyrinthine Impulses, Descending Vestibular Pathways, and Modulation of Vestibular Activity by Proprioceptive, Cerebellar, and Reticular Influences. Neural Mechanisms of the Auditory and Vestibular Systems, G. L. Rasmussen and W. F. Windle, eds., Charles C Thomas, 1960, pp. 324-348.
4. MASSOPUST, L. C.: Terminal Degeneration Study of the Spinal Component of the Medial Longitudinal Fasciculus. Anat. Record, vol. 127, 1957, p. 330.
5. NYBERG-HANSEN, R.: Origin and Termination of Fibers From the Vestibular Nuclei Descending in the Medial Longitudinal Fasciculus. An Experimental Study With Silver Impregnation Methods in the Cat. J. Comp. Neurol., vol. 122, 1964, pp. 355-367.
6. CAMIS, M.: The Physiology of the Vestibular Apparatus. Clarendon Press, Oxford, 1930.
7. CARPENTER, M. B.: Experimental Anatomical-Physiological Studies of the Vestibular Nerve and Cerebellar Connections. Neural Mechanisms of the Auditory and Vestibular Systems, G. L. Rasmussen and W. F. Windle, eds., Charles C Thomas, 1960, pp. 297-323.

8. SZENTÁGOTHAJ, J.: Pathways and Synaptic Articulation Patterns Connecting Vestibular Receptors and Oculomotor Nuclei. *The Oculomotor System*, M. B. Bender, ed., Harper, New York, 1964, pp. 205-223.
9. ANDERSSON, S.; AND GERNANDT, B. E.: Ventral Root Discharge in Response to Vestibular and Proprioceptive Stimulation. *J. Neurophysiol.*, vol. 19, 1954, pp. 524-543.
10. BACH, L. M. N.; AND MAGOUN, H. W.: The Vestibular Nuclei as an Excitatory Mechanism for the Cord. *J. Neurophysiol.*, vol. 10, 1947, pp. 331-337.
11. GERNANDT, B. E.; AND THULIN, C.-A.: Vestibular Mechanism of Facilitation and Inhibition of Cord Reflexes. *Am. J. Physiol.*, vol. 172, 1953, pp. 653-660.
12. KEMPINSKY, W. H.; AND WARD, A. A., JR.: Effect of Section of Vestibular Nerve Upon Cortically Induced Movement in Cat. *J. Neurophysiol.*, vol. 13, 1950, pp. 295-304.
13. WARD, A. A., JR.: Decerebrate Rigidity. *J. Neurophysiol.*, vol. 10, 1947, pp. 89-103.

DISCUSSION

Wilson: This presentation is very interesting and certainly suggests that this medial pathway does not mediate any motor outflows through the ventral roots of the lower cervical and lumbosacral level. In talking about the cervical level, I think it is quite important to emphasize at what particular cervical level you are working, because we found a significant difference between the upper segments dealing with the neck reflexes and the lower cervical segments dealing with the limb. We are going to apply some of these techniques of selective cutting, as you have, to see whether they influence the monosynaptic inhibitory potentials that we have observed. As far as the stimulation in the brainstem is concerned, I completely agree with you that it can be quite dangerous to stimulate in the brainstem and make conclusions from this. However, when small electrodes and threshold shocks are used, and when you track through a region and the threshold changes sharply as you go through it, I think then you are entitled to make some conclusions.

Are you implying that this bundle of fibers, approximately 3 mm deep and 3 mm wide, that you are stimulating in your bridge experiment, contains only fibers originating in the vestibular nuclei?

Gernandt: Yes; in the midline. Those fibers are the medial longitudinal fasciculi.

Wilson: You do not think there are any reticulospinal fibers in that bridge at all?

Gernandt: No; I do not think so. According to the anatomists, that is the classical description of the MLF, and I know that it does not include all the fibers, because they are scattered in the ventral-lateral direction, as I said. But these fibers, I think, are MLF fibers.

Wilson: There must be many more fibers of vestibular origin in the MLF than we thought.

Nyberg-Hansen: I am very glad to see that you can follow the medial vestibulospinal tract to midthoracic levels. That fits very well with my own anatomical findings. Concerning the bilaterality, I would stress that there are many more medial vestibulospinal fibers found ipsilaterally than contralaterally. There are few contralateral fibers, but they can be demonstrated anatomically. Have you ever stimulated more rostrally in the MLF, above the level of the vestibular nuclei? I am particularly thinking about the interstitiospinal fibers.

Gernandt: No; that is what I was trying to tell you. If you go down with the stimulating electrode into that region and apply electric stimulation, you will activate everything. So, no, we have not. We have only used peripheral nerves as inputs for activating the central nervous system. In going down and planting electrodes in the central nervous system for recording purposes you are safe, but not for stimulating purposes. That was my point.

Nyberg-Hansen: I understand perfectly well your point. I am only interested in the interstitiospinal fibers because they also course within the MLF in the brainstem, together with reticulospinal fibers and fibers from the medial vestibular nucleus. Furthermore, in the spinal cord, the interstitiospinal fibers can be followed to the lumbosacral enlargement coursing in the dorsomedial part of the ventral funiculus. They are bilateral, but most numerous on the ipsilateral side. The interstitiospinal fibers terminate within the dorsal part of lamina VIII and adjacent parts of lamina VII, as do the medial vestibulospinal fibers. While the latter fibers are restricted to the upper half of the cord, the interstitiospinal fibers can be followed the whole cord throughout.

SESSION VIII

***Chairman:* WILLIAM D. NEFF
Indiana University**

Evoked Potential and Microelectrical Analysis of Sensory Activity Within the Cerebellum¹

RAY S. SNIDER AND KARL LOWY

University of Rochester

SUMMARY

The extensive to-and-fro connections between the cerebellum and the vestibular system have been reviewed. Purkinje-cell inhibition to the vestibular system is recognized in the direct pathways, and the role of the crossed fastigiovestibular pathway is discussed. There is no overlap of auditory and vestibular areas in the cerebellar cortex, but there may be in the nuclei fastigii. In the cerebello-cerebral projections, there is overlap at the cerebral levels. Microelectrode studies on the auditory area indicate that it has electrophysiological properties similar to those reported for other cerebellar areas. The function of the cerebellum in the habituation of nystagmus is discussed and some electrophysiological interpretations given.

The material to be presented is divided into three parts. Part I is a review of some of the interrelationships between the cerebellum and the vestibular system, including connections with the cerebrum. Part II presents evoked-response and microelectrode data collected from the cerebellar cortex, with special emphasis on the auditory and vestibular systems. Part III contains data pertinent to a discussion on cerebellar function involved with habituation of nystagmus.

By way of emphasizing developmental relationships, figure 1A is shown. The basic vestibular area (in black) arises from the alar plate and develops into a "typical" cerebellar cortex. In lower vertebrate forms, this is the dominant part of the cerebellum which develops. As shown by the concentric dotted lines, however, the newer portions of the cerebellum in higher animals mushroom upward from this area. The base continues to be related to the vestibular system, whereas the newer portions of the cerebellum receive fibers from both the tactile and proprioceptive systems. The tail, leg, arm, and

face receiving areas are shown. There is one area in the anterior lobe and one in the posterior lobe. Sensory impulses arising from the tail region of the animal are located adjacent to the vestibular system. As the sensory areas representing the surface of the animal spread out on the dorsal surface, the two face areas overlap. There are only minor differences between the projections of the two systems, and one usually speaks of the tactile and the proprioceptive areas as being coextensive. The face areas are represented largely by projections from the trigeminal system, and there is overlap with projections from two additional sensory modalities; i.e., auditory and visual (ref. 1). It is curious that the auditory area is located so far from the vestibular area, since both systems originate in end organs so intimately related. Instead, the auditory area is almost coextensive with the visual area, and they both overlap the face areas as is shown in figure 1B. This is a dorsal view of the cerebellum and the midline structures labeled, according to Larsell's terminology, lobules I through X. To the right of the drawing are shown the figurines as viewed from the dorsal surface. The vestibular areas are located at either end, and the tactile and proprioceptive

¹This work was supported in part by grants NB-04592 and NB-06827 from the National Institutes of Health.

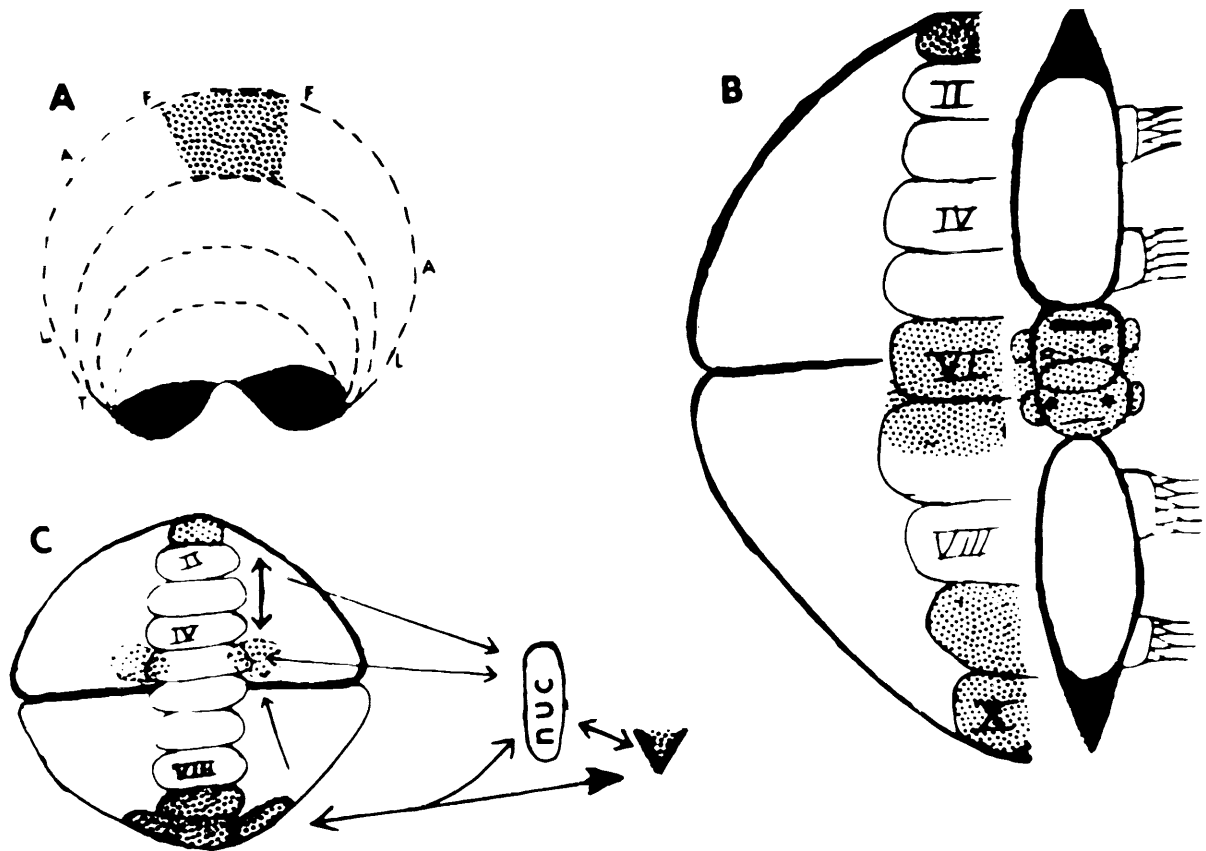

FIGURE 1.—A: Basic drawing of lateral view of cerebellum with vestibular areas (black) at base. Smaller area to left represents portion in anterior lobe. Concentric dotted lines represent growth of cerebellum, especially neocerebellum. Tactile and proprioceptive receiving areas for the tail (T), leg (L), arm (A), and face (F) are indicated. The dorsal stippled area represents visual and auditory receiving areas. B: Basic drawing of dorsal view of cerebellum showing figurines spread on surface to represent tactile receiving areas. Roman numerals on left correspond to Larsell's subdivisions. The auditory receiving area (stippled) is in lobule VI and part of VII. The vestibular areas (stippled) are in lobules I, IX, X. C: Basic drawing of dorsal surface of cerebellum showing (stippled) vestibular areas, fastigial nuclei, and vestibular end organ (nuc), vestibular nuclei. Arrows represent connections.

representations of the different parts of the body represented in between. In the region of lobule VI are the auditory and visual areas.

Figure 1C summarizes the major vestibulo-cerebellar connections. As a result of the studies of Cajal (ref. 2), Ingvar (ref. 3), Larsell (ref. 4), and Dow (ref. 5), the afferent projections were well established. As shown, there is both a direct projection from the end organ and an indirect one containing an additional synapse in one of the vestibular nuclei, and, for unknown reasons, both go to the same basic areas of the cerebellum (ref. 6). Also shown in figure 1C is a summary of the cerebellovestibular connections.

Dow (refs. 5 and 7) showed direct fibers from flocculonodular lobe to the lateral and medial vestibular nuclei. The recent studies of Walberg and Jansen (ref. 8) furnish the evidence of a direct pathway from the anterior and posterior lobes to the vestibular nuclei, while the studies of Brodal, Pompeiano, and Walberg (ref. 9) furnish the details of the projection of the cerebellar nuclei to the vestibular nuclei. A direct projection from the flocculonodular lobe to vestibular hair cells has been described by Llinás et al. (ref. 10). In summary, it is pointed out that there are two cerebellovestibular pathways, and, with few exceptions, vestibular structures which send

impulses to the cerebellum also receive impulses from it—often, from the same area. The functional implications of these to-and-fro projections will be discussed below.

Figure 2 shows the presence of various evoked responses within the (tuber vermis) auditory area of the cerebellum when the cerebral cortex was stimulated: *A*, auditory area; *B*, visual area; *C*, somatic area. Although there was extensive overlapping of these three cerebral systems within this region (see ref. 11 for details), this is the only part of the cerebellum from which visual and auditory responses could be obtained. Auditory responses could not be recorded from the vestibular areas, and vestibular responses could not be recorded from auditory areas. However, as shown in figure 3, there was definite interaction of visual and auditory impulses in this area inasmuch as a conditioning “flash” input altered the responsiveness of the test (click) input signal, which followed at varying intervals up to 120 msec when Flaxedil was used as an anesthetic, and for 360 msec when Chloralose was used. Since it is difficult to find overlapping pathways in these two systems, it is not unreasonable to assume that there is overlapping within the cerebellar cortex.

Furthermore, as shown in figure 4, there is interaction of impulses arising in the auditory area of the cerebrum and click-induced impulses within the auditory area of the cerebellum, with a recovery time between conditioning and test stimuli of as much as 400 msec when Chloralose anesthetic was used. These experiments cannot be performed satisfactorily upon animals under barbiturate anesthesia (ref. 11).

On the basis of the data presented thus far, one might conclude that there is no place within the nervous system where the vestibular and auditory systems overlap. However, this is not true because there is overlap in the least likely of all places, the cerebellocerebral projections. As shown in figure 5, electrical stimulation in the tuber vermis elicits evoked responses within the auditory area of the cerebrum in addition to responses in the visual area (ref. 12), while electrical stimulation within the vestibular areas of the cerebellum (fig. 6), i.e., lingula and uvula and also the flocculonodular lobe, as shown by

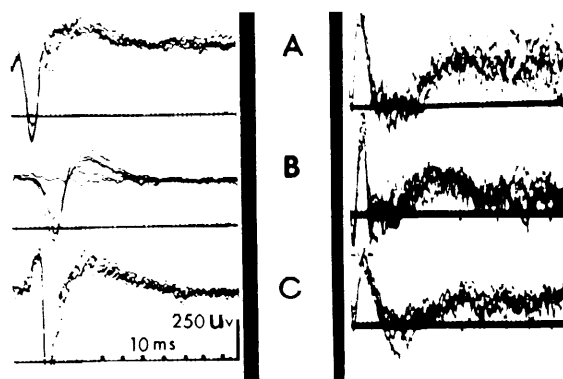

FIGURE 2.—Evoked responses recorded from tuber vermis (dorsal, first turn). Cat under Chloralose medication when responses in left column were taken; under Flaxedil medication when responses in right column were taken. *A*: Middle ectosylvian (auditory) cortex stimulated, 8.5 V, 0.1 msec, single biphasic pulse. *B*: As *A*, except visual cortex (posterolateralis) stimulated. *C*: As *A*, except 5.0 V to posterior cruciate gyrus (somatic receiving area). Five traces superimposed. Calibration signals are 250 μ V (vertical) and 10 msec (horizontal).

Ruwaldt and Snider (ref. 13), evokes potentials in a cerebral area overlapping the cephalic part of the auditory area. In figure 7 is shown a summarizing diagram of these two studies (refs. 12 and 13). The stippled regions represent the auditory areas, while the cross-hatched region represents maximal evoked responses when the vestibular areas of the cerebellum were stimulated (diagonal lines represent regions of lower responses). There is obvious overlap of the two in the anterior parts of the auditory area. The vestibular area in the cerebrum overlaps part of the tactile face area, but this is not the case in the cerebellum. It should also be pointed out that Infantellina, Sanseverino, and Sperti (ref. 14) have found physiological evidences of a prominent vestibular projection to the paraflocculus, and this part of the cerebellum projects to the vestibular area of the cerebrum as shown in this diagram.

METHODS

The microelectrode studies are given in the second part of this paper. The cats were prepared for acute surgery for the recording sessions after administering 12.5 mg/kg of the short-acting

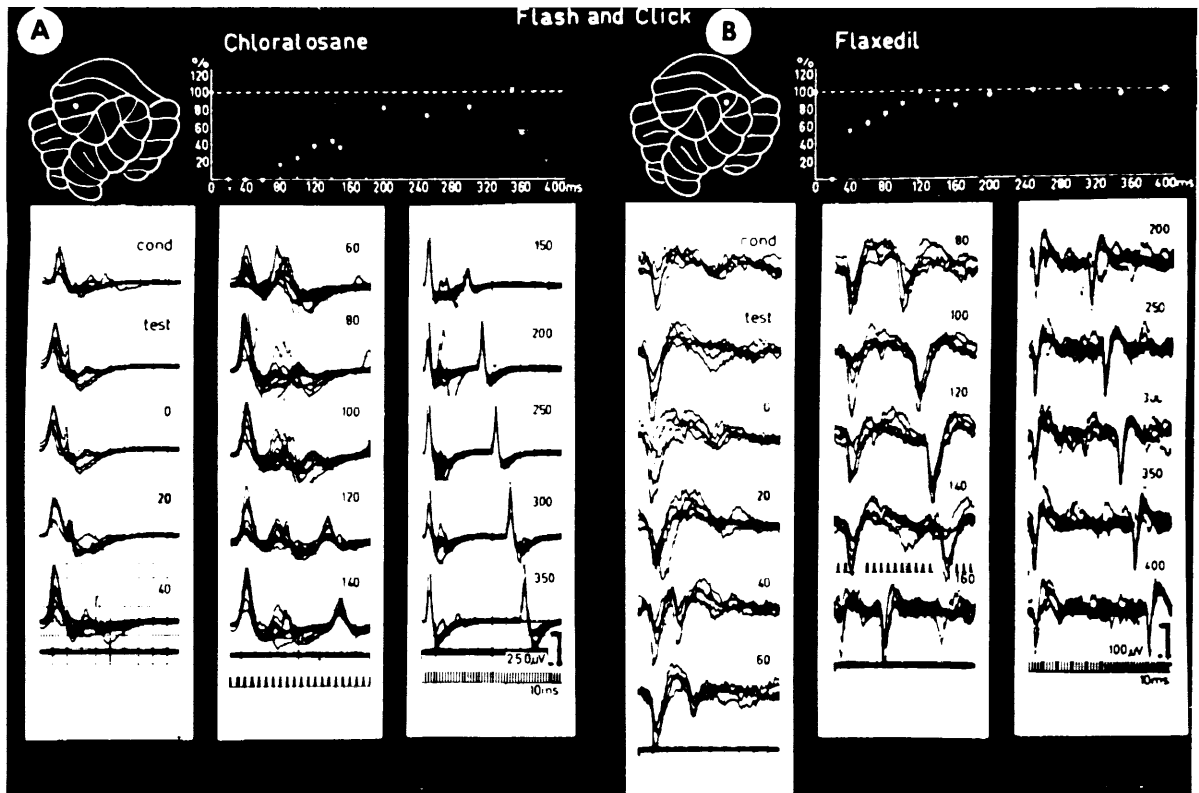

FIGURE 3.—A: Cat under Chloralose medication (70 mg/kg). Recording electrode on first turn of tuber vermis (see insert). Conditioning stimulus: 3-W neon lamp 2 in. from atropined eye—left. Test stimulus: 50-dB click from 8-in. speaker 2 m away. Numerals indicate time in milliseconds between two stimuli. Note 10-msec time signal for traces through 140-msec interval and then slower sweep for the remaining 250 μ V. Unipolar recording. B: As A, except Flaxedil medication was used (15 mg/kg). Records taken from tuber vermis (second turn). Insert shows amplitude of test response when compared with control. Note overlapping areas of visual and auditory responses and the shorter recovery time when Flaxedil medication was used. (From ref. 11.)

anesthetic agent, Surital. The animals were then maintained under Flaxedil medication while attached to a stereotaxic instrument. In some cases Chloralose, 30 mg/kg, was administered. A micromanipulator was attached to the stereotaxic instrument in order to allow fine manipulation of the microelectrode. Care was taken throughout the experiments to maintain body temperature above 34° C and, in the case of the Flaxedil-treated animals, to maintain adequate respiration.

Glass capillary tubing with a tip diameter of 1 to 3 microns (resistance of 5 to 20 megohms), filled with either 3 M potassium chloride or 2 M potassium citrate, was used for recording extracellular unit activity. The microelectrodes were

attached to probes containing one of the input valves of the cathode follower input. The other side was grounded. The signal was amplified by a Grass amplifier and the responses were photographed from the face of a 5-inch cathode-ray tube. Two types of stimulating electrodes were used. One, the so-called concentric electrode, was made by placing insulated stainless-steel wire in metal tubing. These electrodes were especially useful when the central white matter of the cerebellum was stimulated. Surface stimuli were applied directly to the pia by means of bipolar, 26-gauge silver wire with chlorided tips. Usually the distance between the tips was 1 to 1½ mm. At the conclusion of the experiment, a small direct

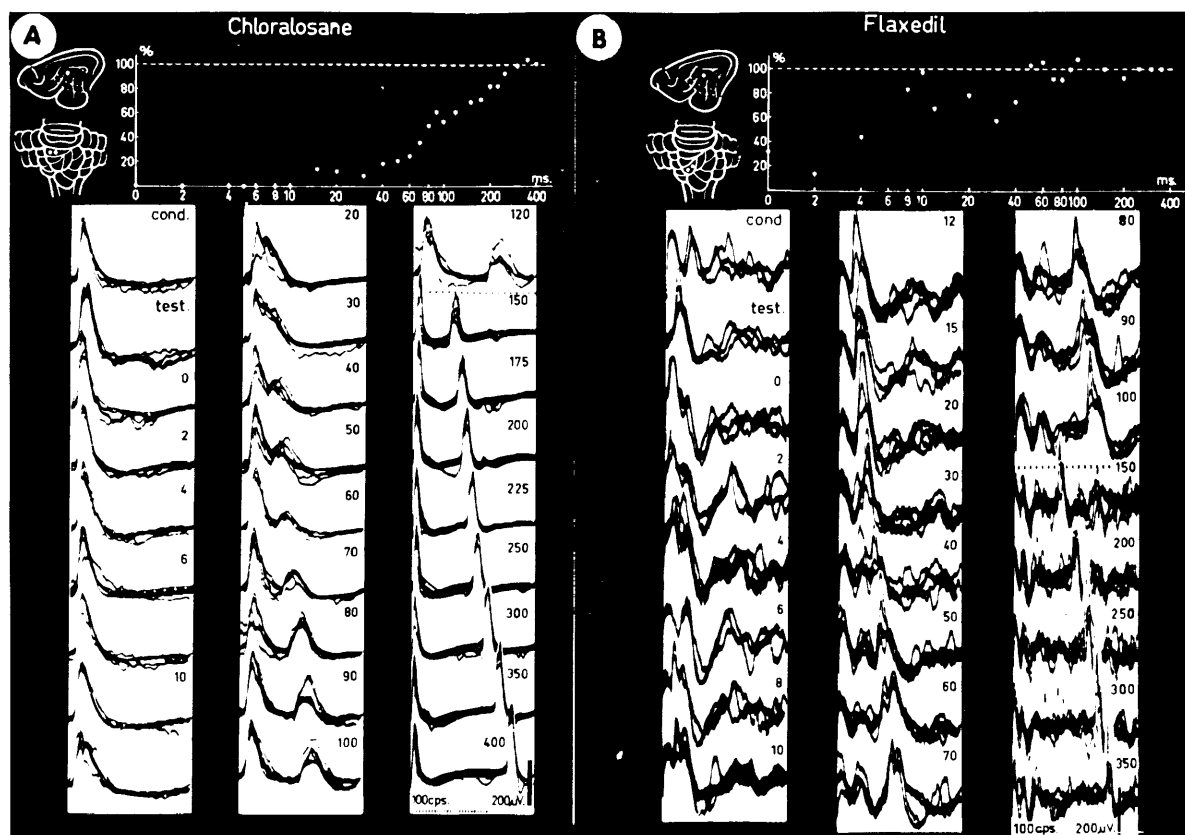

FIGURE 4.—A: Cat under Chloralose medication (70 mg/kg). Recording (bipolar) electrode on lobulus simplex (adjacent to tuber vermis, see insert), and conditioning stimulus was electric shock (6.5 V, 0.2 msec) applied to anterior ectosylvian gyrus. Test stimulus was 50-dB click from 8-in. speaker 2 m in front of animal. Numerals indicate millisecond interval between conditioning and test stimulus. Note faster sweep for intervals through 120 msec. 200- μ V calibration. B: As A, except Flaxedil medication (15 mg/kg) was used and the recording electrode was moved to first turn of tuber vermis. See insert for differences in recovery time of conditioning and test responses at various intervals. Amplitude of test response expressed in percentage of control (100 percent) response.

current was imposed upon the microelectrode, and a lesion which was usually less than 250 microns in diameter was placed in order to identify the area of the recording tip when histological sections were prepared. These sections were stained by the Nissl method.

RESULTS

In figure 8 is shown a series of traces recorded from the auditory area of the cerebellum when a single shock was applied directly to the auditory branch of the eighth nerve. The recording electrode was adjacent to the Purkinje-cell layer, and the high-amplitude units appear to represent dis-

charges of individual Purkinje cells. No stimuli were given in column A (spontaneous activity), but electrical stimuli were applied in order to obtain the tracings shown in column B (see shock artifact at the beginning of the sweep). The inhibition of units lasted for 10 to 20 msec, depending upon the strength of the stimulus. This was an unexpected finding, since excitation rather than inhibition was the anticipated result.

The microelectrode data shown in figure 9 illustrate the interaction of cells in the cerebellar cortex. The records were taken from the Purkinje-cell layer. As shown in 9A, stimulation in the white matter of a folium within the first turn of the tuber vermis induced a prolonged inhibi-

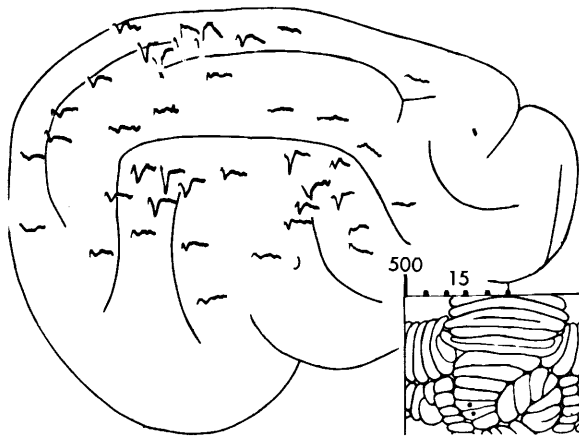

FIGURE 5.—Cat under Chloralose (70 mg/kg) medication. \blacklozenge Electrical stimulation of folia of first turn of tuber vermis (see insert), 12 V, 0.25 msec. Monopolar recording electrode. Note localization of responses in cerebral auditory and visual areas. To obtain this localization, it was necessary to use stimuli just above threshold. Calibration, 15 msec (horizontal) and 500 μ V (vertical).

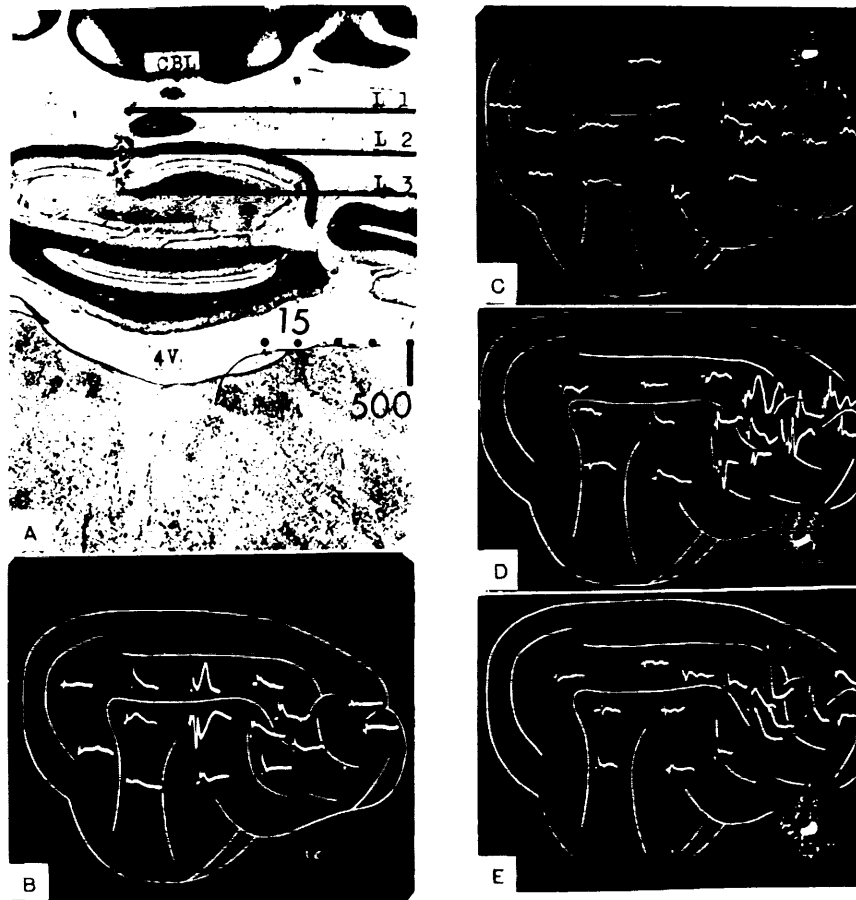

FIGURE 6.—Cerebral responses resulting from electrical stimulation of lingula (B); pyramis (C); uvula (D); and uvula (E). Cat prepared under ether anesthesia and maintained under dihydro- β -erythroidine. A: Photomicrograph showing electrode tract in lingula showing position of stimulation point (L2) for the responses shown in B. B: 20-V, 0.5-msec bipolar stimulation. Note localization of responses. C: Evoked responses in cerebrum resulting from surface stimulation of most posterior folium of pyramis (20 V, 1.0 msec). D: As C, except the most anterior folium of uvula was stimulated (see insert). E: As C, except middle folium of uvula was stimulated (see insert). (From ref. 13.)

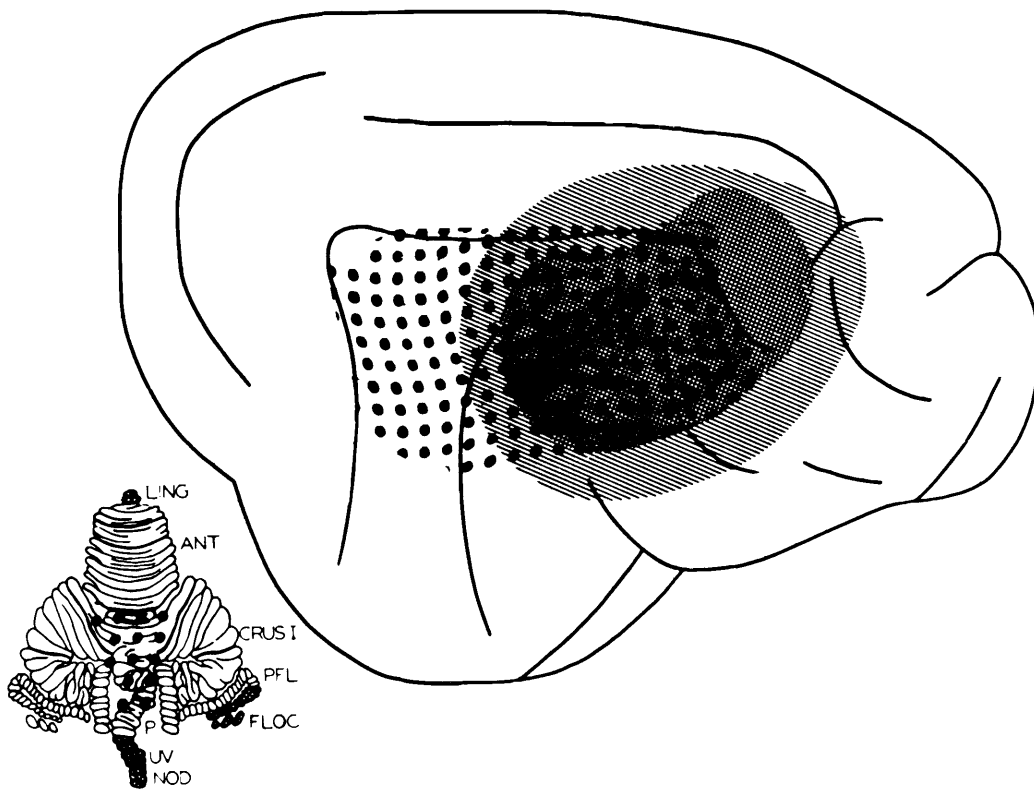

FIGURE 7.—Outline drawing of lateral surface of cerebral hemisphere and dorsal view of cerebellum showing (dotted) cerebellar areas which project to dotted areas of cerebrum. The vestibular areas of cerebellum, i.e., lingula (LING), uvula (UV), nodule (NOD), flocculus (FLOC), and paraflocculus (PFL), project to cross-hatched and diagonal-lined area of cerebrum. Note that the two projection systems overlap in the anterior ectosylvian gyrus. ANT is anterior lobe and P is pyramis. (From ref. 13.)

tion of Purkinje-cell activity. As clearly shown by Eccles and associates (ref. 15), such prolonged inhibition lasting approximately 400 msec can be explained by the inhibitory action of Golgi II cells on incoming signals via granule cells, or by direct basket-cell inhibition of Purkinje-cell activity. In 9B are shown the results of stimulating the pial surface of an adjacent folium and the induction of inhibition of Purkinje-cell activity in the tuber vermis for 200 msec. There are several explanations for this; however, the one we favor is the inhibition induced by the Purkinje-cell axon collateral which passes from one folium to an adjacent folium and induces relatively short inhibition directly on other Purkinje cells.

Figure 10 shows additional extracellular microelectrode records in which the electrode was placed at the junction of the molecular and

Purkinje-cell layers of the tuber vermis. In figure 10A a single shock was applied to the white matter of the same folium, according to the procedure of Eccles et al. (ref. 15). There was an initial deflection which represented ascending fiber activity and then rhythmic 20/sec discharges for less than 100 msec. Since reduction of the strength of the shock by only 10 percent failed to excite activity, this was arbitrarily assigned as threshold; figure 10B shows similar data collected when the shock was increased to $1\frac{1}{2}$ times threshold. In this case the same two Purkinje cells fired for 350 msec, while the higher voltage one continued for an additional 150 msec before stopping. These data show not only the rhythmicity of Purkinje cells but also the sharp localization of active units which can be obtained when small stimulating electrodes are used at near

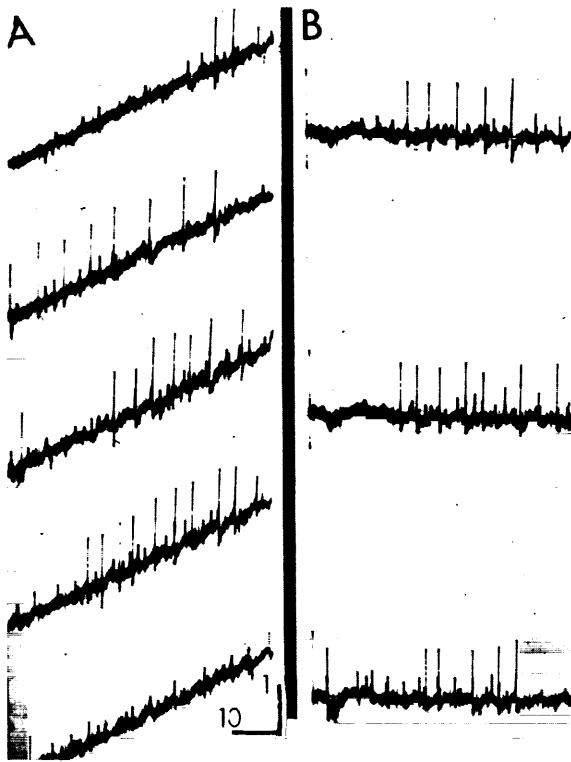

FIGURE 8.—Decerebrate cat. Single-unit recording via 3 M KCl-filled micropipet with 15-M Ω resistance. The tip was located adjacent to Purkinje-cell layer of a folium in first turn of tuber vermis. Record reads from below upward. A: Spontaneous activity. The high-voltage spikes were interpreted to represent Purkinje-cell discharges. The origin of the lower voltage spikes was unknown. B: At the beginning of each sweep, a single pulse $1\frac{1}{2}$ times threshold (9 V) was applied to end (in osseous spinal lamina) of the auditory nerve. Note the 25- to 30-msec inhibition of activity. Calibration, 10 msec (horizontal) and 1 mV (vertical).

threshold values. Figure 10C shows the effect of applying a single electrical pulse to the pial surface and recording from the Purkinje-cell layer of the same folium. There is an initial burst of 300 to 500/sec activity which lasts for approximately 100 msec and then gradually slows. This is followed by a period about 600 msec long in which there is inhibition of the higher voltage single units observed in the pre-stimulatory period which, because of the amplitude and the electrode tip location, were assumed to be Purkinje cells. As shown by Eccles et al. (ref. 15), basket-cell discharges are fast (up to

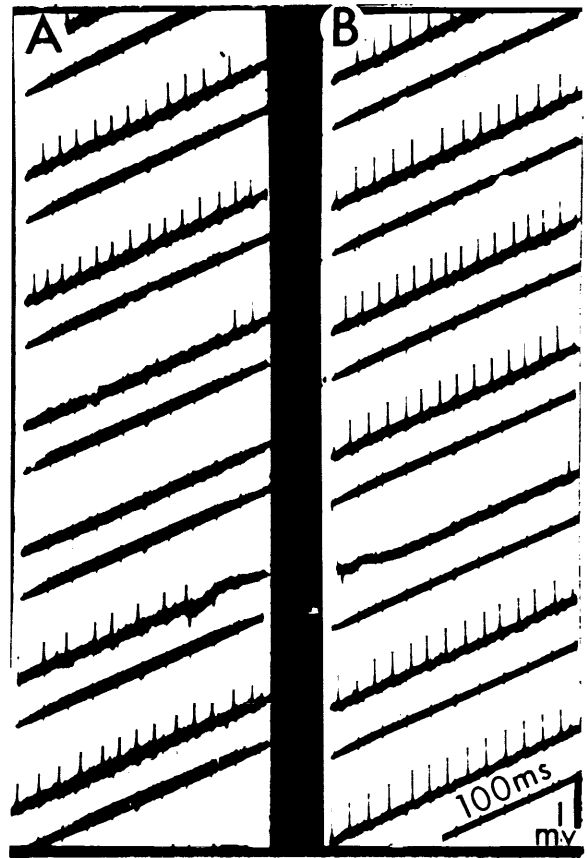

FIGURE 9.—A, B: Decerebrate cat. Micropipet (3 M KCl) 15-M Ω resistance inserted into folium of tuber vermis. Continuous record: read below upward. Single-shock electrical stimulus induced inhibition of unit activity. Calibration, 100 msec and 1 mV.

500/sec) and cause enduring inhibition of Purkinje cells. This, plus the fact that these cells are located in the Purkinje-cell layer, indicates that these data may be indicative of basket-cell discharges.

In figure 11 are shown the effects of local application of 2 percent strychnine on the pial surface of a folium when the central myelinated fibers of the folium are stimulated electrically. A is the control record showing the arrival of the afferent volleys in the Purkinje-cell layer and a 200-msec inhibitory period which follows. In B are shown the alterations which occur 2 minutes after application of the strychnine, while the traces shown in C include activities which were observed 5 minutes after local application of the

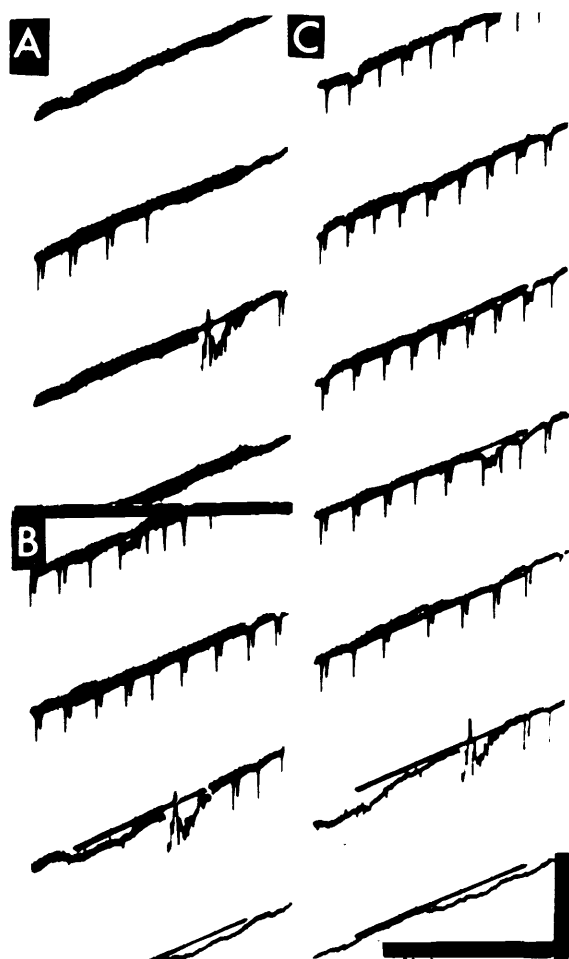

FIGURE 10.—A, B: Decerebrate cat with $13\text{-M}\Omega$ resistance microelectrodes (3 M KCl pipets) inserted into the tuber vermis. Single electrical stimuli were given. Records read from below upward. Calibration, 50 msec (horizontal) and 1 mV (vertical). C: Cat under Chloralose medication (70 mg/kg). Record reads from below upward. Single electrical shock introduced first a fast burst of activity, then an enduring inhibition. Calibration, 50 msec and 1 mV.

drug. Note reduction in size of the afferent volleys and the shortened inhibitory period.

From these data collected from single-unit activity in the auditory-visual area of the cerebellum, one can conclude that the electrical activity does not differ from that described by Eccles and associates (ref. 15) for the somatosensory areas. Unfortunately, our studies on the vestibular areas of the cerebellum have not been completed. However, it is likely that there

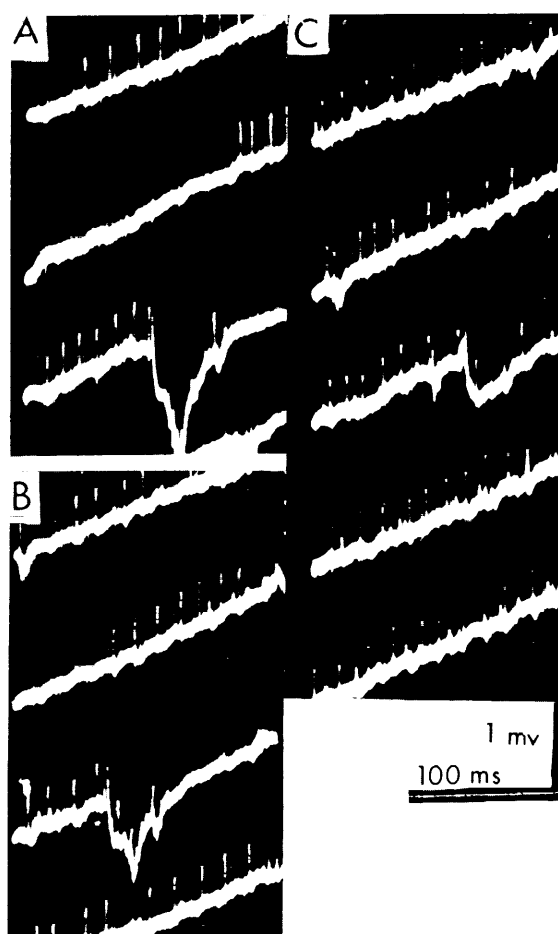

FIGURE 11.—A, B, C: Shows data collected when a $10\text{-m}\Omega$, 3 M KCl-filled micropipet was inserted into the Purkinje-cell layer of the tuber vermis and used as a recording electrode. Single electrical shocks were given at $1\frac{1}{2}$ times threshold. Note prestimulatory and poststimulatory effects. Record reads from below upward. Same recording and stimulating sites for A, B, and C. Calibration, 100 msec (horizontal) and 1 mV (vertical). Two percent strychnine applied locally 2 minutes before B was taken and 5 minutes before C was taken.

will be few if any unique features of this region other than the type of sensory input used to activate the areas. Thus, unlike the cerebral cortex, the cerebellar cortex possesses intrinsic activity which varies little from area to area.

At this point a fundamental question may be asked. If there is this uniformity within the cerebellar cortex, what function does it serve? For example, why have both a direct vestibulo-cerebellovestibular projection in addition to to-

and-fro connections between vestibular nuclei and the cerebellum? A partial answer may come from an analysis of the complex and subtle functional interrelationships which exist between these two structures.

(1) Dow (ref. 5) showed that ablation of the nodulus plus part of the uvula in the primate produced a syndrome of disequilibrium which lasted for 1 to 2 months. A transient nystagmus was observed. Bard et al. (ref. 16) showed that flocculonodular lobe lesions in dog prevented motion sickness and that this effect was long enduring.

(2) Direct cerebello-oculomotor connections have been known since Klinoff's work (ref. 17). Whiteside and Snider (ref. 18) were the first to give electrophysiological evidence for these and pointed out that the latency of response was so short that direct Purkinje-cell fibers might be considered. Manni, Azzena, and Dow (ref. 19) showed that single units in the oculomotor nucleus were affected by both cerebellar and vestibular nuclei stimulation. With these prominent connections to the oculomotor nucleus, it is easy to accept a cerebellar control of eye movements. Such effects have been known since Mussen's work (ref. 20). Koella (ref. 21) was the first to point out that, so far as eye movements are concerned, the cerebellum "appears to be organized with reference to three-dimensional space." The recent work of Cohen et al. (ref. 22) not only supports this concept but emphasizes that the tuber vermis region, i.e., so-called auditory-visual area, when stimulated in the unrestrained animal, produces conjugated horizontal eye movements similar to those seen when the horizontal canal (vestibule) is stimulated. Yet there is no evidence to show that the horizontal canal has connections to this part of the cerebellum.

(3) Evidence in the third category is concerned with the little-known role which the cerebellum plays on the habituation of vestibular nystagmus. Halstead first observed in 1935 (ref. 23) that pigeons with cerebellar lesions in the region of the tuber vermis failed to show habituation of vestibular nystagmus for rotatory stimulation. Di Giorgio and Pestellini (ref. 24) made similar studies on the guinea pig. However, the most

extensive study has been done by Wolfe (ref. 25), and the next two figures show some of these data taken from unrestrained cat during horizontal canal stimulation. In figure 12, note that the burst of fast activity in nucleus fastigii precedes slightly the slow wave in vermis which occurs during point of reversal; i.e., point of zero acceleration. Additional data show that changes in the activity of the fastigial nuclei are time locked to changes in the activity of the medial vestibular nucleus related to the fast phase of horizontal nystagmus. Figure 13 shows data which indicate that there was a normal nystagmic response at the beginning of record, but 24 seconds after stimulus onset the animal habituated to left rotation, while maintaining a normal response to right rotation. A unilateral lesion was placed in right tuber vermis, and 32 hours after surgery this record was taken. Note the slow wave in the nucleus fastigii which appears at zero acceleration during first part of record and which becomes less prominent when animal habituated to left rotation. Seventy-two hours after surgery, the animal did not habituate in either direction. Daily tests on this animal failed to elicit habituation until the 18th postoperative day when the animal reverted to unilateral habituation and on the 21st day showed habituation to both right and left stimulation. Wolfe (ref. 25) concluded that tuber vermis and nucleus fastigii are part of a control mechanism of the fast phases of nystagmus and that the habituation mechanism is located in the tuber vermis.

It is difficult to understand the changes which occurred in the infraslow cerebellar potentials (IFSPC) which have a frequency of only five to seven per minute and are too slow to be related to respiration. The IFSPC appeared in all animals before stimulus onset and increased in frequency and amplitude after the stimuli began. However, as the animal habituated, the IFSPC decreased in amplitude and occasionally disappeared completely during habituation. Thus Wolfe's work (ref. 25) indicates that the tuber vermis contains neural mechanisms capable of modifying the fast phase of vestibular nystagmus and that there is diminished amplitude of potentials during habituation.

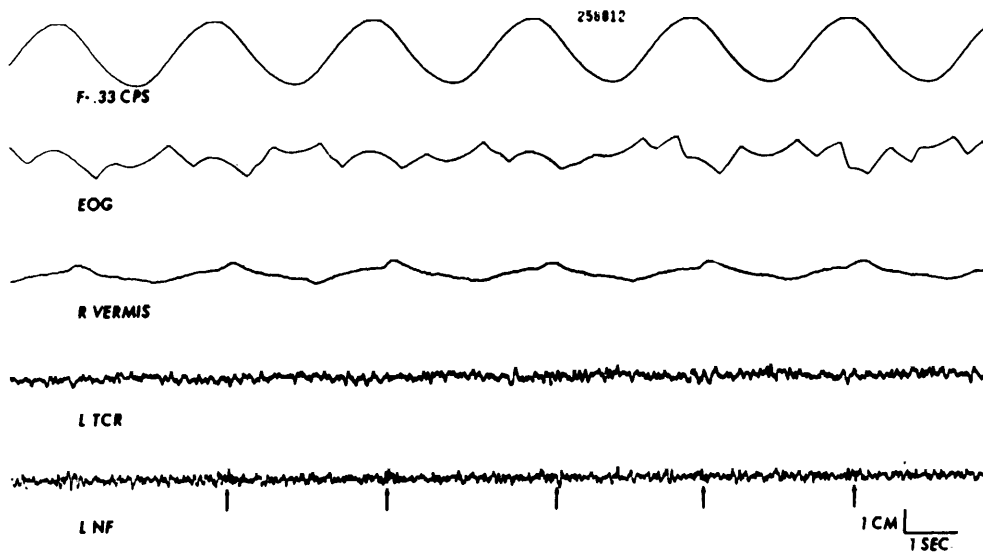

FIGURE 12.—Records taken from free-moving cat during horizontal oscillation of platform. The upper trace shows platform movement at 0.33 cps. The second trace shows electro-oculogram (EOG). Note periodicities related to platform oscillation. The third trace shows EEG recording from right side of tuber vermis. The fourth trace shows EEG recording from left thalamo-cortical radiations (LTCR), and the fifth trace shows EEG record taken from left nucleus fastigii (LNF). Calibration, 25 mm/sec (horizontal); EOG = 500 μ V/cm, vermis = 100 μ V/cm; LNF and LTCR = 50 μ V/cm (vertical). (From ref. 25.)

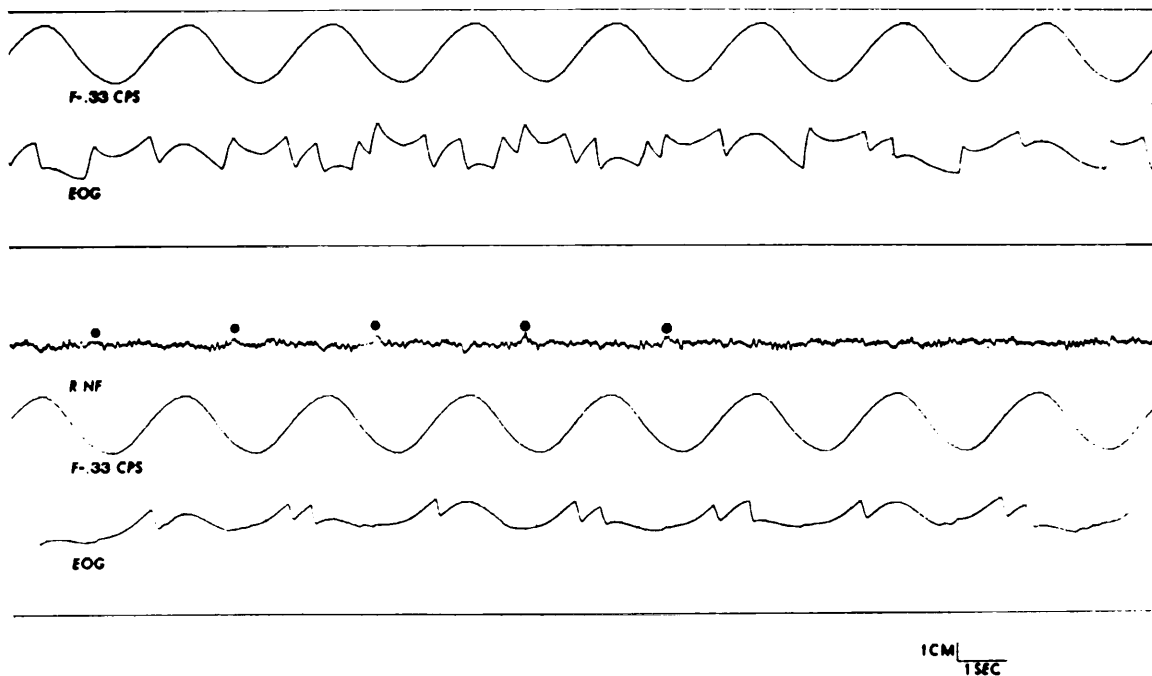

FIGURE 13.—Records taken from free-moving cat on horizontal oscillating platform with cycle of 0.33 cps (trace 1). Trace 2 shows electro-oculogram (EOG). Note the changes in latter half which were correlated with "loss of fast phases to the left and a marked decrement in slow phase output to the left." Trace 3 open. Trace 4 is EEG record taken from right nucleus fastigii (RNF). The bottom three tracings are continued from the first three. Note that the loss of the fast phase of nystagmus (to the left) continues throughout the bottom tracings. Surgical removal of the second turn of tuber vermis was accomplished 32 hours previously. Calibration, 25 mm/sec (horizontal) and 1 mV/cm (vertical). (From ref. 25.)

DISCUSSION

While the sensory receiving areas of the cerebellum are well known, the present paper stresses the point that, despite the anatomical proximity of the auditory and vestibular end organs, the receiving areas are rather widely separated. However, the two systems may converge at the level of the nucleus fastigii and they definitely overlap in the cerebral receiving areas. (See fig. 7.) The biological significance of these cerebellocircuits has not been worked out (ref. 26). Hopefully, microelectrical analysis of these cerebellar areas when paired with measurable behavioral performance will provide some answers.

With the studies of Brookhart, Moruzzi, and Snider (ref. 27) and Granit and Phillips (ref. 28), and especially the recent studies of Eccles et al. (refs 15 and 29), a challenging start has been made. The inhibitory function of the basket, Golgi II, Purkinje, and stellate cells has been established (ref. 29). Of special interest to the present discussion is the paper of Ito, Obata, and Ochi (ref. 30) which showed the direct inhibitory action of Purkinje cells on cells in the lateral vestibular nucleus, as well as the indirect effect of Purkinje cells on nucleus fastigii, thence to cells in lateral vestibular nucleus. A significant unknown in most studies on efferent cerebellar systems is the role of the nuclear cells. Except for cerebellovestibular connections, the Purkinje cell should be considered a very important interneuron (not an effector) synapsing on the efferent neuron in the cerebellar nuclei.

The cerebellar control of eye movements is considered along with the work of Fernández and Fredrickson (ref. 31), which showed that lesions of the nodule produced disequilibrium, positional nystagmus, and prolonged vestibular reactions to rotatory and caloric tests. Of special interest to the present discussion was the prompt and consistent inhibition of nystagmus produced by electrical stimulation of the nodule. Usually the eyes showed conjugate deviation toward the side of the slow component as if the stimulation inhibited the mechanism

from whence the fast component originated.

Evidence is also given for a cerebellar role in habituation of the fast phase of nystagmus. However, it is difficult to obtain data on how the cerebellar cortex functions during habituation because the time course is so much longer than the electrophysiological measurements associated with the stretch reflex, for example. Wolfe's data (ref. 25) would indicate that the tuber vermis is an important part of this circuit. However, since there are no known vestibular connections to the tuber vermis, then the main afferent volleys remain unknown unless they come from the proprioceptive activity of eye muscles. The studies of Higgins, Partridge, and Glaser (ref. 32) on limb musculature indicated that the "cerebellar effect results in muscle tension-leading stretch response in phase under conditions which should stabilize the stretch reflex, thus reducing an inherent tendency to oscillate." If nystagmus were considered a special case of eye-muscle oscillation, then the cerebellum could reduce an "inherent tendency to oscillate" and participate in physiological mechanisms underlying habituation. Under these conditions, lesions of the cerebellum would temporarily eliminate habituation until other areas could assume part of the function.

While experimental evidence seems compatible with some of these assumptions, the basic difference between the precise short-term regulatory function controlling skeletal and eye muscles and the long-term effects of habituation must not be overlooked. Two obvious gaps must be bridged before such a functional role of the cerebellum can be established. (1) Additional data must be obtained concerning the dependence on proprioception of cerebellar control of eye muscles, and (2) the complexities of habituation must be analyzed with data relevant to the function of the cerebellum in long-enduring motor performance. Such experimental data are overdue since, as early as 1943, Rosenblueth, Wiener, and Bigelow (ref. 33) suggested that the "main function of the cerebellum is the control of the feedback nervous mechanisms involved in purposeful motor activity."

REFERENCES

1. SNIDER, R. S.: Recent Contributions to the Anatomy and Physiology of the Cerebellum. *Arch. Neurol. Psychiat.*, vol. 64, 1950, pp. 196-281.
2. CAJAL, S. R.: *Histologie du Système Nerveux de l'Homme et des Vertébrés*. Maloine, Paris, 1909.
3. INGVAR, S.: Zur Phylo- und Ontogenese des Kleinhirns nebst einem Versuche zu einheitlicher Erklärung der zerebellaren Funktion und Lokalisation. *Folia Neurobiol.*, Leipzig, vol. 11, 1918, pp. 205-495.
4. LARSELL, O.: The Cerebellum: A Review and Interpretation. *Arch. Neurol. Psychiat.*, vol. 38, 1937, pp. 580-607.
5. DOW, R. S.: Effect of Lesions in the Vestibular Part of the Cerebellum in Primates. *Arch. Neurol. Psychiat.*, vol. 40, 1938, pp. 500-520.
6. BRODAL, A.: Anatomical Aspects on Functional Organization of the Vestibular Nuclei. Second Symposium on the Role of the Vestibular Organs in Space Exploration, NASA SP-115, 1966, pp. 119-139.
7. DOW, R. S.: The Fiber Connections of the Posterior Parts of the Cerebellum in the Rat and Cat. *J. Comp. Neurol.*, vol. 63, 1936, pp. 527-548.
8. WALBERG, F.; AND JANSEN, J.: Cerebellar Cortico-vestibular Fibers in the Cat. *Exptl. Neurol.*, vol. 3, 1961, pp. 32-52.
9. BRODAL, A.; POMPEIANO, O.; AND WALBERG, F.: The Vestibular Nuclei and Their Connections. *Anatomy and Functional Correlations (Ramsay Henderson Trust Lectures)*, Oliver & Boyd, Edinburgh, London, 1962.
10. LLINÁS, R.; PRECHT, W.; BRACHE, F.; AND HUERTAS, J.: The Inhibitory Cerebello-Vestibular System in the Frog. *Proc. Intern. Union Physiol. Sci.*, vol. 7, 1968, p. 269.
11. DEURA, S.; AND SNIDER, R. S.: The Interaction of Various Impulses in the Cerebellum. *J. Neurol. Sci.*, vol. 1, 1964, pp. 178-196.
12. HENNEMAN, E.; COOKE, P. M.; AND SNIDER, R. S.: Cerebellar Projections to the Cerebral Cortex. *Proc. Assoc. Res. Nerv. Ment. Dis.*, vol. 30, 1950, pp. 317-333.
13. RUWALDT, M. M.; AND SNIDER, R. S.: Projections of Vestibular Areas of Cerebellum to the Cerebrum. *J. Comp. Neurol.*, vol. 104, 1956, pp. 387-402.
14. INFANTELLINA, F.; SANSEVERINO, E. R.; AND SPERTI, L.: Cerebellocerebral Relationships: Projections of Cerebellar Paraflocculus on the Cerebral Cortex in the Cat. *Arch. Sci. Biol.*, vol. 49, 1965, pp. 97-122.
15. ECCLES, J. C.; LLINÁS, R.; AND SASAKI, K.: The Inhibitory Interneurons Within the Cerebellar Cortex. *Exptl. Brain Res.*, vol. 1, 1966, pp. 1-16.
16. BARD, P.; WOOLSEY, C. N.; SNIDER, R. S.; MOUNTCASTLE, V. B.; AND BROMLEY, R. B.: Delimitation of Central Nervous Mechanisms Involved in Motion Sickness. *Fed. Proc.*, vol. 6, 1947, p. 72.
17. KLINOFF, J.: Ueber die Leitungshahnen des Kleinhirns. *Arch. Anat. Physiol. Anat. Abt.*, 1899, pp. 11-27.
18. WHITESIDE, J. A.; AND SNIDER, R. S.: Relation of Cerebellum to Upper Brain Stem. *J. Neurophysiol.*, vol. 16, 1953, pp. 397-413.
19. MANNI, E.; AZZENA, G. B.; AND DOW, R. S.: Cerebellar Influence on the Unitary Discharge of Oculomotor Nuclei and Adjacent Structures. *Exptl. Neurol.*, vol. 13, 1965, pp. 252-263.
20. MUSSEN, A. T.: Cerebellum and Red Nucleus. *Arch. Neurol. Psychiat.*, vol. 31, 1934, pp. 110-126.
21. KOELLA, W. P.: Motor Effects From Electrical Stimulation of Basal Cerebellum in the Unrestrained Cat. *J. Neurophysiol.*, vol. 18, 1955, pp. 559-573.
22. COHEN, B.; GOTO, K.; SHANZER, G.; AND WEISS, A. H.: Eye Movements Induced by Electric Stimulation of the Cerebellum in the Alert Cat. *J. Exptl. Neurol.*, vol. 13, 1965, pp. 145-162.
23. HALSTEAD, W.: The Effects of Cerebellar Lesions Upon Habituation of Post-Rotational Nystagmus. *Comp. Physiol. Monogr.*, vol. 12, 1935, pp. 1-30.
24. DI GIORGIO, A. M.; AND PESTELLINI, G.: Inibizione Acquisita dei Riflessi Vestibolari: Significato Degli Emisferi Cerebrali e del Cervelletto. *Arch. Fisiol.*, vol. 48, 1948, pp. 86-110.
25. WOLFE, J. W.: Evidence for Control of Nystagmic Habituation by Folium-tuber Vermis and Fastigial Nuclei. *Acta Oto-Laryngol.*, suppl. 231, 1968.
26. SNIDER, R. S.: Functional Alterations of Cerebral Sensory Areas by the Cerebellum. *The Cerebellum, Progress in Brain Research*, C. A. Fox and R. S. Snider, eds., Elsevier Publishing Co., Amsterdam, London, New York, 1967.
27. BROOKHART, J. M.; MORUZZI, G.; AND SNIDER, R. S.: Spike Discharges of Single Units in the Cerebellar Cortex. *J. Neurophysiol.*, vol. 13, 1950, pp. 465-486.
28. GRANIT, R.; AND PHILLIPS, C. G.: Excitatory and Inhibitory Processes Acting Upon Individual Purkinje Cells of the Cerebellum in Cats. *J. Physiol.*, vol. 133, 1956, pp. 520-547.
29. ECCLES, J. C.; ITO, M.; AND SZENTÁGOTHAÏ, J.: *The Cerebellum as a Neuronal Machine*. Springer-Verlag, New York, 1967.
30. ITO, M.; OBATA, K.; AND OCHI, R.: The Origin of Cerebellar Induced Inhibition of Deiters' Neurones. II. Temporal Correlation between the Trans-synaptic Activation of Purkinje Cells and the Inhibition of Deiters' Neurones. *Exptl. Brain Res.*, vol. 2, 1966, pp. 350-364.
31. FERNÁNDEZ, C.; AND FREDRICKSON, J. M.: Experimental Cerebellar Lesions and Their Effect on Vestibular Functions. *Acta Oto-Laryngol.*, vol. 58, suppl. 192, 1964, pp. 52-62.
32. HIGGINS, D. C.; PARTRIDGE, L. D.; AND GLASER, G. H.: A Transient Cerebellar Influence on Stretch Responses. *J. Neurophysiol.*, vol. 25, 1962, pp. 684-692.
33. ROSENBLUETH, A.; WIENER, N.; AND BIGELOW, J.: Behavior, Purpose and Teleology. *Philosophy of Science*, vol. 10, 1943, pp. 18-24.

DISCUSSION

Ito: You are producing evoked potentials in various parts of the cerebral cortex by stimulating the cerebellum. I wonder what pathways are responsible for this rather short-latency evoked response.

Snider: I can answer it in relation to the auditory system but not in relation to the vestibular system. I can show you the subsequent data, if you wish additional details. The cerebellar projection passes through the dorsal aspect and synapses in the nucleus fastigii. From the nucleus fastigii it goes forward in the brachium conjunctivum to the anterior medial zone of the medial geniculate body. There is also a second pathway that goes through the reticular formation and is relayed into the cerebral cortex from there. From this anterior and medial zone in the medial geniculate body which is rather narrow, there is a projection to the cerebral cortex. In general, one might consider this the older portion of the medial geniculate body, and maybe that is why it has been missed before. Now, of course, the question arises: Is there not a vestibular area nearby, particularly the parieto-occipital for example, which may act as a relay through to the cerebrum? Perhaps, but it is too early to say so. I would appreciate any information you may have on this.

Whiteside: Dr. Snider, the question is perhaps an elementary one, but in regard to eye-movement control, I do not understand how to equate the afferent fibers from the extraocular muscles with the apparent absence of a position sense in the eye, which is functionally claimed and indeed demonstrable. You can move the eyes and demonstrate quite definitely that there is no position sense as far as the individual is concerned. I am now talking about normal and conscious man.

Snider: The trigeminal projection to the cerebellum is rather well outlined, and includes projections not only from cutaneous sensibility but also proprioceptive endings of eye muscles. (S. Cooper, P. M. Daniel, and D. Whittridge: *Muscle Spindles and Other Sensory Endings in Extrinsic Eye Muscles; Physiology and Anatomy of These*

Receptors and of Their Connections With Brain-Stem. Brain, vol. 78, 1955, pp. 564-583.) According to Cupedo (R. N. Cupedo: *A Trigeminal Midbrain Cerebellar Fiber Connection in the Rat. J. Comp. Neurol.*, vol. 124, 1965, pp. 61-69), the mesencephalic root of the fifth cranial nerve sends fibers into the base of the cerebellum via the brachium conjunctivum and overlaps with the regions that are called an auditory- and visual-receiving area as well as a proprioceptive-face area. One might say that the auditory and visual signals coming into the cerebellum are rather efficiently organized because it is coming into that portion of the cerebellum which, when electrically stimulated, causes eye movement. In other words, when a sudden sound occurs to one side, the eyes are turned, as is the head, toward the signal. The same response holds for a visual input. But the question of where proprioception fits into the movement of the eyes cannot be answered. One would believe that, during nystagmus, there would be a cerebellar interrelation with the vestibule. However, to my knowledge it is not possible to elicit a stretch reflex from extraocular muscles. So there is a gap here, and one has to be very cautious in interpreting cerebellar function. If you think of the cerebellum as being a neurological comparator of exquisite sensitivity, then you can put almost anything in it, including learning mechanisms. It is tempting, for example, to call it the head-ganglion-of-habit formation.

Also, I would point out that very few lesions of the cerebellum produce a permanent motor deficit. Compensation readily takes place. One is reminded of some older experiments of Spiegel et al. in which they removed one labyrinth and noticed recovery from nystagmus, and then placed a subsequent lesion and the nystagmus returned, but to the other side. This would indicate to me that the cerebellum was one of the compensating mechanisms in the nervous system for the nystagmus. This does not exactly answer your question, but the information is not available. I would appreciate any comments you have.

Cortical Projection of Labyrinthine Impulses: Study of Averaged Evoked Responses¹

E. A. SPIEGEL, E. G. SZEKELY, H. MOFFET, AND J. EGYED

Temple University Medical School

SUMMARY

While the observation of the eyeballs, of the reactions of the trunk, and of the extremities permits only a study of the vestibulo-ocular and of the vestibulospinal reflex arcs, the perrotatory or post-rotatory recording of the electroencephalogram or electrocorticogram may help one to ascertain the conduction of labyrinthine impulses and their projection to the cerebral cortex. The cortical responses to single rotations were summed by a Mnemotron computer. After cessation of rotation, long-latency, slow, sometimes multiphasic responses appeared in human subjects and in cats. In man they were either diffuse or were noted chiefly or exclusively in the region of the area preoccipitalis and/or parastriata. They are probably due to excitation of the diffuse thalamic projection system. Short-latency responses in the cat's cerebral cortex at the start of rotation were not limited to the second somatic sensory area, but were found also in parts of the auditory cortex and in the so-called association cortex; in some experiments they were also close to, or in parts of, the second visual area. The initial as well as the postrotatory reactions in posterior parts of the cerebral cortex were not prevented by bilateral ablation of the second sensory area; they depended on a functioning labyrinth.

The usual methods of testing the excitability of the labyrinth are limited to observations or records of reflex reactions to the muscles of the eyes, the trunk, and the extremities. Such tests do not give any information about the state of the cortical projections of the labyrinth and their afferents above the mesencephalon, though they may be influenced by corticofugal impulses. It seemed, therefore, of interest to develop methods of testing these corticopetal labyrinthine systems. In selecting a method of stimulation that would be applicable to man, electric stimulation seemed inadvisable, since it is not possible to stimulate the labyrinth selectively by using surface electrodes without affecting adjacent receptors and nerves. Caloric stimulation may induce cortical responses; usually, however, these are too weak and inconstant to be useful for systematic studies. It would seem, therefore, that production of an

endolymph flow by rotation would be the preferable method of labyrinthine stimulation. The usual type of stimulation by 10 rotations in 20 seconds on a Bárány chair is too intense for a study of possible localized cortical responses because the excitation quickly affects the whole cortex. An attempt was made, therefore, to use single rotations only. By employing an averaging Mnemotron computer, the responses in constant-time relationship to the stimulus (cessation or onset of the rotation) could be summed and the discharges unrelated to the stimulus diminished (refs. 1 to 4).

Two groups of experiments were performed: studies of the responses following the cessation of rotation and of those at its onset. The first series was carried out in 37 cats maintained in bulbocapnine catalepsy, and in 43 human subjects who showed no signs or symptoms of impairment of the inner ear or of the nervous system; the second series consisted of 26 cats only.

¹ Aided by grant 04418, National Institute of Neurological Diseases and Blindness, NIH, USPHS.

TEST SERIES I

Procedure

In the first series, mostly unipolar, but in some instances also bipolar, derivations were used. In cats the recording electrodes were epidural stainless-steel balls; the reference electrode was the head holder or a plate fixed above the frontal sinus. In the human subjects, Grass electrodes were applied, with the reference electrode placed on the chin.

The wires connecting the electrodes to the amplifiers and the averaging Mnemotron computer were conducted over the subject's head in the axis of the rotating chair. Each rotation lasted 3 seconds; as soon as possible after its cessation, the computer was turned on. After the recording of the response, the chair was slowly rotated in the opposite direction (e.g., counterclockwise after clockwise rotation) so that an undesirable twisting of the wires by repeated rotations in the same direction was avoided. The rotation was repeated after a pause of 1 minute. After 10 rotations the averaged responses were displayed on an X-Y plotter (model 500, Electro Instruments Inc.), and this process was repeated, so that the effects of 10 to 30 or even more rotations were averaged. Thus, both the summated responses and possible changes of the excitability, for example, those due to habituation, could be studied. In one test, only the reactions to rotations in one direction were studied. The reactions to the other direction were recorded after a pause of several hours or on another day.

To prevent interference of retinal impulses, the eyelids of the experimental animals and human subjects were kept closed during the rotations.

Results and Discussion

The responses observed in man had a long latency; they were either diffuse (fig. 1), or they prevailed in (fig. 2) or were restricted to (fig. 3) the region of areas 19 and/or 18 of Brodman (preoccipital and parastriate regions). Sometimes they were multiphasic. To ascertain whether eye movements or contractions of neck muscles interfered, electronystagmograms (fig. 1) were recorded in some instances, and in others, electromyograms of the neck muscles were

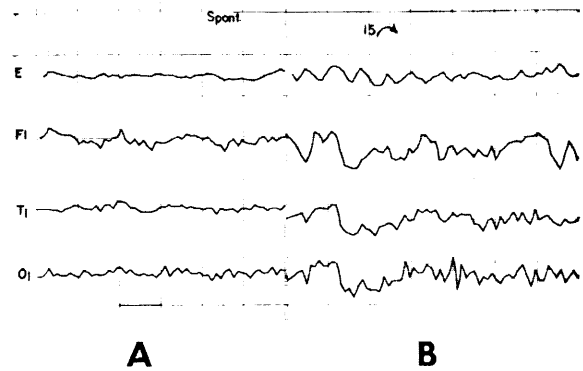

FIGURE 1.—Human subject without organic disease. Averaged electronystagmograms (E) and monopolar EEG (scalp) records. A: Before rotations. B: After 15 single clockwise rotations (averaged). Similar responses in the frontal (F₁), temporal (T₁), and occipital (O₁) leads. Time signal in figures 1 to 8: 0.4 sec. (From ref. 3.)

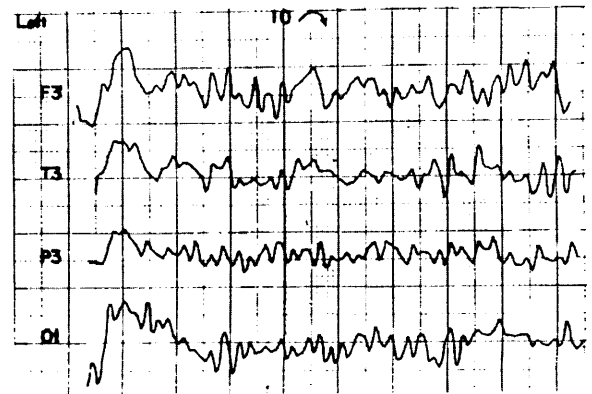

FIGURE 2.—Human subject without organic disease. Postrotatory responses to 10 single clockwise rotations (averaged). F₃, frontal, T₃, temporal, P₃, parietal, O₁, occipital leads. Response in O₁ prolonged and with higher amplitude than in other leads. (From ref. 3.)

recorded. Only rarely did such potentials play a part and invalidate the records. In most records there was no such interference; it seems justifiable to assume a cerebral genesis of the responses.

The experiments on cats (figs. 4 to 8) served as a further analysis of these responses. After peak latencies of 0.3 to 0.6 second, one finds slow, sometimes multiphasic responses. They were recorded not only from anterior parts of the cere-

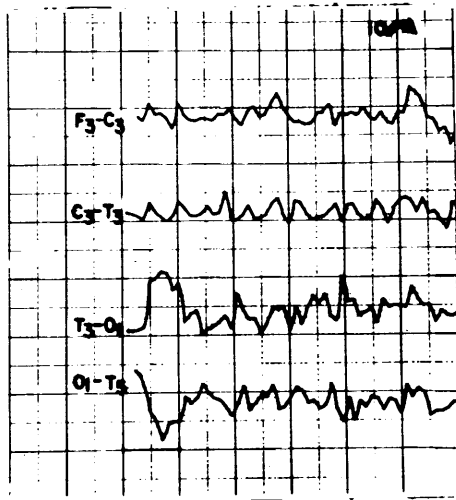

FIGURE 3.—Human subject without organic disease. Bipolar scalp EEG with phase reversal in O_1 . Averaged postrotatory responses to 10 single clockwise rotations. F_3 , frontal; C_3 , central; T_3 , temporal; and O_1 , occipital leads. (From ref. 3.)

bral cortex (anterior part of the gyri ectosylvius and suprasylvius) but also from posterior parts (posterior and middle ectosylvian and suprasylvian and lateral gyri) (fig. 4).

The gyrus ectosylvius anterior and the gyrus suprasylvius anterior are regarded by some as the "vestibular" cortex. It seemed, therefore, of

interest to determine whether unilateral or bilateral ablations of these areas prevent the appearance of these responses in the posterior parts of the cerebral cortex. This is not the case (figs. 5 to 7); therefore, the responses recorded from the posterior areas cannot be caused simply by spread or propagation from the anterior part of the suprasylvian and ectosylvian gyri.

Whether impulses of extralabyrinthine origin, e.g., proprioceptive impulses from striated muscles, are responsible for these reactions was the subject of further study. The fact that the cortical responses are independent of the postrotatory nystagmus (fig. 5) excludes proprioceptive impulses from the eye muscles as the source of the cortical responses. Furthermore, neither muscular paralysis induced by gallamine triethiodide (Flaxedil) nor high transverse section of the spinal cord at C_1 (fig. 4), which interrupted ascending impulses also from the body surface, from joints, and from viscera, interfered with these responses. In contrast, they no longer appeared after chemical destruction of the receptors of the labyrinth by 70 percent alcohol or 4 percent formaldehyde (fig. 4); so, the labyrinthine origin of these responses can be inferred. Acoustic stimuli of low intensity (persistence or

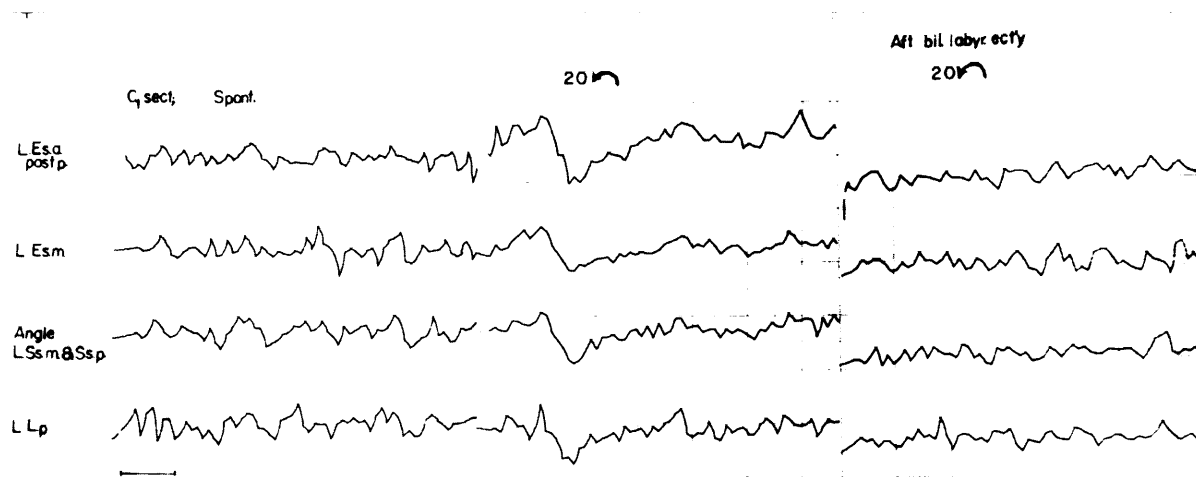

FIGURE 4.—Cat. Transverse section of cord at C_1 . Compare averaged spontaneous discharges of cortex, 20 averaged postrotatory responses before and after bilateral labyrinthectomy. L.E.s.a.post.p.: Left gyrus ectosylvius anterior, posterior part. L.E.s.m.: Left gyrus ectosylvius medius. L.S.s.m.: Left gyrus suprasylvius medius. S.s.p.: Gyrus suprasylvius posterior. L.L.p.: Left gyrus lateralis posterior. (From ref. 3.)

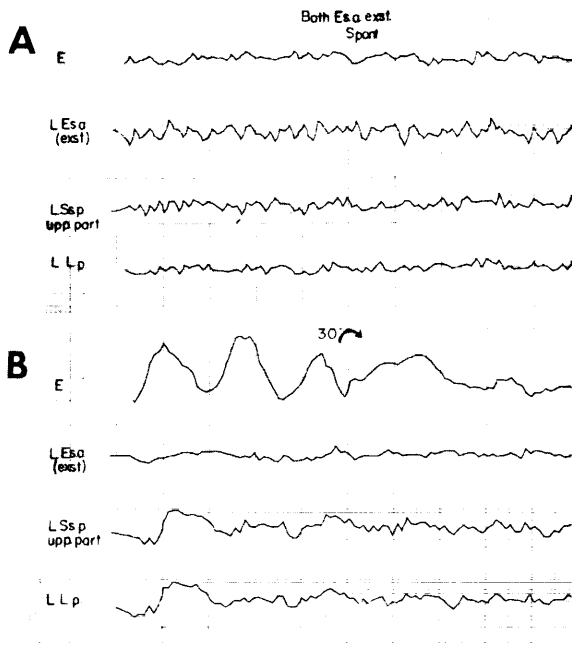

FIGURE 5.—Comparison of electronystagmograms (E) and cortical postrotatory responses in a cat with gyri ecto- and suprasylvius anterior bilaterally extirpated. Cat in bulbocapnine catalepsy. A: Records in resting state (averaged). B: Records following 30 single clockwise rotations (averaged). L.Es.a.: Area of extirpation of left gyrus ectosylvius and suprasylvius anterior. L.Ss.p.: Left gyrus suprasylvius posterior. L.L.p.: Left gyrus lateralis, posterior part. (From ref. 3.)

exclusion of the noise from an adjacent room) did not significantly alter these responses.

With regard to the afferent pathways by which the vestibular impulses elicit these slow cortical waves, the long latency of the responses suggests a multisynaptic system. The same conclusion is suggested by the sensitivity of these responses to anesthesia; pentothal anesthesia, for instance, is able to diminish or to abolish them (fig. 8). Obersteiner (ref. 5), as early as 1912, anatomically traced fibers from the vestibular nuclei to the reticular formation, and Held (ref. 6) and Godlowski (ref. 7) later described reticulo-thalamic pathways. Thus it may be inferred that vestibular impulses activate the diffuse thalamic projection system and that the slow waves appearing after a long latency are so-called secondary evoked responses.

We have seen that these reactions were often

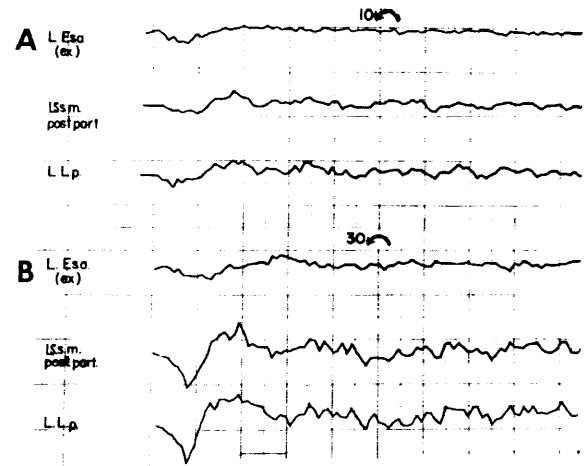

FIGURE 6.—Averaged postrotatory cortical responses in cat kept in cataleptic state by bulbocapnine (brain shown in fig. 7); left gyrus ectosylvius anterior and suprasylvius anterior ablated. A: Effect of 10 single counterclockwise rotations. B: Effect of 30 single counterclockwise rotations. L.Es.a.: Area of ablation of left gyrus ectosylvius anterior. L.Ss.m.: Left gyrus suprasylvius medius. L.L.p.: Left gyrus lateralis posterior. (From ref. 3.)

more marked and/or longer lasting in the posterior part of the cerebral cortex. This suggests that it is particularly those parts of the areas close to the visual cortex which are stimulated. That only a certain part of the diffuse thalamic system is stimulated is not an unusual situation. Moruzzi (ref. 8) has already indicated that sensory stimuli of low intensity may activate only part of the reticular system, and the same may be postulated for the diffuse thalamic system that receives impulses from the reticular activating system.

The question arises whether, besides the activation of parts of the diffuse thalamic system, there exists a more circumscribed cortical projection of the labyrinth. Recordings made after cessation of the rotation hardly permit one to answer this question; since acceleration induces an excitation of the cortex, the corticopetal impulses induced by the deceleration do not act upon a resting cortex but upon one already invaded by impulses of labyrinthine origin.

In further experiments, therefore, an attempt was made to develop a method for averaging the cortical responses to the onset of single rotations by a Mnemotron computer.

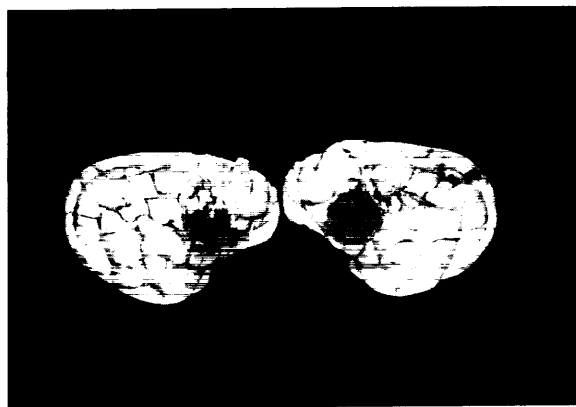

FIGURE 7.—Cat, bilateral destruction of gyrus ectosylvius anterior and gyrus suprasylvius anterior. (From ref. 3.)

TEST SERIES 2

Procedure

The rotation was produced by a weight of 100 grams that acted by means of a string carried over an upper and lower pulley and along the grooved periphery of a rotating disk (radius 35.5 cm) to which its free end was attached (fig. 9). The animal board was fixed to this disk so that the cat's head was at the center of the disk. The experiments were performed on 26 cats; most of them were under Nembutal (3 to 12 mg/kg) and chloralose (25 mg/kg) anesthesia.

The triggering circuit consists essentially of a hand switch (*H*) and a mercury foot switch (*M*) in series with a 3-volt battery (*B*) (fig. 10). If both switches are closed, the sweep of the computer is triggered. The hand switch consists of a rigid straight spring (*A*) and, parallel to it, a shorter plate carrying a screw (*S*) that is in contact with *A*. The spring (*A*) of the hand switch is held by the experimenter against the animal board that is fixed to the rotating disk, thus preventing the rotation of the disk by the pull of the weight. The hand switch is opened by pressure exerted on *A*. In this stage the previously opened mercury foot switch (*M*) is closed. If the experimenter now discontinues the pressure of *A* against the animal board, rotation of the disk by the pull of the weight is started, and the spring (*A*) comes in contact with the screw (*S*) so that the circuit triggering the sweep of the computer is closed.

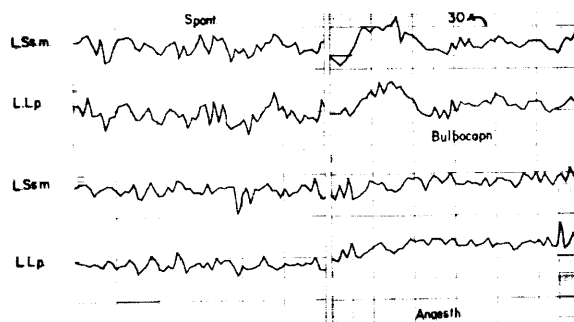

FIGURE 8.—Averaged spontaneous discharges and responses following 30 single counterclockwise rotations. Upper two records: Cat in bulbo-capnine (25 mg/kg) catalepsy. Lower two records: Same cat under sodium pentobarbital anesthesia. L.S.m.: Left gyrus suprasylvius medius. L.L.p.: Left gyrus lateralis posterior. (From ref. 3.)

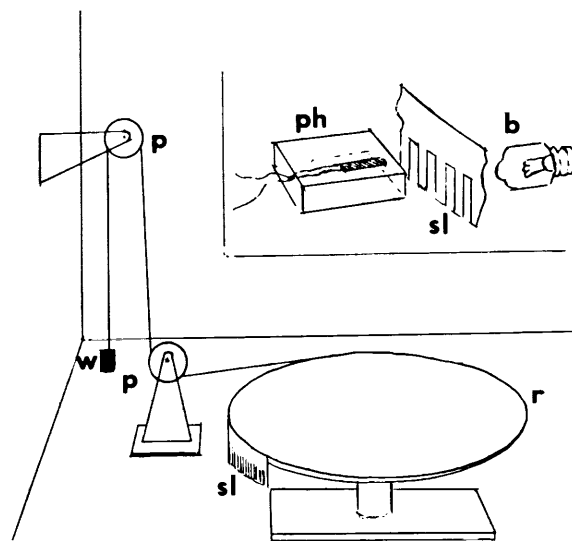

FIGURE 9.—Rotating disk (*r*). Weight (*w*) acts upon it over pulleys (*p*). Light from electric bulb (*b*) reaches photocell (*ph*) through slits (*sl*). (For further details, see text.)

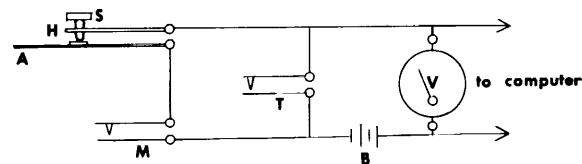

FIGURE 10.—Circuit triggering computer and rotating table. *H*: Hand switch with rigid straight spring (*A*) and screw (*S*). *M*: Mercury foot switch. *B*: 3-volt dry-cell battery. *T*: Triggering switch (for control experiments without rotation). *V*: voltmeter. (For further details, see text.)

To determine the angular acceleration, a small stationary electric bulb was placed below the rotating disk close to its periphery (fig. 9). Two weights totaling 4 or 5 pounds, depending on the weight and position of the cats used, were fixed at the center of the disk. In the early experiments a plastic strip with slits at distances of 0.5° was attached to the part of the periphery at which the electric bulb was placed. The light of this bulb passed through the slits and activated a photocell; its current was conducted to one of the inputs of the computer. For measurement of the acceleration in the beginning of the rotation, the plastic strip was replaced by a photographic film on which a series of equidistant vertical lines had been photographed, so that distances representing angular displacements (ϕ) of 0.05° were obtained.

From the records showing the fluctuations of the output of the photocell, the angular displacements (ϕ), the angular velocities (ω), and the angular accelerations (α) were determined (fig. 11). As can be noted in figure 11, the acceleration gradually increased until a constant value of $40^\circ/\text{sec}^2$ was reached; after 10, 20, 40, 60, and 80 msec, respectively, the angular accelerations were 5° , 10° , 18.5° , 26° , and $30^\circ/\text{sec}^2$.

The above-described arrangement served also for determination of the time interval between the triggering of the sweep of the computer and the beginning of the rotation in that the intensity of the light passing to the photocell—and thus the current emerging from the photocell in the resting state of the disk—was altered when the rotation started. An average time interval of 4.5 msec was measured between the start of the sweep and the onset of the rotation.

Bipolar derivations were used; the stainless-steel-ball electrodes were placed in straight rows (see fig. 12) equidistant as far as possible.

Results and Discussion

The cortical responses obtained by the averaging technique at the onset of rotation had voltages varying between $10 \mu\text{V}$ and $100 \mu\text{V}$ and lasted between 20 and 60 msec. Their peak latencies, i.e., from the beginning of rotation to the peak of the response, were between 10 and

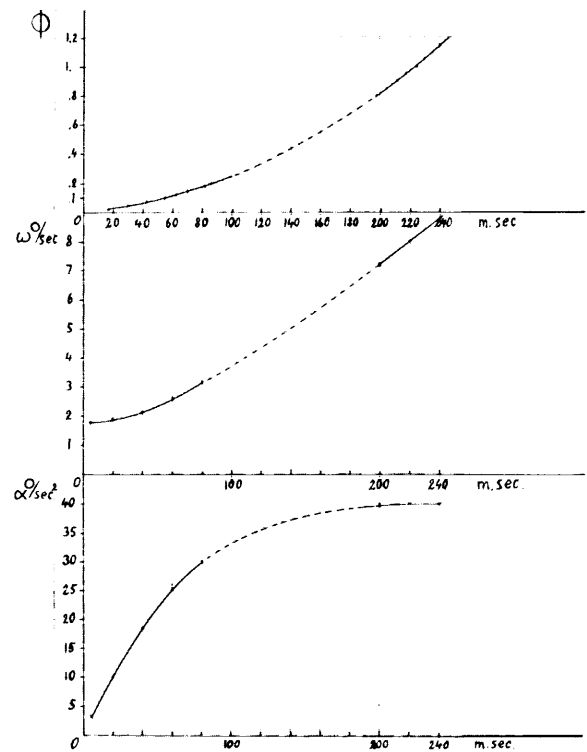

FIGURE 11.—Angular displacements (ϕ), angular velocities (ω), and angular accelerations (α) in the beginning of rotation.

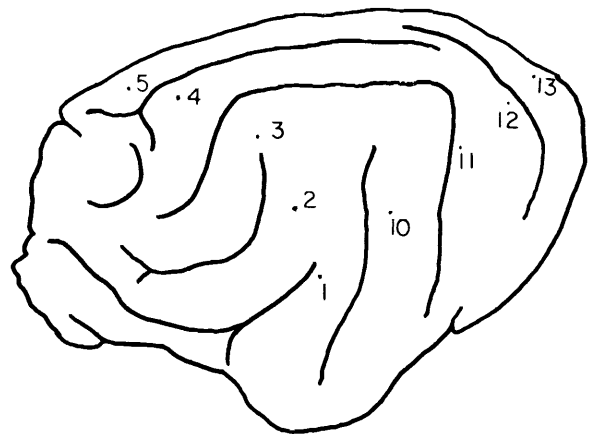

FIGURE 12.—Diagram showing electrode placement corresponding to figure 13 in anterior part and to figure 19 in posterior part. Anterior row of electrodes: 1, gyr. sylv. post.; 2, gyr. sylv. ant. upper part; 3, corner between gyr. ectosylv. ant. and med.; 4, corner between gyr. supra-sylv. ant. and med.; 5, ant. part of gyr. lateral. Posterior row of electrodes: 10, gyr. ectosylv. post.; 11 and 12, gyr. supra-sylv. post.; 13, gyr. lateral. post. (From ref. 4.)

60 msec. In microelectrode studies of the cortical responses to labyrinthine stimulation by polarization, Kornhuber and da Fonseca (ref. 9) distinguished specific primary cortical responses with latencies of 5 to 30 msec and specific associative responses with latencies of 25 to 150 msec. If one accepts this classification according to the latent period, the responses obtained by the averaging technique would have to be considered as belonging partly to the specific primary and partly to the specific associative responses.

There was no definite difference in the response, whether the rotation was directed toward or away from the hemisphere on which the recording electrodes had been placed. Muscle paralysis induced by gallamine triethiodide (Flaxedil) in waking or anesthetized cats did not prevent the reactions. Triggering of the sweep of the computer 10 times without acceleration produced only minimal fluctuations of the baseline.

With regard to the areas from which these responses could be led off, it does not seem possible to define a region from which they could be recorded exclusively. They could be obtained from S_2 , the second somatic sensory area in the anterior part of the ectosylvian and suprasylvian gyri (fig. 13). Phase reversals were also observed from this zone (six times), i.e., deflections in opposite directions in two adjacent electrode pairs (1-2, 2-3), indicating that the area below the common electrode 2 corresponded to the site of the evoked potentials. It seems hardly justifiable, however, to designate the region of the gyri ectosylvian and suprasylvian anteriores as "vestibular" cortex as Kornhuber and da Fonseca do (ref. 9). One has to bear in mind that this region receives also impulses from other receptors (tactile, nociceptive, proprioceptive, acoustic) so that vestibular impulses can interact here with other modalities. The designation, composite sensory projection area or polysensory area (refs. 10 and 11), seems best to reflect these facts.

Furthermore, responses showing the above-mentioned characteristics could also be obtained from areas behind S_2 , particularly from parts of the auditory cortex and of Buser's association cortex. Phase reversals were recorded from the

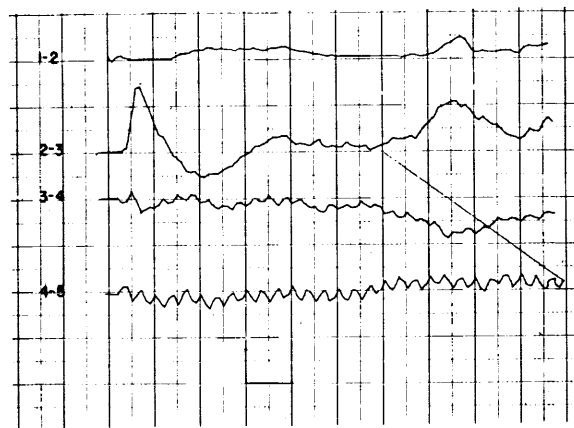

FIGURE 13.—Averaged responses of cat's left cortical areas to onset of 10 counterclockwise rotations. Electrode placements are shown in anterior part of figure 12. Chloralose-sodium pentobarbital anesthesia was used in this and subsequent experiments if not otherwise indicated. Analysis sweep time, 500 msec; time marked 50 msec. Calibration, 25 μV (applies also to subsequent records). (From ref. 4.)

gyrus sylvius anterior (twice), from the gyrus sylvius medius (six times), from the gyrus sylvius posterior (once), from the gyrus ectosylvian medius (six times), and from the gyrus suprasylvian medius (three times).

The most posterior areas exhibiting responses to the onset of rotation of relatively short latency (peak latencies 10 to 60 msec) were the gyrus ectosylvian posterior (figs. 14 and 15) and the most posterior part of the gyrus suprasylvian medius. This corresponds to the so-called second visual area. In 80 percent of the experiments (16 out of 20), the responses in the gyrus ectosylvian posterior had a higher amplitude than those in the adjacent parts of the gyrus suprasylvian. Phase reversals were observed four times from the sulcus ectosylvian posterior, three times from the anterior part of the gyrus ectosylvian posterior, but not at all from its posterior part. Once they were observed from the corner between the sulcus suprasylvian medius and posterior, and once from the sulcus suprasylvian posterior.

Unilateral or bilateral extensive lesions or ablations of the anterior part of the ectosylvian and suprasylvian gyri (figs. 16 to 18) did not prevent the appearance of the responses in

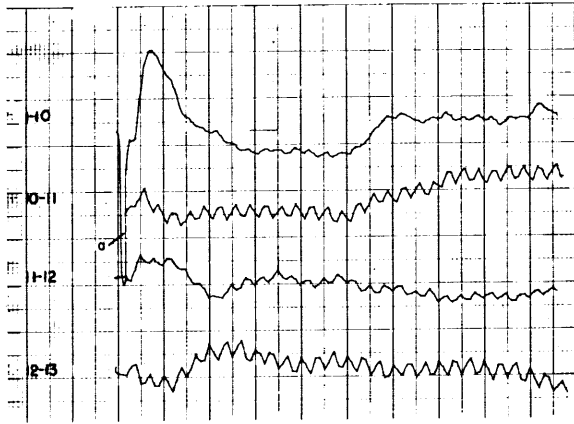

FIGURE 14.—Averaged responses to onset of 10 counterclockwise rotations. Electrode positions are shown in figure 15. Gallamine triethiodide paralysis besides chloralose-sodium pentobarbital anesthesia. a=artifact. (From ref. 4.)

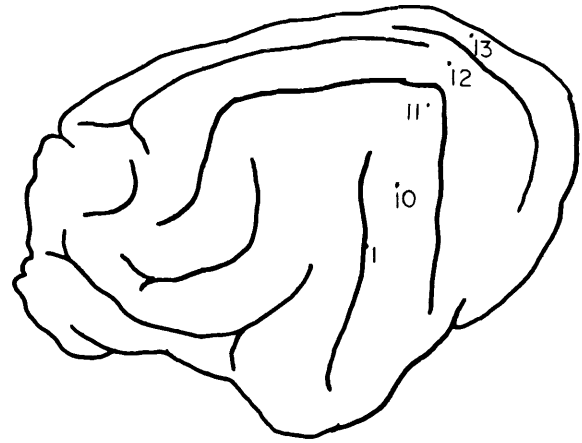

FIGURE 15.—Diagram showing electrode positions corresponding to record in figure 14. 1, sulc. ectosylv. post.; 10 and 11, gyr. ectosylv. post.; 12, corner between gyr. suprasylv. med. and post.; 13, corner between gyr. lateral. med. and post. (From ref. 4.)

the posterior parts of the cortex, while such responses did not appear after bilateral labyrinthectomy (fig. 19A before, fig. 19B after, labyrinthectomy).

CONCLUSIONS

Thus it would seem that the onset of rotation may induce so-called specific primary and specific associative responses not only in S_2 but also in posterior parts of the cortex as far back as close to the second visual area. This may be the basis for a cortical integration of labyrinthine and retinal impulses.

A comparison of our findings with the micro-electrode studies of Grüsser et al. (ref. 13) and of Kornhuber and da Fonseca (ref. 9) shows that the responses recorded by these authors from the visual and paravision regions showed chiefly a long and variable latent period; therefore, they were regarded as unspecific reactions. Yet a specific vestibular influence upon the optic cortex could be demonstrated by Grüsser et al. (refs. 12 and 13) in that the discharge rate of cells of the visual cortex could be influenced only by vestibular stimuli but not by trigeminal or acoustic stimuli. They assumed that afferent

fibers with a specific function exist within the unspecific system. Our present findings seem to indicate that angular acceleration may, at least in some instances, also induce responses with relatively short latency; i.e., primary specific and/or specific associative responses in the vicinity of the visual cortex.

This is in agreement with earlier experiments of Spiegel (refs. 14 and 15) in which labyrinthine stimulation by rotation was able to elicit epileptiform convulsions in dogs and cats in which strychnine had been administered to the region of the gyrus ectosylvius posterior.

Rotation producing an endolymph flow in both labyrinths is, of course, a much stronger stimulus than unilateral polarization of the labyrinth as used by Grüsser et al. and by Kornhuber and da Fonseca, particularly since these authors had to apply rather weak currents in order to avoid an excitation of other nerves, such as the cochlear and intermedius. Furthermore, the averaging technique permits one to visualize responses that may be masked by the background activity of the cortex. These technical details may explain why it was possible to demonstrate responses with relatively short latency in the vicinity of the visual cortex, which did not appear

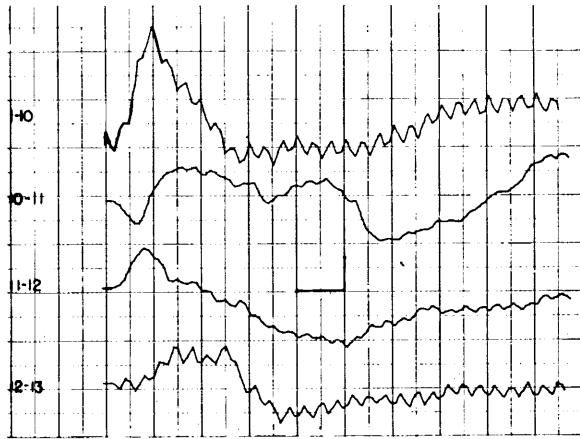

FIGURE 16.—Cat with bilateral ablation of the gyrus ecto- and suprasylvius anterior. Averaged responses to onset of 10 counterclockwise rotations, with phase reversal at the corner between the middle and posterior part of the sulcus suprasylvius (at 11). Other electrode positions: 1, at the gyrus sylvius posterior close to the lower part of the sulcus ectosylvius posterior; 10, gyrus ectosylvius posterior, upper part; 12, gyrus suprasylvius, corner between middle and posterior part; 13, gyrus lateralis, corner between middle and posterior part. (From ref. 4.)

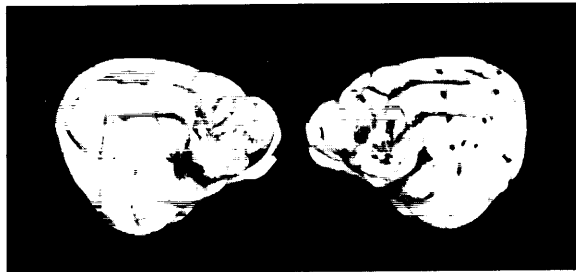

FIGURE 18.—Bilateral ablation of the gyrus ecto- and suprasylvius anterior. (From ref. 4.)

on electric stimulation of the vestibular nerve (refs. 10 and 11) or on unilateral polarization of the labyrinth (refs. 9, 12, and 13).²

² We wish to express our deep appreciation to Dr. G. Henny, Dr. G. Stewart, G. V. Jacoby, and Ch. Zanes for their advice regarding the physical problems.

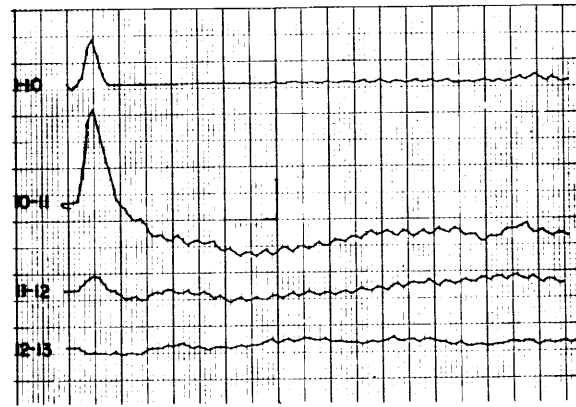

FIGURE 17.—Averaged response to onset of 10 counterclockwise rotations 1 hour after the ablations shown in figure 18. The electrode positions correspond to the posterior row marked by ink dots in figure 18. (From ref. 4.)

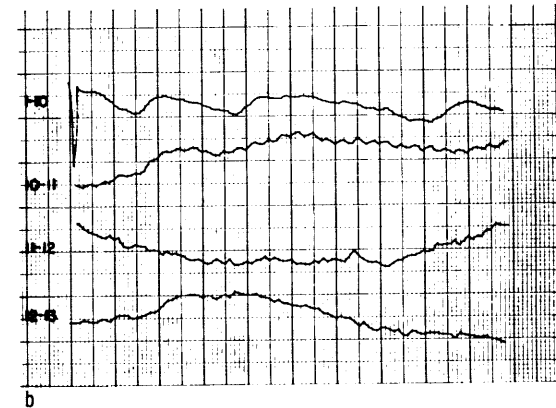
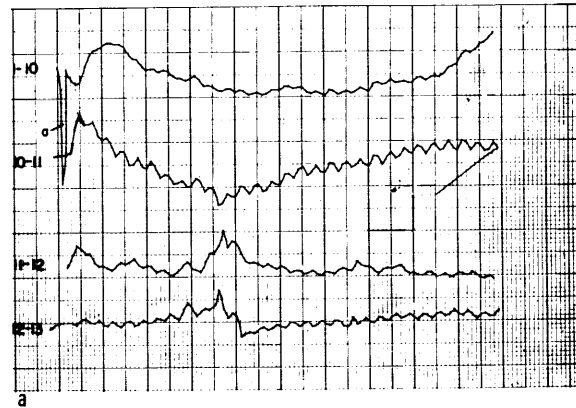

FIGURE 19.—Influence of bilateral labyrinthectomy upon averaged responses to onset of 10 counterclockwise rotations. A: Responses before elimination of both labyrinths. B: Responses 2 hours after elimination of both labyrinths. Electrode positions are shown in figure 12 (posterior part). (From ref. 4.)

REFERENCES

1. SPIEGEL, E. A.; SZEKELY, E. G.; MOFFET, R.; GILDENBERG, P.; LEHMAN, R.; AND ROBBINS, A.: Projection of the Labyrinth to Posterior Areas of the Cortex. *Proc. 8th Inter. Congr. Neurol.*, vol. 3, 1965, pp. 119-122.
2. SPIEGEL, E. A.; SZEKELY, E. G.; MOFFET, R.; GILDENBERG, P.; LEHMAN, R.; AND ROBBINS, A.: Cortical Projections of the Labyrinth. *Proc. Intern. Symposium, Vestibular and Oculomotor Problems*, Univ. of Tokyo, 1965, pp. 9-14.
3. SPIEGEL, E. A.; SZEKELY, E. G.; AND MOFFET, R.: Cortical Responses to Rotation. I. Responses Recorded After Cessation of Rotation. *Acta Oto-Laryngol.*, vol. 66, July-Aug. 1968, pp. 81-88.
4. SPIEGEL, E. A.; EGYED, J.; AND SZEKELY, E. G.: Cortical Responses to Rotation. II. Responses Recorded at the Onset of Rotation From the Second Somatic Sensory and Posterior Areas. *Acta Oto-Laryngol.*, Sept. 1968, vol. 66, pp. 261-272.
5. OBERSTEINER, H.: Anleitung beim Studium des Baues der nervösen Zentralorgane. 5th ed., Deuticke (Vienna), 1912.
6. HELD, H.: Die anatomische Grundlage der Vestibularisfunktionen. *Beitr. Anat., etc., Ohr.*, vol. 19, 1923, pp. 305-312.
7. GODLOWSKI, W.: Les Centres Sous-corticaux du Regard et des Mouvements Associés des Globes Oculaires. *Trav. Clin. mal. Nerv. de l'Univ. Cracovie*, 1936.
8. MORUZZI, G.: The Physiological Properties of the Brain Stem Reticular System. *Brain Mechanisms and Consciousness*, J. F. Delafresnaye, ed., Blackwell (Oxford), 1954, pp. 21-53.
9. KORNHUBER, H. H.; AND DA FONSECA, J. S.: Optovestibular Integration in the Cat's Cortex. *The Oculomotor System*, M. B. Bender, ed., Hoeber Medical Division, Harper & Row, 1964, pp. 239-277.
10. MICKLE, W. A.; AND ADES, H. W.: A Composite Sensory Projection Area in the Cerebral Cortex of the Cat. *Am. J. Physiol.*, vol. 170, 1952, pp. 682-689.
11. MICKLE, W. A.; AND ADES, H. W.: Rostral Projection Pathway of the Vestibular System. *Am. J. Physiol.*, vol. 176, 1954, pp. 243-246.
12. GRÜSSER, O. J.; GRÜSSER-CORNEHLS, U.; AND SAUR, O.: Reaktionen einzelner Neurone im optischen Cortex der Katze nach elektrischer Polarisation des Labyrinths. *Pflügers Arch. ges. Physiol.*, vol. 269, 1959, pp. 593-612.
13. GRÜSSER, O. J.; AND GRÜSSER-CORNEHLS, U.: Mikroelektrodenuntersuchungen zur Konvergenz vestibulärer und retinaler Afferenzen an einzelnen Neuronen des optischen Cortex der Katze. *Pflügers Arch. ges. Physiol.*, vol. 270, 1960, pp. 227-238.
14. SPIEGEL, E. A.: Rindenerregung (Auslösung epileptiformer Anfälle) durch Labyrinthreizung. Versuch einer Lokalisation der corticalen Labyrinthzentren. *Z. ges. Neurol. Psychiat.*, vol. 138, 1932, pp. 178-196.
15. SPIEGEL, E. A.: Cortical Centers of the Labyrinth. *J. Nerv. Ment. Dis.*, vol. 75, 1932, pp. 504-513.

DISCUSSION

Parker: One of the most impressive aspects of this meeting has been the cataloging of the great wealth of neural connections with the labyrinth. In light of this information, and keeping in mind the facts that (1) your data show no association between evoked cortical responses and eye movements and (2) these evoked cortical responses are very widespread, might we consider that there are other possibilities, rather than strict vestibular afferent pathways, to account for your

data? For example, could we account for your data, perhaps, by cardiovascular influences?

Szekely: It could not be, but we did not study it.

Prescott: Did you have an opportunity to look at the evoked potentials in the frontal cortex?

Szekely: No; we did not.

Lowy: Have you used or are you planning to use cats with chronic implants?

Szekely: No.

SESSION IX

***Chairman:* WILLIAM E. COLLINS
Civil Aeromedical Institute**

Experimental and Clinical Experiences and Comments on Ultrasonic Treatment of Ménière's Disease

ARNE SJÖBERG

University of Uppsala

SUMMARY

To date, we have almost 300 patients with Ménière's disease who have undergone ultrasonic treatment and have observed about 200 additional patients who were not so treated. These patients comprise a select series of severely disabled persons in whom no form of medical therapy had been effective. The majority had been referred to us from different parts of our country. The mean duration of the disease was 8 years, but a number of patients had been afflicted for up to 20 years.

The patients are carefully examined before, during, and after irradiation. The tests include nystagmography after caloric stimulation with water at 30° and 44° C, ice water, and audiometry.

A clinical followup investigation of 228 consecutive patients revealed the following:

Freedom from or considerable improvement in vertigo was found in 89 percent; tinnitus had diminished or disappeared in 48 percent; hearing was improved or unchanged in 64 percent; and caloric reaction was clearly reduced in 58 percent. Of the last 200 surgical patients, we have only one with transitory facial paralysis, or a 0.5-percent incidence.

INTRODUCTION

Ménière's disease is closely linked to seasickness, motion sickness, and space sickness—in other words, vestibular sickness—with their special causes and problems. The disease was named in 1861 for the French otologist and teacher of deaf mutes, Prosper Ménière. Today it is the most common of the vestibular-related vertigo conditions. It is estimated that more than 60 percent of all patients with vertigo are afflicted with Ménière's disease, and this probably explains the great interest in this disease all over the world.

Ménière's disease is to be regarded today as a classical, well-characterized, and fairly common condition which mainly affects men and women between 20 and 60 years of age almost equally, with some possible predominance in men. The diagnosis is easy to establish from the case history. The symptoms are of both vestibular and cochlear origin and are manifested as a triad: (1) unilateral tinnitus, (2) increasing unilateral

deafness, and (3) sudden severe dramatic attacks of dizziness of the vestibular type.

True vestibular vertigo is characterized by disturbance in equilibrium, with a subjective sensation of rotatory motion, and, at the same time, a feeling that the surrounding room is moving. Objectively, this rotatory vertigo is observed in the form of an extremely brisk, often third-degree nystagmus which may beat in one particular direction, initially toward the affected side, and then change its direction near the end of the attack toward the unaffected side. But the vertigo and nystagmus are often of the positional type, in which case the direction of the nystagmus varies.

It is certainly no exaggeration to state that one of the greatest scourges of mankind is vertigo in the acute phase of Ménière's disease. A pertinent observation has been made that people learn to tolerate pain of different degrees, but that there are very few who can tolerate the particular disorientation which accompanies vestibular vertigo, with the negative explosion

in the form of nausea, vomiting, and dizziness. In the most severe forms of the disease, the patient may be so severely disabled that he will seek any possible means of being free from his suffering. To many, the dream of becoming free of their attacks seems almost unattainable, since over the course of several years they have probably tested the entire therapeutic arsenal with little relief.

As with motion sickness, there is a classical picture of the disease. It should be remembered in this connection once again that in motion sickness there is no macroscopical nystagmus nor any sensation of rotatory vertigo.

At the Uppsala clinic we have treated ultrasonically almost 300 patients and have observed in all about 500 Ménière's patients. It should be noted that this is a select series of severely disabled patients, in whom no form of medication had had an effect. Some of the patients were from Uppsala, but the majority had been referred to us from different parts of our country.

The results of our neuro-otological work, to be presented here, are the outcome of excellent teamwork. The members of the group are Associate Professors Jan Stahle and Börje Drettner, and the physicist Sven Johnson who designed and constructed our apparatus (refs. 1 to 5).

CHARACTERISTICS OF PATIENT GROUP

Nystagmographic analyses were made of the caloric response in 300 of the total group (ref. 6). In the majority of patients the disease was unilateral (258, or 86 percent), but in 42 (14 percent) both sides were affected. The elapsed time between the onset of the disease in one ear and its development in the other varied between 1 and 20 years. In 84 percent the caloric response was pathological; in 59 percent it was reduced, and in 11 percent it was increased. Directional preponderance was noted in 52 percent.

Most commonly (41 percent) the disease started with both vertigo and impairment of hearing. In 37 percent the first symptom was an attack of vertigo, and in 22 percent the hearing was impaired first. The configuration of the audiogram was analyzed in 124 patients. After weeks, or

sometimes years, of fluctuating hearing, with varying remissions in the course of the disease, hearing impairment often gradually progressed toward an irreversible final stage, when the tone audiogram registered a "flat loss." In 60 percent the audiogram curves were of the horizontal type, the majority being severe (ref. 7). Rising curves were seen in 17 percent and falling curves in 12 percent. In 7 percent the curves were trough shaped, and 4 percent were unclassifiable. Békésy audiography showed a reduced limen difference, so-called recruitment, especially in the higher frequencies. Whispering and conversation distances were obviously greatly decreased. Speech audiometry revealed a pronounced loss of discrimination, and the spoken words became difficult to understand.

TOPICAL DIAGNOSIS

With regard to the topical diagnosis in vertiginous diseases like Ménière's, it is clear that first and foremost a decision must be made, on the basis of the case history and clinical symptoms, as to whether the lesion is central or peripheral or in between the two.

Vertigo of Central Genesis

Vertigo caused by central lesions develops gradually, often very slowly, and persists for a duration of months or years. In these cases the vertigo can be of a rotatory or tactile type, with a tendency to lateropulsion. It is often experienced as "positional vertigo"; i.e., it can be more severe when the head is in a particular position. At the same time, nystagmus of the so-called positional type can often be observed. A varied picture of symptoms is obvious in centrally dependent vertigo and is characterized mainly by vestibulo-ocular disturbances with vertigo and nystagmus, but usually, in addition, by vestibulospinal disorders, wherein the proprioceptive disturbances are manifested as changes in equilibrium and alterations in tonus. It is well known that these symptoms are seen in diseases of the brainstem, the cerebellum, and the cerebellopontine angle. To this category we can also assign acoustic tumors which lie, so to speak, on the borderline between the central and peripheral portions of the vestibular nerve.

Vertigo From Middle-Position Lesions

Cervical Syndrome, Barré-Lieou Syndrome, Cervical Migraine

Middle-position lesions show the disease patterns such as in the cervical syndrome, the Barré-Lieou syndrome, or cervical migraine. The principal symptoms are brachialgia, headache, tinnitus, globus sensation and paresthesia in the face, slight impairment of hearing of the neurogenic type, and vertigo. The symptoms can present considerable difficulties in differential diagnosis. The headache can be unilateral or localized to the back of the neck, which occupies a central position in the equilibrium system in that the occipital muscles, via the neck reflexes, are under the continuous influence of impulses from the apparatus of equilibrium. The afferent impulses from the occipital and neck muscles pass via the posterior roots from C1 to C3. If, for any reason, the occipital muscles go into a state of traction, then they are unable to function as effector organs for the neck reflexes, and a disturbance in equilibrium will occur, resulting in vertiginous symptoms. The occipital muscles can become tender and painful. Electromyography will reveal that the muscles are in a state of contraction.

As far as is possible, we examine otoneurologically all patients with brachialgia. J. Sandström (ref. 8) analyzed a series of patients from the orthopedic clinic of our hospital and found that vertigo with recordable nystagmus on rotation of the head occurred in 18 to 20 percent. Figure 1 shows one of our patients with Barré-Lieou syndrome and recordable nystagmus after turning and bending of the head.

Vertigo in the cervical syndrome can be of a transitory rotatory type, but is usually tactile with a sensation of propulsion or lateropulsion. It is significant that the vertigo has a sudden onset and is transitory, taking the form of a sensation of general insecurity. The patient takes a step sideways or staggers in some direction for a moment as if he were intoxicated. Vertigo can occur on extreme hyperextension or on rapid and sometimes extreme rotatory or nodding movements of the head. The patient may, for example, be backing his car into the garage or doing some painting work above his head, or

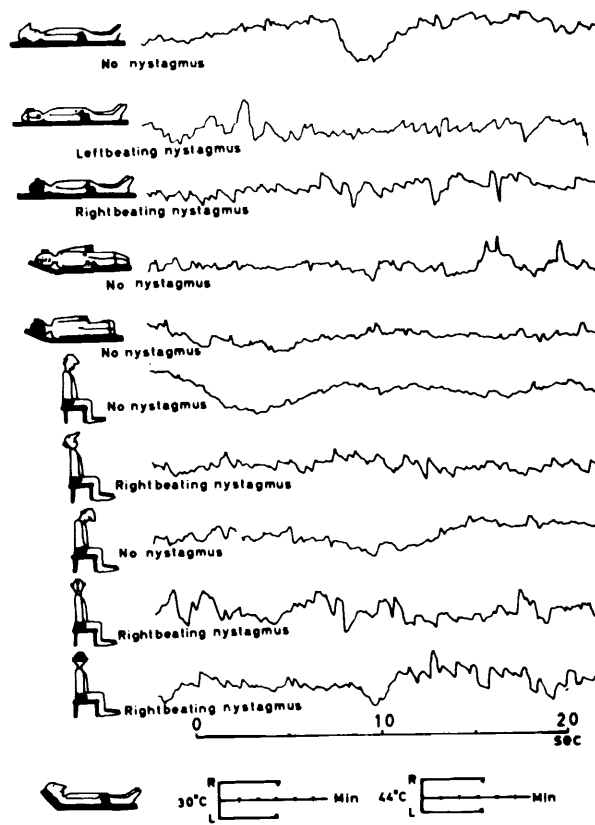

FIGURE 1.—The Barré-Lieou syndrome with recordable nystagmus after turning and bending of the head.

perhaps he may be visiting a museum or art exhibition wearing bifocal spectacles and will have to bend and turn his head in time with his different up-and-down eye movements.

It has been considered pathogenetically that, on rotatory movements of the head, excitation of sympathetic vasomotor fibers may be induced, so that a spasm is provoked in the vertebral artery. This artery passes into the spinal canal at C6, and the excitation can pass via the vertebral sympathetic nerve, which is connected below with the stellate ganglion.

The cause would seem to lie in roentgenologically visible spondylotic lesions in the cervical spinal column, with more or less pronounced arteriosclerotic changes in the vertebral artery. It has also been shown that, on rotation of the head to the one side, the contralateral vertebral artery can be compressed, producing ischemia in the areas of the vestibular nuclei and in

the brainstem and labyrinth. Other possible etiological factors are cervical trauma and manipulations of the chiropractic type. With the presence of lesions in the cervical spinal column, rotation of the head can produce brainstem symptoms with vertigo and syncope, or what is called the "syncopal cervical vertebral symptoms."

It would thus seem that the cervical syndrome is the result of a unilateral vertebral occlusion that is not immediately compensated by adequate collateral supply on the opposite side from a well-functioning circle of Willis. The vestibular nuclei are very vulnerable, since they are supplied by narrow end arteries. If it is considered that the cervical syndrome may be due to intermittent ischemia in the supply areas of the vertebral and basilar arteries, an attempt should be made to investigate the blood flow in the vertebral artery.

With the help of surgeons and clinical physiologists, my coworkers J. Stahle and K. Eriksson have developed a method for measuring blood flow in the vertebral artery by means of impedance plethysmography. One electrode is placed on the posterior wall of the pharynx at the level of the uvula, via the nose, as a suction cup with continuous suction; a second electrode is placed on the back of the neck on the same level as the internal electrode. The curves show arterial pulsations and their amplitudes express the changes in tissue impedance. The smaller the amplitudes, the greater the tissue resistance (impedance), indicating compression. Rotation to the right gives the lowest values in the left vertebral artery.

Ever since Sherrington, Magnus, and de Kleijn made their classical studies, we have known the importance to the reflexes of proprioceptive impulses induced from receptors in occipital muscles and tendons and in joints in the cervical spinal column. These problems have received increasing interest in modern neurophysiological investigations with experimental electrical stimulation of peripheral branches of the vestibular nerve in the cat. Excellent demonstrations have shown the close relationship between proprioceptive cervicothoracic spinal cord impulses and the cerebellar vestibular nerve. Exostosis di-

rected posteriolaterally can constrict the intervertebral foramina and may compress the spinal roots and produce root symptoms in form of pains and vertigo via spinonuclear vestibular communications.

These tonic reflexes in the neck, occipital region, and labyrinth regulate the movements of the head, the trunk, and the four extremities in, for example, all the dynamic positions observed in gymnastic exercises and different sports (ref. 9). The extremities on the "nose-knee" side, to which the head is turned, are extended, while those on the other side are bent.

Vertigo of the Peripheral Type

Vertiginous symptoms provoked from the peripheral portion of the vestibular apparatus are of a different type. They have a sudden onset and are associated with nystagmus, nausea, vomiting, and typical reaction movements. They can be caused by different forms of otitis with labyrinthitis, or vestibular neuritis of a viral origin, and the condition may be referred to as epidemic vertigo. Further causes of vertigo of the peripheral type are Ménière's disease, paroxysmal positional nystagmus, trauma with petrosal fractures, neoplasms, vascular disorders, hematological diseases with labyrinthine hemorrhage, and also ototoxic lesions due to antibiotics such as streptomycin and kanamycin.

TREATMENT OF MÉNIÈRE'S DISEASE

Even if the long duration and natural tendency to remission of Ménière's disease must be taken into account, one of the following methods of surgically treating severely disabled patients who have resisted all forms of conservative internal therapy should be considered:

- (1) Radical surgery with destructive labyrinthectomy;
- (2) Drainage of the endolymphatic sac or the subarachnoid shunt operation; or
- (3) Ultrasonic therapy, in which the vestibular apparatus is selectively destroyed, and hearing conserved.

The possibilities of curing vertigo by ultrasound in Ménière's disease are well documented, but investigators have published no details

on the reduction of the caloric reaction after ultrasonic irradiation. We have made very careful comparative studies of the caloric reaction before and after irradiation in all our patients, and I will present a clinical followup report. The caloric test has been performed with water at 30° and 44° C, and the reactions have been recorded in all cases by means of electronystagmography (ENG). In cases with weak or no response to these stimuli, ice water has been used.

It was essential for us from the beginning (1959) to build a new apparatus that allowed for small dimensions at the tip of the transducer, and above all provided a well-concentrated sound beam that could be directed as far from the facial nerve and cochlea as possible.

Apparatus and Technique

As with other instruments of this type, the apparatus we have constructed (fig. 2) consists of two main parts:

(1) The radiofrequency generator, consisting of oscillator with power amplifier and power supply. The oscillator is coupled for 1.25 MHz.

(2) The treatment head or the transducer with its cooling system. The new type with Teflon tips is shown in figures 3 and 4.

Criticisms have been voiced against ultrasonic treatment of Ménière's disease, mainly because of the relatively high incidence of facial paralysis that constitutes the only serious complication of this form of treatment. The frequency of facial paralysis varies in different series of patients; in general, the paralysis regresses within a few months. We have had 4 incidents of facial paralysis, one of which occurred among the

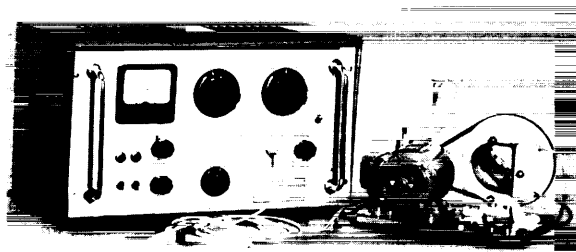

FIGURE 2.—The Uppsala ultrasonic apparatus.

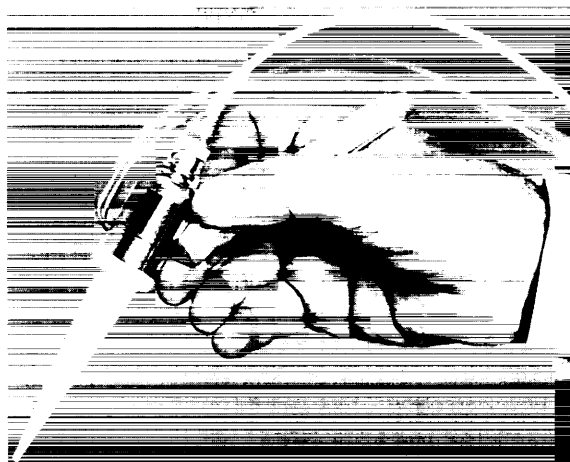

FIGURE 3.—The transducer with Teflon tip, assembled.

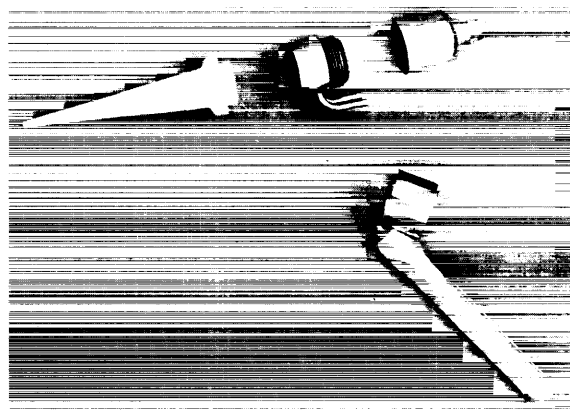

FIGURE 4.—The transducer with Teflon tip, unassembled.

last 200 operated patients (or 0.5 percent). In each case, the paralysis regressed spontaneously after 1 to 3 months. In order to avoid as far as possible any damage to the facial nerve, it was considered especially important to reduce the danger of lateral radiation and to provide for efficient cooling of the tip. With the present construction, the only fluid necessary in the surgical cavity is a small coupling drop between the tip of the treatment head and that point of the labyrinth into which the ultrasound is to be transmitted.

In principle, the apparatus functions as follows: High-frequency alternating current is conveyed from the oscillator to the transducer through a thin, light, flexible cable. Inside the transducer

is a concave disk of barium titanate or lead zirconate-titanate, which converts the electric energy into ultrasonic waves. The radius of the curvature of the disk is selected to give a concentration of energy at the apex of the cone. The beam of the rays is focused in such a way that the focal point lies just inside or at the flat tip of the treatment head (fig. 5).

The tip of the treatment head is continuously irrigated with sterile, boiled, and degassed distilled or deionized water, circulated in a closed system by a special pump. The surface of the tip has no direct contact with the fluid. The water is boiled for a period of 1 to 2 hours just prior to time of irradiation. The water conducts the ultrasound from the crystal to the tip of the transducer and also cools the whole treatment unit.

The entire transducer, including the cable, can be sterilized by boiling or autoclaving.

Before we could undertake the responsibility

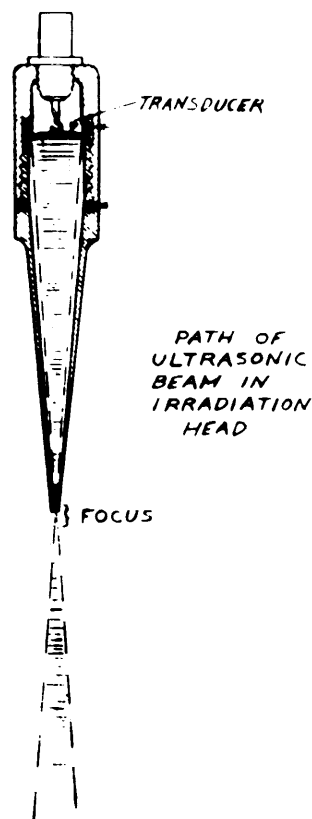

FIGURE 5.—The focused ultrasonic beam.

for the radiation involved in ultrasonic therapy, it was necessary to first test our apparatus in animal experiments in order to determine its exact potentialities. We also had to gain experience ourselves in this special and sensitive operation technique and learn its elements of risk. To study the histological and functional effects of ultrasound, irradiation experiments were performed on pigeon labyrinths. Degeneration of both the neuroepithelium and the secretory epithelium was found in the cochlea, ampullae, sacculus, and utriculus. The perilymphatic space and bony labyrinth were obliterated by callus (refs. 4, 10, and 11).

With regard to the functional aspects, it was also demonstrated that ultrasound eliminated labyrinthine function by serious histological damage. By electronystagmographic control of the nystagmus of the pigeon's head during rotation, it was possible to record the functional loss (ref. 11).

Due to the use of our new Teflon tips, in most cases it has been possible to shorten the irradiation times considerably. The quantity of energy emitted from the various tips used with the treatment head has been measured calorimetrically. In general, power levels of up to 3 watts are used regularly, and at times as much as 4 watts may be employed. This results in peak intensities from 60 to 80 W/cm² for the 2.6-mm tips. The mean dose lies at about 2000 to 3000 joules. Sometimes we see definite paralytic nystagmus after only 2 to 3 minutes' irradiation.

With regard to the irradiation technique, I should like to mention that a good surface for application of the Teflon tip is created by boring a rounded hollow at the junction between the horizontal and the upper vertical semicircular canals (fig. 6) with a diamond drill and under the microscope. To attain maximum effect, the bone of the labyrinthine capsule has to be thinned so that the spongy character of the enchondral bone can be retained (fig. 7). The labyrinthine capsule should be 0.3 to 0.5 mm thick for optimal penetration of the bone by the ultrasound and so that this will not be absorbed or reflected too much during its passage toward the ampullae and vestibule. Care has to be taken not to thin the bone to such an extent that the labyrinthine



FIGURE 6.—Application of the Teflon tip.

capsule cracks, which may cause a complete loss of hearing.

On schlieren photographs of the penetration of the ultrasound for power levels around 2 to 3 watts in bone slices of different thicknesses, we can see how the ultrasound heats the bone; no sound can penetrate. When the bone becomes thinner, less and less sound is reflected, and finally the ultrasonic beam is able to penetrate a 0.2-mm bone beautifully.

Early in our studies we considered it desirable



The bony capsule of the Labyrinth

FIGURE 7.—The spongy character of the enchondral bone.

to construct an apparatus that would make it possible to measure the bone thickness in the labyrinthine capsule to fractions of 1.0 mm. It may perhaps become possible to measure the thickness of other thin tissue layers. We hope to be able to measure the thickness of the footplate of the stapes in otosclerosis, the walls of a vessel and artery, for the localization of foreign bodies, etc.

Our physicist has constructed a rod-shaped probe (refs. 12 and 13) with a barium titanate crystal in its tip. The handle contains titanium, which has an acoustic impedance close to that of lead zirconate. Titanium absorbs and damps extra oscillations in the barium titanate crystal.

The instrument has a working frequency of 4 MHz, but a new system which is under trial has double this frequency and a probe diameter of 3 mm (fig. 8).

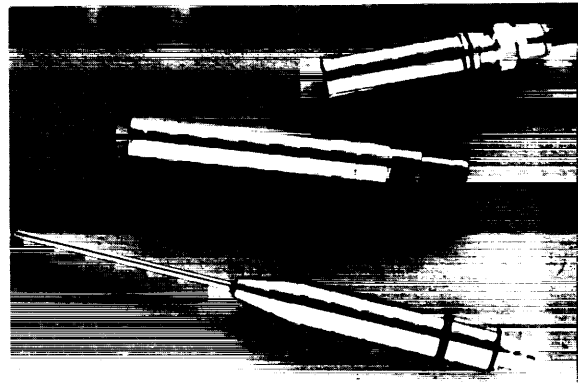

FIGURE 8.—Ultrasonic probe for measuring bone thickness.

An electrical generator produces a short pulse, which is emitted from the crystal of the probe, where echoes are also received on changes in tissue density. The echo is observed as vertical spikes on a cathode-ray tube (oscillograph) and, in the usual way, they can be photographed on this and presented as so-called sonograms. On these, the distance is then measured between the basic pulse and the echo signal, and this gives us an idea of the thickness in millimeters. Figure 9A shows a piece of aorta from a female, 28 years of age; figure 9B shows a sonogram with the thickness of the wall in millimeters. In figure 9C is a sonogram from an arteriosclerotic aorta from a 70-year-old man.

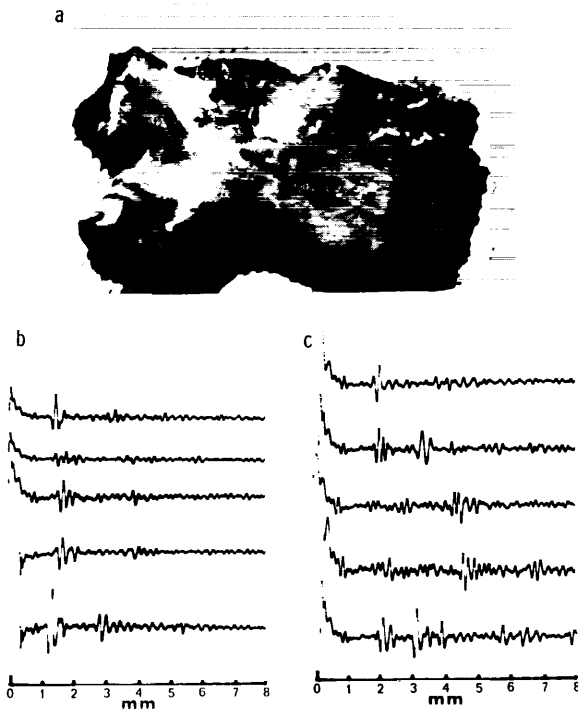

FIGURE 9.—A: Piece of aorta from 28-year-old female. B: Sonograms of pieces of aorta of A. C: Sonograms from arteriosclerotic aorta of 70-year-old man.

In figure 10 we see the sonograms from bone slices on the 0.50 sample; the first echo is just hidden by the transmitted pulse.

The ultrasound transmitter is applied in the dry surgical cavity, and sound transmission is made possible by the use of a small drop of saline as contact medium, whereby the ultra-

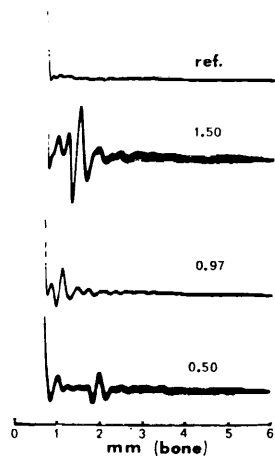

FIGURE 10.—Sonograms from bone slices.

sound is visualized as pulsating reflections of light or as narrow standing waves of blood. We can localize exactly the orientation of the beam in the direction of the ampullae and vestibule, and can thus avoid an orientation toward the facial nerve and cochlea.

RESULTS AND DISCUSSION

In ultrasonic treatment it is a combination of thermal, mechanical, and chemical influences which gives the biological effect. In order to avoid damage to the facial nerve and to preserve hearing to the highest possible extent, a study had to be made of the way in which the heat energy was distributed in the bone. We therefore studied closely the thermal effect on isolated human temporal bones and in man during the process of irradiation.

The ultrasonic apparatus constructed in Uppsala has been tested on temporal-bone preparations (refs. 14 and 15) in which have been placed fine thermoelements (of copper constantan 0.2 mm) connected to an automatic temperature recorder (Potentiometer Speedomax). When metal tips were directed toward the blue line on the lateral semicircular canal, the temperature inside this canal rose to 50° C after 5 minutes' irradiation with 4 watts. Metal or Teflon tips applied at the junction between the lateral and anterior vertical semicircular canal produced a greater increase in temperature in the lateral semicircular canal and in the vestibule than in the cochlea (fig. 11). In the facial nerve the temperature increase was of the same magnitude or sometimes somewhat smaller than in the vestibule (fig. 11). The supposed critical temperature of 46° C in the facial nerve was not reached until after more than 4 minutes of continuous irradiation with 4 watts. By fractioning the irradiation when treating patients with Ménière's disease, the risk of producing facial paresis is probably reduced. Our results deviate from those of several other investigators who have consistently shown a larger temperature increase in the facial nerve than in the vestibule.

On one patient who underwent labyrinthectomy, temperature measurements were made in the vestibule and lateral semicircular canal in connection with ultrasonic irradiation. With

Temperatures after 3 minutes ultrasonic treatment with 3 watts to the enchondral bone in the junction between the horizontal and the superior vertical semicircular canal

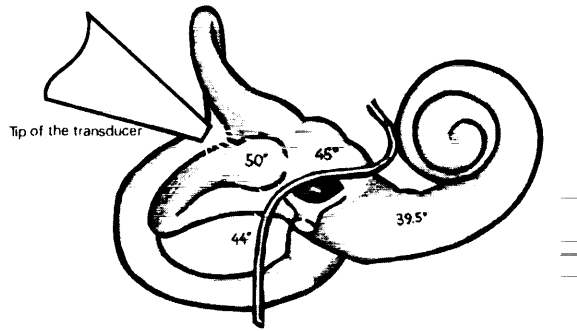

FIGURE 11.—Way in which heat energy is distributed in temporal bone during ultrasonic irradiation.

lower ultrasonic power the temperature increase was of the same magnitude as in temporal bone preparations, but with higher power the increase was smaller than in the preparations, probably due to heat losses via the circulating blood.

Ultrasonic irradiation of rabbits placed in different body positions showed that nystagmus changed its direction when the rabbit was rotated 180°. In each body position the direction of the nystagmus was the same regardless of whether the labyrinth was irradiated with ultrasound or with pure heat. The probe is thus used

Thermal Effects of Ultrasound on Inner Ear

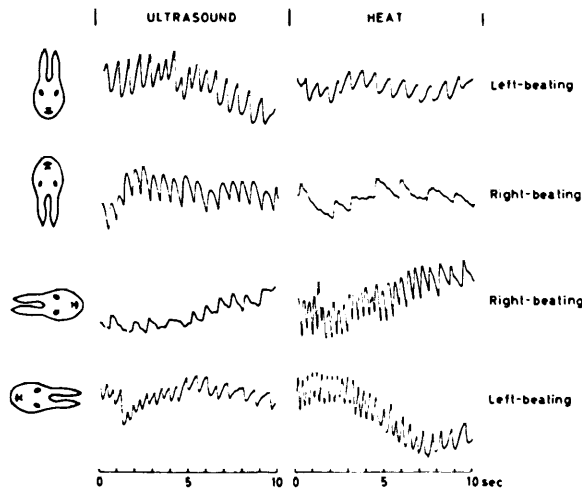

FIGURE 12.—Nystagmography curves from a rabbit with the head in different positions both during irradiation and on the application of pure heat.

also for this latter application, water at 70° C being allowed to circulate in the probe with the ultrasound generator turned off.

Figure 12 shows nystagmographic curves from a rabbit with its head in different positions both during irradiation and on the application of pure heat (refs. 14 and 15). Nystagmus direction was the same in each position, whether ultrasound or heat was applied. With the positional change of 180°, it can be seen that nystagmus altered its direction to that opposite the initial direction. This change to an opposite direction was observed both when the position was changed from prone to supine and from the right to the left lateral.

Figure 13 shows nystagmographic curves from a patient in whom the left ear was irradiated while the body was in different positions. In position (I) with the face upward, nystagmus beat to the left. In prone position (II) with the face downward, the beat was to the right. After further irradiation in the supine position (III), a left-beating nystagmus was again observed. After 10 minutes' irradiation there was contralateral nystagmus to the right, of the pseudo-paralytic type (IV). This did not change direction when the patient was turned to the prone position, but renewal of irradiation in-

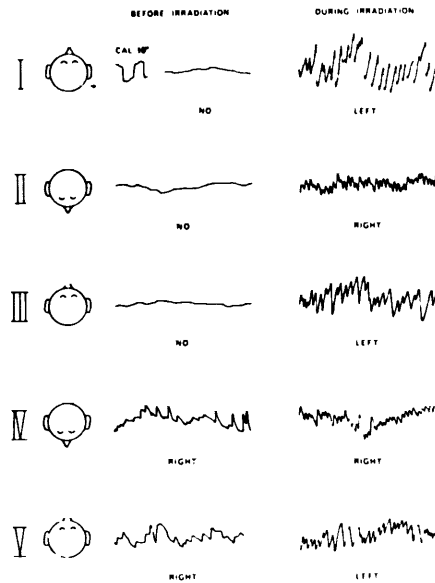

FIGURE 13.—Nystagmography curves from a patient during ultrasonic irradiation.

creased the intensity of the nystagmus. When the patient was then turned to the supine position with the face upward (V), the contralateral-pseudoparalytic nystagmus persisted, but after a few minutes a beat to the left was noted. The labyrinth was thus only habituated to the ultrasound, but not paralytically or selectively completely destroyed. Nystagmus of the destructive type which occurs after a certain period of irradiation does not change its direction, on the other hand, when the patient's position is altered from face up to face down.

Our experiences with ultrasonic irradiation have provided valuable neuro-otological information. Experimental therapy in rabbits and treatment of human beings with the head in different positions have shown that the initial nystagmus caused by ultrasound is probably a caloric reaction provoked by the endolymphatic flow caused by the thermal effect. Experimental temperature studies on ultrasonic irradiation of human temporal bone preparations and in man during labyrinthectomy have shown that the temperature increase in the cochlea is negligible and that the critical temperature in the facial nerve is not reached until after more than 4 minutes of irradiation. Therefore, irradiation is now given intermittently in periods of 3 to 4 minutes.

During the treatment, the function of the facial nerve and the nystagmic effect are checked in a mirror through Frenzel glasses. Naturally, we sometimes have studied by nystagmography all phases of the therapeutic effect in detail (figs. 14 and 15).

In principle, the aim is to first induce a homolateral irritative nystagmus, and as a final effect to produce a definite contralateral nystagmus of the destructive type, as a sign that the vestibular apparatus has been selectively destroyed or paralyzed by, or has been habituated to, the ultrasound.

The main problem is to assess the final point (fig. 15) at which the irradiation should be discontinued. Much experience is required for this, and herein lies one of the greatest difficulties in the technique of this treatment. As a rule, we continue until a reversal to contralateral nystagmus has been recorded two to four times

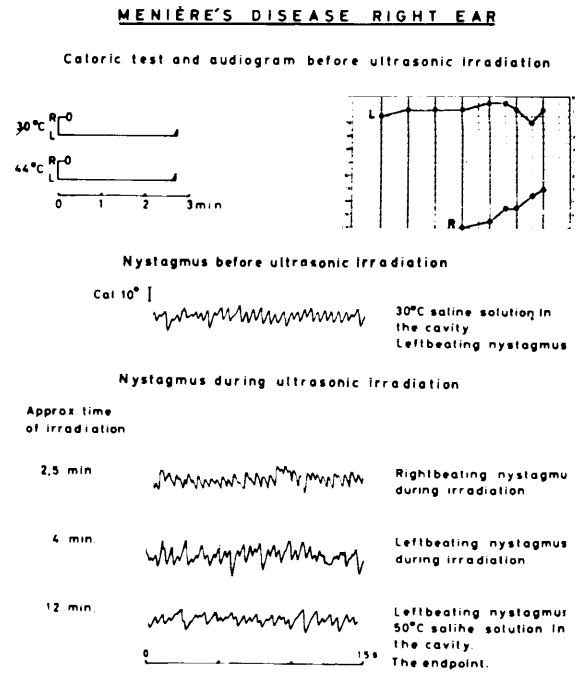

FIGURE 14.—Nystagmic effect during all phases of the treatment.

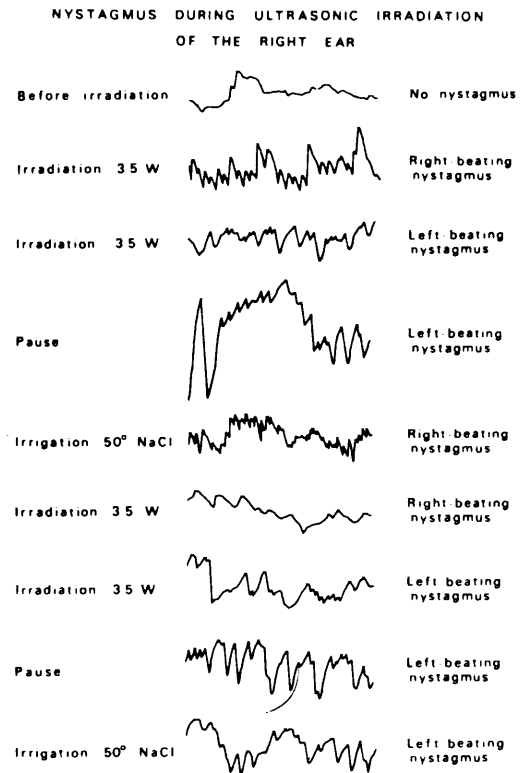

FIGURE 15.—Assessing the final point of the irradiation.

consecutively during the process of irradiation. In all cases it is not possible, however, to invoke such reversal during irradiation (figs. 14 and 15).

We then do a caloric test with injection of sterile physiological saline at 50° C directly into the surgical wound. In spite of the fact that, in this way, the labyrinth may perhaps for the moment seem to show no reaction to calorization—i.e., it may seem habituated to the thermal effect of the ultrasound—a distinct irritative nystagmus of homolateral direction can nevertheless often be seen and can fairly quickly change to a contralateral direction during further irradiation (fig. 15).

The patient often vomits at the same time, and the excitability of the vestibular apparatus becomes increasingly reduced. In cases with an especially prolonged tendency, we then discontinue the irradiation. We dare not give more ultrasound in these cases because of the risk of damage both to the facial nerve and to the cochlea. As a rule, we have then simultaneously raised the power output of the transducer tip to 3.0 to 3.5 watts. The total irradiation time varies from 2 to 4 minutes and 15 to 30 minutes.

A followup examination was made this year of the 228 patients who have been observed for 6 months, 6 years after their operation. All of them answered a questionnaire, and the majority also underwent complete audiological and otoneurological reexaminations. The vertigo had disappeared in 56 percent and had improved in an additional 33 percent; thus there was improvement in a total of 89 percent. The tinnitus had diminished or disappeared in 48 percent. Hearing was improved or unchanged in 64 percent, and the hearing results were, on the whole, independent of the length of the observation period. An increased capacity for work was noted in 54 percent. The caloric reaction had decreased in 58 percent (example in fig. 16). A statistically significant relationship was found between the duration of the postoperative paralytic nystagmus and the reduction in the caloric excitability noted at the followup examination.

With regard to the pathogenesis of the Ménière attacks, it is now probable that it is a temporary rise in pressure that provokes the crisis. Wheth-

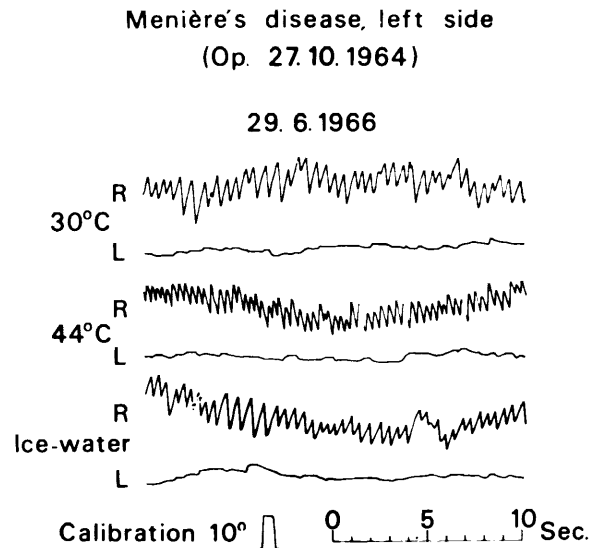

FIGURE 16.—Results of a followup examination.

er the consequence is then a rupture in a weak place in the membranous endolymphatic wall is an open question. Of recent great interest are the experiments of Dohlman and Fernández on the frog and ape where it was shown that potassium chloride seemed to have the greatest importance for the transport of ions in labyrinthine stimulations, and which may also have a depolarizing effect on labyrinthine nerve branches.

When later we studied our results of irradiation in man, we found complete or, in most cases, partial destruction of vestibular function. This appears to correspond well with the hypothesis that the endolymphatic secretion is reduced on irradiation. Conditions are thus created for a reduction of labyrinthine hydrops.

Our own irradiation experiments on animals and those of others have shown histologically and histochemically that the secretory epithelium in the cochlea and ampullae is undoubtedly damaged. Hypothetically, it would seem to be justifiable to assume, therefore, that conditions are thereby created for reduction of the endolabyrinthine pressure in a Ménière hydrops after ultrasonic irradiation.

In addition to its thermal effect, ultrasound also has a mechanical action. Hughes and Chou (ref. 16) have shown that this mechanical effect can influence osmotic processes, with an increase

in the capillary permeability in cell membranes and an effect on the microcirculation of the blood. The pH can be changed. It is considered that the cavitation can damage or burst cells and break open macromolecules in serum, whereby biochemical changes with altered protein concentrations can occur. Blood is hemolyzed, bacteria killed, etc.

Hughes and Chou have experimentally shown biochemical changes with an alteration in the electrolyte content in the labyrinthine fluids. Similarly, on ultrasonic irradiation the transport of sodium and potassium ions is altered, and thereby the capacity of the neuroepithelial system to respond to different stimuli is eliminated or reduced, or at any rate changed.

In other words, it would seem that all these biochemical changes after ultrasonic irradiation, which among other things causes damage to the secretory epithelium in the cochlea and ampullae, might theoretically explain not only the favorable effect of such irradiation in Ménière's disease but also the positive results which have been obtained without always producing full destruction of the sensory cells of the vestibular organ.

In this connection it is also of interest to remember the beneficial effect of our diuretics in Ménière's disease. Apart from the fluid loss, there is also an increased excretion of potassium. The intracellular fluid, the endolymph, has a high-potassium and low-sodium concentration. The

question can be asked then whether part of the favorable effect of diuretics can also be due to a decrease of the potassium concentration in the endolymph. Can we perhaps dare, in our Ménière patients, for short, critical periods, to avoid administration of extra potassium when treating them with diuretics?

It is probably no exaggeration to claim that about 90 percent of our operated cases become free of their vertigo attacks, or considerably improved, and the majority return to full working capacity. Our figures correspond well with those of Arslan in Padova. He operated on 1500 patients from 1952 to 1964, and 90 percent of them were freed of vertigo. Arslan estimated that up to now about 3000 patients have been operated on in the world.

As I have mentioned, we do have patients with recurrent attacks of vertigo of short or long duration after ultrasonic therapy. Sometimes the patient himself has noted, or in answer to particular questioning has stated, that he is now having symptoms from the untreated ear. On some occasions it has been necessary to reoperate because of recurrence. This is very easily done, and no reaction is ever seen in the surgical wound. No signs of labyrinthine neurosis have been seen.

A final but important facet of ultrasonic otosurgery is its stimulating effect upon present-day neuro-otological concepts.

REFERENCES

1. SJÖBERG, A.: Clinical Experience From the Treatment of Ménière's Disease. *Acta Oto-Laryngol.*, suppl. 192, 1964, pp. 139-153.
2. SJÖBERG, A.; AND STAHL, J.: Treatment of Ménière's Disease with Ultrasound. *Arch. Otolaryngol.*, vol. 82, 1965, pp. 498-502.
3. SJÖBERG, A.; STAHL, J.; DRETTNER, B.; AND JOHNSON, S.: Aktuella behandlingsproblem vid morbus Ménière samt demonstration av ultraljudapparat. *Nord. Med.*, vol. 74, 1965, pp. 1146-1147.
4. SJÖBERG, A.; STAHL, J.; JOHNSON, S.; AND SAHL, R.: Treatment of Ménière's Disease by Ultrasonic Irradiation. Physical, Experimental, and Clinical Studies. *Acta Oto-Laryngol.*, suppl. 178, 1963, pp. 1-86.
5. JOHNSON, S.: An Ultrasonic Unit for the Treatment of Ménière's Disease. *Ultrasonics*, vol. 5, July 1967, pp. 173-176.
6. STAHL, J.; AND BERGMAN, B.: The Caloric Reaction in Ménière's Disease. An Electronystagmographic Study in 300 Patients. *Laryngoscope*, vol. 77, 1967, pp. 1629-1643.
7. ENANDER, A.; AND STAHL, J.: Hearing in Ménière's Disease. A Study of Pure Tone Audiograms in 334 Patients. *Acta Oto-Laryngol.*, vol. 64, 1967, pp. 543-556.
8. SANDSTRÖM, J.: Cervical Syndrome with Vestibular Symptoms. *Acta Oto-Laryngol.*, vol. 54, 1962, pp. 207-226.
9. FUKUDA, T.: Studies on Human Dynamic Postures From the Viewpoint of Postural Reflexes. *Acta Oto-Laryngol.*, suppl. 161, 1961, pp. 1-52.
10. STAHL, J.: Ultrasonic Irradiation of the Labyrinth. *Acta Oto-Laryngol.*, suppl. 188, 1964, pp. 183-189.
11. STAHL, J.: Some Effects of Ultrasound on the Inner Ear. *Acta Oto-Laryngol.*, suppl. 192, 1964, pp. 192-198.

12. JOHNSON, S.; SJÖBERG, A.; AND STAHL, J.: Ultraljudssonografi av tunna skikt. Nord. Med., vol. 78, 1967, p. 1590.
13. JOHNSON, S.; SJÖBERG, A.; AND STAHL, J.: Studies of the Otic Capsule. I. Reduced Dearthime Ultrasonic Probe for Measurement of Bone Thickness. Acta Oto-Laryngol., vol. 62, Dec. 1966, pp. 532-544.
14. DRETTNER, B.; JOHNSON, S.; SJÖBERG, A.; AND STAHL, J.: Some Thermal Effects of Ultrasound on the Inner Ear. Acta Oto-Laryngol., vol. 64, 1967, pp. 464-476.
15. DRETTNER, B.; JOHNSON, S.; SJÖBERG, A.; AND STAHL, J.: Studier över ultraljudets termiska effekt i innerörat. Nord. Med., vol. 78, 1967, p. 1591.
16. HUGHES, D. E.; AND CHOU, J. T.: The Biochemistry of the Inner Ear and the Consequences of Treatment by Ultrasound. Acta Oto-Laryngol., suppl. 192, 1963, pp. 199-206.

BIBLIOGRAPHY

- BARAC, B.; HAGBARTH, K.-E.; AND STAHL, J.: EEG in Ménière's Disease. A Study of EEG and Caloric Directional Preponderance Before and After Irradiation of the Labyrinth. Acta Oto-Laryngol., vol. 62, 1966, pp. 333-340.
- SJÖBERG, A.: Studien über den Auslösungsmechanismus der Seekrankheit. Acta Oto-Laryngol., suppl. 14, 1931, pp. 1-136.
- SJÖBERG, A.: YRSEL (1-2). Läkartidningen, vol. 64, 1967, pp. 337-344, 452-460.
- STAHL, J.; AND SAHL, R.: Electronystagmography in Ménière's Disease Before, During and After Ultrasonic Irradiation. Acta Oto-Laryngol., suppl. 192, 1964, pp. 154-166.

DISCUSSION

Graybiel: What was the time course of the postural disequilibrium effects; that is to say, what was it before the ultrasound treatment and afterward? Were the patients ataxic afterward?

Sjöberg: They had some difficulty in walking for 1 or 2 months, but no more. They became accustomed very easily afterward, but they had a slight feeling of lateropulsion and unsteadiness in darkness during this time.

Graybiel: But it did last 1 to 2 months?

Sjöberg: Yes. They could work after 2 or 3 months.

Tolhurst: Have you explored enough so that you can say something about the time-intensity relationship of exposure to ultrasound? As you increase the wattage, do you have to reduce the time, and do you know the parameters of each?

Sjöberg: As a rule we have raised the power output of the transducer to 3.0 to 3.5 watts. The total irradiation time varies between 2 to 3 minutes and 15 to 30 minutes. But the treatment time depends on the quality of the bone, which can be different in every individual. With a hard bone it can be more difficult for the ultrasonic beam to go through the bony capsule at the labyrinth.

Lowy: Dr. Sjöberg is to be congratulated on having a presentation equally interesting from a medical as well as a scientific standpoint, if we will be permitted to separate those two aspects. Dr. Sjöberg has presented us with an overwhelmingly voluminous number of cases. He also made the statement that, according to his own experience, Ménière's

disease is the most frequent vestibular affliction encountered in his practice. It is conceivable that there are very considerable regional differences, because I believe that the consensus of American otologists is probably that Ménière's disease is by no means the most frequent affliction and that benign positional vertigo and so forth occur much more frequently. Do you have any comments on this?

Sjöberg: With regard to the topical diagnosis in vertiginous diseases of the Ménière's type, it is very important to decide whether the lesion is peripheral or central. Therefore, I have just mentioned the Barré-Lieou syndrome, or cervical migraine, which can present considerable difficulties in differential diagnosis. We have not yet treated such cases with ultrasound.

Money: I was interested to see that the rate of retention of hearing was 64 percent. Can Dr. Graybiel tell us what the rate of retention of hearing was in the streptomycin series which he studied?

Graybiel: Our study was based on four patients of Professor Schuknecht's, and we conducted our tests long after they had been treated with streptomycin sulfate. Three normal and five diseased ears were involved. Serial audiograms revealed a substantial and permanent improvement in hearing in four ears which came about over periods measured in months or years. Hearing in one ear improved temporarily but reverted to its pretreatment level.

Patterns of Cochlear Hair-Cell Loss in Guinea Pigs After Intense Stimulation by Sinusoidal Sound¹

HARLOW W. ADES, CHARLES W. STOCKWELL, AND LYNN B. POCHE

University of Illinois

HANS ENGSTRÖM

University of Uppsala

SUMMARY

Guinea pigs were individually exposed to intense sinusoidal sound stimulation of various frequencies and varying also in intensity and duration. After a suitable period to allow for degeneration of damaged hair cells, the animals were sacrificed and surface preparations of the organs of Corti were made according to the method of Engström. Cochleograms of each organ of Corti were constructed to map the position and condition of each cochlear hair cell. The cochleograms were coded for computer reduction of data. Intercomparisons of hair-cell damage were made in terms of variants of the three parameters of the exposure stimulus.

Narrow regions of severe to total hair-cell destruction were seen in the ears exposed to higher frequency stimuli. In general, greater damage was seen in outer than in inner hair cells. This difference was greatest in ears exposed to low frequencies, in which extensive outer-hair-cell damage was seen near the apex. Relations between damage and stimulation patterns are discussed in terms of the nonlinear response of the ear to high-intensity stimulation.

INTRODUCTION

There are two reasons for doing experiments in which damage patterns of cochlear hair cells are mapped after exposing animals to intense sound. The first is the obvious one of trying to determine the parameters of sound stimuli which will produce a given amount and pattern of hair-cell changes. The second rests on the hope of gaining inferential information on the normal pattern of stimulation by sounds of known characteristics, and assumes a direct correspondence between damage patterns and stimulation patterns. To complete the correlations thus implied, it would be necessary to add to the equation the exact pattern of hearing loss. Evidence on all of these points in the past has

ranged from less than adequate to fragmentary.

The greatest amount of functional data and the sketchiest amount of anatomical information have come from human experiments, whereas the fuller anatomical evidence, combined with minimal functional evidence, has been derived from animal experiments. The functional evidence from both human and animal subjects has been limited largely to the pure-tone audiogram, a test which falls considerably short of the subtlety needed to discriminate crucially in terms of frequency analytical function. On the other hand, the damage to hair cells in both human and animal cochleas has been studied almost exclusively by Guild's method of graphic reconstruction from serial sections (ref. 1), a method which is severely limited in that it makes accurate orientation difficult, and leaves possibly crucial segments of the organ of Corti unex-

¹ This research was supported by NASA grant NGL 14-005-074.

plored. The net result of many studies using these methods has been to leave in doubt whether intense stimulation by sinusoidal sound produces hair-cell damage which is truly systematic or selective. This stands in marked contrast to the apparently precise and systematic localization of tonal maxima along the length of the organ of Corti.

Together with a growing list of students and associates, we have worked with a method developed in Professor Engström's laboratory, and it is called the surface-preparation technique, which makes possible the examination of the organ of Corti in toto from its endolymphatic surface. It is quite feasible to chart all the hair cells, each in its proper position in relation to the rest, and to note their condition (i.e., intact, damaged, or replaced by a phalangeal scar). The method was exploited in the present study to explore systematically the relationship between hair-cell damage and frequency analytical function of the cochlea.

METHOD

Forty-five female guinea pigs approximately 300 grams in body weight were used as experimental subjects. They were received from the supplier in groups of 10. In addition to the assurances of the breeder that these animals had been free of disease, had not been previously exposed to harmful acoustic stimulation, or to ototoxic drugs, two further precautions were taken: (1) The animals were isolated from the rest of the colony for at least a week, and (2) one or two animals from each group were used as controls, being treated in all respects like the experimental group except that they were not exposed to sound stimulation.

Three variables of pure-tone exposure were sampled: stimulus frequency, stimulus intensity, and exposure duration. The frequencies included 4000, 2000, 1000, 500, and 125 Hz. Intensities included 110, 120, 130, 140, and 150 dB. Durations of exposures included 16, 8, 4, 2, and 1 hours; 30, 15, and 7.5 minutes. The original plan called for at least one animal at each combination of the variables; however, attrition during the postexposure period (from disease, accident, and the like) left some of the design blocks

unfilled, and generally unequal numbers in the others. Animals were exposed individually in the small plane-wave chamber illustrated in figure 1. This type of enclosure was selected because it provided the most uniform sound field available for the frequencies used. The maximum variation in exposure level, due to changes in head position, was ± 2 dB at 2000 Hz. (I will not go into the detail of the sound-generating and monitoring equipment now. The information is available to anyone who is interested. The outline of the apparatus is seen

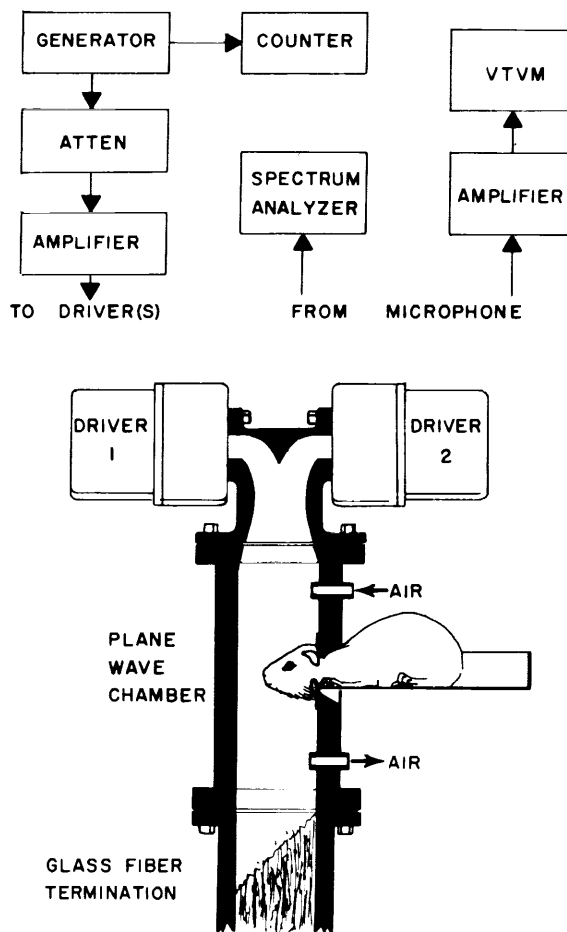

FIGURE 1.—Sound-exposure apparatus. Top: Block diagram of sound-generating and measuring equipment. Bottom: Cross-sectional view of plane-wave chamber fitted with twin drivers and exponential horn. Microphone openings are not shown. They are located in the front and back walls of the chamber at the level of the animal's head. (VTVM: Vacuum tube voltmeter.)

in fig. 1. Fig. 2 shows the harmonic energy analysis for all the applied tones.)

After exposure, the animals were maintained for 4 to 7 weeks to allow time for degeneration of any hair cells damaged by the exposure stimuli. At the end of the survival period, they were anesthetized with pentobarbital sodium and decapitated, and rapid dissection of the ears was carried out as previously described by Engström, Ades, and Andersson (ref. 2). The specimens were fixed and stained in 1.5 percent Veronal-buffered osmic acid solution. Figure 3 shows how the organ of Corti was freed by segments which were mounted in glycerin on a slide, covered, and were then ready for examination.

Under phase-contrast illumination, the epithelium of the guinea pig's organ of Corti appears as in figure 4A. It can be seen that the geometrical pattern of sensory cells is highly regular. Extending nearly from the apex to the base, there are three rows of outer hair cells (OHC), with an approximately equal number of cells in each row. The inner hair cells (IHC) form a single row. When a sensory cell has been damaged and allowed to degenerate, its position in the mosaic is preserved in the form of a "scar."

In view of the high degree of spatial regularity found among these sensory cells, it was a simple, if tedious, matter to literally map the position and condition of each hair cell onto schematic forms that we called cochleograms. These forms underwent continuous evolution in the course of the study; figure 4B shows the latest version. Each cell was represented by a space in the cochleogram and the number entered in the space specified its condition. The layout of the cochleogram and the numerical code were designed to permit direct punching of computer data cards.

A few cells were usually lost through preparation artifact. In some cases of severe damage, where the entire organ of Corti was obliterated, it was necessary to estimate the numbers of hair cells involved. While recourse to estimation was unfortunate, it was imperative to account for all the hair cells so that direct comparison between specimens could be made. The degree of uniformity in numbers of hair cells occupying a given segment of the organ of Corti allows

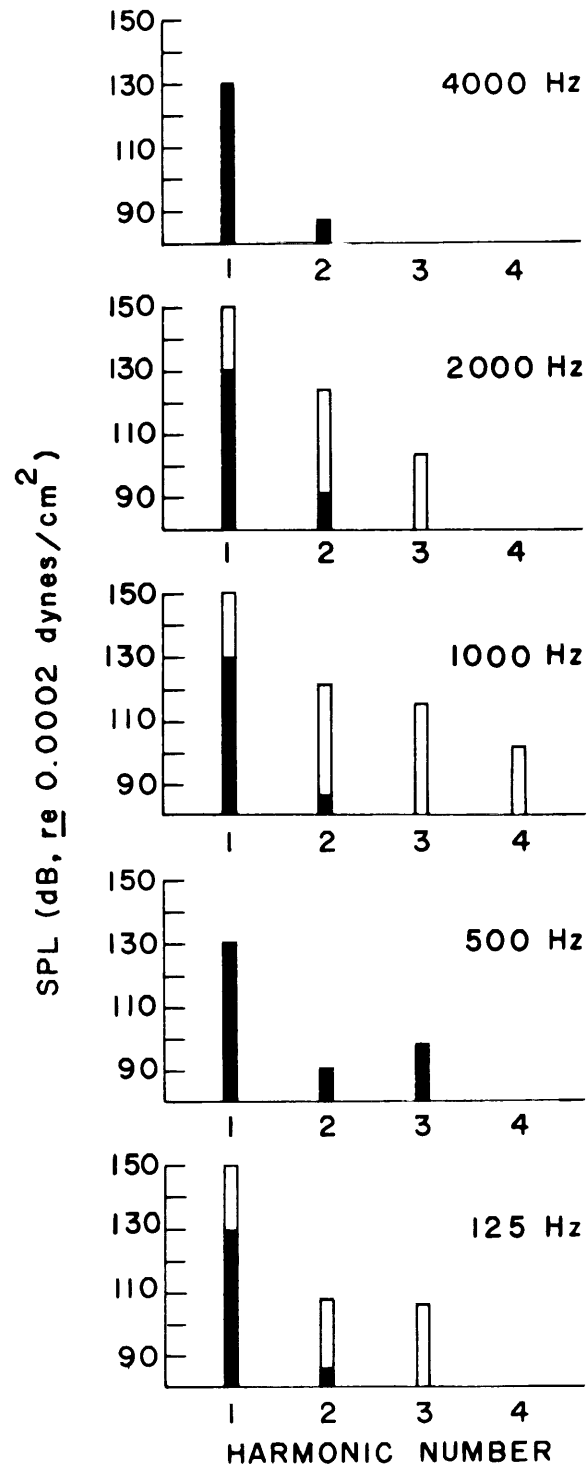

FIGURE 2.—A harmonic energy analysis of the applied tones 4000, 2000, 1000, 500, and 125 Hz at 130 dB (solid bars) and 150 dB (open bars). The 150-dB level was not used at 4000 Hz and 500 Hz.

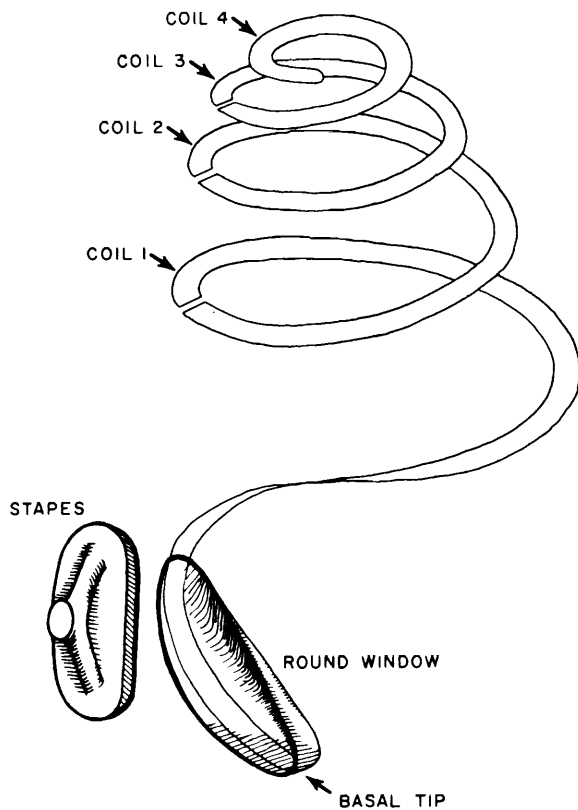
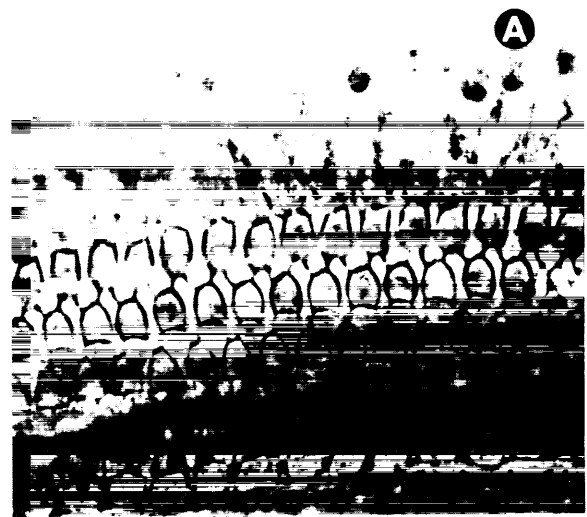

FIGURE 3.—Schematic diagram of the guinea pig's organ of Corti, showing the extent of segments removed from the bony modiolus. Each segment corresponded approximately to one complete coil of the organ of Corti. Also shown are the positions of the stapes and round window.

confidence in the accuracy of estimating missing cells. Each OHC occupies a linear extent of approximately 8.35 microns. Inner hair cells are larger; they occupy a distance of 10.44 microns. When the cochlear partition is prepared using the surface-specimen technique, the fragile parts of the organ of Corti are supported by the bony spiral lamina. Thus, when the hair cells have been swept away either by the sound exposure or by clumsy dissection, the spiral lamina remains intact. Therefore, it was usually sufficient to scale the distance along the missing portion to make a fairly accurate estimate of the number of hair cells that were involved.



B

	1	2	3	4	5	6	7	8	9	10	11	12	13	14	15	16
1																
2																22
3																
4				4					4					4		2

FIGURE 4.—A: Phase-contrast micrograph of guinea pig's organ of Corti. B: Cochleogram of the segment shown above. 850x

RESULTS

Hair-Cell Damage: Comparison Among Groups

For purposes of analysis, the organ of Corti was visualized as consisting of a number of segments lying end to end. The segments each contained 50 OHC of each row and 40 IHC. In each segment, the percentage of damaged hair cells was computed separately for each hair-cell row. A certain number of hair cells were unobservable in some segments due to preparation artifact. In these cases, the percentage of damaged cells was calculated on the basis of the number of cells that were observed. When the number of unobservable cells in a particular row exceeded 50 percent of the total number

in that segment, that row of cells was dropped from the analysis of the segment.

Hair-cell surfaces are uniform in length and all segments were made to contain an equal number of hair cells, so all segments were nearly equal in length. Therefore, a particular segment of one organ of Corti occupied approximately the same position (with respect to the base) as the corresponding segment of any other organ of Corti.

Mean percent damage values were calculated for each hair-cell row in corresponding segments of ears receiving identical exposures. A mean damage curve was constructed for each group of ears by plotting mean damage values of the segments with the segments arranged along the abscissa in the positions they occupy on the organ of Corti. Figure 5 presents the mean damage curves for groups that were exposed to 130-dB sound pressure level (SPL). The mean curves for groups exposed to 150-dB SPL are shown in figure 6, along with the mean damage curve for a group of normal ears.

The curves presented in figures 5 and 6 should be interpreted with caution because the variability within groups was large and sample size differed widely, but several trends are noted:

A comparison between the amount of damage produced by 130- and 150-dB sound exposures at 125, 1000, and 2000 Hz reveals that, as expected, exposure to 150 dB produced considerably more hair-cell damage than did the comparable 130-dB exposure. A more interesting result is the almost complete loss of damage localization caused by the more intense exposure at 1000 and 2000 Hz (fig. 6B through E). The increased sound intensity caused damage to spread primarily toward the base. Hair-cell loss in all rows was nearly 100 percent over the basal 80 percent of the organ of Corti.

Hair-cell damage in ears exposed to 125 Hz at 150 dB appears to be restricted largely to outer hair cells. The damage is shown in only one ear exposed for 4 hours (fig. 6G), so conclusions here must remain tentative, but this ear showed the most extensive damage to OHC of any ear in the sample, while IHC damage averaged only 11 percent. In ears exposed to the same sound for 1 hour (fig. 6F), a similar

effect was seen, but only in the apical two-thirds of the organ of Corti. The tendency for OHC damage to be proportionately greater than IHC damage near the apex appears also in the groups of ears exposed to 130 dB. In figure 5, it can be seen that, when damage is present near the apex, it is confined to OHC. This effect was present in all groups regardless of the exposure frequency.

The relationship between stimulation frequency and position of maximum damage is a matter of paramount interest. All place theories depend on a functional relationship between tonal frequency and position on the cochlear partition at

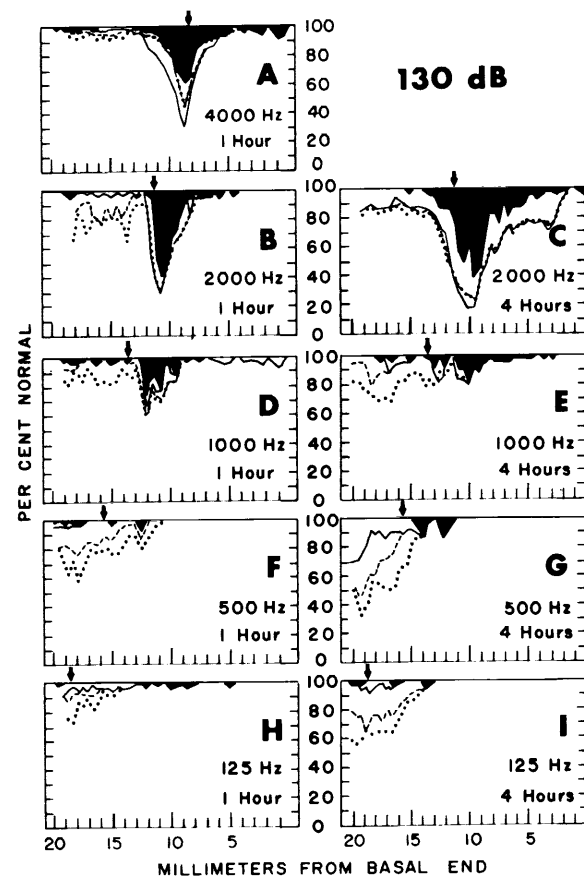

FIGURE 5.—Mean damage curves for groups exposed to 130-dB SPL. The small arrow above each curve indicates the position of maximum stimulation for the exposure frequency. Blackened areas indicate damage to all four hair cell rows; —, IHC; - - - - , OHC 1; ······, OHC 2; - · - · - ·, OHC 3.

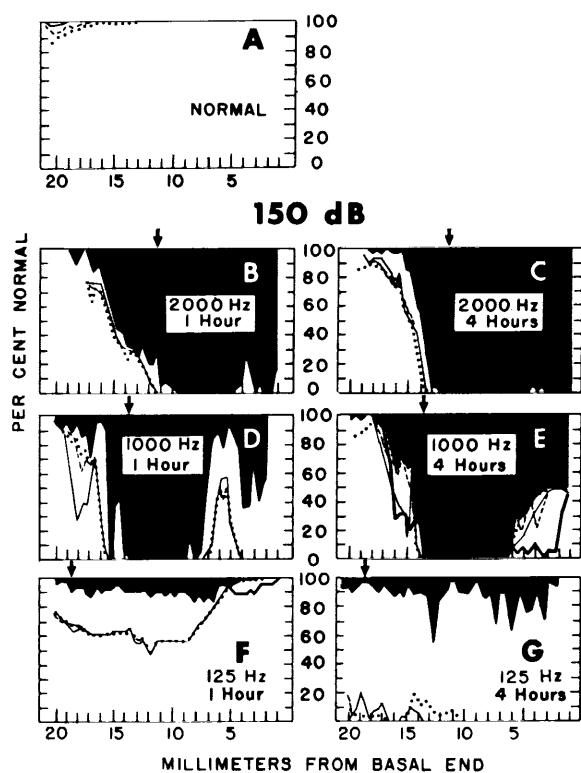

FIGURE 6.—Mean damage curves for groups exposed to 150-dB SPL. The small arrow above each curve indicates the position of maximum stimulation for the exposure frequency. Blackened areas indicate damage to all four hair cell rows; —, IHC; - - - - - , OHC 1; ······, OHC 2; ······, OHC 3. The mean curve for 12 normal (unexposed) ears is shown at the top of the figure.

which it vibrates with maximum amplitude. Evidence of such a relationship has been provided by Steinberg (ref. 3), Culler et al. (ref. 4), and von Békésy (ref. 5). The frequency “maps” of the cochlear partition developed by these investigators differ somewhat in detail, but agree in showing an approximate inverse relation between the logarithm of frequency and distance from the base. Greenwood (ref. 6) constructed an empirical function, based on von Békésy’s observations (ref. 5), which relates frequency to the position of maximum vibration, and is probably the best available expression of the relationship between tonal frequency and position of maximum vibration on the cochlear partition. It is, nevertheless, only an approximation and subject to some errors of assumption.

One way of examining the relation between hair-cell stimulation and hair-cell damage is to compare points of maximum stimulation and maximum damage in relation to stimulus frequency. Figure 5 shows that the position of maximum damage bears some relation to exposure frequency. As frequency is increased, the position of maximum damage moves toward the base. The small arrow above each curve in the figure indicates the position of maximum stimulation (calculated with Greenwood’s formula) for the exposure frequency of that group. Exposure to 2000 and 4000 Hz (fig. 5A through C) produced damage that was most sharply localized. The agreement between stimulation and damage maxima at these frequencies was reasonably close, but not impressive. Exposure at 1000 Hz (fig. 5D and E) produced less localized damage than did exposure to higher frequencies, and maximum damage was closer to the position stimulated by 2000 Hz than to the position stimulated by 1000 Hz. Exposures at 500 and 125 Hz (fig. 5F through I) produced IHC damage that was slight and whose maxima consistently fell at points basalward from the places supposedly receiving maximum stimulation from the exposure tones. Damage confined to OHC appeared near the apex.

It appears that correspondence between maximum stimulation and maximum damage positions on the organ of Corti is best for higher frequencies (where maxima are sharper). If a frequency “map” of damage maxima were made, the separation between frequencies in general would be less than it is in the frequency map of stimulation maxima, with the lower frequencies, in particular, shifting toward the basal end. However, since the damage maxima are not very sharp in these mean curves, support for this statement cannot be very strong.

To determine whether 4-hour exposures cause more hair-cell damage than 1-hour exposures at 130 dB, the groups exposed to 2000, 1000, 500, and 125 Hz were combined and a Mann-Whitney U -test (see Siegel, ref. 7) was applied to compare effects of the two exposure durations. Each hair-cell row was compared separately. The large sample size ($n_1=16$, $n_2=24$) justified referring the obtained U -

value to the normal distribution. The 0.01 significance level was chosen and a one-tailed test was used. Damage to IHC in ears exposed for 4 hours was not significantly greater than damage sustained after 1-hour exposure; however, damage in all three rows of OHC continued to increase after 1 hour. Differences in the amount of outer-hair-cell damage between 1 and 4 hours were significant beyond $P=0.001$.

The small number of ears in some groups exposed at 150 dB do not permit any statistical treatment, but the curves in figure 6 suggest that, for 125-Hz exposures, the picture is similar to that seen at 130 dB. IHC damage appears essentially complete after 1 hour, but OHC damage continues to grow between 1 and 4 hours. At 1000 and 2000 Hz, no appreciable additional damage in any hair-cell row was sustained after an exposure of 1 hour. It appears that hair cells which are susceptible to damage at these frequencies have already sustained damage after 1 hour when the intensity is 150 dB.

Variability was noted in amount or pattern of damage among animals with similar exposures, and even between the two ears of individual subjects. I should like to call attention to one type of variation; namely, that found in the distribution of damage along the organ of Corti. The mean curves presented in figure 5 generally show poorly localized hair-cell loss. Consider, for example, figure 5E which represents the mean curve for ears exposed to 1000 Hz at 130 dB for 4 hours. IHC loss was most severe in the middle regions, and OHC loss was spread rather evenly in the apical half of the organ of Corti. In contrast with their mean curve, the individual damage curves for these ears, shown in figure 7, display much more localized hair-cell loss occurring in a series of sharp peaks. The occurrence of these peaks in different places in the individual ears is expressed by rather broad maxima in the mean curve.

In five of the six ears, there was a single sharp peak of damage involving both IHC and OHC. In four of these (83R, 83L, 88R, and 132L), the peak was located 10 to 11 mm from the base. The fifth (132R) displayed a peak at 13 mm from the base. In the remaining ear (88L), there

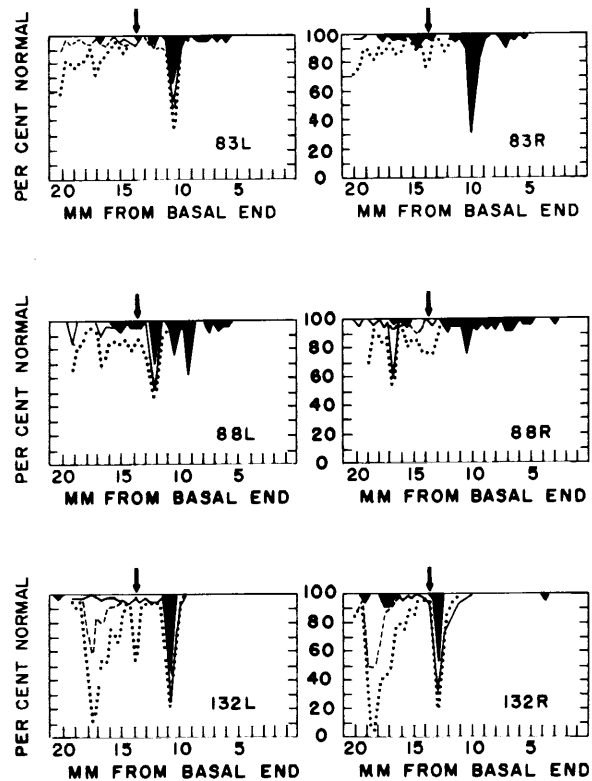

FIGURE 7.—Individual damage curves for ears exposed to 1000 Hz at 130 dB for 4 hours. The small arrow above each curve indicates the position of maximum stimulation for 1000 Hz. Blackened areas indicate damage to all four hair cell rows; —, IHC; — — —, OHC 1; ·····, OHC 2; ······, OHC 3.

were three such peaks, located at 9, 10.5, and 12 mm from the base. These peaks represent areas of total damage on the organ of Corti.

The existence of sharply defined areas of total damage was a common finding in the 56 ears exposed to 130 dB. A photomicrograph of such an area appears in figure 8. In 29 of these ears, a single totally damaged area was found, while in an additional 7 ears, there were 2 or more such areas spaced at intervals along the organ of Corti. These areas varied in extent from 0.1 to 1.5 mm. They could readily be identified as soon as the cochlea was opened during dissection. Even under low-power magnification, an interruption was observed in the organ of Corti where hair cells, pillar cells, and supporting elements had been swept away. In addition, degeneration of the radial nerve supply was plainly visible.



FIGURE 8.—Phase-contrast micrograph of a restricted region of total hair-cell damage located about 9 mm from the base. This was one of several such areas seen in an ear exposed to 2000 Hz at 130 dB for 4 hours. Displacement of cells in the region to the right of the totally damaged area is the result of dissection artifact. 350 ×

The positions on the organ of Corti of total destruction define, as closely as possible, points of maximum damage with which to compare maximum stimulation points predicted by Greenwood's function. The comparisons are made in figure 9 for ears that were exposed at 130 dB. Sixteen ears were exposed at 4000 Hz; of these, 12 ears contained one or more totally damaged areas. Figure 9 shows that areas of total damage in these 12 ears are clustered about a point approximately 9 mm from the base and slightly apical to the point of maximum stimulation for 4000 Hz. Three more such areas lie nearer the base at intervals of about 1 mm; these three areas were contributed by a single ear that also contained an area of total damage between 8.1 and 9.6 mm from the base. Each of the 10 ears exposed at 2000 Hz contained one or more areas of total damage. (This group, as well as the ones exposed at 1000 and 500 Hz, includes the ears exposed both for 1 hour and for 4 hours.) Total damage areas for the ears exposed at 2000 Hz were clustered at approximately the same place as total damage in ears exposed at 4000 Hz and predominantly below the maximum stimulation position predicted by Greenwood's function for 2000 Hz. Nine of ten ears exposed at 1000 Hz showed areas of maximum damage that occupied positions between 8.75 and 12.75 mm from the

base. Among 12 ears exposed at 500 Hz, only five showed an area of total damage; all of these areas were well below the point of maximum stimulation for 500 Hz. None of the ears exposed at 125 Hz showed areas of total damage.

Place theories assume that ears exposed to the same frequency will receive maximum stimulation at the same point on the basilar membrane. Greenwood's function should probably be regarded as a rule of thumb at best, and so some deviation between predicted stimulation maxima

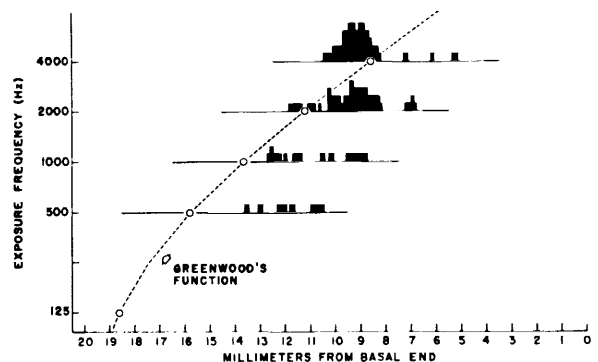

FIGURE 9.—Histograms of totally damaged areas for groups exposed at a 130-dB SPL. Ears exposed both for 1 and for 4 hours are included. Open circles indicate the position of maximum stimulation for the exposure frequency. See text for information on sample size of the various groups.

and observed damage maxima would not be inconsistent with a statement that hair-cell damage mirrors hair-cell stimulation; however, maximum damage points for ears exposed to the same frequency are spread over 3 to 5 mm, which, if Greenwood's function is correct, corresponds to a frequency range of almost two octaves. It seems improbable that the variation in a frequency localization between ears is that large; moreover, the distribution of maximum damage with respect to exposure frequency, as seen in figure 9, clearly departs from the distribution predicted from Greenwood's function. As exposure frequency decreases, the damage maximum falls increasingly basalward in relation to the stimulation maximum.

Less than half the ears exposed at 500 Hz and no ears exposed at 125 Hz showed any areas of total damage. In these ears, damage was confined largely to OHC. In general, damage was not so sharply localized as it was in the ears exposed to higher frequencies, but rather tended to be distributed in multiple peaks. The ears exposed to 1000 Hz (fig. 7) show best the characteristics of damage both from higher and lower frequency exposure. Besides the localized areas of total damage characteristic of high frequencies, these ears display damage limited largely to OHC near the apex, which is characteristic of low frequency exposures. The prominence of multiple damage peaks seen in these ears exposed to a pure tone stimulus provides further argument against a simple correspondence between stimulation and damage patterns.

Hair-Cell Damage: Comparisons Among Hair-Cell Rows

Three differences between damage to IHC and OHC have already been mentioned:

(1) Damage to OHC continued to increase after exposure for 1 hour, whereas IHC damage did not.

(2) OHC sustained more damage than IHC. This was true at all points along the organ of Corti in ears exposed to 130 dB; however, exceptions appear in two groups exposed to 150 dB. Two ears exposed at 1000 Hz for 4 hours (seen in fig. 6E) showed more damage to IHC than to

OHC on either side of the totally damaged region. In the ears exposed to 125 Hz for 1 hour (fig. 6E), IHC damage exceeded damage to OHC between 4 mm from the base and the basal tip. In all other groups exposed to 150 dB, OHC damage was either equal to or exceeded IHC damage in all regions of the organ of Corti.

(3) The difference between the amount of damage to IHC and OHC became progressively larger toward the apex. This effect appeared in groups of ears exposed at 130 dB (shown in fig. 5). It is part of a more general relationship between the radial distribution of damage and distance along the organ of Corti. Damage nearer the base is more likely to involve hair cells lying closer to the modiolus than is damage located farther along the organ of Corti.

This relationship can be seen more clearly when, in addition, one considers differences among the three individual rows of OHC. Hair-cell damage in ears exposed to 4000 Hz (fig. 5A) was confined to the middle region of the organ of Corti. In this region, the most severely damaged OHC row was the innermost row, OHC 1. On the other hand, ears exposed to lower frequencies showed damage near the apex that was increasingly confined to OHC. In these groups, the outermost row, OHC 3, was the one showing the most severe damage. For example, in ears exposed to 500 and 125 Hz (fig. 5F through I), damage was least severe in OHC 1, greater in OHC 2, and still greater in OHC 3.

Distance along the organ of Corti is not, however, the only variable related to these differences in the radial distribution of damage. The above comparisons were made among groups of ears that were exposed to tones of different frequencies. Perhaps radial effects are related to distance along the organ of Corti because both are a function of the same variable; that is, frequency of exposure. The damage curves in figure 6F and G suggest that this is the case. The ears shown here were exposed to 125 Hz at 150 dB. Differences among OHC rows are not seen, but these ears show the large differences between OHC and IHC damage that are characteristic of ears exposed to low frequencies. They failed to show appreciable

IHC damage even in the middle region of the organ of Corti, where IHC damage had become prominent in other ears exposed to higher frequencies. The low-frequency tone was capable of producing damage, largely confined to OHC, in all regions of the organ of Corti. This result suggests that exposure frequency rather than position along the organ of Corti is the relevant variable determining the radial distribution of damage.

DISCUSSION

In the introduction, it was suggested that previous studies failed to reveal selective cochlear lesions because the method of graphical reconstruction from serial sections precluded precise assessment of hair-cell damage, particularly when damage was relatively light. Use of the surface-preparation technique permitted a more complete assessment of hair-cell damage than was possible before. More selective and discontinuous hair-cell loss was seen than has been reported previously, particularly in ears in which damage was relatively slight. Presumably this feature of hair-cell damage went unnoticed in ears prepared by the traditional method.

In general, the gross pattern of hair-cell damage seen in the present material affirms the conclusions based on earlier observations (refs. 8 to 10). Lesions first appeared near the stimulation maximum for the exposure frequency. More intense exposure caused lesions to spread from that point toward the base. It should be noted that Elliott and McGee (ref. 11) described a different pattern of spread in cats. They stated, "The spread of damaging effects is at least as great toward the apical end as toward the basal end of the cochlea, and possibly greater." A species difference cannot be completely ruled out, but our results support the conclusion that the spread of hair-cell damage is primarily toward the base.

The greater susceptibility of OHC than IHC to damage has been reported consistently, but the observation that the radial distribution of damage depends upon exposure frequency has not been mentioned before. Beagley (ref. 12) has stated that OHC 1 was the most damaged

OHC row in guinea pig ears exposed to a 500-Hz tone. It was shown in the present study that OHC 1 was most severely damaged in ears exposed to 4000 Hz, but, contrary to Beagley's results, OHC 1 showed the least damage of any OHC row after exposure to 500 Hz. Other investigators using the surface-preparation technique (refs. 2 and 13) have demonstrated differential radial damage, but they noted no systematic trends.

Other results reported here are relevant to two of the more general problems that plague investigators of auditory damage: (1) Individual ears vary greatly in their susceptibility to damage, and (2) hair-cell damage and hearing losses do not correspond to exposure parameters in a simple way.

The first problem is of considerable clinical importance. Large individual differences retard progress in establishing workable damage-risk criteria. Extensive research has been directed toward predicting individual susceptibility to noise damage using temporary threshold shift as a predictor, but only limited success has been achieved (ref. 14). Development of more successful predictors has been limited largely by the lack of knowledge concerning the relevant variables. In this regard, it is worthwhile to point out that, in the present study, ears exposed to highly controlled acoustic stimulation nevertheless exhibited large differences in the amount of hair-cell damage. A considerable portion of the variability occurred between the two ears of the same animal. The magnitude of the individual differences seen in the present data indicates that a significant source of variation lies between the entrance of the ear canal and the receptors. A search for factors producing this variation could contribute to successful clinical prediction of susceptibility to hearing loss.

The other major problem that concerns investigators of hearing loss arises as a result of the expectations of place theory; each frequency is presumed to cause maximum stimulation at a specific site on the organ of Corti. Hair cells that receive maximum stimulation by a particular frequency should be the first ones to be damaged when the intensity is raised; however, the greatest hearing loss usually occurs one-half

to one octave above the exposure frequency (ref. 15).

Even more disturbing is the fact that a variety of nonsinusoidal stimuli, e.g., impulses and wideband noise, produce their greatest losses in the region of 4000 Hz. Various hypotheses have been offered to account for this. In general, they postulate that, for various anatomical reasons, the region of the organ of Corti focally receptive to 4000 Hz is either more vulnerable to damage or is the site at which particularly destructive forces develop. The results of the present study showed that tonal stimuli caused damage that was generally related to the site of maximum stimulation for the exposure frequency. Damage was not confined to the region of the organ of Corti stimulated by 4000 Hz. If the hypothesis were valid, an indication of special susceptibility in that region should have appeared in ears exposed at low frequencies. Von Békésy (ref. 5, p. 504) found that the basilar membrane of the guinea pig vibrates in phase when stimulated by a pure tone below the frequency of 200 Hz. Thus, at 125 Hz, stimulation along the entire organ of Corti should be fairly uniform, and, if the region receiving 4000 Hz is especially susceptible to damage, then damage should be most severe in that region. According to the present results, there was, in fact, no evidence of especially heavy damage in the 4000-Hz region in such ears. Therefore, those hypotheses designed to account specifically for the effects of nonsinusoidal stimulation do not appear relevant to a discussion of damage patterns caused by pure tones.

Two general notions exist as to the mechanism of hair-cell damage. The first of these attributes hair-cell damage to stresses within the cochlea sufficient to produce mechanical injury. Schuknecht and Tonndorf (ref. 16) have made the following analysis of the distribution of mechanical stress on the cochlear partition. Stress is defined as mass times acceleration per unit area. Schuknecht and Tonndorf assumed that the mass of the cochlear partition is approximately the same over its whole extent; therefore, the stress upon any segment of the partition during its displacement is directly proportional to

its acceleration. Acceleration depends on the ratio of the displacement amplitude and the square of the period of vibration. By analyzing time-displacement patterns in cochlear models, Schuknecht and Tonndorf demonstrated that the period of vibration is least at the basal end of the cochlear partition and increases exponentially thereafter. Since high frequencies produce maximum displacement amplitudes nearer the base, it follows that high frequencies produce greater acceleration, and therefore greater stress, in the region of maximum amplitude than do lower frequencies. High frequencies should cause more hair-cell damage than low frequencies by the mechanism of mechanical stress.

The other notion is the so-called physico-chemical theory which attributes hair-cell damage to exhaustion of cytochemical or enzymatic materials as a result of prolonged exposure to acoustic stimuli (ref. 17). This idea is supported by evidence of ultrastructural changes following fairly intense acoustic stimulation (refs. 18 to 21). The earliest change was an increase in the number of osmiophilic inclusions within apices of OHC that were interpreted as products of intensified oxidative metabolism. More prolonged stimulation produced additional morphological alterations thought to be associated with a lack of oxygen in the inner ear. These changes were most prominent in OHC. Koide et al. (ref. 20) demonstrated a reduction in oxygen tension in the perilymph during exposure to loud acoustic stimulation.

Thus, two mechanisms of hair-cell damage have been postulated: (1) Mechanical stress, which is thought to be more important at higher frequencies; and (2) exhaustion of metabolic materials, which is thought to depend more on exposure duration and to involve mainly OHC. The present results suggest that both of these mechanisms must be adduced to account for the hair-cell damage that was observed. Two findings are relevant: (1) IHC loss was essentially complete after 1 hour of exposure, but OHC loss continued to increase between 1 and 4 hours, indicating that OHC are more sensitive than IHC to gradually accumulating effects of exposure; (2) OHC loss was proportionately greater than

IHC loss at low stimulating frequencies (see figs. 5 and 6), indicating that frequencies somehow differ in their effect. Both of these observations together suggest the following interpretation: At higher frequencies, mechanical stress was the most important mechanism of hair-cell damage. Injuries were seen both to OHC and to IHC, although OHC were affected more. On the other hand, lower frequencies at the same SPL developed less mechanical stress, so this factor was relatively less important as a cause of hair-cell damage; hence, most IHC survived low-frequency exposure, while OHC were damaged in greater numbers. This fact and the fact that OHC damage increased between 1 and 4 hours suggest that OHC are more sensitive to gradually accumulating effects of stimulation, and that this

factor was a more important mechanism of damage at lower frequencies.

In any case, formal analysis of hair-cell-damage patterns depends on the ability to assign frequencies to specific locations on the organ of Corti in the present material. Accordingly, the interpretations offered here must remain qualitative and tentative. They are based, for the most part, on indirect evidence. It is apparent that complex relations exist between the patterns of hair-cell damage and patterns of stimulation. In the fuller elaboration of these relationships, particular attention must be paid to the ear's non-linear response to high-intensity stimulation and to differential susceptibility between ears, and perhaps between different regions of the cochlea, to various stimulation parameters.

REFERENCES

1. GUILD, S. R.: A Graphic Reconstruction Method for the Study of the Organ of Corti. *Anat. Record*, vol. 22, 1921, pp. 141-157.
2. ENGSTRÖM, H.; ADES, H. W.; AND ANDERSSON, A.: Structural Pattern of the Organ of Corti. *Almqvist & Wiksell, Stockholm*, 1966.
3. STEINBERG, J. C.: Positions of Stimulation in the Cochlea by Pure Tones. *J. Acoust. Soc. Am.*, vol. 8, 1937, pp. 176-181.
4. CULLER, E. A.; COAKLEY, J. D.; LOWY, K.; AND GROSS, N.: A Revised Frequency Map of the Guinea-Pig Cochlea. *Am. J. Psychol.*, vol. 56, 1943, pp. 475-500.
5. VON BÉKÉSY, G.: *Experiments in Hearing*. McGraw-Hill, 1960.
6. GREENWOOD, D. D.: Critical Bandwidth and the Frequency Coordinates of the Basilar Membrane. *J. Acoust. Soc. Am.*, vol. 33, 1961, pp. 1344-1362.
7. SIEGEL, S.: *Nonparametric Statistics*. McGraw-Hill, 1956.
8. COVELL, W. P.: Histologic Changes in the Organ of Corti With Intense Sound. *J. Comp. Neurol.*, vol. 99, 1953, pp. 43-49.
9. LURIE, M. H.; DAVIS, H.; AND HAWKINS, J. E., JR.: Acoustic Trauma of Organ of Corti in Guinea Pig. *Laryngoscope*, vol. 54, 1944, pp. 375-386.
10. WEVER, E. G.; AND SMITH, K. R.: The Problem of Stimulation Deafness: I. Cochlear Impairment as a Function of Tonal Frequency. *J. Exptl. Psychol.*, vol. 34, 1944, pp. 239-245.
11. ELLIOTT, D. N.; AND MCGEE, T. M.: Effects of Cochlear Lesions Upon Audiograms and Intensity Discriminations in Cats. *Ann. Otol.*, vol. 74, 1965, pp. 386-408.
12. BEAGLEY, H. A.: Acoustic Trauma in the Guinea Pig. I. Electrophysiology and Histology. *Acta Oto-Laryngol.*, suppl. 60, 1965, pp. 437-451.
13. BREDBERG, G.: Cellular Pattern and Nerve Supply of the Human Organ of Corti. *Acta Oto-Laryngol.*, suppl. 236, 1968, 134 pp.
14. WARD, D. W.: Auditory Fatigue and Masking. *Modern Developments in Audiology*, J. Jerger, ed., Academic Press, 1963, pp. 240-286.
15. KRYTER, K. D.: The Effects of Noise on Man. *J. Speech Dis.*, suppl. 1, 1950.
16. SCHUKNECHT, H. F.; AND TONNDORF, J.: Acoustic Trauma of the Cochlea From Ear Surgery. *Laryngoscope*, vol. 70, 1960, pp. 479-505.
17. SALMIVALLI, A.: Acoustic Trauma in Regular Army Personnel. *Acta Oto-Laryngol.*, suppl. 222, 1967, 85 pp.
18. BEAGLEY, H. A.: Acoustic Trauma in the Guinea Pig. II. Electron Microscopy Including the Morphology of Cell Junctions in the Organ of Corti. *Acta Oto-Laryngol.*, suppl. 60, 1965, pp. 479-495.
19. ENGSTRÖM, H.; AND ADES, H. W.: Effect of High Intensity Noise on Inner Ear Sensory Epithelia. *Acta Oto-Laryngol.*, suppl. 158, 1960, pp. 219-229.
20. KOIDE, Y.; YOSHIDA, M.; KONNO, M.; NAKONA, Y.; YOSHIKAWA, Y.; NAGADA, M.; AND MORIMOTO, M.: Some Aspects of the Biochemistry of Acoustic Trauma. *Ann. Otol.*, vol. 69, 1960, pp. 661-697.
21. SPOENDLIN, H.: Ultrastructural Features of the Organ of Corti in Normal and Acoustically Stimulated Animals. *Ann. Otol.*, vol. 71, 1962, pp. 657-677.

DISCUSSION

Bredberg: Previous studies on the pathology of the organ of Corti have almost completely failed to show multiple areas of damage. I should like to show a few slides from a study on the human cochlea (G. Bredberg: Cellular Pattern and Nerve Supply of the Human Organ of Corti. Acta Oto-Laryngol., suppl. 236, 1968, 134 pp.) illustrating some cases with multiple areas of degeneration. The nerve supply in

the normal human cochlea appears macroscopically to be evenly distributed throughout all coils except in the most basal few millimeters of the basal coil. Figure D1 shows the nerve supply in the basal coil in a case of noise exposure, and figure D2 shows the cochlea from a woman 86 years of age. From my material, it appears that neural damage was most commonly distributed in an uneven, "patchy" way.



FIGURE D1.—Basal coil of the right cochlea from a man 71 years of age, exposed during life to high-intensity noise in a sawmill for many years. The cochlea shows an almost complete degeneration of radial nerves in the osseous spiral lamina as well as a corresponding degeneration of the organ of Corti in the region between 10.5 mm and 14.0 mm from the base. A few thin radial-nerve bundles are found in this area of otherwise complete degeneration (arrows 2 and 3). In addition there are a few narrow areas showing nerve loss (arrows 1, 4, and 5).

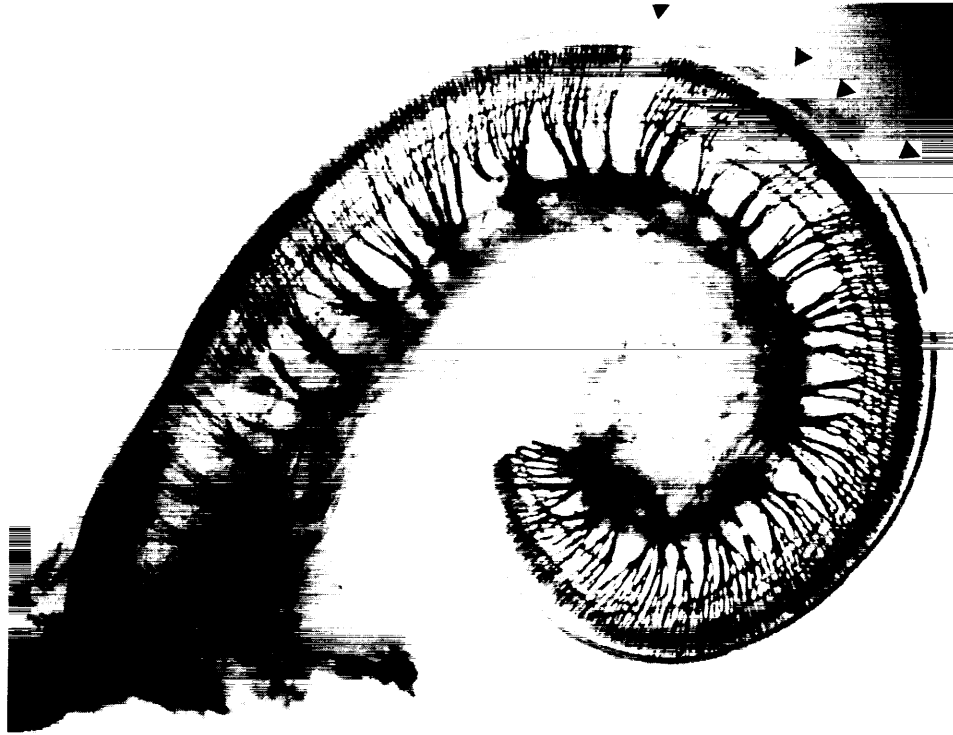

FIGURE D2.—Basal coil of the left cochlea from a woman aged 86 years, with no known excessive noise exposure. The cochlea shows an overall degeneration of nerve fibers, most marked in the base. Moreover, there is a patchy degeneration of nerves and the corresponding areas of the organ of Corti (arrows). The etiology of this patchy loss is unknown.

Thresholds for the Perception of Angular Acceleration About the Three Major Body Axes¹

BRANT CLARK

San Jose State College

JOHN D. STEWART

Ames Research Center, NASA

SUMMARY

This study is concerned with man's sensitivity to body rotation about his three major body axes. The specific purpose was to determine thresholds for the perception of rotation about the x -, y -, and z -axes and to compare these results for the group and for the individual observers. The thresholds of 18 men with normal vestibular function were established for the x -, y -, and z -axes by use of a precision rotation device. The angular acceleration was ordered, using a random, forced-choice, double-staircase procedure, and the order of the determination of the three thresholds for each observer was established by a Latin-square method. Mean thresholds were found to be equal for the x - and z -axes. The mean threshold about the y -axis (somersaulting axis) was found to be substantially greater than those about the x - and z -axes, but these differences were both just below statistical significance. There was a great range in thresholds for all three conditions. The intercorrelations among the three thresholds were not significantly different from zero. It was concluded that under optimum testing conditions, the mean thresholds about the x -, y - and z -axes are essentially the same but that the threshold about one body axis does not predict the threshold about the other two axes for a given observer.

INTRODUCTION

Almost all the studies of the sensitivity of the semicircular canals to angular acceleration have been made with the observer rotating only about his vertical axis (yaw or z -axis) (ref. 1). Consequently, there is a dearth of information regarding man's sensitivity to rotation about the other two major body axes. Indeed, comparisons of the perception of angular acceleration applied about the somersaulting axis (pitch or y -axis) and cartwheeling axis (roll or x -axis) are so extremely limited that no definitive statements on the range of canal sensitivity about these

axes are possible. On the basis of anatomical and physiological information concerning the semicircular canals, it is quite clear that the vertical and the horizontal ones are functionally different in several ways (refs. 2 to 4). For example, Lowenstein and Sand (ref. 2), using single nerve fiber preparations in the ray, reported that the vertical canals can be directly stimulated by rotation in any plane, whereas the horizontal semicircular canals are stimulated almost exclusively by rotation about a vertical axis. They also pointed out that the vertical semicircular canals are phylogenetically older than the horizontal semicircular canals and are subdivided by a septum which is not found in the horizontals. Consequently, upon neurological and physiological bases one might expect some differences in sensitivity in rotating about

¹ The experimental work for this study was carried out at Ames Research Center under National Aeronautics and Space Administration grant NGR 05-046-002 to San Jose State College.

the various axes. At the same time, there is no comparative anatomical evidence regarding the differential functioning of the three pairs of ampular systems, and, furthermore, rotation about any of the three major body axes will stimulate more than one pair of canals.

The limited experimental findings are somewhat conflicting with regard to thresholds for the perception of angular acceleration about the three major body axes. Some investigators have reported that there is no difference in these thresholds (refs. 5 and 6). Much evidence would suggest, however, that rotation about the *z*-axis will produce lower thresholds than would rotations about the *x*- or the *y*-axis (refs. 4 and 7). Only one study has been found that presents even limited information; direct comparisons were made of the perception of angular acceleration in the horizontal and vertical planes on the same observers. Meiry (ref. 8) studied the thresholds for the perception of angular acceleration for three normal men and reported thresholds about the *z*-axis to vary between $0.1^\circ/\text{sec}^2$ and $0.2^\circ/\text{sec}^2$, whereas rotation of the head about the *x*-axis produced thresholds of about $0.5^\circ/\text{sec}^2$. Thresholds as high as $8.2^\circ/\text{sec}^2$ have been reported about the *y*-axis (ref. 9), but the method involved a very complex task of operating a flight simulator, and no direct comparisons were made for the same observers for rotations about the *z*-axis. Data obtained by Decher (ref. 10), using nystagmus as an indicator of sensitivity, lend support to these data on the perception of rotation. Decher reported that for nystagmus, the thresholds for the vertical canals were more than twice those of the horizontal canals. On the other hand, one investigator (ref. 11) has written: "According to our experimental results, the two pairs of vertical canals functioning together are much more effective than the horizontal canals in the perception of passive rotary motion of the body."

Data on differences between the functioning of the horizontal and of the vertical canals are also available from cupulometric studies. Some of these studies support the notion that there are no significant differences in the perception of rotation about the *x*-, *y*-, and *z*-axes. For example, Benson (ref. 12) found no difference be-

tween the "cupulometric thresholds" in the *x*- and *z*-axes. Jones et al. (ref. 13) have reported cupulograms which indicate similar "cupulometric thresholds" in pitch, roll, and yaw. On the other hand, they found different time constants for the duration of the aftereffects of rotation about the three major body axes. They reported that the duration of the aftereffects following acceleration was greatest for yaw and least for pitch, with roll in an intermediate position. Similar results have been reported by Collins and Guedry (ref. 14), Ledoux (ref. 15), and van der Vis (ref. 16). Aschan and Stahle (ref. 17) in a study of pigeons also reported that there were significantly more nystagmus beats and the duration of nystagmus was longer after stimulation of the horizontal canals than after stimulation of the vertical canals. Collins and Guedry (ref. 14) reported similar results for cats and humans. Fluor and Mendel (ref. 4) studied the habituation of the horizontal and vertical semicircular canals and found that it was more difficult to produce habituation of the vertical canals than the horizontal canals as a consequence of repeated stimulation.

This brief survey of the literature makes it clear that definitive data regarding the sensitivity of man to rotation about his three major body axes are lacking. Adequate findings regarding the sensitivity in these three body planes have implications for the theoretical formulation of the behavior of the semicircular canal system. Furthermore, they have practical implications in connection with aircraft and spacecraft flight. In flying aircraft, rotations about the *z*-axis are relatively small and infrequent, whereas rotations about the *x*- and *y*-axes are much more frequent and more significant for efficient flight (ref. 13). Consequently, it was the purpose of the current investigation to compare the sensitivity of normal men to angular accelerations applied around their *x*-, *y*-, and *z*-axes.

METHOD

Apparatus

The observers were rotated in the Ames man-carrying rotation device (MCRD). The MCRD is a one-degree-of-freedom simulator which has

been described in detail elsewhere (refs. 18 and 19). Accelerations may be produced and measured in $0.01^\circ/\text{sec}^2$ steps at the low velocities used in this study. The accelerations are programmed by an analog computer, making it possible to produce changes in acceleration with a rise time of the order of 0.1 second. The simulator is essentially free of vibration that might be perceived by observers at the low velocities used during the threshold measurements in this study. Furthermore, the observer is unable to detect when he accelerates through zero velocity. Two special seats were used to place the observers in the proper position. These seats made it possible to position the observer comfortably in three positions in order to rotate him about the x -, y -, or z -axis of his body while the simulator rotated about an Earth-vertical axis. In each case, his head was positioned at the center of rotation, and his legs were drawn up in a sitting position. For rotation about his z -axis, he sat in a normal, erect, seated position. For rotation about his x -axis, a horizontal chair was arranged so that he was essentially flat on his back with his legs in a seated position. This produced the same angular acceleration as would be found in a roll. To rotate the observer around his y -axis, he was rotated from the previous position 90° so that his right ear was down. Thus, with the simulator rotating about an Earth-vertical axis, the observer was turned around his pitching axis.

Observers

The observers were 18 men who were in good health by their own affirmation, and a general physical examination revealed no significant abnormalities. They had normal hearing, and their responses to a caloric test were judged to be normal.

Procedure

The observer sat with his helmet pressed firmly back in a U-shaped headrest to maintain his head in a fixed position for rotation about the x - and z -axes; for the y -axis, the helmet was secured in position. The angular accelerations were presented for 10 seconds for all trials. The direction of the acceleration varied at random from trial to trial, and a minimum of 30 seconds elapsed between the end of one acceleration and



the beginning of the next. A single series of approximately 32 trials lasted about 30 minutes, and at least 30 minutes elapsed between sessions. A 3-minute rest period was given halfway through each session. Preliminary practice sessions preceded the regular observations of the perception of rotation at each of the three body positions. The observers were given knowledge of results in the preliminary practice trials, but during the regular trials they had no knowledge of results. All data were collected for each observer at a given body position before data were collected on another. The collection of data for body position, however, was systematically ordered among observers by a Latin-square procedure to reduce sequential effects.

All the observations were made in darkness with both eyes closed. The observer's task was merely to indicate the direction of rotation by pressing a switch. The angular accelerations were presented according to a forced-choice, random, double-staircase method which is the same as we have used in previous studies (refs. 18 and 19). The results of this method have been found to correlate closely with a frequency method (ref. 19). Thirty pairs of observations were made following the final level, and the mean of these accelerations was considered to be the threshold for each condition for each observer (refs. 19 and 20).

RESULTS

The data (table 1) show that, for the 18 observers, the mean thresholds about the x - and z -axes are the same to the second decimal place. The variability about the means is essentially the same for the x - and z -thresholds; the difference is not statistically significant ($P > 0.20$). The mean threshold about the y -axis, however, is substantially greater than the thresholds about the x - and z -axes, but the differences do not quite meet conventional criteria for statistical significance at $P = 0.05$ ($t = 1.96$ and 2.08 , respectively; $df = 17$). This is in part due to the very great differences among the observers in y -thresholds (table 1). In this regard it is noteworthy that y -thresholds of individual observers were the highest ($2.24^\circ/\text{sec}^2$) and the lowest ($0.06^\circ/\text{sec}^2$) of the thresholds. The standard

TABLE 1.—Thresholds¹ for the Perception of Rotation About the x-, y-, and z-Axes of the Body for 18 Normal Men
[Thresholds are in deg/sec²]

Body position—				
Observer	Threshold order	Axis of rotation		
		x	y	z
1.....	xyz	0.19	0.06	0.27
2.....	yzx	.43	1.04	.73
3.....	xzy	.36	.18	.49
4.....	yxz	.40	.82	.27
5.....	zxy	.17	.64	.87
6.....	zyx	.20	.12	.17
7.....	xyz	.33	.61	.60
8.....	zxy	.51	.22	.33
9.....	zyx	.45	.58	.39
10.....	yzx	.32	1.03	.45
11.....	yxz	.55	2.24	.47
12.....	xzy	.45	.59	.34
13.....	xyz	1.02	.38	.30
14.....	yzx	.37	.56	.61
15.....	zxy	.78	.68	.41
16.....	yxz	.26	.42	.21
17.....	xzy	.26	.31	.17
18.....	zyx	.25	1.50	.32
Mean threshold (N=18).....		0.41	0.67	0.41
Median threshold.....		.37	.59	.38
Standard deviation.....		.21	.52	.19
Range.....		0.17-1.02	0.06-2.24	0.17-0.87
Thresholds compared.....		x-y	x-z	y-z
Pearson correlation.....		+0.11	-0.06	+0.26

¹ Threshold = mean of accelerations for each condition for each observer based on 30 pairs of observations.

deviation was significantly greater about the y-axis than about the x- or z-axis ($P < 0.01$ in each case). Pearson correlations were also computed between the x-, y-, and z-thresholds (table 1). None of these correlations was found to be significant ($P > 0.20$ at $N=18$ for each correlation). Illustrations of the marked deviation in thresholds among the three axes are to be found in several observers; e.g., 10, 11, 13, 18.

The Latin-square design also made it possible to examine the data to determine whether prac-

tice on threshold determination about any two axes would influence the threshold of the third. Thresholds were available for six observers at each of the three body positions taken first, second, or third. If experience in threshold determination were an important factor, the threshold would be expected to be lower if a particular position were taken second or third in order. An analysis of these effects showed that the order effects were very small and not statistically significant for the x- and z-axes ($P > 0.20$ in each case). This confirms the lack of practice effects for the z-axis previously reported by Clark and Stewart (ref. 19). The thresholds about the y-axis showed a consistent decrease from the first to the third position. In fact, when the thresholds for the x- and z-axes were both taken before the y-threshold, the mean y-threshold was very near the mean of the x- and z-thresholds. However, these differences were also not statistically significant ($P > 0.10$) for the small number of observers.

DISCUSSION

This experiment was concerned with the sensitivity of normal men to angular accelerations applied about their three major body axes. It should be noted that these results are not directly comparable with earlier studies in which there was an attempt to identify the sensitivity of individual pairs of canals. While this is of interest to the clinician (e.g., in the caloric test) and from an analytical point of view, our concern was simply with thresholds of rotation about the three major body axes. Our results are more directly comparable to observer's standards of reference for judgments of his orientation and motion in everyday life situations, e.g., in walking about and in flying in aircraft or spacecraft, although such activities may be quite complex. Consequently, it is obvious that each of the thresholds reported involves the stimulation of all three pairs of semicircular canals.

The mean thresholds for these 18 observers turned out to be the same for the x- and z-axes, and the standard deviations were nearly equal. No definitive data on variability have been found in the literature, but the lack of difference between the mean x- and z-thresholds would appear

to be in agreement with some earlier reports (e.g., ref. 5) and at variance with others (e.g., refs. 8 and 11). It should be noted, however, that the range of thresholds is considerable about both the x - and z -axes even in this relatively small group of observers (table 1) and that with even a smaller number of observers, one might find the mean threshold would fall at any point from about $0.17^\circ/\text{sec}^2$ to $1.0^\circ/\text{sec}^2$. With larger numbers of observers, one would, of course, expect the range of thresholds to increase somewhat beyond the levels reported here. Indeed, some of our unpublished data on about 50 normal men for the z -axis show a range of thresholds very close to that of the y -axis reported above.

It is of importance to note that although the mean threshold about the y -axis is substantially greater than the thresholds about the x - and z -axes, both of these differences are just below conventional levels of statistical significance ($P=0.05$). A second consideration here is that comparisons of the threshold levels for each observer show that the y -thresholds are greater in only 12 instances for the 18 observers than the x - and/or z -thresholds. This, too, is below conventional levels of significance. A third result is that the individual variability about the y -axis is substantially greater. Finally, the y -thresholds tend to be substantially smaller if the observer has had the x - and z -thresholds determined first, despite the practice trials which, in general, amounted to some 60 to 70 observations before threshold data were counted. What interpretation can be placed on these somewhat ambiguous results regarding the thresholds about the y -axis? It is suggested that the observations are more difficult for some observers to make when they are placed on their side. Indeed, several observers reported this. After additional trials, however, this difficulty tended to disappear, and the x -, y -, and z -thresholds became much more alike. Consequently, it can probably be said that the stimulus thresholds about the x -, y -, and z -axes are much the same under optimum test conditions.

The very low correlations between the thresholds about the x -, y -, and z -axes are also noteworthy. These correlations show that no ac-

curate prediction can be made from the thresholds customarily determined with observer seated in an erect position as to his sensitivity about other body axes. Consequently, measurements about the z -axis can reveal little regarding a particular pilot's sensitivity to the very complex angular accelerations produced in operating an aircraft or spacecraft, and no doubt even less prediction is possible for the complex Coriolis accelerations produced in moving about a rotating room or a rotating space platform (refs. 21 and 22).

It should be emphasized that this experiment has been concerned with the perception of rotation as a manifestation of a highly complex vestibular system rather than as a hypothetical threshold for the semicircular canals or more specifically, the cupula (ref. 23). For any particular threshold, whether the perception of rotation, the oculogyral illusion, or nystagmus is used as the indicator, the sensitivity tested does not reflect cupular activity in any simple way. It has been well established from many observations that the vestibular system may be stimulated by extremely low angular accelerations. For example, with the oculogyral illusion as the indicator about half of the observers have been found to have thresholds below $0.10^\circ/\text{sec}^2$. But when the visual target is removed, the threshold of the system increases to about three times that value (refs. 1 and 18). It has also been shown repeatedly that the vestibular system interacts in complex ways with other sensory systems (ref. 23). For example, visual targets affect vestibular sensitivity; general level of alertness influences vestibular effects; body tilt influences the perception of the visual vertical; and angular acceleration affects visual and auditory localization.

With these facts in mind, the findings of this experiment become understandable in terms of a sensory system whose operation is influenced by complex functions and interactions. Thus, the high variability and the possibility of higher thresholds about the y -axis may be considered to be related to the unique tactual and proprioceptive information in this body position which may lead to different spatial orientation in different observers. These effects may be considered

to be comparable to the modification of the observer's perception of the visual vertical and horizontal by changes in body position (ref. 24). The near-zero correlations between the thresholds for the x -, y -, and z -axes and the nonsignificant decrease in the y -threshold with order of presentation may be understood in the same way.

The notion of a complex vestibular system is also supported by our results showing that the x - and z -axes appear to be more alike than the x - and y -axes. On the basis of the orientation of the vertical canals in the head, rotation about the x - and y -axes results primarily in the stimu-

lation of these two pairs of canals while the horizontal canals are less affected. The z -thresholds, on the other hand, result primarily from stimulation of the horizontal canals. Consequently, this implies that all the processes in the vestibular system must be involved in threshold determination rather than the relatively simple characteristics of the transducer mechanism. This notion would appear to be in general agreement with the point of view developed by Groen (ref. 25) and others which emphasizes the importance of the central nervous system in vestibular processes.

REFERENCES

1. CLARK, B.: Thresholds for the Perception of Angular Acceleration in Man. *Aerospace Med.*, vol. 38, 1967, pp. 443-450.
2. LOWENSTEIN, O.; AND SAND, A.: The Individual and Integrated Activity of the Semicircular Canals of the Elasmobranch Labyrinth. *J. Physiol.*, vol. 99, 1940, pp. 89-101.
3. WENDT, R. G.: Vestibular Functions. *Handbook of Experimental Psychology*, S. S. Stevens, ed., Wiley, 1951.
4. FLUUR, E.; AND MENDEL, I.: Habituation, Efference and Vestibular Interplay. IV. Rotary Habituation of the Vertical Semicircular Canals. *Acta Oto-Laryngol.*, vol. 57, 1964, pp. 459-464.
5. VAN EGMOND, A. A. J.; GROEN, J. J.; AND JONGKEES, L. B. W.: The Function of the Vestibular Organ. *Pract. Oto-Rhino-Laryngol.*, vol. 14, suppl. 2, 1952.
6. DE VRIES, HL.; AND SCHIERBECK, P.: The Minimum Perceptible Angular Velocity Under Various Conditions. *Pract. Oto-Rhino-Laryngol.*, vol. 15, 1953, pp. 65-72.
7. DOHLMAN, G. F.: On the Case for Repeal of Ewald's Second Law. *Acta Oto-Laryngol.*, suppl. 159, 1960, pp. 15-24.
8. MEIRY, J. L.: The Vestibular System and Human Dynamic Space Orientation. NASA CR-628, Oct. 1966.
9. SADOFF, M.; MATTESON, F. H.; AND HAVILL, C. D.: A Method for Evaluating the Loads and Controllability Aspects of the Pitch-up Problem. NACA RM A55D06, 1955.
10. DECHER, H.: Neues zur Labyrinthphysiologie: die Drehreizschwellen der vertikalen Bogengänge. *Arch. Hals.-Nas.-u. Kehlkopfheilk.*, vol. 181, 1963, pp. 395-407.
11. TRAVIS, R. C.: The Effect of Varying Position of the Head on Voluntary Response to Vestibular Stimulation. *J. Exptl. Psychol.*, vol. 23, 1938, pp. 295-303.
12. BENSON, A. J.: Spatial Disorientation in Flight. A Textbook of Aviation Physiology. J. A. Gillies, ed., Pergamon Press, 1965.
13. JONES, G. M.; BARRY, W.; AND KOWALSKY, N.: Dynamics of the Semicircular Canals Compared in Yaw, Pitch, and Roll. *Aerospace Med.*, vol. 35, 1964, pp. 984-989.
14. COLLINS, W. E.; AND GUEDRY, F. E., JR.: Duration of Angular Acceleration and Ocular Nystagmus From Cat and Man. I. Responses From the Lateral and the Vertical Canals to Two Separate Durations. *Acta Oto-Laryngol.*, vol. 64, 1967, pp. 373-387.
15. LEDOUX, A.: Les Canaux Semi-circulaires. Étude Electrophysiologique; Contribution à l'Effort d'Uniformisation des Épreuves Vestibulaires, Essai d'Interprétation de la Sémiologie Vestibulaire. *Acta Otorhinol.*, Belg., vol. 12, 1958, pp. 111-346.
16. VAN DER VIS, K.: Cupulometry of the Vertical Semicircular Canals. *Pract. Oto-Rhino-Laryngol.*, vol. 20, 1958, pp. 250-260.
17. ASCHAN, G.; AND STAHL, J.: Cupulometric Studies on the Pigeon. A Comparison Between the Functions of the Horizontal and Vertical Ampullae. *Acta Oto-Laryngol.*, vol. 46, 1956, pp. 91-98.
18. CLARK, B.; AND STEWART, J. D.: Comparison of Sensitivity for the Perception of Bodily Rotation and the Oculogyral Illusion. *Perception and Psychophysics*, vol. 3, 1968, pp. 253-256.
19. CLARK, B.; AND STEWART, J. D.: Comparison of Three Methods to Determine Thresholds for the Perception of Passive, Bodily Angular Acceleration. *Am. J. Psychol.*, vol. 81, 1968, pp. 207-216.
20. CORNSWEET, T. N.: The Staircase-Method in Psychophysics. *Am. J. Psychol.*, vol. 75, 1962, pp. 485-491.
21. CLARK, B.; AND GRAYBIEL, A.: Human Performance During Adaptation to Stress in the Pensacola Slow Rotation Room. *Aerospace Med.*, vol. 32, 1961, pp. 93-106.

22. NEWSOM, B. D.; AND BRADY, J. F.: A Comparison of Performances Involving Head Rotations About y and z Cranial Axes in a Revolving Space Station Simulator. *Aerospace Med.*, vol. 37, 1966, pp. 1152-1157.
23. GIBSON, J. J.: *The Senses Considered as Perceptual Systems*. Houghton Mifflin Co., 1966.
24. MILLER, E. F., II; FREGLY, A. R.; VAN DEN BRINK, G.; AND GRAYBIEL, A.: Visual Localization of the Horizontal as a Function of Body Tilt up to $\pm 90^\circ$ from Gravitational Vertical. Naval School of Aviation Medicine Report NSAM-942, NASA Order No. R-47, Pensacola, Fla., Aug. 1965.
25. GROEN, J. J.: Central Regulation of the Vestibular System. *Acta Oto-Laryngol.*, vol. 59, 1965, pp. 211-218.

DISCUSSION

Waite: How were the subjects restrained in this apparatus? In the y -axis, where you obtained the highest threshold, was there the least amount of body-surface area touching the device as opposed to the other two axes, as it would appear from your presentation?

Clark: We are a little sensitive about safety in rotating devices; therefore, the observers were carefully strapped in, in every case. I would say that there was more weight, let us say, on the back, if that is what you have in mind, when they were lying and rotating around the x -axis. But on the other hand, they were strapped in very firmly, comfortably, but firmly. In the y -position there was a zipper arrangement that held their thighs in position and their feet were clamped into position; they would have to be in order to maintain the position. There was a lot of contact, really. I do not know that I could say precisely how much more.

Money: Could some of the variability in the results using the y -axis be accounted for by a difference in threshold for the two directions of rotation? This would fit in very nicely with observations that have been made in dogs, cats, monkeys, and men, in which the vertical nystagmus with the fast component down is much more easily elicited.

Clark: Yes. I think that this is a possibility. I have discussed this with Dr. Guedry who has similar notions. I would say yes, possibly, but I have some reservations. On the basis of a large amount of data, I believe that predictions from nystagmus measurements do not necessarily give us prediction for sensation measurements. I do not know that we have adequate data on nystagmus thresholds, especially in normal human beings, but certainly there is a difference between perception of rotation thresholds and oculogyral illusion thresholds, for example.

Money: Was the threshold the same in the two directions?

Clark: I do not know, but I am going to find out. The reason we did not do so previously was that we tried many right-left comparisons and failed every time.

Guedry: You indicated that some people were disturbed when the right side was down. Did you mean to imply that others were not disturbed?

Clark: Yes.

Guedry: Did you then turn them on the other side and did they have comparable difficulties?

Clark: No. We have no data for both sides. This might be worth doing. The right-sidedness, I would say, is merely due to their body position itself rather than the particular side down.

Lowenstein: Is your appliance capable of coping with rotation in the plane of the anterior-vertical and posterior-vertical canals?

Clark: No. It rotates only about the Earth-vertical axis.

Lowenstein: Could you orientate it?

Clark: No. We could not.

Lowenstein: It would be extremely interesting to see what the thresholds would be in those positions.

Steer: Some measurements made by Dr. Meiry in our own laboratory a few years ago were done for the y -axis with the head tilted to the side rather than the entire trunk tilted to the side. In that case he found, with a very small number of samples, that there was no real significant difference in threshold between the horizontal and lateral canals. I would agree that it is extra information from the body being tilted that is causing this additional delay.

Clark: Yes. For four subjects in a rather limited number of trials, we measured thresholds in different body positions, one on the back, and then with the subject seated erect and leaning forward with the nose down. We did not test it on the side. The threshold with the nose up was $0.42^\circ/\text{sec}^2$; with the nose down, it dropped to $0.23^\circ/\text{sec}^2$. This would apparently be similar to the findings by Dr. Meiry. We then turned them over so that the head was in the same position, and we found the same threshold again, which complicates the matter, I am afraid. This may very well be related to how the subjects are restrained. Interestingly enough, when we repeated this a second time on these four subjects, the threshold came out to be $0.44^\circ/\text{sec}^2$ compared to $0.42^\circ/\text{sec}^2$. Unfortunately, these data were not properly counterbalanced, and so on. We just made a sort of trial run, but it is interesting to speculate on what this might turn out to mean.

Effect of Instability During Rotation on Physiologic and Perceptual-Motor Function

BERNARD D. NEWSOM¹

General Dynamics

SUMMARY

The requirement for an artificial-gravity space station has not been established because of the limited duration of space missions to date. The eventuality of such a system, however, is generally accepted on the justification of comfort, training, facilitation of mechanical operations, and the more natural environment it offers for prolonged missions. A rotogravity environment has been studied on the basis of radius requirements and rotational velocity limitations for crew habituation and performance. The added parameter that influences design and propellant costs is the stability required for the crew to operate satisfactorily. The effect of perturbation during rotation is the subject of this study.

INTRODUCTION

This study was completed in three experiments. Experiment 1 investigated the effect of rotation and sinusoidal perturbation on a seated subject performing a battery of perceptual-motor tests representative of the tasks required by an astronaut crew. Experiment 2 imposed the added factor of a rapid head motion upon the perturbing environment at high rates of rotation. The criteria were performance of an eye-hand response test and the time it took for the subject to fixate on a point display following the head turn. Experiment 3 was performed to assess the perturbation effects on the time it took for the habituation of a single perceptual element to rotation. The disorientation that results from a rapid head motion can be evaluated by the oculogyral illusion (OGI) that occurs in a darkened room. An illuminated target appears to drift about, and this motion is extinguished as habituation occurs.

Results of the three experiments indicate that

sinusoidal motions of the magnitude anticipated in space stations should not complicate the performance of crew tasks that do not require the translation of a subject in that environment. Perceptual-motor performance was not degraded; rapid head turns caused no more decrement in performance during perturbation than in stable rotation; and the rate of OGI extinction was the same, even though the extent was less, in the perturbing environment.

The consistency of results supports the hypothesis that perturbation during rotation creates a constant stimulus to the vestibular system and, as such, keeps the receptor in a partial refractor state which, in turn, raises the threshold for sensitivity to cross-coupled acceleration.

Certain basic requirements can be predicted for those future vehicle systems requiring multi-man crews to function optimally for long periods in space. A reliable life-support system free from toxicological problems, for example, is a well-recognized requirement. A requirement not so well agreed upon is for artificial gravity to maintain the musculoskeletal and cardiovascular systems of the crew close to normal equilibrium for Earth reentry. Much of the thinking in this

¹ Assisted by J. F. Brady under contract no. NAS 9-6986 at General Dynamics Convair Division.

field has been about the immediate problem of relatively short-duration manned space missions, and it appears from available information that man can survive such exposure. However, there are advantages, in addition to physiological support, to be gained from creating an inertial field. Assembly of parts, repair of equipment, and preparation and ingestion of food are all facilitated by an inertial directing force. Personal hygiene can be more closely controlled and sanitation is easier to maintain if dirt and fluids collect on the floor. Artificial gravity also allows the enjoyment of an occasional shower which is usually a priority desire in confinement studies. All of these considerations take on new importance when mission durations are extended to a year or more, provided that such missions are within engineering feasibility and physiological tolerance.

ENGINEERING GUIDES

To be prepared for possible development of these future artificial-gravity systems, it is necessary to start research on the support technologies. The type of information design engineers require concerning man's functional tolerances in these environments presently does not exist.

Although the response of the otic labyrinth to both weightless and artificial gravity environments certainly requires further elucidation, this study has been directed primarily toward questions concerning man as a functional system in these environments. Engineers choosing optimal man-machine tradeoffs must know the work potential of man in rotating vehicles of various dimensions and force field characteristics. These guidelines must be realistic—not only for the large orbiting vehicles of the future but also (and more acutely) for experimental systems that could be included in the Apollo Applications Program and as backup concepts for vehicles now in the definition phase.

Loret (ref. 1) and Dole (ref. 2) have listed many engineering constraints imposed by the crew during rotation, but neither considered stability of the vehicle as a design limitation. However, in providing a habitable rotating space vehicle, stability could be no less important

than angular velocity, radius, g -level, or rim velocity. In a rotating space vehicle, vehicle precession, as well as head rotation, could stimulate the crewman's labyrinth. Vehicle instability could be anticipated to lower the permitted angular velocity as it seems reasonable that the stimuli to the labyrinth due to vehicle instability would complement that due to the crewman's active head movements.

Vehicle precession predicates caution in assigning spin-rate ceilings at this time. Investigation of the total dynamic environment in a simulated rotating vehicle in relation to habitability and crew performance is necessary. Without such groundwork, design engineers must work in an arbitrary manner, which could be costly and mission limiting. Kurzhals et al. (ref. 3) and Larson (ref. 4) have lent theoretical and empirical consideration to the engineering problem of instability in the manned rotating vehicle. Tests of crew performance as a function of instability, as well as of the previously considered parameters, should be coupled to such efforts.

Disturbances, such as docking impacts and active or passive changes in crew or hardware mass, may cause many combinations of structural and force-field oscillations which could be detrimental to crew function. As stability of a rotating space vehicle is related directly to its total mass, the relatively light state-of-the-art vehicles would be particularly susceptible to instability from mass disturbances. In a discoid or toroidal vehicle rotating about its principal Z -axis, a crewman aligned with one of the transverse X - or Y -axes could be subject not only to the disturbing effects resulting from his active head movements relative to the spin plane, but also to a variety of oscillating forces beyond his active control.

Any impulsive torque applied about either one of the two transverse axes of the rotating vehicle would result in a wobble (defined as an oscillatory curvilinear movement) about both X and Y transverse axes. The amplitudes of these oscillations would be directly proportional to the angular impulse and inversely proportional to the moment of inertia around the transverse axis normal to the axis of torque. A reduction in vehicle size causes a dramatic increase in

wobble. Several methods of active or passive dampening can be used to increase stability, but they entail weight and power penalties.

An inertial unbalance produced by an uncompensated mass movement along a transverse axis within the plane of spin will couple with the moment of inertia about the spin axis to produce a disturbance about the transverse axis that is directly proportional to the initial vehicle spin rate and the product of the moments of inertia of the transverse and spin axes. This generated spin coupled with the initial vehicle spin will produce varying angular velocity patterns. A crewman aligned with this axis will experience the illusion of complex and ever-varying tilting of the floor as his body perceives the resultant of the linear acceleration oscillating along his longitudinal body axis and the linear acceleration normal to this axis. The linear acceleration normal to this axis would trace the vectorial pattern defined by Larson (ref. 4). Simultaneous dynamic mass unbalances along both transverse axes (the anticipated situation) would complex the vector pattern and the resulting disturbances.

APPROACH

In a rotating environment, the crew is subject to Coriolis accelerations that may result in disorientation, vertigo, and motion sickness (refs. 5 to 7). Even without voluntary movement on the part of the crewman, similar effects could possibly be caused by the vehicular perturbations resulting from internal or external mass unbalances in an insufficiently stabilized vehicle. These perturbations—similar in magnitude and effect to the movements of a ship at sea—produce cue conflicts in the orientation triad of vision, inner ear, and deep proprioception.

INFORMATION GOAL

The problem of stability in a rotating space vehicle has received little study in biologic laboratories, probably because of the relatively sophisticated simulator required. It has not been similarly neglected as an engineering consideration and deserves comparable study by workers in bioastronautics.

The low-frequency oscillations involved in perturbation have been thought to affect macular sensors, as well as cupular sensors, while the Coriolis accelerations appear to be detected primarily by the cupulae. Those functions found in previous tests to be sensitive to Coriolis accelerations might be expected to degrade even further due to the simultaneous perturbation of the rotating environment.

MRSSS EXPERIMENTATION

On the basis of the studies that have been completed by using the manned revolving space station simulator (MRSSS),² it has been concluded that man can adjust to and resist performance decrement in a stable rotogravity environment of 6 rpm (refs. 7 and 8); that the functional adjustments required by his passing into and out of a rotating environment can be eased by graduating such transitions in a step-wise manner; that prior to making the physiologic adjustments required by such transitions, he can adjust his behavior very rapidly to perform optimally (ref. 9); and that proper location and orientation of control and display hardware can maximize his performance (ref. 10), especially during the adjustment to force-field changes (ref. 11).

A rotating spacecraft, exposed to either static or dynamic unbalances, would respond gyroscopically with a tendency to oscillatory precession. Presumably, the spacecraft will have stabilization systems to counteract such disturbances, but it is important to know to what extent this control must be effective and what the off-nominal operation tolerance of the crew is in event of system failure. In a rotating environment, this oscillatory precession (wobbling) may create disorientation similar to that resulting from active movements by passively moving the crew. This wobbling can be effectively simulated by oscillation of the MRSSS as it rotates. To facilitate this simulation, the hydropneumatic ram system used to incline the MRSSS on the trunnions was modified, thus making it capable

² The MRSSS is located at Convair, San Diego, Calif., and incorporates the Air Force CEVAT centrifuge complex.

of executing sustained programs of oscillation.

With the capability to simulate an oscillating, rotating environment, it was then necessary to select performance tasks appropriate for determining functional limits within such an environment. Experience from previous testing in the MRSSS has demonstrated that performance adjustment during rotation occurs rapidly.

GENERAL PROGRAM PLAN

The trunnioned cabin of the Convair MRSSS (fig. 1) can be inclined so that the resultant force field is perpendicular to the center of the floor. It also provides a means to perturb the cabin and to vary the angular velocity so inertial forces within the chamber simulate the vector patterns predicted for various sizes and configurations of spacecraft rotated to produce artificial gravity. No information on how such perturbations affect general performance is available; this study is the preliminary effort to generate such data. The perturbations are expressed as deviations of the inertial vector about the subject's Z -axis, so the results of the study can be applied to vehicles of any radius. Studies by other authors (ref. 12) indicate that the problem is virtually radius independent because of the relative vestibular sensitivities to the motions concerned.

The following three studies were completed to assess the effects of perturbation on performance during rotation prior to habituation.

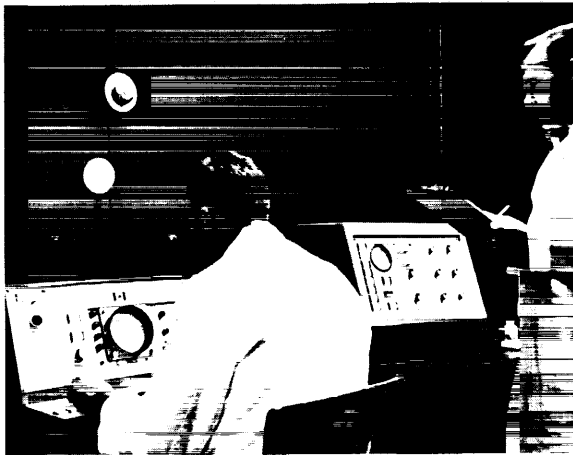

FIGURE 1.—Perpetual-motor-test consoles.

Experiment 1

Baseline measurements were made on 12 subjects under static conditions. Biofunctional efficiency tests were administered repeatedly until a consistent score was obtained. Then, the tests were repeated while the subject was exposed to the following: (1) $\pm 3^\circ$ perturbation at 0.1 Hz, (2) 6 rpm at a 20-foot radius, and (3) simultaneous perturbation and rotation.

Experiment 2

The technique developed on the previous contract (NAS 9-5232) was used as a performance measurement to assess the importance of orientation within an inertial force field perturbed at 0.1 Hz. Ten subjects were tested following baseline measurements. Their performance was measured after making Y -axis head turns at 0° , 45° , and 90° to the spin plane. Regression slopes were determined at the following: (1) $\pm 3^\circ$ perturbation at 0.1 Hz, (2) 12.4 rpm, and (3) 12.4 rpm and $\pm 3^\circ$ perturbation at 0.1 Hz.

Experiment 3

Vestibular habituation was compared for a specific head movement while subjects were exposed to rotation and perturbation independently and in combination. Sixteen subjects were exposed to 8 rpm for 4 hours; every 15 minutes, a frontal (X -axis) head turn was made to the right shoulder, and the duration of OGI was recorded. The extinction rate of the OGI was compared at 0° perturbation and then with $\pm 3^\circ$ perturbation at 0.1 Hz. The first eight subjects were tested with 0° perturbation first and with $\pm 3^\circ$ perturbation 2 weeks later. The second eight subjects were tested in reverse order. All subjects received aural caloric tests before and after rotation.

PERCEPTUAL-MOTOR RESPONSE TO ROTATION, PERTURBATION, AND COMBINED ROTATION AND PERTURBATION

Experiment 1

A survey of possible tests and test batteries was made to find a series of appropriate performance measurements. Both the Air Force

and NASA (ref. 13) developed "face-value" type consoles for the specific purpose of evaluating man's control performance in the types of environments of interest to this study.

Arrangements were made to borrow a unit of the perceptual-motor console model 766³ from the Manned Spacecraft Center (MSC) in conjunction with the performance measurements being made under contract No. NAS 9-5232 and for use in a pilot perturbation study being conducted in the MRSSS. Following the pilot study, permission was obtained from MSC to perform this study as part of the experimental effort. The MRSSS is instrumented and equipped to permit continuous rotational studies of four subjects for unlimited periods of time and is described in greater detail in previous reports (ref. 14). For this study, the room was spun at 6 rpm, an angular velocity which previous studies had determined to be realistic for a stable rotogravity spacecraft of projected dimensions (ref. 8). At this spin rate, and with an effective radius of slightly more than 18 feet, a resultant 1.04 *g* was imposed on the study participants and the inclination of room vertical (about which perturbation took place) was 14°. A perturbation profile of 0.1 Hz and $\pm 3^\circ$ was selected to simulate a reasonable maximum to be encountered in projected rotogravity vehicles (ref. 3).

The testing consoles were designed for NASA by J. F. Parker, Jr., et al. (ref. 13) to integrate devices for a battery of tests that measure the primary dimensions of perceptual-motor performance. The tests used are based on well-established techniques with well-documented interpretations of results. Primary dimensions to be measured were chosen to specify abilities underlying complex perceptual-motor performance and to relate significantly to tasks and duties to be performed by spacecraft personnel.

The two consoles (subject and examiner consoles) are shown in figure 1. Additional test items and accessories included are the manual dexterity test, the stylus and mirror-tracing maze, the mirror-tracing visor, and the finger-dexterity test. The subject and examiner consoles are

arranged so the examiner can visually monitor both consoles and the subject (fig. 1). For this test, the subject was seated in the center of the simulator, the position at which the gravito-centrifugal resultant was perpendicular to the floor. The subject faced tangentially (in the direction of spin), as he would if optimally positioned for monitoring a control-display console (ref. 10) in a rotating space vehicle, and in a position in which he would be perturbed from side to side by vehicular wobbling.

Adequacy of identification (ref. 13) indicates the results of the factor-analytic study. For a test to be considered, it had to load⁴ at 0.30 or above on the primary factor or ability. If the test was not considered pure (loading only on one factor), secondary factors had to load at 0.30 or above.

Previous studies indicated that acceleration produced by the product of angular velocities resulting from head turning and vehicle rotation reduced performance in a rotating environment and that this reduction was partly due to visual location of the task display (ref. 15). Perturbation of the subject during rotation can theoretically elicit similar labyrinthine response from resultant velocity products. Performance could therefore be degraded without movement on the part of the subject (passive motion); however, previous testing had also demonstrated a rapid adjustment to the oscillating force field (rotary pursuit tests) (ref. 9) and fast recovery following forced head turns (ref. 16), so it might be anticipated that adaptation would result from sinusoidal perturbations during rotation. If such adjustment could be determined, the requirement for spacecraft stabilization would be reduced.

Procedures

The MRSSS was used to test the subject for performance while the following activities were taking place: (1) static, (2) perturbing, (3) rotating, and (4) rotating with perturbation. Perturbation of $\pm 3^\circ$ was around the inclined resultant at 0.1 Hz. The rotation rate was 6 rpm.

The NASA perceptual-motor test console was

³Fabricated under contract no. NAS 3-1329 by Biotechnology, Inc., Arlington, Va.

⁴Loading designates the degree of specificity for measurement of a particular ability.

[A→E order of testing]

	Subject No.														
	1	2	3	4	5	6	7	8	9	10	11	12	13	14	15
Static.....	A	A	A	A	A	A	A	A	A	A	A	A	A	A	A
Perturbate.....	B	B	C	C	D	D	B	B	C	C	D	D	B	B	C
Rotate.....	C	D	B	D	B	C	C	D	B	D	C	B	C	D	B
P&R.....	D	C	D	B	C	B	D	C	D	B	B	C	D	C	D
Static.....	E	E	E	E	E	E	E	E	E	E	E	E	E	E	E

used, and all 18 tests were performed. The console was located at the simulator center with the subject facing the leading bulkhead. The subject was seated in front of the console with the test conductor immediately behind him. Each subject practiced on the console for a minimum of three sessions prior to testing on the centrifuge. At the end of each session, a score was obtained to determine the state of learning. No subject was tested that had not reached a learning plateau on each test. Fifteen subjects were scheduled for testing. The results from the first 12 tested successfully were used. The testing order was as indicated in the table above.

Results

The tests were performed on 12 subjects without difficulty. Subjects were not distressed by the environment and appeared to enjoy the testing procedure. The scores, shown in figures 2 and 3, are arranged into groups with common test objectives.

The test console was quite reliable during the tests; the only problems encountered were as follows. One microampere meter failed to work

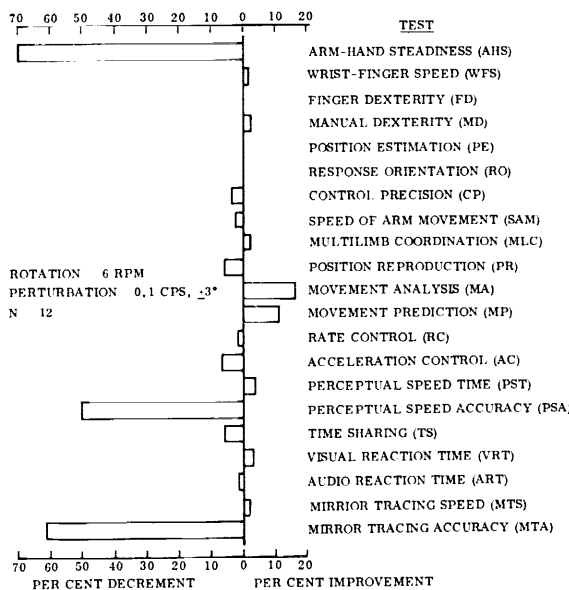

FIGURE 2.—Percent change in perrotatory performance with perturbation.

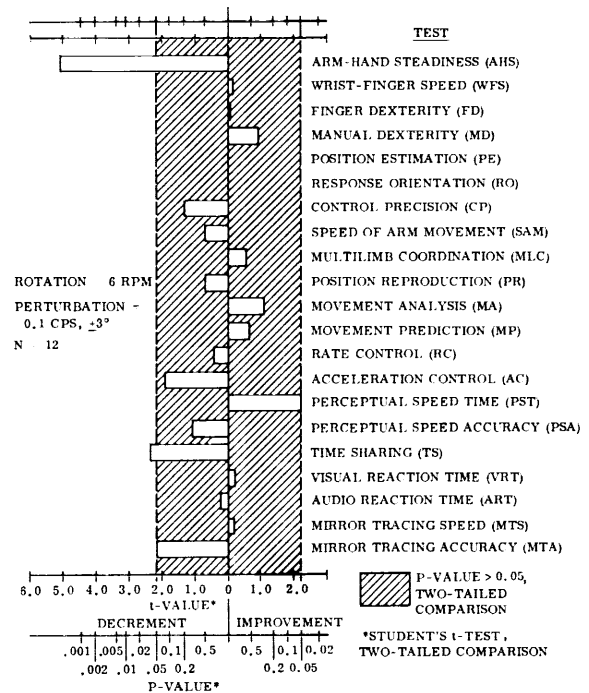

FIGURE 3.—Significance of change in perrotatory performance with perturbation.

for time-sharing and perceptual-speed tests and was replaced. The cam-switch programer was subject to failure unless it was cleaned regularly. Operation of some tests required considerable practice before consistent scores were reached, and even after achieving consistency, it was found that some subjects demonstrated increased capability in the postdynamic test period.

Discussion

Because some learning was still evident in the more difficult tests at the end of the designated 4.5 hours of training, the better of the two static test scores (predynamic and postdynamic) was selected as the score of 100 percent for normalization of the dynamic data. With the above precaution in mind, the results of an analysis of variance of the normalized data suggest the following:

- (AHS) static (S) over all three dynamic modes ($P < 0.01$).
- (WFS) S over all three dynamic modes ($P < 0.05$).
- (FD) S over rotation (R) and rotation and perturbation (RP) ($P < 0.05$).
- (MD) S over R ($P < 0.05$).
- (SAM) S over R and RP (P).
- (MA) S over R ($P < 0.01$) and RP ($P < 0.05$).
- (PST) S over R ($P < 0.05$).
- (TS) S over RP ($P < 0.05$).
- (VRT) S over all ($P < 0.05$).
- (ART) S over P ($P < 0.01$).
- (MTS) S over P₁ ($P < 0.01$).
- (MTA) S over RP (R < 0.01).

All other tests failed to demonstrate significant decrements from static scores. The results in some cases show a significant change in score, but only in one test does decrement indicate the perturbation would be a hindrance to that type of operation. As might be expected, the task of maintaining a probe within a hole without touching the sides is difficult in the rocking environment. Such a task would still be possible if there were a contact between a fixture common to that being probed and the carpal portion of the hand. In the administration of these tests, there was little, if any, head motion, so most vestibular stimulation resulted from passive motion of the subject by vehicle perturbation. Quite different results might be expected if a head motion were incorporated into the testing. Figures 2 and 3 indicate the relation between

the tests as affected by the imposed variables and the significance of the differences in scores.

EFFECT OF PERTURBATION ON PERFORMANCE FOLLOWING Y-AXIS HEAD TURNS DURING ROTATION

Experiment 2

A previous study which was reported at the last symposium (ref. 17) demonstrated a progressive performance decrement as the angle between the spin plane and the plane of the subject's head turn was increased. Experiment 1 of this study did not indicate that the passive movement of a subject during rotation, due to perturbation of the vehicle, would cause a significant problem. Those tests, however, restricted head motion to a minimum for the test being performed. Motion out of the spin plane was sinusoidal and, therefore, predictable in time and magnitude. Tasks requiring head turns in different planes impose cross-coupled stimuli on the semicircular canals that vary in magnitude and direction, depending on subject orientation, vehicle rotation rate, and motion due to the perturbation. The inertial field of such motion is complex and changing, and it is unlikely that prediction would be possible. Rapid habituation would most likely result only from nonspecific suppression of the vestibular signal.

Method

The same test arrangement was used for this study as in previous published studies (ref. 16). Recording techniques, however, were extended. In addition to the eye-motion camera (EMC) and the vertical and horizontal electro-oculogram (EOG), a vectoroculogram (VOG) was made. This is an integration of the horizontal and vertical EOG and provides a light spot on the cathode-ray tube (CRT) that represents the point of visual fixation. The response analysis tester (RATER) test (as reported in ref. 16) was used, and the head-turn recording, EOG, EMC, frame number, and VOG were "stacked" and recorded on a video tape recorder. This allows simultaneous data presentation for analysis. Only Y-axis head turns were made. This limited the anticipated severity of semicircular canal stimulation

and reduced the testing per subject so it could be accomplished in 1 day.

The primary goal of this study was to acquire information of the effect of perturbation on the process of adjustment to rotation. A secondary purpose was to investigate the use of the VOG as a practical substitute for the EMC for recording eye movement.

Subjects

The test sample consisted of 12 volunteers from San Diego colleges. They were males of 22 ± 2 years, 167 ± 23 pounds, and 69 ± 4 inches in height. An additional six subjects of comparable background and vital statistics began testing but did not finish the required regimen—three because of instrumentation malfunctions and the remaining three because they found the most stressful orientations physiologically disturbing. Before being exposed to the environment of the dynamic test simulator, the subjects were required to pass an airman's third-class medical examination. None of the subjects had histories of undue susceptibility to motion sickness; no special instructions were given regarding diet or rest preceding the day of experimental performance.

Apparatus

The simulator, subject restraints, data pickups

at the subject, and performance tester were unchanged from the previous contract. Rotation of the subject was achieved by using the MRSSS. Orientation and restraint were achieved by using the 45° inclined chair and its associated head restraint. With the centrifuge rotating at 12.2 rpm to produce 1 radial g at the restraint chair position (centrally located within the MRSSS at 20 feet from the centrifuge spin axis), the gravito-centrifugal resultant was perpendicular to the MRSSS floor when the simulator was tilted at a 45° angle. The 45° angle tilt combined with the 45° angle of the restraint chair tilting the subject on his left side permitted (as in the previous contract) orientations of the subject for Y -axis head turns at 0° , 45° , and 90° interplanar angles to the centrifuge spin plane by simply rotating the chair (fig. 4). The EMC-2F eye-motion camera (made by Westgate Laboratories) was again used to record direction of gaze. The camera was fixed to the subject by the head-restraint and dental-bite bar as shown in figure 5. The RATER was again used as the perceptual-motor performance device with the display collimated to 1° of visual angle. The RATER tests correct rote responses to lights of four different colors (red, yellow, green, and blue) that are presented in an infinitely random order. The subject depresses one of four console

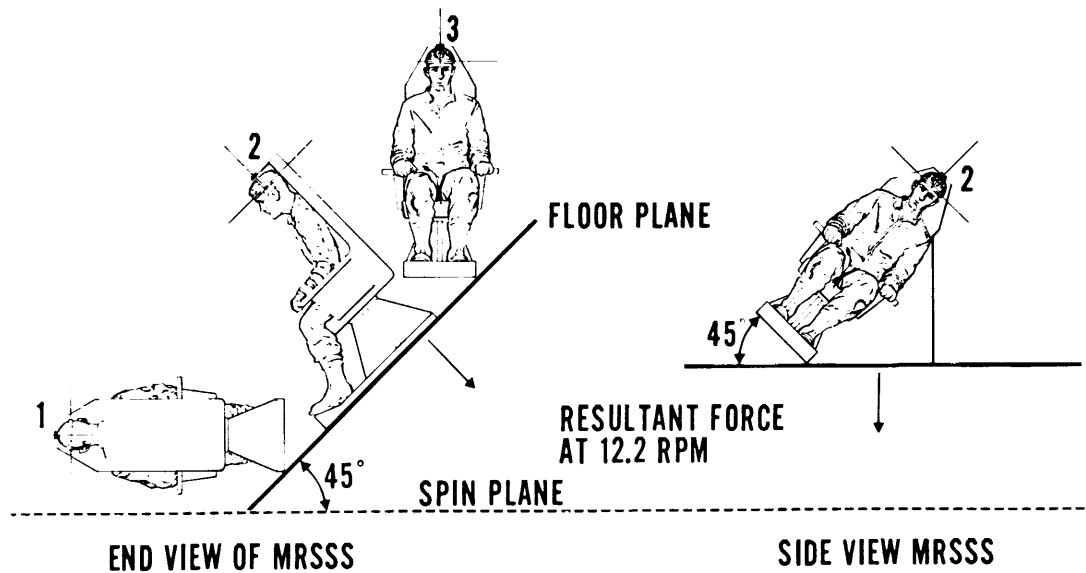

FIGURE 4.—Subject orientations.

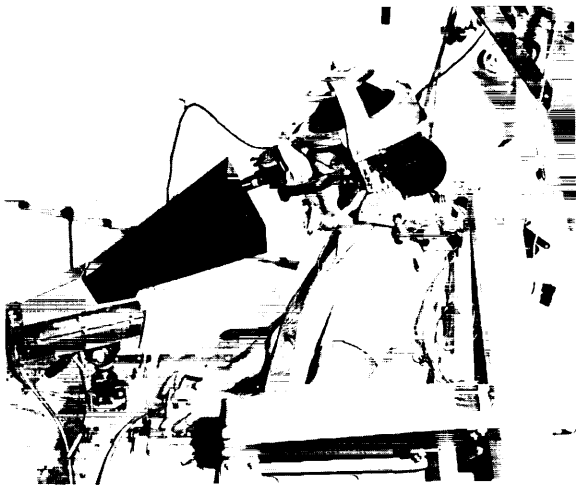

FIGURE 5.—Camera fixed by head restraint and dental bite bar.

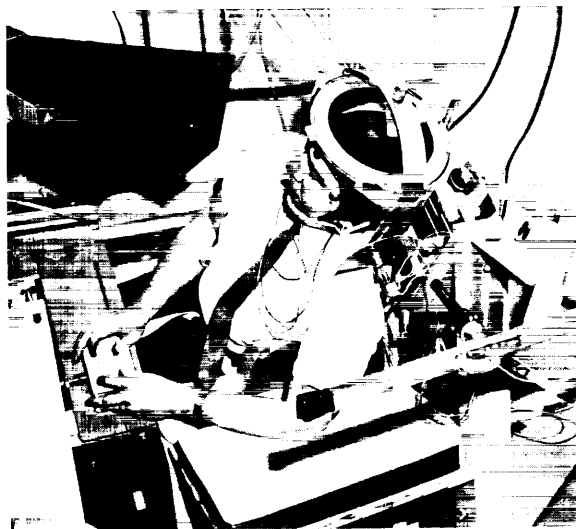

FIGURE 6.—Subject in the inclined chair.

buttons, seen in figure 6, that corresponds to each color; when the correct button is pressed, the next color appears. Total responses and correct responses are recorded automatically. The RATER also produces a dc signal that corresponds to the subject's latency in responding to each color displayed. The RATER response latency was recorded on the polygraph strip-chart. Essential changes in apparatus from the previous contract were made to incorporate the VOG system into the study for addi-

tional data recording. The subject's dc EOG signals were amplified by Kintel 114A amplifiers in the MRSSS before being transmitted through the centrifuge sliprings to the main test control room. In the control room, the EOG signals were simultaneously recorded by two systems. The individual horizontal and vertical EOG were written out by two channels of a Sanborn 150 polygraph on the same chart that recorded the subject's and the onboard examiner's ECG, the RATER response latency, the testing event marker, and the head-turn rate. The horizontal and vertical EOG signals were also paralleled to the VOG system. For this system, the two EOG signals were combined by a Tektronix 503 dual-beam oscilloscope into a single two-dimensional eye-movement vector. To provide an integrated display for data records, three readouts (polygraph EOG, oscilloscope VOG, and a digital count of the EMC frame number) were individually photographed by separate television cameras and synchronized into a single picture by a special effects generator for video taping and/or subsequent kinescoping.

Experiment Design

As in the previous contractual study, the subject's task was to perform a testing sequence in each of the combinations of head-turn orientation and force-field variation. Each sequence consisted of ten 15-second trials separated by 20-second waiting periods at the cue-light position. All head turns were restricted about the subject's cranial Y-axis by the head constraint. The subject would wait for the cue light with his head dorsoflexed 35° back from the horizontal. The automatic timing system turned on the cue light and the RATER display and started the EMC simultaneously. The subject immediately turned his head 70° downward as rapidly as possible and began responding to the RATER display by pressing the appropriate buttons. At the end of the 15-second scoring period, the timer would shut off the RATER display, which was the subject's signal to turn his head back to the cue-light position and to wait for the light to flash on at the end of the 20-second waiting period. At the end of the 10-trial sequence (150 seconds of scoring), the EMC film was

changed, and the subject was reoriented by rotating the restraint chair relative to the centrifuge spin axis.

Each of the subjects was instructed to perform as well as possible during the 150-second (10-trial) sequence in each orientation. The subjects were tested in the same six modes: two each with the head-turn plane at 0° , 45° , and 90° to the MRSSS spin plane; once with the simulator rotating at 12.2 rpm without perturbation; and once with it rotating at 12.2 rpm and perturbing about a tangential axis at $\pm 3^\circ$ at a rate of 0.1 Hz. Permutations of the six testing modes were selected on a basis of balance and randomly assigned to the 12 subjects. The subject numbers and their assigned orders of testing sequences are shown as follows:

1 S 0° , 45° , and 90°	P 0° , 45° , and 90°
2 P 0° , 45° , and 90°	S 0° , 45° , and 90°
3 S 90° , 45° , and 0°	P 90° , 45° , and 0°
4 P 90° , 45° , and 0°	S 90° , 45° , and 0°
5 S 45° , 0° , and 90°	P 45° , 0° , and 90°
6 P 45° , 0° , and 90°	S 45° , 0° , and 90°
7 S 90° , 0° , and 45°	P 90° , 0° , and 45°
8 P 90° , 0° , and 45°	S 90° , 0° , and 45°
9 S 45° , 90° , and 0°	P 45° , 90° , and 0°
10 P 45° , 90° , and 0°	S 45° , 90° , and 0°
11 S 0° , 90° , and 45°	P 0° , 90° , and 45°
12 P 0° , 90° , and 45°	S 0° , 90° , and 45°
S = 12.2 rpm	
P = 12.2 rpm and $\pm 3^\circ$ at 0.1 Hz	

Results

Of the 18 subjects who began testing, 12 performed at all six modes and were grouped within a single sample for data reduction and interpretation. For these 12 subjects, two categories of response were considered: (1) the net RATER score (total correct responses minus total incorrect responses) for the 150 seconds of scoring during each modal sequence and for each of the 10 trials making up a sequence; and (2) the parameters of reaction linking the starting signal to the first correct RATER response—the latent period to beginning of head turn, the head turn, end of head turn to eye fixation, and from eye fixation to first correct RATER response.

Figure 7 shows the mean net RATER score for all 12 subjects for each of the ten 15-second trials in each of the testing modes. The graph (fig. 7) indicates that for most trials there is a

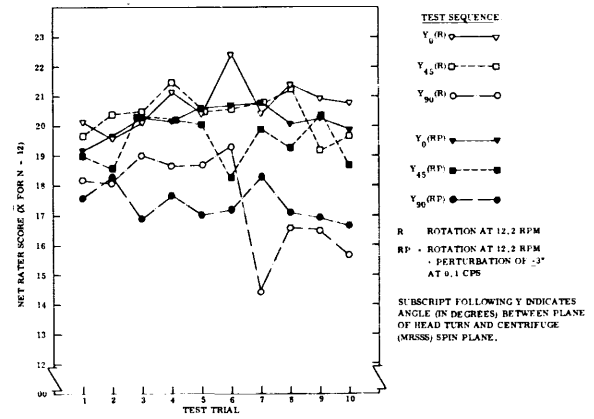

FIGURE 7.—Net RATER score versus test trial.

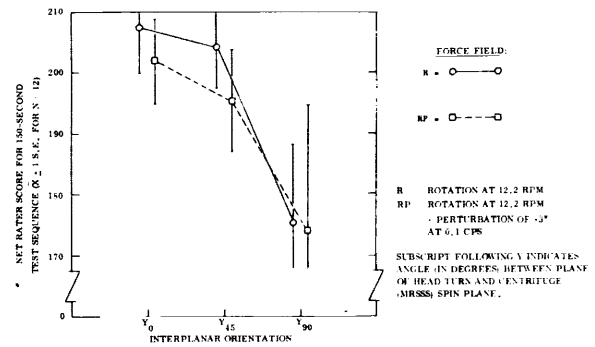

FIGURE 8.—RATER score versus subject orientation.

decrement in the mean scores as the interplanar angle increases; and for all interplanar angles, there tends to be a reduced performance when perturbation is added to rotation. The exceptions to the latter are the last four trials of the Y_{90} sequences where there is a mean-score decrement without perturbation when compared with the situation of combined dynamics.

Figure 8 shows the mean net RATER score for the full sequence as a function of interplanar orientation for each of the dynamic modes. This figure makes the two observations mentioned above more apparent. A decrement of performance is seen as the interplanar angle increases. This decrement is increased with perturbation but becomes obscured during the most stressful interplanar orientation by the cross coupling at Y_{90} .

To test the statistical significance of the data presented in figure 8, each subject's data were

normalized on the basis of 100 percent performance value for his best sequence score. Overall means for the total sample then gave performance percentages ranging from 96 percent for Y_0 (R only) to 80 percent for Y_{90} (RP). An analysis of variance was performed on the normalized data using a P -value equal to or less than 0.05 as being significant. Comparing sequences with one another, only Y_{90} (R) and Y_{90} (RP) demonstrated a significant degradation in performance and only when compared to Y_0 (R). Not included on this graph were the results of perturbation-only sequences run by the last 6 of the 12 subjects. Each of these subjects ran a prerotation and post-rotation perturbation sequence—three subjects with the restraint chair facing tangent to the plane of spin (the orientation for Y_0 and Y_{90} sequences) and three with the chair facing radially (the orientation for Y_{45} sequences). Their scores for these sequences did not differ significantly from their Y_0 performance. Table 1 lists the mean scores achieved by each group of three subjects in their perturbation-only sequences.

Figure 9 shows initial subject performance dynamics as a function of the six model test sequences. Intervals are in real time (seconds) for means of the entire sample. Although these mean values show a progressive increase in time from starting signal to first correct RATER response, an analysis of variance of the data did not show these changes to be significant.

TABLE 1.—RATER Score Versus Perturbation Only

Sequence	\bar{x}	N
Prespin P_{15}	208	3
Postspin P_{15}	207	3
Prespin P_0	212	3
Postspin P_0	207	3

Notes

- \bar{x} = mean RATER score for 3 subjects for 150-second sequence
- N = sample number
- P_{15} = subject facing radially
- P_0 = subject facing tangentially

Data percentage presented in figure 9 was reduced from the polygraph stripchart, the VOG tapes, and the EMC films. In comparing the VOG and EMC eye-motion loci for various trials, it was found that they gave identical measurements of eye movement and could be used interchangeably from that standpoint.

Figures 10 and 11 compare oculograms for the same test trial plotted, respectively, from EMC and VOG film. The numbers in both

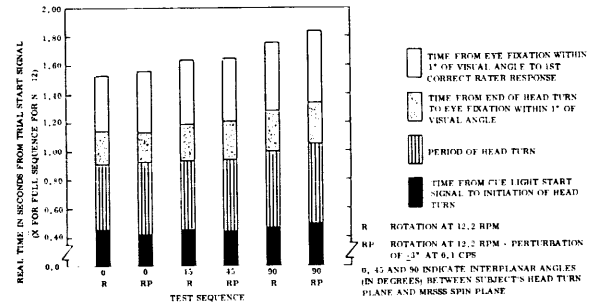

FIGURE 9.—Subject response versus test sequence.

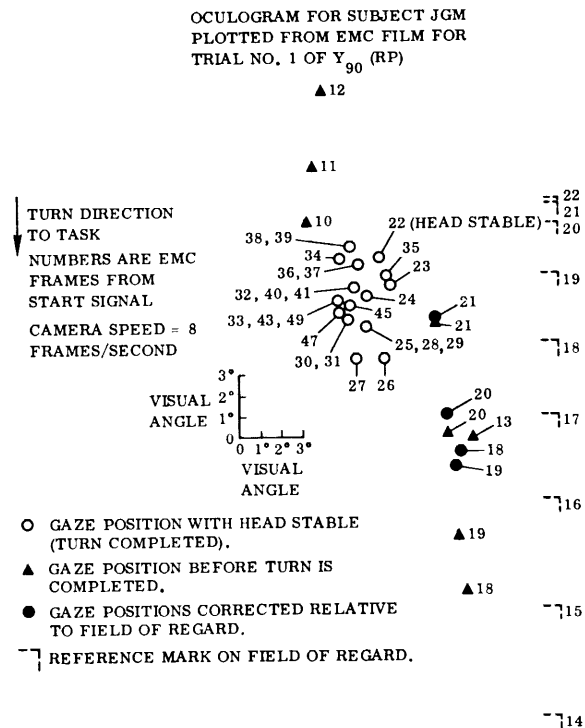

FIGURE 10.—Eye-motion camera oculogram for subject JGM.

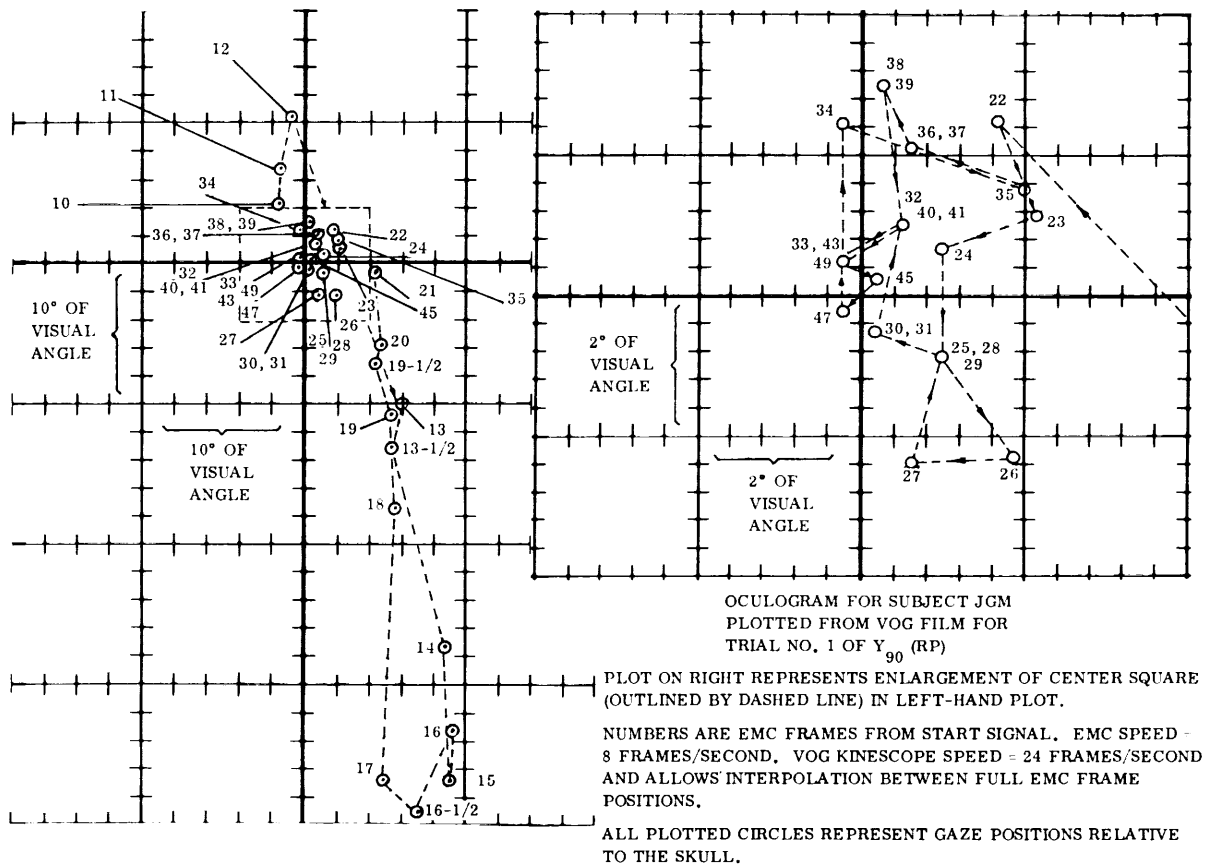

FIGURE 11.—*Vector oculogram for subject JGM.*

oculograms refer to the EMC frame numbers from the cue-light start signal. The EMC was run at eight frames per second. The VOG tape originally records 60 fields (frames per second), and when kinescoped, provides a permanent record of 24 frames per second. A comparison of figures 10 and 11 indicates the major difference between the EMC and VOG data—the EMC fixes gaze position in the field of regard independent of head position, whereas the VOG indicates only gaze position relative to the head. In figure 11, prior to frame 22, when the head becomes stable at the end of head turn, gaze positions 18 to 21 could be repositioned relative to the changing field of regard by correcting relative to a reference mark in that field. Positions 10 to 13 could not be so corrected as the reference mark was not yet in view on film. Subsequent to point 49, all gaze positions lay in the area circum-

scribed by 45 to 49, and therefore were not plotted. Comparing the two plots, it would seem that for tests involving head immobility, the VOG provides an adequate substitute for the EMC.

Discussion

This study was the third experimental effort performed by this laboratory involving *Y*-axis head turns and their effect on perceptual-motor performance. The first study used the logical inference tester (LOGIT) as the performance tester, whereas the second study used the RATER as in this study. The first two studies exposed the subjects to *Z*-axis (side-to-side) head-turn sequences, whereas this study exposed them to *Y*-axis head-turn sequences with perturbation added to rotation. Apart from that, the formats were quite similar, and the *Y*-axis sequences with rotation and no perturbation are capable of comparison.

labyrinths relative to the spin plane of the simulator but in a form that involves a minimum of conscious involvement. It may thus provide some evidence as to what aspects of the stimulus framework, from the consciousness standpoint, are of primary importance in establishing end-organ signal suppression.

The purpose of experiment 3 was to compare the vestibular suppression due to head rotations in a rotating environment with that due to head rotations in an environment that is simultaneously rotating and perturbing.

Method

To maximize the use of available centrifuge time and to provide information on the rate of response extinction, experiment 3 was divided into parts A and B; the subjects involved in part A were reexposed 1 month later in part B. Experiment 3 consisted of exposing subjects to 4 hours of rotation, with or without perturbation. Prior to and subsequent to the dynamic exposures, subjects received vestibular caloric tests—first one ear and then the other. During the dynamic exposures in the simulator, the subjects made *X*-axis head turns (toward one shoulder only) at 15-minute intervals. Responses to both rotational and caloric vestibular stimuli were measured by durations of resultant OGI.

As it is of great importance that responses both to the rotational and caloric stimuli be of sufficient initial magnitude to permit measurable decrement or suppression of response, subjects and stimuli were chosen to insure such adequacy. Head turns were 45° about the *X*-axis at maximum rate, with the simulator angular velocity at 8 rpm (6 rpm was found to be insufficient for consistent response). Caloric stimulation consisted of 50 cc of 25°C water delivered at a rate of 1 cc/sec against the posterior superior wall of the external auditory canal, with the head positioned to place the lateral canals in a vertical position. Only subjects with normal audiometric profiles for the 20- to 30-age span and with active caloric responses were used. A leadtime of 2 days was provided for certification of subjects for use in the study. The bite-bar arrangement that was used to limit the extent of head turn and to insure that the motion was made in a consistent

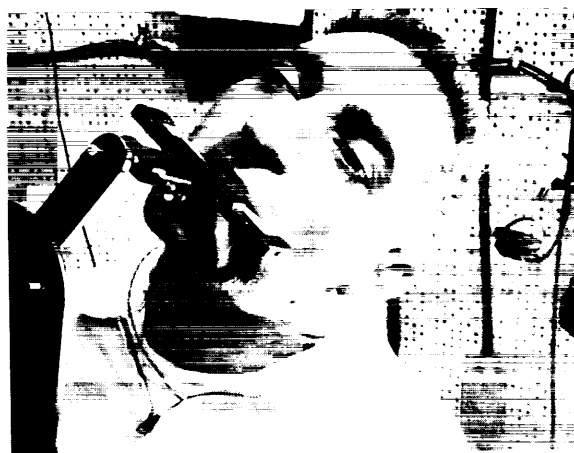

FIGURE 12.—Bite-bar restraint used to limit head-turn motion.

plane is shown in figure 12. After all had received their caloric stimulations, subjects were seated facing the leading bulkhead of the MRSSS (upon which the OGI target light is affixed), and the MRSSS was spun up to 8 rpm.

Subjects were given a stopwatch and were positioned with the restraining bite bar clenched between their teeth. The ambient illumination was extinguished prior to each head turn (the OGI target consisted of a 3-inch wire cube painted with fluorescent paint and illuminated by a 40-watt ultraviolet (UV) fixture; no light was visible). The onboard examiner commanded, "One, two, three, TURN." At the command "TURN," the subject turned his head as rapidly as possible to the right. The bite-bar restraint maintained the turn in the frontal plane and prevented the turn from passing beyond the designated 49° . The subject started his stopwatch at the same time he began his head turn and stopped it when the resultant OGI appeared to have terminated. He did his best to remember the direction (clock-hour numbers) and magnitude (units equal to target light side dimension) of the illusory movement of the target for subsequent recording on paper. This requirement for memory of illusion was meant to provide a mental task to maintain central arousal of the subject for consistency of that aspect of response threshold.

Subjects were instructed to spend an estimated

By comparison, the results of this present study are consistent with the results of the first two studies. The previous experiment (ref. 16) demonstrated a 6-percent degradation in LOGIT performance for Y_{45} and a 12-percent degradation for Y_{90} . The second study demonstrated a 10-percent degradation in RATER performance for Y_{45} and a 25-percent degradation for Y_{90} . This present study demonstrated a 2-percent degradation in RATER performance for Y_{45} and a 16-percent degradation for Y_{90} . The greater degradation witnessed in the first RATER study, in part, must be due to the test regimen including Z -axis head-turn sequences, which have been shown to be significantly more degrading than Y -axis head turns of comparable interplanar angle. In the previous RATER study, the Z_{45} and Z_{90} sequences produced 25 percent and 37 percent performance degradation, respectively. In that study, as in the present one, permutations of the various stress modalities were balanced, but this only serves to balance the cumulative stress effects among all sequences—not nulling out such effects.

Again, comparing these three studies, it is seen that the head-turn times are quite similar in magnitude as well as in proportion. Although the eye-fixation times in the second study are significantly longer than those seen in the present study, this would be anticipated in view of the substantially greater degradation in performance and, in part, must be due to the exposure to Z -axis head turns as part of the test regimen.

In the present study, although perturbation did not produce a significant change in performance, consideration of the mean performance values as a function of perturbation permits some suggestion of possible effect. Table 1 indicated that perturbation alone did not have a degrading effect on performance; therefore, the relative decrement in mean performance values for Y_0 (RP) and Y_{45} (RP) compared to the comparable (R) sequences could result from labyrinthine cross-coupled accelerations due to the passive sinusoidal tilting of the subject relative to the MRSSS spin plane. As it is a sinusoidal tilting, it would be anticipated that the effect might be marginal since the resultant stimulus to the cupula-endolymph system

would reverse in direction every 5 seconds. When considering the more traumatic Y_{90} orientation, however, it appears that the minor degradation due to perturbation no longer manifests itself within the context of the major degradation resulting from cross-coupling due to active head turns. This appears to be especially true in the latter trials of the sequence when the cumulation of stress is causing the most significant performance decay.

In conclusion, it has been demonstrated that perturbation imposed in this experiment does not have significant effect on perceptual-motor performance, either with or without simultaneous rotation. It has also been demonstrated that the VOG is a satisfactory substitute for the EMC in recording two-dimensional eye movements relative to the skull. It is seen, also, that the test results are consistent with previous studies performed of similar format.

OCULOGYRAL ILLUSION EXTINCTION IN STABLE AND PERTURBATING ENVIRONMENTS

Experiment 3

It has been noted in this and other laboratories (refs. 9, 18, and 19) that a suppression (adaptation or habituation) of ocular, perceptual, and somatic responses to Coriolis vestibular stimuli occurs in a rapid and predictable manner when repeated and that the suppression observed is closely specific for the stimulation being used. The transfer of the suppression to other forms of vestibular stimuli, including the unpracticed quadrants of identical Coriolis vestibular stimuli, has not been significant. During combined rotation and perturbation exposures of subjects and examiners in the Convair MRSSS, impressions of altered vestibular suppression rates have been consistently reported that indicate the perturbing environment is more easily tolerated. Experiment 3 provides statistical comparison of rate and transference of vestibular suppression of the OGI resulting from cross-coupled angular acceleration as a function of the presence or absence of perturbation. Perturbation presents a unique stimulus modality in that it provides passive rotation of the subject's

TABLE 2.—Schedule for Experiment 3

Caloric testing, dynamic exposure	Part A: R^1 Part B: $R + P^2$	Part A: $R + P$ Part B: R
(1) Left ear.....	Ss 1 to 4	Ss 5 to 8
(2) Right ear.....		
(1) Right ear.....	Ss 9 to 12	Ss 13 to 16 ³
(2) Left ear.....		

¹ R = rotation (8 rpm).

² P = perturbation ($\pm 3^\circ$, 0.1 Hz).

³ Ss 17 to 20 provided backup for data loss.

Estimated subject time: 0900–1000: 1 hour, predynamic; 1000–1400: 4 hours, dynamic; 1400–1500: 1 hour, postdynamic.

1 minute (at a consistent turning rate) to return slowly back to center stop. Two minutes after the initial TURN signal, the room lights were turned on, the times recorded, and the stopwatch and polygraph connects transferred to subjects 3 and 4. The testing procedure followed for subjects 1 and 2 was repeated for subjects 3 and 4, followed by a repetition of the complete testing cycle for all four subjects every 15 minutes of the 4 hours of dynamic exposure. Just prior to “spindown,” a response to the unexperienced head-turn direction was made. At the end of the 4 hours of dynamic exposure, the subjects received caloric stimulations as during the prespin portion of the test, after which they were released.

Half of the samples (eight subjects) were exposed to rotation plus perturbation ($\pm 3^\circ$ at 0.1 Hz) during part A and the other half during part B. Half the subjects received caloric irrigations in their left ear first; the other half, in their right ear first. This initial order was maintained throughout both parts of the experiment (A and B). Subject numbers were assigned in groups of fours on a random basis as shown in table 2.

Results

Twenty subjects were exposed to the first part of the test program. The first four were exposed to 6 rpm, and it was found that the magnitude of OGI produced on the first head turn was not great enough to satisfactorily demonstrate progressive habituation during the 4 hours of exposure. The remaining 16 subjects were exposed to 8 rpm; at that velocity, a good OGI response was observed. One subject had a

vegetative response as a result of repeated head tilts, and his testing was suspended to avoid possible nausea which would have required the abort of all four test subjects. Eleven of the remaining subjects returned for the second part of testing. Figure 13 shows the results for all subjects tested. From the slope of the regression curves, there is no apparent difference in the rate of adaptation. There is a difference in

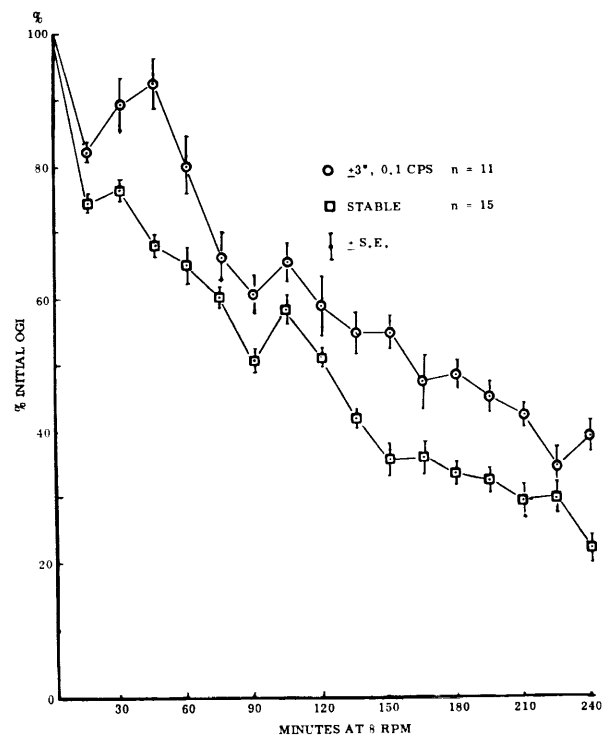

FIGURE 13.—Oculogyral illusion extinction (all subjects).

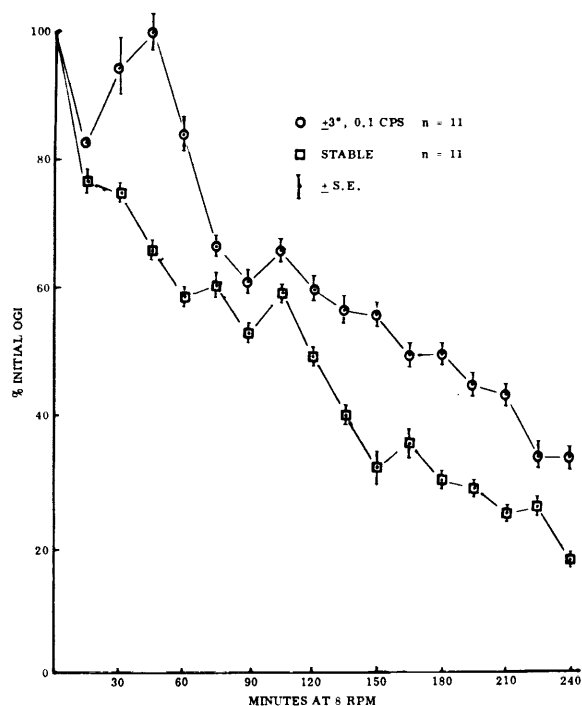

FIGURE 14.—*Oculogyral illusion extinction (subjects completing tests).*

extent of habituation; however, this could be due to the sample size difference. Figure 14 is for the 11 subjects who were tested in both parts A and B. The difference in habituation achieved in the two groups has an even greater significance (points are the mean ± 1 standard error) when the subjects who did not return for the second test are deleted, but the rate of extinction appears the same.

Discussion

It was hypothesized that habituation during rotation with perturbation would take place faster than in the stable situation. This was based on the supposition that the greater the interaction of a subject with the cross-coupled accelerations, the faster the various stimuli would be suppressed centrally. It is clear that the data show a reversed situation. The OGI was extinguished at about the same rate but to a significantly lesser degree than without perturbation. A possible explanation lies in the dynamics involved. The subjects were arranged along a radial line in the MRSSS cabin. The X-axis

head turns were made in a plane perpendicular to the plane of rotation that passed through the center of rotation. The $\pm 3^\circ$ perturbation of the cabin at 0.1 Hz also took place in this same plane, and the stimuli resulting from the subjects' head turn during perturbation was then dependent on the cabin motion at the time of head turn; head turns resulted in a different cross-coupling for each experience and, therefore, could have decreased the rate of habituation. Another important factor is that the perturbation kept a continuous stimulus applied to the semi-circular canals; the cupulae either were being stimulated or recovering and, therefore, could be expected to have a decreased sensitivity—being in a partial refractory state. The raising of the threshold due to a continuous low-level excitation would also explain the feeling expressed by subjects and examiners that rotation seemed to be less disorienting with perturbation.

No explanation can be offered for the simultaneous dip in both curves at 90 minutes of testing. This represents six individual test runs, and the small distribution of data points would indicate a consistent response but no cause has been found to which it could be attributed.

Table 3 lists the duration of OGI resulting from caloric stimulation before and after 4 hours of rotation at 8 rpm with and without perturbation. No difference appears to exist between the stable or perturbing conditions, but a very consistent decrease is observed in the time of illusion when prerotation and postrotation values are compared. Six control subjects, tested without rotation but with a 4-hour interval between irrigations, did not show this decrease in OGI response duration. Subjects who did not have strong illusions resulting from irrigation of both ears prior to testing were not retested after rotation, and caloric data from subjects who did not respond from stimulation in both ears after rotation were also discarded.

The consistent decrease in response of the remaining subjects could reflect a lack of recovery from the first caloric stimulation. There was a period of 5 hours or more between irrigations which should have allowed resensitization. An attractive interpretation of the data would be that they indicate a decrease in receptor sensitivity as a result of transference. Such an inter-

TABLE 3.—*Caloric Illusion Duration (Seconds)*

Left ear			Right ear		
Prerotation	Postrotation	Δ	Prerotation	Postrotation	Δ
8 rpm (steady)					
115	61	-54	51	59	8
125	41	-84	136	29	-107
106	74	-32	121	58	-63
206	84	-122	115	83	-32
144	109	-33	139	64	-75
142	46	-96	100	52	-48
82	99	17	85	99	14
69	45	-14	94	36	-58
8 rpm with $\pm 3^\circ$ perturbation at 0.1 Hz					
114	97	-17	114	65	-49
140	103	-37	156	88	-68
110	147	37	106	110	4
200	42	-138	62	35	-27
109	60	-49	181	108	-73
176	44	032	141	122	-19
49	36	-13	52	34	-18
61	21	140	94	43	-51
Control, 0 rpm (steady) (4-hr repeat)					
182	191	9	170	173	3
59	50	-9	83	112	29
189	198	9	124	116	-8
41	54	13	58	60	2
174	195	21	156	165	9
166	186	20	119	114	25

pretation would give function to the efferent nerves of the labyrinth, but other workers have not been able to demonstrate such transference (refs. 16, 19, and 20).

Table 4 presents the OGI durations; for example, what lack of extinction occurred when repeated X-axis head turns were made, 45° to the right shoulder, every 15 minutes. The OGI time was recorded for right and left motions at the beginning and again at the end of the test period. This procedure has been used to demonstrate the specificity of vestibular habituation to a given motion and the lack of transfer of habituation to nonstimulated receptors.

Using nystagmus as a criterion in addition to the subjective OGI response to head turns, Guedry et al. (refs. 18 and 19) have reported on

the lack of illusion transfer that was observed when their subjects underwent habituation by repeated right head turns in a stable environment at 7.5 rpm. At the end of their test period, a single head turn to the unpracticed left produced an OGI response in 50 of 64 trials, whereas only 12 of 64 trials (sum of turn and return) had any response at all on a turn to the right. Data from the present study were analyzed in a similar manner; however, because very few subjects had a zero OGI response after 4 hours of rotation, the duration of the illusion was considered the important criterion of habituation. The results reported here on duration of OGI are not nearly so conclusive as the cited study on nystagmus, although the distribution of responses is quite similar.

TABLE 4.—*Transfer of Habituation Illusion Duration (Seconds)*

Repeated head turns to the right (conditioned)								
	8 rpm (stable)				8 rpm ($\pm 3^\circ$ at 0.1 Hz)			
	Prerotatation		Postrotatation		Prerotatation		Postrotatation	
	C_L-R	$R-C_L$	C_L-R	$R-C_L$	C_L-R	$R-C_L$	C_L-R	$R-C_L$
\bar{x}	12.2	8.0	3.5	3.3	12.4	6.7	4.4	5.5
σ	2.7	2.8	3.1	2.7	5.4	3.9	2.9	3.4
n ¹	10	13	14	13	13	14	14	14
Total.....	20.2		6.8		20.9		9.9	
Reduction, percent.....	66				52			
Single head turn to the left (nonconditioned)								
	8 rpm (stable)				8 rpm ($\pm 3^\circ$ at 0.1 Hz)			
	Prerotatation		Postrotatation		Prerotatation		Postrotatation	
	C_L-L	$L-C_L$	C_L-L	$L-C_L$	C_L-L	$L-C_L$	C_L-L	$L-C_L$
\bar{x}	6.9	7.4	4.2	4.0	5.2	6.7	5.6	4.7
σ	3.2	3.8	3.1	2.5	5.8	3.5	3.6	2.9
n ¹	13	13	14	14	14	14	14	14
Total.....	14.3		8.2		11.9		10.3	
Reduction, percent.....	41.3				13.5			
Number of responses								
Extent of OGI response declines, ² percent	8 rpm (stable)				8 rpm ($\pm 3^\circ$ at 0.1 Hz)			
	Conditioned		Nonconditioned		Conditioned		Nonconditioned	
100-80.....	12		6		5		1	
80-60.....	6		3		5		4	
60-40.....	5		5		6		5	
40-20.....	1		3		5		2	
20-0 ³	2		11		7		16	

¹ Durations exceeding 2σ from \bar{x} were deleted.² Total of turn and return.³ Includes increases.

The transfer of habituation found in the stable rotation of the present study does not agree with that of the other authors (refs. 18, 20, and 21) and can only be explained by assuming that the unpracticed head turn was not totally isolated from the environment and that some stimulation was somehow being perceived by the supposedly dormant receptors. These stimulations must have been small as the subjects used a bite bar

to limit head motion. There is, however, a decided lack of transfer to the unpracticed side, as well as a reduced magnitude achieved by habituation in the perturbed situation. This reduction, in spite of the apparent stimulation, fits the proposed hypothesis that perturbation raises the cross-coupled threshold of the semicircular canals. The continuous perturbation, which was in the plane of the head turns, could make the

system nonresponsive to small stimuli that provided conditioning to the nonpracticed side during stable rotation.

RELEVANCE TO SPACECRAFT DESIGN

The study reported in this paper is the first attempt, to the knowledge of the author, to empirically assess the problem of instability for a spacecraft employing artificial gravity by centrifugation. The conclusions are limited by the sinusoidal nature of the perturbations which may not fully represent the space situation. Sinusoidal disturbances are sure to exist, but imposed upon these will be random motions. The sinusoidal pattern is easily anticipated by the subject—consciously or unconsciously. As such, habituation to that motion is probably facilitated. The sinusoidal perturbations used in these studies with a range of vehicle angular velocity were as severe as have been predicted by the vehicle dynamicists.

The three types of tests used represent a divergent approach that compared the pure passive motion of the subject to that of active head motions. In all cases, the anticipated decrease in performance did not materialize. On hindsight, it can be rationalized that this should have been thought of as a possible result of the constant semicircular canal stimulation due to cross-coupled acceleration produced by the product of vehicle rotation and angular perturbation. The observed insensitivity, however, may be due to more than a simple raising of the threshold of this organ.

Cross-coupled acceleration thresholds for the semicircular canal cannot be defined in the same manner as is done in pure angular acceleration. The stimulus is continually varying in vector direction even though the magnitude of the product of angular velocities is constant. During a head turn, a point in the labyrinth, as it crosses the vehicle plane of spin, has a stimulus vector reduced to zero because the cosine becomes zero in the formula $\alpha = \omega \times \omega \cos \theta$. As that point leaves the plane of spin, the vector quantity increases so there is a continually changing acceleration imposed on each of the six canals. The time that each stimulus is applied may be

very short—below that of the time constant required for stimulation. In 1960, Carl Clark (personal communications) estimated the threshold on himself for cross-coupled illusions on a centrifuge rotating at 10 rpm to be $3.6^\circ/\text{sec}^2$ due to active head turns. Recently, Newsom (ref. 22) has made a more extensive study, passively tilting immersed subjects at various centrifuge speeds. For turns of low angular velocities (6° to $10^\circ/\text{sec}$), the illusion threshold is very close to $3.6^\circ/\text{sec}^2$, but it varies with the position of the head-turn angle from the plane of spin. However, the same threshold is not reached if the centrifuge speed is reduced and the angular velocity of the head is increased because this decreases the time of stimulus for a given angle of turn, and cross-coupled accelerations of a much higher magnitude are required to reach the threshold. In the same study, exposure of subjects to Coriolis accelerations of $6^\circ/\text{sec}^2$ to $90^\circ/\text{sec}^2$ did not cause nausea or decrease performance. In figure 15, an attempt is made to illustrate the dynamics involved. The MRSSS

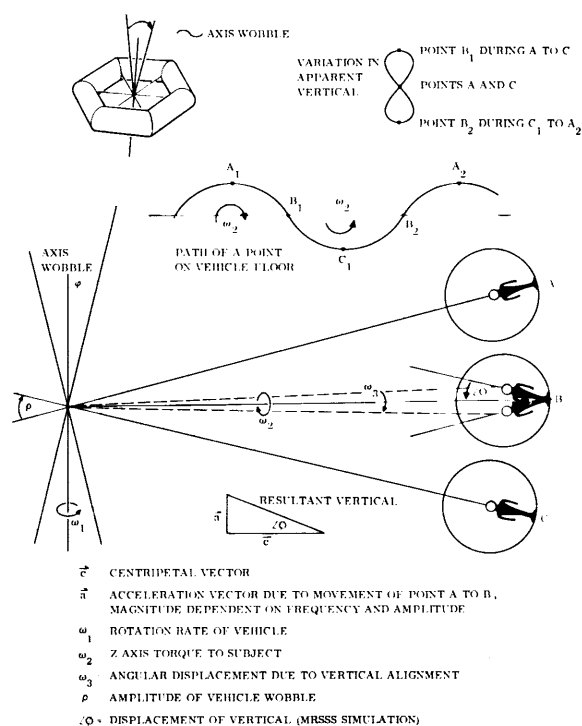

FIGURE 15.—Elements of vestibular disturbance due to vehicle wobble.

perturbation simulates the displacement of the vertical due to vehicle wobble. It does not properly simulate the cross-coupling, $\alpha = \omega_1 \times \omega_2$, where the subject is torqued about his Z -axis (ω_2) during rotation about a displaced X - or Y -axis (ω_1). A second cross-coupling, $\alpha = \omega_1 \times \omega_3$, results from vehicle rotation and the movement of the head to align the body with the changing angle θ . In the MRSSS, this reproduced but is exaggerated by not having the subject's Z -axis close to the plane of spin.

The vehicle perturbation of $\pm 3^\circ$ used in this study is in excess of the mean effective angle through which the man will be realigned in rotogravitic space stations. The man displacement is due to the acceleration-vector addition to the centrifugal vector which will be off the normal to the floor, except when the vehicle is at the peak of excursion. The magnitude of this displacement of the vertical will be determined by the cycle duration and radius of the vehicle, but it will never be that of total vehicle wobble.

This is germane because the simulator used in the reported studies used the maximum angle predicted for vehicle excursion (angle φ in the diagram) of $\pm 3^\circ$ for angle ϕ . In addition, the cross-coupling is a function of the angle from the spin plane. In space, as mentioned before, it will vary a few degrees around zero and, therefore, the cosine factor will be very small. The

simulator perturbation was $\pm 3^\circ$; when the resultant is used to establish the normal to the floor, that normal is 87.5° at 6 rpm, 68.2° at 8 rpm, and 45° at 12.2 rpm to the spin plane. This means the value by which the cross-product of angular accelerations is being multiplied varies from close to 1 to 0.7 instead of being close to zero as in the space situation. In essence, this means the cross-coupling effect of perturbation used in this study far exceeded that to which the space crews would be exposed.

Observations in the study were limited to a maximum of 4 hours, and the subjects did not move around the simulator. The results, therefore, indicate nothing about how perturbation affects habitability in the rotating environment, which should be the next factor to be investigated.

CONCLUDING REMARKS

From the results of these few tests, it appears that the sinusoidal perturbation anticipated in a rotogravity space vehicle will not unduly complicate specific task performance in a restrained subject.

It is important to extend these observations to a test lasting at least 4 days to determine if the perturbation is equally innocuous for longer periods, for then considerable instability could be allowed in the rotogravity vehicle.

REFERENCES

1. LORET, B. J.: Optimization of Space Vehicle Design With Respect to Artificial Gravity. *Aerospace Med.*, vol. 34, 1963, pp. 430-441.
2. DOLE, S. H.: Design Criteria for Rotating Space Vehicles. Rand Research Memorandum RH-2668. Rand Corp., Santa Monica, Calif., Oct. 1960.
3. KURZHALS, P. R.; ET AL.: Space-Station Dynamics and Control. A Report on the Research and Technological Problems of Manned Rotating Spacecraft. Langley Research Center, NASA TN D-1504, 1962.
4. LARSON, C. A.: Space Station Design Parameter Effects on Artificial Gravity Field. *AIAA J.*, Aug. 1964, pp. 1454-1455.
5. GRAYBIEL, A.; CLARK, B.; AND ZARRIELLO, J. J.: Observations on Human Subjects Living in a "Slow Rotation Room" for Periods of Two Days. *Arch. Neurol.*, vol. 3, 1960, pp. 55-73.
6. MAYO, A. F.: Bioengineering and Bioinstrumentation. Bioastronautics, K. E. Schaefer, ed., The Macmillan Co., 1964, pp. 227-273.
7. NEWSOM, B. D.; AND BRADY, J. F.: Observations on Subjects Exposed to Prolonged Rotation in a Space Station Simulator. The Role of the Vestibular Organs in the Exploration of Space, NASA SP-77, 1965, pp. 279-292.
8. NEWSOM, B. D.; BRADY, J. F.; SHAFER, W. A.; AND FRENCH, R. S.: Adaptation to Prolonged Exposures in the Revolving Space Station Simulator. *Aerospace Med.*, vol. 37, 1966, pp. 778-783.
9. BRADY, J. F.; AND NEWSOM, B. D.: Large Excursion Rotary Tracking of Target and Target Light in a Space Station Simulator Revolving at 7.5, 10.0 and 12.0 rpm. *Aerospace Med.*, vol. 36, 1965, pp. 333-342.
10. O'LAUGHLIN, T. W.; BRADY, J. F.; AND NEWSOM, B. D.: Reach Effectiveness in a Rotating Environment. *Aerospace Med.*, vol. 39, 1968, pp. 505-508.
11. NEWSOM, B. D.; AND BRADY, J. F.: XIV International

- Congress Aviation and Space Medicine. Prague, Czechoslovakia, 1966.
12. CORMACK, A.; AND COUGHMAN, C. C.: Considerations of Crew Comfort in Relation to the Dynamics of Rotating Space Stations. First AIAA Annual Meeting, Washington, D.C., June 29 to July 2, 1964.
 13. PARKER, J. F.; REILLY, R. E.; DILLON, R. F.; ANDREWS, T. G.; AND FLEISHMAN, E. A.: Development of Tests for Measurement of Primary Perceptual-Motor Performance. NASA CR-335 (contract NAS 9-2542), Dec. 1965.
 14. NEWSOM, B. D.; BRADY, J. F.; AND GOBLE, G. S.: Equilibrium and Walking Changes Observed at 5, 7½, 10, and 12 rpm in the Revolving Space Station Simulator. *Aerospace Med.*, vol. 36, 1965, pp. 322-326.
 15. NEWSOM, B. D.; BRADY, J. F.; AND O'LAUGHLIN, T. W.: Optokinetic Reflex Responses to Cross-Coupled Gyroscopic Stimuli. Final Report NAS 9-5232, 1968.
 16. NEWSOM, B. D.; AND BRADY, J. F.: Comparison of Performances Involving Head Rotations about Y and Z Cranial Axes in a Revolving Space Station. *Aerospace Med.*, vol. 37, 1966, pp. 1152-1157.
 17. NEWSOM, B. D.; AND BRADY, J. F.: Display Monitoring in a Rotating Environment. Third Symposium on the Role of the Vestibular Organs in Space Exploration, NASA SP-152, 1968, pp. 37-46.
 18. GUEDRY, F. E.; COLLINS, W. E.; AND GRAYBIEL, A.: Vestibular Habituation During Repetitive Complex Stimulation: A Study of Transfer Effects. *J. Appl. Physiol.*, vol. 19, 1964, pp. 1005-1115.
 19. GUEDRY, F. E.; GRAYBIEL, A.; AND COLLINS, W. E.: Reduction of Nystagmus and Disorientation in Human Subjects. *Aerospace Med.*, vol. 33, 1962, pp. 1356-1360.
 20. COLLINS, W. E.: Subjective Responses and Nystagmus Following Repeated Unilateral Caloric Stimulation. *Ann. Otol.*, vol. 74, 1965, pp. 1034-1055.
 21. MERTENS, R. A.; AND COLLINS, W. E.: Unilateral Caloric Habituation of Nystagmus in the Cat. Effects on Rotational and Bilateral Caloric Responses. *Acta Oto-Laryngol.*, vol. 64, 1967, pp. 281-297.
 22. NEWSOM, B. D.: Feasibility Study of a Centrifuge Experiment for the Apollo Applications Program. Vol. IV, NASA CR-66684, 1968.

SESSION X

***Chairman:* LAWRENCE F. DIETLEIN
Manned Spacecraft Center, NASA**



Certain Aspects of Onboard Centrifuges and Artificial Gravity

RALPH W. STONE, JR., W. M. PILAND, AND WILLIAM LETKO

NASA Langley Research Center

SUMMARY

Artificial gravity is an exceedingly complex environment within which man must work. Clearly, habituation to the environment will be required. There appears to be the potential of a physically induced ataxia tendency, a tendency to leg heaviness while walking, and numerous unnaturally induced acceleration phenomena. Design criteria for artificial gravity are presented which show a vehicle of 55 feet in diameter may meet potential criteria. Some limited data indicate, however, that smaller vehicles may be satisfactory. Onboard centrifuges, which have a relatively short radius, require much larger centrifugal forces than are anticipated for basic artificial gravity and exceed some of the tolerable limits for artificial gravity. Thus a restriction of movement on centrifuges is required.

INTRODUCTION

The influence of weightlessness on man and on his performance during extended space missions remains an enigma. The possible influences involve physiological habituation which includes effects on the cardiovascular, muscular, and skeletal systems and involve the possible inability to perform tasks effectively during extended exposure to weightlessness. It is not the purpose of this paper to examine these effects of weightlessness, but to examine certain aspects of imposing artificial gravity by rotation either of the entire vehicle or a portion of it to alleviate or eliminate these potential influences. These aspects encompass the anomalies or side effects of the environments imposed by rotating vehicles such as that of figure 1, or by onboard centrifuges such as shown in figure 2, as well as the effects of these environments on mission goals.

SYMBOLS

a acceleration, ft/sec²
 C_1 to C_8 criteria
 d distance, feet
 G gain of human balancing system

g 32.2 ft/sec² (Earth's gravitational acceleration)
 h height above floor of c.g., feet
 I man's moment of inertia, slug-ft²
 m man's mass, slugs
 M moment, ft-lb
 p pressure, lb/ft²
 r radius, feet
rpm revolutions per minute
 t time
 W weight, lb
 ρ density, slugs/ft³
 ϕ angle of tilt, radians
 ω angular velocity, radians/sec
Subscripts:
 0 initial value
 T threshold
 U unbalance
 r radial
 t tangential
 V vehicle
 R relative
 F floor
 H head
ob object

A dot over a symbol indicates its first derivative with time.

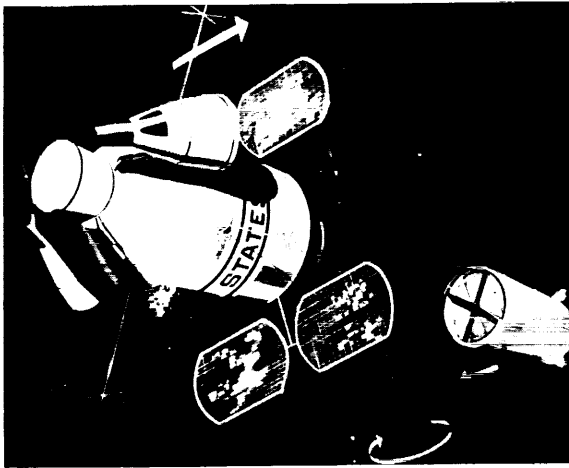

FIGURE 1. — MORL in spinning mode.

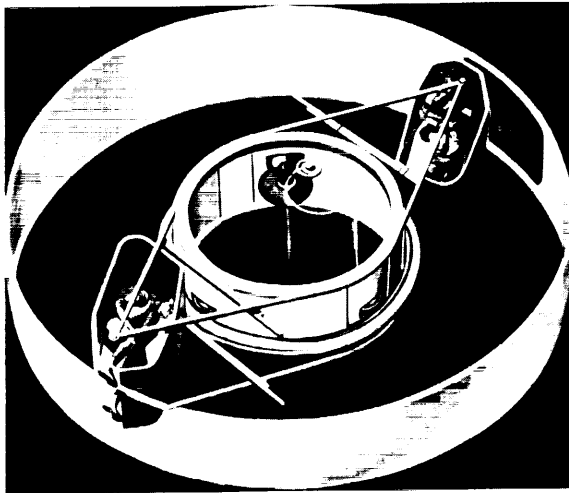

FIGURE 2. — Short-radius centrifuge concept.

THE ROTATING ENVIRONMENT

Those features of a rotating environment that cause artificial gravity to be different from real gravity are listed below. The factors listed are those that create the anomalies of concern relative to the use of artificial gravity and on-board centrifuges. We are all generally familiar with these factors and are conversant with their qualitative effects. The quantitative aspects of these factors, necessary to be known for spacecraft design, will now be considered.

Factors of Rotating Environments

- (1) Artificial gravity level
- (2) Coriolis forces
- (3) Artificial gravity gradients
- (4) Hydrostatic pressure gradients
- (5) Cross-coupled angular acceleration

Artificial Gravity Level

The fundamental purpose of artificial gravity is twofold: to eliminate or reduce the physiological adaptation to the weightless state and to allow the astronaut to function as nearly as possible as he functions in Earth gravity. The level of artificial gravity for steady exposure required for the reduction or elimination of the physiological habituation due to weightlessness is not known and remains a prime area of research. Periodic exposure to artificial gravity by use of a simulated onboard centrifuge (ref. 1) has indicated that 2 to 4 g -hours have an influence on the habituation to bed rest. The g -hours are the product of the g at the feet times the exposure time on the centrifuge. Thus one has a starting point for the therapeutic use of a centrifuge but no data regarding continuous artificial gravity. One can assume that with any value of artificial gravity less than 1 g , some habituation will occur. As noted previously, research is required to establish the degree of physiological change with g -level.

From the standpoint of allowing an astronaut to function more or less normally in artificial gravity, several factors shown on table 1 are related to the convenience with which astronauts perform within the spacecraft. No real data exist to establish desirable g -levels of any of these factors; the remarks in table 1 indicate certain aspects of relevance for each problem. The most critical problem may be that of mobility. There has been a great deal of study of walking in simulated $1/6 g$ (lunar gravity) which demonstrates that walking at $1/6 g$ seems readily possible. It should be noted that such simulations have limitations as to the freedom of the subjects, a factor that must be always considered. There is a possibility that a functional ataxia may exist, which may derive from the sensory-system limitations, particularly the threshold limits of those systems involved with balance. An elementary

TABLE 1.—*Artificial Gravity for Convenience*

Item	<i>g</i> -level	Remarks
Walking	> 1/6 < 1	Simulator studies on a firm flat surface have indicated the adequacy of 1/6 <i>g</i> . Less than this may be adequate, but insufficient data exist. Other means of mobility, as jumping, also may be desirable. Studies on Langley rotating space-vehicle simulator should examine these areas.
Placement of objects.	> 0	Assuming linearity of frictional forces with weight, objects would have identical position stability at any <i>g</i> -level, except objects on flat surfaces will tend to move to the largest radius. An object's stability when placed improperly would be identical at any <i>g</i> -level. Upsetting stability would vary linearly, however, with <i>g</i> -level decreased. Wider bases on objects may be required.
Waste collection	> 0	Natural expulsion processes with any amount of <i>g</i> -level and proper systems design should transport the material and hold it in place. Proper collector design would be required to minimize such problems as splashing which would be effected by radius and rotational rate.
Gas-liquid separation systems.	> 0	Any amount of <i>g</i> will maintain separation once it is accomplished. Sloshing from perturbations, however, will vary with <i>g</i> -level. During a separation process, the rate of separation will be a function of the <i>g</i> -level, and thus system size will be influenced by <i>g</i> -level. If all systems are designed for zero <i>g</i> , as they most likely will be, then with proper orientation any <i>g</i> -level will augment the system process. A study of the influence of <i>g</i> -level on systems seems desirable.
General convection of the settling of dust, etc.	> 0	Forced convection and filtering are common in 1- <i>g</i> systems, as in aircraft, and will certainly be used in spacecraft, especially as they will undoubtedly be designed for zero <i>g</i> . Thus, any amount of <i>g</i> will supplement the system if it is properly oriented.
Manual application of forces and moments.	> 0	The ability to push parallel to the floor would vary linearly with <i>g</i> -level, assuming linearity of frictional forces, and become nil at zero <i>g</i> . Lifting ability increases with reduced gravity. The application of torques by using one's weight will decrease with <i>g</i> -level. Proper use of the floor and other accouterments should allow manned application of forces and moments relatively unaltered by <i>g</i> -level, provided sufficient <i>g</i> exists for man to conveniently arrange himself to apply the forces.

mathematical model which examines the effects of balancing, on one foot has been developed. Three equations are used to model the situation shown in figure 3; these are

$$\phi(t) = \phi_0 \cosh \sqrt{\frac{mgh}{I}} t + \frac{\dot{\phi}_0}{\sqrt{\frac{mgh}{I}}} \sinh \sqrt{\frac{mgh}{I}} t \quad (1)$$

which applies where the angle of tilt ϕ is between zero and that value ϕ_T for which the sensory system exceeds its threshold.

$$\phi(t) = \frac{G}{G-1} \phi_T - \frac{1}{G-1} \phi_T \cos \sqrt{\frac{(G-1)mgh}{I}} t + \frac{\dot{\phi}_T}{\sqrt{\frac{(G-1)mgh}{I}}} \sin \sqrt{\frac{(G-1)mgh}{I}} t \quad (2)$$

which applies where the angle of tilt ϕ is between ϕ_T and that value ϕ_U for which the person becomes unbalanced and can recover only by stepping, and

$$\phi(t) = \phi_U \cosh \sqrt{\frac{mgh}{I}} t + \frac{\phi_U}{\sqrt{\frac{mgh}{I}}} \sinh \sqrt{\frac{mgh}{I}} t \quad (3)$$

which applies after he becomes unbalanced and until he takes a step. The factor *G* in equation (2) is the gain of the human balancing system in shifting the point of application of the floor reaction on the sole of the foot.

Figure 4 shows some preliminary results calculated for 1 *g* and 1/6 *g*, using a threshold sensitivity of 0.01 *g*. These results indicate that an individual who can retain balance, eyes closed, on one foot in Earth *g*, may not be able to do so at

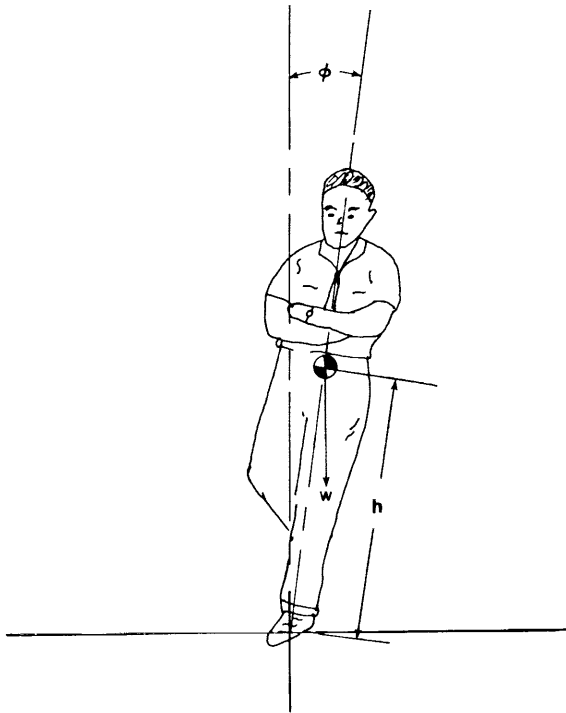

FIGURE 3.—Elements for mathematically modeling in ataxia test.

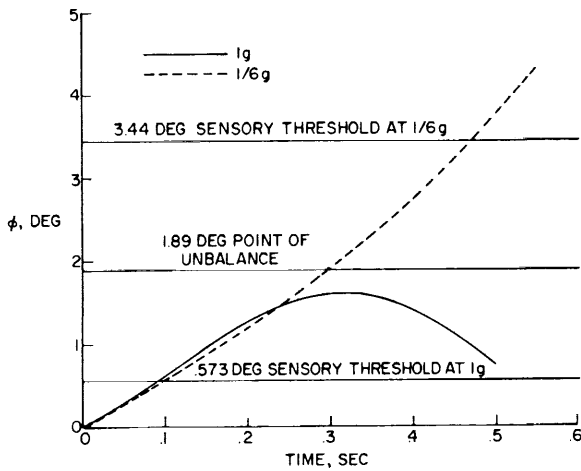

FIGURE 4.—Calculations of variations of tilt angle with time for an ataxia test in Earth and lunar gravity.

1/6 g. These results are based strictly on the physical aspects of the problem and do not consider any psychophysiological effects that may occur at reduced gravity levels. The fundamental problem from this elementary example

is that the individual becomes unbalanced before the sensory stimulus reaches the threshold value. Figure 5 shows angle of tilt required for sensory stimulus at various artificial-gravity levels and at assumed threshold values of Δg of 0.005, 0.010, and 0.015. Also shown is the angle of tilt for unbalance. These results show the potential increase in balance difficulty that may be encountered in reduced gravity.

These results may not be significant, however, as one normally will not stand in artificial gravity with his eyes closed. The stimulus to the eyes is not considered g dependent and balance with this stimulus as ordinarily used for balance on Earth by labyrinthine-defective persons may undoubtedly suffice. It is evident, however, that the situation tends not to be normal as the artificial-gravity level decreases and some adaptation and learning must occur.

Some limited studies of walking in artificial gravity on the Langley rotating space station simulator (fig. 6) have been made. In this simulation, the freedom of the subject is just in the sagittal plane, and certain aspects of reduced gravity may not be evident. Further discussion of these results is included in the next section.

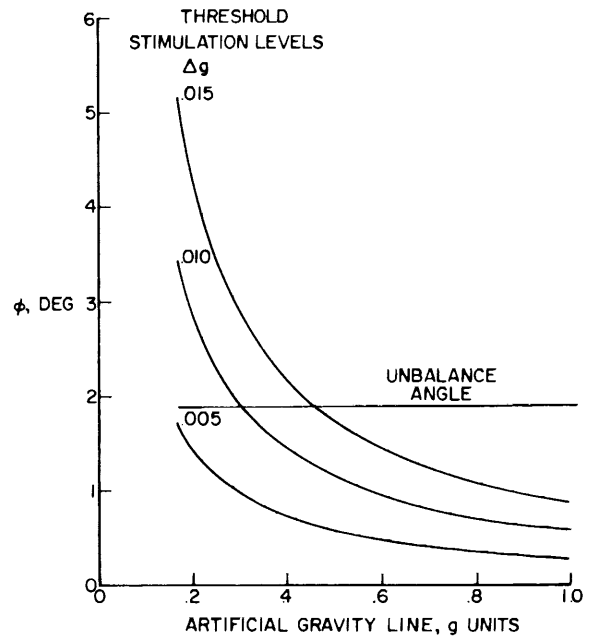

FIGURE 5.—Effect of gravity level on the angle of tilt required for threshold stimulation for an ataxia test.

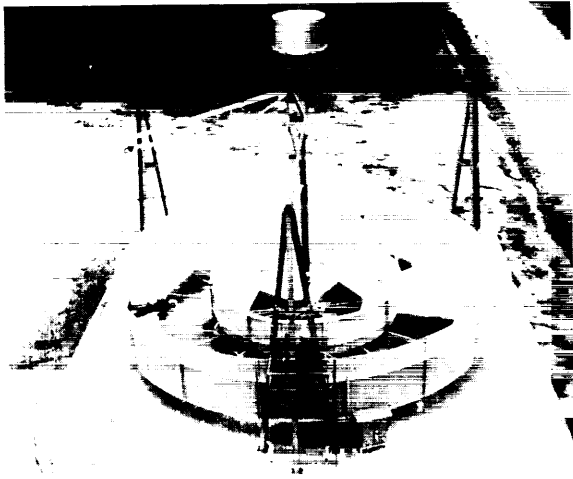

FIGURE 6.—NASA Langley rotating space station simulator.

Coriolis Forces

This section deals with those factors imposed when a linear motion within a rotating environment is attempted. These are distinguished from the effects of angular motions in a rotating environment, which are also commonly called Coriolis effects. The effects of angular motions will be discussed under the section titled "Cross-Coupled Angular Accelerations." The influences of the Coriolis forces are well known, as when someone or something moves tangentially or radially in a rotating environment, a force perpendicular to the motion relative to the rotating environment exists.

Relative to self-locomotion, the movement will primarily be on the floor either axially or tangentially. In the latter, the astronaut, because of Coriolis forces, will feel heavier or lighter depending on the direction of motion. The radial acceleration involved is

$$a_r = -r(\omega_R^2 + 2\omega_R\omega_V + \omega_V^2) \quad (4)$$

where $r\omega_V^2$ is the basic artificial gravitational force due to the vehicle rotation and $r\omega_R$ is the relative velocity due to movement in the rotating environment. The value for ω_R would be positive if motion is with the rotation and negative if against it. The tangential acceleration involved is

$$a_t = 2\dot{r}(\omega_R + \omega_V) + r\dot{\omega}_R \quad (5)$$

It would seem that with some normal velocity of locomotion, 3 or 4 ft/sec, the total effective radial force clearly should not be less than $1/6 g$, which seems to be adequate for locomotion (ref. 2) and not be more than $1 g$ to which man is normally accustomed.

The tests on the Langley rotating space station simulator (ref. 3), previously mentioned, have been performed at 0.1, 0.2, 0.3, and 0.5 artificial-gravity levels with two subjects. The subjective impressions of these conditions are listed in table 2. These results were obtained with a 20-foot radius which influences certain aspects of them. Generally, the subjects felt the floor of the simulator was closing in on them from the front for, in fact, the floor curves up in front of them. Walking at 0.2 g seemed to give good subjective results, although walking against the rotation was not so good as walking with the rotation. It is interesting to note that when walking with the rotation at 0.1 g at 3 ft/sec, the actual total effective gravity, because of the Coriolis force, was about 0.18 g , whereas walking against the rotation at 0.2 g at the same walking speed gives an effective gravity of 0.12 g . These results tend to corroborate the finding of good walking conditions at lunar g (0.167 g). The leg heaviness found at 0.3 and 0.5 g may be caused by the Coriolis forces that result from the relative leg velocity which is larger than the walking speed. As the leg is swung forward, it tends to become heavier. The maximum foot acceleration is expressed in an elementary equation as

$$a_{r_{\text{foot}}} = r\omega_V^2 + 3r\omega_V\omega_R + 2r\omega_R^2 \quad (6)$$

where it is assumed the maximum foot velocity is twice the walking speed. This is a radial force but, in addition, as the leg is raised and lowered, a tangential force also exists to complicate the picture, causing the leg to be forced forward as it is raised and backward as it is lowered.

A comparison of the accelerations on the feet as compared to the nominal artificial gravity and that of the body is shown on figure 7. At a radius of 20 feet, at which the walking tests previously discussed were performed, the foot probably weighed from $1\frac{1}{2}$ to 2 times its expected weight. At 0.6 g the maximum foot acceleration is nearly

TABLE 2.—*Subjective Results of Walking in Artificial Gravity*

Artificial gravity level, <i>g</i>	Comments	
	Walking with rotation	Walking against rotation
0.1.....	Slow initiation of walking Light on feet No leg heaviness Good walking when stepping rate is 3 ft/sec	Tend to soar or float with no control Develop large tilt to initiate
0.2.....	Good walking condition Start and stop well Legs have heavy sensation	Good walking condition Light on feet Less tilt required than for 0.1 <i>g</i>
0.3.....	Heavy legs Stable sensation Tend to walk on heels Not as comfortable as 0.2 <i>g</i>	Easier than at 0.2 <i>g</i>
0.5.....	Laborious Heavy swinging leg sensation Firm heel down steps	

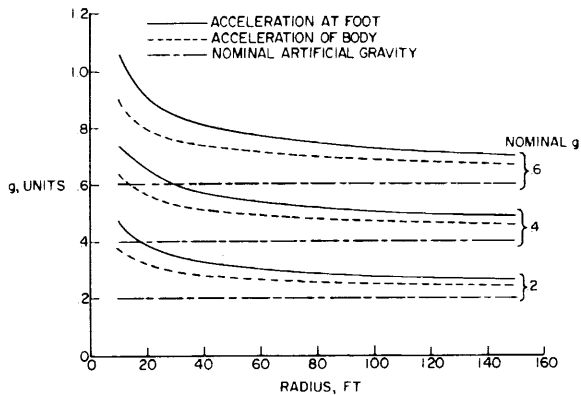

FIGURE 7.—*Acceleration of the foot compared to that of the body and the nominal artificial gravity level. Walking speed, 3 feet per second.*

that in Earth gravity. Clearly, this is greatly dependent on the radius of the vehicle; the effect demonstrated decreases markedly with increasing radius.

Further study of leg heaviness is required, not only that the foot is heavier than normal but also that it varies in weight during a step which may have a distracting effect. A mathematical model more elegant than that of equation (6) should be developed, and leg heaviness could be a significant criterion for vehicle design.

In addition to the problems of locomotion just discussed, the astronauts will experience unusual effects while moving objects within a

rotating spacecraft. Such objects are affected in accordance with equations (4) and (5), and research to determine the degree of such conditions must also be considered.

Another potentially annoying related factor is that objects when dropped will not fall where one would normally expect them to. Human tolerance or adaptation to this situation may require study. The distance that an object strikes the floor from the expected spot is expressed as

$$d = r_F \left[\frac{\sqrt{r_F^2 - r_R^2}}{r_R} - \tan^{-1} \left(\frac{\sqrt{r_F^2 - r_R^2}}{r_R} \right) \right] \quad (7)$$

where r_F is the radius of the floor (or table top) and r_R is the radius from which the object is dropped.

It should be pointed out that within the confines of an onboard centrifuge, most of the factors discussed in this section do not have application as general mobility is not possible. However, as some work tasks, such as small repair and assembly jobs and waste management, may be performed, certain aspects that relate to the handling and dropping of equipment, parts, etc., are applicable to centrifuges.

Artificial-Gravity Gradients

This is a subject that has received considerable discussion but for which there appears to be no accepted effect or applicable criteria to establish acceptable gradients. The artificial gravity

varies, of course, directly with the radius for any given vehicle. From a general standpoint, for vehicles of different radii but having the same artificial gravity at the floor, the gradient is inversely proportional to the floor radius, expressed as follows:

$$\frac{da}{dr} = \frac{a_{F_{desired}}}{r_F} \quad (8)$$

From the physical standpoint, objects would weigh more on the floor than on a shelf and from the physiological standpoint, a person would be heavier when squatting than when standing erect. The significance of these factors relative to adequate astronaut performance seems rather vague, particularly in that the maximum artificial-gravity level probably would be much less than 1 g. Figure 8 shows variations of the gravity gradients per foot of height for consideration of handling objects and per height of man when considering psychological implications. These results show that with a radius as small as 20 feet, the g-level at the head would be 70 percent of that at the feet. The significance of this difference is not clear, and the simulations previously discussed and presented on table 2 were performed at a 20-foot radius without a clear influence of this factor.

Hydrostatic-Pressure Gradients

The pressure distributions along the body,

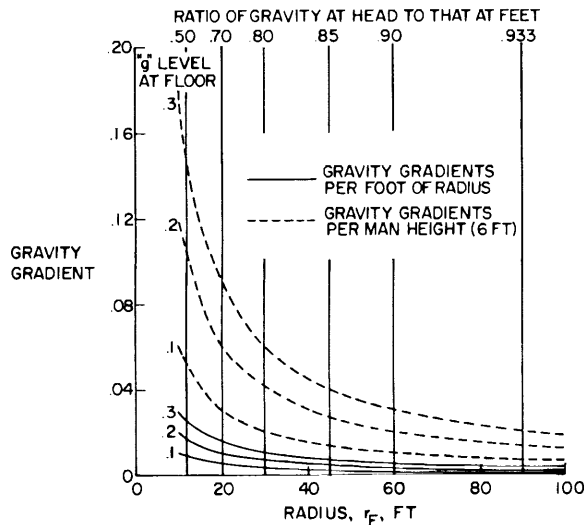

FIGURE 8.—Gravity gradients in rotating spacecraft.

particularly in the cardiovascular system, may have more physiological significance than the gravity gradients just discussed. The circulation of blood to the head and from the lower extremities is a significant element in man's well-being and is influenced by the hydrostatic pressures present. In artificial gravity these pressures vary differently from those in the Earth's gravitational fields. In Earth's gravity there is a linear variation in hydrostatic pressure in a standing man, whereas in artificial gravity the pressures vary with the squares of the radii and are expressed as

$$p = \frac{\rho}{2} (r^2 - r_H^2) \omega^2 \quad (9)$$

where ρ is the fluid density and r_H radius at the head.

The variation of the head-to-heart and the head-to-foot pressure increments with radius for various artificial-gravity levels are presented in figure 9. These results show relatively large variation of pressure with radius up to about 40 feet of radius after which the pressure (at 1 g) tends to asymptote that in Earth g. The head-to-foot pressure becomes 90 percent of that on Earth at about 30 feet of radius, whereas the head-to-heart pressure becomes 90 percent of that on Earth at about 60 feet of radius. It is not evident that these variations would have any critical

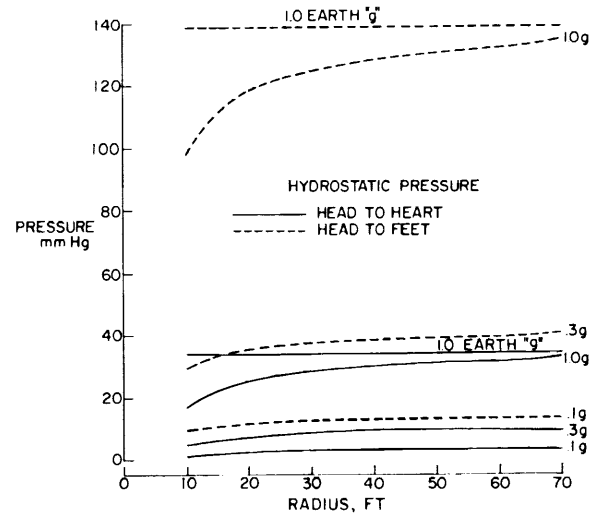

FIGURE 9.—Hydrostatic pressures in a standing man in Earth and artificial gravity.

influence on the man or his systems. It is interesting to note, however, that at a given artificial-gravity level, the shorter radii would have less influence in challenging the cardiovascular system than the larger ones.

With the onboard centrifuge, if used as a therapeutic device to challenge the cardiovascular system, as simulated in reference 1, gravity levels up to about $4g$ may be required. Because of the confinements of space, onboard centrifuges will have radii of the order of 10 feet or less. For these conditions of high g 's and short radii, concern for blackout and leg pain and petechia exists. The results of references 1 and 4, and with consideration of the data in reference 5, indicate that blackout occurs when the head-to-heart hydrostatic pressure gradient is about 134 mm Hg, and the lower leg pain and petechia of the feet occur about when the head-to-foot hydrostatic pressure is 485 mm Hg. Figure 10 presents these conditions in terms of g -boundaries for a seated man in a short-radius system. The therapeutic boundary is based on four short exposures per day with $4g$ at the feet as outlined in reference 4. Longer exposures at smaller artificial g -levels may also be adequate. Because of the characteristics of hydrostatic pressure variations shown on figure 9, and provided the hydrostatic pressure in the blood system is

the important therapeutic factor in preventing adaptation to weightlessness, lesser g at the feet probably may be adequate as the radius of rotation increases. The $4g$'s noted in references 1 and 4 may be the largest g -values required for therapeutic purposes as the centrifuge used was of minimum size.

Cross-Coupled Angular Accelerations

This area is that which has received the most concern relative to vehicles with artificial gravity. The psychophysiological aspects of cross-coupled angular acceleration, often referred to as Coriolis acceleration, were a part of the previous three Symposia on the Role of the Vestibular Organs in Space Exploration, as it is a part of the current symposium. The emphasis on this aspect of the problem of artificial gravity is well founded as it may be the most critical aspect physiologically in that the endpoint can be serious motion sickness. The basic equations for calculating the angular stimulus involved are included in reference 6. These equations are independent of radius, however, because of a possible hydraulic, mechanical, or neural interaction between the otoliths and the semicircular canals (refs. 7 and 8, for example); the entire stimulus situation may be more complex than is expressed in reference 6. Because of this complexity and the broad treatment of the subject by others, no discussion of this basic physiological problem will be made in this paper. It appears only that subjective tolerance and maintenance of performance in cross-coupled angular acceleration probably range between 1 to 4 rad/sec^2 (refs. 6 and 9, for example).

A related phenomenon also exists for astronauts in artificial gravity. When objects are rotated by the astronaut out of the plane of vehicle rotation, the astronaut must apply a moment to the object to prevent it from rotating in an unnatural and undoubtedly undesired direction. The magnitude of the angular acceleration he must impose on the object to prevent the undesired motion is directly proportional to the angular velocity he has purposefully applied to the object and the vehicle rate of rotation. The degree of difficulty is a function of the moment man can apply and the moments of

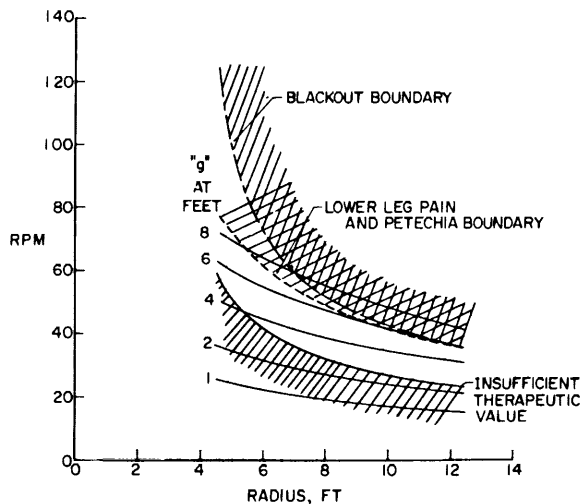

FIGURE 10.—Critical boundaries in short-radius rotating systems related to hydrostatic pressure variations. The results are for a seated man.

inertia of the object rotated. The maximum moment required may be expressed as

$$M = I_{ob} \omega_r \omega_{ob} \quad (10)$$

which certainly must not exceed and, desirably, should be appreciably less than the moment he could apply

$$M = I_{ob} \dot{\omega}_{ob} \quad (11)$$

clearly then

$$\omega_r \leq \frac{\dot{\omega}_{ob}}{\omega_{ob}} \quad (12)$$

where this ratio is approximately equal to the cyclic frequency of the motion applied to the object, assuming one starts and stops the object in the desired motions. Differences in moments of inertia about the axis of the initiated motion and the axis of the cross-coupled acceleration complicate this simple analysis.

THE INFLUENCE OF ARTIFICIAL GRAVITY ON MISSION GOALS

In examination of the influence that artificial gravity may have on the mission goals of space vehicles, let us first examine two configurations: one representative of a simple vehicle and the other representative of a complex vehicle.

The first configuration that will be discussed is the MORL in its spinning mode (fig. 1). Here, the basic laboratory is separated from the SIV-B launch stage by a system of cables, and with the SIV-B stage acting as a counterweight, the entire configuration is rotated to achieve the desired gravity field within the laboratory. As an example, at a radius of 70 feet from the common center of mass of the spinning configuration to the outer floor of the laboratory, a gravity level of 0.333 g can be achieved by rotating the deployed system at 4 rpm (ref. 10).

The inclusion of this spin capability in the basic zero-gravity MORL has considerable effect on the laboratory design. The major impact is the increase in weight of the structure, reaction control, and flight electronic systems to accommodate this additional operating mode. The total changes in dry launch weight of the laboratory/SIV-B combination amount to 3400 pounds and require about 600 pounds of additional propellant to circularize the orbit from an

initial elliptical orbit. Therefore, the impact of the spin capability on the initial launch of the laboratory involves a decrease in discretionary payload capability of approximately 4000 pounds. Fewer consumables, experiments, etc., can thus be carried on the initial launch, and more severe demands are placed on the subsequent logistics schedules.

In addition to the initial launch penalties, the spin capability includes a major increase in reaction control propellant consumption rate. Increased drag and moments of inertia, deployment, and spinup requirements all increase the orbital propellant requirements. For the MORL in the spinning mode, the orbit-keeping requirements are increased by about 200 pounds of propellant per month, and the attitude control expenditures are raised by almost 400 pounds per month. These increases in overall propellant consumption are approximately 80 percent over the basic zero-gravity configuration.

Other than the impacts on system design, there are also other factors which must be considered. One such factor was investigated in the MORL studies for which a typical preliminary experiment program for the mission was selected (ref. 11). The experiment program formulated covered all the major scientific/technical disciplines. As illustrated in figure 11, 40 percent of the total 157 experiments would demand almost absolute zero gravity, 43 percent would require a significant increase in design complexity for artificial-gravity performance, 16 percent would be gravity independent, and only 1 percent would actually require some level of

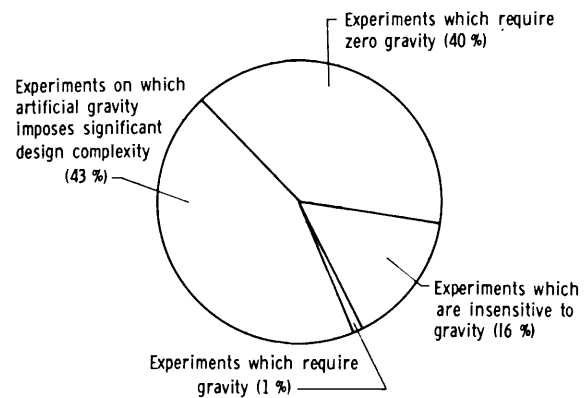

FIGURE 11.—Typical Earth-orbital experiment program.

gravity. Since the primary purpose of most future space missions will be the performance of a meaningful experiment program, perhaps the experiment program itself will be the dominating factor in the decision of "to g or not to g ."

A possible method of providing a continuous gravity force for the crew as well as satisfying the experimental requirements is illustrated in the second rotating spacecraft concept. A proposed, large, rotating, manned orbital space-station configuration is shown in figure 12. There are other concepts, but generally each is basically a 24-man station, rotating to provide artificial gravity at the operational floor levels. Zero-gravity-dependent experiments could be provided for in the counterrotating hub where the gravity level goes to zero.

For these larger rotating vehicles, there are similar, but more complex, problems than those associated with the MORL spinning mode. Besides a tremendous launch weight, the aerodynamic and gravity gradient torques and the orbit-keeping requirements will involve very high propellant consumption rates, although a lesser number of spin/despin operations will be involved since docking would be accomplished at the zero-gravity hub. Although these are highly complicated vehicles requiring subsystems of increased complexity to support the mission, there may be a requirement for such vehicles in the future. It is, however, difficult to justify the initiation of any space mission using such an elaborate vehicle without first thoroughly establishing and understanding the true requirements for artificial gravity.

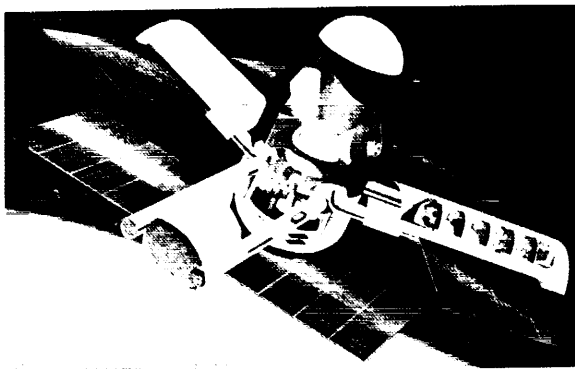

FIGURE 12.—Large rotating space station. Three-radial module configuration.

An onboard centrifuge also imposes on the mission capability of a spacecraft. The basic added weight could range from about 300 pounds to 3000 pounds, depending on the intent of the device. The mere application of acceleration for therapeutic purposes would require the lesser weight, whereas developing a centrifuge with an experimental capability of measuring vestibular responses, sensitivities and thresholds, cardiovascular reactions, performance, reentry proficiency, etc., as was proposed in reference 12, would require the greater weight.

Another significant factor is that the astronaut time directly associated with artificial gravity or the onboard centrifuge results in a direct reduction in time available to perform experiments or operate the vehicle. Basically, artificial gravity requires no specific astronaut time except that, for experiments requiring weightlessness, the system must be despun or the astronaut must transfer to the weightless portion of the vehicle. A centrifuge being used for therapeutic purposes requires from 4 to 6 man-hours per day for riding and monitoring the centrifuge, which time is lost from other activity.

DESIGN CRITERIA FOR ARTIFICIAL GRAVITY

Based on the previous discussion of the rotating environment, eight preliminary criteria for the design of space vehicles with artificial gravity have been developed. These criteria include upper and lower limits of gravity levels, maximum tolerable rates of rotation, rotational radius, percentage change in gravity gradient, and the degree of Coriolis acceleration tolerable and cross-coupled angular acceleration. It must be first noted that the minimum amount of artificial gravity to maintain good physiological tone and to prevent or allay the reconditioning that may occur in weightlessness is not known. These criteria are designated as C_1 through C_8 . Figure 13 is a plot of radius of rotation versus rate of rotation for artificial gravity and indicates the influence of the sundry criteria on potential design values. These criteria incorporated in figure 13 form a design envelope illustrating limits that might be imposed on an artificial

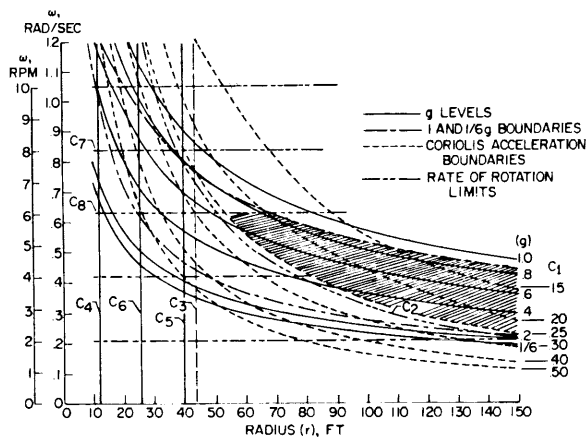

FIGURE 13.—Design envelope for manned rotating space vehicles.

gravity vehicle design. The criteria presented are not as completely supported by experimental evidence as desired. However, if conservative selections are made, an arbitrary rotating vehicle can be defined and an estimation of its practicality can be made. The mathematical expressions used to establish curves on figure 13 are listed on table 3. From the figure, the maximum tolerable rate of rotation seems to be the most critical and restrictive criterion. The next most significant criterion is the amount of Coriolis force that is tolerable. These two criteria generally will set both the rotational rate and radius of the vehicle, since the amount of Coriolis acceleration to be experienced varies with spin rate and radius. From experimental observation, the other criteria would allow vehicles of smaller radii and higher rates of rotation than those just discussed.

The maximum tolerable rate of rotation, as noted previously, has been the subject of extensive research. Generally, a value of about 4 rpm has been suggested as safe, although values of 10 rpm have been tolerated during many tests. It is believed that a relatively conservative value would be about 6 or 7 rpm. A value of 6 rpm more than halves the radius required at 4 rpm. Additional research and flight experiments will be required to establish the actual value to be used.

Relative to the Coriolis force that may be tolerated, the results previously discussed indicate that rather large values of this ratio (C_1) of the

TABLE 3.—Expressions for Criteria for the Selection of Vehicle Radius and Rate of Rotation for Artificial Gravity

Criteria	Mathematical bases
1.....	$(1 + C_1)r_F\omega^2 \geq \frac{16}{r_F} \pm 8\omega_V + r_F\omega^2 \geq (1 - C_1)r_F\omega^2$
2.....	$\frac{2V_R}{r_F\omega_V} \leq C_2$
3.....	$r_F \left(\frac{\sqrt{r_F^2 - r^2}}{r} - \tan^{-1} \frac{\sqrt{r_F^2 - r^2}}{r} \right) \leq C_3$
4.....	$\left(\frac{r_F - r}{r_F} \right) \leq C_1$
5.....	$\left(\frac{r_F - r_H}{r_F} \right) \leq C_5$
6.....	$\left(\frac{r_{heart} + r_H}{r_F + r_H} \right) \geq C_6$
7.....	$\omega_V \frac{\omega_{ob}}{\omega_b} \leq C_7$
8.....	$\omega_V \leq C_8$

order of 0.5 seemed to be readily tolerated provided the basic g -level is about 0.2 g or more.

In figure 13, the value of C_1 represents the tolerable percentage increase or decrease of man's artificial weight as he moves at 4 ft/sec within the vehicle. The correct value of C_1 must be established by experiment, but in figure 13 a graphical representation of values of C_1 from 15 percent to 50 percent are shown.

C_2 represents the percentage weight change in an object when moved. C_2 was selected as 25 percent when the object's velocity is 4 ft/sec.

The value of C_3 is the distance from the local vertical which an object falls to when dropped. C_3 was selected as 1 foot for objects dropped from 3 feet above the floor. This indicates that at a radius greater than 44 feet, such an object will strike the floor not more than 1 foot from where it was expected to fall.

The value of C_4 is the ratio of the weight of an object on the shelf to its weight on the floor. The value of C_4 was chosen as 0.5 for a height above the floor of 6 feet, indicating that an object

so positioned will weigh not less than one-half its artificial weight on the floor. Figure 13 shows that this condition will be satisfied at radii of rotation greater than 12 feet.

C_5 is the criterion for the gravity gradient limit which would be comfortable for man in the rotating environment. For the purpose of figure 13, C_5 was selected as 0.15, indicating that the centrifugal acceleration at the head will not be less than 85 percent of the value at the feet. This condition is satisfied at radii greater than 40 feet for a 6-foot individual. It should be noted that this value is not substantiated by data and that larger values may be readily tolerated.

C_6 is the ratio of fluid pressure at the heart level to that at the foot level. It was selected to be at least 90 percent of the same ratio when in the Earth environment. It is further assumed that the heart is 4.5 feet above the floor level. The ratio equals 90 percent at a vehicle radius of 26 feet and becomes more like the Earth's environment at radii greater than 26 feet. As before, this value of 90 percent is not substantiated.

For the cross-coupled angular acceleration experienced when a man rotates an object, the value of C_7 was selected as 0.50. This indicates that the cross-coupled acceleration will not exceed 50 percent of the angular acceleration that the man can impose on the object. It was assumed that a man can impose a maximum angular acceleration to angular velocity ratio of

16 per second. Eight rpm is the upper limit at which this condition is satisfied.

The maximum rate of steady rotation tolerable to man was taken to be 6 rpm (C_8). However, in figure 13, several values are shown for completeness.

The crosshatched area in figure 13 is bound by an assumed value of Coriolis-force ratio of 0.25 ($C_1=0.25$), a maximum rate of rotation of 6 rpm ($C_8=6$), and an acceleration not exceeding 1 g when moving about the vehicle. This design envelope allows a minimum radius of about 55 feet.

If the artificial-gravity level selected falls within the design envelope of figure 13, the environment produced will satisfy the requirements of walking, performance of everyday tasks (table 1) and, in addition, will simplify some of the mechanical systems designs needed aboard the space vehicle.

The crosshatched area as noted is based on a value of Coriolis-force ratio (C_1) of 0.25. In the walking experiment previously discussed herein, values of Coriolis-force ratio of the order of 0.5 appeared tolerable. With this value, radii of less than 30 feet would be possible. The foot-heaviness problem discussed previously is not considered on figure 13, although it will be experienced generally in the crosshatched area. Further experiments to establish a tolerable level of foot heaviness seem necessary.

REFERENCES

1. NYBERG, J. W.; ET AL.: Modification of the Effects of Recumbency Upon Physiological Functions by Periodic Centrifugation. Presented at the Aerospace Medical Association Meeting, Las Vegas, Nev., Apr. 1966.
2. HEWES, D. E.; AND SPADY, A. A., JR.: Evaluation of a Gravity Simulation Technique for Studies of Man's Self-Loocomotion in the Lunar Environment. NASA TN D-2176, 1964.
3. HEWES, D. E.; AND SPADY, A. A., JR.: Status Report on Recent Langley Studies of Lunar and Space Station Self-Loocomotion. Presented at the AGARD 24th Aerospace Medical Panel Meeting, Brussels, Belgium, Oct. 24-27, 1967.
4. WHITE, W. J.; ET AL.: Biomedical Potential of a Centrifuge in an Orbiting Laboratory. Prepared under Air Force contract no. AF04(695)-679 by Douglas Aircraft Co., Inc., July 1965.
5. Bioastronautics Data Book. (Paul Webb, ed.) NASA SP-3006, 1964.
6. STONE, RALPH W., JR.; AND LETKO, WILLIAM: Some Observations on the Stimulation of the Vestibular System of Man in a Rotating Environment. The Role of the Vestibular Organs in the Exploration of Space, NASA SP-77, 1965, pp. 263-278.
7. BENSON, A. J.; AND BODIN, M. A.: Interaction of Linear and Angular Accelerations on Vestibular Receptor in Man. Aerospace Med., vol. 37, 1966, pp. 144-154.
8. GUEDRY, FRED E., JR.: Orientation of the Rotation-Axis Relative to Gravity. Its Influence on Nystagmus and the Sensation of Rotation. Acta Oto-Laryngol., vol. 60, 1965, pp. 30-49.
9. NEWSOM, B. D.; AND BRADY, J. F.: A Comparison of Performance Involving Head Rotation About Y and Z Cranial Axes in a Revolving Space Station Simulator.

- Aerospace Med., vol. 37, 1966, pp. 1152-1157.
10. DOUGLAS AIRCRAFT CO., INC.: Report on the Optimization of the Manned Orbital Research Laboratory (MORL) System Concept. Vol. XIII, Laboratory Mechanical Systems—Artificial Gravity Systems, prepared under NASA contract no. NAS1-3612, Sept. 1964.
 11. DOUGLAS AIRCRAFT CO., INC.: Report on the Development of the Manned Orbital Research Laboratory (MORL) System Utilization Potential. Final report prepared under NASA contract no. NAS1-3612, Jan. 1966.
 12. STONE, RALPH W., JR.; LETKO, WILLIAM; AND HOOK, W. RAY: Examination of a Possible Flight Experiment To Evaluate an Onboard Centrifuge as a Therapeutic Device. Second Symposium on the Role of the Vestibular Organs in Space Exploration, NASA SP-115, 1966, pp. 245-256.

DISCUSSION

Dietlein: One of the final common pathways of basic neurophysiological research in the vestibular area relates intimately to applied investigative efforts which ultimately influence greatly and sometimes dictate optimal spacecraft design. Such efforts are destined to assume an increasingly important and even critical role in this country's future long-term space flights, inasmuch as the present consensus, at the Manned Spacecraft Center at least, holds that some form of artificial g must be provided to space stations or space-station-like vehicles. The reason for this position is simply to facilitate the simple day-to-day chores of work and habitation, to obviate the need for painstaking relearning of even the most pedestrian of activities and maneuvers, and to add immeasurably to crew effectiveness in increasing their work capacity in space. Mr. Stone's presentation dealt with those advantages and problems of providing artificial gravity and/or centrifugal devices in space stations.

Graybiel: Dr. Jones left for Washington at noontime, and just before he left he asked me if I would open up the discussion on Ralph Stone's paper and point out some of the things that seem to me to be worth doing using an onboard centrifuge. By way of introduction, let me say that when I was talking with Ralph early on about his presentation, I was particularly desirous that he include the figure shown in his next to the last slide. This nomogram contains a great deal of information, and I am going to ask permission to use it as soon as it is published.

There are a few things which I might call to your attention, and they are meant to supplement the material Ralph has just presented. The important question from the biomedical point of view is, What are the operational problems which must be solved in planning for manned space flights measured in years? More specifically, what are the effects of exposure in a weightless spacecraft for this period? With regard to health hazards, the President's Science Advisory Committee has called attention to the need to look for subtle alterations in addition to the manifestations with which we are already familiar as a consequence of short exposure in weightlessness. These subtle effects which might be revealed at the cellular, subcellular, and molecular levels could not be investigated extensively on man for obvious reasons and would require the use of animal subjects. Currently, Dr. Jones is supporting preparatory studies with the object of sending unattended rhesus monkeys into orbital flight for long periods of time. The chief object of interest would be extensive biopsy and postmortem studies which might reveal the effects of chronic exposure to weightlessness

not manifested in clinical studies and laboratory determinations. This initial probe, which could be conducted sometime soon, might be extended later on by the use of rotating capsules to generate different subgravity levels and, indeed, by conducting studies aloft when animal facilities are established in manned orbiting laboratories.

The onboard centrifuge used as a countermeasure would solve the problem of health hazards due to weightlessness, and its contribution to habitability of the spacecraft would depend a great deal on its size and appointments. An onboard centrifuge would be extremely helpful in defining the benefits of different subgravity levels, not only in preventing loss of fitness but also in restoring fitness once it is lost. It would have value in determining postural stability while standing, as a function of the level of artificial gravity (in a rotating spacecraft), but would have limited value in determining stability under the same conditions while walking, due to inability to simulate the force environment in a rotating spacecraft.

The worrisome problem of fitness for reentry after prolonged exposure aloft could be handled not only by using the centrifuge as a therapeutic device but also by using it to simulate the g -profile on reentry.

From the scientific side, the opportunity to investigate physiological and behavioral effects as a function of g -levels ranging from weightlessness, at the one extreme, to supergravity levels, at the other, would contribute enormously to our knowledge. In my opinion, one of the biggest opportunities is to determine the role of the tonic otolithic activity resulting from the stimulus due to gravitational force and the role of the resting activity of the sensory receptors in both the otolith organs and the semicircular canals.

This raises the question as to the exact role of the resting discharge of the semicircular canals under natural terrestrial conditions. Is this role simply to preserve the functional integrity of the canalicular system? With motions of the head they function as angular accelerometers, but with head fixed in what way do they contribute to our well-being?

The situation is very different in the case of the otolith organs. Like the canals, they also act as accelerometers responding to linear accelerations. In addition, it is generally agreed that change in position of the head in the gravitational field constitutes adequate and purposeful stimulus. I would like to add that we have demonstrated persistence of behavioral responses when the head is fixed either in the gravitational or in a gravitoinertial field. Dr. Miller has had some persons tilted for several hours during which time he made

repeated measurements of the amount of counterroll of the eyes. There was only a little falloff in the magnitude of this effect, indicating little in the way of adaptation. The magnitude of the roll is a function of subgravity and supragravity load under otherwise static conditions. In an experiment conducted with Dr. Clark, subjects demonstrated little change in the settings of the oculogravic illusion over periods of 2 to 3 hours. In this experiment subjects were exposed to a change in the gravito-inertial vertical with respect to themselves while observing a dim line of light in the dark. When the change of the vector is in the frontal plane, the line appears to rotate, and its new position accords with the change in this vector.

In short, it appears that with head fixed in the gravitational or in a gravito-inertial field, receptors are continually stimulated by a gravitational or gravito-inertial force. Only when these are lifted, as in weightlessness, will the true resting discharge of the otolith organs become manifest. I believe a major scientific opportunity awaits investigators in an orbiting laboratory studying vestibular problems. Such studies and many others as well will require the advantage of varying the g -loading such as might be accomplished with an onboard centrifuge.

Newsom: I should like to make a comment on Dr. Graybiel's presentation. It appears as if the thing to do is to put up an artificial-gravity station and then have the centrifuge spin in the opposite direction so the level can be decreased from one instead of increased from zero up. I think this was one of Dr. Graybiel's suggestions when I last visited Pensacola. This is a very interesting concept and one I have given a great deal of attention to. It is interesting that the only way this can be done, however, is for the centrifuge to have a common axis as that of the spinning space station; otherwise cross-coupled accelerations are produced and not pure angular accelerations. But the concept itself is certainly a very good one, and one I know that is going to be pursued. I am wondering if it is correct to base our criteria for angular velocity and g on a physiological requirement at this time. We know practically nothing about that, but there are other things we do know about. What I am thinking of is the advantages of an artificial-gravity system for the mechanical system, such as life support and general habitability. Cooling of components in zero- g is a problem. With an artificial-gravity station one then has convective cooling. Fine particle control and water separation can be studied. We should be able to get some of these values from a theoretical basis. These might help us to decide what the level of artificial g should be.

Another very important factor for some life-support systems is the behavior of fine particles. Some of these types of things we might learn a little more about from some of the work that is planned in the Apollo Applications Program. So these physical factors might be used to define a g -level with a higher level of confidence than what is now being proposed for the physiological systems. Perhaps a group such as ours should also be thinking about these other problems associated with rotating systems and then see how they might affect the vestibular organs.

Lowenstein: Dr. Graybiel, we must not forget that the resting discharge both in the semicircular canals and in the

otolith organs is gravity independent; it is metabolic. Therefore, I would not envisage any large-scale disappearance of the resting discharge under weightlessness. So the otolith weight is immaterial. In fact, experiments have been carried out, I cannot quote the reference out of hand, where otolith membranes have been centrifuged off without concomitant tonus loss. You ask what is the significance of the resting discharge in the semicircular canals. They are highly important tonus pumps as well. You can eliminate a single semicircular canal and get lasting tonus asymmetries in a state of rest.

Graybiel: You still have not answered the questions I raised regarding the changes in behavioral responses as a function of g -loading primarily on the otolith organs. Their nature and accuracy imply statotonic reflex activity which has no counterpart in the case of the canals.

Lowenstein: Yes. In such a situation, of course, the otolith organs are more efficient.

Graybiel: Then there must be some increase or decrease in firing as a function of g -loading.

Lowenstein: In the stationary individual.

Graybiel: That is really my point. We all agree the otolith organs act as accelerometers. The point is, do they also have a tonic output related to g -loading?

Lowenstein: Yes. That depends on the spatial position of the individual. Take the utricle; when it lies at 90° to the gravitational pull, I would not anticipate very great changes. But if the individual in his resting position is in fact slanted, and when then weightlessness or additional gravitation exerts its influence on the shearing element in the otolith organ, then you get your effect.

Graybiel: Dr. Miller and I have varied g -loading without varying the direction of g , and these effects are still there.

Lowenstein: In a position with the utricle at 90° ?

Graybiel: We were able to manipulate independently the magnitude and direction of the gravito-inertial force vector on a human centrifuge by controlling the position of an otherwise free-swinging gondola on its trunnions. By this means we demonstrated behavioral changes which could be varied as functions of magnitude or direction of the force vector.

Lowenstein: I think, as Alice in Wonderland, I would like to see this all on paper. One should then discuss it at length.

Waite: I have seen several reports, indeed numerous proposals, in the last several years, primarily from the engineering side of NASA, which have proposed changing the g -level and angular velocity of a rotating vehicle many times in a 2- or 3-day-long mission. In my opinion this is putting us in a position of changing the stimulus before any kind of adaptive response has had time to fully complete itself. I would like to ask Dr. Graybiel if he would care to suggest a minimum duration during which g and angular velocity should be maintained constant before changing them, assuming our goal is to discover the full effect of rotation in space on one's physiology for purposes of extrapolation to longer duration missions and not merely the mission at hand.

Newsom: The work that I presented at the first symposium and that which Dr. Graybiel presented here at this meeting offer a nice solution to that. A stepwise increase in angular velocity allows your engineers to study incremental increases

in g , and permits adaptation. This appears to me the way to satisfy both the engineer and physiologist.

Waite: For how long do you maintain a g -level or an angular velocity before you can be assured that you are not contaminating that level's physiological responses with the new level that you are imposing? How long does it take for adaptation to take place or to reach asymptote, if I can speak of a general physiological adaptive asymptote in this environment?

Graybiel: This is a difficult question to answer without knowing more about the initial symptoms experienced as a result of moving the head or walking about at a particular angular velocity. If the Coriolis illusion and nystagmus are present, the former will usually be the first to go during the process of adaptation. Mild symptoms of motion sickness usually disappear soon unless head movements are restricted.

Postural equilibrium is regained as a consequence of walking and there is abolition of vestibular symptoms on moving the head. After all overt symptoms have largely disappeared, a further period of hours at least or even a day may be necessary before all homeostatic adjustments have been made.

Money: I would like to suggest that although there is good reason to believe that astronauts could adjust to rotation especially if the spacecraft were increased in its rotational speed stepwise as Dr. Graybiel has just shown, successful adjustment is not a certainty. Before such a rotating spacecraft is sent away for a period of 2 years or something like that, it would be really important to have first a rotating spacecraft orbiting the Earth in a position to come back right away to be sure that these people can adapt before sending them away.

Graybiel: That is in the cards. They thought of that.



Walking in Simulated Lunar Gravity

WILLIAM LETKO AND AMOS A. SPADY, JR.

Langley Research Center, NASA

SUMMARY

Experience in aircraft and in ground-based simulators indicates that man will be able to walk in lunar gravity with no apparent difficulty. The metabolic measurements reported herein indicate that the energy cost of locomotion in simulated lunar gravity is considerably less than in 1 *g*, as was found in earlier studies. The simulation technique used was unimportant for level walking, but generally had a large effect on the metabolic data obtained while ascending grades. Increases in the loads carried generally had a relatively small and inconsistent effect on metabolic costs. Changing the walking surface from a hard, smooth surface to one of sandy soil caused a large increase in the metabolic rate at the higher locomotion rate.

INTRODUCTION

Man is destined to play an increasingly important and varied role in extraterrestrial activities, and for this reason his capabilities and requirements will have to be established to assure mission success. The need for adequate knowledge of man's capabilities was dramatically demonstrated by the Gemini flights. The severe energy demands of the attempted extravehicular activities were unexpected and resulted in a curtailment of the activities. Earth simulation of the Gemini mission provided a solution to the early problems and resulted in successful extravehicular activities in later flights. So, too, Earth simulations must be depended upon to evaluate the demands of man's other anticipated space activities.

One of the activities being studied by simulation is man's locomotive capability and the energy expenditure of self-locomotion in reduced gravity. Some studies of man's ability to walk in reduced gravity from 0.10 to 1.0 *g* have been studied in aircraft (refs. 1 and 2) and in ground-based simulators (ref. 3), for example.

The imminence of the lunar mission has focused attention on man's capabilities in lunar gravity. A comprehensive study of locomotion

in lunar gravity is being carried out, therefore, by Garrett AiResearch Corp. under contract with the NASA Langley Research Center. The inclined-plane simulation technique developed at Langley and the gimbal-vertical simulator of AiResearch are being used to simulate lunar gravity. In the study, man's locomotion characteristics and the metabolic cost of walking, running, and loping at velocities ranging from 2 to 12.8 km/hr are being determined. The effects of walkway-surface composition and grade, as well as effects of load carried, on the energy cost of locomotion have been determined for subjects wearing pressurized Gemini-4C suits.

This paper reviews some of the results of the study.

SIMULATION TECHNIQUES

A number of simulation techniques, such as parabolic flight in aircraft, water immersion, the inclined-plane and gimbal-vertical suspension simulators, have been used to simulate reduced-gravity conditions. Each type of simulation has certain features and limitations which dictate its use for some types of activities and preclude its use for others.

The inclined-plane and gimbal-vertical suspen-

sion simulators, used with a treadmill, have been found to be the most practical for the measurements of steady-state energy expenditure during walking, running, and loping in lunar gravity. The inclined-plane simulator (fig. 1) was developed at Langley and is reported on in reference 4. The subject is supported on his side by a series of cables attached to an overhead trolley and monorail system. The monorail runs parallel with an inclined walkway upon which the subject can walk, run, and otherwise perform. The walkway is displaced from beneath the monorail so that the subject's long-body axis is inclined 9.6° from the horizontal, thus resulting in $1/6 g$ on the subject's feet. This suspension system, of course, restricts the subject's movements essentially to a single plane. This restriction does not appear to be serious, however. Subjects who have experienced $1/6 g$ walking both in aircraft with six degrees of freedom and in the inclined-plane simulator with three degrees of freedom have felt that the simulations are nearly identical.

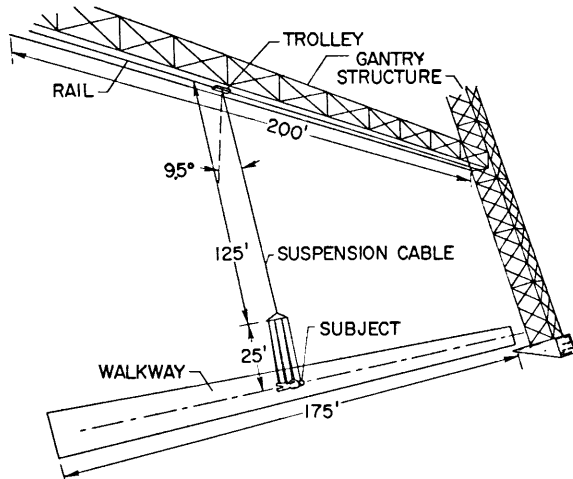

FIGURE 1.—The inclined-plane reduced-gravity simulator.

The gimbal-vertical suspension simulator, as the name implies, supports the subject in an upright position (fig. 2), in contrast to the inclined-plane simulator. A stalled turbine starter is used to support five-sixths of the subject's weight for lunar- g simulation. The dynamic characteristics of this system were such that the simulation was degraded, especially

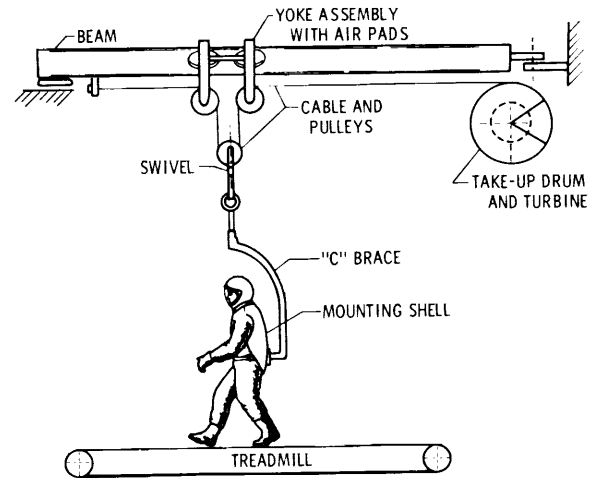

FIGURE 2.—The gimbal-vertical suspension simulator.

for large up-and-down motions. For walking and running on the level, the vertical motions are relatively small and the simulation was not seriously affected. An important feature of the vertical simulator is that its configuration makes it readily adaptable for tests with a depositable soil surface.

REDUCED-GRAVITY WALKING

Both aircraft studies and ground-based simulations have indicated that man is capable of locomotion at g -levels as low as $0.10 g$ with no apparent difficulties. Aircraft, of course, provide the proper g -level for the total human organism, including the vestibular system, which cannot be achieved in Earth simulators. However, its use is limited because the g -level can be maintained only for a very short time. As has been mentioned, experience in aircraft and that in ground-based, inclined-plane, $1/6-g$ simulation are subjectively very similar.

Some vertical floor-reaction forces generated by one foot during walking in reduced g in an aircraft (ref. 2) and in a rotating-vehicle simulator (fig. 3) are compared in figure 4. In the rotating-vehicle simulator, a cable suspension system similar to that of the inclined-plane simulator was used. Figure 4 presents the ratio of the floor reaction force to the subject's Earth weight plotted against foot contact time. The data are presented for g -levels of about 0.17, 0.44, and 1.0.

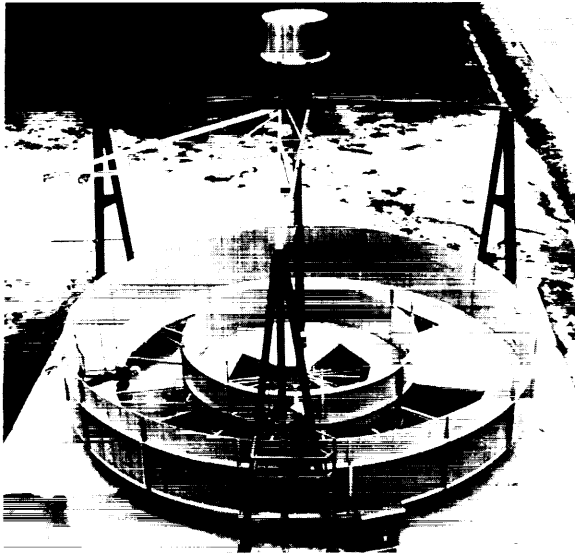

FIGURE 3.—NASA-Langley rotating space station simulator.

The figure shows that, generally, similar changes occur in the floor-reaction patterns with reduction in *g*-level for walking at low speeds in the aircraft and in the ground-based simulator. It should be pointed out that the walking speed was not closely controlled in these investigations, and for the data presented it varied from about 3 to 4 ft/sec. The data are presented to indicate general trends, and additional floor-reaction data, such as fore-and-aft shear and lateral shear, need to be compared for a more complete comparison of aircraft and ground-based simulator walking. These data were not available for the ground-based simulator.

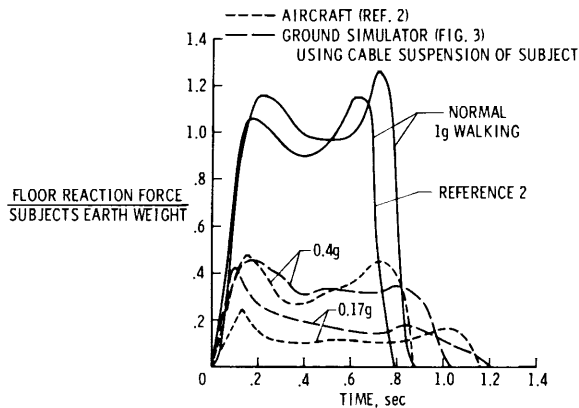

FIGURE 4.—Vertical floor-reaction force patterns for a single foot, low-speed walking.

ENERGY EXPENDITURE

As has been pointed out, the imminence of the lunar missions has resulted in an emphasis on the evaluation of walking in lunar *g*, especially the examination of the metabolic costs that will be incurred.

The following data are concerned, therefore, with the energy costs of self-locomotion in simulated lunar gravity. The data are the average for six subjects, attired in G-4C suits pressurized to 3.7 psi. Figure 5 presents the metabolic costs of walking and running at rates from about 2 to 13 km/hr on a level, smooth, hard surface in simulated lunar gravity. Two sets of data, one obtained using the inclined-plane, and the other the gimbal-vertical suspension simulators, are presented. The results from both simulators show that the metabolic costs increase linearly with locomotive rate. The data from the gimbal-vertical simulator were generally only slightly higher than those obtained with the inclined plane. Thus, it appears that either technique would provide reasonably reliable results for locomotion on level, hard surfaces.

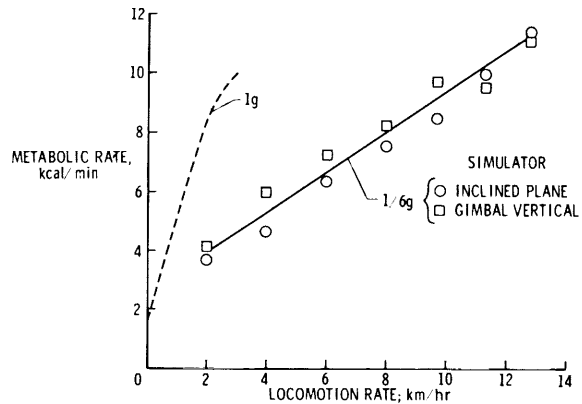

FIGURE 5.—Comparison of metabolic rates for locomotion in 1 *g* and 1/6 *g*.

For comparison purposes, also shown in figure 5, is the 1-*g* metabolic cost for locomotion in the G-4C suit at rates up to 3 km/hr. The data indicate that the metabolic cost for 1-*g* locomotion at 3 km/hr (highest that could be attained in 1 *g*) is twice that in 1/6 *g*. This result is, of course, similar to results obtained in earlier investigations (ref. 4).

The effect of grade on energy expenditure is

shown in figure 6 for two locomotive rates, 2 and 6 km/hr. Data obtained with the inclined-plane and with the gimbal-vertical suspension simulators are shown. Ascending a slope causes increases in the energy expenditure as expected. Ascending grades of 30° requires about twice the energy of level locomotion, as indicated by the inclined-plane results. The gimbal-vertical simulator results generally indicate substantially higher energy expenditures than those obtained with the inclined plane. Steady-state metabolic data were not obtained for the 30° slope in the vertical simulator, except at very low walking rates of 1 km/hr, because the subject's heart rate exceeded 180 beats/min before steady-state conditions could be obtained. The reason for the difference in energy expenditures obtained with the two simulators is uncertain to date, but may be established with the examination of additional data.

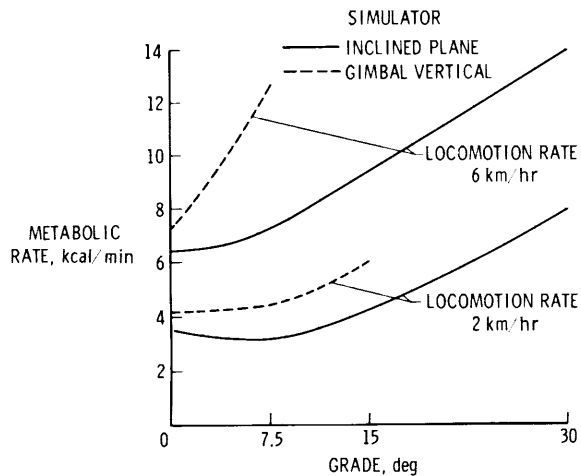

FIGURE 6.—Effect of grade on metabolic rate.

The inclined-plane simulator was used to obtain metabolic costs of subjects carrying loads of 75, 240, and 400 Earth pounds while walking in simulated lunar g . This is equivalent to lunar weights of 12.5, 40.0, and 66.6 pounds. The data are presented in figure 7 and show only a small and inconsistent effect of backpack weight for almost the entire range of locomotive rate used. A possible explanation for this is that the increased traction provided by the additional weights compensated for the cost of carrying these weights.

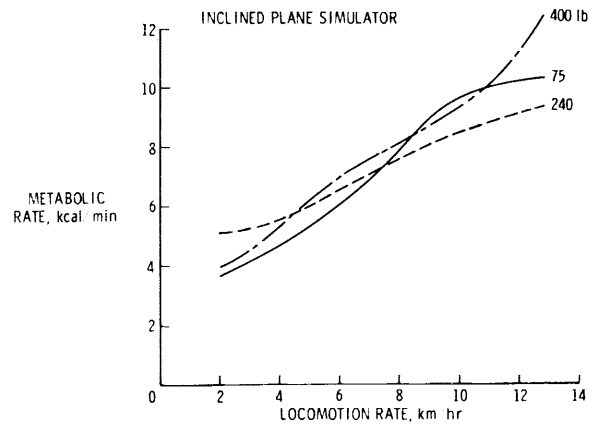

FIGURE 7.—Effect of load carried on metabolic rate.

Some preliminary data were obtained for subjects walking on a sandy soil deposited on the treadmill used with the gimbal-vertical simulator, as shown in figure 8. For comparison purposes, data obtained with a smooth, hard surface are also presented on the figure. The data show little effect of surface on energy expenditure at the low locomotive rates. Above 4 km/hr, however, the metabolic cost of walking on the sandy soil increases very rapidly, and at 8 km/hr the metabolic cost is about 1.5 times that for the smooth surface. This again points up the importance of simulating as closely as possible the conditions that will be encountered in extra-terrestrial missions.

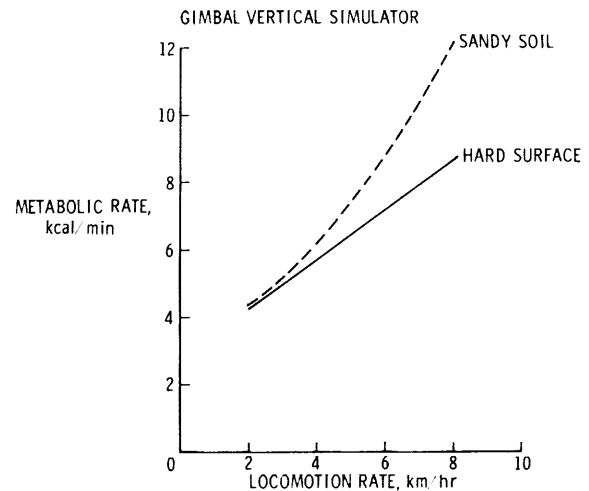

FIGURE 8.—Effect of walkway surface characteristics on metabolic rate.

REFERENCES

1. ROBERTS, JAMES F.: Walking Responses Under Lunar and Low Gravity Conditions. AMRL-TDR-63-112. Aerospace Medical Research Laboratory, Wright-Patterson AFB, Nov. 1963.
2. BEEBE, D. E.: Force Analysis of Walking at Reduced Gravity. Thesis, School of Engineering of the Air Force Institute of Technology, Aug. 1964.
3. WORTZ, E. C.; AND PRESCOTT, E. J.: The Effects of Sub-gravity Traction Simulation on the Energy Cost of Walking. Aerospace Med., vol. 37, Dec. 1966, pp. 1217-1222.
4. KUEHNEGGER, W.; ROTH, H. P.; AND THIEDE, F. C.: A Study of Man's Physical Capabilities on the Moon. Vol. III-Work Physiology Research Program. Doc. No. NSL 65-153. NASA CR-66119. Northrop Space Laboratories, 1965.

DISCUSSION

Tang: Based on your experiment, could you speculate whether a man carrying six times his own weight on the lunar surface will walk just as on the Earth?

Letko: As I pointed out, 600 pounds of Earth weight would be 100 pounds on the Moon.

Tang: I mean if he carries six times his body weight well distributed on his body and walks on the lunar surface, this would be the equivalent of walking on the Earth because as far as the weight on his feet is concerned, it would be the same. Six times his body weight on the lunar surface would be equivalent to his body weight on the Earth.

Letko: I believe some experiments were made in a 1/6-g simulator in which enough weight was added to the subject to bring him back to Earth weight and indicated that he could

walk, but the metabolic costs would be increased.

Dietlein: How is the metabolic rate determined?

Letko: By indirect calorimetry.

Dietlein: Oxygen consumption plus CO₂ production?

Letko: Yes.

Dietlein: You did not just measure oxygen?

Letko: No.

Dietlein: Do you have any data on the metabolic cost of a man righting himself if he fell down repeatedly, say, on the lunar surface?

Letko: No, I do not, but we would like to conduct some experiments in which a total mission is simulated and determine what the metabolic costs would be for the whole mission profile.



Progress in Vestibular Modeling

PART I: RESPONSE OF SEMICIRCULAR CANALS TO CONSTANT ROTATION IN A LINEAR ACCELERATION FIELD

ROBERT W. STEER, JR.

Merrimack College

SUMMARY

The intensification in vestibular research that has been stimulated by the manned space flight program has brought to light several areas of conflict between experimental data and classical concepts of vestibular function. This paper presents the objectives, assumptions, analytic evaluations, and experimental data acquired during the investigations of two such topics which have been examined in some detail at the MIT Man-Vehicle Laboratory.

The disparity between the experimentally evaluated time constants of objective and subjective responses to angular accelerations and the hydromechanical time constants of the semicircular canals is further accentuated by a rigorous analysis of the semicircular canals as a damped hydromechanical angular accelerometer. The dynamic response characteristics of the semicircular canals to angular acceleration are shown to be an order of magnitude faster than can be observed by nystagmus and subjective responses to vestibular stimulation. In addition, it is shown that "roller pump" action of the flexible canalicular duct can maintain an adequate pressure differential across the cupula to give it a constant deflection. This is physiologically equivalent to a constant angular acceleration stimulus, and offers a plausible explanation for the continuous nystagmus responses that are provoked by rotation at a constant angular velocity about an axis which is not colinear with an applied acceleration field.

THE "RIGID TUBE" DYNAMIC CHARACTERISTICS OF THE SEMICIRCULAR CANALS

A rigorous analytical evaluation of the dynamic sensory capabilities of the semicir-

cular canals requires the solution of the classical Navier-Stokes equations of fluid dynamics for an incompressible fluid subject to the boundary conditions of zero flow at the inner surface of the membranous canals. These equations, in cylindrical coordinates, are

$$\rho \left[\frac{\partial v_r}{\partial t} + v_r \frac{\partial v_r}{\partial r} + \frac{v_\phi}{r} \frac{\partial v_r}{\partial \phi} - \frac{v_\phi^2}{r} + v_z \frac{\partial v_r}{\partial z} \right] = F_r - \frac{\partial p}{\partial r} + \mu \left[\frac{\partial^2 v_r}{\partial r^2} + \frac{1}{r} \frac{\partial v_r}{\partial r} - \frac{v_r}{r^2} + \frac{1}{r^2} \frac{\partial^2 v_r}{\partial \phi^2} - \frac{2}{r^2} \frac{\partial v_\phi}{\partial \phi} + \frac{\partial^2 v_r}{\partial z^2} \right] \quad (1a)$$

$$\rho \left[\frac{\partial v_\phi}{\partial t} + v_r \frac{\partial v_\phi}{\partial r} + \frac{v_\phi}{r} \frac{\partial v_\phi}{\partial \phi} - \frac{v_r v_\phi}{r} + v_z \frac{\partial v_\phi}{\partial z} \right] = F_\phi - \frac{1}{r} \frac{\partial p}{\partial \phi} + \mu \left[\frac{\partial^2 v_\phi}{\partial r^2} + \frac{1}{r} \frac{\partial v_\phi}{\partial r} - \frac{v_\phi}{r^2} + \frac{1}{r^2} \frac{\partial^2 v_\phi}{\partial \phi^2} + \frac{2}{r^2} \frac{\partial v_r}{\partial \phi} + \frac{\partial^2 v_\phi}{\partial z^2} \right] \quad (1b)$$

$$\rho \left[\frac{\partial v_z}{\partial t} + v_r \frac{\partial v_z}{\partial r} + \frac{v_\phi}{r} \frac{\partial v_z}{\partial \phi} + v_z \frac{\partial v_z}{\partial z} \right] = F_z - \frac{\partial p}{\partial z} + \mu \left[\frac{\partial^2 v_z}{\partial r^2} + \frac{1}{r} \frac{\partial v_z}{\partial r} + \frac{1}{r^2} \frac{\partial^2 v_z}{\partial \phi^2} + \frac{\partial^2 v_z}{\partial z^2} \right] \quad (1c)$$

$$\frac{\partial v_r}{\partial r} + \frac{v_r}{r} + \frac{1}{r} \frac{\partial v_\phi}{\partial \phi} + \frac{\partial v_z}{\partial z} = 0 \quad (1d)$$

where

v_n = component of velocity of fluid in the n th direction

F_n = component of force on fluid in the n th direction

$\frac{\partial p}{\partial n}$ = pressure gradient in the n th direction

r, ϕ, z = cylindrical coordinates

ρ = density of the fluid

These equations are solved utilizing the physical model of Van Egmond, Groen, and Jongkees (ref. 1) and the assumptions that the canicular duct is a rigid torus of radii 0.015 cm and 0.3 cm filled with an incompressible fluid with a viscosity of 0.852 centipoise. Further, the cupula is considered to be a "flapper" valve with viscous drag and elastic restraint.

Examination of equations (1) shows that the inertial acceleration forces and the pressure gradient forces on a particle of fluid are additive. Thus, it is possible to functionally separate the influence of the cupula and the canicular duct on the performance of the semicircular canal. In figure 1 is presented a system block diagram which provides the necessary functional separation. The net "inertia-pressure feedback" force operates on the endolymph in the membranous duct and results in an average flow of endolymph. The inertia, drag, and elastic restraint characteristics of the cupula introduce a differential pressure feedback proportional to the average flow and flow rate of the endolymph.

To determine the hydrodynamic drag characteristics of the canicular duct, equations (1) can be solved for the average fluid flow which results from any transient angular acceleration. Since these equations are linear differential equations with respect to time, the response

to any angular acceleration can be found by use of the convolution integral and the response for any known input. A step input was used because of its relative simplicity.

The average velocity of fluid through a cross section of the duct as a result of a step input of angular acceleration can be expressed as a weighted sum of exponential functions whose coefficients are determined by the radius of the duct, the viscosity of the fluid, and the zeros of the first-order Bessel function.

$$\bar{v}(t) = \int dr_0^r \int dt v(r, z, t) = D_d \sum_{i=1}^{\infty} D_i [1 - e^{-\lambda_i^2 \nu t}] \quad (2)$$

$$\frac{\bar{v}(s)}{\alpha(s)} = D_d \sum_{i=1}^{\infty} \frac{D_i}{\tau_i s + 1}$$

where

$$\tau_i = \frac{1}{\lambda_i^2 \nu} \quad (3)$$

The dynamic characteristics of the viscous drag of endolymph can therefore be represented as a parallel, weighted sum of the first-order lag networks as shown in figure 2. It is very significant to note that the first term accounts for 96 percent of the flow ($D_1 = 0.957$) and that the time constant of the flow is only 1/220 second. Further, all additional terms are so small in magnitude and have such short time constants that their contributions to the transfer function are negligible.

The influence of cupula dynamics on the sensory capabilities of the semicircular canals can be quantified by evaluation of the influence of an ampullary pressure differential on the position of the cupula. Since a pressure difference across the ampulla results in a torque on the cupula, this functional dependence can be evaluated by a torque balance equation on the cupula.

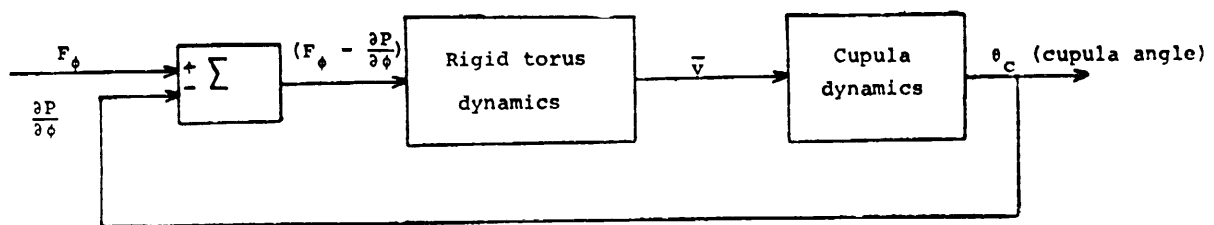

FIGURE 1.—Schematic diagram for dynamics of the semicircular canal.

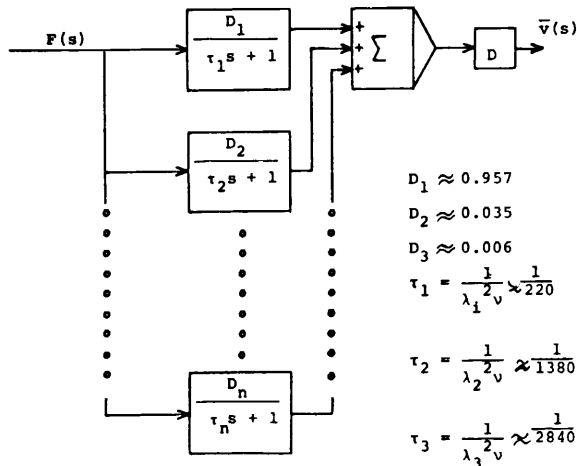

FIGURE 2.—System block diagram for the average endolymph velocity (\bar{v}) in the canalicular duct from an input $F(s)$.

From which obtains

$$(M_p - M_I) = J_c \ddot{\theta}_c + D_c \dot{\theta}_c + K\theta \quad (4)$$

where

M_p = torque on cupula due to a pressure differential across the ampulla

M_I = inertial reaction torque due to an input angular acceleration α

J_c = inertia of the cupula and its surrounding endolymph

D_c = viscous drag coefficient of the cupula

K = stiffness of the cupula

Utilizing the physical model of figure 3, the coefficients J_c and D_c can be approximated to be

$$J_c = \frac{2}{2\pi} \rho [2\pi^2 B^3] \left[\frac{7}{4} B^2 \right] = \frac{7}{2} \pi B^5 \rho \quad (5)$$

$$D_c = 5\pi\mu\psi_1 \frac{B^4}{\Delta B} \quad (6)$$

Because of the lack of any of the elasticity properties of the cupula, its stiffness K can only be expressed in general terms.

A general schematic diagram, which illustrates the interdependence of the cupula and the ducts in determining the cupula position which results from an angular acceleration is shown in figure 4. The overall transfer function, relating cupula position to applied angular acceleration, for the human semicircular canals is determined to be

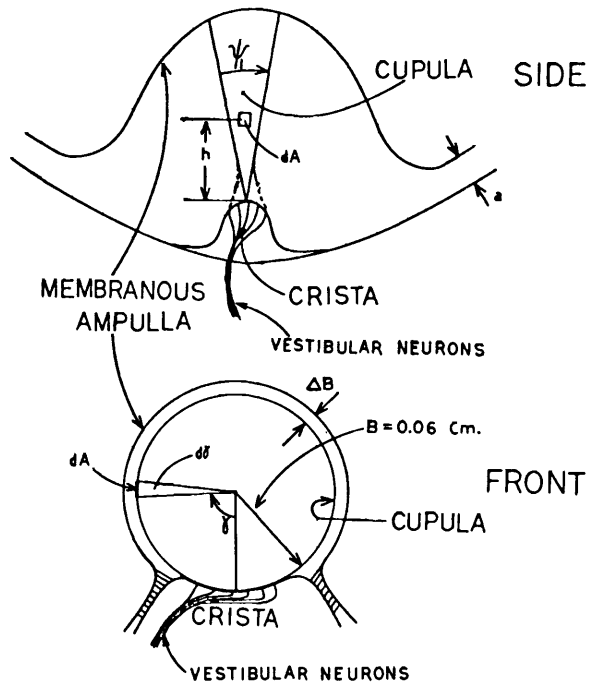

FIGURE 3.—A physical model for the cupula.

$$\frac{\theta_c(s)}{\alpha(s)} = \frac{0.22}{s^2 + 220 \left(1 + \frac{4.5 \times 10^{-6}}{\Delta B} \right) s + 0.07K} \quad (7)$$

By comparing the denominator to the original equation of Van Egmond, Groen, and Jongkees

$$\ddot{\xi} + \frac{\pi}{\theta} \dot{\xi} + \frac{\Delta}{\theta} \xi = \alpha$$

we find that

$$\ddot{\theta} + 220 \left(1 + \frac{4.5 \times 10^{-6}}{\Delta B} \right) \dot{\theta} + 0.07K\theta = 0.22\alpha \quad (8)$$

Using

$$\theta_c = R\xi = 0.3\xi$$

$$\ddot{\xi} + 220 \left(1 + \frac{4.5 \times 10^{-6}}{\Delta B} \right) \dot{\xi} + 0.07K\xi = 0.73\alpha \quad (9)$$

Therefore the calculated values of π/θ and Δ/θ are

$$\frac{\pi}{\theta} = 220$$

$$\frac{\Delta}{\theta} = 0.07K$$

for

$$\Delta B \approx 10^{-4} \text{ cm}$$

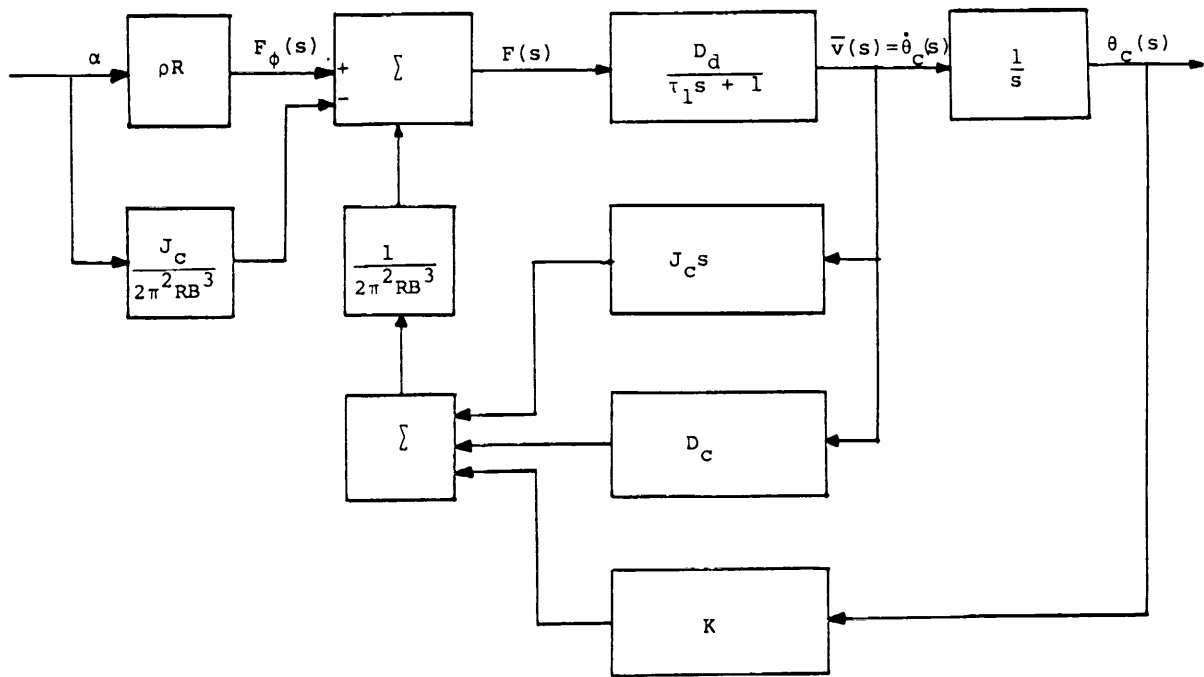

FIGURE 4.—Schematic model for cupula displacement θ resulting from angular acceleration (α) inputs.

The values of π/θ and Δ/θ measured from objective and subjective responses are approximately 10 rad/sec and 1 rad²/sec², respectively.

Thus the calculated damping-to-inertia ratio for an "ideal" rigid torus-shaped acceleration sensor with the physical dimensions of the human semicircular canals is at least an order of magnitude higher than the subjective responses indicate. Further, although the stiffness coefficient of the cupula is not known, a value of $10 < K < 100$ dyne cm/rad is at least a realistic value for a gelatinous material such as we assume the cupula to be.

In summary, the analyses of this section have shown that the effects of the viscous drag of the endolymph in the duct of the semicircular canals can be accurately represented by a first-order system with a time constant of about 0.05 second. They further show that the drag of the cupula on the wall of the membranous ampulla contributes some additional damping to the cupula-endolymph system. It has been shown that the fluid dynamic characteristics of the human semicircular canals have an order of magnitude higher frequency response

than is observed from subjective and objective tests of the vestibular system.

It appears that the observed high-frequency responses of the human semicircular canals are limited more by low carrier frequency of the vestibular neurons and that the experimentally measured values of the coefficients are more a measure of the response of the vestibular neurons, the "computation time" of the central nervous system, and neuromuscular delays than of the dynamic response characteristics of the semicircular canals.

THE "ROLLER-PUMP" CHARACTERISTICS OF A FLEXIBLE TOROIDAL DUCT

A flexible duct immersed in and containing an incompressible fluid will be distended by the influence of a linear acceleration if its density is different from the fluid, and a density difference between the interior and exterior fluids will further accentuate this distention. As shown in figure 5, a flexible circular duct which is attached along its outer periphery to a rigid structure and is denser than the fluid surrounding it will have a constricted cross-sectional area where the acceleration field pushes it against

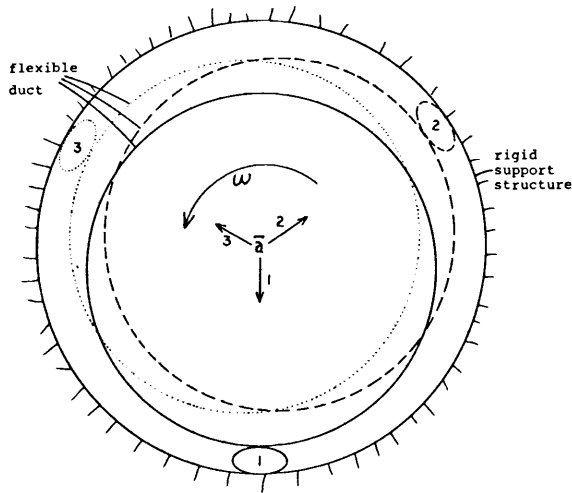

FIGURE 5.—Illustration of the pumping action of the distended duct when the linear acceleration field is rotated at a uniform angular velocity.

its support, and it will be expanded where the acceleration pushes it away from its support.

Further, as also illustrated in figure 5, if the linear acceleration vector \bar{a} is slowly rotated at a constant angular velocity ω , the constriction will move along the outer periphery of the duct in phase with the rotation of the acceleration vector. The effect of the moving constriction is then to move or pump the fluid in the duct in the direction of the rotation. This pumping action works against the viscosity and inertia of the fluid, and at high angular rotation rates the fluid that is being pushed by the moving constriction cannot be displaced fast enough and thereby builds up a pressure gradient which expands the duct toward a uniform circular cross section. Thus, for high angular rotation rates of the linear acceleration vector, the mass of the fluid acts as a hydromechanical filter which reduces the duct constriction and along with it the pumping action of the flexible tube.

For a flexible tube with an elastic flow restraint such as the cupula of the semicircular canals, the fluid is initially pumped against and displaces the elastic restraint which then produces a pressure differential across the tube. A static equilibrium state is then reached where the displaced elastic restraint provides sufficient pressure feedback to inhibit further flow. Thus, for a constant veloc-

ity of rotation in a linear acceleration field, a constant cupula displacement can be maintained by this flexible roller pump action.

By comparison of the cupula pressure differential that is generated by a constant angular acceleration applied to a human semicircular canal, and the pressure differential across a restriction in a flexible toroidal duct with dimensions similar to the human semicircular canals, the relationship between "roller-pump" displacement of the cupula and constant angular acceleration of the cupula can be established.

This relationship between the rate of angular rotation, the magnitude of the duct restriction, and the equivalent constant angular acceleration that would produce the same steady-state cupular displacement in a 1-g acceleration field is

$$\alpha_{equiv} = \frac{8\mu\omega}{a^2\rho G} \left(1 - \frac{A_c}{A}\right) \quad (10)$$

for the human semicircular canals where

- $a = 0.015$ cm
- $R = 0.3$ cm
- $\rho = 1$ gm/cm³
- $\mu = 0.0085$ poise
- $G = 980$ cm/sec²

$$\alpha_{equiv} \approx 0.3 \left(1 - \frac{A_c}{A}\right) \omega \text{ rad/sec} \quad (11)$$

To establish the applicability of the roller-pump principle to the semicircular canal, the relative magnitudes of the bias component of a slow phase nystagmus from rotation in a linear acceleration field and the steady-state nystagmus stimulated by constant angular acceleration can now be compared to determine how large a distention of the duct is necessary to produce a significant physiological response.

From the data of Guedry (ref. 2), a 6°/sec bias component of vestibular nystagmus is noted for a 1 rad/sec rotation about a horizontal longitudinal axis. Several experiments have shown that such a 6°/sec slow-phase velocity would also result from a 0.6°/sec² or 0.01 rad/sec² constant angular acceleration. Solution of equation (11) for the value of A_c/A when

$$\begin{aligned} \omega &= 1 \text{ rad/sec} \\ \alpha_{equiv} &= 0.01 \text{ rad/sec}^2 \end{aligned}$$

gives

$$\frac{A_c}{A} = 0.97$$

This is to say that a mere 3-percent constriction in duct area, or correspondingly, a 1.5-percent contraction of the radius of the membranous canicular duct can produce sufficient roller-pump action to account for the observed bias component of nystagmus which results from constant rotation at 1 rad/sec in a 1-g acceleration field.

The question of whether or not a 3-percent constriction in duct area is a realistic value remains a matter of conjecture. However, since it has been shown by Money et al. (ref. 3) that there is a density difference of the order of 0.1 percent between endolymph and perilymph (in pigeons) and that the duct is more dense than either fluid, by at least 1 percent, and since the duct tissue is only a few cell layers thick and thus quite flexible, it is at least plausible that the duct is sufficiently elastic to permit a 3-percent constriction in area in the presence of the 1-g linear acceleration field.

It is important to note that this roller-pump action does not require a continuous duct to produce the pressure difference which can force cupular displacement. A blocked duct will limit the amount of fluid that can be displaced and thereby reduce the cupula displacement, but it does not necessarily eliminate it.

The rotation rates ω_1 and ω_2 at which the roller-pump action diminishes are determined by the elasticity and strength of the fibrous attachments of the duct and are not readily calculable. However, this cutoff frequency can be accounted for by adjoining to equation (10) a second-order lag term to provide for a diminished response at higher rates of rotation.

From this we obtain

$$\alpha_{\text{equiv}} = \frac{8\mu}{a^2\rho G} \left(1 - \frac{A_c}{A}\right) \frac{\omega}{\left(1 + \frac{\omega}{\omega_1}\right)\left(1 + \frac{\omega}{\omega_2}\right)} \quad (12)$$

EXPERIMENTAL RESULTS

To supplement the various experiments of Guedry, Benson, Bodin, Correia, Money, and others, and to investigate the variation of the bias

and the amplitude of the sinusoidal component of vestibular nystagmus as a function of rotation rate, the MIT Instrumentation Laboratory precision centrifuge with a rotating platform at a 32-foot radius was fitted with the Man-Vehicle Control Laboratory rotating chair simulator, and six experimental subjects were rotated at 5, 7.5, 10, 20, 30, and 40 rpm in a 0.3-g horizontal acceleration field. Nystagmus was measured with eyes open in the dark by use of a Biosystems, Inc., pulsed-infrared eye-movement monitor. The experimental setup is shown in figure 6.

To minimize the influence of habituation and physical discomfort, the total rotation times were kept to a minimum. The subjects were brought up to the desired rotation rate relative to the boom while the boom was stopped. Nystagmus recordings were monitored until the acceleration transient subsided; then the centrifuge room lights were shut off to eliminate all possible light leaks in the rotating chair. The eye-movement monitors were calibrated, and the subjects were instructed to look straight ahead. The boom of the centrifuge was then brought up to speed (5.5 rpm) in about 5 seconds, held there for 2 minutes, then returned to zero. After the nystagmus from deceleration subsided, the eye-movement monitors were again calibrated to insure that no movement of the glasses had occurred during the run. Lights were then turned on, and the subject was accelerated to a different rotation rate. Three data runs were taken at each sitting, and a rest of at least 20 minutes was allowed between sittings. The rate and direction of rotation were randomly ordered for each subject.

The slow-phase nystagmus velocities were calculated and plotted from the nystagmus recordings. The results showed a persistent si-

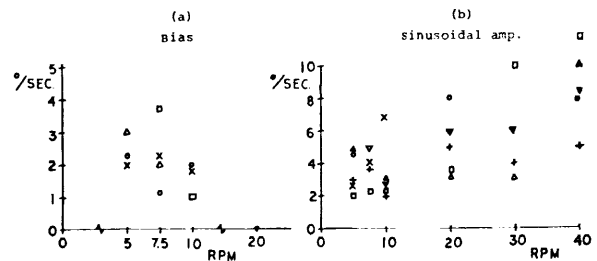

FIGURE 6.—Bias (a) and sinusoidal amplitude (b) of slow-phase nystagmus from rotation in 0.3-g field.

nusoidal component at the period of rotation for all subjects at all rotation rates. For most subjects a clear bias component was observed for 5 and 7.5 rpm, and for some it still existed at 10 rpm. However, for 20, 30, and 40 rpm it was not observable in any of the subjects tested. The amplitude of the sinusoidal component increased with increasing rates of rotation. The amplitudes of the bias and the sinusoidal components of nystagmus are plotted as a function of rotation rate in figure 6 and their mean values and standard deviation range for the six subjects tested are shown in figure 7.

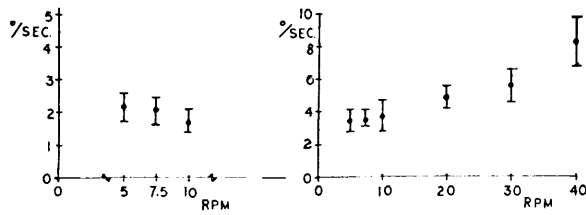

FIGURE 7.—Average values of bias and sinusoidal amplitude ($\pm 1\sigma$) for rotation in 0.3-g field (six subjects).

To compare these results with those of the horizontal rotation experiments, it is necessary, even though the assumption of linearity is tenuous, to normalize the results of the author's experiments with respect to a 1-g gravity field. In figure 8 our normalized results are plotted along with those of Benson (ref. 4) and of Guedry (ref. 2). The model predicted bias component is also plotted in figure 8 for assumed upper break frequencies of $\omega_1 = \omega_2 = 7.5$ rpm.

The average bias components as measured by Guedry for 12 subjects at 10 rpm agree precisely with those found by the author. However, those found by Benson for eight subjects differ by about a factor of 2.

It does appear that the predicted responses from the roller-pump model are borne out by the data in that at low and high rotation rates, the

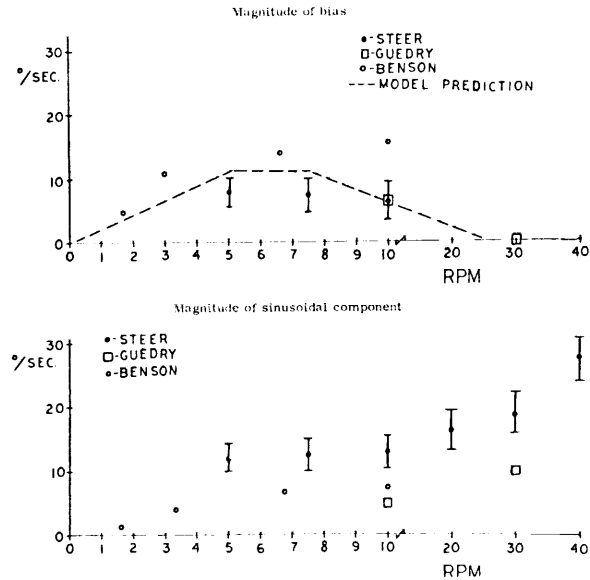

FIGURE 8.—Summary of available data of normalized bias and sinusoidal amplitude of human vestibular nystagmus from rotation in a 1-g field.

bias component was not observable, and there was a general shape of measured response that did conform to the predicted second-order system. Further, the experimental data showed that the upper-break frequencies, which we were unable to calculate because of insufficient data, were in the range from 5 to 10 rpm.

In summary, these experiments, which provide a slightly different vestibular stimulation than the "barbecue-spit" experiments of Guedry and of Benson or the "revolution-without-rotation" experiments of Money, further verify the hypothesis that rotation at a constant velocity in a linear acceleration field does provoke vestibular nystagmus. The results of the analysis show that a duct area constriction of only 3 percent provides sufficient roller-pump action to generate the observed bias component of nystagmus. And the upper cutoff frequencies ω_1 and ω_2 were found experimentally to be in the range between 7.5 and 10 rpm.

REFERENCES

1. VAN EGMOND, A. A. J.; GROEN, J. J.; AND JONGKEES, L. B. W.: The Mechanics of the Semicircular Canal. *J. Physiol.*, vol. 110, 1949, pp. 1-17.
2. GUEDRY, F. E.: Influence of Linear and Angular Accelerations on Nystagmus. Second Symposium on the Role of the Vestibular Organs in Space Exploration, NASA SP-115, 1966, pp. 185-196.
3. MONEY, K. E.; SOKOLOFF, M.; AND WEAVER, R. S.: Specific Gravity and Viscosity of Endolymph and Perilymph. Second Symposium on the Role of the Vestibular Organs in Space Exploration, NASA SP-115, 1966, pp. 91-97.
4. BENSON, A. J.: Modification of Per- and Post-Rotational Responses by the Concomitant Linear Acceleration. Second Symposium on the Role of the Vestibular Organs in Space Exploration, NASA SP-115, 1966, pp. 199-211.

DISCUSSION

Dietlein: The computers in black boxes involved in the spacecraft guidance and control are indeed complex and rather thought-provoking products of man's technical ingenuity. I submit, however, that an even more challenging task and an acid test of scientific creative mettle is the modeling of biological systems, particularly neurophysiological systems such as the multifaceted vestibular complex.

Valentinuzzi: The good mathematical analysis performed by Dr. Steer concerning the hydrodynamics of the semicircular canal and, furthermore, the response of the semicircular canals to the changes of gravity direction are very useful and will help us. When I say help us, I am referring to experiments performed by Dr. Fernández and myself, and we will be helped in the interpretation of two lines of work. In experiments with Coriolis acceleration applied in a continuous way, we have found that there is a contradiction between the prediction based on the classical equation and the experimental results; therefore, the correction introduced by Dr. Steer, I think, will improve the agreement we expect.

On the other hand, Dr. Fernández and I performed a series of experiments in cats last year in which we applied rotation about the cephalocaudal axis. This axis being horizontal, we tried to repeat in the cat what Benson, Bodin, and Guedry have done in the human being. In this case we have obtained a clear nystagmic response. Furthermore, the other type of experiments we have carried out consisted of rotating the cat about an axis which is perpendicular to the sagittal plane; that is, we have rotated the cat in the pitch plane in a continuous way. In both cases the velocity was uniform. In the second case, when the cat was rotated in the pitch plane, the nystagmic response was clear and modulated in a sinusoidal wave. From the point of view of the interpretation, we would say that the condition which Dr. Steer has considered can give a reason for this kind of response. But we think that since there is the same modulation in both types of experiments, we cannot exclude the action of the otoliths, which are surely shifting on the macula in both kinds of rotations.

Steer: I would attribute the sinusoidal component from my own limited experience to the otolith, no matter which axis you rotate about. But for the average value, I would at least conjecture that this type of roller-pump explanation is plausible. I noticed from Kellogg's counterrolling data presented at last year's meeting that he showed a sinusoidal component which he attributed to the otolith function and the

bias component which he chose not to make any comments about because he did not have a theory for it. This would explain that.

In a very brief mention in one of Dr. Guedry's papers, he commented that Hixson has observed, during head-over-heels rotation of the human at a constant angular velocity, that there is a bias component of nystagmus also. Any of these rotations where a canal is out of the plane of the applied linear acceleration should give rise to this roll-pumping action.

Graybiel: In your experiments with plugged canals, Dr. Money, did you rotate your animals in the Earth-horizontal axis?

Money: Dr. Correia and I have just finished an experiment wherein we spun cats about an Earth-horizontal axis before and after plugging all six canals. The results were unlike those obtained with counterrotation on three cats, and the nystagmus was eliminated by canal plugging. We have rotated about a dozen cats around the horizontal axis, and they have all retained constant velocity nystagmus in spite of their having all six canals plugged.

The nystagmus is decreased from what it was before by something like one-third to one-half in the speed of the slow component and the frequency, but the nystagmus that is left is perfectly clear and obvious. It has a cyclical variation that is the same as in normal cats.

Graybiel: I would like to recall at this point an experiment that Dr. Guedry performed using some of our subjects with bilateral loss of labyrinthine function. These subjects have been studied carefully over a long period of time. We assumed on the basis of functional tests that they had complete loss of canal function, with the exception of one ear in one subject. Irrigation with water at temperatures as low as 4° C for periods of a minute or more failed to evoke nystagmus with a single exception. Some manifested a slight amount of ocular counterrolling, and we thought this might be due to some residual otolith function. When Dr. Guedry rotated some of these subjects about an Earth-horizontal axis, nystagmus was evoked in some instances. And I am not over the shock of this yet.

Lowenstein: I think this is a religious shock, sir.

Graybiel: I think that one possible explanation is that the nystagmus may have had its origin in the otolith apparatus, and this cannot be ruled out.

Guedry: I should like to clarify several points. During rotation at 60°/sec about an Earth-horizontal axis, some

of these L-D subjects had nystagmus, but only one of 11 had a clear unidirectional nystagmus, and this for only one direction of rotation. In the other direction, nystagmus was present, but it was weak and of poor quality. Several of these L-D subjects had a fairly systematic direction-reversing nystagmus. Whether or not this reversing nystagmus came from residual otolith function, of course we do not know. The normal response during 60°/sec rotation about an Earth-horizontal axis is clear, prolonged, unidirectional nystagmus. When normal subjects are spun at a rate of 180°/sec about an Earth-horizontal axis, after about 40 seconds of such rotation they exhibit direction-reversing nystagmus and report subjective events like the responses of L-D subjects at 60°/sec.

Anliker: I am fascinated by the presentation from Dr. Steer. I should like to add a few comments in support of the possibility that the semicircular canals could respond to circular translation. We think that the rotating pressure field which you have alluded to briefly is producing pressure waves in the semicircular canals. In reality, the canals do not constitute a rigid system and allow for the development of pressure waves in the membranous and in the bony canal. The rotating pressure field is so strong that we anticipate a sizable response of the cupula on the basis of our mathematical and experimental model studies. Also, the waves induced by the rotating pressure field are much stronger than the roller-pump effects which you have mentioned, which would be due to the density difference between the membranous canal wall and the endolymph and perilymph. We only have a density difference of the order of 1 percent, and such a small volume taken up by the membranous wall itself, that I cannot see how you can get such a strong force that would produce a roller-pump effect, as you have convincingly demonstrated with mercury and water, where you have a density difference of 13 and not 1 percent.

Steer: I formulated it in a way which is extremely simple to look at. This variation in cross-sectional area, A_b/A , that I have indicated in the block diagram could well be caused by a pressure gradient acting on the fluids, as well as it could be by a tiny density difference in the duct. I tried to formulate it in this general way. I looked at it and said, "Look, just a very small change in area makes a significant contribution." It may well be that a fairly intensive circulating pressure wave could be responsible. However, I would add to your comment that it would have to be a flexible duct for the special waves to take effect.

Anliker: Yes. Well, at least part of the duct has to be flexible, not all of it, but part of it.

Steer: At least a portion of it has to be.

Anliker: Yes; I fully agree with you.

Graybiel: If you subject the horizontal semicircular canals to a very high angular acceleration or deceleration when the head is upright and the canals most responsive, and then you do not get a response but do in the Earth-horizontal axis, some way or other this does not add up.

Anliker: We should emphasize that in our studies we have been looking at only the end organ, that is, the mechanical behavior of the semicircular canals plus maybe the otoliths, and not the sensory mechanisms, nor the neural conductors,

nor the CNS, etc. We are focusing our attention on a small part of the problem. Maybe our conclusions will be compatible with what you find from neural responses and perception.

Graybiel: Dr. Money, do you think it is reasonable to believe that, over a long period of years with all the fluid gone and a little bit of cupula left, the crista still might retain its function?

Money: I have had experience with cats that have had their canals plugged for up to 4 years. As far as I can tell, the crista is still putting out its resting discharge after 4 years. The evidence for this is partly histological. The cristas still look normal after that length of time. Nothing seems to have shriveled up. The canal arm is plugged in one spot, but the crista apparently is histologically normal.

The second bit of evidence for thinking that these cristas are still working is that, on some of these cats, after they have had all six canals plugged for a long time, I have done a labyrinthectomy on one side. Then you get the resting nystagmus of unilateral labyrinthectomy. In fact, I even did a second labyrinthectomy on one of these cats and got Bechterew's nystagmus when the second ear was done. So apparently these cristas in the plugged canals are still putting out their resting discharges.

Graybiel: Was there endolymph fluid?

Money: Yes. The membranous canal except near the plug was apparently normal and the canal was open.

Graybiel: In that case your finding is a perfectly reasonable expectation.

Money: Incidentally, the cats which I described as having this horizontal-axis, constant-velocity nystagmus with all six canals plugged, were entirely lacking in any response to angular acceleration about a vertical axis. We did quantitative tests at 10.0 and 20.0 rpm, and we also did some quick stops from 40.0 just to see if we could get anything out of them. There was nothing in response to vertical-axis acceleration.

We found the specific gravity of endolymph in pigeons to be 1.0033 and of the perilymph to be 1.0022. More recently we have measured the specific gravity of sections of membranous canal including the endolymph inside and this was 1.03. So there is a 3-percent difference between membranous canal sections and perilymph.

We have also measured the specific gravity of endolymph droplets including the cupula. We do not know the ratio of cupula to endolymph, but it is of the order of 25 percent. We could not demonstrate any difference between the specific gravity of the cupula plus endolymph globule and globules of pure endolymph. If there was a difference in the specific gravity of cupula and endolymph that was greater than one part in 2500, we think we would have picked it up; we did not see anything at that level.

Anliker: May I add to my previous comment and stress the fact that we would also predict cupula deflection as a result of linear acceleration because of the nonsymmetry of the semicircular canals and the stiffness distribution, again on the basis of waves being generated.

Steer: Based on the discussion we had the other day, I would disagree that the cupula is affected in this way because

you drew me the picture of an asymmetric structure and you are saying, "If I sum the pieces of the moments about the geometrical center, I have a much larger mass over here than over here. I have a net torque."

Anliker: You are alluding to the hydrodynamic paradox. Of course if it would be perfectly rigid, you would not have a flow due to the inertial torque.

Steer: If it were perfectly rigid, you would not, because the only thing that is important is the sum of torques about the center of mass.

Anliker: But you do not have perfect rigidity and therefore you have flexibility.

Steer: If you have flexibility and a substantial mass in balance, it would be possible, but I still doubt it, the reason being that you need off-axial symmetry, off-axial asymmetry. The fact that you have a gradient field and a flexible duct will force some symmetry of the duct to begin with, if the duct is flexible.

Anliker: I am referring to the canal itself plus the cupula. If you look at the cupular region, I think that you do not have the same stiffness as elsewhere.

Steer: I think you have a much greater stiffness if you look at the cupular region, because it is much more firmly attached to the inner edge of the ampullary wall than any other part of the canal.

Anliker: I think maybe we should continue this afterward and not put the patience of the audience to a test.

Billingham: Did you measure the phase angle between the rotating linear acceleration vector and nystagmus; and if so, was it related to the rpm?

Steer: Only in some cases. Unfortunately, with the chair rotating at one velocity and the arm rotating at another, it was not always possible to synchronize the phase because we did not have position pickup on the chair. At the lower rpm's we did, and the maximum nystagmus corresponded to the left side down, and the minimum of the nystagmus swing corresponded to right side down, as Dr. Guedry has found. At the higher rpm we did not check the phase. I thought of it too late to put a sensor on; the data had already been taken.

PART II: A MODEL FOR VESTIBULAR ADAPTATION TO HORIZONTAL ROTATION¹

LAURENCE R. YOUNG AND CHARLES M. OMAN

Massachusetts Institute of Technology

SUMMARY

Short-term adaptation effects are seen in subjective sensation of rotation and vestibular nystagmus. The mathematical model for semicircular canal function is improved by the addition of two adaptation terms (approximately 1/2-minute time constant for sensation and 2-minute time constant for nystagmus) to the overdamped second-order description. Adaptation is represented as a shift of reference level based on the recent history of cupula displacement. This model accounts for the differences in time constants among nystagmus and subjective cupulograms, secondary nystagmus, and decreased sensitivity to prolonged acceleration.

INTRODUCTION

The lack of a suitable mathematical descriptor for adaptation and habituation has been a persistent difficulty with the simple, second-order torsion-pendulum mathematical model for semicircular canal response (ref. 1). In particular, close examination of data for two types of rotation experiments indicates that both the nystagmus and the subjective response are fundamentally different from that predicted purely on the basis of a second-order model, as shown in figure 1.

1. Experimentally, the sensation of rotation to sustained constant angular acceleration has been shown to decay (ref. 2), whereas the model predicts a constant steady-state sensation of angular velocity and nystagmus.

2. The response to a sudden change (step) in

angular velocity has been observed to overshoot, whereas the model predicts an exponential decay to the threshold level. Aschan and Bergstedt (ref. 3) noted that the nature of this overshoot,

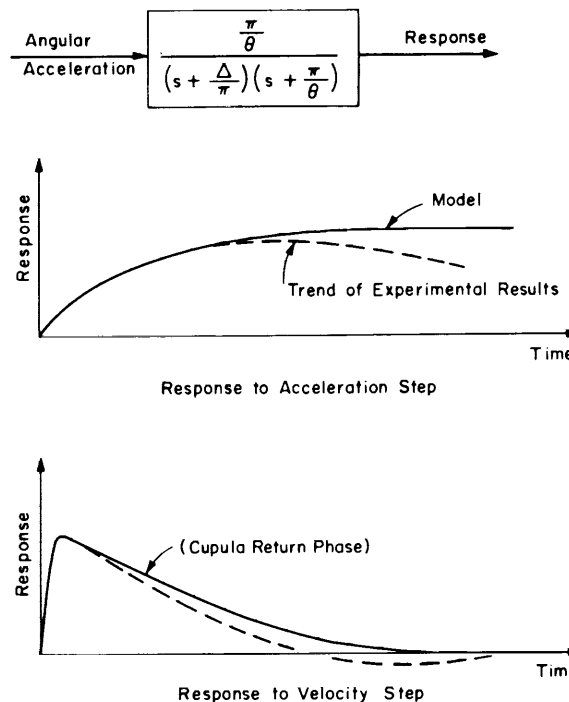

FIGURE 1.—Second-order "torsion pendulum" model.

¹ This paper is based on research supported by National Aeronautics and Space Administration grants NGR 22-009-156 and NSG-577/22-09-025. It contains excerpts from "On the Biocybernetics of the Vestibular System" by L. R. Young, presented at the Ford Institute Symposium on Biocybernetics of the Central Nervous System, Washington, D. C., Feb. 1968, and also the S.M. thesis of Charles M. Oman, MIT, Department of Aeronautics and Astronautics, Sept. 1968.

or secondary nystagmus, depended on the length of the duration of the primary nystagmus.

3. There is ample evidence that the dynamics of the subjective velocity response are fundamentally different from those of the nystagmus: A consistent difference appears in the time constants conventionally determined for the second-order canal model, depending upon whether they are estimated from eye-movement recording or from measurements of subjective sensation of rotation (cupulograms). In particular, Groen (ref. 4) and others pointed out that the long-period time constant of the cupula return phase was estimated at approximately 10 seconds for the horizontal plane by subjective cupulometry, but was estimated at 16 to 20 seconds based on the nystagmus cupulogram. A fundamental assumption behind the second-order model is that both the subjective sensation of rotation and the angular velocity of slow-phase nystagmus are proportional to cupula displacement. Thus one would expect that they would follow a similar time course of decay until passing through their respective threshold levels, thus indicating the ratio of viscous damping to cupula spring constant. Apparently, this is not the case.

As a result of these discrepancies, efforts have been underway at MIT to improve the mathematical model for the canals by including a mathematical descriptor for the effects of short-term adaptation. (Adaptation here refers to the short-term change in response resulting from a continuing stimulus, whereas habituation is taken to mean a decreased sensitivity to a repeated stimulus pattern.)

A MODEL FOR ADAPTATION

A model was developed which cascaded an adaptation operator for nystagmus and for subjective response with second-order dynamics representing the physical behavior of the cupula itself, as shown in figure 2. This approach accounts for all the previously mentioned difficulties with the second-order formulation. The model was developed to fit average response data from a number of sources, and allows a reinterpretation of the results from classical experiments on nystagmus and subjective response.

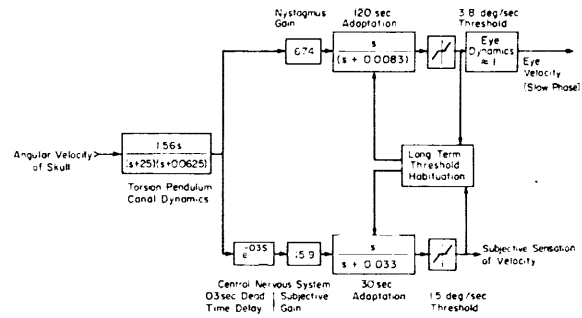

FIGURE 2.—Model for subjective sensation and slow-phase nystagmus velocity for rotation about a vertical axis.

The fundamental assumption in the model is that adaptation has associated with it a short-term homeostatic mechanism which results in a shift in the zero sensation and nystagmus-velocity-response reference levels. We hypothesize that the cupula-response signal undergoes more rapid adaptation in the subjective path than in the nystagmus path. It should be emphasized, however, that despite the success of the model in accounting for the differences between nystagmus and subjective response, little should be inferred directly from the mathematical adaptation operator about the underlying physical mechanism associated with this process. While the form of the model is based on what is known about the dynamic characteristics of the canals, the models are of the nonrational parameter type. The mathematics is not intended to reflect any exact physical mechanism in more than a general way. The approach is similar to that of a control engineer examining the dynamic characteristics of the sensors of a feedback system. The models are, however, valuable in that they provide a unifying mathematical format, which can be used to suggest new experiments and predict their results.

In defining the parameters of the adaptation model, published experimental results on acceleration steps and impulses were examined. It is particularly instructive to study the data of Hulk and Jongkees (ref. 5) and the experimental results obtained by Guedry and Lauver (ref. 2) measuring the sensation of angular velocity in response to steps in angular acceleration. Whereas the nystagmus responses to steps of angular acceleration generally follow

the second-order model, rising exponentially to a constant level, the subjective responses in fact begin to decline after 20 to 30 seconds of constant acceleration stimulation. These observations, combined with the consistent differences between the frequency response phase lags of subjective and nystagmus measurements, lead to a preliminary model for subjective sensation and nystagmus slow phase velocity.

We assume that one of the significant aspects of short-term adaptation is a bidirectional phenomenon which in some way results in a shifting of the zero velocity reference level by some fraction of the time integral of the response itself. In particular, if R is the human response to the angular acceleration, either as subjective velocity or slow phase nystagmus velocity, and $\xi(t)$ is the cupula position at the time t , then

$$R(t) = \xi(t) - \frac{1}{\tau_a} \int_0^t R(t) dt \quad (1)$$

where the second term on the right-hand side of equation (1) accounts for the shift in the response reference level by a fraction of the time integral of the response itself.

The input-output transfer function of the adaptation operator itself appears as

$$\frac{R(s)}{\xi(s)} = \frac{s}{s + \frac{1}{\tau_a}} \quad (2)$$

in Laplace transform notation. The adaptation dynamics represented by the expression in equation (2) exhibits a simple exponential decay with a time constant of τ_a in response to a step deflection of the cupula.

As a model of the dynamics of the physical end organ, we maintain the torsion pendulum form. Steer's rigorous fluid-dynamics analysis (ref. 6) has given support to the adequacy of the overdamped second-order transfer function. Our approach was to hypothesize two paths for the model output, one for the subjective response and one for the nystagmus slow phase velocity. Different adaptation time constants for each pathway were determined and placed in series with a second-order cupula transfer function resulting in the model shown in figure 2. The

model was simulated on a GPS 290T hybrid computer. The responses were calculated for various kinds of inputs both with and without a threshold.

For the subjective path, linear adaptation dynamics of the form $[s/(s + 0.033)]$ representing a 30-second time constant (τ_a) were included. To allow a fit to acceleration latency-time data, a threshold nonlinearity and a pure time delay of 0.3 second were also added. The dead zone of the nonlinearity is taken as $1.5^\circ/\text{sec}$. Note (fig. 2) that the threshold is interpreted in terms of subjective angular velocity rather than mechanical displacement of the cupula.

The cupula return phase time constant of the second-order physical dynamics was chosen to be 16 seconds. Figure 3 illustrates the response of the subjective path of this model to a step change in angular velocity such as that used in the cupulogram test. The predicted cupula response is also shown. Note that the predicted subjective angular velocity decays more rapidly than the cupula return and overshoots slightly.

Also shown in figure 3 is the nystagmus response which exhibits the relatively weak 120-second time constant adaptation dynamics $[s/(s + 0.008)]$ in the oculomotor loop of the model. The nystagmus curve decays with practically the same time constant as does the cupula deflection. When the model nystagmus data taken for several different velocity step magnitudes are examined in terms of the duration of postrotation nystagmus or, equivalently, the time until the model curve passes below threshold, they indicate a long time constant of about 16 seconds. If the subjective angular velocity is

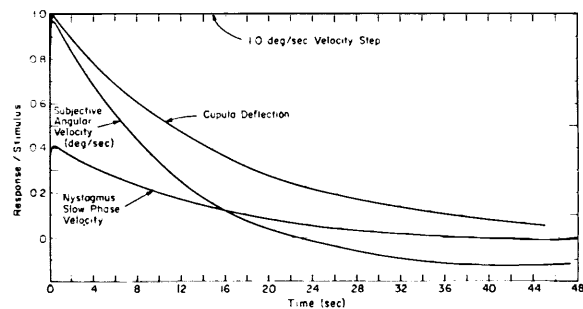

FIGURE 3.—Velocity-step response of MIT semicircular canal linearized model to $1^\circ/\text{sec}$ step in horizontal plane.

similarly treated, however, and the time duration of subjective response is estimated as though the entire system were second order, the apparent time constant is approximately 10 seconds. These two values agree very closely with the observed objective and subjective time constants derived from cupulometry. Thus, the effect of the adaptation operator in the subjective loop is to shorten the apparent (second-order) time constant, and to explain the important discrepancy mentioned earlier.

The linearized subjective response overshoots, as shown in figure 3. A large-enough acceleration impulse will cause the magnitude of the overshoot to exceed threshold, and a "second effect" or subjective reversal of direction is predicted. This reversal has been noted on many occasions. The adaptation model also predicts an overshoot for nystagmus response to velocity steps, but its magnitude is not nearly so great as that of the subjective overshoot.

"Nach-nach nystagmus" or "secondary nystagmus" has been described by investigators (refs. 3 and 7). For example, Aschan and Bergstedt (ref. 3) noted that constant angular accelerations of $2^\circ/\text{sec}^2$ for 25 seconds gave rise to "a secondary phase of nystagmus in a contrary direction with a delay of 20 to 30 seconds between the two phases," while larger accelerations of $3^\circ/\text{sec}^2$ for 10 seconds and $4^\circ/\text{sec}^2$ for 6 seconds produced no secondary nystagmus in the majority of subjects. Aschan and Bergstedt concluded that since the peak cupula deflection should be the same in all three cases on the basis of the model of Van Egmond et al., the strength of the secondary nystagmus depends particularly on "the length of the duration of the primary nystagmus induced." As shown in figure 4, the results of the Aschan and Bergstedt experiments are predicted by the adaptation model. (Note that equal peak cupula deflections are predicted only with the time constants of the original Van Egmond model.) Apparently, then, second effect can also be attributed to the effects of adaptation.

Since it was shown that the adaptation model produced generally correct responses to velocity steps, the time constants determined by the fit with experimental data were verified by matching the model response against data for

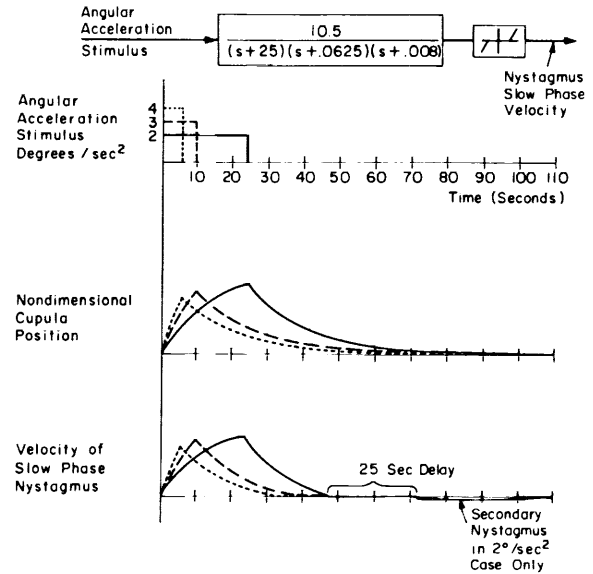

FIGURE 4.—Model response for Aschan and Bergstedt experiment (ref. 3).

higher order inputs. Guedry and Lauer's results were available to check the model for consideration of long-duration steps of angular acceleration. As seen in figure 5, the shape of the transient data agrees with the model for both nystagmus response and for subjective sensation. Note that, whereas adaptation effects are not readily noticeable in the nystagmus response to velocity steps, a definite decay is predicted in the acceleration step tests lasting more than about 30 seconds. This phenomenon is not predicted by the torsion pendulum model alone.

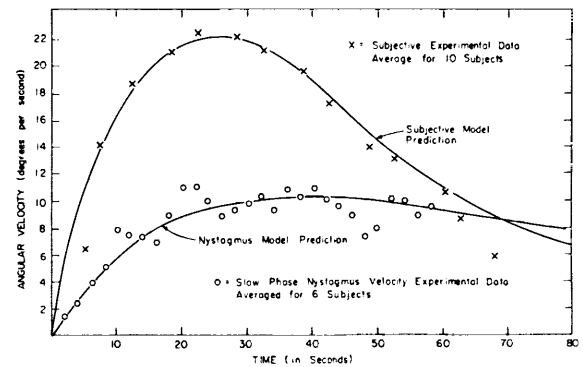

FIGURE 5.—Comparison of adaptation model for vestibular response with Guedry and Lauer experiments (ref. 2) for an angular acceleration step ($1.5^\circ/\text{sec}^2$).

Acceleration steps have often been used in experiments to determine the latency time to sensation of rotation for constant angular acceleration. Latency times were calculated for the model subjective response. The model match with experimental data of Meiry (ref. 8) and of Clark and Stewart (ref. 9) is very good, except at low accelerations, as seen in figure 6. This may be attributable to the fact that for the low accelerations, the response is very near the limit of detection and the response times are unreliable indications.

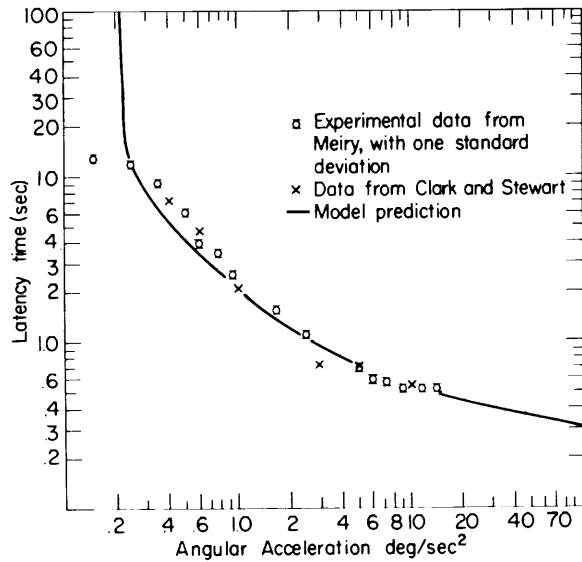

FIGURE 6.—Adaptation model for subjective response latency to constant angular acceleration. Meiry data from reference 8; Clark and Stewart data from reference 9.

The frequency response of the linearized model for subjective response is shown in figure 7. The frequency response is very similar to that of the simple second-order model used to match subjective data over the midrange of frequencies, where all the test results lie. The frequency response for nystagmus velocity is shown in figure 8. As is the case for the subjective frequency response, the adaptation model predicts even greater phase lead and lower amplitude ratio for very low frequencies than does the second-order model.

It should be noted that the time constants and thresholds specified for the model are the result of a fit of a particular set of average re-

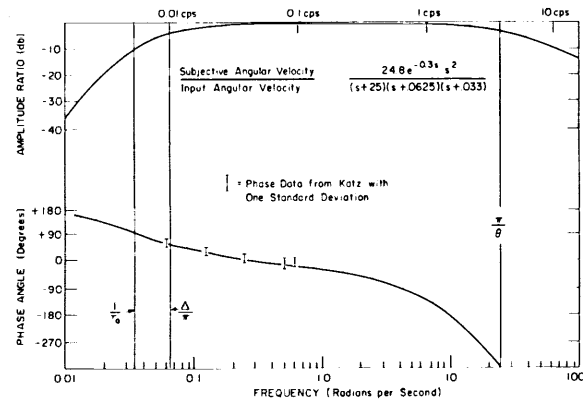

FIGURE 7.—Frequency response of adaptation model for subjective sensation. Katz data from reference 10.

sponse data. Data from individual subjects may deviate somewhat from the responses predicted here. In this regard, however, it is interesting to note that, working independently, Jones and Malcolm (“Quantitative Study of Vestibular Adaptation in Humans,” this symposium) of McGill University have measured nystagmus response for long-duration angular accelerations and also observed that their results were at variance with the second-order model. An adaptation operator for the nystagmus pathway was hypothesized, and an analog computer was used to match the model with the experimental data. The resulting model showed remarkably good fits for individual experimental data, as well as for average response. Significantly, while the assumptions made in the

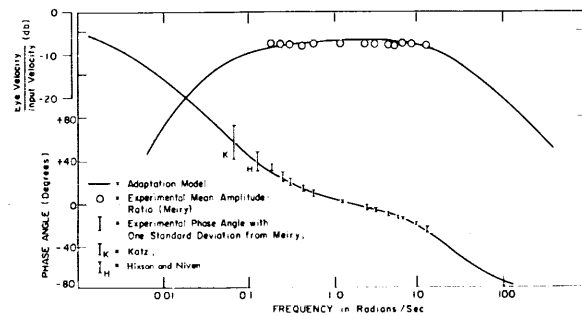

FIGURE 8.—Frequency response of compensatory eye movements for linearized model:

$$\frac{\text{eye velocity}}{\text{input velocity}} = \frac{10.5s^2}{(s + 25)(s + 0.0625)(s + 0.008)}$$

Katz data from reference 10; Hixson and Niven data from reference 11.

derivation of the adaptation operator were quite different in the McGill study, they lead to a dynamic expression for an adaptation operator identical in form with that of the MIT study.

CONCLUSIONS

Dynamic vestibular adaptation effects are evidenced in both the oculomotor and subjective responses. These effects can be incorporated into a control-theory model which accounts for the measured differences in nystagmus and subjective responses not predicted by the torsion-pendulum model: (1) cupulogram slopes, (2) secondary nystagmus, and (3) decaying response to sustained acceleration. Adaptation effects will only be readily observable in long-duration responses to sustained angular acceleration.

The adaptation operator cannot, however, be interpreted as a rational parameter model of a physiological process. Previous studies (ref. 4)

have implied that adaptation might, in some way, be due to a change in the transmission gain of the neurological pathways. The implication of the adaptation operator developed here is somewhat different in that one would not conclude that the transmission gain was changing, but rather that the zero-response reference level was being altered. This is not meant to imply that transmission gain changes do not take place, but only that the overall behavior of the system seems to involve a dynamic process which produces a change in the reference level.

The adaptation model can predict the general form of the average response of a normal, alert individual to angular accelerations in a horizontal plane, provided linear accelerations are not present. Possible effects of bias are not included. The model fails to predict the detailed time course of individual responses and does not account for the effects of habituation to repeated stimulus patterns.

REFERENCES

1. VAN EGMOND, A. A. J.; GROEN, J. J.; AND JONGKEES, L. B. W.: The Mechanics of the Semicircular Canal. *J. Physiol.*, vol. 110, 1949, pp. 1-17.
2. GUEDRY, F. E.; AND LAUVER, L. S.: Vestibular Reactions During Prolonged Constant Angular Acceleration. *J. Appl. Physiol.*, vol. 16, 1961, pp. 215-220.
3. ASCHAN, G.; AND BERGSTEDT, M.: The Genesis of Secondary Nystagmus Induced by Vestibular Stimuli. *Acta Soc. Med. Upsaliensis*, vol. 60, 1955, pp. 113-122.
4. GROEN, J. J.: The Semicircular Canal System of the Organs of Equilibrium. I. *Phys. Med. Biol.*, vol. 1, 1956, pp. 103-117; II. *Phys. Med. Biol.*, vol. 1, 1956-57, pp. 225-242.
5. HULK, J.; AND JONGKEES, L. B. W.: The Turning Test With Small Regulable Stimuli. II. The Normal Cupulogram. *J. Laryngol.*, vol. 62, 1948, pp. 70-75.
6. STEER, R. W., JR.: The Influence of Angular and Linear Acceleration and Thermal Stimulation on the Human Semicircular Canal. Sc. D. thesis, Massachusetts Institute of Technology, 1967.
7. BÁRANY, R.: Physiologie und Pathologie des Bogengangapparates beim Menschen (Funktionsprüfung des Bogengangapparates). *Klin. Studien, Deuticke* (Wien, Leipzig), 1907.
8. MEIRY, J. L.: The Vestibular System and Human Dynamic Space Orientation. Sc. D. thesis, Massachusetts Institute of Technology, 1965.
9. CLARK, B.; AND STEWART, J. D.: Perception of Angular Acceleration About the Yaw Axis of a Flight Simulator. *Aerospace Med.*, vol. 33, 1962, pp. 1426-1432.
10. KATZ, G. B.: Perception of Rotation—Nystagmus and Subjective Response at Low Frequency Stimulation. S.M. thesis, Massachusetts Institute of Technology, 1967.
11. HIXSON, W. C.; AND NIVEN, J. I.: Frequency Response of the Human Semicircular Canals. II. Nystagmus Phase Shift as a Measure of Nonlinearities. NSAM-830. NASA Order R-37. Naval School of Aviation Medicine, Pensacola, Fla., 1962.

PART III: A QUANTITATIVE STUDY OF VESTIBULAR ADAPTATION IN HUMANS

RICHARD MALCOLM

Canadian Forces Institute of Aviation Medicine

SUMMARY

A mathematical model for short-term adaptation to vestibular stimuli is presented in which the physiological response is driven by a signal proportional to the difference between the peripheral end-organ response θ_c and a central reference level R in such a way that $dR/dt \propto (\theta_c - R)$. From this relation a transfer function is derived relating slow-phase angular velocity of resulting nystagmus to the angular velocity of head rotation. The resulting model has been tested by comparing its responses to controlled step and ramp angular velocity stimuli with those of human subjects. A close match was obtained in all cases, which strongly supports the view that a significant adaptive effect is at play. The main time constant of the adaptive term was 82 seconds (S.E. 6.5) and the mean cupular restoration time constant T_c was 21 seconds (S.E. 1.5). It is suggested that previous values quoted for T_c represent underestimates of the true value owing to superposition of the adaptive term here described. The adaptive term accounts well for the phenomenon of secondary nystagmus, especially during either strong stimuli or prolonged rotations. Some implications of the findings in relation to clinical and aviation medicine are discussed.

INTRODUCTION

Secondary nystagmus, or post-rotatory nystagmus as it is sometimes called, has often been described in the literature (ref. 1). It is typically seen after a step change in angular velocity when, after cessation of the primary nystagmic response, a secondary nystagmus develops in the opposite direction from the primary one. The secondary response, although of lower amplitude than the primary one, usually extends over a relatively prolonged period, amounting in the experiments here described to 2 to 3 minutes. It is considered that this prolonged action of the secondary response probably represents an important source of misleading sensory information responsible for the generation of illusions of movement during flight.

This paper describes theoretical considerations and experimental results which strongly suggest that the secondary response is chiefly due to a quantitatively definable adaptive process which operates whenever a signal is generated in the semicircular canals.

THEORETICAL CONSIDERATIONS

The mechanical portion of the semicircular canals can be described as a second-order linear system, comparable to a torsion pendulum with heavy viscous damping (ref. 2). Thus, during angular acceleration, the inertia of the endolymphatic fluid contained in a semicircular canal generates relative fluid flow which is opposed by heavy viscous damping in the thin circular tube and a weak elastic restoring force due to cupular deflection. Assuming parabolic fluid flow, the response of this system, namely the angle of cupular deflection, can be related to the angular velocity of stimulus in the plane of the canal by the following transfer function (ref. 3):

$$\frac{\theta_c}{\dot{\theta}_H}(s) = \frac{ks}{(T_i s + 1)(T_c s + 1)} \quad (1)$$

where

θ_c = angle of deflection of cupula

$\dot{\theta}_H$ = angular velocity of head

T_i \approx polar moment of inertia of endolymph

$J \div$ viscous torque per unit relative angular velocity of fluid flow B
 $T_c \approx B \div$ moment of cupular restoration force per unit angle of fluid displacement in the canal K
 $k = \alpha J/K$, where α is the proportionality constant relating cupular angle to angle of fluid displacement.

In this experiment T_i is the time constant of approach to steady endolymph flow on sudden application of a steady angular acceleration and, as indicated in the above reference, is too short to be significant during the patterns of movement employed in these experiments. Equation (1) may therefore be simplified for the present purposes to

$$\frac{\theta_c}{\dot{\theta}_H}(s) = \frac{ks}{T_c s + 1}$$

or

$$\theta_c(s) = \frac{ks\dot{\theta}_H}{T_c s + 1} \quad (2)$$

in which T_c is the time constant of exponential cupular return due to the interaction of elastic and viscous forces after sudden change in stimulus angular velocity. With this system a step change in angular velocity input will lead to an initial response (cupular deflection) followed by an exponential return to zero response with a time constant $T_c \approx 16$ seconds estimated by cupulometric nystagmography (refs. 4 and 5). The form of this basic response is illustrated in figure 1A. If the oculomotor response were proportional to the vestibular input as suggested by results of Hallpike and Hood (ref. 6), this curve should also represent the time course of the slow-phase eye angular velocity during nystagmus. However, figure 2 exemplifies the time course of the slow-phase eye velocity actually observed in a human subject during the present experiments. The primary response did not simply decay to zero as would be expected from equation (2); it reversed after 34 seconds to yield a prolonged period of secondary nystagmus.

It is suggested in this paper that this form of secondary nystagmus is the result of a superimposed adaptive process. This hypothesis rests on two assumptions. First, signals generated in the canals, proportional to the deflection of

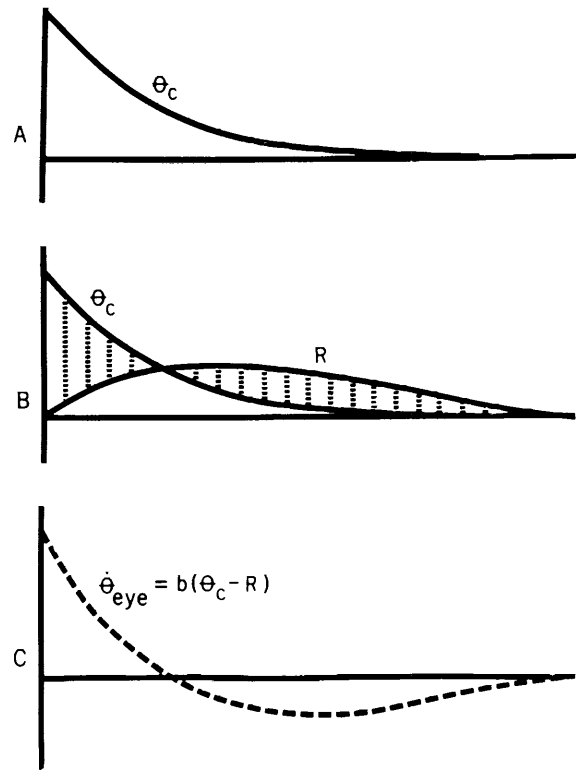

FIGURE 1.—Form of time dependence of response to step change in head angular velocity. A: Cupular deflection θ_c from resting position. B: The shifting reference level R which tends to minimize $\theta_c - R$ (dashed lines). C: Slow-phase eye angular velocity ($\dot{\theta}_{eye}$).

the cupula, are compared to a shifting reference level central to the mechanical components of the canal. This reference level R changes such that it always tends to minimize the difference between θ_c and R . Figure 1B illustrates this point. R continually drifts toward the instantaneous value of the canal signal θ_c , attempting to minimize $\theta_c - R$. In particular, the rate of change of R is assumed to be proportional to the value of the difference $\theta_c - R$. Hence

$$\frac{dR}{dt} = b(\theta_c - R) \quad (3)$$

where b is the constant of proportionality. In Laplace notation

$$R(s) = \frac{b\theta_c}{s + b} = \frac{\theta_c}{T_a s + 1} \quad (4)$$

where $T_a = 1/b$ and is the adaptive time constant. Substituting for θ_c from equation (2)

$$R(s) = \frac{ks\dot{\theta}_H}{(T_c s + 1)(T_a s + 1)} \quad (5)$$

The second assumption is that the slow phase angular velocity of resulting nystagmus is proportional to $\theta_c - R$. The dotted vertical lines in figure 1B indicate $\theta_c - R$, while figure 1C shows $\theta_c - R$ as a function of time. If $\dot{\theta}_{eye}$ represents the slow-phase eye angular velocity relative to the skull during nystagmus, then

$$\dot{\theta}_{eye} \propto (\theta_c - mR) \quad (6)$$

The parameter m is included since there is no a priori reason why θ_c and R are viewed with the same gains. If m is not unity, the model behaves as though it had a directional preponderance.

Substituting from equations (2) and (5) for θ_c and R , the vestibularly driven eye angular velocity ($\dot{\theta}_{eye}$) becomes

$$\dot{\theta}_{eye} = \rho \left\{ \frac{ks\dot{\theta}_H}{T_c s + 1} - \frac{mks\dot{\theta}_H}{(T_c s + 1)(T_a s + 1)} \right\} \quad (7)$$

where ρ is the constant of proportionality.

This transfer function formally describes the relation between head angular velocity as input (stimulus) and resulting slow-phase eye angular velocity as output (response), and defines the variables concerned in a manner permitting experimental verification of the hypothesis from which it is derived.

It may be noted here that in practice none of the subjects tested exhibited a significant directional preponderance (response uniformly biased in one direction), and accordingly the parameter m was held at unity throughout.

EXPERIMENTAL METHODS

After a number of preliminary experiments to determine suitable stimulus profiles, eight human subjects (three male, five female) ranging from age 18 to 39, and free from overt vestibular or oculomotor pathology, were exposed to two sets of stimuli.

The first was a ramp velocity generated by an

angular acceleration lasting 120 seconds and having an amplitude of $4.5^\circ/\text{sec}^2$. This stimulus was chosen since, after approximately 60 seconds, the cupula should have reached a constant angle of deflection, and any changes in the response after this time should be attributable to adaptation. The second stimulus was a step change in angular velocity of $270^\circ/\text{sec}$ requiring 10 seconds for completion. This stimulus was large enough to produce a clear secondary response without generating maximum eye velocities so high as to be limited by eye dynamics. In practice, the ramp velocity was achieved by first taking the subject slowly to the appropriate angular velocity in one direction and leaving him in this steady state for 3 minutes to permit complete cupular restoration. For the ramp velocity profiles, the table was driven to follow the required acceleration through zero velocity to an angular velocity in the opposite direction equal to that of the initial steady condition. This procedure was adopted to minimize the maximum absolute angular velocity attained by the turntable. The step change in velocity was achieved by taking the subject from a constant velocity to zero velocity.

The subjects were rotated while sitting on a servo-controlled rotating chair with their heads fixed to the chair by a dental bite. Their arousal was maintained by having them compete for a monetary reward by working out factorial 10 mentally. The instantaneous eye position was recorded by means of dc electro-oculography (EOG) and static calibration was done at 10 degrees and 20 degrees left and right before and after each experiment.

Before experimental runs, all subjects were dark adapted for at least 40 minutes in red light, previously shown to yield EOG gains indistinguishable from complete darkness after this time (Gonshor and Malcolm, in preparation). All calibrations were performed in red light and all experiments in total darkness. The eyes-closed condition was adopted on account of difficulties with lacrimation, blinking, and extraneous facial EMG activity introduced with eyes open during these high-level stimuli.

From the resulting nystagmographic records, beat-by-beat slow-phase angular velocity was

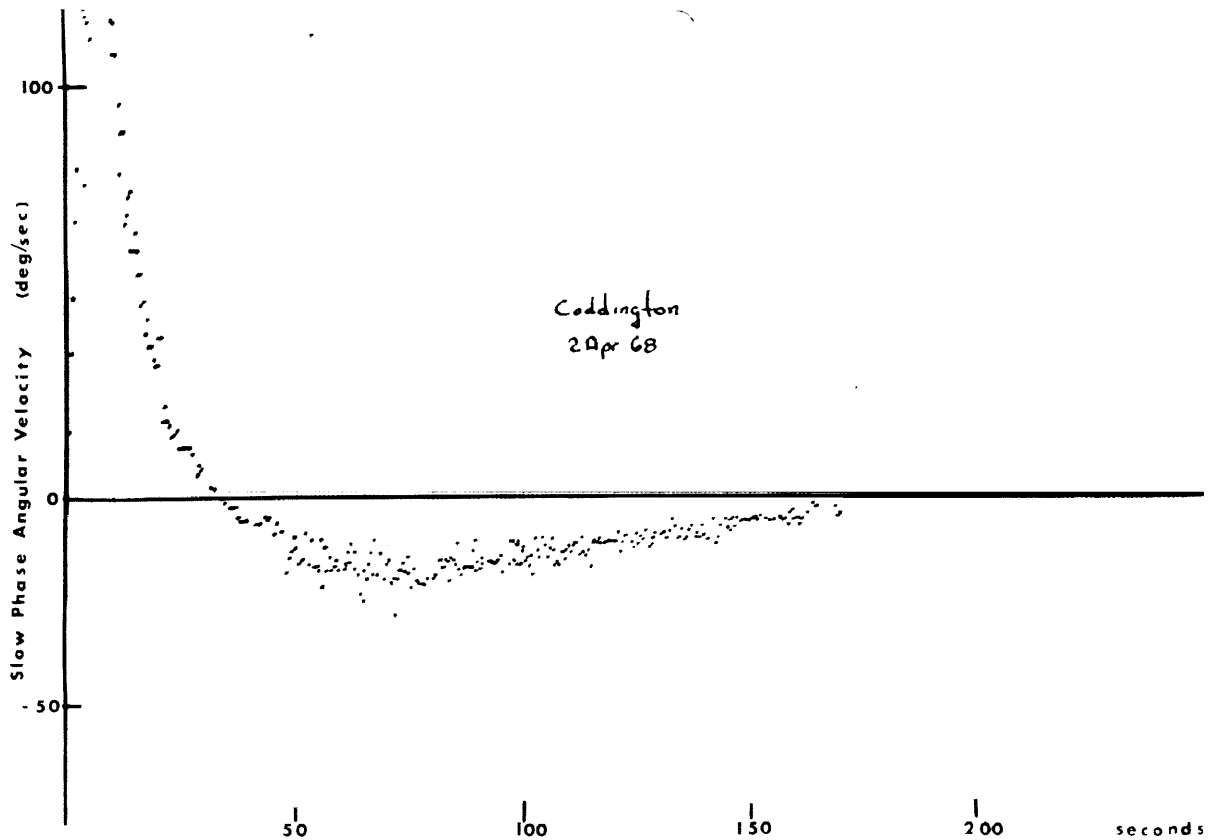

FIGURE 2.—The response of one subject to a sudden change in angular velocity. The slow-phase angular velocity of the nystagmus is plotted beat by beat against the time after the onset of the stimulus. The eye movement after reversal of direction at 34 seconds is secondary nystagmus.

plotted (ordinate) against time elapsed after commencing the rotational stimulus (abscissa) as in figures 2 and 3. Early results were laboriously measured by hand. But the majority of original records were analyzed by means of a tangent analyzer, similar in principal to that described by Benson and Stuart (ref. 7), but generating a direct writeout in graphical form on an X-Y plotter, as in figures 2 and 3. The accuracy of eye angular velocity measurement was of the same order of magnitude as the size of the dots in these figures.

To match the results obtained in this way with the mathematical model, the transfer function defined in equation (7) was programed onto an EAI TR-20 analog computer whose output was displayed on an oscilloscope. The computer could be made to run at 500 times real time, causing the response to any chosen input wave-

form to appear on the oscilloscope as a complete and continuous curve. The values of the parameters in the equation could be manually adjusted, producing an immediate change in the output curve viewed on the oscilloscope.

The graphs of the eye velocity versus time (such as shown in figs. 2 and 3) were photographed, and projected by means of an ordinary 35-mm slide projector onto the face of the oscilloscope. The computer was adjusted so that the output time base corresponded to the time divisions of the graph, and the predicted curve was then matched by eye with the observed responses of the subjects. The superposition thus obtained was photographed for subsequent reference through semisilvered mirrors, the results appearing as in figures 4 and 5.

The matching procedure leading to the values of T_c and T_n in table 1 used the following criteria

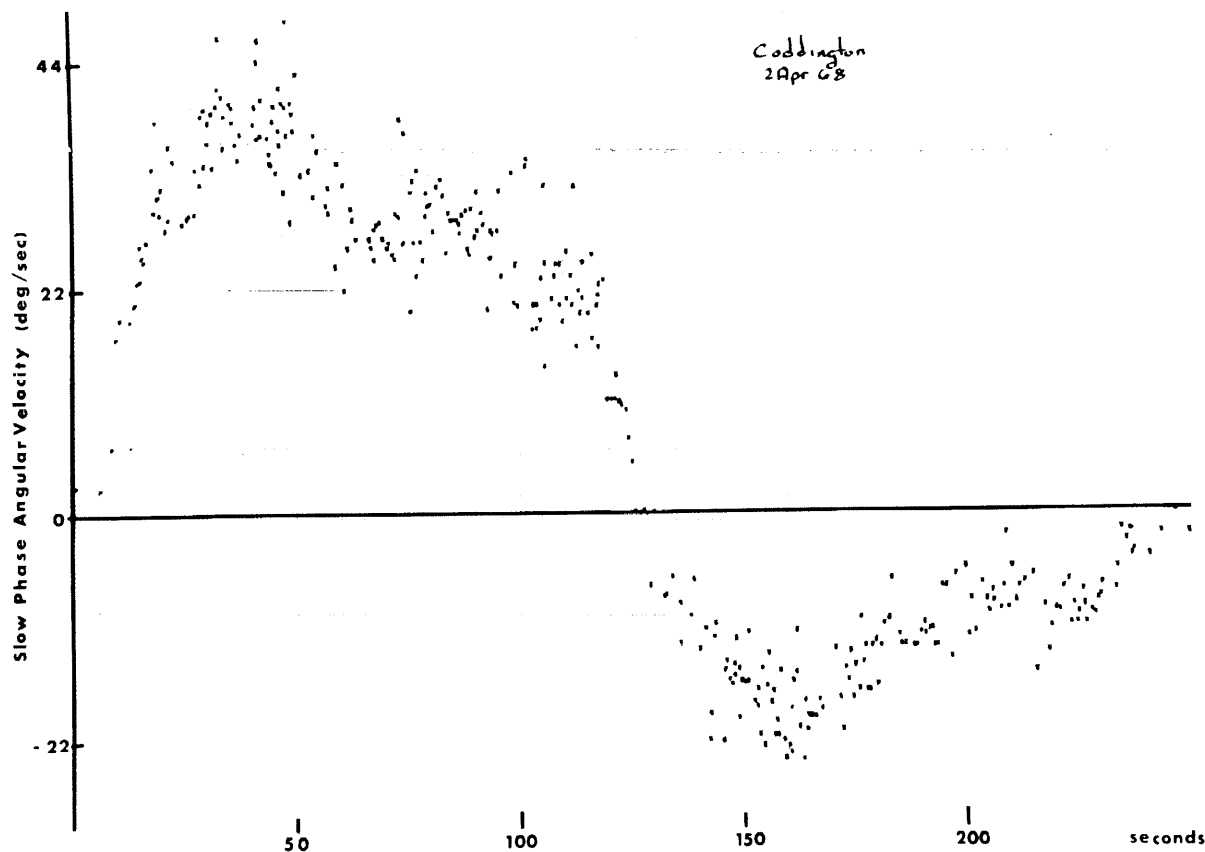

FIGURE 3.—The response of one subject to a velocity ramp. The slow-phase angular velocity of the nystagmus is plotted as a function of the time after onset of the stimulus.

for obtaining the best fit between the model and the observations:

1. The parameters T_c and T_a were adjusted so that the model should fit with similar accuracy, the data from both stimuli for a given subject.
2. Parameters T_c and T_a obtained from the visual fit of a given set of data should be reasonably reproducible (see table 1).

RESULTS

Figures 1 and 6 illustrate the forms of response to be expected from the model defined in equation (7) for a condition approximating $T_a = 4T_c$. In all curves (thick lines) the ordinate indicates response; and the abscissa, time elapsed after commencing the rotational stimulus. The thin line in figure 6A gives the imposed stimulus angular velocity which was a ramp followed by steady angular velocity.

The curves in figures 1A and 6A represent the change of cupular angle (θ_c) with respect to time. As previously mentioned in the theoretical considerations, a stepwise stimulus generates an initial response followed by an exponential decay. The response to a ramp stimulus rises with the same exponential time course as in figure 1A to achieve an asymptotic level which is held steady until cessation of the acceleration (fig. 6A). On assuming steady angular velocity of stimulus ($\dot{\theta}_H$) the response decays to zero.

In the B-curves the hypothetical reference levels R are shown with their time course defined by equations (3) and (4). The vertical dashed lines between θ_c and R give the value $\theta_c - R$ which determines the instantaneous slope of the reference curve R .

In the C-curves the final oculomotor responses, manifest as the slow-phase angular velocity of

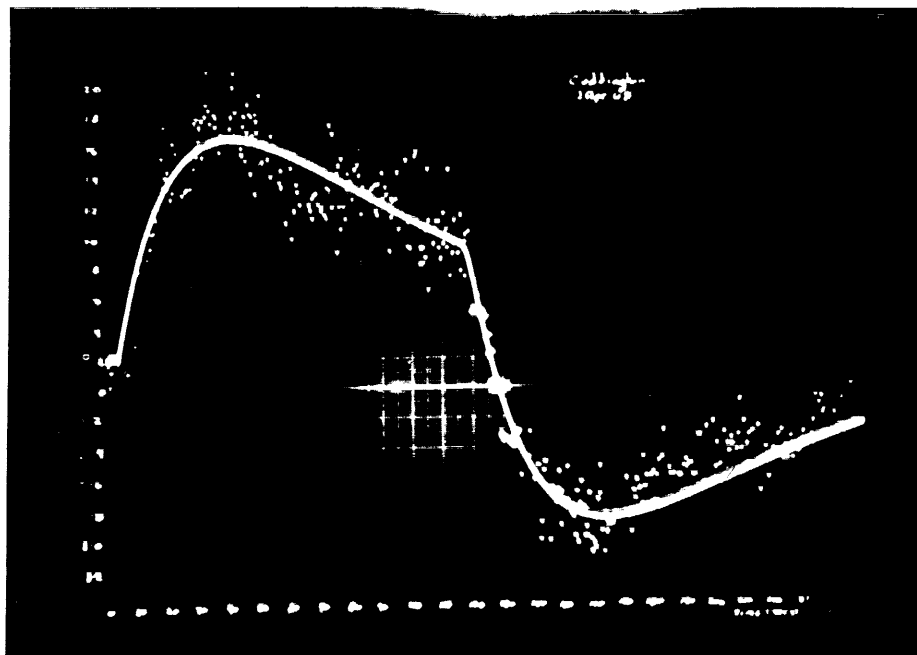
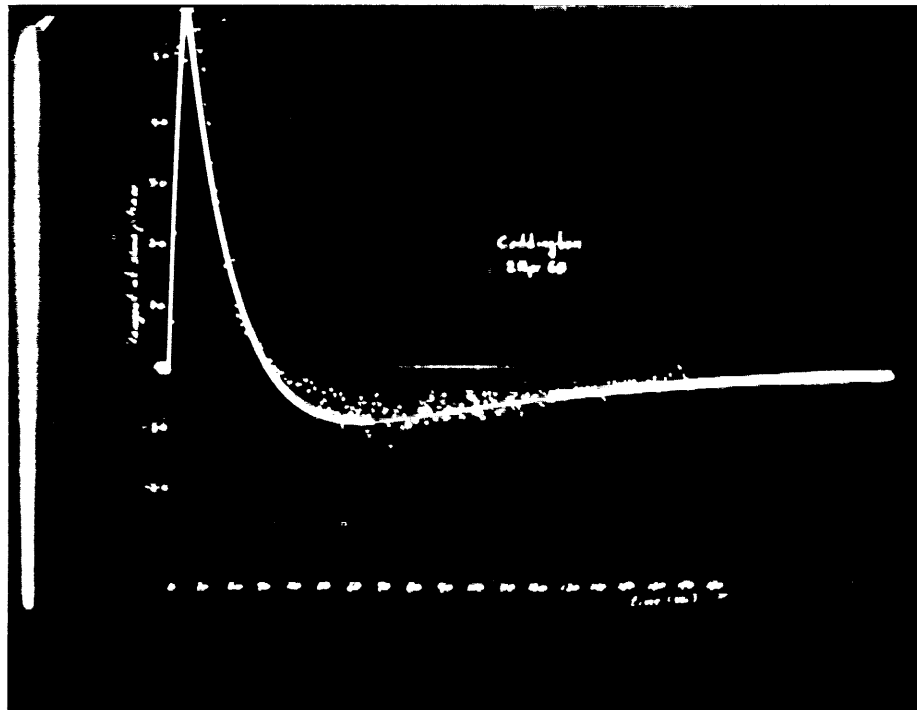

FIGURE 4.—The photographs show the superposition of the experimental data (dots), and the output of the analog computer (solid lines). The upper response is from a sudden change in angular velocity, while the lower one is from a velocity ramp. The ordinates give slow-phase angular velocity of the nystagmus, while the abscissae give the time in seconds after the onset of the stimuli.

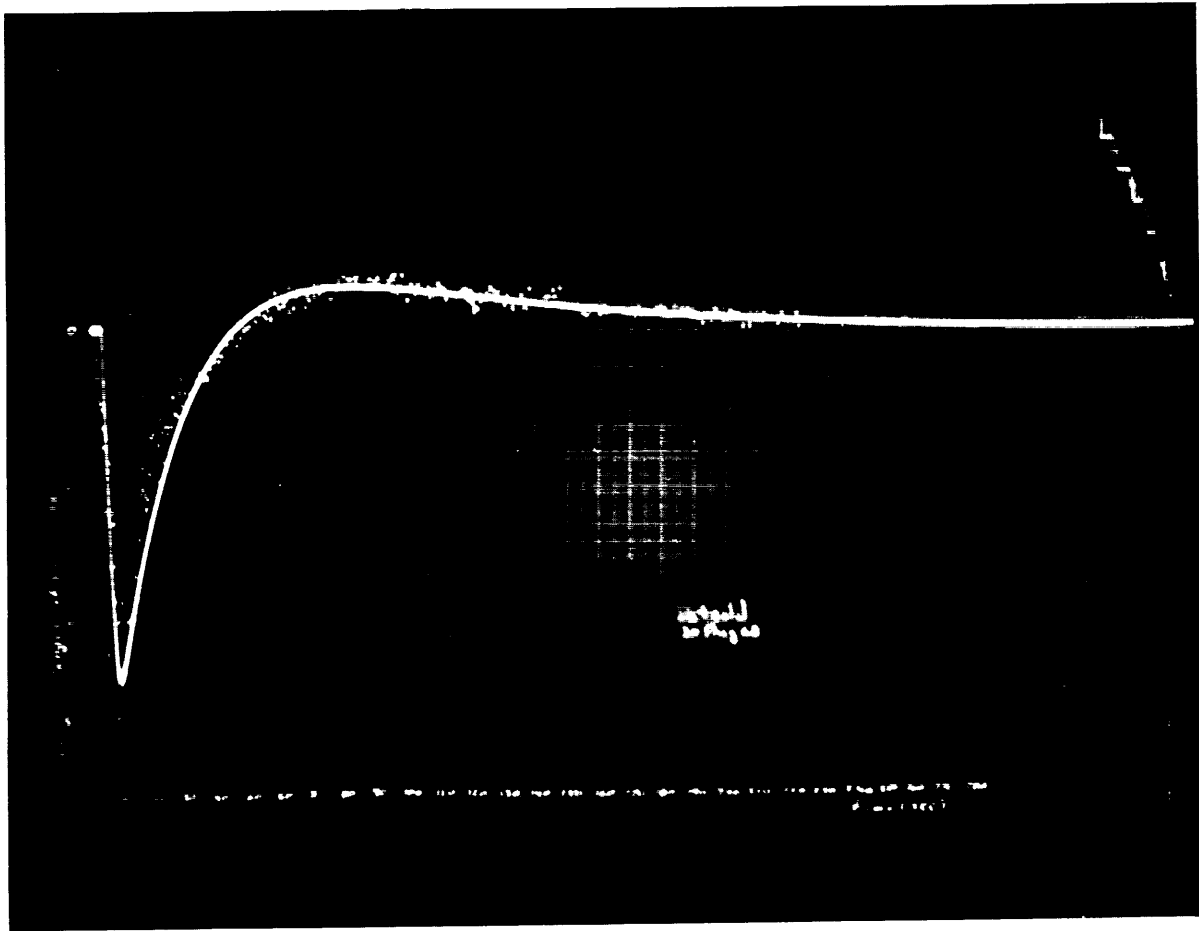

FIGURE 5.—The entire curve, from which the points and dotted curve were taken for figure 7. The dots represent the experimental points while the solid line represents the computed response.

resulting ocular nystagmus and defined by equation (7), are plotted. The deviations of *C*-curves from *A*-curves are easily seen. Not only is considerable secondary nystagmus evident, but the whole shape of the response is changed in a systematic way. It is particularly important to appreciate that if curve 1*C* is plotted on log-linear graph paper, only the portion above zero is normally visible and gives the impression of a decay which is considerably more rapid than the basic exponential decline in figure 1*A*. This matter will be referred to again in the discussion.

Figure 2 illustrates the plot of resulting slow phase eye angular velocity (ordinate) against time, obtained from one subject by the analytical process described above. Each spot gives the velocity during one nystagmic beat. All nystag-

mic beats from one experimental run are included. In practice, the step change of angular velocity occupied approximately 10 seconds, which accounts for the initial rising response. The subsequent primary response decayed smoothly through zero into a prolonged secondary phase of reversed nystagmus. The values of points on the zero ordinate were obtained from clearly defined horizontal lines on the original eye-movement record, interspersed with well-marked saccades, and could be easily measured. It is incidentally noteworthy that the curve passes smoothly, rather than discontinuously, through this zero, the theoretical implications of which will be discussed below.

Figure 3 is a similar plot obtained from the same subject as in figure 2, exposed to the

TABLE 1.—*Experimental Values for the Canal Cupular Restoration Time Constant T_c and the Adaptation Time Constant T_a for Each of the Subjects Tested*

Subject	T_c , sec		T_a , sec	
	A	B ¹	A	B ¹
JR.....	17.5	14	63	66
DC.....	15.5	15.2	82	81
VS.....	18	23	105	93.5
JO.....	23	20.5	66	66
CN.....	21	20.5	125	150
LS.....	26	29.5	78	64
DP.....	30	32	58.5	53
AF.....	15.3	14	81	83
Mean ²	21		82	
S.D. ²	5.9		25.8	
S.E. ²	1.5		6.5	

¹ Col. B values were obtained 10 days after those in col. A.

² Mean, S.D., and S.E. values are calculated from the combined data in cols. A and B.

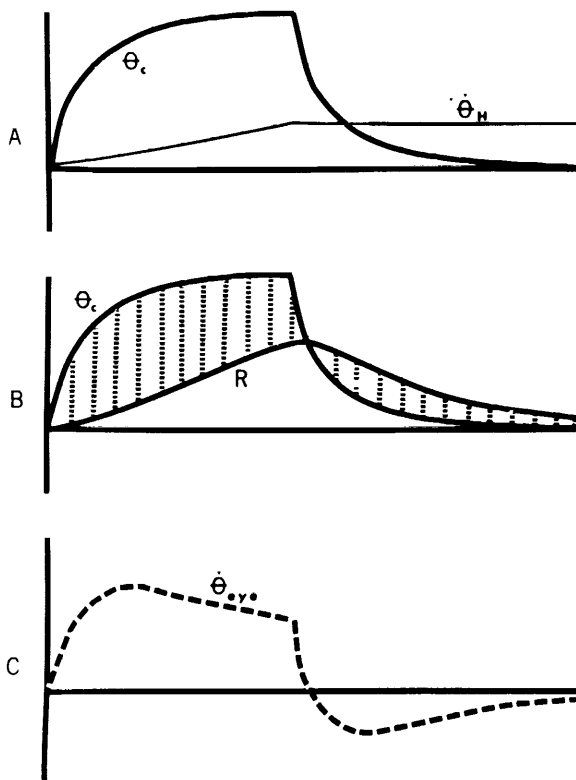

FIGURE 6.—*Form of time dependence of response to ramp velocity of the head (θ_H). A, B, and C as in figure 1.*

stimulus depicted in figure 6A and described numerically under "Experimental Methods." This was the only record in which "lumping" of data points tended to occur on the zero ordinate. The similarities between the plots in figures 2 and 1C, and 3 and 6C are striking and form the basis of the numerical analysis.

Figure 4 (top and bottom) illustrates examples of the actual fits obtained on the oscilloscope face as described under "Experimental Methods" for the two plots shown in figures 2 and 3, respectively.

The values of the time constant of cupular restoration T_c and the adaptive time constant T_a calculated from the relevant potentiometer settings on the analog model of equation (7) are given in table 1 for all subjects and all experiments. The two columns under each parameter heading give duplicate values obtained from curve fittings on a single set of data plots performed with a 10-day interval between the fitting procedures, a period sufficiently long to forget prior knowledge of results. The duplicate sets of results for each time constant indicate reasonable reproducibility.

The standard deviation and standard error values are calculated from the combined results from first and second fittings. Mean values for cupular time constant and adaptive time constant were $T_c=21$ seconds (S.E. 1.5) and $T_a=82$ seconds (S.E. 6.5), respectively.

DISCUSSION

Results such as those exemplified in figures 2 and 3 demonstrate dramatically how wide the divergence of physiological response to rotational stimulation of the canals can be from that predicted by the simple torsion pendulum model usually considered a fair approximation of the cupular-canal-endolymph system. The fact that the recorded divergence of these objective results could in all subjects and all experiments be adequately accounted for by the adaptive model here proposed, strongly suggests that such an adaptive function, or one closely resembling it, is in fact constantly active in all circumstances. It appears that a similar phenomenon may account for subjective effects as well (Young and Oman, personal communication).

The findings raise the question, What functional role could be served by the adaptive effect here described? In attempting to answer this question, it is important to appreciate first that the long time constant attaching to the adaptive phenomenon appropriately precludes it from interfering significantly with the active vestibular sensory message during the relatively short, sharp head movements of everyday life. On the other hand, long time constant adaptation would be highly effective in tending to maintain, over long periods, the steady state, or dc, balance of the differential inputs impinging on the central nervous system (CNS) from the two sides of the head. The physiological implications of this become apparent when it is appreciated that the average neural discharge from each ampulla has a resting value which is increased by rotation in one direction and decreased by rotation in the other direction (refs. 8 to 11). As pointed out by Melvill Jones in 1965 (ref. 12), this evidence, coupled with results of unilateral canal plugging experiments (refs. 13 and 14), indicates that the CNS acts differentially upon the signals from pairs of canals. Let the resting discharge rates from a pair of opposite canals be A and B , respectively. It may then be postulated that reflex response to canal stimulation will be in proportion to the differential term $A - B$, which, for dc balance, may or may not be zero in the stationary condition. But during skull rotation, since each canal is a mirror image of its contralateral counterpart, the change in firing rates will be from A to $(A + \Delta A)$ and B to $(B - \Delta B)$. The CNS would then "see" these two inputs differentially and compare the new result with the resting condition (i.e., $(A + \Delta A - B + \Delta B)$ to $(A - B)$). In this notation the relevant change amounts to $\Delta A + \Delta B$. But presumably such a change would be indistinguishable to the CNS from a change in the value $A - B$ due to natural biological drift or some pathological cause. However, if the reference level R proposed above always shifted toward the difference $A - B$, an effective dc balance would be maintained indefinitely. The process could be akin to automatic maintenance of the dc balance in a differential amplifier. The value of such a feature in the canal vestibular system is further em-

phasized by the fact that the sensory signal is essentially one of angular velocity; and hence a maintained signal, even though very small, would in time indicate a large change in angular position.

In the present context, the significance of this latter observation is highlighted by the fact that, in curves such as that in figure 2, the areas under the primary and secondary responses are of similar magnitude. Since the basic plot is here one of angular velocity, this implies that the total angle (integral of angular velocity with respect to time) of primary response is roughly equaled by the opposite secondary one. Since one's sense of attitude in space is determined by the impression of angular displacement at any given time, the rather surprising conclusion may be drawn that the secondary response, if sufficiently above "threshold," can exert an influence of the same order of magnitude as the primary one.

It is of interest to note the rather long value of 21 seconds obtained for the mean value of the cupular restoration time constant (T_c). This value is considerably greater than those quoted under theoretical considerations. The difference can readily be accounted for by the fact that the earlier values were essentially obtained from data points restricted to the primary response, largely on account of the fact that results were usually plotted on log-linear graph paper. Since from the torsion pendulum model the response to a step change in stimulus angular velocity should be an exponential decay, it has been customary to approximate the plotted response with a straight line, the slope of which then gives the required time constant. Such a plot for one of the present subjects is given as the straight line in figure 7. From the slope of this line a value of 11.5 seconds emerges for the cupular restoring time constant. But adopting the best fit to the whole set of data, as depicted in figure 5 (which represents the same data as in fig. 7 but with primary response displayed downward in this case), a value of 31 seconds emerges for T_c for this individual, which is more than double the value estimated in the customary manner. The intermittent line in figure 7 represents the fitted line of figure 5 superimposed on the log-linear plot of data. It

may be noted that the separation of the two lines in figure 7 corresponds to the small deviation of points from the upward sweep of the continuous line in figure 5.

This is perhaps an extreme example, but it suffices to indicate an inherent error in assessing definitive parameters of the canal system using the method illustrated in figure 7. The present considerations suggest that the tendency in the past has been to underestimate the canal time constant as a result of the adaptive effect here described modifying the end-organ response before generation of the functional physiological one.

Some single-cell recordings from primary vestibular neurons of the rayfish have shown a similar pattern of behavior (ref. 11). Firing frequency, after changing in response to a change in angular velocity, tended to overshoot the rest-

ing frequency and only slowly return. This leads one to speculate as to the possible site of this adaptive process. Possibly the shift in reference level represents a shift in ions which occurs within the hair cells of the crista, so as to compensate the generator potential, following cupula deflection. Perhaps, as has been suggested by Lowenstein (personal communication), it may represent a depletion of the synaptic transmitter of the hair cells. Alternatively the adaptation may manifest as central feedback to the periphery via the efferent pathways (ref. 15), resulting in a sensitivity or gain change of the transducer. And, finally, a number of central mechanisms might combine to bring about the effect. It should be emphasized that the mathematical model is incapable of discriminating between such processes and cannot therefore shed any light on their source. It could be that some or all of the above are acting simultaneously.

As mentioned earlier, figure 2 shows that the response tends to cross the zero axis with little or no discontinuity. This poses the problem as to whether or not a threshold exists. Figure 8A shows diagrammatically what one would expect to find if a threshold to cupula deflection existed. During the time when the cupula was passing through its subthreshold region of deflection, one should get no nystagmus, and this causes a discontinuous curve as shown in figure 8A. However, if the problem was one of resolving the angle of cupula deflection, then the eye velocity during nystagmus would lie between the two lines shown in figure 8B. The similarity between figure 2 and figure 8B leads to the conclusion that resolution of one angular acceleration from another is really the problem, and that if a threshold does exist, it is probably very small. It should be pointed out, however, that a form of threshold would exist if there was stiction between the cupula and the walls of the membranous ampulla. This would be seen only when the subject was rotated from a resting position, and would disappear once he was moved. Should this be the case, the threshold for perception of a change in angular acceleration for a subject who has been at constant angular acceleration should be greater than for a subject who has just previously been exposed to a change in acceleration.

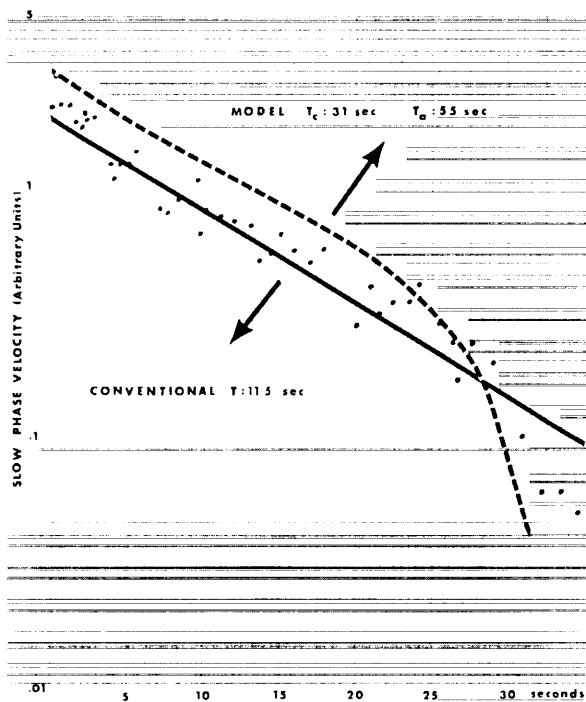

FIGURE 7.—The log of the slow-phase angular velocity of nystagmus plotted as a function of time from the results in figure 5. If adaptation did not occur, the points should lie along a straight line, giving a mistaken value for T_c of 11.5 seconds from these results. The dotted line shows the computer fit based on T_c equal to 31 seconds. The semilog scale exaggerates the error between the points and the dotted line in figure 5.

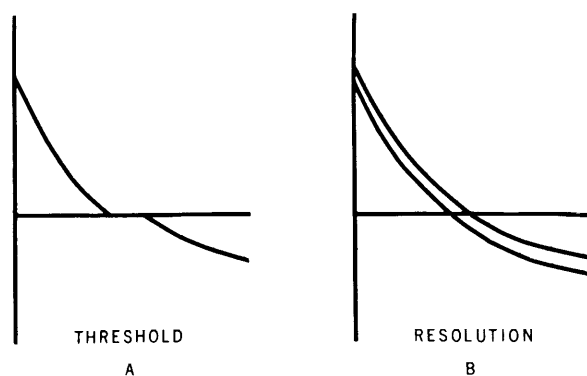

FIGURE 8.—A: The form of the response to a step change in head velocity expected (slow-phase angular velocity of nystagmus versus time) if a threshold to cupula deviation existed. B: The form of the response to a step change in head angular velocity to be expected if only finite resolution of cupular deflection existed. The response should tend to lie within the two lines, which represent the resolution limits.

This point is of particular importance to pilots, since the thresholds found for humans during controlled experiments on smoothly moving platforms may be quite large compared to what the pilot can sense in a constantly moving aircraft.

There are additional implications in the applied context of aviation. First, the unnaturally large and/or prolonged rotational stimuli commonly experienced in flight maneuvers probably generate, at least temporarily, residual unidirectional effects in the vestibular system (ref. 16). Hence an adaptive capability may represent an important functional asset which is normally active in offsetting such an effect. Possibly failure to do so may be associated with generation of the biased impressions of attitude often referred to as "the leans." On the other hand, such "leans" may be due to the secondary effects

which this paper attributes to adaptation. The methods here described provide the basis for tests by which adaptive capability might be assessed before selection for flying duties. Second, alteration of adaptive capability by the flight environment may be important to achieving proficiency as a pilot and is now amenable to testing. Third, as inferred in a general context above, the functional significance of the secondary response may in some circumstances be approximately equal to the primary one. Presumably in violent rotational maneuvers, such as repeated rolls and aerodynamic spinning, the adaptive term stands to introduce adverse effects which would not be accounted for by previously described physiological phenomena (ref. 17). Fourth, it is clearly important to incorporate the adaptive function in any model aimed at permitting calculation of the overall vestibular response to movement (ref. 18).

From the clinical standpoint, the results indicate a certain lability in the conventional cupulometric turning test. It seems from the present work that the response to the test is composed of two main components, that due to cupular restoration and that due to subsequent adaptation. Possibly the effect of the adaptive mechanism could mask a pathological cupular component, and vice versa. Second, it could be that pathological involvement of the adaptive mechanism might itself prove to comprise a significant clinical entity.

Finally, it is of interest to speculate on the extent to which the present results reflect biological adaptive functions in other sensory channels. Possibly the adaptive principle and analytical methods here described could be employed to examine this question on a quantitative basis.

REFERENCES

1. GRAYBIEL, A.; AND HUPP, D. E.: The Oculo-gyral Illusion. A Form of Apparent Motion Which May Be Observed Following Stimulation of the Semicircular Canals. *J. Aviat. Med.*, vol. 17, 1946, pp. 3-27.
2. VAN EGMOND, A. A. J.; GROEN, J. J.; AND JONGKEES, L. B. W.: The Mechanics of the Semi-circular Canal. *J. Physiol.*, vol. 110, 1949, pp. 1-17.
3. JONES, G. MELVILL; AND MILSUM, J. H.: Spatial and Dynamic Aspects of Visual Fixation. *IEEE Trans. Bio-Med. Eng. BME-12*, 1965, pp. 54-62.
4. GROEN, J.: Problems of the Semi-circular Canal From a Mechanico-physiological Point of View. *Acta-Otolaryngol.*, suppl. 163, 1960, pp. 59-67.
5. MELVILL JONES, G.; BARRY, W.; AND KOWALSKY, N.: Dynamics of the Semicircular Canals Compared in Yaw, Pitch and Roll. *Aerospace Med.*, vol. 35, 1964, pp. 984-989.

6. HALLPIKE, C. S.; AND HOOD, J. D.: The Speed of the Slow Component of Ocular Nystagmus Induced by Angular Acceleration of the Head; Its Experimental Determination and Application to the Physical Theory of the Cupular Mechanism. *Proc. Roy. Soc. B*, vol. 141, 1953, pp. 216-230.
7. BENSON, A. J.; AND STUART, H. F.: A Trace Reader for the Direct Measurement of the Slope of Graphical Records. *J. Physiol.*, vol. 189, 1P, 1967.
8. LOWENSTEIN, O.; AND SAND, A.: The Individual and Integral Activity of the Semi-circular Canals of the Elasmobranch Labyrinth. *J. Physiol.*, vol. 99, 1940, pp. 89-101.
9. ADRIAN, E. D.: Discharges From the Vestibular Receptors in the Cat. *J. Physiol.*, vol. 101, 1943, pp. 389-407.
10. GERNANDT, B. E.: Response of Mammalian Vestibular Neurons to Horizontal Rotation and Caloric Stimulation. *J. Neurophysiol.*, vol. 12, 1949, pp. 173-184.
11. GROEN, J. J.; LOWENSTEIN, O.; AND VENDRIK, A. J. H.: The Mechanical Analysis of the Responses From the End-Organs of the Horizontal Semi-circular Canal in the Isolated Elasmobranch Labyrinth. *J. Physiol.*, vol. 117, 1952, pp. 329-346.
12. MELVILL JONES, G.: The Vestibular Contribution to Stabilization of the Retinal Image. The Role of the Vestibular Organs in the Exploration of Space, NASA SP-77, 1965, pp. 163-171.
13. MONEY, K. E.; AND SCOTT, J. W.: Functions of Separate Sensory Receptors of Non-auditory Labyrinth of the Cat. *Am. J. Physiol.*, vol. 202, 1962, pp. 1211-1220.
14. ZUCKERMAN, H.: The Physiological Adaptation to Unilateral Semi-circular Canal Inactivation. *McGill Med. J.*, vol. 36, 1967, pp. 8-13.
15. GACEK, R. R.: Efferent Component of the Vestibular Nerve. *Neural Mechanisms of the Auditory and Vestibular Systems*, G. L. Rasmussen and W. F. Windle, eds., Charles C Thomas, 1960, pp. 276-284.
16. CAPORALE, R.; AND CAMARDA, V.: La Funzionalità Vestibolare di Acuni Pilotidi Pattuglia Acrobatica. *Riv. Med. Aeron.*, vol. 21, 1958, pp. 13-36.
17. MELVILL JONES, G.: Vestibulo-ocular Disorganization in the Aerodynamic Spin. *Aerospace Med.*, vol. 36, 1965, pp. 976-983.
18. YOUNG, L. R.: A Control Model of the Vestibular System. *International Federation of Automatic Control, Symposium on Technical and Biological Problems in Cybernetics, Yerivan, Armenia, U.S.S.R., Sept. 1968.*

DISCUSSION

Lowenstein: This is what one frequently sees when one deals with single-fiber units after step-function stimuli. They return like this and then dip under the reference level, and gradually return to it. This may be in conflict with the mechanical model of the cupula endolymph system, but do not forget that, in the hair cell, the hair processes are ensheathed in the cupula. Up at the top of the cell your mechanical model may be valid, but down in the synaptic region there is a chemical transmission process which may already introduce the first distortion.

Guedry: It seems to me that part of these effects may be explained by events within the end organ, but it does not seem reasonable to explain on this basis certain rather definite discrepancies between the subjective and the nystagmus responses. I can add a little to some of the data that have been reported today. We have done, over the past few years, experiments in which we have maintained a ramp velocity change for 16 seconds, but this was a 40-rpm change in angular velocity, which is a strong stimulus. The average time for the cessation of the primary subjective reaction occurred while primary nystagmus was in progress with a slow velocity of roughly 30 deg/sec. Then after a minute with secondary nystagmus still in progress, we introduced a triangular velocity waveform. The subjective response in most subjects seems to be based on the secondary level of nystagmus, which seems to fit fairly well with the model

that was presented here by Malcolm. In other words, a triangular waveform can be introduced which will increase and then decrease the secondary nystagmus response. The sensation of rotation follows a similar pattern, first increasing and then decreasing, and the point in time when nystagmus crosses over the (extrapolated) secondary baseline is a close approximation to the average point in time when subjects signal a stop. In most cases nystagmus overshoots the (extrapolated) secondary baseline, and during the overshoot period, many subjects signal rotation in the opposite direction even though nystagmus continues in the secondary direction. So we have during this interval a dissociation of directions of sensation and nystagmus.

Malcolm: I find this very interesting. Dr. Guedry, and it certainly bears further looking into. It also serves to illustrate a rather important point, namely, that the process we are examining here is most probably not a simple one such as the model just described, but rather a network of series and parallel loops, each one similar to the one shown in the model. Mathematically, one could not make this distinction, however, and so the very complicated real situation can be nicely approximated by a very simple model, merely by playing with the algebra. The value in doing this lies in the fact that it can imply the kind of processes going on, as well as providing a means of predicting the responses to a complicated stimulus pattern.

PARTICIPANTS

- ACETO, HENRY, JR.
Division of Medical Physics
Donner Laboratory
University of California
Berkeley, Calif. 94720
- ACHENBACH, KARL E.
Department of Anatomical Sciences
University of Florida School of Medicine
Gainesville, Fla. 32601
- ADES, HARLOW W.
Department of Electrical Engineering
University of Illinois
Urbana, Ill. 61801
- ANLIKER, MAX
Department of Aeronautics and Astronautics
Stanford University
Palo Alto, Calif. 94305
- BALDES, E. J.
Headquarters, USA Aeromedical Research Laboratory
Box 577
Fort Rucker, Ala. 36360
- BARBER, HUGH O.
Department of Otolaryngology
Sunnybrook Hospital
2075 Bayview Avenue
Toronto 12, Ontario, Canada
- BARRETT, BERNARD M.
1600 North Palafox Street
Pensacola, Fla. 32501
- BERLIN, CHARLES I.
LSU School of Medicine
1542 Tulane Avenue
New Orleans, La. 70112
- BERRIAN, JAMES H.
Life Sciences Department
Lockheed California Co.
Post Office Box 551
Burbank, Calif. 91503
- BERRY, FRANK W., JR.
School of Aerospace Medicine
Box 4596
Brooks Air Force Base, Tex. 78235
- BILLINGHAM, JOHN
Ames Research Center, NASA
Moffett Field, Calif. 94035
- BLACK, FRANKLIN O.
Division of Otolaryngology
University of Colorado Medical Center
4200 East Ninth Avenue
Denver, Colo. 80220
- BLATT, IRVING
Department of Otorhinolaryngology
LSU School of Medicine
1542 Tulane Avenue
New Orleans, La. 70112
- BORISON, HERBERT L.
Department of Pharmacology
Dartmouth Medical College
Hanover, N.H. 03755
- BREDBERG, GÖRAN
Biophysical Research Laboratory
University of Illinois
Urbana, Ill. 61801
- BROWN, JAMES H.
National Science Foundation
1800 G Street NW.
Washington, D.C. 20550
- CLARK, BRANT
Department of Psychology
San Jose State College
San Jose, Calif. 95114
- COLLINS, WILLIAM E.
Civil Aeromedical Institute
FAA Aeronautical Center, AC-118
Post Office Box 25082
Oklahoma City, Okla. 73125
- CRAMER, DEWEY B.
Naval Aerospace Medical Institute
Naval Aerospace Medical Center
Pensacola, Fla. 32512
- CRAMER, ROBERT L.
School of Aerospace Medicine
Brooks Air Force Base, Tex. 78235
- DIETLEIN, LAWRENCE F.
Chief, Biomedical Research Office/DB
NASA Manned Spacecraft Center
Houston, Tex. 77058
- DOHLMAN, G. F.
Defence Research Establishment Toronto
Post Office Box 2000
Downsview, Ontario, Canada
- EIGHMY, HERBERT H.
Naval Aerospace Medical Center
Pensacola, Fla. 32512
- ENGSTRÖM, HANS
Akademiska Sjukhuset
Uppsala 14, Sweden
- FERNÁNDEZ, CÉSAR
Department of Surgery (ENT)
University of Chicago
950 East 59th Street
Chicago, Ill. 60637

- FREDRICKSON, JOHN M.
Department of Otolaryngology
University of Toronto
92 College Street
Toronto 5, Ontario, Canada
- FREGLY, ALFRED R.
Naval Aerospace Medical Institute
Naval Aerospace Medical Center
Pensacola, Fla. 32512
- FRYER, DAVID I.
British Embassy, RAF Staff
3100 Massachusetts Avenue NW.
Washington, D.C. 20008
- GATES, GEORGE A.
University Medical Center
1405 Ann Street
Ann Arbor, Mich. 48104
- GERNANDT, BO E.
Naval Aerospace Medical Institute
Naval Aerospace Medical Center
Pensacola, Fla. 32512
- GILLINGHAM, KENT K.
Department of Otolaryngology
University Hospitals
Iowa City, Iowa 52240
- GOODMAN, DONALD C.
Department of Anatomical Sciences
University of Florida School of Medicine
Gainesville, Fla. 32601
- GRAYBIEL, ASHTON
Naval Aerospace Medical Institute
Naval Aerospace Medical Center
Pensacola, Fla. 32512
- GUEDRY, FRED E., JR.
Naval Aerospace Medical Institute
Naval Aerospace Medical Center
Pensacola, Fla. 32512
- HARRIS, CHARLES STANLEY
Behavior Science Laboratory
6570th Aerospace Medical Research Laboratories
Wright-Patterson Air Force Base, Ohio 45433
- HIXSON, W. CARROLL
Naval Aerospace Medical Institute
Naval Aerospace Medical Center
Pensacola, Fla. 32512
- HUERTAS, JORGE
2240 Avy Avenue
Menlo Park, Calif. 94025
- HUMPHREYS, J. W., JR.
Director, Space Medicine
Office of Manned Space Flight
Code: MM
NASA Headquarters
Washington, D.C. 20546
- ICARASHI, MAKOTO
Department of Otolaryngology
Baylor University College of Medicine
1200 Moursund
Houston, Tex. 77025
- ITO, MASAO
Department of Physiology
University of Tokyo
Tokyo, Japan
- JANKOVICH, JOHN
Wenner-Gren Aeronautical Research Laboratory
University of Kentucky
Lexington, Ky. 40506
- JOHNSON, DAVID M.
Department of Physiology
University of Toronto
112 College Street
Toronto 5, Ontario, Canada
- JOHNSON, WALTER H.
Department of Otolaryngology
University of Toronto
92 College Street
Toronto 5, Ontario, Canada
- JONES, WALTON L.
NASA Headquarters, Code RB
Washington, D.C. 20546
- KELLOGG, ROBERT S.
Department of Psychology
University of Rochester
Rochester, N.Y. 14627
- KENNEDY, ROBERT S.
Naval Aerospace Medical Institute
Naval Aerospace Medical Center
Pensacola, Fla. 32512
- KING, MARTHA E.
Division of Otolaryngology
University of Florida School of Medicine
Gainesville, Fla. 32601
- KING, ROBERT L., JR.
1750 North Palafox Street
Pensacola, Fla. 32501
- KNAPP, STANLEY C.
School of Aerospace Medicine
Brooks Air Force Base, Tex. 78235
- KNEPTON, JAMES C.
Naval Aerospace Medical Institute
Naval Aerospace Medical Center
Pensacola, Fla. 32512
- KOHUT, R. I.
Division of Otolaryngology
University of Florida School of Medicine
Gainesville, Fla. 32601
- KOWALSKI, LEONARD R.
School of Aerospace Medicine
Brooks Air Force Base, Tex. 78235
- LANSBERG, MARTIN P.
National Aeromedical Center
Soesterberg, the Netherlands
- LETKO, WILLIAM
NASA Langley Research Center
Langley Station
Hampton, Va. 23365
- LICKING, JOHN H.
College of Physicians and Surgeons of Columbia University

- 630 West 168th Street
New York, N.Y. 10032
- LOWENSTEIN, OTTO
Department of Zoology and Comparative Physiology
University of Birmingham
Post Office Box 363
Birmingham 15, England
- LOWY, KARL
Center for Brain Research
University of Rochester
Rochester, N.Y. 14627
- MCCLURE, JOSEPH A.
University of Toronto
92 College Street
Toronto 5, Ontario, Canada
- MCNALLY, W. J.
1509 Sherbrooke Street West, Suite 16-A
Montreal 25, Quebec, Canada
- MALCOLM, RICHARD
Canadian Forces Institute of Aviation Medicine
Toronto, Canada
- MILLER, EARL F., II
Naval Aerospace Medical Institute
Naval Aerospace Medical Center
Pensacola, Fla. 32512
- MOLINA, EFRAIN A.
Naval Aerospace Medical Institute
Naval Aerospace Medical Center
Pensacola, Fla. 32512
- MONEY, KENNETH E.
Defence Research Establishment Toronto
Post Office Box 2000
Downsview, Ontario, Canada
- MORRIS, DAVID P.
Aerospace Medical Research Department
Naval Air Development Center
Johnsville, Warminster, Pa. 18974
- NAGABA, MASAO
Naval Aerospace Medical Institute
Naval Aerospace Medical Center
Pensacola, Fla. 32512
- NEFF, WILLIAM D.
Center for Neural Sciences
Indiana University
Bloomington, Ind. 47401
- NEW, ALBERT E.
Naval Aerospace Medical Institute
Naval Aerospace Medical Center
Pensacola, Fla. 32512
- NEWSOM, BERNARD D.
Manned Spacecraft Center, NASA
Code DA/Assistant for AAP
Houston, Tex. 77058
- NIVEN, JORMA I.
Naval Aerospace Medical Institute
Naval Aerospace Medical Center
Pensacola, Fla. 32512
- NORMAN, JOEL W.
Naval Aerospace Medical Institute
Naval Aerospace Medical Center
Pensacola, Fla. 32512
- Naval Aerospace Medical Center
Pensacola, Fla. 32512
- NYBERG-HANSEN, ROLF
Anatomical Institute
University of Oslo
Karl Johans gt. 47
Oslo 1, Norway
- OMAN, C. M.
Department of Aeronautics and Astronautics
Massachusetts Institute of Technology
Cambridge, Mass. 02139
- PARKER, DONALD E.
Psychology Department
Miami University
Oxford, Ohio 45056
- PARKER, JAMES F., JR.
Bio-Technology, Inc.
3027 Rosemary Lane
Falls Church, Va. 22042
- PERLMAN, HENRY B.
Division of Otolaryngology
University of Chicago
950 East 59th Street
Chicago, Ill. 60637
- PLANTZ, ROBERT G.
Division of Medical Physics
Donner Laboratory
University of California
Berkeley, Calif. 94720
- POMPEIANO, OTTAVIO
Istituto di Fisiologia
University of Pisa
Via S. Zeno 31
Pisa, Italy 56100
- PRECHT, WOLFGANG A.
Institute for Biomedical Research
AMA Building
535 North Dearborn Street
Chicago, Ill. 60605
- PRESCOTT, JAMES W.
National Institute of Child Health and Human
Development
Bethesda, Md. 20014
- RAFFAELLY, NICHOLAS R.
Naval Aerospace Medical Institute
Naval Aerospace Medical Center
Pensacola, Fla. 32512
- RAMSEY, HERSCHEL R.
Naval Aerospace Medical Institute
Naval Aerospace Medical Center
Pensacola, Fla. 32512
- REASON, JAMES T.
Naval Aerospace Medical Institute
Naval Aerospace Medical Center
Pensacola, Fla. 32512
- REID, DONALD H.
Naval Aerospace Medical Institute
Naval Aerospace Medical Center
Pensacola, Fla. 32512

- RYU, JAI H.
Department of Otolaryngology
University Hospitals
Iowa City, Iowa 52240
- SAKAMOTO, MASAOKI
Department of Otorhinolaryngology
LSU School of Medicine
New Orleans, La. 70112
- SANDERS, DANIEL T.
Army Research and Development Command
Office of the Surgeon General MEDDH-RP
Washington, D.C. 20315
- SANSING, JAMES C.
Naval Aerospace Medical Institute
Naval Aerospace Medical Center
Pensacola, Fla. 32512
- SCHAEFER, HERMANN J.
Naval Aerospace Medical Institute
Naval Aerospace Medical Center
Pensacola, Fla. 32512
- SCHIFF, MAURICE
7255 Girard Avenue, Suite 31
La Jolla, Calif. 92037
- SINGLETON, GEORGE T., JR.
Division of Otolaryngology
University of Florida School of Medicine
Gainesville, Fla. 32601
- SJÖBERG, ARNE
Hornsgatan 1
11647 Stockholm Sö.
Sweden
- SMITH, MARGARET J.
Naval Aerospace Medical Institute
Naval Aerospace Medical Center
Pensacola, Fla. 32512
- SNIDER, RAY S.
Center for Brain Research
The University of Rochester
Rochester, N.Y. 14627
- SPINDLER, JOHN
University of Colorado Medical Center
4200 East Ninth Avenue
Denver, Colo. 80220
- STEELE, JACK E.
2313 Bonnieview Avenue
Dayton, Ohio 45431
- STEER, ROBERT W., JR.
Department of Electrical Engineering
Merrimack College
North Andover, Mass. 01845
- STEINBERG, ROY H.
Naval Aerospace Medical Institute
Naval Aerospace Medical Center
Pensacola, Fla. 32512
- STONE, RALPH W., JR.
NASA Langley Research Center
Langley Station
Hampton, Va. 23365
- SZEKELY, EMERY G.
Temple University School of Medicine
Broad and Ontario Streets
Philadelphia, Pa. 19140
- TANG, P. C.
Naval Aerospace Medical Institute
Naval Aerospace Medical Center
Pensacola, Fla. 32512
- THACH, JOHN S., JR.
Naval Aerospace Medical Institute
Naval Aerospace Medical Center
Pensacola, Fla. 32512
- TOLHURST, GILBERT C.
Physiological Psychological Branch
Office of Naval Research, Code 454
Washington, D.C. 20360
- TOROK, NICHOLAS
Illinois Eye and Ear Infirmary
University of Illinois Medical Center
1855 West Taylor Street
Chicago, Ill. 60612
- TRIMBLE, THERON L.
Naval Aerospace Medical Institute
Naval Aerospace Medical Center
Pensacola, Fla. 32512
- TURNIPSEED, GENE T.
Naval Aerospace Medical Institute
Naval Aerospace Medical Center
Pensacola, Fla. 32512
- VALENTINUZZI, MÁXIMO
University of Chicago
950 East 59th Street
Chicago, Ill. 60637
- VINOGRAD, SHERMAN P.
NASA Headquarters, Code MM
600 Independence Avenue SW.
Washington, D.C. 20025
- VORIS, FRANK B.
Bureau of Medicine and Surgery, Code 711
Navy Department
Washington, D.C. 20390
- WAITE, RICHARD E.
Neurophysiology Laboratory
Vestibular Section/DB4
NASA Manned Spacecraft Center
Houston, Tex. 77058
- WALKER, MICHAEL L.
Naval Aerospace Medical Institute
Naval Aerospace Medical Center
Pensacola, Fla. 32512
- WANG, S. C.
College of Physicians and Surgeons of Columbia University
630 West 168th Street
New York, N.Y. 10032
- WEAVER, JOSEPH W.
Naval Aerospace Medical Institute
Naval Aerospace Medical Center
Pensacola, Fla. 32512
- WENDT, G. RICHARD
Department of Psychology
The University of Rochester
Rochester, N.Y. 14627

WHITCOMB, MILTON A.

National Academy of Sciences-National Research Council
2101 Constitution Avenue NW.
Washington, D.C. 20418

WHITESIDE, THOMAS C. D.

RAF Institute of Aviation Medicine
Royal Air Force
Farnborough, Hants, England

WILCOX, JAMES G.

Naval Aerospace Medical Institute
Naval Aerospace Medical Center
Pensacola, Fla. 32512

WILLIAMS, CARL E.

Naval Aerospace Medical Institute
Naval Aerospace Medical Center
Pensacola, Fla. 32512

WILSON, VICTOR J.

The Rockefeller University
New York, N.Y. 10021

WILSON, WILLIAM R.

Massachusetts Eye and Ear Infirmary
243 Charles Street
Boston, Mass. 02114

WOLFE, JAMES W.

School of Aerospace Medicine
Brooks Air Force Base, Tex. 78235

WOOD, CHARLES D.

Shreveport Medical School
Louisiana State University
501 East Stoner Avenue
Shreveport, La. 71101



NATIONAL AERONAUTICS AND SPACE ADMINISTRATION
WASHINGTON, D. C. 20546
OFFICIAL BUSINESS

FIRST CLASS MAIL



POSTMASTER: If Undeliverable (Section 158
Postal Manual) Do Not Return

"The aeronautical and space activities of the United States shall be conducted so as to contribute . . . to the expansion of human knowledge of phenomena in the atmosphere and space. The Administration shall provide for the widest practicable and appropriate dissemination of information concerning its activities and the results thereof."

— NATIONAL AERONAUTICS AND SPACE ACT OF 1958

NASA SCIENTIFIC AND TECHNICAL PUBLICATIONS

TECHNICAL REPORTS: Scientific and technical information considered important, complete, and a lasting contribution to existing knowledge.

TECHNICAL NOTES: Information less broad in scope but nevertheless of importance as a contribution to existing knowledge.

TECHNICAL MEMORANDUMS: Information receiving limited distribution because of preliminary data, security classification, or other reasons.

CONTRACTOR REPORTS: Scientific and technical information generated under a NASA contract or grant and considered an important contribution to existing knowledge.

TECHNICAL TRANSLATIONS: Information published in a foreign language considered to merit NASA distribution in English.

SPECIAL PUBLICATIONS: Information derived from or of value to NASA activities. Publications include conference proceedings, monographs, data compilations, handbooks, sourcebooks, and special bibliographies.

TECHNOLOGY UTILIZATION PUBLICATIONS: Information on technology used by NASA that may be of particular interest in commercial and other non-aerospace applications. Publications include Tech Briefs, Technology Utilization Reports and Notes, and Technology Surveys.

Details on the availability of these publications may be obtained from:

**SCIENTIFIC AND TECHNICAL INFORMATION DIVISION
NATIONAL AERONAUTICS AND SPACE ADMINISTRATION
Washington, D.C. 20546**