

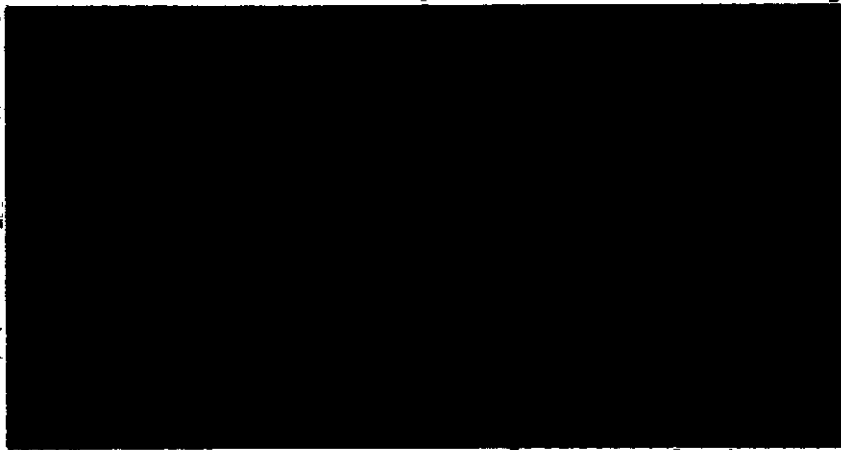

FACILITY FORM 602

_____	_____
(ACCESSION NUMBER)	(THRU)
223	1
(PAGES)	(CODE)
CR-109798	28
(NASA CR OR TMX OR AD NUMBER)	(CATEGORY)



THE
Marquardt
CORPORATION

VAN NUYS, CALIFORNIA

Reproduced by the
CLEARINGHOUSE
for Federal Scientific & Technical
Information Springfield Va 22151

UNCLASSIFIED

2-1
MIA

28 FEBRUARY 1966

5.9.1.1

REPORT 6098

COPY NO. 14

(Title -- Unclassified)

DESIGN STUDY AND EVALUATION
OF A HYPERGOLIC ENGINE
FOR A SPACE POWER SYSTEM

Final Report for Phase II
and Phase II, Modification I
for the Period 1 July 1964 to 10 February 1966

UNCLASSIFIED

UNCLASSIFIED

(Title -- Unclassified)

DESIGN STUDY AND EVALUATION
OF A HYPERGOLIC ENGINE
FOR A SPACE POWER SYSTEM,

Final Report for Phase II /
and Phase II, Modification I
for the Period 1 July 1964 to 10 February 1966

Contract: NAS 9-857
Phase II and Phase II, Modification I

Project: 287

PREPARED BY

M. Arao

M. Arao
Project Engineer

APPROVED BY

E. K. Burnett

E. K. Burnett
General Manager,
Aerospace Equipment Department

B. R. Chandler A.I. Bratton

B. R. Chandler A.I. Bratton

CHECKED BY

J. R. Kessler

J. R. Kessler
Manager,
Secondary Power Projects

UNCLASSIFIED



VAN NUYS, CALIFORNIA

CONTENTS

<u>Section</u>	<u>Page</u>
I	SUMMARY 1
II	INTRODUCTION. 3
III	DESCRIPTION OF TEST ENGINES 5
	A. General Characteristics. 5
	B. SPU-2A-1 Test Engine 5
	C. SPU-2A-2 Test Engine 6
	D. SPU-3 Test Engine. 7
IV	ENGINE DEVELOPMENT. 14
	A. Components 14
	B. Lubrication. 31
V	ENGINE ENDURANCE TEST PROGRAM 36
	A. Requirements and Goals 36
	B. Preliminary Test Runs. 36
	C. 90-hour Endurance Test 39
	D. Condition of Engine and Components After 90-hour Endurance Test 40
	E. Engine Performance During 90-hour Endurance Test 42
VI	ENGINE TEST PROGRAM AND EXPERIMENTAL INVESTIGATIONS 44
	A. Engine Test Program. 44
	B. Experimental Investigations. 45
VII	TEST FACILITIES 52
	A. General Description. 52
	B. Propellant Supply System 52
	C. Cooling System 53
	D. Oil System 53
	E. Power Absorption System. 54
	F. Instrumentation. 54
	G. Component Test Capability. 55
	H. Facility Performance 55

CONTENTS (Continued)

<u>Section</u>		<u>Page</u>
VIII	ANALYSES OF TEST DATA	56
	A. Background	56
	B. Thermodynamic Cycle Analyses	56
	C. Piston Heat Transfer Analyses	61
	D. System Definition	69
	E. Engine Operation and Procedures	73
	F. Propellant Analysis	75
IX	ELECTRICAL GENERATOR FOR THE SPACE POWER UNIT	76
	A. Procurement	76
	B. Performance Specification	76
	C. Evaluation of Available Generators	77
	D. Description of Experimental Generators	77
X	CONCLUSIONS	79
XI	RECOMMENDATIONS	81
XII	REFERENCES	82
--	APPENDIX A -- Investigations on Changing Compositions of Aerozine-50207
--	DISTRIBUTION209

ILLUSTRATIONS

<u>Figure</u>		<u>Page</u>
1.	External Configuration of the SPU-2A-1 Space Power Unit Engine. . .	110
2.	Disassembled View of Components of the SPU-2A-1 Engine.	111
3.	Cylinder Head Components for the SPU-2A-1 Engine.	112
4.	Assembly Drawing for the SPU-2A-1 Engine.	113
5.	External Configuration of the SPU-3 Space Power Unit Engine	115
6.	External Configuration of the SPU-3 Space Power Unit Engine	116
7.	Disassembled View of Components of the SPU-3 Engine	117
8.	Assembly Drawing for the SPU-3 Engine	118
9.	Components of the Dual, Poppet, Mono Seat, Short Duration, Injector Valve Used in the SPU-3 Engine, After 90-hour Endurance Test.	120
10.	Schematic of Short Dwell Injection System for the SPU-3 Engine. . .	121
11.	Fully Adjustable Camshaft Assembly for the SPU-3 Engine	122
12.	Baseline Piston Assembly Used in the SPU-3 Engine, After Test . . .	123
13.	Modification 1 Piston Assembly Used in the SPU-3 Engine, After Test.	124
14.	Basic Components of the Crankcase Assembly for the SPU-3 Engine.	125
15.	Cylinder Housing and Cylinder Liner for the SPU-3 Engine.	126
16.	Upper Cylinder Housing Flange for the SPU-3 Engine.	127
17.	Camshaft Drive Components for the SPU-3 Engine.	128
18.	Schematic of Propellant Pump for the SPU-3 Engine	129
19.	Assembly Drawing of the Propellant Pump for the SPU-3 Engine. . . .	130

ILLUSTRATIONS (Continued)

<u>Figure</u>	<u>Page</u>
20. View of the SPU-3 Engine with Propellant Injection Pump Installed132
21. Basic Injector Valve Configurations Tested with the SPU-3 Engine.133
22. Fuel Injector Valve Housing after Test 5151-4 with the SPU-3 Engine.134
23. Fuel Injector Valve Components after 90-hour Endurance Test with the SPU-3 Engine135
24. Inner and Outer Fuel Injector Valve Seats after 90-hour Endurance Test with the SPU-3 Engine.136
25. Inner and Outer Oxidizer Injector Valve Seats after 90-hour Endurance Test with the SPU-3 Engine.137
26. Piston Configurations Used in SPU Engine Tests.138
27. Configuration C Piston after Operation for 4.76 hours in the SPU-2A-2 Engine139
28. Configuration C Piston after Operation for 4.76 hours in the SPU-2A-2 Engine140
29. Configuration D Piston after Operation for 17 minutes in the SPU-2A-3 Engine141
30. Configuration D Piston after Operation for 9.75 hours in the SPU-3 Engine.142
31. Insulated Crown Piston Configuration F after Operation for 0.3 hour.143
32. Piston Assembly with 440-C CRES Rings after 46-hour Endurance Test.144
33. Modification 1 Piston Assembly after a Test Run145

ILLUSTRATIONS (Continued)

<u>Figure</u>		<u>Page</u>
34.	Modification 1 Piston Assembly after Test 5167-5.	146
35.	Modification 1 Piston Assembly after Test 5167-5.	147
36.	Modification 1 Piston Assembly after 90-hour Endurance Test . . .	148
37.	SPU-3 Connecting Rod Assembly after Test 5151/12/2 Showing Failure of Cage Type Roller Bearing	149
38.	Design Changes in Spring Bridge of Injector Valve Actuating Mechanism	150
39.	Detail of High Pressure Gas Seal for Combustion Chamber	151
40.	Lubricating Oil Test - - Weight Loss vs. Temperature.	152
41.	Thermal Conductivity of Lubricants.	153
42.	Variation of Heat Rejection with Engine Speed	154
43.	Carbon Deposit on Underside of the Modification 1 Piston after 90-hour Endurance Test in the SPU-3A Engine	155
44.	Connecting Rod after 90-hour Endurance Test in the SPU-3A Engine.	156
45.	Accumulated Running Time, Phase II Testing of SPU Series Engines	157
46.	Variation of Horsepower with Engine Speed at Various BMEP Values, SPU-3 Engine.	158
47.	Variation of Specific Propellant Consumption with Brake Mean Effective Pressure for SPU Series Engines	159
48.	Variation of O/F Ratio with Specific Propellant Consumption . . .	160
49.	Exhaust Pressure Sensitivity.	161
50.	SPU-3 Cylinder Head Combustion Chamber after Test 5151-23	162
51.	SPU-3 Cylinder Head Combustion Chamber after Test 5151-23	163

ILLUSTRATIONS (Continued)

<u>Figure</u>	<u>Page</u>
52.	Calibration of Oil Flow 164
53.	Overall View of the SPU-3 Engine Installed in the Test Facility . . 165
54.	Closeup of SPU-3 Engine Installed in the Test Facility. 166
55.	Schematic of Test Pad Fuel System for the SPU-3 Engine. 167
56.	Schematic of Test Facility Fuel Storage System for the SPU-3 Engine. 168
57.	Schematic of Test Facility Oxidizer Storage System for the SPU-3 Engine. 169
58.	Schematic of Test Facility Power Absorption and Safety System for the SPU-3 Engine. 170
59.	Schematic of Test Facility Cooling System for the SPU-3 Engine. . . 171
60.	Schematic of Test Facility Oil System for the SPU-3 Engine. 172
61.	Starting System for the SPU-3 Engine as Installed in the Test Facility 173
62.	Power Absorption Unit for the SPU-3 Engine as Installed in the Test Facility 174
63.	Redesigned Power Absorption Unit for the SPU-3 Engine 175
64.	Redesigned Power Absorption Unit for the SPU-3 Engine 176
65.	Variation of Specific Heat Rejection with Horsepower. 177
66.	Variation of Specific Heat Rejection with Brake Mean Effective Pressure. 178
67.	Estimated Heat Rejection Trends - - CY 1965 179
68.	Variation of Combustion Efficiency with Horsepower and Brake Mean Effective Pressure 180

ILLUSTRATIONS (Continued)

<u>Figure</u>	<u>Page</u>
69.	Variation of Brake Specific Propellant Consumption with Brake Mean Effective Pressure 181
70.	Effect of Engine Speed on Indicator Diagram 182
71.	Variation of Combustion Efficiency with O/F Ratio 183
72.	Variation of Exhaust Temperature with Brake Mean Effective Pressure and Horsepower 184
73.	Variation of Brake Specific Propellant Consumption with Horsepower 185
74.	Estimated Performance Trends - - CY 1965. 186
75.	Typical Indicator Diagram Analysis. 187
76.	Correlation of Test Duration and Heat Rejection 188
77.	Estimated Piston Temperatures 189
78.	Variation of Heat Rejection with Coolant Flow 190
79.	Feasibility Achievements - - Space Power Unit 191
80.	Effect of Expansion Ratio on Engine Temperatures. 192
81.	Variation of Brake Specific Propellant Consumption with Expansion Ratio 193
82.	Effect of Heat Rejection Rate on Piston Temperatures. 194
83.	Baseline Piston Configuration and Input and Output Temperature Data. 195
84.	Modification 1 Piston Configuration and Input and Output Temperature Data. 196
85.	Schematic of the Breadboard System for the SPU-3 Engine 197
86.	Isometric of the Breadboard System for the SPU-3 Engine 198

ILLUSTRATIONS (Continued)

<u>Figure</u>		<u>Page</u>
87.	Isometric of the Prototype Space Power System.	199
88.	Operating Schematic of the Prototype Space Power System.	200
89.	Variation of Ignition Spike Pressure with Fuel Composition from Rocket Research Tests with 0.5 UDMH/0.5 N ₂ H ₄ Fuel.	201
90.	Fuel and Oxidizer Analysis Record.	202
91.	Fuel and Oxidizer Analysis Record.	203
92.	Fuel and Oxidizer Analysis Record.	204
93.	Voltage Regulation Characteristics of First Experimental SPU Generator.	205
94.	Predicted Voltage Regulation Characteristics of the Second Experimental SPU Generator	206

TABLES

<u>Table</u>		<u>Page</u>
I	Summary of Fuel Injector Valve Performance	83
II	Summary of Oxidizer Injector Valve Performance	86
III	Summary of Engine Lubricant Evaluation	89
IV	Test Run Summary for the SPU-2A-1 Engine, 1 July to 10 November 1964	90
V	Test Run Summary for the SPU-2A-2 Engine, 27 January to 4 February 1965.	92
VI	Test Run Summary for the SPU-3 Engine, 1 July to 1 November 1965.	93
VII	Test Run Summary for the SPU-3 Engine, 2 November to 31 December 1965	97
VIII	Test Run Summary for the SPU-3 Engine, 1 January to 10 February 1966	104
IX	Injection Timing Summary - SPU Engine Series	107
X	Summary of SPU-3 Test Instrumentation.	108

I. SUMMARY

This report describes the design study and evaluation accomplished during the Phase II and Phase II, Modification I portions of the hypergolic engine feasibility program for a space power system. This work was performed for the Manned Spacecraft Center of the National Aeronautics and Space Administration under Contract NAS 9-857 during the period 1 July 1964 to 10 February 1966.

A basic requirement of the Phase II program was a demonstration of engine endurance proving feasibility by establishing the potential reliability of the engine. Under a simulated mission requirement of a two-level power profile cycling of 50 minutes at 2.4 HP and 10 minutes at 3.2 HP, a nonstop engine endurance run of 90.4 hours was made. During Phase II, a total of 377.4 hours of engine operation was accumulated. No attempt to improve the efficiency of the engine was made. However, the improvements made to increase reliability often resulted in reduced specific propellant consumption. At the end of the program, a specific propellant consumption of 6.3 lb/HP-hr at 3.2 HP at 3200 rpm was obtained, corresponding to a BMEP value of 200 psi. The SPC obtained at the end of the Phase I program was 12.5 lb/HP-hr.

Two identical engines, featuring low flow lubrication requirements through use of ball and roller bearings for the crankshaft, were used. These engines were built and tested during the latter portion of the Phase I program. The cylinder head and injector valve mechanism were identical (with advancements) to those also used during the latter portion of the Phase I program.

During the endurance run program, it became necessary to improve the reliability of only one component -- the piston assembly. This requirement led to a special investigation on the coking characteristics of various lubricants, since it was determined that piston ring stiction as a result of excess carbonization was contributing to piston failure. In addition, a computer program was inaugurated to determine the heat rejection capabilities of the piston and also to determine methods of improving this function. This resulted in the design of the Modification I piston, a 4-ring type utilizing a composite of a heat resistant piston crown of Rene' 41 and a piston body of cast aluminum. However, the significant breakthrough in piston reliability resulted when 440C stainless steel was used for the ring material in place of high grade cast iron. Numerous other ring materials and protective coatings were tried prior to this, but they were all discarded because of their basic incompatibility with the chrome plated cylinder wall.

Less significant, but important, developments included the flat poppet injector valves and circular exhaust ports. Use of the flat poppet injector valves resulted in increased injector valve reliability and ease of manufacture because it eliminated the requirement for extremely close concentricity between three mating surfaces. The use of circular exhaust ports increased piston ring reliability and also provided ease of manufacture since it eliminated the requirement for angular location of the piston ring gaps.

The endurance program also pointed out the inadequacy of a particular make of roller bearing (used in the connecting rod) fabricated of propellant compatible stainless steel. A nonpropellant compatible bearing of another make was substituted and used for the remainder of the program. It was during this development that a lubricant of lower coke forming characteristic was responsible for high wear rate of the noncompatible bearing due to its inability to protect the components from propellant corrosion. Accordingly, the original lubricant (Brayco 443 oil) was used for the remainder of the program.

Other problems and solutions that developed due to the running of the engine endurance tests are covered in this report together with photographic and descriptive documentation.

II. INTRODUCTION

The Phase I portion (31 October 1962 through 30 June 1964) of NASA Contract NAS 9-857 has been satisfactorily completed. Phase I was programmed to demonstrate the feasibility of a reciprocating engine designed to operate on a hypergolic mixture of storable liquid bipropellants (N_2O_4 and $0.5 N_2H_4 + 0.5 UDMH$). That program resulted in the following conclusions (Reference 1):

1. The efficient Otto cycle could be closely duplicated with the hypergolic propellants.
2. The high speed, short dwell, injector valve concept was highly feasible and indicated high reliability potential.
3. The high pressures and temperatures resulting from the rocket propellant combustion could be effectively and reliably utilized.
4. Utilization of propellant compatible materials for construction of the engine does not detract from its reliability or impose undue hardship on its development.
5. The simple piston exhaust port engine could be operated over the atmospheric range from near vacuum to sea level conditions.
6. The control of the engine is straightforward. Starting, power traverse, O/F mixture ratio control, stopping, and propellant purging are accomplished with a combination of techniques used in liquid rocket and conventional internal combustion engine operation.
7. Specific power (HP/cu in. of piston displacement) is limited only by structural considerations.
8. Wide limits of O/F ratio operation, including stoichiometric operation, are possible without excessive stresses to engine components.

Upon the satisfactory completion of the Phase I program demonstrating the feasibility of operation of the hypergolic reciprocating engine, an extension designated as Phase II was initiated in July 1964. This Phase II program was established to extend the feasibility studies and to culminate in

UNCLASSIFIED

a demonstration of a hypergolic engine system designed and constructed to operate with some of the basic requirements for operation in space. The activity was intended to bring the hypergolic engine space power unit and system to a high state of development whereby the system could be considered for emergency power or primary power for space missions.

A demonstration of an engine endurance of several hundred hours and a continuous run exceeding extended lunar stay times was required to establish the required confidence in using this system concept for lunar exploration..

UNCLASSIFIED

III. DESCRIPTION OF TEST ENGINES

A. General Characteristics

During the test period 1 July 1964 to 11 February 1966, three separate and distinct hypergolic propellant engine configurations were tested. These engines were identified as the SPU-2A-1, SPU-2A-2, and SPU-3 engines. All three engines were designed as test engines, therefore only their internal components were of flightweight configuration. The engines were similar insofar as being single cylinder, liquid cooled, reciprocating units capable of driving a 2 KW electric generator. The engines operated on metered injection of nitrogen tetroxide (N_2O_4) oxidizer and a 50-50 blend of N_2H_4 and UDMH fuel. The operating cycle used for these engines was a modified Otto two-stroke cycle. The design features of each engine are described below.

B. SPU-2A-1 Test Engine

The external configuration of the SPU-2A-1 engine is shown in Figure 1. The basic specifications for this engine are as follows:

1. Piston displacement: 2.06 cu ins. (Effective); 2.43 cu ins. (Actual)
2. Bore: 1.380 ins.
3. Stroke: 1.625 ins.
4. Nominal maximum engine speed: 6,000 rpm
5. Exhaust: Piston controlled port
6. Lubrication: Facility supplied, high pressure, dry sump oil system
7. Bearings: Sleeve type throughout
8. Cooling: Cylinder assembly water cooled from facility system
9. Injector system: Short dwell system using dual concentric valves on common conical seat
10. Expansion ratio: Up to 40:1
11. Engine weight: 32 lbs (less flywheel)

Materials and processes used in the major components of the SPU-2A-1 engine are as follows:

1. Injector head: 6061-T6 aluminum alloy
2. Cylinder: 17-7 stainless steel heat treated with dense chrome plated bore
3. Crankcase: 6061-T6 aluminum alloy
4. Crankshaft: Nitralloy

5. Connecting rod: 2024 aluminum alloy
6. Piston: Composite Rene' 41 or N-155 crown, D-132 aluminum alloy skirt
7. Injector valves: 440-C stainless steel, dense chrome plated outside diameters with multiple Teflon seals (O-rings)
8. Camshaft: Nitralloy

The major components for the engine are shown in Figure 2. Figure 3 is a closer view of the cylinder head components. An assembly drawing of the engine is shown in Figure 4.

The design philosophy for the SPU-2A-1 engine was based on adequate demonstration of the concept feasibility in the most direct manner. Therefore, no engine mounted oil pumps, coolant pumps, propellant pumps, or pressure and temperature controls were provided. Rather, these functions were supplied by the test facility wherein greater control and instrumentation of the power requirements, flow rates, pressures, and temperatures could be obtained.

During the period 1 April through 10 June 1965, the SPU-2A-1 engine was modified for operation with gaseous hydrogen and oxygen propellants. After this modification, the engine was identified as the SPU-2A-3 engine and tested in this multifuel configuration. This work was performed under Contract NAS9-857 Phase II, Modification II, "Design Study and Evaluation of a Multifuel Engine for a Space Power System," and has been reported in Reference 2.

C. SPU-2A-2 Test Engine

The SPU-2A-2 test engine was an interim engine composed of an SPU-2A-1 cylinder head/injector valve assembly and a SPU-3 cylinder and crankcase assembly. A major design goal of the SPU-3 engine was the elimination of high pressure lubrication to the main and rod bearings with a corresponding major reduction in lubrication requirements. Therefore, the crankcase assembly was designed to utilize ball main bearings and a roller rod bearing. The SPU-2A-2 engine was assembled to evaluate the integrity of these SPU-3 components upon completion of fabrication. These components are described in Section D, below. The basic specifications for the SPU-2A-2 engine are as follows:

1. Piston displacement: 2.06 cu ins. (Effective); 2.43 cu ins. (Actual)
2. Bore: 1.380 ins.
3. Stroke: 1.625 ins.
4. Nominal maximum engine speed: 6,000 rpm
5. Exhaust: Piston controlled port
6. Bearings: Antifriction ball and roller bearings for the main and rod journals, respectively
7. Lubrication: Facility supplied, low pressure, dry sump oil system

8. Cooling: Cylinder assembly water cooled from facility system
9. Injection system: Short dwell system using dual concentric conical mono seat valves
10. Expansion ratio: 36:1

D. SPU-3 Test Engine

1. Configuration

The SPU-3 test engine was the final design configuration for the modified Phase II program. Many detail and material changes were incorporated in the design during the test program. The final engine configuration is described below.

The external configuration of the basic SPU-3 engine is shown in Figures 5 and 6. The specifications for this engine are as follows:

1. Piston displacement: 2.06 cu ins. (Effective); 2.43 cu ins. (Actual)
2. Bore: 1.380 ins.
3. Stroke: 1.625 ins.
4. Nominal maximum engine speed: 6000 rpm
5. Exhaust: Piston controlled port
6. Bearings: Antifriction ball and roller bearings for the main and rod journals, respectively
7. Lubrication: Facility supplied, low pressure, dry sump oil system
8. Cooling: Cylinder assembly water cooled from facility system
9. Injection system: Short dwell system using dual concentric, flat mono seat valves and individually adjustable cams
10. Expansion ratio: Up to 40:1
11. Engine weight: 35 lbs (less flywheel)
12. Engine envelope: 8 by 15 by 15 ins. with injection pump and less generator

The materials and processes used in the major components of the SPU-3 engine are as follows:

1. Crankcase: 2024-T351 aluminum alloy
2. Crankshaft: 431 stainless steel
3. Main bearings: MRC 204S-ST 440-C stainless steel
4. Rod big end bearings: McGill GR-16 full complement roller bearing

5. Rod: 2024 T351 aluminum alloy
6. Cylinder: 17-7 PH stainless steel
7. Cylinder liner: 17-7 PH stainless steel heat treated with dense chrome plated bore
8. Piston: composite Rene' 41 crown, D-132 aluminum alloy skirt
9. Piston rings: 440-C stainless steel
10. Cylinder head: 6061-T6 aluminum alloy
11. Injector valves: 440-C stainless steel, chrome plated O D
12. Camshaft: 440-C stainless steel
13. Cam lobes: Speed Star H.S. tool steel heat treated to R_c-65
14. Rocker arms: 6150 steel, flash chrome plated
15. Rocker arm shafts: 8620 steel, flash chrome plated
16. Timing gears: 416 stainless steel

The major components for the SPU-3 engine are shown in Figure 7. An assembly drawing of the engine is presented in Figure 8. Detailed descriptions of the most critical components are presented below.

2. Propellant Injection System

The unique dual poppet, mono seat, short duration, injection valve assembly used in the SPU-3 engine is composed of three units: the valve housing, an outer valve, and an inner valve. These three units are shown in Figure 9. The inner valve fits inside the outer valve and both of these components are then inserted in the housing. The housing is held in the cylinder head with a special ring nut. The nut forces the conical housing face against a matching tapered seat in the head and forms a metal-to-metal seal. To insure positive sealing, a Teflon O-ring is fitted in the seat area. Additional seals are provided on the flanks of the housing to prevent propellant from entering the camshaft chamber. Teflon rings are fitted on the valve stems to seal against stem leakage and reduce operating friction. Two valve assemblies are required for each engine. The only difference between these units is the orifice size. The oxidizer valve housing has an 0.060-inch diameter orifice and the fuel valve housing has an 0.040-inch diameter orifice.

The injector valve poppets have flat seats. Previous engines (i.e., SPU-2A-1 and SPU-2A-2) used conical seats. The change from conical to flat seats improved the valve reliability, simplified manufacture, and resulted in a gain in the flow characteristic of the injector system. The valve stems are fitted to a clearance of approximately 75 millionths of an inch. With clearances of this magnitude, the concentricity of the conical seats on the valves and in the housing with relation to the valve stem flank diameters is critical. Since flat seat valves eliminate shank-to-seat concentricity problems, the producibility of the valve is greatly improved.

The operating principle of the dual concentric, mono seat valve is shown in Figure 10. This schematic shows that high pressure propellant is supplied to the valve housing and that no injection can take place unless both the inner and outer valves are off their seats. The valves are actuated by individual cam and rocker arm systems so that the opening and closing relationships of one valve poppet to the other can be adjusted to give any desired time, dwell period, and operating sequence.

A significant design change was made in the camshaft configuration for the SPU-3 engine. Each cam lobe is separate and indexed to the shaft with keys having various offsets. This change was made so that each propellant injector could be timed independently of the other and allow lead or lag injection characteristics to be evaluated. In addition, various cam materials and cam contours can be evaluated at minimum cost for components. The fully adjustable camshaft assembly is shown in Figure 11.

3. Piston and Piston Rings

Two successful piston and ring designs have been developed for the SPU-3 engine. Both designs feature a Rene' 41 crown, a D132 aluminum skirt, and piston rings fabricated from 440-C stainless steel. The two pistons are identified as the "Baseline" piston and the "Mod 1" piston.

The Baseline piston is fitted with three piston rings, two of which are back to back in the same groove. The top ring is an L-configuration having the top of the L flush with the piston crown. A second ring of conventional rectangular cross section is fitted in the same groove and supports the L-ring. The ring gaps are indexed 180° apart so as to present an initial, gapless seal to the combustion chamber. The first ring assembly is carried in a groove machined in the high temperature crown material and it seats on the aluminum skirt at the crown-to-skirt interface. The third ring is of the conventional rectangular cross section and it is carried completely in the aluminum skirt slightly below the skirt/crown interface. This piston is shown in Figure 12.

The Baseline piston offers advantages of complete protection to the cylinder bore from the Rene' 41 crown because the top ring is flush with the top of the piston crown. Also, the L-ring can be fitted with very little wall tension and still seal properly at high pressure. Another advantage of this design is the precision with which port timing can be controlled.

The Mod 1 piston is a more conventional design. This piston is shown in Figure 13. The piston is fitted with four conventional rectangular shaped rings. All four rings are carried in the D132 aluminum skirt and are individually spaced between the Rene' 41 crown and the wrist pin bore. Ring gap and ring groove side clearance values are critical to a greater degree than in a conventional reciprocating engine because of the higher combustion temperatures and pressures. Presently used nominal dimensions for each ring are listed below:

Ring No.	Side Clearance (in.)	Gap (in.)
1	0.0035	0.017
2	0.003	0.015
3	0.0025	0.012
4	0.0025	0.012

Prior to use, the piston rings and piston outer surfaces are treated with "Micro Seal" Process 100-1. This process is an impingement type lubricative plating that has indicated possibility of reducing the initial galling tendencies of the piston rings and piston skirt.

4. Crankcase Assembly

The basic components of the crankcase assembly are shown in Figure 14. Each of the components is discussed below.

The crankcase of the SPU-3 engine is of a simple cubic shape for simplicity of fabrication. The case is split axially along the horizontal centerline of the crankshaft and is fastened together with four large cap screws. Proper alignment is assured by the use of two large hollow dowl pins that are pressed into opposite, diagonal corners of the case. Two of the cap screw fasteners pass through these dowl pins. An O-ring type seal is provided at the crankcase interface.

The ends of the case are step counterbored to accept two flanged 440-C stainless steel bearing housings. The bearing housings are retained in the case with cap screws. The main loads are transferred into the case by fitting the housings into the case counterbores with a slight interference. The bearings are mounted in steel housings to assure mounting rigidity and strength, eliminate fretting, simplify crankshaft installation, and allow for simple installation of the crankshaft oil seal.

The crankshaft is fabricated in two halves from 431 stainless steel. The halves are joined at the center of the connecting rod journal. The joining technique utilizes a Curvic coupling to align the two halves and take the applied loads. The two halves of the crank are held together at the Curvic coupling joint with a through bolt and nut assembly. The bolt runs axially through the center of the crank throw and is tightened to produce 0.005 to 0.006 in. of stretch to assure proper tensioning of the Curvic coupling joint.

The crankshaft is split in two halves at the connecting rod journal to provide a means of installing the roller bearing equipped connecting rod. It was deemed preferable to split the crankshaft and use solid bearing races rather than use a solid crankshaft and split the rod lower end and bearing races. The Curvic coupling was ideally suited for this purpose because it afforded simple assembly and disassembly techniques for the components with superior load carrying characteristics.

In order to reduce the engine friction and lubrication requirements, ball and roller bearings were chosen for the main and rod bearings, respectively. The ball main bearings are MRC 204-ST 440-C stainless steel and are, therefore, propellant compatible.

At present, the connecting rod bearing used in the engine is a standard McGill GR-16 full complement, guided roller bearing. The bearing has proved satisfactory. However, because stainless steel equivalents are not immediately available, this component is not fully propellant compatible.

In order to assure as perfect a working surface as possible for the connecting rod bearings, a standard McGill ML-12 inner race sleeve is used in conjunction with the GR-16 roller bearing. This sleeve slips over the crankshaft rod journal ends with a light interference fit. This type of assembly shrouds the Curvic coupling joint inside the sleeve, increases the stiffness of the rod journal, and provides an easily replaced bearing surface in the event of damage. The last factor is of primary importance for a test engine because it allows rapid overhaul of the crankshaft by maintaining standard bearing sizes and virtually eliminates replacement of the expensive crankshaft assembly.

The connecting rod is fabricated from 2024 aluminum plate stock and is machined all over. The outer race for the roller journal bearing is pressed into the lower end of the rod. The wrist pin bearing is a standard sleeve type and is machined directly in the base 2024 aluminum material. The wrist pin is fitted to the rod with a 0.001-inch clearance.

5. Cylinder Assembly

Figure 15 is a view of the cylinder housing and cylinder liner for the SPU-3 engine. Both of these components are fabricated from 17-7 PH stainless steel. The housing is essentially a flanged shell that acts as the outer cooling jacket and holder for the cylinder liner. The top and bottom flanges provide attach points to the cylinder head and crankcase, respectively. A welded exhaust collector muff is centrally positioned on the housing and is provided with two large Marmon clamp flanges for exhaust manifold attachments. Three O-rings are provided in the housing bore to seal the cooling jacket when the liner is installed.

The cylinder liner provides the cylinder bore and exhaust ports, doubles as the inner coolant jacket, and contains the top cylinder head sealing surface. The liner is hardened to Rockwell C-40/45 and its bore is dense chrome plated. The exhaust ports are 8 1/4-inch diameter holes equally spaced around the cylinder. Vertically drilled coolant transfer passages are interspaced between the exhaust ports in the separating webs.

When the cylinder liner is inserted and seated in the housing, a section of the liner extends above the top housing flange. The top of this extension is circumferentially microgrooved as shown in Figure 16. When the cylinder head assembly is bolted in place, these grooves physically deform the mating aluminum surface and form a positive high pressure seal.

6. Gear Case Assembly

The gear case assembly (shown in Figure 17) is a conventional unit composed of three 416 stainless steel gears and an aluminum housing. The lower gear is keyed and bolted to the front of the crankshaft. The top gear mounts on the camshaft and is clamped in place rather than being keyed. The clamping arrangement is unusual in that the clamping cap screw intersects the camshaft below its surface. The intersecting section of the cam is machined with a matching circumferential, partial thread which in combination with the gear cap screw forms a "worm" gear assembly. This design allows the gear to be precisely indexed with relation to camshaft position for injection timing adjustment. The cam gear has a slotted square hub extending from its face to hold the cap screw. When the gear is properly indexed, a nut is placed on the cap screw and tightened, thus clamping the gear on the camshaft.

Power is transmitted from the crankshaft gear to the cam gear via a large idler gear. This gear is mounted on a dual ball bearing, flanged shaft assembly. The flanged shaft extends into the gear case through a slotted hole in the aft case so that the idler gear can be adjusted for gross changes in gear center distances for development changes and also for minute settings of proper gear tooth clearance. A nut on the end of the flanged shaft assembly locks the gear and shaft in position after adjustment.

The gear case assembly is a straightforward case and bolted on cover unit. These components are machined from 6061 aluminum plate.

7. Lubrication

The power producing sections of the SPU-3 engine (i.e., crankcase and cylinder assemblies) are designed for minimum lubrication requirements and they therefore are supplied by a low pressure, low volume facility oil system. The oil for these components enters the nose of the crankshaft via a rotary face seal and is transferred into the connecting rod bearing through an internal oil passage. A rifle drilled passage in the connecting rod transfers pressurized oil to the wrist pin. Lubrication for the main bearings and cylinder walls is distributed by spray and splash from the pressurized components.

The cylinder head assembly is supplied with oil at high pressure (50 to 70 psia) because of the sleeve bearings on the cam shaft. Oil enters the front cam bearing and it is transferred into the camshaft via the bearing annulus and drilled passages within the camshaft. Oil is transferred through the cam to lubricate the aft cam bearing. Additionally, oil is sprayed onto the rocker arm followers through holes in each cam lobe. The overspray from the cam lobes also lubricates the rocker arm shafts. Oil seeping from the unsealed forward cam bearing lubricates the cam drive gear train.

A high volume oil scavenge system is provided by the facility to remove excess lubricants from the crankcase, cylinder head, and gear case.

8. Propellant Injection Pump

A major accessory for the SPU-3 engine is a variable displacement propellant injection pump. A schematic of the propellant pump and an assembly drawing are shown in Figures 18 and 19, respectively. The pump is a shaft driven, unitized, two-segment (fuel and oxidizer) configuration utilizing cam/rocker arm operated plunger type pumping elements. Control is achieved by varying the displacement of the pumping element. A modification of the engine dual concentric propellant injector valves is used for these pumping and control elements. For the pump application, the inner plunger position is adjusted to vary the volume of the pump chamber and the outer plunger is the pump. The injector pump is driven directly by the engine crankshaft and thus operates at engine speed.

Several features of the pump are very significant. Firstly, the pumping and control elements are similar to the engine injector valves. Thus, design and manufacturing costs are reduced. Secondly, the volume of propellants displaced per stroke is matched to the engine requirements, thus in the event of an injector valve malfunction the engine could not destructively overspeed. A third feature of the pump is that only one check valve is required per segment for operation. The single check valve is fitted in the discharge line. The inlet port is controlled by the pump plunger, thus requiring a positive head pressure for proper operation.

The design of the pump was completed and the unit was fabricated during the period covered by this report. However, a complete performance evaluation was not undertaken. Figure 20 shows the SPU-3 engine fitted with the propellant injection pump.

IV. ENGINE DEVELOPMENT

A. Components

During the test period of the SFU-3 engine, many of its components were modified or altered to improve their performance and/or durability. Several of the components (specifically pistons and rings) were changed extensively. A discussion of each component so affected, the final configuration, and the performance of each is presented below.

1. Injector Valves

Two basic configurations of injector valves were used during the test period. The major difference between the two configurations was in the type of seat provided on the valves and in the valve housings. All tests from Tests 5140-1 through 5151-55 utilized valves having conical seats. Tests 5167-1 through 5167-9 utilized valves having flat seats. A cutaway view of both types of injector valve assemblies is shown in Figure 21. Although both valve configurations have proved to be satisfactory, the flat seated valve configuration is preferred for three major reasons, namely: higher gain characteristics, simpler fabrication, and greater tolerance to foreign material ingestion.

The higher gain characteristics (i.e., greater area per increment of lift) of the flat seated valve configuration are desirable in order to minimize the injection dwell period and the injection pressure requirements. The simpler fabrication techniques result from the elimination of the concentricity tolerances required between the outside diameters of the valve and the conical seat position of both the valve and the housing with relation to the valve stem centerline. The problem of concentricity is compounded because of the three-element injector valve (the inner valve, the outer valve, and the housing) and the nominal fitting clearance of 50×10^{-6} inch on the running surfaces. Adoption of the flat seated valves and housing eliminated this troublesome fabrication problem.

The third major advantage of the flat seated valve design is its ability to tolerate a greater degree of foreign material contamination. This situation results from the fact that, if a particle of foreign material is trapped on the seat of a conical valve, it tends to cause a slight offset or binding of the valve stem. Since the clearance and concentricity tolerances are very small, any bending or offset can result in high unit side loading on the valve stems and consequent material failure and valve seizure. The flat seat valves are not so affected. Any foreign material trapped on the seat when the valve closes may cause a slight temporary leakage. However, no binding action can result. Test experience has shown that a particle trapped in the seat area of a flat valve is either impacted into the base material or broken up and washed away by the high velocity propellant flows. Of course, every precaution is taken to avoid particle contamination of the propellant system, but this cannot always be successfully accomplished. Therefore, it is a major advantage to have an injector valve system with a high tolerance to particle ingestion.

UNCLASSIFIED



VAN NUYS CALIFORNIA

Report 6098

It can be noted from Figure 21 that a series of grooves are machined in the stems of both the inner and outer valves. It was originally intended that these grooves were to function as particle traps and as a labyrinth seal. The top groove was machined larger than the rest of the grooves to accept a Teflon seal. The top seal provided a separation of the propellant within the valve assembly from the lubricating oil in the camshaft chamber. In conjunction with the seal, an overboard drain port was provided just below the seal groove to prevent propellant working past the seal and mixing with the lubricating oil. Although this configuration worked properly, propellant losses via the overboard drain were greater than desired. Therefore, all the grooves were slightly enlarged and fitted with additional Teflon seals. This sealing technique proved to be very satisfactory.

The performance of the fuel and oxidizer injector valves during the test period is summarized in Tables I and II, respectively. For convenience, the valves are listed in numerical order and not necessarily in the order in which they actually were used. These data are further summarized below.

	Fuel Injector Valves	Oxidizer Injector Valves
Total operating time, hrs	380.92	380.79
Total number of failures or malfunctions	9	13
Total number of malfunctions causing engine shutdown	5	4

During the early phases of the test program, valve seizure was a serious problem. Of the four oxidizer valve failures and the five fuel valve failures causing termination of engine operation, 50% of the oxidizer valve failures and 80% of the fuel valve failures occurred within the first 3.6 hours of accumulated engine running time. These failures were carefully analyzed to determine their cause and the following changes in fabrication and pre-run preparation techniques were incorporated as a result:

1. Marquardt dense chrome plating was substituted for "Electrolyzing" and "Microplate" dense chrome plate processes.
2. The concentricity tolerances between the valve stem diameter and the seats were decreased.
3. The valve stem clearance tolerances were increased from 25×10^{-6} in. to 50×10^{-6} in. + 25×10^{-6} in. - 0 nominal.

UNCLASSIFIED

4. The valves were dynamically run in for 1/2 hour on oil prior to use.
5. The valves were vapor degreased, degaussed, and double sonic cleaned prior to installation.
6. The valves stems were lubricated with PD839 on assembly.

The above listed techniques proved quite successful. Only four engine tests were ended because of valve failure or malfunction in the 376 hours of engine operation subsequent to the adoption of these changed techniques.

The development by the Frankfort Arsenal of PD839 propellant compatible lubricant was of major assistance in achieving reliable injector valve performance. This lubricant is sufficiently inert and cohesive to remain on the valves for prolonged periods of operation. Test experience has shown that injector valve failure occurs generally within the first 2 hours of operation. A protective film on the working surfaces during this critical period is highly desirable because it allows the components to "break in" without galling. After a valve assembly has operated longer than 2 hours, its life appears to be limited only by the severity of the engine operating conditions and foreign material ingestion, because surface wear is negligible.

The severity of engine operation (specifically, late timing, extreme O/F ratio conditions, and nonsynchronous injection) has shown a marked effect on the injector valve housing orifices. Under the conditions enumerated, orifice erosion has been experienced with both injector valves. The most severe erosion of the orifice and face of a fuel injector valve was experienced during July 1965 Tests 5151-4, -1, -2, and -3. This fuel injector housing is shown in Figure 22. During this test series, the engine was operated at rotative speeds up to 5000 rpm, horsepower up to 4.2, and O/F ratios ranging from < 0.7 to > 1.7. Evaluation of the valve housing following these test runs indicated that the valve housing was not remaining on its seat in the cylinder head during operation and it therefore became overheated. The torque on the hold down ring nut was increased and the housing face was chrome plated. This corrective action eliminated further fuel housing face and orifice erosion problems.

Erosion of the oxidizer housing orifice was not so simply corrected. Whenever etching or erosion of the housing face has been encountered it has been caused by the housing lifting off its seat or because of incomplete metal-to-metal contact at the cylinder head/valve housing interface, as in the case of the fuel valve housing. However, erosion within the oxidizer valve housing orifice has occurred without a corresponding valve housing face erosion condition. This erosion takes the form of a "bell mouthing" of the housing orifice at the cylinder head/housing interface. Although the engine severity operating parameters previously listed definitely affect erosion, other causes such as cavitation, oxidation, and combustion chamber configuration appear to be possible contributors to this phenomenon. The exact mechanics of oxidizer orifice erosion have not been precisely determined because of the feasibility nature of the overall test program and the fact that the bell mouthing has not altered the metering characteristics of the valve. Development work is required in this area.

Two fuel injector orifice sizes were evaluated during the test period. Normally, the only difference between a fuel valve and an oxidizer valve is the orifice size, 0.049 in. and 0.061 in., respectively. Because fuel injection pressures as high as 4000 psi were required to achieve some of the high horsepower conditions demonstrated, one fuel valve was fitted with an 0.061-in. orifice. The enlarged orifice had the desired effect and substantially reduced the injection pressure requirements for a given fuel flow rate. However, at the low power conditions (i.e., < 1.5 HP) the injection pressures approached or equaled the combustion chamber pressures. Erratic engine operation and combustion chamber erosion was experienced under these conditions, and use of the 0.061-in. orifice fuel injector was discontinued.

When the flat seat injector valves were designed, it was determined that a significant saving in manufacturing cost could be realized if all of the valves were identical. Also, the valves could be used interchangeably. Therefore, they were designed with an 0.061-in. orifice. The valves were committed to manufacture at the time that 0.061-in. orifices were being tested and prior to the determination of the injection pressure versus combustion chamber pressure relationship to combustion chamber erosion. Therefore, it was necessary to fabricate inserts for the fuel valve orifices prior to their use in test series 5167-1 through -9. The original inserts were fabricated from 304 CRES and were straight sided "plugs" pressed into the housing and redrilled to 0.049-in. diameter. These plugs tended to loosen in use and they were redesigned so as to provide an external step at the apex of the housing face. The step was ground flush with the tapered valve housing face and the combination of a press fit into the valve housing and compression against the cylinder head when the housing was installed eliminated the difficulty.

The durability of the valves was demonstrated in a most convincing manner with a continuous 90.42-hour test. More than 15.6×10^6 valve cycles were demonstrated with each valve assembly without degradation of the units in any respect. The fuel and oxidizer valve assemblies used during this endurance test are shown in Figures 23 and 9, respectively. The fuel and oxidizer inner and outer valve seats are also presented in Figures 24 and 25, respectively. Although other valve assemblies have accumulated more total operating hours, none has been subjected to a duration test of this length. In summary, it can be stated that most of the valve problems encountered during this program, ranging from materials to clearances and from configuration to assembly techniques, have been solved. The valves have proved to be both durable and reliable.

2. Piston and Rings

a. General Discussion

Serious problems were encountered with the piston assembly during the test program. The physical manifestations of the problems were broken piston rings and galled, melted, and burned through pistons in the ring belt area. Seven piston configurations were tested during the program. Of the seven configurations six indicated capability of operating 10 or more hours.

The seven piston configurations are presented schematically in Figure 26. Inspection of this figure shows the basic similarity between six configurations to be specifically two-element construction, i.e., a high temperature material crown and an aluminum skirt. Only the configuration, placement, and number of piston rings are varied between these six designs. The seventh piston differed in concept.

Two basic approaches can be taken in the design of a piston for an engine operating on Aerozine-50 and N_2O_4 propellants. Both approaches recognize the rapid pressure rise and high combustion temperature (4000° to $5600^\circ F$) of these propellants. The first method is to dissipate the heat input to the piston crown as rapidly as possible, this would be classified as the "cool" approach. The second method is to isolate, thermally, the piston crown and allow it to operate "hot". Six of the pistons shown in Figure 27 use a semi-cool approach. The seventh piston configuration uses a thermally isolated crown, or a "hot" approach. Although this latter technique has merit, time limitations precluded serious perusal of the concept and it was, therefore, abandoned in favor of the more immediately promising semi-cool approach.

The semi-cool piston configurations utilize a thin crown section fabricated from N-155 stainless steel or Rene' 41 material bolted to a piston skirt made from D-132 cast aluminum material. The attaching bolt is made from L-605 material. This basic assembly presents to the combustion chamber a material capable of withstanding the high temperature and supported by a material having a high heat transfer capability as well as an excellent bearing surface characteristic.

A completely cool piston approach would require the basic piston to transfer heat to the coolant jacket with as few thermal discontinuities as possible. A piston fabricated completely from aluminum is excellent for this purpose. However, the piston crown temperatures in the hypergolic propellant engine range between $1700^\circ F$ and $2400^\circ F$ making aluminum completely unsuitable for this operation. Therefore, the Rene' 41 crown is fitted to provide partial thermal isolation for the aluminum skirt and it would be classified as a semi-cool design.

The major differences between all six piston configurations are in the shape, number, and location of the piston rings. Using Figure 26 as a reference, the various piston configurations are discussed below.

b. Performance of the Configuration A Piston

The Configuration A (Baseline) piston is the basic piston design evolved from the Phase I test program. This design utilizes the construction previously described and it is fitted with three rings. The top two rings are located back to back in the same groove and are of different configurations. The upper ring is an L-shaped ring and the second ring is a standard, thin, rectangular shaped ring. The upper ring is supported by the

second ring. The ring groove is partially machined in the crown material and the bottom of the groove is the D-132 aluminum skirt. The top of the L ring is almost flush with the piston crown. The two top rings are indexed 180° apart at the pin bore centerline and pinned in position. The combination of two rings presents a gapless seal to the combustion chamber. The L ring shape offers several major advantages over a conventional ring shape when installed in the manner described. These advantages are low wall tension, excellent high pressure sealing, precise exhaust port timing, and positive separation of the crown material from the cylinder wall.

The third ring is a conventional rectangular shaped ring and it is carried in a groove machined in the aluminum skirt material. This ring is also pinned to prevent rotation.

All piston rings are fabricated from standard gray cast iron. This material was chosen for the piston rings for three main reasons:

1. Compatibility in bearing with the chrome plated cylinder
2. Excellent heat transfer characteristics
3. Ease of manufacture

It was realized that the choice of cast iron would be satisfactory only for the test engine because of its lack of corrosion resistance. However, other engine problems were of greater concern at the time and this piston and ring assembly proved adequate for that period of the test program.

Two cases of piston ring breakage and skirt burn through in the ring belt area were encountered during testing with the Configuration A piston between 1 July and 16 October 1964. In both cases, the engine was subjected to a "runaway" condition as a result of previously discussed injector valve seizure and any shortcomings of the piston assembly thus were masked. A minor problem with the piston was indicated by high oil consumption rates and subsequent carbon formation on the piston and in the cylinder exhaust manifold. In order to assure the coolest piston operation possible, oil was sprayed on the underside of the piston crown. A loose piston-to-cylinder fit combined with fairly high oil flow rates within the engine and low exhaust manifold pressures caused the high consumption rates. Therefore, the Configuration B piston was designed to control the amount of oil on the cylinder walls.

c. Performance of the Configuration B Piston

The Configuration B piston was very similar to the Configuration A piston except that provisions were made for two additional rings. One ring groove was provided above the wrist pin bore for either an oil ring or a fourth compression ring. The other groove was machined at the lower end of the piston skirt for a low tension oil ring.

Prior to using the Configuration B piston, the oil cooling technique was discontinued because it did not appear to be effective. Comparison of oil temperatures between tests with and without piston cooling showed an insignificant difference. Therefore, the Configuration B piston was fitted with only three rings in the same manner as the Configuration A piston.

Several changes were made with the Configuration B piston assembly in addition to the ring grooves. The clearances between the piston skirt and the cylinder wall were reduced from approximately 0.006 inch to 0.004 inch and a top L-ring fabricated from NiResist material was fitted. NiResist was chosen for evaluation because of its rated higher temperature capability and ductility in relation to cast iron.

A total of 4 hours of engine operation were obtained with the Configuration B piston, including a 2.16-hour continuous run. The last test with this configuration was a BMEP versus SPC performance mapping investigation. During this run, the piston rings failed at the ring end gaps allowing the skirt to overheat and seize in the cylinder. Inspection after the test run indicated that the top ring lands were bearing heavily on the cylinder walls and had contributed to the ring failure. Therefore, the piston was redesigned to reduce the ring belt diameter and eliminate the no longer required extra ring grooves. This piston was identified as Configuration C.

d. Performance of the Configuration C Piston

The initial application for the Configuration C piston was a targeted 6-hour duration test. This piston had an 0.010-inch diameter reduction in the ring belt area and it was fitted with a NiResist L-ring and two cast iron lower rings. Four runs made on 10 November 1964 totaled 6.81 hours of operation. Teardown inspection of the piston after these runs disclosed a partially failed top L-ring and some minor skirt scoring on the thrust side. The top NiResist L-ring had a 1/2-inch segment broken off the top of the L. Otherwise, the piston design appeared to be very successful. This particular series of runs ended the SPU-2A testing.

The Configuration C piston was again used in the SPU-2A-2 engine for evaluation of the ball and roller bearing crankcase assembly. The total operating time with this piston during this test was 5.66 hours, including a 4.76-hour duration run. Teardown inspection of the engine following these tests disclosed a partially failed piston assembly. The two top rings had broken and some heavy erosion of the upper section of the skirt above the third ring was found. Two views of this piston assembly are shown in Figures 27 and 28. This failure was attributed to a badly warped cylinder bore resulting from several plugged water transfer passages in the area of the piston failure. The cylinder had been fitted with three thermocouples and the wires had partially blocked two of the water passages and caused a localized hot spot on the cylinder wall.

e. Performance of the Configuration D Piston

The Configuration D piston was a marked departure from previous designs in that three, three-element rings of unusual configuration were fitted and the top ring was carried completely in the high temperature crown material. This piston design is shown in Figures 26 and 29 and it was based upon the experience gained during the hydrogen and oxygen fueled engine test program conducted between April and June 1965 (NASA Contract NAS9-857, Phase II, Mod.II)

Careful evaluation of the piston failures previously experienced with both programs indicated the possibility that deflection of the top ring land when loaded thermally and mechanically (pressure) was contributing to piston ring breakage. Additionally "clipping" of the piston rings by the exhaust ports had been noted. The Configuration D design attempted to eliminate both of these possible causes of piston failure.

Section A-A of Figure 26 shows the cross section of the three-element rings. The rings were fabricated from cast iron and were composed of two interlocking outer rings and an inner back-up ring. This configuration offered the following major advantages:

1. Positive end gap sealing
2. Positive constraint of ring ends (cannot spring into exhaust ports)
3. Elimination of ring pins
4. Low leakage at high pressures
5. Low wall tension
6. Improved mechanical strength

During July 1965, a total of 19.44 hours of operation were accumulated with the Configuration D piston. Two piston failures were experienced, both following approximately 9.7 hours of operation. In both cases, the mode of failure was breakage and seizure of the rings in their respective grooves followed by channeling of the combustion gases down the crack in the rings until a hole was melted through the aluminum skirt material above the third ring. Figure 30 is a picture of a Configuration D piston following 9.75 hours of operation.

It was clear from these two failures that piston ring breakage was causing the piston failures. Three possible causes of ring failure were considered, namely: combustion roughness, fatigue, and excessive temperature. Since any one or a combination of several of these three could cause ring failure, a series of tests was undertaken to more clearly define the problem. The series of tests involved three major design areas and one operational technique. The three design areas were:

1. Exhaust port shape, size and location
2. Piston configuration
3. Ring configuration and material

The operational technique alteration was confined to various injector timing effects.

Three cylinders were designed and fabricated. Two had exhaust ports 0.025 inch higher than previous designs to allow a longer period for piston ring cooling. One of these cylinders had 8 large rectangular shape ports and the other had 8 large oval ports. The third cylinder had 8 small, round, ports located in the normal position, i.e., fully uncovered when the piston was at bottom dead center. All three cylinders were made from 17-7 CRES, heat treated to C-60/62 and had dense chrome plated bores. The original low, rectangular port cylinder was also utilized.

Three piston configurations identified as Configurations E, F, and G and having different ring configurations and locations were fabricated and tested. In addition, modified Configuration A pistons were made for use as a standard for comparison. The modification for the Configuration A piston consisted of a tapered skirt (0.001-inch flare toward the bottom) and decreased ring belt diameters above the lower ring land.

f. Performance of the Configuration E Piston

The Configuration E piston was essentially a Configuration B piston without the skirt ring groove. Two rectangular cast iron rings were fitted in the lower two ring grooves. No ring was fitted in the top groove. The concept was to allow the first groove to act as a labyrinth seal reducing the temperatures and pressures applied on the first ring. The piston was used in conjunction with the standard, low, rectangular ported cylinder and standard injector timing. The piston rings and piston failed after 1.33 hours of operation and further work on this design was discontinued.

g. Performance of the Configuration F Piston

The Configuration F piston design was the only one of the seven designs evaluated which utilized the hot crown approach previously discussed. The crown was insulated with a disk of pyrolitic graphite having a high radial and a low longitudinal heat transfer characteristic. The outside diameter was fitted to the bore with a total clearance of less than 0.001 inch so as to act as a partial seal in addition to greatly reducing the ring belt temperatures. The insulator proved to be too effective and allowed the Rene' 41 crown to attain melting temperature. This occurred within 0.3 hour of operation. Figure 31 shows the piston at the end of the test. Further testing of this concept was discontinued for the reasons previously stated.

h. Piston Ring Performance

At the completion of the hot crown piston test, the series of piston ring tests were initiated utilizing one standard piston configuration and the high port cylinders. The piston used was the modified Configuration A with cast iron rings and it was defined as the "Baseline" piston. In addition to the port location and shape effects on ring wear and breakage, various injection timing settings were evaluated. The engine was operated in increments of 1, 2, 4, and 8 hours with piston inspections interspaced between tests. Speed and power settings were also altered to evaluate these effects.

The following observations resulted from this series of tests:

1. Cast iron rings are inadequate for operation longer than 10 hours in this engine.
2. Increased cooling time through use of "high" exhaust ports was ineffectual.
3. Oval ports produced less ring clipping than square ports.
4. Late injection timing or fuel lead bias produced heavy combustion chamber erosion and severe combustion roughness.
5. The basic piston design was adequate for the combustion environment if the piston rings remained intact.

In order to verify the above findings, another piston configuration having four thin, rectangularly shaped cast iron rings was fabricated and tested in both high port cylinders. This piston was generally referred to as the Modification No. 1 piston and it is listed in Figure 26 as Configuration G. This piston assembly verified the findings with the Baseline piston.

Since a piston ring material change was mandatory to achieve operating periods longer than 10 hours, an additional requirement of propellant compatibility was included. This requirement, in addition to those of strength, ductility, good bearing qualities, etc., confined the possible material choice within the stainless steel family. Three choices were made, the first being 420 CRES and the second 440-C CRES and the third Monel. Rings for the Baseline piston were fabricated from both 420 and 440-C CRES.

The initial test with the 420 CRES rings was unsatisfactory because the rings galled on the chrome bore almost immediately. Before discarding the 420 material as unsuitable, the rings were flame plated on their bearing surfaces with tungsten carbide, Linde Process LW-1. Similar results were obtained with the second set of rings, i.e., immediate galling and piston seizure in the cylinders.

The tests with the 440-C rings were as successful as the 420 had been unsuccessful. The initial run with these rings was for 5 hours. The engine was then disassembled sufficiently to inspect the piston and cylinder assembly. The rings were frosty in appearance on the working surface with a trace of initial galling indicated, otherwise they were as installed. Therefore, the engine was reassembled and operated for 41 continuous hours. At the end of this period, the piston assembly was inspected and found to be without change from the 5-hour test. This piston assembly is shown in Figure 32. The high oval port cylinder was used for this test.

i. Performance of the Configuration G Piston

In order to insure that the 440-C CRES material would perform properly under more adverse conditions and in a different configuration, the Configuration G piston was fitted with 440-C rings and installed.

The cylinder used for these tests was a low, round exhaust port configuration. Because some initial galling had been noted with the 440-C ring material, the rings were treated with the Microseal Process 100-1 to minimize this condition during the initial break-in period. The piston exterior and cylinder bore were also treated in this manner. All subsequent engine tests were performed with this combination of piston and cylinder assemblies.

A total of 124.55 hours of testing was successfully accumulated with this piston assembly prior to encountering any further problem areas. Typical photographs of this piston assembly after a test run are shown in Figures 13 and 33. It can be noted from these photographs that some incipient galling is still present. The Microseal 100-1 process reduced this tendency but it did not eliminate it entirely.

The problem encountered after a 31-hour continuous run manifested itself by a refusal of the engine to start. The resulting teardown inspection of the engine disclosed a hole burned through the center of the piston crown and an overheated piston. Engine operation had been normal when it was shut down to correct a facility malfunction.

To insure that this crown failure was not a random occurrence, a second engine similarly equipped was installed in the test facility and operated at slightly more adverse conditions than before. An identical failure was achieved after 6 hours of operation. Two views of this second piston are presented in Figures 34 and 35.

Since this form of failure had not occurred before, comparisons between these two engines and previous engines were undertaken. Two areas of difference were defined. Firstly, two new cylinder heads had been fabricated prior to the initiation of the final series of tests. These two heads had the cylinder pressure transducer port eliminated which increased the effective expansion ratio of the engine. Also the mode of operating the injector valves was altered and had produced a significant improvement in combustion efficiency.

Both of these changes combined to increase the heat input to the piston. In addition to the above, both piston crown center sections had been fabricated to the minimum tolerance limits of 0.027 inch. All previous piston crowns had been approximately 0.047 inch thick at the center above the bolt boss.

On the basis of these findings, the piston crown was re-designed to increase the center section thickness to 0.082 inch in this critical area. A technique of filling the hollow crown attach bolt with powdered silver was developed to improve heat transfer to the aluminum skirt. Also the top of the combustion chamber was remachined to produce a 20.6:1 expansion ratio when the engine was cold. These changes corrected the problem inasmuch as the next engine test was for duration and achieved a continuous 90.4 hours without piston malfunction. Figure 36 shows the piston after the 90.4 hours of operation. Evaluation of the piston after this test indicated that it was capable of additional operation.

On the basis of the piston development conducted during this program and the present maximum power per cubic inch of engine displacement requirements (1.6 HP per cu in. net), two pistons are available to perform reliably at these power levels. Both the Baseline and the Modification No. 1 configuration pistons fitted with 440-C CRES rings have demonstrated adequate structural integrity and reliability to perform presently envisioned space power generation tasks.

3. Bearings

Three basic types of bearings have been used in the SFU series engines, namely: plain bearings, ball bearings, and roller bearings.

The SFU-2A-1 engine utilized plain bearings throughout with the exception of the cam drive idler gear. A double row ball bearing was installed in this gear. Plain bearings were provided for the camshaft, crankshaft, and connecting rod. These bearings were machined directly in the base aluminum material used for these components, i.e., 6061 case and head, 2024 rod. No service problems were experienced with these bearings within the normal operating range of the engine (4.5 HP and 6000 rpm).

The SFU-2A-2 and SFU-3 engines used ball main bearings and a roller bearing on the lower end of the connecting rod. The cylinder head bearings and upper rod bearing were the same as those in the SFU-2A-1 engine. Two types of main ball bearings were used, namely: MRC 204S-ST and ND 3024. The only difference between the two was the material. One bearing (MRC-204S-ST) was made from 440-C CRES and the other (ND 3024) was SAE 52100 steel. MRC 204S-ST 440-C CRES bearings were normally used in the engine with completely satisfactory results. Standard steel ND 3024 bearings were substituted when the utilization rate exceeded the delivery lead times. Replacement of the 440-C CRES bearings was caused by particle ingestion as a result of other component malfunctions or failures. Although the standard steel bearings were subject to corrosive attack and were replaced periodically for this reason, their performance was also completely satisfactory.

The early performance of the connecting rod roller bearings was assuasive. Initially a Torrington HJ-162416 440-C caged roller bearing was used. This bearing operated for 37.86 hours of testing prior to experiencing a failure. A second failure occurred after only 0.47 hour of operation. Inspection of the bearing during engine teardowns had shown some cage wear and the bearing had been replaced twice to insure reliability. The two failures of the bearing during engine operation conclusively demonstrated that the roller cage design was inadequate for this application. Figure 37 shows a cage failure and resulting bearing seizure. Because stainless steel bearings are generally special order only and require many months of lead time before delivery, standard steel bearings in the "off the shelf" category were surveyed as replacements. Two bearings were selected for evaluation: a McGill MR-16 and a McGill GR-16. The MR-16 bearing is a caged roller type having a simpler and heavier cage design than that previously used. The GR-16 is a full complement design having a center roller guide.

The MR-16 bearing was used first and it achieved 7.38 hours of operation before cage failure reoccurred. The full complement GR-16 bearing was then installed and tested with complete success. Several bearings have been replaced because of excessive wear due to very fine abrasive particles in the oil. A complete replacement of the oil supply lines and propellant system type cleaning of the oil tank and pumps corrected this condition. The last 340 hours of engine operation were accumulated without further connecting rod roller bearing problems.

With one exception, resulting from too close an initial fit, the plain bearings in the SPU-3 cylinder heads have given excellent, trouble free service. The plain bearing in the top of the connecting rod has, however, indicated a marginal condition when subjected to prolonged, high temperature operation. Under these conditions, the wrist pin bearing tends to wear on the loaded side at a gradually increasing rate. This bearing was designed to withstand the expected maximum loads if the rod temperatures did not exceed 400°F. There is sufficient evidence to indicate that the upper end of the rod is operating closer to 600° to 650°F. These temperatures are sufficient to degrade the strength of the aluminum and allow the wear rates experienced during extended test periods. If extended, continuous engine operation (greater than 25 hours) is to be required, the upper rod bearing will have to be bushed, the area increased, or the base material of the rod changed.

4. Injector Valve Actuation Mechanism

The injector valve actuation mechanism is composed of the camshaft assembly, rocker arms, four rocker arm shafts, four springs, two spring bridges, and two spring tension adjusting assemblies. Two basic type camshaft assemblies were utilized throughout the test program. The SPU-2A-1 camshaft is a two-piece component. It consists of a forward shaft and an aft shaft. The forward shaft contains the front bearing journal, two cam lobes, and a pilot shaft for joining to the aft shaft. The aft shaft consists of two cam lobes, the rear bearing journal, and an indexing and locking device. The aft cam shaft slips over the forward cam shaft pilot shaft and is clamped in position to form a complete unit. This construction provides relative angular displacements of the two sections, allowing infinite adjustment of injection dwell. The injector valve actuation mechanism for the SPU-2A-1 engine is shown in Figure 3.

The differences between the SPU-3 and SPU-2A-1 camshafts are in the basic materials and the removable cam lobes. The SPU-2A-1 camshaft is fabricated from nitralloy and nitrided to C65-70. The SPU-3 camshaft is 440-C CRES with cam lobes of Speed Star H.S. tool steel heat treated to RC-65. Each lobe of the SPU-3 camshaft is indexed and retained to the basic shaft with keys. This assembly is shown in Figure 11. The removable cam configuration is adapted to provide a simple means of evaluating various materials and cam contours.

The cam follower sections of the rocker arms are fitted with tungsten carbide inserts. The combination of two very hard materials for the follower inserts and cam lobes proved to be an excellent choice. Prior to installing the carbide inserts on the rocker arms, heavy cam and rocker follower face wear had been experienced. Wear on the cams was experienced after installing the carbide inserts only when seizure of the injector valve was experienced or insufficient lubrication was provided. Initial wear problems were experienced with the SPU-3 removable cam lobes until the proper lubrication flow rates were established.

The cam lobes for both cam designs are pressure lubricated through small orifices drilled into the unloaded face of the lobes. These orifices are fed from an oil passage inside the camshaft. Because the removable lobes have a double orifice and annulus interface before the oil reaches the external face of the cams, a 30 psi higher oil supply pressure is required over the nonremovable cam lobe design to achieve the required lubricant flow rates.

Cam lobe breakage was experienced on two occasions during the latter phases of the test program. These two cam lobes had been part of a set returned to the vendor for regrinding to the original profile. A slight reduction in overall size was expected. The lobes were overheated during the regrinding and the internal stresses combined with a strength reduction and operational loading caused the lobes to fail at the key slots. This type of failure was never experienced when lobes which had not been reground were used.

A minor problem area was found in the spring bridges (PNX 19965). These two units rest on the outer valve tops and transmit the spring loads to the valve. The inner valve rocker arm extends through the bridge via a "window" in the side. Because inner valve operation could be adversely affected if the bridge rotated and rubbed on the rocker arm, a positive restraint was provided to prevent bridge rotation. The restraining device was a slot in the outboard side of the bridge and a head mounted roll pin extending into the slot. Heavy wear was experienced in the slot and occasionally produced a sticking condition of the outer valve. This problem was eliminated by widening the slot and replacing the roll pin with a large bearing area 303 CRES block having rounded ends. These changes are shown in Figure 38.

All other components proved completely adequate. The overall success of the injector valve actuating mechanism design was proved by achieving 90.42 continuous hours of testing without measurable wear in any component.

5. Cylinder

Five basic cylinder configurations were used during the test program. The differences in these cylinders were confined to the shape, size, number, and location of the exhaust ports. All of the cylinders were fabricated from 17-7 PH CRES, heat treated to R_c 60/62, and dense chrome plated on the bore.

The initial sizing of the exhaust ports for the SPU-2A-1 engine provided the maximum port area possible in order to obtain maximum scavenging and minimize recompression of residual exhaust gases. Six rectangular ports were provided. They had a total area of 0.9 sq in. and an exhaust dwell period of 100° . Ring clipping in the ports and wear in the webs between ports was experienced with this cylinder so an eight-port cylinder was designed in which the web area was increased. The exhaust dwell period remained the same but the rectangular port area was reduced to 0.75 sq in. This cylinder was used until two high port cylinders were designed for use in the piston ring cooling evaluations.

The two high port cylinders had the eight exhaust ports located 0.25 inch higher in the cylinder which reduced the effective engine displacement to 1.77 cu in. One cylinder had standard rectangular ports and the other had oval shaped ports. The port areas were 0.75 and 0.50 sq in., respectively. The exhaust timing dwell for these cylinders was 140° . The oval shaped ports reduced the piston ring clipping problems but did not eliminate them unless the rings were pinned in position. A more complete presentation of the performance of the high port cylinders is covered in Part 2 of this section, Piston and Rings and also in the analysis section, VIII-C-5.

Based upon the performance of the first four basic cylinder designs, the final configuration was established. Test experience had shown that large exhaust port areas were unnecessary because the cylinder pressures were only about 100 psi at the time of port opening. With 100° of exhaust dwell and 3 psi or less exhaust back pressures, more than adequate scavenging was being achieved. Additionally, large ports with corresponding small web areas were considered to be detrimental to piston ring durability. Therefore, a cylinder with eight round ports having 0.39 sq in. total port area and 100° dwell was fabricated. The round exhaust ports eliminated the necessity of pinning the rings. Additionally, the top of the cylinder liner above the top flange was increased in thickness to increase the sealing surface area, eliminate thermal distortions, and structurally strengthen this highly stressed area. Cylinder wall distortion had been experienced on two occasions. However, in both cases a thermocouple installation had shrouded the water cooling passages and caused a localized "hot spot" and subsequent bore distortion.

A total of 238 hours of test operation was accumulated with the round port cylinder. The configuration proved completely satisfactory throughout the test period.

The water cooling technique used in all the cylinders was somewhat unusual and quite conservative in approach. Normal cylinder cooling for two-cycle engine cylinders is generally confined to the zone between the combustion chamber and the exhaust ports. In order to eliminate any possible bore distortion and to provide maximum cooling for the piston, the coolant transfer ports were machined in the exhaust port webs. This technique allowed the provision of a coolant jacket below the exhaust ports as a continuous extension of the standard jacketing above the ports. The effect of this full length coolant jacket was to decrease piston and exhaust gas temperature at the expense of increased coolant temperatures. Since coolant radiator surface area requirements would be decreased if exhaust port web cooling was not provided, a flight application engine probably would not use this technique.

6. Crankshaft Assembly

Two basic crankshaft designs were used during the Phase II program. One crankshaft was a rigid, one piece, configuration utilizing plain bearings on the two main journals and on the rod journal. This crankshaft was installed in the SFU-2A-1 engine and it performed without fault. The crankshaft was rugged to insure trouble-free operation while other engine problems were determined and corrected.

The crankshaft utilized in the SPU-3 engine was designed to use antifriction bearings for minimum oil flow requirements. This crankshaft was designed for two-section construction. The two halves of the crankshaft were joined at the center of the connecting rod journal with a Curvic coupling tensioned with a through-bolt.

The crankshaft was split in half at the connecting rod journal to provide a means of installing the roller bearing equipped connecting rod. It was deemed preferable to split the crankshaft and use solid bearing races rather than to use a solid crankshaft and split the connecting rod lower end and bearing races. The Curvic coupling was selected because it affords simple assembly and disassembly techniques for the components and it has superior load carrying characteristics. The basic components of the crankshaft are shown in Figure 14. Several minor problems were experienced with this unit. Initially, an oil flow restriction and a balance problem were encountered. These problems were defined during prerun crankcase and cylinder assembly lubrication tests when the entire assembly was being motored.

The lubricating oil for the engine enters the nose of the crankshaft through a face seal and is transferred through internal passages to the connecting rod bearing. To insure that crankshaft alignment was controlled only with the Curvic coupling, ample clearance was provided in the through-bolt bore. The oversize bore acted as one section of the oil transfer passage. Although the oil passage areas were the same in the shaft and around the bolt, the bolt tended to fit in the bore slightly eccentric and shrouded the intersection of the two passages, thus restricting the oil flow. Therefore, an 0.25-inch radius passage was formed in the bottom of the bolt bore to eliminate this restriction.

Another crankshaft problem was an unbalanced condition encountered when the engine was motored at speeds in excess of 2000 rpm. Nominal engine balancing technique is to counterbalance for 50% of the reciprocating mass. Initially, this value was not quite achieved. Because balancing a single cylinder engine is at best only a compromise of horizontal and vertical forces, no attempt was made to exactly achieve the 50% value. The motoring tests showed an excessive vertical component, so the crankshaft was rebalanced to approximately 55% of the reciprocating mass. This balance adjustment proved adequate for rotative speeds up to 5000 rpm and was not changed again during the test program.

The performance of the crankshaft was very satisfactory throughout the power range of the engine. The design feature of utilizing an inner rod bearing race sleeve that slipped over the rod journal ends proved its worth as an easily replaceable bearing surface if damaged. The connecting rod bearing failures experienced during the program would have necessitated crankshaft replacement had the rod bearing operated directly on the crankshaft rod journal.

Two minor modifications were made to the crankshafts after initiation of engine tests. On two occasions following a long test period, oil sludge was found in the internal oil annulus of the connecting rod journal. On one of these occasions, the oil transfer ports were badly restricted. Therefore, the oil ports were enlarged and a centrifugal sludge trap was machined in the front crankshaft web. The sludge trap was an 0.18-inch diameter hole bored through the web at 90° to the crankshaft centerline and intersecting the oil transfer passage and the connecting rod journal passage. The ends of this transverse sludge trap were sealed with tapered aluminum plugs.

In conjunction with the crankshaft centrifugal sludge trap, the facility main oil filter was increased in size and several external sludge traps were included in the system. These changes eliminated further oil passage restrictions.

7. Seals and Sealing Techniques

The four basic sealing requirements in the SPU-3 engine are propellant seals, high pressure gas seals, lubricant seals, and coolant seals.

In most cases, standard O-rings and gaskets are used for lubricant and coolant seals in the crankcase, cylinder and cylinder head. Teflon O-rings and Omniseals are provided for the valve housings and all bulkhead type fittings subject to a propellant environment. These standard sealing techniques proved, with rare exception, to be completely adequate and trouble free.

The high pressure sealing technique used in the combustion chamber area was unconventional and very effective. There are two interfaces subject to high pressure and high temperature combustion gases. One is the interface between the cylinder liner top and the spacer plate and the other is between the spacer plate and the cylinder head.

Concentric micro V-grooves are machined in the top of the cylinder liner and in the face of the combustion chamber insert boss in the cylinder head. When these two components are bolted together the micro V-grooves physically deform the mating aluminum surface of the spacer plate and form a positive high pressure seal. To insure adequate penetration, the mating surfaces are partially lapped together before assembly. At assembly, a thin Teflon disk is placed between the mating surfaces and is deformed into the grooves filling them completely. A cross-sectional view of this area of the engine is shown in Figure 39.

Early in the test program, several engine tests were terminated because of water leakage into the combustion chamber. These leaks were caused by insufficient preload on the grooved surface of the cylinder liner. The final clearances established to provide the proper preload are also shown in Figure 39. Following establishment of these clearances, no further problems were experienced with leakage.

Two Gits No. 58-075-16 face seals were provided on either end of the crankshaft outboard of the main bearings. These seals were installed not only to prevent oil leakage at these points but to provide a positive seal against air leakage in the event engine operation with crankcase pressures less than ambient was desired. These seals proved to be very satisfactory and never required replacement at any time during the test program.

B. Lubrication

1. Mechanical Configuration Effects

Oil consumption by the SPU-3 engine varied during the test program from a low of no measurable use to a rate of several quarts per hour. Oil control on the cylinder walls was achieved with proper piston skirt clearance. Various piston skirt cold clearances ranging from 0.0025 inch through 0.015 inch were used during the test period. The effect on oil consumption was significant. As expected, the larger the clearance the greater the oil consumption. This was only true, however, if the piston skirt was smooth. If, for an example, a piston was fitted with a skirt clearance of 0.008 inch and then knurled to decrease its clearance to 0.003 inch, the oil consumption would be as great or greater than with the 0.008-inch clearance. Oil consumption was therefore determined to be a function of the quantity of oil on the cylinder walls, piston skirt clearance, and scavenge pump effectiveness. Other factors, such as piston ring effectiveness, contributed to oil consumption. However, these were short duration effects and would be classified in terms of incipient malfunctions. In the case of the knurled skirt pistons, a great deal of oil would be trapped on the skirt by the knurling. As it traversed the exhaust ports, the oil would be sucked into the exhaust manifold as a result of the low pressure conditions.

The minimum piston skirt cold clearance found feasible for operation was 0.0035 inch. This clearance when combined with a reduction of oil on the cylinder walls produced an oil consumption of less than 0.2 lb/HP-hr.

The quantity of oil reaching the cylinder walls was effectively reduced by machining a sump chamber in the crankcase. Prior to this configuration change, the crankcase volume had been held to the minimum necessary for crankshaft, etc., clearance to assure adequate oil agitation and distribution within the engine. The system worked well but it restricted the oil from easily entering the scavenge port. By enlarging one side of the crankcase to form a sump chamber, the oil was provided with an area in which to settle and to be picked up by the scavenge pump.

2. Discussion of Lubrication Requirements

The lubrication requirements of the hypergolic propellant engine are basically the same as those for a conventional fuel engine except that the operating conditions are more severe. The primary considerations in choosing the best lubricant for the engine are as follows:

1. High temperature stability
2. Lubricant film strength
3. Chemical breakdown characteristic
4. Possible contact with the oxidizer
5. Thermal conductivity

The chemical structure of the lubricant was the principal factor considered with regard to temperature and contact with the oxidizer. Lubricant film strength is somewhat less dependent on the chemical nature of the lubricant but is significantly influenced by lubricant viscosity and the additives employed. The chemical breakdown characteristics were very dependent on the chemical nature of the lubricant. The type of deposit remaining after breakdown was of utmost importance.

Two basic lubricant types were considered and partially evaluated. They were mineral oil base lubricants and synthetic lubricants. In all cases, the base for comparison was a mineral oil (Brayco No. 443, SAE 30). This particular oil had been used in the hypergolic engine from its inception because of its good film strength, high temperature stability, and thermal conductivity rating. This oil had proved basically satisfactory, however, the decomposition products tended to cause piston ring seizure in their respective grooves. Therefore a series of tests was undertaken to evaluate the deposit formation (coking) characteristics at various temperatures of a number of mineral oil and synthetic base lubricants.

3. Lubricating Oil Coking and Stability Evaluation

Seven petroleum base and seven synthetic lubricating oils and fluids were tested to establish their coking and relative elevated temperature stability characteristics. The following oils and fluids were tested:

1. Brayco 443	SAE 30 Oil
2. Brayco (Outboard)	SAE 30 Oil
3. Kieckhafer (Outboard)	SAE 40 Oil
4. Pennzoil Z-7	SAE 30 Oil
5. Sears	SAE 30 Oil
6. Union Royal Triton	SAE 30 Oil
7. Havoline H D	SAE 30 Oil
8. DuPont	PR 143 AC Fluid
9. UCON	LB 525 Fluid
10. UCON	LB 550X Fluid
11. UCON	LB 1800X Fluid
12. UCON	YT-155T Fluid
13. UCON	YT-165T Fluid
14. UCON	YT-175T Fluid

The DuPont fluid was a fluorocarbon base and the UCON (Union Carbide) fluids were polyglycol base. The variation in thermal stability and coking characteristics between these lubricants was striking. A plot of weight loss versus temperature is shown in Figure 40. These data show that the oxidation inhibited UCON lubricants are very stable at temperatures up to 400° to 425°F but rapidly vaporize at temperatures above 425°F. Mineral oils are not as stable below 425°F as the UCON polyglycol base lubricants but they are vastly superior at temperatures above 425°F. The DuPont PR143AC fluorocarbon base fluid was very stable up to 600°F and was the only lubricant tested that was still a liquid at this temperature. All the other lubricants were reduced to a solid at 600°F.

The changes in physical appearance of the various fluids tested as a function of temperature are summarized in Table III. No attempt was made during the tests to determine viscosity changes or relative lubricity at the various temperatures because the major interest at the time was the coking characteristics of the fluids. One reason for this was the fact that the Brayco

443 oil was providing adequate lubrication for engine operation and that other similarly treated oils would probably perform the same. However, the coking characteristics as a function of temperature would, when known, give a better indication of actual piston operating temperatures and a possible means of eliminating piston ring-to-groove seizure resulting from carbon buildup. The rated cleanliness of the UCON lubricants when decomposed by elevated temperatures was an attractive reason for evaluation. Unfortunately, the cleanliness characteristic was made academic by the failure of the liquid to exceed 450°F without completely vaporizing. Because it was known that several areas within the engine requiring lubrication were operating at steady state temperatures approaching 500°F, further investigation of the polyglycol base lubricants was discontinued.

A parameter of utmost importance for the hypergolic propellant reciprocating engine is the thermal conductivity of the lubricant. Because the present piston design requires rapid heat dissipation and the heat must be transferred from the piston to the cylinder through the lubricant film, it is imperative that the lubricant have a high thermal conductivity. Figure 41 presents thermal conductivity data for four types of lubricants. It is obvious from these data that the Union Carbide UCON lubricants would be far superior to other lubricants if they were capable of withstanding temperatures greater than 450°F.

4. Lubricant Selection and Performance

On the basis of the data accumulated from the coking tests, prior performance in the engine, and known thermal conditions within the engine, Brayco No. 443 oil was used during most of the engine testing. Havoline SAE 30 HD oil was also tested in the engine and its use did reduce the amount and type of deposits on the piston. However, on some occasions when Havoline oil was used, cam wear was noticed, which indicated a reduced film strength in relation to the Brayco No. 443 oil. Several runs were made using a 50-50 mixture of Brayco No. 443 and Havoline SAE 30 HD oils without significantly different results than those obtained with 100% Brayco No. 443 oil. Therefore, the use of lubricants other than Brayco No. 443 was discontinued.

The DuPont PR 143AG fluid appears to offer the only real improvement over the Brayco No. 443 oil in terms of thermal stability and elimination of deposits within the engine. However, four factors must be considered and documented prior to assuming that the PR 143 AC fluid is superior. These are

1. Film strength
2. Disassociation effects
3. Thermal conductivity
4. Availability

Item 1 is self-explanatory. However, Item 2 may prove to be a major problem area for this lubricant. At temperatures over 600°F, the fluorocarbon base material will start disassociating and give off fluorine gas. Fluorine gas at elevated temperature is very corrosive to some stainless steels and other materials normally considered corrosion resistant. This effect on the engine is only speculative but appears to pose a major problem.

The thermal conductivity of the PR 143 AC fluid is significantly less than that of the mineral oils presently used. This may preclude its use unless this characteristic can be altered or the piston can be proved capable of operating at a higher temperature.

The availability of PR 143 AC fluid has been very limited to date. A sufficient quantity was obtained from the manufacturer for use on the injector valves during assembly but not enough for engine operation. It is hoped that sufficient quantities can be obtained in the near future to allow a full scale engine test for evaluation. The proved propellant compatibility and high temperature stability without detrimental deposit formation make the PR 143 AC fluid a promising lubricant for the hypergolic propellant space power unit engine.

V. ENGINE ENDURANCE TEST PROGRAM

A. Requirements and Goals

One of the criteria for determining the feasibility of the hypergolic engine system was the required demonstration of extended engine operation. This endurance test demonstration gave early insight into the potential reliability of the engine and engine system. It identified the component reliability of both the engine and support system and indicated the problem areas and methods of correction for increasing the total reliability. The power profile selected for the endurance testing was 50 minutes at 2.4 HP and 10 minutes at 3.2 HP. This output corresponds to the required shaft horsepower necessary for 1.5 KW and 2.0 KW output of the Space Power Unit with considerations of 90% generator efficiency and constant watt accessory loads. A BMEP value of 200 psi was set as the upper limit for the endurance tests because extended operation at BMEP values above this limit had not been previously investigated.

B. Preliminary Test Runs

The initial attempts at extended duration tests were met with a series of piston and piston ring failures. This led to the investigation of lubricating oil coking evaluation (discussed under Engine Development, Section IV-B above) because of the evidence of heavy carbon formation apparently causing ring failure. In addition to this investigation, the combustion roughness was determined as contributing to piston and piston ring failure, thus leading to experiments with deviations in injector timing and dwells in an effort to reduce pressure rise rates and peak combustion pressures. Other experiments to "soften" the combustion process included variations in the following parameters:

1. Exhaust back pressure
2. Engine coolant temperature
3. Engine BMEP
4. Oxidizer/fuel ratio
5. Expansion ratio
6. Sequence of valve operation (i.e., inner or outer valve opening first)
7. Oxidizer injection relative to fuel injection

A major deviation (which consisted of raising the exhaust port) was tried in an effort to reduce the operating temperature of the piston. The ports were positioned 1/4 inch above their normal location.

The effects on engine life and operation which resulted from the parameter and configuration deviations are discussed under Section IV, Engine Development, and Section VI, Engine Experimental Investigations, of this report.

A breakthrough in engine endurance from 10 hours to 41 hours was made when a set of 440-C stainless steel piston rings was used in place of the cast iron rings on the Baseline L-ring piston design. Immediately, a new piston with conventional piston rings but utilizing the previous composite construction of a Rene' 41 crown fastened to a cast aluminum skirt (designated as the Modification I piston) was tested. Attempts at extended engine operation with the new piston were marred by a series of problems arising from cylinder head gas leaks through the Kistler transducer ports (causing extensive head damage) and also due to unusual malfunctions such as broken cams, overfilling of oil tank, dynamometer bracket failures, etc. At this time, in order to make a successful endurance run, it was deemed necessary to accomplish the following changes:

1. Make the SPU-3A and SPU-3B engines simultaneously available in new condition. This required the fabrication or fitting of the following new components:
 - a. Cylinder heads (Without the troublesome Kistler transducer ports)
 - b. Injector valves
 - c. Ball and roller bearings
 - d. Piston rings
 - e. Connecting rod
2. Update the facility as follows:
 - a. Modify the dynamometer to eliminate cantilever mounting
 - b. Fabricate a substand designed to integrate the engine, dynamometer, and starter system into one unit to eliminate flexing and resultant misalignment of components. Most of starter malfunction was due to misalignment.

Following the rebuilding of the engines, a series of test runs was made to check out the new components. The SPU-3B engine was subjected to the first extended test run. The test was terminated at 30.22 hours (Test No. 5167-4) because the rated power settings could not be maintained. Disassembly disclosed a failed piston crown. A hole approximately 1/8 inch in diameter had formed allowing combustion gases to escape to the crankcase. The components thus damaged included the piston assembly, connecting rod, and wrist pin.

The SPU-3A engine was put immediately into test and it failed at 6.05 hours (Test No. 5167-5) in exactly the same manner, inflicting identical engine damage. Photographs of the piston from this engine are shown in Figures 34 and 35. Investigation of the failures included the following:

1. A "wet chemical" analysis of piston crown material verified the metal alloy as Rene' 41.
2. A heat transfer analysis was made to investigate the variation in film coefficients due to gas velocity between the piston crown and the face of the combustion chamber exit.
3. An analysis of the heat transfer between the piston crown and the piston body was made.

The investigations resulted in the following modifications:

1. The clearance volume height was increased from 0.030 to 0.050 inch to reduce the gas velocity and subsequent heat transfer into the piston crown.
2. The center of the Rene' 41 piston crown was increased in thickness to 0.082 inch. This thickness previously was 0.037 inch.
3. The cavity between the piston crown and the end of the bolt was filled with silver granules to aid in the heat transfer.

Additional specifications for setting up and running the endurance test engines were as follows:

1. Injector valves = Flat seat
2. Injector valve operating sequence = Inner valve opens first
3. Injector valve timing = Oxidizer: 1° BTC to 7° ATC; fuel: 1° BTC to 7° ATC
4. Expansion ratio = 20.5:1
5. Maximum BMEP = 200 psi

6. O/F ratio = 1.0 to 2.0
7. Exhaust pressure = 1.0 to 3.0 psia
8. Oil pressure = Cam shaft, 70 psi maximum; crankshaft, 5 psi maximum
9. Coolant temperature
 - In = 150°F maximum
 - Out = 190°F maximum
10. Coolant flow rate = 1.2 gallons/minute
11. Exhaust ports = 1/4-inch diameter, 8 holes, bottom of ports coincide with top of piston when latter is at lowest portion of stroke
12. Piston = Mod I with 440-C stainless steel piston rings
13. Cam contour
 - SPU-3A - Flank eccentricity = 0.187 inch, lift = 0.050 inch
 - SPU-3B - Flank eccentricity = 0.250 inch, lift = 0.050 inch

C. 90-Hour Endurance Test

The SPU-3A engine was setup as previously described and an endurance test was conducted in a nonstop run of 90.4 hours. The test was terminated because of a sudden increase in oil consumption.

1. Engine Break-in Run

After startup, the engine was subjected to a break-in run at low power. This procedure is necessary primarily to condition the piston rings to the bore. The 440-C stainless material is marginally compatible, as a bearing material, with the chrome plated 17-7 stainless steel cylinder. To alleviate the tendency toward galling, a graphite mixture metal plating process applied by the "Microseal" Corporation was used. The benefits of this process are not conclusive but indications are that it aided in the general running-in operation.

During the initial start-up and through the first hour of running, erratic operation was noticed and it was theorized that some galling of the piston rings was occurring. As running progressed, the nonsteady engine operation diminished and became steady after 5 to 6 hours of engine operation.

2. Power Traverses

At 50-minute intervals, the power was increased from 2.4 HP at 2,800 rpm to 3.2 HP at 3,200 rpm. This was accomplished by increasing only the oxidizer injection pressure from 1450 to 1850 psi. This changed the oxidizer-to-fuel ratio from 1.4 to 1.6. Return to the lower power after a 10-minute run at the higher power was made by simply reversing the procedure.

3. Heat Rejection

Analysis indicated that abnormal combustion or piston operation resulted in high heat transfer to the piston and thence to the coolant. This was verified by accumulation of data which indicated that heat rejection in excess of 6.25 HP (16,000 Btu/hr) at an engine output of 2.4 HP resulted in piston failure. Therefore, this parameter was closely monitored and compared with historical data. A plot of historical performance in this respect is presented in Figure 42.

D. Condition of Engine and Components after 90-hour Endurance Test

1. Injection System

The injection was checked with gaseous nitrogen to determine the operating condition of the system. A check made at 100 psi indicated that no leakage existed at the poppet seats of either propellant valve. However, a decay of 10 psi/minute at this test pressure prevailed in the oxidizer valve. This decay was found to be due to a faulty Teflon O-ring used for the upper high pressure seal between the injector valve body and the cylinder head. In the fuel valve, this sealing function is provided by a self-adjusting Omniseal. The O-ring had been used because of the unavailability of the required component at the time of assembly.

It was found that the system had retained the precise settings -- the start, dwell, cutoff, and synchronization being exactly as originally set. The injector orifices in both the injector valves and the cylinder head were in good condition and there was no evidence of erosion. The chrome plated valve stems and mating unplated surfaces were in equally good condition with no evidence of galling or wear from this endurance test. All seals -- pure Teflon and Teflon with stainless steel spring tensioning (Omniseal) -- had maintained perfect sealing with the exception of the O-ring mentioned above. The valve assemblies were photographically documented as they were removed and they are shown in Figures 9, 23, 24, and 25.

2. Piston

The most severe damage to the Modification 1 piston fitted with four rectangular 440-C stainless steel piston rings was a dishing of the Rene' 41 crown caused by combustion erosion. The silver granules inserted in the bottom of the piston bolt cavity in the crown had melted to form a solid mass, indicating that the operating temperature of this component was at least 1760°F. The microgroove seal between the crown and the piston body prevented any gas leakage. A large carbon deposit formed on the inside of the piston body adjacent to the piston crown. This is thought to have occurred during the last moments of the endurance test, partly due to the excessive oil accumulation (Figure 43) in the crankcase and also to the reduced heat transfer capability of the piston rings. The wrist pin bearings in the piston were in perfect condition and they still maintained the "push" fit originally provided. The dimensions of the piston skirt had not changed.

3. Piston Rings

The piston rings were fabricated from heat treated 440-C stainless steel. They were found to have deviated in the following respects from the installed conditions:

1. The wall contacting tension of the rings was lost. The free gap was reduced 0.050 to 0.095 inch from normal.
2. The hardness value of the rings was decreased from Rc57 to Rc53.
3. The radial thickness of the rings was decreased a maximum of 0.007 inch.
4. The vertical thickness of the rings was reduced 0.001 to 0.002 inch.

Only one piston ring was completely free in the piston groove. The second, third, and fourth rings were stuck approximately 50% of the circumference.

Galling was evident on the face of all piston rings.

4. Connecting Rod

The wristpin bearing formed directly in the aluminum (2024-T4) connecting rod had elongated downward by 0.015 inch. The remainder of the connecting rod was undamaged. The upper end encircling the wristpin had been in contact over its width with the heavy carbon formation in the piston. The resultant high heat transfer raised the temperature of both the lubricant and that portion of the connecting rod to cause reduction of the lubricant viscosity to support the load and plasticity of the aluminum with resultant loss of structural strength.

The small end bearing area provided in the connecting rod is equal to that in the piston.

A photograph of this connecting rod is shown in Figure 44.

5. Cylinder

The typical cylinder bore wear of increasing taper toward the top was nonexistent. However, deposits of metal from the galling piston rings and piston crown were distributed along the bore. The microgroove seal provided at the upper end of the cylinder to seal the combustion out of the water jacket was in perfect condition.

Due to the high consumption of lubricating oil, massive deposits of carbon had accumulated in the vicinity of the exhaust ports and manifold. Of the eight exhaust ports, two were completely clogged by the coke.

6. Crankshaft and Crankshaft Bearings

All bearings of the crankshaft assembly (connecting rod big-end, front and rear mains) were in perfect condition. A slight discoloration occurred due to oxidation because these bearings were of common ball bearing steel (SAE 52100) rather than the previously fitted stainless steel components.

The crankshaft had maintained alignment and the Curvic coupling showed no evidence of fretting. The bolt fastening the halves of the crankshaft had retained its assembled tension.

E. Engine Performance During 90-hour Endurance Test

1. Control

After break-in and steady state operation had been obtained, the engine would remain on the preset performance level of speed and power within + 1%. This condition persisted at both low and high power and with the exception of the adjustments made during the power transitions, the test was made with a "hands-off" type of control.

2. Oil Consumption

During normal engine operation, the engine consumed 1/5 quart of Brayco 443 SAE 30 oil per hour. The oil feed rate was set purposely higher than required to insure adequate lubrication. Had the oil supply pressure to the nose of the crankshaft been set at a normal pressure of 1/2 to 1 1/2 psi rather than 3 to 4 psi, the consumption would have been markedly reduced. The oil system was provided with a remote filling system from a 55-gallon barrel fitted with an electrical transfer pump. The circulation rate of the oil was not instrumented, however the temperatures of the oil entering and leaving the engine were recorded.

3. Specific Propellant Consumption

The specific propellant consumption (SPC) attained during this test was lower than previously recorded values. The average SPC obtained at a lower power level (corresponding to a BMEP of 170 psi) was 7.8 lb/HP-hr. At the high power settings (with a BMEP of 202 psi), the average SPC was 6.3 lb/HP-hr. SPC values of 6.0 lb/HP-hr and lower were recorded several times. The improvement in efficiency is attributed to the change in the operating sequence of the injector valves. The reversed sequence from previous tests could impart two differences in injection characteristics, namely, minimized dribble volume and improved impingement of propellant streams.

The improved efficiency was obtained although the expansion ratio was reduced from 26.5:1 to 20.5:1.

The sequence of the operation of the valves was changed because of hot gas erosion of the inner surface of the outer valve.

4. Instrumentation

The long duration engine test required rugged instrumentation and minimizing of those electronic components having a tendency to drift in calibration or otherwise fail electronically or physically. The linear force instrumentation of the dynamometer torque arm was changed from a strain gage type load cell to that of a precision spring scale, because the electronic component would drift in calibration in a few hours. Similarly, the remote readout of the oil tank gave erroneous indications and was replaced with a sight tube. Dynamic parametric recording included injection pressures, water flow rates, engine speed, and propellant pump actuation velocity.

The critical temperatures instrumented were oil in and out, water in and out, exhaust, and both propellants at the vicinity of the propellant pressurizing pumps.

VI. ENGINE TEST PROGRAM AND EXPERIMENTAL INVESTIGATIONS

A. Engine Test Program

1. Basic Requirements

The basic requirements of the Phase II Test Program were to progressively develop the space power unit engine design in terms of performance and durability. Additionally, reductions in lubrication flow rates and heat rejection to coolant were desired.

2. Test Program Philosophy

The basic test program philosophy was to upgrade and test the existing Phase I engine (SPU-2A-1) with the objective of increasing its performance potential and to establish the subsidiary system requirements. The information thus generated would then be applied to a new engine (SPU-3) having improved performance and reduced lubrication requirements. Additionally, a self-contained propellant injection pump was to be developed as an integral part of the SPU-3 engine system. This engine system would then be tested to establish the following performance parameters:

1. Specific propellant consumption
2. Total heat rejection
3. Power output
4. Thermal efficiency
5. Critical temperatures
6. Overload capability
7. Overspeed controllability
8. Life

Following the initiation of the program using the SPU-2A-1 engine, there was a major emphasis shift from performance to life or durability documentation. This change curtailed the broad based development testing and performance mapping and confined the SPU-3 program to one of increasing the life of each component with performance being of secondary importance. The target requirement was to demonstrate the ability to accumulate 200 hours of operation with each of two engines with long duration test periods.

Because of the emphasis shift to durability documentation with two engines, the development testing of the self-contained injection pump was postponed. The problems encountered with piston durability and the resulting intensive investigation and development of satisfactory components deferred testing of the pump beyond the time scope of this report. However, the pump fabrication was completed and the unit was ready for test if facilities had been available.

3. Summary of Test Results

During the test period, a total of 377.4 hours of running time was accumulated by the three test engine series as follows:

- SPU-2A-1 14.5 hours
- SPU-2A-2 5.7 hours
- SPU-3 357.2 hours

The accumulated running hours and related test periods are presented in Figure 45. The total accumulated hours of operation for each of the two SPU-3 engines (i.e., SPU-3-"A" and SPU-3-"B") are also shown. Following a 90.4 hour test run (147.1 total accumulated hours), testing of the "A" engine was discontinued.

Run summaries for each engine series are presented in Tables IV through VIII. These summaries contain the test number and date, test duration, nominal run conditions, and pertinent comments regarding each test. The run summaries for the SPU-3 series engine are divided into three sections. The latter sections (Tables VII and VIII) include a column for the engine configuration because rapid changes to the engine were made during this period of engine testing.

B. Experimental Investigations

1. Engine Performance

a. Power Output

Unlike a conventional airbreathing reciprocating engine for which breathing limitations and O/F ratio effects will sharply define the horsepower versus rpm characteristics, the hypergolic propellant SPU system will produce any power output at any given rotative speed within the structural limitations of the machine. As an example, during Test 5140-16 the SPU-2A-1 engine (effective displacement = 2.0 cu in.) was subjected to an uncontrolled overspeed condition as a result of partial oxidizer valve seizure while operating at a fuel rich O/F ratio. During this condition, the engine produced in

excess of 21 horsepower at 9600 rpm. The actual peak horsepower is unknown because the data recording galvanometers were driven completely off the chart paper prior to reaching peak rpm. Understandably, the rod bearing and piston assembly failed at this point. However, the fact that structural limitations are the major constraint on the maximum power output of this engine was unquestionably documented.

Figure 46 is a plot of horsepower versus rpm at various BMEP levels. These power levels can be achieved at any oxidizer-to-fuel ratio (O/F) between approximately 0.9 and 2.2. Although these power levels can be achieved across a broad range of O/F ratios, the most efficient O/F ratio in relation to specific propellant consumption (SPC) approaches optimum conditions at an O/F ratio between approximately 1.7 and 1.8.

b. Specific Propellant Consumption

In terms of specific propellant consumption (SPC), the performance of the SPU series of engines has steadily been improved. A baseline SPC was established as a function of brake mean effective pressure (BMEP) with the SPU-2A-1 engine in October 1964 (Test 5140-16). Any changes to the engine and their resulting effect upon this major parameter were compared and evaluated against this baseline. The basic SPC versus BMEP curve is shown in Figure 47. At the time this baseline curve was established, the effects of various O/F ratios and engine speeds did not seem to affect the basic engine SPC performance. Changes in injector valve dwell and timing also did not seem to affect SPC greatly. During this period of the test program, the injector valves were sequenced to operate as follows: The outer valve closed first (controlling injection cutoff) and the inner valve controlled the start of injection. When this sequence was reversed, a significant improvement in SPC versus BMEP was realized. Data from SPU-3 engine operation with the reversed valve sequencing are also shown in Figure 47. It can be noted that an approximate 25 to 30% reduction in SPC in the BMEP range from 100 to 200 psi was achieved.

The injector valve system had been operated in the outer valve opening first mode because of the higher gain characteristic with this sequencing. Test experience indicated that the difference in gain characteristics between the two modes of valve actuation was not of major significance. However, improvements in specific propellant consumption (SPC) and injector valve life could probably be achieved by reversing the valve sequence (i.e., end propellant injection by closing the inner valve first). The concept of improved SPC was based upon the fact that, if the outer valve closed first thus ending the injection period, a "dribble volume" of propellant would remain in the inner injector valve cavity. This propellant volume would then not enter into the combustion process in a normal manner but would be consumed

without performing a useful function. This theory was verified through testing as an approximately 25 to 30% reduction in specific propellant consumption in the brake mean effective pressure (BMEP) range from 100 to 200 psi was achieved as noted above without other changes. Specific propellant consumption of 5 lb/HP-hr at brake mean effective pressures below 300 psi appear to be reasonably achievable with the SPU-3 engine without changes to the present combustion chamber configuration.

In addition to the reduction in SPC, the change in valve sequencing allowed a clearer definition of O/F effects on SPC. Apparently the "dribble" volume was shrouding the actual O/F effects. Figure 48 is a plot of O/F ratio versus SPC for two basic power levels--2.4 HP and 3.2 HP. This plot shows that the best SPC were obtained in the O/F range between 1.7 and 1.8. Additional discussion of the effects of rpm, horsepower, and expansion ratio on SPC are covered in Section VIII, Analysis of Test Data, below.

c. Exhaust Pressure Sensitivity

The SPU series of engines has shown a sensitivity to exhaust back pressure changes. Figure 49 is a plot of the effect of an exhaust pressure traverse on six engine parameters: O/F, exhaust temperature, SPC, BMEP, HP, and rpm. These data were obtained by setting a power condition at an exhaust pressure of 11 psia and then slowly traversing the exhaust pressure to 3.0 psia without alteration of the engine settings (i.e., injection pressure and dynamometer load). The reaction of the engine to exhaust pressure changes was anticipated and is a result of changing recompression pressures within the cylinder. At high exhaust back pressures, the engine does not expell the exhaust products completely and a relatively large volume of residual products of combustion remain in the cylinder and are subjected to recompression. This condition is normal with the hypergolic propellant engine because there is no cylinder charging period to drive out the exhaust products as in a conventional two-cycle airbreathing engine. Although not shown in the exhaust pressure sensitivity plot, the parameters presented continue to change at a decreasing rate until an exhaust pressure of approximately 1.0 psia is reached. Pressures below this value do not seem to affect engine performance. The lowest exhaust pressure tested to date was 0.4 psia. No significant differences in performance were noted for exhaust pressures between 1.0 psia and 0.4 psia. The power levels of the engine can be maintained at any exhaust pressure by adjusting propellant injection pressures for flow rate and O/F ratio.

d. Injection Timing Effects

Table IX is a summary of the 21 different injector timing conditions which were evaluated during the test program. The start of injection ranged from 5° before top center (BTC) to 10° after top center (ATC) and the dwell periods varied from 3° to 10°. Numerous oxidizer lead conditions and one fuel lead condition were evaluated to determine if either propellant lead could suppress the initial reaction rate of the propellants to achieve a slower combustion chamber pressure rise rate.

It was determined from these tests that the reaction rate of the propellants would not allow injection timing earlier than 3° BTC and that propellant leads were ineffectual in diminishing combustion chamber pressure rise rates, except with late injection timing. It was also determined that late injection timing would cause extensive combustion chamber erosion.

Two views of the SPU-3 combustion chamber following 8 hours of operation with late timing are shown in Figures 50 and 51. Injection timing No. 18 (listed in Table IX) was used for this test. The combination of late injection and a fuel lead of 2.5° proved to be a highly detrimental condition for the combustion chamber even though combustion pressures and rise rates appeared to be less severe than with advanced timing. Several late timing conditions were evaluated and prolonged operation (i.e., longer than two hours) resulted in combustion chamber erosion in all cases. Therefore, further testing with late timing was discontinued.

The injection dwell periods were varied from a minimum of 3° to a maximum of 10°. As would be expected, the major effect was to vary the injection pressure requirements for a given engine power condition. Injector dwell periods less than 5° required injection pressures in excess of a nominal desired maximum of 3000 psi to achieve 3.5 HP. Injection dwells of greater than 8° allowed injection pressures approximating the chamber pressure at low power condition. This latter situation had shown a detrimental effect on injector valve life and had given indications of causing combustion chamber erosion.

Therefore, the optimum injection timing for the SPU-3 configuration engine appears to be simultaneous injection starting 1° BTC and having a dwell period of 8°.

2. Lubrication Requirements

The lubrication requirements for the SPU series engines were continually reduced during the Phase II program. The SPU-3 engine was equipped with ball main and roller connecting rod antifriction bearings to minimize lubrication requirements. Prior to operating the SPU-3 engine, a calibration of oil flow to the crankcase area was determined. The flow rates were established as a function of pressure for two temperature conditions. Also a cross check was made between static and dynamic conditions of the crankshaft to determine the flow rate differences, if any. During the dynamic tests, the piston and cylinder assemblies were fitted to the crankcase and the lubrication requirements were established as a function of oil pressure for the components. Visual checks while operating and post run component inspections indicated that an inlet oil pressure to the case of 0.5 psig with the case at ambient pressure was more than adequate to achieve proper lubrication.

The results of the oil flow calibration are shown in Figure 52. The oil flow rate into the crankcase area is controlled by two main factors-- the differential pressure between the crankcase pressure and inlet supply pressure and the connecting rod side clearance to the crankshaft counterweight cheeks. The normal rod clearance is set at 0.015 inch nominal and clearances significantly differing from this value can affect the flow calibration shown in Figure 52. Another factor can affect the oil flow rates if wear occurs and that is the fit between the connecting rod and the wrist pin bearing. The wrist pin is supplied with oil from the connecting rod via a rifle-drilled passage in the rod from the main bearing to the wrist pin bearing. The pin is normally fitted with a tight push fit.

Engine operation at various power levels from 0.5 to 4 HP has been demonstrated with oil inlet pressures of 0.5 psig which corresponds to a flow rate of less than 0.0075 gpm when the oil is at 130°F. Since the present lubrication system removes the excess oil from the crankcase with a scavenge pump, a greatly lower oil addition rate could be used if the removal system were deleted. This concept assumes a fixed quantity of lubricant in the crankcase and a replenishment system based upon the actual utilization rate of the engine. The present configuration of the SPU-3 engine uses lubricant at a rate of 0.2 quart per hour at an oil inlet pressure of 5 psig. The oil consumption rate is basically a function of the clearance between the piston skirt and the cylinder bore because no oil control rings are presently employed.

Excessive oil consumption rates of 1 gallon per hour or more were experienced during the test program. Analysis of the cause of the high consumption rates showed an overly dense oil mist within the engine which forced oil out the exhaust ports. This dense mist was caused by the churning action of the crankshaft assembly and the lack of sufficient sump area in the crankcase. Because the crankshaft fitted the internal case with minimum clearance, the oil could not properly drain into the pickup port of the scavenge pump. A section of the lower half of the crankcase was enlarged thus providing an area for the oil to accumulate. This modification reduced the oil mist density in the crankcase by allowing the scavenge pump system to extract lubricant at the same rate as it was supplied to the engine. This modification reduced the oil consumption rate to 0.2 gallon per hour or less. This value is equivalent to a 16 to 1 propellant-to-lubricant ratio at 3.2 HP and a SPC value of 6.0 lb/HP-hr.

3. Special Engine Assembly Techniques

During the Phase II program, several rather unique assembly methods had to be developed to achieve reliable operation of the engine or to accommodate design innovations. Several of the more important of these techniques are discussed below.

a. Injector Valve Assembly

The sealing technique used for the injector valve stems was through the use of a number of small Teflon rings spaced equidistantly along the inner and outer valve outside diameters. Eight rings were used on the inner valve and 5 rings were used on the outer valve. The installation of these small Teflon rings posed a rather delicate problem because of their very small size. Three simple tools were required to assemble the rings on each valve, namely,

1. A tapered, highly polished mandrel
2. A section of 0.001 CRES shim stock
3. A ring compressor

The tapered mandrel was machined to the same OD of the respective injector valve and then tapered on one end and polished all over. The shim stock was cut so that the ends would butt together when wrapped around the valve stem. These two tools were used as follows. The Teflon rings were slipped on the mandrel and expanded. The shim stock was wrapped around the small end of the tapered mandrel and the ring was transferred onto the rolled up shim stock. The mandrel was inserted into the shim stock tube, opening it up to valve diameter. The mandrel was withdrawn and the injector valve was inserted. The shim stock was slipped over the valve until the end lined up with the desired ring groove. The ring was slipped off the shim stock tube into the groove. The shim stock was wrapped around the ring and the ring was gently rolled into the groove. This procedure was repeated for each ring. After all of the rings were located in their respective grooves, the valves were heated to approximately 200°F and allowed to cool to room temperature. The thermal cycle helped return the Teflon rings to their original size. The valves were then inserted into the ring compressor. This tool was a steel rod with a hole slightly larger than the respective valve diameter. The end of the hole was flared and highly polished. Inserting the valve in this tool compressed the Teflon rings into their grooves sufficiently to allow assembly of the three valve components without breaking the rings. After assembly of the three valve components, they were allowed to set for a period of several hours to seat the rings completely. At this point, the valves were slipped apart and they were sonic cleaned for the final time.

When the valve housings were installed in the cylinder head, the torque value of 200 to 225 in.-lb was used. This value assured proper seating of the housing without overstressing the fingers of the holddown ring nut. When the valves were installed, they were coated with DuPont PR143AC fluid on the stem flanks for lubrication.

b. Piston Assembly

The assembly of the piston was unusual in two respects--its two-piece construction and the method of assisting the cooling of the crown. In order to assure positive sealing of the Rene' 41 crown at the interface to the D-132 aluminum skirt, the two components were lapped together. Because the crown contact to the skirt was through a series of microgrooves, the lapping had to be constrained to assure positive contact of each microgroove peak. If more than the peaks of the microgrooves contacted the skirt the carefully calculated heat transfer rate would be upset and would allow this section of the piston skirt to operate at a higher temperature than that desired.

Following the lapping operation and cleaning, the crown was attached to the skirt with a special bolt. The bolt was torqued to approximately 50 in.-lbs and safetied in position with a tab type locking plate. When this operation was complete the space left by the clearance between the bolt end and the bottom of the threaded hole in the crown and the hole through the bolt caused by the internal wrenching provision was filled with pure silver powder. The powder was packed in place in much the same manner that a dentist would fill a tooth. The end of the internal wrenching hole in the bolt was capped by pressing in a short length of aluminum round stock. This procedure was developed to reduce the operating temperature of the crown in the area directly facing the propellant injectors.

The piston rings were fitted to the ring grooves in the normal manner and lap fitted to the cylinder bore. A special lapping fixture was used for piston ring lapping to preclude inclusion of abrasive material in the chrome plating of the cylinder bore. The rings were checked for end gap and polished on the running face. The polishing reduced the galling tendency of the 440-C CRES rings and the lapping assured their roundness and light tight fit to the bore. When these operations were complete the components were "Micro Sealed" to further reduce their initial galling tendencies during the break-in period.

VII. TEST FACILITIES

A. General Description

The facilities originally built for the Phase I testing of the SPU engine were used for the Phase II effort. However, the facilities were continuously modified to upgrade the durability, performance, and accuracy as well as to simplify operation and test item installation.

The major components of the test facility are:

1. The test stand with all necessary mounts for mechanical, electrical, and instrumentation components
2. An engine starting mechanism and power supply
3. An engine power absorption unit
4. A fully controllable engine cooling system
5. A fully controllable oil supply and scavenging system
6. An exhaust ejector altitude simulation system
7. A large volume propellant storage and supply system

Figure 53 is an overall view of the test facility with the SPU-3 engine installed. A closer view of the engine installation and the power absorption system is shown in Figure 54.

B. Propellant Supply System

The propellant supply system is divided into two major subsystems. These subsystems are defined as the test pad propellant system and the facility fuel and oxidizer storage systems. These systems are shown schematically in Figures 55, 56, and 57. The facility fuel and oxidizer systems feature large volume storage (i.e., 2000 lbs N_2O_4) and a transfer system to the test pad accumulator tanks. This volume is sufficient to allow continuous maximum power engine operation, unrefueled, for periods in excess of 100 hours. The test pad accumulators can sustain operation for a period of approximately 2 hours, a time span sufficient to refuel the facility storage system.

The storage propellant system will deliver propellant to the test pad at pressures up to 250 psi. At this point, there is an option to either boost the propellants to any pressure desired up to 6000 psi with the Haskel pumps or to deliver the propellant directly to the engine driven injection pump (if so equipped). Propellant dump and GN_2 purge systems are also provided to clear the facility propellant lines.

The propellant flow measuring system used to date has been a Marquardt-fabricated system utilizing the fixed displacement per stroke of the Haskel pumps as the data source. The movement of the pump plunger is sensed by a linear potentiometer and recorded. This signal is also conditioned by a differentiating circuit and presented in visual form to the test operator for O/F ratio regulation. This system has proven successful. However, it is limited to steady state engine operation and it is discontinuous because of pump cycling. This system has been augmented with a continuous reading system using Cox No. 6-000 flowmeters. However, the Cox flowmeter system has proven inaccurate because of the pulsing propellant flows. In addition to pressurizing the propellants and measuring the flow rates, the test pad propellant system includes a filtration system capable of filtering the propellants to 1.5 microns absolute. The facility provides an automatic propellant shutoff safety system as indicated in Figure 58.

The exhaust products ejector is a two-stage steam system. It is capable of continuous operation from 12 to 0.5 psia when the SPU-3 test engine is operating at maximum power and rpm. A warning system is provided for low steam pressure conditions.

C. Cooling System

A schematic of the cooling system is presented in Figure 59. This system can be manually controlled to regulate the inlet coolant temperature to any temperature between ambient temperature and 200°F. In addition to temperature regulation, the flow rate of coolant is also adjustable over a broad flow range. The cooling system is actuated during engine startup and it will maintain conditions of flow in the range from 0.1 to 5.0 gpm and inlet temperatures in the range from ambient temperature to 200°F for water. An automatic overtemperature control system is provided. This system will actuate if the exit temperature exceeds a preset value (normally 170°F) and will give an audible and visual warning. Heat influx to the coolant is accurately determined by the flow and temperature instrumentation.

D. Oil System

The oil system is composed of a tank complete with temperature control, a high pressure pump, dual low pressure high volume scavenge pumps, 2-micron filters, a visual oil quantity gage, and the necessary plumbing and control components. All pumps are driven by air motors for ease of control and safety considerations. This oil system is shown schematically in Figure 60. The system is compatible with petroleum and synthetic lubricants. A low oil pressure safety system is provided to give audible and visual warning in the event that a preset pressure condition is not maintained within a tolerance of ± 5 psi.

E. Power Absorption System

The major elements of the power absorption system are a starting system, a torque absorption unit, a top center indicator, a crankshaft position indicator, and a visual and audible safety system. A schematic of this system is shown in Figure 58. The starting system is composed of an air motor and an engagement clutch which transmits rotation via an overrunning clutch to the engine. These components are shown in Figure 61. A water dynamometer provides accurately controllable absorption of power and speed of up to 15 HP and 10,000 rpm, respectively. Prior to initiating engine tests of prolonged duration, the dynamometer (shown in Figure 62) was redesigned to improve its durability and reliability. The redesigned unit is shown in Figures 63 and 64. Problems of cracking and failure of the impeller shaft bearing journal had been experienced with the standard mounting bracket and cantilever mounting method. Therefore, the dynamometer unit was redesigned for a straddle mount. This basic change, in conjunction with short coupling the dynamometer unit to the engine, eliminated all previously experienced shortcomings.

The crankshaft position indicator is a rotary potentiometer capable of being driven at high rotative speeds. This device, if used, is attached to the crankshaft of the test engine and, when used in conjunction with the cylinder pressure transducer, a top center indicator, and an oscilloscope, will produce an indexed, continuous pressure versus crankshaft position diagram. These data are recorded photographically for later reduction into a pressure volume plot.

The engine safety system has two warning circuits, both visual and audible, for low oil pressure and high exit water temperature. These systems are passive and require manual correction. In addition to these passive warning systems, an active engine overspeed circuit is provided. This unit will automatically shut off the propellant supply and relieve the injection pump line pressures if actuated. The unit is normally set for 5000 rpm, but it is capable of being set for any limit speed desired within the expected operating range of the engine. All safety system electrical circuits are "fail safe."

F. Instrumentation

The instrumentation provided to document engine performance is listed in Table X. The instrumentation list is divided into visual and recorded sections. The visual instrumentation operates continuously during engine operation to allow precise setting of engine run conditions and manual recording of performance parameters. The recorded data system normally operates intermittently using the random sampling technique when a prolonged test condition is specified; otherwise it operates continuously.

The locations of each transducer, etc., necessary to produce the required data are shown on the various system schematics, Figures 55 through 59. A major change was made in the method of recording the dynamometer force for the duration tests. The previously used load cells could not be relied upon either structurally or accuracy-wise if run durations exceeded one hour. Therefore, a Chatillon dynamometer scale was installed. This unit proved to be very accurate and reliable.

G. Component Test Capability

In addition to support, control, and documentation of full scale engine operation, the test facility has the capability of testing engine components and subsystems. The basic facility is augmented with additional mounts and drive systems for dynamic development testing of the injector valves, piston rings, and bearings. The cylinder head assembly of the engine or crankcase/cylinder assembly can be mounted on the test pad and supplied with propellants from the facility propellant system or with lubricating oil and can be driven at speeds up to 4500 rpm with a remotely actuated, air drive motor system. The drive system is equipped with a torque limiter to preclude extensive damage to the test item in the event of a component malfunction.

H. Facility Performance

The performance of the facility throughout the Phase II test program was generally satisfactory. It must be stressed that the original design of the test facility was based upon engine feasibility and development test requirements and not upon long duration considerations. When continuous facility operation in terms of weeks became a requirement, serious shortcomings were anticipated with oxidizer propellant pumps and dynamic instrumentation. Therefore, wherever possible, high response, recorded, electronic instrumentation was replaced with conventional direct reading, Bourdon tube type gages, sight gages, or other similar type units. These changes, in conjunction with careful component maintenance and pre-run preparation, permitted continuous facility operation periods in excess of 90 hours.

The anticipated problems with the oxidizer propellant pumps did materialize and pump leakage caused unscheduled engine shutdown, on two occasions. This particular problem (oxidizer pump seal leakage) was aggravated by cold weather operation. Ambient temperatures below 45°F tend to accelerate wear of dynamic Teflon seals in N_2O_4 service. Since all of the long duration engine tests were performed in January (during which temperatures of 20°F were recorded), operation of the oxidizer pump in excess of 90 continuous hours can only be considered excellent. This problem will be eliminated when the requirement for facility supplied high pressure propellants is deleted.

VIII. ANALYSES OF TEST DATA

A. Background

In order to understand more fully the physical phenomena occurring in operation of this two-stroke cycle reciprocating engine, to make more judicious use of test operating time, and to assist in obtaining solutions in the most economical manner, the various aspects of this program were analyzed. These analyses were divided into major sections as follows:

1. Thermodynamic Considerations. - The heat rejection was studied from test data, the combustion efficiencies were calculated, and indicator diagrams were analyzed.
2. Piston Heat Transfer Analyses. - Heat transfer analyses were accomplished jointly by Marquardt and by the Manned Spacecraft Center in order to define the heat transfer conditions of the piston.
3. System Definition. This work was carried out in order to define the next step in making a breadboard system. Also, initial consideration was given to the prototype system.
4. Engine Operation. - As a result of the above and past experience in developing power plants, a brief appraisal of the end item of the development program was made. An acceptance test and operation procedures, on an initial planning basis, have been set forth.

These analyses are described more fully in the following sections.

B. Thermodynamic Cycle Analyses

The SPU-3 test data were analyzed to determine trends in BSFC and heat rejection and combustion efficiency as influenced by the engine variables: BMEP, rpm, HP, and O/F ratio.

Test data from Test Runs 5151-2 through 5151-44 were evaluated at the following conditions:

rpm 2600, 3500, 4100, 5000
BMEP 78 to 240 psi
HP 1.1 to 4.2
O/F 1.4 to 2.4

One typical indicator diagram was analyzed and unusual combustion phenomena were observed which partially explain the high heat rejection and BSFC values which were measured. The operating conditions were as follows:

HP 1.857
BMEP 105.4 psi
rpm 4320
BSFC 10.06
Q/HP 2.9
O/F 1.753

Generalized performance charts depicting the estimated BSFC and Q/HP in terms of BMEP, HP, and rpm were prepared.

1. Heat Rejection

Figure 65 shows that specific heat rejection (Q/HP) decreases as engine output power increases. The ordinate of this curve could be interpreted as specific power (HP/cu in.), and as such would imply that an engine should operate at very high specific power to minimize heat rejection. The high specific power should be attained by operating the engine at very high BMEP and slow speed.

Figure 66 demonstrates the rapid decrease of Q/HP as BMEP increases. The influence of rpm is erratic but it seems to favor operation at slow or high speeds; medium speeds (3000 to 3500 rpm) correspond to operation in the highest heat rejection regime.

The conclusions drawn from studying the curves of Q/HP and BSFC show quite similar trends. Both Q/HP and BSFC are reduced markedly as BMEP increases. Q/HP and BSFC are relatively insensitive to rpm, but high speed operation is generally preferable.

Figure 67 presents the estimated heat rejection of SPU-3 type engines at the current technology level. This plot is based on data from Figures 65 and 66 with minor fairing of the curves to permit illustration of more rational trends.

2. Combustion Efficiency

The combustion efficiencies were calculated by comparing the summation of shaft power, heat rejection, and exhaust energy with the theoretical heat release of the measured propellant flow at the measured O/F ratio. It must be emphasized that this combustion efficiency pertains to the amount of propellant burned, and does not relate to the time in the cycle when combustion occurs. In the section on indicator diagram analysis (below), further insight on the combustion phenomena is presented.

Figure 68 presents a compilation of combustion efficiency data derived from the SPU-3 test program. Combustion efficiency increases as BMEP and power are increased. The relation of combustion efficiency and speed is more complex.

Combustion efficiency appears to be influenced in two ways by rotative speed. At high speeds, turbulence is more pronounced and combustion is better, but the higher speed operation also reduces the time for combustion to occur in cylinder. Figure 68 shows that the best combustion efficiency occurs at approximately 3500 rpm. Somewhat lower efficiency is indicated at both higher and lower speeds.

Referring to Figure 69, it is shown that the best thermal efficiency (i.e., lowest BSFC) is not attained at 3500 rpm where combustion efficiency is maximized, but rather at higher speeds.

Figure 70 schematically illustrates the apparent influence of engine speed on combustion efficiency. P-V and T-V diagrams are illustrated, and the general trends in BMEP, BSFC, Q/HP , and η_c are noted, assuming equal propellant injection per stroke.

The effect of O/F ratio on combustion efficiency was studied and the results are shown in Figure 71. It is difficult to establish any consistent trends from the available data. The influence of speed is fairly pronounced in this plot, but the combustion efficiency appears to be very insensitive to O/F ratios between 1.4 and 2.4.

Closely allied with the combustion efficiency is the exhaust temperature. Generally speaking, exhaust temperature increases with BMEP and HP and is maximum at moderate (3500 rpm) speeds. Figure 72 illustrates these trends. The trends in exhaust temperature and combustion efficiency are similar.

3. Propellant Consumption

Figure 73 illustrates the effect of power on specific propellant consumption. As HP increases, BSFC decreases when rpm is maintained. Since BSFC increases with rpm at constant power, it is apparent that BSFC decreases very rapidly with increasing BMEP.

Figure 69 illustrates the previous point. BSFC is seen to decrease rapidly with BMEP, and to decrease slightly with rpm.

To minimize propellant consumption, the test engine should be operated at the highest allowable BMEP and the highest rpm.

Figure 74 is based on data from Figures 73 and 69 with some fairing done to eliminate obvious discrepancies in the trends. This plot shows the estimated performance of SPU-3 type engines at the current level of technology.

4. Indicator Diagram Analysis

Figure 75 illustrates the combustion and expansion process during a typical test point. The salient engine operating parameters for this run were as follows:

HP	1.857
BMEP	105.4
rpm	4320
BSFC	10.06
Q/HP	2.9
η_c	0.66
T_{ex}	1230°F
O/F	1.753

Propellant injection occurred at 10° ATDC for a duration of 5° of crank angle.

Study of the combustion process trace shown in Figure 75 reveals that combustion began promptly after the propellants were injected. The peak combustion pressure occurred at 25° ATDC. Expansion approximately obeying the relation $PV^{0.8} = \text{Constant}$ followed until 55° ATDC. From 55° ATDC to blowdown at 108° ATDC, the expansion process was described approximately by $PV^{1.3} = \text{Constant}$.

When the polytropic expansion factor (n) is lower than the specific heat ratio (γ) during an expansion process, heat addition is indicated. If n is greater than γ , either heat loss or gas leakage is occurring.

In the expansion between 25° and 55° ATDC, there was considerable indication of late burning, since $n = 0.8$ and $\gamma = 1.22$ at the measured O/F ratio.

In the expansion between 55° and 108° ATDC, there was a net loss of heat from the cylinder. Either combustion was complete and some minor heat loss was occurring or late combustion was accompanied by large heat losses. The large value of Q/HP makes the latter assumption more realistic.

The thermal balance of the engine revealed that only 66% of the theoretically available propellant energy release was accounted for, which is tantamount to 66% of the propellant burning. The calculations further revealed that if 66% of the propellant burned immediately after injection when the total clearance volume is 0.2 cu in., the peak pressure of about 1160 psi would be obtained. However, the high heat rejection measured would require a slope of the expansion curve to satisfy the condition $n > \gamma$. The indicator card plainly shows $n < \gamma$ during the early part of the expansion stroke, which suggests late burning. If late burning occurred, the initial combustion would not produce the indicated pressure of 1160 psi, since less propellant would be burned initially. Thus, the conclusion must be drawn that a lesser amount of propellant was burned in the precombustion chamber initially, and late burning continued until 55° ATDC.

It is estimated that only 27% of the total propellant injected was burning initially in the precombustion chamber to produce the peak pressure spike. The remainder of the propellant was apparently blown out of the precombustion chamber and an additional 39% of the total propellant burned during expansion. A high Q/HP is predictable when late combustion of this magnitude is in evidence. The combustion efficiency and late combustion also account for the high BSFC.

5. Application Data Analysis

A direct application of the analytical work of this program was in determining the best operating conditions and monitoring parameters for the engines in the endurance tests. In studying historical data, certain observations were made as discussed below:

1. Longevity was associated with low heat rejection as shown in Figure 76.
2. High heat rejection was shown to peak about 3400 rpm as shown in Figure 42.
3. Figure 77 shows that for a given rpm the higher crown temperature and the average temperature of the crown of the piston is directly proportional to the rejected heat. With these data at hand, a plot was made of heat rejection versus coolant flow in gallons per minute and was used in the test cell to determine running conditions of the engine. Figure 78 shows the plot that was used for the 90-hour run.

Accordingly, it is firmly believed that the use of analyses and historical data was instrumental in the successful completion of 90 hours of running during the endurance test. The plot of feasibility accomplishment (Figure 79 -- demonstrated life versus years of the program) shows the prominent part played by this analytical work.

C. Piston Heat Transfer Analyses

To aid in the direction of the piston development work to be done in Phase II, analytical effort was expended to define the heat transfer at the piston. Two separate approaches were made toward this definition and the amount of heat transferred from the piston. The first approach was to assume a heat balance based upon experimental data and to work backward through conductances and film coefficients to determine the temperatures of the various components and position on the piston. The second approach was to define the heat transfer functions and the conditions at various boundaries on the piston and compute the temperatures at the boundary intersections. In this latter approach, the total heat transferred was the function of the film conductance and boundary layer conditions. A brief description of these two separate programs follows.

1. Heat Rejection and Expansion Ratio

This section presents the salient results, conclusions, and recommendations drawn from an analysis conducted to evaluate the piston heat transfer in the hypergolic SFU engine. The specific analyses conducted were as follows:

1. Estimate of engine heat balance
2. Estimate of piston, rings, and cylinder temperatures during operation at an expansion ratio of 25:1
3. Estimate of the effect of varying expansion ratio on piston and ring temperatures
4. Estimate of the effect of varying expansion ratio on BSFC for constant power and speed

A discussion of these analyses and examples of sample calculations are set forth below.

a. Engine Heat Rejection

The following tabulation presents a reasonable estimate of the heat rejection distribution in a typical 2 HP engine.

	Btu/hr
Piston heating during expansion	2545
Cylinder heating by gas impingement	2545
Friction	710
Piston heating during blowdown	509
Heat soak from exhaust manifold	509
Cylinder head	<u>3362</u>
Total	10180

These data are based on data from previous NASA piston engine development, Marquardt test data, and data from numerous engine text books and technical publications.

b. Estimate of Piston, Rings, and Cylinder Temperatures During Stabilized Operation at 25:1 Expansion Ratio

The results of these analyses are tabulated below. The calculations assumed the results listed in the previous tabulation and assumed a coolant temperature of 180°F. Film coefficients were determined by semi-empirical methods.

Location	Temperature
Piston crown (Rene' 41)	868°F
Aluminum below top ring	463°F
Aluminum at lower ring groove	453°F
Piston ring (Average at oil surface)	308°F
Cylinder wall (Hot side)	270°F
Cylinder wall (Cold side) = Coolant	180°F

Calculations of these temperatures are shown below.

(1) Fluid:

Oil film heat transfer coefficient

(2) Assumptions:

Flow in oil film will be laminar

Oil film thickness (x) $\approx 2.5 \times 10^{-4}$ in.

Oil conductivity (k) = 0.1 Btu/hr °F ft

and $Nu = \frac{h D_h}{k} = \text{Constant} = 4$ for very low Re values

Order of magnitude of $h_{ring} \approx \frac{4k}{D_h}$

and $D_h = 2$ (Film thickness)

Therefore, $h_{ring} \approx \frac{2k}{x}$

Since this film coefficient occurs on both the ring and cylinder surfaces, the overall heat transfer coefficient (U_r) is

$$U_r = \frac{1}{\frac{1}{h_{ring}} + \frac{1}{h_{cyl}}}$$

and since the two film coefficients are nearly equal

$$\begin{aligned} U_r &= \frac{1}{\frac{1}{h_{ring}} + \frac{1}{h_{ring}}} = \frac{h_{ring}}{2} \\ &= \frac{1}{2} \left(2 \frac{k}{x} \right) = \frac{k}{x} \\ &= \frac{0.1 \times 12}{2.5 \times 10^{-4}} = 4800 \text{ Btu/hr } ^\circ\text{F ft}^2 \end{aligned}$$

(3) Heat Transfer Through Piston Skirt Gap

$$A_s = \pi D \ell = \pi (1.375)(1.8) = 7.8 \text{ sq in.}$$

$$\text{Average radial clearance (cold)} = 0.003 \text{ in.}$$

Differential expansion of piston

$$\Delta_p = C_e r_p \Delta T = 10^{-5} (0.6875)(300) = 0.00206 \text{ in.}$$

Differential expansion of cylinder

$$\Delta_c = C_e r_c \Delta T = 6 \times 10^{-6} (0.688)(170) = 0.0007 \text{ in.}$$

Net clearance change

$$\delta = \Delta_p - \Delta_c = 0.00206 - 0.0007 = 0.00136 \text{ in.}$$

$$\text{Average radial clearance (hot)} = 0.003 - 0.00136 = 0.00164 \text{ in.}$$

Say 0.002 in. or 0.0001665 in.

Approximate heat flux

$$\begin{aligned} Q &= \frac{\left(\frac{k}{x}\right)_{\text{gas}}}{\text{film}} A_s (T_p - T_{\text{cyl}}) \\ &= \frac{2 \times 10^{-2}}{1.665 \times 10^{-4}} \frac{7.8}{144} (400^{130} - 270) \\ &= 845 \text{ Btu/hr or } 1/3 \text{ of total} \end{aligned}$$

Use

$$U_s = \frac{k}{x} = \frac{0.02 (12)}{0.002} = 120 \frac{\text{Btu}}{\text{hr } ^\circ\text{F}} \text{ ft}^2$$

so

$$Q_{\text{skirt}} = U_s A_p (T_p - T_{\text{cyl}})$$

Where

T_p = Piston temperature (local)

A_p = Piston area

T_{cyl} = Local cylinder temperature

Q_{skirt} = Incremental heat flux, Btu/hr

x = Gas film thickness

(4) Temperature Gradient in Piston Ring with Skirt Heat Transfer

$$Q_{\text{Tot}} = \text{Ring heat transfer} + \text{Skirt heat transfer}$$

$$= Q_r + Q_s$$

$$Q_{\text{Tot}} = U_r A_r (T_r - T_w) + U_s A_s (T_p - T_w)$$

$$Q_r = \left(\frac{k}{x}\right)_{\text{ring}} \bar{A} (T_p - T_r)$$

Where \bar{A} is the total average cross-sectional area of the piston rings

$$Q_{\text{Tot}} = \frac{A_r (T_p - T_w)}{\frac{1}{U_r} + \frac{x}{k} \frac{A_r}{\bar{A}}} + U_s A_s (T_p - T_w)$$

$$Q_{\text{Tot}} = (T_p - T_w) \left[\frac{A_r}{\frac{1}{U_r} + \frac{x}{k} \frac{A_r}{\bar{A}}} + U_s A_s \right]$$

$$T_p - T_w = \frac{Q_{Tot}}{\left[\frac{A_r}{\frac{1}{U_r} + \frac{x}{k} + \frac{\hat{A}}{A_r}} + U_s A_s \right]} = \frac{2545 (144)}{\left[\frac{\pi (1.38)(0.125)(2)}{4800} + \frac{0.005}{26} \frac{0.541}{0.13} + 120 (7.8) \right]}$$

$$= \frac{(2545) (144)}{\frac{1.082}{0.00021 + 0.0008} + 940}$$

$$= \frac{(2545)(144)}{1070 + 940} = \frac{(2545)(144)}{2010} = 183^\circ F$$

$$T_p = 270^\circ + 183^\circ = 453^\circ F$$

$$Q_{skirt} = U_s A_s (T_p - T_w) = \frac{940}{144} (183) = 1190 \text{ Btu/hr}$$

$$Q_{rings} = 2545 - 1190 = 1355 \text{ Btu/hr}$$

$$T_r - T_w = \frac{1355 (144)}{4800 (1.082)} = 37.8^\circ F$$

$$T_r = 270^\circ + 37.8^\circ = 307.8^\circ F$$

(5) Steady State Engine Operating Temperatures

- (a) Calculate ΔT across cylinder assuming that $2/3$ of the heat transferred passes through the wall.

For a 2 HP engine with $Q/HP = 2$

Total heat = $2 \times 2 = 4$ HP = 10,180 Btu/hr

$$Q_{cyl} = \frac{2}{3} (10,180) = 6800 \text{ Btu/hr}$$

$$\Delta T_c = \frac{Q_{cyl} x}{\pi D l k} = \frac{6800(0.01)(144)}{\pi(1.38)(1.625)(15)} = 93^\circ F$$

= Approximately 90°F

- (b) Coolant temperature assumed to be 180°F
- (c) Inside wall temperature = 180° + ΔT_c = 270°F
- (d) Oil film ΔT previously computed = 37.8° or 38°F
- (e) Piston ring temperature = 270° + 38° = 308°F
- (f) Maximum piston temperature (aluminum section) is calculated by computing ΔT across a piston ring. Assume 1/2 piston heat flux transmitted per ring

$$\Delta T_r = \frac{Q}{A_n} \frac{x}{k} = \frac{0.50(1355)(144)(0.005)}{(0.13)(26)} = 139^\circ F$$

where x is the mean heat path length of the ring.

The piston temperature (maximum) in the aluminum section is

$$T_{ring_average} + \Delta T_r = 308^\circ + 139^\circ = 447^\circ F$$

c. Effect of Expansion Ratio (r_e) on Engine Temperatures

Figure 80 illustrates the effect of varying the effective stroke (above the ports) on piston, ring, and exhaust temperatures. The present SPU piston configuration is assumed. Also HP, rpm, and O/F ratio are maintained constant. Figure 80 shows slightly rising temperatures as the expansion ratio

(r_e) decreases. The total stroke is constant, and the exhaust timing is altered by raising the ports in the cylinder thereby reducing the effective stroke and the expansion ratio. In this case, the ratio of heating time to cooling time is reduced as the expansion ratio decreases, and the higher gas temperatures encountered at lower values of expansion ratio are offset.

Within the accuracy limits of the assumption, it can be stated that, for this case, the temperature of the piston and piston rings remains practically unchanged as the exhaust port is raised. However, the top ring is exposed to higher gas temperatures and higher film coefficients during blowdown and localized heating of this ring may be more severe.

d. Effect of Varying Expansion Ratio on BSPC

Figure 81 illustrates how BSPC increases as expansion ratio decreases. This is attributed to reduced thermal efficiency. The same general trend is true regardless of the O/F or BMEP values desired.

e. Effect of Heat Rejection Rate on Piston Temperatures

The calculations presented thus far assume the Q/HP to be 2 for a 2 HP engine. The temperatures of the piston, rings, etc., depend directly upon the total heat rejection (Q). Figure 82 shows the influence of the total engine heat rejection rate on these temperatures.

2. Computer Program

The computer program was set up and run at NASA - MSC, Houston. It is based on heat transfer functions, conductances, and the assumption that the boundary conditions are as if a steady state heat transfer were occurring.

Other assumptions made for the analysis were as follows:

1. There is no heat transfer from the inner surfaces of the piston nor down the connecting rod.
2. The piston has circular symmetry and can therefore be treated in two dimensions: axial and radial heat transfer.
3. The cylinder wall temperature is constant.
4. The heat transfer from the piston is independent of piston location within the cylinder.

The input information to the program consisted of the following:

1. The temperature distribution along the top of the piston crown assumed to be constant for the steady state calculation
2. The heat transfer coefficients along the outer surfaces of the piston and rings
3. The piston geometry (dimensions) and material thermal conductivities

The computer results consisted of steady state temperatures at the various region boundaries and the net heat flow from the piston to the cylinder walls.

Nine different piston designs were analyzed. Figures 83 and 84 show two representative piston configurations and some of the input and output data for each case.

Absolute agreement between this program and the hand calculations in the previous section were neither expected nor obtained. The relative values obtained by both methods indicated that the calculations were reasonably consistent. The real value of the NASA computer program became evident as various material and configuration changes were made to study their effects on heat flow throughout the piston and cooling system.

D. System Definition

Since 1962, the demonstrated life of the SFU power plant has increased from seconds to days. During the subject contract period, an engine operating system has been assembled and tested. Components of this system were chosen in order to focus development efforts on the prime mover and the engine ran for 90 hours without shutdown. From engine operation before and during the endurance tests, system data were obtained to determine the requirements for the components.

The data gained from recent testing of this system represent a considerable inventory and background concerning the engine-component interface. Specifically known are such factors as the following:

Starting Requirements

Fuel pressure -- above 150 psi
Oxidizer pressure -- above 150 spi
Cranking speed -- 600 to 1200 rpm

Running Requirements

Fuel pressure -- 1200 to 2400 psi
Oxidizer pressure -- 1200 to 2400 psi
Lubricant pressures
 70 psia to the cams. s. s. s.
 4 psia to the crankshaft
Coolant flow -- 1 gpm
Heat rejection -- approximately 15,000 Btu/hr

Conditions for Extended Life

Injection dwell at 8°
Start of injection at 1° BTDC
Operating speeds used -- 2800 to 4000 rpm

A plot of accumulated engine running time during the Phase II testing is shown in Figure 45, and the accomplishments that established the demonstrated 90-hour life plateau are shown in Figure 79.

1. Breadboard System

A schematic of the breadboard system for the SPU-3 engine is shown in Figure 85 and an isometric view of this system is shown in Figure 86. Each component is shown in its relative position on the engine with its required service. The components and subsystems are described below.

a. Prime Mover

The prime mover is of the configuration that emerged from the endurance testing. It may be described as follows:

The clearance at TDC is 0.050 inch

The injector valves are flat faced poppets

The piston is the Modification I type, incorporating four 440C stainless steel rings

The connecting rod uses a roller bearing at the crank

The timing of both propellants is identical to that described above, i.e., injection starting at 1° before top dead center and continuing for 8° of injection dwell.

b. Starting Subsystem

A hydraulic starter was selected for this breadboard system both because it meets the requirements of the engine as defined by the test programs and because it is versatile enough to meet the requirements of space and lunar applications. Its energy system could be supplied by a separate pump, pressurized gas, an engine driven pump, or by a hand pump, and where desired, it may have a redundancy of any of these combinations.

The initial breadboard version of the starting subsystem will consist of a reservoir, control valve, cranking motor, accumulator, and filter. It will also be equipped with a facility air motor-driven hydraulic pump to keep the accumulator under starting pressure. The operation of this starter is as follows: The accumulator has a permanent charge of nitrogen. This nitrogen is compressed either by a hand pump or by the engine pump recharging the hydraulic section of the accumulator. When cranking of the engine is required at either starting or stopping (for purging and safety), the accumulated pressure is released against the starting motor, the engine is rotated, and starting and stopping can be achieved.

c. Lubrication Subsystem

A tank is planned for the initial lubrication subsystem to simulate the wet sump in the final design engine. This tank will be located below the present engine. The oil level will be maintained at the bottom crank level. Oil from the starter-accumulator may be considered as make-up oil for this lubrication system. There will also be supplied a facility air-driven motor which will pressurize the oil delivered to the cam and the crankcase. This is an air-driven facility motor since the oil consumption of the-flightweight engine will be reduced to a rate for which a tank and bladder pressure system may be used. In future testing of the wet sump system, pressurized oil will be directed to the pump cams, the engine cam, and the crankshaft. The oil supply to the crankshaft will then gradually be reduced.

d. Propellant Pump

The propellant pump employed in this breadboard is described in Section III-D-8 of this report.

e. Control and Governor

The control and governor will be either a complete mechanical or a hydraulic-mechanical system with self-contained fluid and pump. In either case, the sensing element will be a flyball inertia type governor and it will control the engine through a system of levers connected to the propellant pump.

f. Coolant Subsystem

The engine will be supplied with a coolant pump which will be a standard off-the-shelf type adapted to this engine. It will be mounted on the camshaft top forward end and it will supply coolant water at a rate of approximately 1 gallon per minute. It will have a thermally controlled bypass so the temperature to the engine will be maintained at about 130°F.

g. Design and Fabrication

It is planned that final design and fabrication of this breadboard system be proposed to the sponsoring agency as the next logical step to be undertaken in supplying a usable system for lunar applications. This is a step in the definition of a prototype system which will be more fully described below.

2. Prototype SPU System

The prototype space power system envisioned as the end item of the development program is depicted in Figure 87. The physical arrangement of these components and subsystems have been changed in order to compact the envelope to one more realistic for lunar and space applications. Operation of this prototype system will be the same as for the breadboard system except that the oil sump will be included as part of the crankcase in the prototype system. The cam followers will be roller bearings and the small, bladder-fed oil supply will be included within the envelope shown for this engine. The next phase of this work will include vehicle studies and application studies along with further study of the arrangement of this engine. It is anticipated that an end item of the next phase of work will be a more detailed layout of this prototype system.

An operating schematic of this prototype space power system is shown in Figure 88. The schematic shows the vehicle interfaces as envisioned at this time. Quick disconnect couplings are supplied for propellant, coolant, lubricant, and nitrogen purge connections. The electrical interface would be connected to a control panel which would have an oxidizer-to-fuel ratio control, a manual override on the governor, a fuel and oxidizer on-off switch, and a starter switch. These would all be connected to the vehicle power bus. The start signal would simultaneously open the propellant solenoids and initiate the hydraulic starter by imposing pressure on the starter motor. The starter would turn the engine and the propellant pump. The engine rpm would then increase to the governor speed setting where it would be maintained with the imposed load as demanded by the generator. The coolant flow would be controlled automatically by the thermostat.

It is estimated that this system will operate with a specific propellant consumption of approximately 3.5 lbs of propellant per horsepower hour. The heat rejection from the prototype system will be approximately 1 equivalent horsepower per shaft horsepower. The oxidizer-to-fuel ratio would be between 0.7 and 2.5 lbs per lb. The radiator inlet temperature from the engine would be approximately 280°F. The weight of this machine, exclusive of radiator, would be approximately 60 lbs divided as follows: engine 20 lbs, generator 20 lbs, accessories 20 lbs.

E. Engine Operation and Procedures

1. Acceptance Test

Planning relative to the ultimate engine system was initiated in this time period. The following paragraphs have been excerpted from Military Specification MIL-E-25112, Acceptance Test for Aircraft Reciprocating Engines, as being an appropriate procedure for acceptance testing of this type of end item.

a. Initial Run

(1) 2-Hour Initial Run

The engine shall be subjected to a 2-hour initial run, 1 hour of which shall be run at 89 percent normal rated speed on propeller load, 1/2 hour at 90 percent normal rated manifold pressure on propeller load, and 1/2 hour at normal rated manifold pressure and normal rated speed. The 1-hour 89 percent speed run may be split with 1/2 hour at the beginning of the initial test and 1/2 hour at the end. The oil consumption shall be measured during the 89 percent speed run.

(2) Inspection after Initial Run

Upon completion of the 2-hour initial run, clutch shift run, takeoff run, and additional runs, the engine shall be disassembled sufficiently to allow a detailed inspection of all working parts. The extent of the disassembly shall be decided by the Inspector. In the inspection, particular attention shall be given to the accessory drive oil seals to determine that they are functioning satisfactorily. If any part is found to be defective, an acceptable part shall be supplied to replace it and, at the discretion of the Inspector, the following penalty run or any portion thereof shall be made.

b. Penalty Run

Additional running-in prior to the penalty run may, at the option of the contractor, be performed for the accommodation of the replaced parts. The first 1/2 hour of the penalty run shall be run at 89 percent normal rated speed on propeller load, the last 1/2 hour shall be run at normal rated manifold pressure and normal rated speed. In addition, one take-off run of 5 minutes shall be made.

(1) Inspection after Penalty Run

Upon completion of the penalty run, the engine shall, at the discretion of the Inspector, be disassembled to allow for the inspection of replaced parts.

c. Final Run

(1) 1-Hour Final Run

A 1-hour final run shall be made, of which 1/2 hour shall be at 89 percent normal rated speed on propeller load, and 1/2 hour at normal rated manifold pressure and normal rated speed. The engine shall be operated continuously during each 1/2-hour run. Stoppage from any cause may, at the option of the Inspector, require a repetition of the particular 1/2 hour during which stoppage occurred. Coolant, fuel, and oil leaks shall be considered as stoppages. If, on close inspection at the completion of the 1-hour final run, oil or coolant leaks are discovered, a check at normal rated power or a complete 1-hour final run after sealing the leak shall be made at the discretion of the Inspector. During or after the 1-hour final run, two or more determinations of oil rate of flow and temperature rise shall be required only during the normal rated speed running, and with the oil inlet temperatures specified herein. When the oil flow and temperature rise measurements are made during the run, the methods and equipment shall be such that they will not affect the oil consumption measurements. The specific oil consumption shall be determined for the last 25 minutes of each 1/2-hour run.

(2) Performance

During the final run at least one set of readings shall be reduced to determine the engine performance. The engine shall meet the requirements specified in the model specification which are demonstrated by the acceptance tests. The brake horsepower, oil flow, oil heat rejection, and specific fuel consumption shall be corrected for instrument calibration and shall meet the performance specified in the model specification. Previously accepted engines shall not be subjected to retest upon recalibration of the test stand.

d. Rejection and Retest

Whenever, in the opinion of the Inspector, during the final run, there is evidence of insufficient power or other malfunctioning, or evidence that the engine is not meeting model specification requirements, the difficulty shall be investigated and its cause corrected to the satisfaction of the Inspector before the test is continued. If such investigation requires disassembly involving any internal moving part of the engine proper, the portion of the test in which the difficulty was encountered shall, at the option of the Inspector, be repeated.

F. Propellant Analysis

Following the 90.4-hour endurance run made with the SPU-3A engine, the SPU-3B engine was installed for test under an identical performance profile. The duration of the endurance test made with the first engine could not be duplicated with the second because of piston failures which occurred during three successive attempts. All failures had indications of rough combustion with piston and rings exhibiting the classic detonation-caused damage.

Since the engine was identical in construction and assembly except for a small difference in injector cam profile, it was suspected that the problem was caused by the propellants. In support of this conclusion, the engine operation was rough and there was increased difficulty of control.

Rocket research tests have been performed at The Marquardt Corporation to determine the effects on combustion of mixture variation of a 50/50 blend of UDMH and N_2O_4 (Aerozine-50) fuel. These tests have conclusively shown that as little as a 1% hydrazine rich mixture can result in peak chamber pressures exceeding twice those of combustion with a proper mixture of 0.5 UDMH and 0.5 N_2H_4 . A graph from a Marquardt report showing this phenomenon is presented in Figure 89. Slight variations in impurity of the oxidizer (N_2O_4) have no appreciable effect on combustion characteristics.

Therefore, the remaining fuel used during the last SPU-3B engine tests was analyzed. The analysis indicated high loss of hydrazine, verifying the belief that the engine was operating on a hydrazine-rich mixture, resulting in rough combustion. Three records of that analysis are presented in Figures 90, 91, and 92.

The next problem was to determine the cause of hydrazine separation and settling toward the bottom of the supply tank (outlet approximately 1/2 inch from the bottom of the tank). It was theorized that the repeated freezing and thawing might induce this condition because ambient temperatures low enough to cause freezing of the fuel prevailed at the time of the testing. A laboratory investigation of the effect of freezing was made using a sample of Aerozine-50 fuel conforming to specification. The report of this investigation is included herein as Appendix A. It was concluded that Aerozine-50 separates into two or more layers when frozen and thawed, the upper layer being UDMH-rich and the lower layer being N_2H_4 -rich.

IX. ELECTRICAL GENERATOR FOR THE SPACE POWER UNIT

A. Procurement

The generator is a GFE unit. However, to assist in procurement and to expedite delivery the generator specifications were compiled and submitted to prospective bidders by Marquardt in April 1965. A source was selected by NASA and fabrication of two generators is nearing completion. Delivery of the generators has been scheduled for the first week of March 1966. One generator was completed and tested in September 1965. The voltage regulation characteristics of this first experimental generator are shown in Figure 89. It is presently being rewound to bring its output voltage down to the 28 volts originally specified.

B. Performance Specification

The requested performance specifications are given below, together with predicted performance. Actual test data will not be available until after completion of the generators.

1.0 ELECTRICAL PERFORMANCE

1.1 Output Power.-3KW

1.2 Duty Cycle.-Continuous

1.3 Voltage.-28 v d-c nominal

1.4 Voltage Regulation.- $\pm 10\%$ no load to full load (± 0.5 volt predicted)

1.5 Overload Capability.- 125% of rated power for 5 seconds

1.6 Short Circuit.- The generator shall not be damaged or demagnetized by shorting of the machine terminals.

1.7 Efficiency.- Minimum of 85% (predicted 80% at sea level, 85% in vacuum)

1.8 Ripple Voltage.- 1.5 volts peak-to-peak at 1500 cps

2.0 MECHANICAL

2.1 Speed.- 4500 rpm, nominal

2.2 Overspeed.- To 6000 rpm at 3 KW load

- 2.3 Mounting. - The generator shall be a separate complete component. The regulator may be a separate package. A separate heat sink will be supplied by the customer.
- 2.4 Cooling. - Cooling liquid will be supplied by the customer.
- 2.5 Weight. - The total weight of the generator and regulator shall be a minimum compatible with good engineering practice and performance requirements (Predicted weights: Generator = 38 lbs, regulator = 2 lbs).

3.0 ENVIRONMENTAL REQUIREMENTS

- 3.1 Pressure. - 0 psia, normal operating; 15 psia, checkout
- 3.2 Temperature. - Space environment and launch site ambient
- 3.3 Acceleration. - 0 to 12 g in any direction

C. Evaluation of Available Generators

In order to obtain maximum efficiency and reliability, preference for a permanent magnet machine was expressed. A survey of generator sources showed that three types of machines were available that would meet the performance, early delivery date, and budget requirements. These were:

- 1. Permanent magnet, rotating field, radial air gap
- 2. Brushless, 2-section wound rotor with rotating diodes
- 3. Permanent magnet, rotating field, axial air gap

Flux switch type and inductor type machines, in general, were not considered to be suitable for this particular application. The flux switch generator shows superior performance only at higher speeds. Other types of machines have various disadvantages, typical of which are greater weight and size (inductor generator), need for bulky capacitors to correct the power factor (asynchronous generator), and lower magnetic efficiency and complex mechanical construction (Lundell and inductor-Lundell generators).

D. Description of Experimental Generators

The generators being built are 5-phase machines. The unfiltered output from the 5-phase full-wave rectifier will have an RMS ripple component of 1.5 volts peak-to-peak. This component should be adequate for most purposes. Capacitor filters can be used for equipment requiring less ripple. The rectifier efficiency is about 95%.

The rotor is a solid structure encasing the Alnico V permanent magnets. Stationary control field windings are placed on either side of the rotor with their poles arranged so as to shunt the flux of the rotor poles. By varying the current in the control field windings, the amount of rotor flux being diverted from the armature can be varied, thus controlling the voltage in the armature windings.

Only 30 watts of power is required at full load to excite the regulator field windings, thus preserving the high efficiency of the machine.

The predicted regulation characteristics of this second experimental generator are shown in Figure 90. In this typical voltage regulation characteristic plot, the nominal voltage is shown set at 28 volts. The control band is shown as ± 0.5 volts over the range of 0 to 2.85 KW.

Considering the losses in the voltage regulator and the rectifiers, the generator efficiency alone will be about 84%. This is accomplished primarily by using thin laminations of high silicon steel (7 mil, 3% silicon) and by providing a large cross-sectional area for the windings.

The dimensions of the machine are 7 inches OD by 9 inches long. A standard ANC flange at one end will mate with its counterpart on the SPU engine. The shaft coupling is through a standard ANC spline.

A water jacket surrounds the outer housing. It is provided with 1/4 NPT tube fittings for inlet and outlet. A water flow of 4 gal/hr at 80°C maximum inlet temperature will hold the temperature rise to 20°C, maximum. The maximum generator operating temperature is 150°C.

X. CONCLUSIONS

The most significant achievements accomplished during the time period covered by this report were those associated with extending the demonstrated life of the Space Power Unit Engine and its components. Although much remains to be done to insure the reliability of the engine and to increase confidence in it, it is believed that the basic design for the 100-hour life engine is at hand.

It is further concluded that the following developments contributed substantially to the demonstrated longevity:

1. Injection valve run-in procedures have enabled these vital components to be classed with the longer lived elements of the engine.
2. The compatibility of the piston ring-cylinder wall materials has been pinpointed as the major cause of piston failures.
3. Initial investigation has established stainless steel 440-C to be marginally acceptable as a material compatible with chrome plated 17-7 stainless steel cylinder wall.
4. Head clearance volume is critical in determining the life of the present piston configuration.

Additional conclusions derived during this report period are as follows:

1. Heat rejection is one of the more important criteria which should be monitored to determine proper engine operation.
2. Currently, the growth of the piston pin journal bearing diameter causes the rod to be the limiting component to the life of the present configuration. (This situation can be remedied easily.)
3. Services required by the engine have been established and operating conditions which have been documented include:
 - a. High response -- starting to operating speed
 - b. Ease of control
 - c. Utilization of high peak pressure and temperature for maximum efficiency with reliability
4. Initial performance mapping has been accomplished.

Although the program reported herein emphasized documentation of the feasibility of the engine concept, gains in minimizing the specific propellant consumption have been made. Specific propellant consumptions as low as 5.75 pounds per horsepower-hour have been documented during endurance testing with new hardware. Also, the specific propellant consumption remained constant throughout the 90-hour endurance test, indicating little or no wear on many of the vital components.

XI. RECOMMENDATIONS

The Marquardt Corporation has successfully demonstrated a continuous operating life of 100 hours for the Space Power Unit Engine. It is recommended that the following effort be initiated as the next phase of work to be undertaken directed toward the development of a qualified Secondary Space Power System.

1. Continue analyses, design, and fabrication of a breadboard functional system to demonstrate the feasibility of the engine together with its components.

2. Initiate planning of a development program in which all of the tasks required to optimize the system are enumerated and that this plan be such that qualified units be delivered to the government in early 1968.

3. Initiate analysis, design, procurement, and/or fabrication of long lead time elements which are brought into focus by the above plan.

XII. REFERENCES

1. Marquardt Report 6076, "(Unclassified Title) Feasibility Study for Development of a Hypergolic Engine Space Power System, Phase I: Final Report", 25 September 1964. UNCLASSIFIED.
2. Marquardt Report 6095, "(Unclassified Title) Design Study and Evaluation of a Multifuel Engine for a Space Power System, Final Report for Phase II, Modification II", 15 July 1965. UNCLASSIFIED.

TABLE I

SUMMARY OF FUEL INJECTOR VALVE PERFORMANCE

Valve No.	Used During Runs Nos.	Operating Time (hrs)	Remarks
FV 1	5140-7	0.01	Valve galled and partially seized. Relapped to remove galled material and increase clearance.
	5140-10 & 11	1.68	Component test. Valve "run-in" on oil and fuel.
	5140-12 through 5140-39	17.86	Operation satisfactory. PD 839 lubricant used on assembly. Valve cleaned at each engine teardown.
	5151-1-1 through 5151-10-1	30.80	Operation satisfactory. Valve cleaned at each engine teardown. Heavy erosion of housing face and orifice during last 20 hours of operation. Valve housing scrapped.
	Total:	50.35	
FV 1 Mod.	5151-42 through 5151-44	43.66	Operation satisfactory. Prior to use, valve stems modified to accept full set of seals and fitted in used oxidizer valve housing having 0.060-in. orifice.
	5151-48 through 5151-52	28.10	Operation satisfactory.
	Total:	71.76	
FV 2	5140-1	0.19	Valve leaked. Removed and cleaned.
	5140-2	0.36	Valve leaked, chrome failure. Scrapped.
	Total:	0.55	
FV 3	5140-3 through 5140-6	1.43	Valve seized, chrome failure. Salvageable.

TABLE I (Continued)

Valve No.	Used During Runs Nos.	Operating Time (hrs)	Remarks
FV 4	5151-11 through 5151-20	2.36	Valve run-in on oil 0.5 hr prior to use. Operation satisfactory. Inner valve seat reground because of indicated leakage at teardown.
	5151-21 through 5151-30	19.09	Operation satisfactory. Relapped valve seats because of indicated leakage at teardown.
	5151-31 through 5151-41	59.65	Operation satisfactory.
	5151-45 through 5151-46	3.18	Inner valve seized open, foreign material entered system. Cleaned and touch-up lapped.
	5151-47	0.32	Operation satisfactory.
	5151-53 through 5151-55	15.88	Operation satisfactory
	Total:	100.48	
FV 5	5167-1, -3, and -5	8.05	Operation satisfactory. Flat seat valve with insert in housing orifice. Replaced insert with re-designed unit because of 5167-4 test experience between Test Runs -3 and -5.
	5167-6	90.42	Operation satisfactory. No change from original installed condition.
	Total:	98.47	

TABLE I (Continued)

Valve No.	Used During Runs Nos.	Operating Time (hrs)	Remarks
FV 6	5167-2 and 5167-4	31.44	Valve run-in on oil 0.5 hr prior to use. Operation satisfactory. Orifice insert found loose at end of Run 5167-4. Redesign insert, reground valve faces.
	5167-6 through 5167-9	17.51	Operation satisfactory.
	Total:	48.95	

TABLE II

SUMMARY OF OXIDIZER INJECTOR VALVE PERFORMANCE

Valve No.	Used During Runs Nos.	Operating Time (hrs)	Remarks
OV 1	5140-1 through 5140-7	1.99	Operation satisfactory.
	5140-8	0.50	Components test using oil as test fluid.
	5140-12	0.21	Valve seized, foreign material build-up between inner and outer valves. Cleaned and reused.
	5140-13 through 5140-16	0.91	Valve seized, chrome failed. Scrap inner and outer valves, housing OK.
	Total:	3.61	
OV 1-2	5140-17	0.51	Component test. OV 1 housing fitted with new valves. Run-in on oil.
	5140-18 through 5140-22	0.60	Operation satisfactory. Chrome of questionable integrity on outer valve, scrap.
	Total:	1.11	
OV X	5140-33 through 5140-39	16.64	Mod. fuel valve FV 3 rechromed and refitted, 0.060 in. orifice in housing. Operation satisfactory. However, chrome flaking noted at end of Run 5140-39, valve free in run position, scrap.
	Total:	16.64	

TABLE II (Continued)

Valve No.	Used During Runs Nos.	Operating Time (hrs)	Remarks
OV 2	5151-1 through 5151-10	30.80	Valve run-in on oil prior to use. Valve modified to accept full set of stem seals. Operation satisfactory. Some erosion noted in housing orifice during last 20 hours of operation.
	5151-42 through 5151-44	43.66	Operation satisfactory.
	5151-48 through 5151-52	28.10	Operation satisfactory.
	Total:	102.56	
OV 3	--	--	Chrome failed during run-in, scrapped.
OV 4	5151-11 through 5151-20	9.36	Valve run-in on oil prior to use. Operation satisfactory. Reground inner valve face, indicated leakage.
	5151-21 through 5151-30	19.09	Operation satisfactory. Relapped valve seats before reuse.
	5151-31 through 5151-33	1.53	Operation satisfactory. Relapped valve seats before reuse.
	5151-34 through 5151-41	58.12	Operation satisfactory.
	5151-45 through 5151-47	3.50	Operation satisfactory.
	5151-53 through 5151-55	15.34	Operation satisfactory.
	Total:	106.94	

TABLE II (Continued)

Valve No.	Used During Runs Nos.	Operating Time (hrs)	Remarks
OV 5	5167-1 and 5167-3	2.0	Valve run-in on oil prior to use. Flat valve. Outer valve seized, spot chrome pitting, re-lapped to increase clearance and remove sharp edges in pit area.
	5167-5	6.05	Operation satisfactory. Orifice erosion and valve housing face, eroded. Reground housing face and chrome plated.
	5167-6	90.42	Operation satisfactory. No wear or leakage.
	Total:	98.47	
OV 6	5167-2	1.22	Valve run-in on oil prior to use. Flat seat valve. Outer valve seized, spot chrome failure. Re-lapped to increase clearance and remove sharp edges in pitted area.
	5167-4	30.22	Operation satisfactory. However, chrome on outer valve appeared to be failing. Stripped, replated, and refitted outer valve to assembly.
	5167-7 through 5167-9	17.51	Operation satisfactory. Heavy erosion noted in housing orifice.
	Total:	48.95	

TABLE III
SUMMARY OF ENGINE LUBRICANT EVALUATION
COLOR AND CHARACTERISTICS versus TEMPERATURE

Lubricant	Temperature						
	300°F	350°F	400°F	450°F	500°F	550°F	600°F
Brayco 443 SAE 30	Light yellow NC	NC	Darker	Darker	Darker, some BO stains	Very dark and thick, some BO stains	Black solid, some BO stains
DuPont PR 143	Clear	NC	NC	Slightly milky	Milky	NC	Slightly yellowish
Brayco Outboard SAE 30	Light yellow NC	NC	Darker	Darker	Dark, some BO stains	Very dark, some BO stains	Black solid, heavy BO deposits
Kieckhaeffer Quicksilver SAE 40	Light yellow, Slight darkening	Darker	Darker	Very dark	NC, some BO stains	Very dark and thick, heavy BO stains	Black tar, very heavy BO deposits
Pennzoil Z-Z SAE 30	Light yellow NC	NC	Darker	Darker	NC	Dark and thick, some BO stains	Black tar, medium BO deposits
Sears Outboard SAE 30	Light black NC	NC	Darker	Darker	Darker	Very dark, semi- solid, few BO stains	Black solid, light BO deposits
Union RT SAE 30	Purple NC	Lighter	Lighter	Changed from light purple to brown	NC	Dark and thick, few BO stains	Black tar, light BO deposits
Mavoline HD SAE 30	Light yellow NC	NC	NC	Slight darkening	Darker	NC, thicker, few stains	Black tar, very light BO deposits
UCON LB-525	NC	NC	Dark, spotty BO deposits on pan NC	Dark solid, light BO stains	Very light colored stain, light BO deposit	--	--
UCON YT-155T	Darker green	Slightly darker green	Changed to brown color, dark, spotty BO deposits on pan	Dark solid, heavy heavy BO stains	Very dark solid, heavy BO stains	--	--
UCON YT-165T	Darker green	Slightly darker green	Changed to brown color, dark spotty BO deposits on pan	NC Light BO stains	Dark solid, heavy BO stains	--	--
UCON YT-175T	Darker green	Slightly darker green	Changed to brown color, dark spotty BO deposits on pan side	NC Light BO stains	Dark solid, heavy BO stains	--	--
UCON LB 550X	NC	Darker reddish brown	Darker reddish brown	Dark reddish brown semi-solid Medium BO stains	Dark solid, medi- um light BO stains	--	--
UCON LB 1800 X	NC	Darker reddish brown	Darker reddish brown spotty brown BO deposits on pan	Dark semi-solid, medium BO stains	Dark solid, light BO stains	--	--

NOTE

NC = No change
BO = Boil off

UNCLASSIFIED

89

UNCLASSIFIED

TABLE IV

TEST RUN SUMMARY FOR THE SPU-2A-1 ENGINE
1 July to 10 November 1964

Run No.	Date (1964)	Duration (hr)	Nominal Run Conditions			Remarks
			HP	rpm	SPC	
5140-1	30 July	0.19	1.51	3080	20.3	Engine shut down, excessive fuel flow, valve leaking.
5140-2	31 July	0.36	3.5	4550	10.8	Engine stopped. Ran out of fuel, excessive fuel flow, valve leaking.
5140-3	11 Aug.	0.38	3.5	4900 max	--	Engine shut down, water leak at top cylinder seal. High overboard fuel leakage.
5140-4	17 Aug.	0.50	4.0	5000 max	--	Engine shut down, end of test. Timing seemed too far advanced.
5140-5	18 Aug.	0.31	4.0	4000	7.8	Engine shut down, end of test.
5140-6	19 Aug.	0.24	4.15	5500	8.8	Emergency shutdown, engine overspeed, fuel valve stuck open.
5140-7	11 Sept.	0.01	--	--	--	Fuel valve stuck open, engine seized.
5140-8 thru 5140-11	Aug. and Sept.	NA	NA	NA		Injector valve component development tests.
5140-12	1 Oct.	0.21	3.6	4700	11.1	Oxidizer valve stuck, engine oversped and failed piston rings.
5140-13	6 Oct.	0.11	1.0	3400	--	Oxidizer injection pressure transducer failed, normal shutdown.
5140-14	7 Oct.	0.12	4.7	2340	8.9	Checkout run at high power, normal shutdown.
5140-15	7 Oct.	0.27	4.4	4350	8.3	BMEP traverse test, normal shutdown.
5140-16	8 Oct.	0.41	4.9	4900	8.6	Oxidizer valve froze and engine oversped, 21 plus HP at 9600 rpm recorded.
5140-17	16 Oct.	0.5	NA	2000	NA	Injector valve component test.

UNCLASSIFIED

UNCLASSIFIED

TABLE IV (Continued)

Run No.	Date (1964)	Duration (hr)	Nominal Run Conditions			Remarks
			HP	rpm	SPC	
5140-18	19 Oct.	0.22	2.8	1870	6.4	Top cylinder seal failed allowed water in cylinder, high BMEP test.
5140-19	21 Oct.	0.16	--	1450	--	Engine over-temperature indication, normal shutdown.
5140-20	21 Oct.	0.05	--	2000	--	Top cylinder seal failed allowed water in cylinder.
5140-21	23 Oct.	0.15	1.9	1700	7.7	Normal shutdown, facility fuel leak.
5140-22	23 Oct.	0.11	1.1	2800	15.9	Normal shutdown, facility fuel leak.
5140-23	26 Oct.	0.12	1.2	1750	12.4	Normal shutdown, could not achieve normal power, low fuel flow.
5140-24	29 Oct.	0.19	3.1	3040	8.0	Normal shutdown, indicated fuel valve sticking from high head temperature.
5140-25	29 Oct.	0.31	2.4	2320	7.6	Normal shutdown, indicated fuel valve sticking from high head temperature.
5140-26	2 Nov.	2.16	2.2	2030	7.5	Normal shutdown, excellent run.
5140-27	6 Nov.	0.30	2.2	2000	7.7	Piston rings failed, piston froze in cylinder during BMEP traverses.
5140-28	10 Nov.	0.10	--	2000	--	Start of duration test, normal shutdown to repair facility propellant pump leak.
5140-29	10 Nov.	2.00	2.1	1990	8.0	Normal shutdown to refuel facility run tanks.
5140-30	10 Nov.	2.35	2.1	2080	8.6	Normal shutdown to refuel facility run tanks.
5140-31	10 Nov.	2.36	2.1	2120	8.3	Normal shutdown, end of duration test (6.81 hr).
Total time: 14.2 hr						

NA = Not available

SPC = lb/HP-hr

UNCLASSIFIED

UNCLASSIFIED

TABLE V

TEST RUN SUMMARY FOR THE SPU-2A-2 ENGINE
27 January to 4 February 1965

Run No.	Date (1965)	Duration (hr)	Nominal Run Conditions			Remarks
			HP	rpm	SPC	
5140-32	27 Jan	0.22	1.5	2500	--	Component evaluation test, normal shutdown.
5140-33	27 Jan	0.07	--	2500	--	Injector valve timing test, normal shutdown.
5140-34	27 Jan	0.31	1.0	3600	--	Injector valve timing test, normal shutdown.
5140-35	2 Feb	0.30	2.0	4000	--	Performance test, developed cylinder water leak.
5140-36 -1	4 Feb	0.50	2.3	3080	9.4	Oxidizer valve indicating intermittent stickiness, normal shutdown.
5140-36 -2	4 Feb	0.07	2.0	2000	--	Oxidizer valve indicating intermittent stickiness, normal shutdown.
5140-37	4 Feb	2.30	2.2	2225	8.8	Normal shutdown to refuel.
5140-38	4 Feb	1.77	2.3	2300	8.4	Normal shutdown to replace facility coplant filter.
5140-39	4 Feb	0.12	2.3	2200	9.0	Water leak in cylinder.
Total time:		5.7 hr				

SPC = lb/HP-hr

UNCLASSIFIED

UNCLASSIFIED

THE
Marquardt
CORPORATION
VAN NUYS CALIFORNIA

Report 6098

TABLE VI

TEST RUN SUMMARY FOR THE SPU-3 ENGINE
1 July to 1 November 1965

Run No.	Date (1965)	Duration (hrs)	Run Condition			Remarks
			HP	rpm	SPC	
5151-1-2	1 July	0.045	2.3	3800	--	Shut down to check oxidizer flowmeter.
5151-1-3	1 July	0.236				Shut down because of erratic performance, found water leak in cylinder.
5151-2-3	7 July	0.116	2.5	5000	--	Shut down for inspection for cause of very high chamber pressure. Found cylinder head spacer distorted and allowed the piston to partially mask pre-combustion chamber.
5151-3-1	12 July	0.033	2.8	2800	--	Shut down, no visual rpm indication.
5151-3-2	12 July	0.543	2.95	2950	6.6	Shut down for crew break (lunch).
5151-3-3	12 July	0.777	2.49	3950	8.2	Shut down to change seal in oxidizer injection pump.
5151-3-4	12 July	3.033	2.6	4100	8.4	Shut down to change seal in oxidizer injection pump.
5151-4-1	13 July	4.61	4.2	4100	7.6	Lost hypergolic ignition during O/F traverse, fuel rich.
5151-4-2	13 July	0.202	3.8	5000	--	Lost hypergolic ignition during O/F traverse, fuel rich.
5151-4-3	13 July	0.163	1.9	4600	--	Piston failed, total time this piston configuration 9.75 hrs.
5151-5-1	20 July	0.033	0.6	3500	--	Shut down to repair facility fuel manifold leak.
5151-5-2	20 July	0.011	0.6	3500	--	Lost hypergolic ignition during O/F traverse, fuel rich.
5151-5-3	20 July	0.567	1.3	3300	13.1	Shut down to alter oil pressure settings.
5151-5-4	20 July	1.435	2.2	3950	10.3	Shut down to alter oil pressure settings.
5151-5-5	20 July	0.25	0.6	3500	--	Shut down to alter oil pressure settings.

UNCLASSIFIED

THE
Margardt
INTEGRATION

VAN NUYS CALIFORNIA

UNCLASSIFIED

Report 6098

TABLE VI (Continued)

Run No.	Date (1965)	Duration (hr)	Run Condition			Remarks
			HP	rpm	SPC	
5151-5-6	20 July	4.60	1.6	4000	9.8	Shut down and secured operation for day.
5151-6-1	21 July	0.033	2.0	4000	12.6	Shut down to alter oil pressure settings.
5151-6-2	21 July	2.72	2.2	4150	13.3	Shut down to alter oil pressure settings.
5151-6-3	21 July	0.042	0.6	3500	--	Piston failed, total time on this piston 9.69 hrs.
5151-7-1	29 July	1.33	1.7	4000	10.2	Piston failed, mod piston w/o top ring and solid lower rings.
5151-8-1	30 July	2.518	1.9	4100	9.0	Shut down and secured facility for day. Cleaned piston assembly at end of run. Very high oil consumption. SPU-2A-1 piston type.
5151-9-1	31 July	4.005	1.9	4150	8.9	Shut down to clean piston assembly.
5151-9-2	31 July	3.505	2.05	3850	8.4	Shut down to clean piston assembly. Total time this piston 10.03 hr.
5151-10-1	2 Aug.	--	--	--	--	Engine failure. Excessive volume of propellants injected at startup caused excessive pressure failing cylinder, piston, and cylinder spacer disk.
5151-11-1	7 Aug.	0.30	0.46	2300	--	Piston failed. SPU-2A-1 engine w/insulated crown piston. Crown assembly melted.
5151-12-1	28 Sept.	0.18	1.94	4400	--	Engine oil leak. Baseline piston and high, square port cylinder. Engine now displaces 1.77 cu in. net. Corrected oil leak.
5151-12-2	28 Sept.	0.92	1.77	4950	11.1	Rod bearing cage failed. Engine seized.
5151-13-1	4 Oct.	0.47	2.16	4900	8.0	Rod bearing cage failed. Engine seized.
5151-14-1	6 Oct.	0.50	1.78	3950	11.9	Scheduled shutdown. (McGill MR-16 bearing installed). Piston inspection after shut down.

UNCLASSIFIED

UNCLASSIFIED

THE
Margardt
CORPORATION

VAN NUYS CALIFORNIA

Report 6098

TABLE VI (Continued)

Run No.	Date (1965)	Duration (hr)	Run Condition			Remarks
			HP	rpm	SPC	
5151-14-2	6 Oct.	0.20	1.62	4050	11.3	Engine oil leak. Gear case scavenge line loose; tightened.
5151-14-3	6 Oct.	0.80	1.74	4250	10.9	Scheduled shut down. Piston inspection after shut down.
5151-15-1	8 Oct.	0.51	1.63	2400	10.2	Scheduled shut down. (High, oval port, cylinder liner installed.) Piston inspection after shut down.
5151-16-1	11 Oct.	0.05	0.6	2000	--	Facility malfunction. Flowmeters not working properly; corrected.
5151-16-2	11 Oct.	0.52	1.60	2250	9.8	Scheduled shut down. Piston inspection after shut down. Ring groove clearance increasing.
5151-17-1	12 Oct.	1.01	1.70	2500	9.2	Scheduled shut down. Piston inspection after shut down. Second ring badly worn.
5151-18-1	13 Oct.	2.00	1.45	4200	11.9	Scheduled shut down. (New rings installed on same piston.) Piston inspection after shut down.
5151-19-1	14 Oct.	1.89	1.96	4350	9.0	Rod bearing failed. (Changed to Havoline SAE 30 wt HD oil.) Rod bearing cage failed; engine seized.
5151-20-1	20 Oct.	0.01	--	1400	--	Engine seized. Crank timing gear not backed off and jammed in gear housing. No damage to engine.
5151-21-1	20 Oct.	2.01	1.39	4000	12.3	Scheduled shut down. (McGill GR-16 bearing installed.) Piston inspection after shut down.
5151-22-1	22 Oct.	4.03	1.66	4000	10.9	Scheduled shut down. Piston inspection after shut down. Rod bearing found loose. 0.004 inch wear.
5151-23-1	23 Oct.	8.01	1.79	4250	9.5	Scheduled shut down. (New McGill GR-16 bearing installed.) Piston inspection found top rings gone and third ring broken. Estimate 6 hrs operation in this configuration. Rod bearing ~0.002 in. wear. Combustion chamber badly eroded. Very severe P _c spikes with this timing.

UNCLASSIFIED

THE
Marquardt
ILLUMINATION

VAN NUYS CALIFORNIA

UNCLASSIFIED

Report 6098

TABLE VI (Continued)

Run No.	Date (1965)	Duration (hr)	Run Condition			Remarks
			HP	rpm	SPC	
5151-24-1	29 Oct.	0.05	0.55	3050	27.9	Engine seized. (New McGill GR-16 bearing installed.) New piston w/"Micro Sealed" 420 CRES rings. Rings galled.
Total Time: 54.28 hrs						

SPC = lb/HP-hr

TABLE VII

TEST RUN SUMMARY FOR THE SPU-3 ENGINE
2 November to 31 December 1965

Run No.	Date (1965)	Duration (hr)	Nominal Run Conditions			Configuration of Engine	Remarks
			HP	rpm	BMEP		
5151-25	2 Nov.	0.56	1.6	4000	98	High, oval port cylinder. Baseline piston, McGill GR-16 rod bearing. Timing 10° ATC, 3° dwell.	Scheduled shutdown, low cylinder pressures, i.e., 750 psi nom. Very sensitive to oxidizer injection pressure.
5151-26-1 -2	3 Nov.	1.18	1.6	4000	98	Same as 5151-25	Scheduled shutdown. Very sensitive to oxidizer injection pressure. Minor combustion chamber erosion.
5151-27	4 Nov.	0.52	1.5	2400	156	Same as 5151-25 Timing 10° ATC, 4° dwell	Scheduled shutdown. No change from 5151-26.
5151-28	5 Nov.	1.0	1.6	2450	160	Same as 5151-25 Timing 10° ATC, 4° dwell	Scheduled shutdown. Minor etching of combustion chamber 1/8 in. clipped off top ring end, slight leak in oxidizer housing top O-ring.
5151-29-1	8 Nov.	0.38	1.6	2300	170	Same as 5151-25 except new top ring and oxidizer body O-ring. Timing 10° ATC, 5° dwell.	Premature shutdown resulting from fuel pump malfunction.
5151-29-2	8 Nov.	0.65	1.6	2300	170	Same as 5151-29-1	Scheduled shutdown. Top 2 rings broken.

UNCLASSIFIED

UNCLASSIFIED

TABLE VII (Continued)

Run No.	Date (1965)	Duration (hr)	Nominal Run Conditions			Configuration of Engine	Remarks
			HP	rpm	BMEP		
5151-30-1 -2 -3	10 Nov.	0.70 Total	1.6	2500	160	Same as 5151-25 except new top rings, reseated injector valves. Nozzle inserts cut at angle. Timing 1° BTC, 5 1/4° dwell.	Two unscheduled shutdowns because of facility propellant leaks. Cold weather affecting Teflon seals. Engine components excellent after third scheduled shutdown.
5151-30	10 Nov.	0.50	1.55	2300	165	Same as 5151-30	Scheduled shutdown.
5151-32	11 Nov.	1.0	1.6	2450	160	Same as 5151-30	Scheduled shutdown. No change.
5151-33	11 Nov.	0.03	--	--	--	Same as 5151-30 except flame sprayed 420 CRES rings.	Rings galled at start-up.
5151-34	12 Nov.	0.52	1.45	2400	150	"A" cylinder head, Mod. No. 1 piston w/4 cast iron rings. High, square port cylinder "B" case assembly.	Unscheduled shutdown. Fuel valve housing top O-ring leaking. Some ring end clipping from ports.
5151-35	15 Nov.	0.50	1.6	2400	165	Same as 5151-34 except new rings and high, oval port cylinder. Timing 2° ATC, 5° dwell.	Scheduled shutdown. No change. Engine operation slightly unstable at 5° dwell.

UNCLASSIFIED

THE
Margardt
LABORATORIES

VAN NUYS CALIFORNIA

UNCLASSIFIED

Report 6098

TABLE VII (Continued)

Run No.	Date (1965)	Duration (hr)	Nominal Run Conditions			Configuration of Engine	Remarks
			HP	rpm	BMEP		
5151-36	15 Nov.	1.52	1.5	2650	140	Same as 5151-35	Scheduled shutdown. Minor clipping of top ring, approx. 1/16 in. gone from one end. No other changes. Engine slightly unstable at 5° dwell.
5151-37	16 Nov.	1.51	1.7	2500	164	Same as 5151-35 except timing Ox 1.3° BTC, 8° dwell Fuel 1.0° BTC, 8° dwell.	Scheduled shutdown. Engine performance, stability and controllability excellent. No change.
5151-38	17 Nov.	4.0	1.8	2600	166	Same as 5151-37	Scheduled shutdown. No. 2 ring broken with minor damage to piston. No change in performance from Run 5151-37.
5151-39	17 Nov.	4.0	1.1	2650	105	Same as 5151-37 with new rings and piston skirt.	Scheduled shutdown. Heavy carbon build-up in exhaust manifold. Excessive ring wear, otherwise OK.
5151-40	18 Nov.	5.0	1.2	2700	110	Same as 5151-37 except baseline piston fitted with 440C CRES rings.	Scheduled shutdown. Rings slightly etched on wear face, otherwise all components in excellent condition.

UNCLASSIFIED
- 99 -

TABLE VII (Continued)

Run No.	Date (1965)	Duration (hr)	Nominal Run Conditions				Configuration of Engine	Remarks
			HP	rpm	SPC	BMEP		
5151-41	19 to 21 Nov.	41.07	1.2	2800		110	Same as 5151-40	Unscheduled shutdown. P port plug blew out causing heavy erosion in combustion chamber. Performance satisfactory until this occurred.
5151-42	22 Nov.	10.02	1.2	2700		88	"B" cylinder head, "A" case assembly, low round port cylinder, Mod. No. 1 piston with 440 C CRES rings, Timing Ox 1.3 BTC, 8.3° dwell; Fuel 1.0 BTC, 8° dwell.	Scheduled shutdown. Satisfactory performance, no change in engine components. No effect noted as a result of reduced exhaust port area. Engine not disassembled after run.
5151-43	23 Nov.	14.04	1.2	2200		88	Same as 5151-42	Scheduled shutdown. All components excellent condition. Very heavy carbon build-up in exhaust manifold.
5151-44	1 Dec.	19.6	2.2* & 3.3	3300	9.0 & 7.0	135 & 198	"B" cylinder head "A" case assembly, low round port cylinder, Mod. No. 1 piston with 440C CRES rings. Timing Ox 1° BTC, 8° dwell, Fuel 1° BTC, 8° dwell.	Unscheduled shutdown depleted oxidizer supply. Heavy carbon build up in exhaust muffler. Engine previously run 24.06 hr.

* Step power conditions 50 min "low", 10 min "high" cyclic.

UNCLASSIFIED

THE
Margardt
LABORATORY
VAN NUYS CALIFORNIA

UNCLASSIFIED

Report 6098

TABLE VII (Continued)

Run No.	Date (1965)	Duration (hr)	Nominal Run Conditions				Configuration of Engine	Remarks
			HP	rpm	SPC	BMEP		
5151-45	6 Dec.	1.58	2.3	3200	9.3	143	SPU-2A-1/3 cylinder head with full CRES chamber insert, Q-4 and F-4 valves SPU-3 cam assembly with reground cam lobes, "B" case assembly. Mod No. 1 piston with 440C CRES rings. Low round port cylinder. Timing, Ox 1° BTC, 8° dwell, Fuel 1° BTC, 8° dwell.	Unscheduled shutdown, cam lobe failed.
5151-46	6 Dec.	1.60	2.3 & 3.4	3350	8.0 & 6.3	138 & 200	Same as 5151-45 except replaced 2 cam lobes. Same timing.	Unscheduled shutdown, inner fuel valve stuck open, foreign material entered valve.
5151-47	7 Dec.	0.32	2.5	3300	9.8	148	Same as 5151-46 with re-lapped fuel valve. Same timing.	Unscheduled shutdown inner fuel valve cam lobe failed.
5151-48	8 Dec.	10.95	2.5 & 3.5	3400	10.0 & 8.2	143 & 200	Same as 5151-47 except fitted with "B" cylinder head assembly. Same timing.	Unscheduled shutdown. Engine inadvertently filled with oil during refilling of oil tank. Facility oil level gage malfunctioned.
5151-49	8 Dec.	16.83	2.4 & 3.4	3400	10.3 & 8.5	143 & 202	Same as 5151-48.	Unscheduled shutdown torque load cell failed in tension and released dynamometer load.

TABLE VII (Continued)

Run No.	Date (1965)	Duration (hr)	Nominal Run Conditions				Configuration of Engine	Remarks
			HP	rpm	SPC	BMEP		
5151-50	9 Dec.	0.22	2.4	3200	--	145	Same as 5151-48	Unscheduled shutdown, dynamometer forward mount failed.
5151-51	9 Dec.	0.07	--	--	--	--	Same as 5151-48. Timing reset: Ox 1.25° BTC, 7.75° dwell. Fuel 1° BTC, 7.75° dwell.	Scheduled shutdown. Facility check-out run.
5151-52	9 Dec.	0.03	--	--	--	--	Same as 5151-51	Unscheduled shutdown. Fuel valve housing top O-ring leaking.
5151-53	10 Dec.	4.98	2.5 & 3.3	3300	9.3 & 7.9	150 & 200	"A" case assembly, SPU-2A-1/3 head with full CRES chamber insert. O-4 and F-4 valves. SPU-3 cam with standard cams. Mod 1A piston with 440C rings and knurled skirt. Timing Ox 1° BTC, 8° dwell, Fuel 0.7° BTC, 8° dwell.	Unscheduled shutdown, leakage from P _c port. Knurling of piston skirt caused excessive oil consumption.
5151-54	11 Dec	7.97	2.5 & 3.4	3350	10.0 & 7.9	148 & 198	"B" case assembly. 5151-52 cylinder and piston assembly. SPU-2A-1/3 cylinder head with O-4 F-4 valves. Saureisen 31 sealant in CRES chamber insert P _c port interface. Timing, Ox 1° BTC, 8.5° dwell, Fuel 0.75° BTC, 7.75° dwell.	Unscheduled shutdown. Partial blockage of crank internal oil passage with foreign material caused oil starvation resulting in partial piston seizure.

TABLE VII (Continued)

Run No.	Date (1965)	Duration (hr)	Nominal Run Conditions				Configuration of Engine	Remarks
			HP	rpm	SPC	BMEP		
5151-55	12 Dec.	2.93	2.5 & 3.4	3350	10.0 & 7.9	148 & 198	Same as 5151-54	Unscheduled shutdown. Leakage from P _c port.

BMEP = Brake mean effective pressure, psi

TABLE VIII

TEST RUN SUMMARY FOR THE SPU-3 ENGINE
1 January to 10 February 1966

Run No.	Date (1966)	Duration (hr)	Nominal Run Conditions				Configuration of Engine	Remarks
			HP	rpm	SPC	BMEP		
5167-1	10 Jan	1.80	2.4 & 3.2	3200 & 3200	- - - -	150 & 200	"A" engine. O-5 and F-5 flat valves Mod 1 piston w/440C rings low, round port cylinder slip-on cams. Timing Ox 1.1° BTC, 8° dwell Fuel 0.8° BTC, 8° dwell Outer valves open first	Engine shut down because of oil mani- fold pressure loss. New 5 micron oil fil- ters caused excessive flow restriction. Low flow resulted in frozen front camshaft bearing however no damage was incurred by engine.
5167-2	10 Jan	1.22	2.4 & 3.2	3200 & 3200	- - - -	150 & 200	"B" engine. O-6 and F-6 flat valves Mod 1 piston w/440C rings low, round port cylinder SPU-2A-1/3 camshaft Timing Ox 1.2° BTC, 8° dwell Fuel 0.9° BTC, 8° dwell Outer valves open first	Engine shut down because of oxidizer injection pressure loss. Oxidizer in- jection valve stuck in open position.
5167-3	11 Jan	0.22	- -	- -	- -	- -	"A" engine. Increased cam bearing clearance Timing Ox 1° BTC, 8° dwell Fuel 0.5° BTC, 8° dwell Outer valves open first	Engine shut down because of oxidizer in- jection pressure loss. Oxidizer injection valve stuck in open position.

UNCLASSIFIED

- 104 -

THE
Margardt
CORPORATION
VAN NUYS CALIFORNIA

UNCLASSIFIED

Report 6098

TABLE VIII (Continued)

Run No.	Date (1966)	Duration (hr)	Nominal Run Conditions				Configuration of Engine	Remarks
			HP	rpm	SPC	BMEP		
5167-4	12 Jan	30.22	2.5 & 3.7	3400 & 3500	10.1 & 7.9	148 & 207	"B" engine. Timing Ox 1.2° BTC, 8° dwell Fuel 1.0° BTC, 8° dwell Outer valves open first	Engine shut down because of excessive leakage of facility oxidizer pump. Engine failed to restart because of hole burned through center of piston crown.
5167-5	13 Jan	6.05	2.5 & 3.7	3400 & 3500	- - - -	148 & 207	"A" engine. Relapped oxidizer valve Timing Ox 1° BTC, 8° dwell Fuel 0.5° BTC, 8° dwell Outer valves open first	Engine stopped. Hole burned through center of piston crown.
5167-6	28 Jan	90.42	2.4 & 3.3	2800 & 3200	7.8 & 6.3	170 & 202	"A" engine. Thick piston crown center W/silver filled bolt. Insert in head oxidizer orifice 0.050 chamber clearance. Micro sealed piston, rings, pin and cylinder bore. Timing 1° BTC, 8° dwell. Both inner valves open first	Engine shut down because of abrupt change in oil consumption characteristics. Engine delivering normal power when shut down.

UNCLASSIFIED

- 105 -

THE
Margardt
CORPORATION
VAN NUYS CALIFORNIA

UNCLASSIFIED

Report 6098

TABLE VIII (Continued)

Run No.	Date (1966)	Duration (hr)	Nominal Run Conditions				Configuration of Engine	Remarks
			HP	rpm	SPC	BMEP		
5167-7	2 Feb	8.14	2.4 & 3.2	2800 & 3200	8.7 & 6.8	172 & 200	"B" engine. Configuration and timing same as for Run 5167-6 except SPU-2A-1/3 camshaft.	Engine stopped. Piston crown separated from skirt.
5167-8	8 Feb	4.83	2.4 & 3.3	2800 & 3200	7.3 & 5.9	170 & 200	"B" engine. Same as 5167-7 except new piston, rings, and rechromed cylinder bore	Engine shut down because of abrupt change in oil con- sumption character- istics. Engine delivering normal power at shut down. Top 3 piston rings stuck in grooves and heavy galling of piston crown on bore.
5167-9	10 Feb	4.54	2.4 & 3.2	2800 & 3200	9.4 & 8.1	168 & 198	"B" engine. Same as 5167-8 except remachined piston, new rings, and cylinder liner. Liner not microsealed.	Engine stopped. Piston stuck in cylinder because of detonation induced piston failure.

Total time: 357.2 hr

TABLE IX

INJECTION TIMING SUMMARY--SPU ENGINE SERIES

Injection Timing Identification No.	Start of Oxidizer Injection	Oxidizer Dwell	Start of Fuel Injection	Fuel Dwell	Remarks
1	5° BTC	8°	5° BTC	8°	Too far advanced
2	3° BTC	8°	3° BTC	8°	OK
3	1.5° BTC	9°	1.5° BTC	9°	OK
4	1.3° BTC	8.3°	1.0° BTC	8°	OK
5	1.3° BTC	8°	1.0° BTC	8°	OK
6	1.25° BTC	7.75°	1.0° BTC	7.75°	OK
7	1.2° BTC	8°	1.0° BTC	8°	OK
8	1.2° BTC	8°	0.9° BTC	8°	OK
9	1.1° BTC	8°	0.8° BTC	8°	OK
10	1° BTC	10°	1° BTC	10°	Low injection pressures
11	1° BTC	8°	1° BTC	8°	Best performance
12	1° BTC	8.5°	0.75° BTC	7.75°	OK
13	1° BTC	8°	0.7° BTC	8°	OK
14	1° BTC	8°	0.5° BTC	8°	OK
15	1° BTC	7°	1° BTC	7°	OK
16	1° BTC	5°	1° BTC	5°	High injection pressures
17	2° ATC	5°	2° ATC	5°	Engine operation unstable at low power
18	10° ATC	5.2°	7.5° ATC	7.7°	Combustion chamber erosion
19	10° ATC	5°	10° ATC	5°	Combustion chamber erosion
20	10° ATC	4°	10° ATC	4°	High injection pressures
21	10° ATC	3°	10° ATC	3°	High injection pressures

TABLE X
SUMMARY OF SPU-3 TEST INSTRUMENTATION

Parameter	Symbol	Range	Display Method	
			Recorded	Visual
1. Combustion Chamber pressure	P_c	0 to 3000 psi	x	x
2. Crank position indicator	CPI	0° to 360°	x	x
3. Top center indicator	TCI	NA	x	x
4. Torque	T	0 to 25 lbs	--	x
5. Engine speed	rpm	0 to 6000 rpm	x	x
6. Facility GN_2 pressure	P_{N_2}	0 to 1000 psi	--	x
7. Fuel supply pressure	P_{f_s}	0 to 250 psi	--	x
8. Oxidizer supply pressure	P_{o_s}	0 to 250 psi	--	x
9. Fuel injection pressure	P_{f_i}	0 to 4000 psi	x	x
10. Oxidizer injection pressure	P_{o_i}	0 to 4000 psi	x	x
11. Exhaust manifold pressure	P_{ex}	0 to 1 atmosphere	--	x
12. Oil manifold pressure	P_{oil_M}	0 to 100 psi	--	x
13. Oil inlet pressure	$P_{oil_{in}}$	0 to 5 psi	--	x
14. Oil tank level	L_{O_t}	E to F	--	x
15. Coolant pressure	P_{cool}	0 to 30 psi	--	x
16. Fuel flow rate	\dot{W}_f	0 to 20 lb/hr	x	x
17. Oxidizer flow rate	\dot{W}_o	0 to 20 lb/hr	x	x
18. Coolant flow rate	\dot{W}_{cool}	0.1 to 1.0 gpm	--	x

TABLE X (continued)

Parameter	Symbol	Range	Display Method	
			Recorded	Visual
19. Exhaust temperature	T_{ex}	0° to 2000°F	--	x
20. Oil inlet temperature	$T_{oil, in}$	0° to 250°F	--	x
21. Oil outlet temperature	$T_{oil, out}$	0° to 250°F	--	x
22. Oil tank temperature	T_{Tank}	0° to 250°F	--	x
23. Coolant inlet temperature	$T_{c, in}$	0° to 250°F	--	x
24. Coolant outlet temperature	$T_{c, out}$	0° to 250°F	--	x
25. Oxidizer tank temperature	$T_{o, T}$	0° to 200°F	--	x
26. Fuel tank temperature	$T_{f, T}$	0° to 200°F	--	x
27. Oxidizer manifold temperature	$T_{o, M}$	0° to 200°F	--	x
28. Fuel manifold temperature	$T_{f, M}$	0° to 200°F	--	x
29. Crankcase pressure	P_{case}	0 to 1 atmosphere	--	x

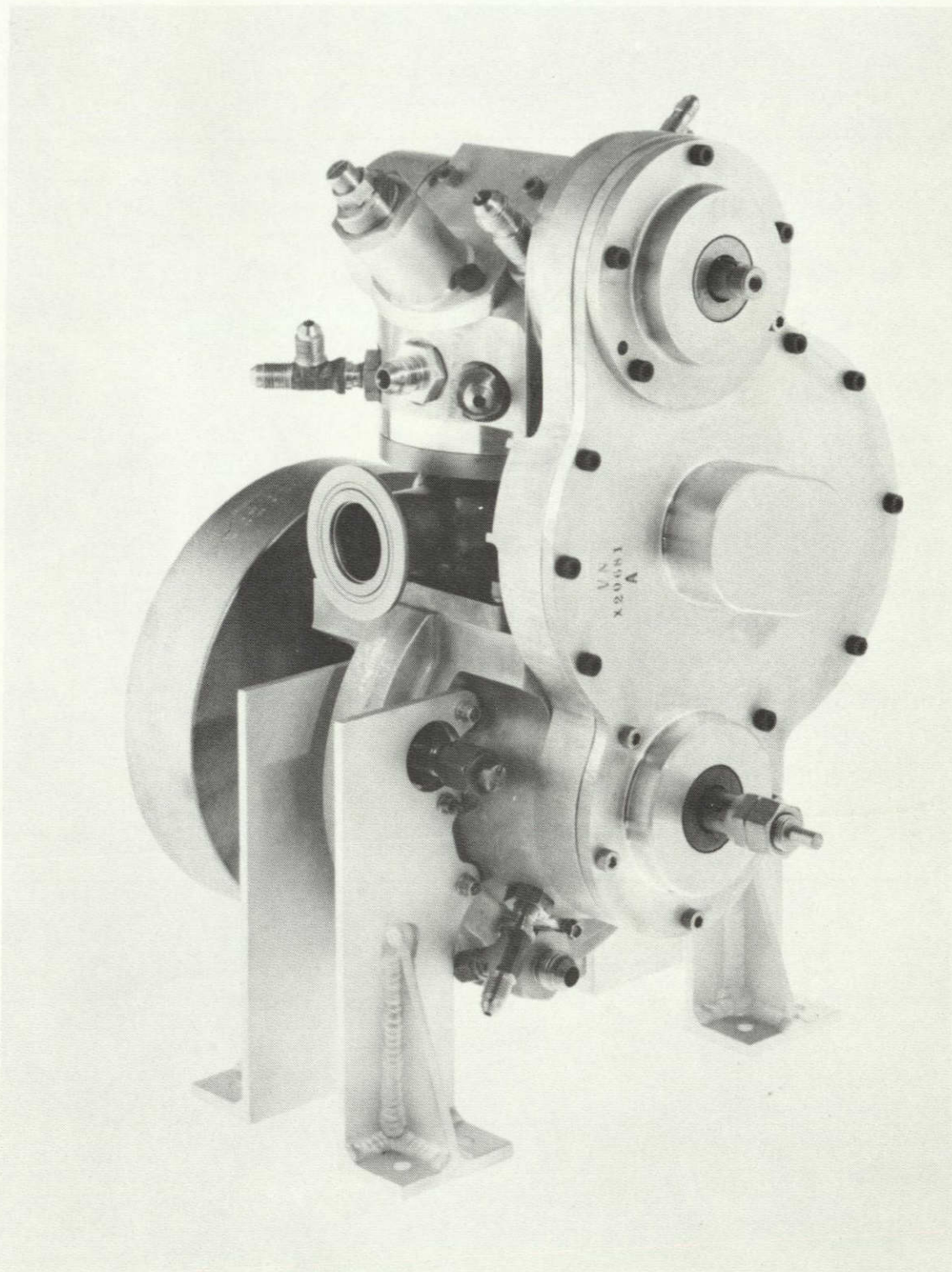

T 5134-19

FIGURE 1. External Configuration of the SPU-2A-1 Space Power Unit Engine

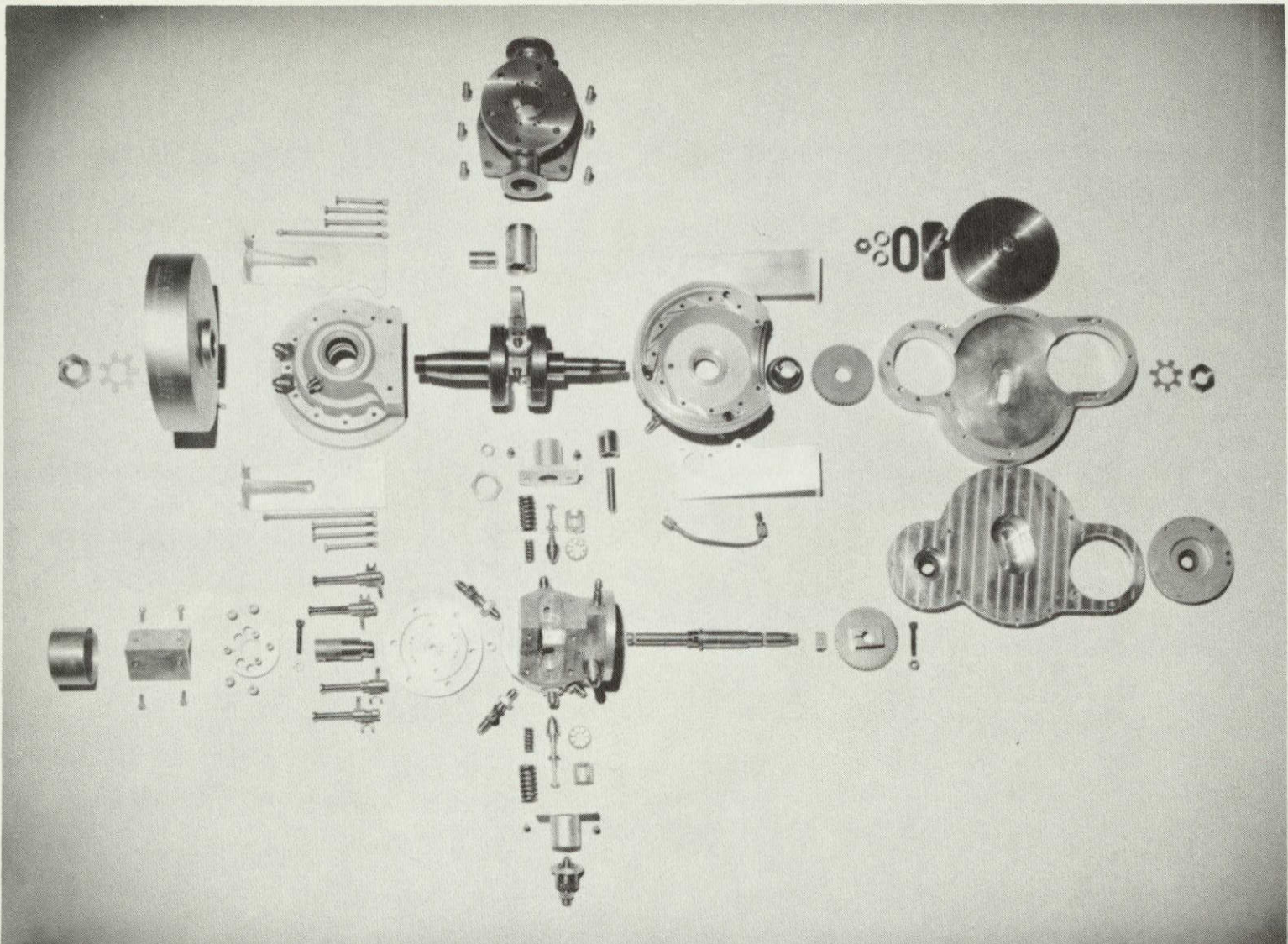

T 5134-14

FIGURE 2. Disassembled View of Components of the SPU-2A-1 Engine

UNCLASSIFIED

THE
Marquardt
CORPORATION
VAN NUYS, CALIFORNIA

Report 6098

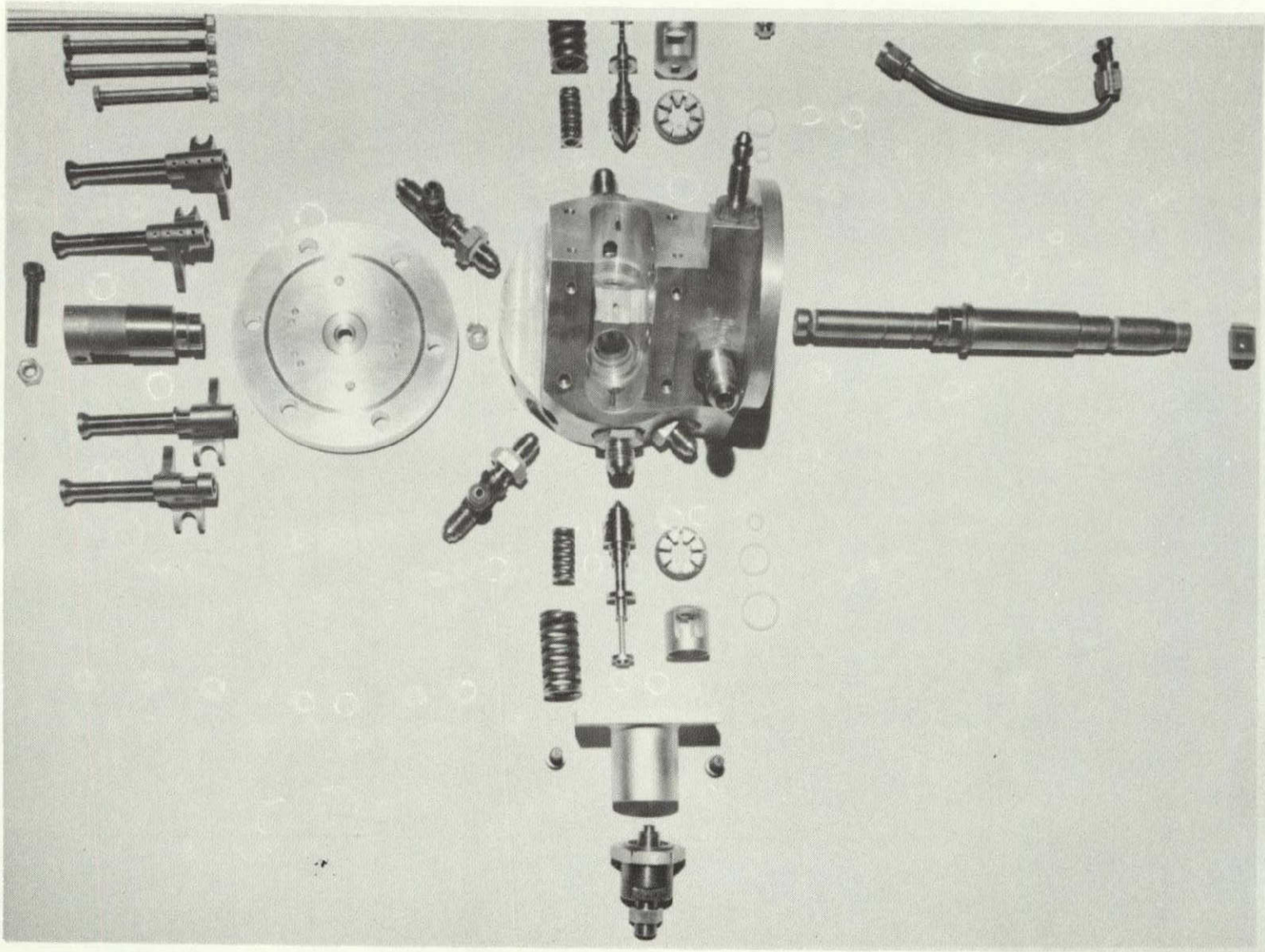

T 5134-15

FIGURE 3. Cylinder Head Components for the SPU-2A-1 Engine

UNCLASSIFIED

- 112 -

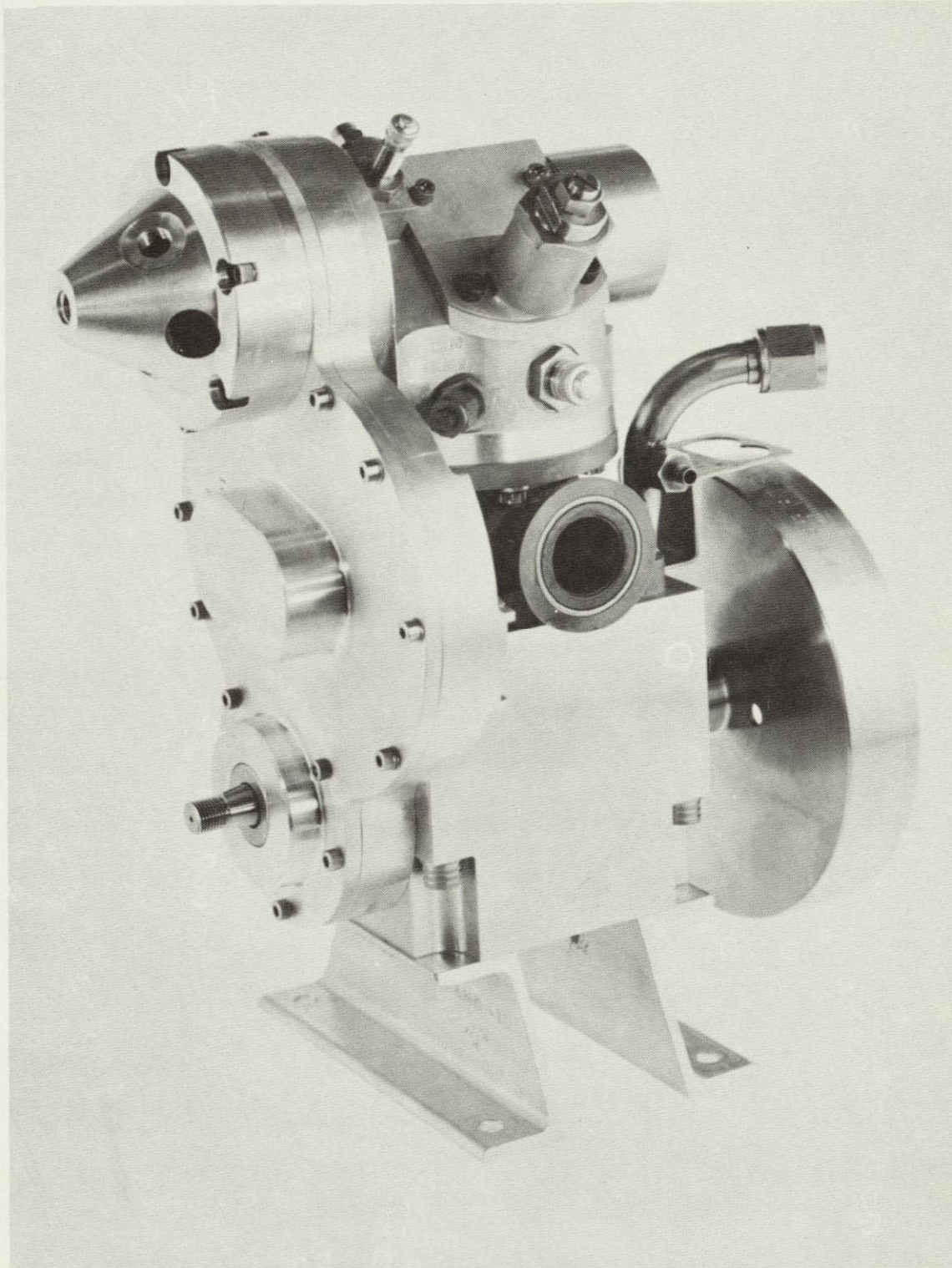

6615-1

FIGURE 5. External Configuration of the SPU-3 Space Power Unit Engine

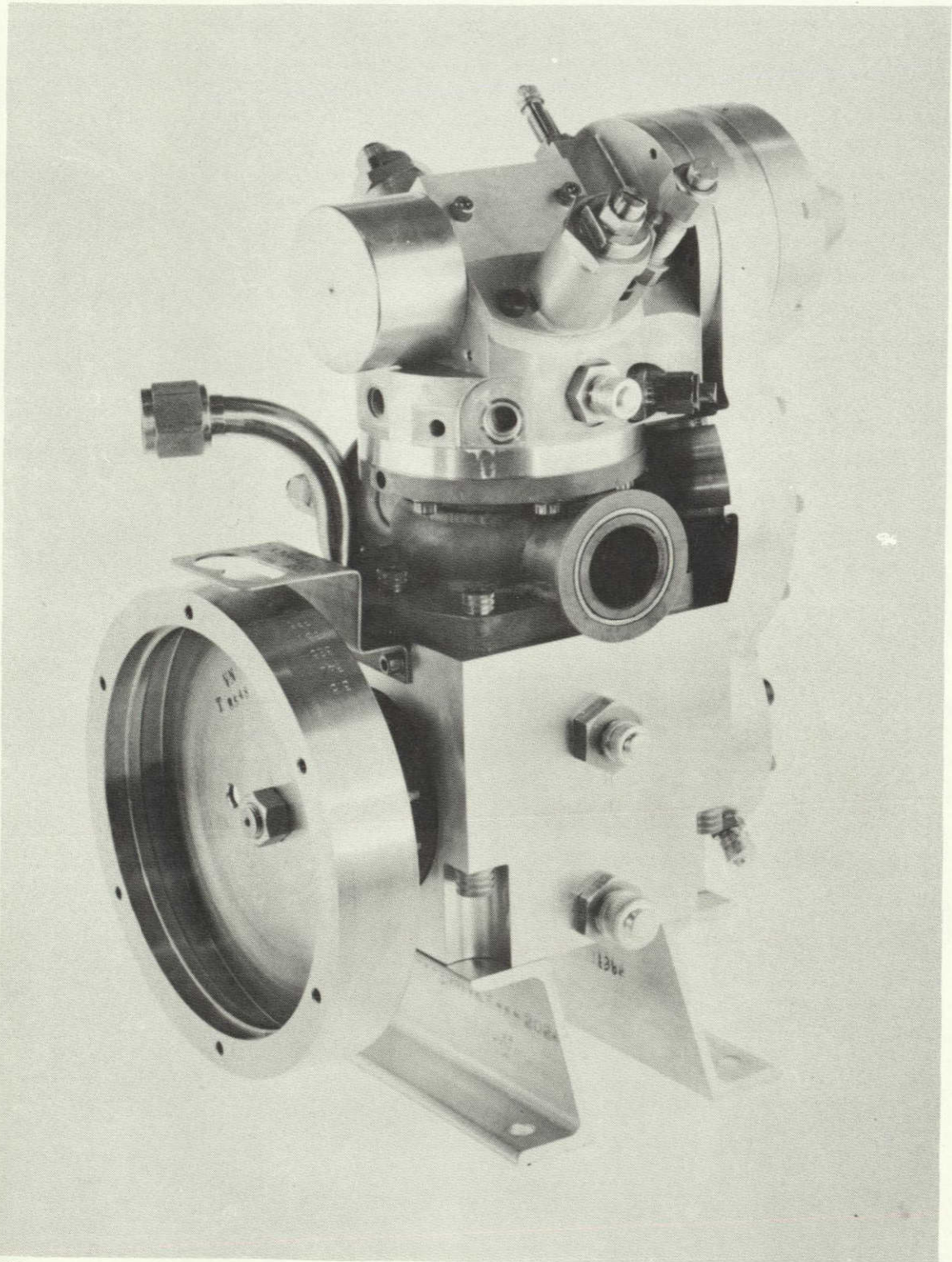

6615-2

FIGURE 6. External Configuration of the SPU-3 Space Power Unit Engine

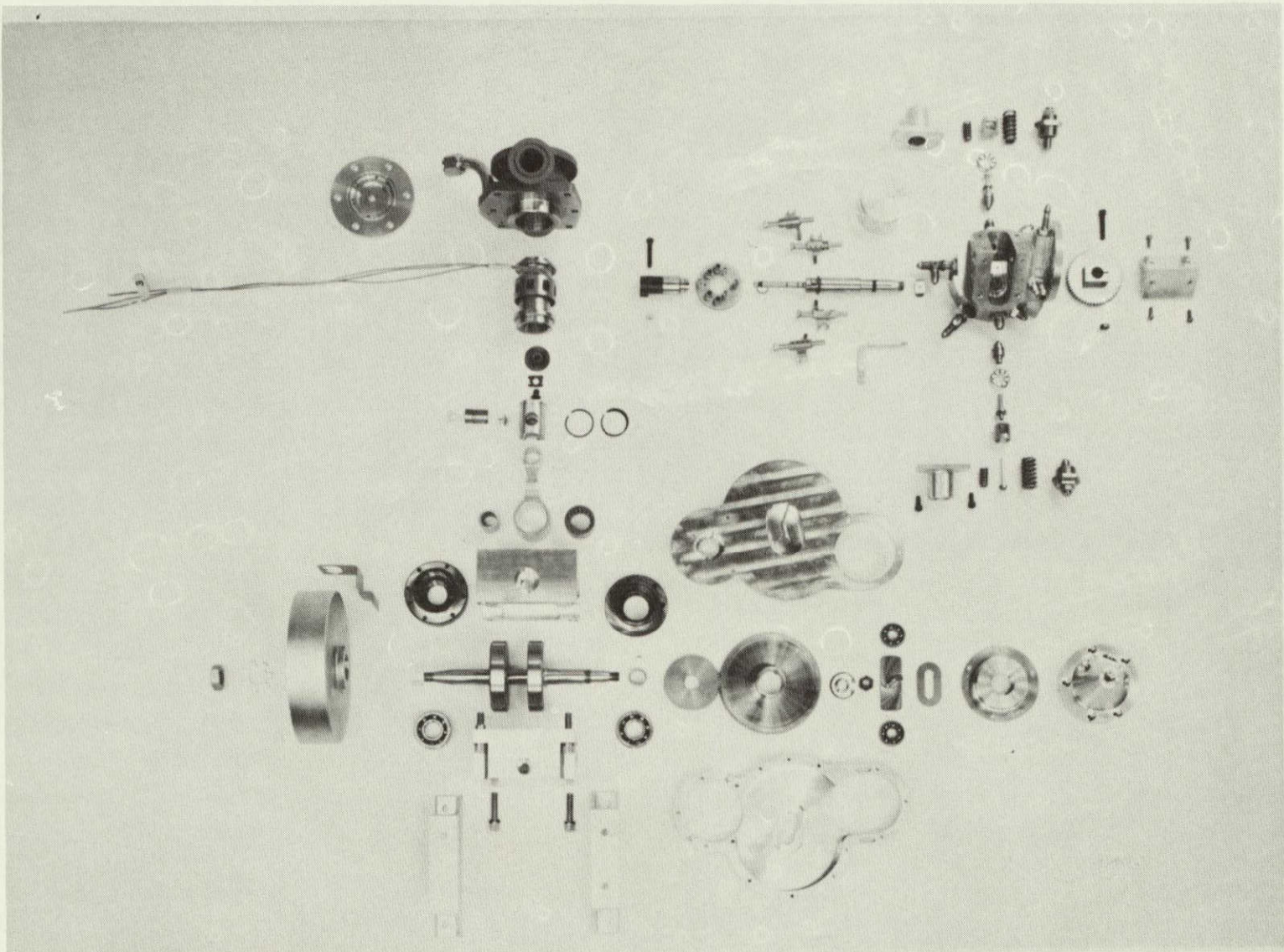

T 5140-15

FIGURE 7. Disassembled View of Components of the SPU-3 Engine

UNCLASSIFIED

Report 6098

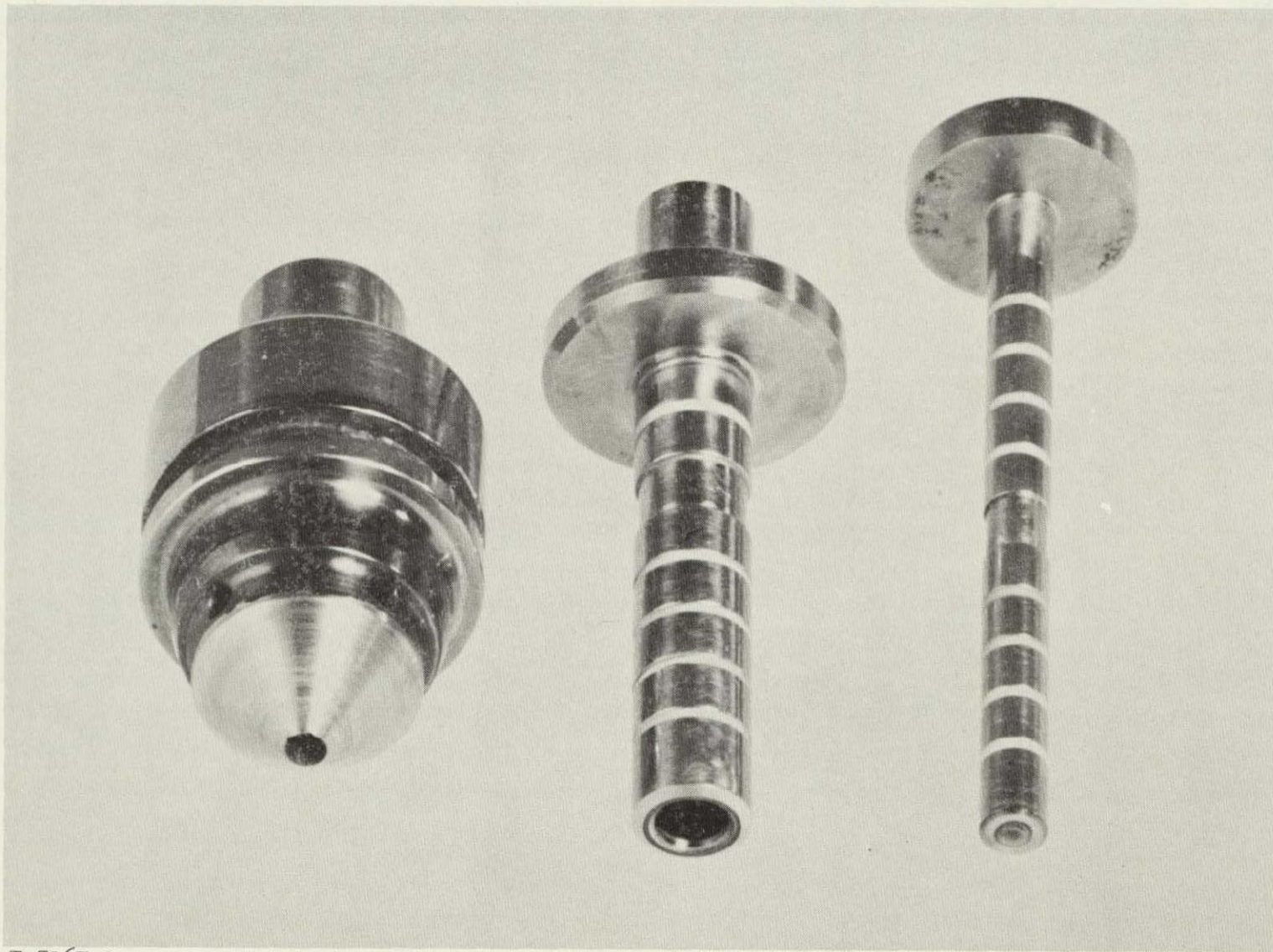

T 5167-9

FIGURE 9. Components of the Dual Poppet, Mono Seat, Short Duration, Injector Valve Used in the SPU-3 Engine, After 90-hour Endurance Test

UNCLASSIFIED

SCHEMATIC OF SHORT DWELL INJECTION SYSTEM FOR THE SPU-3 ENGINE

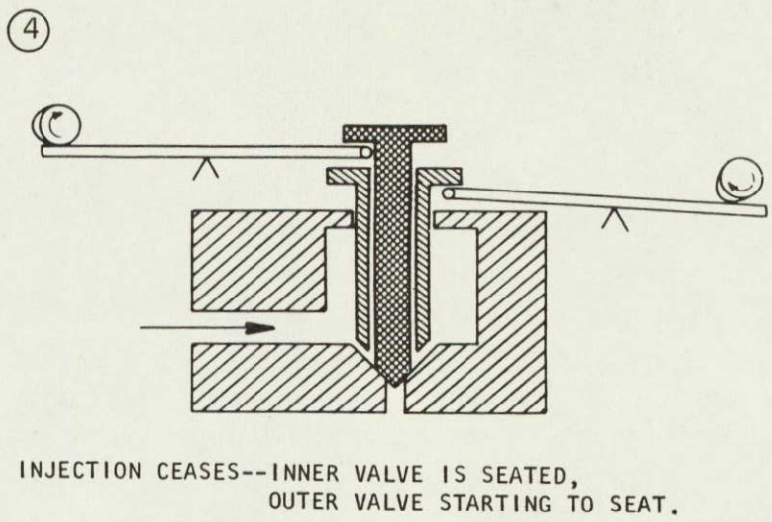
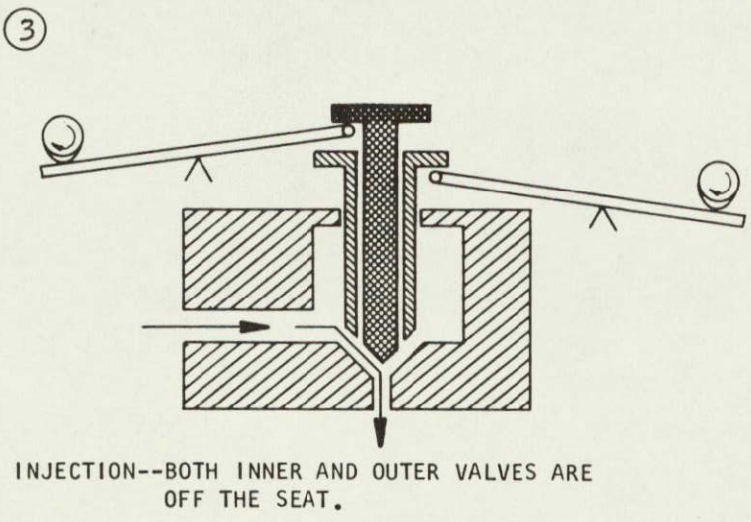
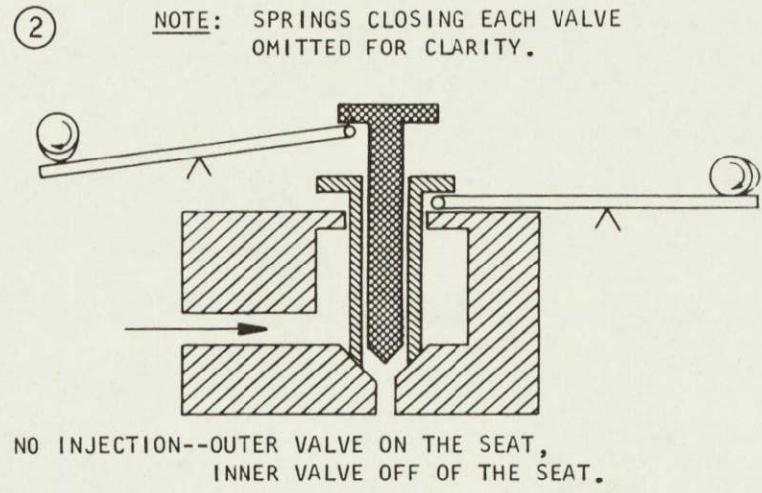
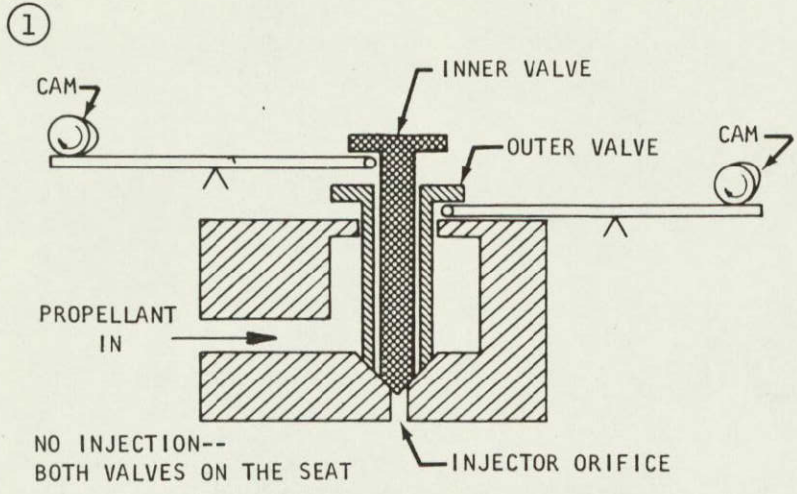

UNCLASSIFIED

FIGURE 10

UNCLASSIFIED

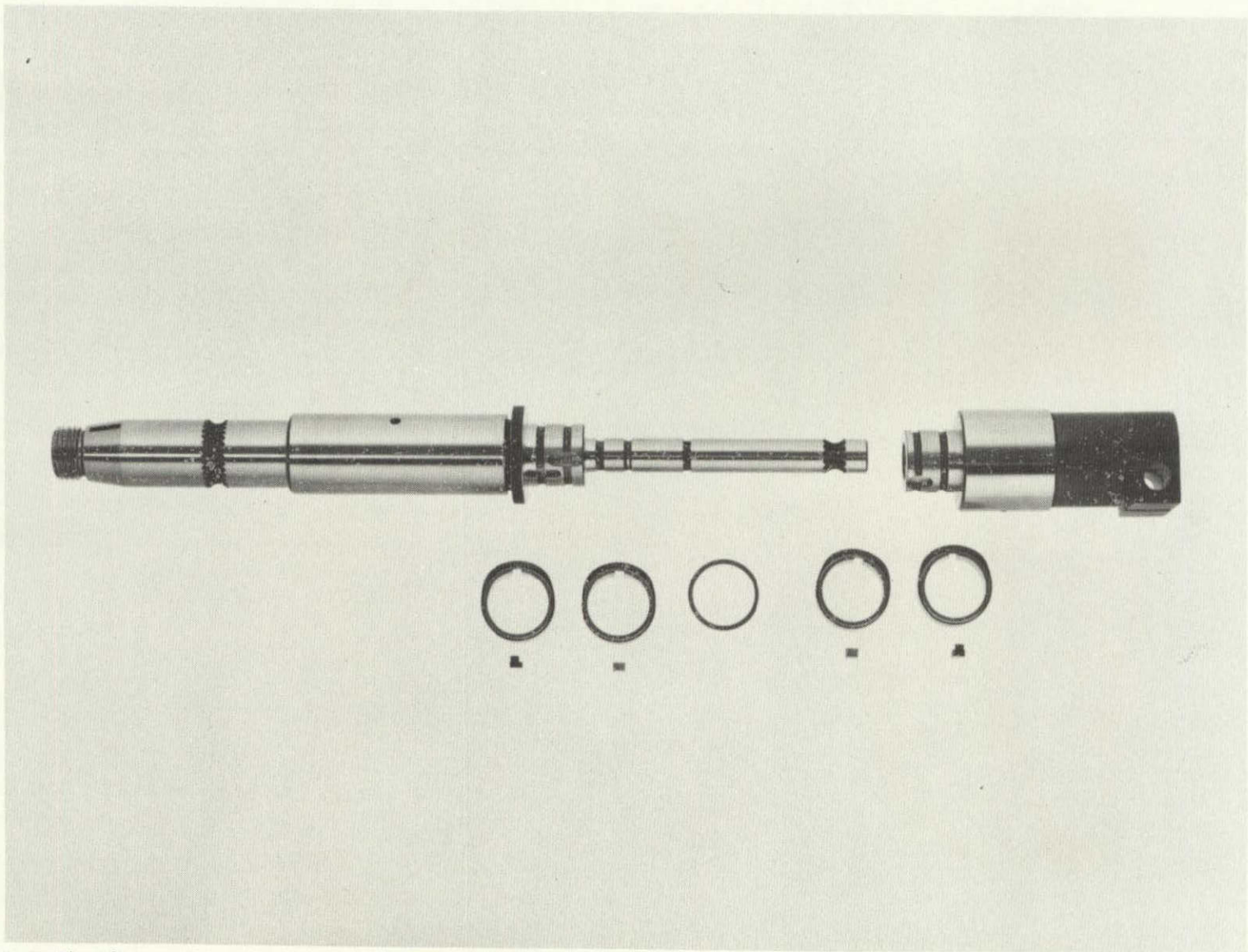

T 5134-18

FIGURE 11. Fully Adjustable Camshaft Assembly for the SPU-3 Engine



T 5151-19

FIGURE 12. Baseline Piston Assembly Used in the SPU-3 Engine,
After Test



T 5151-44

FIGURE 13. Modification 1 Piston Assembly Used in the SPU-3 Engine, After Test

UNCLASSIFIED

Report 6098

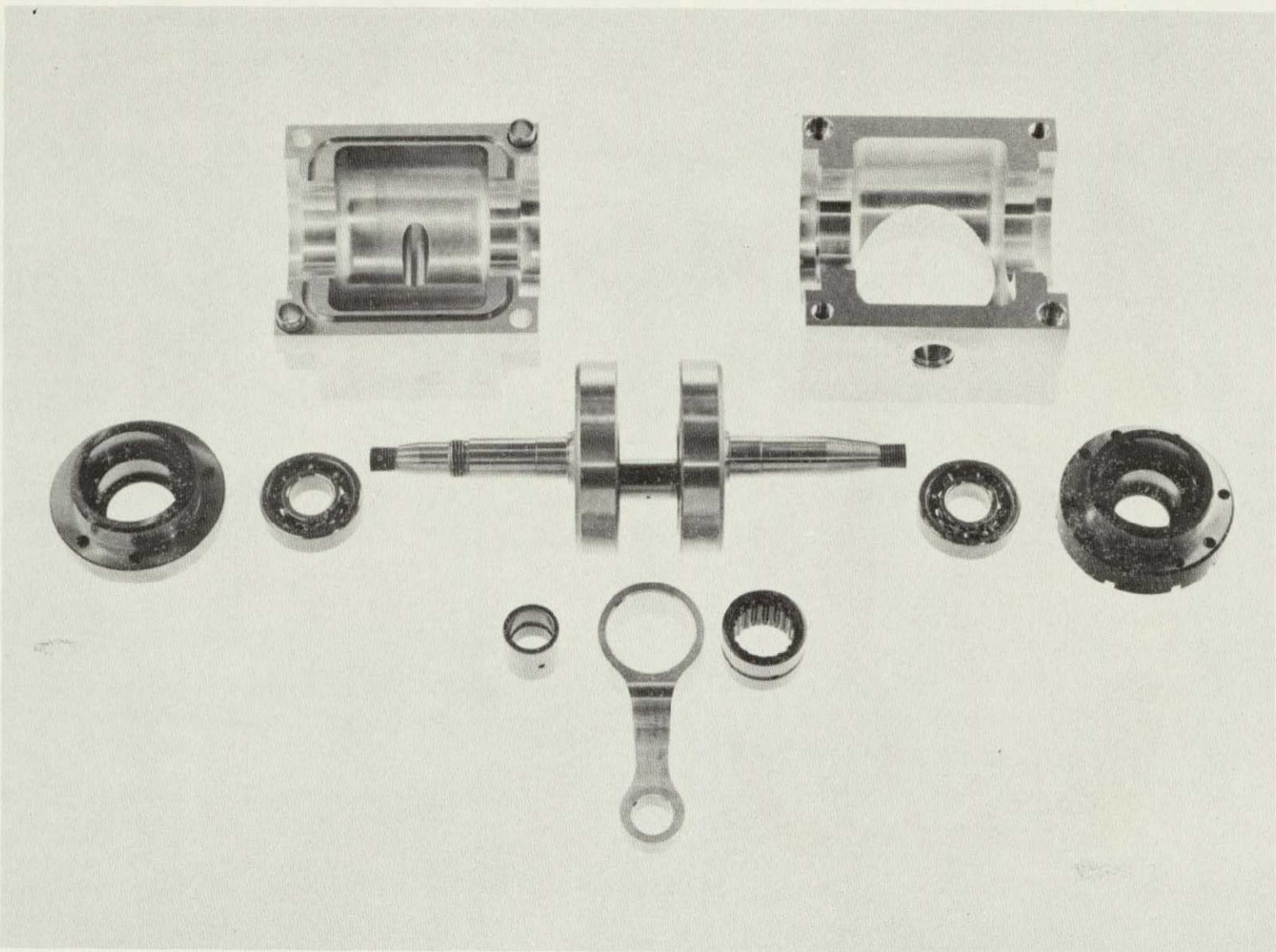

T 5140-17

FIGURE 14. Basic Components of the Crankcase Assembly for the SPU-3 Engine

UNCLASSIFIED

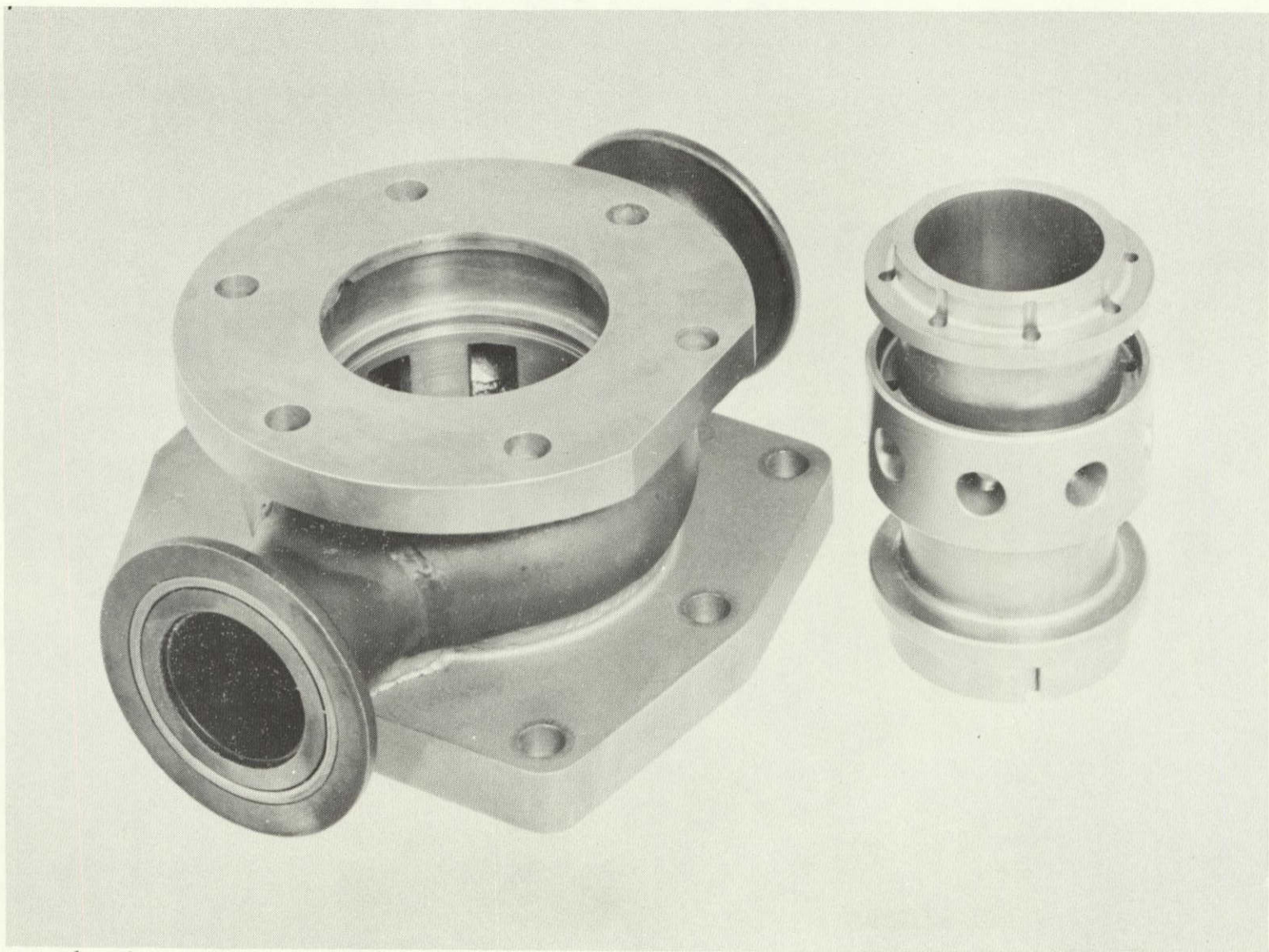

T 5167-16

FIGURE 15. Cylinder Housing and Cylinder Liner for the SPU-3 Engine

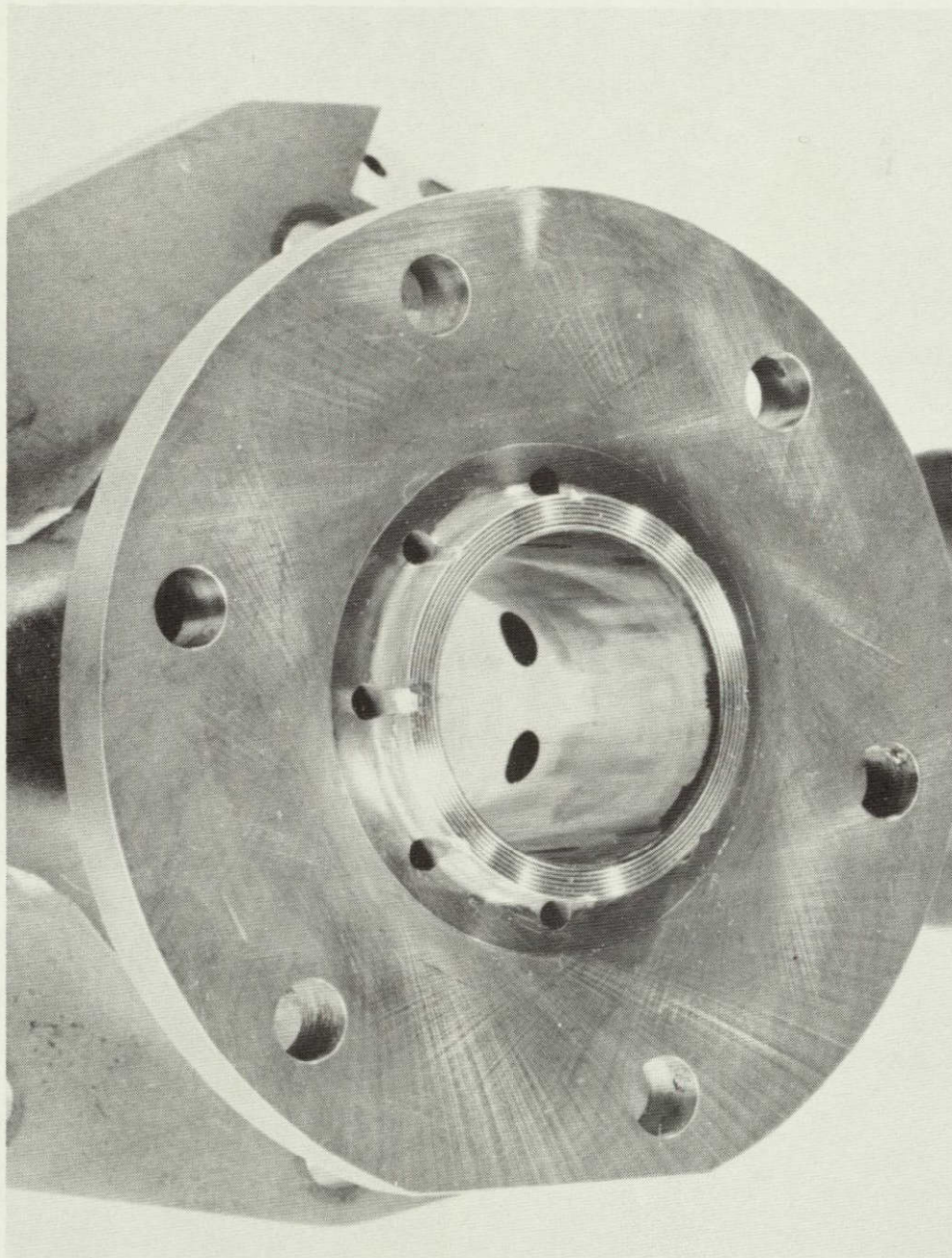

T 5167-12

FIGURE 16. Upper Cylinder Housing Flange for the SPU-3 Engine

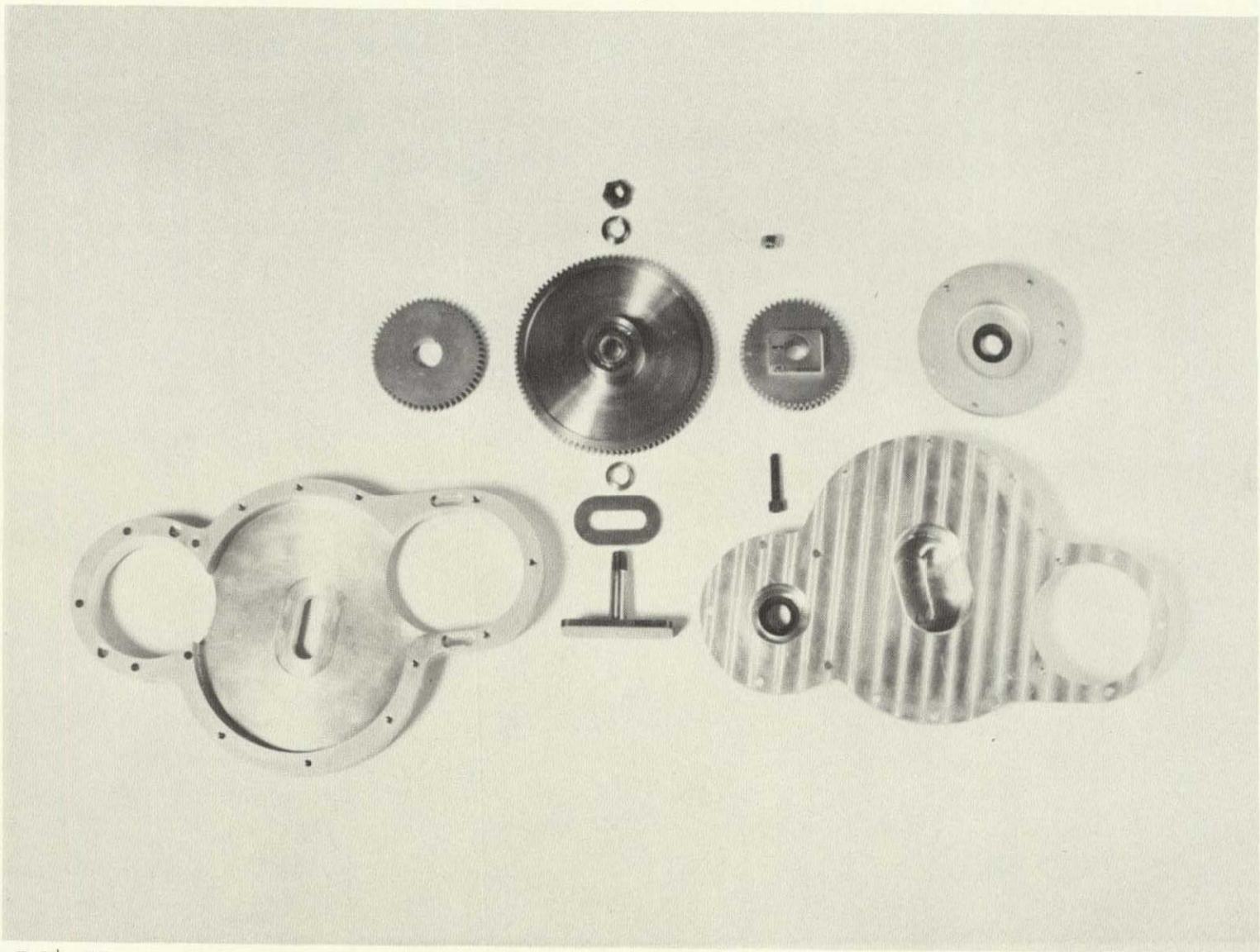

T 5134-17

FIGURE 17. Camshaft Drive Components for the SPU-3 Engine

SCHEMATIC OF PROPELLANT PUMP FOR THE SPU-3 ENGINE

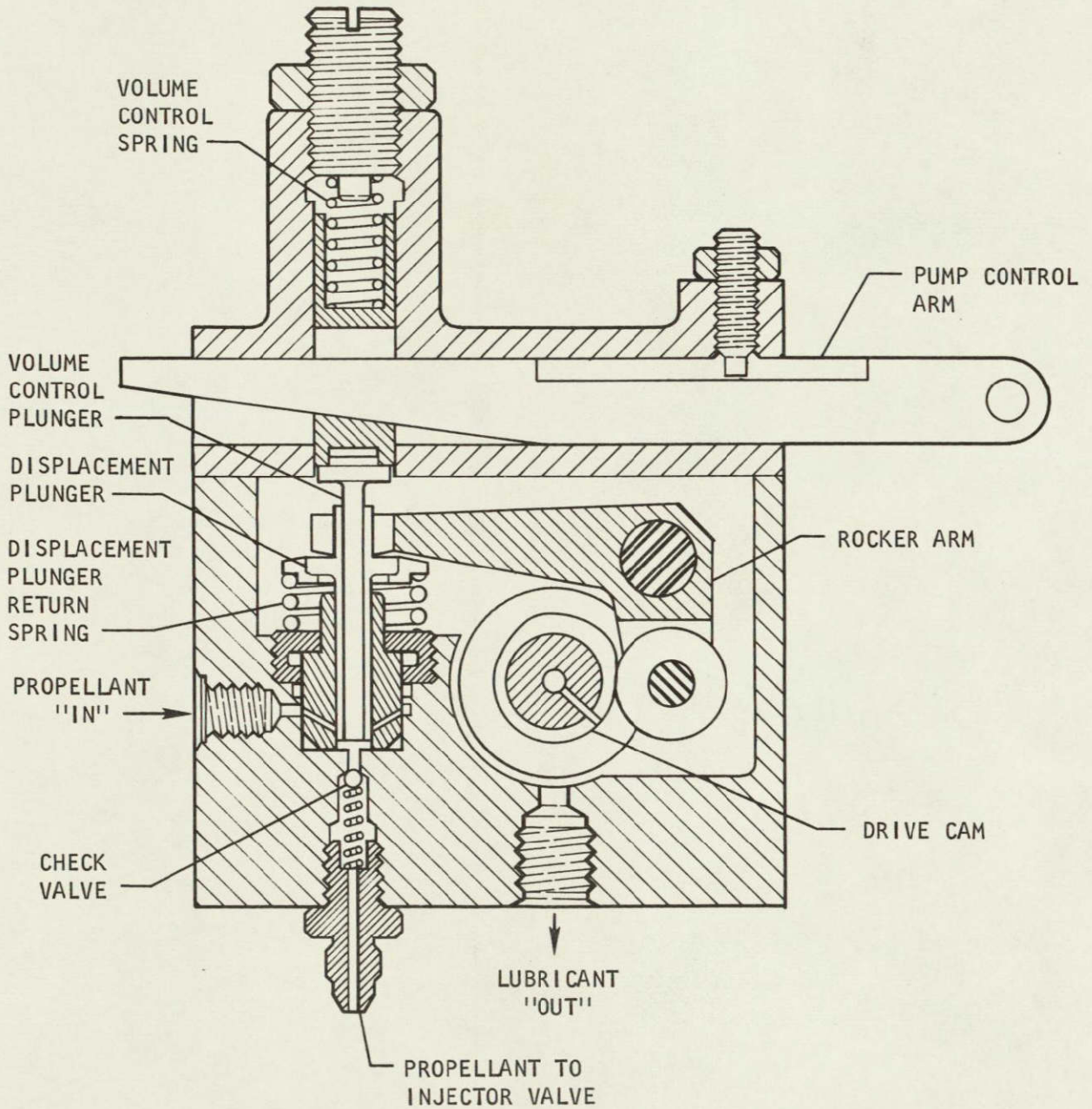
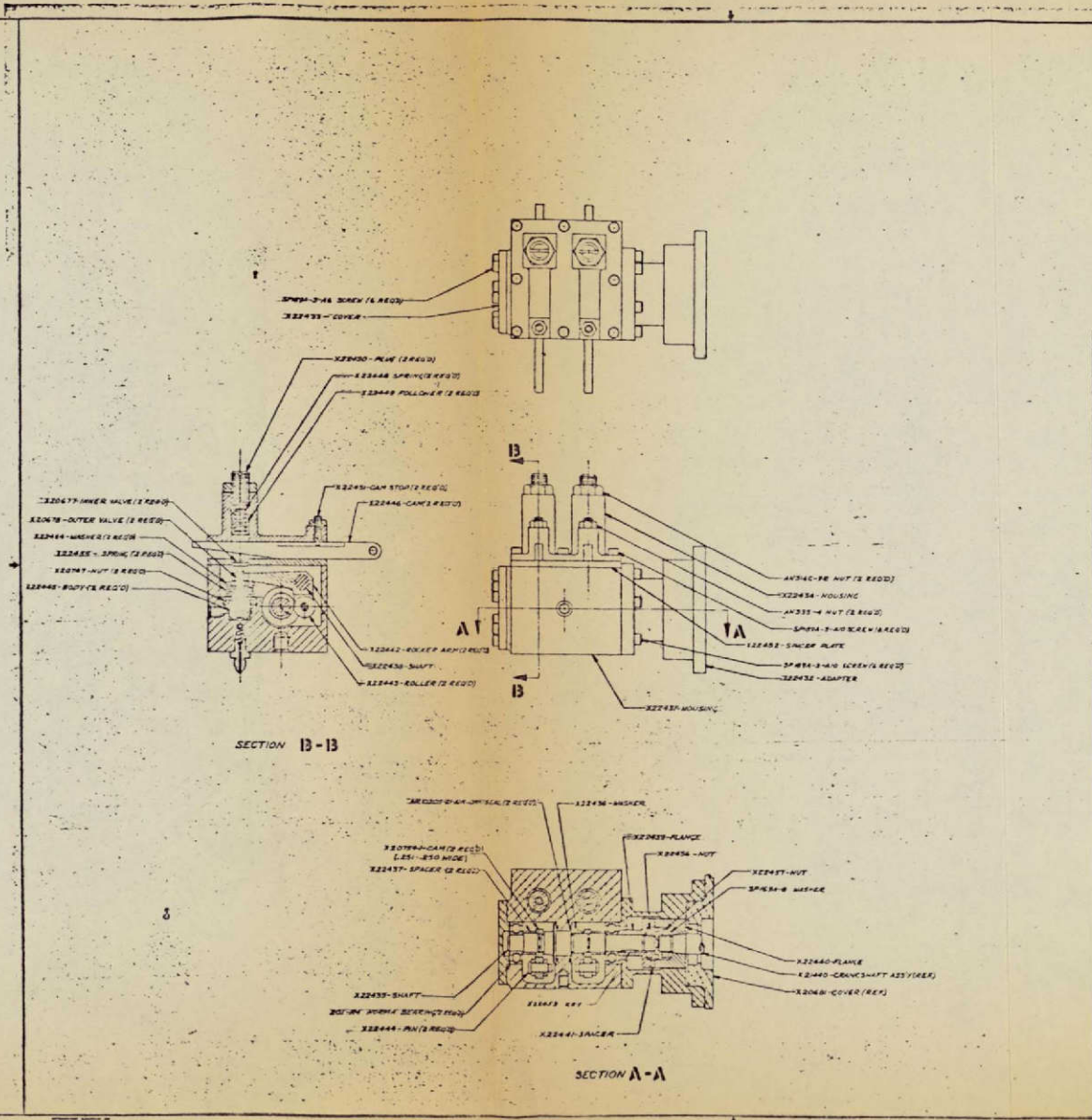
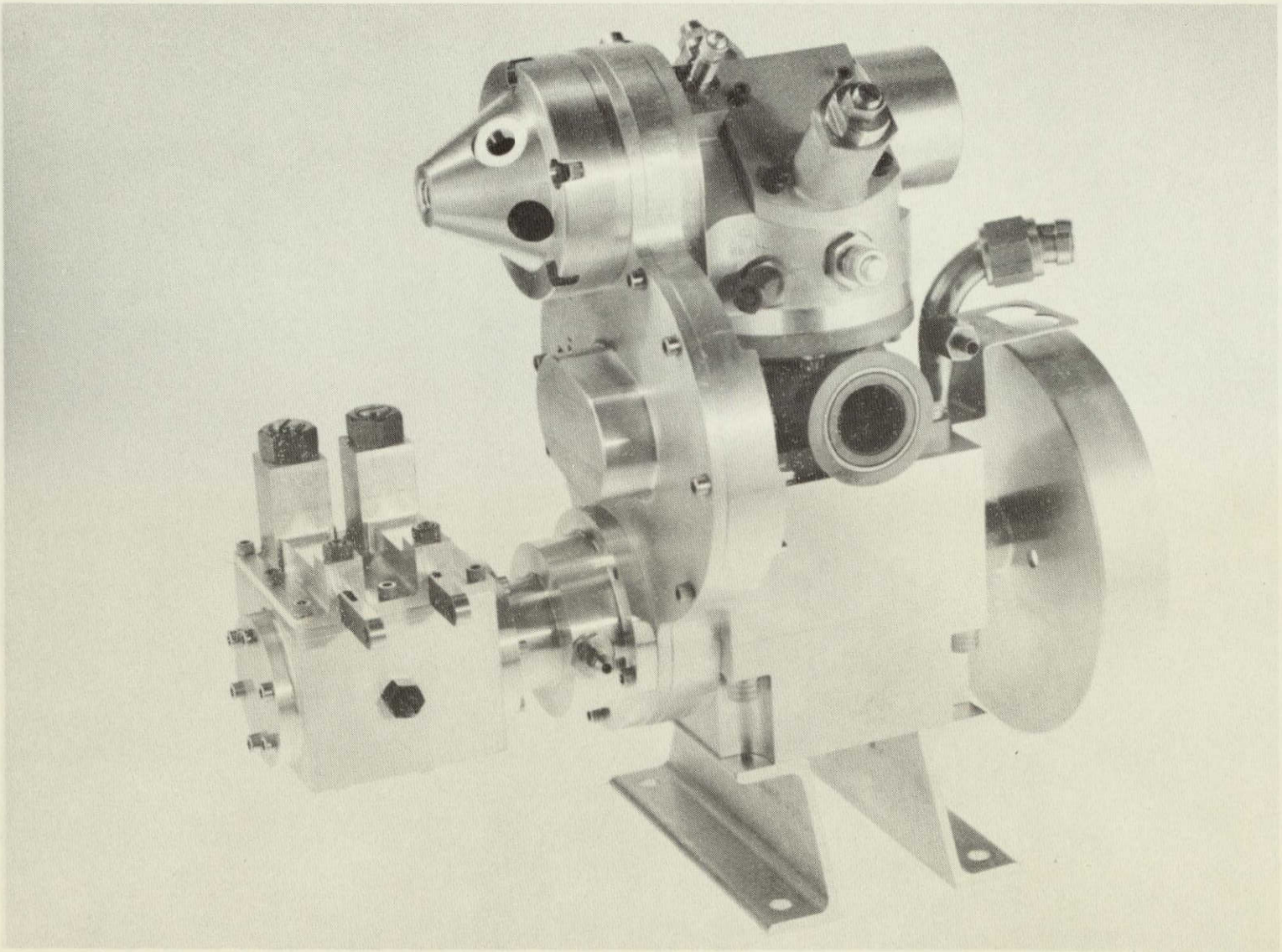

FIGURE 18



QTY	DESCRIPTION	UNIT	REMARKS
1	X22436-PLATE	2 REQD	
1	X22448-FOLLOWER	2 REQD	
1	X22450-CAM	2 REQD	
1	X22446-CAM	2 REQD	
1	X22473-INNER VALVE	2 REQD	
1	X22478-OUTER VALVE	2 REQD	
1	X22444-WASHER	2 REQD	
1	X22455-SPRING	2 REQD	
1	X22477-NUT	2 REQD	
1	X22448-ROD	2 REQD	
1	X22442-ROCKER ARM	2 REQD	
1	X22443-SHAFT		
1	X22445-ROLLER	2 REQD	
1	X22440-FLANGE		
1	X22441-ROCKER ARM	2 REQD	
1	X22442-ROCKER ARM	2 REQD	
1	X22443-SHAFT		
1	X22444-ROD	2 REQD	
1	X22445-ROLLER	2 REQD	
1	X22446-CAM	2 REQD	
1	X22447-NUT	2 REQD	
1	X22448-WASHER	2 REQD	
1	X22449-ROD	2 REQD	
1	X22450-CAM	2 REQD	
1	X22451-NUT	2 REQD	
1	X22452-ROCKER ARM		
1	X22453-ROCKER ARM		
1	X22454-ROCKER ARM		
1	X22455-ROCKER ARM		
1	X22456-ROCKER ARM		
1	X22457-ROCKER ARM		
1	X22458-ROCKER ARM		
1	X22459-ROCKER ARM		
1	X22460-ROCKER ARM		
1	X22461-ROCKER ARM		
1	X22462-ROCKER ARM		
1	X22463-ROCKER ARM		
1	X22464-ROCKER ARM		
1	X22465-ROCKER ARM		
1	X22466-ROCKER ARM		
1	X22467-ROCKER ARM		
1	X22468-ROCKER ARM		
1	X22469-ROCKER ARM		
1	X22470-ROCKER ARM		
1	X22471-ROCKER ARM		
1	X22472-ROCKER ARM		
1	X22473-ROCKER ARM		
1	X22474-ROCKER ARM		
1	X22475-ROCKER ARM		
1	X22476-ROCKER ARM		
1	X22477-ROCKER ARM		
1	X22478-ROCKER ARM		
1	X22479-ROCKER ARM		
1	X22480-ROCKER ARM		
1	X22481-ROCKER ARM		
1	X22482-ROCKER ARM		
1	X22483-ROCKER ARM		
1	X22484-ROCKER ARM		
1	X22485-ROCKER ARM		
1	X22486-ROCKER ARM		
1	X22487-ROCKER ARM		
1	X22488-ROCKER ARM		
1	X22489-ROCKER ARM		
1	X22490-ROCKER ARM		
1	X22491-ROCKER ARM		
1	X22492-ROCKER ARM		
1	X22493-ROCKER ARM		
1	X22494-ROCKER ARM		
1	X22495-ROCKER ARM		
1	X22496-ROCKER ARM		
1	X22497-ROCKER ARM		
1	X22498-ROCKER ARM		
1	X22499-ROCKER ARM		
1	X22500-ROCKER ARM		



T 5140-24

FIGURE 20. View of the SPU-3 Engine with Propellant Injection Pump Installed

BASIC INJECTOR VALVE CONFIGURATIONS TESTED WITH THE SPU-3 ENGINE

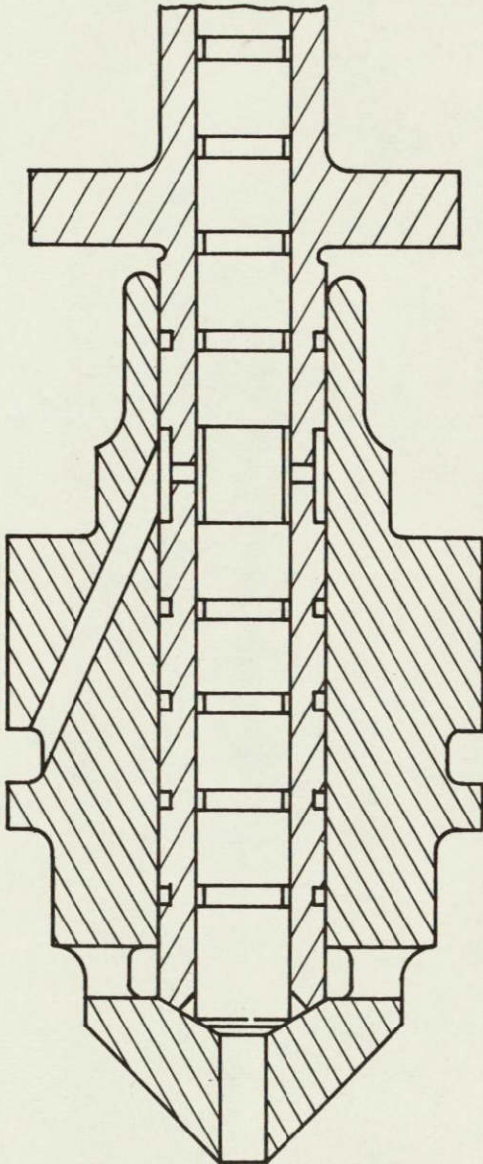

CONICAL SEAT VALVE

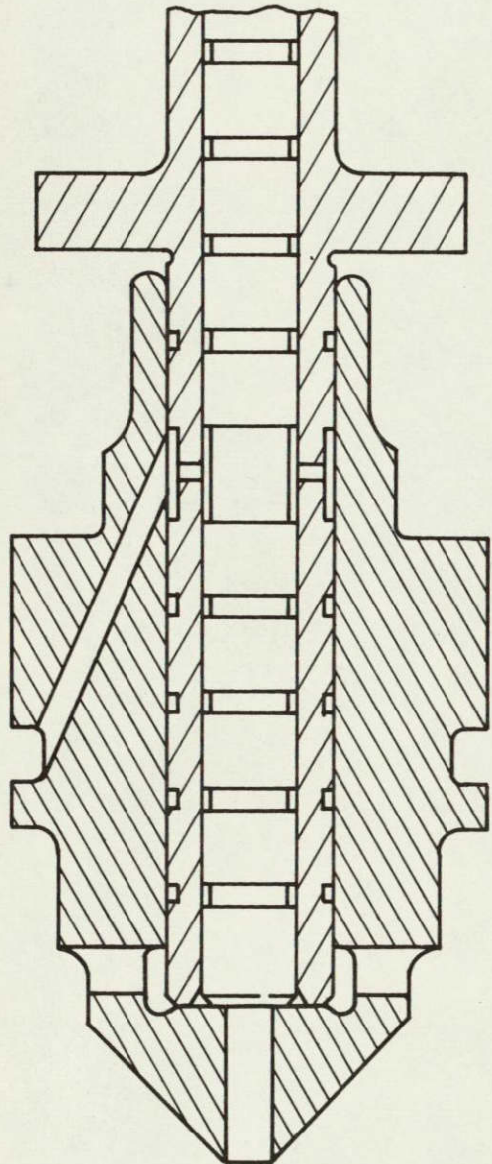

FLAT SEAT VALVE

UNCLASSIFIED

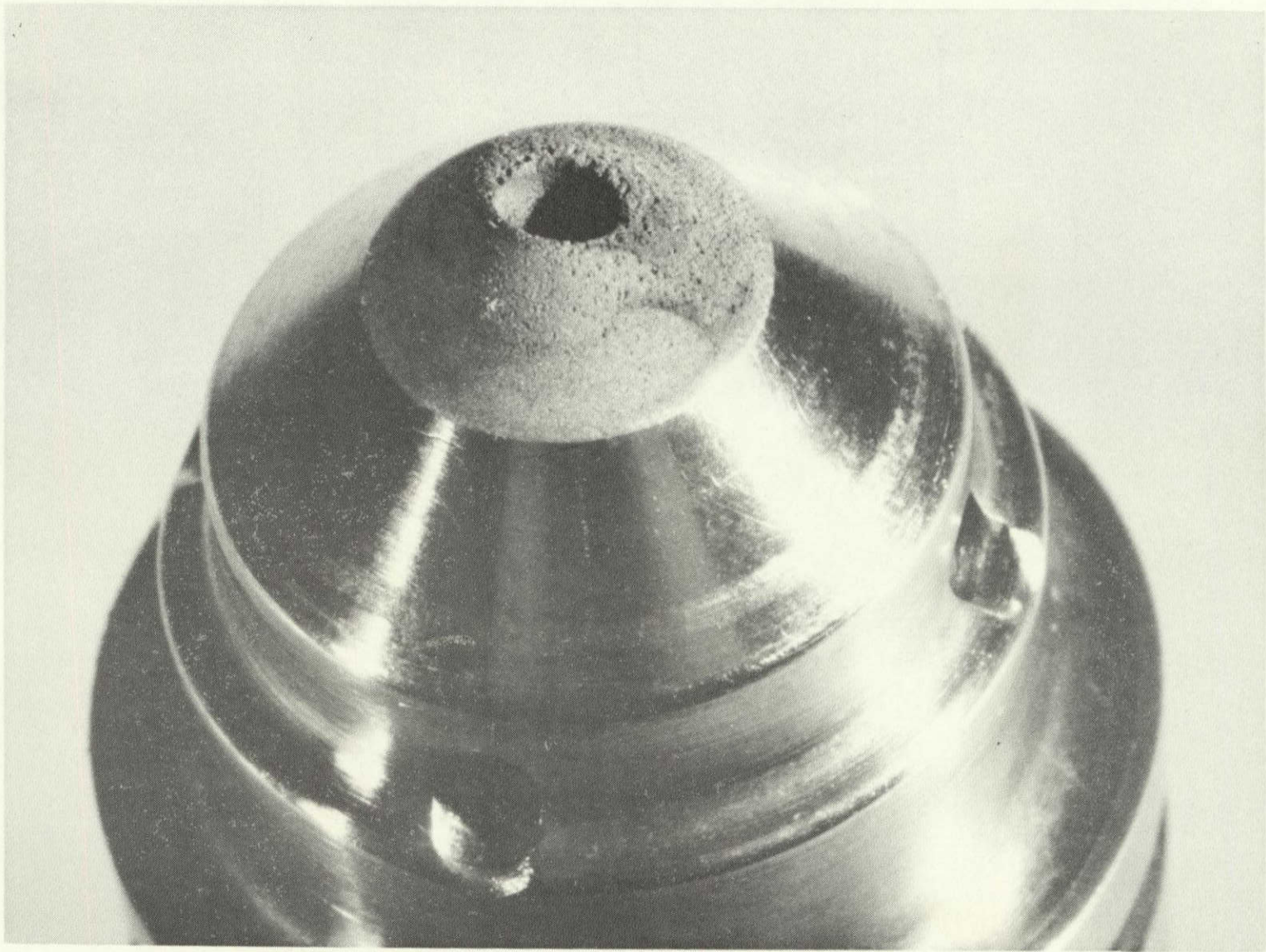

T 5151-4

FIGURE 22. Fuel Injector Valve Housing after Test 5151-4 with the SPU-3 Engine

UNCLASSIFIED

UNCLASSIFIED

Report 6098

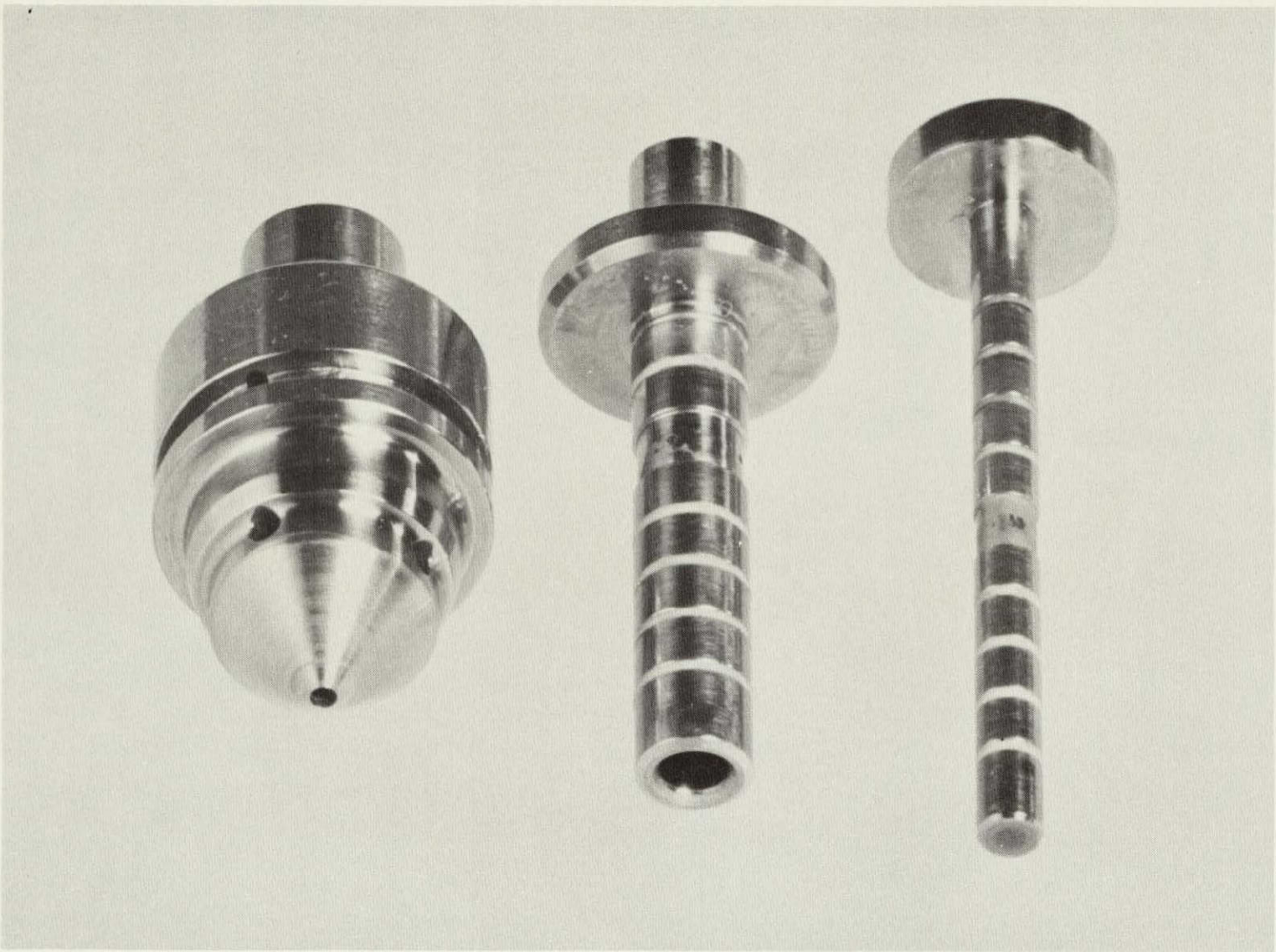

T 5167-8

FIGURE 23. Fuel Injector Valve Components after 90-hour Endurance Test with the SPU-3 Engine

UNCLASSIFIED

UNCLASSIFIED

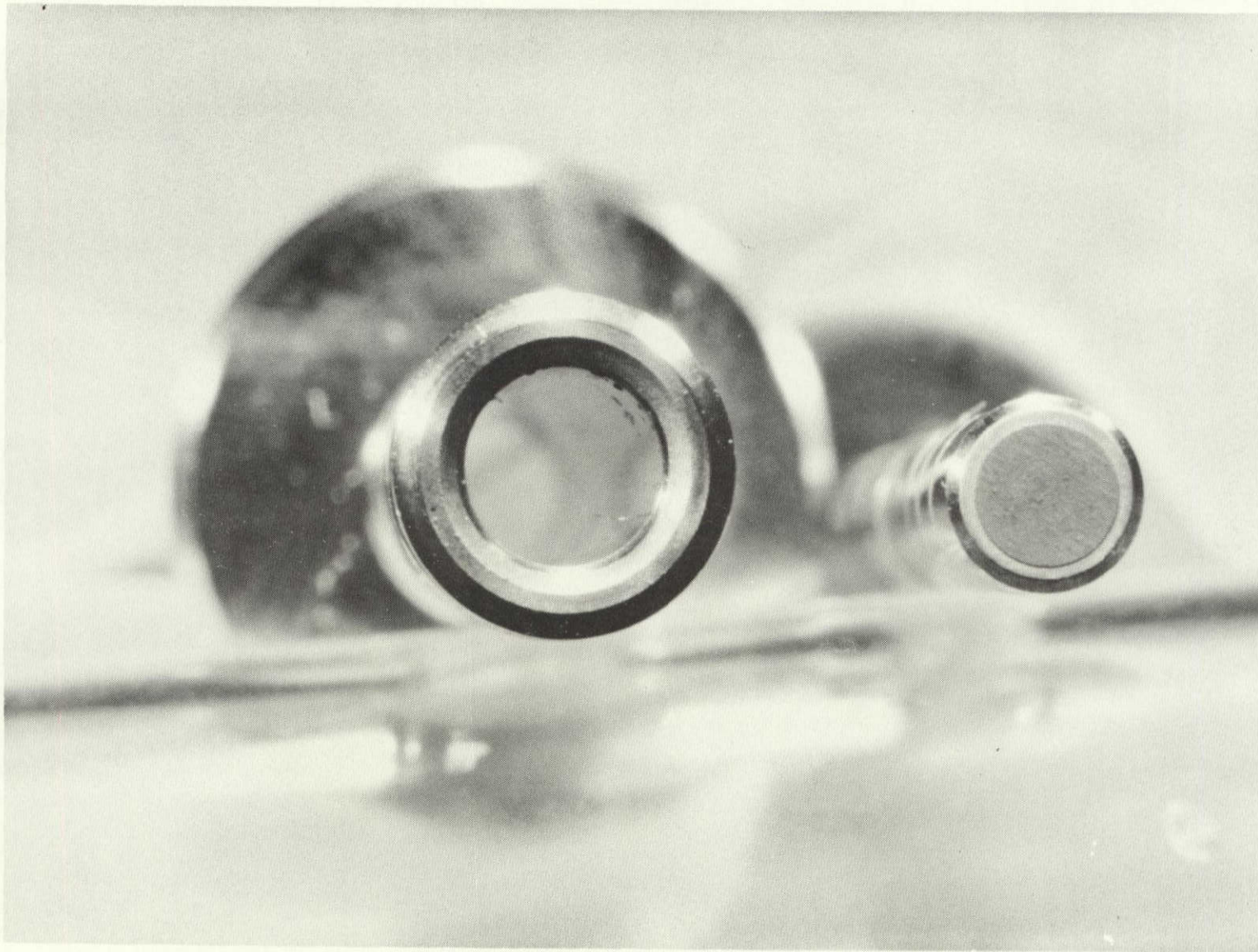

T 5167-6

FIGURE 24. Inner and Outer Fuel Injector Valve Seats after 90-hour Endurance Test with the SPU-3 Engine

UNCLASSIFIED

UNCLASSIFIED

THE
Margardt
CORPORATION

VAN NUYS, CALIFORNIA

Report 6098

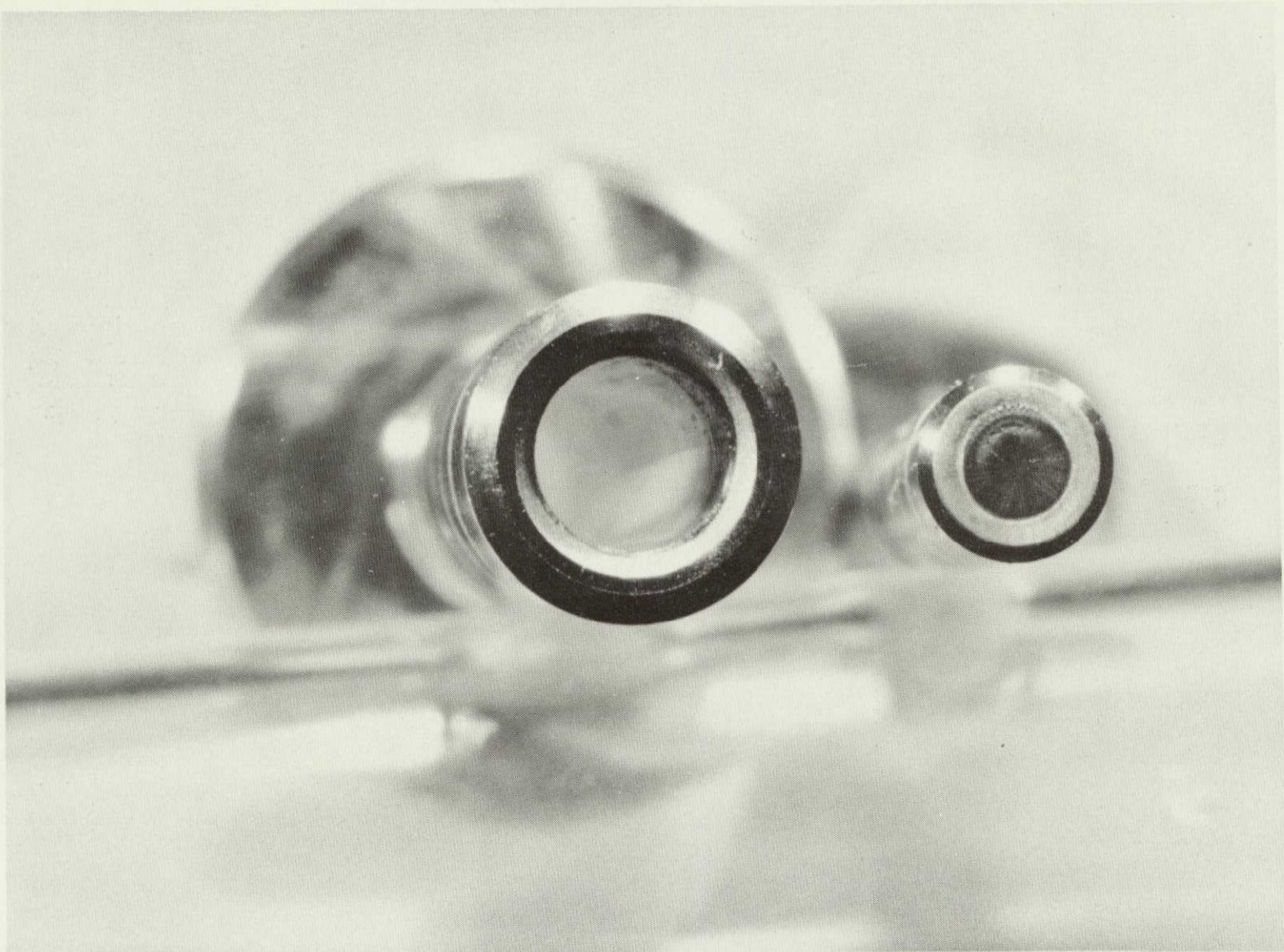

T 5167-7

FIGURE 25. Inner and Outer Oxidizer Injector Valve Seats after 90-hour Endurance Test with the SPU-3 Engine

UNCLASSIFIED

- 137 -

PISTON CONFIGURATIONS USED IN SPU ENGINE TESTS

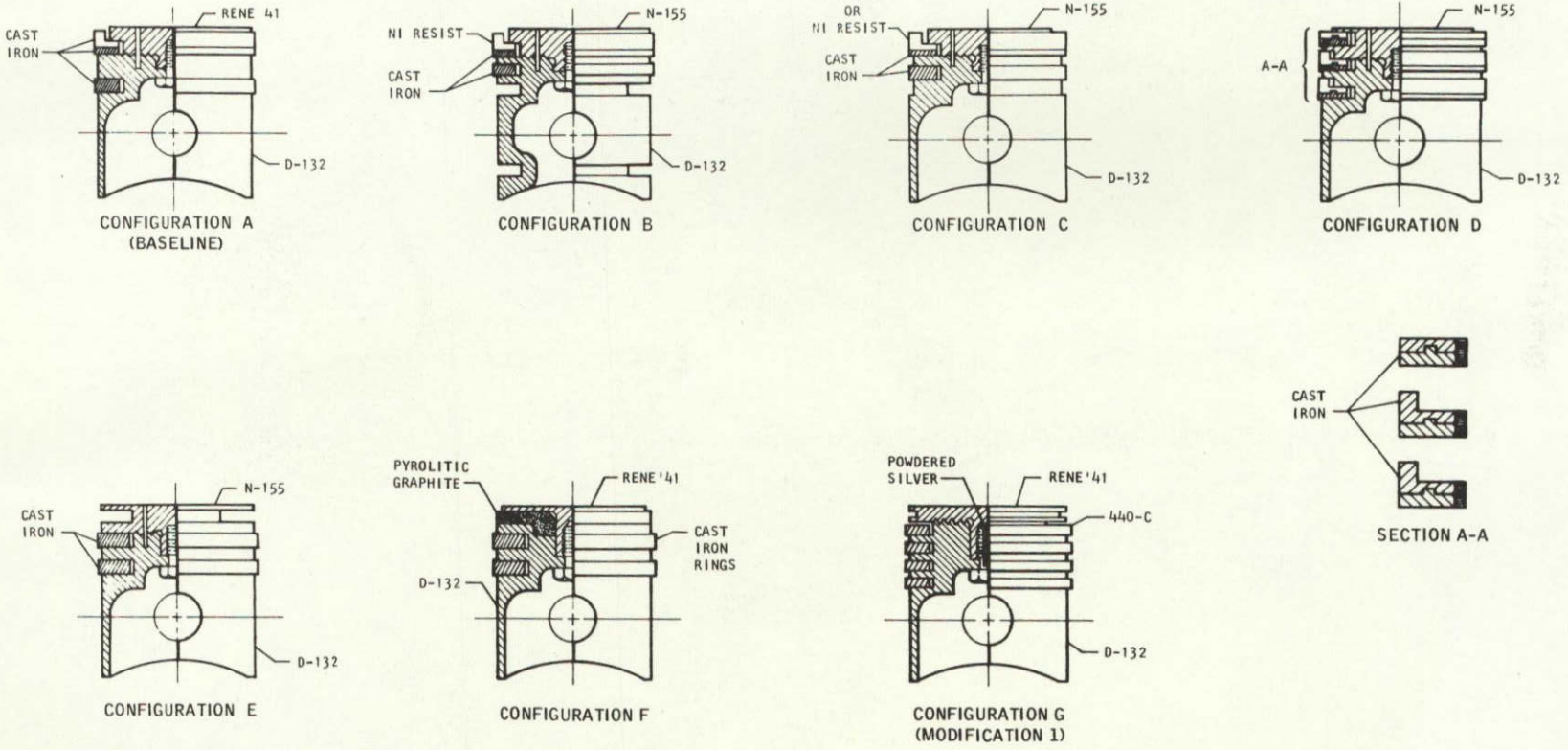

287 - 87A

UNCLASSIFIED
- 138 -

FIGURE 26

UNCLASSIFIED



T 5140-21

FIGURE 27. Configuration C Piston after Operation for 4.76 hours in the SPJ-2A-2 Engine



T 5140-22

FIGURE 28. Configuration C Piston after Operation for 4.76 hours
in the SPJ-2A-2 Engine

UNCLASSIFIED



T 5149-11

FIGURE 29. Configuration D Piston after Operation for 17 minutes in the SPU-2A-3 Engine

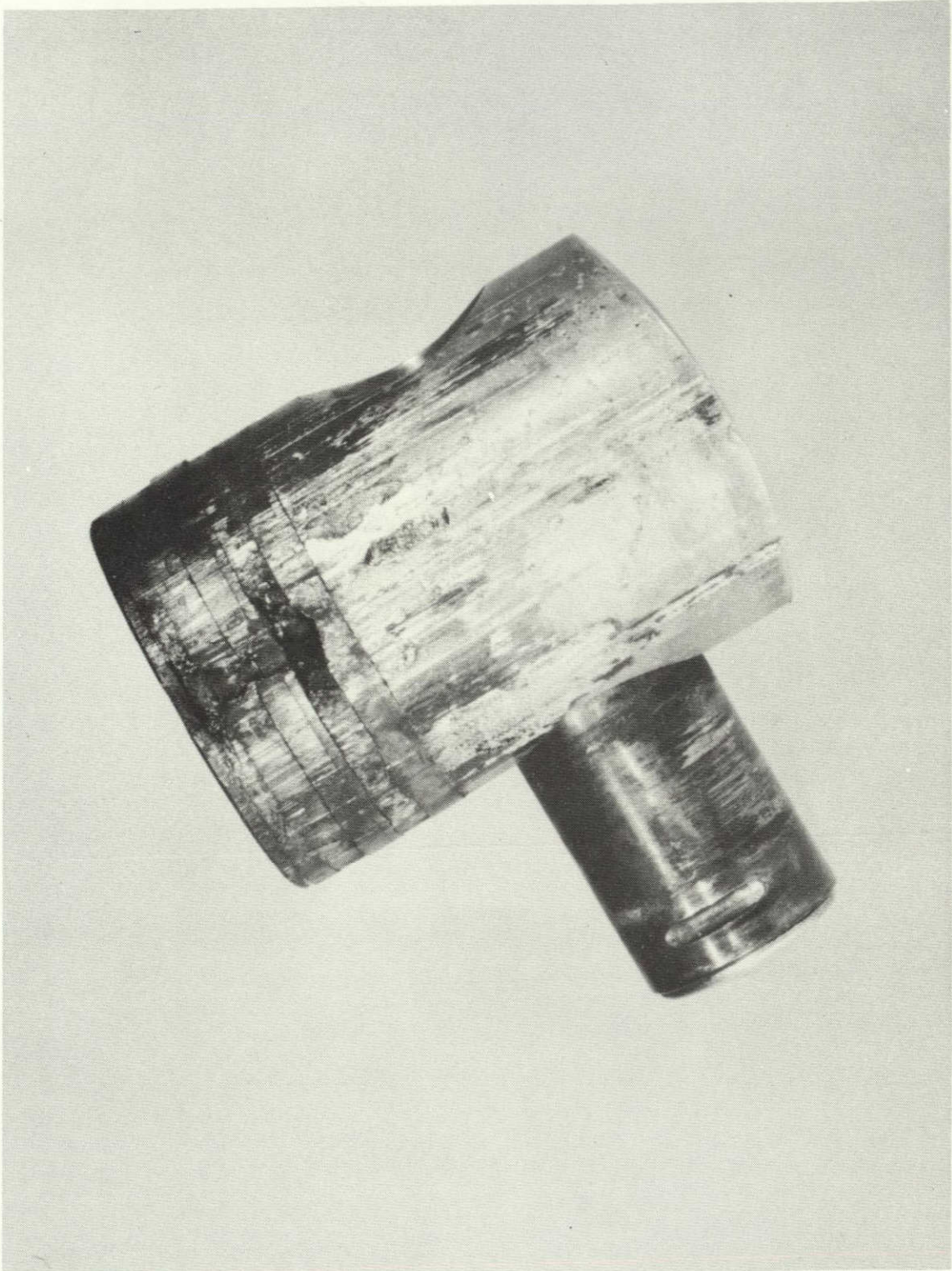

T 5151-2

FIGURE 30. Configuration D Piston after Operation for 9.75 hours
in the SPU-3 Engine.



T 5151-10

FIGURE 31. Insulated Crown Piston Configuration F after
Operation for 0.3 hour



T 5151-42

FIGURE 32. Piston Assembly with 440-C CRES Rings after
46-hour Endurance Test

UNCLASSIFIED

Report 6098



T 5151-45

FIGURE 33. Modification 1 Piston Assembly after a Test Run

UNCLASSIFIED



T 5167-1

FIGURE 34. Modification 1 Piston Assembly after Test 5167/5



T 5167-2

FIGURE 35. Modification 1 Piston Assembly after Test 5167/5



T 5167-5

FIGURE 36. Modification 1 Piston Assembly after 90-hour Endurance Test

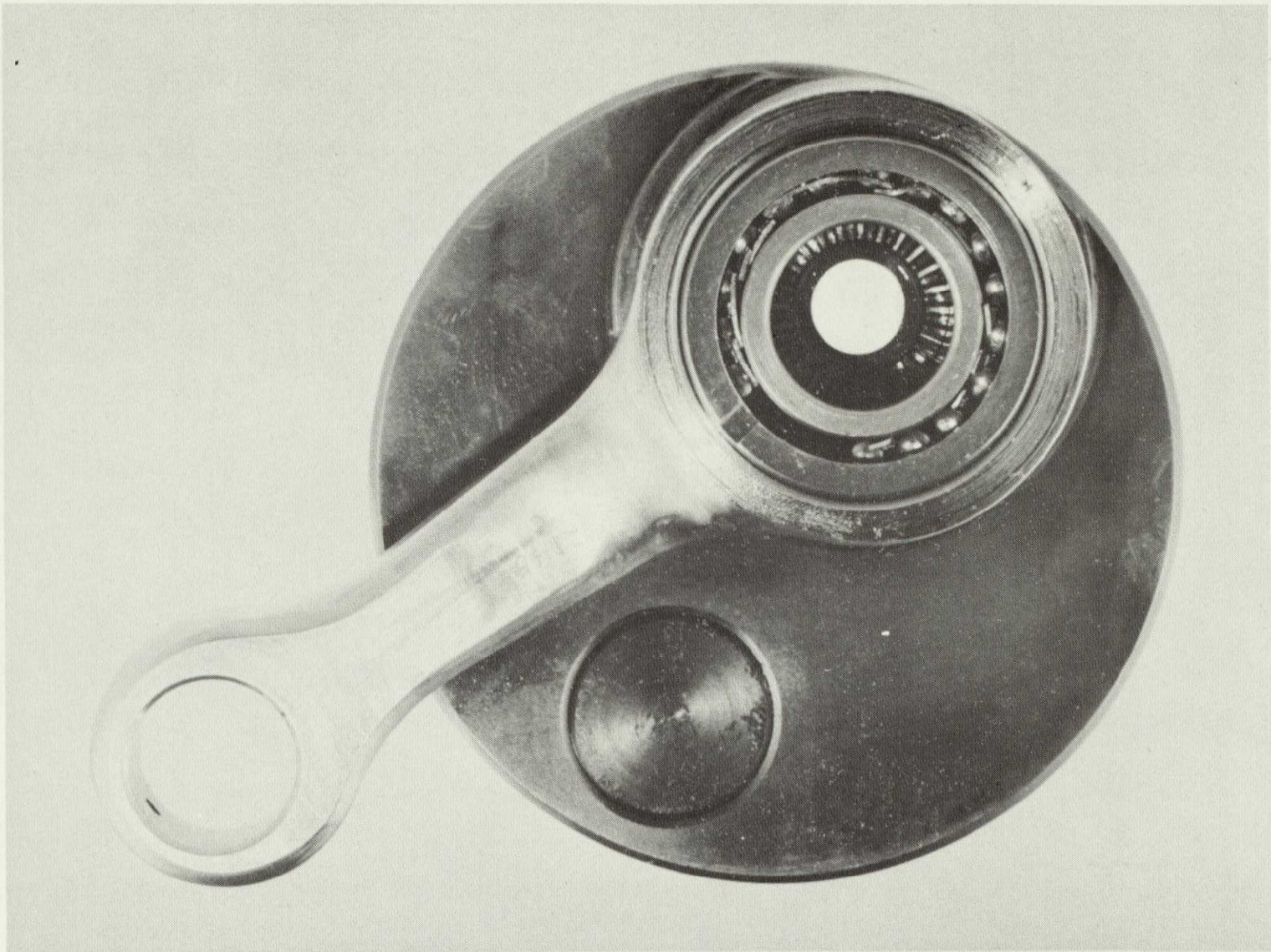

T 5151-16

FIGURE 37. SPU-3 Connecting Rod Assembly after Test 5151/12/2 Showing Failure of Cage Type Roller Bearing

DESIGN CHANGES IN SPRING BRIDGE OF INJECTOR
VALVE ACTUATING MECHANISM

INITIAL DESIGN

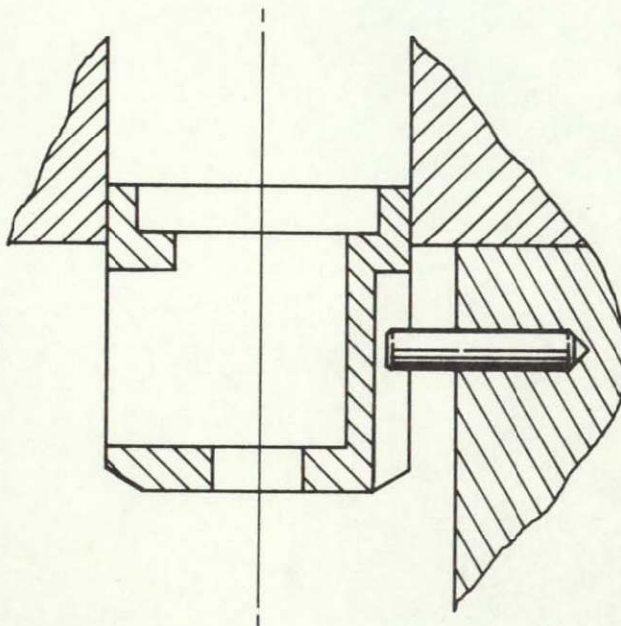

REVISED DESIGN

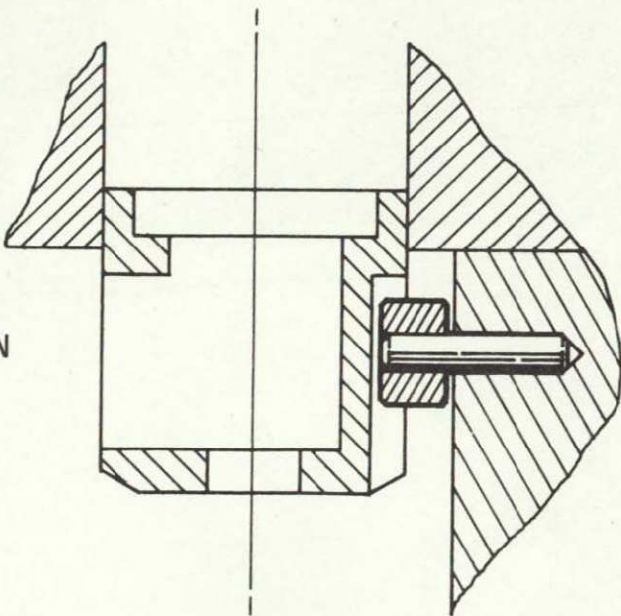

FIGURE 38

SPU-3 ENGINE
DETAIL OF HIGH PRESSURE GAS SEAL FOR COMBUSTION CHAMBER

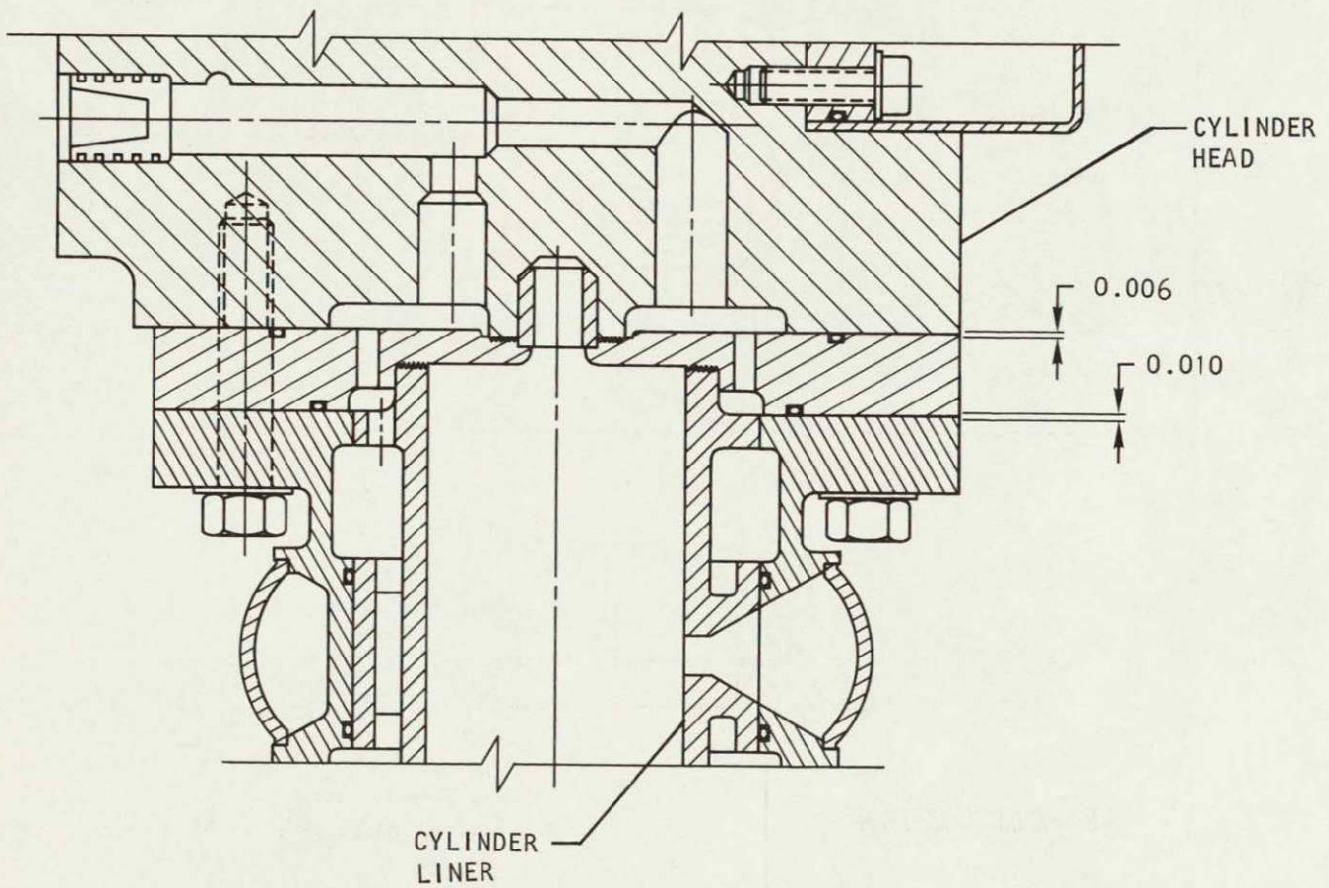

FIGURE 39

LUBRICATING OIL TEST
WEIGHT LOSS VS. TEMPERATURE

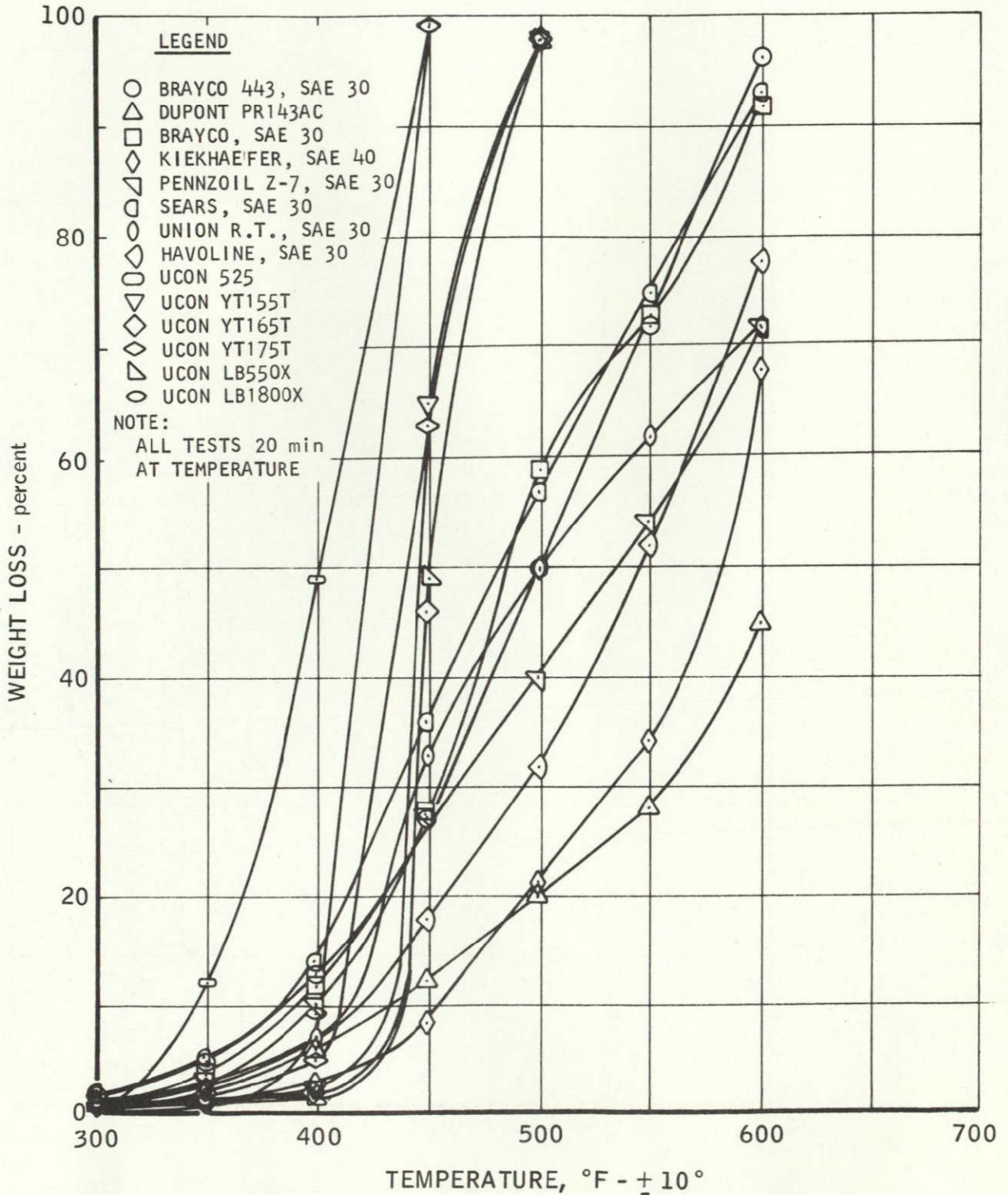
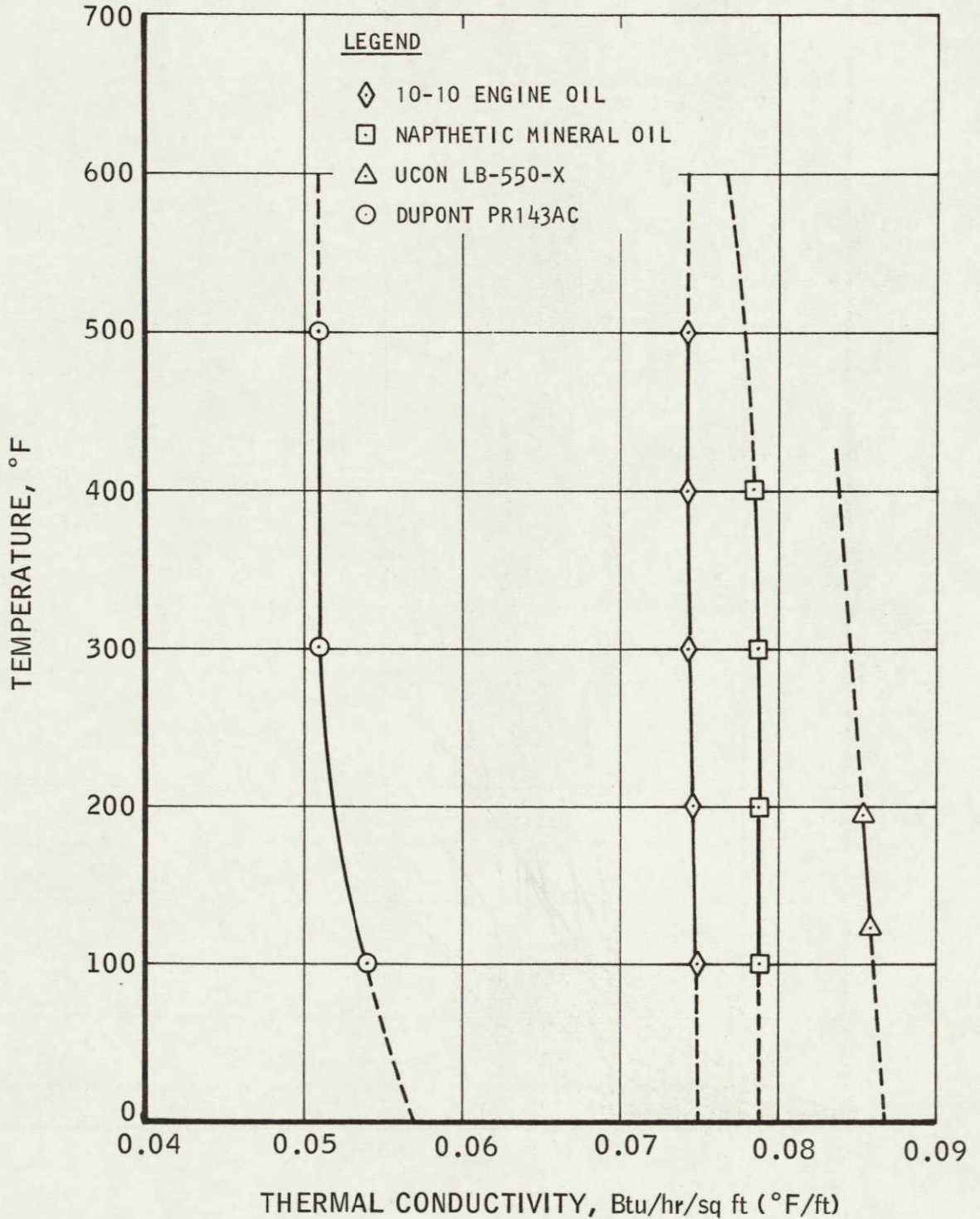

FIGURE 40

THERMAL CONDUCTIVITY OF LUBRICANTS



SPU-3 ENGINE
VARIATION OF HEAT REJECTION WITH ENGINE SPEED

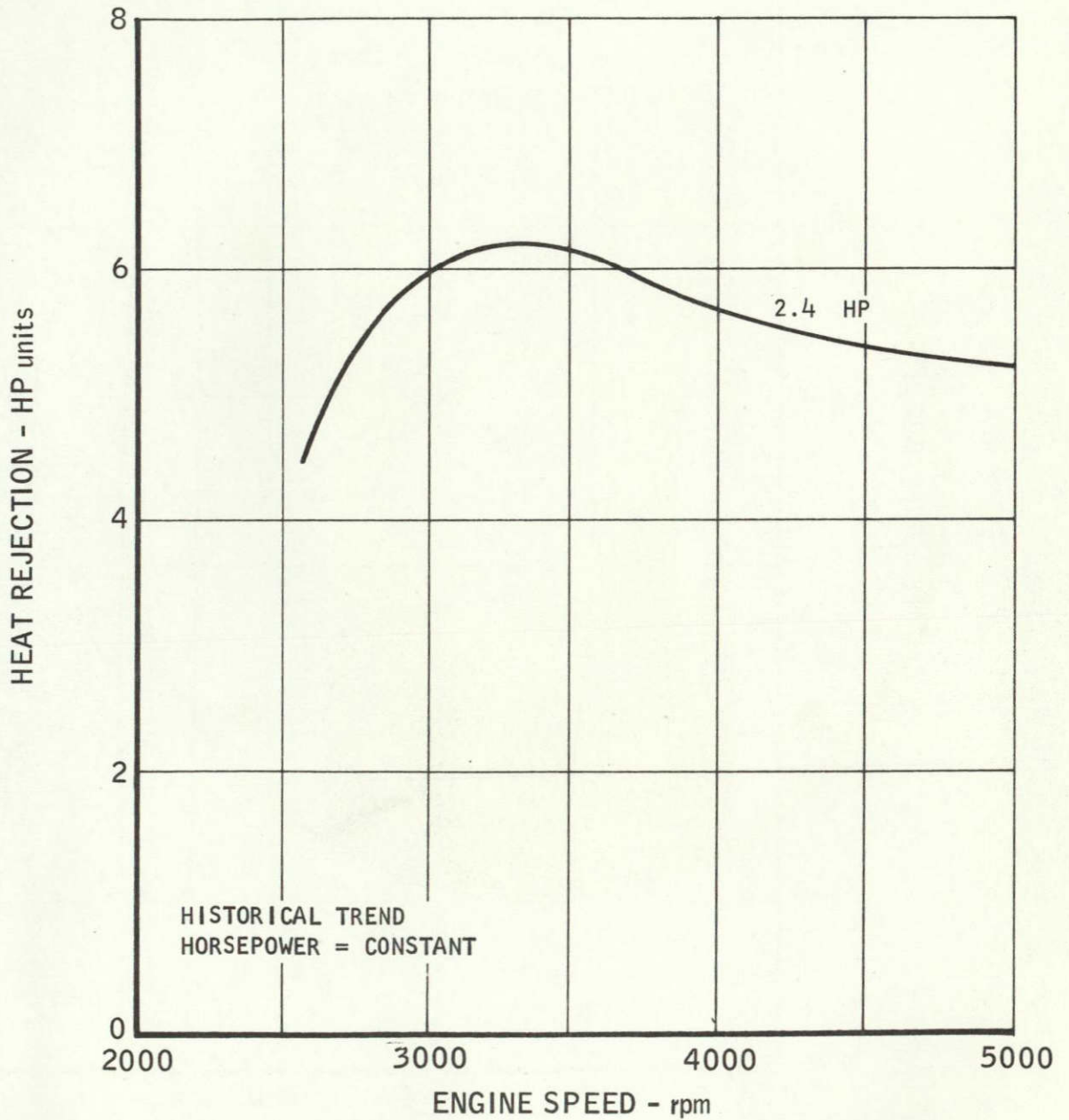
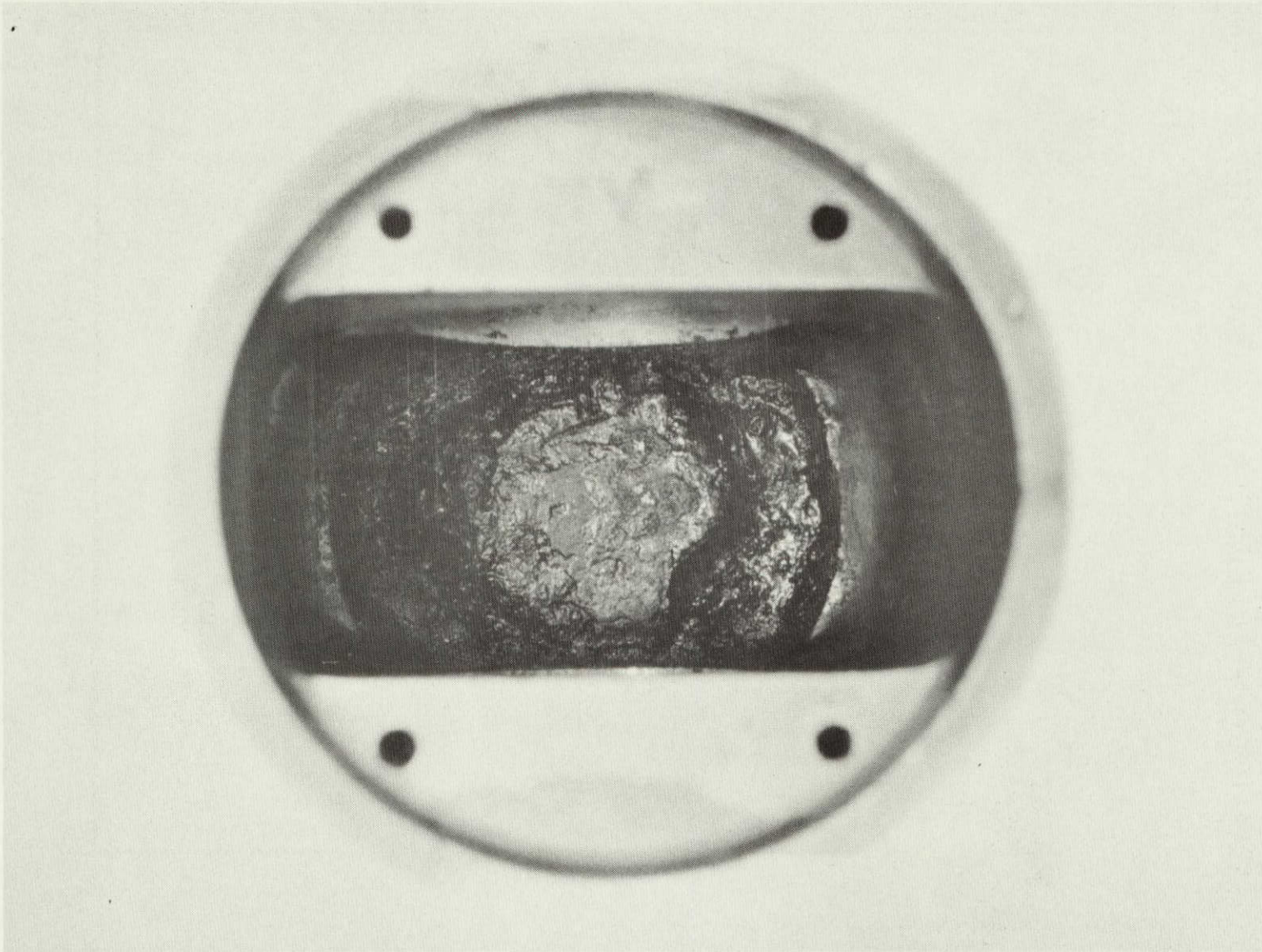

FIGURE 42

UNCLASSIFIED

Report 6098



T 5167-10

FIGURE 43. Carbon Deposit on Underside of the Modification 1 Piston after 90-hour Endurance Test in the SPU-3A Engine

UNCLASSIFIED

UNCLASSIFIED



FIGURE 44. Connecting Rod after 90-hour Endurance Test in the SPU-3A Engine

T 5167-14

UNCLASSIFIED

ACCUMULATED RUNNING TIME
PHASE II TESTING OF SPU SERIES ENGINES

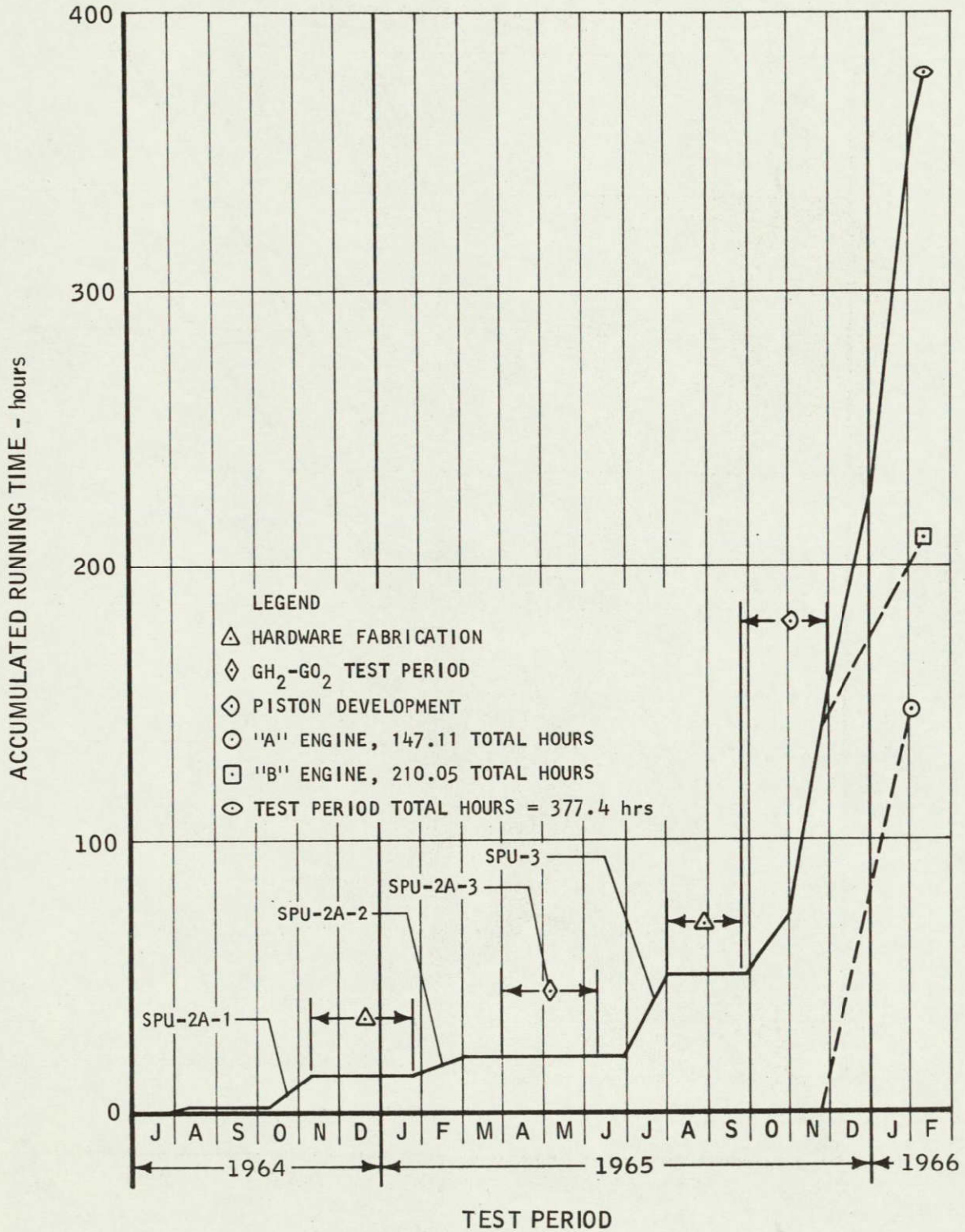

FIGURE 45

SPU-3 ENGINE
 VARIATION OF HORSEPOWER WITH ENGINE SPEED
 AT VARIOUS BMEP VALUES

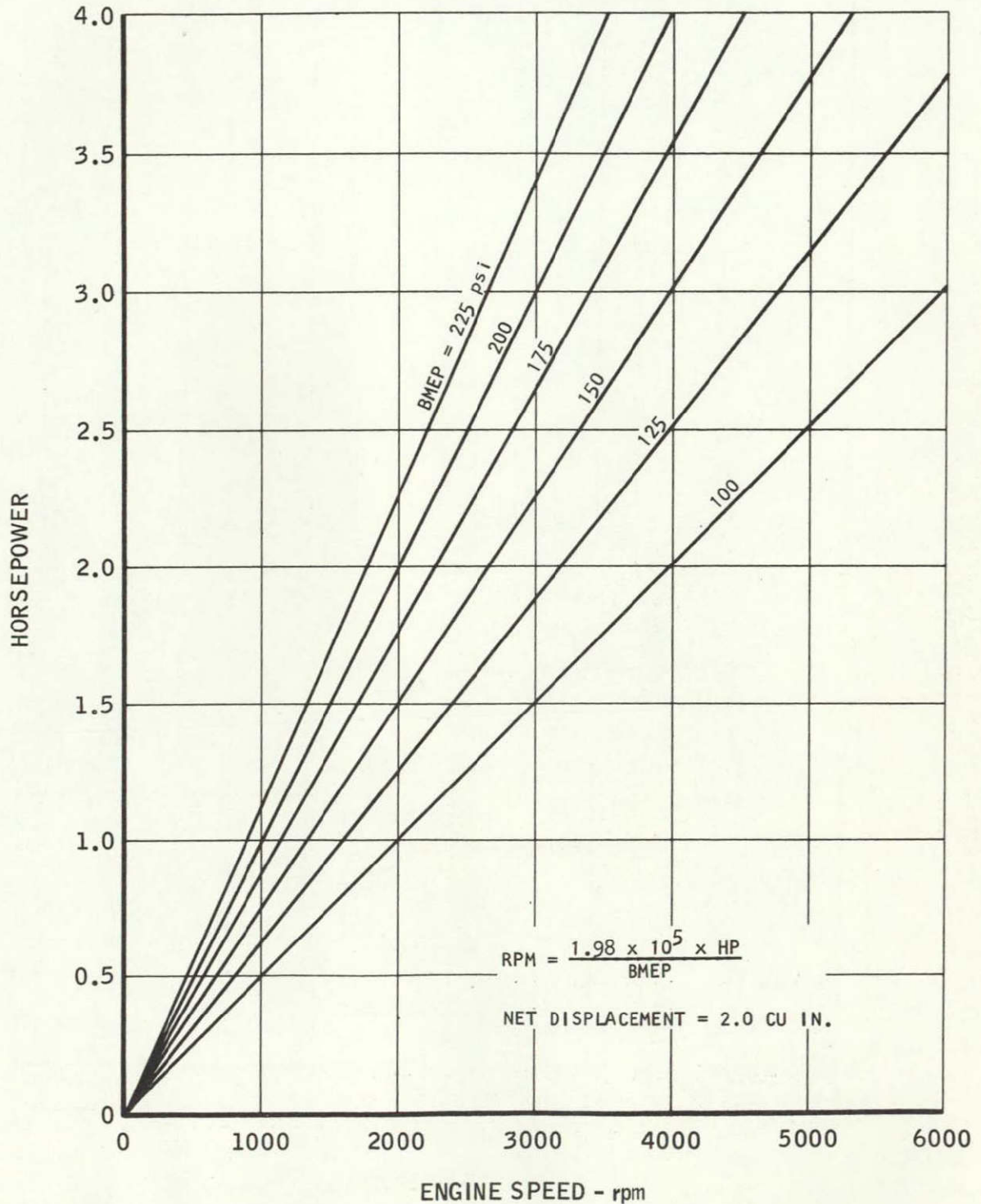

FIGURE 46

VARIATION OF SPECIFIC PROPELLANT CONSUMPTION
WITH BRAKE MEAN EFFECTIVE PRESSURE
FOR SPU SERIES ENGINES

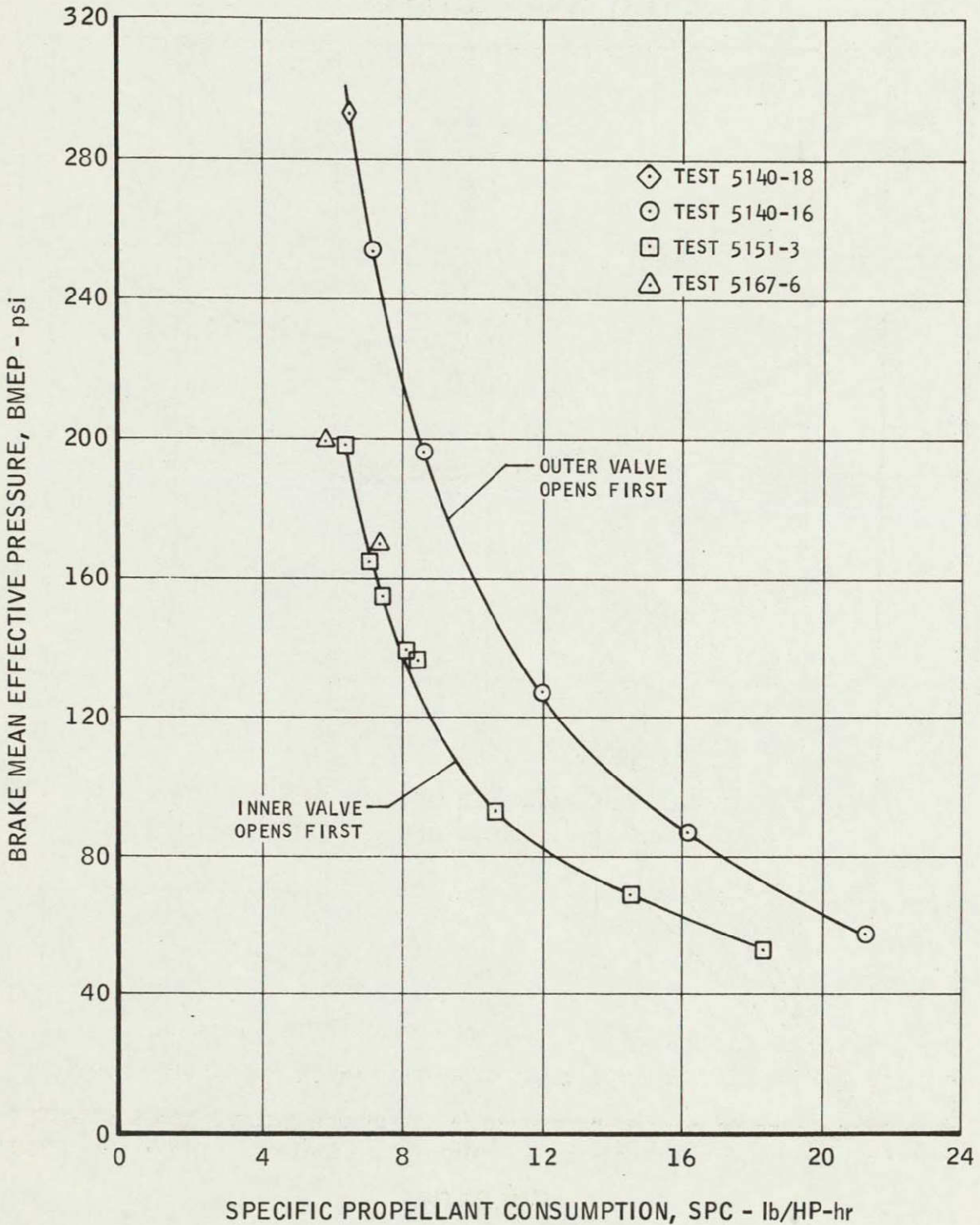

FIGURE 47

SPU-3 ENGINE
 VARIATION OF O/F RATIO WITH SPECIFIC PROPELLANT CONSUMPTION
 TEST SERIES NO. 5167

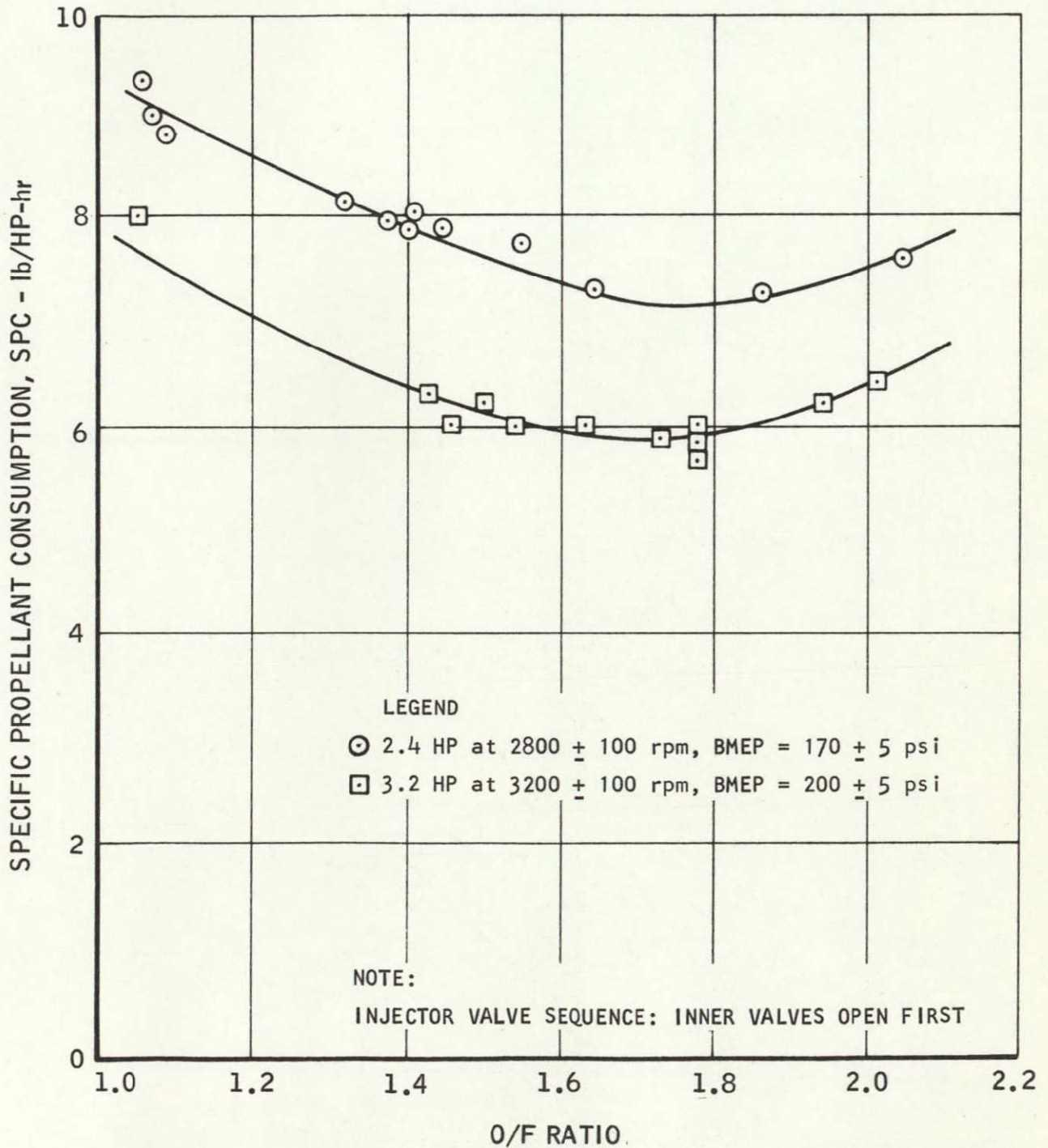

FIGURE 48

SPU-3 ENGINE
EXHAUST PRESSURE SENSITIVITY

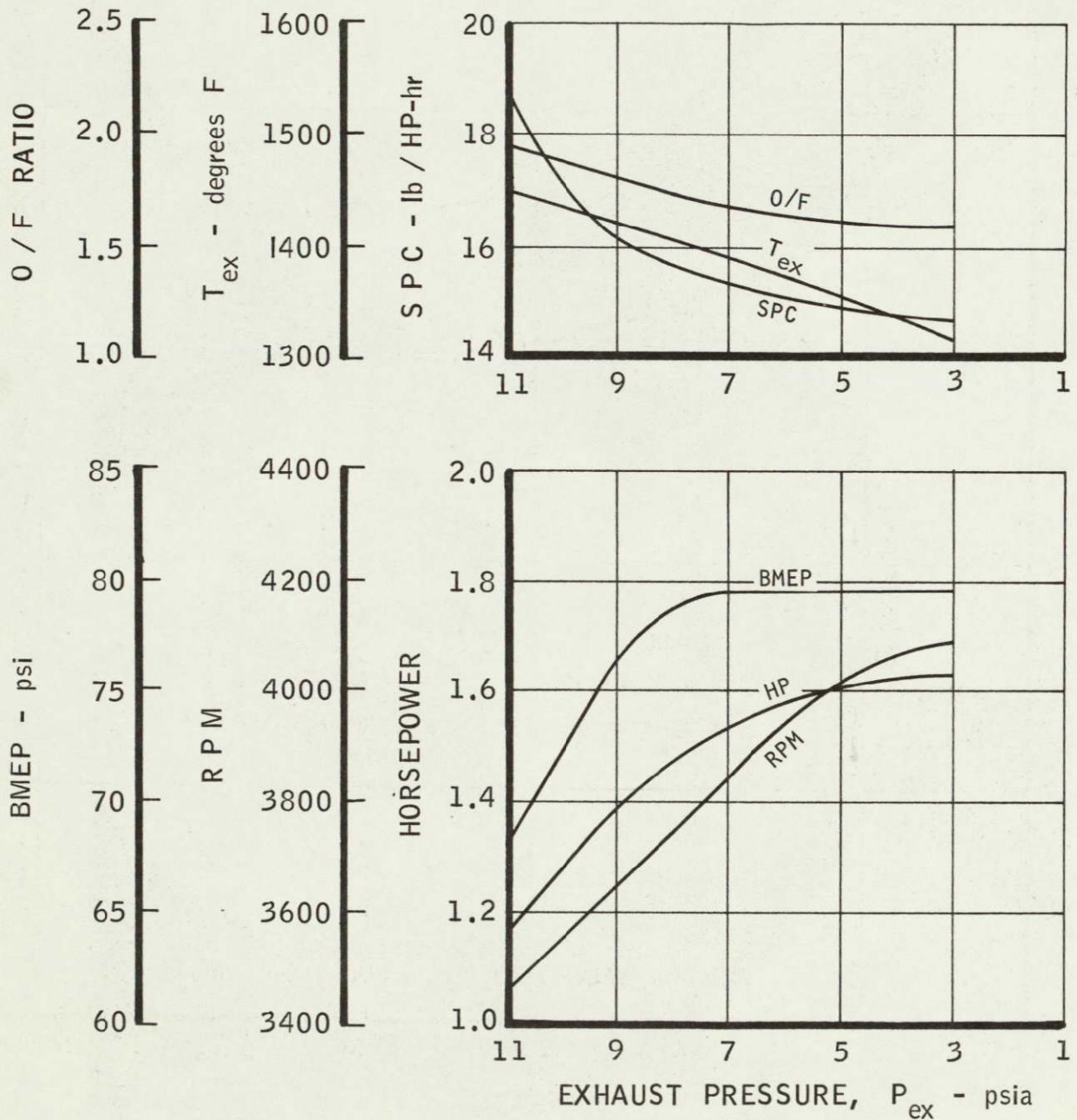

FIGURE 49

4

UNCLASSIFIED

THE
Marquardt
CORPORATION
VAN NUYS, CALIFORNIA

Report 6098

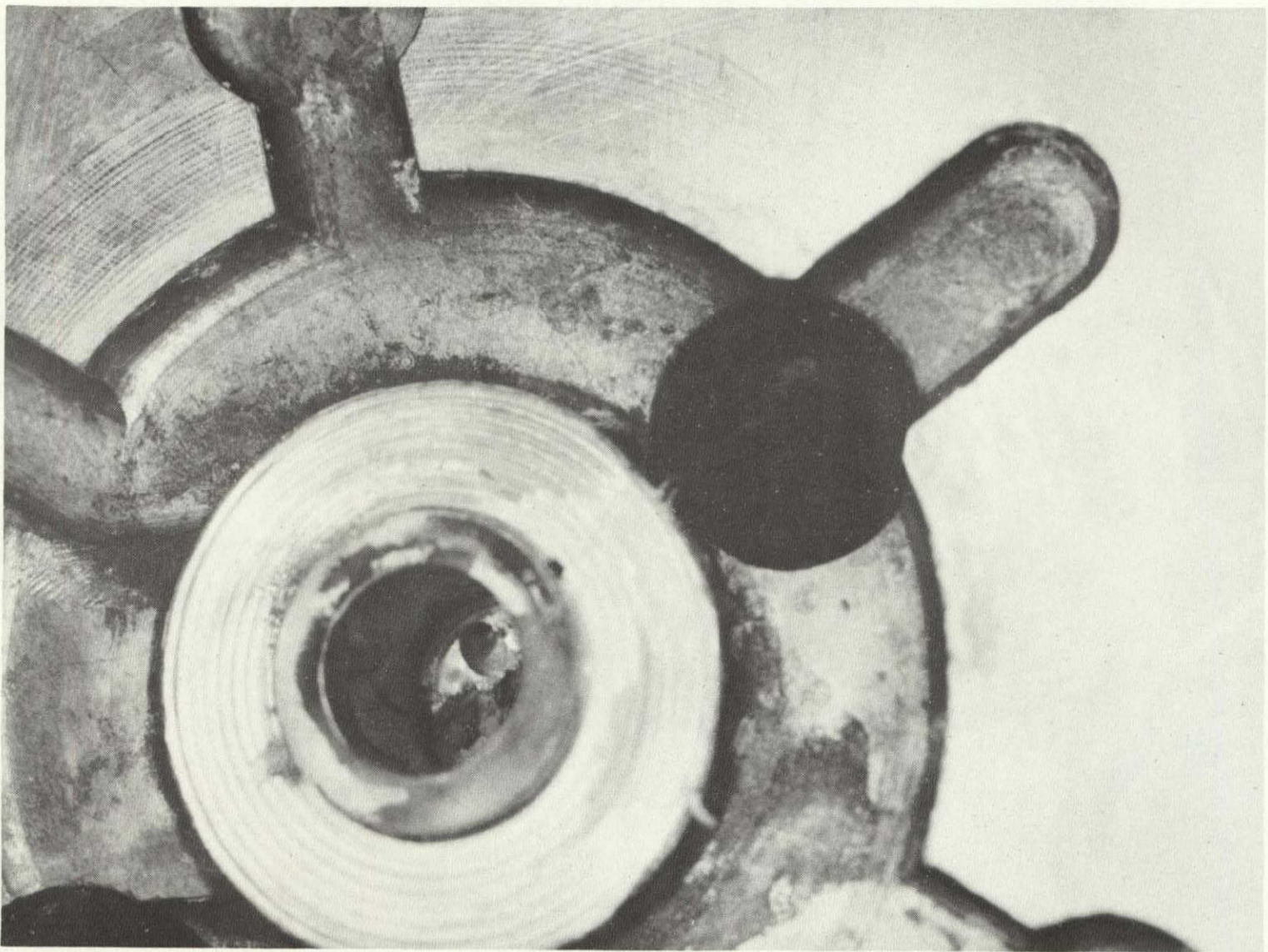

T 5151-23

FIGURE 50. SPU-3 Cylinder Head Combustion Chamber after Test 5151-23

UNCLASSIFIED

UNCLASSIFIED



T 5151-24

FIGURE 51. SPU-3 Cylinder Head Combustion Chamber after Test 5151-23

UNCLASSIFIED

SPU-3 ENGINE
CALIBRATION OF OIL FLOW

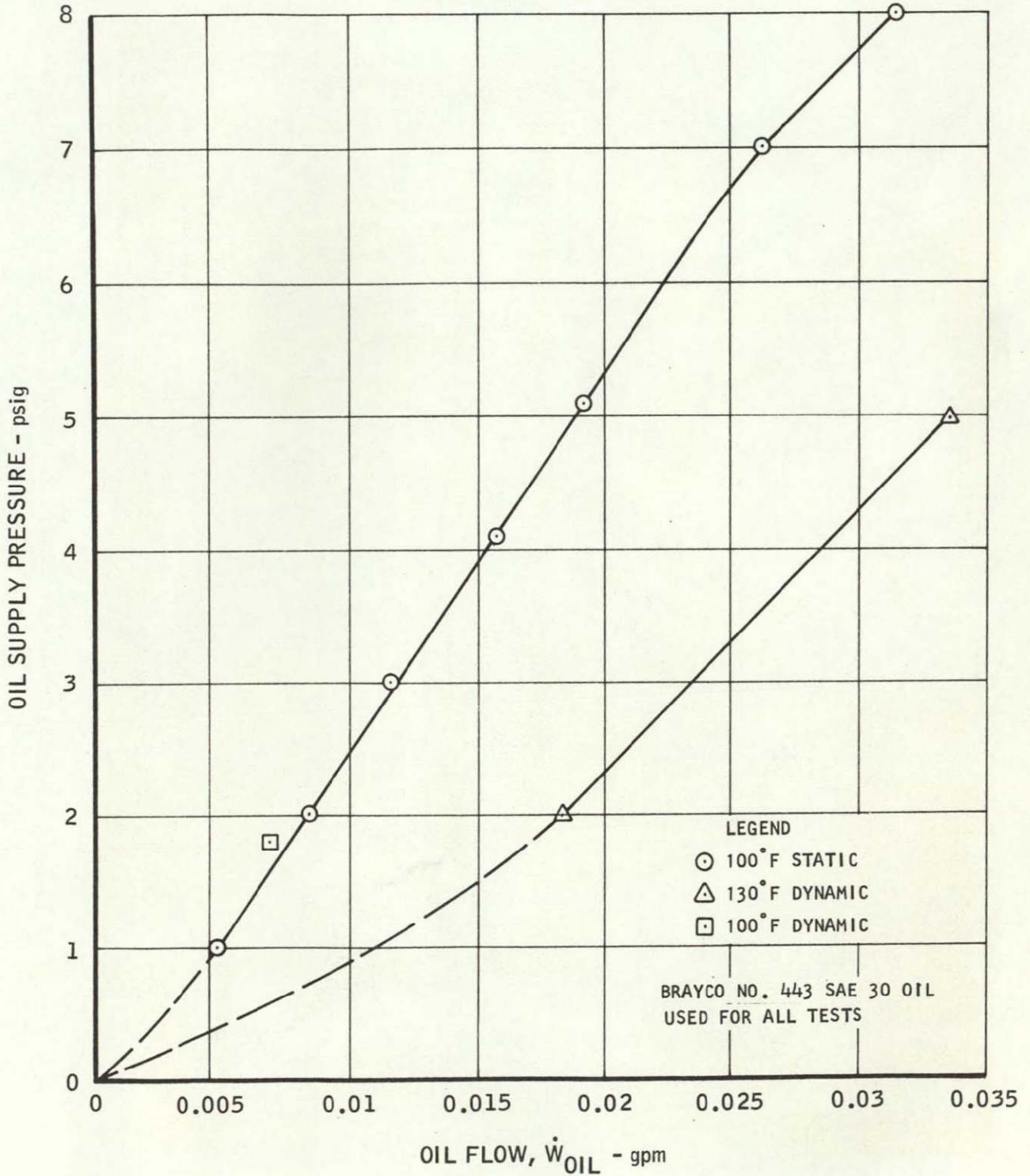
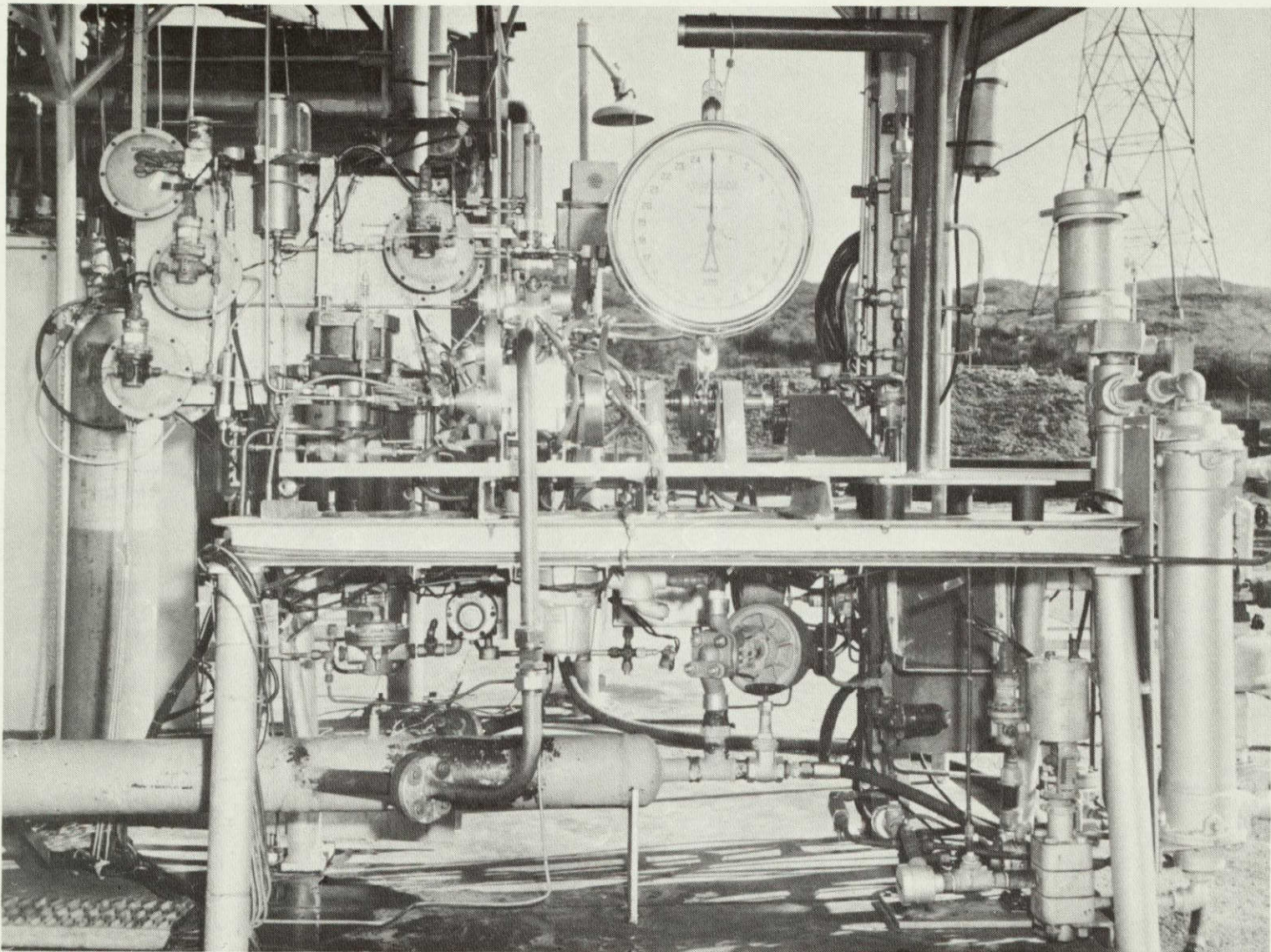

FIGURE 52

UNCLASSIFIED



T 5151-48

FIGURE 53. Overall View of the SPU-3 Engine Installed in the Test Facility

UNCLASSIFIED

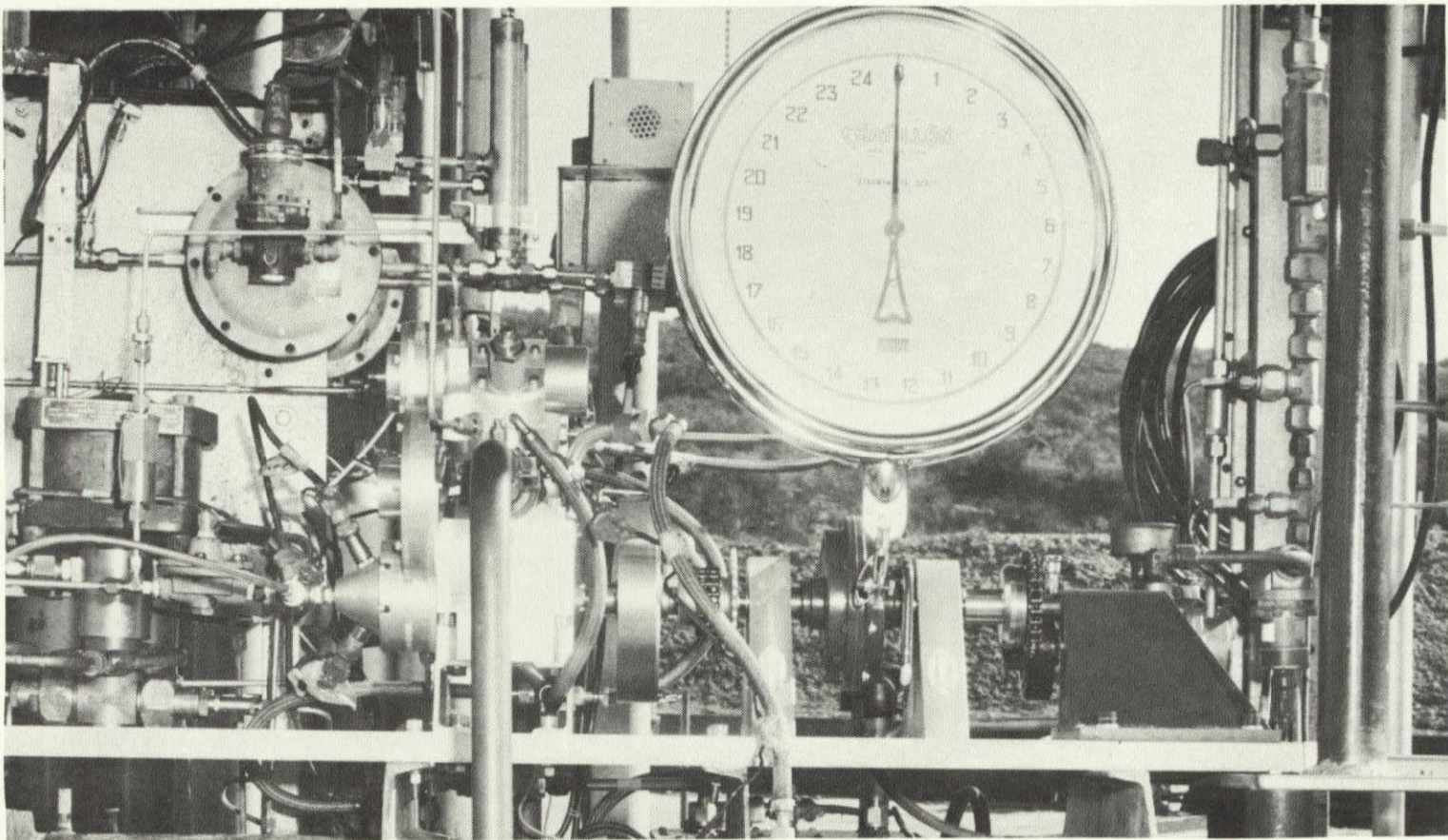

T 5151-54

FIGURE 54. Closeup of the SPU-3 Engine Installed in the Test Facility

SCHEMATIC OF TEST PAD FUEL SYSTEM FOR THE SPU-3 ENGINE (OXIDIZER SYSTEM IDENTICAL)

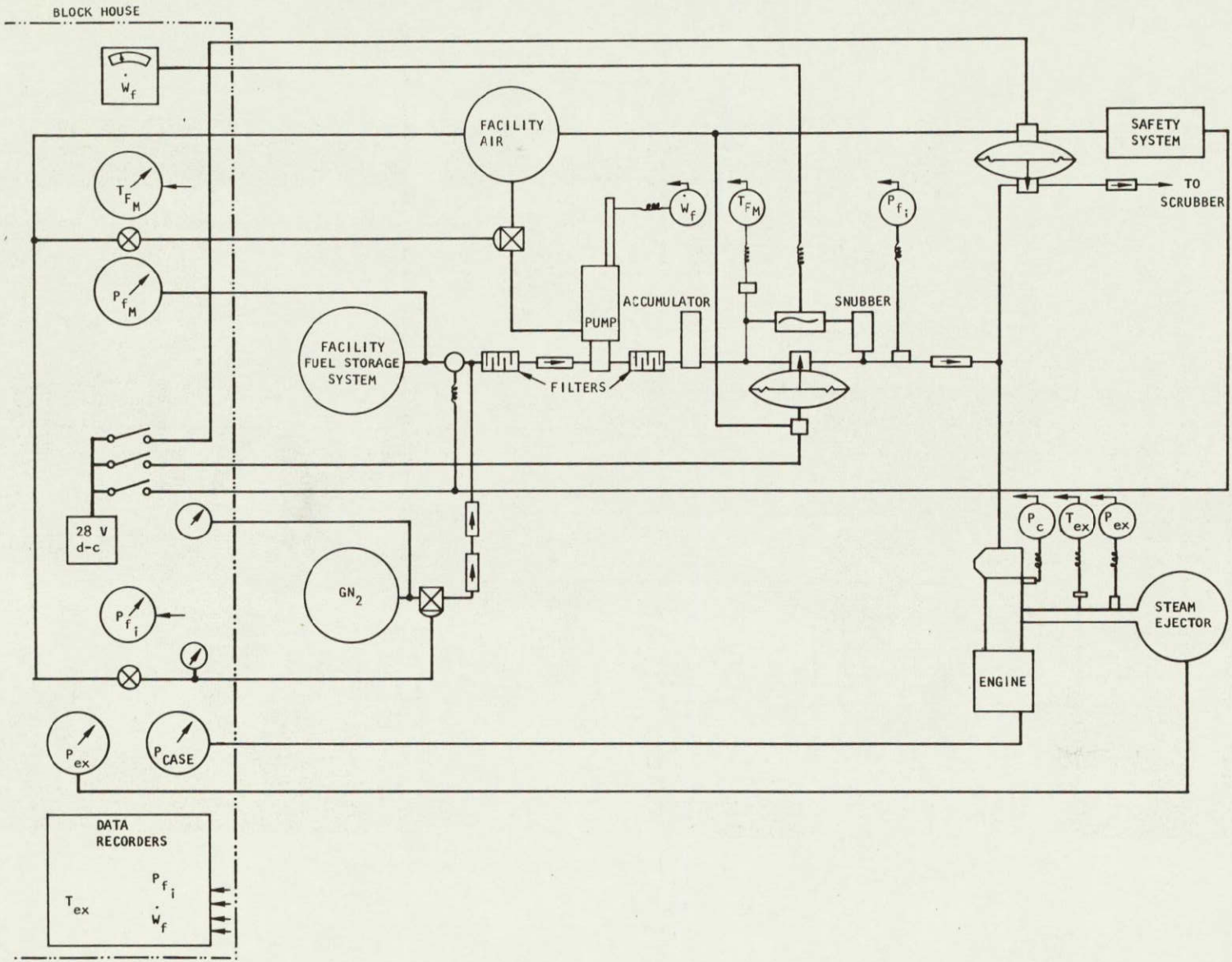

UNCLASSIFIED

THE
Margardt
CORPORATION
VAN NUYS, CALIFORNIA

Report 6098

FIGURE 55

287 - 124

UNCLASSIFIED

- 167 -

SCHEMATIC OF TEST FACILITY FUEL STORAGE SYSTEM FOR THE SPU-3 ENGINE

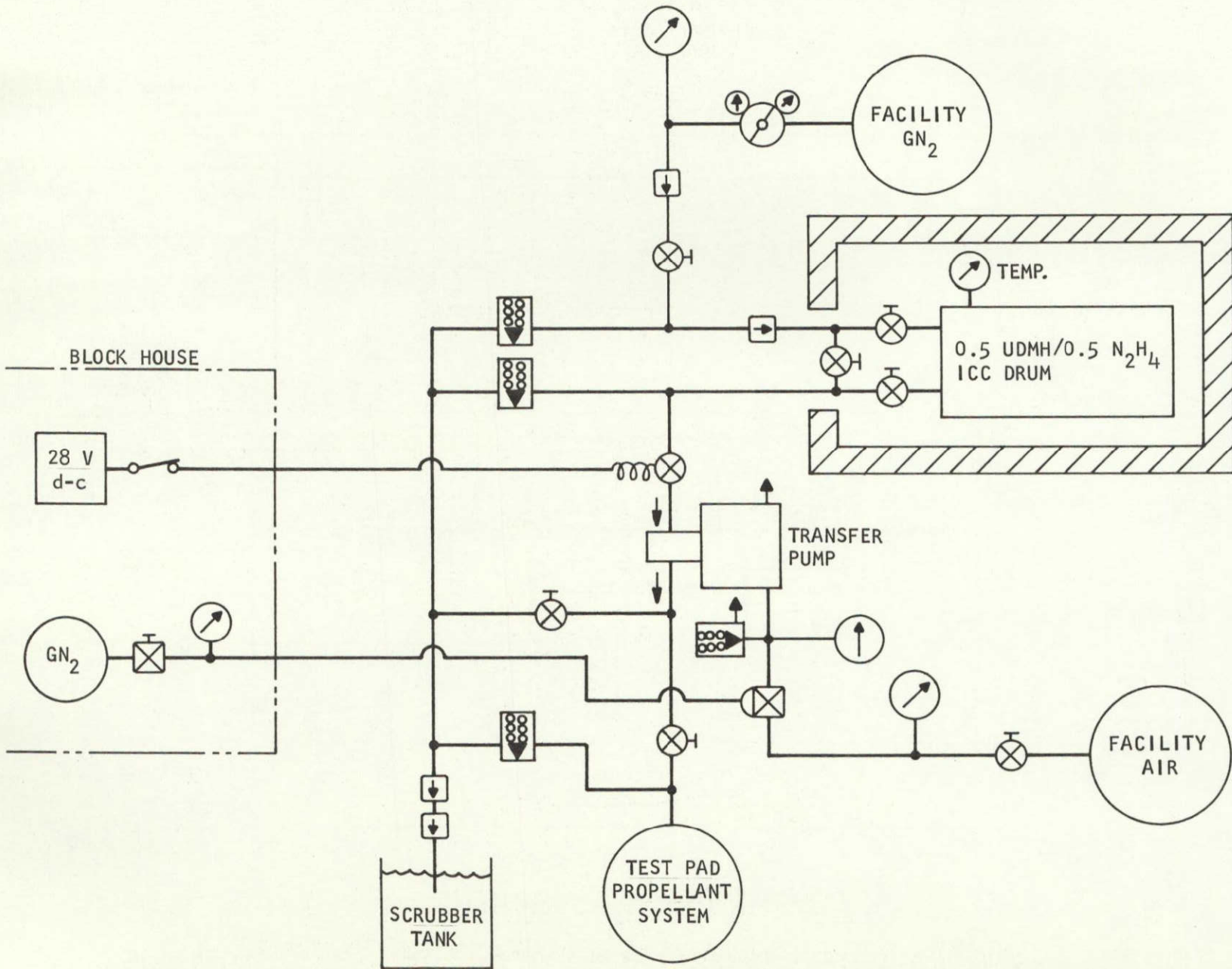

287 - 121

UNCLASSIFIED

- 168 -

FIGURE 56

UNCLASSIFIED

SCHEMATIC OF TEST FACILITY OXIDIZER STORAGE SYSTEM FOR THE SPU-3 ENGINE

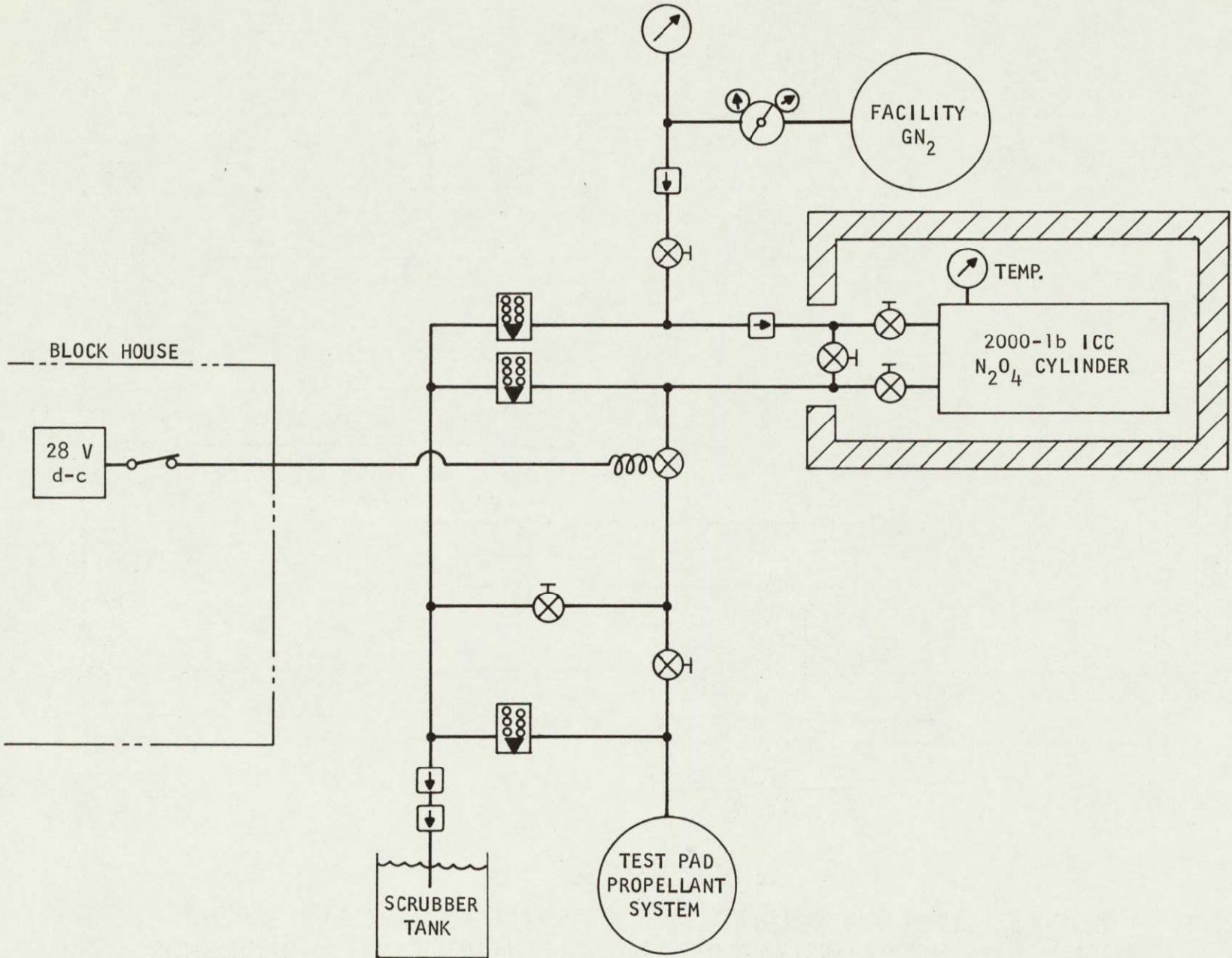

287 - 123

UNCLASSIFIED

- 169 -

FIGURE 57

UNCLASSIFIED

SCHEMATIC OF TEST FACILITY POWER ABSORPTION AND SAFETY SYSTEM FOR THE SPU-3 ENGINE

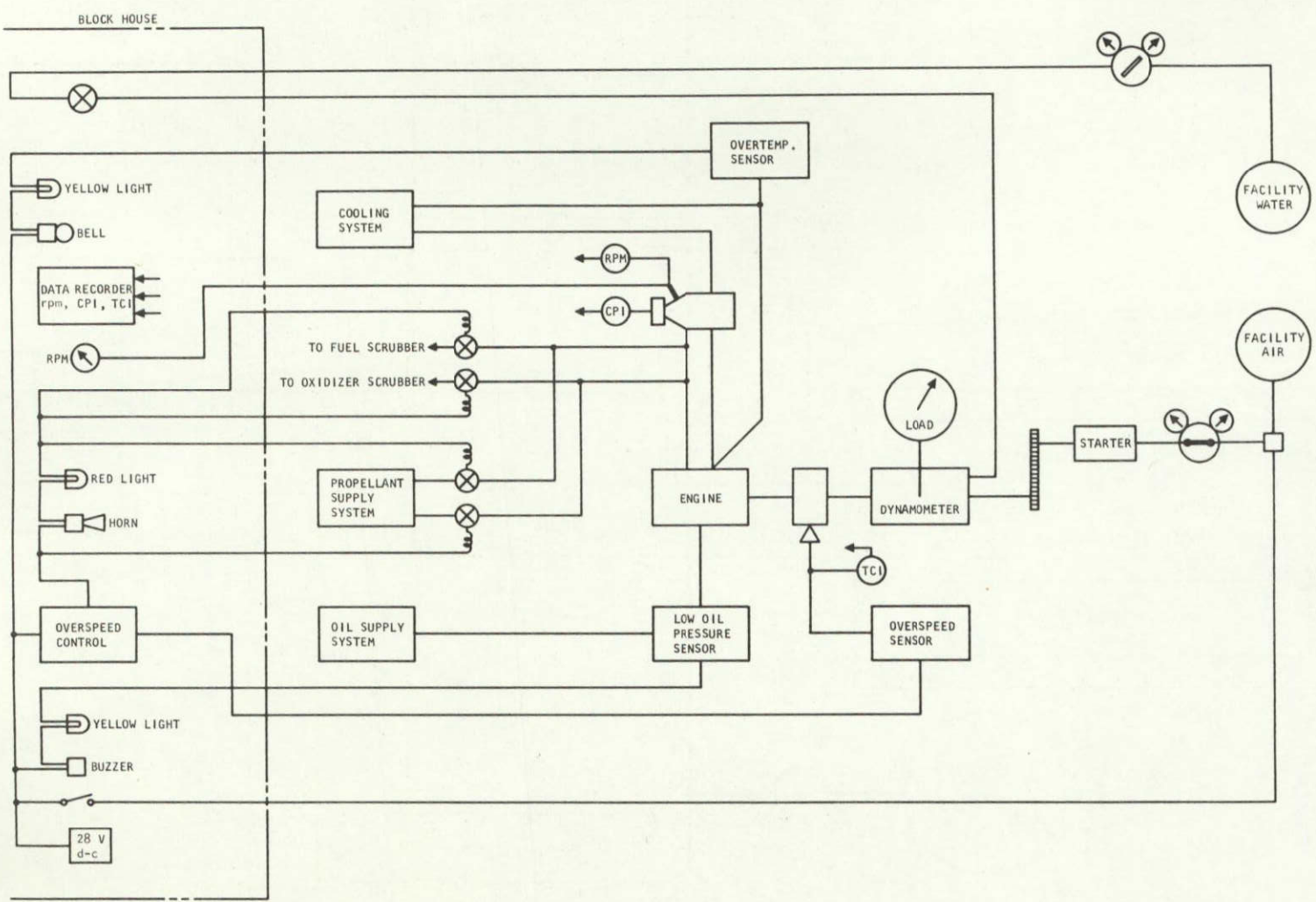

287 - 122

UNCLASSIFIED

- 170 -

FIGURE 58

SCHEMATIC OF TEST FACILITY COOLING SYSTEM FOR THE SPU-3 ENGINE

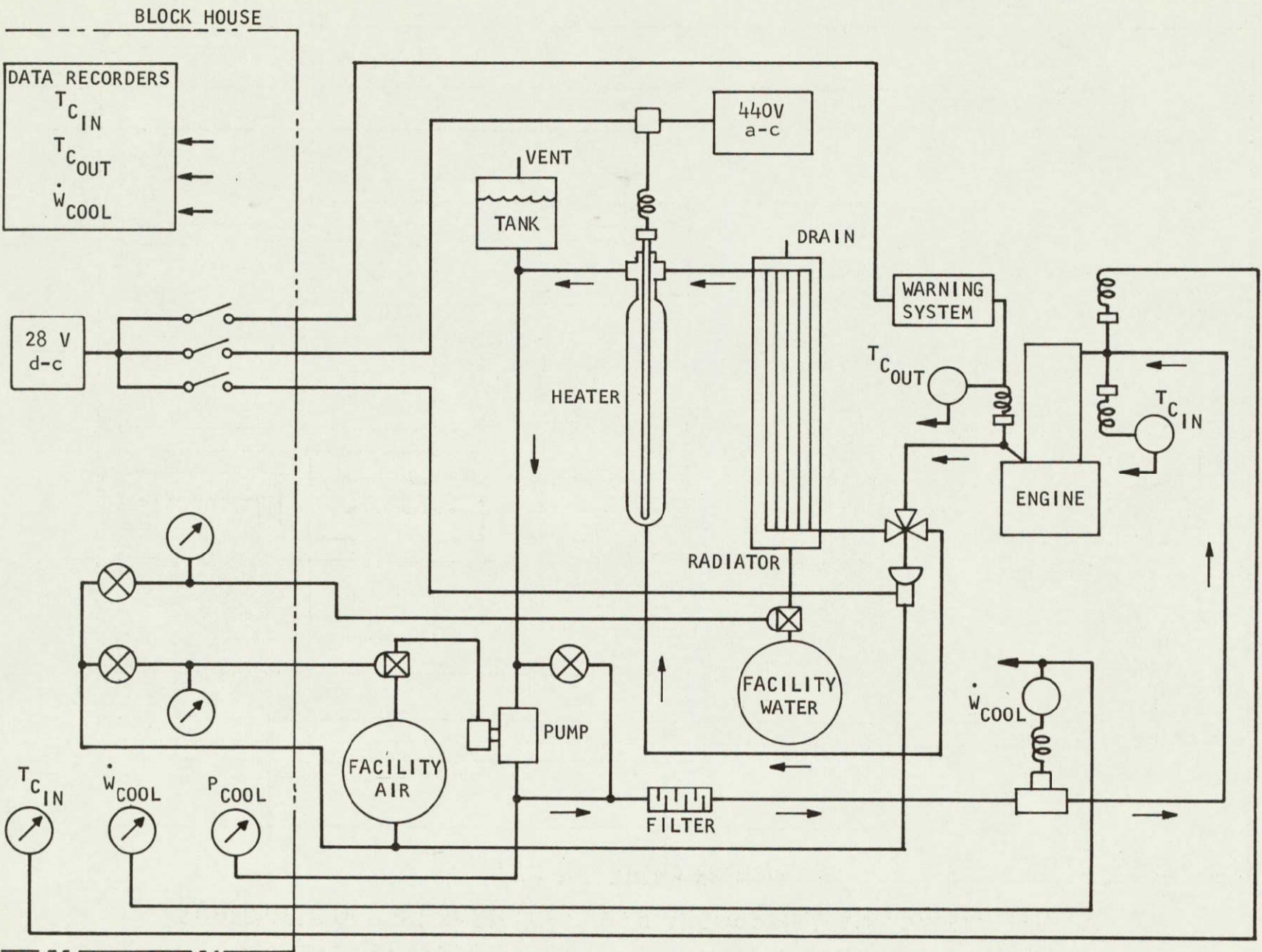

287 - 119

UNCLASSIFIED

- 171 -

FIGURE 52

UNCLASSIFIED

SCHEMATIC OF TEST FACILITY OIL SYSTEM FOR THE SPU-3 ENGINE

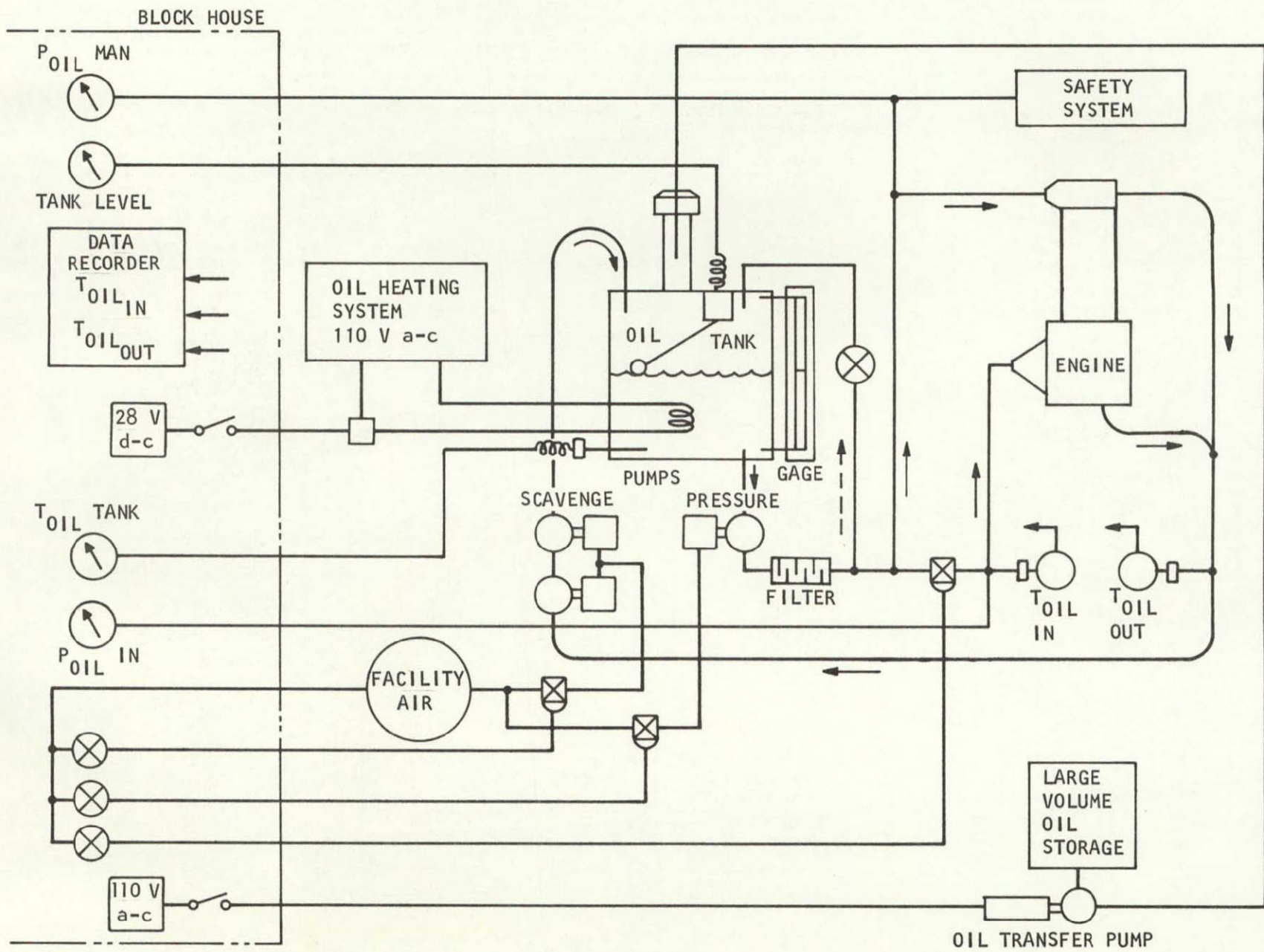

287 - 120

UNCLASSIFIED

- 172 -

FIGURE 60

THE
Margardt
 CORPORATION
 VAN NUYS, CALIFORNIA

UNCLASSIFIED

Report 6098

UNCLASSIFIED

Report 6098

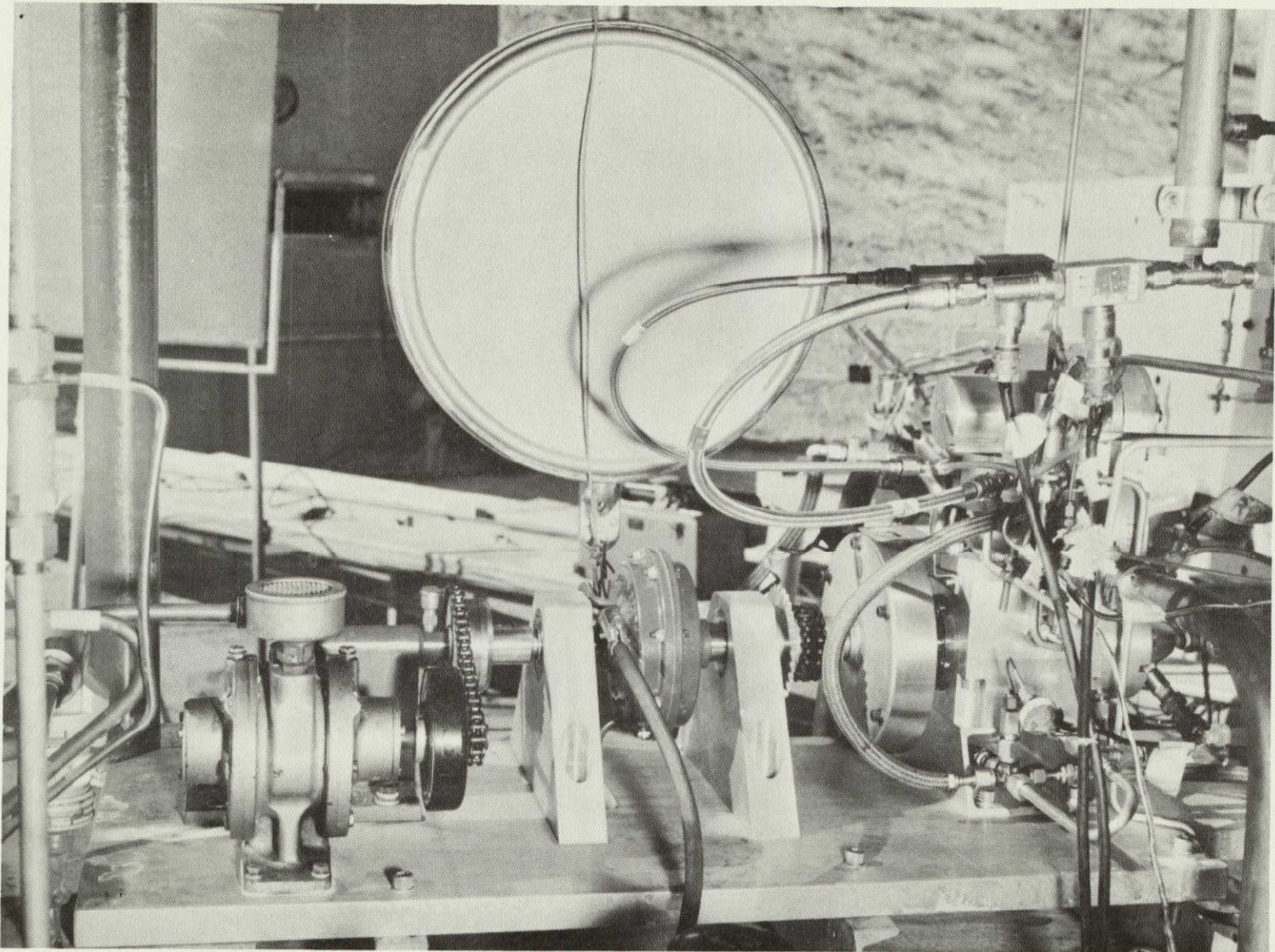

T 5151-53

FIGURE 61. Starting System for the SPU-3 Engine as Installed in the Test Facility

UNCLASSIFIED

- 173 -

UNCLASSIFIED

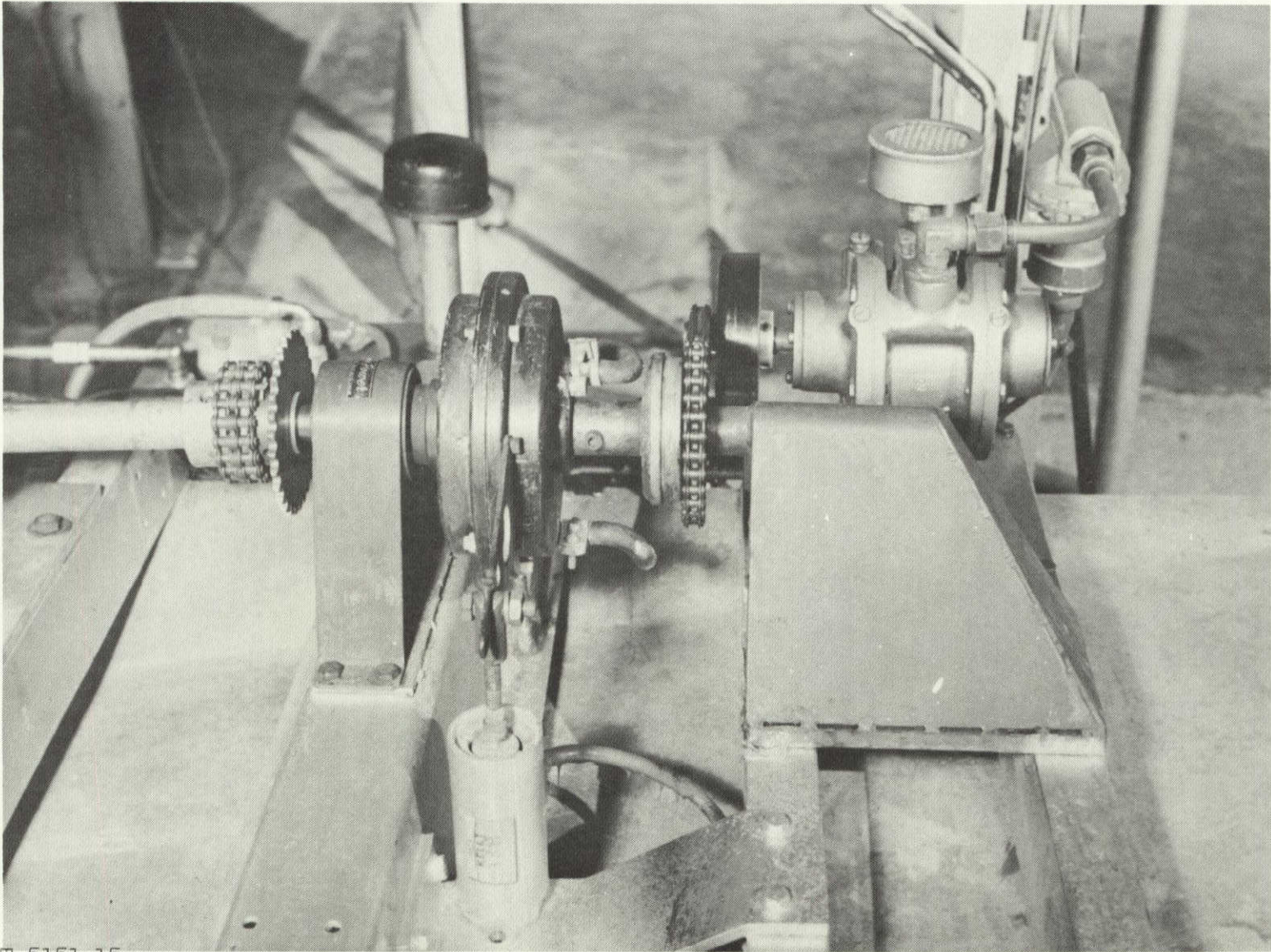

T 5151-15

FIGURE 62. Power Absorption Unit for the SPU-3 Engine as Installed in the Test Facility

UNCLASSIFIED

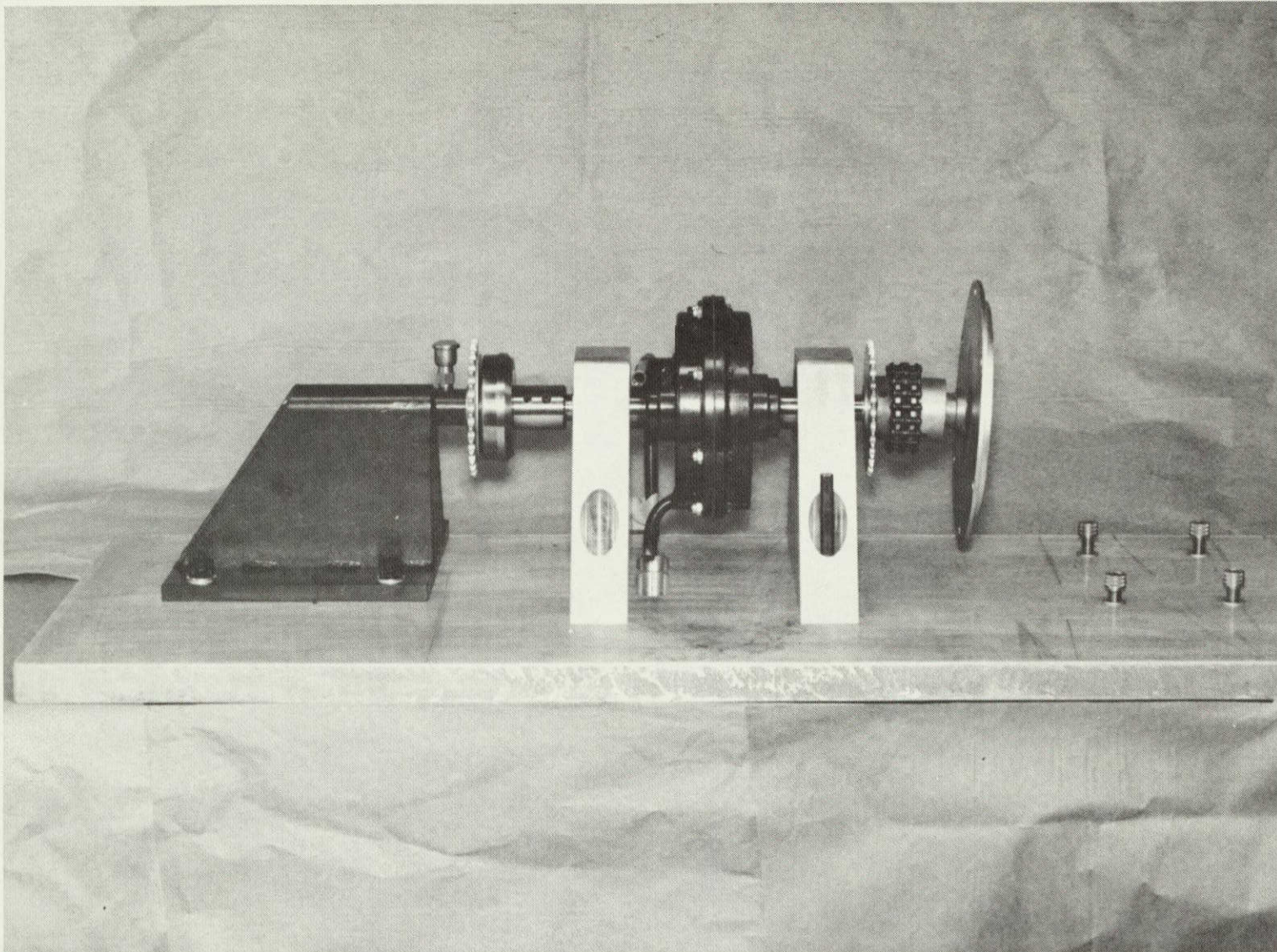

T 5151-46

FIGURE 63. Redesigned Power Absorption Unit for the SPU-3 Engine

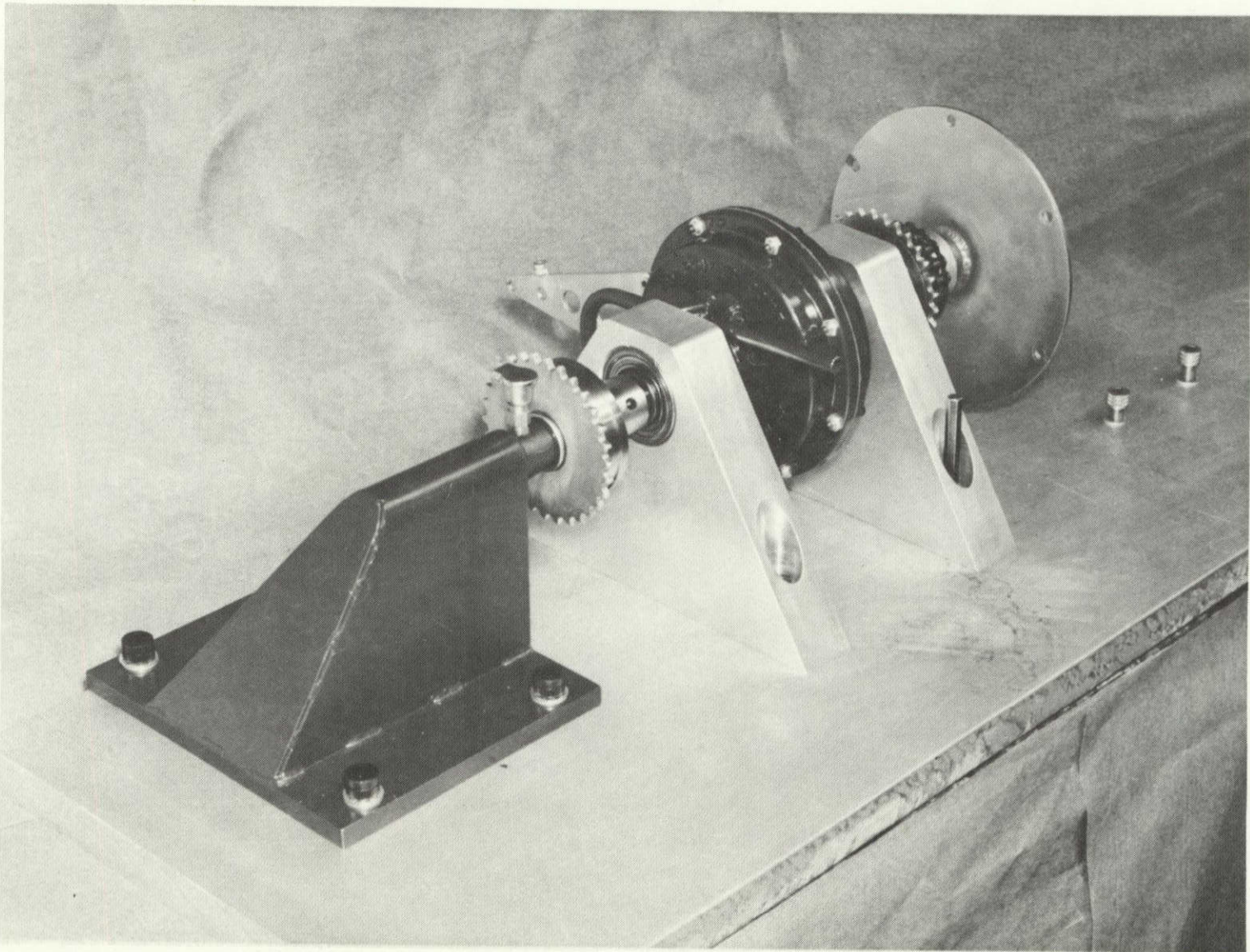

T 5151-47

FIGURE 64. Redesigned Power Absorption Unit for the SPU-3 Engine

SPU-3 ENGINE
VARIATION OF SPECIFIC HEAT REJECTION WITH HORSEPOWER

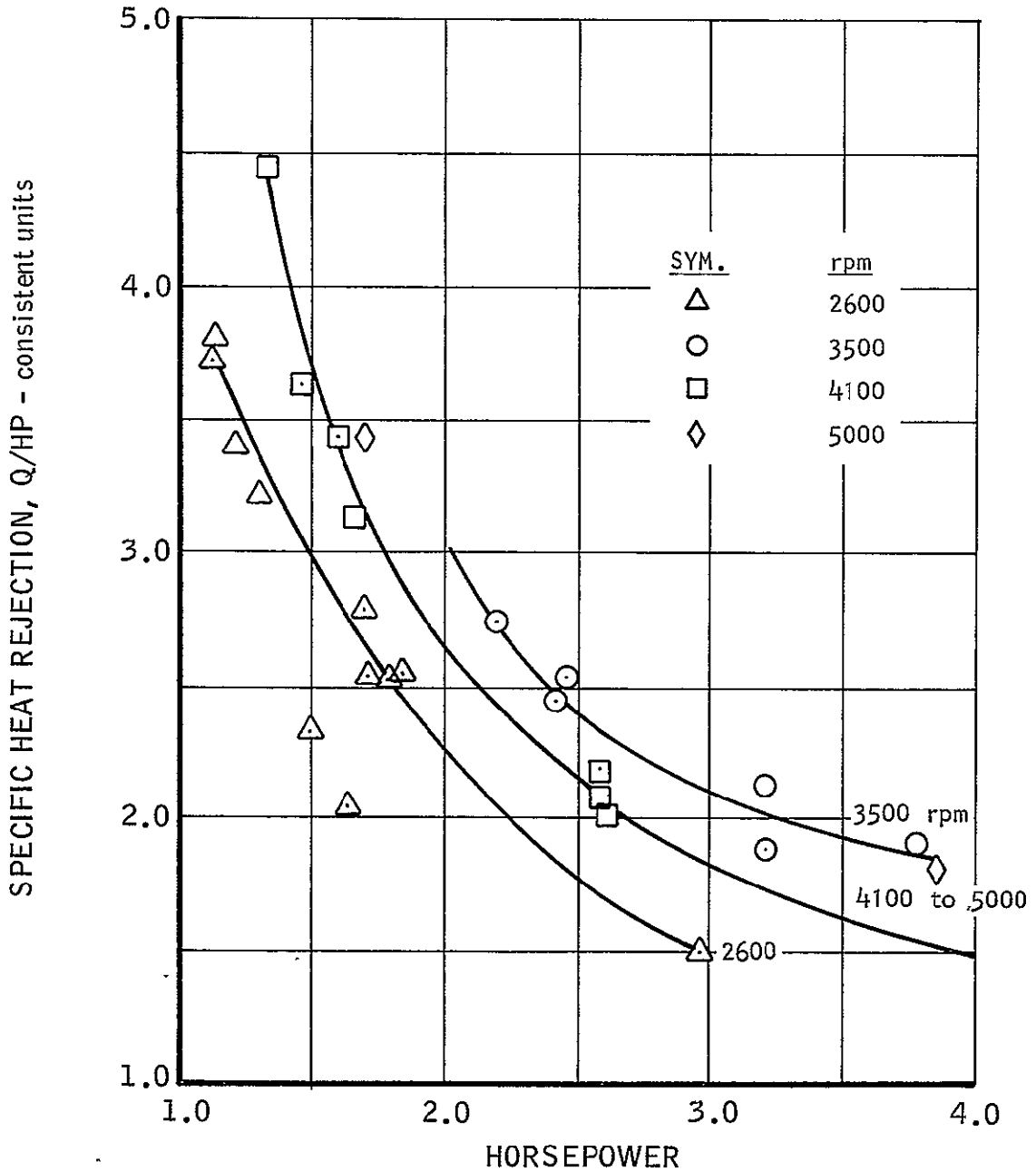

FIGURE 65

SPU-3 ENGINE

VARIATION OF SPECIFIC HEAT REJECTION WITH BRAKE MEAN EFFECTIVE PRESSURE

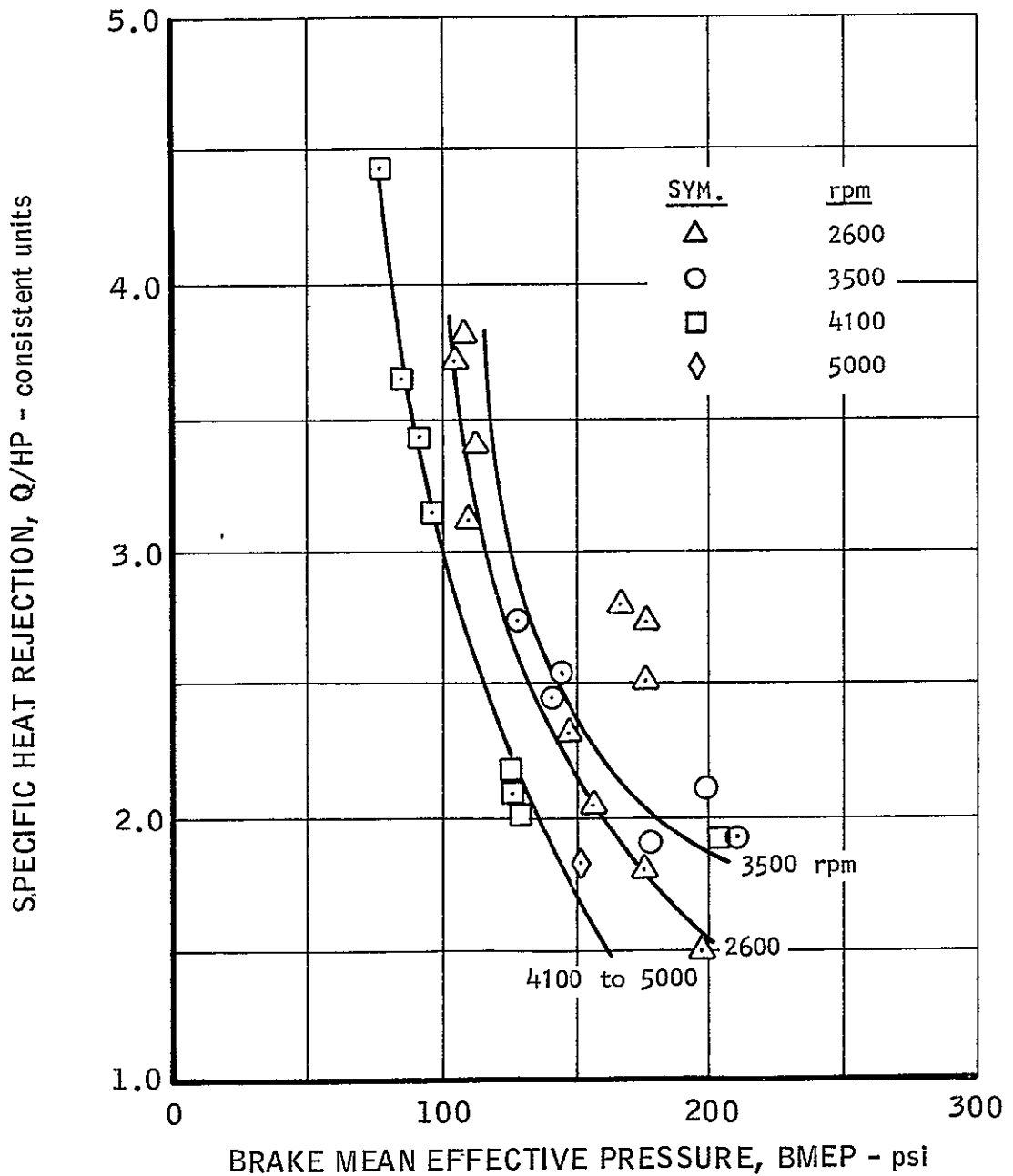

FIGURE 66

SPU-3 ENGINE
 ESTIMATED HEAT REJECTION TRENDS -- CY 1965

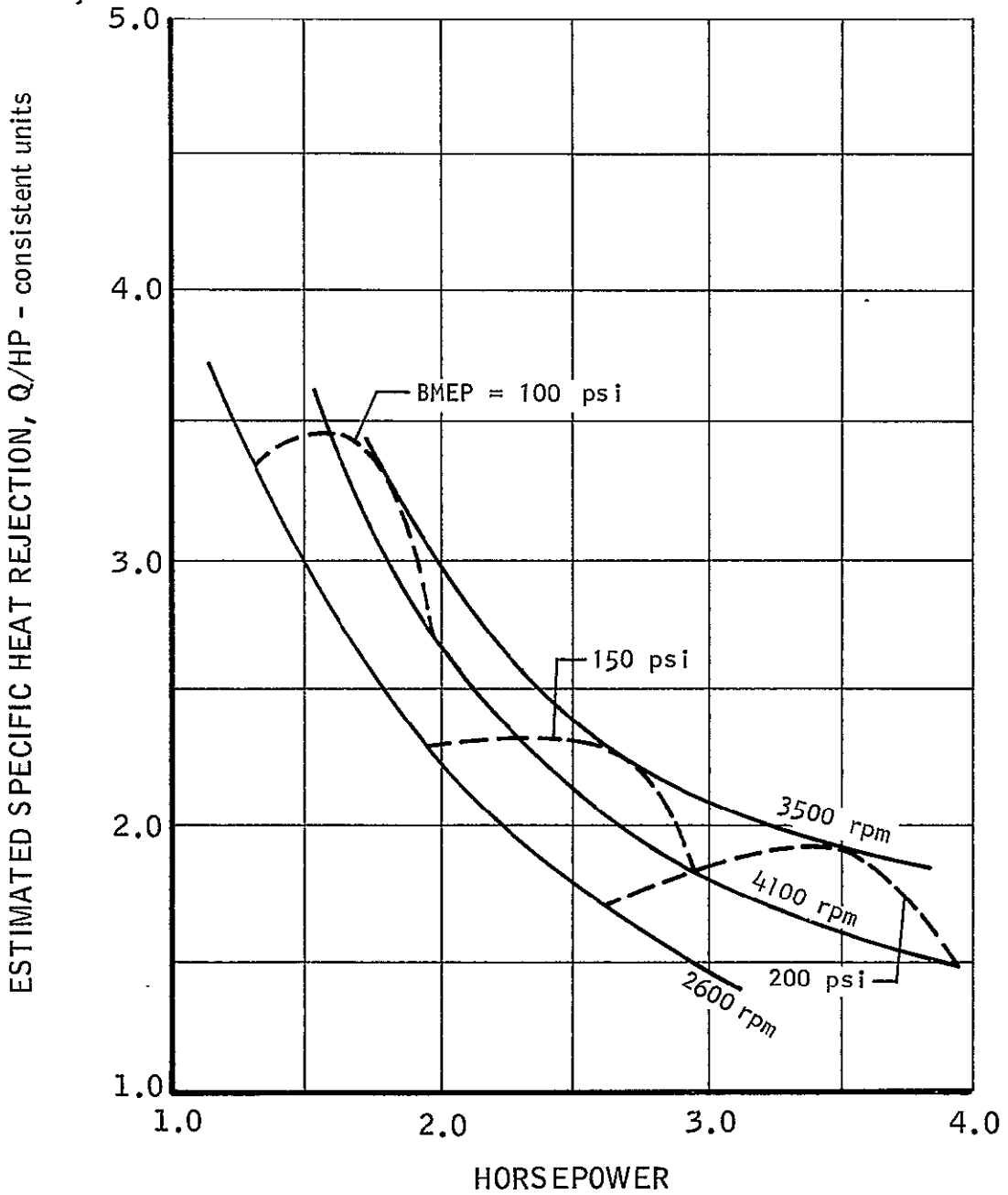

FIGURE 67

SPU-3 ENGINE

VARIATION OF COMBUSTION EFFICIENCY WITH HORSEPOWER AND BRAKE MEAN EFFECTIVE PRESSURE

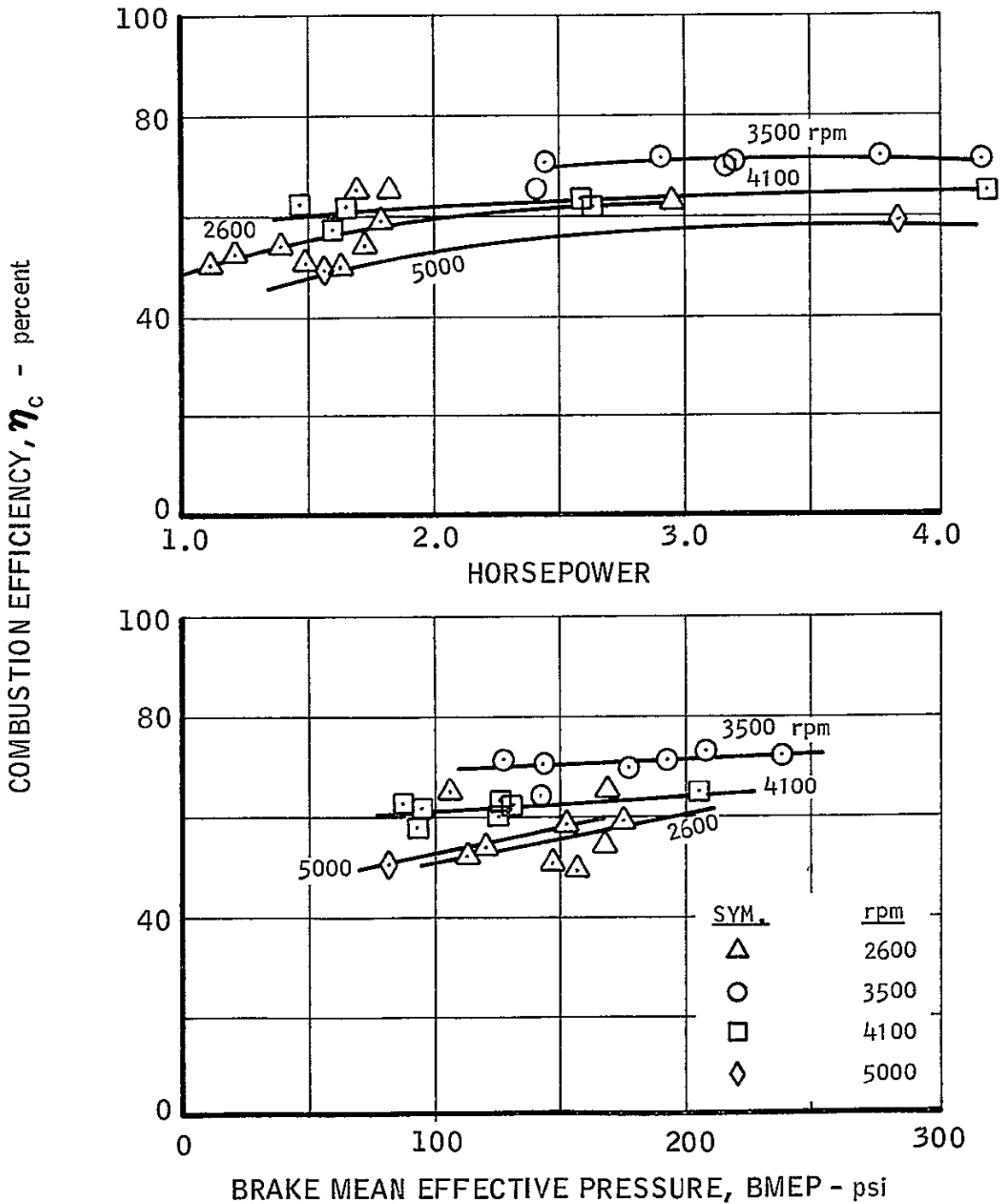

FIGURE 68

SPU-3 ENGINE

VARIATION OF BRAKE SPECIFIC PROPELLANT CONSUMPTION WITH BRAKE MEAN EFFECTIVE PRESSURE

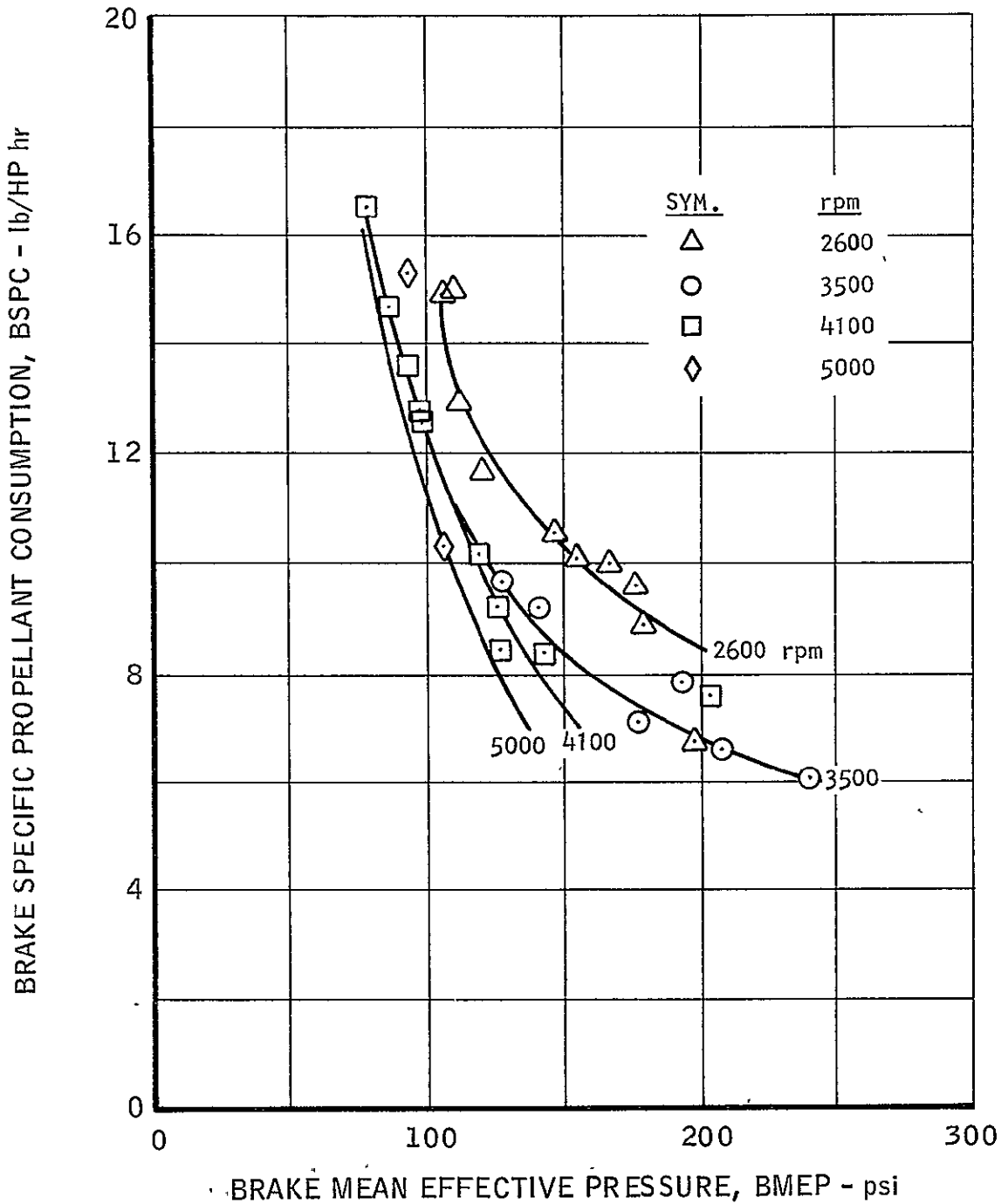
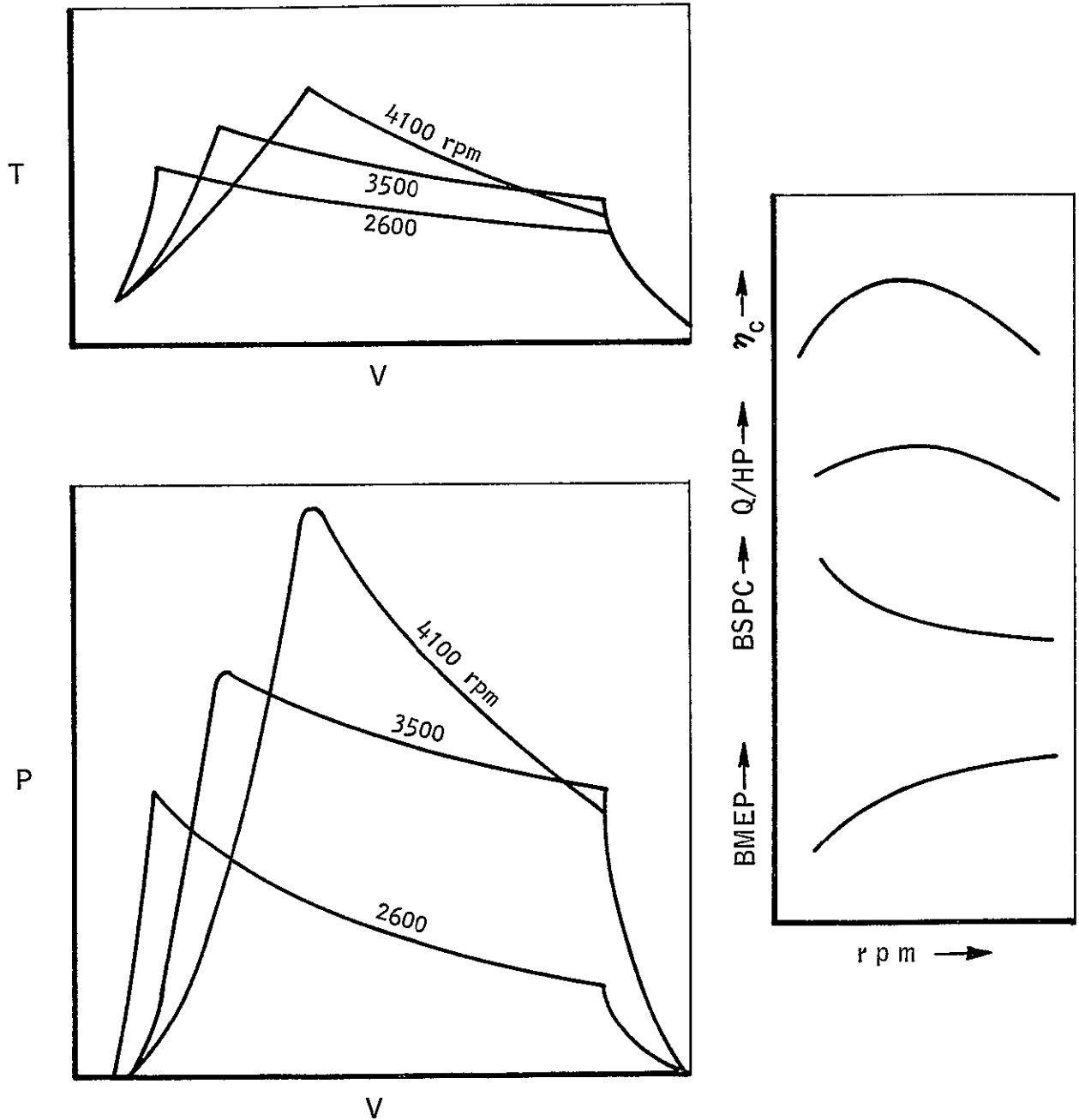

FIGURE 69

SPU-3 ENGINE
EFFECT OF ENGINE SPEED ON INDICATOR DIAGRAM



NOTE: $W_{\text{propellant/stroke}} = \text{Constant}$

FIGURE 70

SPU-3 ENGINE
VARIATION OF COMBUSTION EFFICIENCY WITH O/F RATIO

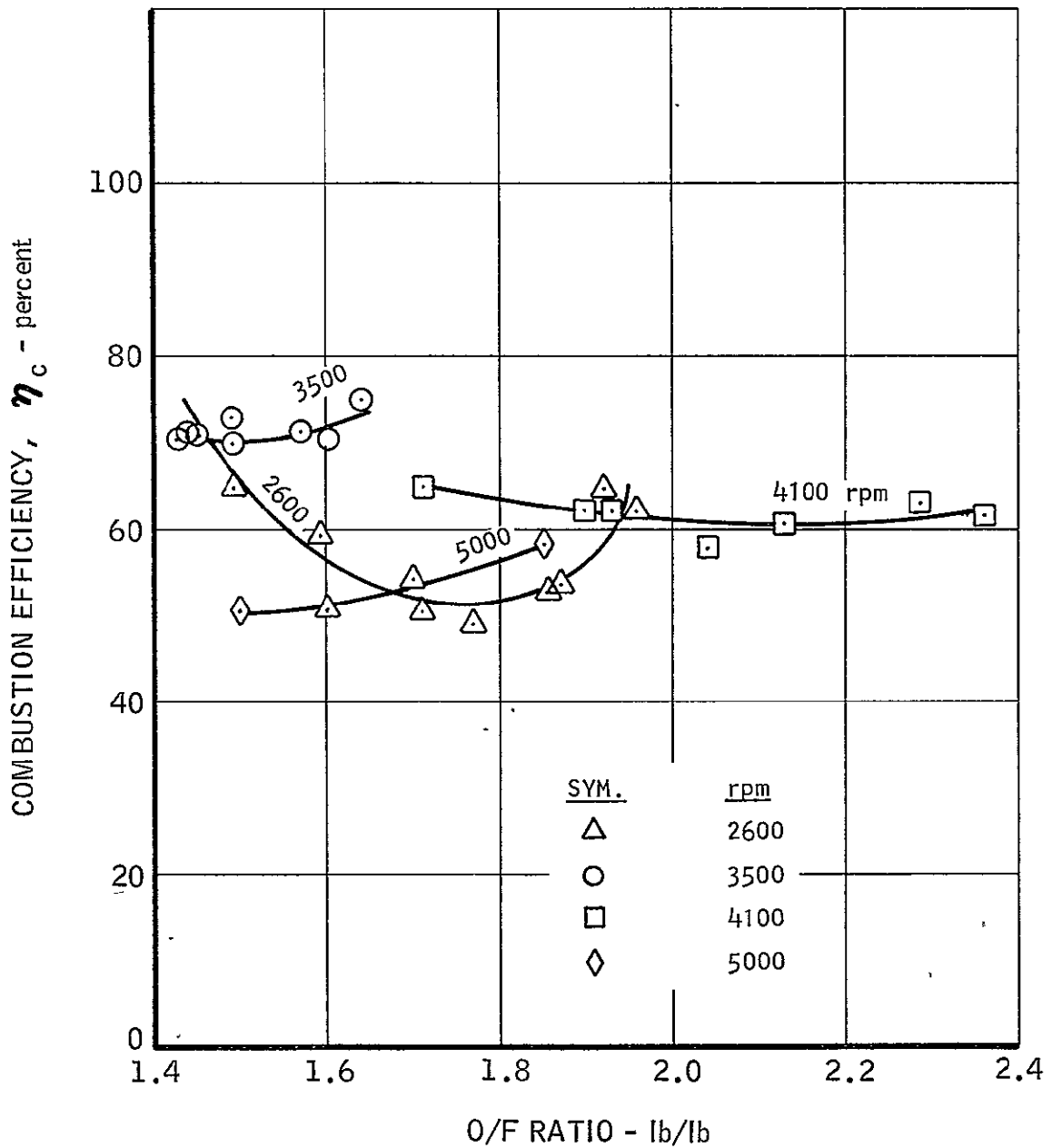

FIGURE 71

SPU-3 ENGINE
VARIATION OF EXHAUST TEMPERATURE
WITH BRAKE MEAN EFFECTIVE PRESSURE AND HORSEPOWER

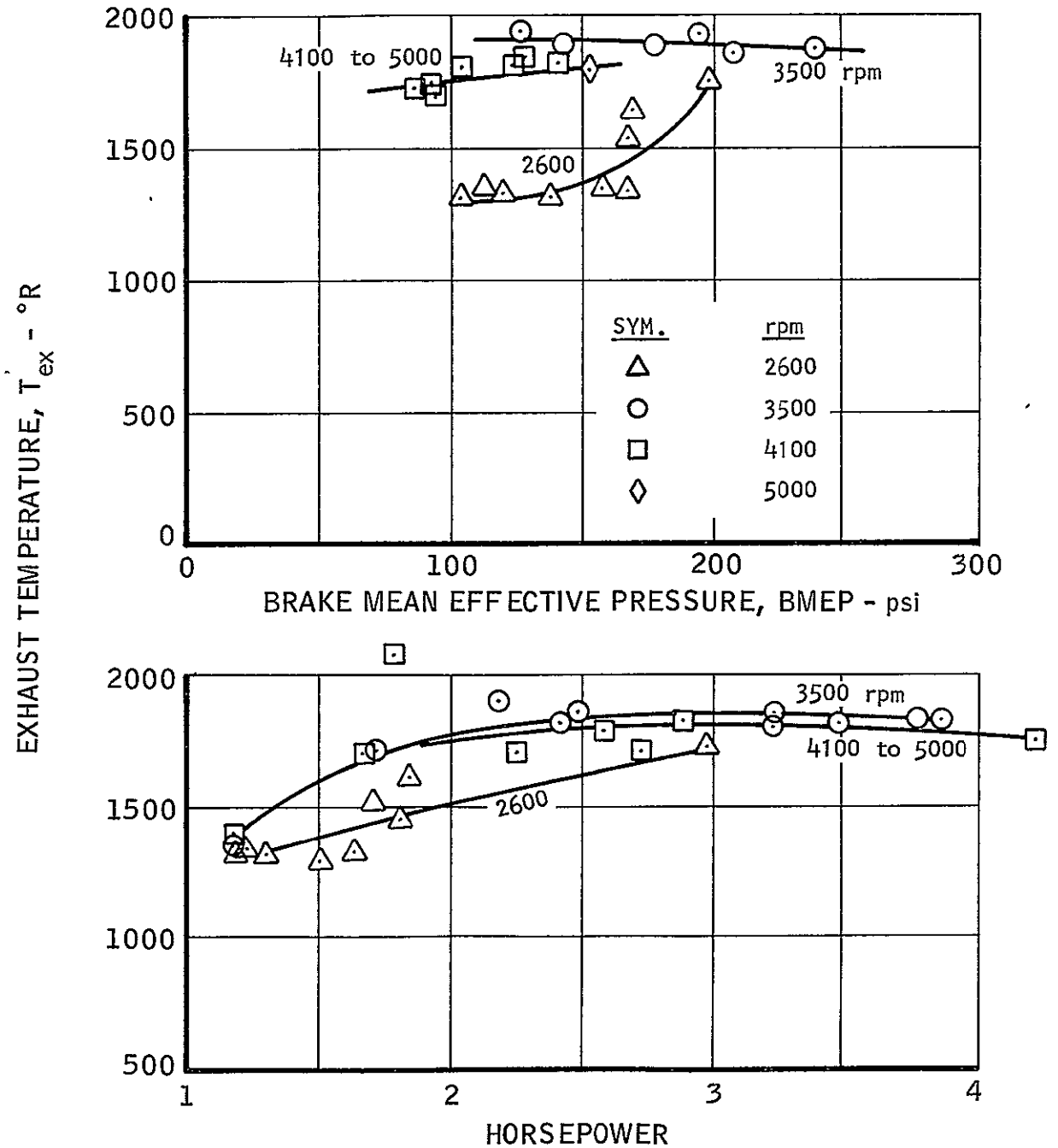

FIGURE 72

SPU-3 ENGINE

VARIATION OF BRAKE SPECIFIC PROPELLANT CONSUMPTION WITH HORSEPOWER

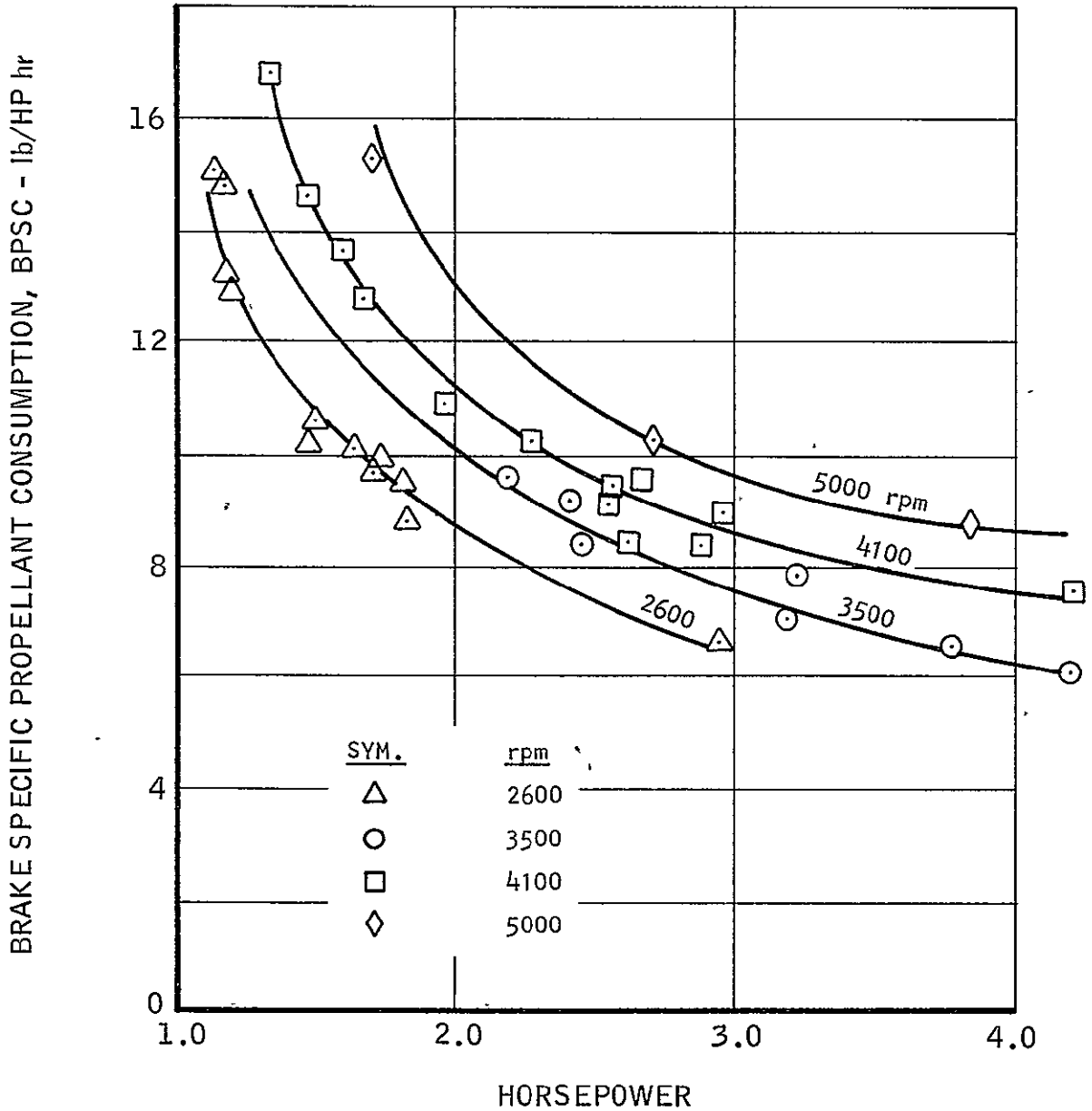

FIGURE 73

SPU-3 ENGINE
ESTIMATED PERFORMANCE TRENDS -- CY 1965

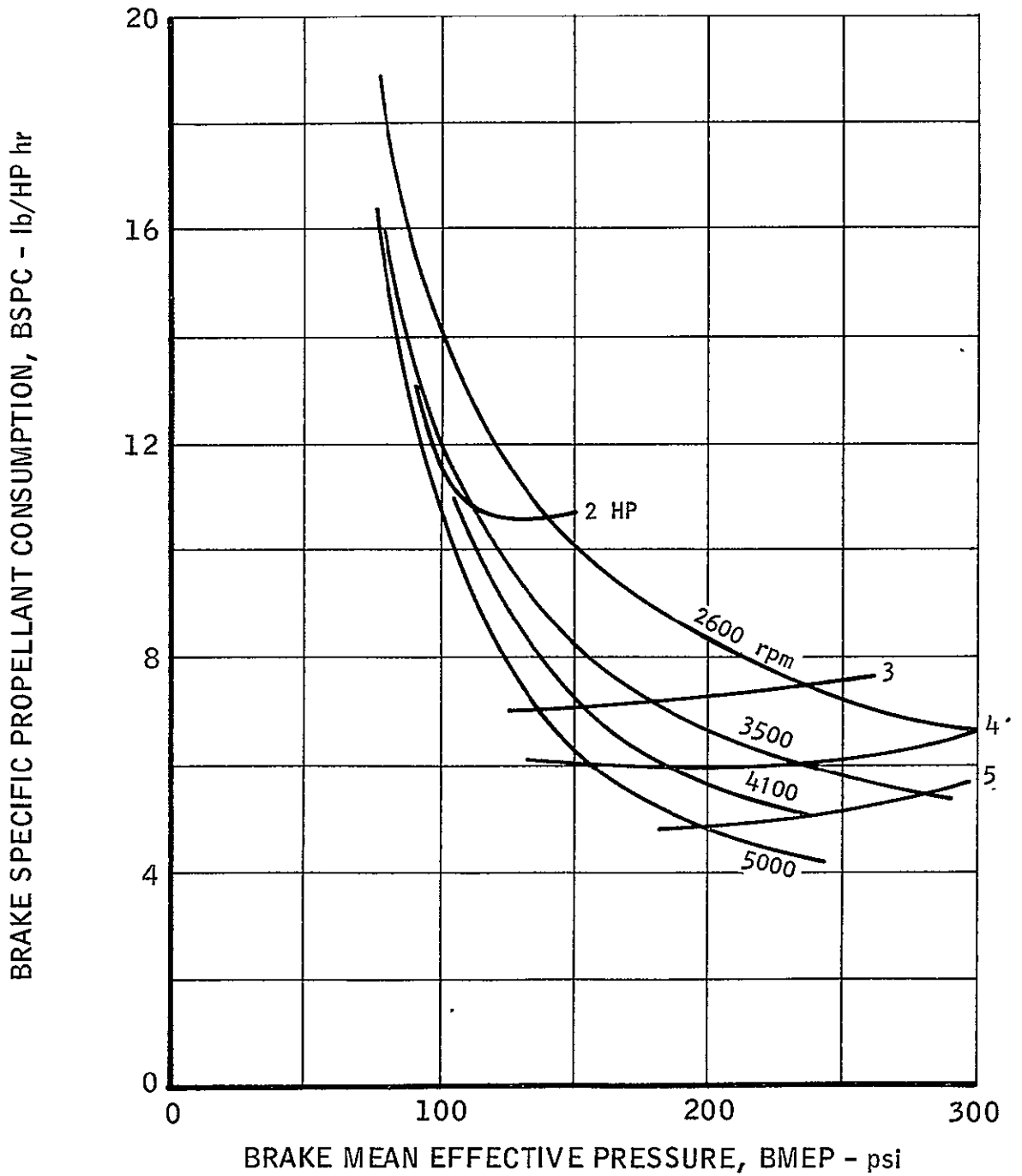

FIGURE 74

SPU-3 ENGINE
TYPICAL INDICATOR DIAGRAM ANALYSIS
RUN 5151-19-8

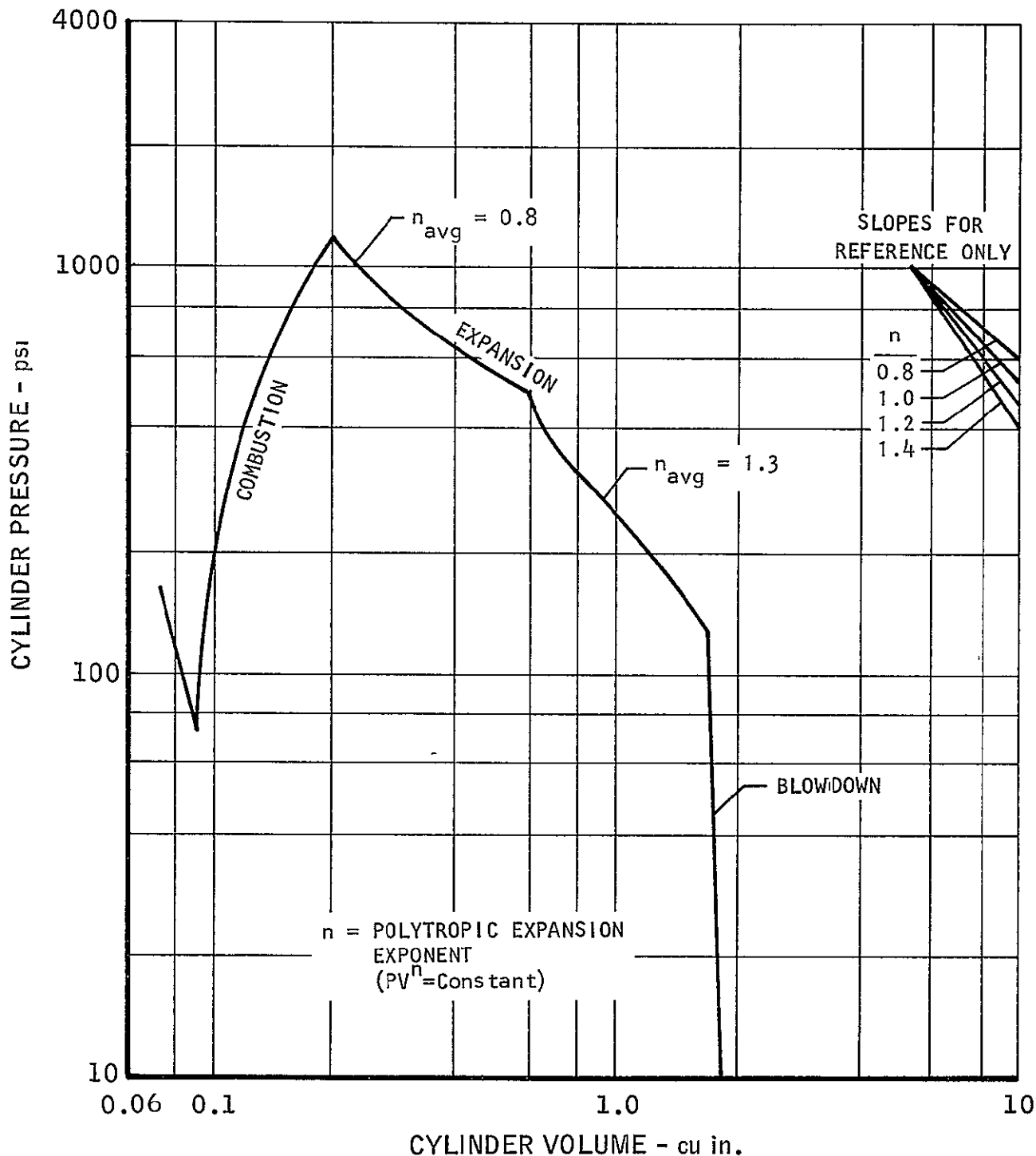

FIGURE 75

SPU-3 ENGINE
CORRELATION OF TEST DURATION AND HEAT REJECTION

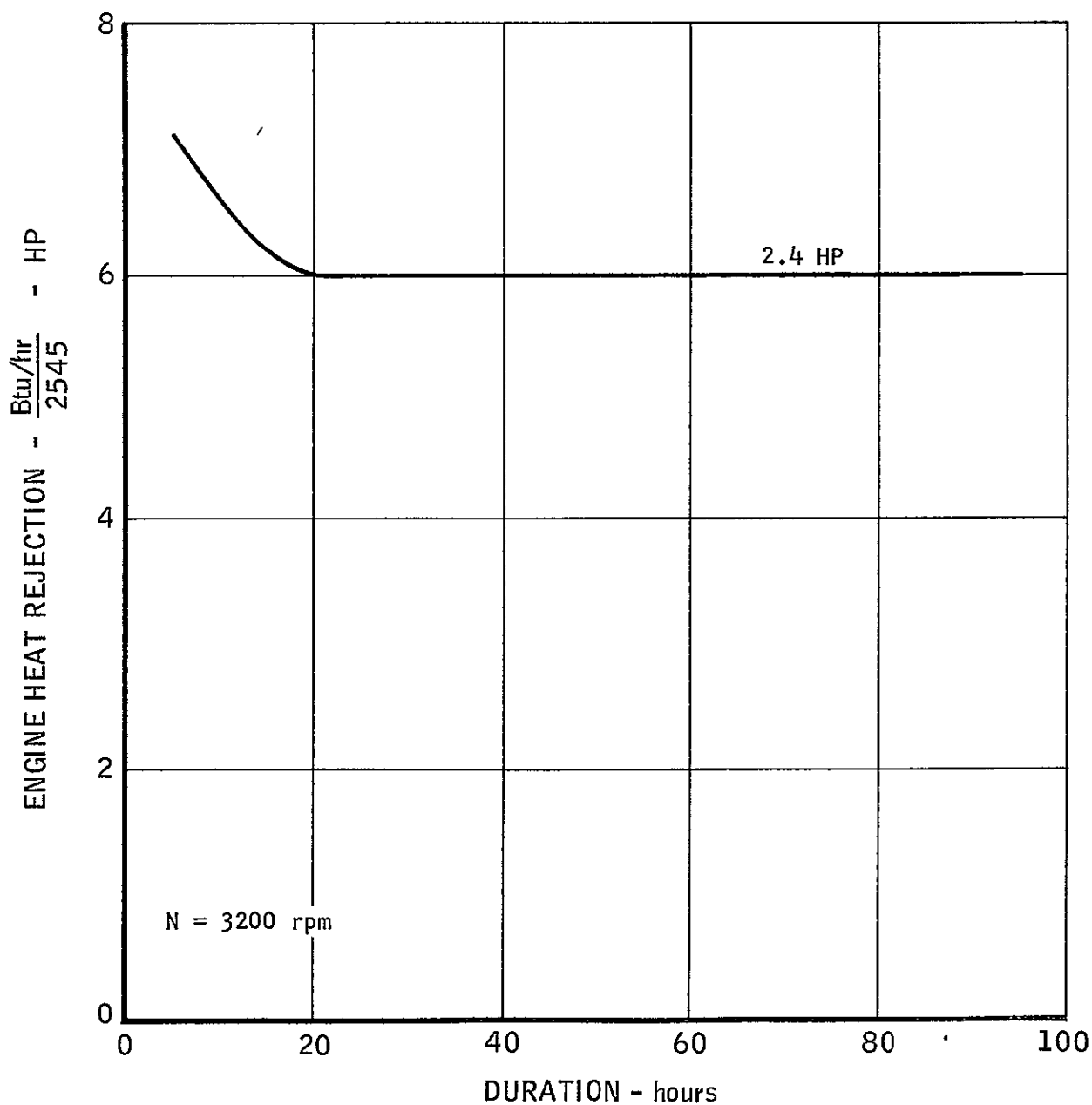

FIGURE 76

SPU-3 ENGINE
PISTON TEMPERATURES

(BASED ON OBSERVATION OF COMPONENTS AFTER TEST)

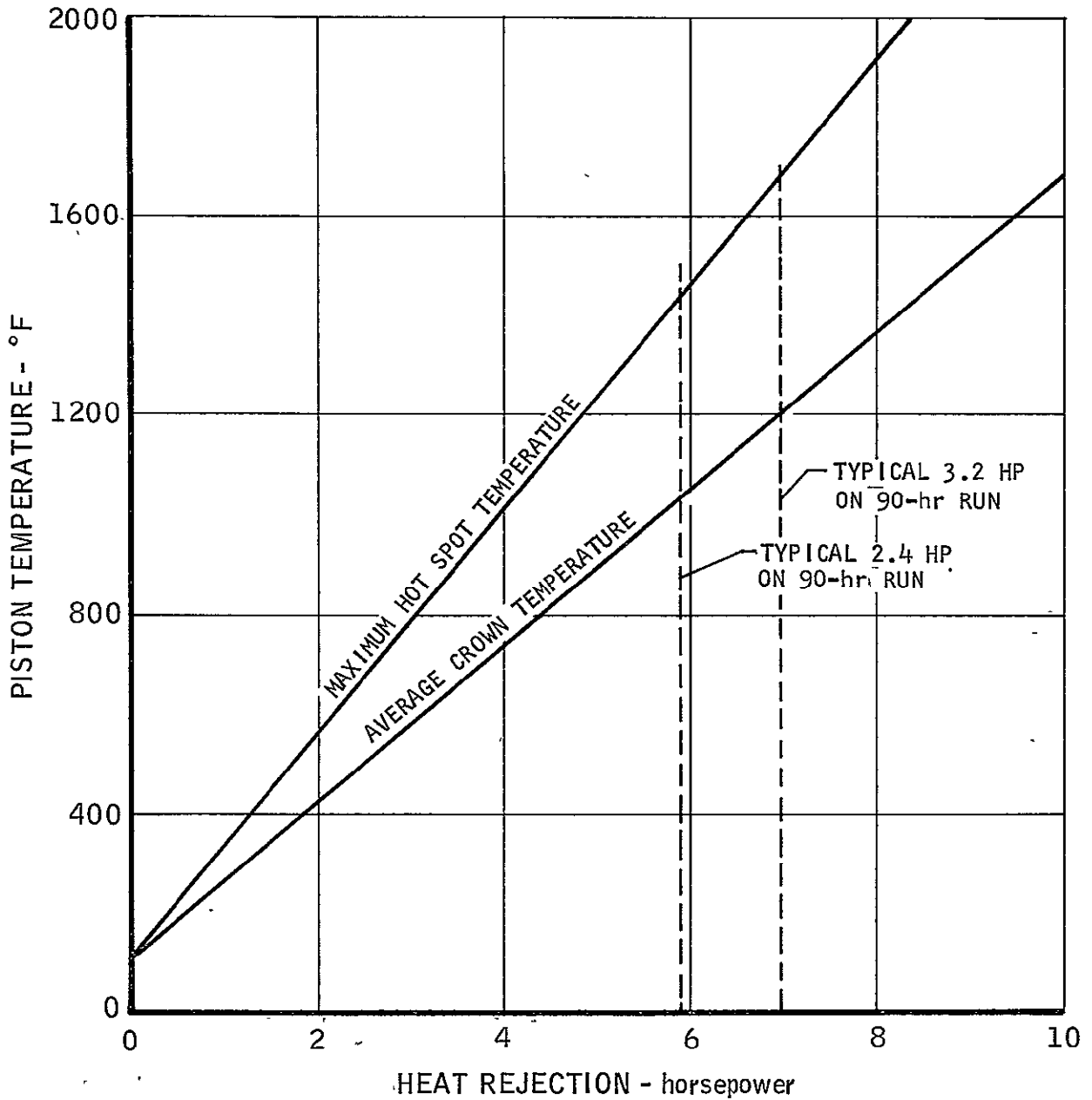

FIGURE 77

SPU-3 ENGINE

VARIATION OF HEAT REJECTION WITH COOLANT FLOW

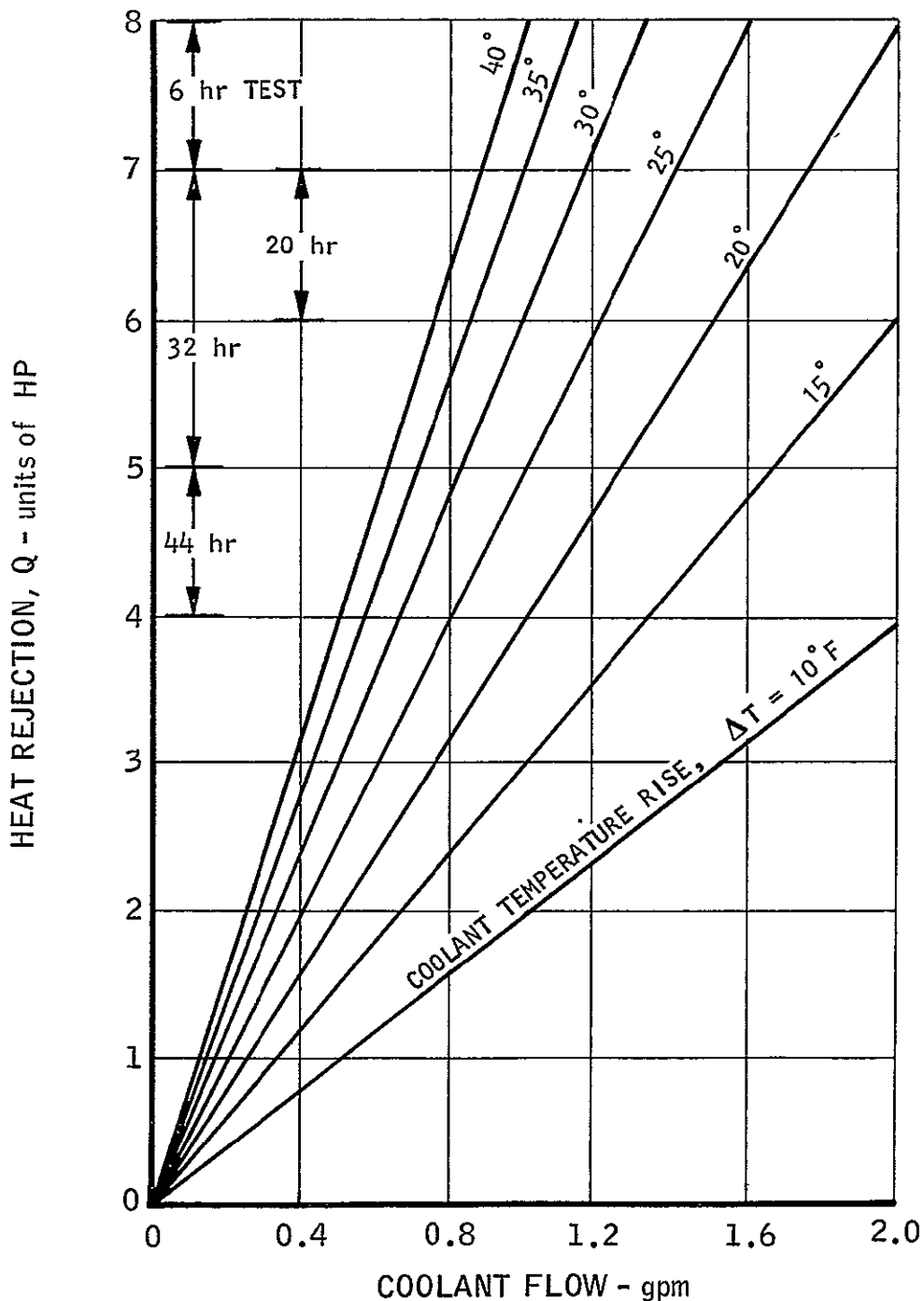

FIGURE 78

SPACE POWER UNIT FEASIBILITY ACHIEVEMENTS

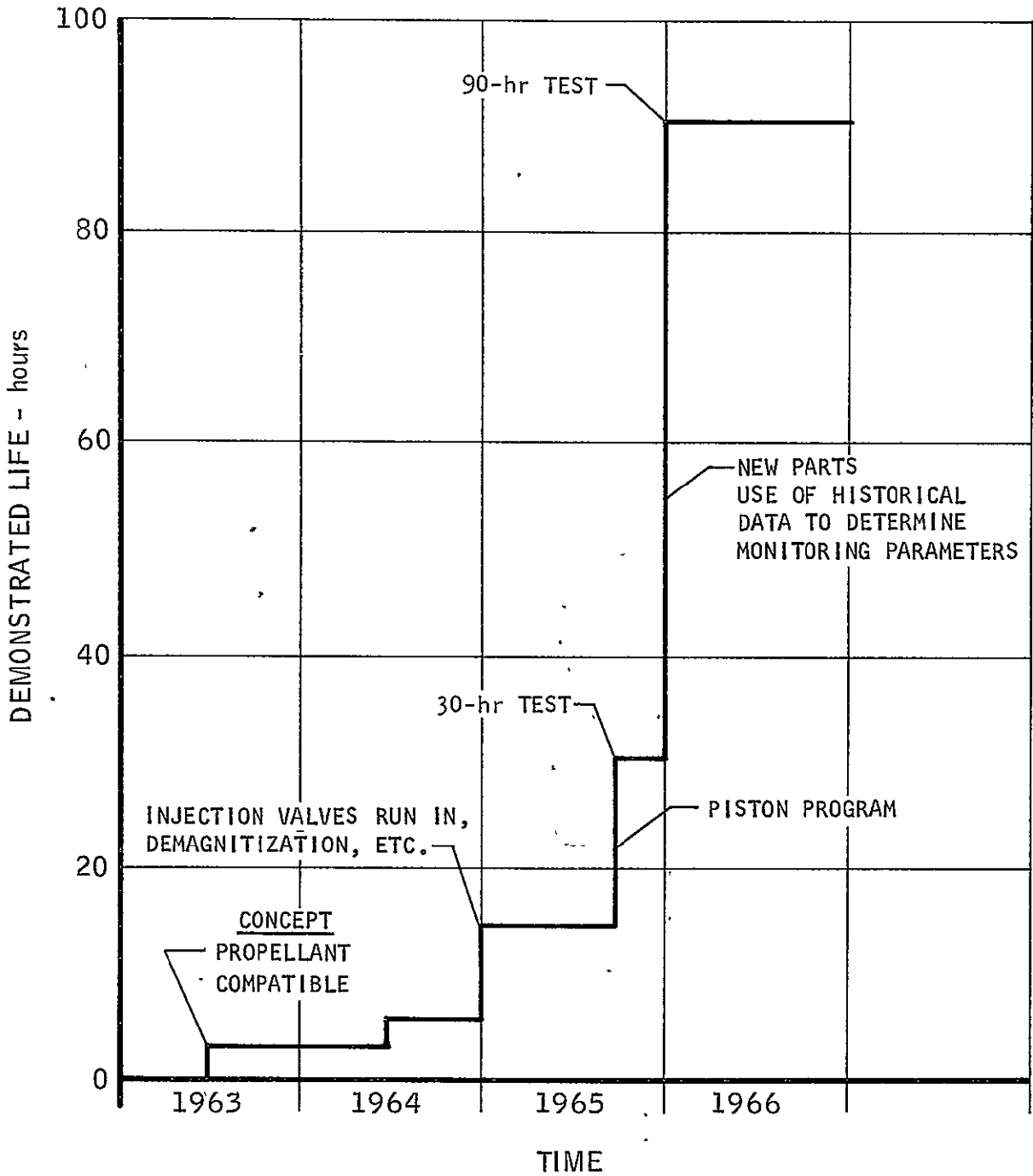

FIGURE 79

SPU-3 ENGINE

EFFECT OF EXPANSION RATIO ON ENGINE TEMPERATURES

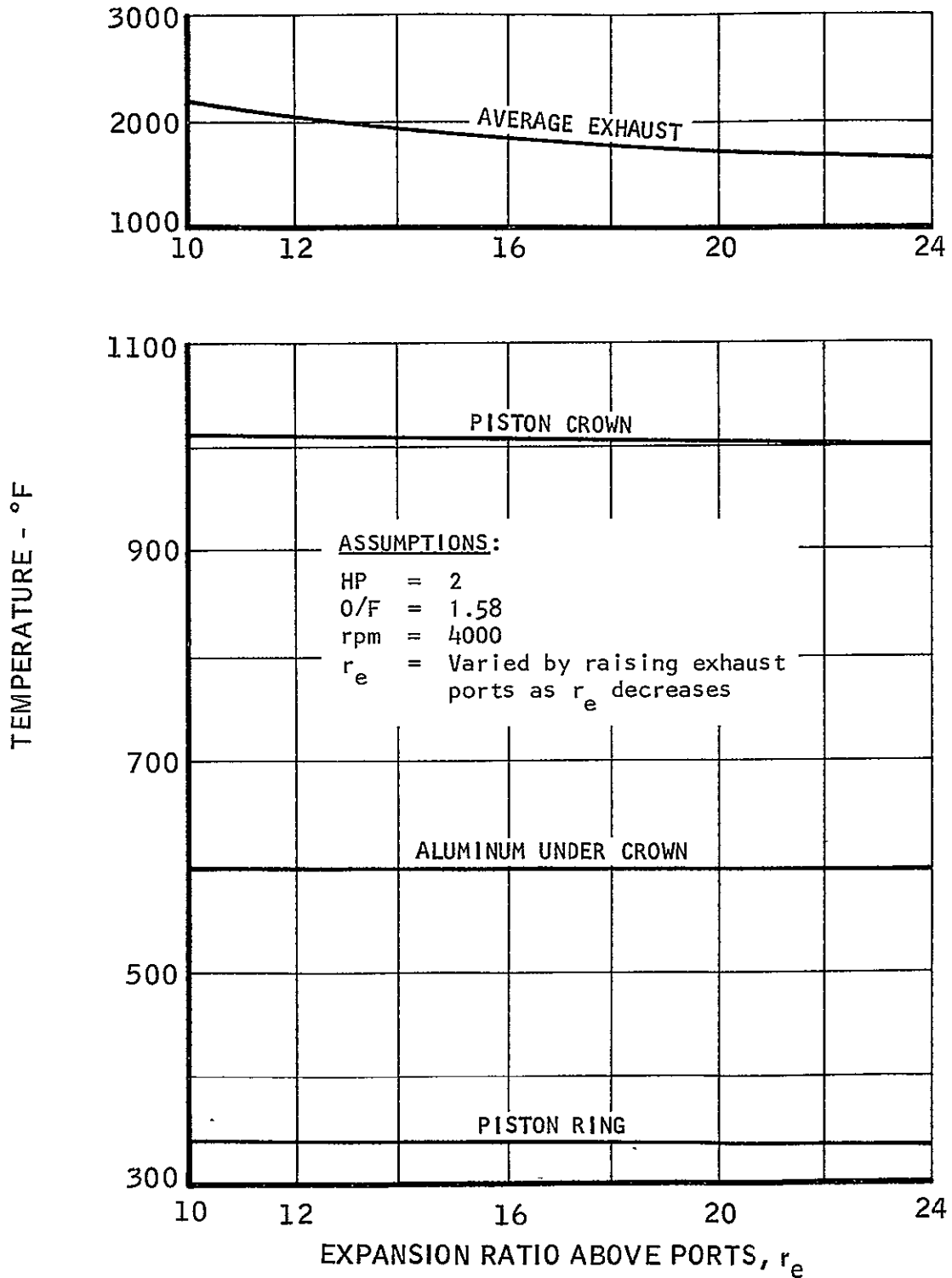

FIGURE 80

VARIATION OF BRAKE SPECIFIC PROPELLANT
CONSUMPTION WITH EXPANSION RATIO

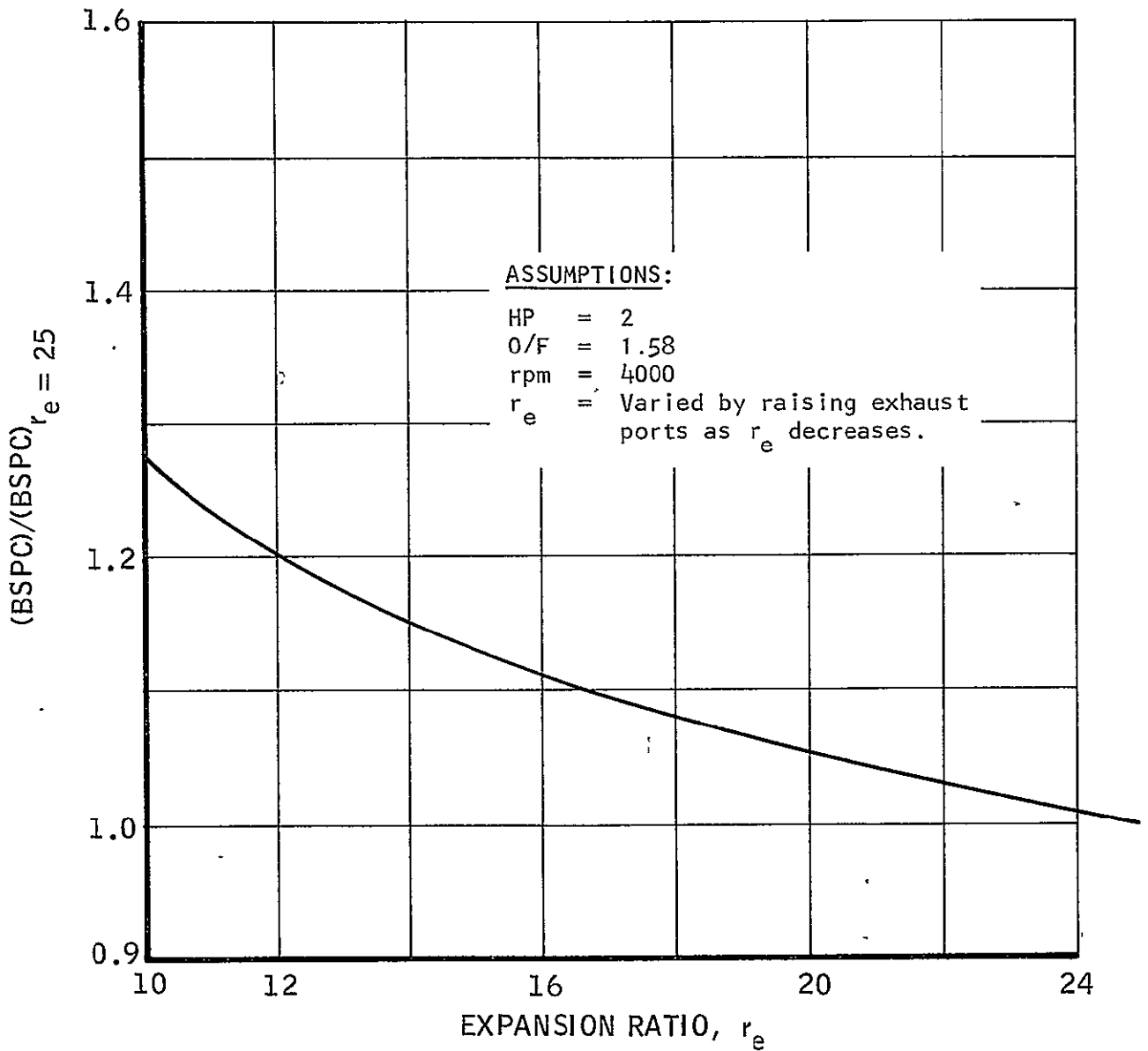

FIGURE 81

SPU-3 ENGINE
 EFFECT OF HEAT REJECTION RATE ON PISTON TEMPERATURES
 (BASED ON ANALYSES)

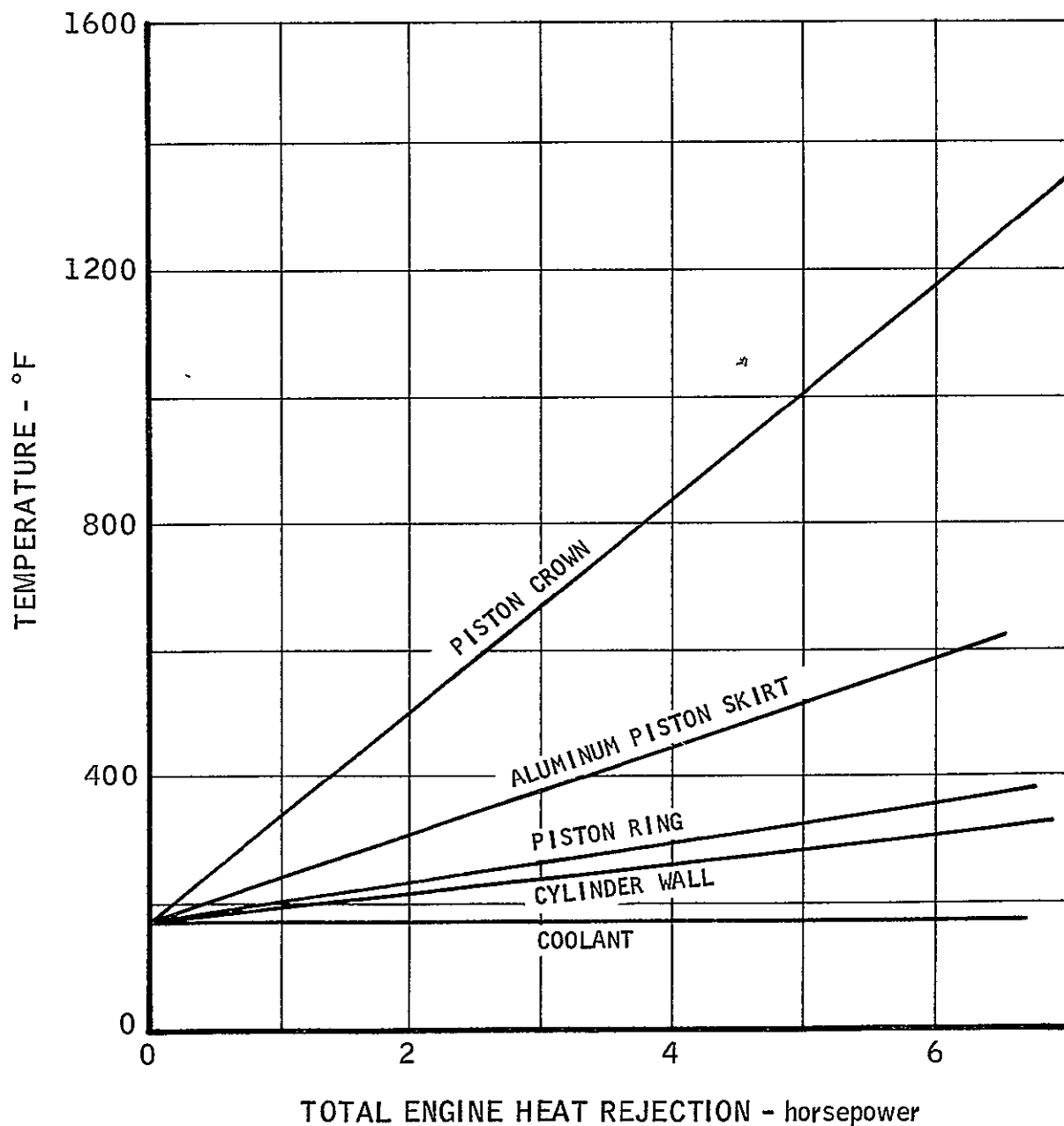

FIGURE 82

SPU-3 ENGINE
 BASELINE PISTON CONFIGURATION AND INPUT AND OUTPUT TEMPERATURE DATA

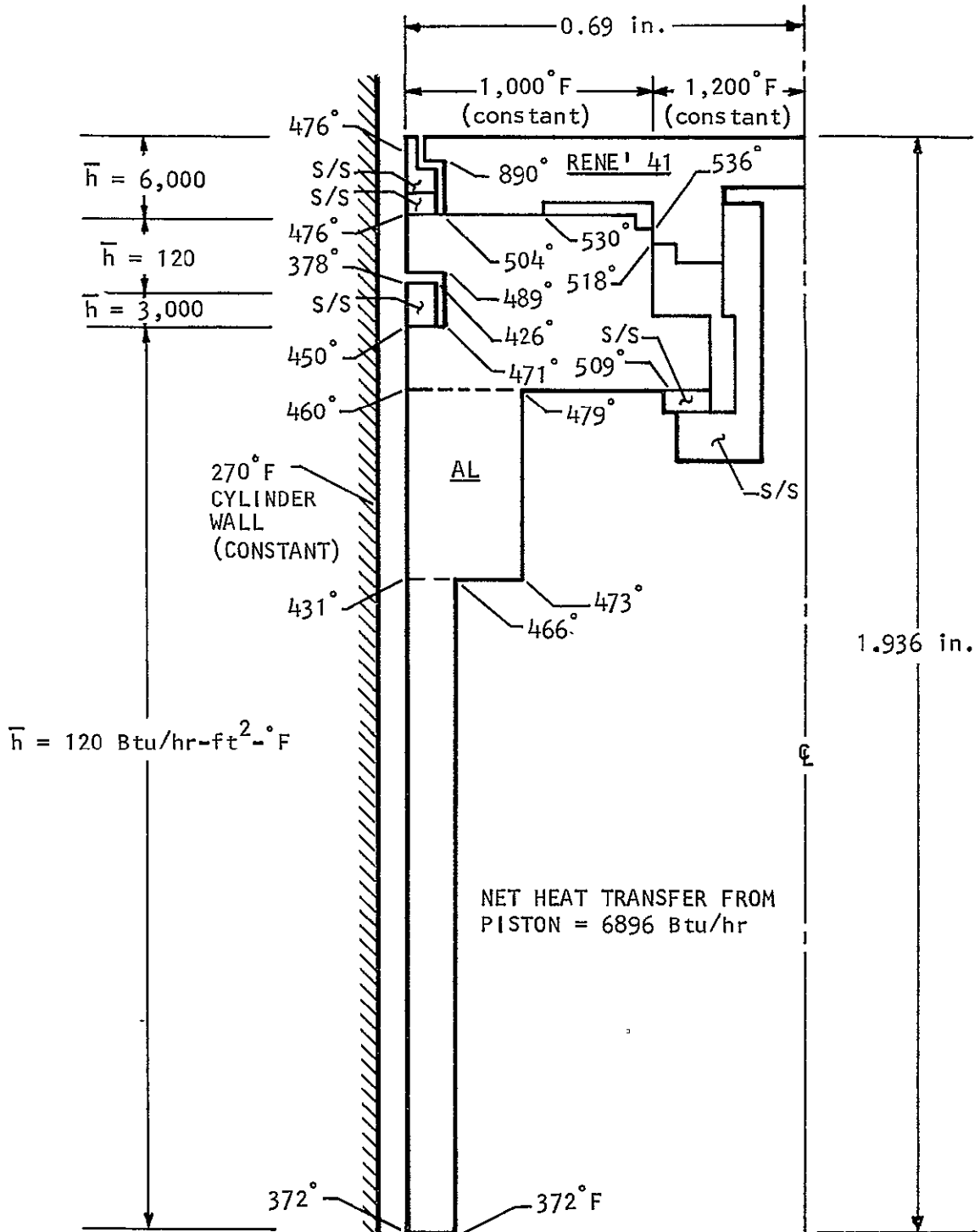

FIGURE 83

SPU-3 ENGINE
MOD. 1 PISTON CONFIGURATION AND INPUT AND OUTPUT TEMPERATURE DATA

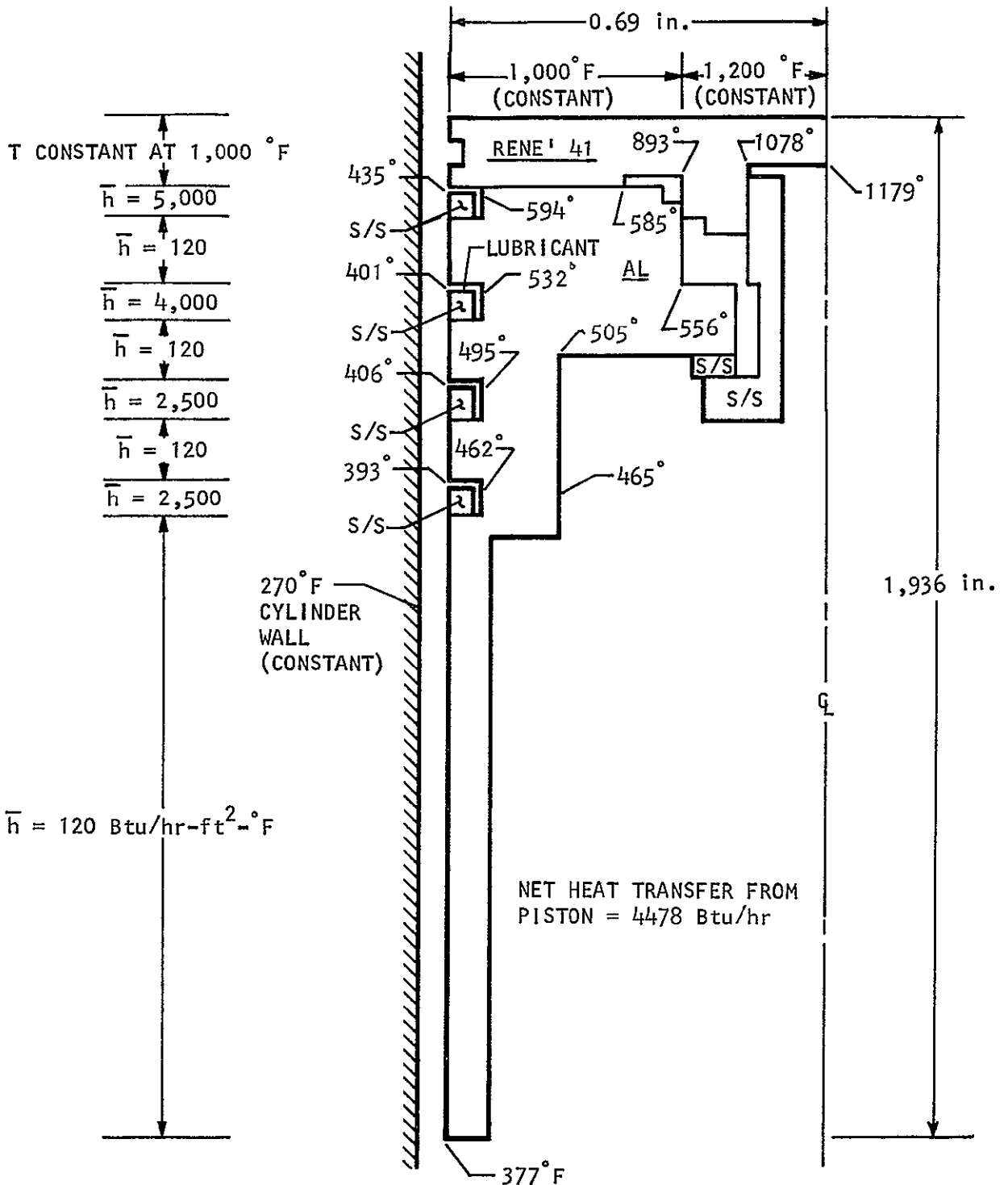
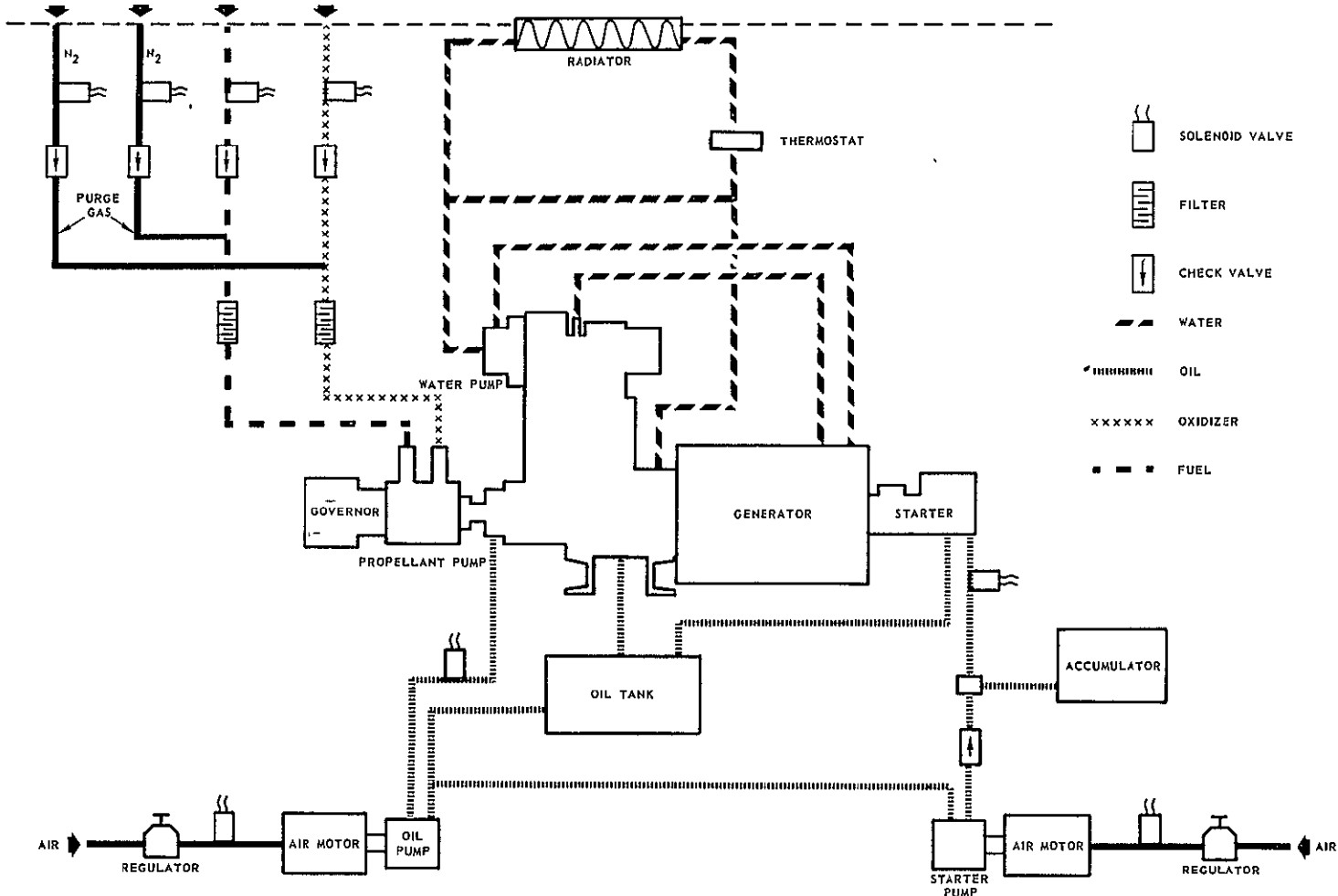

FIGURE 84

SCHEMATIC OF THE BREADBOARD SYSTEM FOR THE SPU-3 ENGINE



V3503-2
2-9-66

UNCLASSIFIED

UNCLASSIFIED
- 197 -

ISOMETRIC OF THE BREADBOARD SYSTEM FOR THE SPU-3 ENGINE

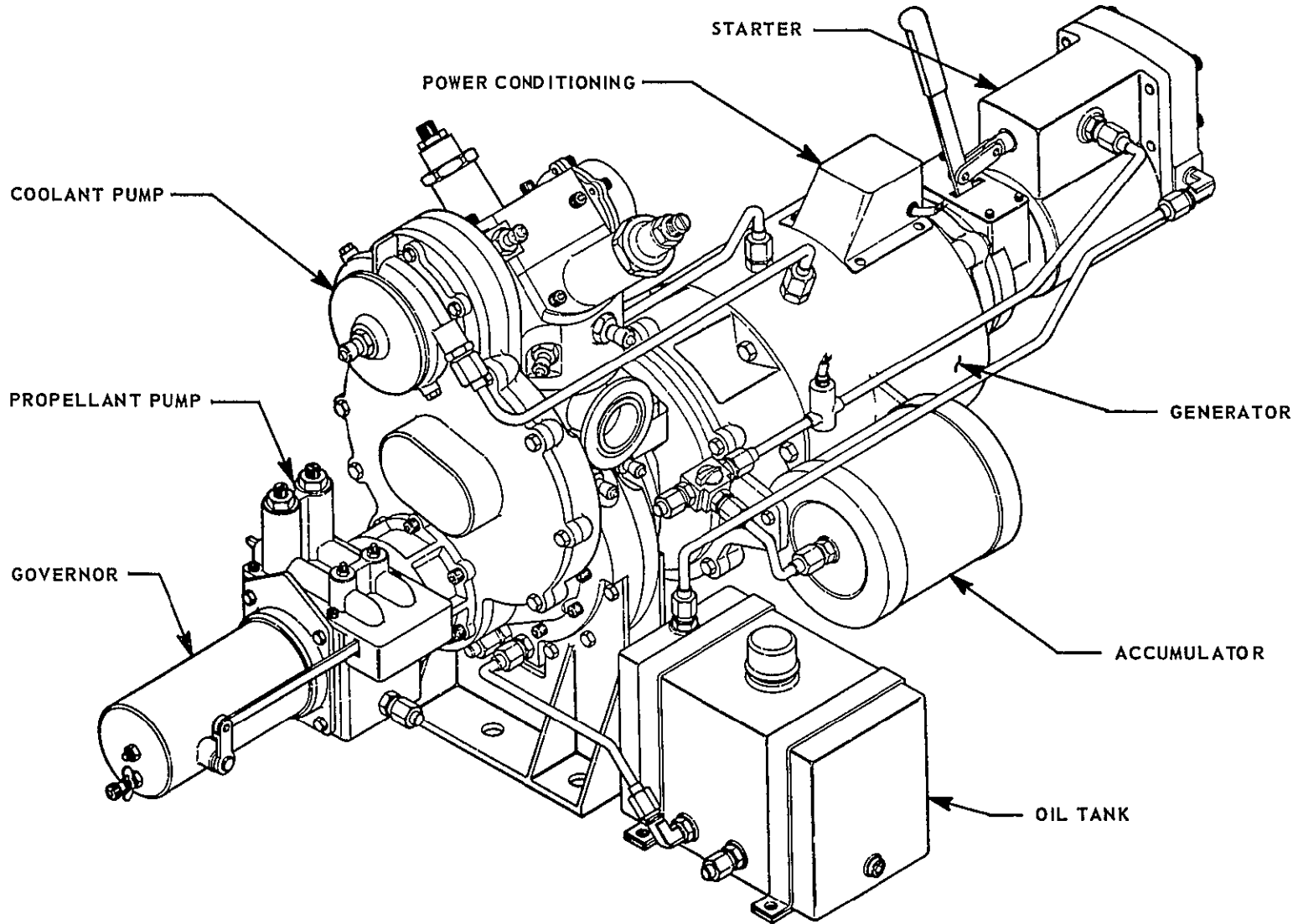

UNCLASSIFIED

- 198 -

FIGURE 86

UNCLASSIFIED

ISOMETRIC OF THE PROTOTYPE SPACE POWER SYSTEM

287-111

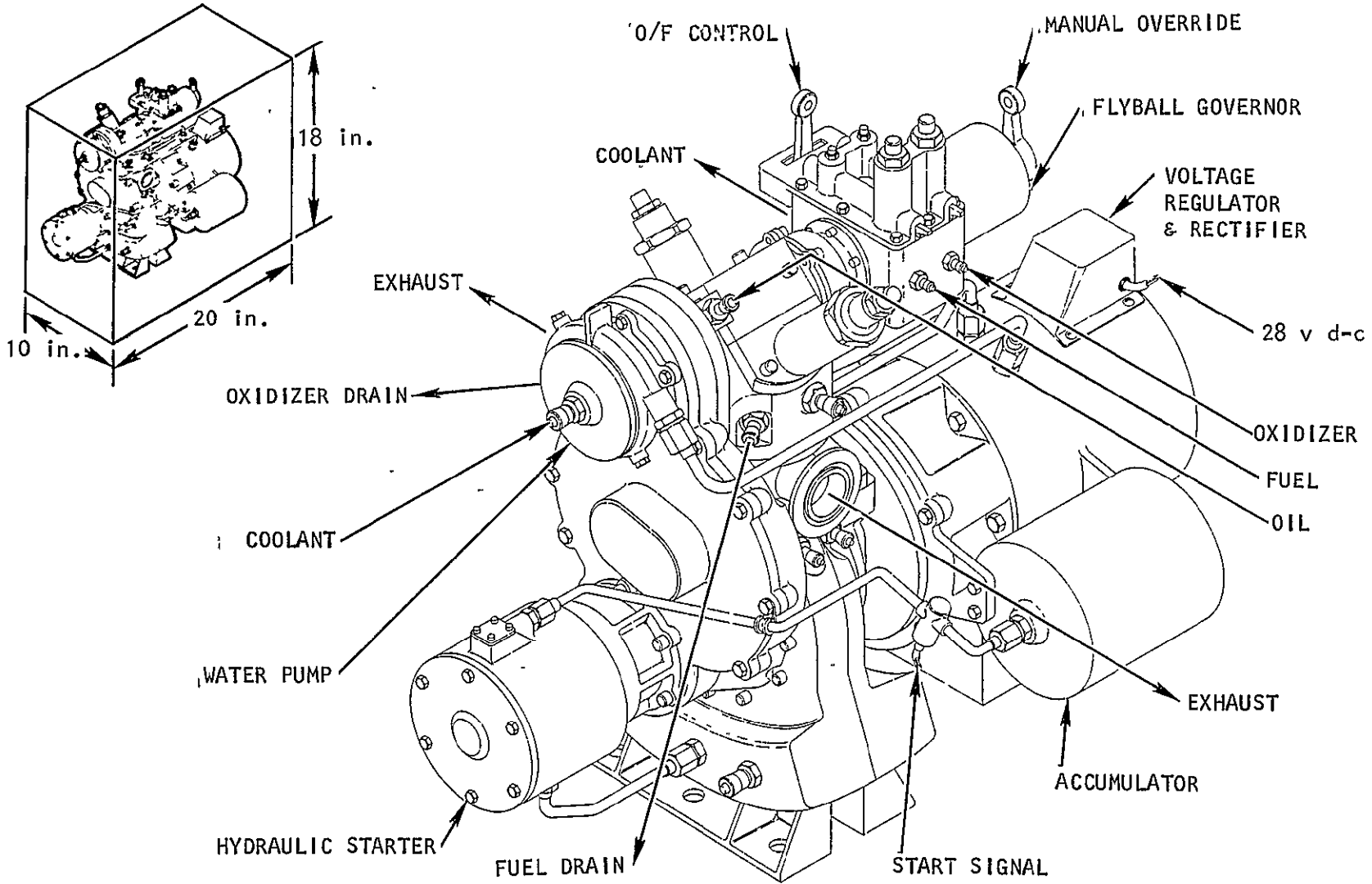

UNCLASSIFIED

- 199 -

FIGURE 87

THE
Margardt
CORPORATION
VAN NUYS CALIFORNIA

UNCLASSIFIED

Report 6098

V3286-4

OPERATING SCHEMATIC OF THE PROTOTYPE SPACE POWER SYSTEM

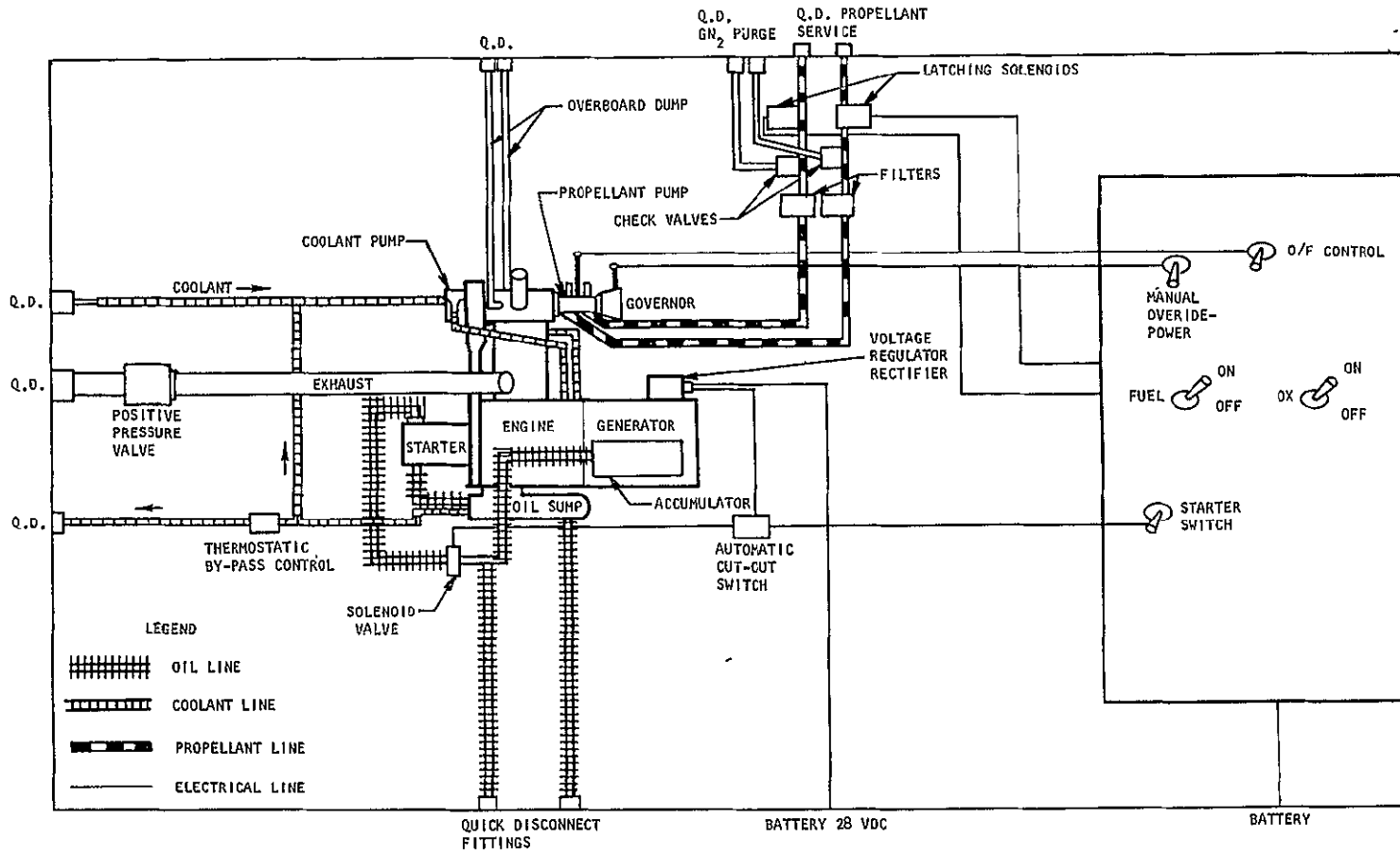

UNCLASSIFIED

FIGURE 88

V3286-5

UNCLASSIFIED

VARIATION OF IGNITION SPIKE PRESSURE WITH FUEL COMPOSITION
 FROM ROCKET RESEARCH TESTS WITH 0.5 UDMH/0.5 N₂H₄ FUEL

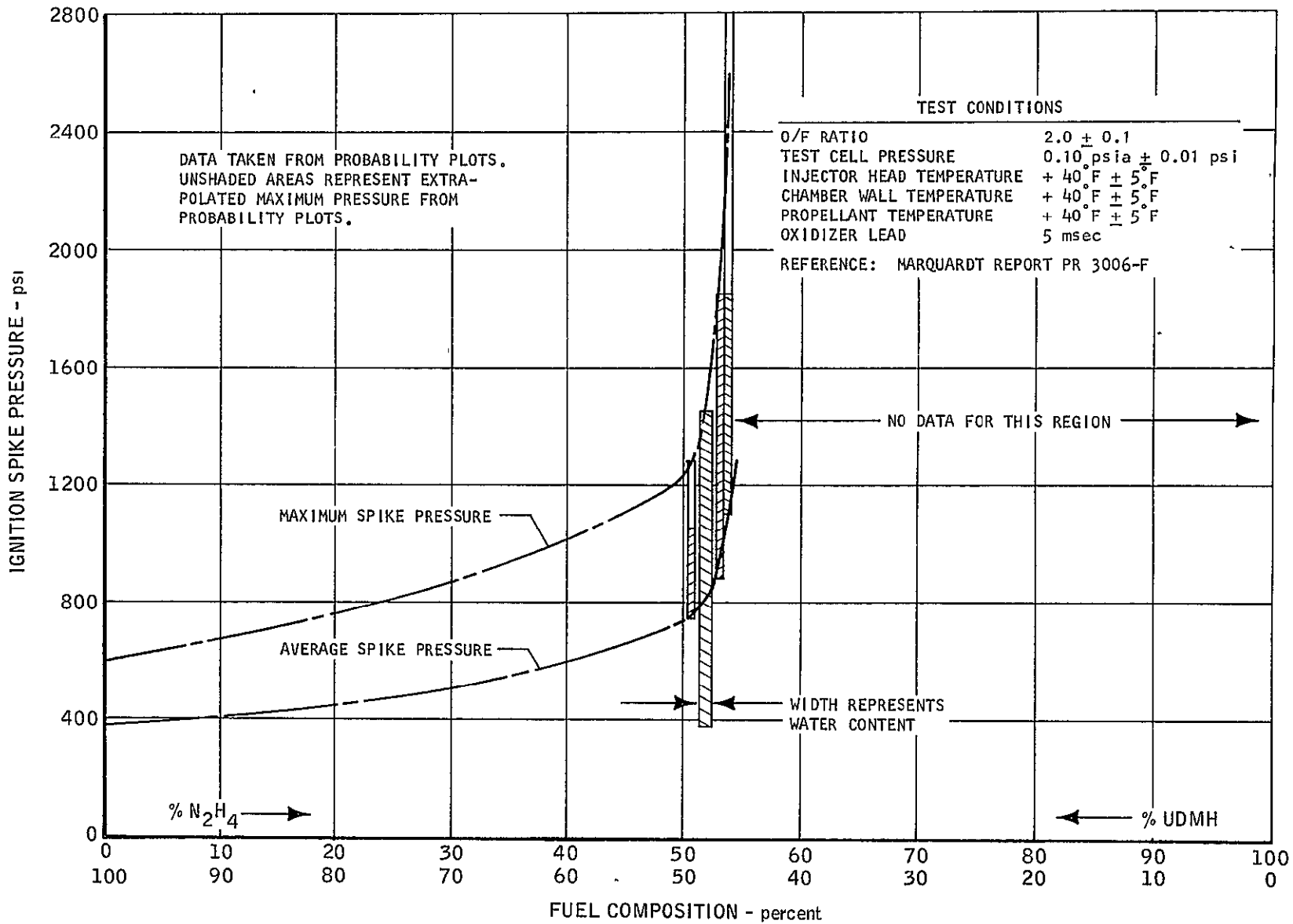

287-132

UNCLASSIFIED

- 201 -

FIGURE 89

FUEL AND OXIDIZER ANALYSIS RECORD

Date: March 9, 1966

Test No. _____

Eng. Assy. P/N _____

S/N _____

Location Saugus C-7

Inspection _____

Stamp _____

Operations Engr. _____

OXIDIZER							RUN TANK ANALYSIS	
Vendor		Run Tank S/N		Date Filled			Sample No. _____	
Storage Cylinder No.	Pounds Transferred	Vendors Batch Analysis				Analyzed By _____		
		N ₂ O ₄ %	Particulate	NOCL %	Water Equivalent %	Date: _____		
(MIL P 26539 A Ref.)		99.5 Min.	10.0 mg/L	0.08 Max.	0.1 Max.	N ₂ O ₄ _____ %		
						Particulate _____ mg/L		
						NOCL _____ %		
						Water Equivalent _____ %		
FUEL							RUN TANK ANALYSIS	
Vendor <u>AF</u>		SPU Run Tank		Date Filled			Sample No. <u>1132-C7-03096-1F</u>	
Shipping Drum No.	Pounds Transferred	Vendors Batch Analysis				Analyzed By <u>C. Rabb</u>		
		N ₂ H ₄ %	UDMH %	H ₂ O + other Sol Impurities %	N ₂ H ₄ -UDMH + Amines %	Particulate Matter	Workmanship	Date: <u>3-10-66</u>
MIL-P-27402 Ref.	51.0 ± 0.8	47.0 Min.	1.8 Max.	98.2 Min.	1.0 mg/L Max.	Homogeneous Liquid	N ₂ H ₄ <u>46.4</u> %	
<u>H2704</u>	<u>50.7</u>	<u>48.2</u>	<u>0.25</u>	<u>98.9</u>	<u>0.7</u>	<u>OK</u>	UDMH <u>53.1</u> %	
		<u>Fuel does not meet spec. requirements</u>					H ₂ O + other Sol. impurities <u>0.5</u> %	
							N ₂ H ₄ -UDMH + amines <u>99.5</u> %	
							Particulate Matter _____ mg/L	
							Workmanship _____	

Density - 0.8905 @ 74°F

UNCLASSIFIED

- 202 -

FIGURE 90

THE **Margardt** CORPORATION

VAN NUYS CALIFORNIA

UNCLASSIFIED

Report 6098

FUEL AND OXIDIZER ANALYSIS RECORD

Date: 3-15-66

Test No. _____

Eng. Assy. P/N _____

S/N _____

Location Saugus

Inspection _____

Stamp _____

Operations Engr. _____

OXIDIZER								RUN TANK ANALYSIS	
Vendor		Run Tank S/N		Date Filled				Sample No. _____	
Storage Cylinder No.		Pounds Transferred		Vendors Batch Analysis				Analyzed By _____	
				N ₂ O ₄	Particulate	NOCL	Water Equivalent	Date: _____	
				%		%	%	N ₂ O ₄ _____ %	
								Particulate _____ mg/L	
								NOCL _____ %	
								Water Equivalent _____ %	
(MIL P 26539 A Ref.)				99.5 Min.	10.0 mg/L	0.08 Max.	0.1 Max.		

FUEL								RUN TANK ANALYSIS	
Vendor <u>FF</u>		Run Tank S/N		Date Filled				Sample No. <u>Run tank</u>	
Shipping Drum No.		Pounds Transferred		Vendors Batch Analysis				Analyzed By <u>C. Robb</u>	
				N ₂ H ₄	UDMH	H ₂ O + other Sol Impurities	N ₂ H ₄ -UDMH + Amines	Particulate Matter	Workmanship
				%	%	%	%		
MIL-P-27402 Ref.		51.0±0.8		47.0 Min.	1.8 Max.	98.2 Min.	1.0 mg/L Max.	Homogeneous Liquid	
<u>H270A</u>		<u>-</u>		<u>50.7</u>	<u>48.2</u>	<u>0.25</u>	<u>98.9</u>	<u>0.7</u>	<u>OK</u>

Out of spec.

Density - 0.9900 @ 72.5°F

UNCLASSIFIED

UNCLASSIFIED

FIGURE 91

FUEL AND OXIDIZER ANALYSIS RECORD

Date: 3-15-66

Test No. _____

Eng. Assy. P/N _____

S/N _____

Location Saugus

Inspection _____

Stamp _____

Operations Engr. _____

OXIDIZER							RUN TANK ANALYSIS	
Vendor		Run Tank S/N		Date Filled			Sample No. _____	
		Vendors Batch Analysis					Analyzed By _____	
Storage Cylinder No.	Pounds Transferred	N ₂ O ₄ %	Particulate	NOCL %	Water Equivalent %		Date: _____	
(MIL P 26539 A Ref.)		99.5 Min.	10.0 mg/L	0.08 Max.	0.1 Max.		N ₂ O ₄ _____ %	Particulate _____ mg/L
							NOCL _____ %	Water Equivalent _____ %

FUEL							RUN TANK ANALYSIS	
Vendor <u>AF</u>		Run Tank S/N		Date Filled			Sample No. <u>Shipping cylinder</u>	
		Vendors Batch Analysis					Analyzed By <u>C. Rabb</u>	
Shipping Drum No.	Pounds Transferred	N ₂ H ₄ %	UDMH %	H ₂ O + other Sol Impurities %	N ₂ H ₄ -UDMH + Amines %	Particulate Matter	Workmanship	Date: <u>3-16-66</u>
MIL-P-27402 Ref.	51.0±0.8	47.0 Min.	1.8 Max.	98.2 Min.	1.0 mg/L Max.	Homogeneous Liquid		N ₂ H ₄ <u>45.6</u> %
<u>H2709 -</u>	<u>50.7</u>	<u>48.2</u>	<u>0.25</u>	<u>99.9</u>	<u>0.7</u>	<u>OK</u>		UDMH <u>54.1</u> %
								H ₂ O + other Sol. impurities <u>0.3</u> %
								H ₂ H ₄ -UDMH + amines <u>99.7</u> %
								Particulate Matter _____ mg/L
								Workmanship <u>OK</u>

Out of Spec.

Density - 0.8895 @ 73°F

287-135

UNCLASSIFIED

- 204 -

FIGURE 92

THE **Margardt** CORPORATION

VAN NUYS CALIFORNIA

UNCLASSIFIED

Report 6098

VOLTAGE REGULATION CHARACTERISTICS
OF FIRST EXPERIMENTAL SPU GENERATOR

50 volts d-c, at 4500 rpm, NOMINAL RATED OUTPUT 3 KW

(REWOUND LATER FOR 28 volts d-c)

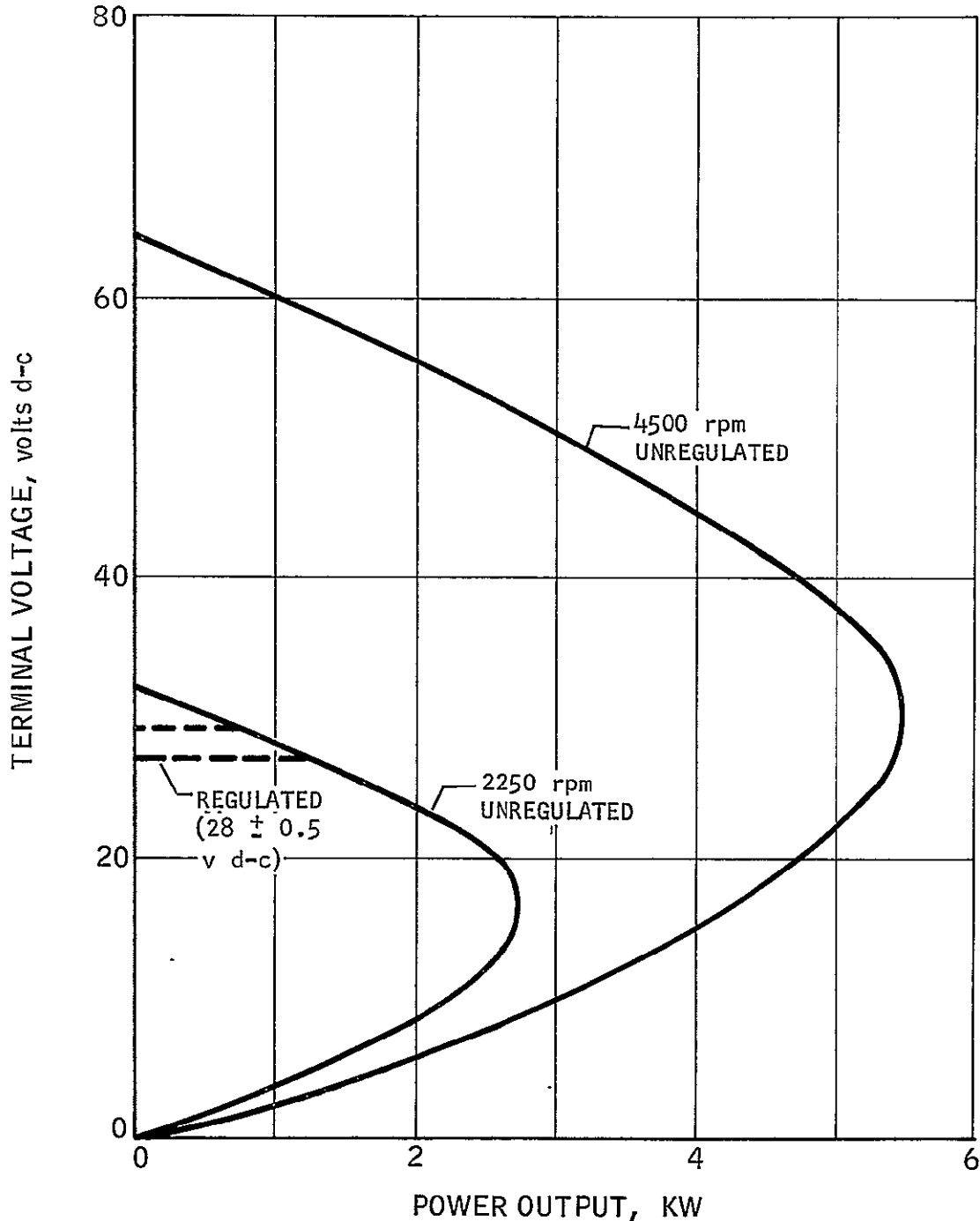

FIGURE 93

PREDICTED VOLTAGE REGULATION CHARACTERISTICS
OF SECOND EXPERIMENTAL SPU GENERATOR

28 volts d-c, at 4500 rpm, NOMINAL RATED OUTPUT 0 to 3 KW

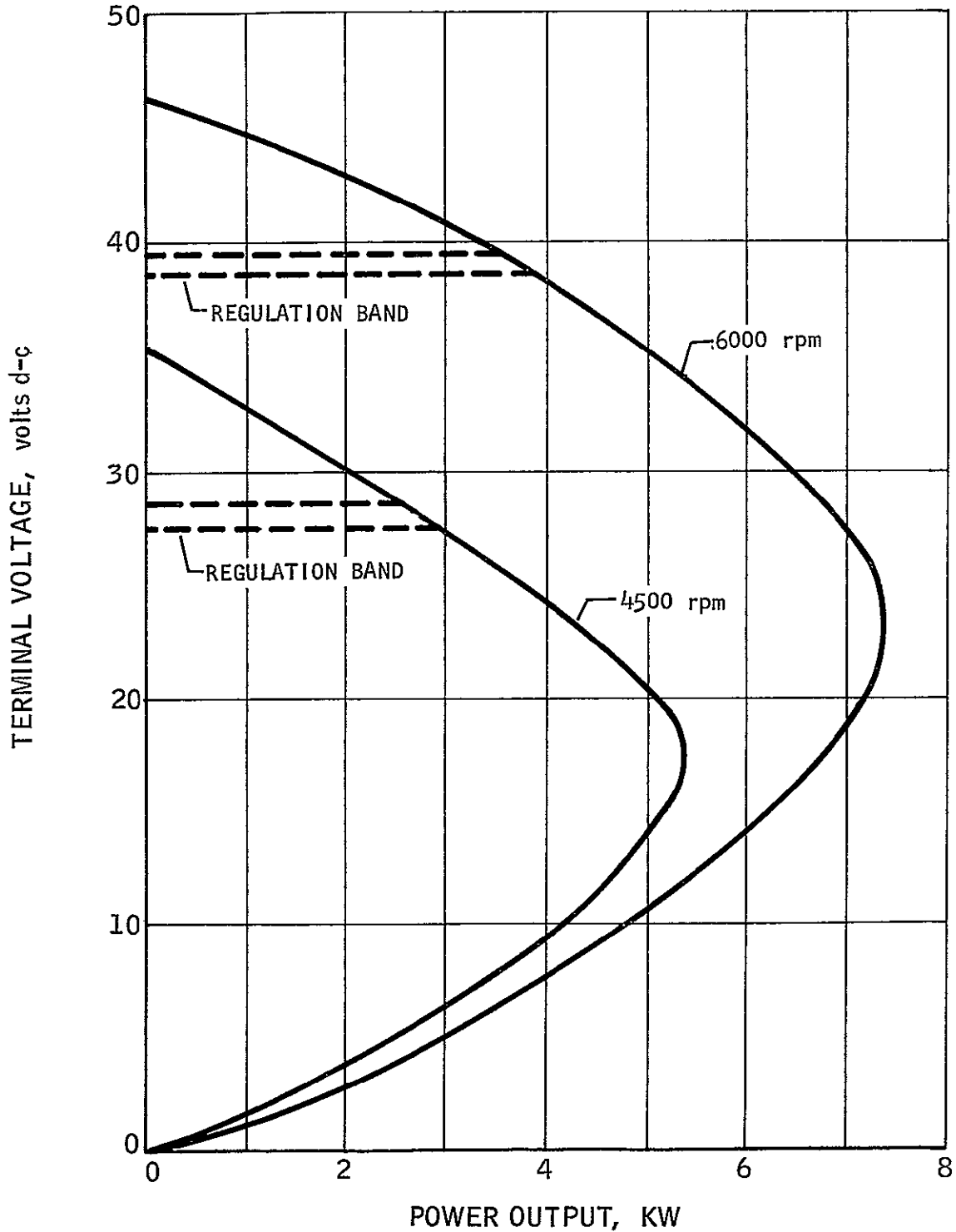

FIGURE 94

UNCLASSIFIED

APPENDIX A

INVESTIGATIONS ON CHANGING COMPOSITIONS
OF AEROZINE-50

(Marquardt Process Memorandum No. 17.197)

UNCLASSIFIED

ORIGINATOR <u>C. Robb</u> C. Robb APPROVAL <u>S. V. Castner</u> S. V. Castner APPROVAL <u>S. V. Castner for</u> F. K. Lampson 4-19-66	THE MARQUARDT CORPORATION PROCESS MEMORANDUM	MPM NO <u>17.197</u> DATE <u>18 APRIL 1966</u> PAGE <u>1</u>
SUBJECT Investigations on Changing Compositions of Aerozine-50 at Saugus RFL (Submitted on RT# 1171, 6 April 1966)		

I. INTRODUCTION

A sample of Aerozine 50 fuel was received from Saugus on March 9, 1966 for the routine analysis of specific gravity, UDMH, N_2H_4 and H_2O contents. The analysis revealed that the UDMH content was too high to meet specification requirements. Since most fuel samples, that fail to meet the requirements, are found to have excess water or too low a UDMH content, an investigation to determine the cause of a high UDMH content was requested.

II. CONCLUSIONS

Aerozine 50 when frozen and rethawed separates into two or more layers. The upper layer is UDMH rich. The lower layer is N_2H_4 rich. If the layered material is not stirred, neither layer will meet the specification requirements. We recommend that fuel not be stored where it is subject to freezing unless it can be remixed before using. We also recommend that if fuel is remixed, that an analysis of the fuel is made after each remixing.

III. TEST PROCEDURE

To demonstrate the actual separation, a fuel sample, which was found to have the normal analysis of 51% N_2H_4 , 48.5% UDMH, and 0.5% H_2O , was cooled to about 20°F where considerable crystals of fuel were observed on the inside walls of the sample bottle. The sample was maintained at this temperature for about fifteen (15) minutes at which time a 2 micro-liter sample was drawn for chromatographic analysis. A composition of 20% N_2H_4 , 80% UDMH was estimated for the chromatogram.

The sample was allowed to warm to room temperature without remixing and a second sample removed for the chromatograph. The chromatograph was examined and a fuel composition of 30% N_2H_4 - 70% UDMH was estimated.

A second sample was cooled to 16°F and shaken vigorously to loosen all frozen fuel from the sides of the container so that the crystals would drop to the bottom before they melted. The temperature rose to 20°F rapidly as expected. After fifteen (15) minutes, a sample was taken from the top of the liquidus to confirm the findings of the previous test. After all solidus had melted and the sample was approaching room temperature a second sample showed a partial return to the original typical analysis.

Another sample was then frozen and thawed four times in succession. After the final thawing, the sample was examined and found to have six (6) or seven (7) separate layers of unknown composition. A sample taken from the top layer and analyzed chromatographically showed an almost total UDMH (> 99%) composition. It is believed that successive layers from the top to bottom would show an increasing hydrazine content from near zero to close to 100%.

IV. RESULTS AND DISCUSSION

It is definite that a problem exists from the standpoint of freezing Aerozine 50 fuel. A UDMH rich fuel will be drawn from the container if taken while frozen N_2H_4 exists either on the walls or as separated crystals. A N_2H_4 rich fuel remaining in the tank will result from this action. If fuel is drawn from the bottom of the tank after freezing and rethawing, the initial fuel will be N_2H_4 rich with the final quantities being UDMH rich.

DISTRIBUTION

<u>Copy No.</u>	<u>Transmitted to</u>
1 to 9 and Reproducible.	National Aeronautics and Space Administration Manned Spacecraft Center Power Generation Branch, PPD Houston, Texas 70058 Attn: Mr. C. D. Haines Contract NAS 9-857
10.	National Aeronautics and Space Administration Manned Spacecraft Center General Research Procurement Office Houston, Texas 70058 Attn: Mr. D. K. Ipson Contract NAS 9-857
11.	National Aeronautics and Space Administration Lewis Research Center 2100 Brookpark Road Cleveland, Ohio 44135 Attn: Mr. H. M. Cameron
12.	National Aeronautics and Space Administration - Headquarters Office of Advanced Research and Technology 600 Independence Avenue S.W. Washington, D.C. 20546 Attn: Mr. Arvin H. Smith
13.	National Aeronautics and Space Administration - Headquarters Office of Advanced Research and Technology 600 Independence Avenue S.W. Washington, D.C. 20546 Attn: Mr. H. D. Rothen
14.	National Aeronautics and Space Administration - Headquarters Office of Advanced Research and Technology 600 Independence Avenue S.W. Washington, D.C. 20546 Attn: Mr. Tom Albert, MTF
15.	National Aeronautics and Space Administration - Headquarters Office of Advanced Research and Technology 600 Independence Avenue S.W. Washington, D.C. 20546 Attn: A. F. Captain Bart Campbell, MTL

DISTRIBUTION (Continued)

<u>Copy No.</u>	<u>Transmitted to</u>
16.	National Aeronautics and Space Administration - Headquarters Office of Advanced Research and Technology 600 Independence Avenue S.W. Washington, D.C. 20546 Attn: Mr. Dick Livingston, MTP
17.	Grumman Aircraft Engineering Corporation Bethpage, Long Island, New York 11714 Attn: Mr. Marcel Piry
18.	Martin-Marietta Corporation Baltimore, Maryland 21203 Attn: Mr. Howard Zachman
19.	National Aeronautics and Space Administration Western Operations Office 150 Pico Boulevard Santa Monica, California 90406 Attn: Mr. Fran Di Lorenzo