

N 70 34065

CASE FILE
COPY

UNIVERSITY OF SOUTHERN CALIFORNIA
School of Medicine
2025 Zonal Avenue
Los Angeles, California 90033

NASA CR 109872

Department of Physiology

15 June 1970

NASA CONTRACT NO. NSR 05-018-087

PROGRESS REPORT

Period Covered: March 1, 1970 to May 31, 1970

SUMMARY

During this reporting period the major efforts were directed toward evaluating and testing blood flow circuitry. A dog was implanted to evaluate the flow probe and circuitry. An implantable unit for use on a large primate was fabricated and readied for implant. A complete analysis of the approach was conducted and prepared for publication. An abstract on implantable biological instrumentation was presented at the 1970 National Telemetry Conference held in Los Angeles April 27-30.

Dog Implant

On April 15, 1970, a small Beagle dog was implanted with a 5 mm flow probe on the terminal aorta. The flow probe leads were exposed on April 26, and connected to external blood flow electronics. Data were recorded periodically until April 30. On May 1, the flow probe leads were placed subcutaneously. The system was again tested on June 1, and found to be quite operable. The dog will be maintained for several months in order to evaluate the ability of the probe to sustain long term implant.

15 June 1970

-2-

Preparation of Publication

It is felt that this technique of acquiring flow data is sufficiently unique to merit publication. Accordingly a paper is being prepared which describes the merits of this approach. A copy of the first draft of this paper is attached.

In April an abstract on implantable biological instrumentation was presented at the National Telemetry Conference. A copy of this abstract is also attached.

Original copy signed
By John P. Meehan, M.D.

John P. Meehan, M.D.
Principal Investigator

JPM/br

A LOW POWER BLOOD FLOW TRANSMITTER

by

Rader, R., Henriksen, J., and Meehan, J.
Department of Physiology
University of Southern California
School of Medicine

INTRODUCTION

Until the maturation of biotelemetry techniques, acquisition of chronic physiological information from unrestrained test subjects was severely limited. The umbilical connection between the test subject and a recording device precluded many types of experiments. In many cases biotelemetry techniques have not produced acceptable experimental conditions. The presence of bulky equipment on the subject and the need to protect the equipment from the subject has restricted its application. The desire to eliminate these problems and produce improved experimental conditions has prompted the development of an extremely low power, small size, totally implantable blood flow telemetry system.

For this effort an ultrasonic technique was selected because of several clearly identifiable advantages. As contrasted with the electromagnetic techniques, the ultrasonic flow sensing probes are lighter, power requirements are less, zero stability is better and the signal level is higher.

FLOW CONCEPT

The block diagram in Figure 1 illustrates the system operation. Piezoelectric crystals resonant at 5 MHz are rigidly positioned diagonally across a flow section. The crystals are electrically pulsed simultaneously in phase opposition for approximately one microsecond. Acoustical energy generated at each crystal-fluid interface is directed toward the opposite crystal. The time required for the energy to cross from each crystal to the other is proportional to the distance between crystals and the magnitude and direction of the flow velocity. If the flow is zero the time required for the acoustical energy to arrive at X_2 from X_1 , and at X_1 from X_2 is equal and therefore remains in phase opposition resulting in cancellation of the electrical signals. If the flow velocity is

not zero and directed to the right, the energy from X_1 to X_2 arrives in advance of that from X_2 to X_1 , resulting in a phase shift and non-cancellation of the crystal voltages. Specifically, if the crystal excitation voltages are:

$$V_{X1E} = V_{MAX} \cos \omega t$$

$$V_{X2E} = -V_{MAX} \cos \omega t$$

then the resonant crystal pickup voltages are:

$$V_{X1P} = -K V_{MAX} \cos \omega t + \gamma + \Theta$$

$$V_{X2P} = K V_{MAX} \cos \omega t + \gamma - \Theta$$

where Θ is the angle in radians attributable to the flow velocity and γ a constant angle attributed to the probe geometry. The constant K is related to attenuation properties of the medium, to distance between crystals and to the Q of the crystals.

If the two pickup signals are added as illustrated in Figure 1, the result is

$$e_o = [A_o 2K V_{MAX} \sin \Theta] \sin \omega t + \gamma$$

where A_o is the amplifier gain. The magnitude of the signal voltage is thus a function of $\sin \Theta$. The value of Θ and γ can be derived by consideration of the geometry and the flow velocity. In particular the time required for energy to radiate from X_1 to X_2 is:

$$T_{1-2} = \int_0^d \frac{dx}{c + v \cos \alpha}$$

Where c is the velocity of the acoustical energy in the medium α is the angle between the flow velocity and the energy direction, v is the velocity of blood flow and D the perpendicular distance between crystal faces. Division of

$$\frac{1}{c + v \cos \alpha}$$

results in

$$\frac{1}{c} \left[1 - \frac{v \cos \alpha}{c} + \left(\frac{v \cos \alpha}{c} \right)^2 - \left(\frac{v \cos \alpha}{c} \right)^3 \dots \right]$$

By the valid assumption that $v \cos \alpha / c \ll 1$

the higher power terms can be neglected to give

$$\begin{aligned} T_{1-2} &= \frac{1}{c} \int_0^d dx - \frac{v \cos \alpha}{c^2} \int_0^d v dx \\ &= \frac{d}{c} - \frac{v d \cos \alpha}{c^2} \end{aligned}$$

The total phase shift between crystal X_2 pickup signal and a continuous wave signal allowed to continue on the same time axis is:

$$\gamma - \theta = \frac{T_{1-2}}{T} = \frac{2\pi f v d \cos \alpha}{c^2}$$

therefore:

$$\gamma - \theta = \frac{2\pi f d}{c} - \frac{2\pi f d v \cos \alpha}{c^2}$$

and thus:

$$\gamma = \frac{2\pi f d}{c} = \frac{\omega d}{c}$$

$$\theta = \frac{2\pi f d v \cos \alpha}{c^2} = \frac{\omega d v \cos \alpha}{c^2}$$

The output voltage then becomes:

$$e_o = \left[A_o 2KV_{max} \sin \frac{\omega d v \cos \alpha}{c^2} \right] \sin \left(\omega t + \frac{\omega d}{c} \right)$$

For convenience let:

$$A_o 2KV_{max} \sin \frac{\omega d v \cos \alpha}{c^2} = E_{sig}$$

The factor $W \frac{d}{c}$ a constant phase related to probe dimensions and excitation frequency, contributes no useful information.

The function $w dv \cos \alpha / c^2$ contains the useful information and produces amplitude modulation of the signal proportional to the sin of the function. For a low value of velocity the phase shift produced is small allowing $\sin \Theta$ to be replaced with Θ .

The signal level then becomes:

$$E_{SIG} = \frac{A_0 2 \omega K V_{MAX} dv \cos \alpha}{c^2} = A_0 K_1 v$$

For typical probes and practical probe excitation voltages the value of $K V_{MAX}$ has been found to be approximately 0.5 volt. The value of K_1 thus becomes approximately 0.3×10^{-3} . The signal is then:

$$E_{SIG} = 3 A_0 v \times 10^{-4}$$

For flow measurement on a 1 cm diameter vessel, a 30 mv signal can be realized. This can be contrasted with an electromagnetic level of 0.3 mv for the same position and a pickup signal on the order of $10 \mu v$ for the back scatter ultrasonic technique. The selection of the 180 degree quiescent phase difference between the pickup voltage results in the maximum sensitivity. If the flow velocity exceeds the value which make $\Theta = \pi/2$ the flow velocity becomes indeterminate. In practice, the flow velocity is quite low, producing a maximum phase shift of less than 0.1 radians.

Negative flow can be detected by proper circuit manipulation. A capacitor placed in parallel with either a summing resistor or a current limiting resistor in the probe drive circuit produces a phase shift at zero flow. This produces an output signal at zero flow which increases with positive flow and decreases with reverse or negative flow.

Flow Circuit

The circuit required to perform the operation illustrated in Figure 1 is shown in Figure 2. The output of a subcarrier oscillator is connected to the cathode gate of SCS₁. When the gate voltage rises above 0.7 volt SCS₁ turns on and forward biases the 5 mc oscillator transistor Q₂ and the 5 mc power amplifier transistor Q₁. Coincidental with the SCS₁ turn on capacitors, C₇ starts to charge through R₁₂. When Q₃ is sufficiently forward biased, SCS₁ turns off leaving a charge on C₉ which bleeds through R₁₅ turning on SCS₂. This turns on the amplifier transistor Q₆, Q₇, Q₈, and Q₉, just prior to the arrival of the incident acoustical energy at each crystal. The on time of the amplifiers is controlled by the time constant determined by R₂₀ and C₁₄. The RC network connected to the emitter of Q₉ rectifies and filters the amplified RF signal producing a D.C. signal proportional to flow velocity. The output is then connected to the subcarrier oscillator to produce frequency modulation proportional to flow velocity. The output of the subcarrier oscillator is also connected to a carrier oscillator operating at 230 mc to effect transmission of the flow velocity signal. Due to the nature of the response there is an inability to differentiate the direction of flow by observing the output. For an ideal case where the crystals are well matched and the summing resistances are equal, the response curve will be as illustrated at the top in Figure 3. By paralleling R₁ with a small capacitor the pickup signal on X₂ leads the pickup signal on X₁ and thus for zero flow there appears to be a flow from X₁ toward X₂. The response curve for this condition is illustrated at the bottom of Figure 3. At zero flow there is a positive voltage getting more positive for positive flow and less positive for reverse flow. Since the maximum negative flow is quite small, only a slight adjustment is required to acquire reverse flow.

The pulsed operation which is necessary for proper functioning also minimizes **current** consumption. For the circuit illustrated, the current consumption is approximately 400 μ a. A prototype circuit package is shown in Figure 4. In this package an 18 volt supply with a 12 volt regulator has been employed. The flow probes employed have been commercially available units modified for our particular use. The recordings in Figure 5 illustrate the results of the instrument application on a small beagle dog. The flow probe was implanted on the terminal aorta and allowed to heal for several days then the connector was exposed and connected to an external instrument package which was contained in a small jacket.

(This work is supported by NASA CONTRACT NO. NSR 05-018-087)

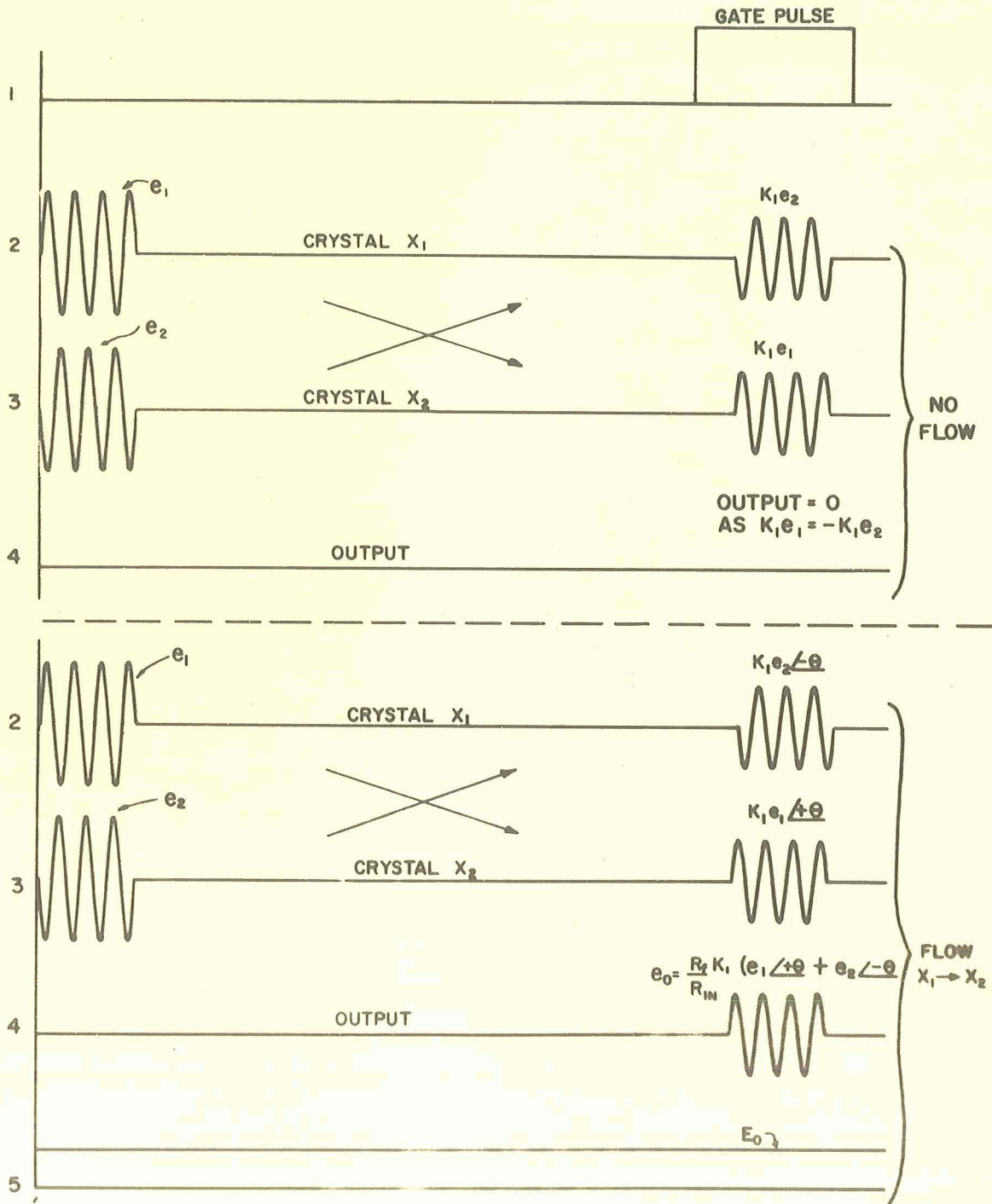
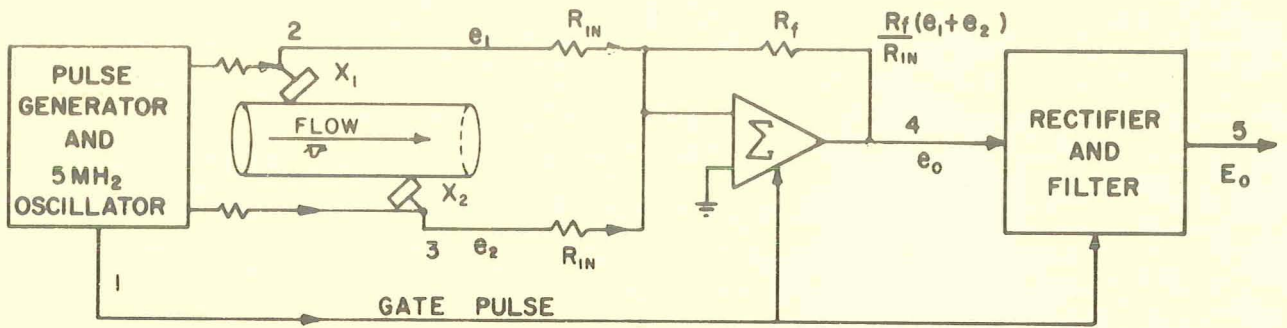

BLOOD FLOW BLOCK DIAGRAM

Figure 1.

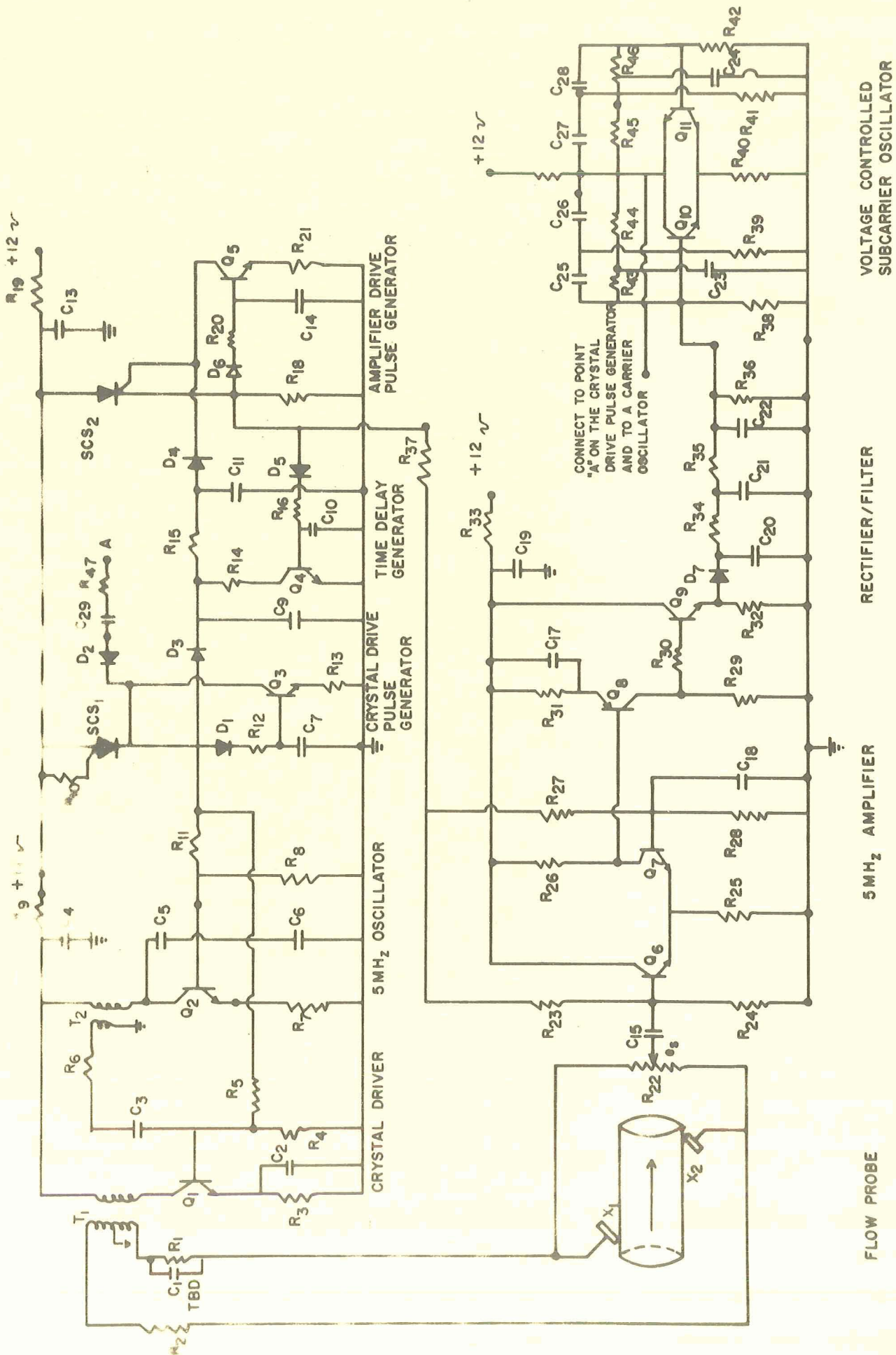

Figure 2.

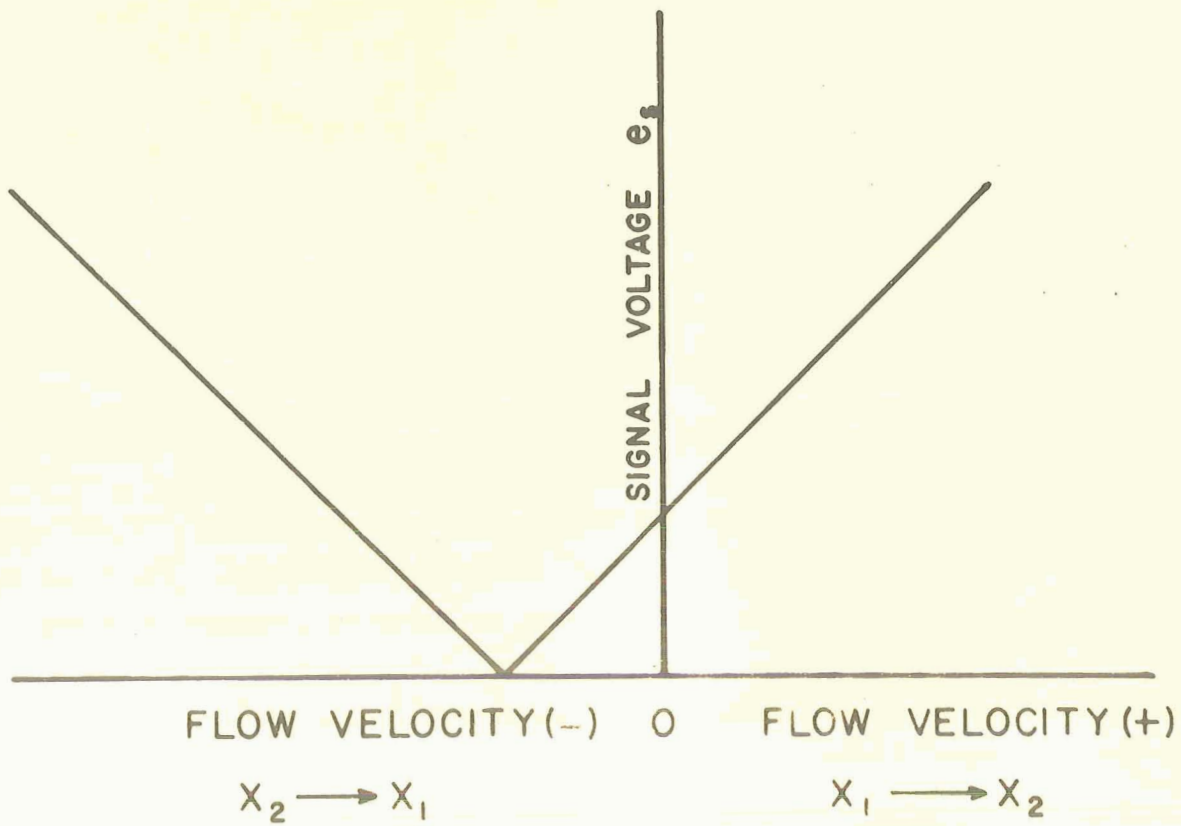
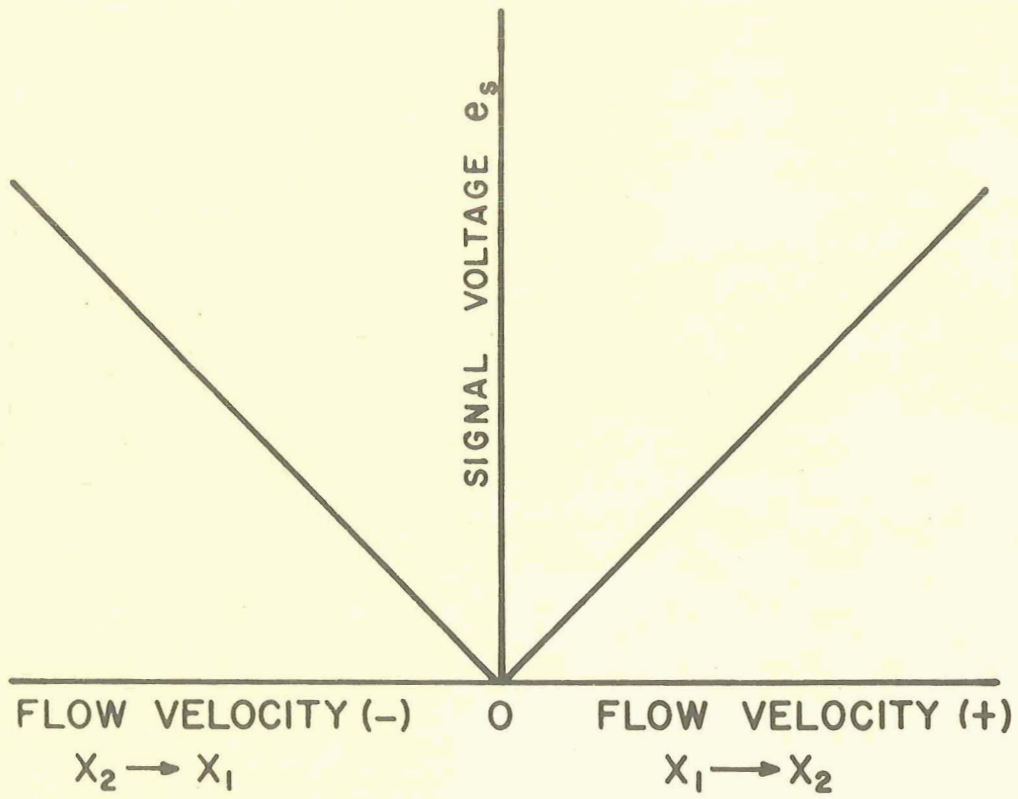

Figure 3.

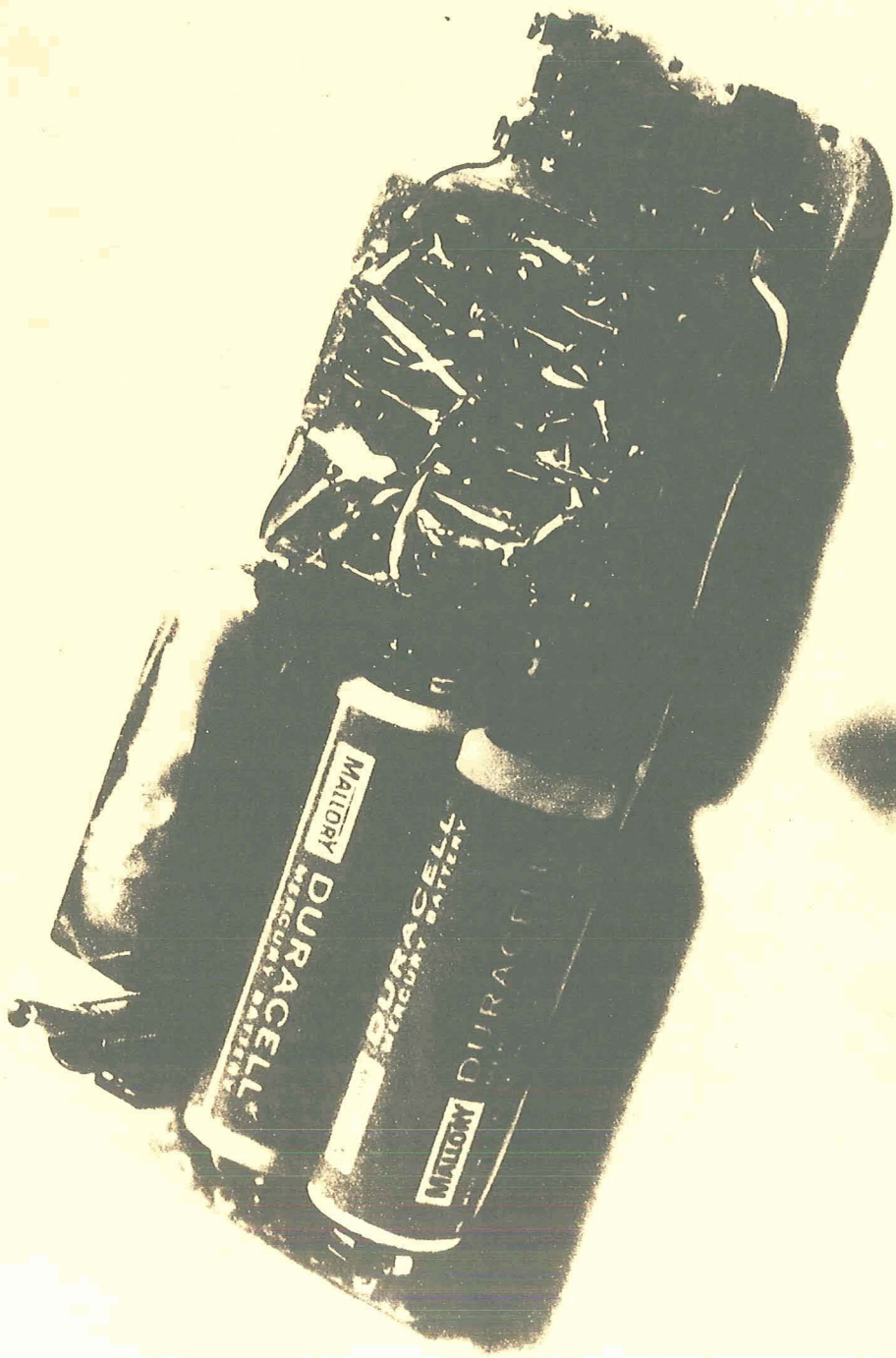

Figure 4.

2

31

32

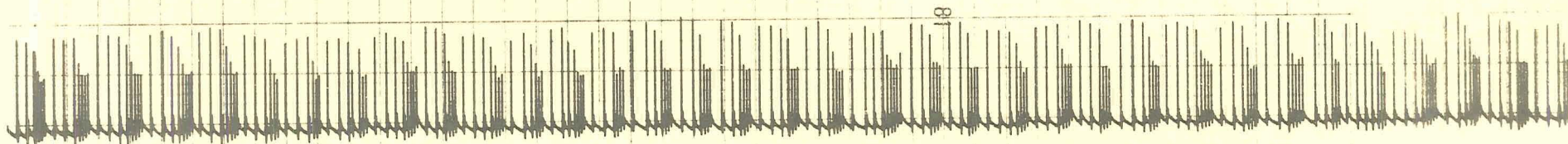

Figure Number	<u>5 a</u>	
Subject Name & Description	<u>"Flo"</u>	<u>Canine</u>
Date & Time	<u>6-1-70</u>	<u>2130</u>
Recording Speed	<u>1 mm/sec</u>	
Recording Condition	<u>Resting Night</u>	
Heart Rate	<u>60 BPM</u>	
Flow Level (Relative)	<u>7</u>	

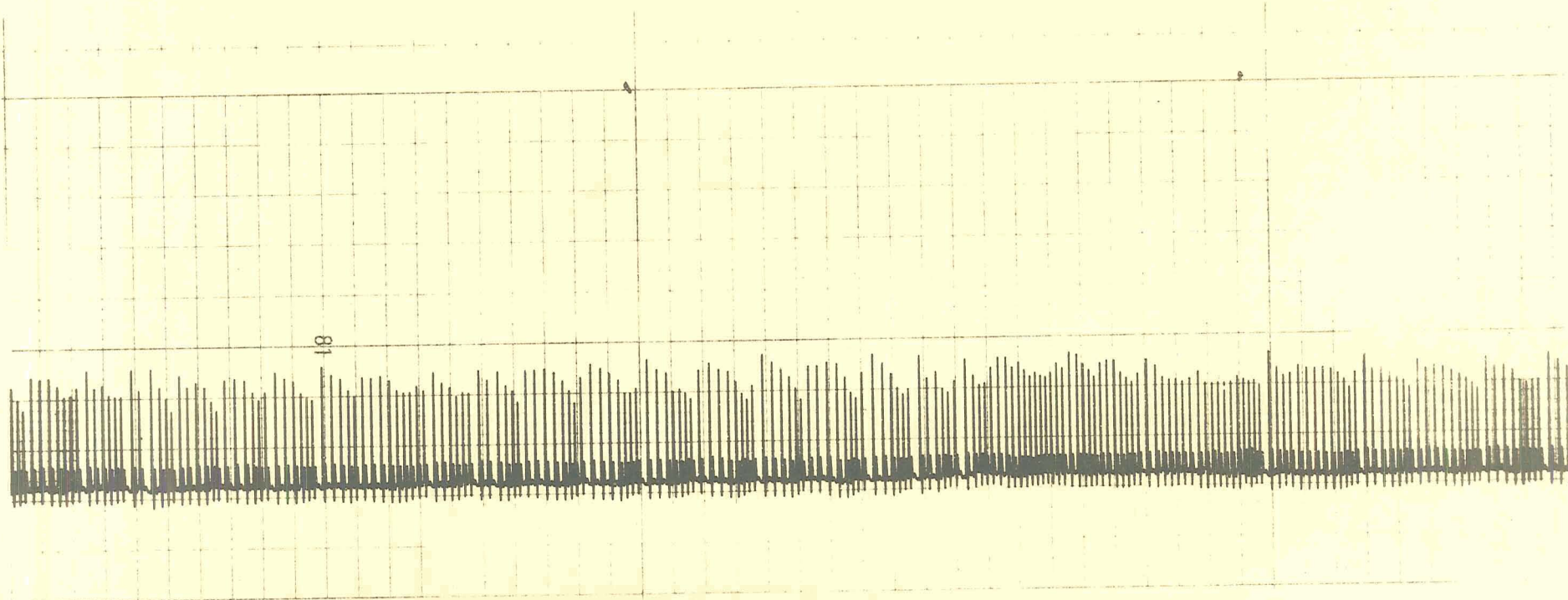
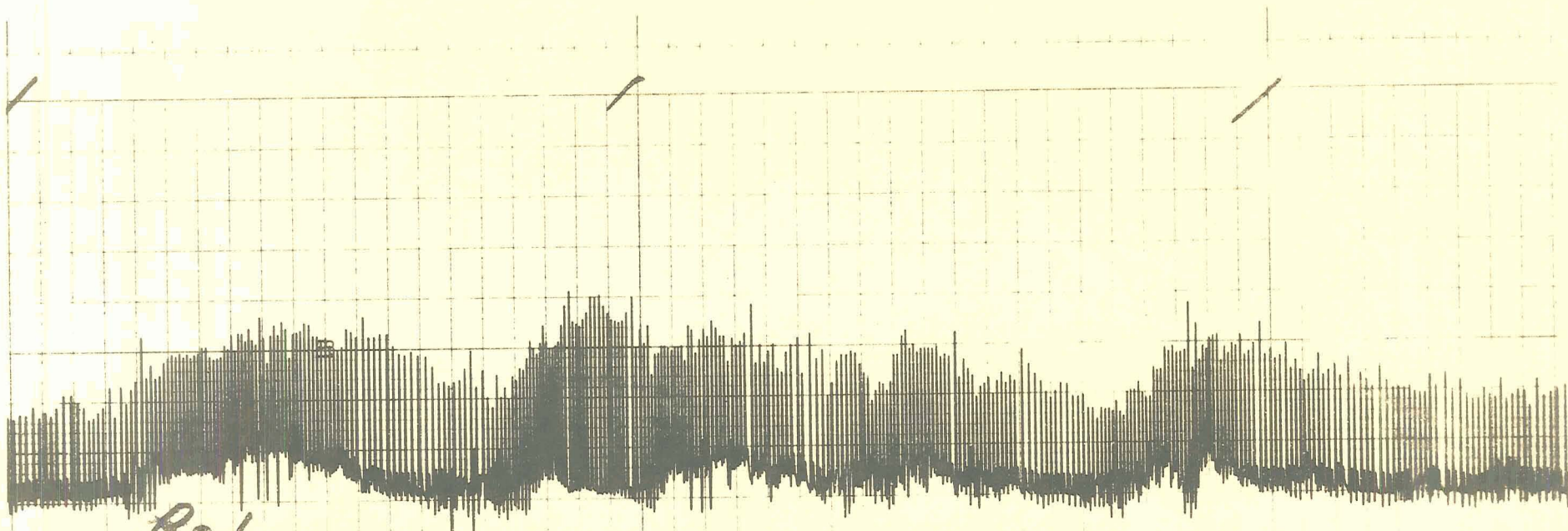

Figure Number	<u>5 b</u>	
Subject Name & Description	<u>"Flo"</u>	<u>Canine</u>
Date & Time	<u>6-2-70</u>	<u>1100</u>
Recording Speed	<u>2 mm/sec</u>	
Recording Condition	<u>Resting Day</u>	
Heart Rate	<u>96 BPM</u>	
Flow Level (Relative)	<u>9</u>	



*Rader
in Cage*

CLEVITE CORPORATION / BRUSH INSTRUMENTS DIVISION CLEVELAND, OHIO U.S.A.

Figure Number	<u>5 c</u>	
Subject Name & Description	<u>"Flo"</u>	<u>Canine</u>
Date & Time	<u>6-2-70</u>	<u>1115</u>
Recording Speed	<u>2 mm/sec</u>	
Recording Condition	<u>Emotional Arousal</u>	
Heart Rate	<u>210 BPM</u>	
Flow Level (Relative)	<u>19</u>	

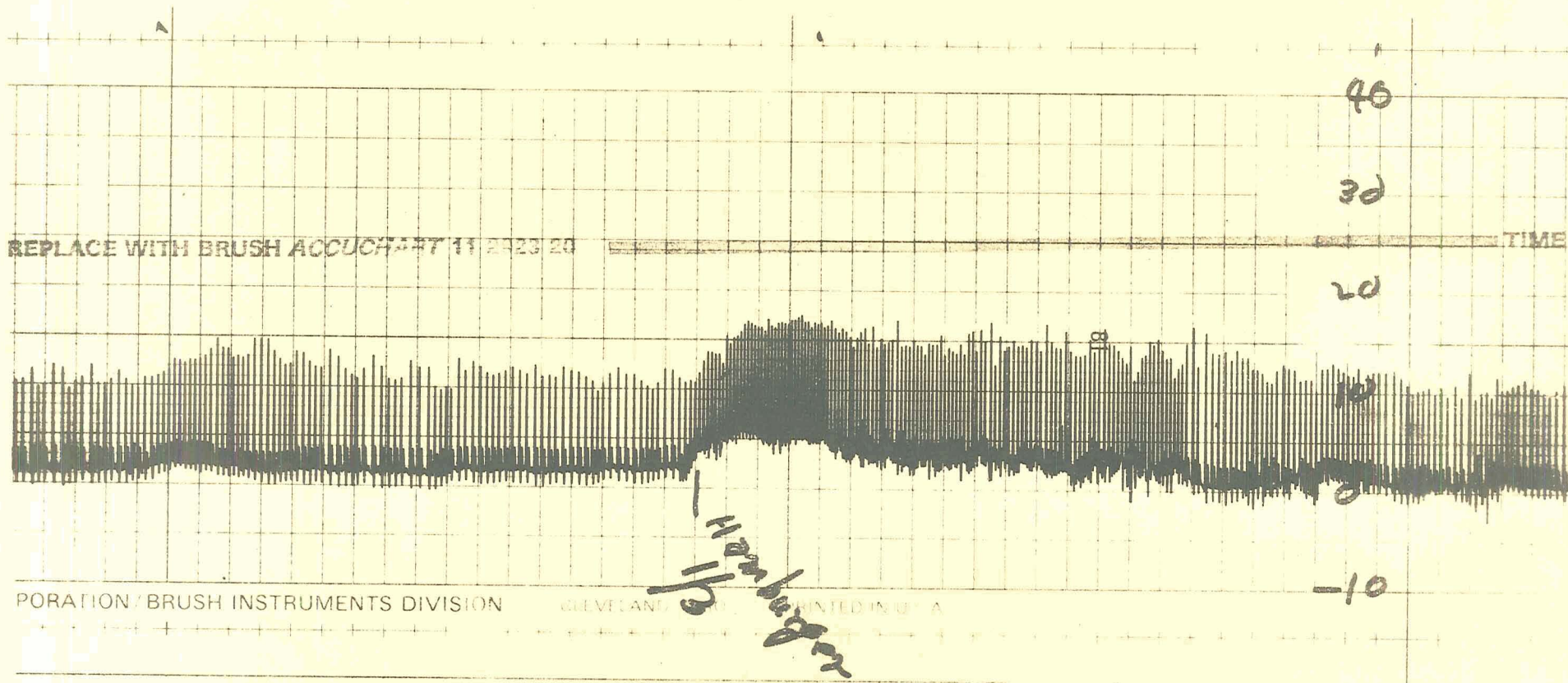
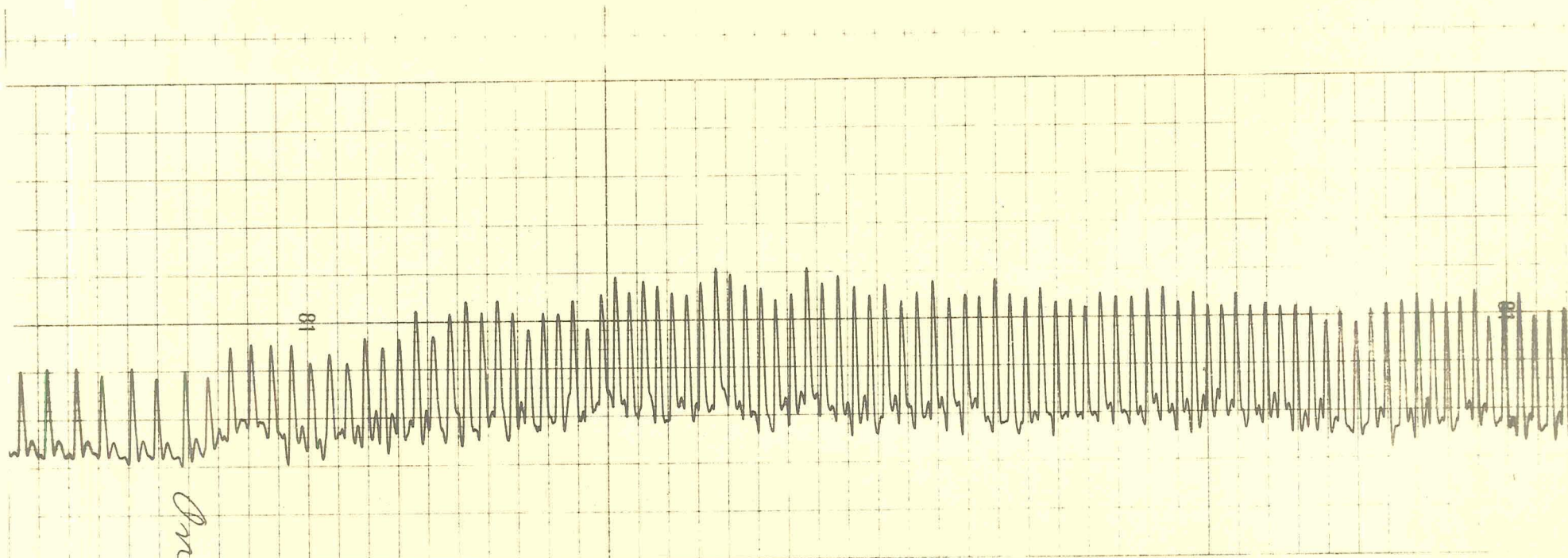

Figure Number	<u>5 d</u>	
Subject Name & Description	<u>"Flo"</u>	<u>Canine</u>
Date & Time	<u>6-2-70</u>	<u>1200</u>
Recording Speed	<u>2 mm/sec</u>	
Recording Condition	<u>Feeding</u>	
Heart Rate	<u>210 BPM</u>	
Flow Level (Relative)	<u>17</u>	



on 2

CLEVITE CORPORATION / BRUSH INSTRUMENTS DIVISION CLEVELAND, OHIO PRINTED IN U.S.A.

Figure Number	<u>5 e</u>	
Subject Name & Description	<u>"Flo"</u>	<u>Canine</u>
Date & Time	<u>6-1-70</u>	<u>1420</u>
Recording Speed	<u>10 mm/sec</u>	
Recording Condition	<u>Treadmill Training</u>	
Heart Rate	<u>240 BPM</u>	
Flow Level (Relative)	<u>20</u>	

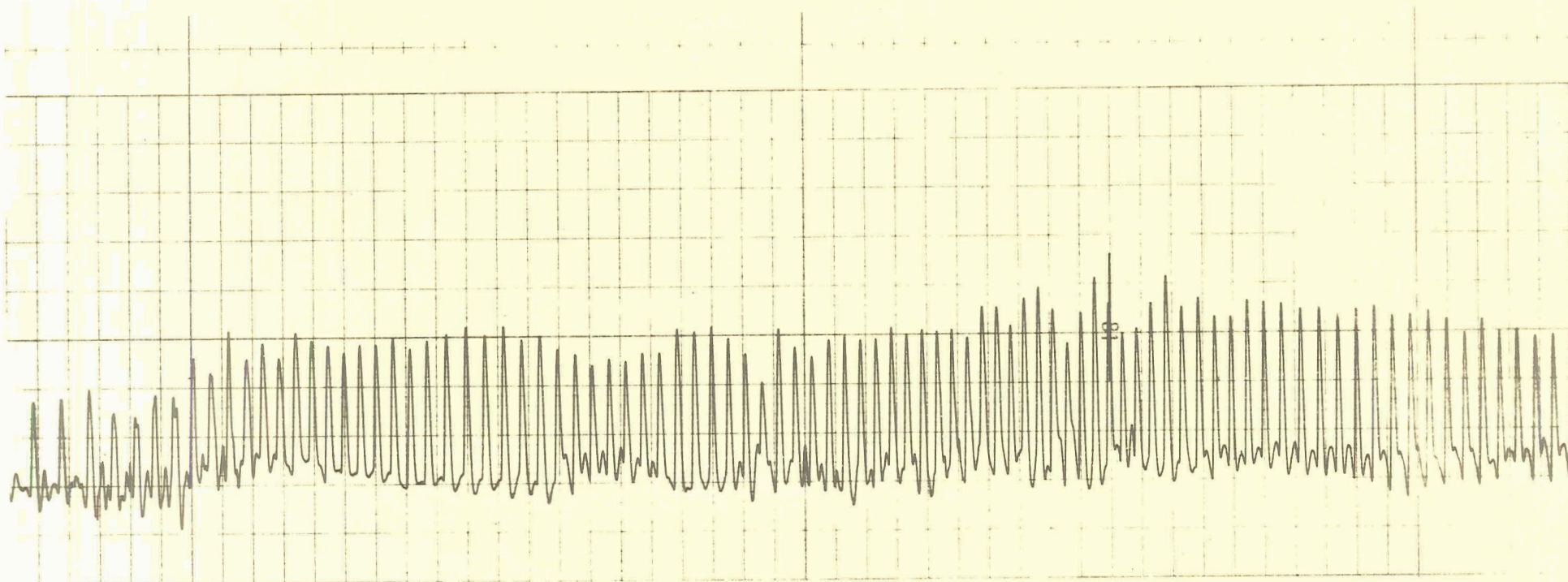

Figure Number	<u>5 f</u>
Subject Name & Description	<u>"Flo"</u> <u>Canine</u>
Date & Time	<u>6-2-70</u> <u>1422</u>
Recording Speed	<u>10 mm/sec</u>
Recording Condition	<u>Post Treadmill Training</u>
Heart Rate	<u>237 BPM</u>
Flow Level (Relative)	<u>20</u>

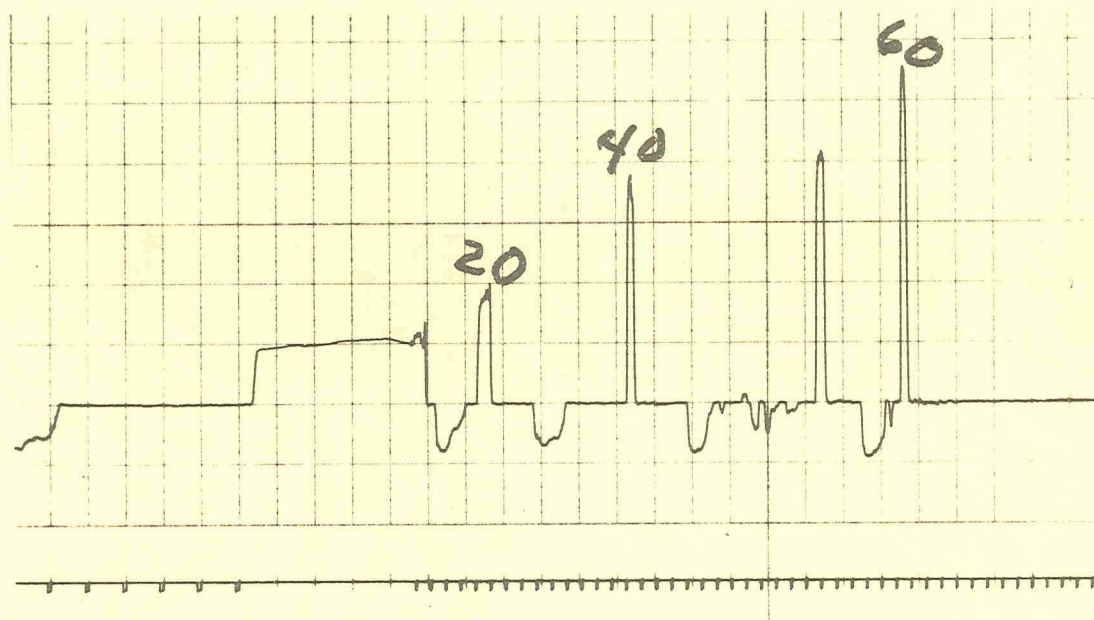

Figure 6: System Calibration

An approximate calibration was performed by expelling known volumes from a syringe in a period of one second. The results are shown in the tracing. The sensitivity is approximately 2 ml/div. SENSITIVITY = 0.1 volt per division.

TRANSMISSION OF CARDIOVASCULAR RESPONSE TO WEIGHTLESSNESS

Rader, R., Meehan, J.P., Henriksen, J., Casados, L.
Department of Physiology, University of Southern California
815 W. 37th Street, Los Angeles, California 90007

Pressures, flows and dimensions characterize cardiovascular dynamics. An implantable system sensing these three parameters has been designed for use on the apollo applications program to determine cardiovascular responses of sub-human primates to long term weightlessness. The use of a 160 ma hour battery with an average current of 500 μ a per data channel and a duty cycle of 2%, results in an operating life of 250 days.

Blood pressure is detected by a miniature implantable sensor which is driven by a sine wave oscillator. The output of the sensor is connected to a differentiator to achieve amplification and a 90 degree phase shift. The differentiator output is summed with the primary feedback to produce frequency modulation proportional to pressure. Blood flow is detected by an ultrasonic technique. Two crystals placed diagonally across a blood vessel are driven 180 degrees out of phase by a pulsed 5 mHz oscillator. Under conditions of no flow, the sum of the crystal voltages is zero because the transit time from one to the other crystal is equal and no phase difference exists. When there is flow, the signal on the crystals differs in phase due to unequal transit times and the summed signal is not zero. The amplitude modulated signal is rectified to yield a voltage analog of blood velocity. Knowledge of the probe diameter is sufficient to yield blood flow. Vascular dimensions are also determined by ultrasonic techniques. One crystal, placed on the vascular structure, is excited with a 5 mHz pulsed oscillator and the transit time of the energy to the second crystal on the same structure is measured. The knowledge of velocity of ultrasonic energy in tissue and body fluids is sufficient to obtain dimensions.

(This work was supported by NASA CONTRACT NO. NSR 05-018-087)