

D2-117017-5

OFFICE OF MANNED  
SPACE FLIGHT

# APOLLO PROGRAM

## FINAL FLIGHT EVALUATION REPORT APOLLO 8 MISSION

N 70-34225

FACILITY FORM 602

(ACCESSION NUMBER)	47	(THRU)	
(PAGES)	TMX-64325	(CODE)	31
(NASA CR OR TMX OR AD NUMBER)		(CATEGORY)	



APRIL 1969



PREPARED BY APOLLO PROGRAM OFFICE  
NATIONAL AERONAUTICS AND SPACE ADMINISTRATION

ABSTRACT

THIS DOCUMENT IS THE FINAL FLIGHT EVALUATION REPORT FOR THE APOLLO 8 MISSION. IT INCLUDES DATA FROM THE NASA CENTER 3-DAY, 15-DAY, 30-DAY AND 60-DAY MISSION REPORTS, AS WELL AS THE ANOMALY STATUS REPORTS FROM MSC AND THE APOLLO 9 FLIGHT READINESS REVIEW. THE REPORT INCLUDES A SUMMARY OF THE MISSION, A SUMMARY OF MISSION ACCOMPLISHMENTS, AND THE ANOMALIES ENCOUNTERED DURING THE MISSION. THE ANOMALIES ARE LISTED IN A SEPARATE SECTION ACCORDING TO SPACECRAFT, LAUNCH VEHICLE AND GROUND SYSTEMS.

THIS DOCUMENT HAS BEEN PREPARED BY THE BOEING COMPANY WDC/TIE UNDER NASA/APO MAT-1 TECHNICAL DIRECTION; CONTRACT NASW-1650, TASK NO. 10.0.

KEY WORDS

ANOMALY

APOLLO 8

FLIGHT EVALUATION

MISSION REPORT

D2-117017-5

FLIGHT EVALUATION REPORT - APOLLO 8 MISSION

CONTENTS

<u>SECTION</u>	<u>PAGE NO.</u>
ABSTRACT	i
ILLUSTRATIONS	iii
1.0 INTRODUCTION	1
1.1 CARRY-OVER ANOMALIES FOR SUBSEQUENT FLIGHT READINESS REVIEWS	1
1.2 MISSION SUMMARY	2
1.3 APOLLO PROGRAM IMPACT	3
1.4 SUMMARY OF MISSION ACCOMPLISHMENTS	4
2.0 ANOMALY LISTING	13
2.1 SPACECRAFT (MSC) ANOMALIES	13
2.2 LAUNCH VEHICLE (MSFC) ANOMALIES	13
2.3 GROUND SYSTEMS (KSC) ANOMALIES	13
3.0 REFERENCES	43

ILLUSTRATIONS

<u>TABLE</u>		<u>PAGE</u>
1	APOLLO 8 SEQUENCE OF EVENTS	10
<u>FIGURE</u>		<u>PAGE</u>
2.1.1-1	SPS OXIDIZER BLEED SCHEMATIC	15
2.1.2-1	CM WINDOW DETAILS	17
2.1.2-2	CHANGES TO SIDE WINDOW	18
2.1.4-1	ENTRY MONITOR SYSTEM G/VELOCITY PLOT OF APOLLO 8 ENTRY	21
2.1.5-1	CABIN FAN INSTALLATION	23
2.1.7-1	SWIMMER'S INTERPHONE SCHEMATIC	26
2.1.8-1	OPTICS DRIVE AND READOUT	28
2.1.9-1	CABIN PRESSURE RELIEF VALVE	30
2.1.10-1	CM RECOVERY LOOP	32
2.1.11-1	POTABLE WATER QUANTITY HISTORY	34
2.1.11-2	POTABLE WATER TANK	35
2.1.12-1	SIMPLIFIED SCHEMATIC OF GSE LOX SERVICING UNIT	37
2.2.2-1	S-II OSCILLATIONS SEQUENCE OF EVENTS	40
2.2.3-1	TYPICAL POWER SUPPLY INSTALLATION	42

1.0 INTRODUCTION

APOLLO 8 WAS THE FIRST MANNED SATURN V LAUNCH AND THE FIRST MANNED LUNAR FLIGHT. THE PERFORMANCE OF THE SATURN V SPACE VEHICLE HAD BEEN TESTED ON TWO PREVIOUS UNMANNED MISSIONS. ONE PREVIOUS MANNED EARTH-ORBITAL MISSION OF THE APOLLO SPACECRAFT HAD BEEN PERFORMED, USING A SATURN IB LAUNCH VEHICLE.

APOLLO 8 (SA-503/CSM-103) WAS A C' TYPE MISSION. THE FLIGHT PROFILE CLOSELY RESEMBLED THE MANNED LUNAR LANDING MISSION. THE PRIMARY OBJECTIVES OF THE MISSION WERE TO DEMONSTRATE THE PERFORMANCE OF THE CREW, THE SPACE VEHICLE AND THE MISSION SUPPORT FACILITIES DURING A MANNED SATURN V MISSION WITH CSM, AND TO DEMONSTRATE THE PERFORMANCE OF NOMINAL AND SELECTED BACKUP LUNAR ORBIT RENDEZVOUS MISSION ACTIVITIES. THESE ACTIVITIES INCLUDED TRANS-LUNAR INJECTION (TLI), CISELUNAR NAVIGATION AND COMMUNICATIONS, LUNAR ORBIT INSERTION (LOI), PASSIVE THERMAL CONTROL, TRANSEARTH INJECTION (TEI), MIDCOURSE TRAJECTORY CORRECTIONS, AND ASSESSMENT OF CSM CONSUMABLES USAGE.

1.1 CARRY-OVER ANOMALIES FOR SUBSEQUENT FLIGHT READINESS REVIEWS

APOLLO 8 ANOMALY	FRR MISSION EFFECTIVITY	REMARKS
2.1.4 ENTRY MONITOR SYSTEM MALFUNCTIONS	AS-504 (APOLLO 9)	SEE P.20 OF ANOMALY FOR DISCUSSION
2.2.2 S-II ENGINE OSCILLATIONS	AS-504 (APOLLO 9)	SEE P.39 OF ANOMALY FOR DISCUSSION

## 1.2 MISSION SUMMARY

THE APOLLO 8 SPACE VEHICLE WAS LAUNCHED FROM LAUNCH COMPLEX 39 AT CAPE KENNEDY ON DECEMBER 21, 1968, AT 07:51:00.9 EST. THE CREW CONSISTED OF FRANK BORMAN, COMMAND PILOT; JAMES A. LOVELL, JR., COMMAND MODULE PILOT AND WILLIAM A. ANDERS, LUNAR MODULE PILOT. THE COUNTDOWN WAS NOMINAL FROM T-9 HOURS THROUGH LIFTOFF. THE BOOST AND EARTH ORBIT PHASES WERE NOMINAL, WITH TRANSLUNAR INJECTION BURN AT 2:50:37 GET. SEPARATION FROM THE S-IVB, TRANSLATION, AND FORMATION FLYING WERE AS PLANNED, AND THE CREW REPORTED SLA PANEL JETISON WORKED PROPERLY. AT 3:40:01 GET AND AT 4:45:01 GET THE SM REACTION CONTROL SYSTEM WAS FIRED TO INSURE ADEQUATE SEPARATION DISTANCE PRIOR TO S-IVB PROPULSIVE VENTING. THE FIRST MIDCOURSE CORRECTION BY THE SERVICE PROPULSION SYSTEM ENGINE WAS PERFORMED WITH SUCH TRAJECTORY ACCURACY THAT MIDCOURSE CORRECTIONS NO. 2 AND NO. 3 COULD BE DELETED.

LUNAR ORBIT INSERTION (LOI<sub>1</sub>) WAS NEAR NOMINAL PLACING THE SPACECRAFT IN A 60.0 X 168.5 NM LUNAR ORBIT. LUNAR ORBIT CIRCULARIZATION (LOI<sub>2</sub>) WAS ALSO NOMINAL, ACHIEVING A 60.7 X 59.7 NM ORBIT. THE SPACECRAFT PERFORMED TEN REVOLUTIONS OF THE MOON.

THE TRANSEARTH INJECTION BURN OCCURRED AT 89:19:17 GET, COMPARED WITH A PRELAUNCH PREDICTION OF 89:15:07 GET. THE SPACECRAFT WAS PLACED IN A RETURN TRAJECTORY SO ACCURATE THAT A MID-COURSE CORRECTION OF 5 FPS AT 103:59:54 GET (MCC<sub>5</sub>) WAS THE ONLY CORRECTION REQUIRED.

EARTH ENTRY WAS NOMINAL RESULTING IN A SPLASHDOWN AT 147:00:42 GET THAT WAS ONLY 5,000 YARDS FROM THE RECOVERY SHIP, USS YORKTOWN, AND WAS ONLY 10 MINUTES EARLIER THAN THE PRELAUNCH PREDICTION.

CONSUMABLES RESERVES WERE EXCELLENT AT SPLASHDOWN AND ALL SYSTEMS HAD PERFORMED WELL. COMMUNICATIONS WERE OUTSTANDING THROUGHOUT THE MISSION, PROVING THE DESIGN OF THE S-BAND HIGH GAIN ANTENNA AS WELL AS THE HARDWARE THAT HAD BEEN QUALIFIED BY PRIOR FLIGHTS.

### 1.3 APOLLO PROGRAM IMPACT

THE APOLLO 8 MISSION WAS THE SECOND MANNED FLIGHT OF THE APOLLO CSM AND THE FIRST MANNED SATURN V FLIGHT. THIS MISSION DEMONSTRATED THE PERFORMANCE OF THE CREW, THE SPACE VEHICLE AND THE MISSION SUPPORT FACILITIES DURING A MANNED LUNAR ORBITAL MISSION.

THE APOLLO 8 MISSION WAS COMPLETED AS PLANNED WITH RECOVERY OF THE SPACECRAFT AND CREW IN THE PACIFIC RECOVERY AREA ON THE 27TH OF DECEMBER 1968. SUFFICIENT DATA WAS OBTAINED TO VERIFY THAT ALL PRIMARY MISSION OBJECTIVES WERE MET. HOWEVER, A PORTION OF ONE PRIMARY DETAILED TEST OBJECTIVE AND A PORTION OF ONE SECONDARY DETAILED TEST OBJECTIVE WERE NOT COMPLETED. FAILURE TO FULLY ACHIEVE THESE TWO DETAILED TEST OBJECTIVES DOES NOT CONSTRAIN ANY SUBSEQUENT MISSION.

THE SUCCESS OF THIS MISSION VERIFIED THE PERFORMANCE OF THE LAUNCH VEHICLE, CSM, SLA AND GROUND SUPPORT SYSTEMS FOR THE LUNAR LANDING MISSION, ENABLING THE PROGRAM TO PROCEED WITH THE VERIFICATION OF THE LUNAR MODULE PERFORMANCE.

#### 1.4 SUMMARY OF MISSION ACCOMPLISHMENTS

##### PRIMARY MISSION OBJECTIVES

##### THE APOLLO 8 PRIMARY MISSION OBJECTIVES WERE:

- o DEMONSTRATE CREW/SPACE VEHICLE/MISSION SUPPORT FACILITIES PERFORMANCE DURING A MANNED SATURN V MISSION WITH CSM.
- o DEMONSTRATE PERFORMANCE OF NOMINAL AND SELECTED BACKUP LUNAR ORBIT RENDEZVOUS (LOR) MISSION ACTIVITIES, INCLUDING: TRANSLUNAR INJECTION; CSM NAVIGATION, COMMUNICATIONS, AND MIDCOURSE CORRECTIONS; CSM CONSUMABLES ASSESSMENT AND PASSIVE THERMAL CONTROL.

THE APOLLO 8 MISSION WAS A SUCCESS AND THE PRIMARY MISSION OBJECTIVES WERE ATTAINED.

THE MISSION INCLUDED 25 PRIMARY DETAILED TEST OBJECTIVES, 10 FOR THE LAUNCH VEHICLE AND 15 FOR THE SPACECRAFT. THE PRIMARY DETAILED TEST OBJECTIVES AMPLIFIED AND DEFINED MORE EXPLICITLY THE BASIC TESTS, MEASUREMENTS, AND EVALUATIONS WHICH WERE PLANNED TO ACHIEVE THE PRIMARY MISSION OBJECTIVE STATED ABOVE. TWENTY FOUR OF THE PRIMARY DETAILED TEST OBJECTIVES WERE COMPLETELY ACCOMPLISHED. ONE PRIMARY DETAILED TEST OBJECTIVE, P20.111, "LUNAR LANDMARK TRACKING," WAS ONLY PARTIALLY ACCOMPLISHED, HOWEVER, SUFFICIENT DATA WERE OBTAINED TO DETERMINE THAT NO CONSTRAINT EXISTS FOR SUBSEQUENT MISSIONS. THE PRIMARY DETAILED TEST OBJECTIVES ARE LISTED BELOW ALONG WITH APPROPRIATE COMMENTS ON THEIR ACCOMPLISHMENT. THE DETAILED TEST OBJECTIVES ARE TAKEN FROM THE MISSION IMPLEMENTATION PLAN FOR THE APOLLO 8 C-PRIME MISSION, THE APOLLO 8 (AS-503) MISSION OPERATIONS REPORT, M-932-68-08, AND THE APOLLO 8 MISSION REPORT, MSC-PA-R-69-1.

##### LAUNCH VEHICLE PRIMARY DETAILED TEST OBJECTIVES

VERIFY THE CAPABILITY OF THE LAUNCH VEHICLE TO PERFORM A FREE-RETURN TRANSLUNAR INJECTION (TLI).

DEMONSTRATE THE CAPABILITY OF THE S-IVB TO RESTART IN EARTH ORBIT.

##### ACCOMPLISHMENT

SUCCESSFULLY ACCOMPLISHED

SUCCESSFULLY ACCOMPLISHED



LAUNCH VEHICLE PRIMARY DETAILED TEST OBJECTIVE

VERIFY THE MODIFICATIONS MADE TO THE J-2 ENGINE SINCE THE APOLLO 6 FLIGHT.

CONFIRM THE J-2 ENGINE ENVIRONMENT IN THE S-II AND S-IVB STAGES.

CONFIRM THE LAUNCH VEHICLE LONGITUDINAL OSCILLATION ENVIRONMENT DURING THE S-IC STAGE BURN.

VERIFY THAT THE MODIFICATIONS INCORPORATED IN THE S-IC STAGE SINCE THE APOLLO 6 FLIGHT SUPPRESS LOW FREQUENCY LONGITUDINAL OSCILLATIONS (POGO).

DEMONSTRATE THE OPERATION OF THE S-IVB HELIUM HEATER REPRESSURIZATION SYSTEM.

VERIFY THE CAPABILITY TO INJECT THE S-IVB/IU/LTA-B INTO A LUNAR "SLINGSHOT" TRAJECTORY.

DEMONSTRATE THE CAPABILITY TO SAFE THE S-IVB STAGE IN ORBIT.

VERIFY THE ON-BOARD COMMAND AND COMMUNICATION SYSTEM (CCS) AND GROUND SYSTEM INTERFACE AND THE OPERATION OF THE CCS IN A DEEP SPACE ENVIRONMENT.

SPACECRAFT PRIMARY DETAILED TEST OBJECTIVE

P1.31 PERFORM A GNCS-CONTROLLED ENTRY FROM A LUNAR RETURN.

P1.33 PERFORM STAR-LUNAR HORIZON SIGHTINGS DURING THE TRANSLUNAR AND TRANSEARTH PHASES.

ACCOMPLISHMENT

SUCCESSFULLY ACCOMPLISHED

SUCCESSFULLY ACCOMPLISHED

SUCCESSFULLY ACCOMPLISHED

SUCCESSFULLY ACCOMPLISHED

SUCCESSFULLY ACCOMPLISHED

SUCCESSFULLY ACCOMPLISHED

SUCCESSFULLY ACCOMPLISHED

SUCCESSFULLY ACCOMPLISHED

ACCOMPLISHMENT

SUCCESSFULLY ACCOMPLISHED

SUCCESSFULLY ACCOMPLISHED, ALTHOUGH THE FIELD OF VIEW IN THE SCANNING TELESCOPE WAS OBLSCURED BY WHAT APPEARED TO BE PARTICLES WHENEVER THE TELESCOPE OPTICS WERE REPOSITIONED.

SPACECRAFT PRIMARY DETAILED TEST OBJECTIVE

ACCOMPLISHMENT

P1.34	PERFORM STAR-EARTH HORIZON SIGHTINGS DURING TRANSLUNAR AND TRANSEARTH PHASES.	SUCCESSFULLY ACCOMPLISHED, ALTHOUGH THE FIELD OF VIEW IN THE SCANNING TELESCOPE WAS OBSCURED BY WHAT APPEARED TO BE PARTICLES WHENEVER THE TELESCOPE OPTICS WERE REPOSITIONED.
P6.11	PERFORM MANUAL AND AUTOMATIC ACQUISITION, TRACKING, AND COMMUNICATION WITH MSFN USING THE HIGH GAIN CSM-S-BAND ANTENNA DURING A LUNAR MISSION.	SUCCESSFULLY ACCOMPLISHED.
P7.31	OBTAIN DATA ON THE PASSIVE THERMAL CONTROL SYSTEM DURING A LUNAR ORBIT MISSION.	SUCCESSFULLY ACCOMPLISHED.
P7.32	OBTAIN DATA ON THE SPACECRAFT DYNAMIC RESPONSE.	SUCCESSFULLY ACCOMPLISHED.
P7.33	DEMONSTRATE SLA PANEL JETTISON IN A ZERO-G ENVIRONMENT.	SUCCESSFULLY ACCOMPLISHED.
P20.105	PERFORM LUNAR ORBIT INSERTION SPS GNCS-CONTROLLED BURNS WITH A FULLY LOADED CSM.	SUCCESSFULLY ACCOMPLISHED.
P20.106	PERFORM A TRANSEARTH INSERTION MANEUVER-CONTROLLED SPS BURN.	SUCCESSFULLY ACCOMPLISHED.
P20.107	OBTAIN DATA ON THE CM CREW PROCEDURES AND TIMELINE FOR LUNAR ORBIT MISSION ACTIVITIES.	SUCCESSFULLY ACCOMPLISHED.
P20.109	DEMONSTRATE CSM PASSIVE THERMAL CONTROL (PTC) MODES AND RELATED COMMUNICATION PROCEDURES DURING A LUNAR ORBIT MISSION.	SUCCESSFULLY ACCOMPLISHED.

SPACECRAFT PRIMARY DETAILED TEST OBJECTIVE

- P20.110 DEMONSTRATE GROUND OPERATIONAL SUPPORT FOR A CSM LUNAR ORBIT MISSION.
- P20.111 PERFORM LUNAR LANDMARK TRACKING FROM THE CSM IN LUNAR ORBIT. (THE INTENT OF THIS OBJECTIVE WAS TO ESTABLISH THAT AN ONBOARD CAPABILITY EXISTED TO COMPUTE RELATIVE POSITION DATA FOR THE LUNAR LANDING MISSION. THIS MODE WILL BE USED IN CONJUNCTION WITH THE MSFN STATE-VECTOR UPDATE).

ACCOMPLISHMENT

SUCCESSFULLY ACCOMPLISHED.

PARTIALLY ACCOMPLISHED. ALL PORTIONS OF THE OBJECTIVE WERE SATISFIED EXCEPT FOR THE FUNCTIONAL TEST, WHICH REQUIRED THE USE OF ONBOARD DATA TO DETERMINE THE ERROR UNCERTAINTIES IN THE LANDING SITE LOCATION. A PROCEDURAL ERROR CAUSED THE TIME INTERVALS BETWEEN THE MARK DESIGNATIONS TO BE TOO SHORT; THUS, THE DATA MAY BE CORRECT BUT MAY NOT BE REPRESENTATIVE. THE ACCURACY OF THE ONBOARD CAPABILITY HAS NOT YET BEEN DETERMINED BECAUSE THE DATA ANALYSES ARE NOT YET COMPLETE. SUFFICIENT DATA WERE OBTAINED TO DETERMINE THAT NO CONSTRAINT EXISTS FOR SUBSEQUENT MISSIONS. A DEMONSTRATION OF THIS TECHNIQUE IS PLANNED FOR THE NEXT LUNAR MISSION.

- P20.112 PREPARE FOR TRANSLUNAR INJECTION (TLI), AND MONITOR THE GNCS AND LV TANK PRES-SURE DISPLAYS DURING THE TLI BURN.

SUCCESSFULLY ACCOMPLISHED.

- P20.114 PERFORM TRANSLUNAR AND TRANSEARTH MID-COURSE CORRECTIONS.

SUCCESSFULLY ACCOMPLISHED, ALTHOUGH THE SPS ENGINE EXPERIENCED A MOMENTARY DROP IN CHAMBER PRESSURE FROM 94 PSI TO 50 PSI DURING THE SPS BURN FOR MCC<sub>1</sub>, AND THE EMS  $\Delta$ V COUNTER COUNTED THROUGH ZEPO AT THE TERMINATION OF MCC<sub>5</sub>.

## SECONDARY MISSION OBJECTIVES

THE MISSION INCLUDED 12 SECONDARY DETAILED TEST OBJECTIVES, ALL FOR THE SPACECRAFT. THE SECONDARY DETAILED TEST OBJECTIVES WERE ESTABLISHED BY THE DEVELOPMENT CENTERS TO PROVIDE ADDITIONAL ENGINEERING AND SCIENTIFIC DATA. ELEVEN OF THE SECONDARY DETAILED TEST OBJECTIVES WERE COMPLETELY ACCOMPLISHED. ONE SECONDARY DETAILED TEST OBJECTIVE, S1.32, "MIDCOURSE NAVIGATION/STAR-EARTH LANDMARK," WAS ONLY PARTIALLY ACCOMPLISHED; HOWEVER, FAILURE TO ACCOMPLISH A SECONDARY DETAILED TEST OBJECTIVE DOES NOT CONSTRAIN ANY SUBSEQUENT MISSIONS. THE SECONDARY DETAILED TEST OBJECTIVES ARE LISTED BELOW ALONG WITH THE APPROPRIATE COMMENTS ON THEIR ACCOMPLISHMENT.

## SPACECRAFT SECONDARY DETAILED TEST OBJECTIVE

S1.27 MONITOR THE GNCS AND DISPLAYS DURING LAUNCH.

S1.30 OBTAIN IMU PERFORMANCE DATA IN THE FLIGHT ENVIRONMENT.

S1.32 PERFORM STAR-EARTH LANDMARK SIGHTING NAVIGATION DURING TRANSLUNAR AND TRANSEARTH PHASES. (THE INTENT OF THIS OBJECTIVE WAS TO DEMONSTRATE ONBOARD STAR-EARTH LANDMARK OPTICAL NAVIGATION).

S1.35 PERFORM AN IMU ALIGNMENT AND A STAR PATTERN VISIBILITY CHECK IN DAYLIGHT.

S3.21 PERFORM SPS LUNAR ORBIT INJECTION AND TRANSEARTH INJECTION BURNS AND MONITOR THE PRIMARY AND AUXILIARY GAUGING SYSTEMS.

## ACCOMPLISHMENT

SUCCESSFULLY ACCOMPLISHED.

SUCCESSFULLY ACCOMPLISHED.

PARTIALLY ACCOMPLISHED; THE THREE SETS OF SIGHTINGS REQUIRED AT LESS THAN 50,000 NM ALTITUDE WERE NOT OBTAINED. THE ACCURACY OF OTHER NAVIGATION MODES IS SUFFICIENT TO PRECLUDE THE NECESSITY OF USING STAR-EARTH LANDMARKS FOR MIDCOURSE NAVIGATION. NO CONSTRAINT ON SUBSEQUENT MISSIONS RESULTED FROM THIS PROBLEM.

SUCCESSFULLY ACCOMPLISHED.

SUCCESSFULLY ACCOMPLISHED.

SPACECRAFT SECONDARY DETAILED TEST OBJECTIVES

- S4.5 OBTAIN DATA ON THE BLOCK II ECS PERFORMANCE DURING MANNED LUNAR RETURN ENTRY CONDITIONS.
- S6.10 COMMUNICATE WITH MSFN USING THE CSM S-BAND OMNI ANTENNAS AT LUNAR DISTANCE.
- S7.30 DEMONSTRATE THE PERFORMANCE OF THE BLOCK II THERMAL PROTECTION SYSTEM DURING A MANNED LUNAR RETURN ENTRY.
- S20.104 PERFORM A CSM/S-IVB SEPARATION AND A CSM TRANS-POSITION ON A LUNAR MISSION TIMELINE.
- S20.108 OBTAIN DATA ON CSM CONSUMABLES FOR A CSM LUNAR ORBIT MISSION.
- S20.115 OBTAIN PHOTOGRAPHS DURING THE TRANSEARTH, TRANS-LUNAR AND LUNAR ORBIT PHASES FOR OPERATIONAL AND SCIENTIFIC PURPOSES.
- S20.116 OBTAIN DATA TO DETERMINE THE EFFECT OF THE TOWER JETTISON MOTOR, S-II RETRO AND SM RCS EXHAUSTS AND OTHER SOURCES OF CONTAMINATION ON THE CM WINDOWS.

ACCOMPLISHMENT

- SUCCESSFULLY ACCOMPLISHED, ALTHOUGH THE NO.2 CABIN FAN WAS NOISY.
- SUCCESSFULLY ACCOMPLISHED.
- SUCCESSFULLY ACCOMPLISHED.
- SUCCESSFULLY ACCOMPLISHED.
- SUCCESSFULLY ACCOMPLISHED.
- SUCCESSFULLY ACCOMPLISHED, ALTHOUGH THE HATCH AND SIDE WINDOWS WERE OBSCURED BY FOG OR FROST THROUGHOUT THE MISSION.
- SUCCESSFULLY ACCOMPLISHED: THE HATCH AND SIDE WINDOWS WERE OBSCURED BY FOG OR FROST THROUGHOUT THE MISSION.

TABLE 1. APOLO 8 SEQUENCE OF EVENTS

PRE-LAUNCH PHASE

ALL EVENTS WERE ACCOMPLISHED ON SCHEDULE, WITH FLIGHT CREW INGRESS COMPLETE 2 HOURS 10 MINUTES BEFORE LIFTOFF (T-2:10:00). THERE WAS A SCHEDULED SIX-HOUR HOLD AT T-9:00:00 AND A SCHEDULED ONE-HOUR HOLD AT T-3:30:00.

EVENT	PLANNED HR:MIN:SEC	ACTUAL HR:MIN:SEC	DIFFERENCE MIN:SEC
LIFTOFF	0:00:00.0	0:00:00.65	0:00.65
MACH 1	0:01:00.6	0:01:01.5	0:00.9
MAXIMUM DYNAMIC PRESSURE	0:01:16.1	0:01:18.9	0:02.8
S-IC CENTER ENGINE CUTOFF (TB-2)	0:02:05.9	0:02:05.9	0
S-IC OUTBOARD ENGINES CUTOFF (TB-3)	0:02:31.4	0:02:33.8	0:02.4
S-IC/S-II SEPARATION	0:02:32.1	0:02:34.5	0:02.4
S-II ENGINE START COMMAND	0:02:32.8	0:02:35.2	0:02.4
S-II SECOND PLANE SEPARATION	0:03:02.1	0:03:04.5	0:02.4
LES JETTISON	0:03:07.6	0:03:08.6	0:01.0
S-II ENGINES CUTOFF (TB-4)	0:08:41.2	0:08:44.0	0:02.8
S-II/S-IVB SEPARATION	0:08:42.0	0:08:44.9	0:02.9
S-IVB ENGINE START COMMAND	0:08:42.2	0:08:45.0	0:02.8
S-IVB ENGINE CUTOFF	0:11:24.2	0:11:25.2	0:01.0

EARTH ORBIT AND TRANSLUNAR PHASES

EVENT	PLANNED HR:MIN:SEC	ACTUAL HR:MIN:SEC	DIFFERENCE MIN:SEC
BEGIN S-IVB RESTART PREPARATIONS (TB-6)	2:40:58.8	2:40:59.5	0:00.7
S-IVB ENGINE RESTART COMMAND (TLI BURN)	2:50:28.8	2:50:29.5	0:00.7
S-IVB ENGINE CUTOFF (TLI BURN)	2:55:52.3	2:55:55.5	0:03.2
TRANSLUNAR INJECTION	2:56:02.3	2:56:05.5	0:03.2
CSM/S-IVB SEPARATION & SLA PANEL JETTISON	3:20:55.3	3:20:59.3	0:03.8
INITIATE CSM EVASIVE MANEUVER	3:35:33	3:40:01	4:28
MANEUVER S-IVB TO SLINGSHOT ATTITUDE	4:44:52.5	4:44:56.6	0:04.1
EXTRA CSM EVASIVE MANEUVER	--	4:45:01	--
INITIATE S-IVB LOX DUMP	5:07:52.7	5:07:56.0	0:03.3
POTENTIAL MIDCOURSE CORRECTION 1 (DELAYED - REAL TIME)	9:00:00 11:00:00	-- 10:59:59.5	-- -0:00.5
POTENTIAL MIDCOURSE CORRECTION 2	28:00:00	NOT REQUIRED	
POTENTIAL MIDCOURSE CORRECTION 3	47:00:00	NOT REQUIRED	
POTENTIAL MIDCOURSE CORRECTION 4	61:00:00	60:59:56.0	-0:04.0

LUNAR ORBIT PHASE

<u>EVENT</u>	<u>PLANNED</u> HR:MIN:SEC	<u>ACTUAL</u> HR:MIN:SEC	<u>DIFFERENCE</u> MIN:SEC
INITIATE LOI BURN #1	69:07:30.0	69:08:20.4	0:50.4
LOI BURN #1 TERMINATION (60.0X 168.5 NM)	69:11:35.8	69:12:27.3	0:51.5
INITIATE LOI BURN #2 (CIRCULARIZATION)	73:30:54.0	73:35:07.0	4:13.0
LOI BURN #2 TERMINATION (60.7X 59.7 NM)	73:31:03.7	73:35:16.0	4:12.3

TRANSEARTH AND ENTRY PHASES

INITIATE TEI BURN	89:15:07.0	89:19:16.5	4:09.6
TEI BURN TERMINATION	89:18:33.0	89:22:40.3	4:07.3
POTENTIAL MIDCOURSE CORRECTION 5	104:00:00	103:59:54.0	-0:06.0
POTENTIAL MIDCOURSE CORRECTION 6	122:00:00	NOT REQUIRED	
POTENTIAL MIDCOURSE CORRECTION 7	144:50:00	NOT REQUIRED	
CM/SM SEPARATION	146:35:00	146:28:48.0	-6:12.0
ENTRY INTERFACE (400,000 FT)	146:50:00	146:46:12.8	-3:47.2
DROGUE CHUTE DEPLOY		146:54:47.8	
MAIN PARACHUTES DEPLOY		146:55:38.9	
LANDING	147:10:00	147:00:42.0	-9:18.0



## 2.0 ANOMALY LISTING

THIS SECTION CONTAINS A LISTING OF ANOMALIES RESULTING FROM THE MISSION, NUMBERED ACCORDING TO SPACECRAFT, LAUNCH VEHICLE AND GROUND SYSTEMS.

	<u>PAGE</u>
2.1 SPACECRAFT (MSC) ANOMALIES	
2.1.1 DROP IN CHAMBER PRESSURE DURING FIRST SPS BURN	14
2.1.2 HATCH AND SIDE WINDOWS OBSCURED	16
2.1.3 OBSCURATION OF TELESCOPE FIELD OF VIEW	19
2.1.4 ENTRY MONITOR SYSTEM MALFUNCTIONS	20
2.1.5 NOISY CABIN FANS	22
2.1.6 INOPERATIVE PERSONAL RADIATION DOSIMETER	24
2.1.7 INOPERATIVE SWIMMER'S INTERPHONE	25
2.1.8 ABNORMAL SHIFTS IN COMPUTER READOUT OF OPTICS TRUNNION ANGLE	27
2.1.9 SEA WATER INFLOW THROUGH CABIN PRESSURE RELIEF VALVE	29
2.1.10 FAILURE OF CM RECOVERY LOOP	31
2.1.11 ERRATIC POTABLE WATER QUANTITY MEASUREMENT	33
2.1.12 CONTAMINATION OF SPACECRAFT LOX	36
2.2 LAUNCH VEHICLE (MSFC) ANOMALIES	
2.2.1 THREE S-IC CAMERAS NOT RECOVERED	38
2.2.2 S-II ENGINE OSCILLATIONS	39
2.2.3 INTERMITTANT OPERATION OF S-II POWER SUPPLIES	41
2.3 GROUND SYSTEMS (KSC) ANOMALIES	
NONE	

# ANOMALY REPORT

NO. 2.1.1	TITLE: DROP IN CHAMBER PRESSURE DURING FIRST SPS BURN	MISSION: APOLLO 8
SYSTEM: SM		EVENT TIME: 10:59:58
SUBSYSTEM: SPS	<p><b>PROBLEM:</b> THE SPS ENGINE EXPERIENCED A MOMENTARY DROP IN CHAMBER PRESSURE FROM 94 PSI TO 50 PSI DURING THE SPS BURN FOR THE FIRST MIDCOURSE CORRECTION. THE DATA IS SIMILAR TO THAT EXPERIENCED DURING HELIUM INGESTION TESTS AT WSTF AND AEDC, AND IT HAS BEEN CONCLUDED THAT THE DROP IN CHAMBER PRESSURE WAS CAUSED BY A HELIUM BUBBLE IN THE OXIDIZER FEED LINE. THE CHAMBER PRESSURE WAS SATISFACTORY DURING THE REST OF THE BURN AND DURING THE THREE SUBSEQUENT SPS BURNS.</p>	
<b>ACTION:</b>	<p>THE CAUSE WAS INSUFFICIENT BLEED OF THE OXIDIZER SYSTEM BECAUSE OF A PROCEDURE WAIVER WHICH PERMITTED EQUAL PRESSURES BETWEEN THE SPACECRAFT TANK AND THE BLEED UNIT. CORRECT BLEED PROCEDURE WILL BE IMPLEMENTED FOR APOLLO 9 AND SUBSEQUENT FLIGHTS.</p>	
<b>ORGANIZATION:</b>	5-2490	DATE:
<b>REFERENCES:</b>	MSC 3-DAY REPORT, P.8	REV:
	RESOLUTION: CLOSED	
		14

DETAIL SHEET

ANOMALY 2.1.1.1

TITLE: DROP IN CHAMBER PRESSURE DURING FIRST SPS BURN

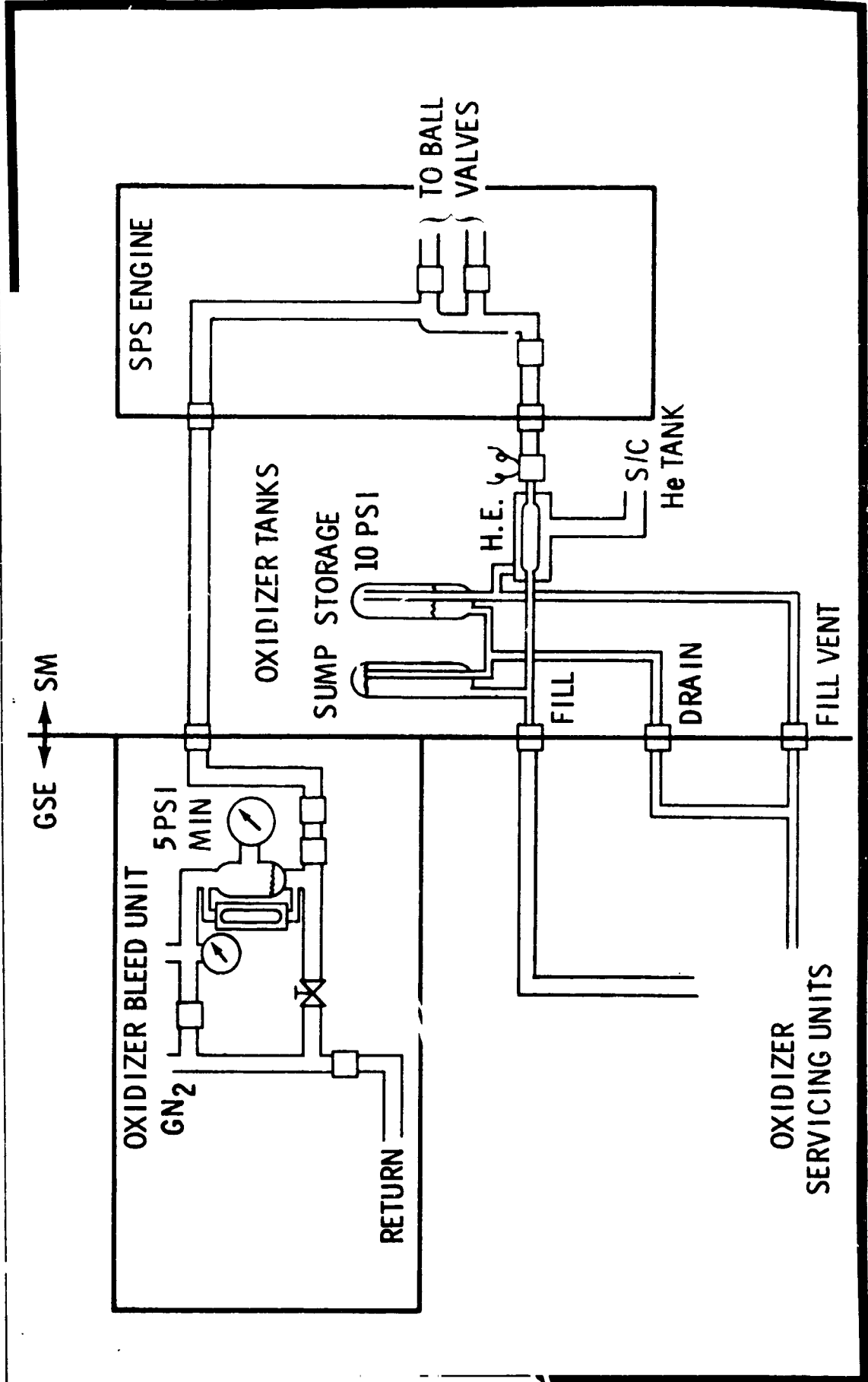

FIGURE 2.1.1-1 SPS OXIDIZER BLEED SCHEMATIC

## ANOMALY REPORT

NO. 2.1.1.2	TITLE: HATCH AND SIDE WINDOWS OBSCURED
SYSTEM: CM	MISSION: APOLLO 8
SUBSYSTEM: STRUCTURE	EVENT TIME: THROUGHOUT MISSION
PROBLEM:	THE HATCH WINDOW (WINDOW 3) BECAME OPAQUE BY APPROXIMATELY 6:00 HOURS GET. THE SIDE WINDOWS (WINDOWS 1 AND 5) WERE ALSO MODERATELY OBSCURED BY FOGGING. THEY WERE USABLE FOR VISUAL OBSERVATIONS BUT NOT FOR PHOTOGRAPHY. THE RENDEZVOUS WINDOWS (WINDOWS 2 AND 4) DID NOT BECOME FOGGED. THIS WINDOW FOGGING IS SIMILAR TO THE FOGGING EXPERIENCED ON APOLLO 7 AND 2TV-1. APOLLO 7 AND APOLLO 8 POSTFLIGHT ANALYSES SHOWED THE FILM TO BE A SILICONE COMPOUND RESULTING FROM THE OUTGASSING OF THE ROOM-TEMPERATURE-CURED ROOM TEMPERATURE VULCANIZING (RTV) COMPOUNDS USED IN THE WINDOW AREA ON THE EDGES OF THE INSULATION BETWEEN THE HEAT SHIELD AND THE PRESSURE VESSEL. (SEE FIGURE 2.1.2-1). THE OUTGASSING PRODUCT HAS BEEN DUPLICATED IN GROUND TESTS AT ALTITUDE AND ELEVATED TEMPERATURES. THE SAME TYPE OF SURFACE CONTAMINATION OCCURRED ON GEMINI FLIGHTS.
ACTION:	THE ROOM-TEMPERATURE-CURED PARTS ARE TO BE REPLACED ON FUTURE SPACECRAFT BY PARTS WHICH HAVE BEEN PRE-CURED AT 10 <sup>-4</sup> TORR AND 400°F FOR 48 HOURS (SEE FIGURE 2.1.2-2). DURING GROUND TESTS WITH THE OLD TYPE HATCH WINDOW INSTALLATION IN A SIMULATED FLIGHT ENVIRONMENT, EXCESSIVE DEPOSITS WERE PRODUCED ON THE INNER SURFACE OF THE OUTER PANE WITHIN HALF A DAY. UNDER IDENTICAL TEST CONDITIONS, A HATCH WINDOW WITH THE NEW CURING PROCESS HAS COMPLETED A 10-DAY TEST. THE WINDOW REMAINED CLEAR EXCEPT FOR AN AREA APPROXIMATELY THREE INCHES IN DIAMETER AT THE CENTER. WINDOWS 1, 3 AND 5 ON CM 104, CM 106 AND CM 107 HAVE BEEN REPLACED WITH THE IMPROVED TYPE WINDOWS. THE HATCH WINDOW CAVITY WILL BE PURGED WITH DRY NITROGEN FOR 72 HOURS AT KSC PRIOR TO FLIGHT. THIS ANOMALY HAS BEEN CLOSED BY MSC.
ORGANIZATION: REFERENCES:	5-2490 MSC 3-DAY REPORT, P. 5 MSC 30-DAY REPORT, P. 2 MSC APOLLO 9 FRR CCB, JANUARY 30 APOLLO 9 FRR MSC 60-DAY REPORT P.12-2
	RESOLUTION: CLOSED
	DATE:
	REV:

# DETAIL SHEET

ANOMALY 2.1.1.2

TITLE: HATCH AND SIDE WINDOWS OBSCURED

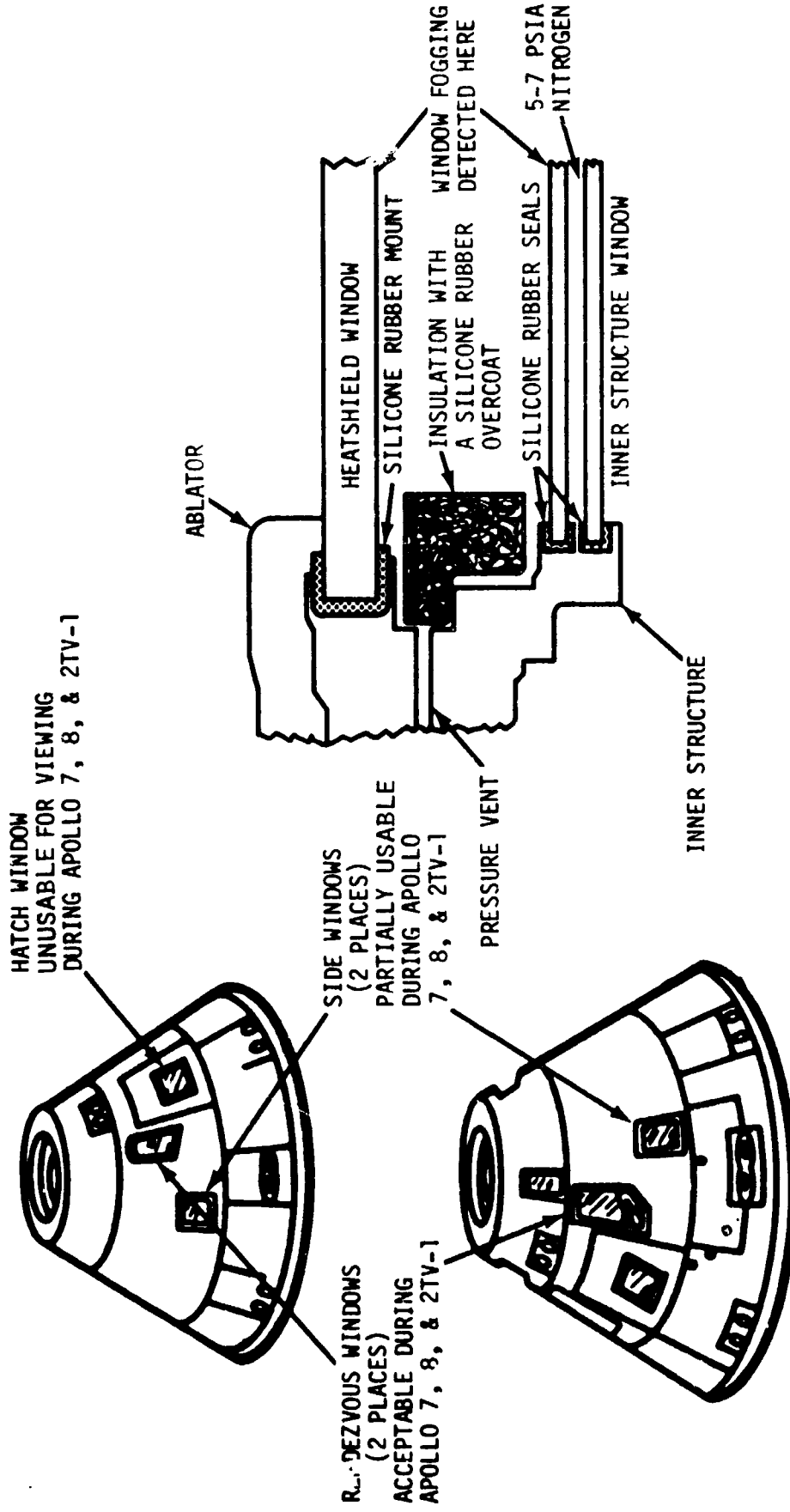

FIGURE 2.1.2-1 CM WINDOW DETAILS

DETAIL SHEET

ANOMALY 2.1.1.2

TITLE: HATCH AND SIDE WINDOWS OBSCURED

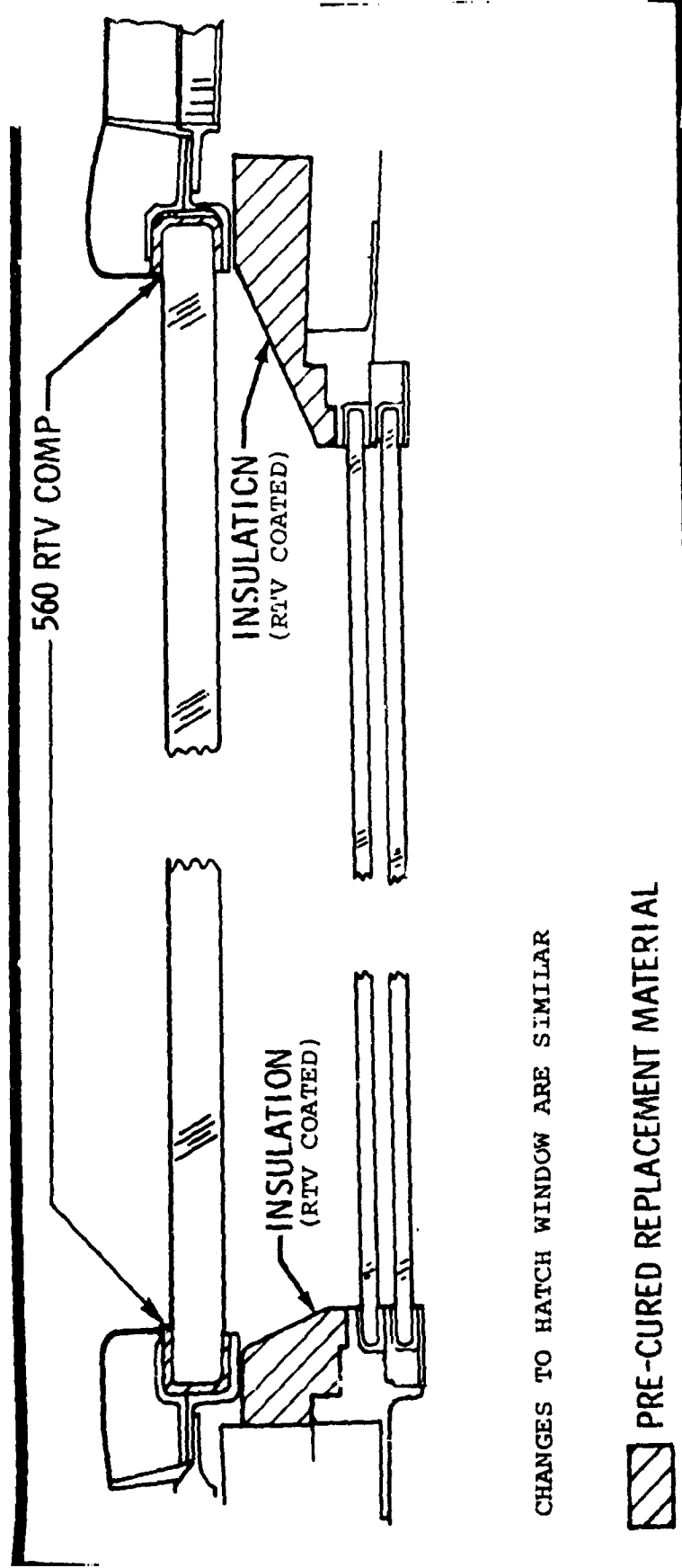

FIGURE 2.1.2-2 CHANGES TO SIDE WINDOW

# ANOMALY REPORT

<p><b>NO. 2.1.3</b></p> <p><b>SYSTEM: CM</b></p> <p><b>SUBSYSTEM: PGNC</b></p>	<p><b>TITLE: OBSCURATION OF TELESCOPE FIELD OF VIEW</b></p> <p><b>MISSION: APOLLO 8</b></p> <p><b>EVENT TIME:</b></p> <p><b>PROBLEM:</b> THE FIELD OF VIEW IN THE SCANNING TELESCOPE WAS OBSCURED BY WHAT APPEARED TO BE PARTICLES WHENEVER THE TELESCOPE OPTICS WERE REPOSITIONED. A BAND OF SCATTERED LIGHT WAS PRESENT IN THE SCANNING TELESCOPE EXTENDING ACROSS THE FIELD OF VIEW FOR ABOUT <math>\pm 10</math> DEGREES FROM ZERO. THIS BAND OF LIGHT VARIED IN INTENSITY WITH CSM ATTITUDE, AND IN SOME ATTITUDES IT OBSCURED THE STARS. A SIMILAR BAND WAS PRESENT IN THE SEXTANT, BUT MAGNIFICATION BROUGHT OUT THE STARS SATISFACTORILY.</p> <p><b>ACTION:</b> THE PARTICLES WERE APPARENTLY CAUSED BY WATER THAT HAD BEEN DUMPED OVERBOARD. THE WATER DUMP PROCEDURES HAVE BEEN CHANGED TO PREVENT INTERFERENCE WITH OPTICAL SIGHTINGS.</p>	<p><b>ORGANIZATION: 5-2490</b></p> <p><b>REFERENCES: MSC 60-DAY REPORT, P. 7-23</b></p> <p><b>RESOLUTION: CLOSED</b></p> <p><b>DATE:</b></p> <p><b>REV:</b></p> <p>119</p>
--	---	--

# ANOMALY REPORT

NO. 2.1.4

TITLE: ENTRY MONITOR SYSTEM MALFUNCTIONS

SYSTEM: CM

MISSION: APOLLO 8

SUBSYSTEM: ENTRY MONITOR SYSTEM (EMS)

EVENT TIME: 104:00:14

PROBLEM:

FOUR MALFUNCTIONS OF THE ENTRY MONITOR SYSTEM OCCURRED AT DIFFERENT TIMES DURING THE MISSION.

1. DURING THE SPACECRAFT/S-IVB SEPARATION SEQUENCE, THE  $\Delta V$  COUNTER JUMPED 100 FT/SEC. FOR THE THIRD MIDCOURSE CORRECTION, A  $\Delta V$  OF 5 FT/SEC WAS ENTERED INTO THE ENTRY MONITOR SYSTEM. THE SYSTEM COUNTED TO ZERO AT  $\Delta V$  CUTOFF; HOWEVER, IT CONTINUED TO COUNT AFTER THE MANEUVER UNTIL TURNED OFF BY THE CREW.
2. THE  $\Delta V$  COUNTER JUMPED 19 TO 20 FT/SEC AT TIMES WHEN THE MODE SWITCH WAS RAPIDLY SWITCHED FROM "STANDBY" TO "AUTOMATIC." THIS CONDITION IS CHARACTERISTIC OF THE DESIGN DURING RAPID MODE SWITCHING.
3. THE G/VELOCITY TRACE ON THE ENTRY SCROLL CONTAINED TWO SHORT, INCORRECT G-TRANSIENTS DURING THE INITIAL ENTRY PHASE (SEE FIGURE 2.1.4-1). OPERATION OF THE SCROLL ASSEMBLY WAS NORMAL IN ALL OTHER RESPECTS.

ACTION:

THE EMS HAS BEEN REMOVED AND TESTED. ABNORMAL X-AXIS ACCELEROMETER SIGNALS OCCURRED DURING THE TILT-TABLE TESTS; RANDOM 0.25G PULSES WERE PRODUCED AT APPROXIMATELY 0.8G. ANALYSIS BY THE VENDOR DETERMINED THAT A BUBBLE WAS PRESENT IN THE ACCELEROMETER DAMPING FLUID. THIS BUBBLE MAY BE ASSOCIATED WITH THE G-TRACE TRANSIENTS AND WITH THE FAILURE OF THE  $\Delta V$  COUNTER TO STOP AT ZERO. VELOCITY COUNTER JUMPS OF ABOUT 100 FT/SEC HAVE BEEN PRODUCED WHEN THE  $\Delta V$  COUNTER IS NEAR ZERO AND AN ORDERED SERIES OF POSITIVE AND NEGATIVE PULSES ENTER THE COUNTER LOGIC FROM THE ACCELEROMETER. CORRECTIVE ACTION THAT WILL BE TAKEN IS: (1) RUN ADDITIONAL ACCEPTANCE TESTS ON ACCELEROMETERS; (2) CHANGE THE ACCELEROMETER FLUID SEALING PORT DESIGN EFFECTIVE ON CM 106; (3) PREVENT  $\Delta V$  JUMPS BY BIASING THE  $\Delta V$  COUNTER OFF ZERO BY +100 FT/SEC FOR ALL  $\Delta V$  MONITORING EXCEPT FOR ENTRY. (4) ENTRY BANK ANGLES WILL BE FURNISHED TO THE CREW IF BOTH THE GUIDANCE AND NAVIGATION SYSTEM AND THE ENTRY MONITOR SYSTEM FAILS. MSC HAS DETERMINED THAT THIS PROBLEM DOES NOT CONSTRAIN APOLLO 9.

ORGANIZATION: 5-2490

REFERENCES: MSC 30-DAY REPORT, P. 1

MSC APOLLO 9 FRR

MSC ANOMALY STATUS REPORT (JAN. 28), PP. 4, 5

CCB, JANUARY 30

APOLLO 9 FRR

MSC-60 - DAY REPORT, P12-2

RESOLUTION: OPEN

NO CONSTRAINT

TO APOLLO 9

DATE:

REV:

20



DETAIL SHEET

ANOMALY 2.1.4

TITLE: ENTRY MONITOR SYSTEM MALFUNCTIONS

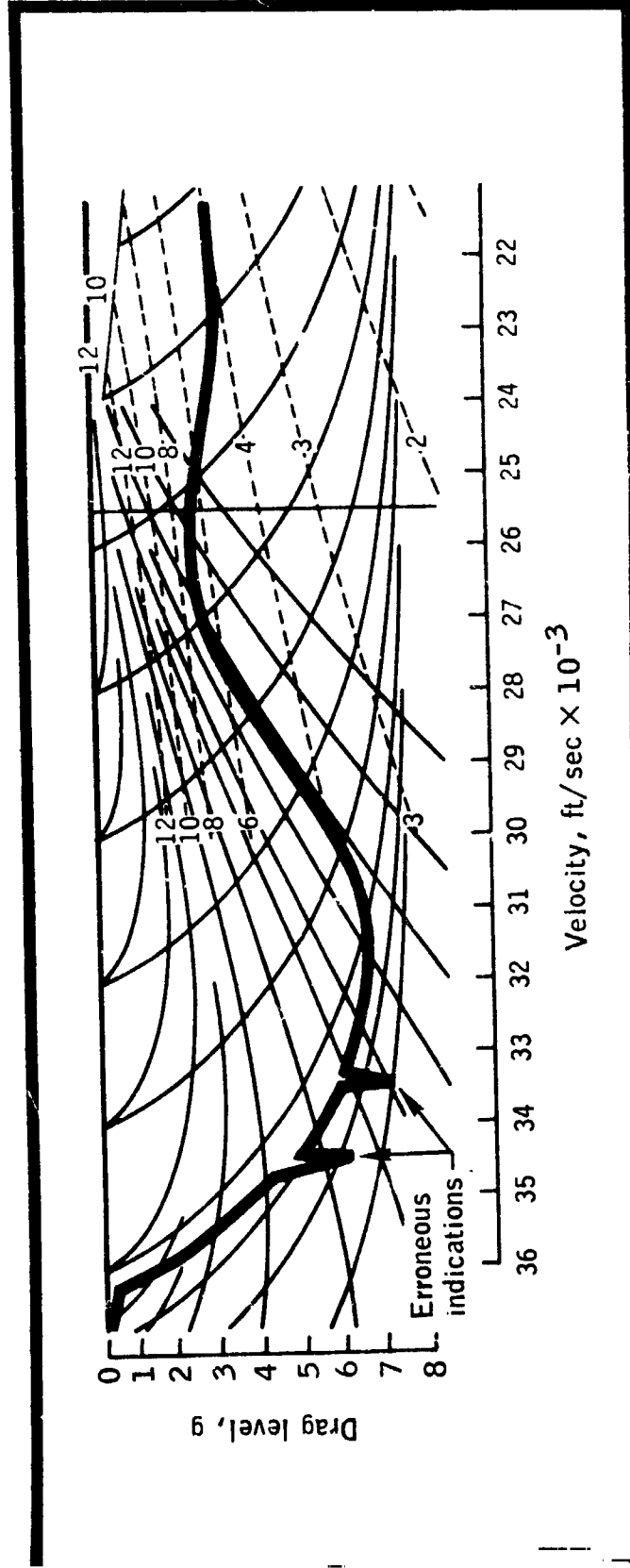

FIGURE 2.1.4-1 ENTRY MONITOR SYSTEM G/VELOCITY PLOT OF APOLLO 8 ENTRY

# ANOMALY REPORT

NO. 2.1.5	TITLE: NOISY CABIN FANS	MISSION: APOLLO 8
SYSTEM: CM		EVENT TIME: 126:52:00
SUBSYSTEM: ECS		
PROBLEM:	DURING THE SIXTH DAY OF THE MISSION, THE CABIN FANS (FIGURE 2.1.5-1) WERE MOMENTARILY TURNED ON, AND THE CREW REPORTED THAT BOTH FANS WERE NOISY. THE CREW DESCRIBED THE NOISE AS SOUNDING AS IF THE FANS HAD FAILED BEARINGS.	
ACTION:	THE ACOUSTIC LEVEL OF THE FANS, BOTH INDIVIDUALLY AND TOGETHER, WAS RECORDED WITH THE HATCHES CLOSED AT THE THREE HEAD POSITIONS ON THE COUCHES, AT THE WORK STATIONS, AND IN THE SLEEP POSITIONS. THE NOISE LEVEL IS CONSIDERED NORMAL COMPARED TO THE CABIN FAN NOISE PREVIOUSLY EXPERIENCED DURING CHECKOUT. THE BLADES MOVED SMOOTHLY AND STOPPED SLOWLY. THERE WAS NO EVIDENCE OF DAMAGED FAN BLADES OR OF LOOSE PARTS IN THE FAN ASSEMBLY AS OCCURED ON THE CM 101 FANS. THE NOISE LEVEL MAY HAVE BEEN CAUSED BY A RESONANT CONDITION WITHIN THE DUCT SYSTEM UNDER THE EXISTING ENVIRONMENT. HOWEVER, NO FURTHER INVESTIGATION IS NECESSARY; RESULTS OF APOLLO 7 AND 9 DEMONSTRATE THAT THE CABIN FANS ARE NOT REQUIRED FOR MAINTENANCE OF A COMFORTABLE ENVIRONMENT. THIS ANOMALY HAS BEEN CLOSED BY MSC.	
ORGANIZATION: 5-2490	RESOLUTION: CLOSED	DATE:
REFERENCES: MSC 3-DAY REPORT, P. 9		REV:
MSC 30-DAY REPORT, PP. 2,3		
MSC ANOMALY STATUS REPORT (JAN. 28), P. 5		
APOLLO 9 FRR		
MSC 60 DAY REPORT, P12-3		

DETAIL SHEET

ANOMALY 2.1.5

TITLE: NOISY CABIN FANS

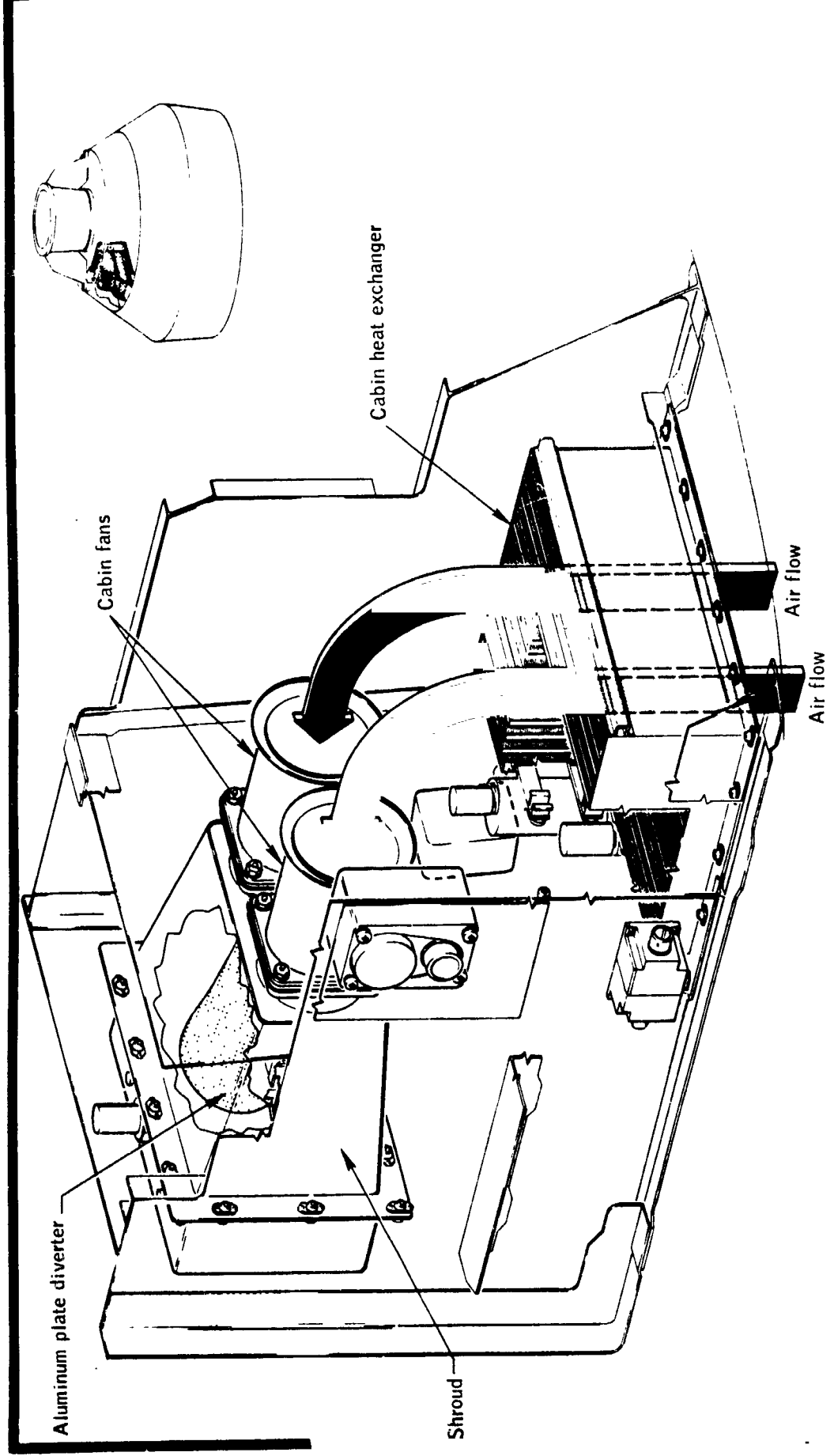

FIGURE 2.1.5-1  
CABIN FAN INSTALLATION

# ANOMALY REPORT

<b>NO. 2.1.1.6</b>	<b>TITLE:</b> INOPERATIVE PERSONAL RADIATION DOSIMETER	<b>MISSION:</b> APOLLO 8
<b>SYSTEM:</b> CM		<b>EVENT TIME:</b> POSTFLIGHT
<b>SUBSYSTEM:</b> RADIATION MEASURING EQUIPMENT		
<b>PROBLEM:</b>	THE COMMAND MODULE PILOT'S RADIATION DOSIMETER INDICATED NO RADIATION DOSAGE FOR THE ENTIRE MISSION. THE DOSIMETER WAS WORKING DURING THE FLIGHT: HOWEVER, THE RADIATION LEVEL MEASURED WAS SO LOW THAT THE SIGNAL WAS IN THE UNCALIBRATED PORTION OF THE INSTRUMENT'S RANGE.	
<b>ACTION:</b>	THE DOSIMETERS WERE CALIBRATED DOWN TO 5 MILLIRADS/HOUR. ON APOLLO 9 AND SUBSEQUENT THE DOSIMETERS WILL BE CALIBRATED DOWN TO 1.5 MILLIRADS/HOUR.	
<b>ORGANIZATION:</b> 5-2490	<b>RESOLUTION:</b> CLOSED	<b>DATE:</b>
<b>REFERENCES:</b> MSC 60 DAY REPORT, P5-3		<b>REV:</b>

# ANOMALY REPORT

<b>NO.</b> 2.1.1.7	<b>TITLE:</b> INOPERATIVE SWIMMER'S INTERPHONE	<b>MISSION:</b> APOLLO 8
<b>SYSTEM:</b> CM		<b>EVENT TIME:</b> POST-LANDING
<b>SUBSYSTEM:</b> TELECOMMUNICATIONS	<b>PROBLEM:</b> THE RECOVERY TEAM WAS UNABLE TO COMMUNICATE WITH THE SPACECRAFT CREW OVER THE INTERPHONE USING THE SWIMMER'S UMBILICAL. THE RECOVERY TEAM ESTABLISHED COMMUNICATION BY USING SMALL PORTABLE RADIOS. THE CREW REPORTED THAT THE SPACECRAFT INTERCOM SWITCHES WERE IN THE PROPER POSITION. AS SHOWN IN FIGURE 2.1.1.7-1, THE SWIMMER'S PHONE, WHICH PLUGS INTO THE SPACECRAFT, HAS A PUSH-TO-TALK SWITCH AND AN ON-OFF SWITCH.	
<b>ACTION:</b>	THE INTERPHONE WAS TESTED TWICE, THE SECOND TIME WITH THE UMBILICAL CONNECTION SOAKED IN SALT WATER AND USING THE SWIMMER'S PHONE THAT WAS ACTUALLY USED DURING THE RECOVERY. THE INTERPHONE WORKED SATISFACTORILY DURING BOTH TESTS, WITH TWO-WAY COMMUNICATIONS ESTABLISHED TO ALL THREE CM CREW STATIONS. THE MOST PROBABLE CAUSE OF THE PROBLEM IS OUTSIDE THE SPACECRAFT AND ASSOCIATED WITH THE OPERATION OF THE SWIMMER'S PHONE. THE TRAINING PROCEDURES FOR OPERATION OF THE PHONE WILL BE EMPHASIZED. THIS ANOMALY HAS BEEN CLOSED BY MSC.	
<b>ORGANIZATION:</b> 5-2490	<b>RESOLUTION:</b> CLOSED	<b>DATE:</b>
<b>REFERENCES:</b> MSC 30-DAY REPORT, P. 4		<b>REV:</b>
APOLLO 9 FRR		
MSC 60 DAY REPORT, P12.4		

DETAIL SHEET

ANOMALY 2.1.1.7

TITLE: INOPERATIVE SWIMMER'S INTERPHONE

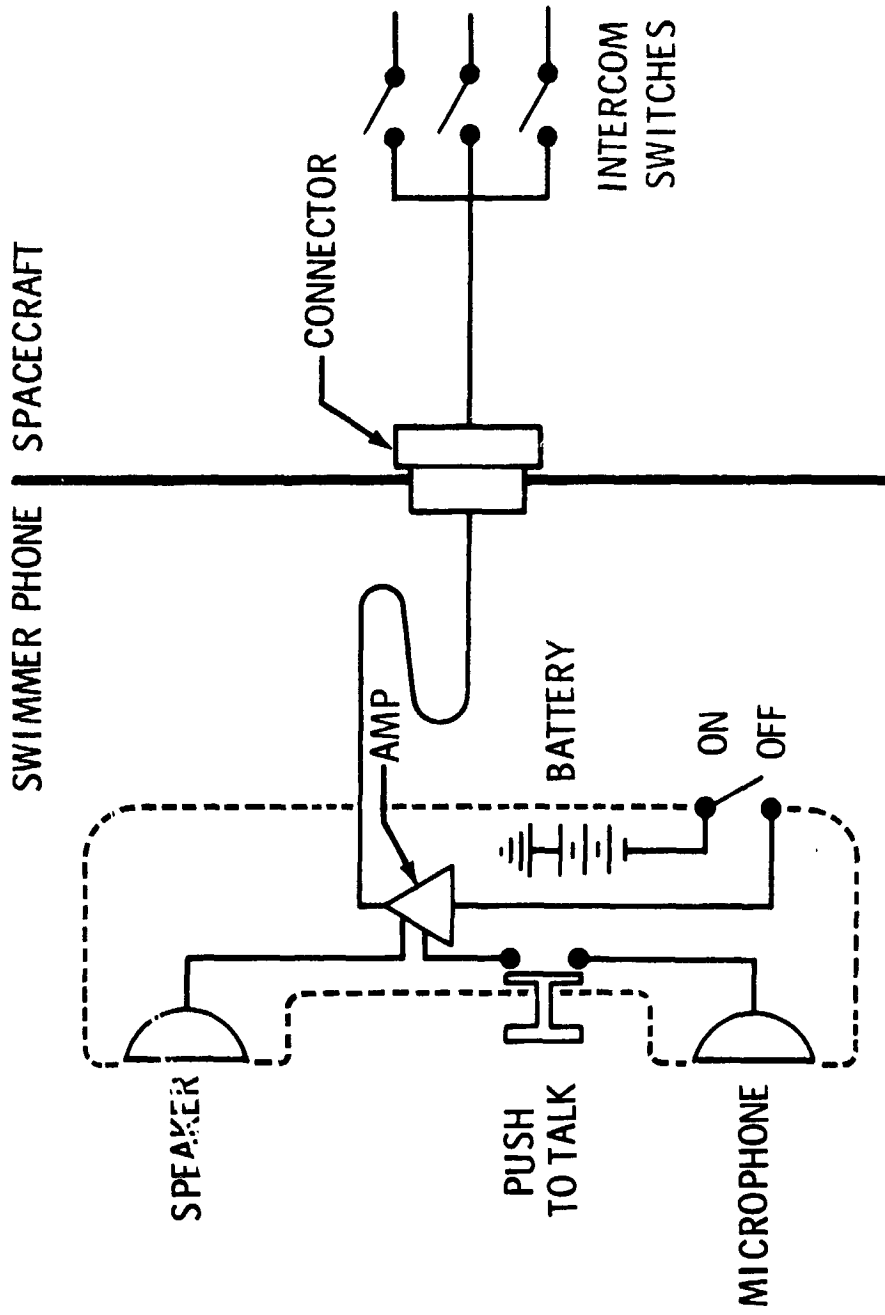

FIGURE 2.1.1.7-1

SWIMMER'S INTERPHONE SCHEMATIC

# ANOMALY REPORT

<b>NO.</b> 2.1.1.8	<b>TITLE:</b> ABNORMAL SHIFTS IN COMPUTER READOUT OF OPTICS TRUNNION ANGLE	<b>MISSION:</b> APOLLO 8
<b>SYSTEM:</b> CM	<b>EVENT TIME:</b>	
<b>SUBSYSTEM:</b> PGNC	<b>PROBLEM:</b> SEVERAL TIMES DURING PERIODS OF NO OPTICS ACTIVITY, THE OPTICS TRUNNION ANGLE READ-OUT SHIFTED FROM 0 TO 45 DEGREES. IN EACH CASE, THE CORRECT READING WAS RESTORED WITH A NORMAL OPTICS ZEROING PROCEDURE, AND NO OPTICS UTILIZATION CAPABILITY WAS LOST.  <b>ACTION:</b> WHEN OPTICS POWER IS REMOVED FROM THE OPTICS, THE ANTI-BACKLASH SPRING WILL DRIVE THE SEXTANT TRUNNION AXIS TO A NEW POSITION (FIGURE 2.1.9-1). IF POWER IS RE-APPLIED WITHOUT ZEROING THE OPTICS COUPLING DATA UNIT (CDU), THE CDU COUNTER WILL TRACK THE ANGLE FROM THE NEW POSITION; THE COUNTER WILL CONTAIN AN ERROR WHICH IS THE DIFFERENCE BETWEEN THE NEW POSITION AND ZERO. THE CORRECTIVE ACTION CONSISTS OF: (1) ZEROING THE OPTICS CDU BEFORE USE; (2) INSERTING AN EXPLANATORY NOTE IN THE APOLLO OPERATIONS HANDBOOK. MSC DOES NOT CONSIDER THIS PROBLEM TO BE AN ANOMALY.	
<b>ORGANIZATION:</b> 5-2490	<b>RESOLUTION:</b> CLOSED	<b>DATE:</b>
<b>REFERENCES:</b> MSC 3-DAY REPORT, P. 8 MSC APOLLO 9 FRR APOLLO 9 FRR	<b>REV:</b>	27
<b>MSC 60 DAY REPORT, P. 6-46</b>		

# DETAIL SHEET

ANOMALY 2.1.1.8

TITLE: ABNORMAL SHIFTS IN COMPUTER READOUT OF OPTICS TRUNNION ANGLE

	OPTICS ZEROED	SPRING DRIFT (POWER OFF)	POWER UP
COUNTER	0°	45°	0°
COMPUTER MEMORY	0°	0°	-45°

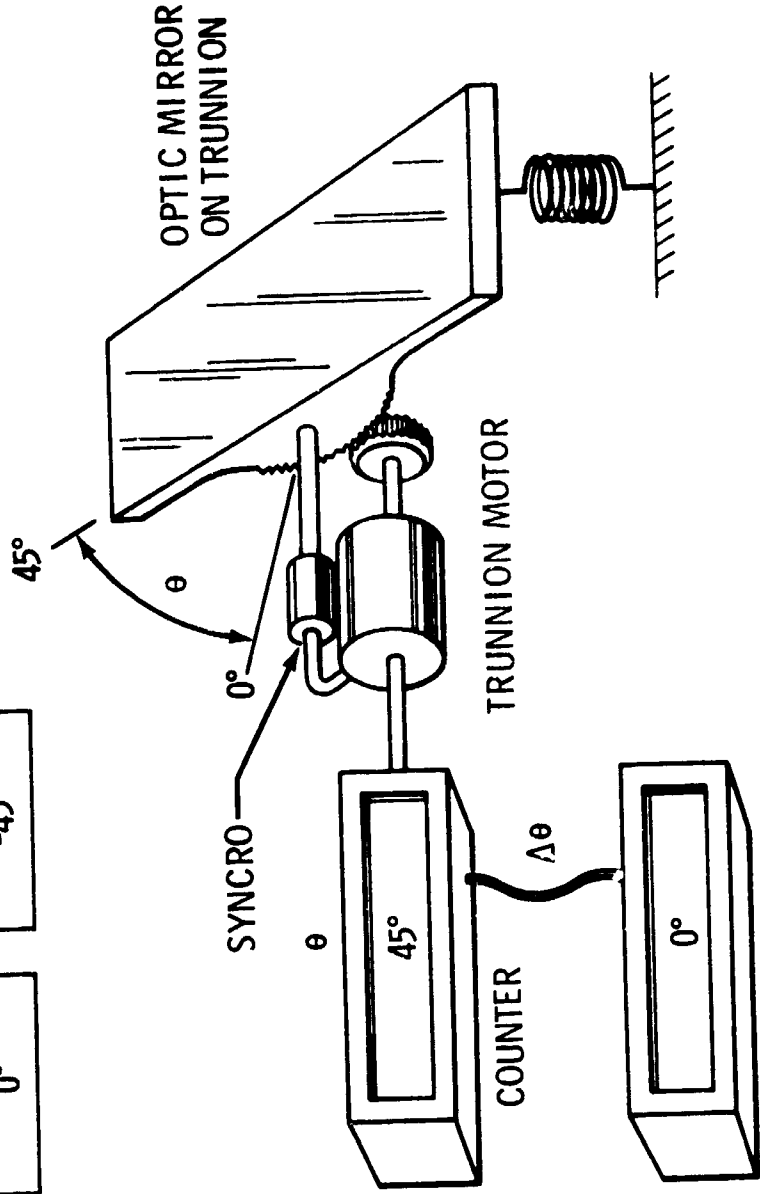

FIGURE 2.1.1.8-1 OPTICS DRIVE AND READOUT



# ANOMALY REPORT

NO. 2.1.9

TITLE: SEA WATER INFLOW THROUGH CABIN PRESSURE RELIEF VALVE

SYSTEM: CM

MISSION: APOLLO 8

SUBSYSTEM: ENVIRONMENTAL CONTROL SUBSYSTEM (ECS)

EVENT TIME: LANDING

PROBLEM: THE COMMANDER REPORTED THAT HIS LEFT SHOULDER WAS SHOWERED WITH WATER AT LANDING. THIS IMPLIES THAT SEA WATER ENTERED THROUGH THE CABIN PRESSURE RELIEF VALVE (FIGURE 2.1.9-1). A MANUAL LEVER IS CONNECTED TO EACH SIDE OF THE REDUNDANT CABIN PRESSURE RELIEF VALVE. WITH THE TWO LEVERS IN THE CLOSED POSITION (DASHED LINES IN FIGURE 2.1.9-1), A CAM PREVENTS THE VALVE FROM OPENING. ANY OTHER POSITION OF THE LEVER AND CAM ALLOWS THE VALVE TO OPEN AT AN AMBIENT-TO-CABIN DIFFERENTIAL PRESSURE OF 0.3 PSI. THE CREW REPORTED THAT BOTH VALVES HAD BEEN POSITIONED TO THE CLOSED POSITION PRIOR TO IMPACT, AS SPECIFIED BY THE CREW CHECK-LIST.

ACTION: DURING POSTFLIGHT LEAKAGE TESTS AT A DIFFERENTIAL PRESSURE OF 13 PSI, THE RATE OF LEAKAGE MEASURED WAS WITHIN SPECIFICATION. INCREASING THE PRESSURE TO 25 PSIG CAUSED A FINE SPRAY AROUND THE VALVES. HOWEVER, THE VALVES DID NOT YIELD PERMANENTLY. ONLY A NEGLIGIBLE AMOUNT OF SEA WATER COULD ENTER BY RAM EFFECT AGAINST THE RELIEF VALVE. IN ADDITION, NO SALT DEPOSITS WERE EVIDENT IN EITHER VALVE (THE APOLLO 6 VALVE WAS FROZEN CLOSED BY SALT DEPOSITS). THE CAM AND LEVER RIGGING AND LEVER DETENT POSITIONS WERE VERIFIED, NO CORRECTIVE ACTION IS REQUIRED, SINCE THE PROCEDURES FOR CLOSING THE VALVES ARE INCLUDED IN THE CREW CHECKLIST, AND IF THE VALVES ARE NOT CLOSED AT LANDING, THE CREW WILL SEE THE WATER INFLOW AND TAKE APPROPRIATE ACTION. THIS ANOMALY HAS BEEN CLOSED BY MSC.

ORGANIZATION: 5-2490

REFERENCES: MSC 30-DAY REPORT, P.3

MSC APOLLO 9 FRR

MSC APOLLO ANOMALY STATUS (JAN. 28), P.6

APOLLO 9 FRR

MSC 60-DAY REPORT, P.12-3

RESOLUTION: CLOSED

DATE:

REV:

DETAIL SHEET

ANOMALY 2.1.1.9

TITLE: SEA WATER INFLOW THROUGH CABIN PRESSURE RELIEF VALVE

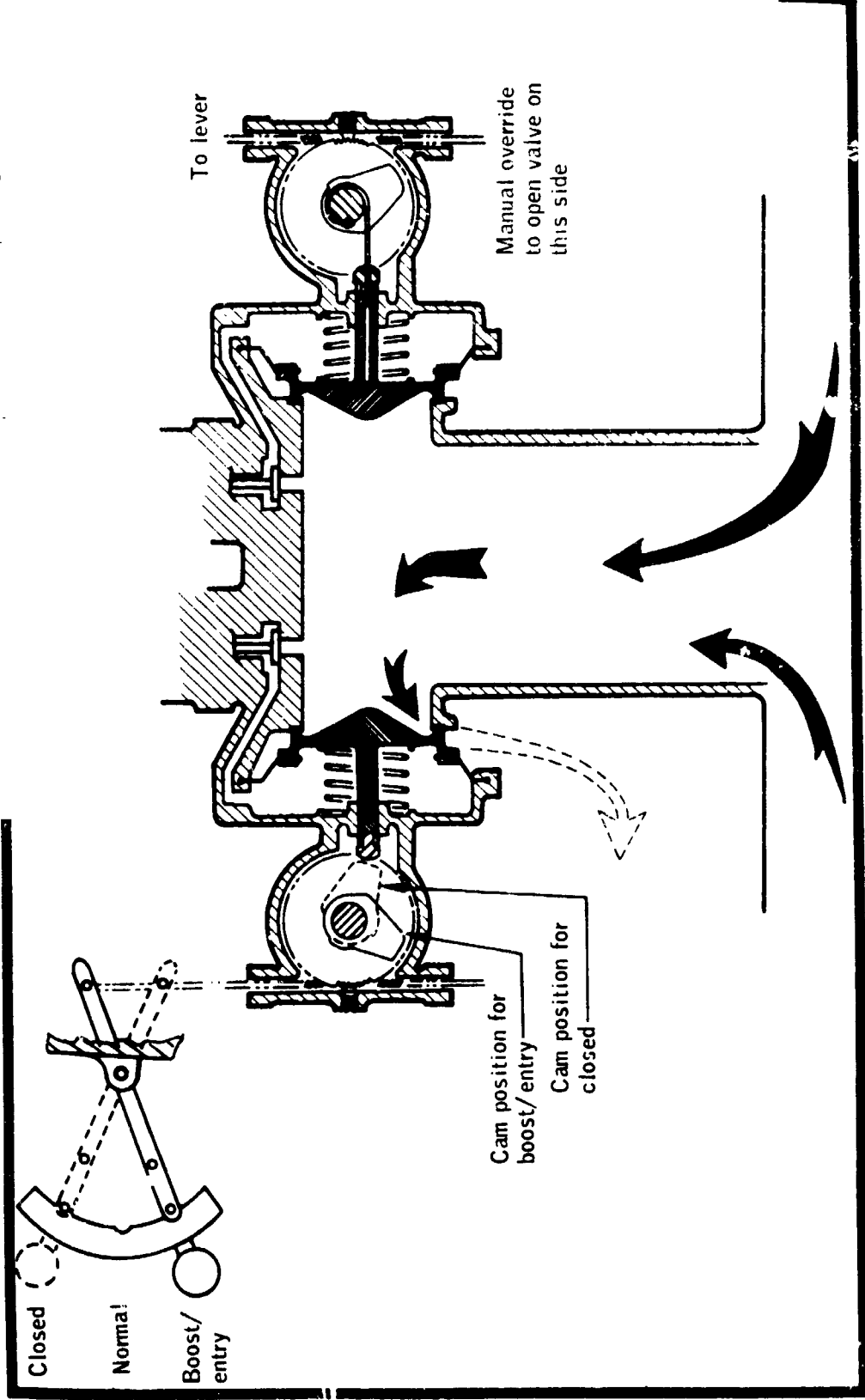

FIGURE 2.1.1.9-1

CABIN PRESSURE RELIEF VALVE

# ANOMALY REPORT

<b>NO.</b> 2.1.10	<b>TITLE:</b> FAILURE OF CM RECOVERY LOOP	<b>MISSION:</b> APOLLO 8
<b>SYSTEM:</b> CM	<b>STRUCTURE</b>	<b>EVENT TIME:</b> RECOVERY
<b>PROBLEM:</b> TWO OF THE SIX STEEL CABLES IN THE COMMAND MODULE RECOVERY LOOP FAILED WHILE THE SPACECRAFT WAS BEING HOISTED FROM THE SEA. THE RECOVERY LOOP HAS EXPERIENCED NUMEROUS FAILURES DURING TESTS AT SNATCH LOADINGS EQUIVALENT TO A 32,000-POUND LOAD, AND AS A RESULT, AN AUXILIARY NYLON LOOP WAS PROVIDED FOR INSTALLATION BY THE SWIMMERS. THE NYLON LOOP ALONE HAS SUFFICIENT SAFETY MARGIN TO TAKE THE SNATCH LOADINGS EXPECTED.		
<b>ACTION:</b> FOR CM 108 AND SUBSEQUENT, THE STEEL CABLE WILL BE REPLACED WITH A NYLON RECOVERY LOOP SIMILAR TO THE NYLON AUXILIARY LOOP. UNTIL THEN, THE AUXILIARY NYLON LOOP, INSTALLED BY THE SWIMMERS, WILL BE USED. THIS ANOMALY HAS BEEN CLOSED BY MSC.		
<b>ORGANIZATION:</b> 5-2490	<b>RESOLUTION:</b> CLOSED	<b>DATE:</b>
<b>REFERENCES:</b> MSC 30-DAY REPORT, P. 4 MSC APOLLO 9 FRR MSC 60-DAY REPORT, P.12-4		<b>REV:</b>

DETAIL SHEET

ANOMALY 2.1.10

TITLE: FAILURE OF CM RECOVERY LOOP

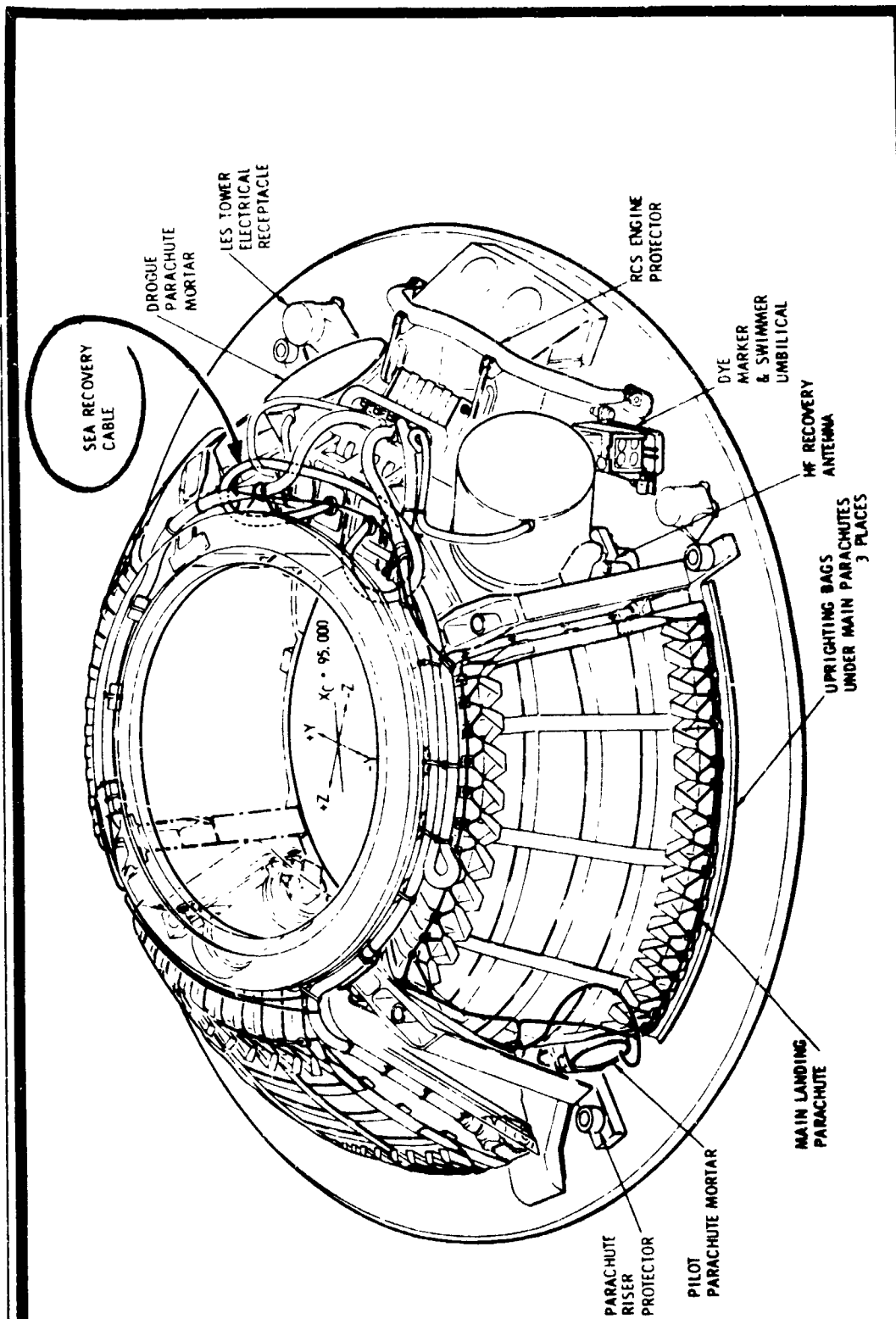

FIGURE 2.1.10-1 CM RECOVERY LOOP

# ANOMALY REPORT

NO. 2.1.11	TITLE: ERRATIC POTABLE WATER QUANTITY MEASUREMENT	MISSION: APOLLO 8
SYSTEM: CM		EVENT TIME: 144:53:00
SUBSYSTEM: ECS		
PROBLEM:	THE POTABLE WATER TANK QUANTITY MEASUREMENT BECAME ERRATIC APPROXIMATELY TWO HOURS BEFORE LANDING. THE QUANTITY INDICATION DROPPED FROM 104% TO 58%, THEN TO 21%, RETURNED TO 50%, AND LATER DROPPED TO 25% (SEE FIGURE 2.1.11-1).	
ACTION:	THE POTABLE WATER SYSTEM DID NOT LEAK IN FLIGHT, AS CONFIRMED BY THE FACT THAT THE CORRECT AMOUNT OF WATER WAS DRAINED FROM THE POTABLE WATER TANK AFTER THE FLIGHT. THE SYSTEM WAS LEAK CHECKED AFTER FLIGHT AND FOUND TO BE WITHIN SPECIFICATION. THE MEASUREMENT INDICATES 50 PERCENT REGARDLESS OF ACTUAL QUANTITY. THE PROBLEM HAS BEEN ISOLATED TO THE SENSOR (FIGURE 2.1.11-2). EXAMINATION OF THE DISASSEMBLED UNIT REVEALED SALT DEPOSITS INSIDE THE BLADDER (DRY OXYGEN SIDE) AND INSIDE THE INDICATOR HOUSING. THE VARIABLE POTENTIOMETER AND PULLEY WERE CORRODED. THE ACTUATOR LINE WAS BROKEN, PROBABLY AS A RESULT OF POSTFLIGHT CALIBRATION WITH THE PULLEY AND POTENTIOMETER FROZEN. FREEZING OF THESE PARTS IS BELIEVED TO BE ASSOCIATED WITH SALT WATER WHICH ENTERED AT LANDING. FRESH WATER WAS FOUND ON THE POTENTIOMETER, AND THIS WAS SHOWN TO CAUSE ERRATIC READINGS. THE SOURCE OF THIS FRESH WATER HAS NOT BEEN DETERMINED. THE QUANTITY MEASURING SYSTEM IN THE WASTE WATER TANK (SAME TYPE AS IN POTABLE TANK) WAS ALSO DISASSEMBLED, BUT NO CORROSION WAS FOUND. A PROCEDURAL CHANGE HAS BEEN MADE TO AVOID FILLING THE TANK TO THE 100% LEVEL. THIS ANOMALY HAS BEEN CLOSED BY MSC.	
ORGANIZATION: 5-2490	RESOLUTION: CLOSED	DATE:
REFERENCES: MSC 30-DAY REPORT, P. 5		REV:
MSC APOLLO 9 FRR		
MSC ANOMALY STATUS REPORT (JAN. 28) PP. 6,7		
APOLLO 9 FRR		
MSC 60-DAY REPORT, P12-5		

DETAIL SHEET

ANOMALY 2.1.11

TITLE: ERRATIC POTABLE WATER QUANTITY MEASUREMENT

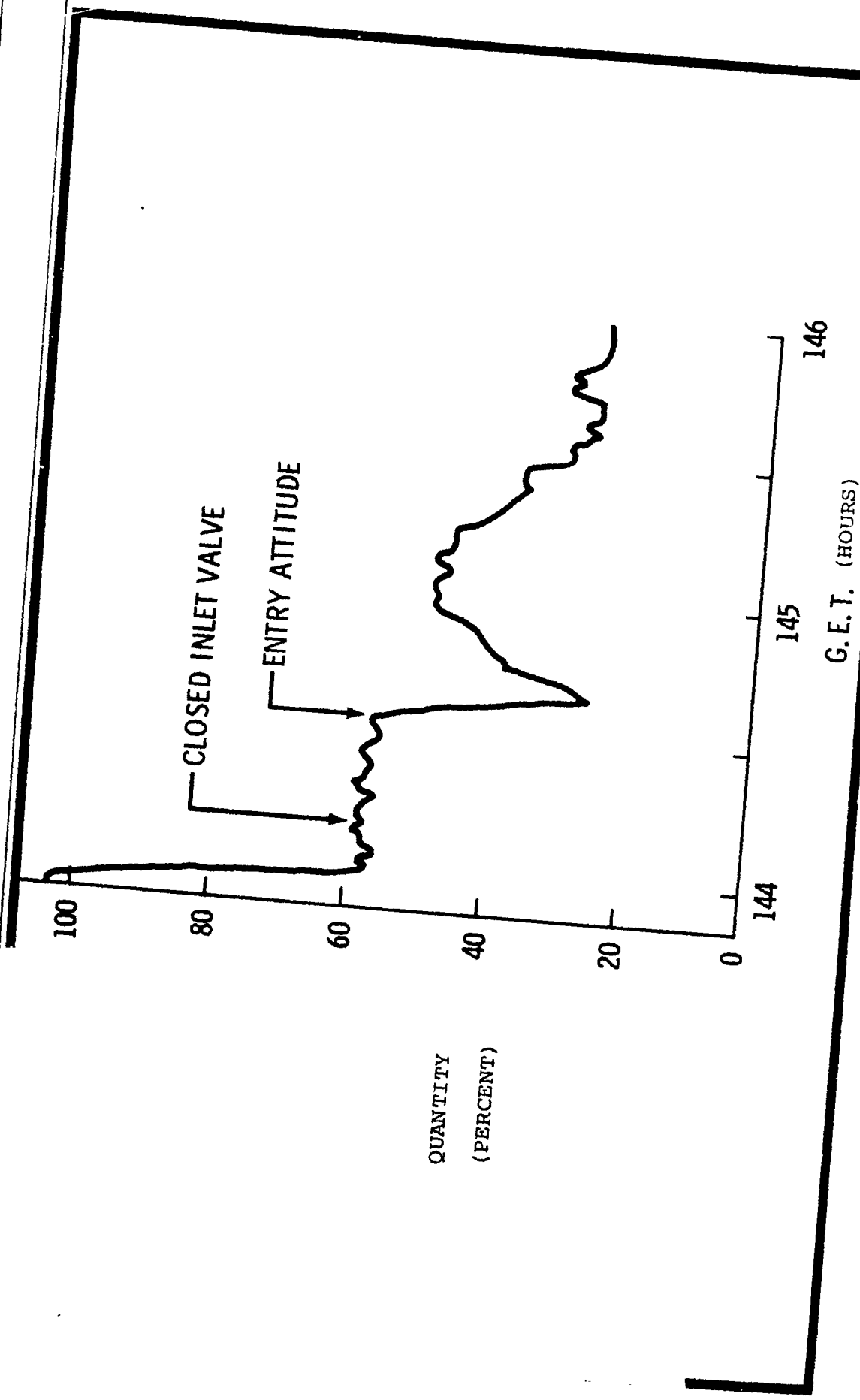

FIGURE 2.1.11-1 POTABLE WATER QUANTITY HISTORY

DETAIL SHEET

ANOMALY 2.1.11

TITLE: ERRATIC POTABLE WATER QUANTITY MEASUREMENT

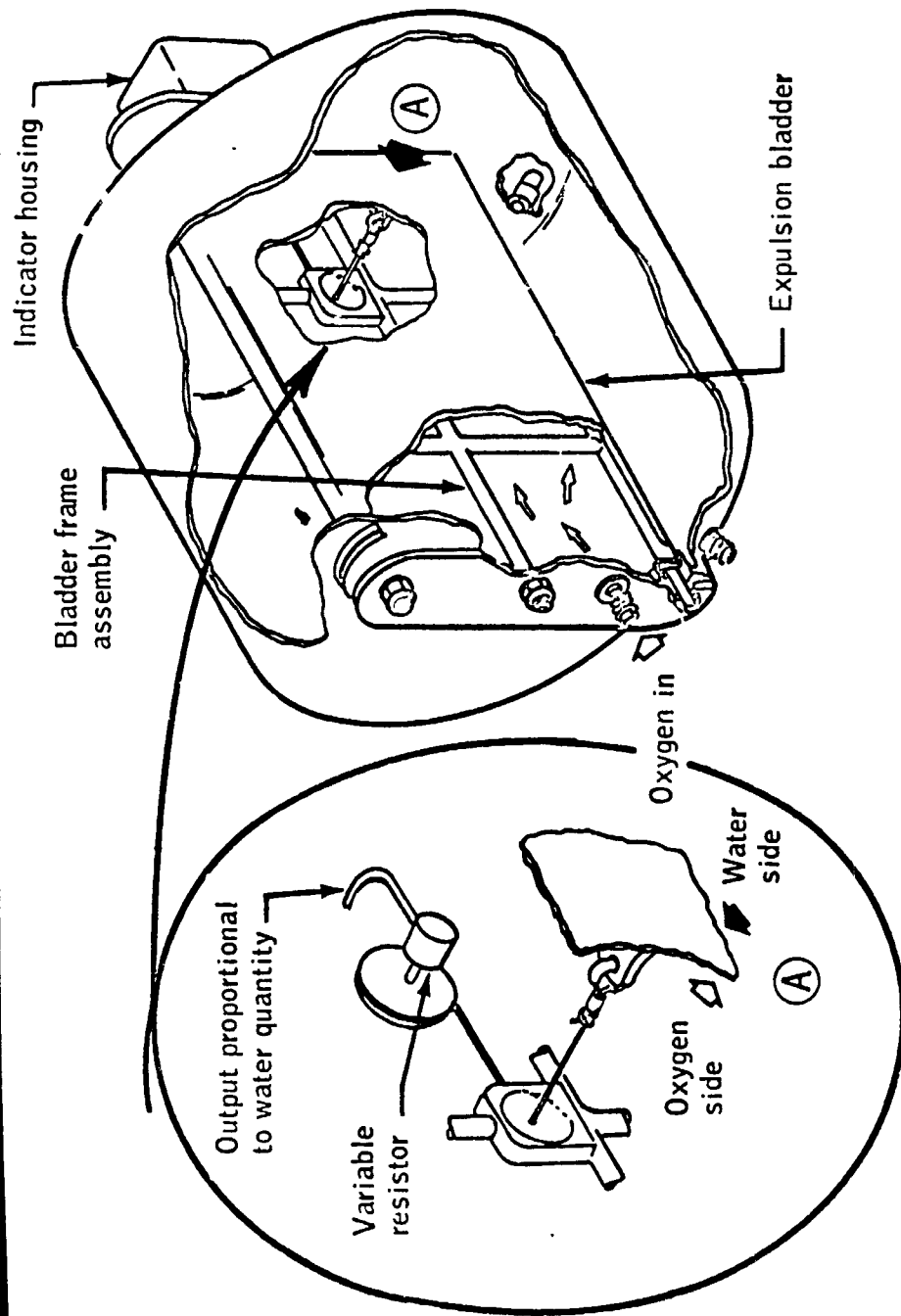

FIGURE 2.1.11-2 POTABLE WATER TANK

# ANOMALY REPORT

NO. 2.1.12	TITLE: CONTAMINATION OF SPACECRAFT LOX	SYSTEM: GSE	MISSION: APOLLO 8
SUBSYSTEM: LOX SUPPLY	EVENT TIME: PRELAUNCH		
PROBLEM:	<p>WHILE SERVICING LIQUID OXYGEN, A LEAK DEVELOPED IN A FACILITY LIQUID OXYGEN LINE CAUSING A SAFETY SHUTDOWN. TO PRECLUDE OVERPRESSURIZATION DUE TO STAGNANT LIQUID OXYGEN, THE SYSTEM WAS VENTED USING THE NORMAL SHUTDOWN PROCEDURE. THIS PROCEDURE CONTAINED AN ERROR WHICH CALLED FOR OPENING VALVE 1 INSTEAD OF VALVE 2 (SEE FIGURE 2.1.12-1). THIS ALLOWED LIQUID NITROGEN TO FLOW THROUGH VALVE 1 INTO THE LIQUID OXYGEN SUPPLY LINE. A GASEOUS OXYGEN PURGE OF THE LINES WAS MADE PRIOR TO LOADING THE SPACECRAFT. LATER DURING THE COUNTDOWN, FUEL CELL #3 OUTPUT CURRENT DROPPED. THE TROUBLE WAS ISOLATED TO NITROGEN CONTAMINATION OF ABOUT 8000 PPM OF THE SPACECRAFT LOX (30 PPM IS ALLOWABLE). THE LN<sub>2</sub> IN THE GROUND SUBCOOLER WAS REPLACED WITH LOX, AND THE SPACECRAFT LOX WAS DRAINED AND RELOADED. AT T-10 HOURS, THE RELOADING HAD RESOLVED THE PROBLEM, WITH THE NITROGEN LEVEL AT 12 PPM.</p>		
ACTION:	<p>THE GOX PURGE OF THE SYSTEM APPARENTLY DID NOT CLEAR ALL THE LN<sub>2</sub> FROM THE SYSTEM. THE LOX SERVICING PROCEDURES HAVE BEEN CORRECTED AND VERIFIED BY A GROUND LOADING TEST. THIS ANOMALY HAS BEEN CLOSED BY MSC.</p>		
ORGANIZATION: REFERENCES:	5-2490 KSC 3-DAY REPORT, PP. 3 AND 10 MSC 30-DAY REPORT, P. 5 MSC 60-DAY REPORT, P.12-6	RESOLUTION: CLOSED	DATE: REV:



DETAIL SHEET

ANOMALY 2.1.12

TITLE: CONTAMINATION OF SPACECRAFT LOX

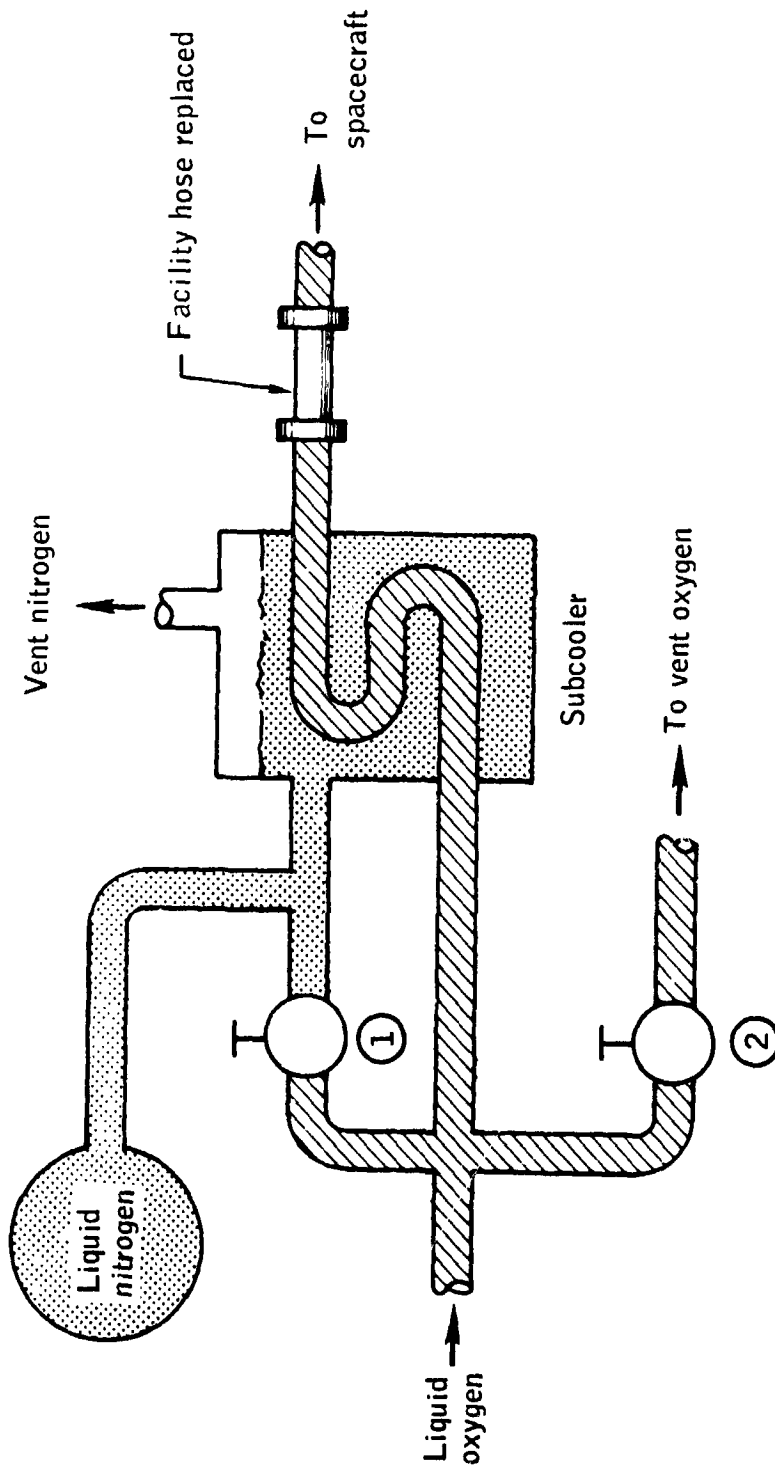

Note: Only valves pertinent to problem shown.

FIGURE 2.1.12-1 SIMPLIFIED SCHEMATIC OF GSE LOX SERVICING UNIT

# ANOMALY REPORT

NO. 2.2.1

TITLE: S-IC CAMERA MALFUNCTIONS

SYSTEM: S-IC

MISSION: APOLLO 8

SUBSYSTEM: CAMERAS

EVENT TIME: 0:01:19 and  
0:09:06

**PROBLEM:**

AT APPROXIMATELY 0:01:19 BOTH LOX TANK CAMERAS AND ONE STROBE LIGHT STOPPED FUNCTIONING. APPARENTLY ALL FOUR S-IC CAMERAS WERE EJECTED, BUT ONLY ONE WAS RECOVERED. THE FILM FROM THE ONE CAMERA THAT WAS RECOVERED WAS BADLY DAMAGED BY SALT WATER AND SEA MARKER DYE THAT LEAKED INTO THE CAMERA CASE.

**ACTION:**

IT IS BELIEVED THAT THREE OF THE CAMERA CAPSULES HAD A BAKO--SWITCH MALFUNCTION OR SOME OTHER TYPE FAILURE SUCH THAT NEITHER THE PARALOONS OR THE TRANSMITTERS FUNCTIONED. IT IS PRESUMED THEY SANK AFTER IMPACT. SEA WATER AND MARKER DYE ENTERED THE RECOVERED CAPSULE BETWEEN THE ELECTRICAL CONNECTOR AND THE CASE BECAUSE THE NUT SECURING THE CONNECTOR HAD LOOSENED. THIS WAS THE LAST FLIGHT SCHEDULED TO USE THE S-IC CAMERAS. MSFC DOES NOT CONSIDER THIS PROBLEM TO BE AN ANOMALY.

**ORGANIZATION:**

REFERENCES: 5-2490  
MSFC 3-DAY REPORT, P. 18  
MSFC 15-DAY REPORT, P. 16  
MSFC 30-DAY REPORT  
MSFC 60-DAY REPORT, P. 5-17

RESOLUTION: CLOSED

DATE:

REV:

# ANOMALY REPORT

NO. 2.2.2	TITLE: S-II ENGINE OSCILLATIONS	MISSION: APOLLO 8	EVENT TIME: 0:07:31
SYSTEM:	S-II		
SUBSYSTEM:	PROPULSION		
PROBLEM:	<p>18 HERTZ OSCILLATIONS WERE EVIDENT IN ENGINE AND SUPPORTING STRUCTURE BEGINNING AT APPROXIMATELY 451 SECONDS, AND THEY BECAME MORE PROMINENT AT ABOUT 480 SECONDS WHEN A SMALL DROP IN ENGINE NO. 5 PERFORMANCE OCCURRED. DESIGN ANALYSIS AND TESTING DID NOT COVER THE 18 HZ OSCILLATORY CONDITION ENCOUNTERED ON THE APOLLO 8 FLIGHT. THE 18 HZ FREQUENCY AND AMPLITUDES OF OSCILLATION WERE NOT PREDICTED FOR THE ENGINE AND SUPPORT STRUCTURE OR THE LINES AND HARDWARE ATTACHED TO THESE.</p>		
ACTION:	<p>AN INTENSIVE INVESTIGATION IS BEING CONDUCTED TO DETERMINE THE CAUSE OF THESE OSCILLATIONS AND THE POSSIBLE EFFECT OF SUCH AN ENVIRONMENT ON FUTURE MISSIONS. THE DATA SHOWS THAT THE FORWARD ENGINE OPERATED AS EXPECTED. THE 18 HZ OSCILLATION IS AN ENGINE-GENERATED PHENOMENON POSSIBLY AMPLIFIED BY STRUCTURAL INTERACTION. THE PROBABLE CONTRIBUTING FACTORS ARE: LOX NPSH, PU VALVE POSITION, AND CROSS BEAM NATURAL FREQUENCY. THE MECHANICS OF THIS INTERACTION ARE NOT UNDERSTOOD, AND INSTRUMENTATION IMPROVEMENTS HAVE BEEN MADE ON APOLLO 9 (ECP 6208 AND 6204) IN ORDER TO OBTAIN BETTER DATA. TESTING IS UNDERWAY AT MSFC AND ROCKETDYNE, BUT IT WILL NOT BE COMPLETED PRIOR TO APOLLO 9 LAUNCH. THE LOX TANK ULLAGE PRESSURE WILL BE INCREASED DURING THE LATTER PORTION OF THE S-II BURN, WHICH WILL RAISE THE LOX NPSH (ECP 6237). THE EFFECT OF THIS WILL BE TO REDUCE THE CAVITATION TENDENCY OF THE LOX PUMP AND REDUCE THE OSCILLATIONS RESULTING THEREFROM. MSFC IS DEVELOPING A DETAILED ANALYTICAL MODEL FOR DETERMINING THE CAUSE OF THE S-II STAGE OSCILLATIONS AND THE EFFECT OF INCREASED LOX TANK ULLAGE PRESSURE. STATUS AND RESULTS OF THE ANALYSIS AND TEST PROGRAMS WERE PRESENTED TO THE APOLLO PROGRAM DIRECTOR BEFORE APOLLO 9 LAUNCH.</p>		
ORGANIZATION:	5-2490	RESOLUTION:	OPEN
REFERENCES:	<p>MSFC 15-DAY REPORT, PP. 2,9, 10  MSFC 30-DAY REPORT  APOLLO 9 FRR  MSFC 30-DAY REPORT--REV. A  MSFC 60-DAY REPORT P. 6A-1</p>	ACCEPTABLE RISK FOR APOLLO 9	DATE: REV:
			39

# DETAIL SHEET

ANOMALY 2.2.2

TITLE: S-II ENGINE OSCILLATIONS

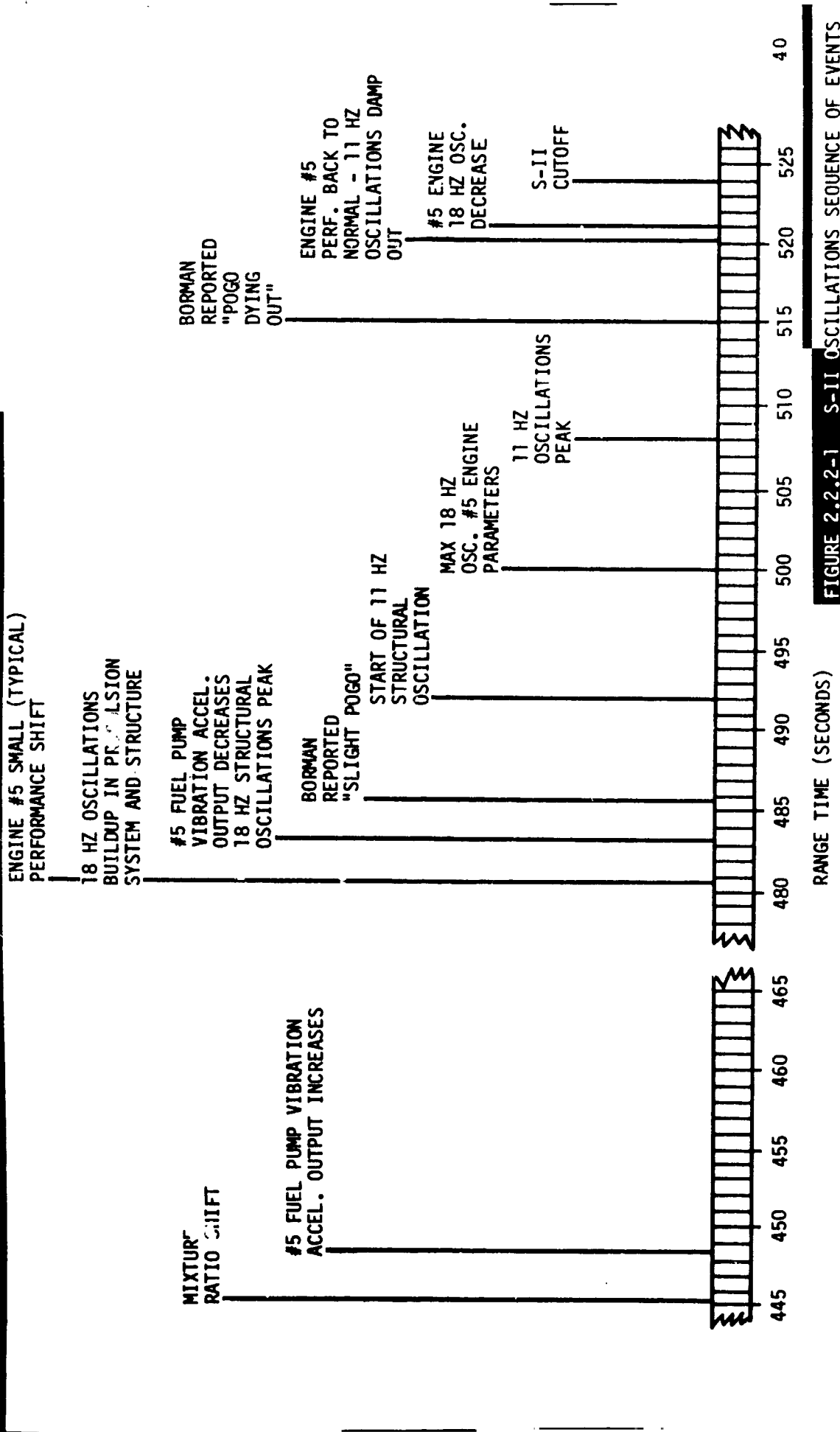

FIGURE 2.2.2-1 S-II OSCILLATIONS SEQUENCE OF EVENTS

# ANOMALY REPORT

NO. 2.2.3	TITLE: INTERMITTANT OPERATION OF S-II POWER SUPPLIES
SYSTEM: S-II	MISSION: APOLLO 8
SUBSYSTEM: INSTRUMENTATION	EVENT TIME: 0:01:08 and 0:07:23
PROBLEM:	TWO OF THE FIFTEEN S-II TEMPERATURE BRIDGE POWER SUPPLIES OPERATED INTERMITTENTLY FOR APPROXIMATELY 30 SECONDS DURING MAX Q. ONE TEMPERATURE BRIDGE POWER SUPPLY OPERATED INTERMITTENTLY FOR APPROXIMATELY 30 SECONDS AFTER THE LOW PU STEP. THE INTERMITTENT OPERATION WAS CAUSED BY A DIMENSIONAL TOLERANCE BUILDUP BETWEEN THE POWER SUPPLIES AND THE CHASSIS RESULTING IN IMPROPER PIN ENGAGEMENT OF THE MATING CONNECTOR (SEE FIGURE 2.2.3-1) DURING PERIODS OF HIGHER THAN AVERAGE VIBRATION.
ACTION:	TO AVOID ANY IMPACT ON THE APOLLO 9 LAUNCH, NO ACTION WILL BE TAKEN ON AS-504; THE RISK OF LOSING TEMPERATURE DATA ON APOLLO 9 HAS BEEN ACCEPTED SINCE IT PRESENTS NO OPERATIONAL HAZARD. ON AS-505 AND SUBSEQUENT, THE POWER SUPPLIES WILL BE INSPECTED AND THE CONNECTORS WILL BE SHIMMED AS REQUIRED (ECP 6201). MSFC DOES NOT CONSIDER THIS PROBLEM TO BE AN ANOMALY.
ORGANIZATION: 5-2490	RESOLUTION: CLOSED
REFERENCES: MSFC 15-DAY REPORT, PP. 2, 16	DATE:
MSFC 30-DAY REPORT	REV:
MSFC 30-DAY REPORT--REV. A	
MSFC 60 DAY REPORT, P.19-4	

DETAIL SHEET

ANOMALY 2.2.3

TITLE: INTERMITTANT OPERATION OF S-II POWER SUPPLIES

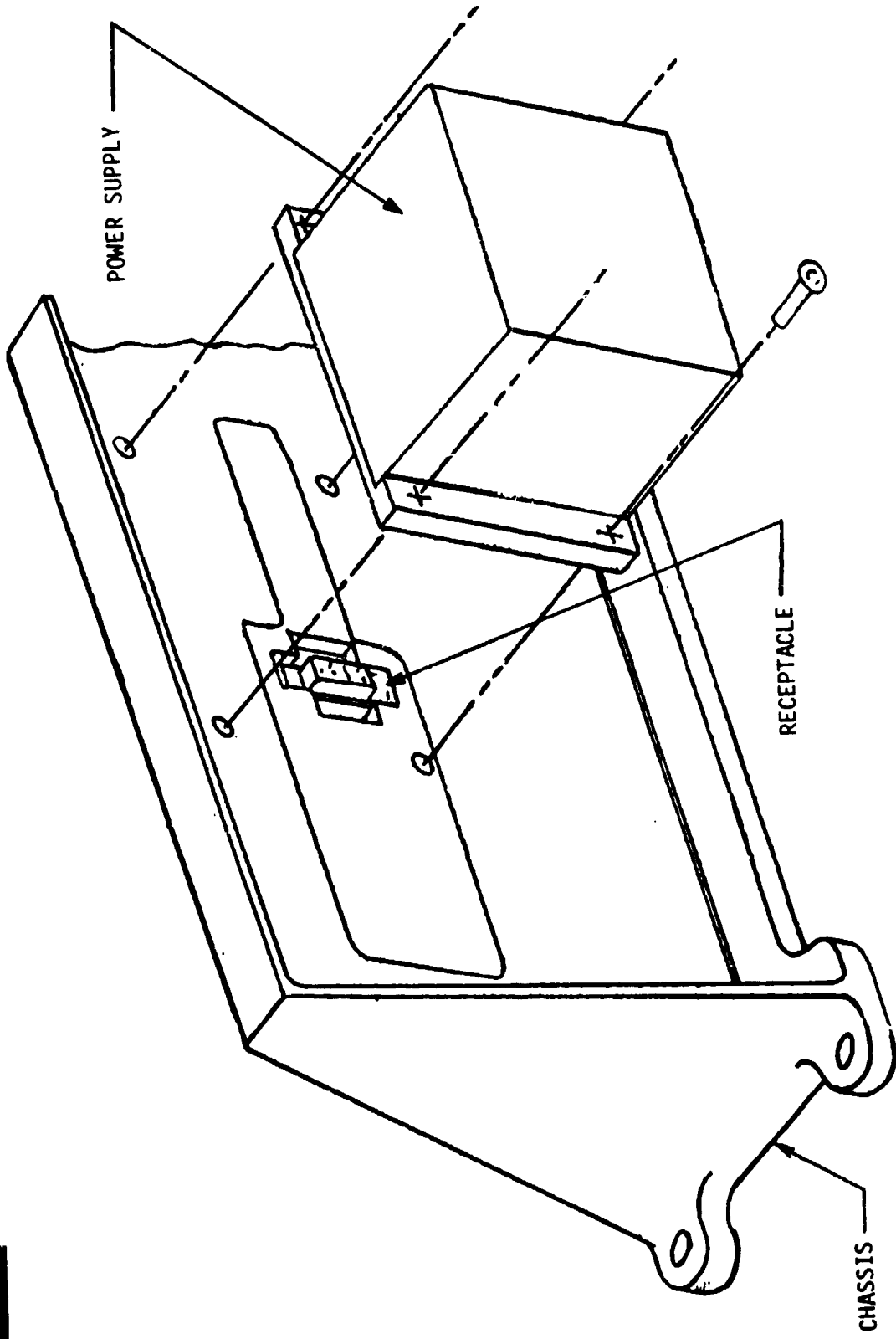

Figure 2.2.3-1 Typical Power Supply Installation

### 3.0 REFERENCES

1. APOLLO 8 DAILY OPERATIONS REPORT NO. 1, NASA-MSFC, DECEMBER 23, 1968.
2. APOLLO 8 DAILY OPERATIONS REPORT NO. 2, NASA-MSFC, DECEMBER 24, 1968.
3. APOLLO 8 DAILY OPERATIONS REPORT NO. 3, NASA-MSFC, DECEMBER 26, 1968.
4. AS-503 3-DAY REPORT, NASA-MSFC TWX NO. R-AERO-F, DECEMBER 26, 1968.
5. APOLLO ANOMALY STATUS, NASA-MSFC REPORT NO. PT-ASR-10, DECEMBER 17, 1968.
6. APOLLO 8 MISSION 3-DAY REPORT, NASA-MSFC REPORT NO. MSC-PT-R-68-45, DECEMBER 1968.
7. APOLLO 8 (AS-503) QUICK LOOK ASSESSMENT REPORT, NASA-KSC MEMO, JANUARY 2, 1969.
8. AS-503 15-DAY REPORT, NASA-MSFC TWX NO. R-AERO-F, JANUARY 7, 1969.
9. MSFC FAILURES AND ANOMALIES LIST--APOLLO/SATURN 503 MISSION, NASA-MSFC LETTER NO. I-V-MGR(I-V-T-14-69), JANUARY 20, 1969.
10. APOLLO 9 Q & RA FLIGHT READINESS ASSESSMENT. NASA-APO REPORT NO. RA045-002-1A, 10 JANUARY 1969.
11. APOLLO 8 FAILURE AND ANOMALY LISTING, NASA-MSFC REPORT NO. MSC-PT-R-68-1, JANUARY 1969.
12. FAILURE AND ANOMALIES REPORT, NASA-KSC TWX, JANUARY 24, 1969.
13. CSM-104/LM-3 PRE-FLIGHT READINESS REVIEW, MSC, JANUARY 24, 1969.

REFERENCES (CONTINUED)

14. APOLLO ANOMALY STATUS, NASA-MSFC REPORT NO. PT-ASR-11, JANUARY 28, 1969.
15. NASA/NR JOINT CONFIGURATION CONTROL BOARD MEETING, JANUARY 30, 1969.
16. APOLLO 9 FLIGHT READINESS REVIEW, NASA-APO REPORT NO. TM052-001-1A, FEBRUARY 6, 1969.
17. MSFC FAILURES AND ANOMALIES LIST--APOLLO/SATURN 503 MISSION--REVISION A, NASA-MSFC LETTER NO. I-V-MGR(I-V-T-40-69), FEBRUARY 14, 1969.
18. MSC-60 DAY REPORT MSC--PA-R-69-1
19. MISSION OPERATION REPORT; APOLLO 8 REPORT NO. M-932-68-08
20. MISSION IMPLEMENTATION PLAN FOR THE C PRIME MISSION APOLLO 8 NOV. 14, 1968.
21. MSFC 60 DAY REPORT, MPR-SAT-FE-69-1, FEB. 20, 1969