

**NASA TECHNICAL
MEMORANDUM**

NASA TM X-52876
Volume V

NASA TM X-52876
Volume V

SPACE TRANSPORTATION SYSTEM TECHNOLOGY SYMPOSIUM

V - Operations, Maintenance, and Safety
(Including Cryogenic Systems)

NASA Lewis Research Center
Cleveland, Ohio
July 15-17, 1970

1. Report No. TM X-52876 - Volume V		2. Government Accession No.		3. Recipient's Catalog No.	
4. Title and Subtitle SPACE TRANSPORTATION SYSTEM TECHNOLOGY SYMPOSIUM V - Operations, Maintenance, and Safety (Including Cryogenic Systems)				5. Report Date July 1970	
				6. Performing Organization Code	
7. Author(s)				8. Performing Organization Report No. E-5866	
9. Performing Organization Name and Address				10. Work Unit No.	
				11. Contract or Grant No.	
12. Sponsoring Agency Name and Address National Aeronautics and Space Administration Washington, D. C. 20546				13. Type of Report and Period Covered Technical Memorandum	
				14. Sponsoring Agency Code	
15. Supplementary Notes Held at the NASA-Lewis Research Center, July 15-17, 1970					
16. Abstract The Symposium encompassed seven technical areas, each published in a separate volume of NASA Technical Memorandum X-52876: Volume I - Aerothermodynamics and Configurations (includes aerodynamics; atmospheric operations; and aerodynamic heating) II - Dynamics and Aeroelasticity (includes dynamic loads and response; aeroelasticity; and flight dynamics and environment) III - Structures and Materials (includes structural design technology; thermal protection systems; and materials technology) IV - Propulsion (includes main propulsion; auxiliary propulsion; and airbreathing propulsion) V - Operations, Maintenance, and Safety (Including Cryogenic Systems) (includes general and cryogenics) VI - Integrated Electronics (Including Electric Power) (includes system integration; data management, systems monitoring, and checkout; navigation, guidance, and control; communication, instrumentation, and display; and power subsystems) VII - Biotechnology					
17. Key Words (Suggested by Author(s))			18. Distribution Statement Unclassified - unlimited		
19. Security Classif. (of this report) Unclassified		20. Security Classif. (of this page) Unclassified		21. No. of Pages 313	22. Price* \$3.00

*For sale by the Clearinghouse for Federal Scientific and Technical Information
Springfield, Virginia 22151; also as microfiche
at \$.65 per copy

FOREWORD

The prospect of undertaking a reusable launch vehicle development led the NASA Office of Manned Space Flight (OMSF) to request the Office of Advanced Research and Technology (OART) to organize and direct a program to develop the technology that would aid in selecting the best system alternatives and that would support the ultimate development of an earth-to-orbit shuttle. Such a Space Transportation System Technology Program has been initiated. OART, OMSF, and NASA Flight and Research Centers with the considerable inputs of Department of Defense personnel have generated the program through the efforts of several Technology Working Groups and a Technology Steering Group. Funding and management of the recommended efforts is being accomplished through the normal OART and OMSF line management channels. The work is being done in government laboratories and under contract with industry and universities. Foreign nations have been invited to participate in this work as well. Substantial funding, from both OART and OMSF, was applied during the second half of fiscal year 1970.

The Space Transportation System Technology Symposium held at the NASA Lewis Research Center, Cleveland, Ohio, July 15-17, 1970, was the first public report on that program. The Symposium goals were to consider the technology problems, their status, and the prospective program outlook for the benefit of the industry, government, university, and foreign participants considered to be contributors to the program. In addition, it offered an opportunity to identify the responsible individuals already engaged in the program. The Symposium sessions were intended to confront each presenter with his technical peers as listeners, and this, I believe, was substantially accomplished.

Because of the high interest in the material presented, and also because the people who could edit the output are already deeply involved in other important tasks, we have elected to publish the material essentially as it was presented, utilizing mainly the illustrations used by the presenters along with brief words of explanation. Those who heard the presentations, and those who are technically astute in specialty areas, can probably put this story together again. We hope that more will be gained by compiling the information in this form now than by spending the time and effort to publish a more finished compendium later.

A. O. Tischler
Chairman,
Space Transportation System
Technology Steering Group

CONTENTS

	Page
FOREWORD	iii
<u>GENERAL</u>	
COMMERCIAL AIRCRAFT TECHNOLOGY APPLICABLE TO THE SPACE SHUTTLE	
Charles L. Carroll, Pan American World Airways	1
SPACE SHUTTLE RELATED MAINTENANCE EXPERIENCE WITH THE X-15 AIRCRAFT	
Vincent N. Capasso, Jr., NASA Flight Research Center	33
NONDESTRUCTIVE TESTING FOR SPACE SHUTTLE	
T. J. De Lacy, General Dynamics/Convair	45
INSTRUMENT LANDING SYSTEMS FOR THE SPACE SHUTTLE	
Herbert P. Raabe, IBM Corporation	73
INTACT ABORT TECHNOLOGY REQUIREMENTS	
T. Barnes, Grumman Aerospace Corporation	91
USE OF EXTENDIBLE BOOM DEVICES FOR SPACE SHUTTLE AND EVA OPERATIONS	
H. Robert Warren, Spar Aerospace Products Ltd., Canada	103
<u>CRYOGENICS</u>	
REQUIREMENTS FOR SPACE SHUTTLE SYSTEMS	
Charles C. Wood, NASA Marshall Space Flight Center	127
CRYOGEN TECHNOLOGY BASE FOR SPACE SHUTTLE	
A. L. Worlund and T. W. Winstead, NASA Marshall Space Flight Center	133
CRYOGEN INSULATION TECHNOLOGY REVIEW FOR THE SPACE SHUTTLE	
James R. Barber, NASA Lewis Research Center	147
CRYOGENIC PROPELLANT ACQUISITION AND TRANSFER	
R. E. Tatro, General Dynamics/Convair	167
CRYOGEN SYSTEMS HARDWARE TECHNOLOGY REVIEW FOR THE SPACE SHUTTLE	
Dieter K. Huzel, North American Rockwell	189
CRYOGENIC SYSTEMS INTEGRATION TECHNOLOGY FOR THE SPACE SHUTTLE	
J. D. Schweikle, McDonnell Douglas Astronautics Company	203
SPACE SHUTTLE CRYOGENIC TECHNOLOGY REVIEW	
Charles C. Wood, NASA Marshall Space Flight Center	215

COMMERCIAL AIRCRAFT TECHNOLOGY APPLICABLE TO THE SPACE SHUTTLE

Charles L. Carroll

Pan American World Airways
Patrick Air Force Base, Florida

INTRODUCTION

Before beginning the technical discussion let me state briefly why Pan American World Airways is sufficiently interested in the Space Shuttle to spend corporate funds on it. Our ultimate interest in the Space Shuttle is in its potential as a commercial space vehicle for use in both space travel to earth orbit and point-to-point transportation on the earth. These applications, we see in the 1985-2000 time frame. In the meantime, we are interested in providing services to the Government in the design, engineering, test and evaluation areas with the objective of operating and maintaining the space shuttle system under Government contract to NASA or the Air Force after the system becomes operational.

In line with these objectives, a Pan Am Task Group has been working on the Space Shuttle for over a year. We are teamed with McDonnell Douglas on Phase B Studies and in a Cargo Handling Study. McDonnell has given Pan American extensive tasks in the Phase B study in the areas of launch operations, mission planning, flight operations, maintainability, maintenance and turnaround time and manpower estimates. In addition, Pan American is providing consulting services on maintenance and maintainability to Aerojet General on the Phase B Main Propulsion System contract.

In the discussion to follow the word technology is used in the general sense (i.e., technology is the application of scientific knowledge to practical purposes in a particular field). Commercial aircraft technology is the application of scientific knowledge to practical purposes in commercial aircraft. From the commercial aviation vantage point, one visualizes the space shuttle as evolving from a series of increasing complex aircraft systems - the DC-3, the DC-8, the B707, the B747, the DC-10 the SST. Since the basic requirements of the space shuttle system are substantially equivalent to those of advanced aircraft systems: high performance, reusable systems, emphasis on safety, operational flexibility, low costs, routine and economic maintenance to allow reasonable turnaround time, it makes good sense to examine commercial aircraft technology for potential application to the space shuttle. We are in a position to discuss this subject since Pan American World Airways has been actively engaged in the problem of reducing maintenance and operations costs on reusable space vehicles, airplanes, for over forty years and has made significant progress in this area.

The subject is too broad for comprehensive coverage in the time and space allowed. The commercial aircraft technology to be discussed will be limited to those topics which will have been developed by 1975. The space shuttle must be based on tried and true technology - those things we know will work, i.e., give the desired performance and have high reliability within minimum cost of operation.

Topics such as satellite navigation, satellite traffic control and avionics beyond the Super Sonic Transport (SST) will not be included.

OPERATIONS AND SAFETY

Of special importance to this discussion is the relationship of costs of operations and safety to the commercial aircraft technology. While always striving for increased performance - thereby providing faster service and more comfortable service, there are two overriding driving forces to commercial aircraft technology - they are costs of operations and safety.

The basic premise of all airline operations is safety. Safety is not negotiable. Airplanes must always be airworthy--that is axiomatic. They are always 100% safe.

However, the achievement of 100% safety does not necessarily require that vehicles operate with no failure of any kind. Designing and operating a no-fail vehicle would be extremely expensive, if not impractical. Safe operation with imperfect parts can be and is achieved simply by designing the vehicle to accept failures. Not only do airlines complete flights after failures have occurred, but we often dispatch aircraft with systems or components inoperative. Dispatch with inoperative parts can, of course, be done only if sufficient redundancy is designed into the system to permit completion of the mission even after additional multiple failures in flight.

2

To achieve the required safety and to keep operating costs within acceptable bounds commercial airlines have made significant technological advances in the maintenance area and in the maintainability area. The following comments are pertinent in the maintenance area.

Experience has shown that routine overhaul or check out of components or systems on an arbitrarily established time basis brings about an expensive maintenance program which is not justified by corresponding increases in safety or reliability. On the contrary, we have found that disturbing systems or components that are operating satisfactorily decreases overall system reliability. When a system or a component fails to meet established performance limits, the fault is rectified. Redundancy insures safe operation in the interim. We are convinced that--other than routine replacement of expendables, lubrication, replacement of time limited components and correction of faults--the best maintenance policy is a "good leaving alone." This has led Pan Am to an "on-condition" maintenance policy.

If a component shows a normal life curve with an inflection, the component may or may not be time limited at the inflection point depending on the maximum acceptable unreliability. An engineering analysis of the reason for failure at the inflection point is always initiated.

NORMAL FAILURE WITH INFLECTION

FAILURES
PER 1000
FLIGHT HOURS

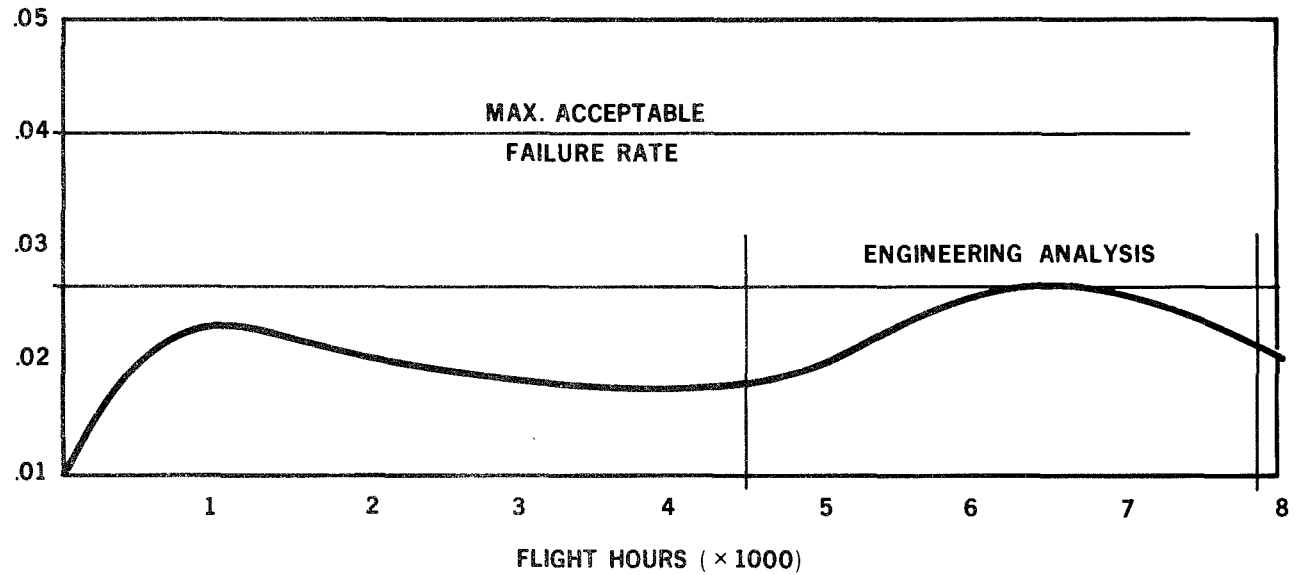

Some components are time limited; some are not. If a component shows a wearout trend, we determine the maximum acceptable degree of unreliability and establish a time limit at this point.

Most components in fact do not show a wearout trend, rather they manifest their reliability in the way illustrated on the normal failure pattern.

NORMAL FAILURE PATTERN

FAILURES
PER 1000
FLIGHT HOURS

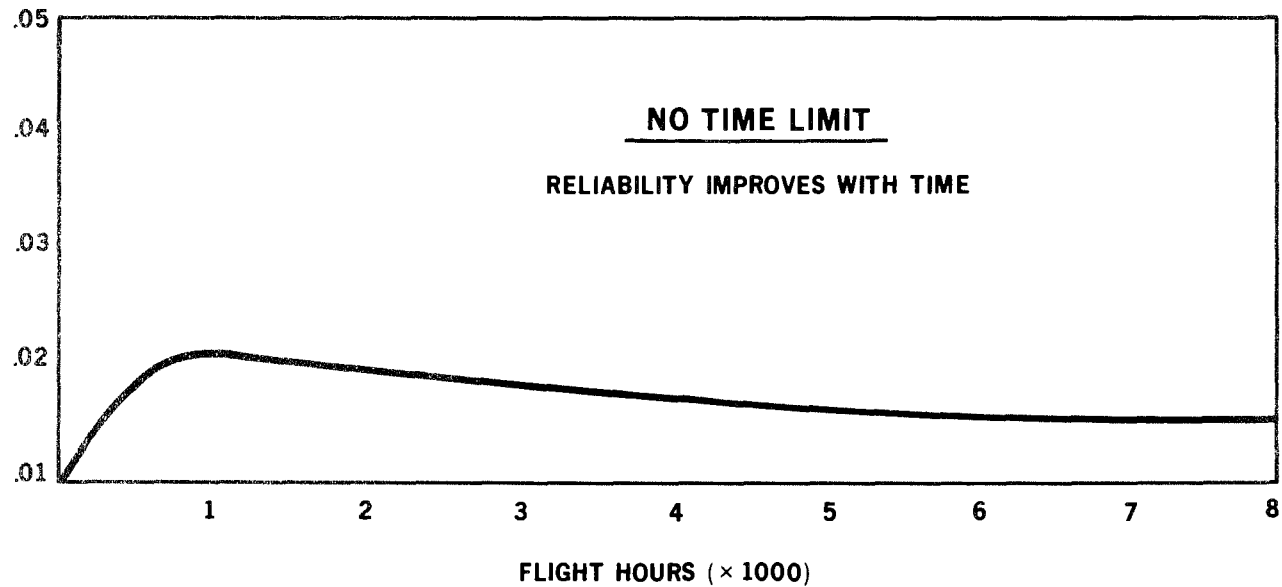

The condition of systems and subsystems are monitored in various ways (to be discussed later). When the performance or reliability of a system becomes questionable, it is put "on condition" and it is put under special surveillance.

"On condition" means that the condition is monitored, and as long as the condition is satisfactory to complete the next mission or series of missions, the system or component is left alone. Do we ever fly it until it fails? Yes, if there is sufficient redundancy to assure airworthiness--sufficient redundancy to permit additional failures and continuation of the mission with complete safety and if it is advantageous economically to let it fail.

CURRENT LARGE AIR TRANSPORT MAINTENANCE PHILOSOPHY

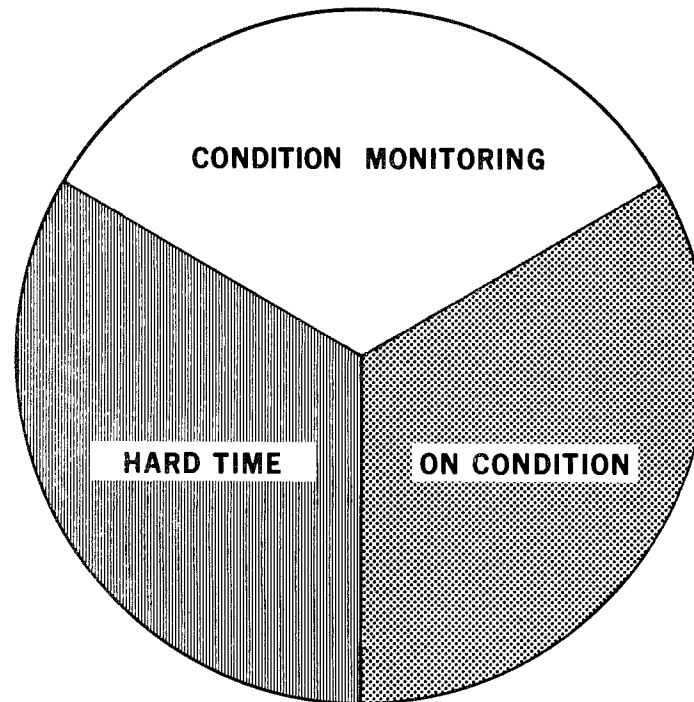

The condition of units may be monitored in various ways. When an airplane is landed and the pilot reports that the electronic systems he used were accurate throughout the flight, and if the systems are not disturbed prior to the next flight, it is highly probable that these systems will work satisfactorily on the next flight. In fact, their satisfactory operation is much more probable under these conditions than when the systems are disturbed by the installation of new components.

When a system is not used on a flight and therefore the pilot cannot comment on the condition, the systems require a self-test feature to assure satisfactory operation on the next flight.

Some other items--for example, turbine blade condition or structure cannot be adequately checked by self-test features or by the crew. In these cases we rely on inspectors and their inspection techniques to assure satisfactory condition to complete the next flight.

Are we only concerned about the next flight? From a safety standpoint, yes. From a practical economic standpoint, no.

I have stated that it is logical to accept a failure in a system. We will correct the fault in due time. We would, of course, prefer to correct the fault at a scheduled maintenance period. To assist in this area the installation of systems such as AIDS (Airborne Integrated Data System) which will predict out of tolerance conditions in some cases, detect trends, and enunciate to the crew will be valuable.

9

ON CONDITION MAINTENANCE

1. ON CONDITION INSPECTION TECHNIQUES:
 - A. PERIODIC OPERATIONAL CHECK AGAINST A "STANDARD".
 - B. CREW LOGBOOK.
 - C. INSPECTORS.
2. CONDITION MONITORING RELIES ON AIDS CONCEPT - PRIMARY MAINTENANCE CONTROL IS RELATED TO GATHERING AND ANALYSIS OF DATA.

In commercial airlines, operating patterns define the scheduled maintenance program. We buy airplanes to fly them, not to fix them. Hence scheduled maintenance programs must be designed to mesh with the flight scheduling requirements.

In designing the program, efficiency requires routine work be equalized among services as regards elapsed time requirements, overall manpower requirements, and specialty manpower requirements. This doesn't necessarily mean that a service done every 300 hours must be the same size as a 1,200-hour service, but that all 300-hour services be similar. Non-routine work must be predicted and sufficient time allocated for its completion.

Our B727 operates under a maintenance program consisting of only two service sizes. One is an annual interior refurbishing and modification service. The other, a scheduled maintenance service. This service, lasting eight hours block to block, is accomplished after each 325 hours of aircraft operation (approximately monthly). While it is improbable that any two services have identical work content, each service takes eight hours and requires (statistically) 8.17 manhours of radio work, 14.15 manhours of hydraulic work, 7.48 manhours of electrical work, etc. Services are end-to-end to get maximum utilization out of our working force. This aircraft is never overhauled.

Our average labor expenditure at this service is 260 manhours. Our average cost per service is \$3,328 which includes all materials and labor, but excludes labor burden. This figure incidentally represents .07% of the purchase price of a B727.

The direct maintenance cost per flight hour is \$129.31 (i.e., annual direct maintenance cost divided by total flight hours per year).

TOTAL DIRECT MAINTENANCE COST B-727-21

DIRECT MAINTENANCE COST PER HOUR: \$ 129.31

AVERAGE FLIGHT TIME: 1 HOUR

DIRECT MAINTENANCE COST PER FLIGHT: \$ 129.31

The term "100% safety" has been used often, but, of course, there is a degree of risk in operating any vehicle. Currently, the American Airline Industry is experiencing 1,200,000 flights per fatal accident. You will notice, however, that fatal accidents occur more frequently in the early years of operation of a new technology aircraft. This is to be expected as 90% of all fatal accidents are "operational" in nature and the rate of accidents will normally be inversely proportional to flight and ground crew time on the aircraft.

FLIGHTS PER FATAL ACCIDENT 1.2×10^6
(1965 - 1968)

6

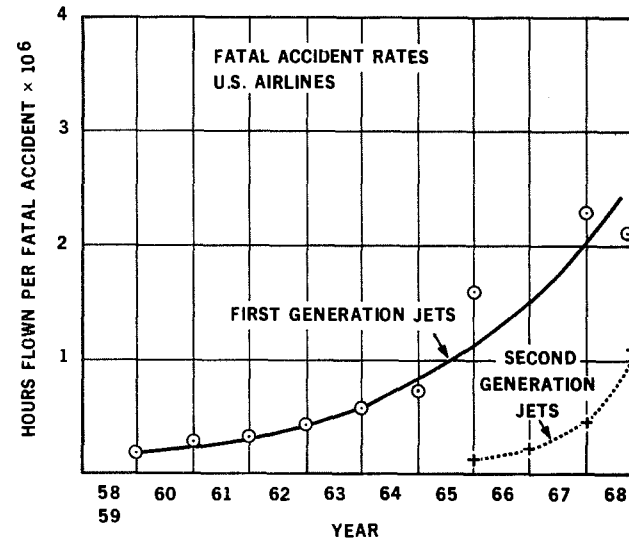

MAINTAINABILITY

Maintainability is that part of technology that is concerned with the ease with which an operation can be sustained or restored and is substantially determined by design. Hence, maintainability attributes must be sustained into the product, beginning with its conception and throughout its development.

Maintainability goals for commercial aircraft are:

- (1) to reduce the frequency and extent of scheduled maintenance,
- (2) to eliminate, wherever possible, those inspections and maintenance operations that do not effect airworthiness,
- (3) to develop and apply maintenance methods that will detect degradation of component performance, impending malfunctions and wear.
- (4) to adopt a maximum use maintenance plan for component replacement.
- (5) to incorporate service-proven design features that permit the most rapid restoration for revenue use.

As an important part of the maintainability study, all components will be reviewed to determine whether a failure would cause a mission delay or abort. In general, the following rules are used:

1. Design the system so that the vehicle can be dispatched with that component inoperative.
2. Provide additional redundancy for components that can cause mission abort.
3. If the vehicle cannot be dispatched with the component inoperative, make the item readily replaceable. Time for trouble shooting and replacing must be less than fifteen minutes or the failure is considered a delay item.

A review of reliability data based on unscheduled removals shows that many components are removed for trouble, checked out on the bench and no discrepancy found. These findings require on-board instrumentation which provides fault analysis.

MAINTAINABILITY

DESIGNING SO THAT MAINTENANCE REQUIREMENTS ARE MINIMIZED.

1. SIMPLICITY AND ISOLATION
2. RELIABILITY
3. PREDICTION OF IMPENDING FAILURES
4. DESIGN TO MINIMIZE CONNECTIONS
5. DESIGN FOR PROPER ROUTING, FLEXIBILITY, AND SUPPORT OF WIRE BUNDLES, TUBING, DUCTS AND CABLES
6. SELECT MATERIALS TO MEET CONDITIONS.

DESIGNING TO MAKE MAINTENANCE EASY AND ECONOMICAL.

1. STRUCTURE INSPECTION PLAN
2. MINIMIZE IMPROPER REMOVALS BY RAPID, ACCURATE FAULT ISOLATION
3. EASY ACCESS, REMOVAL AND REPLACEMENT.

DESIGNING TO MINIMIZE DELAYS AND PROVIDE ALTERNATE MEANS OF SYSTEM OPERATION.

1. DISPATCH WITH EQUIPMENT INOPERATIVE
2. POSTPONABLE MAINTENANCE
3. QUICK REPAIR WITH SCHEDULED GROUND TIME
4. SERVICE LIMITS WHICH ARE LESS RESTRICTIVE THAN DESIGN OR OVERHAUL LIMITS.

PROJECT MANAGEMENT TECHNOLOGY

Airlines have developed advanced techniques for the procurement of complicated aircraft systems. Pan American was the first airline to purchase aircraft to the buyer's specifications and have on several occasions provided the catalyst to crystallize development of new aircraft systems. For example, the commitment of 269 million dollars by Pan Am to the purchase the first generation of airline jets and the billion dollar order for Boeing 747 were necessary in each case to put Boeing into production and to assure the development of these aircraft. In this financial posture, the airline can actively participate in the planning and design of the aircraft. Of particular importance is the opportunity to provide inputs to the design which reflect airline operations and maintenance philosophy. Optimum operational systems and maintainability must be built into the design from the preliminary definition phase.

Philosophy with respect to the mean time between failure (MTBF) and inventory of spare parts which was generated within Pan Am, is both technically and economically interesting. For example, the MTBF for a system is guaranteed by the manufacturer of the system. In the event the system does not achieve its guaranteed rate during actual operation, the manufacturer, under some contracts, is required to furnish additional hardware with the original MTBF. Where the manufacturer has been over zealous in his salesmanship, this cost runs into the millions of dollars. Airlines are attempting to make this type of agreement cover most systems. Similarly, in the inventory of spare parts, the airline usually has an agreement in which the manufacturer specifies the type and number of spare parts that are required. The operator then buys exactly what the manufacturer has stipulated with the contractual agreement that the excess will be repurchased if the manufacturer has over-estimated the inventory required.

Economic Models

For planning purposes, economic models have been developed to simulate the operations of an airline to assist in decisions to purchase new aircraft like the SST (or a cargo version of the B747). Such a model relates the factors (a) traffic model, (b) airplane characteristics of price, performance, and operating expenses, (c) route characteristics for the airline structure, (d) passenger and cargo revenue, (e) passenger preference as related to fare levels, flight frequency and trip times, and (f) a level of operation for the airplane mix which will provide an adequate level of service and a satisfactory return on the airline investment.

A similar model is used on an operational basis for developing airline schedules and routes and to measure cost effectiveness.

PROJECT MANAGEMENT TECHNOLOGY

1. PARTICIPATE IN THE PLANNING AND DESIGN OF AIR-CRAFT.
2. RELIABILITY AND INVENTORY OF SPARE PARTS PHILOSOPHY.
3. ECONOMIC MODELS.
4. DESIGN REVIEW.
5. ACCEPTANCE TESTS.

MAINTENANCE CONTROL SYSTEM (MCS)

I would like to spend the time allotted to computer technology to Pan American's Maintenance Control Program. This program has been under development since 1968 and plans call for it to be operational in 1972. Cost savings of \$5 million per year to Pan American are estimated from the use of this program. It is basically a management information system which incorporates maintenance programming and control functions into an integrated operation. A.I.L., a division of Culter-Hammer, provided technical consulting services to Pan American in the feasibility studies.

All of Pan American's maintenance requirements through 1980 have been considered in the design of the program. The program will give all levels of management, an adequate amount of information and control of the maintenance operations.

The system has been designed in a functional manner. This was done in order to construct a control process which would insure a fully integrated cost effective system. The three basic functional areas chosen were forecasting, scheduling and monitoring.

In broad terms, the system would begin to function upon the receipt of a new flight timetable. Management control over the maintenance processes would follow through the three main functional areas.

From data contained in the timetable, information is generated with respect to assignment of aircraft to flights, times into and out of maintenance, and provisioning requirements for main base and line stations. Based upon the new operating plan, past performance histories and aircraft, material and resource status, a capability is developed to forecast every phase of operations and maintenance.

Forecasts are used to schedule maintenance work. Also, new data is accumulated to revise performance history. This could be defined as a control function.

Performance history and forecasts serve as a base for the determination of the adequacy of operations and inventories. This provides guidelines for performance evaluation.

To integrate these fundamental functional areas into a total system, 12 subsystems were designed. These serve as the core of MCS.

In arriving at the subsystems, such factors as aircraft, manpower, materials and flow of work were described in detail. These descriptions were applied as the platform on which the framework of the 12 subsystems was constructed. The subsystems and the major areas each involves are:

Aircraft routing and service forecasting (forecasting and scheduling).

Diagnostics (monitoring).

Provisioning (forecasting).

Manpower and shop load (forecasting).

Modification (monitoring, scheduling and forecasting).

Parts identification (monitoring and scheduling).

Ground support equipment maintenance (scheduling).

Aircraft service work planning and control (scheduling).

Personnel (forecasting, scheduling and monitoring).

Powerplant/sop production (scheduling).

Warranty claims (forecasting, scheduling and monitoring).

Cost/performance (monitoring). This function combines the monitoring of all subsystems to establish an evaluation capability.

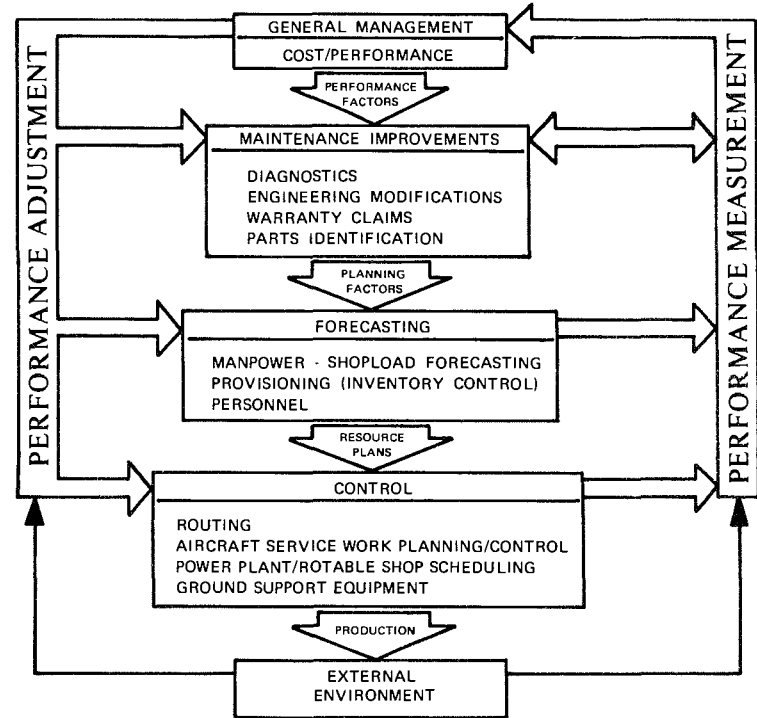
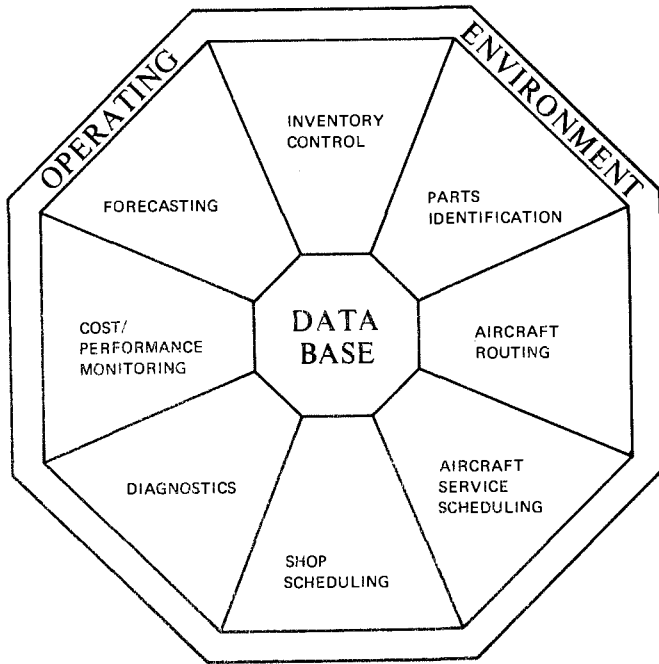

AVIONICS

The first step in avionic procurement and development within Pan Am has always been an assessment of the mission. The major mission of most avionics systems is to assist in providing for the safe and expeditious conduct of the aircraft from its origin to its destination within the air traffic control environment. During system planning and design, there is a continual effort to reduce crew and ATC controller workloads to improve the safety and efficiency of the operation. The mission must be accomplished reliably and in a cost effective manner.

Airline efficiency was dramatically influenced by avionics in the 60's. The ability to land a jet aircraft under adverse weather conditions, reduction in crew complement, and reduction in crew workload, are major advances which have been made through judicious avionics system planning. In late 60's after delivery of majority of 707 fleet and before introduction of all weather program to obtain approval to operate in Category I and II condition, diversions ran about 2 1/2%. After approval, they were reduced to less than 3/4% with large savings in operational costs. The B747, which contains triple inertial navigation systems, Category II landing capability expandable to Category III, satellite communications provisions, and greatly improved instrumentation, is an excellent example of this planning.

We feel that a considerable amount of airline avionics design philosophy is applicable to the space shuttle operation, particularly with regard to the safe and successful conduct of the mission. Within Pan Am, there has always been an emphasis on reliability and maintainability in systems selected for installation. Normally, maximum reliability is achieved through redundancy rather than accepting an increase in system complexity. Over the past 15 years, there has been a significant increase in reliability and at the same time reduction in the size, and weight, of aircraft systems with the advent of solid state and integrated circuitry. Two systems, VOR and ILS, which required a total of four boxes, were integrated into a single 1/2 ATR system with an attendant reduction in volume. Reliability of the system has improved about four-fold.

The airlines have moved cautiously toward system integration. Where integration of certain systems which perform closely related functions appeared to be attractive, this has been done as in the case of VOR/ILS and the B747 autopilot/flight director system. There are, however, several advantages to maintaining separate boxes designed to perform specific functions. Industry competition is encouraged; many manufacturers who would not otherwise have produced certain hardware elect to do so. The ability to reasonably improve maintainability, reliability, and system capability is directly affected. A manufacturer can make significant advances in all of these areas with advanced versions or modifications to first generation hardware often with considerable ease and minimum cost. This subject needs detailed review for possible application to the space shuttle.

Several recent efforts and other major projects presently in progress have and will directly affect avionics technology applications for the airline and space shuttle operations. Following is a brief summary of these projects:

Inflight Information System

To improve operating efficiency, Pan Am is planning the development of an inflight information system. The system will employ wide use of airborne and ground computers, data, and voice to provide a real-time information flow between aircraft and the ground. The system will collect, analyze, transmit, store, receive, and present information required by: air traffic control, the flight crew, and company offices.

It is planned that services provided to company offices and flight crews will include the following:

Company Operations:

- Flight Following
- Operational Messages
- Flight Performance Analysis
- Abnormal Aircraft Operations

Company Maintenance

- Engine Performance Analysis
- System Degradation and Analysis
- Advance Information to Line Stations of system or Engine Faults
- Abnormal Aircraft Operation (overspeeds, hard landings, etc.)

Company Traffic Department

Passenger Handling Requirements

- A. Medical Information
- B. Connecting Flights
- C. Hotel Accommodations

Company Accounting Department

- Aircraft Ground and Flight Operating Time
- Crew Flight Time

Some of the technology required to develop the system exist however, a number of new developments will be required. Two of the most important elements of the total system are an air-ground data link and satellite communications.

FLIGHT INFORMATION SYSTEM

COLLECT, ANALYZE, TRANSMIT, STORE, RECEIVE AND PRESENT INFORMATION REQUIRED BY:

AIR TRAFFIC CONTROL AND ADVISORY SERVICES

FLIGHT CREW

FLIGHT OPERATIONS

MAINTENANCE

MANAGEMENT

DATA LINK

Beginning next month, air-ground operational trials of prototype hardware designed to a draft industry characteristic will be flight-tested between the West Coast and Honolulu. The airborne hardware, consisting of a I ATR unit and control panel, will respond to a ground interrogation with aircraft identification, position (latitude and longitude from the inertial navigation system), altitude, and a pilot inserted coded message. Aeronautical Radio, Inc., is providing the ground radio terminal, consisting of an extended range VHF station covering the eastern one-third of the route and a computer processor which will poll aircraft and process and switch received messages to airline offices or the FAA for flight following.

The purpose of the trial is to confirm technical decisions and demonstrate operational utility. It is expected that production airborne hardware will be available in late 1971.

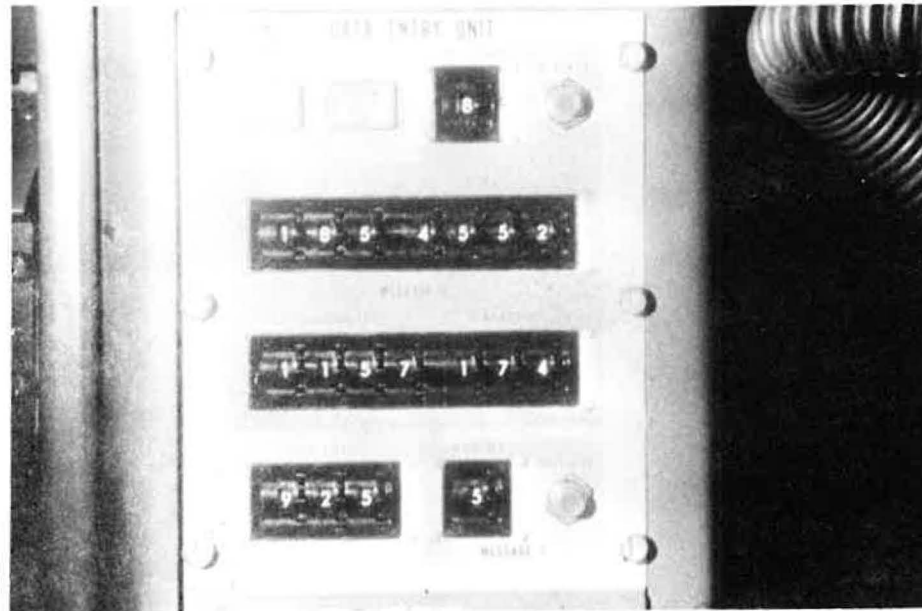

SATELLITE COMMUNICATIONS

The feasibility of air-ground VHF communications via synchronous satellite has been demonstrated. The NASA ATS-1 and ATS-3 have been used by the industry to develop production airborne hardware. Two U. S. manufacturers presently produce the VHF transceiver hardware capable of satellite communications that have been purchased by several airlines. The B747 aircraft has wiring provisions for satellite communications, including antenna.

COMSAT presently has a proposal for consideration by the airline industry and the FAA for preoperational VHF satellite service and L-Band experimentation. The VHF system would provide operational experience by serving airline company offices using both voice and data link as well as providing direct pilot-to-controller communications for air traffic control. At the same time, comparison tests would be conducted between VHF and L-Band.

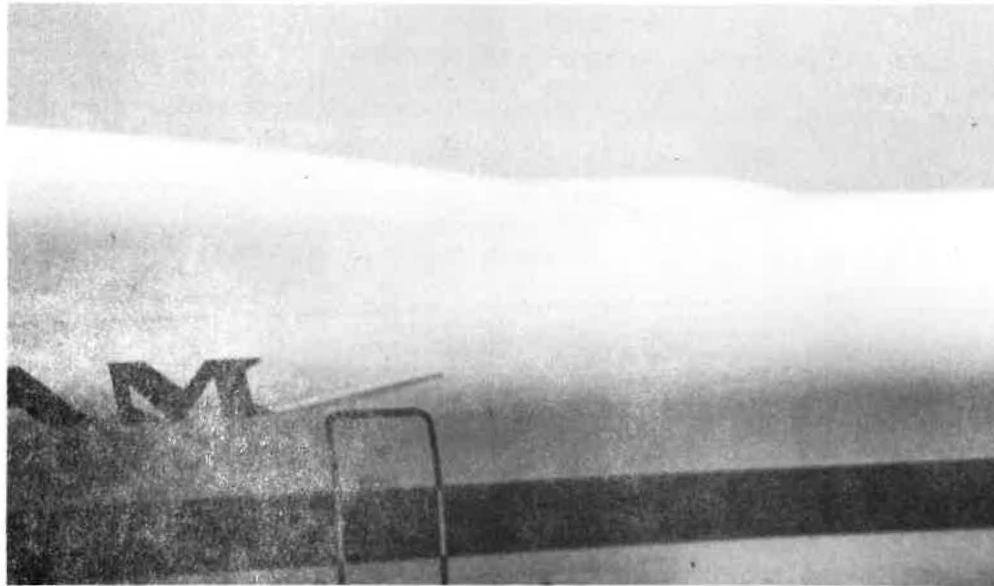

INTERTIAL NAVIGATION

The B747 was the first commercial aircraft to be delivered with an operational inertial navigation system. Pan Am aircraft are equipped with three Carousel IV systems built by AC Electronics. Total value of the installation is about \$400,000 per aircraft. Only two systems are required for dispatch of the aircraft, and one serves as a spare to ensure reliable on-time performance.

22

Inflight MTBF of the unit to date has been approximately 2500 hours; 95 percent accuracy is 1.85 nm/hr; CEP is 0.55 nm/hr. Pilots have been highly receptive to this greatly improved method of long-range navigation. An important feature that has caused this acceptance has been the development of an excellent pilot-to-machine interface in the cockpit.

The airline is now focusing attention on reliability improvement and improved maintenance training for the Carousel IV. Data collected in this program should be of value in determining operational costs and maintenance procedures for the space shuttle system.



AIRBORNE INTEGRATED DATA SYSTEM (AIDS)

This term has been generally applied to the acquisition and recording of maintenance data from on board systems. Illustration shows the basic structure of one possible configuration for the system. Pan Am has taken the view that maximum processing of data should be done on board and that the crew should be advised in real-time of the performance of the monitored systems. This prevents the delay and work necessary to process data at a later date after on board recording of large amounts of data.

Processing capability will be required to analyze data for tolerance and trend, reject redundant data, and alert the crew when tolerances are exceeded. To help achieve this goal, fault detection and analysis capability has been built integral with a number of systems, such as the radio altimeter, VOR/ILS receiver, HF transmitter/antenna couplers, DME, INS ATC transponders, electrical generating systems, etc. Pan Am favors fault detection to at least the line replaceable unit where practicable. When an abnormal situation is detected or anticipated, it is planned that most of the information will be provided via data link to the aircraft destination in advance of the arrival of the aircraft to allow expeditious corrective action.

Pan Am has just completed flight test of an airborne engine monitoring system which used engine data on a B707 aircraft to compute solutions to engine performance equations for comparison with stored values to determine trends in engine performance. Exception data was provided to the crew on a 600 word per minute printer. The system will soon be flight tested aboard a B747 aircraft.

An industry characteristic developed by the Airline Electronic Engineering Committee has recently been completed covering an airborne data acquisition system and flight data recorder which will be utilized by the airlines to satisfy pending FAA requirements for expanded flight data recording. Provisions have been made in the characteristic for providing data to an airborne AIDS processor and data link.

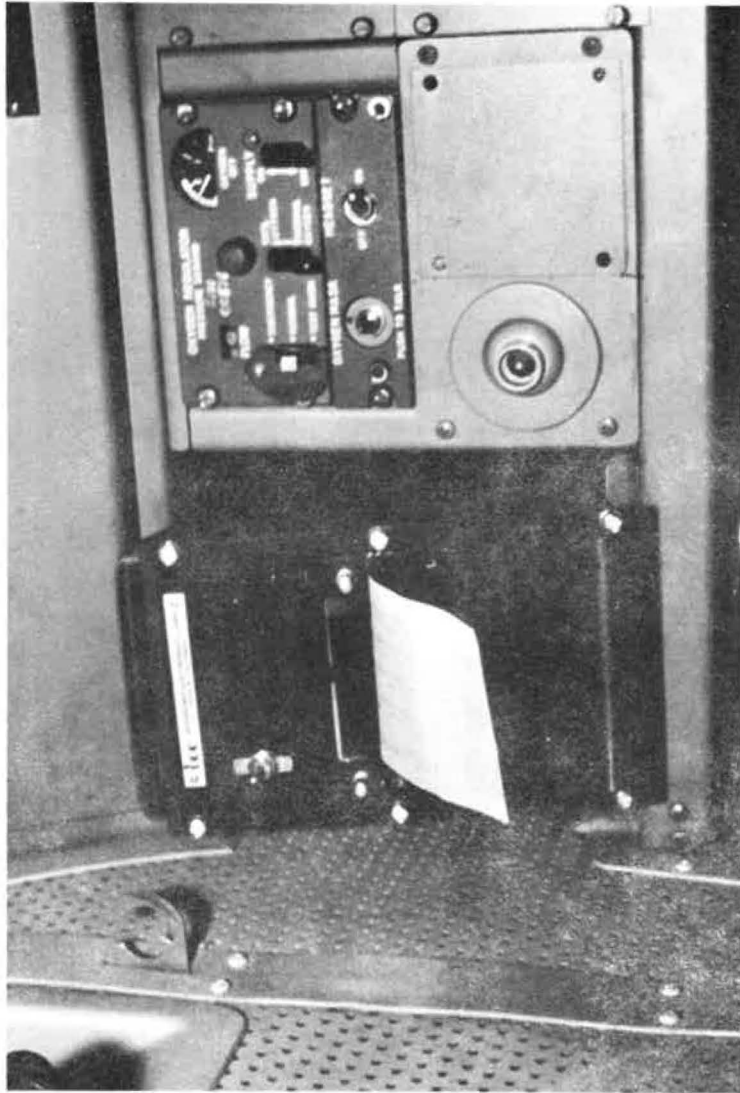

AUTOMATIC LANDING SYSTEM

Over 80 per cent of U. S. jet transports are qualified for Category 2 landings. Pan Am's entire fleet has been qualified. The Category 2 airport qualification program is far behind. For more than 20 years, it has been possible to make R & D demonstrations of automatic landings. The problem has been to translate this capability to a day-to-day operation using skills and maintenance practices found in an airline environment. The airlines have arrived at that point where automatic landings can be made practical on a line operation. Pan Am has made considerably more than a thousand automatic landings of which 500 were on scheduled passenger operation. Pilot acceptance and enthusiasm are good.

The basic mode of Category 3a operations will be automatic to touchdown. Redundant operational flight control capability (two operational landing systems making a fail-operational landing system) at least down to the predetermined alert height is required. The 747 has two independent automatic/manned landing systems with integrated flight directors, plus about half of the components needed for a third independent system. Pan Am will probably seek 3a approval by providing a monitored automatic landing system plus an independent manual landing channel or expand the existing complement of equipment to include three independent automatic systems. The SST and the Concorde will be certified for Category 3 operation.

In addition to overcoming low ceiling problems, the airlines believe that a safer operation and landings with less wear and tear on the aircraft can be made by automation of this function. Airlines believe that a safe, efficient and highly reliable operation can be conducted under Category 3 conditions.

The new Navy automatic landing system, AN/SPN-42, which has been made operational on McDonnell Douglas F-4 fighters for fully automatic all-weather landings may be of interest to the space shuttle. It is all digital. It takes the opposite approach from most land-based automatic landing systems currently being developed, where the steering and throttle commands are generated within an airborne computer. The Navy also used the C-Scan System (AIL) which has two microwave transmitters and two separate azimuth and elevation scanning antennas to transmit coded pulses to the aircraft. These are processed and used to drive the heads-up display on conventional ILS cross pointer. The system can be employed from 20 miles out and it guides the aircraft to capture by the SPN-42. Estimated touchdown dispersion with the system is 15 feet laterally and 40 feet longitudinally.

COCKPIT DESIGN AND DISPLAYS

Major interest in this area is directed toward simplifying the task of the crew and reducing the crew workload. Some of the most promising prospects present pictorial displays to the crew associated with flight management systems. Examples of these displays are:

- Cathode ray-tube for the electronic attitude director indicator. The display, at top center will have four modes: taxi, takeoff/approach, cruise and attitude. The tube will present, either by television or digital or symbolic displays, such items as speed error, radar altitude, flight path angle, flight path acceleration and attitude. The tube will also serve as visual display for the aircraft's instrument landing system. When in taxi mode, a television picture will present that operation.
- Large moving map for the inertial navigation system. The display could be directly underneath the electronic attitude director indicator for both the captain and first officer. The moving map will show desired course and actual position. It will also have the capability of providing short-term prediction of probable ground track of up to one minute.
- Multi-function screen for alpha-numeric, symbolic or graphic data presentation such as rate of climb profile and vertical navigation.

The crew would sketch desired climb profile on a scaled grid on the display. The system would provide real-time pictures of actual vertical position in relation to desired position. Similarly, other vertical navigation problems could be monitored on the display along with such items as fuel management.

Another cockpit change that crews will find is the lack of a control column - yoke or wheel - for roll and pitch. In its place will be a pair of control handles permitting an unblocked view of main panel for the electronic attitude direction indicator and area navigation displays.

Subsonic aircraft in airline service do not have the total capability afforded the supersonic transport by these advanced systems, but they will have much of it by 1975. Several of the main components are already in advanced stages of development. Electronic attitude director indicators have been used extensively in military aviation and a cathode ray-tube area navigation pictorial display was tested in a Boeing 727 last year. An electronic attitude indicator system has been tested in the Boeing prototype 707, and has been considered for the Lockheed L-1011.

ADVANCED SIMULATORS AND CREW TRAINING

Significant advancement in the state of the art in simulators is taking place. Advanced simulators generate as many as three different synthetic pictures simultaneously and include radar as well as direct viewing. They include capability for normal landing, takeoff, emergency landing and takeoff, aborts, unusual and routine maneuvering, fueling, and reconnaissance. Simulation techniques are also being used as visual environmental simulation system to aid in design and evaluation of new aircraft control systems and the evaluation of new image generation concepts. Computer image generation techniques are being applied to the development of the electron attitude director indicator.

The computer generated visual imagery, both the "out of the window" display and the radar landmass simulation use digital data stored in the computer to describe terrain and cultural features in three dimensions and in color. No physical models or films are employed as data sources.

Change of altitude, perspective and relative motion of runways, buildings and other aircraft respond instantly to simulated motion of the pilot's own aircraft. Perspective of the runway and near by buildings changed with lateral positioning of the aircraft.

In commercial airlines, flight training is the extension and laboratory application of ground school training. The basic objectives are to provide crew with essential information and knowledge needed and useful to operate the aircraft under: (a) normal condition, (b) abnormal conditions, and (c) emergency conditions (meaning a condition in which safety is threatened until corrected or contained).

Pan American training is based on the specific behavioral objectives (SBO) concept. It is intended that such training will be accomplished in a positive manner. In so doing, it is intended to: (a) cover essentials for safe and successful operations under the conditions noted above; (b) establish and demonstrate basic knowledge and technical operational competence prior to aircraft operation; (c) concentrate flight operation to fundamental and important aircraft differences which have bearing on ground and flight management of the aircraft; (d) during the entire training process, teach to provide specific airmen knowledge and know-how required to establish competence and verification thereof, with a design to retain proper elements of personal confidence.

NOTE: Pan American airmen are all swept wing turbojet qualified. The transition training to B747 in this case will be built on their experience and benefited by state-of-the-art improvements in the training area and the aircraft itself.

The SBO training concept will be optimized through coordination and control of all inputs and their consistent treatment in the aircraft operating manual which will be used as a ground school and flight training textbook, and the SBO applications in the laboratory aspects of training on the cockpit procedures trainer, the simulator and the aircraft.

Pan American flight training for the B747 is being carried out at Roswell, New Mexico. The most effort is exerted on touch and go landings on facilities with a 13,000-foot runway. A typical course involves several hours of classroom work, including cockpit familiarization in a cardboard mockup and about eight hours of flying, a two-hour rating flight and a two hour oral examination completes the training. The amount of training is not set, but varies with the proficiency of the individual.

CARGO HANDLING

Pan Am air freight facility at New York's Kennedy International Airport is designed to handle one billion pounds of cargo per year.

Three handling systems form backbone of Pan Am Cargo Terminal. The combination of three mechanical cargo processing systems form the backbone of the air freight terminal. The three systems are: a package conveyor arrangement, an automatic tow cart network, and an AirPak pallet system.

Applying unique techniques to processing flights in mass volume, the three systems are linked to an electronic computer network. It is estimated that this combination permits a reduction in ground handling time for individual shipments by as much as 80 per cent.

Using AirPak, up to 13 pallets, each 88 inches by 125 inches, may be loaded on Pan Am's all-cargo jets in a few minutes.

When a package is delivered to the terminal for export, it is first necessary to obtain pertinent data on the shipment, not already contained on the waybill. This information includes the height of the package, the width, length, actual volume, cubed volume and weight in pounds or kilos, and is obtained in two basic ways. This information is obtained using two separate and different electronic measuring systems.

The Caprocon system utilizes an electronic photo unit to determine much of the readout information. The Data-Cube System obtains the same readout information through a sonic beam unit.

Each unit is also capable of sending information directly to the cargo inventory computer system. Depending on size and weight, individual packages arriving at the terminal for export are placed in one of the three automated handling systems.

The first system is called the Package Conveyor System. Employing powered and gravity conveyors, the package conveyor or Rapistan system, handles both import and export shipments.

Packages smaller than eight inches long, eight inches wide, and four inches high are stored in a small package area.

When placed in the package conveyor system, the package moves to a sorting station where it is coded by destination or flight. From the sorting station it is dispatched by conveyor to any one of 120 gravity flow rack storage lanes elevated 12 feet above the terminal floor. Each lane represents a particular destination or flight.

For aircraft loading, cargo is retrieved from the package conveyor system by triggering an escapement release. This permits the cargo to move out of its lane by gravity and then by conveyor to a check station. There it is dispatched by conveyor to either the shuttle platform for transfer to the passenger jet; to the AirPak pallet buildup area; or to one of the loading fingers for placement in the belly compartment of an all-cargo aircraft.

The second system is called the Towline Cart System. A floor-level towline cart arrangement is generally used when a package is too large for the package conveyor system.

The third cargo handling arrangement is the AirPak pallet system. Cargo exported via the AirPak pallet system is usually assembled on pallets at the terminal. However, completely loaded pallets may be received at the terminal via highway truck.

Essentially, cargo arrives in the pallet make-up area from either the tow cart system or the package conveyor network. When the pallets are made up, they are raised to an upper level where all storage and aircraft loading activities take place. Average pallet make-up time is 30 minutes.

Completed pallets are stored in any of 51 holding stations prior to being loaded on the aircraft. The loading system is designed to permit placing in pallets in an aircraft in a 20-minute period.

An electronic computer system, the most extensive of its kind ever developed, is the nerve center for the automated air freight terminal. Working in harmony with the three mechanical ground handling systems, the computerized facility permits the airline to reduce handling time on individual shipments.

The main computers, located in the Pan Am Building, are linked to electronic equipment in cargo terminal by high speed telephone lines. Primary aim of the computer/handling system network is to speed the flow of freight through the terminal by providing instant readout on freight inventory, handling of reservations, and simplifying the dispatch and tracing of cargo movements.

Backbone of the system is an IBM 7080 computer and an IBM 7750 programmed transmission control unit. Located in the Pan Am Building, this equipment is linked by high speed telephone lines to two Bunker Ramo control units at the cargo terminal. The Bunker Ramo control units in turn are connected to some 26 input/output sets which are strategically placed throughout the terminal.

A shipment of cargo arrives at the terminal for export overseas. As the freight is unloaded from the truck and placed on one of the three mechanical handling systems, information regarding the shipment is typed into a input/output set. The operator views what he is typing on a miniature television screen.

Included in the basic information record are the date and time of cargo receipt, airwaybill number, destination, number of pieces in the shipment, weight of the total shipment, cube of the total shipment in cubic feet, a description

of the contents and where the cargo will be stored in the terminal. In addition, other data such as special handling instructions for animals and perishables may be recorded. If the freight is placed in a tow cart, the number of the tow cart is recorded, as is the number of a pallet if the shipment is palletized.

This information is relayed in seconds by the input/output set to a central control unit in the terminal, and then via high speed telephone lines to the computer complex in the Pan Am Building. Here the information is stored. When it is time to begin assembling freight for a flight, cargo load control personnel utilize either an IBM high speed printer or a teletype unit to retrieve information from the computer in the Pan Am Building.

From the computer a list of cargo holding reserved space for a particular flight is first obtained, including the information on each piece of freight which was initially fed into the computer. Cargo load control next requests a listing of all of the cargo for the flight destination. The information received from the computer by load control lists the order in which the cargo was delivered to the freight terminal and other pertinent data, including the location of the cargo in the terminal.

The load list is received from the computer in only a few minutes. This information in turn is dispatched to the various areas of the terminal where the cargo is stored. The individual freight pieces are then moved via the three handling systems to the loading area.

Some of the freight will proceed to the pallet make-up area, some directly to the loading finger for placement in the belly compartment of the freighter, while complete pallets are moved directly to the aircraft for loading.

Under this procedure, cargo load control, with the information obtained from the computer, is able to quickly decide on the best combination of space utilization for the flight and request a final manifest from the computer.

On the import side, as soon as a freighter arrives at the terminal, the cargo manifest is entered into the computer via an input/output unit. Then as the cargo is unloaded, each piece is again recorded in the computer via a separate input/output unit. In this way the manifest is checked against the actual cargo received with the computer pointing out any errors.

Thus, the computer retains complete storage of all pertinent data.

In addition to speeding the flow of cargo through the terminal by retaining all of the information on the individual cargo movements, the computer provides Pan Am with a vast source of record data.

For example, a shipper may call the cargo telephone sales department in the Pan Am Building and request information regarding his shipment. By utilizing any of five input/output units the cargo sales agent can retrieve the entire record of the shipment and relay this information to the shipper in a matter of minutes.

Reservations for cargo space, of course, are able to be confirmed in a matter of seconds with the computer.

SUMMARY

Certain topics in commercial aircraft technology with potential application to the space shuttle have been briefly reviewed. It can be concluded that much commercial aircraft technology available in 1975 will be directly applicable. This includes maintainability, maintenance, avionics, management techniques and operations. We strongly recommend (1) that airline management, engineering, maintenance and operations techniques be used in the procurement, design, test and operation of the space shuttle; (2) insofar as possible only technology available in 1975 time frame - so called - off the shelf technology be used in the space shuttle.

REFERENCES

82

1. Halaby, Najeeb E., The Participation of Airlines In the Development of Advanced Space Transportation Systems, AIAA Symposium, February 1970.
2. McLeod, Ben F., Communications Requirements 1970's, AIAA Symposium Communication, May 1970.
3. McLeod, Ben F., Automatic Landing Systems, Flight, 1968.
4. Howard, Lee R., A Cost-Effectiveness Example: Supersonic Transport, Cost Effectiveness, John Wiley and Sons, New York, 1968.
5. NASA Space Shuttle Task Group Report, Volumes I, II, III, IV, May 23, 1969.
6. Airline Maintenance Philosophy as Applied to the Space Shuttle Concept, 19 August 1969.
7. McDonnell Douglas Astronautics Company, Space Shuttle, Phase B, Technical Orientation presented at the NASA Kennedy Space Center on 30 June 1970.
8. Pan American World Airways, Inc., Aerospace Services Division "Airline Methods Applied to Space Shuttle Turnaround Plan and Cost Analysis", 6 October 1969.

SPACE SHUTTLE RELATED MAINTENANCE EXPERIENCE WITH THE
X-15 AIRCRAFT

Vincent N. Capasso, Jr.

NASA Flight Research Center
Edwards, California

INTRODUCTION

The X-15 airplane was a rocket-engine-powered research vehicle which made many flights to 250,000 feet altitude and higher and to Mach numbers greater than 5. In maintaining the airplane, many small repair items were required between flights. Although each item might not be significant in itself, the total number of items required a significant amount of maintenance time. The time at which a problem occurred or was found in relation to the preflight activity which had already been accomplished would sometimes cause an otherwise minor discrepancy to have a major effect on the flight schedule.

This paper discusses the maintenance activity between X-15 flights and the number and types of repair items which would be related to space shuttle requirements. The increased size and complexity of the shuttle systems will magnify the number of repair items, making the required turnaround time difficult or impossible to achieve unless careful consideration is given to problem prevention and access for system repair and maintainability.

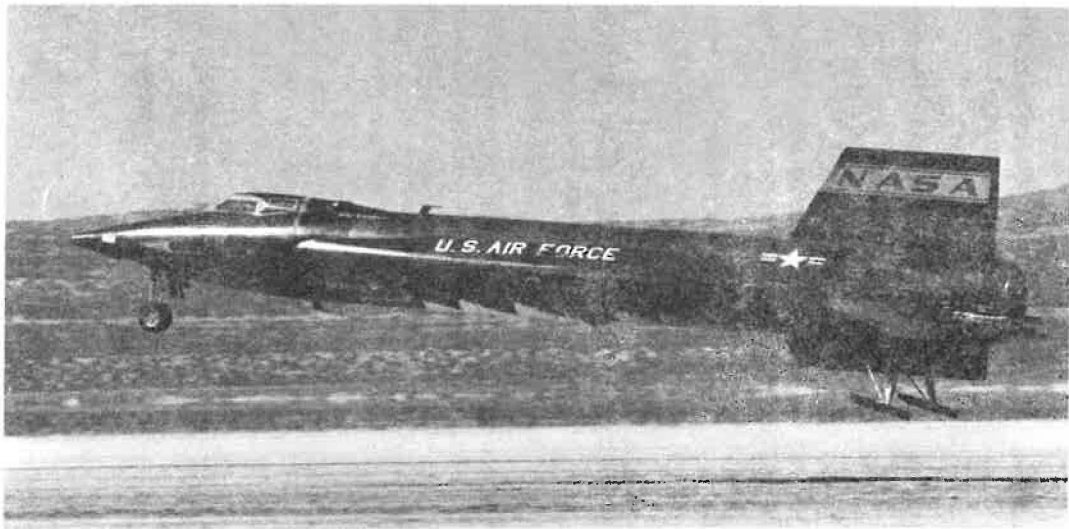

Figure 1

Figure 1 is a photograph of the X-15 airplane immediately prior to touchdown. The airplane had an overall length of 50 feet, a wing span of 22 feet 4 inches, a launch weight of 34,000 pounds, and a landing weight of 15,500 pounds.

Figure 2

The between-flight activity on the X-15 airplane can be divided into three primary periods or areas of activity: post-flight, modification and repair, and pre-flight. When no configuration changes or repairs were required, only post-flight and pre-flight activities were necessary. There was, of course, no sharp dividing line between these periods of activity; in fact, there was usually an overlap to provide better utilization of available time. Careful planning was required for an overlap of activity to prevent conflicting requirements or wasted effort.

The post-flight activity consisted initially of "safelying" the airplane and of draining and purging the propellant system, which normally took about 2 hours. The post-flight inspection was the second phase and took about 2 days. This consisted of a thorough visual inspection of the aircraft for such items as loose fasteners, cracks, and evidence of leakage (hydraulic or propellant), overheating, or any other discrepancies. The engine system was leak-checked with helium. Recorded data on the operational systems were scanned for any anomalies. At the end of this period, the project engineer met with representatives from the research and instrumentation groups, the aircraft crew, and the shops to discuss work requirements and schedule the next flight.

Immediately following the post-flight period was the modification and repair period. The first item was troubleshooting problems or discrepancies from the flight that were reported by the pilot, found during the post-flight inspection, or were observed in the data. Some items were straightforward (i. e. , cracks, leaks) but some were vague and difficult to pin down (i. e. , pilot reports that the engine sounded strange during start transient).

Modifications usually consisted of items required for research or research instrumentation purposes which would not be applicable to an operational vehicle but were very applicable to a development vehicle. Close control of these types of items will be necessary to conduct the development program for the space shuttle in a timely manner. However, this control should be left with the flight-test operational personnel conducting the flight-test program to maintain the flexibility required to expedite the program.

Modifications also consisted of items to update the aircraft. Flight-safety items were scheduled according to their urgency, and convenience items were accomplished with the least schedule delay possible. Periodic maintenance was also accomplished at this time.

Pre-flight activity was built around a complete functional test of all the aircraft systems within 15 calendar days of the flight. The functionals were in the form of written procedures to be followed by the aircraft crew and witnessed by quality assurance personnel. Problems found during the functionals were resolved during the pre-flight activities and the functional was performed again, which sometimes required careful planning as for modification/repair overlap. Often, pre-flight activities were repeated because the time limit was exceeded, and discrepancies were sometimes found and repaired during the repeated pre-flight activity. The last two pre-flight items presented no related problems and were normally accomplished the day before and the day of the flight, respectively.

BETWEEN-FLIGHT ACTIVITY

● POST-FLIGHT
'SAFETYING' THE AIRPLANE
DRAIN AND PURGE OF PROPELLANTS
POST-FLIGHT INSPECTION

● MODIFICATION AND REPAIR
TROUBLESHOOTING PROBLEMS OR DISCREPANCIES
PERIODIC MAINTENANCE ITEMS
MODIFICATIONS
PRE-FLIGHT ENGINE OPERATION (WHEN REQUIRED)

● PRE-FLIGHT
FUNCTIONALS
MATING TO B-52
PROPELLANT SERVICING

Figure 3

At the start of the X-15 program, an engine run was required before each flight. By the end of the program, when confidence in the engine and engine checkout was established, a pre-flight engine run was required only when the engine was removed or changed, when any major maintenance was performed on the installed engine, or after three flights.

Figure 3 shows the aircraft being prepared for an engine run. The primary purposes of this operation were: (1) to provide a leak check of the engine/propellant system with propellants (at cryogenic temperatures) and (2) to prove out the aircraft/engine combination. To accomplish item (1), four crew members in protective clothing visually inspected the propellant system components and engine in the pressurized/prime condition and with the engine turbopump operating, which pressurized most of the engine system. The airplane systems were operated by one of the project pilots from the cockpit. Many times small leaks were found and repaired as a result of this operation. Some examples of aircraft/engine combination problems were: (1) unstable turbopump operation caused by internal leaking of ullage helium past the swing spout O-rings into the turbopump H₂O₂ system; (2) internal leakage of the helium through the NH₃ safety valve into the NH₃ feed line, causing pump cavitation during the start transient; and (3) helium leakage through a faulty flapper valve in the NH₃ tank into the feed line when more than half the NH₃ was used, causing rough engine operation. These were feed system problems which would not be found in normal feed system checks (except possibly item (2)).

Thrust measurement during the engine run was of secondary importance and was measured indirectly by utilizing chamber pressure and the engine pressure budget (calibration) generated prior to installation during tests on the engine maintenance stand. Although the maintenance stand simulated the airplane in tankage configuration and utilized aircraft system components, the chamber pressure (thrust) was found to be consistently slightly higher in the aircraft. The installed thrust was important in flight planning and could have a significant effect on some profiles.

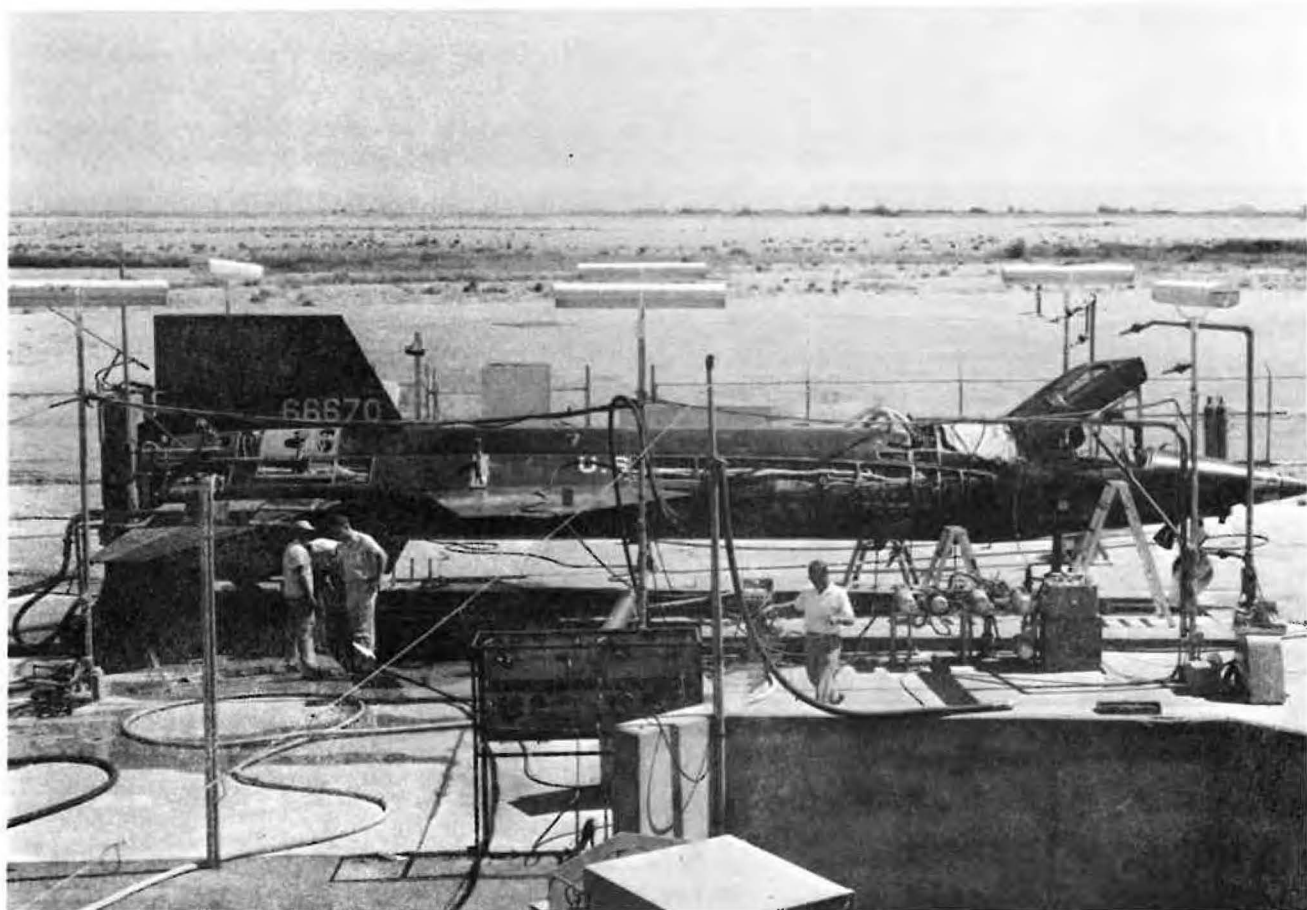

Figure 4

Periodic maintenance items may be divided into two categories: those which were calendar time dependent, and those which were flight time or flight cycle dependent. For the X-15 airplane, flight time and flight cycle were essentially the same. The flight time per flight varied only slightly. Figure 4 presents sample items of each category. The items were selected for their varied requirements. An explanation of each item follows.

The 30-day ejection seat inspection was primarily an exercising of the ejection seat hydraulic system. If the system were not exercised, the pistons and lock assemblies would bind because the O-rings would dry and not function properly.

The 360-day ejection seat inspection was primarily an overhaul and re-rigging of the ejection system.

The pyrotechnic life was established by the contractor and was related to the X-15 environment. The primary problem was the unique devices used and the long lead time for obtaining qualified replacement items, with 1 year not being unusual.

The hydrogen peroxide tank corrosion inspection was based on a reasonable time to check for a potential problem.

Shoulder harness is typical of an item which deteriorates with calendar time and must be periodically proof loaded.

The tension regulators had to be periodically checked for freedom of movement and no binding throughout their travel.

The landing gear was very highly stressed and operated with low margin because of the increase in basic aircraft weight with time. Measurement points were located on the landing gear struts to check for deflection. Landing gear deflection measurement and X-rays were taken after every 5 flights.

Because of its configuration and landing loads, the X-15 airplane could not be landed safely without flaps. The flap teleflex gear box was one of the weak points in the system and was, therefore, a periodic inspection item.

The complete alinement of the stability augmentation system and auxiliary stability augmentation system was accomplished on initial installation and checked thereafter on a periodic basis. The routine preflight activities did not check alinement.

100 percent lubrication was a routine maintenance periodic item.

Engine and APU inspection/overhaul periods were a function of their operating time, but did require consideration in maintenance scheduling because of the added workload of changing the units.

SAMPLE PERIODIC ITEMS

- TIME DEPENDENT

EJECTION SEAT

EJECTION SEAT

PYROTECHNIC LIFE

H₂O₂ TANK CORROSION INSPECTION

SHOULDER HARNESS

TENSION REGULATOR CHECK

30-DAY INSPECTION

360-DAY INSPECTION

5-YEAR SHELF

3-YEAR INSTALLED

12 MONTHS

180 DAYS

180 DAYS

- FLIGHT DEPENDENT

LANDING GEAR DEFLECTION MEASUREMENT
AND X-RAY

FLAP TELEFLEX GEAR BOX WEAR

SAS, ASAS ALINEMENT

100 PERCENT LUBRICATION

ENGINE MAJOR INSPECTION

APU MAJOR INSPECTION

5 FLIGHTS

5 FLIGHTS

5 FLIGHTS OR 5 MONTHS

3 FLIGHTS

30 MINUTES OPERATION

15 HOURS OPERATION

Figure 5

Two periods were selected to analyze the X-15 maintenance history. The periods were selected on the basis of a series of similar flight plans with almost the same aircraft and instrumentation configuration. The first period, July 8, 1964, to April 23, 1965, covers preparations for flights 31 to 41 for the X-15-3 airplane. This was a series of heat transfer flights with similar flight plans and some minor research instrumentation changes. The ballistic control system was not required or used for these flights. The second period was April 4, 1968, to December 20, 1968, and covers the last 7 flights of the X-15-1 airplane. These flights were all altitude flights which required an operating ballistic control system. In figure 5 a 5-flight sample of the two periods was analyzed by aircraft systems to show the problem areas.

The data were taken from two sources: (1) the engineering log maintained by the flight operations project engineer which contained items he was concerned with and (2) the inter flight work sheets (IFWS) which were included in the airplane work book maintained by the airplane crew. Problems related to weather or research configuration changes were not included; only problems of an operational type were counted. There were some deviations between engineering log and flight work sheet data for the following reasons:

(1) Engineering log data contain items which had a definite effect on flight schedule or flight preparation activity but not routine repair items handled by the aircraft crew chief which did not affect the schedule.

(2) Components removed for access or inspection, found faulty, and repaired or replaced away from the aircraft were not always noted on the flight work sheets. If the schedule was affected, a note was made in the engineering log.

(3) Inertial and research instrumentation system items were noted in a separate set of flight work sheets which are no longer available. When the schedule was affected, a note was made in the engineering log.

The figure shows many more items from the inter flight work sheets than from the engineering log, which corresponds with the sheets containing the routine items taken care of by the aircraft crew. Where the engineering log number approaches the IFWS number, as under propellant/pneumatic system leaks, it means that the problems usually affected the flight schedule or increased the effort required to retain the schedule.

Propellant/pneumatic system leaks were the most troublesome problems, probably because they usually occurred or were found during pre-flight functional activity or flight servicing. Many of the leaks were due to O-ring or gasket failures, both in the system plumbing and in the components. Although the number of structural repair items was high, most were minor and were found during post-flight inspection, which permitted them to be considered in the flight schedule. The electrical wiring in the X-15-3 airplane was becoming a serious problem during the period considered and the aircraft was subsequently rewired to eliminate the problem.

MAINTENANCE ITEM SUMMARY FOR 5 TYPICAL FLIGHT PREPARATIONS

BETWEEN FLIGHTS 3-32 AND 3-37
(119 CALENDAR DAYS)

BETWEEN FLIGHTS 1-76 AND 1-81
(181 CALENDAR DAYS)

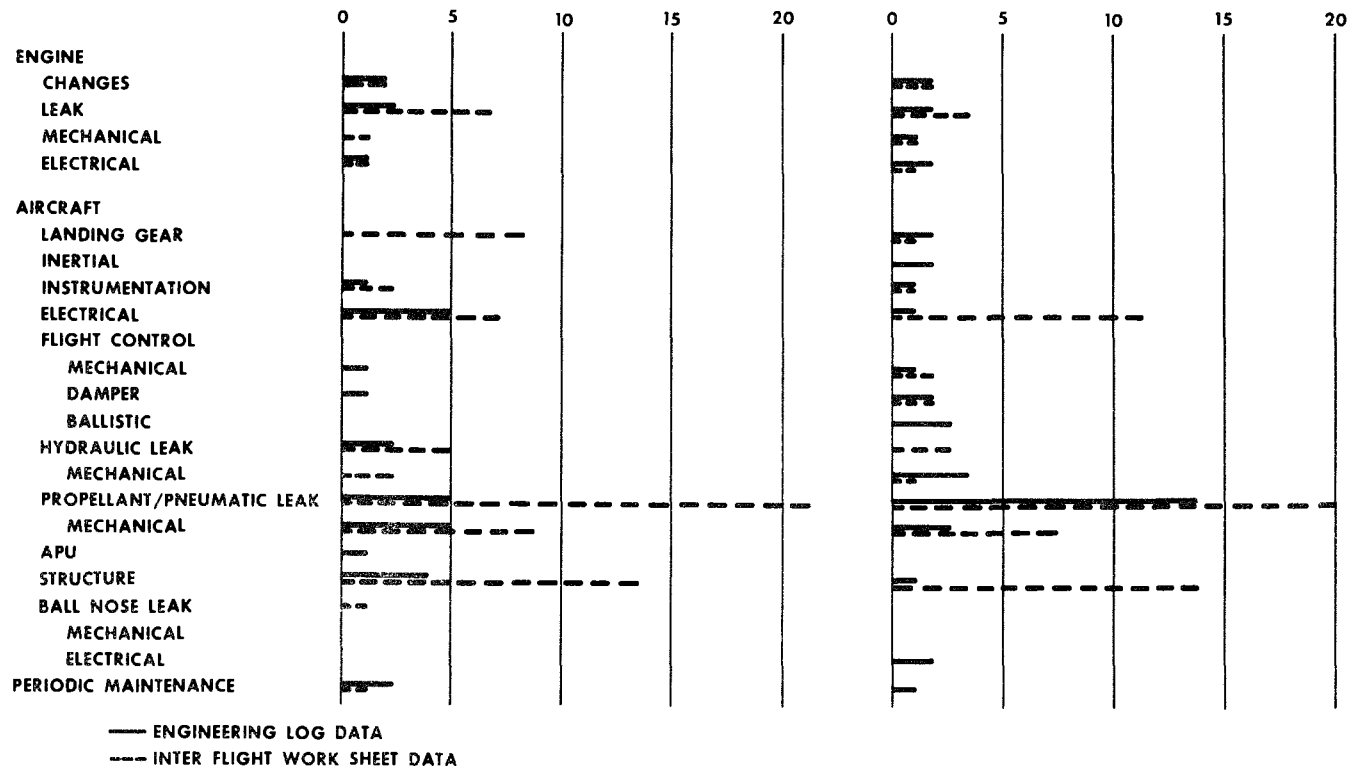

Figure 6

The number of leaks in all systems and the total number of items required versus the calendar days between flights for the time periods considered in the discussion related to figure 5 are presented in figure 6. Complete inter flight work sheet data were not available. It is well known by those who work around aircraft that an airplane that does not fly in a reasonable time develops problems, usually leaks due to drying out of seals and O-rings. For example, the B-52 airplane has a series of inspection requirements of increasing severity, depending on the number of calendar days since the last flight. The X-15 functionals were designed to exercise and test all the systems and were sometimes performed to exercise the system during long periods of lay up. The 30-day seat inspection (fig. 4) is an example.

The figure shows the trend of increasing number of items versus calendar days and the higher number of inter flight work sheet items. The question naturally arises, "Did the number of items between flights determine the calendar days, or did the calendar days determine the number of items?" The X-15 experience was usually the latter, particularly during the last year of flying (X-15-1 data) when coordination for one of the experiments determined the flight schedule date and time, which was somewhat inflexible.

The fact that the lines do not go through the origin points out that there were normally items to be repaired when the aircraft returned from flight.

42

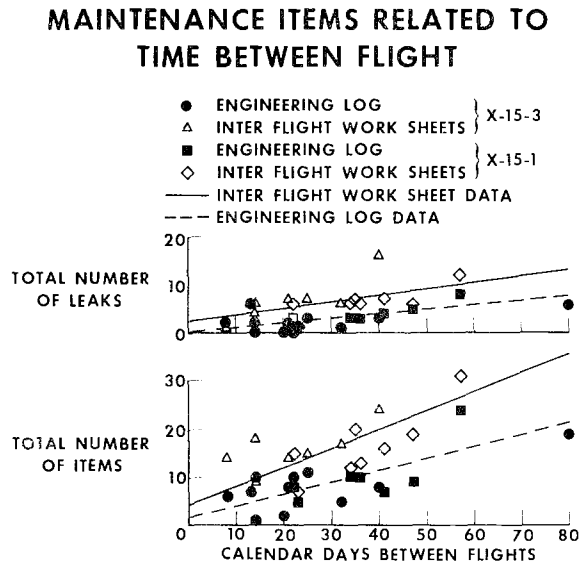

CONCLUDING REMARKS

The maintenance history of the X-15 airplane shows that propellant pneumatic system leaks and structural repair were the biggest problem areas. Although the space shuttle will utilize newer equipment, materials, and techniques, the systems will be more complex and the operating environment far more severe than for the X-15 systems. To minimize the turnaround time, the number of maintenance items must be kept to an absolute minimum by careful application of the lessons learned in maintaining the X-15 airplane.

COMMENTS

The following was reconstructed from memory, from questions and comments after the oral presentation.

1. Question. Did you have any problems with ghosts?

Answer. Rather than ghosts, there were very real problems for which a cause could not be found. After flight, the symptoms would completely disappear and no problem could be found. As an example, an APU shut down at launch on flight 3-50, was restarted later in flight, operated properly for the remainder of the flight, and operated properly through every ground test we could think of.

2. Question. How many problems did you find during an engine run which would have not been found otherwise?

Answer. During the time period considered, 16 engine runs were accomplished, four of which uncovered engine or engine/aircraft compatibility problems. The engine was required to pass the same functionals for an engine run as for flight and would therefore have been considered ready for flight if the ground run had not been required. The table summarizes the run activity.

3. Question. What percentage of leaks were in the LOX system?

Answer. Of the 41 leaks listed in figure 5, 15 were H₂O₂ system, 1 LOX, 3 NH₃, 16 He, 2 LN₂ cooling, 4 GN₂ (cooling and inflatable seals), and 1 pilot's breathing O₂ (not counted in the 41). Engine leaks were counted separately under engine system.

4. Question. What were some internal structure problems?

Answer. In the cockpit area failure of a clip occurred in two aircraft due to differential expansion between the hot outer skin and cool internal skin of the pressurized cockpit area, resulting in loss of cabin pressurization. The third aircraft had a camera window installed in this area, relieving the stresses. Three small cracks were found by X-ray in the titanium inner wing structure of X-15-1 during the last year of flight. They were checked by X-ray between flights and did not increase.

5. Question. What was minimum turnaround time?

Answer. With no configuration changes, engine run required, or other problems, the aircraft could be turned around in one week (6 working days). The maximum number of flights per month for one aircraft was three; the overall average was about one flight per month per aircraft.

Date of run	Reason for run*	Good or bad	Comment
5 Aug 64	P	G	Engine had flown twice since previous ground run
15 Sep 64	P	G	First time engine had flown 3 times between runs
7 Nov 64	R	G	Engine had been changed for fire warning initiation in flight
19 Dec 64	R	G	Engine had been changed for lube seal leakage
8 Jan 65	R	G	Engine had been removed for access
5 Mar 65	R	G	Engine had been changed for chamber coating damage
10 Mar 65	M	G	Engine control box had been replaced
23 Mar 65	M	B	Engine control box had been changed; governor was found sticky during engine run
25 Mar 65	R	B	Engine had been changed; aircraft NH ₃ valve had internal He leak cavitating the pump during start
27 Mar 65	R	B	Previous run attempt was unsatisfactory; metering valve was found stuck on engine
29 Mar 65	R	G	Engine had been changed
22 Apr 68	R	G	Engine had been changed
25 Jun 68	R	G	Engine had been changed
5 Sep 68	R	G	Engine had been changed
18 Nov 68	R	B	Engine was removed to repair engine mount; injector was found cracked after run
22 Nov 68	R	G	Engine had been changed

*P Periodic requirement

R Engine was removed or replaced

M Major maintenance was performed on installed engine

NONDESTRUCTIVE TESTING FOR SPACE SHUTTLE

T. J. De Lacy

General Dynamics/Convair
San Diego, California

INTRODUCTION

The quest for earth-orbit shuttle by the mid 70's demands awareness of material capability and performance well beyond standard characterization. In addition to providing reliable data, candidate nondestructive testing must perform within the economics of the Space Shuttle concept. Where practical, suitable instrumentation must be developed for onboard surveillance and/or for limited operation during shuttle turnaround.

NDT considerations require tradeoffs between maintainability and design. For example, should sections of the vehicle such as the TPS be designed to be removable in total or in part for replacement with new, refurbished, or recertified material, and the removed panels subsequently tested at leisure? Or should NDT methods be designed for inplace testing? Can reliable evaluation be performed by sampling over the intended service life of the vehicle? To what extent will accessibility be required? May existing NDT technology and standard airline maintenance be utilized in formulating a meaningful master plan for reliable and, equally important, economical determination of reusability?

Company-sponsored research has been conducted at Convair in nondestructive testing of advanced materials currently under development for Space Shuttle. Methods which have been investigated to date include eddy current, high frequency ultrasonics, microwave, beta backscatter, thermal and infrared methods, acoustic emission analysis, Mossbauer spectroscopy, and techniques for handling and processing NDT data. The use of radionuclides for incorporation into a coating system to monitor TPS in service is currently under development.

The most significant barrier that must be overcome to develop confidence among potential users of NDT is agreement on the problem — what are the inspection requirements for reusability? Certainly onboard surveillance is desirable, but is it necessary considering compromises that may reduce vehicle performance? The strive for NDT sophistication is fostered by the advanced technology sought for Space Shuttle, but it is the responsibility of the designer and nondestructive investigator, as well, to temper the approach with system awareness and effective utilization of the inherent serviceability and inspectibility of the vehicle.

SUMMARY

Nondestructive testing has been used extensively at Convair to aid development of advanced materials and design for Space Shuttle. In early work, considerable attention has been given to thermal protection systems, and in particular to coated metal refractories, deployment of which is desirable to meet the economic objectives of the shuttle concept. Additionally, nondestructive testing has been used to assist the development of candidate backup material such as carbon-carbon composites and ablatives. The requirements for NDT of structure, tankage, and insulation are currently under investigation. While suitable methods for most applications are available to predict initial performance, further development is required to extend these methods to measure reusability.

The NDT considerations for shuttle may be divided into three general areas:

- (1) thermal damage, i.e., oxidation, properties degradation, local distortion;
- (2) fatigue damage, i.e., cycled loads — thermal, mechanical, acoustical; and
- (3) structural damage, other than fatigue, i.e., damage due to subcritical defects, accidents, and corrosion. On the exterior of the vehicle, the major areas of concern are leading edges and areas subject to repeated loads. For example, areas aft of flyback engines and forward of the rocket engines, including the entire aft section and stabilizers will be susceptible to sonic fatigue. Transducer arrays operating as passive detectors in critical attachment areas have been considered for inflight monitoring of crack initiation and propagation in these areas. While it is too early to determine the need for onboard sensing, the requirements for such a concept must be examined to perform tradeoffs necessary for the selection of materials and inspection approach.

In few instances are the inspection requirements independent of materials selection. However, in several cases the approach for a particular material requires no major development affecting shuttle turnaround. For example, the performance of ablative materials can generally be characterized. Suitable NDT prior to installation can be employed to guarantee satisfactory performance. If such materials are selected, postflight evaluation will not be required since the materials are not reusable.

While thermal insulation may not be required between the tankage and TPS for the booster, it is currently planned for the orbiter. Accordingly, the need to monitor insulation is being investigated by North American Rockwell Corporation's Space Division, prime contractor for the North American/Convair Phase B team. Detection of moisture buildup may prove to be impractical considering the volume of space and restrictions surrounding tankage and fuel lines. An alternate approach is simply to eliminate it. Accordingly, at Convair a dry nitrogen purge system for operation during tanking is currently being considered.

In addition to eliminating the need to detect moisture buildup, the purge system might also be used to carry off leak gas, either the fuel itself or helium introduced externally, to sensors located at purge outlets in the system.

Cryogenic insulation inside fuel tanks requires a bond to the tank wall. Candidate materials include rigidized foam and fiber or foam-filled honeycomb gas layer systems. Moisture buildup or gas convection may propagate or initiate disbonds, rupturing or eroding the insulation. Large defects may produce cryopumping, or ice buildup, resulting in increased weight and stress. While the insulation is accessible, at least initially, from inside the fuel tanks, it is accessible from the wrong side. Sonic or ultrasonic techniques for reliable evaluation of bond area require access to the tank wall and depend on energy transferred from the metal wall to the insulation to produce a measurable dampening. While novel techniques such as the use of piezoelectric coatings for application to such problems are currently being investigated, as yet a reliable NDT method is not available for evaluating internal insulation.

North American Rockwell Corporation's Space division is currently studying NDT methods to assess structural integrity for Space Shuttle under contract with NASA Kennedy Space Flight Center (NAS 10-7250). Emphasizing high speed methods and onboard techniques, the objective of the program is to identify nondestructive testing suitable for Space Shuttle. A second objective is to recommend necessary technology programs to meet objectives during turnaround. Techniques currently being evaluated include fiber optics, holography, in-place ultrasonics, and thermal methods. Convair is providing consultants for the program.

The use of acoustic emission analysis for in-situ NDT of structural materials is currently under investigation at Convair. Among other forms of energy, mechanical pressure or stress waves are spontaneously emitted by materials undergoing deformation. The energy arises from many sources, including shifting of unseen imperfections in the material (dislocations) and nucleation or propagation of cracks. The application of acoustic emission for in-situ life monitoring of critical structures and components and/or to assist process control will be investigated.

Problems associated with NDT of structural components cannot be identified until material and design have been decided. In the mean time, adequate inspectability cannot be assumed. A significant tradeoff among material candidates is the need and relative ease of testing each to determine its capability for reuse flight after flight. One candidate material, coated columbium, was deemed a primary candidate for booster and orbiter leading edges, but presented difficulties in testing. While techniques had been suggested for NDT of this material, previous studies had been confined to the laboratory. Convair instituted a program to build on this early work and apply knowledge gained in the laboratory to NDT processes suitable for factory and field evaluation (Refs. 1 and 2).

1. DeLacy, Thomas J. and Anderson, R. T., "Nondestructive Testing of Refractory Coatings — Solutions and Problems," 16th Meeting of Refractory Composites Working Group, Seattle, Washington, 13-15 October 1969.
2. DeLacy, Thomas J. and Anderson, R. T. "Nondestructive Testing of Composites and Refractory Coatings," 17th Meeting of Refractory Composites Working Group, Williamsburg, Virginia 16-18 June 1970.

The development of NDT methods for process control of coated refractories produced standard techniques to assist early design studies and fabrication development. An ultrasonic transmission reflection technique was shown to be satisfactory for detecting disbond in diffusion bonded base metal. The technique, which records ultrasonic energy transmitted through the test specimen to a smooth reflector as a function of bond area, is valuable for process development and inspection of bonded or brazed shield structures.

Methods to evaluate the integrity of the coating include eddy current, thermoelectric monitoring, and electron emission radiography. Eddy current testing employs an induced electric field in the substrate, which is modified by variation in the diffusion layer between the coating and substrate and/or by distance between the probe and substrate. It is used by some coating manufacturers for green state monitoring. Thermoelectric testing, which is based on a reverse thermocouple principle, is sensitive particularly to chemistry variation in the coating. This technique, which requires point by point monitoring over the entire surface of the shield, is not applicable to shuttle turnaround due to a nonconductive oxide layer developed on the surface of the coating during high temperature service.

Of the three principal NDT methods for manufacturing process control, electron emission radiography has proven most valuable. The technique employs the use of electrons ejected from the metal substrate by x-ray bombardment to image variability in the coating. While extensive use of the method has aided the development of an improved coating technique, the method requires close control. Setup time and restrictions to personnel working near the exposure area make the technique less suitable for application to shuttle turnaround.

During re-entry, the heat shield will encounter extreme temperature and pressure regions as well as mass flow, which may reduce the thickness of the coating. Spalling or other damage to the coating during landing or cool-down of the vehicle may also reduce coating thickness. Accordingly, periodic monitoring will be required to assess coating losses and/or damage that may initiate early failure.

The use of radioactive labelling (tagging) to provide inherent radiation emission properties to the coating has been under investigation at Convair. It appears that a safe quantity of radioisotope can provide a rapid means for measuring coating thickness and discernment of flaws. The tag provides two useful categories of nondestructive measurement: (1) autoradiography, which provides a very detailed and high resolution picture of the coating, and (2) direct counting, which before and after abrasion tests correlate with coating thickness and which provides a measurement of coating uniformity.

While further development is required, the indications are positive that the radioactive tag will provide a practical means for in-situ NDT of thermal shields. The radioactivity loading can be increased sufficiently to reduce autoradiography time to less than one hour per exposure with complete safety. Since many films can be exposed at one time, complete autoradiography interrogation could be carried out within a 24-hour period without interruption of required maintenance.

Based on studies using ^{147}Pm (a weak beta emitter), the thickness of the coating in a 0.05 square foot area would be measurable using a single G-M detector (3-inch diameter) to a precision of better than 1% within a 0.2-minute count. Thus, 1 square foot could be measured every 4 minutes; 300 square feet would require approximately 20 hours of measurement time. However, just as a multiplicity of areas can be simultaneously autoradiographed, a multiplicity of G-M counters would reduce the required inspection time.

Mossbauer Spectroscopy has been investigated for measuring coating service life, specifically changes in chemical bond relating to oxidation and diffusion. While the results of the tests were inconclusive, the application remains feasible. Considerable investigation would be required to apply the method outside the laboratory. Beyond the cost of material, the method requires a relatively sophisticated setup and considerable counting time. However, for its intended application, a relatively simple device is conceivable for sampling the shield in areas previously screened.

The need for further investigation will be determined by continued experience with coated metal refractories and particularly by the degree to which these systems can be characterized.

CONCLUDING REMARKS

The reliability, possibly the success, of the Space Shuttle concept will require extensive but most important, proper application of nondestructive testing. Techniques required for reusability must be economical as well as reliable. While suitable instrumentation requires development, a practical inspection plan will depend on serviceability, in particular on the amount of inspection required and, where necessary, accessibility for inspection and repair. Consideration of these requirements must be clear throughout our analysis and design approach.

NDT REQUIREMENTS

The inspection requirements for reusability are unprecedented. NDT must be developed concurrently with materials technology and design to meet objectives for turnaround.

- DEVELOPMENT – CHARACTERIZATION
- IN PROCESS – MANUFACTURE (INSPECTION)
- IN SERVICE – OPERATIONS CHECKOUT

EXTERNAL NDT REQUIREMENTS

Areas susceptible to repeated loads and overheating are of major concern for reusability.

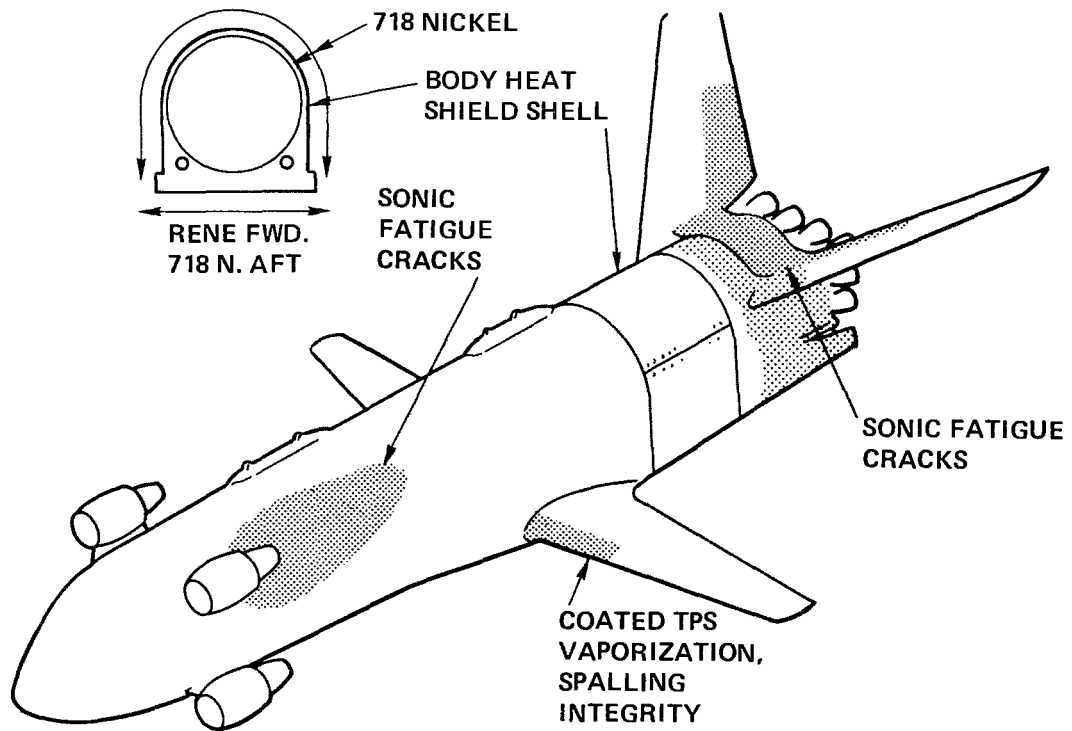

INSULATION AND TANKAGE

Suitable techniques have not been developed for inspection of cryogenic (internal) insulation. Inaccessibility is a major limitation.

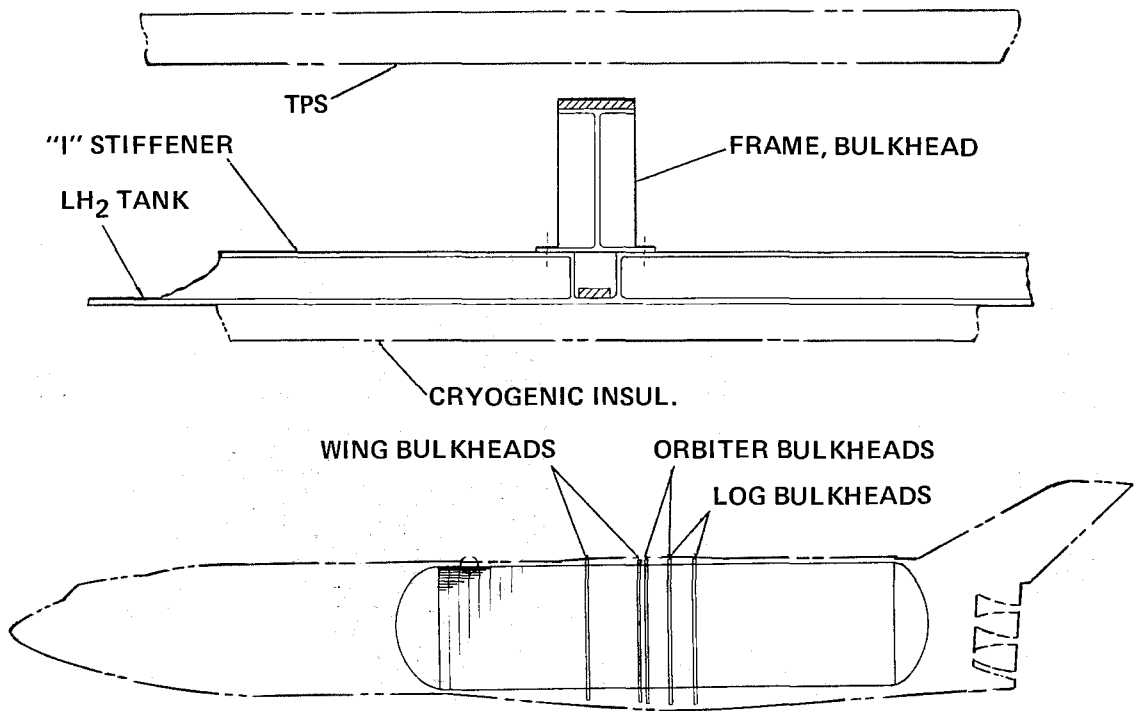

LIQUID CRYSTAL THERMOGRAPHY

Thermal techniques are currently being investigated for application to Space Shuttle by North American Rockwell Corporation's Space Division. Under contract to NASA Kennedy Spaceflight Center, NAR has begun a program to assess structural integrity for space shuttle vehicles. Convair is providing consultants to the program.

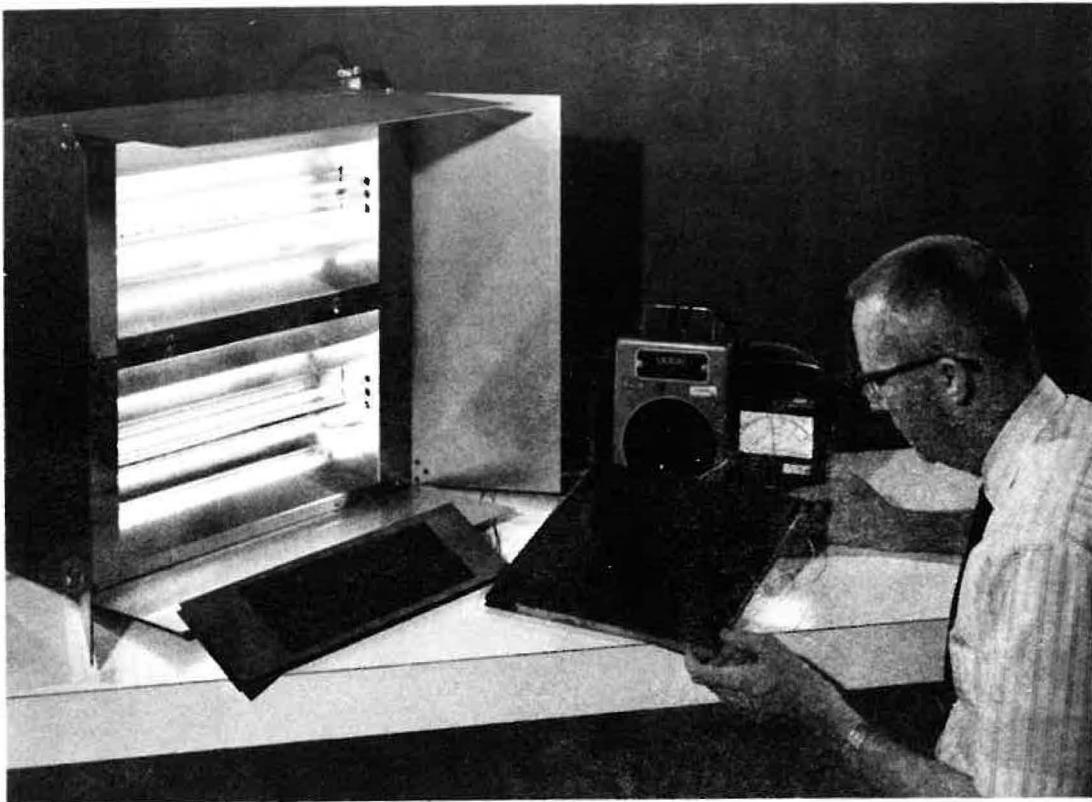

PURGING & SAFETY

A dry nitrogen purge system is currently a principal candidate to eliminate moisture buildup in the booster. In addition to eliminating the need to detect moisture, a leak detection system for the tankage utilizing the purge manifold and outlet sensors is feasible to detect leakage prior to refueling.

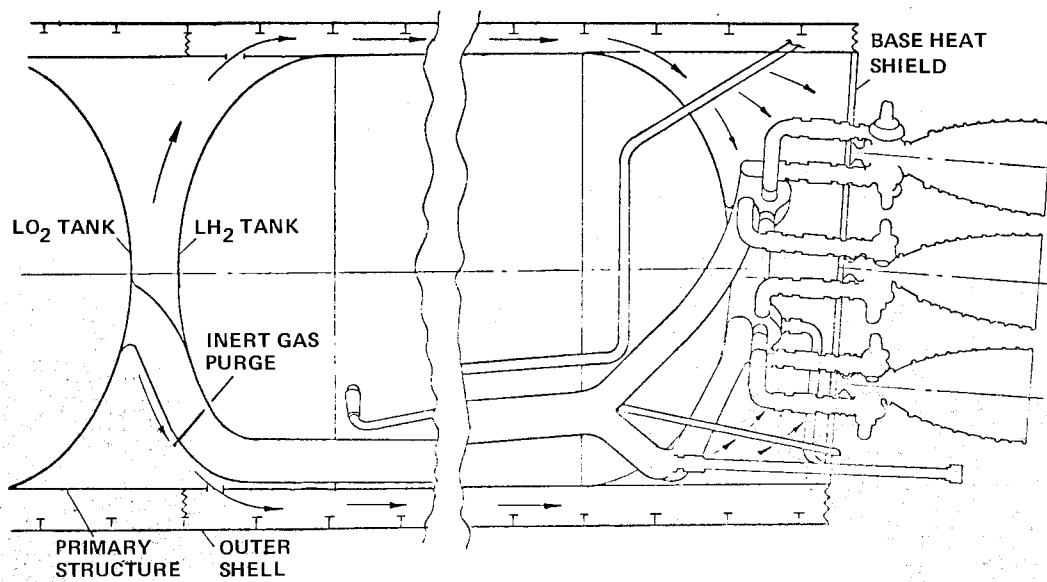

FIBER OPTICS

The use of fiber optics for remote sensing in inaccessible areas is currently under investigation at NAR. Potential applications include the detection of corrosion, cryopumping, and leakage in critical stress areas. Weight and cost factors are primary obstacles.

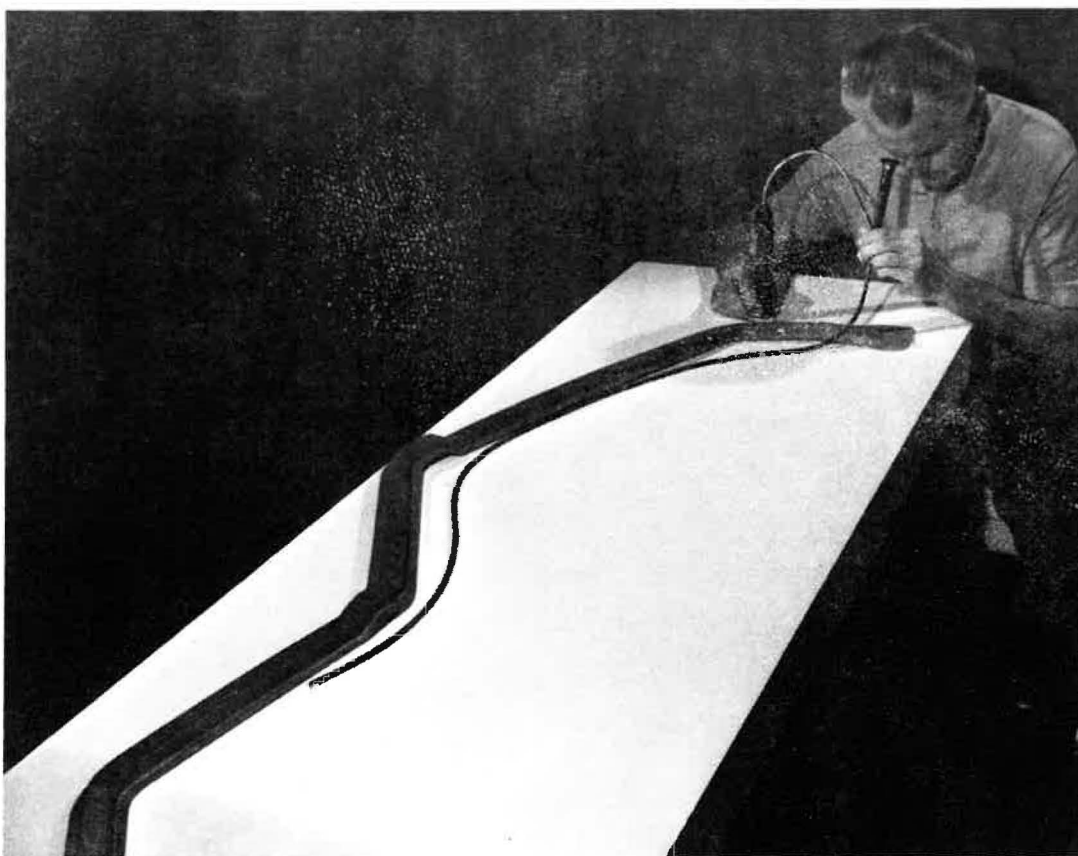

HOLOGRAPHY

The application of laser holography to assist manufacturing control is included in the NASA investigation of techniques to assess structural integrity currently in progress at NAR.

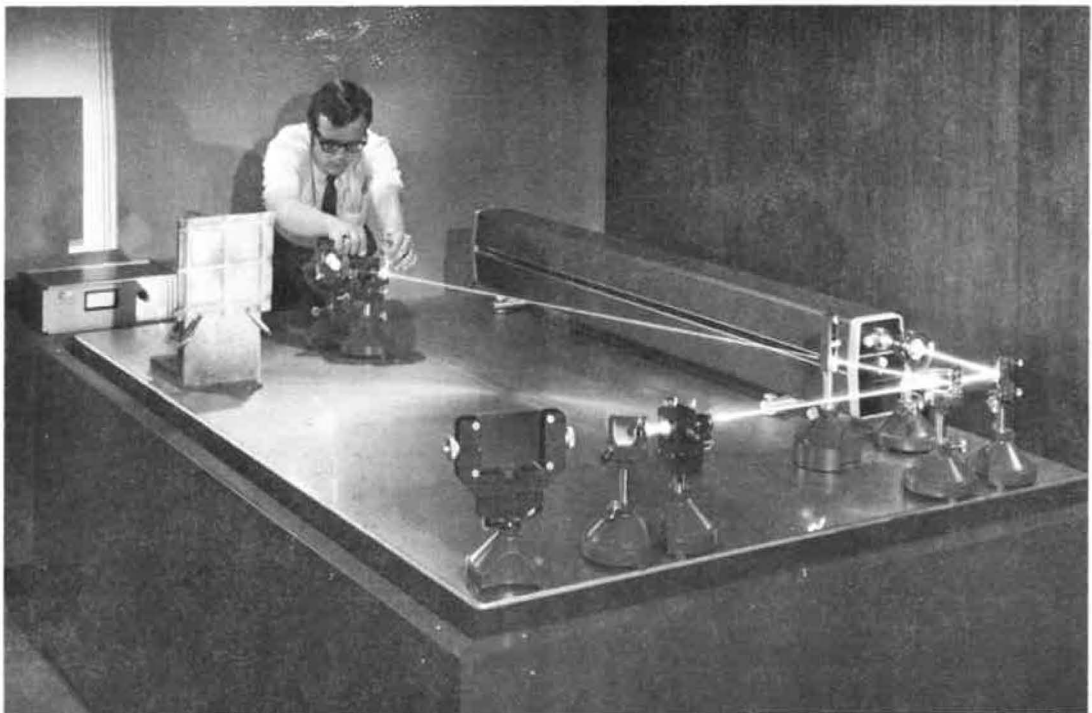

ACOUSTIC EMISSIONS FROM GRAPHITE-EPOXY FLEXURAL TEST SPECIMENS

Flexural tests on two similar fiberglass-epoxy specimens produced the load-emission results shown. Note on the lower pair of traces (specimen A3-3) that burst emissions associated with filament failures started at about 130 pounds of applied load. The upper pair of traces show fewer and lower amplitude emissions leading to fairly abrupt interlaminar shear failure. Eventhough the loads at failure were comparable in this particular example, being able to clearly predict the mode of failure is an important feature.

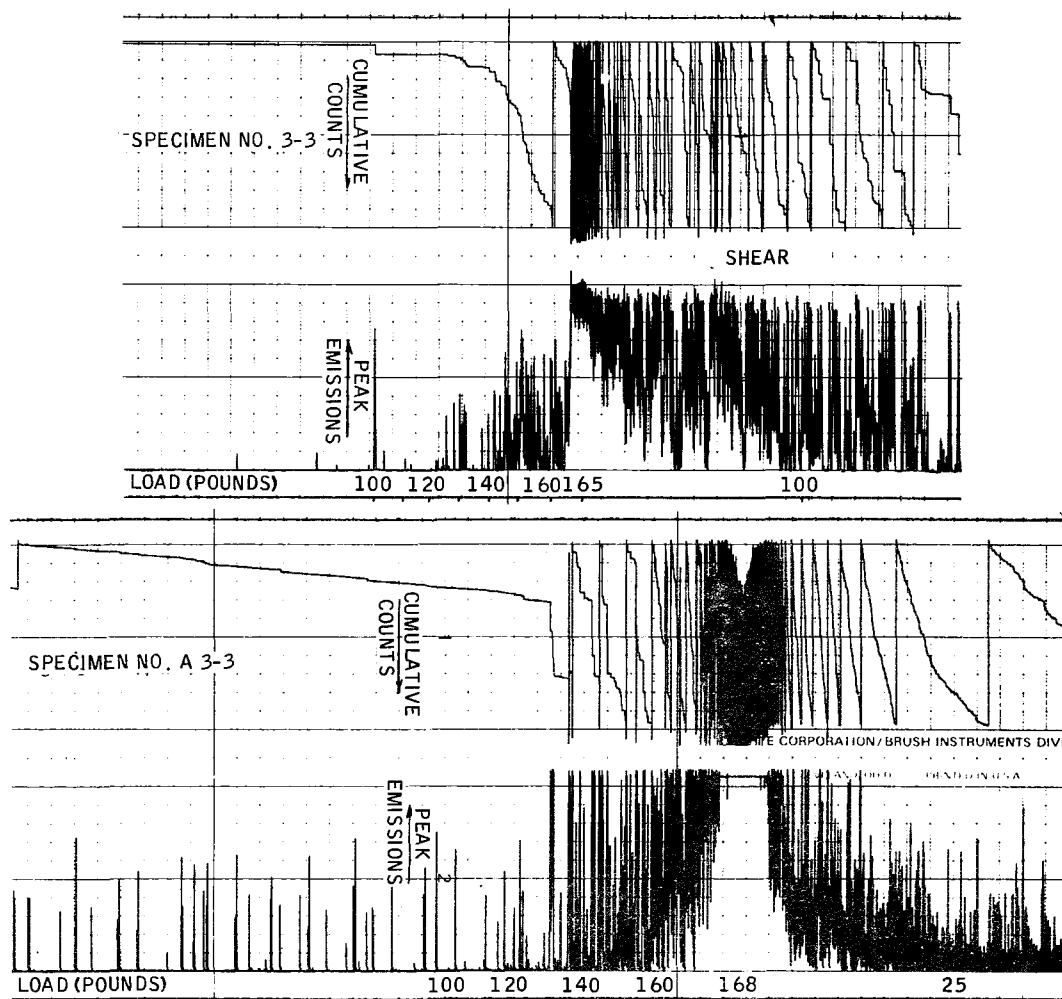

ULTRASONIC TRANSMISSION REFLECTION TECHNIQUE

A schematic showing position of transducer, test specimen, and reflector plate for ultrasonic bond inspection of diffusion bonded or brazed shield structure is shown.

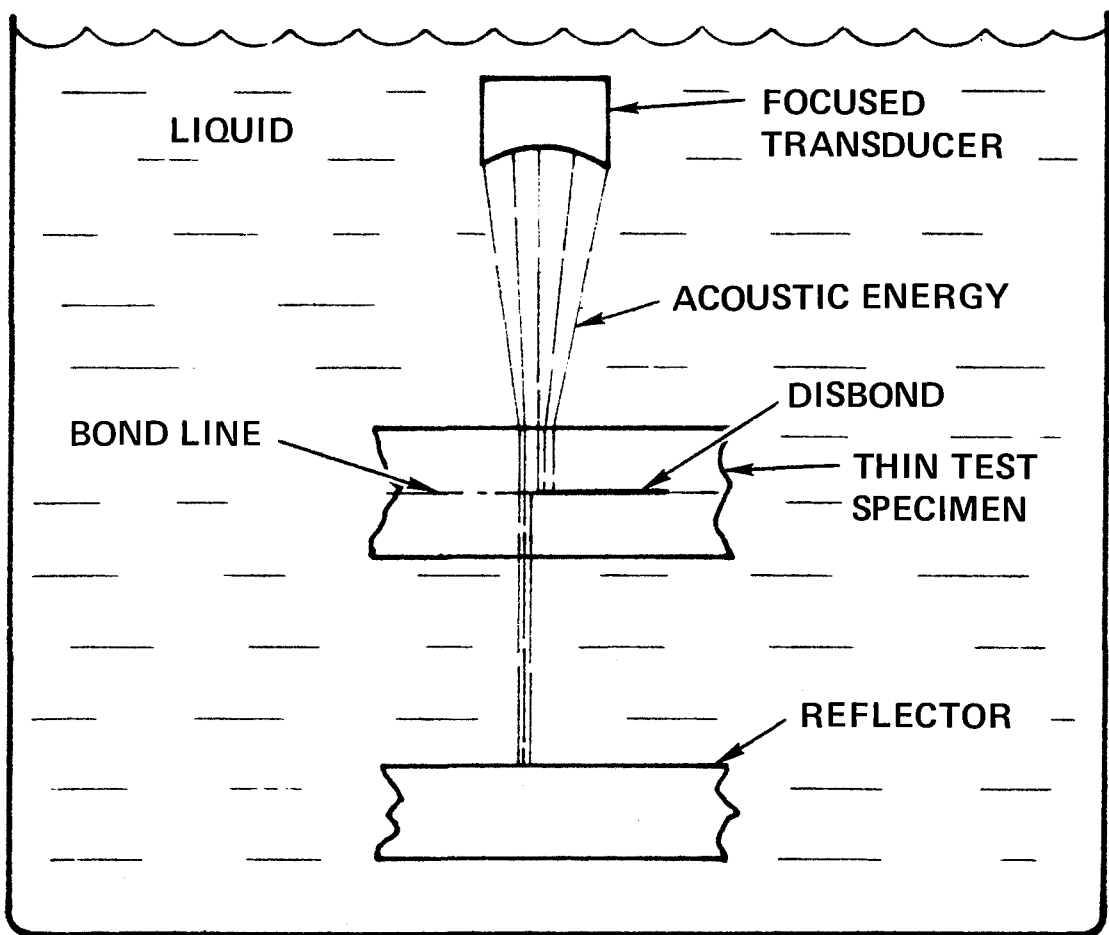

ULTRASONIC C-SCAN VS. RADIOGRAPH OF Td-Ni-Cr BRAZED HEAT SHIELD

A comparison between the radiograph showing lack of braze alloy and corresponding indications on the ultrasonic C-scan recording is evidence of the accuracy of the ultrasonic technique. Since radiography is sensitive to material change whereas ultrasonics is relatively unaffected by such change but sensitive to material interfaces, correlation between the two tests in this case should be expected. The large white strips in the center of the C-scan recording are attributable to specimen geometry.

A. ULTRASONIC C-SCAN



B. RADIOGRAPH



THERMOELECTRIC TEST SETUP

Setup showing reverse thermocouple principle used to detect coating variation.

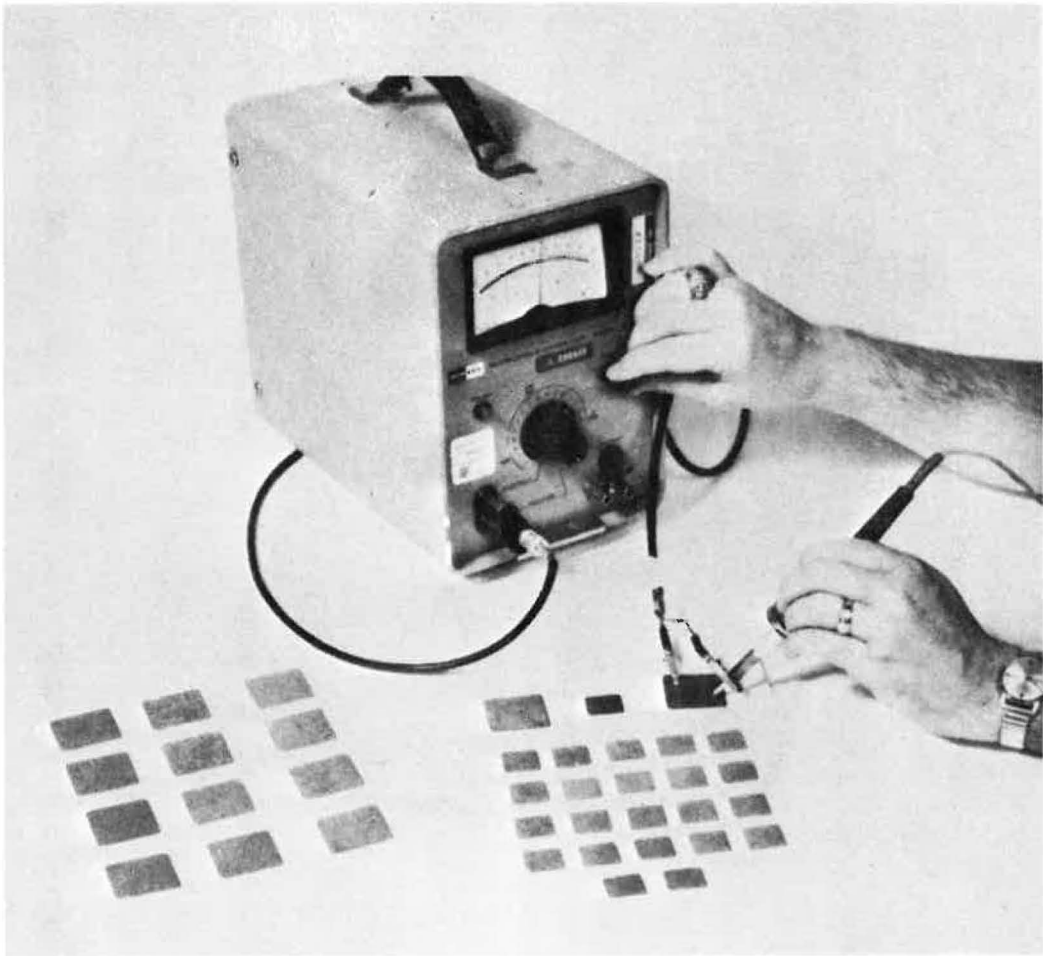

SHIELD STRUCTURE GRIDDED FOR THERMOELECTRIC TESTING

A major limitation of thermoelectric testing is the time required to adequately cover the surface of a large shield structure. A nonconductive oxide layer developed on the surface of the coating in service prevents its application during shuttle turnaround.

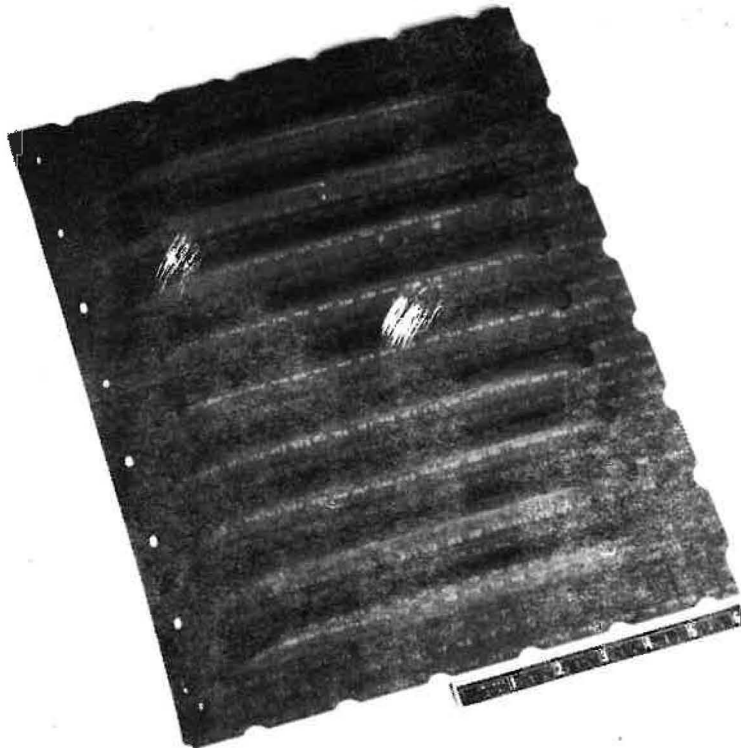

TECHNIQUE FOR ELECTRON-EMISSION RADIOGRAPHY

Either forward or backward emission techniques may be employed to examine the uniformity of silicide coatings on substrates such as tantalum and columbium. The technique is most effective to assist process control and to provide necessary direction for design and fabrication studies involved with coated TPS. Restrictions to maintenance personnel, inspection time, and geometry limitations make it less suitable for turnaround inspection.

TECHNIQUE FOR ELECTRON-EMISSION RADIOGRAPHY INSIDE COATING SURFACE

RADIOGRAPH SHOWING COATING DISTRIBUTION
ALONG INSIDE OF BEAD (TOP OF BEAD)

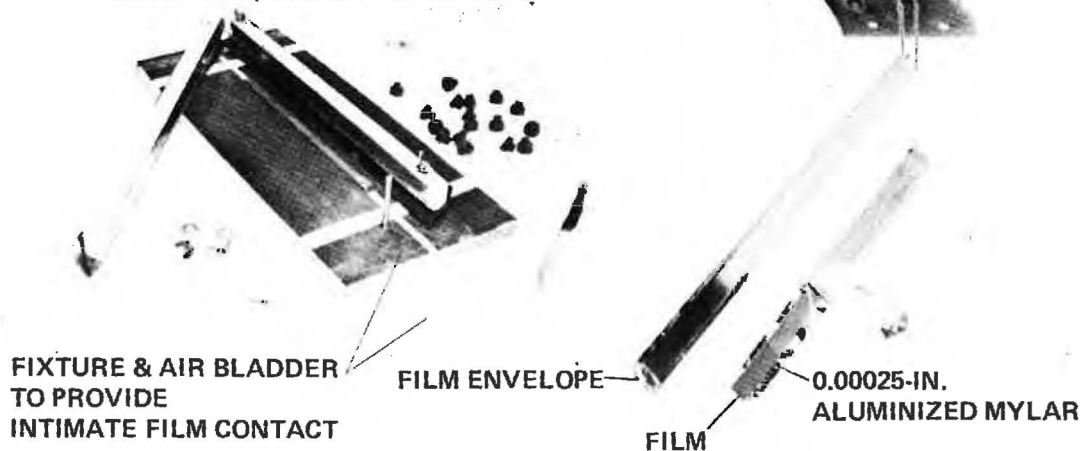
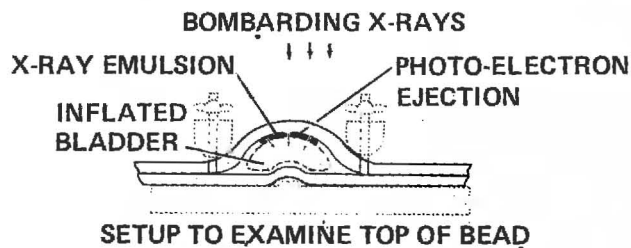

CORRELATION BETWEEN TEST RESULTS

While correlation between coating performance and the results of electron emission radiography has been observed, abrupt variation in coating chemistry frequency has no apparent effect on coating behavior. In general, however, our experience is that coatings containing significant variation fail more frequently than do coatings which contain less variation. In controlled simulated re-entry cycling of full-scale test articles (bead-stiffened panels), overall shield performance improved markedly with uniformity of the coating.

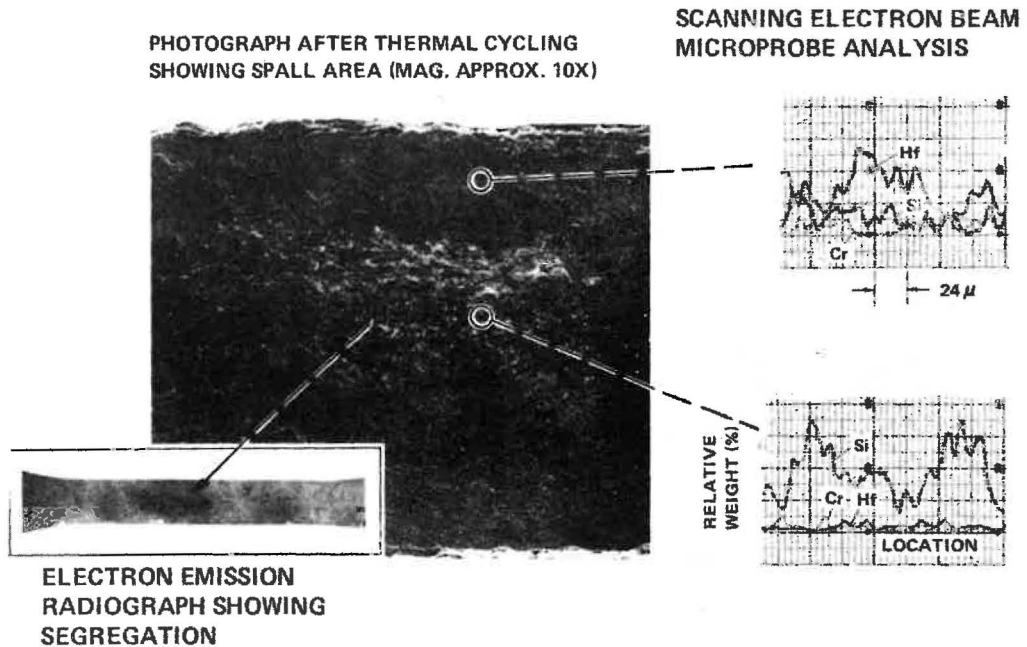

**ELECTRON EMISSION RADIOGRAPHS OF COATED COLUMBIUM
ALLOY HEAT SHIELDS**

The electron radiographs of two columbium heat shields (12 by 18 inches) are shown. The radiographs show marked improvement in coating uniformity between early and recent applications.

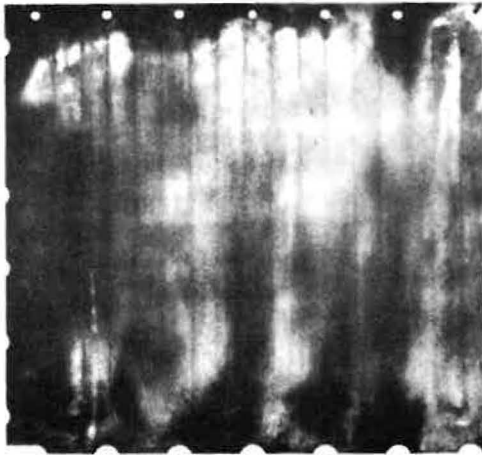

EARLY COATED HEAT SHIELD

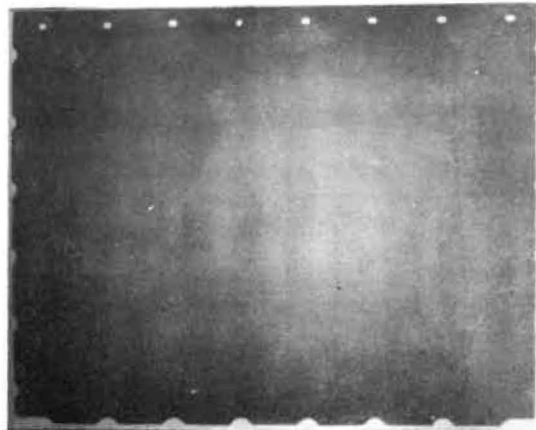

RECENTLY COATED HEAT SHIELD

AUTORADIOGRAPHS AND ELECTRON-EMISSION RADIOGRAPHS
SHOWING DISTRIBUTION OF RADIOACTIVITY AND MAJOR
ELEMENTS, RESPECTIVELY

The use of low energy beta emitting isotopes in high temperature coatings is currently under investigation at Convair. The technique offers the potential of in-situ NDT of metallic or nonmetallic coated TPS. The objective is to develop a practical inspection approach that can be economically applied during shuttle turnaround.

The autoradiographs (top of figure) were produced by contact with Kodak Type T x-ray film. It is interesting to note that apparent concentrations of radioactivity are identically mirrored in the electron radiographs of the same specimens, bottom of figure. The indications on both radiographs probably report segregation of a heavy element modifier in the coating, which behaves similarly to the isotope carrier, i. e., flowing and/or chemically combining in a like manner.

AUTORADIOGRAPHS

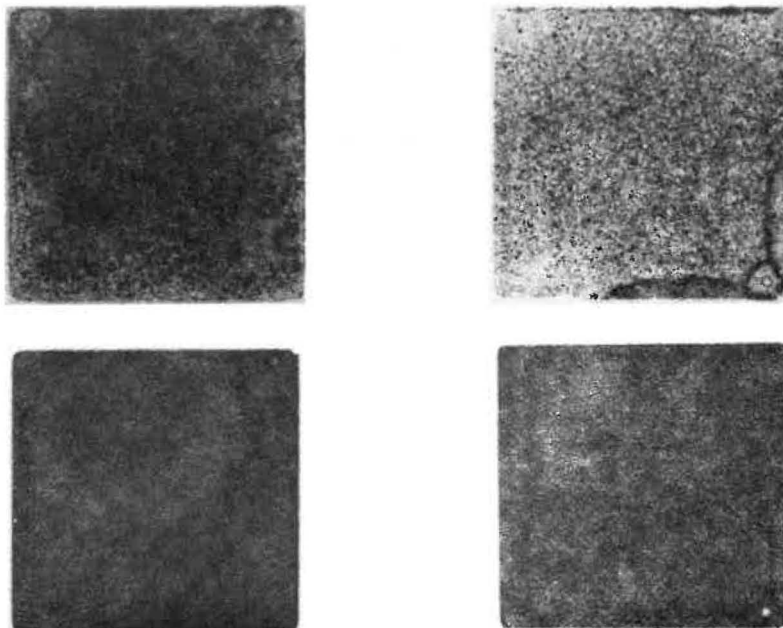

ELECTRON EMISSION RADIOGRAPHS

**AUTORADIOGRAPHS SHOWING REMAINING RADIOACTIVITY
FOLLOWING CONTROLLED ABRASION**

Autoradiography following controlled abrasion in eight equal steps (approximately 0.5 mils removed per step), shows the overall dispersion of the radioactive tag to remain essentially unchanged although the final abrasion removed essentially all radioactivity from portions of the surface. Even dispersion of the tag can be achieved with improved mixing procedures.

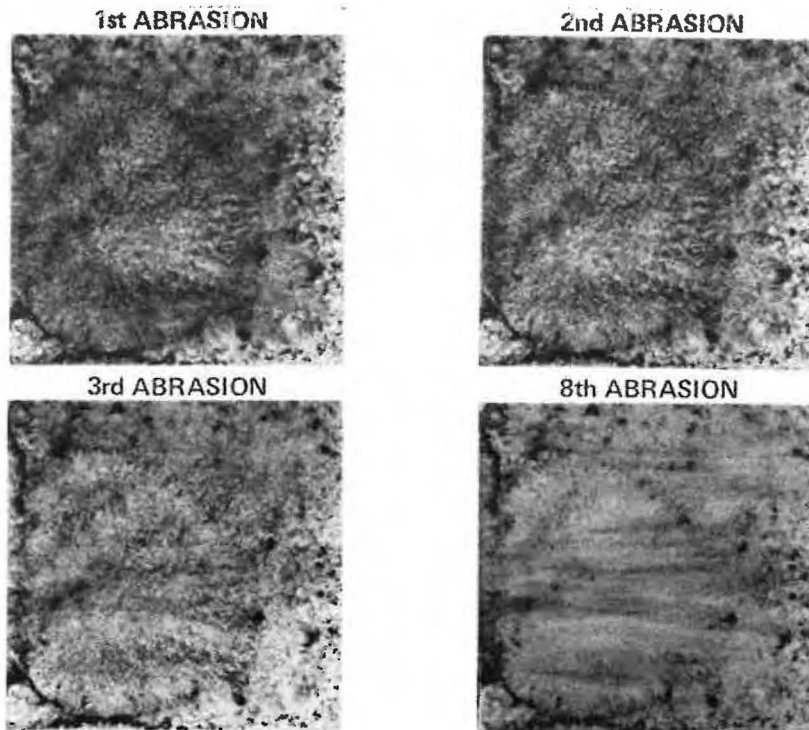

SILICIDE COATING, TAGGED WITH Pm-147

Figures 18 and 19 report changes in the initial count rate at the surface of a coating tagged with ^{147}Pm as a function of remaining coating weight and thickness. It can be noted that the level of radioactivity measured by a wide aperture (1.25-inch end window) G-M counter is a marked function of the fractional remainder of coating after abrasion.

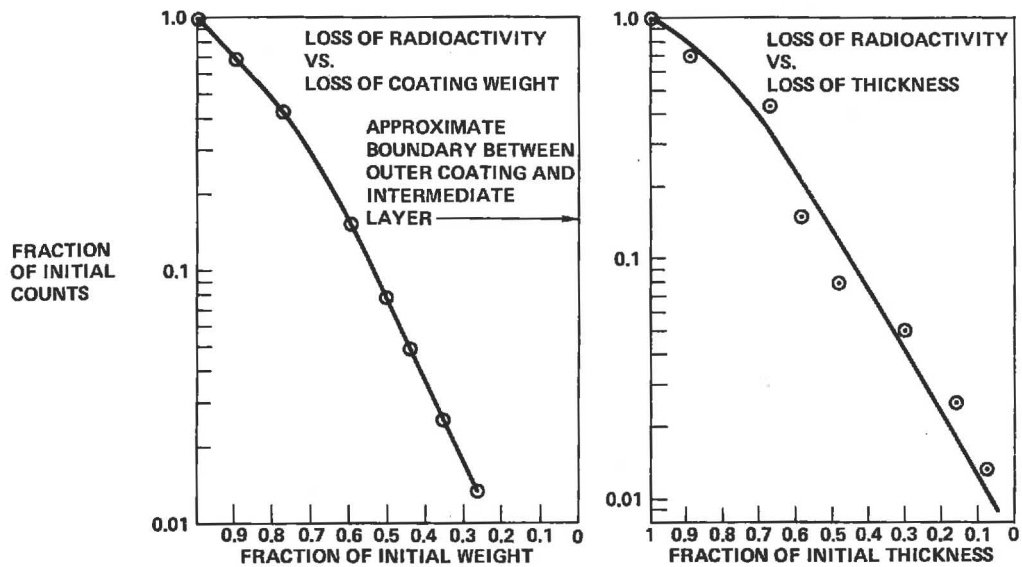

RADIATION COUNTER

This figure shows an artist's concept of a radiation counter to measure coating thickness during shuttle turnaround inspection.

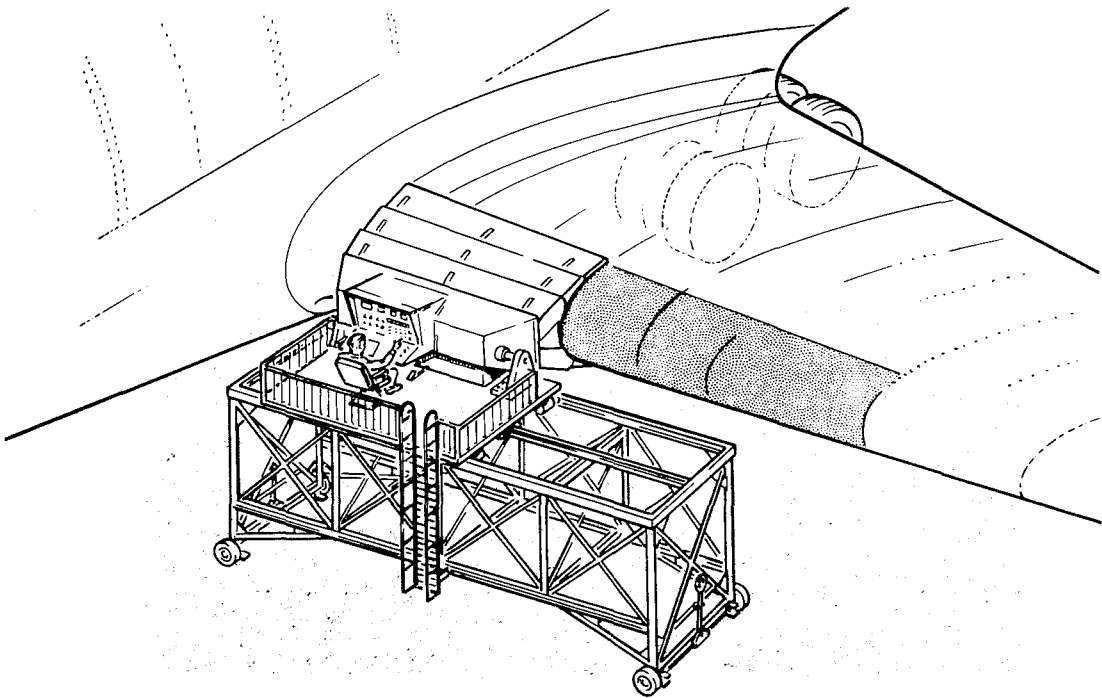

ACTUAL MOSSBAUER SIGNATURE OF VH101/Cb752 CONTAINING 57 Fe

Early investigation of Mossbauer Spectroscopy to measure coating service life was performed by Sanders, Inc. for Convair. Further study in this area will be determined by continued experience with coated metal refractories and specifically by the degree to which these systems can be characterized.

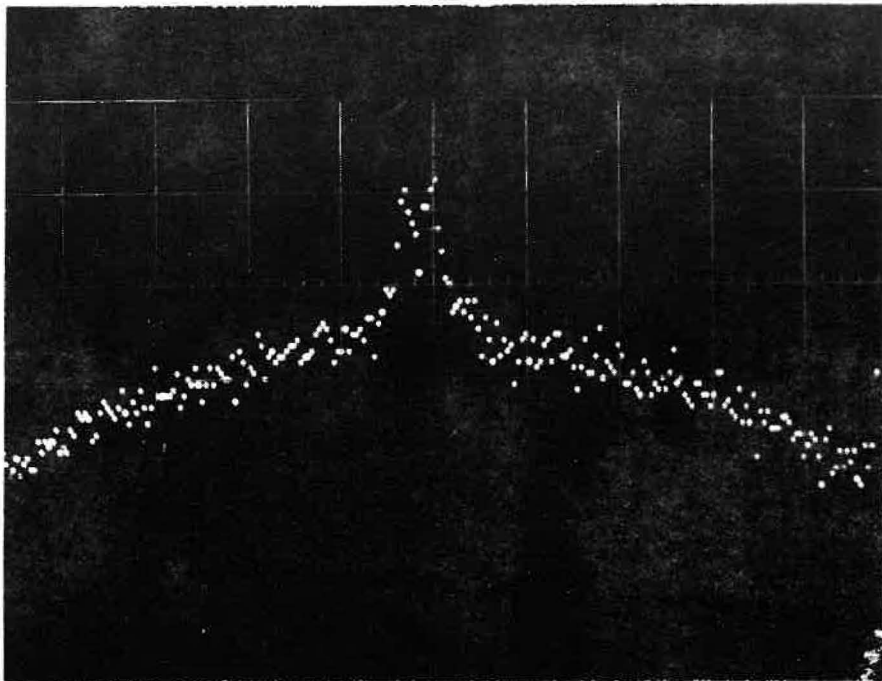

INSTRUMENT LANDING SYSTEMS FOR THE SPACE SHUTTLE

Herbert P. Raabe

IBM Corporation
Gathersburg, Maryland

Abstract

The terminal flight characteristics of the returning space shuttle are described and the requirements for an instrument landing system (ILS) derived. The presently available systems are reviewed and their deficiencies to serve the shuttle are pointed out. The effort of the special committee SC-117 of the Radio Technical Commission for Aeronautics (RTCA) is reported. This effort consists of defining future requirements for aircraft ILS's, screening proposed techniques for their potential in meeting these requirements and establishing a common waveform. The requirements for space shuttle and aircraft landing operations are compared. An ILS concept potentially capable of meeting shuttle and aircraft requirements is described.

Terminal Flight Characteristics and Requirements for a Shuttle ILS (Figure 1)

The terminal flight characteristics of the space shuttle have not been definitized yet. Since the shuttle may have to land safely in various configurations as dictated by emergency conditions, various terminal flight paths will have to be accommodated. From preliminary studies two configurations have been selected which place extreme demands on an instrument landing system:

1. Space Shuttle unpowered with wings.
2. Space Shuttle powered without wings.

These two configurations operate on glide angles of 20 degrees and 3 degrees, respectively. Both flight paths flare out into a final glide angle of 0.75 degrees to touchdown. The horizontal speed will be 300 ft/s with a corresponding sink rate of 4 ft/s. Except for the steep glide angle the approach of the shuttle is like that of a jet plane. The required range of the landing guidance system should be 20 nmi where the altitudes are 40,000 feet and 6,000 feet, respectively, for the two configurations.

Angular guidance and distance data must be available from a 20 nmi range all the way to roll out. The sampling rate of these data should be at least 5Hz at long ranges and at least 15Hz before the shuttle enters the flare-out maneuver until it reaches the end of the roll out. Various glide angles up to 20 degrees must be provided. Hence manual as well as automatic landing capability must be provided.

Fly-out guidance for a missed approach and repeated landing support must be provided.

The allowable error at touchdown shall be +15 feet lateral, +800 feet longitudinal on a runway of 150 ft. x 10,000 ft.

The Present FAA ILS and its Suitability to Serve the Space Shuttle and to meet future Requirements of Aircraft Operations (Figure 2)

The present ILS is shown schematically. It consists of a localizer, glide slope facility and distance measurement equipment. The localizer defines the vertical plane over the center of the runway by radiating two overlapping beams from the end of the runway. The carrier of both beams is the same ≈ 110 MHz but the two beams are modulated by different audio frequencies, 90 Hz and 150 Hz, respectively. Balance of the modulation intensity identifies the localizer plane.

The glide slope equipment operates on the same principle as the localizer. The radiating array is vertical and positioned off the forward end of the runway. Again two overlapping beams are formed. Radiation of the carrier of ≈ 330 MHz is restricted to the forward sector. The two beams are also modulated by 90 Hz and 150 Hz, respectively. The glide slope angle is ~ 3 degrees. The intersection of the glide slope cone with the localizer plane defines the single available approach path. However, guidance to touchdown is not provided so that landing requires pilot control and visibility of the runway on the final approach.

The distance measurement equipment (DME) requires the initial pulse transmission from the spacecraft to which the ground transponder responds. Thus range measurement requires a wide band signal.

The present ILS can serve the space shuttle only when approaching as configuration 2, with manual landing control with visibility assured before the flare-out maneuver starts. Even in this case the present ILS must perform nearly ideally.

The major deficiencies of the present ILS to serve the space shuttle and aircraft operations are:

1. Limitation to one approach path of low glide angle. The space shuttle requires guidance along a variety of glide angles up to 20 degrees. Many types of aircraft will require steeper glide paths and curved approaches in the horizontal plane.
2. The glide path does not terminate on the ground. Flare-out to touchdown and roll out maneuvers must be made manually and visibility of the runway is required.
3. The wide VHF beams of the localizer lead to RF scattering from buildings and terrain features resulting in errors of the flight path.
4. No guidance in elevation is provided by the present system for the fly-out in the case of a missed approach.

In January 1969 SC 117 published the "Tentative Operational Requirements for a New Guidance System for Approach and Landing" and invited submission of proposals to meet these requirements. In response to this invitation twenty-three specific proposals were received. From the SC 117 membership the Techniques Assessment Team (TAT) of experts was chosen which divided the proposals into three categories. The first category comprised seven microwave Scanning Beam Systems, the second category included Multilateration Systems, while the remainder of proposals based on various techniques was placed into the third category of Miscellaneous Systems.

Although no single proposal met all requirements, TAT decided in October 1969 that the scanning beam techniques held the greatest promise and that the signal structure should be based on the capabilities of these techniques. Therefore the proposers of the seven scanning beam techniques were invited to participate in the Signal Format Development Team and to establish final specifications for the signal structure.

So far the effort of SC 117 has been highly successful considering the complexity of the task. The working group of Signal Format Development Team will present their recommendations to SC 117 in August 1970. If these recommendations are supported by the full committee, then it is up to the Federal Aviation Administration (FAA), the military, foreign governments and other interests if they are willing to accept the recommendations of SC 117.

In the case of acceptance by these interests, verification hardware should be built and tested at selected locations. Thus a number of years will pass before the new system will begin to replace the existing installations. This may occur by 1980.

The Effort of Special Committee SC-117 of RTCA to Promote the Evolution of an Advanced ILS (Figure 3)

In 1967 the airlines agreed that it was about time to start work on the evolution of an advanced ILS to overcome the deficiencies of the present system. These deficiencies were not and still are not severe enough as to require a pursuit of this effort with great urgency. On the contrary, the system is still doing such a good service that more installations are recommended which will be quite useful for years to come. However, in anticipation of increased traffic density and a greater variety of aircraft with different flight characteristics and in order to overcome certain restrictions due to inclement weather, an advanced ILS was eventually needed, and an early coordinated effort was necessary to avoid wasteful proliferation of new techniques.

The task was not merely a technical one, economic and political consideration played a major part. The military had already adopted advanced systems, meeting very specific requirements and the future system should serve the military as well.

Furthermore, international acceptance was required to make the effort a success. Last but not least the cost should be low, especially for smaller aircraft, although they may not get the full service of the system.

To maximize the chance of success for the evolution of a new ILS, it was mandatory that a committee was organized in which all interests were represented. Thus, the Executive Committee of the Radio Technical Commission of Aeronautics (RTCA) established in 1967 the Special Committee 117 under the able leadership of S. Poritzky of the Air Transport Association (ATA).

The task of SC 117 was two-fold. First they had to establish specifications or requirements for the future ILS, second a standard signal structure had to be agreed upon so that any airborne equipment could communicate with any ground installation. Specifications of techniques and hardware were to be limited to the absolute minimum to allow full participation and competition between manufacturers. However, techniques and hardware considerations were initially important so that the final specifications and signal structure would be realistic and economical. Thus an Operational Working Group developed a Statement of Operational Requirements during 1968.

Principles of Angle and Distance Measurement Techniques (Figure 7)

To generate the two angular inputs for the guidance function on-board of an aircraft or the space shuttle a receiver records the time t_0 when the scanner illumination takes place. If the angular positions of the scanners with respect to time are known, azimuth and elevation angles can be derived. To avoid the requirement of a clock which is accurate in absolute time, a timing signal is transmitted from the ground. Two principles are illustrated, the time reference and the code reference technique.

To provide the time reference signal an omnidirectional transmitter generates a pulse at the periodicity of the scanner transmission. For example in the case of an azimuth scanner the omnidirectional pulse may be transmitted whenever the fan beam is parallel to the center line of the runway which happens at time t_0 . In the case of code reference, the timing information is modulated on the scanner signal.

To obtain distance information, an on-board transmitter generates a wideband signal, e.g. a short pulse. The pulse is received by a ground transponder which generates a pulse to be received by the on-board receiver. From the time delay the distance is derived.

Integrated Precision Angle and Distance Measurement Technique (Figure 8)

The precision of time measurement when the peak illumination of the scan beam function occurs is inadequate. A split beam technique offers much greater precision. To generate this beam system, a phased array with two RF inputs may be used. Perfect symmetry of the split beam system is assured if the same frequency is applied to these inputs. To enable the receiver of the scanner signal to keep the two beam signals apart, pulse transmission and time multiplexing is suggested.

The receiver demultiplexes the received pulse series and derives the beam envelope-time function of the two beams in two low-pass filters. A subtractor generates the difference function of the two beam envelopes. This function shows a zero crossing which triggers a pulse. The timing of this pulse indicates the time t_0 when the fan beam plane scans the on-board receiver, except for a fixed time delay due to the low-pass filters.

The precision of the zero crossing time is also assured by the fact that no electronic components are used in the separate paths between the demultiplexer and the subtractor.

To automatically generate distance measurement signals at the rate of the angular signals, the on-board pulse transmission is triggered by the pulse at time t_0 which propagates to the ground and releases a pulse in the ground transponder. This pulse is received by the on-board receiver at time t_D .

The ILS V-Beam Concept by IBM (Figures 9, 10)

An ILS concept which shows promise of meeting all requirements for the service of the space shuttle as well as the great variety of aircraft is based on the V-Beam scanning technique. The scanner which rotates continuously in azimuth generates a left beam system B_l and a right beam system B_r . Each beam system consists of split beam pair, a leading and a tracking beam, B_{ll} with B_{lf} and B_{rl} with B_{rf} , respectively. These beam systems define precise beam planes I_l and I_r which are inclined 45 degrees to form a "V". As the scanner rotates, two scanner pulses f_l and f_r are triggered in the airborne receiver during each revolution. The receiver also receives a pulse 0 from the omnidirectional transmitter 0 every time when the scanning beam plane intersection is parallel to the runway center. From the timing of the three pulses the azimuth angle α and the elevation angle ϵ can be derived. While aircraft A is still waiting outside of the main approach path of the runway, shuttle S is descending over the runway center line. Thus the fan beam pulses are symmetrically disposed to either side of the omnidirectional pulse. The distance measurement may be triggered by the leading fan beam signal and is not shown. The scanner may be located beyond the runway on the center line or off the side of the runway. Its location determines the variation of α and ϵ with distance D for a given approach pattern. The space shuttle computer will derive these angles.

The range and angular accuracy requirements necessitate the use of two frequencies: C-band offers adequate penetration of dense rain over a distance of at least 20 nmi, K_u-band enables the construction of narrow-beam antennas of reasonable dimensions. Furthermore, the sampling rate of guidance information should be at least 15 Hz during the final phase of the landing while a sampling rate of 5 Hz is adequate for the long range guidance.

These requirements are met by a spinning antenna system consisting of a pair of coarse-beam arrays on one face of a cube and 4 pairs of fine-beam arrays covering 4 faces of a cube. Each array has two RF inputs to generate a split-beam fan pattern as previously described. While the coarse-beam arrays are energized over the full azimuth of 300 degrees, the fine-beam arrays are energized only over the quadrant pointing in the direction of the approaching space shuttle. The signal structure due to the two systems is the same, except that the repetition rate of the fine-beam system is 4 times that of the coarse-beam system and the precision of the former is 2.5 times greater. Thus the computation of the guidance data does not require any change in the computer.

By switching the receiver from the coarse-beam to the fine-beam scanner, the distance measurements also repeat at the higher rate.

FIG. 1.

TERMINAL FLIGHT CHARACTERISTICS OF THE SPACE SHUTTLE

CONFIGURATION 1: SPACE SHUTTLE UNPOWERED WITH WINGS.

CONFIGURATION 2: SPACE SHUTTLE POWERED WITHOUT WINGS.

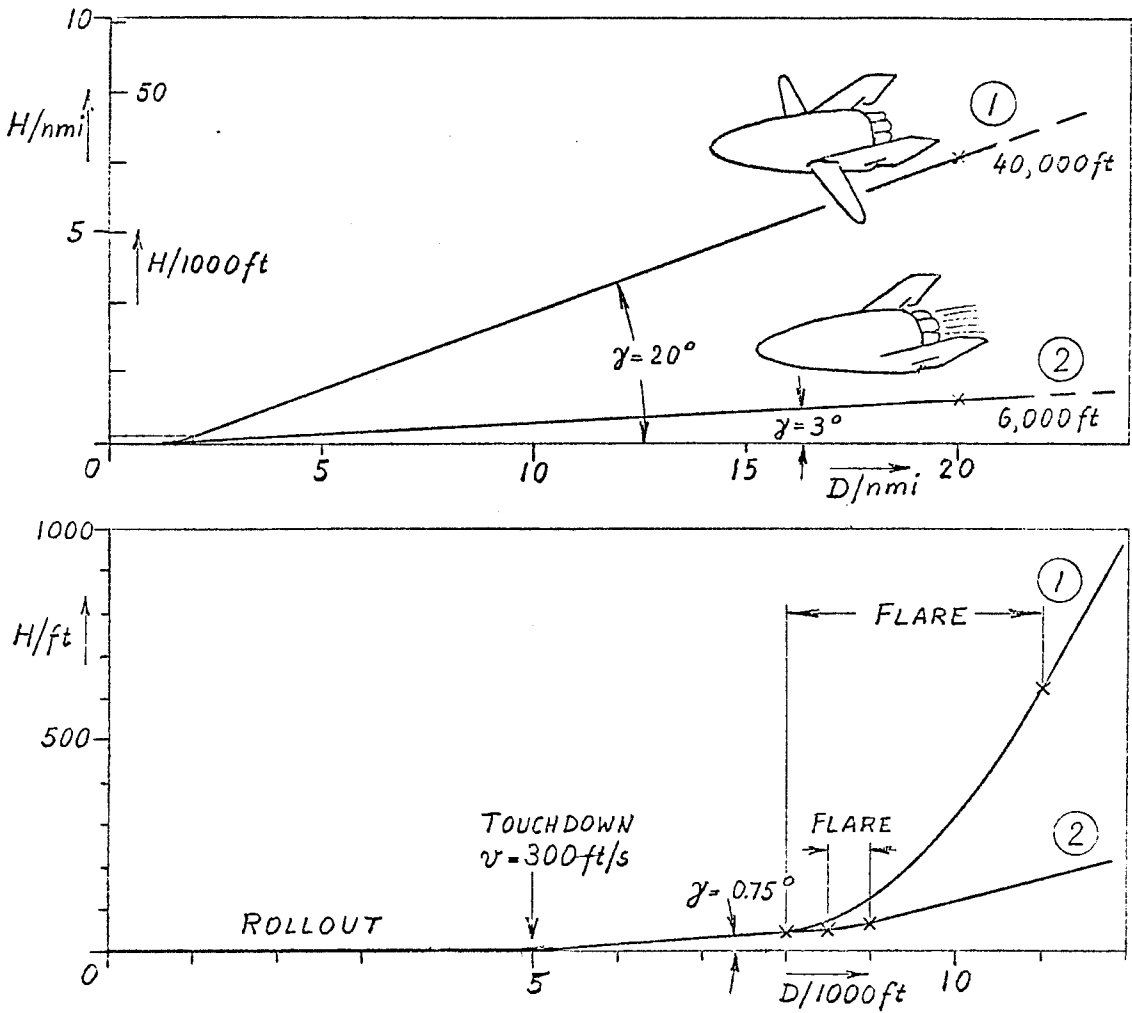

FIG. 2

THE PRESENT FAA ILS AZIMUTH AND ELEVATION GUIDANCE

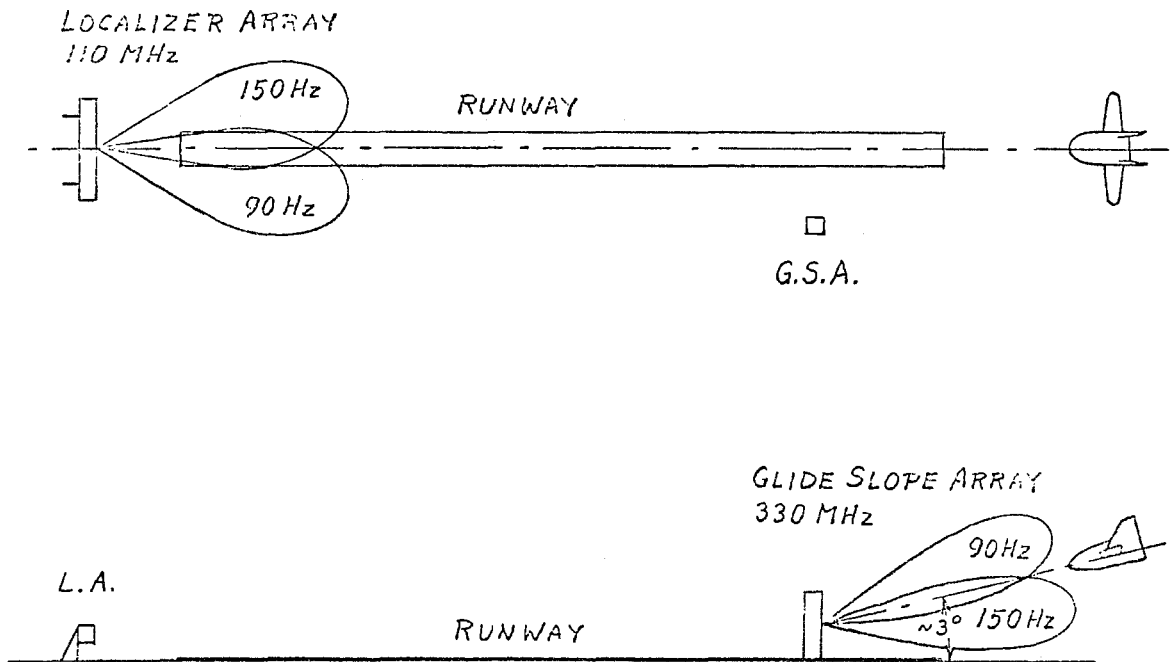

FIG.3

THE EFFORTS OF SPECIAL COMMITTEE SC 117
OF RTCA TO PROMOTE THE EVOLUTION OF
AN ADVANCED ILS

- (1) IN ANTICIPATION OF THE NEED OF AN ADVANCED ILS, THE SC 117 WAS ESTABLISHED BY THE EXECUTIVE COMMITTEE OF THE RADIO TECHNICAL COMMISSION OF AERONAUTICS IN 1967.
- (2) AN OPERATIONAL WORKING GROUP DEVELOPED A STATEMENT OF OPERATIONAL REQUIREMENTS DURING 1968.
- (3) TENTATIVE OPERATIONAL REQUIREMENTS FOR A NEW GUIDANCE SYSTEM FOR APPROACH AND LANDING PUBLISHED JANUARY 1969.
- (4) CALL FOR PROPOSALS OF NEW GUIDANCE SYSTEM FOR APPROACH AND LANDING ISSUED FEBRUARY 1969.
- (5) EVALUATION OF PROPOSALS BY THE TECHNIQUES ASSESSMENT TEAM DURING APRIL THROUGH SEPTEMBER 1969.
- (6) RECOMMENDATIONS MADE BY THE TECHNIQUES ASSESSMENT TEAM AND ESTABLISHMENT OF THE SIGNAL FORMAT DEVELOPMENT TEAM OCTOBER 1969.
- (7) RECOMMENDATION OF A SIGNAL FORMAT BY THE SIGNAL FORMAT DEVELOPMENT TEAM TO SC 117 AUGUST 1970.

FIG. 4

GUIDANCE BY MULTILATERATION

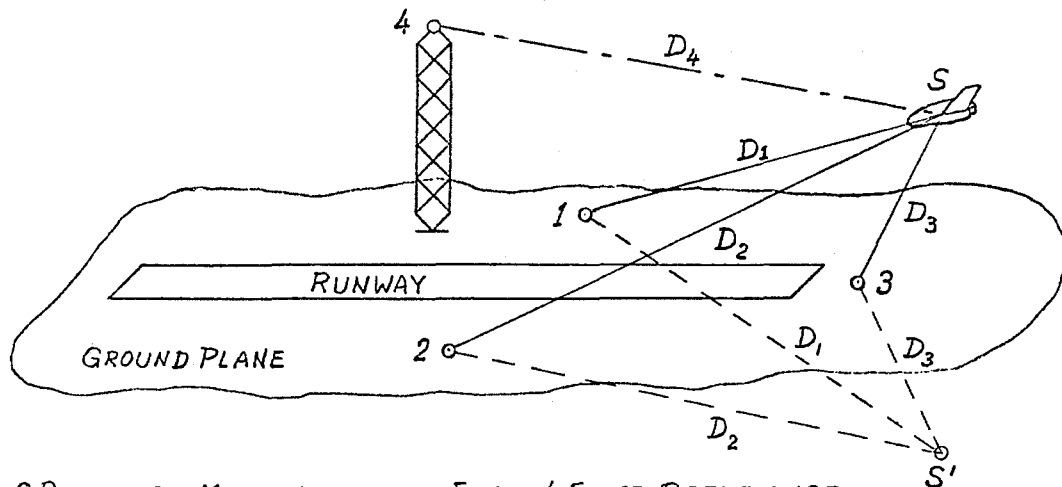

- DISTANCE MEASUREMENTS FROM 4 FIXED REFERENCE POINTS REQUIRED TO DEFINE LOCATION IN SPACE.
- 3 REFERENCE POINTS DEFINE PAIR OF LOCATIONS IN SYMMETRIC POSITIONS WITH RESPECT TO PLANE OF REFERENCE POINTS.
- AMBIGUITY RESOLVED WHEN REFERENCE POINTS ON GROUND PLANE, BUT LOW ELEVATION ANGLES ARE POORLY DEFINED.
- LOW ELEVATION ANGLES REQUIRE 4TH ELEVATED REFERENCE POINT.
- RADIATION OMNIDIRECTIONAL, WIDE BANDWIDTH (MICROWAVE), HIGH POWER.

ADVANTAGES:

- SMALL ANTENNAS.
- REJECTION OF MULTIPATH PROPAGATION
- SMALL RADIAL POSITION ERROR

DISADVANTAGES:

- 4 DISPERSED RADIATORS (ONE ELEVATED)
- HIGH POWER
- WIDE BANDWIDTH
- TANGENTIAL POSITION ERROR INCREASES WITH DISTANCE
- COMPLEXITY OF COMPUTATION

FIG.5

GUIDANCE BY TRIANGULATION

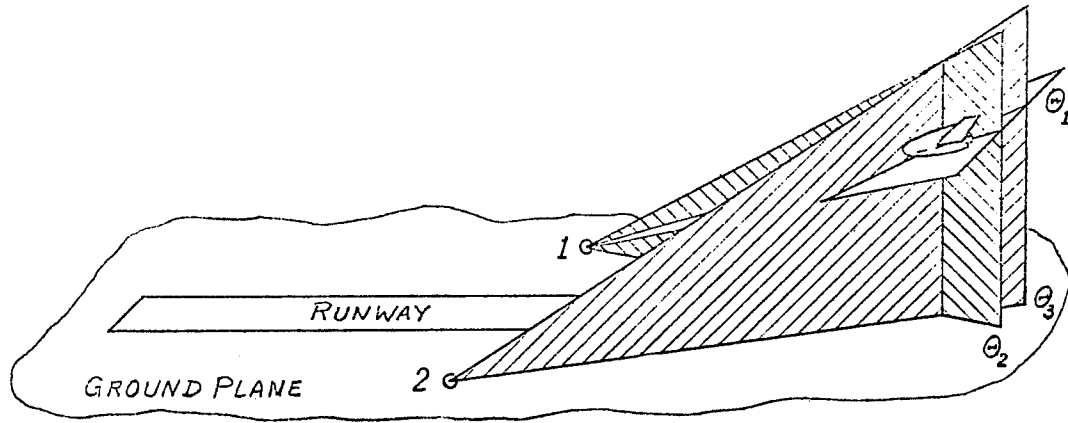

- ANGLE MEASUREMENTS FROM AT LEAST 2 GROUND BASED REFERENCE POINTS REQUIRED (E.G. ONE ELEVATION ANGLE θ_1 , AND TWO AZIMUTH ANGLES θ_2 AND θ_3).
- PLANAR OR CONICAL FAN BEAMS.
- SCANNING REQUIRED TO COVER SPACE.
- RADIATION DIRECTION (MICROWAVE), NARROW BANDWIDTH (CW), LOW POWER.

ADVANTAGES:

- RADIATORS ON GROUND PLANE
- NARROW BANDWIDTH
- LOW POWER

DISADVANTAGES:

- TWO DISPERSED RADIATORS
- SCANNING WIDE-APERTURE ANTENNAS
- MULTIPATH CAN BE A PROBLEM
- RADIAL AND TANGENTIAL POSITION ERRORS INCREASE WITH DISTANCE

FIG.6

GUIDANCE BY COMBINATION OF TECHNIQUES

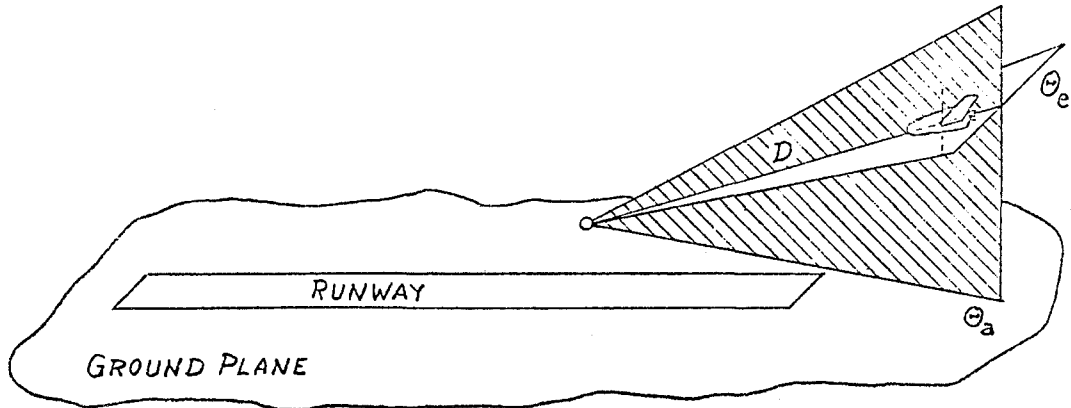

COMBINATION OF ANGLE AND DISTANCE MEASUREMENTS
RESULT IN SUPERIOR SYSTEMS.

EXAMPLE:

TWO SCANNING FAN BEAMS SERVE TO DETERMINE
AZIMUTH AND ELEVATION ANGLES, WHILE
DISTANCE IS DERIVED FROM THE TWO-WAY
PROPAGATION TIME OF A WIDE-BAND WAVEFORM.

ADVANTAGES:

- ALL RADIATORS IN ONE LOCATION ON GROUND PLANE
- SMALL RADIAL POSITION ERROR INDEPENDENT OF DISTANCE
- SIMPLICITY OF COMPUTATION

DISADVANTAGES:

- SCANNING WIDE APERTURE ANTENNAS
- WIDE BANDWIDTH
- TANGENTIAL POSITION ERROR INCREASES WITH DISTANCE

FIG. 7

PRINCIPLES OF ANGLE AND DISTANCE
MEASUREMENT TECHNIQUES

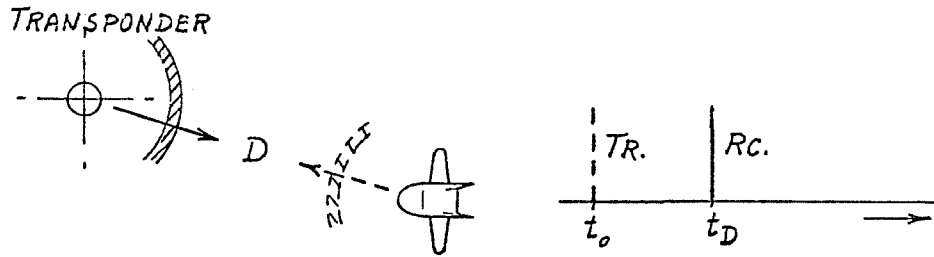
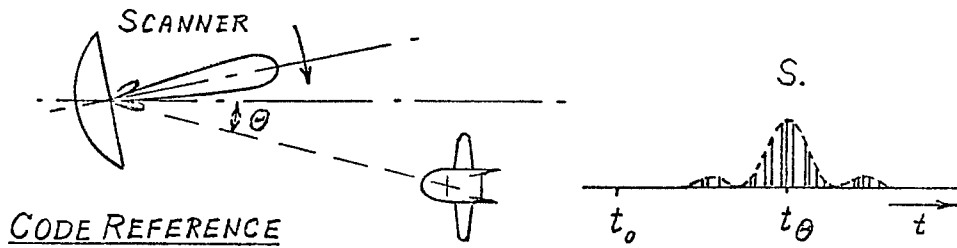
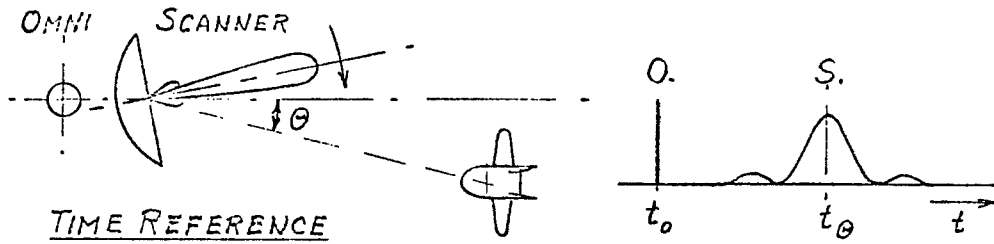
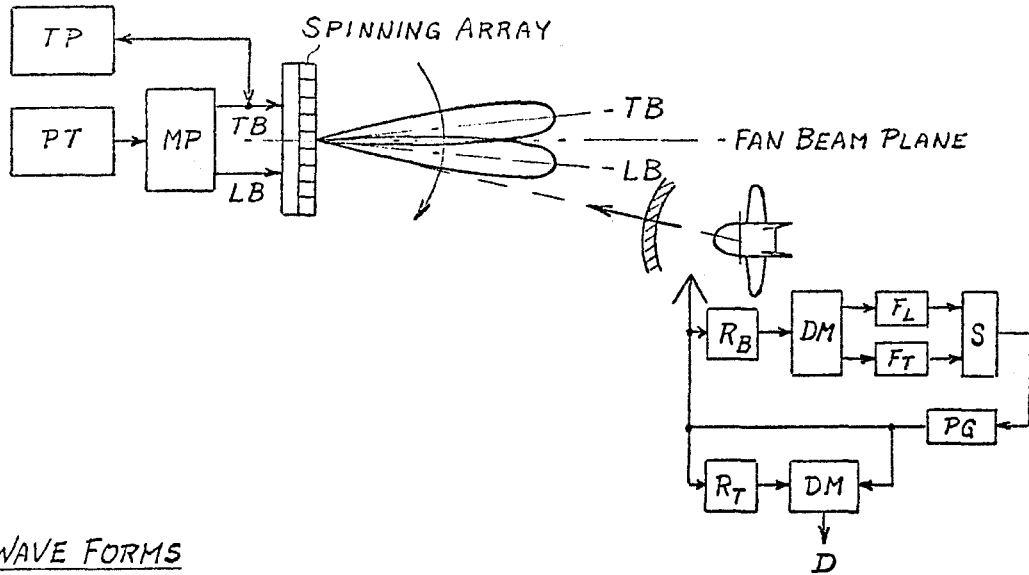

FIG. 2

INTEGRATED PRECISION ANGLE AND DISTANCE MEASUREMENT TECHNIQUE



WAVE FORMS

PULSE TRANSMITTER PT

MULTIPLEXER {
LEADING BEAM
TRAILING BEAM

RECEIVER R_B

SUBTRACTOR S

PULSE GENERATOR PG AND
RECEIVER R_T

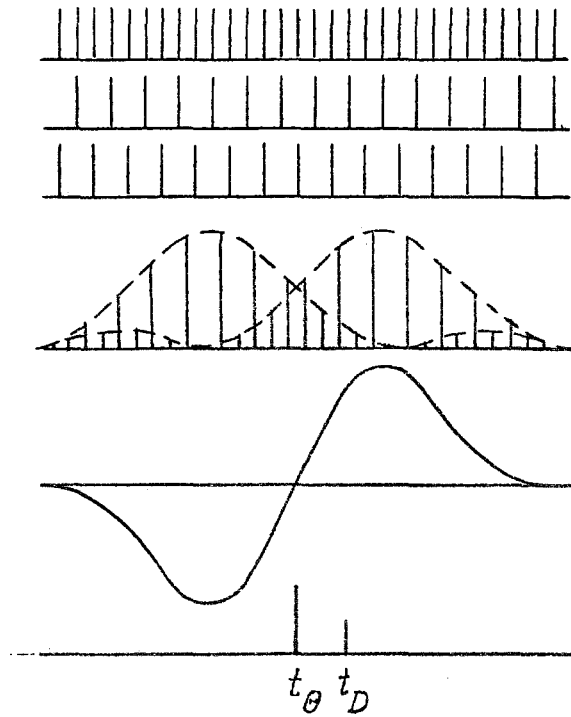
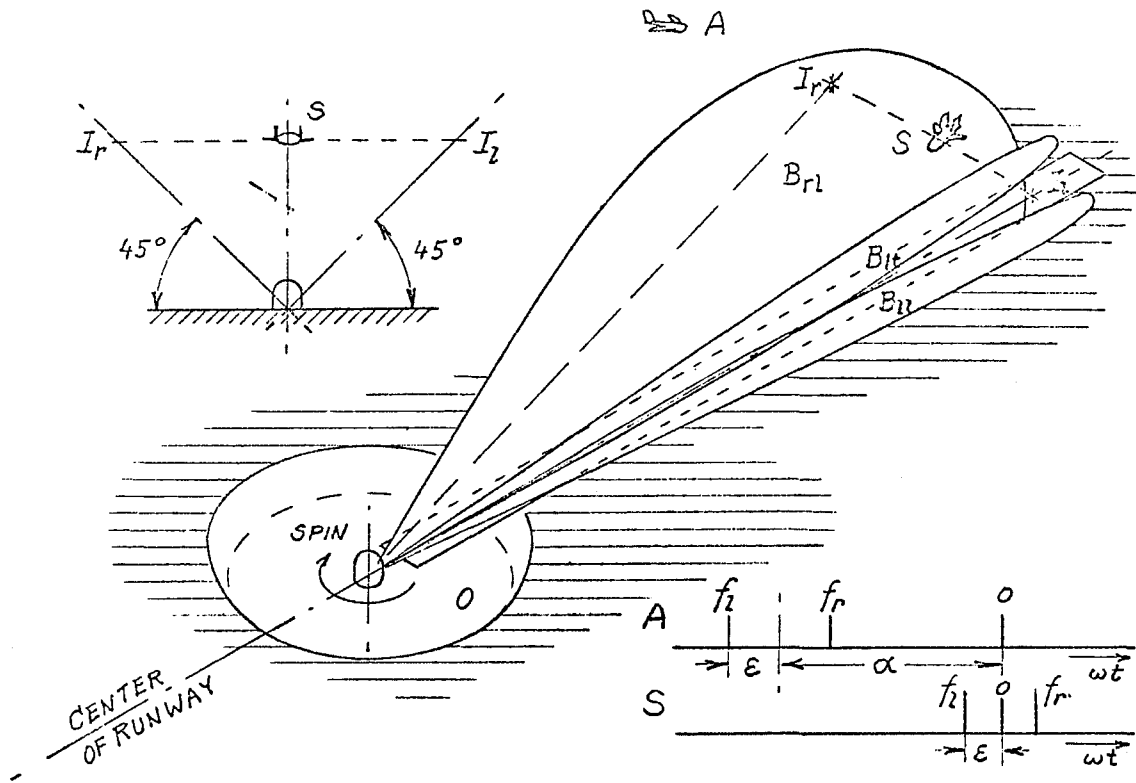
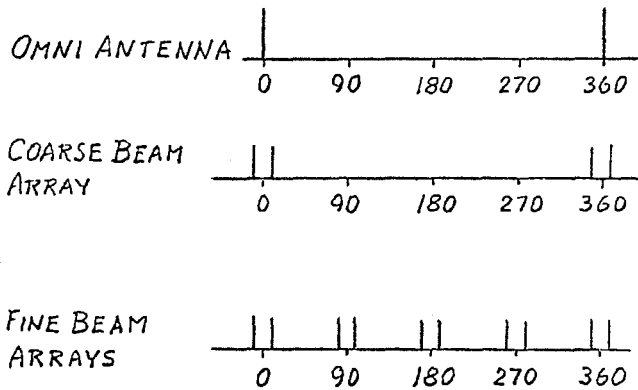
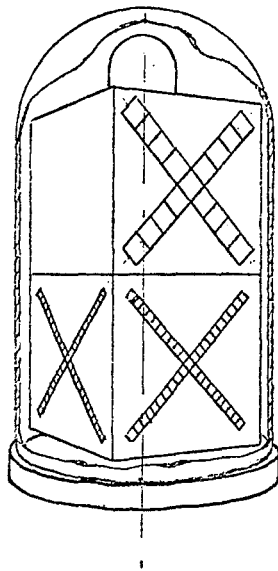
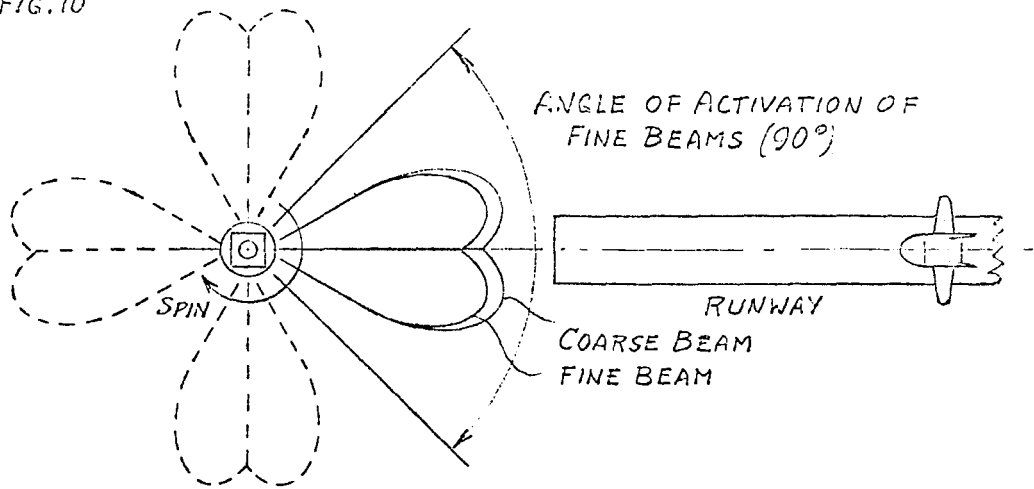

FIG. 9



THE ILS V-BEAM CONCEPT BY IBM

FIG. 10



	COARSE BEAM	FINE BEAM
RADIO FREQUENCY	5 GHz	15 GHz
PULSE REPETITION RATE	12,800/2 Hz	32,000/2 Hz
POLARIZATION	VERTICAL	VERTICAL
BEAM WIDTH, SLANTED	3.54°	1.414°
BEAM WIDTH, HORIZONTAL	5°	2°
PULSES PER BEAM WIDTH	18	18
ARRAY LENGTH	46 in.	39 in.
SIGNAL DWELL TIME	2.78 ms	1.11 ms

INTACT ABORT TECHNOLOGY REQUIREMENTS

T. Barnes

Grumman Aerospace Corporation
Bethpage, New York

This material is based on studies of two-stage, fully recoverable, earth orbital shuttle systems. The studies indicate that the requirements for safe, intact abort capability in both the booster and the orbiter could have significant effects on the design of these vehicles. The purposes of this paper are to briefly identify these potential effects, to present some preliminary study results, and to recommend areas to be emphasized in future studies. The major study areas that have been considered thus far include:

- Minimum safe abort altitude
- Propellant depletion
- Orbiter ability to fly back
- Orbiter ability to abort-to-orbit

MAJOR ABORT STUDY AREAS

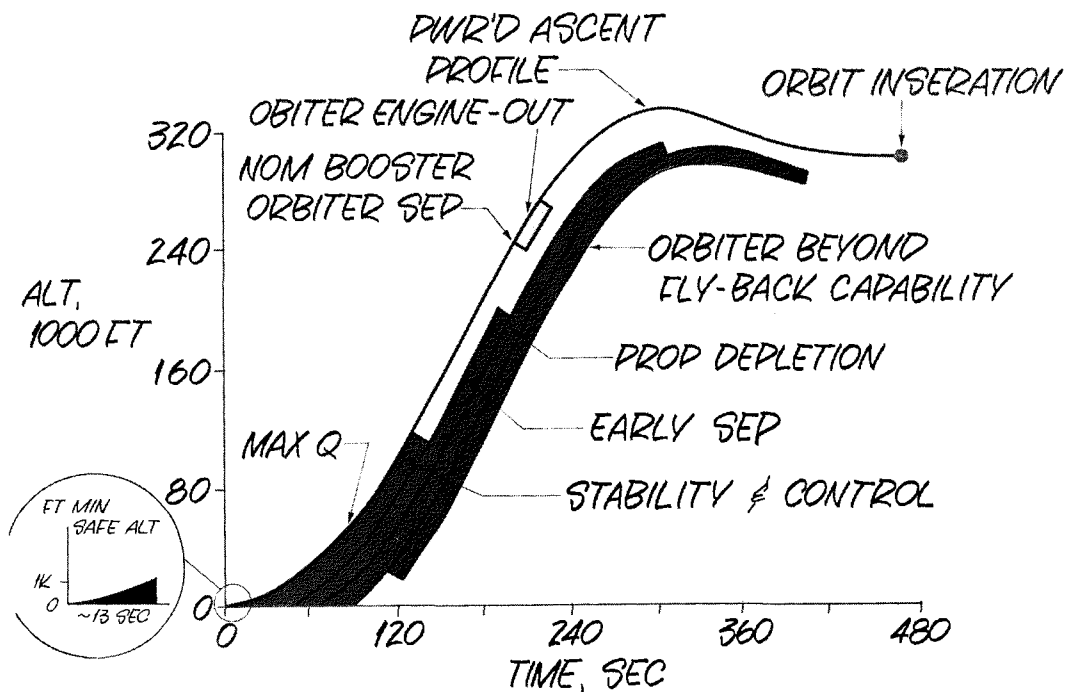

A complete study of abort effects on design should include the indicated potential requirements by mission phase. Means should be provided for rapid crew and passenger evacuation from cabin closeout to liftoff, and may require elevators, chutes, or slide wires. Because the orbiter engines will not be ignited at liftoff, there will be an unsafe separation period following liftoff that will depend upon the time to start those engines and separate. Based on a startup time of about 5 seconds, this period is estimated to be about 13 seconds following liftoff.

The requirements to be able to continue the mission (in addition to abort) with a single booster engine out must be weighed, although this does not appear to be a significant requirement for new boosters, which have a large number (9 to 11) of engines with emergency overthrust capability. It must be possible to adequately gimbal the orbiter engines for attitude control with the skirts retracted. The definition of attitude control requirements during separation in the atmosphere will require six-degree-of-freedom simulations that use the results of wind tunnel tests of mated and separated models. Following early separation, guidance steering techniques must be developed which provide transitions to various flight regimes within angular and angular rate limits. As discussed later, methods for providing propellant dump capability will probably be required, particularly in the orbiter.

ABORT STUDY REQUIREMENTS

PRELAUNCH

- **RAPID CREW EVAC IN EVENT OF HAZARDOUS CONDITIONS**

LIFTOFF THROUGH MINIMUM SAFE ALTITUDE

- **ORBITER ENGINE STARTUP & SEPARATION**

FROM UNSAFE SEP REGIMES TO NOMINAL SEP

- **ABILITY TO CONTINUE MISSION WITH ONE BOOSTER ENGINE OUT**
- **BOOSTER/ORBITER SEPARATION SEQUENCE**
- **ATTITUDE CONTROL DURING SEPARATION SEQUENCE**
- **STARTUP OF ORBITER ENGINES IN ATMOSPHERE**
- **GUIDANCE STEERING TECHNIQUES FOLLOWING SEPARATION**

Following early separation, it must also be possible to safely return the booster and the orbiter within temperature and limits. Return to the launch site would obviously be most desirable, and this should be possible with boosters which nominally do so. It may also be possible with orbiters which have air-breathing engines, as discussed later. The availability and desirability of ground assistance in the form of backup navigation (i. e., state vector updates, targeting, weather information) and other ground aids must be considered.

Orbiter aborts near nominal separation should probably be to a minimum safe orbit (50 x 100 n miles), if possible. Time-critical returns by means other than abort-to-orbit probably will not result in returns substantially earlier, and could require landing at long downrange distances. A redundant propulsive capability should be required to deorbit.

ABORT STUDY REQUIREMENTS (CONT)

FROM UNSAFE SEP REGIMES TO NOMINAL SEP (CONT)

- METHODS FOR PROVIDING PROPELLANT DUMP CAPABILITY*
- ORBITER & BOOSTER RETURN WITHIN TEMPERATURE & "G" LIMITS*
- AVAILABILITY & DESIRABILITY OF GRD ASSISTANCE*

NOMINAL SEPARATION TO INSERTION

- ORBITER PROPULSION TO ACHIEVE SAFE INSERTION WITH ONE ENGINE OUT*

ORBITAL INSERTION THROUGH DE-ORBIT

- REDUNDANT SYSTEM TO DE-ORBIT*

Abort studies at Grumman have emphasized techniques for the orbiter to abort intact from any launch azimuth. These were "exploratory" studies done to a depth necessary to identify potential first-order design and operational effects. The five different techniques listed were each examined for applicability for aborts up to nominal separation. The cause for the abort was not considered. Further, it was assumed that a safe early separation was possible and that the orbiter has its full propulsion capability.

ORBITER ABORT TECHNIQUES BEING STUDIED

- *USE MAIN PROPULSION TO NORMAL INJECTION (ABORT TO ORBIT), RETURN TO U.S. NEXT PASS*
- *USE MAIN PROPULSION TO CLIMB, TURN & RETURN TO LAUNCH SITE*
- *USE MAIN PROPULSION TO INCREASE VELOCITY TO EQUILIBRIUM GLIDE CONDITION, LAND DOWNRANGE*
- *WITHOUT PROPULSION, DUMP OXYGEN, CRUISE TO LANDING SITE WITH H₂*
- *PARTIAL USE OF MAIN PROPULSION FOR TRANSITION TO EQUILIBRIUM GLIDE, DUMP OXYGEN, AERODYNAMIC TURN & CRUISE TO LAUNCH SITE WITH H₂*

For each orbiter abort technique studied, performance was determined by trajectory analyses within assumed constraints as shown. The maximum thermal protection system (TPS) underbody temperature of 1800-2000^oF is typical for low cross-range orbiters. The total stagnation heat load is of interest to leading edges where ablators may be used. The maximum dynamic pressure, q , and $q\alpha$ are of interest in the development of loads. The total normal aero force (vehicle weight times normal g's) can be the critical design condition for wings and fins.

CONSTRAINTS REQUIRED FOR ABORT TRAJECTORY STUDIES

<i>CONSTRAINT</i>	<i>TYPICAL VALUE</i>
• <i>MAX TPS UNDERBODY TEMP</i>	<i>1800°-2000°F</i>
• <i>TOTAL STAGNATION HEAT LOAD</i>	<i>40,000 BTU/FT²</i>
• <i>MAX DYNAMIC PRESSURE, q</i>	<i>500-800 LB/FT²</i>
• <i>MAX $q\alpha$ (LESS THAN $M=6$)</i>	<i>4000 LB-DEG/FT²</i>
• <i>TOTAL NORMAL AERO FORCE</i>	<i>900,000 LB</i>

Four of the five potential orbiter abort techniques studied are illustrated here. The top line illustrates the altitude vs velocity history of an abort-to-orbit from the nominal separation point. The use of main propulsion to climb, turn, and return to the launch site appears feasible for aborts up to about 120 seconds after launch. Aborts later than this will place the orbiter too far downrange to return by this technique. Use of main propulsion to increase velocity to an equilibrium glide condition (labelled "thrusting to deplete propellant") is shown for an abort near nominal separation. Although large downrange distances are possible, land landings are not possible for all launch azimuths from KSC.

Two aborts are shown from nominal separation, assuming no orbiter thrust. One illustrates that if propellant is not dumped, temperature and g limits will be exceeded on entry. The other indicates that even if propellant dump is provided, the ability to enter from this condition without thrusting to increase velocity may only be marginally acceptable. Thus, it is concluded that if abort capability with no orbiter thrust (no ability to burn off propellant) is required, propellant dump will be required. Dump rates will have to be near the normal rate of propellant consumption, around 100,000 lb/min. Preliminary studies indicate that these rates may be achieved by normal tank pressurization with large vents. An area to be studied is the best means of providing this pressurization if the main engines are not functioning.

TYPICAL ABORT TECHNIQUES

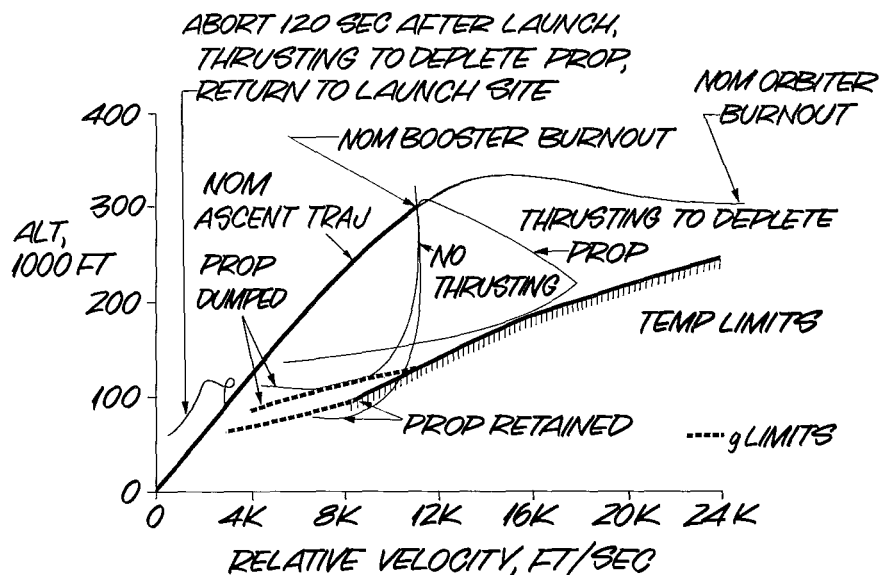

The most promising technique for returning the orbiter to the launch site from abort late in boost is as follows. The procedure includes a coast period between separation and the onset of atmospheric effects. At the entry interface (sensible $g = 0.05$) the main engines are ignited to rapidly reduce vehicle weight and to perform a transition to a safe equilibrium glide reentry trajectory. Simultaneously with the burning of the main engines, oxygen is dumped. The H_2 not used during the main-engine burn is used as fly-home propellant.

This abort technique permits aborts to be performed within the orbiter constraints while providing orbiter fly-home capability. The technique has been found to work on a typical design up to about 190 sec after liftoff, or nearly to nominal separation.

ORBITER ABORTS TO LAUNCH SITE

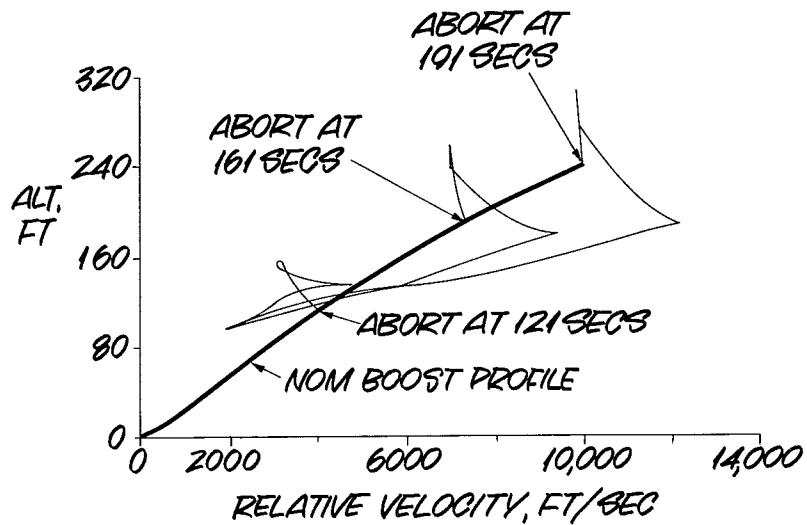

The orbiter abort previously shown at 191 sec is more fully described here. After about 310 sec, the main engines are ignited to increase velocity and reduce flight path angle. The thrust vector was 60 deg from the velocity vector and roll angle was modulated to result in burnout at the desired flight path angle. Following burnout, the angle of attack was maintained at 60 deg and roll angle was again modulated to turn as tight as possible within thermal and load constraints. (In some cases it has been found necessary to also modulate angle of attack to stay within these constraints.)

ORBITER LAUNCH ABORTS AT 191 SEC

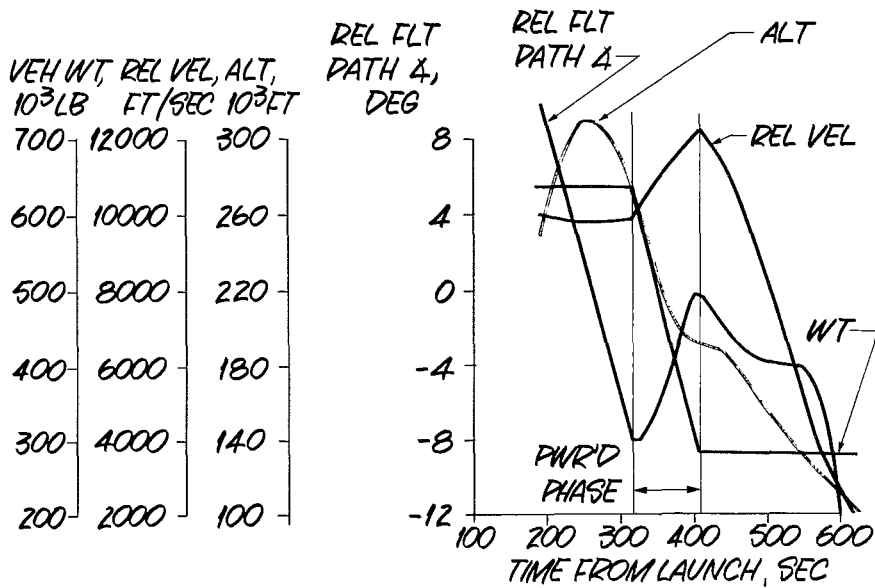

The behavior of the orbiter during this abort is shown to be within the established constraints. The maximum underbody temperature was maintained below 1800°F, and the peak g's were less than 2.5. Maximum q is low, and although $q \propto$ exceeds 4000, it occurs at hypersonic (M greater than 6) velocities.

ORBITER LAUNCH ABORTS AT 191 SEC (CONT)

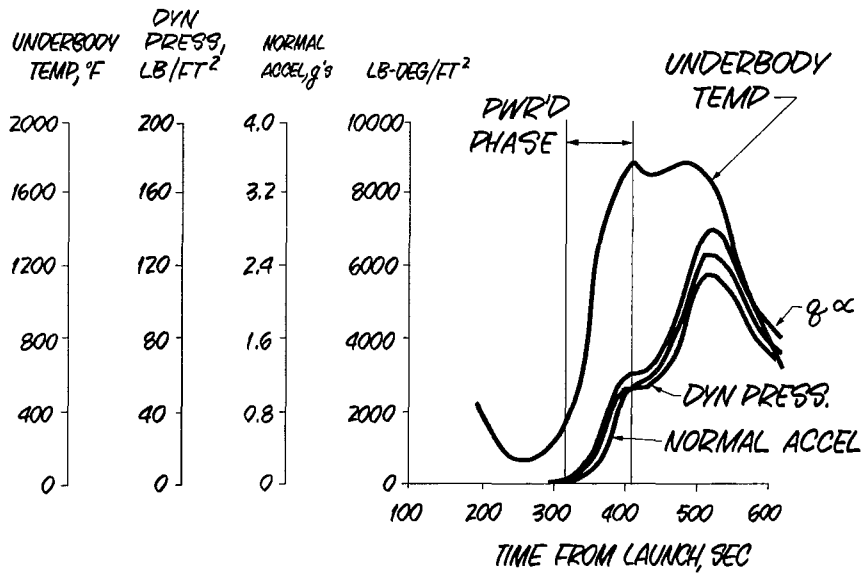

Another potential effect of aborts is on tank pressure requirements. Startup of the orbiter engines requires greater engine inlet pressures when at low altitudes than when they are normally started, due to the greater back-pressure. The inlet pressure difference between low- and high-altitude starts can be greater than 14.7 psi, because the engine is sensitive to pressure ratio rather than pressure differential.

Providing increased engine inlet pressure at low altitudes can require relatively high oxygen tank ullage pressures if the oxygen tank is located aft in the vehicle, and the hydraulic head is, therefore, low. This is illustrated for a typical orbiter, assuming that the booster is able to provide a thrust-to-weight ratio of at least 1.0 as the orbiter engines are started. If the fuel tank was located ahead of the oxygen tank, the maximum ullage pressure required increased from 38 to 71 psia for a sea level abort. If this increased tank pressure was provided it would result in about a 1500-lb inert weight penalty. Reversing the hydrogen and oxygen tanks eliminated this penalty.

TYPICAL EFFECT OF ORBITER TANK ARRANGEMENT ON ULLAGE PRESSURE REQMTS

TANK ARRANGEMENT	MAX ULLAGE PRESS REQ'D, PSIA			
	FUEL		OXIDIZER	
	NORMAL	SL ABORT	NORMAL	SL ABORT
FUEL FWD OF OXYGEN	36	36	37	71*
OXYGEN FWD OF FUEL	38	39	38	38

* INCREASED PRESS. FROM 37 TO 71 PSI RESULTS IN
APPROX 1500 LB VEHICLE WEIGHT PENALTY

The last example of potential abort effects is concerned with this requirement for the orbiter to abort to orbit with one engine out. The loss of an engine will increase the gravity delta-V losses.

Studies have shown that a typical three-engine orbiter with an initial thrust-to-weight ratio (T/W) of about 1.2 can still abort to a safe orbit with one engine out by using part of the on-orbit propellant. However, a two-engine orbiter with T/W = 1.2 may have more difficulty with one engine out. The example shows how one typical two-engine orbiter cannot achieve orbit with one engine out without increasing the over-thrust capability of the engine and/or adding orbital maneuvering system (OMS) engines.

TYPICAL ABORT TO ORBIT REQMTS

- TWO 400K ENGINES (ONE ENG OUT)
- OLOW = 637,250 LB
- PROPELLANT QTY = 391,400 LB

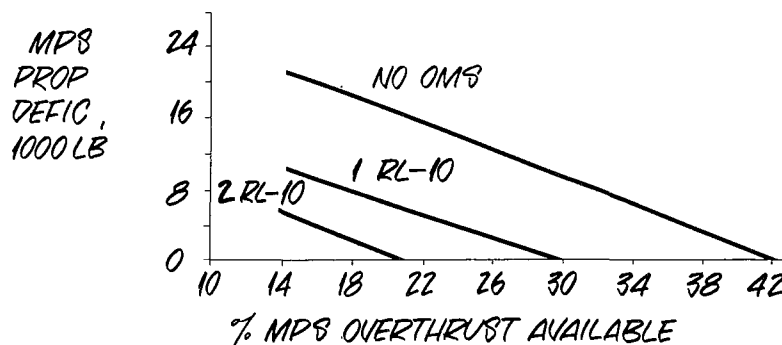

The studies previously described, although quite preliminary, have indicated the potential nature of the effects that abort requirements may have on the design and operation of the shuttle.

PRELIMINARY RESULTS

- *IF COMPLETE LOSS OF ORBITER THRUST IS A DESIGN CONDITION, PROP DUMP CAPABILITY IS REQD*
- *IF PROP DUMP CAPABILITY EXISTS IN THE ORBITER, SUBORBITAL ABORTS WHICH RETURN TO THE LAUNCH SITE MAY BE POSSIBLE ANYTIME FROM THE UNSAFE SEP REGION TO NORMAL SEP*
- *AFTER SEP, THE PRIMARY MODE OF ABORT SHOULD BE TO ORBIT*
- *THE AREAS POTENTIALLY AFFECTING VEHICLE DESIGN THAT SHOULD BE EMPHASIZED ARE:*
 - *SEPARATION IN THE ATMOSPHERE*
 - *STARTUP OF ORBITER ENGINES IN ATMOSPHERE*
 - *METHODS OF PROPELLANT DEPLETION*

Acknowledgement

The material presented in this paper has been assembled from studies performed by L. Deutsch, A. Nathan, F. Schifano, J. Sobiarajski, and M. Vele.

H. Robert Warren

Spar Aerospace Products Ltd.
Toronto, Canada

1.0 INTRODUCTION

The purpose of this paper is to give a "state-of-the-art" review on a particular device that could have wide application in orbital maintenance and safety activities on the space shuttle. This is the extendible boom device for which we use the general term of STEM (Storable Tubular Extendible Member).

The STEM principal was first invented in the National Research Council just after World War II and in 1959 was adapted by Spar (at that time the SPAR Division of The de Havilland Aircraft of Canada) for the 150ft. sounding antennas on the Alouette I ionospheric research satellite.

Since then over 350 of the units have flown successfully on rockets and satellites for a variety of applications, some of which will be described in this paper. By showing the varied uses to which the basic principle has been put, it is hoped to illustrate the specialized design techniques that have been developed and the extent of flight experience gained to date.

The principle of operation for the STEM is shown in Figure 1. During launch the material, in the form of a flat strip, is wound on a storage drum. In orbit, the drum is rotated so that the resilient spring material forms into a tubular shape of high strength. To increase the strength and reduce packaging size, the BI-STEM principle in Figures 2 and 3 has also been developed. With either type, the drive arrangement can be motorized, if partial extension or retraction is required, or, using the spring energy of the element material, extension can be achieved by simply releasing the tip of the unit.

In Section 2.0 illustrations are given of STEM units that have already been developed and have either flown, or been qualified for flight. Section 3.0 reviews current and future developments which have more direct relevance to the space shuttle program.

Section 4.0 provides a brief summary of design characteristics that are available to the designer for future space shuttle applications.

2.0 STEM UNITS DEVELOPED PAST PROGRAMS

The boom units described here illustrate the state-of-the-art in the time period 1960-1969.

The figures are grouped according to function. Figures 4 to 10 are actuators. Figures 11 & 12 show an antenna. Figure 13 illustrates a docking application and Figures 14 and 15 are astronaut aids.

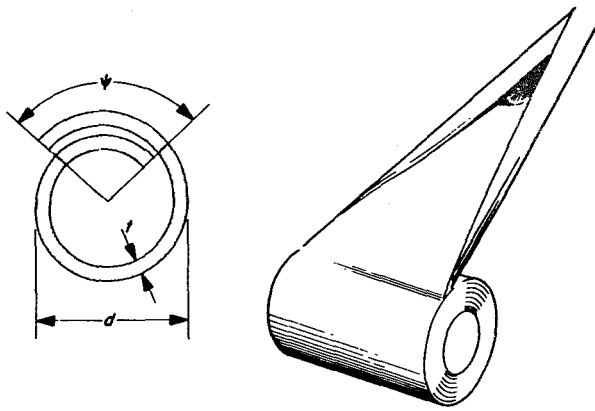

Fig. 1. The STEM principle

Fig. 2 The BI-STEM principle

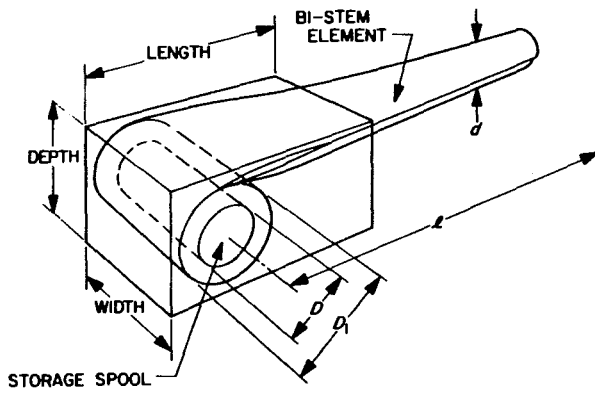
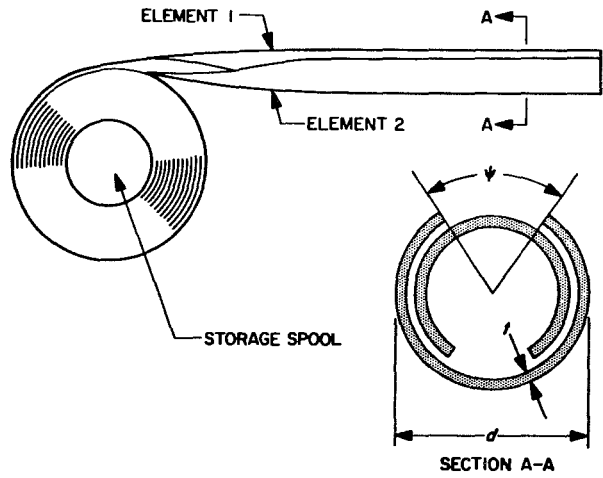
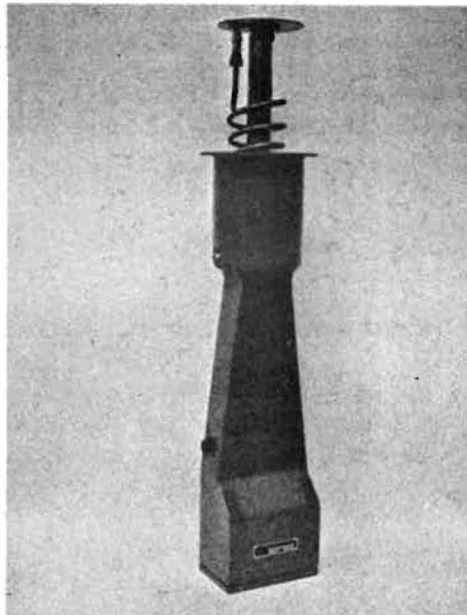
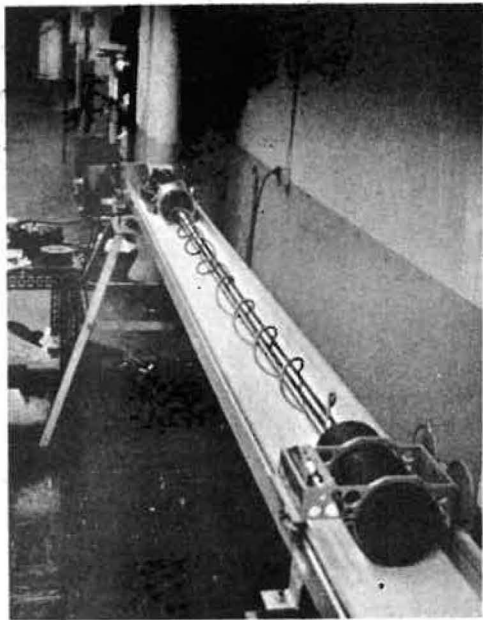

Fig. 3. BI-STEM dimensions

104

This unit, termed a TELE-STEM, was used to extend the radar transponder on the Agena Target Docking Vehicle.

Cable deployment was arranged by an external coil similar to a telephone cord. As the boom was required to withstand the bending loads resulting from restart of the Agena engine, it was designed with a system of close-fitting telescoping tubes which resisted the bending moment while the STEM provided the actuation force.





Gemini 6 is shown in orbit in this figure, with a STEM boom at the base extending a three-axis magnetometer.

In this case, cable deployment for the instrument leads is achieved by a flat conductor cable which feeds up the centre of the STEM element.

A design feature which has been developed for instrument applications such as this is an interlocked element which provided greatly increased torsional rigidity. This is often required if the instrument must be oriented in a particular direction.

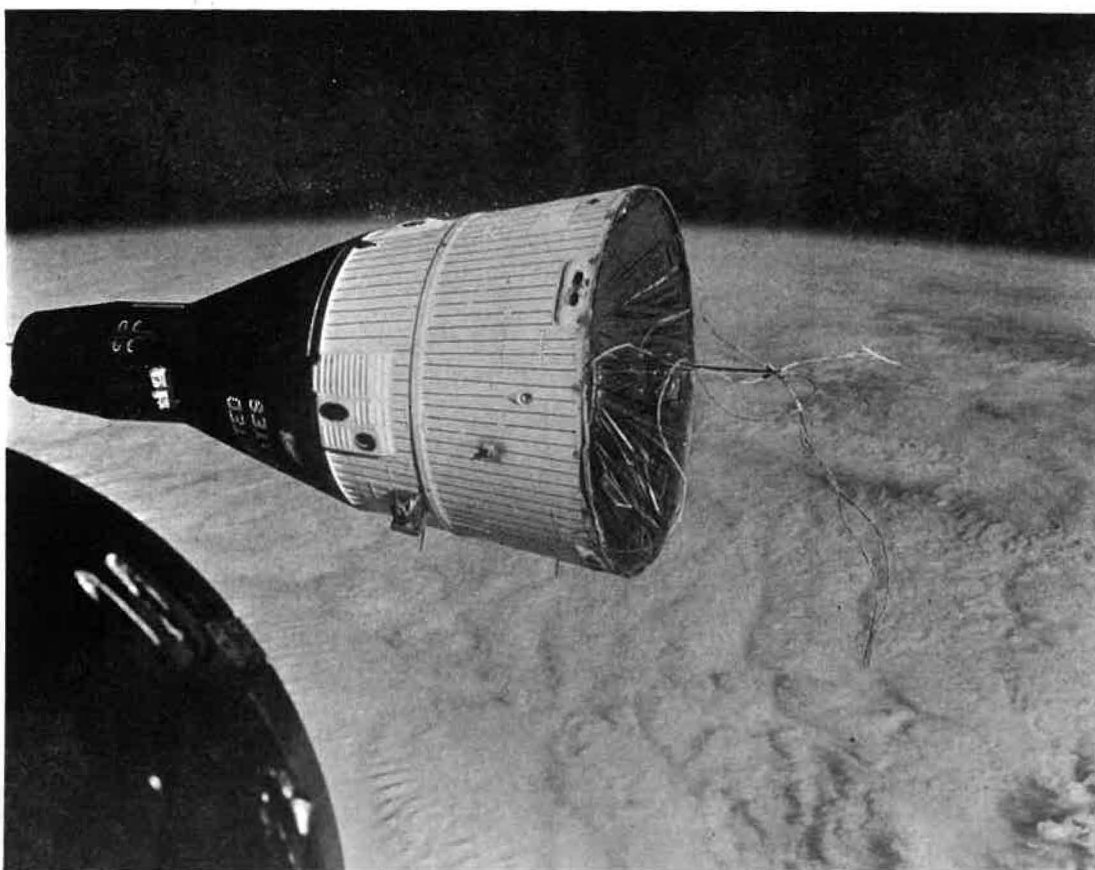

A view of the A-26 magnetometer boom with the cover removed shows the system used to feed the 26 element flat conductor cable into the center of the STEM. A special interchange chamber is used to enable the cable to be rewound as the element is retracted without recourse to slip rings.

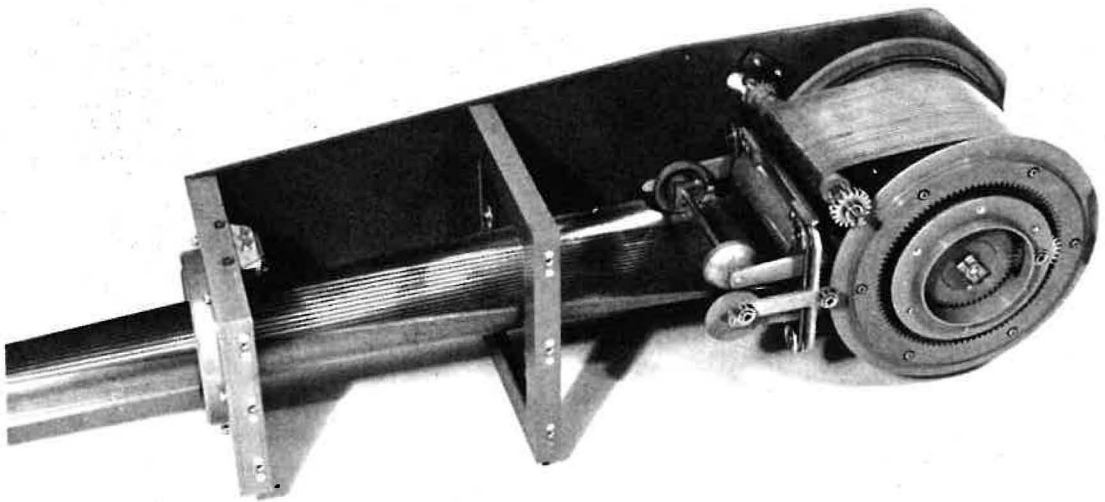

A ground application shown here is a unit designed to enable a camera and light unit to be fed into the cavity of a large solid fuel rocket to inspect for cracks in the grain.

The STEM element is maintained in a flat form as it passes through a series of articulated links which enable the unit to be fed up past several corners before entering the propellant chamber.

Such a device, possibly combined with a fibre optics inspection head, could be useful to inspect inaccessible areas in the wings or fuselage of the space shuttle.



An example of the extension of a large diameter STEM boom is shown here with a 3.12 inch ground mast supporting a large tip mass.

The bending moment and compressive loads generated in such a ground environment are similar to those which could arise in a space shuttle cargo transfer operation.



An important current application is the use of booms to extend flexible solar cell panels.

Here four BI-STEMs, 0.86 in. in diameter, are extended in synchronism to deploy a pair of Hughes roller type solar cell panels.

An alternative arrangement is with a single central boom flanked by two panels which are attached to a tip mounted tee-bar.

Such designs require the boom to withstand compressive loads both during and after the extension so that the panel is kept in tension.

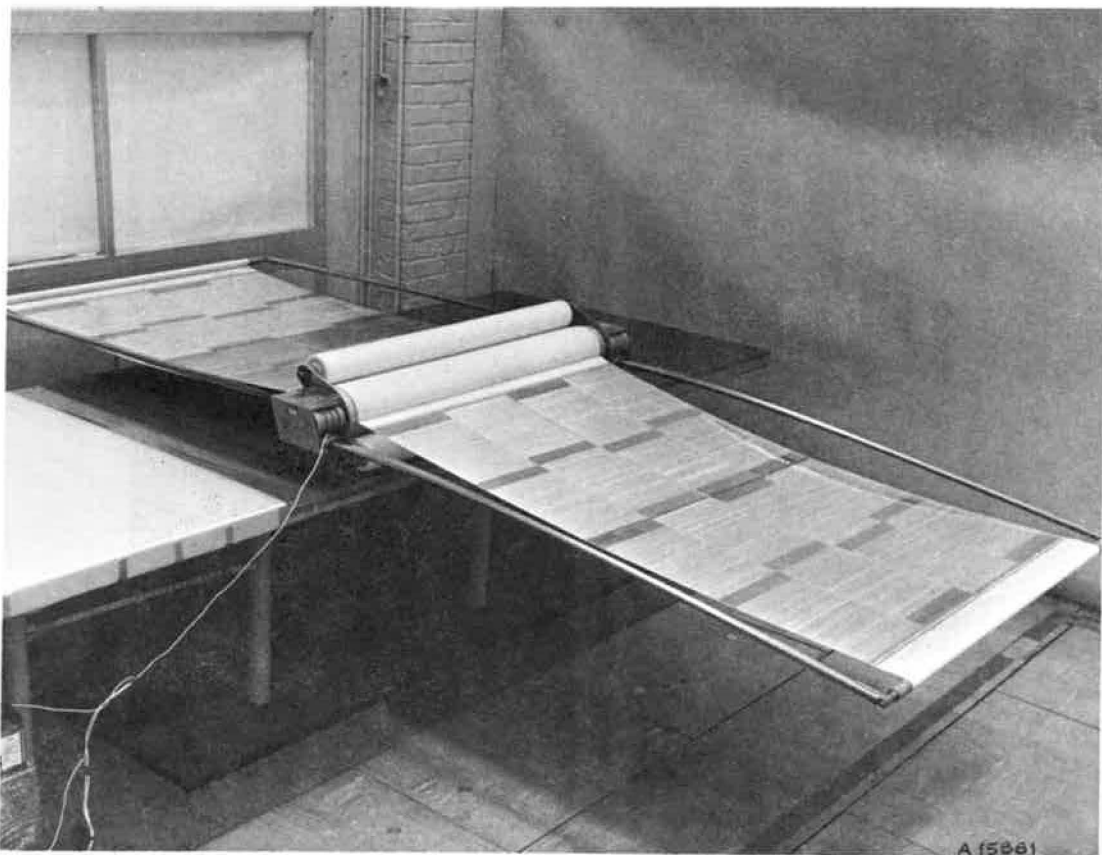

In this view of the recovery operation of one of the Gemini capsules, the HF recovery antenna can be seen extended from the spacecraft. A similar unit was used for orbital HF communications.

The whipping action caused by heavy sea state conditions required the use of a nesting technique with 8 separate elements inside one another at the root of the antenna.

At the base of the antenna the white silicone guard sleeve can be seen. This prevented the ingress of sea water to the inside of the unit.

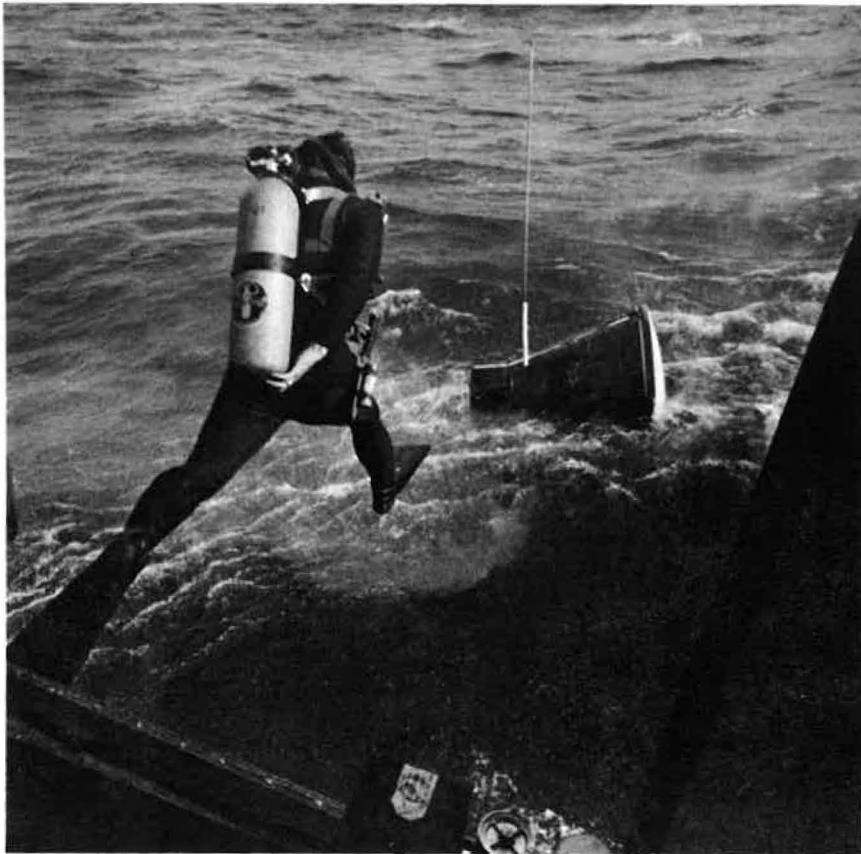

The HF antenna used for Gemini recovery operation is shown in this view.

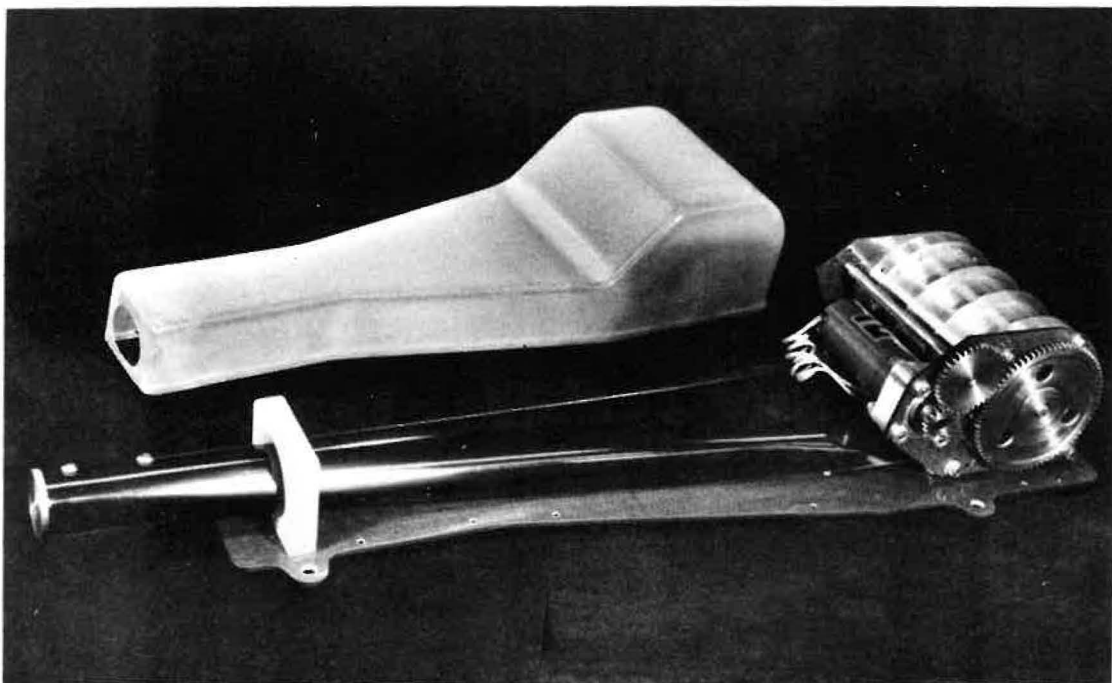

Early in the Gemini program, a soft docking procedure was evaluated. For this, the two spacecraft maintain formation while a grappling boom extends into a receiving cone. After the tip of the boom is secured in the cone, the boom is retracted, thus bringing the two vehicles together.

Although this approach was abandoned for Gemini in favour of a hard docking procedure, its feasibility was demonstrated with dynamic tests conducted at NASA/MSC using space frames on a large air bearing table to simulate the full scale vehicles.

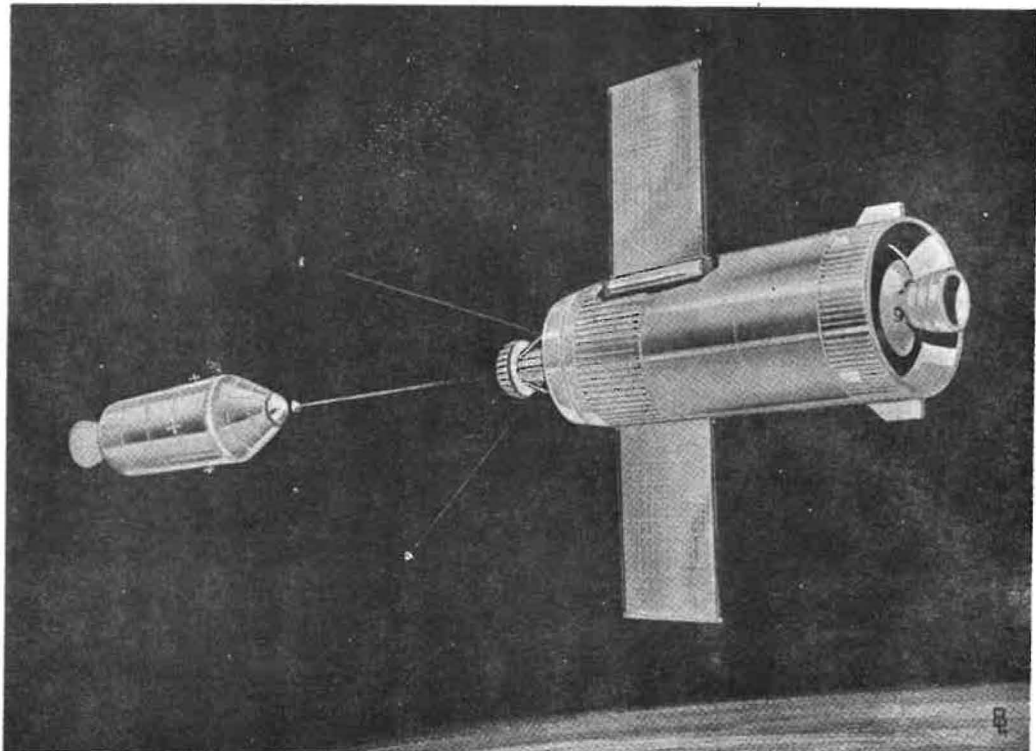

An example of an astronaut aid is the back pack unit developed for the U.S. Air Force. Three STEM units with special end fittings are used to enable an astronaut to secure himself at an external location on a spacecraft. In this way, torque reactions from a maintenance task can be transferred to the spacecraft.

The control pack enables the three booms to be actuated either in unison or individually.



A second astronaut tool is the Extra Vehicular Crew Transfer (EVCT) device shown here. Used with a pistol grip, it enables the astronaut to extend the boom up to 25 feet and grapple onto a bar on an adjacent spacecraft.

In this way, he has an emergency procedure to permit personnel transfer between two vehicles even if there is a failure in the docking system.



3.0 STEM UNITS FOR CURRENT AND FUTURE PROGRAMS

The next series of figures shows the present status of boom technology and touches on future applications envisaged.

Figures 16 to 19 show actuation applications, Figures 20 to 23 described a novel approach to in-orbit manufacture of a space structure, and Figure 24 is a space shuttle application.

The unit shown here is a 2 inch steel BI-STEM originally designed for a ground application but converted to serve as a 25 foot instrument boom on the Apollo J missions.

Using two such units, it is planned to extend a mass spectrometer and a gamma ray spectrometer laterally from the service module while the Apollo is in orbit around the moon.

The elements are silver plated to minimize thermal bending and made of extra-thickness maraging steel to withstand manoeuvring loads as the spacecraft maintains its attitude.

The dynamics of the combined boom and spacecraft must be carefully studied in such cases to assess the binding loads in the boom and the probable tip deflection.



An artist's impression of an actuating boom performing grappling functions on the lunar surface is shown here.

Such a device is now being developed for the Viking Soil Sampler experiment where unusual environmental conditions of wind, and blowing sand are combined with digging loads from the sampler's operation. Prior to this, the unit must also survive pre-launch sterilization and the hard vacuum of the long interplanetary voyage.



One of the major tasks for the astronauts on the AAP or Skylab project is to transfer film packs and cameras from the airlock out to the work stations on the Apollo Telescope Mount (ATM).

A preferred approach for this is the use of a 2.0 inch BI-STEM hard mounted near the hatch of the airlock. With one astronaut in this location to load the film packs on the end of the boom and a second astronaut at the ATM work station, the unexposed film can be passed out and the exposed film returned to the workshop.

AAP CLUSTER

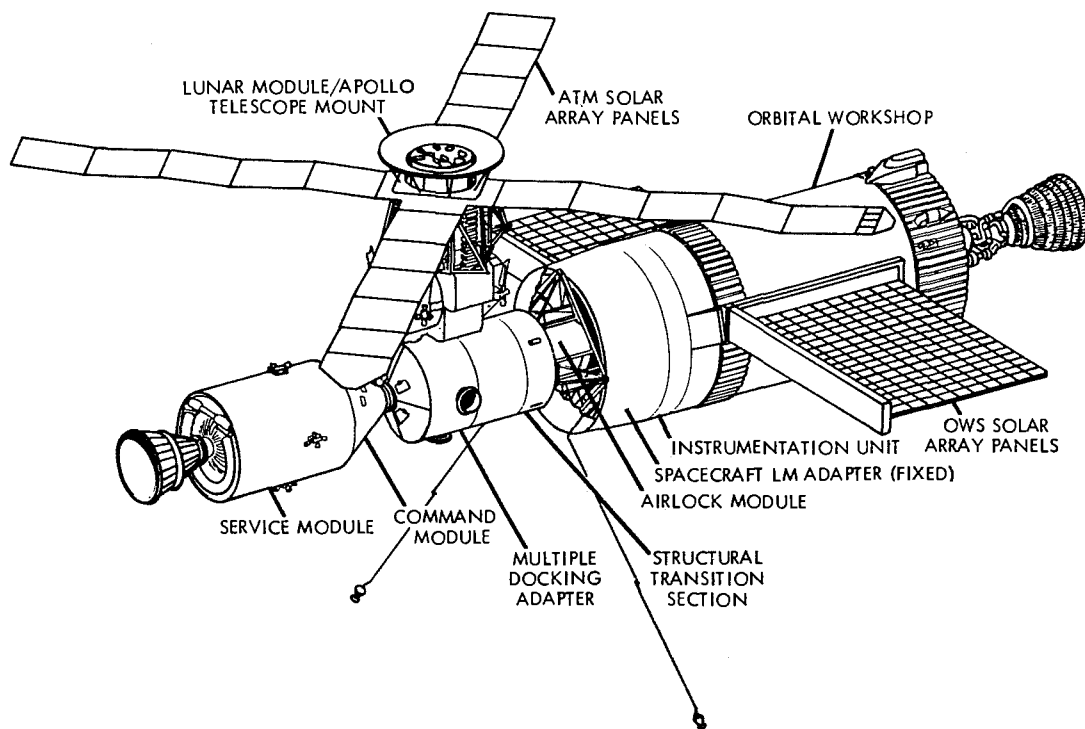

Feasibility of the Skylab film transfer activity has been demonstrated by rehearsals on the full scale mock-up in the large neutral buoyancy water tank at NASA/MSFC.

In this photograph the first astronaut is shown at the airlock location guiding the boom down to the ATM lower work station.

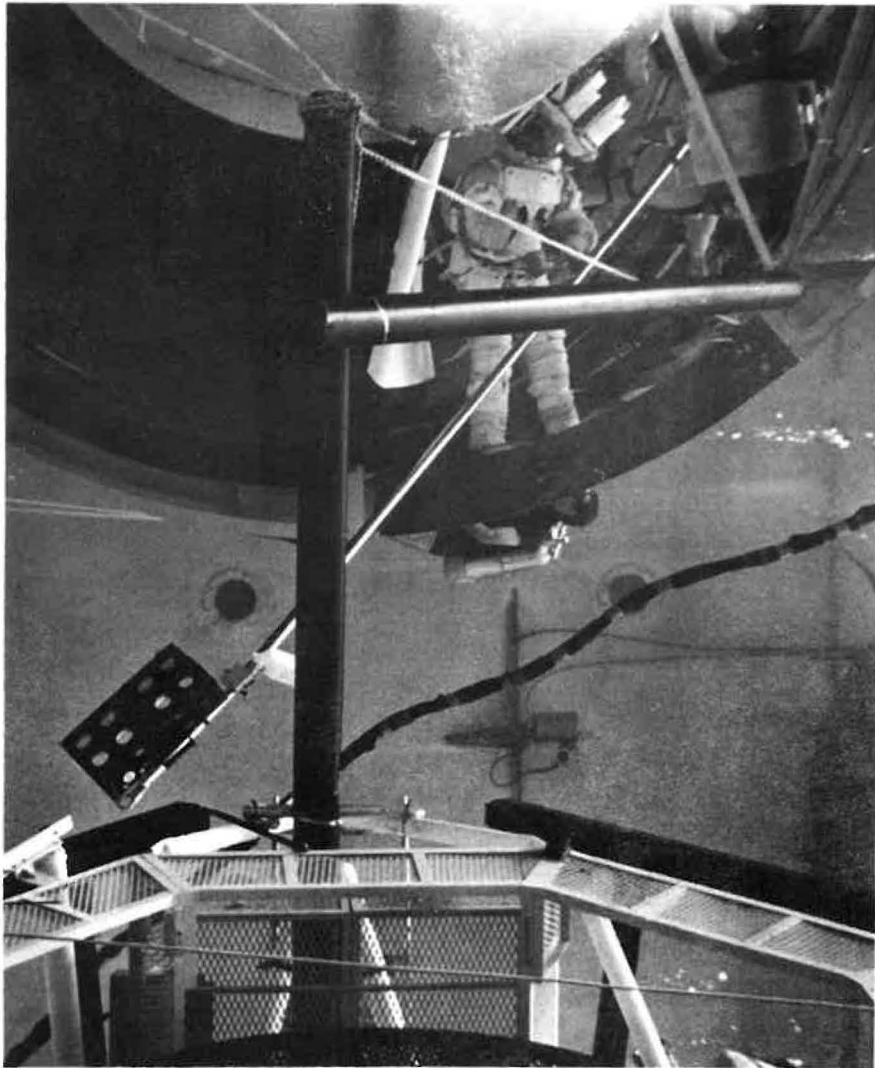

The STEM FAB tool shown here embodies a 105ft. element in a replaceable cassette with a guillotine fitting to cut off pre-determined lengths of element. These can then be assembled into spaceframes of various configurations as required.



An example of spaceframe formed with the STEM FAB approach is shown in this photograph. In this case, the frame was strong enough to be scaled by a 200 lb. man.

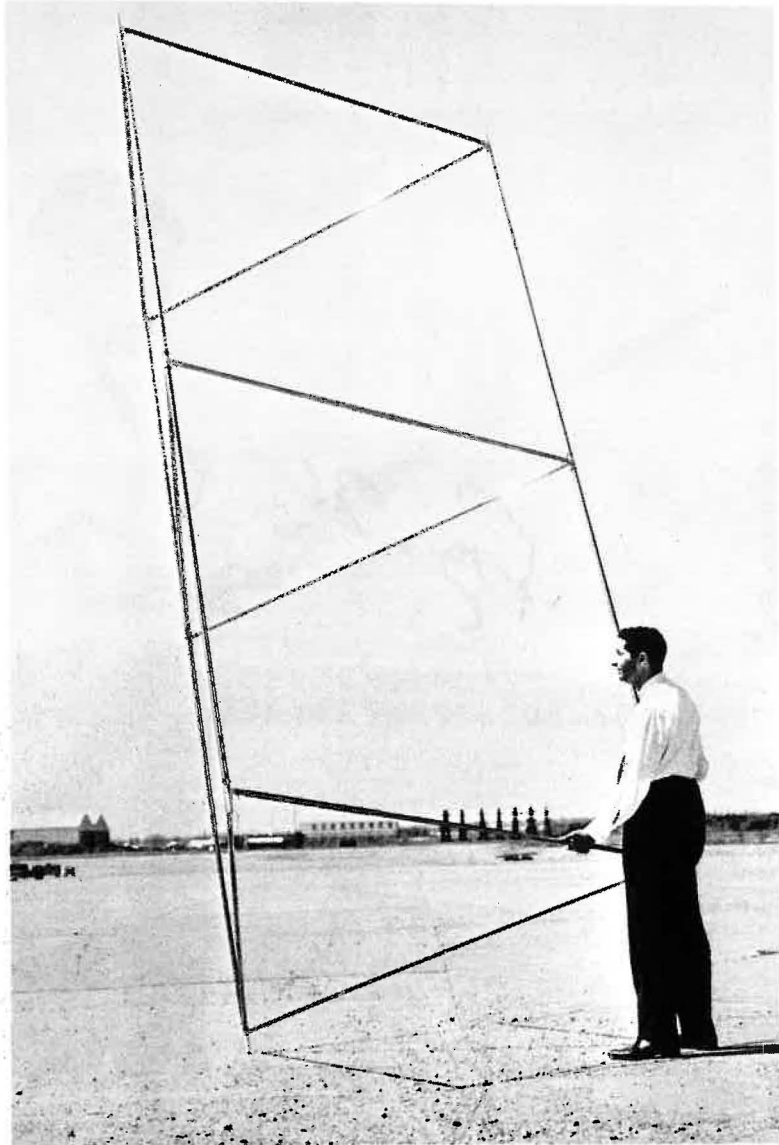

A unique form of self-locking corner joint suitable for triangulated structures is shown here. The astronaut needs only to insert the end of the STEM element and a preloaded locking spring is tripped clamping the element onto a central core.

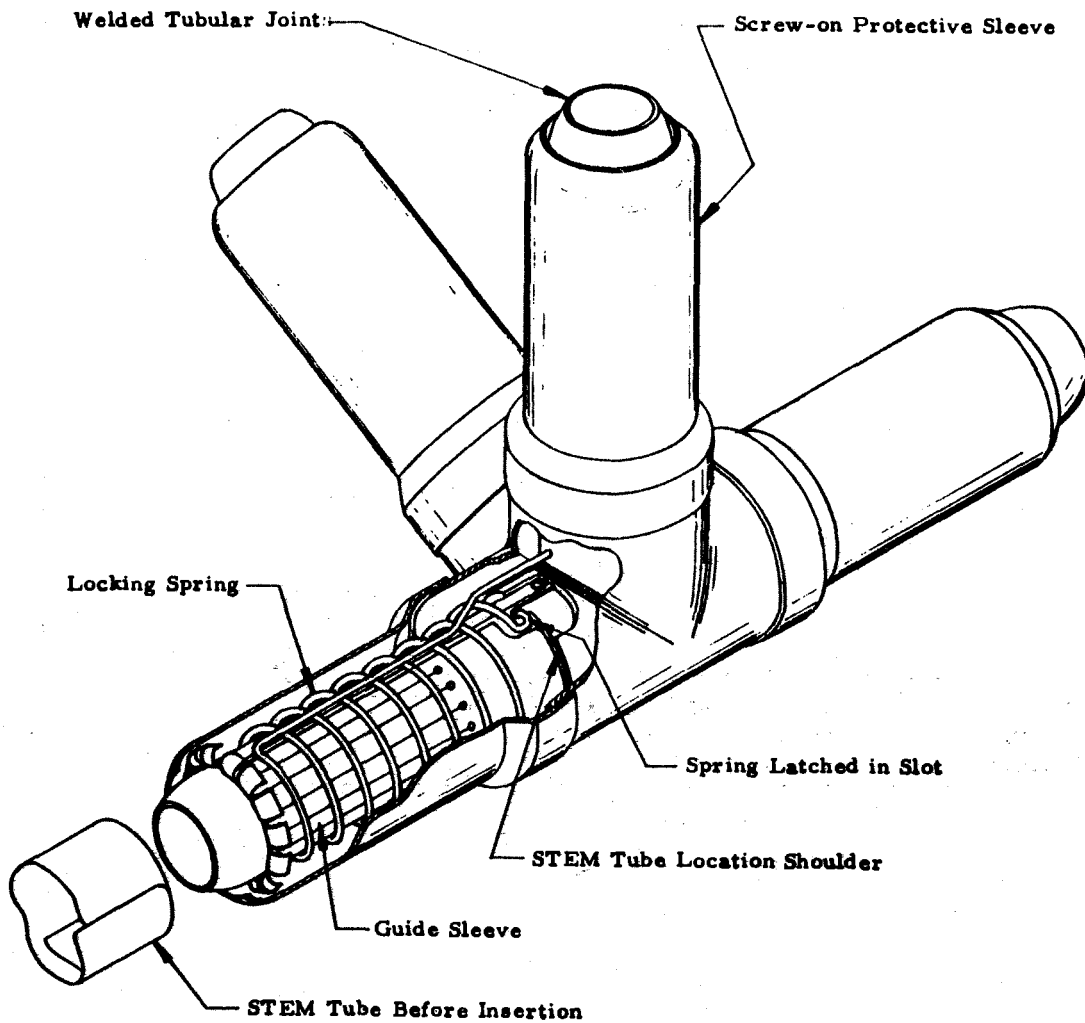

An artist's impression of a large dish antenna structure formed from such triangulated components is shown here.

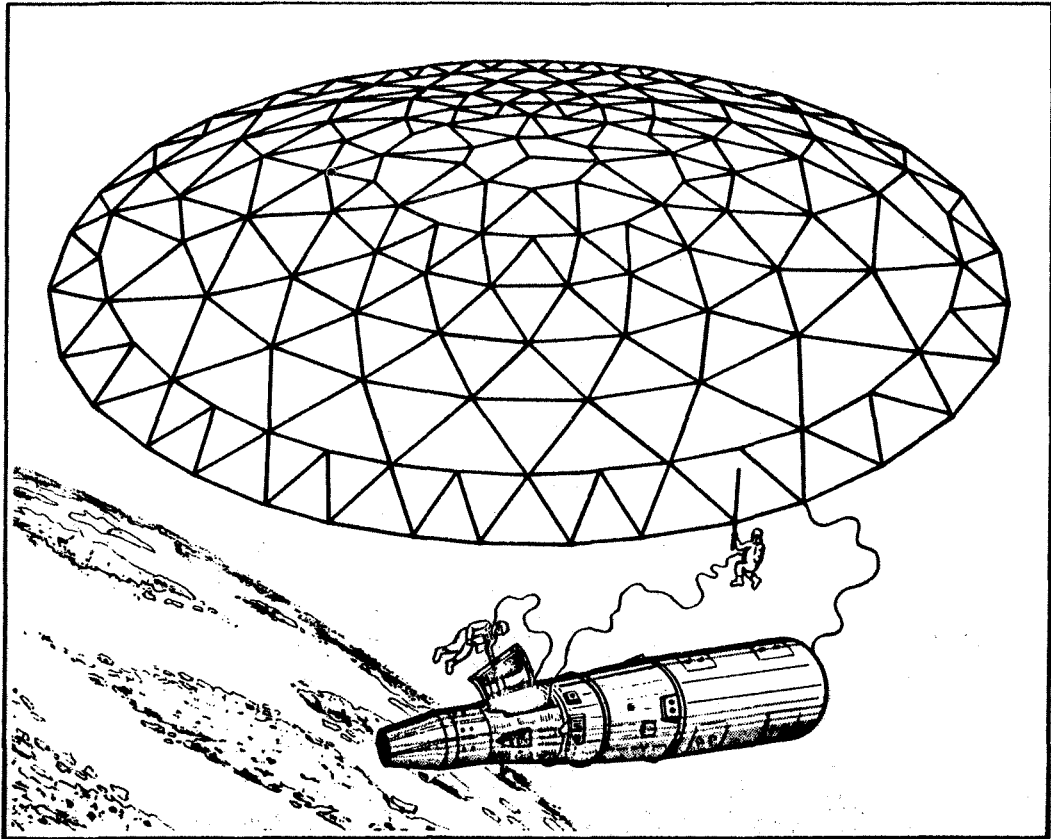

Perhaps the most obvious application for actuator booms on the space shuttle is the cargo transfer function.

This view shows such an arrangement with a system of booms being used to transfer a fuel tank into the nuclear shuttle as conceived by Lockheed Missiles and Space Corporation.

Synchronization of the boom extension rates is a design requirement here and consideration must also be given to techniques for resisting bending loads in the event of lateral motion of the cargo.

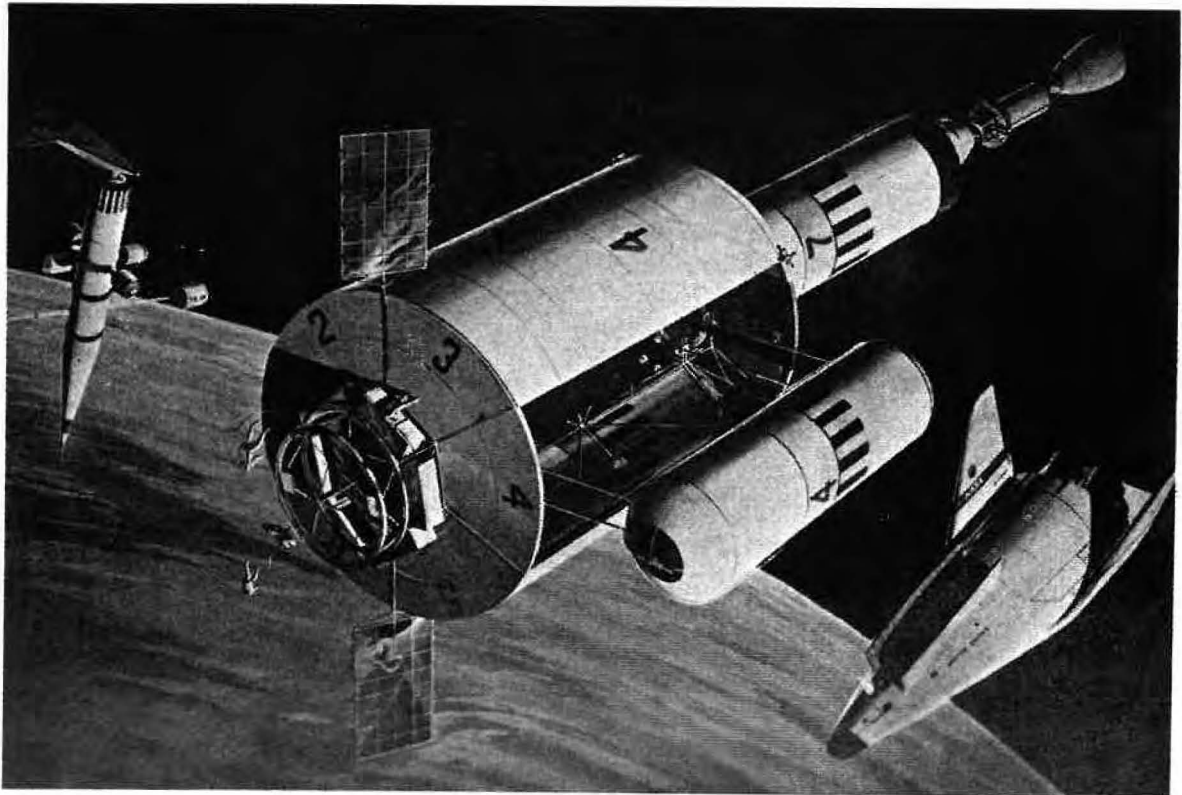

4.0 CONCLUSIONS

With the need for equipment in the space shuttle to be reliable, of light weight and basically simple, STEM units can be used for a number of orbital applications and offer the benefit of extensive flight experience.

The designer has a wide range of characteristics to choose from in meeting particular requirements. Some of these are as follows:

- Bending strength and stiffness
- Torsional strength and stiffness
- Compressive strength
- Thermal curvature
- Natural element curvature
- Synchronization of multiple units
- Element length and diameter
- Package size
- Extension rate
- Extension power

The STEM device is a good example of the benefits that can derive from a joint Canadian-NASA program such as Alouette - ISIS. It is hoped that with the space shuttle program, a similar international co-operation can be achieved.

REQUIREMENTS FOR SPACE SHUTTLE SYSTEMS

Charles C. Wood

NASA Marshall Space Flight Center
Huntsville, Alabama

This paper, "Requirements for Space Shuttle Systems," is the introductory paper for the session on Space Shuttle Cryogenic Technology Review. The purpose of this session is three-fold: (1) to identify the technology disciplines required in the area of Shuttle cryogen systems, (2) to identify deficiencies which exist and to discuss current programs and identify new programs which eliminate the deficiencies. In addition to providing management with a rapid and thorough technology assessment, the session will hopefully accomplish significant data exchange between the various research and development government and contractor organizations. Although the time for preparation has been short, the papers to follow attempt to assess technology on a national basis contrasted to technology existing within a specific government installation or contractor facility. Participating in this review are Marshall Space Flight Center, Lewis Research Center and three contractors involved in the Phase B Shuttle definition studies: (1) General Dynamics, Convair Division, (2) North American Rockwell/Space Division, and (3) McDonnell Douglas Corporation. Each participant has many years experience in cryogenics as related to space vehicles.

This introductory paper attempts to accomplish three factors: (1) to identify for the Space Shuttle vehicle the systems utilizing cryogens, (2) to identify the technology disciplines which must be addressed by the designer and which will be addressed to this technology session, and (3) to identify the specific Shuttle requirements which appear to most adversely affect the design of cryogen systems.

CRYOGEN APPLICATIONS

Cryogenics are required on the Space Shuttle for propulsion and power purposes, for environmental control and for logistics. Requirements are for both H₂ and O₂ for propulsion and power, O₂ and N₂ for environmental control and H₂ and perhaps others, for logistics. Neither the individual cryogen quantities nor the total quantities are well defined, however, the total quantity is very large, comparable to the Saturn V quantity.

SUBSYSTEM	BOOSTER	ORBITER
* ASCENT PROPULSION	X	X
ATTITUDE PROPULSION	X	X
* ON-ORBIT PROPULSION		X
AUXILIARY POWER UNIT	X	X
JET ENGINES	X	X
* ENVIRONMENTAL CONTROL	X	X
LOGISTICS		PAYLOAD

* PRE SHUTTLE PROGRAMS

CRYOGEN TECHNOLOGY DISCIPLINES

Mission duration is a significant "driver" relative to the cryogen technology discipline to be encountered. The mission duration and mission profile selected for the Space Shuttle allow for grouping of technology according to short term missions, representative of the booster and orbiter ascent phase of flight (FIG 3), and medium term missions, representative of the orbiter during orbit flight (FIG 4). The technology disciplines identified with the two distinctive flight phases are shown on the respective figures. On both figures the technologies are grouped according to system definition, performance type task (thermal management and propellant utilization) and the mechanical design and supply aspects of specific hardware items (reuse maintainable hardware). For simplicity of presentation, the wording on the two figures is concise and each task implies a multitude of related or closely associated tasks. For example, the identified technology discipline "Fluid Components" includes such items as valving, seals, ducting, expansion joints, regulators, etc., while the term "pressurization" implies a multitude of technical information associated with establishing gas requirements, control dynamics, heat exchanger sizing and selection, etc. The broadness of the cryogen technology area becomes immediately obvious with the realization that each technology discipline depicted can exist for each of the cryogen applications shown on Figure 2. In spite of this broad area, the most important aspects in cryogen technology related to the Shuttle will be addressed in the subsequent papers.

For the so-called short term missions on the Shuttle, a tremendous amount of technology has been accumulated during the Saturn program. The appropriateness and applicability of this technology and complementary technology from research programs conducted over a number of years for application to Shuttle will be reviewed from a systems design aspect in the second paper of this session, and from the hardware aspect in the fifth paper. The more critical technology availability areas will be identified and addressed separately.

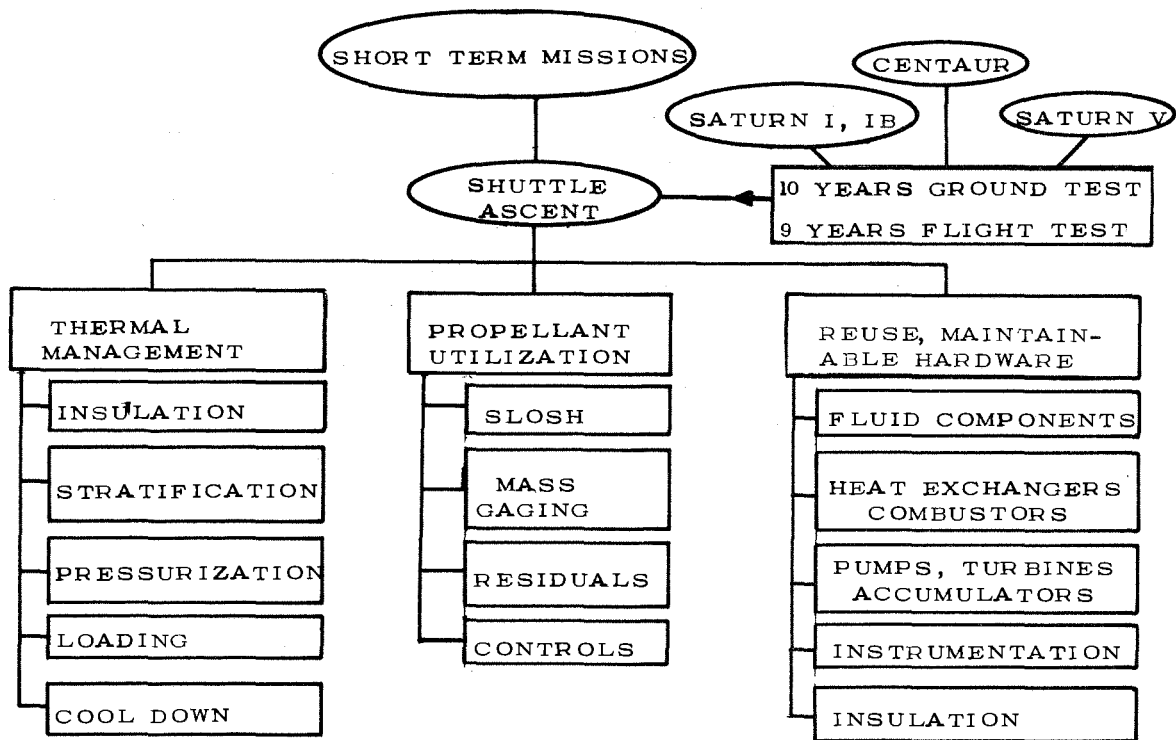

CRYOGEN TECHNOLOGY DISCIPLINES

Technology disciplines peculiar to the orbital flight phase of the Shuttle are shown on Figure 4. These are in addition to or are special cases of those specified for ascent, Figure 3. For example, stratification, appearing under the category of thermal management occurs during ascent flight as well as during orbital flight, however, the technology needs are distinctly different. Also, the additional orbital requirement on "Fluid Components," relative to Figure 3, includes factors such as lower allowable thermal and fluid leakage, disconnects for propellant transfer in orbit; more rigid thermal environment, etc. Similar factors account for other terms which are used on both Figures 3 and 4.

Technology programs have been in progress for a number of years in many of the required areas and the approximate number of years devoted to each area is shown in each technology block.

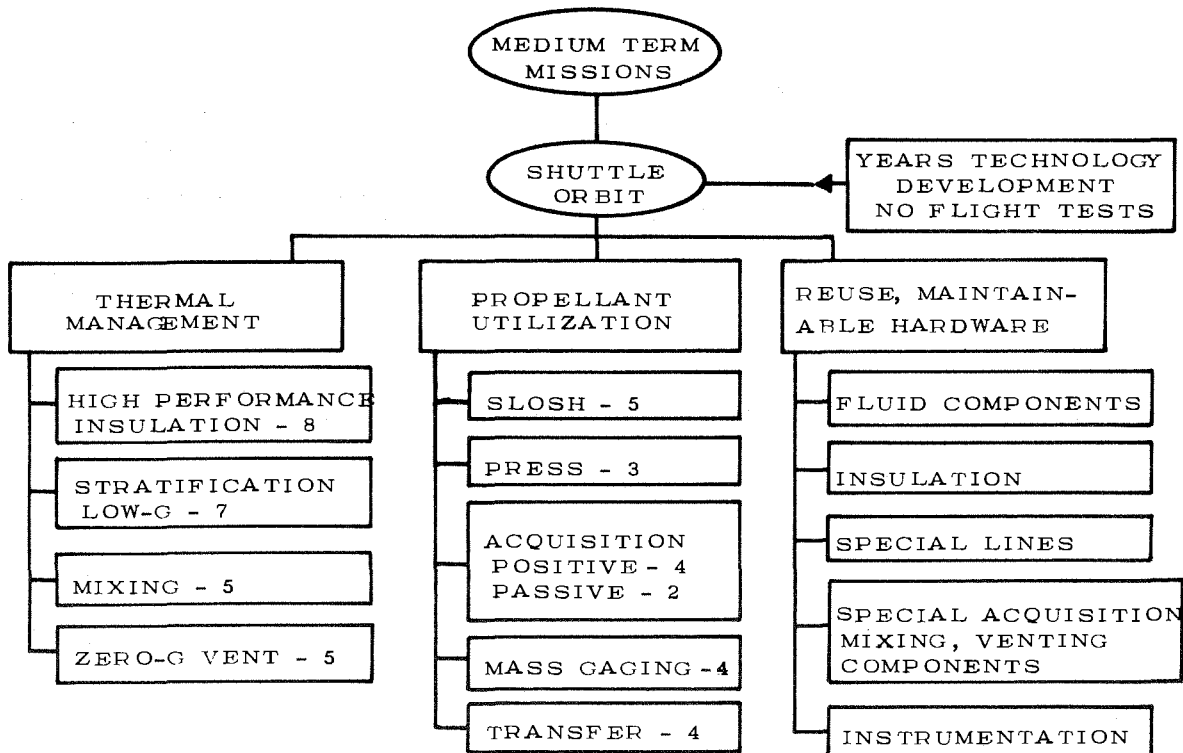

SPECIFIC SHUTTLE REQUIREMENTS

The Shuttle requirements having a major impact on Shuttle cryogen systems are depicted here. The impacts on cryogen systems attributed to each indicated requirement are by no means equal. The most severe requirement appears at this time to be reuse, cryogen acquisition in a zero "g" environment, and cryogen transfer associated with the Shuttle logistics role.

- 7-30 DAYS CRYOGEN STORAGE; \approx 15' TANKS
- ZERO "G" CRYOGEN ACQUISITION; CONTINUOUS
- ZERO "G" CRYOGEN TRANSFER; \approx 40,000 LB's.

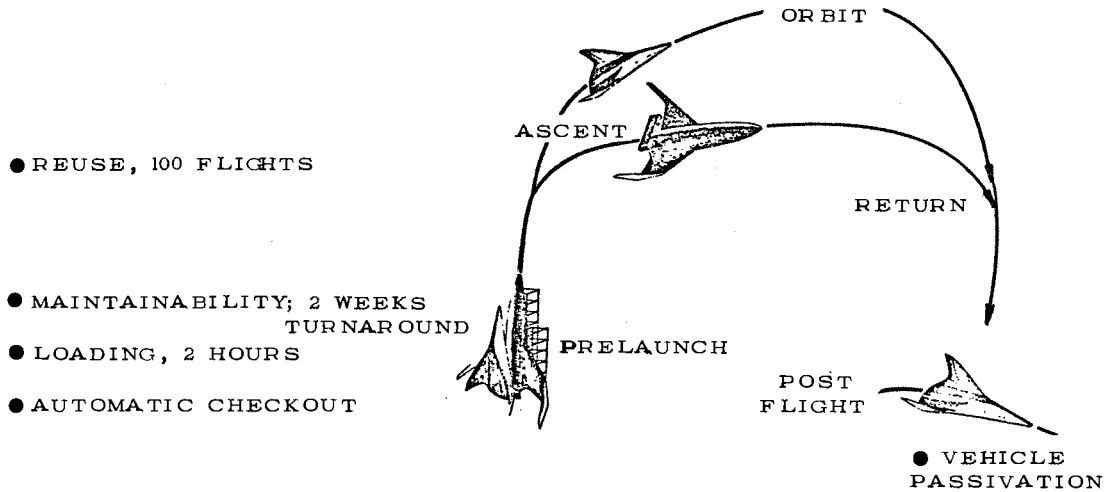

SHUTTLE FLIGHTS FOR PROPELLANT
MAKEUP VERSUS TRANSFER EFFICIENCY

The cryogen technology discipline will be a "major driver" to vehicle configuration, vehicle design and mission planning. One simple illustration as to the importance of the technology disciplines is the requirement for 20 extra flights per year if as a H₂ logistics vehicle the propellant transfer efficiency is 75 percent contrasted to 90 percent and the quantity of propellant to be delivered each year is 3 million pounds.

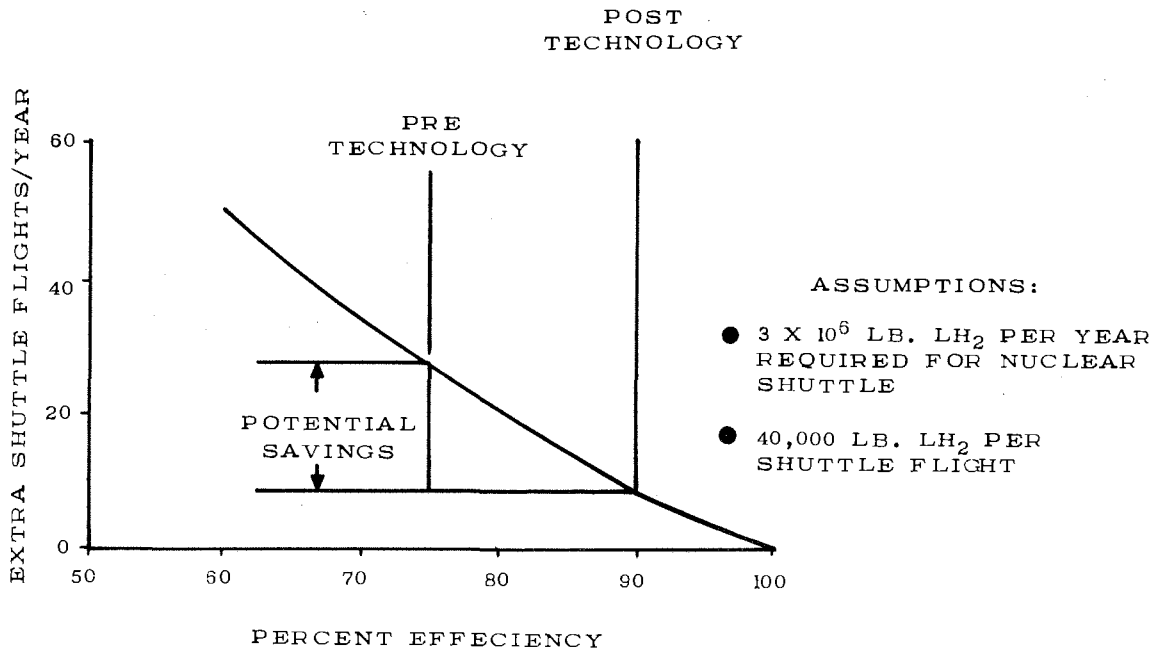

CRYOGEN TECHNOLOGY BASE FOR SPACE SHUTTLE

A. L. Worlund and T. W. Winstead

NASA Marshall Space Flight Center
Huntsville, Alabama

Introduction

The cryogen technology is multiple discipline technology with application to main propulsion, auxiliary propulsion, jet engine, life support, and auxiliary power systems of the Space Shuttle vehicle. The extensive technology base available to support cryogen utilization has been developed from ground base technology programs and the highly successful manned space flight programs. The technology base for the disciplines presented on chart 1 will be summarized and assessed to identify potential problem areas and technology deficiencies. Prelaunch and flight environments are discussed.

Discipline	Application			
	Ascent		Orbit	
	O ₂	H ₂	O ₂	H ₂
Stratification	x	x	x	x
Mixing	-	-	x	x
Thermal Conditioning				
- Geyser Suppression	x	-	-	-
- Quality Control	x	x	x	x
In-Space Venting	-	-	x	x
Pressurization	x	x	x	x
Mass Gauging	x	x	x	x
Tank Insulation Acquisition And Transfer Systems Integration Hardware	Discussed Individually			

Technology Status Categories

The technology status for concepts applicable to each discipline are categorized as being (1) adequate, (2) reasonable, or (3) insufficient information. Entries in the adequate category are judged to have sufficient data to support subsequent development, or to select baseline concepts for the anticipated environment. In the reasonable category, the available data is sufficient to initiate subsequent development with an acceptable risk. However, unresolved problems may exist. In the third category, insufficient information, limited or immature data preclude initiating subsequent development or consideration of baselining the concept with an acceptable risk.

Technology Status Categories

- 1** Adequate - Available Data Are Sufficient To Support Subsequent Development, Select Baseline Concepts
- 2** Reasonable - Available Data Are Sufficient To Initiate Subsequent Development With Acceptable Risks
- 3** Insufficient Information - Limited Or Immature Background Data Precludes Baselineing The Concept For The Anticipated Environment

Stratification and Mixing

Reliable predictions for propellant thermal stratification are essential to determine tank pressures needed to suppress boiling and to provide adequate pump net positive suction pressure. Semi-empirical analytical models based on Saturn and earlier launch vehicles are adequate to develop design criteria for the Space Shuttle ascent tanks. Additional confidence in the extrapolation of the models should result from the study presently in progress.¹

The capability to pump saturated propellants at about 45 psia is indicated. Therefore, the primary influence of stratification in the on-orbit tanks will be the frequency of vent system cycling. Prediction methods for stratification in the on-orbit cryogen tanks are inadequate, and the available data are from small storage tanks and short duration orbital data from the S-IVB stage. However, the analytical models and limited data both indicate that tank pressure rise rates resulting from thermal stratification can be one to two orders of magnitude greater than for a "mixed" system. This characteristic can impose fundamental design penalties, since (1) the vent system component life cycles are increased, (2) a tank pressure collapse can occur when stratified propellants are mixed due to vehicle maneuvers, and (3) mass gauging techniques may be influenced.

The potential design impact of inadequate on-orbit tank stratification techniques can be minimized. Studies^{2,3} have indicated that low-power mixers can preclude low-g stratification using state-of-the-art components. Axial mounted jet pumps appear to be optimum. The penalties for redundancy appear to be minimal, since the primary system cost or weight is in electrical power utilization.

¹Holmes, L. A., "The Development of Thermal Stratification and Destratification Scaling Concepts," Contract NAS8-24747 (In Process)

²Poth, L. J. et al, "A Study of Cryogenic Propellant Stratification Reduction Techniques," Final Report, Contract NAS8-20330, Nov. 1968

³Sterbentz, W. H., "Liquid Propellant Thermal Conditioning System," Interim Report, NAS3-7942, April 1967

Stratification And Mixing

	High Tank Heat Input		Low Tank Heat Input	
	High-G	Low-G	High-G	Low-G
Stratification	Industry ¹	Centaur S-IVB ²	Industry ¹	Industry ³
Mixing	-	-	-	MSFC/GDC LeRC/LMSC ¹

Key: Technology Status

- ¹ Adequate
- ² Reasonable
- ³ Insufficient Information

Propellant Thermal Conditioning

Feedline geyser suppression and propellant quality control are two critical considerations to cryogen utilization for propulsion. A geyser results from the formation of a Taylor bubble in a line filled with boiling liquid. When the Taylor bubble fills a majority of the cross section of the line, it reduces the pressure on the fluid below, which feeds the Taylor bubble by flash boiling and "burps" fluid from the line. Geyser suppression is essential since the hydraulic forces produced during the refill of long vertical LOX lines can exceed design loads. For example, S-IC LOX feedline geysers resulted in pump inlet pressures approaching 1400 psi.

Preliminary design criteria for prelaunch conditioning of propellant feedlines has been established.⁴ This geyser-nongeyser region correlation, developed for vertical feedlines, may require re-evaluation to establish utility for line configurations with significant horizontal runs or multiple branches.

Orbiter main-engine start requirements for propellant thermal conditioning are primarily to prevent vapor from forming in feed systems. The loss of acceleration head pressure at booster cutoff will cause propellant "flashing" if the feed system propellants are superheated at tank pressure. Vapors would then have to be ingested by the engine pumps during the engine start.

Propellant thermal conditioning systems used to suppress feedline geysers and control propellant quality are summarized on chart 4. These approaches may be applicable to the Shuttle vehicle. However, complex sequence schemes and single-point failure modes must be avoided. The natural recirculation system is the preferred concept for ascent propulsion. It results in minimum vehicle-facility interfaces, does not require active auxiliary components, and is relatively insensitive to stage configuration.

⁴Murphy, D. W., "Mechanics of Geysering of Cryogenics," Final Report, NAS8-5418, June 1964.

Propellant Thermal Conditioning

Concept	Geyser Suppression	Quality Control		Remarks
		Ascent	Restart	
Subcool Replenish	-	Atlas	-	Facility Constraints
Evaporative Cooling	-	S-IB S-IV	-	Limited Capability
Overboard Dump	-	S-IV Centaur	Centaur S-IVB (Contingency)	Payload Impact Complex Sequencing
Recirculation - Natural	S-IC	S-II (O ₂) Atlas	-	Preferred Ascent Concept
- Forced	-	S-IVB S-II (H ₂) Centaur	S-IVB Centaur	Auxiliary Systems Required

In-Space Venting

A vent system that exhausts only vapor is essential for propellant management of the tanks for on-orbit maneuvers. The S-IVB and Centaur stages employ positive acceleration to maintain settled propellants and to prevent liquid entrainment. Vent system designs that do not have to rely on vehicle acceleration enhance mission flexibility. The technology status of the primary methods investigated to ensure vapor venting from cryogen containers under in-space conditions are summarized in chart 5.

The heat exchanger/mixer is a preferred concept, based on demonstrated feasibility, system simplicity, performance in 100 percent liquid, weight, and a favorable system failure rate analysis. Prototype hydrogen systems have been successfully tested^{5,6} in a 1-g environment, and the technology is readily adaptable to long term storage. An optimum system for in-space venting of LOX containers has not been defined. However, the heat exchanger/mixer concept appears to be applicable. Baseline consideration of this concept for LOX tank venting appears to be a reasonable development risk.

⁵Stark, J. A., and Blatt, M. H., "Cryogenic Zero-Gravity Prototype Vent System," Final Report, Phase 2, Contract NAS8-20146, Oct. 1967

⁶Sterbentz, W. H., "Liquid Propellant Thermal Conditioning System," Final Report, NAS3-7942, August 1968

In-Space Venting

Concept	Feasibility Studies	Process Investigation	Subsystem Tests	Orbital Experiments	Operation Systems	Remarks
Vehicle Acceleration	Industry ¹	Industry ¹	Industry ¹	AS-203 ¹	Saturn Centaur ¹	Heavy
Hx/Mixer	Industry ¹	MSFC/GDC LeRC/LMSC ²	MSFC/GDC LeRC/LMSC ²	None ²	None	Preferred Concept
Wall Hx	Industry ¹	Industry ²	AF/MMC MSC ²	AS-203 ²	None	Design Problems
Mechanical Separators	Industry ¹	Industry ²	GDC ²	None	None	Inadequate
Dielectrophoresis	Industry ¹	Industry ²	Industry ²	None	None	Design Problems

Key: Technology Status

1 Adequate 3 Insufficient Information
 2 Reasonable

Tank Pressurization

Tank pressurization is required to suppress bulk boiling of propellants, to satisfy pump net positive suction pressure requirements, and to stabilize tank structure. The technology background within the industry is adequate for autogenous or helium pressurization, employing diffused gas techniques.^{7,8} The thermal management studies of the on-orbit propellant systems are expected to indicate that saturated or low temperature pressurant is desired. This will be a unique application of pressurization technology, and may present some development problems. The available data on sub-surface pressurization techniques are limited to small tanks at one-g. This technology is immature for low-g applications.

Historically, extensive heat exchanger development has been required to assure performance and stability.⁹ The theory developed for instability in cryogenic heat exchangers has emphasized supercritical fluids, and defined generalized corrective solutions. The generalized solutions are applicable as guidelines to new heat exchanger development programs.

The major considerations for pressurization of the Space Shuttle cryogen tanks will be to determine the most economical compromises between performance, flexibility, and maintainability. Studies to assess improvements in cost effectiveness of tank passivation are in process (NAS10-7258).

⁷Nein, M. E., and Thompson, J. F., "Experimental and Analytical Studies of Cryogenic Propellant Tank Pressurant Requirements," NASA TN D-3177, February 1966

⁸Epstein, M., and Anderson, R. E., "An Equation for the Prediction of Cryogenic Pressurant Requirements for Axisymmetric Propellant Tanks," Cryogenic Engineering Conference, August 1967

⁹Friedly, J. C., Manganaro, J. L., and Kroeger, P. G., "Investigation of Thermally Induced Flow Oscillations in Cryogenic Heat Exchangers," General Electric Company, Final Report, NAS8-21045, October 1967

Tank Pressurization

Concept		High Tank Heat Input		Low Tank Heat Input	
		High-G	Low-G	High-G	Low-G
Diffused Gas	Small Tank	Industry ¹		Industry ¹	MSFC/MDAC ²
	Large Tank	Titan Atlas Thor Centaur Saturn ¹	Centaur Saturn ¹	AF LeRC ¹	²
Sub-Surface (Bubbled)	Small Tank	-	-	LeRC ² AF MDAC	³
	Large Tank	-	-	²	³

Key:

Technology Status

¹ Adequate

² Reasonable

³ Insufficient Information

Low-G Mass Gauging

The mass gauging of propellants in a zero-g environment is essential to provide operational flexibility. The technology base is inadequate to support baselining any of the primary candidate concepts summarized on chart 7. The potential advantages of the Radio Frequency and the Point Phase Detector systems are low weight and power input, and presents no hazards to personnel. However, these systems are immature. Capacitance concepts that require a wire matrix within the tanks are complex and may be limited to small tank applications. Nucleonic systems applicable to cryogenics may require complex electrical networks and shielding. Also, studies indicate that system accuracy may be sensitive to orientation. The acoustical system is not applicable since it has been developed for non-cryogenics and positive expulsion bladders.

The technology base is adequate for mass gauging systems required for loading and propellant utilization under one-g applications. However, improvements in maintenance and reliability are indicated.

Concept	Feasibility Studies	Development Test	Orbital Experiments	Operational Systems	Remarks
Radio Frequency	MSFC/Bendix ²	Gov't/Bendix ³	None	None	Immature; Low Weight And Power
Capacitance	MSFC/Transonic Simmonds ¹	MSFC/Transonic Simmonds ²	AS-203 ²	None	Complex Limited Application
Nucleonic	Industry ¹	Industry ²	None	None	Complex; Sensitive To Orientation
Point Phase Detectors	MSFC ¹	MSFC/MPI MSFC ³	None	None	Immature; Potential Mapping Technique
Acoustical	Industry ¹	AF/Acoustica ¹	Mol-HSQ (Non-Cryogen) ²	None	Applicable To Positive Expulsion

Key: Technology Status ¹Adequate ²Reasonable ³Insufficient Information

Summary

The cryogen technology available to the Space Shuttle is more mature and comprehensive than that on which previous launch vehicles were designed and developed. The disciplines and flight application are summarized on chart 8. The data is sufficient to select baseline concepts with the following exceptions:

Orbit Stratification - Technology is inadequate due to wide range of analytical results and limited applicable data. Inadequate technology has no significant impact on Shuttle concepts since mixer implementation can negate requirement.

Orbit Mass Gauging - The concept evaluations in progress are immature. Additional technology development is required to provide the operational flexibility desired for the Space Shuttle.

Discipline	Application			
	Ascent		Orbit	
	O ₂	H ₂	O ₂	H ₂
Stratification	Adequate	Adequate	Inadequate	Inadequate
Mixing	-	-	Reasonable	Reasonable
Thermal Conditioning				
- Geyser Suppression	Adequate	-	-	-
- Quality Control	Adequate	Reasonable	Adequate	Adequate
In-Space Venting	-	-	Reasonable	Adequate
Pressurization	Adequate	Adequate	Adequate	Adequate
Mass Gauging	Adequate	Adequate	Inadequate	Inadequate

CRYOGEN INSULATION TECHNOLOGY

REVIEW FOR THE SPACE SHUTTLE

James R. Barber

NASA-Lewis Research Center
Cleveland, Ohio

INTRODUCTION

The cryogenic insulation required for a reusable space shuttle vehicle falls into two general categories. These are (1) the insulation required for the ascent LH₂ tanks on both the booster and orbiter and (2) the insulation required for the on-orbit propellant tanks within the orbiter. This figure shows one possible arrangement of propellant tanks in a typical orbiter. The larger LH₂ and LO₂ tanks contain the ascent propellant and the smaller tanks contain the on-orbit propellant. This paper provides a brief description of the technology available for the insulation systems required for the LH₂ ascent tanks and the LH₂ and LO₂ on-orbit tanks. In addition, programs to provide the technology necessary to achieve acceptable insulations for the space shuttle, that are already in progress or planned for the immediate future, are identified.

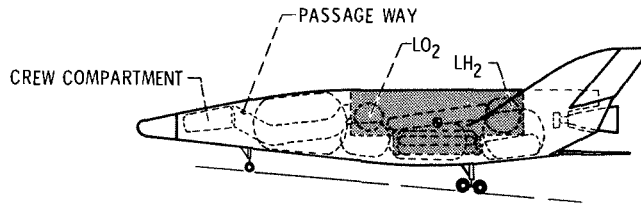
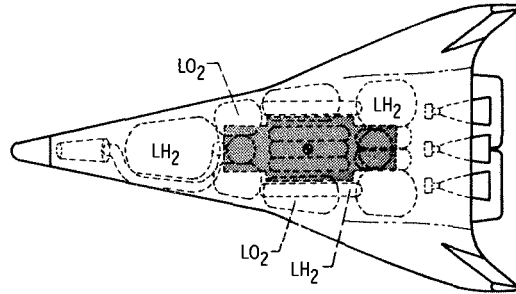

Environment and Design Considerations

The environment to which the shuttle will be exposed is, in several respects, similar to that of the Saturn vehicle. The ground hold and ascent portions of the flight for both the shuttle booster and shuttle orbiter are similar to those of the Saturn II and Saturn IV-B vehicles. Where the environment for the shuttle differs from that of the Saturn is in the requirements for stay time in orbit and the need to withstand the stresses of re-entry in a reuseable condition. The shuttle environment is summarized in this figure. The 250°F external temperature in orbit is considered to be a maximum temperature and would result from using currently available exterior thermal control coatings. If coatings with lower solar absorptivity to emissivity ratios that can withstand rigors of flight in the earth's atmosphere without degradation become available, this temperature could approach 100°F.

The design considerations that must be included in the selection of a cryogenic insulation are minimum weight, ability to withstand the rigors of 100 flights while maintaining adequate thermal performance and structural reliability, be easily inspected, require minimum repair effort, and assure satisfactory performance on the next flight.

As might be expected, the problem of providing a reuseable insulation system is going to be a primary concern of the technology efforts directed toward developing a cryogenic insulation for the shuttle. It is this phase of the flight profile which to date has had the least effort expended and is therefor the least understood.

CRYOGENIC INSULATION

SHUTTLE ENVIRONMENT

- GROUND HOLD - 1 ATM MOIST AIR; $\approx 70^{\circ}$ F EXTERNAL TEMP
- ASCENT - RAPIDLY DECAYING EXTERNAL PRESS; $> 70^{\circ}$ F EXTERNAL
- ORBIT - VACUUM EXTERNAL; 250° F EXTERNAL; 7-30 DAYS
- REENTRY - RAPIDLY INCREASING EXTERNAL PRESS \rightarrow 1 ATM MOIST AIR $\gg 70^{\circ}$ F EXTERNAL

DESIGN CONSIDERATIONS

- WEIGHT - BOILOFF WT + TANK WT + INSULATION WT
- PERFORMANCE - INFLUENCES WT; FUNCTION OF PROP SUBSYSTEM
- REUSE - 100 FLIGHTS (TEMP CYCLES; DAMAGE FROM MOISTURE OR AIR CONDENSATION)
- REFURBISHMENT - 2 WEEK TURN-AROUND; REQUIRE EASILY INSPECTED SYSTEM; EASILY CHECKED-OUT (OR PREDICTABLE) SYSTEM

CS-53043

Ascent Tanks - Internal Insulation

A considerable amount of experience has been gained on a reinforced foam insulation system installed internally on the LH₂ tank of the Saturn S-IVB stage. The accompanying figure shows a schematic of that system. Dearing¹ reports that the thermal conductivity increases with time due to the intrusion of hydrogen gas into the pores of the foam. The seal presently being used is adequate for Saturn flights but in order to be suitable for the shuttle, improvements must be made. NASA has recently contracted for work to be done to make this internal foam system available to the shuttle. In addition to improving the seal, the insulation system will be evaluated for effects of varying thickness and increased hot side temperature. Temperature as high as 300°F may be encountered during re-entry and an evaluation of material capabilities to that temperature is required. As long as hydrogen gas permeates the internal seal, the chance for rapid expansion of this gas with attendant damage to the insulation can occur during re-entry. The importance of this factor will be more fully determined. Also to be investigated are (a) adhesives that have adequate strength at both high and low temperature and (b) inspection and repair techniques to be employed between flights.

Another insulation system under consideration for use inside LH₂ tanks is one that is currently under investigation by Lewis Research Center at the Martin Company under Contract NAS3-12425. This program is investigating the principle of the internal gas layer barrier for the methane tanks of the SST. By bonding a series of cells, in this case plastic honeycomb, to the tank wall and covering it with a facing sheet which has one small pore for each cell, a surface tension barrier is set up at each pore and each cell fills with gas. By further filling each cell with a material to reduce convection and radiation, a thermal conductivity equivalent to static gas can be achieved. This system is attractive for the space shuttle LH₂ tanks because high temperature resistant materials are presently available, and venting during reentry should be no problem due to the open pore nature of the system. As with the foam system, work to provide thermal data on varying thicknesses, high temperature effects, effect of many operational cycles, and inspection and repair techniques is required and NASA has recently awarded a contract to start this work.

¹Dearing, D.L. Paper B-8, "Development of the Saturn S-IV and S-IVB Liquid Hydrogen Tank Internal Insulation", Advances in Cryogenic Engineering, Vol. 11

INTERNAL INSULATION

S-IV B SYSTEM

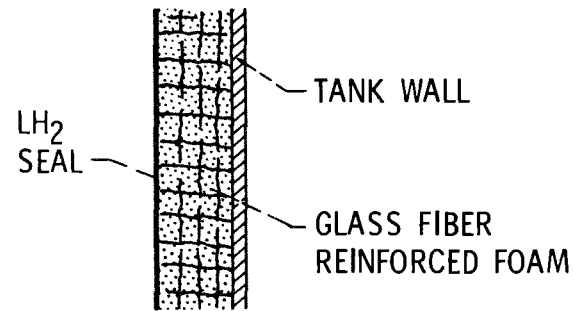

6.0 LB/FT³

$k = 0.025-0.035 \text{ BTU/HR-FT-}^{\circ}\text{R}$
(EXPOSURES < 50 HR)

SST METHANE TANK (NAS3-12425)

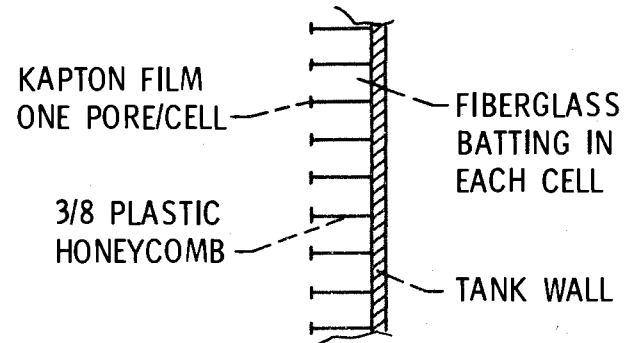

4.0 LB/FT³

$k = 0.05-0.06 \text{ BTU/HR-FT-}^{\circ}\text{R}$
(GH₂ CONDUCTIVITY)

WORK REQUIRED

1. EFFECTS OF INCREASED THICKNESS
2. DEVELOPMENT OF HIGH TEMP ADHESIVES
3. APPLICATION AND INSPECTION FOR LARGE, COMPLEX TANKS
4. FOAM VENTING DURING REENTRY

CS-53044

Ascent Tanks - External Insulation

In addition to the experience available on the internal foam system used on the S-IVB, there is a significant amount of experience on the external foam system used on the S-II². Although there were several insulations developed for the S-II, this is the most recent one and is currently used on the Apollo launches. In developing this system for the S-II, a great deal of work was done on temperature cycling effects and evaluating the exterior seal for temperature effects during launch. A peak temperature of 525°F is experienced during a Saturn launch and this coupled with exposure to the atmosphere has resulted in erosion of the insulation surface. Since the tanks of the shuttle will be protected by the vehicle structure, erosion is not expected to be a problem, but resistance to high temperature for both launch and re-entry must be evaluated. In addition, work will be needed to determine the effect on performance of many operational cycles, and to develop the necessary inspection and repair techniques. To avoid air and moisture condensation during operation in the atmosphere, a dry gas purge system may be required. The extremely low thermal conductivity and light weight achieved for this system makes it very attractive for the shuttle and NASA presently has plans to contract for this effort during FY '71.

²Smith, M.E. and Mack, F.E. "High-Performance Spray Foam Insulation for Application on Saturn S-II Stage", Space Division, North American Rockwell Corporation.

EXTERNAL INSULATION-ASCENT TANKS

S-II FOAM

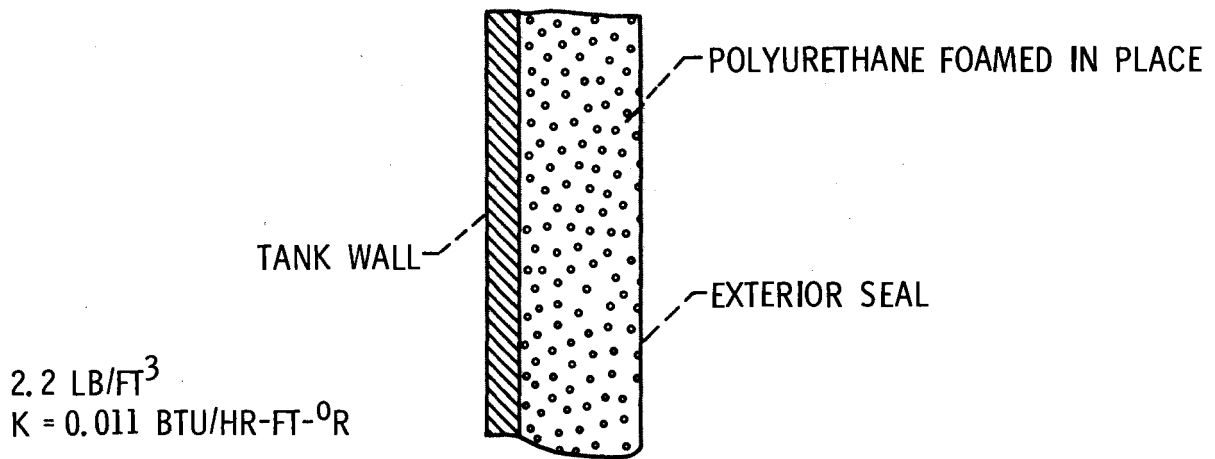

ADVANTAGES - EASILY INSPECTED & REPAIRED

WORK REQUIRED

1. PURGE SYSTEM DEVELOPMENT
2. TEMP CYCLING EFFECTS
3. HIGH TEMP MATERIALS DEVELOPMENT
4. APPLICATION, INSPECTION, & REPAIR ON LARGE COMPLEX TANKS

CS-54831

Multilayer Insulation (MLI)

The on-orbit tanks hold the LH₂ and LO₂ propellants for the Orbital Maneuvering System and the Altitude Control System, and the LH₂ fuel for the Air Breathing Propulsion System. These tanks require an insulation system with a performance level many times better than those previously discussed for the ascent tanks.

Multilayer insulations which consist of alternating radiation shields and low conductivity spacers have been studied by several investigators.^{3 4 5} Typical results of laboratory data are shown in this figure taken from ref. 5. The radiation shields are aluminized mylar sheets 1/4 mil thick. Doubly aluminized mylar (DAM) is mylar aluminized on both sides and singly aluminized mylar (SAM) is mylar aluminized on one side only. These systems were chosen for comparison because each has 20 reflecting surfaces. As can be seen there is not a significant difference between any of the systems at low compressive loads. However, as the contact pressure between the layers increases causing more direct thermal shorting, each system reacts differently. The goal of most of the investigations to date has been to try to understand the heat transfer process through multilayer insulations and at the same time minimize the effects of variations in performance caused by differing application techniques which result in more or less thermal contact between layers of MLI.

-
- 3 "Advanced Studies on Multi-Layer Insulation Systems", Final Report Contract NAS3-6283, NASA CR-54929, Arthur D. Little, Inc.
 - 4 "Investigation of High Performance Insulation Application Problems", Fourth Quarterly Report Contract NAS8-21400, MDC G0274, McDonnell Douglas Astronautics Company - Western Division.
 - 5 Cunnington, G.R., Keller C.W. and Bell, G.A. "Thermal Performance of Multilayer Insulations," Interim Report Contract NAS3-12025, NASA CR 72605, Lockheed Missiles and Space Company.

HEAT FLUX VS COMPRESSIVE LOAD FOR MLI

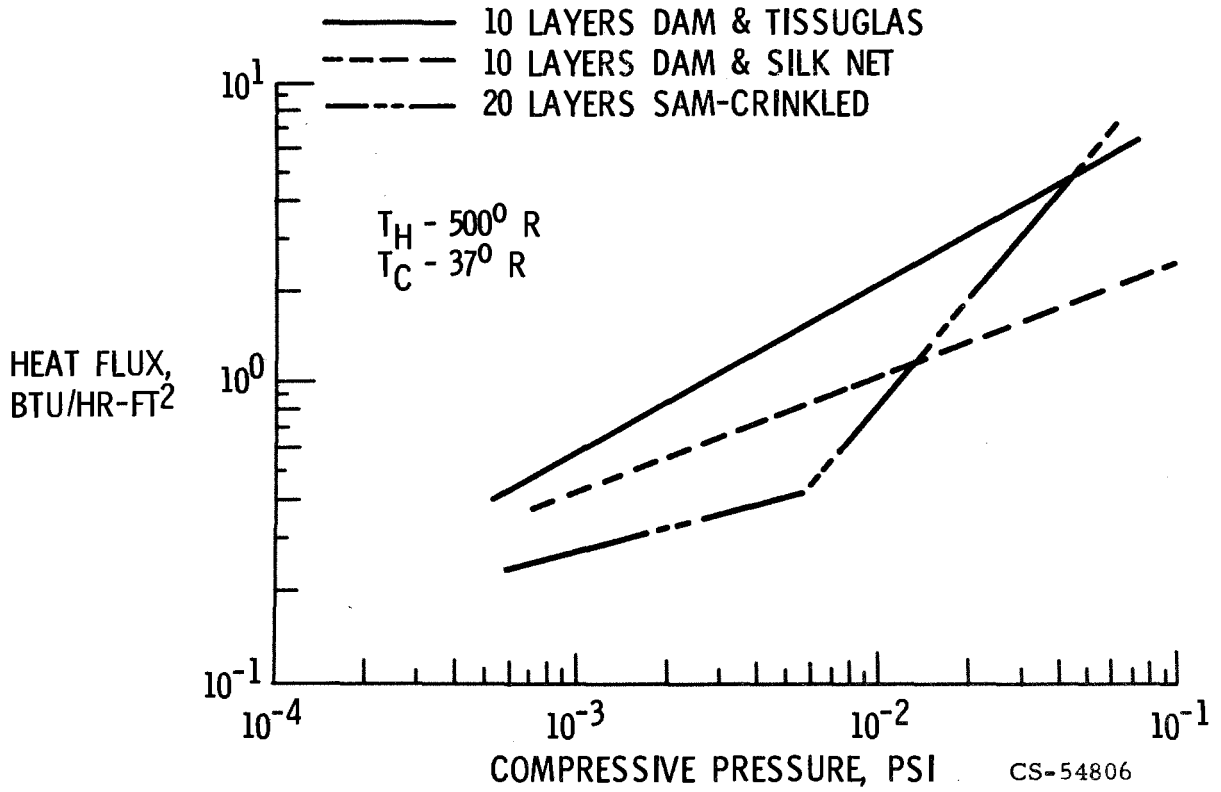

Heat Flux Vs. Layer Density for MLI

Performance of multilayer insulation expressed as a function of compaction pressure is not particularly useful. An insulation system installed on a tank can not readily be inspected to determine the compressive load between layers. Thus an effort was made⁶ to relate compaction pressure of multilayer insulations to layer spacing or density. An example of the results is shown in this figure. Several insulation systems (of which only one example is shown) were tested in a flat plate calorimeter. Insulation systems with varying numbers of radiation shields were tested at four different combinations of hot and cold boundary temperatures and at a minimum of four layer densities. The expression shown was obtained by using a least squares fitting technique.

With an expression of this type available for a particular tank mounted insulation and having made a determination of layer density by inspection a better estimate of thermal performance can be made.

⁶ Ibid

HEAT FLUX VS LAYER DENSITY FOR MLI

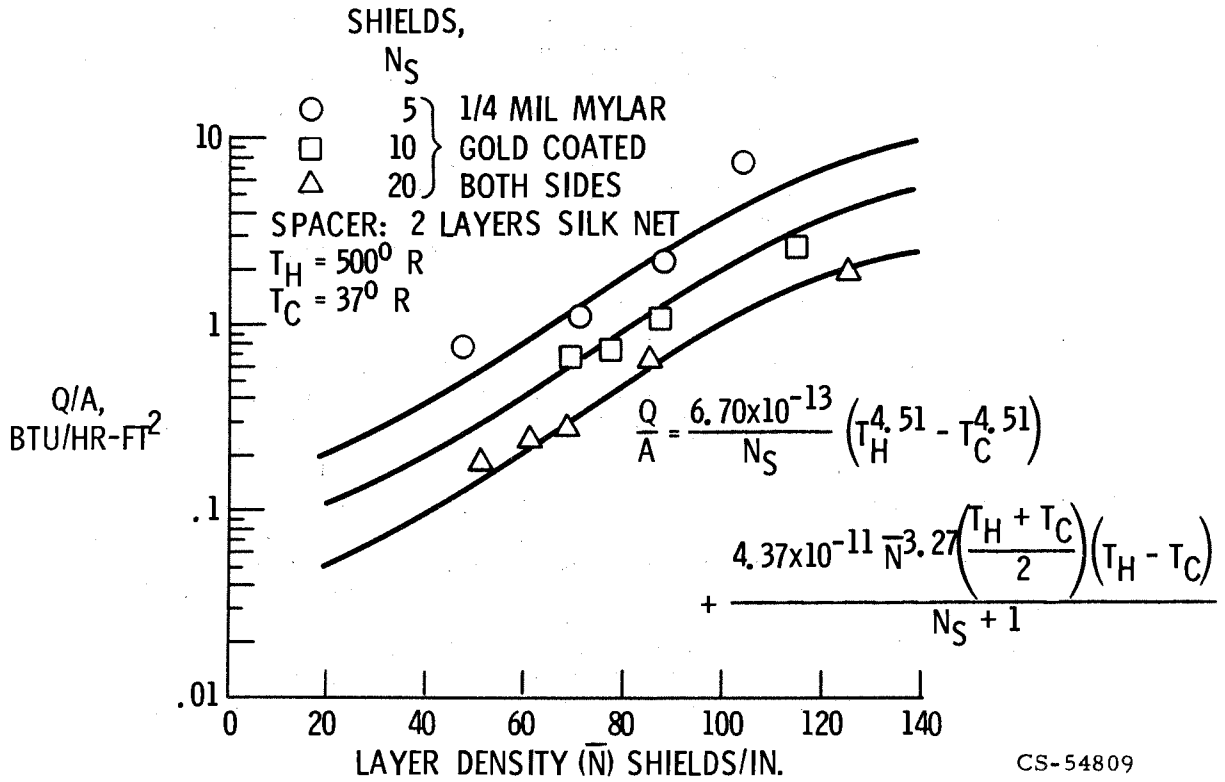

Tank Tests vs Flat Plate

The ability to predict tank installed MLI performance from flat plate calorimeter data is illustrated in this figure. A four foot diameter tank was insulated with gold coated mylar radiation shields and silk net spacers ⁷. A total of twenty radiation shields were carefully applied such that there was no direct contact between individual shields as determined by electrical resistance measurements. The tank was inspected by X-ray photographs to determine layer density. Following inspection, it was installed in a vacuum chamber. After attainment of minimum chamber pressure, the tank was filled with cryogen. As in the calorimeter tests, two hot boundary temperatures and two cold boundary temperatures were used to obtain four different boundary temperatures. Boiloff tests were performed at each set of boundary temperatures. The vacuum chamber pressure was then returned to one atmosphere completing the test of the 20 layer system. Ten layers of insulation were removed and the X-ray process was repeated. Four boil-off tests were run as in the twenty layer tests. Similarly four boil-off tests were run with five layers of insulation on the tank. As can be seen from the figure, the five layer and twenty layer tests were close to the prediction based on the flat plate Calorimeter results. The ten layer system performed about 50% higher than predicted. In addition it should be noted that there was an apparent change in layer density between tests. This should not be surprising as the insulation system was first exposed to decreasing pressure and then increasing pressure between X-ray measurements. Further, it should be noted that no knowledge could be obtained of the actual layer density during test. Thus, although X-ray measurements were made prior to each test, the insulation system was exposed to a pressure decay after it was measured and before it was tested. Also it was exposed to a pressure increase after test and before it could be measured again. Although neither of these pressure excursions were as severe, either as to rate or temperature of a shuttle flight profile, the concern for an exposed multilayer insulation on the shuttle tanks should be obvious.

⁷ "Thermal Performance of Multilayer Insulation Systems"
20th Monthly Report Contract NAS3-12025 LMSC/6955581
Lockheed Missiles and Space Company.

COMPARISON OF TANK TEST WITH FLAT PLATE CALORIMETER TESTS

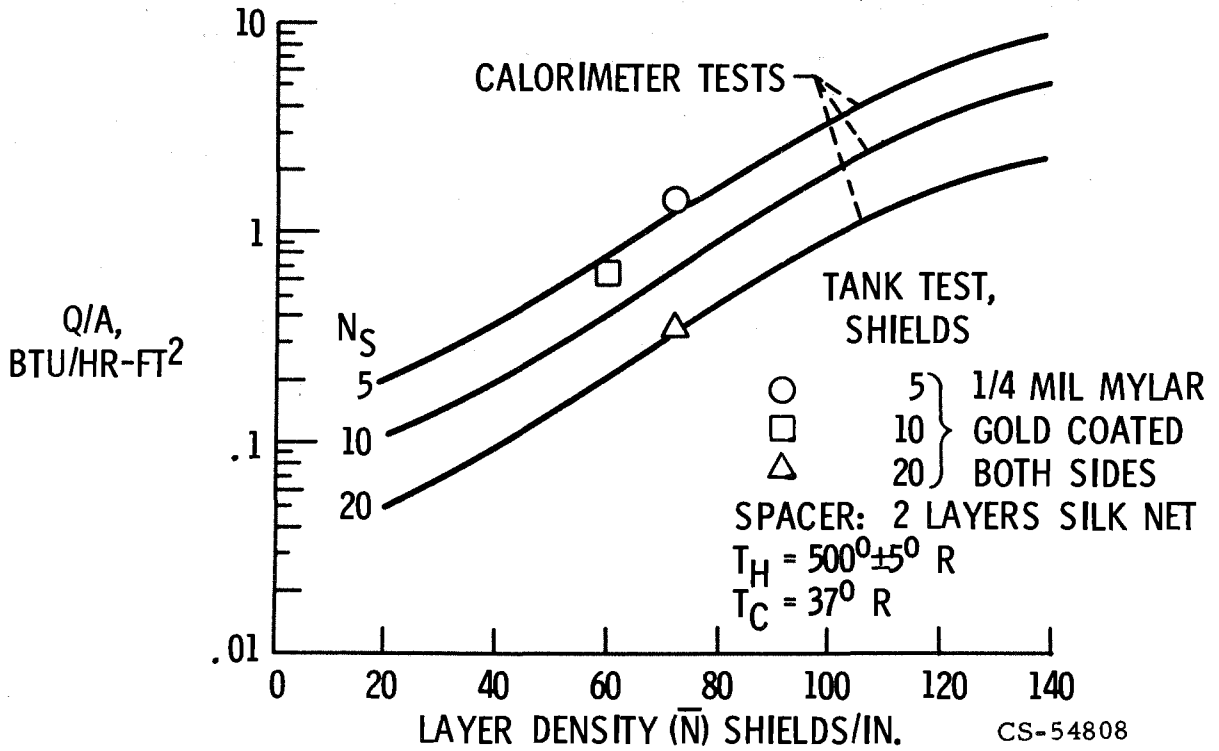

Environmental Effects on MLI

Multilayer insulation mounted on the exterior of a cryogenic tank will be exposed to a number of environmental contaminants both prior to launch and during re-entry. The effects of these contaminants has not been fully evaluated but an indication of the effects of high humidity on metallized polyester is shown in this figure.⁸ High humidity is potentially present at any time the vehicle is in the launch area. In addition, after the propellants have been loaded, the insulation system could be exposed to formation of frost, purge gases to prevent water vapor from entering the insulation, and leaking propellants. The work being performed under contract NAS3-14342, recently awarded to Lockheed Missiles and Space Co. by Lewis Research Center, will examine the effects of these environments on several materials used for fabrication of multilayer insulation systems. In addition to exposure during ground operations, leaking propellants can be present during space operations, and during re-entry both leaking propellants and high humidity can be expected.

⁸ "Advanced Studies on Multi-Layer Insulation Systems," Final Report Contract NAS3-6283, NASA CR54929, Arthur D. Little, Inc.

EFFECT OF HUMIDITY ON METALLIZED POLYESTER

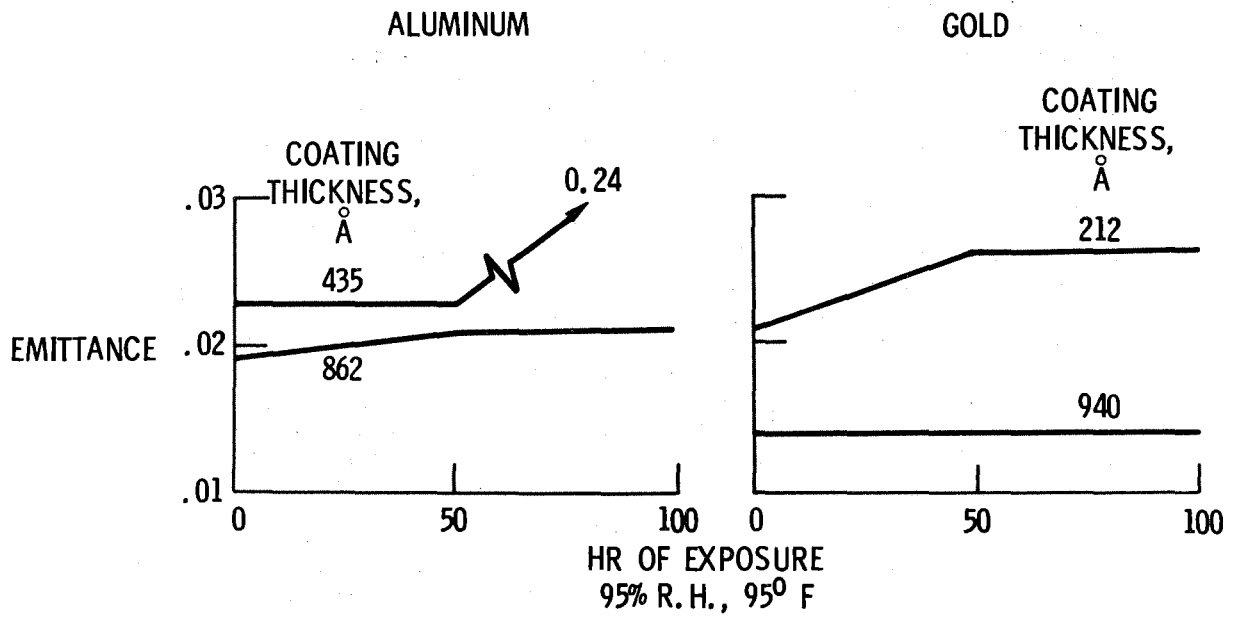

CS-54807

High Performance Cryogenic Insulation-Purged MLI

One candidate insulation system for the on-orbit propellant tanks is shown in this figure. Specifically this system is under consideration for the LH₂ tanks. The system for the LO₂ tanks would be similar but would not require the internal insulation. The internal insulation could be one of those previously considered for use on the ascent tanks. Its purpose in this system is to provide a tank wall temperature, during ground hold, above the liquifaction point of nitrogen or air, and allow the use of gaseous nitrogen as a purge gas during ground hold. The alternative would require gaseous helium and the cost both in dollar amount and loss of critical material (helium gas) would be high. During space flight, the highly efficient MLI on the outside of the tank provides the majority of thermal resistance to heat flow to the propellant. This means that the tank wall temperature approaches that of LH₂. For re-entry the purge system on the LH₂ tank must be helium. Some consideration can be given to use of a nonpurged system during re-entry, providing the condensation of air, freezing of water vapor, and leaking propellants are controlled so as not to constitute a hazard to the vehicle and crew, and acceptable levels of performance can be attained by the insulation system on subsequent flights. An in-flight purge system will be a weight penalty charged to this particular insulation system and will be quite complex in operation. Kline and Mendelsohn⁹ suggest a possible purge system for re-entry and offer the opinion that it will be a challenging and expensive task.

In addition to the requirement of a purge system, materials development work is required to provide multilayer insulation systems that can withstand temperatures above 300°F. Also to be evaluated is consistency of performance over many thermal and pressure change cycles and the establishment of post flight inspection and repair techniques.

This work is presently being pursued under a contract recently awarded by NASA.

⁹ Kline, R.L. and Mendelsohn, A.R. - "Thermal Integration Considerations for the Space Shuttle." Contributed for presentation at The American Society of Mechanical Engineers' Space Technology and Heat Transfer Conference, Los Angeles, California, 21-24 June, 1970. Grumman Aerospace Corporation.

HIGH PERFORMANCE CRYOGENIC INSULATION

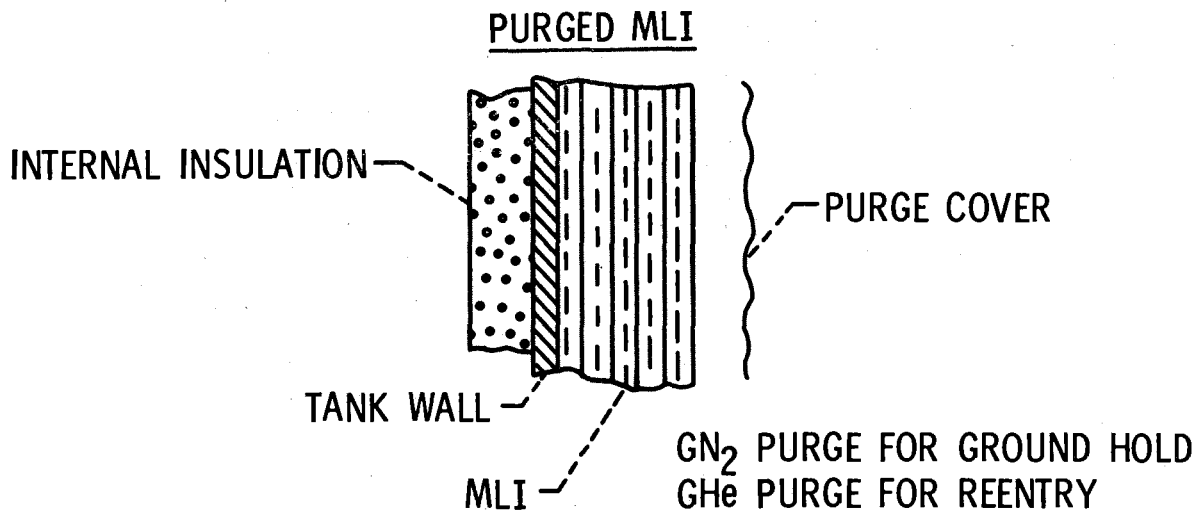

WORK REQUIRED:

1. OBTAIN CONSISTENT PERFORMANCE OVER MANY THERMAL & PRESSURE CHANGE CYCLES
2. DEVELOP IN-FLIGHT HELIUM PURGE SYSTEM
3. ESTABLISH INSPECTION & REPAIR TECHNIQUES
4. EVALUATE MATERIALS FOR HIGH TEMP EXPOSURE

CS-54804

High Performance Cryogenic Insulation-Evacuated Multilayers

An alternate to exposing the multilayer insulation to the environment is to encapsulate it. The encapsulation system can be either rigid or flexible. Shown in this figure are examples of each of these concepts.

The Self Evacuating MLI (SEMI) system consists of radiation shields separated by load bearing spacers encapsulated in flexible bags of low permeability. The bags are filled with CO₂. When the tanks are empty the CO₂ gas prevents air and moisture from contaminating the insulation. When the tanks are loaded with cryogen the CO₂ cryopumps to a low pressure and thermal performance during ground hold is very good. When the external atmospheric pressure is reduced simulating launch into space, the contact resistance between layers of insulation is increased and thermal performance improves.^{10 11} In order to evaluate this concept for the shuttle, the effect of many thermal and pressure change cycles must be determined. Also needed are materials that can withstand exposure to high temperature. Since re-entry temperatures will in all probability exceed the temperature at which the CO₂ was loaded, a pressure relief system to prevent pressure build up in the panels may be required. The establishment of inspection and repair techniques is also necessary. This insulation system has the advantages of good ground hold performance, adequate space hold performance, and does not require an in-flight purge system. Its disadvantages are that the flexible bags may be susceptible to leakage which will require recharging the CO₂ during ground operations. Since this system is attractive for use on the space shuttle, NASA presently plans to fund an effort during FY 71 to provide the technology necessary for a more complete evaluation.

By completely enclosing an insulation system in a rigid vacuum jacket all of the disadvantages of changing environments, purge systems, and varying performance are eliminated. Vacuum jackets as presently designed of monocoque construction are heavy. The use of light-weight sandwich construction could be considered and the potential for designing a total system whose weight and performance approach that of a purged MLI appears possible. The advantages of this system are constant performance in all phases of the flight and no degradation caused by environmental exposure. The problems posed by this system are leakage of propellants into the vacuum annulus and difficulty of fabrication of a leak tight vacuum shell out of thin, light-weight materials. NASA presently plans to fund an effort during FY '71 to provide the technology necessary for a more complete evaluation of this system.

¹⁰ Neindorf, L.R. and Nies, G.E. - "Investigation of a Light Weight Self-Evacuating Prefabricated Multi-Layer Insulation System for Cryogenic Space Propulsion Stages" Final Report Contract NAS3-6289, NASA CR 72017, Linde Division, Union Carbide Corporation.

¹¹ Lindquist, C.R. and Nies, G.E. - "Lightweight Multilayer Insulation System" Final Report Contract NAS3-7953, NASA CR72363, Linde Division, Union Carbide Corporation.

HIGH PERFORMANCE CRYOGENIC INSULATION

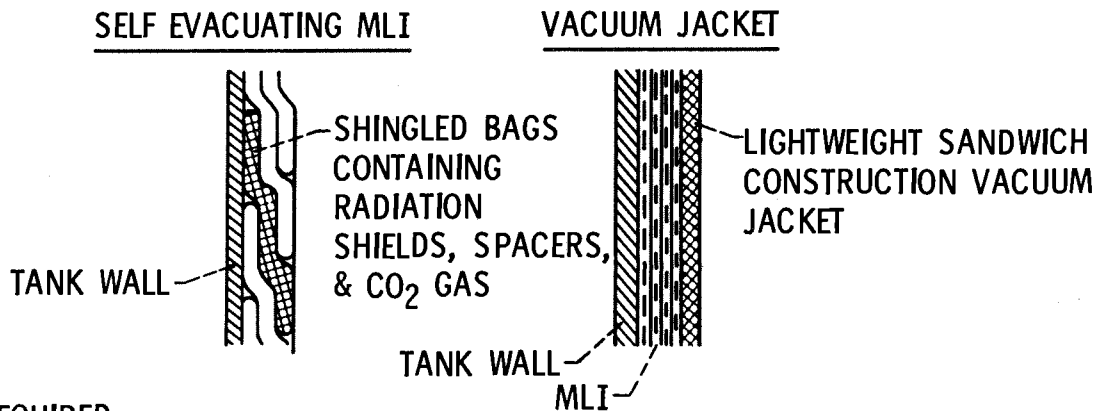

WORK REQUIRED:

1. DETERMINE EFFECT ON PERFORMANCE OF MANY THERMAL & PRESSURE CHANGE CYCLES
 2. DEVELOP PRESSURE RELIEF SYSTEM FOR REENTRY
 3. ESTABLISH INSPECTION & REPAIR TECHNIQUES
 4. EVALUATE MATERIALS FOR HIGH TEMP EXPOSURE
1. DEVELOP FAB TECHNIQUE FOR LIGHTWEIGHT SHELLS
 2. DEVELOP LOW OUTGASSING INSULATION
 3. ESTABLISH INSPECTION CRITERIA
 4. EVALUATE MATERIALS FOR HIGH TEMP EXPOSURE

CS-54805

Summary

Several insulation systems potentially useful for the space shuttle have been discussed. Supporting research and technology efforts are currently underway for three such systems. These are:

<u>Insulation System</u>	<u>Contractor</u>	<u>Sponsoring Agency</u>
Internal Foam	McDonnell-Douglas	NASA-MSFC NAS8-25973
Internal Gas Barrier	Martin Company	NASA-MSFC NAS8-25974
External MLI	McDonnell-Douglas	NASA-MSFC NAS8-26006

Present plans are to initiate efforts during FY '71 on three additional systems. These are:

External Foam Insulation - NASA-MSFC
Self Evacuating MLI - NASA-LeRC
Light-Weight Vacuum Jacket - NASA-LeRC

ASCENT TANKS

INTERNAL INSULATION - TWO PROGRAMS (FY 70)

EXTERNAL INSULATION - ONE PROGRAM (FY 71)

ON-ORBIT TANKS

PURGED MLI - ONE PROGRAM (FY 70)

SELF-EVACUATING MLI - ONE PROGRAM (FY 71)

LIGHTWEIGHT VACUUM JACKET - ONE PROGRAM (FY 71)

CS-54832

CRYOGENIC PROPELLANT ACQUISITION AND TRANSFER

R. E. Tatro

General Dynamics/Convair
San Diego, California

SUMMARY

The technologies required to successfully design the acquisition and transfer systems for the shuttle are in the areas of storage tank fluid dynamics and thermal conditioning, pressurization and pumping system interfaces, and receiver tank thermodynamics.

Shuttle tradeoff studies which are being performed will have a direct impact on acquisition system design.

Comparing bladders, diaphragms, bellows, linear acceleration, dielectrophoresis and capillary devices for propellant acquisition indicates the selection of capillary devices based on versatility, reusability and weight. Considerations in design of a cryogenic acquisition system are fluid dynamics, thermal conditioning and fabrication.

Pressurization and pumping considerations involve prevention of tank pressure decay, feedline conditioning, and pump transient tradeoffs.

Transfer line and receiver tank considerations involve configurations, and flow rates based on thermal conditioning, chilldown, geysering and venting requirements.

Conclusions are that present studies are adequate to satisfy preliminary design requirements. However, additional studies are necessary to verify advanced concepts which could improve shuttle payload capability.

Future studies are recommended in areas which would have the greatest impact on shuttle performance and versatility.

ACQUISITION DEVICE SELECTION

For shuttle restart and propellant transfer it is imperative to have an efficient means of liquid acquisition in subcritical storage tanks. The technique used most commonly on existing vehicles is linear acceleration to bottom the propellants prior to engine restart. This approach while operationally acceptable for a single restart mission has significant weight penalties and vehicle dynamic problems which are magnified for a multiple restart vehicle such as the shuttle orbiter. Linear acceleration also forces a constraint on the mission because of the time required for settling and the vehicle perturbation caused by settling thrust.

Bladders, bellows and diaphragms are useful in positive expulsion applications for small tankage using non-cryogenic fluids. Positive expulsion devices are applicable only for a small number of recycles. For cryogenic fluids, brittleness, permeability and membrane tears have limited recycling demonstrations. Work in cryogenic positive displacement devices currently centers around LeRC with contractual studies being undertaken at Bell and Martin for cryogenic bellows of 304 stainless and at Boeing for cryogenic bladders of gold coated Kapton. Diaphragm work is being done for LeRC by Arde. None of these devices show sufficient promise to satisfy shuttle recycling capability. If significant technology breakthroughs are made in recycling of positive expulsion devices, they should be reconsidered for the cases where they appear competitive. The most likely application is the oxygen tanks where pressurant requirements for collapsing generated vapor are not excessive.

Dielectrophoresis has some merit in its ability to actively expel vapor using dielectrophoretic forces thus possibly circumventing the need for thermal conditioning of the acquisition device. Its disadvantage lies in its weight and complexity. For most propellant acquisition applications in large scale vehicles, the weight of the dielectrophoretic control surfaces approach that of the surface tension device. The dielectrophoretic system has the additional weight and complexity associated with the power supply and electrical hardware. Additionally, safety problems using dielectrophoresis in a LOX environment have not been completely resolved.

The surface tension device is the most promising acquisition concept based primarily on weight, complexity and reusability considerations. Capillary devices have the capability of being completely passive, and supplying pure liquid to a pump inlet with minimum start up transient eliminating the need for a recirculation system with proper feedline conditioning. If proper propellant cleanliness levels are maintained and design loads are not exceeded, the capillary device should be fully reusable within a minimum amount of periodic checkout required to assure system integrity.

ACQUISITION DEVICE SELECTION

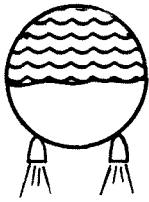

LINEAR ACCELERATION

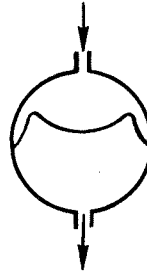

POSITIVE DISPLACEMENT

BLADDERS, DIAPHRAGMS, BELLOWS

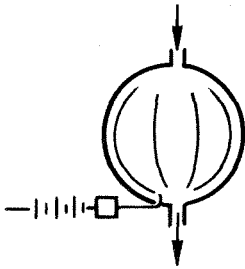

DIELECTROPHORESIS

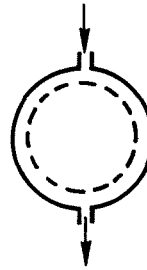

SURFACE TENSION

SHUTTLE TRIPS

Capillary devices will be utilized for shuttle subcritical acquisition systems based mainly on weight, complexity and reusability considerations. Acquisition and transfer systems will also be required for the transfer of fluid payload from the EOS to other orbital vehicles such as space tug, lunar shuttle and nuclear ferry or to an orbital fluid depot. The importance of increasing the efficiency of shuttle fluid acquisition and transfer systems is illustrated in the figure for a series of shuttle missions requiring propellant transfer. NASA/MSFC data project the following yearly loading requirements.

Nuclear Ferry to Synchronous Orbit	1,000,000#
Nuclear Ferry to Moon	1,500,000#
Lunar Shuttle	480,000#
Space Tug	<u>480,000#</u>
	3,460,000#

The curve is based on an E.O. Shuttle vehicle supplying this propellant requirement in 35,000 lb increments. Propellant transfer efficiency is affected by storage tank expulsion efficiency and boiloff, transfer line and receiver tank chilldown and vented propellants. It is estimated by MSFC that a transfer efficiency of 75% could be achieved for this mission by using ground testing and analytical tools as the only basis for the design. If orbital test data is obtained for transfer system design then transfer efficiencies could exceed 90%. The propellant savings accruing from technology advances incurred from ground based and orbital testing and analytical studies can have a significant impact on reducing shuttle missions required for orbital propellant transfer.

SHUTTLE TRIPS SAVED vs. TRANSFER EFFICIENCY

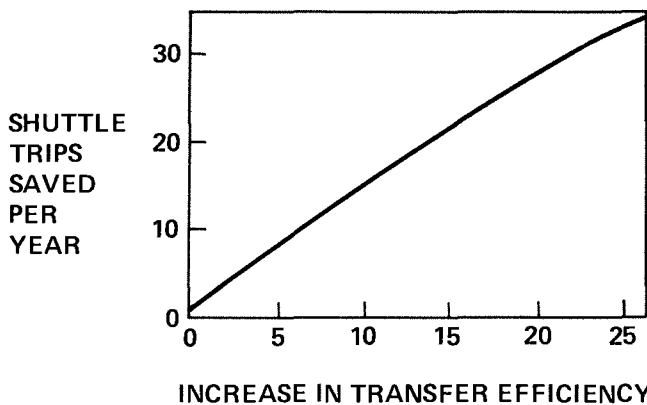

ASSUMPTIONS:

35,000 LB. PROPELLANT PER TRIP

3.5×10^6 LB. REQUIRED/YR. FOR NUCLEAR FERRY, LUNAR SHUTTLE, & SPACE TUG

TRADEOFFS - CRYOGENIC TANKAGE

For systems where vapor supply is required, such as FCP, APU, ECLSS and ACPS, supercritical systems must be compared with subcritical systems. Subcritical systems of this type require that acquisition devices be used which supply high density fluid in a low gravity environment independent of vehicle or propellant orientation.

The use of integrated tankage is another concept being considered to save weight and minimize components. An integrated tankage system would require the use of a hybrid total acquisition/partial acquisition capillary device to satisfy mission requirements. Compartments could be designed for continuous low gravity outflow in series with compartments designed for engine restart which would be refilled with settled propellant. If separate tanks are selected, individual systems would be designed for each subcritical storage tank requiring low gravity feedout.

Other tradeoffs deal specifically with acquisition system design philosophy. The use of cryogenic capillary devices imposes restrictions on the pressurization system which must be adhered to in order to prevent vapor formation in the capillary device. The use of an autogenous hot gas pressurization system during engine firing can cause vapor to be generated in the start basket. A tradeoff is required between the weight of increased pressurant required if using a cool gas pressurizing system and the weight of a start tank to isolate the capillary device from the effects of hot gas system ullage collapse.

Feedline conditioning system weight and pump transients is another tradeoff which affects capillary device design. The cooling capacity of a thermodynamic vent system can be used to maintain a liquid filled feedline by intercepting the heat leak through the feedline insulation and the heat input from the engine or receiver tank. Maintaining feedline liquid in a state of readiness for withdrawal can reduce pump transient operating periods, thereby effectively minimizing mission constraints due to transfer effects and minimizing pump development problems.

SUPERCRITICAL VS. SUBCRITICAL STORAGE

INTEGRATED VS. SEPARATE TANKS

HOT GAS VS. COLD GAS PRESSURIZATION OF
SUBCRITICAL STORAGE

FEEDLINE CONDITIONING VS. PUMP TRANSIENT

SUBCRITICAL VS SUPERCRITICAL

The combination of subcritical storage and low gravity liquid feedout dictates the use of a propellant acquisition device. The principal advantage of supercritical storage compared to subcritical storage is the ability to supply high density fluid with no propellant acquisition device. Technology advancements in cryogenic acquisition device and transfer will increase subcritical system confidence and allow tradeoffs to be made on a direct weight basis.

For cases where liquid flow is required, such as the OMS, subcritical storage and supply is the only feasible approach. For cases where vapor is the required supply state, supercritical storage becomes competitive with subcritical. Supercritical storage has a higher tank weight than the subcritical due to the higher storage pressure. For the APS application, accumulators to provide sufficient vapor to minimize pump transient, are required for the subcritical storage mode. Weight comparisons show that the supercritical and subcritical storage modes are competitive for both orbiter and booster.

If the subcritical storage mode is used exclusively for power, environmental control, orbit maneuvering and auxiliary propulsion, reductions in GSE, and weight will result. Reliability and safety constraints also enter into the tradeoff.

The discussion is intended to point out that subcritical storage systems are required for the shuttle. Technological improvements in acquisition and transfer devices will result in improved subcritical storage methods and could eliminate dual storage techniques.

SUBCRITICAL vs. SUPERCRITICAL STORAGE

SUBCRITICAL REQUIRED FOR OMS,
SUBCRITICAL COMPETITIVE FOR APS

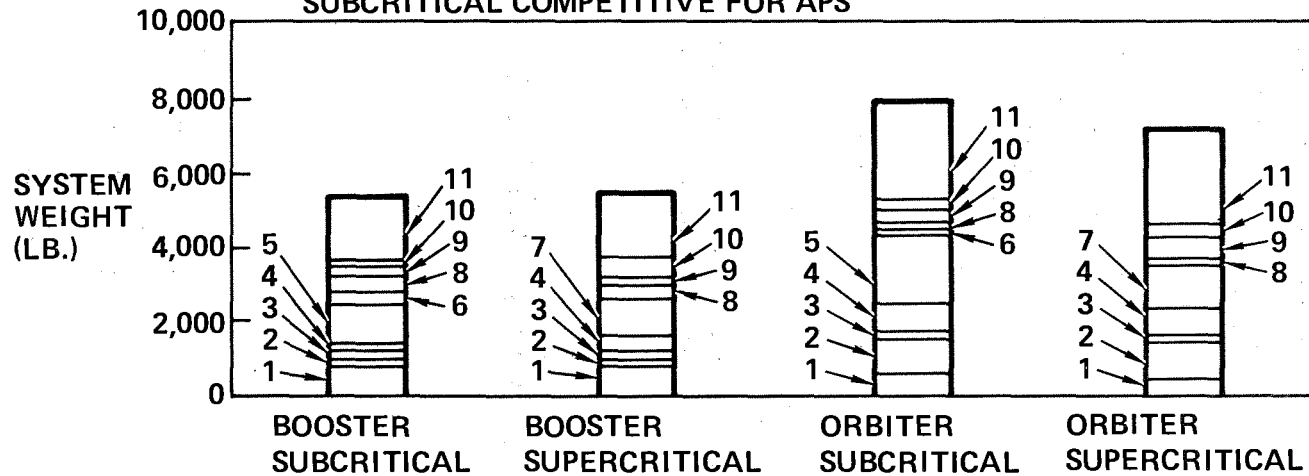

LEGEND:

- | | |
|-----------------------|------------------------------------|
| 1. THRUSTORS | 7. STORAGE TANKS |
| 2. LINES | 8. GAS GEN. & HT. EXCH. |
| 3. VALVES | 9. ACCUMULATOR RESIDUAL |
| 4. REGULATORS | 10. ΔI_{sp} (CONDITIONING) |
| 5. ACCUMULATORS | 11. PROPELLANT |
| 6. ROTATING MACHINERY | |

INTEGRATED STORAGE SYSTEM (SUBCRITICAL COULD REDUCE COMPONENTS)

ACQUISITION SYSTEM CONCEPTS

Capillary devices may be divided into two classes; restart devices which rely on propellant reorientation for refill and transfer devices which operate in a continuous low gravity environment. The system shown schematically illustrates a transfer device, such as needed for ACPS requirements, in series with a restart device as required by an OMS restart.

The capillary device in the first tank is subjected to possible pressure collapse prior to engine cutoff if a hot gas pressurization system is used. This pressure decay would result in bulk boiling and possible vapor formation in the capillary device. Vapor entrained in the liquid flowing to the engine pumps disrupts smooth pump operation and increases the chances for cavitation in the pump. The LH₂ tank capillary device configuration must therefore use cold gas during firing to prevent this bulk boiling.

An alternate scheme which allows hot gas pressurization to be used, employs a start tank with a refill valve to thermally isolate liquid from the OMS tank during any ullage collapse subsequent to engine cutoff. This system has the weight penalty of the start tank, refill system and controls and introduces a nonpassive component in the acquisition system configuration. This weight and complexity increase must be traded off against the pressurization system weight saved.

Restart Combined With ACPS

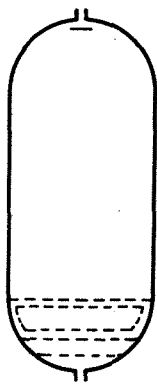

LH₂ TANK
CAPILLARY DEVICE

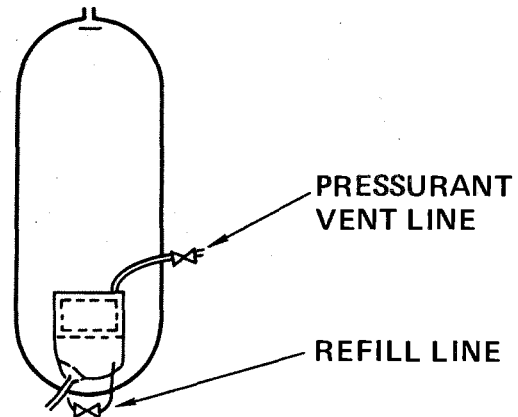

LH₂ TANK
START TANK &
CAPILLARY DEVICE

THERMODYNAMIC VENT SYSTEM

A cryogenic capillary device requires a technique to prevent vapor from forming within its contained liquid. A thermodynamic vent system was shown to be the optimum method for venting LH₂ storage tanks in studies by Convair for MSFC and Lockheed for LeRC. This type of vent system, shown schematically operates by throttling tank fluid to a low temperature and pressure allowing heat to be transferred to the vented fluid. The temperature difference between the vent fluid downstream of the throttling valve and the fluid in the tank allows heat to be transferred from the tank to the vent fluid. Transferring sufficient heat to the vented fluid will allow a superheated vapor to be vented, thus minimizing the weight of fluid vented. A pump-mixing device may be utilized to reduce heat exchanger weight by increasing hot side heat transfer coefficients. Effective mixing is essential for destroying temperature stratification in the tank and effective controlling tank of tank pressure. This type of thermodynamic vent system has demonstrated its ability to control tank pressure to within one psi, thus minimizing the deleterious effects of large tank pressure reductions as would occur in a tank blowdown.

SCHEMATIC OF BULK HEAT EXCHANGER VENT SYSTEM

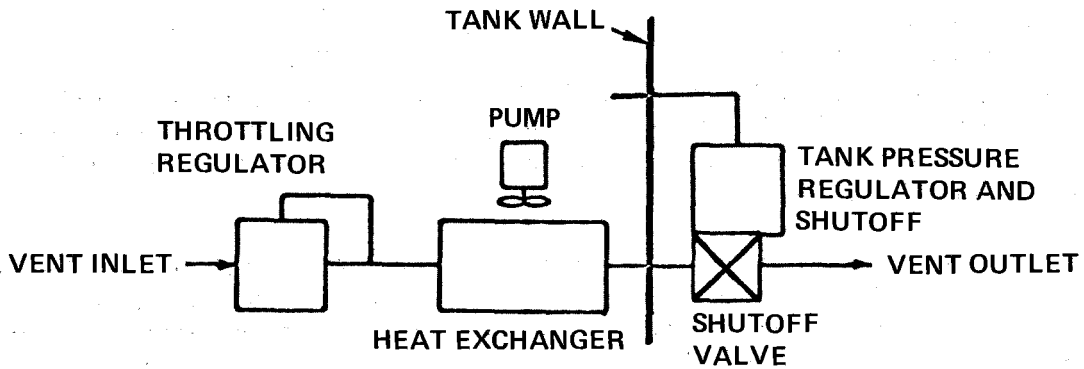

ACQUISITION SYSTEM THERMAL CONDITIONING

The thermodynamic vent system cooling capacity can be used to prevent vapor formation due to localized heat leaks, and to maintain the capillary device fluid in a slightly subcooled state. This cooling capacity can also be used to maintain pure liquid in the feedline. The liquid supply required to assure sufficient vent fluid cooling capacity, may be bled off the capillary device. After cooling the capillary device, the vent fluid passes through a compact heat exchanger/mixer unit. The mixer unit is located and sized to control temperature stratification in the tank and thus aids in the control of tank pressure. The cooling system is sized to maintain slightly subcooled liquid in the conditioned area at all times while not exceeding the cooling capacity of the vent fluid. The cooling capacity of the GH_2 may then be used to maintain the LO_2 tank in a vent free condition with pure liquid contained in the capillary device and feedline.

The mixer function is to control tank pressure by setting up a flow pattern which will cause energy removal from the tank to be evidenced by a drop in ullage pressure. The mixer configuration should minimize velocity patterns in the vicinity of the capillary device in order not to impose excessive cooling requirements on the vent system cooling coils. The second function of the mixer, if used in a compact heat exchanger vent system, is to reduce heat exchanger length by increasing hot side heat transfer coefficients.

Cooling systems of this type were investigated by Convair under contract NAS8-21465 for MSFC and will be examined for shuttle payload propellant transfer by Convair under Contract NAS8-26236 with MSFC. Experimental studies are being conducted by Lockheed for AFRPL to verify the outflow and fluid conditioning performance of a prototype LH_2 capillary device for an AMPS type mission. A cryogenic capillary device evaluation related to the shuttle is being conducted by Martin for MSC with the objective of developing parametric design data and a scale model prototype capillary device for LN_2 testing.

Mixing has been thoroughly investigated in the chemical engineering literature for processes relating to blending of mixtures. Recent work for spacecraft applications has been conducted to evaluate the effect of mixing on reducing temperature stratification in a heated tank in order to control pressure rise. Destratification studies are in progress at GD/Fort Worth for MSFC to develop analytical models and correlate them with non-cryogenic small scale and large scale tank tests for both subcritical and supercritical fluid. Mixing flow patterns are being examined by Lockheed under contract to LeRC in order to determine fluid velocities under a variety of mixing configurations. For mixing applications, AiResearch has under development a brushless DC motor for LeRC.

ACQUISITION SYSTEM CONSIDERATIONS

THERMAL CONDITIONING

VENTING

CAPILLARY DEVICE COOLING

DESTRATIFICATION

PRESSURIZATION

LH₂ OMS TANK LO₂ OMS TANK

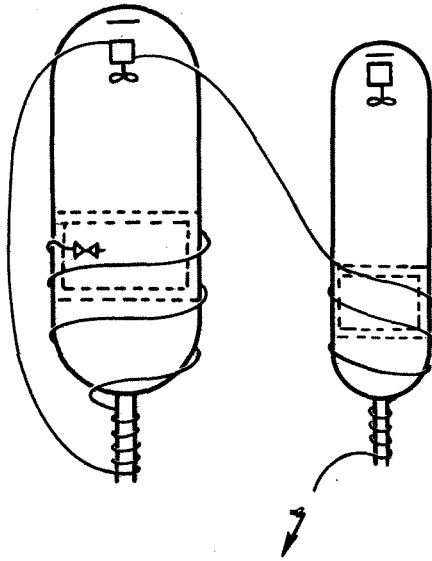

ACQUISITION SYSTEMS CONSIDERATIONS FLUID DYNAMICS

Most cryogenic capillary device fluid dynamic problems have already been encountered in noncryogenic capillary device applications. For large tankage applications, the most significant fluid dynamic problem which exists is the prediction of reorientation times and fluid configurations in high inertia fields. Reorientation of the fluid from its initial low gravity position to a location where capillary device refilling may be accomplished has a direct effect on capillary device sizing since during this reorientation period the liquid supply to the engine must come directly from the capillary device. This problem has been recently investigated by Convair, Martin and McDonnell-Douglas under contracts to MSFC and MSC, however, additional work is needed particularly in predicting decay of turbulence subsequent to liquid impingement on the aft bulkhead. Techniques for reducing settling time by use of baffles or dual thrust modes should be investigated in more detail.

Refilling of a capillary device with collected fluid is a significant problem for a multi-restart, high Weber number settling case. Turbulent fluid can impinge on the partially empty capillary device causing it to become completely wetted before all the vapor can be replaced by liquid. Use of non-wicking screens, flow baffles, dual thrust modes and refill valves are means which have been explored to eliminate this problem. Refilling should be investigated in conjunction with reorientation. Some drop tower studies are planned at LeRC. Previous analytical investigations have been made at Convair, Lockheed and McDonnell-Douglas.

Draining of a tank with a capillary device under high Bond number conditions has been investigated by Convair under contract NAS8-21465 with MSFC. For low Bond number conditions with highly curved interfaces, LeRC has conducted drop tower investigations in baffled and unbaffled tanks. Lockheed is attempting to develop an analytical model of draining for LeRC which correlates the experimental data. LeRC plans to conduct additional drop tower studies to evaluate draining of low gravity capillary devices in order to predict outflow efficiency in terms of residuals.

Wicking along screens and between perforated plates may be used to prevent drying out of a capillary device which is subjected to heating. Analytical and experimental studies of screens have been conducted at Convair to simulate low gravity wicking.

Retention capability of a screen is normally found by the well known bubble point test method. Stability limits for screens have been obtained for square weaves by Martin for MSFC using drop tower tests. Additional testing is needed to evaluate hydrodynamic stability of dutch twill screens. The effect of heat transfer on retention has been qualitatively evaluated by Convair at normal gravity in experiments for MSFC. Additional work is required to obtain a quantitative evaluation of heat transfer effects on retention and screen wetting at low gravity.

ACQUISITION SYSTEM CONSIDERATIONS

FLUID DYNAMICS

REORIENTATION

REFILLING

DRAINING

WICKING

RETENTION

ACQUISITION SYSTEM

FABRICATION

Cryogenic capillary device structural designs must reflect the requirement for minimum heat leak and minimum weight configurations. Low heat flux can be obtained by using low thermal conductivity supports and placing the internal support points away from tank insulation penetrations. The primary structural considerations are designing the capillary device to resist impingement loads, screen pressure drops and deflections which could cause structural failure of the configuration or alteration of the screen micron rating. Important factors to be incorporated into the design are repairability and ease of assembly. Any repairs required should be possible without having to remove the capillary device from the tank. Assembly procedures should, if possible, consider installing the capillary device into the tank in assemblies or subassemblies in order to minimize activity on and handling of the capillary device. The design must also consider the filtration properties of the screen and propellant cleanliness to eliminate screen clogging problems. Procedures need to be established for capillary device in-tank checkout during servicing by measuring capillary device bubble point and screen pressure drops.

Although capillary devices of up to sixty two inches in diameter have been manufactured for noncryogenics, no large scale cryogenic devices have been fabricated which remotely approach the size needed for shuttle. Shuttle reusability requirements dictate development of advanced handling, cleanliness and repairability procedures. A critical need exists for a fabrication study to establish practical methods of assembly, handling, checkout, cleaning and refurbishment of large scale capillary devices for cryogenic applications.

ACQUISITION SYSTEMS CONSIDERATIONS

FABRICATION & STRUCTURAL DESIGN

LOW CONDUCTIVE SUPPORTS – MINIMUM HEAT SHORTS

FABRICATION

ASSEMBLY

CHECKOUT

REFURBISHMENT

PRESSURIZATION AND PUMPING INTERFACES

The primary interface consideration between the acquisition system and pressurization system is that the ullage pressure should not be allowed to decay and cause bulk boiling within the capillary device.

Pressure decay due to venting can be minimized by using a thermodynamic vent system as previously described. Pressure decay subsequent to engine cut-off may occur if a hot gas ullage pressurization system is used. If hot gas is injected directly into the ullage, the liquid will not be in thermal equilibrium with the hotter ullage gases at burnout. Tank pressure will decay as liquid sloshes into and cools the ullage. Simultaneous evaporation occurs and thermal equilibrium is approached as the tank contents are mixed. The mixing process, depending upon the amount of fluid in the tank and the type, quantity and amount of pressurant used, may result in vapor being generated by bulk boiling. Analyses of shuttle pressurization system operations should reveal whether this could produce bulk boiling in the capillary device. It should be noted here that utilizing the cooling capacity of a thermodynamic vent system can prevent bulk boiling in the capillary device for small pressure decays. If bulk boiling appears to be a problem, a pressurization system could be used with the pressurant injected up through the liquid outside the capillary device or by injecting cold gas directly into the ullage. With cold gas, the temperature difference between liquid and vapor at burnout should be small enough to minimize ullage pressure decay and prevent vapor formation in the capillary device due to bulk boiling.

If ullage pressure decay with a hot gas system creates too much bulk boiling for satisfactory capillary device operation, it is also possible to use a start tank rather than accept the pressurant weight penalty of a cold gas system. A start tank configuration as conceived by McDonnell Douglas was shown previously. The start tank propellant is isolated from the thermodynamics of the main tank. Heat transfer from the main tank into the start tank will not effect system operation if the start tank pressurization is used to collapse any bubbles formed or if a thermodynamic vent system is used to cool the start tank. This system introduces additional valves which are not necessary on the capillary device designs previously discussed. The weight of the start tank system will have to be traded off against the weight of the additional pressurant required for cold gas injection.

The primary influence of the pumping system is in the fluid quality required to be supplied from the capillary device. If the pump can operate with some vapor during low speed "idle mode" startup, a chilldown recirculation system can be eliminated. Conversely, the use of thermal conditioning as previously shown can produce a feedline which maintains pure liquid close to the engine interface, reducing start-up transient. There is another trade-off between pump inlet conditions and capillary device and feedline outlet requirements.

PRESSURIZATION & PUMPING INTERFACES

ULLAGE COLLAPSE

HOT GAS

COLD GAS

ZERO NPSH PUMPS

TRANSFER LINE AND RECEIVER TANK

Conditioning of a transfer line to retain liquid during no-flow periods can reduce start up transient and overall transfer time. The conditioning system must remove the incident heat leak to the feedline thru the insulation and the heat conducted and radiated from the hot engine or receiver tank. A capillary barrier and feedline vent is required to prevent any vapor which may be generated downstream of the feedline from displacing conditioned liquid in the capillary device.

Chiltdown will be accomplished in minimum time and with minimum weight penalty by optimizing transfer line size, insulation, transfer rate and the design of baffle devices for aiding chiltdown. In the receiver tank, inlet geysering and means of establishing optimum inlet chiltdown patterns must be investigated to eliminate excessive tank pressure rise. It may be possible for some transfer systems to maintain the receiver tank in a non-vented condition during transfer through efficient chiltdown techniques. For these cases, a vent device, sized for the steady state condition and similar to the storage tank thermodynamic vent system, would be the only one required. Baffling or directing the inlet flow appears to have the most potential in providing relatively uniform tank chiltdown. LeRC has been studying tank inlet geysering problems using their drop tower facility and has additional effort planned to evaluate cryogenic storage tank pressure during inflow including the effect of rapid spray cooling and controlled cooling of tank walls. Work is also planned to determine vent losses during inflow to baffle and retention type capillary devices. MSFC is studying the inlet geysering problem analytically using the Convair developed SURF computer code. This code is a numerical solution to the Navier Stokes equations with surface forces included. Lockheed has studied transfer line and receiver chiltdown analytically for MSFC resulting in the development of computer programs for thermodynamic evaluation of these phenomena. Orbital experiments in the space station experiment module are proposed to evaluate line and receiver tank chiltdown, geysering and venting.

If receiver tank venting during transfer is required, studies performed by Convair for MSFC have shown that a mechanical separator is most efficient under a wide range of inlet qualities and vent rates. This mechanical separator was selected on the basis of weight, reliability, and cost after comparison with compact heat exchanger vent systems, wall heat exchanger vent systems, surface tension devices, vortex separators, and a combined wall heat exchanger/mechanical separator system. Mechanical separators have been built for the Centaur and successfully tested. Before a device of this type could be employed with confidence, an orbital test would be required to accurately simulate receiver tank fluid dynamics and liquid/vapor distribution at the separator inlet.

Filling a receiver tank which contains a capillary device could result in trapping vapor within the compartments reserved for liquid. Drop tower tests at LeRC will investigate this problem.

TRANSFER LINE & RECEIVER TANK CONSIDERATIONS

FEEDLINE CONDITIONING

CHILLDOWN — TRANSFER LINE

— GEYSERING

— BAFFLES

VENTING — MECHANICAL SEPARATOR

CAPILLARY DEVICE FILLING

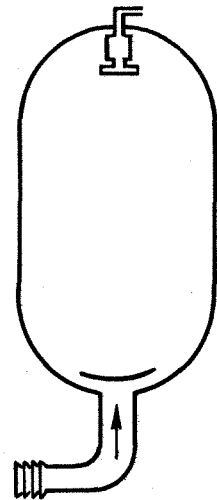

CONCLUSIONS

The results of recent and current technology studies indicate that capillary devices are superior to bladders, bellows, diaphragms, dielectrophoretic and linear acceleration devices for restart and transfer of cryogenics. Future emphasis should be placed on advanced development and verification of the capillary devices since they have the greatest potential for shuttle applications. Periodic review of the other methods of acquisition should be made in order to assess the impact of any improvements on shuttle development and performance.

Current studies are developing technology which is directly applicable to shuttle acquisition and transfer problems. Studies sponsored by NASA/LeRC, NASA/MSFC, NASA/MSC and AFRPL are developing analytical methods and ground based experimental correlations in the areas of acquisition device fluid dynamics and thermal conditioning. A smaller amount of work is being done on receiver tank and transfer line problems at LeRC and MSFC. These studies and existing information from recently completed programs provides an adequate technology base for supporting the initial shuttle designs.

Additional technology studies are necessary to increase acquisition and transfer system efficiency. A deliberately conceived, coordinated, integrated plan will expose technology deficiencies and provide the basis for their systematic solution. The plan should encompass analytical investigations, ground based testing and orbital experimental to verify advanced acquisition and transfer technology and to qualify "state of the art" designs.

CAPILLARY DEVICE APPEARS MOST PROMISING FOR CRYOGENIC ACQUISITION

CURRENT STUDIES ARE POINTED TOWARD SOLVING SHUTTLE ACQUISITION & TRANSFER TECHNOLOGY PROBLEMS

FUTURE TECHNOLOGY STUDIES HAVE NOT BEEN SOLIDIFIED IN A COHERENT INTEGRATED PLAN

RECOMMENDATIONS

Future studies should be coordinated to advance the technology which will improve shuttle acquisition and transfer system performance. The main areas for study are in the areas of thermal conditioning, fluid dynamics, and fabrication.

Thermal conditioning studies should be conducted to investigate low gravity destratification, receiver tank and transfer line chilldown techniques, and capillary device and feedline conditioning concepts. Low gravity vent devices should be flight qualified. Boiling heat transfer, heated screen retention properties, bubble dynamics and thermophoresis studies would increase confidence in internal tank thermodynamics, capillary device performance and heat transfer predictions. Orbital testing is necessary for attaining sufficient time at low gravity to obtain accurate thermal data.

Fluid dynamics studies are needed in the areas of reorientation, refilling, geysering, capillary device draining and wicking. These should primarily be low gravity drop tower and orbital tests with analytical studies required in reorientation, refilling and inlet fluid geysering.

Fabrication studies should be initiated to establish practical methods of assembly, checkout, cleaning and refurbishment of large scale capillary devices for cryogenic applications. A typical device should be built and flow cycled in a simulated shuttle environment to demonstrate reusability and ease of checkout.

FUTURE TECHNOLOGY STUDIES MUST BE PLANNED TO SATISFY SHUTTLE REQUIREMENTS

THERMAL CONDITIONING

FLUID DYNAMICS

FABRICATION

GROUND & ORBITAL BASED EXPERIMENTAL STUDIES

CRYOGEN SYSTEMS HARDWARE TECHNOLOGY REVIEW FOR THE SPACE SHUTTLE

Dieter K. Huzel

North American Rockwell

INTRODUCTION

The technical portions of the space shuttle Phase B studies presently being conducted by several major contractors, as well as on-going or proposed related systems studies, concern themselves with vehicle preliminary designs, conceptual studies, tradeoffs and optimizations, with emphasis on the systems and their technologies. Little effort can, and is, currently being devoted to a systematic appraisal of the availability, state of the art, and required technologies for specific pieces of hardware in these various systems. This evaluation concerns itself with the hardware required for shuttle cryogenic systems. It will be postulated that certain of the current - mainly Saturn V - designs and design concepts appear to be basically suitable to fill some of the needs, while for others potentially serious technology voids may exist. To remedy the latter, effective utilization of available lead time is urged, and recommendations are presented.

During the contacts with a number of Saturn cryogenic hardware suppliers and users, opinions about the scope of technology deficiencies varied widely. However, rather uniform agreement was noted with the conclusion that diligence and ideas, rather than breakthroughs, will be required for successful design and development of reliable shuttle hardware.

Mainly as the result of a consensus of expert opinion than of a systematic study, it is expected that the more serious technology voids will be with the cryogenic hardware required for the main propulsion systems, because of problems caused by their size, in combination with substantially more demanding performance requirements. Emphasis, therefore, will be placed on these components, within the confines of space and time allotted. However, reference will be made as needed to the other propulsion systems. The bulk of the discussion concerns itself with feed system valves and ducting, and with tank pressure regulation and vent components. Peripheral cryogenic hardware will be touched upon, or at least identified for future attention.

TRAIN OF THOUGHT

To reliably identify cryogenic hardware technology voids, an understanding is needed of the differences between the conditions to which components that were successfully used on current launch systems are qualified, and those conditions that components needed for the shuttle will have to meet. This must be the first step. Unfortunately, the information currently available is incomplete, and opinions vary over a wide range. The assumptions made for this survey, therefore, must be considered best guesses, based on currently available information. With this reservation, they do provide a guide to create a feeling for what is available, or may be available, and what is missing and which, therefore, requires action. Whatever these identified actions are, they entail risks that must be taken into account through alternate contingency plans.

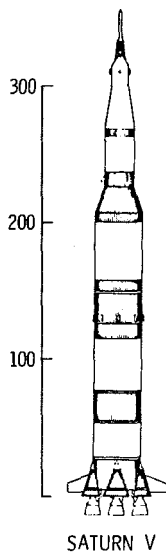

WHAT'S DIFFERENT?
WHAT'S AVAILABLE?
WHAT'S MISSING?
WHAT MUST BE AND IS BEING DONE?
RISKS

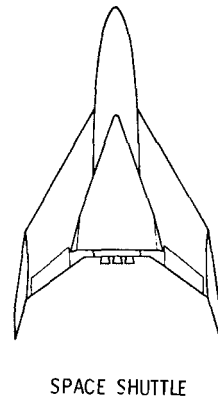

DEFINITION OF CRYOGENIC SYSTEMS HARDWARE

To establish a boundary for this discussion, the tabulation identifies those cryogenic components that are expected to be required regardless of which overall design for shuttle orbiter and booster is chosen. It further underscores the fact that almost exclusively, these are functional types that have been used extensively on current cryogenic systems. Within the time and space available, a preliminary assessment will be attempted for some of the foremost currently used (Saturn) components listed.

- ENCOMPASSES PROPELLANT FEED AND VEHICLE TANK LOADING AND PRESSURIZATION HARDWARE

- INCLUDES:

- VENT VALVES
- SHUTOFF VALVES (SUCH AS PREVALVES)
- FILL & DRAIN VALVES
- REGULATORS
- DISCONNECTS
- VACUUM JACKETED LINES
- CHECK VALVES
- SEALED JOINTS

- MAY INCLUDE:

- AUXILIARY GAS GENERATORS
- AUXILIARY TURBOPUMPS
- AUXILIARY HEAT EXCHANGERS
- PROPELLANT MANAGEMENT SYSTEM COMPONENTS
- PROPELLANT ACQUISITION AND THERMODYN. VENTING SYSTEM COMPONENTS
- SOLENOID VALVES, PRESSURE SWITCHES
- PROPELLANT RECIRCULATION SYSTEM COMPONENTS
- INSTRUMENTATION COMPONENTS

CRYOGENIC HARDWARE PERFORMANCE COMPARISON

Information on required cryogenic hardware cycle life, allowable leakage, and resistance to vibration effects is meager to unavailable. Estimates, where made, differ over a wide margin. The figures presented for expected average shuttle operational life are the author's best guesses. Where challenged, they are usually considered too low. The allowable shuttle component leak rates are dictated predominantly by orbiter needs to maintain internal tank pressure during stay in orbit. However, because of expected emphasis on common hardware use, several booster components would be similarly affected. The values quoted (assumed to be for nonvibrational environment) are more than an order of magnitude smaller than those specified for the Saturn S-II stage, as an example. These low rates, coupled with larger nominal component sizes, in several instances represent a major area of concern. Nothing reliable is known, nor will be known for some time, about the flight vibration characteristics to which the cryogenic hardware will be exposed. Even if it is assumed that these are not worse than those encountered on the Saturn stages, it leaves an awesome factor of two orders of magnitude for cumulative flight duration. This is another area of major concern.

The vibration durations listed for Saturn Component Qualification represent the total of sinusoidal sweep and dwell, and of random vibrations, in all axes. For the shuttle, the figures represent accumulated flight time only. How difficult the task will be will depend on the philosophies applied to shuttle component qualification testing.

- NOTES: 1 S-II powered flight time is six minutes
 2 Leak rates not fully defined (gas type, pressure, temperature, vibration)

COMPONENT	"ORDER OF MAGNITUDE" ESTIMATED SHUTTLE REQUIREMENT				S-II ACTUALS		
	NOM SIZES (EST INCHES)	AVERAGE OPERATIONAL LIFE CYCLES (100 MISSIONS)	RECOMMENDED DESIGN LIFE CYCLES	MAX ALLOWABLE LEAK RATES (SCIM)	NOM SIZE (INCHES)	DESIGN LIFE CYCL	MAX ALLOWABLE LEAK RATES (SCIM)
VENT VALVES	7 (0) 10 (B)	5000	15000	10	7	600	500
PREVALVES	14	3000	10000	20	8	750	450
FILL & DRAIN VALVES	8 (0) 10 (B)	1000	3000	10	8	1000	1500
REGULATORS	2 TO 3	5000	15000	-	2.3	1500	-
DISCONNECTS (VENT; F&D; PRE-PRESS. ETC.)	1 TO 10	500	1500	-	1, 7, 8	-	APPROX 20 SCIM ACTUALS 1 IN. SIZE
CHECK VALVES	1/2 TO 2	1000	3000	5	1/4 to 1-1/2	1500	100
FEED LINES	14 TO 16		100 MISSIONS		8	1 MISSION	

VIBRATION REQUIREMENTS: UNDEFINED (COMPARATIVE CUMULATIVE SHUTTLE COMPONENT FLIGHT EXPOSURES OF 10 HOURS, VS 6 MINUTES ON SATURN V, MUST BE EXPECTED)

TYPICAL PROPOSED SHUTTLE MAIN PROPULSION SYSTEM SCHEMATIC

The schematic shown may be considered typical for both, orbiter and booster, except that the two would differ as to the number of engines and, depending upon which specific concept is being considered, the subdivision of propellant tankage and the required duct and line manifolding. In many respects, this functional diagram is also representative of the other (auxiliary) shuttle propulsion systems (booster and/or orbiter), except that the latter may include systems concepts such as are required for propellant storage and acquisition, ability to operate vertically and horizontally (air breathing system), and zero-g venting. These are not shown here. It is expected, however, that the success of these subsystems and concepts will depend more on systems technology than on the state-of-the-art of the hardware of which they will be composed.

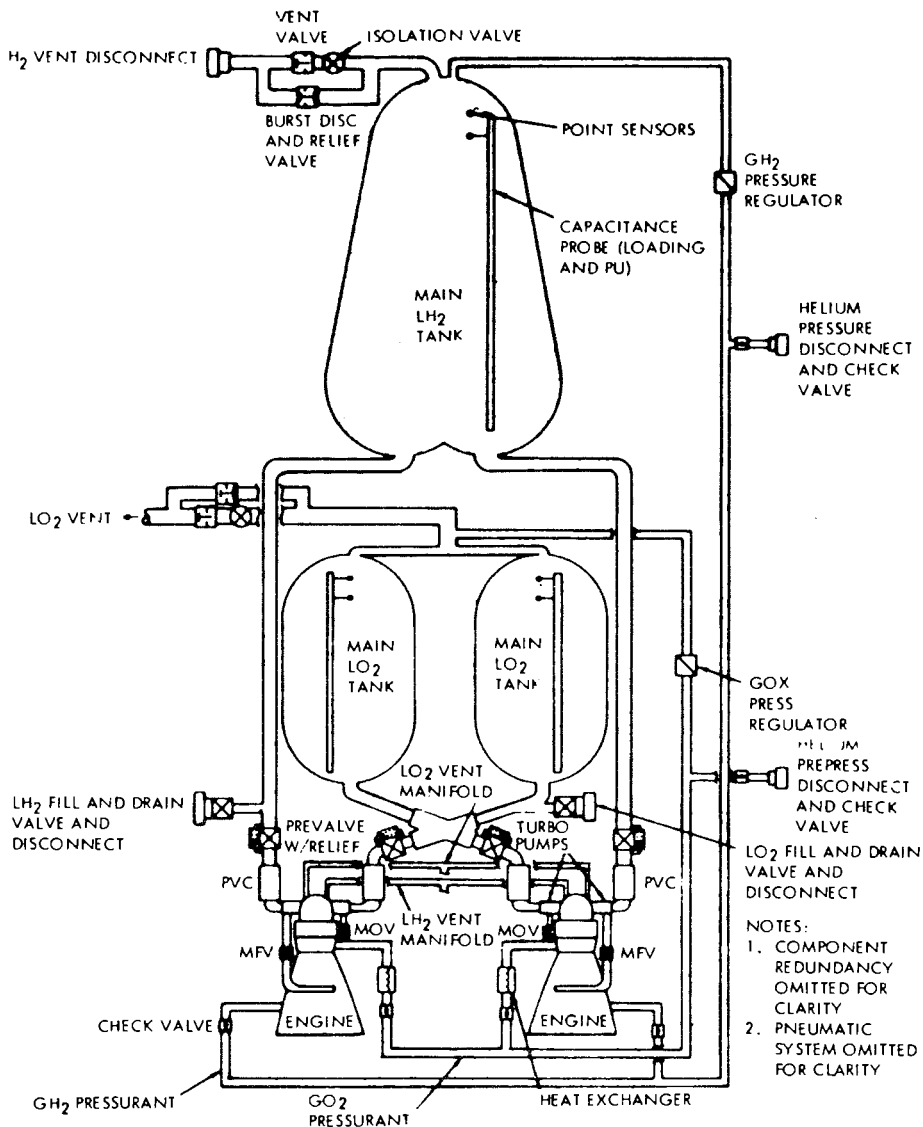

7-INCH VENT & RELIEF VALVE

Requirements for shuttle use in the areas shown are over an order of magnitude more stringent than for Saturn. S-II hardware condition following qualification is reported to have been excellent, suggesting a potential for increased life. Full achievement of shuttle requirements without modifications and verification appears doubtful. Leak requirements may be unachievable and indicate the potential need for alternate systems solutions (such as in-orbit isolation valves). Improvements to achieve narrower vent bands and improved position indicators will require special attention.

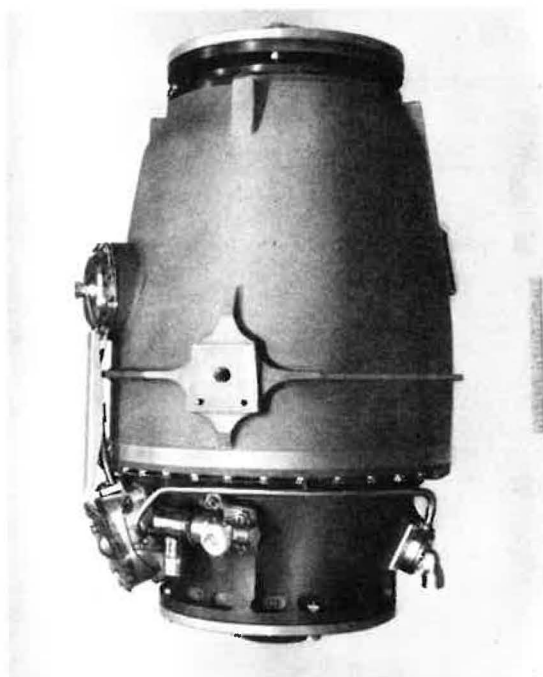

DESIGN & PRODUCTION: AMETEK/CALMEC

USE: SATURN S-II, LH₂ & LOX

TYPE: POPPET

PRINCIPAL REQUIREMENTS:

PARAMETER	SATURN COMPONENT QUALIFICATION	ESTIMATED REQUIRED SHUTTLE DESIGN POINTS (0)
CYCLES	600 MINIMUM	15000
VIBRATION	5-1/2 HOURS	>10 HOURS
LEAKAGE	500 SCIM He	10 SCIM

STATUS: QUALIFIED FOR SATURN S-II

TECHNOLOGY ASSESSMENT:

POTENTIAL CANDIDATE FOR SHUTTLE ORBITER

SCOPE OF ADDITIONAL DEVELOPMENT UNCERTAIN

(ENDURANCE LIMITS NOT EXPLORED)

10-INCH VENT & RELIEF VALVE

A better definition of booster in-flight (vibration) maximum allowable leak rates is required for a better assessment of the basic suitability of this valve for Space Shuttle use. It appears that cycle-life limits have not been explored.

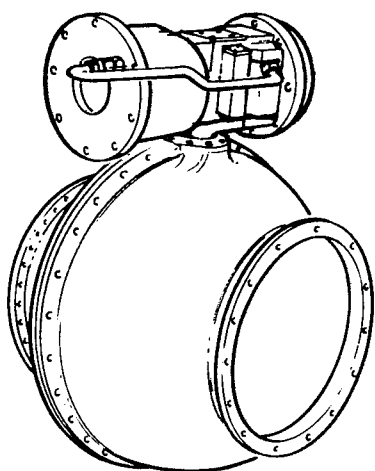

DESIGN AND PRODUCTION: WHITTAKER

USE: SATURN S-IC

TYPE: VISOR

PRINCIPAL REQUIREMENTS:

PARAMETER	SATURN COMPONENT QUALIFICATION	ESTIMATED REQUIRED SHUTTLE DESIGN POINTS (B)
CYCLES	1000	15000
VIBRATION	1.2 HOURS	10 HOURS
LEAKAGE	750 SCIM He	\leq 750 SCIM GH ₂

STATUS: QUALIFIED FOR S-IC

TECHNOLOGY ASSESSMENT: POSSIBLE CONCEPT FOR PREVALVE BUT PROBABLY NOT FOR VENT VALVE

2.8-INCH REGULATOR

The regulator embodies a principle that has been successfully demonstrated in operational use. Those familiar with its performance believe that it is a strong candidate for booster use, subject to exploratory tests, modifications, and demonstration.



DESIGN & PRODUCTION: PARKER-HANNIFIN

USE: SATURN S-IC GOX

TYPE: BUTTERFLY/BELLOWS ACTUATOR

PRINCIPAL REQUIREMENTS:

PARAMETER	SATURN COMPONENT QUALIFICATION	ESTIMATED REQUIRED SHUTTLE DESIGN POINTS (B)
CYCLES	APPROX. 1500	15000
VIBRATION	2 HOURS	10 HOURS
LEAKAGE	NO SHUTOFF MODE	NO SHUTOFF MODE
CAPACITY LB/SEC	50 GOX	38-45 GOX; 19 GH ₂ (MAX EST)

STATUS: QUALIFIED FOR SATURN S-IC

TECHNOLOGY ASSESSMENT:

PROMISING CANDIDATE FOR SHUTTLE BOOSTER, WITH LIMITED MODIFICATIONS, MAINLY FOR GH₂ USE

8-INCH FILL & DRAIN DISCONNECT

In the design shown, the airborne half essentially consists of the mating ring with sealing surfaces. All more complex parts of the coupling are ground-stationed. The current practice is to have the supplier refurbish the ground half, including its built-in butterfly shutoff valve, after every launch. This practice stems from the fact that it is exposed to copious amounts of launch pad cooling water, salty air and atmospheric moisture, essentially without protection downstream (outside) of the built-in valve. Also, sufficient time is available.

In the opinion of experts, the ground half would be reusable an indefinite number of times if it were adequately protected against the cited effects. Based on experience from Saturn and other launch vehicles, they believe this would be a matter of implementing such protection. This may include operational changes, angular attitude of disconnects, purges, doors. Similarly, the airborne half should be reusable as is, except that simple provisions for routine replacement of mating parts (especially the seal) may be the most economical way.

A number of smaller disconnects is in use on Saturn. These are also considered basically ready for shuttle use, if cleanliness and dryness are assured by proper means.

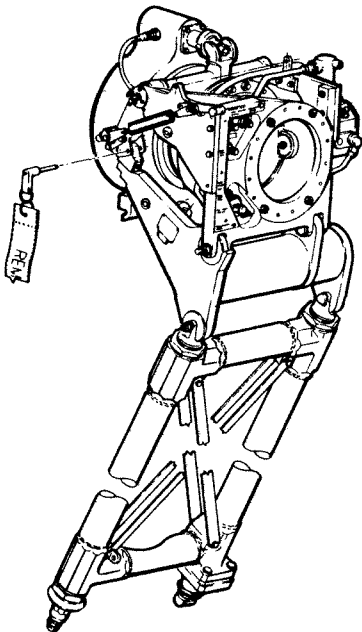

DESIGN & PRODUCTION: ROYAL INDUSTRIES

USE: SATURN S-II, LOX & LH₂

TYPE: BUTTERFLY (BUILT-IN GROUND VALVE)

PRINCIPAL REQUIREMENTS:

PARAMETER	SATURN COMPONENT QUALIFICATION	ESTIMATED REQUIRED SHUTTLE DESIGN POINTS
NOM SIZE	8 IN.	8 IN. (0); 10 IN. (B)
CYCLES (DISENG)	100	500
CYCLES (GR VALVE)	500	1500
VIBRATION	4 HOURS	10 HOURS
LEAKAGE (GR VALVE)	300 SCIM	300 SCIM
LEAKAGE (COUPLING)	60 SCIM	60 SCIM

STATUS: QUALIFIED FOR SATURN S-II

TECHNOLOGY ASSESSMENT:

BASICALLY READY FOR SHUTTLE USE, IF ADEQUATELY PROTECTED

PRINCIPAL AREAS OF CONCERN

In discussions with suppliers and users of current cryogenic systems hardware the principal areas of concern listed emerged. For vibration requirements, the concern was virtually unanimous. This may be attributed to the fact that a number of current cryogenic components had - sometimes substantial - difficulties in passing qualification, and that qualification specifications for the Space Shuttle may be vastly more stringent. Not much less concern is in evidence regarding leakage requirements, especially when viewed in combination with the vibration conditions, the increased life cycle requirements, and potential cumulative contamination. Lesser concern is voiced about the life-cycle numbers, the only areas in which shuttle data are cautiously predictable. It is believed that full utilization of current technology and meticulous attention to all details will solve life-cycle problems. It was noted that cryogenic components of comparable size are in successful operational use, although with less stringent requirements.

- VIBRATION ENVIRONMENT - MAJOR
- LOW LEAKAGE REQUIREMENTS - SERIOUS
- LIFE CYCLE REQUIREMENTS - MODERATE

EXTRAPOLATION TO OTHER SHUTTLE CRYOGENIC SYSTEMS HARDWARE

The hardware required for auxiliary shuttle propulsion systems, specifically the de-orbit, airbreathing, and attitude control systems, and as defined earlier, is expected to consist of components of smaller nominal size, compared to those for the main propulsion system. The smaller masses, smaller diameters, shorter sealing circumferences, and the smaller absolute contraction/expansion factors, among perhaps others, are expected to lessen some of the expected problems.

With this in mind, the cursory evaluation performed and the conclusions drawn here are largely applicable to this hardware. This does not include, however, technologies associated with systems concepts such as propellant storage, systems packaging (RCS), expulsion devices and the like.

Several successful operational systems (Centaur; S-IV; RL10, and J-2 Engines) should provide valuable experience for extrapolation to the Space Shuttle.

- THE GENERALLY SMALLER SIZES REQUIRED SUGGEST SMALLER PROBLEMS
- SPECIFIC AND GENERAL CONSIDERATIONS FOR MAIN PROPULSION SYSTEM CRYOGENIC COMPONENTS APPLY
- RECOMMENDATIONS AND CONCLUSIONS INCLUDE THIS HARDWARE
- REPRESENTATIVE EXPERIENCE EXISTS (CENTAUR, S-IV J-2, RL-10)

RISKS

Whatever is done or planned at this early stage, there are certain risks involved that will remain despite all careful planning and evaluating. The list shown probably is incomplete but may convey a feeling for potential risks that have actually been incurred and with which most agencies and contractors are well familiar.

- BELATED ATTENTION TO HARDWARE DETAIL -- "PANICS"
- ENVIRONMENTAL CONDITIONS SIGNIFICANTLY MORE SEVERE THAN EXPECTED
- DISCOVERY OF TECHNOLOGY DEFICIENCIES SIGNIFICANTLY LARGER THAN EXPECTED
- MAJOR LATE SYSTEMS CHANGES AFFECTING HARDWARE
- EXPERIENCED SUPPLIERS DEFUNCT OR UNWILLING TO BID
- LATE NEED TO SWITCH A SUPPLIER
- NEW PROCUREMENT PERSONNEL

RECOMMENDATIONS

In order to channel the thinking of those who will be responsible for generating the cryogenic hardware for Space Shuttle use in the right direction, to permit them to start thinking, and to open a channel for idea exchange, early, albeit conditional, definition of the most likely basic design and qualification requirements is urgently recommended.

For the optimum utilization of time and funding, early evaluation of design concepts that had been successful for past applications, notably Saturn, is advised. Similarly, experiments to uncover hidden unknowns should prove beneficial.

The availability of some of those suppliers who contributed quality hardware in the past appears to be uncertain in some instances. Since relearning and educating is known to be a costly process, early thought should be given to avoidance of problems.

Since unforeseen situations will arise as always, alternative routes to solve the most likely problems should be included in all planning efforts.

- "MAXIMUM RESULTS FOR MINIMUM \$"

GENERAL

- FULL UTILIZATION OF VALUABLE TIME

SPECIFIC

- EARLY DEFINITION OF DESIGN AND QUALIFICATION PARAMETERS
- EARLY HARDWARE DESIGN STUDIES AND EXPERIMENTAL EVALUATION OF PROMISING CONCEPTS
- EXPERIMENTS TO IDENTIFY EARLY HIDDEN TECHNOLOGY DEFICIENCIES
- STEPS TO ASSURE AVAILABILITY OF EXPERIENCED AND PROVEN MANUFACTURERS
- ADEQUATE CONSIDERATION OF CONTINGENCIES

CRYOGENIC SYSTEMS INTEGRATION TECHNOLOGY FOR THE SPACE SHUTTLE

J. D. Schweikle

McDonnell Douglas Astronautics Company
Huntington Beach, California

INTRODUCTION

THE NUMBER OF CRYOGENIC TANKS AND THEIR SUPPORTING HARDWARE SHOULD BE MINIMIZED TO REDUCE VEHICLE COMPLEXITY, MAINTAINABILITY, GROUND OPERATIONS AND MAXIMIZE MISSION FLEXIBILITY AND USE OF RESIDUALS. CRYOGENIC TANK INTEGRATION IS NOT A TECHNOLOGY IN ITSELF, BUT IS MADE UP OF A SERIES OF TECHNOLOGY OUTPUTS THAT HAVE BEEN PREVIOUSLY DISCUSSED IN DETAIL. THE RESOLUTION OF THOSE TECHNOLOGY ISSUES WILL AFFECT THE DEGREE OF INTEGRATION. THIS PRESENTATION COVERS THE RANGE OF INTEGRATION FROM THE ONE EXTREME OF ALL PROPELLANTS IN THE BOOST TANKS TO THE OTHER EXTREME OF COMPLETELY SEPARATE TANKS FOR EACH CRYOGENIC SYSTEM. THE ARGUMENT EMPLOYED IS ONE OF FORCING TANK INTEGRATION AS MUCH AS POSSIBLE AND TRYING TO DEFINE A REASONABLE BREAK POINT FOR INTEGRATION BASED ON TECHNOLOGY SIMILARITY.

SHUTTLE CRYOGENIC SYSTEMS

THE SHUTTLE BOOSTER AND ORBITER VEHICLES REQUIRE MANY DIFFERENT CRYOGENIC SYSTEMS TO SUPPORT THE MISSION OBJECTIVES. LARGE, CONVENTIONALLY INSULATED CRYOGENIC HYDROGEN AND OXYGEN TANKS ARE REQUIRED FOR BOOST PROPULSION. LIQUID HYDROGEN AND OXYGEN TANKS ARE REQUIRED FOR THE ATTITUDE CONTROL PROPULSION SYSTEM (ACPS), ORBIT MANEUVERING SYSTEM (OMS), FUEL CELLS, AND AUXILIARY POWER UNITS (APU). OXYGEN TANKAGE FOR THE ENVIRONMENTAL CONTROL AND LIFE SUPPORT (ECLS) AND HYDROGEN TANKAGE FOR THE AIRBREATHING PROPULSION SYSTEM (ABPS) ARE REQUIRED. WITH THE EXCEPTION OF THE BOOST TANKS, ALL OF THESE SYSTEMS REQUIRE HIGH PERFORMANCE INSULATION TO MEET THE MISSION ORBITAL STAY TIME OF 7 TO 30 DAYS.

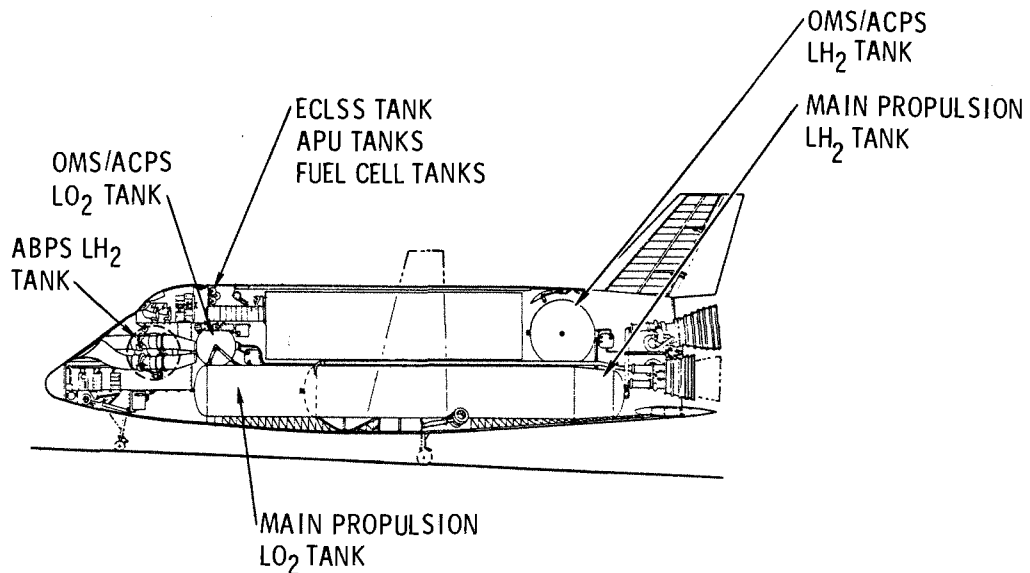

ORBITER SYSTEM INTERFACE REQUIREMENTS

THE SHUTTLE CRYOGENIC SYSTEMS EACH REQUIRE DIFFERENT PRESSURES, TEMPERATURES, AND FLUID STATE AT THEIR INTERFACES. THE MAIN BOOST AND AIRBREATHING PROPULSION SYSTEMS REQUIRE LIQUID STATE AND LOW INLET PRESSURES. THE PRIMARY REQUIREMENT FOR THESE TWO SYSTEMS IS ONE OF PROVIDING NET POSITIVE SUCTION PRESSURE (NPSP) TO THE LIQUID PUMPS. THE REMAINING SYSTEMS REQUIRE GAS AND HIGHER OPERATING PRESSURES. THE MAIN BOOST PROPELLANT COMPRISES 91 PERCENT OF THE TOTAL HYDROGEN AND OXYGEN LOAD ON THE VEHICLE. THE SECOND LARGEST PROPELLANT SYSTEM IS THE OMS COMPRISING 8 PERCENT WITH THE REMAINING SYSTEMS REQUIRING ONLY ABOUT 1 PERCENT.

		PRESSURE (PSIA)	TEMPERATURE (°R)	NPSP (PSI)	STATE	MASS (LB)
MAIN BOOST	LH ₂	20-35		2	LIQUID	58,120
	LO ₂	20-350		8		348,720
OMS	LH ₂	700	200		GAS	6,870
	LO ₂	700	300			26,920
ACPS	LH ₂	700	200		GAS	330
	LO ₂	700	300			1,670
APU	LH ₂	500+	40+		GAS	60
	LO ₂	500+	165+			60
FUEL CELLS	LH ₂	60+	200+		GAS	60
	LO ₂	60+	200+			450
ABPS	LH ₂	20+		2	LIQUID	2,200
ECLS	LO ₂	100-110	530		GAS	200

WHY INTEGRATE

THERE ARE SEVERAL REASONS FROM A VEHICLE/MISSION OPERATIONAL VIEW THAT DICTATE INTEGRATION OF ALL CRYOGENIC SYSTEMS INTO ONE TANK. INTEGRATION PROVIDES MISSION FLEXIBILITY AS TO HOW PROPELLANTS ARE BUDGETED IN ONE TANK FOR EACH MISSION. THIS REBUDGETING OF PROPELLANT CAN BE TRADED AMONG SYSTEMS AND NOT BE CONFINED BY TANK SIZE AS IT WOULD BE WITH SEPARATE TANKAGE. LAUNCH PREPARATIONS ARE CERTAINLY SIMPLIFIED BY HAVING TO LEAK CHECK AND LOAD ONLY ONE COMMON TANK. THE REDUCED NUMBER OF COMPONENTS, SUCH AS REDUNDANT VENT VALVES, REQUIRED FOR ONLY ONE TANK INSTEAD OF SEVERAL WILL EASE THE MAINTAINABILITY PROBLEM. FINALLY, MANY OF THE SYSTEMS HAVE COMMON FUNCTIONAL REQUIREMENTS SUCH AS LONG TERM ORBITAL STORAGE, PROPELLANT ORIENTATION IN ZERO G, WITH COMPATIBLE PRESSURE, TEMPERATURE AND FLUID STATE INLET CONDITIONS.

MISSION FLEXIBILITY

LAUNCH PREPARATIONS

MAINTAINABILITY

FUNCTIONAL COMMONALITY

DESIGN/TECHNOLOGY CONSIDERATIONS

THIS MATRIX EXPANDS THE ADVANTAGES AND DISADVANTAGES OF INTEGRATED VERSUS SEPARATE TANKS FOR THE OPERATIONAL CONSIDERATIONS. THIS CHART POINTS OUT THE REQUIREMENT FOR AN ADDITIONAL TECHNOLOGY ADVANCE IF SEPARATE TANKS ARE USED WITH INTERCONNECTING PLUMBING TO TRANSFER PROPELLANT FROM ONE SYSTEM TO ANOTHER. PROPELLANT TRANSFER UNDER A ZERO G ENVIRONMENT IS A TECHNOLOGY ISSUE REQUIRING RESOLUTION IF EMPLOYED. HOWEVER, IF THE TANKS ARE INTEGRATED THIS RESOLUTION WOULD NOT BE REQUIRED FOR THE SHUTTLE VEHICLE.

CONSIDERATION	INTEGRATED	SEPARATE
REDUNDANCY	NO LOW-G PROPELLANT TRANSFER	REQUIRES TANK-TO-TANK COMMUNICATION TO TRANSFER PROPELLANT. TRANSFER IS A PROBLEM AT LOW-G LEVEL
VERSATILITY	SMALL INCREASES IN SYSTEM REQUIREMENTS ACCOMMODATED	CAN ACCOMMODATE LARGE SIZE CHANGES WITH MINIMUM IMPACT ON OTHER SYSTEMS
MAINTAINABILITY-SERVICEABILITY-REUSEABILITY	SINGLE LOCATION FOR ALL CRYOGENIC STORAGE - TANK DIAMETER LITTLE LARGER THAN OMS TANK ALONE	LARGE NUMBER OF UNITS EACH REQUIRING THE SAME ATTENTION AS A SINGLE LARGE ONE
RELIABILITY-FAILURE MODES	MINIMUM TANK PENETRATIONS/LEAK POINTS	LARGE NUMBER OF TANK PENETRATIONS INCREASING LEAK SOURCES

BOOSTER PROPELLANT TIME LINE

THE PROPELLANT USAGE HISTORY THROUGH THE MISSION TIME FROM LIFT-OFF TO BOOSTER CRUISE BACK AND LANDING IS SHOWN IN THIS CHART. THE AXIAL AND NORMAL G LEVELS ACTING ON THE BOOSTER DURING THESE TIMES SHOW THAT THE CRYOGENIC SYSTEMS HAVE TO WORK FROM A MINUS ONE G TO A PLUS THREE G AXIAL LEVEL AS WELL AS OPERATE APPROXIMATELY SEVEN MINUTES IN A ZERO G ENVIRONMENT. PROPELLANT POSITIONING MUST BE SATISFACTORILY ACCOMPLISHED THROUGH THIS WIDE RANGE OF G LEVEL AND DIRECTION. PROPELLANT STORAGE TIME IS RELATIVELY SHORT FOR THE BOOSTER WITH THE ABPS HAVING THE LARGEST REQUIREMENT OF 1.5 HOURS.

SYSTEM	PROPELLANT USAGE HISTORY			G LEVEL		POSITIONING FORCE	
	3.5 MIN	7 MIN	1.5 HRS	AXIAL	NORMAL		
MAINBOOST	[Bar from 3.5 MIN to 7 MIN]			1 TO 3	0	ACCELERATION	
ACPS		[Bar from 7 MIN to 1.5 HRS]		-1 TO 0	0 TO 4	ACCELERATION AND SURFACE TENSION	
APU	[Bar from 3.5 MIN to 1.5 HRS]			-1/0/3	0 TO 4	ACCELERATION AND SURFACE TENSION	
ABPS			[Bar from 1.5 HRS to REENTRY]		0 TO 1	1	GRAVITY

LIFT OFF BOOSTER BURNOUT REENTRY LANDING



ORBITER PROPELLANT TIME LINE

THIS CHART SHOWS THE SAME TYPE OF INFORMATION FOR THE ORBITER AS WAS SHOWN FOR THE BOOSTER. THE MAJOR DIFFERENCES ARE THE SEVEN DAY STORAGE TIME IN ORBIT AND THE EXTENDED PERIOD AT ZERO G. THIS EXTENDED ORBITAL STORAGE TIME REQUIRES TECHNOLOGY IMPROVEMENTS IN REUSABLE HIGH PERFORMANCE INSULATION AND PROPELLANT ORIENTATION CONCEPTS COMPATIBLE WITH CRYOGENIC PROPELLANTS.

SYSTEM	PROPELLANT USAGE HISTORY			G LEVEL		POSITIONING FORCE
	3.2 MIN	7 DAYS	1/2 HR	AXIAL	NORMAL	
MAIN BOOST				1 TO 3	0	ACCELERATION
OMS				0 TO 0.02	0	ACCELERATION AND SURFACE TENSION
ACPS				-0.15/0/2	0 TO 2	ACCELERATION AND SURFACE TENSION
APU				-0.5/0/2	0 TO 2	ACCELERATION AND SURFACE TENSION
FUEL CELL				-0.5/0/2	0 TO 2	ACCELERATION AND SURFACE TENSION
ABPS				-0.5 TO 0	1	GRAVITY

ORBITER ORBIT REENTRY LANDING
 IGNITION INJECTION

CANDIDATE SYSTEM INTEGRATION

THE DEGREE OF CRYOGENIC SYSTEM INTEGRATION IS CATEGORIZED FROM COMPLETELY SEPARATE SYSTEMS TO TOTALLY INTEGRATED SYSTEMS. TWO INTERMEDIATE CONSIDERATIONS BEING AN INTEGRATION BY MISSION PHASE; I.E., MAIN BOOST, ORBITAL OPERATION AND RE-ENTRY, AND POWERED LANDING, AND INTEGRATION BY LENGTH OF STORAGE TIME.

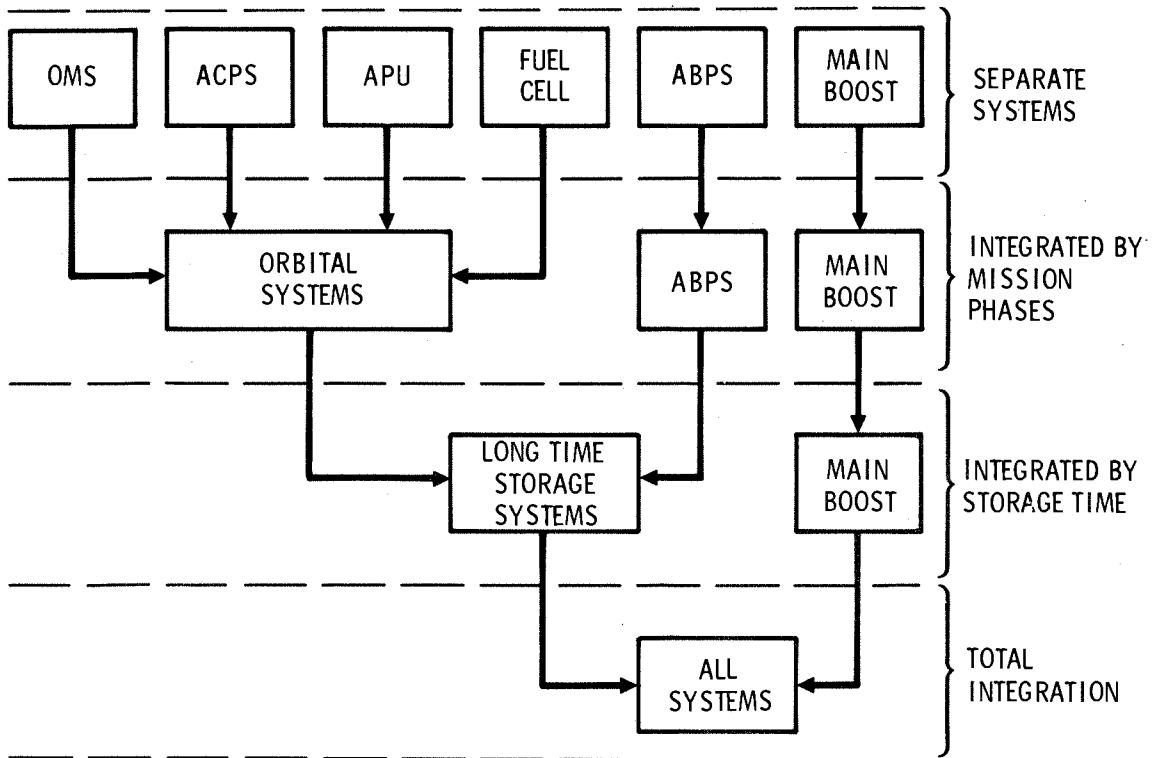

TOTAL SYSTEM INTEGRATION CONSIDERATIONS

TO INTEGRATE ALL CRYOGENIC SYSTEMS INTO THE BOOST TANKS REQUIRES THAT THE BOOST TANKS BE CAPABLE OF STORAGE TIMES OF SEVEN DAYS. CONSEQUENTLY, THE BOOST TANKS WOULD HAVE TO BE INSULATED WITH HIGH PERFORMANCE INSULATION AND BE REUSABLE FOR 100 MISSIONS. BECAUSE OF THE SIZE OF THE BOOST TANKS, THE GROUND AND RE-ENTRY PURGES OF THE INSULATION WOULD BE GREATLY INCREASED. CONTROL OF HEAT SHORTS TO MINIMIZE HEAT LEAKS TO SUCH A LARGE STRUCTURALLY INTEGRAL TANK WOULD BE VERY DIFFICULT. PROPELLANTS FOR ORBITAL, RE-ENTRY AND LANDING OPERATIONS ONLY TAKE UP APPROXIMATELY 9 PERCENT OF THE TOTAL TANK VOLUME. FOR THIS REASON AN UNDESIRABLE LARGE TANK SURFACE AREA TO USABLE PROPELLANT EXISTS AFTER ASCENT. A PROPELLANT ORIENTATION DEVICE MUST BE INCORPORATED WHICH CANNOT INTERFERE WITH THE FEED SYSTEM FOR THE MAIN BOOST ENGINES. THE HOT PRESSURANT GAS USED DURING ASCENT TO PRESSURIZE THE TANK MUST BE VENTED OVERBOARD AFTER ORBITAL INJECTION WITHOUT DISRUPTING THE PROPELLANT ORIENTATION SYSTEM. AT MAIN ENGINE SHUTDOWN, PROPELLANT IN THE FEED DUCTS WILL SURGE BACK INTO THE TANK AND THE PROPELLANT ORIENTATION DEVICE MUST BE PROTECTED FROM THIS. THE OMS REQUIRES MULTIPLE STARTS WHICH REQUIRES PRESSURIZATION OF THE OVERSIZED TANKS. IN SHORT, THE INTEGRATED LARGE BOOST TANK COMPLICATES ALREADY SEVERE EXISTING TECHNOLOGY PROBLEMS.

HIGH PERFORMANCE INSULATED BOOST TANKS

- REUSABILITY
- LARGE PURGE REQUIREMENTS
- HEAT SHORTS
- LARGE SURFACE AREA TO USABLE PROPELLANT

PROPELLANT ORIENTATION DEVICE

HOT PRESSURANT GAS FROM BOOST

MAIN ENGINE SHUTDOWN PROPELLANT DYNAMICS

MULTIPLE START REPRESSURIZATION

LARGE TANK SIZE COMPLICATES EXISTING TECHNOLOGY PROBLEMS

LONG TERM STORAGE INTEGRATION

IF THE BOOST PROPELLANT IS KEPT SEPARATE FROM THE LONG TERM STORAGE PROPELLANTS, THE ADDITIONAL SYSTEMS CAN BE ADDED TO THE OMS TANKAGE WITH VERY LITTLE GROWTH IN TANK SIZE. CONSEQUENTLY, THE TANK VOLUME TO PROPELLANT MASS IS VERY FAVORABLE AND ELIMINATES MANY OF THE PROBLEMS ASSOCIATED WITH TOTAL INTEGRATION. CONSTRAINTS THAT MAY LIMIT THE INTEGRATION OF ALL OF THE LONG TERM STORAGE SYSTEMS ARE PROPELLANT PURITY FOR THE FUEL CELLS (HELIUM CONTAMINATION) AND MULTIPLE TANK OUTLETS TO BYPASS THE PROPELLANT ORIENTATION SYSTEM FOR THE AIRBREATHING PROPULSION SYSTEM.

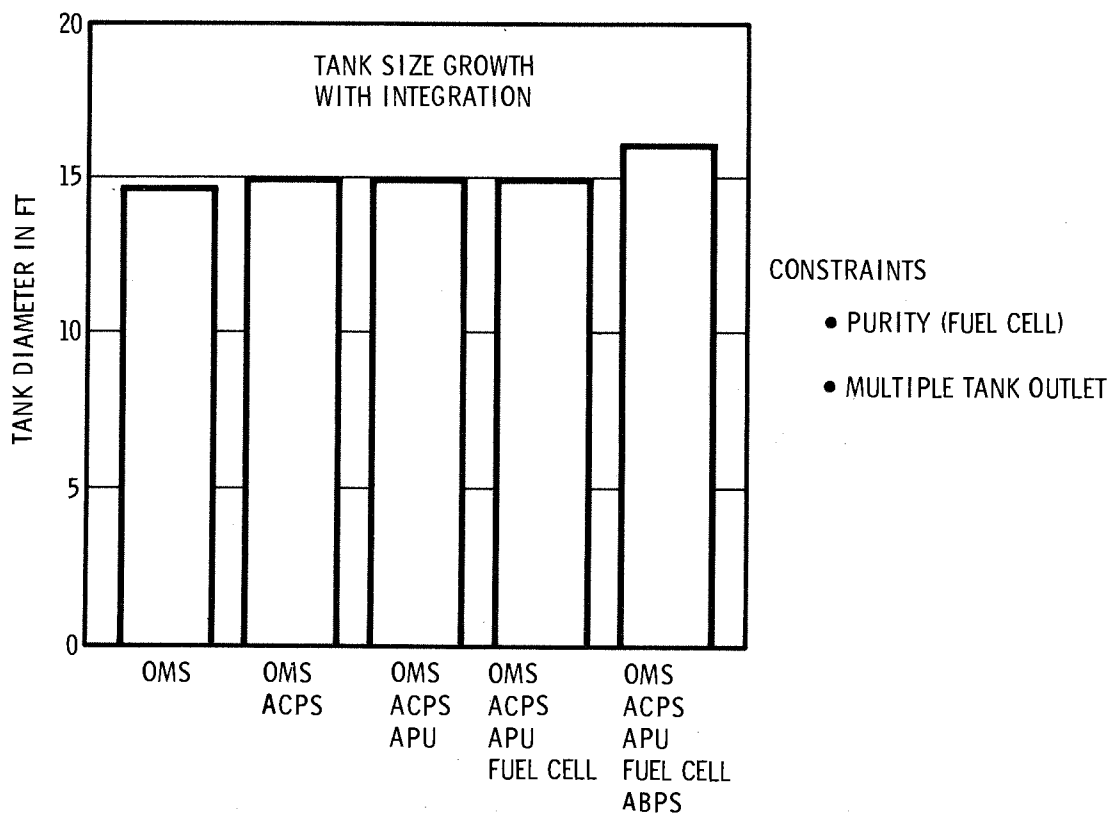

CRYOGENIC SYSTEM INTEGRATION SUMMARY

THIS SUMMARIZES THE CRYOGENIC SYSTEMS THAT CAN BE INTEGRATED. POTENTIAL INTEGRATION OF THE FUEL CELLS AND ABPS IS SHOWN IF THE PROBLEMS ASSOCIATED WITH PURITY AND MULTIPLE TANK OUTLETS CAN BE OVERCOME. THE PRESSURE, TEMPERATURE AND STATE INTERFACE REQUIREMENTS ARE COMPATIBLE AND THE TECHNOLOGY REQUIREMENTS FOR LONG TERM STORAGE AND ZERO G OPERATION ARE THE SAME FOR ALL SYSTEMS.

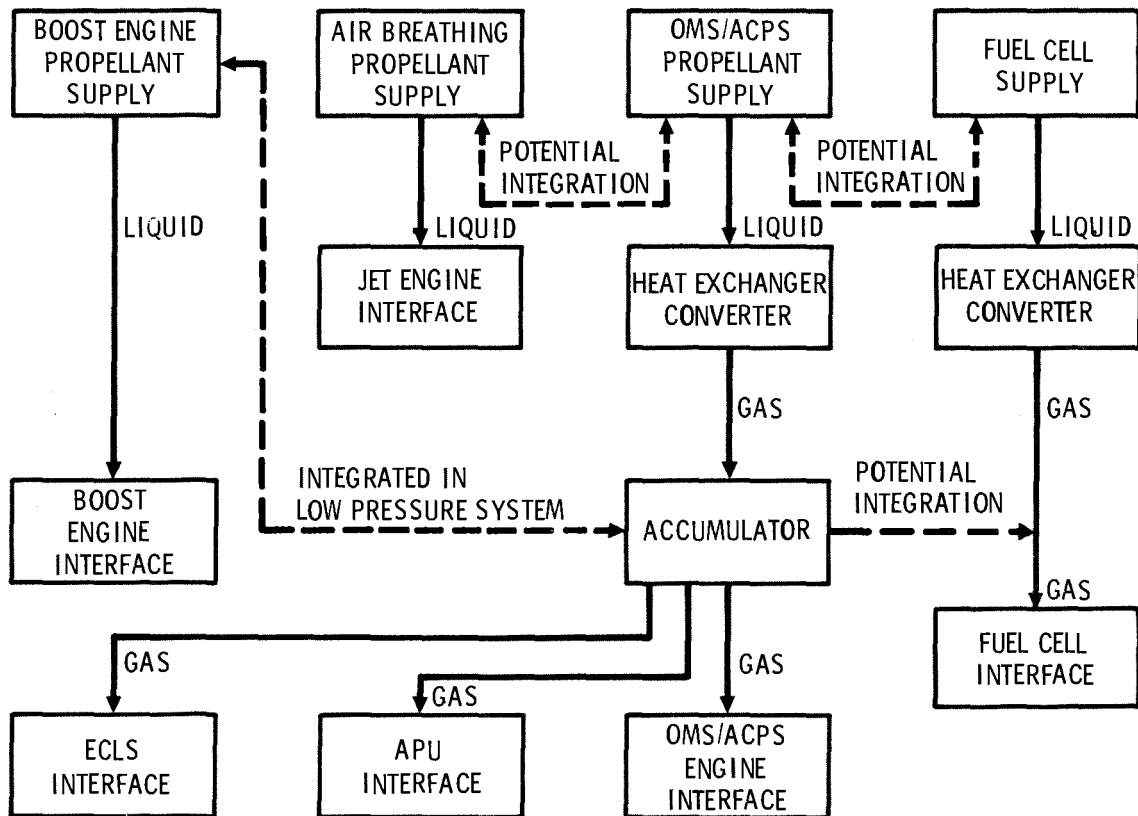

CONCLUSION

THE RESOLUTION OF IDENTIFIED TECHNOLOGIES IN LONG TERM CRYOGENIC STORAGE WITH A REUSABLE INSULATION SYSTEM AND OPERATION OF A PROPELLANT ORIENTATION SYSTEM IN A ZERO G ENVIRONMENT WILL SATISFY THE DESIRE TO INTEGRATE THE LONG TERM STORAGE SYSTEMS ON THE SPACE SHUTTLE. THIS DEGREE OF INTEGRATION WILL REDUCE LAUNCH PREPARATIONS AND VEHICLE COMPLEXITY, ENHANCE MAINTAINABILITY, AND WILL PROVIDE MISSION FLEXIBILITY. THE INTEGRATION BY STORAGE TIME DOES NOT PENALIZE THE ORBITAL SYSTEMS. THE ADDITIONAL COMPLICATIONS TO ALREADY TOUGH TECHNOLOGY PROBLEMS ASSOCIATED WITH INTEGRATION OF THE ORBITAL PROPELLANT IN THE LARGE BOOST TANKS CAN BE ELIMINATED.

SPACE SHUTTLE CRYOGENIC TECHNOLOGY REVIEW

Charles C. Wood

NASA Marshall Space Flight Center
Huntsville, Alabama

CONCLUSIONS

- (1) THE SATURN V, CENTAUR AND TECHNOLOGY PROGRAMS CONDUCTED DURING THE PAST SEVERAL YEARS HAVE PROVIDED AN EXCELLENT BASE FOR SPACE SHUTTLE CRYOGEN SYSTEM DESIGN.

- (2) ALTHOUGH TECHNOLOGY ADVANCEMENTS ARE REQUIRED TO SUPPORT THE SPACE SHUTTLE DEVELOPMENT, NO MAJOR TECHNOLOGY BREAKTHROUGHS ARE REQUIRED. HOWEVER, LIMITED OR IMMATURE BACKGROUND DATA PRECLUDE BASELINING AT THIS TIME THE MOST DESIRABLE APPROACHES IN THE AREAS OF PROPELLANT ACQUISITION, PROPELLANT TRANSFER, PROPELLANT MASS GAUGING IN ORBIT, INSULATION AND VARIOUS HARDWARE ASPECTS.

- (3) TECHNOLOGY PROGRAMS IN PROGRESS, IDENTIFIED NEW PROGRAMS AND THOSE CURRENTLY BEING IDENTIFIED THROUGH THE SHUTTLE TECHNOLOGY PANEL STRUCTURE ARE EXPECTED TO PROVIDE THE REQUIRED MATURITY IN THE SPACE SHUTTLE CRYOGEN TECHNOLOGY AREAS.