

NASA
SPACE VEHICLE
DESIGN CRITERIA
(GUIDANCE AND CONTROL)

NASA SP-8027

CASE FILE
COPY

SPACECRAFT RADIATION TORQUES

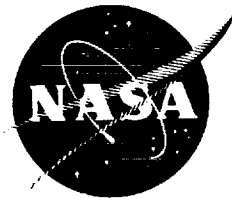

OCTOBER 1969

NATIONAL AERONAUTICS AND SPACE ADMINISTRATION



FOREWORD

NASA experience has indicated a need for uniform design criteria for space vehicles. Accordingly, criteria are being developed in the following areas of technology:

Environment
Structure
Guidance and Control
Chemical Propulsion

Individual components of this work will be issued as separate monographs as soon as they are completed. This document, "Spacecraft Radiation Torques," is one such monograph. A list of all monographs in this series issued prior to this one can be found on the last page of this document.

These monographs are to be regarded as guides to design and not as NASA requirements, except as may be specified in formal project specifications. It is expected, however, that the criteria sections of these documents, revised as experience may indicate to be desirable, eventually will be uniformly applied to the design of NASA space vehicles.

This monograph was prepared under the cognizance of the NASA Electronics Research Center. Principal contributors were Mark Harris and Robert Lyle of Exotech, Inc.

The effort was guided by an advisory panel consisting of the following individuals:

R. F. Bohling	NASA, Office of Advanced Research and Technology
F. J. Carroll	NASA, Electronics Research Center
J. P. Clark	The Boeing Co.
D. B. DeBra	Stanford University
B. M. Dobrotin	Jet Propulsion Laboratory, California Institute of Technology
R. E. Fischell	Applied Physics Laboratory, Johns Hopkins University
A. J. Fleig	NASA, Goddard Space Flight Center
D. Fosth	The Boeing Co.
J. A. Gatlin	NASA, Goddard Space Flight Center
H. Perkel	RCA, Princeton, N. J.
R. E. Roberson	Consultant, Fullerton, Calif.

A. E. Sabroff TRW Systems Group
E. D. Scott Lockheed Missiles & Space Co.
C. H. Spenny NASA, Electronics Research Center
B. E. Tinning NASA, Ames Research Center

Contributions in the form of design and development practices were provided by many other engineers of NASA and the aerospace industry.

Comments concerning the technical content of these monographs will be welcomed by the National Aeronautics and Space Administration, Office of Advanced Research and Technology (Code RVA), Washington, D.C. 20546.

October 1969

For sale by the Clearinghouse for Federal Scientific and Technical Information
Springfield, Virginia 22151 - Price \$3.00

CONTENTS

	Page
1. INTRODUCTION	1
2. STATE OF THE ART	2
2.1 General	2
2.2 Historical Background	2
2.3 Flight Experience	3
2.4 Radiation Sources	8
2.5 Radiation Forces	13
2.6 Radiation Torque	15
2.7 Surface Properties	17
2.8 Testing	19
2.9 Summary	20
3. CRITERIA	20
3.1 Radiation-Torque Analysis	20
3.2 Evaluation of Radiation-Torque Effects	22
3.3 Control of Radiation Torque	22
4. RECOMMENDED PRACTICES	22
4.1 Radiation-Torque Analysis	23
4.2 Minimization of the Effects of Radiation	29
REFERENCES	33
NASA Space Vehicle Design Criteria Monographs Issued to Date	37

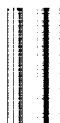

Spacecraft Radiation Torques

1. INTRODUCTION

In the design of spacecraft attitude-control systems, all torques that tend to disturb the attitude of a spacecraft must be considered. One of these is the torque resulting from radiation forces on the spacecraft surfaces.

The principal source of radiation force is direct solar illumination. Earth-reflected sunlight and infrared emission from the Earth and its atmosphere are additional sources for spacecraft in Earth orbit. Asymmetrical emission of electromagnetic energy (typically heat or radio signals) from onboard the spacecraft should also be considered as a radiation source.

Major factors in the determination of radiation torques are

- (1) The intensity, spectrum, and direction of the incident or emitted radiation
- (2) The shape of the surface and the location of the Sun face with respect to the mass center of the spacecraft
- (3) The optical properties of the surface upon which the radiation is incident or from which it is emitted

Solar irradiation varies as the inverse square of the distance between the spacecraft and the Sun. Consequently, for spacecraft in Earth orbit, this contribution to the radiation force is essentially independent of altitude. Because most other disturbance torques tend to diminish with increasing altitude, radiation torque is most likely to be a significant factor in the design of spacecraft with large surface area that operate at orbital altitudes above about 1000 km.

Where radiation torque is an important factor in the determination of spacecraft attitude motion, in the sizing of control actuators, or in the determination of expendable fuel requirements, attention should be given to the geometry and characteristics of the external surfaces of the spacecraft to control or minimize the torques. The configuration and orientation of large solar arrays and antennas and the effects of thermal-control coatings on surfaces must be carefully considered.

When the spacecraft deploys extended, flexible structures, deformations or deflections caused by gravitational or aerodynamic forces and thermal stresses may cause changes in the spacecraft geometry and the location of the mass center. The consequences of these

structural deflections on the radiation torque are discussed in this document; effects of dynamic coupling and interaction with the spacecraft attitude-control system are treated in a separate monograph, NASA SP-8016 (ref. 1).

2. STATE OF THE ART

2.1 General

Radiation incident on a spacecraft's surface generates forces that may cause a torque about the spacecraft's mass center. Surface characteristics are dominant among the factors causing both the radiation and aerodynamic torques that act on a spacecraft. Because the aerodynamic forces diminish rapidly with increasing altitude, and because radiation forces are nearly constant (for near-Earth orbits), radiation torques generally are the larger at altitudes above 1000 km.

2.2 Historical Background

In the 18th century, the widely accepted corpuscular theory of light prompted scientists to associate a force with electromagnetic radiation. Attempts to demonstrate this force in experiments failed because of the inadequacy of experimental techniques. When the wave theory of light gained general acceptance, interest in these experiments waned.

In 1873, Maxwell published his "Treatise on Electricity and Magnetism" (ref. 2), in which he defined the concept of radiation pressure caused by light radiation as follows: "... in a medium in which waves are propagated there is a pressure in the direction normal to the waves [i.e., in the direction of propagation] and numerically equal to the energy in the unit of volume." Maxwell provided a derivation for this relationship based on the electromagnetic theory. More recently, the quantum-theory approach yielded the same result (ref. 3). The first measurements of radiation pressure and of its numerical equivalence to the energy of the propagating medium were made by Lebedew in 1900 (ref. 4) and Nichols and Hull in 1903 (ref. 5). It is unfortunate that the term "pressure" has remained in use, for this term can be taken to imply only normal forces acting on surfaces. The existence of both normal and shear components of the radiation force acting on a surface was recognized and reported by several investigators early in this century, including Poynting (ref. 6).

Although radiation forces are very small in absolute magnitude, certain space missions (e.g., interplanetary flight) present opportunities to use these forces constructively, as evidenced in proposals for spacecraft propulsion (refs. 7 and 8) and attitude control (ref. 9).

Flight experience with associated disturbance torques is described in the following section.

2.3 Flight Experience

2.3.1 Radiation Torque Caused by Thermally Induced Bending

The Alouette 1 satellite represents one of the first documented flight experiences in which significant effects of radiation disturbance torque were encountered. This spacecraft had four long antennas extended radially outward from its spin axis. The combination of solar heating and an intrinsic thermal time delay caused asymmetrical bending of these antennas. As shown in figure 1, an antenna moving away from the Sun is bent in the direction of satellite rotation; an antenna swinging toward the Sun is bent counter to the rotation. Thus, an antenna swinging away from the Sun is exposed to the radiation force for a shorter time than is one moving toward the Sun. The result of this unequal exposure of antennas is a torque about the spin axis. As shown in figure 2, Alouette 1 was thus subjected to a slow but steady decrease of spin rate.

The Explorer 20 satellite had extended flexible booms, which exhibited the same asymmetrical bending properties as did the antennas of Alouette 1 and caused comparable anomalous spin behavior. The resulting despin rate of Explorer 20 was 1.6 rpm/yr (ref. 10).

To reduce the despin rate of Alouette 2, specially designed solar-radiation-torque compensation plates were added to the antenna tips (ref. 10). Immediately after antenna deployment, the spin rate was 2.25 rpm. After 2.5 yr, the spin rate decreased to 1.99 rpm (ref. 11). This despin rate of 0.10 rpm/yr, compared to 0.60 rpm/yr for Alouette 1 and 1.60 rpm/yr for Explorer 20, shows the improvement achieved through the use of compensating tip plates.

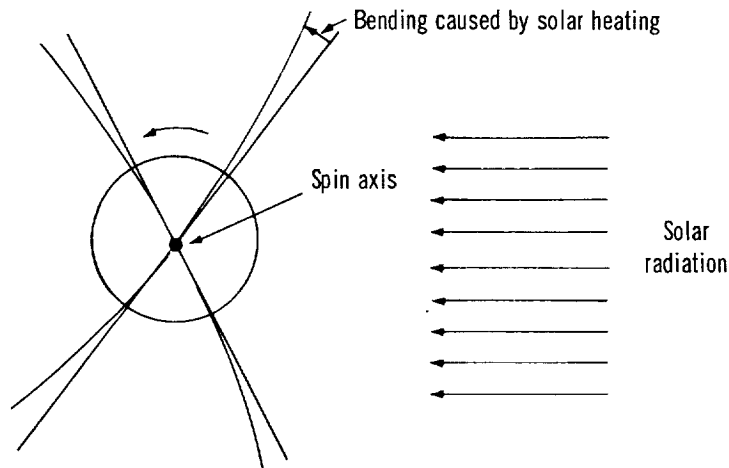

Figure 1.—Bending of the antennas of Alouette 1.

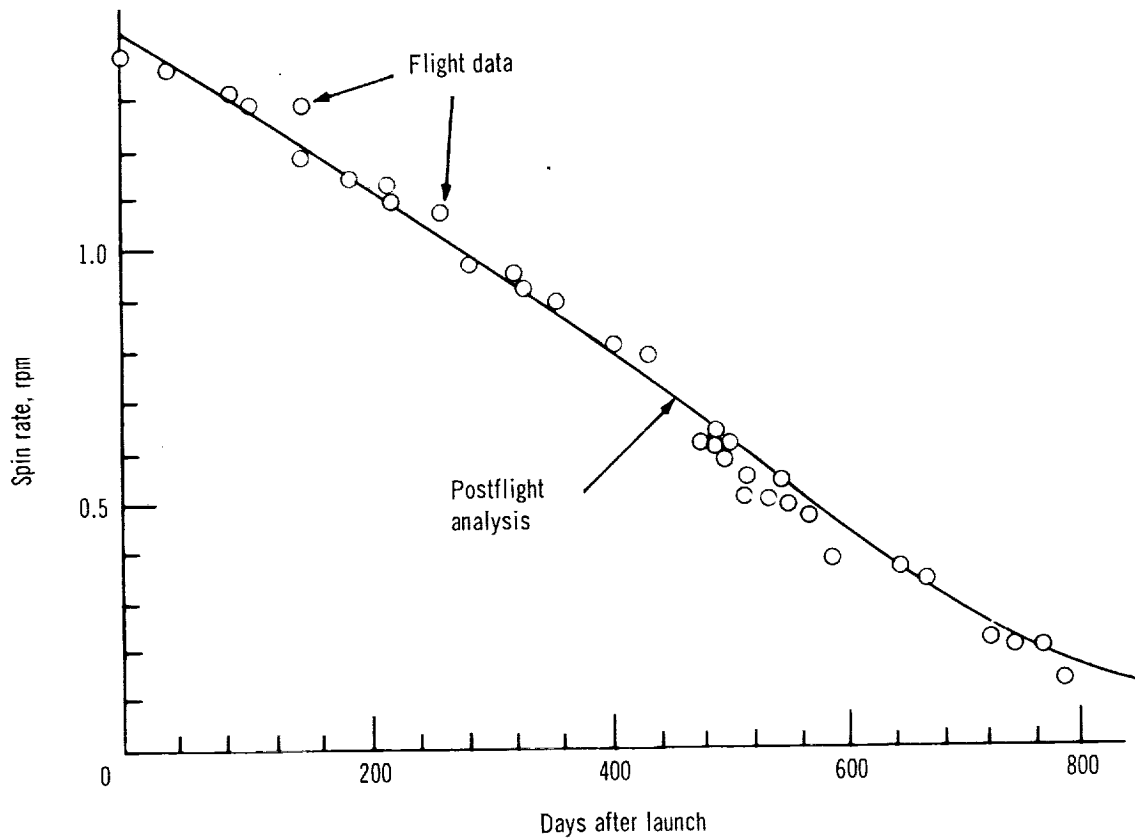

Figure 2.—Alouette 1 spin decay (ref. 9).

2.3.2 Radiation Torques Caused by Tilted Solar Panels

When a spacecraft uses tilted solar-cell panels, the radiation force on a panel produces a component of torque along the symmetry axis in a manner analogous to that of windmill or propeller blades. If all panels have a pitch angle of the same sign, the resultant net torque along the symmetry axis perturbs the existing angular rate about this axis. The Beacon Explorer-B (Explorer 22) satellite, illustrated in figure 3, experienced this type of disturbance when the solar radiation torques caused its spin rate to increase and decrease alternately (ref. 12). On the Transit 4A and 4B satellites, this radiation torque was used to generate a slow spin rate to improve the thermal balance during periods of 100 percent illumination. These satellites used four vanes that were black on one side and highly reflective on the other. The vanes were attached to the spacecraft as if to a windmill, and solar radiation provided the required spin torque (ref. 13).

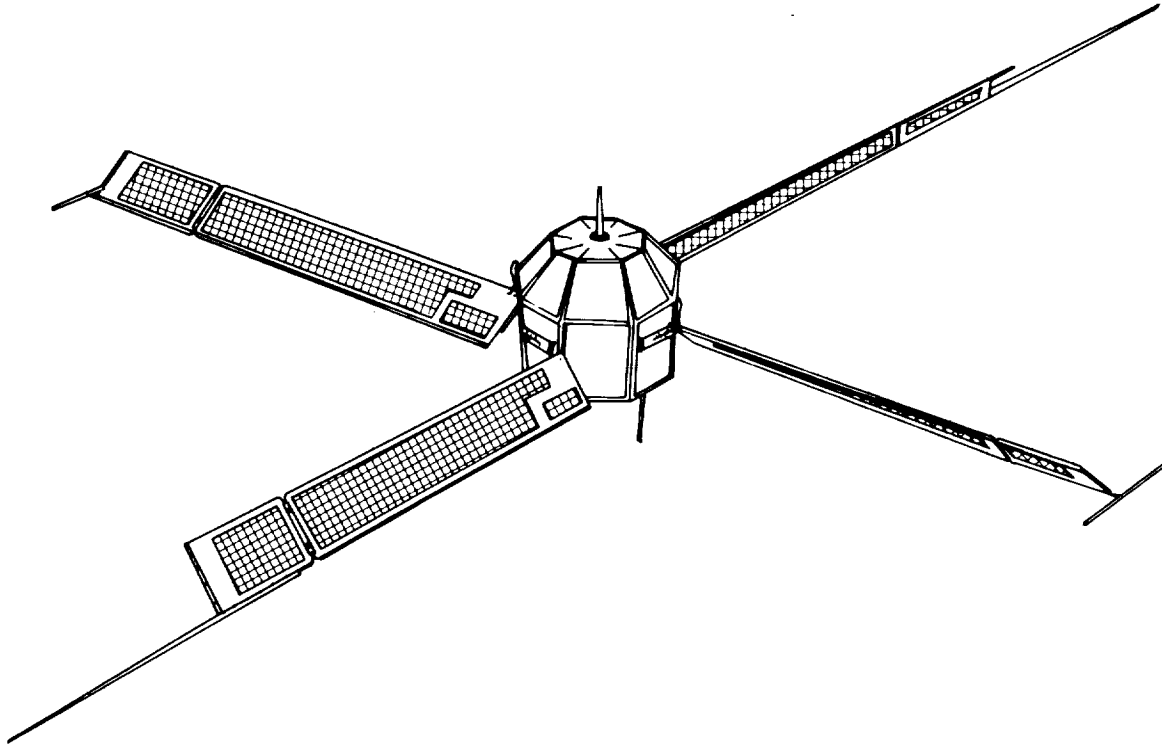

Figure 3.—Beacon Explorer-B (Explorer 22).

2.3.3 Spacecraft Tumbling Because of Radiation Torques

The DODGE satellite, illustrated in figure 4, contained 10 extendable booms, which were to be used to study gravity-stabilization techniques at near-synchronous altitudes. Initially, two booms were deployed to 22.9 m (75 ft) each to form the unsymmetrical configuration illustrated in figure 5. The solar radiation torques on this configuration were sufficient to cause the DODGE satellite to tumble. Calculations that had not included the effects of radiation torque had indicated that the satellite should swing to a peak angle of about 55° relative to the local vertical and would then librate in pitch. This libration was to be reduced to zero by extending two additional booms to form a symmetrical X configuration (ref. 14) at the end of the first half of the first libration period (about 6 hr). When the radiation-torque effect was included in more detailed calculations, it was verified that radiation torques would indeed cause the unsymmetrical satellite to tumble. When the symmetrical X configuration was used, the effect of the radiation torque was reduced, the tumbling was eliminated, and gravity capture was achieved.

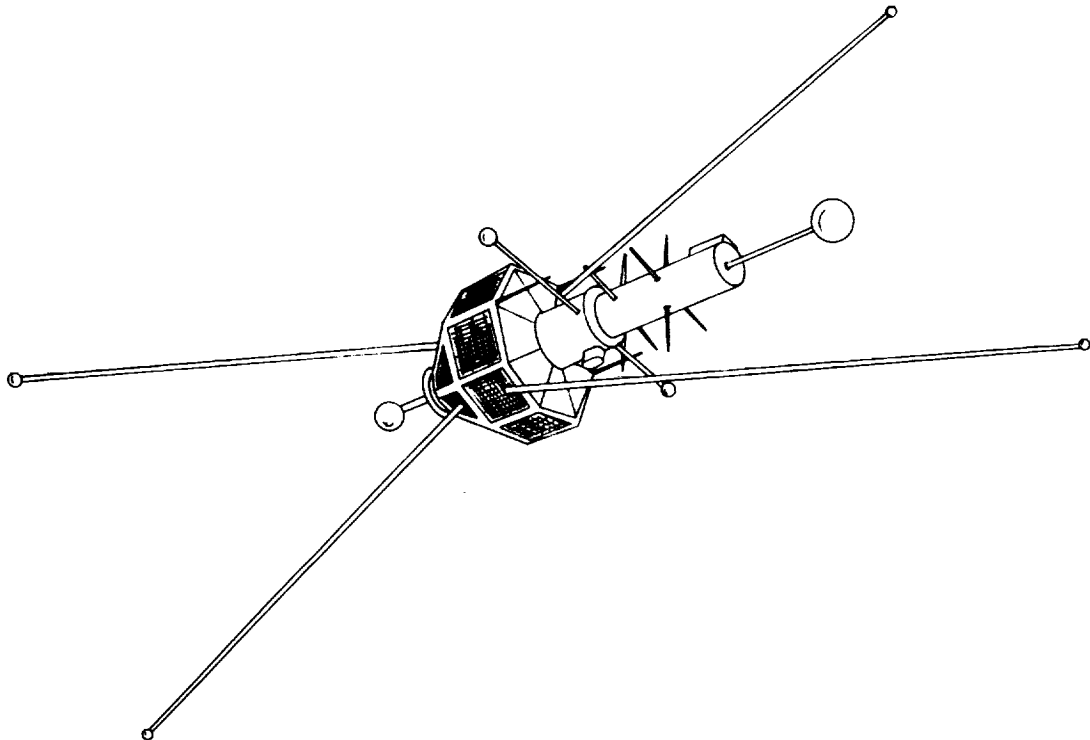

Figure 4.—DODGE satellite.

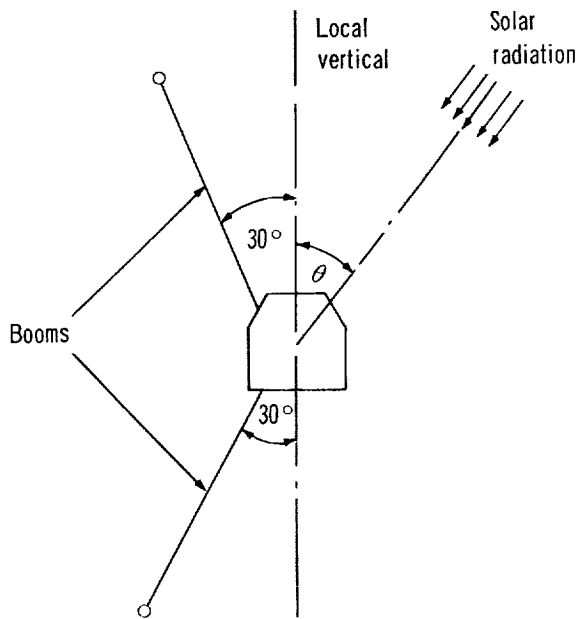

Figure 5.—Unsymmetrical configuration for DODGE satellite.

2.3.4 Active Balance of Radiation Torques

On Mariner 4, controllable solar vanes were mounted on the outboard tips of each of the four solar panels (fig. 6). The vanes provided 0.65 m^2 (7 ft^2) of reflecting surface and were to be deployed to a nominal 35° angle to the plane of the solar panels. The vanes had three functions. They shifted the point of application of the net solar radiation force to a point behind the spacecraft center of mass to give a statically stable configuration, allowed for adjustment and neutralization of solar radiation torques, and produced spacecraft-oscillation damping by producing a slight force in opposition to the spacecraft angular velocity.

The first function was accomplished by deploying the vanes in a swept-back position; the second, by moving the vanes with stepping motors connected to the attitude-control gas jets. The third function was accomplished by sensing the spacecraft attitude with respect to the Sun and moving the vanes through a small angle to damp spacecraft oscillation.

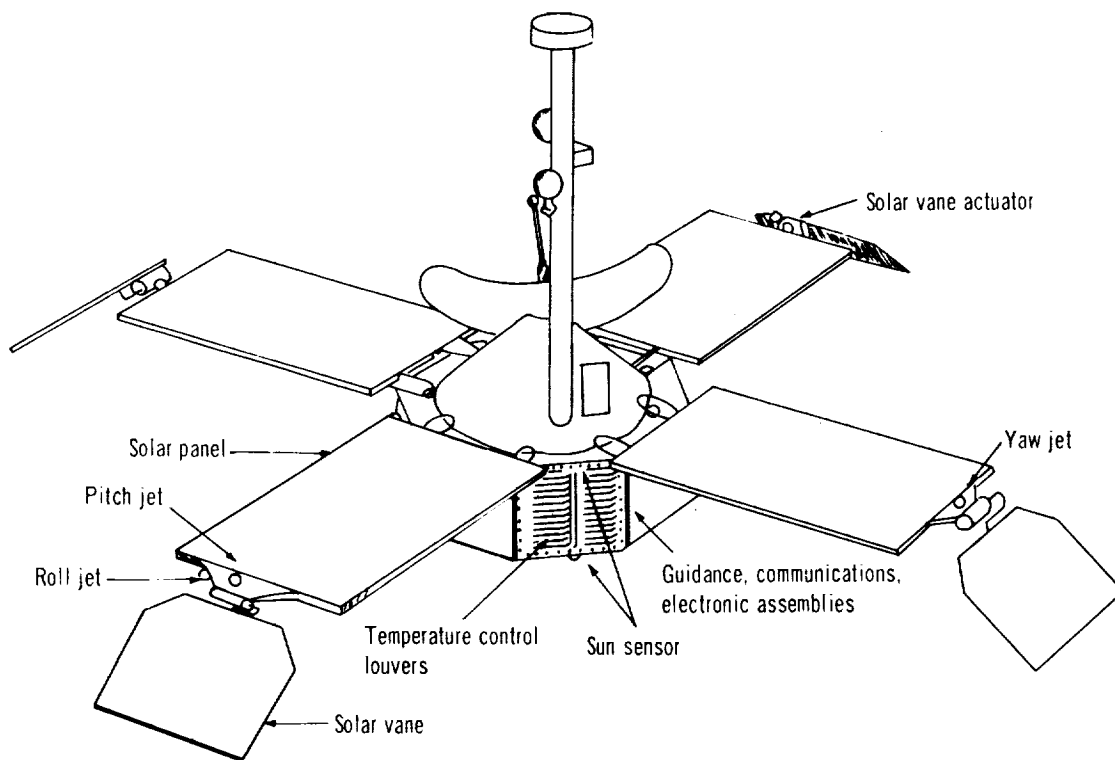

Figure 6.—Mariner 4 satellite.

When deployed during flight, the solar vanes overtraveled and assumed initial angles that ranged from 21° to 11° . Despite the overtravel, the first function was successfully accomplished, and a net restoring torque of 1.1 dyn-cm/deg in pitch and 1.7 dyn-cm/deg in yaw achieved. In addition, the automatic torque-balancing system functioned in yaw and compensated for the radiation torque on the high-gain antenna. The pitch-axis vanes failed to operate because of an electrical lockup in the actuators. Because variations in the leakage from the gas valves produced disturbance torques that exceeded the vane damping capability, it was not possible to establish whether the mechanism intended to accomplish spacecraft oscillation damping was working (ref. 15). Because the radiation disturbance torque was small compared to other disturbance torques, primarily mass expulsion, solar vanes were not used on the recently launched Mariners 6 and 7.

2.3.5 Structural Bending Because of Radiation Forces

Radiation and gravitational forces and thermal gradients may cause deflections resulting in structural asymmetry and displacement of the mass center when long, flexible structures are present on a spacecraft. The Radio Astronomy Explorer, with its four 229 m (750-ft) extendable antennas, furnishes an example of the large deflections that can occur. Solar radiation force accounts for a tip deflection of only 4.6 m (15 ft), but combined with other environmental forces and thermal effects, a total tip deflection of approximately 46 m (150 ft) results. Tip deflections of this magnitude produce a considerable increase in the radiation torque and can produce a significant angular motion of the satellite during half an orbit (ref. 16).

2.4 Radiation Sources

Sources of electromagnetic radiation that cause forces and possible torques to act on a spacecraft are

- (1) Direct solar photon radiation
- (2) Solar radiation reflected by the Earth and its atmosphere
- (3) Radiation from the Earth and its atmosphere
- (4) Radiation from the spacecraft

The most important cause of radiation torques is direct solar photon radiation. The forces caused by the other sources are usually at least an order of magnitude smaller. In force calculations, the intensity of solar corpuscular radiation (the solar wind) is usually negligible.

2.4.1 Solar Photon Radiation

The Sun provides essentially collimated radiation with a reasonably well defined intensity and spectrum (the Sun's visible disk subtends an angle of 32 arcmin at 1 AU). The solar constant I_0 is the rate at which solar energy at all wavelengths is received above the Earth's atmosphere on a surface normal to the incident radiation and at the Earth's mean distance from the Sun. A commonly used value of this constant is 2.00 ± 0.04 g-cal/cm² min (1396 ± 28 W/m²) refs. 17 and 18). A recent reevaluation of the constant indicates a value of 1.94 ± 0.02 g-cal/cm² min (1353 ± 20 W/m²) (ref. 19).

The Earth's eccentric orbit about the Sun causes a periodic variation in the observed solar intensity. The adjusted solar intensity I for a near-Earth orbiting satellite can be expressed as a function of time as

$$I = I_0 \beta(t)$$

where I_0 is the solar constant at 1 AU and $\beta(t)$ is a correction factor that varies with the actual Earth-Sun distance during a year. The values of I and β as a function of time are illustrated in figure 7.

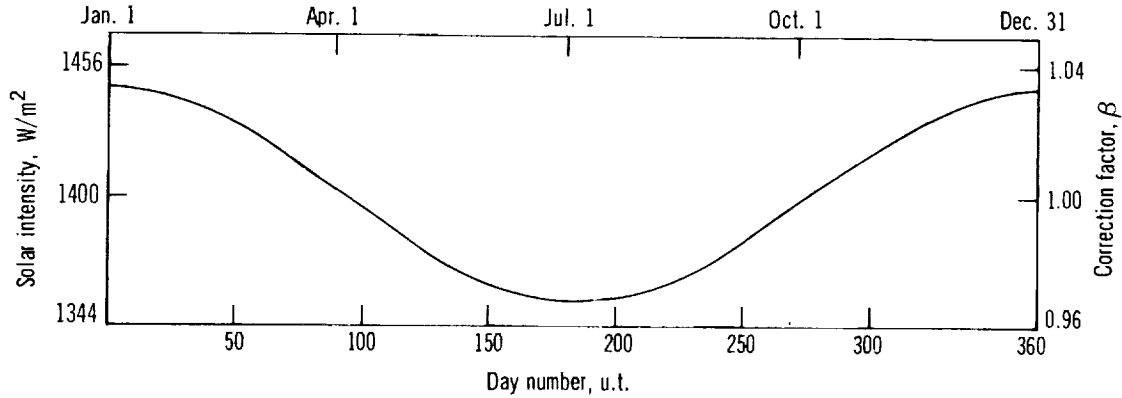

Figure 7.—Solar intensity as a function of day number.

2.4.2 Earth Reflectance

The Earth and its atmosphere comprise a diffuse¹ reflector whose spectrum is generally assumed to be the same as that of direct solar radiation. An often used measure of Earth reflectance is the Earth albedo, defined as the fraction of incident solar radiation, averaged over a time period, that is reflected to space. Because the reflected radiation is not collimated, the mathematical complexity of integrating the reflected radiation over the visible surface of the Earth makes it difficult to determine the resulting force on the spacecraft. The average intensity, in watts per square meter, of reflected solar radiation that

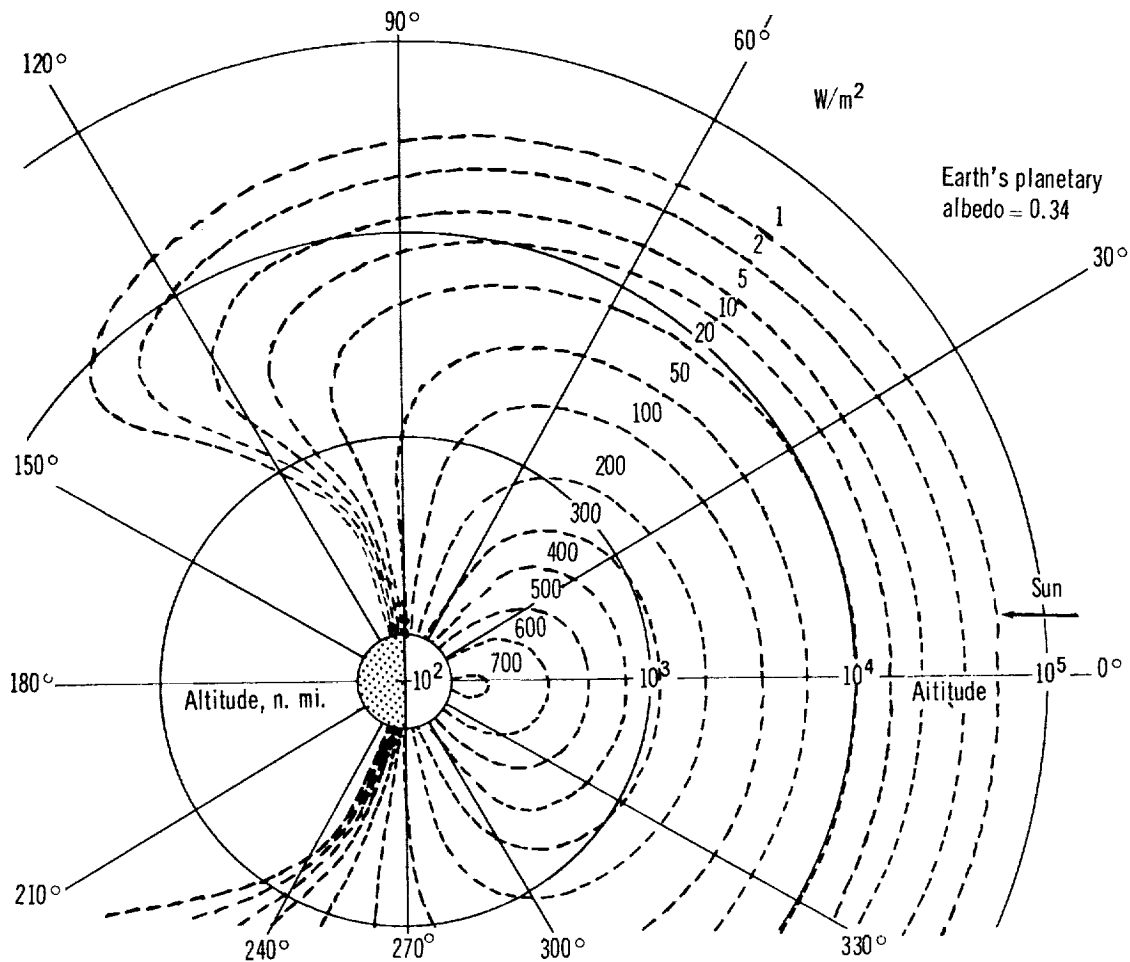

Figure 8.—Average intensity of solar energy reflected by Earth (from ref. 21).

¹This assumption is weak, because the Earth and its atmosphere are not homogeneous and Earth reflectance is nonisotropic and wavelength dependent (ref. 20).

is incident on a surface normal to the local vertical at altitudes between 10^2 and 10^5 n.mi. and at various angles from the Earth-Sun line is illustrated in figure 8. The values are based on an annual average albedo of 0.34 (ref. 21).

2.4.3 Earth Radiation

The Earth and its atmosphere emit diffuse radiation with a spectrum that is approximated by the spectrum of a 288°K blackbody in the regions where the atmosphere is transparent, and by the spectrum of a 218°K blackbody in regions where the atmosphere has low transmittance, as illustrated in figure 9 (ref. 22). About 95 percent of this emitted radiation originates from the Earth or in the lower atmosphere and the remainder from above the troposphere. Emitted radiation as a function of latitude is illustrated in figure 10 (ref. 22). The effect of Earth radiation on a satellite at synchronous altitude is between 0.2 and 0.3 percent of the effect of direct solar radiation.

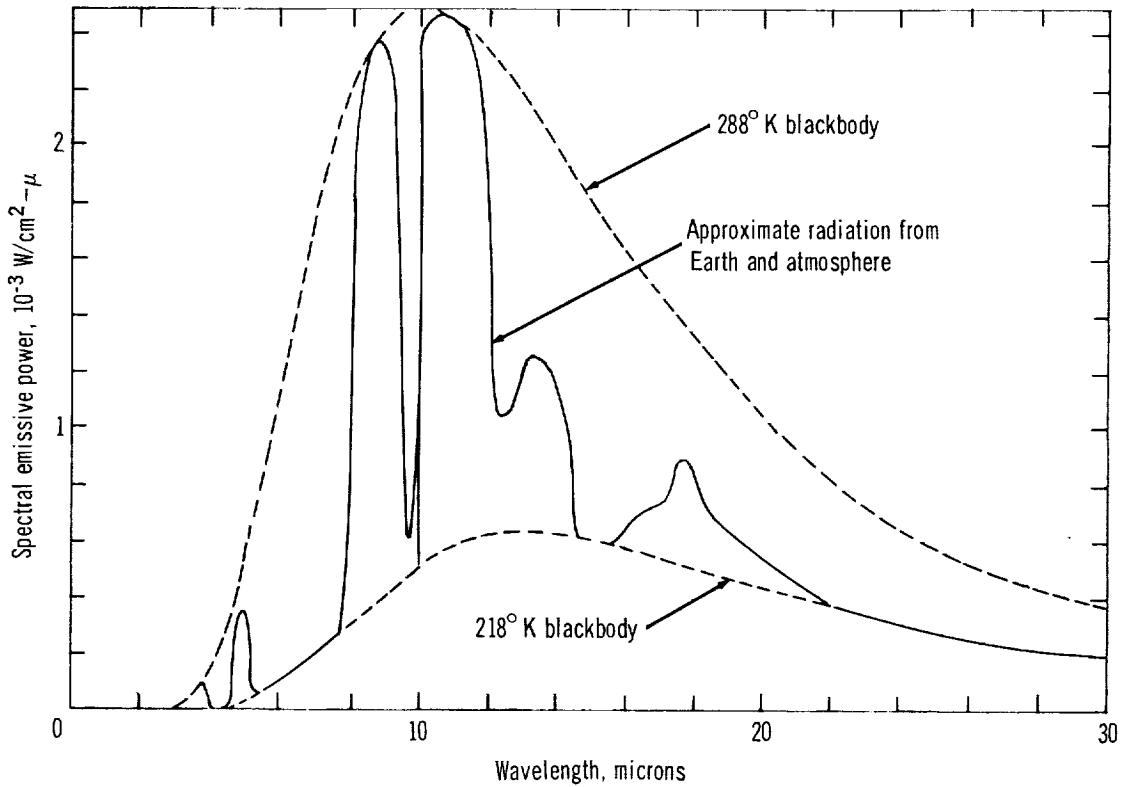

Figure 9.—A typical spectral emissive power curve for thermal radiation emitted by Earth (ref. 27).

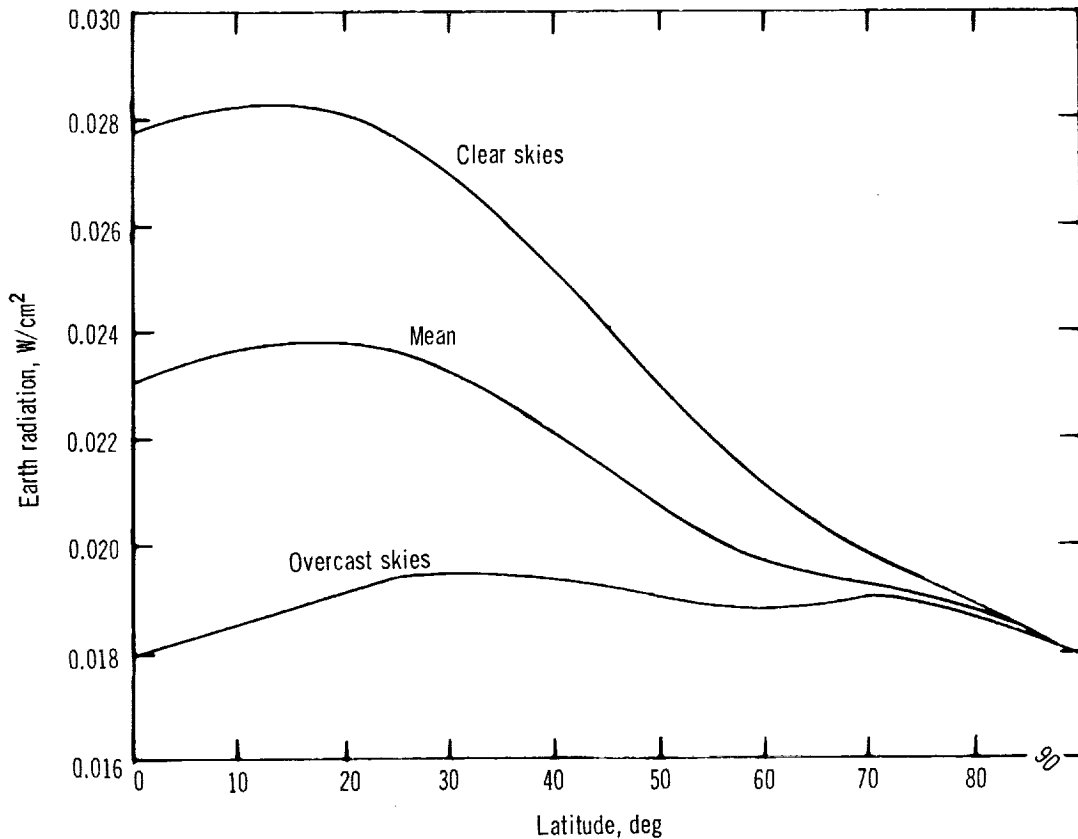

Figure 10.—Earth radiation as function of latitude under various sky conditions.

2.4.4 Spacecraft Radiation

Spacecraft commonly emit thermal and radiofrequency radiation that can cause a disturbance torque. This emitted radiation causes a reaction force upon emission, and if it impinges on another part of the spacecraft structure, generates an impingement force. The amount of thermal power radiated per unit area is a function of the emissivity and temperature of the radiating surface as well as of the solid angle into which the surface radiates. For the most general case, the emissivity at a point of the spacecraft surface depends on the temperature at the point and on the direction in which the energy is radiated. In the determination of radiation forces caused by emission, it is common to assume that the emissivity is a function only of temperature, and that each element of area radiates diffusely into a hemisphere. A diffuse radiator, or Lambertian source, has equal radiant power per unit solid angle per unit projected area in any direction. The power

radiated from an element of area on the spacecraft is

$$E = \sigma \epsilon T^4$$

where

E = emissive power in W/m^2

ϵ = nondirectional emissivity, dimensionless

σ = Stefan-Boltzmann constant = $5.67 \times 10^{-8} \text{ W}/\text{m}^2 - (\text{K})^4$

T = surface temperature in degrees Kelvin

A consequence of the assumption of diffuse radiation is that the reaction force is normal to the surface and is equal to $2/3(E/c)$, where c is the speed of light in a vacuum.

Determination of the force and associated torques generated by emitted thermal radiation requires a knowledge of the temperature distribution over the spacecraft and the temperature-dependent emissivity of the materials used in the exterior components. For most spacecraft, the thermal radiation is nearly isotropic. This source of disturbance torque is much smaller than previously described sources and is not included in the analysis. This source could, however, be of significance on future spacecraft using radioisotope thermionic generators (RTG) or thermoelectric generators. For example, in the generation of 100 W of electrical power, it may be necessary to provide for the radiation of 2000 to 5000 W of thermal power. In this case, the force per unit area resulting from spacecraft radiation considerably exceeds the solar radiation forces and must be accounted for in the design and location of the RTG radiator. Thus, in the mission analysis and configuration studies for the Thermoelectric Outer Planet Spacecraft (TOPS) for the Grand Tour type of mission, the design of the RTG interacts with both the control-system design and the trajectory analysis.

Emitted radiation in the radiofrequency range does not presently make a significant contribution to the forces and disturbance torques acting on a spacecraft.

2.5 Radiation Forces

When radiant energy is incident on a surface, the surface is subjected to a force per unit area, i.e., surface stress, equal to the vector difference between the impinging and reflected momentum flux. If the impinging flux on the surface is known, the reflected flux can be analytically described by the reflection distribution function and the directional emissivity as described in reference 23. In practice, the properties of the surface (sec. 2.7) are rarely known in sufficient detail to evaluate the required functions, and therefore the assumption is made that all the incident radiation is absorbed, reflected specularly, reflected diffusely, or some combination of these. Both the nonisotropic optical properties of the surface and the variation of these properties as a function of the spectral content and angle of incidence of the impinging radiation are generally ignored.

Figures 11, 12, and 13 give the radiation-force expressions for an absorbing, a specularly reflecting, and a diffusely reflecting surface.

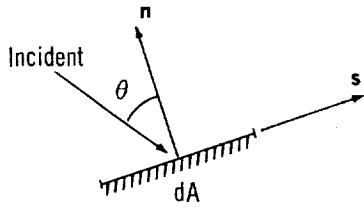

Figure 11.—Radiation force for a completely absorbing surface.

$$df_a = \frac{I}{c} [c_a (-\cos \theta \mathbf{n} + \sin \theta \mathbf{s})] \cos \theta dA$$

where c_a = absorption coefficient, the fraction of the incident radiation that is absorbed. For this case, $c_a = 1$, $c_{rs} = 0$, $c_{rd} = 0$.

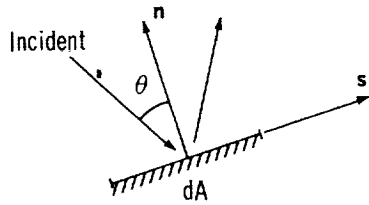

Figure 12.—Radiation force for a completely specularly reflecting surface.

$$df_a = \frac{I}{c} [-(1 + c_{rs}) \cos \theta \mathbf{n} + (1 - c_{rs}) \sin \theta \mathbf{s}] \cos \theta dA$$

where c_{rs} = coefficient of specular reflection, the fraction of the incident radiation that is specularly reflected. For this case, $c_a = 0$, $c_{rs} = 1$, $c_{rd} = 0$.

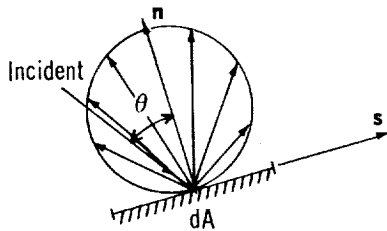

Figure 13.—Radiation force for a completely diffusely reflecting surface.

$$df_{rd} = \frac{I}{c} [-(\cos \theta + 2/3 c_{rd} \mathbf{n} + \sin \theta \mathbf{s})] \cos \theta dA$$

where c_{rd} = coefficient of diffuse reflection, the fraction of the incident radiation that is diffusely reflected. For this case, $c_a = 0$, $c_{rs} = 0$, $c_{rd} = 1$.

In general, when assuming that the incident radiation is partly absorbed, partly reflected specularly, partly reflected diffusely, and that negligible backscattering occurs, the differential radiation force on an elemental area dA is given by equation (2-1):

$$df = \frac{I}{c} \left\{ - \left[(1 + c_{rs}) \cos \theta + \frac{2}{3} c_{rd} \right] \mathbf{n} + (1 - c_{rs}) \sin \theta \mathbf{s} \right\} \cos \theta dA \quad (2-1)$$

with

$$0 \leq c_a + c_{rs} + c_{rd} \leq 1$$

where

I = energy per unit time through a cross-sectional unit area, in N/m^2
 c = speed of light, in m/sec

and c_a , c_{rs} , and c_{rd} are as defined in figures 11, 12, and 13.

In the above equation, the force contributions of diffuse reflection are based on the assumption that the reflected energy varies as the cosine of the angle between the direction of the reflected flux and the surface normal n . It is also assumed that the incident radiation is either completely absorbed or completely reflected; i.e., the surface under consideration is completely opaque. This assumption is reasonable for most spacecraft materials, but is invalid when a continuous surface is used to approximate discontinuous surfaces such as a mesh antenna or a screen boom. Generally, I/c is modified to account for the radiation that does not impinge on a surface.

The differential-radiation-force expression can be extended to partially include secondary reflection (ref. 24). Secondary reflection is normally not a significant factor, but when large portions of the spacecraft structure are illuminated by reflection from extended surfaces, e.g., solar arrays, it is often necessary to ascertain whether secondary reflection effects can be ignored.

Interested readers are referred to the work by L. E. Wiggins (ref. 25) on the application of radiation forces to space vehicles. This work gives the completely generalized force for a nonisotropic surface, specializes this to isotropic surfaces, further specializes to particular types of reflection, gives the effect of variable reflectance on the forces and moments, and presents tables of certain functions needed to calculate forces and moments on flat plates, cylinders, cone frustums, and spherical segments.

2.6 Radiation Torque

The general expression for the radiation torque acting on a spacecraft is

$$L_r = \int_{\text{s.e.s}} \mathbf{l} \times d\mathbf{f}$$

where

L_r = radiation torque
 \mathbf{l} = vector directed from the spacecraft mass center to element of area dA
 $d\mathbf{f}$ = radiation force on element of area dA (as derived in sec. 2.5)
s.e.s. = spacecraft exposed surface

The practical application of this expression involves a number of approximations in the determination of df as discussed in section 2.5 and in the integration over all spacecraft surfaces.

In computing the torque contribution from the irradiated surfaces on the spacecraft, the usual procedure is to approximate these surfaces by means of simple geometric shapes (planes, cylinders, cones, spheres, etc.). If \mathbf{l}'_i is the vector from the mass center to an infinitesimal area dA_i on the surface under consideration, then the torque contribution from this surface is

$$\mathbf{L}_{r_i} = \int_{\text{e.a.}} \mathbf{l}'_i \times d\mathbf{f}_i$$

where e.a. = exposed area

$$d\mathbf{f}_i = \mathbf{F}_i dA_i$$

with

$$\mathbf{F}_i = \frac{I}{c} \cos \theta \left\{ - \left[(1 + c_{rs}) \cos \theta + \frac{2}{3} c_{rd} \right] \mathbf{n} + (1 - c_{rs}) \sin \theta \mathbf{s} \right\}$$

If the radiation force is constant or can be assumed constant over the surface, then the torque contribution from this surface is

$$\mathbf{L}_{r_i} = \mathbf{l}'_i \times \mathbf{f}_i = (\mathbf{l}'_i \times \mathbf{F}_i) A_i$$

where A_i is the total area of the surface. However, because the radiation force is seldom constant over the surface, it is usually necessary to determine the radiation force, \mathbf{f}_i , by evaluating the integral

$$\int_{\text{surface}} \mathbf{F}_i dA_i$$

directly or approximately. The torque on the spacecraft is then obtained from the vector sum of the torques on the elementary shapes that approximate the spacecraft, that is,

$$\mathbf{L}_r = \sum_i \mathbf{l}'_i \times \mathbf{f}_i$$

Further details on the application of this technique and its adaptation to computer methods are found in references 24 and 26.

Many of the difficulties in precisely determining the radiation torque on a spacecraft are evident from the above expressions. Factors affecting \mathbf{f}_i include changes in the optical

characteristics of the surface; changes in geometry; e.g., bending of a boom, rotation of a solar panel, etc.; partial shadowing of the surface, and so on. Shifts in the spacecraft mass center will cause I'_i to change, but if the direction and magnitude of the shift are known, the new I'_i can be computed.

Torque calculations based on the projected area of the spacecraft on a plane normal to the incident radiation must be used with caution, because components of torque in the direction of the incident radiation are not accounted for.

2.7 Surface Properties

The radiation force on a surface is functionally related to the reflective, emissive, and absorptive properties of the surface. The magnitude of the radiation force developed depends on the angle of incidence or emission, the wavelength, the temperature, the surface roughness, the amount of time the surface is exposed to a particular environment, and the effect of nuclear radiation on the surface. Table I lists some typical values for the spectral reflectance, emittance, and solar absorptance of selected spacecraft materials. This table is not intended to provide design information, but only to illustrate the range of possible values for different materials. Use of the data in design is not recommended, because the materials and surfaces are not sufficiently characterized.

The amount of radiation reflected from a selected surface varies primarily as a function of the angle of incidence, the wavelength, and the material used. References 28 and 29 provide figures illustrating the theoretical change in reflectivity as a function of the above-mentioned parameters.

References 30, 31, and 32 include plots showing the variation of emittance as a function of wavelength, time, angle of emission, and surface roughness. The accurate analytical determination of the emittance of a surface when several parameters are varied simultaneously is presently beyond the state of the art.

The absorption of incident radiation by opaque spacecraft materials generally occurs in the protective coating on the surface and is essentially constant for thick films. A technique for computing the normal solar absorptance from reflectance measurements is discussed in reference 29.

The radiation reflected or emitted by the solar cells mounted on a spacecraft can contribute significantly to the radiation force in the spacecraft. The amount of radiation reflected from both bare and silicon oxide (SiO) coated solar cells is illustrated in figure 14 (ref. 33). As illustrated, the silicon oxide coating significantly decreases the amount of incident radiation reflected.

Table I.—Parameters for Selected Spacecraft Surface Materials^{a,b}

Material	Reflectance, 0.6 to 2.0 microns	Emittance at room temperature, 1 micron	Solar absorptance
White paints		0.79 to 0.93	0.33
White paints exposed to Sun		.82 to .92	.59
Black paints		.88 to .91	.94
Black paints exposed to Sun		.84 to .87	.98
White paints after nuclear radiation			.35
Inorganic paint			.10
Inorganic paint after nuclear radiation			.23
Aluminum film		.01	.07
Silver film		.01	.05
Gold film		.01	.19
Copper film		.01	.17
Platinum film		.03	.24
Sandblasted aluminum	0.4 to 0.7	.2	.42
Sandblasted stainless steel		.85	.75
Aluminum foil		.04	.12
Inconel foil		.1	.38
Inconel X foil		.15	.66
Chemically polished beryllium	.4 to .9	.10	.50
Alumina	.8 to .98 ^c		
Zirconium oxide	.8 to .98 ^c	.03	
Magnesium oxide	.82 to .96	.04	
Thorium oxide	.8 to .94 ^c	.06	
Steel with various finishes	.15 to .8 ^c		
Oxidized stainless steel at 600° C		.2	
Oxidized stainless steel at 1000° C		.4	
Bare n-on-p solar cell	.32 to .31 (.4 to 1.0 micron)	.3 at 149° C	
SiO-coated solar cell	.01 to .16 (.6 to 1.0 micron)		

^aAdapted from refs. 21 and 26.

^bValues are approximate, intended to be indicative and not for design use.

^cBelow 0.6 micron, a sharp decrease in reflectance occurs.

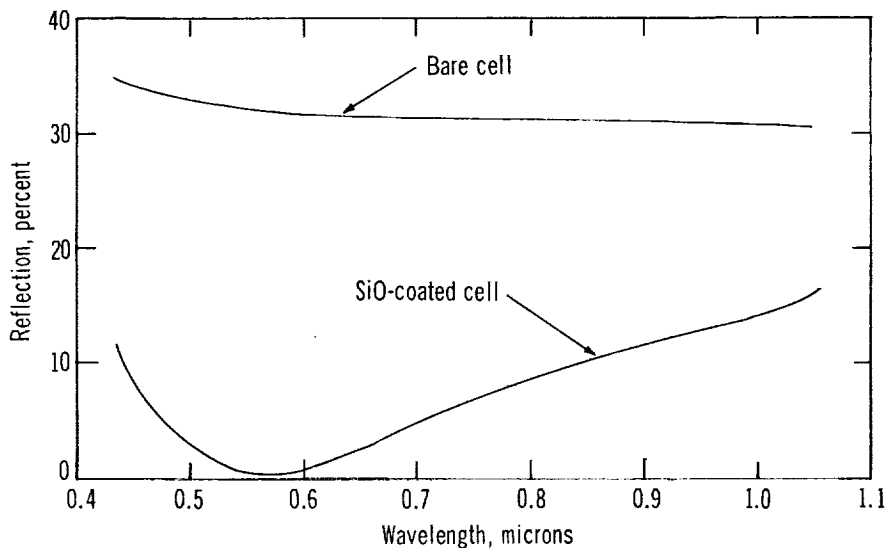

Figure 14.—Reflection from bare and coated solar cells as a function of wavelength (ref. 33).

The infrared emittance of a bare solar cell is about 0.3, but when a thin glass, fused silicon, or sapphire cover is used on the solar cell, the infrared emittance is about 0.9 (ref. 31).

Surface properties of materials change during the life of a spacecraft. These changes can be caused by contamination, ultraviolet irradiation, high-energy particle bombardment, nuclear radiation, high temperatures, and sputtering. A nominal value for the surface and its expected range of variation as the surface properties change can often be obtained from the spacecraft's thermal-design group. In addition, the latest documents on the surface properties of materials can be obtained from the Thermophysics Properties Research Center.²

2.8 Testing

No practical ground test has been devised to measure the radiation torque on a spacecraft. Flight data for spacecraft of similar configuration can be used to determine analytically radiation-torque effects when the flight data are sufficient to allow the radiation-torque disturbance to be separated from other disturbances (as was the case on the Mariner 4 and 5 spacecraft, refs. 15, 34, and 35).

²Thermophysics Properties Research Center, Purdue University Research Park, 2595 Yeager Road, West Lafayette, Ind. 47906.

Generally, test measurements of parameters such as the location of the mass center and the surface characteristics are available from the structural-design, thermal-design, and material-specifications groups. These data, and data obtained from a flight analysis of similar spacecraft configurations, should be used to approximate the radiation torque and to check the accuracy of the approximation.

2.9 Summary

Flight experience has shown that radiation torques can significantly disturb the attitude and spin rate of a spacecraft and therefore must be considered in the design of the spacecraft's attitude-control system. Radiation torques should be considered in the design of large, high-altitude spacecraft, gravity-stabilized satellites, and interplanetary spacecraft. Analytical techniques for determining the radiation torque require several simplifying assumptions and approximations to make the problem solvable by numerical techniques, but the results are sufficiently accurate to enable prediction of a spacecraft's performance.

Variable surface properties are commonly considered constant over fairly extensive areas so that an approximation of the radiation torque can be made. Nominal values of the surface parameters and of the range of variation of these values can generally be obtained from the responsible design group, especially when the surfaces are used for thermal control.

Verification of the accuracy of the radiation-torque calculations can only be obtained from in-flight measurements, because no practical laboratory test method has been developed for measuring these torques.

3. CRITERIA

Consideration of disturbance torques arising from forces acting on the spacecraft is essential to satisfactory design of attitude-control systems. It should be demonstrated that radiation torques acting in combination with all other disturbance torques do not degrade the performance of the attitude-control system. Where it is determined that radiation disturbances are an important factor in the attitude-control-system design, the properties and configuration of the spacecraft's exposed surfaces should be afforded special attention during design, development, and fabrication.

3.1 Radiation-Torque Analysis

Analytical studies to determine the radiation torque acting on a spacecraft require the following data. Accuracy of the data should be consistent with the phase of the

development program and the sensitivity of the attitude-control system to radiation-torque disturbances.

3.1.1 Radiation Sources

The irradiance and angle of incidence from all principal sources of radiant energy (e.g., Sun, Earth reflectance, Earth emission, and spacecraft emission) should be determined for all anticipated flight orientations of the spacecraft.

3.1.2 Surface Orientation

The area and orientation relative to radiation sources should be determined for surfaces of all discrete shapes used to approximate the spacecraft.

3.1.3 Radiation Force

The net force acting at the spacecraft's effective center of pressure or the individual force acting at the centers of pressure of the approximating shapes should be determined for all expected flight configurations.

3.1.4 Radiation Torque

The radiation torque should be determined at such points in the orbit and times of the year as are necessary to generate a profile of disturbance torques for all expected environmental conditions.

3.1.5 Radiation-Torque Variations

The effects on the radiation torque of shifts in the spacecraft's mass center (caused by mass expulsion, deployment, equipment jettison, etc.) and changes in the characteristics of exposed surfaces (caused by environmental bending of booms, controlled or uncontrolled motion of appendages, changes in surface properties, shadowing, etc.) should be evaluated.

3.2 Evaluation of Radiation-Torque Effects

The evaluation of the effects of radiation torques on spinning and nonspinning spacecraft should include, but not be limited to, the following considerations:

- (1) Attitude-control-system actuator requirements; viz, peak torque, momentum storage, and momentum transfer
- (2) Attitude-control accuracy
- (3) Deflection of extended structures
- (4) Dynamic interactions of resonances caused by torque variation on spacecraft and appendages
- (5) Control-system propellant requirements

3.3 Control of Radiation Torque

Whenever radiation torques are dominant or, in combination with other torques, contribute significantly to spacecraft attitude-control disturbances, procedures should be instituted for the determination and control of the spacecraft's mass distribution, exposed areas, and surface properties. These procedures should be initiated in the early design phase and maintained throughout the development program.

4. RECOMMENDED PRACTICES

Assessment of radiation torques should be accomplished in the early design phase of spacecraft development. Other than actual flight experience with a prototype, experimental or test techniques to ascertain the magnitude of radiation torque do not exist. Therefore, current practices for estimating these torques are based on knowledge accumulated from previous flight experience and on analytical techniques developed to obtain useful approximations.

Radiation torques generally can be reduced to acceptable levels by properly designing the exposed surfaces so that the radiation forces are balanced about the spacecraft's mass center.

4.1 Radiation-Torque Analysis

4.1.1 General Procedure

The objectives of a torque analysis in the preliminary phase of spacecraft design are to achieve a reasonable approximation of the magnitude of the torques, to identify the geometrical features having the greatest potential for causing attitude-stabilization problems, and to determine the constraints imposed on the attitude-control system for each proposed geometry. The preliminary analysis should facilitate development of decision values concerning the tradeoffs associated with alternative design configurations and indicate whether more precise analysis is needed. The technique of locating the point of application of the net radiation force by projection of the approximated configuration of the spacecraft onto a plane normal to the incident radiation is useful in the preliminary analysis, if applied with caution. However, these techniques, such as the shadowgraph, etc., are not recommended when more than an approximation of the magnitude is required, because the results are limited by approximating the surface characteristics and by neglecting those components of radiation force in the plane of the projection.

When radiation torques are indicated as a significant cause of spacecraft-attitude disturbance, detailed analysis is necessary. This analysis will require close coordination among the control-systems, structural-design, thermal-design, and material-specification groups. Approximations of mass center and the point of application of the net radiation force at this preliminary state can only be based on gross mass estimates for the main spacecraft structure, all major appendages, and spacecraft geometry that can be approximated by an appropriate combination of tetrahedrons, cylinders, spheres, cones, and plates in combination with estimates of their surface optical properties. As the design progresses, the participating groups should be aware of all changes in configuration and materials, so that the effects of these changes may be evaluated from each group's viewpoint.

Methods of analysis that treat the radiation-torque problem with a level of detail commensurate with the state of the art are discussed in references 23, 24, and 26. These methods (briefly reviewed in secs. 2.4 and 2.5) should be adapted to the design effort being undertaken.

4.1.2 Characterization of Radiation Environment

The analytical techniques described in section 4.1.1 require that the source characteristics of the incident radiation be defined. The following expressions and the values listed in Table II are recommended for describing the incident radiation associated with the identified sources.

Direct solar radiation.— Collimated electromagnetic radiation with spectra are presented in references 17 and 27. The solar flux, I_0 , at 1 AU is approximately 1396 W/m^2 with a variation of about 2 percent for the eccentricity of the Earth's orbit. For solar orbits

$$I_d = \frac{1396}{R^2} \text{ W/m}^2$$

Table II.—Intensity of Radiation Sources for a Satellite at the Subsolar Point^a

Geocentric distance, km	Radiation sources		
	Solar radiation, W/m^2	Earth reflectance, W/m^2	Earth radiation, W/m^2
500	1395	600	150
1 000	1395	500	117
2 000	1395	300	89
3 000	1395	230	75
4 000	1395	180	62
5 000	1395	140	53
6 000	1395	120	46
7 000	1395	100	40
8 000	1395	75	38
9 000	1395	65	33
10 000	1395	60	27
12 000	1395	45	18
15 000	1395	30	14
20 000	1395	20	8
25 000	1395	15	4
30 000	1395	12	3
60 000	1395	7	2

^aValues for Earth reflectance and Earth emission assume a spherical satellite.

where R is the distance from the Sun in AU. Direct solar radiation is the most significant source of radiation incident on the spacecraft.

Earth reflectance.—Diffusely reflected solar radiation has a spectrum approximately the same as that of the Sun. The intensity of Earth reflectance is at least one order of magnitude smaller than that of direct solar radiation for altitudes above 7000 km. This intensity is dependent upon the illuminated surface of the Earth that is visible to the spacecraft, the solar angle, and the position of the spacecraft in space. The effect of Earth reflectance is greatest when the spacecraft is at the subsolar point.

Earth radiation.—Diffusely emitted thermal radiation having the spectrum illustrated in figure 9 (sec. 2.4.3). This thermal emission is approximated by a 255° K blackbody yielding an average intensity of about 243 W/m² at the Earth's surface.

The incident radiation on a spherical satellite of unit cross-sectional area can be expressed as

$$I_e = \frac{I_e^\circ}{\pi} \int_{\text{E.s.s.s.}} \frac{\cos \psi}{d^2} dS$$

where

- I_e° = global average emission constant (243 W/m²)
- dS = element of differential area on the surface of the Earth
- d = distance from satellite to dS
- ψ = angle between the normal to dS and $d\theta$
- E.s.s.s. = Earth surface seen by satellite

Spacecraft emission.—The thermal radiation emitted by the spacecraft at any point (y, θ) on a surface with a temperature distribution $T(y, \theta)$ and emissivity $\epsilon(T)$, and expressed as

$$E(y, \theta) = \epsilon [T(y, \theta)] \sigma T^4(y, \theta) \text{ W/m}^2$$

For diffuse emission, the effective flux is normal to the surface and of magnitude $2/3E(y, \theta)$ (ref. 20).

4.1.3 Radiation Force

The two most commonly used techniques for determining the radiation force on a spacecraft involve the approximation of the surface configuration using a number of simple geometric shapes, and the assumption that the radiation force is equivalent to the force normally incident on a plane representing the projected area of the spacecraft. The latter

method is not recommended for accurate determination of the radiation torque when diffuse or specular reflecting surfaces are asymmetrically distributed about the mass center.

The incident radiation force on a surface depends on the surface's characteristics, that is, on what fraction of the radiation it absorbs, or reflects specularly or diffusely. When considering a curved surface, a common practice is to consider these characteristics, which vary considerably as a function of the angle of incidence, as constant. For flat plates, the variation in reflectivity as a function of angle of incidence can be estimated.

Because many spacecraft surfaces receive thermal coatings, nominal (handbook) values for the optical properties of commonly used materials may not be valid. Values for each surface should be obtained from the group responsible for the thermal characteristics of the spacecraft. When the characteristics of the (opaque) surface have been determined, the differential force df on an element of surface dA is determined from the following expression:

$$df = \frac{I}{c} \left\{ \left[(1 + c_{rs}) \cos \theta + \frac{2}{3} c_{rd} \right] \mathbf{n} + (1 - c_{rs}) \sin \theta \mathbf{s} \right\}$$

(See sec. 2.5 for definition of terms.)

4.1.4 Center of Radiation Pressure

A simplifying concept used in determining the torque contribution from the various irradiated surfaces of the spacecraft is the center of pressure (c.p.). The center of pressure is defined as a point defined by the intersection of a plane, through the spacecraft center of mass, and the line of action of the single force normal to that plane, which can replace the resultant radiation force and couple acting on the spacecraft. A condition for the existence of the center of pressure is that the resultant force and couple be coplanar. Its location relative to a reference point on the spacecraft can be expressed mathematically as follows:

$$\rho_{c.p.} \times \int d\mathbf{F} = \int \rho \times d\mathbf{F}$$

where

- $\rho_{c.p.}$ = the vector distance of the center of pressure from a reference point on the spacecraft (such as the mass center)
- ρ = L/F
- L = total torque

The center of pressure, when it exists, does not represent torque components parallel to the incident force.

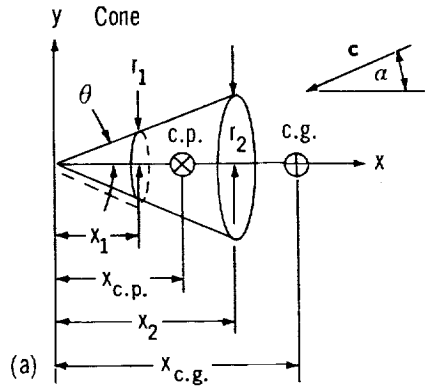

Generating curve: $x = y \tan \theta$

$$x_{c.p.} = 2/3 \tan \theta \left[\frac{r_2^3 - r_1^3}{r_2^2 - r_1^2} \right]$$

$$\left[x_{c.p.} \right]_{x_1=0} = 2/3 x_2$$

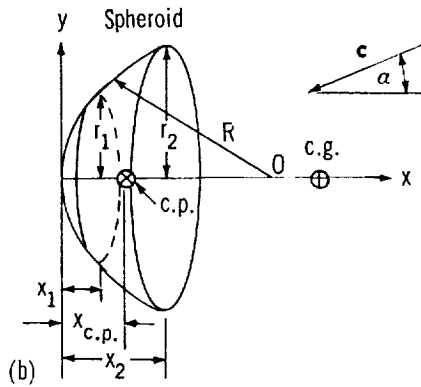

Generating curve: $(x - R)^2 + y^2 = R^2$

$$x_{c.p.} = \frac{R(x_2^2 - x_1^2) - 2/3(x_2^3 - x_1^3)}{x_2(2R - x_2) - x_1(2R - x_1)}$$

$$\left[x_{c.p.} \right]_{x_1=0} = x_2 \left[\frac{R - 2/3 x_2}{2R - x_2} \right]$$

$$\text{For } 0 \leq x_2 \leq R, \quad 1/2 x_2 \leq \left[x_{c.p.} \right]_{x_1=0} \leq 1/3 x_2$$

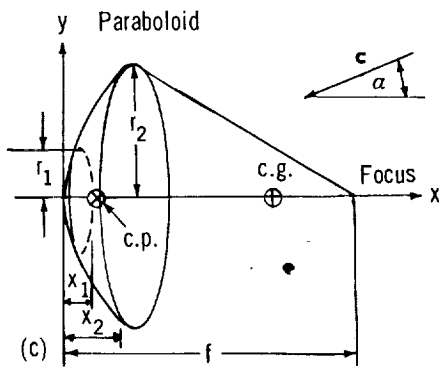

Generating curve: $y^2 = 4 f x$

$$x_{c.p.} = 1/2 (x_2 + x_1)$$

$$\left[x_{c.p.} \right]_{x_1=0} = 1/2 x_2$$

Figure 15.—Torque and center of pressure for absorbing surfaces of revolution: (a) cone, (b) spheroid, and (c) paraboloid.

$$x_{c.p.} = \frac{2}{r_2^2 - r_1^2} \int_{y=r_1}^{y=r_2} xy \, dy$$

If the surface is inverted, i.e., if the generating curve is defined in the $(-x, +y)$ quadrant, the moment arm becomes $(x_{c.g.} + x_{c.p.})$.

When the assumption is made that the spacecraft absorbs all the incident radiation, an estimate of the radiation torque can be obtained by assuming that the radiation force is equivalent to the force normally incident on a plane representing the projected area of the spacecraft. Thus, when this method is used, the center of pressure is at the centroid of the projected area.

The determination of the center of pressure can also be obtained by using simple geometrical shapes to approximate the spacecraft surface. Figure 15 (ref. 36) shows the location of the center of pressure for several simple figures of revolution, assuming total illumination. Reference 26 gives other examples that include cylinders, spheres, and booms.

For the case of determining the center of pressure, a coordinate frame is assumed at the centroid of the simple geometrical shape under consideration. For convenience, one axis of the coordinate frame is oriented toward the incident radiation. The location of the center of pressure relative to the local body centroid (in local body coordinates) can be determined from the following equation:

$$\int_s \mathbf{r} \times \mathbf{F} dA = \mathbf{r}_{c.p.} \times \mathbf{F}_r$$

where

- \mathbf{r} = vector to the surface element dA
- \mathbf{F} = force per unit area acting on dA
- $\mathbf{r}_{c.p.}$ = vector from the origin of the local frame to the center of pressure
- \mathbf{F}_r = radiation force on the entire illuminated area = $\int \mathbf{F} dA$

4.1.5 Radiation Torque Acting on the Spacecraft

Location of the center of pressure of each of the sub-bodies used to approximate the spacecraft allows calculation of the total torque acting on the spacecraft from the equation

$$\mathbf{L}_r = \sum_{i=1}^n \mathbf{l}_i \times \mathbf{f}_i$$

where

- \mathbf{L}_r = radiation torque
- \mathbf{l}_i = vector distance from the spacecraft's mass center to the center of pressure of the i th sub-body (\mathbf{l}_i also equals $\mathbf{l}_{ic} + \mathbf{r}_{c.p.}$, where \mathbf{l}_{ic} is the distance from the spacecraft's mass center to the centroid of the i th sub-body)
- \mathbf{f}_i = $\int_s \mathbf{F}_i dA_i$ = total force acting on the i th sub-body
- n = number of satellite surfaces

4.1.6 Variation of Radiation Torque

The dependence of the total radiation torque on various factors requires that a sensitivity analysis be performed to determine the magnitude of the change in torque as a function of the departure of these various factors from their nominal values. The torque calculations can be repeated assuming worst-case departures from nominal values for such parameters as mass center, surface characteristics, motion of the sub-bodies, etc. Alternatively, sensitivity parameters for each of the factors can be developed by differentiating the defining torque equations.

4.2 Minimization of the Effects of Radiation

Proper design of the spacecraft can reduce radiation torques to manageable levels. An applicable technique is to balance the radiation forces about the spacecraft's mass center by designing the exposed surfaces so that the proper distribution, surface shape, angle relative to the source(s), and optical properties are achieved. Frequently the disturbance torque can be reduced to a tolerable level by adding properly positioned fixed compensating plates. Because only surface area is important, a negligible weight penalty is involved.

Radiation torques associated with thermal radiation from the spacecraft can be reduced to negligible levels by controlling the temperature distribution on surfaces so that the resultant radiation force passes through, or very near, the spacecraft's mass center. The surface properties and configuration that are important to radiation-torque control are constrained by the requirements for thermal control; these constraints, however, do not necessarily compromise efforts to minimize the disturbance torque.

4.2.1 Passively Stabilized Spacecraft

The stabilizing torques for passively stabilized spacecraft are typically smaller than are those encountered on actively stabilized spacecraft. Therefore, these types of spacecraft are more susceptible to disturbances caused by radiation torques.

4.2.1.1 Spin-Stabilized Spacecraft

Many spin-stabilized satellites do not have the capability of controlling the torque about their spin axis, but use inertia to maintain their spin rate. These satellites are sensitive to alterations of their spin rates by any external torque, even the comparatively small torques resulting from radiation forces.

Small satellites with rigidly attached tilted solar panels are susceptible to the windmill effect, which causes spin-rate changes. This effect can be alleviated by tilting the solar panels so that the radiation torque from adjacent panels is as nearly equal in magnitude and opposite in direction as is possible for prevailing Sun angles. When this technique is used, steps should be taken to insure that the center of pressure lies on the spin axis of the spacecraft, because displacement of the center of pressure in a plane normal to the spin axis (as might be caused by asymmetrical shadowing from a despun section of the spacecraft) will produce a torque along the spin axis.

If the center of pressure of a spacecraft is displaced along the spin axis, the resulting torque will tend to cause the spacecraft to precess around the incident radiation vector. If this problem exists, a solution would be to add compensating plates.

If the spacecraft requires long, flexible appendages, such as those used on Alouette 1 and 2 satellites, the despin rate caused by radiation forces can be reduced by attaching tip plates as shown in figure 16. The tip plates are placed normal to the booms and generate an additional average torque, opposite in sign, about the spin axis by virtue of the same thermal-bending phase lag that is responsible for the torque on the booms (ref. 9). An alternative practice is to use extendable structures designed to minimize thermal bending.

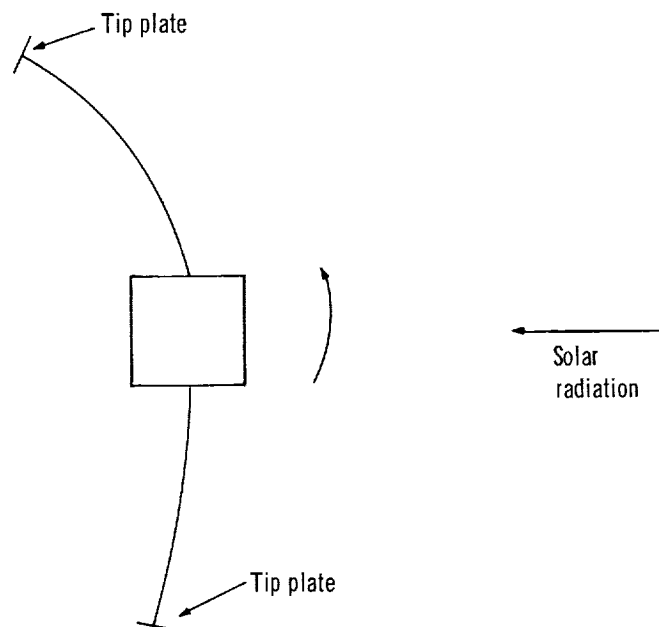

Figure 16.—Tip plates.

4.2.1.2 Gravitationally Stabilized Satellites

Gravitationally stabilized satellites, especially those orbiting at high altitudes, are sensitive to thermal bending because of the comparatively small magnitude of the gravity-restoring torque and because of the long booms required for gravity stabilization. At low altitudes (viz, below 4000 km), the gravity torque is large compared to radiation torques, and therefore, symmetry might be violated in favor of simplicity for modest pointing accuracies. At high altitudes (viz, synchronous altitude), a technique for minimizing radiation torques is to use booms that provide a symmetrical area about the satellite's mass center. When the Sun is at oblique angles relative to a pair of symmetrical booms, thermal bending can create an asymmetry that results in an unbalanced solar radiation torque as shown in figure 17. At oblique Sun angles, the thermally deformed upper boom has a greater length, L_1 , for producing solar radiation torque than does the lower boom with length L_2 . To minimize this problem, booms that are less susceptible to thermal bending should be used. For example, the interlocked, perforated booms used on the Radio Astronomy Explorer A (RAE-A) satellite (ref. 16) can be used to reduce solar radiation torques.

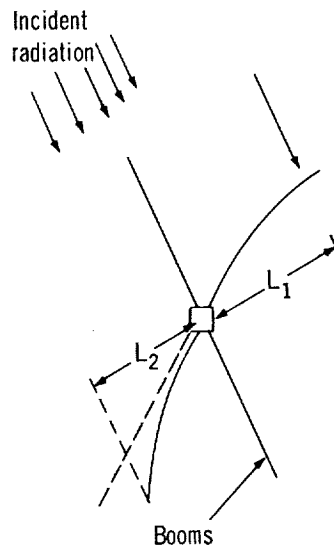

Figure 17.--Booms parallel to incident radiation are not deflected.

4.2.1.3 Solar-Radiation-Stabilized Spacecraft

Spacecraft using passive solar stabilization (refs. 26 and 36) have been suggested but not flown. The functional design of these spacecraft makes them sensitive to other sources of

radiation, such as Earth reflectance and emission, spacecraft emission, etc. In addition, care should be exercised in designing a passive, solar-stabilized spacecraft, because it would be very sensitive to all other disturbance torques, such as to mass expulsion in the case of Mariner 4.

4.2.2 Actively Stabilized Spacecraft

Radiation torques present no difficulty for the typical actively stabilized spacecraft. To insure that the spacecraft is capable of controlling radiation-torque disturbances, a calculation of the largest radiation torque on the spacecraft when it is in the most asymmetrical attitude relative to the Sun should be made. During the design of the attitude-control system, design features can be incorporated that use radiation torques to stabilize rather than to disturb the attitude of the spacecraft.

When the spacecraft is solar or stellar oriented, the radiation torque is essentially constant, and the angular impulse imparted to the spacecraft continually increases. If the control system must expend fuel to reduce or eliminate this accumulated angular momentum, even a small radiation torque may create a problem on a mission of extended duration. If a worst-case analysis indicates that a problem exists with respect to fuel requirements, a system of active torque-compensating vanes such as used for Mariner 4 (sec. 2.3) may provide the desired radiation-torque balance.

REFERENCES

1. Anon.: Effects of Structural Flexibility on Spacecraft Control Systems. NASA SP-8016, 1968.
2. Maxwell, T. C.: A Treatise on Electricity and Magnetism. Vol. 2. Dover Pub., Inc., 1959, p. 440.
3. Heisenberg, Werner: The Physical Principles of the Quantum Theory. Dover Pub., Inc., 1930.
4. Lebedew, Professor: Experiments on the Pressure of Light. Ann. Physik, vol. 6, Nov. 1901, pp. 433.
5. Lorentz, H. A.: The Theory of Electrons and its Applications to the Phenomena of Light and Radiant Heat. Dover Pub., Inc., 1952, p. 34.
6. Poynting, J. H.: The Pressure of Light. Society for Promoting Christian Knowledge (London), 1910, pp. 12 and 83. [Available from E. S. Gorham, New York.]
7. Urbanczyk, Mgr.: Solar Sails—A Realistic Propulsion for Spacecraft. NASA TM X-60560, Aug. 1967, p. 16.
8. Sohn, R. L.: Attitude Stabilization by Means of Solar Radiation Pressure. ARS J., vol. 29, no. 5, May 1959, pp. 371-373.
9. MacNeal, R. H.: The Heliogyro, an Interplanetary Flying Machine. ARC-R-249, Astro Res. Corp., n.d.
10. Etkin, B.; and Hughes, P. C.: Explanation of the Anomalous Spin Behavior of Satellites with Long, Flexible Antennae. J. Spacecraft Rockets, vol. 4, no. 9, Sept. 1967, pp. 1139-1145.
11. Anon.: ISIS 16th Tri-Annual Progress Report, Period 1 March to 30 June 1968. Tech. Note no. 604, Defence Res. Telecommunications Estab. (Canada), Oct. 1968.
12. Fedor, J. V.: The Effect of Solar Radiation Pressure on the Spin Rate of Explorer XXII. NASA TN D-1855, 1963.
13. Kershner, R. B.: Satellite Rotation by Radiation Pressure. U.S. Patent 3,145,948.
14. Fischell, R. E.: A Gravity-Gradient Satellite Experiment at Synchronous Altitude. Proceedings of the 2nd IFAC Symposium on Automatic Control in Space (Vienna, Austria), Sept. 1967.
15. Anon.: Mariner Mars 1964 Project Report: Mission and Spacecraft Development. Vol. I. From Project Inception Through Midcourse Maneuver. Tech. Rept. 32-740, Jet Propulsion Lab., Mar. 1965.

16. Staff, Space and Electronics Group: Interim Report for the Investigation of the Dynamic Characteristics of a V Antenna for the RAE Satellite. Final Report Phases B and C. AVSSD-0103-RR, Space Systems Div., AVCO Missiles, 1967.
17. Anon.: Solar Electromagnetic Radiation. NASA SP-8005, 1965.
18. Thekaekara, M. P.: Survey of the Literature on the Solar Constant and the Spectral Distribution of Solar Radiant Flux. NASA SP-74, 1965.
19. Weidner, Don K., ed.: Space Environment Criteria Guidelines for Use in Space Vehicle Development (1969 Revision). NASA TMX 53957, Oct. 1969.
20. Bartman, F. L.: The Reflectance and Scattering of Solar Radiation by the Earth. ORA Project 05863, High Altitude Eng. Lab., Dept. Aerosp. Eng., College of Eng., Univ. of Michigan, Feb. 1967.
21. Haviland, R. P.; and House, C. M.: Handbook of Satellites and Space Vehicles. D. Van Nostrand Co., Inc., 1965, p. 212.
22. Goetzl, C. B.; Rittenhouse, J. B.; and Singletary, J. B., eds.: Space Materials Handbook. Ch. 6. Addison-Wesley Pub. Co., Inc., 1965.
23. Edwards, D. K.; and Bevans, J. T.: Radiation Stresses on Real Surfaces. AIAA J., vol. 3, no. 3, Mar. 1965, pp. 522-523.
24. McElvain, R. J.; and Schwartz, L.: Minimization of Solar Radiation Pressure Effects for Gravity-Gradient Stabilized Satellites. J. Basic Eng., June 1966, pp. 444-451.
25. Wiggins, L. E.: Theory and Application of Radiation Forces. Report LMSC-A384055 (AF 04(647)-787, DDC no. AD 444 242L), Lockheed Missiles & Space Co., Sept. 1963.
26. Palmer, J. L.; Blakiston, H. S.; and Farrenkopf, R. L.: Advanced Techniques for Analyzing and Improving Gravity Gradient Satellite Pointing Accuracies at High Orbital Altitudes. Vols. I and II. Tech. Repts. AFFDL-TR-66-206-I and -II, TRW Systems, 1967.
27. Katzoff, S., ed.: Symposium on Thermal Radiation of Solids. NASA SP-55, 1965.
28. Cox, R. L.: Fundamentals of Thermal Radiation in Ceramic Materials. NASA SP-55, 1965, pp. 83-101.
29. Hass, G.: Solar Absorptance and Thermal Emittance of Evaporated Metal Films With and Without Surface Coatings. NASA SP-55, 1965, pp. 189-195.
30. Brandenburg, W. M.; and Clausen, O. W.: The Directional Spectral Emittance of Surfaces Between 200° and 600° C. NASA SP-55, 1965, pp. 313-319.
31. Vajta, T. F.: Materials for Thermal Control Surfaces. Space Materials Handbook, Addison-Wesley Pub. Co., Inc., 1965, p. 110.

32. DeWitt, D. P.: Comments on the Surface Characterization of Real Metals, NASA SP-55, 1965, pp. 141-144.
33. Ralph, E. L.; and Wolf, M.: Effect of Antireflection Coatings and Coverglasses on Silicon Solar Cell Performance. Cell Research Paper in Heliotek Information and Silicon Solar Cell Data Book, Mar. 1966.
34. Prelewicz, D. A.: Mariner IV and V Disturbance Torques and Limit Cycles. NASA CR-97151, 1968.
35. Bourke, R. D.; McReynolds, S. R.; and Thuleen, K. L.: The Mariner V Flight Path and Its Determination from Tracking Data. Part II. Nongravitational Forces. Tech. Rept. 32-1363 (NAS7-100), Jet Propulsion Lab., July 1969.
36. Schalkowsky, S.: Attitude Control by Solar Radiation Pressure. Rept. TIS-61SD77, Defense Electronics Division, General Electric, May 1961.

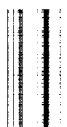

NASA SPACE VEHICLE DESIGN CRITERIA MONOGRAPHS ISSUED TO DATE

SP-8001 (Structures)	Buffeting During Launch and Exit, May 1964
SP-8002 (Structures)	Flight-Loads Measurements During Launch and Exit, December 1964
SP-8003 (Structures)	Flutter, Buzz, and Divergence, July 1964
SP-8004 (Structures)	Panel Flutter, May 1965
SP-8005 (Environment)	Solar Electromagnetic Radiation, June 1965
SP-8006 (Structures)	Local Steady Aerodynamic Loads During Launch and Exit, May 1965
SP-8007 (Structures)	Buckling of Thin-Walled Circular Cylinders, revised August 1968
SP-8008 (Structures)	Prelaunch Ground Wind Loads, November 1965
SP-8009 (Structures)	Propellant Slosh Loads, August 1968
SP-8010 (Environment)	Models of Mars Atmosphere (1967), May 1968
SP-8011 (Environment)	Models of Venus Atmosphere (1968), December 1968
SP-8012 (Structures)	Natural Vibration Modal Analysis, September 1968
SP-8013 (Environment)	Meteoroid Environment Model—1969 (Near Earth to Lunar Surface), March 1969
SP-8014 (Structures)	Entry Thermal Protection, August 1968
SP-8015 (Guidance and Control)	Guidance and Navigation for Entry Vehicles, November 1968
SP-8016 (Guidance and Control)	Effects of Structural Flexibility on Spacecraft Control Systems, April 1969
SP-8017 (Environment)	Magnetic Fields—Earth and Extraterrestrial, March 1969
SP-8018 (Guidance and Control)	Spacecraft Magnetic Torques, March 1969

SP-8019 (Structures)	Buckling of Thin-Walled Truncated Cones, September 1968
SP-8020 (Environment)	Mars Surface Models (1969), May 1969
SP-8021 (Environment)	Models of Earth's Atmosphere (120 to 1000 km), May 1969
SP-8023 (Environment)	Lunar Surface Models, May 1969
SP-8024 (Guidance and Control)	Spacecraft Gravitational Torques, May 1969
SP-8025 (Chemical Propulsion)	Solid Rocket Motor Metal Cases, April 1970
SP-8028 (Guidance and Control)	Entry Vehicle Control, November 1969
SP-8029 (Structures)	Aerodynamic and Rocket-Exhaust Heating During Launch and Ascent, May 1969
SP-8031 (Structures)	Slosh Suppression, May 1969
SP-8032 (Structures)	Buckling of Thin-Walled Doubly Curved Shells, August 1969