PROJECT TECHNICAL REPORT
TASK 703

ARTIFICIAL GRAVITY SPACE STATION
PHYSIOLOGICAL EFFECTS AND DESIGN CRITERIA

NAS 9-8166

15 APRIL 1971

Prepared for
NATIONAL AERONAUTICS AND SPACE ADMINISTRATION
MANNED SPACECRAFT CENTER
HOUSTON, TEXAS

Prepared by
J. E. Earl
Guidance and Control Systems Department



FACILITY FORM 602	N71 24454	
	(ACCESSION NUMBER)	(THRU)
	65	63
	(PAGES)	(CODE)
CR-114982		04
(NASA CR OR TMX OR AD NUMBER)		(CATEGORY)

CR-114982

PROJECT TECHNICAL REPORT
TASK 703

ARTIFICIAL GRAVITY SPACE STATION
PHYSIOLOGICAL EFFECTS AND DESIGN CRITERIA

NAS 9-8166

15 APRIL 1971

Prepared for
NATIONAL AERONAUTICS AND SPACE ADMINISTRATION
MANNED SPACECRAFT CENTER
HOUSTON, TEXAS

Approved by J. E. Alexander
J. E. Alexander, Manager
Guidance and Control
Systems Department

Approved by R. Lee
R. Lee, Manager
Task 703

PRECEDING PAGE BLANK NOT FILMED

FOREWORD

In the Space Station program, a period of the mission will be dedicated to the assessment of artificial gravity. Therefore, it is essential to establish the human physiological effects resulting from artificial gravity, rotation, vibration and acceleration in order to define the physiological design criteria. Much research has been performed in this field and preliminary design criteria have been established.

The study documented in this report extracts data from the many investigations in this field and presents up-to-date physiological design criteria for the Space Station. This work was performed under TRW Task 703, NASA Contract NAS 9-8166.

PRECEDING PAGE BLANK NOT FILMED

SUMMARY

From the available literature a thorough study has been made of the physiological effects on man in a rotating environment. This, together with the requirements and constraints that will be imposed by a revolving space station, is used to develop physiological design criteria for an artificial gravity spacecraft. These criteria (Figure 4-2 and Table 4-1) relate to dynamic and geometric properties in spacecraft design that must be limited in order to provide an environment within which man can be safe, feel comfortable and perform well. Similar design criteria were previously developed by Dole and Loret but did not include an effective constraint on the allowable Coriolis force. Further, the design criteria proposed herein increases the maximum spin rate from 4 to 6 RPM, places no upper limit on the radius of rotation, and provides design limits for additional parameters such as angular acceleration, angular jerk, vibration and noise. Still, additional work is needed, especially in relating physiological effects and spacecraft stability. Until this area has been fully investigated, the existing design criteria can only be considered preliminary.

PRECEDING PAGE BLANK NOT FILMED

CONTENTS

<u>Section</u>	<u>Page</u>
FOREWARD	ii
SUMMARY	v
1. INTRODUCTION	1
2. ADVERSE PHYSIOLOGICAL EFFECTS	2-1
2.1 GENERAL	2-1
2.2 MAJOR EFFECTS	2-1
2.2.1 Spatial Disorientation	2-1
2.2.2 Motion Sickness	2-7
2.2.3 Visual Acuity Decrement	2-10
2.2.4 Locomotion and Posture Instability	2-11
2.3 MINOR EFFECTS	2-14
2.3.1 Bio-Medical	2-14
2.3.2 Vibration and Noise	2-14
3. EFFECTS OF TRAINING, AIDS AND HABITUATION	3-1
3.1 TRAINING	3-1
3.2 AIDS	3-1
3.3 HABITUATION	3-2
3.4 DO'S AND DON'T'S	3-6
4. PHYSIOLOGICAL DESIGN CRITERIA	4-1
4.2 DYNAMICS LIMITATIONS	4-1
4.2.1 Angular Motion	4-1
4.2.2 Linear Motion	4-5
4.2.3 Vibration and Noise	4-9
4.3 GEOMETRIC LIMITATIONS	4-9
4.3.1 Radius of Rotation	4-9
4.3.2 Space Station Diameter	4-9
4.4 STABILITY CONSIDERATIONS	4-13
5. CONCLUSIONS AND RECOMMENDATIONS	5-1
6. REFERENCES	6-1
APPENDIX A - Dictionary of Terms Related to Physiology and a Rotating Environment	A-1
APPENDIX B - Physiological Tolerance to Linear Acceleration Above 1 g	B-1

1. INTRODUCTION

A requirement of the Space Station program is a specific phase for the assessment of artificial gravity. This phase will occur prior to routine operations and will probably last 35 days. The probable configuration of the space system for the artificial-G period is shown in Figure 1-1 along with some related characteristics. "R" is the radius of rotation and varies with the extension of the Saturn S-II stage which is to be used as the counterweight¹.

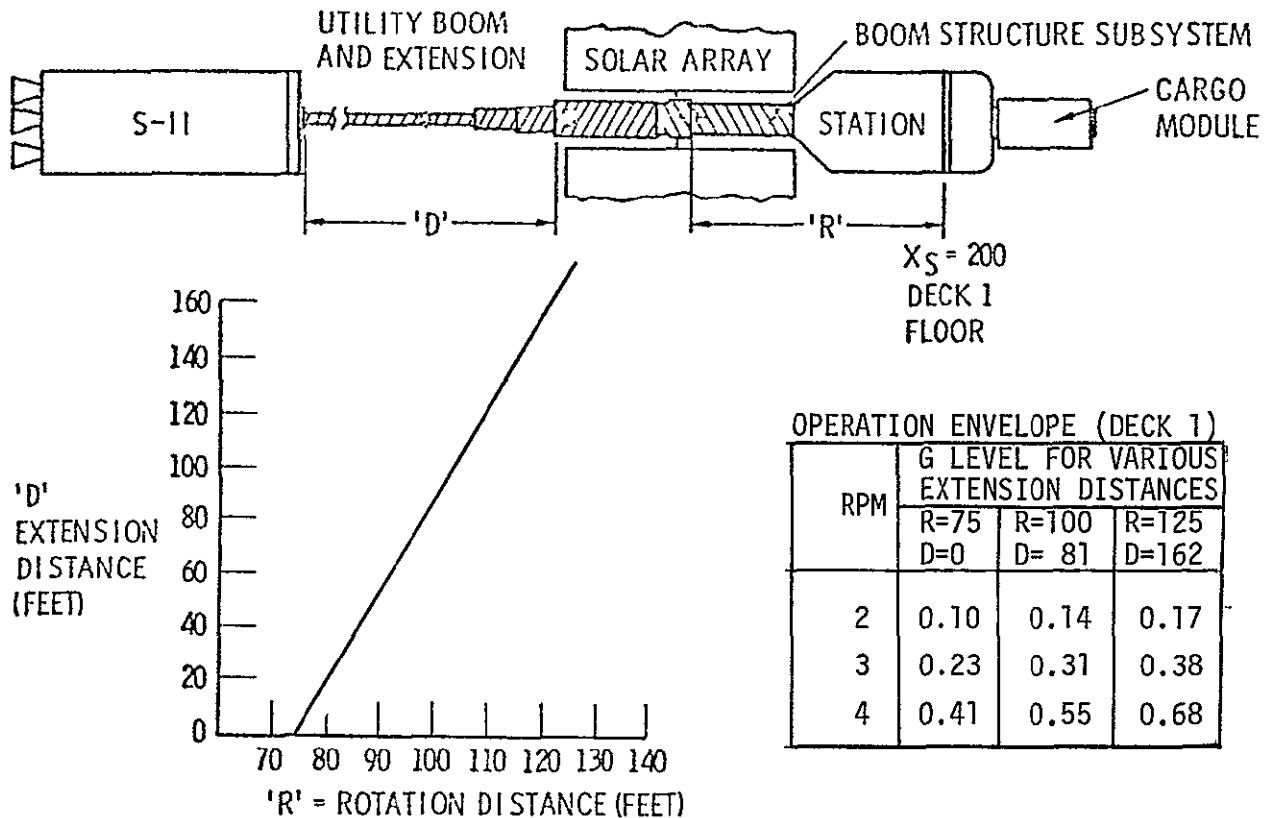

FIGURE 1-1. Probable Artificial-G Configuration Characteristics

¹Superscript refers to reference.

Although the artificial-G assessment phase will be for the purpose of determining true physical design limits, considerable effort is being expended to arrive at preliminary design criteria based on analysis, centrifuge tests and high flying aircraft data. These preliminary design criteria will then establish the bounds within which the actual artificial-G assessment will be performed. This is necessary so that limits can be imposed on such parameters as vehicle spin rate, radius of rotation, etc., to provide a high level of assurance that an environment will be produced within which the crew members can be safe, feel comfortable and perform well.

The purpose of this study is to determine, from an extensive literature search, the known adverse physiological effects of a rotating environment, their relationships to geometric and dynamic parameters of the spacecraft, and the areas where further study is required. Based on this information and related analyses, preliminary design criteria are formulated and recommendations made for additional work.

Most of the available data have resulted from studies of humans subjected to various centrifuge tests, which have produced much useful data during the past 12 years or so. The number and types of centrifuges vary almost as much as the tests. (A typical centrifuge set-up is shown in Figure 1-2; here, the subject is in a supine position and enclosed in a chamber at the end of the centrifuge arm with a harness to prevent up or down head motion). From these and other data much progress has already been made by engineers, scientists and medical doctors in establishing physiological design criteria for a rotating space station. This study attempts to extract this information from the available data and present up-to-date design criteria.

As stated above, most of the results presented herein are based on centrifuge tests. Obviously, a typical spacecraft environment (artificial-G) cannot be exactly simulated due to the ever presence of the earth's gravity. However, many of the effects of an artificial-G environment can be

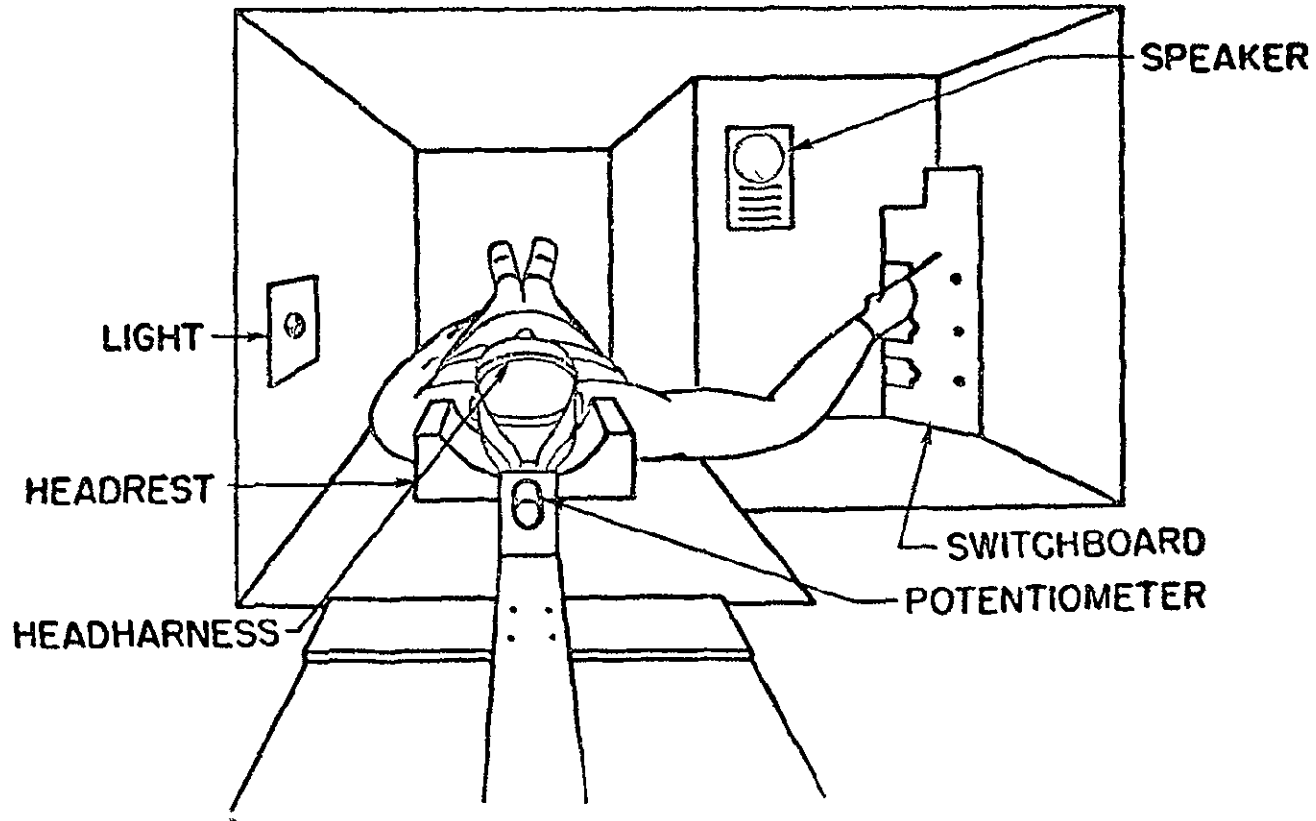

Figure 1-2. Internal Features of Typical Centrifuge. (Ref. 2)

produced in this manner, e.g., spatial disorientation, motion sickness, locomotion problems, etc. As a matter of fact, these three effects are among the major adverse physiological effects.

Spatial disorientation and motion sickness result primarily from unnatural stimulation of the vestibular system (Figure 1-3), such as that experienced in vehicles undergoing angular acceleration. Concomitant head motion makes the effect even more pronounced. Unusual pressures (acceleration) in the semi-circular canals result in stimulation (sensed by deflections of the cupula, Figure 1-4) to the brain that are not in phase with the actual angular motion, causing conflict with that which is visualized and/or sensed by the proprioceptive sensors. In a rotating vehicle, linear acceleration, as sensed by the otoliths (Figure 1-5), can also create confusion, resulting in an illusory effect commonly known as the oculogravic illusion, or sense of tilt. Human functions that occur in an effort to provide equilibrium and guidance are most appropriately depicted by the block diagram of Figure 1-6.

As an aid to the reader in understanding some of the terms associated with human physiology, applicable data related to motion, stimulation and response are presented in Tables 1-1, 1-2, and 1-3. A dictionary of pertinent physiological terms is included in Appendix A.

Many tests have been performed on the centrifuge which are not pertinent to this study, but are of interest. These tests were conducted at high rotation rates (> 6 RPM), or for the purpose of studying the effects of high acceleration ($> 1g$), or for determining human tolerance levels, etc. The resulting physiological problems such as blackout, pain, impairment of cognitive processes, etc., would, in general, be non-existent for the space station artificial-G environment. Appendix B discusses these and other adverse physiological effects occurring under conditions that are not expected to exist on the space station. However, due to system malfunctions adverse conditions creating some of these effects could occur.

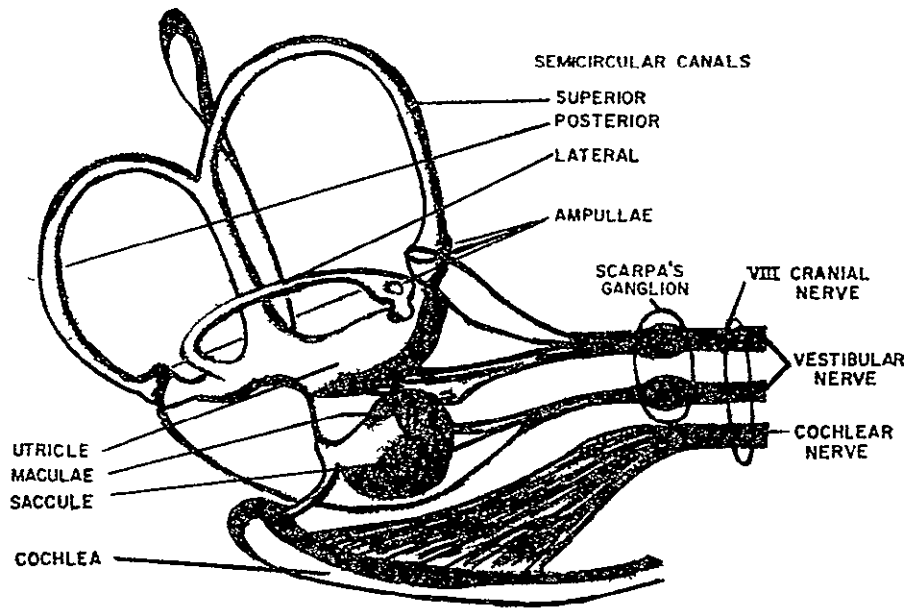

FIGURE 1-3. Diagrammatic representation of the lateral view of the membranous labyrinth of the right ear. (Ref. 3)

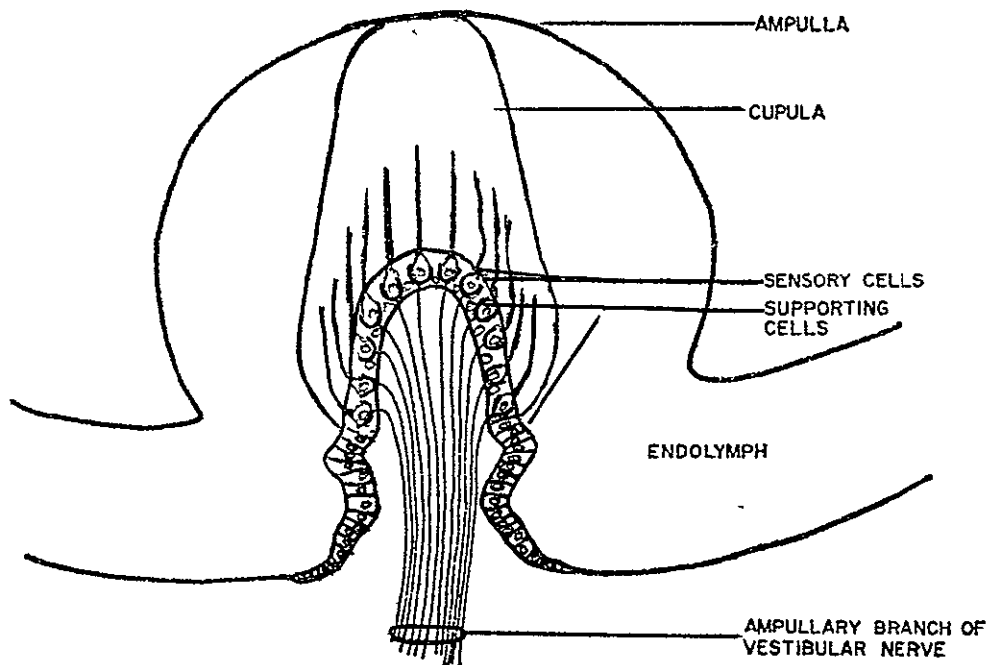

FIGURE 1-4. Simplified diagram of the ampulla of a semicircular canal sectioned in the plane of the canal. The hairs of the sensory cells pass into fine canals in the gelatinous cupula which surmounts the crista. (Ref. 3)

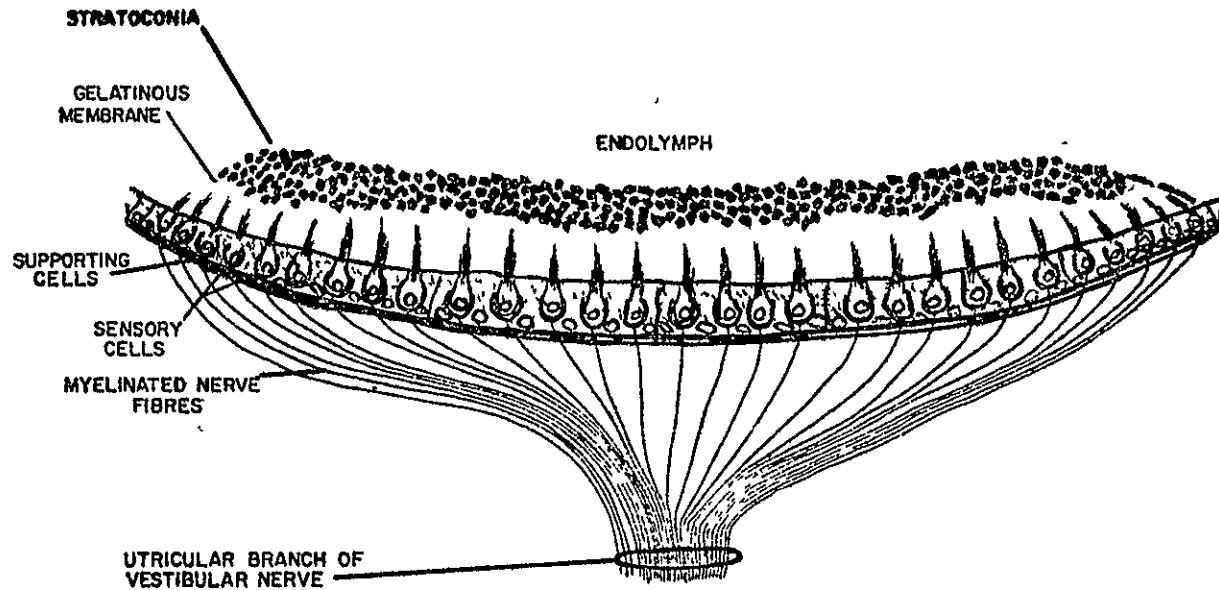

FIGURE 1-5. Simplified diagram of a vertical section through the utricular macula. The hairs of the sensory cells pass into the fine canals of the gelatinous otolithic membrane, in the upper part of which there are many crystals of calcium carbonate - the statoconia. (Ref. 3)

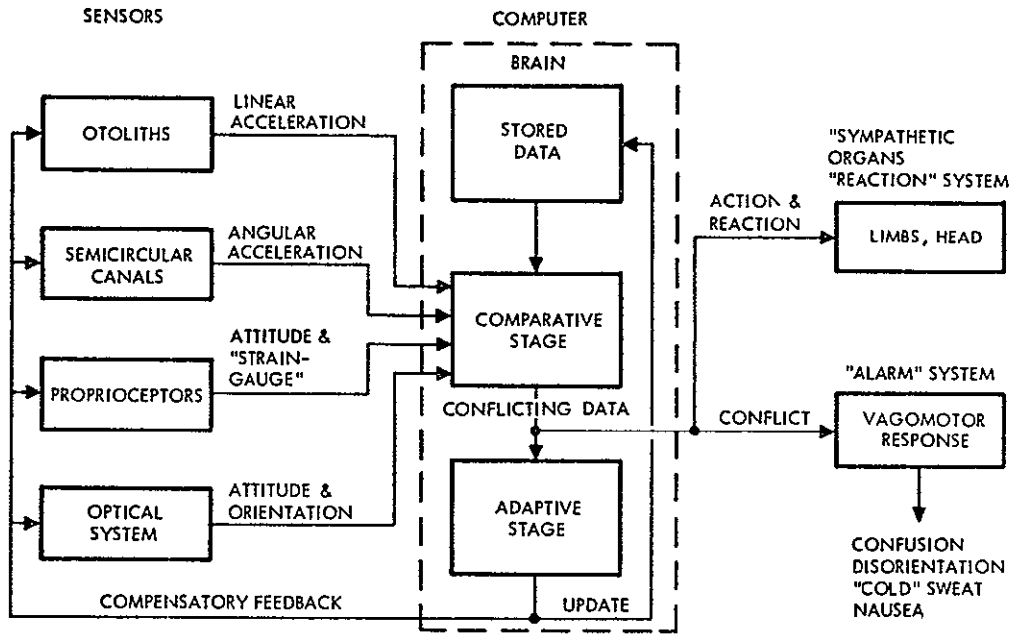

FIGURE 1-6. Functional Diagram of Human Guidance System (Ref. 4)

TABLE 1-1. Acceleration Terms - Table of Equivalents

Linear Motion (Ref. 5)

Vehicle coordinate systems			Human coordinate systems			
			Direction of applied force or resulting acceleration		Direction of kinetic reaction or inertial resistance and movement of organs relative to the skeletal frame	
<p>The zero point of the vehicle coordinate system along the longitudinal axis is arbitrarily set by the individual vehicle manufacturer</p>						
			4	5	6	7 8
<p>(symbol)</p> <p>noseward → +ax</p> <p>tailward → -ax</p> <p>to starboard → +ay</p> <p>to port → -ay</p> <p>floorward → +az</p> <p>ceilingward → -az</p>			<p>seated or standing facing noseward</p> <p>forward</p> <p>transverse A-P supine chest to back</p>		<p>Foot note 1 (symbol)</p> <p>+Gx → eyeballs in (EBI) → backward</p>	
<p>prone crosswise head to starboard</p> <p>prone crosswise head to port</p> <p>prone, head toward nose</p>			<p>backward</p> <p>transverse P-A prone back to chest</p>		<p>-Gx → eyeballs out (EBO) → forward</p>	
<p>prone, head toward tail</p> <p>supine crosswise, head to starboard</p> <p>supine crosswise, head to port</p> <p>supine, head toward nose</p> <p>supine, head toward tail</p>			<p>rightward</p> <p>left lateral</p> <p>kinetic reaction or inertial resistance</p> <p>with respect to the vehicle axis, imposes a</p> <p>acting force and acceleration on the occupant. Because of this accelerative force the occupants' body instantaneously produces an opposing</p> <p>and or</p> <p>leftward</p> <p>heart movement relative to the skeletal frame and erect head</p>		<p>+Gy → eyeballs left (EBL) → leftward</p> <p>-Gy → eyeballs right (EBR) → rightward</p>	
			<p>leftward</p> <p>right lateral</p>		<p>+Gz → eyeballs down (EBD) → tailward</p>	
			<p>headward</p> <p>positive</p>		<p>-Gz → eyeballs up (EBU) → headward</p>	
			<p>tailward</p> <p>footward</p> <p>negative</p>			

Inter-relationships between vehicle acceleration, the consequent force acting on the occupant, and terms used to describe directions of these variables are shown in the table. Possible inter-relationships are derived as follows: Direction of the vehicle acceleration, based on the above vehicle coordinate system, is selected in column 1. Position of an occupant with respect to the vehicle is selected in column 3. Direction of force acting on vehicle, column 1, combined with the occupant's position with respect to vehicle, column 3, determines direction of force with respect to occupant. Result then determines proper relationship to be selected in column 4. Once correct selection has been made, the two sentences, reading from left to right, list terms and symbols in present use describing directions of forces and accelerations of body, and organ movement relative to skeletal frame. Sentences also describe relationships that must exist because of Newton's laws of motion.

Footnotes
 1 Large letter, G, used as unit to express whole body acceleration in multiples of the acceleration of gravity. Acceleration of gravity, $g_0 = 980.665 \text{ cm/sec}^2$ or 32.1739 ft/sec^2
 2 A-P, P-A refers to anterior-posterior, posterior-anterior
 3 Symbols $(\pm Gxyz)$ represent orthogonal directions of kinetic reaction opposing applied force and thus units must be pounds of reaction force per pound of involved object. Laws of motion indicate that 'G' may not represent an acceleration in situations and context depicted and statement '+ Gx acceleration' would be a misnomer.

NOT REPRODUCIBLE

TABLE 1-2. Acceleration Terms - Table of Equivalents
Angular Motion (Ref. 5)

Vehicle coordinate systems			Human coordinate system		
1	2	3	4	5	6
<p>seated or standing facing noseward</p> <p>seated or standing facing tailward</p> <p>seated or standing facing to starboard</p> <p>seated or standing facing to port</p> <p>prone crosswise head to starboard</p> <p>prone crosswise head to port</p> <p>prone, head toward nose</p> <p>prone, head toward tail</p> <p>supine crosswise, head to starboard</p> <p>supine crosswise, head to port</p> <p>supine, head toward nose</p> <p>supine, head toward tail</p>	<p>(symbol)</p> <p>right roll → p</p> <p>left roll → -p</p> <p>positive pitch → q</p> <p>negative pitch → -q</p> <p>right yaw → r</p> <p>left yaw → -r</p> <p>angular acceleration</p>	<p>of vehicle with occupant placed</p> <p>with respect to vehicle axis imposes a</p>	<p>head right cartwheeling</p> <p>head left cartwheeling</p> <p>backward somersaulting</p> <p>forward somersaulting</p> <p>left twist</p> <p>right twist</p>	<p>L R</p> <p>top of the heart tilts toward the left shoulder</p> <p>top of the heart tilts toward the right shoulder</p> <p>top of the heart tilts toward the sternum</p> <p>top of the heart tilts toward the spine</p> <p>heart twists toward the subject's right</p> <p>heart twists toward the subject's left</p>	<p>moment and angular acceleration on occupant. Because of this moment and inertia of the heart, the</p>
<p>The inter-relationships between vehicle acceleration the consequent force acting on occupant and terms used to describe directions of these variables are shown in table. These various possible inter-relationships are derived as follows. Direction of vehicle acceleration, based on above vehicle coordinate systems, is selected in column 1. Position of occupant with respect to vehicle is selected in column 3. Direction of force acting on vehicle, column 1, combined with occupant's position with respect to vehicle, column 3, determines direction of force with respect to occupant. This result then determines proper relationship to be selected in column 4. Once correct selections have been made, the two sentences, reading from left to right, list terms and symbols in present use to describe the directions of forces and accelerations of body and organ movement relative to skeletal frame. Sentences also describe relationships that must exist because of Newton's laws of motion.</p>					
<p>^a Footnote Statements true only when intersection of axes is below heart</p>					

TABLE 1-3 Sense Modalities and Organs,
Their Stimulation and Response to Subgravity (Ref 6)

	Mechanoreceptors ¹				Photoreceptors ⁴
	Specific Gravireceptors ²	Nonspecific Gravireceptors ³			
	Exteroceptors ⁵	Proprioceptors ⁶		Tangoreceptors ⁷	Exteroceptors
	motion and position sense	muscle sense	posture sense	pressure sense	optical sense
Sense organ	otoliths	muscle spindles ⁸	Vater-Pacini corpuscles ⁹	nervous plexuses & Meissner corpuscles ¹⁰	eyes
Normal stimulus	acceleration and weight	tension & weight	tension	pressure & weight	light
Effect of subgravity	decreased weight and displacement of otoliths	decreased weight & tension of muscles	no effect	decreased pressure at contact points of body with support	no effect
Effect of zero-gravity	lack of weight and displacement of otoliths	lack of physical stress	no effect	lack of pressure at contact points of body with support	no effect
Sensory input during zero-gravity	no or zero-gravity stimulation	no stimulation	no effect	no stimulation	no effect
Sensory output during zero-gravity	no or zero-gravity signal	no signal	no effect	no signal	no effect
Sensation during zero-gravity	no gravitational vertical	stress-free sensation	no effect	stress-free sensation	no effect
Psychophysiologic result	loss of vertical orientation without visual reference	disturbance of muscular coordination	no effect	loss of tactile orientation	no effect when visual cues available

Footnotes

- ¹Nerve endings and receptor organs stimulated by differences of pressure (such as those of touch and hearing)
²Nerve endings and receptor organs with the specific function of responding to stimuli having a gravitational source
³Nerve endings and receptor organs which do not have the sole function of registering gravitational forces on the body but which provide similar information to the brain
⁴A nervous end-organ or receptor sensitive to light
⁵Sensory nerve terminals stimulated by the immediate external environment (such as those in the skin)

- ⁶Sensory nerve terminals which give information concerning movements and position of the body. They occur chiefly in the muscles, tendons, and inner ear
⁷A sense organ that responds only to physical contact (such as touch)
⁸Bundles of fine muscular fibers enclosed in a sheath of connective tissue
⁹Sense corpuscles, the largest of the end-organs of the skin, scattered throughout the tissues beneath the skin, as in the pulp of the fingers and along the course of nerves
¹⁰Sense corpuscles (of touch) in the tips of the fingers and toes, in the skin over the lips, etc

2. ADVERSE PHYSIOLOGICAL EFFECTS

2.1 GENERAL

This section describes in detail those physiological effects of a rotating environment that are considered harmful and/or undesirable. Much of the data is based on the results of centrifuge experiments performed by various investigators. In these experiments the adverse physiological effects were related to such quantities as centrifuge speed, angular and linear acceleration, head motion, body position, etc. Many intolerable and highly undesirable conditions have been created in a large number of centrifuge tests but, in general, these do not fall within the realm of this study because of very high rotation rate or g level. However, as a matter of interest, and for the purpose of disqualifying the tests under which they were obtained, some of these results are presented in Appendix B.

2.2 MAJOR EFFECTS

2.2.1 Spatial Disorientation

Spatial disorientation occurs when the subject is uncertain of the attitude or position of himself (or his spacecraft) with respect to some reference. The uncertainty stems from various illusions and is most pronounced in a continuously rotating environment, e.g., a centrifuge. In this section these illusory effects are described in detail.

2.2.1.1 Cross-Coupled Acceleration

Many centrifuge studies have been made to determine the physiological effects of head motion in a rotating environment^{2,7,8}. In all cases spatial disorientation (and motion sickness) occurred, the degree of severity increasing as the cross-coupled acceleration (product of head rate $\bar{\omega}$ and centrifuge rate $\bar{\omega}$) increased. It was also found that the stimulation was more pronounced when $\bar{\omega}$ and $\bar{\omega}$ were perpendicular and non-existent when parallel.

Considering the head rate and vehicle rotation to be applied about perpendicular axes, as in Figure 1-2, where the head motion is about the spinal axis, the cross-coupled acceleration sensed by the semi-circular canals occurs about the third orthogonal axis. During such an experiment, the subject has the illusory effect of somersaulting forward or backward, depending on the direction of applied head motion. This result is similar to that experienced by a gyroscope when a rate is applied about its input axis: a corresponding torque occurs about an axis that is mutually perpendicular to both the input axis and the spin axis. Several researchers have considered the semi-circular canals a gyroscopic element when the head is rotated in a spinning vehicle^{8,9,10,11}. In fact, attempts have been made to determine the resulting torque values on the endolymph and relate them to tolerability to determine maximum vehicle rate for a given head rate (See Section 2.2.2).

Obviously, crew members will turn their heads in a rotating space station, partly as a natural act and partly out of necessity. Since this could result in undesirable or intolerable physiological effects, limits should be established on cross-coupled acceleration (which would also apply to pure angular acceleration since the stimulation on the semi-circular canals would be the same). According to Clark and Hardy¹², the onset of illusions was experienced by a subject being rotated at 1 rad/sec in a centrifuge, (for 24 hours) when a head rate of 0.06 rad/sec was made about an axis perpendicular to the spin axis. This corresponds to an angular acceleration ($\omega\Omega$) of 0.06 rad/sec², which is close to the value (≈ 0.07 rad/sec²) indicated by Stone and Letko as the threshold below which angular accelerations are not evident to a person through the vestibular apparatus². Reference 10 indicates this threshold to be between 0.05 and 0.1 rad/sec² for 200 subjects tested at spin rates of 5-10 RPM.

2.2.1.2 Oculogyral Illusion

The oculogyral illusion is the apparent movement of an object which is fixed in relation to the observer, the movement taking place in the same direction as the angular acceleration of the observer^{3,14}. Thus a subject who is rotated in a dark room with an illuminated target (in front of him) which does not move with respect to him, will have the sensation that the target is moving to the right (clockwise) as the room is accelerated to

the right. When the velocity becomes constant, the target returns to its original position and, upon decelerating, appears to move in the opposite direction (to the left).

Apparent motion of objects which are fixed with respect to the observer occur because of stimulation of the semi-circular canals. Under either condition of actual acceleration or cross-coupled acceleration the canals are stimulated and the subject feels that he is rotating, and that objects around him must also rotate if their position relative to him is to be maintained. For example, a pilot on recovery to straight and level flight from a prolonged roll or spin may momentarily feel not only that he is rotating but that his seat, instrument panel and the entire aircraft are also rotating. However, if visual orientation cues are strong enough, he will realize the false nature of the perception, even though the illusion of rotation of his own body may still be present. This effect is amplified by head motions just before and after the actual rotation phase ends.

2.2.1.3 Nystagmus

Involuntary movements of the eyeballs is known as nystagmus and is commonly associated with, or resulting from, vestibular stimulation, specifically, as related to the semi-circular canals. As mentioned previously, the vestibular canals are only stimulated by angular acceleration.

Of the many centrifuge tests on human subjects, most have recorded the occurrence of nystagmus and have shown its relation to angular acceleration. However, some experimenters have shown that linear acceleration can affect the nystagmus characteristics¹⁶. This occurs when the resultant linear acceleration vector acting on the body continuously changes during periods of rotation. Such a situation exists when the body is rotated about a horizontal axis, as depicted in Figure 2-1. In both cases the physiological axis (Z) of rotation and the direction ($-R_z$) of rotation are the same. It is obvious, however, that the body is continuously reoriented relative to the gravity vector when horizontally rotated. Results have shown that, in the case of the horizontal axis, the nystagmus response is prolonged following angular acceleration but is almost completely suppressed following deceleration. Because of the different responses it appears

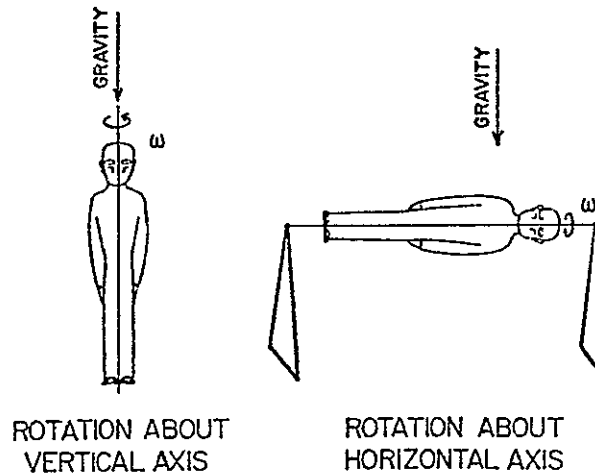

Figure 2-1. Rotational Position to Study Effect of Linear Acceleration on Nystagmus Response (Reference 16)

that the otoliths contribute to illusory effects when the linear acceleration vector is changing.

In any event angular motion must be present before nystagmus can be triggered. The resulting movements of the eyeballs occur in an attempt to keep the image of the outside scene momentarily fixed¹⁴. Each movement contains a quick component in the direction of rotation followed by a slow component in the opposite direction. This is typified by the recording in Figure 2-2 of the nystagmus response to a variable angular acceleration applied to the Human Disorientation Device in which the subject was seated and rotated about the vertical axis (head motion restricted)¹⁵. During the quick component no movement is sensed, but during the slow component

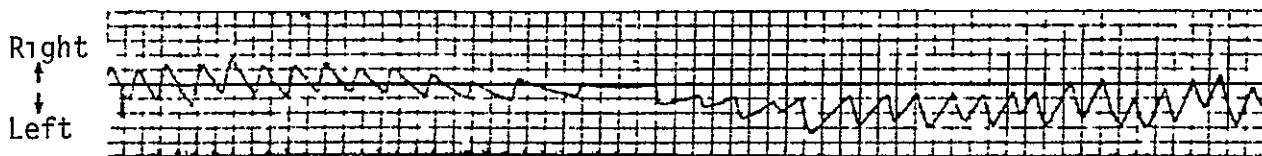

Figure 2-2. Recording of Horizontal Eye Nystagmus Resulting from Variable Angular Acceleration

the eye movement causes the image of any stationary object to pass across the retina and, being unaware of the eye movement, the subject interprets the sensation as movement of the object.

Although most investigations of nystagmus have been made under conditions of angular acceleration not to be expected on a rotating space station, the phenomenon does occur to some degree for all rotating environments. In fact, some experimenters have noticed the effect long after cessation of angular acceleration¹⁶. But the acceleration ($<1^\circ/\text{sec}^2$) to be used in bringing the space station up to the required rotation rate will be much less than that of the experiments, which has been as much as $40^\circ/\text{sec}^2$.

2.2.1.4 Oculogravic Illusion

When a person is seated in a fixed position at the end of a centrifuge arm, he will experience a sensation of tilt while he is rotated, as in Figure 2-3. In the example the centrifugal acceleration of 1 g combines with the acceleration of gravity to produce a resultant vector acting at an angle of 45° from the vertical. Although the subject is not tilted, the otoliths sense the true position of the body with respect to the force vector, and the resulting stimulation is interpreted by the brain as a real tilt. Not

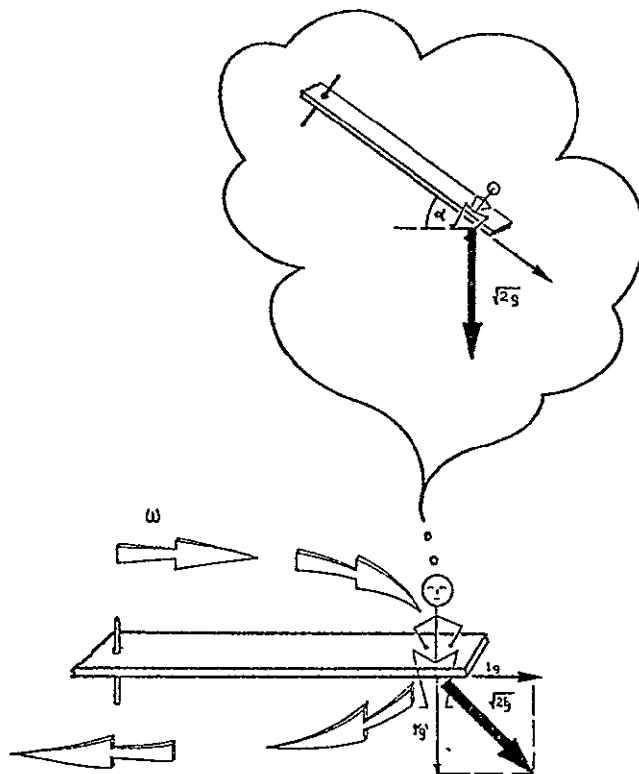

Figure 2-3. Oculogravic Illusion - The Perception of Apparent Tilt

only does he feel that he is tilted, but also that objects which are fixed relative to him appear to be displaced through an angle corresponding to the tilt. This phenomenon is known as the oculogravic illusion^{3,14,17,18}.

Clark and Graybiel tested 5 men in the Pensacola Slow Rotation Room to determine the characteristics of the oculogravic illusion¹⁷. In each test the subject was strapped in a chair located 5.5 ft from the center of rotation, his head firmly held in position. A collimator was mounted directly in front of him which contained a luminous line that could be rotated about its center. The subject was to maintain the luminous line in a horizontal position throughout the experiment. Two different experiments of two minutes each were performed on each subject with a resultant force vector of 20° and then repeated with a vector of 30°. One experiment was performed with a pre-exposure time to darkness of two minutes and the other with a pre-exposure time to light of two minutes.

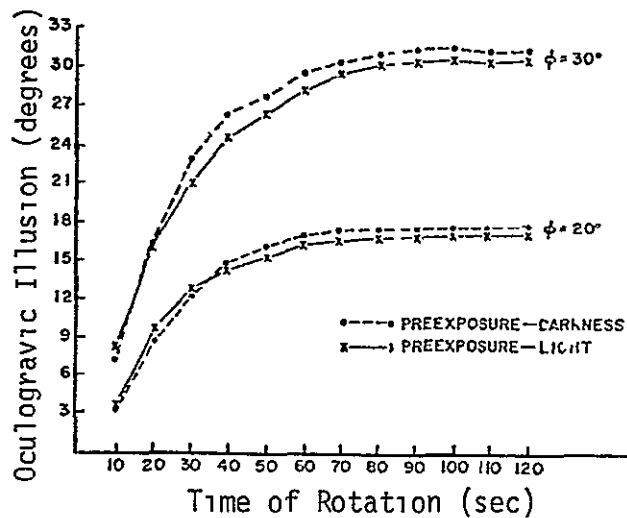

Figure 2-4. Mean Values for the Oculogravic Illusion of Five Normal Subjects

Results of the tests are shown in Figure 2-4. Clearly, an apparent displacement takes place, however, little difference can be observed in the results for the different exposure conditions.

In the artificial-G environment of a revolving space station the influence of earth's gravity will not be felt. But the oculogravic illusion will occur whenever a crew member is sitting or standing (walking) in a position where the artificial-G vector is inclined to the physiological Z axis.

This condition will exist for displacements in the tangential direction across the station floor which is assumed to be flat, as in Figure 2-5. The illusion becomes more pronounced as this displacement increases. A

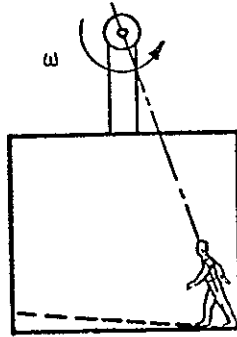

Figure 2-5. Oculogravic Illusion in Rotating Space Station

curved floor sloping upward from the center would eliminate the illusion but would present a real visual problem which could be more undesirable.

2.2.1.5 Autokinetic Illusion

The autokinetic illusion manifests itself in the form of a fixed light that appears to move when one stares at it in a darkened room^{3,14,18}. This illusion can occur in the absence of vestibular stimulation and takes the form of a rather aimless wandering of the light source. If the light occults so that continuous fixation cannot be maintained, the illusion occurs earlier with a more pronounced effect.

Visual illusions of this type could occur in a darkened space station room upon intense viewing of some light source, as might be on an instrument panel of some kind. Adequate visual cues such as horizontal and vertical lines (relative to the artificial-G vector) of objects and walls in a lighted room will help to alleviate illusory effects of this nature.

2.2.2 Motion Sickness

Johnson and Taylor indicate that angular acceleration is the primary stimulus of motion sickness¹⁰. The incidence is increased by simultaneous angular acceleration in more than one plane of the semi-circular canals, e.g., free motion of the head while rotating. But even angular velocity in more than one plane will cause a cross-coupling acceleration to be sensed

by the vestibular system (This was pointed out in Section 2.2.1.1.). Thus in a rotating space station angular head movements would result in cross-coupling effects which could over-stimulate the semi-circular canals. Such stimulation could cause varying degrees of motion sickness, depending on its magnitude.

If a person is seated in a centrifuge, he will, during acceleration of the centrifuge, experience a sensation of vertigo. When a constant speed is reached, he will no longer have a sense of rotation other than that which he receives from non-vestibular sources such as vision (he is routinely blindfolded), hearing and air movement. If, at this point, he moves his head forward, he will experience (if the cross-coupled effect is strong enough) a most disturbing feeling of motion sickness. A similar effect will occur if he moves his head to the side. Bobbing motion creates a sensation closely resembling that on a ship at sea.

To study the physiological effects of cross-coupled acceleration, Stone and Letko ran centrifuge tests on 29 subjects who were asked to observe lights of different colors and, after turning their heads, to actuate appropriate switches to turn out the lights². The internal features of the centrifuge and the position of the subject are shown in Figure 1-2. Each subject was rotated in sequence at 0, 7, 10, 14 and 17 RPM. The average head rate during the tests was determined as 225°/sec (3.93 rad/sec). Malaise was experienced by all subjects after the 7 RPM (0.73 rad/sec) run. Some stopped at this point through fear of vomiting.

In an experiment performed on the centrifuge at the Naval Aviation Medical Laboratory in Johnsville, Pennsylvania, a subject was rotated 24 hours at 1 rad/sec. Any head rotation at 0.6 rad/sec about an axis perpendicular to the spin axis resulted in nausea¹². This corresponds to an angular acceleration of 0.6 rad/sec². However, it should be kept in mind that this value was obtained by testing only one subject.

Of 100 untrained subjects tested in the Slow Rotation Room at the Naval School of Aviation Medicine by Graybiel and Kennedy 67% experienced motion sickness and 10% vomited¹³. The tests were conducted at a spin rate of 7.5 RPM with the subjects performing head and trunk motions to 5 different

positions in order to set 5 dials. The mean age of the subjects was 22.3 years.

As pointed out previously, the semi-circular canals respond similarly to a gyroscope when subjected to a spinning environment, i.e., an output torque (acceleration) occurs on the endolymph in one canal, which is mutually perpendicular to the spin axis (2nd canal) and the input axis (3rd canal), when a rate (head motion) is applied about the input axis⁹. This is more easily visualized with the aid of Figure 1-3 in Section 1. Thompson used the following relationship to calculate the torque values from subjects tested on a centrifuge at NASA's Langley Research Center.

$$\text{TORQUE} = I\omega\Omega_{av}$$

where I = moment of inertia about center axis of the endolymph in a single semi-circular canal

ω = angular velocity of spinning vehicle

Ω_{av} = average angular velocity of turning or nodding head

Two values of torque were determined: 1) that value corresponding to a torque which was tolerable to all the subjects and calculated to be 3.03×10^{-10} ft lb and 2) that value which resulted in the onset of malaise in all the subjects, 4.35×10^{-10} ft lb. A plot of head rate vs. vehicle rotation rate for each value is presented in Figure 2-6.

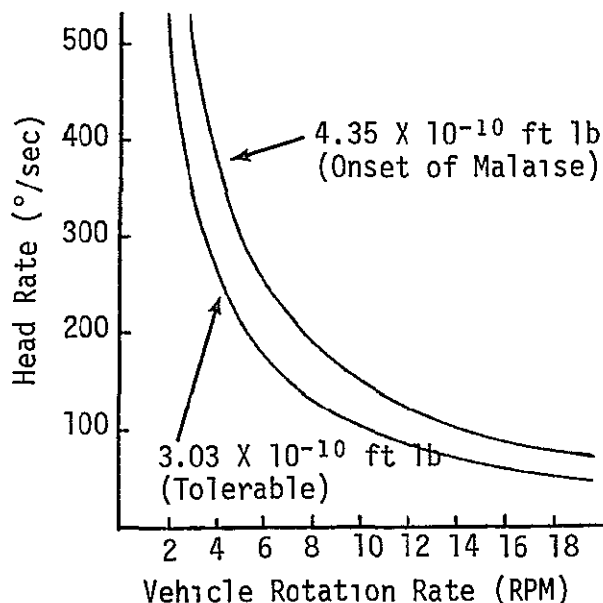

Figure 2-6. Nominal Resultant Gyro Torque Limits on Cross-Coupled Rotations of Semi-Circular Canal System

According to the figure a nominal head rate of 225°/sec could be tolerated by all in a rotating environment up to 5 RPM. Obviously, many could tolerate rotation rates above 5 RPM and, with training, probably all could (See Section 3).

It is interesting to note that, in previous work by Stone and Letko, the subjects used head motions as the vehicle speed increased that exceeded all of the proposed boundaries². The results seem to correlate better with those above, lending support to Figure 2-6 as a good indication of the restrictions that should be imposed on head rate in a given rotating environment.

Motion sickness is probably the most severe of the physiological effects that could occur in a revolving space station. The condition is actually associated with an advanced state of spatial disorientation and could lead to vomiting. Such a state would be difficult to overcome because of the persistent rotation. Not only would the crew feel uncomfortable, but performance would suffer and the mission could fail.

2.2.3 Visual Acuity Decrement

It is important that visual acuity be maintained in an artificial-G environment as in any other, and perhaps, more so. Even though visual illusions will be kept to a minimum, they nevertheless exist. Adding to this a decrement in the keenness of visual perception certainly will enhance the confused state.

Degraded visual acuity can occur with vestibular stimulation, especially as related to nystagmus. This is possible in a rotating space station where movements of the head couple with the rotation to stimulate the semi-circular canals. This prevents the crew member from perceiving those visual cues upon which orientation depends at a time when the false sensation of turning is most intense³.

Vibration can also decrease visual acuity. This could present a problem when one is attempting to read an instrument and a serious problem if he must maintain a close vigil on several instruments simultaneously. Studies have shown that visual acuity is degraded by vertical whole-body vibration at acceleration amplitudes between 0.1 and 0.75 g in the frequency range from 4 to 40 cps (Figure 2-7)¹⁹.

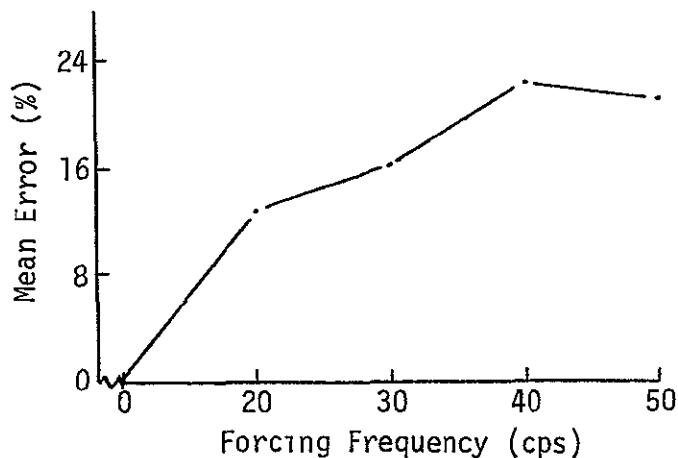

Figure 2-7. Effect of Whole-Body Sinusoidal Vibration on Visual Acuity

However, it is not clear whether the acuity decrement is purely frequency-dependent or amplitude-dependent. But it has been shown that, during whole-body vibration, deterioration in visual acuity can be alleviated by reducing the amount of vibration transmitted to the head and by providing adequate illumination of the observed object.

2.2.4 Locomotion and Posture Stability

The ability of man to walk about and maintain posture stability in a rotating space station will be significantly different from that in an earth environment. This is due to the unusual forces he will be subjected to as he attempts to move his body while being rotated. As long as the crew member remains still and the spacecraft spins at a constant velocity, the only linear acceleration (or force) occurring on him is the centrifugal acceleration (artificial-G) due to the spin. Since this acceleration occurs in the radial direction, it is subscripted by R and given by

$$a_R = R\omega^2 \tag{2-1}$$

where R is the radius of rotation and ω the spin rate. Once body motion is initiated, he experiences other forces and the expression for a_R becomes more complicated. This is pictorially shown in Figure 2-8. If motion takes place in the tangential direction, two additional terms, one the Coriolis acceleration $2\omega R\dot{\theta}$, must be added to Equation 2-1. Thus

$$a_R = R\omega^2 + R\dot{\theta}^2 + 2\omega R\dot{\theta} \tag{2-2}$$

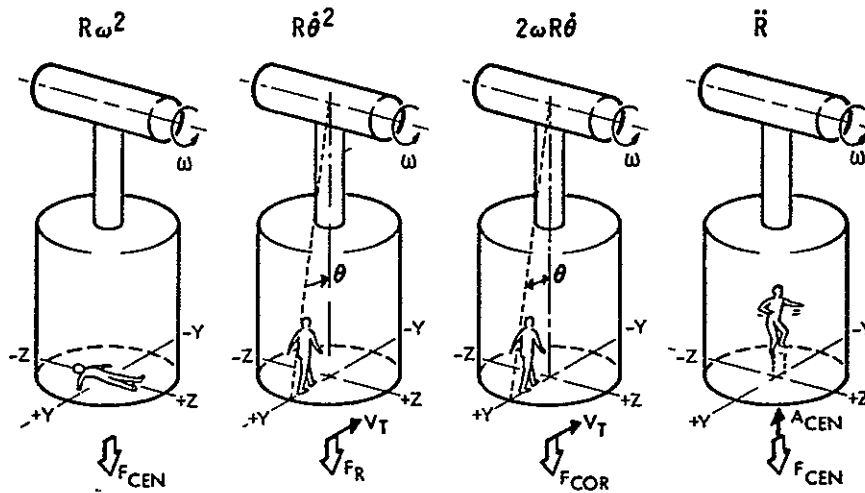

Figure 2-8. Radial Forces on Man in a Rotating Space Station (Reference 4)

where $\dot{\theta}$ is the angular velocity due to the motion of the crew member. Such motion has the effect of making the person feel heavier or lighter, depending on whether he is walking in the direction of the spacecraft rim velocity or against it, respectively. Obviously, this effect, which can be as much as 60% of the artificial-G when man is walking at 3 fps in a spacecraft with $\omega = 2$ RPM and $R = 60$ ft, will vary if his velocity changes in moving across the floor. Another term which can be added to Equation 2-1 is that for radial acceleration \ddot{R} which occurs as man initiates "vertical" motion. Since this is not likely to exist simultaneously with tangential motion, the expression,

$$a_R = R\omega^2 + \ddot{R} \quad (2-3)$$

describes radial acceleration experienced by man as he moves up or down, e.g., jumping.

Man will also be subjected to unusual forces in the tangential direction. In Figure 2-9 it is observed that the usual force due to his own acceleration $R\dot{\theta}$ will be accompanied by a Coriolis acceleration $2\dot{\theta}\dot{R}$ due to a changing radius as he moves across a flat floor. Under these circumstances the tangential acceleration is given by

$$a_T = 2\dot{\theta}\dot{R} + R\ddot{\theta} \quad (2-4)$$

If tangential motion occurs during spin-up to attain artificial-G (or spin-down), another term must be added to the equation above so that

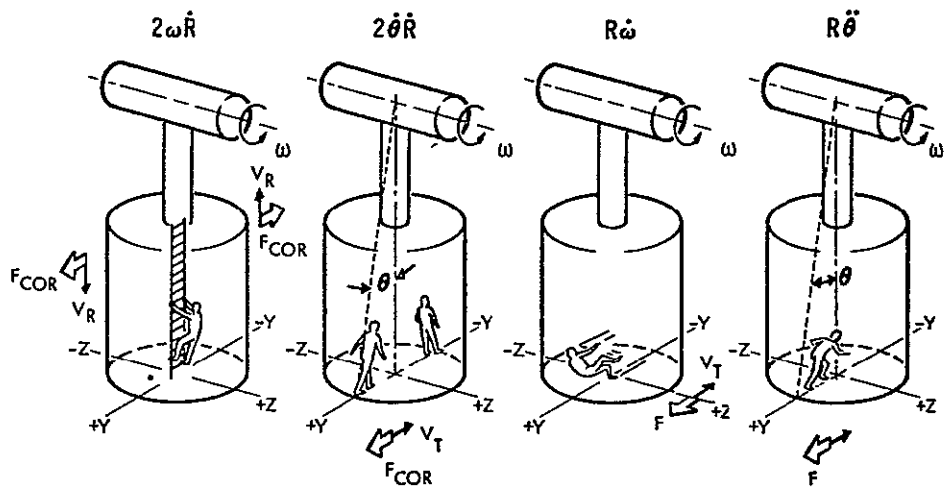

Figure 2-9. Tangential Forces on Man in a Rotating Space Station (Reference 4)

$$a_T = 2\dot{\theta}\dot{R} + R\ddot{\theta} + R\dot{\omega} \quad (2-5)$$

The most disturbing tangential force occurs when the man moves radially, such as in climbing or arising from a chair. This Coriolis force could make it difficult, if not unsafe, to climb ladders without appropriate precautions. The corresponding expression for a_T is

$$a_T = 2\omega\dot{R} \quad (2-6)$$

which is unlikely to occur at the same time as the other tangential accelerations.

It should be apparent that the peculiar types of forces a man will experience in a rotating spacecraft could make locomotion and posture control somewhat difficult. For instance, a person normally arises from a chair with an initial vertical velocity of 5 fps²⁰. Under this condition an astronaut would lurch forward (if facing in the +Y direction) noticeably upon arising, unless he has learned how to counteract this effect. If he were to climb a ladder facing laterally, he would be subjected to side forces that might push him off the ladder. Another peculiarity is the unusual manner in which these forces affect the performance of manual tasks, e.g., in hammering a nail with a 5 lb hammer driven one foot vertically downward with a force of 10 lb, the hammer would miss the nail by 0.78 in²⁰.

Equilibrium problems can also be caused by vestibular stimulation and inadequate visual cues. Certainly, instability in moving about will be enhanced by the illusory effects of disorientation. And, if sufficient visual cues are not available to establish an outside reference, walking could be an arduous task.

2.3 MINOR EFFECTS

2.3.1 Bio-Medical

No evidence has been found from the available literature that exposure to an artificial-G environment will cause serious bio-medical effects if the gravity level does not exceed 1 g. At the same time, however, it does point out the adverse effects of weightlessness. The two human systems most likely to be affected by an artificial gravity between 0 and 1 g are the cardiovascular and the musculoskeletal²⁰.

Prolonged exposure to linear acceleration different from 1 g is expected to change the distribution of blood. Although the pooling of blood in the legs is not expected to be much of a problem in a reduced gravity environment, it is of some concern by many researchers. In reference 20 the ratio of fluid pressure at the heart to fluid pressure at the feet is selected to be at least 90% of that in the earth environment as a criterion for the cardiovascular system.

Since bone tissue calcifies along the internal lines of stress and grows locally in response to local mechanical stress, it is probable that a gravity gradient environment would cause the leg bones to be thicker than those of the upper portion of the body. However, this would occur only after an extended period in space of probably more than two months.

2.3.2 Vibration and Noise

In general, a space station under constant rotation should exhibit little or no vibration and noise. During periods of spin-up/spin-down, however, it is quite possible that perceptible, if not annoying, levels of both will occur.

Although vibration affects visual acuity, as mentioned previously, performance is not significantly affected, especially in the range of frequencies between 0 and 23 cps²¹. But of the two quantities, amplitude and

frequency, amplitude appears to be the predominant factor related to performance decrement.

Severe whole-body vibration causes increases in respiratory rate, pulmonary ventilation and oxygen consumption¹⁹. In the artificial gravity environment of the space station it is very possible that even mild vibration might not occur. But some people might prefer a noticeable level of vibration since it is known that its absence is disturbing to some. As a matter of fact, airline passengers have been known to prefer piston-engined or turboprop aircraft, in which there is considerable noise and vibration, to jet aircraft where there is little. To some the feeling that the engines are running is comforting.

3. EFFECTS OF TRAINING, AIDS AND HABITUATION

3.1 TRAINING

It has been shown in several cases that training is significant in reducing certain adverse physiological effects resulting from a rotating environment. In particular, Graybiel showed that training greatly reduced motion sickness by tests conducted in the Slow Rotation Room on three different test groups¹³. In the tests each subject was required to move his head and trunk to 5

TABLE 3-1. Comparison of Three Groups of Naval Aviation Personnel in Standard Screening Test

	Incoming Flight Students	Aviators in Proficiency Billets	Graduates of Test Pilot School
Number of Subjects	100	40	22
Mean Age	22.3	29.6	32.7
Percent Sick	67	30	5
Percent Vomiting	10	0	0

different positions to set 5 dials. The rate of rotation was 7.5 RPM. Results are presented in Table 3-1 and clearly indicate the effect of training on motion sickness.

3.2 AIDS

Various kinds of physical aids can be provided to alleviate some of the problems that will be encountered day by day while subjected to artificial gravity. For instance, handrails, head harnesses, objects with horizontal and vertical lines judiciously located, and many others.

The use of drugs to reduce motion sickness susceptibility is another way of aiding the astronaut. Tests made by Graybiel, et al, in the Slow Rotation Room have shown that a combination of hyoscine (1.2 mg.) and d-amphetamine (20 mg.) increased the total number of head movements over all other drugs,

dosages and combinations²². In the related tests 8 men in good health were required to set a sequence of 5 dials to numbers given at 4-second intervals until motion sickness was induced. Head motions about the physiological X, Y and Z axes were required.

3.3 HABITUATION

It is almost certain that habituation will allow man to adapt himself to the artificial-G environment. The amount of time this may take will certainly be influenced by the characteristics of the environment and the role he must play in that environment. In other words, rotation rate, g-level, stability, etc., are space station characteristics that, for different intensities, affect the adversity of the physiological response. The degree and frequency of movement that man must make in the performance of his duties and daily routines of life also relate to the severity of undesirable physiological effects. To fully appreciate man's ability to adjust himself to the artificial-G environment, one must wait until an assessment has been made of an actual artificial-G flight mode of extended duration.

Several centrifuge studies have shown that adaption to the particular environment occurs after long-time exposure. Tests in the Slow Rotation Room at the United States Naval Aviation Medical Center have shown that tolerance to cross-coupled acceleration can be increased by habituation⁹. Other studies on the effects of cross-coupled acceleration, such as that by Stone and Letko², possibly could have resulted in higher tolerances had the subjects been exposed to the environment much longer than one hour.

Perhaps the most significant, and certainly the most extensive, studies on the effects of habituation in a rotating environment have been made by Newsom, et al^{23,24}. The related tests were made on the MRSSS (Manned Revolving Space Station Simulator), especially designed to closely simulate a rotating space station environment. A sketch of the MRSSS is shown in Figure 3-1. The experiment room can be inclined and swings out from a nominal radius of 18 ft. to a maximum radius of 24 ft. Other important features are:

- The inclinability allows alinement of the simulator with the inertial resultant of the rotogravity and geogravity vectors. This permits standing normal to the floor.

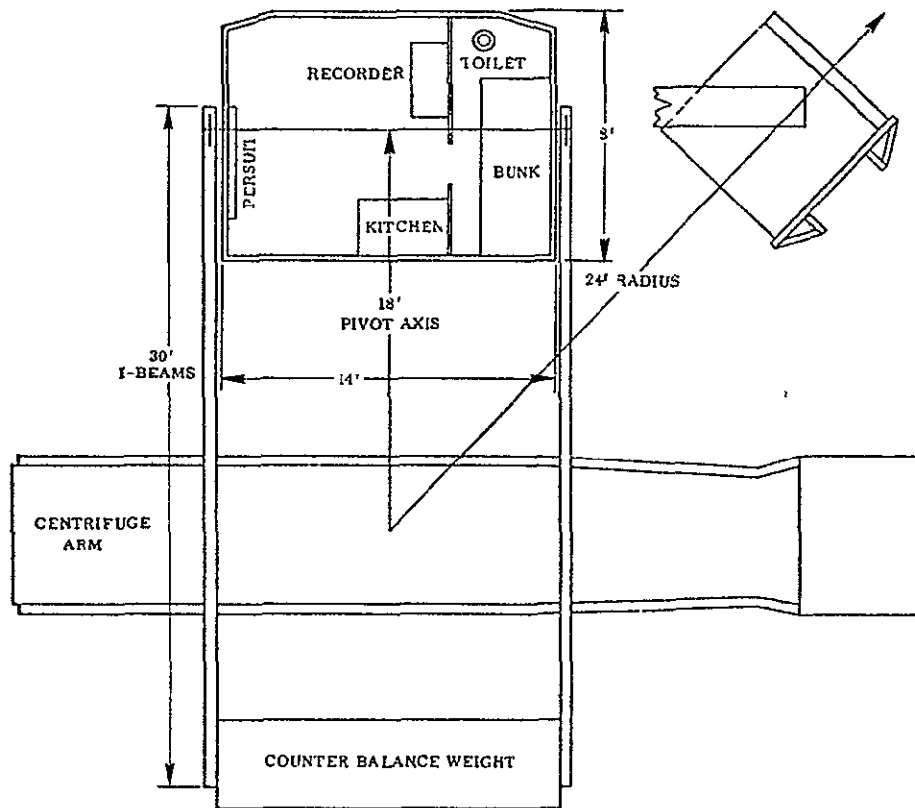

FIGURE 3-1. Arrangement of the MRSSS

- The long-radius peripheral location reduces the amount of radial translation during a series of random movements and reduces the relative linear velocity variation associated with such translations.
- Room inclination and long radius combine to cause head rotations that produce different vestibular stimulation, depending on the orientation of the subject.

In performing the tests 4 subjects were confined to the MRSSS for a period of 5 days. The simulator was rotated 4 hours at 2 RPM, 4 hours at 4 RPM, 104 hours at 6 RPM, 4 hours at 4 RPM and finally, 4 hours at 2 RPM. Throughout this period the subjects were required to perform auditory, illusion, equilibrium and performance tests. Results are presented in Figures 3-2 thru 3-5. In Figure 3-2 the subjective habituation of the subject is plotted. This is the subject's feelings of habituation (based on his diary and onboard medical history) and measure his total feeling of adaptation to

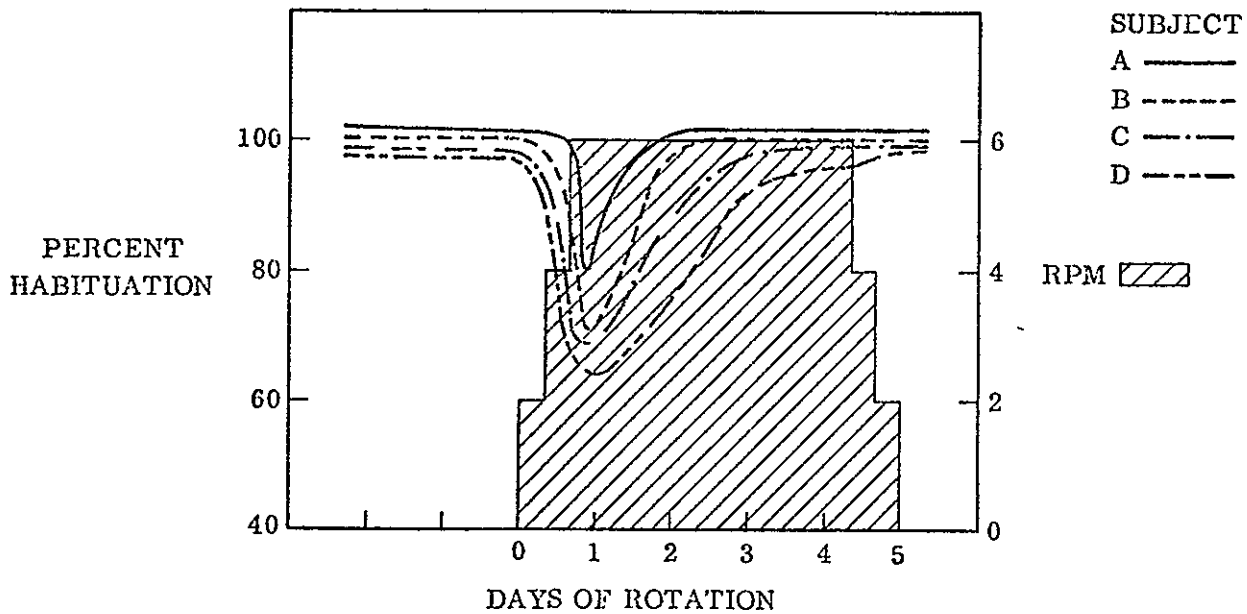

FIGURE 3-2. Subjective Habituation in MRSSS

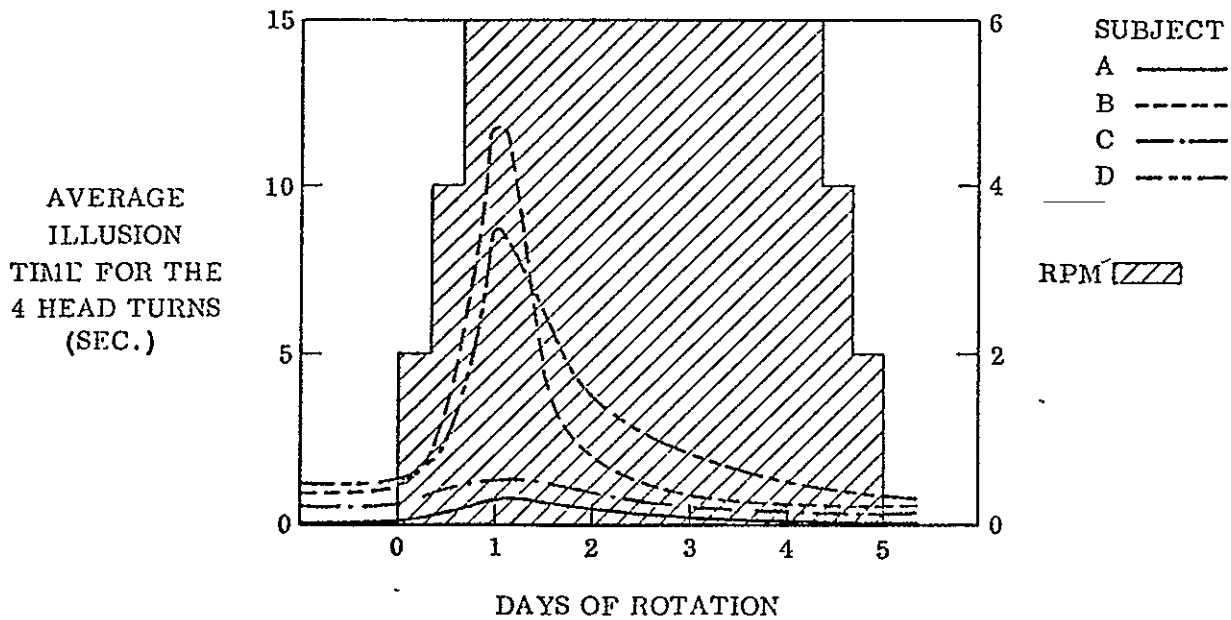

FIGURE 3-3. Oculogyral Illusion in MRSSS

the environment. The head turns performed in the oculogyral illusion test were made about the X cranial axis in interrupted sequence, to and from 45° to the right and to and from 70° to the left. (Subjects were constrained by a bite-bar.) Figure 3-4 indicates that, in heel-to-toe radial walking (5 steps toward spin axis and then 5 steps backward) with arms folded on chest, rapid adaptation occurs. The results of Figure 3-5 show increases

in auditory acuity for all the subjects tested. The curves represent the average of the percent auditory acuity norms for the frequencies, 500, 1000, 2000 and 4000 cps.

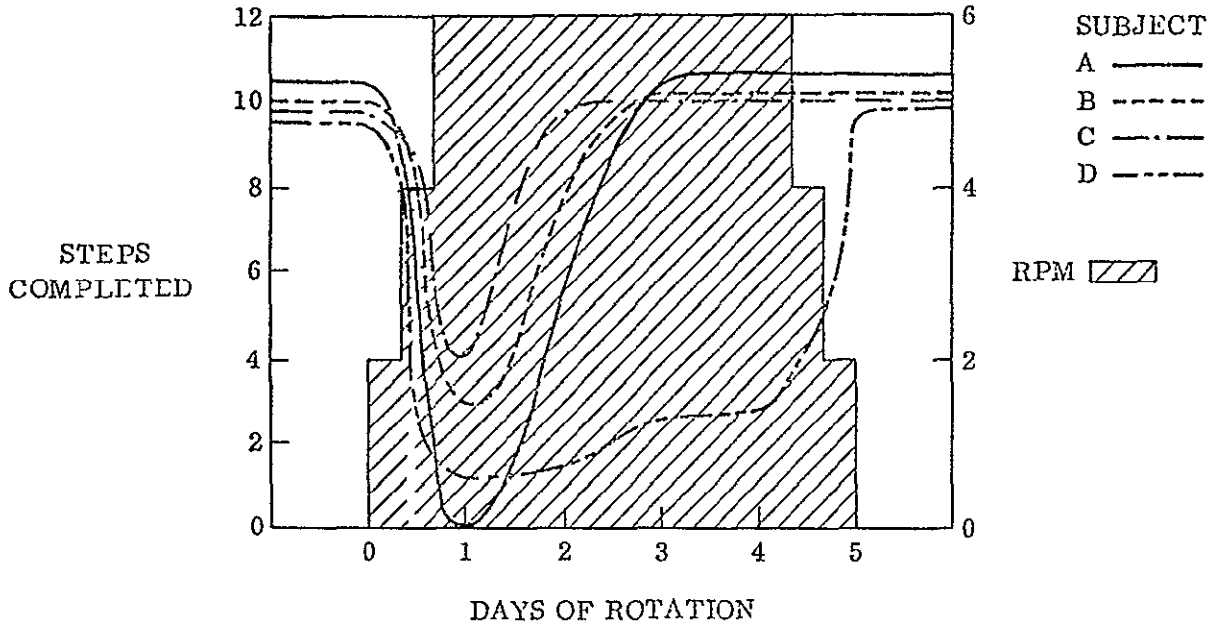

FIGURE 3-4. Blind Tandem Walking in MRSSS

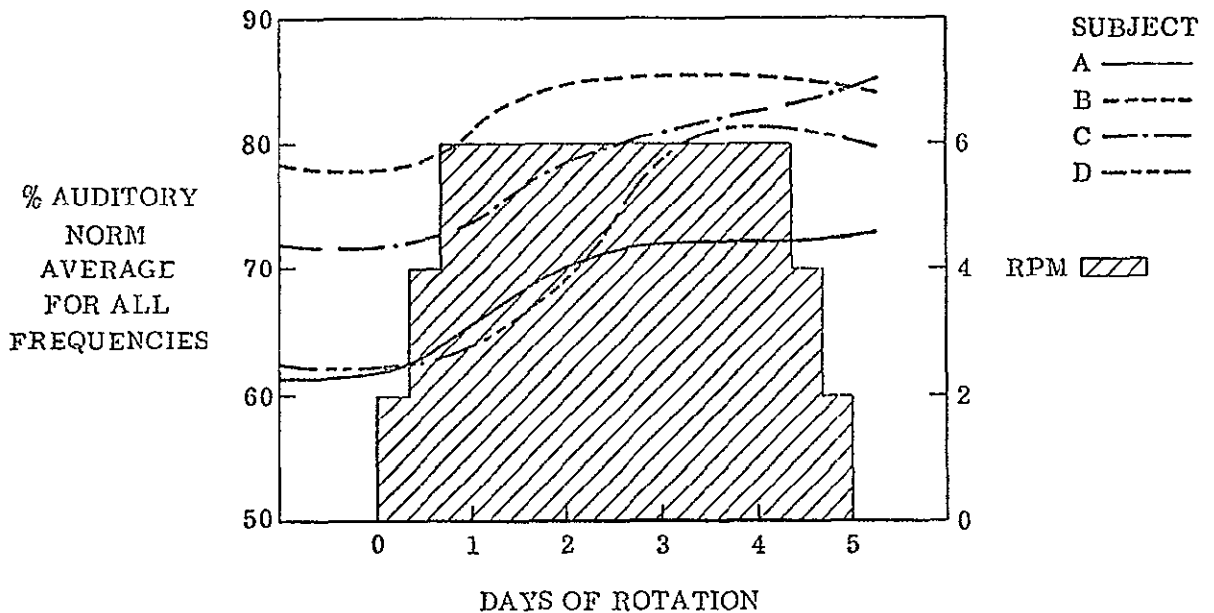

FIGURE 3-5. Auditory Acuity in MRSSS

From these test results it appears certain that man will be able to adapt himself in just a few days to an artificial-G environment in which the vehicle rate of rotation is 6 RPM.

3.4 DO'S AND DON'T'S

The following "do's and don't's" are provided as precautions for crew personnel to ensure safety and comfort:

- During spin-up or spin-down (acceleration periods), don't walk unless necessary (it is best to lie down, sit down or stand, in that order).
- Don't run!
- Use extreme caution in the vicinity of the spin axis.
- When climbing (or descending), keep head still and move slowly from one step to the other. Align radial ladders in ZX plane - ascend on +Y side and descend on -Y side (Coriolis force will push you into ladder rather than off).
- Don't walk tangentially unless necessary. Work areas and other places requiring heavy traffic (within or to and from) should be arranged so traffic is mostly in the axial (parallel to spin axis) direction.
- Arise slowly from a chair or bed.
- Get in habit of moving head slowly (< 200 °/s).
- Use eyes instead of moving head (if possible), e.g., to look at dials, charts, etc.

4. PHYSIOLOGICAL DESIGN CRITERIA

4.1 GENERAL

This section presents the physiological design criteria for an artificial gravity space station. Based on human factors considerations, limits are established, where possible, on dynamic, geometric and stability parameters. The overall design criteria are shown in the cross-hatched area of Figure 4-1 and are similar to that proposed by Loret²⁵ (Figure 4-2). Design criteria are also presented in tabular form in Table 4-1. Parameters in the table which have in no way affected the limits of the figure are station diameter, wobble angle, jerk, vibration and noise. Detailed explanations of all limits are presented in the discussion.

It should be pointed out that the upper limit of 6 RPM on the vehicle spin rate was influenced by the habituation results presented in Section 3.3. Furthermore, trained personnel and the use of drugs to prevent motion sickness should increase man's ability to tolerate the peculiarities of a rotating environment and hasten his adaptation. This means it might be possible to use even higher spin rates. The importance of this is that the radius, which is inversely proportional to the square of the spin rate, can be greatly reduced, resulting in a less complex, more rigid, revolving space station.

4.2 DYNAMICS LIMITATIONS

4.2.1 Angular Motion

4.2.1.1 Applied Angular Acceleration

Angular acceleration is the primary stimulus of spatial disorientation and motion sickness, hence a limit should be placed on its magnitude. Many investigators have reported thresholds for the perception of angular acceleration that vary between $0.035^\circ/\text{sec}^2$ and $4^\circ/\text{sec}^2$ for humans.^{3,26} However, the extensive studies of Clark and Stewart²⁷ indicate the threshold should lie in the range $0.12^\circ/\text{sec}^2$ to $0.17^\circ/\text{sec}^2$. (Threshold, in most cases, is the level at which the subject's response is 75% correct).

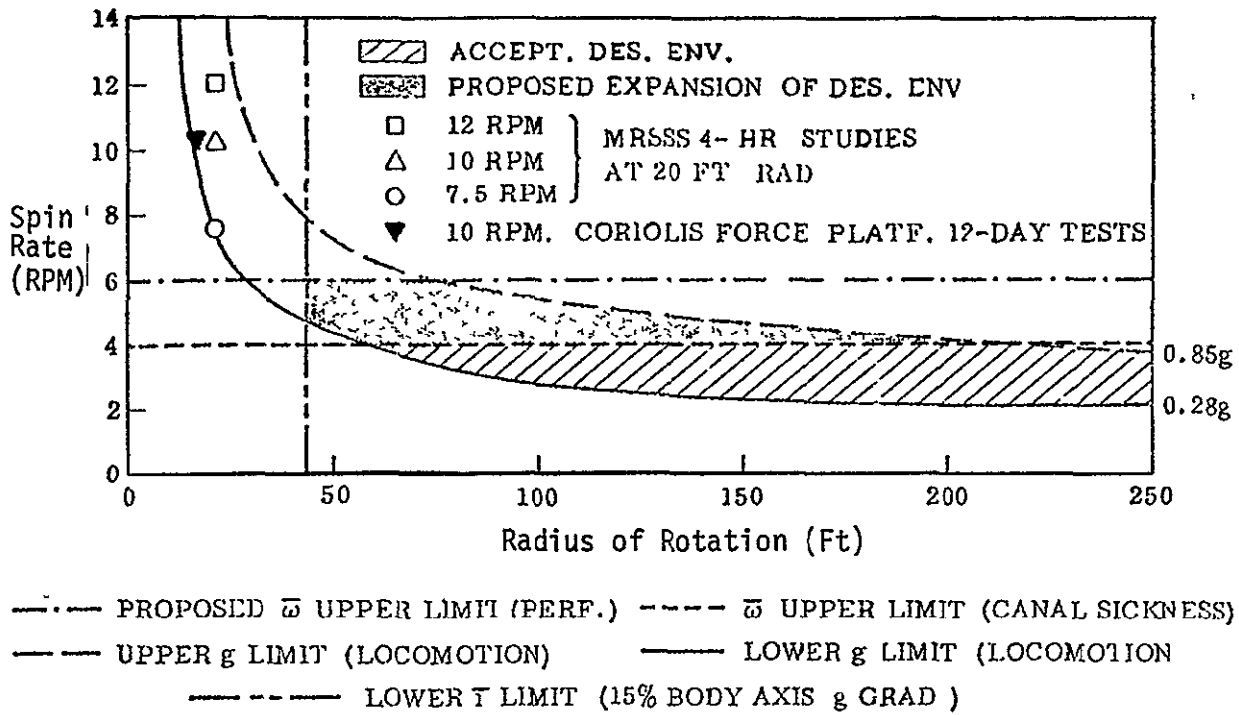
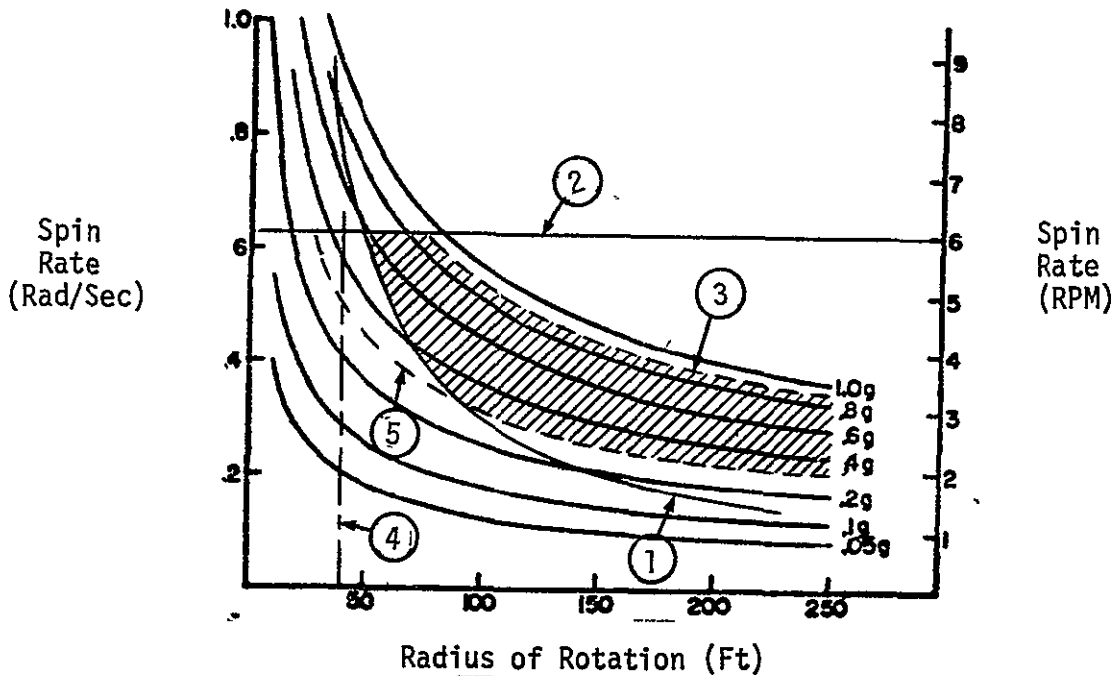

FIGURE 4-1. Physiological Design Criteria (Loret)



- (1) Max ratio of Coriolis accel to cent accel
- (2) Spin rate max (Canal sickness, habituation)
- (3) Max artificial-G (Velocity of man $v_T = 3$ fps)
- (4) Min radius of rotation (Grav. Gradient = 15% max)
- (5) Min artificial-G ($R = 40$ ft, $v_T = 3$ fps, $\omega = 4.6$ RPM)

FIGURE 4-2. Proposed Physiological Design Criteria

TABLE 4-1. Proposed Physiological Design Criteria

Design Parameter	Value		
	Minimum	Maximum	Nominal
Artificial-G	0.29g	0.88g	0.50g
Radius of Rotation (R)	40 ft	---	60 ft
Spin Rate (ω)	---	6 RPM	5 RPM
Angular Accel. ($\dot{\omega}$)	---	± 0.15 °/sec ²	± 0.1 °/sec ²
Wobble Angle	---	$\pm 15^\circ$	$\pm 10^\circ$
Gravity Gradient	---	15%	10%
Coriolis/Centrifugal	---	20%	18%
Angular Jerk	---	± 0.0015 °/sec ³	---
Spacecraft Diameter	---	60 ft	30 ft
Vibration	0-50 cps	{ < 0.005 in displacement < 0.01g avg peak accel.	
Noise	All frequencies: < 75 db		
Related Parameters			
Velocity of Man (v_T)	---	5 fps	3 fps
Head Rate (Ω)	---	300 °/sec	225 °/sec

Since some degree of spatial disorientation will occur above the threshold of perception, it seems the limit on applied angular acceleration should be made in relation to the threshold. Thus a value close to the mean determined by Clark and Stewart should be appropriate. Accordingly, a value of $0.15^\circ/\text{sec}^2$ is selected as the limit on applied angular acceleration (as during spin-up or spin-down).

4.2.1.2 Cross-Coupled Acceleration

Cross-coupled acceleration is that stimulation on a semi-circular canal resulting from a coupling of angular rates on the other two canals. Apparently, the human vestibular system is not as sensitive to cross-coupled angular acceleration as it is to pure angular acceleration. In fact, the threshold of perception has been found to be much higher^{2,10,12}, the value being approximately $3.5^\circ/\text{sec}^2$.

Since cross-coupled acceleration will occur primarily as a result of head motion coupling with the vehicle spin rate, it appears reasonable that the maximum spin rate should be governed by this effect (since it will be much easier to control than head motion). Because continual head motion will not be occurring, it seems appropriate to consider, as a limit, a level of cross-coupled acceleration that is tolerable rather than a threshold. In Section 2.2.2 it is seen that a cross-coupled acceleration corresponding to a torque on the endolymph of 3.03×10^{-10} ft lb represents the tolerable condition for the subjects tested.

4.2.1.3 Spin Rate

For a nominal head rate² of $225^\circ/\text{sec}$, the maximum spin rate is determined from Figure 2-6 of Section 2.2.2 to be approximately 5 RPM. This, tempered with the results of Section 3 (especially, as relates to habituation) and Reference 28, indicate the maximum should be 6 RPM or more. The maximum spin rate for the station is, at this time, selected to be 6 RPM.

4.2.1.4 Angular Jerk

The only known study to determine sensitivity to the derivative of angular acceleration, or angular jerk, is that of Bartley, et al.²⁹ Several hundred centrifuge tests were conducted on 5 subjects with varying degrees

of angular acceleration. Results of the study indicate a threshold of $0.12^\circ/\text{sec}^2$ per an exposure time of 80 seconds; to avoid stimulation of the semi-circular canals by angular jerk, angular acceleration levels should change no more than $\pm 0.0015^\circ/\text{sec}^2$ per second.

4.2.2 Linear Motion

4.2.2.1 Coriolis Acceleration.

The Coriolis acceleration due to man's velocity (neglecting flat floor effects) is given by

$$\bar{a}_{\text{COR}} = 2\bar{\omega} \times \bar{v} \quad (4-1)$$

where $\bar{\omega}$ is the spin rate and \bar{v} the velocity of man. When motion takes place in the radial direction (toward or away from the spin axis), a Coriolis force is created in the tangential direction. The ratio of the accompanying acceleration to the centrifugal acceleration developed by artificial-G is

$$\frac{a_{\text{COR}}}{a_{\text{CEN}}} = \frac{2\omega v_R}{R\omega^2} = \frac{2v_R}{R\omega} \quad (4-2)$$

where v_R is the radial velocity of man. If the ratio above is large enough, a man could be forced off a ladder if he is facing the lateral direction while ascending or descending. This obviously points out the precautions that should be taken before moving radially, especially in the vicinity of the spin axis, as R becomes small.

When man walks tangentially (perpendicular to spin axis) in a space station, a Coriolis force is created on him along the radial axis. This tends to make him feel heavier or lighter as it affects the total acceleration in the radial direction. Neglecting the effects of a flat floor, the radial acceleration is given by

$$a_R = R\omega^2 + 2\omega v_T \quad (4-3)$$

where v_T is the tangential velocity of man and the first term is the centrifugal acceleration (artificial gravity). The ratio of the second term to the first,

$$\frac{2v_T}{R\omega} (100) = A_C, \quad (4-4)$$

represents the Coriolis acceleration in percent of the centrifugal acceleration when multiplied by 100. A plot of this relationship is presented in Figure 4-3, where 3 fps is assumed to be the nominal velocity of man. The solid line in the figure presents the centrifugal acceleration as a function of R for several values of the spin rate ω . In Section 2.2.4 it was emphasized that significant Coriolis forces could seriously affect locomotion. A value of $A_C = 20\%$ is selected as a maximum on the basis that smaller values places too severe a design constraint on the other artificial-G parameters and larger values result in locomotion difficulty.

4.2.2.2 Artificial Gravity

The term artificial gravity is the centrifugal acceleration acting at the floor of the space station. This same acceleration also acts on the person located on the floor (neglecting flat floor effects). However, when the person moves tangentially, he is subjected to an additional acceleration, as described in the preceding section. This, the Coriolis acceleration, combines with the artificial gravity to form the total radial acceleration a_R .

In establishing a maximum value for artificial-G, a maximum must be placed on the total acceleration that will be imposed on the man. Since cardiovascular and other problems begin to occur when man is subjected to more than 1g for prolonged periods of time,³⁰ the total acceleration a_R should not exceed 1g. Thus

$$a_R(\max) = R\omega^2 + 2\omega v_T = 32.2 \quad (4-5)$$

or, in terms of artificial-G,

$$a_{\text{GEN}}(\max) = R\omega^2 = 32.2 - 2\omega v_T \quad (4-6)$$

The maximum value for the spin rate ω was determined in Section 4.2.1.3 as 6 RPM, or 0.628 rad/sec. Using this value and a nominal walking speed of 3 fps for v_T , the maximum value for artificial-G is calculated (in g units) as

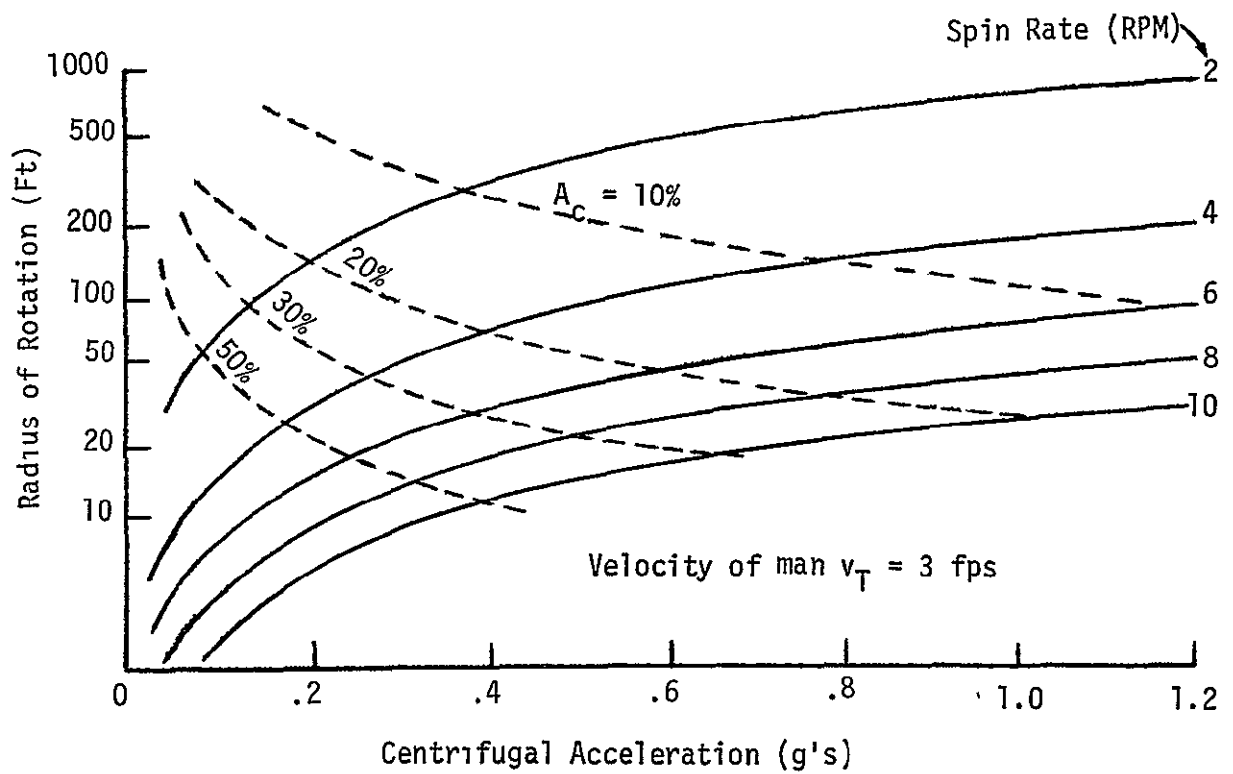

FIGURE 4-3. Coriolis Acceleration A_c in Percent of Centrifugal Acceleration

$$a_{\text{CEN}}(\text{max}) = 1 - \frac{(2)(0.628)(3)}{32.2} = 0.88g$$

This means R and ω can take on any values within their respective limits as long as the product $R\omega^2$ does not exceed 0.88g.

For the lower limit on artificial-G use is made of the value quoted by Loret³¹ as the minimum reduced gravity level at which man can walk unaided. This value is 0.2g. Proceeding as before,

$$a_{\text{CEN}}(\text{min}) = R\omega^2 = 6.44 + 2\omega v_T \quad (4-7)$$

At this point the maximum value of ω that will satisfy the equation above must be determined. This will be based on the minimum value of R, which is established as 40 ft by an arbitrary choice for the maximum gravity gradient of 15%³² (This means the variation in artificial gravity between head and feet will not exceed 15%). Using R = 40 ft and $v_T = 3$ fps, Equation 4-7 is solved for ω . The result is $\omega = 0.483$ rad/sec (4.6 RPM). This yields the following minimum value for artificial-G:

$$a_{\text{CEN}}(\text{min}) = \frac{R\omega^2}{32.2} = \frac{(40)(.483)^2}{32.2} = 0.29g$$

A summary of the results of this section are given below:

$$a_{\text{CEN}}(\text{max}) = 0.88g \quad (\text{Art-G max})$$

$$a_{\text{CEN}}(\text{min}) = 0.29g \quad (\text{Art-G min})$$

$$\text{Grav. Grad.} = 15\% \text{ max}$$

$$R (\text{min}) = 40 \text{ ft}$$

It should be pointed out that the maximum value for artificial-G would actually increase somewhat with decreasing ω and increasing R, i.e., if the total radial acceleration were to be maintained at 1g. With the constant value proposed (0.88g) the total radial acceleration will be slightly lower than 1g for decreasing ω and increasing R. For example, with $\omega = 4$ RPM and R = 161 ft, the artificial-G is 0.88g but the total radial acceleration on man is 0.96g as he walks tangentially at 3 fps. The minimum value for artificial-G should be similarly treated.

4.2.3 Vibration and Noise

4.2.3.1 Vibration

In the space station environment, care should be taken to see that vibration amplitude and frequency are not excessive. Tolerance limits²¹ are presented in Figures 4-4 and 4-5. The former relates frequency to displacement, the latter, frequency to acceleration.

4.2.3.2 Noise

Tolerance criteria for noise is shown in Figure 4-6. Actually, the criteria should be adjusted several db to include the effects of the peculiar environment developed in a rotating spacecraft. According to Krylov³³, subjects rotated at 10.6 °/sec (1.77 RPM) and 21.2 °/sec (3.54 RPM) for a period of 24 hours in a chamber creating periodic Coriolis effects had their hearing thresholds (acoustic sensitivity) changed by 12.5-25 db.

4.3 GEOMETRIC LIMITATIONS

4.3.1 Radius of Rotation

The radius of rotation R has no upper limit, i.e., no specific reason has been given for limiting it to a certain maximum value. Obviously, from a practical viewpoint, the size, and length, of the rotating space station must be limited. Perhaps the governing factor will be based on stability considerations.

In determining a minimum R, the chief consideration is gravity gradient. Dole³² arbitrarily selected 15% as the head-to-foot gradient. Based on this and an average height for man of 6 ft, the radius of rotation is calculated to be 40 ft. It does not seem practical to reduce the maximum gradient because of the large, accompanying change in R. For instance, if the value were lowered to 10%, minimum R would increase to 60 ft.

4.3.2 Space Station Diameter

As explained in Section 2.2.1.4, a flat floor in the space station will give rise to the illusion of tilt as a person is displaced tangentially from the center of the floor. Although this tilt sensation would not

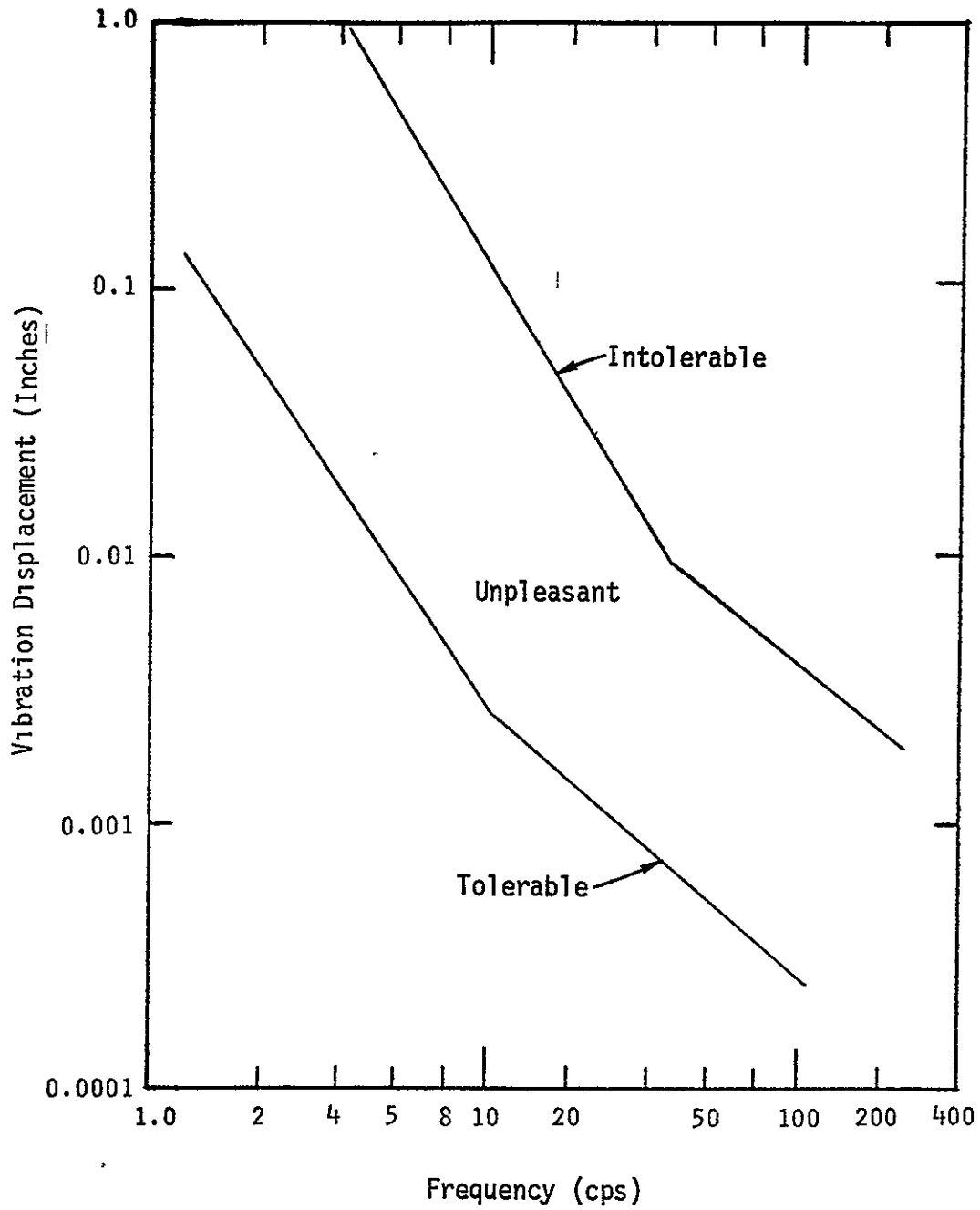

FIGURE 4-4. Vibration Tolerance Limits

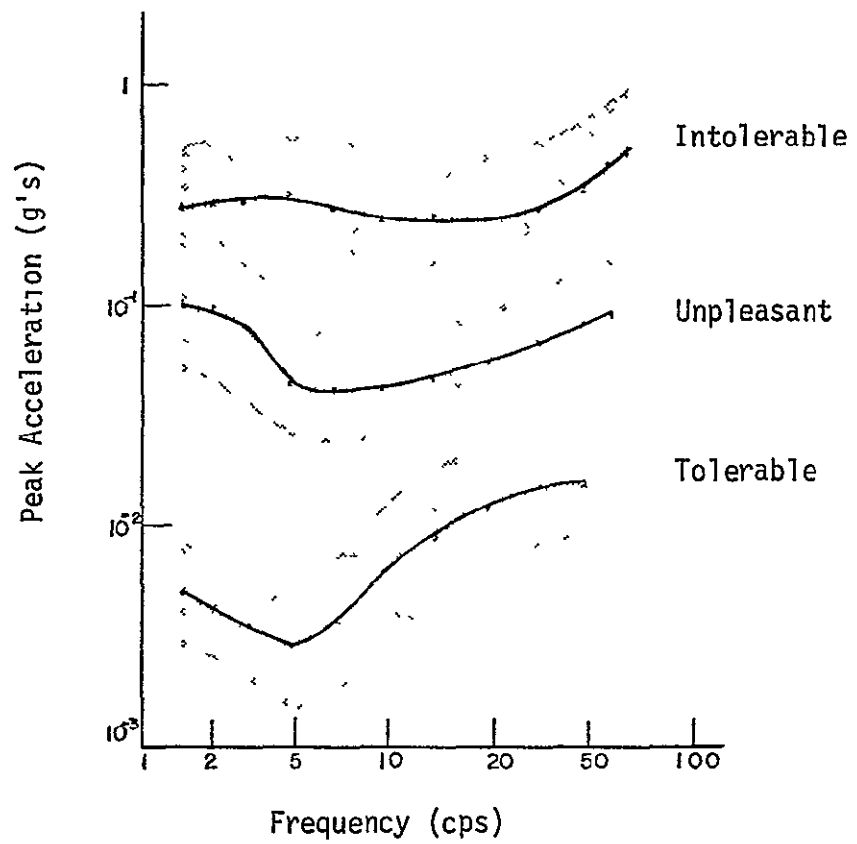
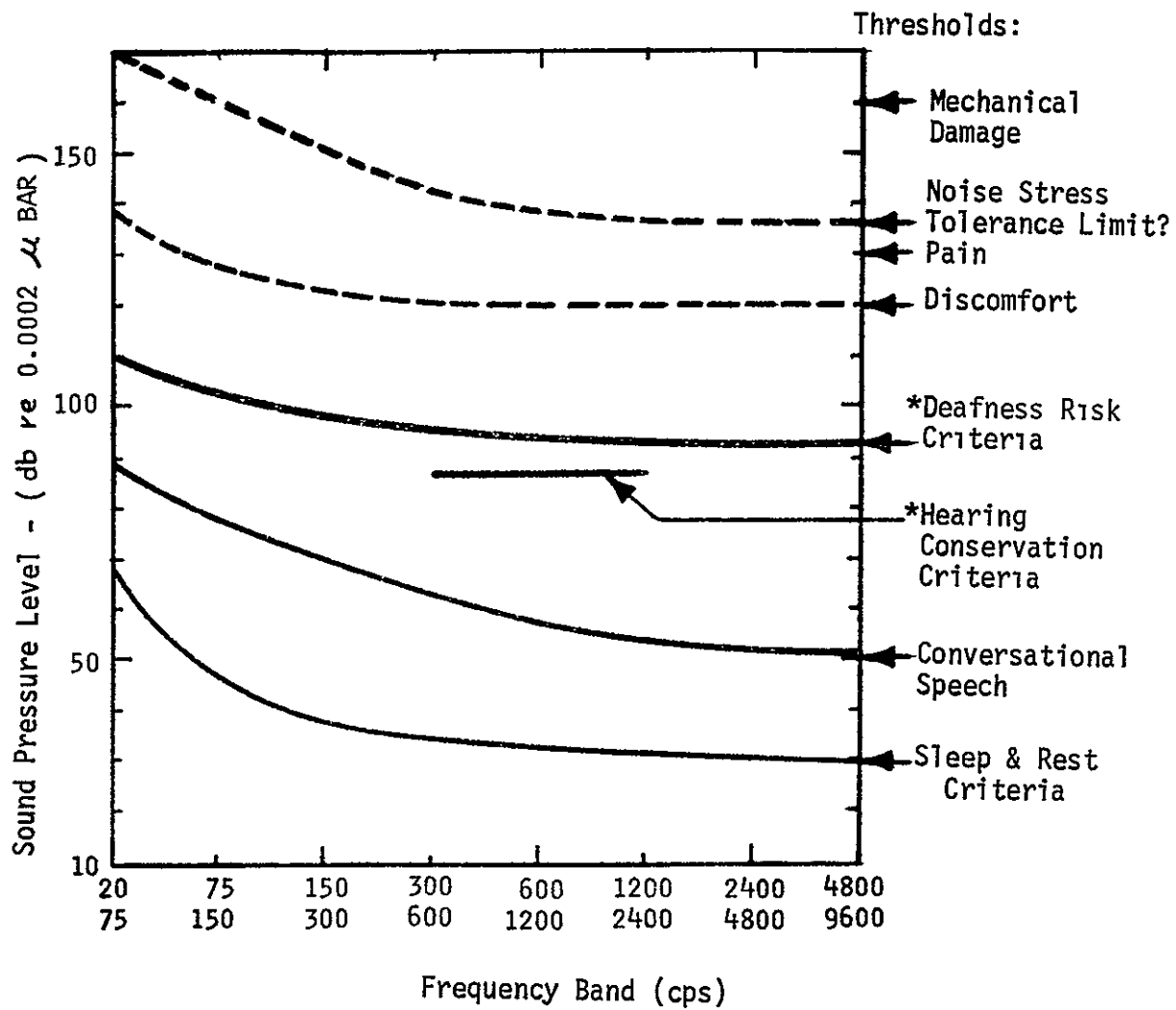

FIGURE 4-5. Average Peak Acceleration at Various Frequencies of Vibration



*Lifetime Exposure, 8 hrs/day

FIGURE 4-6. Tolerance Criteria for Noise

occur if the floor were curved, a real visual problem would be created. Much curvature in the surface of the floor would be readily noticeable and, perhaps, confusing since objects at a distance would actually be tilted and, to varying degrees.

In Figure 4-7 it is seen that, for a diameter of 33 ft and radius of 75 ft, a person on the periphery would experience an apparent tilt of approximately 12° . Although man could probably adjust to this condition, it seems that a compromise between real and apparent tilt might be the best solution. In other words, for the example, if the floor is allowed to gradually slope upward from the center to an angle of 6° at the wall, the apparent tilt would be reduced to 6° .

4.4 STABILITY CONSIDERATIONS

If stability could be overlooked, it seems that the physiological design criteria presented above would be sufficient for designing an acceptable space station configuration. This might not be practical, however, because instability could cause serious effects, depending upon the degree. The most significant stability problems of a spinning space station are spin axis wobble, spin vector wobble, and body flexibility. These problems arise from such things as disturbance rates, mass movement, jet (RCS) firings, etc., and can stimulate the human vestibular system and ocular senses as does head motion and normal angular movement of the space station. Little work has been done to relate vehicle stability to physiological effects, leaving an important gap (that must be bridged) in the establishment of realistic physiological design criteria.

Spin axis wobble and spin vector wobble (rotogravic oscillation) result from disturbance rates, mass unbalance, etc. and exhibit different characteristics depending on the axis (principal or geometric) chosen as the spin axis. Spin axis wobble is deviation of the effective spin axes (geometric axes) with respect to a fixed inertial reference and is not necessarily concomitant with spin vector wobble, which is oscillation of the angular momentum vector.

Some work has been done by Newsom²⁸ to study the physiological effects of a perturbed rotating environment. In the MRSSS Newsom tested several

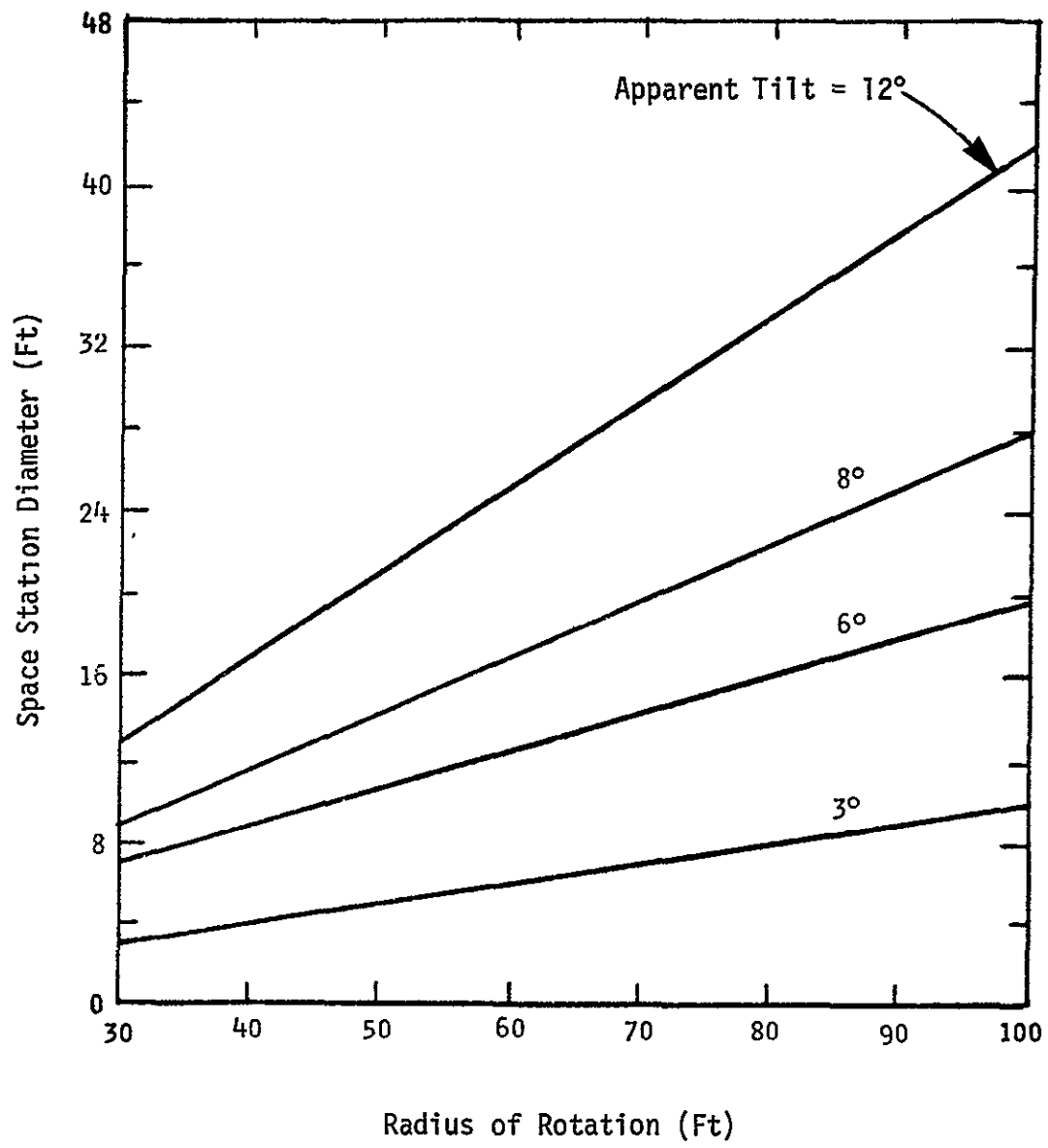

FIGURE 4-7. Apparent Tilt as a Function of Station Diameter

subjects under a series of conditions in sequence:

- static (pre-motion)
- perturbed ($\pm 3^\circ/\text{sec}$ at 0.1 cps)
- rotating (6 RPM)
- perturbed, rotating
- post dynamic

While the perturbed, rotating environment does not necessarily simulate the "in-flight" condition, it is a step forward in relating physiological effects with stability. Results of Newsom's investigation did not reveal more than slight degradation in the subjects ability to perform tests related to fine manipulative abilities, gross positioning and movement, perceptual-cognitive abilities, and mirror tracing abilities. Figure 4-8 presents results of this last test which are typical of other results.

In order to fully understand the effects stability might have on the physiological design criteria, complete and extensive studies must be made, both on centrifuges and computers. In addition to the problem sources listed above, other potential problems such as angular jerk and limit cycle characteristics should be included.

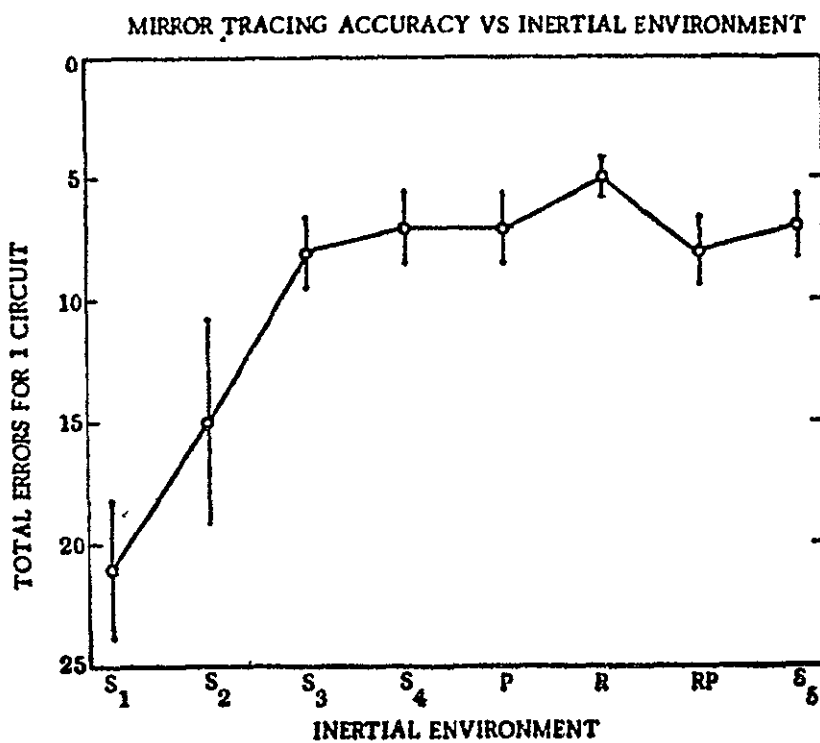
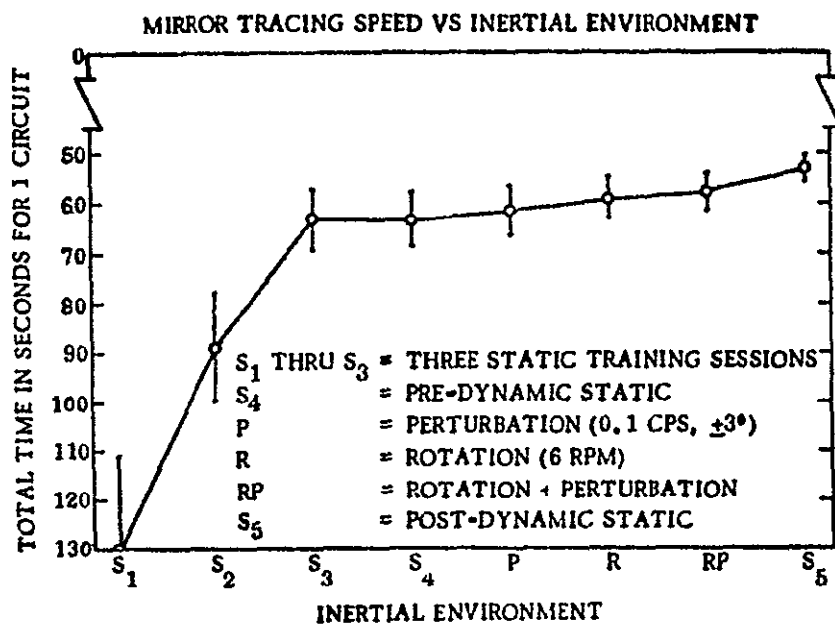

FIGURE 4-8. Mirror Tracing ($\bar{X} \pm 1$ S.E. for N=12) Versus Inertial Environment

5. CONCLUSIONS AND RECOMMENDATIONS

Based on the expected human physiological effects of a continuously revolving spacecraft, preliminary design criteria are proposed. These criteria, presented in Figure 4-2 and Table 4-1, are similar to those generated by Dole and Loret. However, the criteria proposed in this study provide an effective constraint on the allowable Coriolis force, raise the maximum spin rate from 4 to 6 RPM, place no upper limit on the radius of rotation and provide design limits for additional parameters. If spacecraft stability could be overlooked, these criteria would probably be sufficient for designing an artificial-G space station that would be suitable for man to live and work in for extended periods of time. However, this is impractical and stability effects must be studied in detail before firm physiological design criteria can be established.

Recommendations for continued work in this area are directed toward studies that will determine the adverse effects vehicle stability might have on the physiology of man. This work should include

- 1) Continued studies on space station simulators, such as the MRSSS
- 2) Six-degree-of-freedom computer simulation to study spin axis and spin vector wobble effects
- 3) Studies to determine bending mode effects, utilizing simulation of 2) above
- 4) Studies to determine the effects of jerk, limit cycling, etc., as relates to RCS system used for spin control

In 1) more realistic perturbations should be imposed on the rotating environments where the spin rate is maintained at levels between 2 and 6 RPM. Under 2) angular and linear motion of the space station as a rigid body would be simulated. Terms consisting of products of inertia would be included to study the effects of mass movement within the space station. Various runs for different initial conditions, radii of rotation, spin

rate, mobile mass, etc., would be made to determine limits on such things as wobble rate and acceleration, size of mobile mass, etc. Vehicle flexibility (body bending) effects would be investigated under 3) by adding at least the first three modes to the simulation of 2). The effects of RCS jet firings, mass movement, etc., would be investigated in detail. Under 4) the spin control system software and hardware would be scrutinized to determine potential problem areas such as jerk, limit cycling, etc. These conditions would then be incorporated in the simulation above and investigated in detail. Work under these 4 items should go a long way in establishing more realistic physiological design criteria.

6. REFERENCES

1. NASA Document MSC-00141, Revision 0, Guidelines and Constraints Document, Space Station Program Definition, Phase B, 12 June 1970.
2. Stone, R. W. Jr. and Letko, W., "The Effects of Angular Motion of Rotating Space Vehicles on the Ability of an Astronaut to Perform Simple Tasks", NASA Langley Research Center, Va., April 1962.
3. Benson, A. J., "Spatial Disorientation in Flight", in Textbook of Aviation Physiology, 1965.
4. North American Rockwell Document SD 69-606, Space Station Program, Phase B Definition - Second Monthly Progress Report, November 17, 1969.
5. Pesman, G. J., "Acceleration Terminology Table of Comparative Equivalents", in Principles of Biodynamics as Applied to Manned Aerospace Flight, AGARD, August 1960.
6. Clark, C. C., Hardy, J. D., and Crosbie, R. J., "A Proposed Physiological Acceleration Terminology with an Historical Review", in Human Acceleration Studies, 1961.
7. Graybiel, A., Clark, B. and Zarruello, J. J., "Observations on Human Subjects Living in a Slow Rotation Room for Periods of Two Days", in AMA Archives of Neurology, Vol. 3, July 1960.
8. Stone, R. W., Jr., and Letko, W., "Tolerance to Vehicle Rotation of Subjects Using Turning and Nodding Motion of the Head While Performing Simple Tasks", in AIAA Paper No. 64-218, 1st AIAA Annual Meeting (Washington, D. C.), June 29 - July 2, 1964.
9. Thompson, Allen B., "Physiological Design Criteria for Artificial Gravity Environments in Manned Space Systems", in The Role of the Vestibular Organs in the Exploration of Space, 1965.
10. Johnson, W. H., and Taylor, N. B. G., "A Review of the Physiological Effects of Angular Acceleration", in Bio-Assay Techniques for Human Centrifuges and Physiological Effects of Acceleration, AGARD, 1961.
11. Kurzahls, P. R., Adams, J. J., and Hodge, W. F., "Space Station Dynamics and Control", in NASA TN D-1504, A Report on the Research and Technological Problems of Manned Rotating Spacecraft, August 1962.
12. Clark, C. C. and Hardy, J. D., "Gravity Problems in Manned Space Stations", in Proceedings of the Manned Space Station Symposium, Institute of the Aeronautical Sciences, New York, N. Y., 1960.

13. Graybiel, A. and Kennedy, R. S., "A Comparison of the Susceptibilities of Three Groups of Naval Aviation Personnel to Symptomatology of Motion Sickness", presented at Am. Psychological Assoc. Meeting, Philadelphia, Penn., September 1963. (Unpublished Data).
14. Whiteside, T. C. D., "Visibility and Perception", in A Textbook of Aviation Physiology, 1965.
15. Hixson, W. C. and Niven, J. I., "Frequency Response of the Human Semi-Circular Canals - Steady State Ocular Nystagmus Response to High Level Sinusoidal Angular Rotations", Naval School of Aviation Medicine, 10 March 1961.
16. Guedry, F. E., Jr., "Influence of Linear and Angular Accelerations on Nystagmus", in The Role of the Vestibular Organs in Space Exploration, 1966.
17. Clark, B. and Graybiel, A., "Factors Contributing to the Delay in the Perception of the Oculogravic Illusion", in American Journal of Psychology, Vol. 79, September 1966.
18. Billingham, J., "Physiology of Man in the Space Environment", in Manned Spacecraft - Engineering Design and Operation, NASA MSC, 1964.
19. Guignard, J. C., "Vibration", in A Textbook of Aviation Physiology, 1965.
20. Hoffman, D. B. and McGaughy, R. E., Centrifugally Obtained Artificial Gravity, 4 April 1969.
21. Nadel, A. B., "Vibration", in Unusual Environments and Human Behavior, 1963.
22. Graybiel, A., Kennedy, R. S., and Wood, C. D., "Comparison of Effectiveness of Some Antimotion Sickness Drugs Using Recommended and Larger than Recommended Doses as Tested in the Slow Rotation Room", in Aerospace Medicine, Vol. 37, March 1966.
23. Newsom, B. D. and Brady, J. F., "Observations on Subjects Exposed to Prolonged Rotation in a Space Station Simulator", in The Role of the Vestibular Organs in the Exploration of Space, January 1965.
24. Brady, J. F., French R. S. and Newsom, B. D., "Adaptation to Prolonged Exposures in the Revolving Space Station Simulator", in Aerospace Medicine, Vol. 37, August 1966.
25. Loret, B. J., "Optimization of Space Vehicle Design With Respect to Artificial Gravity", in Aerospace Med., Vol. 34, 1963.

26. Graybiel, A., Kerr, W. A. and Barthy, S. H., "Thresholds of the Semi-Circular Canals as a Function of Angular Acceleration", in American Journal of Psychology, 1949.
27. Clark, B. and Stewart, J. D., "Perception of Angular Acceleration about the Yaw Axis of a Flight Simulator: Thresholds and Reaction Latency for Research Pilots", presented at Aerospace Medical Association Meeting, Atlantic City, N. J., April 9-12, 1962.
28. General Dynamics/Convair Document GDC-DBD67-002-12, Effect of Instability During Rotation on Physiologic and Perceptual - Motor Function, June 1968.
29. Bartley, S. H., Graybiel, A., Hupp, D. and Kerr, W. A., "Threshold of Stimulation of the Horizontal Semi-Circular Canals in Man with Particular Reference to the Significance of the First Derivative of Angular Acceleration as a Stimulus", Naval School of Aviation Medicine, Pensacola, Fla., 12 March 1947.
30. Howard, P., "The Physiology of Positive Acceleration", in A Textbook of Aviation Physiology, 1965.
31. Lout, B. J., Optimization of Manned Orbital Satellite Vehicle Design with Respect to Artificial Gravity, Aerospace Medical Research Laboratories, December 1961.
32. Dole, S. H., "Design Criteria for Rotating Space Vehicles", Rand Corp., 18 October 1960.
33. Krylov, Y. V., "Function of the Human Acoustic Analyzer after Exposure to Coriolis Accelerations of Different Values", Izvestia Akademii Nauk SSSR, Seriya Biologicheskaya (News of the Academy of Sciences USSR, Biology Series), No. 3, May-June, 1966.

APPENDIX A

DICTIONARY OF TERMS RELATED TO PHYSIOLOGY AND A ROTATING ENVIRONMENT

acuity. keenness of perception.

arrythmia. alteration in rhythm of heartbeat either in time or force.

anthropometry. the study of human body measurements, especially on a comparative basis.

biodynamics. effects of exposure of the human body to forces including the physiological changes that take place in response to the imposition of these forces.

blackout. temporary loss of central vision, wherein a person is sightless but fully conscious.

cardiovascular. relating to the heart and blood vessels.

cardiovascular reactivity. the response and function of the heart and blood vessels to various types of stress, such as acceleration, exercise, heat and cold.

centrifuge. a large motor driven apparatus with a long rotating arm at the end of which human and animal subjects or equipment can be revolved at various speeds to simulate very closely the prolonged accelerations encountered in high performance aircraft, rockets, manned missiles and spacecraft.

Coriolis force. that force resulting from linear motion in a rotating environment and acting perpendicular to the linear motion vector and

the rotation vector which are perpendicular to one another.

cupula. gelatinous device located in ampulla of semi-circular canal, the deviation of which is caused by pressure of the endolymph resulting from angular acceleration in the plane of the canal.

d-amphetamine. a drug which stimulates the central nervous system and has been used successfully to sustain human proficiency. Known commercially as Dexedrine.

dyspnea. difficult or labored breathing.

EKG (ECG). abbreviation for electrocardiogram, a graphic record of the heart's action traced by an electrocardiograph.

endolymph. fluid of the semi-circular canals.

ergometer. an instrument for measuring muscular work.

fatigue. the temporary loss of power to respond induced in a sensory receptor or motor end organ by continued stimulation

g force. force (inertial force) produced by accelerations or by gravity, expressed in gravitational units. One g is equal to the pull of gravity on the earth's surface (32.2 ft/sec^2) and thus refers to one's normal resting weight. See negative g, positive g.

gravireceptors. highly specialized nerve endings and receptor organs located in skeletal muscles, tendons, joints, and in the inner ear. Gravireceptors furnish information to the brain with respect to body position, equilibrium, the direction of gravitational forces, and the sensation of "up" and "down".

greyout. temporary fading of peripheral vision.

hemodynamics. a branch of physiology concerned with the movement of blood through the heart and blood vessels, particularly with the pressure, volume, flow, and resistance relationships within the cardiovascular system.

hydrostatic effects. the pressures exerted by a column of liquid (water, blood, etc.) under normal gravitational conditions on the surface of the earth or in a gravitational field during an acceleration. In zerogravity a column of liquid is weightless and these pressures cease to exist.

locomotion. the ability to move from place to place.

malaise. a vague feeling of uneasiness.

metabolic. relating to the sum of the processes in building up and destruction of protoplasm incidental to life.

motility. capability of movement.

nausea. feeling of sickness.

negative g. the opposite of "positive g". In a gravitational field or during an acceleration the human body is so positioned that the force of inertia acts on it in a foot-to-head direction, i.e., the headward inertial force produced by a footward acceleration. Example: flying an outside loop in the upright seated position. Standing on one's head equals one negative g.

nystagmus. a rapid, involuntary oscillation of the eyeballs (as from dizziness).

ocular. done or perceived by the eye; relating to the eye.

oculogravic illusion. illusion of tilt during rotation.

oculogyral illusion. apparent rotation opposite in direction to the actual rotation, especially during periods of angular acceleration.

otoliths. calcareous concretions of the vestibular system which sense linear acceleration, two in number (utricle and saccule), positioned perpendicular to one another.

positive g. in a gravitational field or during an acceleration, the human body is normally so positioned that the force of inertia acts on it in a head-to-foot direction i.e., the footward inertial force produced by a headward acceleration. Example: pulling out from an airplane dive in the upright seated position, or during a turn. Standing upright on the ground equals one positive g.

proprioceptive stimulation. stimulation originating within the deeper structures of the body (muscles, tendons, joints, etc.) for sense of body position and movement and by which muscular movements can be adjusted with a great degree of accuracy and equilibrium can be maintained.

psychomotor ability. of or pertaining to muscular action ensuing directly from a mental process, as in the coordinated manipulation of an airplane's stick, rudder bar, and throttle.

pallor. paleness.

pulmonary. relating to the lungs

reaction latency. time between beginning of the acceleration and the subject's response.

semi-circular canals. three, tiny, fluid-filled arcs, located in the vestibular system, placed approximately 90° to each other so that angular acceleration in any axis can be sensed.

spatial disorientation. pertaining to all incidents in which the subject fails to appreciate correctly, or is uncertain of, the attitude or position, or changes in the attitude or position, of himself (and his spacecraft) with respect to some reference.

subgravity. a gravitational environment that is less than the normal gravitational influence on the earth's surface; less than 1 g.

tachycardia. very rapid action of the heart.

transverse g. the inertial force produced by an acceleration acting across the body, perpendicular to the long axis of the body, as in a chest-to-back direction. For example, the mild transverse accelerations during take-offs and landings in the upright seated position, and when in a prone or supine position during a pullout or turn. See positive g and negative g.

ventilation. biologically the aeration of the lungs and blood by breathing. The inhalation and exhalation of air in the process of respiration.

vertigo. illusory sense of rotation.

vestibular system. sensory apparatus located in the bony structure of the skull near each ear, composed of the semi-circular canals and otoliths to sense motion for purpose of maintaining equilibrium of body.

weightlessness. the weight of an object is the result of a gravitational force acting on a supported mass. Any object deprived of support and freely falling in a vacuum is weightless. An orbiting satellite above the earth's atmosphere is a special case of "free fall" and is also weightless. Within the earth's atmosphere it is possible, with powered flight, to fly a parabolic curve which in part is similar to the curve for free fall, creating a weightless condition. In this case, both inertial and aerodynamic forces are utilized to counterbalance the gravitational attraction of the earth. See zerogravity.

zerogravity. the complete absence of gravitational effects, existing when the gravitational attraction of the earth (or other spatial body) is exactly nullified or counterbalanced by inertial force. For example, during the proper parabolic flight-path of high-performance aircraft, or an orbiting satellite. See weightlessness.

APPENDIX B

PHYSIOLOGICAL TOLERANCE TO LINEAR ACCELERATION ABOVE 1g

Centrifuges, slides, aircraft, etc., have provided considerable information on man's ability to function in an environment where he is subjected to linear accelerations greater than 1g. Here is where man begins to have real physiological problems. This appendix is a brief presentation of some of the adverse effects. The nomenclature used is shown in Figure B-1.¹

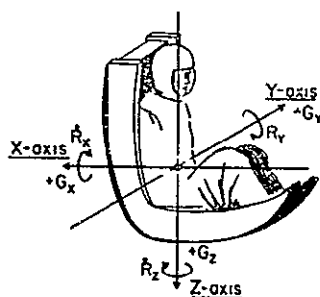

(Body Fluids, Heart Displacement, With Respect to Skeleton)
Linear Acceleration Modes

Description of Heart Motion

<u>Actual</u>	<u>Other Descriptions</u>		<u>Symbol</u>	<u>Unit</u>	
Towards spine	Eye balls-in	Chest to back	Backward facing	$+G_x$	g
Towards sternum	Eye balls-out	Back to-chest	Forward facing	$-G_x$	g
Towards feet	Eye balls down	Head-to foot	Headward	$+G_z$	g
Towards head	Eye balls up	Foot to-head	Footward	$-G_z$	g
Towards left	Eye balls left	————	Rightward	$+G_y$	g
Towards right	Eye balls right	————	Leftward	$-G_y$	g

$$NG = \frac{a}{g} = N_1 G_x + N_2 G_y + N_3 G_z$$

$$N^2 = N_1^2 + N_2^2 + N_3^2$$

Angular Acceleration Modes

Acceleration about X-axis (roll axis)	R_x	rad/sec ²
Acceleration about Y-axis (pitch axis)	R_y	rad/sec ²
Acceleration about Z-axis (yaw axis)	R_z	rad/sec ²

(Angular acceleration is positive or negative by right hand rule)

FIGURE B-1. Physiological Acceleration Nomenclature

Just above 1g undesirable effects on man's biomedical function begin to appear. Some of the cardiovascular problems are pooling of blood in the lower parts, decrease in blood pressure and increase in heart rate.² When the positive longitudinal acceleration ($+G_z$) reaches 4 g's, some capillaries in the feet become ruptured. In over 2000 $+G_x$ runs made at the Aerospace Medical Research Department, U. S. Naval Air Development Center³, between 1961 and 1965, cardiac arrhythmia occurred with an incidence of just a little more than 1%; tachycardia was noted only 19 times during peaks of 5 to 6 g's. The same tests revealed that shortness of breath occurred 29 times between peaks of 6 to 9 g's. During over 2000 $+G_z$ runs, at the same place, dyspnea was noted only infrequently.

High acceleration can also cause chest pain, difficulty of motion and visual problems.⁴ For a negative transverse acceleration ($-G_x$) of -4 g's it is impossible for one to hold his head up without a restraint system, and at -5 g's pain occurs in the arms and legs. Higher values cause blurring of vision, as do high values of $+G_x$.

TABLE B-1. Human Tolerance to Accelerative Stress (N=1000)

Criterion	Mean Threshold in g Units	Standard Deviation	Range
Greyout	4.1	±0.7	2.2 - 7.1
Blackout	4.7	±0.8	2.7 - 7.8
Unconsciousness	5.4	±0.9	3.0 - 8.4

Table B-1 presents some endpoints for tolerance to $+G_z$.⁵ The number of subjects tested was 1000. Values obtained in the tests at the U. S. Naval Air Development Center closely agree with these. Stoll⁶, using

these criteria as endpoints, determined the tolerance levels and the duration of tolerance (Figure B-2).

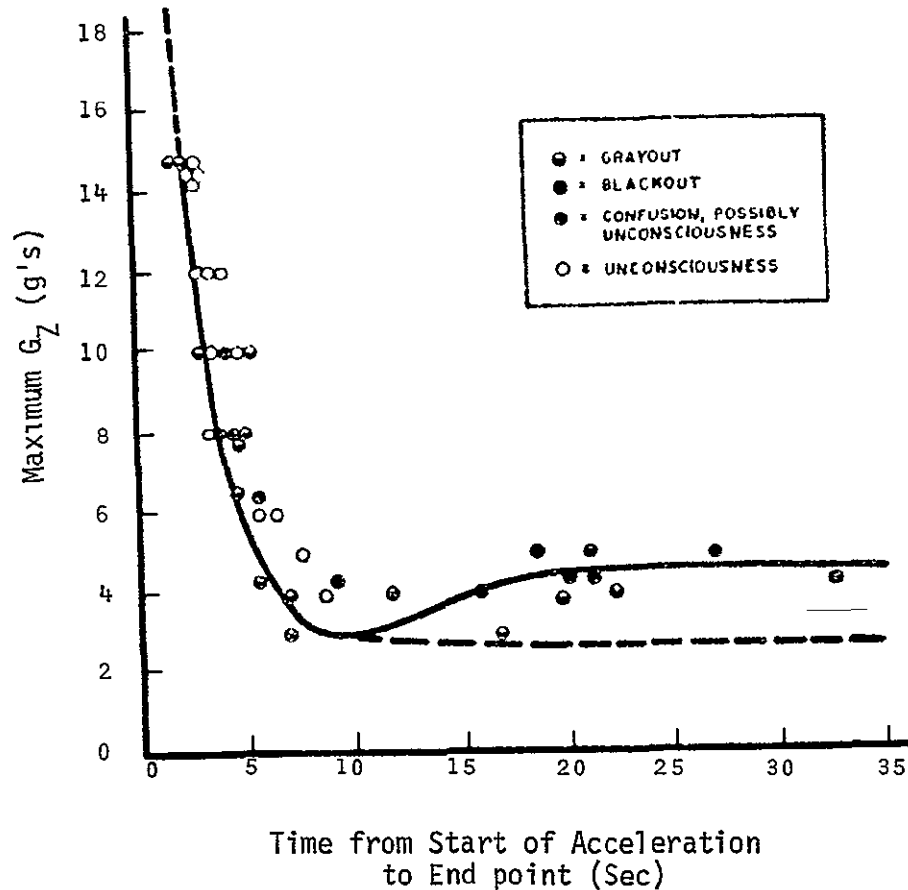

FIGURE B-2. Human Tolerance to $+G_z$

In Figure B-3 results of an experiment are summarized in which a group of healthy pilots attempted to endure high values of $+G_x$, $-G_x$ and $+G_z$ for long periods of time using the Ames restraint system. Not only did this system provide restraints for the arms, feet and head, it also provided physiological G protection. Although the time tolerances are unusually

outstanding, it must be remembered that physiological G protection was provided, which points out the fact that man's ability to live in an adverse linear acceleration environment can be enhanced by protective devices.

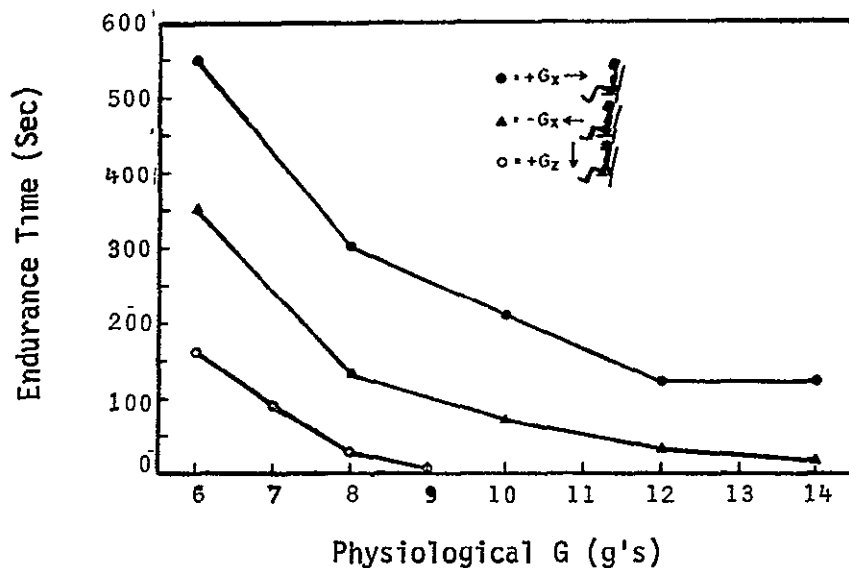

FIGURE B-3. Endurance Time for Highly Motivated Pilots with Physiological G Protection

REFERENCES:

1. Chambers, R. M. and Wray, W. S., "Pilot Performance During Centrifuge Simulations of Acceleration Environments", in Solution to Navy Problems Through Advanced Technology, Naval Air Development Center, Johnsville, Penna., 1963.
2. Howard, P., "The Physiology of Positive Acceleration", in A Textbook of Aviation Physiology, Oxford, Pergamon Press, Ltd., 1965.
3. Oleynik, R. J., Patton, R. M. and York E., Human Acceleration Experience at the Aerospace Medical Research Department, U. S. Naval Air Development Center - Johnsville - 1 January 1961 to 30 December 1965, 31 May 1967.
4. Webb, M. G., "Endpoints for Acceleration Tolerance on the Centrifuge", in Bio-Assay Techniques for Human Centrifuges and Physiological Effects of Acceleration, AGARD, Paris, France, 1961.

5. White, W. J., "Visual Performance Under Gravitational Stress", in Gravitational Stress in Aerospace Medicine, 1961.
6. Stoll, A. M., "Human Tolerance to Positive G as Determined by Physiological Endpoints", U. S. Naval Air Development Center, Johnsville, Penna., 30 August 1955.