

## **General Disclaimer**

### **One or more of the Following Statements may affect this Document**

- This document has been reproduced from the best copy furnished by the organizational source. It is being released in the interest of making available as much information as possible.
- This document may contain data, which exceeds the sheet parameters. It was furnished in this condition by the organizational source and is the best copy available.
- This document may contain tone-on-tone or color graphs, charts and/or pictures, which have been reproduced in black and white.
- This document is paginated as submitted by the original source.
- Portions of this document are not fully legible due to the historical nature of some of the material. However, it is the best reproduction available from the original submission.



MCR-71-62

Final Report

SPACE SHUTTLE PROPULSION SYSTEMS  
ON-BOARD CHECKOUT AND  
MONITORING SYSTEM DEVELOPMENT STUDY

VOLUME I - SUMMARY

March 1971

Approved by



R. W. VandeKoppel  
Program Manager

Contract NAS8-25619  
DRL No. 187 Rev. A  
Line Item No. 3

Prepared for

George C. Marshall Space Flight Center  
Marshall Space Flight Center, Alabama

MARTIN MARIETTA CORPORATION  
Denver, Colorado 80201

## FOREWORD

This report was prepared by the Martin Marietta Corporation under Contract NAS8-25619, "Space Shuttle Propulsion Systems On-board Checkout and Monitoring System Development Study," for the George C. Marshall Space Flight Center of the National Aeronautics and Space Administration. The report is comprised of four volumes:

- Volume I - Summary
- Volume II - Propulsion System  
Definition and Criteria
- Volume III - OCMS Criteria  
and Concept
- Volume IV - Appendices

CONTENTS

	<u>Page</u>
Foreword . . . . .	ii
Contents . . . . .	iii and iv
Abstract . . . . .	v thru x
I. Introduction . . . . .	I-1 and I-2
II. Technical Approach . . . . .	II-1 thru II-12
III. Conclusions and Recommendations . . . . .	III-1
A. OCMS Approach . . . . .	III-1
B. Sensor Technology Recommendations . . . . .	III-5
C. Propulsion Recommendations . . . . .	III-7 and III-8
IV. Program Participants . . . . .	IV-1 and IV-2
Appendix A - Bibliography . . . . .	A-1 thru A-11
Appendix B - Terminology . . . . .	B-1 thru B-3
 <u>Figure</u>	
II-1 Technical Approach . . . . .	II-4
II-2 Mission Phases . . . . .	II-5
II-3 Orbiter Propulsion . . . . .	II-6
II-4 Booster Propulsion . . . . .	II-7
II-5 Main Engine . . . . .	II-9
II-6 Vehicle Data Management System . . . . .	II-10

### ABSTRACT

This final report describes the effort completed by the Martin Marietta Corporation under Contract NAS8-25619, "Space Shuttle Propulsion Systems On-Board Checkout and Monitoring System Development Study". The work was comprised of an evaluation of the Space Shuttle main, auxiliary, and airbreathing propulsion systems' functional, performance and durability requirements to define checkout and monitoring criteria, and to evolve an approach for performing the functions of preflight checkout, performance monitoring, fault isolation, emergency detection, display, data storage, post flight evaluation, and maintenance retest.

BACKGROUND - The Space Shuttle program objective of providing an economical space transportation system requires maximum reuse of components as well as minimal time, labor and equipment for servicing and checkout between flights. A requirement for high mission success probability also is inherent in this objective. Recent technology has demonstrated the feasibility of meeting these requirements by incorporating on-board checkout and performance monitoring capability. The propulsion systems (particularly the main engines) are pacing items in the Space Shuttle program; therefore, the checkout and performance monitoring techniques, data management requirements, and sensor requirements must be defined for incorporation in the basic propulsion system designs. This study has been conducted to define an approach and establish procedures, methods and design requirements for implementation.

SCOPE - The intent of the program was to develop analytical techniques and apply them in defining an approach for accomplishing the checkout and performance monitoring functions of the Space Shuttle propulsion systems. Program guidelines were:

- . Operational Space Shuttle program.
- . Booster and Orbiter, both recoverable and reusable.
- . Main, auxiliary and airbreathing propulsion systems.
- . No inflight maintenance; 10 working day turnaround between flights.
- . No telemetry data link.
- . Baselined mission and vehicle configuration.

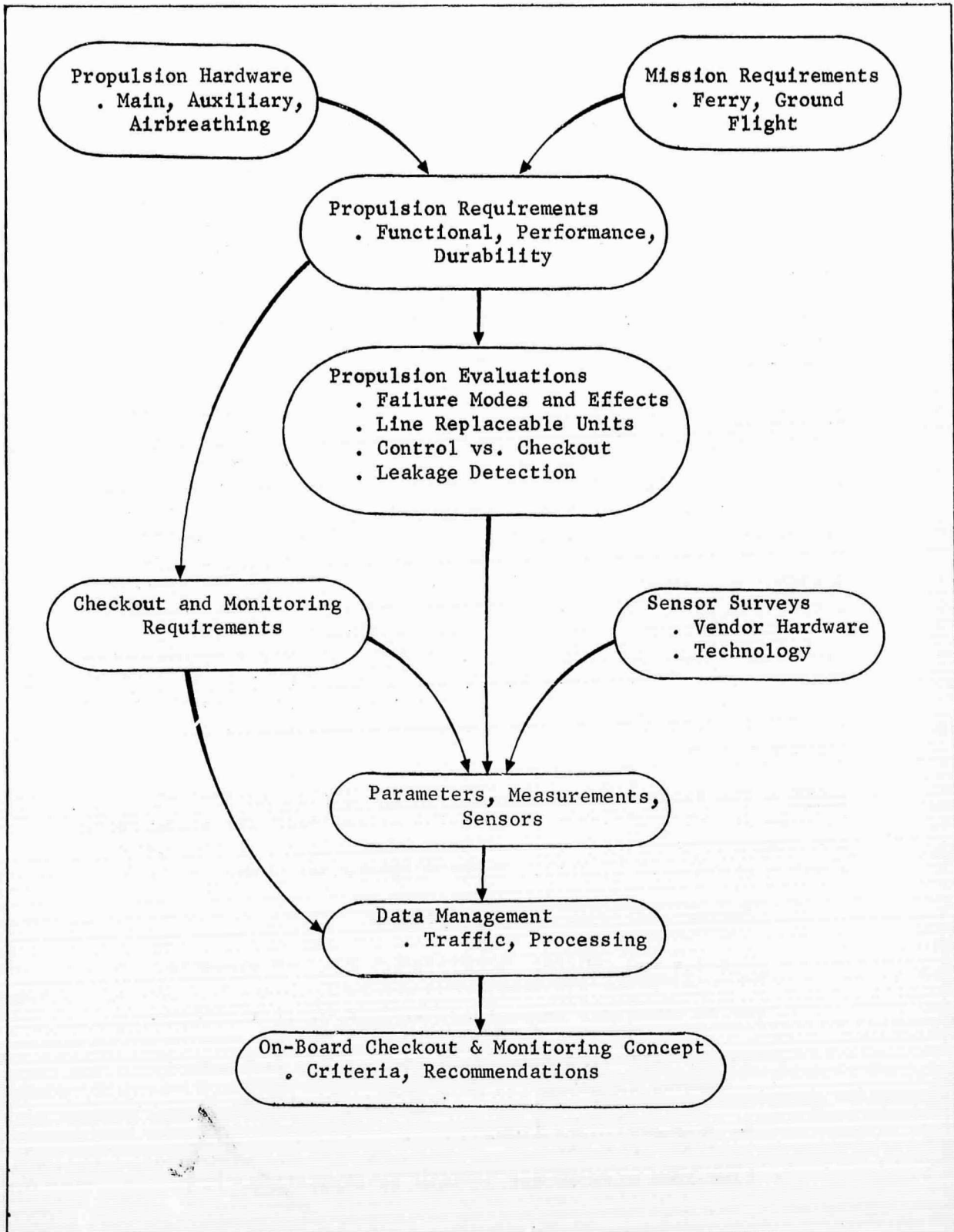
ABSTRACT (Continued)

STUDY APPROACH

ABSTRACT (Continued)

CONCLUSION - The result of this study indicates that the on-board checkout and monitoring approach is technically feasible, will improve system reliability, and will simplify ground operations. The implementation of the function must be controlled by a requirements standard, to ensure that the necessary approach and methodology are utilized, and so that the required degree of propulsion and electronics systems integration is accomplished. The basic design of the propulsion systems must incorporate the checkout and monitoring functional requirements, including sensors.

METHOD - The technical approach that was developed and used to meet the program objectives is illustrated on the facing page. Key aspects of these study elements are discussed in the remainder of this abstract.

BASELINING - A baseline vehicle configuration with main, auxiliary, and airbreathing propulsion systems on the booster and the orbiter was selected. The propulsion systems, subsystems, assemblies and components were defined on functional schematics. Components were identified by selecting from Space Shuttle Phase B Program definitions and from specific Saturn components. The booster had 14 staged combustion oxygen/hydrogen main engines, 7 hydrogen-fueled turbofan engines, and 38 hydrogen/oxygen separation and attitude control thrusters; a total of 1303 booster propulsion components were defined. The orbiter had 2 main engines, 3 airbreathing engines, 39 thrusters, and a total of 625 propulsion components.

A space station resupply mission was selected. Ferry, ground and flight operations were defined by activity timelines for the 17 sequential phases of the mission.

PROPULSION REQUIREMENTS - The propulsion configuration was related to the mission requirements by defining the propulsion performance, functional, and durability requirements of the mission, including operational interfaces with ground systems.

PROPULSION EVALUATIONS - Failure modes and effects were analyzed at the propulsion component level. This analysis provided visibility to:

- Hazard warning functions;
- Candidate parameters, measurements and sensors;
- Single point failures and excessive redundancy.

ABSTRACT (Continued)

Line replaceable units (propulsion elements which could be fault-isolated inflight and replaced in maintenance operations) were identified, 929 on the booster and 322 on the orbiter. The propulsion control sensors are not included in these quantities.

Diagrams illustrating the sequence and logic involved in propulsion system control functions (start, modulation, shutdown, etc.) were prepared.

Leakage sources and consequences were determined, and a recommended approach was identified for performing the functions of leakage detection and monitoring for hazardous concentration levels of hydrogen gas.

PARAMETERS, MEASUREMENTS, SENSORS - The propulsion evaluations resulted in candidate parameters for the checkout and monitoring function. Recommended measurements were compiled and the associated sensor criteria identified by determining such requirements as accuracy, rate, and environment. Sensor availability was investigated by surveying 93 sensor vendors. In-work sensor technology was also evaluated for potential applications; the following areas were recommended for further sensor technology work:

- Leak detection - ultrasonics.
- Bearing wear detection - acoustic emission and deflection.
- Ignition detection - light detectors, ultrasonics.
- Differential pressure transducers - small  $\Delta P$ 's in high pressure systems.

The measurement definitions (which maximized usage of control functions) resulted in the following measurement quantities:

	<u>Booster</u>	<u>Orbiter</u>
Main Engines (14 booster, 2 orbiter engines)	1274	198
Airbreathing Engines (7 booster, 3 orbiter engines)	287	123
Other Propulsion	1569	1027
TOTAL	<u>3130</u>	<u>1348</u>

ABSTRACT (Continued)

By incorporating checkout and monitoring function requirements in the basic designs of the propulsion components and subsystems, these quantities could be reduced.

DATA MANAGEMENT - The baseline vehicle electronics included the following:

- Central Computer Complex
- Vehicle Data Bus
- Dedicated Peripheral Computers (main and airbreathing engine controllers)
- Displays and Controls
- Recorders.

The vehicle data bus was configured to provide maximum flexibility and minimum remote hardware, at the expense of relatively high data bus rates. Propulsion system vehicle data bus traffic and central computer processing loads were as follows for peak periods:

	<u>Booster</u>	<u>Orbiter</u>
Data Rate, Bits/Second	430,000	64,000
Processing, Seconds/Second	0.76	0.11

Also, during main engine start the data rate across the engine controller/vehicle data bus peaked at 10,600 Bits/second.

ONBOARD CHECKOUT AND MONITORING CONCEPT - Criteria for functional capability and usage in the following areas were developed to establish the degree of on-board checkout, monitoring and evaluation functions:

- Preflight checkout and monitoring
- Inflight monitoring
  - Ready-to-start condition verification
  - Emergency detection
  - Fault detection
  - Fault isolation
  - Real time trend analysis
  - Operating histories
  - Performance data

ABSTRACT (Continued)

- Post flight evaluation
- Maintenance retest
- Control and checkout processing integration

Key elements of these criteria include:

- Preflight checkout of mechanical elements is limited to verification of correct initial conditions for start.
- Inflight functions incorporate maintenance and performance parameters as well as flight safety and mission success parameters.
- Evaluation of flight-recorded data will be accomplished by the on-board computer complex after landing to generate maintenance printouts, trend analysis results, and performance data records.
- The on-board checkout capabilities will be utilized in maintenance operations for verification retest of replaced propulsion elements.
- Control, checkout and monitoring will be treated as a single function for purposes of computer processing.
- Only that information necessary for crew evaluation or action will be displayed.

RECOMMENDATIONS - General recommendations pertaining to the implementation of the propulsion checkout and monitoring function include:

- Incorporate the function into the basic propulsion subsystem and component design.
- Ensure thorough technical coordination between the propulsion and avionics disciplines.
- Minimize number of measurements and complexity of sensors by analyzing requirements of and alternate techniques for each candidate parameter.
- Integrate the propulsion control function with the checkout and monitoring function.
- Conduct further sensor technology work in the areas of leak detection, bearing wear detection, ignition detection, and accurate measurement of small differential pressures in high pressure systems.

A primary objective of the Space Shuttle program is to provide an economical space transportation system. To meet this objective, the program definition studies have evolved a concept which approaches an airliner configuration and mode of operations - a vehicle that can safely and reliably perform a mission, return to the base, and be readied quickly for the next flight.

Implementing this concept requires a departure from many of the ground equipment and flight hardware design approaches and operational procedures which are used on existing launch vehicles. For example, contemporary launch vehicles require many months of preflight checkout and testing operations to ensure flight readiness. A significant amount of test equipment and labor is required to perform these operations; much of the time is spent in attaching the ground equipment to the vehicle, performing tests, and then removing the test hardware. A significant step toward accomplishing the Space Shuttle program objective could therefore be realized by reducing the time, labor and equipment required to service and check out the operational Space Shuttle vehicles between flights.

Recent technology has demonstrated the feasibility of approaching this goal by incorporating on-board checkout and performance monitoring capability. For example, experience is being gained from advanced aircraft operational performance data gathering and analysis systems, such as the Airborne Integrated Data Systems (AIDS) for commercial aircraft and the Malfunction Detection Analysis and Recording (MADAR) system for the C-5A. These systems characteristically monitor from twenty to four hundred aircraft parameters, and process the data to extract maintenance action requirements and establish flight profile analyses. As another example, five years of on-board checkout technology work at the Martin Marietta Corporation culminated in 1970 with the delivery to NASA of a general purpose, flight packaged on-board checkout system. This hardware is currently being used by NASA to develop further on-board checkout concept technology.

This on-board checkout technology background together with the Space Shuttle requirements and characteristics have lead into Contract NAS8-25619, "Space Shuttle Propulsion Systems On-board Checkout and Monitoring System Development Study." Since the propulsion systems (particularly the main engines) are pacing items in the Space Shuttle program and require early development, the establishment of checkout and performance monitoring techniques, data management requirements, and sensor technology requirements must be accomplished early enough to allow the criteria to be incorporated in the basic design. This study has been conducted to define an approach and to establish the candidate procedures, methods and design requirements by which the approach could be implemented.

This final report presents the work accomplished under the subject contract. The report is comprised of four volumes. Volume I, Summary, includes an abstract which presents the highlights of the approach and findings; an elaboration of the technical approach; and the conclusions and recommendations. Volume II, Propulsion System Definition and Criteria, defines the baseline model used in the study and presents the propulsion systems criteria for checkout and monitoring. Volume III, OCMS Criteria and Concept, defines the propulsion systems' on-board checkout and monitoring requirements, measurement and sensor requirements, and presents the on-board checkout and monitoring concept. Volume IV, Appendices, contains significant supporting data produced in the study.

## A. OBJECTIVE AND SCOPE

The objective of Contract NAS8-25619, "Space Shuttle Propulsion Systems On-board Checkout and Monitoring System Development Study," was stated in the Contract Scope of Work as follows:

"Objective: To define an onboard, checkout, inflight monitoring, emergency detection and post flight evaluation system for the Space Shuttle Propulsion systems. This system should be consistent with an overall vehicle approach and optimize for a minimum of operating personnel required for the various phases of Launch and Support Operations. The defined approach should accomplish the goal of assuring an acceptable probability of mission success with requisite probability of safe return. Additionally, the approach should be consistent with the constraints of minimum onboard weight and system complexity. A study should establish the checkout, monitoring and evaluation approach which defines the degree to which the function of preflight checkout, subsystem and/or components ready to start condition, inflight performance monitoring, fault isolation, diagnosis, emergency detection, display, data storage, post flight evaluation and maintenance will be performed. This study will include the main, auxiliary and air breathing propulsion systems."

Certain guidelines were used in the study to ensure applicability of the results to the Space Shuttle program, and to provide a set of constraints to bound the study. These constraints and guidelines included the following:

1. Pertinent Space Shuttle Phase B program definitions and requirements were to be incorporated.
2. The study was directed specifically at the operational Space Shuttle program, rather than the development test phase.
3. Inflight maintenance of the Space Shuttle vehicle was excluded; all maintenance was to be performed in ground operations, with a total time allowed for turnaround between flights of 14 calendar days (10 working days).

4. A telemetry data link (for checkout and monitoring) between the Space Shuttle vehicle and ground stations or a space station was excluded.

5. The study was to be conducted on a selected vehicle configuration (including the booster and orbiter propulsion system configurations) and a defined mission.

6. In-flight fault isolation to the line replaceable unit (LRU) level was considered a requirement, where an LRU is a propulsion element that can be removed, replaced and verified during maintenance without deleteriously impacting the Space Shuttle turnaround time.

The conduct of this study was in compliance with the Contract Statement of Work, and the subtasks presented therein were accomplished. The general item in the Statement of Work which read, "In performing this task proper recognition must be given to the demands and requirements of other space shuttle systems such as simultaneous demands for on-board capability" was not expressly met by providing numerical data on the vehicle data bus traffic and processing loads imposed by other subsystems during periods of peak propulsion data traffic. Such numerical data were not available for the baseline data management system used in this study. Also, mathematical models for processing of the propulsion data were deleted as a required product of the study.

## B. APPROACH

The technical approach used in conducting the study is illustrated in Figure I-1. The work was organized in two categories. Task I consisted of a definition of the propulsion systems, their functional, performance, and durability requirements, and analyses to establish the propulsion checkout and monitoring criteria. Task 2 was comprised of evaluations to establish the checkout and monitoring requirements for the propulsion systems, definition of measurements and sensors, and evolution of the approach for on-board checkout and monitoring.

As indicated in Figure II-1, the study used a Design Reference Model (DRM) approach. The DRM was comprised of a vehicle configuration (booster and orbiter) with main, auxiliary and airbreathing propulsion systems, baseline vehicle electronics including a data bus and central computer complex, and a reference mission. It was necessary, in forming an adequate base for the study, to define the propulsion systems and the reference mission in detail. The propulsion systems were defined to the components level (there are a total of 1928 components in the booster and orbiter propulsion systems) and the mission in activity timelines for each of the 17 mission phases. Schematic illustrations of the reference mission, booster and orbiter propulsion systems, main engine, and vehicle data management system are presented in Figure II-2 through Figure II-6. The Design Reference Model is described in detail in Volume II.

The functional requirements of each propulsion subsystem were then established. This effort provided visibility to the operational status and interfacing functions of the propulsion subsystems during each mission phase. This information is presented in Volume II, Chapter III.

A key analytical tool used in the study was the Failure Modes and Effects Analyses (FMEAs). The failure modes for each propulsion component were established, and the effect of these failures on the propulsion system, vehicle, mission and crew safety were identified. The failure modes were evaluated to determine candidate failure detection methods. The FMEA results were used in subsequent elements of the study to aid in establishing propulsion checkout and monitoring requirements, to define candidate parameters, measurements and sensors, to define hazard warning functions, to identify areas of excessive or inadequate redundancy in the propulsion systems, and also

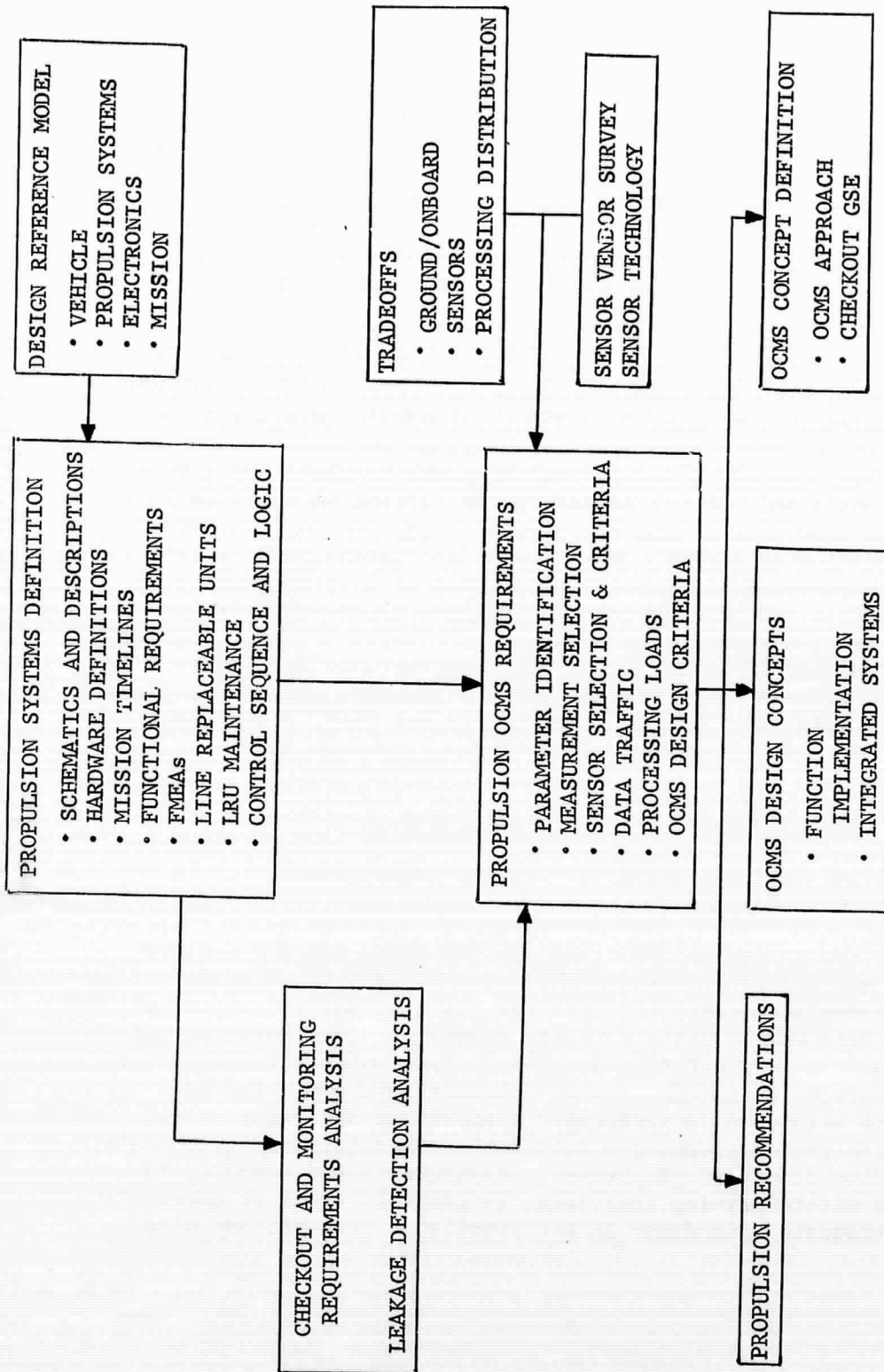

FIGURE II-1 TECHNICAL APPROACH

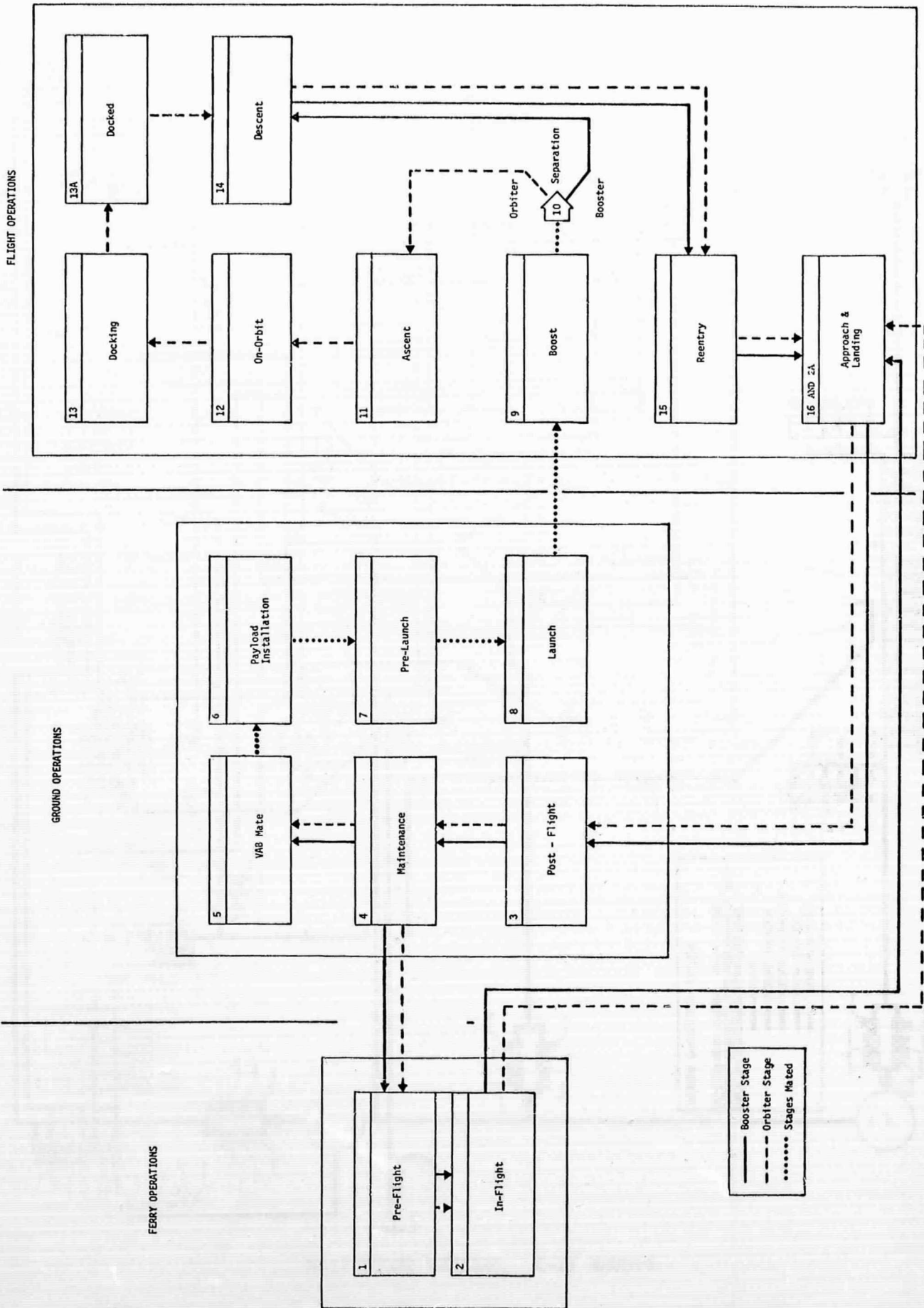

FIGURE II-2 MISSION PHASES

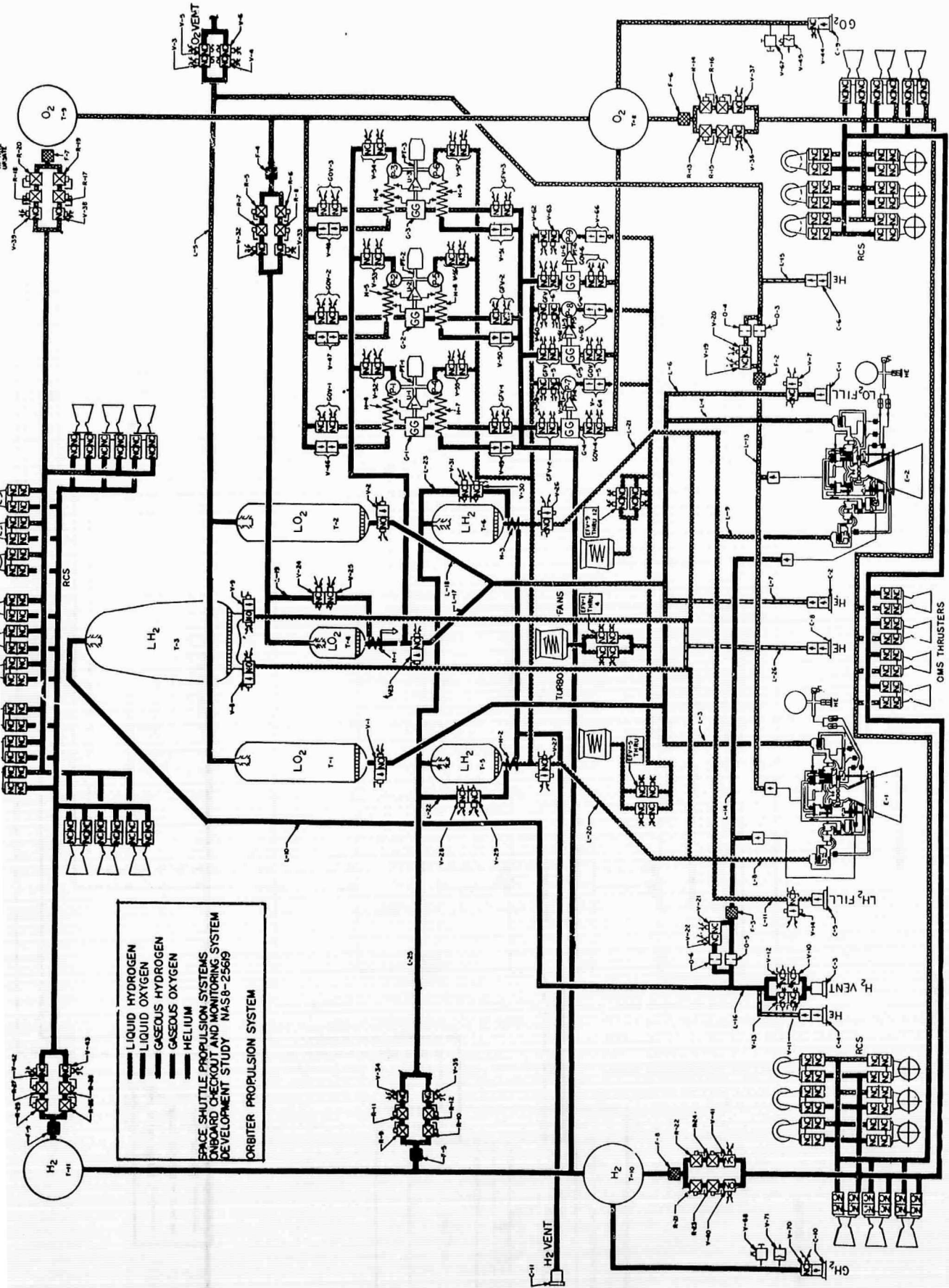
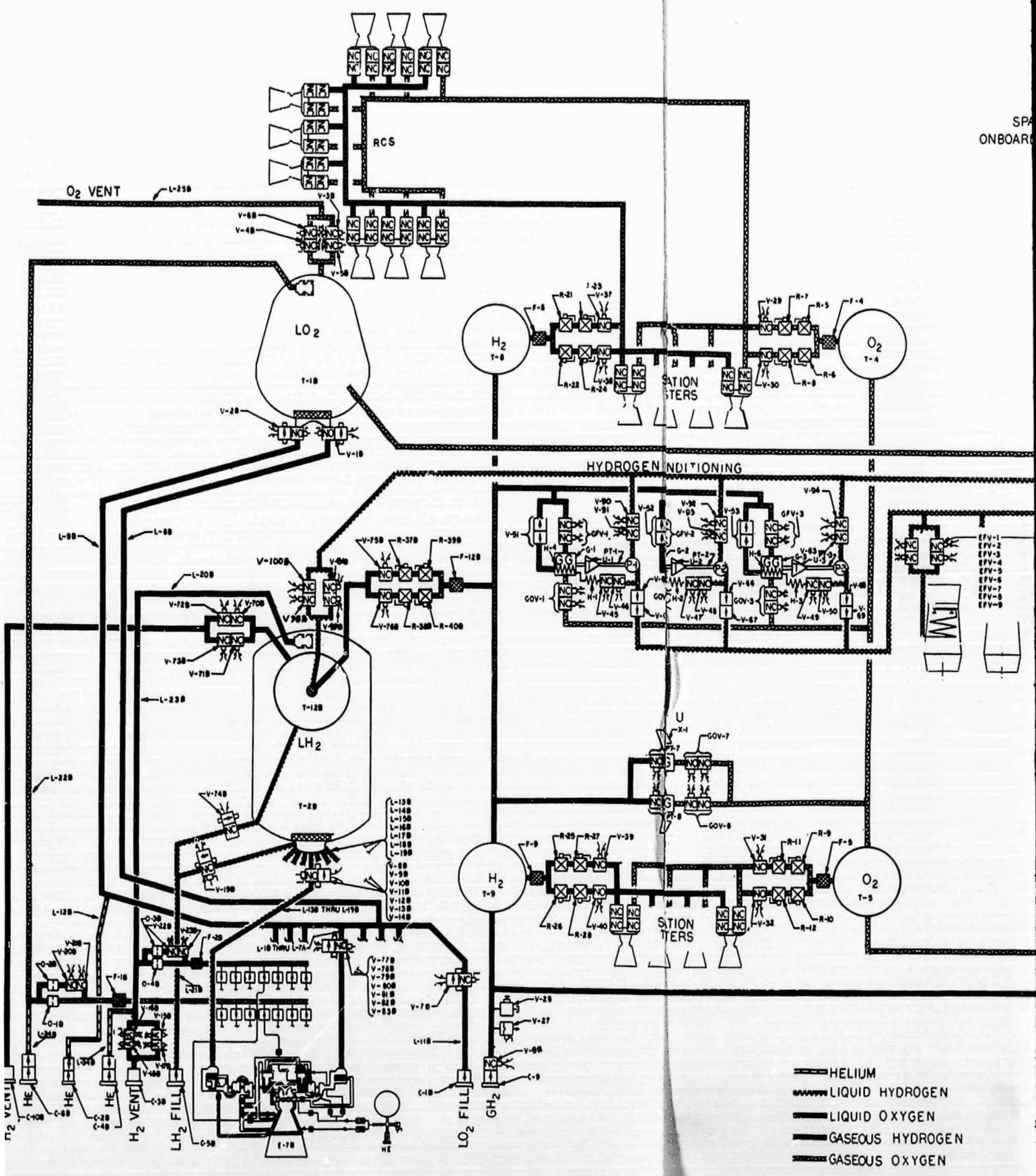
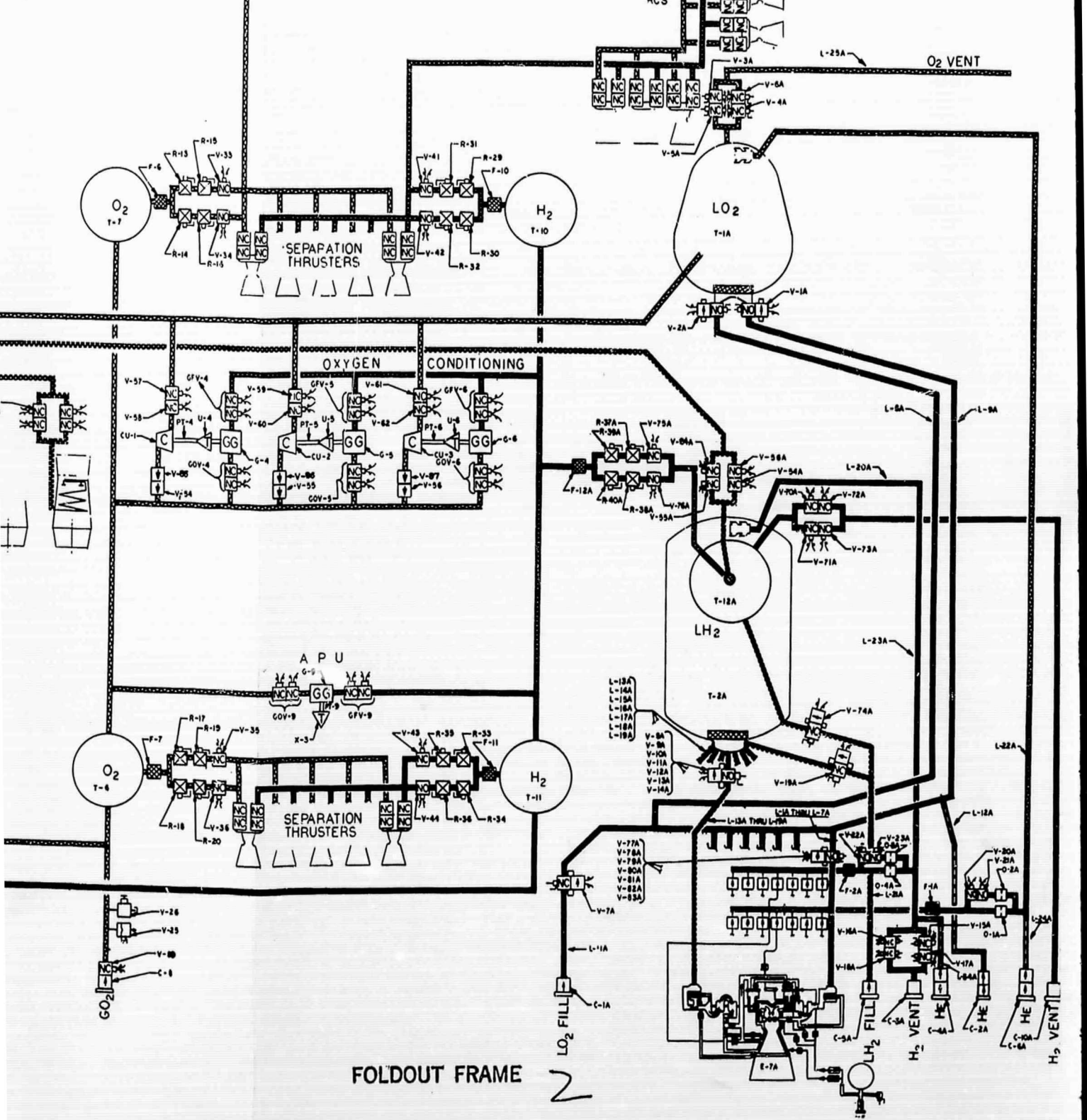

FIGURE II-3 ORBITER PROPULSION

SPA  
ONBOARD



SYSTEMS



FOLDOUT FRAME

FIGURE II-4 BOOSTER PROPULSION

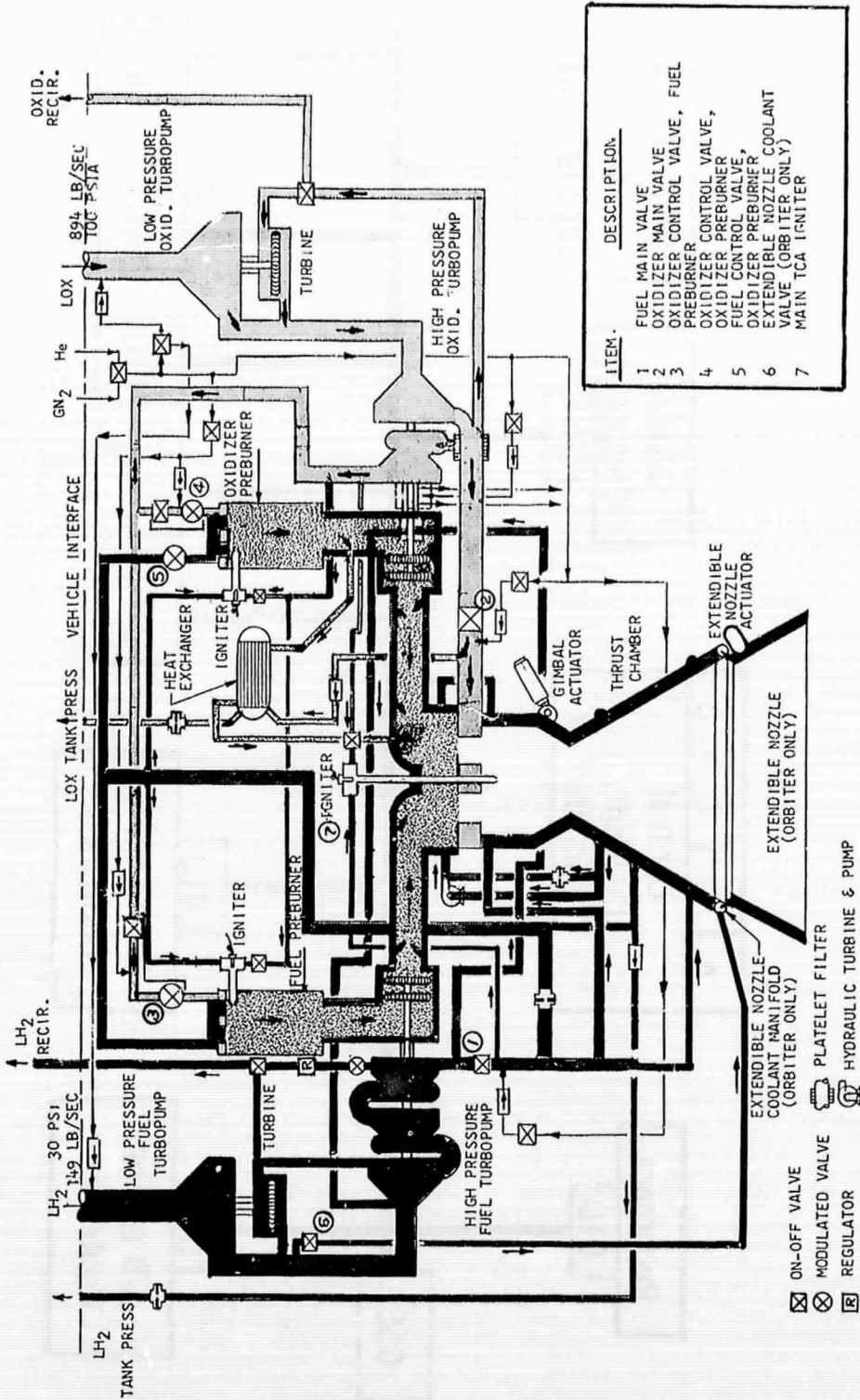
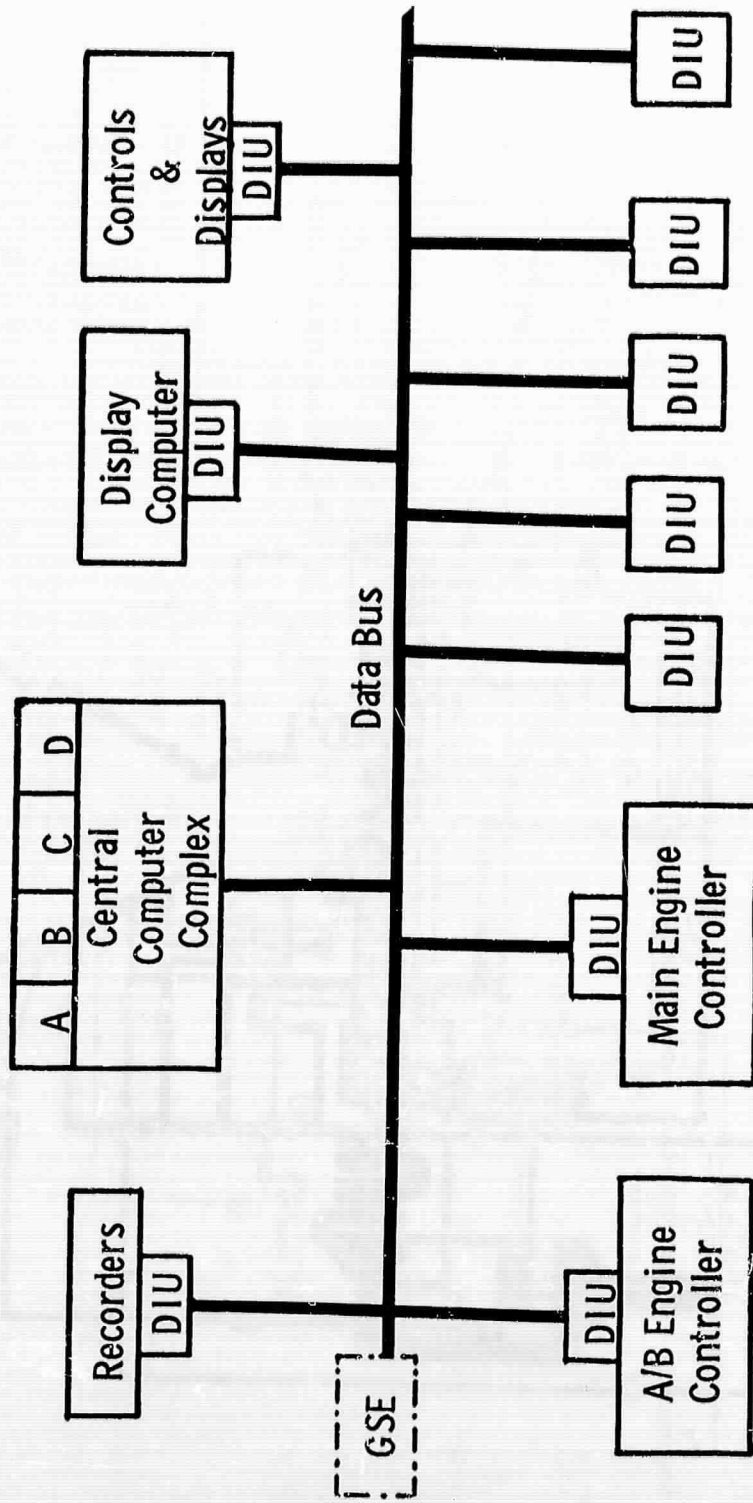

FIGURE II-5 MAIN ENGINE



DIU = Digital Interface Unit

FIGURE II-6 VEHICLE DATA MANAGEMENT SYSTEM

to define potential ground support equipment requirements. The approach and groundrules used in conducting the FMEAs are described in Volume II, Chapter III, and the FMEA data are contained in Volume IV, Appendix B.

Propulsion line replaceable units (LRUs) were defined, and the maintenance activities and times required for removal, replacement and retest of the LRUs were established. This definition was necessary because of the requirement for in-flight fault isolation to the LRU level. A total of 929 booster propulsion LRUs and 322 orbiter LRUs were identified. The LRU selection procedure and listings are in Volume II, Chapter III, and the LRU maintenance procedures are summarized in Volume IV, Appendix C.

The final step in the detailed definition of the propulsion systems was the construction of diagrams which illustrated the sequences and logic for control of the propulsion subsystems during significant activity periods. The generation of these control sequence and logic diagrams was necessary because of the large degree of interaction between control functions and checkout and monitoring functions.

The work summarized in the preceding paragraphs comprised the propulsion system definition and the establishing of propulsion systems checkout and monitoring criteria, i.e., Task 1. These criteria were then analyzed as follows:

A comprehensive analysis of the checkout and monitoring requirements was made. This effort identified, by sequential mission phase, each checkout and monitoring step, including the values expected for each measurement. The results are presented in Volume IV, Appendix D.

Preflight and inflight leak detection is a checkout and monitoring function, and therefore was included in this study as a special area of investigation. Sources and types of leaks were defined, and their effects were evaluated. An on-board approach toward leak detection and hazardous gas concentration monitoring was recommended; this topic is discussed in Volume III, Chapter II.

The propulsion criteria and the results of the checkout and monitoring analysis and the leak detection analysis were evaluated to identify the candidate parameters for propulsion system checkout and monitoring, as well as to identify techniques for implementing the checkout and monitoring functions. To assist in defining measurements and sensors, this program included a survey of sensor vendors. Information was acquired on the availability, characteristics and applications of sensors to match the potential requirements. Additionally, a sensor technology study was made by literature reviews and contacts with appropriate government agencies and industry to identify new work with potential applications. The candidate propulsion system parameters were refined into a definition of required measurements and corresponding sensors. Criteria were prepared for many of the sensors to illustrate the approach necessary for adequate sensor definition (a total of 3130 measurements were stipulated for the booster propulsion checkout and monitoring function, and 1348 measurements for the orbiter function). The measurement and sensor analyses and definitions are described in Volume III, Chapter III and Appendix A.

The vehicle data bus traffic and the processing loads on central computer complex (imposed by the propulsion checkout and monitoring function) were determined for periods of peak data traffic and processing. The definition of the measurement and sensor requirements included analyses of the corresponding sample rates. (The engine controllers incorporated sample averaging to permit a reduced data rate across the engine/vehicle data bus interface as compared with the engine internal sample rate.) The techniques used in establishing sample rates and converting to vehicle data bus traffic are discussed in Volume III, together with a presentation of the peak period traffic and processing loads.

The study was completed by defining the propulsion systems onboard checkout and monitoring function concept. This is described in Volume III, Chapter IV, in terms of the OCMS approach, and implementation concepts. The few items of ground support equipment recommended for the checkout function are also identified in this chapter.

## A. OCMS APPROACH

The previous chapter described the technical approach that was derived and used in the study to determine the propulsion checkout and monitoring requirements, and to derive from those requirements the implementation criteria. This chapter presents a summary of the study results. Section A summarizes the implementation criteria; Section B outlines recommendations for further technology work in sensors; and Section C presents further recommendations for implementation.

The basic conclusions of the study are:

- The on-board checkout and monitoring function is technically feasible, will improve system reliability, and will simplify ground operations.
- The implementation requires a substantial degree of coordination between propulsion and electronics. The implementation should be in accordance with a requirements standard to ensure that the necessary approach and methodology are utilized and so that the requisite degree of interdiscipline integration is accomplished.
- The basic design of the propulsion systems, subassemblies and components must incorporate the necessary provisions for checkout and monitoring.

Criteria were developed which establish the degree of performance of on-board checkout, monitoring, and evaluation functions. The derivation of these criteria is discussed in volume III, Chapter IV. The criteria are summarized below.

Preflight Checkout

- Preflight checkout of mechanical elements of the propulsion systems will be limited to verification of correct initial conditions for start, and to monitoring of the start-up and operation of those subsystems which are started prior to flight.
- Preflight self-checks of electronic subsystems and elements will be performed, including verification of sensor electrical elements.
- Applicable system parameters will be monitored and evaluated by onboard equipment during ground operations for purposes of fault detection, fault isolation, and operating history recording.

In-Flight Ready-to-Start Condition Verification

- Appropriate onboard monitoring and evaluation will be provided to verify, just prior to inflight start, that all applicable equipment and associated system parameters are in the correct conditions for start.

Emergency Detection

- Emergency detection provisions must be redundant.
- Redundant caution and warning display capability will be provided for the following conditions:

Loss or impending loss of major functions  
Flight Safety parameters exceeding safe limits  
Redundancy reduced to "safe" level  
Hazardous leakage.

#### Fault Detection

- Provisions will be made for inflight detection of failures (including out of specification performance, incipient failures, and transient or intermittent faults) for all identifiable failure modes for which suitable onboard detection techniques and equipment are practical.

#### Fault Isolation

- Data for fault isolation will be acquired in flight, by onboard equipment.
- Diagnosis for fault isolation will be accomplished with onboard equipment. This diagnosis will isolate any faults to the line replaceable unit, and record the data necessary to provide postflight identification of maintenance requirements.
- Fault isolation will be accomplished as soon after detection as is necessary to identify lost redundancy and to initiate corrective or safing action when applicable. In cases when no LRU-level redundancy exists and where corrective or safing action is taken in response to failure detection only, as in the case of ACPS engine emergency shutdown, diagnosis for fault isolation may be performed on stored data at a later time. Preferably, this type of diagnosis will be accomplished prior to landing, but may be delayed until after landing if necessary.

#### Real Time Trend Analysis

- Real time trend analysis will be performed only for those failure mode cases where it would result in avoidance of significant damage or in early initiation of precautionary action to cope with an impending emergency condition.

#### Operating Histories

- Where correlation exists, or is likely, between an LRU's performance and its operating time, stresses, number of on/off cycles, number of revolutions or strokes, or combinations of these, a history of

operation of the LRU will be maintained in computer storage so that when an LRU's operating history exceeds the limit for that LRU, a post-flight print-out will provide notification of required replacement. These operating histories will not be continuous, but will be periodic or on-condition updated total of accumulated time, cycles, etc., at discrete states (on, standby, NPL, MPL, etc.) or discrete stress levels (20% overtemperature for example).

#### Performance Data

- Propulsion systems flight performance data will be acquired and recorded on the vehicle maintenance recorder to enable postflight evaluation for verification of inflight diagnosis, identification of incipient failures, and identification and analysis of trends.

#### Post Flight Evaluation

- In-flight type monitoring and evaluation will be continued until completion of shutdown operations. Servicing programs then will be loaded into the onboard computers, replacing the flight programs. Flight-recorded data will be sorted, edited, and evaluated by the onboard computer complex to produce maintenance printouts, trend analysis results and performance data records.
- Ground connections to the vehicle data bus will be utilized to provide for transmitting commands and data between ground remote control and display provisions and the vehicle control computer complex.

#### Maintenance Retest

- Maintenance retest of replaced LRU's will employ the onboard checkout function.

#### Control and Checkout Processing Integration

- Control and checkout will be treated as a single function for purposes of computer processing.

## B. SENSOR TECHNOLOGY RECOMMENDATIONS

The majority of the measurement requirements identified for the propulsion on-board checkout and monitoring function can be accommodated through use of conventional sensor concepts. However, it is recommended that additional technology work be conducted in the following categories, because of probable benefit to the OCMS function.

1. Acoustic/Ultrasonic techniques appear to hold the most promise for resolving many fault detection/isolation/prediction requirements not amenable to conventional sensing techniques. Work by Boeing has shown acoustic emission to be a good indicator of bearing incipient failures. Deflection measurement is a possible alternative or supplementary technique. Further work should be done to establish the feasibility of applying both acoustic emission and deflection measurement approaches in application to Space Shuttle propulsion system rotating machinery, and to establish feasibility of applying acoustic emission sensor approaches to ignition detection and igniter spark location discrimination.
2. Ultrasonic Leak Detection for both internal and external leaks has been shown to be feasible, using combinations of ultrasonic contact probes and ultrasonic microphones. There is insufficient data, however, to show that state-of-the-art devices will work satisfactorily and maintain integrity with cryogenic temperature cycling and at Space Shuttle vibration and acoustic environment levels.
3. Accurate Measurement of Small Differential Pressures in high pressure systems cannot be accomplished with today's technology except in the laboratory. A study to identify and assess approaches for measurement of small differential pressures in high system pressure is recommended. A primary application would be for derivation of flow rate, as an alternate to use of a flow meter.
4. Igniter spark presence and location are not readily detectable with any known suitable technique. In addition to the evaluation of acoustic techniques (as recommended above), it is recommended that other approaches be identified and assessed. One approach that should be investigated is the use of excitation current signatures to determine whether sparking is occurring at the spark plug gap or at some point between the exciter and the plug gap.

## C. PROPULSION RECOMMENDATIONS

The study performed under this contract developed a technical approach for incorporating the function of onboard checkout and performance monitoring in the Space Shuttle propulsion systems. Design criteria which define the degree of incorporation of the function were summarized in Section A of this chapter. Additional recommendations for implementation (as extracted from the bulk of the study results) are summarized in the subsequent paragraphs of this section.

1. A substantial degree of coordination between the propulsion and avionics disciplines should be conducted to ensure an optimum implementation of the propulsion systems onboard checkout and performance monitoring function. Both the development of the propulsion systems' checkout and monitoring criteria (measurement requirements and sampling rates, sequences of functional operations, etc.) and the design of the data management system to accommodate the propulsion functions require an integrated systems approach.

2. The basic design of the propulsion system should incorporate the checkout and monitoring functional requirements. Component configuration designs should enable readiness assessment, fault detection and performance monitoring, and should incorporate the requisite sensing elements. Subsystem designs should allow redundancy assessment and fault isolation, and should enable usage of the onboard system for post-maintenance (LRU replacement) verification testing.

3. Emphasis must be placed on minimizing the number of measurements and the complexity of the sensors. The measurements required for propulsion control functions should also be used for checkout and monitoring functions; alternative measurement and sensor techniques (including application of new technology) should be investigated for each candidate parameter; and the sensor criteria (accuracy, sample rate, response, etc.) should be determined by analyzing the requirements of each individual measurement with emphasis on imposing the least stringent criteria.

4. The propulsion control functions should be completely integrated with the onboard checkout function. Since the checkout function must be cognizant of responses to control commands, and the control function must provide data management for cataloging and utilizing redundant hardware, a minimization of total data management complexity can result from combining these two functions.

PRECEDING PAGE BLANK NOT FILMED

This study was conducted under Contract NAS8-25619 by the Martin Marietta Corporation, Denver Division. Technical direction was provided by the George C. Marshall Space Flight Center, National Aeronautics and Space Administration, with Mr. Werner Voss as Technical Monitor.

The members of the project team at Martin Marietta were:

R. W. VandeKoppel	W. R. Scott
J. S. Worrell	A. R. O'Connell
R. J. Drew	R. F. McConnell
L. E. Gilbert	D. A. Ruscio
H. E. Meyer	

Under subcontract with Martin Marietta, the Aerojet Liquid Rocket Company conducted the necessary studies of the main and auxiliary rocket engines. Mr. Gordon Deppe was program manager of the Aerojet effort.

The study was monitored by the following members of the NASA review team:

Werner E. Voss (COR)	Don Woodruff (COR, ALT)
Joe Fries (MSC)	Harlan Harman
Loren Gross	Buford Gallaher
Edward Mintz	Hoyle Yearwood
Don Thompson	

Also, acknowledgement is given to the support and contributions provided by Pratt and Whitney Aircraft and General Electric in supplying air breathing engine data.

1. Martin Marietta Corporation, Spacemaster - A Two-Stage fully Reusable Space Transportation System, Phase A Final Report, MCR 69-36, Dec. 1969.
2. McDonnell Douglas Corporation, Space Shuttle Program - Phase B Systems Study - Design Data Book, Volume I Baseline, Part 1 and 2, June 1970.
3. Garrett Corporation, Turbine Engine Lubrication and Moving Parts Checkout Technical Report AFAPL-TR-68-136. Wright Patterson AFB, Ohio.
4. Martin Marietta Corporation, Flight Packaged OCS Development Unit Design Review Report, MCR-69-317, NAS9-8000. June 1969.
5. NASA-MSFC, RFP - Space Shuttle Auxiliary Propulsion System Definition. February 17, 1970.
6. Lockheed Missiles Space Company, Final Report - Systems Safety Guidelines of New Space Operations Concepts - Volume I - Executive Summary. Contract NAS8-25576, July 1970.
7. LMSC, Final Report - Systems Safety Guidelines of New Space Operations Concepts, Volume II - Detailed Guidelines by Subsystems. Contract NAS8-25576, July 1970.
8. LMSC, Final Report - Systems Safety Guidelines of New Space Operations Concept, Volume III Detailed Guidelines By Mission Phase and Event. Contract NAS8-25576, July 1970.
9. Douglas, Aircraft Company, Instrumentation Program and Components List for the Saturn S-IV-B.
10. NASA-MSFC, RFP - Space Shuttle System Program Definition (Phase B). February 1970.
11. Speith, C. W. and Woodis, W. R. - A Fully Reusable Space Shuttle Concept and Technology Requirements, ASME Paper, August 1970.
12. General Dynamics, Space Shuttle - Final Technical Report, Volume VII - Integrated Electronics. Report No. GDC-DCB69-046, 31 October 1969

13. Martin Marietta Corporation, Integrated Electronics System for Space Shuttle Vehicle, October 1969.
14. North American Aviation, Apollo Measurements Requirements - Test Fixture 2A - Block II, NAS9-150, 15 September 1966.
15. NASA Lewis, RFP - Space Shuttle Airbreathing Engine - Methane Fuel System, March 1970.
16. McDonnell Douglas Corp. - Saturn S-IVB Program Propulsion System Components Status Report, Vol. I Summary.
17. Aerojet Liquid Rocket Co. Space Shuttle Main Propulsion Engine Interface Data. 1 July 1970.
18. North American Rockwell Corp. Design and Operational Interface Data for the Rocketdyne Reusable Space Shuttle Engine. 1 April 1970.
19. Pratt & Whitney Aircraft. Space Shuttle Engine Baseline Configuration Preliminary Design, 16 April 1970.
20. Parker Hannifin Co. - Component Design Data, 22 June 1970.
21. Martin Marietta Corporation - Task II High Pressure Auxiliary Propulsion Systems (Technical Proposal), P-70-33 (Folder 1), March 1970.
22. Rocketdyne - Evaluation and Demonstration of the use of Cryogenic Propellants (O<sub>2</sub>-H<sub>2</sub>) for Reaction Control Systems. Volume I Final Report, NASA-CR-72176. Contract NAS3-7941
23. Rocketdyne - Evaluation and Demonstration of the use of Cryogenic Propellants (O<sub>2</sub>-H<sub>2</sub>) for Reaction Control Systems. Volume II Final Report, NASA-CR-72244. Contract NAS3-7941, June 1968.
24. North American Rockwell Corporation - Propulsion System Components for the S-II Stage of Saturn V - Component Manual, October 9, 1969.
25. Bell Aerosystems - Auxiliary Propulsion System Technology for the Space Shuttle, October 1969.
26. IBM Federal Systems Division - Wright-Patterson Air Force Base, Ohio - On-Board In-Flight Checkout - Technical Report AFAPL-TR-67-39. April 1967.

27. Martin Marietta Corporation - Space Shuttle Propulsion Systems - Onboard Checkout and Monitoring System Development Study - (Technical Proposal), P-70-70 (Folder 1), May 1970.
28. Aerojet-General Corporation - Space Shuttle Vehicle Auxiliary Propulsion, 4 November 1969.
29. Aerojet-General Corporation - Space Shuttle Vehicle Auxiliary Propulsion 4 November 1969.
30. General Electric - Model Specification E1134 Engine, Aircraft, Turbojet, J85-GE-17A, 12 October 1966.
31. General Electric - Candidate Study Engines for Advanced Attack Aircraft (Confidential) April 1970.
32. General Electric - Cutaway Drawing of F101-GE-100 (Confidential) - Package Which Identifies LRU Replacement Times, and Engine Measurement List: Including Letter - Copies of 8/6/70 Presentation.
33. General Electric - Report, Preliminary Airbreathing Engine Requirements, MDAC/MMC Space Shuttle Airbreathing Engines, July 1970.
34. Pratt and Whitney Aircraft - PWA Oper. Instr. 200, The Aircraft Gas Turbine Engine and its Operation, June 1952.
35. Pratt and Whitney Aircraft - Data Package from 7/29/70 Meeting with MMC. Includes Instrumentation Requirements from JT90 Turbofan Installation Handbook, Definition of ENCOMS System and Four Pages Description
36. Rolls Royce - Aero Engine Data Report - Bristol/SNECMA OLYMPUS 593.
37. Rolls Royce - Aero Engine Data Report - TURBOMECA ADOUR.
38. Rolls Royce - Preliminary Project Performance Report - RB 162-86 Feb. 1968.
39. Rolls Royce - Engineering Liaison Report RB 162-86 Booster Engine Installation Brochure, July 1969.

40. North Carolina State University, Raleigh, North Carolina - AIAA Paper No. 69-581 State of the Art Review of Turbine Engine Techniques by Rolin F. Barrett and Fredrick O. Smentane, June 1969.
41. Article from Space/Aeronautics - April 1968 - Automatic Avionics Testing
42. S.A.E. Reinforced Plastics Design, Rolls Royce RB-162 Lift Engine by R. V. Blockhuts, Rolls Royce Ltd., October 1969 - Spacemaster Airbreathing Engine Presentation - January 1970.
43. Lockheed - Georgia Company - Development of C-5A Propulsion System Monitoring by M. S. Edwards and A. Sennock (Partial AIAA Paper).
44. General Electric Co. - ASME Publication 67-WA/FE-33, Fluid Control of a J79 Turbojet Engine by R. K. Rose and W. T. Phipps.
45. General Electric Co. Letter to Arlen Reichert, MMC, dated 5 May 1970, Dual Control System for Space Shuttle Engine.
46. Garrett Corporation - ASO-TDR-62-842, Turbojet Engine Analyzer System Study, March 1963.
47. AFAPL-TR-62-88, Turbine Engine Checkout, by R. F. Barrett
48. AFAPL-TR-68-136, Turbine Engine Lubrication and Moving Parts Checkout, by H. K. Ziebarth.
49. Bell Aerosystems - Reverse Flow High Pressure Rocket Engines for Space Shuttle ACS, December 1969.
50. Bell Aerosystems - Propulsion Technology for a Manned Space Station, Report No. 8500-945011, November 1969.
51. Consolidated Controls Corp. - Electro Mechanical Space Hardware Capability, July 1970.
52. McDonnell Douglas Astronautics Company - Space Shuttle Program Ground and Logistics Operations Design Note, July 1970.
53. Sperry Gyroscope Company - Development of Launch Vehicle Malfunction Effects Model, NASA Contractor Report CR-288, August 1965.

54. Aerojet Liquid Rocket Co. - Schematics and Drawings of the ACPS Engine Components, August 1970.
55. Aerojet Liquid Rocket Co. - OCMS Study, LRU Analysis and Preliminary Maintenance/Checkout Procedures, August 1970.
56. Martin Marietta Corporation - Shuttle Cryogenic Supply System Optimization Study, (Technical Proposal), P-70-78 Volume I, June 1970.
57. General Electric Co. - Engine Condition Monitoring - Catalog of Vibration Monitoring.
58. Pratt and Whitney Aircraft Data Package on Hydrogen Jet Engine Study (received 8/24/70).
59. Pratt and Whitney Aircraft Space Shuttle Coordination Sheet No. 3A-5 - Airbreathing Engine Schematics (Received 8/24/70).
60. General Electric Co. Space Shuttle Booster Airbreathing Engine Study - Monthly Progress Report No. 1 for July 1970 (Received 8/25/70).
61. General Electric Co, ASD-TDR-62-975 Turbojet Engine Analyzer Design Study, April 1963.
62. Pratt and Whitney Aircraft letter and enclosures which include schematics on Turbofan Engine Subsystems and Failure Mode and Effects Analysis for Turbofan Engines.
63. Baldersten, H. L., Incipient Failure Detection in Bearings, American Society for Nondestructive Testing, 28th National Conference, 1968.
64. Baldersten, H. L., The Detection of Incipient Failure in Structural Material Samples, Air Transport Association Non-Destructive Testing Subcommittee Meeting in San Antonio, Texas, September 1970 (The Boeing Company).
65. Baldersten, H. L., On-Board Incipient Failure Detection Subsystem, Air Transport Association Subcommittee Meeting on Non-Destructive Testing in Minnesota, September/October 1969 (The Boeing Company).
66. Bowes, L. A., Engine Vibration Monitoring on the Boeing 747 Aircraft, ISA Meeting at Seattle, Washington, May 1970 (Endevco Corporation).

67. Pearce, J. L. and Assoc. Inc., Study to Develop Improved Methods to Detect Leakage in Fluid Systems, First Monthly Progress Report, July 1970, Contract NAS10-7291.
68. Adler, A. J., Wireless Temperature and Strain Measurement, ISA Conference Proceedings, 1969, No. 69-554 (Aerotherm Corporation).
69. Fellows, B. W., et al, A Direct Digital Pressure Transducer, ISA Conference Proceeding, 1969, No. 69-526 (University of New Hampshire).
70. LMSC, RF Liquid-Level Sensing Technique, Technical Report No. LMSC A785006, February 28, 1966, NAS8-11476, by J. D. Lockhart.
71. Martin Marietta Corporation, A Review of Sensor Technology (Draft) by A. Gibson, August 1970.
72. Rand, Advanced Sensing Techniques for Automatic Checking: A Comparative Discussion, Memo RM-4937-NASA, March 1966, NASr-2168.
73. North American Aviation, Apollo Training, Block II CSM Propulsion System, August 1968, by W. F. Green.
74. LMSC, Analysis of Zero-G Mass Gaging Methods, Excerpt from Orbital Refueling Study, Vol. V, T1-51-67-21, February 1968.
75. NASA-MSFC, Saturn V Failure Effects Analysis and Criticality Determination Reports, Vol. 5, BK 1-4, June 1969.
76. NASA-Langley, A Computerized Onboard Expeditious Monitor and Maintenance Analyst (EMMA) for Spacecraft Systems, Technical Note, TN-D-5725, May 1970, by W. W. Anderson, et al.
77. Proceedings of the Sixteenth International ISA Aerospace Instrumentation Symposium Paper by W. Brenner, Grumman Aerospace Corporation, "Non-Avionics Integrated Data System for an Advanced High Performance Aircraft".
78. McDonnell Douglas Corporation, Low Pressure APS Definition Study, conducted under NAS9-11012, October 1970.
79. Pearce, J. L. and Associates, Inc., Study to Develop Improved Methods to Detect Leakage in Fluid Systems, Second Monthly Progress Report, August 1970. Contract NAS 10-7291.

80. Pearce, J. L. and Associates, Inc., Study to Develop Improved Methods to Detect Leakage in Fluid Systems, Third Monthly Progress Report, September 1970. Contract NAS 10-7291
81. Martin Marietta Corporation, Propellants and Gases Handling in Support of Space Shuttle, Bi-Monthly Progress Report No. 1, August 1970. Contract NAS 10-7258.
82. Martin Marietta Corporation, Propellants and Gases Handling in Support of Space Shuttle, Bi-Monthly Progress Report No. 2, October 1970. Contract NAS 10-7258.
83. Moses, Howard J., Computerized Airborne Integrated Data Systems, AIAA Paper No. 70-935, July 20, 1970.
84. Simmonds Precision Company, Operations and Checkout Manual for the Apollo Block II Propellant Utilization and Gaging System. May 1968.
85. Aerojet Liquid Rocket Company, On-Board Checkout and Monitoring Study - Task I Report, October 1970, under MMC Contract RCO-446108.
86. McDonnell Douglas Corporation, High Pressure APS Definition Study - conducted under NAS 8-26248, October 1970.
87. TRW Systems Group, Space Shuttle Low Pressure Auxiliary Propulsion Subsystem Definition. Conducted under NAS 8-26249, October 1970.
88. Martin Marietta Corporation, Spacemaster - A two-Stage Fully Reusable Space Transportation System, Ground Systems, Revision 1, M-69-24 (Rev. 1), October 8, 1969.
89. Martin Marietta Corporation, Maintainability Specifications for Design, Shuttle Maintainability Design Guidelines Handbook.
90. Vaughan, Chester A., Apollo Reaction Control Systems, AIAA Paper number 68-566, AIAA Fourth Propulsion Joint Specialist Conference, Cleveland, Ohio, June 10-14, 1968.
91. Aerojet General Corporation, Auxiliary Control Propulsion System, Notes, R. J. Kuntz, 20 August 1970.

92. Aerojet General Corporation, ACPS Failure Detection Method, Notes, R. J. Kuntz, 28 August 1970.
93. Aerojet General Corporation, On-Board Checkout Study, Thruster Maintenance Procedure, Notes, R. J. Kuntz, 4 August 1970.
94. Weiner, Richard S., Basic Criteria and Definitions for Zero Fluid Leakage, J.P.L. Technical Report No. 32-926, December, 1966.
95. General Electric - Leakage Testing Handbook - Revised Edition prepared for J.P.L. under NASA Contract NAS7-396, July, 1969.
96. Ohio University Research Institute - Leak Detection Technique Improvement Study For Space Vehicles - Annual Report No. 2-a, Contract NAS8-11199, January, 1967.
97. General Electric - Development of a Non-Magnetic Flight Type Mass Spectro-meter - Final Report, Contract NAS8-21217.
98. Nassau Instruments, Inc. - A Hydrogen - Air Detector Suitable For Use Aboard Spacecraft - Final Report, prepared for MSFC under NASA Contract NAS8-20597, December, 1967.
99. General Electric - Development of a Flight Prototype Hydrogen Sensor - Final Report, prepared for MSFC under NASA Contract NAS8-20600, March, 1969.
100. General Electric - Gaseous Hydrogen Detection System - Final Report, prepared for MSFC under NASA Contract NAS8-24526, April 1970.
101. Keller, Roy A., Gas Chromatography, Scientific American, July, 1965.
102. Martin Marietta Corporation, Acceptance Criteria SSLV Propulsion, March, 1966.
103. Lem, John D., Jr., Application of Gas Chromatography in Manned Space Flight, Aerospace Medicine, November, 1967.
104. Rochost, Robert J., Leak Testing Welded Vessels, Materials Evaluation, October, 1969.

105. Balderston, Harvey L., The Detection of Incipient Failure in Certain Hydraulic Components, Internal Report - The Boeing Co.
106. Brown, James L., Diffusion of Trace Gases For Leak Detection in Aerospace Systems, NASA TM X-53742, June, 1968.
107. Decastra, J. E. and Wells, F. E., Proposed Standards Describing and Estimating Leaks in Aerospace Hardware, February, 1968.
108. Decastra, J. E., A Description of the Freon Injection System, IN-R-Qual-66-52, December, 1966.
109. Sodergren, Jan H., Criterion For Mass Drop-Off Measurements Based Upon Precise Pressure and Temperature Measurements, NASA TM X-53551, December 1966.
110. Morris, T. F., Flowmeter For Space, NASA TN D-5517, December, 1969.
111. Morris, T. F., Development of A Space Crane, IN-S and E-Qual-70-1, January, 1970.
112. Wells, F., Development of the Mass Spectrometer Leak Detection Techniques, IN-S and E-Qual-70-7, May, 1970.
113. Wells, F., A Practicability Study of Present Leak Detection Checkout and Acceptance Methods, IN-R-Qual-66-26, May, 1966.
114. Woodis, K. W., Leak Detector For Use In Space Environment, NASA TN D-5841, June, 1970.
115. General Electric - Study of Techniques for Automatic Self-Contained Readiness Assessment and Fault Isolation For Ground and On-Board Mechanical Systems, Phase III Progress Report, prepared for KSC under NASA Contract NAS10-7145, October, 1970.
116. General Electric - Study of Techniques for Automatic Self-Contained Readiness Assessment and Fault Isolation For Ground and On-Board Mechanical Systems, Final Report, prepared for KSC under NASA Contract NAS10-7145, November, 1970.

117. Arthur D. Little, Inc. - Final Report on an Investigation of Hazards Associated With the Storage of Liquid Hydrogen in Close Proximity to Liquid Oxygen and RP-1. Contract No. AF 18(600)-1687, Conf.
118. Perkin-Elmer Corporation - Analytical Study of Contaminant and Atmospheric Sensor, Phase 1, prepared for Langely Research Center under contract NAS 1-7260, September 1969.
119. Pratt & Whitney Aircraft, Vibration Signature Analysis for Turbine Engine Diagnostics, PDS 3984, August 1970.
120. NASA-MSFC, Digital Transducers - Types and Trends. A. E. Schuler.
121. H. R. Hegner, R. S. Braman, J. E. Bridges - Indirect Sensing of Quiescent Parameters for Built-in Test Equipment. Proceedings of the 1966 Automatic Support Systems Symposium for Advanced Maintainability, IEE.
122. E. G. Johnson - New Advancements in Propulsion Instrumentation. Instrumentation in the Aerospace Industry (Proceedings of the 16th International ISA Aerospace Instrumentation Symposium, May 1970.)
123. J. C. Telinde - Discovery, Development and Use of a Cryogenic Linear Temperature Sensor. Instrumentation in the Aerospace Industry (Proceedings of the 16th International ISA Aerospace Instrumentation Symposium, May 1970.)
124. Conductron-Missouri - Engine Monitoring and Control System for Gas Turbine Engines. R. L. Klamm.
125. J. G. Klapp - Swirlmeter: The High Performance Gas Flowmeter, ISA Conference Proceedings, 1969.
126. F. F. Shamp - Accuracy in Cryogenic Liquid Measurement, ISA Conference Proceedings, 1969.
127. L. H. Groeper - In-Place Calibration of Cryogenic Flowmeters for Rocket Engine Testing. ISA Conference Proceedings, 1969.
128. S. J. Bailey - Two New Flowmeters Have No Moving Parts, Control Engineering, December 1969.

129. McDonnell Douglas Corporation - A State of the Art Survey of LOX and LH<sub>2</sub> Propellant Gaging for Space Shuttle Applications, Attachment to Memo A3-830-BH00-733, 28 October 1970.
130. J. L. Pearce and Associates, Dynamatec Corporation - Final Report, Study to Develop Improved Methods to Detect Leakage in Fluid Systems, TR-1088, Contract NAS 10-7291, December 22, 1970.
131. Marquardt Corporation - Evaluation and Demonstration of a Propellant Quantity Gaging System for Auxilliary Propulsion Systems, Final Report, Contract NAS8-21488, February 1970.
132. E. G. Goddard - Ultrasonic Leak Detection, 56th Air Force/ Industry Conference, February 1965. Copies available from Delcon Division, Hewlett-Packard Company.
133. Martin Marietta Corporation - Recommendations and Rationale for Solenoid Valve Signature Traces, Memorandum SSP-71-003, January 1971.
134. Martin Marietta Corporation - Propellants and Gases Handling in Support of Space Shuttle, Bi-Monthly Progress Report No. 3, December 1970. Contract NAS10-7258.

BIT: A single binary digit. The smallest informational element of a digital system.

BUILT-IN-TEST EQUIPMENT (BITE): An integral part of a functional unit which serves to test and/or provide status on that functional unit, but does not participate in performing the unit's principle function.

BYTE: A specified number of BITS.

CHECKOUT: The process of determining whether or not specified physical quantities or operations meet their prescribed criteria. The process can include such functions as data acquisition, processing, storage, display, stimulus generation, etc.

CONTROL: The act or process of initiating, regulating and/or terminating the operation and performance of a functional element in a prescribed manner.

CONTROLLER: A device which governs the state or performance of a particular functional element in a prescribed manner, e.g. engine controller.

DATA BUS: The transmission line(s) along which the system computer(s) communicate with the various Digital Interface Units, controllers, peripheral equipment, and other computers.

DATA COMPRESSION: The process of screening and selecting data such that only desired information is retained for further processing and/or storage.

DESIGN REFERENCE MODEL: The baseline configuration.

DIAGNOSIS: The determination of the state or condition of an element or parameter through evaluation of available data.

DIGITAL INTERFACE UNIT: An intermediary unit between the computer(s) and another device which formats that device's output for communication to a computer, and accepts and translates a computer's transmissions to the device.

FAULT ISOLATION: The processing of analyzing a malfunction or abnormality to the extent of determining which functional element is defective, where the functional element is ordinarily a Line Replaceable Unit.

FUNCTIONAL ELEMENT: A unit which performs a characteristic action. Parts, components, assemblies, and subsystems are functional elements of increasing complexity.

GAS PATH ANALYSIS: An assessment of engine performance that is made through evaluation of a set of measured values of pressures, temperatures and/or flow rates.

GROUND SUPPORT EQUIPMENT: (for checkout and monitoring) that equipment in addition to the onboard equipment, which is needed to accomplish the functions of checkout and monitoring.

LINE REPLACEABLE UNIT: A component or group of components that can, as a unit, be removed and replaced in the normal vehicle maintenance area. Such criteria as allowable replacement time spans and degree of complexity of post-replacement calibration form a basis for Line Replaceable Unit selection.

MAINTENANCE: Those functions and activities associated with restoring the vehicle to an operational condition between flights.

MEASUREMENT: A physical quantity or event whose magnitude or time of occurrence is of significance.

MONITORING: Repetitive acquisition and evaluation of needed data.

POGO: An oscillatory instability resulting from a dynamic coupling between the fluid and structural elements of the vehicle.

PROCESSING: The manipulations and operations performed on data from the time and place it is acquired to the time and place it is used in its final form.

SELF CHECK: The process by which a functional element assesses its own operational integrity and readiness.

SENSOR: A functional element which responds to a physical quantity or event and converts that response to transmissible data which is proportional to the magnitude of the quantity or indicates occurrence of the event.

SINGLE POINT FAILURE: A functional element whose inability to operate within prescribed limits would cause loss of vehicle, crew, and/or mission objectives.

STIMULUS: An excitation or forcing function which is applied from an external source at a prescribed place and time.

TIMELINE: A representation of a sequential series of events which depicts the time of occurrence and duration of each event.

TRANSDUCER: Same as sensor.

TREND ANALYSIS: The process of evaluating successive samples of the same data to forecast end of useful life and/or incipient failure as an aid to maintenance operations and to mission or vehicle configuration decisions.