

MDC A0013
2 OCTOBER 1970

NASA CR 114322

Hypersonic Research Facilities Study

Volume I

Summary

Prepared Under Contract No. NAS2-5458

by

Advanced Engineering

MCDONNELL AIRCRAFT COMPANY

for

OART - ADVANCED CONCEPTS AND MISSIONS DIVISION
NATIONAL AERONAUTICS AND SPACE ADMINISTRATION

Moffett Field, California 94035



FACILITY FORM 602

N71-35384
(ACCESSION NUMBER)

87
(PAGES)
CR-114322
(NASA CR OR TMX OR AD NUMBER)

(THRU)
G3

(CODE)
11

(CATEGORY)

MCDONNELL AIRCRAFT COMPANY

MCDONNELL DOUGLAS CORPORATION



MDC A0013
2 OCTOBER 1970
COPY NO. 53

NASA CR 114322

Hypersonic Research Facilities Study

Volume I

Summary

Prepared Under Contract No. NAS2-5458

by

Advanced Engineering

MCDONNELL AIRCRAFT COMPANY

for

OART - ADVANCED CONCEPTS AND MISS'ONS DIVISION
NATIONAL AERONAUTICS AND SPACE ADMINISTRATION
Moffett Field, California 94035

MCDONNELL AIRCRAFT COMPANY

Box 516, Saint Louis, Missouri 63166 Tel (314)232 0232



MDC A0013 • 2 OCTOBER 1970
VOLUME I

HYPERSONIC RESEARCH FACILITIES STUDY

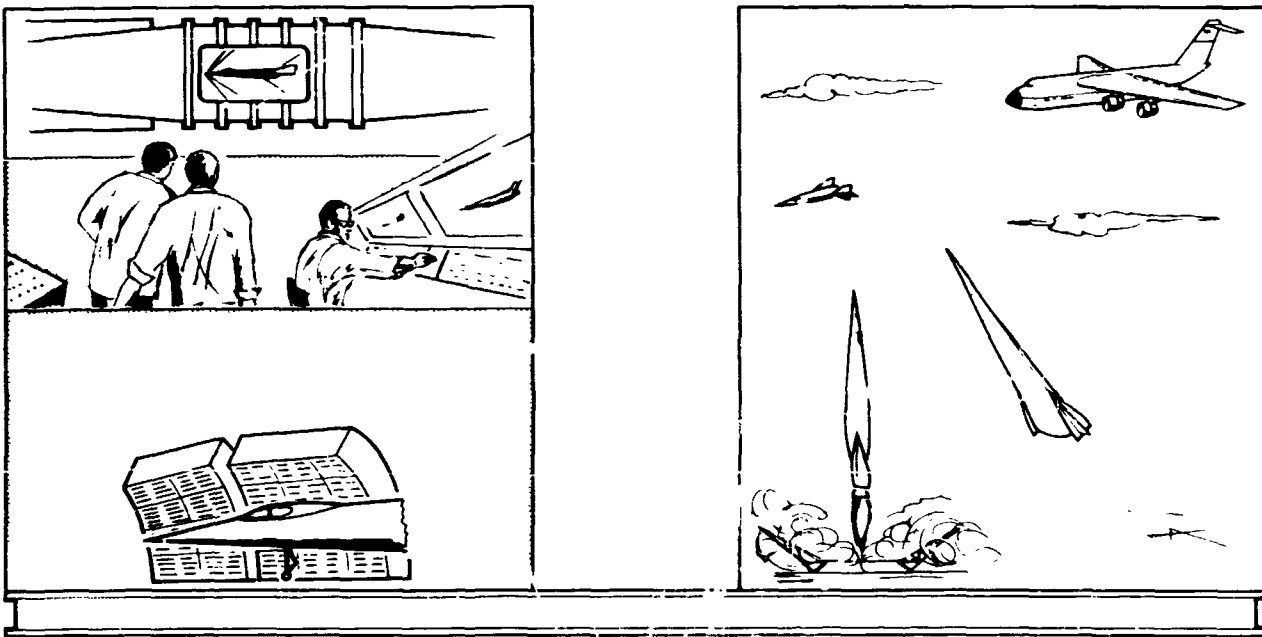

RESEARCH PROGRAM BALANCE

MDC A0013 • 2 OCTOBER 1970
VOLUME I

FOREWORD

This report summarizes the results of the Hypersonic Research Facilities Study performed from 1 July 1969 through 26 June 1970 under National Aeronautics and Space Administration Contract NAS2-5458 by McDonnell Aircraft Company, (MCAIR), St. Louis, Missouri, a division of McDonnell Douglas Corporation.

The study was sponsored by the Office of Advanced Research and Technology with Mr. Richard H. Petersen as Study Monitor and Mr. Hubert Drake as alternate Study Monitor.

Mr. Charles J. Pirrello was Manager of the HYFAC project and Mr. Paul A. Czysz was Deputy Manager. The study was conducted within MCAIR Advanced Engineering, which is directed by Mr. R. H. Belt, Vice President, Aircraft Engineering. The HYFAC study team was an element of the Advanced Systems Concepts project managed by Mr. Harold D. Altis.

The support of the following engine companies in the flight vehicle synthesis is gratefully acknowledged: AiResearch Manufacturing Division of the Garrett Corporation, The General Electric Company, The Marquardt Company, and Pratt and Whitney Aircraft.

The support of the following companies in the ground facility synthesis is gratefully acknowledged: The Cabot Corporation for extensive design, performance, and operational refinement in carbon combustor concepts; Allis-Chalmers for definition of compressor plant design and equipment requirements. Fluidyne Engineering Company, as a subcontractor on the HYFAC study, contributed significantly to the detailed structural and operational requirements of the flow facility test legs.

This is Volume I of the overall HYFAC Report, which is organized as follows:

		<u>NASA Contractor Report Number</u>
Volume I	Summary	CR 114322
Volume II	Phase I Preliminary Studies	
	Part 1 - Research Requirements and Ground Facility Facility Synthesis	CR 114323
	Part 2 - Flight Vehicle Synthesis	CR 114324
Volume III	Phase II Parametric Studies	
	Part 1 - Research Requirements and Ground Facility Synthesis	CR 114325
	Part 2 - Flight Vehicle Synthesis	CR 114326
Volume IV	Phase III Final Studies	
	Part 1 - Flight Research Vehicles	CR 114327
	Part 2 - Ground Research Facilities	CR 114328
	Part 3 - Research Requirements Analysis and Facility Potential	CR 114329
Volume V	Limited Rights Data	CR 114330
Volume VI	Operational System Characteristics	CR 114331

MCDONNELL AIRCRAFT

MDC A0013 • 2 OCTOBER 1970
VOLUME I

TABLE OF CONTENTS

<u>Section</u>	<u>Title</u>	<u>Page</u>
1.	INTRODUCTION	1
2.	OBJECTIVES	5
3.	STUDY PLAN	7
4.	FLIGHT VEHICLE SYNTHESIS	9
4.1	Phase I Preliminary Studies	10
4.2	Phase II Parametric Studies	12
4.3	Phase III Final Studies	19
4.3.1	Mach 6 Turboramjet Vehicle	20
4.3.2	Mach 12 Rocket Vehicle	30
5.	GROUND FACILITY SYNTHESIS	41
5.1	Phase I and II Studies	41
5.1.1	Gas Dynamic Facilities	45
5.1.2	Turbo Machinery/Ramjet Facility	46
5.1.3	Scramjet Engine Research Facilities	47
5.1.4	Structural/Fluid System Facility	49
5.1.5	Material Research Facility	50
5.2	Phase III Final Studies	51
6.	FACILITY POTENTIAL AND COMPARISONS	59
7.	OBSERVATIONS AND CONCLUSIONS	69
8.	RECOMMENDATIONS	75

List of Pages

Title Page
Frontispiece
i through iv
1 through 82

LIST OF ILLUSTRATIONS

<u>Figure</u>	<u>Title</u>	<u>Page</u>
1	Applicable Aeronautical Systems	1
2	Study Plan	7
3	Vehicle Configurations	9
4	Flight Envelope Comparison	10
5	Flight Research Vehicles	11
6	Phase II Research Aircraft	12
7	Effect of Thrust Loading	13
8	Effect of Propellant Mixture Ratio.	13
9	Effect of A_{LE} Sweep	13
10	Effect of Fatness Ratio	13
11	Comparison of Thermal Protection Concepts	15
12	Tankage Comparison	15
13	Load Factor - Weight and Temperature Effects	16
14	Mach Number Effects	17
15	Test Time Effects	17
16	Flight Research Vehicles	19
17	Mach 6 Turboramjet Airplane General Arrangement	21
18	Mach 6 Turboramjet Airplane Capabilities.	23
19	Mach 6 Turboramjet Airplane Structural Arrangement	25
20	Mach 6 Turboramjet Airplane and Options	28
21	Mach 6 Turboramjet Airplane - Typical Mission	29
22	Mach 6 Turboramjet Airplane Development Schedule	29
23	Mach 12 Rocket Airplane General Arrangement	31
24	Mach 12 Rocket Airplane Capabilities	33
25	Mach 12 Rocket Airplane Structural Arrangement	35
26	Mach 12 Rocket Airplane and Options	37
27	Mach 12 Rocket Airplane Typical Mission	38
28	Mach 12 Rocket Airplane Development Schedule	39
29	Phase I Ground Research Facility Matrix	43
30	Gas Dynamic Parametric Results	46
31	Turbomachinery Alternates	47
32	Effect of Scramjet Module Capture Area Variation	48
33	Structural Test Article Size Major Impact on Cost and Research Value	49
34	Simulation Requirements Dominate Facility Costs	50
35	Materials Facility Size Definitions	51
36	Mach 0.3 to 8.5 Polysonic Tunnel (GD20)	53
37	Mach 8 to 13 Hypersonic Impulse Tunnel (GD7)	54
38	Mach 0 to 5.5 Compound Turbomachinery Engine Test (E20)	55
39	Mach 3 to 11 Dual Mode Ramjet Engine Tests Facility (E9)	56
40	Major Structures/Fluid Systems Research Facility (S20)	57
41	Quantification Process	59
42	Most Important Research Objectives	60
43	Flight Vehicle Research Value Summary	62
44	Ground Facility Research Value Summary	63

LIST OF ILLUSTRATIONS (Continued)

<u>Figure</u>	<u>Title</u>	<u>Page</u>
45	Research Program Comparisons for Operational System L2	65
46	Research Program Comparisons for Operational System C1	65
47	Research Program Comparisons for Operational System M1	66
48	Research Program Comparisons for Operational System M2	66
49	Relative Research Facility Potential	70
50	Five-Year Lead Time is Needed for Hypersonic Research Program to Impact Operational System Development Cycle	77
51	Progressive Technology Enhancement - Through Balanced Aeronautics Program	81

1. INTRODUCTION AND SUMMARY

The HYFAC program was a 1 year study to:

- o Identify high priority research required for future hypersonic cruise aircraft.
- o Evaluate the research potential and total costs of new candidate research facilities, both ground and flight.
- o Assess the usefulness of these research facilities in support of other aerospace systems.

That airbreathing hypersonic aircraft employing advanced propulsion and propellant systems have the potential of satisfying a number of mission requirements in the 1980-2000 time period was an accepted premise for this study. However, major advances in the technological state of the art are necessary before such hypersonic aircraft can be considered either feasible or practical.

The potential applications of hypersonic cruise aircraft are diverse, cover a very broad flight spectrum, and involve significant differences in configuration concepts, Figure 1.

FIGURE 1 AERONAUTICAL SYSTEM APPLICATIONS

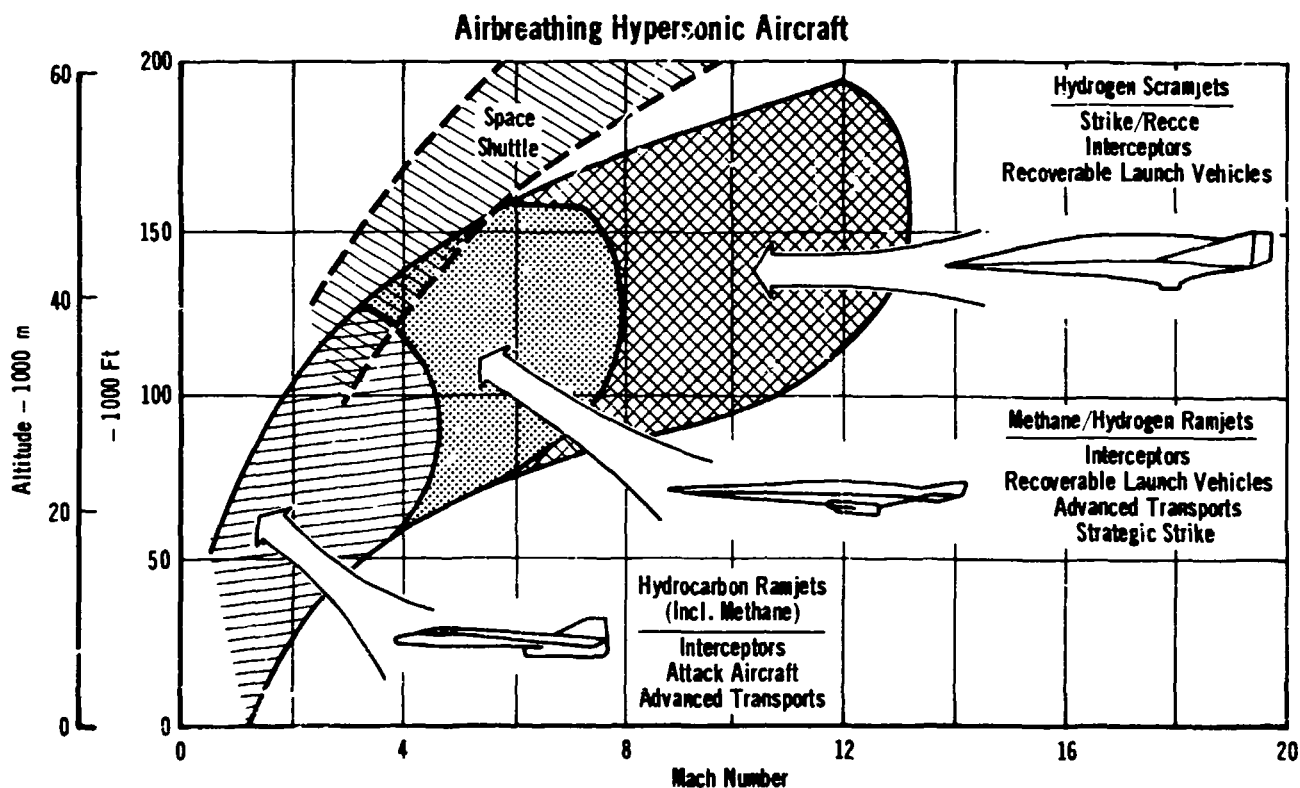

MDC A0013 • 2 OCTOBER 1970
VOLUME I

These aircraft are characterized by their ability to operate for extended periods at high speed and altitude, achieving long range or high maneuverability, in contrast to the transient traversing of this regime by re-entry type space vehicles such as the current space shuttle.

The accomplishment of critical technology research properly phased with advanced systems requirements is the key to this nation's leadership in the exploration of hypersonic flight. This is particularly true in the areas of propulsion, propulsion system-airframe integration, structural materials, thermal protection, refurbishment techniques, and operational procedures. Much of the knowledge needed can only be acquired through flight experience. Current ground research programs are addressing some of the fundamental technology questions associated with hypersonic flight. However, current flight research, while providing valuable data, is extremely limited in scope, including only lifting body tests and the joint NASA/USAF YF-12A program.

Many flight and ground research facility concepts have been studied and compared. As a result, two technically feasible, attractive, flight research aircraft have been defined and five attractive ground research facilities offering unique improvement over existing ground facilities have been identified. In summary, the facilities and their significant research application are:

Flight Vehicles

- o Mach 6, Manned, Conventional Takeoff and Landing, Turboramjet
 - Advanced compound engine test bed.
 - Reusable structures and heat shields.
 - Regeneratively cooled structures.
 - Engine/airframe compatibility demonstration.
 - Operational demonstration - piloting and ground control.
- o Mach 12, Manned, C-5A Airlaunched, Rocket
 - Aerothermodynamic configuration in true environment.
 - Reusable structure and heat shields.
 - Airbreathing propulsion development.
 - Staging demonstration.
 - Operational demonstration - piloting and ground control.

Ground Facilities

- o Mach 8 to 13, High Re , Hypersonic Impulse Tunnel
 - Hypersonic aerothermodynamic configuration development.
 - Propulsion system integration - powered and unpowered.
 - Shock/boundary layer studies.
- o Mach 0.3 to 8.5, High Re , Polysonic Tunnel
 - Subsonic/hypersonic aerothermodynamic configuration compatibility and development.
 - Propulsion system integration - powered and unpowered.
 - Shock/boundary layer studies.

MDC A0013 • 2 OCTOBER 1970
VOLUME I

o Mach 0 to 5.5, Compound Turbomachinery Engine Test

Full scale - continuous operation - development and qualification.
Duplicated flight conditions.
Component development research.
Airframe/inlet compatibility.
Structural development - true temperature.

o Mach 3 to 11, Dual Mode Ramjet Engine Test

Subscale to full scale - continuous operation - development and qualification.
Duplicated flight conditions.
Combustion stability.
Inlet/nozzle development.
Thrust characteristics.
Structural development - true temperature.

o Major Structural Test

Full scale static, fatigue verification.
Major section mechanical, thermal, altitude-time variant verification.
Component mechanical, acoustic, thermal, altitude-time variant structural development.
Fluid system component development.

2. OBJECTIVES

According to the NASA statement of work, "The primary objective of the study will be to assess the research and development requirements for hypersonic aircraft and, based on these requirements, to provide the NASA with descriptions of a number of desirable hypersonic research facilities and estimates of their performance, costs, development time schedules, and research capabilities." A secondary objective was to identify any areas in which the NASA should intensify or reorient its present hypersonic research program in order to contribute to the development of such facilities.

Specific areas of emphasis included: (1) identification of the necessary research associated with a group of operational systems agreed to at the beginning of the study and described in Volume VI; (2) evaluation of methods of accomplishing the necessary research through a ground test program and through a flight test program; and (3) analysis of the capability and costs of various conceptual ground facilities and flight research vehicles.

A number of general ground rules from the Statement of Work were applied to all phases of the study. Two of the more noteworthy are paraphrased.

(1) Proven technology should be employed; where not feasible, conservative overdesign practices should be employed.

(2) Aircraft construction should conform to experimental shop procedures and engine development should be consistent with a research program, not requirements for an operational system.

The feasibility of accommodating these ground rules for both the ground and flight research facilities has been confirmed. In general off the shelf equipment has been identified which will suitably meet the system requirements. At most only moderate extensions of proven technology were found necessary. This result has contributed significantly to reduced costs.

A further reduction in flight vehicle costs resulted from application of experimental shop procedures. Such an approach is both feasible and practical and would employ austere program controls and minimize documentation expenditures. To accomplish the stated objectives MCAIR has:

(1) Developed a disciplined method to identify high priority research required for given aeronautical systems, and to establish the relative importance of the identified research.

(2) Defined and analyzed a large number of new candidate research facilities, both ground and flight, and developed credible design detail for each consistent with the requirements for each study phase.

(3) Developed a realistic costing rationale that provides understandable and realistic cost estimates for the new research facilities.

(4) Compared and evaluated the most attractive candidates in each phase of the study, and presented this evaluation data for further scrutiny and consideration by decision makers.

(5) Drawn observations and conclusions as a result of the overall study and presented recommendations for future programs.

3. STUDY PLAN

The study logic and phasing is shown in Figure 2. The first phase consisted of: selection and definition of a group of potential future operational systems (summarized in Volume VI) which form the basis for the study, a preliminary identification and evaluation of research requirements, and a preliminary analysis of a broad group of flight research vehicles and ground research facilities. The most attractive concepts were carried into Phase II for parametric study. A unique aspect of this early effort involved incorporation of the advice and opinions of persons recognized as knowledgeable in the area of hypersonic vehicle requirements. Over forty individuals from Ames Research Center, Langley Research Center, Flight Research Center, Lewis Research Center, and the USAF along with 24 individuals from within MCAIR participated in identifying and evaluating the basic research needs for the defined operational aircraft systems in order to provide a comprehensive technical base to the study.

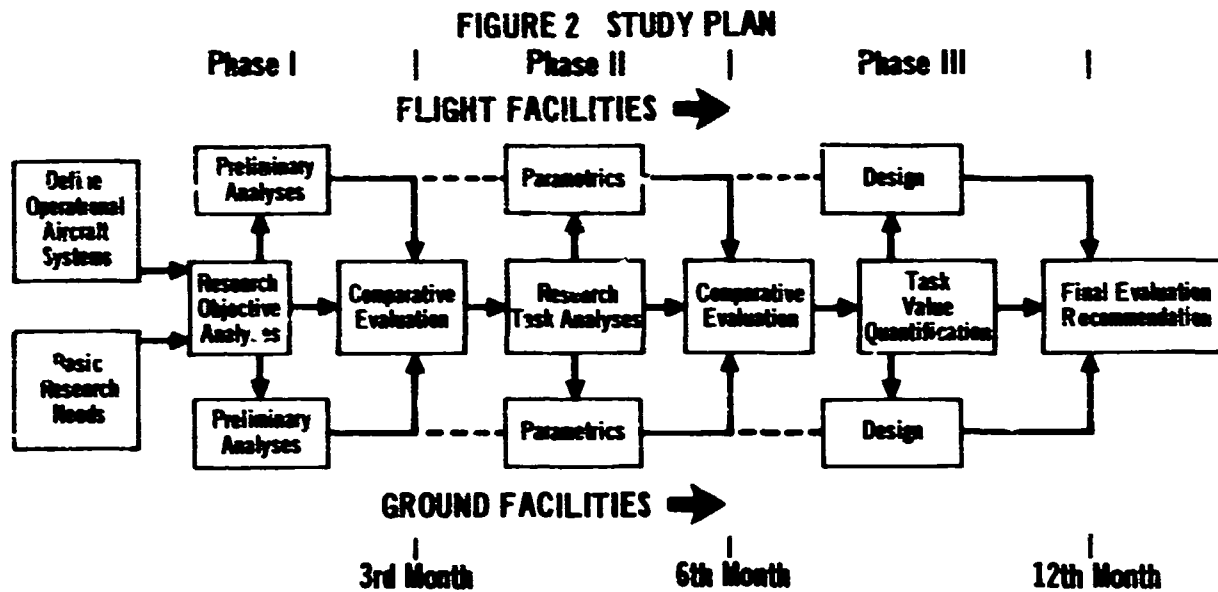

In Phase II the research requirements were subdivided into more specific task statements. The attractive facilities were refined and a number of parametric studies conducted.

Two attractive flight vehicles and seven attractive ground facilities were carried into the final Phase III refinement. Research requirements were further refined.

The final study output includes a design description of each of the most attractive facilities, estimates of their cost and acquisition schedule, and assessments of their capability and value. It also identifies critical technology research for advanced aeronautics.

4. FLIGHT VEHICLE SYNTHESIS

The first two phases of this study were devoted to preliminary analysis of a broad group of flight research vehicle concepts followed by parametric studies of seven of the most attractive concepts. The purpose of these initial studies was to select the most attractive vehicles for design refinement and detailed technical studies in the final phase. A number of variations in vehicle shape were examined as summarized in Figure 3.

Two attractive vehicles were selected for the final study phase. The first vehicle, a turboramjet powered aircraft, provides capability for technology demonstration of advanced airbreathing propulsion systems as well as a broad spectrum of research applicable to the defined potential operational systems. This vehicle was designed for five (5) minutes of steady state cruise at Mach 6, is manned, and operates in a conventional ground takeoff mode. It employs a near term turboramjet designated STRJ11A-27, which includes a modified P&WA J58 JP-fueled turbojet core engine with a special LH₂-fueled wraparound ramjet.

The second vehicle, representing a quantum jump in performance, is a manned, rocket powered vehicle designed to cruise for five minutes at Mach 12 and is air-launched from the C-5A. The engines employed are P&WA RL10-A-3-9 rockets using LO₂/LH₂ propellants. Five engines are employed for acceleration to cruise speed and cruise is achieved on a single engine throttled to approximately 30% thrust.

These vehicles are capable of exploring the aeronautical environment illustrated in Figure 4. Also shown in Figure 4 are the trajectories of several of the potential operational systems. Clearly the research aircraft capabilities encompass the region of interest. For contrast with other aerospace systems, a representative environment for the space transportation system vehicle is also illustrated.

FIGURE 3 VEHICLE CONFIGURATIONS

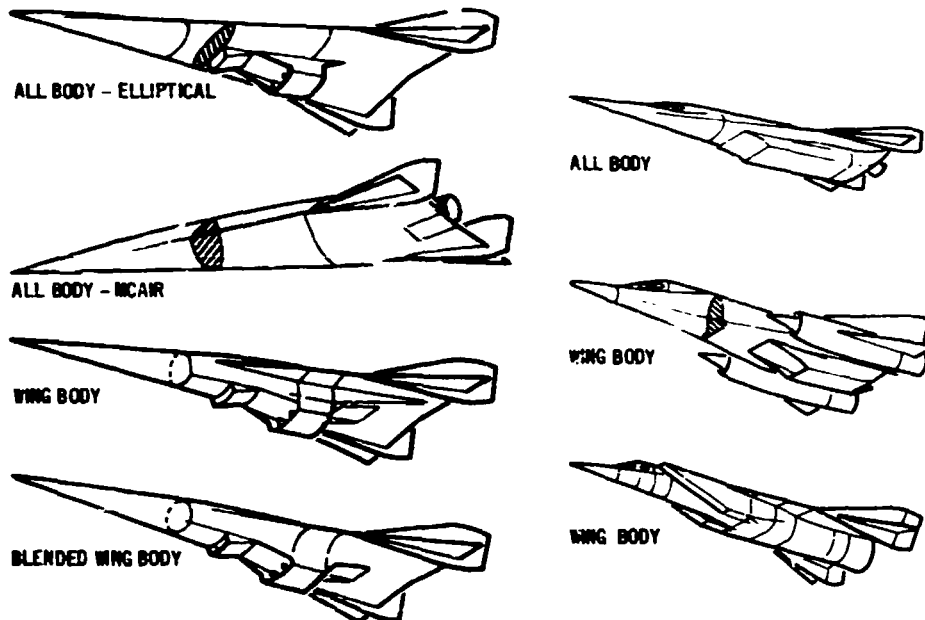

MCDONNELL AIRCRAFT

**FIGURE 4 FLIGHT ENVELOPE COMPARISON
HYFAC Research Vehicles – Potential Operational Systems**

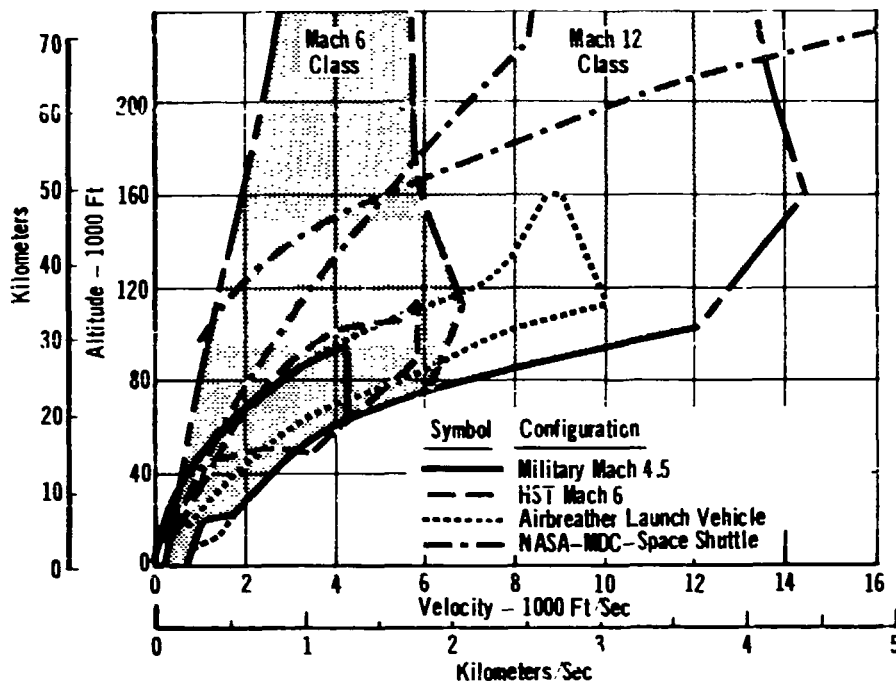

4.1 PHASE I PRELIMINARY STUDIES

A series of flight research aircraft concepts were developed and the performance, research capability, and total program costs (i.e., acquisition plus research program) were determined for each concept. This data is summarized in Figure 5. A diverse group of vehicles were retained for further study in Phase II and are so noted in the figure. Selections were based on research value, program cost, and on assessments of adaptability, development confidence, and ability to contribute to a broad range of research. A number of significant observations were evident as a result of these preliminary studies.

1. Airbreathing propulsion systems are costly to develop.
2. Manned research vehicles are not significantly larger or heavier than unmanned research vehicles (at least when low density, cryogenic fuels are employed).
3. Wing body shapes are best suited to storable propellants.
4. All body shapes are best suited to cryogenic propellants.
5. Off-the-shelf rocket or turbojet acceleration engines can be integrated into desirable vehicle concepts and the result is an appreciable cost reduction.
6. Specialty vehicles (low speed, variable stability, staged) are most economical for selective tasks, although the scope of these tasks is limited.

FIGURE 5 FLIGHT RESEARCH VEHICLES

Configuration	Design Mach Number	Launch Concept	Control Mode	Type of Configuration	Propulsion System		Fuel	OWE (Lb)	TOGW (Lb)	OWE (Kg)	TOGW (Kg)	Program Cost (\$x10 ⁶)	Maximum Research Value	Retained for Phase II Study
					Accelerate and Climb	Cruise								
-291	0.9	VTO	M	AB	TJ	TJ	Stor	-	-	-	-	50	228	
-292	1.0	HTO	M	AB	TJ	TJ	Stor	-	-	-	-	75	406	
-290(VS)	2.0	HTO	M	WB	TJ	TJ	Stor	-	-	-	-	30	200	
-200	4.5	VTO	M	WB	TRJ	TRJ	Stor	19,922	25,508	9,036	11,568	574	1585	
-201	4.5	HTO	M	AB	TRJ	TRJ	Stor	-	-	-	-	-	-	
-204	6.0	Air	U	WB	TRJ	TRJ	Cry.	22,490	25,079	10,160	11,376	780	1637	
-205	6.0	Air	M	WB	TRJ	TRJ	Cry.	23,000	25,740	10,432	11,675	883	1891	
-206	6.0	Air	M	AB	TRJ	TRJ	Cry.	-	-	-	-	-	-	
-207	6.0	Air	M	AB	Rkt	RJ	Cry.	24,800	43,000	11,249	19,504	573	1769	✓
-210	6.0	HTO	M	WB	TRJ	TRJ	Cry.	26,450	41,450	16,533	18,801	1123	1966	
-211	6.0	HTO	M	AB	TRJ	TRJ	Cry.	-	-	-	-	-	-	
-212	6.0	HTO	M	AB	TJ-RJ	RJ	Cry.	-	-	-	-	-	-	✓ (In WB Shape)
-213	6.0	HTO	M	AB	Rkt	RJ	Cry.	30,300	64,850	13,744	29,420	663	1870	
-214	6.0	HTO	M	AB	Rkt	Rkt	Cry.	18,500	45,850	8,391	20,797	348	1607	
-220	6.0	Staged	U	AB	Rkt	RJ	Cry.	12,800	13,230	5,806	6,001	310	1443	
-221	6.0	Staged	U	EAB	Rkt	RJ	Cry.	13,970	13,530	5,937	6,137	312	1443	
-231	12.0	Air	M	AB	TJ-CSJ	CSJ	Cry.	-	-	-	-	-	-	
-232	12.0	Air	M	AB	Rkt	SJ	Cry.	23,900	69,700	10,841	31,615	809	2228	✓
-233	12.0	Air	M	AB	Rkt	Rkt	Cry.	21,980	74,780	9,970	33,920	484	1786	✓
-234	12.0	Air	M	WB	Rkt	Rkt	Cry.	27,900	96,050	12,655	43,114	564	1786	
-250	12.0	HTO	M	AB	Rkt	Rkt	Cry.	31,800	130,040	14,061	58,985	621	1816	✓ (Combined with 270)
-250 VS	12.0	HTO	M	AB	Rkt	Rkt	Cry.	42,500	194,280	19,278	88,124	556	1816	
-251	12.0	HTO	M	WB	Rkt	Rkt	Cry.	37,840	148,640	17,165	67,422	691	1816	
-252	12.0	HTO	M	EAB	Rkt	Rkt	Cry.	31,700	132,380	14,379	60,047	628	1816	
-253	12.0	HTO	M	AB	Rkt	Rkt	Stor	50,200	314,900	22,770	142,836	736	1639	
-254	12.0	HTO	M	AB	Rkt	SJ	Cry.	36,460	135,180	16,538	61,317	994	2258	
-255	12.0	HTO	M	WB	Rkt	SJ	Cry.	48,000	176,400	21,772	80,014	1078	2258	
-256	12.0	HTO	M	WB	Rkt	Rkt	Stor	41,420	248,420	18,788	112,681	635	1727	
-256 MID	12.0	HTO	M	WB	Rkt	Rkt	Stor	55,600	378,100	25,220	171,583	660	1727	
-257	12.0	HTO	M	WB	TJ-CSJ	CSJ	Cry.	58,000	80,200	26,308	36,378	902	2231	✓
-270	12.0	VTO	M	AB	Rkt	Rkt	Cry.	31,600	144,500	14,334	65,544	635	1745	✓ (Combined with 250)
-271	12.0	VTO	M	AB	Rkt	SJ	Cry.	41,200	165,360	18,724	75,086	1045	2276	
-280	12.0	Staged	U	AB	Rkt	SJ	Cry.	12,410	12,830	5,629	5,820	486	1820	
-281	12.0	Staged	U	AB	Rkt	Rkt	Cry.	10,880	13,820	4,935	5,986	184	1366	
-282	12.0	Staged	U	AB	Rkt	Rkt	Stor	13,360	17,310	6,060	7,852	222	1222	
-284	12.0	Air	U	WB	Rkt	Rkt	Cry.	21,680	73,780	9,834	33,466	472	1420	✓
-285	12.0	HTO	U	AB	Rkt	Rkt	Cry.	30,700	128,700	13,925	58,377	619	1488	

Notes:

- | | | |
|--|----------------------------|--------------------------------|
| 1. Constant Mission Performance w/ 5 Minutes Steady State Cruise | 6. WB = Wing Body | 13. CSJ = Convertible Scramjet |
| 2. HTO = Horizontal Takeoff | 7. AB = All Body | 14. Rkt = Rocket |
| 3. Air = Air Launched | 8. EAB = Elliptic All Body | 15. Stor = Storable |
| 4. VTO = Vertical Takeoff | 9. TJ = Turbojet | 16. Cry. = Cryogenic |
| 5. Staged = Boosted like ASSET | 10. TRJ = Turboramjet | 17. VS = Variable Stability |
| | 11. RJ = Ramjet | 18. M = Manned |
| | 12. SJ = Scramjet | 19. U = Unmanned |

7. Significant size and cost differentials exist between the following launch concepts: STAGED - AIRLAUNCH - HTO.

The design concepts for the seven (7) attractive vehicles retained from Phase I are illustrated in Figure 6.

FIGURE 6 PHASE II RESEARCH AIRCRAFT

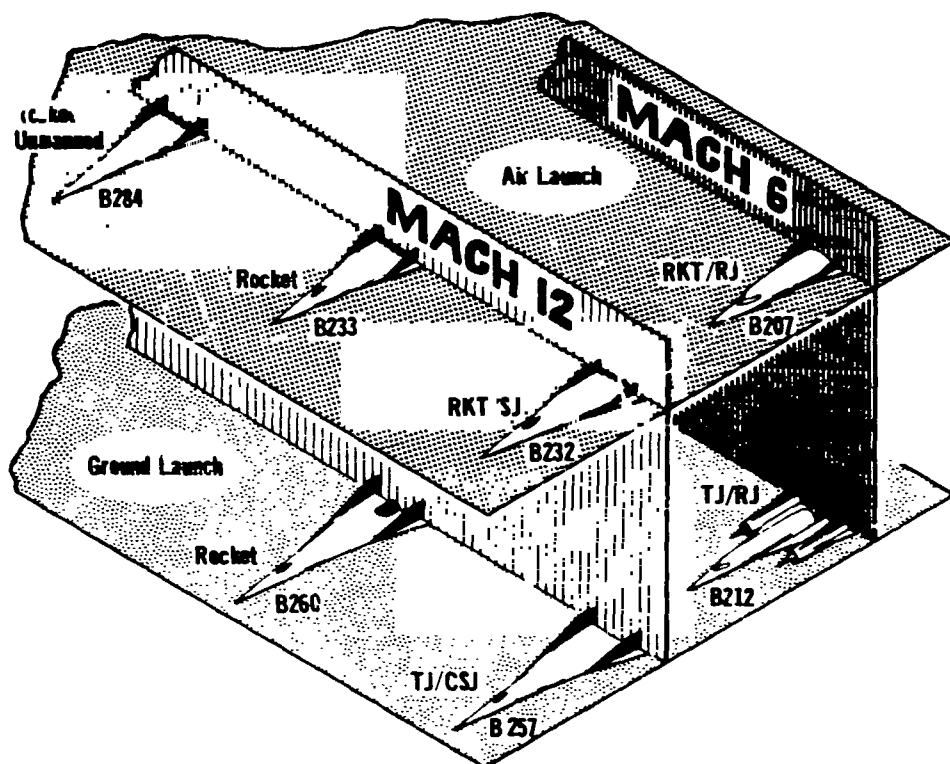

4.2 PHASE II PARAMETRIC STUDIES

A number of parametric studies were conducted during Phase II and the early part of Phase III, on particularly selected study vehicles. In all cases, the cruise speed and steady state test time were constant with vehicle size being varied to meet the mission performance. Separate trade studies of design cruise speed and cruise test time were also performed. On rocket accelerated vehicles a comparison was made between the use of near term engines and specially developed advanced engines.

Configuration and propulsion system studies were conducted to define the combination of parameters which would most improve the vehicle performance. Also included were structural and payload size tradeoffs. In most cases, the aircraft research value was not affected by the variation in a design parameter. It was, therefore, possible to select design values solely in consideration of vehicle weight or cost. This was not the case for those tradeoffs which involved significant changes in the vehicle mission capability. For these cases, it was necessary to determine the variation in research capability and make the final selection in consideration of this factor as well as the effect on vehicle weight and cost.

In the engine selection study it was found that use of the Rocketdyne J2S or multiples of the P&WA RL10-A-3-9 would reduce the vehicle acquisition costs (i.e., RDT&E plus investment) by 10 to 15%.

Typical tradeoff results for rocket engine thrust loading and for oxidizer to fuel (O/F) ratio are shown in Figures 7 and 8, for a Mach 12 airlaunched, rocket vehicle (configuration B233). Since the vehicle OWE influences the vehicle acquisition and total program costs much more than TOGW, the results indicate that a lower vehicle thrust to weight ratio (on the order of 1.25) and the higher values of O/F (on the order of 6 to 7) are most desirable.

FIGURE 7 EFFECT OF THRUST LOADING

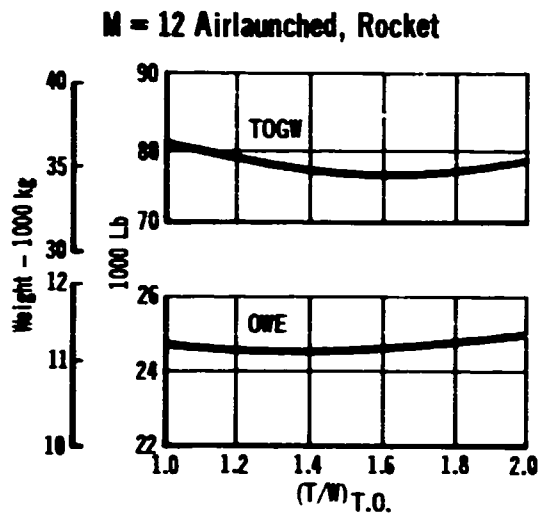
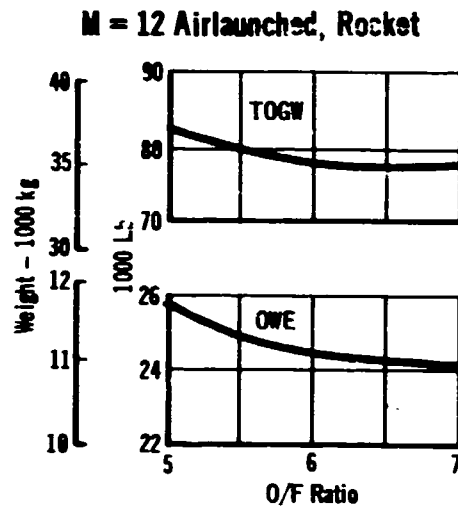

FIGURE 8 EFFECT OF PROPELLANT MIXTURE RATIO



Results of configuration studies on the effect of vehicle sweep angle and fatness ratios on the all body vehicles are illustrated in Figures 9 and 10, for

FIGURE 9 EFFECT OF LEADING EDGE SWEEP

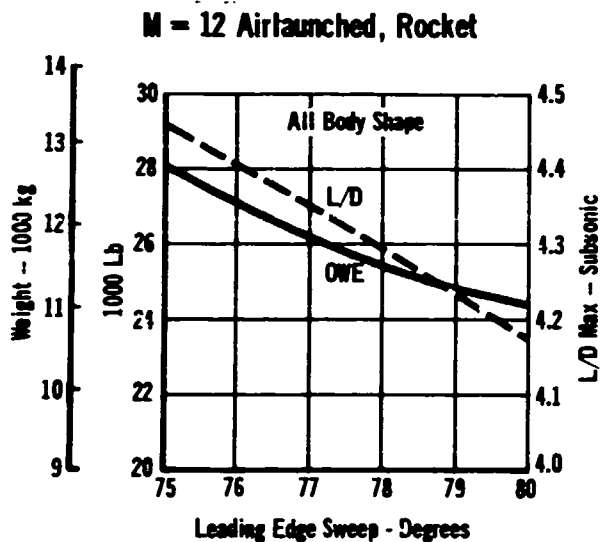
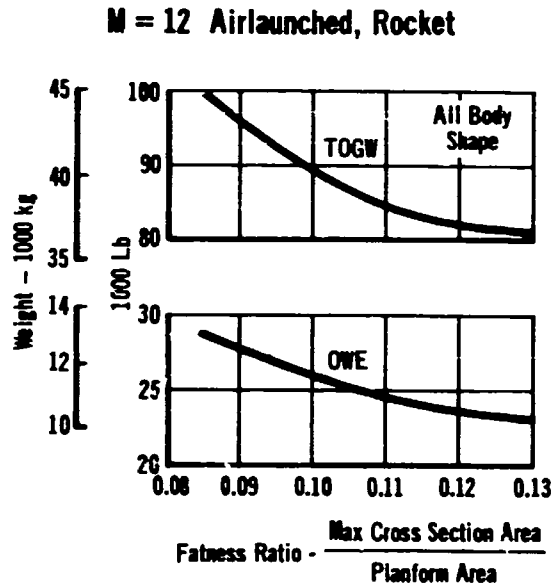

FIGURE 10 EFFECT OF FATNESS RATIO



a Mach 12 air-launched, rocket vehicle (configuration B233). Figure 9 indicates that as the leading edge sweep is increased, the vehicle OWE continues to decrease. An 80° sweep was selected in order to maintain a reasonably good landing L/D_{max} and lateral control. The higher fatness ratio vehicles resulted in lower vehicle weight, thus a value of .125 was selected.

Study of the use of subcooled liquid hydrogen in lieu of normal boiling point hydrogen indicated that a 3 to 4% reduction in total program cost could be achieved. This was true for two $M = 12$ configurations studied, an air-launched rocket/scramjet vehicle (configuration B232) and the HTO turbojet/convertible scramjet vehicle (configuration B257). No increase in airborne equipment is required and only a minor amount of ground refrigeration equipment is necessary. In addition to the vehicle size benefits resulting from the increased fuel density, the fuel tank operating pressures are reduced and an increased unattended ground hold capability is also possible.

The use of JP fuel as the initial turbojet acceleration fuel compared to use of LH_2 fuel gave the same results for two airbreather vehicles studied. The vehicles were a $M = 6$ turbojet/ramjet (configuration B212) and a $M = 12$ turbojet/convertible scramjet (configuration B257), both designed for horizontal takeoff. In both cases, the vehicle size, OWE, and cost showed a significant reduction where the more dense JP fuel was used for the turbojet.

Structural studies included evaluation of (1) an active and passive thermal protection system, (2) integral and non-integral tankage, and (3) the effects of design load factor on vehicle weights and costs. A comparison between an active and passive thermal protection system as employed on a $M = 12$ air-launched rocket accelerated vehicle (configuration B233) is illustrated in Figure 11. Use of the active system resulted in an appreciable reduction in vehicle weight and program cost. A comparison between integral and non-integral tankage was examined for a $M = 6$ horizontal takeoff, turbojet/ramjet vehicle (configuration B212). Comparison was made between an integral tank employing insulated (cool) structure, a non-integral tank employing insulated structure, and a non-integral tank employing uninsulated (hot) structure. As illustrated in Figure 12, the insulated structure employing integral tankage was found to be most attractive.

Studies of the effects of design load factor were made on three vehicles: (1) a $M = 6$, horizontal takeoff, turbojet/ramjet vehicle (configuration B212), (2) a $M = 12$, horizontal takeoff, turbojet/convertible scramjet vehicle (configuration B257), and (3) a $M = 12$ air-launched, rocket accelerated vehicle (configuration B233). In all cases the results were similar; the $M = 12$ rocket vehicle is used as an illustration. Figure 13 shows the variation in surface temperature at two points as maneuver load factor is varied, indicating the need for use of higher temperature capability materials (with resulting weight and cost effects) as load factor is increased. The variation of the TPS weight, the structural weight (based on a constant structural temperature), and the total airframe weight also is illustrated. It is seen that design load factor has a strong effect on the TPS and a small effect on the structure, thus the selected design point for the structure is slightly higher than that for the thermal protective system giving some additional structural margin. This tradeoff was conducted for a fixed size vehicle and, thus, represents a structural capability tradeoff only. To achieve a constant mission range, the vehicle would have to be resized, due to the performance losses incurred during the maneuver. However, this was not the objective of the tradeoff and was not considered in the analysis.

FIGURE 11 COMPARISON OF THERMAL PROTECTION CONCEPTS
Mach 12 Rocket, Airlaunched 5 Minute Test Time

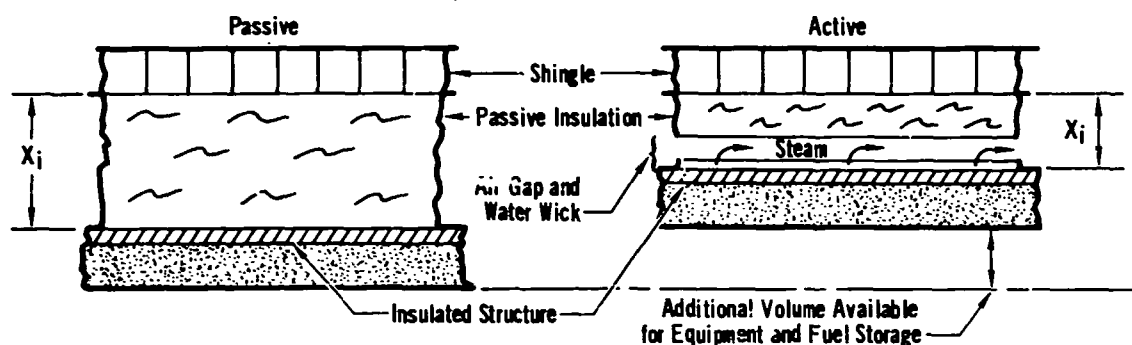

Thermal Protection Concept	Insulation				Takeoff Gross Weight	Program Cost x 10 ⁶ Dollars
	Unit Weight ^(a)		Unit Thickness, X_i ^(a)			
	(psf)	(kg/m ²)	(in.)	(cm)	Lb. (kg)	
Passive	1.75	8.52	1.53	3.89	77,950 (35,358)	545
Active	0.55	2.69	0.78	1.98	67,210 (30,486)	506

(a) Average Values

FIGURE 12 TANKAGE COMPARISON
Mach 6 – HTO, TJ/RJ

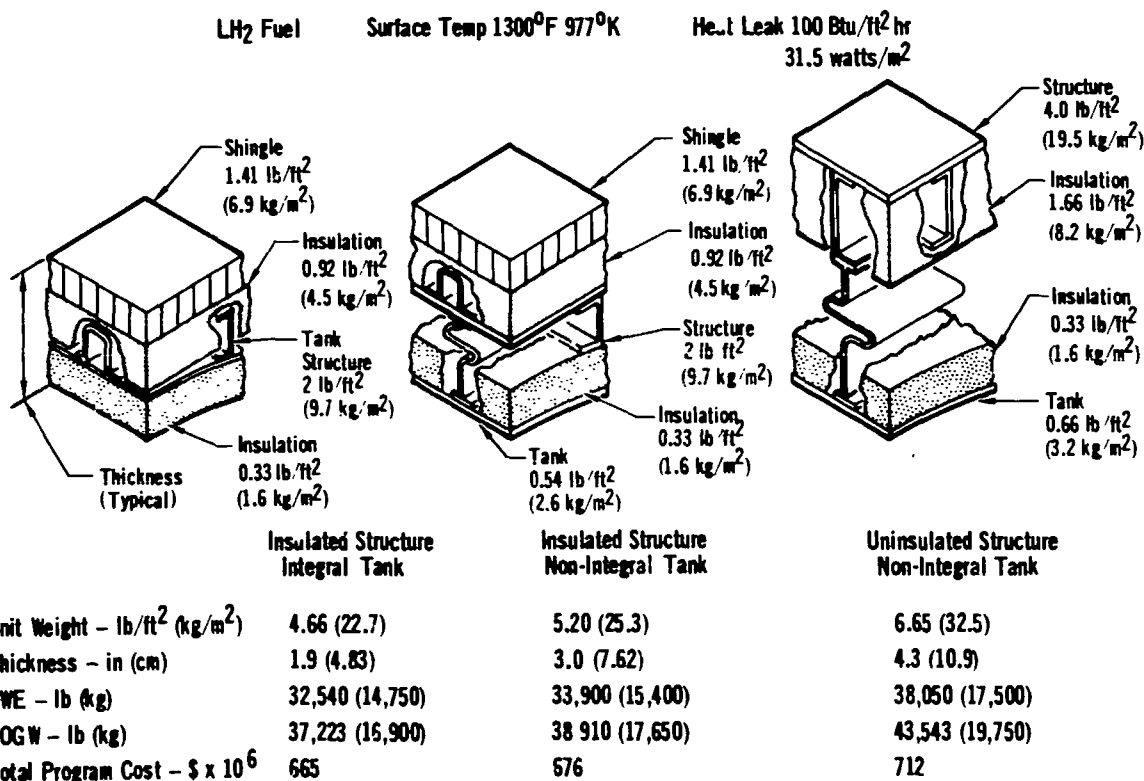
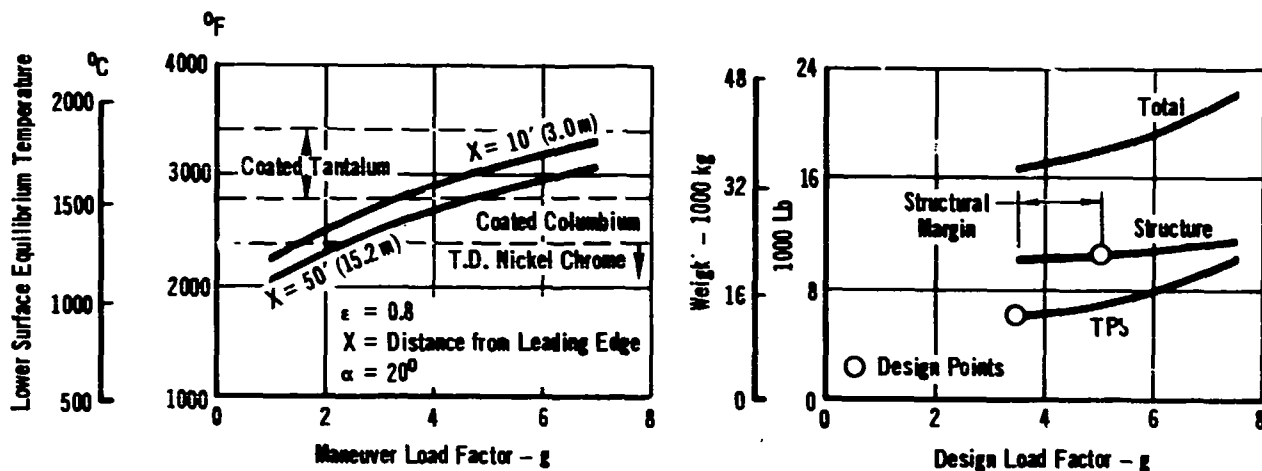

FIGURE 13 LOAD FACTOR - WEIGHT AND TEMPERATURE EFFECTS
M = 12 All Body, Air Launched, Rocket



The effect of varying the mission performance requirements was studied by varying the design cruise speed, test time, and payload requirements. Unlike the trade studies previously discussed, these variations did have an impact on the vehicle research capability. The effect of varying the design cruise speed (maintaining a constant cruise test time) was examined on one Mach 6 class vehicle and three Mach 12 class vehicles. The variation in research value and costs for each vehicle are illustrated in Figure 14. Based on these data, design speeds of Mach 6 and Mach 12 were chosen. For the Mach 6 class vehicle, as the design cruise speed is increased, the vehicle cost increases significantly while the research value increases only modestly. Therefore a design point of Mach 6 was selected. In the case of the Mach 12 class of vehicles the cost increase with increasing speed is offset by the significant increase in research value. Therefore a design point of Mach 12 was selected.

The effect of varying the design cruise test time was examined on one Mach 6 class vehicle and two Mach 12 class vehicles. The variations in research value and cost for each vehicle are illustrated in Figure 15. It is apparent that increasing test time for vehicles that employ rockets for cruise has a significant effect on program costs, whereas the effect on the airbreather configuration is small. For the Mach 6 class vehicle, both the cost and research value increase modestly with increasing design speed. It appears that a test time of 10 minutes is a reasonable goal for the Mach 6 class vehicles. In the case of the Mach 12 class of vehicles, the cost penalties are too great to accept for the modest increase in research value. Therefore, a design point of 5 minutes was selected for the Mach 12 vehicles.

FIGURE 14 MACH NUMBER EFFECTS

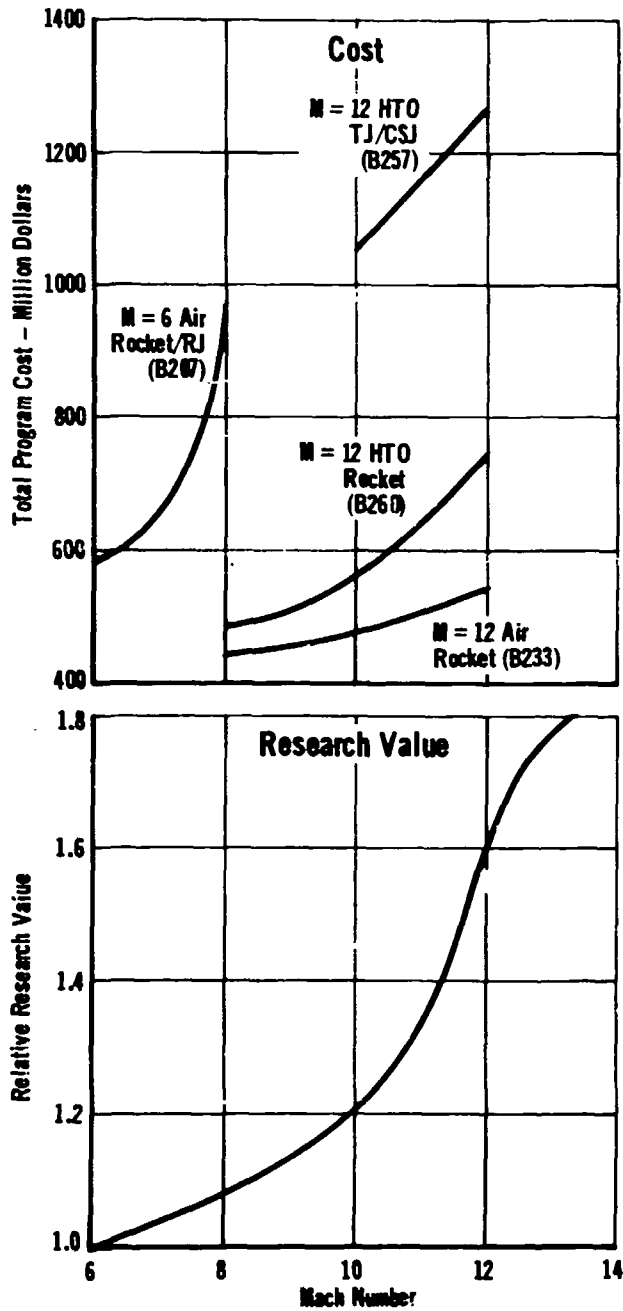

*Relative to the Value of Research at Mach 6.

FIGURE 15 TEST TIME EFFECTS

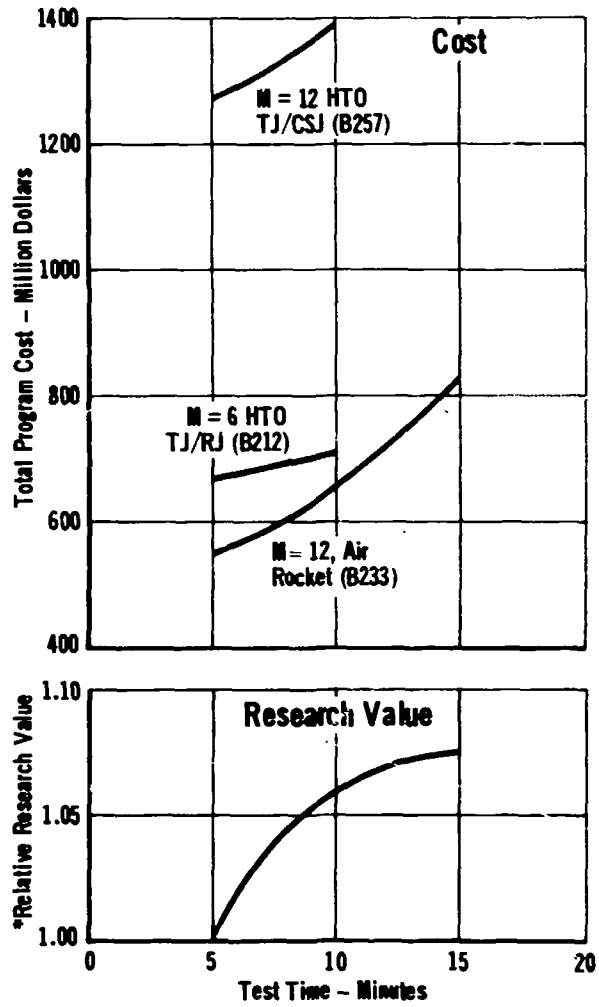

*Relative to the Value of Research for a 5 Minute Test Time, for Mach 6 to 12 Vehicles.

MDC A0013 • 2 OCTOBER 1970
VOLUME I

The effect of decreasing and increasing the payload weight requirement on vehicle size and costs was found to be small. This result is due to the fact that the volumetric requirement to contain the LH₂ fuel is considerable, thus, the small changes in volume resulting from payload variations have an insignificant effect.

As a result of the parametric studies, the following determinations were made:

1. Near term engines should be used for all rocket accelerated vehicles. (Multiple RL10 engines are used for all configurations with the exception of the horizontal takeoff M = 12 vehicle which uses a single J2S engine.)
2. A thrust to weight of as close to 1.25 as possible is desirable.
3. A fuel to oxidizer ratio of 6 should be employed. (Since this was a refinement determined in the early part of Phase III, the final Phase II aircraft did not reflect this result. It is judged that it would not have changed the final Phase II selections.)
4. Off-the-shelf F-100 engines and JP fuel should be used for all turbojet accelerated vehicles.
5. Subcooled liquid hydrogen should be used in all concepts.
6. Active thermal protection (water wick) systems should be employed.
7. Integral tankage should be used.
8. The basic structure should be designed for 5 g capability and the thermal protection system for 3.5 g capability.
9. A design cruise speed capability of M = 12 is best for the M = 8 to M = 12 class of vehicles.
10. A design cruise speed capability of M = 6 is best for the M = 6 to M = 8 class of vehicles.
11. The rocket systems should be designed for 5 minutes of steady state cruise and the airbreather systems for 10 minutes of cruise.
12. A payload capability of 1500 pounds should be provided for research instrumentation and telemetry systems.

Characteristics of the flight vehicles incorporating the results of the parametric studies are given in Figure 16.

Of the M = 12 class of vehicles, the manned air-launched, rocket configuration (B233) was retained for Phase II refinement, with growth or optional capability to test advanced propulsion systems, various thermal protection systems, armament systems, stage separation, and horizontal and vertical takeoff.

FIGURE 16 FLIGHT RESEARCH VEHICLES

	Mach 6 Air	Mach 6 HTO	Mach 12 Air	Mach 12 HTO/VTO	Unmanned Mach 12 Air	Mach 12 Air	Mach 12 HTO
Acceleration	(3) RL 10 Rockets	(2) F100 TJ	(5) RL 10 Rockets	(1) J2S Rocket	(5) RL 10 Rockets	(5) RL 10 Rockets	(4) F100 TJ
Engines (Number)	(1) 2 Dim. RJ	(2) 2 Dim. RJ	(1) Throttled	(1) Throttled	(1) Throttled	Scramjet	Convertible Scramjet
Hypersonic							
TOGW - Lb (kg)	46,095 (20,909)	46,810 (21,233)	37,000 (39,463)	167,000 (75,751)	82,500 (37,422)	88,000 (39,917)	99,320 (45,052)
OWE - Lb (kg)	26,095 (11,837)	36,940 (16,756)	25,660 (11,639)	41,200 (18,688)	24,250 (11,000)	29,050 (13,177)	64,820 (29,402)
Program Cost MIL - \$ (3 Vehicles, 5 Years, 200 Flights)	607	717	480	622	542	818	1077
Test Duration - Minutes	10	10	5	5	5	5	5
Configuration No.	207	212	233	260	284	232	257
Maximum Research Value	7090	7510	6610	6690	6620	7650	7470

Of the M = 6 class of vehicles, the horizontal takeoff, TJ/RJ configuration was retained. In an attempt to reduce total program costs, it appeared that an attractive vehicle could be obtained by using a turboramjet concept employing a J58 turbojet core engine with a liquid hydrogen ramjet wrapped around the core engine. The adaptability of this vehicle to accept testing of advanced propulsion systems, various thermal protection systems, and armament systems was studied in Phase III.

4.3 PHASE III FINAL STUDIES

As a result of the preliminary studies, two distinctly different concepts were selected for detailed refinement in Phase III.

To provide a near-term technology research aircraft, a Mach 6 airbreathing configuration was selected. This vehicle, a turboramjet-powered wing body aircraft, provides capability for technology demonstration of advanced airbreathing propulsion systems, as well as a broad spectrum of research applicable to the defined potential operational systems. The vehicle is designed for steady state cruise at Mach 6 for five (5) minutes, operates in a conventional ground takeoff mode, and is manned. It employs a turboramjet designated P&WA STRJ11A-27, using the existing Pratt & Whitney J58 JP fueled turbojet engine together with a LH₂ fueled wraparound ramjet modification. This would provide early research on a turboramjet engine. At the same time, the aircraft can be designed to accept an advanced compound airbreathing engine when it becomes available for tests. Therefore, the development of this concept will not be paced by the parallel development of an advanced engine, nor

burdened by the associated costs.

To provide a quantum jump in performance, a Mach 12 rocket-powered all body aircraft was selected. This vehicle is manned, C-5A air-launched, and designed to cruise for five minutes at Mach 12. The engines employed are P&WA RL10-A-3-9 rockets using LO_2/LH_2 propellants. Five engines are employed for acceleration to cruise speed and cruise is achieved on a single engine throttled to approximately 30% thrust. Like the Mach 6 concept, the use of existing engines will free the research program of engine development costs and preclude pacing the aircraft development to a parallel advanced engine development program. Provisions to accommodate advanced airbreathing engines for future testing is an attractive option available with this vehicle.

The objective of the Phase III studies was to refine and optimize these two vehicles and determine in greater depth their research capabilities, costs, and time schedules.

Specific emphasis was given to examining approaches to expand the research capability of each vehicle by adapting various research options to the basic vehicle. In this manner, a significant improvement in overall performance capability can be achieved and thus provide a broad degree of research flexibility and versatility.

4.3.1 MACH 6 TURBORAMJET AIRCRAFT

The basic aircraft general arrangement is shown in Figure 17 along with pertinent general characteristics. Selected performance, weight, and cost characteristics are presented in Figure 18.

The aircraft concept consists of a wing body configuration powered by a near-term turboramjet (P&WA STRJ11A-27). It is manned and designed for horizontal take-off and landing. Initial acceleration is provided by the JP fueled turbojet core engine which operates through the speed range of Mach 0 to 3.5. At Mach 3.5 the turbojet is shut down, sealed from the main airflow using closure doors, and wind-milled with a small amount of inlet air which has been cooled to 1000°F (538°C). The wraparound ramjet engine operates on hydrogen fuel at stoichiometric conditions through the speed range of Mach 0.8 to 6. The fuel flow required to regeneratively cool the engine and inlet at Mach 6 corresponds to the stoichiometric fuel flow rate ($\phi = 1.0$). During cruise the engine is operated in a throttled condition at an equivalence ratio of 0.5. The remaining fuel (required for cooling) is dumped overboard without burning.

Along with a normal complement of avionic equipment, the vehicle provides capability to house 1290 lb (585 kg) of research instruments and related electronics.

As illustrated in Figure 19, the primary structure is protected from the external aerodynamic environment by an insulation system consisting of a single faced corrugated heat shield and a layer of high temperature insulation. The LH_2 fuel tank, located in the center fuselage section is integrated with the fuselage structure and made of frame stiffened aluminum sheet alloy. The fuselage and wing structure aft of the fuel tanks house the engine and inlet and are made of conventionally stiffened titanium sheet alloy. The titanium inlet structure is protected from the high temperature inlet environment by a regeneratively cooled Rene' 41

FIGURE 17
MACH 6 TURBORAMJET AIRPLANE GENERAL ARRANGEMENT

Mission Performance

5 Minutes Steady State
Cruise at Mach 6
1300 Lb (589.7 Kg) Research
Instrumentation Payload

Engine

F&WA STRJ11A-27 Turboramjet

Landing Gear -

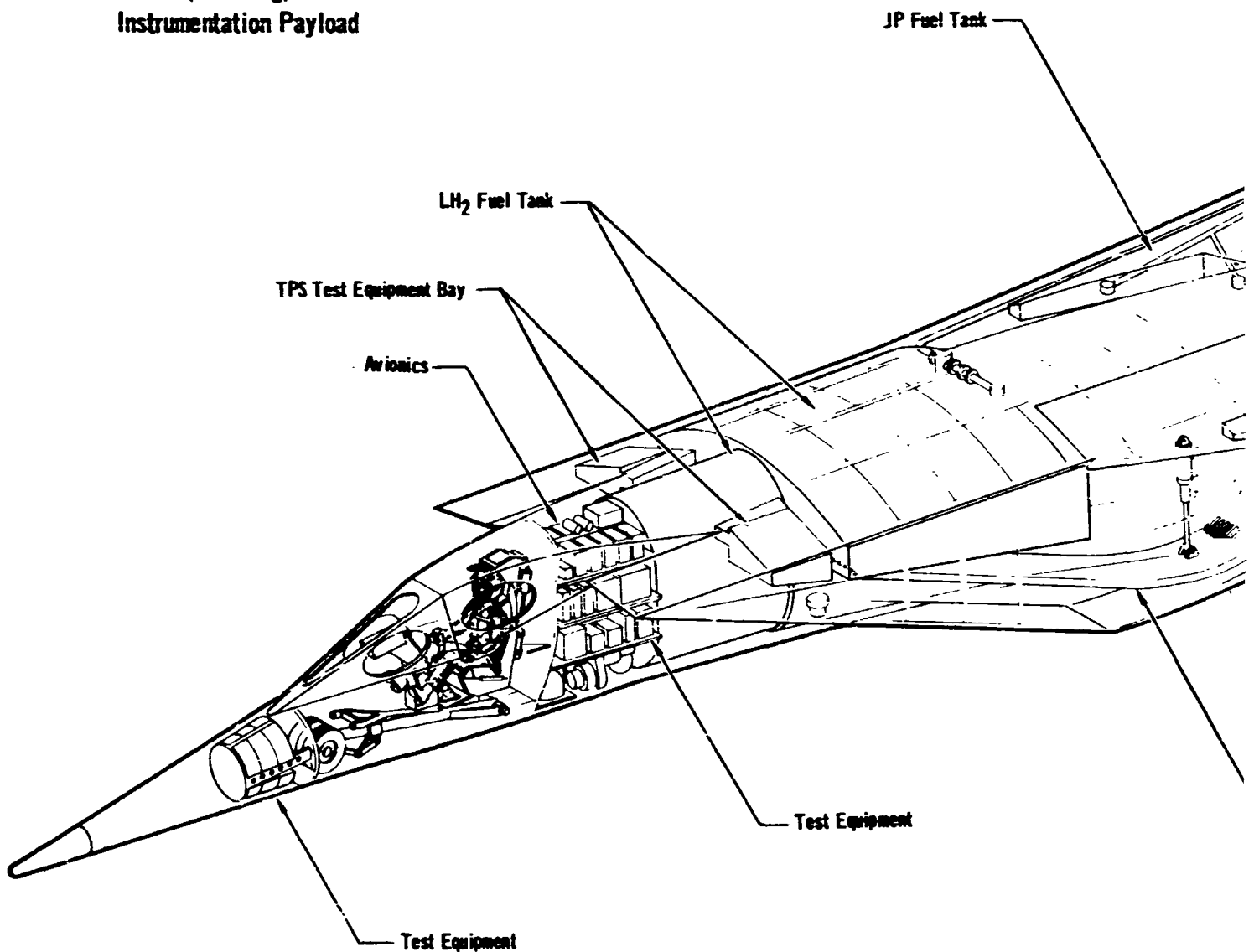

FOLDOUT FRAME 2

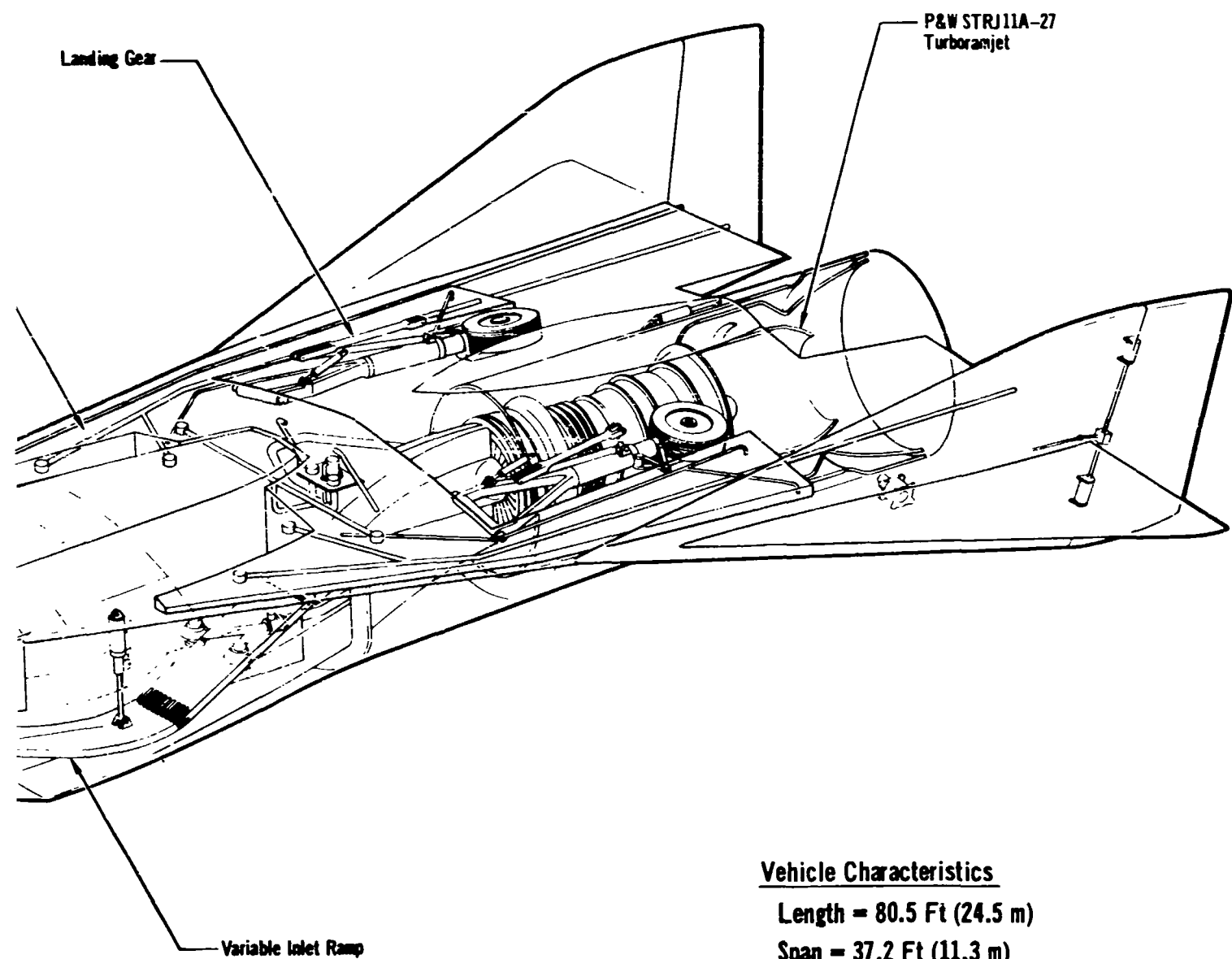

Vehicle Characteristics

Length = 80.5 Ft (24.5 m)

Span = 37.2 Ft (11.3 m)

Sp = 1103 Ft² (102.47 m²)

OWE = 48,456 Lb (21,976 Kg)

TOGW = 61,426 Lb (27,859 Kg)

Acquisition Cost = 398 Million Dollars

Total Program Cost = 490 Million Dollars

FIGURE 18 MACH 6 TURBORAMJET AIRPLANE CAPABILITIES

P & WA STRJ11A-27 INSTALLED ENGINE PERFORMANCE
(Along Design Mission Trajectory)

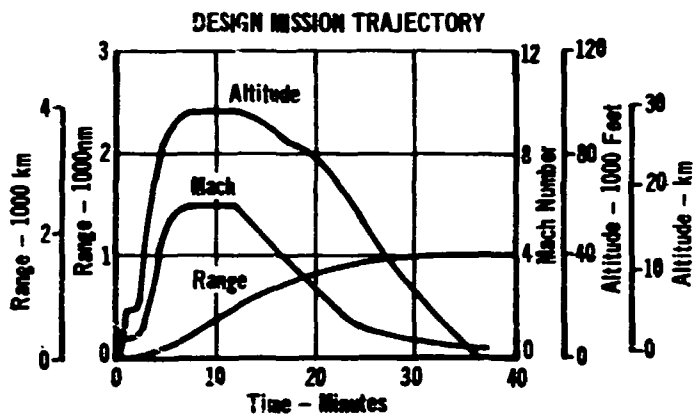
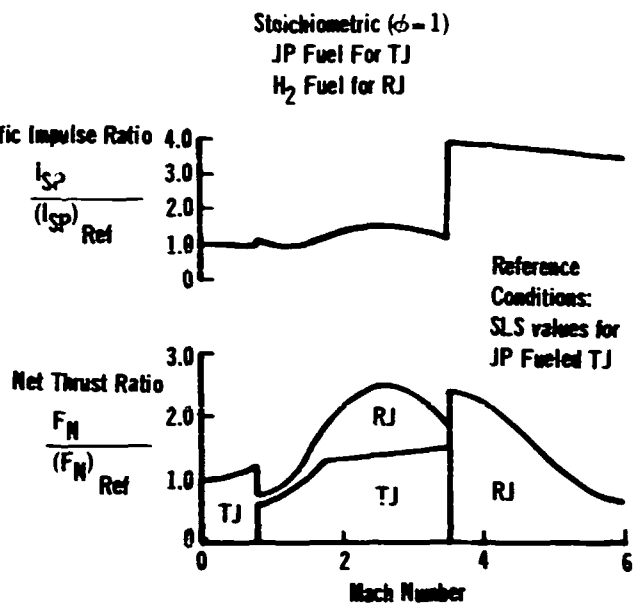
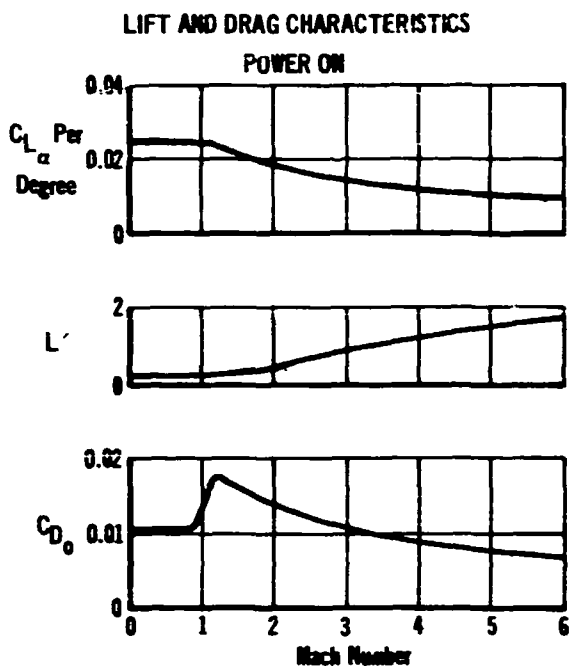

WEIGHT SUMMARY

	lbm	kg
Structure	21,033	9,539
Equipment	5,802	2,630
Propulsion	21,621	9,807
Propellant	12,970	5,883
OWE	48,456	21,976
TOGW	61,426	27,859

COST SUMMARY

3 Vehicles Millions of 1970 Dollars	
RDT&E	212
Investment	'96
Operating	92
Total	490

FULLSCALE DRAWING

FIGURE 19 MACH 6 TURBORAMJET AIRPLANE STRUCTURAL ARRANGEMENT

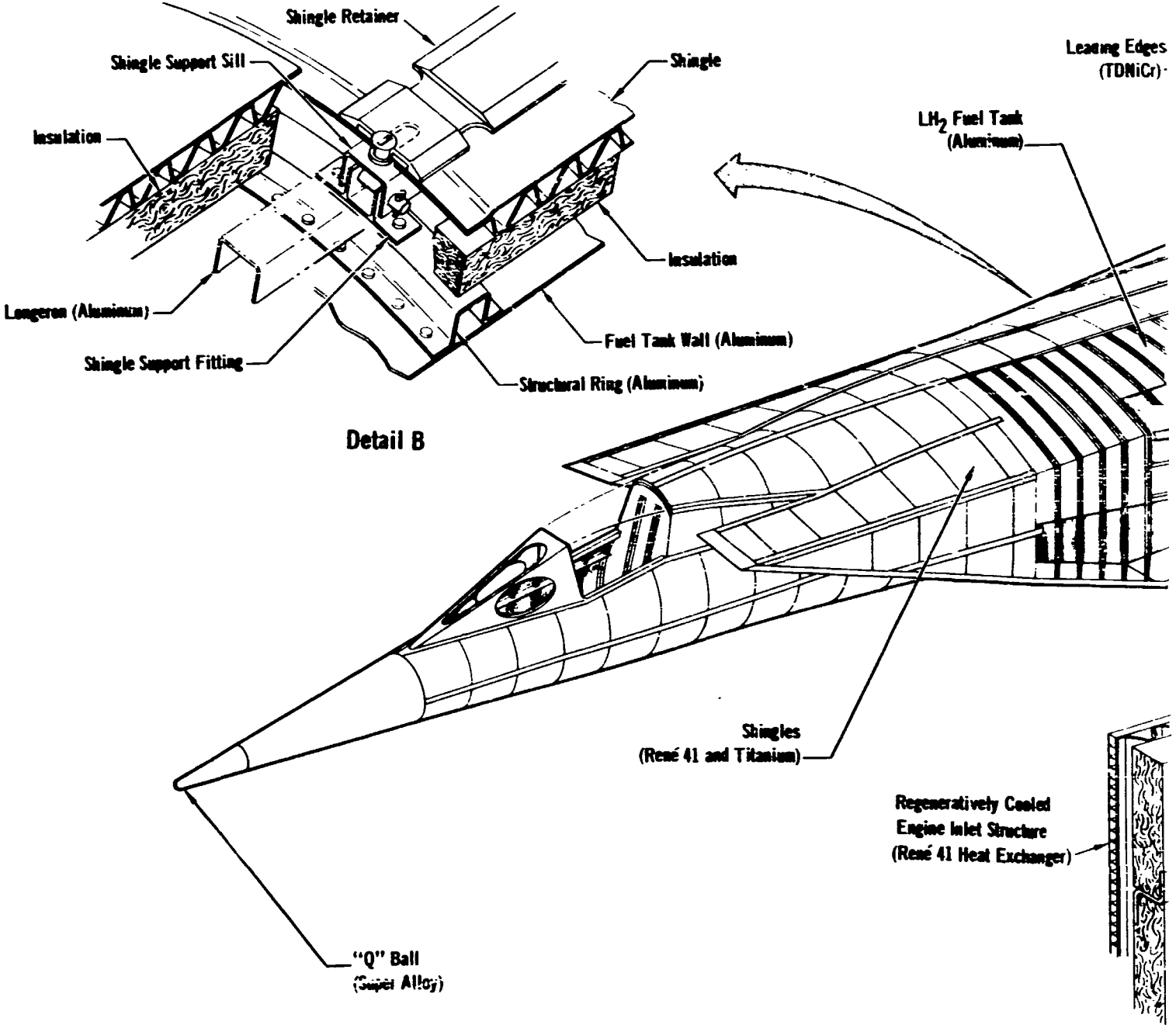

FOLDOUT F2_{rev. 2}

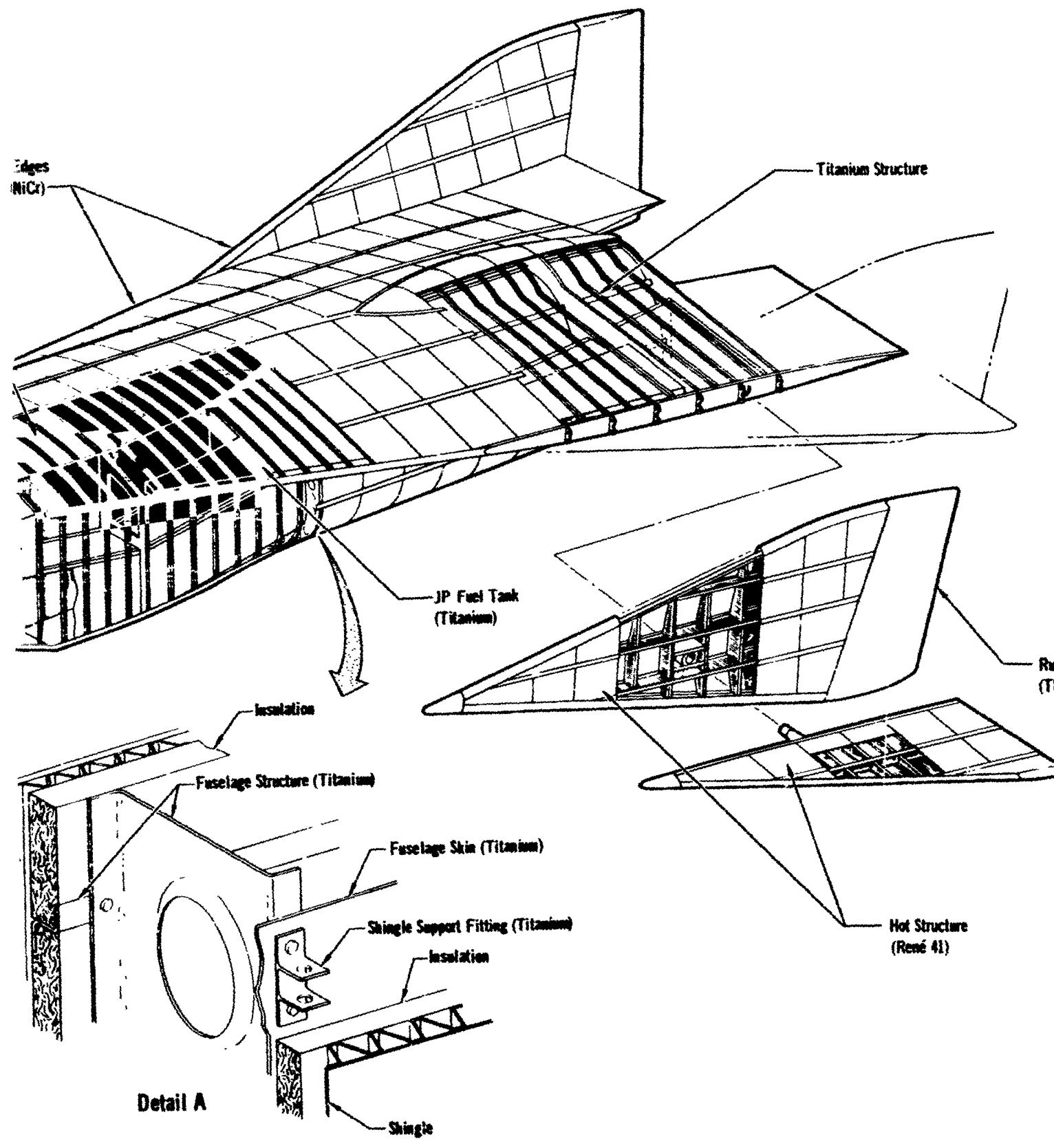

heat exchanger and a layer of insulation. Control surfaces are unprotected hot structure of superalloy skin and frame construction. The nose tip proposed is a regeneratively cooled "Q-Ball" similar to the X-15.

In order to expand the research capability of the basic vehicle, design methods of adapting various research options to the basic vehicle were examined. The various options examined are illustrated in Figure 20. These studies were based on modifying the basic vehicle by incorporating the structural provisions for eventual adoption of the research packages. Incorporating the structural provisions in the basic vehicle was found to be feasible. Minor provisions are needed for the armament, thermal protection system, and ramjet options. The incorporation of the advanced turboramjet requires more extensive modification to the aircraft in the inlet duct to engine face transition area. The convertible scramjet option, while structurally feasible, resulted in very poor vehicle performance. Both the vehicle weight and drag increased significantly and estimates indicate that the vehicle would not be capable of reaching appreciable supersonic speeds, thus detailed performance analysis was not accomplished.

Capability as a flying test bed for advanced propulsion systems was judged an absolute necessity for this vehicle. The engine compartment for the basic engine is sufficiently large that it should readily accommodate many advanced engines. It could handle any of the turboramjets, turbofanramjets, and supercharged ejector ramjets proposed in recent studies of military applications. The capability to accept a hydrogen fueled advanced turboramjet has been confirmed and is judged as a significant capability of this vehicle.

Dual base operations are required for the basic vehicle for missions in which the test speed exceeds Mach 3. Typical mission operations are illustrated in Figure 21. In all cases, the recovery site is Edwards Air Force Base. For the higher speed flights, Holloman Air Force Base is used as the test launch site. Adequate communication and tracking networks exist along the flight path as well as emergency landing sites, and therefore, no new ground facilities are required.

While there appear to be no major problem areas in the development of the basic vehicle, there are a number of technological areas in which special emphasis should be applied, specifically:

- o Engine/airframe integration
- o Regeneratively cooled panels
- o Component and subsystem demonstration.

Establishment of concept feasibility does not require specific solutions in these areas, since the basic technologies are relatively well understood. The major areas of effort lies in substantiation of specific design/operational details in conjunction with subsystem/vehicle integration for the basic vehicle design.

As illustrated in Figure 22, a little over three years will be required to develop the aircraft to first flight status and another year is required to bring the vehicle to a status suitable to start the research program.

FIGURE 20 MACH 5 TURBORAMJET AIRPLANE AND OPTIONS
Thermal Protection System Test Bay

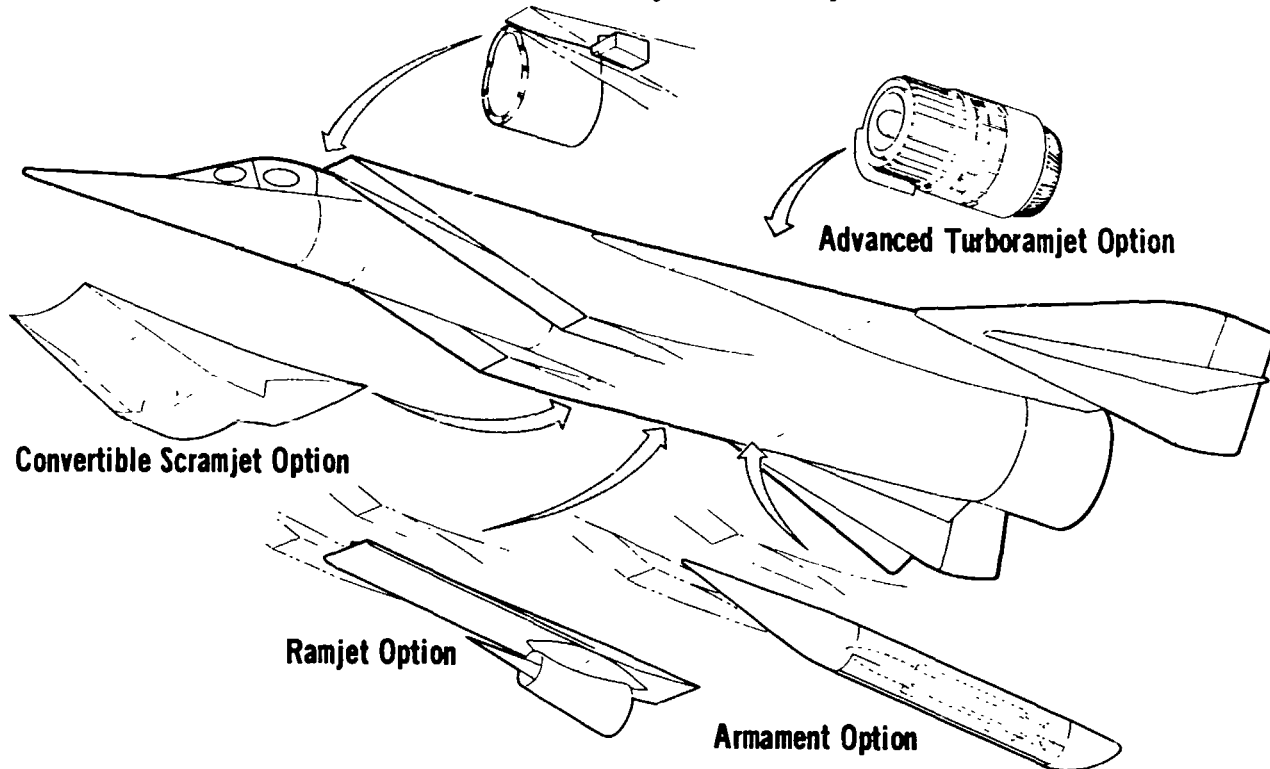

Configuration Description	Performance:		Weight - lb (kg)		Acquisition Cost - Millions of Dollars				
	Mach	Time (min)	OWE	TOGW	Basic Vehicle Including Provisions	Research Option Increments (One Aircraft)			Total System
						Airframe	Engine	Facilities	
Basic Vehicle	6.0	5.0	48,456 (21,979)	61,426 (27,862)	398	-	-	-	398
Armament Option	6.0	3.2	50,648 (22,974)	63,618 (28,857)	399	+3	0	0	402
TPS Option	6.0	5.0	48,792 (22,132)	61,762 (28,015)	398	+6	0	0	404
Advanced Turboramjet (JZ6)	6.0	0.3	46,144 (20,931)	51,504 (23,362)	399	+43	Flight Rated ¹		1318
							+500	+376	
							Partial Flight Rated ²		723
+281	0								

1 Flight Rated - The engine is developed in the traditional MIL specification method (accumulation of test hours and operating cycles) including preliminary flight rating tests and manufacturing qualification tests.

2 Components Developed - All major elements of the engine have been functionally and structurally tested. A complete flight weight engine has been structurally tested up to maximum design conditions. The engine has been functionally operated up to the limits of existing engine test facilities (estimate as approximately Mach 3 to 3.5 depending upon engine size).

FIGURE 21 MACH 6 TURBORAMJET AIRPLANE - TYPICAL MISSION

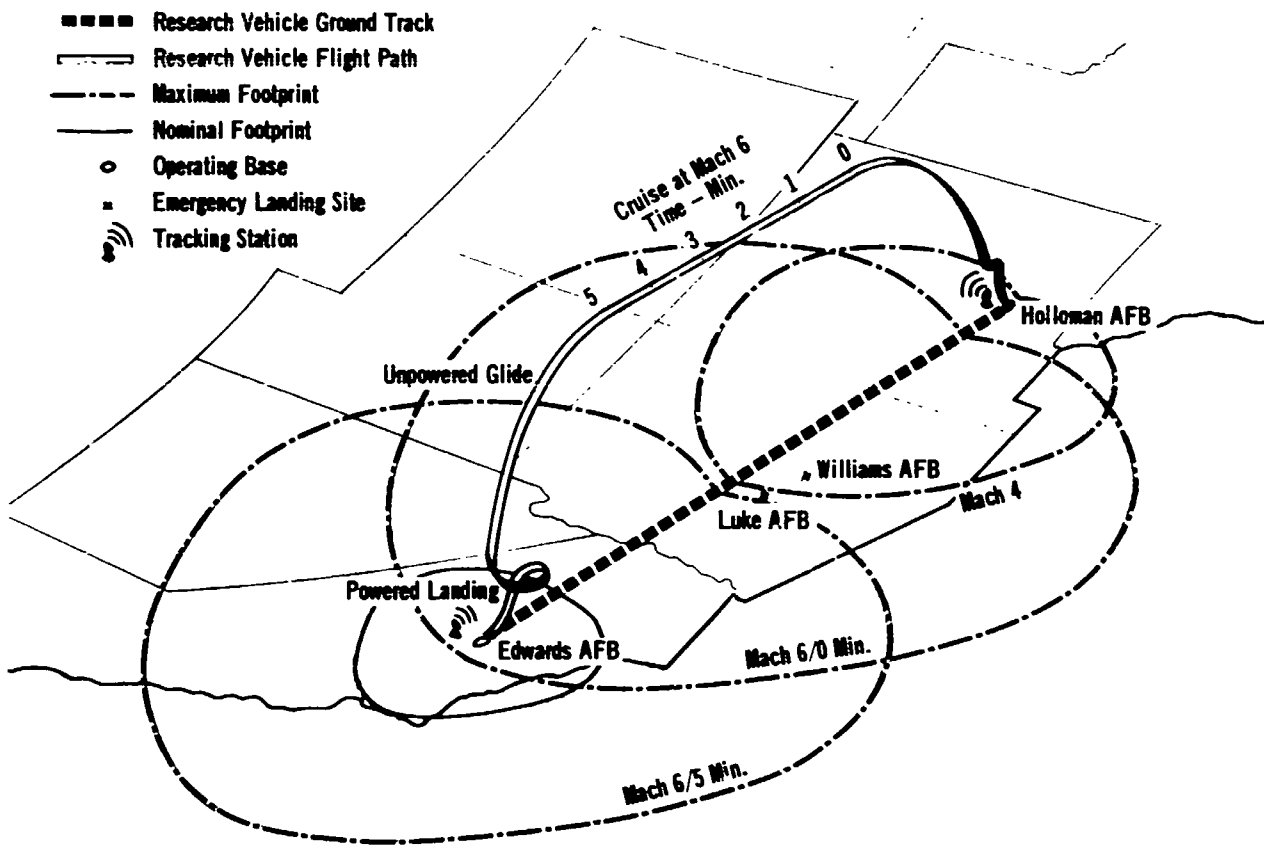

FIGURE 22 MACH 6 TURBORAMJET AIRPLANE DEVELOPMENT SCHEDULE

Activity	Years																					
	0		1				2				3				4				5			
			1	2	3	4	5	6	7	8	9	10	11	12	13	14	15	16	17	18	19	20
Go-Ahead.....			▲																			
Engineering Design.....			■	■	■	■	■	■	■	■	■	■	■	■	■	■	■	■	■	■	■	■
Development Testing.....			■	■	■	■	■	■	■	■	■	■	■	■	■	■	■	■	■	■	■	■
Engine Development Program.....			■	■	■	■	■	■	■	■	■	■	■	■	■	■	■	■	■	■	■	■
Manufacturing & Preflight Tests (3 Vehicles).....																						
First Flight.....																						
Pre-Delivery Flight Test.....																						
Delivery of Aircraft to NASA.....																						

4.3.2 MACH 12 ROCKET VEHICLE - The basic aircraft general arrangement is shown in Figure 23 along with pertinent general characteristics.

Selected performance, weight, and cost characteristics are presented in Figure 24. The vehicle is air-launched from the wing of a specially equipped C-5A launch aircraft, at Mach .8 and at 35,000 ft (10,660m) altitude. Initially headed toward the landing site at Edwards Air Force Base, the airplane accelerates on all (5) rocket engines climbing to the cruise altitude. At cruise altitude, four of the engines are shut down and the centerline engine is throttled back to 30% for cruise.

Along with a normal complement of avionic equipment, the vehicle provides capability to house 1,500 lb (680.4 kg) of research instruments and related electronics.

While the engine concept illustrated uses multiple RL10 rockets, another attractive option is also available using a single J2S rocket. Because of its large physical size and thrust concentration, this design alternative would require different structural load paths to support and redistribute the basic thrust loads. Deep throttling would be required to achieve steady state flight or engine pulsing could be employed to achieve quasi-steady state flight. Roll and yaw control, available through gimbaling of the RL10 rockets, would require addition of an altitude control system for the J2S version when conducting research where insufficient aerodynamic control is available.

The primary fuselage structure is fabricated using conventional aluminum alloys and mechanical attachments, as illustrated in Figure 25. Integral tanks are employed to house the propellants. Hot structure concepts are employed for the control surfaces utilizing T.D. nickel chrome and coated columbium. The nose tip proposed is a "Q-Ball" type nose similar in concept to that employed on the X-15. This nose tip is fabricated from superalloy materials and regeneratively cooled.

The primary fuselage structure is protected from the thermal environment by a water rich thermal protection system. Elements of this system along with the shingle materials are also illustrated in Figure 25.

In order to expand the research capability of the basic vehicle, design methods of adapting various research options to the basic vehicle were examined. The various options examined are illustrated in Figure 26. These studies were based on modifying the basic vehicle (i.e., the vehicle size was held constant) by incorporating structural provisions in the basic vehicle for eventual adoption of research packages. The effects on vehicle performance, weight, and cost are noted in Figure 26. In all cases, incorporating the structural provisions in the vehicle was found to be feasible and resulted in small weight and cost increments. The greatest cost increments are incurred with the scramjet and convertible scramjet options. For these options, the total acquisition costs are doubled if the cost of developing, testing in new facilities, and building these engines is included. An attractive alternate approach would be to use the basic vehicle as the test facility to develop these advanced engines, which would result in a major reduction in cost.

Dual base operations are required for the basic vehicle for missions in which the test speed exceeds Mach 7. Typical mission operations are illustrated in Figure 27. In all cases, the recovery site is Edwards Air Force Base. For the high

FOLDOUT FRAME |

FIGURE 23 MACH 12 ROCKET AIRPLANE GENERAL ARRANGEMENT

Mission Performance

5 Minutes Steady State

Cruise at Mach 12

1500 Lb (680 Kg) Research
Instrumentation Payload

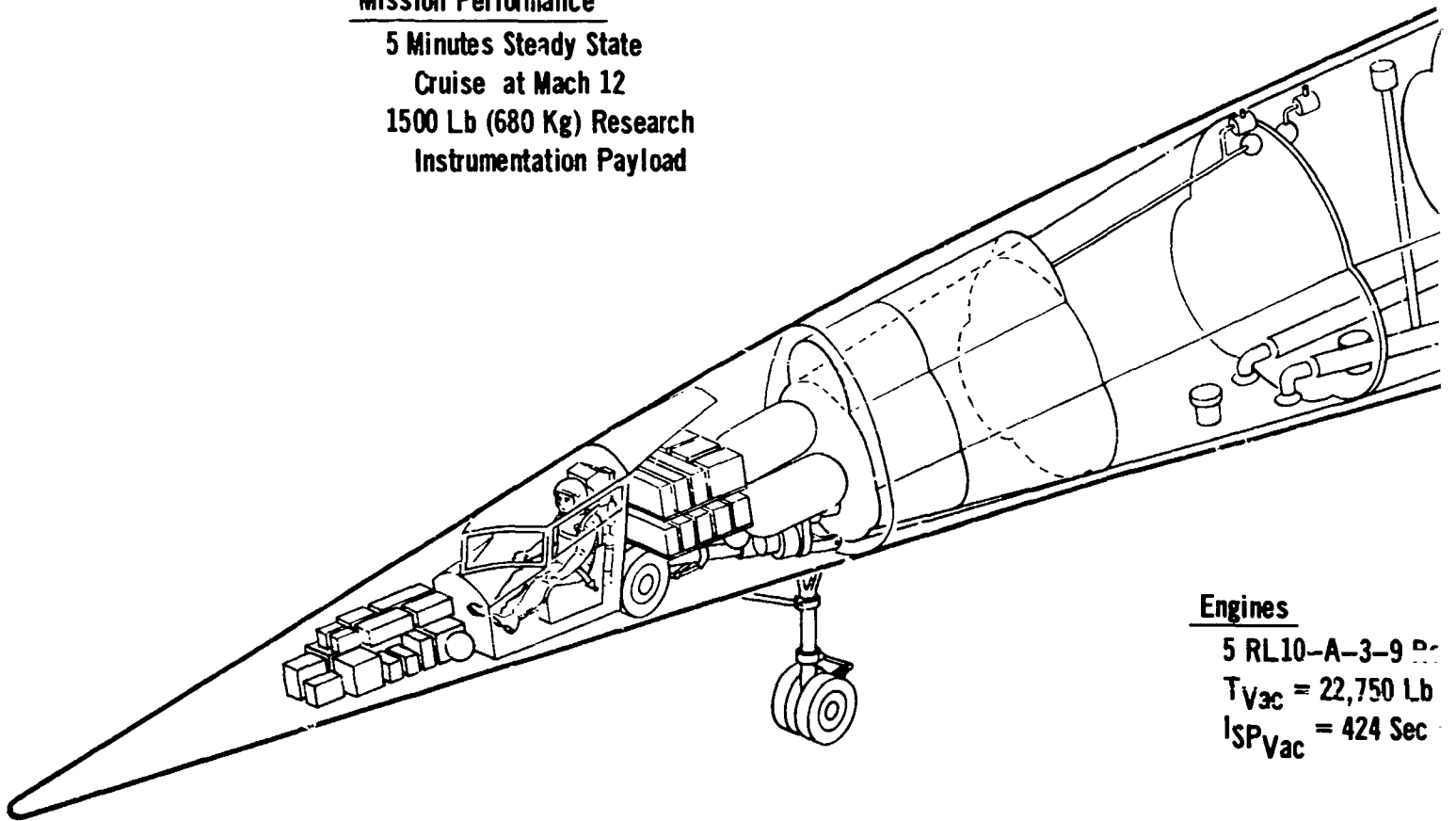

Engines

5 RL10-A-3-9

$T_{Vac} = 22,750 \text{ Lb}$

$I_{SP_{Vac}} = 424 \text{ Sec}$

FOLDOUT FRAME Z

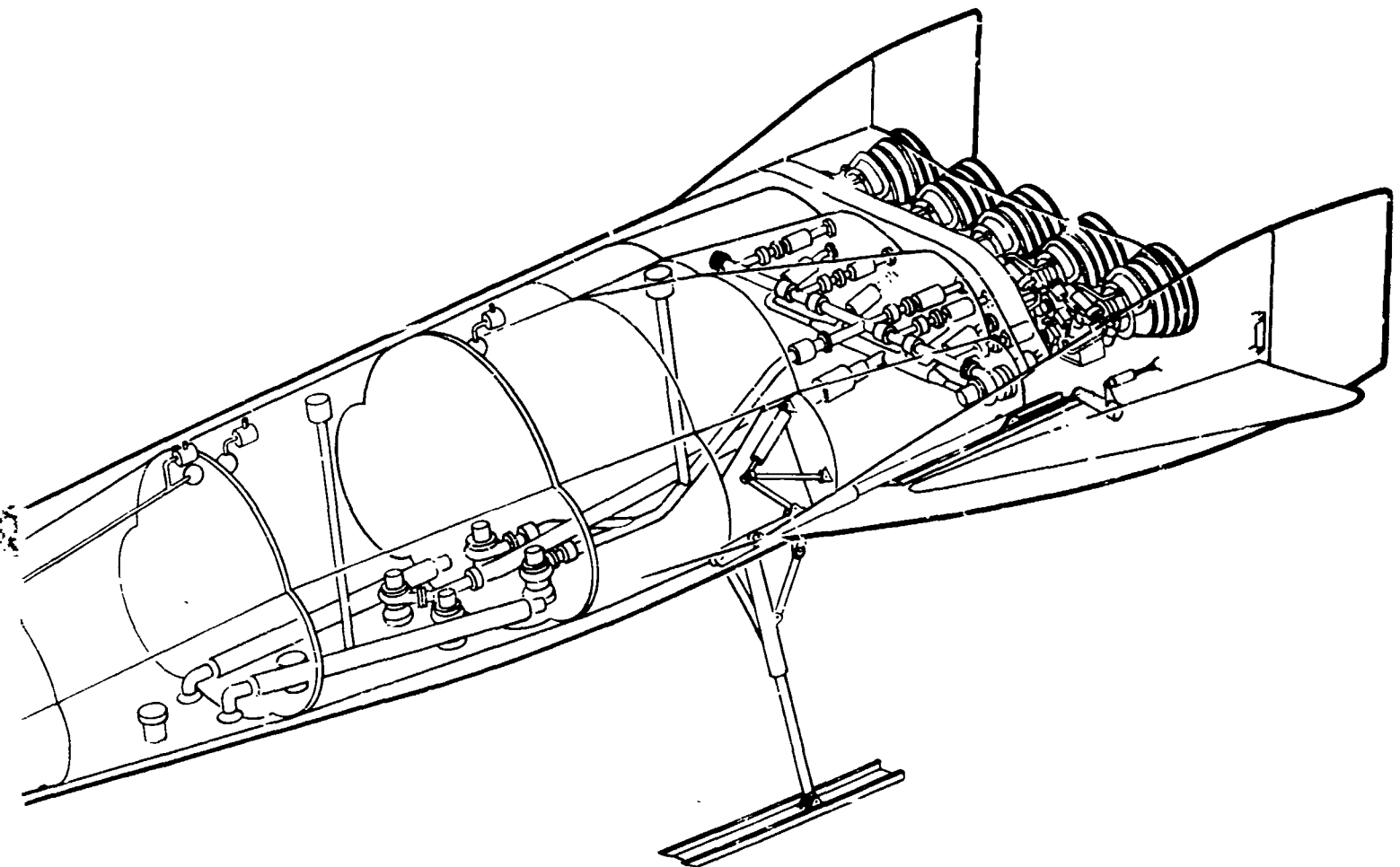

Engines

5 RL10-A-3-9 Rockets, $\epsilon = 32$
 $T_{Vac} = 22,750 \text{ Lb (101,000N)}$
 $I_{SP_{Vac}} = 424 \text{ Sec at } C/F = 6$

Vehicle Characteristics

Length = 83.3 Ft (26.6 m)
Span = 30.3 Ft (9.3 m)
 $S_p = 813 \text{ Ft}^2 (75.5 \text{ m}^2)$
OWE = 23,340 Lb (10,585 Kg)
TOGW = 79,650 Lb (36, 129 Kg)
Acquisition Cost = 263 Million Dollars
Total Program Cost = 351 Million Dollars

FIGURE 24 MACH 12 ROCKET AIRPLANE CAPABILITIES

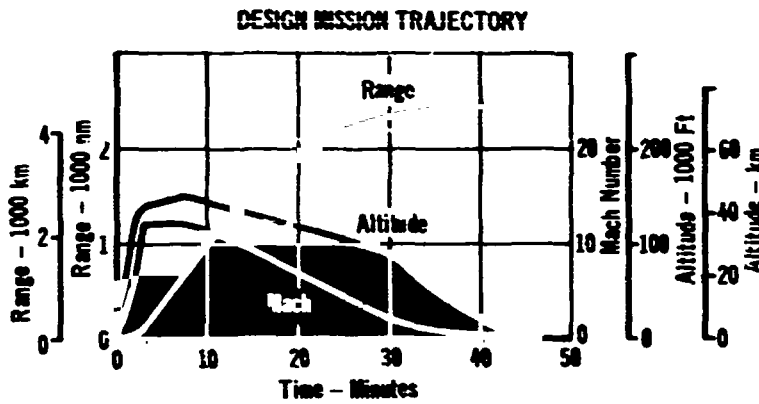
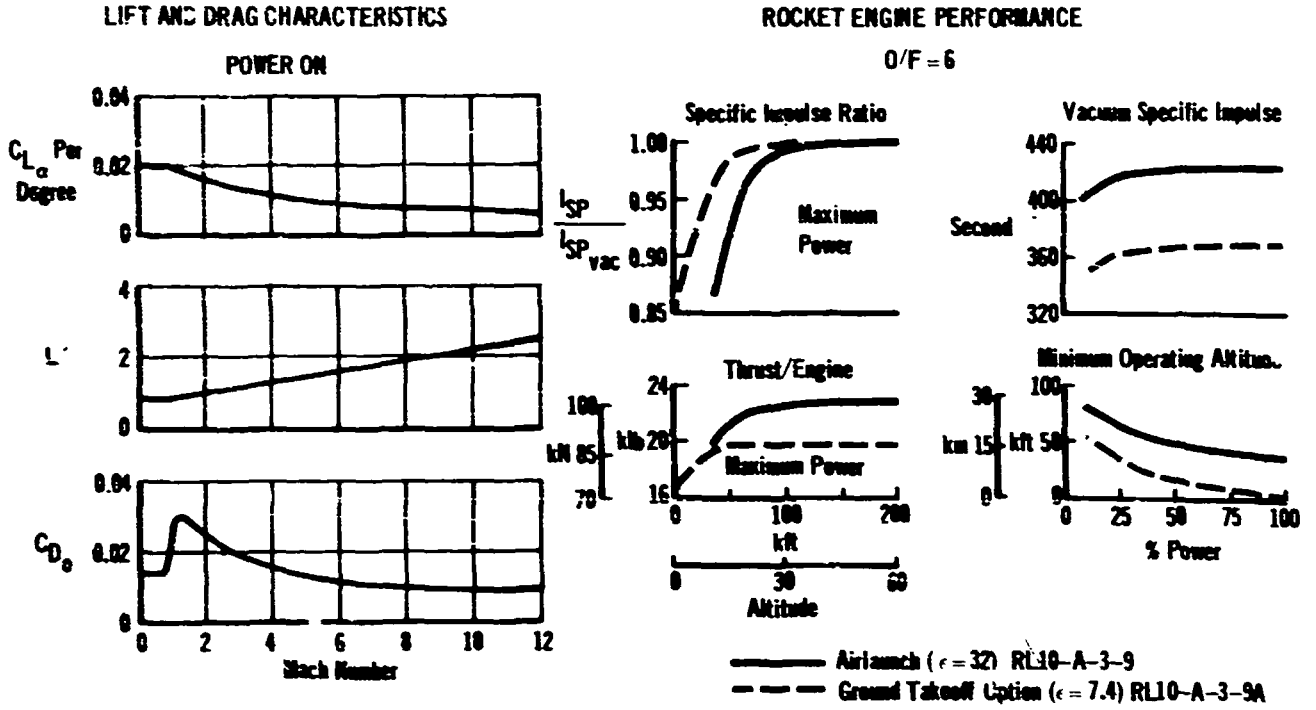

WEIGHT SUMMARY

	lbm	Kg
Structure	13,958	6,331
Equipment	6,242	2,829
Provision	3,140	1,425
Propellant	56,310	25,544
OWE	23,340	10,585
TOGW	79,650	36,129

COST SUMMARY

(3 Vehicles)	
Millions of 1970 Dollars	
RDT&E	126
Investment	137
Operating	88
Total	351

FIGURE 25 MACH 12 ROCKET AIRPLANE STRUCTURAL ARRANGEMENT

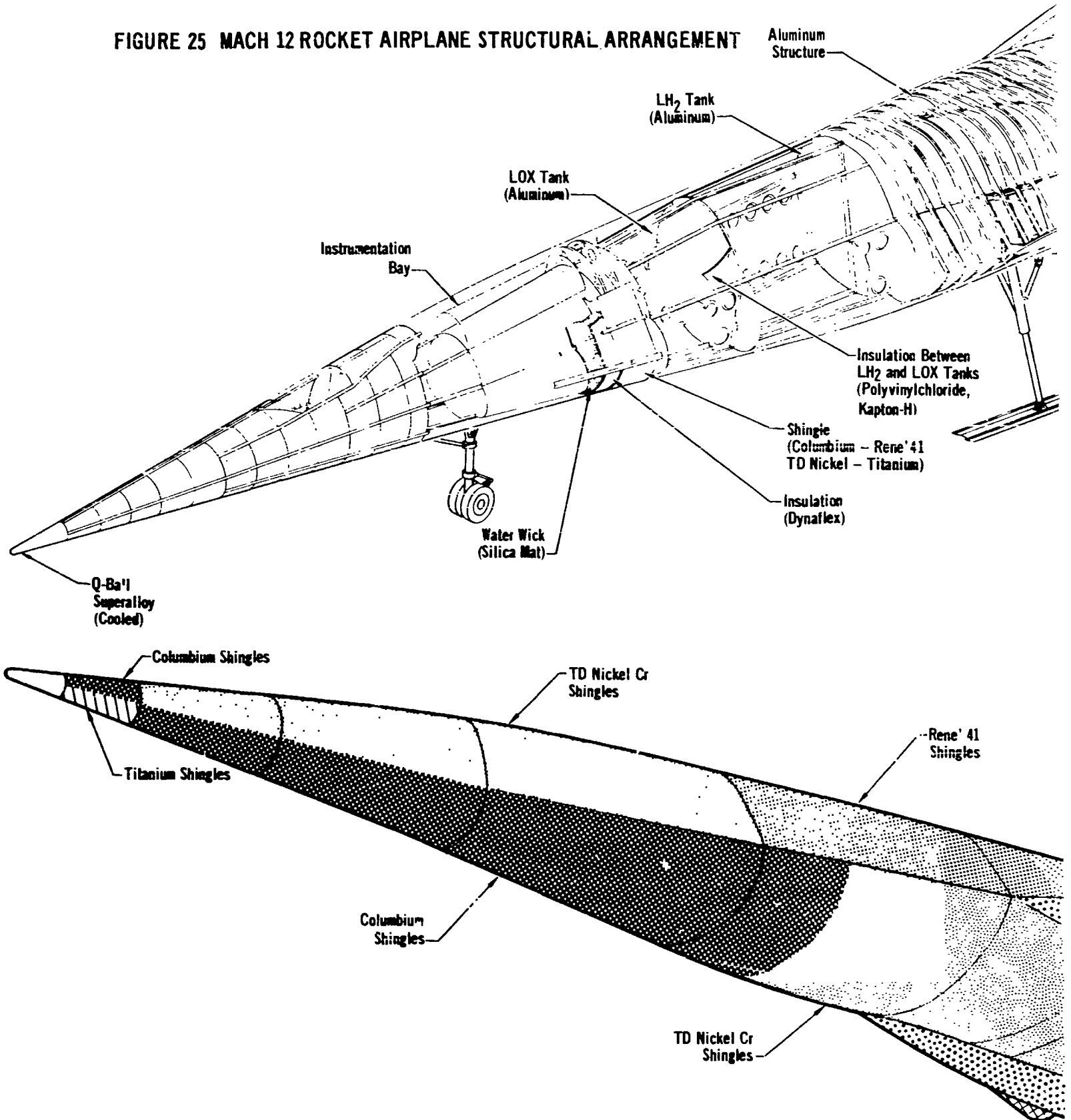

FOLDOUT FRAME 2

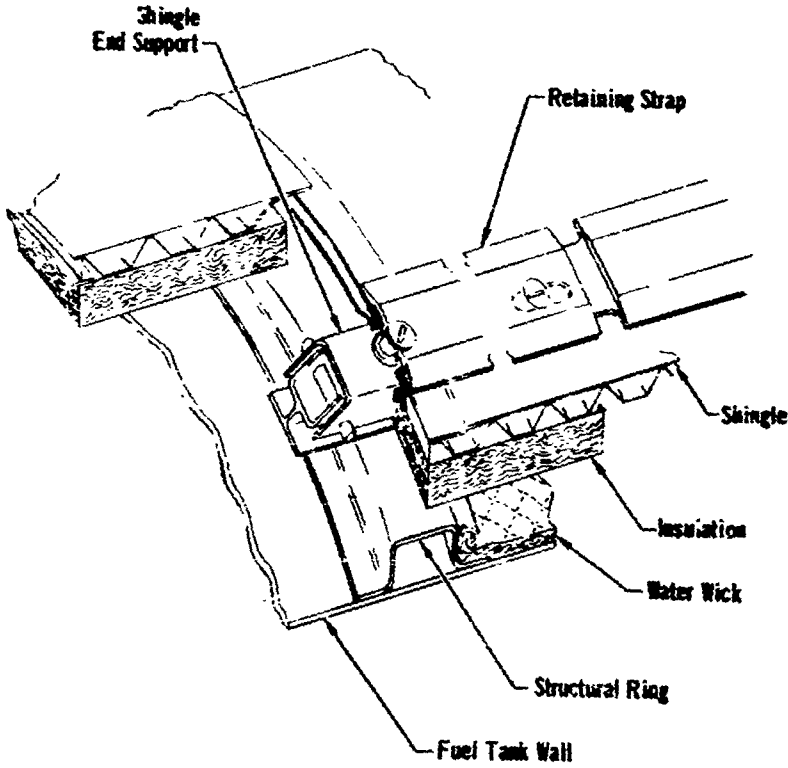
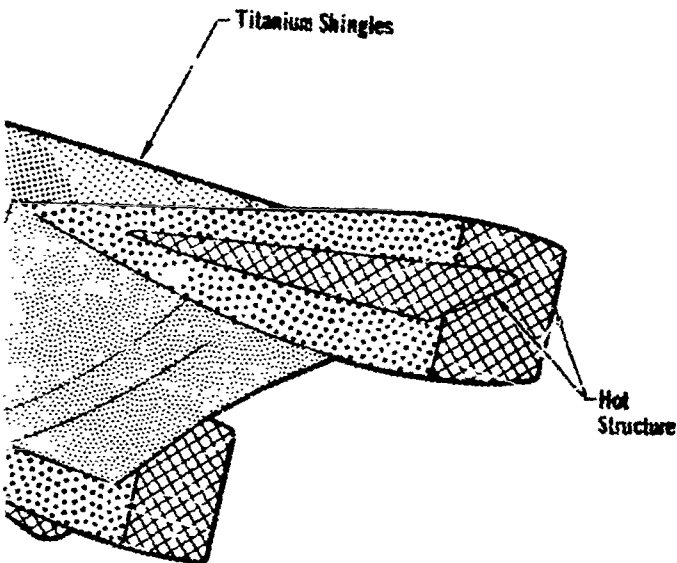
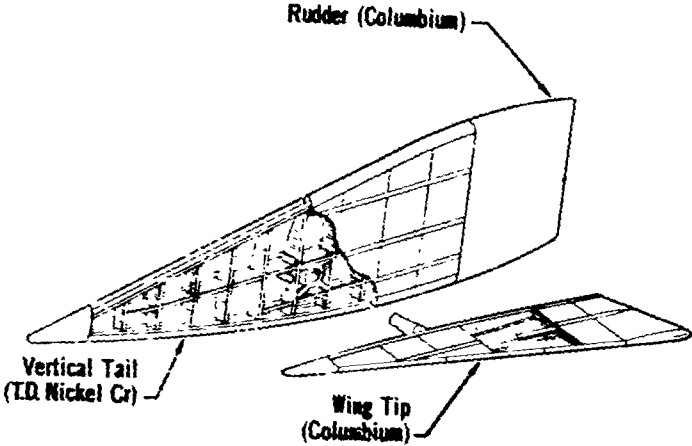
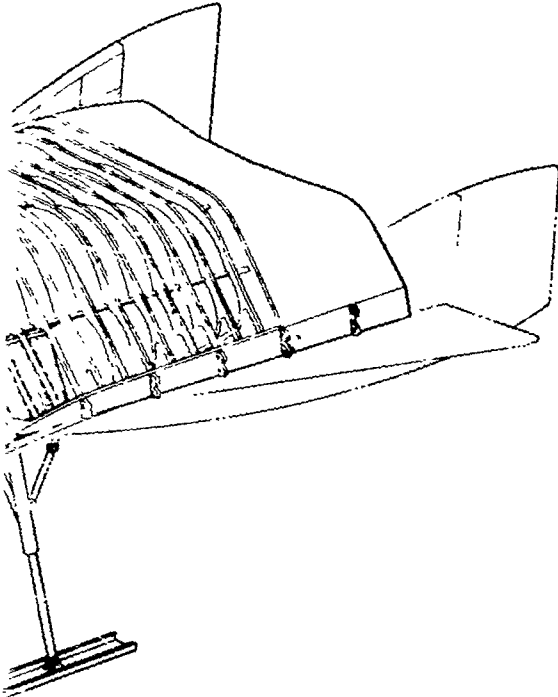
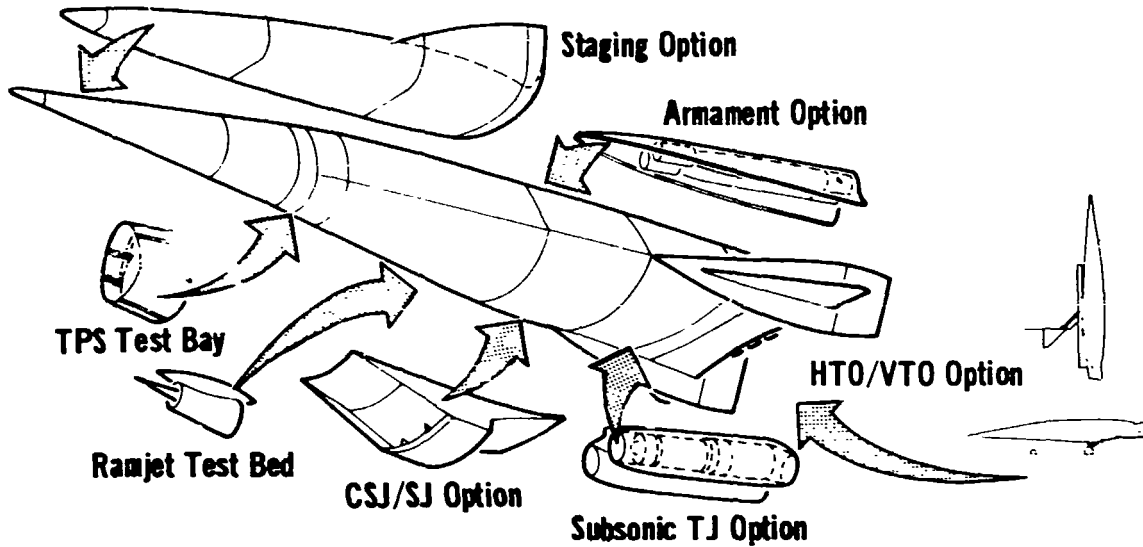

FIGURE 26 MACH 12 ROCKET AIRPLANE AND OPTIONS



Configuration Description	Performance		Weight - Lb (Kg)		Acquisition Costs - Millions of Dollars				Total System	
	Mach	Time (Minutes)	OWE	TOGW	Basic Vehicle Including Provisions	Research Option Increments (One Aircraft)				
						Airframe	Engine	Facilities		
Basic Vehicle	12	5	23,340 (10,584)	79,650 (36,129)	263	-	-	-	263	
Scramjet Option	11.5	0	29,309 (13,296)	69,200 (31,349)	264	41.2	Flight Rated ⁵		483	
	10.7	5					52.8	15		
							Components Devel'd			
						52.8	0		368	
Convertible Scramjet Option	11.8	0	30,798 (13,970)	52,300 (23,763)	265	50.5	Flight Rated		524	
	11.1	5					178.5	30		
							Components Devel'd ⁶			
						73.5	0		389	
TPS Option	12	5	23,613 ¹ (10,710)	79,923 ¹ (36,262)	263	5	0	0	268	
Armament Option	10.3	5	28,036 ² (12,710)	84,348 ² (38,300)	264	8	0	0	272 ⁷	
Staging Option	Varies with Weight of Staged Vehicle		24,538 ³ (11,130)	80,848 ³ (36,672)	264	13 (10 Units)	0	0	277	
HTO Option	9.4	0	23,423	79,733	265	3.3	4.7	0	273	
	7.6	5	(10,624)	(36,166)						
VTO Option	8.7	0	23,682	79,992	267	5.3	4.7	0	277	
	6.9	5	(10,742)	(36,284)						
Turbojet Option	0.6	Extended	42,305 (19,185)	52,305 ⁴ (23,725)	266	27.5	0.5	0	294	

1 Includes 200 Lb (91 Kg) Allowance for TPS Research Package
 2 Includes 3100 Lb (1437 Kg) Allowance for Missiles
 3 Excludes Weight of Staged Vehicle
 4 Includes 10,000 Lb (4536 Kg) Allowance for JP Fuel
 5 Excludes S150 MIL Engine and S147 MIL Ground Facility
 6 Excludes S175 MIL Engine and S147 MIL Ground Facility

5 Flight Rated - The engine is developed in the traditional MIL specification method (accumulation of test hours and operating cycles) including preliminary flight rating tests and manufacturing qualification tests.

6 Components Developed - All major elements of the engine have been functionally and structurally tested. A complete flight weight engine has been structurally tested up to maximum design conditions. An engine module has been functionally operated up to the limits of existing engine test facilities, (estimated as approximately Mach 6 for research aircraft size engine modules).

7 Excludes Missile Cost

Note: Ramjet Option - Design Concept Only, Was Developed

FIGURE 27 MACH 12 ROCKET AIRPLANE TYPICAL MISSION

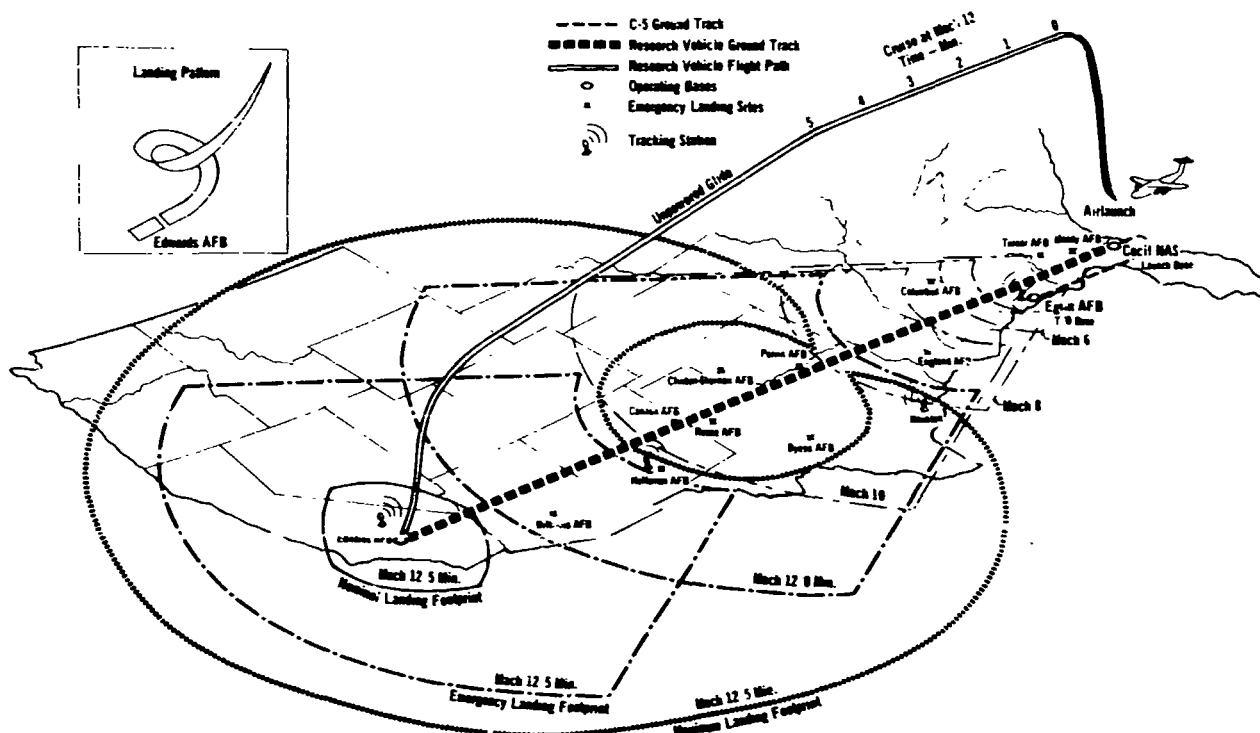

speed flights, Eglin Air Force Base is used as the staging base. During the speed envelope expansion, Holloman Air Force Base is also used. Adequate communication and tracking networks exist along the flight path as well as numerous emergency landing sites, and therefore, no new ground facilities are required.

While there appear to be no major problem areas in the development of the basic rocket vehicle, there are a number of technological areas in which special emphasis should be applied, specifically:

- o Configuration development
- o Structural/thermal protection systems
- o Component and subsystem demonstrations.

Establishment of concept feasibility does not require specific solutions in these areas, since the basic technologies are relatively well understood. The major area of effort lies in substantiation of specific design/operational details in conjunction with subsystem/vehicle integration for the basic vehicle design.

As illustrated in Figure 28, approximately three years will be required to develop the vehicle to first flight status and another year is required to bring the vehicle to a status suitable to start the research program.

FIGURE 28 MACH 12 ROCKET AIRPLANE DEVELOPMENT SCHEDULE

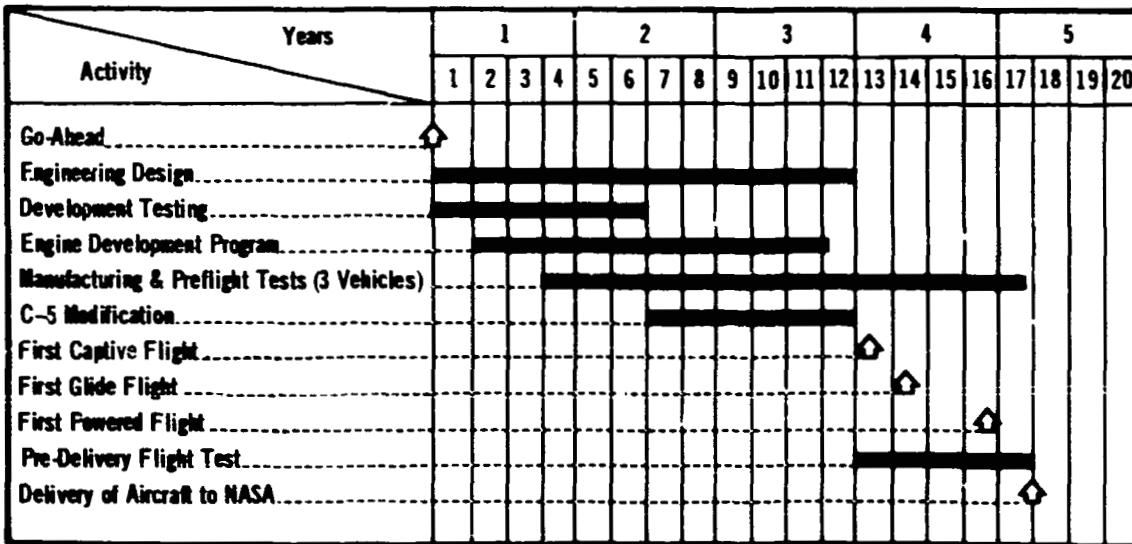

5. GROUND FACILITY POTENTIAL

Historically new operational aircraft systems are developed from an experimental data base provided by ground research facilities. When limitations in experimental simulation and research capability existed, flight research aircraft such as the X-1, X-2, D558-2, and X-15 were necessary to provide research data to measure the adequacy of extrapolated data from ground research experiments. For the nine potential operational hypersonic aircraft, as for present aircraft systems, ground research will be an important element in their development. A number of attractive ground research facility concepts have been developed which provide a significant improvement in research capability over existing facilities. As a result of application of current technology, and adaptation of some industrial processes, these concepts do not require prohibitive dollar commitments. These facility concepts resulted from an analysis of the nine potential operational hypersonic aircraft which identified the required research to provide a development base for the airframe, engines, and subsystems.

5.1 PHASE I AND II STUDIES

Determination of realistic design requirements for each facility was a most important element of the Phase I effort. This was necessary to assure (1) that the requirements were not too extensive so as to result in unreasonably high facility costs and (2) that the requirements would result in a facility providing the capability to adequately conduct the required research.

In Phase I the potential operational hypersonic aircraft described in Volume VI were used as the basis for determining the design requirements for each facility type including size and simulation capability.

Where test article size requirements were not dictated by the size of the operational system hardware (as in the case of propulsion systems and aircraft structure) separate evaluations were made to establish sizing criteria. For example, for wind tunnels the minimum sized facility was based on the maximum dynamic pressure a model/balance combination representative of the operational system configurations could sustain.

In order to determine required environmental simulation levels a composite flight corridor representative of the nine potential operational systems was established. This corridor nominally lies between dynamic pressures of 200 psf (9570 N/m²) and 2000 psf (95700 N/m²). This flight corridor, in conjunction with the aircraft weight, size, and load factor, established the range of pressures, temperatures, Mach numbers, angle-of-attack, and surface temperatures required to duplicate the flight environment. Rather than using a constant angle-of-attack as a basis for determining surface temperatures, a constant load factor analysis was employed.

Employing techniques and hardware consistent with current aeronautical and industrial technology, a group of facilities which could achieve the specified requirements in each ground facility category were evaluated. The categories and primary purpose of facilities in each category are presented in Figure 29. A diverse group of facilities providing a unique improvement in capability as compared to existing facilities were retained for further study in Phase II and are so noted in the figure. Selections were based on their ability to provide a unique research

FIGURE 29 PHASE I GROUND RESEARCH FACILITY MATRIX

	Code	Facility Name	Capability
Gasdynamic Facilities	GD1	Subsonic Wind Tunnel (Continuous)	High Reynolds Number Aerodynamic Research, Low Speed, Takeoff and Landing Research, High Reynolds Number Aerodynamic Research, Subsonic Transonic, Cruise Flight Research, High Reynolds Number Aerodynamic Research, Subsonic Transonic, Cruise Flight Duplicated Reynolds Numbers, Transonic Research in Viscous Flow, High Reynolds Number Aerodynamic Research, Lacked Purpose Time, High Reynolds Number Aerodynamic Research, About One-Thousand, High Reynolds Number Aerodynamic Research, Intermediate Flight Duplicated Conditions to Mach Number 6. Provided as Part of Flight Duplicated Conditions to Mach Number 8. Flight Duplicated Conditions to Mach Number 14 (Continuous) or Mach 12 (Intermittent). Flight Duplicated Conditions to Mach Number 12 (Continuous). Redefined High Reynolds Number Flight Dynamics - Modification to NOL Aeroballistics Research. Flight Duplicated Reynolds Number - Modification to Holloman Sled Test Facility. Athena, Scout Boosted Scale Model - Capability Inconsistent with Cost of Facility. High Reynolds Number Aerodynamic Research, Low Hypersonic Mach Number Aerodynamic Research, High Reynolds Number Aerodynamic Research, Low Hypersonic Mach Number Aerodynamic Research. Continuous Version of GD17
	GD2	Nearsonic Wind Tunnel (Continuous)	
	GD3	Trisonic Wind Tunnel (Intermittent)	
	GD4	Ludwig Tube Transonic Tunnel (Impulse)	
	GD5	Hypersonic Impulse Tunnel (Hotshot)	
	GD6	Hypersonic Impulse Tunnel (Shock Tube)	
	GD7	Hypersonic Impulse Tunnel (Gas Piston)	
	GD8	Alumina Storage Heater Facility (Intermittent)	
	GD9	Zirconia Storage Heater Facility (Intermittent)	
	GD10	Multirecompression Heater Facility (Continuous)	
	GD11	High Pressure Arc Heater Facility (Continuous)	
	GD12	Large Bore Aeroballistics Range	
	GD13	Sled Test Track	
	GD14	Rocket Launched Models	
	GD15	Hypersonic Blowdown Tunnel (Intermittent)	
	GD16	Hypersonic Impulse Tunnel (Ludwig Tube)	
	GD17	Trisonic Wind Tunnel (Continuous)	
Engine Facilities	E1	Large Rocket Engine Facility (Full Scale Engines)	Capability Represented by Existing AEDC and NASA Facilities. Intended to Represent GD8, GD9, GD10, GD11 as Applicable to Engine Research Facility Analogous to AEDC 16S, 16 with Mach 5.5 Flight Duplicated Conditions. Engine Nozzle, Airframe Integration Research, Incorporated into E6, E7, E8, E9, E10. Simulation of Engine Airframe Dynamic Interactions. Represented as E10. Flight Duplicated Engine Research to Mach 6, Turbomachinery, Ramjets, Scramjets, Continuous Version of GD17
	E2	Wind Tunnel Accommodating Engines (Subscale to Full Scale Engines)	
	E3	Turbomachinery Engine Facility (Full Scale Engines)	
	E4	Exhaust Nozzle Test Facility (Full Scale Engines)	
	E5	Engine Dynamic Simulator	
	E6	Direct Connect Turbomachinery Facility (Full Scale Engines)	
	E7	Free Jet Turbomachinery Facility (Full Scale Engines)	
	E8	Multirecompression Heater Facility (Subscale Engine Module)	
	E9	Hybrid Heater Facility (Subscale Engine Module)	
	E10	High Pressure Arc Heater Facility (Subscale Engine Module)	
Simulators	FS1	Crew Trainer Facility	Research Requirements for Advanced Aircraft Flight Trainers. Very Flexible Pilot Control and Conditions Necessary for Adequate Handling Margins/Pilot Control During Second Stage Launch, Cruise Flight Control Sensitivity Research
	FS2	Takeoff and Landing Simulator	
	FS3	Launch Cruise Simulator	
Structural Facilities	S1	Airframe Static Facility (Complete Aircraft)	Static and Dynamic Structural Qualification at Ambient Pressure and Temperature. Time Variant Simulation of Mechanical Thermal Altitude Inputs, with Fatigue Life Research for Combined Mechanical Thermal Time Variant In-Sonic Fatigue Acoustic Structural Research, High Sound Pressure Levels. Same as S5 with Addition of Time Variant Thermal Inputs. Materials, Insulation, Cooling, and Structural Research Associated with Demonstration of Adequate Operational Life for Crew and Passenger Section. Flight Duplicated Local Flow Conditions, Research Associated with Pro Research Associated with Rapid Cool-Down During Descent, and Thermal Research
	S2A	Airframe Dynamic Facility (Complete Aircraft)	
	S2B	Airframe Dynamic Facility (Major Section)	
	S3	Thermal-Mechanical Fatigue Facility (Major Section)	
	S4	Acoustic Research Facility (Major Section)	
	S5	Thermal-Acoustic Facility (Component)	
	S6	Tankage Thermal-Structural Facility (Major Section)	
	S7	Cabin Pressurization Facility (Major Section)	
	S8	Transparency Test Facility (Major Section)	
S9	Cruise-Descent Thermal-Altitude Facility (Major Section)		
Material Facilities	M1	Local Flow Simulation Facility (Component)	Providing Flight Duplicated Local Flow Condition to Mach 12 for Material Research. Materials Research Leading to Coupon Data which Can Be Used for Evaluation of Structural Elements in S20 Based on Coupon Data
	M2	Thermal Mechanical Physical Properties (Coupon)	
	M3	Thermal Mechanical Fatigue Facility (Coupon)	
	M4	Fabrication Technology Facility (Component-Element)	
Fluid Systems	F1	Environmental Control Systems Facility (Full Scale Hardware)	Development of Operational Sized Systems Qualified in Simulated Local Flow Conditions. Simulation of Mechanical Thermal Altitude Inputs with Fuel Flow, Material Research, Research Associated with Transfer of Large Volumes of Crude Oil
	F2	Heat Exchanger Facility (Components)	
	F3	Fuel System Component Facility (Full Scale Hardware)	
	F4	Fuel System Dynamic Facility (Full Scale Hardware)	
	F5	Fuel Handling Technology Facility (Full Scale Hardware)	
Miscellaneous	SS1	Fire Suppression System Facility (Major Section)	Development of Flight Rated Fire Suppression Systems under Simulated Conditions. Research and Development into New Landing Gear Concepts, Moving Base Research
	SS2	Landing Gear Facility (Full Scale Hardware)	
	A1	Antenna Anechoic Chamber (Full Scale Hardware)	
	A2	Microwave Antenna Range (Full Scale Hardware)	
	R1	Nuclear Simulation Facility (Coupon)	

* Deleted cost and research value quantities are indicative of facilities deleted from further refinement based on performance or need prior to cost estimating and research evaluation.
 ** High Reynolds number for HYFAC study is defined as providing 1/5 of the Reynolds number for a 310 ft (0.95m) long aircraft flying at a dynamic pressure of 2000 psf (96,000 N/m²).
 *** (Facility Code) integrate into indicated facility for Phase II refinement.
 (R) Does not have high research value as applicable to HYFAC but does to other aircraft systems - recommended for further later study.
 (I) Entered into Phase II for further refinement.
 (D) Deleted from further refinement.

FACILITY MATRIX

	Capability	1970 Dollars		
		Research Value	Cost (Millions)	Disposition Code***
	High Reynolds Number** Aerodynamic Research, Low Speed, Takeoff and Landing, Maneuvering Conditions. $M \leq 0.5$	- *	- *	GD2
	High Reynolds Number Aerodynamic Research, Subsonic Transonic, Cruise and Maneuvering Conditions. $M < 1.0$.	111	45.0	R
	High Reynolds Number Aerothermodynamic Research, Subsonic Transonic Supersonic Flight Conditions. $0.3 \leq M \leq 5.0$.	494	48.8	II
	Flight Duplicated Reynolds Numbers, Transonic Research in Viscous Flows with Shock Interactions. $0.3 \leq M \leq 3$.	33	19.6	R
	High Reynolds Number Aerothermodynamic Research, Lacked Run Time, Greater Operational Risks Than GD7.	-	-	D
	High Reynolds Number Aerothermodynamic Research, About One-Thousandth of Run Time of GD7 at Same Conditions.	-	-	D
	High Reynolds Number Aerothermodynamic Research, Intermediate Flight Mach Numbers. $8 \leq M \leq 13$	248	33.1	iI
	Flight Duplicated Conditions to Mach Number 6.	-	-	E9
	Flight Duplicated Conditions to Mach Number 8. > Provided as Part of Engine Research Facility E9.	-	-	E9
	Flight Duplicated Conditions to Mach Number 14 (Continuous) or Mach Number 18 (Impulse). Redefined as Engine Facility E8.	-	-	E8
	Flight Duplicated Conditions to Mach Number 12 (Continuous). Redefined as Engine Facility E10.	-	-	E10
	High Reynolds Number Flight Dynamics - Modification to NOL Aeroballistic Range.	7	1.0	R
	Flight Duplicated Reynolds Number - Modification to Holloman Sled Track.	20	8.6	R
	Athena, Scout Boosted Scale Model - Capability Inconsistent with Cost Considering GD2, GD3, GD7, GD15 Capability.	-	-	D
	High Reynolds Number Aerothermodynamic Research, Low Hypersonic Mach Numbers. $4.5 \leq M \leq 8.5$.	245	29.6	D
	High Reynolds Number Aerothermodynamic Research, Low Hypersonic Mach Number. $4.5 \leq M \leq 8.5$.	121	16.2	II
	High Reynolds Number Aerodynamic Research, Continuous Version of GD3.	500	440.4	D
	Capability Represented by Existing AEDC and NASA Facilities.	-	-	U
	Intended to Represent GD8, GD9, GD10, GD11 as Applicable to Engine Research, Flight Duplicated Condition, Inherent in Concept.	-	-	D
	Facility Analogous to AEDC 16S, 16T with Mach 5.5 Flight Duplicated Capability, Redefined as E6, E7.	-	-	E6
	Engine Nozzle Airframe Integration Research, Incorporated into E6, E7.	-	-	E7
	Simulation of Engine Airframe Dynamic Interactions. Represented as Existing Hybrid Computer Facilities, and in E6, E7.	-	-	E7
	Flight Duplicated Engine Research to Mach 6, Turbomachinery, Ramjets, and Composite Cycle Engines.	184	103.8	II
		211	208.2	II
	Flight Duplicated Condition to Mach 12, Ramjets, Scramjets, Continuous Operation.	274	79.4	II
	Flight Duplicated Conditions to Mach 10, Ramjets, Scramjets, Continuous Operation Vitiated Air. Intermittent Clean Air to Mach 8.	232	53.2	II
	Flight Duplicated Conditions to Mach 12, Ramjets, Scramjets, Continuous Operation (30 Minutes)	212	92.4	D
io Cues.	Research Requirements for Advanced Aircraft Flight Trainers, Very Flexible Programming and Crew Station Concept.	99	13.5	R
	Pilot Control and Conditions Necessary for Adequate Handling Margins/Visual Aids/Aerodynamic Characteristics.	79	14.0	R
	Pilot Control During Second Stage Launch, Cruise Flight Control Sensitivities.	138	15.0	R
	Static and Dynamic Structural Qualification at Ambient Pressure and Temperature.	137	54.1	S2
	Time Variant Simulation of Mechanical Thermal Altitude Inputs, with Option for Onboard Fuel and Fuel Flow.	149	309.9	II
		145	101.7	II
	Fatigue Life Research for Combined Mechanical Thermal Time Variant Inputs.	184	17.3	S2
	Sonic Fatigue Acoustic Structural Research, High Sound Pressure Levels, Multispectrum Capability.	87	34.3	S2
	Same as S5 with Addition of Time Variant Thermal Inputs.	224	11.3	S2
	Materials, Insulation, Cooling, and Structural Research Associated with Large Cryogenic Tankage.	96	33.6	S2
	Demonstration of Adequate Operational Life for Crew and Passenger Sections of Aircraft.	4	5.3	D
	Flight Duplicated Local Flow Conditions, Research Associated with Providing Operational Visual Flight Capability.	-	-	D
	Research Associated with Rapid Cool-Down During Descent, and Thermal Residuals at Landing.	4	254.6	S2
	Providing Flight Duplicated Local Flow Condition to Mach 12 for Materials Research	-	-	E7,E9
	Materials Research Leading to Coupon Data which Can Be Translated into Design Data for Operation Aircraft by Evaluation of Structural Elements in S20 Based on Coupon Data from M2 and M3.	181	4.2	II
		152	4.4	II
		176	2.6	II
	Development of Operational Sized Systems Qualified in Simulated Local Environments.	51	31.1	S2
	Simulation of Mechanical Thermal Altitude Inputs with Fuel Flow, Materials, Fabrication, Operation Technology Research.	52	6.6	S2
	Development of Operational Sized Systems Qualified in Simulated Local Environment.	171	3.3	S2
	Technology Research Associated with Transfer of Large Volumes of Cryogenic Fuels at High Transfer Rates.	199	16.0	S2
		63	13.7	S2
	Development of Flight Rated Fire Suppression Systems under Simulated Local Environments	81	216.2	S2
	Research and Development into New Landing Gear Concepts, Moving Base Type Facility.	12	2.6	D
	Near and Far Field Communication/Data Transmission Research	25	3.1	D
		0	0.7	D
	Evaluation of Weapon Damage to Materials (High Level Radiation, Crew/Passenger/Materials Effects from High Altitude Flight.	0	3.0	D

ement based on performance or need prior to cost estimating and research evaluation stage.
 e for a 310 ft (0.95m) long aircraft flying at a dynamic pressure of 2000 psf (96,000 N/m²).

- recommended for further later study.

MDC A0013 • 2 OCTOBER 1970
VOLUME I

capability not currently existing, research value, and acquisition costs and assessments of their versatility, development confidence, and ability to be used in a broad range of research.

An important result of the Phase I effort was the determination that significant cost savings could be accomplished by consolidating and integrating capability in common facilities. Seven facility concepts were identified as warranting further refinement in Phase II. These were:

- (1) Integrated trisonic/hypersonic blowdown gas dynamic research facility (GD20).
- (2) Hypersonic impulse gas dynamic research facility (GD7).
- (3) Integrated turbomachinery/ramjet engine research facility (E20).
- (4) Two scramjet engine research facilities, each employing a different enthalpy source concept. One a carbon combustor/zirconia heater, and the other a multi-recompression heater concept (E9 and E8).
- (5) Integrated structures/fluid systems research facility (S20).
- (6) Integrated materials research facility (M20).

In Phase II definitions of these seven facility concepts were refined, as was the performance of individual hardware items comprising the various facilities. Variations in the size and capability of the facilities were examined to establish the sensitivity of the component acquisition costs to these parameters. This established those items which dominated the growth potential of each facility concept and influenced the selection of the facility size which could accomplish a satisfactory portion of the defined research at an acceptable cost.

Parametric variations examined are discussed in the following:

5.1.1 GAS DYNAMIC FACILITIES - The Reynolds number requirements were based on achieving in a wind tunnel 1/5 of the flight Reynolds number for a 310 ft. (95m) vehicle flying a 2000 psf (95,700 N/m²) dynamic pressure flight path. The minimum facility size was based on the maximum tunnel pressure a model/balance combination representative of the operational aircraft configurations, could sustain. Figure 30 presents the results of the following parametric variations:

- (1) Varying the extent of the maximum full scale Reynolds number which can be duplicated in a minimum sized facility which will not structurally fail the model or balance. (Variable tunnel size and Reynolds number simulation level, fixed tunnel dynamic pressure.)
- (2) Increasing facility physical size beyond the minimum size without increasing Reynolds number duplication capability. (Variable tunnel size and dynamic pressure, fixed Reynolds number simulation level.)

FIGURE 30 GAS DYNAMIC PARAMETRIC RESULTS

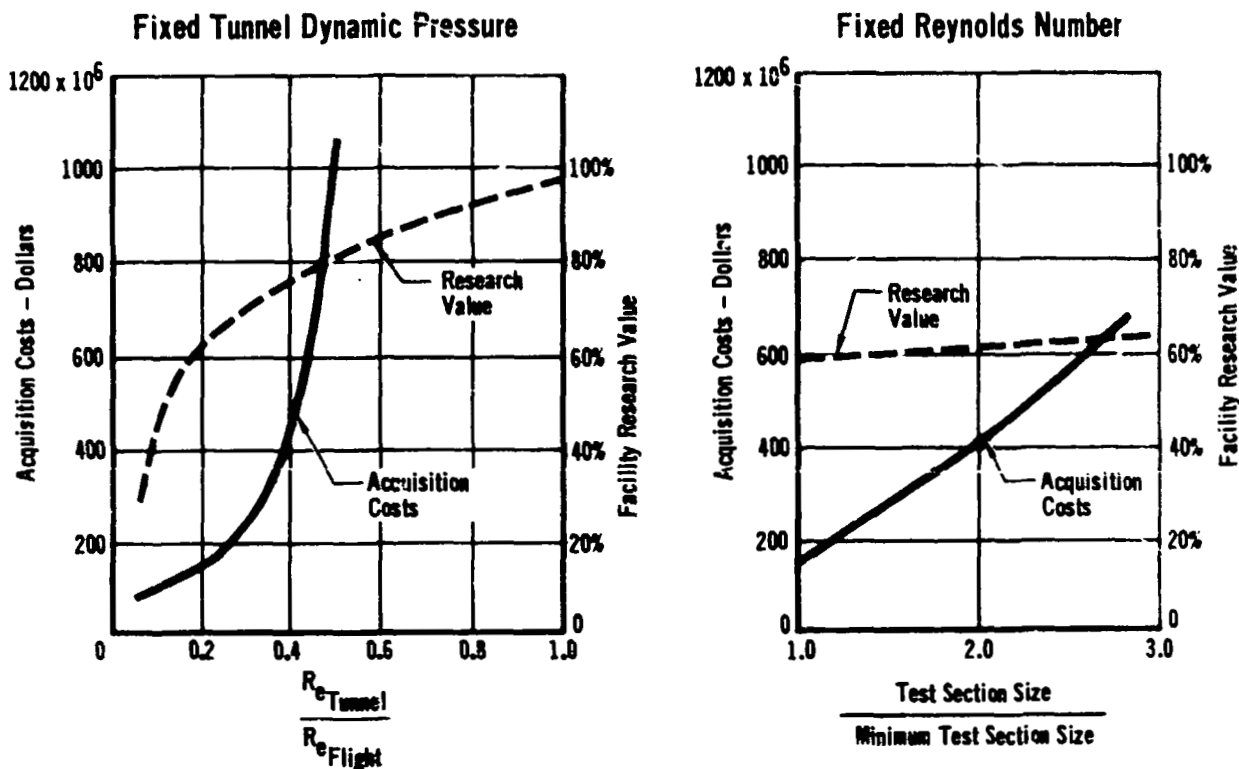

These parametric studies showed that as the Reynolds number simulation level increases beyond 20% of the maximum flight Reynolds number there is only a small increase in Research Value, but a very rapid increase in facility acquisition costs. This tradeoff indicated that the 1/5 maximum Reynolds number selected for the baseline gasdynamics facilities was a good choice. Increasing the tunnel size beyond a minimum size did not appreciably increase research capability but did significantly increase costs. Although operating pressures are lower when the test section size is increased without changing Reynolds number, increases in mass flow, structural sizes, and fabrication time offset this, thus increasing costs. The parametric evaluations also provided improved definition of hardware components which indicated that compressor and air-storage systems represent a major portion (about 50% to 60%) of the costs for an intermittent run facility.

5.1.2 TURBO MACHINERY/RAMJET FACILITY - Unlike the gasdynamic facilities, the turbomachinery facilities did not present as straightforward a parametric evaluation because they were based on accommodating a full sized engine and providing flight duplicated conditions. Two evaluations did appear logical.

- (a) The alternative of free jet or direct connect testing.
- (b) Examination of areas of the flight corridor that could be compromised in terms of flight duplication without impairing research value.

Figure 31 presents the costs for the various alternates considered and the research value for those alternates that were evaluated.

FIGURE 31 TURBOMACHINERY ALTERNATES

Facility Type	Research Value (%)	Acquisition Cost (\$ x 10 ⁶)	Test Mach Capability
Direct Connect	75	114.5	0.2 - 5.5
Free Jet	-	688.0	0.2 - 5.0
Free Jet Plus Direct Connect	79	712.0	0.2 - 5.5
Free Jet Plus Direct Connect Less Transonic Duplication	78	423.7	1.5 - 5.5

The unexpected result was that the difference in research value between free jet and direct connect was only a few percent. Analysis of the judgements which lead to this evaluation indicated that the modified direct connect option for the direct connect facility, which provided duplication of the flow from the last inlet ramp to the engine face, was nearly equal to the free jet facility in providing the source of the flow fluctuation related to time variant engine distortion. That is, the shock/boundary layer interactions in the throat region were judged to be a primary source of engine/inlet incompatibility. This meant that the cost to establish a given capability was dominated by the technique selected, while the research value was not. In light of this result continuation of a full sized, free jet engine facility into Phase III appeared unreasonable. Thus the facility sizing for Phase III study was determined by the direct connect requirements and with the free jet capability being a fallout.

Since the engine facilities are primarily flight duplicators, the effect of the maximum Mach number duplicated did strongly affect the costs. Substantial reductions in acquisition costs could be realized, for example, by deleting complete duplication capability in the transonic Mach number range where the maximum weight flows occur. The Phase II evaluations provided improved definition of facility components which permitted the following observations:

- o Air heater systems, in conjunction with accompanying air coolers, and dehumidifying coolers will require high power levels, and could represent a high risk item in terms of attaining design performance.

- o Compressor and exhaustor plants could represent up to 65% of total facility costs for continuous operation facilities.

5.1.3 SCRAMJET ENGINE RESEARCH FACILITIES - For the scramjet facilities the minimum altitude flight path was established as approximating a 2000 psf (95,700 N/m²) dynamic pressure. It was established early in Phase I that a complete scramjet engine facility was far beyond the present state of the art, however, a facility

accommodating an engine module was probably feasible. The primary parametric evaluation involved the physical size of scramjet engine modules in relation to the research which can be accomplished. This required analysis of equipment performance, size, and acquisition costs for two facility concepts - the hybrid clean air/vitiated air heater system and the multi-recompression heater (MRCH). The results are presented in Figure 32.

FIGURE 32 EFFECT OF SCRAMJET MODULE CAPTURE AREA VARIATION

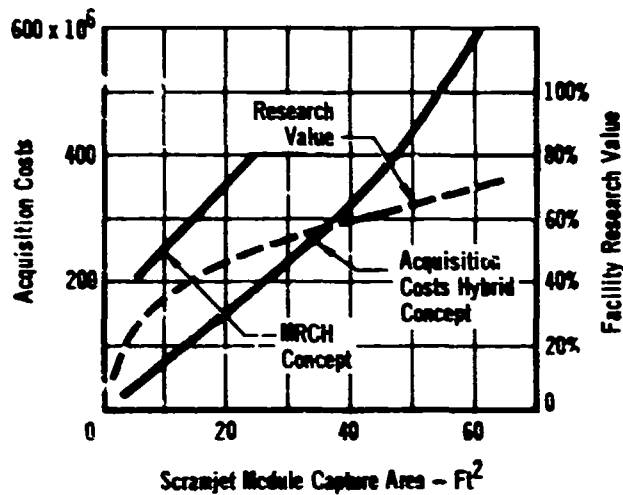

A minimum sized module of about 10 ft.² (.93m²) capture area provides a significant research value. As module capture areas increase above 30 ft.² (2.8m²) the costs begin to increase non-linearly with module area, and there are diminishing returns in terms of increased research value. Once module capture areas on the order of 60 ft.² (5.6m²) are achieved multiple smaller module arrangements are possible as well as single large installations. This provides about the maximum return possible from a modified direct connect facility. Providing the thermal energy by chemical energy instead of electrical/mechanical provides a significant reduction in acquisition costs. The essentially water free test gas provided by the carbon combustor concept in the hybrid facility yields a testing medium closely approximating air, and having a smaller ratio of combustion products quantity to air quantity than any hydrocarbon fuel. These parametric evaluations provided improved definition of hardware components which permitted the following observations:

- o For the chemical combustion system the compressor/exhauster plant will dominate the facility costs.
- o The mechanical drive system, and power source dominate the acquisition costs for the multi-recompression heater concept, as well as system feasibility.
- o Air heater systems for continuous scramjet facilities will be costly to provide at high power levels. Electric resistance and induction, and oil fired heat exchangers require additional refinement in Phase III for accurate cost estimates. The multi-recompression heater requires mechanical power inputs beyond the current state-of-the-art in gearing and shafting.

5.1.4 STRUCTURAL/FLUID SYSTEM FACILITY - There are many variables in structural research, however, it is possible to condense the many factors into two considerations, the test article size and number of simultaneous simulation inputs attempted. The parametric evaluation therefore, involved only these factors.

The test article size was one of the dominating factors in the acquisition costs for the structures facility as illustrated in Figure 33. The diminishing increases in research value with size for test articles greater than 7,000 ft.² (650m²) did not appear to justify a complete aircraft test capability.

**FIGURE 33 STRUCTURAL TEST ARTICLE SIZE
MAJOR IMPACT ON COST AND RESEARCH VALUE**

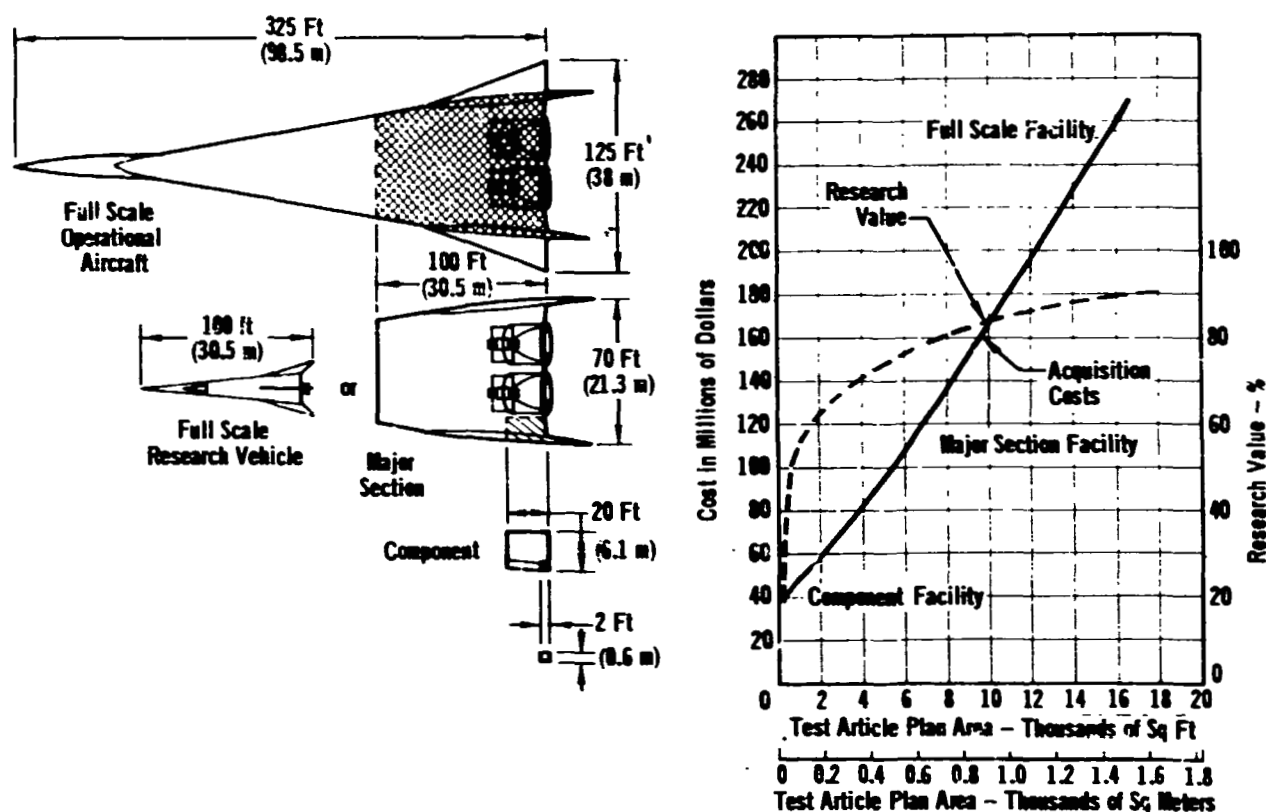

Another significant cost consideration is the degree of simulation, especially that for simulation of high speed climbs to altitude on a real time basis, as shown in Figure 34. The provision for duplication of the altitude time history during climb about doubles the cost of the facility, compared with perhaps a 5% increase in cost for a static altitude simulation capability. However, the requirement to evaluate leak rates and internal pressure build-ups during rapid climbs was judged a significant enough reason for inclusion in the 520 facility for rocket powered aircraft to warrant its inclusion. This judgement was for cold structural concepts which are surrounded by multiple layers of active and passive cooling systems as well as external radiation shingles forming the external aircraft surface. For a hot structured aircraft this judgement may not be applicable.

FIGURE 34 SIMULATION REQUIREMENTS DOMINATE FACILITY COSTS

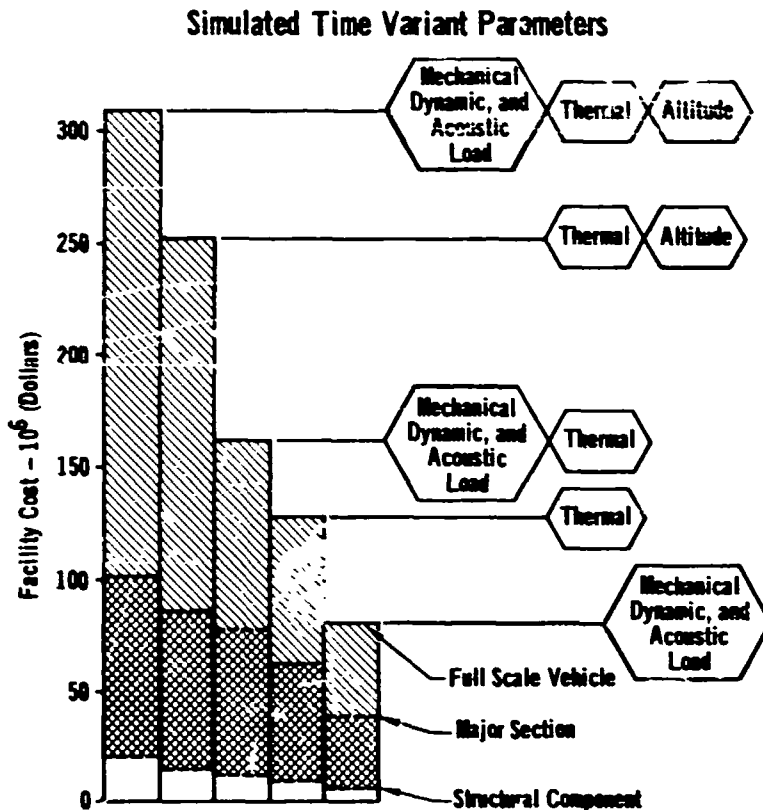

The equipment comprising the structures/fluid systems research facility (S20) consists of various equipment currently in use in existing structures facilities, but assembled into a singular facility complex providing about ten times the present test article size capability.

5.1.5 MATERIAL RESEARCH FACILITY - This facility represents an integration of present individual laboratory capability to accommodate research on coupon and structural element sized specimens, as illustrated in Figure 35. The primary purpose of this facility is to provide a capability to experimentally correlate and confirm structural concepts and theories in order to provide a technology base for viable structural design of operational aircraft systems, which can be then evaluated in structures/fluid system facilities. As such there were no parametric variations performed for M20, as its already low cost (\$17,595,000) and high research value (75%) did not appear to warrant parametric evaluation. Instead the emphasis was placed on providing a comprehensive description of the equipment needed to provide the desired capability.

Five facilities remained after the Phase II parametric evaluations as warranting further refinement in Phase III. These were essentially the same as described in Phase II except as follows:

FIGURE 35 MATERIALS FACILITY SIZE DEFINITIONS

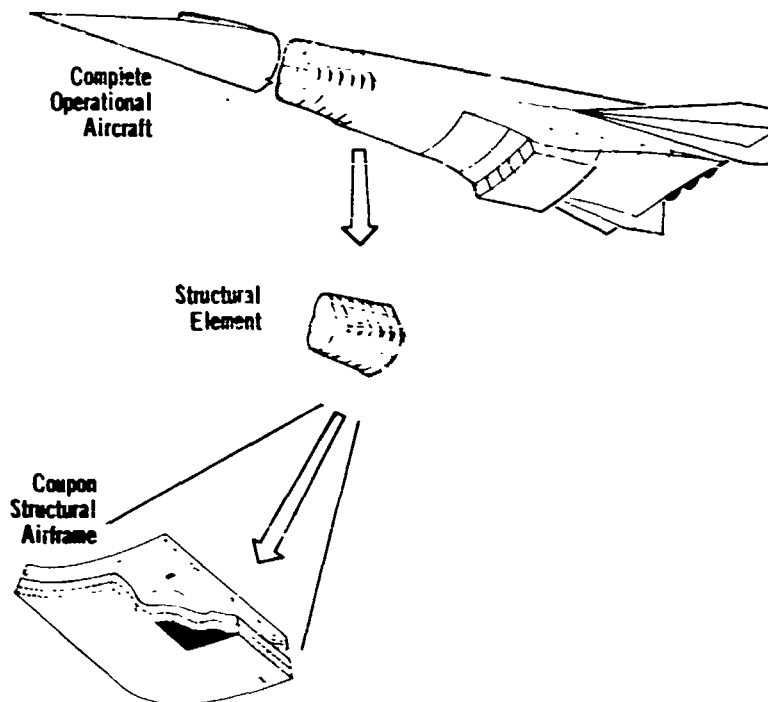

o The free jet leg of the integrated turbomachinery/ramjet engine research facility was reduced in size to match its airflow requirements with the direct connect leg.

o The multi-recompression heater concept for the scramjet engine research facility required a primary drive system with a torque/speed requirement far beyond current capability. Further cost refinements were judged to have only marginal reliability, thus this concept was not carried into Phase III for further refinement.

o The integrated materials research facility was sufficiently refined in cost and description at the end of Phase II that further refinement in Phase III was not warranted.

The five facilities remaining for Phase III evaluation represent the most feasible concepts to provide needed research at the minimum cost consistent with acquiring data of acceptable quality.

5.2 PHASE III FINAL STUDIES

In Phase III, the performance of the facility mechanical systems was further refined so that reliable cost estimates could be obtained for the dominant items and realistic facility development assessments could be made. The five facilities

refined in Phase III illustrate an important increase in current experimental research capability is achievable, with facilities in which there is a high confidence of obtaining predicted performance, schedules, and costs. These five facilities can be used to contribute significantly to accomplishing the research necessary for any of the nine potential operational hypersonic aircraft. Description of these five facilities together with a development assessment in terms of feasibility, schedule, and costs; and a statement of their primary contribution to the overall research effort is presented in Figures 36 through 40.

A number of additional interesting results were obtained from the study. A study of the availability of large power sources indicated the advantages and ease of acquisition of large shaft power inputs using gas turbine drives. Also in Phase I, a near sonic wind tunnel (GD2) with a 400 million Reynolds number simulation level was indicated as being required for aeronautical research in general, but not a necessary facility in terms of the HYFAC Aircraft. If a 460,000 kw multiple gas turbine drive system (using 9-GE4/J5P engines) was added to the Ames 12 Foot Wind Tunnel, which presently has a 9000 kw electric motor system, a constant stagnation pressure of 75 psia (51N/cm^2) could be maintained up to near Mach one. This would provide a capability to achieve Reynolds numbers from 100 to 150 million based on model length. The cost is estimated to be 40 million dollars, but utilizing an existing facility as a base, the current Reynolds number performance of the Ames' 12-ft. tunnel at Mach 0.9 can be increased 50 times.

The five facility concepts described in Figures 36 to 40 reflect a major increase in the existing research capability. Each in itself can make an important contribution to research in its area of application, although varying in applicability to each of the nine potential operational hypersonic aircraft. Through application of industrial techniques outside the aerospace field, and utilization of hardware items based on existing equipment and technology the facility concepts presented represent a minimum technical risk in achieving stated goals. As in all large, complex arrays of hardware, integration of all components into a correctly functioning system does not occur immediately and a period of time will be required to attain the overall maximum capability, even though each system has individually performed satisfactorily. The costs represent a best estimate of the dollars which must be committed to acquire the facility with the resources required to operationally integrate all systems into an acceptable overall system and calibrate the facility.

Because of the innovations suggested in the facility concepts, it appears that the existing technology base can provide more capability at less cost than previously estimated. This is especially true for scramjet engine facility concepts.

FOLDOUT FRAME I

FIGURE 36 MACH 0.3 TO 8.5 POLYSONIC TUNNEL (GD 20)

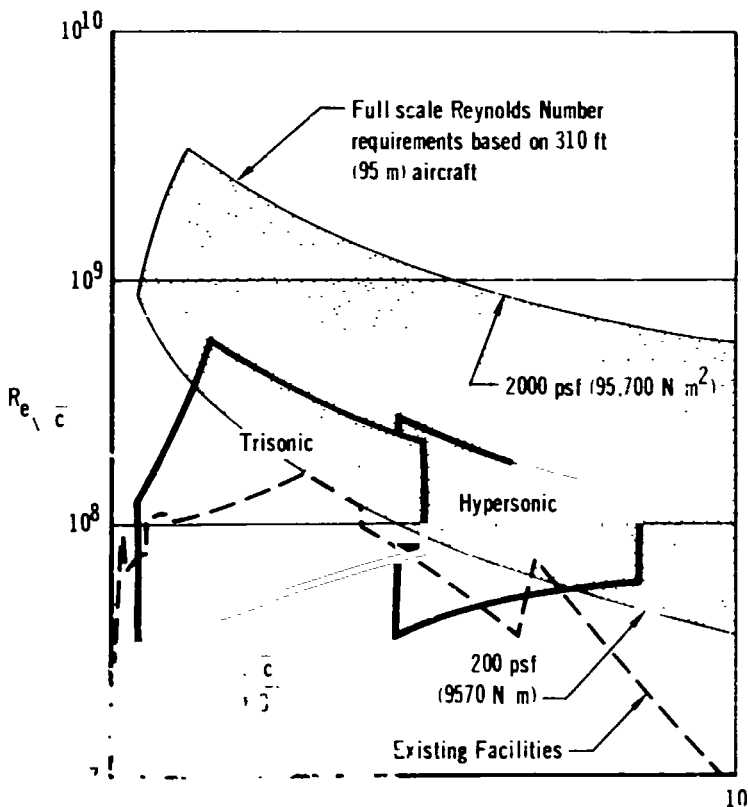
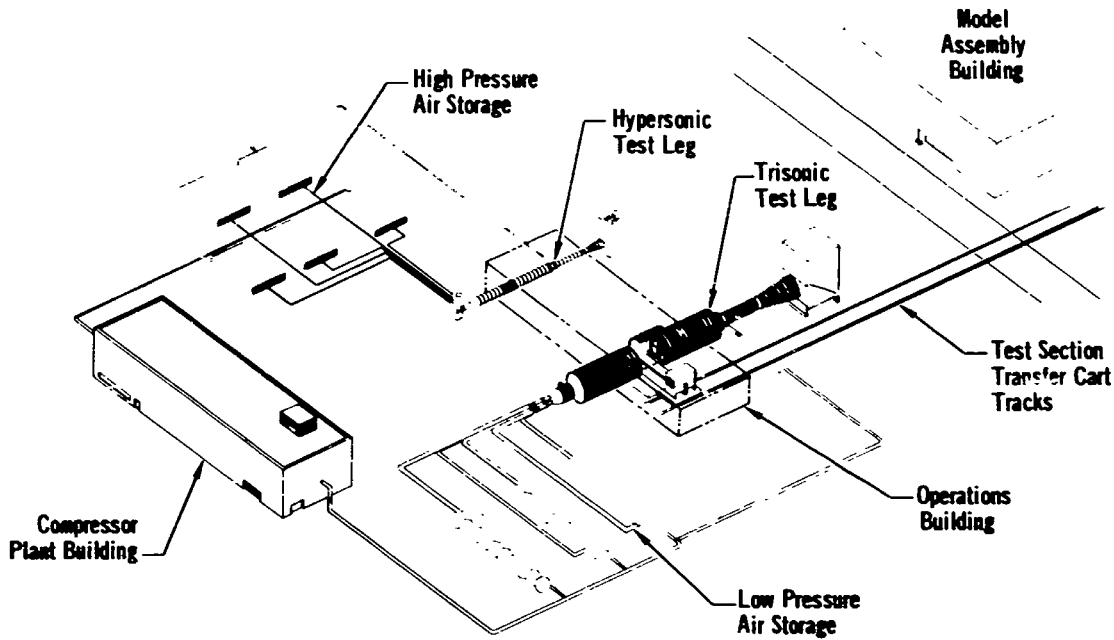

	Leg 1	Leg 2
Test Section Size	16 x 16 Ft (4.9 x 4.9 m)	12 x 12 Ft (3.7 x 3.7 m)
Run Time	15 to 60 Sec	15 to 25 Sec
Runs Per Day One 8-Hour Shifts	7 to 15	5 to 12
Facility Cost	\$145,943,000 \$131,661,000 Integrated into AEDC	
Operating Cost	\$1525 Per Occupancy Hour Per Leg.	

FOLDOUT FRAME 2

FACILITY DESCRIPTION

GD20 is an intermittent, blowdown wind tunnel operating in the Mach number range of 0.5 to 8.5. Two independent test legs are employed. The trisonic/supersonic leg has a 16 x 16 ft (4.9 x 4.9 m) test section and can operate to Mach number 5. The hypersonic test leg operates between Mach number 4.5 and 8.5 and has a test section 12 x 12 ft (3.7 x 3.7 m). The useful run time over which data may be acquired ranges from 10 to 90 seconds. This facility is capable of providing a Reynolds number simulation equal to one-fifth that for a 310 ft (95 m) aircraft flying along a 2000 psf (95,700 N/m²) dynamic pressure flight path. The maximum dynamic pressure was established by the model and balance strength capability. Sufficient temperature to avoid air condensation in the test section and no more than $\pm 10\%$ change in Reynolds number in test section during a run is provided. The nominal time between runs is 1 hour.

RESEARCH CAPABILITY

- o Up to five-fold increase in Reynolds number capability over existing facilities
- o Supplies Reynolds number simulation necessary for airbreathing hypersonic, launch vehicle, transport and military systems.
- o Provides high confidence level data in critical problem areas.
- o Capable of wide spectrum of gasdynamic research, applicable to:
 - Aerodynamic configuration development
 - L/D optimization
 - Thrust minus drag of propulsion systems
 - Inlet performance
 - Configuration dependent heat transfer research
 - Stability and control

DEVELOPMENT ASSESSMENT

This facility concept is a larger version of existing blowdown, and continuous wind tunnel facilities, in use by governmental and industrial organizations. Except for the hypersonic leg nozzle, which has been fabricated in a smaller version, all of the facility components specified have been fabricated and operated at the size required, though not necessarily at the same performance level. The overall risks associated with accomplishing the design goals is very low, however because of the size and complexity of the overall facility, achieving maximum performance may require a lengthy program of operational systems integration.

Normal development time is estimated as a little over six years (74 months) at a cost of \$146 million. Through incremental acquisition of the facility, i.e., initially constructing the trisonic leg and then constructing the hypersonic leg, the development time and costs are increased to eight and one half years (102 months) and \$158 million respectively, however the yearly expenditure rate is reduced by approximately 20%.

Leg 2
12 x 12 Ft (3.7 x 3.7 m)
15 to 25 Sec
5 to 12
Integrated into AEDC
Occupancy Leg.

EOLDOUT FRAME 1

FIGURE 37 MACH 8 TO 13 HYPERSONIC IMPULSE TUNNEL (GD 7)

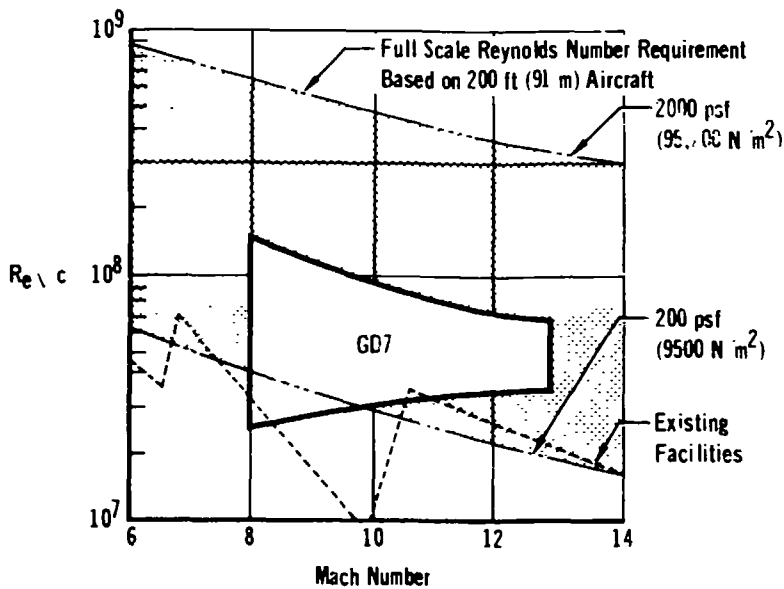
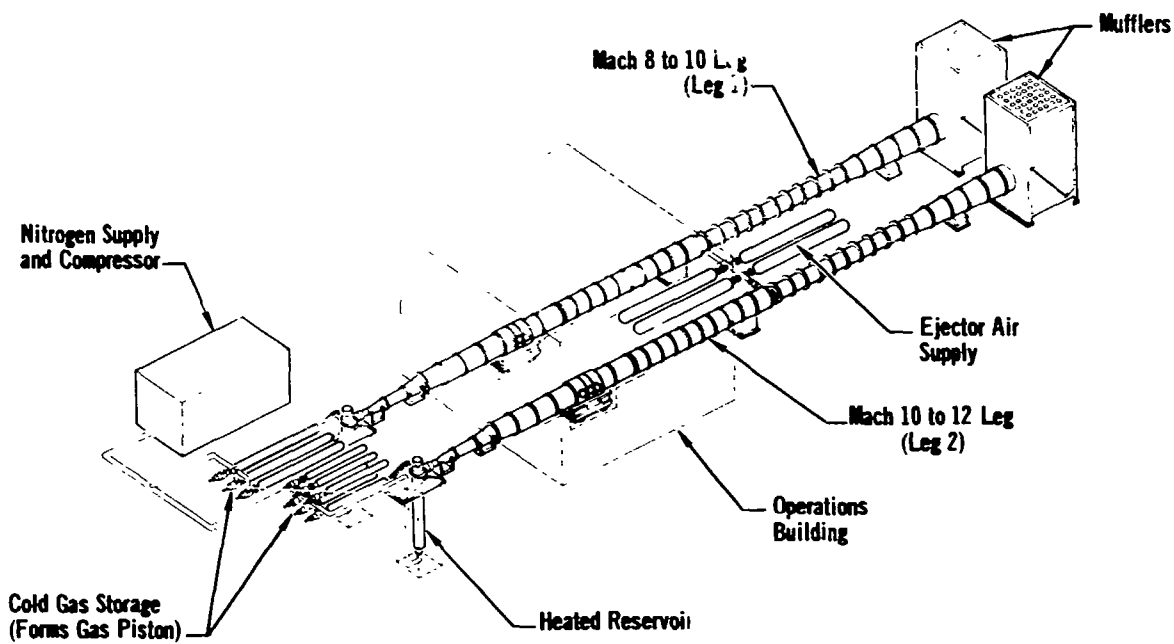

	Leg 1	Leg 2
Test Section Size	10 Ft Dia (3.05 m)	10 Ft Dia (3.05 m)
Run Time	1 to 4 Sec	2 Sec
Runs Per Day One 8-Hr Shifts	4 to 7	3 to 6
Cost	\$26,606,000	
Operating Cost	\$1730/Occupancy Hour	

FACILITY

GD 8 to 13 provides a full run facility that for pressur test se model a

RESEARCH

- o
- o
- o
- o
- o

DEVELOP

The New York have be require 24,000 The ove because mum per

It approxi legs se in aver months

EOLDOUT FRANKL Z

FACILITY DESCRIPTION

GD7 is a gas piston, impulse wind tunnel operating in the Mach number range of 8 to 13. Two independent test legs are employed. One leg provides a Mach number 8 to 10 capability with a 10 ft (3.05 m) diameter nozzle. The other test leg provides a Mach number 10 to 13 capability with a 10 ft (3.05 m) diameter nozzle. Useful run times from 1 to 4 seconds are characteristic of this type facility. This facility is capable of providing a Reynolds number simulation equal to one-fifth that for a 310 ft (95 m) aircraft flying along a 2000 psf (95,700 N/m²) dynamic pressure flight path. Sufficient temperature to avoid air condensation in the test section is provided. The maximum dynamic pressure was established by the model and balance strength capability. Time between runs is nominally 2 hours.

RESEARCH CAPABILITY

- o Up to five-fold increase in Reynolds number capability over existing facilities.
- o Supplies Reynolds number simulation necessary for airbreathing hypersonic, launch vehicle, transport, and military systems.
- o Provides high confidence level data in critical problem areas.
- o Capable of wide spectrum of gasdynamic research, applicable to:
 - Aerodynamic configuration development
 - L/D optimization
 - Thrust minus drag of propulsion systems
 - Inlet performance
 - Configuration dependent heat transfer research
 - Stability and control.
- o Provides additional research capability to other hypersonic operational vehicles such as missiles and spacecraft systems.

DEVELOPMENT ASSESSMENT

This facility concept is a larger version of facilities now in operation at New York University, and the Naval Ordnance Laboratories. The hardware components have been fabricated and operated at the performance necessary, but not in the size required. The highest risk components are the high pressure control valves (up to 24,000 psia, 16,600 N/cm²) which must provide fast response at high mass flows. The overall risks associated with accomplishing the design goals is low, however, because of the hardware size in relation to existing hardware items, achieving maximum performance may require an operational procedures development period.

It is estimated that normal acquisition of the complete facility will require approximately 55 months, at a cost of \$26.6 million. By constructing the test legs sequentially; instead of simultaneously, a reduction of approximately 19% in average annual cash flow can be obtained. The facility would then take 74 months to build and cost \$29 million.

-eg 2
Ft Dia .05 m)
2 Sec
3 to 6
)
ncy

FOLDOUT FRAME 1

FIGURE 38 MACH 0 TO 5.5 COMPOUND TURBOMACHINERY ENGINE TEST (E 20)

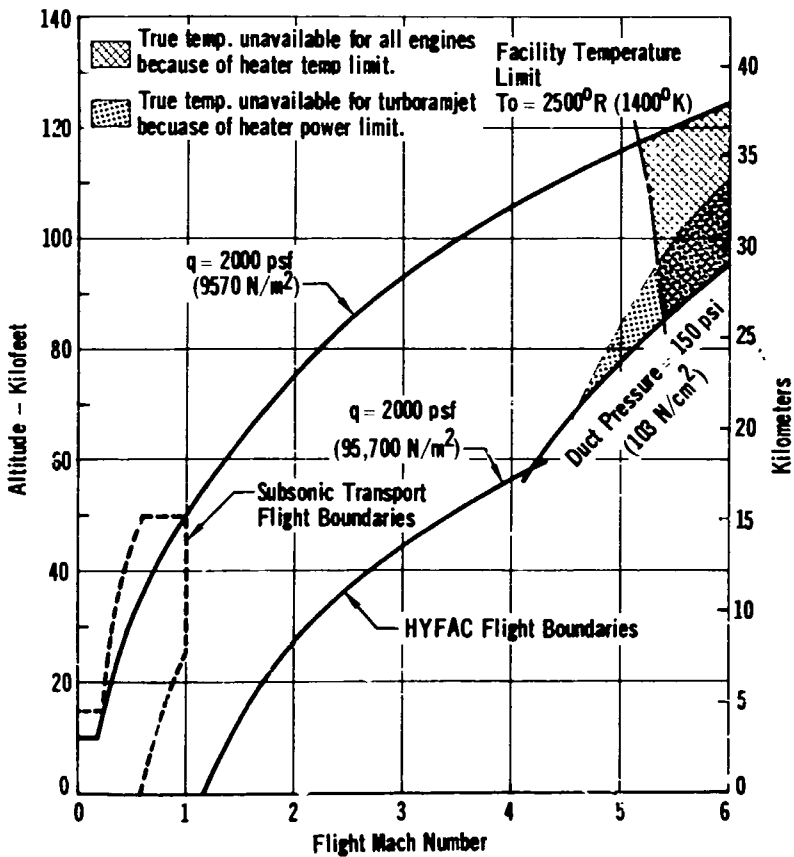
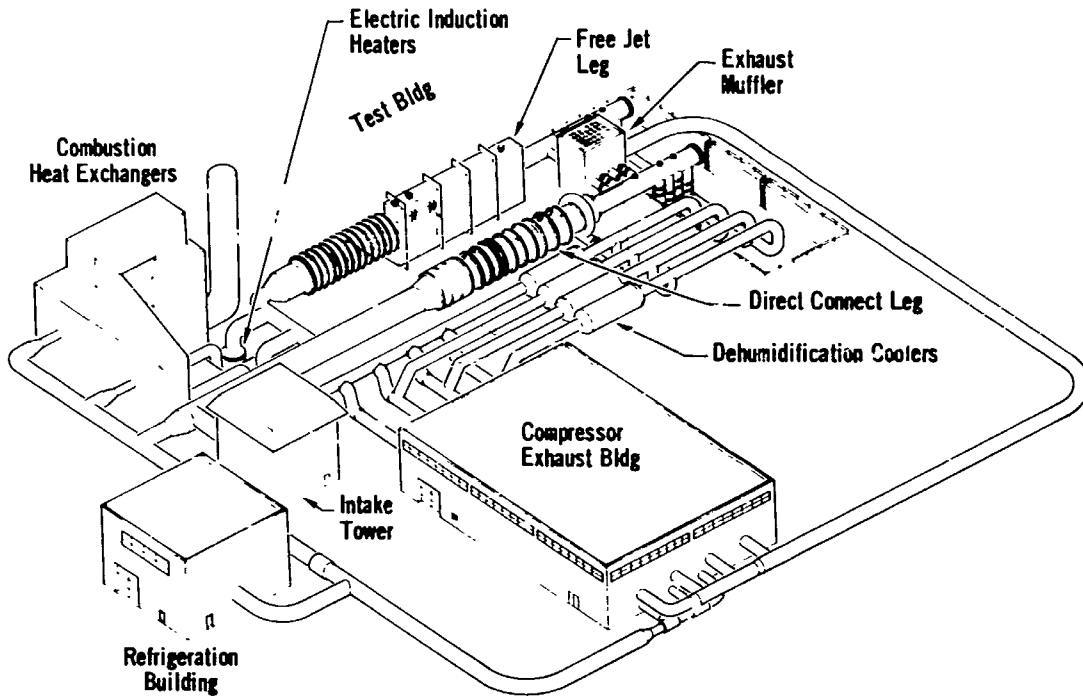

	Free Jet	Direct Connect
Test Section Size	8 Ft x 4-1/2 Ft (2.4 x 1.4 m)	10 Ft Dia. (3 m)
Stagnation Temperature	2500 °R (1400 °K)	2500 °R (1400 °K)
Stagnation Pressure	310 psia (213 N/cm ²)	150 psia (103 N/cm ²)
Run Time	Continuous	
Acquisition Costs	\$381,262,000	
Operating Costs	\$7000 per Occupancy Hour	
Maximum Flight Duplicated Mach Number	5.5	

FOLDOUT FRAME 2

FACILITY DESCRIPTION

E20 is a continuous operation engine research facility which provides flight duplication of subsonic engine duct flow in the direct connect mode. A modified direct connect mode is provided where the sonic throat and last inlet ramp conditions can be duplicated for inlet/engine compatibility determinations with shock/boundary layer interactions. A free jet leg is also provided, embodying a novel geometric arrangement, which has been sized for the direct connect flow requirements. The free jet leg can accommodate about one-half scale inlet and engine packages for inlet/engine integration research.

RESEARCH CAPABILITY

- o Full scale engines of the size:

TYPE	TURBOJET		TURBOFAN BPR=0.7	TURBOFAN BPR=8	TURBO-RAMJET
	HYDRO-CARBON	LH ₂	HYDRO-CARBON	HYDRO-CARBON	LH ₂
FUEL	100,000 lb. (45,400 kg.)	150,000 lb. (68,000 kg.)	100,000 lb. (45,400 kg.)	60,000 lb. (27,000 kg.)	100,000 lb. (45,400 kg.)
THRUST					

- o Flight duplicated conditions, up to dynamic pressures of 2000 psf (96,000 N/m²), and Mach number 5.5.
- o Time histories of maneuvers and flight paths can be duplicated.
- o Inlet flow, time variant distortion characteristics can be simulated.
- o Continuous operation for qualification and performance guarantee program.
- o Provides PFRT capability in one month's operation.
- o Capability for structural research in flight duplicated conditions using free jet leg.
- o Duplicated flight conditions at lower flight altitudes, including Mach 1.2 at sea level not currently available.

DEVELOPMENT ASSESSMENT

Development of a facility of this size and performance is a major undertaking and not entirely without technical risk. The principle high risk item is the electric heater used to provide air temperatures above 1000°R (550°K). If these, and the free jet leg were deferred and added at a later date, the cost of acquiring the facility would be about 209 million dollars. Maximum flight duplicated Mach No. would be reduced to 3.8 as a result. In deferring the electric heaters, the risk associated with the facility is substantially reduced. The integration of a 1,000,000 cfm (1900 m³/sec) compressor/exhauster plant, a 12 x 10⁹ Btu/hour (3570 MW) dehumidifying cooler system, heaters and test legs into an integrated, working system will represent a major challenge. Complete realization of the maximum run conditions will require an operational development period.

The complete facility as specified will require approximately 9 years for acquisition at a cost of \$381 million. Operational capability of the facility, without refrigeration, could be obtained in about 7 1/2 years. Provision of this reduced initial capacity would provide an initial cost saving, but would not appreciably affect acquisition time as compared to the complete facility. Eventual upgrading of the initial facility to final specifications would require an additional 3 years and bring the total cost to \$397 million.

Connect
1 Dia. (m)
0 R
0 n
10 psia (1/cm ²)

FOLDOUT FRAME 1

FIGURE 39 MACH 3 TO 11 DUAL MODE RAMJET ENGINE TESTS FACILITY (E9)

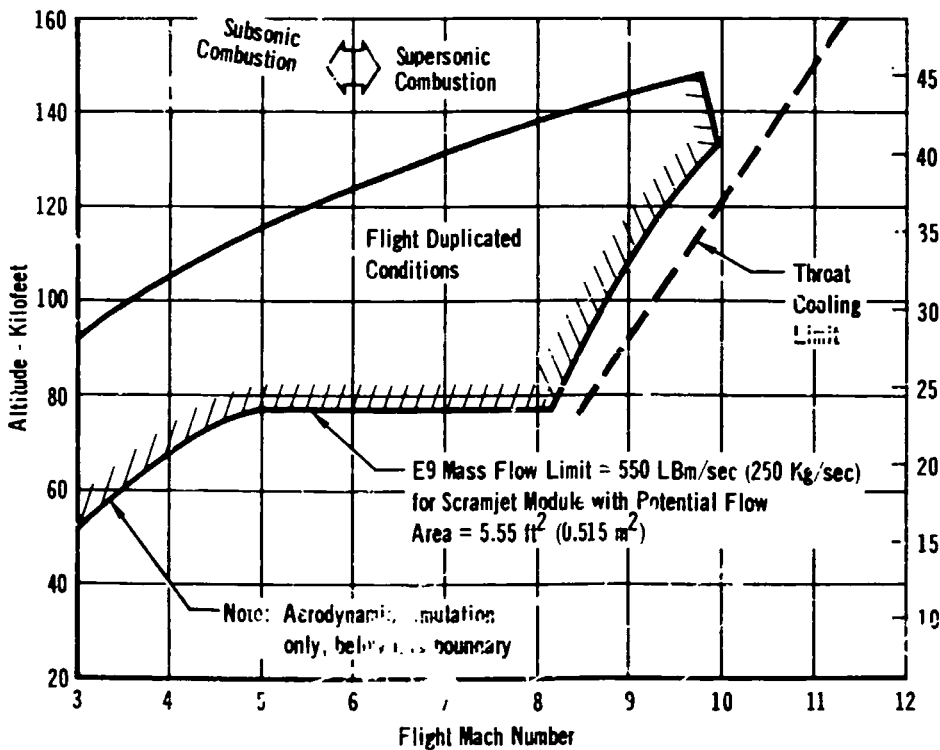
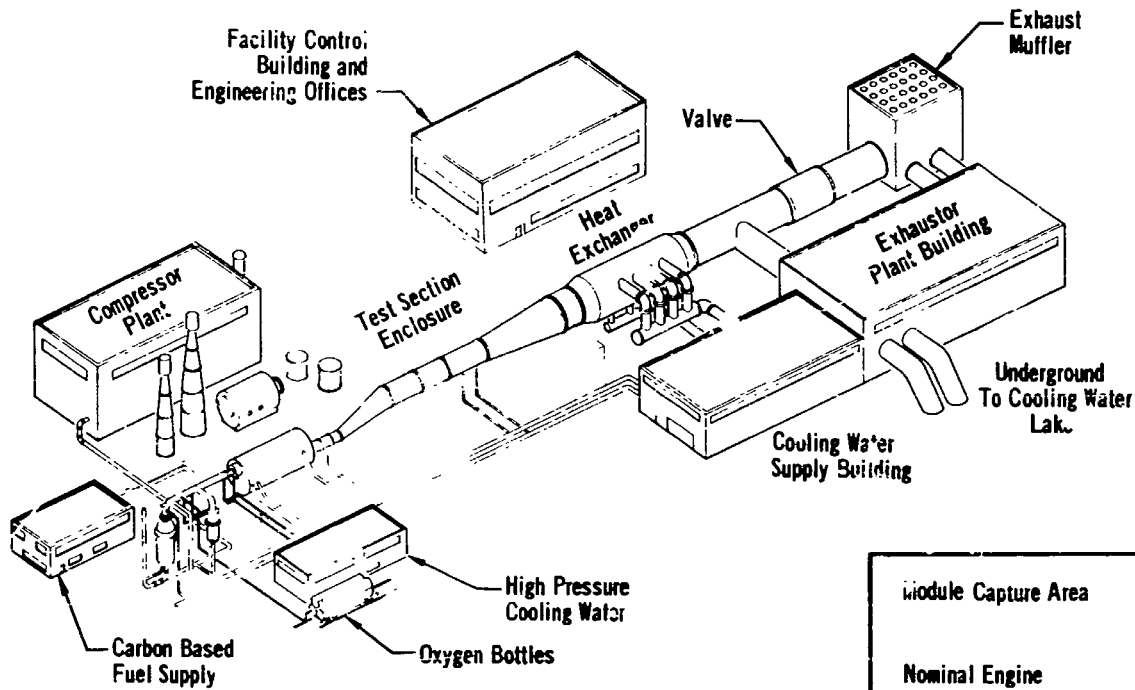

Module Capture Area	27.6 ft ² (2.56 m ²)
Nominal Engine Size, at Cowl	16.3 x 43.2 in. (41.5 x 110 cm)
Stagnation Temperature	7000°R (3900°K)
Stagnation Pressure	3000 psia (2070 N/cm ²)
Run Time	
Acquisition Costs	\$147,085,000
Operating Costs	\$7,272 Per Occupancy Hour
Maximum Flight Duplicated Mach Number	10

Flight Duplicated Conditions from Mach 3 to Mach 10 Thermo/Structural Nozzles

Mach Number	Nozzle Diameter	Test Core Diameter
6	6.45 ft (1.97 m)	5.7 ft (1.74 m)
9	12.2 ft (3.72 m)	8.8 ft (2.69 m)
12	18.6 ft (5.67 m)	13.0 ft (3.96 m)

FOLDOUT FRAME

FACILITY DESCRIPTION

EP is a continuous vitiated air, intermittent clean air ramjet engine facility. It can provide flight duplicated conditions over a Mach number range of 3 to 10 for an engine module 16 in. (0.41 m) high and 43 in. (1.10 m) wide for either subsonic combustion modes. A modified direct connect test section concepts proving flow simulation from the last inlet ramp to the termination of the exhaust expansion nozzle. A set of interchangeable axisymmetric nozzles provides thermo/structural research capability with flight duplicated conditions. The facility was sized to accommodate an engine module for a 600,000 lb (270,000 kg) vehicle of about 27.6 ft² (2.5 m²) capture area.

RESEARCH CAPABILITY

- o An order of magnitude increase in scramjet engine size test capability
- o Provides high confidence level data in critical problem areas
- o Significant increase in thermo/structural research capability under flight duplicated flow conditions
- o Significant improvement in the chemical similitude of vitiated air using carbon based fuel
- o Capable of a wide spectrum of ramjet/scramjet engine research applicable to airbreathing hypersonic aircraft and missile systems as well as thermo-dynamic research, and structural research in flight duplicated conditions.
- o Capable of Preliminary Flight Rating Test (PFRT) in about one month with continuous operation for qualification tests.

DEVELOPMENT ASSESSMENT

This facility concept is a growth version of existing aerospace, and industrial equipment. The transfer of technology from an industrial application to this ground facility may entail a short period of development. This facility is essentially a continuous operating version of the TRIPLTEE concept with the addition of a carbon based fuel combustor for increased temperatures and continuous operation. The scramjet test section employs some techniques new to facility fabrication but in use in the aerospace industry. The overall risks associated with accomplishing the design goals are moderate, primarily associated with integration of the heater systems. This aspect could be developed using existing, small, zirconia storage heaters such as the one at PARD, Langley Research Center.

The complete facility can be available for use in about 5 1/2 years, at a cost of \$147 million. About \$6.4 million can be initially saved by postponing the design and construction of the thermo-structural test leg components, but this would have no impact on the acquisition schedule. However, since these components provide a considerable portion of the total facility research value, this option is not recommended.

ft²
(m²)
x 43.2 in.
x 110 cm)

n
n)

psia
N/cm²)

.085,000
72 Per Occupancy Hour

from Mach 3 to Mach 10
Nozzles

Test Core Diameter
5.7 ft (1.74 m)
8.3 ft (2.69 m)
9.0 ft (2.75 m)

FOLDOUT FRAME /

FIGURE 40 MAJOR STRUCTURES/FLUID SYSTEMS RESEARCH FACILITY (S20)

- 1 High Bay Structural Test Area
- 2 Offices
- 3 Acoustic Research Cell
- 4 Vibration and Acoustic Control Room
- 5 Thermal Acoustic Research Cell

- 6 Vibration Shaker Power Supply and Equipment Room
- 7 430 MW Substation for Thermal Testing
- 8 Mechanical Equipment Room
- 9 Altitude Chamber Control Room
- 10 Steam Ejector Control Room
- 11 Chemical Steam Ejector for Altitude Chamber

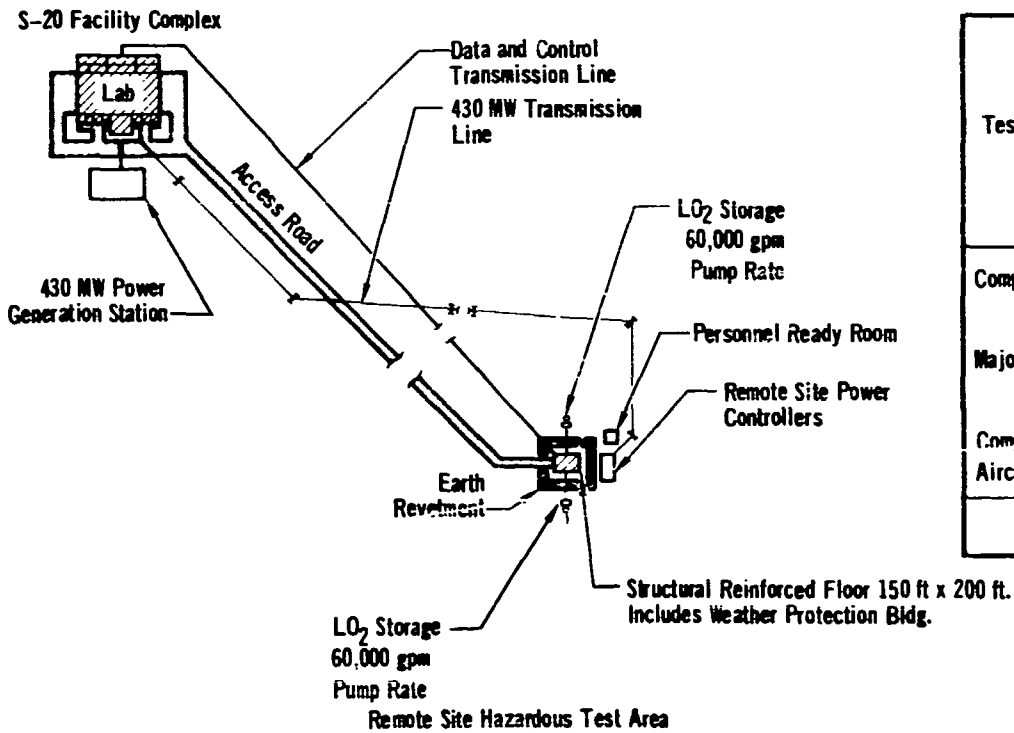
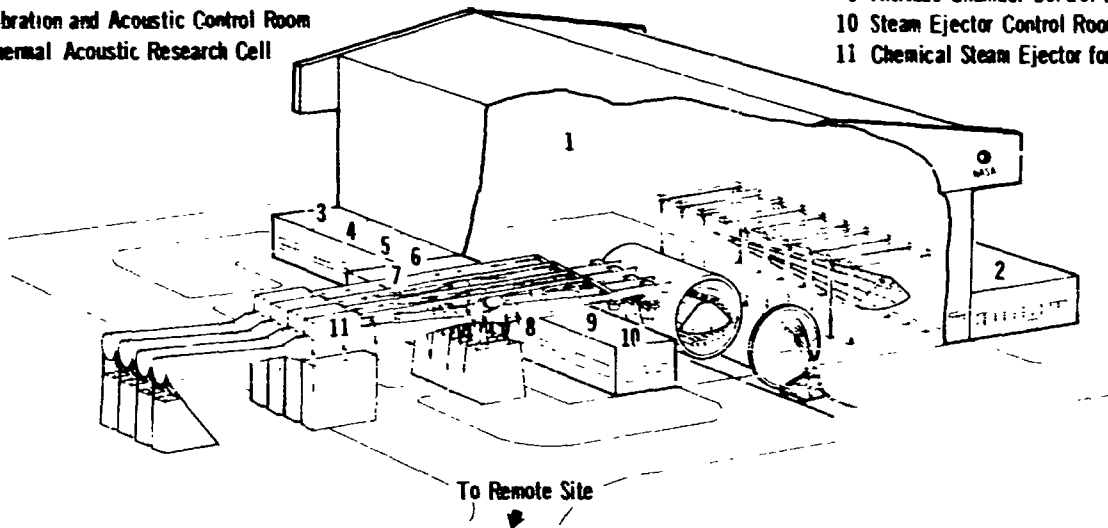

Test Article	Size	Test Capability				
		Mechanical Loads	Thermal	Altitude	Acoustic	Vibration
Component	20 x 20 ft (6 x 6m)	X	X	X	X	X
Major Section	130 x 80 ft (40 x 24m)	X	X	X	X	X
Complete Aircraft	328 x 50 ft (100 x 46m)	X				
Acquisition Cost = \$237,351,000						

FOLDOUT FRAME 2

FACILITY DESCRIPTION

The structural test complex consist of 3 facilities, 1) structural laboratory, 2) hazardous fuel test areas, and 3) fuel slosh test track. The structural test laboratory is a high bay test area that incorporates a structurally reinforced floor. Test equipment was provided to duplicate mechanical loads, vibration, thermal, altitude, acoustic, and thermal-acoustic environments.

A remote site cryogenic fuel test area provides testing of: 1) fuel tank thermal protection systems, 2) thermodynamic studies with cryogenic fuel usage, 3) cryogenic heat exchangers, and 4) rapid re-fueling techniques. This site has adequate cryogenic and hydrocarbon fuel storage and transfer capability to test representatively sized fuel tank and structural specimens. Flowrates approaching 60,000 gpm (3.8m³/sec) are provided for cryogenic fuels and slush hydrogen. The facility consists of a structurally reinforced floor covered by a weather protection shell, surrounded by an earthen revetment to protect personnel and to contain a cryogenic fuel spill. The basic environments or conditions duplicated include fuel flow, thermal, and mechanical loads.

The slosh test track will subject realistically sized tank configurations to sustained acceleration combined with random vibration simulating takeoff roll and vibration, aerodynamic maneuvers, and thrust cutoff. The Test Track Facility at Holloman AFB, New Mexico can fulfill the majority of slosh testing required for a hypersonic vehicle development program. The track length is sufficient to allow test times of 16 seconds at a sustained 3g acceleration, with an equal amount of time for deceleration. Fuel flow could be accomplished by burning the fuel in a suitable rocket motor or dumping it overboard at a predetermined rate.

RESEARCH CAPABILITY

- o An order of magnitude increase in the size of structural specimens which can be subject to combined loads.
- o Sea level ambient pressure and temperature environment for time variant mechanical loading of complete operational aircraft.
- o Local altitude-thermal-mechanical time variant inputs duplicated for major section of operational aircraft or complete research aircraft.
- o Combined thermal, altitude, acoustic, mechanical fatigue research on components of operational aircraft.
- o Major advance in fluid systems research for airbreathing aircraft.

DEVELOPMENT ASSESSMENT

For the majority of the research performed substantial advances in testing know-how are probably not required. The large size of the test articles will present new challenges to design economical test setups.

The total amount of power that will be used in the thermal testing of a major section is approximately 10 times more than the largest heat test ever run. Precautions must be taken to insure that the load can be dumped to some type of power absorbing device to prevent the generator damage in the event of heater failure. Instrumentation technology will require significant research to develop economical and reliable methods for measuring temperature and high temperature strain.

S. J represents a low risk facility in terms of hardware components most of which are in operation in current facilities. It will represent a major development in terms of integrating many different simulations, on a time one facility. The facility is estimated to require 39 months to complete in its full specification, at a cost of \$237 million. The nature of this facility permits the use of an expanded construction schedule, starting with the component-sized laboratories and working up to the major sections and complete aircraft capabilities over a ten year program. The total cost of such an expanded program would be approximately \$285 million, but would result in an average annual cash flow savings of 61%.

Capability		
Acoustic	Vibration	Fuel Flow
X	X	X
X	X	X

000

6. FACILITY POTENTIAL AND COMPARISONS

One of the major objectives of this study was to assess the inherent worth of various conceptual research facilities. Thus, it was not only necessary to determine the capability and costs of the various candidate facilities but to place a value on the importance of the research that could be accomplished by each facility. This was accomplished with the cooperation of NASA and Air Force personnel in conjunction with the study team by identifying and ranking in importance the necessary research for each of the nine potential operational systems. The quantification process is illustrated in Figure 41.

Initially broad Research Objectives were identified which were then sub-divided into Research Tasks which are more specific problem statements of the desired research. Seventy-eight (78) Research Objectives and two hundred and thirty seven (237) Research Tasks were so identified. A numerical measure of the research value (intrinsic value) for each defined area of necessary research was derived from an application of the Law of Comparative Judgement, in which NASA, Air Force, and MCAIR engineers compared each Research Objective within particular groupings of the 78 Research Objectives. Intrinsic values were determined as a result of computerized statistical analysis of the paired comparisons.

FIGURE 41 QUANTIFICATION PROCESS

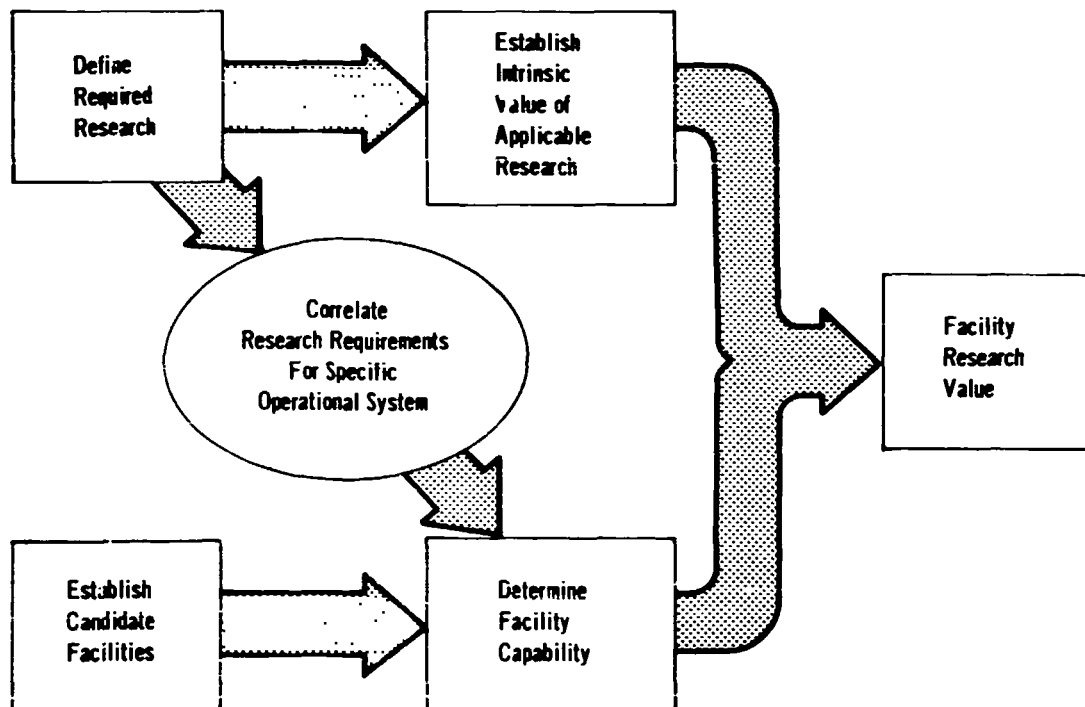

Ten (10) of the highest ranked Research Objectives are listed in Figure 42 to illustrate the results. The ranking is based on a relative value scale of intrinsic values which varied from a maximum of about 84 for the higher ranked Objectives to 27 for the lower ranked Objectives taken from the total list of 78 Objectives.

FIGURE 42 MOST IMPORTANT RESEARCH OBJECTIVES

<u>RESEARCH OBJECTIVE CODE NUMBER</u>	<u>RESEARCH AREA</u>
28	Reusable Thermal Protection Systems Cryogenic Tankage
60	Large Scale Convertible Scramjets
43	Reusable Thermal Protection Systems Primary Structure
57	Large Scale Turboramjet
3	Supersonic and Hypersonic Aerodynamic Characteristics
61	Large Scale Scramjets
48	High Performance Inlet Configurations
34	Regeneratively Cooled Structures
4	Reynolds Number, Shock Wave and Boundary Layer Phenomena
44	Properties of Advanced Materials

To determine the research value of each facility the intrinsic values are used along with an assessment of the capability of the facility to accomplish the desired research according to:

$$FRV = \Sigma (IV) \left(\frac{\% \text{ CAPABILITY}}{100} \right)$$

Where: FRV = Facility Research Value (a measure of the ability of the facility to accomplish the required research)

Σ = Summed over all applicable research which can be accomplished in the facility

IV = The intrinsic value of the particular research

% Capability = A quantified assessment of the percentage of the research that can be accomplished in the facility when used in conjunction with existing facilities.

MDC A0013 • 2 OCTOBER 1970
VOLUME I

Facility capability was determined according to the following criteria:

- (a) Physical Environmental Simulation
 - o To what extent are key parameters (e.g. noise, pressure, temperature, Mach No., loads, etc.) simulated, either individually or in combination, in a static or time-variant manner?
 - o What is the capability of the facility to accommodate a wide range of test conditions contributing to a broad research base, in terms of multi-point research, wide parametric variation capability, and research time available for satisfying the objective as it relates to a reasonable research program?
- (b) Configuration Arrangement and Size Similitude
 - o What is the capability of the facility to accommodate a model or experimental specimen, in terms of the limits of scaling factors, experimental section, and model size?
 - o To what extent can unknown interactions be uncovered?
- (c) Verification and Demonstration Capability
 - o To what extent can operational flight hardware be tested?
 - o To what extent can operational flight profiles and vehicle utilization be simulated?
 - o To what extent can the actual operational flight environment characteristics be proven?

The effectiveness of candidate research facilities is defined in this study as research potential measured in terms of facility research value. Two basic measures of facility research value are presented. One measure of facility research value is based on the facilities "characteristic" capability, that is, a measure of the facility to accomplish a spectrum of research not only in the predominant technology area for which it is normally built but in other ancillary areas in which it provides a capability. This value provides a measure of the facilities' broad versatility. A second more specific measure evaluates the "focused" facility research value. This is a value representative of its capability to conduct research in the technology area for which it is primarily used. As previously stated, the capability of each facility includes the contribution of existing ground facilities. Direct comparison between ground and flight facility can only be made on a relative contribution basis. Ground facilities are only evaluated against the type research one would normally expect to accomplish in ground facilities and flight facilities are evaluated against those things one would normally expect to accomplish in a flight research program in conjunction with the associated ground tests for the particular flight research vehicle. Characteristics and focused research values for the candidate facilities are illustrated in Figures 43 and 44. The shaded area represents the facility capability and the complete bar represents the total of all of the research applicable to the particular facility for the operational system involved.

FIGURE 43 FLIGHT VEHICLE RESEARCH VALUE SUMMARY

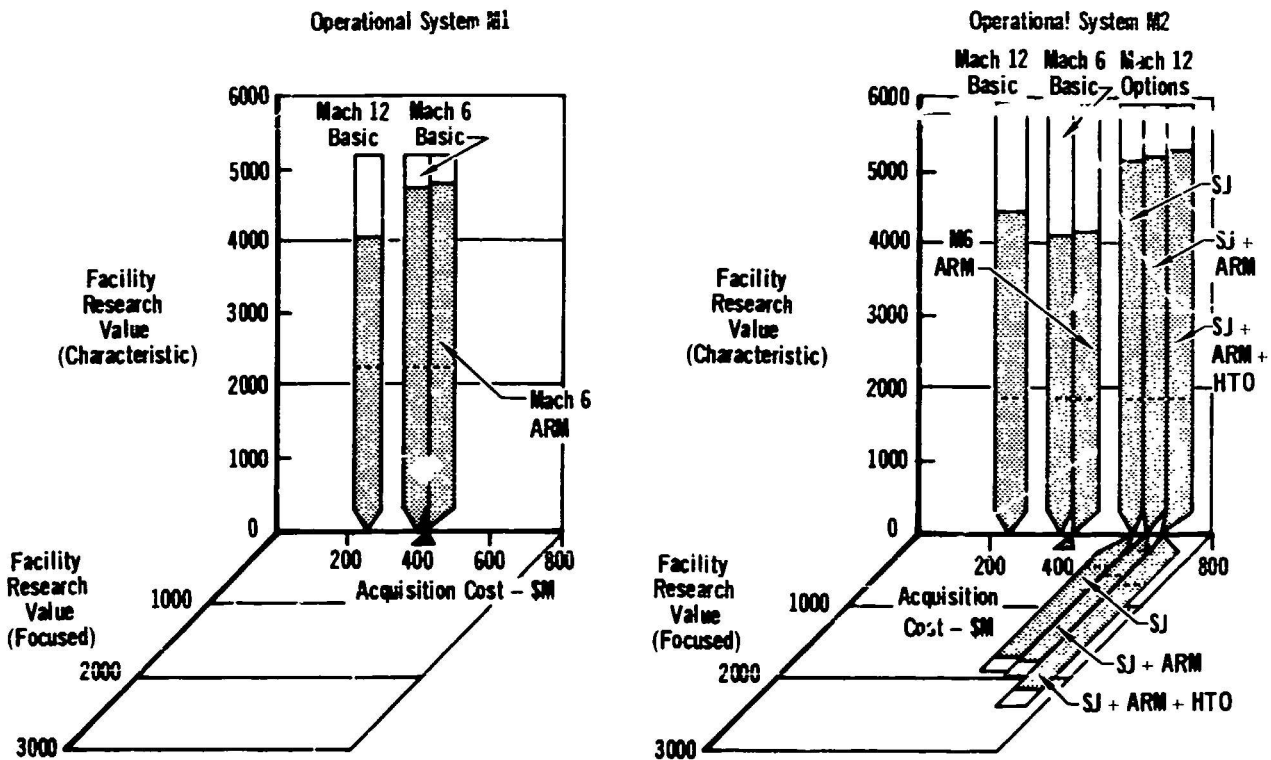
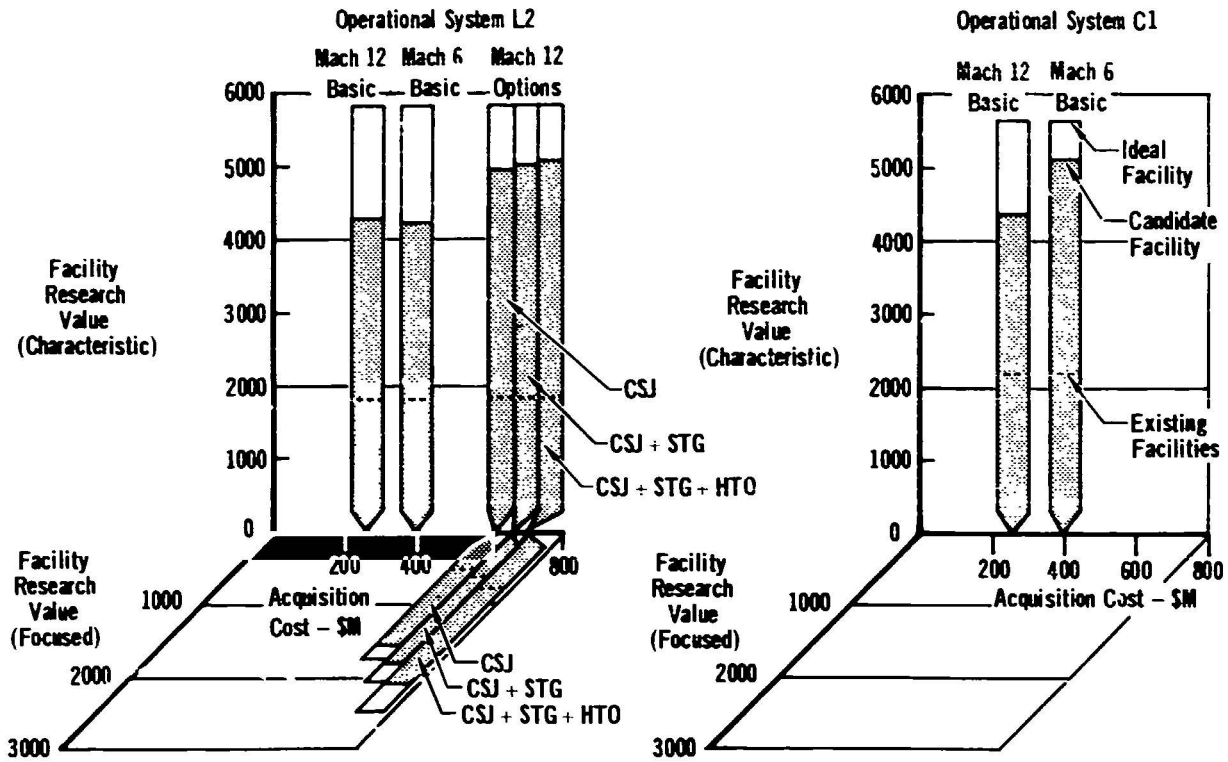
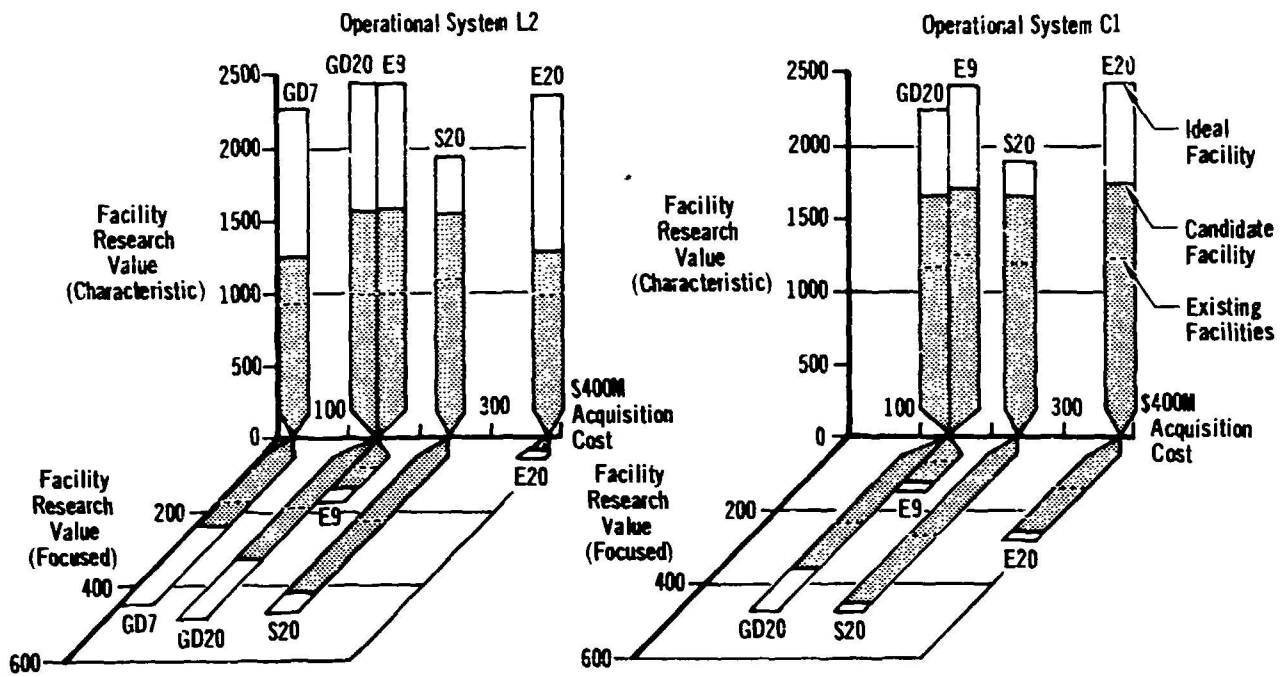
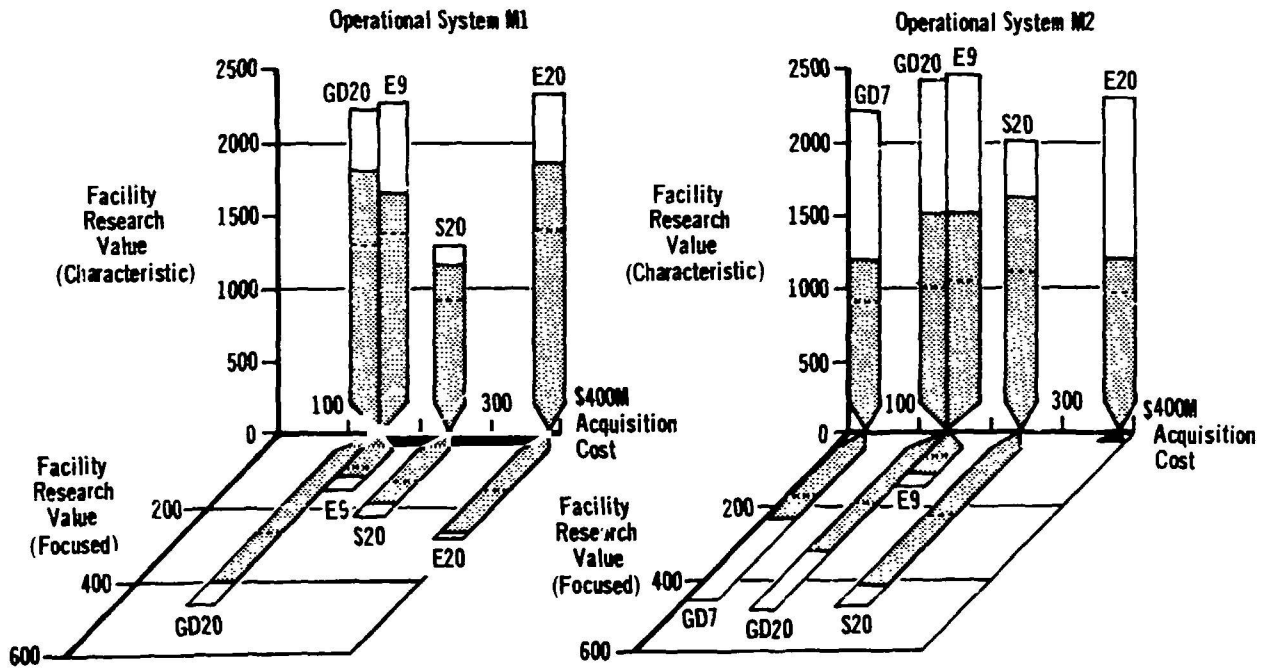

FIGURE 44 GROUND FACILITY RESEARCH VALUE SUMMARY



GD7 = Hypersonic Wind Tunnel (M = 8 to 13)
 GD20 = Polysonic Wind Tunnel (M = 0.3 to 8.5)
 E9 = Dual Mode Ramjet (M = 3 to 11)
 E20 = Compound Turbomachinery (M = 0 to 5.5)
 S20 = Major Structural Test



MDC A0013 • 2 OCTOBER 1970
VOLUME I

Four representative systems of the nine potential operational systems are illustrated, namely:

- (L₂) Mach 8 to 10, Turbojet/Convertible Scramjet Recoverable Launch Vehicle
- (C₂) Mach 6, Turboramjet, Hypersonic Transport
- (M₁) Mach 4.5, Turboramjet, Military
- (M₂) Mach 12, Rocket/Scramjet, Military

The basic Mach 12 research vehicle can accomplish, in conjunction with existing facilities, from 73% to 77% of the applicable research for all representative operational systems. This relatively consistent research potential across the spectrum of candidate operational hypersonic vehicles is a result of the Mach 12 research vehicles' broad contribution to fundamental hypersonic research. The research potential of the Mach 12 vehicle is considerably enhanced by the vehicle options which contribute to the development of a particular operational system, as illustrated by the addition of the convertible scramjet, staging and horizontal takeoff options for operational system L2. The influence of the operational system for which the flight research vehicle is being evaluated is even more pronounced for the Mach 6 vehicle. For instance, the accomplishment of "characteristic" research varies from a low of 69% for M2 where the Mach 6 vehicle does not duplicate the high speed end of the flight regime or the cruise propulsion system, to a high of 91% for M1, where the operating characteristics, speed capability, and propulsion system of the flight research vehicle result in a near prototype of the potential operational system. For both vehicles the capability as measured by "focused research" values is very high.

All of the candidate ground test facilities exhibit a good "characteristic" research value across all operational systems indicating the broad versatility of these facilities. When evaluated against their "focused" capability the results are dramatically high indicating the feasibility of constructing high performance facilities to accomplish specific research. Particularly interesting is the compound turbomachinery engine test facility (E9). It has a good "characteristic" capability which results from the ability to use this facility to conduct research in a number of structures, subsystems and operational areas. When evaluated as a pure propulsion facility its capability is low when evaluated against operational systems employing propulsion concepts different than those for which it was designed, and extremely high when evaluated against operational systems employing propulsion systems for which it was specifically designed.

Figures 45 through 48 illustrate the "characteristic" facility research value for, (1) the combination of all existing ground facilities, (2) the appropriate individual new ground facilities in combination and, (3) the new flight research aircraft.

It is evident that a significant improvement over existing facility capability is available with either new ground facilities or flight research vehicles. No attempt was made to evaluate the research capability of a combination of new ground facilities with the new flight research vehicles, which would be quite high.

FIGURE 45 RESEARCH PROGRAM COMPARISONS FOR OPERATIONAL SYSTEM C1

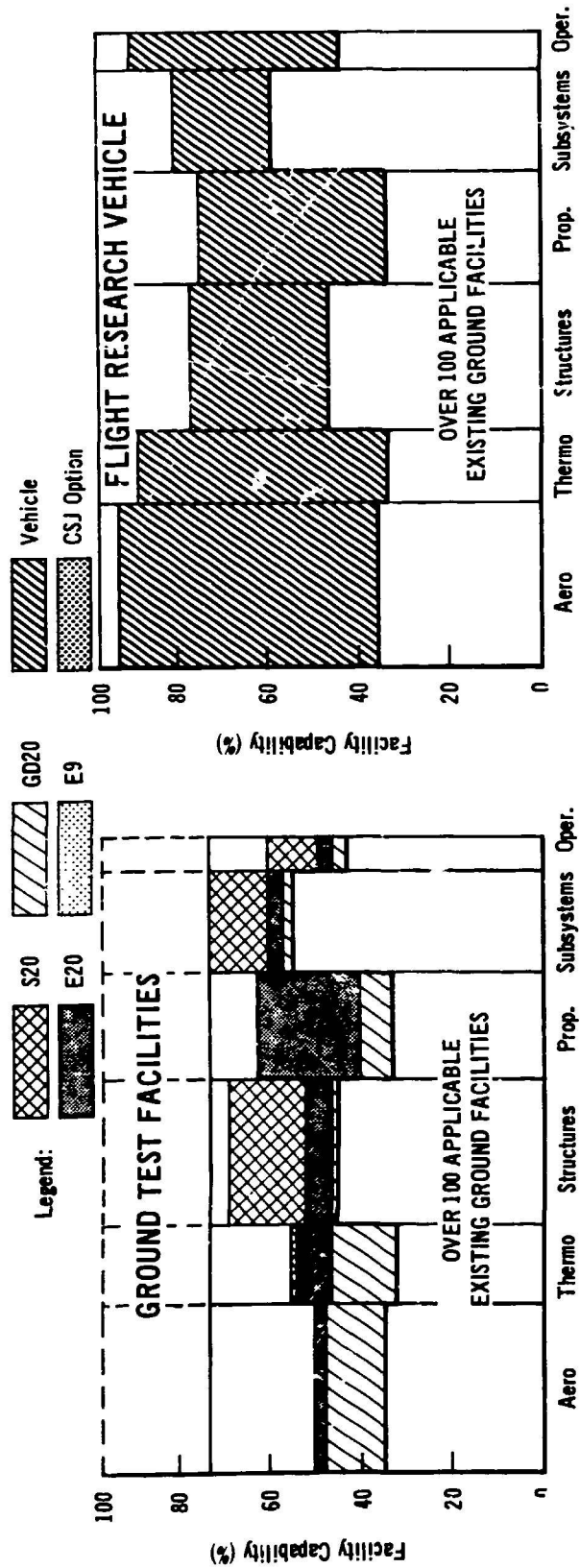

FIGURE 46 RESEARCH PROGRAM COMPARISONS FOR OPERATIONAL SYSTEM L2

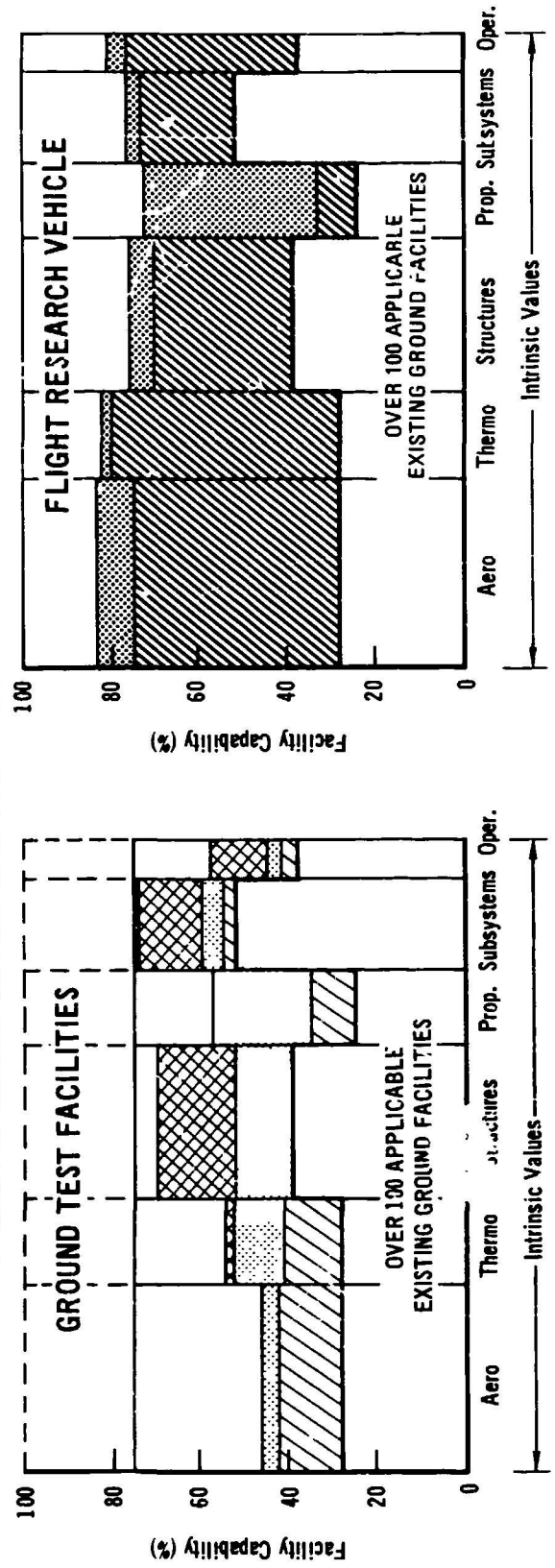

FIGURE 47 RESEARCH PROGRAM COMPARISONS FOR OPERATIONAL SYSTEM M1

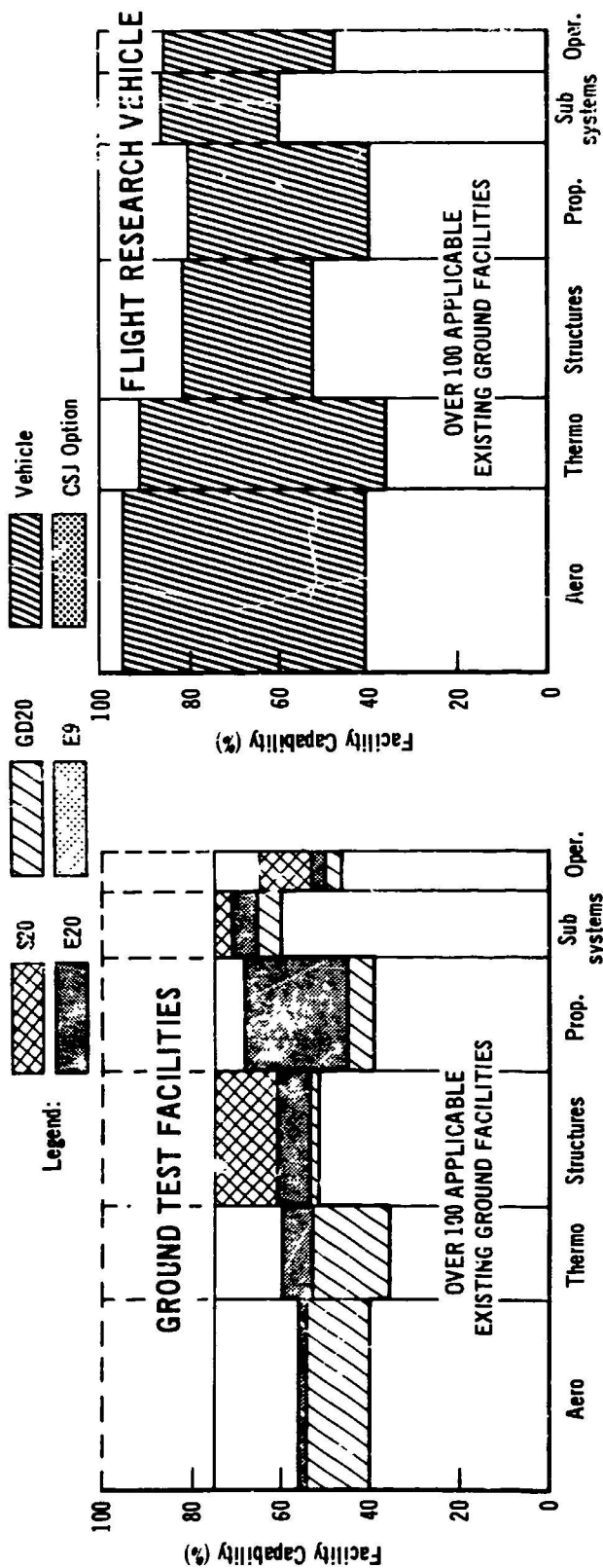
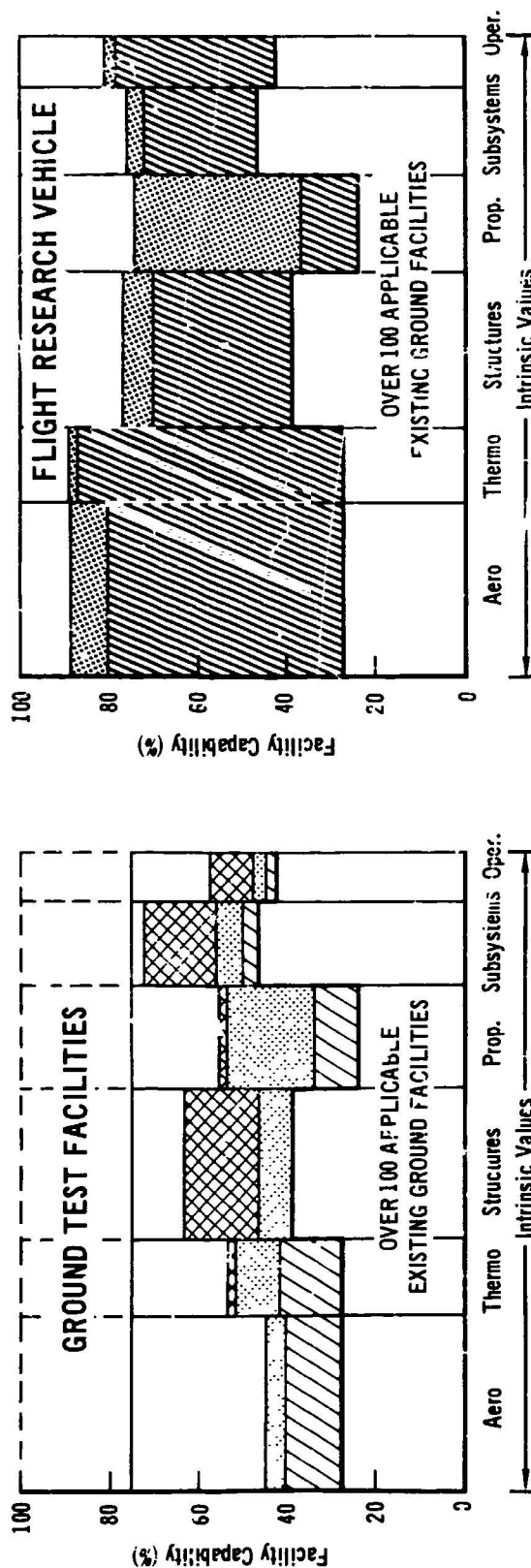

FIGURE 48 RESEARCH PROGRAM COMPARISONS FOR OPERATIONAL SYSTEM M2



MDC A0013 • 2 OCTOBER 1970
VOLUME I

The specialized capability of the ground facilities is quite evident. For example, wind tunnels contribute little if any to structures research, and vice versa, structural test facilities do not contribute to aerodynamics research. However, the strong interactions between technologies is also evident by examining the contribution of the wind tunnels to aerodynamics, thermodynamics and propulsion systems. These interactions are a major factor in increasing the research value of the flight research vehicles. For the Mach 12 flight research vehicle the additional enhancement of the scramjet option is very pronounced particularly in the propulsion area.

Thus, each of the candidate facilities is seen to offer unique capability in various areas, with the flight facilities offering the broadest overall capability.

7. OBSERVATIONS AND CONCLUSIONS

A sound engineering, cost, and planning basis has been established by this study for undertaking acquisition of new hypersonic research facilities when the need and urgency is appropriate.

In addition to the final descriptions of the most attractive flight and ground research facilities, another important contribution has been the sensitivity studies conducted in the earlier phases. This sensitivity data is important in view of the dynamic state of design and operational concepts for hypersonic aircraft. The facility concepts and capabilities presented in this study are directly related to the potential operational systems used as the study base. For different operational systems the sensitivity data will provide visibility on how changes in flight operational modes or design speeds affect the design requirements for ground facility size, Reynolds No. capability, and mass flow and influence facility concepts and resulting capability and costs.

The costs derived for both the flight facilities and ground facilities are judged to be reasonable estimates. No technological breakthroughs were found necessary for any of the presented final facilities. The basis for deriving both ground and flight facility costs includes allowance for normal development problems encountered in any new facility development.

A number of attractive ground test facilities and two attractive flight research aircraft, which incorporate the ability to adapt to varying research goals, have been identified. The research potential of these concepts, their performance, and approximate costs and development schedules have been determined and are summarized in Figure 49. The research capabilities of each facility are assessed in view of the operational system being considered and the type of research required. This accounts for the variation in research capability indicated for each facility. In general, the research capability of the new ground facilities is about 1.5 times that of similar existing ground facilities, and the research capability of the new flight research aircraft is about 2 to 2.5 times the combined research capability of all existing ground facilities.

Both research aircraft offer high research capability at an appreciable cost. In contrast, the Hypersonic Impulse Tunnel, while offering a relatively low research capability is low in cost. Considering broadness of application to all potential future aircraft, the applicability of this tunnel is limited to the high Mach capability aircraft only. On this basis, this tunnel, while fulfilling a very important need, appears somewhat limited in application.

The major structural test facility satisfies a very important need. It integrates in one location the capability to conduct almost any individual type or combined types of structural testing including static and time variant mechanical and thermal testing. Major structural components up to 50 feet (15.2m) by 100 feet (30.5m) can be accommodated in altitude chambers. Full scale aircraft of 300 feet (91.5m) can be accommodated when altitude simulation is not required. This facility appears very attractive and would make a major contribution to providing a high research capability in a very important technology area. The compound turbomachinery engine test facility is necessary if today's approach is used to develop advanced propulsion systems, but appears too costly to recommend without having a firm need

FIGURE 49 RELATIVE RESEARCH FACILITY POTENTIAL

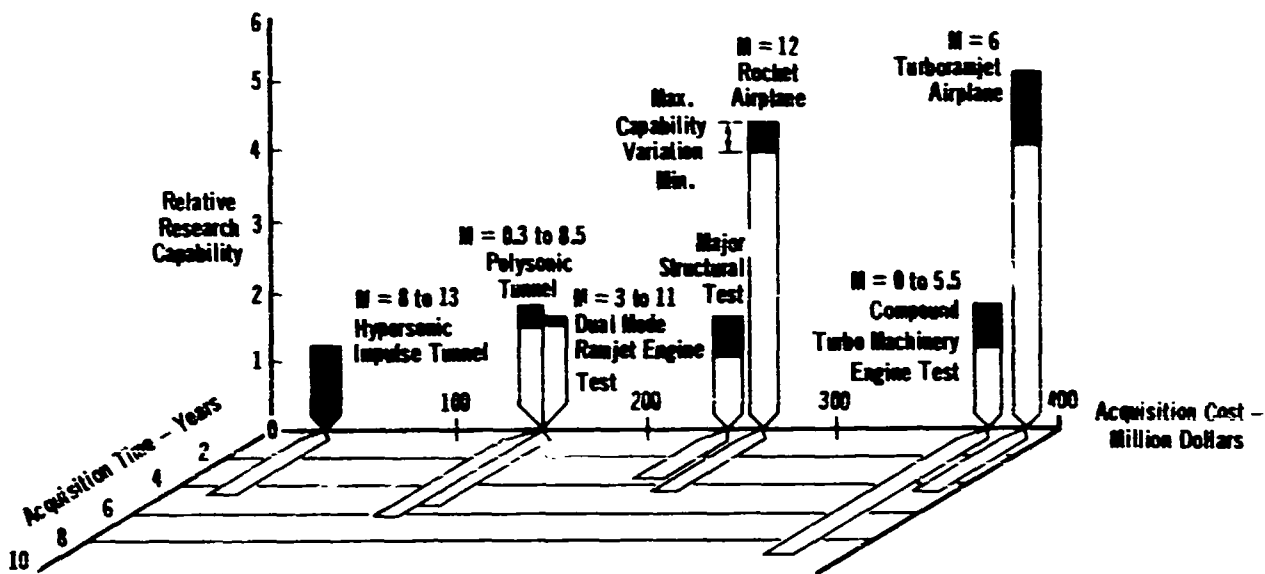

defined. The long lead time involved in fabricating the facility suggests that serious consideration should be given to starting such a facility, particularly in view of the interest in advanced turbojet and turboramjet engines. An alternate approach would be to initially develop this facility with a maximum Mach capability of 3.8. This would eliminate 2/3 of the coolers and the induction heaters, and thus reduce the acquisition cost and time to 209 million dollars and 6 years. The additional equipment could be added later to provide the maximum Mach capability of 5.5.

The ground facilities appearing most attractive are: (1) the High Reynolds Number Mach 0.3 to 8.5 polysonic wind tunnel offering a capability to conduct a broad range of aerodynamic, thermodynamic and propulsion internal aerodynamics to test both subsonic and supersonic combustion ramjets using an intermittent pure air supply and obtaining continuous engine qualification testing on vitiated flow.

Both research aircraft appear attractive, each offering a capability of exploring different flight regimes and design concepts. The Mach 12 vehicle appears somewhat more versatile and offers growth versions for the adaptation of many different types of research testing, including scramjet engine testing and launching of upper stage vehicles.

The principal overall study conclusions are:

RESEARCH REQUIREMENTS

1. The most important areas (technology) of research for the defined operational aircraft systems are:
 - (a) Configuration design
 - (b) Engine integration and cooling
 - (c) Operational life structures
 - (d) Controllability
 - (e) Flow interactions.
2. While many of the potential operational systems are widely different in operational concept, there is a significant commonality in the required research in each technology area.
3. Most of the defined research involves interactions between technologies.

FLIGHT RESEARCH AIRCRAFT

4. Specialty flight research vehicles, such as low speed hypersonic shape aircraft, variable stability, and staged vehicles, are most economical for selective tasks, although the scope of these tasks is limited.
5. Significant size and cost differentials exist between Airlaunch and Horizontal Takeoff launch concepts. Airlaunched vehicles are substantially lower in program cost and provide the best test operation capability.
6. For research vehicles, the wing body shape is best suited to storable propellants and the all body shape is best suited to cryogenic propellants.
7. Active thermal protection systems and integral propellant tanks reduce vehicle weight and cost.
8. A conservative design approach has a small cost effect. All vehicles are therefore designed for 3.5 g at maximum thermal protection system temperatures and 5.0 g structurally at reduced temperatures and provide a high payload capability.
9. Propellant costs are a minor cost element. The use of LH₂ for rockets and hypersonic engines is both feasible and economical.
10. The development of ramjet and scramjet engines is a significant cost element. Development of composite cycle turbomachines, if required, is a major cost element.
11. Off-the-shelf rocket and turbojet engines are available to satisfy the requirements for accelerator engines, thus reducing program costs and program initiation risks.

MDC A0013 ● 2 OCTOBER 1970
VOLUME I

12. The diversity of the defined research clearly indicates that the flight research vehicles should be flexible and adaptable to new and varying research goals. When evaluated for a broad research program capability, unmanned vehicles neither provide this capability nor do they reduce overall program costs.
13. A design cruise speed capability of $M = 6$ was best for the $M = 6$ to $M = 8$ class of research vehicles.
14. A design cruise speed capability of $M = 12$ was best for the $M = 8$ to $M = 12$ class of research vehicles.

GROUND RESEARCH FACILITIES

15. Based on model and balance strengths, there is a maximum dynamic pressure and therefore a minimum facility size to achieve a given Reynolds number.
16. Gasdynamic facilities can provide research capability for many other aircraft concepts in addition to the HYFAC operational aircraft.
17. High Reynolds number gasdynamic facilities are within current state-of-the-art and existing equipment performance capability.
18. Engine size and aircraft flight path have major impact on engine facility size and cost.
19. The low altitude transonic regime is the most costly and difficult regime in which to provide flight duplicated conditions.
20. Small compromises in trajectory simulation capability can make large changes in acquisition costs.
21. High temperature air heaters represent a sizable acquisition cost element.
22. Engine facilities for high mass flows are dominated by compressor/exhauster and dehumidifying cooler costs.
23. Air storage systems represent a major gasdynamic facility acquisition cost.
24. A carbon-fueled, vitiated-air, dual mode ramjet facility can provide flight duplicated conditions with less technical risk and about 1/3 the cost of comparable clean air systems.
25. Based on the dual mode ramjet engine test facility concept, a much larger engine module can be tested for less facility acquisition cost than estimated in prior studies.
26. Over a ten-fold increase in specimen size for conducting structural research with simultaneous simulation of time variant inputs of altitude aerodynamic heating and mechanical loads can be achieved with current equipment technology.

MDC A0013 • 2 OCTOBER 1970
VOLUME I

27. Structural research facility capability can be supplemented with research capability in fluid systems and fuel tank dynamics using common facility hardware.

8. RECOMMENDATIONS

It is clear that a large amount of research is required before we can proceed confidently with advanced aeronautical systems. Historically, various approaches have been followed in the development of new systems. The approach followed depends upon a number of complex and interacting factors. Among these factors are: (1) the program urgency based on geopolitical environment and the national economy, which has a direct bearing on the program time available and the rate of expenditure, and (2) the soundness of the technology base, which has a direct bearing on the risks involved in being able to meet performance objectives and cost goals.

Within the framework of a well defined set of system requirements, one approach is to proceed with direct procurement of the system as with the C-5A. An alternate approach is to proceed initially with a prototype system as with the SST. This also is a direct approach. Only that research necessary to develop the particular operational system, through prototype testing within the development program, is accomplished. The test results obtained have specific and immediate applicability. However, they are often so narrowly defined that the data base cannot be extrapolated with confidence to other potential systems. Hence, in practice with either approach, the development of each system involves particular associated research testing with modest overall application.

A second approach is to expand the technology base as a whole by undertaking a focused but broad research program well in advance of initiating the development of potential operational systems. This is the premise on which the HYFAC study was conducted. This route is not so direct. Such a program must consider the development needs of foreseeable and plausible future systems. It requires careful planning and timely execution. The research results obtained will be only as valuable as the anticipation of requirements and the forethought employed in formulating the program. But when properly carried to completion, this approach will yield results that are applicable to the development of not just one, but several advanced systems.

The potential applications of hypersonic vehicle technology are wide-ranging. There is considerable interest in hypersonic commercial transports. Several studies have concluded that commercial transports cruising at Mach 6 and above are potentially competitive with current and proposed long-range transports at ranges on the order of 5000 nm (9260 km). There has been considerable interest over the past several years in a recoverable launch system for many earth-to-orbit launch operations. Application of hypersonic aircraft to this mission holds strong promise for the future. Many potential military applications of hypersonic cruise aircraft have been studied. These include weapon systems designed to satisfy national requirements in the categories of strategic offense, reconnaissance, and defense. For all of these missions, hypersonic systems provide the advantages of reliability, operational flexibility, and the high performance necessary for mission effectiveness and survival. The requirements for these civil and military missions were considered in this study and the conceptual research facilities have the potential for contributing to the development of any one of these hypersonic systems.

A gross idea of the time span required to introduce an effective hypersonic operational system may be obtained by examining the procurement cycle of a number of recent programs. Programs considered include those essentially employing state of the art systems and concepts, such as the C5, F14 and F15 and those essentially

employing advanced state of the art systems and concepts, such as the B70, SST and Bl. Representative time spans (based on actual and projected dates) are illustrated in Figure 50. The span time from requirement identification to first flight includes the research and development, concept formulation and definition, and the system development efforts. These times vary from 4 to 7 years for state of the art systems to 10 to 15 years for the more advanced technology systems. First flight to Initial Operational Capability (IOC) varies from 2 to 3 years and from 4 to 5 years respectively for the above classes.

Also shown in Figure 50 is a representative time span for a research program. Using the results of the HYFAC study as a baseline for concept definition such a program could start immediately. Reasonable confidence in achieving program goals would be available even utilizing existing technology. Increased confidence could be achieved through further technology R & D efforts. Knowledge gained from such a research aircraft program would have direct application to reducing the development time for advanced technology systems. Acquisition of new ground facilities is not shown in this example, but they would be phased into a comprehensive research program in a manner which would not affect the conclusion of this analysis.

Although the hypersonic flight regime has broad potential no specific requirement has been identified to lend emphasis and stimulate dedication to hypersonic research. Further, a mandatory precursor to commitment to operational systems will be the advancement of basic technology through ground facility research with proof of system through demonstration of flight hardware. Therefore it appears that without a research aircraft the 1970's will be a period of evolutionary growth. Considering the contribution of a flight research vehicle program in accomplishing the required research to establish confidence to proceed with development of an operational system, five to ten years could be saved in the time cycle to introduction of an operational capability (IOC). This analysis is not rigorous, but it emphasizes that the U. S. cannot wait for a firm operational need to be identified prior to initiation of a hypersonic research program.

The development of hypersonic aircraft represents a somewhat greater challenge than the development of civil and military aircraft now in operation. The longer development cycle necessarily demands an early start on applied research programs employing suitable facilities in order to provide the availability of technology options for operational hypersonic systems in the 1980's. A key element in this development cycle is the acquisition time span for new research facilities. As previously shown, the flight research vehicles can be delivered in less than five years from go-ahead. New ground facility acquisition time spans vary from nearly four years to over eight years. These facility acquisition time spans prohibit a quick-reaction capability to a high-priority need for an operational hypersonic system.

To present a program rationale for the initiation of new research facility programs that can survive the necessarily critical evaluation of decision makers is indeed challenging. A practical overall assessment must recognize:

- (1) Competing national priorities for new programs, including the impact of the space transportation system on resources within the aerospace budget.

FIGURE 50 ACQUISITION OF NEW SYSTEMS REQUIRE LONG TIME SPANS

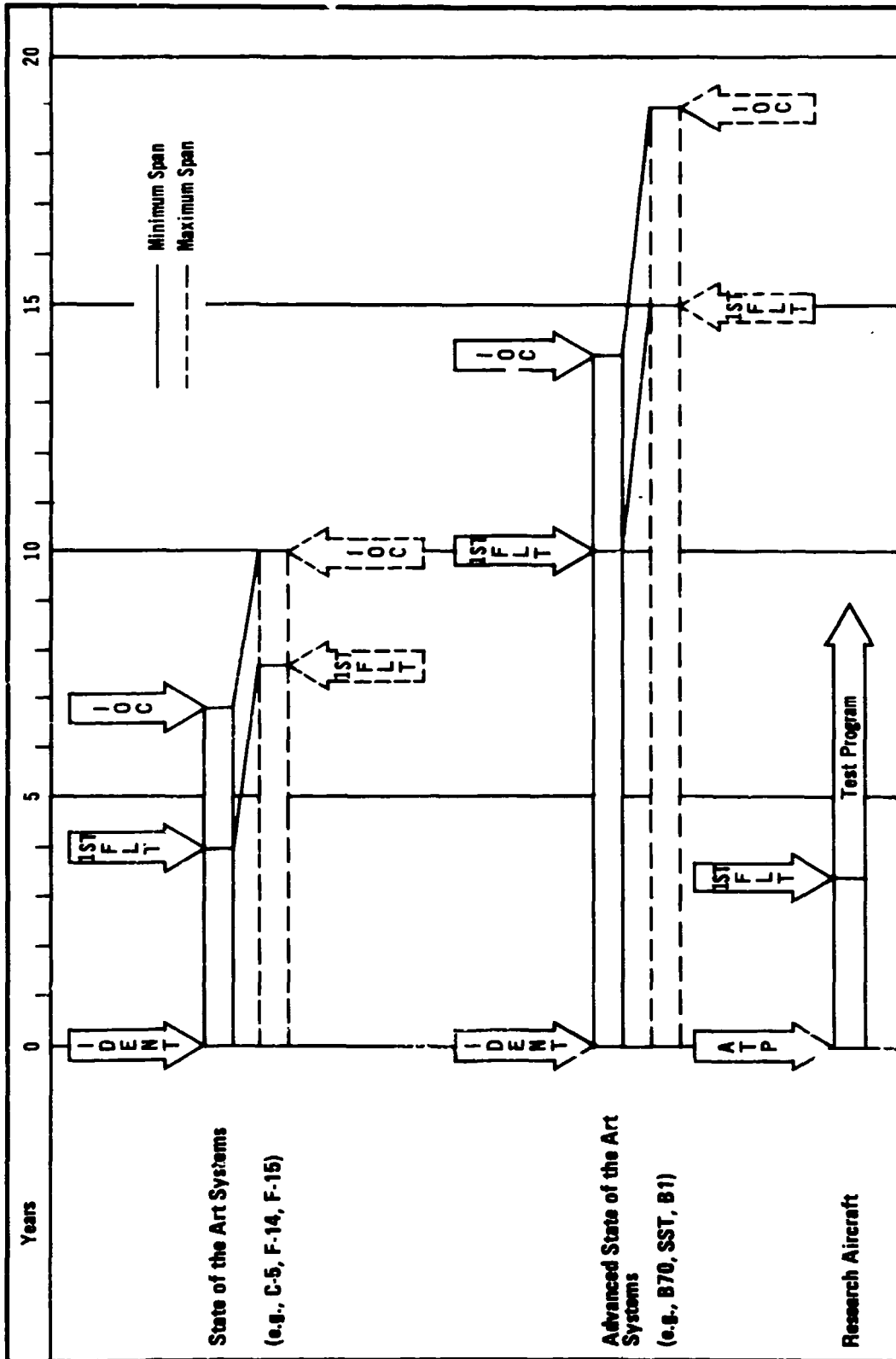

MDC A0013 • 2 OCTOBER 1970
VOLUME I

- (2) The declining appeal of research and exploratory development programs that are not specifically directed toward a particular application.
- (3) The absence of any generally accepted need and sense of urgency for hypersonic cruise aircraft, yet the prevalence of almost limitless attractive applications for such aircraft.
- (4) A generally accepted conviction that it is more difficult to determine what problems need to be solved than to find the solution to known problems.
- (5) An environment of conflicting views. Advocates who claim we have reached a "Technological Plateau" and an equal number who claim there is no such thing as a "Technological Plateau". Advocates who claim we must continue research programs as a margin of safety to ensure we have many options available to us and an equal number who claim every technological effort must have a clearly defined need which cannot be met adequately by other means.

Guidance in ordering priorities and developing a program logic can be obtained by examination of the results of each element of the HYFAC study.

A major effort was devoted to establishing a comprehensive identification of high priority research. Figure 42 lists the 10 most important research objectives as applied to the complete spectrum of operational systems considered in this study. Emphasis is clearly indicated in structures, propulsion, and aerodynamic research. Further, if we examine the complete list of research objectives (Reference Vol. IV, Part 3) for a representative system, such as the Mach 12 Military Strike System, we see that eleven (11) research objectives involve development of advanced materials and structures, emphasizing reusable thermal protection concepts, seven (7) involve engine development and engine/airframe integration, and eleven (11) involve configuration development, boundary layer research, and inlet/nozzle integration. The intrinsic value of these 29 research objectives of the 68 applicable research objectives represents 55% of the total identified research. Similar results are obtained for each of the operational systems; thus rather dramatically indicating the importance of conducting research in the three areas previously mentioned. Since these results represent the collective judgement of industry (represented by the study team) and government scientific personnel obtained in a systematic disciplined manner we believe they provide valid guidance.

An effective program for accomplishing the required research and achieving the technology advancements can be developed by analyzing Figure 49. It appears that gradual development of new ground test facilities to fill existing deficient research capability areas along with a flight research aircraft to demonstrate and verify technology advancements would be a reasonable program goal. Such a directed research facilities program would provide solutions for many problems currently well known to the scientific community as well as to many problems currently unknown. Both the Mach 6 and Mach 12 research aircraft provide high research capability. The Mach 12 vehicle, although representing a quantum jump in potential results in a lower acquisition cost (\$263 million compared with \$398 million). The Mach 12 vehicle offers extensive growth capability including: (1) horizontal takeoff and landing capability for evaluating subsonic and transonic aerodynamics; (2) ability to test

MDC A0013 • 2 OCTOBER 1970
VOLUME I

thermal protection concepts and materials; and (3) scramjet engine development and airframe integration. These options are available at modest increases in program cost. In view of its lower cost, and greater growth potential the Mach 12 vehicle appears to be a better choice than the Mach 6 aircraft.

The Hypersonic Impulse Tunnel is a very effective facility for hypersonic wind tunnel research and may be acquired at reasonable cost. However its application is limited to systems operating at speeds above Mach 8. The Polysonic Tunnel however, has application to all of the potential operational systems studies and may be acquired at reasonable cost.

The Major Structural Test facility provides a capability to conduct development and verification tests in all areas of structural interest and in a single central location. To acquire this capability is quite costly, but it could be acquired in incremental steps thus reducing the spending rate.

The development of advanced airbreathing propulsion systems is the key to future hypersonic aircraft. Modest speed increases are achievable with turboramjets, but substantial increases in the performance capability of existing engine test facilities are required to develop and flight qualify such engines. Significant increases in temperature, pressure and mass flow capability are necessary. Acquisition of such new engine test facilities is therefore quite costly. A specific identified program application would be required to justify initiating acquisition of the complete Turbomachinery facility capability. However, as with the structure facility, the total capability could be acquired in incremental steps, thus reducing the necessary funding rate, while available testing capability was being increased.

Major speed increases are achievable with supersonic combustion ramjets. Unlike turboramjets, modules of the complete scramjet engine may be tested to develop and qualify the complete engines. The concept developed for a dual mode ramjet test facility integrates the engine module in the facility. This reduces the mass flow requirements and, combined with a unique application of a carbon combustor for producing high temperature vitiated air, results in reducing the costs of such facilities by an order of magnitude (compared to previous design concepts). This facility also provides a capability to perform direct connect testing of smaller turboramjets and thermostructural tests of significant size structures. It has wide application and can be acquired at reasonable cost. However it does require development of a carbon combustor system. As discussed in Vol. IV, Part 2, a smaller size supersonic combustion ramjet test facility would be achievable by modifying the Von Karmen Facility at AEDC, incorporating a new test section and a carbon combustor.

In consideration of the above a comprehensive research program including initiation of a Mach 12 flight research aircraft and a gradual upgrading of selected ground research facilities, is recommended.

Elements of the Mach 12 research aircraft program should include:

- (1) An in-depth system definition, development plan, and flight test plan, with specific research goals established and related to particular future aircraft, followed by acquisition of the research aircraft.

MDC A0013 • 2 OCTOBER 1970
VOLUME I

- (2) A design development and test program for hydrogen regeneratively cooled panels of the inlet.
- (3) Design definition of the scramjet engine, followed by component development and testing.

Concurrent effort directed toward ground facility upgrading should include:

- (1) Development of carbon combustor system
- (2) Modification of the VFK facility
- (3) Acquisition of the Dual Mode Ramjet facility
- (4) Acquisition of the Polysonic wind tunnel

The time phasing for this concurrent program is illustrated in Figure 51.

Many studies terminate with recommendations for further studies to explore additional options and alternatives and examine new problems. This is not the case with HYFAC. The results from this study indicate that the time for action is now.

The program recommended from this study presents a viable plan for progress through action. It recognizes the need for a balance between ground research and flight research. Each type of research is necessary if we are to significantly advance the various technology areas identified in the research requirements analysis of the HYFAC study. Each type of research will satisfy specific needs in

- o obtaining understanding of fundamental principles and laws
- o developing design methods and concepts
- o obtaining proof of design and environment

In this way the confidence, in the ability to commit the various technologies to operational systems, will be achieved.

The recommended program will focus effort and resources to exploit the unexplored aeronautical frontiers. Only by such programs will this nation retain its leadership and superiority in aeronautics.

FIGURE 51 MASTER SCHEDULE

