

SPACE NUCLEAR POWER SYSTEMS

by

R. T. Carpenter

AEC/NASA Space Nuclear Systems Office

Abstract

Space nuclear power systems have been, are being and will be developed for use in those particular spacecraft applications for which nuclear power systems offer unique advantages over solar and/or chemical space power systems. Many of these advantages are discussed relative to the past and future applications of nuclear power systems in our space program. Both isotopic and reactor heated space electrical power units are described in an attempt to illustrate their operating characteristics, spacecraft integration aspects, and factory-to-end of mission operational considerations. Much experience has been gained with nuclear space power sources which have been flown. This experience is being used to guide current developments to make those units more attractive for operational use.

The status of technology developments in nuclear power systems is presented. Some projections of these technologies are made to form a basis for the applications of space nuclear power systems to be expected over the next 10-15 years.

I. Introduction

Some of the major sources of manmade radiation in space which you will hear much more about in the next few days are the nuclear power sources being used or expected to be used in non-propulsive nuclear space power systems. In the next few moments I will describe various space nuclear power systems which are designed to produce electricity for spacecraft payloads. Nuclear heat sources are also being developed which will be used for thermal power applications in space to provide thermal control and/or process heat for various spacecraft. The space nuclear electric power program, which I will discuss, does not include these thermal power applications except, possibly, in the case where waste heat from the heat-to-electricity conversion equipment is used to provide thermal control for the spacecraft.

Some examples of purely thermal applications of nuclear (only isotope) sources in space include the radio-isotope heaters used on the Experimental Scientific Experiment Package left on the moon by the Apollo 11 crew or the isotope heater used on the Russian lunar rover (Lunokhod-1) where the nuclear heat maintains the electronics at a survivable temperature during the long, cold lunar night. The electrical power for the two missions is provided by solar cells during the lunar daytime. Another thermal control source is the radio-isotope heater unit planned for use on Pioneer spacecraft. A typical process heat application is the use of an isotope heater with the life support/waste management system which can regenerate potable water from body wastes in manned space vehicles. As you can readily conclude,

these thermal sources are being omitted here not because they are unimportant, but because of the short time I have and because what I will cover in terms of nuclear heat sources for electrical power systems is generally applicable to thermal power sources for use in space.

So, nuclear space power systems, as used through the remainder of this paper, refer to the combination of a nuclear heat source and a heat-to-electricity power conversion subsystem for the production of electrical power in space. Two types of heat sources are used: Radioisotopes, which generate heat by their own spontaneous decay; and reactors, which derive their heat from the controlled fission process.

As you will see, there is more than one isotope and several types of nuclear reactors which can be used in space power systems. There are many different types of power conversion concepts which have been developed for use with these nuclear heat sources. My intent here is to concentrate on those systems which have survived the elimination process rather than dwell on why certain other systems are not being pursued in this program. We have lots of ways of building these systems which are good enough; but, because of budgets and other constraints, we attempt to build a few versatile systems using what we consider the best available technology and try to advance the state-of-the-art at the same time we are building systems to fly.

II. General Applications

Space nuclear power systems have been, are being, and will be developed for use with those particular spacecraft applications for which nuclear electric power systems are attractive as listed in Figure 1.

Typical missions which have these conditions are shown on Figure 2 and include planetary missions to Jupiter and beyond or missions of extended duration on the surfaces of the planets or the moon. These missions require the use of nuclear power. In addition, high performance electric propulsion missions require the use of nuclear reactor power systems. The requirements of these few types of missions dictate the need for the development of space isotope and reactor power systems. The selection of these nuclear or non-nuclear power systems for those many missions which can be done with competitive chemical and/or solar power systems are made on the basis of superior mission capabilities, spacecraft integration, technology readiness, cost effectiveness, and other mission program considerations.

There is no question that there will be a continuing need for nuclear power in space which will increase as the space missions become more ambitious in the future. Therefore, the space nuclear electric power program conducted by the AEC and NASA will provide isotope heated power systems in the lower range and reactor heated power systems in the higher power range as dictated by the mission needs.

Figure 1

CONDITIONS UNDER WHICH NUCLEAR POWER SYSTEMS ARE ATTRACTIVE

- * LACK OF SUNLIGHT
- * HIGH RADIATION FIELDS
- * LOW CROSS-SECTIONAL AREA
- * HIGH POWER LEVEL & LONG LIFE
- * HEAT REQUIRED IN PAYLOAD
- * EXTREME TEMPERATURES
- * DENSE METEORITE FIELDS

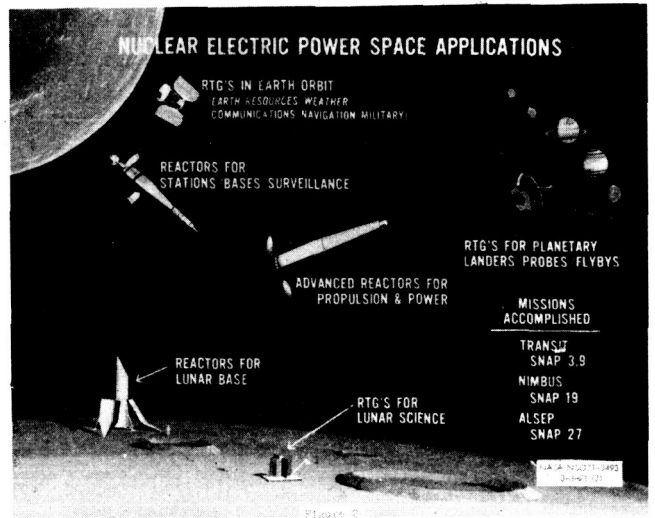

III. Systems in Use

The first use of nuclear power in space was the SNAP-3A launched on the Transit 4A Navy Navigation Satellite in June 1961. This 2.7 watt, Plutonium-238 fueled, 5 pound, PbTe thermoelectric generator paved the way for a series of nuclear power systems which have been launched in the past ten years as listed in Figure 3. SNAP-3A is still operating as are all the isotope units which have been successfully launched.

All of the isotope power systems launched to date have used PbTe thermoelectric converters and Pu-238 heat sources (see Figure 4). Pu-238 was selected for space use primarily because of its long half-life (87.5 years) and its low radiation levels. As larger heat sources were used, the aerospace nuclear safety philosophy changed from burn-up in the atmosphere to intact reentry which forced an evolution of fuel forms and heat source designs. Plutonium metal was used in SNAP-3A and SNAP-9A; PuO₂ microspheres were used in SNAP-19 and SNAP-27. The introduction of the oxide increased the neutron levels of the sources, but provided a higher melt temperature, lower inhalation hazard, and less soluble or reactive fuel form.

Summary of Space Nuclear Power Systems
Launched by U. S. A. (1960-1971)

System	Mission	Launch Date	Fate
SNAP-3A	TRANSIT-4A	6/29/61	Successfully achieved > 1000 year orbit.
SNAP-3A	TRANSIT-4B	11/15/61	Successfully achieved > 1000 year orbit.
SNAP-9A	TRANSIT-5BN-1	9/28/63	Successfully achieved > 1000 year orbit.
SNAP-9A	TRANSIT-5BN-2	12/5/63	Successfully achieved > 1000 year orbit.
SNAP-9A	TRANSIT-5BN-3	4/21/64	Failed to achieve orbit, burned up on reentry.
SNAP-10A	SNAPSHOT	4/3/65	Successfully achieved ~2,300 year orbit.
SNAP-19B2	NIMBUS-B-1	5/18/68	Failed to achieve orbit, retrieved from ocean floor.
SNAP-19B3	NIMBUS-III	4/14/69	Successfully achieved ~3000 year orbit.
SNAP-27	APOLLO-12	11/14/69	Successfully placed on lunar surface.
SNAP-27	APOLLO-13	4/11/70	Failed to reach moon, returned to Pacific Ocean.
SNAP-27	APOLLO-14	1/31/71	Successfully placed on lunar surface.

Figure 4

Space Isotopic Power Systems

System	Power (watts)	Weight (lbs.)	Converter	Fuel Form	Fuel Quantity (curies)	Safety Philosophy
SNAP-3A	2.7	4.6	2N/2P PbTe	Pu-238 Metal	1,800	Fuel Burn-Up
SNAP-9A	25	27	2N/2P PbTe	Pu-238 Metal	16,000	Fuel Burn-Up
SNAP-19B1	30	30	2N/2P PbTe	PuO ₂ -238 Microspheres	34,000	Capsule Burn-Up Fuel Dispersal
SNAP-19B2	30	30	2N/2P PbTe	PuO ₂ -238 Microspheres	34,000	Intact Reentry
SNAP-19B3	30	30	2N/3P PbTe	PuO ₂ -238 Microspheres	37,600	Intact Reentry
SNAP-27	63	68	2N/3P PbTe	PuO ₂ -238 Microspheres	44,500	Intact Reentry

Figure 5 shows a cutaway view of SNAP-19 to illustrate the generator configuration used in all of these isotope systems where the heat is generated in a central heat source, about 5% of it is converted to electricity as it passes through the static thermocouples and the rest is radiated away to space. Figure 6 shows the two SNAP-19's on the Nimbus 3 weather satellite which are still supplementing the main solar cell/battery power system.

SNAP 19 RADIOISOTOPE ELECTRIC GENERATOR

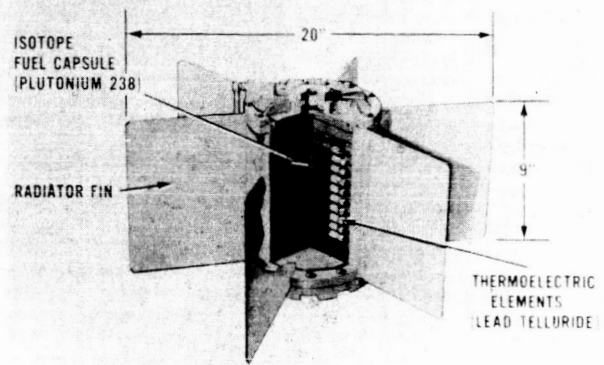

DESIGN POWER OUTPUT 25 WATTS
DESIGN WEIGHT 30 LBS

Figure 5

NIMBUS III SPACECRAFT
WITH SNAP-19 RADIOISOTOPE THERMOELECTRIC GENERATOR

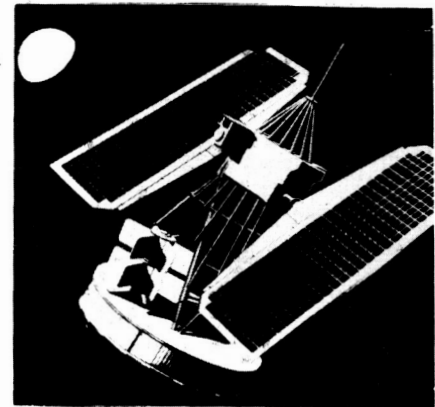

Figure 6

SNAP 19 CHARACTERISTICS

Launched	April 1969
No of Units	2
Initial Power	56 Watts
Fuel	Pu 238
Weight	59 Pounds
Lifetime	1 Year

Figure 7 shows the SNAP-27 being deployed on the moon to provide the total power to the Apollo Lunar Surface Experiments Packages. The Apollo 12 and Apollo 14 stations are both working very well. In fact, if the first SNAP-27 powered station had not lasted well beyond its design life of one year, we would not be getting the added benefits of two simultaneous stations on the moon which we are now receiving.

ALSEP/SNAP-27 DEPLOYMENT

APOLLO 12 - NOVEMBER 1969

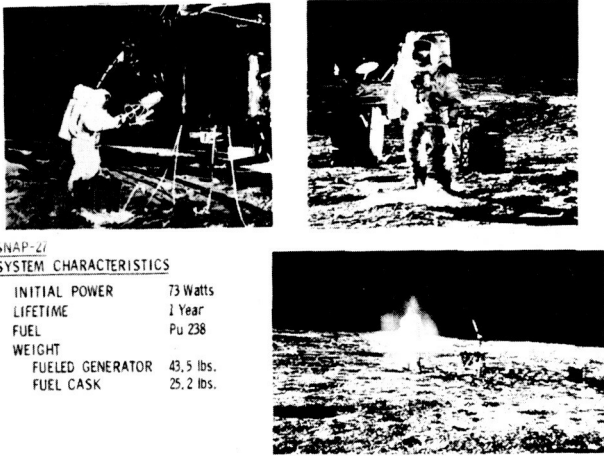

Figure 7

**SNAP-27
SYSTEM CHARACTERISTICS**

INITIAL POWER	73 Watts
LIFETIME	1 Year
FUEL	Pu 238
WEIGHT	
FUELED GENERATOR	43.5 lbs.
FUEL CASK	25.2 lbs.

The radiation levels from SNAP-19 and SNAP-27 are shown in Figure 8. The predominant emissions from these sources are the neutrons from spontaneous fission and the Alpha-neutron reactions with the light elements in the fuel, such as oxygen and impurities. You can see that measurements made on SNAP-27 after about two years shows a factor of two increase in gammas which is due to a build-up of gamma emitting products such as thallium-208. The gamma level from Pu-238 can be 7 or 8 times higher after 15 to 20 years.

Radiation Levels for SNAP-19 and SNAP-27
(Dose Rate at 1 meter)

	Neutrons (nrem/hr)	gammas (mrem/hr)	Total (mrem/hr)	
SNAP-19B (630w., PuO ₂ microspheres)				
Capsule 402/432	Side	39	2.8	41.8
	End	27	1.3	28.3
(2.5 x 10 ⁷ n/sec)				
Capsule 453/454	Side	37	3	40
	End	26	1.8	27.8
(2.4 x 10 ⁷ n/sec)				
SNAP-27 (1480 w., PuO ₂ microspheres)				
Capsule No. 4	Side (6/68)	99	7	106
	(8/70)	97	16	113

Figure 8

The first reactor power system used in space was the SNAP-10A launched in 1965 (see Figure 9). This reactor operated successfully for 43 days at which time it was inadvertently shut-down due to a failure in the voltage regulator. This 500 watt, SiGe thermoelectric system was powered by a 40 Kw Uranium-Zirconium-Hydride reactor which has been the cornerstone for the technology in space reactor power systems. The radiation levels for the SNAP-10A flight configuration are shown in Figure 10. The reactor systems require shielding tailored to the payload requirements, as will be illustrated later.

SNAP 10A SYSTEM & CYCLE

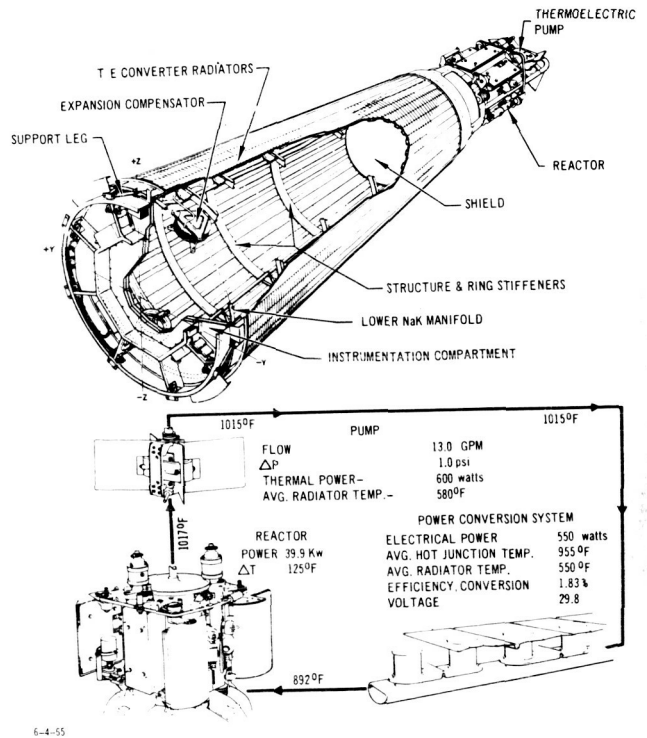

6-4-55

Figure 9

IV. Isotope Power Systems Under Development

Flight Systems

Three near-term missions for which radioisotope thermoelectric generators (RTG's) are now being developed are shown in Figure 11. The primary reasons RTG's are to be used on these missions are: For Transit-long life and resistance to radiation levels expected at this orbital altitude; for Pioneer - independence of solar flux and resistance to radiation to be encountered on the way to Jupiter; and for Viking - independence of the environment on the surface of Mars. Fueled ground test units have been built for Transit and Pioneer and flight systems will soon be built.

SNAP 10A NPU AGENA RADIATION LEVELS

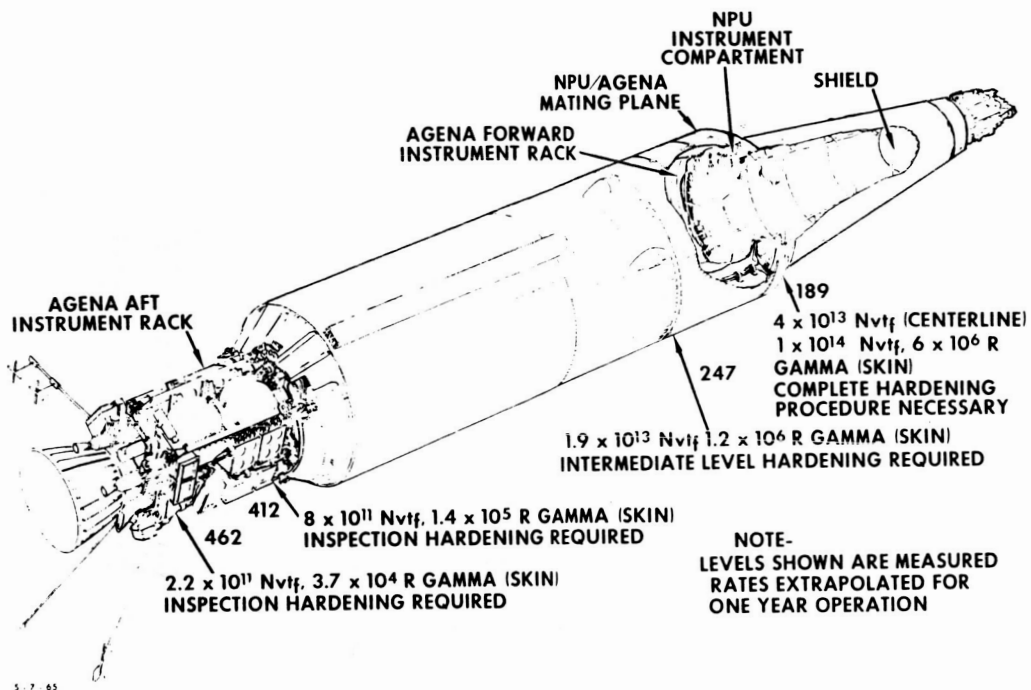

Figure 10

RADIOISOTOPE THERMOELECTRIC GENERATORS MISSION COMMITMENTS



TRANSIT

PIONEER

VIKING

PROGRAM	OBJECTIVE	AGENCY	LAUNCH SCHEDULE	POWER REQUIREMENT	LIFETIME	SELECTED PWR. SUPPLY
TRANSIT	NAVIGATIONAL SATELLITE	NAVY (DOD)	Classified	30 WATTS EOL	5 YEARS	TRANSIT RTG
PIONEER (F & G)	JUPITER FLYBY	NASA	1972 & 1973	120 WATTS	3 YEARS	FOUR SNAP-19's (Modified)
VIKING	MARS SOFT LANDER	NASA	1975	70 WATTS	2 YEARS	TWO SNAP-19's (Modified)

Figure 11

The Transit RTG, shown in Figure 12, is 24 inches in diameter and about 18 inches high. It is to be mounted directly on the satellite so as to provide up to 100 watts of heat to the satellite to help maintain fairly constant temperatures in the electronics of the payload as it passes into and out of the shadow of the earth. The RTG is to produce 37 watts at BOL and 30 watts after 5 years. It is fueled with 850 watts of Pu-238. Heat is radiated from the heat source to the light-weight 2N/3P PbTe Isotec panels which operate between 752 and 288°F. The total weight, including the mounting cone, is about 30 pounds.

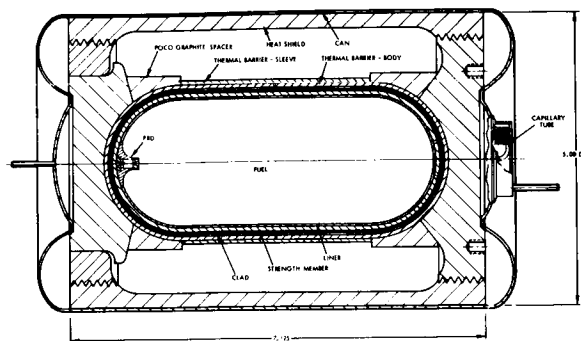

Figure Transit Heat Source

TRANSIT RADIOISOTOPE THERMOELECTRIC GENERATOR

SYSTEM CHARACTERISTICS

POWER LEVEL	
BOL	37 WATTS
EOL	30 WATTS
LIFETIME	5 YEARS
FUEL	Pu 238
WEIGHT	27 lbs.
CONVERTER	ISOTEC
SAFETY	IMPACT CAPSULE SURVIVAL

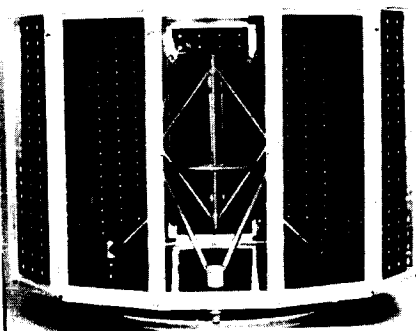

Figure 12

The Pioneer RTG is a modified SNAP-19, shown in Figure 14. It is 15.8 inches across the fins, 11.1 inches high, and weighs 29.2 pounds. It is fueled with 645 watts of PMC and produces 38 watts at BOL or 30 watts after 3 years or at Jupiter encounter. The thermoelectric converter employs 2N/TAGS materials operating between 950 and 350°F. The Pioneer RTG is filled with a cover gas and welded shut. The heat source for Pioneer, shown in Figure 15, is made of almost identical materials as that for Transit. The reentry protection design is somewhat different because of the size constraints of the SNAP-19 heat source (3.5 inches across the flats by 6.75 inches long) and the more severe Pioneer heating environments of the possible Pioneer mission aborts which could lead to super-orbital reentry. Since the generator is sealed, no can is used around the heat source. The heat source weighs 11.3 pounds.

PIONEER (MODIFIED SNAP19) RADIOISOTOPE THERMOELECTRIC GENERATOR

The heat source, which is designed to contain the fuel during reentry and impact, is shown in Figure 13; it weighs about 14 pounds. The fuel, a plutonium oxide-molybdenum cermet (PMC), is contained in layers of refractory and noble metals surrounded by graphite for protection from reentry heating. The assembly is canned in a thin superalloy to prevent deterioration of the materials in the heat source while exposed to air before launch and to maintain a back pressure of gas in the gaps to minimize operating temperatures in space.

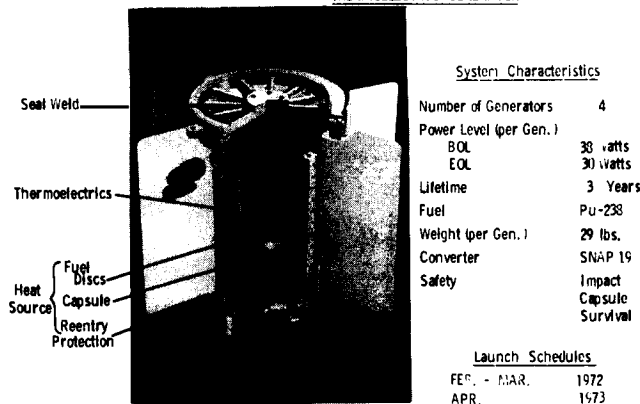

Figure 14

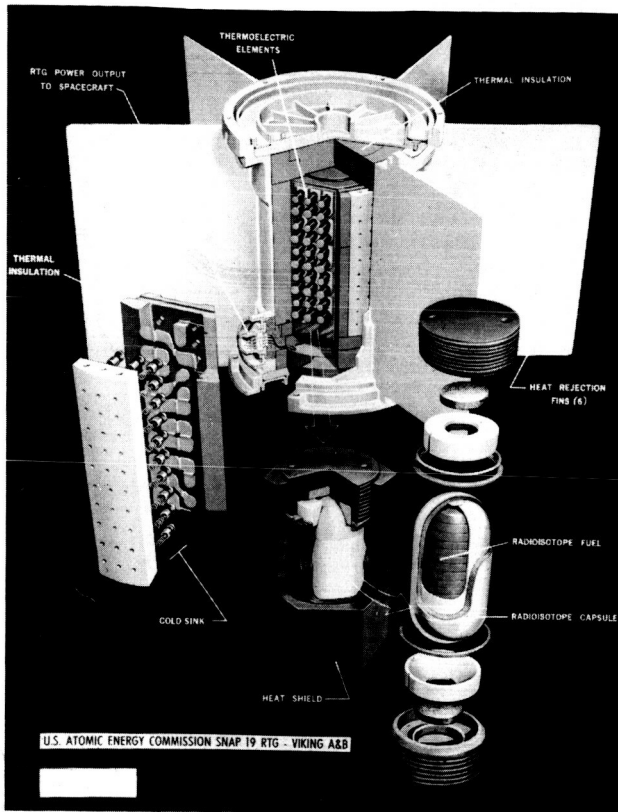

Figure 15

The generators to be used on Viking are similar to the Pioneer RTG's. The fuel loading will be 675 watts to get 35 watts after 2 years and the thermal

design (fin length and housing thickness) will be tailored to the Viking mission environment.

An enlarged cross section of the PMC fuel is shown in Figure 16. The PMC is made from PuO_2 particles 105-250 micrometers in size which are coated with about 3 micrometers of molybdenum, as shown on the left. These are pressed into discs 2.14 inches by 0.2 inch thick which produce 40 watts each. The PMC is 17.5% Mo and has a power density of 3.5 watts/cc, and is shown on the right.

The radiation levels which have been measured for the Transit and Pioneer capsules are given in Figure 17. The average neutron activity in this PMC fuel ranges from 3.29×10^4 - 4.5×10^4 n/Sec./GM Pu-238, even though it is made from oxygen enriched in O-16. It can be improved by using a MoCl_5 coating process in place of the MoF_6 process, as will probably be explained in detail in Section VIII-2 on Thursday afternoon. Using a neutron activity of 4×10^4 N/SEC/GM Pu-238, the neutron flux on the Pioneer spacecraft (3 meters away) is calculated to be about 28 N/SEC/ cm^2 or 1.8×10^9 N/ cm^2 over the 2-year mission.

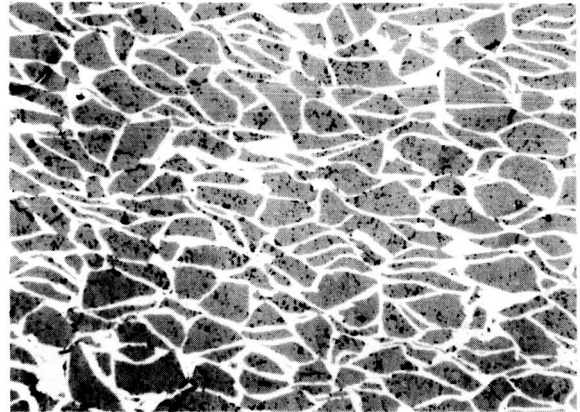
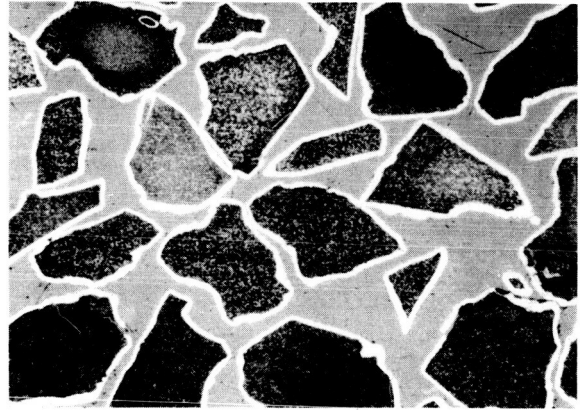

Figure 16

For higher powered applications, such as the two shown in Figure 18, the Multi-Hundred Watt (MHW) modular RTG is being developed. The Grand Tour missions to three different outer planets are good examples of the unique capability of RTG's. These missions require on the order of ten times as much power for mission lifetimes up to twice as long as any other mission to date with very tight constraints on size and weight to explore a region of space where we have never been before.

Radiation Levels from
PMC Capsules for Transit & Pioneer

<u>Bare Capsule</u>	<u>Neutrons (n/sec)</u>	<u>Dose Rate Neutrons</u>	<u>(mrem/hr) gemmas</u>	<u>at 1 meter Total</u>
Transit TF-1 (950 w)	5.43×10^7	80	2.6	82.6
Pioneer PF-1 (645w)	5.15×10^7	70.9	3	73.9
Pioneer PF-2 (645w)	4.26×10^7	53.3	2.7	63
Pioneer FF-3 (645w)	3.77×10^7	53	1.5	54.5
Pioneer PF-4 (645w)	3.73×10^7	53	1.6	54.6

<u>Capsule in Case</u>	<u>Total Dose Rate at Surface (mrem/hr)</u>			
Transit TF-1	123-166	30.3	0.9	31.2
Pioneer PF-4	330-410	27	0.7	27.7
Multiplication Factor in fuel:	1.24 to 1.32			
Capsule neutron Count:	$3.29 \times 10^4 - 4.5 \times 10^4$ n/sec/gm Fu-238			

Figure 17

The thermal design uses radiative coupling between the heat source and the thermocouples. This allows for some flexibility in heat source design. The reference insulation is refractory metal foils with ceramic separators. The very high operating temperatures of the MHW RTG and the safety goals, to withstand the environments of any launch vehicle and any mission and still remain intact after reentry and impact, require a more advanced heat source design. One of the designs being considered for MHW is shown in Figure 20. This heat source is 6.85 inches in diameter by 15.0 inches long, and it weighs over 40 pounds. It maximizes the use of graphitic and ceramic materials and shapes to bring the fuel through reentry and impact.

The heat source design will not be frozen until late this year. One of the changes in MHW may be in the fuel. Pure PuO₂ is being considered as a replacement for the PMC. With 2200 watts, or 66,000 curies, per module, the Grand Tour spacecraft will require an inventory of 8800 watts, or 264,000 curies of Pu-238. This will be a neutron source of about 1.6×10^8 N/SEC (based on 10,000 N/SEC/GM Pu-238) to be reckoned with.

MULTI-HUNDRED WATT RADIOISOTOPE GENERATOR APPLICATIONS

LINCOLN EXPERIMENTAL SATELLITE

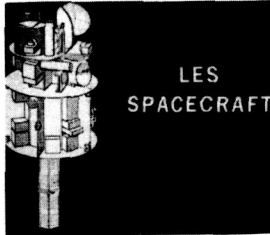

LES
SPACECRAFT

OUTER PLANET SPACECRAFT

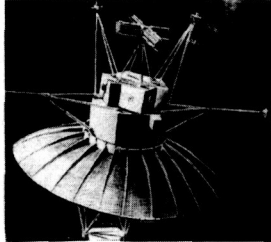

<u>PROGRAM</u>	<u>OBJECTIVE</u>	<u>AGENCY</u>	<u>LAUNCH SCHEDULE</u>	<u>POWER REQUIREMENT</u>	<u>LIFETIME</u>	<u>SELECTED POWER SUPPLY</u>
LES	SPACE COMMUNICATION	DOD (Air Force)	MID- 1970's	220-300 W(e)	5 YEARS	TWO MHW RTG's
GRAND TOUR	UNMANNED OUTER PLANETARY EXPLORATION	NASA	1977 & 1979	300-500 W(e)	>9 YEARS	FOUR MHW RTG's

Figure 18

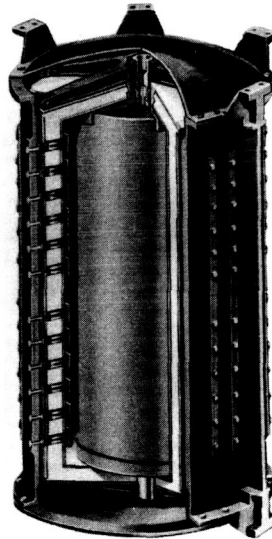

MULTI-HUNDRED WATT
RADIOISOTOPE THERMOELECTRIC GENERATOR

Power Level	145 W(e)
Weight	75 pounds
T/E Material	SiGe
Fuel	Pu-238
Safety	Qualified to Composite Mission Environment

Figure 19

The MHW RTG (or module) is shown in Figure 19. It will produce at least 145 watts at BOL from 2200 watts of Pu-238. It is 11 inches in diameter by about 21 inches high and weighs about 75 pounds. The thermoelectric converter employs 80% GeSi Airvac thermocouples operating at 1832°F (or higher) in a Be housing which is sealed for operation in air.

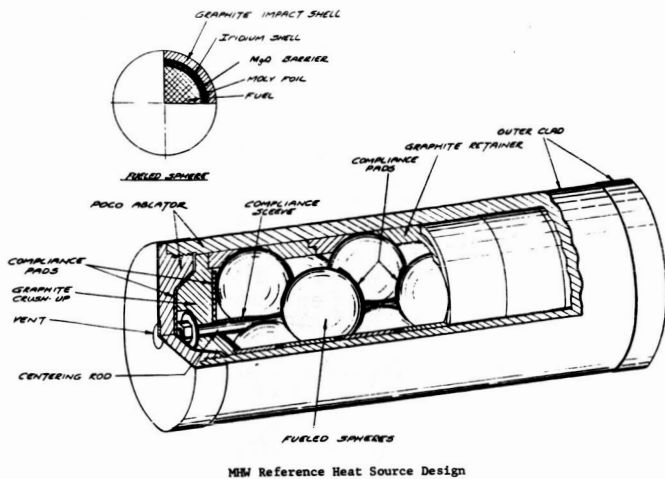

Figure 20

Future Systems

Some improvements in these current flight systems can be projected for future systems to make them more attractive for some applications. The MHW SiGe RTG can be cascaded with the PbTe or TAGS Isotec panels similar to those used on the Transit RTG to provide a higher power, a wider useful power range, and more efficient use of the fuel meaning lower cost and radiation levels per electrical watt. A drawing of such a cascaded RTG is shown in Figure 21. This cascaded RTG would produce over 200 watts at 9-10% efficiency at over 2 watts/pound with the same Pu-238 heat source.

DUAL STAGE MHW-RTG SEALED DESIGN

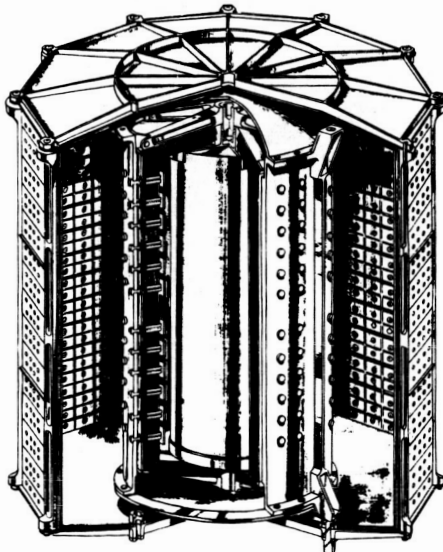

Figure 21

If Curium-244, another long-lived alpha emitter, were used in the MHW, the power to weight ratio would be increased about 10-15%. Cm-244 has a higher power density than Pu-238 because of its shorter half-life (~18 years) and a promise of about 1/5 the cost per thermal watt (see Figure 22). The penalty to be paid with Cm-244 which is of interest here is the higher neutron count due to spontaneous fission (approximately 1000 times higher for Cm-244 than for Pu-238). This could influence the use of Cm-244 fueled systems on radiation sensitive scientific payloads and manned missions.

LONG-LIFE ISOTOPE FUELS TECHNOLOGY PLUTONIUM-238 AND CURIUM-244

	Pu-238	Cu-244
POWER DENSITY (microspheres, thermal watts/cc)	2.7	13.5
FUEL COST \$/per thermal watt)	650 TODAY 500 OBJECTIVE	500 TODAY 100 Pu-RECYCLE
WEIGHT (lb per thermal kw)*		
Small Heat Sources (2 kw) Without shield	15	5
25 kw Heat Source w/Rentry Vehicle Without shield	120	32
With manned shield		
Crew at 3 meters	170	320
Crew at 15 meters	130	100 - 120

* Including re-entry protection

For power levels above that which is practical with the MHW, above 1 Kw, more efficient power conversion technologies are being considered for isotope power systems. These are the static thermionic system and the dynamic Brayton system. Design studies have been completed on a 110 watt Cm-244 fueled thermionic module. This program was an outgrowth of the SNAP-13 Thermionic generator development which was completed in 1965. These studies have shown that thermionic modules in the 200-500w range offer a module efficiency about twice that of thermoelectric and a specific power of about 4 watts/pound - also about twice as good as for thermoelectric generators. The thermionic generator is also smaller in

HEAT SOURCE REENTRY VEHICLE ASSEMBLY

size because of the high radiator temperature. This feature makes thermionic generators very attractive for missions close to the sun or on the surface of the inner planets where high ambient temperatures are experienced. To achieve these advantages, the high power density fuel, Cm-244, must be used and the heat source operating temperatures must be in excess of 3000°F. Quite a bit more development work must be done in isotope thermionic generators to demonstrate their operating performance and lifetimes. This development activity is currently being deferred due to budgetary constraints.

The use of the dynamic Brayton cycle allows efficiencies as high as 25-28% at heat source temperatures comparable to those for the MHW in the power range of 2-10 Kw. It can use Pu-238 or Cm-244. The Brayton conversion machinery has been under development at NASA's Lewis Research Center for several years. An electrically heated system (minus the radiator) has been tested for over 2500 hours and the combined rotating unit is still undergoing a life test after some 5000 hours, most of which has been unattended. A joint NASA-AEC program is underway to conduct an isotope-heated test of the system under simulated space conditions.

The isotope heat source assembly for the Brayton system is shown in Figure 23. An array of heat sources, probably based on the MHW technology, are carried in a reentry vehicle which provides double protection during reentry mishaps and maximizes the chances of recovery of the large isotope inventory. A 12.5 Kw power system, which has been studied for use on the manned orbital space station, would contain 52.8 Kw (thermal) or 1.6 Megacuries of Pu-238 at beginning of life. The reentry vehicle, including the isotope heat sources, would be about 8 feet in diameter and would weigh about 3900 pounds. The total 12.5 Kw system would weigh about 6,000 pounds or about 2 watts/pound. This type of system is especially attractive for low orbit, man-tended spacecraft which can be launched and recovered by the planned space shuttle.

V. Reactor Power Systems

At very high power levels, 5 Kw and up, the nuclear reactor heated power systems come into play. Space applications expected to require such high power levels are shown in Figure 24. These include unmanned satellites (communication and military uses), manned earth orbital space stations or

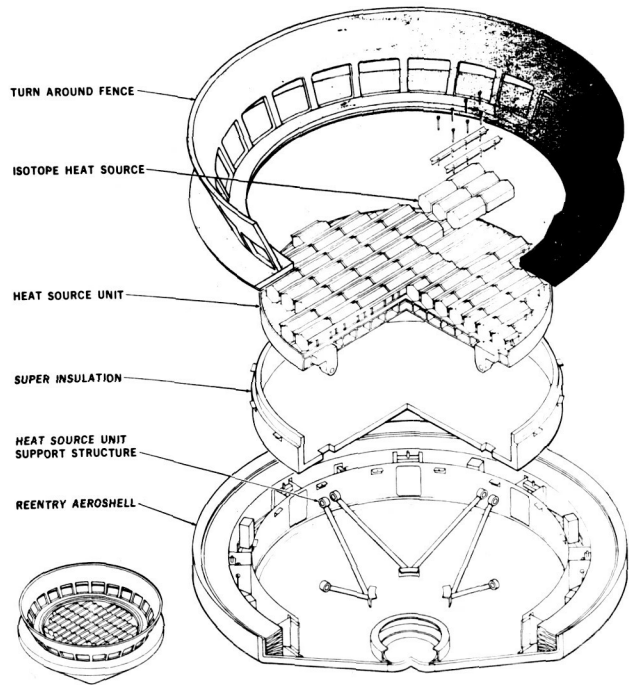

Figure 23

bases and lunar orbit stations or lunar bases which require auxiliary power levels up to 100 Kw. These requirements can be met with the uranium-zirconium-hydride reactor in combination with either thermoelectric or Brayton power conversion systems. To meet the requirements for nuclear electric propulsion missions, which cannot be done any other way, a more advanced space reactor system will be required which has a specific weight of about 50 pounds/Kw at power levels greater than 100 Kw.

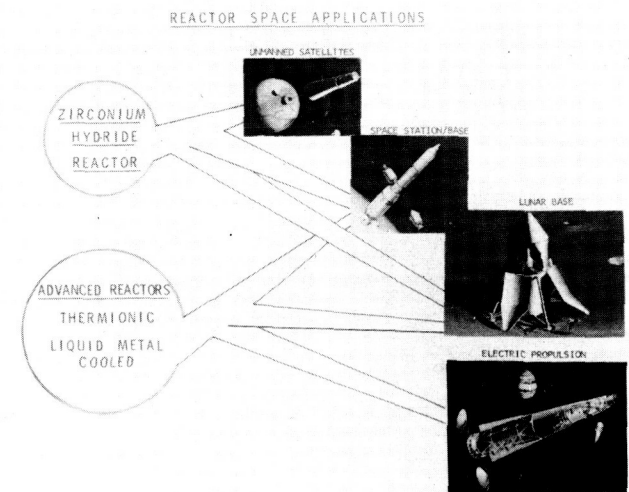

Figure 24

The uranium-zirconium-hydride (UZrH) reactor program (see figure 25) has three main threads of effort - the reactor technology, the thermoelectric power conversion system (PCS) technology, and the large Brayton PCS technology. The UZrH reactor technology extends the capability which was first flight demonstrated in SNAP-10A. Work being performed has the goals of a long-lived (5 year) reactor which will provide 100-600 Kw of heat at operating temperatures between 1000 and 1200°F. The UZrH reactor design is shown in Figure 26 where the SNAP-8 development reactor is compared with the long lived reference design with the new reflectors that allow for smaller shield weights in a manned mission. The reference reactor is about 36 inches high and 22 inches in diameter.

The UZrH reactor (using the number of fuel elements and reflector design sized for the job) in combination with the tubular compact converter thermoelectric modules is very attractive for 5-20 Kw unmanned satellite applications in terms of size, weight, and costs. A two-loop system (see figure 27) can be used for unmanned missions because the activated NaK coolant in the primary loop does not have to be shielded. For manned missions, a split shield, 3-loop system is used to allow the PCS to be maintainable by the astronauts. The UZrH-Brayton power system requires 3 loops because of the need for NaK and gaseous working fluids on the hot-side of the PCS.

Studies are going on considering the use of UZrH-TE systems in unmanned satellites in the late 1970's. Work is also progressing on a large Brayton PCS for demonstration with a UZrH reactor for higher powered missions, such as the space station, to be flown in the 1980's.

ZIRCONIUM HYDRIDE REACTOR SPACE POWER SYSTEMS

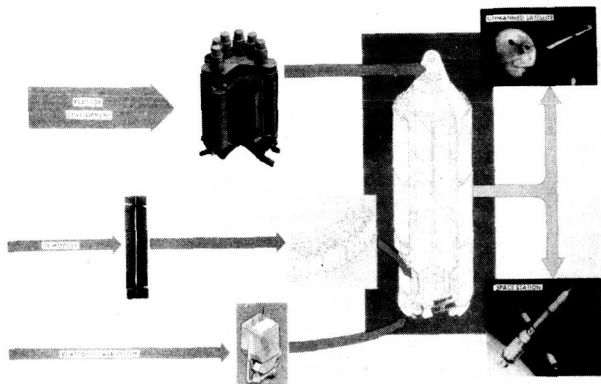

ZIRCONIUM HYDRIDE REACTOR DESIGNS

DEVELOPMENT REACTOR
211-Element Core
Design Life ~1 Year

REFERENCE REACTOR
295-Element Improved
Design Life ~Several Years

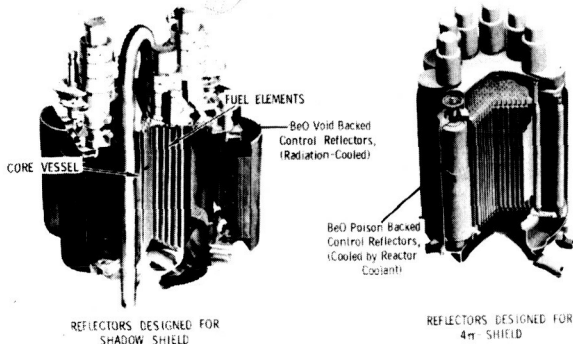
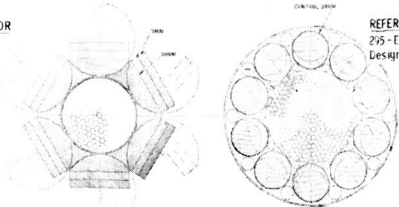

REACTOR-SPACE POWER SYSTEM SCHEMATICS

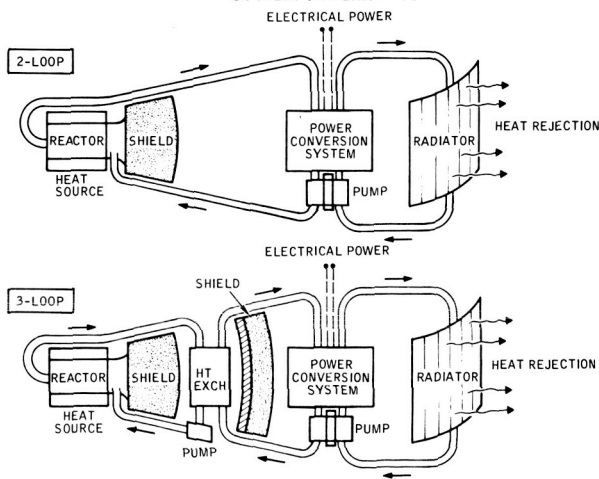

The UZrH reactor technology also forms a building block for moving on to the advanced thermionic reactor (see Figure 28) which is required for nuclear electric propulsion missions, such as Halley's Comet rendezvous. The key element of the thermionic reactor is the thermionic fuel element (TFE) which is tested in a UZrH moderated reactor and will be clustered to make a fast.

SPACE REACTOR PROGRAM ELEMENTS

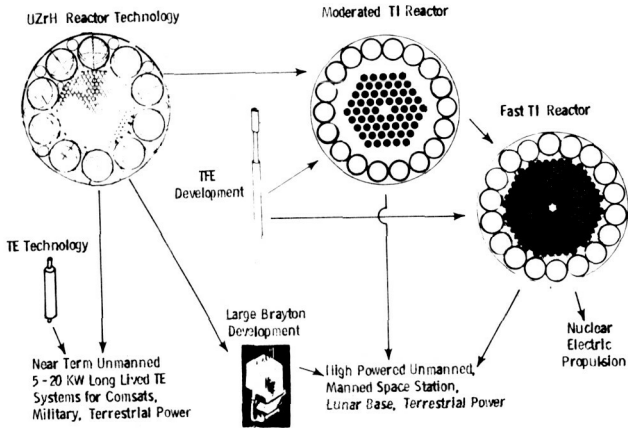

Figure 28

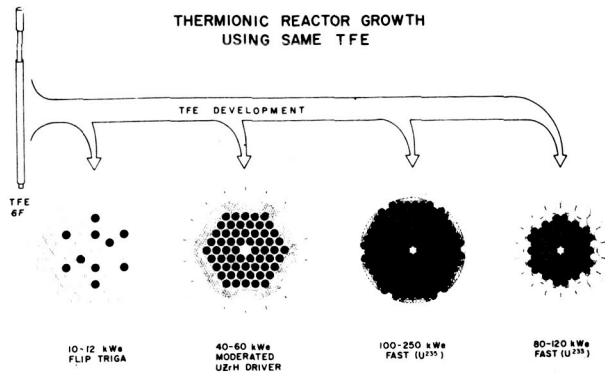

Figure 30

thermionic reactor (shown in Figure 29). Each TFE contains 6-10 thermionic diodes in series. The fuel is inside the diode and the electricity is formed directly in the TFE itself. This same TFE technology is the basis for a series of advanced reactors shown in Figure 30. The use of TFE's in a moderated UZrH driver reactor would provide useful static power systems which overlap the power range of the UZrH-Brayton power system. An attractive feature of this reactor is that the only very high operating temperature encountered are in the TFE itself. The emitter temperature is about 3100°F. The coolant outside the TFE is at the same 1000-1200°F where the UZrH reactor operates. This allows much higher radiator temperatures and therefore smaller radiators than the UZrH reactor power systems using the thermoelectric or Brayton PCS. In addition only one or two coolant loops are required because the PCS is in the reactor core (see Figure 31). Currently the thermionic reactor program effort is concentrating on the development of the TFE and the first full sized TFE is built and awaiting test in the TRIGA reactor.

THERMIONIC REACTOR POWERPLANT SCHEMATICS

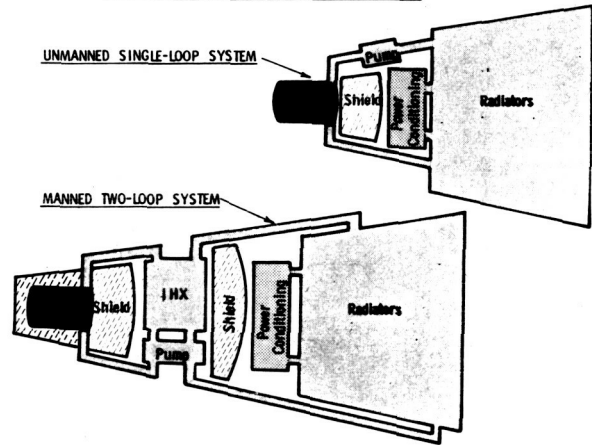

Figure 31

The other advanced space reactor technology concept which is being pursued as an alternative to the thermionic reactor for greater than 100 Kw type systems is the Advanced Liquid Metal Reactor. This is a fast reactor which will operate at 1800°F or higher and will be cooled by molten lithium metal. The attractive features of such a high temperature reactor are that it is applicable to many different types of power conversion and to many different high powered missions (see Figure 32). The current efforts are directed primarily toward the materials development and neutronic measurements, such as the fast critical experiment.

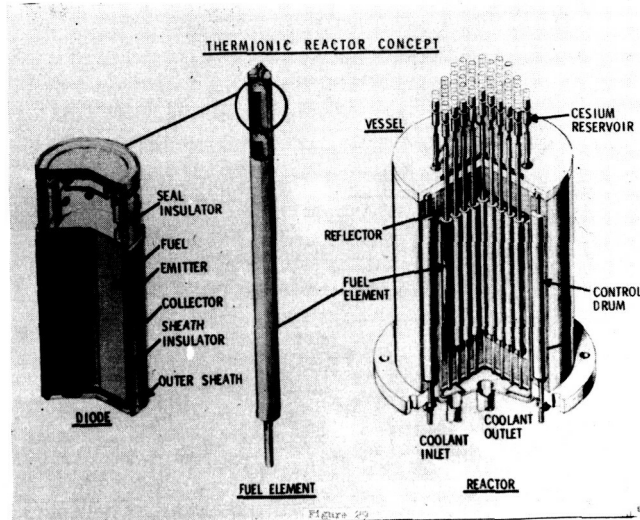
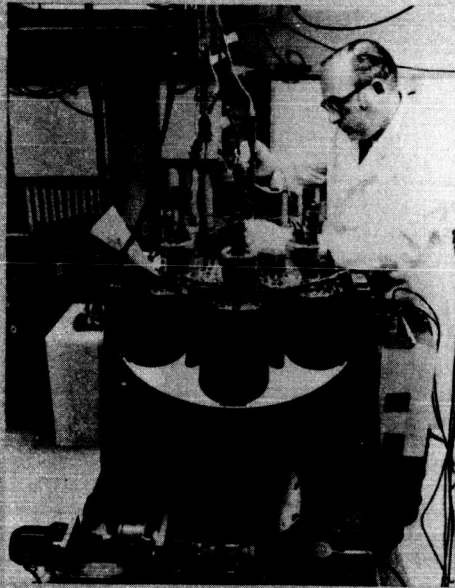

Figure 29

ADVANCED LIQUID METAL REACTOR TECHNOLOGY



**FAST CRITICAL EXPERIMENT
(At Atomics International)**

- **CURRENT EMPHASIS**

- IN-HOUSE DESIGN
- HIGH-TEMPERATURE STRUCTURAL MATERIALS
- FUEL PROPERTIES
- NEUTRONICS DETERMINATION
- ADVANCED COOLANT PROPERTIES

- **APPLICABLE TO MANY CONVERSION SYSTEMS**

- ADVANCED RANKINE
- ADVANCED THERMOELECTRIC
- ADVANCED BRAYTON
- MHD

- **MISSION OBJECTIVES**

- ELECTRIC PROPULSION
- HIGH POWER
- COMPACT
- LIGHTWEIGHT

NASA HQ NS71-15519 11-27-70

Figure 32

VI. Conclusions

I have attempted to describe the current and foreseeable radiation sources that are or will be in space as the result of the use of nuclear space power systems. Our primary concern over radiation in space is due to our plans to conduct more numerous and ambitious operations in space. To do that one needs electrical power which can be, and in some cases can only be, provided by nuclear power and radiation sources.