

N 7 2 - 2 4 7 2 7

N 7 2 - 2 4 7 2 7

CASE FILE COPY

RADIOACTIVE NONDESTRUCTIVE TEST METHOD

Final Report D180-14227-1

December, 1971

Prepared for

THE JET PROPULSION LABORATORY
PASADENA, CALIFORNIA

under

NATIONAL AERONAUTICS AND SPACE
ADMINISTRATION CONTRACT NAS7-779

THE BOEING COMPANY
SEATTLE, WASHINGTON

RADIOACTIVE NONDESTRUCTIVE
TEST METHOD

FINAL REPORT D180-14227-1 DECEMBER, 1971

Prepared for

THE JET PROPULSION LABORATORY
PASADENA, CALIFORNIA 91103
UNDER NATIONAL AERONAUTICS AND SPACE
ADMINISTRATION CONTRACT NAS7-779

THE BOEING COMPANY
SEATTLE, WASHINGTON 98124

J. R. O'Brien, Project Manager
K. E. Pullen, Principal Investigator

FOREWORD

The work in this program was performed at The Boeing Company, Seattle, Washington, under NASA Contract NAS7-779 during the period May 1 - October 31, 1971. The NASA Headquarters project manager was Mr. Frank Compitello. The program was administered under the direction of the technical manager, Mr. Louis R. Toth of the Jet Propulsion Laboratory, Pasadena, California.

The project was managed at The Boeing Company by Mr. James R. O'Brien of the Aero/Propulsion Department (Rocket Propulsion Group) of the Research and Engineering Division of the Aerospace Group. The technical effort was the responsibility of Dr. Kent E. Pullen.

TABLE OF CONTENTS

		<u>Page</u>
1.0	SUMMARY	1
2.0	INTRODUCTION	3
3.0	THEORY	5
4.0	EXPERIMENTAL SECTION	12
4.1	Task 1 - Propellant Analysis	12
4.1.1	Procedure	12
	4.1.1.1 Propellant and Sample Handling	12
	4.1.1.2 Preparation of Standards	16
	4.1.1.3 Activation	17
	4.1.1.4 Counting	20
4.1.2	Results and Discussion	21
	4.1.2.1 Detection Limits	21
	4.1.2.2 Propellant Analysis	21
	4.1.2.3 Submission of Samples and Standards to Reactor	27
4.2	Task 2 - Flow Diagnostics in Propulsion Feed Systems	28
4.2.1	Procedure	30
	4.2.1.1 Equipment	30
	4.2.1.2 Cleaning	34
	4.2.1.3 OF ₂ Characterization	40
	4.2.1.4 Introduction of Radioactive Tracers into the OF ₂	40
	4.2.1.5 Liquid OF ₂ Handling	43
4.2.2	Results and Discussion	44
	4.2.2.1 Summary of Flow Tests	44
	4.2.2.2 Discussion	44
	4.2.2.3 Sensitivities	49
4.3	Task 3 - Flow Diagnostics in the Liquid/Gas Phase	49
4.4	Task 4 - Other Propellant Applications	51
5.0	CONCLUSIONS	52
6.0	RECOMMENDATIONS	54
7.0	REFERENCES	56

LIST OF TABLES

	<u>Page</u>
1. List of Candidate Radioactive Tracers	8
2. Neutron Activation Analysis Detection Limits	22
3. Neutron Activation Analysis of Metals Dissolved or Dispersed in Liquid Oxygen Difluoride	24
4. Radioisotope Technical Data as of Reference Date	41
5. Summary of Liquid Oxygen Difluoride Flow Tests	45

LIST OF FIGURES

	<u>Page</u>
1. Schematic Representation of 6Al-4V-Ti/OF ₂ Interaction Apparatus Used for Activation Analysis	14
2. Polyethylene Vial and Glass Container Tube	15
3. Polyethylene Vial and Rabbit	18
4. Pneumatic Transfer System	19
5. Vial in Position for Counting	22
6. Photograph of 6Al-4V Titanium Foils After Contact with Liquid OF ₂	26
7. Suggested Form to be Used When Submitting Samples for Activation Analysis	29
8. Schematic Representation of Liquid Oxygen Difluoride Flow Assembly	31
9. Cross Section of Orifice Plate	32
10. Two Views of a 10.4 Mil Orifice Plate	33
11. Vacco Filter and JPL Filter	35
12. Environmental Test Chamber	36
13. View of Tanks and Lines Within Test Chamber	37
14. Counting Equipment	38
15. Detector	39

1.0 SUMMARY

The objective of this program was to advance the art of employing various radioisotope techniques as practical and highly sensitive diagnostic tools for determining the performance of spacecraft propulsion feed system elements. Applications of selected techniques were studied in four tasks, the first two of which required experimental testing involving the propellant liquid oxygen difluoride (OF_2): (1) the neutron activation analysis of dissolved or suspended metals and (2) the use of radioactive tracers to evaluate the probability of the constrictions in certain passive components (orifices and filters) becoming clogged by the action of matter dissolved or suspended in the OF_2 . The other tasks, explanatory in nature and conducted at a low level of effort, were (3) an appraisal of the applicability of radioisotope techniques to problems arising from the exposure of components to liquid/gas combinations, and (4) an assessment of the applicability of the techniques to other propellants. Generally speaking, the program objective was met in each of the above tasks.

Neutron activation analysis, performed on residues left after evaporating OF_2 that had contacted coupons of 6Al-4V titanium, proved to be a practical and highly sensitive technique. This technique was readily applied, and very low detection limits were demonstrated (Ti, 0.01 ppm; Al, 0.0001 ppm; and V, 0.00001 ppm). A detailed experimental procedure was outlined which described how such analyses easily could be accomplished utilizing the U.S. mail service.

The liquid OF_2 flow tests were conducted using orifices (6.7 and 10.4 mils) and filters as components. Radioactive isotopes of Ti, Al, Fe, Cr, Ni, Mn, and Zn were employed in order to trace the movement and clogging potential of these metals. A striking result was that all of these tracers tended to remain in the feed tank and not be carried throughout the system, regardless of whether the tracers were added directly to the feed tank or whether addition of

radioactive contamination into the propellant was attempted by means of the interaction of liquid OF_2 with radioactive surfaces of various alloys (foils of 6Al-4V-Ti, 6061 Al, and 304 stainless steel).

It was concluded that the metal compound impurities studied in these tests possess extremely low solubilities in OF_2 , and there is little likelihood of experiencing any feed system performance degradation from clogging mechanisms similar to those operative in N_2O_4 . In general no flow anomalies occurred when the OF_2 was passed through either the filters or the 10.4 mil orifice, but serious clogging occurred when the OF_2 was passed through the smaller 6.7 mil orifice. Arguments are presented which support the thesis that the clogging resulted from the presence of frozen nonmetallic impurities such as HF, CO_2 , or SiF_4 .

2.0 INTRODUCTION

Work during the first phase of Contract NAS 7-779 was reported in the interim final report, "Application of Radioactive Tracer Techniques to Flow Decay Problems." ¹ In that program various applications of radioactive tracers to flow decay problems were explored. The main object of the program was to develop a sensitive tool which could be used to detect the time, place, and degree of deposition of metal contaminants within various components of a propellant feed system. Such a tool was successfully developed and readily applied to flow studies involving nitrogen tetroxide and hydrazine.

Although results of the first phase were encouraging, certain questions concerning the generality, overall practical utility, and sensitivity of the method remained unanswered. For example, activation analysis studies during phase 1 were limited to the elements Fe, Cr, and Zn. These elements undergo neutron activation to form gamma ray emitters whose half lives are relatively long (about a month or more), thus simplifying the radiation measurement (counting) of the isotopes. However, the elements Ti, Al, and V activate to form short-lived isotopes (6 minute half life or less). The question of whether these and other elements of interest could be quantitatively analyzed in a sensitive fashion was unanswered. Also not answered was whether liquid OF_2 samples could be handled in a reactor.

Somewhat similar questions could be asked in connection with flow tests in which radioactive tracers are used to diagnose the behavior and clogging potential of dissolved metal contaminants. Besides the need to designate candidate tracer isotopes and accompanying detection limits, knowledge of counting methods, equipment handling, and propellant tracer interactions were required for space storable propellants such as liquid OF_2 .

Finally, the matter of the generality of the techniques arose. One could ask in what other areas radioisotope methods could be applied.

In the light of these considerations the following four tasks were established for this program:

1. Analyze quantitatively by neutron activation for metals dissolved or dispersed in liquid OF_2 .
2. Establish the use of radioactive tracers as a tool for predicting and diagnosing (in a practical, highly sensitive manner) incipient performance degradation in a feed system, with emphasis placed on detecting potential degradation resulting from the clogging of a filter or an orifice with metal compounds of dissolved (or colloidal) contaminants that are formed in (or naturally present in) liquid OF_2 .
3. Evaluate the applicability of radioisotope techniques to the solution of problems arising from the exposure of feed system components to liquid/gas or liquid/vapor propellant combinations.
4. Consider the generality of the techniques as applied to other propellants.

3.0 THEORY

The theory of neutron activation and subsequent gamma ray counting was discussed in an interim final report.¹ The results of that report will be repeated here without derivation where needed to support the discussion of radioisotope methods that were studied in the present phase of the contract. The theoretical discussion will center around two main topics: (1) neutron activation analysis, particularly of short lived isotopes; and (2) choice and practical application of radioactive tracers.

The decay rate, $-dN/dt$, of the number of radioactive atoms, N , formed in time t during neutron activation is given by

$$- \frac{dN}{dt} = N_0 \phi \sigma (1 - e^{-\lambda t}) \quad (1)$$

where ϕ is the thermal neutron flux in the reactor, σ is the cross section of the isotope undergoing activation, λ is the disintegration constant, and N_0 is the number of atoms available to undergo activation to the radioisotope in question. If the λt product is small (that is, less than about 0.1) the approximation $e^{-\lambda t} = 1 - \lambda t$ may be used to simplify equation (1) to

$$- \frac{dN}{dt} = \lambda N_0 \phi \sigma t \quad (2)$$

Equation (2) is valid for the previously-studied elements (Fe^{59} , $t_{1/2} = 45$ days; Zn^{65} , $t_{1/2} = 245$ days; and Cr^{51} , $t_{1/2} = 28$ days) which have long half lives (that is, λ , which is defined by $\ln 2/t_{1/2}$, is very small), resulting in a small λt product for activation times of many hours. However, for the short-lived isotopes studied in the present program (Al^{28} , $t_{1/2} = 2.3$ minutes; Ti^{51} , $t_{1/2} = 5.8$ minutes; and V^{52} , $t_{1/2} = 3.8$ minutes) the λt product is not small and equation (1) must be used.

From (1) the value for N_0 can be calculated and substituted in the previously derived ¹ expression for the detection limit

$$\text{Limit (in grams)} = \frac{(N_0)(W)}{(f)(A)} \quad (3)$$

where W is the gram-atomic weight of the element being analyzed, f is its fractional natural abundance, and A is Avogadro's number. To calculate N_0 from (1), some assumptions regarding the term $-dN/dt$ are necessary. For long-lived isotopes the practical detection limit is reached when the detector records a gamma count rate of the activated sample equal to no less than about 0.1 of the background count rate. Reasonable counting times (no longer than an hour) then result. The actual numerical value of the term $-dN/dt$ is set equal to 0.1 of the background count rate (in the previous study¹ background was about 2 counts per second in the 1.0-1.4 Mev energy range) divided by the product of the gamma counting efficiency of the detector (about 0.15 for 1 Mev gammas in the previous study) and the fraction of gammas emitted per disintegration ² (a characteristic of the element in question; for example, only 0.1 or 10% of the disintegrations of Cr^{51} result in the emission of a 0.32 Mev gamma, while essentially all of the disintegrations of Ti^{51} , Al^{28} , and V^{52} yield a countable gamma).

For short-lived isotopes (e.g., Al^{28} , Ti^{51} , and V^{52}), however, the term $-dN/dt$ must be set equal to a higher initial disintegration rate (so that allowance is made for the substantial amount of decay that occurs during the counting period). A value of $-dN/dt$ corresponding to an initial count rate at least equal to background is desirable. Of course, background can vary with such factors as location, amount of shielding, and type of counting equipment. Detection limits should be considered only guides to the approximate sensitivity with which analyses can be made rather than fixed, absolute limits.

In the present study a germanium detector was employed to count radioactive Al²⁸, Ti⁵¹, and V⁵². This remarkable instrument allowed resolution of gamma energies to within a very small band (0.01 Mev), thus reducing the background and increasing the detection sensitivity (by virtue of the increased signal-to-background ratio). However, some sensitivity was lost because of shortened activation and counting times (about 2 and 3 minutes, respectively). These circumstances entered into the calculation of the detection limits listed later in this report.

A second application of radioisotopes in this study involved the use of radioactive tracers in Task 2 to monitor the movement of metal contaminants in a laboratory feed system. At this point it is worthwhile to define the ideal tracer and establish those that possess practical utility. Ideally a tracer should be commercially available or preparable by simple and efficient methods such as neutron activation in a reactor. Furthermore, the half life must be long enough so that the tracer does not decay appreciably during use. Gamma emitters are desirable for counting purposes, since the high penetrability of gamma rays permits counting through large thicknesses of matter. (At energies below about 0.05 Mev absorption starts to become significant.) Alpha (α) particles, emitted by radioisotopes of high mass number, beta (β^-) particles, and X-rays are readily absorbed and must be counted under more restrictive conditions. However, positrons (β^+) are readily counted because of the characteristic annihilation radiation (0.51 Mev) that is also produced.

Table 1 lists candidate tracers for the common elements. For completeness beta as well as gamma emitters were listed. Only half lives greater than one hour were considered. Such a short half life is acceptable if the test does not last longer than about a day.

As can be seen, only He, Li, B, N, O, and Ne do not have any tracer radioisotopes. Two common elements, H and C, have only low energy beta

Table 1. List of Candidate Radioactive Tracers

<u>Atomic Number</u>	<u>Element</u>	<u>Mass Number</u>	<u>Half Life</u>	<u>Preparation or Source</u>	<u>Specific Activity</u>	<u>Approximate Cost</u>	<u>Principal Radiation (Energy in Mev)</u>
1	H	3	12.3 years	(1)	160 mc/mg	\$90/c	0.018 β^-
2	He		none				
3	Li		none				
4	Be	7	53 days	(1)	350 c/mg	\$50/mc	0.48 γ
		10	2.7×10^6 years	(1), (2)	15 mc/g, (2)	\$200/ μ c, (2)	0.56 β^-
5	B		none				
6	C	14	5600 years	(1)	4 mc/mg	\$14/mc	0.16 β^-
7	N		none				
8	O		none				
9	F	18	1.9 hours	(3)	(3)	(3)	0.65 β^+ , 0.51 γ
10	Ne		none				
11	Na	22	2.6 years	(1)	6.2 c/mg	\$200/mc	1.28 γ
		24	15 hours	(1), (2)	3c/mg, (2)	\$30/mc, (2)	1.37 γ
12	Mg	28	21.3 hours	(3)	(3)	(3)	0.32 γ
13	Al	26	7×10^5 years	(1)	18.5 mc/g	\$10,000/ μ c	1.78 γ
14	Si	31	2.6 hours	(2)	(2)	(2)	1.26 γ
		32	100 years	(3)	(3)	(3)	0.1 β^-
15	P	32	14.5 days	(1), (2)	285c/mg, (2)	\$15/mc, (2)	1.71 β^-

<u>Atomic Number</u>	<u>Element</u>	<u>Mass Number</u>	<u>Half Life</u>	<u>Preparation or Source</u>	<u>Specific Activity</u>	<u>Approximate Cost</u>	<u>Principal Radiation (Energy in Mev)</u>
		33	25 days	(1)	157 c/mg	\$60/mc	0.25 β^-
16	S	35	87 days	(1), (2)	42 c/mg, (2)	\$20/mc, (2)	0.17 β^-
17	Cl	36	3×10^5 years	(1), (2)	10 c/g, (2)	\$400/mg (2)	0.71 β^-
18	Ar	37	35 days	(2)	(2)	(2)	X-rays
		39	260 years	(2)	(2)	(2)	0.57 β^-
		41	1.8 hours	(2)	(2)	(2)	1.3 γ
19	K	40	1.3×10^9 years	(1), (2)	(2)	(2)	1.5 γ
		42	12.4 hours	(1), (2)	450 mc/g, (2)	\$30/mc, (2)	1.5 γ
		43	22 hours	(3)	(3)	(3)	0.62 γ
20	Ca	41	1.1×10^5 years	(2)	(2)	(2)	x-rays
		45	165 days	(1), (2)	25 mc/mg, (2)	\$20/mc, (2)	0.25 γ
		47	4.7 days	(3)	(3)	(3)	1.3 γ
21	Sc	46	84 days	(1), (2)	2 mc/mg, (2)	\$25/mc, (2)	1.1 γ
22	Ti	44	48 years	(1)	169 mc/mg	\$200/ μ c	0.07 γ
		45	3.1 hours	(3)	(3)	(3)	1.02 β^+ , 0.51 γ
23	V	48	16.2 days	(1)	170 c/mg	\$200/ μ c	0.99 γ
		49	330 days	(1)	8 c/mg	\$45/c	x-rays
24	Cr	51	28 days	(1), (2)	500 c/g, (2)	\$20/mc, (2)	0.32 γ
25	Mn	54	303 days	(1)	8c/mg	\$100/mc	0.84 γ
		56	2.6 hours	(2)	(2)	(2)	0.85 γ

<u>Atomic Number</u>	<u>Element</u>	<u>Mass Number</u>	<u>Half Life</u>	<u>Preparation or Source</u>	<u>Specific Activity</u>	<u>Approximate Cost</u>	<u>Principal Radiation (Energy in Me)</u>
26	Fe	55	2.6 years	(1), (2)	2.5 c/mg, (2)	\$120/mc (2)	x-rays
		59	45 days	(1), (2)	20 c/g, (2)	\$30/mc, (2)	1.3 γ
27	Co	60	5.2 years	(1), (2)	300 c/g, (2)	\$20/mc, (2)	1.3 γ
28	Ni	56	6.4 days	(3)	(3)	(3)	0.81 γ
		57	1.5 days	(3)	(3)	(3)	1.38 γ
		59	8×10^4 years	(1), (2)	10 mc/g, (2)	\$25/ μ c, (2)	x-rays
		63	80 years	(1), (2)	10 c/g, (2)	\$25/mc, (2)	0.063 β^-
		65	2.6 hours	(2)	(2)	(2)	1.5 γ
29	Cu	64	12.8 hours	(1), (2)	10 c/g, (2)	\$40/mc, (2)	0.66 β^+ , 0.51 γ
		67	2.5 days	(3)	(3)	(3)	0.18 γ
30	Zn	65	245 days	(1), (2)	8.2 c/mg, (2)	\$100/mc, (2)	1.1 γ

(Suitable tracers exist for most elements of atomic number greater than 30.)

(1) Commercially available

(2) Preparation by thermal neutron activation is possible. The specific activity of an isotope and its cost of preparation are functions of the isotopes in question, the flux of the reactor, and the activation time. Typical reactor costs are about \$80 per hour in a flux of 10^{13} neutrons per cm^2 per sec.

(3) Information relating to the preparation can be found in the references cited elsewhere.² In some instances the isotope may be difficult to prepare, with the specific activity and cost depending on the exact means of preparation.

emitters as tracers. All of the common metals have at least one gamma-emitting isotope, although in a few cases availability and/or cost may be a problem. Preparations of those isotopes that are neither commercially available nor obtainable by neutron activation can be found in the literature.²

The detection limit of a gamma-emitting tracer as employed in Task 2 is simply defined as the smallest quantity of an element that can be deposited and counted during the course of a test. This definition is expressible by the equation

$$\text{Limit (in grams)} = \frac{B}{(S) (E) (F) (3.7 \times 10^{10})} \quad (4)$$

where B is the background in counts per second, S is the specific activity of the tracer in curies per gram, E is the counting efficiency, F is the number of gammas of the energy being counted emitted per disintegration,² and 3.7×10^{10} is the value of a curie in disintegrations per second. This equation indicates that the detection limit is reached when the element being counted produces a count rate equal to background, which is about the minimum count rate that can be readily detected while continuously monitoring the action of a tracer during a flow test. The specific activity, S, may vary with the tracer and method of manufacture. The specific activity reaches its theoretical maximum when all the atoms of the tracer element are radioactive, in which case the tracer is termed carrier-free.

4.0 EXPERIMENTAL SECTION

4.1 Task 1 - Propellant Analysis

The objective of this task was to demonstrate the high sensitivity and practical utility of the neutron activation technique relative to the analysis of indigenous metals or other constituents in liquid OF_2 . Since OF_2 is withdrawn from a storage cylinder as a gas, it is initially metal-free, provided that the system in which it is handled is clean and that the flow of gas does not entrain any finely divided metal contamination. Any metals naturally present in liquid OF_2 likely arise from the interaction of the liquid with metal surfaces. The metal concentrations would then be expected to vary with time.

The analyses in this task were limited to three samples of liquid OF_2 that had contacted foils of 6Al-4V titanium for varying times. Analytical emphasis was placed on the metals Ti, Al, and V, but possible trace impurities of Fe, Cr, Ni, Mn, Cu, Zn and Mg were also sought in the analyses.

4.1.1 Procedure

With the inclusion of certain necessary modifications, the analytical procedure was generally similar to that previously employed.¹ The four major steps of the analysis were (1) preparation and handling of the propellant samples, (2) preparation of standards, (3) activation, and (4) gamma counting. A fifth step, resolution of spectra, was sometimes required when a sodium iodide detector was used,¹ but in the present study the use of a germanium detector, which possesses high resolution capabilities, eliminated the need for a fifth step.

4.1.1.1 Propellant and Sample Handling

Consideration was given to both "wet" and "dry" analyses. In the case of a wet analysis the liquid propellant and its contents are activated while in the case of a dry analysis the residue left after evaporating the propellant is activated. Although a wet analysis was deemed

possible, a consideration of the numerous handling and safety obstacles that had to be overcome at the reactor site led to the conclusion that the dry method was the most practical.

The OF_2 (Allied Chemical Co.) was handled in a vacuum line constructed of stainless steel and Pyrex glass. Other than passing the gas through a tube packed with NaF, the OF_2 was used without further purification. Analysis by infrared spectrometry (Beckman IR-12) showed CF_4 (about 1%) and a trace of SiF_4 to be the only detectable impurities. Analysis by mass spectrometry (CEC Model 21-110B) showed in addition trace amounts of HF, CO_2 , N_2 , F_2 and O_2 .

The OF_2 was allowed to contact the 6Al-4V-Ti foils in polyethylene vials as shown in Figure 1. The 1 mil foil (1.5 cm x 1.7 cm) was held by friction between the walls of the 2 dram vial (Olympic Plastic Company, Los Angeles, California, purchased from Van Rogers and Waters, catalog number 66017-026). Polyethylene was chosen as a container material because it possesses many desirable characteristics for use in activation analysis. While polyethylene and OF_2 should be considered incompatible, limited contact for short periods is possible provided that the system is clean and sensible safety precautions are observed.

The cleaning procedure used for the 6Al-4V-Ti foils was (1) degrease with acetone; (2) soak in 50/50 nitric acid/water for 1 hour at ambient room temperature; (3) rinse in deionized water until a neutral pH is reached; and (4) allow to dry in air. The cleaning procedure for the polyethylene vials was (1) rinse with deionized water and (2) wipe dry with a MARA WIPE lint-free towel. The vials were handled with gloved hands.

A clean, lidless vial containing the foil was inserted through the bottom end of a 20 mm O.D. glass tube, the other end of which was fitted with a 10/30 inner glass joint. Figure 2 shows a photograph

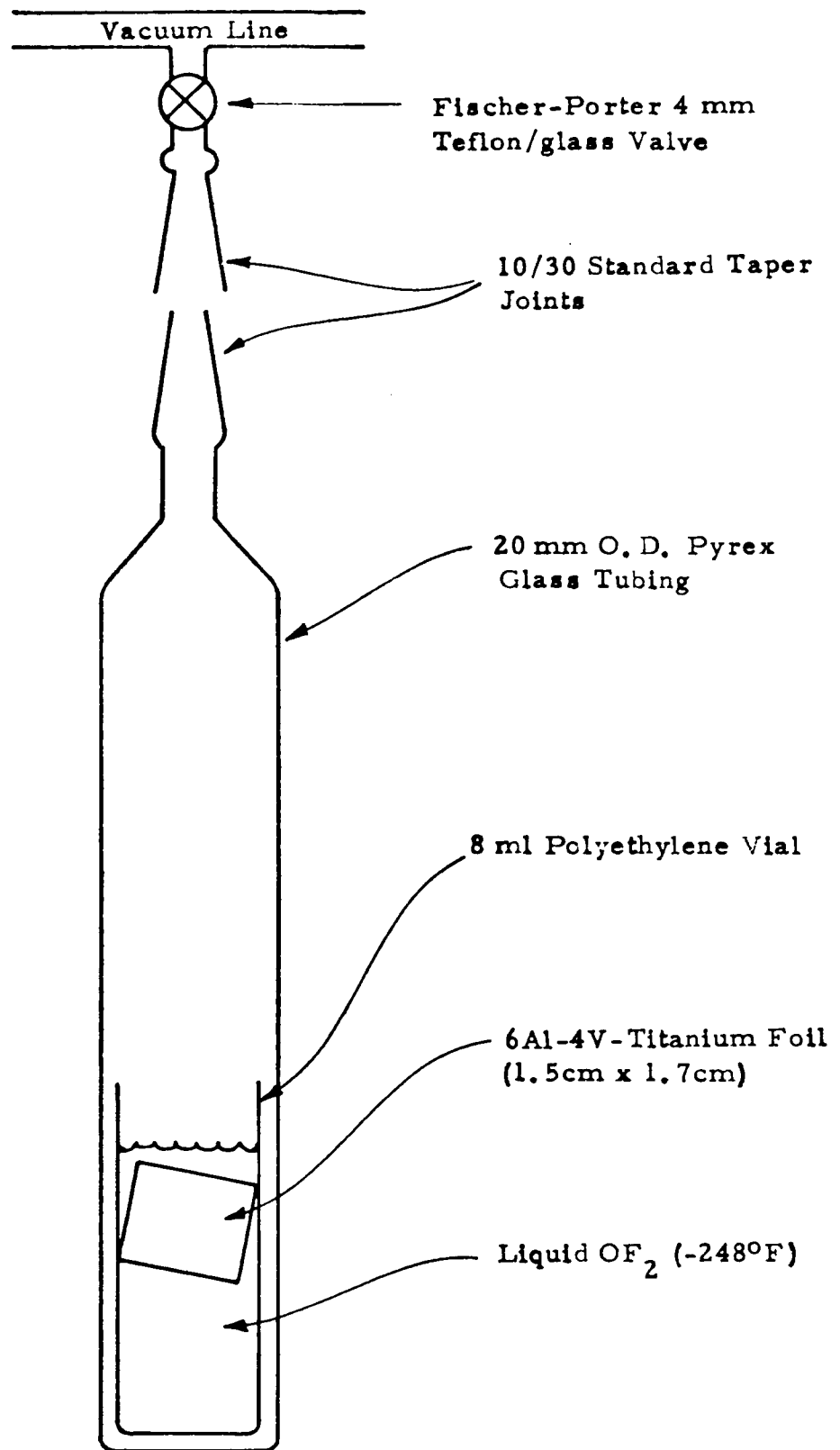

Figure 1: Schematic Representation of 6Al-4V-Ti/OF₂ Interaction Apparatus Used for Activation Analysis

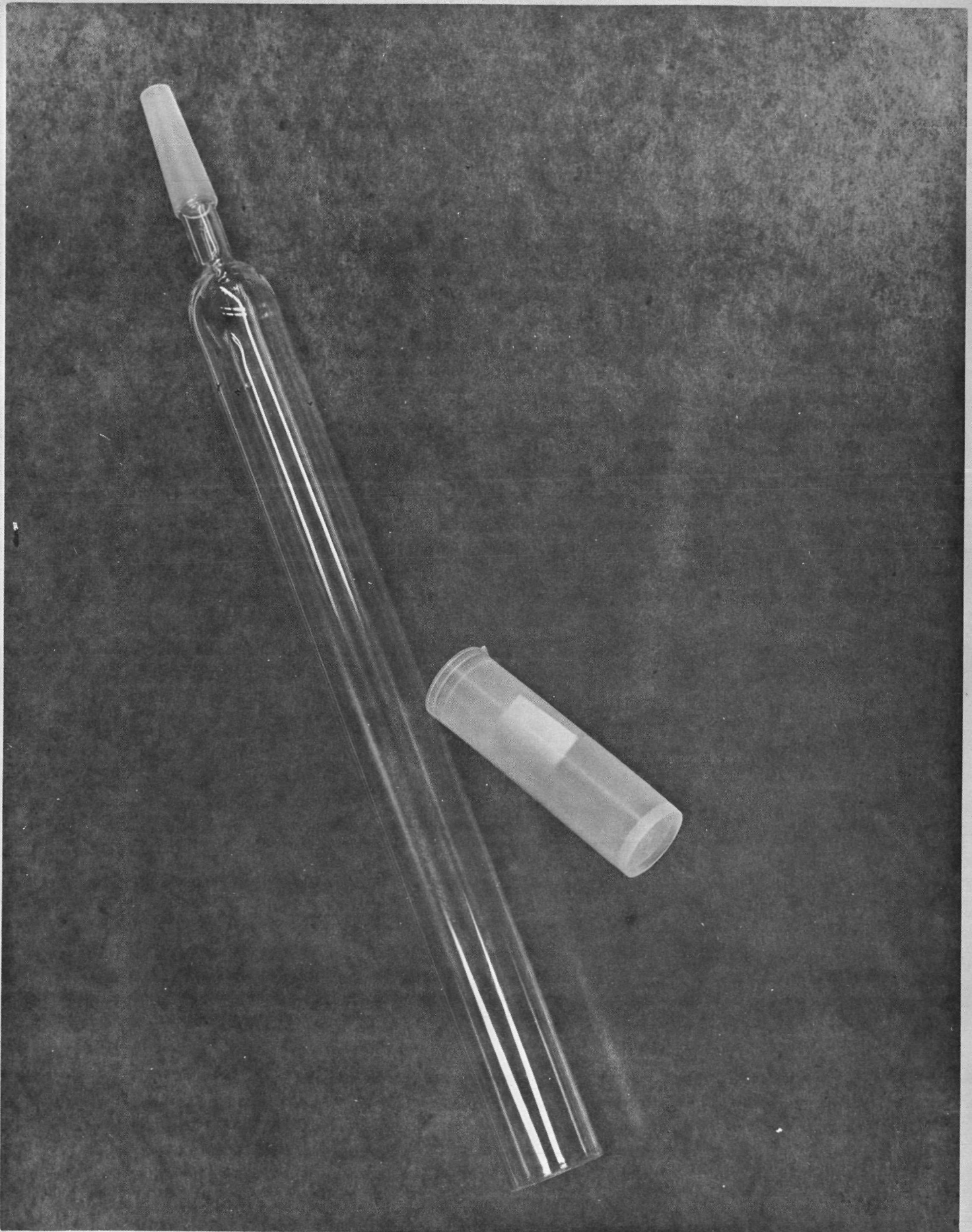

Figure 2: POLYETHYLENE VIAL AND GLASS CONTAINER TUBE

of a vial beside a tube. After sealing the bottom of the glass tube, a rod was inserted through the 10/30 joint, and the vial was pushed to the bottom of the glass tube, reaching the configuration illustrated in Figure 1. The vial was tightly held in place by friction, so as to minimize any tendency of the vial to float when OF_2 was condensed into the system.

The glass tube was then attached to a 10/30 outer joint of the glass vacuum line. Kel-F number 90 stopcock grease was used as a lubricant for the connections. Valves of the glass vacuum line were the Fischer-Porter 4 mm Teflon-glass type.

Oxygen difluoride was then condensed into the vials with the aid of a liquid nitrogen cold bath. The OF_2 was next warmed to -248°F with a Freon-12 slush bath. The volume of the liquid (5 ml) was such that the top of the foil was just covered. The three samples were held at -248°F for 0.1, 2.4, and 5.3 hours prior to evaporation of the OF_2 . No apparent reaction with the polyethylene was observed during any of these periods.

After evaporation of the OF_2 the vials were removed. This was accomplished by scratching the glass tube and breaking it with a hot glass rod. Care was taken not to let fine chips of glass get inside the vial or become imbedded in the outer surface, since the presence of traces of glass would interfere with the analysis. The foils were then withdrawn from the vials. No residues were visible within any of the vials.

The final step, prior to readying the vials for activation, was to flush the vials with nitrogen, replace the lid, and heat seal it shut with a hot glass rod.

4.1.1.2 Preparation of Standards

Previous studies involving dry analyses identified a small random error associated with the lack of reproducibility or residue deposition

during the evaporation process.¹ Minor variations in the distribution of radioactive residue occurred from tube to tube, and the well-type detector, which was sensitive to such geometrical differences, recorded varying gamma disintegration rates.

In an effort to simplify the preparation of the standards, 100-microgram particles of pure metals were used as standards. The metals were obtained from Wilshire Chemical Co. (Gardena, California), and in most cases could be conveniently obtained as 5 mil wires. The 100-microgram particle of metal (Ti, Al, V, Fe, Cr, Ni, Mn, Mg, Cu, or Zn) was imbedded in the middle of the bottom of the vial by gently touching the particle with a hot glass rod. The metal particle after activation was more nearly a point source than the diffusely deposited residue in the bottom of the vial, but at a distance of about 3 inches from the detector face (as was common in the present study) this difference was not important.

4.1.1.3 Activation

Thermal neutron activation was accomplished in the Washington State University reactor, where the flux in the core is about 10^{13} neutrons per cm^2 per sec. Since analyses of short lived isotopes were contemplated, some modifications in procedure from that previously used were required. In order to lose no time which could be applied to counting, a pneumatic transfer system was used to propel the vials (enclosed by larger polyethylene containers called "rabbits") in and out of the core of the reactor. Figure 3 shows a photograph of the rabbit next to a vial, while Figure 4 shows the pneumatic transfer system control panel and some of the associated tubing.

Prior to the actual activation, the vials were flushed with nitrogen (helium could also have been used) to remove air which contains argon. The activation of argon yields Ar^{41} (half life, 1.82 hours), a 1.3 Mev gamma emitter. Neither nitrogen nor helium activates to produce a countable radioisotope. After replacing the lids the vials were heat-

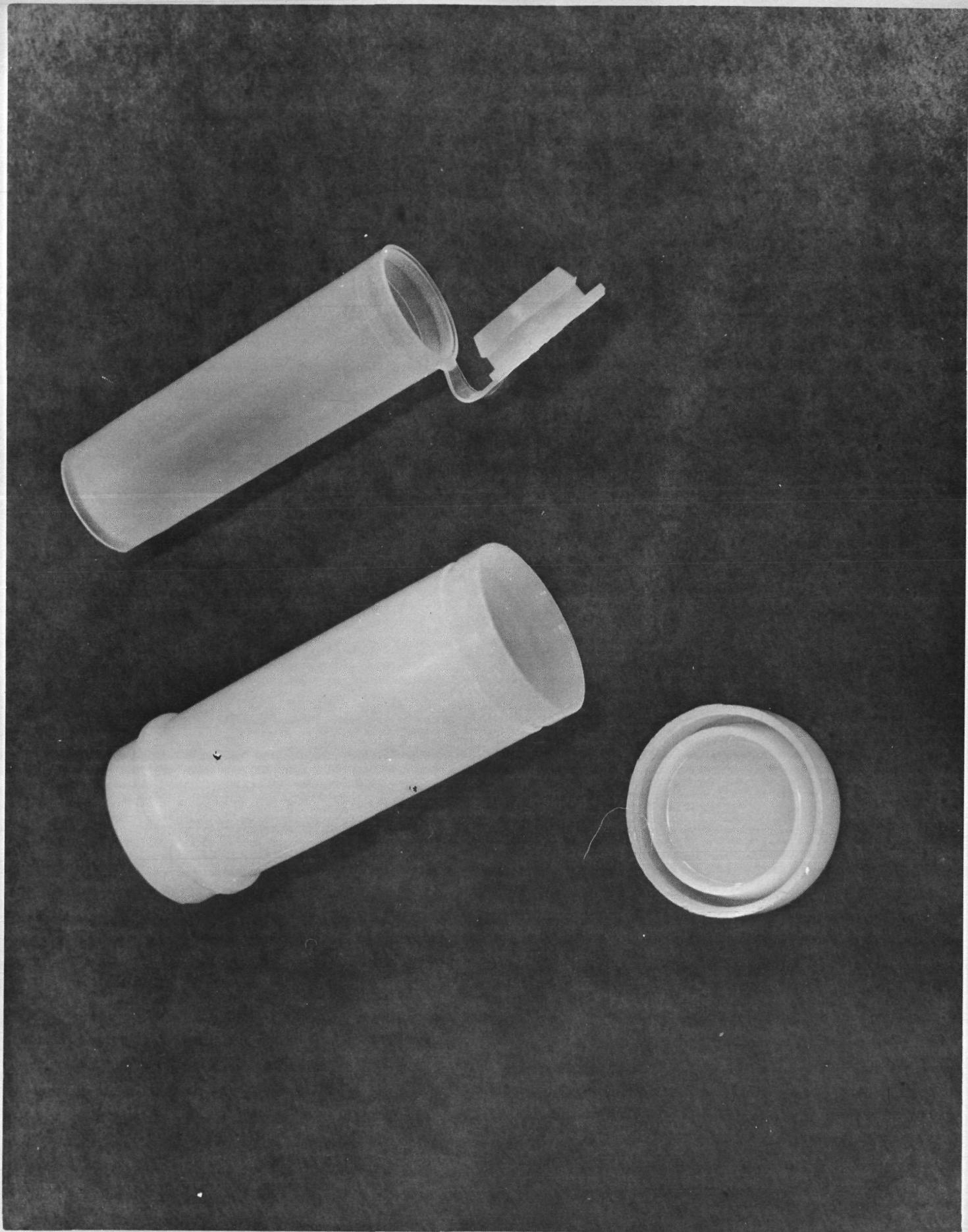

Figure 3: POLYETHYLENE VIAL (UPPER) AND RABBIT (LOWER)

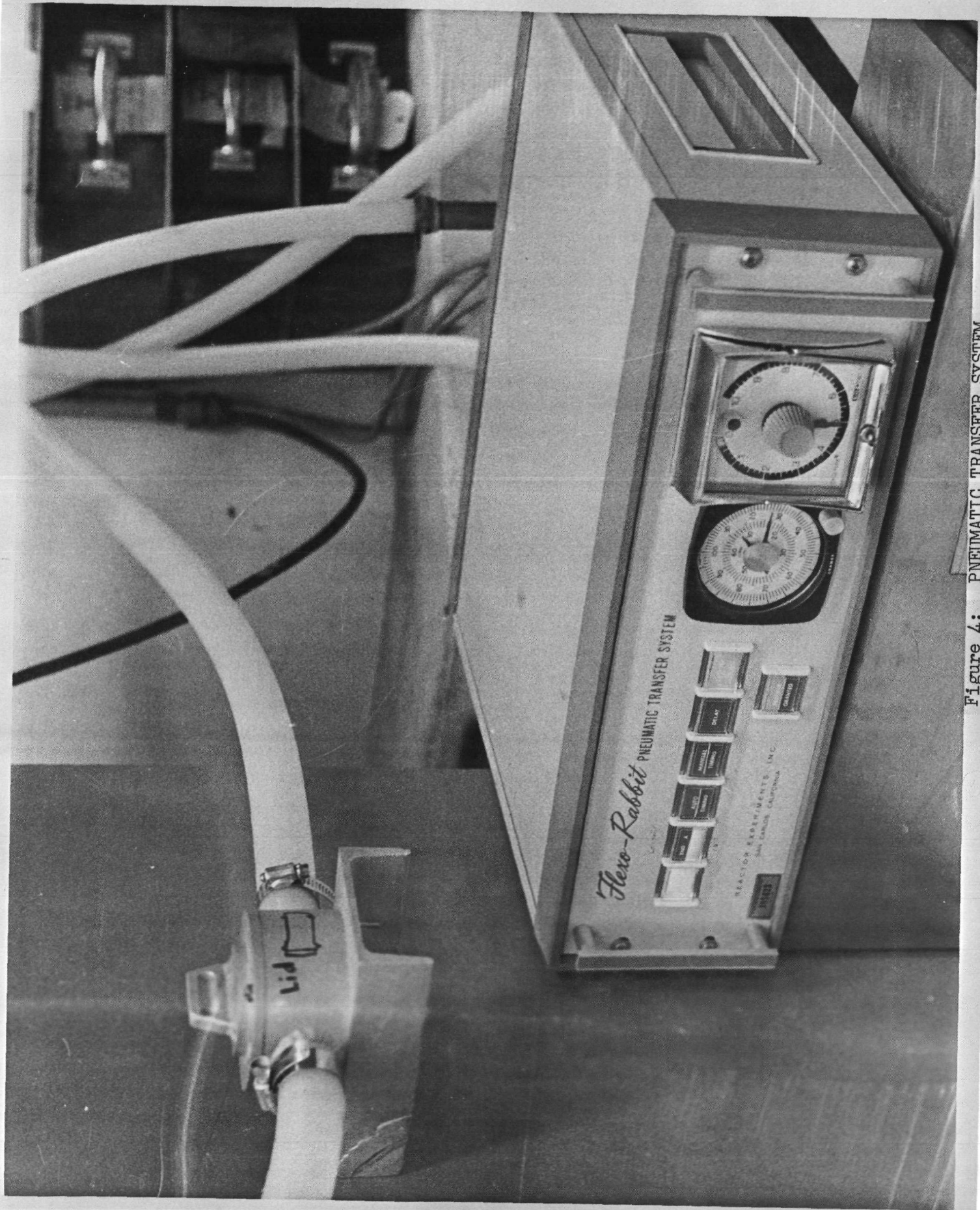

Figure 4: PNEUMATIC TRANSFER SYSTEM

sealed by fusing the cap to the vial with a hot glass rod. This was done partly to make an airtight seal, but the main purpose was to prevent the cap from being forced out due to the pressure build-up when the vial was admitted to the hot core of the reactor.

The heat from the core of the reactor placed a limitation on the activation time. Polyethylene vials left in the core for five minutes exhibited signs of melting. Activation times of two minutes were therefore employed, although three and possibly even four minutes could have been used. For short-lived isotopes such as Al^{28} , Ti^{51} , and V^{52} which approach saturation activity quickly, the two minute limitation does not significantly affect the limits of detection.

All of the vials containing residues or standards were handled with gloved hands. The vial was placed inside a rabbit which was then propelled into the reactor for a 2-minute period. The rabbit was then propelled out of the reactor and was collected in a polyethylene bag. Most samples were counted after a 2 minute delay. The 2 minutes was ample time for retrieving the rabbit from the bag, removing the vial from the rabbit, checking for unexpected excess radioactivity, and positioning the vial at the proper distance from the detector.

The analysis is greatly simplified if the unknowns and the standards are treated identically (i.e., each should be activated for 2 minutes, each counted after the same delay time, and each positioned in the same location relative to the detector). Many possible systematic errors are then cancelled, and no calculations are necessary to correct for unequal decay times.

4.1.1.4 Counting

Counting of gamma ray emissions was the final step of the procedure. The gamma sensing was done with a germanium detector (ORTEC 47.4 cc detector, serial number 9-405). This excellent instrument detected a gamma ray energy within a very small range (0.01 Mev or less), thus

obviating the need for the spectra resolution that was sometimes required when a sodium iodide detector was used.

Figure 5 shows a photograph of a vial being counted. The vial could be positioned on shelves at varying distances from the detector. At very high levels of radioactivity the detector/counter unit could become saturated, and the sample then had to be placed on a shelf farther away from the detector face so that dead time was reduced to negligible levels.

4.1.2 Results and Discussion

Generally speaking Task 1 was quite successful. The activation analyses were easily performed, and most elements were readily detected in a sensitive fashion.

4.1.2.1 Detection Limits

Detection limits are reported for the 10 elements for which standards were made (Al, Ti, V, Cu, Zn, Fe, Cr, Ni, Mn, and Mg). The detection limits for different activation and counting times are summarized in Table 2. Part of the results are based on a 2 minute activation period in the WSU reactor, a 2 minute delay before counting, and a 5 minute counting interval with the sample 1/2 inch from the germanium detector face. These are practical detection limits determined from data of the second task. Detection limits are, of course, functions of variables such as activation time (until the activation time is about equal to the half life, after which saturation activity is rapidly approached) and flux; therefore, some additional detection limits were calculated and included in Table 2 to show that a higher sensitivity could be obtained by activating and counting the elements of long half life (Cu, Zn, Fe, Cr, Ni, and Mn) for a longer time.

4.1.2.2 Propellant Analysis

Table 3 summarizes the results of the OF₂ analysis. In addition to the contact times for the three samples at -248°F, contact at liquid

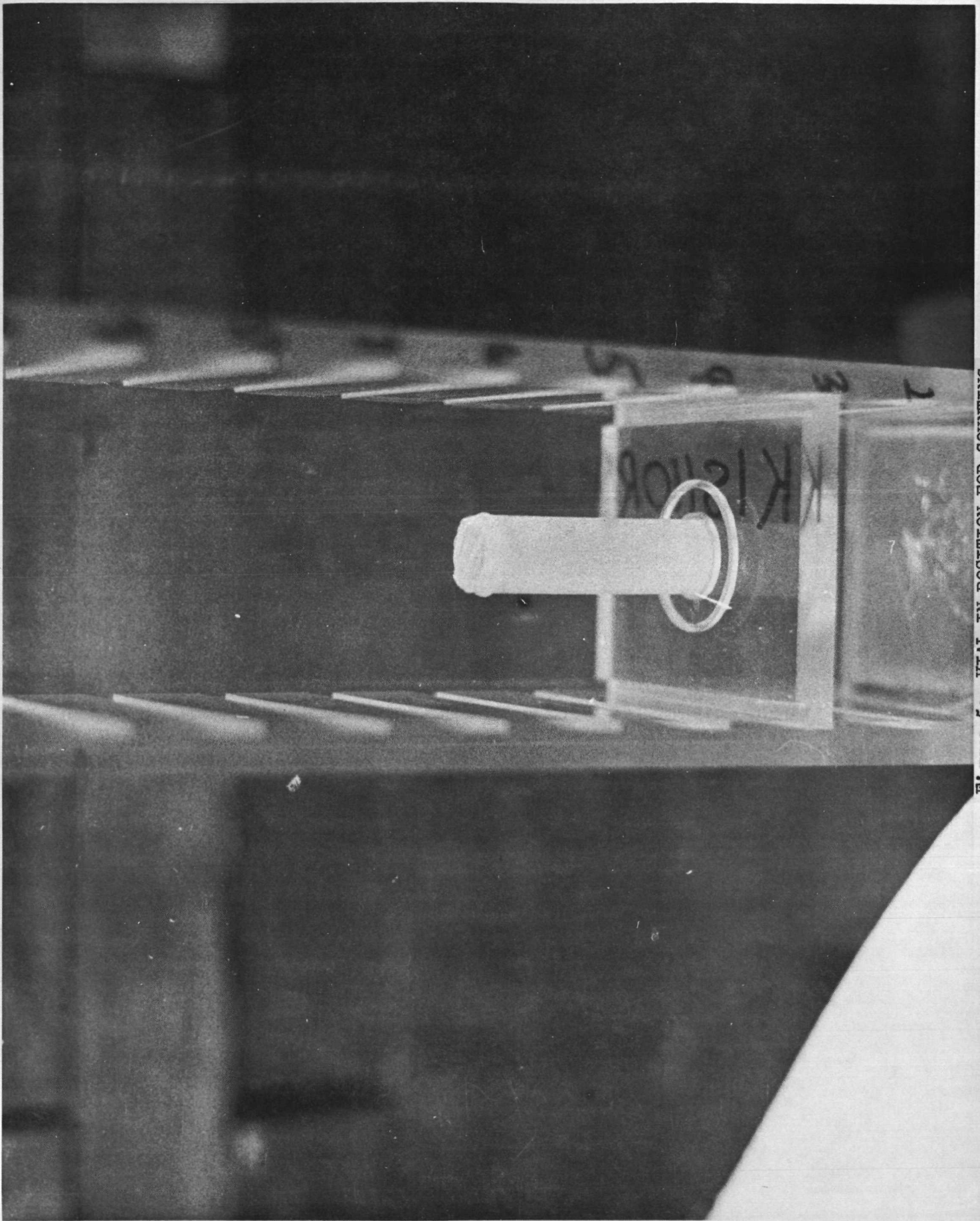

Figure 5: VIAL IN POSITION FOR COUNTING

Radioisotope Formed	Half Life	Principal Gamma Energy (Mev)	2 Minute Activation 5 Minute Count PPM *	10 Hour Activation 2 Hour Count PPM *
Mg ²⁷	9.5 min	0.83	.01	**
Al ²⁸	2.3 min	1.79	.0001	**
Ti ⁵¹	5.8 min	0.32	.01	**
V ⁵²	3.8 min	1.44	.00001	**
Cr ⁵¹	27 days	0.33	3.	.001
Mn ⁵⁶	2.6 hr	0.85	.0001	.0000001
Fe ⁵⁹	45 days	1.10	300.	.1
Ni ⁶⁵	2.6 hr	1.12	.1	.0001
Cu ⁶⁴	12.8 hr	0.51	.01	.000003
Zn ⁶⁵	245 days	1.12	30.	.01

Table 2. Neutron Activation Analysis
Detection Limits (WSU Reactor)

* Limit in parts per million (PPM) is based on the activation of a 10 gram sample of propellant.

** Because of the short half life of the isotope, a long activation or counting time does not improve the detection limit significantly.

Sample Number	Volume of Liquid OF ₂	6Al-4V-Titanium Foil Surface Area	Temperature of Liquid °F	Exposure Time hr	Foil Surface Appearance After Contact with OF ₂	Parts per Million Ti	Parts per Million Al	Parts per Million V															
1	5 ml at -248°F	5.1 cm ²	-321	0.2	Substantially darkened	1.11	<1	0.031															
			-248	0.1					2	5 ml at -248°F	5.1 cm ²	-321	0.1	Slightly darkened	0.42	<1	0.009	-248	2.4	3	5 ml at -248°F	5.1 cm ²	-321
2	5 ml at -248°F	5.1 cm ²	-321	0.1	Slightly darkened	0.42	<1	0.009															
			-248	2.4					3	5 ml at -248°F	5.1 cm ²	-321	0.2	Moderately darkened	0.57	<1	0.016	-248	5.3				
3	5 ml at -248°F	5.1 cm ²	-321	0.2	Moderately darkened	0.57	<1	0.016															
			-248	5.3																			

Table 3: NEUTRON ACTIVATION ANALYSIS OF METALS DISSOLVED OR DISPERSED IN LIQUID OXYGEN DIFLUORIDE

nitrogen temperature occurred for brief periods during transfer operations (0.2, 0.1, and 0.2 hours respectively).

Table 3 shows that only small amounts of Ti, Al, and V were found. No other elements (defined by the characteristic gamma energies of Table 2) could be identified in the residues. Accurate data could not be reported for aluminum because of interference from traces of aluminum contamination picked up within the reactor system. (The tubes that led into the core of the reactor were constructed of aluminum.) It is believed that the contamination arose when the vials contacted the inside of the rabbits. The rabbits had been previously used in other studies, and the opportunity for contamination probably arose then. After each activation some Al^{28} was detected in the bag that received the rabbit. A trace of manganese, a common constituent of aluminum alloys, was also detected. To check whether the inside of the rabbit was contaminated, an empty vial was activated. A count of the vial then confirmed the presence of aluminum. Any future analyses of aluminum will be performed using a new rabbit for each vial that is activated.

The amounts of Ti and V found in the three residues could not be correlated with alloy/ OF_2 contact time. The first OF_2 sample, analyzed after an alloy/ OF_2 contact time of only 0.1 hour at -248°F , showed the largest quantities of Ti and V. Of interest is the observation that the surfaces of all three foils were darkened with an adherent deposit, one which may be similar to that described by TRW.³ Figure 6 shows a photograph of (from left to right) a shiny, unused foil and the three darkened foils in order of increasing contact time. The degree of darkening on each foil surface corresponded reasonably well with the amount of Ti and V found in each residue. The surface attack may be promoted by the presence of impurities in the OF_2 (e.g., H_2O , HF , F_2 , O_2 , and SiF_4), with the amount of the impurity in each sample controlled by subtle variations in the OF_2 handling procedure. This possibility is supported by a Task 2 test (run 5), in which no darkening of a 6Al-4V-titanium foil occurred after about 2 hours

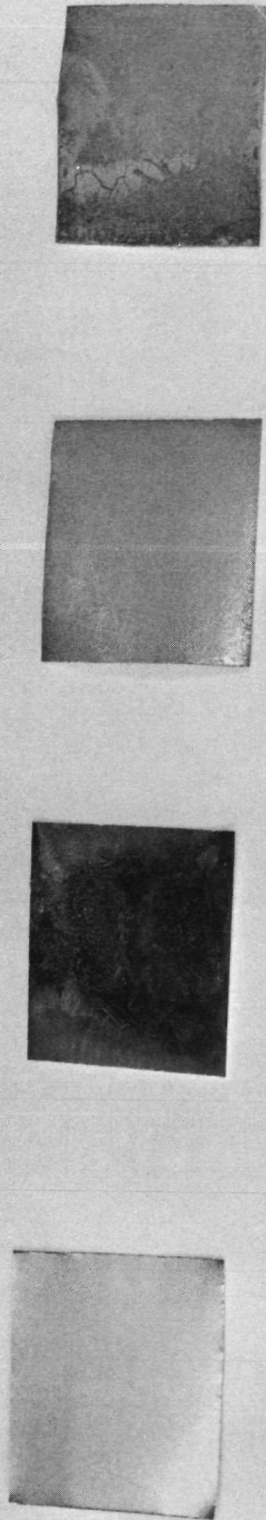

Figure 6: PHOTOGRAPH OF 6Al-4V TITANIUM FOILS AFTER CONTACT WITH LIQUID OF₂
FROM LEFT TO RIGHT: (1) CONTROL (2) 0.1 HOUR (3) 2.4 HOURS (4) 5.3 HOURS

contact with liquid OF_2 at -250°F , but it is not clear at this time what subtle handling differences might account for the observed results. Consideration was given to the possibility that the corrosion was promoted by stress. (The three foils were bent somewhat to insure a tight fit between the walls of the vials.) The tension stress, however, was calculated to be only about 13,700 psi, a value which was not high enough to be suspect. Also, the foils were equally corroded on both sides, which is consistent with simple chemical attack rather than stress corrosion.

4.1.2.3 Submission of Samples and Standards to Reactor

The ease with which the analysis was accomplished suggested a routine procedure could be devised for those desiring to avail themselves of neutron activation analysis. Activation analysis is generally speaking a very flexible technique and can be adapted to meet a large variety of analytical problems. A substantial number of these problems could be attacked using the WSU pneumatic transfer system; consequently, the procedure outlined below was developed. Such a procedure is suitable when dry residues and short (2 minute) activation times are sufficient. Activating liquid propellants or activating for longer times require methods similar to those previously discussed¹ or may require special coordination with reactor personnel.

The recommended steps are as follows:

- (1) Place sample to be activated in a clean vial (maximum dimensions are 2.3 inches in length and 0.8 inch in diameter, the internal dimensions of the rabbit). A 2 dram polyethylene vial (Van Waters and Rogers, catalog number 66017-026) is suitable. Various methods for introducing the sample into the vial are possible. Section 4.1.1.1 discusses the method used in this study. The vial is then filled with nitrogen or helium and heat-sealed shut.

- (2) Prepare standards of the elements for which analyses are desired. The 100 microgram particles of metal used as standards in the present study (Section 4.1.1.2) tended to be somewhat too heavy in the cases of manganese, aluminum, and vanadium, since upon activation the resulting high level of radioactivity saturated the detector, unless the standard was counted at a relatively long distance from the detector. Small amounts of metals can be introduced into the vials by diluting a solution of known concentration to the desired level, withdrawing an appropriate portion of the dilute solution, adding it to the vial, and evaporating to dryness. Ideally standards should weigh about the same as the element being analyzed, but in the absence of this knowledge the standards should weigh 100 to 1000 times the detection limits reported in Table 2. As in the case of the unknown sample, the lid of the vial is heat-sealed to the vial after flushing with nitrogen or helium.

- (3) Submit the sample and standards along with the form illustrated in Figure 7 to the Operations Manager, Nuclear Radiation Center, Washington State University, Pullman, Washington, 99163.

Of course a similar procedure is possible at many other reactors, although minor details may be handled differently. The procedure specifically outlined above is intended to aid engineers who can not make arrangements elsewhere.

4.2 Task 2 - Flow Diagnostics in Propulsion Feed Systems

This task emphasized the use of radioactive tracers to evaluate the probability that constrictions in certain passive components (orifices and filters) will become clogged by the action of metal compounds dissolved or suspended in the OF_2 . The general approach

NEUTRON ACTIVATION ANALYSIS EMPLOYING
PNEUMATIC TRANSFER SYSTEM

(Item 2 and the last three columns of item 8 are to be completed by reactor personnel. Items 3, 4 and the first two columns of item 8 are to be completed by the customer.)

1. Reactor: Washington State University
2. Date:
3. Sample vial to be activated: (e.g., Residue left from the evaporation of 10 grams of propellant "X".)
4. Elements sought and for which vials containing the following standards are provided: (e.g., Al, Ti, V)
5. Activation time requested for all vials: 120 ± 3 seconds
6. Delay time between removal of vial from reactor and start of count: 60 ± 3 seconds.
7. Count time applied to principal gamma emission of each element: 300 seconds
8. Results:

<u>Radioisotope</u>	<u>Weight of Standard</u>	<u>Counts Above Background of Standard</u>	<u>Counts Above Background of Sample</u>	<u>Wt. of Element in Sample (Cols. 2 x 4 ÷ 3) *</u>
Ti ⁵¹	(e.g., 1.01×10^{-5} g)			
Al ²⁸	(e.g., 1.04×10^{-6} g)			
V ⁵²	(e.g., 1.02×10^{-7} g)			

9. Special instructions, if any: (e.g., Use a new rabbit for each activation in order to avoid possible contamination of vials.)

* Note to reactor personnel: this calculation presupposes that the sample and standard are treated identically; for example, both are counted at the same distance from the detector with negligible (or equivalent) corrections for "dead time". If the activation or counting procedures should for some reason require any deviation from identical handling of the sample and standard, appropriate adjustments to the calculations must be made.

Figure 7. Suggested Form to be Used When Submitting Samples for Activation Analysis

was similar to that of the previous study,¹ but was considerably broadened by virtue of a larger number of isotopes, a wider variety of handling procedures, and an increase in the types of components studied.

4.2.1 Procedure

4.2.1.1 Equipment

Acquisition of equipment was directed towards a propellant flow assembly and suitable gamma counting (measuring) apparatus.

A schematic representation of the flow assembly is shown in Figure 8. The valves, fittings, and fluid lines (1/4 inch O.D.) were of 304, 316, or 321 stainless steel. The feed and catch tanks, capable of holding one pound of liquid OF_2 , were of 321 stainless steel. They were flanged at the top to permit access to the interior. A copper gasket acted as a seal between the flanges.

Figure 8 also shows the location of pressure and temperature sensing probes. Pressure transducers and thermocouples were employed to continuously monitor the pressure and temperature at key locations within the test system. Temperature within the environmental chamber was controlled by a cold nitrogen gas conditioning system, which maintained the temperature at $-250 \pm 10^\circ$.

Flow rate was determined by measuring the pressure drop across a previously calibrated 0.018 inch diameter orifice. The diameter of the orifice was chosen to be much larger than the orifices tested in this study so that there would be little chance of the flow measuring orifice becoming clogged.

Two sizes of orifices were tested in this program. The smaller was nominally 6.7 mils and the larger 10.4 mils in diameter. Figure 9 is a diagram showing a cross section of an orifice plate. Figure 10

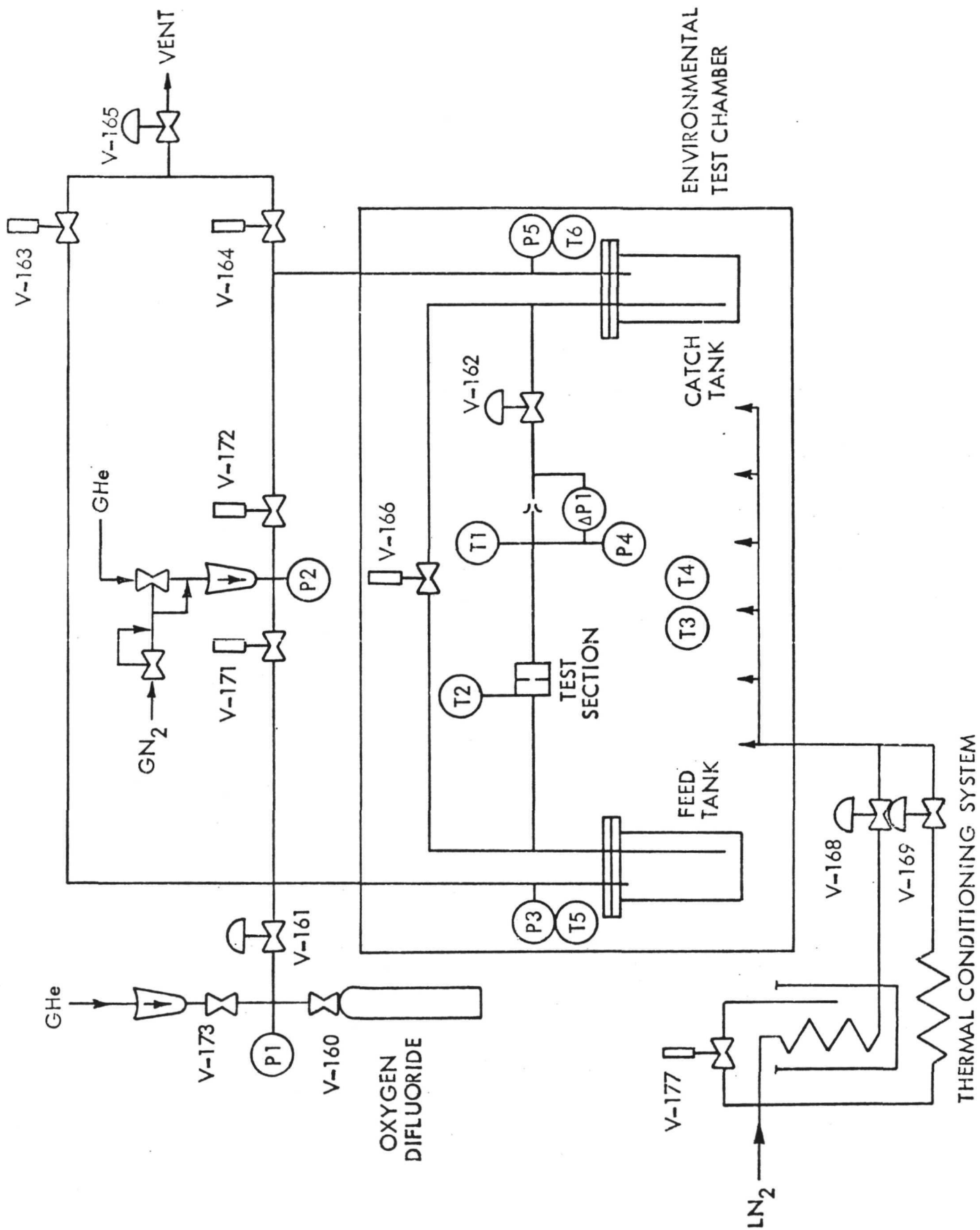

Figure 8 SCHEMATIC REPRESENTATION OF LIQUID OXYGEN DIFLUORIDE FLOW ASSEMBLY

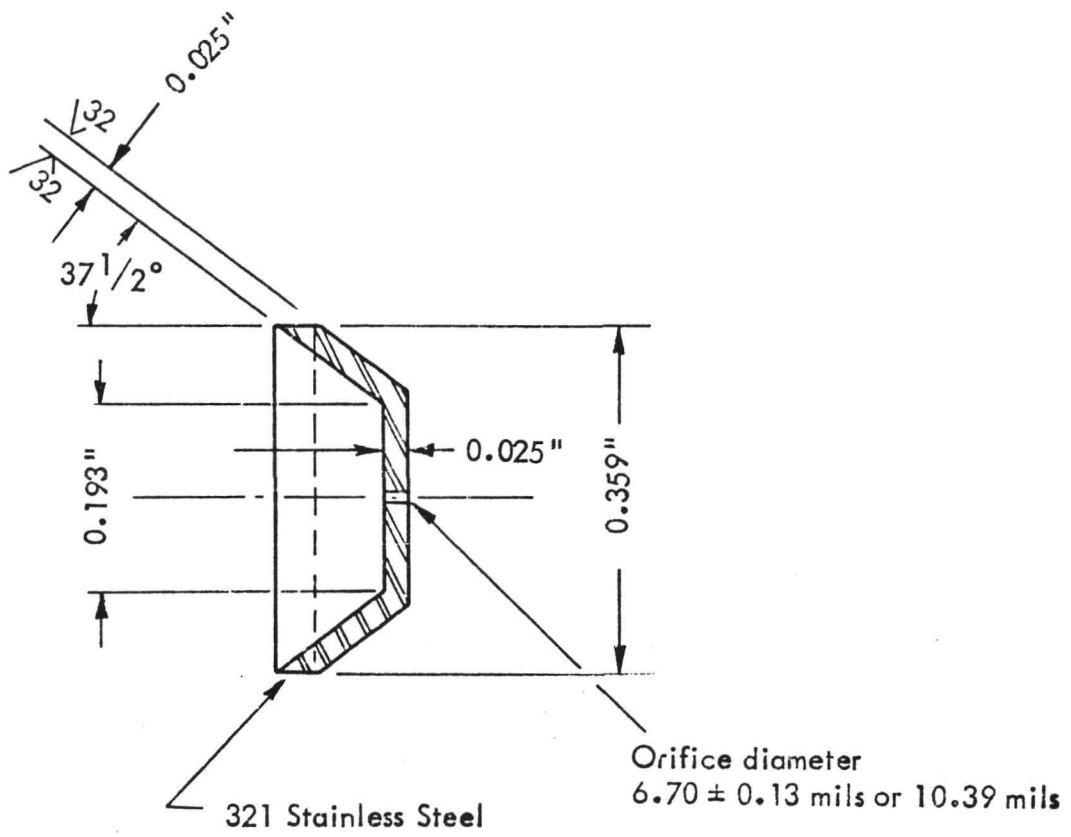

Figure 9 CROSS SECTION OF ORIFICE PLATE

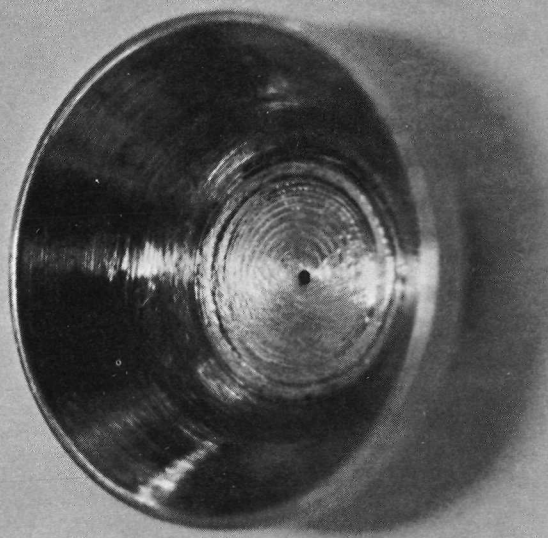
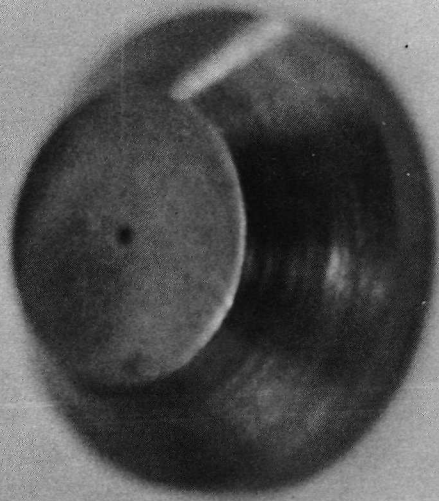

Figure 10: TWO VIEWS OF A 10.4 MIL ORIFICE PLATE

is a photograph of two views of a 10.4 mil orifice.

Two types of filters were also tested. The first was made by Vacco Industries, South El Monte California (P/N SI-81847-2). It was an "airborne" type, 12 micron absolute rating, constructed of 304L stainless steel. The second type was a special JPL design (P/N 10041051A). Figure 11 shows a photograph of the two filters.

Figure 12 shows the environmental chamber and some associated equipment. Figure 13 is a view inside the box, showing the feed tank, catch tank, and propellant lines.

The counting equipment was very similar to that previously employed. Gamma emissions from the radioactive tracers were detected with a 3" x 3" right cylindrical NaI crystal detector in close proximity to the test section. Counts were analyzed and recorded with a Baird Atomic Model CS202 dual channel analyzer, two Model CS127 scalers and one Model CS107 scaler, and a CS905 timer. The three scalers allowed the simultaneous counting (measurement) of three different tracers. Figure 14 shows the counting equipment, while Figure 15 is a view of the detector in place. The face of the detector was against the wall of the environmental chamber, about one inch from the test section (orifice or filter). The detector was shielded with lead bricks to reduce background. Surrounding the detector and lead bricks was a plastic bag into which a stream of dry nitrogen was circulated. This served to warm the area and to prevent condensation of moisture on the detector. (The NaI crystal is prone to crack if subjected to sharp thermal gradients.)

4.2.1.2 Cleaning

Prior to the start of flow tests all components (lines, valves, and tanks) which would contact OF_2 were cleaned in a seven step procedure: (1) vapor degreasing with trichloroethylene, 10 min; (2) detergent (Diversey-909) flush, 15 min; (3) cold water flush, 10 min; (4) 50%

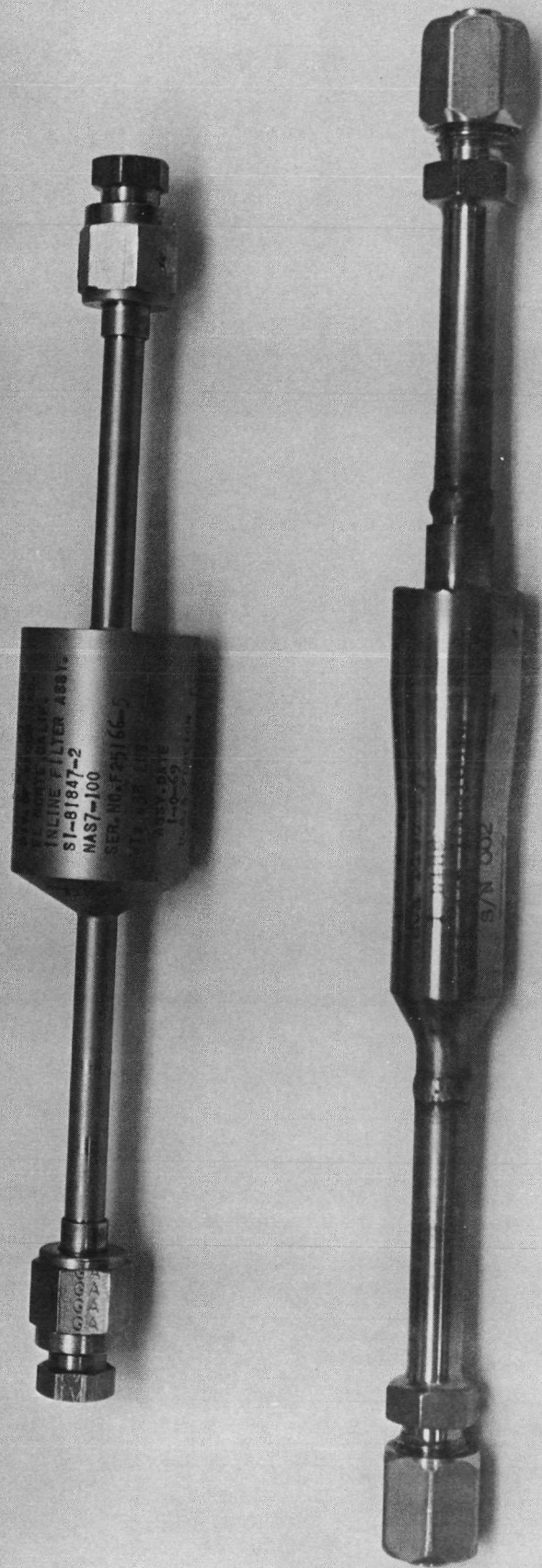

Figure 11: VACCO FILTER (LEFT) AND JPL FILTER (RIGHT)

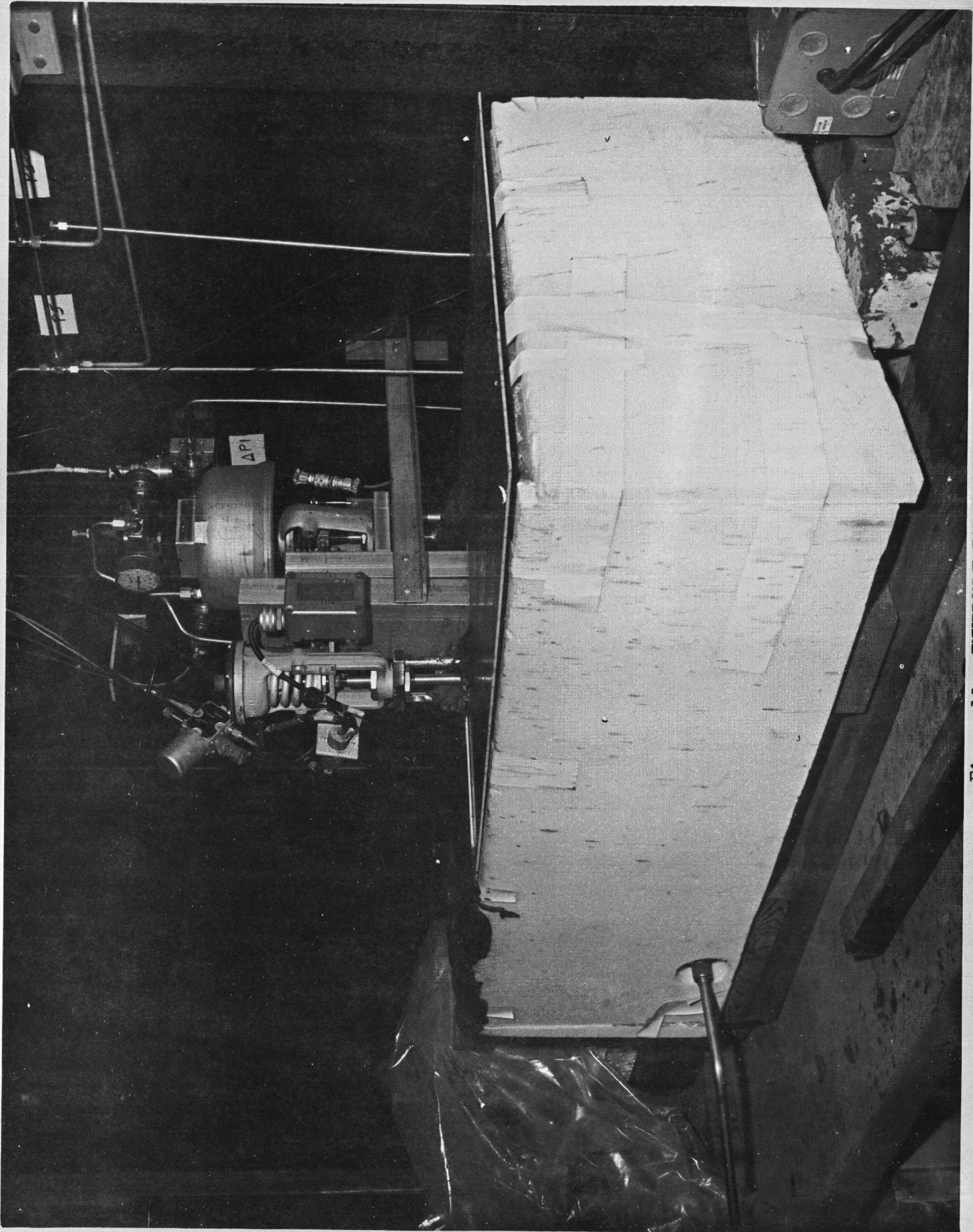

Figure 12: ENVIRONMENTAL TEST CHAMBER



Figure 13: VIEW OF TANKS AND LINES WITHIN TEST CHAMBER

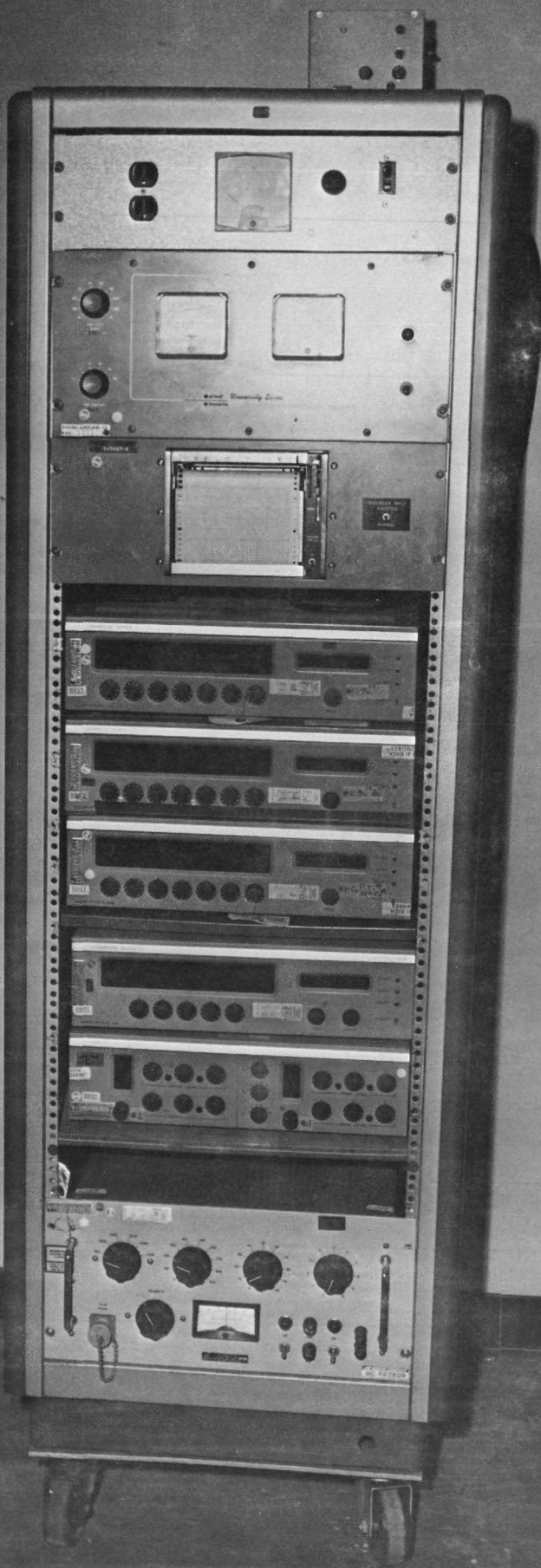

Figure 14: COUNTING EQUIPMENT

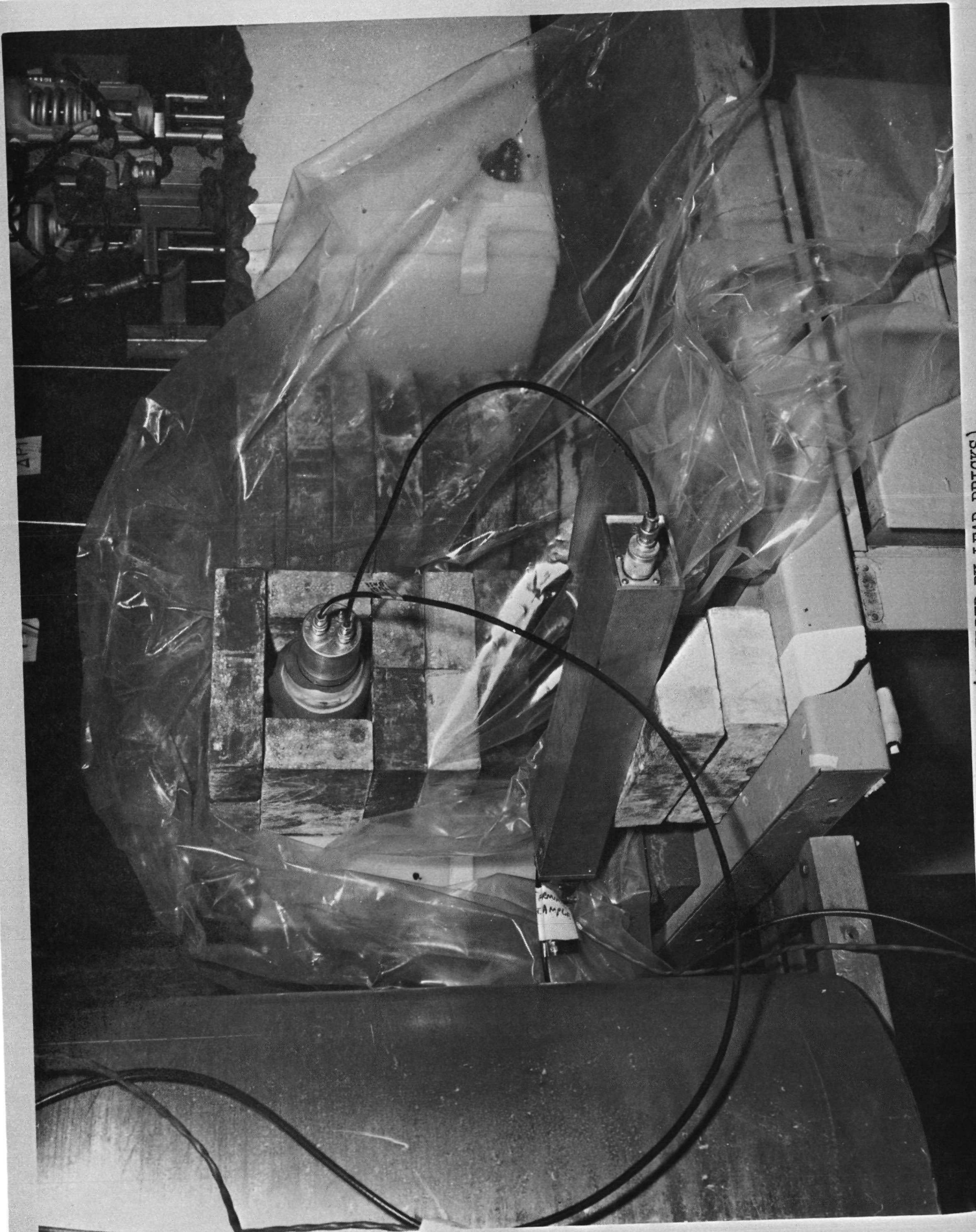

Figure 15: DETECTOR (SHIELDED BY LEAD BRICKS)

HNO₃ passivation, 5 min; (5) deionized water flush, 10 min; (6) dry N₂ gas purge; and (7) oven drying for 2 hours. At the conclusion of the fourth run the feed tank was cleaned again. The inside was wiped with cloths wet with WEDAC detergent (West Chemical Products Inc.) until all radioactive tracers were removed. The tank was then rinsed with deionized water and dried in a stream of dry nitrogen. Before resuming the runs the reassembled system was purged with helium; then, gaseous OF₂ was admitted at 70-80°F for about 10 minutes prior to condensing liquid OF₂ in the system.

The Vacco filter was cleaned per JPL specification GMM-30009-PRS. The JPL filter was cleaned per JPL specification FS504574.

4.2.1.3 OF₂ Characterization

A second cylinder of OF₂ (Allied Chemical Co.) was used for the Task 2 tests. The OF₂ was similar to that of Task 1 in that analysis by infrared spectrometry revealed the presence of about 1% CF₄. Mass spectrometry confirmed the presence of the CF₄, and also showed about an equivalent amount of HF in addition to small quantities of SiF₄, CO₂, H₂O, N₂, and O₂. A concentration of 1% HF may be in error on the high side, since reactive fluorinating agents sometimes generate HF within a mass spectrometer through combination with organic residues.

4.2.1.4 Introduction of Radioactive Tracers into the OF₂

Isotopes used in this task were purchased from International Chemical and Nuclear Corporation (Chemical and Radioisotope Division, Irvine, California). The as-received isotopes were described by the data in Table 4.

In the earlier runs of this program radioisotopes were manually added to the feed tank by distributing a few drops of an aqueous solution containing a known amount of the desired isotope on the bottom of the tank. The aqueous solution was then evaporated to dryness. The

<u>Isotope</u>	<u>Oxidation State, Dilute Acid Solvent</u>	<u>Radioactivity</u>	<u>Specific Activity</u>	<u>Metal Weight (g)</u>
Fe ⁵⁹	Fe(III), HCl	1 mc	20.6 mc/mg	4.85x10 ⁻⁵
Cr ⁵¹	Cr(III), HCl	1 mc	342 mc/mg	2.92x10 ⁻⁶
Ni ⁵⁹	Ni(II), HCl	0.01 mc	1.32 mc/g	7.58x10 ⁻³
Mn ⁵⁴	Mn(II), HCl	0.25 mc	7945 mc/mg	3.15x10 ⁻⁸
Zn ⁶⁵	Zn(II), HCl	1 mc	0.966 mc/mg	1.04x10 ⁻³
Ti ⁴⁴	Ti(IV), HF+HCl	1 μ c	168.6 mc/mg	5.93x10 ⁻⁹
Al ²⁶	Al(III), HNO ₃	0.023 μ c	18.5 mc/g	7.30x10 ⁻⁵

Table 4. Radioisotope Technical Data As of Reference Date (June 24, 1971)

residues were conditioned by exposure to gaseous OF_2 for at least 10 minutes at about 75°F , although knowledge of the kinetics of reactions between OF_2 and metals or metal salts is very limited, and it is difficult to speculate on the results of the conditioning. Any tracers remaining in the feed tank at the conclusion of a run were allowed to remain there in all subsequent runs in which isotopes were manually added. The quantities of tracers added were as follows; Fe^{59} , Cr^{51} , Ni^{59} , Mn^{54} , and Zn^{65} equal to 10% of the amounts shown in Table 4 with the activities of Fe^{59} , Cr^{51} , Mn^{54} , and Zn^{65} reduced by 1.0, 1.7, 0.15, and 0.29 half lives of decay, respectively; Ti^{44} , 20% of the amount in Table 4; Al^{26} , 13% of the amount in Table 4.

In the later runs of this program liquid OF_2 was allowed to interact with radioactive surfaces of foils of 6Al-4V titanium, 6061 aluminum, and 304 stainless steel. While the principal elements in stainless steel can be rendered suitably radioactive by neutron activation, titanium and aluminum do not activate to yield isotopes of sufficiently long half life. Therefore, an effort was made to devise a method of rendering surfaces of metals radioactive by interaction with a solution of an appropriately long-lived isotope of the metal in question. This was accomplished by immersing foils in aqueous solutions of the selected isotope for one week. Three 2.5 inch x 10 inch foils were used: 1 mil 6Al-4V titanium, 2.5 mil 6061 aluminum, and 0.5 mil 304 stainless steel; the surfaces of the three foils were contacted, respectively, by solutions containing 30% of the Ti^{44} of Table 4, 39% of the Al^{26} , and 20% of the Fe^{59} (with the activity of the Fe^{59} reduced by 1.8 half lives of decay). The Ti^{44} solution (0.8 ml) was 0.017 M in HCl and 0.042 M in HF; the Al^{26} solution (3.8 ml) was 0.32 M in HNO_3 , and the Fe^{59} solution (1.2 ml) was 0.025 M in HCl. The volumes of the solutions were kept small in order to maintain as high a concentration as possible of the radioisotope. The conditioning procedure was accomplished in polyethylene bottles, and each bottle was frequently rotated to insure that the entire foil surface was exposed to the small volume of solution. At the end of the one week contact period, the foils were removed and thoroughly rinsed

with water. All three foils were found to have radioactive surfaces. This radioactivity was strongly attached to the surfaces and could not be removed by rinsing in water, although no effort was made to determine if atomic exchange had occurred between the radioactive tracer ions and the surface metal atoms or whether some sort of surface adsorption occurred. The titanium and stainless steel alloy foils were moderately active, each being of the order of a microcurie. The aluminum alloy foil was of very low activity (about a nanocurie), due largely to the low activity of the aluminum solution.

The tracers Al^{26} and Ni^{59} require special comment, since their properties had a bearing on the procedures in this program. Al^{26} is in many ways an ideal gamma-emitting tracer, but its present high cost (Table 1) dictates that small quantities be used whenever possible. Smaller than optimum activities of Al^{26} were used for the flow test studies, and in an effort to compensate for any loss in sensitivity, longer counting times were employed. Although there are several gamma-emitting tracers of nickel, Table 1 shows that they are either not commercially available (Ni^{56} and Ni^{57}) or else possess a half life that is inconveniently short (Ni^{65}). Consequently, Ni^{59} was chosen for this study. Its X-ray emissions are not energetic enough to penetrate the walls of a typical feed system line. Therefore, deposition of this tracer within a component cannot be monitored while flow is in progress. The component must be dismantled for counting at the conclusion of a test.

4.2.1.5 Liquid OF_2 Handling

One pound of OF_2 was condensed in the feed tank at $-250 \pm 10^\circ\text{F}$. The tank was then pressurized with helium at pressures ranging from 16 psig to 188 psig depending on the run. Flow commenced upon opening valve 162 (Figure 8). With the exception of runs 1 and 7(d) of Table 5 the valve was quickly adjusted to a point where further opening of the valve had little or no effect on flow rate. The catch tank was maintained at a constant pressure by venting it to the atmosphere during a run.

4.2.2 Results and Discussion

4.2.2.1 Summary of Flow Tests

Table 5 summarizes the results of the liquid oxygen difluoride flow tests. The subruns (a), (b), etc. denote recirculation of the OF_2 through the test section. In general, no clogging occurred within either the Vacco filter (runs 4-5) or the 10.39 mil orifice (run 7). However, severe clogging occurred when the nominal 6.7 mil orifice was employed. In some runs the orifice clogged before commencing flow, suggesting that an impurity in the OF_2 (such as HF , CO_2 or SiF_4) was freezing out in the orifice upon liquefaction of the OF_2 . This hypothesis was supported by a general absence of radioactive metal contaminant deposition in the test section. No build-up of tracers was noted while any of the runs were in progress, and the tracers tended to remain in the feed tank rather than be transferred to other parts of the system. In run 8 a 6.7 mil orifice was again tested, but this time the JPL filter was placed upstream of the orifice. Completely normal flow was observed, indicating that the JPL filter was successful in protecting the orifice.

4.2.2.2 Discussion

In run 1 (6.7 mil orifice) an attempt was made to obtain a flow rate of about 0.001 lb/sec with the feed tank pressurized at 100 psig. A flow rate of about 0.001 lb/sec was chosen largely because of the convenient run time that would result (a little more than 15 minutes). Upon opening the flow control valve (valve 162, Figure 8) no flow of liquid OF_2 was observed. A few minutes later however, the apparent obstruction broke loose and steady flow resulted. At this low flow rate and relatively high pressure it was found that most of the pressure drop in the system was not across the orifice but rather across the valve. Evidently a flow rate of about 0.001 lb/sec at 100 psig could be obtained only by slightly cracking the valve, with the result that the effective opening of the valve was smaller than that of the orifice. No deposition of radioactive contaminants

Run	Constriction in Test Section	Tracer	Feed Tank Pressure (psig)	Flow Rate (lb/sec x 10 ³)	ΔP Across Test Section (psi)	Description of Flow	Radioactive Metal Contaminants Deposited in Test Section
1	6.68 mil orifice	Fe ⁵⁹ , Cr ⁵¹ , Ni ⁵⁹ , Mn ⁵⁴	100	0.74 after unclogging	**	No flow initially	None detected
2(a)	6.57 mil orifice	Fe ⁵⁹ , Cr ⁵¹ , Ni ⁵⁹ , Mn ⁵⁴ , Zn ⁶⁵	50	Flow wouldn't start	50	Clogging before start of flow, while line was being filled	None detected
(b)	6.57 mil orifice	Fe ⁵⁹ , Cr ⁵¹ , Ni ⁵⁹ , Mn ⁵⁴ , Zn ⁶⁵	30	Flow wouldn't start	30		1.6 x 10 ⁻¹⁰ g Fe; 3.3 x 10 ⁻³ % of Fe added 6.0 x 10 ⁻¹³ g Mn; 2.8 x 10 ⁻³ % of Mn added
3	6.69 mil orifice	Ti ⁴⁴ , Al ²⁶ , Fe ⁵⁹ , Cr ⁵¹ , Ni ⁵⁹ , Mn ⁵⁴ , Zn ⁶⁵	20	0.67 (initial)	14 (initial)	Steady flow for 1 minute; then orifice clogged	None detected
4(a)	12μ Vacco filter	↓	20	0.89	2	Steady	None detected
(b)	12μ Vacco filter		20	0.94	2	Steady	None detected
5	12μ Vacco filter	Ti ⁴⁴ , Al ²⁶ , and Fe ⁵⁹ foils*	18	0.94	1	Steady	None detected
6(a)	6.76 mil orifice	↓	19	0.62	18	Flow rate slightly erratic	None detected
(b)	6.76 mil orifice		60	0.99 (initial) 0.52 (min.) 1.07 (max) 1.07 (final)	58 (initial)	Erratic	None detected
7(a)	10.39 mil orifice	↓	18	1.22	12	Steady	None detected
(b)	10.39 mil orifice		16	1.12	10	Steady	None detected
(c)	10.39 mil orifice		17	1.26	10	Steady	None detected
(d)	10.39 mil orifice	100	1.40 (initial) 0.98 (min.) 1.48 (max.) 1.08 (final)	18 (initial) **9 (min.) 18 (max.) 11 (final)	Erratic behavior due to clogging of flow control valve	None detected	
8(a)	JPL filter/ 6.63 mil orifice	↓	20	0.60	19	Steady	None detected
(b)	JPL filter/ 6.63 mil orifice		188	1.89	185	Steady	None detected

*Ti⁴⁴, Al²⁶, and Fe⁵⁹ on surface of, respectively, 6Al-4V-titanium, 6061 aluminum, and 304-stainless steel.

**In runs 1 and 7(d) most of the ΔP was across a flow control valve instead of across the test section orifice.

TABLE 5: SUMMARY OF LIQUID OXYGEN DIFLUORIDE FLOW TESTS

was noted during run 1. In fact, a post-run check with the detector indicated that essentially all of the manually added tracers (Fe^{59} , Cr^{51} , Ni^{59} , and Mn^{54}) had remained on the bottom of the feed tank, with no apparent physical disturbance of the tracers having occurred. The contaminant compounds probably exhibited extremely low solubility in liquid OF_2 , although surface adsorption could also account for their tendency to remain in the feed tank. The hypothesis that these metal compounds were essentially insoluble would be consistent with the physicochemical nature of the propellant: its low temperature together with a general absence of any complexing, solvating, or self-ionizing properties would explain its limited solvent capabilities. The lack of mobility of the tracers indicated that they did not contribute to the obstruction initially observed. This lack of mobility is very different from the results observed in the cases of N_2O_4 and N_2H_4 ,¹ in which the radioactive tracers were readily carried by the propellant out of the feed tank to other parts of the system.

It was decided to use a smaller feed tank pressure in subsequent runs involving the 6.7 mil orifice. This would allow the desired flow rate to be reached with the flow control valve opened wider, thus insuring that most of the pressure drop in the system was across the orifice (or, in other words, the orifice was the smallest constriction in the system). Before the start of run 2(a) Zn^{65} was added to the feed tank as a tracer in addition to the other four remaining from run 1. While filling the feed tank with OF_2 it was observed that the orifice had become clogged. This was determined by noting that the pressure upstream of the orifice was different than the pressure downstream (P4 in Figure 8 was constant at 0 psig and would not change regardless of whether P3 was increased or decreased.) As expected, when the flow control valve was opened no flow occurred. The fact that the orifice would clog during the OF_2 condensation process suggested that a normally gaseous impurity in the OF_2 (such as HF , CO_2 , or SiF_4) was solidifying upon cooling the OF_2 to -250°F . (HF , CO_2 , and SiF_4 are all solids at this temperature.) Condensation of the OF_2 while filling the feed tank occurred in the line leading to the orifice as well as in the feed tank itself. Hence, there was ample opportunity for the impurity to freeze out in or near

the orifice. Small currents through the orifice prior to starting the run could occur because of thermal gradients or agitation during the pressurization process. These currents could carry particulate matter to the orifice. Thus the orifice could easily become plugged before or just after opening the flow control valve.

The OF_2 was removed from the system by evaporation and a fresh sample was added for run 2(b). Nearly identical clogging behavior as in run 2(a) was observed. Clogging occurred while filling the feed tank and lines, and flow could not be started. Attempts to dislodge the obstruction by pressurizing on both the upstream and downstream sides of the orifice failed. In runs 2(a) and (b) no radioactive contaminants were detected in the vicinity of the orifice while filling the system with OF_2 or while attempting to start flow. At the conclusion of run 2(b), the orifice plate was removed for examination. Two small extraneous particles could be seen on the plate, but the orifice was unobstructed. The radioactivity associated with the orifice plate was then measured (counted) in special low-background equipment in an effort to lower the detection limits an order of magnitude below those present during the run. Very small amounts of Fe and Mn were found (1.6×10^{-10} and 6.0×10^{-13} g, respectively), but these were only about $10^{-3}\%$ of the original tracer added. A count was also made of the feed tank which showed that practically all of the tracers had remained on the bottom of the tank. It seems certain that the very small amount of tracer detected in the vicinity of the orifice was not responsible for the clogging.

In run 3 the tracers Ti^{44} and Al^{26} were added. No deposition of any tracers was observed in this or any subsequent runs. In this run flow was started, but the 6.7 mil orifice clogged after only about one minute of flow. As in run 2(b), a post-run examination of the orifice revealed no obstructions, a fact which is consistent with the hypothesis that frozen nonmetallic impurities such as HF , CO_2 , or SiF_4 were responsible for the clogging. These contaminants would vaporize upon warming the system to room temperature.

Run 4 tested the Vacco filter. The flow was steady, indicating that the filter was not adversely affected by whatever had clogged the 6.7 mil orifice.

Prior to run 5 the feed tank was thoroughly cleaned. The radioactive foils were then put in the tank and were used for the remaining runs. Run 5, which involved the Vacco filter, produced data essentially identical to run 4. The flow was steady with no indications of erratic behavior. No deposition of tracers in the filter was observed during the run. Furthermore, no tracer deposition could have occurred, since a count of the three foils, which were removed at the end of the run, showed the same radioactivity levels that were recorded prior to placing the foils in the tank. This was further evidence that under conditions prevailing in Task 2, metal compounds do not tend to become dissolved or dispersed in liquid OF_2 . Of interest was the fact that the 6Al-4V titanium foil, which had contacted the OF_2 for about two hours during this run, did not exhibit any of the dark surface deposits observed in Task 1. Table 3 shows that the production of these deposits is accompanied by the entry of metal compound contaminants into liquid OF_2 , but the conditions that produced these deposits during Task 1 were apparently absent during Task 2.

In run 6, another 6.7 mil orifice was tried. The first pass through the orifice, 6(a), did not result in clogging, but the flow was not steady. The second pass through the filter, 6(b), resulted in even greater erratic behavior.

Run 7 examined a larger orifice (10.39 mils). The first three passes (runs 7(a), 7(b), and 7(c)) through the orifice resulted in steady flow, leading one to conclude that an orifice size greater than 6.7 mils but less than 10.4 mils was a critical size at which clogging could occur. A higher feed tank pressure (100 psi) was used in run 7(d), but to achieve a flow rate similar to that of runs 7(a)-(c), the flow control valve was just barely cracked. Under these conditions, as in run 1, most of the pressure drop was taken across the small opening in the flow control valve rather than the orifice. The flow rate immediately began to decrease with an accompanying pressure drop

increase across the flow control valve. It was concluded that the effective opening in the valve must have been below the critical size at which clogging can occur.

Run 8 tested the JPL filter. A 6.7 mil orifice was placed downstream of the filter to see whether the presence of the filter would prevent the orifice from clogging. This was found to be the case. Perfectly normal, steady flow was observed at feed tank pressure of both 20 and 188 psig.

4.2.2.3 Sensitivities

As indicated by equation (4) in Section 3.0 the limit of detection of a gamma-emitting radioactive tracer is a strong function of several variables. However, some generalizations can be made for the conditions of measurement that prevailed in this study so that calculations with equation (4) can be made. The background (B) varied with the energy range of interest, but the overall average was about 5 counts per second. The counting efficiency (E) was about 1% with the face of the detector about one inch from the source. For the principal gamma emission the number of gammas per disintegration (F) are as follows²: Fe⁵⁹, 0.57; Cr⁵¹, 0.10; Mn⁵⁴, 1; Al²⁶, 1; Ti⁴⁴, 1; and Zn⁶⁵ 0.46. Utilizing the specific activities of Table 4 and substituting in equation (4) the detection limits can be calculated: Fe⁵⁹, 1.2×10^{-9} g; Cr⁵¹, 4.0×10^{-10} g; Mn⁵⁴, 1.7×10^{-12} g; Al²⁶, 7.3×10^{-7} g; Ti⁴⁴, 8.0×10^{-11} g; and Zn⁶⁵, 3.0×10^{-8} g.

4.3 Task 3 - Flow Diagnostics in the Liquid/Gas Phase

Consideration at a low level of effort was given to the applicability or radioisotope methods to problem areas that may arise when feed system components are exposed to liquid/gas or liquid/vapor combinations. There is a wide gamut of different potential problems associated with interactions between various components and liquid/gas combinations, and each must be individually considered. Consequently, the practical utility of an applicable method varies with the problem. Work in Task 3 was limited to only a general consideration of a few possible

techniques.

One interesting and potentially useful method deals with the capability of externally determining propellant density (and, hence, the capability of monitoring the location and movement of liquid/gas interfaces within a feed system). This is accomplished by measuring the percent absorption when a beam of gamma rays is passed through a part of the feed system containing the fluid to be checked.

Locating matter by the absorption of gamma rays suggests another useful method - leakage determination. The extent that leaking molecules attenuate a beam of rays (alphas, betas, or gammas depending on the application) in a vacuum environment can determine the degree of leakage. Another method utilizing a different approach would be to label the propellant with a low energy beta-emitting atom or add a trace of an appropriate beta-emitting substance. Beta rays emitted within the component would be completely absorbed by the metal walls; any beta rays detected external to the component would have to originate from tracer leakage. Simply positioning the detector near the suspected component would locate the leak and determine its rate. These leak determining methods would certainly not supplant the highly sensitive and useful helium leak tester, but could possibly augment established leak testing procedures.

A third tool, which is not too widely used throughout industry, involves the counting of gammas as they are formed in radiative capture reactions. In such a reaction a gamma is emitted when a neutron combines with a nucleus. An example is the nuclear reaction

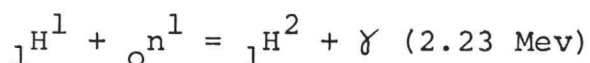

in which the irradiation of hydrogen in a reactor produces deuterium along with a 2.23 Mev gamma. Calculations indicate that this method is a highly sensitive analytical technique for hydrogen (detection

limit, about a nanogram) and other elements, although the requirement of a reactor is a minor inconvenience. The penetrability of neutrons allows one to analyze within a component without removing the contents. One possible application might be to the problem of heat soak back to the injector on shutdown of a B_2H_6 feed system. Such heat under certain circumstances can decompose B_2H_6 into higher molecular weight, solid boron hydrides, thus producing deposits in the vicinity of the injector. These deposits can be quantitatively analyzed in a very sensitive fashion for both boron and hydrogen, provided the component can be taken to a reactor and provided the component alloys do not contain elements that would yield interfering emissions.

4.4 Task 4 - Other Propellant Applications

Radioisotope methods as applied in Tasks 1 and 2 are apparently not in any way limited by the choice of propellant. While minor variations in approach may be necessary to conform to the changes in chemical and physical properties of the propellant, no basic alterations in procedure are required.

5.0 CONCLUSIONS

The successful application of neutron activation analysis to the short-lived isotopes encountered in Task 1 indicates that the method is now well advanced in its development. Small (10 gram) samples of propellant can be analyzed for Ti, Al, and V with great sensitivity (Ti, 0.01 ppm; Al, 0.0001 ppm; and V, 0.00001 ppm). Although the analysis of residues left from the evaporation of three samples of OF_2 that had contacted foils of 6Al-4V titanium for varying times indicated that small (of the order of 1 ppm or less) quantities of metal had transferred to the OF_2 , the extent of corrosion could not be correlated with time, and it was concluded that the surface attack may have been dependent on the amount of some impurity in the OF_2 (e.g., H_2O , HF, F_2 , O_2 , or SiF_4), with the amount of the impurity in each sample being controlled by subtle variations in the OF_2 handling procedure. In general activation analysis seems to possess considerable practical utility, with the major limitations being the time required to send samples to a reactor and the fact that direct activation of a liquid propellant, though feasible, may give rise to complicated operational procedures.

One important result of the Task 2 flow tests was that radioactive metal contaminants tended not to transfer throughout the system but to remain in the feed tank (adhering either to the bottom of the tank or to the surfaces of metal foils depending on the method of tracer addition). This behavior was quite the opposite of that of metal contaminants in N_2H_4 or N_2O_4 ¹ and led to the conclusions that either solubilities of metal compounds in liquid OF_2 are very small or adsorption of metal compounds on surfaces within a liquid OF_2 system readily occurs. These conclusions suggest that for the conditions prevailing in these tests, the likelihood of clogging resulting from the action of dissolved or suspended metal compounds is minimal, since there is no mechanism for producing an appreciable concentration of dissolved or suspended metal contaminants. A second important result of Task 2 was that clogging of small (6.7 mil) orifices readily occurred. Since this clogging sometimes occurred while condensing the OF_2 , it was concluded that the obstructions resulted from the solidification of nonmetallic impurities such as HF, CO_2 , or SiF_4 in or near the

orifice. These nonmetallic impurities probably constitute only a minor threat to an actual feed system, since the JPL filter was apparently successful in removing them and since, if necessary, they could be removed from the OF_2 prior to loading.

The use of radioactive tracers to diagnose clogging problems in a feed system is a method that possesses a high degree of practical utility, largely because of high sensitivity, nondestructive capability, and simplicity of equipment and procedures. (Even the use of a simple Geiger counter would provide a fairly sensitive means of monitoring externally the movement of a tracer within a feed system.) The only major disappointing feature of the method is the absence of suitable tracers of some common light elements, notably H, B, C, N, and O. Thus, the movement of several common nonmetallic impurities (e.g., CO_2) through a feed system cannot be monitored.

Other radioisotope and nuclear techniques were briefly examined in Task 3 relative to liquid/gas interactions within a feed system. Although some techniques appear promising, conclusions on their practical utility must await the appropriate tests.

In Task 4 consideration was given to applying radioisotope methods to other propellants. It was concluded that the choice of propellant did not limit the application of the methods.

6.0 RECOMMENDATIONS

The technology of neutron activation analysis seems well established with regard to activation and counting procedures. Some further work with highly reactive propellants such as liquid fluorine, which may require special handling to prepare the sample for activation, would be desirable.

Conclusions from Task 2 definitely suggest the need for further work. Data on the solubility of many substances in liquid OF_2 is lacking and such data would be very valuable to predicting and understanding potential problems of corrosion and clogging. If solubilities of metal compounds in liquid OF_2 are very low (due in part to the low temperature and in part to the lack of any ionizing, solvating, or complexing capability of OF_2), then solubilities in liquid F_2 are also likely to be low and similar solubility data should be collected for F_2 . Radioactive tracers provide an ideal means of measuring these very low solubilities. The data could then be correlated with the results from liquid fluorine flow tests.

Efforts should be made to identify the nonmetallic substance responsible for clogging the 6.7 mil orifice. This possibly could be done by monitoring the action of compounds labeled with radioactive F^{18} (half life, 1.9 hours), although the short half life would introduce experimental difficulties.

Knowledge of the conditions under which metal contaminants transfer from an alloy surface into a propellant is of considerable importance to feed system clogging studies. For those metals which do not yield long-lived gamma-emitting tracers upon neutron activation (such as Al and Ti), methods should be found which will allow the incorporation into the alloy surface of radioactive atoms from the appropriate commercially available radioactive metal (such as Al^{26} or Ti^{44}). A method which does not alter the chemical and physical nature of the surface (such as atomic exchange between radioactive tracer atoms and alloy surface atoms) is the most desirable, but conditions

under which this can be accomplished are not well known. Consequently, a study of these conditions is indicated.

Finally, the techniques identified in Task 3 need to be appraised with regard to specific systems. The most promising techniques could then be experimentally tested.

7.0 REFERENCES

1. "Application of Radioactive Tracer Techniques to Flow Decay Problems," Boeing Report D180-12741-1, Contract NAS7-779, December 1970.
2. Dzhelepov, B. S., and L. L. Peker, "Decay Schemes of Radioactive Nuclei," Pergamon Press, New York, 1961.
3. "Investigation of the Formation and Behavior of Clogging Material in Earth and Space Storable Propellants," TRW Report 08113-6025-R000, Contract NAS7-549, November, 1969.

DISTRIBUTION LIST FOR FINAL REPORT

RADIOACTIVE NON-DESTRUCTIVE TEST METHOD

CONTRACT NAS7-779

COPIES	RECIPIENT	DESIGNEE
1	NASA HEADQUARTERS WASHINGTON, D.C. 20546 CONTRACTING OFFICER	(X)
1	NASA LEWIS RESEARCH CENTER 21000 BROOKPARK RD. CLEVELAND, OHIO 44135 OFFICE OF TECHNICAL INFORMATION	(X)
1	NASA MANNED SPACECRAFT CENTER HOUSTON, TEXAS 77058 OFFICE OF TECHNICAL INFORMATION	(X)
2	NASA MARSHALL SPACE FLIGHT CENTER HUNTSVILLE, ALABAMA 35812 OFFICE OF TECHNICAL INFORMATION, MS-IP	(X)
1	TECHNICAL LIBRARY	(X)
1	DALE BURROWS S+E-ASTN-PJ	(X)
1	TECHNOLOGY UTILIZATION OFFICE, MS-T	(X)
1	NASA AMES RESEARCH CENTER MOFFET FIELD, CALIF. 94035 PATENTS AND CONTRACTS MANAGEMENT	(X)
4	JET PROPULSION LABORATORY 4800 OAK GROVE DR. PASADENA, CALIF. 91103 LOUIS TOTH	(X)
3	MANAGER, LIQUID ROCKET PROPULSION TECH., CODE RPL OFFICE OF ADVANCED RESEARCH AND TECHNOLOGY NASA HEADQUARTERS WASHINGTON, D.C., 20546	(X)
1	DIRECTOR, TECHNOLOGY UTILIZATION DIVISION	(X)

OFFICE OF TECHNOLOGY UTILIZATION
NASA HEADQUARTERS
WASHINGTON, D.C. 20546

- 25 NASA SCIENTIFIC AND TECHNICAL INFORMATION FACILITY (X)
P.O. BOX 33
COLLEGE PARK, MARYLAND 20740
- 1 DIRECTOR , LAUNCH VEHICLES AND PROPULSION , SV (X)
OFFICE OF SPACE SCIENCE AND APPLICATIONS
NASA HEADQUARTERS
WASHINGTON , D. C. 20546
- 1 DIRECTOR, ADVANCED MANNED MISSIONS, MT (X)
OFFICE OF MANNED SPACE FLIGHT
NASA HEADQUARTERS
WASHINGTON , D. C. 20546
- 1 MISSION ANALYSIS DIVISION (X)
NASA AMES RESEARCH CENTER
MOFFETT FIELD, CALIFORNIA 24035

NASA FIELD CENTERS

- 1 AMES RESEARCH CENTER HANS M. MARK
MOFFETT FIELD, CALIFORNIA 94035
- 1 GODDARD SPACE FLIGHT CENTER MERLAND L. MOSESON
GREENBELT, MARYLAND 20771 CODE 620
- 2 JET PROPULSION LABORATORY HENRY BURLAGE, JR
CALIFORNIA INSTITUTE OF TECHNOLOGY PROPULSION DIV. 38
4800 OAK GROVE DRIVE
PASADENA, CALIFORNIA 91103
- 2 JOHN F. KENNEDY SPACE CENTER, NASA DR. KURT H. DEBUS
COCOA BEACH, FLORIDA 32931
- 2 LANGLEY RESEARCH CENTER ED CORTWRIGHT
LANGLEY STATION DIRECTOR
HAMPTON, VIRGINIA 23365
- 2 LEWIS RESEARCH CENTER DIRECTOR
21000 BROOKPARK ROAD
CLEVELAND, OHIO 44135
- 2 MARSHALL SPACE FLIGHT CENTER HANS G. PAUL
HUNTSVILLE, ALABAMA 35812 CODE R-P+VED
- 2 MANNED SPACECRAFT CENTER J.G. THIBODAUX, JR.
HOUSTON, TEXAS 77058 CHIEF, PROP. + POWER DIV.
H. POHL

GOVERNMENT INSTALLATIONS

1	HEADQUARTERS, U.S. AIR FORCE WASHINGTON 25, D.C. 20546	COL.C.K. STAMBAUGH AFRST
1	ARNOLD ENGINEERING DEVELOPMENT CENTER ARNOLD AIR FORCE STATION TULLAHOMA, TENNESSEE 37388	DR. H.K. DOETSCH
2	AIR FORCE ROCKET PROPULSION LABORATORY RESEARCH AND TECHNOLOGY DIVISION AIR FORCE SYSTEMS COMMAND EDWARDS, CALIFORNIA 93523	RPRPD/MR. H. MAIN AFRPL/LKPC LT. LANTZER
1	AIR FORCE MISSILE TEST CENTER HOLLOMAN AIR FORCE BASE NEW MEXICO 45433	LIBRARY
1	AIR FORCE MISSILE TEST CENTER PATRICK AIR FORCE BASE, FLORIDA	L.J. ULLIAN
1	AERONAUTICAL SYSTEMS DIVISION AIR FORCE SYSTEMS COMMAND WRIGHT-PATTERSON AIR FORCE BASE DAYTON, OHIO 45433	D.L. SCHMIDT CODE ASRCNC-2
1	SPACE AND MISSILE SYSTEMS ORGANIZATION AIR FORCE UNIT POST OFFICE LOS ANGELES 45, CALIFORNIA 90045	COL. CLARK TECHNICAL DATA CENTER
1	DEFENSE DOCUMENTATION CENTER HEADQUARTERS CAMERON STATION, BUILDING 5 5010 DUKE STREET ALEXANDRIA, VIRGINIA 22314 ATTN- TISIA	
1	BUREAU OF NAVAL WEAPONS DEPARTMENT OF THE NAVY WASHINGTON , D. C. 20546	J. KAY RTMS-41
1	U.S. NAVAL ORDNANCE TEST STATION CHINA LAKE CALIFORNIA 93557	CODE 4562 CHIEF, MISSILE PROPULSION DIV.
1	PICATINNY ARSENAL DOVER, NEW JERSEY 07801	I. FORSTEN, CHIEF LIQUID PROPULSION LABORATORY,
1	U.S. ARMY MISSILE COMMAND REDSTONE ARSENAL ALABAMA 35809	DR. WALTER WHARTON

CPIA

1	CHEMICAL PROPULSION INFORMATION AGENCY APPLIED PHYSICS LABORATORY 8621 GEORGIA AVENUE SILVER SPRING, MARYLAND 20910	TOM REEDY
---	--	-----------

INDUSTRY CONTRACTORS

1	AEROJET-GENERAL CORPORATION P. O. BOX 296 AZUSA, CALIFORNIA 91703	W. L. ROGERS
1	AEROJET-GENERAL CORPORATION P. O. BOX 1947 TECHNICAL LIBRARY, BLDG 2015, DEPT. 2410 SACRAMENTO, CALIFORNIA 95809	R. STIFF
1	AEROJET-GENERAL CORPORATION SPACE DIVISION 9200 EAST FLAIR DR. EL MONTE, CALIFORNIA 91734	S. MACHLAWSKI
1	AEROSPACE CORPORATION 2400 EAST EL SEGUNDO BOULEVARD P. O. BOX 95085 LOS ANGELES, CALIFORNIA 90045	JOHN G. WILDER MS-2293
1	AVCO SYSTEMS DIVISION WILMINGTON, MASSACHUSETTS	HOWARD B. WINKLER
1	BATTELLE MEMORIAL INSTITUTE COLUMBUS LABORATORIES 505 KING AVENUE COLUMBUS, OHIO 43201	LIBRARY
1	BEECH AIRCRAFT CORPORATION BOULDER DIVISION BOX 631 BOULDER , COLORADO	J. H. RODGERS
1	BELL AEROSYSTEMS COMPANY P.O. BOX 1 BUFFALO, NEW YORK 14240	W. M. SMITH
1	BELLCOMM 955 L-ENFANT PLAZA, S. W. WASHINGTON, D. C.	H. S. LONDON
1	BENDIX SYSTEMS DIVISION BENDIX CORPORATION 3300 PLYMOUTH ROAD ANN ARBOR, MICHIGAN 48105	JOHN M. BRUEGER
1	BOEING COMPANY P. O. BOX 3999 SEATTLE, WASHINGTON 98124	LIBRARY
1	MISSILE DIVISION CHRYSLER CORPORATION P. O. BOX 2628 DETROIT, MICHIGAN 48231	MR. JOHN GATES

1	WRIGHT AERONAUTICAL DIVISION CURTISS-WRIGHT CORPORATION WOOD-RIDGE, NEW JERSEY 07075	G. KELLEY
1	RESEARCH CENTER FAIRCHILD HILLER CORPORATION GERMANTOWN, MARYLAND	RALPH HALL
1	REPUBLIC AVIATION CORPORATION FAIRCHILD HILLER CORPORATION FARMINGDALE, LONG ISLAND, NEW YORK	LIBRARY
1	GENERAL DYNAMICS, CONVAIR DIVISION P. O. BOX 1128 SAN DIEGO, CALIFORNIA	LIBRARY
1	MISSILE AND SPACE SYSTEMS CENTER GENERAL ELECTRIC COMPANY VALLEY FORGE SPACE TECHNOLOGY CENTER P.O. BOX 8555 PHILADELPHIA, PA.	F. MEZGER F. E. SCHULTZ
1	GRUMMAN AIRCRAFT ENGINEERING CORP. BETHPAGE, LONG ISLAND NEW YORK 11714	JOSEPH GAVIN
1	HONEYWELL, INC. AEROSPACE DIV. 2600 RIDGWAY RD MINNEAPOLIS, MINN.	MR. GORDON HARMS
1	HUGHES AIRCRAFT CO. AEROSPACE GROUP CENTINELA AND TEALE STREETS CULVER CITY, CALIF. 90230	E. H. MEIER V.P. AND DIV. MGR., RESEARCH + DEV. DIV.
1	ITT RESEARCH INSTITUTE 10 WEST 35TH STREET CHICAGO, ILLINOIS 60616	LIBRARY
1	WALTER KIDDE AND COMPANY, INC. AEROSPACE OPERATIONS 567 MAIN STREET BELLEVILLE, NEW JERSEY	R. J. HANVILLE DIR. OF RESEARCH ENGR.
1	LING-TEMCO-VOUGHT CORPORATION P. O. BOX 5907 DALLAS, TEXAS, 75222	LIBRARY
1	ARTHUR D. LITTLE, INC. 20 ACORN PARK CAMBRIDGE, MASSACHUSETTS 02140	LIBRARY
1	LOCKHEED MISSILES AND SPACE CO. ATTN-TECHNICAL INFORMATION CENTER P.O. BOX 504 SUNNYVALE, CALIFORNIA 94088	J. GULL S. DE BROCK
1	LOCKHEED PROPULSION COMPANY P. O. BOX 111	LIBRARY

REDLANDS, CALIFORNIA 92374

1 THE MARQUARDT CORPORATION LIBRARY
16555 SATICOY STREET
VAN NUYS ,CALIF. 91409

1 BALTIMORE DIVISION MR. JOHN CALATHES (3214)
MARTIN MARIETTA CORPORATION
BALTIMORE, MARYLAND 21203

1 DENVER DIVISION DR MORGANTHALER
MARTIN MARIETTA CORPORATION A. J. KULLAS
P. O. BOX 179
DENVER, COLORADO 80201

1 MCDONNELL-DOUGLAS CORP. R. A. HERZMARK
P. O. BOX 516
MUNICIPAL AIRPORT
ST. LOUIS, MISSOURI 63166

1 MIDWEST RESEARCH INSTITUTE LIBRARY
425 VOLKER BLVD
KANSAS CITY, MISSOURI 64116

1 SPACE+INFORMATION SYSTEMS DIVISION LIBRARY
NORTH AMERICAN ROCKWELL
12214 LAKEWOOD BOULEVARD
DOWNEY, CALIFORNIA 90241

1 ROCKETDYNE (LIBRARY 586-306) DR. R. J. THOMPSON
6633 CANOGA AVENUE S. F. IACOBELLIS
CANOGA PARK, CALIF. 91304

1 NORTHROP SPACE LABORATORIES DR. WILLIAM HOWARD
3401 WEST BROADWAY
HAWTHORNE, CALIFORNIA 90250

1 AERONEUTRONIC CORPORATION LIBRARY
PHILCO CORPORATION
FORD ROAD
NEWPORT BEACH, CALIFORNIA 92663

1 ASTRO-ELECTRONICS DIVISION Y. BRILL
RADIO CORPORATION OF AMERICA
PRINCETON, NEW JERSEY 08540

1 ROCKET RESEARCH F. MCCULLOUGH, JR.
YORK CENTER
REDMOND, WASHINGTON 98052

1 SCIENTIFIC SERVICE BUREAU INC T. F. SEAMANS
P. O. BOX 375
MORRISPLAINS, NEW JERSEY 07950

1 STANFORD RESEARCH INSTITUTE DR. GERALD MARKSMAN
333 RAVENSWOOD AVENUE
MENLO PARK, CALIFORNIA 94025

1	SOUTHWEST RESEARCH INSTITUTE POST OFFICE DRAWER 28510 SAN ANTONIO, TEXAS	
1	SUNSTRAND AVIATION 2421 11TH STREET ROCKFORD, ILLINOIS 61101	R. W. REYNOLDS
1	TRW SYSTEMS GROUP TRW INCORPORATED ONE SPACE PARK REDONDO BEACH, CALIF. 90278	G. W. ELVERUM
1	TAPCO DIVISION 23555 EUCLID AVENUE CLEVELAND, OHIO 44117	P. T. ANGELL
1	THIOKOL CHEMICAL CORP AEROSPACE SERVICES	LIBRARY
1	THIOKOL CHEMICAL CORPORATION HUNTSVILLE DIVISION HUNTSVILLE, ALABAMA 35807	JOHN GOODLOE
1	RESEARCH LABORATORIES UNITED AIRCRAFT CORP. 400 MAIN ST. EAST HARTFORD, CONN. 06108	ERLE MARTIN
1	HAMILTON STANDARD DIVISON UNITED AIRCRAFT CORP. WINDSOR LOCKS, CONN. 06096	MR. R. HATCH
1	UNITED TECHNOLOGY CENTER 587 METHILDA AVENUE P. O. BOX 358 SUNNYVALE, CALIFORNIA 94088	DR. DAVID ALTMAN
1	FLORIDA RESEARCH AND DEVELOPMENT PRATT AND WHITNEY AIRCRAFT UNITED AIRCRAFT CORPORATION P. O. BOX 2691 WEST PALM BEACH, FLORIDA 33402	R. J. COAR
1	VICKERS, INC. BOX 302 TROY, MICHIGAN ELKTON DIVISION BRISTOL, PENNSYLVANIA	LIBRARY