

APOLLO 11 MISSION REPORT

SUPPLEMENT 5

PERFORMANCE OF LUNAR MODULE
REACTION CONTROL SYSTEM

PREPARED BY

Propulsion and Power Division

APPROVED BY

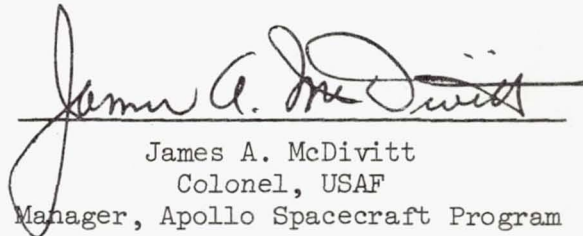

James A. McDivitt
Colonel, USAF
Manager, Apollo Spacecraft Program

NATIONAL AERONAUTICS AND SPACE ADMINISTRATION
MANNED SPACECRAFT CENTER
HOUSTON, TEXAS
December 1971

PROPULSION AND POWER DIVISION
 NASA - MANNED SPACECRAFT CENTER
 HOUSTON, TEXAS

PERFORMANCE OF THE LM RCS DURING THE
 AS-506/CSM-107/LM-5 MISSION (APOLLO 11)

DOC. NO. MSC-PA-R-69-2 DATE 8-25-69

PREPARED BY:	Donald R. Blevins
	Lonnie W. Jenkins
APPROVED BY:	(SECTION) Reaction Control
APPROVED BY:	(BRANCH OFFICE) Auxiliary Propulsion and Pyrotechnics
APPROVED BY:	(DIVISION) Propulsion and Power
APPROVED BY:	

NO. OF PAGES 34

REVISIONS

DATE	AUTHOR	APPROVALS				CHG. LETTER
		SECTION	BRANCH	DIVISION		

CONTENTS

Section	Page
SUMMARY	1
INTRODUCTION	2
FLIGHT PERFORMANCE	3
System Configuration	3
Instrumentation	3
Caution and Warning System	4
Preflight Activity	4
Flight Time Line	5
Helium Pressurization System	5
Propellant System	6
Engine Performance	6
Thermal Control	7
Propellant Utilization and Quantity Gaging	8
Thrust Chamber Pressure Switches	9
CONCLUSIONS	10
ABBREVIATIONS	10

TABLES

Table		Page
I	MAJOR LM RCS COMPONENTS	12
II	PRESSURE SWITCH CONFIGURATION SCHEDULE	13
III	LUNAR MODULE RCS MEASUREMENT LIST	14
IV	LUNAR MODULE RCS CAUTION AND WARNING LIMITS	17
V	PROPELLANT SERVICING DATA	18
VI	LUNAR MODULE RCS PRELAUNCH PRESSURE HISTORY	19
VII	FLIGHT TIME LINE	20
VIII	LUNAR MODULE RCS ΔV PERFORMANCE	21
IX	LUNAR MODULE RCS PROPELLANT CONSUMPTION SUMMARY	22
X	LUNAR MODULE RCS PROPELLANT CONSUMPTION DURING MAJOR EVENTS	23

FIGURES

Figure		Page
1	Lunar module RCS simplified schematic	24
2	Lunar module RCS mechanical schematic	25
3	Lunar module RCS component locations	26
4	Thrust chamber assembly (engine)	27
5	Thrust chamber assembly cluster (quad)	28
6	Lunar module RCS PQMD and helium tank pressure profiles	29
7	Reaction control system quads 1 and 2 temperature histories	30
8	Reaction control system quads 3 and 4 temperature histories	31
9	Comparison of predicted and actual propellant consumption	32
10	Propellant consumption from each systems A and B	33
11	Pressure switch assembly — LSC 310-651-5-1	34

PREFACE

This report is published as supplement 5 to the Apollo 11 Mission Report. This report contains a detailed analysis of lunar module reaction control system performance.

PERFORMANCE OF THE LM RCS DURING THE
AS-506/CSM-107/LM-5 MISSION (APOLLO 11)

By Donald R. Blevins and Lonnie W. Jenkins

SUMMARY

The Apollo 11 vehicle was launched from John F. Kennedy Space Center launch complex 39A at 13:32:00.6 Greenwich mean time (G.m.t.) on July 16, 1969. The command module (CM) landed in the Pacific Ocean at 16:50:35 G.m.t. on July 24, 1969. Apollo 11 was a lunar-landing mission.

The lunar module (LM) reaction control system (RCS) performed satisfactorily throughout the mission. The only problem noted was two thrust chamber pressure (TCP) switch failures. All test objectives were satisfied.

The spacecraft velocity data which were available indicated that RCS engine performance was nominal. In addition, the crew reported that engine performance was nominal throughout the mission. It is estimated that the RCS engines accumulated a total of 1060 seconds "on" time and 12 000 firings during the mission.

The thermal performance of the RCS was satisfactory. The quad temperatures ranged from 132° to 232° F during the period when the heaters were active. All temperatures were within predicted ranges.

The total propellant consumption from the RCS tanks was about 319 pounds, compared to a predicted value of 253 pounds. An additional 69 pounds of propellant were used from the ascent propulsion system (APS) tanks during interconnect feed operations associated with APS lift-off. Slight propellant quantity measuring device (PQMD) overshoots were noted following periods of rapid propellant usage; the maximum overshoot was approximately 9 pounds on a single system.

The switch used to monitor the thrust chamber pressure on the quad 1 down-firing engine failed in the closed position for approximately 3 minutes during powered descent and then returned to normal operation for the remainder of the mission. The switch used to monitor the quad 2 aft-firing engine failed to respond to seven consecutive minimum-impulse commands just prior to terminal phase initiation (TPI). This resulted in a

master alarm and a thrust chamber assembly (TCA) warning flag which were quickly reset by the crew. Engine performance was nominal on both of the above engines, and the switch failures had no affect on the mission.

During the postflight debriefing, the crew reported that the overall performance of the RCS was satisfactory.

INTRODUCTION

This report on the performance of the LM RCS is a supplement to the Apollo 11 mission report. Apollo 11 was the first manned lunar landing mission. Lift-off occurred at 13:32:00.6 G.m.t. on July 16, 1969, and splashdown occurred in the Pacific Ocean at 16:50:35 G.m.t. on July 24, 1969. The total mission covered a period of 195:18:35 hours. The crewmembers were Neil Armstrong, commander; Michael Collins, command module pilot; and Edwin Aldrin, lunar module pilot.

The mission was a "G" type mission with objectives as defined in Change C of the Mission Requirements Document, "G" Type Mission, Lunar Landing. The primary purpose of the mission was to perform a manned lunar landing and return. Determination of the effects on the LM structure and components caused by RCS plume impingement during lunar landing was the only detailed test objective (DTO) involving the LM RCS.

The Apollo Mission G plan consisted of the following 12 periods of activities:

1. Launch to earth orbit
2. Translunar injection
3. Translunar coast
4. Lunar orbit insertion
5. Lunar module descent
6. Lunar landing site
7. Lunar surface operations
8. Lunar module ascent
9. Transearth injection
10. Transearth coast

11. Entry and recovery
12. Postlanding operations

The LM RCS was used in the lunar module descent and ascent activities which included the following operations. Two astronauts entered the LM and checked out the LM for separation from the command and service module (CSM). The CSM was separated from the LM using the SM RCS. The LM descent propulsion subsystem (DPS) was used for descent to the lunar surface. Powered ascent was accomplished using the APS and resulted in a 9- by 45-nautical-mile elliptical orbit. Subsequent LM maneuvers required for docking were accomplished by the LM RCS. Once docked to the CSM, the two LM crewmen transferred to the CSM with the lunar samples and exposed film. The LM/CSM separation was performed by using the SM RCS.

FLIGHT PERFORMANCE

System Configuration

A LM-5 RCS simplified schematic and complete mechanical schematic are shown in figures 1 and 2, respectively. Figure 3 illustrates the location of the RCS components relative to the LM structure. Figures 4 and 5 are illustrations of the RCS thrust chamber assembly (engine) and the thrust chamber assembly cluster (quad). Table I includes the specification numbers of the major LM RCS components. There were no configuration changes between the LM-4 and LM-5 vehicles. The only planned change from the LM-5 configuration for LM-6 and subsequent vehicles is the thrust chamber pressure switches which will be changed as shown in table II.

Instrumentation

The LM-5 RCS measurement list is included in table III; figure 2 illustrates the locations of the various measurements in the system. The only instrumentation problem noted during the mission involved the TCP switches. One switch failed closed for about 3 minutes during powered descent initiation (PDI) and another exhibited slow response to engine commands throughout most of the mission. These failures had no effect on the mission and will be discussed in detail in the "Thrust Chamber Pressure Switches" section of this report.

Caution and Warning System

The RCS measurements monitored by the caution and warning system (C&W) and their associated trip limits are included in table IV. The reader should note that the TCP switches are considered to be part of the RCS, not part of the C&W.

The crew reported that LM RCS TCA warning flags were displayed on the 4A, 2A, and 4B thruster pair isolation valve talkbacks. The 4A and 2A flags occurred simultaneously during an attitude/translation maneuver associated with LM stationkeeping. The 4B flag occurred shortly thereafter and twice more just prior to PDI. In each case the flags were reset by cycling the caution and warning electronic assembly (CWEA) circuit breaker. The flags could not be removed by tapping the control panel. The crew also stated that, as best they could recall, the flags were accompanied by master alarms. The 4B flag appeared to be overly sensitive and did not occur during attitude/translation maneuvers. No TCP switch failures, illegal engine "on" combinations or master alarms were observed in the telemetry (TM) data which were available during the time periods mentioned. It should be noted that engine command and TCP switch bilevels were available during only portions of stationkeeping and pre-PDI time periods; however, master alarm data were available for all of the stationkeeping period and only portions of the pre-PDI period. Because of the nature of the flags (simultaneous and overly sensitive) and the fact that no master alarms were observed in the TM data, it appears that the flags were caused by erroneous CWEA or display flag operation rather than valid TCA warnings.

During an 18-minute period just prior to TPI (126:26 to 126:44), the A2A TCP switch failed to respond to seven consecutive minimum-impulse commands. This resulted in a master alarm and a TCA warning flag which were both quickly reset by the crew. Engine performance was nominal on the A2A engine; consequently, the engine failure indication was the result of a TCP switch failure which will be discussed later. Apparently the crew did not perform any investigative procedures to ascertain if the engine had actually failed.

Preflight Activity

The LM 5 RCS propellant tanks and propellant manifolds were loaded in the following sequence to the values shown in table V:

1. The RCS manifolds were evacuated and the cluster isolation valves were closed at 0000 eastern daylight time (e.d.t.), June 18, 1969.
2. The RCS fuel and oxidizer tanks were loaded on June 19 and June 22, 1969, respectively. Nominal ullages were drawn and a blanket pressure of about 50 psia was set.

3. The system A fuel and oxidizer manifolds were reevacuated at 0300 e.d.t. on July 9, 1969.

4. The interconnect valves were opened to fill the manifolds from the APS interface down to the isolation valves; the secondary interconnect valves were then closed. The main shutoff valves were opened at 0930 e.d.t. on July 11, 1969.

5. The isolation valves were opened to fill the manifolds to the engine valves at 1245 e.d.t. on July 14, 1969.

Helium loading was completed at about 2200 e.d.t. on July 11, 1969. The helium loads were 3043 psia at about 73° F on both system A and system B. The nominal load is 3050 psia at 70° F (1.03 lbm of helium), and the PQMD calibrations were based on a nominal load. Therefore, both PQMD should have indicated slightly lower than normal throughout the mission. This was not the case since the PQMD initially indicated 101.4 and 103.5 percent (nominal is 102.9 percent) on systems A and B, respectively. Therefore, there were apparently slight biases in the PQMD readings since the helium tank pressure decreased an equal amount at pressurization, indicating equal ullages and propellant loads.

Table VI is a summary of the preflight system pressure histories. After initial evacuation, the system A manifold pressures increased to 4.2 and 5.5 psia for the system A fuel and oxidizer manifolds, respectively. The system A manifolds were reevacuated prior to manifold priming. The maximum leakage rate observed was within allowable limits. The gradual increase in regulator outlet pressure during the prelaunch period was within the allowable check valve reverse leakage limits. All prelaunch helium and propellant manifold pressures were nominal.

Flight Time Line

Table VII contains a list of the major mission events and activities pertinent to the LM RCS.

Helium Pressurization System

The helium pressurization system performance was nominal throughout the mission. The helium squib valves were actuated at 98:47:29 ground elapsed time (g.e.t.) to pressurize the RCS propellant tanks and manifolds to operating pressure. Operating pressure was reached in all manifolds in about 2 seconds. The regulators maintained acceptable outlet pressures (between 178 and 184 psia) throughout the mission. No evidence of external leakage was observed.

Figure 6 is a comparison of the system A and system B helium tank pressures and PQMD outputs for the portions of the mission which required LM RCS operation. The close relationships between tank pressure and the PQMD output are evident from the figure. As the result of helium cooling, the helium tank pressures and the PQMD overshoot following periods of rapid propellant consumption. The overshoots ranged as high as 83 psi and 3.0 percent (9 pounds of propellant) on the tank pressures and PQMD, respectively.

Propellant System

The propellant supply system functioned normally throughout the mission. No evidence of propellant leakage was noted. Normal RCS propellant manifold pressure was 178 to 181 psia in both the fuel and oxidizer manifolds. During ascent interconnect operations associated with APS lift-off, the manifold pressure was 186 to 188 psia. Since the RCS manifold pressure telemetry sample rate was only 1 sample per second, the RCS manifold pressure fluctuations associated with engine firings could not be evaluated. During rendezvous, the system B oxidizer manifold experienced manifold pressure fluctuation extremes of 99 to 305 psia. These values are within the extremes of 86 to 329 psia experienced in ground tests simulated mission duty cycles.

The crew reported that RCS propellant solenoid valve talkbacks did not produce a correct indication of valve position when the valves were energized. This is normal operation for the Parker valves. The main shutoff valves, crossfeed valves, and thruster pair isolation valves will read gray (open) while they are energized regardless of the actual position of the valves. Under normal operation (primaries open and secondaries closed) the interconnect valve talkbacks will read barberpole (closed) while the primaries are energized and gray while the secondaries are energized. However, if the primaries are closed and the secondaries are open, the interconnect talkbacks will read gray while the primaries are energized and barberpole while the secondaries are energized. If both the primaries and secondaries are open (during interconnect feed operation), the talkbacks will remain gray while either the primaries or secondaries are energized closed. In each of the cases mentioned, a true indication of valve position will return as soon as the energizing power is removed.

Engine Performance

Engine performance was reported by the crew as nominal throughout the mission. Specific performance data were limited; however, the available data contained no indication of other than nominal operation. Accurate performance data were available for only the quads 1 and 3

down-firing engines and the quads 2 and 3 aft-firing engines. No accurate performance data were available from the attitude control firings because of the combination of low sample rate, short pulse widths, and rate gyro insensitivity.

The calculated performance values are summarized in table VIII for the major LM maneuvers. The " ΔV expected" values were based on the summation of the engine ontimes corrected for attitude control firings and the engine effective thrust corrected for predicted plume impingement losses. The " ΔV actual" data were simply the summation of the computer word pulse integrating pendulous accelerometer (PIPA) counts converted to feet per second. The "average effective thrust" values were calculated using the vehicle mass, the indicated ΔV (computer word PIPA counts), and the engine ontimes.

The data in table VIII are presented as a maximum and minimum effective thrust. This was necessary because the ΔV data (PIPA counts) are telemetered once every 2 seconds in whole numbers only. The PIPA registers are then zeroed, thus any fractional counts are lost. The minimum thrust values were calculated assuming that the lost fractional counts were zero, whereas the maximum values assumed the loss was 0.9999 counts per 2 seconds. As a result, an actual check against the predicted thrust loss of down engine firings with the unstaged vehicle was not available. The loss, because of plume impingement on the RCS plume deflectors installed on the LM descent stage, was predicted to be 10.4 pounds on all the down-firing engines. The discrepancies between actual and expected ΔV can be attributed to difference between actual and nominal engine thrust. The average steady-state thrust on three manned lunar modules has been 103.0 pounds instead of the nominal 100 pounds. The increased thrust is the result of higher engine inlet pressure on the actual RCS (about 178 psia) than was used in single engine performance testing (about 172 psia).

The lack of complete data coverage plus the occasional noise in the available jet-driver bilevels made it impossible to determine exact values for total firing time and total number of firings. However, a rough estimate of the total burn time through LM jettison is 1060 seconds based on total propellant consumed. The estimated number of pulses is 12 000 based on an assumed 50-millisecond average pulse width exclusive of steady-state firings.

Thermal Control

The thermal performance of the RCS was satisfactory throughout the mission. When the engine heaters were active, the quad temperatures ranged from 132° to 232° F. All temperatures were within predicted ranges. When the engine heaters were not active (during the initial

cabin entry at 83:00 g.e.t.), quad temperatures ranged from 71° to 83° F, well above the freezing points of the propellants (18° to 21° F for the fuel and 12° F for the oxidizer). Unfortunately, the exact quad warmup time (time from heater activation to steady-state temperature) was not available because of limited station coverage. The RCS fuel tank temperatures ranged from 68° to 71° F throughout the mission. The quad temperatures during the mission are shown in figures 7 and 8.

Propellant Utilization and Quantity Gaging

A comparison of the total RCS propellant consumption profile with the flight plan predicted profile is included in figure 9. The propellant consumption was measured by the onboard PQMD and ground calculated pressure-volume-temperature (PVT) analysis. Results of the PVT analysis and data from the PQMD were in close agreement during all phases of the mission. Both the PQMD and PVT measurements were subject to overshoot resulting from rapid helium cooling during periods of high propellant usage. The PQMD overshoots are evident in figures 9 and 10. Figure 6 illustrates the relationship between helium tank pressure and PQMD output. As previously noted, the maximum PQMD overshoot was about 9 pounds on a single system.

Figure 10 includes individual system propellant consumption profiles as determined by the onboard PQMD. The maximum imbalance between system A and system B usage during rendezvous and docking was about 48 pounds and occurred at docking with system B having the greater usage. About 25 pounds of the imbalance were the result of the RCS constant delta height (CDH) maneuver and the ullages for the DPS descent orbit insertion (DOI) and DPS PDI maneuvers which used system B propellant exclusively. The remainder of the imbalance was primarily the result of the final midcourse corrections and braking maneuvers required for docking.

Systems A and B were used in the ascent interconnect mode during the APS lift-off burn. As an additional precaution, the crossfeed valves were opened during interconnect operation. Approximately 69 pounds of propellant were used from the APS propellant supply.

Table IX is a summary of the LM RCS propellant loaded, consumed, and remaining. Table X is a breakdown of RCS propellant consumption associated with the major mission events. Propellant consumption measured by the onboard PQMD during manned operations was 319 pounds, compared to a predicted value of 253 pounds. About 57 pounds of the excess usage occurred during powered descent. Total consumption was about 230 pounds less than the total 549 pounds of guaranteed usable propellant.

Thrust Chamber Pressure Switches

The switch used to monitor thrust chamber pressure on the quad 1 down-firing engine (BID) failed in the closed position for about 3 minutes during powered descent (102:41:37 to 102:44:30 g.e.t.) and then returned to normal operation for the remainder of the mission. The switch used to monitor the quad 2 aft-firing engine (A2A) exhibited slow response to jet driver commands during most of the mission. During an 18-minute period just prior to TPI (126:26 to 126:44 g.e.t.), the switch failed to respond to seven consecutive minimum-impulse commands. This resulted in a master alarm and a TCA warning flag which were both quickly reset by the crew. The TCA flag was reset by cycling the CWEA circuit breaker rather than cycling the isolation valves. Engine operation was nominal on both of the above engines, and the switch failures had no affect on the mission. Apparently, the crew did not attempt any investigative procedures to see if the A2A engine had actually failed. A section drawing of the switch is shown in figure 11.

The failure mode for the BID switch is believed to be the same as that of the LM-3 and LM-4 units and several others during ground testing. Particulate contamination and/or propellant residue is forced into the switch diaphragm flexure cavity by chamber pressure and holds the diaphragm deflected and the electrical contacts closed. The small stroke of the diaphragm (0.007 inch) and the low diaphragm restoring force generated by the negative-rate return spring make the switch extremely susceptible to failure by contamination. The only consequence of a failure of this type is the loss of capability to detect an engine failed "off."

The A2A switch failure was the first of its type to be observed in flight or in ground testing. The switch closing response (time of jet driver "on" command to switch closure) appeared to increase from an average of about 15 to 20 milliseconds during stationkeeping to a value of 25 to 30 milliseconds at the time of failure. Normal switch closing response is 10 to 12 milliseconds based on ground test results. The closing response remained at the 25- to 30-millisecond level following the failure and continued to fail to respond to some minimum-impulse commands. The switch opening time (time from jet driver "off" command to switch opening) appeared to be normal throughout the mission. In view of these results, it appears that the most probable cause of the switch failure was particulate contamination in the inlet passage of the switch. Contamination in this area would reduce the flow rate of chamber gases into the diaphragm cavity, thus reducing the switch closing response. However, the contamination would not necessarily affect switch opening response since normal chamber pressure tailoff requires approximately 30 to 40 milliseconds to decrease from approximately 30 psia to the normal switch opening pressure of approximately 4 psia. The 30- to 40-millisecond time period would probably be sufficient to allow the gases in the diaphragm cavity to vent such that switch opening would occur normally.

An "open" failure of the nature experienced on the A2A switch is a potentially serious problem since an erroneous TCA failure indication could be produced during a critical mission phase. This could cause a needless mission abort and/or further loss of confidence in the C&W. As a corrective action, future crews will be briefed never to abort a mission because of a TCA flag alone. All flags must be verified by vehicle dynamics before considering an abort.

CONCLUSIONS

The LM RCS performance was satisfactory during the Apollo 11 mission, and the system demonstrated the capability to perform a lunar-landing mission. The only hardware problem noted was the "closed" failure of the BID TCP switch and the probable "open" failure of the A2A switch. The switch failures did not affect the mission or RCS performance.

ABBREVIATIONS

AGS	abort guidance system
APS	ascent propulsion system
BID	engine thrust chamber pressure switch
CDH	constant delta height
CES	control electronics section
CM	command module
CSI	coelliptic sequence initiation
CSM	command and service module
C&W	caution and warning system
CWEA	caution and warning electronic assembly
DOI	descent orbit insertion
DPS	descent propulsion system
DTO	detailed test objective
e.d.t.	eastern daylight time
GAEC	Grumman Aircraft Engineering Corporation
g.e.t.	ground elapsed time
G.m.t.	Greenwich mean time
ISOV	isolation shutoff valve
LLM	lunar landing mission
LM	lunar module
MSOV	main shutoff valve
O/F	oxidizer-to-fuel ratio
oxid	oxidizer

PDI powered descent initiation

PIPA pulse integrating pendulous accelerometer

PIT preinstallation test

PQMD propellant quantity measuring device

PVT pressure-volume-temperature

reg regulator

RCS reaction control system

TCA thrust chamber assembly

TCP thrust chamber pressure

TM telemetry

TPI terminal phase initiation

ΔV velocity change

TABLE I.- MAJOR LM RCS COMPONENTS

Description	GAEC spec no.
Helium tank (2)	LSC 310-301
Helium squib valve (4)	LSC 310-302
Helium filter (2)	LSC 310-303
Helium regulator (2)	LSC 310-305
Check valve (4)	LSC 310-306
Relief valve (4)	LSC 310-307
Propellant tank (4)	LSC 310-405
Main shutoff valve (4)	LSC 310-403
Ascent interconnect valve (8)	LSC 310-403
Crossfeed valve (2)	LSC 310-403
Cluster isolation valve (16)	LSC 310-403
Propellant inline filter (16)	LSC 310-125
Thruster heater (32)	LSC 310-601
Thrust chamber pressure switch (16)	LSC 310-651
Engine (16)	LSC 310-130

TABLE II.- PRESSURE SWITCH CONFIGURATION SCHEDULE

Part number	Effectivity	Changes cumulative
LSC 310-651-5	Basic design	Backup for Belleville washer added
LSC 310-651-5-1	LM-2 through LM-5 PA-1 5 only	Teflon sleeve added to pigtail
LSC 310-651-5-2	PA-1 11 only	Electron beam welded closure hole and diaphragm
LSC 310-651-5-3	LM-6	Diaphragm weld aged. Thermal cycled and pressurization tested at GAEC
LSC 310-651-5-4	LM-7	Hole drilled in cover to facilitate potting and inspection of weld
LSC 310-651-5-5	LM-3 2 only, LM-8 and subs	Thermal cycled and pressurization tested at the vendor during acceptance test. Only PIT tested at GAEC.

NOTE: See figure 11 for section drawing of switch.

TABLE III.- LUNAR MODULE RCS MEASUREMENT LIST

Measurement no.	Description	Telemetry data						Onboard display			
		Low	High	Units	Sample rate, Hz	Type recording	rss accuracy, percent	Low	High	Units	rss accuracy, eu
GR1085Q	Prop A quantity	0 *	100	percent	1	L/H	4.0	0	100	percent	4.5
GR1095Q	Prop B quantity	0	100	percent	1	L/H	4.0	0	100	percent	4.5
GR1101P	A He tank press	0	3500	psia	1/1	L/H	2.0	0	3500	psia	2.6
GR1102P	B He tank press	0	3500	psia	1/1	L/H	2.0	0	3500	psia	2.6
GR1201P	A He regulator press	0	350	psia	1	L/H	2.0	0	350	psia	2.6
GR1202P	B He regulator press	0	350	psia	1.1	L/H	2.0	0	350	psia	2.6
GR2121T	A fuel tank temp	20	120	°F	1/1	L/H	2.8	20	120	°F	3.4
GR2122T	B fuel tank temp	20	120	°F	1/1	L/H	2.8	20	120	°F	3.4
GR2201P	A fuel manifold press	0	350	psia	1/1	L/H	1.9	0	350	psia	10.2
GR2202P	B fuel manifold press	0	350	psia	1/1	L/H	1.9	0	350	psia	10.2
GR3201P	A oxid manifold press	0	350	psia	1/1	L/H	1.9	0	350	psia	10.2
GR3202P	B oxid manifold press	0	350	psia	1/1	L/H	1.9	0	350	psia	10.2
GR5031X	TCP switch B4U		1 = on		200	E, H					
GR5032X	TCP switch A4D		1 = on		200	E, H					
GR5033X	TCP switch B4F		1 = on		200	E, H					
GR5034X	TCP switch A4R		1 = on		200	E, H					
GR5035X	TCP switch A3U		1 = on		200	E, H					
GR5036X	TCP switch B3D		1 = on		200	E, H					
GR5037X	TCP switch B3A		1 = on		200	E, H					
GR5038X	TCP switch A3R		1 = on		200	E, H					
GR5039X	TCP switch B2U		1 = on		200	E, H					
GR5040X	TCP switch A2D		1 = on		200	E, H					
GR5041X	TCP switch A2A		1 = on		200	E, H					
GR5042X	TCP switch B2L		1 = on		200	E, H					

NOTE: H = High bit rate
 L = Low bit rate
 E = Event
 G = Gray
 BP = Barberpole
 eu = Engineering units

TABLE III.- LUNAR MODULE RCS MEASUREMENT LIST - Continued

Measure- ment no.	Description	Telemetry data						Onboard display			
		Low	High	Units	Sample rate, Hz	Type record- ing	rss accuracy, percent	Low	High	Units	rss accuracy, eu
GR5043X	TCP switch ALU		1 = on		200	E, H					
GR5044X	TCP switch BLD		1 = on		200	E, H					
GR5045X	TCP switch ALF		1 = on		200	E, H					
GR5046X	TCP switch BLL		1 = on		200	E, H					
GR6001T	Quad 4 temp	-60	260	°F	1/1	L/H	2.2	-60	260	°F	7.1
GR6002T	Quad 3 temp	-60	260	°F	1/1	L/H	2.2	-60	260	°F	7.1
GR6003T	Quad 2 temp	-60	260	°F	1/1	L/H	2.2	-60	260	°F	7.1
GR6004T	Quad 1 temp	-60	260	°F	1/1	L/H	2.2	-60	260	°F	7.1
GR9609U	RCS main A closed		1 = closed		1/1	E, L/H		Panel monitor (G = open, BP = closed)			
GR9610U	RCS main B closed		1 = closed		1/1	E, L/H		Panel monitor (G = open, BP = closed)			
GR9613U	A/B crossfeed open		1 = open		1/1	E, L/H		Panel monitor (G = open, BP = closed)			
GR9631U	Ascent feed A fuel open		1 = open		1/1	E, L/H		Panel monitor (G = open, BP = closed)			
GR9632U	Ascent feed B fuel open		1 = open		1/1	E, L/H		Panel monitor (G = open, BP = closed)			
GR9641U	Ascent feed A oxid open		1 = open		1/1	E, L/H		Panel monitor (G = open, BP = closed)			
GR0642U	Ascent feed B oxid open		1 = open		1/1	E, L/H		Panel monitor (G = open, BP = closed)			
GR9661U	A4 isolation valves closed		1 = closed		1	E, H		Panel monitor (G = open, BP = closed)			
GR9662U	B4 isolation valves closed		1 = closed		1	E, H		Panel monitor (G = open, BP = closed)			
GR9663U	A3 isolation valves closed		1 = closed		1	E, H		Panel monitor (G = open, BP = closed)			

NOTE: H = High bit rate
 L = Low bit rate
 E = Event
 G = Gray
 BP = Barberpole
 eu = Engineering units

TABLE III.- LUNAR MODULE RCS MEASUREMENT LIST - Concluded

Measurement no.	Description	Telemetry data					Onboard display				
		Low	High	Units	Sample rate, Hz	Type recording	rss accuracy, percent	Low	High	Units	rss accuracy, eu
GR9664U	B3 isolation valves closed		1 = closed		1	E, H					Panel monitor (G = open, BP = closed)
GR9665U	A2 isolation valves closed		1 = closed		1	E, H					Panel monitor (G = open, BP = closed)
GR9666U	B2 isolation valves closed		1 = closed		1	E, H					Panel monitor (G = open, BP = closed)
GR9667U	A1 isolation valves closed		1 = closed		1	E, H					Panel monitor (G = open, BP = closed)
GR9668U	B1 isolation valves closed		1 = closed		1	E, H					Panel monitor (G = open, BP = closed)

NOTE: H = High bit rate
 L = Low bit rate
 E = Event
 G = Gray
 BP = Barberpole
 eu = Engineering units

TABLE IV.- LUNAR MODULE RCS CAUTION AND WARNING LIMITS

Measurement no.	Description	Theoretical CW limits, psia		Indicator lights
		Low	High	
GR1101P	A He tank pressure	1696		RCS caution
GR1102P	B He tank pressure	1696		RCS caution
GR1201P	A He regulator pressure	164.4	204.3	RCS A reg. warning
GR1202P	B He regulator pressure	164.4	204.3	RCS B reg. warning
GR5031X to GR5046X	Thrust chamber pressure switches ^a			RCS TCA warning and red quad flag

^aTCA failure detection system — signals engine "on" or "off" failure subject to following logic:

1. Off failure — One on-command greater than 80 msec or six consecutive on-commands of less than 80 msec with no corresponding TCP switch response signalling a TCA failure (failure signaled on 7th pulse).
2. On failure - Opposing engine on-commands combinations, in the table shown to the right, signal a TCA failure.

THRUSTER FAILED ON	ON COMMAND SIGNALS																
	A1U	B1D	A1F	B1L	B2U	A2D	A2A	B2L	A3U	B3D	B3A	A3R	B4U	A4D	B4F	A4R	
A1U	●	●							●								
B1D	●	●								●							
A1F			●					●									●
B1L				●					●								●
B2U					●	●									●		
A2D					●	●											●
A2A			●					●			●						
B2L				●				●				●					
A3U	●								●	●		●					
B3D		●								●	●						
B3A							●				●						●
A3R								●				●					●
B4U					●								●	●			●
A4D						●								●	●		●
B4F			●									●					●
A4R				●									●				●

TABLE V.- PROPELLANT SERVICING DATA

Parameter	System A fuel	System A oxidizer	System B fuel	System B oxidizer
Required load, lb	107.7 ± 0.9	208.8 ± 1.9	107.7 ± 0.9	208.8 ± 1.9
Ullage requirement, in ³	117 ± 6	231.5 ± 6	117 ± 6	231.5 ± 6
Actual load, lb	107.7	208.8	107.7	208.8
Actual ullage, in ³	117	231.5	117	231.5
Trapped manifolds, lb	5.3 to 5.4	8.5 to 8.8	5.3 to 5.4	8.5 to 8.8
Trapped in tanks, lb	1.0 to 2.1	2.0 to 4.0	1.0 to 2.1	2.0 to 4.0
Nominal deliverable ^a	100.8	197.1	100.8	197.1

^aThe O/F ratio uncertainty not included.

TABLE VI.- LUNAR MODULE RCS PRELAUNCH PRESSURE HISTORY

Date	Eastern daylight time	A helium tank pressure, psia	B helium tank pressure, psia	A regulator pressure, psia	B regulator pressure, psia	A fuel tank temperature, °F	B fuel tank temperature, °F	A fuel manifold pressure, psia	A oxid manifold pressure, psia	B fuel manifold pressure, psia	B oxid manifold pressure, psia	Remarks
6-18-69	0000							0.0	1.4	0.0	0.0	Manifold evacuation
6-21-69	1530			18.0	16.6			1.4	5.5	0.0	0.0	
7-9-69				23.5	20.8			4.2	5.5	0.0	1.4	Prior to A manifold reevacuation
7-9-69	0300			23.5	20.8			1.4	1.4	0.0	1.4	A manifolds reevacuated
7-11-69	0930			24.9	22.1			47.0	51.2	49.8	51.2	Interconnects closed and MSOV's open
7-14-69	1000			26.3	23.5			48.4	54.0	51.2	54.0	Helium loaded at 2200 on 7-11-69
7-14-69	1245							38.7	48.4	40.1	48.4	MSOV's and ISOV's open
7-15-69	1040	3057	3057	26	25	75	73	38	52	41	51	
7-16-69	0800	3043	3043	26	25	73	72	38	50	41	50	Prelaunch
7-19-69		3030	3030	28	26	71	70	38	49	40	47	First flight data (83:06:07 g.e.t.)

TABLE VII.- FLIGHT TIME LINE

Event	Start (g.e.t.), hr:min:sec	End (g.e.t.), hr:min:sec	Duration, sec
Lift-off (13:32:00 G.m.t.)	00:00:00.6		
RCS pressurization	98:47:29		
RCS hotfire no. 1	99:20:39		
LM/CSM undocking	^a 100:13:38		
DPS DOI ullage (2 engine-B)	^a 101:36:07.6	^a 101:36:15.1	^a 7.5
DPS DOI maneuver	^a 101:36:14.7	^a 101:36:44.5	^a 29.8
DPS PDI ullage (2 engine-B)	102:32:57.6	102:33:05.6	8.0
DPS PDI maneuver	102:33:05.2	102:45:42.2	757.0
Lunar landing	102:45:39.9		
RCS hotfire no. 2	122:38:35.5		
APS lift-off	124:22:00.8	124:29:15.7	434.9
RCS CSI maneuver (2 engine, +Z)	^a 125:19:36	^a 125:20:23	^a 47.0
RCS CDH maneuver (2 engine, +X, B)	126:17:49.6	126:18:03.6	^b 14.0
RCS TPI maneuver (2 engine, +Z)	127:03:51.8	127:04:14.5	22.7
LM/CSM docking	^a 128:03:00		
LM jettison	130:09:31.2		
CM landing	195:18:35		

^aTimes unverified by reduced data.

^bBurn followed by 3.8 seconds +X trim.

TABLE VIII.- LUNAR MODULE RCS ΔV PERFORMANCE

Event	g.e.t., hr:min:sec	Engines	Firing duration, sec	Vehicle weight, lb	ΔV expected, ft/sec (a)	ΔV actual from PIPA, ft/sec (b)	Average effective thrust (min. and max. value, lb) (b)
DPS DOI ullage	101:36:07.6	1,3 down	7.51	33 647	^c 1.29	No data available	No data available
DPS PDI ullage	102:32:57.6	1,3 down	8.0	33 329	1.40	1.37 to 1.54	^d 87.7 to 98.6
RCS CSI maneuver	125:19:36	2,3 aft	47.0	5 878	^c 51.50	No data available	No data available
RCS CDH maneuver	126:17:49.6	1,3 down	14.0	5 837	15.47	15.82 to 16.21	102.2 to 104.8
RCS TPI maneuver	127:03:51.8	2,3 aft	22.7	5 820	24.94	25.50 to 26.00	102.2 to 104.3

^aBased on expected effective thrust and firing duration corrected for attitude control.

^bMaximum and minimum thrust value stated because PIPA data are printed out every 2 seconds in whole numbers only, then rezeroed; thus, fractional counts are lost.

^cFiring performed between stations; therefore, the expected ΔV is only an estimate and the actual ΔV was not available.

^dEffective thrust with unstaged vehicle because of plume impingement is predicted to be 89.6 pounds for all down-firing engines.

TABLE IX.- LUNAR MODULE RCS PROPELLANT CONSUMPTION SUMMARY

[O/F ratio assumed to be 1.94]

Parameter	Fuel, lb	Oxidizer, lb
Loaded		
System A	108	209
System B	108	209
Consumed from RCS supply ^a		
System A	46	90
System B	62	121
Remaining at LM jettison (130:10 g.e.t.)		
System A	62	119
System B	46	88

^aValues are based on onboard propellant quantity measuring device results.

NOTE: A portion of the RCS propellants was supplied from the APS tanks during APS lift-off. A summary of RCS propellant usage from the APS tanks is as follows:

Oxidizer, lb	46
Fuel, lb	23
Total, lb ^b	69

^bNumbers are based on engine ontime and flow-rate data.

TABLE X.- LUNAR MODULE RCS PROPELLANT CONSUMPTION DURING MAJOR EVENTS

Event	g.e.t., hr:min:sec		PQMD results, lb			
	From	To	System A	System B	Total A + B	Accumulated RCS total
RCS hotfire no. 1	99:20:00	100:13:00	5.3	5.0	10.3	10.3
Undocking and station- keeping	100:13:00	101:27:00	10.0	10.0	20.0	30.3
DPS DOI maneuver	101:27:00	102:28:00	2.3	12.6	14.9	45.2
DPS PDI maneuver	102:28:00	102:46:00	46.8	51.5	98.3	143.5
RCS hotfire no. 2	122:38:00	124:22:00	2.3	2.6	4.9	148.4
APS lift-off (normal feed) ^a	124:22:00	125:04:00	11.5	11.5	23.0	171.4
RCS CSI maneuver	125:04:00	125:58:00	18.8	22.3	41.1	212.5
RCS CDH maneuver	125:58:00	126:30:00	2.4	15.3	17.7	230.2
RCS TPI maneuver	126:30:00	127:04:17	12.6	13.8	26.4	256.6
TPI through docking	127:05:00	129:00:00	23.8	38.9	62.7	319.3

^aAscent interconnect operation during APS lift-off resulted in an additional 69 pounds usage from the APS propellant tanks.

NOTE: Table values represent total quantity of propellant consumed during the time intervals shown, not just during the event listed (figs. 9 and 10).

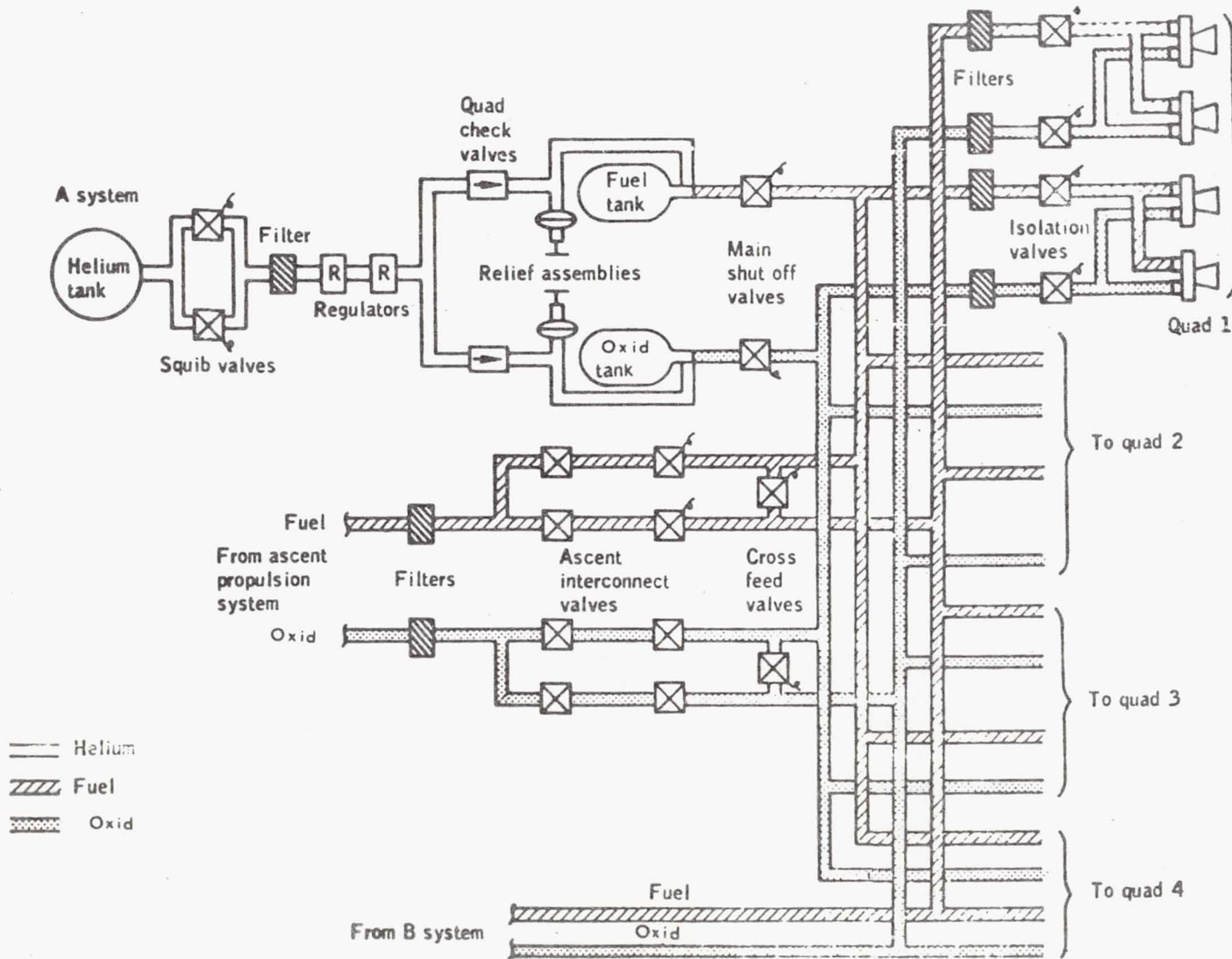

Figure 1.- Lunar module RCS simplified schematic.

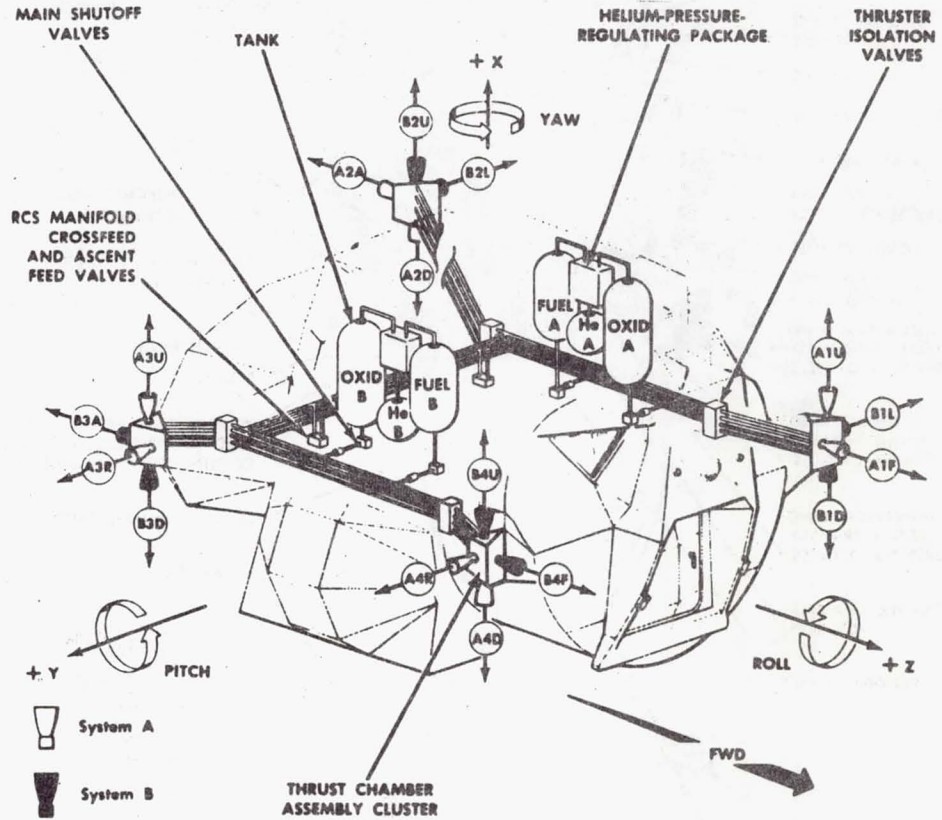

Figure 3.- Lunar module RCS component locations.

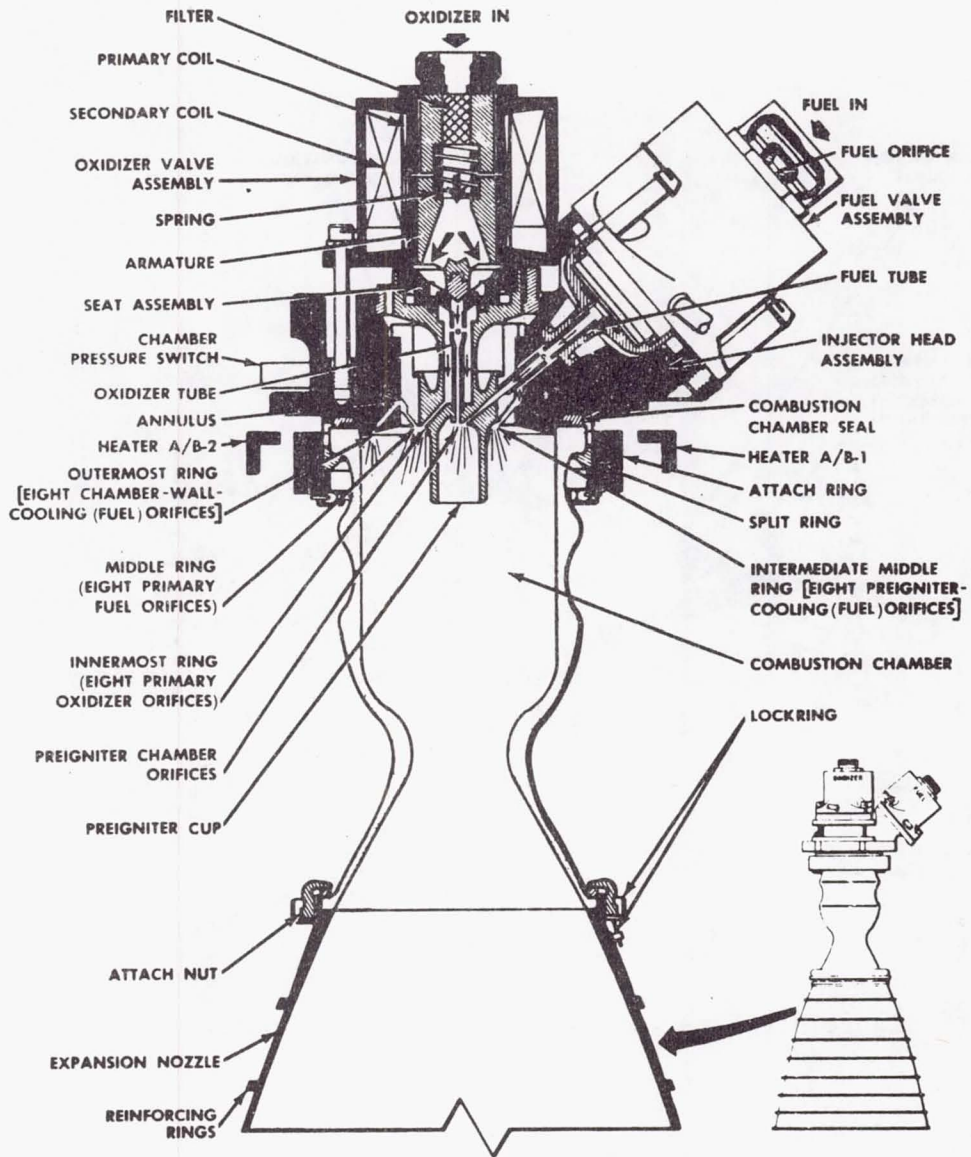
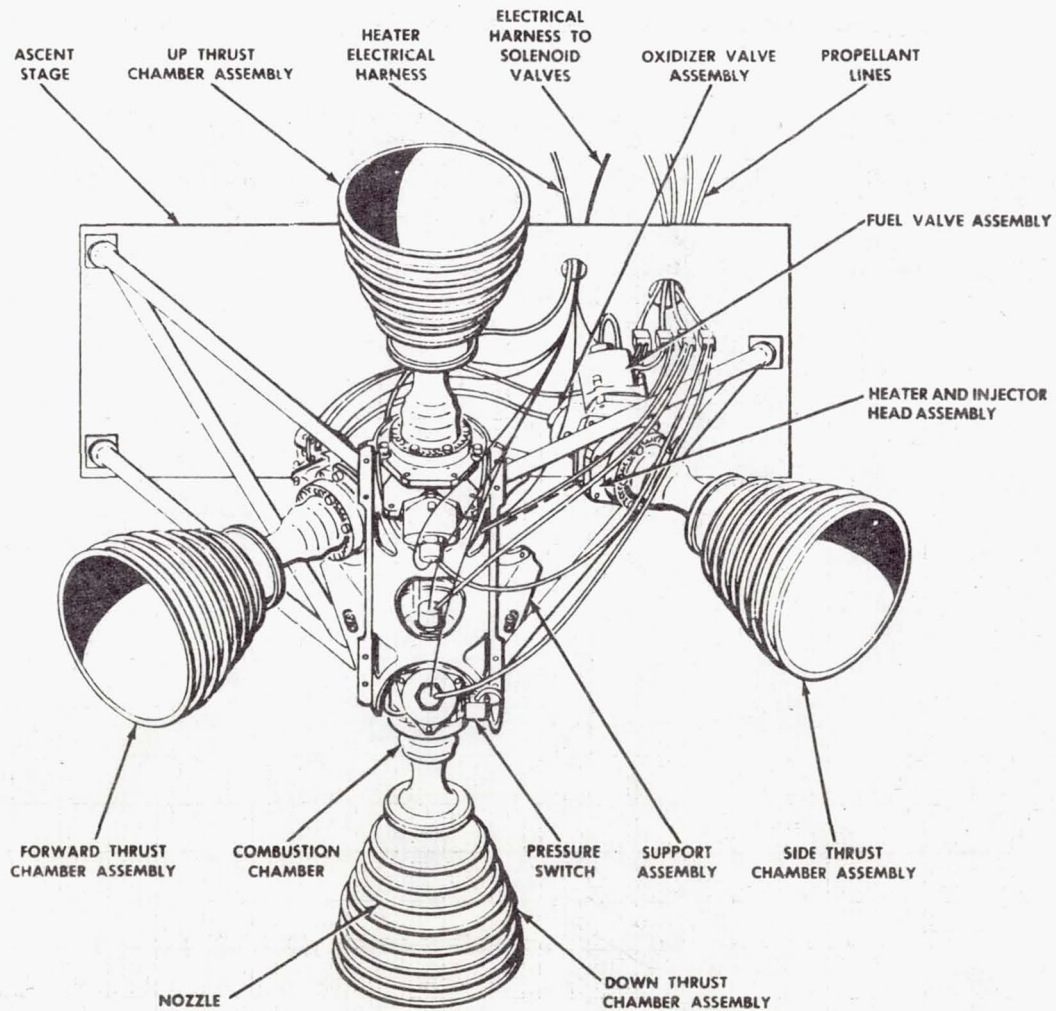

Figure 4.- Thrust chamber assembly (engine).



Note:
The cluster is shown
with the thermal
shield removed.

Figure 5.- Thrust chamber assembly cluster (quad).

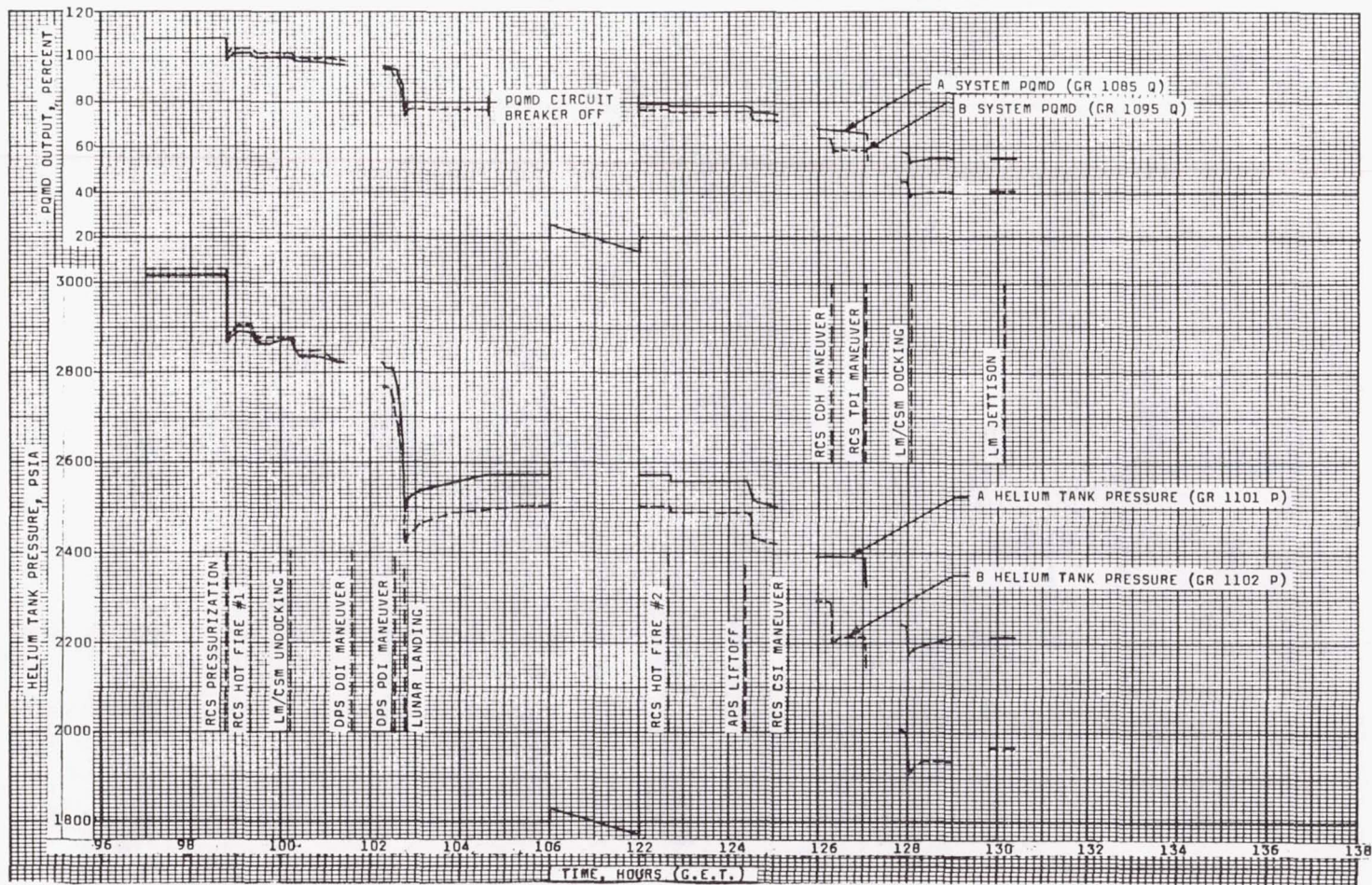

Figure 6.- Lunar module RCS PQMD and helium tank pressure profiles.

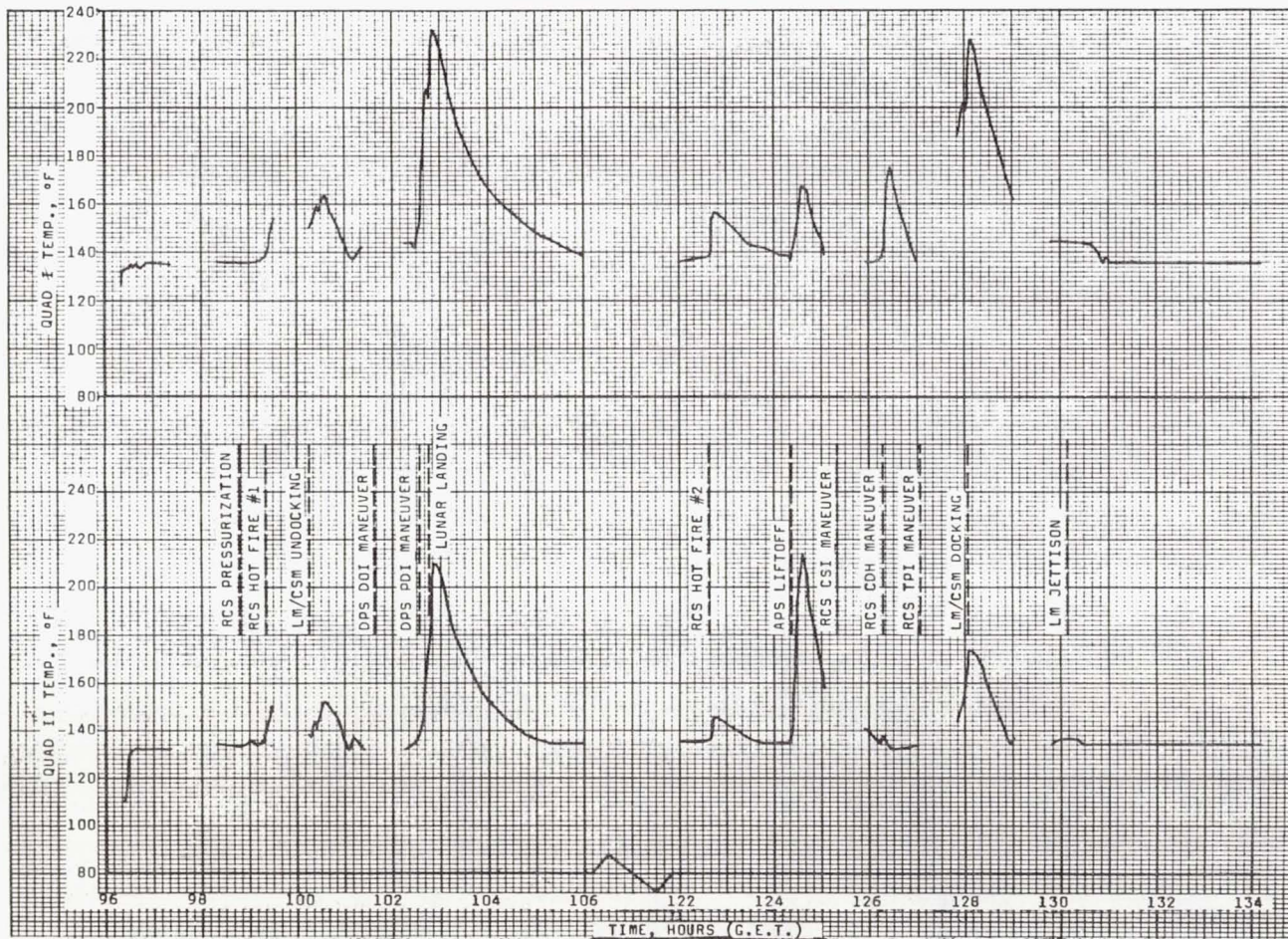

Figure 7.- Reaction control system quads 1 and 2 temperature histories.

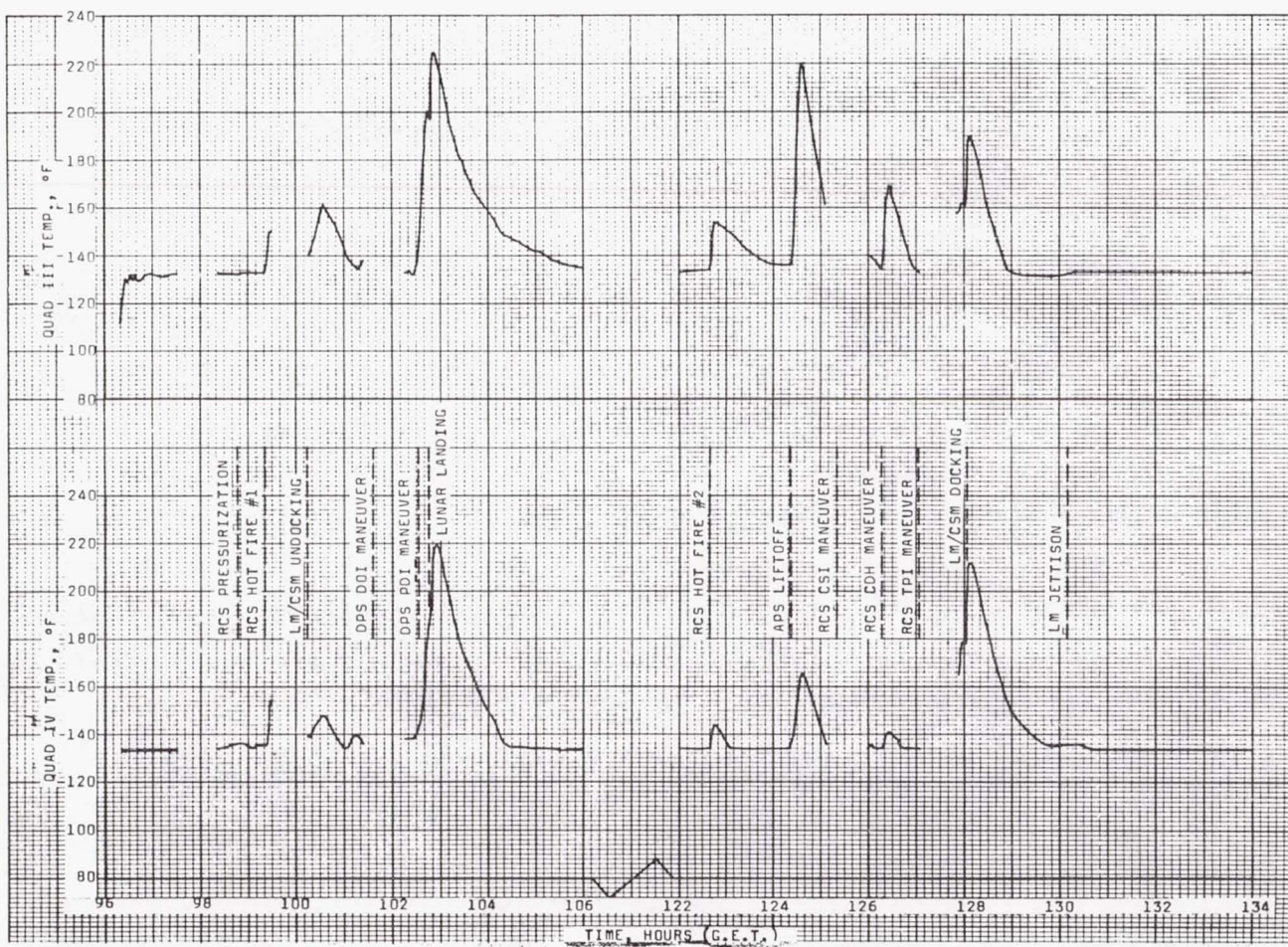

Figure 8.- Reaction control system quads 3 and 4 temperature histories.

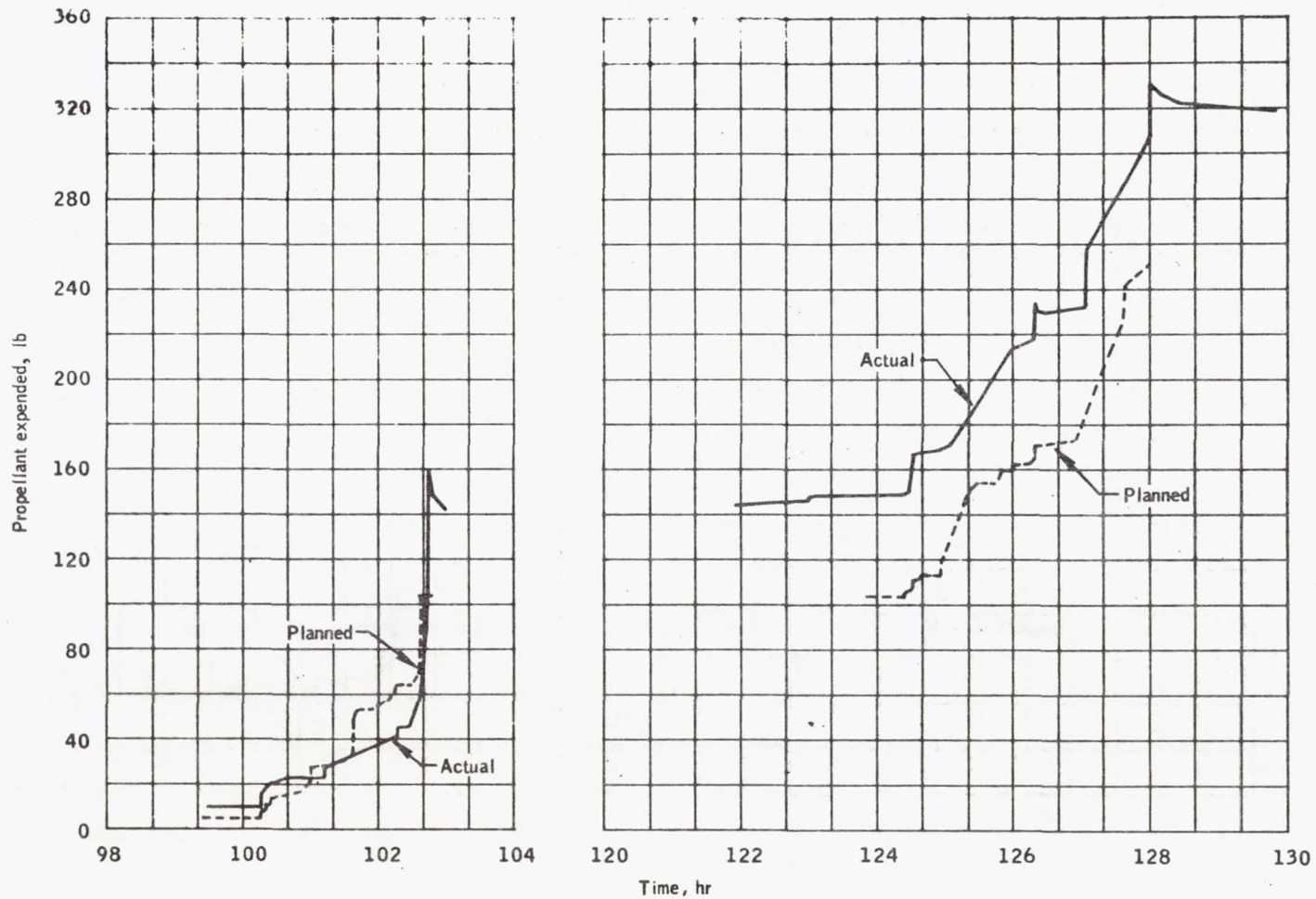

Figure 9.- Comparison of predicted and actual propellant consumption.

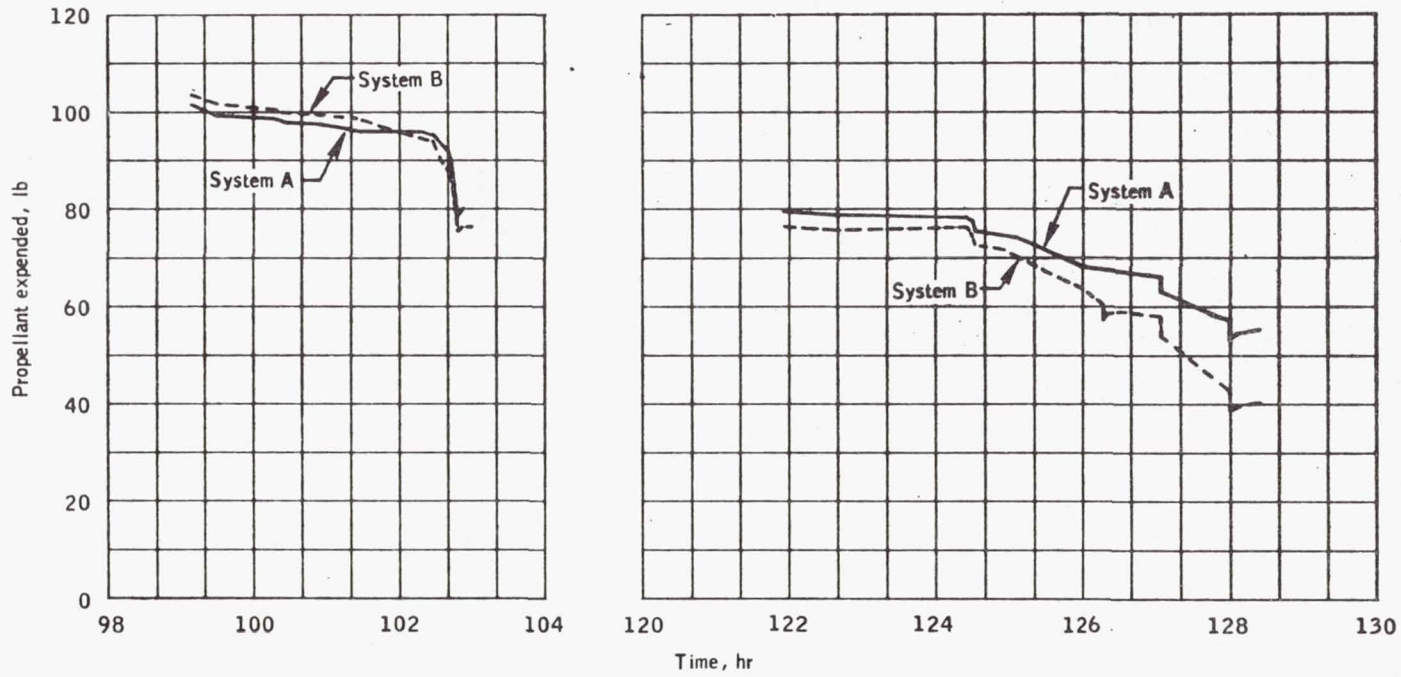

Figure 10.- Propellant consumption from each systems A and B.

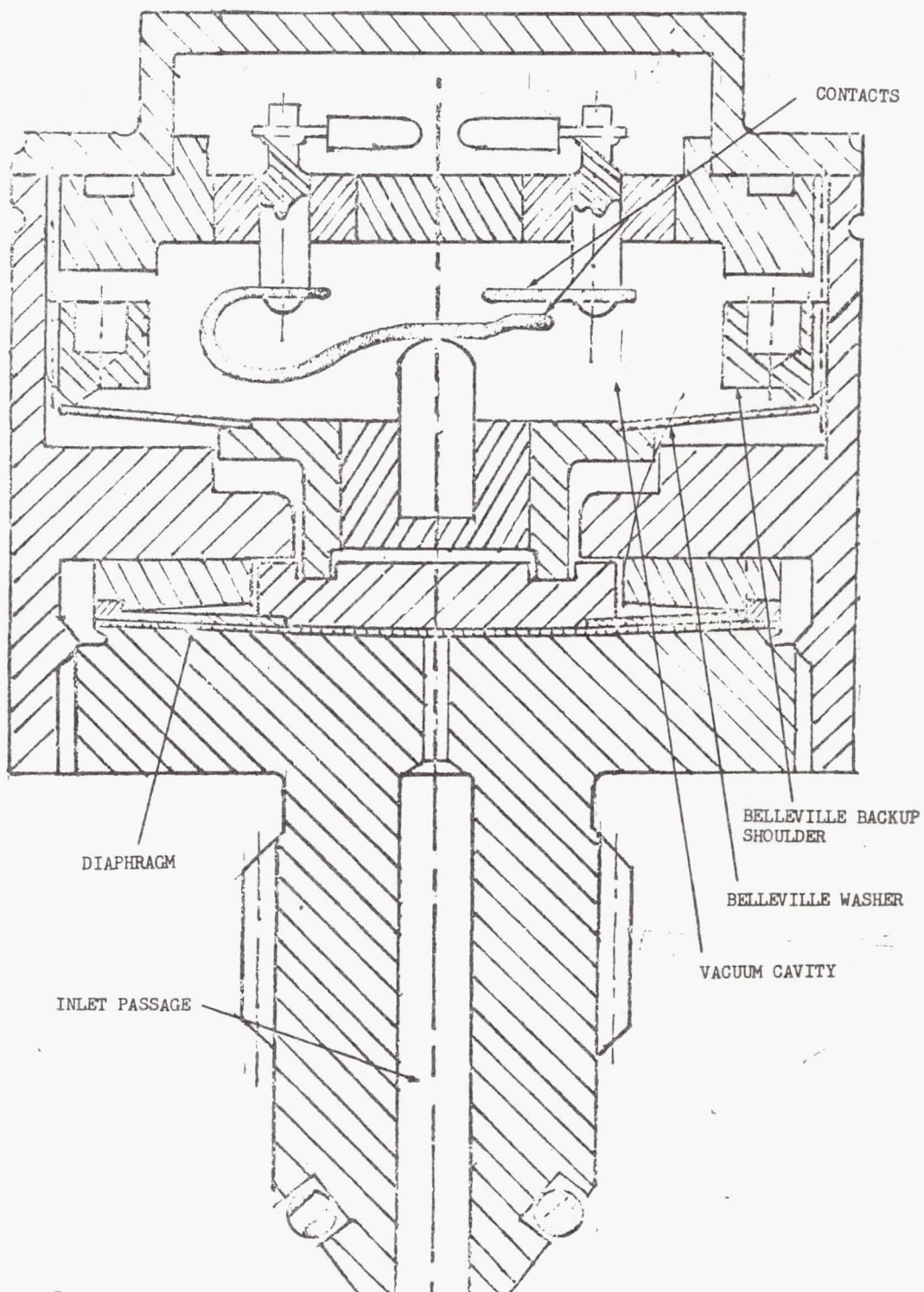

Figure 11.- Pressure switch assembly — LSC 310-651-5-1.