

15610

NASA-CR-62084

# ORBITING FROG OTOLITH EXPERIMENT (OFO-A)

FINAL REPORT  
ON THE DATA REDUCTION  
AND CONTROL EXPERIMENTATION

January 1972  
Contract NASW-2211

DR A

Prepared for  
NATIONAL AERONAUTICS AND SPACE ADMINISTRATION

Prepared by  
University of Milan  
Second Department of Human Physiology  
Milan, Italy

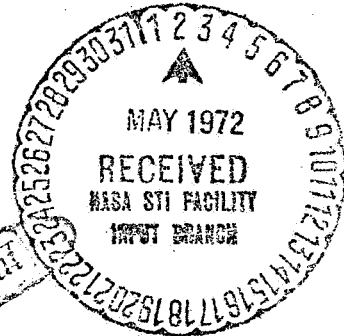

(NASA-CR-62084) ORBITING FROG OTOLITH  
EXPERIMENT (OFO-A): DATA REDUCTION AND  
CONTROL EXPERIMENTATION Final Report T.  
Gualtierotti, et al (Milan Univ.) Jan.  
1972 353 p

N72-30055

Unclas  
CSCL 06C G3/04 15610

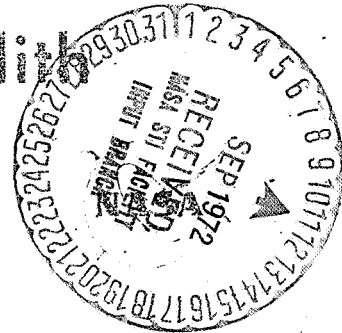
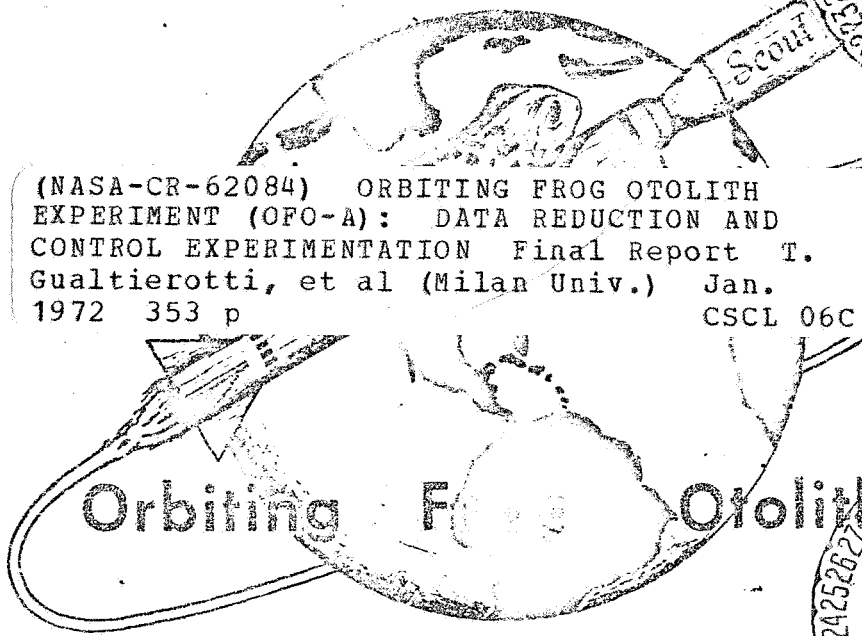

PICCIN MEDICAL BOOKS

# ORBITING FROG OTOLITH EXPERIMENT

(OFO - A)

FINAL REPORT  
ON THE DATA REDUCTION  
AND CONTROL EXPERIMENTATION

January 1972  
Contract NASW-2211

*Prepared for*  
NATIONAL AERONAUTICS AND SPACE ADMINISTRATION

*Prepared by*  
University of Milan  
Second Department of Human Physiology  
Milan, Italy

Details of illustrations in  
this document may be better  
checked on microfiche

PICCIN MEDICAL BOOKS



TORQUATO GUALTIEROTTI  
Principal Investigator

Dr. Francesco Bracchi  
and  
Dr. Emilio Rocca  
co-workers

## CONTENTS

	<u>Page</u>
Section 1 - INTRODUCTION . . . . .	1-1
Section 2 - SUMMARY . . . . .	2-1
Section 3 - THE LATEST RESULTS IN THE FIELD OF VESTIBULAR PHYSIOLOGY (LIMITED TO PRIMARY NEURONS) . . . . .	3-1
Section 4 - PRELIMINARY WORKS . . . . .	4-1
4.1           The General Physiology of the Bullfrog Under Water . . . . .	4-1
4.1.1         The EKG Changes as a Function of Temperature and PO <sub>2</sub> . . . . .	4-10
4.1.2         The Firing Rate and the Shape of the Action Potential of the Vestibular Nerve . . . . .	4-11
4.1.3         The Oxygen Consumption . . . . .	4-12
4.1.3.1       The Oxygen Poisoning . . . . .	4-14
4.1.3.2       Biological Example of Protection Against HPO . . . . .	4-16
4.1.3.3       Effects of Oxygen on Blood Formation and Destruction . . . . .	4-17
4.1.3.4       Effects of Oxygen upon the Eye Structures . . . . .	4-18
4.1.3.5       Pulmonary Oxygen Poisoning . . . . .	4-19
4.1.3.6       Oxygen Toxicity in Neuronal Elements . . . . .	4-20
4.1.3.7       CO <sub>2</sub> Disposal . . . . .	4-23
4.2           The Technique of Recording from a Single Unit for Several Days in Physiological Conditions and, at Lift Off, during High Mechanical Stress . . . . .	4-24
4.3           The FOEP . . . . .	4-25
4.4           The Physiology of the Primary Neurons in the Frog as a Closed Loop System . . . . .	4-27
Section 5 - PROBLEMS AND DIFFICULTIES CONNECTED WITH A SCOUT MISSION. PRELIMINARY WORK DONE AT MILAN PHYSIOLOGY LAB AND AT WALLOPS . . . . .	5-1
5.1           Preparation of the OFO-A Experiment . . . . .	5-1
5.1.1         Frog Surgery and Instrumentation . . . . .	5-2
5.1.2         Frogs Evaluation . . . . .	5-10
5.1.3         Frogs Failure Analysis (Problems Outline - Specific Incidents) . . . . .	5-17
5.1.3.1       Specific Incidents . . . . .	5-21

	<u>Page</u>
5.1.4	Conclusions . . . . . 5-27
5.1.5	Tests in the FOEP . . . . . 5-29
5.1.6	Base Line Data and Survival Tests . . . . . 5-31
Section 6	- PREPARATION FOR THE FLIGHT - THE QUALIFICATION TESTS . . . . . 6-1
6.1	Report on the Centrifuge Tests of the Frog Preparation for the Orbital Frog Otolith Experiment . . . . . 6-1
6.2	Report on the Vibration Tests of the Frog Preparation for the Orbital Otolith Experiment . . . . . 6-5
Section 7	- PREPARATION FOR THE FLIGHT . . . . . 7-1
7.1	The Problem of Multiple Preparations with a Very Shorth Turn Around Time . . . . . 7-1
7.2	The Quick Look Analysis Program at Goddard . . . . . 7-4
7.3	Flight Program Rationale . . . . . 7-6
Section 8	- FINAL ANALYSIS DONE AT MILAN . . . . . 8-1
8.1	Data Analysis . . . . . 8-1
8.1.1	The Health Condition of the Frog . . . . . 8-1
8.1.2	The Activity of the Vestibular Units . . . . . 8-4
8.1.3	Dynamic Response . . . . . 8-20
8.1.4	Shape and Amplitude of the Biological Pulses . . . . . 8-27
8.2	Control Experimentation . . . . . 8-28
8.2.1	Effect of Increased Housing Pressure . . . . . 8-28
8.2.2	Temperature Effect . . . . . 8-30
8.2.3	Control Experiment on Vibration . . . . . 8-31
Section 9	- INFORMATION ON THE COMPUTER PROGRAM FOR THE DATA REDUCTION AND ANALYSIS . . . . . 9-1
9.1	Data Acquisition Program (E1) . . . . . 9-1
9.2	Data Reduction Program (E2) . . . . . 9-3
Section 10	- INTERPRETATION OF RESULTS . . . . . 10-1
Section 11	- OBSERVATION OF THE GENERAL IMPACT OF THE CHANGES OF THE SINGLE PRIMARY NEURONS ACTIVITY ON THE FUNCTION OF THE VESTIBULAR ORGAN AS A WHOLE AND RELATED BODY SYSTEMS . . . . . 11-1

	<u>Page</u>
Section 12 - REPORTS TO CONGRESSES, ETC. . . . .	12-1
Section 13 - CONCLUSIONS . . . . .	13-1
13.1            Technical Achievements - General Application	13-1
13.2            The Basic Results on Vestibular Physiology .	13-10
13.3            Conclusions in Relation to Space Flight . .	13-15
Section 14 - PROPOSAL AND JUSTIFICATION FOR THE NEXT FLIGHT . . . . .	14-1

## INTRODUCTION

The OFO-A mission was prepared as a part of a special program of vestibular physiology with the purpose of studying in which way the lack of the gravity pull will affect the functioning of that part of the labyrinth which controls balance by measuring the gravitational components corresponding to the different head positions, namely, the gravity sensitive or positioning receptors. It is quite evident that in weightlessness the gravity sensitive receptors will be deprived of their primary input. However, two points have to be emphasized.

1. The stimulus deprivation does not correspond to the destruction of the organ. In fact all the inner ear receptors, acoustic or vestibular, show a spontaneous activity even when the input to the receptor is equal to zero. This is a well known fact in physiology that does not require any demonstration as shown by the following statement contained in an article by Engstrom (7) that was presented in the Fourth Symposium on the Role of the Vestibular Organs in Space Exploration. "In the vestibular nerve even at rest, the nerve fibers have a low frequency activity with a rather steady firing rate. The stimulus acting on the vestibular sensory regions thus in reality modifies the discharge and the frequency change follows the distinctive patterns as described by many

others and reported to this group a few years ago by Lowenstein." It is important to insist on this point because even well-known physiologists make the wrong assumption that the lack of an input, identified as deafferentation of the vestibular organ, provokes a complete stopping of all the activity of the receptors.

2. Every movement of the head corresponds to some kind of acceleration and, therefore, stimulates the positioning receptors provided that the acceleration vector lies within the receptor field of the unit.

It can, therefore, be assumed that in weightlessness the spontaneous firing of the gravity sensitive receptors is maintained and what is deranged is the organized pattern of the different stimuli of the whole of the receptors resulting on earth from two constants: 1) the earth gravity which has a fixed direction and an approximately constant value and 2) the anatomical and functional location of the positioning receptors in the macula.

The importance of a possible alteration of the labyrinth output is not limited to a change in its primary function, namely, the orientation in space and balance but also on the control exerted on other important organs of the body like the muscles especially in the regulation of the tonus; the vegetative system, the malfunction of which promotes the motion and sea sickness; the cardiovascular system; the eye movements, etc.

Moreover, the positioning receptors of the labyrinth are in an unique condition in regard to the other sense organs: they alone, during the entire development of the vestibular organ throughout the species starting 400 million years ago in the lamprey, and in each individual when the apparatus is formed in the fetus, are constantly subjected to earth's gravitational field. Therefore, if we consider the organ as a whole, its development takes place under a constant stimulation. This situation could only change very briefly during jumps, free fall and, recently, during parabolic jet plane flight. It has to be emphasized that there is no way to eliminate the effect of the earth gravitational field and therefore the stimulation on earth; even submersion in water doesn't affect the pull on the otolith system. Space flight only introduced a completely new environmental condition in the fact that it subjected humans, animals and plants to an extended period of lack of gravity or better lack of the effect of gravity.

It is, therefore, self-evident that a program of investigation of the vestibular physiology in condition of extended weightlessness is of paramount importance not only for acquiring practical knowledge on the effect of weightlessness during the space missions but to understand the basic mechanism of this sense organ and perhaps other sense organs in general. It will in effect provide essential information on the coupling function across the vestibular receptors starting from zero

input and moreover on the adjustment of the end organs to an extended basic change in the main variable operating on the input. In fact it could be said that in general a complete reappraisal of vestibular physiology per se is necessary at the present time. In this respect I would like to quote from a personal communication of Dr. Lowenstein, one of the leading physiologists working on the vestibular apparatus. "... the treatment of the subject (the function of the otolith apparatus) in many standard medical textbooks dates from before the event of electrical, physiological and finally ultra structure work and cannot possibly be made the basis for up-to-date theorizing. In fact vestibular physiology at the present time is in lively turmoil and the basis of established fact is indeed very small. Modern system analysis (cybernetics) and the making of mathematical models of the interaction of the vestibular end organs among themselves and with other postural control systems is in urgent need of new reliable physiological information with respect to both the functioning of the semicircular canals and otolith organs. Transfer functions contain a number of very "black boxes" and rigorously quantitative work on open and closed loop vestibular systems is urgently needed if we are to assess the theoretical implication of a vestibular organ under the condition arising from man's active deployment in weightlessness space."



In preparing the experiment the following base lines were followed: 1) to investigate a closed loop vestibular system, namely, to work on the intact animal, 2) to record directly from the single primary neurons and 3) to protect the animal by immersion in water - this, in fact, has been shown to be very effective against high acceleration (25).

Investigating a closed loop system has the advantage to obtain information in fully physiological conditions, namely, with all the related systems working (see Section 4 for further discussion on this subject). The recording from primary neurons would facilitate the study of the coupling function across the vestibule as it will monitor the output directly. Recording from single units will allow a good quantitative evaluation of the input-output relationship. Maintaining the animal under water, besides providing a good cushioning effect against acceleration, will also assure a more constant environmental condition both as far as temperature control is concerned and for the metabolic exchanges. This condition, however, requires the use of either an aquatic animal or an amphibian and the problems exist as how the data thus obtained can be extended to mammals. This also will be discussed in detail in Sections 3 and 4.

## SECTION 2

### SUMMARY

The main purpose of the OFO-A orbital mission was to study the long range effect, on the gravity sensors of the inner ear, of a state of weightlessness extended for several days. The sensors were subjected to a maximum  $10^{-3}$  g during the flight and periodically to up to 0.6 g of stimulations by means of a centrifuge. The basic stimulus deprivation does not correspond to the destruction of the organ as spontaneous activity remains; moreover every movement of the head is bound to stimulate the vestibular organ according to the corresponding acceleration. The basic knowledge of the single gravity sensitive receptor of the bullfrog in a closed loop system, resulting from the work performed in the field by several authors, has been completed by extensive research work lasting several years, based on prolonged recording of single unit activity for up to 17 days, using the new technique of neutral buoyancy microelectrodes, developed on purpose for the experiment. Nothing comparable could be found in the bibliographical data. Equally new has been the investigation on bullfrog biology while permanently submerged: within given limits of physiological temperatures, it was found that the metabolism and general behavior of the frog organism was similar to the one in air, at steady state, if the  $PO_2$  of the environmental water was kept above 650 mm Hg. No indication of toxicity was found at this  $PO_2$  level.

The preparation of the instrumented bullfrog specimen for the flight was organized in such a way as to meet the requirements of the orbital flight, namely readiness at the appropriate time and reasonable certainty that the bullfrog preparation would be able to last in working conditions during the flight. Indices of the frog physiological responses had been devised for the purpose, and possible failures analyzed. The main difficulty during lift off was presumed to be the high g level during the rocket engine thrust and vibration, as these mechanical factors might have displaced the microelectrodes; appropriate qualification tests had been successfully performed. The fact that recording was possible even during the firing of the rocket engines proved the success of the technique of the neutral buoyancy microelectrodes and the importance of the multiple vibration tests performed.

The results were based on a complete data reduction of three vestibular units and identification of two more, through an IBM 1800 computer and special computer programs.

The results are as follows.

1. The frogs appeared in good health during the entire flight, as shown by the EKG parameters.
2. The vestibular units have been identified on the ground, on the pad and through lift off. According to the shape and the minimum interval the results proved quite satisfactorily that recording of the same units was maintained in all conditions.

3. Control experimentation on the two malfunctions during the flight, namely, an increased pressure in the canister to 11 psi and a decrease of temperature for nine hours to 55°F. (accepted lowest level 60°F.) proved that those events did not alter the basic results and when necessary allowed data correction to be made.

4. The data have been classified for the analysis in two classes, static and dynamic response.

The main changes observed were:

a) An alteration of the firing rate at rest, first decreasing and then increasing with a period of approximately 24 hours. A similar decrease of the firing rate was observed during prolonged coasting (approximately 15 minutes) immediately after the burning off of the third stage and before ignition of the fourth.

b) A very minor change in the firing rate during the second half of the centrifuge spin at constant speed.

c) The dynamic response showed an overshoot during the positive transient (centrifuge increasing its speed) and an undershoot during the negative change (centrifuge speed decreasing). These responses also showed variation with an approximate 24 hour period.

d) The response to the centrifuge cycle showed a marked increase of the phasic against the chronic phase between the 72nd and 92nd hour of the flight.

e) All the observed changes reverted to normal in the last 10-20 hours of the flight.

The profound changes in the output of the vestibular units could not fail to exert a deep impact on related systems both in the vestibule itself and in various parts of the body. The overall decreasing firing rate at rest and the increase in sensitivity of the unit might explain space sickness through the connection with the vagus and the control of muscle tonus.

The capability of adjusting to a specific environment change at single unit level seems to be the most important result of this experiment: a different functional set up is then achieved by the organ and a further adjustment might be needed upon the return to 1 g.

The process of normalization might be humoral in essence, and similar to training or learning.

The discussion of the functional and anatomical characteristics of the single vestibular units of the bullfrog and of mammals seem to indicate that the conclusions reached on the effect of weightlessness on amphibians may apply to mammals too.

The possibility during the flight to record from single nerve fibers the pulse activity for several days throughout the impact of lift off, using a telemetry link seems to propose an entirely new field of applications both on basic research work on all the substrates the activity of which is

accompanied by action potentials, at single unit level, and on future application on space flight specifically.

For the first time it will be possible to study the electrical pulse activity of several systems as a function of time cycles, multiple of 24 hours, in a controlled environment, after complete recovery from surgical routines, and at a distance with no link with the animal.

A new experiment is suggested as necessary in order to better study the adaptability curves of the vestibular receptors and the adjustment to reentry to 1 g field after weightlessness.

### SECTION 3

#### THE LATEST RESULTS IN THE FIELD OF VESTIBULAR PHYSIOLOGY (LIMITED TO PRIMARY NEURONS)

Most of the references on the positioning receptors of the inner ear up to 1969 are discussed in the enclosed reprints, The Gravity Sensing Mechanism of the Inner Ear (B) (11) and Analysis of Single Vestibular Responses (C) (10). Since 1969 a number of additional results have been obtained both in cats and in the frog. However, in most cases recording from single primary neurons has not been performed in a real closed loop system or in a truly physiological condition, namely, in unanesthetized intact animals. Moreover, all the recording performed so far was made acutely limiting the recording time to minutes. For information in truly chronic recording lasting several days, see Section 4.

The most recent and complete paper on the gravity sensitive receptors is the one performed in the adult cat under deep pentobarbital sodium anesthesia by J. Vidal (36) and co-workers. This work will be discussed in some detail as it seems to provide a good comparison with the results obtained in the frog and described in the next Section. The fact has to be mentioned, however, that half of the cerebellum has been removed in such experiments which, of course, might impair some of the servo mechanisms of the closed loop system.

Another limitation was that the maximum tilt was limited to  $10^{\circ}$  in the static experiment and  $5^{\circ}$  in the dynamic experiments on each side with frequency ranging between .01 to .50 cycles per second with most recording confined to frequency below .1. The gravity sensitive receptors were taken as the one responding to position changes that were insensitive to sound and with <sup>a</sup> firing rate showing different values when the head was maintained at different positions. The following results were obtained. The steady state discharge of 80% of the cells had relatively small coefficients of variation, narrow histograms and periodic autocorrelograms. The other 20% had large coefficients of variation, nearly exponential histograms and flat or weakly periodic autocorrelograms.

The static relation between head position and discharge showed that each cell had directional sensitivity. Many cells showed multivaluedness, that is, the interval mean and other statistics from different stations at any given position covered a range greater than that at each station. These characteristics varied from cell to cell. In addition to a tonic part, responses showed a phasic component with the characteristics of a unidirectional rate sensitivity that determined a phase-lead of the response with respect to the stimulus. The relative proportions of tonic and phasic components varied from cell to cell. As it will be shown in



the next Section the same results were obtained during similar investigation in the frog.

Another recent paper deals with recording from frog vestibular fibers during physiological excitation. This preparation was not anesthetized. Unluckily the publication by W. Precht (29), R. Llinas and M. Clarke only deals with fibers coming from the semicircular canal and responses to horizontal angular rotation. Moreover, the animal was immobilized by D-tubalcurarine and sometimes this process alters the vestibular activity. As far as I know there are no other recordings from single vestibular fibers in the frog in a closed loop system and also in this case the recording was only limited to some minutes.

The important element in this paper is that the responses are "in complete agreement with the results obtained by Lowenstein and Sand in elasmobranch and Gerandt in the cat vestibular nerve."

SECTION 4  
PRELIMINARY WORKS

4.1 THE GENERAL PHYSIOLOGY OF THE BULLFROG UNDER WATER

During the preparation of the OFO-A mission, one of the first problems that had to be solved was to determine the capability of the frog to maintain a physiological steady state condition underwater. The frog is an amphibian cold-blooded animal, temperature dependent and it is therefore supposed to be able to survive both in the air and in a water environment. However, the frog doesn't have any gill system except in some particular species of which the bullfrog is not one. In the bullfrog the respiration can be divided into cutaneous and pulmonary. This is not particular of the frog as it can be said that all higher vertebra have an exchange of gas between the blood and the atmosphere not only through the lung but also through the skin as the latter is permeable to air and interwoven with blood vessels. In the frog, however, the cutaneous respiration is highly facilitated by the fact that the pulmonary artery divides into two branches one of which goes to the lungs while the other provides a blood supply for a great part of the skin, the mucous membrane of the mouth, the tympanum (which is very superficial), besides a few muscles. Moreover, this artery carries highly venous blood and the capillary network of the skin is very close and the covering epidermis very thin.

It was found that very few works existed in relation with the skin respiration in a frog submerged for a period of time extending to several days. A paper published by Helge Leivestad (20) in 1960 studies the underwater respiration metabolism and heart rate in the toad: it was found that both the O<sub>2</sub> consumption and the metabolic rate is reduced to 20% of the resting value while breathing in air. Bradycardia was observed with irregularity in the heart beat. There was no O<sub>2</sub> debt and a certain delay was apparent when the animal was reverted to air respiration. Obviously in this condition the animal, although in steady state, cannot be considered in a physiological situation.

Another paper by Serfaty (32) and Gueutal on the resistance of the frog during a prolonged submersion stated that at 14-15°C. of temperature the animal could survive underwater for two to three weeks but above 20°C. only 10-15 days and at 26-27°C. only 48 hours. With an O<sub>2</sub> consumption equivalent to 19 cubic centimeters of O<sub>2</sub> per kilogram and per hour, the conclusion was that above 19°C. the frog could not be considered in a steady state.

The most complete work on the cutaneous and pulmonary respiration of the frog (August Krogh (19)) dates back to 1904 in Copenhagen. The conclusions are as follows. The skin and the lungs in the frog share the respiratory function, the CO<sub>2</sub>

being mostly eliminated through the skin while the  $O_2$  is absorbed through the lungs. There are differences between the different frogs. For instance, in the *Rana esculenta* the skin is a far more important respiratory organ than in the *Rana fusca*. The potential respiratory exchange through the skin, at least in some species, is approximately constant all the year round with the exception of  $CO_2$  which shows a considerable rise during the spawning season while the respiratory exchanges of the lung is seasonal with a maximum during the spawning season and a minimum in winter. There is a large difference, however, between the gas exchange surfaces in the lung and in the skin. As known the gas exchange is a function of the interface between the air phase and the blood phase, namely, it is ultimately dependent on the surface of the capillary network. In the frog lung the capillary network is extremely tight, occupying about 2/3 of the respiring surface. The epithelium is a very thin squamous epithelium, the nuclei of which are lying together in the capillary interstices. Therefore, the distance which the gases have to pass between the blood in the capillaries and the atmosphere will be extremely short and, of course, in this case the interface is between air with a  $PO_2$  of 155 mm of mercury and the blood.

The capillary network of the skin is much wider. Immediately beneath the epidermis there is a rather tight net

of capillaries but it is much less extended than in the lung, covering only 1/3 or perhaps 1/4 of the surface of the skin. Furthermore, the epidermis through which the air has to pass is many times thicker than the epithelium of the lungs. Therefore both the  $O_2$  to reach the blood and the  $CO_2$  to abandon the blood toward the surface has to pass first through a rather thick layer of cells with a resulting fall of tension. It is not known, however, how much this fall of tension is. Also, given the distribution of the blood in the skin, only part of the skin itself can be considered truly respiratory, the one supplied by the pulmonary arteries. Whereas the part of the skin which is supplied by the carotid arteries and by the aorta carrying arterial and therefore nearly fully oxygenated blood might not be able to participate in the skin respiration. However, this part of the skin is not too large.

The author calculated that the breathing surfaces of the skin and the lung show a 11.5:8.4 ratio. It was apparent from the results reported in this paper that at least on *Rana fusca* the cutaneous absorption of the  $O_2$  averages 43-66 cc per kilogram per hour as a maximum while the pulmonary absorption varies from 160 during the spawning season to 51 in the winter experiment. On the basis of several experiments performed by cutting the nerve supply, the author concludes that the  $O_2$  absorption to the skin is happening through diffusion only and the only possible regulation, therefore, can be vasomotor.

This is also proven by experiments performed by Dolk (6) and Postma in 1926. These authors found out that the rate of diffusion of  $O_2$  was lowered at low  $O_2$  tension (down to 8%) and this was compensated by the increase of the pulmonary intake of  $O_2$ .

Jullien (16) and others, 1958, by ligating the pulmonary and cutaneous arteries respectively, concluded that the pulmonary and cutaneous respiration were of approximately equal importance.

According to Bastert (3), 1929, there is evidence showing that the lungs of *Rana esculenta* and *Rana temporaria* can act as  $O_2$  stores if the animals are kept underwater for long periods.

The regulation of the  $O_2$  consumption both through the lung and the skin seems to be due to varying the number of open capillaries under the control of the central nervous system (15 and 28).

As far as the  $O_2$  transport in the blood is concerned, it was demonstrated by Macela (24) and Seliskar that the affinity for  $O_2$  of a dilute solution of hemoglobin of the frog *Rana esculenta* at  $15^{\circ}C$ . is almost the same as for human hemoglobin for  $35^{\circ}C$ . That means that the frog hemoglobin is adapted for carrying out its functions at a lower temperature than mammals.

This was confirmed also by Wolvekamp (37) who found that the  $O_2$  disassociation curve of the blood was similar in the frog at  $20^{\circ}C.$  and in man at  $38^{\circ}C.$  The effect of  $CO_2$  in shifting the  $O_2$  disassociation curves in *Rana temporaria* and *Rana esculenta* was also similar (38).

According to the fact that amphibians live in different temperatures and they are poikilotherm, it was found that the  $O_2$  affinity of the blood can be altered according to temperature. Kirkberger (17) found out that at  $3^{\circ}C.$  the blood was holding 1.64% in volume of  $O_2$ , at  $13-15^{\circ}C.$ , 1.66% and at  $25^{\circ}C.$ , 2.06%. But after acclimatization, the values were very different, namely, at  $3^{\circ}C.$ , 4.27%, at  $15^{\circ}C.$ , 4.41% and at  $25^{\circ}C.$ , 5.1%. Acclimatization is also present at high temperatures.

In the bullfrog, F. H. McCutcheon (26) showed a curve similar to the air breathing vertebrates and the tadpole a rectangular hyperbola like the fetus hemoglobin in mammals.

However, an additional question has been raised by A. R. de Graaf (5) who worked on toads (*Xenopus laevis*) and concluded that blocking hemoglobin with  $CO_2$  or finding a specimen in which there were no red cells, normal life was possible. He suggested that in amphibians the  $O_2$  content of the blood linked with hemoglobin might be more as a store of  $O_2$  than the  $O_2$  actually transported for tissue use. This is, however, a matter still under investigation.

The available information on the frog respiration underwater can be summarized as follows.

1. It seems that a frog can survive underwater for several weeks, provided the temperature is not raised above 14-15°C., at a normal atmospheric  $PO_2$ , namely, 155 mm of mercury.

2. In these conditions, however, the  $O_2$  consumption is reduced to 20% of the normal value in air and survival is achieved only by the corresponding decrease of the metabolic rate and caloric production.

3. The condition in No. 2 cannot, therefore, be considered completely satisfactory as representing a normal metabolism for the frog.

4. The  $O_2$  transport through the skin seems to be due to passive diffusion only and therefore is bound to be proportional to the  $PO_2$  of the environment.

5. The thickness of the skin is such that a sizeable  $O_2$  gradient must exist between the environmental  $PO_2$  and the  $PO_2$  of the blood in the capillary network.

6. Most of the  $CO_2$ , if not all, is eliminated through the skin whereas the  $O_2$  is absorbed partly from the skin (at a constant level through the air) and partly through the lung with large seasonal variation.

7. The volume of  $O_2$  carried in the blood is a function of the temperature but much less so in acclimatized animals.



8. The importance of hemoglobin as an  $O_2$  carrier is in doubt and the physically dissolved  $O_2$  might be more important or even sufficient for frog survival.

An additional point can be made, particularly for the bullfrog. It is obvious that the efficiency of the skin respiration depends on the surface/mass ratio of the animal, the surface being proportional to the amount of  $O_2$  provided and the mass to the amount of  $O_2$  consumed during the metabolic activity. In the bullfrog the ratio is not particularly favorable as with size the mass increases more than the surface. As most of the  $O_2$  is consumed by the muscles during exercise, a partially paralyzed frog would need less  $O_2$  than a fully active one.

It is obvious from what is stated above that the animal underwater in normal condition can survive within rather narrow limits of temperature. In fact raising the temperature the metabolic needs might increase up to exceed the maximum capability of the skin to provide  $O_2$  and, therefore, the frog incurs progressive anoxia which would impair function and finally kill it. On the cold side, the frog can stand even freezing point but its function would become more and more depressed with no danger as far as survival is concerned but reaching a stage in which it would be near to a condition of suspended animation: at  $4-8^{\circ}C$ . the firing of a nerve fiber practically ceases.

Even during the preparation of the OFO-A (then TS4) experiment for the Apollo Mission it was necessary, therefore, to perform an extensive study of the physiology of the frog underwater. As indicated previously in this Section the available data are more concerned with limited survival than studying stationary physiological conditions for several days. In this case as the frog is maintained in a closed loop system, it was necessary to establish the following parameters.

1. A temperature range the upper most limit of which would still maintain the  $O_2$  supplied and  $O_2$  consumed equal; the lowest limit would be the one at which the nervous activity is still normal. It is obvious that such a condition is very far from the limit for survival. This problem is linked with the  $O_2$  supplied, namely, with the  $PO_2$  in the environmental water.

2. To establish a reliable index for assessing the physiological conditions of the frog.

During the three years preceding the Apollo Mission a large number of frog preparations had been studied (about 100) using the following technique. The frog, prepared and implanted as for the OFO-A Mission, was submerged in water at a  $PO_2$  of different values at different temperatures. As a working hypothesis the EKG parameters and the otolith firing rate, the shape and amplitude of the action potentials have been taken as an index of the frog welfare. For each temperature a fixed three-hour exposure at any given  $PO_2$  was established.

In some experiments the  $O_2$  consumption of the frog was determined while immersed in water but free breathing through the lung as baseline data and then compared with the consumption of  $O_2$  when breathing through the skin after complete submersion in water. In all, therefore, three indices have been considered: 1) the EKG parameters, 2) the firing rate and the shape of the action potential of the vestibular nerve and 3) the  $O_2$  consumption; all three as a function of temperature and  $PO_2$  in the surrounding water.

#### 4.1.1 THE EKG CHANGES AS A FUNCTION OF TEMPERATURE AND $PO_2$

The  $PO_2$  values in the water were raised step like by 50 mm of mercury from 155 (atmospheric  $PO_2$ ) to 720 (nearly 1 atmosphere of  $O_2$ ). For each one of these  $PO_2$ 's the temperature was increased from 50°F. up to 80°F. and the EKG observed. It was found that a critical temperature value exists for all the ranges investigated. The first change that appeared in the EKG was an increase of the amplitude and duration of the T wave (Fig.1 ). As known the T wave corresponds to the repolarization period of the heart muscle. At this stage the frog can go on for several hours. As soon as the temperature is decreased, the heart reverts to normal. With further increase of temperature or prolonging the exposure at the previous temperature, the heart beat becomes irregular and even at this stage the phenomenon is reversible. With still higher temperatures the duration of the R waves increases and its amplitude decreases. At this stage reversibility tends to disappear. (fig. 2)

On the cold side, when the temperature decreases below 55°F., the heart rate decreases faster than the normal change within physiological limit and soon irregularity appears

The amplitude of the R waves can be reduced to a much as 1/3. Below 50°F. the heart beat is barely visible. All these phenomenons are reversible although it might require a very long time to go back to normal.

#### 4.1.2 THE FIRING RATE AND THE SHAPE OF THE ACTION POTENTIAL OF THE VESTIBULAR NERVE

The effect of temperature on firing rate is due to the fact that the bullfrog is a cold blooded animal and, therefore, all the body reactions are changed according to the environmental temperature (equal to the body temperature). The variation in frequency of discharge has been studied both during the preparation of the OFO-A experiment and in control experiments performed as a result of the temperature profile observed during the flight. The temperature/firing rate ratio is not a linear one (see Fig. 3). It approaches an hyperbolic function. Of course, the fact that most of the units fire irregularly introduces a sizeable error on the data reduction. However, between 55 and 63°F., which is the range of the flight temperature, the frequency at rest increases approximately by one pulse per second. As expected, the curve of the frequency changes in the firing rate of the vestibular unit follows closely the one corresponding change in the heart beat (Fig. 4)

although at a different overall frequency. The maximum change happens between 59 and 62°F. which seems to be within the normal temperature for the frog. Below 59°F. the frequency stabilized to a low value with occasional bursts of high firing. On the basis of these results the data from the flight has been corrected: the final results, however, were not modified significantly. No change appears in the amplitude and shape of the action potentials within this temperature range.

#### 4.1.3 THE OXYGEN CONSUMPTION

Within the limit in which the changes in the firing rate and in the EKG were kept relatively minor, the O<sub>2</sub> consumption of the frog has been investigated as a function of the PO<sub>2</sub> in the surrounding water. This was made first in an appropriate container built for the purpose and later on in the experimental prototype of the FOEP.

A typical experiment was carried out as follows. A frog of known weight and prepared as for the flight except for the chronic electrodes implant was placed in the FOEP, kept at constant temperature, and the oxygen consumption of the animal carefully measured by feeding the gas circuit of the FOEP from a small gasometer filled up with O<sub>2</sub>. The system was sensitive enough to measure even minimal changes in oxygen consumption and the pressure of the oxygen feeding pipe was maintained similar to the one provided by the damand valve when the package was intact. The environmental PO<sub>2</sub> in the water containing the frog

was changed from 700 mm to 500 mm of mercury in steps. The  $O_2$  consumption of the frog was previously determined while immersed in water but with free breathing through the lungs as a basic data. It was found that, as an average, a bullfrog uses from 160 and 180 ml of oxygen per hour per kilogram at a temperature of 63-72°F. when the forelimbs are paralyzed by means of the ordinary technique of cutting the branches of the lumbar and thoracic plexuses. An equivalent consumption of oxygen was found at between 600 and 700 mm of mercury of  $PO_2$  in the environmental water at the same temperature; but below 500 and with a sharp decrease between 550 and 500 the oxygen consumption was reduced to an average of 30 ml per hour per kilogram. In this condition the frog after a couple of hours shows evident distress symptoms like irregular heart beats and increase in the T wave of the EKG. If the low oxygen pressures were kept for much longer the frog would die, while most of the time a full recovery was observed by increasing the  $PO_2$  to 600-700 mm of mercury. In each of the four experiments performed the observation was kept for at least ten hours for each  $PO_2$  value in the environmental water and in two cases for 24 hours. Naturally when the critical value of 500 was reached, the experiment was interrupted except in one case in which the animal was allowed to die for experimental purposes.

It is obvious, therefore, that 650-700 mm of mercury of  $PO_2$  in the environmental water are the appropriate values

for maintaining the frog in a stationary state. At this environmental value of  $PO_2$  the temperature could be increased up to about  $72^{\circ}F$ . without producing an oxygen deficit.

As a conclusion, therefore, it was found that a partial pressure of  $O_2$  up to 650-700 mm of mercury is necessary to assure that (at a temperature between  $60-65^{\circ}F$ .) the firing rate of the vestibular fibers remain within normal limits. This introduced an additional problem, namely, the possibility of  $O_2$  toxicity.

#### 4.1.3.1 THE OXYGEN POISONING (40)

Although oxygen is necessary for the production of energy and survival of all aerobic cells, it is also a universal cellular poison against which cells in the course of evolution developed special defense mechanisms. In fact the difference between the biological effects of  $O_2$  at .2 atmosphere (partial pressure in air at sea level) and at 1, 2, 3 or 10 atm is only a question of degree. In a complex organism as against the unicellular the tension of  $O_2$  is a function of the blood supply, the diffusion of  $O_2$  from the blood vessel to the cells, and finally the rate of  $O_2$  uptake per unit weight of tissue. The real mechanism by which  $O_2$  exerts its toxic effects on cells is still an unsolved problem.

One of the reasons is probably that there is more than one site at which  $O_2$  exerts its effect on cellular reaction.

Among the possible biochemical sites of  $O_2$  toxicity are 1) the SH enzymes; 2) thiol-containing coenzymes, lipoic acid, coenzyme A, and GSH; 3) flavoprotein enzymes, especially those containing nonheme iron in addition to SH groups; 4) enzymes requiring pyridoxal phosphate as a coenzyme and especially the glutamic acid decarboxylase (GAD), the enzyme responsible for the formation of gamma-aminobutyric acid (GABA) in the nervous system; and finally, 5) lipid peroxidation should be considered as a function of the biochemical site and  $O_2$  aggression.

There is still to be studied the relevant physiological functions that are being interfered with. For instance the typical convulsions exhibited by mammals at 3 atm  $O_2$  or above certainly indicate an alteration of the neuronal pathways in the CNS and this may be due to a disturbance of the metabolism of glutamate and GABA.

Other possible sites of  $O_2$  toxicity are the synapses in the nervous system (autonomic or central) and a third site might be the mitochondria.

In summary the  $O_2$  toxicity has the following characteristics.

1. It can manifest itself in a great variety of ways. Most, if not all, cells are susceptible to  $O_2$  toxicity. Toxic effects of  $O_2$  have been demonstrated in bacteria, plants, cell cultures, amphibians, and mammals. Impairment of highly specialized functions such as those performed by the lung, retina, or CNS can be produced by high oxygen tension.



2. Oxygen poisoning must involve many fundamental biochemical reactions like the one associated with energy production, transport of substances across membranes, and oxidation and synthesis of vital constituents in the tissues.

3. Oxygen toxicity is very likely associated with the oxidation of basic chemical groups like the SH. Also peroxidation of lipids might take place.

4. The oxygen toxicity is not due to a typical level of oxygen above which the injury starts. It occurs in man as an interference with pulmonary function even after a few hours of breathing pure oxygen at sea level barometric pressure above 1 atm. Pure oxygen produces a large number of cellular changes long before gross alterations of functions becomes evident.

5. Finally, the progress and severity of O<sub>2</sub> poisoning can be influenced by a number of factors. For instance, trace metals, chelating agents, SH compounds and disulfides, hormones, body temperature and diet.

#### 4.1.3.2 BIOLOGICAL EXAMPLE OF PROTECTION AGAINST HPO

There are several examples in nature in which a resistance is developed against HPO. One of these is the tissue of the swimbladder which must carry out all the normal cellular functions by using energy derived from O<sub>2</sub>-sensitive catabolic processes and is being filled up with pure oxygen. In deep sea, fishes are subject to an extremely high oxygen

pressure. For instance, during the SeaLab II experiment a rockfish was caught at a depth of 200 m equivalent to 22 atm and most specimens used in the investigation contained 80-95%  $O_2$ . This last specimen in the SeaLab was caught at 30-60 m, equivalent to 3 atm.

It can be said that the low temperature in this case, especially for deep sea fish, protects the swimbladder tissue against the toxic effects of  $O_2$ .

#### 4.1.3.3 EFFECTS OF OXYGEN ON BLOOD FORMATION AND DESTRUCTION

The effect of high oxygen pressure on the blood can only involve the  $O_2$  physically dissolved as hemoglobin is fully saturated at normal ambient  $PO_2$  and 90% of the available hemoglobin in mammals is saturated with a  $PO_2$  of 100 mm of mercury.

The relationship between the amount of gas dissolved in plasma and the partial pressure of the gas is a linear function and it is described by Henry's law of solubility of gases in liquids.

Under conditions of hyperoxia, physically dissolved oxygen damages the red blood cells by 1) direct inhibition of the glycolytic enzymes containing active SH groups and 2) formation of lipid peroxides from lipid component of the RBC membrane lipoproteins. A third mechanism did produce oxidation of catecholamine thus damaging the RBC.

Experiment conducted during the Gemini project in which pure oxygen was used at 1 atm as in comparison with the Apollo project in which a partial pressure of 304 mm of mercury mixed with 454 mm of N<sub>2</sub> show that breathing pure oxygen always produced a decrease in the circulating RBC mass.

Other significant biochemical changes were 1) reduction in plasma levels of vitamins E and A; 2) decreased activity of enzymes containing active SH groups; 3) alterations in the transmembrane cation flux; 4) reduction in total RBC membrane lipids, particularly the phospholipid fraction and 5) abnormal RBC morphology.

The conclusion is that 1) the increase in physically dissolved O<sub>2</sub> contributes more to the chemical toxicity of hyperoxia than the one that is chemically bound; 2) the noxious effect of O<sub>2</sub> on RBC brings about a decrease in the circulating RBC mass; 3) the addition of N<sub>2</sub> or He may significantly reduce or inhibit the deleterious effects of hyperoxia.

#### 4.1.3.4 EFFECTS OF OXYGEN UPON THE EYE STRUCTURES

Of the different gases used so far to form the environmental atmosphere only O<sub>2</sub> has been found to alter vision and produce structural changes in the eye. The effect on the eye can either be reversible or irreversible.

One of the main effects is constriction of the retinal vessels and peripheral visual field. Between 8-10% of damage in the diameter of the retinal vessels have been

found at  $PO_2$  of 1 atm going up to 3 atm. There is a 19% decrease in the diameter in the vessel as an average. However, the degree of vessel constriction is dependent also from the partial pressure of  $CO_2$ .

More severe symptoms occur at an environmental 100%  $O_2$  at 3 atm for 4 hours or 1 atm for 40-48 hours. In this case the visual cells of the animal can be destroyed. Also detachment of the retina and fibroplasia on the cornea and the lens is observed after 5.5 hours of exposure to 3 atm and they are irreversible.

#### 4.1.3.5 PULMONARY OXYGEN POISONING

The oxygen poisoning is particularly evident in mammals and all air breathing animals affecting both the airways and the lung respiratory surface. The effect is related both with partial pressure and exposure time. A  $PO_2$  of 254 mm of mercury did not produce any toxic effect in man even after 30 days of continuous exposure. However, 80% of  $O_2$  at sea level might produce irritation of the respiratory surfaces even after only 12 hours of exposure producing coughing, nasal congestion and sore throat. After the exposure up to 24 hours to 100% of  $O_2$  even bronchial pneumonia was observed. After more than 100 hours the pulmonary reaction has been much more severe producing persistent coughing, bronchial pneumonia, pleural effusion. Brief intermissions do not significantly diminish the toxic effect on the pulmonary surface.

The pulmonary damage is much faster at 2 instead of 1 atm of inspired  $PO_2$ . First, after 6 hours a 5% reduction of vital capacity develops followed very rapidly by coughing and bronchial irritation and becomes very severe within 10 hours. The alteration of the pulmonary surface produced by  $O_2$  pressure up to 2 atm does not seem to limit the pulmonary gas exchange. However, if the high  $O_2$  pressure is maintained for a long period of time, structural changes and pulmonary edema, infusion of red cells into the airways, atelectasis might develop up to death from hypoxia.

The toxic effect of the  $O_2$  is definitely due to the local effect of the high tension of  $O_2$ . In fact the first alteration involves the upper respiratory tracts where the  $O_2$  concentration is higher.

#### 4.1.3.6 OXYGEN TOXICITY IN NEURONAL ELEMENTS

It is very likely that the  $O_2$  induced changes on the nervous system elements are due to several mechanisms but one of the most important seems to be the effect of  $O_2$  upon the metabolism of the gamma-aminobutyric acid which is in significant amount in vertebrates in the CNS where it can act as a modulator or inhibitor of nerve transmission and of an intermediate of the oxidative metabolism.

It seems that a high pressure of oxygen causes a significant decrease in brain GABA in rats. There are marked differences between this affect according to the different

animal species. If we compare the rate of decrease of GABA as a function of the  $O_2$  pressure a linear relationship between these two factors is observed but, more important, the critical pressure causing brain GABA to decrease was 30 psig (3 atm abs) which is, by the way, the same pressure known to produce seizures in animals and man.

Another factor important in influencing  $O_2$  toxicity is the amount of  $CO_2$  in the breathing mixture. The presence of  $CO_2$  concentration like .5 to 1% shortens the delay between the beginning of the breathing and the onset of the seizures in mice whereas a higher value like 5% prevents them and the same values of  $CO_2$  correspondingly accelerates the rate of decrease in brain GABA and blocks it. The mechanism of action of HPO on the nervous system is linked with this decrease in GABA is further proved by the fact that the administration of GABA prior to exposure to HPO prevents or delays convulsions.

The effect of decreased GABA levels is demonstrated at the nerve synapses inhibiting or modulating nerve transmission.

A recent article published by Cymerman (4) and Gottlieb is most pertinent for the purpose of this report. These authors studied the result of high oxygen pressure on the bioelectric properties of frog sciatic nerve. They were able to distinguish the affect of oxygen per se as against mechanical pressure by using helium as a control at the same

pressure that was used for the oxygen investigation. The effect of oxygen pressure was studied up to 51 atmosphere. The main changes found were decrease in conduction velocity, interspike coupling and increases in the rheo base. They also found that at 13.2 atmosphere of pressure complete nerve blockage took place in about 4.5 hours at 25°C. They also found out that low temperature seems to exert a protecting effect on the oxygen toxicity. The lack of hydrostatic pressure effect noted in the helium experiments confirm the previous findings of Tasaki (35) and Spyropoulos. Especially important from the point of view of this report is the affect on the spike amplitude and this seems to be a good index of the beginning of an oxygen toxic effect.

The spike amplitude, therefore, has been taken as the main index together with the EKG and the observation of the frog after a long period in the FOEP of the beginning of a high O<sub>2</sub> pressure effect on the nervous activity and generally on the animal. This will be further discussed in Section 8.2 which describes control experiments performed on the effect of an increase of the O<sub>2</sub> tension which developed during the OFO-A mission. In all the test experiments performed prior to launch, it was found that a partial pressure of up to 700 mm of mercury in the environmental water never gave any indication of O<sub>2</sub> toxicity. In fact in the few months before the flight, it was found that it was convenient to maintain the frogs even in the

holding tank with an environmental  $PO_2$  pressure of the same values of 700 mm of mercury as used during the flight. The frogs have been kept in this condition for up to 20 days with no visible ill effect. Particularly important is the fact that the  $O_2$  consumption is nearly the same while breathing in air ( $PO_2$  equal to 155 mm of mercury) and while breathing through the skin ( $PO_2$  of 700 mm of mercury).

#### 4.1.3.7 $CO_2$ DISPOSAL

As already mentioned nearly all the  $CO_2$  produced is expelled from the body through the skin. Moreover, the skin of the frog is continuously shedding mucous membranes and even segments of epithelium. In a water environment the excretion of urine also has to be taken into account. Feces were not a particular problem because it was found that the frog can stay with no food for up to a month without any visible impairment and, therefore, the production of feces is relatively minor after the frog has been purged of all the food. The  $CO_2$  problem might have been an accumulation of the gas as a shell around the frog body, therefore impairing  $O_2$  breathing. The shedded mucous also has to be disposed of because if it remains attached to the frog it will slowly impair respiration. The amount of urine produced by the frog required only a high enough volume of environmental water to be sufficiently diluted. It was found that owing to the high solubility factor of  $CO_2$  in water, the  $CO_2$  would not accumulate around the frog even when the water was still but diffused rapidly outward.



To eliminate the debris produced by the frogs, it was necessary to assure a proper flow, namely, 300 ml of water per minute. It was necessary, however, to filter the debris coming from the frog through an appropriate filtering system so that the water would come back into the frog chamber with no solid parts suspended.

The production of  $\text{CO}_2$  closely followed the  $\text{O}_2$  consumption being in the order of 140-150 ml of  $\text{CO}_2$  per kilogram and per hour. This was disposed of through a lung and baralime system (see 4.3 on FOEP). The amount of water used (11 pounds) was enough to assure a sufficient dilution of the urine so that no relevant Ph change or high enough concentration of damaging elements was observed.

#### 4.2 THE TECHNIQUE OF RECORDING FROM A SINGLE UNIT FOR SEVERAL DAYS IN PHYSIOLOGICAL CONDITIONS AND, AT LIFT OFF, DURING HIGH MECHANICAL STRESS

The main problem of the OFO-A experiment was to devise a technique by which the spike train data could be recorded from a single vestibular nerve fiber 1) for a period of several days, 2) in the intact animal in a physiological condition, and 3) during the high mechanical stress corresponding to the lift off. An additional problem was to have the preparation ready at the time of the launch with a good chance not to have to replace it. Such a technique did not exist and it was developed for the experiment.

The working hypothesis was simple, namely, a body of the same density as the environment will not be displaced, even by high acceleration, in respect to the environment itself. The technique has been published and a reprint is included (see Reprint A).

Some changes have been made between the Apollo Mission that was cancelled and the OFO-A Mission on the Scout and they will be described in Section 5. The technique passed all the qualification tests for the Apollo but they will not be described in Section 5 as much more severe conditions were caused by the shift to the Scout and, therefore, only the testing made for the new situation will be described in detail. As shown in Reprint A, a special water-tight emitter-follower preamplifier had to be developed for this purpose.

#### 4.3 THE FOEP (fig. 5)

The FOEP, or Frog Orbital Experiment Package, has been built upon the specifications provided by the results described previously in this Section. It is composed of three different systems. A life supporting system divided into a water system and a gas system which assured to the frog a water environment of the appropriate flow as indicated (300 ml per minute), a  $PO_2$  between 650-700 mm of mercury and a temperature maintained when in space within the indicated range of  $62.5^{\circ}F. \pm 2.5^{\circ}F.$  The gas system was pure  $O_2$  supplied by an  $O_2$  bottle through a demand regulator and the gas exchange

took place through an especially built lung providing a large surface for the gas exchange by means of several sheets of thin silicon rubber. These are, as known, highly permeable to  $O_2$ ,  $CO_2$  and water vapor. The  $CO_2$  was eliminated from the gas side by absorption while passing through a bed of baralime. The circulation of the gas and water system was assured by two small pumps. The container in which the frog was placed and through which the water circulated passing through a filter system covering the entire walls was the arm of a centrifuge that assured the appropriate g level at the labyrinth site of the two frogs placed tail to tail in the centrifuge arm. This system provided the appropriate stimulation for the labyrinth when needed (for details see Section 8). The pressure in the gas side and the water side was equalized through an accumulator system consisting in a container with two chambers divided by a non-elastic collapsible partition. One side of the partition was in communication with the water circulation and the other with the gas circulation: the system was set according to the differential pressure between the two to the point of equilibrium.

The temperature was controlled on the water side through a thermostat and a heat exchanger that could either cool or warm the water, the first by evaporation in the space vacuum and the second by an appropriate heater. The temperature control was manually operated from the ground. It could not function as far as the cooling part is concerned in the atmosphere and that,

as shall be discussed in Section 7, was a problem. The water temperature and the water pressure was controlled continuously. The biological signal was recorded through the emitter-followers connected to the frog jaw (see Section 7) and amplified by the main amplifiers which increased the voltage level to the appropriate value for telemetry. The FOEP was encased in an air-tight canister containing air at the pressure of 1 atm during the flight and on the ground.

#### 4.4 THE PHYSIOLOGY OF THE PRIMARY NEURONS IN THE FROG AS A CLOSED LOOP SYSTEM

As indicated in Section 3, no data were available on the gravity sensitive receptors of the frog (and even of other animals) for a period of time anything near to the one required for the OFO-A Space Mission. It was, therefore, necessary to carry out a complete new investigation recording from the primary neurons of the gravity sensitive vestibular receptors of the bullfrog for a period of at least three days (minimal duration of the mission). Also, as a comparison, other vestibular receptors had to be studied in this way. The bulk of the results obtained from 1963-69 in preparation of the OFO-A Mission are contained in a number of publications of which the three most important are herewith included: The Gravity Sensing Mechanism of the Inner Ear (Reprint B), Analysis of Single Vestibular Responses (Reprint C), and Unidirectional Response of Statoreceptors to Vibration - A Mean for Artificial Gravity in Space Flight (Reprint D). Additional work performed especially

in relation to the character of the Scout Mission will be described in Section 5.

The main conclusions can be summarized as follows.

1. The vestibular gravity sensitive receptors have been identified as the ones showing a stationary response significantly different for the different positions of the head with or without a preceding partial adaptation. This deals with the accepted definition (see Section 3).

2. Most of the receptors studied showed a very irregular resting discharge. However, after the three papers were published, further work showed that some regularly firing units are found also in frogs very much with the same characteristics as in cats. For the irregular firing the main relevant parameter is considered to be the interspike histograms.

3. Each unit responds within a certain receptor field. Such receptor fields never cover the full one g change of maximum sensitivity. Within the central part of the response the main changes seem to approach a logarithmic function of the stimulus although the overall response is an S-shaped curve.

4. The unit responds both to static and dynamic stimulation. The gravity receptors respond to vibratory acceleration within their receptor field. They respond to a maximum of frequency of vibration which approaches the reciprocal of the minimal interval. The response to vibration differs in the three main vestibular components. The vibratory

receptor proper responds to vibration in all directions and the semicircular canal only responds to vibration at a very low frequency.

5. The gravity receptors seem to be able to distinguish the vibratory stimulus from the linear one when a stimulation equivalent to the sum of the two is applied.

6. After the electrode implant a certain amount of time is necessary (up to some hours) before nearly constant distribution is maintained in the interspike intervals at rest or during constant stimulation and the response becomes sufficiently constant: these constant characteristics are maintained for some days till the preparation starts decaying. No multivaluedness was observed in these conditions.

7. A frog in stationary physiological condition would show a very active nerve. This seems to be in accord with the fact that all components of the vestibular nerve show spontaneous activity. When it was difficult to record activity from single units in the nerve, it was found that no physiological condition prevailed, normally due to hypoxia. In fact a good oxygenation restored a very lively activity throughout the nerve.

Fig. 1. EKG records from the instrumented frogs in the FOEP : effect of the discrepancy between oxygenation and temperature : A) steady state B) a relative hypoxia is denounced by an increase in the T wave C) the hypoxia becomes more severe and the heartbeat becomes irregular : at this stage a slight increase in the R wave might take place. The situation is reversible so far : if further deterioration is allowed, the R wave becomes smaller and recovery might not be possible in some cases. Amplitude in the figure Time 1 division= 5 seconds

Fig. 2. EKG recorded as in fig. 1 : deep alterations due to severe relative hypoxia ( $O_2$  deficit in relation with the environmental temperature) are shown. In A) : decrease in the heartbeat rate is followed by an inversion of the R wave. In B) a marked decrease of the R wave is shown at the beginning : at this stage an increase of  $PO_2$  was applied (from 450 to 700 mmHg). Note the nearly immediate return to normal of the EKG.

Gain 100/ $\mu$ V per each large horizontal division.

Time 10 sec/div (vertical).

Fig. 3. Changes in the firing rate of one vestibular unit (ordinate) as a function of temperature (abscissa). Values in the figure: each white dot.- mean frequency over 10 sec.

As shown, a non-linear relationship exists.

Fig. 4. Diagram showing the relationship between one vestibular unit rate of firing (ordinate on the left) at rest, the heart rate (ordinate on the right) and temperature (abscissa).

Each dot is the average frequency over 10 seconds (vestibular spike) and over 1 minute (EKG).

A non-linear relationship is shown. It approaches however a linear ratio from 59° F upwards.

Fig. 5. Schematic illustration of the different systems of the Bio-package (Bio-package orbital otolith experiment=FOEP). The figure is self-explaining.



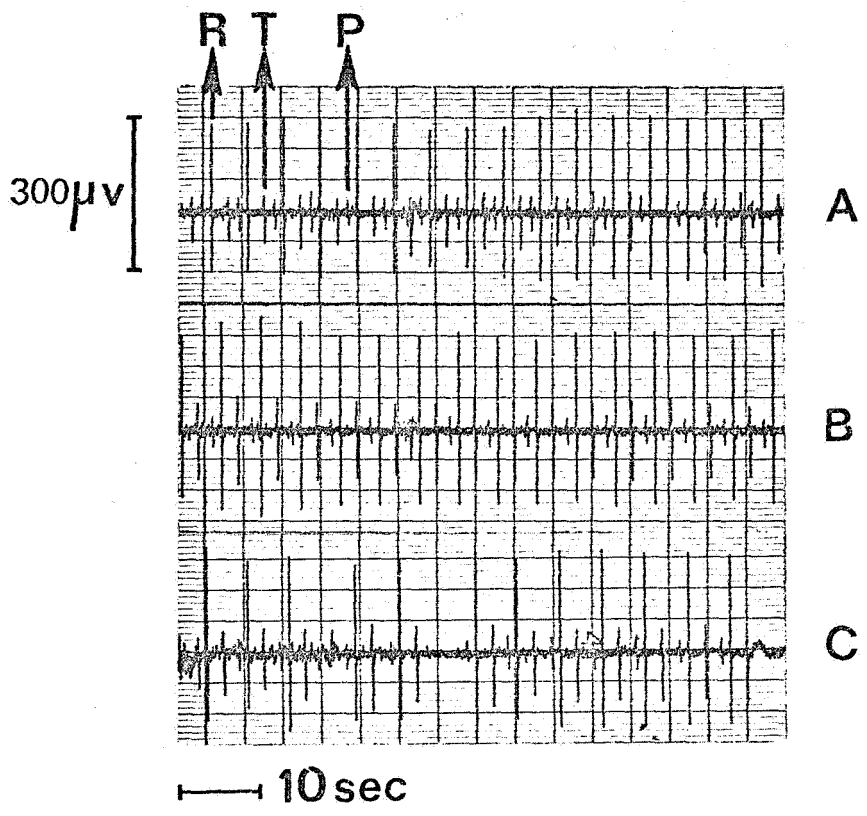

Fig. 1

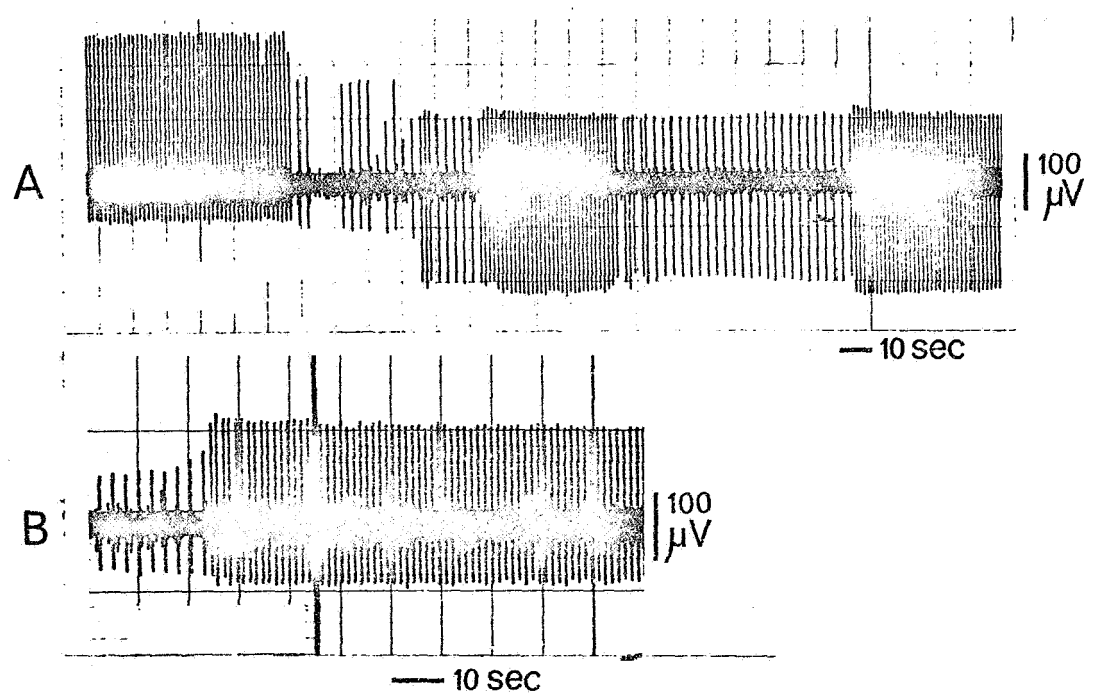

Fig. 2

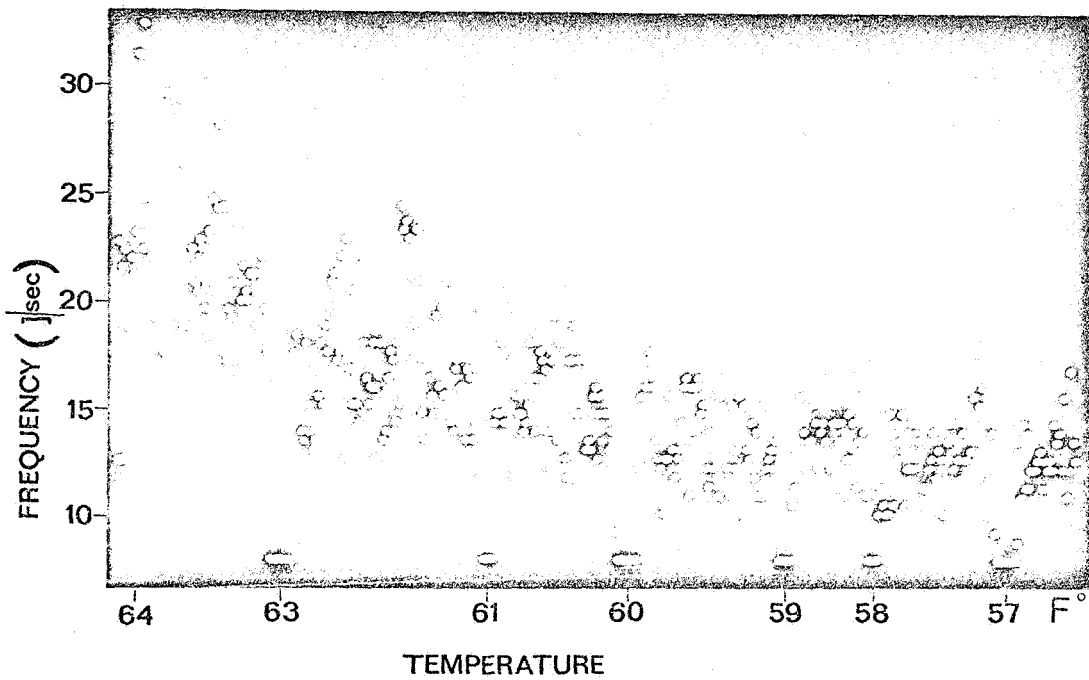

Fig. 3

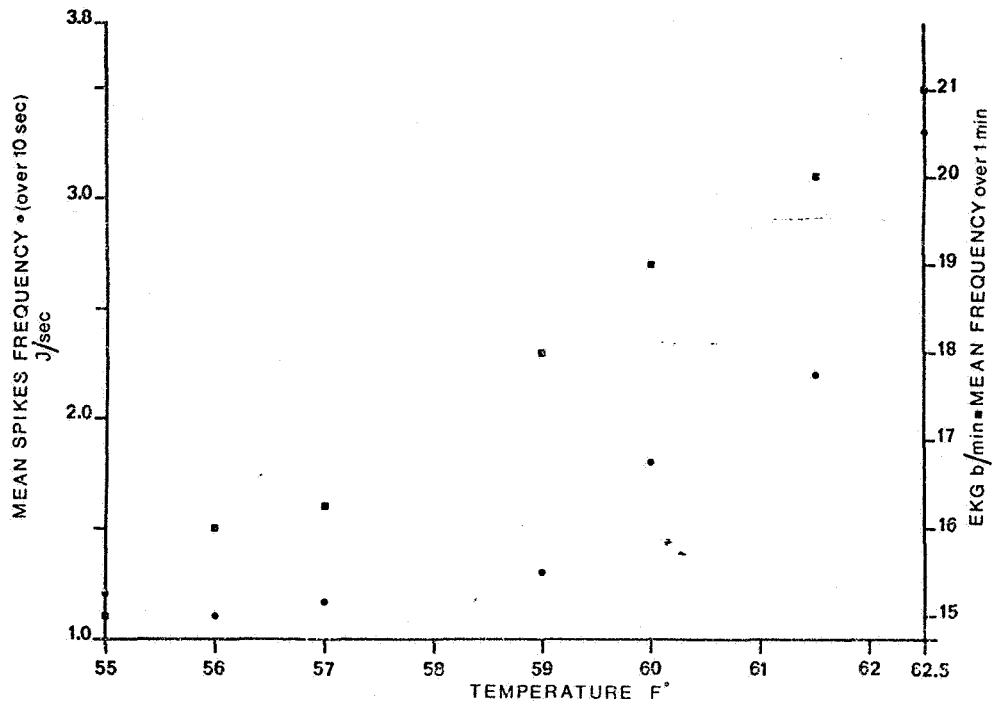
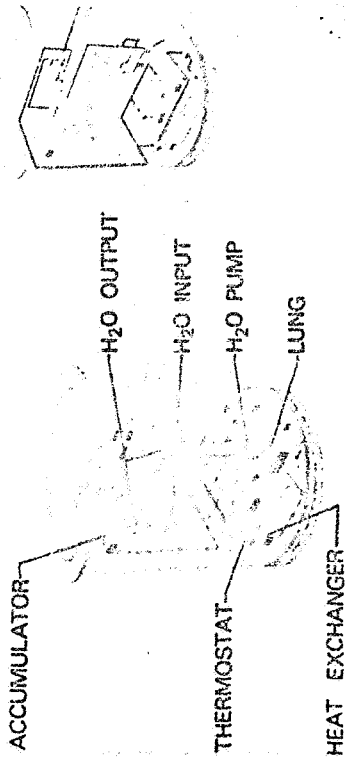

Fig. 4

**BIOPACKAGE ORBITAL OTOLITH EXPERIMENT**  
WATER SYSTEM



**A**

**BIOPACKAGE ORBITAL OTOLITH EXPERIMENT**  
ELECTRICAL SYSTEM

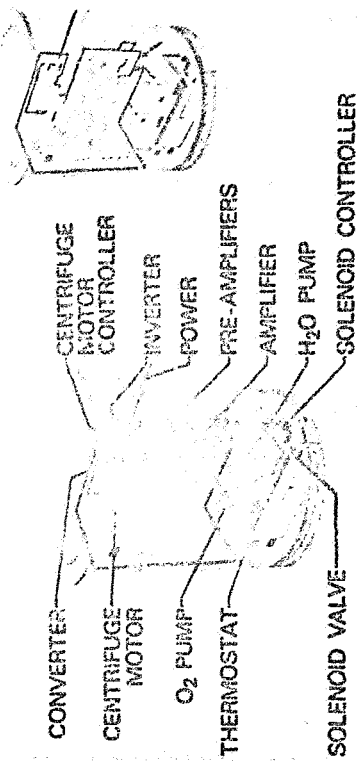

**B**

**BIOPACKAGE ORBITAL OTOLITH EXPERIMENT**  
GAS SYSTEM

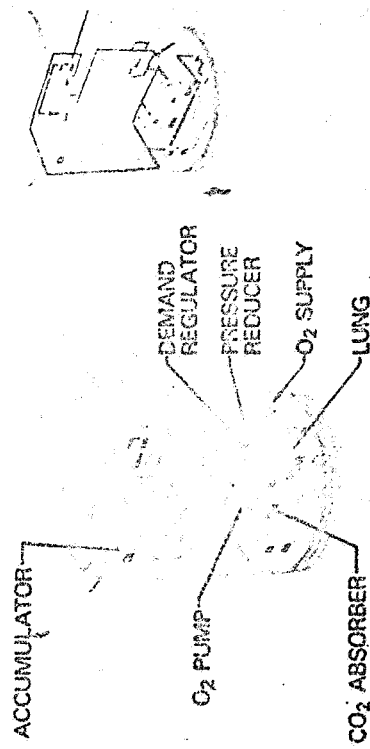

**C**

**BIOPACKAGE ORBITAL OTOLITH EXPERIMENT**  
OUTPUT SIGNAL AND TEMPERATURE CONTROL SYSTEM

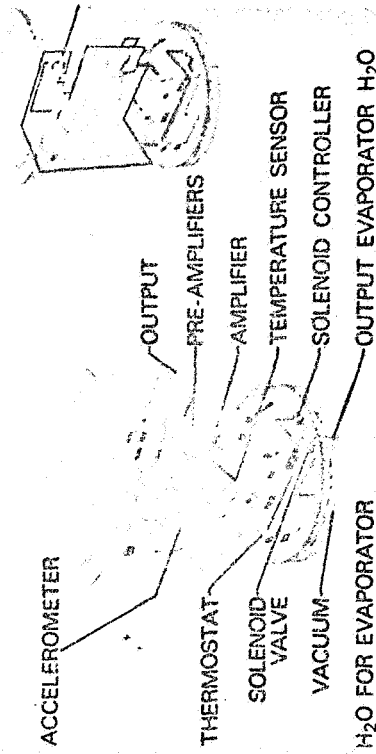

**D**

Fig. 5

Blank

## SECTION 5

### PROBLEMS AND DIFFICULTIES CONNECTED WITH A SCOUT MISSION. PRELIMINARY WORK DONE AT MILAN PHYSIOLOGY LAB AND AT WALLOPS.

#### 5.1 PREPARATION OF THE OFO-A EXPERIMENT

The surgery on the frog and the chronic electrode implant to be used in the OFO-A Mission are a complex operation. The animal thus instrumented survives a limited period of time only; therefore, the entire procedure has to be performed as soon as possible before the launch. As in all biological preparations, certain random factors intervene by which some animals die for different causes. Moreover, the frog, being an amphibian, has certain limitations as to the ability to endure environmental conditions while maintaining a normal performance of the nervous and sensory systems. Consequently a series of test studies have been performed in the Milan Laboratory and while at Wallops prior to the launch in order to assure the best possible survival and normal functioning of the frog preparation. The purpose was:

1. To work out a routine, relative to the instrumentation of the frog, which will assure the best conditions for the frog preparations to be used during the launch.

2. To study the environmental factors in order to determine the ranges within which the preparation itself has the best chance of maintaining healthy conditions for a prolonged period of time.

3. To perfect the handling of the preparation in the FOEP and to perform repetitive tests of the frog preparation in the FOEP prototype, for periods beyond the flight duration. This provides an index of the reliability of the experiment in connection with the environmental factors and the handling procedure.

4. To obtain extensive base line data in the laboratory during the period (3) to be used for a) testing the related equipment, like telemetry, computer programs for data analysis, etc.; b) gathering enough information on the vestibular activity in 1 g conditions using the FOEP centrifuge and general environment, following the same routine as during the flight: this allows the comparison of the activity of the vestibular unit at 1 g and at  $10^{-3}$  g obtained during the orbital flight; c) establishing the minimum time necessary for getting sufficient base line data for the frog preparations prior to the launch.

It has to be kept in mind that access to the FOEP of the principal investigator has been rather limited up to the end of 1969, and some four years have elapsed since the training on the bio-package performed during the Apollo 205 Mission.

5. To work out a schedule for the mission biological preparation.

#### 5.1.1 FROG SURGERY AND INSTRUMENTATION

As a result of extensive experimentation on approximately

60 frogs, the following variation of the original procedure has been found to assure better results. The surgery is performed in three stages; a fourth stage corresponds to the chronic microelectrode implant.

First Stage - Demotorization of upper and lower limbs.

After narcosis by immersion in a 0.5% solution of Tricaine methane sulphonate for 20-25 minutes, all branches of the thoracic and lumbar plexuses are cut; then the frogs are placed back in the holding tank for at least four days at a temperature maintained between 57° and 60°F. A constant flow of fresh water is assured.

In this way nearly all frogs survive, with only occasional deaths mostly due to hemorrhage. This involves, however, not more than 1% of all demotorized frogs, and normally happens within the second or third day. After the fourth day the animals appear in good health and full recovered from the rather severe shock of the operation.

Second Stage - The exposure of the vestibular nerve.

In a second stage, after 2-3 days, the frogs were again anesthetized and the vestibular nerve exposed. The surgical procedure adopted to expose the vestibular nerve has been modified during the OFO-A flight experiment preparation period.

The method previously used was to cut through the bones of the mouth roof by means of a dental drill shaped like



a ring rotating around its axis. With this method a round piece of bone 5 mm in diameter could be isolated from the surrounding bones down to the dura. It could then be easily extracted with a pair of forceps. With some practice the hole could be made so that it centered on the vestibular nerves so no other cutting of bony tissues was necessary. This method, however, in its simplicity had some important drawbacks. It was not very easy to stop exactly at the dura, and injury to the underlying nervous tissue on blood supply was a hazard (see Section 5.1.3); also it was not possible to control hemorrhages from the bones during the drilling procedure.

The ring-shaped tip was then substituted with ball-shaped dental burrs of different diameter according to the need.

With this method the hole through the bone could be carefully drilled, hemorrhage could also be controlled and any damage to the underlying blood supply and nervous structure avoided, because both could be seen through the bones in the last stages of the hole drilling. The last part which is mostly cartilage, was removed by means of stainless steel forceps (Dumond N.2). The vestibular nerve was then freed from the surrounding membranes with the aid of forceps (Dumond N.5).

A small amount only of cephalo-rachidian liquid is left in the opening to barely cover the nerves and the medulla, the remaining part being filled with 1.5-2% Agar in isotonic

solution: it was found that this assures a better protection and less swelling of the nervous tissue.

Only one screw is secured to the bone structure with a flange to accept the terminal part of the microelectrode output wire, protected by a length of polyethylene tubing. As no dental cement is used anymore, the second screw is not necessary (see Stage Four).

The tongue is cut, close to its connection with the anterior part of the mouth (frog tongues are attached to the rim of the front part of the upper jaw, contrary to their position in mammals) to avoid it displacing the microelectrode which is no longer protected by the dental cement.

This is the most critical stage and about 30% of the frogs do not survive. The surgery is quite demanding as it involves working in a close space near the medulla, one of the most vital areas of the central nervous system. Moreover, it is heavily supplied with blood vessels and hemorrhage is quite common, especially while freeing the nerves from the delicate membranes which surround them and cannot be pierced by the microelectrode tip. A deep narcosis, which would decrease the blood pressure and therefore the danger of hemorrhage cannot be used as blood pressure in the vestibular vascular circuit is quite low and the decrease of the general blood pressure would stop the circulation altogether with irreversible damage to the vestibular cells. These in fact cannot stand stoppage of circulation for any extended period of time.

The wound is sutured and the frogs are then placed again in their tanks (at 57<sup>o</sup>-60<sup>o</sup>F. temperature) and left there for 3-4 days. This has a three-fold purpose: a) it eliminates the preparations which were not fit for survival as death normally happens within 1-2 days; b) it shows possible functional damage of the labyrinth, as the frog will maintain an abnormal position in water if this happens<sup>+</sup>; c) it allows a good healing of the nervous structures involved, with disappearance of the swelling and of circulatory disorders resulting from surgery allowing the microelectrodes to maintain their position relative to the nerve. It has in fact been observed that quite a sizeable displacement of the nerve structure takes place in the first 1-2 days after surgery owing to change of dimensions and position during the first swelling and the following return to normal. It is therefore more convenient to implant the electrode with no further surgical maneuvers after the nervous system is normalized.

<sup>+</sup>Note an inversion of procedure: in the original technique the second stage, namely the nerve exposure, was performed first, and the demotorization afterwards, on the assumption that a better appraisal of labyrinth damage could be done observing a frog free to move. It was found out, however, that reversing the procedure assured a better survival ratio without seriously impairing the testing of the labyrinthine function (see later).

Third Stage - Insertion in the centrifuge end-caps.

No narcosis is provided. The opening in the palate is exposed and the vestibular nerve preparation carefully inspected, after removal of the Agar protection by suction. Critical points are: circulation: the network of blood vessels has to be intact and the blood briskly circulating; no hemorrhage, as indicated by even minor blood clots, is acceptable; nerve condition: the nerves must appear intact, with no lesions, and the capillaries in the nerve must be filled with circulating blood. Swelling should have disappeared. Minor cleaning of the preparation may be performed but no major surgery: if this is needed, the frog is treated as in the second stage.. Then Agar is placed again on the opening and this is covered with gel foam. The soft tissue of the palate is left wide open.

The frog is secured in the head clamp of the end cap. One preamplifier is fixed to each side of the upper jaw with silk wire. The mouth is then clamped closed. The EKG electrodes are fixed under the skin of the thorax over the heart and the EKG recorded.

The frog is placed, hanging from the end cap, in the specially built support in flowing water kept at the usual 58-60°F. for at least one more day: at this stage O<sub>2</sub> is bubbled through the water in the tank as the frog might not be able to breathe air at this stage. Occasional death might occur at this stage, but is very rare, and normally it would be due to injury produced during the procedure. (fig. 6)

Fourth Stage - Microelectrode implant. (fig. 7)

This is performed 48-24 hours before utilization of the preparation. It is made following the procedure described elsewhere, except for two major changes: a) the two microelectrodes are implanted in succession instead of simultaneously and b) the preparation is not sealed with dental cement.

In a) a first microelectrode is implanted as usual in the nerve, tested and secured with Agar which is allowed to become gel. Then, by means of the hot tip of the same microelectrode handle, which is now free, the Agar mass is cut midway along the medulla to separate the half including the microelectrode already implanted from the other half covering the not yet instrumented nerve. The latter Agar is then sucked off, while continuously recording from the implanted microelectrode to check possible displacements: these, however, very seldom occur.

At this point, the second nerve is exposed and ready to accept the microelectrode which is implanted as the first one. Agar is then poured in and the preparation is completed.

The advantage of this procedure is the possibility of working independently on the second side, and of changing as many microelectrodes as it is wished, without having to perform each time a double implant. It avoids moreover to ruin one good implant (owing for instance to frog movements) which performing the second.

The elimination of the dental cement seal was studied originally in 1968-69 in the Milan Laboratory, as soon as the increased vibration and linear acceleration of the Scout were known. It was then felt that an additional length of the free portion of the enamelled platinum wire, connecting the floating microelectrode to the outgoing main wire, would improve the staying capacity of the microelectrode. Besides, the anchorage of the block of dental cement would be unstable under the additional stress. A displacement of such block could unseal the opening in the skull and pull on the above-mentioned platinum wire, thus displacing the electrode.

Extensive tests showed that by shaping the connecting enamelled platinum wire as a free loop curving upwards from the end of the polyethylene tubing, secured on the bone, to the floating microelectrode enclosed in the Agar, displacement of the electrode even under the severest vibrations and shock, was nearly impossible. This was definitely proven by the vibration tests performed in August 1969, in which none of 20 electrodes tested were displaced.

Furthermore, by firmly closing the lower jaw with the corresponding clamp, adequate protection for the preparation was provided. Prolonged submersion in water for up to 15 days did not alter the quality of the vestibular signal. It must be noted that in a few hours a sufficient natural protection is built on top of the Agar (enclosing a small section of the

enamel wire too) to eliminate possible effects of the water entering the mouth. This protection, originally a thin film of tissue, becomes thicker with time without hardening; the connecting wire goes right through it and is sealed all around.

This preparation has proven to be quite reliable, maintaining unit activity for up to 17 days, with an average of 5-8 days, both in the holding tank and in the FOEP (see later).

#### 5.1.2 FROGS EVALUATION

##### A. Vestibular Reflexes

During the recovery period between surgical procedure stage two and stage three the frogs were daily tested for vestibular reflexes.

This test is very simple and gives information about the vestibulo-ocular reflexes and vestibulo-spinal reflexes.

For the test a frog was taken and put in its normal squatting position on the palm of the hand and kept horizontally with the head facing the experimenter. It is necessary at this point to wait until the frog opens the eyes and raises the head well clear of the hand of the experiment. With few movements of the animal it is then possible to check the reflexes. First the animal is rotated in a horizontal plane, this is accomplished by the experimenter rotating his body. Only a few degrees of motion is necessary to elicit a response (about  $\pm 10^\circ$  from the resting position). During rotation the frog's eyes and the

head position in respect to a reference point on the hand are observed.

Both the eyes and the head can be seen rotating in the horizontal plane, a counter rotation can be seen on a sudden stop of the movement. The rotation movement is done very slowly and with the minimum displacement necessary to show a reaction. This test gives a good indication of the sensitivity of the horizontal canals and the status of the reflex arch. Next the animal is tilted back and forth. This is best accomplished by the experimenter keeping the hand steady and rocking his own body back and forth, while looking at the position of the frog's head in respect to the hand. The frog's head tends to be always horizontal so that when the frog is tilted back the head tends to be nearer the palm of the hand and when tilted forward the head rises above the hand. This is a static test, the head position is sustained until the tilting is maintained and gives good indications on the statoreceptors condition. The animal is then finally rolled around an antero-posterior axis. The head and the eyes can be seen counterrotating.

No attempt should be made to make these tests when the animal has the eyes closed, no reflex can be elicited in this state even on healthy unoperated frogs. This has been shown also from recording of frog electromiogram during rotation on a rotating table (Bracchi, unpublished data).



All tests are best accomplished keeping the hand and the arm of the experimenter at a constant angle and making all the movements with the body. It is easier in this way to observe fine movements of the animal. All reflexes tested in this way should be the same for characteristics and sensitivity as in the animal before the operation.

B. Eye Blinking Test

A second test was the eye blinking test; this is done by touching the open eyes of a frog. This test shows the integrity of the sixth nerve and the conditions of the central nervous system.

The exit of the sixth nerve is in the medial part of the medulla near the center line at a level just below the seventh nerve and runs over the medulla in a cranio lateral direction.

The nerve is made up of few fibers that innervate the retractor bulbi and the rectus externus muscles. In between the fibers of this nerve runs a very small blood vessel.

During the surgical procedure to expose the vestibular nerve by means of the special ring-shaped drill tip, it was easy to injure this tiny nerve or its blood supply. The blood supply is very sensitive also to mishandling of the dura when the membrane is opened to expose the vestibular nerve. Overstretching of the dura results in impaired blood circulation in the medulla, in the vestibular nerve and in the sixth nerve, the latter being the most sensitive.

When circulation stops in the small blood vessel running with the sixth nerve the retractor bulbi loses its tonus and the frog's eyes become wide open and bulging out. In this case there is no blinking when the eye is touched.

C. Mouth Tonus

A third test was the mouth tonus. It is not usually easy to open the mouth of a healthy frog without the help of a blunt instrument, like the back side of a pair of surgical forceps. Poor tonus results in easy opening of the mouth and only partial or late closure when released.

D. Skin

Frogs in the aquarium have a dark green color. When in poor health condition the skin turns to a lighter yellow-green color. Formation of ulcers is also considered a sign of degrading health condition.

E. Circulation

Circulation evaluation was done through the observation of the color and the speed of blood in the small capillaries and in the arteries of the medulla. Blood should be running in all capillaries both in the medulla and vestibular nerves, where no hemorrhage should be present. The speed should be such that under a magnification x 40 and with a 12,5 x ocular (Zeiss surgical stereo microscope), red cells should not be distinguishable as single units in the major vessels, red cells should be barely distinguishable and only in small capillaries.

The inspection could be carried out both during operation to expose the vestibular nerve and during the waiting period or while connecting the frog to the centrifuge end cap. This was possible by the transparency of the Agar used to protect the opening.

F. Electrocardiogram (EKG)

The EKG was the main parameter used to ascertain the health condition of a frog during the implanting procedure and during the experiment itself. The parameters taken into consideration were:

1. heart beat frequency in beats/minute
2. R wave amplitude
3. EKG waveforms
4. QRS complex conduction times

1. The frog's heart beat frequency is temperature dependent. The temperature used for the OFO-A experiment were from 55°F. (tanks water temperature) to 60°F. (room temperature).

In healthy frogs the frequencies were from 24 (at 55°F.) to 28 (at 60°F.) beats/minute with a variability of  $\pm 2$  beats/minute. (fig. 4)

Other factors besides the temperature can temporarily modify the heart frequency. A decrease in frequency for a few beats can be seen whenever the frog moves on the table. When the animal is put from an air environment into water the amplitude and waveforms can also be modified for some time. A

decrease in frequency below 20 beats/minute at the temperatures mentioned above can be an indication of degrading health. The EKG however has to be always considered as a complex and also the other parameters have to be taken into consideration.

2. The R wave amplitude had a greater variability than the heart frequency. Here however a number of factors can interfere; like the position of the electrodes, liquid in the lymphatic spaces that can partially shortcircuit the electrodes and electrode polarization in long term experiments. More important than the actual amplitude is its constancy throughout the experiment. The amplitudes are always diminished when the animal is in water due to the shortcircuiting effect of the external media.

3. No accurate study was made of the frog EKG waveform modifications in pathological conditions. It was noted however that an excessive amplitude of the T wave was sure sign of a degrading animal, usually death occurred within 24 hours also if R wave amplitude, frequency and rhythm were within the normal limits. An exception to this was noted with the frogs into the FOEP package when passing from open O<sub>2</sub> to closed O<sub>2</sub> circuits. For some hours following this operation there was an increase in the amplitude of the T wave, the return to normal however was complete; at this time no sure explanation can be given of this phenomenon.

4. In the normal frog the QRS complex takes place in 100 msec at 60°F. An increase in conduction time (up to 150 msec) is almost invariably associated with other signs of degradation like arithmia and severe amplitude modifications of the EKG waveforms.

In conclusion. Gross EKG examination is useful in determining the state of the animal at the moment the tracing is taken. Its usefulness is limited however as a prognosis tool in determining the survivability of the animal, because changes in the EKG take place when the other tests, like vestibular tests, already showed signs of deterioration. After the first signs of EKG alteration the animal seldom lived for more than 48 hours.

A frog was discarded:

1. if during the operation a blood vessel on the medulla or any nerve was injured even if the blood vessel was a single capillary;

2. if at any time the blood flow stopped in any vessel (also capillaries) on the medulla or on any nerve that could be inspected;

3. if at any time the blood flow in the major vessels (central spinal artery) showed an excessive slowing down or "pumping" action, e.g., blood changing direction of flow during the cardiac cycle;

4. if during the waiting period or implantation the blood flow in the major vessels slowed down so that in the

major vessels the blood stream could be seen as composed of discrete entities (red blood cells).

(A small decrease in the blood flux might occur during the operation to expose the vestibular nerve, however, this is temporary and a full recovery takes place shortly after the operation.)

5. If frogs were anaemic. Red blood cells should fill up completely the major blood vessels as seen through the stereomicroscope at a 40x position. In anaemic frogs red blood cells occupy only the central portion of the stream.

Circulatory conditions are very stringent for a successful implant. (An implant is considered successful when the nerve potentials recorded from the implanted electrode have the same characteristics of amplitude, shape and response to stimuli from 2 hours to after 24 hours from implantation.) Occurance of any of the points above-described under circulation was reason enough to discard a frog, even if the evaluation with the other tests (vestibular reflexes, eye blinking, mouth tone) were considered satisfactory.

#### 5.1.3 FROGS FAILURE ANALYSIS (Problems Outline - Specific Incidents)

A. Hemorrhages from the soft tissues of the roof of the mouth seldom occurred: Usually cutting the soft tissues with a cautery is a bloodless operation. When hemorrhages occurred they were usually profuse and associated with other conditions like congestion of the skin, congestion of the mouth

mucosae and ulcers. But in these cases the frogs were discarded before the operation. Even successive openings of the wound in the roof of the mouth for inspection of the circulation in the medulla or for electrode implantation are bloodless or very few drops of blood are lost. During the vestibular nerve exposure procedure, hemorrhages occurred when the exposure was carried out using the circular drill and some blood vessels of the plexuses surrounding the hypophysis were damaged. This was one of the reasons why the circular drill has been abandoned. The technique using the round dental burr is much safer. Accidental rupture of even small blood vessels was a rare occurrence and the operation was completely bloodless. The dura and the pia membranes around the vestibular nerve were carefully removed with the aid of two Dumond N 5 straight forceps. Here too rupture of vessels was rare.

Rupture of a vessel in the calcareous bodies around the hypophysis was not reason enough to discard a frog unless a profuse hemorrhage was associated, while rupture of even a capillary on the vestibular nerve or on the medulla was enough to discard the animal.

B. Damage to the sixth nerve was a frequent occurrence using the circular drill. It never occurred with the round burr.

C. Drowning can occur if the frog is put back in the tank before it is fully recovered from anaesthesia. It can also

occur as a terminal stage of a progressive deterioration of the animal, in this case the stomach is full of water and secretions and usually there is urine retention.

D. Anaemia was occasionally observed particularly during autumn. In this case the blood has a light pink color instead of the usual red. This occurs also after profuse hemorrhages.

E. Infections. Infection of wounds can occur with formation of pus in the lymphatic spaces. However, this occurrence was easily avoided with thorough cleanliness of the operating instruments. Complete asepsi was never attempted but all instruments were stored in alcohol and dried when used. All towels were changed with each frog and the instruments disinfected in alcohol.

The EKG electrodes were prepared before insertion with sterile cables, Silver-Silver Chloride electrodes surrounded by cotton and gauze dipped in sterile agar-frog saline solution.

During the surgical procedure for the EKG electrodes insertion, the electrodes were kept moist in a beaker containing about 100 cc of sterile saline. Occasionally Ampicilline was used in this solution in an empirical concentration of about 50 mg/100 cc saline.

F. "Red legs". This is a congestion of the abdominal side of the skin and of the inner part of the hind legs and is not a specific disease, also if it is commonly seen in infected



frogs, usually in this case skin ulcers are associated. It shows up also on frogs dead by asphyxiation.

A number of factors, however, can lead to a temporary reddening of the skin with the same pattern as in the "Red leg" disease. Such as anaesthesia, dryness during shipping, lying for a long time on the belly on a flat surface, even under water, as it happens for paralyzed frogs.

G. Tanks overcrowding. Death occurred at a lower rate in tanks containing lesser number of operated frogs. It has been observed that in tanks containing operated frogs, no more than 1 frog/6-7 liters of water should be kept.

H. Pesticides. All frogs were collected in irrigation canals and rice paddies where agricultural pesticides containing phosphor compounds were sprayed. Of these frogs only about 10% could be successfully implanted, many of the frogs (20-25%) had sluggish responses upon arrival, they could be put laying down on their back on a flat surface or in the water without trying to right themselves for periods of minutes. These frogs did not show any external pathological sign and survived if kept in the aquarium; their condition was not modified by antibiotics. On one occasion, during the month of October, 40 frogs were specially obtained by Dahl Co. from areas where no pesticides were used. None showed external pathological signs or sluggishness in responses. About 50% could be successfully implanted, the rejection being due to

operation accidents, but mostly to poor circulatory conditions or poor EKG.

I. Post Mortem. On dead frogs only gross post-mortem examination was carried out. Usual findings were: skin ulcers, edema, urine retention, congestion of mesenteric vessels, stomach distension containing mostly water and mucous secretions, the intestines were usually empty of contents. Occasionally nematodes were found curled under the skin or more frequently in the stomach lining, more common was the Pneumonics in the lungs.

#### 5.1.3.1 SPECIFIC INCIDENTS

After the attempted launch of August 21st, when the launch was scrubbed for technical difficulties on the launch pad, the next attempt was set for August 31st. Frogs were prepared according to the schedule but the flight was cancelled on August 28 due to rocket problems. Next date was set for September 10th. During the waiting period difficulties were experienced in obtaining new frogs, so it was decided to use the left over frogs of the previous launch attempt (of Aug. 31st). Fourteen frogs went through the surgical procedure previously outlined. Of these, eight were judged good enough to be implanted during the night between September 8th and September 9th: of these frogs at least three were considered space flight worthy. At this time all the tests made on the frogs to check the general conditions, i.e., the EKG, reflexes and muscle tonus,

appeared very good. After the implant and before the frogs were put into the FOEP package for the experiment, it was customary to wait a few hours for the frogs to recover from the manipulations necessary for the implantation, and also to allow the experimenter to follow the signals recorded from the vestibular nerve and make sure that no degrading was occurring. The frogs during this rest period were left in the cold tank. It soon became apparent that some problem existed and two additional frogs were prepared for possible use. The problem, however, became worse and at the time in which the frogs should have been chosen for the launch all the implanted frogs but one were in extremely bad conditions with the EKG nearly disappearing, lack of muscular tonus, and the otolith signal either not existing or minimal. All the frogs showed various degrees of reddening of the abdominal region and inside of the hind legs. Also some of the 'back-up' frogs that were kept in the same tanks showed signs of degrading. In the healthy frog of the group, even if the otolith signals were good, some signs in the EKG, like increasing in the amplitude of the T wave, demonstrated that there was an initial asphyxia. It was decided anyway to put this frog into the FOEP on the assumption, which later proved correct, that the high oxygen environment might solve the situation. In fact the EKG became normal again. In the mean time also the EKG of the newly implanted frogs was disappearing only three hours after they had been implanted. It was then

considered unsafe to proceed with the launch with preparations in this kind of health condition.

The first factor taken into consideration to explain the rapid decline of the healthy conditions of the frogs was some kind of spreading infection generally termed as "red leg disease". Many other factors, however, had to be taken into consideration. These frogs were not fed for a long time, in fact it has to be reminded that many were left over from the previous launch attempt of August 31st. Another possible problem was the area in which the frogs were collected, but the first consideration was the possibility of an asphyxiation. In fact it seemed difficult to justify a rapid decay in the conditions of all the frogs in one tank within a few hours, taking into consideration only an infection.

Another factor considered was the possibility of metal poisoning from the water of the tank. The water was cooled in a closed circuit through a water cooler. It was decided to proceed along two different main lines: 1) to take into consideration infections and experiment on a group of frogs with antibiotics and 2) to take into consideration the possibility of asphyxiation and metal poisoning.

During this period experiments were made also using a particular batch of frogs collected in areas where agricultural pesticides were not used.

1. Infections. A group of 10 frogs was treated with ampicilline. Ampicilline is known to be a wide spectrum antibiotic used for the treatment of variety of infections in fish aquariums, besides it was readily available in quantity at Wallops Station. The antibiotic was dissolved in the frog tank water in a concentration of about 50 mgr/l.

A few drops of a saline solution of injectable ampicilline were put in the wounds on the back of the frogs when they were paralyzed. The total amount of ampicilline injected by this way into the frog was about 25 mgr/Kg of frog. No ampicilline was used directly on the wound on the mouth roof to expose the vestibular nerve, instead 25 mgr/Kg of frog were injected in the lymphatic spaces just before the operation. The same concentration of ampicilline was injected in the lymphatic spaces together with the EKG electrodes.

No difference was noted between the behaviour of this group of frogs and previous.

The treatment with antibiotics of frogs was abandoned as a general use also considering the fact that nothing was known about the oto-toxicity in frogs of antibiotics. The FOEP package, however, was disinfected between one experiment and the next by circulating for at least 24 hours water containing a concentration of 300 mg/liter of ampicilline and a few drops/liter of chlorine solution of the kind generally found in aquarium supply stores for tropical fishes.

The FOEP was then repeatedly washed with sterile water before the experiment.

2. Metal Poisoning and Asphyxiation. The tank water was tested for heavy metals particularly cadmium and copper: cadmium is extremely toxic and is sometimes used to protect metal parts from corrosion; copper is the constituent of the tubings of the water cooler, its toxicity on frogs is not known.

No cadmium was found while copper was present in more than 50 parts per million. To prevent this copper concentration, when the frogs were in the cold tanks, the water was daily changed so that copper concentration was kept below 1 ppm.

A rapid deterioration of the healthy state of a frog seemed always to take place after the frog was attached to the centrifuge end caps (third surgical stage). The main differences between stage two and three being that when the frog was clamped to the mouth holder of the centrifuge end cap the tongue was removed, so that it would not interfere with the chronic electrodes when they were implanted, and the mouth was tightly closed by the mouth holder.

Frogs can breathe through three systems: the lungs, the mucosa of the mouth and the skin.

Under normal conditions at room temperature it seems that the respiration through the mucosa of the mouth is the most important while respiration through the lungs is sporadic.

Underwater respiration takes place through the skin but it is less efficient than the other means previously mentioned, and can be sufficient only at lower temperatures. In the frogs prepared for implantation the roof of the mouth is open, the tongue is removed, this decreases very much the available areas for gas exchange in the mouth mucosa, in addition the swallowing action needed for lung breathing is impaired by the removal of the tongue and by the clamp that keeps the mouth closed. Only the skin respiration is left for gas exchanges between water and blood. Due to the low efficiency of this system frogs were kept at 15°C.

Operated frogs could live under water in these conditions only for a few days showing a progressive deterioration of EKG.

The EKG returned to normal in amplitude and frequency opening the mouth of the frog in air or pumping a few cc's of air in the lungs.

It became apparent that the O<sub>2</sub> exchange through the skin was not enough when the water was saturated with air.

This could have been due to the fact that on a paralyzed frog, membranes continue to form on the skin due to the shedding of the outer layers of the skin and to skin secretions. In a moving frog these membranes are continuously removed, but this is not the case in a paralyzed one. These membranes increase the effective thickness of the skin possibly

lowering the O<sub>2</sub> transport mechanism. Lung respiration was tried with insufflation of about 3-4 cc/air/minute. This solved the situation but was impractical, because of frequent accidents (the small plastic tubing in the trachea could perforate the lungs) and because the tubing used could damage the implant in the vestibular nerve.

The problem was solved by bubbling O<sub>2</sub> in the aquariums instead of air. The aquariums were equipped with a closely fitting lid. The amount of O<sub>2</sub> bubbled was around 1 liter/minute/aquarium, this gave a PO<sub>2</sub> in the water between 600 and 680 mmHg depending upon how often the lid was removed. Five aquariums were so equipped. The O<sub>2</sub> pressure in the room did not differ from O<sub>2</sub> pressure in the normal air, so no fire hazard was introduced by this method.

The method proved very satisfactory and no cases of asphyxiation were observed anymore.

To prevent excessive swallowing of water the operated frogs (stages one and two) were kept on a slanted perspex surface so that while the body was immersed in water the mouth was always above the surface. (See Fig. 6.)

#### 5.1.4 CONCLUSIONS

The surgical procedure, frog handling, aquarium and implant procedures seem to be adequate to provide frogs with adequate life expectancy after implant. The main problem lies in the frog itself. Frogs taken from an unsupervised environment



are not suitable for long term experiments, in fact only a small percentage of these frogs which were used reached a survival period of 15 days or more after implant.

A high percentage of failure could be ascribed to the initial health condition of the frogs (parasite infestation, poor feeding, infections, possibly water pollution, etc.). Even starting from frogs taken from the wild a tremendous improvement was observed when taken from selected areas not spread with agricultural pesticides.

It seems, then, to be necessary for long term experiments, to have available frogs that are bred in the laboratory under controlled conditions, or at least be treated and fed for periods in excess of six months from when taken from external sources.

It must be emphasized that poor responses, poor electric potentials and poor life expectancy experienced during the preparation of this flight can be easily overlooked in normal acute experiments because the deterioration of the nerve potentials, reflexes or EKG takes place in a matter of hours or more frequently of days, beyond the normal duration of an acute experiment. This is not to say, however, that results of acute experiments cannot be affected by frog health conditions. It is our experience for instance that tonic responses to sustained stimuli are very difficult to record from frogs not in their best conditions, while phasic responses to tilting or responses of semicircular canals (phasic in nature) are still present.

It is at this moment impossible to state with confidence that phasic responses are a sign of deterioration of tonic receptors, or if tonic and phasic receptors are of completely different kinds, or tonic responses can go phasic and then return to tonic under normal conditions. We have records, however, that show how a receptor can show tonic responses, then phasic ones and then tonic again, the whole cycle being of the order of 5-6 days long. The effect of antibiotics on vestibular receptor should also be investigated before any treatment be judged adequate for laboratory frogs used for vestibular research.

#### 5.1.5 TESTS IN THE FOEP

A prototype of the FOEP, identical to the flight units, has been worked upon for four weeks at the present date. During this period the following results have been obtained.

##### A. Vibration.

The first problem to be dealt with was vibration. It was found that the existing vibratory background, originated by the water pump in the system was way above the threshold of the vestibular units involved. In fact, placing an instrumented specimen in the centrifuge, continuous firing of the otolith unit resulted, due to the stimulating effect of approximately 400 mg peak to peak of 800 Hz/sec vibration. Irregularly shaped waves, approaching occasionally a sine curve, were recorded directly with an accelerometer (frequency of response =

2kHz) placed in the water, in the same position as the frog's head, in the radial direction of the centrifuge, namely, the direction of the functional axis of the vestibular sensors. Up to 200 milli g vibrations of the same characteristics were found from an identical accelerometer placed vertically at 90° from the other.

Such noise disappeared when the pump, still running, was disconnected from the FOEP, with the water circulation still working normally. Consequently, different kinds of shock mountings were tested and finally satisfying results were obtained, with no visible trace of vibration being detected at the frog's head. Tests performed with instrumented specimens confirmed that whatever residual vibration might exist, below the sensitivity of the accelerometers used, it was subthreshold for the sensors too.

This achievement is important, as the presence of an above threshold vibration would have been contrary to one of the basic conditions of the experiment, namely, the lack of stimulation of the vestibular sensors in orbit, in the intervals between the centrifuge runs.

It was therefore recommended that the modified shock mounting be applied to the flying units.

B. Loading Procedure.

The procedure adopted previously for loading the instrumented frogs in the FOEP was not completely satisfactory.

In fact, while introducing the first frog in the centrifuge in the normal horizontal position was not too difficult, as the opposite opening could be used for pulling the frog's legs in a convenient position, the loading of the second frog sometimes ruined the preparation, as guiding the frog inside the centrifuge tubing was rather awkward.

Consequently, a modified technique has been devised, (fig. 8) by which the loading takes place vertically with the FOEP lying on one side, sustained by a specially built support. In this way, with the centrifuge filled near the brim with oxygenated water, the first frog is lowered slowly into the water. Then the FOEP is placed horizontally, the centrifuge drained of the water and the legs of the frog secured to the opposite end. This will avoid the first frog sliding when the procedure described above is repeated for the second frog. In this way no difficulty at all was met anymore, nor any preparation lost.

#### 5.1.6 BASE LINE DATA AND SURVIVAL TESTS

##### A. Vestibular activity in the FOEP and on tilting table.

During four weeks, seven frogs have been tested in the FOEP, with all systems running smoothly. Five of these frogs have been kept in the FOEP for up to six days. Routine running of the centrifuge was performed each day and data recorded on tape, together with long periods of activity at rest. EKG and accelerometer output were also recorded simultaneously. (fig. 9)

In no case a failure was noted and the preparation was active normally during the entire period.

It was found that death of the preparation results in 10-12 hours if either the oxygen or the water pump stops as the frog is deprived of  $O_2$ : the several hours survival is due to residual  $O_2$  in the water and will allow action to be taken in time to restart the pumps themselves if they stop during flight. A large amount of base line data was also obtained in the laboratory and stored on tape, simulating the centrifuge spins with tilts of the supporting table which produced g forces equivalent to the centrifugal force of the centrifuge. This allows a direct comparison between the effect on vestibular sensors of centripetal acceleration and the gravitational acceleration, especially as in some cases the test was made on the same specimens.

B. Base line data prior to launch.

Owing to the large amount of base line data recorded in this period of time, it was found that in about two hours enough base line data will be obtained from each of the instrumented preparations before the launch to allow a good comparison with the orbital behavior of the vestibular units involved. About 15 minutes of data at rest, plus several groups of three centrifuge cycles either close together or sufficiently apart not to induce summation effect was performed and the resulting activity recorded. This time was also sufficient

(fig.10)

to determine the survival factor of the preparation using the EKG as an index. It was in fact found that after about one hour the EKG shows alterations if the environmental conditions of the frogs are not compatible with the welfare of the animals.

C. Test of telemetry and computer programs with frog data.

The base line data obtained during the test on the FOEP prototype have been used to reproduce the exact configuration of the flying conditions during telemetry. Data transmitted through the entire system included vestibular unit activity, EKG and centrifuge accelerometer output. This proved to be satisfactory and data thus transmitted was quite adequate for analysis. The same data have been used for testing the computer programs to be used at Goddard during launch for quick analysis and final satisfactory results obtained.

Fig. 6. Diagrammatic representation of the special aquarium devices to keep the frogs healthy in the III and IV stage of the surgical preparation. After the partial denervation and bilateral exposition of the VIII nerve the frogs are kept with the mouth above the water level to avoid drowning (upper sketch). When the frogs are already fixed to the end-caps they are suspended in the water by means of semicilinders (lower sketch).

Fig. 7. General view of the set-up for the chronic implant of the microelectrodes in the frog.

A. The tilting and rotating table carries the frog already attached to the end-caps, the main amplifiers connected with the emitter-followers, the hydraulic micromanipulator, the coil heater, and the lower part of the surgical stereomicroscope.

B. Detail of the frog and of the positioning system holding the microelectrodes in the proper position. Note the 2 emitter-followers fixed to the frog's head.

Fig. 8. Insertion of the frog into the Bio-package.

A. The frog attached to the end-caps and fully instrumented is carefully lowered into the centrifuge of the Bio-package, already nearly filled up with oxygenated water. The bottom part of the Bio-package is shown: the oxygen bottle, the lung, the CO<sub>2</sub> absorber and the two pumps for water and gas circulation (see fig.5 for more details).

B. The end-caps are secured to the centrifuge. Note that the 3

connecting plugs (2 vestibular signals + EKG leads) are still disconnected. The package is ready to be put back in the horizontal position lifting it from the special holder: then the  $N_2$  purging will start (see text).

Fig. 9.

A) Simulated mission on the ground. Activity at rest and response to the centrifuge cycles recorded for 120 hrs. The average frequency at rest of 1000 spikes corresponds to each round dot. The square dots represent the mean rate of 50 spikes during the second half of the centrifuge cycle at steady speed. Note between arrows a sudden spontaneous shift of the frequency of discharge at rest by ab.50%. This happens quite frequently for reasons still unknown.

B) Another simulated mission on the ground. The mean frequency at rest of 1000 spikes for each round dot is here represented as a % change of the overall mean frequency. The square dots correspond to the standard deviation in % of the mean.

Fig. 10. Otolith unit A 2

Dynamic response on the ground.

1. 110 sec of activity at rest on the ground.
2. 3. 4. Frequency response to the centrifuge cycles. The first



dynamic response is followed by a tonic one. The responses to the three isolated cycles are very similar.

In 5. three isolated cycles are shown plus four close together. The decrease of both dynamic and tonic response is evident in the latter case. Note also the reduction of the firing rate after the four close cycles which lasts several minutes. This is a typical behaviour of gravitoceptors (see reprints B and C) : Centrifuge cycles arrowed in the figure.

On the ordinate : frequency of discharge in impulses per sec, each point being the average of 1/2 sec firing. This technique introduces a small artifact as some of the features of the activity may be obscured; for instance during the four close cycles the base line does not appear to return to 0 after each intermediate cycle as in fact it does.

Lower record: centrifuge acceleration profile 0-0.6 g.

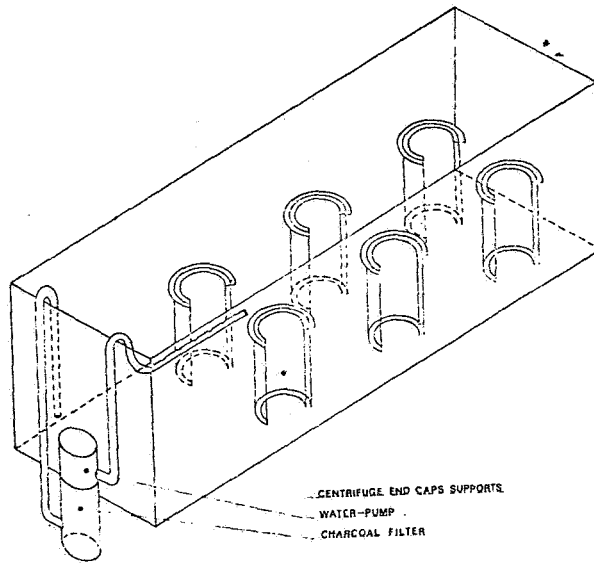
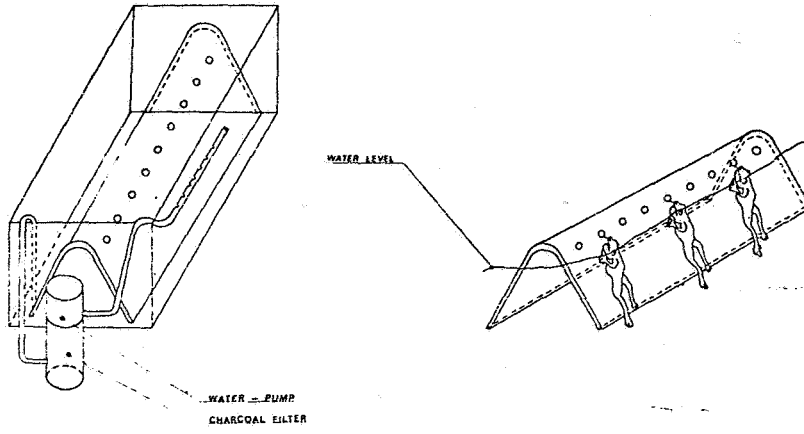
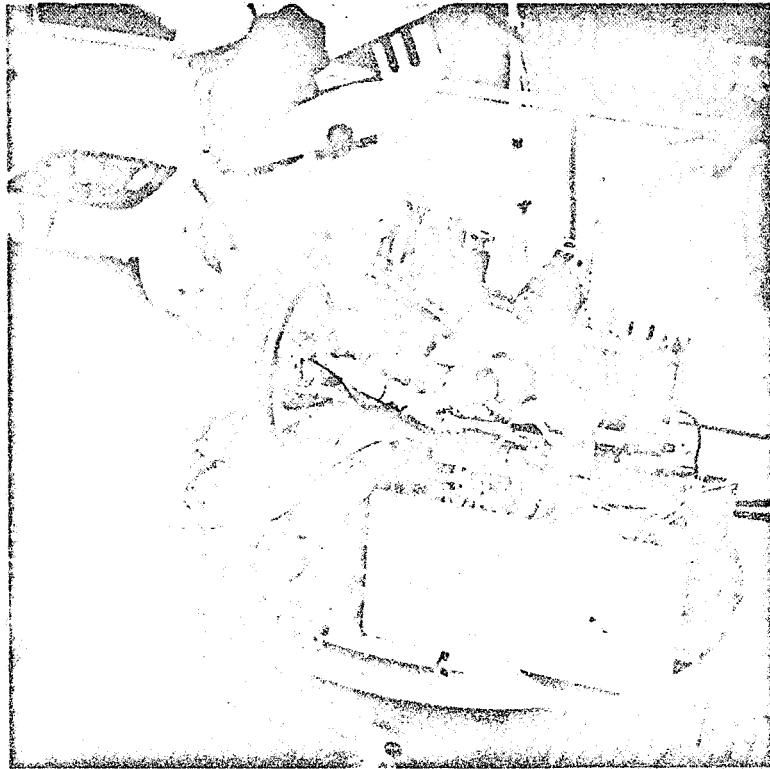
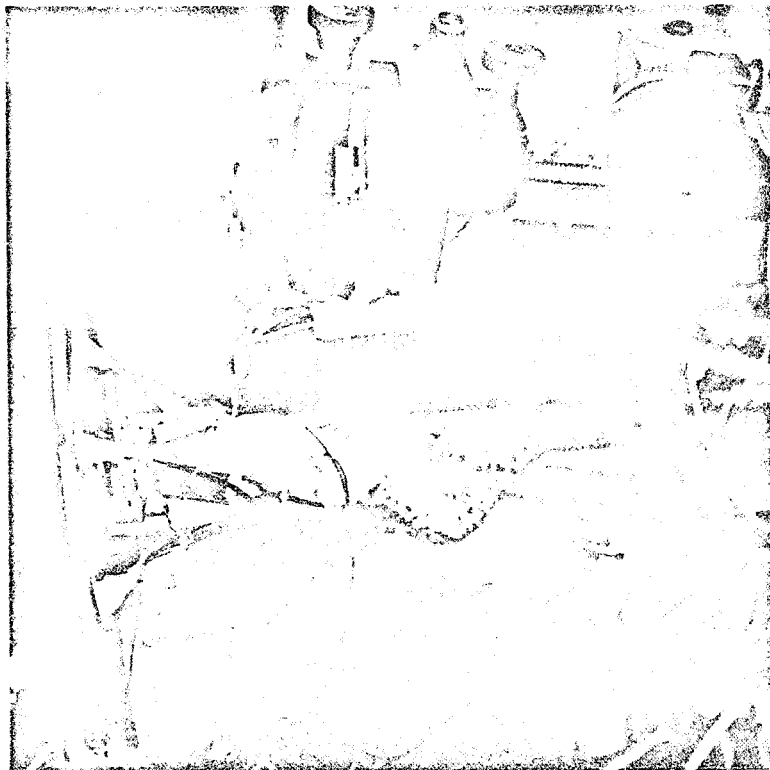

Fig. 6



A



B

Fig. 7

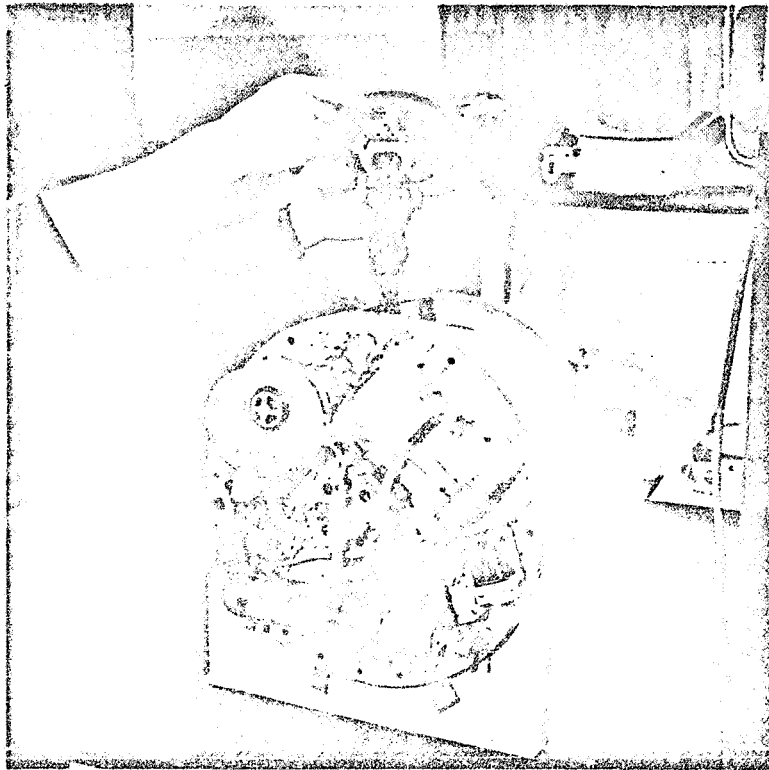

A



B  
FIG. 8

A

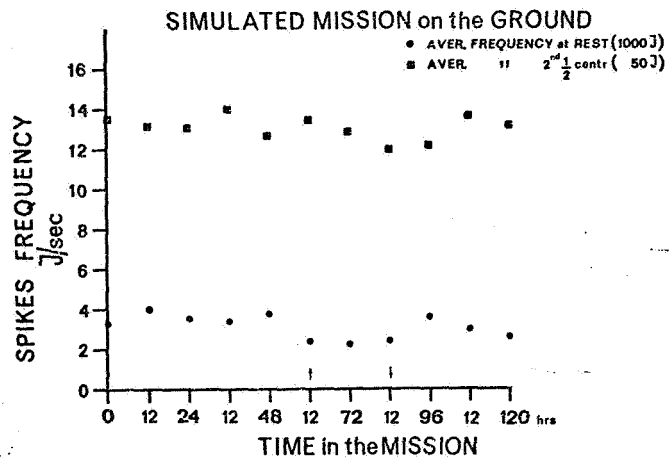

B

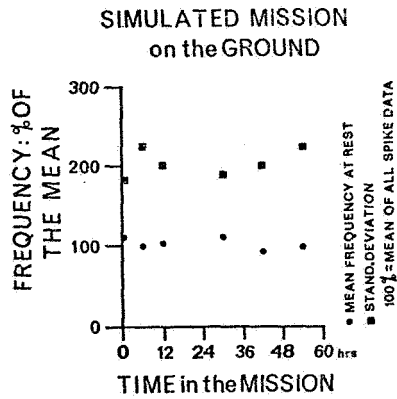

Fig. 9

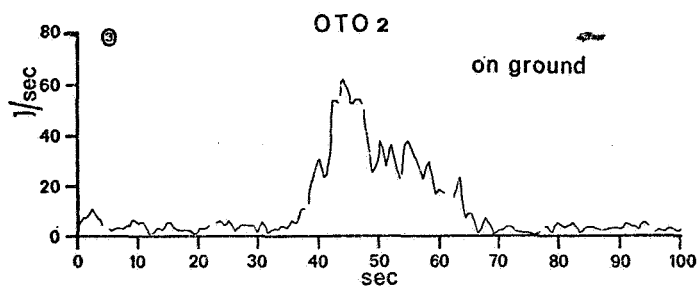
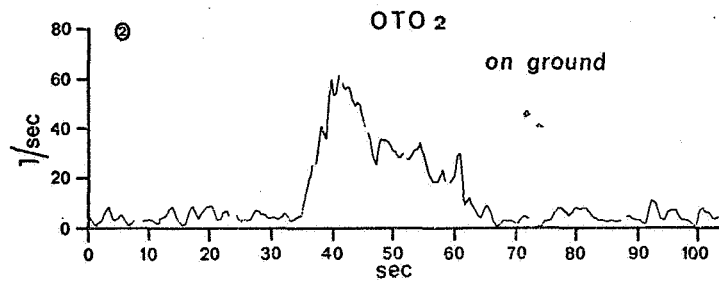
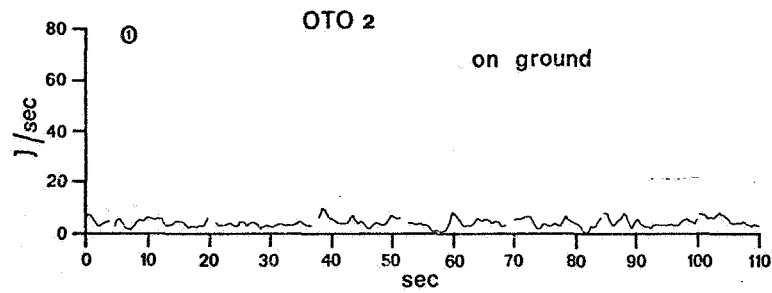

Fig. 10

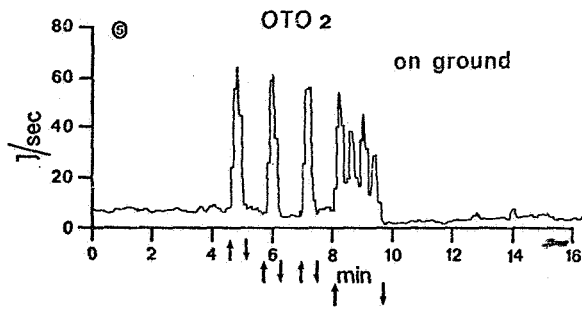
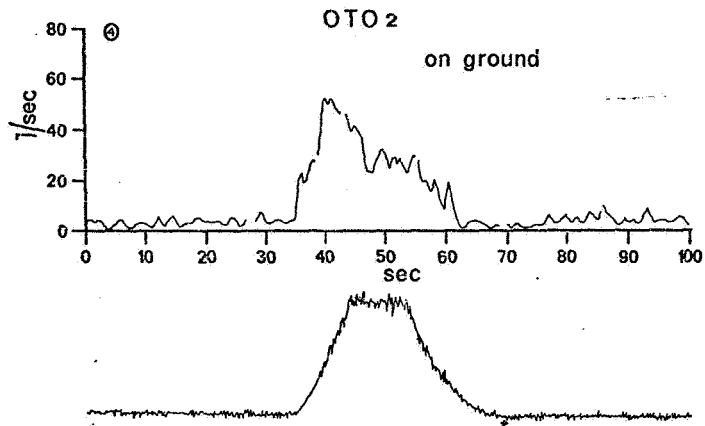

Fig. 10

## SECTION 6

### PREPARATION FOR THE FLIGHT - THE QUALIFICATION TESTS

#### 6.1 REPORT ON THE CENTRIFUGE TESTS OF THE FROG PREPARATION FOR THE ORBITAL FROG OTOLITH EXPERIMENT.

Introduction. The shifting of the formerly TS4, then OFO-A, experiment from the APOLLO program to a launch involving a Scout system required further centrifugation tests to make sure that the increased linear acceleration during takeoff (9.6 g instead of approximately 6) plus 3.6 g angular acceleration due to the spinning of the rocket could be tolerated by the frog preparation. Accordingly, three tests have been performed to analyze the frog preparation's behavior at 12 g belly-back and 5 to 7 g head-tail acceleration (fig. 11) corresponding to the lift off situation.

Technique. The VIII nerves were exposed in the frog the thoracic and lumbar plexus were cut following the standard technique already described. In the first two animals one workable electrode only was implanted chronically in the left VIII nerve. In the third frog, two electrodes were also implanted in the right and left VIII nerve - EKG electrodes were also implanted in all three cases. Each electrode was connected to a waterproof emitter follower, chronically implanted in the frog. The animal was attached to a lid by means of a head holder. The output and power wires of the emitter followers and EKG wires went through the lid to a connector by means of a waterproof gland.



The animal was then placed in a cylinder, completely filled with water and the lid secured watertight to the cylinder itself. The cylinder was a part of the package containing an oxygen supply and the main amplifiers (gain 1 K) for the vestibular and EKG signal. The oxygen, by bubbling through the water around the frog, allowed respiration through the frog's skin.

The package was then secured to the arm of the centrifuge. In the first run the centripetal acceleration up to 12 g was directed from belly to back. Then the package was turned on the side and the acceleration was directed from tail to head. A maximum of 7 g was applied this time. (fig. 11)

The vestibular signals and the EKG were recorded on magnetic tape throughout the test. The acceleration profile was recorded on a Brush recorder.

#### Results.

Test No. 1: During this test good signals from the vestibular unit were recorded throughout the test (Fig. 12). No EKG signal was recorded during the tests, owing to a defective EKG amplifier in the package, but the EKG pulses were recorded before and after the test through an alternative system.

The single microelectrode recorded the activity of two vestibular units, one much larger than the other and therefore easily recognizable. The units were otolith cells, responding

to acceleration in the longitudinal direction only, the larger in the head-tail sense, the smaller vice versa. Accordingly, no major change in the rate of firing was recorded during the 12 g spin, as the acceleration was in the lateral direction with respect to the body (Fig . 12A ). After the package was moved sideways the resultant acceleration in the tail-head direction was rapidly increased to 5 g (Fig . 12B ). The largest otolith unit firing was suddenly blocked, while the smaller one increased its firing rate to its maximum capacity. This behavior is as expected. When the centrifuge stopped (Figs. 12C ) the largest unit started firing again and after some after-effect (longer intervals) it showed normal activity. The smallest <sup>one</sup> decreased its firing rate. This too was expected.

After the package was disconnected from the centrifuge, the frog was taken out of the cylinder and rechecked. EKG and otolith pulse appeared normal.

Conclusion. No alteration of the preparation or displacement of the electrodes was observed. The preparation remained normal throughout the test.

Results.

Test No. 2: Good signal from the vestibular unit and the EKG was recorded during the test. To avoid excessive firing and to observe a response during the 12 g test a semicircular canal unit was chosen this time, responding to a change in angular speed in the head-tail and the belly to back position.

The 12 g acceleration was applied in the belly-back direction; in the tail-head direction 2, 3, 4, 5 and 6 g were applied step-like. At the onset of the 12 g acceleration (Fig . 13A ) the unit responded as expected with a fast burst of firing. When the steady 12 g level was reached, the rate of firing became normal again (Fig.13B). At the end of the 12 g spin (Figs. 13C ) after a transient increase of frequency, probably due to irregularity in the centrifuge run a long pause was observed, as expected, followed by a normal activity.

After the change of position the unit responded with a burst of high firing at any change of angular speed (Fig . 13D = 2 g, 13E = 6 g). However, a decrease in amplitude was observed at 5 g. That indicated a deterioration of the preparation (see difference between figs. 13D-E ) or an electrode displacement. At the end of the spin the amplitude remained at the lower value. The EKG signal remained normal throughout the test.

Conclusion: No alteration was provoked by 12 g acceleration applied in the belly-back direction. Above 5 g, alteration of the preparation is observed, when the direction of the acceleration is in the tail-head axis.

Results.

Test No. 3: One semicircular canal unit, of the same characteristic as in Test No. 2, plus another unit, probably of the efferent system type not responding to any acceleration were chosen.

The 12 g acceleration was applied as in the previous test. In the head-tail axis, acceleration was increased step-like to 7 g starting with 2 g. The results were similar to Test No. 2 on the semicircular canal suit. No damaging effect was noted in the 12 g test, whereas a change showing possible injury appeared above 5 g in the longitudinal direction (Fig. 14 ).

The efferent unit did not show any impairment. This seems to indicate that a possible damage of the biological substrate at the vestibular level might be the reason for the changed unit activity instead of a displacement of the electrode.

General Conclusions: It is felt that the tests performed provide enough data to conclude that the characteristics of the Scout launch will not damage the OFO-A experiment, if the linear acceleration during takeoff is kept at or below approximately 10 g and the angular acceleration due to spinning does not exceed the indicated value of 3.6 g.

#### 6.2 REPORT ON THE VIBRATION TESTS OF THE FROG PREPARATION FOR THE ORBITAL OTOLITH EXPERIMENT

Introduction. One of the most critical aspects of the microelectrode technique is the capability of the microelectrode to withstand vibration without being displaced and damaging the nerve. The neutral buoyancy microelectrode is a good answer to the effect of linear acceleration: in effect being of nearly the same density as the tissue in which it is implanted it will move together with the nervous mass along the accelerating pull without any relative displacement within the

limits of its restraint and the approximation of the relative densities. During vibrations, however, the situation is more complex and the possibility of displacement increases for the following reasons:

1. The microelectrode is balanced against a torquing momentum. However, during a sinusoidal vibration a moment of inertia develops by which a pendular movement of the electrode might take place around the center of the mass, thus provoking damage of the tissue in the site of the tip.

2. The electrode is not completely free to float. It is connected to a rigid point (the larger output wire) through a thin and flexible platinum wire. The system microelectrode plus platinum wire, owing to the constricted end, has a specific elasticity: a resonance frequency is then observed. At this frequency displacement will take place after a given time, at a relatively low level of vibration intensity.

Method. Fully instrumented frogs, as by the already described technique for the OFO-A experiment have been used for testing. Each frog was placed in a cylindrical container and the head firmly attached through a head holder to the lid (Fig. 15). The container was completely filled up with water, care being taken that no air bubbles remained. The cylinder was rigidly attached to the plate of a shaker. The frog remained either vertical (Fig.15) or horizontal (Fig.16) in respect of the plate. Vibration was directed therefore

either in the head-tail direction (Fig.10 ) or in the lateral direction (Fig.10 ). An accelerometer was fixed on the top of the container as shown in the figures. However, owing to the low frequency response of the accelerometer the indications of the accelerometer above 10-30/sec were not correct. The values considered were therefore the ones indicated by the panel of the shaker.

Sinusoidal vibrations were applied, with a frequency from 2 to 600/sec and an intensity up to a maximum of 5 g.

Continuous recording of the vestibular electrical activity was performed during the tests and the results stored on a magnetic analog tape.

Results. Each tested frequency was increased in intensity slowly and progressively till oscillation of the baseline in vestibular records showed that mechanic movements of the microelectrode started: at the onset, this was not accompanied by a permanent displacement of the electrodes, as decrease of the intensity produced a normalization of the records (Fig.17 ). If, however, the intensity of vibration at that particular frequency was maintained for a prolonged period of time, permanent displacement of the electrode, and/or terminal injury of the nervous fiber took place, as shown by the final disappearance of the recorded spikes. When the frequency at which the oscillation of the baseline was observed at a given intensity was slowly increased, a range of values

was reached at which the amplitude of the base line oscillation increased progressively with time (intensity and frequency being constant) till final disappearance of the spikes (Fig. 18).

Twenty-one separate frogs were tested: in some cases the critical frequency was maintained up to the permanent disappearance of the spike data. In some cases the intensity of that frequency was decreased till the disappearance of the base line oscillation, in order to test the intensity threshold for the critical frequency. In a third case, the frequency was rapidly increased, at constant intensity, to observe the far limit of the critical frequency. In this case it was observed that above a certain value, the oscillation of the base line disappeared and the preparation could stand a much higher intensity (Fig. 19).

The range between the lower and higher critical frequency was considered as the critical or resonant frequency range. Fig. 18B shows diagrammatically the overall results of 10 units thus studied plotting the g level at which no self increasing oscillation was observed as a function of the frequency of vibration. As shown a range between 60-70/sec and 150/sec indicates the overall critical (resonant) frequency for the ten frog group. The range for a single electrode is usually narrower, approximately equal to one third. At the center of the critical range an intensity of 1-1.50 g is enough to damage the preparation.

Conclusions. Using 21 instrumented frogs fully submerged in water a critical frequency range producing injury of the nerve and/or displacement of the neutral buoyancy microelectrodes has been found. At such frequencies the effect increases with time. The intensity threshold at those frequencies is from 3 to 5 times lower than at the other ranges (1-1.5 against 5 g). Care have therefore <sup>been</sup> taken to shield the package against such frequencies.



Fig. 11. A) Direction and values of the centripetal accelerations applied to the instrumented frogs during the qualification tests on the centrifuge performed at NASA Ames Research Center. B) The vestibular and central nervous system of the frog are shown diagrammatically: note the vestibular nerve and the position of the neutral buoyancy floating microelectrode on it.

Fig. 12. Recording from a single otolith unit, one larger and the other smaller in amplitude. These units respond to steady centripetal acceleration in the belly to back direction. Do not respond to tail to head acceleration.

A) During 12 g spinning in the belly to back direction: note no change in the unit activity. No sign of displacement or other artifacts.

B) At arrow, a 5 g acceleration is applied in the tail-head direction. Note suppression of firing of the largest unit while the smallest one increases remarkably its rate of firing.

C) End of the 5 g spinning (noise underlined). The largest unit starts firing again, the smallest decreases its rate of firing. No alteration is shown in the preparation behaviour as a result of the 12 g + 5 g test.

Fig. 13. IInd test. Single unit from the semicircular canal.

This unit responds to transients only, on a large angle, including belly to back, and tail to head accelerations.

A) At arrow, the 12 g spinning starts. Note high frequency firing at this point: when the acceleration reaches a steady 12 g the unit goes back to its normal rate. The frequency of the discharge is proportional to the rate of the angular acceleration increase.

B) During steady 12 g spinning.

C) At the end of 12 g spinning, note increase of rate of firing, probably for some irregularity in the slow decrease followed by a long pause. Normal firing is shown at the end of the pause.

D) The position of the frog is changed in order to apply acceleration in the tail to head direction. A sudden burst of high frequency discharge marks the start of the spinning up to 2 g.

E) Spinning up to 6 g. Note 1) decrease amplitude of the spike indicating the beginning of injury and 2) the expected burst of high frequency firing going from 5 to 10 g (underlined).

Fig. 14. IIIrd test. Single semicircular canal unit similar to the one in test IInd.

A) Normal activity. At arrows the 12 g spinning starts. Note the corresponding high frequency discharge (direction, belly to back).

B) During the steady 12 g note no change in the general characteristics of the unit activity.

C) 6 g constant spinning in the tail-head direction. Note decrease of amplitude as indication of the altered condition of the preparation.

D) Steady 7 g and back to 0: the alteration is permanent.

Fig. 15. Upright position of the instrumented frog on the shaker for the vibration tests. Vibration in the vertical plane. Location of the accelerometer indicated in the figure. The frog with the head firmly clamped is completely submerged in water throughout the test.

Fig. 16. Sideways position of the instrumented frog on the shaker. Everything else as in fig. 15.

Fig. 17. Recording of the spike train data from a semi-circular canal unit during the vibration test. Upper record, spike data. Lower record, accelerometer output.

- A) No vibration. Normal resting discharge (one spike only appears).
- B) The intensity of the vibration reaches 3 g and above: note the beginning of mechanical artefact shown by oscillation of the base line.
- C) The vibratory stimulus starts, increasing progressively in intensity. Note the increase in frequency of the spike train and the occasional firing in duplets.
- D) Vibration back to 0: no alteration exists in the receptor activity and microelectrode position. Time value in msec, intensity of vibration, amplitude of the spike in the figure.

Fig. 18. Same method of recording as in fig. 17.

Different unit.

A) At approximately 0.5 g at this frequency (approximately 90/sec) a mechanical artifact is shown (oscillation of the base line).

At approximately 1 g (not shown) the microelectrode loses the unit.

B) After the unit is lost and the intensity of vibration is decreased note the damped oscillation on the base line of the upper record (vestibular unit) indicating a resonance effect. Values of time, intensity and amplitude as in fig. 15.

C) Diagram showing the critical frequency for the appearance of the mechanical artifact in 10 units. On the "x" axis frequency in cy/sec. On the "y" axis, intensity in g. The value of acceleration were acquired directly from the shaker. Each point corresponds to the mean and standard deviation of the intensity of the critical frequencies of the 10 units group. As an index of the onset of the critical frequency range, the value of "g" and of frequency were taken corresponding to the start of an evident oscillation of the base line. The disappearance of such oscillation was taken as the end of the critical frequency range for the unit.

Fig. 19. Same method as in fig. 17.

A) At about 1 g and a frequency of approximately 75/sec this preparation shows the beginning of mechanical artifact as indicated by oscillation of the base line.

B) Increasing the frequency of the vibration to 110/sec the mechanical artifact disappears even increasing the intensity to approximately 5 g. Values of time, intensity and amplitude as in fig. 17.

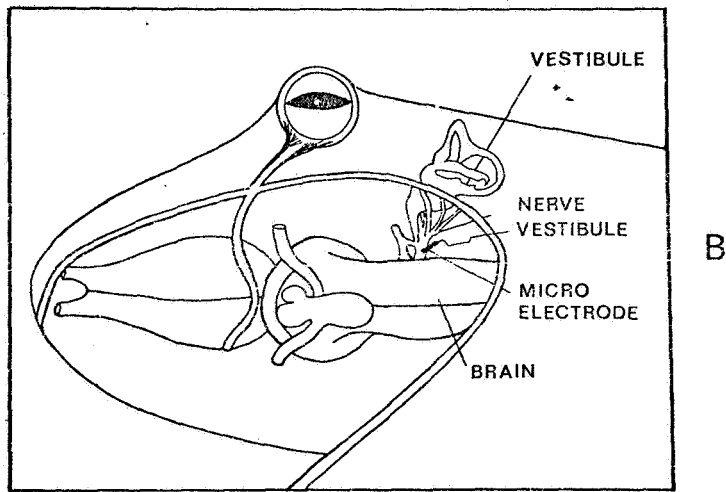
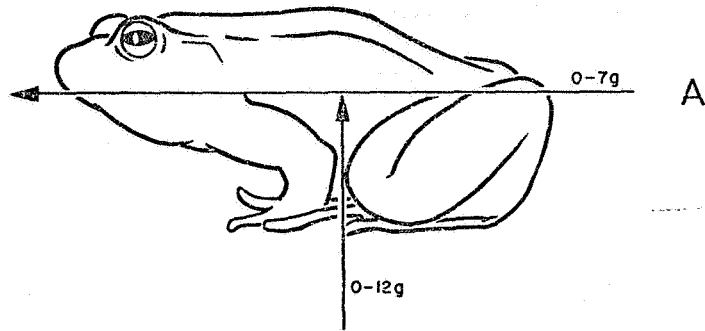

Fig. 11

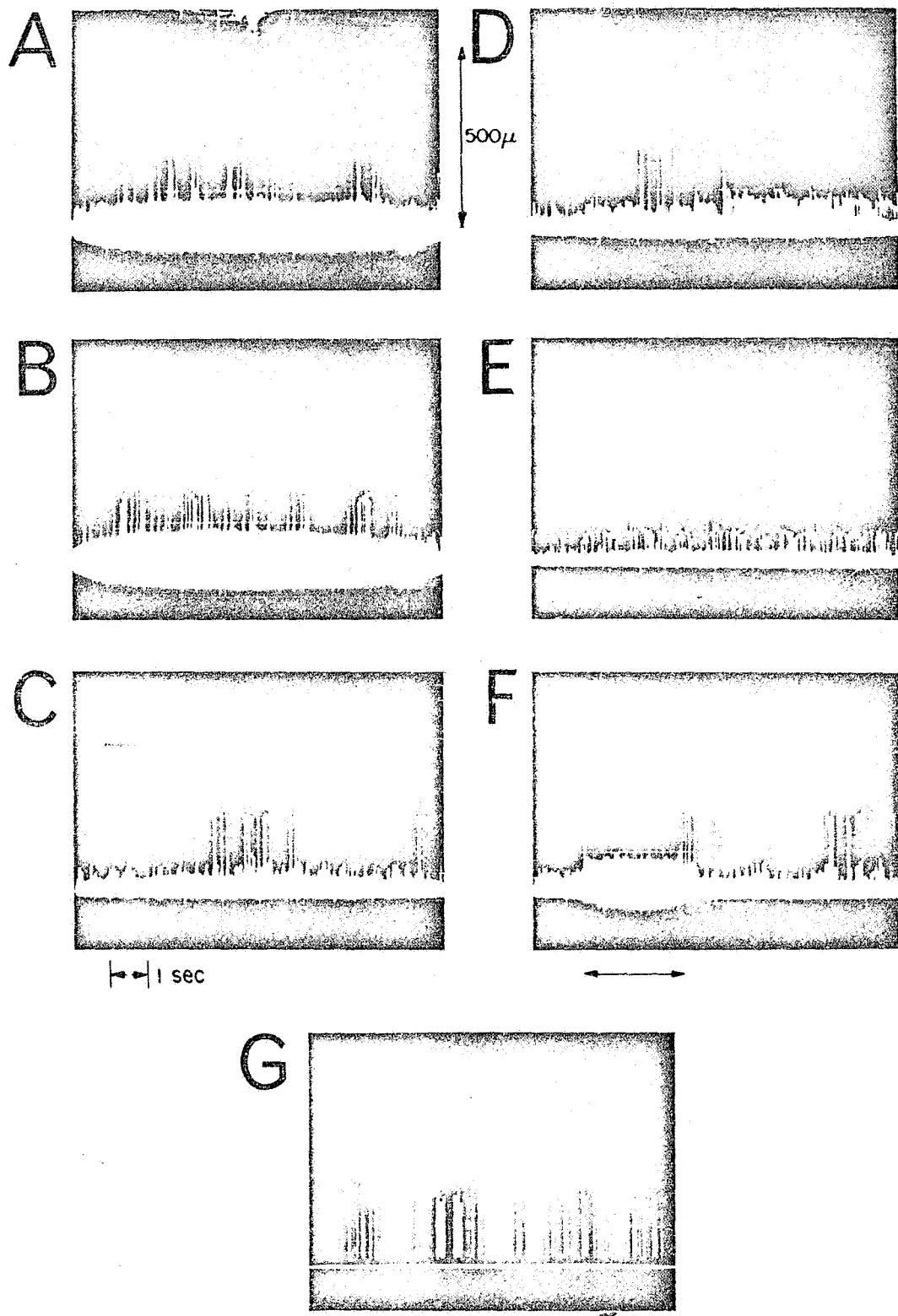

Fig. 12

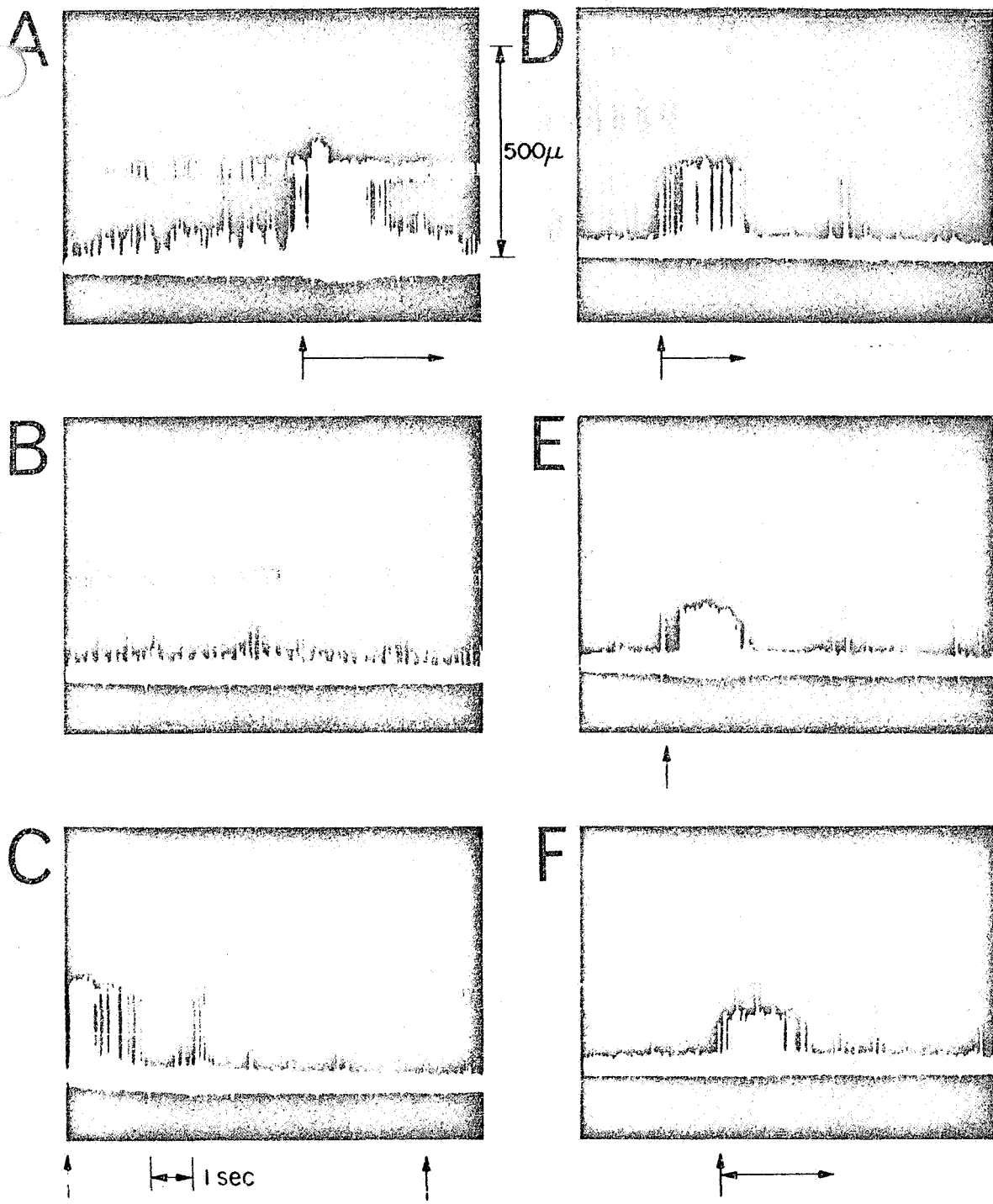

Fig. 13



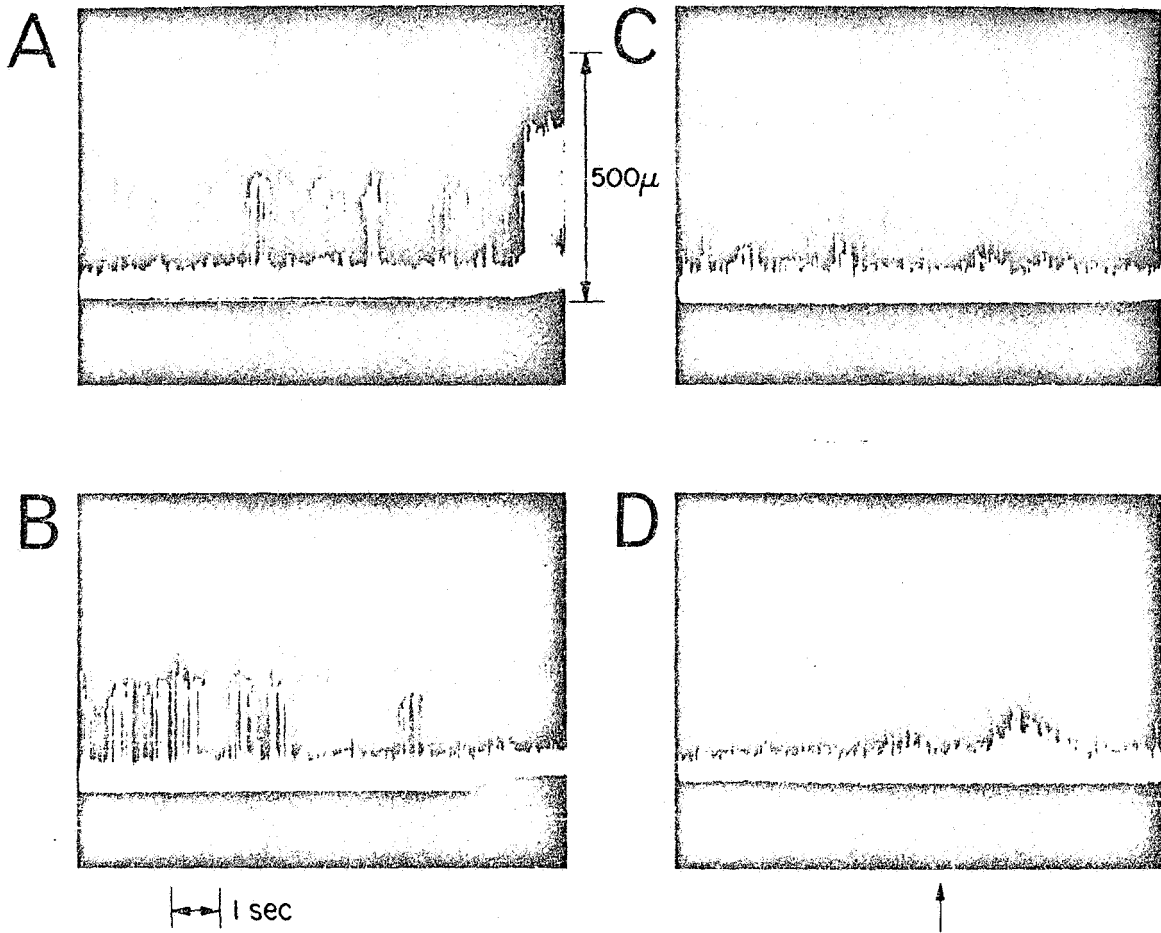

Fig. 14

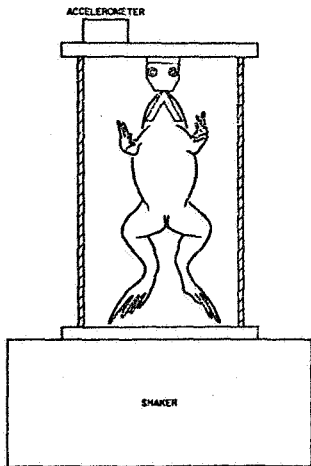

Fig. 15

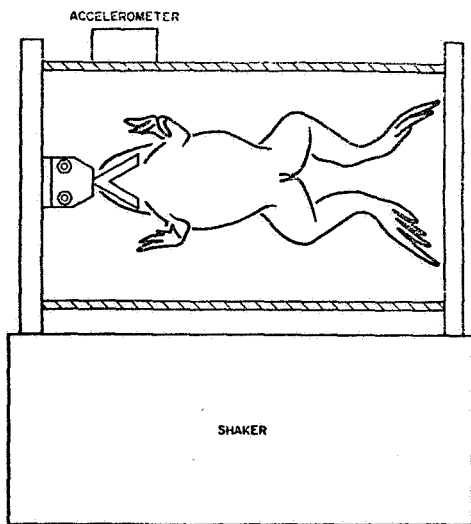

Fig. 16

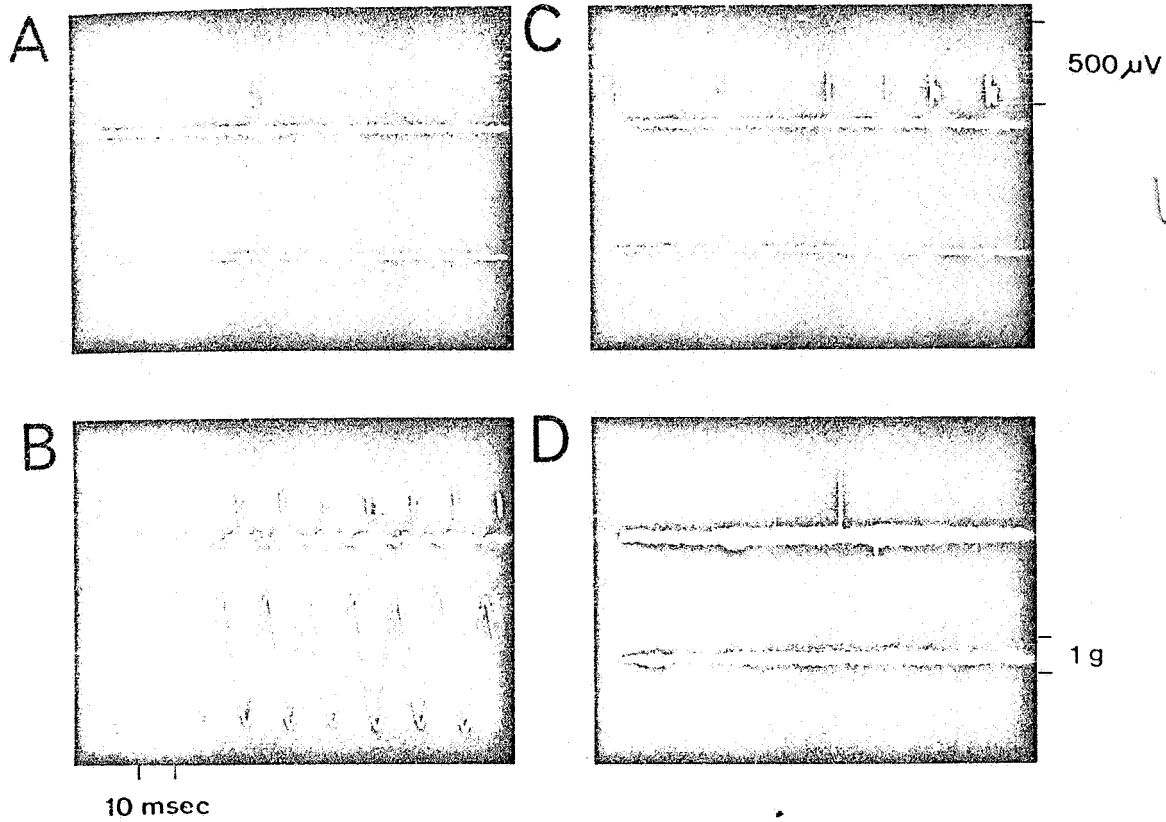

Fig. 17

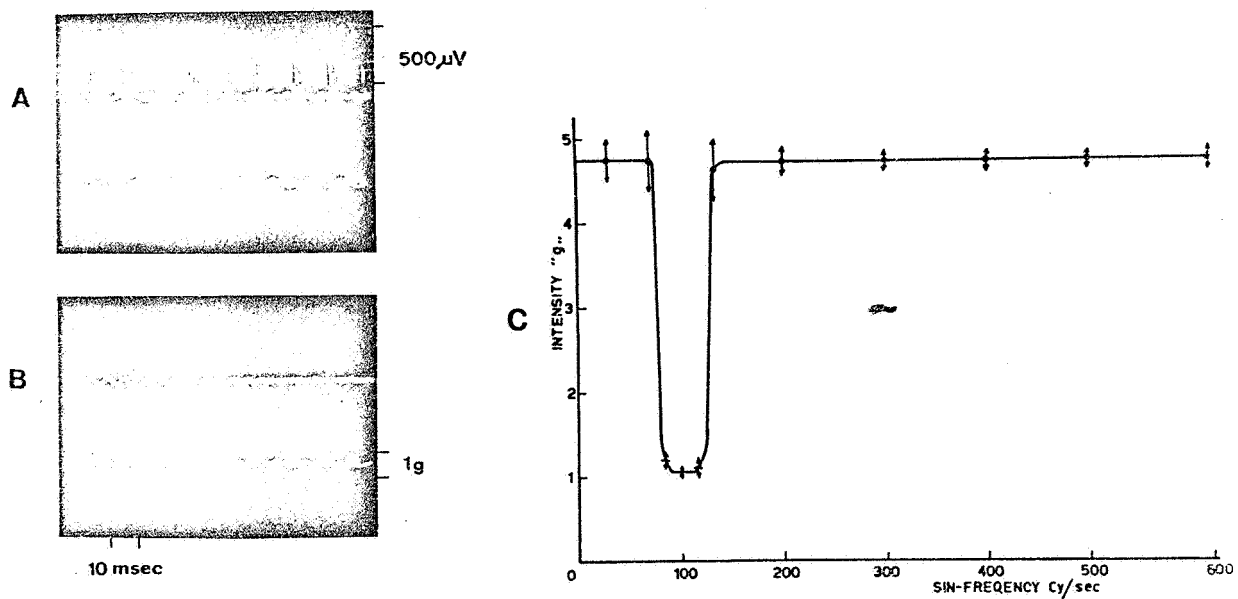

Fig. 18

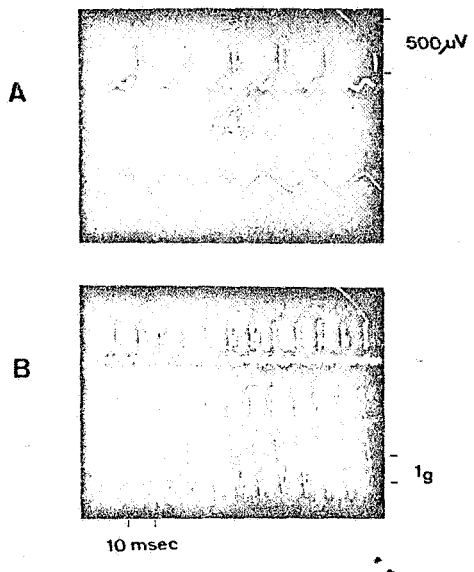

Fig. 19

## SECTION 7

### PREPARATION FOR THE FLIGHT

#### 7.1 THE PROBLEM OF MULTIPLE PREPARATIONS WITH A VERY SHORT TURN AROUND TIME

The main problem connected with the Scout launch of the OFO mission was 1) precise timing and 2) the need of being ready for a repeat mission in case of failure with a minimum turn around time. The complexity of these problems will be immediately clear by the simple inspection of the schedule for the biological preparation (Table 1). As it is the case for all biological work there is a large factor of uncertainty as far as the reliability and duration of the preparation is concerned. In this case in which two frogs were used with four electrodes implanted (one in each vestibular nerve) the requirements were particularly severe especially as the preparations were due to last several days and the need for two perfectly working preparations was imperative at exactly the time of the loading into the package and then to the rocket. Anyone connected with biological works knows that a certain chance exists that however carefully a preparation is made something might go wrong. In the laboratory this is not absolutely essential as the experiment can be postponed or another animal can be substituted in the event that the first preparation deteriorates. For the OFO-A flight, however, there was a deadline of no return. If both preparations were not in

good condition six hours before the flight, the flight itself had to be postponed with all the problems that any such decision involves. In order to solve this problem the only possible safety was in having such a large number of frogs fully instrumented that the chances of not finding a couple in good working condition would be minimized. Preliminary work has shown that there was near certainty that at least 30% of the prepared frogs would be in a perfect working condition at any given time, for each stage of preparation some of the animals either died or were not suitable for the continuation of the surgery. To reach a final number of at least six frogs in perfectly good condition it was planned to start with 24 at the first stage and at the third stage have 12 prepared and another 12 in reserve. As shown in Table 1, the teamwork allowed a continuous substitution of the deteriorated specimens so that in the end six frogs were completely instrumented. Other specimens were kept ready at each stage so that they could be processed further when required with a very minor delay. It was calculated that this allowed a minimum turn around time of 48 hours. In fact except on two occasions two good preparations were always available out of the six implanted at least 24 hours earlier. This elapsed time allowed both the stabilization of the firing rate of the vestibular unit and the inspection of the animal for general welfare (see previous Section). As the animals were kept in O<sub>2</sub> saturated water two advantages

c-3

appeared: 1) the possible toxic effect of  $O_2$  could be detected prior to the insertion of the frog in the FOEP and 2) the frogs were already partially saturated with  $O_2$  which decreased the flushing time of the FOEP after the animals were introduced into it.

The preparation for the flight and the testing prior to the actual launch was performed as follows.

Prior to launch the two frogs selected for the flight were implanted 24 hours earlier to allow observation of the firing of each of the four selected vestibular units for at least one day. The animals were kept in oxygen saturated water after having been placed on the corresponding centrifuge end caps, instrumented with EKG electrodes and microelectrodes. The units were monitored in this period to assure stationary firing and response. Twelve hours before being transported to the pad the two frogs were positioned in the FOEP 1 for the flight. Following the standard routine the system was flushed through an open loop oxygen circuit in the FOEP itself to dispose of the residual nitrogen in the frogs themselves and in the system due to the handling of the package: the presence of nitrogen in fact would decrease the  $PO_2$ . Periodical samples of centrifuge water were tested for oxygen content. The open oxygen loop was maintained till the  $PO_2$  reached approximately 700 mm Hg. The loop was then closed and the system supplied by the FOEP oxygen container. The water  $PO_2$  was tested again and

this procedure repeated several times till the  $PO_2$  was maintained at slightly above 700 mm Hg. The FOEP was then ready to be placed into the canister. This being done, ground control data were acquired and stored on analog tape: such data were: (fig. 10)

1. 20 minutes of activity of the four units at rest;
2. a number of single centrifuge spin cycles, several minutes apart;
3. a number of triple cycles during which the centrifuge was restarted as soon as it stopped;
4. 10 additional minutes of data immediately following the last centrifuge cycle.

At 6.15 p.m. of November 9, 1971, the flying unit was carried to the pad and installed in the spacecraft. During the entire period preceding the lift off the activity of the four vestibular units and EKG of the two frogs were tested periodically during radiation period. The data were recorded on a strip chart and on analog tape. Starting approximately from 10 minutes before the lift off, data have been recorded continuously and the recording was carried out without interruption through the entire lift off up to injection in orbit, when the satellite disappeared beyond the horizon.

#### 7.2 THE QUICK LOOK ANALYSIS PROGRAM AT GODDARD

As the results of the flight were largely unknown some preliminary hypothesis have been made on which a flight program has been established. (To be discussed in 7.3.)



The program provided the possibility of adapting new experimental conditions according to the first results of the flight itself. It was decided that the data of the first 24 hours be used as a base for choosing of the follow up. A quick look analysis of the data after the first 24 hours in the mission was therefore necessary that would allow the reaching of sufficiently clear conclusions in time. A maximum of 10 hours was set apart for such a program. The quick look analysis was as follows. First of all the data incoming from the Rosman Station only were considered as they could be sent to Goddard immediately after receiving. These data were recorded directly thus minimizing the basic noise as the data didn't go through an additional tape recorder before reaching the experimenter. From the biological point of view the welfare of the frogs was continuously monitored, on a Brush recorder, the EKG of the frog from the incoming data of the Rosman Station. The data upon the arrival at Goddard were immediately edited for noise and artifacts and digitized and then reduced according to four different computer programs.

1. The time history of the acceleration profile and of the interspike intervals as a function of time.

2. The interspike histogram of the steady state firing during the activity at rest and the first and second half of the centrifuge run at constant speed.

3. The changes in the interval value as a function of the positive acceleration transient during the increased speed of the centrifuge.

4. The same as a function of the logarithm of the acceleration on the assumption that the response might follow the Weber-Fechner law. This could be immediately displayed on a stereo display and if necessary enlarged.

An additional program was also added providing an enlarged histogram. Photographic hard copies were provided simultaneously and could be examined immediately (Fig. 20) and such a program was rehearsed previously a number of times with data collected during simulated missions on the ground and it proved to be satisfactory.

### 7.3 FLIGHT PROGRAM RATIONALE

The flight program was established taking in to account all possible results.

1. All the information were provided regarding the activity at rest for at least six minutes after the centrifuge cycle and for one and a half minutes before the centrifuge cycle.

2. The centrifuge cycle provided information both during static and dynamic stimulation. The first during the increasing and decreasing speed of the centrifuge and the second during the rotation of the centrifuge at a constant speed.

The changes that might be expected in the gravity sensitive vestibular unit activity during the space flight

consisted in an alteration of 1) the spontaneous firing in the absence of any rotatory stimulation; 2) the response to rotation both during the increase and decrease of the acceleration and during the constant 0.5 g period; 3) the after discharge period following the end of the rotatory stimulation. Accordingly, after the first 24 hours and the evaluation of data, one of three routines (A, B or C) were to be followed. (Table 2)

First 24-hour test. The standard test is the one with normal centrifuge cycling.

<u>Hour</u>	<u>Test N. (Standard)</u>
1	1 - within 5-10 minutes after injection into orbit
	2 - 30 minutes from initial launch
	3 - 30 minutes from previous test
2	4 - 30 minutes from previous test
	5 - 30 minutes from previous test
3	6 - 30 minutes from previous test
	7 - 30 minutes from previous test

From hours 4 through 25, one test every hour.

Between hours 26 and 36 there will be a ten hour interval for acquisition and analysis of data and to prevent the otoliths adjustment to the routine.

Routine A - Standard Test. If the first 24-hour tests show a) no change from norm or b) change from norm without any trend toward adaptation, this routine will be used:

<u>Hour</u>	<u>Test N.</u>	<u>Hour</u>	<u>Test N.</u>
37	1	55	9
38		56	
39		57	
40	2	58	
41		59	
42		60	
43		61	10
44	3	62	11
45		63	
46	4	64	
	5		
	6	65	
Tests 4, 5,			
6 will be every			
20 minutes			
47		66	12
48		67	
49	7	68	13
50		69	
51		70	
52	8	71	
53		72	14
54			15 - will follow test 14 by 10 minutes

Routine B - Routine B will be used if the first 24-hour data showed changes in the spontaneous activity in the absence of any stimulation, and if these changes varied during the previous 24-hour flight by becoming either more severe or showing habituation.

<u>Hour</u>	<u>Test N.</u>	<u>Hour</u>	<u>Test N.</u>
37	1-8 minute recording without rotation	54	
		55	
	2 - same as test 1	56	
	3 - standard test	57	
38		58	
39		59	
40	4 - same as test 1	60	9 - same as test 1
41			10 - standard test
42			11 - same as test 1
43		61	
44	5 - same as test 1	62	
	6 - standard test	63	
45		64	
46		65	
47		66	12 - same as test 1
48		67	
49	7 - same as test 1	68	

<u>Hour</u>	<u>Test N.</u>	<u>Hour</u>	<u>Test N.</u>
	8 - standard test	69	
50		70	
51		71	
52		72	13 - same as test 1
53			14 - standard test
			15 - same as test 1

Comments - The tests in the same hour are to be performed consecutively. Immediately after maneuvering, tests without rotation and standard tests are to be alternated.

Example: 42nd hr = maneuver = test without rotation

45th hr = maneuver = standard test

The scope of Routine B is to study changes in spontaneous activity of the otolith due to weightlessness. Consequently a) tests without rotation are performed serially to detect the trend and time course of the change; b) tests without rotation are performed close to maneuvering, which produces acceleration, to assess the influence of artificial gravity on a spontaneous activity; c) tests without rotation are performed immediately after a standard test to study the effect of 0.5  $g$  artificial gravity.

Routine C - Routine C will be used if the first 24-hour data show changes mainly of responses to acceleration and of the after effect, and if these changes show habituation or become larger during the previous 24 hours.

<u>Hour</u>	<u>Test N.</u>	<u>Hour</u>	<u>Test N.</u>
37	1 - standard test	53	
	2 - standard test		
	immediately after test 1		
		55	
	3 - standard test		
	followed by additional 8	56	
	minutes of recording		
	without rotation	57	
38		58	
39		59	10, 11, 12 same as
			tests 1, 2, 3
40		60	
41		61	
42	4, 5, 6 same as	62	
	tests 1, 2, 3		
43		63	
44		64	
45		65	
46		66	
47		57	
48		68	
49	7, 8, 9 same as	69	
	tests 1, 2, 3		

<u>Hour</u>	<u>Test N.</u>	<u>Hour</u>	<u>Test N.</u>
50		70	
51		71	
52		72	13, 14, 15 same as tests 1, 2, 3

Additional triple tests consisting of two consecutive standard tests followed by standard test plus 8 minute recording should be performed after each maneuvering.

Comments - The purpose of Routine C is to study changes of responses and especially possible prolonged rebound changes of the spontaneous otolith activity following the end of rotation. Consequently, a) two standard tests close together are performed to see if the stimulation applied during an abnormal after activity produces a summation effect; b) the recording of the otolith activity following the rotation for an additional 8 minutes time will provide information on a time course of the after effects, hopefully until return to normal. As shown the tests are more widely distributed in time as the main interest here is the time course of the changes during flight.

Routine D - This routine will be operated if the experiment is extended beyond the 72 hours. This will require that sample data from the last ten hours of the flight be made available to the experimenter to establish: a) if the experiment is still active and shows no tendency toward deterioration; b) which are the main characteristics of the



otolith's spontaneous and evoked activity after 72 hours of space flight. On the basis of the information from b above the experiment will be further continued following A, B or C respectively until the termination of experiment.

From the preliminary analysis during the flight, two main changes were observed: 1) in the spontaneous activity at rest and 2) in the response to decreasing acceleration and after discharge. Therefore, after the first 24 hours it was decided to continue the experiment according to Routine C; in addition to perform a number of records without activating the centrifuge cycle as in Routine D. The final data reduction seems to justify this decision. It was found therefore that the quick look analysis was adequate to its purpose.

Fig. 20. Examples of the time history of the interspike intervals obtained from the video display at Goddard (7th day of flight). Continuous line acceleration profile during the turning of the centrifuge. The black dots correspond to the consecutive interspike intervals measured from the base line.

TABLE 1

1.st Stage: demotorization of 24 frogs (all branches of thoracic and lumbar plexuses are cut).

2.nd Stage: surgery on vestibular nerves; wiring for microelectrodes and preamps; removal of tongue (24 frogs).

3.rd Stage: inspection of vestibular preparations; insertion in endcaps. Preamps and EKG electrodes are fixed on frogs.

EKG tested (12 frogs out of previous 24).

4.th Stage: microelectrodes are implanted and tested; 4 frogs are inserted in FOEPs (6 frogs or more are prepared).

Test in FOEP: base line data are recorded on tape from FOEPs with fully instrumented frogs; some replacing of the animals is possible.

Exercise at Goddard: with data of previous "test in FOEP" analysis through computer is performed at Goddard, for base line data and program training.

First, second and third quick analyses: data from previous 24 hours' orbital flight are analyzed to determine (1) success of the mission, (2) choice of routine a, b, c for continuation of mission.

TABLE 2

Standard routine (first on top) and routine A, B, C.

The standard routine operates automatically during the first 24 hours of the mission.

Routine A, B, C are selected for the progress of the mission.

For details see text.

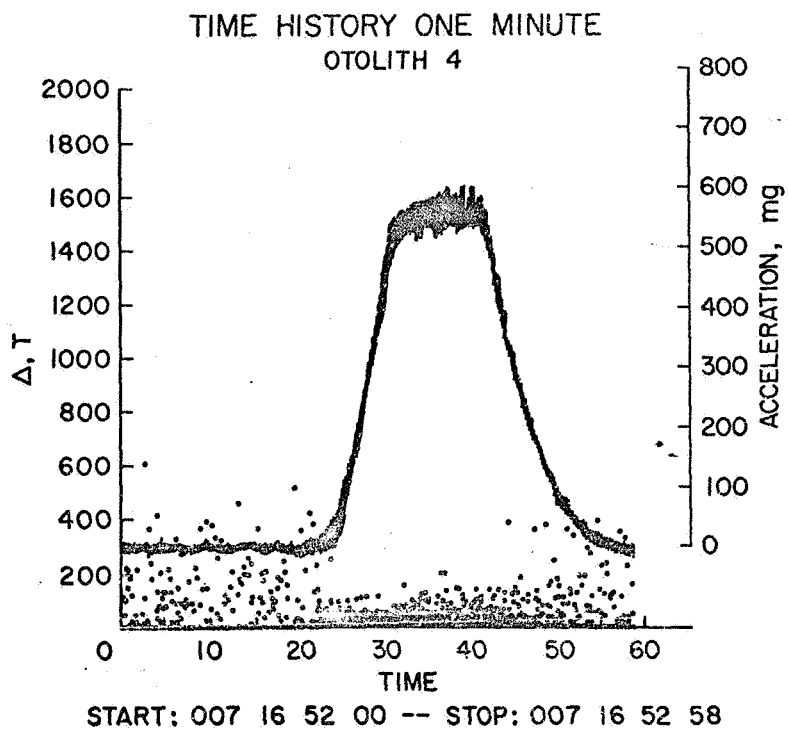
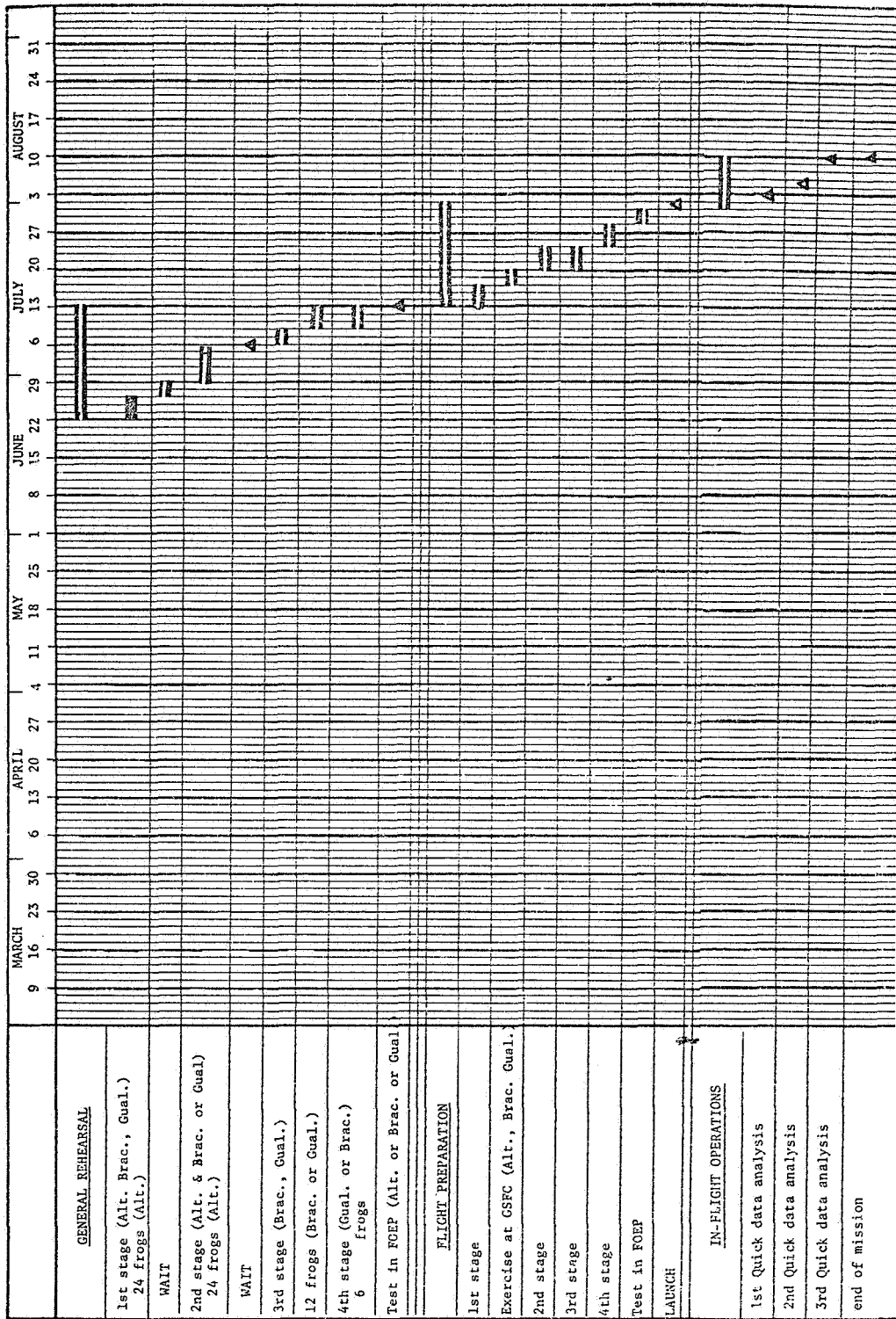
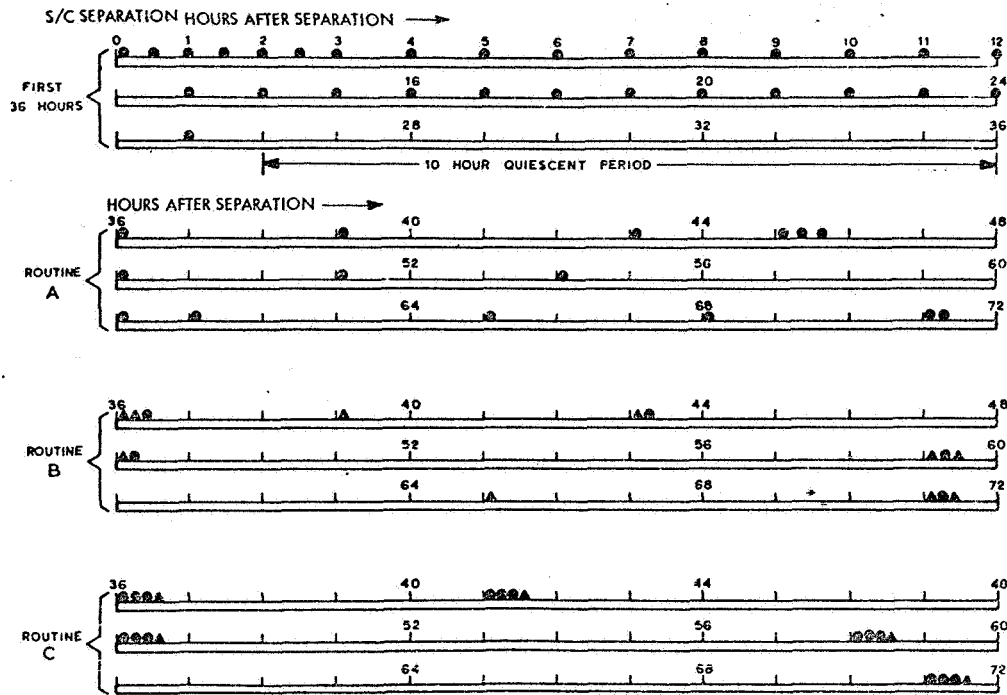

Fig. 20

OFO-A  
 SCHEDULE FOR BIOLOGICAL WORK  
 (June 22 through Launch and Mission)



Tab. 1



**LEGEND:**

- - Standard 3 minute centrifuge cycle.
- ▲ - 8 minutes recording without rotation.

**ORBITING FROG OTOLITH OPERATIONAL TIME LINE**

**Tab. 2**

SECTION 8  
FINAL ANALYSIS

8.1 DATA ANALYSIS

8.1.1 The Health condition of the Frog

The condition of the frog has been investigated on the ground, during lift off, and in orbit by the examination of the EKG. This was particularly easy for Frog B as the EKG was clear from noise all the way through the experiment, whereas for Frog A noise appeared after 24 hours of flight in such a way that at T+48 the EKG was difficult to examine. It was felt therefore that analysis of Frog A units should be limited to the first 40 hours of flight in this Final Report; insufficient indication of the health conditions would introduce some doubt on the interpretation of the observed changes.

The EKG frequency appeared to be only a function of temperature following the same general relationship as shown in the ground control experiment (fig. 21). As it appears from the changes following the temperature variation within the observed range the heart rate showed a non linear relations with the temperature. A certain shift appears when the temperature is increasing and when the temperature is decreasing. This is due to the thermal inertia of the frog body the deep temperature of which lags behind the water changes. In fact the temperature sensor was placed in the FOEP in the output of the centrifuge water and therefore a difference certainly existed between the



core temperature of the frog and the one measured. The correspondence between the changes shown during the flight and in the control experiment on the ground (8.2) are important as it demonstrates that the 0 g condition did not alter the frog circulatory system. This was to be expected owing to the fact that even on the ground the frog, being kept submerged in water, was subjected to a condition very similar to the one in weightlessness as far as circulation is concerned. The response to temperature changes also indicates that all the controlling systems of the heart and circulatory complex were functioning properly as on the ground. It may be added that, as it will be discussed in Part 8.2, for the same temperature ranges no difference appears in the general behavior of the EKG whether the frog is in air or submerged in water.

The detailed analysis of the EKG waves and especially the R and the T also showed these electrical events to be within the physiological range throughout the flight (Fig. 22). The QSR complex - T wave conduction time too remains within the physiological limits. The analysis of the P wave and of the P-QR has been difficult to assess owing to the fact that the P wave is small and it tends to disappear in the noise of the records but whenever it was possible to measure this parameter it appeared to be normal and equivalent to the one recorded on the ground. Particularly important is the fact that the T wave remains at the proper amplitude and duration throughout the entire

mission. In fact a change of the T wave in the sense of increasing amplitude and duration is the first index of stress on the heart due to hypoxia. Although this change is reversible, it is an important factor that none of such indications or cardiac sufferance was detected even during lift off. This seems to prove that submersion in water effectively cushioned the high g and high vibration impact especially during the prolonged firing of the first stage and during the high thrust acceleration corresponding to the firing of the third and fourth stages. The EKG recording performed on the pad also appears to show values within the normal range when related to the temperature, which was kept within the prescribed limit. During the decrease of temperature below the accepted values between the 9th and 15th hour in the mission the EKG rate showed the expected decrease and the relationship with the temperature seemed to deviate from a linear function as it happened during the control experiment on the ground (see 8-2). Also the fact that the EKG waves however did not show a reduction in amplitude seems to indicate that the animals were not in a stressing condition. In fact the recovery was prompt and as soon as the temperature reached again the required level, the heart rate reverted to the value corresponding to the temperature itself. It must be emphasized here, however, that a complete control of such events was possible mainly for Frog B because of the noise of Frog A already indicated in the beginning of this Section. However

at T+48 hours in the mission (Fig.22 E) the EKG of Frog B, although regular, showed a decrease in frequency and slightly in amplitude.

In conclusion it can be said that the entire mission from the standing on the pad throughout the lift off and during the 155 hours in orbit did not show any unexpected change in the cardio-circulatory system and it followed closely the behavior already observed during the simulated missions on the ground, at least for Frog B.

#### 8.1.2 The Activity of the Vestibular Units

##### I. Identification of the Unit Pulses.

After the first quick inspection of the four channels of vestibular activity during waiting on the pad, the lift off and the mission in comparison with the previous data on the ground of the same unit the following observations were immediately possible.

1. In at least three channels, Frog B3-4 and Frog A2, the signal to noise ratio was quite satisfactory and computer analysis of a large number of superimposed tracings showed the pulses to be well recognizable with the typical parameters of a normal nerve action potential (Fig.23 ). The characteristics of these potentials remained constant on the ground, on the pad, during lift off and throughout the mission indicating that recording from the same unit was extremely likely. Some stations especially Johannesburg appeared to be noticeably noisier than

others but this did not make the spikes detection more difficult (Fig. 24 ). Frog A1 was, however, a problem owing to the low signal to noise ratio (due to the high noise level typical of this channel). A special computer program for the identification of the spikes has been devised (see later).

2. During lift off no mechanical artifact was noted even during the firing of the rockets indicating that the chronic microelectrode technique was even more successful than originally thought. However, owing to the strong stimulation provided by the high acceleration level a remarkable recruiting (Fig. 25BC) appeared during the rocket firing making it very difficult to identify the original pulse that was being evaluated. During coasting (Fig. 25D) the recruited spikes disappeared or at least went down to an acceptable level so that the original unit could be easily recognized and analysis of it became possible again. However, a computer program is being studied for possible identification of the original spike even within a large number of intervening spikes due to recruiting. This program is a modification of the one used for identifying spikes covered by noise (see later) but it will require an additional study and cannot be included in this final report. If the program is successful, additional information on the behavior of the vestibular units during high g acceleration corresponding to the firing of the thrust motor will be provided in due time.

3. In the second channel of Frog B and also in the first, it appeared that smaller sized spikes were present (Fig. 26) and could be analyzed separately by proper computer programming (Fig. 27 A, B, C, D). Such a program consists in identifying typical parameters of the action potential like the duration and steepness of the rising part of the spike, the duration of the spike itself as measured between the onset of the spike, the peak and the end of the down stroke of the spike itself (points a, b, and c in the figure) and measuring the area of the resulting triangle. As it is shown in the figure in this way even a spike the amplitude of which is within the amplitude of the noise can be detected and isolated and statistical analysis performed. Two of such spikes have been already found in channel three (Fig. 26 - Frog B) and further studies will be made later on on this matter.

As a standard method an average of 60 spike data has been used to provide the basic information on the parameters of the action potential of each unit studied in order to eliminate the effect of the noise superimposed on the spikes themselves (see Fig. 28). Computer analysis was used to make sure that the parameters thus identified were kept within narrow limits: and, therefore, that the recording was performed from the same unit throughout the entire mission starting with the ground data. The alterations of the spikes due to telemetry (especially because of the lower telemetry frequency response

than the one used in the laboratory (2000 cycles instead of 5000) were so minor (the spike appears slightly longer in duration and a little flatter) to be well within the limit of the instrumental error and no different from what might be observed in a prolonged recording in laboratory conditions. The difference between different spikes were quite evidently much larger (Fig. 23) so that identification of each one spike appeared to be easy.

4. The statistical analysis of the spike train data requires that no additional spikes intervene as this event would alter the results. It is obvious that visual inspection is not feasible in an experiment of this sort in which hundreds of thousands of data are involved. A special method, therefore, has been used which was already applied during the preliminary data reduction (see Sections 4 and 5), namely, the identification of a minimum interval. (On the rationale of this, see Section 4.) The minimum interval detection technique was, however, modified to adapt it to the handling of a large number of data continuously running. In fact the previous technique, as described in Section 4, required that the processing of data be made through an extended interspike interval histogram, and it was felt that such a technique would take too much computer time. Therefore, a simpler method was used as follows: the spike triggered a square pulse of .5 millisecond in duration that was continuously recorded on a memoscope screen. The first spike would trigger

the time base and the second spike immediately consecutive would appear at a given time after the first (Fig. 29). In this way the intervals between the consecutive spikes were immediately evident and any pulse that happened to be within the minimum interval typical of the unit being evaluated would indicate either an artifact or an additional biological signal. Such a technique has the advantage that the entire series of data can be run continuously with an immediate possibility of checking any untoward event with no delay in the tape running. With this technique it was possible to:

a) Identify bursts of noise and artifacts due to frog movements, telemetry gap during the radiation of housekeeping data and of any other event interfering with the vestibular unit firing. The timing of such event was noted on the timing code running continuously and the computer instructed to ignore data coming within the identified period of artifact after having identified these as irrelevant. This eliminated human error in the data handling.

b) It allowed the adjustment of the clipping level in order to make sure that no additional unwanted biological signal might suddenly appear at a time among the data to be analyzed: at a time a double clipping technique was used as follows. When the nerve spike showed a sizeable second phase opposite to the main pulse (Fig. 30) the signal went through two clippers in parallel. Clipper 1 triggered open, after a

delay, a gate which remained open for a certain period of time. If during this time the opposite phase signal from clipper 2 entered the gate, a square pulse appeared at the output of the gate. In this way, adjusting properly the time of the gate opening, biphasic biological pulses only, the two phases of which were of given parameters, could result in a pulse in the output of the system and all the artifacts could be eliminated. The block design of the system is shown in Fig. 31 .

c) It was possible to determine that a given minimum interval seems to be typical of each unit. This was also demonstrated on a large number of units during preliminary experimentation on the ground (see Section 4).

5. The data analysis was divided in two classes: static response and dynamic response. Of the static response the main problem was to determine the statistically significant sample. As known, this is a very difficult problem and a satisfactory answer is far from having been found. Anyway, an empirical mean has been devised, i.e., the calculation of the sequential mean: it is done by measuring the first interval of a given volley of spikes then adding the second one determining the mean and then the third one to the second and again determine the mean and so on. After a certain number of intervals, the means appear to be very closely constant (Fig 32 ) and this was taken as an indication of a statistically significant sample. Another way was to use the interspike



intervals distribution by means of the interspike intervals histograms in different samples of the same number of events (Fig. 33). When in a stationary response condition the distribution appeared to be closely the same the corresponding number of intervals were taken as being sufficient for a statistically significant sample,

6. During the static response analysis of all units it has been determined if the units themselves were subjected to no stimulation, namely, if the input was functionally zero or if a stimulus was present. The only sources of a stimulus were the vibration of the water pump providing circulation in the FOEP (see Section 4) and the low level linear acceleration residual of the g component slowly changing below  $10^{-3}$  g's. This latter appeared to be insignificant for all units. The former, namely, the vibration induced by the pump, on the contrary, appeared to be able to stimulate at least one unit during a certain period in the mission. This was determined by an enlarged interspike interval histogram which showed peaks equivalent to the reciprocal of the number of turns of the pump (Fig. 34). Moreover, a more direct way of determining that the vibration was a positive stimulus for a particular unit was to trigger the time base of an oscilloscope with one spike, recording simultaneously the vibratory acceleration curve (Fig. 35) averaged through computer to eliminate noise. As shown, the

vibratory curve is synchronized in such a way that the envelope is quite clear. This technique was previously developed during the preliminary work done in Milan in 1969 (see Reprint D). Both methods could give also some quantitative idea of the sensitivity of the unit to that particular kind of stimulus.

II. Analysis of the Unit Activity on the Pad and during Lift Off.

While on the pad the attitude of the frog changed from when the position of the rocket was horizontal to when it became vertical. In both conditions the resulting gravitational components lie mostly outside the receptor field of the vestibular units except for a very small vector. In fact while the rocket was horizontal the two frogs were on the side one left, one right and going vertical they changed from being on one side to a position back down. As the vestibular unit has been selected to respond from horizontal to head down and the receptor field only extends for some  $75^{\circ}$  on the horizontal the side down situation was clearly outside the receptor field as it was the horizontal. However, during the rocket erection a dynamic response was observed, especially for unit 4 (Fig. 36).

As indicated in the previous part the possibility does not exist by now to explore the response of the units during the actual rocket firing except for the very beginning of the first stage firing in unit 3 in which a high frequency discharge appeared (Fig. 36). The most important results

have been observed during the long coasting following the burn off of the third stage before ignition of the fourth. A nearly immediate decrease in the average frequency of discharge was observed (Fig. 36). This remained at low level for about one minute, followed by a slowly and fairly linear increase of the firing rate till the firing of the fourth stage (Fig.36 ). The same behavior was observed in all units. This result seems to be in agreement with what has been observed during the mission only reduced in time, namely, first a decrease in frequency and then a slow increase. It is particularly interesting to note how the general pattern is the same in the same animal on the two sides (Fig. 36). The prolonged recording before lift off on the pad lasting more than 20 minutes is a good demonstration of the stability of the unit on the ground just before the launch and provides a good last minute background data for the changes observed later.

It is quite evident during the erection of the rocket the step-like increase of activity that follows the step-like increase in the corresponding acceleration (Fig.36 ). Once the new position is achieved the new firing rate appears to be quite constant within the variability limits of the unit and for unit 4 significantly different from the one in the horizontal position (Fig36 ).

It also appears how the decrease in frequency, although always present, is different for the various units with a maximum change in unit B 4 and a minimum in unit B 3. It has to be kept in mind that the erection provokes g forces acting outside the receptor field of the vestibular units: the effect is therefore marginal, or due mostly to vibration (see Fig. 59).

The recording immediately after injection in orbit was too short for any kind of statistics to be significant (only about four seconds before the spacecraft out-reached the recording antenna at Wallops). Unfortunately, no information exists at this point. However, the coasting between the third and fourth stage seems to indicate that the transient high g to 0 g does not introduce any new element on the observed changes during a steady and extended 0 g condition. This also will be important on the reappraisal of the results obtained during a parabolic flight on a jet plane performed with the same technique as described for the OFO-A experiment (see Reprint E)..

### III. Data analysis during the Orbital Flight

#### 1. Steady State Analysis

Following the results of the control experiment on temperature, the data have not been corrected for changes due to the

temperature as these were very minor except in the period from the 9th-15th hour in the mission. The data during steady state condition (the firing before and two minutes after the centrifuge cycle and during the second part of the centrifuge cycle) are given here: a) as a mean frequency versus time diagram, b) as a series of histograms of statistically significant samples and c) as a number of statistical data (see on top of the histograms) as a function of time in the mission.

For the units that showed subthreshold input (A 2 - B 4) it is confirmed, as already communicated in the Progress Reports, that two main changes are evident. First the frequency of discharge decreases to a value significantly smaller than the corresponding data on the ground. This lasts for up to 72 hours (Fig. 37). Sudden period of high frequency firing are observed at approximate intervals of 24-30 hours. Unit B 4 showed the most evident lowering of the rate of firing and this was accompanied by typical very short bursts of very high firing. It is important to note at this point that such an event was not present on the unit of the same frog on the opposite side, unit B 3.

The analysis of the bursts (Fig. 38) showed that the same unit was involved (Fig. 39 C) and that the frequency of discharge started at high frequency, slowed down and then disappeared. Analysing the EKG records it was possible to

determine<sup>a</sup> muscular contraction corresponding to minor movement as the EKG electrodes are bound to record the electromogram of a large section of the muscular system of the frog. It appears that the bursts correspond to a movement every time (Fig 39B ). Now the question arises whether the movement produces a change in the position in the head corresponding to an effective stimulation of the otolith system, namely, whether the discharge of the vestibular unit is secondary to the movement or whether the opposite is true, namely, the discharge of the vestibular fiber triggers a response through the descending influence on the spinal motoneurons that produces a jerk. It is apparent, by the way, that all these bursts of firing and corresponding movement have a relatively short duration of about .5 seconds and they are remarkably similar one to the other. More detailed analysis of the onset of both the vestibular discharge and the movement seems to show that the vestibular discharge starts well in advance to the muscular contraction (Fig. 39B). If this is the case it is very likely that the vestibular discharge is an important factor in determining the alterations in the systems controlled by the labyrinth. However, it is still very difficult to be sure about this point as such an event was not foreseen and it might be that a muscular contraction starts before the EKG electrodes are able to record it in some particular part of the muscular system. One possibility is that these are swallowing movements. The fact,

however, that such movements 1) provoke in the unit of the opposite side a quite different response, namely, a normal change of firing rate followed by some recruiting and 2) that such irregular periodic bursts are only visible during a very low firing rate seems to indicate a certain relationship between an excessive decrease of the vestibular unit activity and the production of these jerk like contractions of the frog. A second observation might be made, namely, that this high frequency firing bursts indicates that the unit is functioning perfectly and that, therefore, the decrease of activity is not due to deterioration of the unit condition. In effect, the firing rate during the bursts is up to nearly 100 per second which is the highest possible rate for such a unit. The firing mechanisms of the unit, therefore, appears to be in normal condition and the decrease must be due to an outside mechanism independent from the spike generation. Unfortunately this event has been observed only in this unit so far.

After the 72th hour period the unit presents an highly significant increase in the firing rate against the activity on the ground and this condition lasts for about 15-20 hours. It is then followed by a return to normal, namely, to the average firing rate recorded prior to the flight on the ground, preceded by some hours of low rate firing.

The variability of each sample was determined by the variation coefficient (Fig. 40 ) plotted as a function of the mean. The curve can be divided in two parts. The first part represents the average rate of firing up to approximately 6 per second and the second part from 6 per second downward to less than 1 per second. The second part fits nearly perfectly in exponential distribution while the first part is very much deviated from the expected exponential.

Normal values appear again starting at the 129th hour. There seems to be a quick change around the 126th hour, the frequency going down from the high level achieved before by nearly half in three hours. For unit 4, for instance, the mean frequency values have been followed for the last six hours and they appear to remain constant within a very narrow range and a spot check around the 145th hour still shows the same value, namely, after 16 hours.

A detailed analysis of the variation in the rate of firing of unit B4 is shown in Fig. 41 in which the average firing rate has been followed hour by hour until the 23rd hour and then every two or four hours up to the remaining 135 hours. A minor oscillation of the value is shown with peak high frequency as early as around the 19th hour but the beginning of the high rate of firing with some high variability is observed between the 70th and 92nd hours. A consistent high rate of firing at a lower level is, however, present at between the 119th and 126th hours.



Comparing these changes with the activity during simulated mission on the ground (Fig. 9 A - B) it is shown that these variations are highly significant as on the ground the changes are limited within a range of 80% average while the changes observed in 0 g are up to 1500% and over. A careful check at the period of maximum rate of firing, namely, the 82nd hour (with some oscillation of value around the 70th hour) shows that the input to the unit is still subthreshold, namely, this is not the effect of a sudden pick up of the water pump vibration (see later).

## 2. Unit Responding to Pump Vibration.

The unit responding to vibration starts showing such a response immediately after the first recording in orbit (Fig. 42A,B). Unit B3 is particularly significant in this respect as the rate of firing on the ground and after return to normal (when no response to vibration was present) appeared to be very constant. Compare the three samples on the ground with the samples taken from 115th to the 144th hours. The mean of the rate of firing only changes very little. In this case the return to normal is not only complete but also maintained for nearly 20 hours so that the described changes appear to be highly significant.

The discussion of the data of the unit responding to vibration has to be made assuming that the stimulus remains constant. In fact the analysis of the vibration profile due the water pump shows that this is the case (Fig. 43), namely that the intensity and the frequency of the vibration itself does not change during the mission. At the same time the frequency response of the vestibular unit B3 shows remarkable periodical peaks and dips which in the first 105 hrs appear to have a varying periodical alternation of from 10-15 hrs, the frequency going from a maximum of 40 per sec to a minimum of approx. 8. It is quite relevant that whereas the maximum frequency could oscillate from 12-40, the dip frequency seems to remain very constant between 8 and 9 per sec. In the first part of the flight a long period of relatively steady high firing is observed lasting up to the 75th hours. Even in this case as for the other unit (B4) there is a sudden change between the 75th and 82nd hours with the rate of firing reaching a new low to less than 1 per sec. This is followed by another increase between the 96th and 105th hour and then slowly the unit goes back to the normal rate of firing which, as it has been mentioned before, reaches nearly constant rate equal to the one on the ground around the 115th hour. The results are also shown as a solid 3-dimensional diagram in Fig. 44. All the statistical data and the interspike interval histograms are shown for unit A 2 in Fig. 45, for unit B 3 in Fig. 46 and for unit B 4 in Fig. 47. The overall distribution shows that the increase or decrease of the firing rate is mostly due to the fact that the long intervals are reduced in

number or augmented respectively. The type of distribution seems, however, to remain the same. Return to normal of the mean frequency observed in the last hours of the flight is accompanied by a similar normalization of the interspike interval histograms, the parameters of which closely resemble the ones observed on the ground.

The most relevant feature of the second steady state condition, namely the second half of the centrifuge cycle (Fig. 48, unit A2; Fig. 49, unit B 3 and Fig. 50, unit B 4), is that the changes are less pronounced than the ones of the intercycle activity. The variation of the responses in respect to the values on the ground considered =1, are shown for unit B 3 and B 4 in Fig. 51 A and B, and the differential values in respect to the activity in the intercycle period in Table 3. As in some periods of the flight the tonic discharge disappears when the response becomes phasic (between the 34th and 115th hours for unit B 4 and between the 75th and 105th hours for unit B 3), the data in these periods are not significant. The units respond only to transients. In the remaining periods the relative lack of change in the steady state response is quite evident. As simultaneously the basic intercycle activity is deeply modified, the differential firing rate, which is the relevant information for the analyzing center, oscillated widely going from an increase of 500% to a decrease to 0 (Table 3).

#### 8.1.3. Dynamic Response

The dynamic response can be divided into 3 stages: a) during the centrifuge cycle the positive transient corresponding to the increase of acceleration from 0 to 0.6 g's; b) the negative transient from 0.6 g's to 0 followed by a reduced firing after the stopping of

the centrifuge and c) the response to vibration.

1. Response to Positive and Negative Transients.

As already reported by several authors (see Section 4) the gravity sensitive receptors respond to an increase in acceleration with a dynamic response that shows an overshoot if the rate of the acceleration increase is above a certain critical value. Experiments on the ground have shown that the critical change is in the order of approx.  $0.017 \text{ g/sec}^2$  according to the different units.

The rotational speed of the centrifuge was increased in such a way to determine the overshooting. Moreover, it was impossible to avoid a jerk-like start of the centrifuge and the gear effect during the rotation. As a result (Fig. 10, 52 and 53) a high overshoot appeared bringing the frequency of discharge up to about 50 per sec in one unit, 60 per sec in another, 34 per sec in a third as against a mean frequency during constant speed of 10 per sec in one unit, 48 per sec in another and 22 per sec in the third respectively.

The overshoot appeared to be higher by a multiple as against the steady state response. The overshoot, as indicated by J.Vidal et al. (36) could be considered a phasic response, more or less pronounced in the different receptors. If, according to what Vidal and co-workers said, the mechanical part of the otolith system enclosed between the basic membrane and the supporting jelly is not a purely elastic system but has a certain degree

of plasticity or irreversible deformability as shown by the multivaluedness of the response found by these authors and if such a fact is due to be load in a 1 g field it was to be expected that at 0 g the system would have been mechanically freer. In effect the otolith mass would float in such condition and no load will, therefore, be applied to the supporting structures. However, no consistent increase in the overshoot has been found in any part of the flight for any of the units studied: on the contrary the overshoot is consistently reduced in some part of the flight, especially between the 82nd and 92nd hours all units showed a disappearance of the overshooting. The units response was similar either to the ones described both in literature or studied in the preliminary ground experimentation that didn't show any overshoot at all or to a response to increased angular acceleration below the critical value mentioned above. The overshoot effect returned with the same characteristics as in the first hour of the flight in the very end of the flight itself starting respectively at 119 hours, at 124 hours, 139 hours for the 3 units maintaining thereafter a constant value. In no occasion, however, the overshoot showed the same high firing rate as on the ground. Control experimentation on the ground demonstrated that the overshoot is somewhat dependent on the gravity component so that the more the rotational plane is tilted from the horizontal the higher the overshoot firing rate

appears. It can, therefore, be assumed that the overshoot is partly provoked by the gravitational component and that both in the beginning of the flight (within the first 24 hours) and when in the end the response becomes similar to the one in the beginning of the flight the normalization process is completed even at this particular aspect of the response.

Even the dynamic positive response (to increasing angular speed) shows the same periodical changes, approximately every 24 hours, that has been described for static responses. In fact a maximum increase was shown at  $T + 39$  hours for one unit, a dip at  $T + 92$  hours, another high at  $T + 112$  hours and return to normal from 119 hours later. A second unit showed a maximum at  $T + 32$  hours increasing further up to the 39th hour and a low at  $T + 82-92$  hours and so forth.

One of the most striking features of the change produced by 0 g is the modification from tonic to phasic in the response, namely, (Fig 52,53) the units tend to show a prevalence of the dynamic instead of the static response. This seems to confirm the hypothesis by Vidal and co-workers of the relative independence between the phasic and tonic activity in each receptor possibly due to separate mechanisms. The important fact here is that the dynamic/static response ratio can be modified by changes in the <sup>enviromental</sup> main variable <sup>acting upon</sup> / the organ, gravity. The change from tonic to phasic in the dynamic response takes

place gradually and disappears still gradually at the end of the flight. The tonic or static response does not disappear completely even at the maximum of the phasic effect (Fig.52,53). A complete inversion of response to the negative transient (slowing down of the centrifuge) is observed during the maximum change to phasic of the response. In this case instead of a decrease or even a complete blocking of the unit firing an increase in the frequency of discharge occurs. In Unit B 4 (Fig. 53) this is even larger than the response to the positive transient. At a certain stage around the 105th and 107th hours in the mission it is the only one response present. In this extreme condition in which the firing rate of this unit increases to nearly 100 per second the static response nearly disappears. From the 112th hour on the responses tend to go back to normal: the static response increases and the dynamic positive response to the negative transient disappears progressively. After the 120th hour the dynamic and static response of the unit is practically back to the values as in the beginning of the flight.

Except during the above-described very peculiar phenomenon, the responses to the negative transients and the after effect following the stopping of the centrifuge remain similar to the ones observed on the ground and in the very beginning of the flight. Namely, when the centrifuge starts decreasing its angular speed the firing rate diminishes

till it reaches a value lower than the resting discharge frequency. This can be observed even at the very beginning of the change to a phasic response (Fig. 52,53). The return of the response from phasic to tonic includes also the slow reappearance of this suppression or slowing down of the firing rate during the negative transient. As the two phenomenon seem to run in parallel it looks as if the overshoot during the positive transient and the blocking effect of the negative transient are linked as a single mechanism. In fact both are dependent and proportional to the speed of the centripetal acceleration change as it was shown also in control experiments on the ground (Fig. 10). This is also understandable as both are related to a dynamic factor and even if the hypothesis holds good that the dynamic factor is independent from the static one it is very unlikely that two different mechanisms act during the increase or decrease of the receptor firing rate according to the direction of the stimulus change.

## 2. Response to Vibration.

A vibratory stimulus was present in between the centrifuge cycles also, owing to the mechanical artifact of the water pump. At the frog head this vibratory stimulus was in the order of about 2-3 mg's and its effect on the resting activity has been described in the previous sections. As indicated it was above threshold only for one unit. During the centrifuge run, however, a much higher vibration was superimposed to the



centripetal and tangential acceleration. The vibration was relatively high (in the order of 100-150 mg's) and it was mainly due to the effect of the mechanical transmission of the motor to the centrifuge itself and to some irregularity in the centrifuge run. Another source of periodical stimulus but only present on the ground was the  $\pm$  g component with a maximum period of 1 second (number of turns of the centrifuge at steady rotation = 60/min). To the latter all units responded with a modulation of firing rate over and above the change produced by the centripetal and tangential acceleration. This corresponds to the typical behaviour of the gravity sensitive receptors as indicated in the enclosed Reprint D. Even to the vibratory stimulation corresponding to the centrifuge run the unit responded with an appropriate modulation of the firing rate both during the increasing and decreasing angular speed and during the constant speed period of the centrifuge cycle

In this case the unit was able to respond differentially to the linear acceleration and the vibratory one. However, the situation was modified during the higher response in the phasic period and during the overshoot as in this case the units seem to have reached the maximum possible firing rate and the vibratory response disappeared. The response to vibration both during the resting activity and during the centrifuge cycle (Fig. 34), as shown by the relative histograms, is in accord with the results obtained by several authors on

the response of the vestibular sensory receptors to a sine-like acceleration. In fact, the profile of the acceleration during the centrifuge cycle, although somewhat irregular, approaches closely enough a sine wave with a period of one second. Consequently the units followed the sine excitation with a typical variation of frequency of discharge: the results are similar to the ones obtained in the laboratory. (fig. 54)

Owing to the vibration superimposed to the linear change in acceleration during the period of increasing speed of the centrifuge, the original plan of plotting the change in the firing rate of each unit against the g change has been discarded as it was felt that it would not be significant. In fact if any decrease of the acceleratory stimulus takes place, a blocking effect appears on the unit firing and, therefore, the correlation between the g level and the firing rate is altered. This is found to happen in the down stroke of the sine-like vibrations. An attempt to correlate the peak of the firing rate with the peak of the vibratory stimulus and the dip of the firing rate and the lower values of the acceleration during the down stroke of the vibratory stimulus did not seem to provide meaningful information or to indicate a simple enough relationship between the increase in acceleration and the increase in firing rate.

#### 8.1.4 Shape and Amplitude of the Biological Pulses

The hypothesis can be forwarded that a possible alteration of the shape and amplitude of the action potentials

might result from the 0 g condition owing to some mechanical effect at the membrane level due to the differential density of the structures and the surrounding tissue fluid. To test this hypothesis careful measurements have been made of the shape of the units sampled on the pad and during the flight. Moreover, a direct evidence has been provided by superimposing the spikes recorded on the pad and during the 0 g condition.

No significant difference appeared. It can, therefore, be concluded that gravity does not seem to exert any influence on the basic mechanism of the spike generation.

## 8.2 CONTROL EXPERIMENTATION

As known, during the flight two main failures were observed. First, an increase of pressure due to oxygen leakage in the canister up to 11 psi and second, owing to the malfunction of a temperature control command, a decrease of temperature, below the tolerance, to 55°F. in a period of about nine hours.

### 8.2.1 Effect of Increased Housing Pressure

Three control experiments have been performed increasing, by means of O<sub>2</sub> from an external source, the housing pressure to 11 psi and studying the effect on EKG and the vestibular units firing. To provide background data the EKG and the activity of the units have been investigated each time for two days before increasing the pressure. In one experiment the short range effect was studied for about eight hours after reaching the full increased pressure. In the others the experiment was continued for three days after the increased pressure was applied.

The housing pressure was increased by applying through a valve oxygen from a high pressure bottle till the required level was reached. The EKG of the frogs was monitored as an index of the animal welfare during the entire period and the temperature was kept constant within 2°F. around 62°F. (fig.55) The observation was limited in all cases to spontaneous activity although some centrifuge runs were also performed. It was, however, found that spontaneous activity was a better index than the response to acceleration owing to the many variables in this latter case. Particularly evident was the case of the short range experiment as in this case, at the temperature at which the experiment was performed (67°F), the firing rate of one unit was nearly constant and, therefore, even minute changes of the activity was evident (Table 4). The amplitude and the shape of the action potentials have been studied in order to assess a possible alteration due to the effect of the excess of oxygen on the nerve directly. As shown in the example of fig. 56, no significant changes were observed owing to the increased pressure. Neither within an hour after the increased pressure was applied, nor during the following three days (fig.57,60,61) the mean frequency changes. Only during the rapidly increasing pressure a decrease or an increase in the firing rate could be observed probably owing to the dynamic effect on the labyrinth directly (fig.61A) or to an increase on the water pump induced vibrations (fig.58-59).

The EKG of the animal also didn't show any alteration following a long period of increased oxygen tension (fig.61B). After the end of the experiment the animal was inspected for general health-

including the study of the eye and vestibular reflexes - and found normal. An additional and direct evidence that the increased pressure in the canister during the flight didn't alter the vestibular responses and the general welfare of the frogs appears from the investigation of the activity immediately before and after the pressure was applied during the flight. No relevant change was observed.

The absence of any effect on both the EKG and the nerve activity of the frog when the already high  $PO_2$  is further increased by nearly .7 atm. seems to further confirm the conclusion reached in Section 4, namely, that for this particular animal the tolerance to  $PO_2$  when the  $O_2$  is physically dissolved in water is sufficiently high that even an increase by nearly double the partial pressure of  $O_2$  does not affect the animal welfare and function. Tests for oxygen consumption of the frogs were performed in order to assess the  $O_2$  needs in the condition of the flight, with the same technique as described in Section 4. These tests have been made in the same period of the year as the flight itself, namely, the beginning of November. This is an important fact as it has been proven that the  $O_2$  consumption of the frog changes very much according to the season of the year being maximum during the spawning season. As an average the same values as in the previous control experiments were found, namely 150-180 ml  $O_2$ /hr/Kgr at an environmental  $PO_2$  of 700 mmHg and a temperature of 62-65  $F^\circ$ .

#### 8.2.2 Temperature Effect

Three experiments have been performed in order to:

- 1) establish the effect of temperature within the accepted

range during the flight ( $62^{\circ}\text{F.} \pm 2^{\circ}$ ), 2) to see the effect of the maximum decrease of temperature ( $55^{\circ}\text{F.}$ ) that happened during the flight. Figure 4 gives a typical change in the frequency of firing of the otolith units and of the EKG of the same animal as a function of a change of temperature between  $62.5^{\circ}\text{F.}$  and  $55^{\circ}\text{F.}$  As shown, the function seems to be non linear with the frequency of firing decreasing as a function of the temperature. The smaller periodical changes during most parts of the flight from T + 19 hours on, exert a relatively minor effect on the firing rate. On the contrary on a  $10^{\circ}\text{F.}$  range the variation is quite evident.

#### 8.2.3 Control Experiment on Vibration

Two experiments have been performed in order to study the effect of the vibrations induced by the water pump. It was difficult to simulate the conditions observed during the flight. However, a special heavy support was built consisting of a cylinder filled with sand to provide a steady base for the FOEP (Fig. 55). This was adjusted in such a way that the vibration indicated by the accelerometer on the centrifuge of the FOEP provided approximately the signal of the same general characteristics as during the flight. We assume, therefore, that in this condition the three axis accelerometers inside the centrifuge in a position equivalent to the frog labyrinth would read the net vibration value prevalent during the flight.

We could only devise this indirect method as we don't have any possibility of duplicating the 0 g condition and, therefore, to determine the level of vibration inside the centrifuge in weightlessness. It was found that at the labyrinth level the vibration appeared to be in the order of 2-5 mg's (Figs. 58 and 59) and was obviously further decreased through the frog head system: previous experiments (see enclosed Reprint D) indicate the threshold of the response to sine vibrations of the three different vestibular units, namely, the semicircular canals, the saccular and utricular receptors. The vibration induced by the water pump is not, however, a pure sine vibration.

In the condition of the 15 units studied so far only two of the vibration sensitive type showed significant response to vibration.

Further tests made in the laboratory confirmed that at the level of vibration as measured in the FOEP during the mission no gravity sensitive receptors responded to it. Therefore, we can reach the conclusion that, except for possible different results later on, at least for the greater majority of the gravity receptors the level of vibration produced by the FOEP is not enough to provoke excitation: thus the response to the vibration itself which was observed

during the flight in two of the units, was due to a truly significant decrease in the threshold.



Fig. 21. Response of the frog heart beat to the temperature during the flight. Note a delay between the increasing and decreasing temperature effect due to the thermal inertia of the frog.

Fig. 22. EKG of frog A and B, before the flight, during lift off and in the mission.

A) On the ground in the lab.

B) On the pad and, at arrows, during ignition of the 1st stage and lift-off: some additional noise and irregularity appears, probably an artifact at the receiving station.

C) Coasting

D) In orbit at  $T + 12$  hrs. Note inversion of the records: the upper record is now frog B. In D a relevant noise starts on the EKG record of frog A, becoming more evident with time, till at  $T + 48$  hrs the EKG of frog A nearly disappears. The EKG of frog B remains normal till  $T + 144$  hrs when, although regular in shape and frequency, it becomes much smaller.

Time and amplitude in the figure.

Fig. 23. Samples of B4, B3 and A2 spikes. As shown, they are definitely different in shape and duration.

Gain and time in the figure.

Fig. 24. Unit B3 recorded from the station of Johannesburg shows a superimposed artifact (a sine frequency) that increases the basic noise.

Fig. 25. Otolith Unit B4: A) on ground; B) during 1st stage burning; C) during 2nd stage burning; D) coasting just before the 4th stage ignition. A marked recruiting effect follows the ignition of the 1st stage in a lesser degree of the 2nd, so that the original spike is covered by the firing of many units stimulated by the 10 g thrust, vibration and possibly noise: after the burn off, during coasting, the original spike becomes evident again.

The base line does not show any mechanical artifact even during the high impact of ignition. The sine waves artifact is due to the faulty recording during the tracking of the rocket from the ground: it appears in all records with the same characteristics (see for example the EKG in fig. 22).

Fig. 26. Recording from channel B 3. Beside unit B 3 (arrowed A) two more units appear in the record, namely B and C. The three units are sufficiently different in amplitude to make it possible to reduce them separately by a proper computer programming. Lower tracing = output of the centrifuge accelerometer. Time and gains in the figure.

Fig. 27. Computer identification of the action potentials of the same unit within a noise of the same or even higher amplitude (see text).

As shown the biological spike, completely covered by the noise (A-B) becomes completely free from it (C). The vertical lines are an artifact of the xy plotter and should be disregarded.

As a comparison in D the B4 unit is shown with a good signal to noise ratio, identified with the same method: spikes of different parameters may therefore be analysed separately. Gain and time in the figure.

Fig. 28. Identification of the spike data during the flight in a number of superimposed tracing (upper record) and as a computerized average of 60 spikes (lower record). For details and discussion see text.

Fig. 29. Identification of a minimum interval during continuously running data in order to make sure that the action potentials are recorded from one nerve fibre only. As the interspike intervals only are significant for this text, each spike triggers a 0,5 msec square wave. The first one starts the time base of a memoscope. If the activity of one unit only is recorded, a significant gap will follow the triggering spike, in this case of approx. 6 msec. If more than one unit is present, no such gap will appear as the intervening signal will fill up entirely the time after the first triggering spike. This method allows continuous identification of any number of biological pulses belonging to a single unit. The amplitude of the square pulse can be adjusted to a proper level for recording. Note the brightness modulation of the top of each pulse. Time (in the figure) 2 msec/div.

Fig. 30. A typical biphasic spike (Unit B4). It must be emphasized however that such a shape is mostly due to the metal microelectrodes - nerve fibre coupling and is not the true wave form. The biphasic spike allows the double clipping described in fig. 31.

Fig. 31. Double clipper diagram (for description in detail see text).

Fig. 32. Determination of the statistically significant sample by means of the sequential mean of the interspike intervals. This is done by measuring the first interval then adding the second and determining the mean then the third to the two and again determining the mean and so on. At the arrows the curve becomes flat and parallel to the abscissa corresponding to 750 intervals approximately. This is taken as a significant sample. The bottom record is equivalent to the upper one but the sampling started 30 sec later.

Fig. 33. Using a dimension of the sample as determined with the method shown in the previous figure the interspike intervals distribution is studied with interspike intervals histograms of three different samples. They appear very much the same. This proves that the sampling technique is correct.

Fig. 34. Interspike interval histogram in a unit which during this period responded to the water pump vibrations. The peaks shown in the figure correspond exactly to the 1870 turn per minute of the pump.

Fig. 35. Response to vibration of otolith unit B 3.

A Brightness modulation by the spikes: each spike appears as a white dot.

B Computer average of the several output runs of centrifuge accelerometer.

C Raw output of same accelerometer.

The time bases are triggered simultaneously by the first spike and a number of runs are superimposed: thus the amplitude of the sine wave acceleration does not correspond to its true value, but is only shown to indicate the time parameters and shape of the vibration. The synchronism between the spikes and the sine wave acceleration is shown by the appearance of the sine wave itself (see reprint D). In the ground data and at T + 119 hrs, although the vibration is still there (see Fig. 43 ), the sine wave does not appear anymore, as it is not synchronous with the nerve spike.

Fig. 36. Otolith Unit B3 and B4 (upper record) : changes in the rate of firing during erection of the rocket. Note that at the end of the erection the frequency although different that in the horizontal position goes back to a much lower value that during the angular movement of the rocket from horizontal to vertical. This is due

mostly to the vibration effect.

Otolith Unit B 4 and B 3 are shown before lift-off as compared with coasting after the burning off of the 3rd stage engine and before ignition of the 4th stage. Unit B allowed the recording of the sharp increase of firing rate during the ignition of the 1st stage (lift off at arrow), for few seconds before recruiting becomes such as to hide the original spike (Fig. 25 )

Fig. 37. Unit B4. Changes in the vestibular unit activity during the mission with no centrifuge cycle. The main rate of firing is shown, both on the ground and during 144 hours of orbital flight. As this unit never showed any response to the water pump induced vibration, its activity can truly be considered at rest. A significant decrease in the rate of firing is observed in the first 24 hours, with a sudden increase at the end of this period, followed by another period of low rate, up to the 70th hours. This follows closely the behaviour of unit A2 (fig. 45 ). A high frequency resting discharge builds up progressively from the 70th to the 92th hours followed by a low point from the 92 to the 120th hours and then by normalization. In this part Unit B4 shows the same trend as B3 (fig. 42 ).

Fig. 38. Otolith Unit B 4: burst of high frequency firing during the very low activity observed during the first 70 hours in the mission. The burst starts at a very high frequency (above 100/sec) and slows down at the end.

Fig. 39. Further analysis of the bursts shown in fig. 38. Simultaneous recording from the EKG leads (lower record) provides an indication of movement through the recording of muscular activity (EMG). In B the time scale is expanded to 50 msec/div to show that the beginning of the discharge seems to precede the movements: however a more precise experimental procedure is necessary to fully clarify this point. In A and B the R wave of the EKG is arrowed (first arrow in A, second in B). In B the assumed start of the EMG discharge corresponds to the 1st arrow.

In C the superimposed traces of one full burst shows that the action potentials are of nearly identical shape, belonging therefore to the same unit: this is confirmed also by the minimum interval technique. (fig 29 ).

Fig. 40. Variation coefficient as a function of the mean of the interspike intervals.

The curve can be divided in two parts. The first, representing the means of the intervals showing a duration of up to 150 msec, is very much deviated from the expected exponential. The second part, up to the maximum intervals corresponding to a low rate of firing, fits better the exponential. This is not unexpected as it has already been known that there is a difference between short intervals and long intervals.

Fig. 41. Same as in <sup>fig. 37</sup> but considering the mean frequency at rest on the ground = 1 and the other data as corresponding multiples (on the ordinate). Lowest values down to 1/12 and peak values up to 16 times the mean frequency on the ground are observed.

Fig. 42. Unit B3: A) changes in the vestibular activity during the mission with no centrifuge cycles. The mean rate of firing is shown both on the ground and during 144 hours of orbital flight. However, between 9 and 112 hours the unit was stimulated by the 2-3 millig.s due to pump vibration (see fig. <sup>34</sup> ). Therefore the activity was truly at rest between the 109 and 144 hours only: the pump vibration however maintained the same characteristics of intensity frequency etc. both on the ground and during the flight (fig. 43). Therefore the changes shown during the mission correspond to a constant input, that becomes above threshold for a certain period of time: note the increased response to vibration at the approx. 30th and 72th hours, and the low values (below the one on the ground) during the 82-92 hours period. Note also the return to normal values after the 119th hour. B) Same data reduction as in fig. 41. The described changes appear to be even more evident with this kind of data presentation.

Fig. 43. Vibration induced on the centrifuge casing as recorded by the centrifuge accelerometer: the values at the frog head was attenuated by at least a factor of 10, being therefore in the order of less than 1-2 milligs. As shown the basic intensity of the vibrating acceleration does not change



during the mission and is mostly covered by the amplifier noise (see fig. 35 for computer identification of such curve): note especially the vibration at T + 70 (the unit responded then maximally to it) and at T + 119 (the unit did not respond anymore to the vibration).

Fig. 44. Three-dimensional figures indicating the interspike interval distribution through histograms starting with data on the ground and throughout 124 hours of flight. The histograms were made with smaller classes on the left and larger ones on the right to indicate the response to vibration, on left, (peak in the histograms corresponds to the burst of spikes following the higher vibration amplitude) and the average distribution, on right. It is immediately evident that the alteration in the basic activity of this unit (No. 3) starts at +9 hours in the mission and ends around 110 hours. From 112 to 124 hours the histograms are similar to the ones obtained on the ground.

Fig. 45. Interspike interval histograms of otolith unit A2. The distribution and statistical analysis of the activity at rest shows that, although the overall rate of firing is decreased, the parameters studied have the same trend as the ones on the ground for the first 40 hours.

Fig. 46. Interspike interval histograms of otolith unit B3, and statistics.

The response to vibration and the higher rate of firing is clearly illustrated by the histograms. Note that the distribution at T + 119 hrs closely resembles the one observed on the ground before the flight.

C-4

Fig. 47. Interspike interval histograms and statistics of otolith unit B4.

The higher rate of firing at T + from 72 to 82 hrs is clearly shown by the histograms. At T + 142 hrs the general pattern of the distribution and the statistics closely resemble the one on the ground.

Fig. 48. Otolith unit A2.

Analysis of the activity at rest and during the second half of the centrifuge cycle at steady speed. The mean frequency of approx. 200 spikes at rest and 25 spikes during stimulation correspond to each round and square dot respectively.

The analysis is limited to the first 40 hrs in the mission as frog A, after this time did not show a readable EKG and its health conditions could not be fully assessed. This unit did not respond to the water pump induced vibration and is truly at rest between the centrifuge cycles. A remarkable decrease of frequency during the flight (as in otolith unit B4, fig. 41) is observed. The response to the centrifuge stimulation is also lowered.

Fig. 49. Unit B3. Same data analysis as in fig. 48 : the square dots correspond to the mean frequency of the response to the centrifuge cycle at constant speed and during the last 4 sec when adaptation was nearly 0 (the 2000 impulses are valid only for the round dot). Although an increase in the frequency response to the centrifuge cycle is observed during the flight, when the starting activity shows a very high rate of firing the differential

response becomes minimal or non existent. When the unit becomes phasic (between the arrows in the figure ) the response might paradoxically show a lower rate of firing than the basic activity (for further discussion of this point see text). This is observed also for unit B4 (fig. 50). After the 112th hour in the mission the response to the centrifuge also becomes normal. The period during which the unit responds to vibration ends at the thick arrow.

Fig. 50. Unit B4. Same data analysis as for unit B3. The same observations apply, except for the fact that no response to water pump vibration is observed here; however during the peak frequency of the activity at rest and during the change to phasic of the unit response to the centrifuge (between arrows) the same ineffectiveness and paradoxal response is observed as in unit B3. Normalization is observed also in this unit in the response to centrifuge stimulation after 130 hrs.

Fig. 51. A). Otolith unit B3. Changes in the response to the steady speed cycle of the centrifuge (second half) considering the value on the ground = 1. The flight data are indicated as multiples of this value (on the ordinate). The response tends to increase during the first 75 hrs in the mission. The phasic response period apparently decreases the firing rate but this depends only on the lack of the sustained discharge typical of a tonic response. At the end of the phasic response period the

firing rate goes back to the average value as during the first 75 hrs. Normalization of response appears after 112 hrs. The period during which the unit responds to vibration is also indicated. For the differential response in respect to intercycle activity see Table 3 . B) Otolith unit B4. Same analysis as for otolith unit B3. The decrease of response shown here parallels the simultaneous decrease of the activity at rest. See also Table 3.

Fig. 52. Time history of otolith unit B3 (made with the same technique as otolith unit A2 on the ground) up to 119 hrs in the mission.

The dynamic phase of the response is particularly evident on the ground (1). Note also the vestibular response to a movement (arrowed in the figure) after the centrifuge cycle. The dynamic phase of the response tends to decrease during the first 16 hrs in the mission (2 and 3) while the tonic one increases, reaching its maximum at T + 39 hrs. From T + 82 hrs on the response starts becoming phasic and this disappears at T + 107 hrs. From T + 112 hrs on the response is stabilized in a nearly normal fashion although the phasic part remains reduced (see text).

Lower record: centrifuge acceleration profile 0-0.6 g

Fig. 53. Time history of otolith unit B4 on the ground and during 129 hrs in the mission. On the ground the phasic response is particularly evident in this unit. Note here too the response to a movement (arrowed in 1) to be expected as this unit belongs to the same frog as B3. Two main facts are observed: first, the phasic response is reduced in weightlessness, secondly, starting

much earlier than in B3 a phasic response only appears at T + 39 hrs up to T + 105 hrs. During this period a positive response to the negative transient when the centrifuge slows down is also evident. Normalization, except for the phasic response, is attained at T + 129 hrs.

Lower record: centrifuge acceleration profile 0-0.6 g

Fig. 54. Control exp.No.2 on HPO (see fig<sup>55</sup>) Interspike histograms and statistics performed before and immediately after pressurization. In the latter case the response of the unit to vibration is clearly shown by the regular multipeak histogram.

Fig. 55. The experimental set-up for the control experiments, in this case the hyperpressure experiment.<sup>(HPO)</sup> The FOEP containing the instrumented frog (on one side only: on the opposite end-cap the 3 extrasensitive water-proof accelerometers are fixed in the same position as the frog labyrinth) connected with the suitcase with all the controls is secured to the specially built support (see text) and it is connected with the O<sub>2</sub> bottle for increasing pressure. An air conditioner is used to assure constant temperature. The equipment is located in an isolated room to avoid noise and other disturbances.

- A) Note the wiring going through the floor to the next room.
- B) where the data acquisition system is located: from right to left 1) a 7 channel 1/2 inch tape recorder, 2) various equipment for pulse editing and shaping, 3) a C.A.T. average

transient computer, a 565 Oscilloscope with a recording camera and 4) a 14 channel Ampex tape recorder and time coder for raw and edited data are led in a 1800 IBM computer for reduction and analysis. The following data are recorded from the FOEP: 1 or 2 vestibular signals, raw, edited and shaped to fit the computer, the EKG, water temperature and pressure, the acceleration as measured by the accelerometers on the centrifuge, XYZ accelerations measured by the accelerometers inside the centrifuge in the 2nd end-cap and time down to milliseconds.

Fig. 56. Control experiment No. 2 on the effect of 11 psi HPO. Spike data before (A-B) and after CD/HPO: no changes observed.

Fig. 57. Control experiment No. 1: a number of histograms is shown with the relative digital values. The time of the experiment is indicated in the figure on the right and all the statistics in the bottom of the figure. The histograms are presented before, during and after pressurization for a few hours. The distribution of the interspike intervals appear to remain similar during high pressurization and at normal one atmosphere pressure although a high  $PO_2$  was present (approximately 1300 mm of mercury in the environmental water). As a conclusion it can be said that no significant effect is produced on the otolith discharge by the increased oxygen pressure as it appeared during the orbital flight.

Fig. 58. Profile of the water pump induced vibrations during the control experiment described in fig. 54. After a quick pressurization to +11 psi with oxygen (see also fig. 59) a significant transitory increase in the intensity of vibration is observed.

Time and calibration in the figure. XYZ accelerometer measurements in the 3 directions of space  
286-289 = days in the year.

Fig. 59. A) Same experiment as in fig. 58. Response of the vestibular unit to vibration at its peak intensity. The time base is triggered by the vestibular spike: it responds in phase with the vibration as the vibratory curve is shown on the y accelerometer. In A) few, in B) 100 runs superimposed; C) Otolith unit E4. Synchronization of the spikes with the vibration induced by the rocket erection. In D) recruiting is observed.

Fig. 60. HPO control experiment No 3. The increase of pressure to 11 psi  $O_2$  was performed slowly as it happened in the flight. No change is apparent in the vestibular activity even after more than 24 hrs exposure.

Fig. 61. A) Control experiment No. 2 of the effect of pressurization with  $O_2$  up to 11 psi to determine the effect of HPO on the vestibular unit firing rate.

A quick pressurization introduces a sudden change in the firing rate to more than 5 times the original value; the apparent increase appears however to be the response to an increase in the vibrations induced by the water pump (see fig.58-59 )

Except for that there is no change in the general activity of the unit, which even after 2 1/2 days shows the same general characteristics as during normal activity.

B) Effect of rapid pressurization on the frog's EKG frequency. No significant change is observed.



TABLE 3

Frequency at rest and during the centrifuge cycle (second half at steady speed). Differential value between activity at rest (R) and during the second half of the centrifuge cycle at steady speed (C) are reported in absolute value and in percentage of the activity at rest (Column 1 to 4). Column 5: position in the mission. Column 6: character of the response: phasic response equal to change from tonic to phasic during the mission. Vibration: response to vibration.

TABLE 4

Experiment No. 1 controlling the effect of HPO on the firing rate of one vestibular unit.

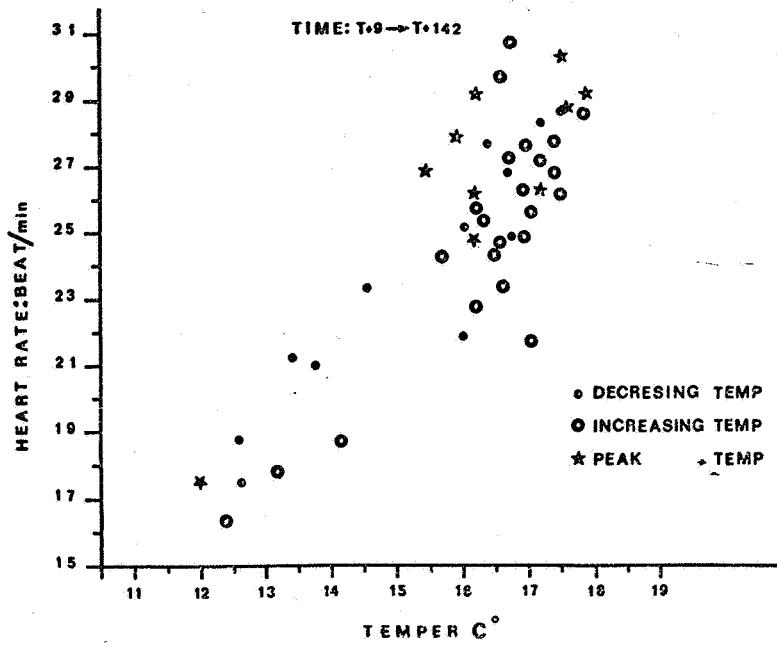

Fig. 21

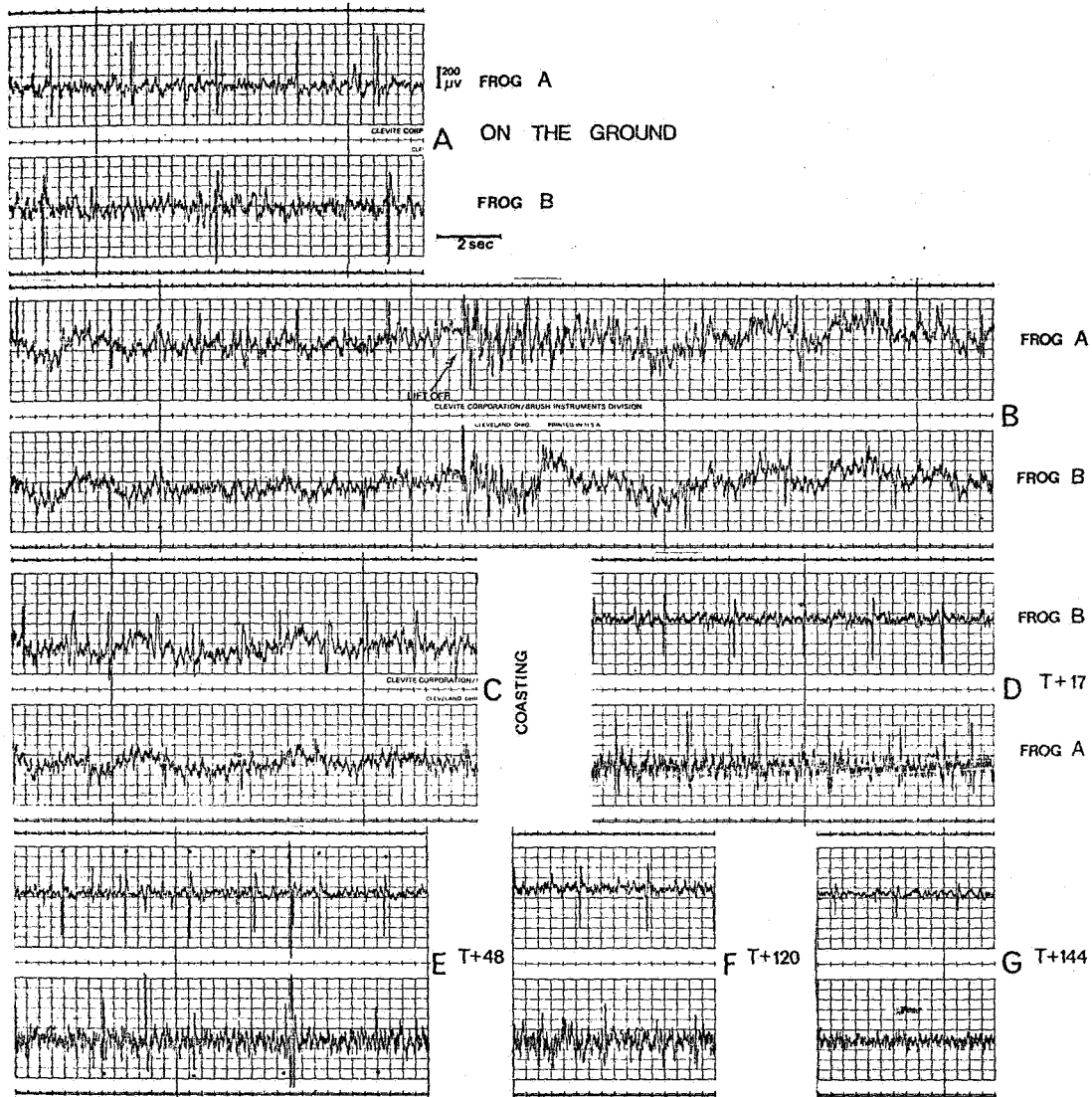
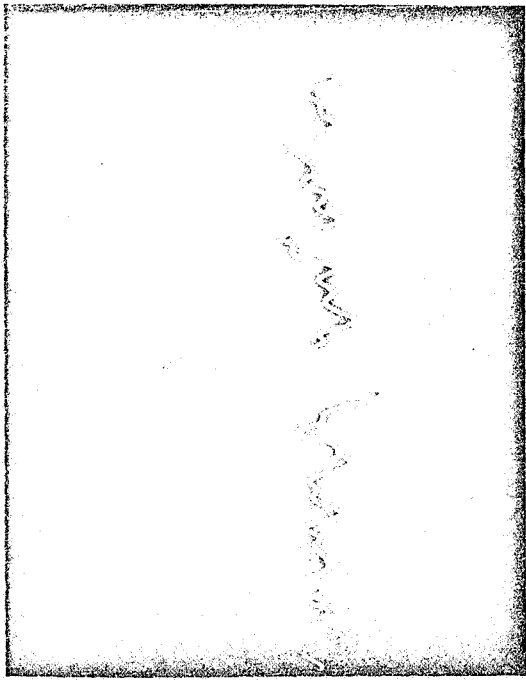
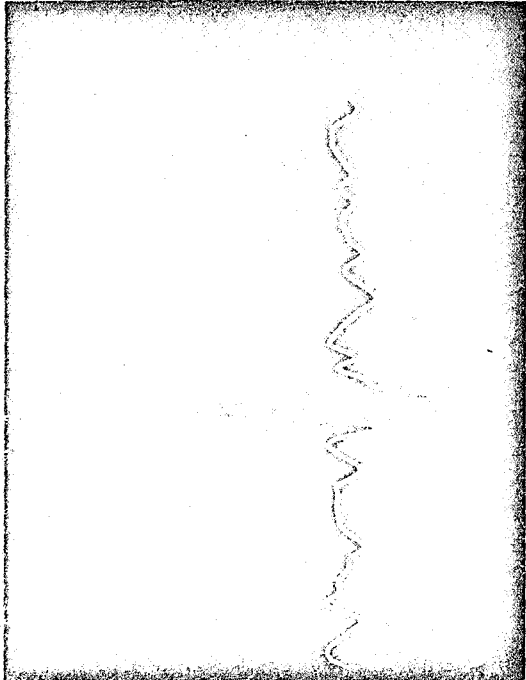

Fig. 22

A



B



300  
μV

C

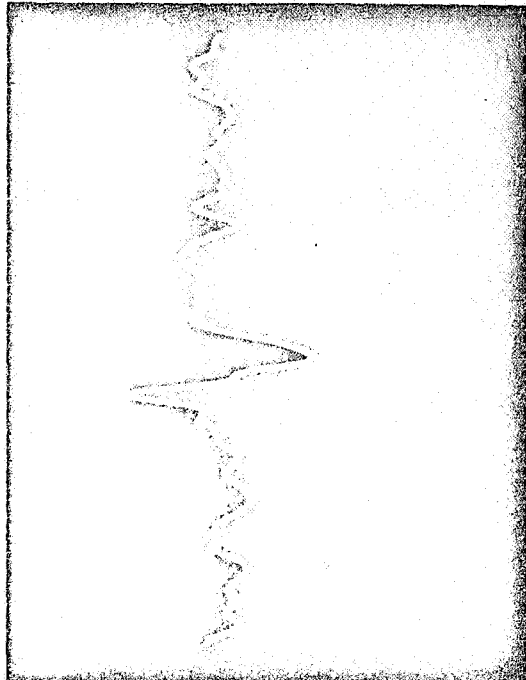

— 1msec

Fig. 23

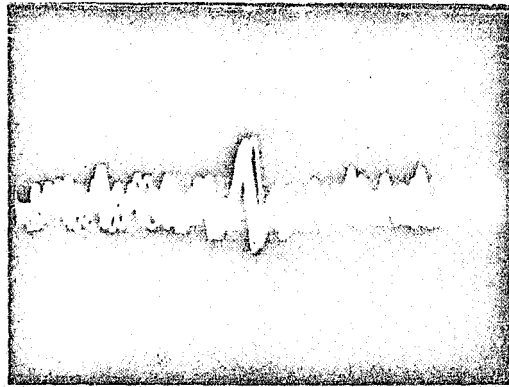
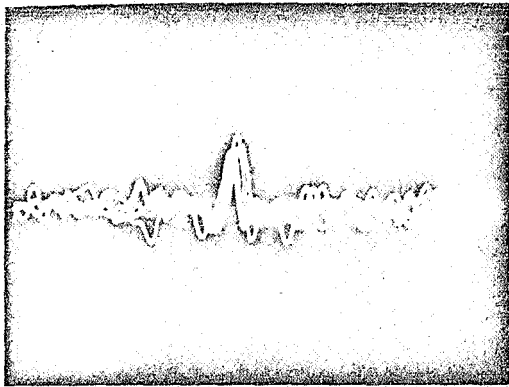

300  $\mu$ V

1msec

A

B

Fig. 24

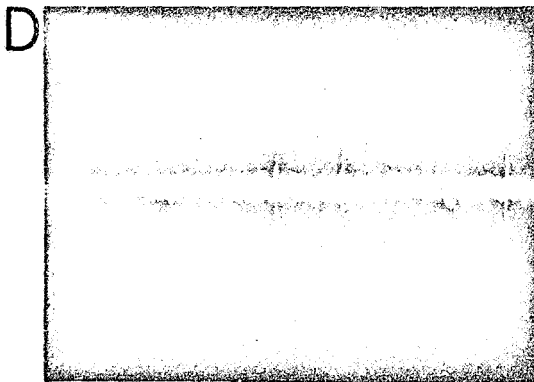
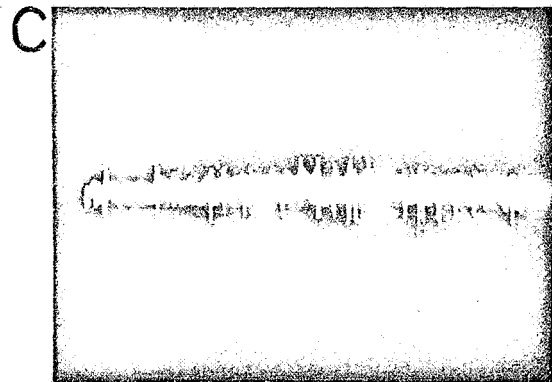
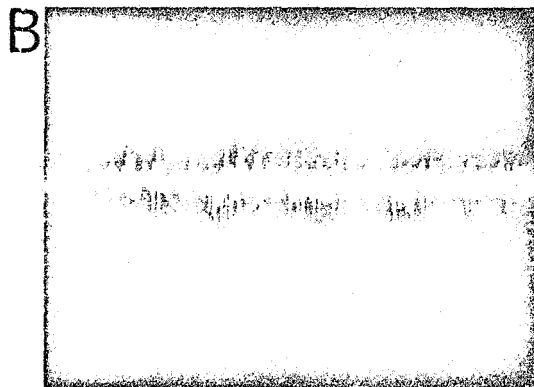
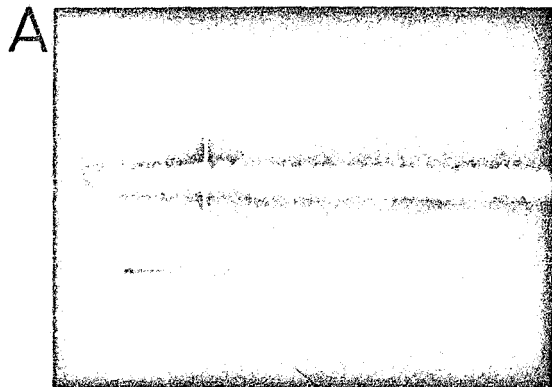

300 mV

— 20 msec

Fig. 25

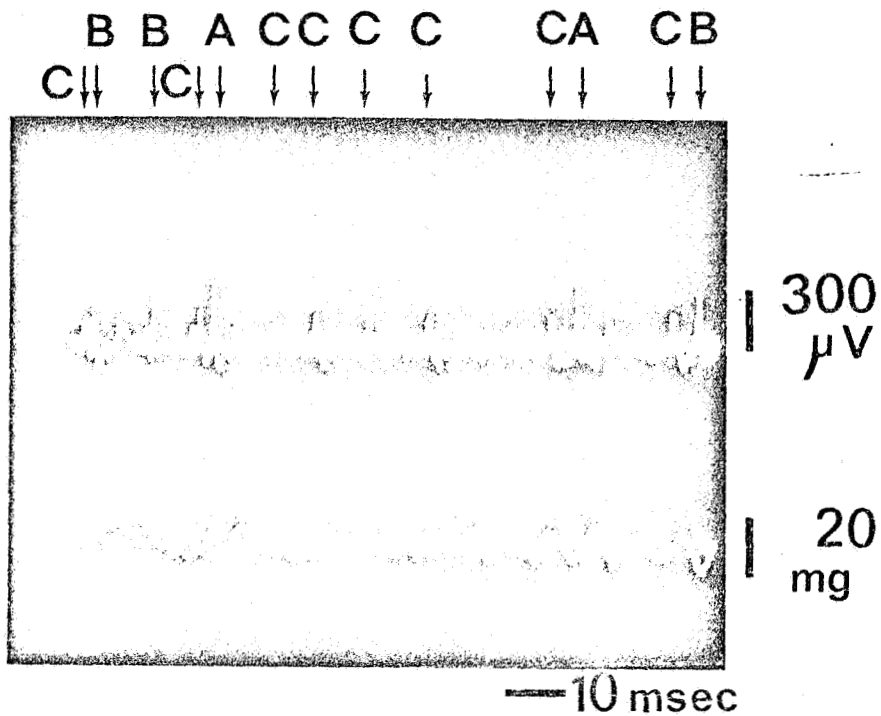

- UNITS
- A The main one
  - B Second unit
  - C Almost regular firing rate
- T+70

Fig. 26

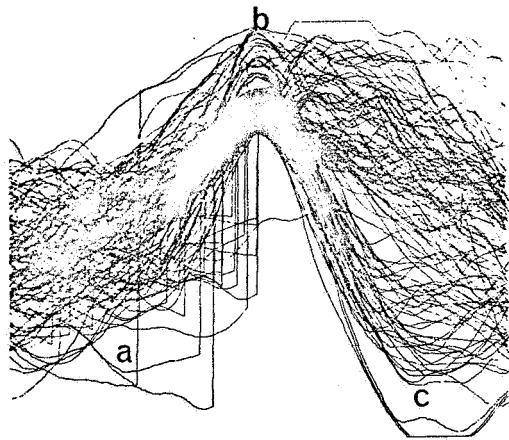

A

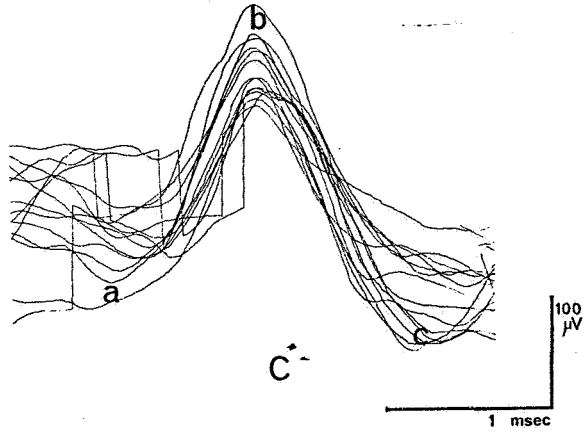

C

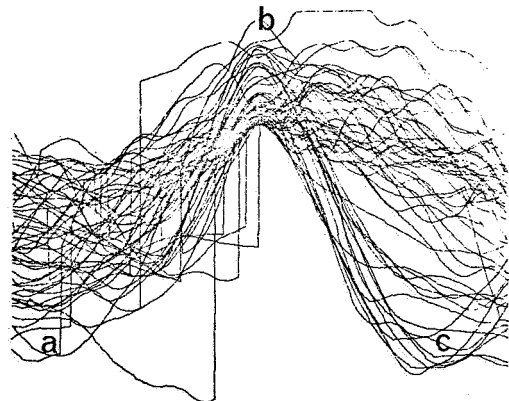

B

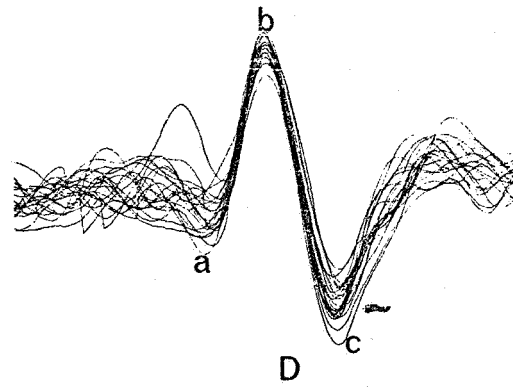

D

Fig. 27

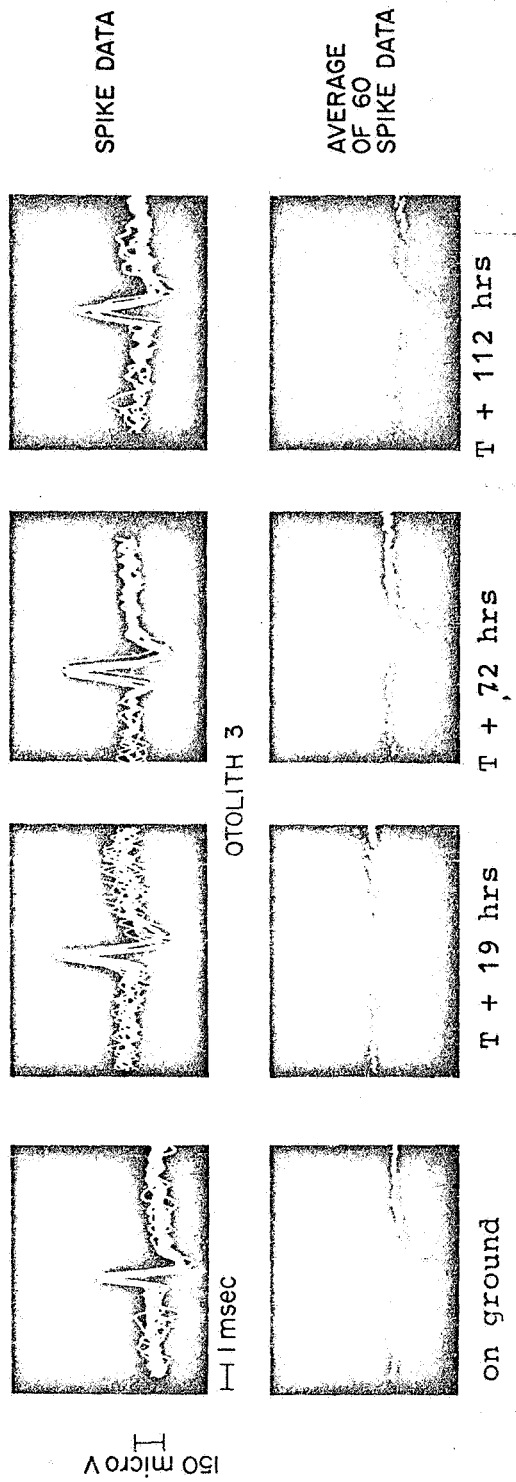
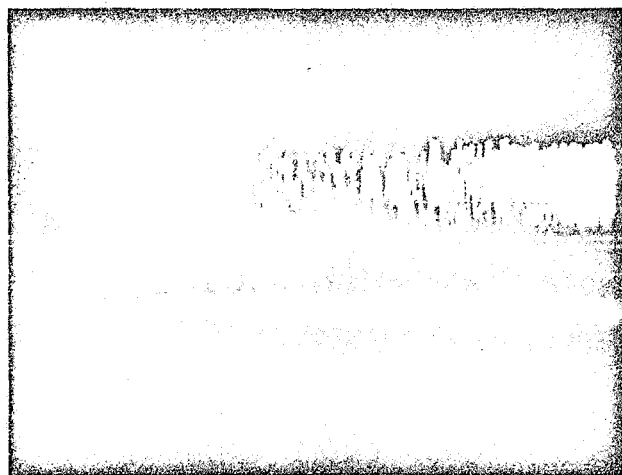
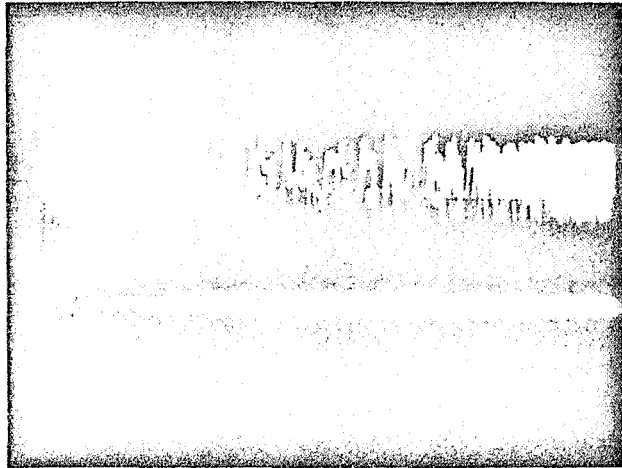

Fig. 28





—2msec

Fig. 29

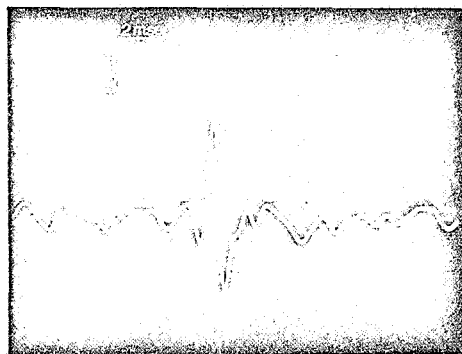

Fig. 30

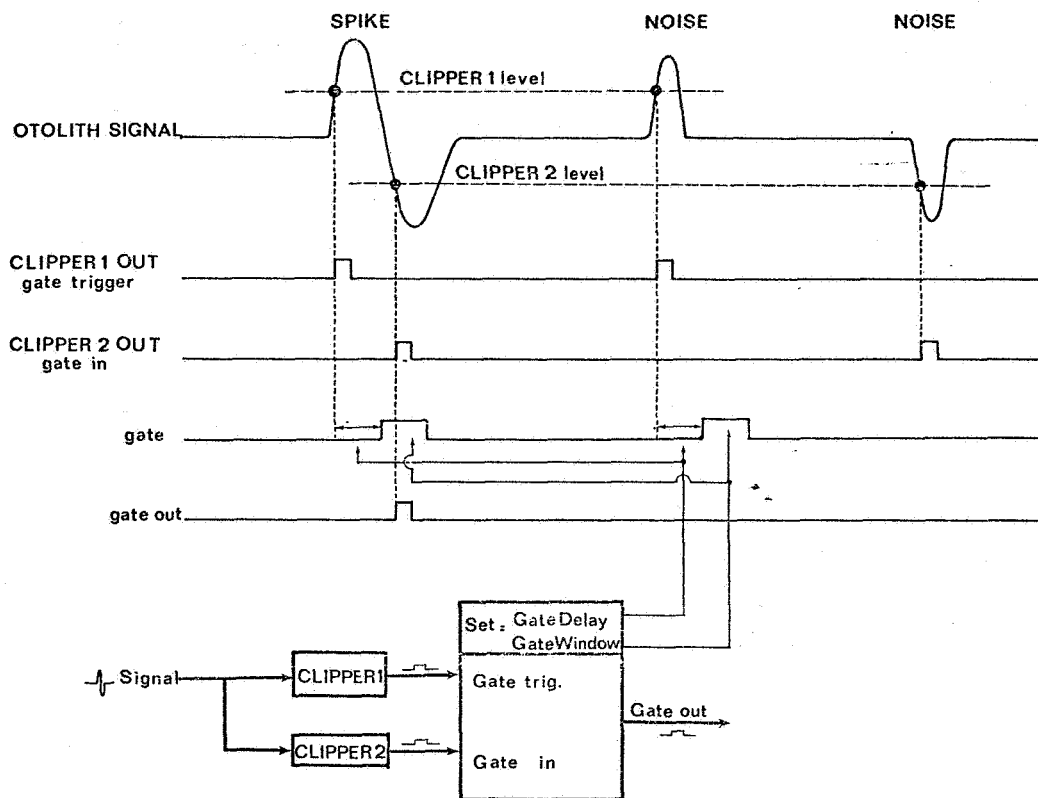
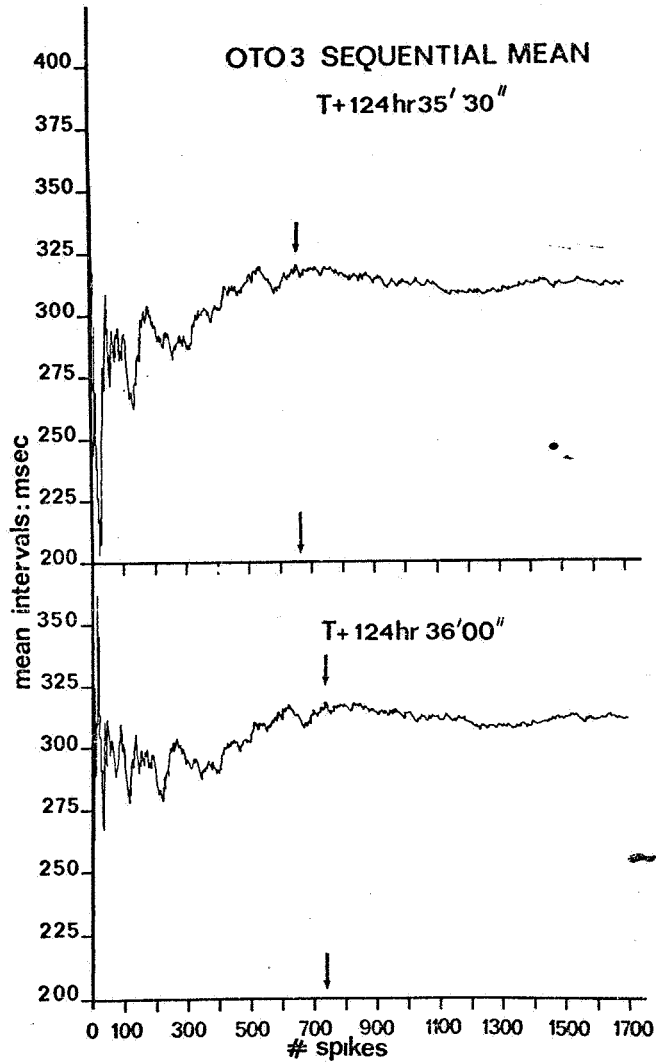

Fig. 31



**Fig. 32**

DURATION (SEC.) 1722.740 No. SPIKES 5373.  
 FREQUENCY (C/SEC.) 3.118 MEAN (MSEC.) 0.3206291E 03  
 STAND. DEV. (MSEC.) 0.4123906E 03 VARIAT. COEFF. 0.1286192E 01  
 MAXIMUM (MSEC.) 0.3915576E 04 MINIMUM (MSEC.) 0.8160001E 00  
 RANGE (MSEC.) 0.3914759E 04

Spikes	%	msec.	N.	
		0.00	0	
1203	223	50.00	1	XX+
728	135	100.00	2	XXXXXXXXXXXXXXXXXXXXXXXXXXXXXXXXXXXX+
524	97	150.00	3	XXXXXXXXXXXXXXXXXXXXXXXXXXXX+
434	80	200.00	4	XXXXXXXXXXXXXXXXXX+
355	66	250.00	5	XXXXXXXXXXXX+
291	54	300.00	6	XXXXXXXXX+
223	41	350.00	7	XXXXXXX+
211	39	400.00	8	XXXXXX+
174	32	450.00	9	XXXXX+
152	28	500.00	10	XXXX+
133	24	550.00	11	XXX+
102	18	600.00	12	XX+
92	17	650.00	13	XX+
69	12	700.00	14	X+
76	14	750.00	15	X+
57	10	800.00	16	X+
61	11	850.00	17	X+
54	10	900.00	18	X+
38	7	950.00	19	+
38	7	1000.00	20	+

DURATION (SEC.) 1635.790 No. SPIKES 5309.  
 FREQUENCY (C/SEC.) 3.245 MEAN (MSEC.) 0.3081166E 03  
 STAND. DEV. (MSEC.) 0.3723406E 03 VARIAT. COEFF. 0.1208441E 01  
 MAXIMUM (MSEC.) 0.4534920E 04 MINIMUM (MSEC.) 0.8160001E 00  
 RANGE (MSEC.) 0.4534104E 04

Spikes	%	msec	N.	
		0.00	0	
1078	203	50.00	1	XX+
701	132	100.00	2	XXXXXXXXXXXXXXXXXXXXXXXXXXXX+
543	102	150.00	3	XXXXXXXXXXXXXXXXXXXX+
434	81	200.00	4	XXXXXXXXXXXX+
381	71	250.00	5	XXXXXXXXX+
324	61	300.00	6	XXXXXXXX+
239	45	350.00	7	XXXXXXX+
253	47	400.00	8	XXXXXX+
194	36	450.00	9	XXXXX+
161	30	500.00	10	XXXX+
125	23	550.00	11	XXX+
116	21	600.00	12	XX+
84	15	650.00	13	XX+
76	14	700.00	14	X+
86	16	750.00	15	XX+
62	11	800.00	16	X+
55	10	850.00	17	X+
41	7	900.00	18	+
45	8	950.00	19	+
27	5	1000.00	20	+

DURATION (SEC.) 1763.989 No. SPIKES 5016.  
 FREQUENCY (C/SEC.) 2.843 MEAN (MSEC.) 0.3516726E 03  
 STAND. DEV. (MSEC.) 0.4738226E 03 VARIAT. COEFF. 0.1347340E 01  
 MAXIMUM (MSEC.) 0.4628353E 04 MINIMUM (MSEC.) 0.1224000E 01  
 RANGE (MSEC.) 0.4627127E 04

Spikes	%	msec	N.	
		0.00	0	
1039	207	50.00	1	XX+
656	130	100.00	2	XXXXXXXXXXXXXXXXXXXXXXXXXXXX+
496	98	150.00	3	XXXXXXXXXXXXXXXXXXXX+
389	77	200.00	4	XXXXXXXXXXXX+
316	62	250.00	5	XXXXXXXXX+
265	52	300.00	6	XXXXXXXX+
252	50	350.00	7	XXXXXXX+
193	38	400.00	8	XXXXXX+
170	33	450.00	9	XXXXX+
144	28	500.00	10	XXXX+
131	26	550.00	11	XXX+
103	20	600.00	12	XX+
86	17	650.00	13	XX+
68	13	700.00	14	X+
61	12	750.00	15	X+
67	13	800.00	16	X+
55	10	850.00	17	X+
52	10	900.00	18	X+
45	8	950.00	19	+
47	9	1000.00	20	+

Fig. 33

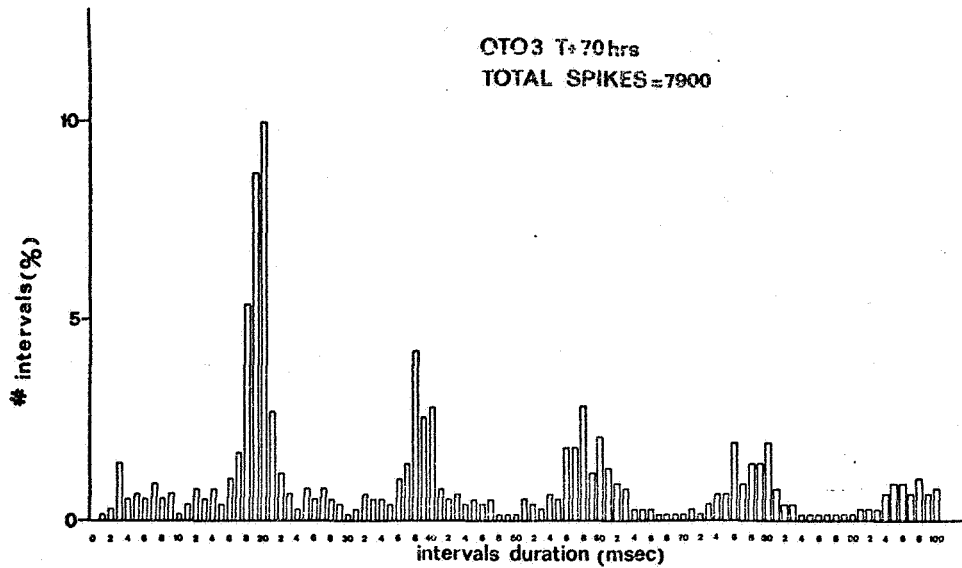

Fig. 34

### OFO-A FLIGHT-UNIT B-3 RESPONSE TO VIBRATIONS

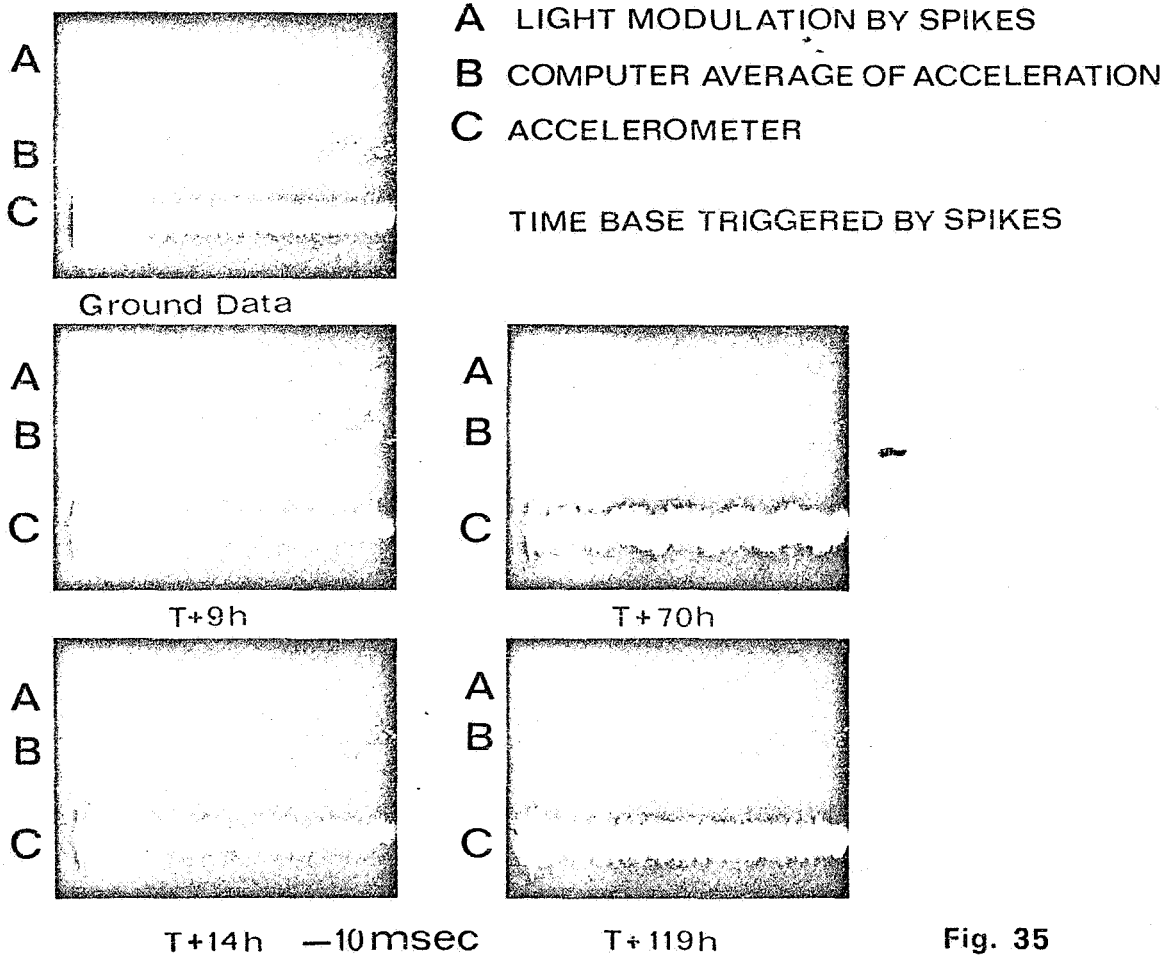

Fig. 35

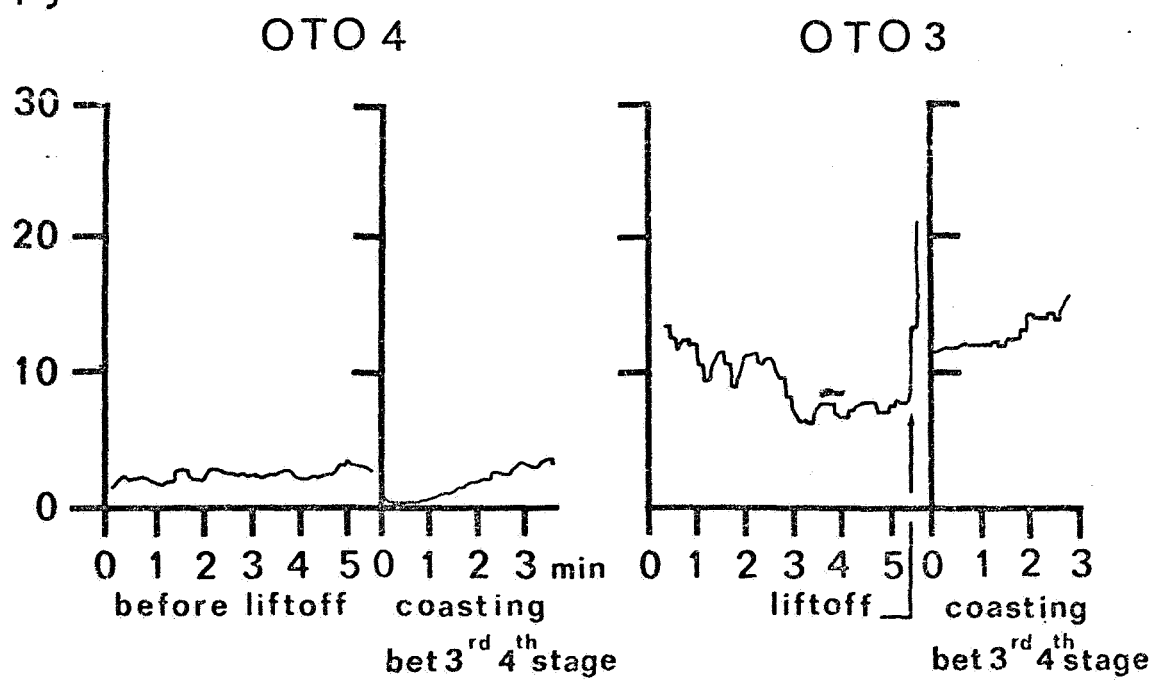
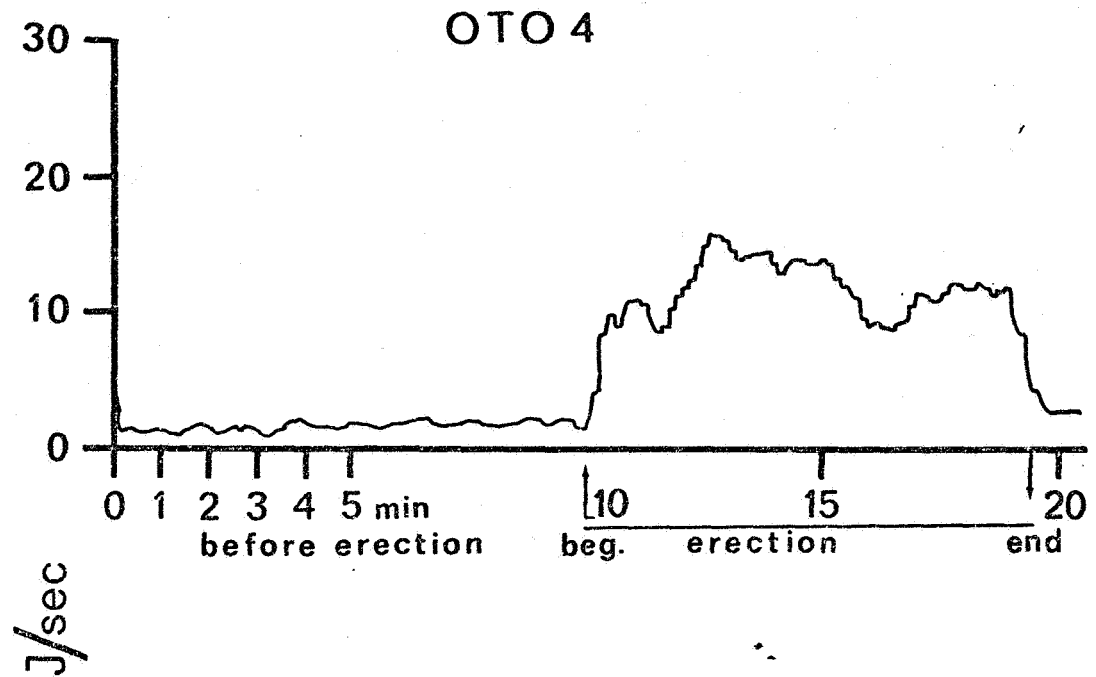

Fig. 36

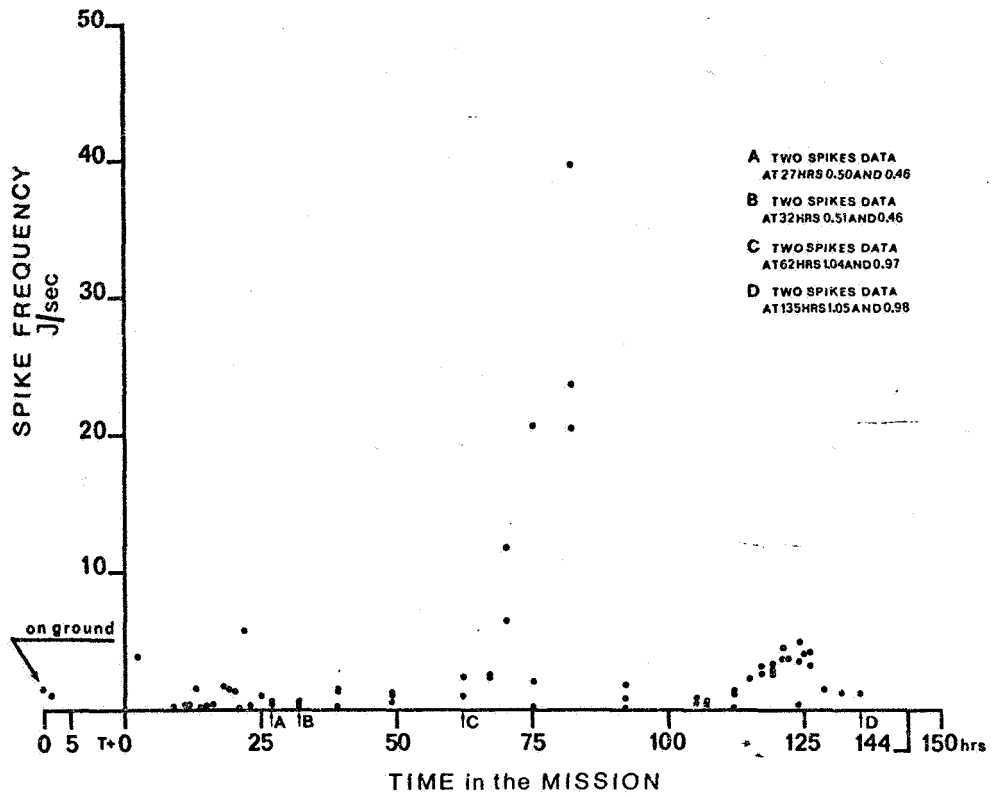

Fig. 37

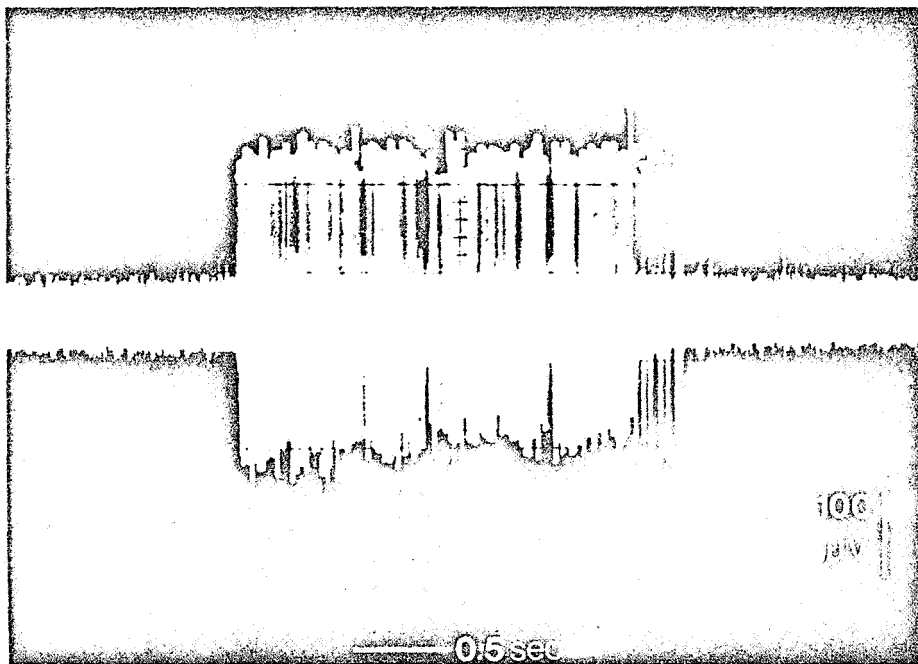

Fig. 38

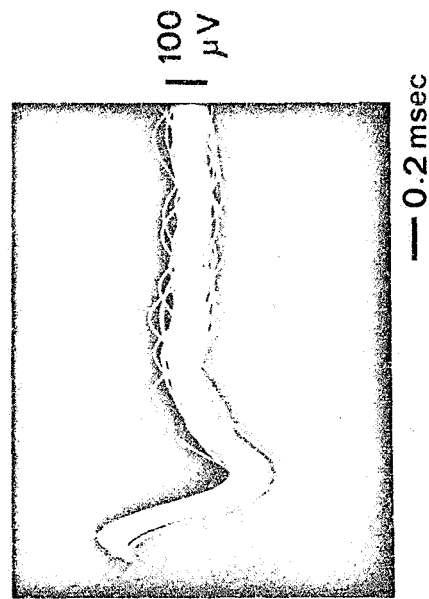
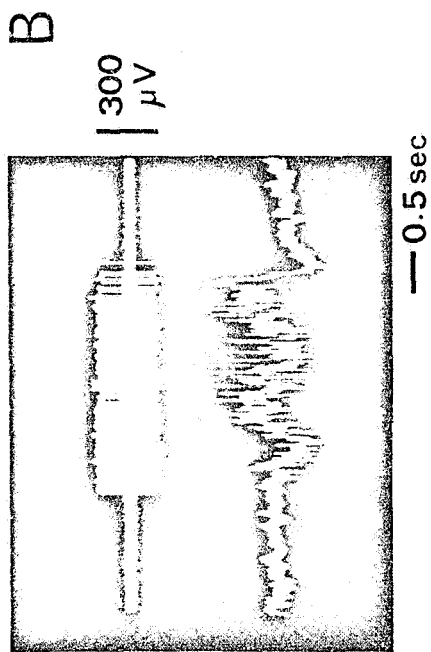
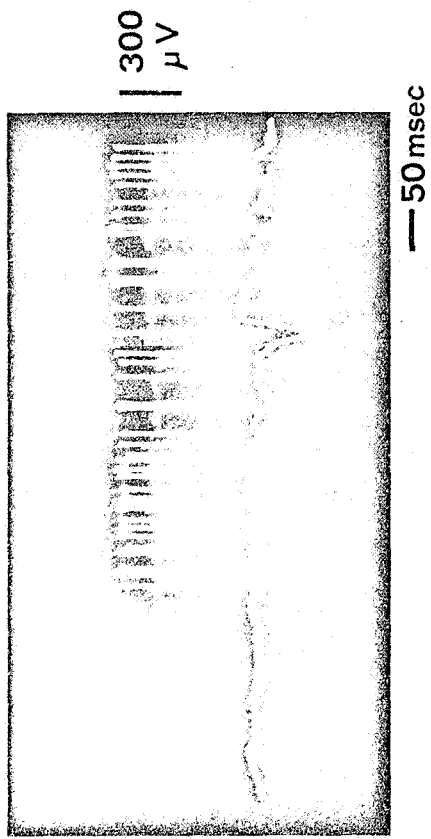

Fig. 39



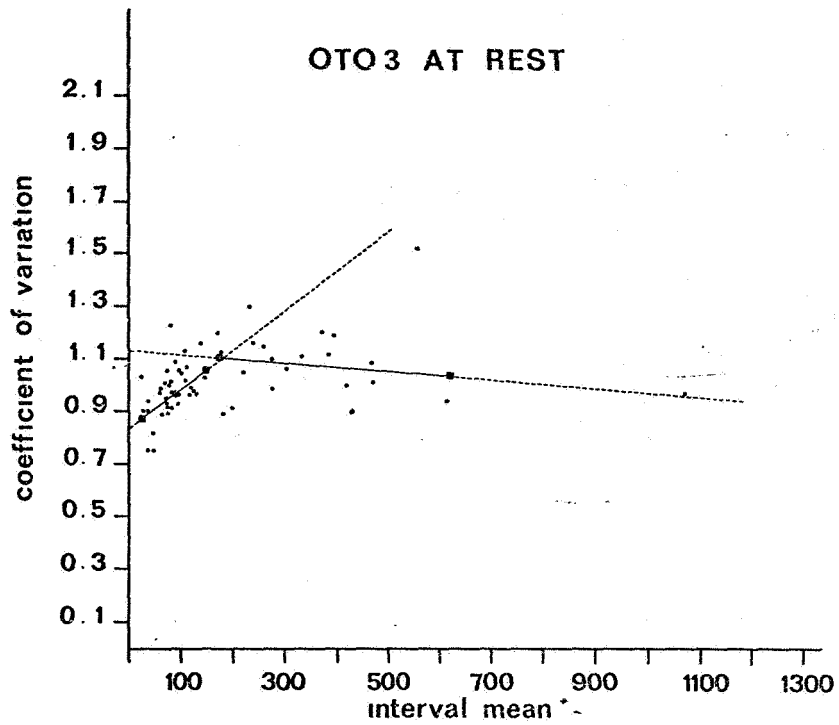

Fig. 40

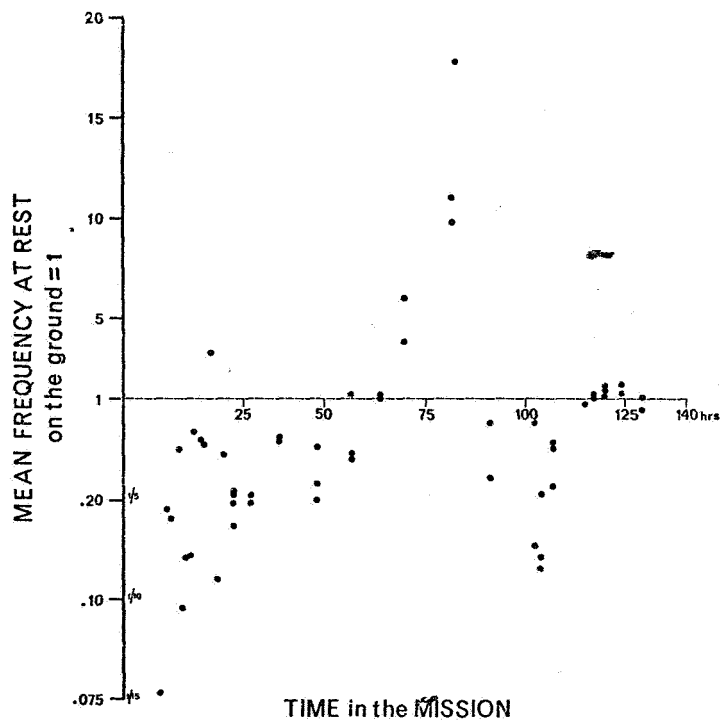

Fig. 41

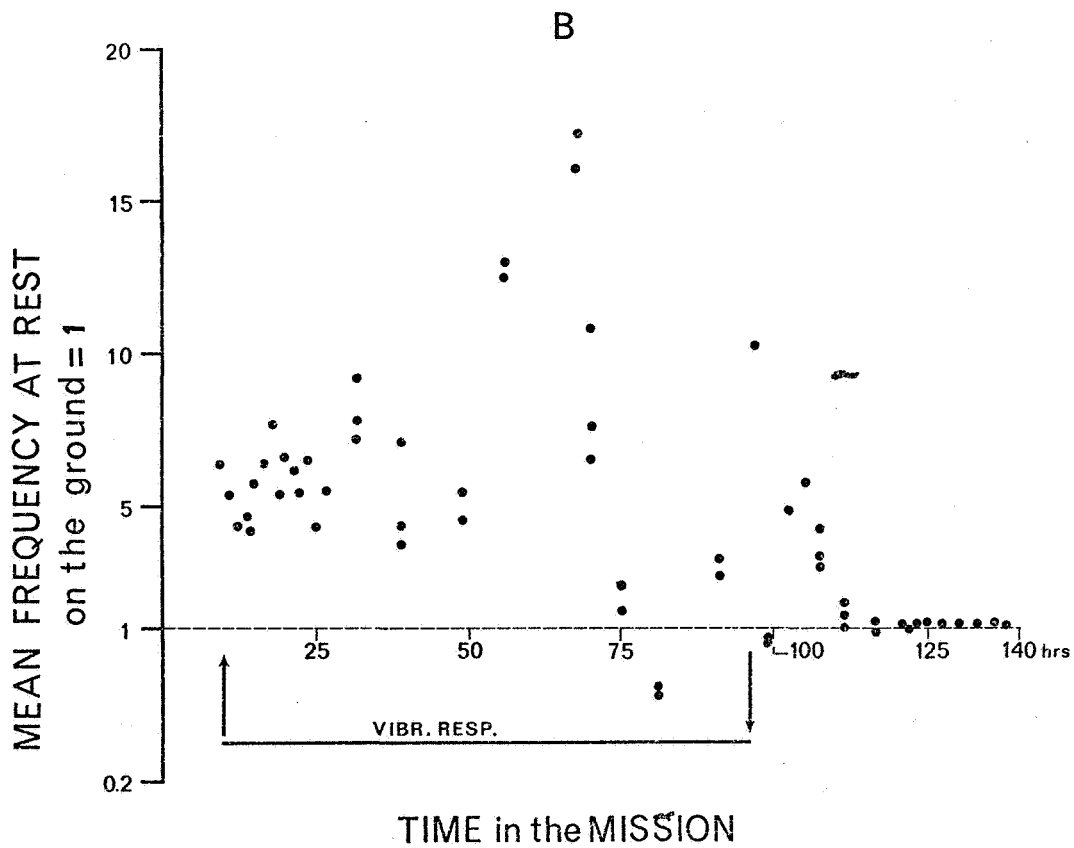
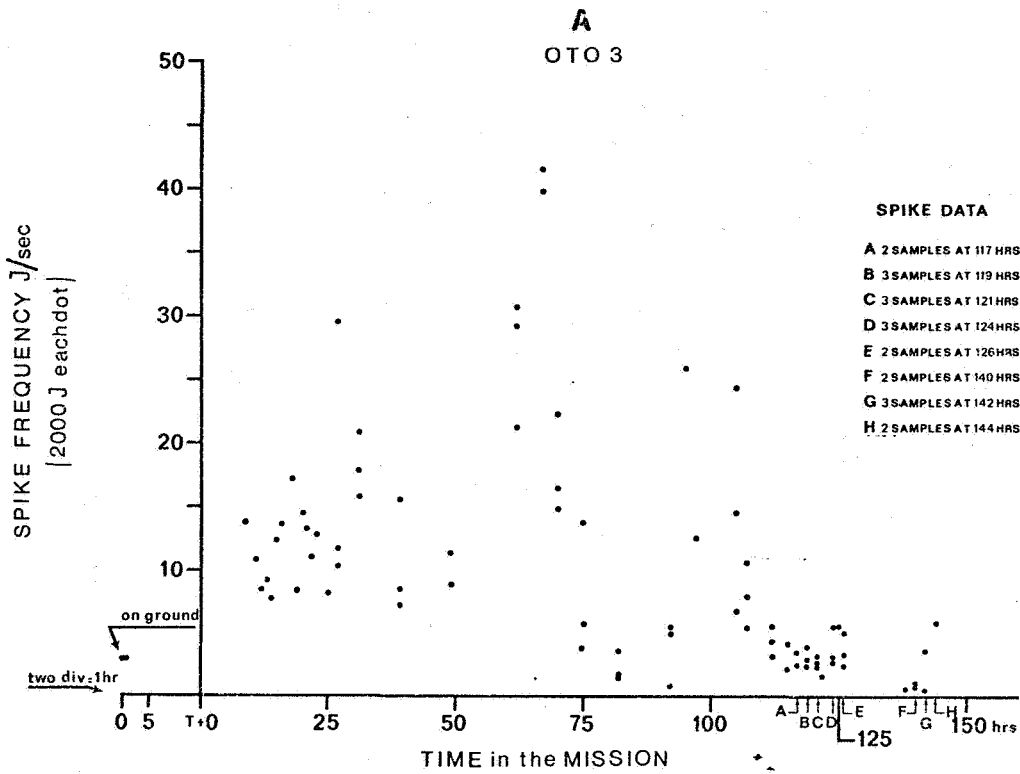
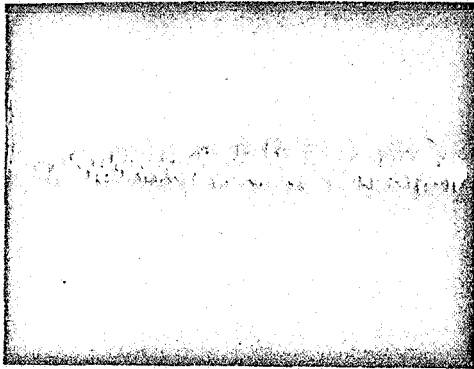
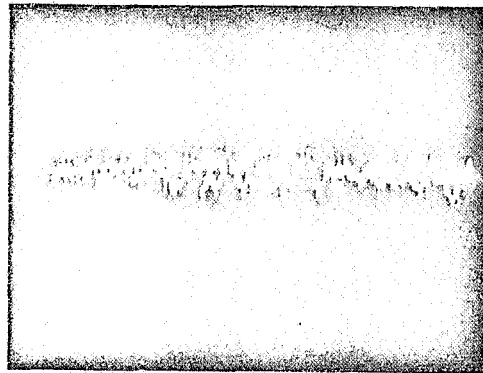

Fig. 42

T+9



T+14



T+70

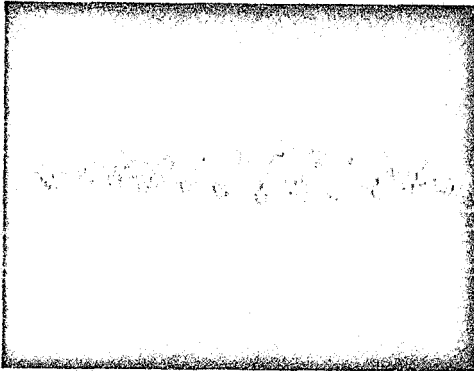

T+119

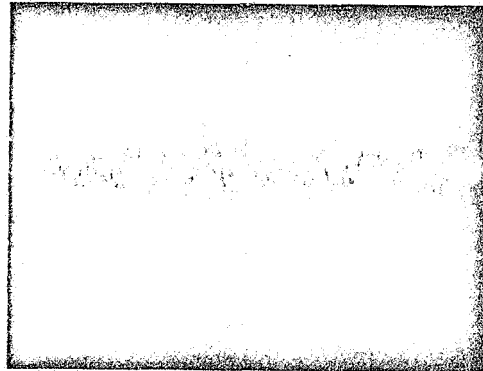
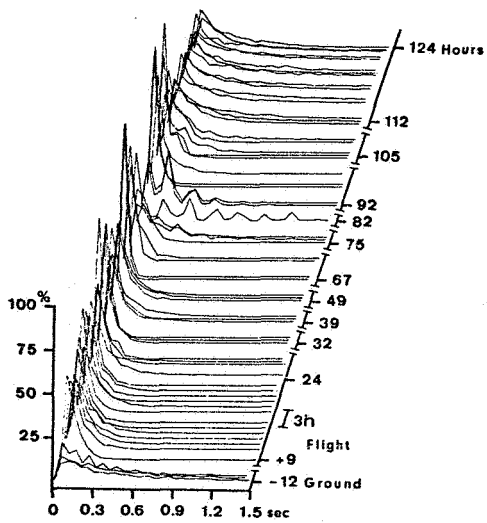
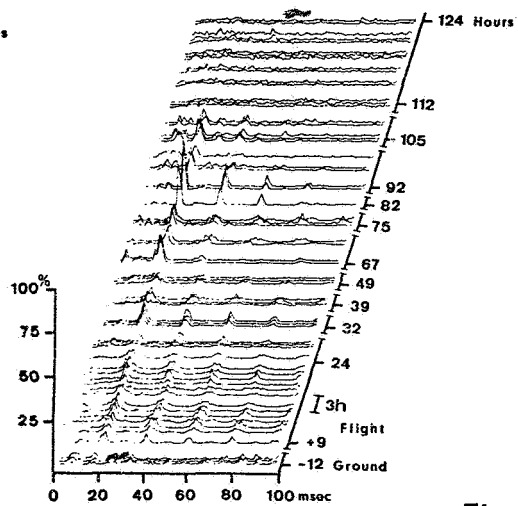

Fig. 43

40mg  
40msec



A



B

Fig. 44

DURATION(SEC.) 1392.852  
 FREQUENCY(C/SEC.) 5.384  
 STAND. DEV. (MSEC.) 0.1865598E 03  
 MAXIMUM(MSEC.) 0.2102016E 04  
 RANGE(MSEC.) 0.2100792E 04

N. SPIKES 7500 .  
 MEAN(MSEC.) 0.1857136E 03  
 VARIAT. COEFF. 0.1004556E 01  
 MINIMUM(MSEC.) 0.1224900E 01

N 1  
 OTO A2  
 ON THE GROUND

1610	214	214	50.00	1	1XXXXXXXXXXXXXXXXXXXXX+
1500	200	414	100.00	2	1XXXXXXXXXXXXXXXXXXXXX+
1071	142	557	150.00	3	1XXXXXXXXXXXXXXXXXXXXX+
808	107	665	200.00	4	1XXXXXXXXXXXX+
641	85	750	250.00	5	1XXXXXXXXXXXX+
420	56	806	300.00	6	1XXXXX+
360	48	854	350.00	7	1XXXXX+
266	35	890	400.00	8	1XXX+
197	26	916	450.00	9	1X+
148	19	936	500.00	10	1+
104	13	950	550.00	11	1+
90	12	962	600.00	12	1+
70	9	971	650.00	13	1+
48	6	977	700.00	14	1+
36	4	982	750.00	15	1+
26	3	986	800.00	16	1+
20	2	988	850.00	17	1+
18	2	991	900.00	18	1+
14	1	992	950.00	19	1+
9	1	994	1000.00	20	1+
10	1	995	1050.00	21	1+
10	1	996	1100.00	22	1+
3	0	997	1150.00	23	1+
5	0	997	1200.00	24	1+
3	0	998	1250.00	25	1+
			1300.00	26	1
1	0	998	1350.00	27	1+
			1400.00	28	1+
4	0	998	1450.00	29	1+
			1500.00	30	1
2	0	999	1550.00	31	1+
2	0	999	1600.00	32	1+
1	0	999	1650.00	33	1+
			1700.00	34	1
			1750.00	35	1
			1800.00	36	1
			1850.00	37	1
1	0	999	1900.00	38	1+
			1950.00	39	1
1	0	999	2000.00	40	1+
			2050.00	41	1
			2100.00	42	1
1	01000		2150.00	43	1+
			2200.00	44	1
			2250.00	45	1
			2300.00	46	1
			2350.00	47	1
			2400.00	48	1
			2450.00	49	1
			2500.00	50	1
			2550.00	51	1

DURATION (SEC.) 341.590  
 FREQUENCY(C/SEC.) 0.664  
 STAND. DEV. (MSEC.) 0.2103135E 04  
 MAXIMUM (MSEC.) 0.1251621E 05  
 RANGE(MSEC.) 0.1251417E 05

N. SPIKES 227.  
 MEAN(MSEC.) 0.1504802E 04  
 VARIAT. COEFF. 0.1397616E 01  
 MINIMUM (MSEC.) 0.2040000E 01

N2  
 OTO A2  
 T+9

36	158	158	200.00	1	1XXXXXXXXXXXXXXXXXXXXX+
37	162	321	400.00	2	1XXXXXXXXXXXXXXXXXXXXX+
23	101	422	600.00	3	1XXXXXXXXXXXX+
16	70	493	800.00	4	1XXXXXXXXX+
15	66	559	1000.00	5	1XXXXX+
16	70	629	1200.00	6	1XXXXXX+
13	57	687	1400.00	7	1XXXXX+
12	52	740	1600.00	8	1XXXXX+
9	39	779	1800.00	9	1XXX+
7	30	810	2000.00	10	1XXX+
4	17	828	2200.00	11	1+
5	22	850	2400.00	12	1X+
3	13	863	2600.00	13	1+
			2800.00	14	1
1	4	867	3000.00	15	1+
2	8	876	3200.00	16	1+
			3400.00	17	1
1	4	881	3600.00	18	1+
			3800.00	19	1+
			4000.00	20	1+
17	903				
961000			4200.00	21	1XXXXXXXXXXXX+

Fig. 45

DURATION(SEC.) 384.477  
 FREQUENCY(C/SEC.) 0.499  
 STAND. DEV. (MSEC.) 0.3564753E 04  
 MAXIMUM(MSEC.) / 0.3685423E 05  
 RANGE(MSEC.) 0.3671836E 05

N. SPIKES 192.  
 MEAN(MSEC.) 0.2002488E 04  
 VARIAT. COEFF. 0.1780161E 01  
 MINIMUM(MSEC.) 0.1358640E 03

N3  
 OTO A2  
 T+11

22	114	114	200.00	0 1
20	104	218	400.00	1 IXXXXXXXXXX+
15	78	296	600.00	2 IXXXXXXXXXX+
23	119	416	800.00	3 IXXXXXXXXXX+
16	83	500	1000.00	4 IXXXXXXXXXX+
8	41	541	1200.00	5 IXXXXX+
10	52	593	1400.00	6 IXXX+
9	46	640	1600.00	7 IXXX+
9	46	687	1800.00	8 IXXX+
14	72	760	2000.00	9 IXXXXX+
2	10	770	2200.00	10 IXXXXX+
7	36	807	2400.00	11 IXX+
2	10	817	2600.00	12 IXX+
4	20	838	2800.00	13 IXX+
2	10	848	3000.00	14 IXX+
2	10	859	3200.00	15 IXX+
2	10	869	3400.00	16 IXX+
1	5	875	3600.00	17 IXX+
2	10	885	3800.00	18 IXX+
3	15	901	4000.00	19 IXX+
19	981000	4200.00	21 IXXXXXXXXXX+	

DURATION(SEC.) 405.294  
 FREQUENCY(C/SEC.) 0.365  
 STAND. DEV. (MSEC.) 0.4381854E 04  
 MAXIMUM(MSEC.) 0.2745391E 05  
 RANGE(MSEC.) 0.2745187E 05

N. SPIKES 148.  
 MEAN(MSEC.) 0.2738476E 04  
 VARIAT. COEFF. 0.1600106E 01  
 MINIMUM(MSEC.) 0.2040000E 01

N4  
 OTO A2  
 T+15

21	141	141	200.00	0 1
17	114	256	400.00	1 IXXXXXXXXXXXXX+
17	114	371	600.00	2 IXXXXXXXXXXXXX+
13	87	459	800.00	3 IXXXXXXXXXXXXX+
6	40	500	1000.00	4 IXXXXXXXXXX+
7	47	547	1200.00	5 IXXXXX+
7	47	594	1400.00	6 IXXXXX+
4	27	621	1600.00	7 IXXXXX+
4	27	648	1800.00	8 IXX+
3	20	668	2000.00	9 IXX+
4	27	695	2200.00	10 IXX+
2	13	709	2400.00	11 IXX+
1	6	716	2600.00	12 IXX+
4	27	743	2800.00	13 IXX+
3	20	763	3000.00	14 IXX+
2	13	777	3200.00	15 IXX+
1	6	783	3400.00	16 IXX+
1	6	790	3600.00	17 IXX+
1	6	797	3800.00	18 IXX+
30	2021000	4200.00	21 IXXXXXXXXXXXXXXXXXXXXX+	

DURATION (SEC.) 402.135  
 FREQUENCY(C/SEC.) 0.559  
 STAND. DEV. (MSEC.) 0.3978597E 04  
 MAXIMUM(MSEC.) 0.2098956E 05  
 RANGE(MSEC.) 0.2098670E 05

N. SPIKES 225.  
 MEAN(MSEC.) 0.1787269E 04  
 VARIAT. COEFF. 0.1722514E 01  
 MINIMUM(MSEC.) 0.2856000E 01

N5  
 OTO A2  
 T+16

38	168	168	200.00	0 1
25	111	280	400.00	1 IXXXXXXXXXXXXX+
23	102	382	600.00	2 IXXXXXXXXXXXXX+
23	102	484	800.00	3 IXXXXXXXXXXXXX+
15	66	551	1000.00	4 IXXXXXXXXXX+
11	48	600	1200.00	5 IXXXXX+
9	40	640	1400.00	6 IXXXXX+
12	53	693	1600.00	7 IXXXXX+
12	53	746	1800.00	8 IXXXXX+
6	26	773	2000.00	9 IXXXXX+
8	35	808	2200.00	10 IXX+
4	17	826	2400.00	11 IXX+
6	26	853	2600.00	12 IXX+
4	17	871	2800.00	13 IXX+
2	8	880	3000.00	14 IXX+
2	8	888	3200.00	15 IXX+
2	8	897	3400.00	16 IXX+
1	4	902	3600.00	17 IXX+
2	8	911	3800.00	18 IXX+
1	4	915	4000.00	19 IXX+
19	841000	4200.00	21 IXXXXXXXXXX+	

Fig. 45

DURATION(SEC.) 438.412  
 FREQUENCY(C/SEC.) 0.380  
 STAND. DEV. (MSEC.) 0.4522994E 04  
 MAXIMUM(MSEC.) 0.2770564E 05  
 RANGE(MSEC.) 0.2770156E 05

N. SPIKES 167.  
 MEAN(MSEC.) 0.2625223E 01  
 VARIAT. COEFF. 0.1722898E 01  
 MINIMUM(MSEC.) 0.4980001E 01

N6  
 OTO A2  
 T+ 25

---

			0.00	0 1
17	101	101	200.00	1 IXXXXXXXXXX+
16	95	197	400.00	2 IXXXXXXXXXX+
13	77	275	600.00	3 IXXXXXXXXXX+
19	113	389	800.00	4 IXXXXXXXXXX+
8	47	437	1000.00	5 IXXX+
13	77	514	1200.00	6 IXXXXXX+
14	83	598	1400.00	7 IXXXXXXXXXX+
3	17	616	1600.00	8 I+
8	47	664	1800.00	9 IXXX+
1	5	670	2000.00	10 I+
8	47	718	2200.00	11 IXXX+
3	17	736	2400.00	12 I+
3	17	754	2600.00	13 I+
5	29	784	2800.00	14 IX+
5	29	814	3000.00	15 IX+
4	23	838	3200.00	16 IX+
			3400.00	17 I
			3600.00	18 I
1	5	844	3800.00	19 I+
1	5	850	4000.00	20 I+
25	1491000	4200.00	21 IXXXXXXXXXX+	

Fig. 45

DURATION (SEC.) 728.466  
 FREQUENCY(C/SEC.) 2.389  
 STAND. DEV. (MSEC.) 0.4189455E 03  
 MAXIMUM(MSEC.) 0.3056328E 04  
 RANGE(MSEC.) 0.3055104E 04

N.SPIKES 1741.  
 MEAN(MSEC) 0.4184181E 03  
 VARIAT. COEFF. 0.1001260E 01  
 MINIMUM(MSEC.) 0.1224000E 01

N.1  
 OTO B3  
 ON THE GROUND

		0.00	0 1
206	118	50.00	1 lXXXXXXXXXXXXXXXXXXXXX+
169	97	100.00	2 lXXXXXXXXXXXXXXXXXXXXX+
158	90	150.00	3 lXXXXXXXXXXXXXXXXXXXXX+
116	66	200.00	4 lXXXXXXXXXXXXXXXXXXXXX+
146	83	250.00	5 lXXXXXXXXXXXXXXXXXXXXX+
106	60	300.00	6 lXXXXXXXXXXXXX+
90	51	350.00	7 lXXXXXXXXXXXXX+
77	44	400.00	8 lXXXXXXXXX+
79	45	450.00	9 lXXXXXXXXX+
63	36	500.00	10 lXXXXXX+
54	31	550.00	11 lXXXXXX+
53	30	600.00	12 lXXXXXX+
60	34	650.00	13 lXXXXXX+
53	30	700.00	14 lXXXXXX+
29	16	750.00	15 lXX+
33	18	800.00	16 lXX+
21	12	850.00	17 lX+
25	14	900.00	18 lX+
18	10	950.00	19 lX+
26	14	1000.00	20 lX+
17	9	1050.00	21 l+
13	7	1100.00	22 l+
23	13	1150.00	23 lX+
15	8	1200.00	24 l+
6	3	1250.00	25 l+
5	2	1300.00	26 l+
7	4	1350.00	27 l+
9	5	1400.00	28 l+
7	4	1450.00	29 l+
7	4	1500.00	30 l+
6	3	1550.00	31 l+
6	3	1600.00	32 l+
5	2	1650.00	33 l+
6	3	1700.00	34 l+
		1750.00	35 l
2	1	1800.00	36 l+
3	1	1850.00	37 l+
1	0	1900.00	38 l+
2	1	1950.00	39 l+
1	0	2000.00	40 l+
3	1	2050.00	41 l+
4	2	2100.00	42 l+
1	0	2150.00	43 l+
		2200.00	44 l
		2250.00	45 l
		2300.00	46 l
2	1	2350.00	47 l+
2	1	2400.00	48 l+
		2450.00	49 l+
2	1	2500.00	50 l+
4	2	2550.00	51 l+

Fig. 46

DURATION(SEC.) 722.356  
 FREQUENCY(C/SEC.) 2.129  
 STAND.DEV.(MSEC.) 0.4785950E 03  
 MAXIMUM(MSEC.) 0.3578976E 04  
 RANGE(MSEC.) 0.3577343E 04

N.SPIKES 1538.  
 MEAN(MSEC.) 0.4696727E 03  
 VARIAT.COEFF. 0.1018997E 01  
 MINIMUM(MSEC.) 0.1632000E 01

N.2  
 OTOB3  
 ON THE GROUND

		0.00	0 1
142	92	50.00	1 LXXXXXXXXXXXXXXXXXX+
162	105	100.00	2 LXXXXXXXXXXXXXXXXXX+
157	102	150.00	3 LXXXXXXXXXXXXXXXXXX+
115	74	200.00	4 LXXXXXXXXXXXXXXXXXX+
113	73	250.00	5 LXXXXXXXXXXXXXXXXXX+
72	46	300.00	6 LXXXXXXXXXX+
74	48	350.00	7 LXXXXXXXXXX+
61	39	400.00	8 LXXXXXXXX+
69	44	450.00	9 LXXXXXXXXXX+
54	35	500.00	10 LXXXXXXXX+
53	34	550.00	11 LXXXXXXXX+
38	36	600.00	12 LXXX+
36	23	650.00	13 LXXX+
46	29	700.00	14 LXXXX+
23	14	750.00	15 LX+
27	17	800.00	16 LXX+
38	24	850.00	17 LXXX+
18	11	900.00	18 LX+
24	15	950.00	19 LXX+
16	10	1000.00	20 LX+
20	13	1050.00	21 LX+
19	12	1100.00	22 LX+
20	13	1150.00	23 LX+
10	6	1200.00	24 L+
9	5	1250.00	25 L+
7	4	1300.00	26 L+
17	11	1350.00	27 LX+
8	5	1400.00	28 L+
10	6	1450.00	29 L+
8	5	1500.00	30 L+
6	3	1550.00	31 L+
5	3	1600.00	32 L+
5	3	1650.00	33 L+
3	1	1700.00	34 L+
4	2	1750.00	35 L+
6	3	1800.00	36 L+
7	4	1850.00	37 L+
5	3	1900.00	38 L+
4	2	1950.00	39 L+
4	2	2000.00	40 L+
4	2	2050.00	41 L+
2	1	2100.00	42 L+
4	2	2150.00	43 L+
3	1	2200.00	44 L+
1	0	2250.00	45 L+
		2300.00	46 L
1	0	2350.00	47 L+
1	0	2400.00	48 L+
		2450.00	49 L
		2500.00	50 L
6	3	2550.00	51 L+

Fig. 46



DURATION(SEC.)	380.020	N. SPIKES	3990.	<b>N 3</b>
FREQUENCY(C/SEC.)	10.499	MEAN(MSEC.)	0.9524323E 02	<b>OTO B3</b>
STAND. DEV.(MSEC.)	0.9146847E 02	VARIAT. COEFF.	0.9603672E 00	<b>T+11</b>
MAXIMUM(MSEC.)	0.1077936E 04	MINIMUM(MSEC.)	0.1224000E 01	
RANGE(MSEC.)	0.1076712E 04			

---

	0,00	0	1	
1562	391	50,00	1	XXX +
1072	268	100,00	2	XXX+
529	132	150,00	3	XXX+
377	94	200,00	4	XXXXXXXXXXXXXXXXXXXXX+
196	49	250,00	5	XXXXXXXXX+
82	20	300,00	6	LXXX+
78	19	350,00	7	LXX+
45	11	400,00	8	LX+
22	5	450,00	9	1+
13	3	500,00	10	1+
3	0	550,00	11	1+
4	1	600,00	12	1+
2	0	650,00	13	1+
2	0	700,00	14	1
2	0	750,00	15	1+
2	0	800,00	16	1+
		850,00	17	1
		900,00	18	1
		950,00	19	1
		1000,00	20	1
		1050,00	21	1
1	0	1100,00	22	1+

DURATION(SEC.)	388.606	N. SPIKES	5291.	<b>N.4</b>
FREQUENCY(C/SEC.)	13.615	MEAN(MSEC.)	0.7344671E 02	<b>OTO B3</b>
STAND. DEV.(MSEC.)	0.6777742E 02	VARIAT. COEFF.	0.9228110E 00	<b>T+16</b>
MAXIMUM(MSEC.)	0.5936401E 03	MINIMUM(MSEC.)	0.2040000E 01	
RANGE(MSEC.)	0.5916000E 03			

---

	0,00	0	1	
2537	479	50,00	1	XXX +
1486	280	100,00	2	XXX+
634	119	150,00	3	XXX+
355	67	200,00	4	XXXXXXXXXXXXXXXXX+
108	20	250,00	5	LXXX+
97	18	300,00	6	LXX+
42	7	350,00	7	1+
13	2	400,00	8	1+
14	2	450,00	9	1+
3	0	500,00	10	1+
1	0	550,00	11	1+
1	0	600,00	12	1+

DURATION (SEC.)	583.731	N. SPIKES	17207.	<b>N.5</b>
FREQUENCY(C/SEC.)	29.477	MEAN(MSEC.)	0.3392405E 02	<b>OTO B3</b>
STAND. DEV.(MSEC.)	0.2574820E 02	VARIAT. COEFF.	0.7589954E 00	<b>T+27</b>
MAXIMUM(MSEC.)	0.2297040E 03	MINIMUM(MSEC.)	0.1632000E 01	
RANGE(MSEC.)	0.2280720E 03			

---

	0,00	0	1	
13706	796	50,00	1	XXX +
3070	178	100,00	2	XXXXXXXXXXXXXXXXXXXXX+
347	20	150,00	3	LX+
80	4	200,00	4	1+
4	0	250,00	5	1+

Fig. 46

DURATION (SEC.) 291.748  
 FREQUENCY (C/SEC.) 3.476  
 STAND. DEV. (MSEC.) 0.1342037E 03  
 MAXIMUM (MSEC.) 0.1293768E 04  
 RANGE(MSEC.) 0.1291319E 04

N. SPIKES 2473.  
 MEAN(MSEC.) 0.1179733E 03  
 VARIAT. COEFF. 0.1137577E 01  
 MINIMUM (MSEC.) 0.2448003E 01

N. 6  
 OTO B3  
 T+ 39

		0.00	0	1	
925	374	50.00	1	1	XX
590	238	100.00	2	1	XX
296	119	150.00	3	1	XX
218	88	200.00	4	1	XX
144	58	250.00	5	1	XXXXXXXXXXXX+
83	33	300.00	6	1	XXXXXX+
59	23	350.00	7	1	XXXX+
48	19	400.00	8	1	XX+
28	11	450.00	9	1	X+
27	10	500.00	10	1	X+
16	6	550.00	11	1	+
12	4	600.00	12	1	+
6	2	650.00	13	1	+
3	1	700.00	14	1	+
5	2	750.00	15	1	+
		800.00	16	1	
6	2	850.00	17	1	+
1	0	900.00	18	1	+
		950.00	19	1	+
1	0	1000.00	20	1	+
1	0	1050.00	21	1	+

DURATION (SEC.) 856.805  
 FREQUENCY (C/SEC.) 41.585  
 STAND. DEV. (MSEC.) 0.2208358E 02  
 MAXIMUM (MSEC.) 0.1823760E 03  
 RANGE(MSEC.) 0.1811520E 03

N. SPIKES 35631.  
 MEAN(MSEC.) 0.2404662E 02  
 VARIAT. COEFF. 0.9183655E 00  
 MINIMUM (MSEC.) 0.1224000E 01

N. 7  
 OTO B3  
 T+ 67

		0.00	0	1	
31294	878	878	50.00	1	XX
4006	112	990	100.00	2	XXXXXXXXXXXX+
310	8	999	150.00	3	+
21	01000	200.00	4	1	+

DURATION (SEC.) 134.207  
 FREQUENCY (C/SEC.) 3.867  
 STAND. DEV. (MSEC.) 0.2977135E 03  
 MAXIMUM (MSEC.) 0.2574888E 04  
 RANGE (MSEC.) 0.2573255E 04

N. SPIKES 519.  
 MEAN(MSEC.) 0.2585886E 03  
 VARIAT. COEFF. 0.1151302E 01  
 MINIMUM (MSEC.) 0.1632000E 01

N. 8  
 OTO B3  
 T+ 75

		0.00	0	1	
104	200	200	50.00	1	XX
90	173	373	100.00	2	XX
52	100	473	150.00	3	XXXXXXXXXXXXXXXXXXXXXXXXXXXX+
48	92	566	200.00	4	XXXXXXXXXXXXXXXXXXXXXXXXXXXX+
35	67	633	250.00	5	XXXXXXXXXXXXXXXXXXXX+
24	46	680	300.00	6	XXXXXXXXXX+
45	86	766	350.00	7	XXXXXXXXXXXXXXXXXXXX+
23	44	811	400.00	8	XXXXXXXXXX+
10	19	830	450.00	9	XXX+
12	23	853	500.00	10	XXXX+
17	32	996	550.00	11	XXXXX+
3	5	892	600.00	12	+
7	13	905	650.00	13	IX+
7	13	919	700.00	14	IX+
7	13	932	750.00	15	IX+
2	3	936	800.00	16	+
7	13	949	850.00	17	IX+
6	11	961	900.00	18	IX+
2	3	965	950.00	19	+
1	1	967	1000.00	20	+
3	5	973	1050.00	21	+
1	1	974	1100.00	22	+
2	3	978	1150.00	23	+
4	7	986	1200.00	24	+
1	1	988	1250.00	25	+
			1300.00	26	+
1	1	990	1350.00	27	+
			1400.00	28	+
1	1	992	1450.00	29	+
			1500.00	30	+
			1550.00	31	+
			1600.00	32	+
1	1	994	1650.00	33	+
			1700.00	34	+
			1750.00	35	+
1	1	996	1800.00	36	+
1	1	998	1850.00	37	+
			1900.00	38	+

Fig. 46

N. SPIKES 186.  
 MEAN (MSEC.) 0.1073620E 04  
 VARIAT. COEFF. 0.9779228E 00  
 MINIMUM (MSEC.) 0.8160001E 00

DURATION (SEC.) 199.693  
 FREQUENCY(C/SEC.) 0.931  
 STAND. DEV.(MSEC.) 0.1049917E 04  
 MAXIMUM (MSEC.) 0.393976E 04  
 RANGE(MSEC.) 0.3935159E 04

N. 9  
 OTO B3  
 T + 92

EXPANDET NO RESPONSE  
TO VIBR.

19	100	100	0	00	0	1	XXXXXXXXXXXXXXXXXXXXX+
14	73	173	100	00	2	XXXXXXXXXXXXXXXXXXXXX+	
14	73	247	150	00	3	XXXXXXXXXXXXXXXXXXXXX+	
4	21	268	200	00	4	IXXX+	
8	42	310	250	00	5	XXXXXXXXXX+	
4	21	331	300	00	6	IXXX+	
10	52	384	350	00	7	XXXXXXXXXXXXX+	
1	5	389	400	00	8	+	
3	15	405	450	00	9	IXX+	
2	10	415	500	00	10	IX+	
5	26	442	550	00	11	IXXX+	
3	15	457	600	00	12	IXX+	
2	10	468	650	00	13	IX+	
2	10	478	700	00	14	IX+	
4	21	500	750	00	15	IXXX+	
3	15	515	800	00	16	IXX+	
2	10	526	850	00	17	IX+	
2	10	536	900	00	18	1	
2	10	552	950	00	19	IX+	
3	15	552	1000	00	20	1	
6	31	584	1050	00	21	IXX+	
2	10	594	1100	00	22	IXXXXX+	
2	10	605	1150	00	23	IX+	
4	21	626	1200	00	24	IX+	
3	15	642	1250	00	25	IXXX+	
2	10	652	1300	00	26	IXX+	
1	5	657	1350	00	27	IX+	
4	21	678	1400	00	28	1	
3	15	694	1450	00	29	IXXX+	
1	5	700	1500	00	30	IXX+	
2	10	710	1550	00	31	+	
1	5	715	1600	00	32	1	
3	15	731	1650	00	33	IX+	
2	10	742	1700	00	34	1	
6	31	773	1750	00	35	IXX+	
1	5	778	1800	00	36	IX+	
1	5	784	1850	00	37	IXXXXX+	
1	5	794	1900	00	38	1	
2	10	800	1950	00	39	+	
1	5	805	2000	00	40	1	
3	15	821	2050	00	41	1	
4	21	842	2100	00	42	1	
2	10	852	2150	00	43	IX+	
1	5	857	2200	00	44	+	
3	15	867	2250	00	45	+	
4	21	882	2300	00	46	IXX+	
2	10	892	2350	00	47	IXXX+	
1	5	897	2400	00	48	IX+	
1	5	907	2450	00	49	1	
1	5	917	2500	00	50	+	
1	5	927	2550	00	51	1	

1	5	873	2750.00 55 1+
			2800.00 56 1
3	15	889	2850.00 57 1XX+
			2900.00 58 1
1	5	894	2950.00 59 1
1	5	900	3000.00 60 1+
2	10	910	3050.00 61 1X+
1	5	915	3100.00 62 1+
3	15	931	3150.00 63 1XX+
1	5	936	3200.00 64 1+
			3250.00 65 1
			3300.00 66 1
2	10	947	3350.00 67 1X+
1	5	952	3400.00 68 1+
2	10	953	3450.00 69 1X+
			3500.00 70 1
			3550.00 71 1
			3600.00 72 1
			3650.00 73 1
			3700.00 74 1
1	5	968	3750.00 75 1+
			3800.00 76 1
			3850.00 77 1
1	5	973	3900.00 78 1+
1	5	978	3950.00 79 1+
			4000.00 80 1
			4050.00 81 1
			4100.00 82 1
			4150.00 83 1
			4200.00 84 1
1	5	984	4250.00 85 1+
			4300.00 86 1
			4350.00 87 1
			4400.00 88 1
			4450.00 89 1
			4500.00 90 1
2	10	994	4550.00 91 1X+
			4600.00 92 1
			4650.00 93 1
1	5100		4700.00 94 1+
			4750.00 95 1
			4800.00 96 1
			4850.00 97 1
			4900.00 98 1
			4950.00 99 1
			5000.00 100 1
			5050.00 101 1

Fig. 46

DURATION (SEC.) 924.096  
 FREQUENCY (C/SEC.) 1.578  
 BAND DEV. (MSEC.) 0.5102149E 03  
 MAXIMUM (MSEC.) 0.1994712E 04  
 RANGE (MSEC.) 0.1990224E 04

N. SPIKES 1459.  
 MEAN (MSEC.) 0.6333769E 03  
 VARIAT. COEFF. 0.8055471E 00  
 MINIMUM (MSEC.) 0.4488001E 01

OCTOBER 4 N.1  
 ON GROUND

107	73	73	0.00	01
			50.00	1 IXXXXXX+
99	67	141	100.00	2 IXXXXXX+
87	59	200	150.00	3 IXXXX+
61	41	242	200.00	4 IXXX+
79	54	296	250.00	5 IXXXX+
77	52	349	300.00	6 IXXXX+
50	34	383	350.00	7 IXX+
47	32	416	400.00	8 IXX+
57	39	455	450.00	9 IXX+
55	37	492	500.00	10 IXX+
43	29	522	550.00	11 IX+
49	33	555	600.00	12 IXX+
47	32	588	650.00	13 IXX+
52	35	623	700.00	14 IXX+
35	23	647	750.00	15 IX+
35	23	671	800.00	16 IX+
40	27	699	850.00	17 IX+
24	16	715	900.00	18 I+
36	24	740	950.00	19 IX+
36	24	764	1000.00	20 IX+
31	21	786	1050.00	21 IX+
25	17	803	1100.00	22 I+
35	23	827	1150.00	23 IX+
24	16	843	1200.00	24 I+
24	16	860	1250.00	25 I+
13	8	869	1300.00	26 I+
18	12	881	1350.00	27 I+
19	13	894	1400.00	28 I+
17	11	906	1450.00	29 I+
15	10	916	1500.00	30 I+
18	12	928	1550.00	31 I+
13	8	937	1600.00	32 I+
14	9	947	1650.00	33 I+
11	7	954	1700.00	34 I+
13	8	963	1750.00	35 I+
11	7	971	1800.00	36 I+
14	9	980	1850.00	37 I+
10	6	987	1900.00	38 I+
13	8	996	1950.00	39 I+
5	31000		2000.00	40 I+

107	68	68	0.00	01
			50.00	1 IXXXXXX+
99	63	131	100.00	2 IXXXXXX+
87	55	186	150.00	3 IXXXX+
61	38	225	200.00	4 IXX+
79	50	275	250.00	5 IXXXX+
77	49	324	300.00	6 IXXXX+
50	31	356	350.00	7 IXX+
47	29	386	400.00	8 IX+
57	36	422	450.00	9 IXX+
55	35	457	500.00	10 IXX+
43	27	485	550.00	11 IX+
49	31	515	600.00	12 IXX+
47	29	546	650.00	13 IX+
52	33	579	700.00	14 IXX+
35	22	601	750.00	15 IX+
35	22	623	800.00	16 IX+
40	25	649	850.00	17 IX+
24	15	664	900.00	18 I+
36	22	687	950.00	19 IX+
36	22	710	1000.00	20 IX+
31	19	730	1050.00	21 I+
25	15	746	1100.00	22 I+
35	22	768	1150.00	23 IX+
24	15	783	1200.00	24 I+
24	15	798	1250.00	25 I+
13	8	807	1300.00	26 I+
18	11	818	1350.00	27 I+
19	12	830	1400.00	28 I+
17	10	841	1450.00	29 I+
15	9	851	1500.00	30 I+
18	11	862	1550.00	31 I+
13	8	870	1600.00	32 I+
14	8	879	1650.00	33 I+
11	7	886	1700.00	34 I+
13	8	894	1750.00	35 I+
11	7	901	1800.00	36 I+
14	8	910	1850.00	37 I+
10	6	917	1900.00	38 I+
13	8	925	1950.00	39 I+
5	3	928	2000.00	40 I+
4	2	931	2050.00	41 I+
9	5	936	2100.00	42 I+
7	4	941	2150.00	43 I+
9	5	947	2200.00	44 I+
4	2	949	2250.00	45 I+
4	2	952	2300.00	46 I+
5	3	955	2350.00	47 I+
6	3	959	2400.00	48 I+
3	1	961	2450.00	49 I+
3	1	963	2500.00	50 I+
58	361000		2550.00	51 IX+

Fig. 47

DURATION (SEC.) 100.339  
 FREQUENCY(C/SEC.) 1.734  
 STAND. DEV. (MSEC.) 0.2324166E 04  
 MAXIMUM(MSEC.) 0.1994794E 05  
 RANGE(MSEC.) 0.1994671E 05

N. SPIKES 174.  
 MEAN(MSEC.) 0.5766616E 03  
 VARIAT. COEFF. 0.4030382E 01  
 MINIMUM(MSEC.) 0.1224000E 01

N.2  
 OTO B4  
 T+ 18

			0.00	0	1
64	367	367	50.00	1	1XXXXXXXXXXXXXXXXXXXXXXXXXXXXXXXXXXXX+
31	178	545	100.00	2	1XXXXXXXXXXXXXXXXXXXX+
14	80	626	150.00	3	1XXXXXXXX+
7	40	666	200.00	4	1XXX+
7	40	706	250.00	5	1XXX+
9	51	758	300.00	6	1XXX+
4	22	781	350.00	7	1X+
6	34	816	400.00	8	1XX+
3	17	833	450.00	9	1+
2	11	844	500.00	10	1+
7	40	885	550.00	11	1XXX+
2	11	896	600.00	12	1+
3	17	913	650.00	13	1+
1	5	919	700.00	14	1+
			750.00	15	1
1	5	925	800.00	16	1+
			850.00	17	1
1	5	931	900.00	18	1+
			950.00	19	1
1	5	936	1000.00	20	1+
1	5	942	1050.00	21	1+
			1100.00	22	1
			1150.00	23	1
			1200.00	24	1
1	5	948	1250.00	25	1+
			1300.00	26	1
			1350.00	27	1
			1400.00	28	1
			1450.00	29	1
			1500.00	30	1
1	5	954	1550.00	31	1+
			1600.00	32	1
			1650.00	33	1
			1700.00	34	1
			1750.00	35	1
			1800.00	36	1
			1850.00	37	1
			1900.00	38	1
1	5	959	1950.00	39	1
			2000.00	40	1
			2050.00	41	1
			2100.00	42	1
			2150.00	43	1
			2200.00	44	1
			2250.00	45	1
			2300.00	46	1
			2350.00	47	1
			2400.00	48	1
			2450.00	49	1
			2500.00	50	1
7	401000		2550.00	51	1XXX+

Fig. 47

DURATION (SEC.) 479.643  
 FREQUENCY(C/SEC.) 0.402  
 STAND. DEV. (MSEC.) 0.3873102E 04  
 MAXIMUM(MSEC.) 0.1955544E 05  
 RANGE(MSEC.) 0.1955258E 05

N. SPIKES 193.  
 MEAN(MSEC.) 0.2485201E 04  
 VARIAT. COEFF. 0.1558466E 01  
 MINIMUM(MSEC.) 0.2856000E 01

N.3  
 OTO B4  
 T+27

			0.00	0	1
50	259	259	50.00	1	1XXXXXXXXXXXXXXXXXXXXXXXXXX+
28	145	404	100.00	2	1XXXXXXXXXXXXXXXXXX+
8	41	445	150.00	3	1XXX+
6	31	476	200.00	4	1XX+
4	20	497	250.00	5	1X+
2	10	507	300.00	6	1+
			350.00	7	1
			400.00	8	1
2	10	518	450.00	9	1+
			500.00	10	1
2	10	528	550.00	11	1+
			600.00	12	1
			650.00	13	1
1	5	533	700.00	14	1+
			750.00	15	1
			800.00	16	1
			850.00	17	1
			900.00	18	1
			950.00	19	1
1	5	538	1000.00	20	1+
1	5	544	1050.00	21	1+
2	10	554	1100.00	22	1+
2	10	564	1150.00	23	1+
2	10	575	1200.00	24	1+
			1250.00	25	1
			1300.00	26	1
2	10	585	1350.00	27	1+
4	20	606	1400.00	28	1X+
			1450.00	29	1
			1500.00	30	1
			1550.00	31	1
			1600.00	32	1
			1650.00	33	1
			1700.00	34	1
			1750.00	35	1
1	5	611	1800.00	36	1+
2	10	621	1850.00	37	1+
			1900.00	38	1
1	5	626	1950.00	39	1
			2000.00	40	1
2	10	637	2050.00	41	1+
3	15	652	2100.00	42	1+
1	5	658	2150.00	43	1+
			2200.00	44	1
			2250.00	45	1
1	5	663	2300.00	46	1+
			2350.00	47	1
3	15	678	2400.00	48	1+
			2450.00	49	1
			2500.00	50	1
62	3211000		2550.00	51	1XXXXXXXXXXXXXXXXXXXXXXXXXX+

Fig. 47

DURATION (SEC.) 286.430  
 FREQUENCY(C/SEC.) 0.516  
 STAND. DEV. (MSEC.) 0.3818967E 04  
 MAXIMUM(MSEC.) 0.1964561E 05  
 RANGE(MSEC.) 0.1964356E 05

N.SPIKES 148.  
 MEAN(MSEC.) 0.1935340E 04  
 VARIAT. COEFF. 0.1973279E 01  
 MINIMUM(MSEC.) 0.2040000E 01

N.4  
 OTO B4  
 T+32

			0.00	0 1
52	351	351	50.00	1 LXXXXXXXXXXXXXXXXXXXXXXXXXXXXXXXXXXXX+
18	121	472	100.00	2 LXXXXXXXXXXXXX+
10	67	540	150.00	3 LXXXXX+
6	40	581	200.00	4 LXXX+
3	20	601	250.00	5 LX+
3	20	621	300.00	6 LX+
			350.00	7 1
1	6	628	400.00	8 1+
1	6	635	450.00	9 1+
			500.00	10 1
			550.00	11 1
			600.00	12 1
			650.00	13 1
2	13	648	700.00	14 1+
1	6	655	750.00	15 1+
1	6	662	800.00	16 1+
1	6	668	850.00	17 1+
1	6	675	900.00	18 1+
1	6	682	950.00	19 1+
			1000.00	20 1
			1050.00	21 1
			1100.00	22 1
1	6	689	1150.00	23 1+
			1200.00	24 1
			1250.00	25 1
			1300.00	26 1
1	6	695	1350.00	27 1+
1	6	702	1400.00	28 1+
			1450.00	29 1
			1500.00	30 1
			1550.00	31 1
1	6	709	1600.00	32 1+
			1650.00	33 1
1	6	716	1700.00	34 1+
			1750.00	35 1
2	13	729	1800.00	36 1+
			1850.00	37 1
			1900.00	38 1
1	6	736	1950.00	39 1+
			2000.00	40 1
1	6	743	2050.00	41 1+
			2100.00	42 1
1	6	750	2150.00	43 1+
			2200.00	44 1
			2250.00	45 1
			2300.00	46 1
			2350.00	47 1
1	6	756	2400.00	48 1+
			2450.00	49 1
			2500.00	50 1
36	2431000		2550.00	51 LXXXXXXXXXXXXXXXXXXXXXXXXXXXX+

Fig. 47



DURATION (SEC.) 127.560  
 FREQUENCY(C/SEC.) 2.383  
 STAND.DEV.(MSEC.) 0.2383438E 04  
 MAXIMUM(MSEC.) 0.1961787E 05  
 RANGE (MSEC.) 0.1961542E 05

N.SPIKES 304.  
 MEAN(MSEC.) 0.4196072E 03  
 VARIAT.COEFF. 0.5680167E 01  
 MINIMUM (MSEC.) 0.2448000E 01

N.5  
 OTOB4  
 T+62

			0.00	0 1
271	891	891	50.00	1 LXX +
18	59	950	100.00	2 LXXXX+
1	3	953	150.00	3 1+
			200.00	4 1
			250.00	5 1
2	6	960	300.00	6 1+
			350.00	7 1
			400.00	8 1
			450.00	9 1
			500.00	10 1
			550.00	11 1
			600.00	12 1
			650.00	13 1
			700.00	14 1
			750.00	15 1
			800.00	16 1
			850.00	17 1
			900.00	18 1
			950.00	19 1
			1000.00	20 1
			1050.00	21 1
			1100.00	22 1
			1150.00	23 1
			1200.00	24 1
1	3	963	1250.00	25 1+
			1300.00	26 1
			1350.00	27 1
			1400.00	28 1
			1450.00	29 1
			1500.00	30 1
			1550.00	31 1
			1600.00	32 1
			1650.00	33 1
			1700.00	34 1
			1750.00	35 1
			1800.00	36 1
			1850.00	37 1
			1900.00	38 1
			1950.00	39 1
			2000.00	40 1
			2050.00	41 1
			2100.00	42 1
			2150.00	43 1
			2200.00	44 1
			2250.00	45 1
			2300.00	46 1
			2350.00	47 1
			2400.00	48 1
			2450.00	49 1
			2500.00	50 1
1	361000		2550.00	51 LXX+

Fig. 47

DURATION(SEC.) 14.152  
FREQUENCY(C/SEC.) 23.740  
STAND. DEV. (MSEC.) 0.3916638E 03  
MAXIMUM(MSEC.) 0.7186105E 04  
RANGE(MSEC.) 0.7182840E 04

N. SPIKES 336.  
MEAN(MSEC.) 0.4212188E 02  
VARIAT. COEFF. 0.9298347E 01  
MINIMUM(MSEC.) 0.3264000E 01

N.6  
OTOB4  
T+82

		0.00	0 1
117	943	943	50.00 1 IXXX +
14	41	985	100.00 2 IXXX+
1	2	988	150.00 3 1+
2	5	994	200.00 4 1+
			250.00 5 1
1	2	997	300.00 6 1+
			350.00 7 1
			400.00 8 1
			450.00 9 1
			500.00 10 1
			550.00 11 1
			600.00 12 1
			650.00 13 1
			700.00 14 1
			750.00 15 1
			800.00 16 1
			850.00 17 1
			900.00 18 1
			950.00 19 1
			1000.00 20 1
			1050.00 21 1
			1100.00 22 1
			1150.00 23 1
			1200.00 24 1
			1250.00 25 1
			1300.00 26 1
			1350.00 27 1
			1400.00 28 1
			1450.00 29 1
			1500.00 30 1
			1550.00 31 1
			1600.00 32 1
			1650.00 33 1
			1700.00 34 1
			1750.00 35 1
			1800.00 36 1
			1850.00 37 1
			1900.00 38 1
			1950.00 39 1
			2000.00 40 1
			2050.00 41 1
			2100.00 42 1
			2150.00 43 1
			2200.00 44 1
			2250.00 45 1
			2300.00 46 1
			2350.00 47 1
			2400.00 48 1
			2450.00 49 1
			2500.00 50 1
1	21000		2550.00 51 1+

DURATION(SEC.) 7.759  
FREQUENCY(C/SEC.) 39.821  
STAND. DEV. (MSEC.) 0.3841367E 02  
MAXIMUM(MSEC.) 0.5736481E 03  
RANGE(MSEC.) 0.5703841E 03

N. SPIKES 309.  
MEAN(MSEC.) 0.2511218E 02  
VARIAT. COEFF. 0.1529682E 01  
MINIMUM(MSEC.) 0.3264000E 01

N.7  
OTOB4  
T+92

		0.00	0 1
289	935	935	50.00 1 IXXX +
13	42	977	100.00 2 IXXX+
4	12	990	150.00 3 1+
1	3	993	200.00 4 1+
1	3	996	250.00 5 1+
			300.00 6 1
			350.00 7 1
			400.00 8 1
			450.00 9 1
			500.00 10 1
			550.00 11 1
1	31000		600.00 12 1+

Fig. 47

DURATION (SEC.) 630.124  
 FREQUENCY(C/SEC.) 0.387  
 STAND. DEV. (MSEC.) 0.3005161E 04  
 MAXIMUM(MSEC.) 0.1749300E 05  
 RANGE(MSEC.) 0.1748892E 05

N. SPIKES 244.  
 MEAN(MSEC.) 0.2582476E 04  
 VARIAT. COEFF. 0.1163674E 01  
 MINIMUM(MSEC.) 0.4080001E 01

N.8  
 OTO B4  
 T + 107

			0.00	0 1
7	28	28	50.00	1 1X+
4	16	45	100.00	2 1+
11	45	90	150.00	3 1XXX+
8	32	122	200.00	4 1XX+
6	24	147	250.00	5 1X+
8	32	180	300.00	6 1XX+
7	28	209	350.00	7 1X+
3	12	221	400.00	8 1+
3	12	233	450.00	9 1+
5	20	254	500.00	10 1X+
4	16	270	550.00	11 1+
4	16	286	600.00	12 1+
5	20	307	650.00	13 1X+
1	4	311	700.00	14 1+
8	32	344	750.00	15 1XX+
1	4	348	800.00	16 1+
2	8	356	850.00	17 1+
4	16	372	900.00	18 1+
3	12	385	950.00	19 1+
2	8	393	1000.00	20 1+
5	20	413	1050.00	21 1X+
2	8	422	1100.00	22 1+
2	8	430	1150.00	23 1+
3	12	442	1200.00	24 1+
			1250.00	25 1
1	4	446	1300.00	26 1+
3	12	459	1350.00	27 1+
5	20	479	1400.00	28 1X+
2	8	487	1450.00	29 1+
2	8	495	1500.00	30 1+
1	4	500	1550.00	31 1+
3	12	512	1600.00	32 1+
4	16	528	1650.00	33 1+
1	4	532	1700.00	34 1+
2	8	540	1750.00	35 1+
5	20	561	1800.00	36 1X+
1	4	565	1850.00	37 1+
			1900.00	38 1
2	8	573	1950.00	39 1+
2	8	581	2000.00	40 1+
2	8	590	2050.00	41 1+
3	12	602	2100.00	42 1+
			2150.00	43 1
5	20	622	2200.00	44 1X+
2	8	631	2250.00	45 1+
1	4	635	2300.00	46 1+
1	4	639	2350.00	47 1+
2	8	647	2400.00	48 1+
			2450.00	49 1
			2500.00	50 1
86	3521000	2550.00	51	LXXXXXXXXXXXXXXXXXXXXXXXXXXXXXXXXXXXX+

Fig. 47

DURATION (SEC.) 493.887  
 FREQUENCY(C/SEC.) 1.111  
 STAND. DEV. (MSEC.) 0.9572651E 03  
 MAXIMUM (MSEC.) 0.8352576E 04  
 RANGE(MSEC.) 0.8313407E 04

N. SPIKES 549.  
 MEAN(MSEC.) 0.8996126E 03  
 VARIAT. COEFF. 0.1064086E 01  
 MINIMUM(MSEC.) 0.3916800E 02

N. 9  
 OTOB4  
 T+135

			0.00	0 1
1	1	1	50.00	1 1+
11	20	21	100.00	2 1X+
32	58	80	150.00	3 1XXXXX+
35	63	143	200.00	4 1XXXXXX+
32	58	202	250.00	5 1XXXXX+
29	52	255	300.00	6 1XXXXX+
22	40	295	350.00	7 1XXXX+
29	52	347	400.00	8 1XXXXX+
20	36	384	450.00	9 1XXX+
19	34	418	500.00	10 1XXX+
27	49	468	550.00	11 1XXX+
17	30	499	600.00	12 1XXX+
17	30	530	650.00	13 1XXX+
18	32	562	700.00	14 1XXX+
11	20	582	750.00	15 1X+
15	27	615	800.00	16 1X+
13	23	633	850.00	17 1X+
11	20	653	900.00	18 1X+
11	20	673	950.00	19 1X+
15	27	701	1000.00	20 1X+
12	21	723	1050.00	21 1X+
6	10	734	1100.00	22 1+
11	20	754	1150.00	23 1X+
8	14	768	1200.00	24 1+
7	12	781	1250.00	25 1+
8	14	795	1300.00	26 1+
8	14	810	1350.00	27 1+
5	9	819	1400.00	28 1+
6	10	830	1450.00	29 1+
5	9	839	1500.00	30 1+
3	5	845	1550.00	31 1+
5	9	854	1600.00	32 1+
7	12	867	1650.00	33 1+
1	1	868	1700.00	34 1+
2	3	872	1750.00	35 1+
5	9	881	1800.00	36 1+
5	9	890	1850.00	37 1+
3	5	896	1900.00	38 1+
4	7	903	1950.00	39 1+
3	5	908	2000.00	40 1+
5	9	918	2050.00	41 1+
			2100.00	42 1
4	7	925	2150.00	43 1+
			2200.00	44 1
4	7	932	2250.00	45 1+
1	1	934	2300.00	46 1+
2	3	938	2350.00	47 1+
1	1	939	2400.00	48 1+
1	1	941	2450.00	49 1+
2	3	945	2500.00	50 1+
30	541000		2550.00	51 1XXXXX+

DURATION(SEC.) 756.732  
 FREQUENCY(C/SEC.) 1.039  
 STAND. DEV. (MSEC.) 0.1203363E 04  
 MAXIMUM(MSEC.) 0.1725962E 05  
 RANGE(MSEC.) 0.1725881E 05

N. SPIKES 787.  
 MEAN(MSEC.) 0.9615410E 03  
 VARIAT. COEFF. 0.1251495E 01  
 MINIMUM(MSEC.) 0.8160004E 00

N. 10  
 OTOB4  
 T+142

			0.00	0 1
65	82	82	100.00	1 1XXXXXXXXX+
80	101	184	200.00	2 1XXXXXXXXXX+
68	86	270	300.00	3 1XXXXXXXXX+
68	86	357	400.00	4 1XXXXXXXXX+
56	71	428	500.00	5 1XXXXXXXXX+
57	72	500	600.00	6 1XXXXXXXXX+
41	52	552	700.00	7 1XXXXX+
39	49	602	800.00	8 1XXXX+
35	44	646	900.00	9 1XXXX+
29	36	683	1000.00	10 1XXX+
22	27	711	1100.00	11 1X+
23	29	740	1200.00	12 1X+
23	29	770	1300.00	13 1X+
21	26	796	1400.00	14 1X+
8	10	806	1500.00	15 1+
16	20	827	1600.00	16 1X+
11	13	841	1700.00	17 1+
17	21	862	1800.00	18 1X+
15	19	881	1900.00	19 1+
5	6	888	2000.00	20 1+
13	16	904	2100.00	21 1+
4	5	909	2200.00	22 1+
7	8	918	2300.00	23 1+
5	6	925	2400.00	24 1+
3	3	928	2500.00	25 1+
56	711000		2600.00	26 1XXXXXXXXX+

Fig. 47

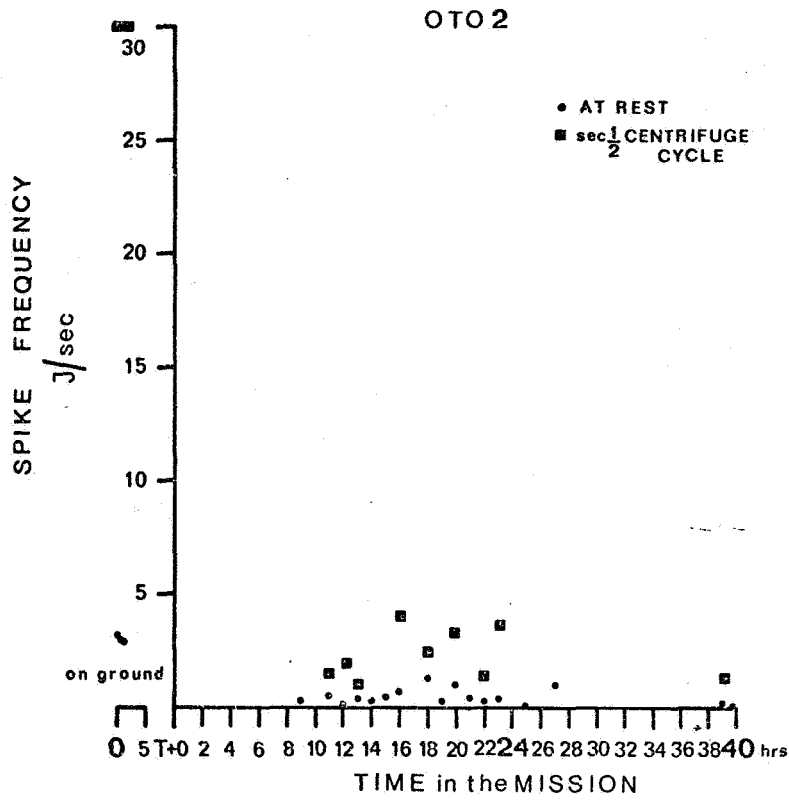

Fig. 48

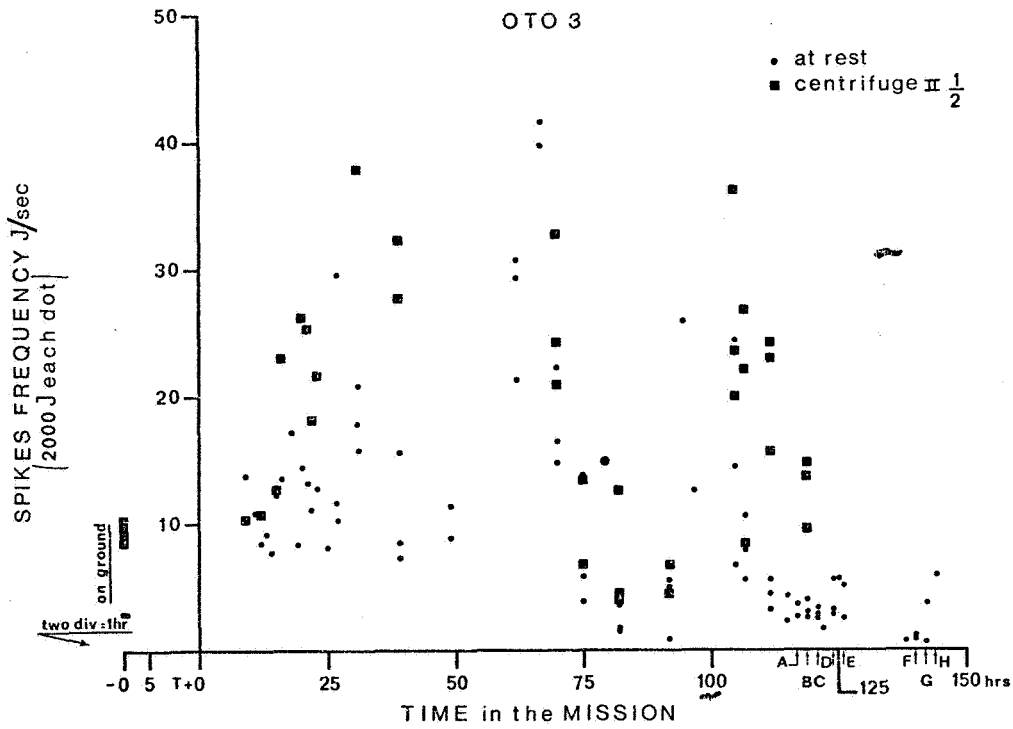

Fig. 49

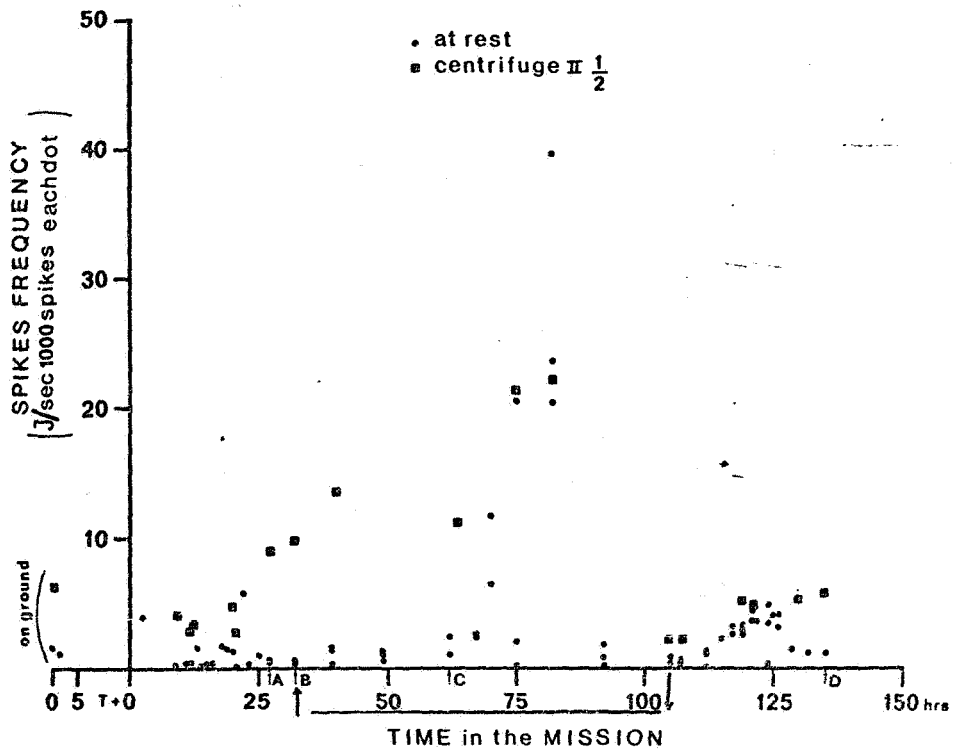

Fig. 50

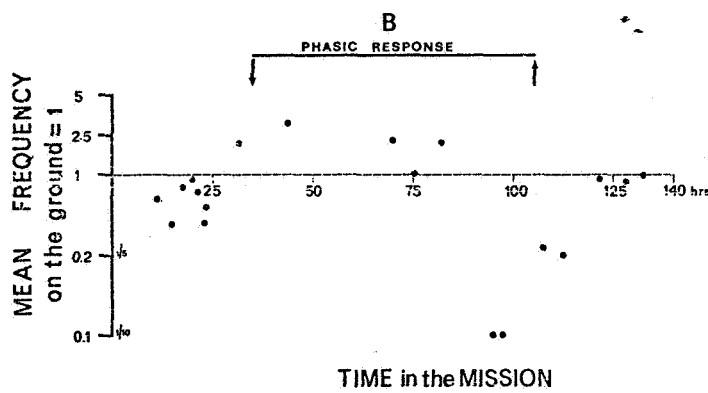
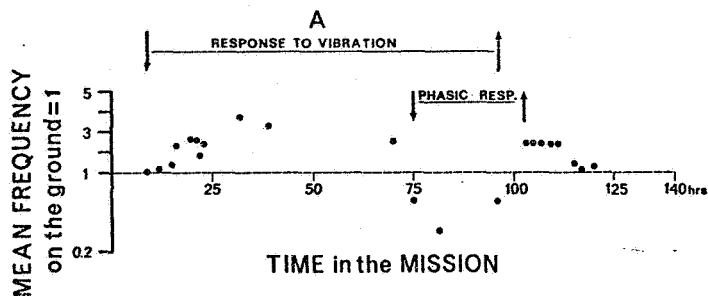

Fig. 51

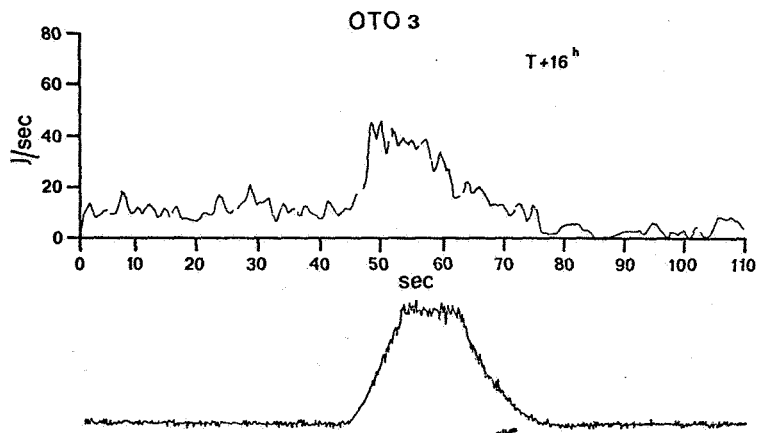
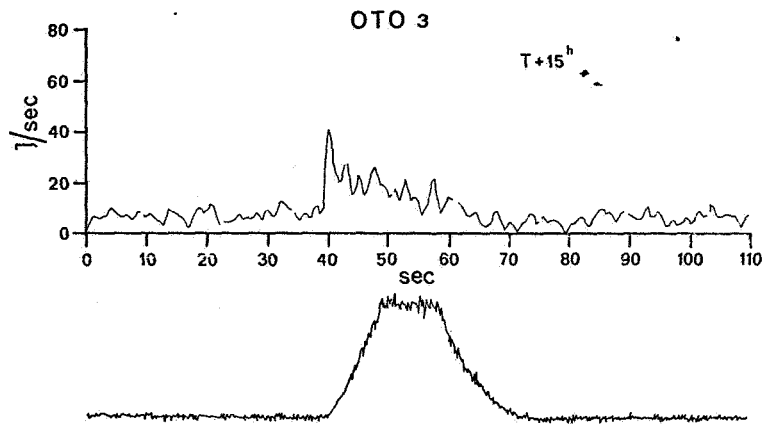
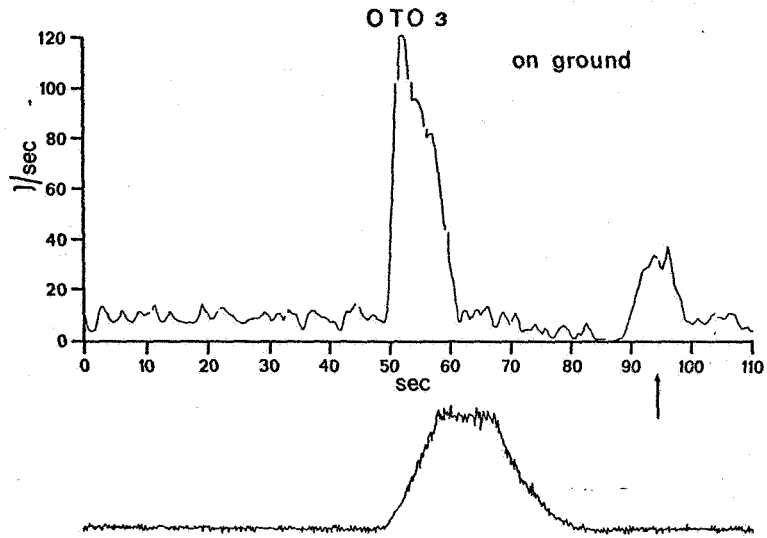

Fig. 52 1.2.3



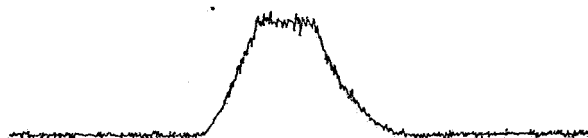
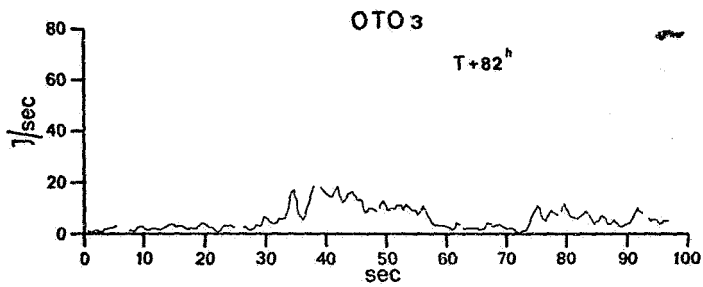
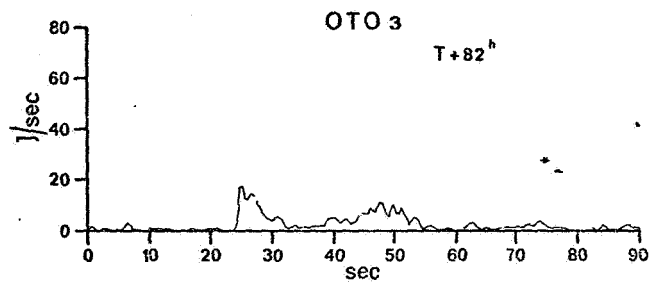
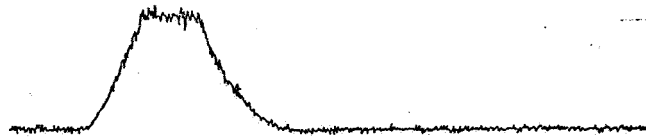
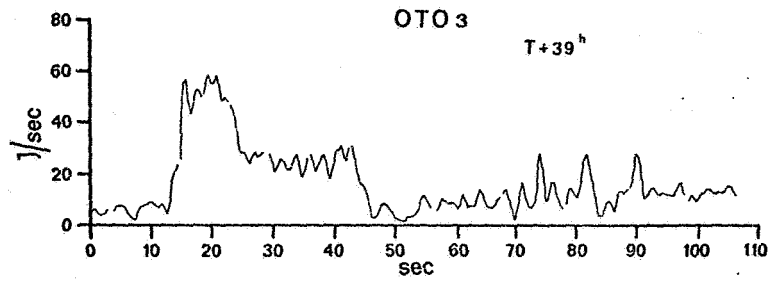

Fig. 52 4.5, 6

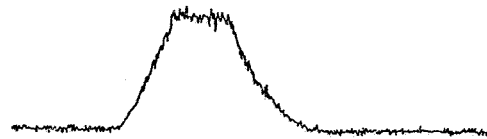
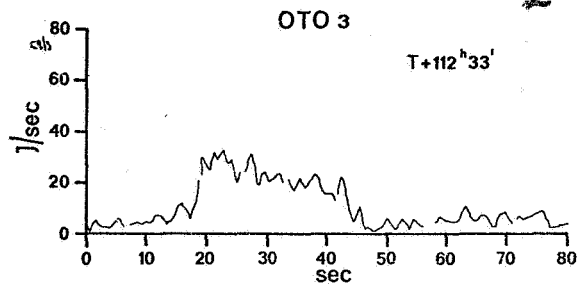
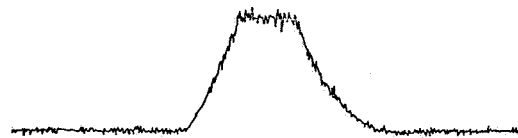
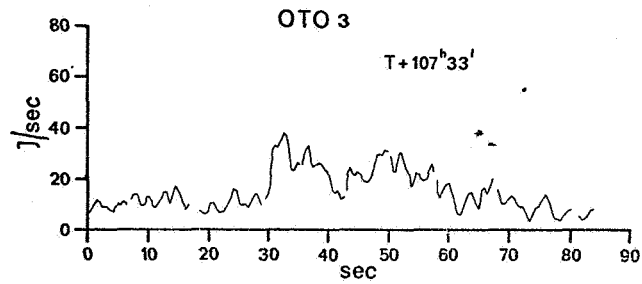
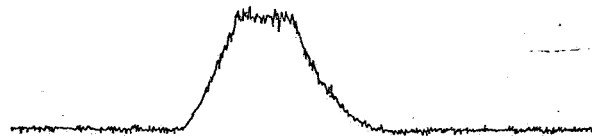
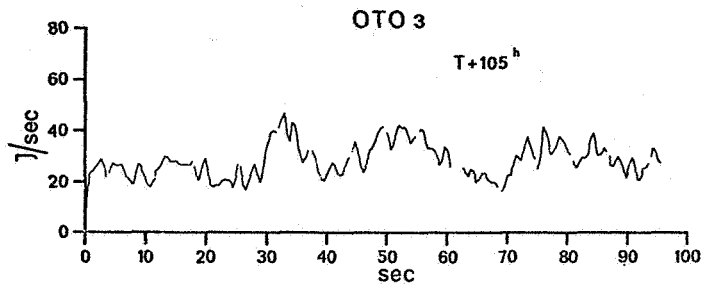

Fig. 52 7.8.9

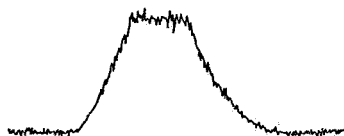
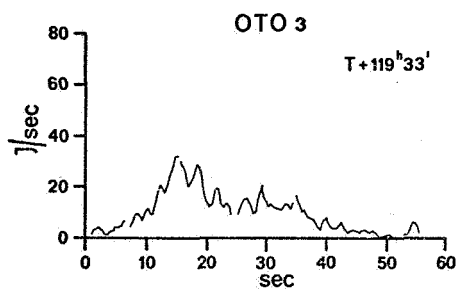
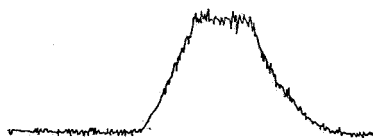
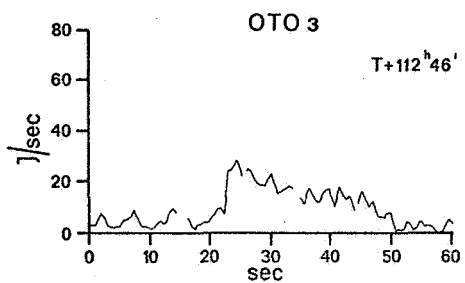
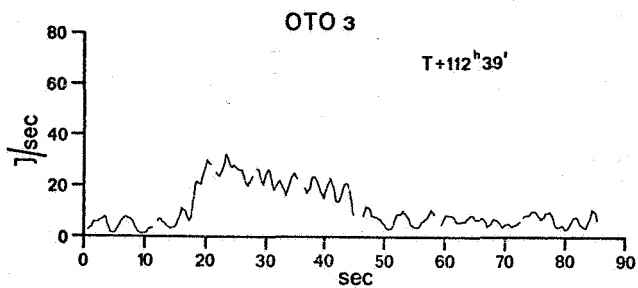

Fig. 52 10, 11, 12

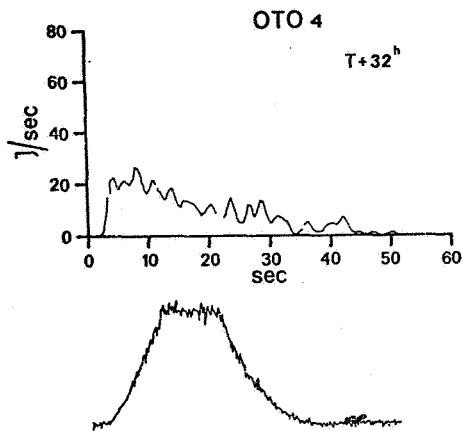
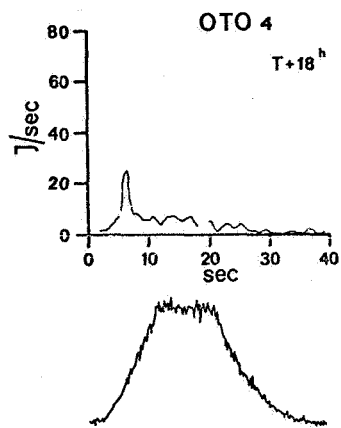
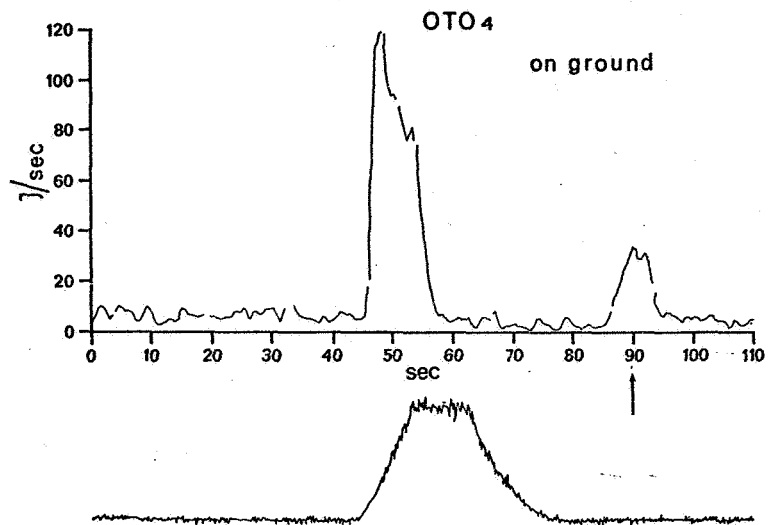

Fig. 53 1,2,3

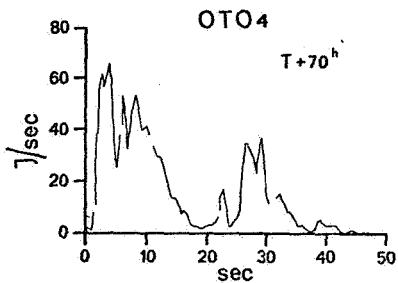
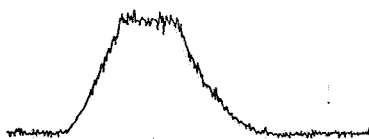
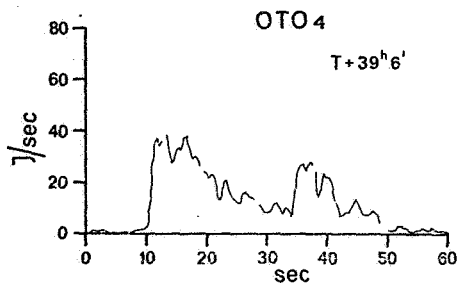
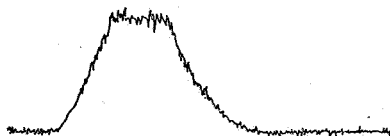
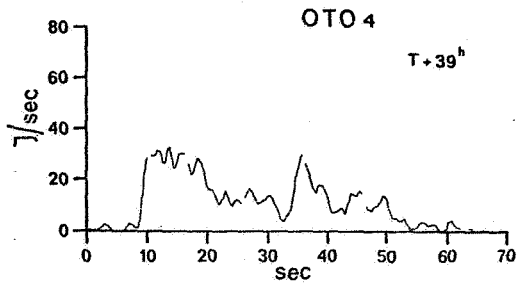

Fig. 53 4.5.6

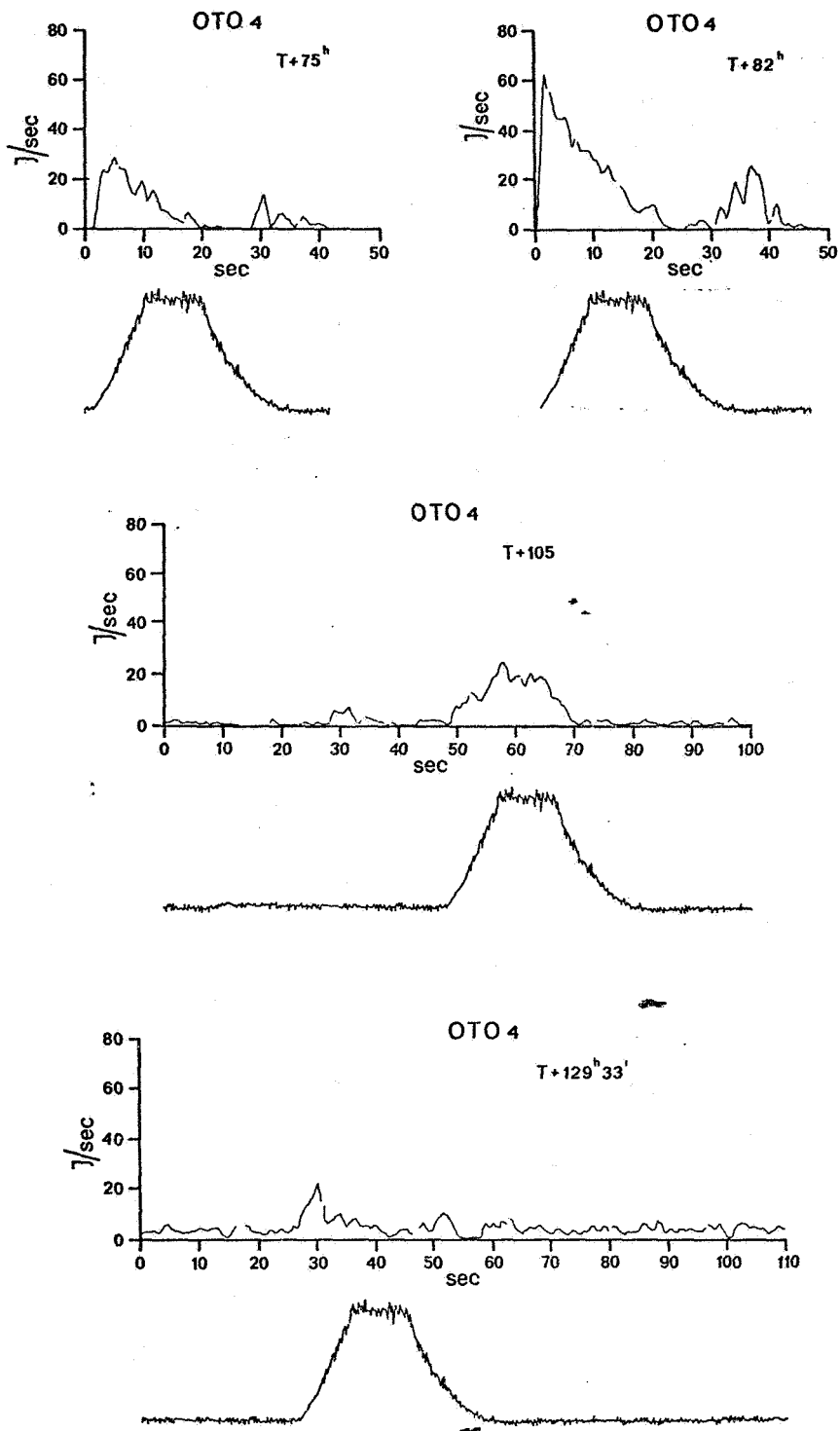

Fig. 53 7, 8, 9, 10

DURATION(SEC.) 3.013  
 FREQUENCY(C/SEC.) 29.202  
 STAND. DEV. (MSEC.) 0.2227240E 02  
 MAXIMUM(MSEC) 0.9873602E 02  
 RANGE(MSEC) 0.9588001E 02

N.SPIKES  
 MEAN(MSEC.) 0.3424404E  
 VARIAT. COEFF. 0.6504025E  
 MINIMUM(MSEC) 0.2836000E

88.  
 02  
 00 N.1 287  
 01 2:59 am

DURATION(SEC.)  
 FREQUENCY(C/SEC.)  
 STAND. DEV. (MSEC.)  
 MAXIMUM (MSEC.)  
 RANGE(MSEC.)

DURATION(SEC.)	FREQUENCY(C/SEC.)	STAND. DEV. (MSEC.)	MAXIMUM (MSEC.)	RANGE(MSEC.)
0.00	0	1		
1.00	1	1		
2.00	2	1		
2 22 22	3.00	3	1XXXXXXXXXXXXX+	
	4.00	4	1	
	5.00	5	1	
	6.00	6	1	
2 22 45	7.00	7	1XXXXXXXXXXXXX+	
	8.00	8	1	
2 22 68	9.00	9	1XXXXXXXXXXXXX+	
	10.00	10	1	
2 22 90	11.00	11	1XXXXXXXXXXXXX+	
1 11 102	12.00	12	1XXXXX+	
1 11 113	13.00	13	1XXXXX+	
5 56 170	14.00	14	1XXXXXXXXXXXXXXXXXXXXXXXXXXXXXXXXXXXX+	
2 22 193	15.00	15	1XXXXXXXXXXXXX+	
2 22 215	16.00	16	1XXXXXXXXXXXXX+	
2 22 238	17.00	17	1XXXXXXXXXXXXX+	
2 22 261	18.00	18	1XXXXXXXXXXXXX+	
4 45 306	19.00	19	1XXXXXXXXXXXXXXXXXXXXXXXXXXXX+	
4 45 352	20.00	20	1XXXXXXXXXXXXXXXXXXXXXXXXXXXX+	
1 11 363	21.00	21	1XXXXX+	
1 11 375	22.00	22	1XXXXX+	
3 34 409	23.00	23	1XXXXXXXXXXXXXXXXXXXX+	
	24.00	24	1	
1 11 420	25.00	25	1XXXXX+	
1 11 431	26.00	26	1XXXXX+	
1 11 443	27.00	27	1XXXXX+	
1 11 454	28.00	28	1XXXXX+	
3 34 488	29.00	29	1XXXXXXXXXXXXXXXXXXXX+	
	30.00	30	1	
2 22 511	31.00	31	1XXXXXXXXXXXXX+	
2 22 534	32.00	32	1XXXXXXXXXXXXX+	
	33.00	33	1	
2 22 556	34.00	34	1XXXXXXXXXXXXX+	
1 11 568	35.00	35	1XXXXX+	
1 11 579	36.00	36	1XXXXX+	
5 56 636	37.00	37	1XXXXXXXXXXXXXXXXXXXXXXXXXXXX+	
3 34 670	38.00	38	1XXXXXXXXXXXXXXXXXXXX+	
2 22 693	39.00	39	1XXXXXXXXXXXXX+	
1 11 704	40.00	40	1XXXXX+	
1 11 715	41.00	41	1XXXXX+	
2 22 738	42.00	42	1XXXXXXXXXXXXX+	
	43.00	43	1	
1 11 750	44.00	44	1XXXXX+	
	45.00	45	1	
1 11 761	46.00	46	1XXXXX+	
2 22 784	47.00	47	1XXXXXXXXXXXXX+	
	48.00	48	1	
2 22 806	49.00	49	1XXXXXXXXXXXXX+	
	50.00	50	1	
	51.00	51	1	
	52.00	52	1	
1 11 818	53.00	53	1XXXXX+	
1 11 829	54.00	54	1XXXXX+	
1 11 840	55.00	55	1XXXXX+	
	56.00	56	1	
	57.00	57	1	
2 22 863	58.00	58	1XXXXXXXXXXXXX+	
1 11 875	59.00	59	1XXXXX+	
1 11 866	60.00	60	1XXXXX+	
	61.00	61	1	
	62.00	62	1	
	63.00	63	1	
	64.00	64	1	
	65.00	65	1	
	66.00	66	1	
	67.00	67	1	
	68.00	68	1	
1 11 897	69.00	69	1	
1 11 909	70.00	70	1	
	71.00	71	1	
	72.00	72	1	
1 11 920	73.00	73	1XXXXX+	
1 11 931	74.00	74	1XXXXX+	
	75.00	75	1	
	76.00	76	1	
1 11 943	77.00	77	1XXXXX+	
	78.00	78	1	
	79.00	79	1	
	80.00	80	1	
	81.00	81	1	
	82.00	82	1	
	83.00	83	1	
	84.00	84	1	

Fig. 54

69.319  
21.624  
0.2583407E 02  
0.9832801E 02  
0.9628800E 02

N.SPIKES  
MEAN(MSEC.)  
VARIAT.COEFF.  
MINIMUM(MSEC.)

1499.  
0.4624364E 02  
0.5586515E 00  
0.2040000E 01  
N 2 287  
h 1  
12 12 pm

0.00 0 1  
1.00 1 1  
2.00 2 1  
3.00 3 1+  
4.00 4 1+  
5.00 5 1+  
6.00 6 1+  
7.00 7 1+  
8.00 8 1X+  
9.00 9 1+  
10.00 10 1+  
11.00 11 1  
12.00 12 1X+  
13.00 13 1+  
14.00 14 1XX+  
15.00 15 1XXXX+  
16.00 16 1XXXXXXXXXXXXXXXXX+  
17.00 17 1XXXXXXXXXXXXXXXXXXXXX+  
18.00 18 1XXXXXXXXXXXXXXXXXXXXXXXXXXXXX+  
19.00 19 1XXXXXXXXXXXXXXXXXXXXX+  
20.00 20 1XXXXXXXXXXXXXXXXXXXXXXXXXXXXX+  
21.00 21 1XXXXXXXXXXXXX+  
22.00 22 1XXXXXXXXXXXXX+  
23.00 23 1XXX+  
24.00 24 1+  
25.00 25 1X+  
26.00 26 1+  
27.00 27 1+  
28.00 28 1+  
29.00 29 1+  
30.00 30 1+  
31.00 31 1X+  
32.00 32 1XX+  
33.00 33 1XX+  
34.00 34 1XXXXXXXXXX+  
35.00 35 1XXXXXXXXXX+  
36.00 36 1XXXXXXXXXXXXXXXXXXXXXXXXXXXXX+  
37.00 37 1XXXXXXXXXXXXXXXXXXXXX+  
38.00 38 1XXXXXXXXXXXXXXXXXXXXXXXXXXXXX+  
39.00 39 1XXXXXXXXXXXXX+  
40.00 40 1XXXXXXXXXXXXX+  
41.00 41 1X+  
42.00 42 1X+  
43.00 43 1+  
44.00 44 1+  
45.00 45 1+  
46.00 46 1+  
47.00 47 1+  
48.00 48 1+  
49.00 49 1X+  
50.00 50 1+  
51.00 51 1+  
52.00 52 1XX+  
53.00 53 1XXXX+  
54.00 54 1XXXXXXXXXXXXX+  
55.00 55 1XXXXXXXXXXXXX+  
56.00 56 1XXXXXXXXXXXXXXXXXXXXXXXXXXXXX+  
57.00 57 1XXXXXXXXXX+  
58.00 58 1XXXXXXXXXX+  
59.00 59 1XX+  
60.00 60 1+  
61.00 61 1+



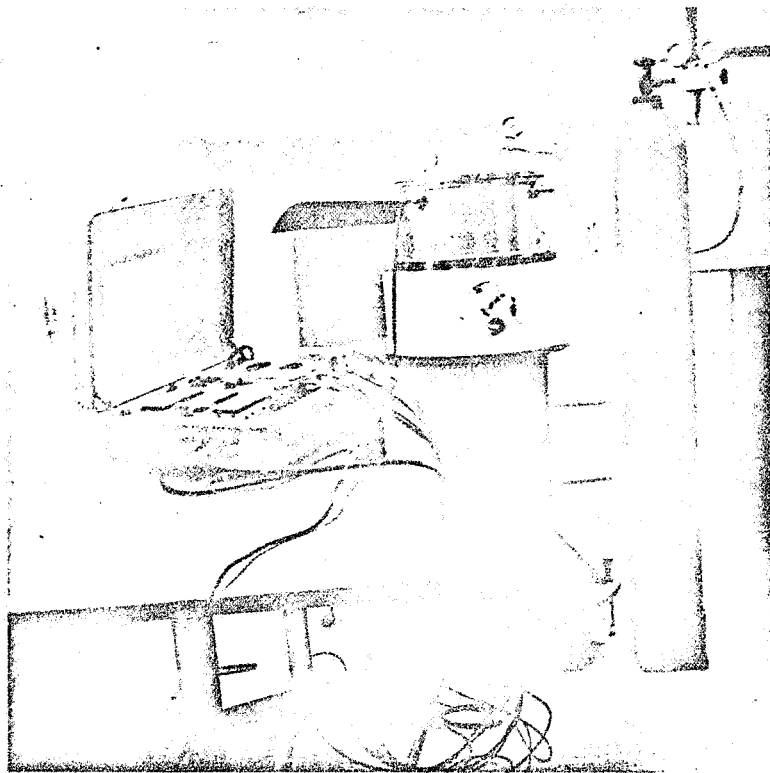

A

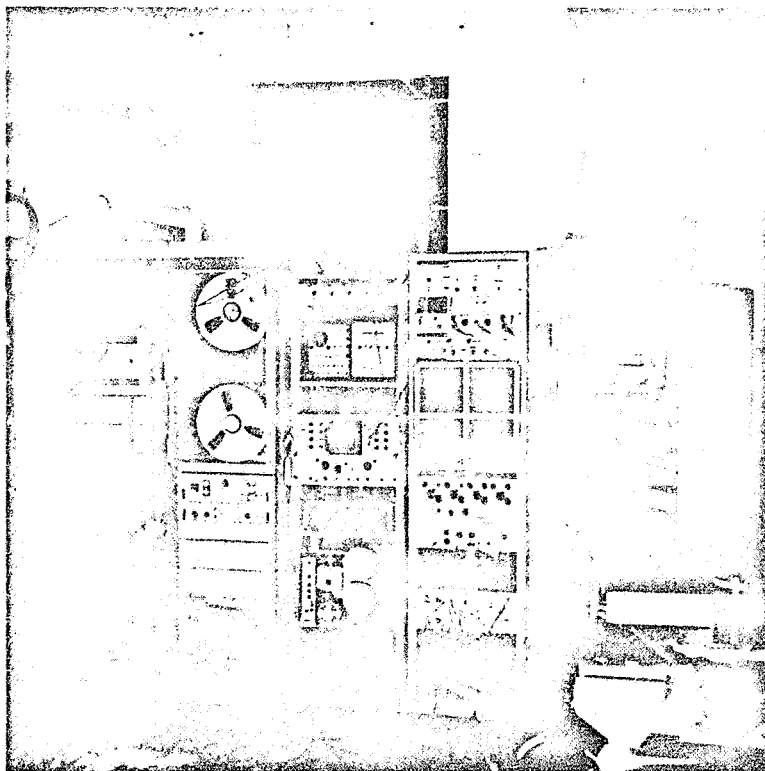

B

Fig. 55

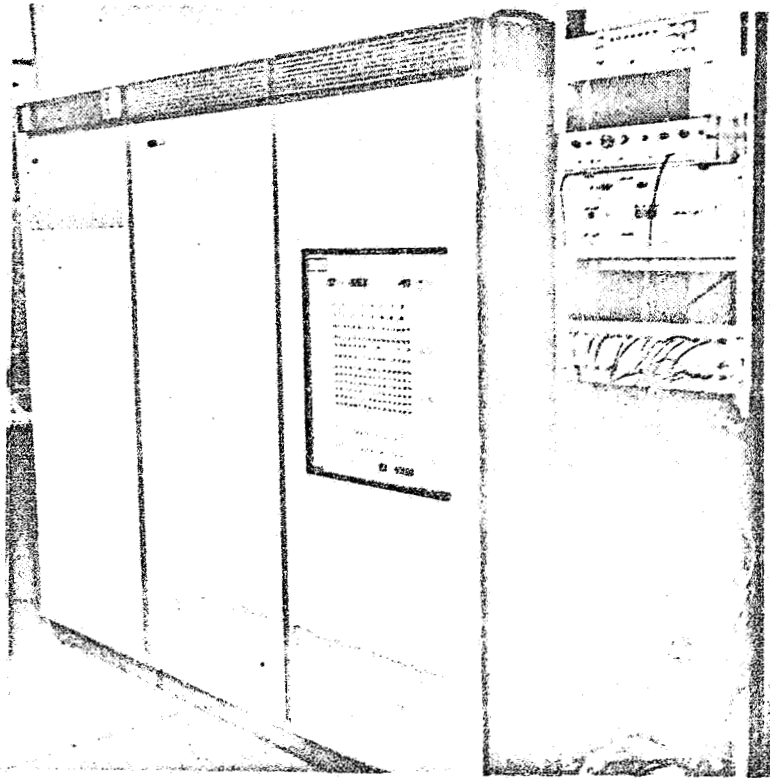

C

Fig. 55 c

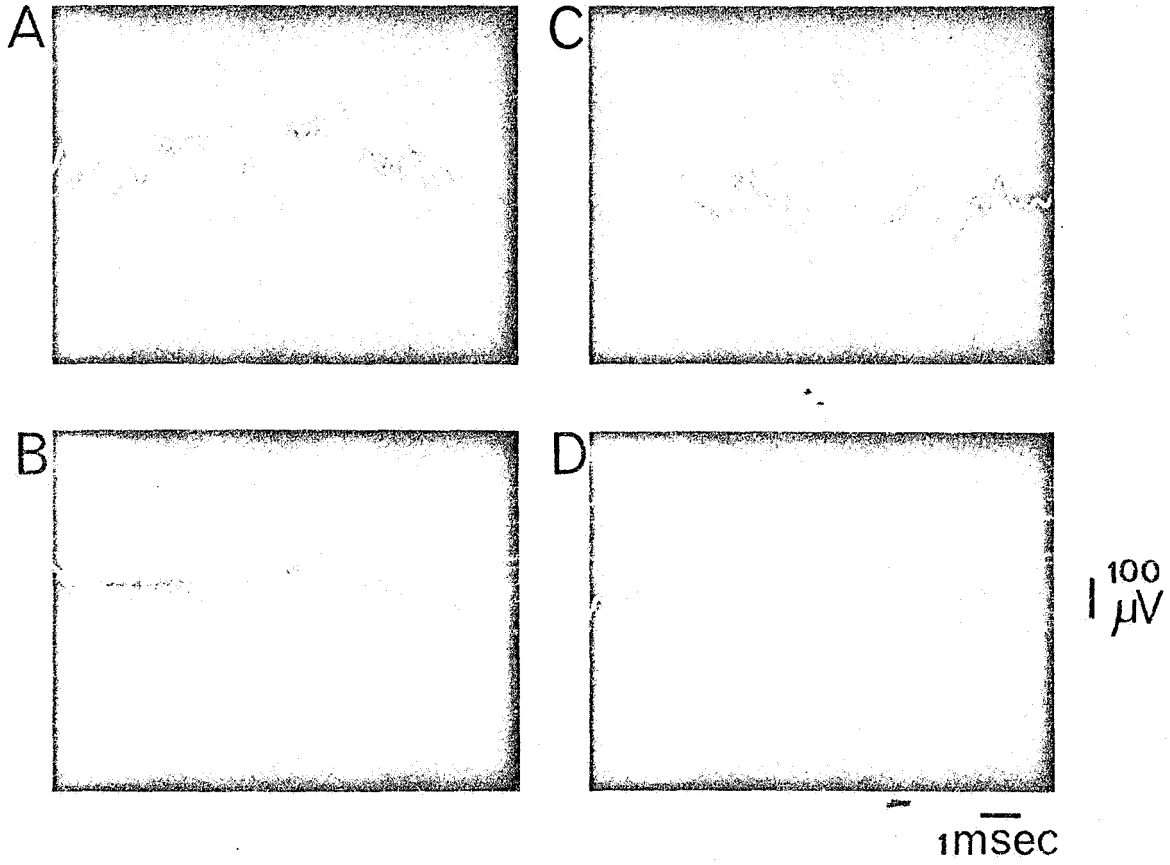
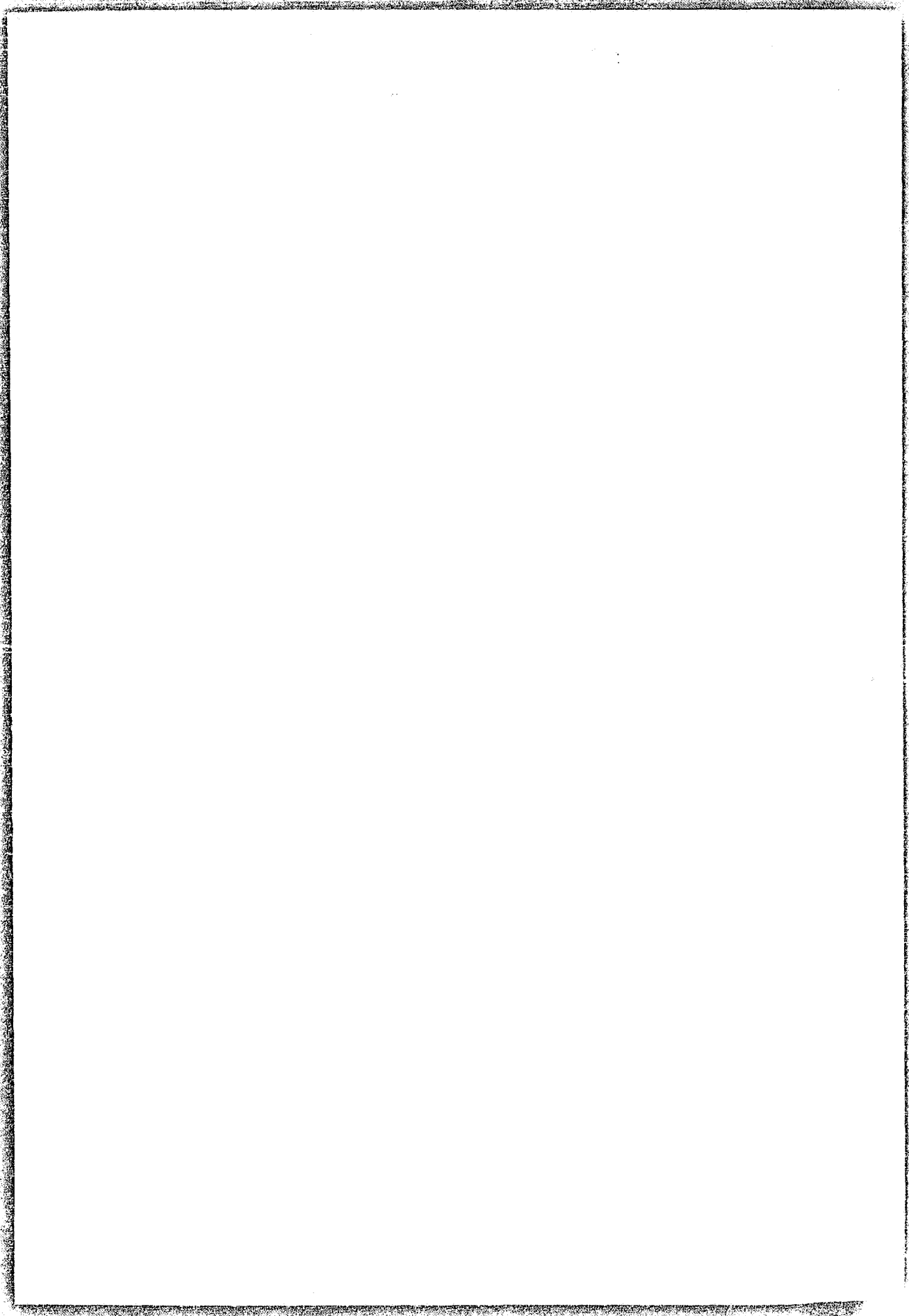

Fig. 56



DURING PRESSURIZATION

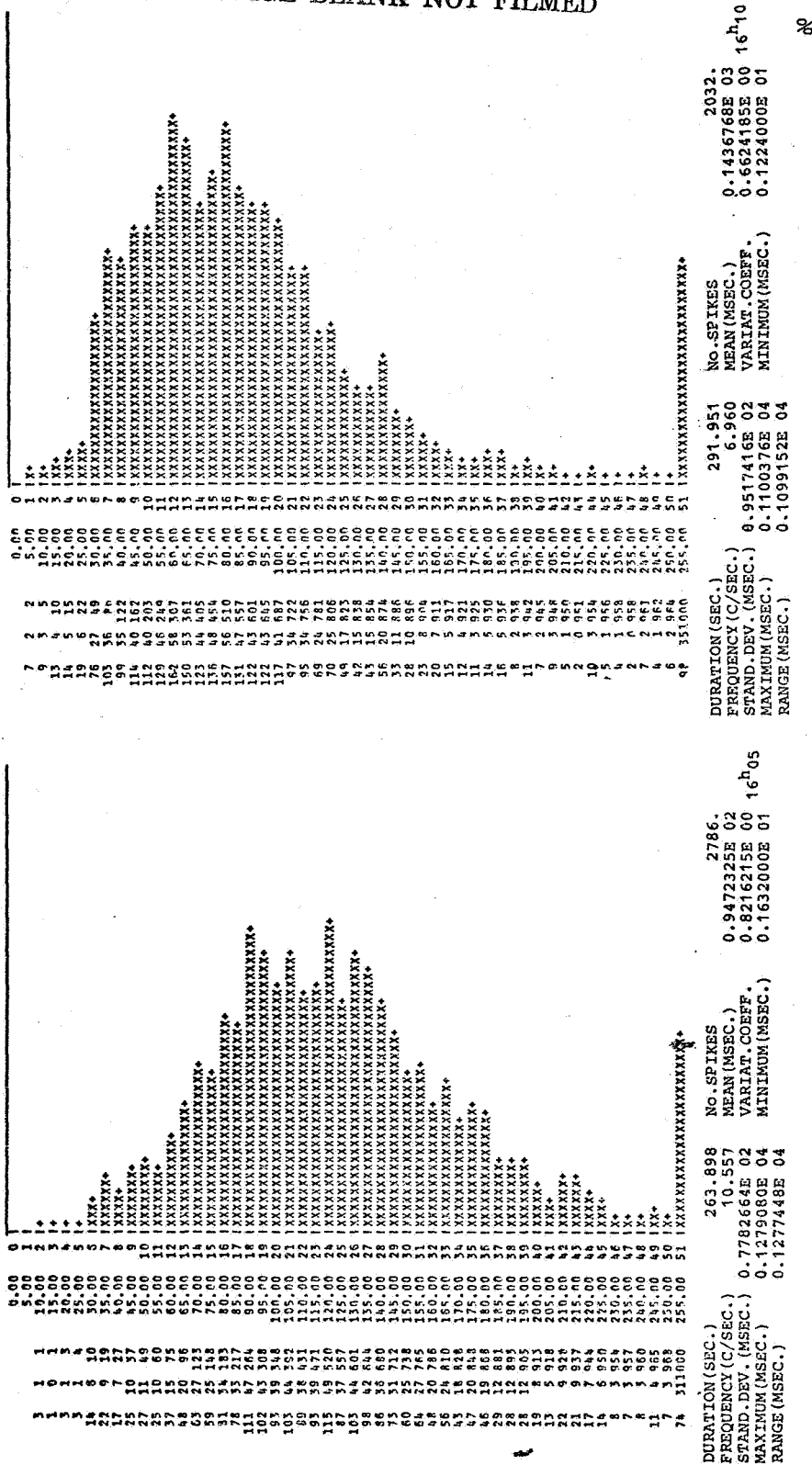

Fig. 57

C-5

0.00	1	2	3	4	5	6	7	8	9	10	11	12	13	14	15	16	17	18	19	20	21	22	23	24	25	26	27	28	29	30	31	32	33	34	35	36	37	38	39	40	41	42	43	44	45	46	47	48	49	50	51	52	53	54	55	56	57	58	59	60	61	62	63	64	65	66	67	68	69	70	71	72	73	74	75	76	77	78	79	80	81	82	83	84	85	86	87	88	89	90	91	92	93	94	95	96	97	98	99	100
0.00	1.00	2.00	3.00	4.00	5.00	6.00	7.00	8.00	9.00	10.00	11.00	12.00	13.00	14.00	15.00	16.00	17.00	18.00	19.00	20.00	21.00	22.00	23.00	24.00	25.00	26.00	27.00	28.00	29.00	30.00	31.00	32.00	33.00	34.00	35.00	36.00	37.00	38.00	39.00	40.00	41.00	42.00	43.00	44.00	45.00	46.00	47.00	48.00	49.00	50.00	51.00	52.00	53.00	54.00	55.00	56.00	57.00	58.00	59.00	60.00	61.00	62.00	63.00	64.00	65.00	66.00	67.00	68.00	69.00	70.00	71.00	72.00	73.00	74.00	75.00	76.00	77.00	78.00	79.00	80.00	81.00	82.00	83.00	84.00	85.00	86.00	87.00	88.00	89.00	90.00	91.00	92.00	93.00	94.00	95.00	96.00	97.00	98.00	99.00	100.00

0.00	1	2	3	4	5	6	7	8	9	10	11	12	13	14	15	16	17	18	19	20	21	22	23	24	25	26	27	28	29	30	31	32	33	34	35	36	37	38	39	40	41	42	43	44	45	46	47	48	49	50	51	52	53	54	55	56	57	58	59	60	61	62	63	64	65	66	67	68	69	70	71	72	73	74	75	76	77	78	79	80	81	82	83	84	85	86	87	88	89	90	91	92	93	94	95	96	97	98	99	100
0.00	1.00	2.00	3.00	4.00	5.00	6.00	7.00	8.00	9.00	10.00	11.00	12.00	13.00	14.00	15.00	16.00	17.00	18.00	19.00	20.00	21.00	22.00	23.00	24.00	25.00	26.00	27.00	28.00	29.00	30.00	31.00	32.00	33.00	34.00	35.00	36.00	37.00	38.00	39.00	40.00	41.00	42.00	43.00	44.00	45.00	46.00	47.00	48.00	49.00	50.00	51.00	52.00	53.00	54.00	55.00	56.00	57.00	58.00	59.00	60.00	61.00	62.00	63.00	64.00	65.00	66.00	67.00	68.00	69.00	70.00	71.00	72.00	73.00	74.00	75.00	76.00	77.00	78.00	79.00	80.00	81.00	82.00	83.00	84.00	85.00	86.00	87.00	88.00	89.00	90.00	91.00	92.00	93.00	94.00	95.00	96.00	97.00	98.00	99.00	100.00

# AFTER PRESSURIZATION

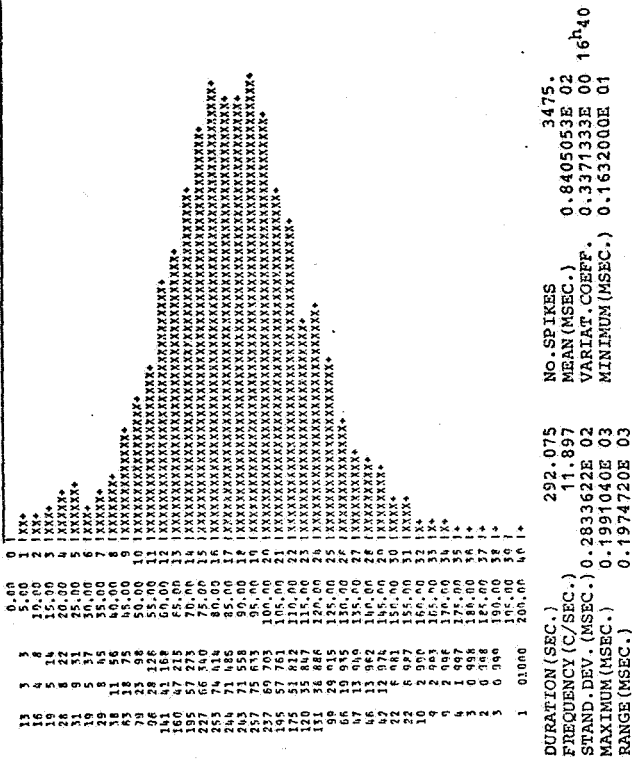

NO. SPIKES 2965.  
 MEAN (MSEC.) 0.9851580E 02  
 VARIAT. COEFF. 0.3247504E 00 16<sup>h</sup>25  
 MINIMUM (MSEC.) 0.8160001E 00  
 DURATION (SEC.) 292.099  
 FREQUENCY (C/SEC.) 10.150  
 STAND. DEV. (MSEC.) 0.3199304E 02  
 MAXIMUM (MSEC.) 0.2737680E 03  
 RANGE (MSEC.) 0.2729520E 03

Fig. 57

NO. SPIKES 292.075  
 MEAN (MSEC.) 11.897  
 VARIAT. COEFF. 0.3371333E 00 16<sup>h</sup>40  
 MINIMUM (MSEC.) 0.1632000E 01  
 DURATION (SEC.) 292.075  
 FREQUENCY (C/SEC.) 11.897  
 STAND. DEV. (MSEC.) 0.2833622E 02  
 MAXIMUM (MSEC.) 0.1991040E 03  
 RANGE (MSEC.) 0.1374720E 03

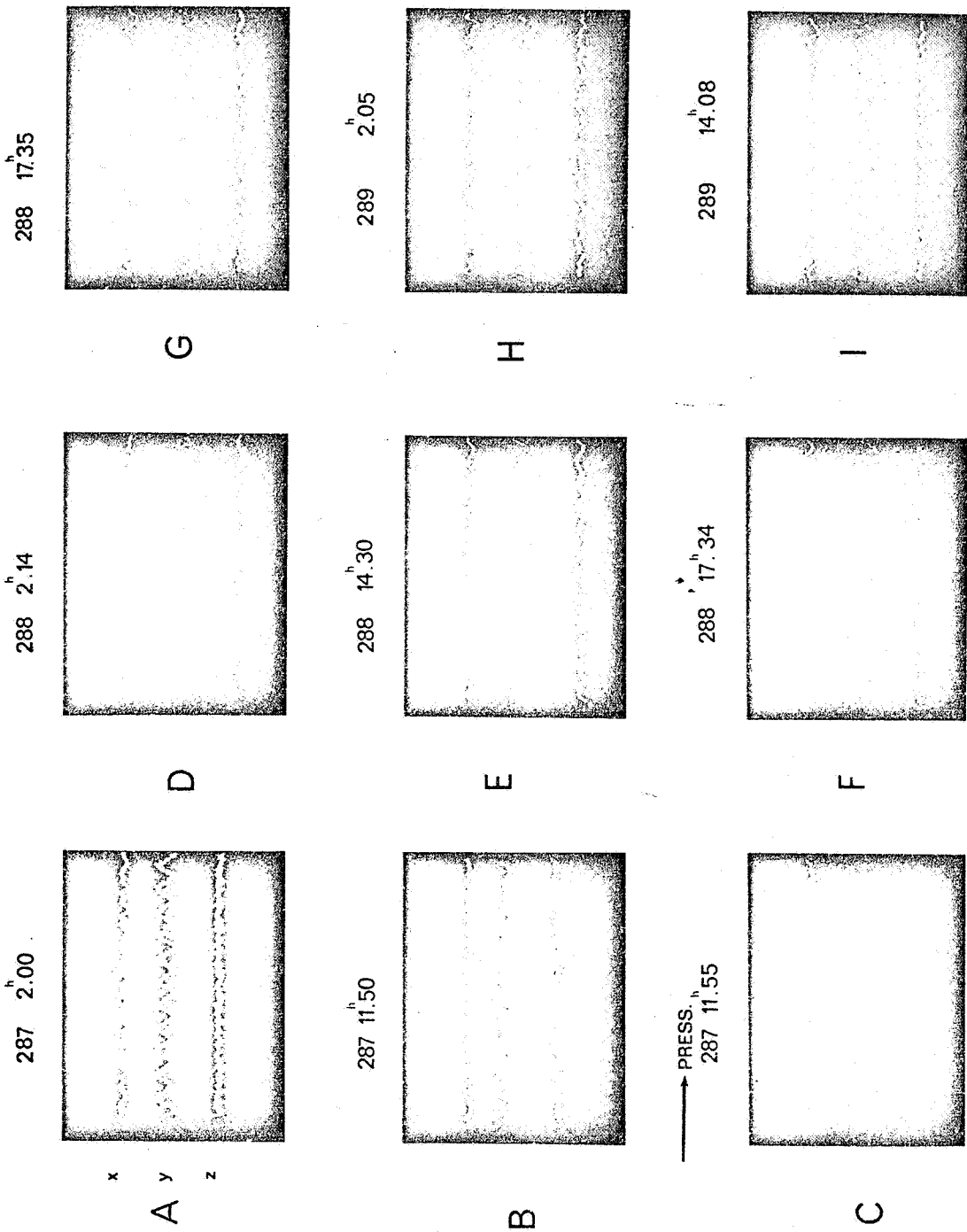

Fig. 58



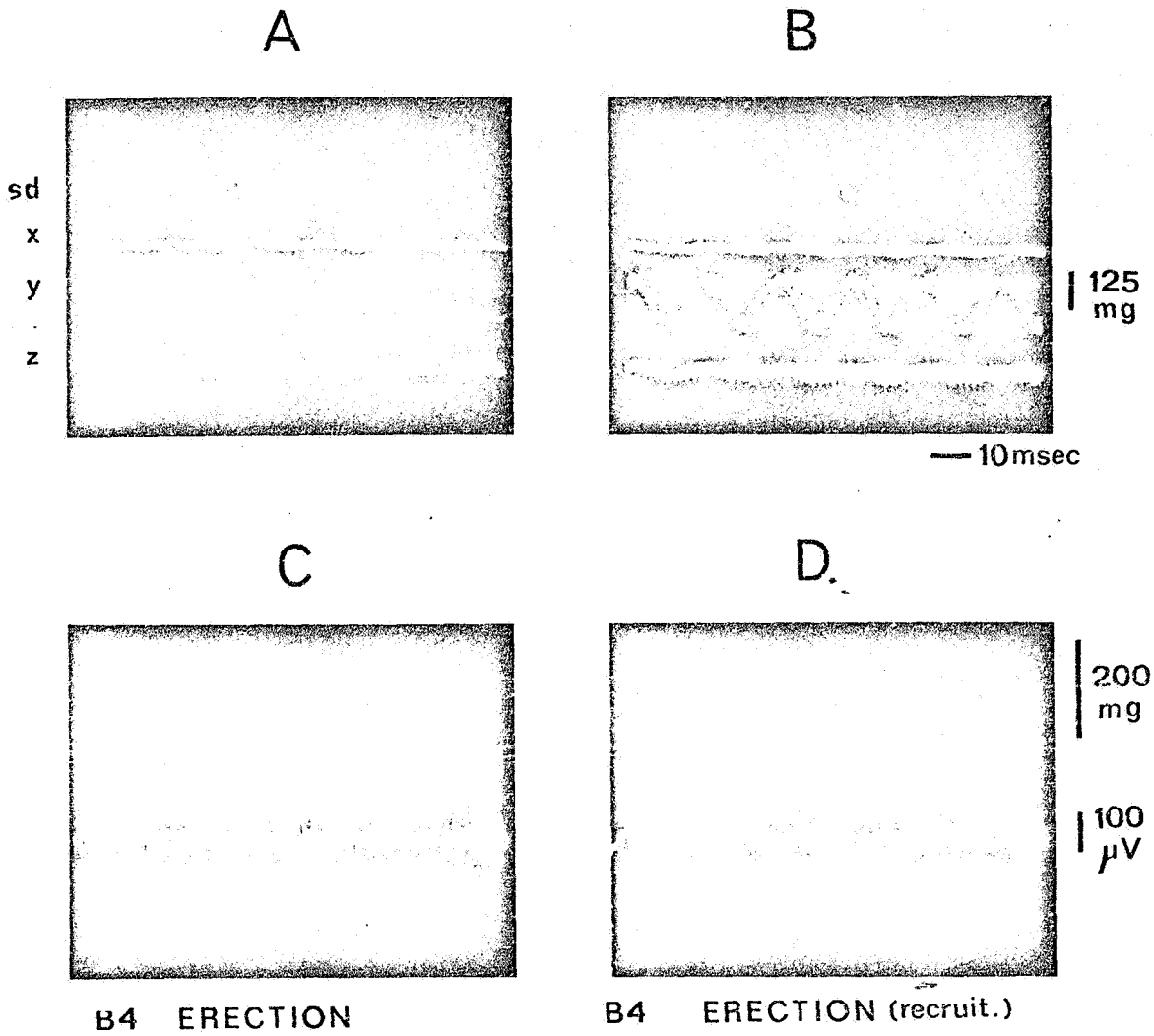

Fig. 59

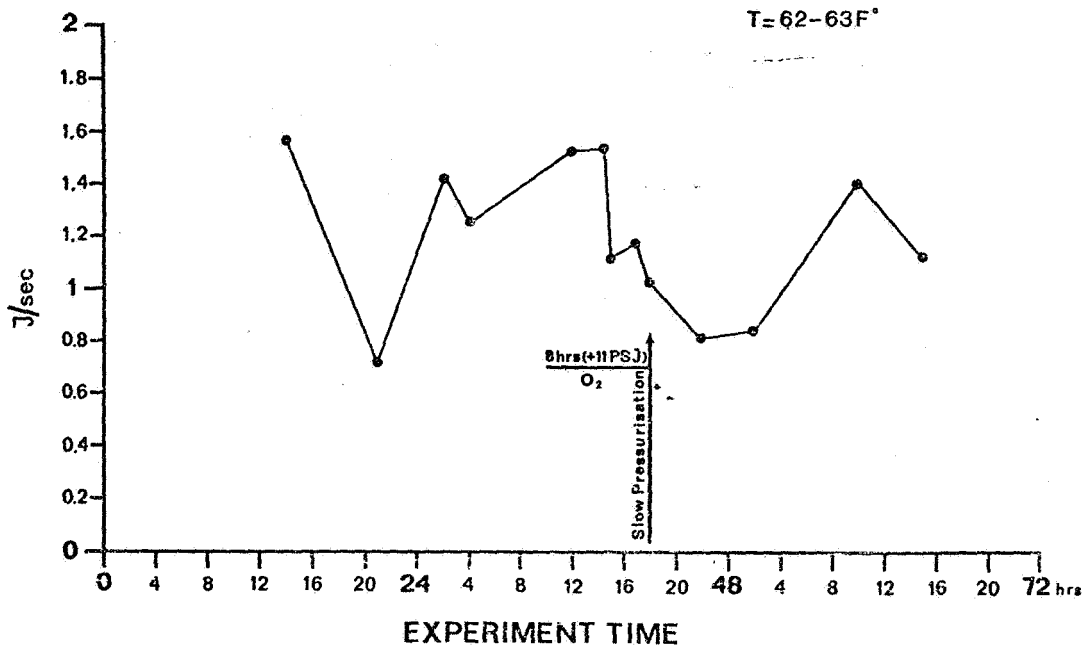

Fig. 60

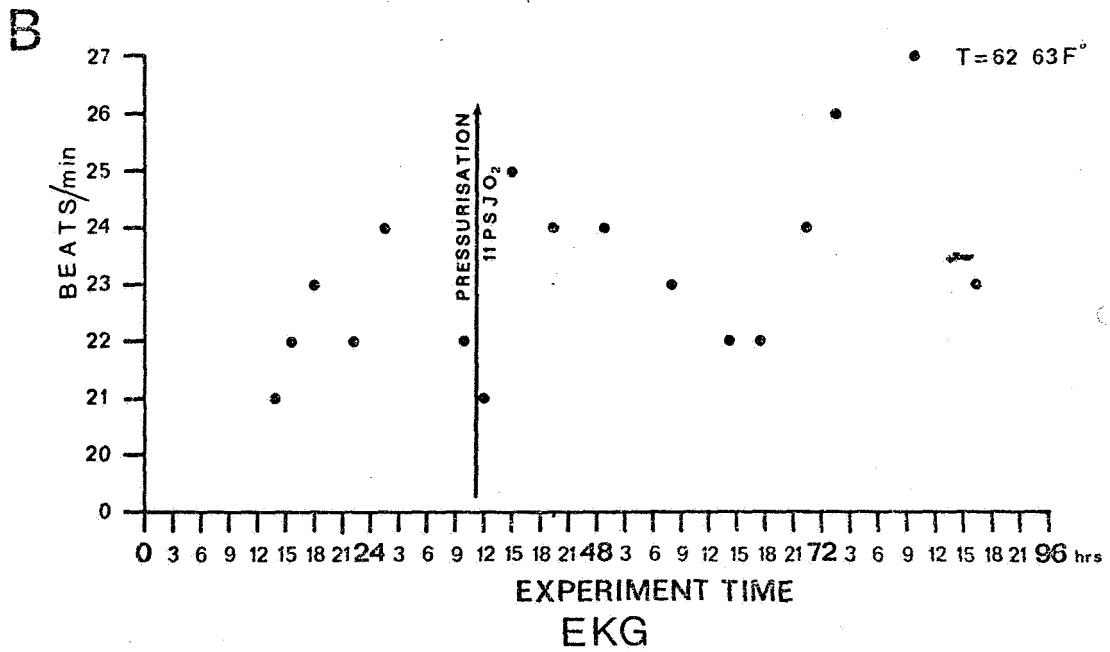
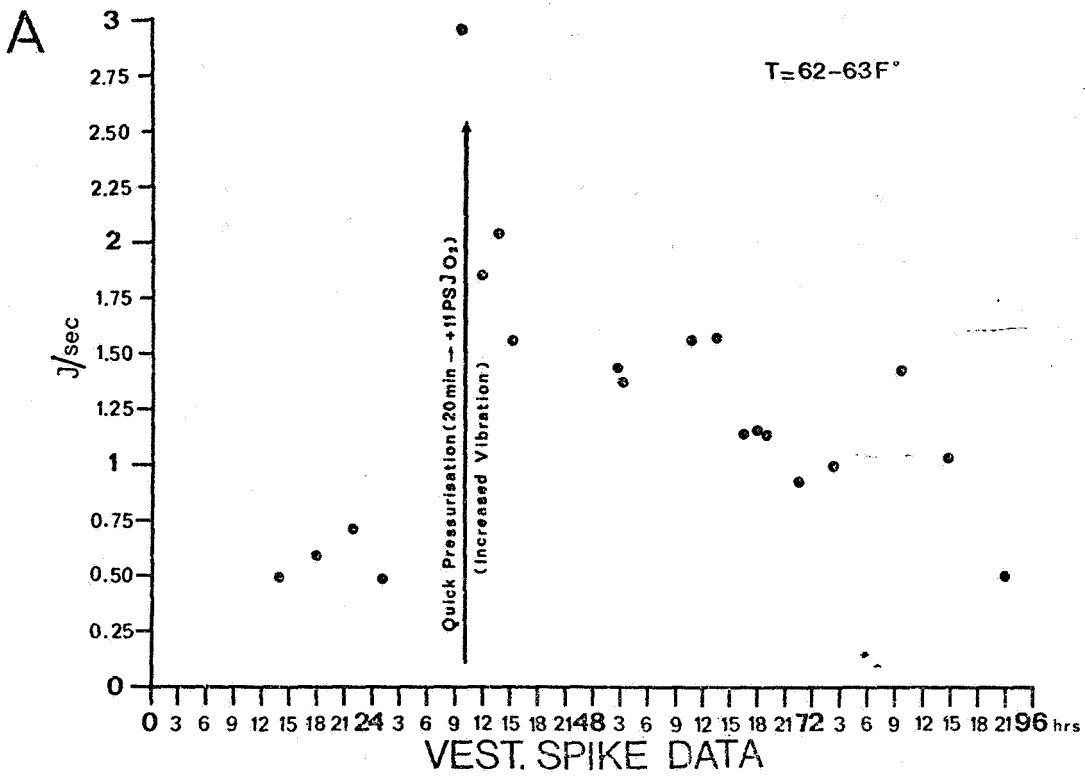

Fig. 61

TABLE 3

OTO A2

At Rest	Centrifuge	Diff.R-C	Diff.%	Situation	
5.1	22	16.9	+331%	on ground	
0.12	1	0.88	+733%	T+9-15	
0.3	2.7	2.4	+800%	T+16-20	
0.15	1.5	1.35	+900%	T+21-23	
0.1	3.	2.9	+2900%	T+39	

OTO B3

At Rest	Centrifuge	Diff.R-C	Diff.%	Situation	
2.5	10	7.5	+300%	on ground	
11	11	0	+0%	T+9-11	<div style="display: flex; flex-direction: column; align-items: center; justify-content: center;"> <div style="border: 1px solid black; padding: 2px;">basic response</div> <div style="border: 1px solid black; padding: 2px;">vibration</div> </div>
8	10.8	2.8	+40%	T+12-14	
12.3	12.8	0	+0%	T+15	
13.6	23.3	9.7	+71%	T+16	
13.0	23.0	10	+76%	T+20-23	
17.0	38.0	21	+123%	T+32	
22.3	33	10	+45%	T+70	
14.0	24	10	+71%	T+70	
16.5	21	5.5	+33%	T+70	
3.0	6	3		T+75-92	
14.0	24	10		T+97-105	
6	20	14	+233%	T+112	
2.5	10	7.5	+300%	T+119-144	

TABLE 3

OTO B4

At Rest	Centrifuge	Diff.R-C	Diff. %	Situation	
3	5	2	+66%	on ground	
0. 5	3	2. 5	+500%	T+9-16	phasic response
1. 5	4	2. 5	+166%	T+18-20	
0. 5	3	2. 5	+500%	T+22-32	
1. 3	12	10. 7		T+39-49	
25	10	-15		T+82	
0. 4	1. 5	1. 1		T+92-107	
2. 3	4	1. 7		T+115-119	
1. 2	3	1. 7	+141%	T+119-129	

TABLE 4

<u>TIME</u>		<u>Interspike Intervals</u>			
<u>Hour</u>	<u>Minutes</u>	<u>MEAN (msec)</u>	<u>STANDARD DEVIATION</u>		
10	40	920	457	Prior to Pressurization	
10	45	967	470		
10	50	814	285		
10	55	851	296		
11	00	875	308		
14	15	997	411		
14	20	913	259		
14	25	904	253		
14	45	1000	683		
14	50	855	372		
14	55	806	357		
15	00	913	346		
<hr/>					During Pressurization
16	00	1250	553		
16	05	947	778		
16	10	1430	951		
16	15	1010	329	After Pressurization	
<hr/>					
16	20	1060	434		
16	25	985	319		
16	30	872	294		
16	35	859	292		
16	40	840	283		
16	45	820	279		
16	50	814	268		
16	55	821	277		

## SECTION 9

### INFORMATION ON THE COMPUTER PROGRAM FOR THE DATA REDUCTION AND ANALYSIS

The data have been analyzed through an IBM 1800 Computer with an A to D converter. The characteristics of the system are shown in Table 5 . The computer has been used on a full-time basis, starting in April 1971 to the end of January 1972, with two teams alternating during the 24 hours. The main personnel involved were:

Dr. Francesco Bracchi

Dr. Emilio Rocca

Dr. Alberto Morabito

Richard Forgie

Lena Pavesio

The following programs have been written for data reduction and analysis.

#### 9.1 DATA ACQUISITION PROGRAM (EI)

The memory of the computer has been divided into three coreloads:

SPECIAL AREA (SPARA) with two routines called by interrupts. The first routine (TIME) is called every second to read the real time (hour, minutes and seconds) of the experiment which is recorded on one of the channels of the analog tape and is presented to the computer through the digital inputs.

The time is read second by second and memorized on the disk with the data for further reference. The digital

input word is also compared with a series of words memorized in the COMMON INSKEL. These words indicate the time to which special operative functions have to be carried on, like beginning and end of acquisition or "end of file".

The second routine (STOP) is called by a manual interrupt to stop or start the acquisition.

AREA CORELOAD 1 contains the program D 1810 for the input-output operation from the buffer of the COMMON INSKEL to the sectors of the disk and vice versa.

The programs contained in other areas of the coreloads control the input-output operation of the program D 1810 switching on a word of the COMMON INSKEL. During data acquisition a signal is provided for disk end. As soon as the disk is filled up a word in the COMMON is switched on to provide a digital output to stop the analog tape.

AREA CORELOAD 2 (V.CORE). The SPIKE program of this coreload measures the interspike time intervals and the analog to digital conversion of the acceleration signal and stores this information on the disk memory. Square waves corresponding to the otolith signals are sent to the first 15 inputs of the multiplexer connected in series. The last available channel of the multiplexer is connected with the acceleration channel on the tape. The analog to digital conversion values are memorized in two chained tables with a size of 1600 words each. After one table has been filled up, an "operation complete



interrupt" starts the routine working on that table. Meanwhile the A/D converter continues to memorize the other values on the other table. The time of completion of the routine must be less than the time needed to fill up the tables. A spike is recognized when the input voltage to the A/D converter exceeds a predetermined threshold. The interspike time intervals are measured by counting the conversion points between the subsequent values above threshold. The number of these points is proportional to the interspike interval and is placed in buffers of COMMON INSKEL in sequence with the acceleration value analyzed every 50 msec. The information is then transferred to the disk and packed in the best possible configuration so that a disk cartridge contains several hours of recording. The minimum resolution of interspike intervals is of about 500 microseconds. The routine TIME at the end of every data acquisition indicates on the typewriter the number of the last filled up sector of the disk.

All the routines and programs as described above are written in ASSEMBLER 1800 language.

## 9.2 DATA REDUCTION PROGRAM (E2)

The memory is divided in two coreloads:

AREA CORELOAD 1 with program D 1810 already described to transfer data from the disk to the central memory bank.

AREA CORELOAD 2 on which the different data reduction programs can be loaded (through consecutive LINK).

Program YY is for statistics and for drawing histograms. With this program it is possible to choose through the keyboard by means of a number of options what kind of analysis has to be done. The data reduction itself can then be carried out automatically by means of punch cards. This program provides basic statistics (average frequency, standard deviation, maximum and minimum intervals, dimension of the sample, range, variation coefficient, etc.) and drawing of histograms whose characteristics, e.g., number of bins, bin amplitude and the scale factor, can be selected through the keyboard. By means of the program INDEX a complete index of sectors and the fraction of the disk corresponding to minutes and seconds of the time code recorded on the analog tape can be obtained on the typewriter.

The program MSEQ provides for the drawing of a graph of the sequential means and standard deviation. The purpose of this program is the evaluation of the mean and standard deviation on a sample whose size is increased by a constant quantity. The results are drawn on the plotter.

Program MATIM provides for the graphic representation of the statistics and of the acceleration values: instantaneous frequency of the interspike time interval or the average frequency on samples of variable dimension on the plotter together with the acceleration signal. The real times of the experiment are also indicated and the scale factors of the graphs are calculated automatically.

### 9.3 IDENTIFICATION AND CLASSIFICATION OF THE SPIKES'

The digitalized electrical signal is analyzed. The maximum and minimum values of the record and the time intervals between the maximum and the minimum and the maximum and the maximum are noted.

The discriminating parameters are: (a) the integer area between minimum, maximum and minimum, (b) the increment time of the signal between the minimum and the maximum.

The proper threshold values of the different class parameters are predetermined. The spike is identified when the values of the parameters are above threshold.

The program is written in ASSEMBLER 1800 IBM.

To digitize, samples are taken every 60 microseconds and the analog signal speed = 1/4 of the recording speed.

TABLE 5

Description of the 1800 IBM system used for data reduction of the  
OFO-A experiment.

TABLE 5

1800 IBM SYSTEM (4 msec base cycle)

Type	Model	No.	Description
1801	1CB	1	Processor Controller
	4430	1	1442 Adapter
	5710	1	Proc. Intrpt Adapter
	5716	1	Proc. Intrpt Voltage
	3262	1	Dgtl Input Adapter
	3285	1	Dgtl Input Contact
	3296	1	Dgtl Otpt Control
	3295	1	Dgtl Otpt Adapter
	3612	1	Elec Contact Operate
	1232	1	Analog Dgtl Cnvtr Mod. 2
	1233	1	Anal Inp Data Chan Adapter 1 *
	1234	1	Anal Inp Data Chan Adapter 2
	5258	1	Mltplex S Control
	5487	1	Output Printer Expander
	7188	1	1627 Control
	3222	3	Data Channel
1442	006	1	Card Read Punch
1810	B02	1	Disk Storage
1816	001	2	Printer Keyboard
1828	002	1	Enclosure
1851	001	1	Multiplexer Terminal
	5253	1	Multiplexer S. Hlse
029	A22	1	Card Punch
1627	001	1	Plotter

## INTERPRETATION OF RESULTS

The sudden disappearance of the gravitational pull provokes on that part of the vestibular organ that deals directly with the measure of the gravitational components significant changes 1) on the spontaneous activity, 2) on the dynamic response and 3) in a much lesser way, on the static response. To understand this statement it has to be kept in mind that even on the ground some units show no stimulation whereas the organ as a whole is always subjected to the 1 g gravity. On the ground in between these two conditions (stimulation = 0 and stimulation = 1 g) several units are excited by a more or less strong gravitational component according to their position relative to the gravity vector: this is a function of the anatomical position in the macula and the position of the head. The hypothesis can be made that at steady state the units that are not excited are the ones in which the kinocilium is either vertical or pushed away from the stereocilia. In this condition there appears to be no significant change in the firing rate: in effect while determining the receptor field the frequency of discharge does not change from a position in which the kinocilium is pushed away from the stereocilia till when it reaches a vertical stand in respect to them (see schematic Fig. 62 - abstract C). If this is due to the fact that the kinocilium after being pushed away from the

stereocilia during a dynamic excitation tends to go back to normal when the movement is ended and the head maintains its acquired position or if a change away from the stereocilia does not significantly alter the firing rate of the unit cannot be established here. The statements above are deduced by the functional behavior of the unit: no anatomical evidence has been provided so far to support this theory.

The fact that a decrease in the frequency of firing of the receptor unit takes place during a dynamic negative stimulation of the receptor being investigated, namely, when a quick jerk is applied (Fig. 12) <sup>RepB</sup> seems to indicate a high probability for the second hypothesis. Anyway the experimental results indicate that if the head of the frog is subjected to a continuous motion (slow enough to produce an overshoot) covering the entire  $360^\circ$  solid angle nothing happens up to a certain point at which the units start firing at increasing rate till saturation, maintains then this firing rate while the tilt is further increased (Fig. 63): thereafter from a certain position on it suddenly decreases the frequency of discharge going back afterward to the level of activity at rest. As it was said in the previous section the chosen units were such that with the frog back down there was no excitation of the vestibular units from head up to the horizontal position and excitation started moving head down. Equivalent "g" values in tilt and during rotation in an horizontal plane provoked in

this situation an equivalent response. While the rotation is applied the vector resulting from the centripetal acceleration and the gravitational pull has to be calculated to make this comparison. However, on the ground a number of other units were very likely subjected to stimulation in any given position of the frog head owing to the fact that the gravitational component was contained within their receptor field. The main change, therefore, as far as the activity of the receptors in general is concerned, is that nearly all of them were not excited during the orbital flight with the exception of possibly the highly sensitive ones that could still feel the  $10^{-3}$  g's residual gravity or the vibration of the water pump.

In the first case, however, the "g" level changed slowly with the tumbling of the spacecraft around  $5 \times 10^{-4}$  g. Therefore, what was really lacking was the constant direction of the 1 g vector which is typical of the earth gravitational field and which is supposed to act as a reference point to determine the vertical. Another point is that the lack of weight on the organ will make the otolith structure float instead of being pushed one way or the other according to the position of the head.

The first observation that can be made is that the existence of the activity at rest is confirmed for all units. There is no doubt in effect that for a long period of the flight the input to the unit was 0 or at least it was below the



threshold of the units themselves. This result is highly interesting as on the ground one can never be sure that some accelerating stimulus might not be present and that the lowest frequency of firing recorded would not be simply the result of the lowest but still active stimulus. This was not the case in this mission, at least for the units studied: the linear acceleration value was below  $10^{-3}$  g's and even the vibration was of the same order of magnitude.

As far as the basic parameters of the units discharge are concerned it seems that in the conditions of weightlessness the minimum interval and the mode remain constant as it has been shown on the ground in the extensive study made on the gravity sensitive receptors in the laboratory during the preparation of the flight (see Reprint C). The mean frequency seems to return to an approximately constant value after the changes observed in 0 g. The interspike interval distribution seems to follow the same general character, even during the frequency changes due to extended period of weightlessness.

The most striking character of the changes produced by the 0 g conditions is their periodicity. A cycle of approximately 20-30 hours has been observed in the changes. Normally this periodicity corresponds to an alternation of opposite effects:

1. The activity at rest decreases progressively reaching its lowest value between 25 and 30 hours; this is followed by an increase the peak of which was recorded at about

the 60th hour, followed by a second dip in the 80-90th hour. Even in the unit in which the vibration of the pump stimulates for a large part of the flight, the receptor shows the same periodical increase and decrease in the firing which was observed approximately at the same time. Return to the norm was observed after 120-130 hours.

2. The dynamic response followed approximately the same cycle with an increase or decrease of the overshoot and of the variation of the blocking effect when the centrifuge slows down to stop. Even in this case there is an alternation of plus and minus effect, namely, a higher response that alternates with a lower response. Such a behavior can be interpreted as due to a controlling system with no set point but based on the correction of a deviation from norm after this deviation has been detected. As usual in a system of this kind an over-correction very often is observed which is in turn corrected. A series of adjustment, therefore, takes place reaching finally normalization.

3. After adaptation the tonic response to constant stimulation (second half of the centrifuge cycle at constant speed) does not change much in weightlessness. The stimulation here is supramaximal and the conclusion is that little change in the highest firing capability of the vestibular unit is induced by the basic 0 g condition. This means that if a tonic inhibitory or/and facilitatory effect is exerted reciprocally by the activated

units as it might be the case on the ground (on the ground some units are always excited by a gravitational component in every head position) this factor does not differ significantly when the organ is subjected to an overall 0.6 g than when it is subjected to a 1 g.

These (No. 1 - 2) are long term effects that might be due to a mechanism similar to a learning or a training process. It might be either nervous or humoral. The fact that although generally in the same period of time the dynamic and the static changes are not similar seems to support the idea that in the gravity sensitive receptors the dynamic and static response are based on two different mechanisms, whereas the fact that the interspike interval distribution corresponding to the activity at rest and the steady response to a stationary stimulation (the second half of the centrifuge cycle) seems to be of the same type might indicate that the origin of the activity at rest and during stationary excitation is the same.

The response during a certain period of the flight to the pump vibration indicates an increase of sensitivity. In fact it has been proven (see Reprint D) that gravity sensitive receptors respond to vibration. However, both the same units on the ground and the control experiments performed in the laboratory showed that at such minute intensity of vibration the gravity receptors normally are not excited. However, the general characters

of the response appeared to be similar in the 1 g gravitational field and in orbit although at different intensity of the vibratory stimulus. It is, therefore, a quantitative and not qualitative variation. It is of interest to note that even this change disappears after a certain period of habituation.

The short-term change observed during lift off, especially during the coasting after the third stage burned out and before the fourth ignited, follows a similar trend as the more prolonged 0 g condition during the orbital flight. In this case the firing rate decreases first and this is followed by a slow return to higher values. It is impossible to establish differentially the effect of the dynamic factor, namely, the change from the high g level during thrust and the nearly 0 g level during coasting but it does not seem to introduce a new element of change by itself. The slowing of the rate of firing was observed also during the short period of low gravity during a parabolic flight (12). But owing to the observation above the changes seem to be induced by the low gravity and not by the transient from the high to low g. The fact that at the end of the coasting period the rate of firing seems to approach normal value might not be true normalization. It looks more like the beginning of that alternative periodic change that has been seen more clearly in the prolonged 0 g period of the flight. It is, however, important to note that the immediate effect of reaching the 0 g stage is a slowing down of the

rate of firing at rest. It is important to emphasize once more that the decreased firing rate is not due to a decrease in the stimulus as we are dealing with spontaneous activity. This seems to prove that there is no release from a tonic inhibitory action as this would have determined at the very onset of the low g a sudden increase in the frequency of discharge. It was, of course, impossible to check further the hypothesis as the first recording during the flight itself was only after two and a half hours after reaching orbit but from the data observed during the lift off it appears that in the first few seconds after reaching 0 g the first cycle of changes is already in progress.

The decrease in the spontaneous firing rate noted at the onset of the '0' g situation (zero stimulation for the vestibular organ) could instead be due to the decrease of an excitatory tonic activity originating in that part of the organ that is stimulated by the gravity vector.

Fig. 62. Schematic of the response of the vestibular gravity receptors to the bending of the cilia according to the current knowledge. The 2 kinds of receptors commonly described are shown (the flask shaped ones (on left) and the cylindrical ones (on right) ).

Note that only the latter are present in amphibians.

Fig. 63. A) Response of a gravitoreceptor to tilting, upper 3 tracings xyz accelerometers. White dots in the 4th record represent the consecutive interval values as a distance from the abscissa (0 line) and each dot. The unit responds head down (x accelerometer line going up). Interspike intervals value, accelerometer and time base calibration in the figure. Both the dynamic and statistic changes at arrows 2 and 3 do not alter the interspike interval values: as this will correspond to a bending of the cell hair in the inhibitory direction (see fig. 62 extreme right), it seems to indicate that such a movement cannot produce a slowing down effect on the firing rate of the unit when it is performed slow enough. A fast tilt however will do it (fig. 12 Rep.B)

B) Experimental set-up (diagrammatic) for mapping the receptor field of a gravity sensitive receptor in the bull frog:

explanations in the figure.

C) Results of one unit of the experiment sketched in B. The consecutive interspike intervals are measured as in A. The horizontal amplifier records the X accelerometer (marked in the figure) output. The gravity sensitive unit responds to the  $12^\circ$  tilt downwards increasingly within a given horizontal angle.

The numbers on the left of the pictures correspond to the degree of horizontal rotation starting at a conventional "0" when the frog is in the extreme left position of figure (head on left) and going toward the middle. At 0 the head is tilted downwards, at  $45^\circ$  left it goes half way between right side down and head down. Between  $40^\circ$  and  $50^\circ$  horizontal the maximum response to the  $12^\circ$  tilt is recorded.

Calibration and legends: interspike intervals (20 msec/div), marked in the figures. Horizontal:  $12^\circ$  (0,2 g = 10 divisions recorded within the field of max. response of the accelerometer).

O: ordinate (interspike intervals) and abscissa (g level) origins.

A  $12^\circ$  tilt (0,2 g) which gives full responses (decrease of the interspike interval values = increased rate of firing), does not alter the unit activity when the frog is moved full head down (see 1st record on top, left =  $10^\circ$  horizontal from O) and the response increases as the head approaches a position half

way between head down and right side down ( $40^{\circ}$ - $50^{\circ}$  horizontal from 0).

The unit response only covers therefore  $70^{\circ}$ - $80^{\circ}$  of horizontal angle: at the center of the field it reaches saturation at approx. 0.04 g ( $2.5^{\circ}$  vertical,  $40$ - $50^{\circ}$  horizontal). Outside the field no change is observed in the interspike interval values (reciprocal of the firing rate) although the cilia must be bent in the presumed inhibitory direction.



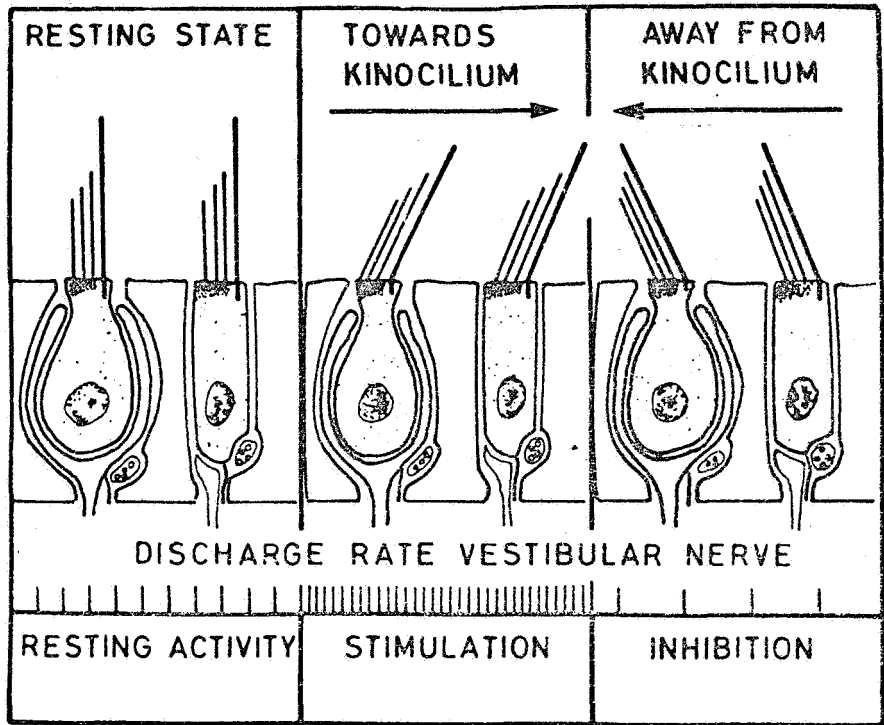
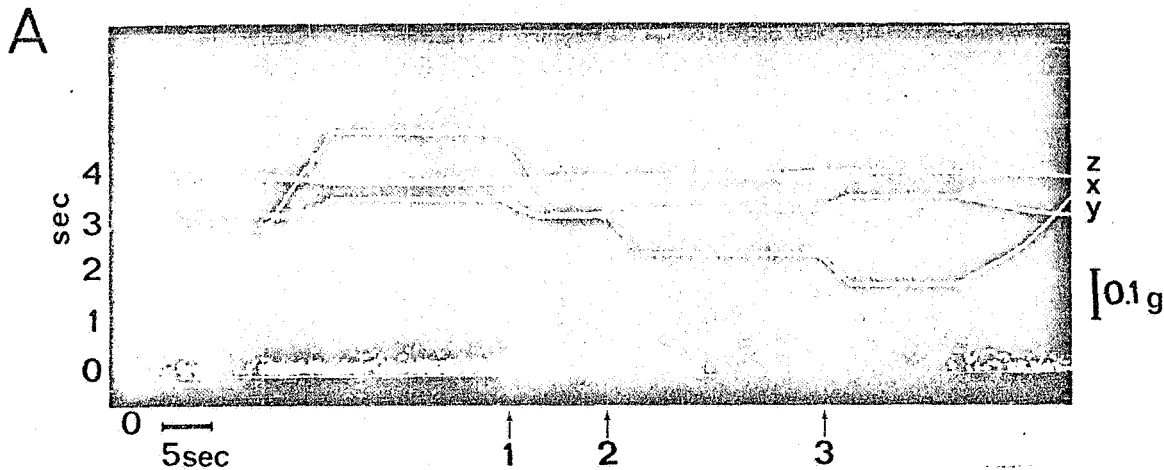
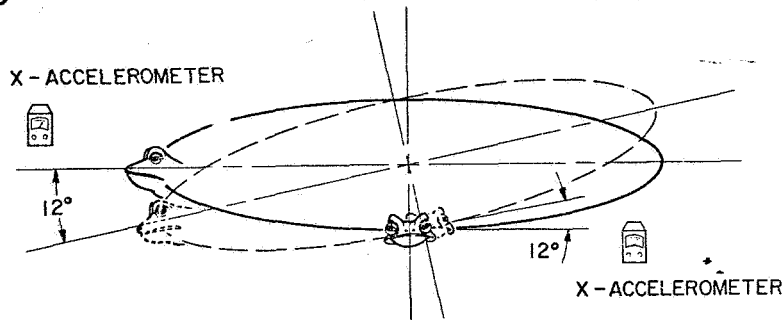

Fig. 62



**B** MAPPING OF A SINGLE OTOLITH UNIT



THE ANIMAL IS TILTED BY THE SAME ANGLE ( $12^\circ = .2g$ )  
AND THE SAME VELOCITY, IN DIFFERENT POSITIONS  
ON THE HORIZONTAL PLANE (INDICATED IN DEGREES)

**C** MAPPING OF ONE OTOLITH UNIT

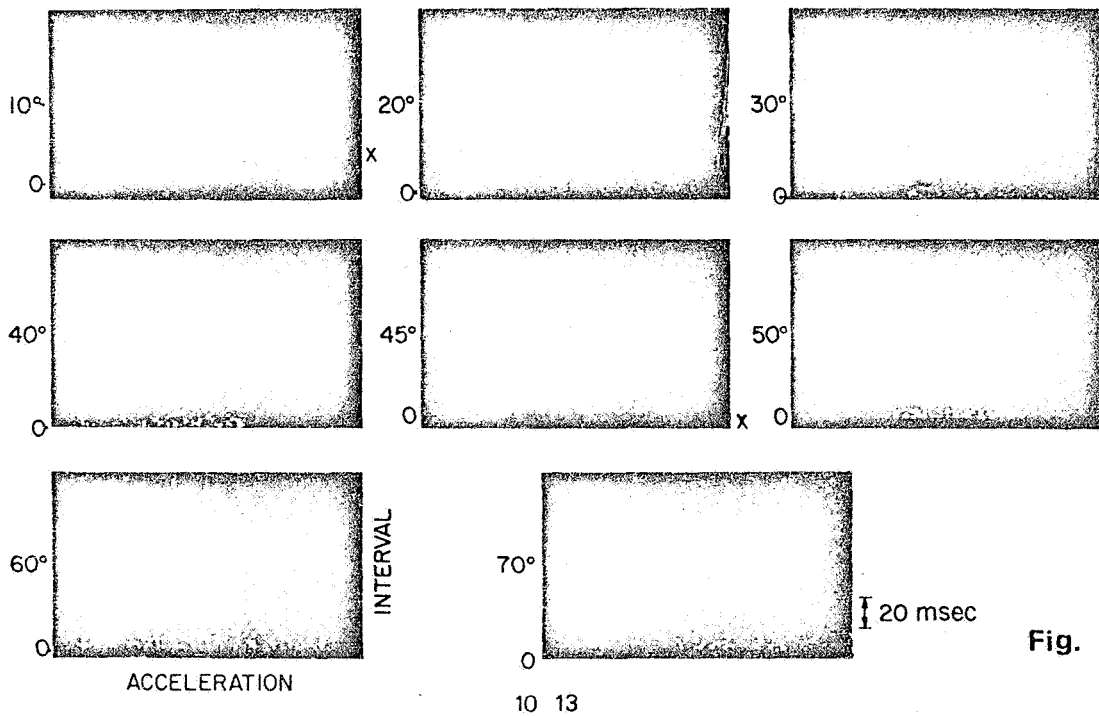

**Fig. 63**

## SECTION 11

### OBSERVATION OF THE GENERAL IMPACT OF THE CHANGES OF THE SINGLE PRIMARY NEURONS ACTIVITY ON THE FUNCTION OF THE VESTIBULAR ORGAN AS A WHOLE AND RELATED BODY SYSTEMS

If we consider the vestibular organ as a whole and if we think that the data obtained on very few units might be representative of the behaviour of all the units then we are dealing with an organ the spontaneous activity of which is oscillating slowly from peak values well above and low values well below the normal rate of firing at rest. Although the study of only three units might be considered insufficient the fact that the periods and the trend of the changes seem to be approximately the same within a certain limit and that such event takes place not only for two opposite vestibules of the same animal but also in a different animal might support the above expressed point of view. There are two factors that have to be considered in trying to explain this peculiar behavior. First, the otolith membrane and related jelly structure are without any load during free fall and, therefore, they might tend to float in all directions in a much freer way than in the gravitational field in which the mass of the otolith exerts a pressure and, therefore, a pull on the supporting structure. This fluctuation might in turn modulate the activity at rest. The second element is that the high activity in the organ on earth due to those units that are stimulated more or less by the gravitational components might exert a controlling effect

via a feedback system of which the outgoing pathway will be the afferent and the incoming control tract will be the efferent fibers that have been described, although in a very limited number in the vestibular nerve, together with particular synaptic junctions (much granulated) on the lower part of the vestibular receptor of the frog (9, 27, & 30).

The slow rate of firing (changing with a period of nearly one day) is often interrupted by a superimposed burst of spikes that could be due to an increased sensitivity to minute stimulation following limited movement of the head or might be a primary phenomenon of which the movements are the secondary effect. The burst-like activity has been seen in one frog on one side only and therefore it introduces a functional asymmetry between the two labyrinths. The situation exists, therefore, in which a nearly simultaneous variation in the same direction is observed in the activity of the two organs placed symmetrically at the two sides of the head, whereas some additional superimposed effect is limited to one side only creating a differential input to the central analyzer. Even the change from a tonic to a phasic response happens in a different period of time in the two units of the same frog belonging to the vestibular nerves situated on the opposite side of the head and this too will create an asymmetry with a differential input on the two sides.

The output of the organ as a whole, therefore, shows a coherent periodical change with a very slow period added to a highly assymetrical and very rapid activity. This assymetry is further enhanced as a result of the general decrease of the threshold of the units so that some are able to pick up signals to which they were before insensitive, whereas some others are not. On top of this the disruption of the basic pattern existing in the 1 g gravitational field has to be considered. The result is a profound alteration of the basic output of the vestibular organ that is bound to have a significant effect both on the vestibular units and on related structures.

One last alteration has to be considered, namely, the fact that as the response to a steady rotation does not seem to change as much as the activity at rest some units in some periods of the flight show a very little contrast and a low discrimination whereas in some others just the opposite takes place. This too will determine an assymetry.

The profound changes in the output of the vestibular organ cannot fail to exert a deep impact on related systems both in the vestibule itself and in the various parts of the body which are controlled by the vestibule. The overall decreased firing rate in the first three days although interrupted by high frequency peak might be the origin of the space sickness. This might be further enhanced by the functional assymetry mentioned above. In fact if the theory that the otolith system

might in certain conditions control the semicircular canals holds true a decreasing influence of the otolith might result in an increased sensitivity of the canals and, therefore, produce the motion sickness syndrome. Even the increased sensitivity of the otolith units themselves might help in this direction as the main influence of the vestibule are taking place through two main systems: the descending tract reaching the motor neurons controlling muscle tone and posture and the vegetative system. Such controlling effect is bound to be exerted by the tonic influence of the vestibular activity at rest and, therefore, such profound changes as the one described here are bound to alter the muscle tone, the eye movement, and the activity of the vegetative system and, therefore, for instance, the cardiovascular and digestive functions. It is not possible without further experimental work to prove such an assumption but similar effects as found in 0 g can be duplicated experimentally in the laboratory and the resulting alterations studied in the related systems.

The capability of adjusting to a specific environmental change at the single unit level seems to be the most important finding of this experiment. It appears, in effect, that the single unit of a sense organ is able to slowly adjust to a change of the basic variable of its input through a prolonged trial and error process. However, this slow changing process that finally assures a normal functioning of the vestibular

organ at 0 g must result in a completely different functional equilibrium of the organ as a whole.

Examples of similar adaptive mechanisms show that changing back to the original value of the environmental variable involved might take just as long a time and provoke just as important an alteration as the previous change. Experiments performed by inverting the images in front of the eyes through appropriate lenses showed that the training period took approximately five days and that as many days were necessary when vision returned to normal by taking away the lenses (18). The adjustment of the blood composition to low  $PO_2$  in people that start living at high altitudes takes a very long period of time, up to some weeks, and the same is true for the readjustment to the  $PO_2$  value at sea level. Learning curves through conditioning in animals and man has a similar long time course as the unlearning curves for the same variable.

It is quite possible that after adjustment at 0 g, upon the return to the ground condition, an equivalent process of adjustment could be necessary: this has already been observed on other biological changes like the circulatory and blood composition, bone calcium, etc. There is some indication that this may be the case also for the vestibular apparatus from the behaviour of one of the three astronauts of the Apollo 15 flight. Irwin was subjected for three days to a sensation of disorientation in flight with the impression of being inclined by  $30^\circ$  when

lying horizontal on his couch. This impression was so strong that the couch being free to move he actually found himself, while waking up, inclined upward by  $30^{\circ}$  as if his vestibular senses did correct his posture on the wrong impression. After return to the ground Irwin had the same kind of disorientation for about seven days till it finally disappeared. Even the sensation of altered position during the flight disappeared around the fourth or fifth day. This result seems to correspond nicely to what was observed on the frog labyrinth and this brings up the problem of whether or how the observed results on the bullfrog might be applied to higher species.

In a paper by Sir E. D. Adrian (1), Nobel Prize winner for physiology, it is stated "The foregoing results have not shown any marked differences between the cat's vestibular apparatus and that of the frog or fish. There are the gravity receptors to signal the posture and linear acceleration of the head and the rotation receptors to signal turning movements, and all of them react in a manner which is consistent with the structure of the sense organs and with the reactions which it produces in the intact animal". This statement can be substantiated by anatomical and functional considerations. From the anatomical point of view work to be published by D. A. Hillman (13), University of Iowa, Iowa City, Iowa, shows throughout photographs obtained with a scanning electron microscope that the vestibular receptors of the frog are identical with the similar vestibular



cylindrical hair cell Type 2 receptors in the cat, the guinea pig and monkey (34). The only difference being that in mammals there is an additional type of hair cell, namely, the flask-shaped hair cell. This difference, however, does not apply to the fact that investigating a single unit activity we can compare successfully the mechanism of the cylindrical type hair cell of the frog and of lower and higher mammals.

In the frog the evolution from bony fishes has already been accomplished insofar as instead of a single otocone a large amount of calcium carbonate crystals exists connected together on a basal otolith membrane as it is the case in all superior species. The hair distribution on top of the hair cells follow the same polarized system; namely, a single kinocilium placed in an eccentric position in respect to a large number of stereocilia (between 60-100) assures polarization of response by the same identical setup as shown in the squirrel monkey's labyrinth. The nerve fiber junction in the two kinds of cells is the same, reaching the bottom part of the sensor cell. Tests made by Osborne in Dr. Lowenstein's Birmingham Laboratory have shown that frog's receptor cells have the same efferent controlling system demonstrated first in the guinea pig by Catherine Smith (33).

These facts demonstrate that in the frogs the cylindrical type receptors are structurally identical to the analogue cell type in all mammals, man included.

Functionally, it only takes to compare the results published by A. Rupert (31) and co-workers using the same technique in the cat that we have been using in the frog and especially the kind of response to tilt of the cat head in Figure 1, page 103, with the one published in Gravity and the Organism (11), page 266, in the frog to show the same functional characteristics, namely, a) irregular firing at rest; b) increased frequency of discharge during positive tilt; c) blocking of discharge during back tilt; polarized response, restrictive receptive field, overshooting at high speed tilt, threshold of stimulation are extremely similar in the two cases. (See also Vidal (36) and co-workers.)

Recently a work published by F. Barale (2) and co-workers from Pisa comparing the control influence of the labyrinth on postural muscles indicate a striking similarity between the frog and the cat.

There isn't any evidence in the literature of anybody having found a significant difference between the single unit mechanism of the frog and even of lower animals like fish and that of higher mammals up to man. In fact all the classical physiological work on the vestibular mechanisms both for the otolith system and the semicircular canal done by Lowenstein (21, 22, 23) as has been made on the ray and nobody disregarded it as a relevant information on the vestibular mechanism.

As a conclusion, therefore, it can be strongly suggested that limited to single unit activity the results obtained during the OFO-A flight on the bullfrog are to be taken into account even for assessing similar activities in mammals, and, therefore, on man.

SECTION 12

REPORTS TO CONGRESSES, ETC.

The results described here have been already reported in part to the following Congresses:

1. XIV COSPAR Meeting, Seattle, Washington, June 1971. "OFO Experiment Technique and Preliminary Conclusion: Is Artificial Gravity Needed during Prolonged Weightlessness?"
2. XXV International Congress, Munich July 25-31, 1971. "Spontaneous and Evoked Activity of Bullfrogs Vestibular Statoreceptors in Weightlessness. Four Units Sampled Continuously during a Six-Day Orbital Flight." and presentation of NASA Film "Orbital Frog Otolith Experiment. The Activity at Rest and the Responses to Centrifugal Accelerations of Single Vestibular Statoreceptors During 7 Days of Orbital Flight at  $10^{-3}$  G."
3. AIAA/ASMA Weightlessness and Artificial Gravity Meeting, Williamsburg, Virginia, August 9-11, 1971. "The Vestibular Space Experiment OFO-A: Some Results and Conclusions" and presentation of NASA Film "Orbital Frog Otolith Experiment. The Activity at Rest and the Response to Centrifugal Accelerations of Single Vestibular Statoreceptors During 7 Days of Orbital Flight at  $10^{-3}$  G."
4. National Physiological Congress, Palermo, September 27-30, 1971. "L'esperimento vestibolare OFO-A. Una dimostrazione a livello delle singole unità del meccanismo

del processo di adattamento fisiologico ad un nuovo fattore ambientale." and un film NASA sull'esperimento orbitale OFO-A "L'attività spontanea e risposte all'accelerazione centripeta di singoli statocettori vestibolari esposti per 6 giorni e mezzo allo stato di imponderabilità ( $10^{-3}$  max)".

Two papers are in preparation to be published by some leading journals in the physiological field.

SECTION 13  
CONCLUSIONS

13.1 TECHNICAL ACHIEVEMENTS - GENERAL APPLICATION

The experiment OFO-A 1) was completely automatic; 2) was planned in such a way to last several days, 3) was based on the recording of the action potential of single fibers of the vestibular nerve of animals kept in a true physiological condition, 4) all the environmental variables (temperature,  $PO_2$ , humidity, pressure, etc.) were carefully controlled, 5) a carefully constant proper stimulus was applied periodically according to a predetermined program that could be changed as a function of the results. It was necessary, therefore, to solve the following technical problems as nothing existed in the literature that could be used.

1. To devise a system for the recording through microelectrodes of the activity of the single nerve unit that a) could be performed in animals in good physiological condition with no narcosis and with no alteration in the central peripheral nervous system, b) was continuous from the same unit for several days with no deterioration and c) would as in a and b not be altered by the extremely high mechanical disturbances.

2. To build up an environment that maintained the animals in normal conditions from the physiological point of view both in the earth atmosphere and in space. This would also include proper monitoring of the basic parameters of such an environment.

3. To study a telemetry system that might be able to record the action potential of single units with such a minimum distortion as to increase the well known shape and general characteristic of the action potentials themselves.

4. If the flight was successful several hundred of hours of information both of the single nerve units and of the EKG would have been obtained. Owing to the fact that the experiment was an absolute first and the conditions applied to the vestibule were never tested before some unforeseen results might be obtained. Consequently, it was necessary to be able to switch the experimental program to different routines during the experiment according to the results that were previously achieved. To this end it was necessary to devise a data reduction program that allowed:

a) to perform an immediate analysis during the flight of sufficient enough number of data that were incoming continuously from the receiving stations and to achieve clear enough conclusions in order to determine how the flight program had to progress. This required a quick look analysis comprehensive enough to give significant information and contained in a limited enough time as to be able to provide the plan for the continuation of the experiment while the experiment was in progress.

b) As the experiment was necessarily limited as far as the number of units explored and very costly, therefore, not easily repeatable, it was necessary to devise a data reduction

and analysis program that will extract all possible information from the acquired data and that within a reasonable time.

All these problems have been solved satisfactorily as it is shown by the complete success of the experiment and of the data analysis that followed it and that is herewith reported. Point 1, namely the recording technique with neutral buoyancy microelectrodes has been described in the enclosed Reprint A and later modified for the experiment according to the new requirements of the Scout launch as indicated in Section 4. For the success during the qualification tests for linear acceleration vibration see Section 6. The final test of the success during the flight proved this technique unique in the fact that it answered all the questions, namely, it was able to withstand up to 10 g's linear acceleration plus up to 3 g's of centripetal acceleration during the spinning of the fourth stage and the superimposed high level sine vibration not only without losing the fiber from which the recording took place but to the point of allowing continuous recording from the same fiber during lift off. Some minor problems existed in the fact that during the actual firing of the thrust motor the activity of the nerve increased to a point that additional units activity masked the original action potential. However, it is hoped that the special computer program provided for the purpose of recognizing a given action potential in between several others might allow analysis of data even during the actual firing



of the rockets. Anyway it is quite feasible to build more discriminating electrodes for future possible applications now that the problem has been identified and tests provided for achieving a high enough discrimination.

During simulated mission on the ground recording up to 17 days from the same unit has been obtained and the actual recording of the unit for the flight was started two days before launch and continued till the frog deteriorated in health probably due to exhaustion of the power of the spacecraft. Even in this case at least eight days of the same single units activity was obtained. The possibility of implanting electrodes according to the routine described in Section 5 allows the animal complete recovery before the data are considered valid. In fact even the surgically provoked opening in the skull in order to implant the microelectrode is after two or three days sufficiently protected by a new formation of tissue as to completely enclose the cavity in which the medulla and the vestibular nerve are situated: consequently, the original conditions are restored and as the days pass such protection thickens and becomes partially ossified. In the simulated mission that lasted beyond 12 days inspection showed a nearly completed reconstruction of the bone structure which although still soft was quite sufficient for an efficient protection of the nervous tissue underneath. Histological evaluation of the condition of the vestibular nerve showed that after two or

three days swallowing due to handling of the nerve itself completely disappeared and the material used for the micro-electrode construction appeared to be completely neutral as far as the reaction of the tissue was concerned. Work now in progress in Dr. Lowenstein's laboratory is studying the lesion produced by the microelectrode with the electron microscope technique in order to further examine possible reaction of the tissue. This work is not yet completed and the results will be transmitted to NASA as soon as available at a later date.

Even from the functional point of view the lack of any alteration with time of the action potential parameters seems to indicate that no functional injury was observed even at the level of the nerve fiber from which the recording took place. This was very likely the one nearest to the micro-electrode tip. The inspection of the animal after the end of a prolonged simulated mission on the ground has shown that no visible alteration both morphological and functional appeared. The parameters of both the EKG and the single fiber action potentials after the high acceleration and vibration due to the firing of the third stage during coasting did not show any significant modification. Moreover, no mechanical artifact was shown during the actual firing of the rocket (Fig.25 ). These results seem to prove that the microelectrode technique in every way satisfied the requirements.

The FOEP proved to be a perfect solution for maintaining physiological condition in an animal underwater. It will provide a suitable tool for new experiments both in space and in the laboratory performed on fish or amphibians, namely, animals that live in water in which the environmental conditions are carefully controlled and monitored. However, some inconveniences existed. The water circulation system introduced an unwanted artifact as the water pump vibration at a certain stage was too strong and although additional information was provided by the fact that some units reacted to it it did not satisfy the original requirement of no mechanical stimulus for all the vestibular unit. The centrifuge that provided the centripetal acceleration for the stimulation of the units was not completely satisfactory. The gear system introduced irregular vibration that made the analysis of data more difficult to interpret. These were the only parts that were not completely satisfactory. The life supporting system performed very well and the monitoring of the different parameters provided all the necessary information. The telemetry system allowed the recording of the action potentials with such a minor distortion that even in the laboratory it is difficult to obtain signals of the same high quality (see Fig.23 ). This too is an absolute first and can be used for a number of scientific applications.

Both the quick look program and the final data reduction program allowed most of the required information to be achieved. This work is constantly progressing. Many original programs have been studied and tested satisfactorily. A team has been put together that continues this kind of work on computer application in biological applications and very valuable experience was achieved in the field. This work is due to the fact that for the first time hundreds of hours of activity from the same unit were available and, therefore, a number of tests could be made for determining both the usefulness of the programs themselves and the repeatability of the biological information in stationary condition over a long period of time, namely, containing several cycles of 24 hours.

The points 1-4 above mentioned and the relative discussion provide the solution of a number of problems never before achieved that might open a new path in the physiological research. In fact they allow the investigation of the single unit activity of any biological system the function of which is accompanied by action potentials a) in stationary physiological condition, b) in an environment with constant parameters within predetermined limits and c) for a long enough period of time to include several 24 hour cycles. All this is possible now without any difficulty involving movements both spontaneous of the animal or due to the environment. Using the new implantable biotelemetry systems (8) it is possible to

allow the animal to go free in a large controlled environment with no constraint and to record at a distance in these conditions the activity of single units of any system showing electrical pulses. It has to be emphasized that up to now none of this was possible and the recording of single unit activity was only feasible with a completely immobilized animal that underwent surgery immediately before the recording. The implant of microelectrodes or micropipette only allowed recording for some minutes and even methods described in the literature (14) that applies chronically in the cat or other mammals a device that allows the implanting of a microelectrode through a remote control system does not really avoid the fact that the recording is still performed after an acute implant with the tissue injured by the microelectrode penetration and no time allowed for recovery. Besides even in this case the recording is limited to a few minutes and there is no way of avoiding displacement even for minor mechanical impacts.

It is self-evident that the investigation of the electrical pulses at single unit level as a function of time and as a response to a voluntary or imposed environmental activity of the animal, after its complete recovery from the experimental surgery, is a new and important field of the physiological research. With this technique it will be possible to study in several consecutive cycles of 24 hours the changes both spontaneous or due to the experimental routine of the single unit activity

of sense organs, of different centers of the central nervous system, of the central analyzer like the specific and aspecific center of the reticular substance. This can be done by implanting a number of microelectrodes in related nervous centers and studying the prolonged biorhythm of, for instance, the cardiovascular nervous center, the different parts of the hypothalamus, the reticular substance, etc., and studying the response of single units of the substrates for several days while the animal is subjected to a number of environmental conditions or stresses. This technique allows completely automatic experiments in an environment that can be totally controlled. In fact it is possible to investigate single unit activity in animals placed in large rooms or containers completely free to move. A miniaturized implantable telemetry system with several channels is the only additional apparatus necessary for performing such an experiment and the experience obtained through the telemetric link between the OFO-A capsule and the ground provided a series of parameters concerning the specifications of such a transmitter.

As a conclusion it can be said that the OFO-A experiment over and beyond its specific results in the field of the vestibular physiology and in space biology provided new remarkable possibilities in the field of physiological research in general.

### 13.2 THE BASIC RESULTS ON VESTIBULAR PHYSIOLOGY

To assess the contribution that the experiment OFO-A provided for basic vestibular physiology it has to be taken into account both the preliminary work done in the laboratory with simulated missions and the results of the OFO-A mission proper. The main point is that for the first time it has been possible to record the activity of a nerve fiber connected with the vestibular receptors of different kinds in a closed loop system, namely, with the animal intact except for a minor limitation of the animal freedom of movement due to the cutting of the main nerve connection of the four limbs. This was not necessary for the recording of the vestibular activity per se but to avoid movement of the head following kicking and contraction of the limbs. In fact to be sure that the stimulation of the labyrinth both in the laboratory on the tilt table and in the capsule during centrifugation corresponded to the imposed mechanical change the head had to be firmly fixed. It was found that this was practically impossible if the frog has the freedom of its leg movements especially the posterior ones but except for this all the systems of the frog were in physiological condition.

The main results of the contribution to the vestibular physiology are summarized in the three enclosed reprints (B, C and D) and further up-to-date information will be given in two articles that are now in preparation. One of the most important

points is that it requires a certain time from a minimum of one hour to a maximum of three to four hours before the activity recorded from single nerve fibers through the tungsten micro-electrode stabilized to a stationary state. Once this is achieved and a given high enough number of intervals are considered in order to provide statistically significant samples, all the parameters that can be used as an index of the physiological activity of the unit indicate a steady condition with no detectable trend. If such a trend develops, and normally corresponds to a progressively decreasing rate of firing, this is due to the deterioration of the animal as a whole. When the physiological conditions are stationary even the index of the single unit activity is stationary, namely, both the average and the variability of the firing is contained in a given limit. The indices that have been taken as significant to define the single unit vestibular activity are the minimum interval, the average frequency, and the interspike interval distribution as represented by the interspike interval histogram. Another point that appeared quite clearly from the study of about 500 vestibular units so far had shown that all receptors both responding to vibration or to angular acceleration show a resting discharge even if originally they appeared quiescent. These units show a typical slow resting discharge. A third point which in a way seems to be the consequence of the previous one is that in an animal in which the physiological



conditions are maintained good the vestibular nerve is extremely active. This was confirmed by the fact that after a successful implant of a microelectrode in which a single unit was quite evident on a nearly silent background, after 24 hours or 48 hours an additional background activity appeared that could be detected at a lower amplitude and the general pattern of the recording remained thereafter constant. This can be interpreted as an indication that the handling of the preparation, the recent surgery, possibly slight impairment in the general condition will effect the vestibular activity blocking some units reversibly. Allowing enough time the recovery both of the local and general condition will restore the normal activity of the vestibular organ end nerve.

Nearly all the already known information achieved with acute experimentation on the vestibular receptor has been confirmed even during the long range recording. One point that appeared quite clear during this research work was that the gravity receptors respond quite easily to vibration. This is a somewhat controversial point but it is difficult to object to the results as presented in Reprints C and especially D. It has to be emphasized that during these experiments the vestibule was not touched at all and was completely closed within the normal situation and that even the opening in the palate at the time of the experimentation was sufficiently closed by a new tissue formation to provide a nearly physiological situation.

The lack of mechanical artifact during the vibration and especially the fact that even a high g thrust and vibrations as during the lift off was not able to provoke not only the displacement of the electrode but mechanical artifact indicates that no alteration of the nerve at the implant site was likely. A last point is that there seems to be less variability in a response to a control stimulus in stationary condition when all the environmental variables are controlled than it is reported in the literature.

A large amount of data have been collected during the seven years preceding the launch and during the launch itself. These have been analyzed only partly so far and the analysis continues so that further data will be obtained and some uncertain results will be confirmed or disproved going through the existing acquired information. The main results in the field of the vestibular physiology achieved during the flight are as follows.

1. An environmental change involving the basic input of the sense organ is able to modify over a long term both the activity at rest and the response to stimulation of a vestibular unit.

2. These changes appear to be the result of the effort of a servo mechanism, nervous or humoral, to adjust the organ to the new condition by a process of over-correction. Normalization is finally achieved even at the single unit level.

3. The dissociation between the tonic and the phasic response of the receptors sensitive to gravity seems to support the idea that the two responses are due to two different mechanisms.

4. The alteration in the activity at rest that seems to be largely independent from the alteration of the response to an appropriate stimulus confirms the role of the activity at rest which cannot be considered white noise. In fact the changes of the activity at rest increase or decrease the differential between the baseline and the response to the stimulus of the receptor, from zero to a maximum, in a way which is independent from the input. It seems, therefore, that the general activity constitutes a kind of set point on which the evoked responses are based.

5. If the activity at rest is the vehicle through which a tonic control is maintained on related organs like the spinal motor neurons and the vegetative system, the fact that it can change as a function of some environmental variable introduces a new parameter in the relationship between the vestibule and the related organs themselves.

6. The capability of the vestibular receptors to adapt to a change in the environment seems to indicate a better adapting mechanism than the one based on a compensatory activity of the analyzers or of the central nervous system in general. On the other hand, such a complete adaptation reaching the

receptor level indicates such a profound change that return to the original condition requires an equally complex process.

7. The fact that normalization takes place slowly even at single vestibular unit level indicates the existence of a slowly working process of the same kind as training or learning.

All these points that are mentioned here are in fact very important fields of future research that are made possible by the technique of prolonged recording developed for the OFO-A experiment. As an example, to study the impact of the observed changes of single units activity on the function of the organ as a whole, a program of research is about to start in this laboratory using the new acquired capability of recording for several days and investigating the receptor fields of the units by exploring the response of several gravity sensitive receptors during slow tumbling covering a  $360^{\circ}$  solid angle. To avoid overshooting and to avoid after effect the time required for each such exploration has been calculated as 72 hours.

### 13.3 CONCLUSIONS IN RELATION TO SPACE FLIGHT

Three main conclusions can be made in relation to space flight.

1. There is no doubt that, as it was very likely, the vestibular organ at single unit level is subjected to a profound change in its activity as a result of going from 1 g to 0 during the orbital mission. On the contrary it does not

seem that the transient from high g during lift off and 0 g is in itself a factor for a significant alteration of the vestibular organ. This is shown by the data analyzed during lift off of the OFO-A experiment.

2. Through a slow process that lasted up to more than 100 hours the single units adjusted to the new weightlessness condition nearly completely both as far as their basic activity at rest is concerned and their response to movement of the head as simulated by the centrifuge spinning during the OFO-A mission. Both dynamic and static responses returned to normal.

3. Such a complete adaptation very likely requires a readjustment going back to the 1 g field.

The disappearance of alteration in the end organs after four to five days signifies from the practical point of view that the situation is stable as far as the functioning in space of a living organism down to the periphery level. The alteration in the first days might explain the instances of space sickness that has been reported even recently in the Apollo 15 flight. The very possible need for a period of adjustment on the ground after prolonged mission should be taken into account while planning the prolonged stay in space and the transfer of personnel from earth to the space labs that are now being prepared for the near future.

## SECTION 14

### PROPOSAL AND JUSTIFICATION FOR THE NEXT FLIGHT

Although answering to a number of problems connected with the vestibular behaviour during 0 g conditions, namely, a true alteration at the single unit level followed by adjustment to the new situation until a normal activity is restored, some important questions remain unanswered and some new problems need to be solved. In fact,

a) the time course of the adaptability curve of the units studied varied considerably although all of them followed the same general trend. This is due to the insufficient duration of the mission time that allowed to observe complete recovery in only two of the six units studied, the others being in a more or less advanced stage of the same process. We can calculate that to complete the cycle to total normalization some 10-12 days would be needed.

b) Although a normal behaviour could be observed in at least two units for 10 and 20 hours respectively, the possibility that other cycles of alteration might appear with a more prolonged exposure to 0 g cannot be ruled out. This too can be solved only by a more prolonged mission.

c) The very fact that adjustment to the new 0 g condition takes place through a prolonged slow process lasting several days indicates that a profound modification in some slow changing process takes place reaching a completely different

functional equilibrium for the vestibular organ at 0 g condition. Examples of similar adaptive mechanisms show that changing back to the original value of the environmental variable studied might take just as long a time and provoke just as important an alteration as the previous change. Experiments performed by inverting the images in front of the eyes through appropriate lenses showed that the retraining period for making the subject capable of normal visual responses took approximately five days and that as many days were necessary when vision returned to normal by taking away the lenses (18). The adjustment to low  $PO_2$  value at sea level. Learning curves through conditioning in animals has a similar long time course as unlearning curves for the same variable.

It seems, therefore, that the most important problem that remains to be investigated is the vestibular behaviour at the single unit level when the reverse step is taken from 0 to 1 g. This is particularly important as the coming space laboratory will involve missions in which ordinary subjects will be subjected to 0 g conditions for several weeks (and therefore the vestibular apparatus will adapt to such a condition) and then brought back to earth. It seems very likely that they will undergo a further adjustment and it might be that, as it happens for the circulatory system, going from 0 to 1 g will be more difficult than the reverse.

d) An additional problem of interest will be to investigate the mechanism underlying the adjustment process assuming as a working hypothesis that, whatever the primary factor, the terminal pathway for such an adjustment is the efferent system reaching the vestibular receptors.

The first three problems can be investigated by a second flight (OFO-B) increasing the duration of the orbital conditions to a four-week period. This would allow the following investigations. First, by allowing the 0 g condition to extend for 15-20 days with extended periods of no stimulation through the centrifuge cycle, it will be learned whether the units reach a steady state adjustment or not, as it will be possible in this way to have several days of stationary activity after the end of the changes produced in the first 10-12 days. A side effect of such an event will be the possibility of comparing the circadian rhythm already observed during simulated mission on the ground for several days with a similar, or different, rhythm in orbit as far as the nervous activity is concerned. This is by itself an important achievement. Second, if the units activity stabilize on the newly reached equilibrium reentry might be simulated and the effect of return to the 1 g gravitational field studied by respinning the spacecraft in such a way as to apply at the vestibular level of the two frogs a centripetal acceleration equivalent to 1 g. This method, besides requiring little or no modification in the



existing hardware, has the advantage of avoiding the intervening effect of the high stress of a real reentry before the investigation could be made comparatively in the earth gravitational field. In this way it will be possible to study the reversion to 0 from 1 g condition for a long enough time to supply valuable information on the problem.

As far as the fourth problem is concerned, it depends on the developing of a technique that will allow the experimenter to interrupt either definitely or reversably the efferent pathway or the efferent terminals reaching the vestibular receptors on one side only. In this case the two sides might be compared to demonstrate or disprove the working hypothesis described above. But this is considered a secondary problem related more to basic physiology than to the space flight proper and, therefore, even if the appropriate method could not be developed, an OFO-B experiment remains necessary.

PRECEDING PAGE BLANK NOT FILMED

BIBLIOGRAPHY

1. ADRIAN, E. D. Discharges from vestibular receptors in the Cat. Journal of Physiology, 101:389-407, 1943.
2. BARALE, F., N. Corvaja and O. Pompeiano. Vestibular Influences on Postural Activity in Frog. Arch. ital. Biol., 109:27-36, 1971.
3. BASTERT, D. Respiration and circulation of the blood of Rana esculenta and Rana fusca in connection with their diving habits. Tijdschr. Ned. Dierk. Ver., 1:98-104, 1929.
4. CYMERMAN, A. and S. F. Gottlieb. Effects of increased oxygen tensions on bioelectric properties of frog sciatic nerve. Aerospace Med., 41(1):36-39, 1970.
5. de GRAAF, A. R. A note on the oxygen requirements of Xenopus laevis. J. Exptl. Biol., 34:173-176, 1957.
6. DOLK, H. E. and N. Postma. Über die Haut-und Lungenatmung von Rana temporaria. Z. Vergleich. Physiol., 5:417-444, 1926.
7. ENGSTRÖM, Hans. The First-Order Vestibular Neuron. The fourth symposium on the role of the vestibular organs in space exploration, Pensacola, Florida, 1968.
8. FRYER, T. B. Implantable Biotelemetry Systems. NASA SP-5094, 1970.
9. GLEISNER, L. and N. G. Henriksson. Efferent and afferent activity pattern in the vestibular nerve of the frog. Acta Oto-Laryng. Suppl. 192:90-103, 1963.
10. GUALTIEROTTI, T. Analysis of single vestibular responses. In Technical and Biological Problems of Control - A Cybernetic View, edited by A. S. Iberall and J. B. Reswick, 1968.
11. GUALTIEROTTI, T. The gravity sensing mechanism of the inner ear. In Gravity and the Organism, edited by Solon A. Gordon and Melvin J. Cohen, The University of Chicago Press, 1971.
12. GUALTIEROTTI, T. and S. J. Gerathewol. Spontaneous firing and responses to linear acceleration of single otolith units of the frog during short periods of weightlessness during parabolic flight. The first symposium on the role of the vestibular organs in the exploration of space, Pensacola, Florida, NASA, SP-77:221-229, 1965.

13. HILLMAN, D. A. Science. In press.
14. HUBEL, D. H. Tungsten micro-electrode for recording from single units. Science 125:549-550, 1957.
15. JORDAN, H. J. La régularisation de la consommation d'oxygène chez les animaux à tension gazeuse alvéolaire variable. Arch. Neerl. Sci. IIIC 14:305-314, 1929.
16. JULLIEN, A., J. Ripplinger, J. Cardot, J. Bagle and M. Tisserand. Influence de la ligature des troncs pulmo-cutanes et de leurs branches sur la survie de la Grenouille et possibilité de rétablissement de la circulation apres arret. Compt. Rend. Soc. Biol. 152:1161-1163, 1958.
17. KIRKBERGER, C. Temperaturadaptation der Sauerstoffbindung des Blutes von *Rana esculenta* L. Z. Vergleich Physiol. 35:153-158, 1953.
18. KOHLER, J. Sitber. Oester. Adad. Wiss. 277:118, 1951.
19. KROGH, A. On the cutaneous and pulmonary respiration of the frog. Skandin. Archiv. XV, 1904.
20. LEIVESTAD, H. The effect of prolonged submersion on the metabolism and the heart rate in the toad (*Bufo Bufo*) Arb. Univ. Bergen, Mat.-Naturv. Ser. No. 5, 1960.
21. LOWENSTEIN, O. The functional significance of the ultra-structure of the vestibular end organs. Second symposium on the role of the vestibular organs in space exploration, NASA SP-115, 1966.
22. LOWENSTEIN, O. and Land. J. Physiol. 110:392-415, 1950.
23. LOWENSTEIN, O. and T. D. M. Roberts. J. Physiol. 110: 392-415, 1950.
24. MACELA, I. and A. Seliskar. The influence of temperature on the equilibrium between oxygen and haemoglobin of various forms of life. J. Physiol. (London) 60:428-442, 1925.
25. MARGARIA, R., T. Gualtierotti and D. Spinelli. Protection against acceleration forces in animals in water. The J. of Aviation Medicine, Vol. 29:433-437, 1958.
26. McCUTCHEON, F. H. Hemoglobin function during the life history of the bullfrog. J. Cellular Comp. Physiol. 8:63-81, 1936.

27. OSBORNE, Michael. Birmingham Laboratory. In press.
28. POCZOPKO, P. Further investigations on the cutaneous vasomotor reflexes in the edible frog in connection with the problem of regulation of the cutaneous respiration in frogs. Zool. Polon. 8:161-175, 1957.
29. PRECHT, W., R. Llinas and M. Clarke. Physiological responses of frog vestibular fibers to horizontal angular rotation. Exp. Brain Res. 13:378-407, 1971.
30. ROMA, F. and S. Iurato. Fiber analysis of the statoacoustic nerve in the bullfrog. Personal communication.
31. RUPERT, A., G. Moushegian and R. Galambos. Microelectrode studies of primary vestibular neurons in cat. Experimental Neurology 5:100-109, 1962.
32. SERFATY, A. and J. Gueutal. La résistance de la grenouille a l'asphyxie lors d'une immersion prolongée. Compt. Rend. Soc. Biol. 137:154-156, 1943.
33. SMITH, Catherine. Third symposium on the rôle of the vestibular organs in space exploration, Pensacola, Florida, NASA SP-152:183-203, 1967.
34. SPOENDLIN, H. H. Ultrastructural studies of the labyrinth in squirrel monkeys. First symposium on the role of the vestibular organs in space exploration, Pensacola, Florida, NASA SP-77:7-22, 1965.
35. TASAKI, I. and C. S. Spyropoulos. Influence of changes in temperature and pressure on the nerve fiber. In Influence of Temperature on Biological Systems, edited by F. H. Johnson, Baltimore, Waverly Press, 209-220, 1957.
36. VIDAL, J., M. Jeannerod, W. Lifschitz, H. Levitan, J. Rosenbert and J. P. Segundo. Static and dynamic properties of gravity-sensitive receptors in the cat vestibular system. Kybernetik, Band IX. Heft 6, December 1971.
37. WOLVEKAMP, H. P. Untersuchungen über den Sauerstofftransport durch Blutpigmente bei Helix, Rana und Planorbis. Z. Vergleich. Physiol. 16:1-38, 1932.
38. WOLVEKAMP, H. P. and J. M. Lodewijks. Über die Sauerstoffbindung durch Hämoglobin vom Frosch (*Rana esculenta* und *Rana temporaria*). Z. Vergleich. Physiol. 20:382-387, 1934.

Books:

39. Physiology of the Amphibia, edited by John A. Moore, Academic Press, New York and London, 1964.
40. Underwater Physiology edited by C. J. Lambertsen, Academic Press, New York and London, 1971.

## A NEUTRAL BUOYANCY MICRO-ELECTRODE FOR PROLONGED RECORDING FROM SINGLE NERVE UNITS

TORQUATO GUALTIEROTTI<sup>1</sup> AND PEARL BAILEY

*Neurobiology Branch and Instrumentation Division, Ames Research Center, NASA, Moffett Field, Calif. 94035 (U.S.A.)*

(Accepted for publication: December 20, 1967)

A new electrode has been developed to allow continuous recording from the same single neurone or nerve fibre for a long period of time, up to 2-5 days. In addition, the electrode is designed to withstand sudden and large movements and even high intensity vibration (Fig. 1) and acceleration without being displaced and without damage to the nerve unit involved.

Current micro-electrode techniques do not fulfil these specifications. In the chronic implantation method described by Hubel (1959), and modified later by Everts (1960), a positioner for a hydraulic micro-manipulator is chronically anchored to the animal's skull, but the micro-electrode is acutely implanted, since it is inserted for each recording. A number of undesirable conditions are thus eliminated, e.g., drugs, lesions, restraint, etc., but it is basically an acute technique requiring delicate handling and avoidance of abrupt movements of the animal (Bizzi *et al.* 1964).

The electrode shown in Fig. 2 consists of a very short ordinary tungsten micro-electrode (Hubel 1957) attached to a piece of polyethylene tubing. The enclosed air pocket reduces the over-all density to that of an isotonic solution. To avoid a torque momentum during acceleration, the tubing is counterweighted to bring the centre of gravity towards the geometrical centre of the electrode. Also, the initial leading off wire is small and flexible so that restraint on the electrode is minimized.

The density compensation improves by a factor of 10 to 1 the capability of the electrode to withstand high acceleration without displacement. Tests performed on a centrifuge using the small floating tungsten micro-electrode attached to the 25  $\mu$  platinum wire, without polyethylene tubing and the counterweight, indicated that displacement could take place at 2-3 g of linear acceleration instead of at 15-20 g. The same applies to vibratory acceleration in all three directions of space: testing performed with frequencies from 2 to 600 c/sec showed a resonant band between 70-100 and 250 c/sec. In this range the upper limit before displacement was lowered to 10-12 g.

<sup>1</sup> Present address: Istituto di Fisiologia Umana, via Mangiagalli 32, Milan, Italy.

The micro-electrode with its buoyant component is assembled as follows. A piece of 130  $\mu$  tungsten wire<sup>2</sup>, which has been machine sharpened to a 3-14  $\mu$  tip and a 0.89 mm  $\pm$  0.025 to 0.012 mm taper, is rinsed and brushed in ethyl acetate. An insulated 25  $\mu$  platinum wire is attached to the tungsten with conductive epoxy resin at 1.6 mm from the tip; the tungsten is cut at the required length, usually 1.75 mm; the conductive epoxy resin is coated with Epoxylite to protect and add bulk to the junction; the tungsten with its leading off wire is inserted into one end of a polyethylene tube and bonded to it with Epoxylite No. 223; the polyethylene tubing is progressively cut until enough buoyancy is assured by the air pocket to compensate for the weight of the electrode and the counterweight; the other end of the tubing is plugged with Epoxylite No. 223 and the counterweights; the platinum wire is passed out of the tubing between the counterweights and the inside wall of the tubing<sup>3</sup>.

A drop of paraffin with a meniscus of 0.05 mm is melted on to a copper wire handle. The handle is lowered, paraffin downwards, to the counterweighted end of the electrode where it is fused to the electrode itself.

<sup>2</sup> For finer work a 50  $\mu$  tungsten wire can be used.

<sup>3</sup> All the materials indicated here and in Fig. 2 can be obtained from the following sources in the United States: Epoxy 3021: Epoxy Products Co., Division of Allied Products Corp., 166 Chapel St., New Haven, Conn. 06513.

Epoxylite No. 223: Epoxylite Corp., 1428 N. Tyler Av., P. O. Box 3397, South El Monte, Calif.

SR4: Baldwin Lima Hamilton Corp., Electronic Div., 42 Fourth Av., Waltham, Mass. 02154.

Thinner for SR4 is MEK (methyl-ethyl-ketone).

Stoner-Mudge protective coating No. S-986-015 clear vinyl: Stoner-Mudge, Westhall at Ohio River, Pittsburgh, Pa.

Thinner for Stoner-Mudge is 40% toluene, 60% MEK.

Platinum wire (0.001" diameter, Epoxy Enamel): Western Gold and Platinum Co., 525 Harbor Bld., Belmont, Calif.

Tungsten wire (pure tungsten 99.95%, fine ground, hard drawn, 0.002" diameter  $\pm$  1.5%): Sylvania Electric Products Inc., Chemical and Metallurgical Div., Hawes St., Towanda, Pa.

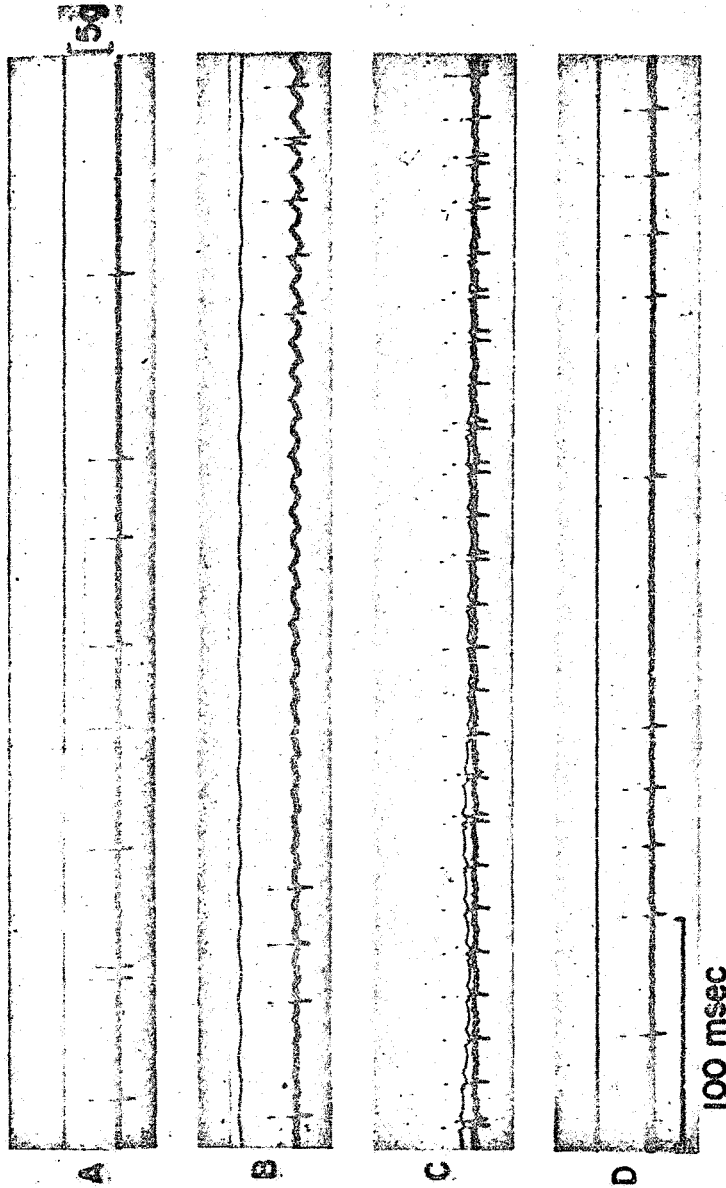

Fig. 1

Otolith unit. Action potential recorded from a fibre in the vestibular nerve during a  $55 \text{ c/sec}$  vibration test. The animal (bullfrog) was partially paralysed by cutting all the branches of the brachial and lumbar plexi. The vestibular nerve was exposed through a hole trephined in the palate and the micro-electrode was implanted according to the technique described in the text. The roof of the mouth was then reconstructed with dental cement, maintained in place by two metal structures screwed in the bone at the sides of the hole and included in the cement. As a result the artificial cavity in the bone was closed and water-tight. The animal was then placed in a cylinder filled with water, in which it floated. Its head was fixed to the endcap of the container by a nylon head clamp. The container was attached to a shaker providing vibrations of various frequencies and intensities.

Upper trace: output from accelerometer indicating vibratory acceleration integrated to produce a linear deflection proportional to the intensity of the vibration at a given frequency (downwards, calibration in figure). As the accelerometer was applied to the container, secondary vibrations of its mass produced some irregularity in the record resulting in distorted wave forms: the reading, however, was made on the linear deflection: the values indicated below were controlled on the instrument panel of the shaker. In the case in the figure the vibration was nearly transverse in respect of the electrode. Lower trace: action potential from the vestibular nerve. A, spontaneous firing of the unit previous to the test and D, immediately after it. B and C, vibration of increasing intensity reaching more than  $5 \text{ g}$  at the end of C on right. The baseline shows some oscillation, not synchronous with the basic frequency of the shaker, especially in B, but no significant alteration of the recording capability of the electrode. Note that the extremely high stimulation provoked occasional double firing of the unit (C, particularly evident on the right). At this point the firing became synchronous with the oscillation. Immediately after the test the vestibular activity appeared to be normal.

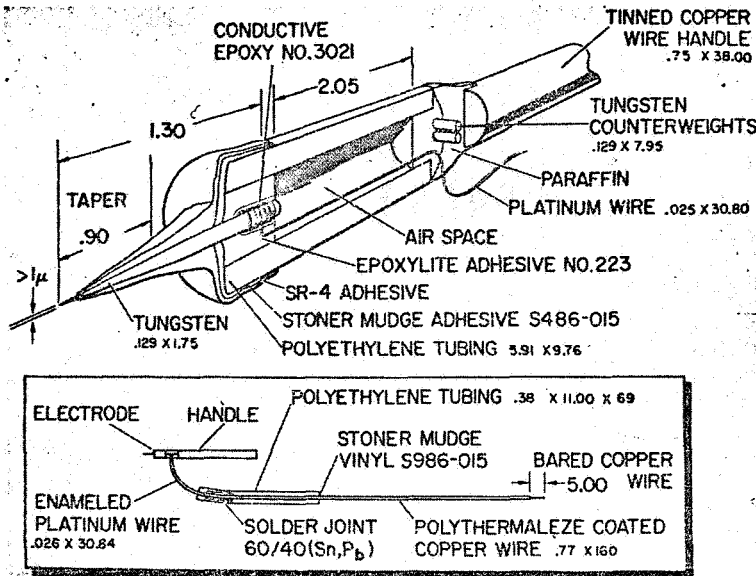

Fig. 2

Diagram of the neutral buoyancy micro-electrode. All measures in mm. For explanation and sources of materials see text.

The tungsten part of the electrode is then sharpened and insulated according to Hubel's technique (Hubel 1957) and tested for leakage. The platinum off wire is soldered to a heavier copper wire which is insulated with tubing and vinyl. This leaves approximately 30 mm of unrestrained platinum between the tubing and the electrode.

When checked for density in 0.65% saline these electrodes were found to stay suspended in a horizontal position and to rotate freely on their vertical axes with 0.25-1.0 mm length of platinum wire extending from the tubing.

The micro-electrode is implanted in the usual way with a hydraulic micro-manipulator: if it is not completely enclosed in the tissue, the part of the electrode sticking out from the structure is covered by a blob of agar which links mechanically the electrode to the nerve structure. After the experimenter is satisfied that the recorded biological responses are adequate, the electrode is released from the handle by passing current through a coil surrounding the upper end of the wire handle. As the coil warms up, enough heat is radiated to the handle to meet the paraffin connecting it with the electrode. At this point the micro-manipulator withdraws, thus slowly freeing the handle from the micro-electrode. Continuous recording of the unit activity during this process assures that the micro-electrode is not displaced. This is possible by using a battery source for the DC current through the coil.

The critical points are: to choose a neurone which has not been even slightly damaged during implantation; a good index is an approximately constant activity for at

least half an hour. To use a pre-amplifier with an input current of  $10^{-14}$  A or less, since the critical factor is the current density at the tip. A miniature, solid state, unity gain pre-amplifier has been developed for use with the micro-electrode. It is capable of operation when immersed in saline solution for prolonged periods: therefore it can be directly implanted in the animal's body, as near as possible to the micro-electrode. In this way input capacitance problems are minimized. The device has low input noise and uses very little power. Its reliability has been proven over 2 years of use.

Fig. 3 is a circuit diagram of the pre-amplifier.

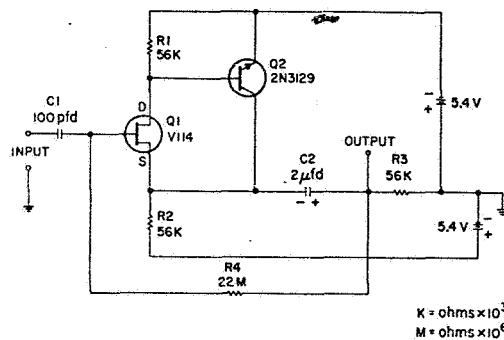

K = ohms  $\times 10^3$   
M = ohms  $\times 10^6$

Fig. 3  
Diagram of the pre-amplifier circuit.

*Electroenceph. clin. Neurophysiol.*, 1968, 25: 77-81



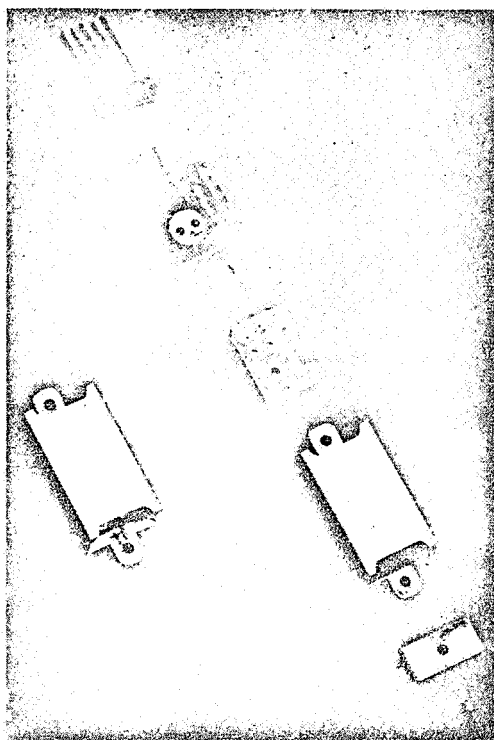

Fig. 4

Assembly of the pre-amplifier. From top to bottom: (1) power connector and output; (2) electronic circuit and input; (3) plexiglas base; (4) metal case; (5) anterior metal plate; (6) input wire. To the left: the pre-amplifier assembled. Dimension of the casing:  $20 \times 14$  mm.

Q1, a field effect transistor employed as a voltage follower, provides both a high input resistance and low noise operation with high generator impedances.

Q2 provides additional open-loop gain and improves the simple source follower in a number of ways. It raises the input impedance, lowers the output impedance, stabilizes the gain and makes the gain more closely approach unity, since the circuit is essentially an amplifier with high open-loop gain, connected as a voltage follower. Q2 is necessary mainly to lower the output impedance, since the pre-amplifier has to be capable of driving the capacity of an output cable subjected to mechanical vibration and electrical noise pick-up.

R4 provides a DC bias return path for the gate of Q1 and C2 bootstraps R4 so that the effective value of R4 to AC signals is much greater than its actual value. In fact, even though this resistance path is only a little over  $22 \text{ M}\Omega$ , the circuit input resistance is over  $1000 \text{ M}\Omega$ .

C1, a high quality glass capacitor, isolates the electrode from DC gate current and reduces the electrode current to less than  $10^{-14} \text{ A}$ , which has been found to be a suitably low level.

#### Measured circuit data:

Input impedance	> $1000 \text{ M}\Omega$
Input capacity	3 pF
Gain	0.99
Output impedance	< $100 \Omega$
Equivalent input noise with a 10 $\text{M}\Omega$ source and a 40–1000 c/sec bandwidth	$120 \mu\text{V RMS}$
Power required	$\pm 5.4 \text{ V}$ at $\pm 110 \mu\text{A}$

The electronic circuitry is protected from the effects of moisture by being placed in a hermetically sealed metal can, on which are mounted two small flanges with holes for securing purposes (Fig. 4). The output signal, common and power leads are brought out through glass-to-metal seals at one end of the can, while the input lead is brought out through its own seal at the other end. All wires soldered to the pins brought out through the seals are covered with wax for moisture sealing and the whole pre-amplifier is painted with several layers of Tygon plastic paint to give mechanical strength to the wax and further to seal the insulated wire leads.

The critical factor represented by the current density

at the tip of the micro-electrode makes it advisable always to use the largest size of tungsten micro-electrode tip which is compatible with good single unit recording. It is of paramount importance, also, to use material in the construction of the electrode (the insulating varnish, for instance) which does not react with the tissue. For this reason platinum black on the tip of the electrode is not advisable owing to its catalytic properties.

Electrodes such as the one described here have been used satisfactorily to record the activity of single fibres of the vestibular nerve of the frog during parabolic flights in a jet plane. The same preparation has been used on consecutive days, and during as many as 14 parabolic paths flown on the same day, with acceleration changes from 0 to 2.5 g and all the vibrations due to the movement of the airplane (Gualtierotti 1965; Gualtierotti and Gerathewohl 1965).

#### SUMMARY

A new electrode is described which allows continuous recording from single neurones or nerve fibres for an extended period of time. It also allows recording during gross movement and high acceleration and vibration. The basic principle of such an electrode is that its density equals that of the surrounding tissue. Moreover, to avoid standing oscillations, the electrode is counterbalanced against torque momentum and it is floating.

A miniaturized voltage-follower to be used with the micro-electrode is also described. It is completely sealed to allow implantation in the animal. The output impedance is kept so low that output wire movement artifacts are avoided.

#### RÉSUMÉ

UNE MICRO-ÉLECTRODE AYANT LA MÊME DENSITÉ  
QUE LE MILIEU TISSULAIRE

La nouvelle électrode illustrée ici est capable d'enre-

gistrer continuellement pendant plusieurs jours l'activité électrique des neurones individuels ou des fibres nerveuses, malgré les mouvements de l'animal et les intenses accélérations et vibrations. La densité de cette électrode est pareille à celle du tissu nerveux où elle est placée. Afin d'éviter des oscillations de l'électrode elle-même, celle-ci est libre et balancée contre le moment de torsion.

Un voltage-follower miniaturisé, destiné à être utilisé avec cette électrode est décrit également; on peut l'introduire dans le corps de l'animal car il est complètement imperméable. L'impédance de l'output est si basse qu'aucun effet parasite n'est produit par les mouvements des fils de l'output.

The pre-amplifier here described was developed by Gordon Deboo, research scientist, Electronic Research Branch, Instrumental Division, Ames Research Center, NASA, Moffett Field, Calif.

#### REFERENCES

- BIZZI, E., POMPEIANO, O. and SOMOGYI, I. Vestibular nuclei: activity of single neurons during natural sleep and wakefulness. *Science*, 1964, 145: 414-415.
- EVARTS, E. V. Effects of sleep and waking on spontaneous and evoked discharge of single units in visual cortex. *Fed. Proc.*, 1960, 19: 828-837.
- GUALTIEROTTI, T. Otolith activity in weightlessness. *Commun. XXIII. int. physiol. Sci., Tokyo*, 1965: 231.
- GUALTIEROTTI, T. and GERATHEWOHL, S. J. Spontaneous firing and responses to linear acceleration of single otolith units of the frog during short periods of weightlessness during parabolic flight. *Proc. I. Symp. on "The role of the vestibular organs in the exploration of space"*, Pensacola, Fla., 1965, NASA SP-77: 221-229.
- HUBEL, D. H. Tungsten micro-electrode for recording from single units. *Science*, 1957, 125: 549-550.
- HUBEL, D. H. Single unit activity in striate cortex of unrestrained cats. *J. Physiol. (Lond.)*, 1959, 147: 226-238.

Reference: GUALTIEROTTI, T. and BAILEY, P. A neutral buoyancy micro-electrode for prolonged recording from single nerve units. *Electroenceph. clin. Neurophysiol.*, 1968, 25: 77-81.

**The Gravity Sensing Mechanism of the Inner Ear \***

Torquato Gualtierotti, *University of Milan*

A major question in the consideration of gravity sensing mechanisms in organisms is whether specialized receptors really exist. Are there specialized structures in the examined organism (whether plant or animal, invertebrate or vertebrate, uni- or pluricellular systems) which respond to differences in magnitude or direction of gravitational force? Moreover, is the evoked activity of such receptors proportional to constant levels of linear acceleration or, possibly, only to the transients from one value of linear acceleration to another?

A second relevant problem is concerned with the way in which information about the relation of the organism to the gravitational pull is coded in the afferent neurons and presented to the first level of analyzers in the nervous system. Extending the problem above this level would intrude on the more general field of second-order information processing within the central nervous system, an area beyond the scope of this meeting. Therefore, my discussion of the above-mentioned questions will be limited to the most specialized gravity sensing mechanisms, the utricular and saccular otolith cells of the inner ear.

**Functional Characteristics of the Statoreceptors**

There is no doubt that the otolith cells are the mechanoelectric transducers for the detection of gravitational information. The anatomical characteristics of the two kinds of receptors shown so far (fig. 1) have been already described by Professor Lowenstein. Functionally, three different events can be described in each receptor: 1) the mechanical alteration provoked by the gravitational component; 2) the corresponding energetic changes in the receptors; and 3) the consecutive electrochemical events at the synaptic junction that fire the information along the nerve fiber. The first mechanism is situated in the system, including the statoconia surrounded by a protein statolith membrane, the endolymph, and the receptor's hair. This system acts as a density difference accelerometer, as the density of the statoconia and the statolithic membrane that acts as a whole is twice the density of the endolymph—1.9-2.2 and 1.02-1.04 respectively (Trincker 1962). The statoconia shift along the decline with every movement of the head and act on the hair, beginning the energetic and electrical change.

Although some doubts still exist about the relative roles of the stereocilia and the kinocilia in the transformation of the mechanical deformation into electrical change (Lowenstein 1966, 1967), the prevalent opinion is that the shearing movement of the statoconia and the corresponding bending of the hair process provide adequate mechanical stimulus. There are still some different views: Sasaki et al. (1961) maintain that pressure perpendicular to the macula is the acting force. A new hypothesis was presented by Dohlman (1960), namely, that the excitation of the hair cells is not

263 - FOLLOWS PL. 81

\* *From: Gravity and the Organism*  
*Edited by Solon A. Gordon and Melvin J. Cohen*  
*The University of Chicago Press, 1971*

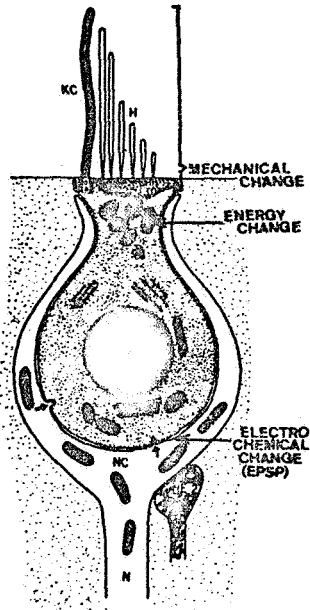

Fig. 1

Functional changes in one flask-shaped gravitoceptor: (1) At the upper end, the statoconia (not shown), the hair, the basal membrane of the stereocilia (H) and the foot of the kinocilium constitute the site of the mechanical alteration. 2) At the mitochondria (M) level the energy change takes place. 3) At the nerve chalice (NC) junction the electrochemical event produced the EPSP. Note a) two synaptic areas (arrowed) and a probable efferent nerve ending (NE2) (modified from Ades and Engstrom 1965).

due to hair bending but, at least in the cristae of the semicircular canals, to a transduction from fluid movement into static charges in the large surface of the hair, thus inducing a change of potential in the cell.

De Vries (1956) has measured directly the shifting of the single otolith of the Ruff as a function of linear acceleration up to 11 g (fig. 2). He found a value of approximately  $200 \mu$  for 5 g (maximum displacement) and of about  $\pm 70 \mu$  for  $\pm 1$  g. The displacement is less for smaller otoliths (from amphibia on up to mammals), although the entire mass of the statoconia acts as a single body (Trincker 1962). The work of Vilstrup (1951) indicates that during extreme positional changes with gravity acting as a sole force only tangential displacement occurs, of about  $\pm 15$  or  $30 \mu$  in total.

Fig. 2  
Displacement of the otolith of the Ruff as a function of the applied linear acceleration: on the abscissa, acceleration in g, on the ordinate, displacement in mm (modified from De Vries 1956).

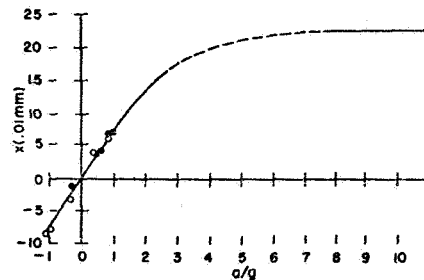

In any given position of the head the statoconia mass will reach a corresponding given position along the decline and stay there. This might be an argument in favor of a direct response to a constant linear acceleration, at least in the mechanics of the system, as against a response to the transient only (Lowenstein 1966); this would restore the mechanical state of the hair, and consequently the excitatory state of the cells, even if the statoconia maintain their shifted position.

The mechanoelectric transduction process inside the receptor and at the synaptic junction is still largely unknown. Some indirect evidence, however, exists about its nature. In the central part of the vestibular cell, immediately below the cuticular plate, there is a large concentration of mitochondria. The deformation of the cuticle plate due to the bending of the stereocilia, or a polarized compression of the root of the kinocilium, might produce a chemical and possibly an electrical change at the high energy level of the mitochondria beneath. The ultrastructure of the connection between the hair cells and the afferent fiber shows a typical presynaptic structure in the cell membrane. Synaptic bars surrounded by vesicles seem to indicate the release of a chemical transmitter toward the neuron terminals. This will produce a postsynaptic excitatory potential (EPSP) that will start the firing along the initial part of the afferent endings. The synaptic junction of the sensory cell nerve endings will therefore behave like an ordinary neuron synapsis.

Unfortunately, there is no experimental evidence of the EPSP as no one has been able to stick a micropipette in a vestibular receptor and measure the membrane polarization. However, Flock at the Bell Laboratory (pers. communic.) was able to measure the membrane polarization of some large cells of the lateral line of the *Necturus maculosus*. He found a resting potential of 40-60 mV and depolarization and hyperpolarization during induced movement of the cilium in opposite direction. But he could not record any action potential. The receptors of the lateral line system are similar enough to the ones in the vestibule to take these results at least as an indication of an EPSP.

The depolarization or the hyperpolarization of the synaptic membrane are interpreted as due to an alteration of sodium-potassium transfer across the membrane. It is unlikely that the electrical change is generated directly at the apex of the cell. In fact, it has been shown that the outside concentrations of Na<sup>+</sup> and K<sup>+</sup> in the endolymph are very close to the ones inside the receptors: no Na<sup>+</sup> - K<sup>+</sup> mechanism can work in these conditions, as the cell top has to be hermetically sealed (Trincker 1965). There is no convincing explanation of the excitation transfer from the hair zone to the synaptic area. Trincker (1965) has suggested that a large enough potential might be generated by the deformation of a thin layer of mucopolysaccharides surrounding the hair bundle through the hermetic seal of the upper cells. The charge might be transferred capacitatively inside, therefore producing the generator potential. But this is still mere speculation, although the polysaccharides are found in high concentration in the endolymph (Dohlman 1960).

### **Output of the Statoreceptors**

The output of the transducer system, namely the firing along the corresponding nerve fiber, has been well studied and is the best answer to our early question on the gravity sensing mechanism. It is in fact the proper channel of information to reach the first analyzer. While it is irrelevant to consider how many receptor cells correspond to a single channel, it is important that the response

analysis be made for the primary neurons. Recordings from the nuclei introduces a complexity which tends to make it more difficult to analyze the firing and to have it interpreted (Gernandt 1949, Duensing and Schaefer 1958, Shimazu and Precht 1965).

The response to linear acceleration recorded from the primary neurons consists always of a change in the characteristics of the pulse train along the nerve fiber (fig. 3). At steady state under constant acceleration, however, the main factor to be considered is accommodation. If 100% accommodation is not achieved after an indefinite period of time, the receptors can be considered as being truly sensitive to gravity. In fact, in this case a different activity will correspond to a different gravity vector. Accommodation is present in all vestibular units studied so far (Ross 1936, Adrian 1943, Ledoux 1949, Lowenstein and Roberts 1950, Coppee and Ledoux 1951, Lowenstein 1956, Rupert et al. 1962, Trincker 1962, Lowenstein 1966), but it varies widely from one unit to the other. Most of the units show only partial accommodation and some to a very small degree. Hence a definite relation exists between the responses of the units and the constant acceleration applied (Adrian 1943), although there are some reports of a 100% accommodation of all units of the maculae utriculi (Cramer 1962).

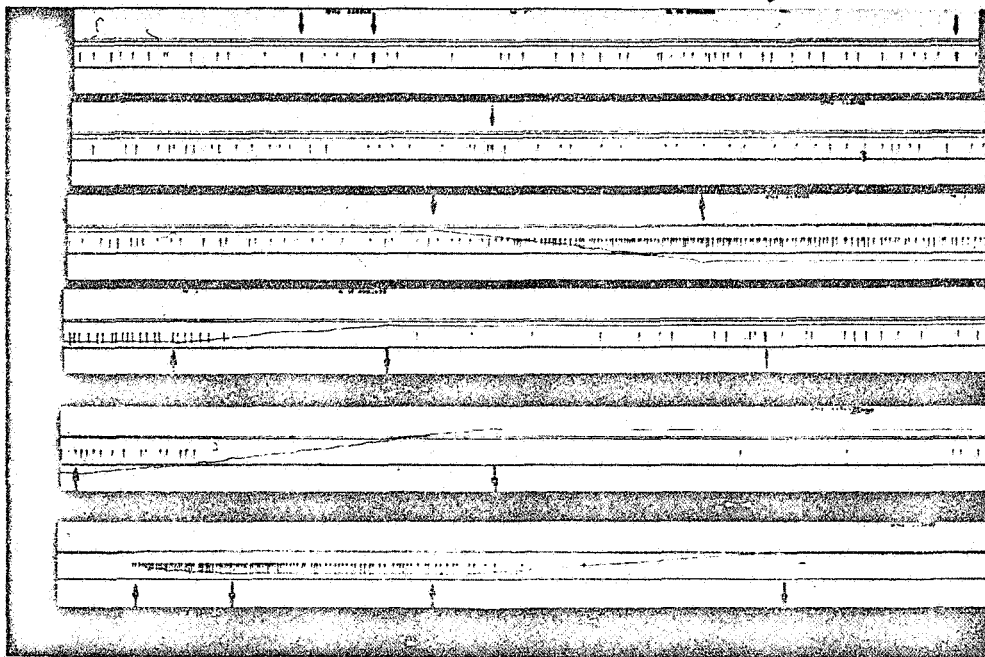

Fig. 3. Lower record: resting discharge (A-B) and evoked response (C) of a single fiber of the eighth nerve in the bullfrog corresponding to a gravitoceptor. The three upper tracings indicate the linear accelerations in the x, y and z axis. In C: the head-down tilt provokes an increase in the average rate of firing. In D, E and F back tilting suddenly stops the discharge (P = pause). This is followed by a slower firing (aftereffect). The pause seems to be related to the speed and duration of the back tilt. Note the irregularity in the rate of firing: very short intervals, practically double firing, are arrowed in A and B. Note also the accommodation effect at a steady tilt in C and D, indicated by a spontaneous decrease of the rate of firing. Calibration of the accelerometer and time in the record amplitude of the spike: 500  $\mu$ V.

Lowenstein and Roberts (1950), for instance, reported that a unit from the isolated labyrinth of the Raja had a resting discharge of 6 per sec. It went up to 16 per sec during nose-up tilting. After 30 sec it decreased to 11 per sec, and then held constant for the remaining 20 min of observation. Units with very limited accommodation show a truly stationary state during constant stimulation (fig. 4). It is possible to conclude at this point that gravisensors do exist in the vestibule.

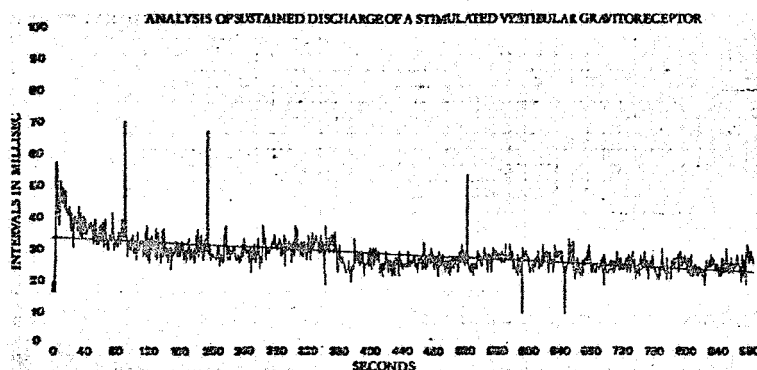

Fig. 4. Analysis of a sustained discharge of a stimulated gravitoceptor in the bullfrog. At 0 time the end of the tilt: the head maintains the acquired position; note slight accommodation at the very beginning of the curve. Stationary state is observed from the 300th second of recording on. On the abscissa, duration of discharge in seconds. On the ordinate, intervals in milliseconds. Each point is obtained averaging 100 msec of discharge.

The statoceptors have been classified in different ways according to their response. In the frog, Ross (1936) distinguished a receptor type, group "i," which responds when the head is tilted out of normal position. A second receptor type, group "ii," responds only when the head is tilted back toward the normal position. Lowenstein (1956) also confirms the existence, in the ray, *Raja*, of "out of position" and "in position" receptors, the latter showing a fast accommodation. Hiebert and Fernandez (1965), recording from the nuclei of the cat, classified their responses in four groups: steady increase of frequency, steady decrease of frequency, no change, varying frequency. Adrian (1943), in the cat, found results comparable to those of Ross (1936), and concluded that no significant difference exists between amphibians and mammals as far as the gravitoceptors are concerned. Rupert et al. (1962), also in the cat, essentially confirmed Lowenstein's data (1956), distinguishing one group of gravitoceptors proper, and one group responding only to transients. In summary, two kinds of gravitoceptors are described. One responds to "out of position" displacements with a graded response in a preferred direction and significant differences in the adapted firing rate at different stationary levels of tilt. The other is the "in position" receptor and responds only near or at the normal position of the head. It is rapidly adapting and is insensitive to the direction of the tilt.

Once the conclusion is reached that the sensory cells of the maculae of the utricle and saccule are capable of measuring directly constant linear acceleration, and therefore gravity, the second problem remains: what kind of sensory coding is used to transmit the information to the analyzer? According to classical theory, sensations are transmitted from the sensors up to the first analyzer by means of a change of the rate of firing proportional to the stimulus. Such a mechanism might

still be considered valid for units which show fairly constant discharges, both under resting conditions and during excitation. These units have been described in the isolated vestibule of the Raja (fig. 5) (Lowenstein and Roberts 1950, Lowenstein 1956, 1966). Trincker (1952) also described regular firing rates in mammals. However, in the vestibule, the irregularity of both spontaneous firing and single cell response to controlled acceleratory stimuli has been observed by many authors, starting from Ross (1936), in the severed frog head, and by Adrian (1943), in the decerebrated cat. Records from papers by Gernandt (1949, 1950) and by Rupert et al. (1962) show the same variability in the resting discharge and in the response to stimulation as described above (cf. fig. 6). On the other hand, these authors also describe units with a fairly constant rate of firing. Most of these studies, except that of Rupert et al., dealt with decerebrated or deeply narcotized animals. This might be the reason for the large variability observed. Bizzi et al. (1964), however, recorded from the vestibular nuclei of an intact cat free to move, and reported irregular discharges from the lateral vestibular nuclei, although the medial vestibular nuclei showed a remarkable constancy in the rate of firing.

The existence of regularly firing units, with a simple frequency of firing-stimulus relationship, cannot be denied. Evidence exists, however, that irregular resting discharges and irregular evoked firing are very common in the vestibules of all species, just as they are widespread in the sensory systems in general. For instance, irregular firing has been found even in the muscle spindle receptors. Stein and Matthews (1965), working on 200,000 interspike intervals from 13 muscle spindles from the soleus muscle of the anaesthetized cat, found in the primaries a standard deviation of 3.5-6.8% of the mean (coefficient of variation 0.035-0.068). A large variability is found in the activity of the primary neurons on the acoustic side of the inner ear (Weiss 1964, Kiang 1964). The same irregularity is reported for the resting discharge, in darkness, of retinal units (Kuffler et al. 1957) and of somatic afferents (Werner and Mountcastle 1965).

The cause of irregularity may be intrinsic in the cell or extrinsic (Moore et al. 1966). The intrinsic irregularity might be due to a number of processes. Fluctuation of the junction membrane potential provoked by thermal agitation has been suggested by Fatt and Katz (1952). Molecular agitation in the mechanical receptor substance may also be a source of noise (Katz 1950).

Another mechanism which might produce a large variability both in the resting discharge and during excitation is the convergence of several receptor cells onto the same afferent. Branching of the fiber takes place, in fact, both in the unmyelinated ending and in the myelinated part of the fiber. Whereas the first can be considered as a synergic mechanism providing from a number of cells the amount of excitation of the axon necessary for the onset of the spike, myelinated branches should show some occlusion phenomena with possibly the antidromic invasion of the quiescent receptors from the convergent excited ones. The pulse discharge might therefore be subjected to a complex interplay within the cluster of cells connected to the same fiber. Consequently, a large irregularity in the fiber firing might result.

Buller (1965) considers the mechanism for the generation of firing rate to be independent of the source of random fluctuation. The latter only modifies the regular discharge pattern. It is difficult to say whether the vestibular mechanoreceptors are the site of an intrinsic randomness in the firing. Their sensitivity is so high that the existence of a true threshold is doubted (Jongkees 1960).



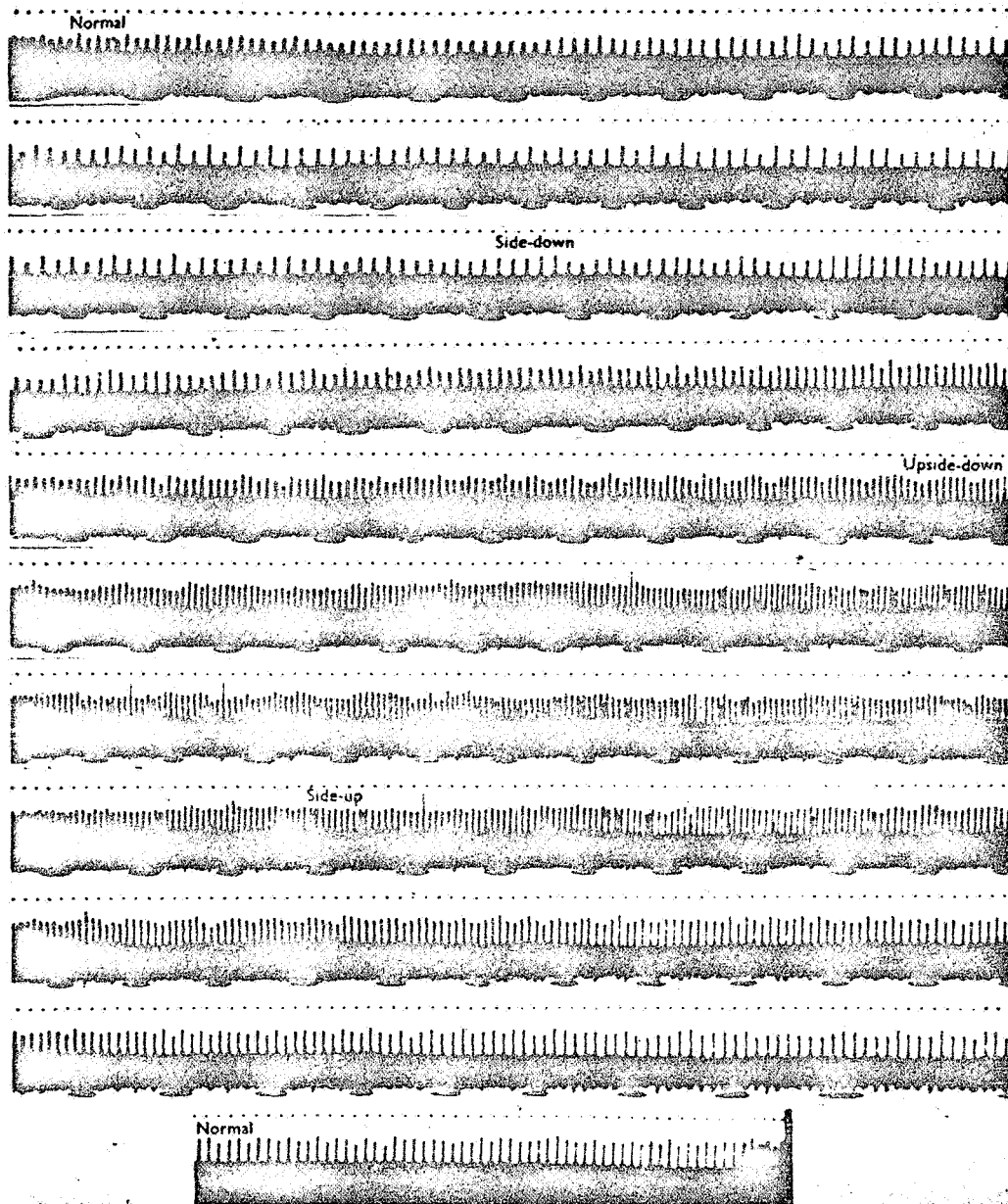

Fig. 5. Isolated labyrinth of the Raja. Utriculus: recording of the response of a 2-fiber preparation to a full circle lateral tilt. Time marker 24/sec. Speed of rotation approximately 10°/sec. Note the regularity of the firing in contrast with the record in figure 4 (from Lowenstein and Land 1950).

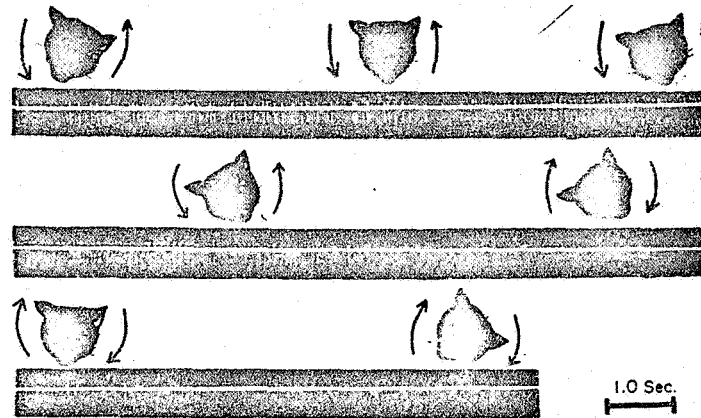

Fig. 6. Chronic cat in normal conditions. Response of an otolith unit to the tilting of the head: the direction of the movements is indicated by the arrows. Note a) irregular firing, b) increase in the average rate of firing during left tilt, c) the pause at the onset of the back tilt. This record is very similar to the one shown in fig. 4 in the frog (from Rupert et al. 1962).

Data in the literature show that the receptors of the vestibular apparatus which respond to linear or angular acceleration are sensitive to accelerations of less than  $1 \text{ cm per sec}^2$ . Buys (1940) found that an acceleration of  $1^\circ/\text{sec}^2$  was enough to cause nystagmus in man ( $1^\circ/\text{sec}^2$  corresponds to a tangential acceleration of about  $0.08 \text{ cm/sec}^2$  at the human labyrinth). Ter Braak (1936), observing photographically the ocular deviations in rabbits, found a much lower threshold ( $0.1^\circ/\text{sec}^2$ ). Groen and Jongkees (1948), working on thirty healthy human subjects with three different methods, found that the average threshold value to produce a rotational sensation was  $0.5^\circ/\text{sec}^2$  (corresponding to a tangential acceleration of about  $0.04 \text{ cm/sec}^2$  at the labyrinth).

In the intact frog the threshold at  $1 g$  level for the single otolith unit during linear acceleration is well below  $1 \text{ cm/sec}^2$  for a duration of acceleration of less than 5 msec (fig. 7, lower record). In 1908 Mulder was the first to point out that the product of stimulation time and acceleration level to reach the threshold of rotational sensation, is constant. Groen and Jongkees (1948) found that it took approximately 30 sec to bring about a rotational sensation at an acceleration of  $0.5^\circ/\text{sec}^2$  ( $0.04 \text{ cm/sec}^2 = 1.2$ ). With a stimulus lasting 100 msec, at labyrinth level an acceleration of  $12 \text{ cm/sec}^2$  ( $0.1 \text{ sec} \times 12 \text{ cm/sec}^2 = 1.2$ ) would be needed. The results obtained by monitoring directly the otolith unit in the frog indicate, however, a much lower threshold, namely  $0.005 \text{ sec} \times 1 \text{ cm/sec}^2$ . This is understandable, as the sensitivity at the receptor site must be much higher than the one involving the complex overall mechanism of sensation.

The result of such a high sensitivity is that extrinsic factors producing fluctuations in firing must be taken into consideration as well as the intrinsic randomness. As the gravitoceptors appear to be highly sensitive to vibration, the particular position of the head must also be considered; physiological movements of the head actually produce a modulated excitation of the labyrinth receptors.

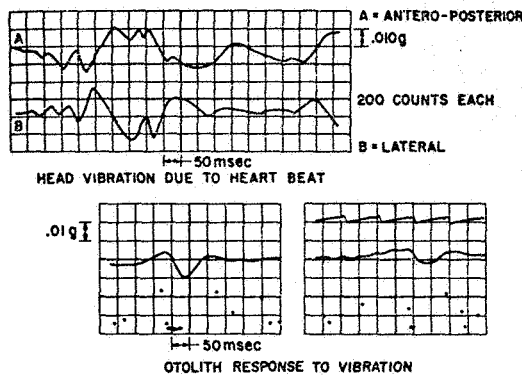

Fig. 7

Upper record: vibration of the head in a human subject sitting in a chair comfortably. Lower record: response of a single otolith unit of the bullfrog to vibration comparable in intensity to the one in the upper record. Upper tracing, acceleration profile. Lower tracing, each dot corresponds to an interval. The value is read from the "0" line to each consecutive dot.

### Head Accelerations Acting on the Vestibule

We have measured the movements of the head in man under various conditions. Five healthy subjects were used. Two accelerometers were fixed on a cast of the head of each subject to obtain a tight fit; the accelerometers were placed in different positions in order to measure accelerations in different planes. EKG, vibrocardiogram and carotid pulse were recorded simultaneously. The accelerations of the head were measured while the subjects were instructed either to stand still with their two feet close together and their eyes open or closed, or to sit comfortably resting against the back of the chair, with their eyes open or closed. Only the observations obtained for the sitting position will be discussed, as a number of artifacts due to larger movements are avoided when in this position.

The results showed that beside the maintenance of balance, the most consistent periodic source of movements of the head appeared to be linked to the cardiac cycle (fig. 7, upper record). In effect, during rest the acceleration profile shows two peaks with an interval of 300 msec. The acceleration peak value of single cycles ranged from 15 to 25  $\text{cm}/\text{sec}^2$ , the two waves being of similar value, with a duration of approximately 100 msec. A number of minor oscillations indicated further periodic acceleratory components beside the one described.

In a second series of tests the effect of exercise and fatigue on head movements was studied. During exercise the heart rate and blood pressure increase proportionally to the physical work performed. Consequently, the head movements related to the cardiac cycle should increase also. It was found that this was indeed the case, even with mild exercise. The subjects were instructed to squat twenty times consecutively. The two peaks of the acceleration were still present but their values were increased by a factor of 2, namely 40-50  $\text{cm}/\text{sec}^2$ . As reported above, these two waves seem to be related to the cardiac cycle, particularly to the carotid pulse. It appears that the first head movement follows the rise in pressure in the carotid arteries while the second movement follows the decrease in pressure in the carotids and the closure of the aortic valves.

It seems clear from the above observations that the vestibule is subjected to a continuous background of periodic excitation. One possible consequence is a decrease in the inertia of the system of the maculae, since the statoconia mass will be in a state of continuous vibration. Secondly, it will upset, to some extent, receptor accommodation by maintaining excitation of the macula.

### Efferent Systems

In the intact animal another potential source of firing fluctuation of the gravitoceptors may be due to central control of the receptor cells. The existence of efferent fibers in the eighth nerve has been postulated since the end of the last century. Not until 1927, however, was the existence of centrifugal fibers in the eighth nerve shown by van Gehuchten. Ernyei (1935), discussing the existence of unmyelinated fibers in the vestibular nerve, advanced the hypothesis that they might be part of an efferent system. In 1955 Petroff stated explicitly that efferent fibers do exist in the trunk of the eighth nerve. Rasmussen (1946) had suggested that part of the olivo-cochlear tract, through the cochleo-saccular anastomosis of Hardy, might reach the sacculus, thus supplying it with efferent fibers. But Petroff (1955) described, in the vestibular neuro-epithelium of cat and monkey, efferent fiber projections reaching the maculae sacculi and utriculi, as well as the three semicircular canal cristae. By serial sections he was able to prove that such fibers are central in origin. This was later confirmed by Rasmussen and Gacek (1958) and Gacek (1960). Rossi and Cortesina (1962), using a histochemical method, have described an efferent cholinergic cochleo-vestibular system composed of five tracts, four of them direct and the fifth crossed.

Strong evidence of an efferent system impinging on the vestibular receptors is found in the electron microscope studies (Wersäll 1956, 1960, Engström 1958, 1965, Spöndlin 1965). Iurato and Taidelli (1964) showed that two types of nerve endings occur in the vestibular receptor cells; one type was heavily granulated and might represent the endings of an efferent system.

The efferent vestibular system was described in detail at a recent symposium on vestibular organs. The centers and the descending pathways in the medulla and the distribution of the bundle of efferent fibers in the eighth nerve and its branches were shown. Smith (1967), through degenerative studies following intramedullary sections of the vestibular fibers, suggested the existence of two kinds of efferent structures in the macula utriculi of the Chinchilla: the button terminals, synaptic junctions on the chalice of the receptor cell and on the terminals of the sensory fibers, and the buttons *en passant*, connected mainly with the nerve fibers and the button terminals. This author also reported that the origin of the efferent fibers was near the lateral vestibular nucleus; these fibers thereafter descend in the vestibular nerve. Gacek (1967) characterized in detail the distribution of the efferent system in the medulla, in the eighth nerve and inside the vestibule. It has been found that some 400 efferent fibers, or approximately 10% of the total, exist in the vestibular nerve of the cat. Rossi (1967), with degenerative and histochemical methods, described in the cat the position and the characteristics of the two nuclei which originate the efferent fibers in the region of the medulla and pons.

Although the efferent system is now well enough described anatomically, there are few physiological studies as to its significance. Ledoux (1958) observed a reduction of the nerve potentials of one semicircular canal when the contralateral one was stimulated. Sala (1962) showed that the stimulation of the contralateral vestibular nuclei produced spikes in the vestibular nerve; the response disappeared with a medial cut in the IV ventricle floor. He also demonstrated that the spontaneous activity of the vestibular nerve decreased simultaneously with the appearance of the evoked efferent spikes. It was concluded that the suppression was mediated by the efferent system, through which the vestibular receptors might be directly controlled. Similar conclusions were reached by Fluor and Mendel (1963); they reported that the efferent system is mainly inhibitory. Schmidt (1963) recorded efferent impulses from the free end of nerves detached from

the ampullae, sacculus, utriculus, and lagena in the leopard frog. These impulses originated from any ampulla and a variety of extralabyrinthine proprioceptors. None were evoked in response to the stimulation of the auditory or otolith organs. Recently Wersäll was able to record in the frog the activity of efferent nerve fibers (pers. communic.), and I have also been able to obtain similar records. The activity is maintained after the cutting of the connection with the labyrinth, and shows a typical modulation of firing. Figure 8 shows an example of such discharges in the eighth nerve of the bullfrog. The analysis of this activity shows a regular modulation in the firing, resulting in a 5-peak histogram (fig. 9).

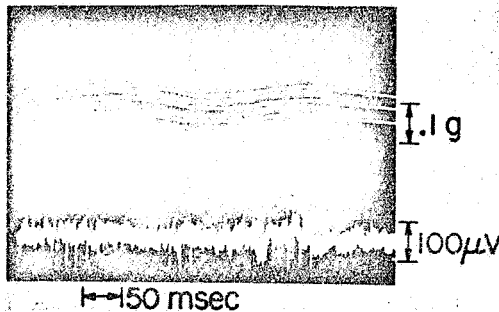

**Fig. 8**  
Activity of an efferent fiber recorded from the eighth nerve of a bullfrog (lower record). The three upper tracings correspond to x, y and z acceleration. Note the modulated firing quite independent of the artificially provoked vibration. Calibration and time in the record.

**Fig. 9**  
Histogram of the activity of the unit in figure 8 (see text).

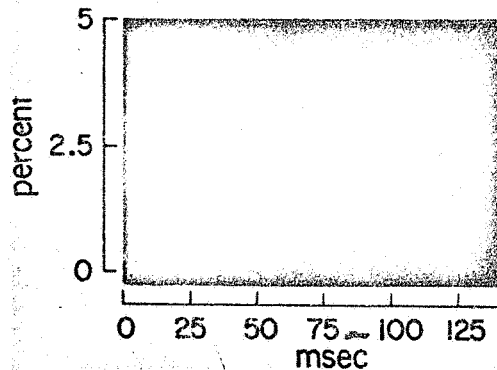

### Stimulus/Response Ratio

The responses of otolith receptors have to be considered in terms of dynamic and static factors: the dynamic factors are the exaggeration of the response (if the speed of the applied accelerating stimulus is above a certain range) and the abaptation. The exaggeration of response is, very approximately, a function of the speed of the change, although no information exists up to now as to which function it is. If the animal is rotated very slowly but continuously (at or below  $1^\circ/\text{sec}$ ) the dynamic factors are minimized and the stimulus response ratio can be studied.

Most mechanoreceptors are known to follow the Weber-Fechner law. This law is expressed by the equation  $\Delta I/I = C$ , where  $I$  is intensity of the stimulus,  $\Delta I$  the smallest detectable difference in intensity, and  $C$  a constant. It signifies that the smallest difference in the stimulus intensity bears a constant relation to the absolute value of the stimulus intensity. Therefore, the increase of

sensation follows a step-like pattern, each step being a quantum of the stimulus corresponding to a quantum of sensation. It is expressed by the equation

$$S = a \log I + b$$

S = sensation  
I = stimulus

This logarithmic stimulus-response ratio has been verified for a number of mechanoreceptors, such as the frog muscle spindle (Von Leuwen 1949), and other receptors, such as the ommatidia in the eye of *Limulus* (Hartline and Graham 1932). A logarithmic term in the stimulus-response ratio would be consistent with the existence of ionic equilibria across receptor cell membranes.

As far as the otolith cells are concerned, Lowenstein (1967) concludes that the increase in activity is a linear function of the acceleration, that is, of the sine of the vertical rotation angle, over a considerable range. This does not exclude a logarithmic relationship. In fact, the initial branch of a logarithmic curve can be readily approximated as a linear ratio. The log stimulus-response ratio approximates well our own data on the frog (fig. 10*a, b*). The linear ratio suggested by Lowenstein might represent the onset of a logarithmic curve. This could result if the unit under study were functioning at the edge of the response field. In this case the unusually broad range of response, over the full 360° of rotation, might be related to the unit being minimally sensitive to the stimulus because it is at the edge of the receptive field. A second possibility is that the response itself, being far from maximum, does not reach the knee of the logarithmic curve and therefore appears to be in linear relationship to the stimulus. In our results, from mapping the otolith units that were maximally sensitive at the center of the field, no range was found extending above 0.7 g (45° of tilt from the horizontal). The sensitivity decreases and the range increases progressively up to the edge of the field (fig. 11*b*).

### Sensory Coding

The coding of the vestibular messages or, more generally, of the sensory systems which are the site of large fluctuations in the firing rate, is complex and difficult to understand. Negrete et al. (1965) have delineated several mathematical models to describe the impulse code in the visual systems of

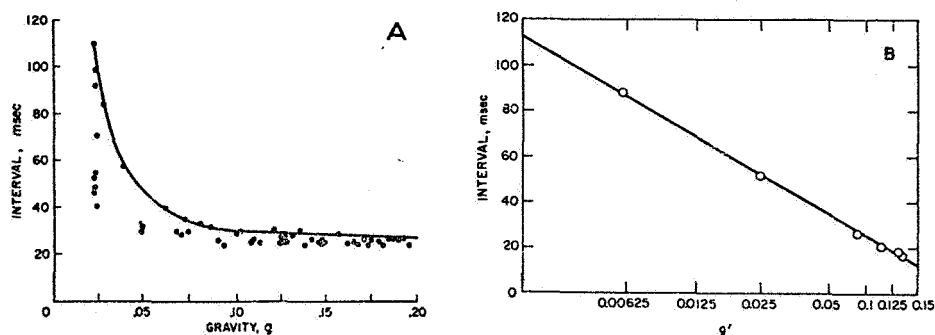

Fig. 10. Diagram showing the stimulus-response ratio of a single otolith unit in the bullfrog, taking in account the envelope of the curve only: in A on a linear and in B on a logarithmic scale. Note a nearly perfect fit with the Weber-Fechner law (see text).

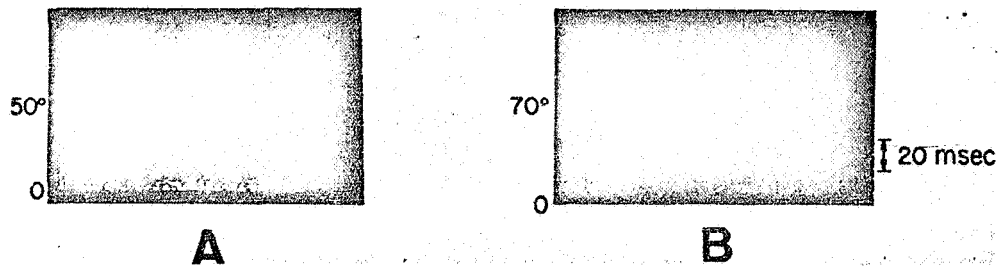

Fig. 11. Diagram of the stimulus-response ratio during the same tilt ( $12^{\circ}\cdot 1^{\circ}/\text{sec}$ ) of a single otolith unit in the bullfrog at the center (A) and near the edge of its field. The horizontal rotation (marked on left) between A and B is  $20^{\circ}$ .

men and crayfish. Two of these were: the detailed pattern code, in which every impulse is significant and the average frequency code, in which the mean of the activity of a number of units is considered necessary for meaningful information. Negrete et al. (1965) favor the latter hypothesis. Models of an analysis mechanism at different levels above the peripheral sensory system have been presented. A gate which allows the information to go through on the basis of a convergency pattern of numerous irregularly responding units is postulated by Wall and Melzack (1965) for the skin receptors, and by Desmedt (1965) for the auditory system. A centrifugal control system plus a feedback from the peripheral activity itself are supposed to regulate this gate.

The second leading idea on the information transfer is based on the "edge" theory. Whitfield (1965) emphasizes the importance of such edges in the auditory information processes. According to this hypothesis, the central analyzers obtain their information by their ability to recognize the number and the pattern of active versus passive channels reaching them and each channel originates in a primary sensory cell or group of cells. The precise characteristics of the activity in each channel are of minor importance, provided that they are sufficiently different in the active and passive channels. The fact that sensory units seem to be not only the site of excitation but also of inhibition is very useful for this concept. In fact, the main task of the inhibitory process is to define the edges between excited and unexcited units, surrounding the active ones with a circle of sensors, the firing of which is completely suppressed. Retinal function appears to be consistent with the above model (Barlow and Levick 1965).

Study of the resting discharge and the evoked response of the otolith receptor type that does not show regularity of firing leads to the following conclusions:

1. During spontaneous activity and during excitation the rate of firing varies through such a large range that a mechanism of information based only on frequency modulation cannot work. Long intervals between spikes are found only at low stimulus levels or in the resting discharge. However, short intervals between spikes, characteristic of the excited state, are commonly found in the long bursts often seen in the resting discharge. It would be very difficult for the analyzer to determine if a few spikes occurring at short intervals are related to a particular stimulus level.
2. For the same reason, a mechanism based on time-averaging of the discharge in a single unit cannot work. If only information from a single unit is involved, the analyzer should average a large number of intervals to differentiate between long bursts during rest or fast firing during excitation.

number of intervals to differentiate between long bursts during rest or fast firing during excitation. This process would require some seconds, and would not be compatible with the rapid responses demanded during equilibration responses.

3. The results seem to agree to some extent with the edge concept mentioned above (Whitfield 1965). The change in the parameters of the activity is particularly sharp between units which are stimulated increasingly or at a constant level, and units in which the stimulation is decreasing. The main rate of firing increases in the former while the latter is subjected to a pause (fig. 11). In this way contrast during any given movement of the head is sharpened. For fast movements the pause is also present in quiescent units, with suppression of spontaneous firing. Thus, for fast movements, contrast is even more pronounced owing to the additional pause of quiescent units.

There are some elements, however, which do not completely fit into the edge theory. When analyzing the response to acceleration of an otolith unit, two different conditions must be considered: the transient resulting when the stimulus changes, and a steady state stimulus, such as a gravity component or a constant linear acceleration. The two conditions of stimulation (transient and steady) have to be considered separately.

*Transients.* During a transient a graded response, both negative and positive, is observed. Both show a profile of response that is related to the rate of the change (fig. 12). The positive response, following an increasing stimulation, consists of an increase in the number of short intervals which is the more marked the greater the rate of change. The negative response consists of a pause, the duration of which is proportional to rate and duration of the decrease of the stimulus. Even the resting discharge of a quiescent unit shows a pause if a sudden tilt is applied. Such events may be used by the central analyzer to determine speed and duration of the movement in respect to the gravity vector. The edge theory does not take into account these graded responses to acceleratory events. The described phenomena do not take any part in its "pattern" analysis, even if a third channel with "negative" response is considered.

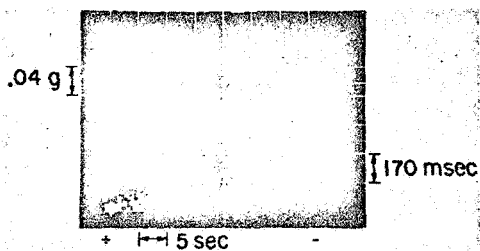

Fig. 12. Positive and negative response to a rapid tilt ( $20^\circ/\text{sec}$ ) and a back tilt, respectively, of a single otolith unit in the bullfrog. The consecutive intervals are shown as the distance between the "0" line and each white dot. The acceleration resulting from the tilt is indicated by the continuous line.

*Steady State.* After the end of a transient and a period of accommodation, a stationary state in the unit firing is observed which is significantly different at different levels of excitation. It is also different from the resting discharge. The graded response does not agree with the edge theory, as the theory does not take into account a change in the unit activity proportional to the amount of stimulation.

A second mechanism may therefore be hypothesized by which the information is passed on the higher level centers according to the input density (cf. Gualtierotti and Alltucker 1966). Let us imagine the existence of a time gate in the level immediately above the peripheral organs on which



a number of otolith units converge. Let us suppose that such a gate opens, allowing the information through, only when two or more spikes reach it within a given time. Naturally the probability of transfer in this system will be a function of the density of the spikes in each channel (fig. 13).

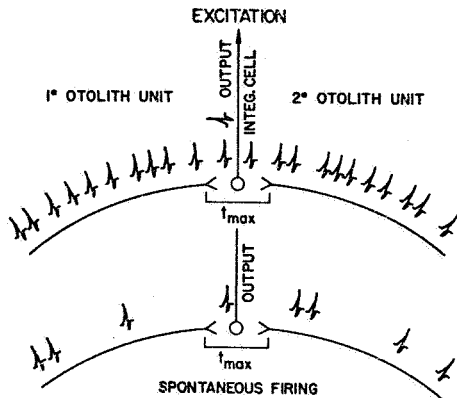

Fig. 13

Schematic of a possible mechanism for central analysis of the information incoming from the otolith unit. Two conditions are shown, one during spontaneous activity with long intervals and high variability (lower sketch), and one during excitation. The long intervals have disappeared and although there is still some variability, all intervals are shorter than the maximum time for the gate to open.  $t_{max}$ : maximum time at the gate that allows the spikes coming along the otolith nerve fiber and converging on the analyzer (integrative cell) to trigger the analyzer to activity. This happens when the spikes coming from the two pathways reach the integrative cell within  $t_{max}$ . For a full discussion see text (from Gualtierotti and Alltucker 1966).

The "edge" and the "gate" theories may be combined. In fact edges are provided by the excitation plus inhibition effect. Considering even only one excited unit partially surrounded by inhibited ones, a channel will result, the field of which will be sharply defined by a ring of suppressed responses of inhibited channels. This would enhance contrast. Alternatively, positive (excited) fields might be alternated with negative (inhibited) fields; the resulting pattern might serve as the basic element for the central analyzer to work on. Within each field, however, a graded response is observed, as the response of each unit is proportional to the logarithm of the stimulus. This will result, in each field, in an area of maximum response surrounded by an area of progressively fading evoked activity. The edge mechanism might provide stationary information on steady head position. The gate mechanism would add more knowledge on the kinetics of the transients, like the speed and the direction, following the head movements and the history of preceding events.

In conclusion, there is no doubt that true gravitoceptors exist in the inner ear, and that their activity is a function of the gravitational vector in all directions. The mechanism by which the mechanotransducers, having acquired the information of a gravity force pattern in each head position, transmit such information to the first analyzer is still, however, an unresolved problem.

### Summary

The existence of true statoceptors in the vestibule is discussed. The main index for receptors responding to gravity is indicated as lack of accommodation of the evoked activity, or at least as the presence of only a partial accommodation over an indefinite period of time of constant linear acceleration. Various observations show that true statoceptors are found in the vestibule, according to the accommodation standard. The basic characteristics of the statoceptors do not seem to vary significantly in mammals in comparison with lower vertebrates.

A second problem discussed is the sensory coding by which the statoceptors send information to the primary analyzers. Some cells seem to fire at a surprisingly constant rate. For these a simple

stimulus-frequency relation may be assumed as a satisfactory sensory code. The majority of the receptors, however, show a great variability both in the resting discharge and in the evoked discharge. The problem of the sensory information is therefore more complex. The origin of the randomness of firing is classified as due to two factors, one intrinsic to the cell and one extrinsic. The intrinsic factor might originate in the thermal noise in the nerve ending and/or in fluctuations in the cell membrane. It is difficult to pinpoint such an intrinsic factor with the high sensitivity of the statoceptors to linear acceleration and to vibration. One of the most important extrinsic factors is the vibration of the head following the heart beat (head ballistocardiogram). Accelerations more than ten times the threshold of the vestibular receptors are recorded from the human head. These accelerations are further increased during and after physical exercise. A variable excitatory background is therefore always present under normal conditions.

The high "noise" of the statoceptors disqualifies a simple stimulus-frequency relation. A number of theories of information processing are summarized. The edge theory proposed for the auditory system might be applied to the vestibular apparatus, based on the positive and negative responses of the gravity receptors (positive response = increase in the rate of firing, negative response = prolonged suppression of the discharge when the stimulus decreases). However, the graded responses obtained during various levels of stimulation, do not agree completely with the edge theory. A gate theory is also described; the gate would open according to the density of the spikes in the converging channels. A sensory code which utilizes both "edges" and "gates" is also considered.

#### Acknowledgment

The study of human vestibular response to acceleration was performed in cooperation with Dr. F. Bracchi at the NASA Ames Research Center, Moffett Field, California.

#### References

- Ades, H. W., and Engstrom, H. 1965. Proc. 1st symp. on the role of the vestibular organs in space exploration, Pensacola, Fla.: NASA SP-77, p. 25.
- Adrian, E. D. 1943. *J. Physiol.* 101: 389-407.
- Barlow, H. B., and Levick, W. R. 1965. *J. Physiol.* 178: 477-504.
- Bizzi, E.; Pompeiano, O.; and Somogyi, I. 1964. *Science* 145: 414-15.
- Buller, A. J. 1965. *J. Physiol.* 179: 402-16.
- Buys, E. 1940. *Ann. d'Otolaring.* 3-4: 109-15.
- Coppee, G., and Ledoux, A. 1951. *J. Physiol.* 114: 41P.
- Cramer, R. L. 1962. *Aerospace Med.* 33: 663-66.
- Desmedt, J. E. 1965. *Sci. Proc.* 4: 242-44. Tokyo: IUPS.

- De Vries, H. 1956. In *Progress in Biophysics* 6: 207-63.
- Dohlman, G. 1960. *Confin. Neurol.* 20: 169-80.
- Duensing, F., and Schaefer, K. P. 1958. *Arch. Psychiat. Nervenkr.* 128: 225-52.
- Engström, H. 1958. *Acta Otolaryng.* 49: 109-18.
- Ernyei, J. 1935. *Arch. F. Ohrenheilk.* 141: 343.
- Fatt, P., and Katz, B. 1952. *J. Physiol.* 117: 109-28.
- Fluur, E., and Mendel, L. 1963. *Acta Otolaryng.* 56: 521-22.
- Gacek, R. R. 1960. In *Neural mechanisms of the auditory and vestibular systems*. Springfield, Ill.: Ch. C. Thomas, pp. 276-84.
- . 1967. Proc. 3d symp. on the role of the vestibular organs in space exploration, Pensacola, Fla.: NASA SP-152, pp. 203-13.
- Gernandt, B. E. 1949. *J. Neurophysiol.* 12: 173-84.
- . 1950. *Acta Physiol. Scand.* 21: 61-72.
- Groen, J. J., and Jongkees, L. B. W. 1948. *J. Physiol.* 107: 1-7.
- Gualtierotti, T., and Alltucker, D. 1966. Proc. 2d symp. on the role of the vestibular organs in space exploration, Ames Res. Ctr., Moffett Field, California: NASA SP-115, pp. 143-49.
- Hartline, H. K., and Graham, C. H. J. 1932. *J. Cell. Comp. Physiol.* 1: 277.
- Hiebert, T. G., and Fernandez, C. 1965. *Acta Otolaryng.* 60: 180-90.
- Katz, B. 1950a. *J. Physiol.* 111: 248-60.
- . 1950b. *J. Physiol.* 111: 261-82.
- Kiang, N.Y.-s. 1964. *Acta Otolaryng.* 59: 186-200.
- Kuffler, S. W.; FitzHugh, R.; and Barlow, H. B. 1957. *J. Gen. Physiol.* 40: 683-272.
- Iurato, S., and Taidelli, G. 1964. Congr. Electron. Microscopy. Prague.
- Jongkees, L. B. W. 1960. *J. Laryng.* 74: 511.
- Ledoux, A. 1949. *Acta Otorhinolaryng. Belgica* 3: 335-49.
- . 1958. *Acta Otorhinolaryng. Belgica* 12: 111-346.

Lowenstein, O. 1956. *Brit. Med. Bull.* 2: 110-14.

———. 1966. Proc. 2d symp. on the role of the vestibular organs in space exploration. Ames Res. Ctr., Moffett Field, California: NASA SP-115, pp. 73-90.

Lowenstein, O., and Land. 1950. *J. Physiol.* 110: 392-415.

Lowenstein, O., and Roberts, T. D. M. 1950. *J. Physiol.* 110: 392-415.

Moore, G. P.; Perkel, D. H.; and Segundo, J. P. 1966. *Ann. Rev. Physiol.* 28: 493-522.

Mulder. 1908. Thesis. Utrecht (from Groen and Jongkees 1948).

Negrete, J.; Yankelevich, G. N.; and Stark, L. 1965. *Quart. Progr. Rept. Mass. Inst. Technol. Res. Lab. Electron.* 76: 336-343.

Petroff, A. E. 1955. *Anat. Rec.* 121: 352-53.

Rasmussen, G. L. 1946. *J. Comp. Neurol.* 84: 141-219.

Rasmussen, G. L., and Gacek, R. R. 1958. *Anat. Rec.* 130: 361-62.

Ross, D. A. 1936. *J. Physiol.* 86: 117-46.

Rossi G. 1967. Proc. 3d symp. on the role of the vestibular organs in space exploration, Pensacola, Fla.: NASA SP-152, pp. 213-25.

Rossi, G., and Cortesina, G. 1962. *Minerva Otorinolaringol.* 12: 1-63.

Rupert, A.; Moushegian, G.; and Galambos, R. 1962. *Exp. Neurol.* 5: 100-109.

Sala, O. 1962. *Boll. Soc. It. Biol. Sper.* 38: 1048.

Sasaki, H.; Yamagata, M.; Wanatabe, T.; Ogino, K.; Ito, M.; and Otahara, S. 1961. *Acta Otolaryng. Suppl.* 179: 42-55.

Schmidt, R. S. 1963. SAM-TDR-63-66, 11 pp.

Shimazu, H., and Precht, W. 1965. *J. Neurophysiol.* 28: 991-1013.

Smith, Catherine. 1967. Proc. 3d symp. on the role of the vestibular organs in space exploration. Pensacola, Fla.: NASA SP-152, pp. 183-203.

Spoendlin, H. H. 1965. Proc. 1st symp. on the role of the vestibular organs in space exploration, Pensacola, Fla.: NASA SP-77, pp. 7-22.

Stein, R. B., and Matthews, P. B. C. 1965. *Nature* 208: 1217-18.

- Ter Braak, J. W. G. 1936. *Pflüg. Arch. Ges. Physiol.* 238: 319-26.
- Trincker, D. 1962. *Symp. Soc. Exp. Biol.* 16: 289-316.
- Van Gehuchten, P. 1927. *Rev. Otoneur.* 5: 777.
- Vilstrup, T. 1951. *Ann. Otorhinolaryng.* 60: 974-81.
- Von Leuwwen. 1949. *J. Physiol.* 109: 142.
- Wall, P. D., and Melzack, R. 1965. *Sci. Proc.* 4: 234-241. Tokyo: IUPS.
- Weiss, T. F. 1964. *Tech. Rept. Mass. Int. Technol. Res. Lab. Electron.* No. 418.
- Werner, G., and Mountcastle, V. B. 1965. *J. Neurophysiol.* 28: 359-97.
- Wersäll, G. 1956. *Acta Otolaryng. Suppl.* 126: 1-85.
- . 1960. In *Neural mechanisms of the auditory and vestibular system.* Springfield, Ill.: Ch. C. Thomas, p. 48.
- Whitfield, I. C. 1965. *Sci. Proc.* 4: 245-47. Tokyo: IUPS.

#### Discussion

COHEN: Is the change in frequency always downwards in these slowly adapting receptors or does it sometimes oscillate? One can get misled by looking at a single unit when the receiver may be dealing with tens of thousands of units. These fluctuations that you see in one unit may be smoothed out by the receiver.

GUALTIEROTTI: Actually the discharge frequency in these units is oscillating around an approximately constant value. In effect, if we look at the regression line while analyzing a long recording of one hour, the slope tends to zero. Sometimes it goes up very slightly but it is practically horizontal.

COHEN: Normally if a discharge oscillates around some mean frequency for 15 or 20 sec after coming into the steady-state stimulus situation, this unit is classified as a "non-adapting" or "tonic" receptor. You have to deal with this problem statistically. It may be misleading to look at one unit because the properties of the single unit may not encompass the properties of the whole system. The ambiguities and imperfections of the single unit may be resolved by simultaneous integration of information from many units.

GUALTIEROTTI: Yes, but how? If I had time to talk about coding, the conclusion would have been that there is no information possible except through cross correlations of the activity of a number of different units.

COHEN: This is true only when the discharge is random.

GUALTIEROTTI: I agree.

Reprint C

LABORATORIO DI BIOLOGIA SPAZIALE  
CONSIGLIO NAZIONALE DELLE RICERCHE  
Via Mangiagalli N. 32 - 20133 MILANO

# TECHNICAL AND BIOLOGICAL PROBLEMS OF CONTROL A Cybernetic View

Proceedings of the International Federation of  
Automatic Control Conference held in Yerevan  
Armenia, September 24-28, 1968, under the  
sponsorship of the Components and Systems  
Committees of IFAC

Edited by

**A. S. Iberall**

General Technical Service, Inc.  
Upper Darby, Pennsylvania

and

**J. B. Reswick**

Rancho Las Amigos Hospital  
Downey, California

*A Publication of the International Federation of Automatic Control*

Distributed by

INSTRUMENT SOCIETY OF AMERICA  
Pittsburgh, Pennsylvania

FOLLOWS Pg. 281

## ANALYSIS OF SINGLE VESTIBULAR RESPONSES

Dr. Torquato Gualtierotti  
Istituto di Fisiologia Umana  
Milano, Italia

### INTRODUCTION

A true *statoreceptor* will respond to a steady position of the head or to a steady linear acceleration with a stationary response; namely, although some initial adaptation might occur, the response shows, finally, constant characteristics. In this case, a recognizable different activity will correspond to each different position of the head within the proper range of the unit, and a quantitative evaluation of the stimulus/response ratio by the central analyzer is possible.

Recording from primary neurons is best suited to study the *statoreceptor* mechanism. The receptor's responses are bound to be modified through the next level, and direct recording from the receptors themselves is not yet feasible.

Resting activity and responses of true *statoreceptors*, identified according to the above definition, have been recorded from the vestibular nerve by many authors, both from few isolated fibers (Ross, 1936, in the frog; Lowenstein, 1950, 1956 in the Ray) and through microelectrode technique in the cerebellectomized cat under Pentothal anaesthesia (Levitan *et al.*, 1967) or even in the intact awake cat (Rupert, *et al.*, 1962).

The findings of all authors are basically in agreement. According to Ross (1936), however, the gravity *statoreceptors* do not respond to vibration, while, according to Lowenstein (1956) they do so, even at relatively high frequency. The question is relevant; in fact, the head is the site of continuous vibrations (fig.1) due to muscular activity and to the heart beat, and a corresponding stimulation will be superimposed to the positional response of the *statoreceptors*, introducing an uncertainty element. The main purpose of this paper is, therefore, to clarify this point, by studying the response to vibration of the *statoreceptors* and its relation to the *statoresponse*.

### METHOD

**Surgical preparation.** Bull frog. The animal was narcotized by immersion for approximately 25 min. in a solution of Tricaine methasulphonate 2% (1). The two vestibular nerves were exposed through a hole in the palate. The animals were then allowed to recover for 48 hours and observed for any indication of vestibular injuries. If they appeared to be normal in posture, jumping and swimming capability, they were then partially demotorized by cutting all branches of the thoracic and lumbar plexuses. At this stage, as they were unable to move, they were left under water at a temperature of 13° C°. This is necessary at normal air Po<sub>2</sub> (155 mm Hg), as skin respiration assures a steady metabolic state at or below this temperature only.

After a 24 hours recovery period, without any further anaesthesia, the animal was placed on a tilting and vibratory table, with the head firmly clamped. Neutral buoyancy tungsten microelectrodes were implanted chronically by means of a hydraulic micromanipulator with the technique described elsewhere (Gualtierotti and Bailey, 1968). In most of the cases one microelectrode was implanted in each vestibular nerve.

**Experimental procedure and data acquisition.** Immediately after the microelectrode implantation the resting discharge of each single unit was recorded and analyzed for at least one hour except when the experimental routine required differently. Then the experiment proper started. When the unit was studied for more than one day, at the end of each experiment the animal was carefully detached from the tilting table and replaced in the refrigerated tank. The next day the experimentation was started again as described above.

(1) MS 222 (Sandoz)

The tilting table which provided the appropriate gravitational stimulation allowed tilting in all directions up to +90°. The tilting could be performed either manually, or, for precise and smooth movements, limited to a range of 20°, through a hydraulic system. The table was placed on an antivibratory pedestal. The required vibratory stimulation was assured, by a small shaker applied to the tilting table itself. With this method, tilting and vibration could be applied either separately or simultaneously.

Acute experiments were also occasionally performed as a control using the same electrode and the ordinary microelectrode technique.

Vibratory and linear accelerations were recorded through appropriate strain gauge accelerometers.

All data were recorded on analog tape.

Data analysis: interspike intervals were directly measured through a multiple range (0.1-0.2-0.5-1-2-5 sec) ramp generator. The data thus obtained were immediately tested for single unit activity. This was done, both in line and from the magnetic tape by means of an interspike interval histogram of the entire recording, irrespective of the experimental procedure, through a CAT 400. The time base was so short that the onset only of the histogram was shown. If a large enough number of intervals (0.078 msec/address) were so processed (over 1000) even a two unit recording would show the absence of a minimum interval (fig. 2). In this case, shifting of the spikes corresponding to the two units would in effect cover all possible situations from synchronization to any interspike interval. In fact, a single unit does not fire a second time except after a delay from the previous spike, considerably larger than the refractory period (see Discussion). In this way it is possible to make sure easily that even during a discharge containing hundreds of thousands of spikes, no additional unit has intruded.

Responses to transients were plotted against time, simultaneously with the acceleration involved or against the acceleration itself. Steady state responses, even to "0" stimulation (resting discharge), were analyzed by computer. Interspike interval histograms for statistical distribution tests for stationary state firing by trend analysis and by determining the coefficient of variation ( $v = \frac{\sigma}{\bar{m}}$ ).

## RESULTS

Except for comparative studies statoreceptors only will be described here; as already mentioned, these units were identified by the fact that they did not reach full adaptation even after 30 min. of steady stimulus; their firing, therefore, became stationary after a certain time and this was proved by trend analysis.

Of 394 vestibular units studied, not belonging to the semicircular canals, 84 proved to be statoreceptors according to the above criteria. Within this number 20 have been studied for more than 10 h. and 11 for 48 h. and more. The results here presented are based mostly on the analysis of these units. Some basic parameters are summarized in Table 1.

Resting discharge, gravitational responses both during continuous tilting at various speed and in stationary position, and discharges induced by vibration at various frequency from 2/sec. to 600/sec. have been studied.

In most of the cases simultaneous vibratory and tilting stimuli were also applied in order to reproduce a truly physiological situation.

Resting discharge (R.D.). All units showed a resting discharge. Some appeared to be silent immediately after the implantation of the electrode but started firing spontaneously after a variable period of time (from 10-15' to 1 hr.): these units were characterized by a very low rate of firing (For example unit n. 2, 15, 18 - Table 1). The resting discharge became stationary in all units approximately 1-2 hours after the microelectrode implantation; in fact, before this period a high percentage of fast activity, in bursts, was recorded, resulting in a large early peak in the histogram (Fig. 3).

The fast activity consisted in 2-3 spikes with very short intervals, appearing in between the slower firing, at random (Fig. 4AB arrowed). Although such activity remained more or less present in some unit throughout the entire experiment while disappearing nearly completely in others it always showed a marked decrease after the initial 1-2 h. period (Fig. 3). Autocorrelation tests showed no periodicity in the appearance of the bursts even in the units in which they were more frequent.



TABLE N. 1

Units	MSEC INTERVAL			MODE		MSEC ADAPT.		MSEC TRANSIENT POS.					MSEC TRANSIENT NEG. (pause)		RANGE OF STIMULUS IN G.
	min	max	average	m sec	%no.	Init. av. (Max)	Stat. av. (st.)	1	2	3	4	5	Min	Max	
1	4	560 (300)	240 (32)	100 (55)	14.4 (54.0)	42	(65%) 70 (20")	212	115	76	42	12	950	15	0.20
2	5	3100 (120)	930 (120)	740 (130)	16 (95)	60	(83%) 110 (30")	1200	640	300	80	12			0.37
3	12.25 (6)	220 (62)	90 (30)	25 (12)	43 (58)	35	(91%) 67 (31")	110	70	43		28	1300	40	0.62
4	5 (4)	250 (210)	42 (10)	24 (10)	37 (55)	15	(17%) 22 (5")	125	95	50	37	13	1100	17	0.045
5	7.5 (3.8)	380 (34)	76 (8)	13.8 (7.5)	17 (87)	42	41	210	75	40		5.3	1400	23	0.44
6	5 (5)	2000 (75)	300 (20)	35 (20)	2.9 (39)	45	60% 72 (25")	180	150		45	32	1700	35	0.01
7	4 (7)	500 (65)	50 (20)	120 (45)	4.7 (72)	16	(200%) 48 (3")	40	20			16	1300	32	0.13
8	3.2	400 (40)	150 (30)	52 (37)	7.2 (57)	10	(600%) 70 (6")	120		60		10	1500	40	0.14
9	4 (7)	250 (74)	105 (60)	22 (18.7)	2 (4.9)	70	(20%) 84 (12")	90	74	40	20		1050	65	0.04
1 (Vibrat.)	3.7 (6.25)	490 (310)	60 (55)	44 (24)	6 (4.6)	Total		60	55	40	50	37	1700	50	0.13
10	5.1	530	262 (50)	51 (20)	2.2 (43)	36	(39%) 50 (13")	250	200	115		32	2000	50	0.15
11	2.0	275	95 (15)	27 (22)	15 (67)	4	(320%) 4 (4")	54		35		2.5	700	18	0.26
12	2.0 (2.0)	250 (42)	60 (11)	15 (15)	2.2 (9.4)	50	(20%) 60 (12") (11%)	85	35	10	6.5	4.3			0.4
13	3.7 (4.5)	175 (37.5)	70 (18)	25.5 (10)	9.5 (4.3)	18	20 (18") (37%)	70	25	20		15	250	16	0.17
14	2 (2.0)	190 (49)	95 (37)	31 (25)	8 (51)	37	50 (7") (50%)	42	29	20	17	10	1000	15	0.1
15	4.4	1400	670 (45)	20 (12)	3.6	30	45 (6")	320	50		22	11	1200	14	0.035
16	2.5 (3)	250 (41)	71 (69)	50 (41)	11 (53)	fast to total		56		51	41	30			0.07
17	2.2 (3)	420 (50)	100 (26)	20 (20)	4.1 (37)	25	26		80	55		25	1800	30	0.30
18	10	1560 (178)	1100 (93)	20 (70)	2.1 (34)			740	410	230		58			0.30
19	5.0	220	120	47 (45)	8 (72)	31	(318%) 130 (15")	98	48	31	24	21	1400	120	0.175g
20	1.95	400 (120)	120 (145)	22 (15)	6 (74)			68	61	40	38	35			0.08

The interspike intervals histogram indicated that no unit showed a minimum interval equal to the refractory period, the minimum value observed being 2 msec. In the different units the minimum interval values ranged (Table 1, 1st column) within relatively wide limits (from 2 to 12:25 msec) with an average of 4 msec. The analysis of several tenth and even hundredth thousands of interspike intervals of the same units showed that each value is a constant for each statoreceptor.

The intervals mean is a poor indication of the unit activity owing to the large variability observed for the resting discharge: it shows, however, (Table 1, column 2) large differences in the different units from 42 msec (a rate of approximately 24/sec) to 1100 msec (a rate of 0.9/sec). Statoreceptors resting activity, therefore, varies from a very slow to a fairly frequent one. A better index of the receptor activity are the interspike intervals histograms: these are defined in Table 1 by three parameters: the mode (5), the percentage of intervals within the mode (column 6) and the tail (column 3) (the largest interval). A low percentage number in the mode indicates, of course, a wider dispersion of data. The mode, which indicates the most frequent interval, seems to be included in a narrow range, between 13 and 100 msec, with a mean of 32 msec. Much wider is the variability of the percentage of intervals in this class, as it varies between 2% and 43% with an average of 16%. The reason is shown comparing in Fig. 5 histogram n. 1 with n. 3. The first shows a very relevant peak and the other a nearly even distribution in all classes. The distribution does not really match a Poisson curve, although it might seem very similar, because of the extended tail: this is due to the appearance of occasional very long intervals equal to several times the mean. These long intervals seem to be related to the fast or slow basic activity of the units; a fast unit (10-20/sec) will never show an interval longer than some hundreds of milliseconds while a slow (1-5/sec) unit might show intervals of several seconds occasionally. However, between the mean and the largest interval a clear cut relation is not observed. For example, in unit n. 7 (mean 50 msec) the longest interval is 500 msec, while in unit n. 9 (m. 105) the longest interval is 250 msec.

The early peak shown in the histogram of some units (Fig. 3 A B) varies in amplitude within a narrow range at stationary state. As mentioned before, it corresponds to the high frequency burst shown in Fig. 4. The characteristics of this activity are strictly related to the behavior of the slower phase of the R.D. In effect it was modified in parallel with the R.D. and in no way it has been possible to differentiate the fast and the slow component of R.D.

The R.D. was modified in two instances: as an after-effect of the response to stimulation after the pause (Fig. 4 C, E) and when a rapid back tilt was applied to the preparation (a back tilt is tilting towards a direction opposite to the one that stimulates the units: when performed slowly it does not seem to produce any alteration of the R.D.) A prolonged suppression of firing was then observed, quickly reversed by a tilt in the appropriate direction (Fig. 6 A, B).

Steady state stimulus and stationary response. The highest response was always observed during a transient stimulus due to a continuous tilt; when at the end of it the head was kept in a steady position, after an initial adaptation period, a stationary activity was recorded, significantly different from the resting discharge (Fig. 7), from all the statoreceptors studied. The adaptation period varied from few seconds to 20-30 seconds. As shown in Table 1 the decrease in the rate of firing due to adaptation varies very much in the group of the statoreceptors considered. Some hardly show any change at all (see units 17 and 18), some show a decrease of as much as 300% (unit 11). However, the activity is stabilized after this period and no trend is shown (Fig. 8) thereafter, indicating a true stationary discharge.

The change in interval distribution at different levels of excitation is exemplified in Fig. 9A. The mean value, the largest interval and the percentage of the mode are shown. The range of the unit is 0.62 g as a change in the activity starts in b) and saturation is reached in e). Within this range the only parameters that change significantly are the average interval value, the percentage of interval in the mode and the maximum interval. The variation of the three parameters is shown

OTOLITH UNIT: SINGLE UNIT TEST

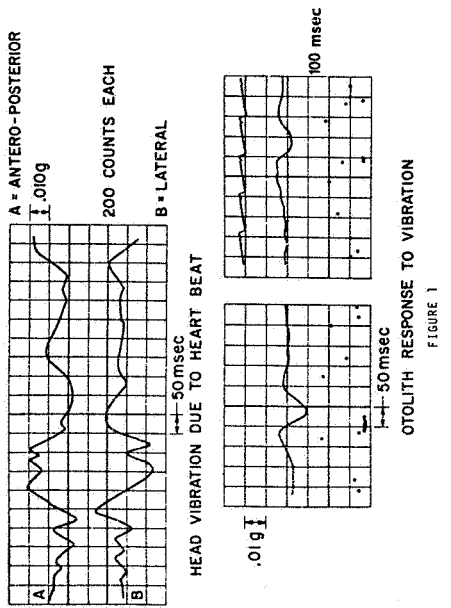

FIGURE 1

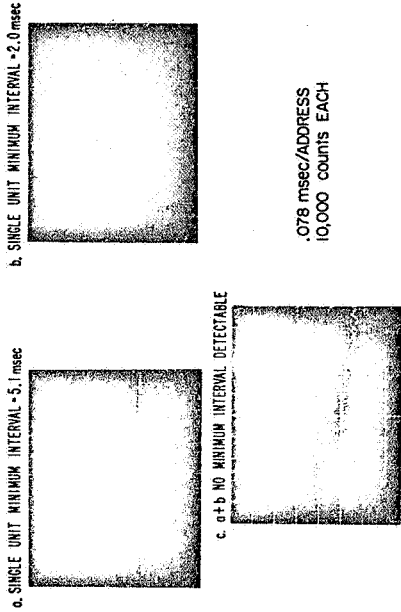

FIGURE 2

VESTIBULAR UNIT - HISTOGRAM OF TIME INTERVALS DURING SPONTANEOUS FIRING

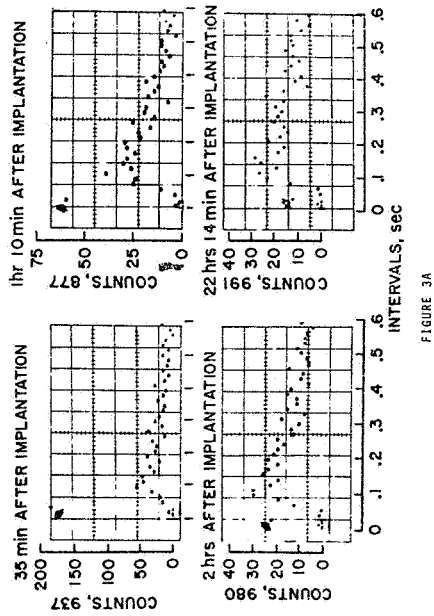

FIGURE 3A

VESTIBULAR UNIT - HISTOGRAM OF TIME INTERVALS DURING SPONTANEOUS FIRING

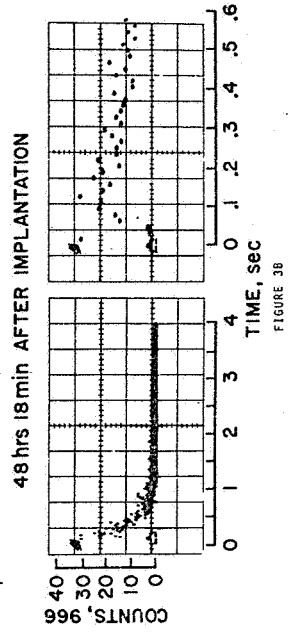

FIGURE 3B

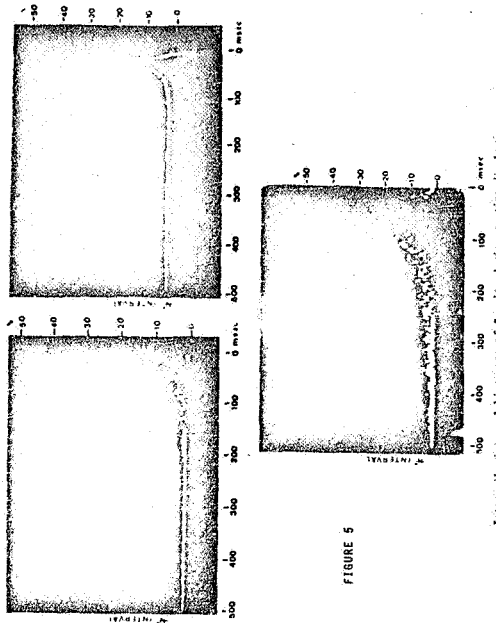

FIGURE 5

Interspike interval histogram of 3 units during resting discharge.

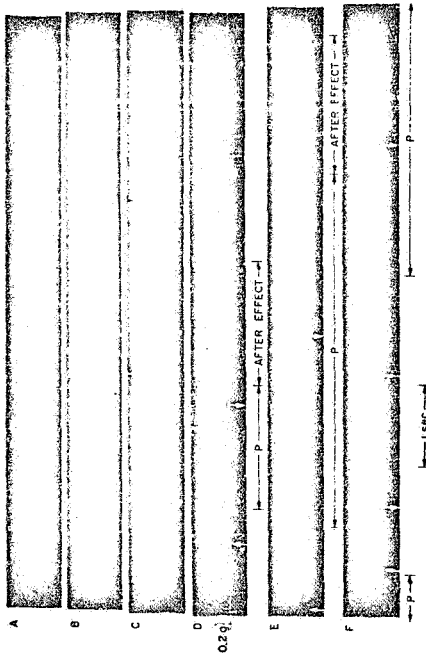

FIGURE 4  
High frequency burst.

OTOLITH UNIT: SUPPRESSION OF THE DISCHARGE DURING A SUDDEN BACKTILT

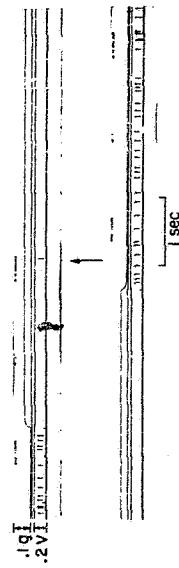

FIGURE 6A

OTOLITH UNIT: POSITIVE AND NEGATIVE RESPONSE TO TILT ( $\pm$ )

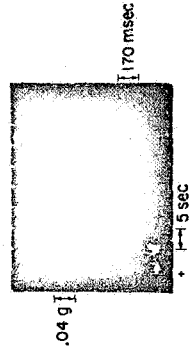

FIGURE 6B

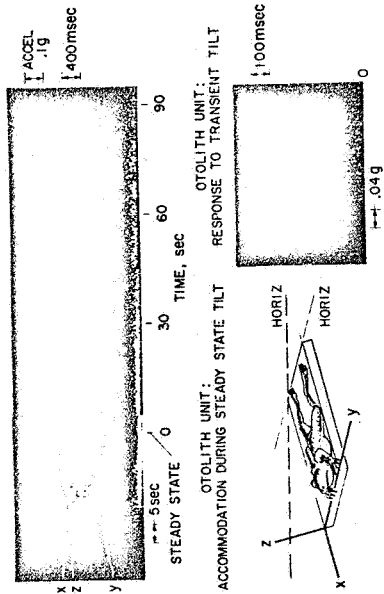

FIGURE 7

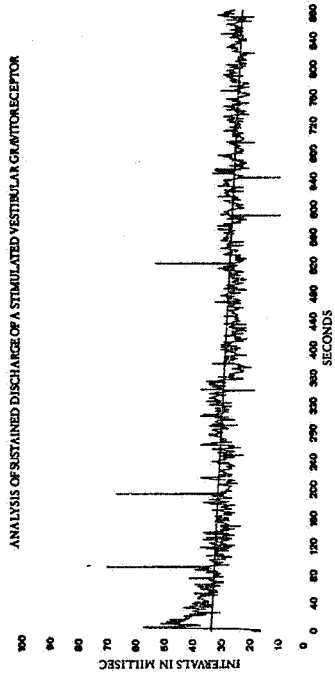

FIGURE 8

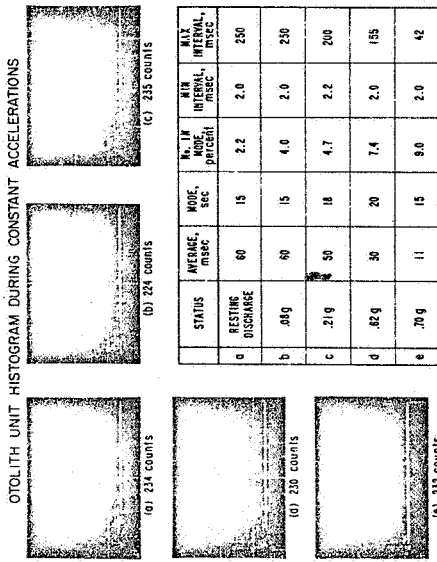

FIGURE 9A

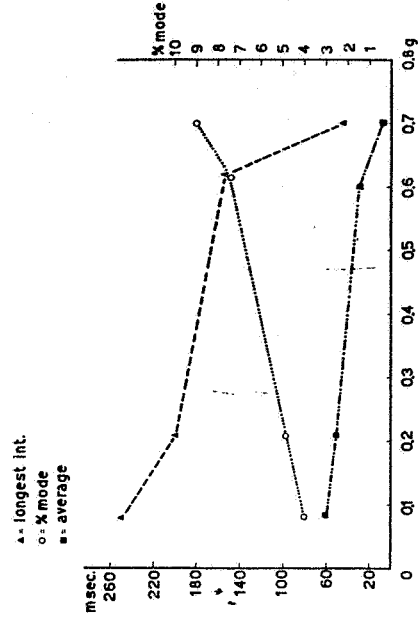

FIGURE 9B  
Diagram showing the course of the three main significant changes shown in the histograms of the previous figure.

diagrammatically in Fig. 9B. All three are significantly different at the different excitation intensity. Some of the resulting curves appear roughly S shaped, different from the simple logarithmic relationship shown during continuous tilt (see later). Analyzing the same data for the entire group (Table 1, column 8,9, 10,11,12) of statoreceptor an equal complex stimulus response ratio is observed although in many cases it approximates a log curve (Fig. 9B). The range of the statoreceptors varies widely (Table 1, last column on the right) from a minimum of 0.01 to a maximum of 0.6: none was found covering the entire 1 g range and many were remarkably limited to a few hundredths of g. It must be emphasized that the stimulation was always performed at the center of the field of the unit, namely, in the conditions of maximum sensitivity and minimum range (Gualtierotti, 1968).

Transients: linear, vibratory, linear plus vibratory. Whatever the transient stimulation, two kinds of responses were always recorded: to an acceleration applied in the appropriate direction for the unit excitation, an increase of the mean of the firing rate, and a decrease of the largest interval value was observed parallel to and proportional to the increasing stimulation. As soon as the stimulus was decreased a suppressory effect in the firing was observed, largely independent from the course of deceleration. This was followed by a period of lower rate of firing till normal resting discharge was observed (Fig. 4 d-e). During a smooth tilt at a speed of or below 1°/sec, resulting in an excitatory linear acceleration (the gravity component in the appropriate direction) a log stimulus response ratio was recorded when the largest interval (Fig. 10A & B) or the mean was taken as the significant data. The range of the response following continuous tilt was the same for each unit as at a steady stimulation. If the speed of the tilt exceeded the value indicated above, some bursts of quick firing preceded the normal response (overshooting). Back tilting after a stimulation always produced a suppressory effect as mentioned before; its duration appeared to be related with the speed and the duration of the back tilt (Fig. 4 C,D,E). If the backtilt was performed very slowly and smoothly the suppression effect might be very short, but a return to normal following in reverse the same curve as by stimulation was never observed.

All statoreceptors studied seem to be able to follow the course of vibratory stimuli up to 3-400/sec. The limiting factor was the shortest interval: if the vibration frequency was higher than the reciprocal of the shortest interval of that particular unit the response was erratic.

The statoreceptors response was limited to the field in which the response to linear acceleration was also recorded (Fig. 11): frequency, amplitude and shape of the vibration corresponded to significant changes in the parameters of the response. The firing pattern during a vibration followed the characteristics described in the previous chapter for the response to linear acceleration: the rate of firing increased as a function of the intensity and the speed of that part of the vibratory charge corresponding to a positive stimulus (Fig. 1): when vibration produced what for the unit appeared as a deceleration, the already described suppressory effect was shown, with a long interval. The succession of the two phenomena was relevant. In fact, if the deceleration was fast enough, a long interval preceded the burst of fast firing; this did not happen for a lower velocity. If the deceleration followed the stimulus, a long interval was nearly always present, proportional to the speed of the deceleration. As a result, a sinusoidal vibration will produce either, a) an alternation of burst of firing followed by long intervals. This will cover two possibilities - a positive acceleration followed by a negative one, a negative slow acceleration followed by a positive one. Or b) a long interval followed by a burst when a quick deceleration is followed by a positive stimulus. The rate of the burst was proportional to the speed of the stimulus and its duration to the time course of the increasing acceleration during the vibration. The values of the interval following the burst were proportional to the speed and duration of the deceleration. By the combination of these factors the vibration acceleratory curve was identified closely by the firing pattern of the receptor involved: see for instance Fig. 12 where vibratory waves of different amplitude and frequency provoke a recognizable change in the statoreceptor activity. An example with a complex vibratory wave is shown in Fig. 13. In a series of nearly identical vibratory wave forms the responses of the statoreceptors were also very similar to each other. When a vibration was superimposed to a tilt, the

COMPUTER ANALYSIS

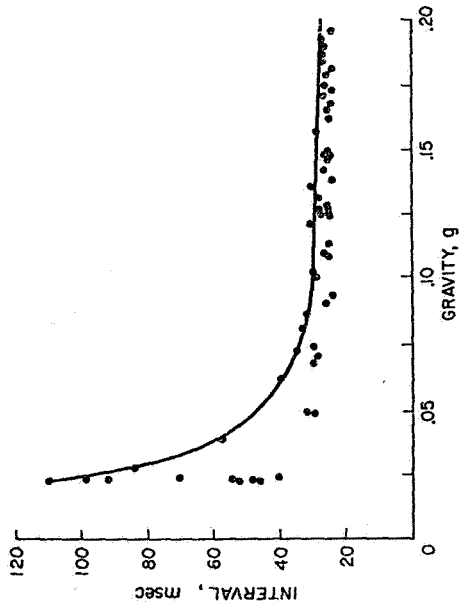

FIGURE 10A

OTOLITH RESPONSE TO VIBRATION (VERTICAL Z ONLY)

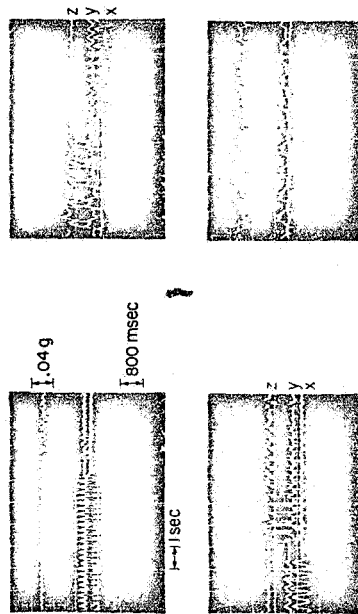

FIGURE 11

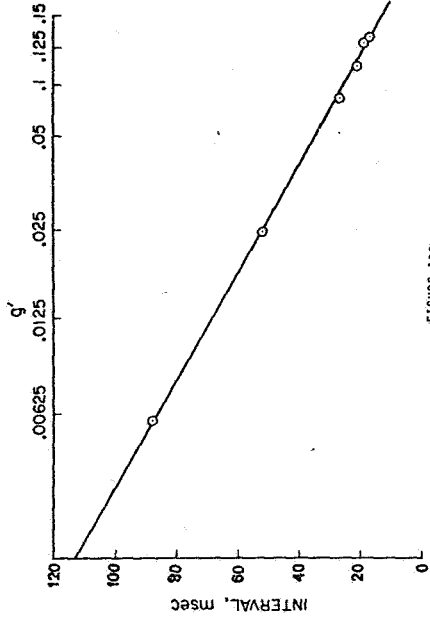

FIGURE 10B  
Computer analysis.

OTOLITH RESPONSE TO OSCILLATORY VERTICAL ACCELERATION (5/sec)

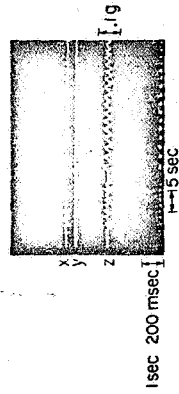

FIGURE 12

## LEGENDS

Table n. 1 - Here shown are the main parameters of 20 statoreceptors plus one receptor responding to vibration only (n. 1 after n. 9). The statoreceptors have been studied for at least ten hours.

Column n. 1: number of units. Columns n. 2-3-4: minimum interval, maximum interval and average interval, respectively, in msec. Columns n. 5-6: mode and percentage of the mode in the histogram. (The upper number corresponds to the values during resting discharge. The number between brackets during maximum stimulation).

All steady state data were analyzed for at least 10 K intervals.

Columns n. 7-8: adaptation during maximum constant stimulus: average interval value in millisecond immediately after transient (7) and at stationary firing (8). In (8) the numbers between brackets indicate the adaptation time (from the end of the transient to the beginning of the stationary activity). Columns n. 9-13 indicate the average firing rate at 5 arbitrary levels of excitation from threshold to maximal stimulus during a smooth tilt. Columns n. 14-15 indicate the response to deceleration at maximum and minimum speed respectively. The last column on right indicates the range of the unit in the area of the field of maximum sensitivity. For further observation see text.

Fig. 1 - Upper record: vibration of the head in a human subject sitting in a chair comfortably. Lower record: response of a single otolith unit of the bull frog to vibration of comparable intensity as the one in the upper record. Upper tracing, acceleration profile. Lower tracing, each dot corresponds to an interval. The value is read from the "0" line to each consecutive dot.

Fig. 2 - Demonstration of the method for determining a single unit firing during a prolonged recording: initial part of the interspike interval histogram is shown: a) and b) of a single unit each, c) of the sum of the two units a + b: as shown in a) and b) a minimum interval of 5.1 and 2 msec is determined. In c) no minimum interval is visible, owing to the presence of two different units activity.

0.078 msec/address.

10.000 (10K) intervals each histogram.



Fig. 3A - Histograms of intervals during spontaneous firing of the same unit over a 48-hour period. Results of the first 24 hours. Note bimodal distribution; first peak arrowed.

Fig. 3B - The same as Fig. 3A after 48 hours. On the right, same histogram with an expanded time base for better demonstration of the bimodal distribution. First peak arrowed.

Fig. 4 - Lower record: resting discharge (A-B) and evoked response (C) of a single fiber of the VIII nerve in the bull frog corresponding to a gravitoceptor. The three upper tracings indicate the linear acceleration in the x y and z axis. In C: the head down tilt provokes an increase in the average rate of firing. In D, E and F back tilting stops suddenly the discharge (P=pause). This is followed by a slower firing (after effect). The pause seems to be related to the speed and duration of the back tilt. Note the irregularity in the rate of firing: very short intervals, practically double firing are arrowed in A and B. Note also the accommodation effect at a steady tilt in C and D indicated by a spontaneous decrease of the rate of firing. Calibration of the accelerometer and time in the record amplitude of the spike: 500 uV.

Fig. 5 - Interspike interval histogram of 3 units during resting discharge. The wide difference in distribution is shown. 10 K intervals for each unit have been analyzed: on the abscissa, interval's duration in msec; on the ordinate: number of intervals in % of total.

Fig. 6A - Suppression of firing during a resting discharge due to rapid back-tilt outside the unit range. A spike (arrowed) in the middle of the suppression period shows that no artifact exists like for instance the displacement of the electrode during the tilt: upper record, gravity acceleration component; lower record, spike train data (the base noise is clipped away). Calibration of the spike amplitude and acceleration in the figure.

Fig. 6B - Positive and negative response to a rapid tilt ( $20^\circ/\text{sec}$ ) and a back tilt respectively of a single otolith unit in the bull frog. The consecutive intervals are shown as the distance between the "0" line and each white dot: the acceleration resulting from the tilt is indicated by the continuous line.

Fig. 7 - Response to continuous tilt and to a steady state stimulus at the end of the tilting motion. The intervals are measured as in Fig. 6B. Continuous lines: accelerations in the

three directions of space as shown in diagrammatic figure of the frog on left. Insert on bottom right: changes of interval values as a function of the gravitational component during tilt.

Interval values in msec, acceleration in "g" and time in the figure.

Incomplete adaptation is shown: the intervals duration increases up to 30" after the end of the tilting motion: then the activity becomes stationary (see Fig. 8).

Fig. 8 - Computer analysis of trend during a steady state stimulation resulting as a sustained discharge. The regression line proves that no adaptation is shown after a few seconds and stationary firing is reached. Each point = to the mean over a 400 msec period. On the abscissa: duration of the discharge in seconds; on the ordinate: interval values in msec.

Fig. 9A - Series of interspike interval histograms of the same unit at different levels of constant excitation. The main parameters of the histogram are described in the figure. As shown the unit starts responding after an interval tilt corresponding to 0.08 g.

Fig. 9B - Diagram showing the course of the three main significant changes shown in the histograms of the previous figure: the longest interval, the percentage in the mode and the average interval value; on the abscissa, acceleration in g; on the ordinate on left, intervals in msec; on the ordinate on right, percentage of intervals in the mode. The curves indicate a complex stimulus response ratio, but certainly not a linear relationship.

Fig. 10A-B - Diagram showing the stimulus response ratio of a single otolith unit in the bull frog, taking in account the envelope of the curve only: in A on a linear and in B on a logarithmic scale. Note a nearly perfect fit with the Weber Feckner law (see text).

Fig. 11 - Statoreceptor response to vibration: intervals and accelerations continuously measured as in Fig. 3A. g level, time and interval duration in msec in the record. As shown, the statoreceptor responds to vertical vibration only (Z, see second on top, left, compare with absence of response in record on top, right). Frequency and amplitude changes are followed clearly by bursts of firing followed by a long interval: this is especially evident at low frequency (record on bottom, right).

Fig. 12 - Same statoreceptor as in Fig. 11, same method of analysis, vibration on vertical plane only (z). A sine wave vibratory stimulus of different amplitude and frequency is clearly analyzed by the receptor. For further information see text.

Fig. 13 - The response to a complex vibratory stimulus is shown. A basic sine wave is superimposed by a faster frequency of lower amplitude. The receptor response follows with very similar patterns the main frequency, the shape of which is very approximately constant. It does not follow the superimposed one as this is higher than the reciprocal of the minimum interval. The main character of the response are the increase of the rate of firing up to a very high frequency burst of two spikes during the downgoing deflection of the vibratory wave (positive acceleration = increasing stimulus). This is followed by a longer interval during the second part of the curve: (deceleration = decreasing stimulus). Time, interval, duration values in seconds and acceleration in "g" in the figure.

Fig. 14 - Example of analysis of a statoreceptor during vibration, and tilt plus vibration. On top, left, direct recording of the raw spike train data (lower record) during vibrations on the x and y only (no response, possibly suppression) and on z only (fast discharge, modulated by the vibratory frequency). (Upper three records right, test for single unit firing covering the entire experiment (see Fig. 2). A minimum interval of 2.9 msec is shown. On bottom, left: changes of intervals duration as a function of the gravitational acceleratory component due to tilting plus vibration in "g". On the ordinate intervals measured as a distance of each white-dot from the abscissa; on the abscissa, acceleration in "g". On bottom, right, analysis of a portion of the response measured as in Fig. 6B. On top, time marker. Continuous line, gravitational component plus vibratory wave. Note dots measuring intervals as described above. The responses to vibration are arrowed. The total response shows an overall decrease of the intervals duration, plus bursts of quick firing alternated with longer interval, following the wave form of the vibration.

Fig. 15 - Recording and analysis of one efferent fiber in the VIII nerve cut peripherally; on top, spike train data (lower record) and imposed vibratory accelerations in the three directions of space. Three upper records: note the periodic burst of spikes, at a very constant frequency but with variable interbursts intervals. No relation exists between the vibration and the periodical activity: bottom, on left, the modulated activity persists even if no vibration is imposed. From the interspike intervals histogram on bottom right, a five peak distribution is shown.

Fig. 16 - Response to rapid rotation of the dorsal muscles in the bull-frog on left upper and lower records and of one unit of the semicircular canal. The four record on left shows the electromiogram of the two muscles on right and left (first and third record). Middle record: acceleration in the horizontal plan before and after cutting of the vestibular nerve bilaterally. Single figure on right: changes in the interspike intervals analysed as in previous figure in the same conditions. As shown the muscular response follows the semicircular canal stimulation and is provoked by it.

response of the statoreceptors followed a complex pattern by which both the acceleratory components were recognized by the unit (Fig. 14). Namely, while the general envelope of the curve describing the variation of the interval duration as a function of the gravitational component change during the tilt followed the usual log stimulus response ratio, bursts of fast activity with the characters described above were recorded simultaneously with the vibration waves (bottom on right: vibration responses arrowed). It can be concluded that the response to an acceleration of any kind within field of each statoreceptor is the result of three factors: 1) the absolute value of the acceleration (linear and vibrating for example), 2) the direction, and 3) the speed of the preceding accelerating change.

#### DISCUSSION

Statoreceptors are characterized here as those vestibular receptors that do not show complete adaptation. This is a legitimate assumption as, in this case, the position of the head will correspond to a specific level of activity in the sensory input, thus assuring the proper information to the central analyzer (Ross, 1936; Lowenstein and Roberts, 1950; Trinker, 1962; Rupert et al., 1962; Levitan, Rosenberg and Vidal, 1967). This means that at a certain time during a steady stimulation, a stationary firing must be recorded, significantly different for any position of the head. This condition can be conclusively shown by a trend analysis of the spike train data as performed here. An approximate but not wholly satisfactory indication might be provided by a steady mean rate of firing lasting some minutes.

All of the 84 statoreceptors thus identified (and for that matter the other non-semicircular canal units also) showed a resting discharge, although some of the units might fail to fire for as long as 1 h. after the microelectrode implantation: after that period, however, firing started spontaneously. In nearly all such cases a very low rate of discharge was recorded; this is contrast of Ross finding (Ross, 1936), namely, that the receptors of ear remain inactive in the absence of movement or vibration. However, all other researchers in the field conclude differently and the possibility exists that Ross results might be due to a preparation less than in good physiological condition.

In an intact animal, with good circulation, as it is the case here, it seems that even the implanting of the microelectrode provokes some transitory irritative reaction. This is indicated by the frequent bursts of 2-3 spikes firing at relatively high frequency, that correspond to the first peak of the interval histogram: this peak decreases progressively up to 1-2 hours after the implantation. In most units it disappears completely, but there are examples (see Fig. 3B) in which the fast bursts, although reduced, remained evident. In the case showed in Fig. 3 A-B' the unit was followed for 96 hours and the early peak in the histogram never disappeared. It is, therefore, possible that such activity is truly physiological. This might also be proved by the fact that a fast deceleration provokes a suppression of the fast activity also; therefore, it must be linked with the statoreceptor condition.

The resting discharge particularly, but also the evoked activity during stimulation, was always very irregular. This confirms Ross (1936) results on the frog but not the observations of Lowenstein and Roberts (1950) in the isolated labyrinth of the Ray. Those authors, in fact, reported a very steady firing recorded from the isolated fiber of the VIII nerve both during the resting discharge and the response to excitation. It has to be emphasized, however, that these recordings were obtained from isolated preparations; thus, the feedback through efferent pathways was absent (Lowenstein, 1967). On the other end, even in Ross preparation that shows irregular firing the central pathways were interrupted by cutting of the VIII nerve towards the medulla and by removing the remain of the CNS; but the blood supply was absent in this case also. It is conceivable that the activity in the intact, non-narcotized animal, with good blood circulation might be different from that of the isolated labyrinth. In the intact non-narcotized cat Rupert et al (1962) showed the same variability recorded here in the electrical activity of most of the single primary vestibular neurons they investigated. They also described units firing at a very constant rate. These, however, behaved in a very peculiar manner, with very little or no response to tilting; it is doubtful if they can be considered statoreceptors. On the other end, a number of examples exist of a large variability in the activity of the primary neurons of many sensory system; the acoustic receptors (Weiss, 1964; Kiang, 1964) the reticular units in darkness (Kuffler et al, 1957), the somatic afferents (Werner and Mountcastle, 1965).

The cause of the irregularity might be intrinsic in the cell or extrinsic: intrinsically it might be due to the fluctuation of the junction membrane potential due to thermal agitation (Fatt and Katz, 1952); extrinsically it might be provoked by the efferent system which in the frog shows a peculiar activity. It consists of bursts of a variable number of spikes (from 2 to 10) firing at a rather regular frequency. The intervals between bursts is, however, very irregular (Fig. 15). Such activity, if it can modulate the firing of the statoreceptor is bound to produce irregularity; however, autocorrelation analysis does not show any periodicity in the resting discharge of the afferent comparable to the one seen in the efferent activity (Fig. 15B). It seems, therefore, that the intrinsic factors are predominant in producing the variability of afferent firing.

Although variable, the resting discharge cannot be considered white noise; in fact, a quick deceleration provokes a suppression of firing, which is a valuable element to increase contrast: Lowenstein and Sand (1940) demonstrated clearly the functional significations of such an activity. The existence of a continuous barrage of impulses in the VIII nerve (Ledoux, 1949) is an important factor in the vestibularly originated tonus. The VIII nerve activity controls the vagus activity (Akert and Gernandt, 1962) the motoneurons of the spinal cord (Gernandt and Terzuolo, 1955; Gernandt and Thulin, 1953), the gamma efferent of muscle spindle (Totsuka et al, 1963) and many other systems.

A highly variable activity both in the resting discharge and during responses makes it difficult to understand the coding to be used by the central analyzer of the system. There is no doubt that significant sensory changes correspond to different stimulations; however, a problem exists--which of the changing parameters of the vestibular unit activity is significant to the central analyzer.

The analysis of the data by means of the interspike interval histograms indicates that three elements vary consistently as a function of the stimulus: the mean, the number of the percentage of the intervals in the mode class and the longest interval value. In fact, the shift in the mode does not appear to be consistent and the minimum interval tends to be a constant.

In the frog the motor response to a vestibular stimulation takes place after a delay of 20-30 msec (Fig. 16). Owing to the low frequency of response (50-60/sec max) this will result in 1-2 intervals only. The same situation exists in mammals. It seems therefore, that a significant mean of a single neuron activity is to be discarded as the main information datum; the same applies to the percentage of intervals in the mode. The most likely information is the disappearance of the largest intervals as a function of the increasing stimulus. An alternative would be averaging of a sufficient number of units responding equally to the same stimulus. This is unlikely given the limited number of the units in the system: in fact, 2500 at the most cover the entire spectrum of the utricle and the saccule maculae. Of these much less are pure statoreceptors. If the findings in this paper are statistically significant 84/393 statoreceptors have been found, namely, a little less than 20%; in absolute number = 500. As each unit responds within a very limited range, different from the others, averaging seems impossible to cover the 360° solid angle. Considering the longest interval at any given time (Fig. 10A) continuous cross-correlation between units with overlapping field might be an adequate coding system.

On this assumption the characters of the single statoreceptor response appear clearly. Whatever the kind of stimulation, linear acceleration or vibration, the pattern of response is a function not only of the intensity and of the speed of the stimulus, but also of the preceding events. If by convention, acceleration is the effective stimulus and deceleration the decrease of the stimulus (or an acceleration opposite in direction to the excitatory one) a definite pattern of fast firing followed or preceded by a pause (a long interval, a suppression of firing) will be the results of the succession of acceleration and deceleration or vice versa. This pattern is particularly evident during a vibratory stimulus in which a series of waves can be interpreted as a series of acceleration + deceleration + acceleration, etc., with the resulting bursts of firing followed and preceded by a long interval (pause). The rate of firing, the number of spikes in the burst and the length of the pause are a function of the acceleration and deceleration intensity and speed, therefore, of the frequency of the vibration.

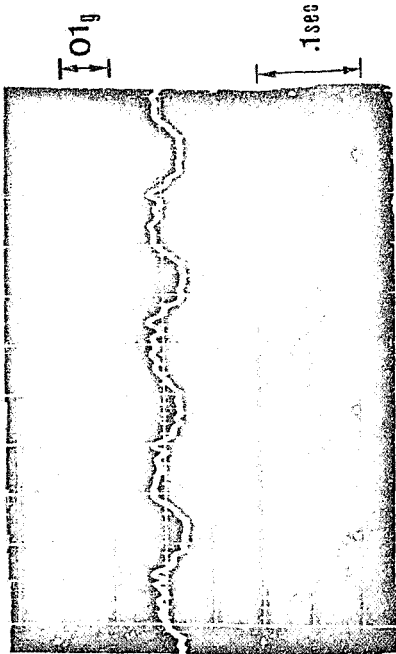

FIGURE 13  
The response to a complex vibratory stimulus.

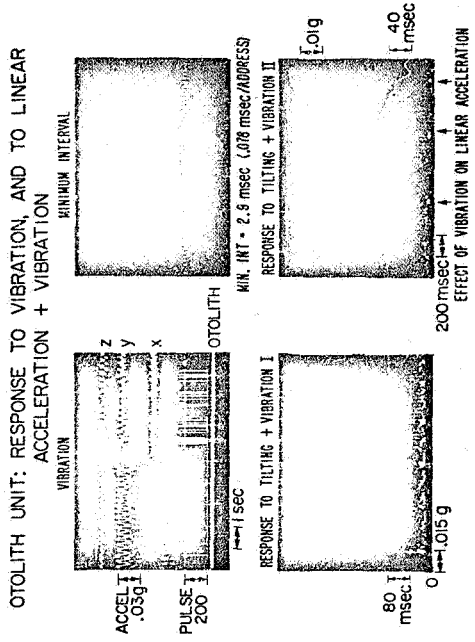

FIGURE 14

Reproduced from  
best available copy.

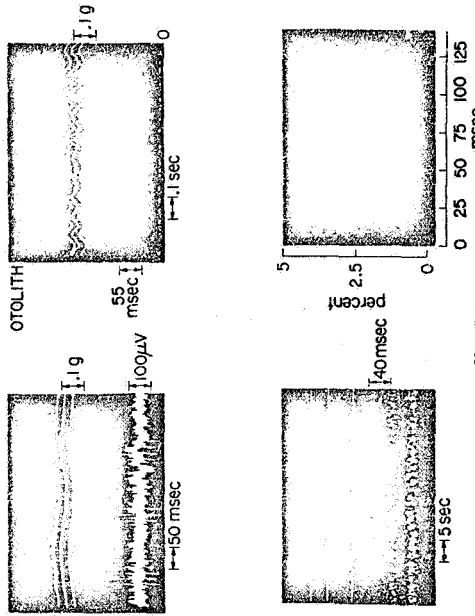

FIGURE 15  
Recording and analysis of one efferent fiber in the VIII nerve cut peripherally.

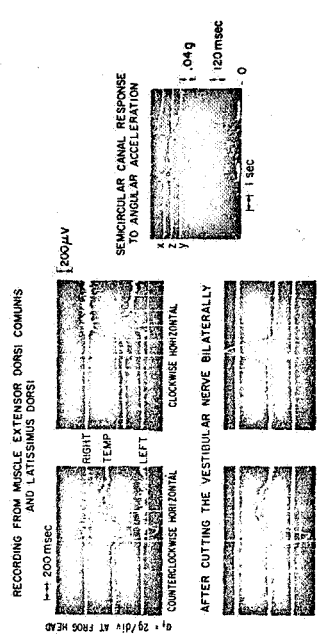

FIGURE 16

Vibratory plus linear acceleration result in a complex response pattern in which the two components are recognizable; the importance of this finding is that this interaction is the most physiological one, as the head is the site of periodic vibrations due to the heart beat (Fig. 1). This problem is fully discussed elsewhere (Gualtierotti, 1967). Lowenstein (1955) was the first to indicate that otolith cells were able to respond to vibration. De Vries (1956) fully proved the possibility of this by theoretical analysis of the mechanics of the otolith. Very recently Levitan et al (1967) reported that in the cat single statoreceptors were able to follow closely pendular oscillation. Their experimental routine was, however, limited to a rate of 30 cycles/minute and this value was too low to determine the dynamic limitation of the system. De Vries put it at or around 500/sec. In the present experiment, the limitation seems to be linked to the minimum interval value. Consistently the statoreceptors were able to follow frequencies up to the reciprocal of the minimum interval. After that the response became saltatory.

The minimum interval value suggests an interesting problem. It is much more than the refractory period; in fact, it is quite long in respect to any known physical parameter of the system. As the firing is presumably due to a d.c. generator potential depolarizing the initial part of the axon, and/or to a chemical transmitter, the interaction might be interpreted in two ways; either in a quantum increase of the transmitter substance, the minimum interval due to the quantum value at the junction (Lowenstein, 1967) or to a depolarization due to an electrical current flowing at the central axon site. An analysis of this mechanism has been made by Fuortes et al (1962) in the eccentric cells of the limulus, using a depolarization step current. In this case even the first interval in the sub-stained firing recorded is longer than the refractory period. Later intervals are even longer. Their inclusion is that repetitive firing is both controlled by the after-effect of firing (refractory period) and the depressant effect of sub-stained stimuli (accommodation). The same conclusion might explain the relatively large minimum interval here. If this is the case, it is understandable that the minimum interval is the limiting factor of the frequency response: it is much more limiting than the pure dynamic of the mechanical system and, therefore, the nervous factor is the predominant one in this respect.

Two last points have to be mentioned here, although they are fully discussed elsewhere (Gualtierotti, 1968). Contrary to the classical results of Lowenstein and Roberts (1950), 1) no statoreceptor has been found with the full range of  $\pm 1$  g, and 2) the stimulus response ratio is definitely not a linear function of the sine of the tilting angle. It is a log function in the continuous slow tilt; it is a complex wave with a high initial peak in a fast tilt and it is a rather complex wave approaching an S shaped curve in a stationary state. This, by the way, contradicts an early finding of this work as the analysis of few data seemed to indicate a log stimulus response ratio even at a steady state. The reason for this divergence of result are, as already said, discussed extensively elsewhere but it is worthwhile mentioning here that: it is important to define the field of the unit; the response is different in the center of the field than at the edges; in the center the sensitivity is maximal and the range minimal and a clear non linear stimulus/response function is demonstrated when the stimulation ranges from threshold to saturation. At the edges a position exists in which the unit follows the behavior reported by Lowenstein and Roberts (1950); a large decrease of sensitivity corresponds to a wider range, even above  $\pm 1$  g, and the stimulus response ratio, being only a segment of the total curve, might appear, untruly, as a linear function.

#### SUMMARY

- 1) Vestibular statoreceptors in the bull frog partially paralyzed are identified by recording the spike train data from the corresponding primary neurons through chronically implanted neutral buoyancy tungsten microelectrodes: a stationary response, different for the different positions of the head, after a preliminary uncomplete adaptation, is considered the main index of a true statoreceptor.
- 2) Resting activity and responses to linear and vibratory acceleration are analyzed by computer; interspike interval histogram, changes of intervals value parallel to or as a function of the applied acceleration, autocorrelation and trend analysis are performed.
- 3) 84 statoreceptors, over 394 non semicircular canal units have been studied: of these 20 for more than 10 hours and 11 for more than 48 hours.

4) A highly irregular resting discharge was recorded in all cases: intrinsic and extrinsic causes of this irregularity are discussed: the variable activity is not considered a white noise but a significant base line activity. This activity became stationary 1-2 hours after the electrode implantation: burst of fast activity in the resting discharge decreases in quantity within this period but cannot fully be explained as due to purely irritative factor, although it is maintained in some receptors only.

5) During stimulation, the parameters changing significantly are the mean, the percentage of intervals in the mode of the interspike intervals histogram and the longest interval: owing to the time factor the first two elements are not considered relevant for the sensory coding.

6) Statoreceptors respond both to linear and vibratory acceleration; the limiting factor of the frequency response of the receptor appears to be the minimum interval: this is considerably longer than the refractory period.

7) A positive stimulus due to a smooth continuous tilt showed a log stimulus response ratio: steady state stimulation owed to different positioning of the head results in a complex but always non linear stimulus response function: a quick positive stimulus provokes overshooting.

8) A deceleration after a stimulus results in a suppression of discharge proportional to the speed of the deceleration: during resting discharge a deceleration induces, if quick enough, a suppression of firing: if the deceleration is slower no change is observed.

9) A vibratory stimulus is analyzed by the statoreceptor as a sequence of acceleration and deceleration: burst of quick firing is followed and preceded by long intervals.

10) Variation + linear acceleration provokes a combined response with the characters described above: the overall envelope of the response being proportional to the linear stimulus. Sudden burst of firing and pauses are recorded coincident with the vibration: these results are discussed taking in account the physiological situation of the head: the positioning corresponds to a linear gravitational component superimposed by vibration, mainly due to the heart beat.

11) The non linear stimulus response ratio, contrasting with the finding of other authors, is discussed taking in account the field of the unit: in the same way it is explained why no statoreceptor has been found covering the entire  $\pm 1$  g earth gravitational field, at least in the area of the field showing maximal sensitivity.

12) As a conclusion the sensory coding of the statoreceptors is indicated as a cross correlation analysis of the activity of overlapping statoreceptors, performed by the central analyzers.

#### REFERENCES

- Akert, K. and Gernandt, B. E., Electroenceph. clin. Neurophysiol., **14**: 904-914, 1962.
- De Vries, Hl., Progr. in Biophys., **6**: 207-245, 1956.
- Fatt, P. and Katz, B., J. Physiol., **117**: 109-128, 1952.
- Fuortes, M. G. F., and Mantegazzini, F., J. Gen. Physiol., **45**: 1163-1179, 1962.
- Gernandt, B. E. and Terzuolo, C. A., Am. J. Physiol., **183**: 1-8, 1955.
- Gernandt, B. E. and Thulin, C. A., Am. J. Physiol., **172**: 653-660, 1953.
- Gualtierotti, T., Abstr. Symp. on Gravity, Tuxedo, N. Y., Sept. 1967.
- Gualtierotti, T., Abstr. XXIV Int. Congr. Physiol. Sci., Washington, Aug. 25-31, 1968.
- Gualtierotti, T. and Bailey, P., Electroenceph. clin. Neurophysiol. (in press).
- Kiang, N. Y., Acta Otolaryng., **57**: 186-200, 1964.
- Kuffler, S. W., FitzHugh, R. and Barlow, H. B., J. Gen. Physiol., **40**: 683-272, 1957.
- Ledoux, A., Acta Otolaryng, Belgica, **3**: 335-349, 1949.
- Levitan, H., Rosenberg, J. and Vidal, J., The Physiologist, **11**: 231, 1968.
- Lowenstein, O., Brit. Med. Bull., **12**: 110-114, 1956.
- Lowenstein, O., In: Ciba Foundation Symp. on Myotatic, Kinesthetic and Vestibular Mechanisms, 1967, pp. 121-128.
- Lowenstein, O. and Roberts, T. D. M., J. Physiol., **110**: 392-415, 1950.
- Lowenstein, O. and Sand, A., J. Exptl. Biol., **13**: 416-428, 1936.
- Ross, D. A., J. Physiol., **86**: 117-146, 1936.
- Rupert, A., Moushegian, G. and Galambos, R., Exp. Neurol., **5**: 100-109, 1962.
- Totsukā, G., Suzuki, M. and Kubota, K., Acta oto-laryng., suppl. **179**: 18-24, 1963.
- Trincker, D., Symp. Soc. Exp. Biol., **16**: 289-316, 1962.
- Weiss, T. F., Tech. Rept. Mass. Inst. Technol. Res. Lab. Electron. No. 418, 1964.
- Werner, G. and Mountcastle, V. B., J. Neurophysiol., **28**: 359-397, 1965.



Reprint D

PROCEEDINGS  
OF  
THE EIGHTH  
INTERNATIONAL  
SYMPOSIUM  
ON  
SPACE  
TECHNOLOGY  
AND  
SCIENCE

TOKYO  
1969

Follows Pg. 331

# UNIDIRECTIONAL RESPONSE OF STATORECEPTORS TO VIBRATION. A MEAN FOR ARTIFICIAL GRAVITY IN SPACE FLIGHT

Torquato GUALTIEROTTI

## Abstract

Recently Russian and American astronauts reports seem to indicate that vestibular disturbances do take place during extended periods of weightlessness. Previous experiments had shown that approaching a state of 0 g in parabolic flights a significant alteration of the vestibular single unit output is observed. As an increase of spontaneous activity is observed the tonic influence of the vestibule is maintained and even increased in 0 g. The vestibular disturbances might be due to the disruption of the learned pattern in the utricular maculae depending upon anatomical distribution of the single hair cells in respect to the 1 g constant. The lack of this reference point is bound to provoke an altered function.

Statoreceptors respond to vibratory acceleration in a given plan only, typical of each receptor. This happens physiologically following the head periodical vibrations due to the heart beat. This increases the accuracy of response of the single units and overcomes adaptation. As the statoreceptors respond fully to a few milli g of vibration it is suggested that an equivalent to an artificial gravity might be obtained through a small vibrator applying the appropriate vibratory stimulus to the astronaut head in one direction only. Thus a reference point is ripristinated.

## 1. Introduction

The biological significance of gravity may be further investigated in relation with space flight. In fact the main change produced by free fall conditions both in orbits and during flights toward planets is the disappearance of the gravitational pull as a constant environmental factor. It is however incorrect to consider the lack of gravity effect as the equivalent to a deafferentation of the vestibular organ; in fact, of the three components of the vestibule, the semicircular canals, which are inertial accelerometers, do not change their functional characteristics, as they respond to a change of the rotational speed of the head irrespective to the linear acceleration applied (Ref. 4). Although some recent results seem to show otherwise (Ref. 2) and the changes of activity of different parts of the vestibule might influence the semicircular canals (Ref. 10), the lack of gravity should not basically alter the functioning of the organ. The receptors of the sacculus, which respond to vibration only, should not be affected essentially; in fact, as it will be shown here, the response to vibration is not different at different gravitational levels. The only receptors that are directly involved in the change of the gravity environment are the statoreceptors. A statoreceptor can be identified by its response to a steady

---

Professor, Chairman of Human Physiology, Dept. of Physiology, University of Milan and Director of the Laboratory for Space Biology of the CNR, via Mangiagalli 32, 20133 Milan, Italy.

position of the head or to a steady linear acceleration with a stationary response after eventual adaptation (fig. 1). Therefore to each position of the head, a typical activity level will be shown recording from the statoreceptors

Fig. 1 - Analysis of a sustained discharge of a stimulated gravitoreceptor in the bullfrog. At 0 time the end of the tilt. The head maintains the acquired position: note a very partial adaptation at the beginning. Stationary state is observed from 300 seconds of recording on. On the abscissa: duration of discharge in seconds. On the ordinate: intervals in msec. Each point is obtained averaging 100 msec of discharge.

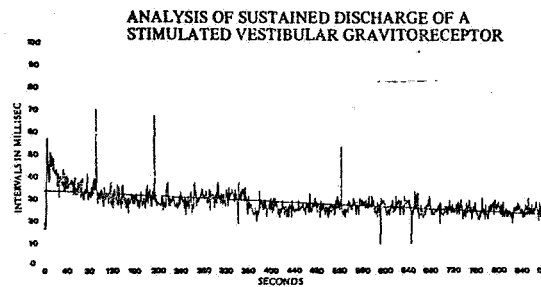

which are in range (Ref. 8). An overall response of the organ, as resulting from the sectorial analysis of each unit will cover head positioning in the entire  $360^\circ$  solid angle. The appropriate stimulus of the statoreceptors is the gravitational component in the direction of the functional axis, namely parallel to the statoconia layer. The maximum of such stimulus will obviously be obtained when the functional axis is coincident with the vertical. The stimulus will be "0" at  $90^\circ$  from the vertical. In between these two positions the stimulus will be proportional to the sine of the angle included. In the intact animal no statoreceptor covers the entire  $90^\circ$  angle (Ref. 5 and 6) and most are limited to about  $1/5$  of such angle. The overall coverage of the entire range is assured by the different functional directions of the receptors. Consequently the relevant information result from two constants: the 1 g earth gravity and the position of the statoreceptors in respect to the vertical. A multichannel pattern results from each position of the head (Ref. 1). Every situation involving the maintenance of equilibrium, like walking, cycling, etc., requires a process of learning based on such pattern. It is obvious that the lack of the gravity constant will disrupt this organized base of information. In effect it can be assumed that the absence of such recognizable pattern is the real critical alteration of the organ in free fall as the pattern itself results from the absolute dimension of the gravity pulling force and from its constant direction. The latter will be the element missing in free fall, as various acceleratory stimuli will be applied to the receptors following any movement, active or passive, of the head. Moreover periodical stimulation results from the accelerating stimuli due to heart beat (Ref. 6 and 8). In this case however the directions and the intensity of the acceleration vector varies. Man, as shown by scuba divers and aquanauts, has proved to be highly adaptable to the lack of expected information from all gravity receptors (muscle, joints, etc.) except the ones of the inner ear. Only free fall involves the statoreceptors of the inner ear together with all the others. Results from orbital flights, although not yet conclusive, seem to indicate that adjustment is more difficult. Consequently it is still quite possible that, for extended space flight, some sort of artificial substitute for gravity will be necessary. It is proposed here that the ready response of the statoreceptors to vibration in their narrow angle of reception might be used for supplying an effect equivalent to artificial gravity. A preliminary investigation on statoreceptors response to vibration has already been reported (Ref. 8). Consequently further investigations have been carri-

ed out involving the behaviour of all three vestibular components (utricle, statoreceptors, semicircular canals, sacculus). The results showed that statoreceptors respond readily to high frequency vibration, in the appropriate plane. This appears to be in contrast with some data in literature. Lowenstein and Roberts (Ref. 3) in an extensive study on the vibratory response of the isolated labyrinth of the elasmobranch reported that true statoreceptors did not respond to vibration, the sensitive elements being only the proper vibroreceptors of the sacculus and of the utricle. As however in the otolith system in fishes the otoconia consist in a single large stone, whereas from amphibians up, thousands of minute crystals are found, it is possible that the lack of vibratory responses at high frequency be due to the large mass of the single otolith body.

## 2. Technique

Through chronically implanted microelectrodes (Ref. 9) resting discharges and responses to tilting and vibration have been recorded from the primary neurons of the intact bullfrog following a technique already described (Ref. 8). Data analysis were also performed according to the said technique. Units belonging to different systems (utricle, saccular maculae, semicircular canal cristae) were identified from their typical response to their appropriate stimulus. No attempt has been made to identify the units anatomically. Therefore the above classification is not strictly accurate as for instance statoreceptors exist in the sacculus and in the lagenae.

## 3. Results

The effect of vibration, ranging from 2/sec to 600/sec, on all three components of the vestibule has been studied, namely the statoreceptors (utricle, part of the sacculus and lagenae), the vibroreceptors (2/3 of the sacculus) and the unit responding to a change of rotational speed (semicircular canal): no results are reported for acoustic units. Of the three components only two responded readily to vibration, namely the statoreceptors (fig. 2A) and the vibroreceptors (fig. 2C). The semicircular canal units do not respond except at intensi-

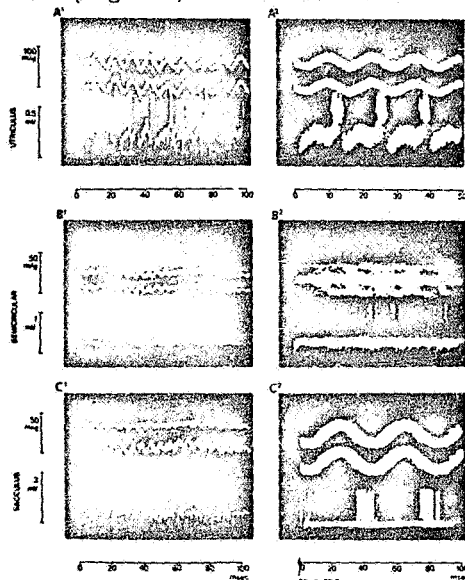

Fig. 2 - Intact bullfrog: comparison between the response to a standard vibration of A<sub>1-2</sub>: a statoreceptor, B<sub>1-2</sub>: a semicircular canal unit, C<sub>1-2</sub>: a vibroreceptor. On left (A<sub>1</sub>, B<sub>1</sub>, C<sub>1</sub>) free running time base, on right (A<sub>2</sub>, B<sub>2</sub>, C<sub>2</sub>) the time base is triggered by the first spike. The two traces on top correspond respectively to acceleration on the x (upper trace) and on the y (lower trace) axis. The third trace on the bottom: action potential recorded from single fibers of the vestibular nerve through chronically implanted electrodes. The units were identified from their typical response to gravity component, to change of rotational speed in the appropriate plane and to vibration (see text). No response is shown from the semicircular canal to vibration (B);

in fact a number of triggered traces in B<sub>2</sub> results in a blurred image of the  
(continues next page)

(cont.ed)

the vibrational stimuli as no correlation exists with the spike distribution. On the contrary, both for the statoreceptors ( $A_2$ ) and the vibroreceptors synchronization of the acceleration traces shows nearly perfect correlation between the spike volley and the place of the acceleratory stimulus. This is also evident in  $A_1$ , in which the responses fall always at the same point of the vibration wave profile. However, the statoreceptor is more directly related with a part of the descending branch of the vibration wave while the vibroreceptor responds to a more widespread part of the same curve. All calibrations in the figure.

ties which are at least ten times the threshold for the two other components of the vestibule and even then very irregularly. There is however a significant difference between the vibroreceptors response and the one from statoreceptors: while in the latter case the response is limited rather strictly to a constant given part of the acceleration curve (fig. 2A), the vibroreceptors respond to a much larger part of the curve, both in the ascending and descending branch (fig. 2C). This is understandable as the vibroreceptors having the kinocilium in the middle of the stereocilia do not have an asymmetrical polarization. The opposite is the case of the statoreceptors in which the kinocilium is on one side. The saccular vibroreceptors therefore respond to vibration in all direction while the statoreceptors are excited by vibration within the angle of reception for linear acceleration only (fig. 3). The vibroreceptors are not affected by linear acceleration; in fig. 4 the same response is provoked by the same stimulus at different tilting angle, i.e. at different values of the gravitational component. In a statoreceptor the vibratory and linear acceleration combine giving a summated response (fig. 5). The statoreceptors seem to have a resonance frequency at which their threshold is much lower; the

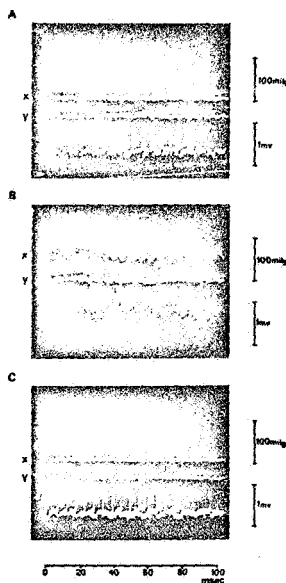

Fig. 3 - Intact bullfrog: statoreceptors responding to vibration on the y axis (A-C) and not on the x axis (B). Calibrations in the figure.

response for linear acceleration only (fig. 3). The vibroreceptors are not affected by linear acceleration; in fig. 4 the same response is provoked by the same stimulus at different tilting angle, i.e. at different values of the gravitational component. In a statoreceptor the vibratory and linear acceleration combine giving a summated response (fig. 5). The statoreceptors seem to have a resonance frequency at which their threshold is much lower; the

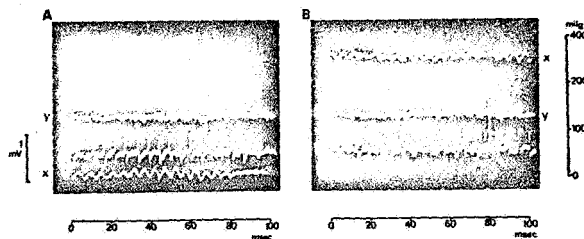

Fig. 4 - Intact bullfrog. Response of a vibroreceptor (sacculus) to a standard vibration at horizontal level (A = 0 g) and at a tilt corresponding to 0.3 g (B). As shown no difference exists between the response in the two conditions. All calibrations in the figure.

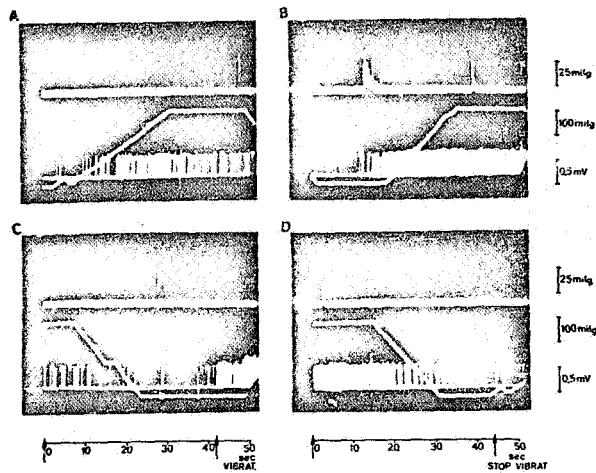

Fig. 5 - Intact bullfrog. Statorceptor: A-C without, B-D with vibratory stimulus at resonance frequency. As shown, the added vibration summate with the stimulus resulting by tilting while the general pattern of the response to the gravitational component does not change significantly. Acceleration in the x axis only is shown, in the upper trace at higher gain, AC', to show vibration; in the lower trace at lower gain to show the gravitational component (on the ordinate in millig). Spike amplitude calibration in the figure.

resonance frequency is different for different receptors: the first indication of approaching the resonance condition is given by a shift of the spike response toward the onset of the excitatory branch of the acceleration wave as threshold decreases (fig. 6). Only minor differences are shown in the general pattern of the response of the statorceptor to a change of the gravitational component, as through tilting, when a vibratory stimulus is added (fig. 5). The increase of frequency with the increase of gravity and the temporary suppression provoked by a decrease of the linear acceleration stimulus is still present with the same course. The only difference is that a somewhat smaller

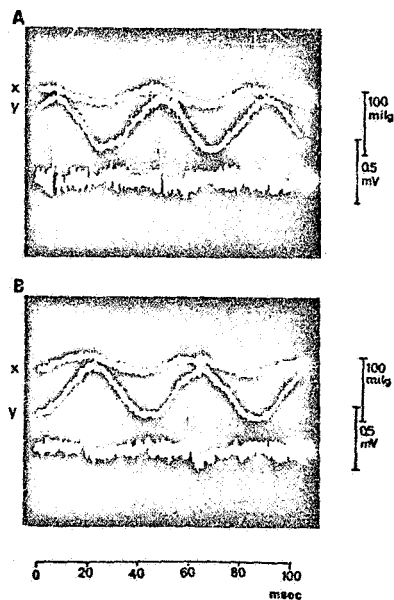

Fig. 6 - Intact bullfrog. Statorceptor responding to vibration on the y axis. A 5% change in the frequency of the vibratory stimulus (B) shows a shift of the correlation between spike and the vibratory wave. As resonance frequency approaches, a lowered threshold corresponds to a lower value of the effective acceleration intensity.

adaptation is shown. This however is hardly significant in true statoreceptors as, as said above, they adapt very little anyway (fig. 7 and 8).

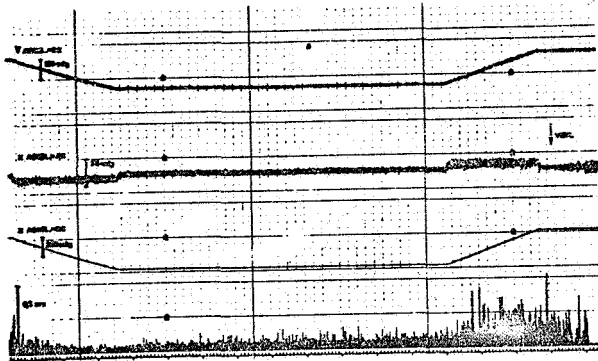

Fig. 7 - Intact bullfrog. Statoreceptor response to tilting: the corresponding y and x acceleration curves are shown. Another trace shows the x acceleration in AC, with higher gain to show vibration. The bottom trace corresponds to the consecutive interspike intervals measured as the distance between the baseline and

each peak. No vibration is applied here except at the far right end of the record (marked by arrows). As shown adaptation is only very limited, a recognizable level of activity marks the maintained tilting position. A stationary response corresponds to a steady stimulus. Calibrations in the figure. Time marker 1 sec.

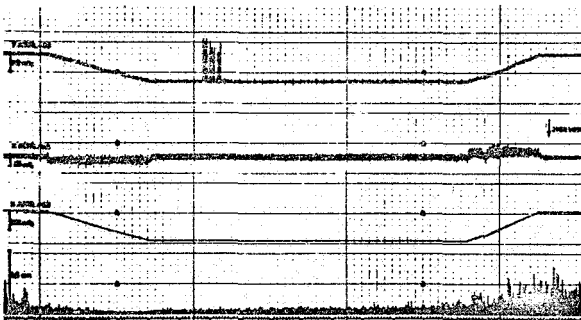

Fig. 8 - Same preparation and experimental routine, the only difference being that a continuous suprathreshold (200/sec) vibration is superimposed on the gravitational component. Vibration stops at arrow. As shown, while a lower mean interval corresponds to the highest steady state gravitational stimulus, the general pattern of response to gravity remains the same, with a limited adaptation at the onset of the steady stimulation and the rebound increase of the intervals value during and after back tilt.

**4. Conclusions.** A vibratory stimulus is excitatory to statoreceptors of the inner ear in their limited receptor angle only and to vibroreceptors in all directions. It does not affect the receptors of the semicircular canal below intensities which are supramaximal for the two other kinds of vestibular units. Statoreceptors continuously stimulated by a vibratory stimulus respond normally to an added linear acceleration with a combined response just as, on earth, acceleratory stimuli of any kind and duration are added to the gravitational component for that particular receptor in that particular position. The main factor here is that the statoreceptor is polarized in its response to a vibration in a given plane just as it is polarized for linear acceleration in that same plane. In the opening section of this paper it was indicated that the main bio-

ion vector will result, as a substitute for the one assured by gravity on earth.

At present a space experiment is scheduled (Ref. 7) for recording directly the output of single statoreceptors of the inner ear in two bullfrogs as their labyrinth is very similar to the human one. The possible changes in the resting discharge and in the response to a test centripetal acceleration will be studied. The same general technique might be used in a followed up experiment, applying to the package vibration in given constant plane at appropriate intensity and frequency to acquire supporting evidence for the hypothesis above described: if this holds true an engineering solution of the technical problem involved will be studied.

#### REFERENCES

1. Fujita, Y., Rosenberg, J. and Segundo, J.P., Activity of cells in the lateral vestibular nucleus as a function of head position., J.Physiol., 196, 1-18, 1968.
2. Lowenstein, O., Vestibular responses to linear acceleration., Seminar, Mario Negri Inst., March 18th, 1969, Milan.
3. Lowenstein, O. and Roberts, T.D.M., The localization and analysis of the responses to vibration from the isolated elasmobranch labyrinth. A contribution to the problem of evolution of hearing in vertebrates., J.Physiol., 114, 471-489, 1951.
4. Lowenstein, O. and Sand, A., The mechanism of the semicircular canal. A study of the responses of single-fibre preparations to angular accelerations and to rotation at constant speed., Proc.Roy.Soc.B, 129, 256-275, 1940.
5. Gualtierotti, T. and Alltucker, D., The relationship between the unit activity of the utricle-sacculae of the frog and the information transfer., Proc. II Symp. on "The role of the vestibular organs in the exploration of space", Ames Research Center, Moffett Field, Cal., 1966, NASA SP-115, p. 143-149.
6. Gualtierotti, T., The gravity sensing mechanism of the inner ear., Abstr. Symp. on Gravity and the Organism, 18-22 Sept. 1967, Tuxedo, N.Y.
7. Gualtierotti, T., Orbital otolith experiment T(S)4: a space flight experiment to investigate the effect of weightlessness on the activity of single vestibular unit., J.Physiol., 192, 2-3P, 1967.
8. Gualtierotti, T., Data acquisition and analysis from single vestibular statoreceptors in the bullfrog with chronically implanted microelectrodes: responses to linear acceleration and vibration., Comm.IFAC Symp. on Automatic Control, 24-28 Sept. 1968, Yerevan, USSR.
9. Gualtierotti, T. and Bailey, P., A neutral buoyancy micro-electrode for prolonged recording from single nerve units., Electroenceph.clin.Neurophysiol., 25, 77-81, 1968.
10. Shimazu, H. and Precht, W., Inhibition of central vestibular neurons from the contralateral labyrinth and its mediating pathway., J.Neurophysiol., 29, 467-492, 1966.



Reprint E

---

## *Prolonged Recording from Single Vestibular Units in the Frog During Plane and Space Flight, Its Significance and Technique*

T. GUALTIEROTTI, M.D. and D. S. ALLTUCKER, M.A.

The vestibular apparatus is especially affected by the acceleratory changes from multi-"G" profiles to weightlessness during plane and space flight. Recording the gross output of the VIII nerve is not significant as different sensory systems are represented there. Single unit recordings allow a good quantitative analysis especially if several receptors are studied simultaneously for an extended time. The main technical problems involved consist of withstanding high acceleration and vibration and maintaining the continual response of the unit for a period of 2 to 3 days. This first problem has been solved by utilizing floating micro-electrodes of the same density of the nerve tissue and by keeping the animal submerged in water. Frogs are used, and their survival while submerged under space conditions has been insured by a specially designed life support system. Maintaining the continual response of the units depends on the input current of the high impedance preamp connected with the microelectrode. As chronic implantation does not allow adjustment a special preamp has been developed.

---

**T**HE GRAVITORECEPTORS of the vestibular apparatus are subjected to a peculiar situation among the sensory organs: their development takes place under a constant 1 G stimulation which is present before they differentiate and which is maintained throughout the life span.

From the NASA, Ames Research Center, Moffett Field, Cal.

Jet flight and space flight and the future missions on planets with different gravitational constants, have suddenly changed this situation. It will be of interest to study how sensors long adapted to a constant environment will respond when the environment is radically changed.

The vestibular activity and responses are best monitored by recording from the VIII nerve. This eliminates both the possible alteration of the delicate sensory organ resulting from a direct surgical intervention and the complications of an indirect approach through associated systems, as is the case when recording from the vestibular nuclei or studying nystagmus and the oculogravitic illusion.

Recording from the entire nerve, however, does not provide useful information. Fibers belonging to four different systems are represented in the nerve, namely: the otolith (gravity), the semicircular canals (angular acceleration), units responding to vibration, and audioreceptors. In each system the single units composing it show discrete responses to discrete stimuli. As the information carried in the nerve is a modulation of the time intervals between consecutive impulses (Figure 1) in all four systems, and there is no indexing of each

*Aerospace Medicine* • May, 1967 513

Follows Pg. 1200

activity, the overall output is helplessly confused. It is therefore necessary to record impulses from a single unit of a selected system only: in the present case, a single otolith unit. By studying the basic activity and the responses to stimulation of a large enough number of such units for a prolonged time, the general picture of the organ's whole activity can be understood.

Even with such a simplified approach, the investigation of basic and evoked activity during changes of the fundamental 1 G constant, involves two large classes of problems: technical problems and interpretation problems.

**Technical problems.** Starting with the 1 G constant, the investigation of the behavior of a single graviceptor must be extended down to 0 G (weightlessness) and up to several Gs. Parabolic jet flights supply the entire range from 0 to 2-3 G, but only for very brief periods: approximately 20 seconds of weightlessness and transients of 1.5 to 3 G at the onset and end of the

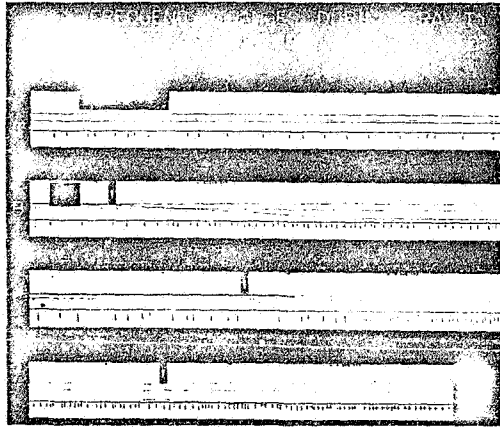

Fig. 1. Curarized frog. Spontaneous firing and responses to tilting of two different otolith units (AB and CD) recorded from the corresponding fibers in the vestibular nerve. Note irregularity in the rate of discharge and the overall increase of frequency during tilting (onset of tilting arrowed).

Top records: output of the accelerometers in the three directions of space. Time and accelerometer calibration in the figure.

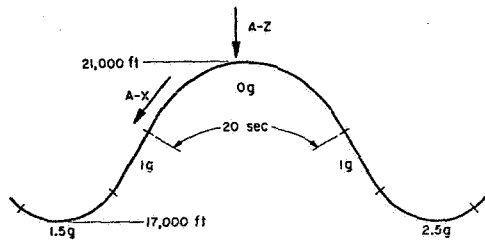

Fig. 2. Profile of a parabolic flight. The values of the acceleration in the different parts of the parabola are shown. 1.5 G is recorded immediately before the onset of the parabola followed by 20 seconds of 0 G. A period of high acceleration (2.5 G) marks the exit from the parabolic path.

parabola (Figure 2). Space flight provides extended periods of weightlessness and a prolonged high acceleration and vibration period during takeoff and maneuvering.

The main technical problem here is to maintain the capability of recording from single nerve fibers throughout the high acceleration and vibration of the takeoff and for at least 2-3 days during the space flight. This problem has been solved by using a microelectrode of special design, having the same density as the tissue, and by allowing it to float, thus avoiding standing waves (Figures 3 and 4). Also the submersion of the animal in water minimizes the impact during violent movements. Details of the microelectrode technique have been reported elsewhere.<sup>2,3,4</sup>

To facilitate the submersion of the animal, frogs are used on the assumption that no fundamental difference in the function of the otolith systems exists in amphibians and mammals.<sup>6</sup> As known, frogs have two respiratory systems: very simplified lungs for air breathing and the entire skin for gas exchange under water. Most frogs do not have gills and the skin respiration is not very efficient. Krogh,<sup>5</sup> working with *Rana esculenta*, reported that oxygen consumption under water was about half that in air, and CO<sub>2</sub> release three times as much. In the present experiments, using bull frogs (*Rana catesbriana*), no attempt has been made to determine the metabolism of the animal, but a number of survival tests proved that the frog can be maintained submerged in water in good health for up to six days at 13°C with normal PO<sub>2</sub> (155 mmHg), or at 23°C at PO<sub>2</sub> 500 mmHg. Jumping, swimming, the righting reflex and posture

MICROELECTRODE

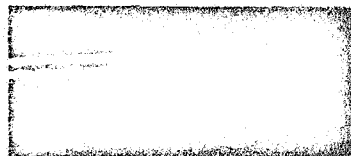

EMITTER FOLLOWER (I<sub>i</sub>=117MΩ)

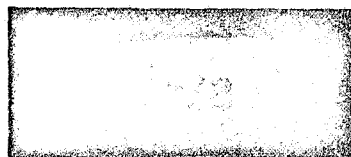

Fig. 3. The dimensions of the microelectrode and the high impedance preamplifier used for chronic recording from the single vestibular nerve fiber in the frog are shown. The preamplifier is directly attached to the jaw of the animal.

RECORDING FROM SINGLE VESTIBULAR UNITS IN FROG DURING FLIGHT—GUALTIEROTTI & ALLTUCKER

tests proved that there was no significant change because of submersion. In the same conditions, direct recording of a single otolith unit was possible for six days, showing no significant alteration in the sense organ.

The metabolic rate was particularly low in these animals as they were nearly completely paralyzed, by cutting the principal motor nerves. The glossopharyngeal nerve was also cut to avoid swallowing. In this way the animal could not perform any movement that would displace the electrode and add unknown stimuli to the labyrinth.

In the conditions described above, microelectrode recording from single VIII nerve fibers was possible during high acceleration and vibration (Figure 5).

Accordingly, a life support system has been built for a space experiment, capable of both assuring the survival of two fully instrumented and paralyzed bull frogs for up to six days and applying an acceleratory stimulus of fixed parameters to the otolith unit involved (Figure 6). As shown, it consists of a centrifuge, filled up with water; the water circulates through a lung where O<sub>2</sub> and CO<sub>2</sub> are exchanged through layers of silicon rubber, according to the respective concentration gradient, and CO<sub>2</sub> is absorbed by baralime. Temperature is controlled by an evaporator system, and the output from two otoliths per frog and the EKG are conveyed to a telemetry system. Temperature and pressure are monitored. The

six-day recording from single VIII nerve fibers from one otolith organ was performed with this package.

A less sophisticated package, based on the same principle, has been used successfully in 25 jet plane flights, during the entire period from takeoff to touchdown and



Fig. 4. A frog head is shown schematically. The vestibule, the nervous system and the vestibular nerve are presented in the proper place. A fully developed cochlea is also shadowed in, although it doesn't exist as such in the frog, to show the equivalence to the mammal's vestibule. Note the position of the microelectrode in the vestibular (VIII) nerve, in the branch corresponding to the utricle-sacculle system.

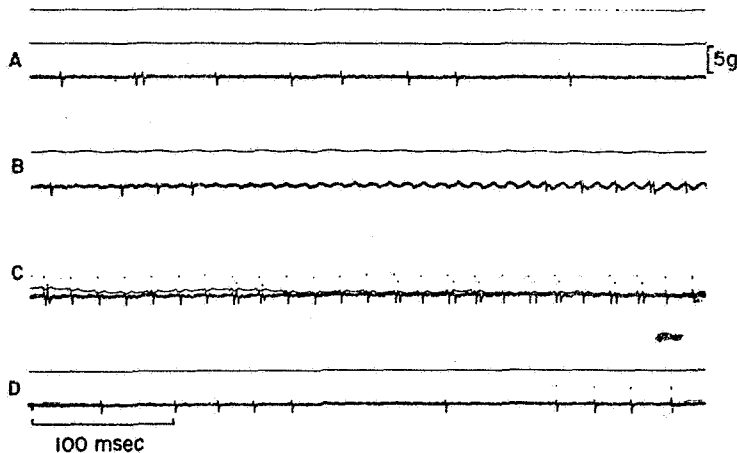

Fig. 5. Otolith unit. Action potential recorded from the corresponding fiber in the vestibular nerve during a 55 per sec vibration test. The animal (bullfrog) was previously partially paralyzed by cutting all the branches of the brachial and lumbar plexus. The vestibular nerve was exposed through a hole trephined in the palate, the microelectrode implanted according to the technique described in the text. The roof of the mouth was then reconstructed with dental cement. This was maintained solidly in place through two metal structures screwed in the bone at the two sides of the hole and included in the cement itself. As a result the artificial cavity in the bone was completely closed and water-tight. The animal was then placed in the cylinder filled up with water in which it floated. Its head was however firmly fixed to the endcap of the container by means of a nylon head clamp. The container was then attached to a

shaker providing vibrations of various frequencies and intensities. Upper record: output from the accelerometer indicating the vibratory acceleration as a linear deflection (downwards, calibration in the figure). Lower record: action potential from the vestibular nerve. A spontaneous firing of the unit previous to the test; D spontaneous firing of the unit immediately after the test. B and C vibration of increasing intensity reaching more than 5 G at the end of C on right. The base line shows some oscillation especially in B but no significant alteration of the recording capability of the electrode. Note that the extremely high stimulation provokes occasional double firing of the unit (C, extreme right). At this point the firing becomes synchronous with the oscillation. Immediately after the test the vestibular activity appears to be normal.

RECORDING FROM SINGLE VESTIBULAR UNITS IN FROG DURING FLIGHT—GUALTIEROTTI & ALLTUCKER

during 12-14 parabolic paths for each flight.

**Interpretation problems.** The main mechanism of the information transfer from the gravitoceptors to the higher levels consists in the modulation of the time interval between successive impulses, as a function of the acceleration applied. However, as shown for other sense organs, both in basic conditions without any stimulus and during excitation, the rate of firing is so irregular (Figures 1 and 7) that a simple change in frequency cannot be taken as the relevant information. A central analyzer could never determine whether a short interval is due to a given excitation, as such intervals are present in every condition.

This problem has been discussed elsewhere.<sup>3</sup> The conclusion is that the relevant information is conveyed by the progressive disappearance of the longest intervals as a function of the increasing stimulus, as shown in Figures 7 and 8. If we consider the envelope of the 2-dimensional figure (solid line in Figure 8), a logarithmic stimulus/response ratio results. The central ana-

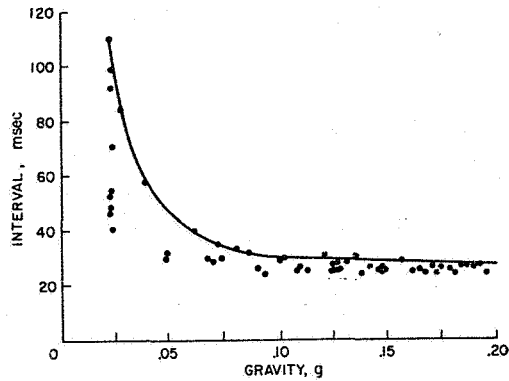

Fig. 8. Computer analysis of the discharge of the vestibular nerve fiber corresponding to a single otolith unit as a function of the applied excitatory stimulus. On the abscissa: acceleration in G. On the ordinate: time intervals in milliseconds measured as in Figure 7. At 0.025 G (threshold for this unit) the longest intervals progressively disappear. Saturation is reached at 0.1 G. Note the large variability at both zero and maximum stimulation.

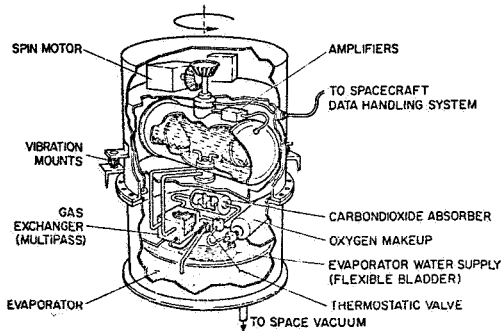

Fig. 6. Schematic of the life supporting system for T(S)4 orbital experiment.

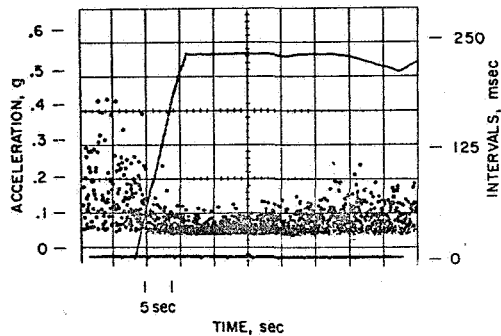

Fig. 7. Computer analysis of a discharge of the vestibular nerve fiber corresponding to a single otolith unit. The continuous line indicates the output in G of the appropriate accelerometer (ordinate on left). The distance between the 0 line and each black dot expresses the time interval in milliseconds between consecutive pulses (ordinate on right). Note the disappearance of the longest intervals during excitation. Note also how a decrease of excitation is accompanied by an increase in the interval value.

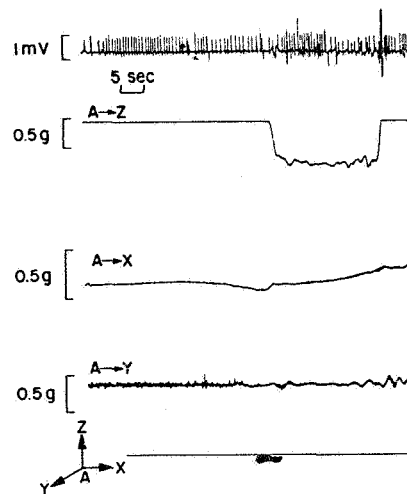

Fig. 9. Otolith unit response to linear acceleration in a Keplerian path. Chronically implanted electrode. Curarized frog. Recording from a single vestibular nerve fiber during parabolic flight. First recording (top): vestibular impulses. Second, third and fourth tracings: the vertical, longitudinal and lateral accelerations, respectively. A period of 25 seconds of weightlessness is shown by a downward deflection of the A-Z recording (vertical acceleration). Appropriate stimulation for vestibular unit consists of a positive acceleration in A-X direction only. As shown, stimulation has been applied twice during level flight at 1 G and during the 25 seconds of weightlessness. Frequency response of unit appears to be normal during level flight and is greatly increased during first 10 seconds of weightlessness. After this period a sudden reduction of the rate of firing is observed. As soon as level flight is resumed, normal response is again shown by unit. Spontaneous firing shows a much higher frequency during weightlessness than at 1 G.

RECORDING FROM SINGLE VESTIBULAR UNITS IN FROG DURING FLIGHT—GUALTIEROTTI & ALLTUCKER

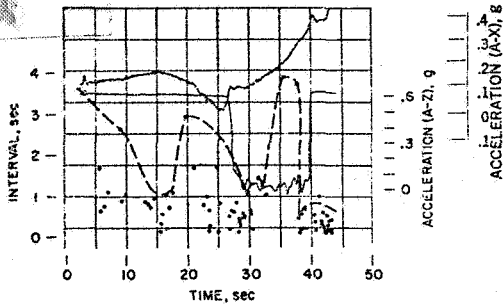

Fig. 10. Computer analysis of a response of an otolith unit similar to that shown in Figure 9. The analysis is performed with the same technique as in Figure 8 and the profile of the response corresponds to the dotted line connecting the longest intervals at every value of acceleration. As shown, it follows the acceleration changes quite closely, except during the weightlessness period in which suppression takes place. The two continuous lines correspond to the gravity changes and to the horizontal acceleration values as shown on the ordinates on right.

lyzers average the response of a number of such units, obtaining both precision and speed in processing the relevant information.

Data obtained from the airplane flights have been analyzed in this way. Otolith units responding to two types of stimulus have been studied: (1) stimulus of acceleration other than vertical, and (2) stimulation due to altered gravity states. In the first case the stimulation was provided by the increase or decrease of plane speed. The resulting linear acceleration or deceleration was applied both during level flight (1 G) and in weightlessness. The stimulation due to weightlessness was provided by changes of gravitational pull during flight in a parabolic path.

The results upheld the Weber-Fechner law in that sensitivity increased during weightlessness when there was no basic stimulation of the organ. However, a peculiar suppressory effect upon the response to acceleration (Figures 9 and 10), was shown in weightlessness. The rate of firing was blocked at a certain fixed value with no further response to continued acceleration stimulus. In a unit responding to vertical stimulation zero gravity produced zero excitation, and a low rate of firing was to be expected (Figures 11 and 12).

Such results are in accordance with other authors' data. Sala,<sup>7,8</sup> showed that the stimulation of the contralateral vestibular nuclei produced spikes in the vestibular nerve which disappeared with a medial cut and demonstrated that the spontaneous activity of the vestibular nerve decreased. The author concluded that this was due to the efferent system through which the vestibular receptors might be directly controlled. Similar conclusions were reached by Fluor & Mendel,<sup>1</sup> who indicated that the efferent system is mainly inhibitory.

The suppressory effect damps the influx of impulses during altered conditions. It might be due either to weightlessness or to the transients from high to low acceleration. A new series of airplane flights will provide 0 G for 10 seconds during a dive with added thrust of the engine. In this case the transient will be limited

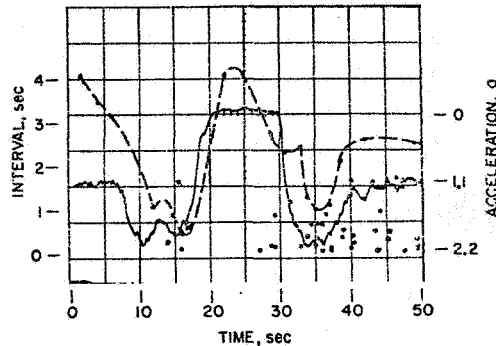

Fig. 11. Same as Figure 10 except for the fact that the otolith unit responds directly to the gravity changes. Accordingly, the intervals are modulated following the gravitational variations, with the maximum values during the 0 G period.

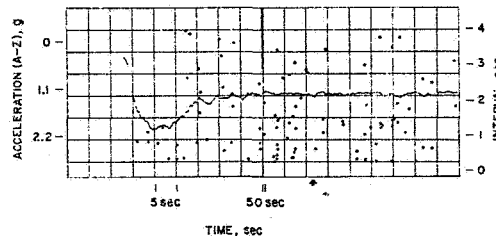

Fig. 12. Same unit as shown in Figure 11, analyzed with the same method, immediately after exit from the Keplerian path and during a prolonged period of level flight at 1 G. The interval value distribution is normal as on the ground.

to the 1 G to 0 G range. Results seem to indicate that the suppressory effect is transitory and is a part of the mechanism of habituation to the new condition. The planned three-day space flight in the mission 205 Apollo will answer many such questions.

REFERENCES

1. FLUOR, E., and MENDEL, L.: Habituation, Efference and Vestibular Interplay. *Acta Oto-Laryng.*, 56:521-522, 1963.
2. GUALTIEROTTI, T., and GERATHEWOHL, S. J.: Spontaneous Firing and Responses to Linear Acceleration of Single Otolith Units of the Frog During Short Periods of Weightlessness During Parabolic Flight. NASA 49-77:221-229, Jan. 1965.
3. GUALTIEROTTI, T., and ALLTUCKER, D. S.: The Relationship Between the Unit Activity of the Utricle-sacculus of the Frog and Information Transfer. NASA SP-115:143-149, Jan. 1966.
4. GUALTIEROTTI, T., and BAILEY, P.: Chronic Microelectrodes for Prolonged Recording from Single Units. In preparation.
5. KROGH, A.: On the Cutaneous and Pulmonary Respiration of the Frog. *Skandinav. Arch. f. Physiol.*, 15:328-417, 1904.
6. ROSS, D. A.: Electrical Studies on the Frog's Labyrinth. *J. Physiol.*, 86:117-146, 1936.
7. SALA, O.: Modificazioni Dell'Attività del Nervo Vestibolare a Seguito Della Stimolazione del Sistema Vestibolare Efferente. *Boll. Soc. Ital. Biol. Sper.*, 38:1048, 1962.
8. SALA, O.: The Efferent Vestibular System, Electrophysiological Research. *Acta Oto-Laryng.*, Suppl. 197:1-34, 1965.