

MR-3

~~S.C. HIGHT~~

UNITED STATES  
 NATIONAL AERONAUTICS  
 AND SPACE ADMINISTRATION  
 IN COOPERATION WITH  
 NATIONAL INSTITUTES OF HEALTH  
 AND  
 NATIONAL ACADEMY OF SCIENCES

JUN 8 1961	
S. C. HIGHT	
J. J. HIBBERT	2
<del>E. W. SCHRAMM</del>	<del>2</del>
<del>R. O. WISE</del>	<del>2</del>
<del>J. P. ...</del>	<del>2</del>
FILE	
MISS. D. D. CORRETT	<i>Last</i>

DRA

(NASA-TM-X-68523) CONFERENCE ON MEDICAL  
 RESULTS OF THE FIRST US MANNED SUBORBITAL  
 SPACE FLIGHT (NASA) 6 Jun. 1961 110 p

872-73829  
 thru  
 872-73839  
 Inclas  
 32839

CONFERENCE ON  
 MEDICAL RESULTS OF THE FIRST  
 U. S. MANNED SUBORBITAL SPACE FLIGHT

Technical Library, Bellcomm, Inc.

A COMPILATION OF THE PAPERS PRESENTED  
 JUNE 6, 1961

JUL 11 1961	
J. J. Hibbert	2
F. A. POLKINGHORN	1
E. W. SCHRAMM	2
<del>R. O. WISE</del>	<del>2</del>
FILE	
MISS J. L'BAR	

WASHINGTON, D. C.

UNITED STATES  
NATIONAL AERONAUTICS AND SPACE ADMINISTRATION

In Cooperation With  
NATIONAL INSTITUTES OF HEALTH  
And  
NATIONAL ACADEMY OF SCIENCES

CONFERENCE ON  
MEDICAL RESULTS OF THE FIRST  
U.S. MANNED SUBORBITAL SPACE FLIGHT

A Compilation of the Papers Presented

June 6, 1961

WASHINGTON, D.C.

CONTENTS

Page

FOREWORD . . . . . v

TECHNICAL PAPERS PRESENTED

June 6, 1961

GENERAL CHAIRMAN: Dr. Lloyd V. Berkner, Chairman, Space Science Board,  
National Academy of Sciences

I. MERCURY PROGRAM SUMMARY

SESSION CHAIRMAN: Dr. Abe Silverstein, Director, NASA Space Flight  
Programs

1. INTRODUCTION  
By Robert R. Gilruth, Director, Space Task Group . . . . . 1 ✓

2. FLIGHT PLAN FOR THE MR-3 MANNED FLIGHT  
By Christopher C. Kraft, Jr., Asst. Chief, Flight Operations  
Division . . . . . 7 ✓

3. MERCURY SPACECRAFT SYSTEMS  
By Aleck C. Bond, Asst. Chief, Flight Systems Division . . . . . 15 ✓

4. REVIEW OF BIOMEDICAL SYSTEMS FOR MR-3 FLIGHT  
By Stanley C. White, M.D., Chief, Life Systems Division;  
Richard S. Johnston, Asst. Chief, Life Systems Division;  
Gerard J. Pesman, Crew Equipment Branch, Life Systems  
Division . . . . . 29 ✓

II. BIOMEDICAL DATA

SESSION CHAIRMAN: Dr. C. H. Roadman, Acting Director, NASA Life  
Sciences Programs

5. RESULTS OF PREFLIGHT AND POSTFLIGHT MEDICAL EXAMINATIONS  
By Carmalt B. Jackson, Jr., M.D., Aerospace Medical Branch;  
William K. Douglas, M.D., Astronaut Flight Surgeon; James F.  
Culver, M.D., USAF School of Aviation Medicine, Brooks AFB,  
San Antonio, Texas; George Ruff, M.D., University of  
Pennsylvania; Edward C. Knoblock, Ph.D., Walter Reed Army  
Medical Center; and Ashton Graybiel, M.D., USN School of  
Aviation Medicine, Pensacola, Florida . . . . . 47 ✓

	Page
6. BIOMEDICAL INSTRUMENTATION IN MR-3 FLIGHT By James P. Henry, M.D., Head, Aerospace Medical Branch; and Charles D. Wheelwright, Aerospace Medical Branch . . . . .	59 ✓
7. PHYSIOLOGICAL RESPONSES OF THE ASTRONAUT IN THE MR-3 FLIGHT By William S. Augerson, M.D., Aerospace Medical Branch; and C. Patrick Laughlin, M.D., Aerospace Medical Branch . . . . .	71 ✓

### III. PILOT PERFORMANCE

SESSION CHAIRMAN: Walter C. Williams, Associate Director, Space  
Task Group

8. PILOT TRAINING AND PREFLIGHT PREPARATION By Donald K. Slayton, Astronaut . . . . .	87 ✓
9. RESULTS OF IN-FLIGHT PILOT PERFORMANCE By Robert B. Voas, Ph.D., Head, Training Office; John J. Van Bockel, Training Office; Raymond G. Zedekar, Training Office; and Paul S. Backer, McDonnell Aircraft Corporation . .	97 ✓
10. PILOT'S FLIGHT REPORT, INCLUDING IN-FLIGHT FILMS By Alan B. Shepard, Jr., Astronaut . . . . .	109 ✓



## FOREWORD

This document is a compilation of papers presented at a Conference on the Medical Results of the First U.S. Manned Suborbital Space Flight. This conference was held by the NASA, in cooperation with the National Institutes of Health and the National Academy of Sciences, at the U.S. Department of State Auditorium on June 6, 1961. The papers were prepared by representatives of the NASA Space Task Group in collaboration with personnel from various Department of Defense medical installations, the University of Pennsylvania, and McDonnell Aircraft Corporation.

## INTRODUCTION

By Robert R. Gilruth

Project Mercury is this nation's first venture into manned space flight. The purpose of this introductory paper is to acquaint the audience with the history of the program and its broad objectives and to provide an idea of the scope and present status of the program.

## PROJECT GROUND RULES

At the initiation of Project Mercury in October 1958, approximately a year of research and study by the National Advisory Committee for Aeronautics (predecessor to NASA), industry, and other Government agencies had taken place. This early study permitted the establishment of program objectives and of a set of ground rules under which the program would be undertaken.

The scientific objective of Project Mercury is to determine man's capabilities in a space environment and in those environments to which he will be subject upon going into and returning from space. The accomplishment of this scientific objective requires the accomplishment of the technological objective of orbiting and safely recovering a manned spacecraft. The ground rules under which we hope to accomplish these objectives are as follows:

- (1) Drag reentry (retro-rockets)
- (2) Atlas (propulsion and guidance)
- (3) Automatic escape system
- (4) Animal flights
- (5) Parachute landing system
- (6) Water landing (primary)
- (7) In-flight monitoring
- (8) Buildup type of flight program
- (9) Extensive field tests

These rules, incidentally, are those adopted early in the program, and so far they have stood the test of time.

In order to simplify the program and to use the present state of the art to the greatest extent practicable, it was planned to use a drag reentry vehicle with the entry initiated by retrorockets. To avoid developing a new propulsion and guidance system, it was decided to use the existing Atlas as the launch vehicle. Since the Atlas was not designed originally for manned flight operation, it was necessary to provide an automatic escape system which would sense impending launch-vehicle malfunctions and separate the spacecraft from the launch vehicle in the event of such malfunctions.

Man had never before flown in space and thus it was felt desirable to include animal flights in the program to provide early biomedical data and to prove out, realistically, the operation of the life-support systems. Again in the interests of simplicity, it was planned to use a parachute for the final letdown and landing and to plan on water as the primary landing area.

It was considered wise to monitor the performance of the spacecraft, its systems, and its occupant, whether animal or man, almost continually. To this end, a worldwide network of tracking, telemetry, and communications stations has been set up.

Since a new area of flight was being approached, it was planned to use a buildup type of flight-test program, in which each component or system would be flown to successively more severe conditions in order first to prove the concept, then to qualify the actual design, and finally to prove, through some repeated use, the reliability of the system. The Redstone flight which is the subject of this conference is a vital part of this buildup flight program.

The flight program, finally, is being supported by extensive field testing of all components and systems to assure a useful, reliable, vehicle.

#### MANAGEMENT ORGANIZATION

The accomplishment of Project Mercury has required the development of a management organization to utilize effectively the broad spectrum of Government agencies and industry which such a complex program requires. This organization is shown in figure 1.

Overall direction of Project Mercury is the responsibility of the National Aeronautics and Space Administration and is exercised through the NASA Headquarters, Office of Space Flight Programs. Detailed program management is delegated to the Space Task Group, shown in the center area of figure 1. The Space Task Group looks for assistance in research

and development activities to all the other NASA Centers and to the three services, wherever specialized knowledge or facilities exist. For implementation of the ground monitoring network the NASA Langley and Goddard Centers have managed a team composed of a prime contractor, Western Electric, and its subcontractors, with advice and assistance from elements of the Department of Defense, the MIT Lincoln Laboratory, the Federal Aviation Agency, and the Australian Weapons Research Establishment. The operation of this network is handled by NASA through the Department of Defense, drawing on the various National Missile Ranges, the Australian WRE, and several NASA network stations.

Production of the Mercury spacecraft is done by McDonnell Aircraft Corporation and its subcontractors under a contract with NASA managed by the Space Task Group. The launch vehicles are provided by the Air Force Space Systems Division and its contractors (for the Atlas) and the NASA Marshall Space Flight Center and its contractors (for the Redstone).

Launch and recovery operations are managed by the Space Task Group and are accomplished and supported by the Atlantic Missile Range, McDonnell Aircraft, the Air Force Space Systems Command, Marshall Space Flight Center, a special Navy recovery task force, the Weather Bureau, and a large Department of Defense medical support team drawn from the Army, Navy, and Air Force. For orbital operations, the Public Health Service will supply medical monitors for some of the network stations.

#### BASIC FLIGHT PROBLEMS

The problems which demand solution for the successful accomplishment of a project such as Mercury are many and varied, as indicated by the scope of the organizations involved in the program (fig. 1). A few of the more basic problems are as follows:

- (1) Automatic escape
- (2) Control during insertion
- (3) Behavior of space systems
- (4) Pilots' capability in space
- (5) In-flight monitoring
- (6) Retrofire and reentry maneuvers
- (7) Landing and recovery

First, the problem of automatic escape from a malfunctioning launch vehicle is vital to pilot safety - the solution chosen, automatic abort-sensing system and escape rocket, has been well proven in many flight tests.

The problem of control during insertions into orbit, while not of concern for this conference, required the development of the real-time computation and display of trajectory and vehicle performance for the Mercury Control Center at Cape Canaveral, together with the Atlas guidance and control system.

The behavior of space systems is being continually studied and proved out by extensive ground tests and by flights such as that being reported in this conference.

The question of pilots' capability in space can, of course, be studied only through flight tests; however, as discussed in subsequent papers in this conference, an intensive and extensive astronaut training program is required to prepare the pilots for space flight.

In-flight monitoring has been the subject of considerable training and development effort. Although the complete monitoring network has yet to be put to actual use, various training exercises with the complete network and use of part of the network for the MR-3 flight have been encouraging.

Retrofire and reentry maneuvers and landing and recovery have been demonstrated in the many flights accomplished in Project Mercury. These problems appear to have been adequately solved; however, these techniques have not been demonstrated for orbital flight.

#### CONCLUDING REMARKS

The subsequent papers in this conference will attempt first to explain the operations and space vehicle used in the MR-3 flight and then to present pertinent results from this flight.

PROJECT MERCURY FUNCTIONAL RELATIONSHIPS

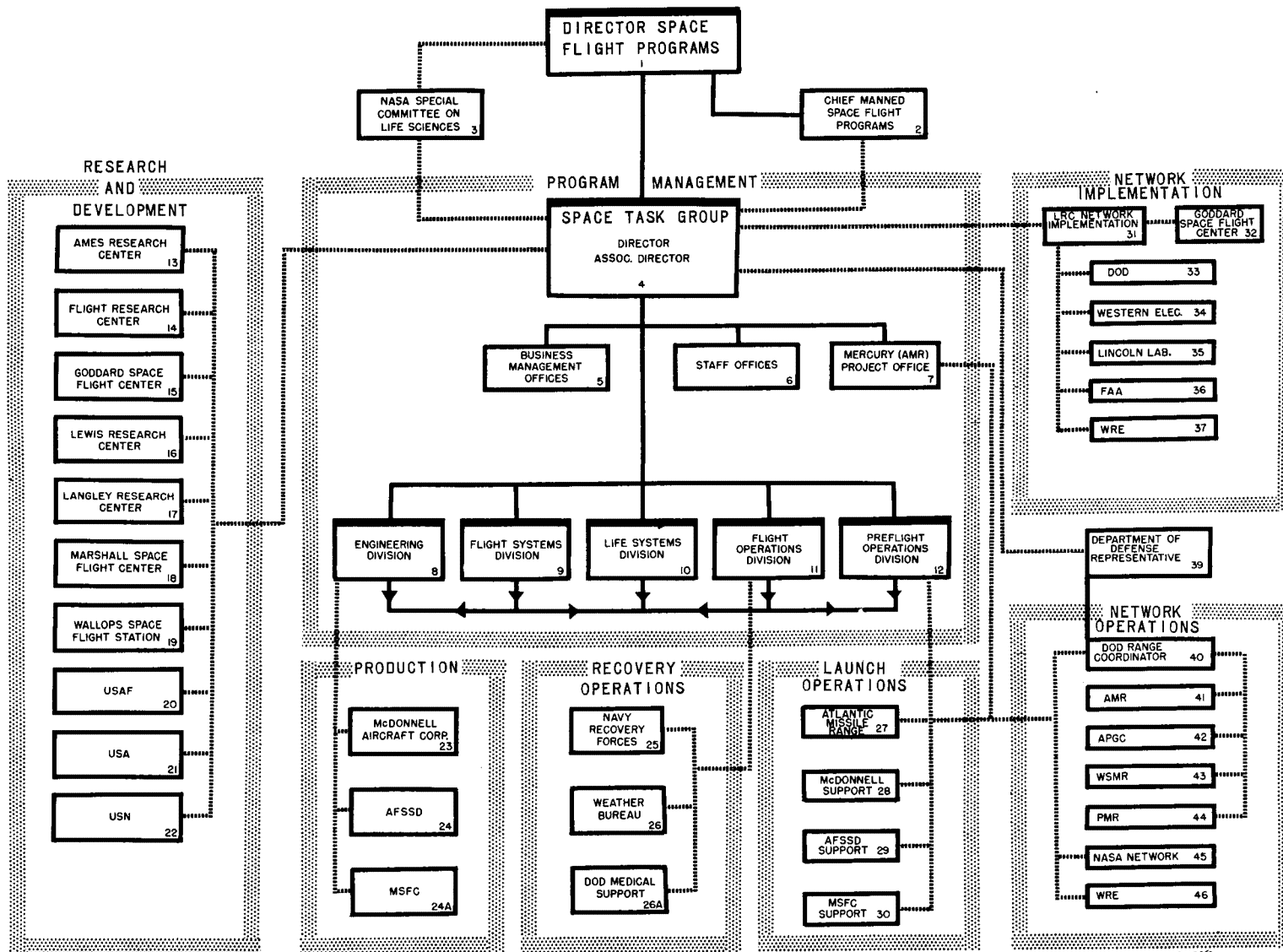

JAN. 1, 1961

Figure 1.



FLIGHT PLAN FOR THE MR-3 MANNED FLIGHT

By Christopher C. Kraft, Jr.

This paper presents some of the preflight preparations for the manned Mercury-Redstone (MR-3) flight and gives an outline of the flight plan. Also, a brief description of the recovery operations will be given. The preflight operations will deal with the preparations that were carried out, and the flight plan will be based on the times that the events occurred during the flight test. Astronaut Shepard will describe the flight test in more detail in a later presentation.

S  
1  
2

Starting in September 1960, the ground crews and the Astronauts began to make simulated flights of the Mercury-Redstone missions. The first unmanned and the chimpanzee Redstone flights, of course, furnished a great deal of experience from the standpoint of ground preparations and in-flight flight control. Previous to the actual manned flight, approximately 40 simulated flight tests were carried out at the Mercury Control Center. The Astronaut was in the procedures trainer during the simulations and participated with the flight control personnel so that a great amount of realism was obtained. It was during these simulated flights that the procedures to be used during the actual flight were developed. Such procedures as reporting techniques, voice communications, and transfer of information between the Astronaut and the control center were developed. The simulated flights dealt not only with the normal flight conditions but also with a large number of runs in which both the Astronaut and the flight control team were subjected to various types of spacecraft malfunctions which could occur. This type of training has proven to be invaluable to the ground control personnel and to the refinement of proper procedures for manned flights.

The formal countdown for the preparation for launching the MR-3 manned spacecraft started on the day previous to the launch day. The countdown was actually split into two parts because previous experience had shown that it was preferable to run the countdown in two shorter segments and allow the launch crew of both the spacecraft and the launch vehicle to obtain some rest before starting the final preparation for Astronaut insertion and launch of the vehicle. The countdown started at 8:30 a.m. EST on May 4, 1961. All the operations proceeded normally and were completed ahead of the scheduled time. A built-in hold of approximately 15 hours was called at T - 6 hours 30 minutes (where T indicates the time of predicted lift-off). During this time the various pyrotechnics were installed in the spacecraft and the hydrogen peroxide system was serviced. The countdown was resumed at T - 6 hours 30 minutes at 11:30 p.m. EST on May 4, 1961. A built-in hold of 1 hour had been previously agreed upon at T - 2 hours 20 minutes. This hold was to assure that spacecraft preparations had been completed before the

Astronaut was transported to the pad. The countdown proceeded with only minor delays until T - 2 hours 20 minutes. At this time, final preparation of the spacecraft was conducted and the Astronaut was apprised of the continuance of the countdown and transported to the pad. (The details concerning the Astronaut's preparations will be presented in subsequent papers by Jackson et al. and by Augerson and Laughlin.)

The countdown was continued after the hold at T - 2 hours 20 minutes and, except for some minor holds, which probably resulted from all concerned being extremely careful during the insertion of the Astronaut, the countdown continued until T - 15 minutes. At this time it was determined that photographic coverage of the launch and flight could not be obtained because of low clouds which were being blown into the launch area. The weather forecaster predicted that the visibility would improve rapidly within the next 30 to 45 minutes, and it was decided to hold the launch until more favorable camera coverage could be obtained. During this hold it was determined that one of the inverters supplying 400-cycle power to the launch vehicle was not regulating properly. The test conductor of the launch vehicle felt that this inverter should be replaced and this replacement would require a hold of approximately 45 minutes to 1 hour. At this time the Astronaut was consulted and he indicated that he was fine; the aeromedical people agreed that the Astronaut was in good condition and, therefore, it was decided to continue on and make a replacement of the inverter and pick up the count as soon thereafter as possible. The countdown was recycled to T - 35 minutes and resumed after a hold of 86 minutes. Again at T - 15 minutes it was necessary to hold the launch countdown in order to make a final check of the computer being used to give real time trajectory information and impact prediction. After this point, the countdown proceeded smoothly through to the time of lift-off. The total hold time during the launch countdown was 2 hours 34 minutes. The effects of this hold on the Astronaut will be discussed by Astronaut Shepard.

Figure 1 shows the MR-3 flight plan which was worked out by both the engineering and aeromedical groups, in conjunction with the Astronauts, to obtain an initial assessment of man's capability to operate in a space environment, and an appraisal of the spacecraft systems under similar conditions. The various phases of the mission are presented, and the values given are the times in minutes and seconds after lift-off at which an event occurred or a given task was performed. The flight as flown by Astronaut Shepard was almost identical to the intended flight plan and for purposes of this discussion can be considered the same. During the countdown several planned communications checks were made with the Astronaut on both UHF and HF radio. At T - 2 minutes the UHF radio was turned on and continuous communications were maintained between the Astronaut acting as the spacecraft communicator in the Mercury Control Center and the Astronaut in the spacecraft. This was to assure that the



communications systems were functioning properly at lift-off. The lift-off occurred at 9:34 a.m. EST on May 5, 1961.

The first critical time after lift-off occurred at 1 minute 24 seconds. At this time the spacecraft and launch vehicle passed through the point of maximum dynamic pressure (that is, the point in the exit trajectory at which the spacecraft and launch vehicle are subjected to the largest aerodynamic load). In addition, it was at this time that the cabin pressure sealed and was maintained at about  $5\frac{1}{2}$  psi. A communication procedure had been developed between the Astronaut and the control center so that if cabin and suit pressure were not maintained, an abort was to be initiated so that the time spent above 50,000 feet would be minimized and the maximum altitude reached would be limited to 70,000 feet. By aborting at this time (that is, between T + 1 minute 16 seconds and T + 1 minute 29 seconds), the time above 50,000 feet could be limited to about 60 to 70 seconds.

The shutdown of the launch-vehicle engine occurred at T + 2 minutes 22 seconds, and, at the same time, a signal was to be given to the spacecraft to separate the escape tower. Spacecraft separation occurred 10 seconds later by means of the separation of the Marman clamp and the firing of the posigrade rockets. Both of these operations were to be manually initiated by the Astronaut if the automatic systems had failed. This backup action by the Astronaut was to be taken in the initiation of all major spacecraft events. After a 5-second period during which the motions of the spacecraft were damped, a turnaround maneuver was initiated in which the spacecraft was yawed  $180^\circ$  so that the spacecraft was proceeding with the heat shield forward. The pitch attitude was also regulated to an attitude of  $14\frac{1}{2}^\circ$  from the local horizontal. At T + 3 minutes 10 seconds, the Astronaut turned off the automatic control systems and took over manual control of the spacecraft attitude. The plan was to have the Astronaut maintain manual control of the spacecraft throughout the remainder of the flight by using various combinations of the spacecraft attitude and rate-control systems. At T + 3 minutes 50 seconds, the Astronaut made a number of visual observations using the periscope. These observations included such things as weather fronts, cloud coverage, and certain preselected reference points on the ground. At T + 4 minutes 44 seconds, the retrofire sequence was initiated by an onboard timer; that is, the spacecraft was reoriented to the retrofire attitude of  $34^\circ$  in pitch and  $0^\circ$  in yaw and roll. Thirty seconds after initiation of the retrofire sequence, firing of the three retrorockets took place. Each rocket was to burn for approximately 10 seconds and they were fired sequentially at 5-second intervals. At T + 6 minutes 14 seconds (60 seconds after the firing of the first retrorocket), the retropackage jettisoned. It should be pointed out that, although firing of the retrorockets would have little effect on

the Redstone suborbital flight, this same procedure would be followed during an orbital flight in which the conduct of this maneuver is extremely critical to the reentry and subsequent recovery of the Astronaut and the spacecraft.

Shortly after jettison of the retropackage, a check of the HF radio onboard the spacecraft was made and, during this time (at T + 6 minutes 20 seconds), the Astronaut placed the spacecraft in the reentry attitude of  $40^\circ$ ; that is, with the heat shield pointed down  $40^\circ$  from the local horizontal. The periscope was retracted at T + 6 minutes 44 seconds. In a nominal reentry from orbit, the periscope is retracted just previous to atmospheric reentry to prevent damage due to reentry heating. This procedure was followed in this flight, although no heat damage would have occurred in this particular reentry maneuver. The start of the reentry, as indicated by the sensing of 0.05g, initiated the 0.05g light on the Astronaut's panel at T + 7 minutes 48 seconds, and the acceleration built up to a maximum of 11.0g at T + 8 minutes 20 seconds. This maximum acceleration occurred at an altitude of approximately 83,000 feet.

The deployment of the stabilizing drogue parachute occurred at 21,000 feet at 9 minutes 38 seconds after lift-off. The spacecraft continued to descend down to 10,000 feet, at which time the main parachute was deployed and this occurred at T + 10 minutes 15 seconds. It might be noted that a backup parachute was provided should the first parachute have failed, and the deployment of this parachute would have been initiated by the Astronaut. The descent of the spacecraft was approximately 30 feet per second after the deployment of the main parachute, and landing took place 5 minutes 7 seconds later. After landing, the Astronaut initiated the various recovery aids; these include a dye marker and an HF whip antenna. The SARAH beacon, which is a radio homing device, was turned on at the time that the main parachute was deployed.

Figure 2 is presented to give a pictorial presentation of the overall flight. As noted previously, the launch occurred at 9:34 a.m. EST. Two minutes 22 seconds later maximum velocity was achieved at launch-vehicle cutoff. This inertial velocity was 7,388 feet per second or 5,036 miles per hour, which was within 86 feet per second of the predicted velocity. The maximum altitude occurred 5 minutes 11 seconds after lift-off and was  $116\frac{1}{2}$  statute miles. The landing, as noted previously, occurred 15 minutes 22 seconds after lift-off, 302 statute miles downrange from Cape Canaveral, Fla. In order to give an idea of the accuracy that can be expected from the computations made immediately after cutoff of the launch vehicle and separation of the spacecraft, a comparison is given of the impact point which was predicted at cutoff and the point at which the spacecraft was retrieved. It can be seen that the prediction was within 2 minutes of longitude and 1.7 minutes of latitude (which was within 3 miles of the retrieval point).

The acceleration profile experienced by the Astronaut during the flight is presented in figure 3. Shown in this figure is the acceleration along the longitudinal axis of the spacecraft plotted as a function of time after lift-off. The acceleration built up gradually from 1.0g and reached a maximum of 6.2g at launch-vehicle cutoff. The acceleration immediately dropped to 0g and remained at 0g for approximately 5 minutes except for the short period during retrorocket firing. At 7 minutes 48 seconds, the reentry acceleration started and built up rapidly to a maximum of 11g at 8 minutes 20 seconds. The acceleration reduced to near 1.0g at 8 minutes 40 seconds and continued at approximately 1.0g. This 1.0g was interrupted by a spike of from 3g to 4g when the main parachute was deployed. The accelerations experienced at landing were not measured in this flight. Previous tests have indicated this acceleration to be on the order of 12g to 14g. Astronaut Shepard will describe this landing in more detail.

The recovery operations for this flight were as good as could ever be hoped for in any Mercury operation. At the time of launch-vehicle cutoff, a message giving the impact point predicted by the computer was sent to the aircraft carrier in the intended landing area. This allowed the pickup helicopters to be dispatched to the area about 10 minutes before the time of landing. As a result, the helicopters were actually able to follow the spacecraft down to the water as the spacecraft descended. About 2 minutes after the spacecraft landed, the helicopters contacted the Astronaut and the recovery procedure was initiated. It had been planned to have the helicopter hook on to the top of the spacecraft and apply sufficient power so that the spacecraft was suspended with the heat shield and landing bag still in the water. This procedure was to guarantee that the hatch on the side of the spacecraft was sufficiently clear of the water to prevent water from entering the spacecraft when the hatch was opened. Then the Astronaut was to remove the hatch and come to a sitting position on the edge of the hatch frame of the spacecraft. The helicopter was then to lower the rescue collar to the Astronaut and raise him in the normal fashion up into the helicopter. After the retrieval of the Astronaut, the spacecraft was to be hoisted from the water and delivered to the deck of the aircraft carrier. The process that has been described was carried out without incident and proved to be a very good operation. Visual inspection of the spacecraft indicated no damage had occurred to the spacecraft during the flight or upon impact with the water. Subsequent detailed investigations of the spacecraft have been made and show that the spacecraft was indeed in excellent condition and could be used again to make similar flights.

The results of the flight and the landing will be described in more detail by Astronaut Shepard and others.

### MR-3 FLIGHT

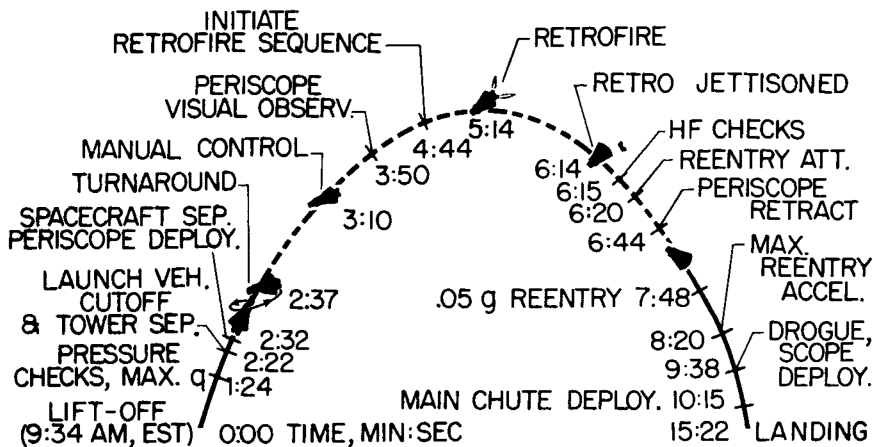
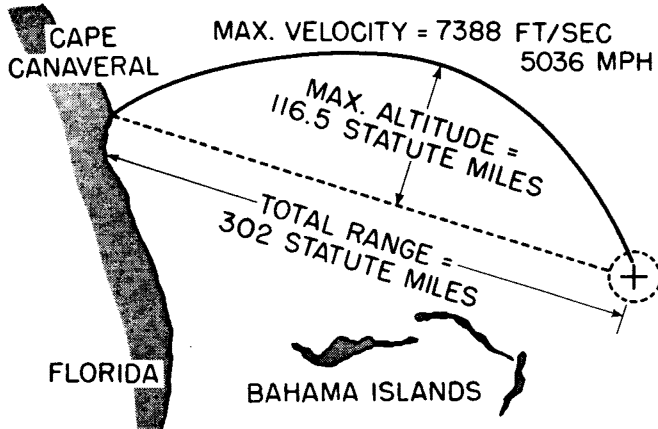

Figure 1.

### MR-3 GROUND TRACK AND FLIGHT PROFILE



#### LANDING POINT

	LONG.	LAT.
COMPUTED	75° 51'	27° 12'
ACTUAL	75° 53'	27° 13.7'

Figure 2.

## MR-3 ACCELERATION PROFILE

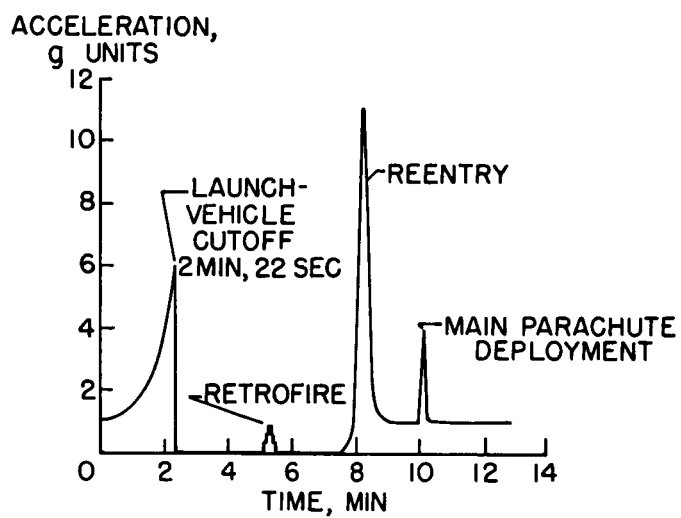

Figure 3.

## MERCURY SPACECRAFT SYSTEMS

By Aleck C. Bond

## INTRODUCTION

The Mercury flight test program has included full-scale spacecraft flight tests using the Atlas, Redstone, and Little Joe launch vehicles. The Atlas launch vehicle is the launch vehicle that will be used for the subsequent orbital flight tests. The Little Joe launch vehicle, which is relatively simple and inexpensive, has been used primarily for proving system concepts and flight qualification of certain spacecraft components. For instance, the Little Joe launch vehicle has been used to check thoroughly and qualify the Mercury escape system under the most critical escape conditions of the Mercury flight spectrum. Flight tests with the Redstone launch vehicle are being used to further the flight qualification of many of the spacecraft systems as well as to provide a means of astronaut training on short-range suborbital or ballistic flights. Prior to Astronaut Shepard's recent flight, three Redstone missions were flown which demonstrated the readiness of the systems for manned flight. The first was unmanned, the second was made with the primate Ham onboard the spacecraft, and the third provided further launch-vehicle qualification.

Even though the flight tests with the Redstone are suborbital, they do provide a short period of weightlessness as well as a simulation of the g-levels which will be encountered during reentry from orbit. These flights are considered as valuable stepping stones to the orbital mission. The purpose of this paper is to present a brief review of the Mercury spacecraft and some of its primary systems in order to provide a better understanding of the subsequent presentations on Astronaut Shepard's recent venture into space.

## SPACECRAFT AND ESCAPE SYSTEM

Figure 1 shows a sketch of the Mercury spacecraft with and without its escape system. The overall length of the vehicle including the escape tower and retro pack is just under 26 feet. The maximum diameter of the spacecraft is  $74\frac{1}{2}$  inches.

The spacecraft configuration is characterized by certain features: the blunt reentry face, the conical afterbody, the cylindrical recovery compartment, and the antenna canister. The blunt end which is oriented forward during reentry is protected from reentry heating by a heat shield.

For the Redstone missions, a heat shield constructed of beryllium is employed, whereas for the orbital missions an ablative-type shield constructed of fiber glass and resin is used. The inward sloping surfaces of the cone tend to minimize the afterbody heating and the extensions to the cone enhance both the static and dynamic stability. The afterbody is of double-wall construction, the walls being separated with bulk insulation material. The outer wall of the conical afterbody and antenna canister consists of overlapping shingles made of thin sheets of refractory metal which dissipate heat by radiation. These shingles are corrugated to provide stiffness. The recovery-compartment outer wall is constructed of a series of beryllium plate elements, which are unrestrained for thermal expansion. The inner-wall structure in the region of the conical portion of the afterbody constitutes the pressure vessel or cabin and is constructed of two layers of thin-gage titanium.

Entrance to the cabin is gained through a hatch in the wall of the conical afterbody. Figure 1 shows one of the two porthole-type windows incorporated in the MR-3 spacecraft. These windows utilize heat-resistant glass and are of multipane construction. The later Mercury spacecraft incorporate only a single but much larger window which is located directly above the astronaut's head. This modification was made to give the astronaut a more unrestricted view for making visual observations independent of the existing optical system.

The escape tower is attached to the spacecraft structure by means of a Marman-type clamping band which is held together by explosive bolts. The solid-propellant escape rocket mounted on top of the tower is designed to provide an adequate separation distance in case of launch vehicle failure. If the launch vehicle fails on the launch pad, the escape rocket will lift the spacecraft to an altitude sufficient to allow deployment of the main parachute. Recent tests of this system simulating an off-the-pad abort, an abort at maximum dynamic pressure, that is, maximum air loading, and an abort at very high altitude have all been successful. In a normal Redstone mission the escape tower is jettisoned by firing the escape motor immediately after the launch-vehicle motor is shut down. A small solid-propellant rocket motor located just behind the escape motor is used to jettison the tower from the spacecraft in an aborted mission.

The retropack, which is shown mounted to the heat shield in figure 1 and also in figure 2, contains six solid-propellant rocket motors, three being retrograde motors and the other three being posigrade motors. The retrograde or braking motors which are used to initiate reentry from orbit will provide a velocity decrement of 450 feet per second along the longitudinal axis of the spacecraft. The posigrade motors, which are smaller and provide a velocity increment of 30 feet per second, are used to effect separation from the launch vehicle. The retropack is attached to the heat shield by means of three metal tie straps. It

is jettisoned by firing the single explosive bolt which retains the straps at the center of the retropack.

### MAJOR SPACECRAFT SYSTEMS

In addition to the heat protection and rocket systems discussed in the foregoing section, the spacecraft incorporates seven other major systems. These systems are (1) communications, (2) attitude control, (3) environmental control, (4) electrical power, (5) explosive devices, (6) cabin equipment, and (7) landing and recovery systems. Since all the systems cannot be covered in detail in this presentation, only certain features of systems of special interest are discussed. One thing which should be noted at this point is that, although all spacecraft systems have been designed for completely automatic operation, provisions have also been made for operation and control of the systems by the astronaut.

When all the many systems and subsystems are integrated within the spacecraft, the internal arrangement is essentially that shown in the sketch of figure 3. With this arrangement, the astronaut has about the same amount of room as in a typical fighter cockpit. The astronaut is shown seated in his contoured couch with his back to the heat shield. It should be noted that the direction of spacecraft travel is reversed between the launch and reentry phases of flight. During launch the small end of the spacecraft is pointed forward but for reentry the orientation is reversed and the heat shield is pointed forward. This reversal in attitude simplifies the astronaut's support system since the support couch is properly aligned for both the acceleration and deceleration phases of flight.

By starting at the small end of the spacecraft one can distinguish such items as the antenna canister, two horizon scanners, the drogue parachute, the main and reserve parachutes, the pitch and yaw jets and associated plumbing, the periscope, the instrument panel, the side arm controllers, the various electronic packages, and the many other items of equipment needed to carry out the Mercury mission. The environmental control system which is discussed in the paper presented by Dr. S. C. White is located primarily below the astronaut's couch.

#### Communications System

Because of the importance of maintaining contact with the spacecraft throughout all phases of the Mercury mission, the communications system has been designed with considerable backup and redundancy. The various communications subsystems are outlined as follows:



## Two-way voice:

- (a) Two primary radio links
- (b) Two secondary radio links

## Telemetry:

- (a) High frequency (code transmission capability)
- (b) Low frequency

Two command receivers (voice receiving capability)

Two radar beacons

## Recovery beacons:

- (a) Two beacons (designated SARAH/SEASAVE unit)
- (b) Ultra SARAH (in survival kit)

Under normal conditions, two-way voice communications can be carried out on either of the two primary radio links. Two secondary voice links are also provided, one of which is a backup for in-flight voice communications, and the other is provided for redundancy in recovery communications. Two independent telemetry subsystems are provided for transmission of capsule and astronaut performance data. The high-frequency telemeter can be keyed by the astronaut for code transmission in the event of failure of all voice communications. Two identical command receivers operating on the same frequency are provided for receiving ground command functions such as emergency abort and retrofire commands. Ground voice communications can be received by the astronaut through the command receivers. The two radar beacons (S and C band) are required for ground radar tracking. As an aid to search and recovery, a combination unit containing both the SARAH and SEASAVE rescue beacons is carried on the spacecraft. The SARAH beacon is activated at main parachute deployment, whereas the SEASAVE beacon is not energized until landing. An Ultra SARAH rescue beacon is also provided in the astronaut's survival kit. In addition, a seven-track magnetic tape recorder is included in the spacecraft to record the telemetered data and voice transmissions.

### Landing System

The main components of the landing system are, of course, the parachutes. The drogue parachute which is housed in the antenna canister

S  
1  
3

(fig. 3) is a six-foot ribbon-type parachute which is employed to stabilize and decelerate the spacecraft further prior to main parachute deployment. It is deployed at a nominal altitude of 21,000 feet. The photograph of figure 4 shows a view of the recovery compartment of the MR-3 spacecraft. The main and reserve parachutes are seen in their stowed locations. The two parachutes, which are identical, are 63-foot-diameter, ring-sail parachutes. The main parachute is deployed at 10,000 feet through the action of jettisoning the antenna canister. The antenna canister is jettisoned by an electrically fired mortar which is located below the post in the center of the recovery compartment. In the event that the main parachute is damaged or fails to deploy properly, deployment of the reserve parachute is manually initiated by the astronaut. In addition, one may see other items of equipment in the compartment such as the ultra high frequency descent antenna, the flashing light, the recovery loop, and so forth.

#### Attitude Control System

On the MR-3 spacecraft, three methods of operation were available to the astronaut for effecting the control and stability of the capsule. These methods included the use of (1) the automatic stabilization and control system, (2) the manual control system, and (3) the "fly-by-wire" system. The automatic and manual systems are completely independent. In fact, they have completely separate hydrogen peroxide fuel tanks, use different fuel flow control valves, and employ different sets of jet thrusters for providing the reaction-control forces.

Electrical signals generated by the "brain" of the automatic system are used to control its various solenoid-operated fuel valves. However, with the manual system, the astronaut uses the right-hand controller to manipulate directly the manual fuel control valves. The "fly-by-wire" system has been provided in order to give the astronaut further manual control of the capsule. With this system, the astronaut can control the solenoid valves of the automatic system by means of a series of electrical switches incorporated in the right-hand controller.

The right-hand controller, which is shown in figure 5, is a three-axis controller which allows the astronaut to make control inputs by short hand movements. Fore-and-aft movements provide control in the pitch plane; side-to-side movements give roll inputs, and the twisting of the controller about its vertical axis gives yaw or directional control. This type of hand controller incorporates the standard aircraft stick motions for the pitch and roll control. The twisting motion for yaw control replaces the function of the conventional airplane rudder pedals. The left-hand controller incidentally is used to provide the astronaut with a quick means for initiating an abort. Twisting of the left controller will initiate the abort sequence. A simple locking feature is incorporated in the controller to prevent an abort from being inadvertently initiated.

Figure 6 gives the planned sequence of operations for the automatic stabilization and control system for the MR-3 spacecraft. It is known, of course, that Astronaut Shepard took over after the spacecraft turnaround and he performed manually various control training exercises and some of the control sequences. Nevertheless, the spacecraft attitudes were essentially as shown in the figure. At the left-hand side of figure 6, the automatic stabilization and control system (ASCS) becomes active with the jettisoning of the escape tower. At this time, sequence A, the vertical gyro is slaved to the horizon scanners. At spacecraft separation, sequence B, the control system maintains rate damping for a period of 5 seconds in order to minimize disturbances arising from firing of the posigrade rockets. The turnaround is then effected and the spacecraft is oriented to an attitude of  $14\frac{1}{2}^{\circ}$ , as shown in sequence C. The control system then orients the spacecraft to the retrofire attitude of  $34^{\circ}$  and holds this attitude throughout the firing of the retromotors, as shown at sequence D. Sixty seconds after retrofire the retropack is jettisoned and then the spacecraft is oriented to the reentry attitude of  $-40^{\circ}$  as shown in sequence E.

As the capsule reenters the atmosphere and perceptible g-forces begin to be sensed, sequence F, the control system discontinues the attitude programing. It then introduces a steady roll of  $10^{\circ}$  to  $12^{\circ}$  per second to reduce landing-point dispersion and also maintains rate damping to prevent large oscillation buildup. At main parachute deployment the control system is turned off and its fuel is jettisoned.

### Instrument Panel

The instrument panel (fig. 7) was chosen to be discussed next since it represents a culmination of essentially all the spacecraft systems. It should be mentioned that the MR-3 panel shown here differs somewhat from that of the orbital spacecrafts, in that certain instruments which were not required for the mission have been deleted. Otherwise, the general arrangement is essentially the same. The controls and displays shown on the panel are grouped according to function. The group on the left has various astronaut controls such as those concerned with the attitude control and retrorockets. The next group is a sequencing display consisting of a series of light indicators designed to tell the astronaut whether various functions occurred at the proper time. A green light will show that the function occurred and a red light will indicate some failure in the automatic system. The handle or switch just to the left of each indicator allows the astronaut to override and correct the failure of a given function. The two larger handles at the bottom of this group are for decompression and repressurization of the cabin. Decompression would be the method used for extinguishing a fire.

The three circular dials at the upper left of the center console read acceleration, altitude, and rate of descent. The combination display at the top center presents angular rate and attitude data in three axes. The rate display is in the center and is surrounded by the three attitude dials. The astronaut's control of spacecraft attitude is aided by observations through the periscope. The astronaut also uses the periscope during descent to observe parachute deployment. The periscope screen is seen in the lower center of the panel. The instrument just above the periscope screen is a clock which indicates time of day and elapsed time from launch. This instrument was also used to initiate the retrofire sequence for the MR-3 spacecraft. The switch in the upper right-hand corner of the center console is the ready switch and is used during countdown to inform the test conductor of the astronaut's readiness for launch. Below this switch is the Mayday light which warns the astronaut of an abort.

The environmental control system display is grouped in the upper right-hand section of the panel. This group indicates functional information on the system such as cabin pressure and temperature, relative humidity, coolant and oxygen quantity, and so forth. The electrical-power-system monitor dials and the communication controls are directly below this group. The small panel shown in the upper left-hand corner of the figure incorporates the cabin and suit temperature controls.

Three cameras were carried onboard the MR-3 spacecraft: an earth-sky camera, a pilot-observer camera, and an instrument-panel camera. The earth-sky camera, which is a 70-millimeter camera, was aimed out of the lower right-hand window to photograph earth and sky features and cloud formations. The other two cameras are 16-millimeter cameras. The instrument-panel camera is mounted just to the left of the astronaut's head and is used to record the movements of the dials on the instrument panel during the flight. The astronaut-observer camera is mounted behind the instrument panel. Its lens can be seen extending from the instrument panel just to the left of the periscope screen.

#### ACCELERATION AND IMPACT ATTENUATION

One of the primary areas of concern in the design of the Mercury spacecraft was the protection of the astronaut from excessive accelerations during the various flight phases and during landing. Normal boost and reentry accelerations are an order of magnitude higher than those associated with high performance aircraft; however, they are by no means the highest accelerations to which the astronaut may be subjected. The emergency abort situations actually represent the more severe loading conditions. Under certain abort conditions the astronaut could be subjected to g-levels of 15 to 17 during the escape maneuvers and of the order of 20g during reentry. The astronaut is protected from undue localized loadings by means of the contoured couch mentioned earlier.

The astronaut couch and restraint system is discussed in detail in the paper presented by Dr. S. C. White.

During the course of testing the capsule, it was found that impact on water under certain surface conditions could produce accelerations as high as 40g for a few milliseconds with average onset rates of about 8,000g per second to 10,000g per second. Impact on land could produce even higher loadings. In order to attenuate these impact accelerations, particularly for cases with attendant high surface winds, a simple air cushion was devised as shown schematically in figure 8. The air cushion consists of a 4-foot skirt made of rubberized fiber glass that is attached on the one end to the heat shield and on the other end to the spacecraft. After the main parachute is deployed, the heat shield is released from the spacecraft structure; thus, the skirt extends and fills with air. Upon impact, the air trapped between the capsule and shield is vented through the series of holes in the upper and lower ends of the skirt. A series of thin metal straps which are slightly shorter than the skirt are used to absorb the lateral impact loads and hence prevent damage to the skirt.

A recent series of drop tests with this system with surface winds as high as 20 knots have yielded measured impact accelerations no higher than 16.5g, the average onset rates being reduced to 200g per second.

#### SPACECRAFT—LAUNCH-VEHICLE COMBINATION

Figure 9 shows a photograph of the MR-3 spacecraft and Redstone launch-vehicle combination on the launch pad at ignition. The spacecraft is attached to a short adapter section on the launch vehicle by means of a Marman-type clamping band which was explosively disconnected just before capsule separation.

In order to protect the astronaut from an impending launch vehicle failure, both the Redstone and Atlas launch vehicles are equipped with an automatic abort-sensing system. This system senses the functioning of several critical launch-vehicle systems and will automatically initiate escape in the event performance is abnormal. The astronaut may also initiate an escape by simply twisting his left-hand control grip as previously mentioned. During countdown the blockhouse test conductor can also initiate an escape through a direct electrical connection with the spacecraft.

The booster is approximately 59 feet long and the overall combination length is about 85 feet. The spacecraft payload weight on the MR-3 flight was 4,040 pounds. Total vehicle lift-off weight was 66,000 pounds and the takeoff thrust of the launch vehicle was 78,000 pounds.

## SPACECRAFT AND ESCAPE SYSTEM CONFIGURATION

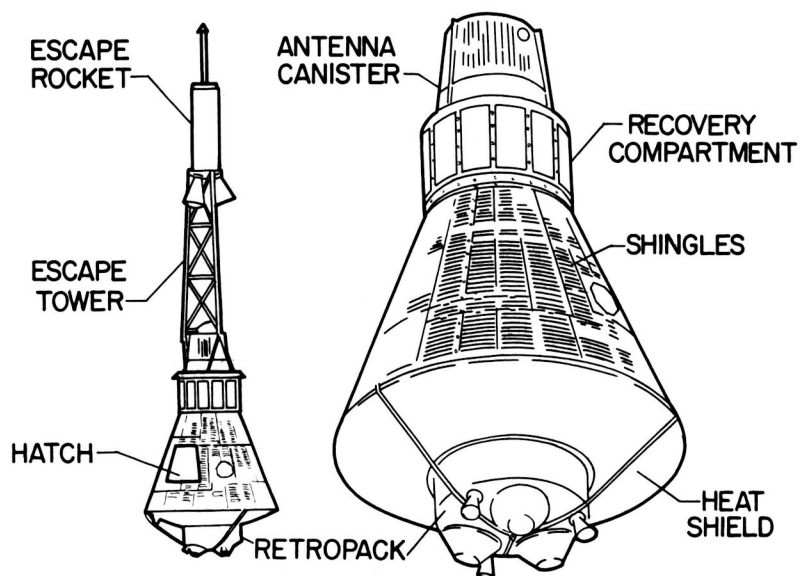

Figure 1.

## MERCURY SPACECRAFT IN HANDLING STAND

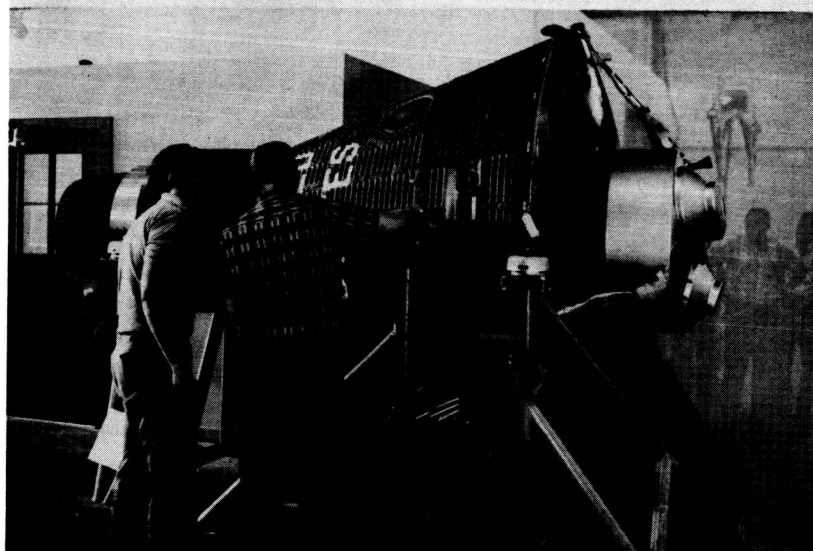

Figure 2.

### SPACECRAFT INTERNAL ARRANGEMENT

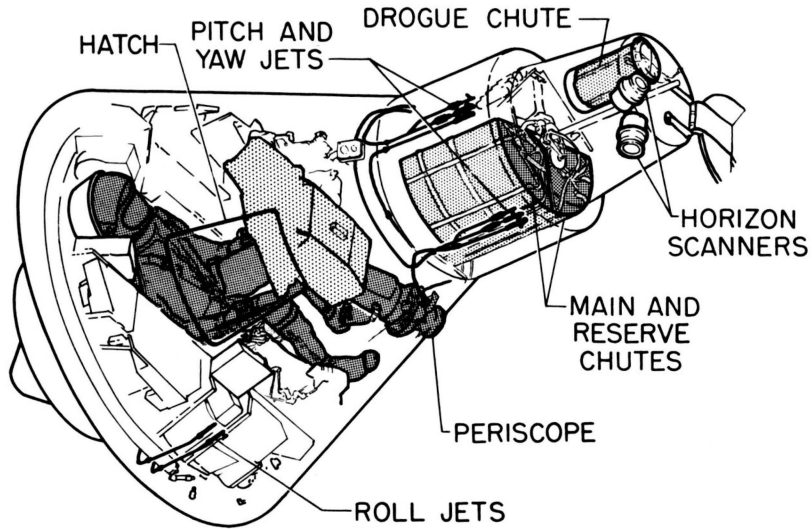

Figure 3.

### VIEW OF RECOVERY COMPARTMENT SHOWING STORAGE OF PARACHUTES

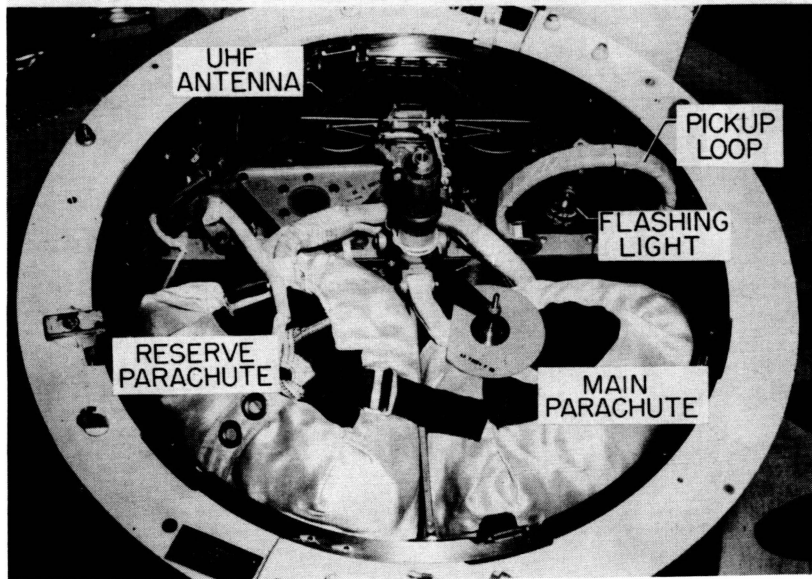

Figure 4.

### THREE-AXIS HAND CONTROLLER

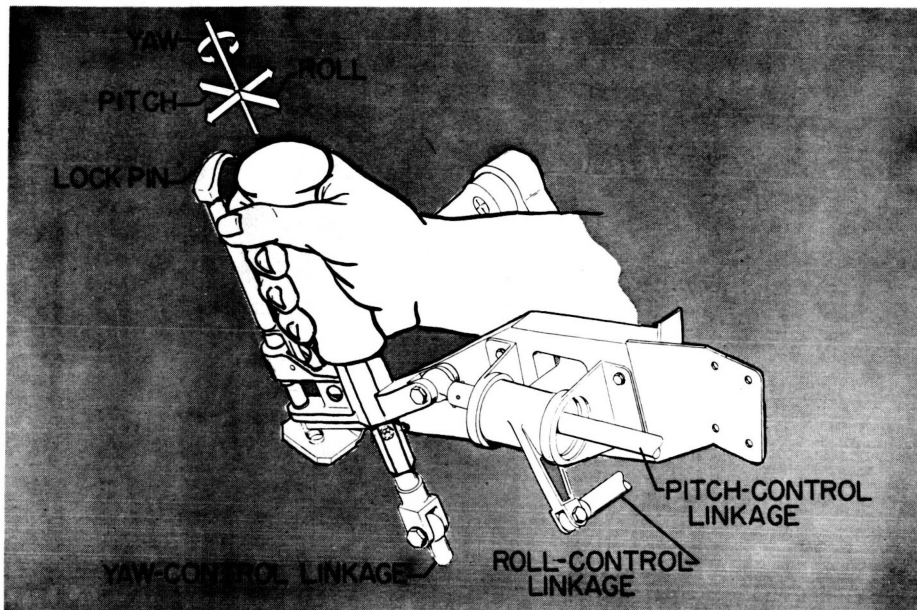

Figure 5.

### MR-3 SPACECRAFT ASCS SEQUENCES

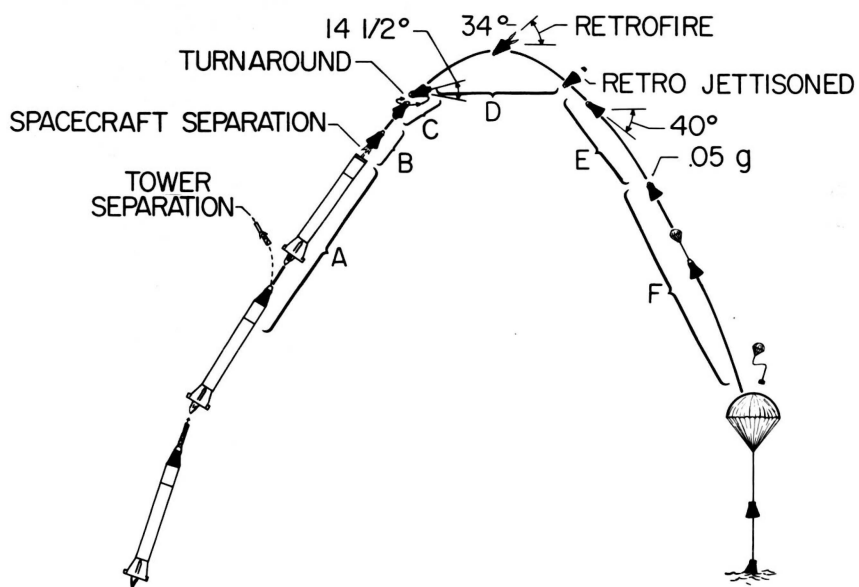

Figure 6.



## MAIN INSTRUMENT PANEL AND CONSOLES FOR MR-3 CAPSULE

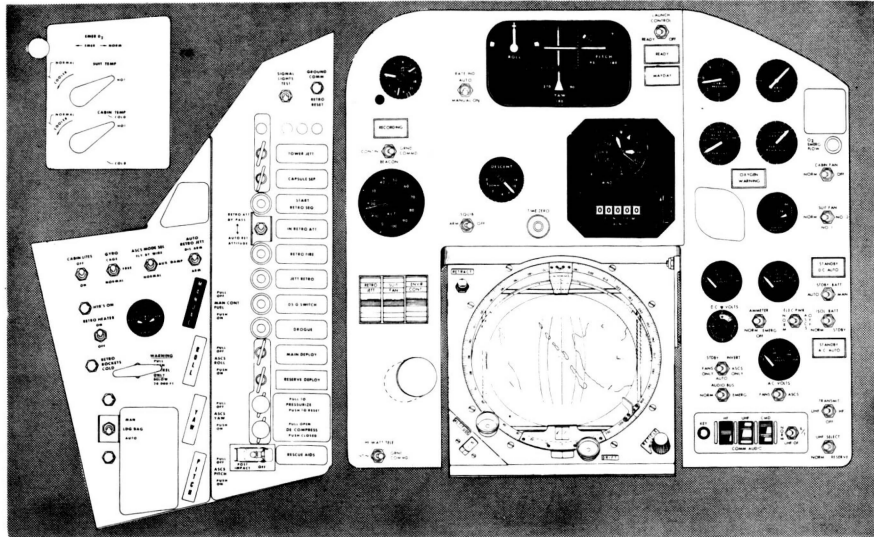

Figure 7.

## IMPACT ATTENUATION

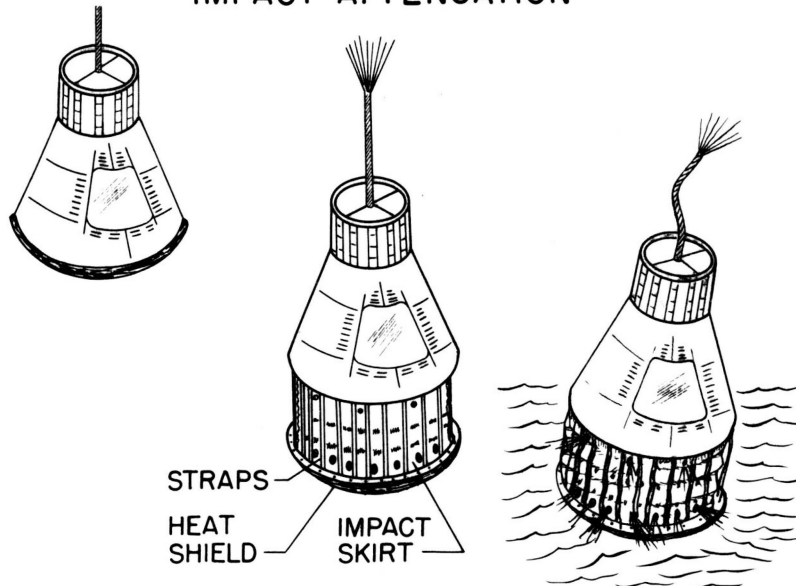

Figure 8.

LAUNCH VEHICLE IGNITION, MR-3 VEHICLE

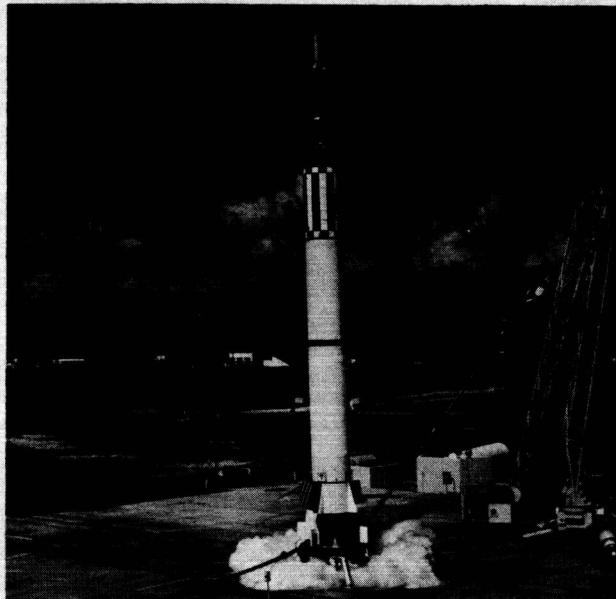

Figure 9.

## REVIEW OF BIOMEDICAL SYSTEMS FOR MR-3 FLIGHT

By Stanley C. White, M.D., Richard S. Johnston,  
and Gerard J. Pesman

### INTRODUCTION

The successful conclusion of the manned ballistic flight of MR-3 was the culmination of approximately 2 years of preparation of the life support systems for the spacecraft and of the selection and training of the Astronauts for space flight. The major spacecraft systems which are essential for sustaining the Astronaut during flight are the environmental control system and the Astronaut acceleration protection system. This discussion will be limited to a summary of the status of these two systems at the time of the flight of MR-3, a review of the biomedical portions of the Astronaut training, and a discussion of the animal program preceding the manned flight.

### ENVIRONMENTAL CONTROL SYSTEM

The Mercury environmental control system has been described in previous papers (refs. 1 and 2) and therefore only a brief description is included herein.

The primary function of the environmental control system is to provide a livable gaseous environment to the Astronaut. Table I lists the system design requirements and system provisions. The basic system requirement was to provide a 28-hour flight capability based on an oxygen consumption of 500 cc/min standard temperature and pressure (STP) and a maximum cabin leakage rate of 300 cc/min STP. In order to meet this requirement, 4 pounds of oxygen is needed. In the Mercury system 8 pounds of oxygen is provided to allow for complete redundancy. The next requirement established was the spacecraft pressurization level of 5 pounds per square inch absolute (psia) with a pure oxygen atmosphere. This pressure level was chosen as the best compromise to provide the necessary oxygen partial pressure, efficient use of supply for emergency modes of operation, a pressure giving small differential change during spacecraft decompression emergencies, and the level where decompression illness would be minimal. The spacecraft system controls pressures between 4.0 and 5.5 psia. The heat exchanger system was designed on the basis of an Astronaut metabolic heat production of 500 British Thermal Units per hour (Btu/hr). Suit ventilation was established at a fixed flow of 10 cubic feet per minute at 5 psia with a variable ventilation gas temperature. The maximum carbon dioxide partial pressure was established at 8 mm of Hg.

In order to meet these system requirements, a closed type of environmental control system was developed by the AiResearch Manufacturing Division of the Garrett Corporation under a McDonnell Aircraft Corporation subcontract.

The environmental control system (fig. 1) is located in the lower portion of the spacecraft under the Astronaut support couch. The Astronaut is clothed in a full pressure suit to provide protection in the event of a cabin decompression. The pressures in the cabin and pressure suit are maintained at 5 psi in normal flight with a 100-percent oxygen atmosphere. The system is designed to control automatically the environmental conditions within the suit and cabin throughout the flight. Manual controls are provided to enable system operation in the event of automatic control malfunction. In describing the environmental control system, it can be considered as two subsystems: the cabin system and the pressure suit control system. Both of these systems operate simultaneously from common coolant water and electrical supplies. The coolant water is stored in a tank with a pressurized bladder system to facilitate weightless flow of water into the heat exchanger. Electrical power is supplied from an onboard battery supply. Oxygen is stored at 7,500 psi in two spherical bottles.

Pressure-suit control system.- The pressure-suit control system provides breathing oxygen, maintains suit pressurization, removes metabolic products, and maintains, through positive ventilation, gas temperatures.

The pressure suit (fig. 2) is attached to the system by two connections, the gas inlet connection at the waist and the gas exhaust at the helmet. This single-piece suit was developed by the U.S. Navy, NASA, and the B. F. Goodrich Company. The helmet incorporates the communications equipment and a buffet protection liner for the head. A biosensor connector is provided on the suit to permit the exit of the biosensor leads. The distribution of ventilation gas flow in the suit is illustrated by figure 3. This figure shows the inlet port location at the torso and the outlet port on the helmet. Oxygen is forced into the suit distribution ducts, carried to the body extremities, and permitted to free-flow back over the body to facilitate body cooling. The oxygen then passes into the helmet where the metabolic oxygen, carbon dioxide, and water vapors are exchanged. The gas mixture leaves the suit, figure 4, and passes through a debris trap where particulate matter is removed. Next, the gas is scrubbed of odors and carbon dioxide in a chemical canister of activated charcoal and lithium hydroxide. Following this, the gas is cooled by a water evaporative type of heat exchanger which utilizes the vacuum of space to cause the coolant water to boil at approximately 35° F. The heat-exchanger exit gas temperature is regulated through manual control of the coolant-water flow valve. The heated water vapors are dumped overboard. The water-vapor exit

temperature is monitored by a temperature switch which actuates a warning light when the water-vapor temperature drops below 50° F. The light is on the Astronaut's panel and provides a visual indication of excessive water flow into the heat exchanger. Proper monitoring of the light and correction of the water flow rate will prevent the heat exchanger from freezing. In the gas side of the heat exchanger, water vapors picked up in the suit are condensed into water droplets and are carried by the gas flow into a mechanical water separation device. The water separator is a sponge device which is squeezed periodically to allow the collecting of the metabolic water in a small tank. The constant flow rate of the atmosphere is maintained through the compressor.

Pressurization in the pressure-suit control system is maintained by a demand type of regulator. In normal operation this regulator meters oxygen into the system to maintain the pressure suit at nominal cabin pressure; thus, in normal operation the pressure suit is not inflated but merely provides body ventilation. In the event of a cabin decompression, the regulator senses the loss in pressure and maintains the suit at 4.6 psi.

An additional emergency mode of operation is provided by the emergency oxygen rate valve. This valve provides an open-type pressure-suit operation similar to aircraft pressure-suit systems. A fixed flow of oxygen is directed through the suit for ventilation and metabolic needs. The remainder is dumped into the cabin. This system is used when the suit pressurization system fails. The other components of the suit system are closed off during this mode of operation.

Oxygen is provided in two bottles, each containing sufficient oxygen for a 28-hour flight. The bottles are equipped with pressure transducers to provide data on the supply volume. They are connected in such a way that depletion of the primary supply automatically activates the emergency bottle. This change to the emergency oxygen bottle is called to the Astronaut's attention through a warning light and buzzer on his panel.

Cabin system.- The cabin system controls cabin pressure and temperature. A cabin relief valve controls the upper limit of cabin pressure. This valve allows cabin pressure to follow the ambient pressure during the climb of the vehicle to 27,000 feet where it seals the cabin at 5.5 psi. In addition, a manual decompress feature is incorporated in this valve to dump the cabin pressure if a fire or buildup of toxic gases occurs.

A cabin pressure regulator meters oxygen into the cabin to maintain the lower limit of pressurization at 5.1 psi. A manual recompress feature is incorporated in the regulator for cabin repressurization after the emergencies just mentioned are corrected.

Cabin temperature is maintained by a fan and heat exchanger of the same type as that described in the discussion of the pressure-suit system.

Postlanding ventilation is provided through a snorkel system. At 20,000 feet, following entry, the snorkels open and ambient air is drawn by the suit compressor through the inlet valve. The gas ventilates the suit and is dumped overboard through the outlet valve.

Test program.- The environmental control system, like all other spacecraft components, underwent an exhaustive series of development, qualification, and reliability tests. In addition to these hardware tests, a series of manned altitude simulation tests were conducted. The purpose of these tests was to verify man, pressure suit, and system compatibility under normal and emergency conditions. The manned test program is summarized in table II. The manned development tests were conducted in December 1959 at the AiResearch Manufacturing Corporation laboratories. In these tests the Mercury pressure suit and the environmental control system were first tested as a single unit. Many changes and improvements resulted from these first tests. A total of 24 manned test hours was accumulated during this series of tests.

A series of 12 manned tests under various normal and emergency modes, including a manned 28-hour test, were next conducted at McDonnell Aircraft Corporation. A total of 257 manned hours was accumulated on the system at McDonnell Aircraft Corporation. At the conclusion of these tests, a series of Astronaut familiarization tests were made using the system and spacecraft utilized in the McDonnell test program. In these manned tests, the combination stresses of pressure and temperature were simulated simultaneously. The test flights used a profile of the three-orbit mission. A total of 85 manned hours was accumulated on the system during these tests.

In October 1960, a pressure-suit control system was installed in the Johnsville human centrifuge and dynamic Redstone flights were made under normal and emergency conditions. During this dynamic test series, the system performed satisfactorily without any component or system malfunction. Approximately one-half of this total was under the dynamic loads expected for MR-3. A total of 134 manned hours was accumulated on the system.

The results of the manned test program showed that the system was capable of supporting an Astronaut in orbital flight. In addition, system improvements resulted and a high degree of reliance in the system capabilities was developed. Following these prototype manned tests, a total of 14 hours was gained on actual spacecraft systems of spacecraft 3, 5, and 7 during their preflight checkouts. A total of 514 hours of manned operation preceded the MR-3 flight.

The environmental control system was utilized in part and as a complete system in all flights previous to the MR-3 flight. The flight program is summarized in table III. Complete systems were flown in three spacecraft prior to the MR-3 flight. Information was obtained on various system components and on the total system during these flights.

### ACCELERATION PROTECTION SYSTEM

The requirement to provide an adequate support and restraint system for the Mercury Astronauts resulted in a study considering the accelerations that every phase of the normal mission or possible emergencies might impose. The areas included in the normal mission are the launch, separation, retrofiring, entry, parachute deployment, and water landing of the spacecraft.

Since it was assumed that all missions will not proceed normally, it was necessary also to consider the emergencies which could occur. Of the many emergencies, the following ones could impose sudden accelerations on the occupant: escape from the launching pad; termination of the mission at maximum dynamic pressure on the vehicle; termination of the mission immediately preceding entry into the orbital phase; and possible ground landings.

In each phase of the normal mission and in the emergencies just listed, it was necessary to appraise the hazard which the acceleration imposed, select a remedy for the problem if the appraisal indicated that this was necessary, and, finally, prove that the problem had been solved. These three steps will be discussed for each phase of both normal missions and emergencies.

At the beginning of the Mercury program, it was known from centrifuge studies that launch accelerations were tolerable up to orbital velocities if the occupants were placed in a supine-position form-fitting couch with the head and shoulders raised slightly and feet and knees drawn up in a seated position as shown in figure 5. (Also see ref. 3.) It was established that this phase of the mission was not a problem, except for the development of techniques for form-fitting a couch to each individual. These techniques were successfully developed by NASA and adapted to production by the McDonnell Aircraft Corporation.

Calculations and data showed that the accelerations of the spacecraft separating from the launch vehicle, retrorocket firing, deployment of the drogue and reefed main parachute, and unreefing of the main parachute were within known tolerance limits and did not present problems. The entry accelerations, however, particularly if the mission was terminated

just prior to the time that orbital velocity was reached, were beyond the available data on man's tolerance. The entry acceleration pulse is sinusoidal in shape and either the magnitude or duration could be beyond known experience. Consequently, experiments were conducted at the Navy's Aviation Medical Acceleration Laboratory to determine man's tolerance to such accelerations when supported in a contoured couch in the supine position. These experiments showed that entries, with the vehicle producing no lift, were tolerable up to about 20g (refs. 3 and 4). Subsequent training experience by the Astronauts, using the contoured couches while on the human centrifuge, have demonstrated that the normal flight accelerations are not a hazard.

The entry experiments, just cited, also showed that the calculated emergency entry accelerations which the Mercury spacecraft might encounter were within human tolerance. Subsequent full-scale flights, Big Joe and MA-2, which simulated such an emergency, confirmed the validity of the acceleration calculations. Thus, missions terminated a few moments before orbital velocity is reached can be tolerated.

These results left the landing accelerations as the only normally occurring area needing an answer. At the beginning of the Mercury program, the accelerations which would be imposed on a ballistic-type reentry vehicle during a water landing were not known. Consequently, the Langley Research Center of the NASA conducted a series of experiments to determine the magnitude of the accelerations. The experiments showed that the magnitude of the accelerations was within tolerance limits; however, the rate of application of the force was beyond the known limits. At this time, it became apparent that ground landings were quite probable in the case of an "off the pad emergency." For this reason, it was concluded that it was necessary to attenuate the landing shock of both the water and ground landings.

Experiments were conducted at the Wright Air Development Division to determine how rapidly an accelerating force can be imposed without exceeding human tolerance. These experiments have progressed to the stage where forces of up to 35 times a person's own weight can be applied at a rate of 11,200 g/sec without more than slightly confusing the individual. No physical injury was apparent. These experiments showed that a water landing could be tolerated without a landing bag. A slight confusion, however, is not considered acceptable as a routine operational measure.

The emergency ground landing imposes the maximum load on both the couch structure and the occupant. Full-scale experiments showed that longitudinal accelerations of about 90g would be imposed on the spacecraft if the impact is not attenuated. When such accelerations are combined with those due to wind drift and tumbling, it is apparent that



a ground landing cannot be tolerated by a human without possible injury unless some form of attenuation material is provided. Crushable material was placed underneath the couch (fig. 5), to help attenuate the vertical components of the impact forces. Experiments by both the McDonnell Aircraft Corporation and the Langley Research Center indicated that aluminum honeycomb material, which was used, would attenuate the maximum longitudinal accelerations to within human tolerance. The crushable material was designed to limit the acceleration to 40g on the occupant. Proof tests conducted by the McDonnell Corporation showed that the final crushable material permitted a momentary peak of approximately 60g on the occupant and the remainder of the pulse was slightly under 40g. Little lateral acceleration protection was provided by the crushable material; therefore, it was considered satisfactory as an emergency measure only. Through this method, an emergency ground landing is tolerated, marginally, unless there is a considerable wind. If there is a fairly large wind component and the spacecraft is swinging under the parachute, injury may result.

In order to meet the impact loads on land and water landings better, an impact bag which could attenuate the combined shock resulting from the parachute sinking rate, the horizontal velocity resulting from wind, the parachute swing, and the impact surface conditions was developed by the McDonnell Aircraft Corporation. The design requirement of the impact bag limited the accelerations to 10g in the lateral vectors and 20g in the longitudinal vector. The impact-bag tests have confirmed that the design requirements have been met.

The remaining emergency condition which must be discussed results from termination of the mission when the spacecraft is exposed to the maximum dynamic pressure. During such an abort, the spacecraft is suddenly lifted away from the launch vehicle by the escape rocket. Since the spacecraft is now traveling at high speed, it will be suddenly exposed to a large drag when the escape rocket burns out. The occupant will first be pressed back into the couch while the escape rocket is burning and, then, when the escape rocket burns out, suddenly thrown forward into his restraint harness. Lateral components may also occur. This sudden reversal of force on the spacecraft produces the maximum loads on the restraint harness. The reversal accelerations can reach a magnitude of 18g (fig. 6). It also raises the question of whether a head restraint is necessary. In order to determine whether a head restraint was necessary, the Aeromedical Field Laboratory, Holloman Air Force Base, New Mexico, conducted a series of tests using a full pressure suit and human subjects on their small "Bopper" track. From these experiments, it was apparent that the pressure suit helps to restrain the Astronaut's head. Experiments on the centrifuge indicated that the lateral components combined with the transverse forces are tolerable. Therefore, no added head restraint is necessary.

The restraint harness (fig. 7) chosen for the Astronaut is basically the standard shoulder strap and lap strap combination used by the military services. To this basic harness has been added a chest strap to give the upper torso more support, an inverted V-strap fastened to the lap strap to keep the lap strap in the proper position over the abdomen, and two knee straps. The knee straps together with the lap strap hold the pelvis in place during forward accelerations and, thus, reduce the probability of lumbar spine injury. This harness was statically tested by McDonnell Aircraft Corporation and then proof tested on the centrifuge using a dummy. Subsequently, the Astronauts used this harness during their centrifuge training sessions.

At the time of the first manned ballistic mission (MR-3), a completely proved restraint and support system was available (table IV). An entire normal mission could be conducted without the Astronaut's enduring intolerable accelerations. Likewise, because of added tolerance information and a reserve impact attenuation system (the crushable material below the couch), it was expected that all of the emergencies could be endured without injury.

#### BIOMEDICAL PORTION OF ASTRONAUT TRAINING AND THE ANIMAL PROGRAM

A major area for the preparation of the MR-3 flight concerned the readiness of the Astronaut for the flight. Two parallel avenues were followed to meet this requirement. The first concerned the selection and training of the Astronauts and the second concerned the animal program used to qualify the man support systems before manned flight.

The selection of the Astronauts has received sufficient publication and therefore needs no further discussion here. The Astronaut training program is a many faceted program with all portions of the physical sciences, engineering sciences, and biological sciences participating. The physical science and engineering portions of the training are discussed in detail in the paper by Astronaut Slayton; therefore, this discussion will be confined to the biomedical aspects.

The biomedical preparation of the Astronauts has taken two directions. First, they have been given a rather extensive course in the physiology concerning their body systems in order that they could understand the effects of the stress loads to be imposed upon them during flight and to enable them to be better reporters of the effects of the stress upon them. Second, the men were given a complete program of dynamic testing and training. The program design was based upon the dynamics of the flight. Learning through repetitive experience was used in this phase of preparation. Time was allowed each Astronaut during the phases of training for the development of his own defenses

in meeting the stresses. In addition, these training events were used as controls for the flight data. Due to the lack of statistically significant numbers, it was necessary to use each man as his own control. A comparison of his flight results with the training data would give the first hint as to adequacy of the man and his training in meeting the space flight.

While the Astronaut program was moving along, the second avenue, the animal program, was started. The animal program was designed to parallel the man program. Its primary goal was the qualification of the man support systems. Through this approach, the objective of flying first unmanned, followed by an animal flight, would give the logical sequence for the qualification of the spacecraft for manned flight.

The chimpanzees considered for the Redstone program were thoroughly trained using the calculated flight dynamics. The centrifuge and heat chambers were used. The physiological training was incorporated with the psychomotor tasks to be done by the chimpanzee during flight. It was found that early in the training program the chimpanzee would cease working during the accelerative periods and assume his normal trained pattern promptly after the forces were released. However, subsequent training indicated that the chimpanzee could accept these new stresses and continue performance at a high level through all normal stress loads. This fact was confirmed by the MR-2 data on the chimpanzee named "HAM." The results of the MR-2 flight indicated that the chimpanzee was able to sustain consciousness and continued activity on the psychomotor apparatus with the exception of the periods of high acceleration associated with the firing of the escape tower and the entry acceleration. Both of these events were beyond the nominal flight dynamics. The performance of the chimpanzee returned to his normal range values during the weightless period. The performance, after the entry acceleration, did drop below his normal work pattern; however, he was able to sustain a satisfactory rate. Figure 8 shows a plot of the heart rate and respiration rate of the chimpanzee with a comparison of the acceleration profile and elapsed time of the flight. It can be seen that the pulse and respiration rates were responding to the accelerative forces but returned to normal values during the weightless and the postentry periods. The values in pulse and respiration were considered within normal range for the chimpanzee under stress. The flight profile on MR-2 exceeded the limits expected on MR-3; therefore, it was concluded that man could be put safely in the MR-3.

## REFERENCES

1. Johnston, Richard S.: Mercury Life Support Systems. Life Support Systems for Space Vehicles, S.M.F. Fund Paper No. FF-25, Inst. Aero. Sci., Jan. 1960.
2. Greider, Herbert R., and Barton, John R.: Criteria for Design of the Mercury Environmental Control System - Method of Operation and Results of Manned System Operation. Paper presented to Aerospace Medical Assoc. (Miami Beach, Fla.), May 11, 1960.
3. Eiband, A. Martin: Human Tolerance to Rapidly Applied Accelerations: A Summary of the Literature. NASA MEMO 5-19-59E, 1959.
4. Clark, Carl C., and Gray, R. Flanagan: A Discussion of Restraint and Protection of the Human Experiencing the Smooth and Oscillating Accelerations of Proposed Space Vehicles. MA-5914, Aviation Medical Acceleration Lab., U.S. Naval Air Dev. Center (Johnsville, Pa.), Dec. 1959.

TABLE I

## ENVIRONMENTAL CONTROL SYSTEM

	Requirement	System provision
Flight duration . . . . .	28 hr	<sup>a</sup> 31 to 35 hr
Oxygen supply . . . . .	4 lb	8 lb
Metabolic O <sub>2</sub> . . . . .	500 cc/min	>10 liters/min
Cabin leak . . . . .	300 cc/min	1,500 to 2,500 cc/min
Pressurization level . . . . .	5 psia	5.5 to 4.0 psia
Oxygen partial pressure . . . . .	5 psi	5.5 to 4.0 psi
Suit circuit heat		
production . . . . .	1,000 Btu/hr	1,000 Btu/hr
Metabolic . . . . .	500 Btu/hr	700 Btu/hr
Equipment . . . . .	300 Btu/hr	300 Btu/hr
Suit ventilation flow at		
5 psi . . . . .	10 cu ft/min	11.5 cu ft/min
Carbon dioxide output . . . . .	400 cc/min	>400 cc/min

<sup>a</sup>Additional coolant water required.

TABLE II  
 ENVIRONMENTAL CONTROL SYSTEM - MANNED TEST PROGRAM

Tests	Devel- opment	McDonnell Aircraft Corporation	Astronaut training	Centrifuge	Spacecraft 3	Spacecraft 5	Spacecraft 7
Number . . .	6	12 manned plus checkout	6 manned plus checkout	15 astronaut runs plus checkout	2	2 chimp	3 manned
Duration, hr . . . . (total, 514)	24	257	85	134	3	4	7

TABLE III  
 MERCURY ENVIRONMENTAL CONTROL SYSTEM FLIGHT TEST PROGRAM

Environmental control system components	Completed flights					Scheduled flights	
	LJ-5 <sup>a</sup>	MR-1A <sup>b</sup>	MR-2	MA-1 <sup>c</sup>	MA-2	LJ-5A	All others
Complete system (all major components)	X	X	X				X
Cabin pressure relief valve				X	X	X	
Cabin blower				X	X	X	
Cabin heat exchanger and related equipment				X	X	X	
Snorkel valves				X	X	X	
Control box				X	X	X	
Instrumentation heat exchanger					X		

<sup>a</sup>LJ, Little Joe

<sup>b</sup>MR, Mercury-Redstone

<sup>c</sup>MA, Mercury-Atlas

TABLE IV  
ACCELERATION SYSTEM STATUS

Area of consideration	Problem	Solution	Status at time of MR-3
Tolerance	Sudden application of forces (abort off pad, $q_{max}$ abort, water landing, ground landing)	WADD drop tests	System qualified
Couch	Must withstand impact loads and fit occupant	McDonnell tests; AMAL tests 1, 2, and 3	Couch qualified
Harness	Withstand load reversal; easy to release	AMAL test 2 and "Bopper"	Harness qualified
Crushable structure	Not overload occupant	McDonnell tests	Structure qualified
Impact bag	Must attenuate impacts to manned experience limits	Develop bag, McDonnell; STG, full-scale drops	Bag qualified



## PROJECT MERCURY ENVIRONMENTAL CONTROL SYSTEM

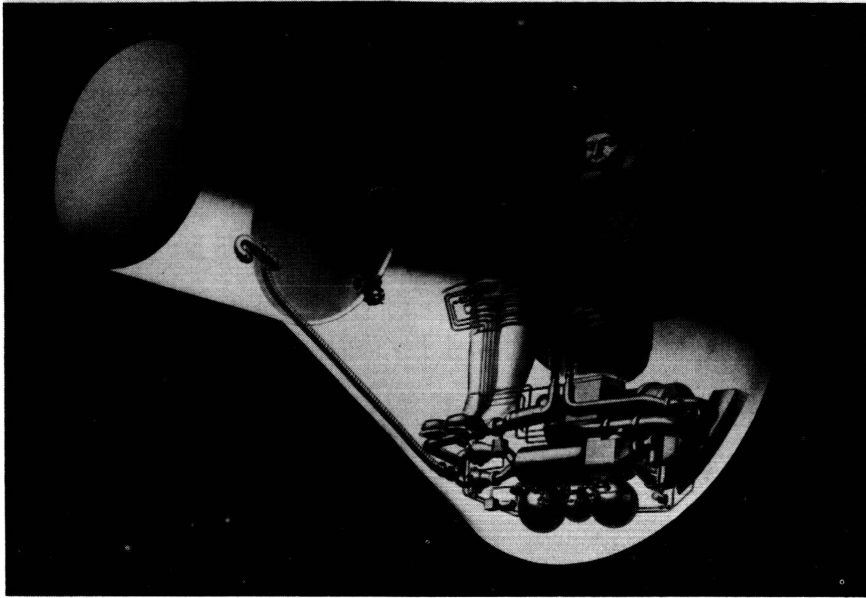

Figure 1.



Figure 2.

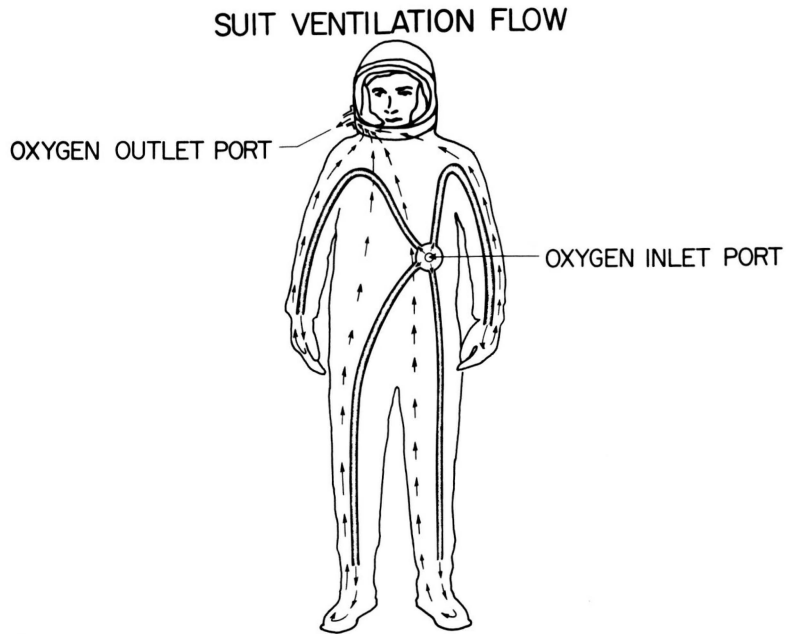

Figure 3.

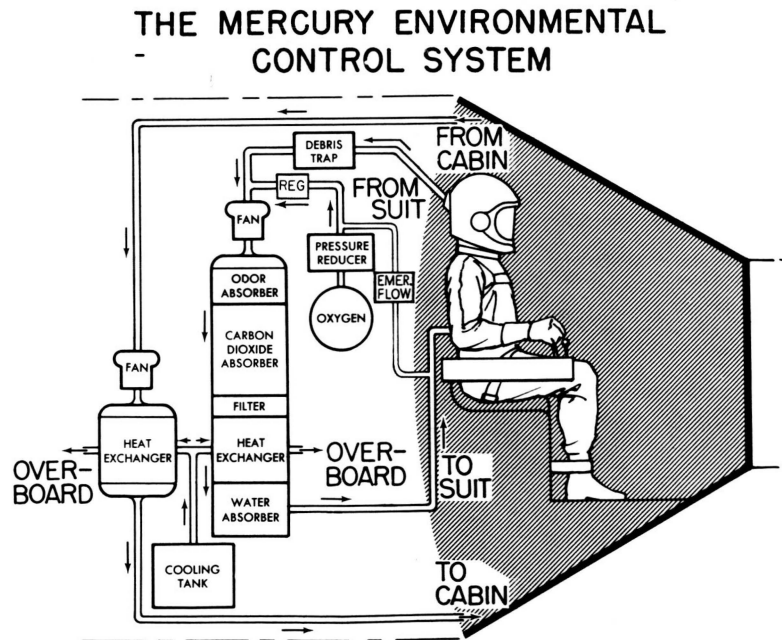

Figure 4.

### ASTRONAUT POSITION AND CRUSHABLE STRUCTURE

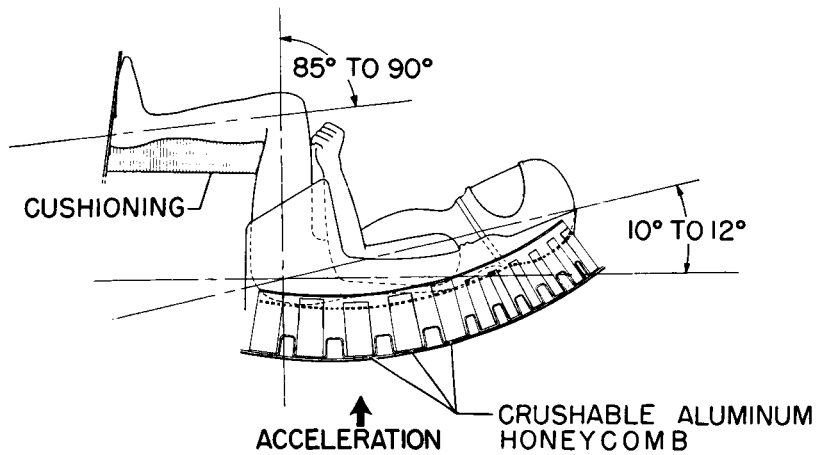

Figure 5.

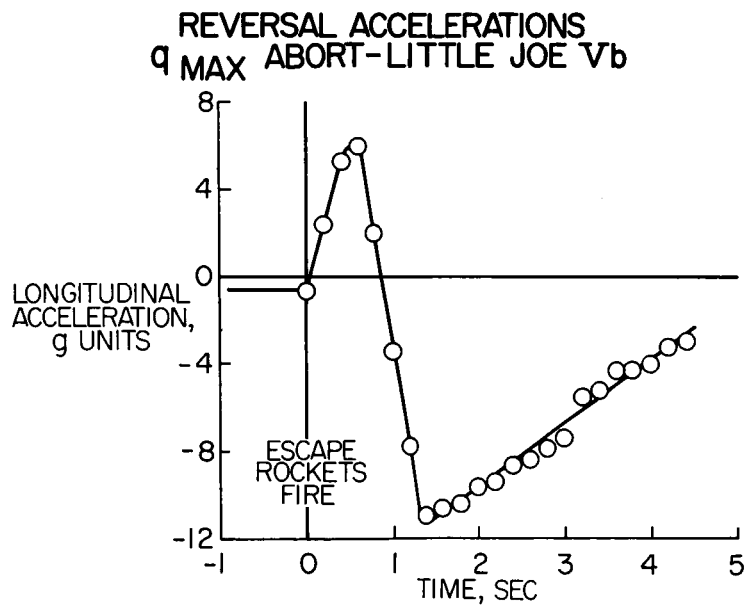

Figure 6.

## PILOT'S RESTRAINT SYSTEM



Figure 7.

MR-2 — SUBJECT 65 ("HAM")  
RATES BASED ON 10-SEC INTERVALS

Figure 8.

## RESULTS OF PREFLIGHT AND POSTFLIGHT MEDICAL EXAMINATIONS

By Carmault B. Jackson, Jr., M.D., William K. Douglas, M.D.,  
James F. Culver, M.D., George Ruff, M.D.,  
Edward C. Knoblock, Ph. D.,  
and Ashton Graybiel, M.D.

This report of the preflight and postflight medical examinations on Alan B. Shepard, Jr., includes the data obtained before and after Mercury-Redstone Mission No. 3. The interval of study was 6 days. In this period several detailed observations were completed. Multiple observers, other than the authors, were necessarily utilized and the authors would like to express their indebtedness to them. In particular, the authors acknowledge the assistance of Dr. Walter Frajola, University of Ohio, Dr. Kristen B. Eik-Nes, University of Utah, Dr. Hans Weil-Malherbe, St. Elizabeth's Hospital, Washington, D.C., and S. Sgt. Carlton L. D. Stewart of the U.S. Air Force Hospital, Lackland Air Force Base, Texas. This paper reveals only a few changes in the pilot whose role continuously represented subject and observer.

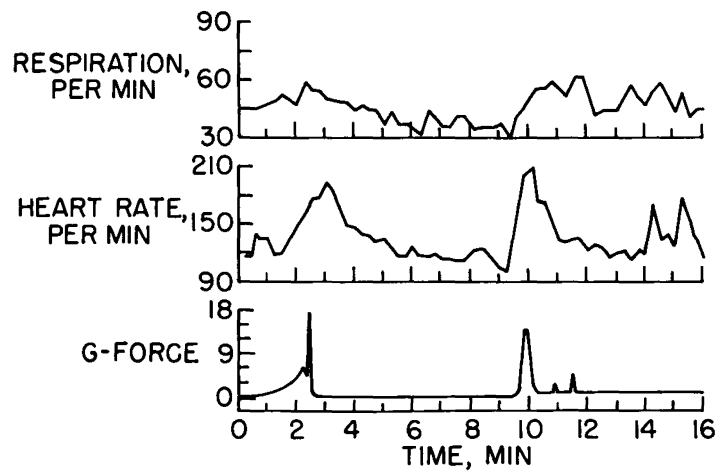
The purpose of the examination program was twofold: prior to a launch it ascertained pilot fitness and after recovery it was expected to reveal any significant changes resulting from the combined stresses of actual space flight. It is to be understood that these paired examinations could not discern time-critical in-flight changes or changes which were so evanescent that they persisted only minutes after impact. The purpose of this paper is to present the findings of the examination program and relate them to stressful training experiences. It is within the scope of this program to point out that in the interval between preflight and postflight studies certain deviations appeared. Additionally, it is within the scope of this program to search for delayed changes and to discern areas where fundamental knowledge is needed.

Control experiences were gleaned from selection, simulator, and interim studies performed over the past 26 months. Additional control information is still being added. More data regarding the effect of diet, 100-percent oxygen environment, activity, and body position on some of the biochemical assays are required. The preflight examiners represented the disciplines of internal medicine, aviation medicine, neurology, ophthalmology, psychiatry, and biochemistry.

The outline of the examination is included in the following narrative of the preflight and postflight evaluation. The day before the original date set for the MR-3 flight, May 1, 1961, the preflight physical examination was performed. In general appearance, the pilot seemed relaxed and confident and said that he felt in good health. A brief running review of systems disclosed nothing other than the fact that he had incurred an

injury to his left foot and that he was about to lose the fourth toenail. He was receiving no medications. The pilot stated that he had recently been "sunburned" and over the thorax he was "losing some skin." There were no other systemic complaints or comments. A psychiatric interview was accomplished. The psychiatrist noted that the "pilot appeared relaxed and cheerful. He was alert and had abundant energy and enthusiasm. Affect was appropriate. He discussed potential hazards of the flight realistically and expressed slight apprehension concerning them. However, he dealt with such feelings by repetitive consideration of how each possible eventuality could be managed. Thinking was almost totally directed to the flight. No disturbances in thought or intellectual functions were observed."

The general physical examination began with inspection of the entire body surface. There was a 2-cm<sup>2</sup> area of maculopapular eruption surrounding a 2-mm tattoo on the upper sternum (the site of upper chest electrocardiographic-electrode placement). A search for lymph nodes revealed no significant adenopathy. The ophthalmologist then performed his examination; the eyes were normal. Examination of the oral cavity, mucous membranes, teeth, and tongue disclosed slight reddening of the mucosa at the medial margins of the posterior tonsillar pillars. The ear canals were clear. The tympanic membranes were likewise clear. Three audiograms had been previously entered in the pilot's record and were consistently normal. When a tuning fork of low register (126 cps) was placed in the middle of the forehead, there was no reference of sound to either ear. In the neck, the thyroid was found to be just barely palpable, smooth, and symmetrical. There was no tenderness. The thorax was symmetrical; movement was full and equal bilaterally. Over the lung fields, percussion and auscultation revealed no abnormality. Palpation of the anterior thorax disclosed the point of maximal cardiac impulse to be in the sixth left intercostal space 11 cm from the midline. Pulse and blood-pressure data are presented in table I. During auscultation of the heart the rhythm was regular and the aortic second sound was slightly louder than the pulmonic second sound. Examination of the abdomen, external genitalia, extremities, and spine disclosed no abnormality. Neurological examination, a standard electroencephalogram, posterior, anterior, and lateral chest X-rays, and a standard electrocardiogram were normal, unchanged from September 1960. The urine and blood studies are reported in tables II and III, respectively. In brief, all of the findings were consistent with previous physical examinations of the pilot.

When this study was completed, most of the examining team was moved to Grand Bahama Island. As is already known, the flight which was anticipated for May 2, 1961 did not occur. Two members of the original specialty group continued their observations and considered the pilot's status unchanged. The flight profile was completed without difficulty on May 5, 1961. The first postflight physical examination was performed

aboard the aircraft carrier Lake Champlain. Blood and urine specimens were collected and the pilot was asked to begin debriefing in the form of free dictation. Three hours from lift-off Astronaut Shepard was taken to Grand Bahama Island by aircraft from the Carrier. On arrival at this remote island site, he seemed quietly elated and offered no complaints. His own statement of general fitness included "a wonderful flight," "everything went well," "I feel fine." The psychiatrist at the time of his interview, which actually took place after the next general physical examination, believed that the "subject felt calm and self-possessed. Some degree of excitement and exhilaration was noted. He was unusually cheerful and expressed delight that his performance during the flight had actually been better than he had expected. It became apparent that he looked upon the flight as a difficult task about which he was confident, but could not be sure, of success. He was more concerned about performing effectively than about external dangers. He reported moderate apprehension during the preflight period, which was consciously controlled by focusing his thoughts on technical details of his job. As a result, he felt very little anxiety during the immediate prelaunch period. After launch, he was preoccupied with his duties and felt concern only when he fell behind on one of his tasks. There were no unusual sensations regarding weightlessness, isolation, or separation from the earth. Again, no abnormalities of thought or impairment of intellectual functions were noted."

There were no systemic complaints. However, during flight either at  $q_{max}$  (the period when maximum aerodynamic pressures are present) or at Mach number 1.0, vibration was so severe that the pilot stated he "could not see very well." He felt that this inability to see clearly was due to vibration transmitted through his helmet.

The two postflight examination periods revealed the following findings: There was redness at the upper margin of both scapulae, an area approximately 2 by 6 cm in size (corresponding to the pressure points of harness and couch). There were no petechiae or ecchymoses. The tympanic membranes were slightly reddened at their periphery. Complete ophthalmological evaluation disclosed no abnormality. In the thorax, inspiratory and expiratory measurements were the same; there was no impairment of expansion. Some decrease in breath sounds was found over the lung fields at both bases posteriorly. In these same areas, crepitant and subcrepitant rales were heard. These sounds were cleared by coughing and did not reappear. Diaphragmatic movement was normal. The point of maximal cardiac impulse had not shifted. The aortic second sound remained slightly louder than the pulmonic second sound. No other abnormalities or changes were found. A 12-lead electrocardiogram, an electroencephalogram, and chest X-rays were normal.

In the laboratory, routine blood and urine studies were performed immediately on arrival at the debriefing area (3 hours from lift-off)

and again at 45 hours after the flight. The major body of information was gathered after samples were processed, frozen, and transported to the various participating laboratories. These data are presented in tables II, IV, and V. In all instances micromethods were utilized when available. Bibliographic references indicating methodology are appended.

There is some danger inherent in reporting and discussing one experience. However, the studies performed and described have been designed to cover areas of predictable flight stresses - that is, psychophysiological stress, rapidly changing ambient pressures, noise, vibration, acceleration, physical restraint, 5-psi 100-percent oxygen environment, and thermal stress.

In simulator training, it has been customary to find chemical evidence of adrenal response in blood and urine. Barotitis, mild to severe, has been frequently noted after periods of exposure to rapidly changing ambient pressures. Areas of erythema, occasionally petechiae and ecchymoses, appeared after acceleration ( $g A_x$ ). Minimal atelectasis has been a frequent finding after combined exposures to acceleration and 5-psi 100-percent oxygen environments. Mild dehydration and early signs of heat exhaustion were also evident when an individual in an impermeable Mercury pressure suit was not adequately ventilated. With Redstone training profiles, there has been no nystagmus as a result of high noise levels; there has been no vibration injury.

As a result of this one brief ballistic space-flight experience, a number of changes have been noted. These changes are summarized as follows:



	Preflight	Postflight
Body weight . . . . .	169 lb 4 oz	166 lb 4 oz
Rectal temperature . . . . .	99.0° F	100.2° F
Pulse after exercise . . . . .	Returned to normal in $2\frac{3}{4}$ min	Returned to normal in 3 min
Ears . . . . .	Canals and mem- branes clear	Slight injection of both tympanic mem- branes; most marked on right
Skin . . . . .	2-cm <sup>2</sup> area of maculopapular eruption at upper sternal ECG site	Areas of erythema 2 by 6 cm on both shoulders at upper border of scapulae
Lungs . . . . .	Normal; X-ray negative	Diminished breath sounds. Crepitant and subcrepitant rales noted over both lung fields, posteriorly, at bases; cleared by coughing. X-ray negative
Urine specific gravity . . . . .	1.020	1.013
Serum protein . . . . .	7.4 g/100 ml	8.3 g/100 ml
Plasma norepinephrine . . . . .	5.2 g/L	12.9 g/L

The program for obtaining medical data has proved generally satisfactory. A few laboratory deficiencies were noted in this rehearsal for orbital mission. It will be the intent of this specialty team to continue with this plan of data acquisition, to make more rigid demands for urine collection, to shorten the preflight-study interval (the interval between examination and flight), and to continue the accumulation of control data.

From the material reviewed, it is obvious that a brief sortie has been made into a new environment. Similarities between this sortie and previous training experiences have been noted. No conclusions have been drawn except that in this flight the pilot appears to have paid a very small physiologic price for his journey.

## BIBLIOGRAPHY

## Glucose:

Nelson, M.: Photometric Adaptation of Somogyi Method for Determination of Glucose. *Jour. Biol. Chem.*, vol. 153, 1944, p. 375.

## Total protein, albumin:

Cohn, C., and Wolfson, W. G.: *Jour. Lab. Clin. Med.*, vol. 32, 1947, p. 1203.

Gornall, A. G., Bardawill, C. J., and David, M. M.: *Jour. Biol. Chem.*, vol. 177, 1949, p. 751.

## Urea nitrogen:

Gentzkow, C. J., and Masen, J. M.: *Jour. Biol. Chem.*, vol. 143, 1942, p. 531.

## Calcium:

Diehl, H., and Ellingboe, J. L.: *Anal. Chem.*, vol. 28, 1956, p. 882.

## Chloride:

Schales, O., and Schales, S. S.: *Jour. Biol. Chem.*, vol. 140, 1941, p. 879.

## Epinephrine and norepinephrine:

Weil-Malherbe, H., and Bone, A. D.: *Lancet*, vol. 264, 1953, p. 973.

Gray, I., and Young, R.: *Clin. Chem.*, vol. 3, 1957, p. 239.

## Sodium potassium by flame photometry:

Berkman S., Henry, R. J., Golub, O. J., and Seagalove, M.: *Jour. Biol. Chem.*, vol. 206, 1954, p. 937.

## Urine norepinephrine:

Weil-Malherbe, H., and Bone, A. D.: *Jour. Clin. Investigation*, vol. 10, 1957, pp. 138-147.

## Vanyl mandelic acid:

Sunderman, F. W.: *Am. Jour. Clin. Pathology*, vol. 34, 1960, p. 273.

TABLE I.- VITAL SIGNS

	Preflight	Postflight	
	-8 hr	Shipboard	+3 hr
Body weight nude (post voiding) . . . . .	169 lb 4 oz	167 lb 4 oz	166 lb 4 oz
Temperature, °F . . . . .	99.0 (rectal)	100.2 (rectal)	98 (oral)
Pulse per min . . . . .	68	100	76
Respiration per min . . . . .	16	-----	20
Blood pressure, mm Hg:			
Standing . . . . .	-----	-----	102/74
Sitting . . . . .	120/78	130/84	-----
Supine . . . . .	-----	-----	100/76
Pulse per min:			
Before exercise . . . . .	68	-----	76
After exercise . . . . .	100	-----	112
	$\left(2\frac{3}{4} \text{ min}\right)^*$		$(3 \text{ min})^*$

\*Time for return to normal.

TABLE II.- URINE SUMMARY

	Centrifuge		MR-3 flight			
	Prerun	Postrun	Preflight	Postflight		
		+2 hr	-4 days	+30 min	+3 hr	+45 hr (a)
Sample volume, ml . . . . .	355	170	100	400	90	1,420
Specific gravity . . . . .	1.028	1.011	1.020	1.013	1.021	1.024
Albumin . . . . .	Neg.	Neg.	Neg.	Neg.	Neg.	Neg.
Glucose . . . . .	Neg.	Neg.	Neg.	Neg.	Neg.	Neg.
Ketones . . . . .	Neg.	Neg.	Neg.	Neg.	Neg.	Neg.
Occult blood . . . . .	Neg.	Neg.	Neg.	Neg.	Neg.	Neg.
pH . . . . .	6.6	6.4	6.6	6.6	6.4	(b)
Na, mEq/L . . . . .	94	88	137	178	104	137
K, mEq/L . . . . .	82	44	143	49	29	65
Ca, mEq/L . . . . .	8.1	6.9	1.4	5.2	7.7	5.0
Cl, mEq/L . . . . .	180	120	203	87	148	(b)
Microscopic check . . . . .		Rare white blood cells		Occasional red blood cells and white blood cells in high-power field		

<sup>a</sup>24-hour specimen.

<sup>b</sup>Hydrochloric acid in specimen.

	Preflight	Postflight		
	-4 days	+30 min	+3 hr	+45 hr (a)
Creatinine, mg/ml . . . . .	0.88	0.65	0.86	1.7 g
Epinephrine, $\mu\text{g}/\text{mg}$ creatinine . . . . . (Normal range: 5 - 25 $\mu\text{g}/24$ hr)	24.7	33.4	27.4	8.65 $\mu\text{g}$
Norepinephrine, $\mu\text{g}/\text{mg}$ creatinine . . . . . (Normal range: 20 - 80 $\mu\text{g}/24$ hr)	19.9	29.6	23.6	27.7 $\mu\text{g}$
Dopamine, $\mu\text{g}/\text{mg}$ creatinine . . . . . (Normal range: 50 - 1,000 $\mu\text{g}/24$ hr)	297	426	76	530 $\mu\text{g}$
Vanyl mandelic acid, $\mu\text{g}/\text{mg}$ creatinine . . . . . (Normal range: 2.0 - 5.0 $\mu\text{g}/24$ hr)	1.92	2.63	2.89	3.92 mg

<sup>a</sup>24-hour specimen.

TABLE III.- PERIPHERAL BLOOD<sup>a</sup>

	Preflight	Postflight		
	-4 days	+30 min	+3 hr	+45 hr
Hematocrit, percent . . . . .	45	---	40	46
Hemoglobin, g (Sahli) . . . . .	13	---	13.5	14
White blood cells, per mm <sup>3</sup> . . . . .	6,500	---	9,800	7,100
Red blood cells, millions/mm <sup>3</sup> . . . . .	5.1	---	5.0	5.2
Differential blood count:				
Lymphocytes, percent . . . . .	33	---	42	32
Ventrophiles, percent . . . . .	56	---	51	54
Band, percent . . . . .	0	---	0	1
Monocytes, percent . . . . .	8	---	6	8
Eosinophiles, percent . . . . .	3	---	1	4
Basophiles, percent . . . . .	0	---	0	1

<sup>a</sup>Determinations performed by different technicians under field conditions. Values are in doubt and are included only for completeness.

TABLE IV.- BLOOD SUMMARY

	Centrifuge			MR-3 flight			
	Prerun	Postrun		Preflight	Postflight		
		+30 min	+2 hr	-4 days	+30 min	+3 hr	+45 hr
Sodium (serum), mEq/L . . . . .	146	135	145	137	137	143	151
Potassium (serum), mEq/L . . . . .	5.1	5.6	5.5	4.4	4.6	3.9	5.7
Calcium (serum), mEq/L . . . . .	5.4	4.4	3.9	4.7	5.4	4.9	4.8
Chloride (serum), mEq/L . . . . .	116	102	83	102	106	107	90
Protein (total serum), g/100 ml . . . . .	7.9	8.6	7.4	7.4	8.3	7.4	7.3
Albumin (serum), g/100 ml . . . . .	4.6	5.0	4.3	4.0	4.0	3.7	3.7
Globulin (serum), g/100 ml . . . . .	3.3	3.6	3.1	3.4	4.3	3.7	3.6
Urea nitrogen, mg/100 ml . . . . .	15.4	15.1	14.5	15.4	15.2	15.7	14.4
Epinephrine (plasma) <sup>a</sup> , μg/L . . . . .	0.1	0.1	0.1	0.0	0.0	0.0	0.0
Norepinephrine (plasma) <sup>b</sup> , μg/L . . . . .	6.1	9.6	2.2	5.2	12.9	9.6	3.3

<sup>a</sup>Normal values: 0.0 - 0.4 μg/L.

<sup>b</sup>Normal values: 4.0 - 8.0 μg/L.

TABLE V.- SERUM AND PLASMA ENZYMES SUMMARY

	Normal range, units	Centrifuge			MR-3 flight		
		Prerun	Postrun		Preflight	Postflight	
			+30 min	+2 hr	-4 days	+3 hr	+45 hr
Transaminases:							
SGOT . . . . .	0-35	19	17	10	23	22	16
SGPT . . . . .	0-20	4	4	9	0	6	8
Esterase							
acetylcholine . . .	<sup>a</sup> 130-260	235	230	210	195	210	220
Peptidase							
leucylamino . . . .	100-310	240	220	310	360	415	400
Aldolase . . . . .	50-150	25	28	19	28	38	41
Isomerase							
phosphohexose . . .	<sup>b</sup> 10-20	12	11	11	5	15	7
Dehydrogenases:							
Lactic . . . . .	150-250	200	190	235	185	170	190
Malic . . . . .	150-250	190	155	220	225	190	220
Succinic . . . . .	Neg.	Neg.	Neg.	Neg.	Neg.	Neg.	Neg.
Inosine . . . . .	Neg.	Neg.	Neg.	Neg.	Neg.	Neg.	Neg.
Alpha keto-glutaric . . . .	Neg.	Neg.	Neg.	Neg.	Neg.	Neg.	Neg.

<sup>a</sup>ΔpH units.<sup>b</sup>Bodansky units.

## BIOINSTRUMENTATION IN MR-3 FLIGHT

By James P. Henry, M.D., and Charles D. Wheelwright

## INTRODUCTION

The continuous monitoring of physiological data from a pilot during a test flight is a relatively recent concept. Usually, physiological recordings are reserved for measurement of response to unusual stresses. In fact, when Project Mercury was started nearly three years ago, there were no off-the-shelf techniques available for reliably measuring any physiological parameters for prolonged flights. It was decided to try to measure body temperature and to record chest movements and the electrocardiogram. Blood pressure was considered, but at that time the available techniques for autosphygmomanometry did not look sufficiently promising. When the animal flights were added to the program, it was decided to use the chimpanzee as far as possible as an experimental subject with which to prove out the human bioinstrumentation techniques, including telemetry and monitoring.

The sensors had to meet the specifications of compatibility to the electrical system; they had to be reliable, not interfere with the duties of the occupant, and be comfortable for the duration of the mission.

The development of a satisfactory sensor package was started at McDonnell Aircraft Corporation. In support of this program, Space Task Group designed and tested several models of each type of sensor and conducted a series of tests to determine those best suited. A photograph of the biosensor assembly used in the MR-3 flight is shown as figure 1. It was found that a surprising amount of work was necessary before the requirements of the Mercury bioinstrumentation were met. Recently, it has been decided to include blood-pressure measurements; here again, despite recent advances in autosphygmomanometry, much work will be required before a flight-acceptable technique will be available. In what follows, the methods adopted for each of the parameters will be reviewed in turn.

## BODY TEMPERATURE SENSOR

When the Mercury recordings were chosen, body temperature was believed to be a most critical parameter, especially in view of the then recent "Man-High Balloon Gondola" experiences with near fatal hyperthermia. The theoretically attractive approach of using enteric capsules containing tiny temperature-sensitive radio oscillators was



considered too untried and premature for Project Mercury. The use of skin or axillary temperature was desirable but somewhat less definitive than rectal temperature. Hence, a development program was initiated to seek a more comfortable and reliably placed instrument than the relatively bulky rectal catheters currently available. A view of the various types tested in this program is shown in figure 2. After a number of trials, a device was produced whose bulk was greatly reduced, whose bulb shape took cognizance of the anatomy of the rectal sphincter, and whose rigidity was sufficient to permit easy introduction. This thermistor-tipped device has been in routine use for many tests prior to the MR-3 flight, where it worked out very satisfactorily, giving good data without unduly obtruding on the subject's awareness when once in place. Measurements in the MR-2 animal flight were made with a standard catheter 3.5 millimeters in diameter, which was taped in place.

#### RESPIRATION RATE AND DEPTH

Respiratory activity would ideally be monitored by measuring the tidal air (that is, the air displaced with each breath). However, the Mercury system does not call for placement of a mask on the face; hence, some indirect method must be used. In the beginning, the possibilities of a simple pneumographic method were studied: first, by using a linear potentiometer, then by employing carbon impregnated rubber whose resistance varies with its length. These approaches not only restricted the chest, annoying the subject; but, more importantly, they did not prove that air was moving into and out of the respiratory passages. The subject could easily create a false response by tensing his muscles and could cause registrations by chest contractions against a closed glottis.

A more direct method would be a device recording the air movement. For this, an old technique was used - that of a thermistor heated to 200° F (fig. 3), which is cooled by the movement over it of the exhalations and inhalations. This technique needed further development to insure that the air movement would be registered whether it came from the mouth or the nostrils and despite movement of the head in the pressure suit helmet. The final design uses a single thermistor in a special fitting attached to the microphone. On it is a funnel catching air currents from the nostrils above while air from the mouth passes directly across the instrument. It has worked very well in tests on the centrifuge and in the MR-3 flight (fig. 4). Note that this technique gives only an indication of air movement and no quantitative information about the volume of gas inhaled, for, should the pilot move his head slightly within the helmet away from the microphone, a lowering of the response amplitude will result, which is not related to the volume of gas exchanged. In the MR-2 flight, the chimpanzee had to be fitted with a pneumograph (fig. 5), for he could move his head quite freely away from any

thermistor. After many trials, an old technique using a rubber tube filled with saturated copper sulphate was finally employed. After considerable work and the addition of a low-frequency, alternating-current amplifier which eliminated drift, this device was stabilized and came to give excellent readings in the MR-2 flight.

#### ELECTROCARDIOGRAPHIC SENSOR

In the case of the electrocardiogram, it is interesting that, despite a half century of clinical use, a great deal had to be done to give us a device that was acceptable for flight. Essentially, this is the clinical problem of recording the electrocardiogram during exertion. The requirement was for a comfortable set of electrodes which had a low impedance to match the capsule amplifiers, would record during arm movement, and would stay effective with a low resistance throughout a 24-hour period. After a number of in-house trials with various experimental models (fig. 6) had been made, a fluid electrode was finally independently developed that had much in common with that worked out by the bioinstrumentation group for the X-15 flights. It also closely resembled that recently described by Dr. Donald A. Rowley of the Department of Pathology of the University of Chicago who was searching for an electrode to permit 24-hour pulse counts in active people. It is an encouraging confirmation of the approach to find this convergence in technique.

The basic principle of this approach is to glue firmly to the skin a nonconducting cup containing a nonirritating electrode paste and to use this paste as the lead off from the skin. The potential is picked up from the paste mass by a shielded wire attached to a stainless steel mesh buried in the paste but not touching the skin. The resistance of such electrodes stays constant if the paste is hygroscopic and the cup well sealed to prevent drying out. A resistance comparison of two ECG electrodes tested for 24 hours on a subject is shown in table I. The tests indicated that a good electrolyte consisted of 30 percent calcium chloride in water with a sufficient amount of aluminum silicate powder (Bentonite) to bring it to a paste. These electrodes appear to give less background noise than the standard metal plates used in clinical electrocardiography and also less baseline shift when the region to which they are attached is actively moved (fig. 7).

Once a suitable electrode had been devised, a further step was necessary to reduce interference. This was accomplished by abandoning the classical limb placement with its valuable vector information and vast background of clinical experience and going to new locations on the trunk (fig. 8). In consultation with Drs. James A. Roman and Lawrence E. Lamb of the U.S. Air Force School of Aviation Medicine and Capt. Ashton

Graybiel of the Naval School of Aviation Medicine, a compromise location was worked out which gave a modified lead I between the two axillae and at right angles to this a sternal lead which, because of the subjacent bone and location close to the heart, is unusually free from muscle noise. These locations were tested out on the centrifuge and found to be flight acceptable. They have given good results in the MR-3 flight (fig. 9). For the animal tests, the axillary locations were retained and a fluid electrode was employed on the leg to give it flight trial, but the main reliance was placed on use of a modification of the old embedded-wire suture techniques (fig. 10), whose reliability has been established by use since the earliest days of electrocardiography.

A final note might be added concerning the electrocardiographic amplifiers. A great deal of skill, ingenuity, and effort was expended before clean respiratory and cardiac recordings could be achieved in the Mercury spacecraft with its many sources of electrical interference and variably loaded battery-operated main-power supply.

#### BLOOD-PRESSURE RECORDINGS

A final note on the need for a record in man and animal of the blood-pressure changes during a Mercury flight is now in order. It was always recognized that venous pressure recordings give valuable information on straining movements, as well as on the state of filling of the central blood stores. Continuous arterial pressure records, especially during the transition period from weightlessness to reentry acceleration would also be valuable during flights involving prolonged subgravity. An uninterrupted effort has, therefore, been made, since the inception of the animal program, to develop a direct technique for measuring central venous and arterial pressure which could be incorporated in the Mercury spacecraft. This method involves the extremely gradual infusion through intravascular catheters of anticoagulant to prevent clotting and direct recording onto a compact self-powered 16-hour-capacity multichannel oscillograph. The equipment is undergoing final qualification testing and centrifuge trials. If satisfactory, it will be installed in the orbital chimpanzee flights.

In man the original decision not to measure blood pressure has been modified by a number of factors. During the past three years, auto-sphygmomanometry has advanced. Four separate groups are working on the problem and the recent development by Dr. J. N. Waggoner and his associates at AiResearch Manufacturing Co. of a unidirectional microphone with associated 35-cycle filtering circuits appears to be a definitive advance (fig. 11). Active work on incorporating this technique with the Mercury full pressure suit and spacecraft is in progress. Centrifuge trials of the method will be held during the summer and, if satisfactory, equipment

will be installed in the orbiting Mercury spacecraft which will permit its use, both whenever desired by the astronaut, and at preset fixed intervals. One of the two electrocardiograph channels will be taken over intermittently to record systolic and diastolic pressure during arm cuff pressurization cycles of approximately 30 seconds.

The remote monitoring on a noninterference basis of parameters such as temperature, respiration, the electrocardiogram, and blood pressure in active men fully engaged in prolonged and exacting tasks is a new field. Hitherto, flight medicine has accepted the information concerning well being that could be derived from the pilot's introspection and conveyed by the invaluable voice link. For the rest it has relied on performance to tell how close the man was to collapse.

It is to be hoped that some of the developments in automation necessitated by Project Mercury will find application in clinical medicine.

TABLE I

RESISTANCE COMPARISON OF TWO ECG ELECTRODES 24 HOURS ON SUBJECT

[K = 1,000 ohms; resistance taken on Sampson volt ohmmeter M260]

Subject	Run	1/2-in.-mesh electrode, electrolyte, silver powder			Fluid electrode, electrolyte, 40% CaCl Bentonite		
		Start	12 hour	24 hour	Start	12 hour	24 hour
A	1	75K	----	150K	1.5K	1.6K	2.5K
A	2	110K	----	800K	3.5K	4.3K	6.5K
B	2	80K	140K	172K	----	-----	-----
C	2	100K	290K	450K	3.1K	3.1K	2.5K
D	2	50K	72K	250K	----	-----	-----
E	1	----	----	----	2.5K	2.8K	3.3K
F	1	----	----	----	2.4K	-----	4.6K
G	1	----	----	----	2.5K	2.7K	3.0K
Mean	---	83K	167K	364K	2.6K	2.9K	3.7K
Increase	---	----	100%	338%	----	11.5%	42.3%

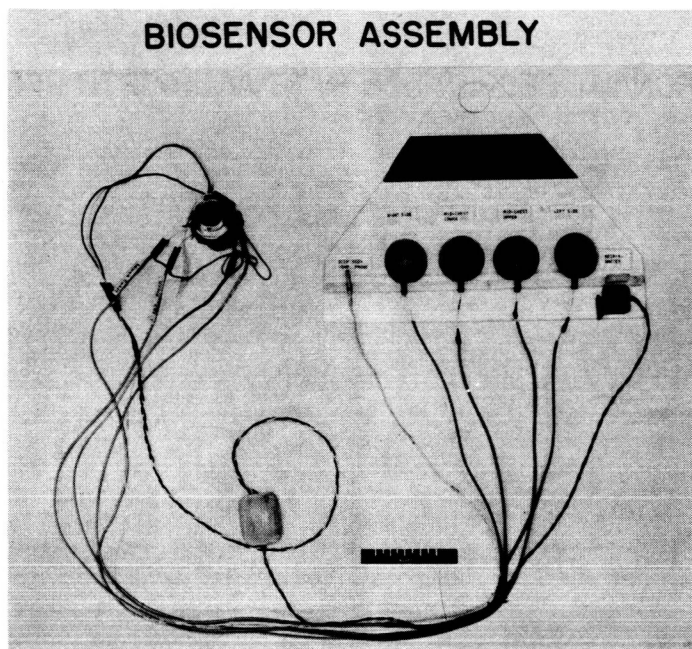

Figure 1.

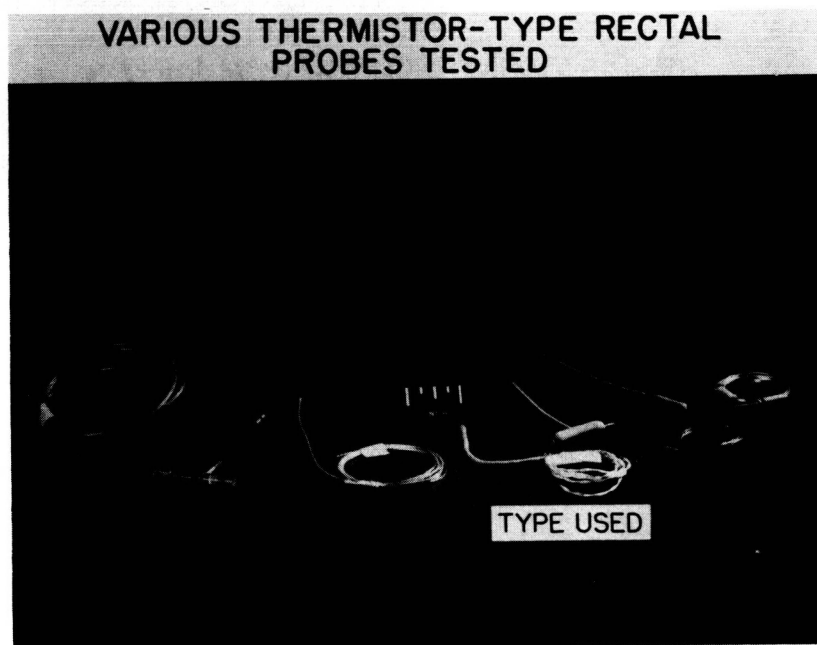

Figure 2.

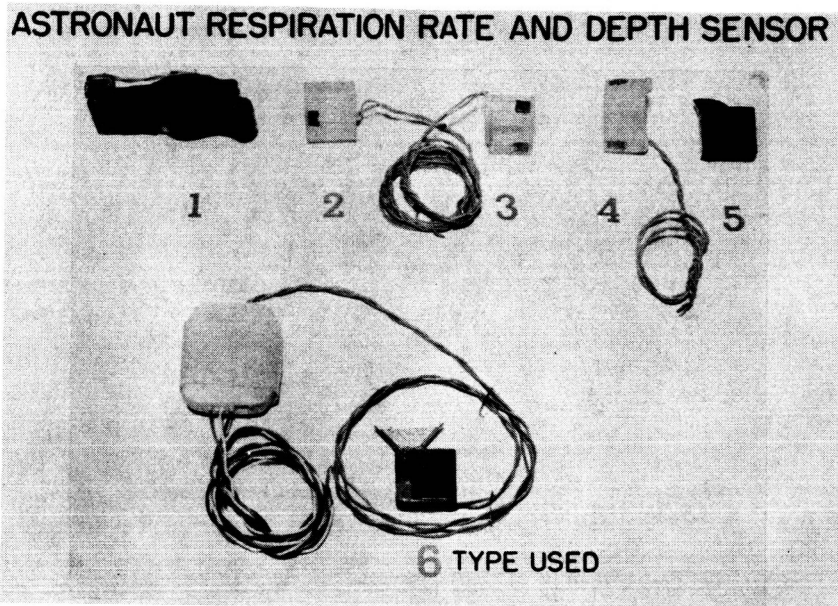

Figure 3.

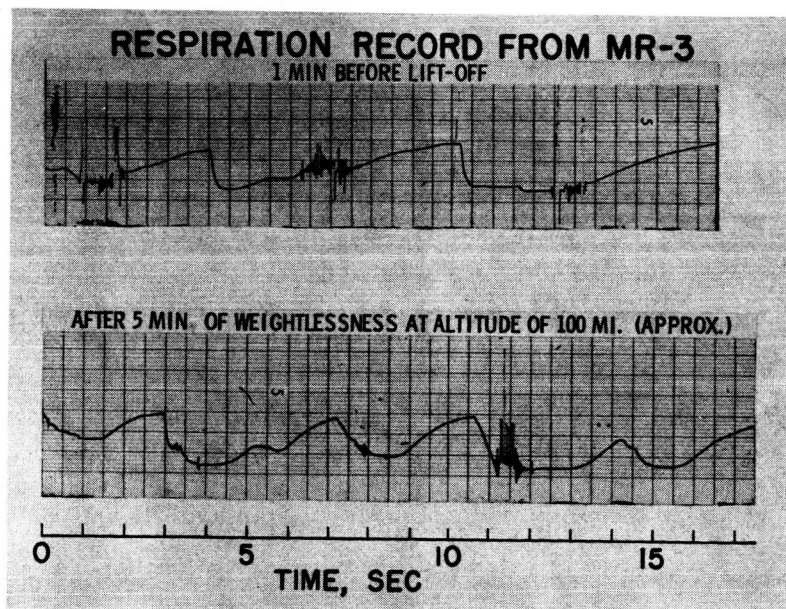

Figure 4.

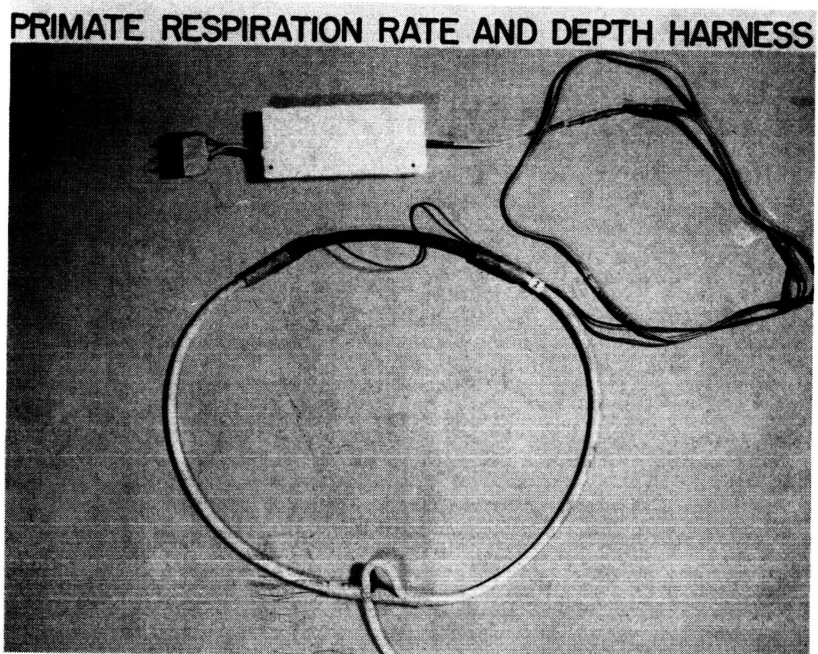

Figure 5.

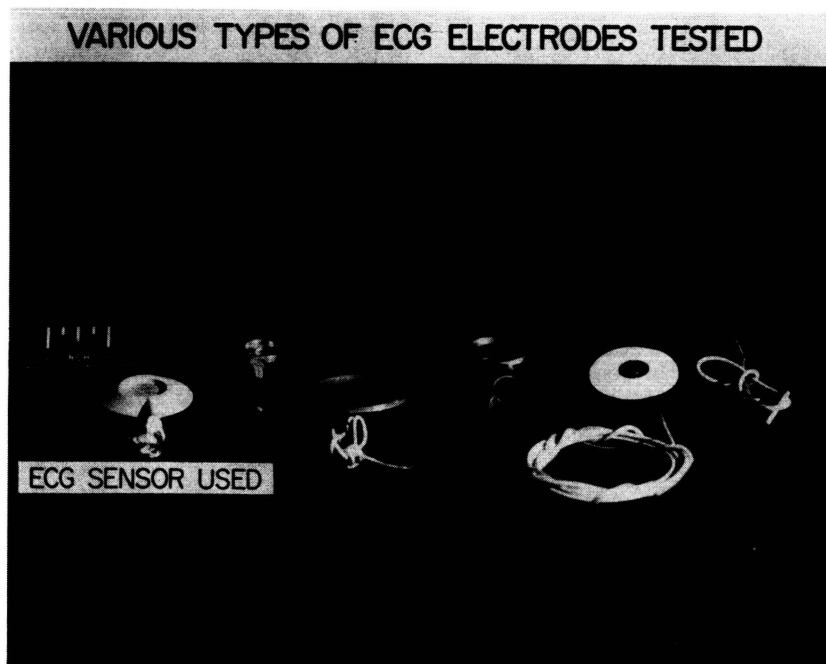

Figure 6.



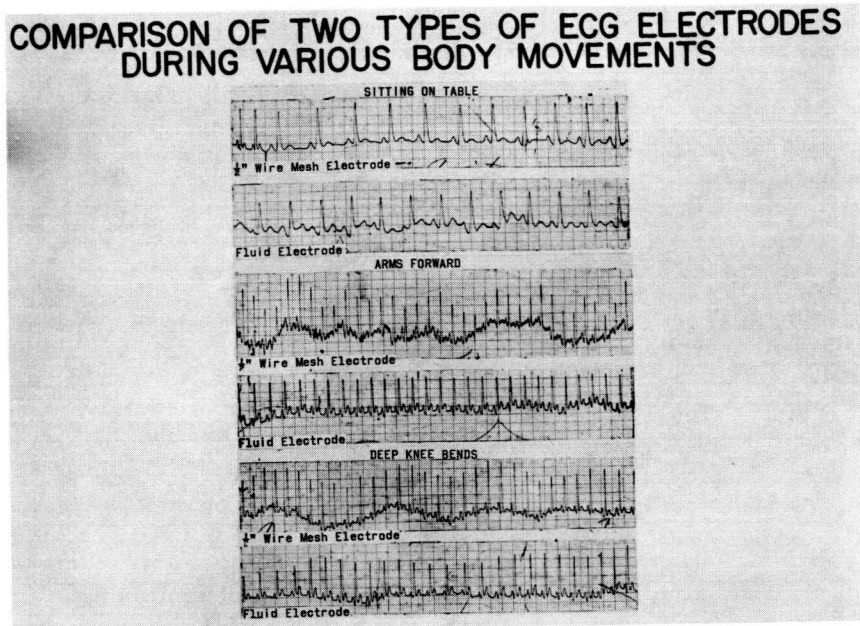

Figure 7.

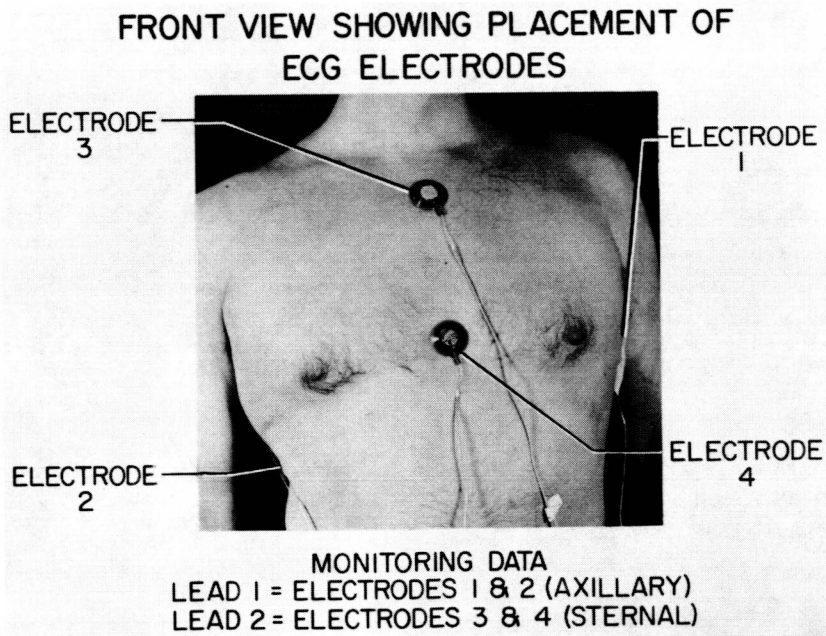

Figure 8.

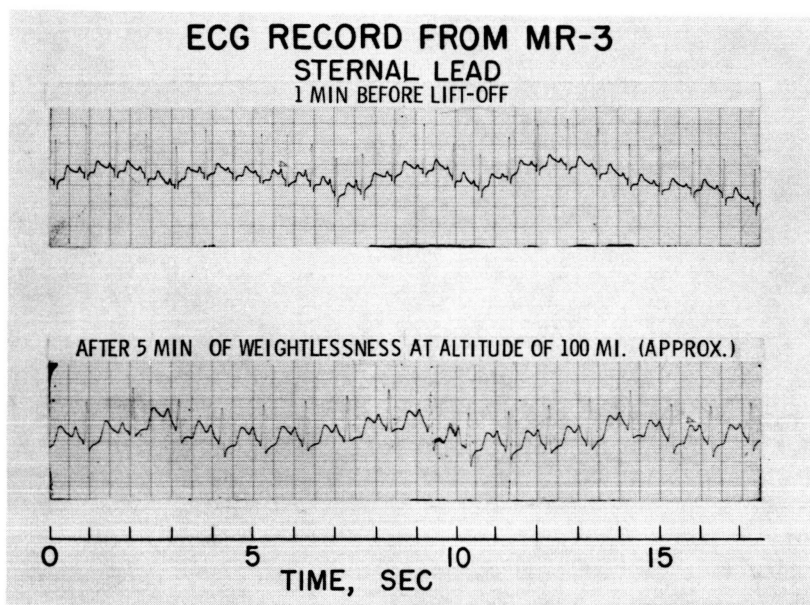

Figure 9.

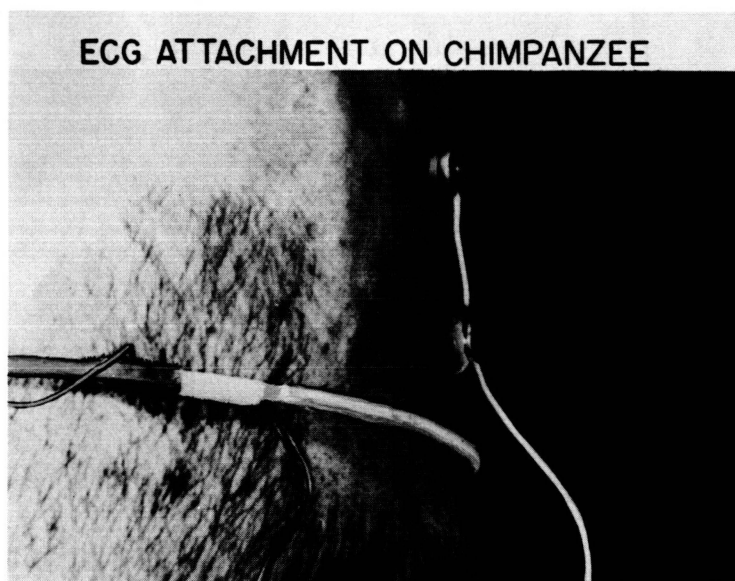

Figure 10.

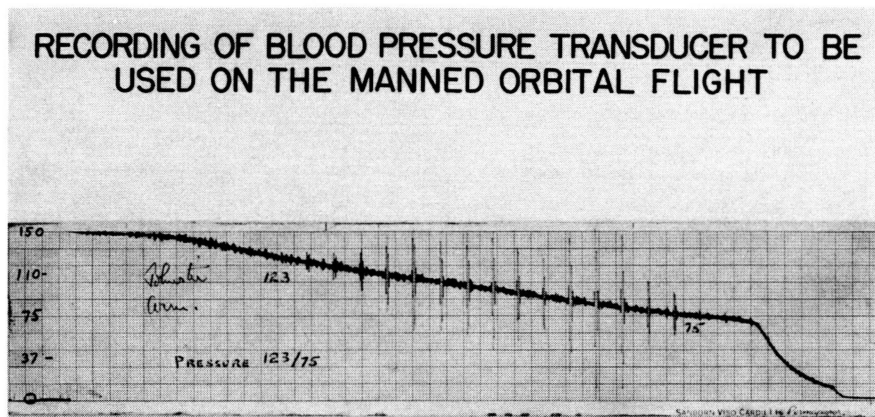

Figure 11.

## PHYSIOLOGICAL RESPONSES OF THE ASTRONAUT IN THE MR-3 FLIGHT

By William S. Augerson, M.D., and C. Patrick Laughlin, M.D.

A major objective of the MR-3 flight was to record and study the Astronaut's physiological responses to the space-flight stresses imposed. Weightless flight and acceleration-weightlessness transition periods were of special interest. Additional flight objectives were to demonstrate the performance capability of the Astronaut in space flight and to familiarize him with a space-flight experience. A review of the specific stress components inherent in the MR-3 flight is essential to a better understanding of the physiological response patterns.

Astronaut Shepard wore a full pressure suit, which was not inflated during the flight. He was restrained in a form-fitting couch throughout the countdown and flight and remained in the couch until immediately after landing on the water. He was maintained in the supine position with legs and thighs flexed at angles of approximately  $90^{\circ}$  except for the period of weightless flight when spacecraft attitude change placed him in the seated position.

The Astronaut was supplied with 100-percent oxygen during the countdown and flight. An analysis of the cabin atmosphere during countdown after approximately 1 hour of 100-percent oxygen purge indicated a level of 98-percent oxygen. Opening of the cabin pressure relief valve at about 23,000 feet on descent introduced ambient air into the cabin. Cabin and suit pressure levels fell from 14.7 to 5.7 pounds per square inch during the immediate 1 minute 30 second period after lift-off. This pressure of 5.7 pounds per square inch was maintained throughout the remainder of the flight until repressurization was initiated at approximately 23,000 feet during parachute descent.

The cabin-air temperature ranged from  $95^{\circ}$  F to a maximum of  $111^{\circ}$  F during descent. The suit temperature rose from  $71^{\circ}$  F at launch to  $80^{\circ}$  F at landing.

Illumination in the spacecraft fluctuated as a function of the spacecraft attitude with increases in light intensity when the sunlight came through the spacecraft windows.

The Redstone-launched ballistic trajectory produced a peak launch acceleration of 6.2g, rising from 1g in 2 minutes 22 seconds. Reentry peak g-forces were 11.0g, rising from 0.05g in 31 seconds. Small magnitudes of g-forces were encountered during the time of retrofire when an approximate level of 1g was reached. Two closely timed, brief acceleration "spikes" with a maximum of 4g were encountered at the time of main

parachute deployment and unreefing on descent at 10,600 feet. Maximum vibration levels occurred during the launch phase of flight at approximately 1 minute 10 seconds, lasting for 15 seconds and corresponding with the period of maximum dynamic pressure.

Weightless-flight duration was 5 minutes 4 seconds, commencing with spacecraft separation and continuing to the onset of reentry g-forces. This period of weightlessness was interrupted briefly by a 23-second period of retrofire when about 1g was reached.

The Astronaut preparation for space flight is a rather involved procedure and began approximately 8 hours prior to lift-off. The major events in his preparation are presented in detail in table I.

S  
1  
7

Physiological control data (electrocardiogram, respiration rate, and body temperature) on Astronaut Shepard were obtained during multiple Redstone g-profile centrifuge runs. The same physiological parameters were recorded during spacecraft preparation tests in which the actual countdown procedures are exercised. This information is of value for correlation with the MR-3 countdown and flight data. A further description of the data sources follows.

The Astronaut was monitored continuously from installation in the spacecraft at 0520 EST until landing on the water at 0934 EST. Electrocardiogram, respiratory rate, and body temperature were displayed continuously on Sanborn trace recorders in the blockhouse. The Mercury Control Center medical monitoring panel was activated at T - 18 minutes, where T indicates the time at lift-off. The air-to-ground voice loop was also monitored continuously at the same stations. During the latter part of the flight, telemetry and voice contact were maintained with downrange stations and a telemetry aircraft.

The Astronaut was instrumented to obtain two channels of electrocardiogram, body temperature, and respiration rate. These data were transmitted by telemetry channels to ground monitoring stations, and the identical data were recorded onboard the spacecraft. Electrocardiogram electrodes were placed at the axillary and sternal positions. Electrode placement was selected because of stability and minimal interference from muscle movement. On this flight electrodes 2 and 3 (as shown in paper by Henry and Wheelwright) were displaced 1.5 inches to the left of the tattoo marks because of skin irritation from a previous test at the preferred sites. A microphone-mounted respiration thermistor was directed to register either nasal or oral breathing. A body-probe temperature thermistor was also in place. An additional data source was the Astronaut observer film, operating in the spacecraft at 6 frames per second. Astronaut-voice transmissions constituted a particularly valuable source of data and were of a quality sufficient to convey a suggestion of mental state. All information mentioned

previously was monitored continuously from Astronaut insertion into the spacecraft, with the exception of the onboard camera which was started at approximately T - 2 minutes.

An intensive debriefing, commencing at recovery aboard the aircraft carrier and continuing over the subsequent 48 hours, was performed with the flight Astronaut. Every attempt was made to elicit spontaneous impressions of the flight, followed by a series of detailed flight analysis questionnaires.

During the 12-month period prior to the flight, Astronaut Shepard had completed three Redstone centrifuge training programs. He had undergone a total of 17 Redstone g-profiles in which he experienced cabin runs at sea level and at 5 pounds per square inch. These were rigorous programs, with emphasis on as accurate mission simulation as possible. The Astronauts used their personal contour couches, wore full pressure suits, breathed 100-percent oxygen, and performed a hand controller task while riding the centrifuge. Electrocardiogram, respiration rate, and body temperature was recorded with each run, both static and dynamic. The runs were monitored by medical personnel utilizing closed circuit television from the centrifuge gondola, voice communication, and the physiological parameters noted previously. Physical examinations were conducted prior to and following the run sessions.

Manned-spacecraft preparation tests conducted with the MR-3 spacecraft at Cape Canaveral were performed just prior to the launching date, and the same physiological parameters were monitored during these preparations. During these tests, Astronaut preparation procedures and countdown functions in the operating spacecraft were followed to lift-off time.

Because of the differences between the environment associated with the countdown and that of the flight, the physiological data generated during these two phases are presented separately.

The Astronaut's pulse and respiration rate responses during countdown are shown in figure 1. Pulse rates were plotted at approximately 5-minute intervals during the early part of countdown by counting the rates for a 30-second duration. As lift-off time approached, pulse rates were counted at 15-second intervals for 10-second duration and this procedure continued during the flight. Respiration rates were charted at approximately 5-minute intervals for 30-second durations during the countdown and at 30-second intervals during the flight. Mission times and events occurring during the countdown are shown on the abscissa scale. The Astronaut maintained a pulse rate of approximately 80 beats per minute during countdown with transient rises to 90 to 95 beats per minute during significant spacecraft checkout events. In figure 2 pulse and respiration rates for the MR-3 flight phase are shown. Again, mission times and events as well as g-forces are present for correlation. Pulse rate rose to 108 at

30 seconds prior to lift-off and was 126 at the lift-off signal. The pulse rate climbed during the launch phase to a peak of 138, coincident with launch-vehicle engine cutoff and the spacecraft separation maneuver. This rate was sustained for approximately 45 seconds. Pulse-rate responses to the weightless flight period were somewhat erratic, but there was a general downward trend to reach a low of 108 just prior to the onset of reentry accelerations. It was during the weightless flight period that the Astronaut was most active, manipulating the spacecraft manual attitude control system and making external observations. The Astronaut reached a pulse rate of 132 approximately 30 seconds after peak reentry acceleration, and the pulse rate on descent fluctuated between 130 and 108 beats per minute. At loss of signal after impact, the rate was 111 beats per minute.

The respiration-rate trace quality was fair, although there were several uninterpretable periods during the countdown and flight. The Astronaut's head movements within the helmet away from the respiratory thermistor and an unfavorable paper-recording speed account for some of the respiration trace problems. Respiration rate was maintained at a range of approximately 15 to 20 breaths per minute during countdown. A peak rate of 40 occurred during the launch phase of the flight, and the rate declined to 20 near the end of the weightless flight phase. During reentry, the respiration rate reached a high of 30 and fluctuated on descent between 20 and 25. On this flight, no comment is possible about the respiration-wave trace depth as a flow volume indicator.

The electrocardiogram trace quality in the sternal lead (2) was satisfactory during the countdown and flight. The axillary lead (1) was of intermittently readable quality, as deterioration of this trace occurred at T - 120 minutes during the countdown. The electrocardiogram displayed no significant abnormality during the entire countdown and flight. Minimal sinus arrhythmia was observed during countdown which Astronaut Shepard has demonstrated during prior training sessions. S-T segment changes consistent with those found in exercise electrocardiograms are noted in portions of the flight record. Samples of telemetry flight physiological data as received in the blockhouse are shown in figure 3.

Deep body temperature was 99° at installation into the spacecraft and rose to a high of 99.2° near the end of the flight.

Voice transmissions throughout the flight were of excellent quality. The Astronaut demonstrated coherent communications which were on schedule during all flight phases. A review of the Astronaut observer motion picture revealed no evidence of unconsciousness. Eye movements, which could be discerned fairly well, did not demonstrate nystagmus. A study of eye movements relative to instrumentation monitoring and control manipulation indicates that such movements were appropriate to the task involved. Astronaut monitoring of spacecraft instrumentation was performed satisfactorily. (See subsequent paper by Voas et al.)

Specific questioning of the Astronaut regarding somatic sensations perceived during the flight revealed little information. During the phase of launch approximating maximum dynamic pressure, considerable vibration was encountered so that the instrument panel could not be read. This vibration lasted for a period of approximately 15 seconds. No disturbing sensations were noted during weightless flight and Astronaut physiological function appeared in no way to be impaired. Acceleration launch and reentry g-forces produced stress magnitudes consistent with those encountered during the training programs. Acceleration-weightlessness transition phases were noted to produce no subjectively recognized disturbances.

Pulse and respiration rate responses during the countdown of a spacecraft preparation test are shown in figure 4. As one might have anticipated, these rates are lower than the actual flight countdown rates.

The pulse rate responses of the Astronaut from the Redstone g-profile centrifuge program are plotted graphically against the MR-3 pulse rate data in figure 5. Pulse rate responses during the countdown and flight were entirely consistent with intact physiological function. As depicted graphically, they are in excess of Astronaut Shepard's centrifuge training experience. During the centrifuge runs, he frequently demonstrated a sinus bradycardia, usually occurring after simulated reentry g-forces. This heart-rate slowing phenomenon was not demonstrated during the MR-3 flight.

Respiration rates during the countdown phase of the MR-3 flight closely correspond with those rates obtained during the spacecraft preparation tests. As shown in figure 6, the respiration-rate responses during the flight were consistent with the range of pulse-rate responses during the centrifuge training programs.

#### Summary and conclusions:

1. Astronaut Shepard demonstrated physiological responses consistent with intact conscious performance during all phases of the MR-3 flight.
2. Physiological responses to 5 minutes of weightless flight (interrupted by 23 seconds of retrofire) were uneventful.
3. Acceleration-weightlessness transition periods produced physiological responses within the limits of intact function. The relative change in pulse rate in going from weightlessness to reentry acceleration was comparable to that in going from 1g to reentry acceleration on the centrifuge.
4. Special senses, that is, vision, semicircular canal function, and hearing appeared intact throughout the flight.

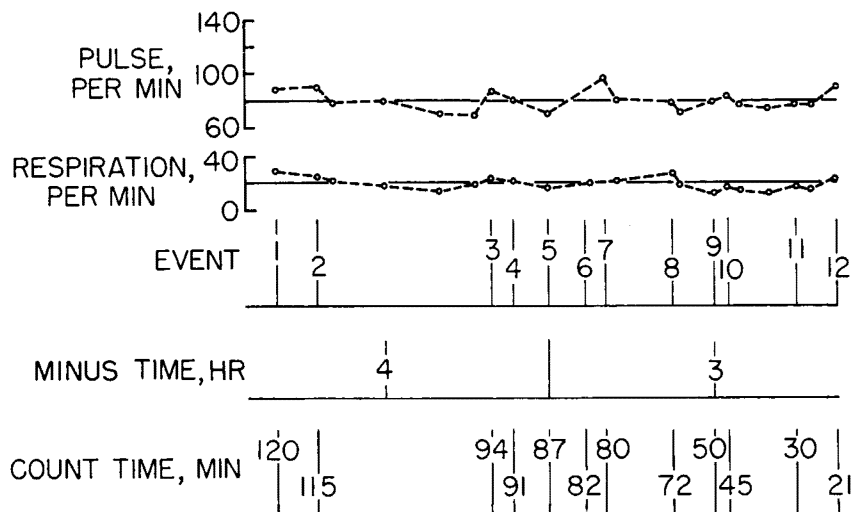

TABLE I

## ASTRONAUT PREPARATION SCHEDULE MR-3

EST	EVENT
0110	AWAKENED SHOWER HIGH PROTEIN BREAKFAST PHYSICAL EXAM (BRIEF) DON SENSORS (A) PAIR OF STERNAL ECG LEADS (B) PAIR OF AXILLARY ECG LEADS (C) RESPIRATION THERMISTOR (D) DEEP BODY TEMPERATURE DON SUIT, PRESSURE CHECKS
0355	ENTER TRANSFER VAN (BRIEFING)
0435	ARRIVE AT PAD
0515	ASCEND GANTRY
0520	INSERTION BEGUN
0625	DENITROGENATION PERIOD ENDS
0637	GANTRY REMOVED
0700	SCHEDULED LAUNCH
0713	HOLD FOR WEATHER, ETC.
0934	LIFT-OFF

PHYSIOLOGICAL DATA  
MR-3 COUNTDOWN



EVENTS

- 1 INSTALLATION
- 2 STARTING PURGE
- 3 TIGHTEN HARNESS: PURGE OFF
- 4 SUIT PRESSURE CHECK
- 5 NORMAL SUIT PRESSURE
- 6 HOLDING: HATCH ON
- 7 COUNTING: CABIN PRESSURE CHECK
- 8 PURGE OVER
- 9 GANTRY REMOVED
- 10 CABIN INSTRUMENT CHECKS
- 11 DISCUSS WEATHER
- 12 SQUIBS FULLY ARMED

Figure 1(a)

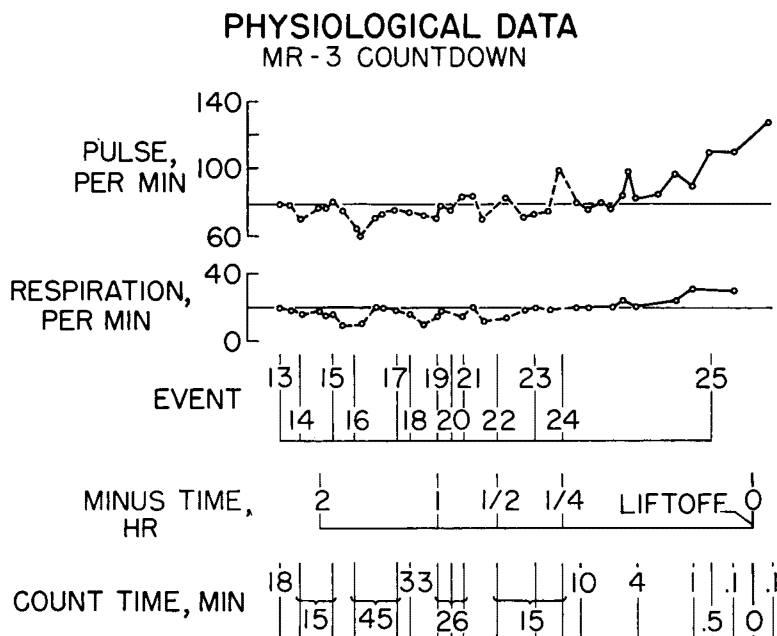
**EVENT**

- 13 LOCAL WEATHER PROBLEM:  
INFORMED POSSIBLE 1 HR HOLD
- 14 HOLDING
- 15 HOLDING: LAUNCH VEHICLE INVERTER PROBLEM
- 16 HOLDING: GANTRY IN
- 17 COUNTING: REPURGE CABIN
- 18 HOLDING: GANTRY AWAY
- 19 ON STANDBY INVERTER
- 20 COUNTING
- 21 REARM SQUIB
- 22 HOLDING: COMPUTER HOLD:  
PILOT INQUIRY
- 23 COUNT RESUMED
- 24 ON INTERNAL POWER
- 25 FIRING COMMAND

Figure 1(b)

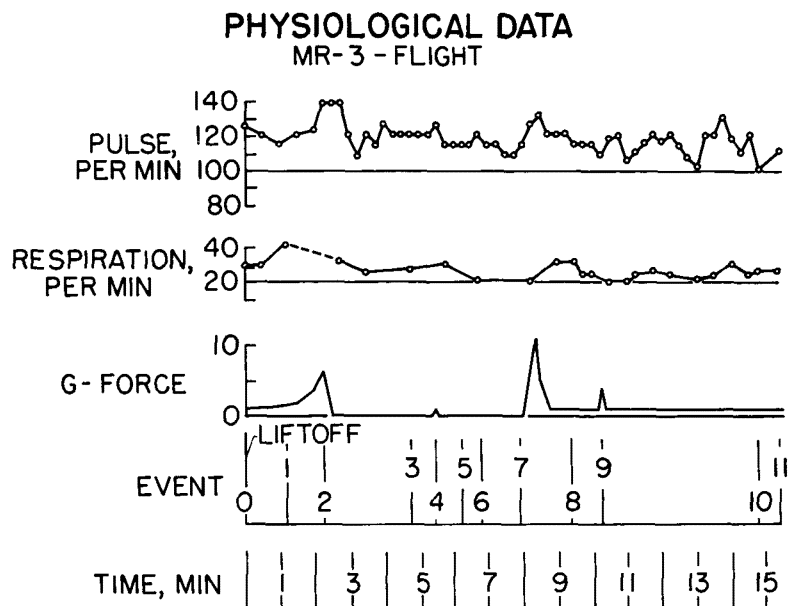
EVENT

- 1 MAXIMUM DYNAMIC PRESSURE
- 2 LAUNCH-VEHICLE ENGINE CUTOFF;  
SPACECRAFT SEPARATION.: TURNAROUND
- 3 RETROATTITUDE
- 4 RETROFIRE
- 5 RETROJET
- 6 REENTRY ATTITUDE
- 7 .05 g
- 8 DROGUE CHUTE DEPLOYMENT
- 9 MAIN CHUTE DEPLOYMENT
- 10 IMPACT
- 11 LOSS OF SIGNAL

Figure 2

### PHYSIOLOGICAL DATA FROM MR-3 FLIGHT

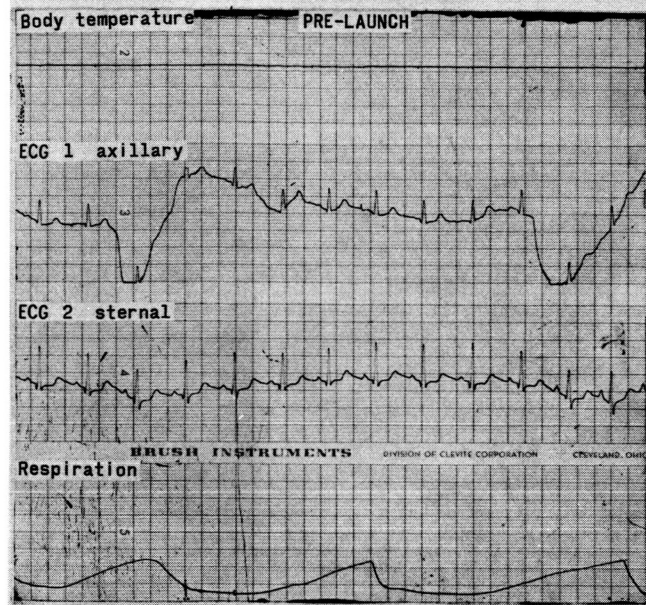

Figure 3(a)

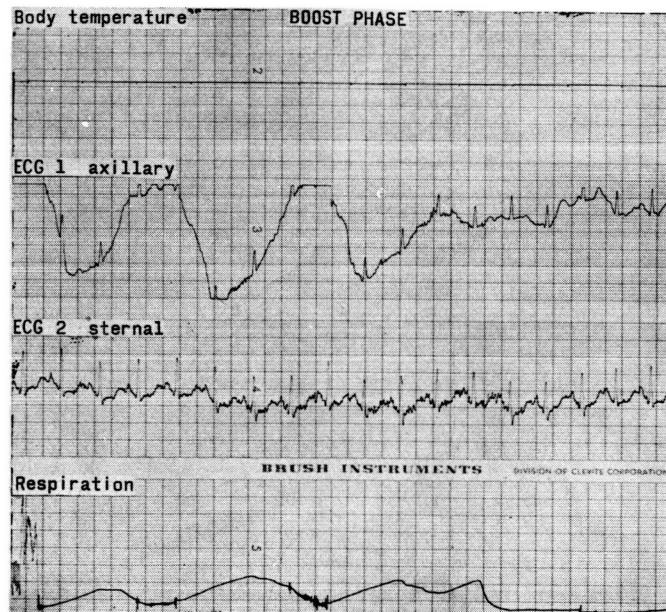

Figure 3(b)

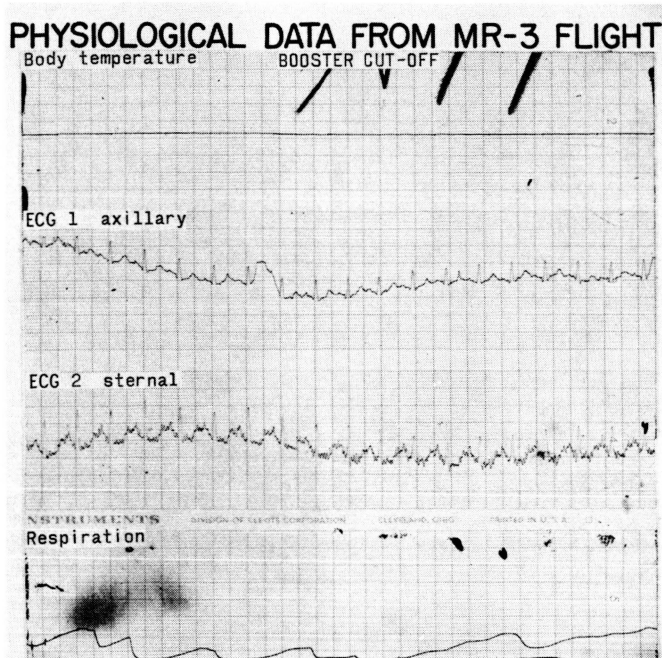

Figure 3(c)

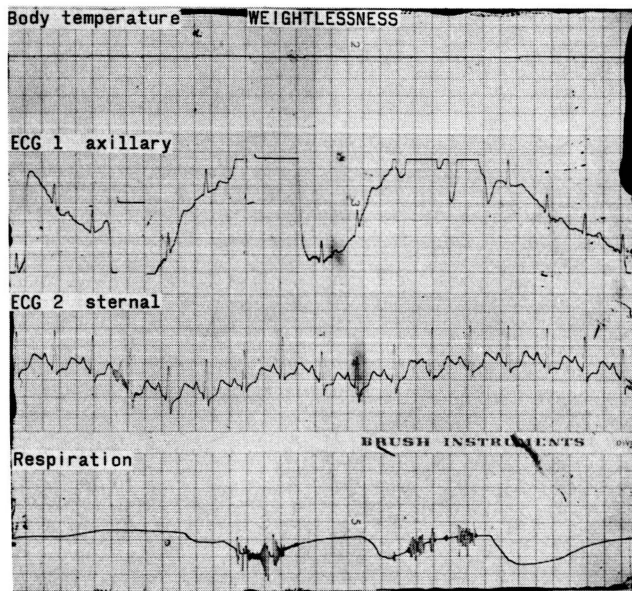

Figure 3(d)

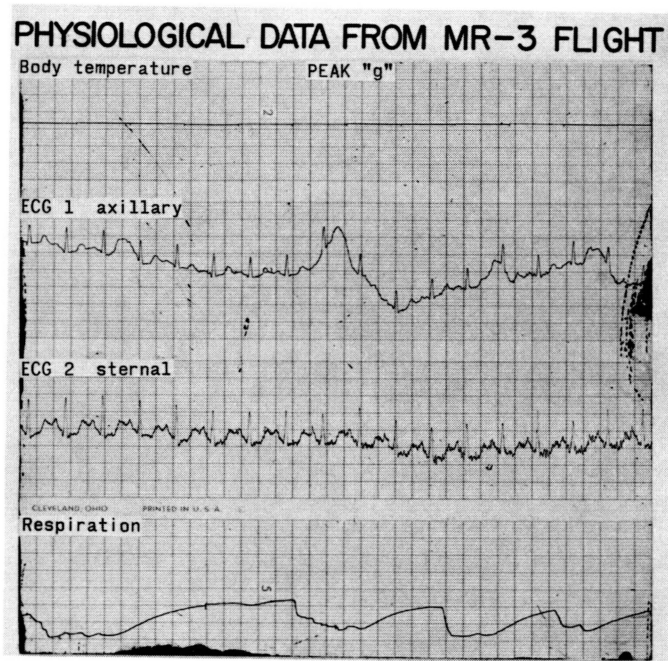
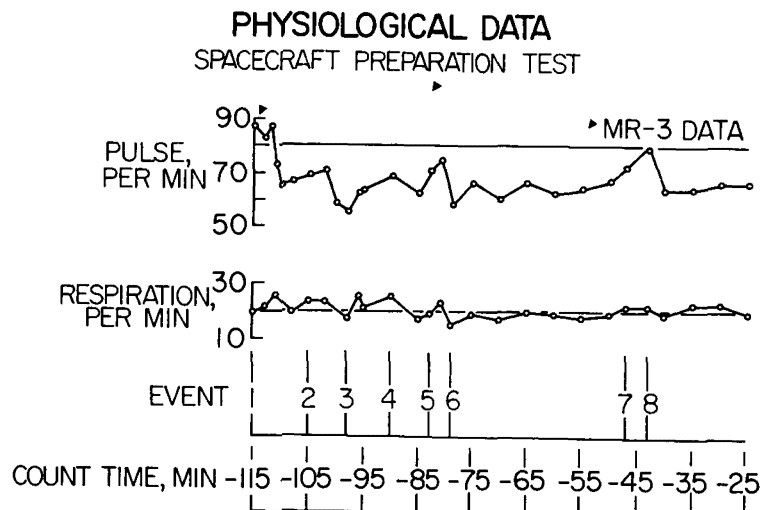

Figure 3(e)

EVENT

- 1 INSTALLATION:  
PURGE STARTS
- 2 SUITFAN TO NORMAL
- 3 END PURGE:  
SUIT PRESSURE CHECK
- 4 ADJUST STRAPS
- 5 HATCH CLOSURE BEGINS
- 6 CABIN PRESSURE CHECK
- 7 GANTRY MOVING BACK
- 8 CHERRY PICKER TO POSITION

Figure 4(a)



**PHYSIOLOGICAL DATA**  
SPACECRAFT PREPARATION TEST

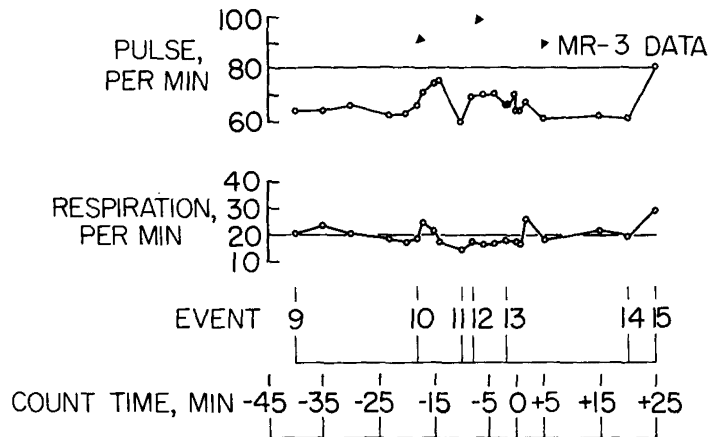

**EVENTS**

- 9 CHERRY PICKER TO POSITION
- 10 READY TO ARM SQUIB
- 11 CAMERA & TAPE RECORDERS ON
- 12 ON INTERNAL POWER
- 13 CHERRY PICKER REMOVED
- 14 GANTRY BACK: READY FOR EGRESS
- 15 JUST BEFORE REMOVAL

Figure 4(b)

PHYSIOLOGICAL DATA COMPARISON OF  
CENTRIFUGE AND MR-3 FLIGHT  
PULSE RATE

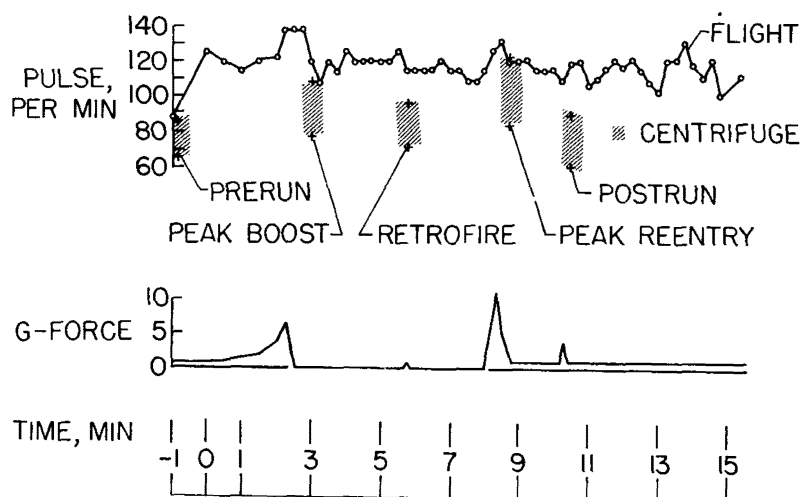

Figure 5

PHYSIOLOGICAL DATA COMPARISON OF  
CENTRIFUGE AND MR-3 FLIGHT  
RESPIRATION RATE

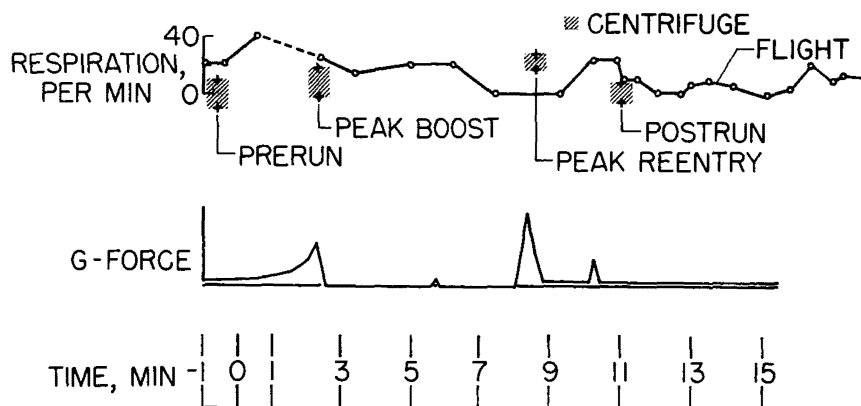

Figure 6

## PILOT TRAINING AND PREFLIGHT PREPARATION

By Donald K. Slayton

### INTRODUCTION

All phases of the Astronaut training program are discussed herein, including the generalized areas pointed toward all rocket flights and the specialized aspects pointed directly toward the MR-3 flight. Initially, the original qualifications of the trainees should be given. Each is a highly qualified jet fighter pilot who graduated from one of the service test-pilot schools and has experience as an experimental test pilot. Each has a bachelor's degree in engineering or one of the basic sciences, is physiologically and psychologically sound, and is in good physical condition.

Since no ground rules existed for the training of Astronauts at the inception of this program, three basic philosophies were adopted:

- (a) Utilize any training device or method which has even remote possibilities of being of value
- (b) Make the training as difficult as possible with these devices even though analytical studies indicate the task is relatively easy
- (c) Conduct the training on an informal basis except in the interests of intelligent scheduling of instructor and trainer time since we were all assumed to be well-motivated mature individuals.

### TRAINING PROGRAM

The training program can be broken down into five major categories as a function of training devices. These categories are academics, static training devices, dynamic training devices, egress and survival training, and specific mission training.

#### Academics

All of us needed to brush up on basic mechanics and aerodynamics. In addition, prior to this training we had been only briefly exposed to many fields of science such as astronomy, meteorology, astrophysics,

geophysics, space trajectories, rocket engines, and physiology. Instructors for these subjects were drawn from the scientists of the Langley Research Center and the Space Task Group. For example, one of the scientists of the Space Task Group gave us a lecture on the principles of rocket engines and rocket propulsion. Dr. William K. Douglas gave us a series of lectures on physiology designed to give us a better understanding of the physiology and construction of the human body, a subject of which we had little knowledge prior to this program. One of the subjects he discussed was the effect on the body of various g-loadings obtained during flight and landing impact.

In addition to the lectures on basic astronautics, we were given detailed systems briefings by the McDonnell Aircraft Corporation engineers concerned with the design of the various subsystems. Also, the engineers within the Space Task Group who were concerned with the various individual systems gave us detailed briefings and continuously brought us up to date with the changes occurring to these systems. Our knowledge of these systems was gained both from formal briefings and from our attending coordination meetings in which these systems were discussed and changes to them made.

As a supplement to the classroom or academic work, we also made many field trips as a group. One such field trip was a visit to the Convair Astronautics Division of the General Dynamics Corporation in San Diego, Calif., where we observed a test facility where the components of the Atlas are tested. We also went to the McDonnell Aircraft Corporation, manufacturers of the Mercury spacecraft, where we had our first look at the mock-up of the spacecraft, and at the basic spacecraft structure and its subsystems being assembled. As a result of this initial visit, we were able to make many recommendations for changes to the cockpit layout and instrument panel, and to recommend incorporation of a single large window and an explosive side hatch for escape. We went to the Redstone Arsenal at Huntsville, Ala., where we observed the Redstone launch vehicle being constructed and checked for flight. We also went to Rocketdyne where we observed rocket engines being constructed and tested. As a group, we visited practically every facility directly concerned with the launching of the Mercury spacecraft. In addition, as individuals, we probably visited every subcontractor involved in the program.

It was obvious quite early in the program that the program was too complex for all of us to command a knowledge of all the detailed aspects of the spacecraft, launch vehicles, and flight. Therefore, by each of us assuming responsibility for one major area, we were able to maintain detailed contacts with all aspects of the program. The following table shows the assignment of specialty areas:

Astronaut	Specialty area
Malcolm S. Carpenter Leroy G. Cooper John H. Glenn Virgil I. Grissom	Navigation and navigational aids Redstone launch vehicle Crew space layout Automatic and manual attitude control system
Walter M. Schirra Alan B. Shepard	Life support system Range, tracking, and recovery operations
Donald K. Slayton	Atlas launch vehicle

As an example, I was assigned the Atlas launch vehicle. Where possible, I attended all meetings concerned with mating of the Atlas launch vehicle with the Mercury spacecraft and with modifications to the Atlas launch vehicle which affected our mission. In addition, I observed many Atlas research and development launchings to note procedures which might require change for manned operations. It was then my duty to report my findings and the results of my trips to the rest of our group in order to keep them up to date with the progress of the Atlas. Each of us did the same in his particular specialty area.

A valuable byproduct of the assignment of specialty areas was the ability to get an Astronaut input into the design of each of the systems involved in Project Mercury. We operated essentially in the same manner as the experimental test pilots who work for an aircraft company; we followed through the design phases of our particular area to insure that no obvious operational aspects were overlooked.

#### Static Training Devices

The next set of training devices used were the fixed-base or so-called static trainers. The first devices were the series of procedures trainers. One early approach used for practicing of retromaneuvers and reentry maneuvers consisted of an analog computer tied in with a locally constructed hand controller and prototype flight instruments to allow us practice in flight control while we were waiting for the production procedures trainer. A modification of that device used the Mercury hand controller and flight instruments and was driven by an F-100 gunnery simulator computer. We could operate this trainer on a contour couch and in a pressure suit, and gain further training in retrofire and reentry.

The final production procedures trainer was constructed by McDonnell Aircraft Corporation. The instructor sat in the outer control console of the procedures trainer. The instruments in the outer control console

are essentially the same as within the procedures trainer itself, so the instructor can follow the motions of the pilot onboard. In addition, the instructor is capable of creating any failure mode or emergency that it is possible to encounter with the vehicle, either singularly or in combinations. With this device we have learned to cope with every possible emergency that can occur by developing skill in rapid troubleshooting and in taking appropriate corrective actions.

In addition to use of the trainer for learning modes of failure and corrective actions for failures, we have also run normal mission profiles, for both the Redstone and the Atlas launch vehicles, and any abort profiles that it is possible to obtain, so that we could develop an intimate familiarity with these flight profiles. In the process, we have developed flight plans for our actual flights, since we get an exact feeling for the timing of events and know when we have spare time to do something that is not a mandatory part of the operation. Since this trainer was wired in exactly the same manner as the actual flight spacecraft, and since all spacecraft changes were immediately cranked into the trainer, it has also proved a valuable device in troubleshooting systems design. There have been many cases where a system did not operate exactly as we had envisioned, and we would not have known this fact without having the procedures trainer with which to work. In these cases, we either redesigned the system or modified our procedures to compensate for the changed system.

The next training device we used was the ALFA Trainer, or Air Lubricated Free Attitude Trainer. A contoured couch was mounted on top of an air bearing, which was essentially frictionless, and with the use of a Mercury hand-controller which actuates compressed-air jets, this trainer could be stabilized and controlled about all three axes. Obviously magnitudes of roll and pitch are limited. At first the trainer was completely open; it has now been completely enclosed so that the Astronaut can only see up through the periscope, which is mounted between his legs. On one wall, a screen has been set up upon which the flight path over the earth is projected and with this device we can practice maintaining attitude control by watching through the periscope and also practice navigation around the earth. In addition, compressed-air retrorockets have been attached to the back of the trainer and allow practice in controlling retrofire under dynamic conditions rather than merely by watching instruments as in the initial procedures trainer. We feel our primary backup mode of retrofire would be with the use of the periscope.

Because one-half of our orbital flight path will be on the dark side of the earth, and because some people feel that stars can be seen even on the bright side, it was felt that some training in astronomy was highly desirable. Therefore, we went to the Moorehead Planetarium at the University of North Carolina and were given basic instructions in the location of the various constellations and stars. When we felt

that we were fairly familiar with these basic instructions, a Link trainer with a window the exact size of the Mercury spacecraft was installed within the planetarium and we practiced navigation by the stars as we went through an orbital flight path. Since the field of view is rather limited through the Mercury spacecraft window, this Link trainer provided very valuable exercise. We could run through an orbit in approximately 9 minutes and, therefore, obtained a large amount of training in a short time.

### Dynamic Training Devices

The next group of trainers are the dynamic or stress-type trainers. The first of these are the weightless or zero-g trainers. Since there is no way to simulate weightlessness on the surface of the earth, we flew in aircraft such as the C-131 through a parabolic trajectory. For these simulations we obtained approximately 15 seconds of weightlessness as we flew over the top of the maneuver. We also flew in the back of the KC-135 where we were able to get approximately 30 seconds of weightlessness. The interior of the KC-135 was well padded and we were allowed to move or attempt to move at will in a free zero-g state. At least for limited periods of time, weightlessness was a lot of fun, and we don't anticipate that it will be greatly different for extended periods of time. This condition of free-floating weightlessness has no direct application to flight in the Mercury spacecraft since in the spacecraft we are strapped in a fairly small cockpit. Therefore, we flew in the back seat of F-100's at Edwards Air Force Base, where we could obtain up to 1 minute of zero-g time while strapped in a fighter cockpit. During this time we could eat food, drink water, and so forth. In general, our impressions were that weightlessness, when we were restrained in an aircraft or in the Mercury spacecraft, was essentially the same as any other g-loading encountered during flight. It doesn't really matter whether the g-force is zero or 2 or -2, because the Astronaut is a part of the vehicle anyway.

As a follow-on to this zero-g or weightlessness training, we went into the centrifuge training or high-g training at the Johnsville human centrifuge. A gondola is mounted on the end of a large revolving arm. Within the gondola we installed a mock-up of our total instrument panel with active flight instruments, driven by the centrifuge computer and our Mercury hand controller, and also a complete environmental control system from the Mercury spacecraft. The gondola was then sealed so that we could depressurize the gondola to the actual flight pressure of 5 pounds per square inch. In this way, we could simulate flying at 27,000 feet with a 5 pound per square inch, 100 percent oxygen atmosphere, and we could note the effects, if any, of applying high-g under reduced pressure. In general, we found no ill effects. We made simulated flights with and without the pressure suit inflated and were able to run through all Atlas and Mercury normal launch profiles and reentry profiles,

as well as most of the possible Atlas abort reentry profiles. These abort profiles can call for accelerations as high as 21g but we did not go quite to this level. Some of the Astronauts underwent accelerations of 18g with no excessive difficulty. The primary advantage of the centrifuge was to give us some practice in straining techniques in order to retain good vision and consciousness under high-g loadings and also to develop techniques for breathing and speaking under high-g loads. We also gained practice in controlling the vehicle through the g-load range during the reentry, essentially a rate-damping maneuver. We were also able to tumble the gondola, to go rapidly from a fairly high positive g to a negative g. This tumbling was an attempt to simulate some of our aborts, primarily at maximum dynamic pressure where the accelerations would go from 10g to -10g in approximately 1 second. We feel the centrifuge has been one of our most valuable training devices.

Another dynamic training device was the MASTIF or multiaxis spin test inertia facility at Lewis Laboratory in Cleveland, Ohio. For this device, a seat was mounted within a gimbaled frame. A Mercury control handle actuated compressed-nitrogen jets, and Mercury flight instruments were onboard. From an external control station, high-powered nitrogen jets could be actuated which would revolve the device up to 30 rpm about all three axes simultaneously. Our task was then to take over control with the hand controller and, with the use of our flight instruments attempt to bring the rates back to zero and establish our original attitude. We experienced no difficulty as far as the control task was concerned. However, the multiaxis spin test did prove to be a somewhat nauseating exercise after a few runs. This training represents one case of training under extreme conditions which we do not anticipate encountering. The two main cases where we could enter into a tumble-type maneuver would be coming off the booster without any control system operational or having a control jet jam in the open position. In either case, it is anticipated that we could stop tumbling before rates reached any significant magnitude.

We also took an orientation ride in the Revolving Room at Pensacola, Fla. This room rotates at approximately 10 rpm in an attempt to simulate proposals for rotating a large space ship to induce a small g-field artificially, with the assumption that weightlessness becomes a major problem. The object of the room is to show the Coriolis effects present, which are not too apparent until movement is attempted. This rotating room is again a somewhat nauseating experience to many people.

Since the heats of reentry initially were assumed to be of a fairly high magnitude, we dressed in ventilated pressure suits and climbed into a steel box. The interior of this box was heated up to approximately 250° F by radiating heat from quartz lamps through the walls. We found that these temperatures were no great problem at all, and since the time



this program was run, we have discovered that our interior cabin heat load during an actual Atlas reentry is considerably lower. We no longer have any qualms about the high heat loads involved.

We also took a ride in the carbon-dioxide chamber at Bethesda, Md. We climbed into the chamber; it was sealed; and the carbon-dioxide content was gradually increased from a normal 0.05 percent to approximately 4 percent over a period of 3 hours. We were able to note the physiological effects such as increased breathing, pulse rate, flushing, and in some cases, a slight headache. We feel that this carbon-dioxide chamber was a valuable part of our training, since no one has been able to devise a completely satisfactory partial-pressure measuring device, at least for measuring small partial pressures. Therefore, we feel that our best indication of excessive carbon dioxide onboard the capsule will be our own sensations.

Another very valuable part of our training has been the flying of high-performance aircraft. Mainly, we flew two F-102A airplanes which we have now converted to two F-106A airplanes. Since we were all brought into this program as highly qualified jet pilots, and since this was one reason we were selected to be Astronauts, we felt that it was highly desirable to maintain this proficiency. Ground simulators and trainers are very valuable for practicing procedures. However, the only penalty for erring in a simulator is to shut down the procedure and start over. We feel that by staying highly proficient as pilots of conventional aircraft, we can maintain our sharpness in making rapid judgments and in reacting accordingly, under somewhat adverse conditions where the penalty for erring is greater than merely shutting down a machine and starting over again.

Another part of our training has been the athletic program. Basically, the athletics have been an individual responsibility. Some of us play hand ball, some run, some swim, and if we feel like doing absolutely nothing, that is our prerogative. We have found that being as competitive as we are, the inducement of keeping up with our fellow troops is adequate to keep most of us working away at maintaining good physical condition. The only organized athletics in which we have engaged has been some SCUBA diving with the Underwater Demolition Team at Little Creek. Here, we eventually became proficient enough to swim a mile underwater fairly easily. We also obtained some additional benefits because of the similarity of underwater swimming to the condition of weightlessness, especially in murky water such as the Chesapeake Bay. Of course, we also developed practice in breathing with an artificial system under pressurized conditions. We also felt that any increase in familiarity with a water environment was desirable since our primary recovery area is in the water.

## Egress and Survival Training

Another major section of our training is the egress and survival training. As previously mentioned, our primary recovery area is in the water and, therefore, all of our practice in egressing has been in the water. Initially, we put our egress trainer in a hydrodynamics tank at Langley Research Center and practiced egressing first in smooth water and then in artificially generated waves. When we felt that we had developed a reasonable amount of proficiency in that facility, we took the trainer down to the Gulf of Mexico, near Pensacola, Fla. We took the egress trainer out to sea on a barge, dropped it over the side, and practiced egressing in the open sea, which was quite rough on numerous occasions. Our primary exit for egress is through the small end of the Mercury spacecraft. The Astronaut has the option of dropping out directly into the water and then inflating his raft, or inflating it first and egressing into the raft. This is a method of egress which would be used if the Astronaut decided to get out of the spacecraft before the arrival of the recovery forces.

Another method of egressing was practiced, where it is assumed the helicopters are in the recovery area at the time of impact. The helicopter hooks on the spacecraft and lifts it partially out of the water so that the lower frame of the door is above the water line. The Astronaut then ejects the hatch and climbs out of the spacecraft. The personnel lifting line or "horse collar," as we call it, is then lowered to the Astronaut and, theoretically, he climbs into this and is lifted onboard the helicopter. Our first attempt at the exercise was obviously not too smooth and is another indication of why we need training in these things. Astronaut Shepard used this method of exit on his particular flight without, of course, dropping into the water first. He entered the helicopter completely dry. The advantage of this method of egress is that it is the most rapid way out of the spacecraft and puts the Astronaut onboard the recovery helicopter in minimum time. Also, since a helicopter dropped a spacecraft en route to the recovery area during one early recovery exercise, we haven't had ultimate confidence in riding in the spacecraft while being carried by the helicopter.

The last method of egress is the underwater one. This method would be used, for example, if the spacecraft developed a leak rate after impact of such a magnitude that the Astronaut had insufficient time to get out through the small end. In this case, the Astronaut would have to blow off the side hatch. Once the hatch is off, the capsule rapidly fills with water, and the Astronaut cannot get out until it is completely filled and, hence, sinking. We have found that we can get out under these conditions in around 10 seconds, at which time the small end of the spacecraft is barely under water.

In conjunction with our water egress training, we conducted some water survival training. We spent approximately 1/2 day in one-man rafts learning how to distill water, protect ourselves from the sun, and signal the rescue forces. This exercise convinced us that we could survive for a great number of days if forced to reenter in an unspecified recovery area and await recovery for extended periods of time.

We also spent 3 days learning desert survival techniques at Stead Air Force Base, near Reno, Nev. Here again, we learned how to protect ourselves from the sun, how to utilize the limited water supply, and to build clothing and shelter from our parachutes. There is a remote possibility that we could impact in the west African desert, should our orbital insertion be somewhat under speed and our retrorockets not have adequate thrust. This possibility is very remote, but it is an indication of our attempt to train for any possibility, no matter how remote.

### Specific Mission Preparation

We have specific mission preparation which prepares us for an individual spacecraft and an individual launch vehicle. This training covers a period of time of approximately 8 weeks during which the spacecraft is at Cape Canaveral undergoing hangar and pad checkouts. The first object of this training is orientation to the specific spacecraft configurations. Even though all the spacecraft are built to a specific set of drawings and specifications, each is an individual and has peculiarities which are not the same in the others. In order for the Astronaut to become intimately familiar with his particular spacecraft, he participates in all the hangar checkouts on it. He participates in reaction control system checks where he can develop a good feel for his particular control system. This participation is also where we get our primary environmental control system training. The Astronaut rides in the spacecraft when it is put in the pressure chamber for pressure checks, and he operates the environmental control system in conjunction with this checkout. He also attends all meetings concerned with the check-out and modification of the spacecraft, so he is probably the one person most familiar with all details of the spacecraft.

In addition to maintaining a familiarity with the hardware, each Astronaut must practice his specific mission flight plan since each mission is somewhat different. He does this in the procedures trainer, where he runs time and time again over the flight plan which has been laid down for his particular mission. He also runs through all emergencies that anybody can envision happening. During this time, Astronaut performance data is procured for comparison with flight-test results after the flight.

In addition to the pure Astronaut training flights, each Astronaut also practices with the Mercury Control Center flight controllers and the down-range stations involved in his particular flight. The procedures trainer is tied into the Mercury Control Center, and simulated missions are flown while various emergencies are simulated primarily to test the flight controllers. In the process of these exercises, ground rules and mission rules are evolved which apply to this particular mission.

Once the spacecraft is moved to the pad and mated with the booster, the Astronaut then participates in all practice countdowns, radio-frequency compatibility checks, simulated flight tests, and so forth. Detailed launch procedures are developed with the pad crew. Astronaut ingress training is also obtained at this time. In addition, the emergency pad rescue crew is also exercised and techniques are developed for rescuing the Astronaut on the pad should some emergency develop prior to the launch. These are also full-scale training programs, with all personnel involved participating. During this latter period of training the Astronaut is also concentrating on maintaining himself in the best of physical condition. Medical personnel are continuously monitoring his health and insuring that he stays healthy during this period. Part of this program involves placing the Astronaut on a special low-residue diet and collecting specimens for comparison with post-flight specimens.

#### DISCUSSION

The success of any training program can only be evaluated when compared with an actual flight. It appears that our training was entirely adequate for this flight and that nothing was missed. As expected, some facets of the training program proved to be of relatively little value and will probably be eliminated from future training. On the other hand, some items proved to be of very great value, and we will probably place much greater emphasis on these facets in future training.

## RESULTS OF IN-FLIGHT PILOT PERFORMANCE

By Robert B. Voas, Ph. D., John J. Van Bockel,  
Raymond G. Zedekar, and Paul S. Backer

## INTRODUCTION

Studies of man's capability to perform efficiently in the space environment have been underway for some time. Particular attention has been devoted to the novel weightless condition. Research with special subjects in the rear seat of fighter aircraft during zero-g maneuvers has indicated that the restrained man generally manifests a slight but transitory psychomotor incoordination in passing from high-g to zero-g conditions. At the same time, the success of the pilots in accurately flying these Keplerian trajectories indicates the capacity of the trained pilot to operate efficiently at zero-g for at least the short periods achievable in manned aircraft. This type of demonstration has been extended as the increased power of jet aircraft permitted increased periods of weightlessness. The recent flight of the X-15 aircraft indicated the ability of the pilot to perform effectively through  $2\frac{1}{2}$  minutes of weightlessness. With the advent of rocket-propelled vehicles, new opportunities to observe man during more prolonged zero-g periods are available. This paper presents a report on some qualitative observations of the Astronaut's performance during the MR-3 flight.

## SOURCES OF DATA ON THE ASTRONAUT'S PERFORMANCE

The highly successful flight of the MR-3 is a partial demonstration of the Astronaut's performance capacity in space. However, since many of the spacecraft functions are automatic, the full extent of the Astronaut's capacity to control the vehicle can best be indicated by a detailed analysis of the tasks he attempted to accomplish. In evaluating the effects of the space environment on his performance capability, four major sources of data are available: the Astronaut's communications to the ground during the flight, the pictures from the onboard pilot-observer camera, telemetered records of the vehicle attitude while under manual control, and his own narrative description of his activities given at the postflight debriefing. Since the MR-3 flight is described in a subsequent paper by Astronaut Shepard, this presentation will be limited to a discussion of data from the first three sources.

## THE ASTRONAUT'S FLIGHT ACTIVITIES PLAN

The tasks performed by the Astronaut during the flight can be divided into four groups. First he must monitor the major flight events in order to insure that they have occurred correctly. In the event of a malfunction he must back up the function manually. Twenty-seven major flight events occurred during the MR-3 flight. A second major area of activity for the Astronaut is communications. The basic communication ground rules were that the Astronaut would report all significant events and all his major actions. In addition, he would make one report at least every 30 seconds during the launch and reentry to keep the ground informed of his status. In all, these requirements resulted in approximately 70 communications during the flight. In addition to these two types of activities which were required to insure a normal flight and to keep the ground informed of the flight's progress, activities in two other areas were scheduled. In order to evaluate the manual attitude control systems, it was decided to have Astronaut Shepard take manual control at the beginning of the zero-g period shortly after the autopilot had turned the spacecraft around. From this point, manual control was maintained until shortly before the end of the weightless period when the Astronaut returned to the autopilot for a short time while looking out the window for stars before returning to manual control during the reentry. Astronaut Shepard made a number of maneuvers to demonstrate the adequacy of the manual control system, in addition to those required by the mission flight plan, such as pitching to retrofire attitude or orienting the spacecraft to the proper reentry attitude. A final area of activity was observing the earth and sky through the spacecraft periscope and window. Astronaut Shepard made a study of the surface areas which would be visible through the periscope during the mission; this study is described in his report.

The flight plan which resulted from the incorporation of these activities was a full one as illustrated by figure 1. Here the approximate time during which Astronaut Shepard was engaged in each type of activity is indicated. At the bottom of the graph are shown the time and duration of the 78 communications made by Astronaut Shepard during the flight. The 27 important spacecraft events which the Astronaut must monitor are shown as a function of mission time. The period during which the Astronaut maintained control of the spacecraft attitude is shown by the unbroken bar, whereas specific attitude maneuvers are shown raised above this level. Finally, the time spent on external observations is indicated by the upper line.

As can be seen from this analysis, the Astronaut was heavily task loaded during most of the flight. This was particularly true during the weightless period when he was attempting to check out the manual attitude control system and observe and report on the ground terrain as

well as carry out the normal monitoring and communications required by the flight plan. During this 5 minutes he made more maneuvers than are typically attempted in a similar period in aircraft test flights. This full program resulted from the decision to make maximum use of the short time of weightless flight available. It had been agreed that activities concerned with external observation and attitude control would be curtailed should any variation of spacecraft function require the Astronaut's attention.

#### Analysis of the Pilot-Observer Camera Film

The onboard pilot-observer camera film presents a picture of the Astronaut's eyes and permits a rough determination of the area at which the Astronaut is looking. From an analysis of this film, it may be determined whether the Astronaut's attention appears to be directed toward appropriate instruments throughout the flight.

Figure 2 shows the areas into which the panel was divided for the purpose of this analysis. These numbered areas start at the upper left of the panel and proceed vertically and horizontally to the lower right-hand corner of the panel. Figure 3 presents a bar chart showing the percent of time that the Astronaut appeared to be looking at each of the areas shown in figure 2 for various portions of the flight. Each block symbol represents the percent of time spent looking at a particular area of the panel during a 20-second time interval. The panel-area numbers proceed horizontally across the top and the elapsed time intervals proceed vertically down the left-hand side of the figure.

Figure 3(a) presents the period from lift-off to launch-vehicle cutoff. Note that for the first 20 seconds after time zero the pilot concentrates visually upon area 9, which is where the Ready and Mayday lights are located. From approximately 1 minute 10 seconds to 1 minute 40 seconds, his attention is focused on area 10 which includes the cabin pressure gage. The pilot's concentration on these particular gages is in agreement with the importance of these instruments during these two different time periods. During the launch phase of the flight, the pilot also frequently scans areas 2, 4, 5, 6, 7, 9, and 11 as he monitors altitude, acceleration, pitch programming, time, cabin pressure, fuel, and oxygen.

A more detailed example of the eye-scan pattern for a 1-minute time period during the launch phase of the mission is provided in figure 4(a). This figure represents a standard eye-scan pattern diagram showing the link values (frequency scan between two instruments), number of fixations, and the percent of time spent looking at each particular area during a 1-minute period from  $T + 1$  minute to  $T + 2$  minutes. This figure and figure 3(a) indicate that the pilot maintained a good visual cross-check of

pertinent instruments during the launch phase of the flight, that he did not become fixated upon any particular instrument for a long period of time, and that the indicators were monitored at times appropriate to the flight program. A point of interest is the high link value on the rather long link between the clock and the fuel gage. Future manned spacecraft will have the fuel gage located just below the g-meter which will considerably shorten this link. The desirability of this change is demonstrated by the frequent reference to this gage during the launch period.

The eye-scan pattern during the weightless flight phase (fig. 3(b)) is similar to that during the launch phase, with the exception that different areas that contain gages commensurate with their importance for this particular phase of the flight receive the maximum attention. Note here that areas 6, 7, and 8, which include the rate and attitude indicator, the clock, and the periscope, are used extensively during this phase of the flight. As would be expected, particular attention is focused on the rate and attitude instrument while making the scheduled attitude maneuvers and controlling the retrorocket firing.

Figure 4(b) presents a standard scan pattern for the first minute of weightlessness. This figure covers a time interval from  $T + 2:20$  to  $T + 3:20$ . This includes the time period from launch-vehicle cutoff through the first three attitude maneuvers. Once again the link values, number of fixations, and the percentage of time spent viewing each instrument are given. During this time period, a few different instruments, such as the periscope, are included in the eye-scan pattern as compared with the scan pattern during launch. The pilot again indicates a good logical cross-check of the instruments that should be monitored during this phase of the flight.

Figure 3(c) presents the approximate panel area being observed during the reentry flight phase. Again the eye-scan patterns appear to be consistent with the requirements of this phase of the flight. In the reentry portion of the mission, his visual attention is first on area 4 which includes the accelerometer during the high-g phase and then shifts to area 8 which includes the periscope as he closely monitors the deployment of the drogue and main parachutes.

Thus, throughout the mission the Astronaut's attention appears to be directed towards the appropriate instruments or, at least, towards the areas of the panel that contain the appropriate instruments. His scan pattern was active and there appeared to be no wandering of attention, no fixation, or any illogical concentration on a specific set of instrumentation. There was no evidence of nystagmus.



## Flight Voice Communications

The flight voice communications provide an indication of how well the Astronaut was able to keep up with the mission events, how accurately he was able to read his cockpit instruments, and how well he was able to respond to novel or unusual events during the flight. In general, the Astronaut made all the normal reports during launch and reentry very close to the times appropriate to the events. Comparison of the instrument readings relayed to the ground with telemetered data verified that these reports were accurate. Throughout the flight Astronaut Shepard used standard voice procedures developed during simulations with the ground control center. In addition to the standard reports of spacecraft events and instrument readings, Astronaut Shepard made a number of unscheduled reports of unique events during the flight. During the period of weightless flight he responded rapidly to ground communications. In addition, he was able to describe clearly the unusual sights he saw through his periscope. In general, the communications confirm the impression given by the analysis of the pilot-observer camera pictures that the pilot kept up with the mission events and that he was alert at all times for novel or unprogramed events.

## Attitude Control

The third major source of Astronaut in-flight performance information was the record of spacecraft attitude during the period in which the manual control system was in use. The attitude during this period is shown in figure 5. In spacecraft attitude control is less critical than in aircraft since the flight path is independent of attitude unless rocket power is being applied. Furthermore, the lack of aerodynamic damping permits small residual rates to displace slowly the spacecraft attitudes. For this reason the spacecraft attitude is controlled to tolerances less fine than those typical of aircraft. In order to determine the amount of drift to be expected a reference is needed. Since there is no comparable previous manned flight experience the best reference available is the ground simulator. For this purpose, use was made of the 10 Mercury procedures trainer runs made the week before the MR-3 flight. The maximum excursions observed during any of these simulator flights were used to define the shaded area behind the three attitude lines.

This envelope illustrates the amplitude of the attitude limits habitually maintained by Astronaut Shepard during these training sessions. Tighter attitude control is possible and can be maintained if required; however, since the spacecraft attitude is not critical, except during retrofire, expenditure of additional fuel to maintain tighter limits is not justified. Note that the envelope of trainer runs defines not only the normal variation in attitude about the three axes but, in addition, it defines the scheduling of maneuvers throughout the flight as shown

by the expansion and contraction of the envelope and by the shifting of the center of the pitch envelope to retrofire attitude and back to reentry attitude. Note that the spacecraft attitude in each of the three dimensions is almost always within these limits during the period it is under manual control.

An area of particular interest is the retrofire portion of the mission. During this period the firing of the retrorockets produces acceleration disturbances about the axis of the vehicle due to slight misalignments of the retrorockets. The Astronaut must counteract these misalignment torques with the manual control system. This is the most difficult, and in an orbital flight the most critical, maneuver required of the Astronaut. From figure 5 it can be seen that the attitude in all three axes was held fairly steady during the retrofire period. The slight divergence in yaw attitude toward the end of the period is not significant and would not have greatly affected the accuracy of the orbital reentry. Although the accelerations produced by the retrorockets about each axis could not be determined precisely, Astronaut Shepard reported that the retrofire misalignment torques felt about the same as those used in the trainer. If this is true then his performance is comparable to that shown in the Mercury procedures trainer and well within the limits required for the orbital mission.

Five specific maneuvers carried out using the instrument reference during the flight had been practiced on the ground simulator. These maneuvers are circled in figure 5 and shown in figure 6 against a background of six simulator runs. The first four attitude maneuvers were scheduled at a rate of  $4^{\circ}$  per second with a total attitude change of  $20^{\circ}$ . However, because of the tight program it was often impossible to carry out the full maneuver even on the simulator. This is illustrated by the second roll maneuver in which the attitudes vary among trainer runs. Often there was not time available to reorient to proper initial attitude before starting a particular maneuver. Thus, not all the maneuvers start from the same attitude nor do they all achieve precisely the nominal levels. Once again, the trainer data present a better definition of what the Astronaut was attempting to do and what he was normally able to do than does the nominal definition of the maneuver. As shown in figure 6 all the maneuvers fell within the envelope of those done on the simulator except the first roll maneuver. In this case, due to time restrictions Astronaut Shepard did not accomplish a full  $20^{\circ}$  attitude change but cut the maneuver short at approximately  $12^{\circ}$ .

The comparison with the ground simulator data is of particular interest since it gives an indication of the performance level under essentially optimal environmental conditions. During the trainer runs used in this report Astronaut Shepard did not wear his full pressure suit. He experienced no acceleration, noise, vibration, heat, reduced ambient pressure, or weightlessness. He did not have a long period of

waiting in the spacecraft during the countdown. He did not experience the psychologically stressful conditions of the countdown, launch, and flight.

His performance on the trainer illustrates the general level that is maintained under essentially optimal environmental conditions. The fact that the performance level achieved in flight with all its attendant sources of environmental stress was generally within the envelope of performance under optimal conditions demonstrates that these environmental factors did not have a major effect on Astronaut Shepard's performance.

It should also be noted that the deviation between flight and simulator performance cannot be solely attributed to the effects of the different environmental conditions encountered. Another source of deviation is the failure of the trainer to reproduce with complete accuracy the dynamics of the vehicle in flight. To the extent that the vehicle control system performs differently than the simulated system, the man's apparent performance will change. Thus, the fact that the attitudes were controlled within the limits observed in the trainer also provides some evidence that the control system simulation was fairly accurate.

#### CONCLUDING REMARKS

The three sources of data reviewed in this report, the onboard pilot-observer camera film, the flight voice communications, and the spacecraft attitude record during manual control, indicate that the pilot met all requirements of the mission, that he monitored and reported accurately the critical events of the flight, that he controlled the attitude of the spacecraft within normal limits, that he was alert at all times to novel or unprogramed events, and that he showed no tendency to become fixated on irrelevant instrumentation or activities. In addition to the basic activities required to insure a successful mission he made several attitude maneuvers to evaluate the manual control systems and spent some time examining the earth's surface and reporting what he was able to see. His performance of these activities was not only within the limits required for a successful mission but the quality of the performance was comparable to that achieved on the procedures trainer under optimal environmental conditions. The close correspondence between attitude maneuvers on manual control in the simulator and those in flight indicate that the trainers used in the Mercury program were relatively successful in reproducing the vehicle characteristics in flight.

It is apparent that the outcome of the MR-3 flight is in keeping with the previous experience with manned aircraft flying zero-g trajectories. During a short ballistic flight Astronaut Shepard was able to operate a complex vehicle with no significant reduction in performance while exposed to unusual environmental conditions, such as a 5-minute period of weightlessness.

### ACTIVITY SCHEDULE DURING MR-3 FLIGHT

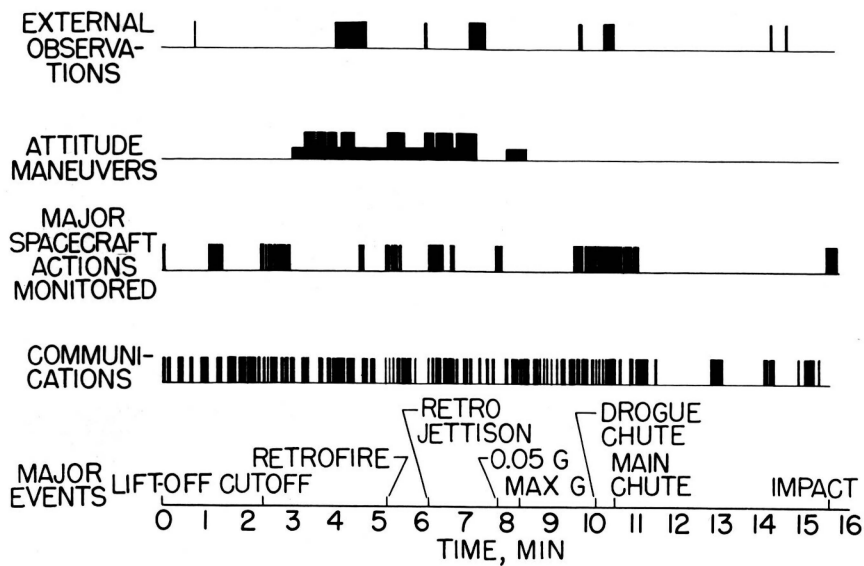

Figure 1.

### APPROXIMATE PANEL AREAS BEING OBSERVED

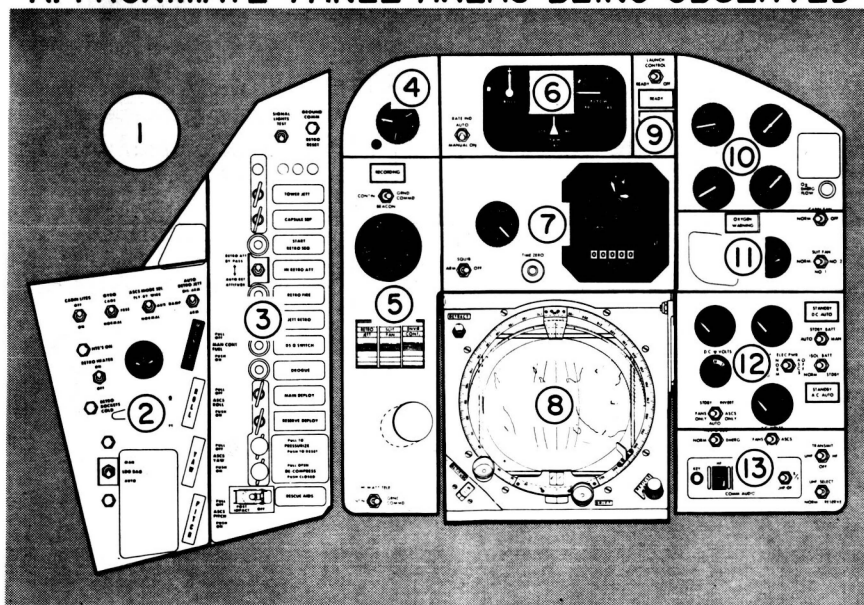
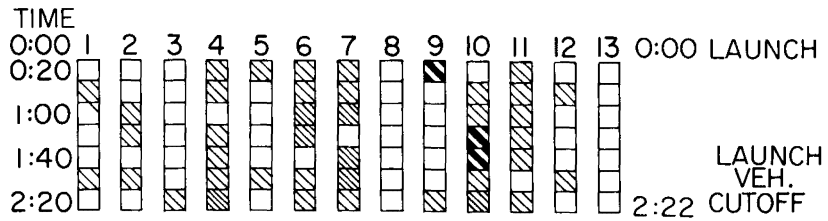
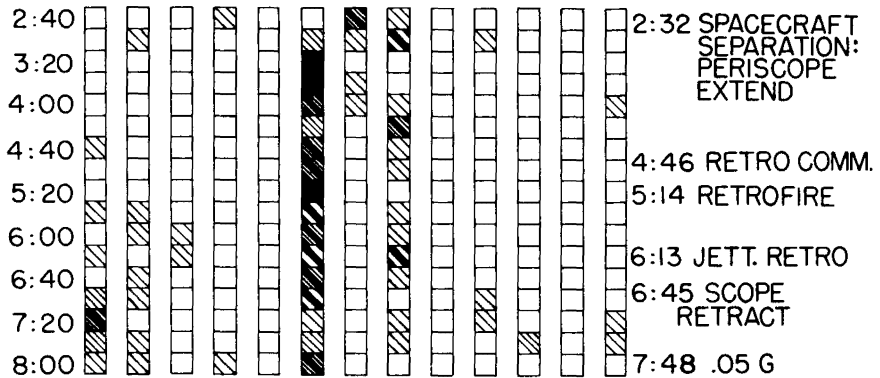

Figure 2.

### APPROXIMATE PANEL AREA UNDER OBSERVATION



(a) During launch.



(b) During weightlessness.

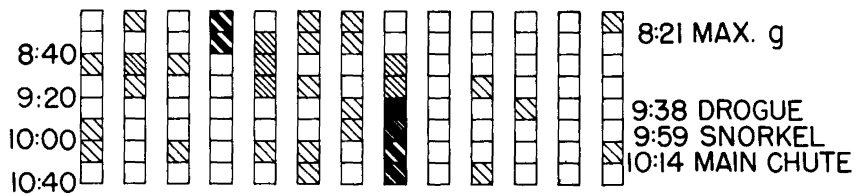

(c) During reentry.



Figure 3

## APPROXIMATE EYE-SCAN PATTERN

T + 1 MIN TO T + 2 MIN

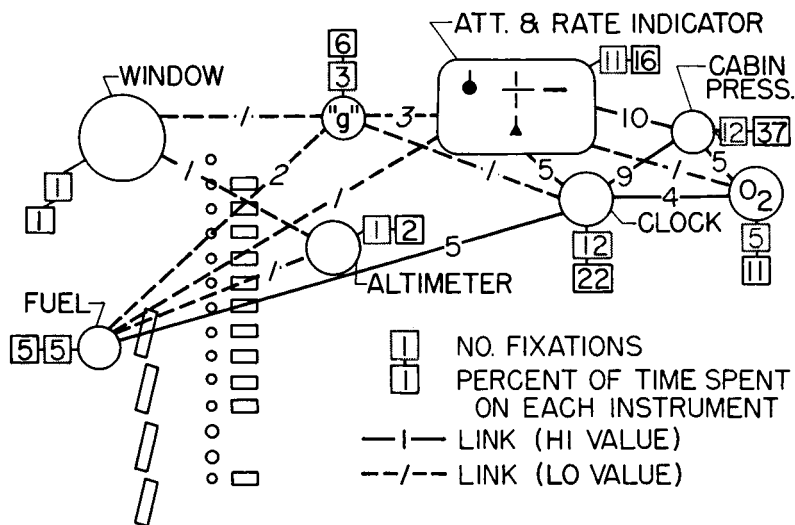

(a) During launch.

T + 2:20 MIN TO T + 3:20 MIN

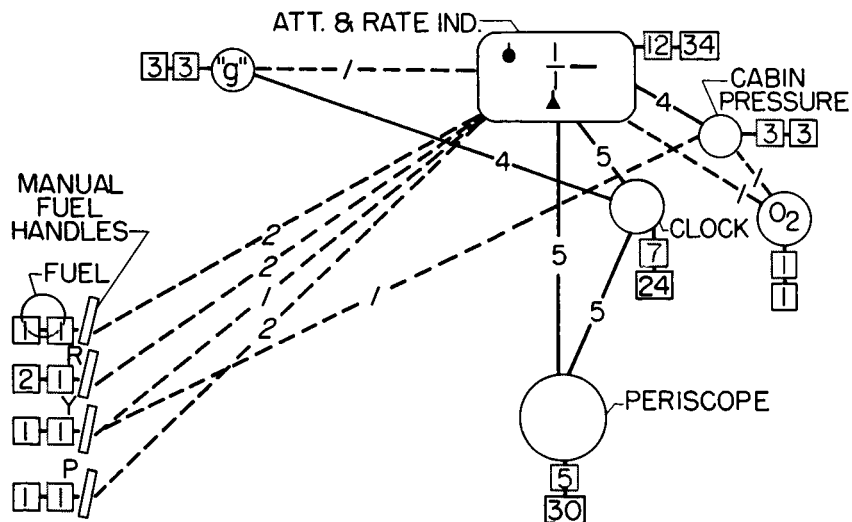

(b) During weightlessness.

Figure 4

### FLIGHT ATTITUDE WITH 10 TRAINER RUNS IN THE BACKGROUND

CIRCLED AREAS ARE THE MANEUVERS

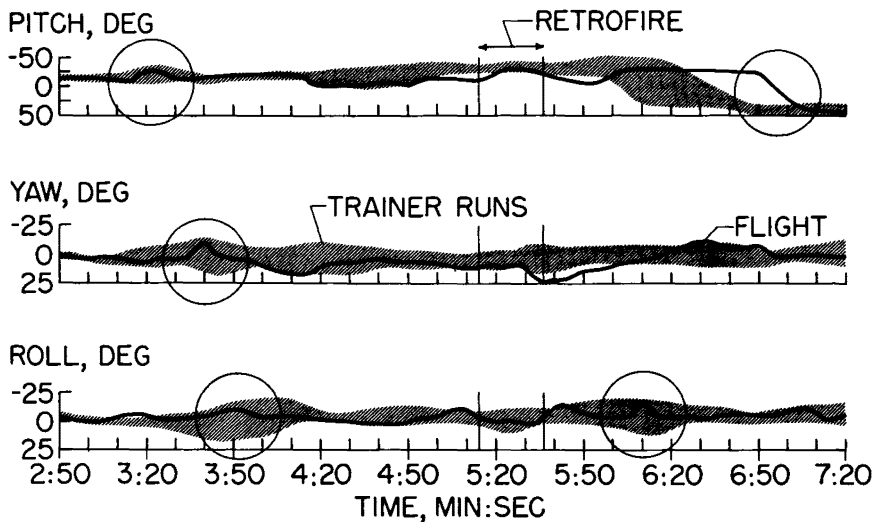

Figure 5.

### COMPARISON OF 5 FLIGHT ATTITUDE MANEUVERS WITH TRAINER ATTITUDE MANEUVERS

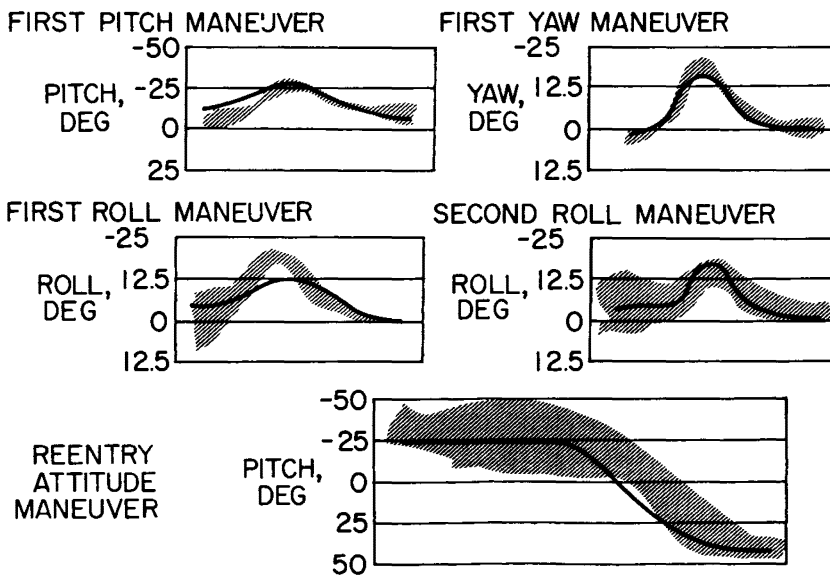

Figure 6.



## PILOT'S FLIGHT REPORT, INCLUDING IN-FLIGHT FILMS

By Alan B. Shepard, Jr.

## INTRODUCTION

My intention is to present my flight report in narrative form and to include three phases. These phases shall be: (1) the period prior to launch, (2) the flight itself, and (3) the postflight debriefing period. I intend to describe my feelings and reactions and to make comments pertinent to these three areas. I also have an onboard film of the flight to show at the end of my presentation.

## PREFLIGHT PERIOD

Astronaut D. K. Slayton in a previous paper described the program followed by the Project Mercury Astronauts during a two-year training period with descriptions of the various devices used. All of these devices provided one thing in common; namely, the feeling of confidence that the Astronauts achieved from their use. Some devices, of course, produced more confidence than others but all were very well received by the group. There are three machines or training devices which provided the most assistance. The first of these is the human centrifuge. We used the facilities of the U.S. Naval Air Development Center at Johnsville, Pa., which provide the centrifuge itself and a computer to control its inputs. This computer, through an instrument display, provided a control task similar to that of the Mercury spacecraft, with inputs of the proper aerodynamic and moment-of-inertia equations. Thus, we were able to experience the acceleration environment while simultaneously controlling the spacecraft on a simulated manual system. This experience gave us the feeling of muscle control for circulation and breathing, transmitting, and general control of the spacecraft. I found that the flight environment was very close to the environment provided by the centrifuge. The flight accelerations were smooth, of the same magnitude used during training, and certainly in no way disturbing.

The second training device that proved of great value was the procedures trainer. This device will be recognized as an advanced type of the Link trainer, which was used for instrument training during the last war. We were able to use it to correlate preflight planning, to practice simulated control maneuvers, and to practice operational techniques. The Space Task Group has two such trainers, one at Langley Field, Va., the other at Cape Canaveral, Fla., and both are capable of the simultaneous training of pilots and ground crews. As a result of the cross-training between pilots and the ground crews at the Project Mercury Control Center, we experienced no major difficulties during the flight.

We had learned each others' problems and terminology, and I feel that we have a valuable training system in use for present and for future flights.

The third area of preflight training, which is considered as one of importance, concerns working with the spacecraft itself. The Mercury spacecraft is tested at Cape Canaveral before being attached to the Redstone launch vehicle. These tests provide an excellent opportunity for pilots to learn the idiosyncrasies of the various systems. After the spacecraft has been placed on the launch vehicle, more tests are made just prior to launch day. The pilots have a chance to participate in these tests and to work out operational procedures with the blockhouse crew.

These three areas then, the centrifuge, the procedures trainer, and spacecraft testing at the launching area provided the most valuable aids during the training period. We spent two years in training, doing many things, following many avenues in our desire to be sure that we had not overlooked anything of importance. As a general comment concerning future training programs, these experiences will undoubtedly permit us to shorten this training period.

During the days immediately preceding the launch, the preflight physicals were given. These examinations do not involve more than the usual probing, listening, and other medical tests, but I hope that fewer body fluid samples are required in the future. I felt as though an unusual number of needles were used.

Preflight briefing was held at 11:00 a.m. on the day before launch to correlate all operational elements. This briefing was helpful since it gave us a chance to look at weather, radar, camera, and recovery force status. We also had the opportunity to review the control procedures to be used during flight emergencies as well as any late inputs of an operational nature. This briefing was extremely valuable to me in correlating all of the details at the last minute.

#### PERIOD OF FLIGHT

I include as part of the flight period the time from insertion into the spacecraft on the launching pad until the time of recovery by the helicopter. The voice and operational procedures developed during the weeks preceding the launch were essentially sound. The countdown went smoothly, and no major difficulties were encountered with the ground crews, the control-center crew, and the pilot. There has been some comment in the press about the length of time spent in the spacecraft prior to launch, some 4 hours and 15 minutes to be exact. This period was about two hours longer than had been planned. A fact that is most

encouraging is that during this time there was no significant change in pilot alertness and ability. The reassurance gained from this experience applies directly to our upcoming orbital flights, and we now approach them with greater confidence in the ability of the pilots, as well as in the environmental control systems.

A view of the flight plan is shown in figure 1. Our plan was for the pilot to report to the blockhouse crew primarily prior to T - 2 minutes on hard wire circuits, and to shift control to the Center by use of radio frequencies at T - 2 minutes. (The symbol T refers to lift-off time.) This shift worked smoothly and continuity of information to the pilot was good. At lift-off I started a clock-timer in the spacecraft and prepared for noise and vibration. I felt none of any serious consequence. The cockpit section experienced no vibration and I did not even have to turn up my radio receiver to full volume to hear the radio transmissions. Radio communication was verified after lift-off, and then periodic transmissions were made at 30-second intervals for the purpose of maintaining voice contact and of reporting vital information to the ground.

Some roughness was expected during the period of transonic flight and of maximum dynamic pressure. These events occurred very close together on the flight, and there was general vibration associated with them. At one point my head vibration was such that my vision was blurred for a few seconds. We intend to avoid a recurrence of this experience by providing more foam rubber for the head support and a more streamlined fairing for the spacecraft adapter ring. These modifications should take care of this problem for future flights.

I had no other difficulty during powered flight. The training in acceleration on the centrifuge was valid, and I encountered no problem in respiration, observation, and reporting to the ground.

Rocket cutoff occurred at T + 2 minutes 22 seconds at an acceleration of about 6g. It was not abrupt enough to give me any problem and I was not aware of any uncomfortable sensation. I had one switch movement at this point which I made on schedule. Ten seconds later, the spacecraft separated from the launch vehicle, and I was aware of the noise of the separation rockets firing. In another 5 seconds the periscope had extended and the autopilot was controlling the turnaround to orbit attitude. Even though this test was only a ballistic flight, most of the spacecraft action and piloting techniques were executed with orbital flight in mind. I would like to make the point again that attitude control in space differs from that in conventional aircraft. There is a penalty for excessive use of the peroxide fuel and we do not attempt to control continually all small rate motions. There is no aerodynamic damping in space to prevent attitude deviation, but neither is there any flight-path excursion or acceleration purely as a function of variation in spacecraft angles.

At this point in the flight I was scheduled to take control of the attitude (angular position) by use of the manual system. I made this manipulation one axis at a time, switching to pitch, yaw, and roll in that order until I had full control of the craft. I used the instruments first and then the periscope as reference controls. The reaction of the spacecraft was very much like that obtained in the air-bearing trainer (ALFA Trainer) described previously in the paper by Astronaut Slayton. The spacecraft movement was smooth and could be controlled precisely. Just prior to retrofiring I used the periscope for general observation.

The view shown in figure 2 was taken on an earlier Redstone flight but it is used here because it shows several features in one photograph. The particular camera orientation during my flight happened to include many clouds and is not as clear for land viewing. This photograph shows the contrast between land and water masses, the cloud cover and its effect, and a good view of the horizon. There appears to be a haze layer at the horizon. This haze is a function not only of particles of dust, moisture, and so forth, but also of light refraction through atmospheric layers. The sky itself is a very deep blue, almost black, because of the absolute lack of light-reflecting particles. We are encouraged that the periscope provides a good viewing device as well as a backup attitude-control indicator and navigation aid.

At about this point, as I have indicated publicly before, I realized that somebody would ask me about weightlessness. I use this example again because it is typical of the lack of anything upsetting during a weightless or zero-g environment. Movements, speech, and breathing are unimpaired and the entire sensation is most analogous to floating. The NASA intends, of course, to investigate this phenomenon during longer periods of time, but the Astronauts approach these periods with no trepidation.

Control of attitude during retrofiring was maintained on the manual system and was within the limits expected. There was smooth transition from zero gravity to the thrust of the retrorocket and back to weightless flying again. After the retrorockets had been fired, the automatic sequence acted to jettison them. I could hear the noise and could see one of the straps falling away in view of the periscope. My signal light inside did not show proper indication so I used the manual backup control and the function indicated proper operation.

After retrorockets were jettisoned, I used a combination of manual and electric control to put the spacecraft in the reentry attitude. I then went back to autopilot control to allow myself freedom for some other actions. The autopilot control functioned properly so I made checks on the high-frequency voice link for propagation characteristics and then returned to the primary UHF voice link. I also looked out both portholes to get a general look at the stars or planets as well as to get oblique horizon views. Because of sun angle and light levels I was unable to see any celestial bodies. The Mercury Project plans are to investigate these phenomena further on later flights.

At an altitude of about 200,000 feet, or at the edge of the sensible atmosphere, a relay was actuated at 0.05g. I had intended to be on manual control for this portion of the flight but found myself a few seconds behind. I was able to switch to the manual system and make some controlling motions during this time. We feel that programing for this maneuver is not a serious problem and can be corrected by allowing a little more time prior to the maneuver to get ready. We were anxious to get our money's worth out of the flight and consequently we had a full flight plan. However, it paid off in most cases as evidenced by the volume of data collected on pilot actions.

The reentry and its attendant acceleration pulse of 1lg was not unduly difficult. The functions of observation, motion, and reporting were maintained, and no respiration difficulties were encountered. Here again, the centrifuge training had provided good reference. I noticed no loss of peripheral vision, which is the first indication of "gray-out."

After the acceleration pulse I switched back to the autopilot. I got ready to observe parachute opening. At 21,000 feet the drogue parachute came out on schedule as did the periscope. I could see the drogue and its action through the periscope. There was no abrupt motion at drogue deployment. At 10,000 feet the main parachute came out and I was able to observe the entire operation through the periscope. I could see the streaming action as well as the unreefing action and could immediately assess the condition of the canopy. It looked good and the opening shock was smooth and welcome. I reported all of these events to the control center and then proceeded to get ready for landing.

I opened the faceplate of the helmet and disconnected the hose which supplies oxygen to its seal. I removed the chest strap and the knee restraint straps. I had the lap belt and shoulder harness still fastened. The landing did not seem any more severe than a catapult shot from an aircraft carrier. The spacecraft hit and then flopped on its side so that I was on my right side. I felt that I could immediately execute an underwater escape should it become necessary. Here again, our training period was giving us dividends. I could see the water covering one porthole, I could see the yellow dye marker out the other porthole, and later on, I could see one of the helicopters through the periscope.

The capsule righted itself slowly and I began to read the cockpit instruments for data purposes after impact. I found very little time for that since the helicopter was already calling me. I made an egress as shown in the training movie; that is, I sat on the edge of the door sill until the helicopter sling came my way. The hoist itself was uneventful. At this point, I would like to mention a device that we use on our pressure suits that gives watertight integrity. There is a soft rubber cone attached to the neck ring seal of the suit. When the

suit helmet is on, this rubber is rolled and stowed below the lip of the neck ring seal bearing. With the helmet off, this collar or neck cone is rolled up over the bearing and against the neck of the pilot where it forms a watertight seal. The inlet valve fitting has a locking flapper valve. Thus the suit is waterproof and provides its own buoyancy.

#### POSTFLIGHT DEBRIEFING

The helicopter took me to the aircraft carrier Lake Champlain, where the preliminary medical and technical debriefing commenced. Since no serious physiological defects were noted, only an immediate cursory examination was necessary. The period I spent in talking into a tape recorder at this time with the events fresh in my mind was also a help. I had a chance to report before becoming confused with the "facts."

I went from the carrier to the Grand Bahama Island where I spent the better part of two days in combined medical and technical debriefings. A great deal of data was gathered, and the experience was not unduly uncomfortable. It appears profitable to provide a location where a debriefing of this sort can be accomplished.

It is now our plan to show you a film of the flight taken from the onboard equipment. The film has been taken from the onboard camera and step-printed to real time, and the tape recorder conversations have been synchronized for the entire flight. These two recording mediums were not flight synchronized since there was no requirement for this in data gathering, but they have been ingeniously joined for your benefit.

There are some terms used during this film, which may be confusing. These terms are explained as follows:

CO	pilot prior launch
FREEDOM 7 or 7	pilot after lift-off
CAPCOM	spacecraft communicator in Control Center
STONEY	spacecraft communicator in blockhouse
CTC	spacecraft test conductor in blockhouse
TM	telemetry
CHASE	pilots of the chase planes
INDIAN OCEAN CAPCOM	communicator of a ship in the landing area
CARDFILE 23	relay airplane in the vicinity of the Bahamas

[An onboard film of the flight was introduced at this point.]

In closing I would like to say that the participants in Project Mercury are indeed encouraged by the pilot's abilities to function during the ballistic flight which has just been described. No inordinate physiological change has been observed, and the control exercised before and after the flight overwhelmingly support this conclusion. The Space Task Group is also encouraged by the operation of the spacecraft systems in the automatic mode, as well as in the manual mode. We are looking forward to more flights in the future, both of the ballistic as well as the orbital type.

### MR-3 FLIGHT

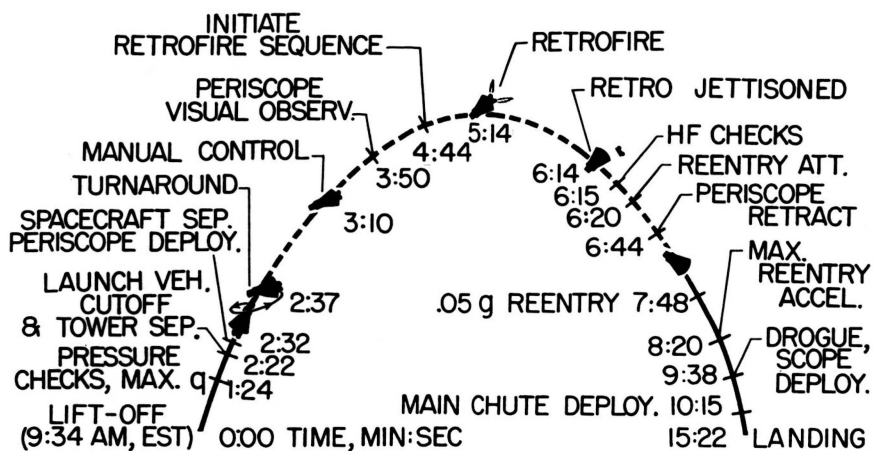

Figure 1.



Figure 2.