

# THE INTERACTION OF THE SOLAR WIND WITH THE INTERSTELLAR MEDIUM

W. I. Axford

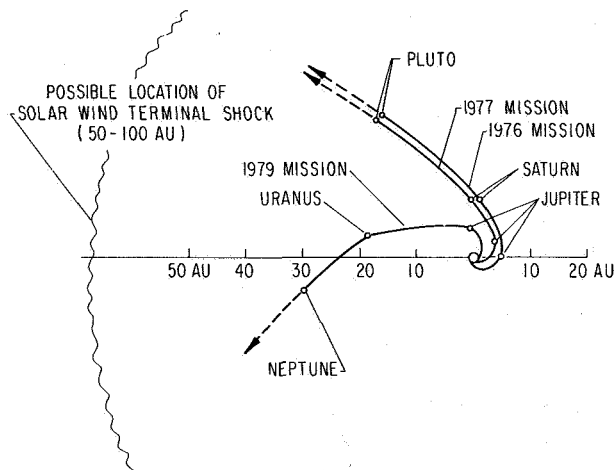
An invited review

## INTRODUCTION

The interaction between the solar wind and the interstellar medium has been a topic of interest for many years [Davis, 1955, 1962; Parker, 1961, 1963; Axford *et al.*, 1963], but progress has been rather slow largely because of the paucity of relevant observations. Recently, however, the situation has changed as a result of the clear evidence for the penetration of interstellar gas into the inner solar system obtained from OGO 5 [Thomas and Krassa, 1971; Bertaux and Blamont, 1971]. Furthermore, the prospect that there will be space probes traveling toward the outer regions of the solar system within a few years (see fig. 1) has created a need for a better understanding of the subject so that the most effective use can be made of the missions.

This review is a survey of the work, both published and unpublished, that has been carried out up to the time of writing. To the best of our knowledge, the bibliography is complete up to mid-1971. First, the expected characteristics of the solar wind, extrapolated from the vicinity of the earth are described, and several simple models are examined for the interaction of the solar wind with the interstellar plasma and magnetic field. The possibility that there is a substantial neutral component of the interstellar gas is ignored. In later sections, we consider various aspects of the penetration of neutral interstellar gas into the solar wind, and describe the dynamic effects of the neutral gas on the solar wind (to the extent that they are understood). Finally, we discuss problems associated with the interaction of cosmic rays with the solar wind.

We briefly summarize here the present status of knowledge concerning the properties of the interstellar medium in the vicinity of the solar system [see, e.g.,



**Figure 1** Spacecraft trajectories for the proposed "Grand Tour" missions to Jupiter-Saturn-Pluto (1976-1977), and Jupiter-Uranus-Neptune (1979). The trajectories carry the spacecraft in the general direction of the projection of the solar apex into the ecliptic plane, the direction in which the distance to the solar wind termination is a minimum. The final portion of the trajectories (dashed) can be varied, since it depends on the last planetary encounter.

Allen, 1963]. The sun is located on the inner edge of the local (Orion) spiral arm at a distance of  $\sim 8$  parsec north of the plane of the galaxy. The solar motion relative to neighboring stars is  $20 \text{ km sec}^{-1}$  in the direction  $\alpha \approx 271^\circ$ ,  $\delta \approx +30^\circ$ , or  $l^{\text{II}} \approx 57^\circ$ ,  $b^{\text{II}} \approx +22^\circ$  (the "solar apex"). The nearest star is more than 1 parsec away, and the mean density of stars in the solar neighborhood is  $\sim 0.057$  solar masses per cubic parsec. Since the region containing the solar wind (the "heliosphere") has dimensions that are at most of the order of  $10^2$ - $10^3$  AU ( $< 10^{-2}$  parsec), and it seems reasonable to assume that stellar winds associated with nearby stars are not significantly more intense than the solar wind, we can be fairly

The author is with the Departments of Physics and Applied Physics and Information Science, University of California, San Diego, La Jolla, California.

sure that the solar wind interacts directly with the interstellar medium and that there is no overlapping of stellar winds in our vicinity. It should be noted that the sun appears to be on the fringes of the Gum nebula; however, according to *Brandt et al.* [1971] it lies some 60 parsecs outside and the local interstellar medium may not be directly affected by the presence of the nebula.

The mean interstellar electron density  $n_e$  in the disc of the galaxy can be determined in two ways: (1) by measurements of low frequency radio wave absorption [*Ellis and Hamilton*, 1966; *Smith*, 1965; *Bridle*, 1969; *Bridle and Venugopal*, 1969; *Alexander et al.*, 1969]; and (2) by measurements of the frequency dispersion of pulsar emissions [*Pilkington et al.*, 1968; *Lyne and Rickett*, 1968; *Habing and Pottasch*, 1968; *Davies*, 1969; *Prentice and Ter Haar*, 1969a,b; *Davidson and Terzian*, 1969; *Mills*, 1969; *Gould*, 1971; *Grewing and Walmsley*, 1971]. The first method yields the quantity  $\langle n_e^2 T_e^{-3/2} \rangle$ , where  $l$  is the distance in the galaxy along the line of sight and  $T_e$  is the electron temperature; this tends to overemphasize the contributions from denser regions [*Gould*, 1971]. The second method yields  $\langle n_e \rangle l$  and thus permit us to estimate  $\langle n_e \rangle$  directly if we know the distance to the pulsar by independent means (as in the case of the Vela and Crab pulsars), or if an estimate can be made of the neutral hydrogen content in the line of sight (e.g., from 21-cm absorption of the pulsar emission, as in the case of CP0329) so that a comparison can be made with 21-cm emission in the same direction. In fact, the interpretation of the observations is not easy because of the confusion introduced by dense HII regions, and the structure associated with the spiral arms of the galaxy. According to *Davidson and Terzian* [1969] the mean electron density in the disc of the galaxy is  $0.03\text{--}0.10 \text{ cm}^{-3}$ . However, the result is model dependent, and according to *Gould* [1971], who notes that the path to the Crab pulsar crosses the interarm region where the density could be low, the local mean electron density in the galactic plane is  $\sim 0.12 \text{ cm}^{-3}$ .

Evidence for the presence of a large-scale interstellar magnetic field arises from observations of (1) the polarization of starlight [*Davis and Greenstein*, 1951; *Mathewson*, 1968]; (2) the polarization of galactic non-thermal radio emission [*Mathewson and Milne*, 1965]; (3) the Zeeman effect at 21-cm wavelength [*Verschuur*, 1968; 1969a,b,c, 1970; *Davies et al.*, 1968]; (4) the Faraday rotation of polarized extragalactic radio sources [*Gardner and Whiteoak*, 1966; *Gardner and Davies*, 1966; *Gardner et al.*, 1967; *van de Hulst*, 1967; *Berge and Seielstad*, 1967; *Mathewson and Nicholls*, 1968]; and (5) the Faraday rotation of pulsar emissions [*Smith*, 1968a,b; *Radhakrishnan et al.*, 1969; *Ekers et al.*, 1969;

*Staelin and Reifenstein*, 1969; *Goldstein and Meisel*, 1969; *Hewish*, 1970], and of other polarized galactic sources [*Morris and Berge*, 1964; *Milne*, 1968]. Of these various types of observation, only the 21-cm Zeeman effect and the pulsar Faraday rotation measurements provide a value for the magnetic field strength, and these refer only to some weighted mean of the line-of-sight component. Magnetic fields of the order of  $10 \mu\text{G}$  have been found in some absorbing clouds; however, it seems likely that the field strength in such clouds is not typical of the interstellar magnetic field as a whole, and is in fact amplified as a result of the contraction of the clouds [*Verschuur*, 1969c]. The pulsar observations provide the most satisfactory results for our purposes since they refer to a region relatively close to the sun. If it is possible to obtain reasonably good values for the rotation measure ( $RM = 0.85 \int n_e \mathbf{B} \cdot d\mathbf{l}$ , with  $B$  in  $\mu\text{G}$  and  $l$  in parsecs) and the dispersion measure ( $DM = \int n_e dl$ ) from the ratio  $RM/DM$ , one can obtain a value of the mean line-of-sight component of  $\mathbf{B}$ , weighted with respect to the electron density. The measured values of  $B_{\parallel}$  range from  $0.7 \mu\text{G}$  to  $3 \mu\text{G}$ , and it seems reasonable therefore to assume that the largest value is representative of the interstellar magnetic field strength. This value is consistent with that found using the mean value of  $n_e$  obtained from pulsar measurements together with the rotation measures of extragalactic sources [*Davies*, 1969]. Furthermore, a magnetic field strength of this order is required to account for the nonthermal galactic radio emission [*Felten*, 1966; *Webber*, 1968; *Goldstein et al.*, 1970a], although there is some uncertainty concerning the unmodulated spectrum of cosmic ray electrons. These and other arguments concerning the interstellar magnetic field have been reviewed by *Burbidge* [1969].

Interstellar atomic hydrogen can be detected by observations of (1) the 21-cm line in emission and absorption [*Kerr and Westerhout*, 1965; *Kerr*, 1968, 1969], including absorption of pulsar emissions [*deJager et al.*, 1968; *Guelin et al.*, 1969; *Gordon et al.*, 1969; *Gordon and Gordon*, 1970; *Hewish*, 1970]; (2) Lyman  $\alpha$  absorption in the ultraviolet spectra of nearby early type stars [*Morton*, 1967; *Jenkins and Morton*, 1967; *Carruthers*, 1968, 1969, 1970a; *Morton et al.*, 1969; *Jenkins et al.*, 1969; *Smith*, 1969; *Wilson and Bokseberg*, 1969]; (3) the absorption of soft X rays from discrete sources [*Gorenstein et al.*, 1967; *Fritz et al.*, 1968; *Rappaport et al.*, 1969; *Grader et al.*, 1970]; and (4) the backscattering of solar Lyman  $\alpha$  [*Chambers et al.*, 1970; *Barth*, 1970a; *Thomas and Krassa*, 1971; *Bertaux and Blamont*, 1971]. Observations of 21-cm radio emission suggest that the mean

density of neutral hydrogen in the vicinity of the sun is  $\langle n_{\text{H}} \rangle \approx 0.7 \text{ cm}^{-3}$ . The 21-cm absorption measurements yield an estimate for  $\langle n_{\text{H}} \rangle l$  (where  $l$  is the distance to the source), provided one assumes a value for the spin temperature  $T_s$ ; it is generally assumed that  $T_s \approx 100^\circ \text{ K}$ . However, discrete sources such as pulsars do not show the absorption one would expect on the basis of measurements made using extended sources. This suggests that the interstellar medium may have a "raisin pudding" structure, with most of the 21-cm absorption occurring in small, dense clouds with low spin temperature [Clark, 1965; Kerr, 1969; Gordon and Gordon, 1970]. The ultraviolet absorption measurements show much the same effect; that is, the column density obtained from Lyman  $\alpha$  absorption lines in the spectra of early-type stars is usually, but not always, about one-tenth the value obtained from 21-cm emission measurements made in the same region of the sky [Carruthers, 1970a for a review of this topic]. Where Lyman  $\alpha$  and 21-cm absorption measurements have been made for essentially the same path (between the sun and the Orion nebula) the results suggest that  $T_s \approx 20^\circ$  [Carruthers, 1969].

There seems to be a discrepancy between the 21-cm emission and Lyman  $\alpha$  absorption measurements that needs to be resolved. Since the 21-cm measurement refers to the entire line of sight, it is possible that the answer is simply that there is a low density ( $n_{\text{H}} \approx 0.1 \text{ cm}^{-3}$ ) region near the sun, which affects the absorption measurements in at least some directions. In contrast, Jenkins *et al.* [1969] have reported values of  $\langle n_{\text{H}} \rangle$  from Lyman  $\alpha$  absorption measurements that exceed those obtained from 21-cm emission measurements. It is possible that the 21-cm emission process is not completely understood [Fischel and Stecher, 1967; Storer and Sciama, 1968]; however, more detailed comparisons are needed before we can be sure that a real discrepancy exists. The soft X-ray absorption measurements indicate that in the direction of the Crab nebula,  $\langle n_{\text{H}} \rangle \approx 0.3 \text{ cm}^{-3}$  [Rappaport *et al.*, 1969; Grader *et al.*, 1970], which is consistent with the 21-cm measurements. However, in the direction of ScoXR-1, where Jenkins *et al.* [1969] report  $\langle n_{\text{H}} \rangle \approx 1.4\text{--}3.0 \text{ cm}^{-3}$ , the soft X-ray absorption measurements are somewhat contradictory [Fritz *et al.*, 1968; Grader *et al.*, 1970]. As far as the region in the immediate vicinity of the sun is concerned, recent measurements of the intensity of backscattered solar Lyman  $\alpha$  can be interpreted as implying that  $\langle n_{\text{H}} \rangle \approx 0.03\text{--}0.12$ , depending on the model used [Blum and Fahr, 1970a; Thomas, 1971]. This is a relatively low value, but it is not inconsistent with other

observations (all of which refer to path lengths of the order of 100 parsecs or more), and indeed is quite consistent with most of the ultraviolet absorption measurements.

It has been conjectured that the interstellar gas might contain a significant fraction of molecular hydrogen [Gould and Salpeter, 1963; Gould *et al.*, 1963], and in cool, dense, dusty regions where the presence of a number of radicals has been detected from their radio emissions, this is to be expected [Hollenbach *et al.*, 1971]. Ultraviolet absorption measurements failed to show the presence of molecular hydrogen initially [Carruthers, 1967, 1970a]; however, recent measurements indicate that in some regions the concentrations of molecular and atomic hydrogen are comparable [Werner and Harwit, 1968; Carruthers, 1970b]. In the vicinity of the sun, however, where the atomic hydrogen density is quite low, and there is no evidence for dust, it is to be expected that molecular hydrogen is not an important constituent of the interstellar gas.

In HII regions, the temperature of the interstellar gas is usually  $5\text{--}10 \times 10^3 \text{ }^\circ \text{ K}$ , and is determined by a balance between heating due to photoelectrons, and cooling due to recombination, collisional excitation, and free-free transitions [Spitzer, 1968a,b]. In HI regions, the situation is more complex; taking into account the effect of heating by low-energy cosmic rays [Hayakawa *et al.*, 1961; Field, 1962; Spitzer and Tomasko, 1968; Pikel'ner, 1968] and cooling by collisional excitation it is found that two thermally stable states are possible, one with neutral hydrogen densities of the order of  $0.1 \text{ cm}^{-3}$ ,  $T \approx 10^4 \text{ }^\circ \text{ K}$ , and  $n_e/n_{\text{H}} \approx 0.1$ , and the other with neutral hydrogen densities of the order of  $10 \text{ cm}^{-3}$ ,  $T \lesssim 300^\circ \text{ K}$ , and  $n_e/n_{\text{H}} \approx 10^{-3}$  [Field *et al.*, 1969]. There are, however, some difficulties associated with cosmic ray heating [Werner *et al.*, 1970], especially in view of our lack of knowledge of the galactic cosmic ray spectrum at low energies [Goldstein *et al.*, 1970b; Gleeson and Urch, 1971a]. Limits placed on the low energy cosmic ray flux by indirect observations [Habing and Pottasch, 1967; Greenberg, 1969; Fowler *et al.*, 1970; Solomon and Werner, 1970] appear to make cosmic ray heating ineffective. It has been suggested that heating by soft X rays may be more important [Silk and Werner, 1969; Sunyaev, 1969; Werner *et al.*, 1970], and there are observational means of distinguishing between the two modes of heating [Silk and Brown, 1971; Bergeron and Souffrin, 1971; Habing and Goldsmith, 1971]. In any case, there is evidence from 21 cm and other observations in support of a two-component model of interstellar HI regions with properties as described above [Clark, 1965; Radhakrishnan and

Murray, 1969; Riegel and Jennings, 1969; Hjellming et al., 1969; Rohlfs, 1971], and this would also be compatible with the Lyman  $\alpha$  absorption measurements [Jenkins, 1970].

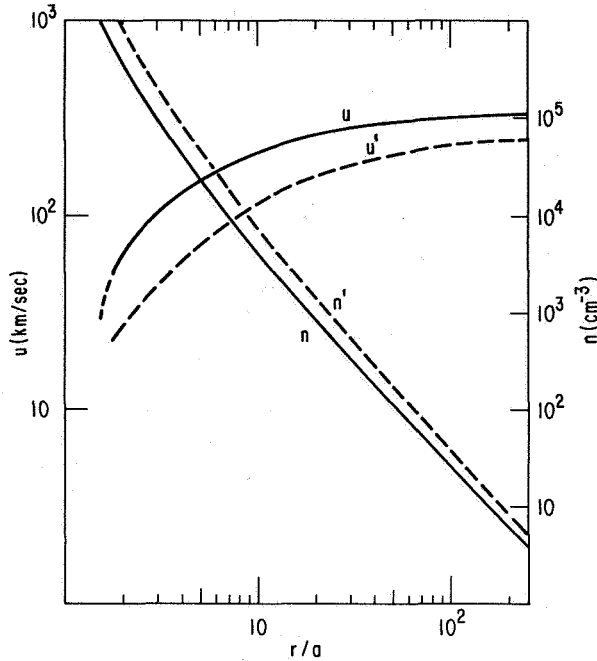
It is to be expected that the interstellar gas has a velocity component of  $20 \text{ km sec}^{-1}$  from the direction of the solar apex. In addition, however, there is likely to be a component associated with a general streaming of the interstellar gas relative to the stellar population, perhaps associated with the "density wave" structure described by Lin et al. [1969] [see also Humphreys, 1971; and Burton, 1971], and a "turbulent" component that is evident from observations of interstellar absorption lines [Munch, 1968] and 21-cm observations [Kerr, 1968, 1969; Goldstein and MacDonald, 1969]. Since the "streaming" and "turbulent" components of the interstellar gas velocity can easily amount to  $10 \text{ km sec}^{-1}$  or more, we should not be surprised if the direction of relative motion between the sun and the gas differs substantially from the direction of the solar apex. Indeed the OGO 5 measurements of scattered solar Lyman  $\alpha$  suggest that the direction of relative motion lies close to the ecliptic plane [Thomas and Krassa, 1971; Bertaux and Blamont, 1971; Thomas, 1971], although as pointed out by Blum and Fahr [1971] this may result in part from the asymmetry of the solar Lyman  $\alpha$  emission.

A first estimate of the radius of the region in which the solar wind is supersonic can be obtained by equating the solar wind ram pressure to the pressure of the interstellar gas and magnetic field (see p. 616). On the basis of the observations described above, the radius is nominally of the order of 100 AU if the effects of neutral interstellar gas, the interplanetary magnetic field, and cosmic rays are neglected. This is well beyond the orbit of Pluto, the most distant of the known planets, and it is probably too far to be considered as a major objective of the proposed Outer Planet Grand Tour missions (fig. 1). However, according to the analyses presently available, all the effects that have been neglected in this estimate tend to reduce the distance by perhaps 10 to 15 percent, and hence together they could give rise to a significant and favorable change in our first estimate. In figure 1, therefore, we have shown the solar wind termination as occurring somewhere in the region 50 to 100 AU from the sun, with  $\sim 50$  AU being a not unrealistic possibility. It is recommended that a major effort be made to improve our understanding of this problem, and to provide better values for the various parameters involved.

## THE INTERPLANETARY MEDIUM BEYOND THE ORBIT OF EARTH

To date, *in situ* observations of the interplanetary medium have been carried out only in a very restricted region lying close to the ecliptic, between the orbits of Venus (0.7 AU heliocentric distance) and Mars (1.5 AU). Extensive reviews of these observations have been given by Hundhausen [1968a, 1970], Axford [1968], Ness [1967, 1968], Lüst [1967], Davis [1970], and Brandt [1970]. For information concerning other regions we have had to rely on inferences drawn from less direct observations, notably those involving comets, radio techniques, and cosmic rays [Axford, 1968]. Within the next decade we can reasonably hope for a considerable extension of the region of *in situ* observations as a result of the planned missions to the vicinity of Mercury, to Jupiter and the outer planets, and possibly out of the ecliptic following a Jupiter swingby. In this section we consider the extrapolation of theoretical models of the interplanetary medium into the unexplored regions at great distances from the sun, neglecting external influences (notably those due to the neutral interstellar gas).

From the theoretical point of view the solar wind is probably understood rather well in a qualitative sense, although the complexity of the phenomenon is such that we are unlikely ever to be able to produce a complete, quantitative model. Recent reviews of theoretical work have been given by Parker [1965a, 1969] and Holzer and Axford [1970a]. As a result of the lack of observations we must rely on theoretical models, even if they are oversimplified, to extrapolate our knowledge of the solar wind to heliocentric distances beyond the orbit of Mars, and to high heliolatitudes. The results of calculations based on one such model are shown in figures 2 and 3 [Leer and Axford, 1971]. In this model, it is assumed that the solar wind velocity is radial everywhere, and that the protons are heated by hydromagnetic waves emitted by the sun in a region with a characteristic radius of  $5 R_{\odot}$  [Barnes, 1968, 1969]. Otherwise, it is assumed that the interplanetary magnetic field does not affect the dynamics apart from its effects on the electron thermal conductivity and on the proton temperature anisotropy. Whatever assumptions are made concerning the processes that take place near the sun (in  $r \lesssim 0.5$  AU), it is to be expected that at large distances from the sun ( $r \gtrsim 1$  AU), the predictions of any steady flow model are essentially as shown in figure 2 provided the effects of the interstellar medium are not taken into account. In particular the solar wind speed is very nearly constant and the number density varies inversely as  $r^2$  beyond  $r \approx 1$  AU.



**Figure 2** Variation of the solar wind number density  $n$  and radial velocity  $u$  with radial distance from the sun in units of solar radii  $a$ , according to the model of Leer and Axford [1971]. The dashed lines refer to the case in which there is no heat input [Hartle and Sturrock, 1968].

The interplanetary magnetic field, which is controlled by the solar wind, by the rotation of the sun, and by conditions in the solar photosphere, should be such that at large distances the field lines form conical Archimedean spirals in the manner described by Parker [1958, 1963]; the spirals are determined by the intersection of the surfaces

$$r = \frac{u}{\Omega} (\phi - \phi_0) \quad \theta = \theta_0 \quad (1)$$

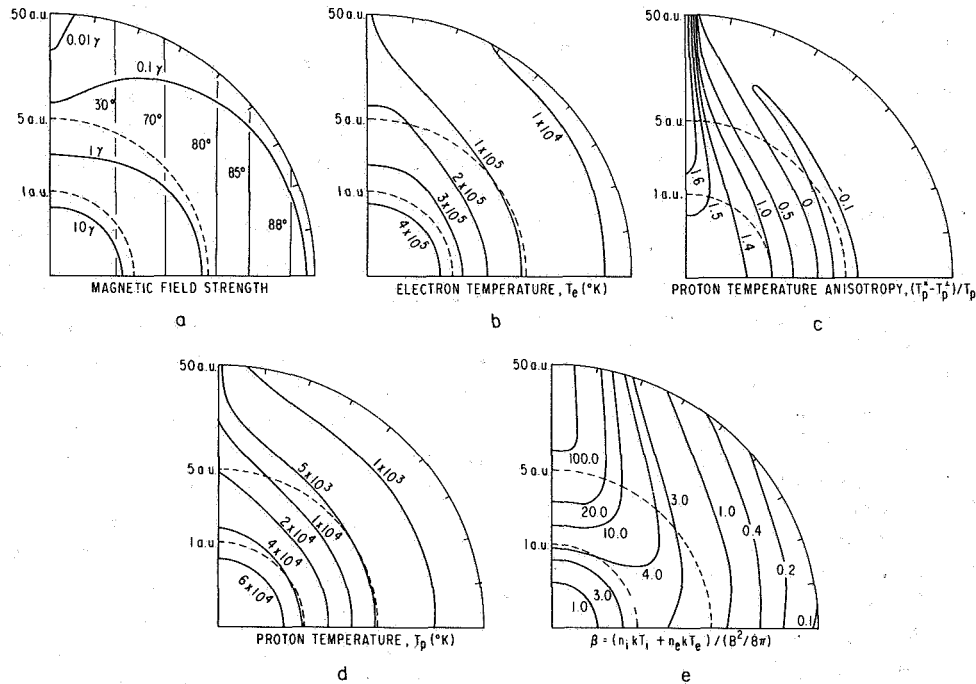
where  $u$  is the solar wind speed,  $\Omega$  is the angular velocity of the sun, and  $(r, \theta, \phi)$  are spherical polar coordinates. The angle made by the spiral relative to the radial direction (the "garden hose" angle) is given by

$$\psi = \tan^{-1} \left( \frac{r\Omega \sin \theta}{u} \right) \quad (2)$$

The garden hose angle is shown as a function of radial distance and heliolatitude in figure 3(a). The components of the magnetic field can be written

$$(B_r, B_\theta, B_\phi) = \left( \frac{B_0 a^2}{r^2}, 0, \frac{B_0 a^2 \Omega \sin \theta}{ru} \right) \quad (3)$$

where  $B_0$  is the field strength at the corresponding point at the surface of the sun ( $r = a$ ). The magnetic field strength is also shown as a function of radial distance



**Figure 3** Contours of various quantities in the interplanetary medium in a polar plot in which the abscissa lies in the ecliptic plane and the ordinate coincides with the axis of rotation of the sun, according to the model of Leer and Axford [1971].

and heliolatitude in figure 3(a). It should be noted that in the ecliptic plane ( $\theta = \pi/2$ ) the direction of the magnetic field becomes essentially azimuthal at large distances from the sun (i.e.,  $\psi > 80^\circ$  for  $r > 5$  AU), and the field strength varies as  $1/r$ . In contrast, in the polar regions ( $\theta = 0, \pi$ ) the magnetic field lines are radial and the field strength varies as  $1/r^2$ . As a result of this behavior the ratio of solar wind dynamic pressure to the magnetic field pressure

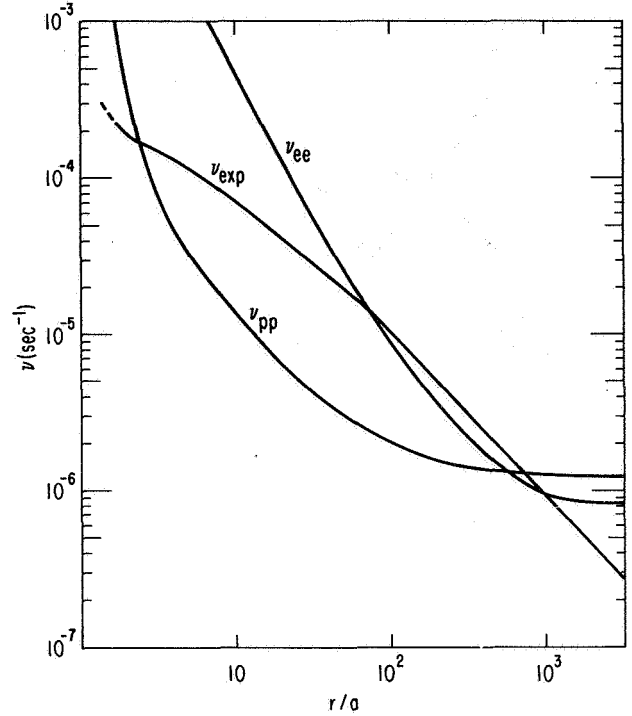
$$\beta_v = \frac{8\pi n \bar{m} u^2}{B^2} \quad (4)$$

tends to a constant value ( $\beta_v \approx 500$ ) at large values of  $r$  near the ecliptic plane, but increases as  $r^2$  at high heliolatitudes. Here and elsewhere, we have taken the mean mass of the solar wind ions  $\bar{m}$  to be  $2 \times 10^{-24}$  gm to allow for the presence of helium and heavier elements.

Wherever the garden hose angle is small the electron temperature is dominated by heat conduction; hence

$$T_e \approx T_{e0} \left( \frac{r}{r_0} \right)^{-2/7} \quad (5)$$

where  $T_{e0}$  is the electron temperature at some reference level  $r = r_0$ . As the direction of the magnetic field becomes more azimuthal however, the effects of adiabatic expansion become more important, and ultimately  $T_e \propto r^{-4/3}$ . The electron temperature is shown as a function of heliocentric distance and heliolatitude in figure 3(b). As shown in figure 4, the electron collision frequency is everywhere comparable with, or greater than, the characteristic expansion rate ( $v_{\text{exp}} = -(u/n)(dn/dr)$ ), and hence we do not expect that the electron temperature should be anisotropic anywhere under normal conditions. In contrast the proton collision frequency may be less than  $v_{\text{exp}}$  beyond a few solar radii and remain so until the magnetic field direction becomes essentially azimuthal. Thus, we can expect the proton temperature to be anisotropic, since when it approaches a constant speed the expansion of the solar wind takes place anisotropically (the radial dimension of an element of fluid remains unchanged, while the transverse dimensions expand in proportion to  $r$ ). In regions where the magnetic field direction is essentially radial we should find  $T_p^{\parallel} > T_p^{\perp}$ , while in regions where the field is essentially azimuthal we should find that  $T_p^{\parallel} \propto 1/r^2$ ,  $T_p^{\perp} \propto 1/r$  so that eventually  $T_p^{\perp} > T_p^{\parallel}$ . However, in the latter case the mean temperature  $T_p = (T_p^{\parallel} + 2T_p^{\perp})/3$  may decrease sufficiently rapidly for the proton collision frequency to become comparable to the expansion rate



**Figure 4** The characteristic expansion rate ( $v_{\text{exp}}$ ), the electron collision frequency ( $v_{ee}$ ), and the proton collision frequency ( $v_{pp}$ ) in the ecliptic plane as functions of distance from the sun in units of solar radii, according to the model of Leer and Axford [1971].

once more, so that collisions suppress the anisotropy and  $T_p \propto r^{-4/3}$ . These effects are all evident in figures 3(c) and 3(d), which show the proton temperature anisotropy and the mean proton temperature, respectively, as functions of heliocentric distance and heliolatitude.

The model from which the above description of the behavior of the solar wind is drawn involves several assumptions that are not strictly valid. The most important of these is that the flow is assumed to be steady and (near the sun) spherically symmetric. Unsteady flow may affect the behavior of the solar wind at great heliocentric distances since the interaction of fast and slow streams beyond the orbit of the earth can result in a mean flow that is considerably hotter than suggested in figure 3(d), with correspondingly smaller proton collision frequencies and hence a larger temperature anisotropy than suggested in figure 3(c). Departures from spherical symmetry that do not involve unsteady effects must occur since at any given time solar active regions tend to be concentrated in latitude; however, apart from producing a variation with heliolatitude of the asymptotic solar wind speed and perhaps slightly changing the temperature contours in figures 3(b), (c), and (d), it is

unlikely that qualitatively significant effects can arise in this way.

The effects on the solar wind of the interplanetary magnetic field and of the rotation of the sun have been neglected in the model calculation apart from the control exerted by the field on the electron thermal conductivity and on the proton temperature anisotropy. Close to the sun, however, where the solar wind speed is comparable with or less than the Alfvén speed, the magnetic field is capable of inducing significant nonradial motions of the plasma [Weber and Davis, 1967]. Indeed, it seems likely that the solar wind has almost the full angular velocity of the sun out to perhaps  $20 R_{\odot}$ . This rotational component of the solar wind velocity should decay inversely with heliocentric distance and become negligible at the orbit of earth and beyond. A meridional component of the solar wind velocity should be induced near the sun, causing the magnetic field to bend toward the solar equatorial plane as suggested by observations of radio sources near the sun [Hewish and Wyndham, 1963; Slee, 1966]. Accordingly, the solar wind in the polar regions must expand more rapidly than spherical geometry would suggest, and hence it can reach a higher velocity at a given heliocentric distance than it would achieve at the same distance in the solar equatorial plane. It seems possible that the observations of Dennison and Hewish [1967], which suggest that the solar wind speed increases at high heliolatitudes, could be explained in this way. It is unlikely, however, that any of these effects lead to substantial departures from the description given in figures 2 and 3 of the behavior of the solar wind at large distances from the sun.

It has been assumed in the previous discussion that the solar wind can be considered to be a perfect electrical conductor, and hence the magnetic field behaves as if it were frozen into the plasma. Field lines cannot reconnect in these circumstances, and hence adjacent regions of inward- and outward-directed fields are separated by neutral sheets that spiral away from the sun indefinitely in the same manner as the field lines themselves. These neutral sheets can be identified with "sector boundaries" [Wilcox and Ness, 1965; Wilcox, 1968], and their observed persistence can be taken to indicate that the configuration is stable against reconnection in the sense that this would not lead to a state of lower energy [Axford, 1967]. As shown in figure 3(e), the parameter  $\beta$ , defined as

$$\beta = \frac{8\pi nk(T_p + T_e)}{B^2} \quad (6)$$

is an increasing function of heliocentric distance in regions where the magnetic field lines are almost radial (i.e.,  $\beta \propto r^{12/7}$ ) and a decreasing function of heliocentric distance in regions where the field lines are almost azimuthal and the plasma is cooling adiabatically ( $\beta \propto r^{-4/3}$ ). If the stability of neutral sheets against reconnection is determined by  $\beta$ , it seems possible that the sector boundaries may begin to break up somewhere beyond the orbit of earth where  $\beta$  is small [cf. Davis, 1970]. This process may be aided by the divergence of the flow, which causes elements of plasma in the neutral sheet to drift apart where the magnetic field is azimuthal; in contrast, near the sun where the field is nearly radial, the separation between elements of plasma in the neutral sheet stays almost constant. It is emphasized that if such an instability should occur it is likely to be of a macroscopic rather than a microscopic nature, since it has been shown that quasilinear diffusion can easily stabilize a neutral sheet against microscopic tearing instabilities [Biskamp et al., 1970].

We have neglected the possible effects of plasma instabilities associated with anisotropies of the velocity distributions of solar wind particles. Perhaps the most important of these is the instability resulting from the asymmetry of the electron distribution function associated with heat conduction [Forsslund, 1970]; this can reduce the effective electron thermal conductivity and also alter its dependence on temperature, so that the distribution of electron temperature could be significantly different from that shown in figure 3(b). Other instabilities may be associated with anisotropy of the proton temperature [Parker, 1963; Kennel and Scarf, 1968; Hollweg and Volk, 1970]; however, the anisotropy is not observed to be large [Hundhausen et al., 1967; Eviatar and Schulz, 1970] nor is it expected to be so (see, e.g., fig. 3(c)). Thus any instabilities that may result from this source might be expected to produce only a rather low level of plasma turbulence. On the other hand, there is at least indirect evidence for important instabilities involving the protons and other ions, in that the heavier ions usually appear to have the same bulk speed, but a higher temperature than the protons [Snyder and Neugebauer, 1964; Robbins et al., 1970; Bame et al., 1970; Egidi et al., 1970]. Furthermore, it is possible that the solar wind ions are heated via the electrons, rather than directly as we have assumed, in which case some form of plasma turbulence must be generated to provide sufficiently high electron-proton energy exchange rates and to reduce the proton temperature anisotropy to the observed low values [Nishida, 1969; Toichi, 1971]. As far as the solar wind at great distances is concerned, plasma turbulence may play an important

role in providing an effective interaction with ions of interstellar origin [Holzer and Axford, 1971].

As a first approximation, the composition of the solar wind might be expected to be that of material having something like the cosmic abundance of elements in ionization equilibrium at the temperatures of  $1-2 \times 10^6$  °K that exist in the solar corona [cf. Holzer and Axford, 1970b]. The observed variability of the helium abundance in the solar wind [Robbins et al., 1970; Hundhausen, 1970] and some theoretical work [Jokipii, 1966a; Geiss et al., 1970a] suggest that the approximation might not be wholly adequate, although there is no indication that it is seriously wrong [Bame et al., 1970; Geiss et al., 1970b]. As pointed out by Hundhausen et al. [1968], the ionization state of the solar wind plasma is essentially "frozen" at a heliocentric distance of at most a few solar radii, where the electron temperature is not substantially less than it is in the lower corona. At great distances from the sun, radiative recombination times are very long indeed and one cannot expect this process to play an important role in determining the dynamics of the solar wind. For example, for an ion with charge  $Ze$  in the region beyond  $r = 1$  AU where  $T_e \propto r^{-4/3}$ , the radiative recombination time  $\tau_{\text{rec}}$  [Allen, 1963] is such that

$$\tau_{\text{rec}} \nu_{\text{exp}} \approx \frac{3 \times 10^9 T_e^{3/4} u |dn/dr|}{Z^2 n^2} \approx \frac{2 \times 10^7}{Z^2} \quad (7)$$

which is a large number even for the more highly ionized constituents ( $Z \approx 15$ ). In high latitude regions where  $T_e \propto r^{-2/7}$ ,  $\tau_{\text{rec}} \nu_{\text{exp}}$  is larger and increases with increasing  $r$ . Nevertheless, changes in the state of ionization may occur as a result of neutralization of solar wind ions on interplanetary dust grains [Bandermann and Singer, 1965; Banks, 1971], evaporation of the dust grains themselves followed by photoionization [Banks, private communication, 1971], evaporation of material from comets and planets, and most importantly the penetration of interstellar gas into the inner solar system, as discussed in a later section (p. 623). The suggestion that the solar wind should contain a substantial (solar) neutral component [Akasofu, 1964; Wax et al., 1970] encounters difficulties [Brandt and Hunten, 1966; Cloutier, 1966; Axford, 1969], and would lead to a much larger flux of  $\text{He}^+$  ions than is observed.

#### INTERACTION OF THE SOLAR WIND WITH IONIZED INTERSTELLAR GAS AND MAGNETIC FIELD

Here we consider the nature of the interaction between the solar wind and the local interstellar medium for the case where the latter is part of an *HII* region containing

only a negligible neutral component. Many of the essential features of this interaction were discussed by Davis [1955, 1962] in his work concerning the effect of the solar wind cavity on cosmic rays. A more detailed analysis was carried out by Parker [1961], with the assumption that the effects of the interplanetary (solar) magnetic field can be neglected. This discussion is based largely on Parker's work [1963].

It was pointed out by Clauser [1960] and Weymann [1960] that the solar wind should undergo a shock transition so that it can come into equilibrium with the interstellar medium [McCrea, 1956; Holzer and Axford, 1970a]. The situation is closely analogous to the discharge from a Laval nozzle into the atmosphere [Liepmann and Roshko, 1957], and to the flow of water over a dinner plate (see appendix). In the absence of a neutral component of the interstellar gas, a shock must always exist if the pressure exerted by the interstellar medium is finite. The suggestion made by Faus [1966] that the solar wind might terminate as a "free expansion" is incorrect; indeed, the solar wind itself can be regarded as a free expansion within the shock transition.

If the effects of the interplanetary magnetic field are neglected, and the solar wind is assumed to behave as a perfect fluid with specific heat ratio  $\gamma = 5/3$ , then since the Mach number ( $M$ ) of the supersonic solar wind is very large at the expected position of the shock transition, the shock is "strong." In this case the Rankine-Hugoniot relations yield

$$u_{n2} \approx \frac{\gamma-1}{\gamma+1} u_{n1}, \quad \rho_2 \approx \frac{\gamma+1}{\gamma-1} \rho_1, \quad p_2 \approx \frac{2}{\gamma+1} \rho_1 u_{n1}^2 \quad (8)$$

and

$$M_{n2}^2 = \frac{(\gamma-1)M_{n1}^2 + 2}{2\gamma M_{n1}^2 - (\gamma-1)} \approx \frac{\gamma-1}{2\gamma} \quad (9)$$

Here subscripts 1 and 2 denote conditions on the upstream (supersonic) and downstream (subsonic) sides of the shock, respectively, and the subscript  $n$  indicates that the component of velocity normal to the shock is involved;  $p$  is the total pressure, and  $\rho = n\bar{m}$  is the mass density of the gas. In the subsonic region beyond the shock, the Bernoulli equation holds along each streamline:

$$\frac{1}{2} u^2 + \frac{\gamma}{\gamma-1} \frac{p}{\rho} = \frac{\gamma}{\gamma-1} \frac{p_s}{\rho_s} \quad (10)$$

together with



$$\frac{p}{\rho^\gamma} = \frac{p_s}{\rho_s^\gamma} \quad (11)$$

where the subscript  $s$  denotes the stagnation value ( $u = 0$ ). On combining equations (10) and (11) and using the definition  $M^2 = u^2/c^2 = \rho u^2/\gamma p$ , the following equations can be obtained for  $p$ ,  $\rho$ ,  $c^2$ , and  $T$ :

$$\frac{c^2}{c_s^2} = \frac{T}{T_s} = \left(1 + \frac{\gamma-1}{2} M^2\right)^{-1} \quad (12)$$

$$\frac{\rho}{\rho_s} = \left(1 + \frac{\gamma-1}{2} M^2\right)^{-1/(\gamma-1)} \quad (13)$$

$$\frac{p}{p_s} = \left(1 + \frac{\gamma-1}{2} M^2\right)^{-\gamma/(\gamma-1)} \quad (14)$$

It is evident from (9) that  $M^2$  is small on the subsonic side of the shock transition, and if it remains small it is permissible to neglect terms  $O(M^4)$ , so that (10) reduces to

$$\frac{1}{2} \rho_s u^2 + p = p_s \quad (15)$$

Also from (13) we see that  $\rho = \rho_s + O(M^2)$ , so that if  $M^2 \ll 1$  the flow can be considered as being incompressible.

In general the shock is not spherical, and hence the flow in the subsonic region contains vorticity, and the stagnation pressure is not the same along all streamlines. However, for streamlines that lead to stagnation points at the interface between the solar plasma and the interstellar medium, the conditions for equilibrium require that  $p_s = p_o$ , where  $p_o$  is the local pressure of the interstellar gas and magnetic field. In the simple configurations of interest, these streamlines are normal to the shock and hence  $u_{n1} = u_1$  (the solar wind speed on the supersonic side of the shock). For these streamlines it can be deduced from equations (8), (9), and (10) that

$$\rho_1 u_1^2 = n_1 \bar{m} u_1^2 = \frac{\gamma+1}{2} \left[ \frac{4\gamma}{(\gamma+1)^2} \right]^{\gamma/(\gamma-1)} p_o = K p_o \quad (16)$$

where, for  $\gamma = 5/3$ ,  $K \approx 1.13$ . Since  $n_1 = n_e e^2/r_s^2$ , where  $r_s$  is the radial distance to the shock and the subscript  $e$  denotes quantities evaluated at the orbit of earth ( $r_e = 1$  AU), this equation can be used to determine  $r_s$ . Note that this should be expected to be the minimum distance to the shock, and that  $r_s$  may be substantially different on other streamlines.

Let us consider the case in which the interstellar gas is at rest with respect to the sun and there is no interstellar magnetic field. The configuration is spherically symmetric, and hence (16) must apply to all streamlines if we interpret  $p_o$  as the pressure of the interstellar medium (and therefore of the solar wind) at infinity. Since the Mach number in the subsonic region can only decrease with heliocentric distance ( $M^2 < M_2^2 \approx 0.2$ ), the approximation of incompressibility must be quite accurate. Hence, from mass conservation we obtain

$$u = u_2 \left( \frac{r_s}{r} \right)^2 \quad r > r_s \quad (17)$$

and thus at large distances the sun would appear to be a point source of incompressible fluid.

Next let us consider the case in which there is an interstellar magnetic field which is uniform and has strength  $B_o$  at great distances from the sun. We generalize Parker's [1963] treatment of this problem by the inclusion of static interstellar gas, which exerts a uniform pressure  $p_g$ , and also by allowing for the effects of compressibility in the region of subsonic solar wind flow. It is assumed that the magnetic scalar potential in the external region (fig. 5) is given approximately by

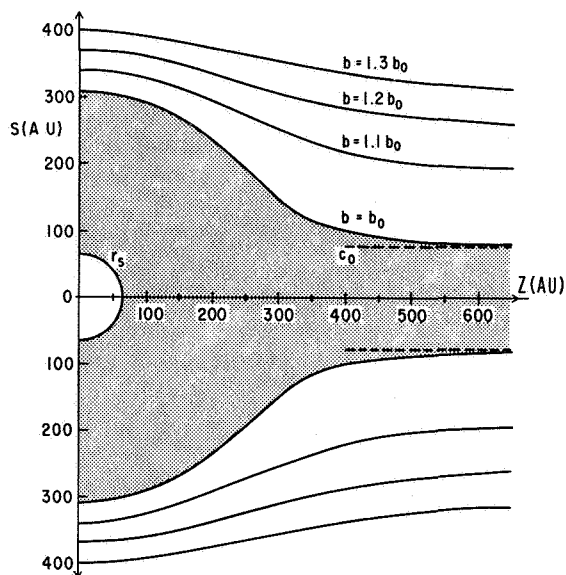
$$\Psi_m = -[(1/2)l^3/r^2 + r] B_o \cos \theta \quad (18)$$

where  $(r, \theta, \phi)$  are spherical polar coordinates with  $\theta = 0$  the axis of symmetry, and  $l$  is the radius of the diamagnetic sphere that would produce the same external field. The magnetic field lines are given by

$$\left[ \left( \frac{r}{b} \right)^3 - \left( \frac{l}{b} \right)^3 \right] \sin^2 \theta = \left[ 1 - \left( \frac{l}{b} \right)^3 \right] \left( \frac{r}{b} \right) \quad (19)$$

where  $r = b$  is the radial distance to the point where the field line intersects the plane  $\theta = \pi/2$ . If the interface between the interstellar medium and the solar wind is determined by (19) with  $b = b_o$ , then at large distances from the sun ( $z = r \cos \theta$  large) the distance of the interface from the axis of symmetry is given by

$$c_o = b_o \left[ 1 - \left( \frac{l}{b_o} \right)^3 \right]^{1/2} \quad (20)$$



**Figure 5** Calculated shape of the region of subsonic solar wind flow (shaded), for the case when the solar wind plasma is entirely confined by a uniform interstellar magnetic field. The solar wind is supersonic in  $r < r_s$ , and exits in the  $\pm z$  directions to infinity. The configuration of the interstellar magnetic field is indicated by some sample field lines in the outer region. The parameters used in this example are as follows:  $B_g = 6\mu G$ ,  $n_s = 0.05 \text{ cm}^{-3}$ ,  $T_g = 10^4 \text{ }^\circ K$ , with  $B_e = 3 \times 10^{-5} G$ ,  $\rho_e = 10^{-23} \text{ gm cm}^{-3}$ ,  $u_e = 400 \text{ km sec}^{-1}$ .

The condition of pressure balance at the stagnation line  $r = b$ ,  $\theta = \pi/2$ , yields

$$p_s = \frac{B_0^2}{8\pi} \left[ 1 + \left( \frac{1}{2} \right) \left( \frac{l}{b_0} \right)^3 \right]^2 + p_g = \frac{\rho_1 u_1^2}{K} \quad (21)$$

Similarly, along the interface of the exit channels, where  $M^2 \rightarrow M_\infty^2$  as  $z \rightarrow \infty$ , we require for pressure equilibrium that

$$p_s \left( 1 + \frac{\gamma-1}{2} M_\infty^2 \right)^{-\gamma/(\gamma-1)} = \frac{B_0^2}{8\pi} + p_g \quad (22)$$

Finally, from mass conservation, and assuming that the flow in the exit channels becomes uniform as  $z \rightarrow \infty$ ,

$$2\pi c_0^2 (\gamma p_s \rho_s)^{1/2} M_\infty \left( 1 + \frac{\gamma-1}{2} M_\infty^2 \right)^{-1/2(\gamma+1)/(\gamma-1)} = Q \quad (23)$$

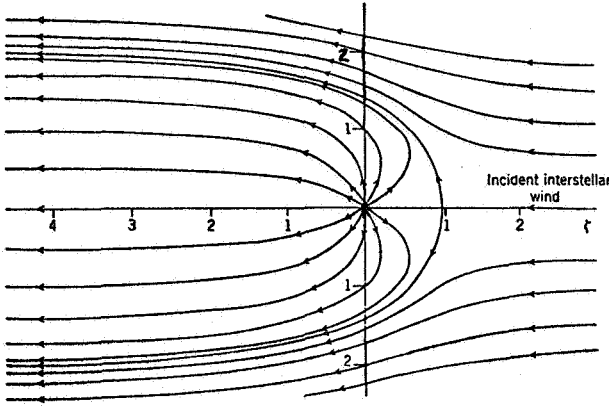
where  $Q$  is the total solar wind mass flux. Given  $B_0$ ,  $p_g$ ,  $M_\infty$ , and the parameters characterizing the supersonic solar wind, we can solve equations (20) through (23) for  $c_0$ ,  $b_0$ ,  $r_s$ , and  $l$ . As in the analogous problem of the flow due to a point source in a rotating fluid [Barua, 1955], it is necessary to specify the exit conditions to obtain a unique solution. In the case of the solar wind, the appropriate condition would seem to be that the fluid should escape freely to infinity, and hence we have taken  $M_\infty^2 = 1$  together with reasonable values of  $B_0$  and  $p_g$  to obtain the solution shown in figure 5.

The above solutions are likely to be inadequate as representations of the actual interaction between the solar wind and the interstellar medium, since any relative motion between the sun and the interstellar gas must cause the solar wind plasma in the subsonic region to be blown away. This effect is illustrated in the third problem treated by Parker [1961]: the case in which there is no interstellar magnetic field but a steady interstellar wind having a small Mach number relative to the sun. The solution to this problem is obtained easily if it is assumed that the solar wind can be replaced by a point source of incompressible fluid, and that the interstellar gas can also be considered as being incompressible. On combining the scalar velocity potentials for a source and a uniform flow, the streamlines of the resulting flow are found to be given by

$$\frac{z}{(z^2 + s^2)^{1/2}} = \frac{s^2}{2r_0^2} + C \quad (24)$$

in terms of cylindrical polar coordinates  $(s, \phi, z)$ , where  $C$  is a constant on each streamline, and  $r_0 = r_s (\rho_2 u_2^2 / \rho_g V^2)^{1/4}$ . The streamline defining the interface between the solar wind and the interstellar gas is given by  $C = -1$  if the interstellar wind flows in the positive  $z$  direction. The stagnation point occurs at  $s = 0$ ,  $z = -r_0$ , and for  $z \gg r_0$ , the solar wind is confined to a circular cylinder of radius  $2r_0$ , as shown in figure 6(a).

The major defects of this model, as far as the solar wind is concerned, are (1) the assumption that the interstellar gas behaves as an incompressible fluid, and (2) the implicit assumption that  $r_s^2 \ll r_0^2$ ; that is,  $u_2/V \gg (\rho_g/\rho_2)^{1/2}$ . Although it is not easy to satisfy these requirements with acceptable values for the various quantities involved, we expect that the general nature of the flow remains more or less the same, as indicated in figure 6(a), even for the extreme case of a hypersonic interstellar wind. Thus, the value of  $r_s$  can still be calculated from (16), provided  $p_0$  is taken to be the stagnation pressure of the interstellar wind ( $p_0 = p_g + \rho_g V^2$ ).



**Figure 6(a)** Streamlines in a model of the interaction between the solar wind and the interstellar wind in which both fluids are treated as being incompressible [Parker, 1961, 1963].

This will represent only the minimum value of  $r_s$ , however, since the cavity within which the solar wind is supersonic must become progressively more asymmetric as the Mach number of the interstellar wind increases.

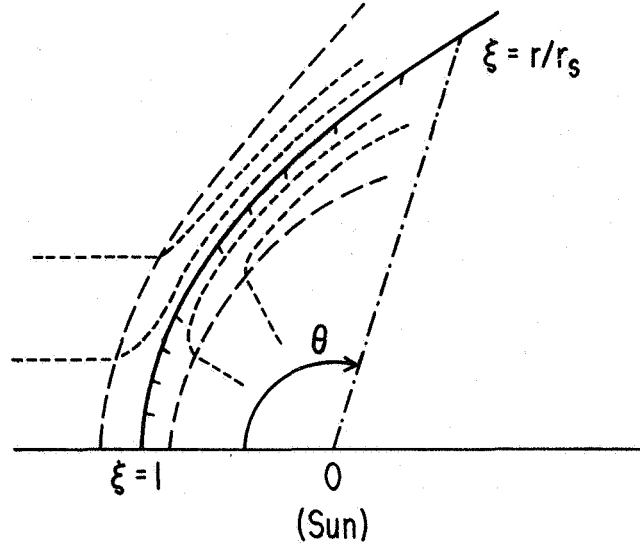
Provided we restrict our attention to the flow in the vicinity of the axis of symmetry in the upstream direction, it should be possible to obtain estimates for the radius of curvature of the solar wind shock and for the positions of the interface and of a possible shock in the interstellar medium, using the approximate theory for a hypersonic shock standoff region due to Lighthill [Hayes and Probstein, 1966; pp. 232-254]. If the radius of curvature of the solar wind shock exceeds  $r_s$  on the axis of symmetry as indicated in figure 6(b), the shock is not normal to the flow everywhere, and the vorticity induced in the subsonic region can play an important role in turning the flow into the wake.

An alternative procedure using Busemann's method [Hayes and Probstein, 1966; pp. 78, 156] has been adopted by Baranov *et al.* [1970], who treat the subsonic region as a thin layer separating two hypersonic streams. In this case the details of the region of subsonic flow are ignored and one simply writes equations representing conservation of mass and momentum for the layer as a whole, which can be represented as a curve of the form  $r = r_s \xi(\theta)$ . Thus, the mass flow is

$$\Phi = \pi r^2 \rho_g V^2 + 2\pi r^2 (1 - \cos \theta) \rho_2 u_2 \quad (25)$$

at a point  $(r, \theta)$  in the layer. The momentum equations are

$$\rho_g V_n^2 = \rho_2 u_{2n}^2 + \frac{\Phi v}{2\pi r R \sin \theta} \quad (26)$$



**Figure 6(b)** Calculated shape of the interaction region of the solar and interstellar winds assuming hypersonic flow [Baranov *et al.*, 1970]. The shape of the streamlines, and the positions of shock fronts are indicated by the (sketched) dashed lines.

$$\frac{d}{ds} (\Phi v) = 2\pi r \sin \theta (\rho_g V_n V_t + \rho_2 u_{2n} u_{2t}) \quad (27)$$

where subscripts  $n, t$  indicate normal and tangential components, respectively,  $v$  is the mean speed of the compressed gas in the layer,  $s$  is the distance measured along the layer from the stagnation point at  $\theta = 0$ , and

$$R = \frac{(r^2 + r'^2)^{3/2}}{r^2 + 2r'^2 - rr''}$$

is its radius of curvature. Note that the equation for momentum conservation in the direction of the normal contains a term representing the centrifugal force acting on the plasma in the layer, but this does not affect the distance to the stagnation point ( $r = r_s$ ) since  $\Phi v = 0$  at  $\theta = 0$ . With some manipulation  $v$  and  $\Phi$  can be eliminated from these equations, leaving a third-order, non-linear differential equation for  $\xi(\theta)$  that must be solved numerically (see fig. 6(b)). The thickness of the layer, which can be obtained using the Lighthill method, would be expected to be of the order of 30 percent of the radius of curvature of the layer at the stagnation point ( $R = 5r_s/3$ ).

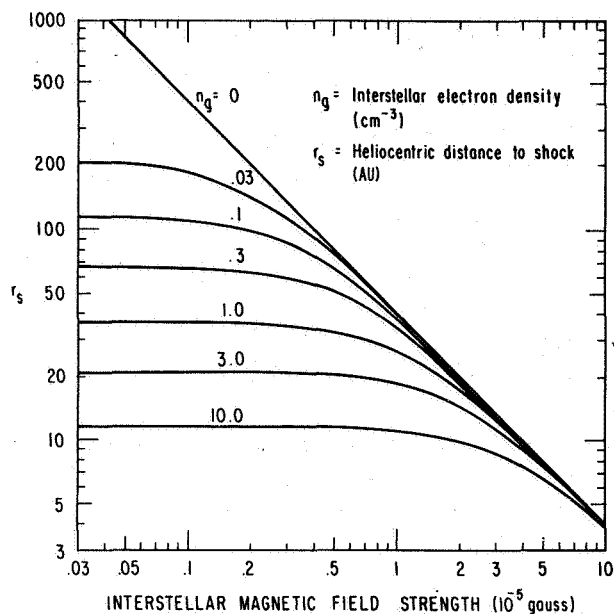
The closely analogous problem of the interaction between the solar wind and the ionized head of a comet has been treated as being equivalent to a source of incompressible fluid in a supersonic flow by Ioffe

[1966a,b; 1968]. Other aspects of the case in which the interstellar wind is supersonic have been considered by *Dokuchaev* [1964], *Brengauz* [1969], and *Sakashita* [1970], who note that the shock waves produced by randomly moving stars surrounded by extensive stellar wind regions could be a significant source of energy for the interstellar gas. It should be noted, however, that provided the stellar winds are supersonic near the stars, there can be no drag whatsoever on the stars themselves. The momentum imparted to the interstellar gas is taken up by the outer subsonic part of the stellar wind region as it is turned to form a comet-like wake behind the star. In fact, this must be essentially correct even if the stellar wind is subsonic everywhere, provided the dimensions of the star are small compared with those of the associated stellar wind region.

Although we have not been able to construct a completely satisfactory model of the interaction between the solar wind and an ionized interstellar medium, three significant results have been established: (1) in the presence of an interstellar wind the region of subsonic solar wind flow should form a comet-like tail in the wake of the sun; (2) the cavity within which the solar wind is supersonic can be expected to be asymmetric; (3) the minimum radius of the cavity is determined by the maximum pressure exerted by the interstellar gas and magnetic field, since the point of maximum external pressure must be a stagnation point of the (subsonic) interior flow. Thus, we can calculate the minimum radius of the solar wind shock transition from equation (16) by taking  $p_O$  to be the maximum external pressure:

$$n_e \bar{m} u_1^2 \left( \frac{r_e}{r_s} \right)^2 = K \left[ \alpha \frac{B_O^2}{8\pi} + n_g (2kT_g + \bar{m} V^2) \right] \quad (28)$$

where  $\alpha$  is a factor that allows for the enhancement of the interstellar magnetic field due to the presence of the solar wind (cf. eq. (21)). The minimum  $r_s$  according to (28), for a range of possible values of  $B_O$  and  $n_g$ , and fixed values of the remaining parameters, can be read directly from figure 7. It should be noted that in the absence of any ionized interstellar gas,  $r_s \approx 140$  AU if we assume that  $B_O \approx 3 \times 10^{-6}$  gauss as suggested by the observations described earlier. If we assume that  $n_g \approx 0.05 \text{ cm}^{-3}$  then with  $V \approx 20 \text{ km sec}^{-1}$  our estimate for  $r_s$  is reduced to 100 AU. For the transition to occur in the vicinity of the orbit of Jupiter as suggested by *Lanzerotti and Schulz* [1969], or even closer to the sun as suggested by *Brandt and Michie* [1962], quite



**Figure 7** Minimum distance to the solar wind shock transition ( $r_s$ ), as a function of interstellar magnetic field strength for various values of the interstellar electron density. The curves have been calculated from equation (28) assuming  $\alpha = 2.25$ ,  $T_g = 10^4 \text{ }^\circ\text{K}$ , and  $V = 20 \text{ km sec}^{-1}$ .

implausible values of the parameters involved in equation (28) are required, or else an entirely different model should be considered, as discussed later (p. 623).

In the previous discussion we have ignored the effects of the interplanetary magnetic field on the flow of the solar wind. This is a reasonable procedure in the supersonic region in the absence of effects associated with neutral interstellar gas, since  $\beta_v \gtrsim 500$ , and in any case the Maxwell stresses are very nearly in self equilibrium. However, in the subsonic region it is easily seen that inconsistencies arise if the effects of the magnetic field are neglected and the flow is treated as if it were incompressible. For example, if we assume that the flow is spherically symmetric and radial, and that the magnetic field is azimuthal, then since

$$ruB = \text{constant} \quad (29)$$

we see that with  $u \propto r^{-2}$  (eq. (17)),  $B \propto r$  and hence the magnetic field strength increases indefinitely. Although the flow is likely to be nonradial and the dimensions of the subsonic region are restricted as indicated in figures 6(a) and (b), the tendency for the magnetic field strength to increase is unavoidable. Indeed, a very similar situation is found in the earth's magnetosheath where

the interplanetary magnetic field strength near the solar wind stagnation point is often found to be comparable to that of the geomagnetic field just within the magnetopause [Cahill and Amazeen, 1963].

The manner in which the magnetic field can be enhanced in the subsonic region, so that it ultimately dominates the plasma behavior, is demonstrated rather well by the case of steady, radial flow with spherical divergence, in the presence of a purely azimuthal magnetic field [Cranfill, 1971]. Let us assume that the region of subsonic flow begins at a shock transition occurring at  $r = r_s$ : the Rankine-Hugoniot equations can be written in normalized form

$$\bar{\rho}_2 \bar{u}_2 = 1 \quad (30)$$

$$\bar{p}_2 + \bar{\rho}_2 \bar{u}_2^2 + \frac{\bar{B}_2^2}{\beta_v} = 1 + \frac{1}{\beta_v} \quad (31)$$

$$\frac{1}{2} \bar{u}_2^2 + \left( \frac{\gamma}{\gamma-1} \right) \frac{\bar{p}_2}{\bar{\rho}_2} + \left( \frac{2}{\beta_v} \right) \frac{\bar{B}_2^2}{\bar{\rho}_2} = \frac{1}{2} + \frac{2}{\beta_v} \quad (32)$$

$$\bar{B}_2 \bar{u}_2 = 1 \quad (33)$$

where  $\bar{\rho} = \rho/\rho_1$ ,  $\bar{u} = u/u_1$ ,  $\bar{B} = B/B_1$ ,  $\bar{p} = p/\rho_1 u_1^2$ , and subscripts 1,2 denote upstream and downstream conditions, respectively. The equations of motion in the subsonic region can be integrated to yield

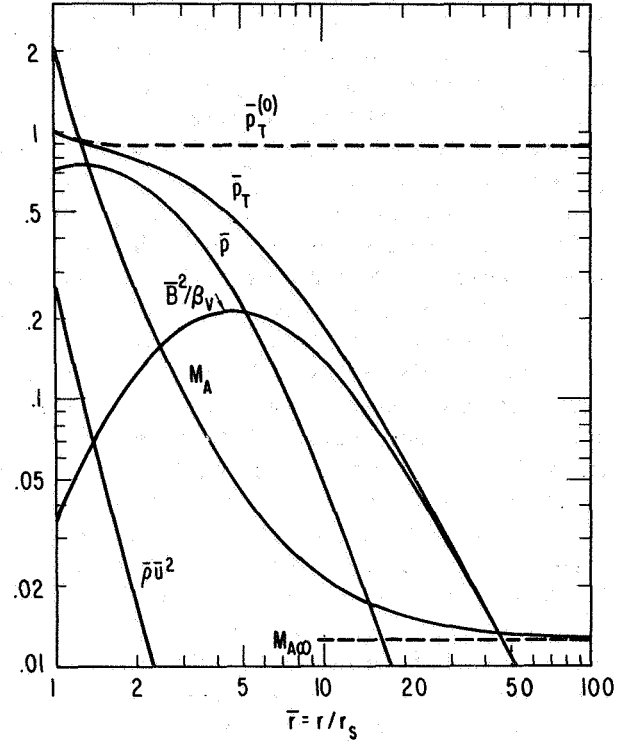
$$\bar{\rho} \bar{u} \bar{r}^2 = 1 \quad (34)$$

$$\frac{1}{2} \bar{u}^2 + \left( \frac{\gamma}{\gamma-1} \right) \frac{\bar{p}}{\bar{\rho}} + \frac{2\bar{B}^2}{\beta_v} = \frac{1}{2} + \frac{2}{\beta_v} \quad (35)$$

$$\frac{\bar{p}}{\bar{\rho}^\gamma} = \frac{\bar{p}_2}{\bar{\rho}_2^\gamma} \quad (36)$$

$$\bar{r} \bar{u} \bar{B} = 1 \quad (37)$$

where  $\bar{r} = r/r_s$ . For a given value of  $\beta_v$ , equations (30) through (33) can be solved for  $\bar{p}_2$  and  $\bar{\rho}_2$ , and equations (34) through (37) can in turn be solved for  $\bar{u}$ ,  $\bar{B}$ ,  $\bar{\rho}$ , and  $\bar{p}$  as functions of  $\bar{r}$ . It should be noted that the normalization results in the elimination of  $r_s$  from the equations, leaving  $\beta_v$  as the only parameter. The solution for a value of  $\beta_v$  appropriate to the ecliptic plane is shown in figure 8. It is evident that  $\bar{r}$  must be large to



**Figure 8** Solution of equations (34)-(37) with initial conditions determined by equations (30)-(33) and with  $\beta_v = 500$ . Note that the presence of the magnetic field has caused the total pressure  $\bar{p}_T$  to decrease to zero as  $\bar{r} \rightarrow \infty$ , rather than remaining constant ( $\bar{p}_T^{(0)}$ ) as it does in the field-free case [from Cranfill, 1971].

make a substantial change in the total pressure  $\bar{p}_T = \bar{p} + \bar{\rho} \bar{u}^2 + \bar{B}^2/\beta_v$ , although the changes are not insignificant for moderate values of  $\bar{r}$ . At  $\bar{r} = 2$  for example,  $\bar{p}_T$  is reduced by about 12 percent from the value  $\bar{p}_T^{(0)}$  obtained in the absence of magnetic field.

In a more realistic model with nonradial flow it should be expected that the effectiveness of the magnetic field in reducing the total pressure beyond the shock transition is more marked than in the model with strictly radial flow. Lateral flow along the magnetic field lines permits the gas pressure to decrease and be compensated by a corresponding increase in the pressure of the magnetic field. It is easily shown that the reduction in total pressure  $\Delta p$  across a layer of thickness  $d$  and radius of curvature  $R$  is given approximately by

$$\Delta p \approx \frac{\langle B^2 \rangle}{8\pi} \left( \frac{2d}{R} \right) \quad (38)$$

where  $\langle B^2 \rangle$  is the mean square magnetic field strength in the layer. This result applies equally well to the earth's

magnetosheath, and one might expect the values of  $\Delta p/p_s$  to be comparable in the two cases. Observations made in the magnetosheath suggest that  $\Delta p/p_s$  could easily be 0.1–0.2, and hence we can reduce the minimum distance to the solar wind shock transition from our previous estimate of 100 AU to perhaps 80 to 90 AU.

We have assumed that the interplanetary magnetic field can be considered as being frozen into the solar wind plasma in the above discussion. However, magnetic field directional discontinuities must exist within the solar wind plasma (sector boundaries), and at the interface with the region of interstellar plasma and magnetic field. Throughout most of the region of subsonic solar wind flow, it might be expected that sector boundaries are stable against reconnection since  $\beta$  tends to be O(1) or greater. However, there is no obvious reason why the interface with the interstellar region should be stable against reconnection, and hence we can expect that the interstellar and interplanetary (solar) magnetic fields are connected in much the same manner as the interplanetary magnetic field connects with the geomagnetic field [Dungey, 1961; Levy et al., 1964].

It would be of great interest if the shell of hot plasma

formed by the region of subsonic solar wind flow could be observed from a distance; however, this does not appear to be feasible. The suggestion that free-free transitions in this region might produce a detectable flux of soft X rays with a roughly isotropic distribution was originally made by Reiffel [1960]. The spectrum of the observed isotropic X-ray background is shown in figure 9, together with calculated spectra based on the (favorable) assumptions that the electron and proton temperatures are equal in the shell of hot solar wind plasma, and that the thickness of the shell is  $4r_s$ . The contribution from free-bound transitions associated with the ultimate recombination of all stellar wind plasma originating from stars within 330 parsecs of the sun is also shown. It is evident that neither the solar wind nor stellar winds in general can be considered to be likely sources for the observed X-ray flux [Bowyer and Field, 1969; Cranfill, 1971].

The shock transition that terminates the supersonic solar wind may be collision free, in which case its thickness is no more than a few proton gyroradii (about  $10^{10}$  cm for  $\theta = \pi/2$ ,  $r_s \approx 100$  AU). However, it is also possible that the transition is as wide as the system will

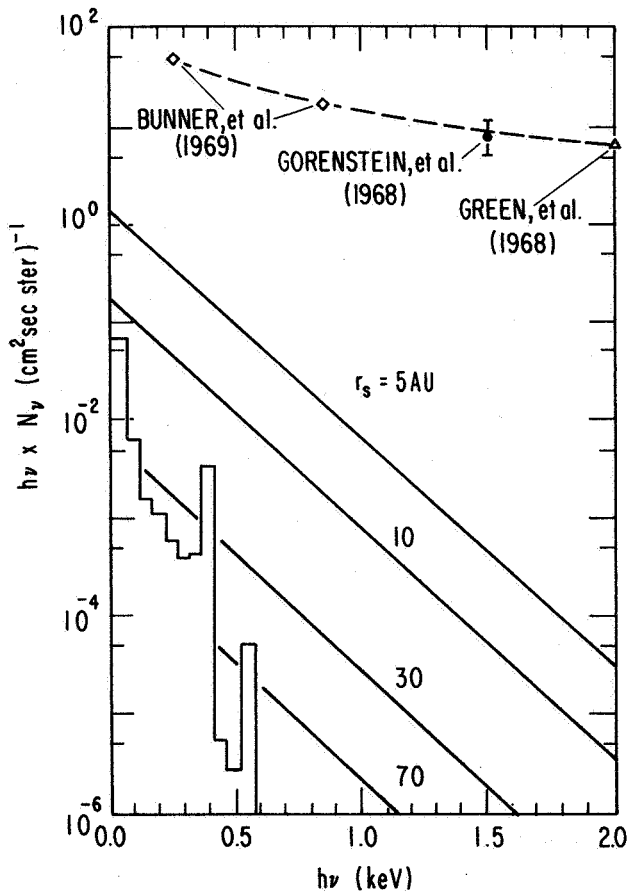


Figure 9 A comparison of observations of the diffuse soft X-ray flux (dashed line), with estimates of the X-ray flux resulting from (a) free-free emission from the region of subsonic solar wind flow (straight solid lines), and (b) recombinations of stellar wind ions (bar graph). The thickness of the region of subsonic solar wind flow is taken to be  $4r_s$ , with  $T_e = 184$  eV, and  $n = 4n_e r_e^2 / r_s^2$  with  $n_e = 5$  cm $^{-3}$ . Even though we have assumed a rather large thickness for the subsonic region, it is evident that for reasonable values of  $r_s$  (i.e.,  $r_s \gtrsim 50$  AU) the free-free emission fails to account for the observed flux by a factor of the order of  $10^3$ . The bar graph represents 0.05 keV averages of the free-bound emission resulting from the recombination of heavy ions that have been injected into the interstellar medium by stellar winds. It is assumed that a steady state has been reached with the recombination rate equal to the injection rate, and that all stars within 330 parsecs of the sun contribute. The star density is taken to be 0.08 parsec $^{-3}$ , and all stellar winds are assumed to be similar to the solar wind in composition and total flux. Ground state recombinations of all appropriate ion states of He, C, N, O, Ne, Mg, Si, and Fe have been included. It is evident that the recombination radiation is also insufficient to account for the observed soft X-ray flux [Cranfill, 1971].

permit [Schindler, private communication], in which case the shock structure would be determined by proton-proton collisions. The thickness of such a shock is presumably of the order of  $\lambda \cos^2 \psi \approx \lambda(u/r\Omega \sin \theta)^2$  where  $\lambda$  is the mean free path. Since at large distances  $\lambda/u < 1/v_{\text{exp}} \approx r/2u$  (fig. 4), it is evident that the thickness must be less than  $1/(2r_s \sin^2 \theta)$  AU. Thus, in the ecliptic plane ( $\theta = \pi/2$ ), we expect that the shock thickness is less than  $10^{11}$  cm, even if the shock is collision dominated.

### NEUTRAL INTERSTELLAR GAS IN THE VICINITY OF THE SUN

If there were no relative motion between the sun and the surrounding interstellar gas, and if the complications introduced by the solar wind could be ignored, the sun could produce a quite substantial HII region if the density of the ionized gas is not too large [Newkirk *et al.* 1960; Brandt, 1964a; Lenchek, 1964; Williams, 1965]. However, if there is relative motion, the situation is drastically altered, and even with quite modest speeds of the order of  $20 \text{ km sec}^{-1}$  it can be shown that the neutral interstellar gas can penetrate almost unattenuated into the inner solar system within the orbit of Jupiter [Blum and Fahr, 1969, 1970a; Holzer, 1970; Holzer and Axford, 1971; Semar, 1970]. In this section, we assume that the interstellar medium in the vicinity of the solar system is part of an HI region, and examine the manner in which the neutral gas is affected by the solar wind and by ionizing radiation from the sun.

Let us consider first the very simple model in which the nearby interstellar gas is stationary with respect to the sun, with the solar HII region assumed to be fully ionized and having the same pressure as the surrounding HI region. On equating the flux of ionizing photons emitted by the sun  $Q$  to the total recombination rate we find that the radius of the HII region  $r_{II}$  is given by Stromgren's result:

$$r_{II} = \left( \frac{3Q}{4\pi\alpha n_{II}^2} \right)^{1/3} \quad (39)$$

where  $\alpha \approx 3 \times 10^{-10} T_{II}^{3/4}$  is the coefficient for recombination to all levels [Allen, 1963, p. 90]. The condition of pressure equilibrium yields

$$2n_{II}T_{II} = n_I T_I \quad (40)$$

Figure 10 gives these relationships for various values of  $T_I$  and  $T_{II}$  for the case  $n_I = 0.2 \text{ cm}^{-3}$ , with

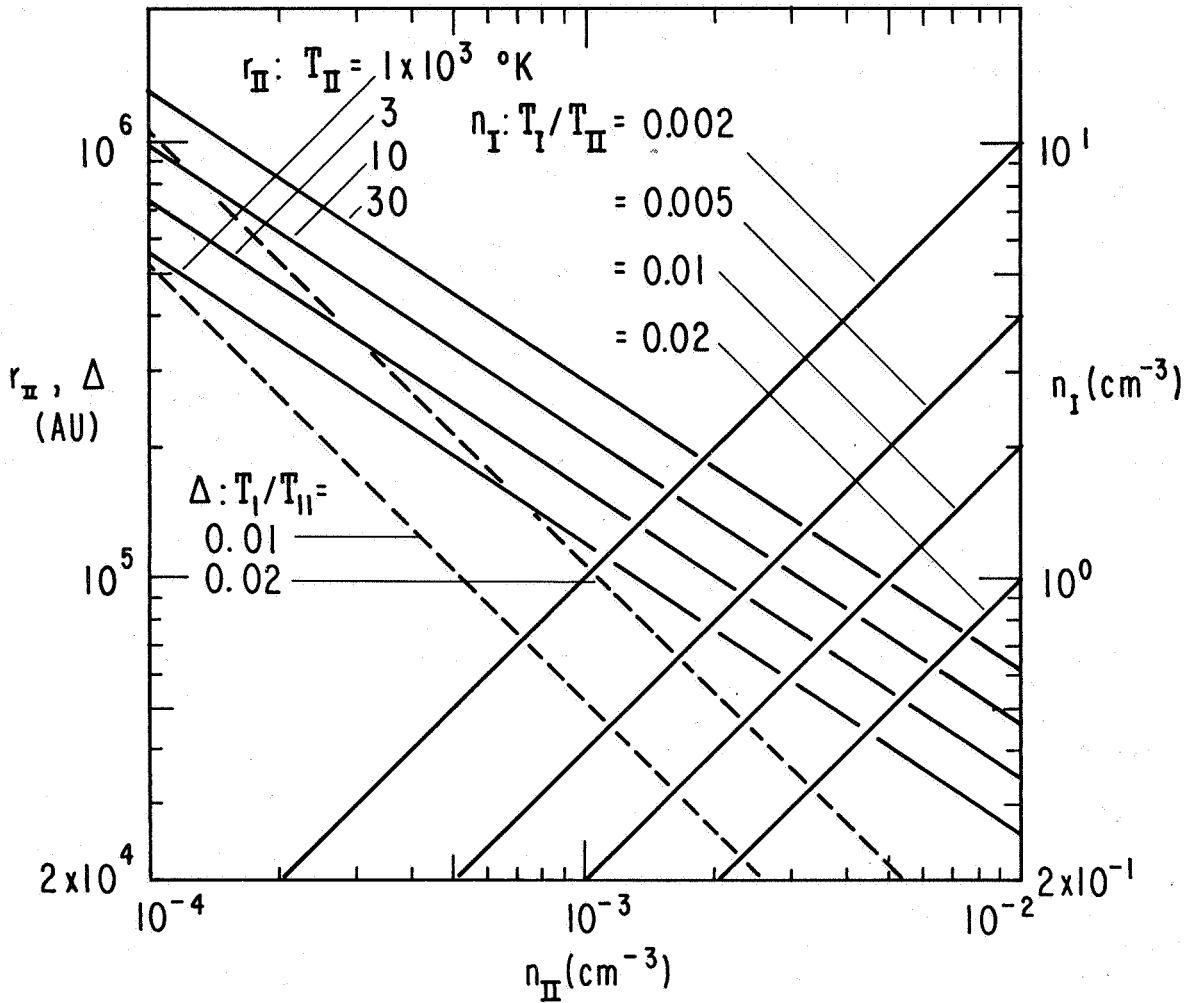
$Q = 4 \times 10^{37} \text{ sec}^{-1}$ ; the points of intersection of the two sets of lines give the values of  $r_{II}$  for the various combinations of values of  $T_I$  and  $T_{II}$ . The thickness of the ionization front separating the HI and HII regions is of the order of  $\Delta = 1/\sigma_L n_I$ , where  $\sigma_L \approx 6.3 \times 10^{-18} \text{ cm}^2$  is the photoionization cross section for hydrogen atoms at the Lyman limit. In cases where  $r_{II} \leq \Delta \approx 5 \times 10^4 \text{ AU}$  our assumption that the HII region is well defined is invalid and a more detailed analysis must be carried out [Gould *et al.*, 1963; Lenchek, 1964; Williams, 1965]. The thickness of the ionization front is somewhat greater than  $\Delta$  since the absorption coefficient decreases approximately as  $\nu^{-3}$  beyond the Lyman limit, and consequently the radiation reaching the outer part of the HII region is such that the effective absorption coefficient is much less than  $\sigma_L$ . Nevertheless, the value of  $r_{II}$  calculated from equation (39) has some significance as a "characteristic" dimension, even in circumstances where the HII region is not sharply bounded.

In principle, the solar HII region could contribute to the low frequency cutoff in the spectrum of galactic nonthermal radio noise, as suggested by Lenchek [1964]. However, the density required to produce significant absorption at frequencies of the order of 1 MHz is quite large ( $n_{II} \approx 10 \text{ cm}^{-3}$ ) even if the electron temperature is as low as  $10^3 \text{ }^\circ\text{K}$ .

In the absence of any interstellar magnetic field, there would be little point in considering a static HII region of the type described above, since the solar wind would push the interstellar gas to such a great distance that ultimately the HII region would either overlap those of other stars or be limited by recombination of the solar wind plasma. In the latter case, the solar wind would terminate at a recombination front [Newman and Axford, 1968]. The interstellar magnetic field should not be expected to have any important direct effect on a static, approximately spherical solar HII region; however, it would effectively shield the HII region from the solar wind, which would be channeled harmlessly away in the manner indicated in figure 4.

The chief defect of these models of a solar HII region is the requirement that there be no relative velocity between the sun and the local interstellar gas, when in fact a relative speed of the order of  $20 \text{ km sec}^{-1}$  might be considered more appropriate. An atom of interstellar gas, approaching the sun with speed  $V = 20 \text{ km sec}^{-1}$ , has a mean free path against loss by ionization given by

$$\lambda_i = \frac{V}{\beta} = \frac{V}{\sum_j \beta_j} \quad (41)$$



**Figure 10** The values of  $r_{II}$  and  $n_I$  (solid lines) are plotted for various values of  $T_{II}$  and  $T_I/T_{II}$  according to equations (39) and (40). The intersection of these lines defines representative allowed sets of parameters describing model solar HII regions. The ionization front thickness  $\Delta$  is shown for two values of  $T_I/T_{II}$  (dashed lines). As an example, for  $T_{II} = 3 \times 10^3$  °K, and  $T_I = 30$  °K, we see that  $r_{II} \approx 7 \times 10^4$  AU, and  $\Delta \approx 10^4$  AU.

where the  $\beta_j$  are rate coefficients for all possible ionization processes (table 1). In general,  $\beta = \beta_0(r_e^2/r^2)$ , where  $\beta_0$  is a constant for each atomic species. It is to be expected therefore that a substantial fraction of interstellar atoms approaching the sun can penetrate to within a heliocentric distance of the order of  $r_i = (\beta_0 r_e^2/V)$ . From table 1 we see that interstellar hydrogen atoms can easily penetrate to within the orbit of Jupiter, while interstellar helium atoms can penetrate to the orbit of earth. Clearly then, we must expect to be involved in quite a different situation than that of a static, spherical HII region that effectively excludes neutral interstellar gas from the region occupied by the solar wind.

The flow of neutral interstellar gas past the sun has been studied by *Fahr* [1968a], *Blum and Fahr* [1969, 1970a], *Holzer* [1970], *Holzer and Axford* [1971], *Tinsley* [1971], and *Semar* [1970]. The following discussion is based on *Holzer's* treatment of the problem (essentially the same as that of *Blum and Fahr*), with a slight generalization to allow for solar radiation pressure. As a first approximation, solar radiation pressure can be assumed to produce a radial outward force that varies inversely with the square of the distance from the sun. Thus it can be taken into account by introducing an "effective" gravitational constant  $(1-\mu)G$ , where  $\mu$  is the ratio of the force on an atom resulting from radiation pressure to the force of gravity. For hydrogen, the large



**Table 1** Loss coefficients at  $r=r_e(\beta=\beta_0)$ , and penetration distances for  $V=20 \text{ km sec}^{-1}$  ( $r_i$ ). The solar ultraviolet flux has been taken from Hinteregger [1970]

Species	Reaction	$\sigma(\text{cm})^2$	Reference	Rate ( $10^{-7}\text{s}^{-1}$ )	$r_i(\text{AU})$
H	$\text{H} + h\nu \rightarrow \text{H}^+ + e$		Banks and Kockarts [1972]	1.5	
	$\text{H} + \text{H}^+ \rightarrow \text{H}^+ + \text{H}$	$2 \times 10^{-15}$	Fite <i>et al.</i> [1962]	4	4
	$\text{H} + \text{He}^{+2} \rightarrow \text{H}^+ + \text{He}^+$	$4 \times 10^{-16}$	Fite <i>et al.</i> [1962]	0.036	
	$\text{He} + h\nu \rightarrow \text{He}^+ + e$		Lowry <i>et al.</i> [1965]; Cairns and Samson [1965]	0.62	
He	$\text{He} + \text{H}^+ \rightarrow \text{He}^+ + \text{H}$	$1.5 \times 10^{-17}$	Afrosimov <i>et al.</i> [1969]	0.03	0.5
	$\text{He} + \text{He}^{++} \rightarrow 2\text{He}^+$	$2 \times 10^{-17}$	Hertel and Koski [1964]	0.0018	
C	$\text{C} + h\nu \rightarrow \text{C}^+ + e$		McGuire [1968]	40	30
N	$\text{N} + h\nu \rightarrow \text{N}^+ + e$		Henry [1968]	1.7	
	$\text{N} + \text{H}^+ \rightarrow \text{N}^+ + \text{H}$	$1.8 \times 10^{-15}$	Stebbing <i>et al.</i> [1960]	3.6	4
O	$\text{O} + h\nu \rightarrow \text{O}^+ + e$		Huffman [1969]	2.4	
	$\text{O} + \text{H}^+ \rightarrow \text{O}^+ + \text{H}$	$8 \times 10^{-16}$	Fite <i>et al.</i> [1962]	1.6	3
Ne	$\text{Ne} + h\nu \rightarrow \text{Ne}^+ + e$		Ederer and Tombouljian [1964], Samson [1965]	1.9	
	$\text{Ne} + \text{H}^+ \rightarrow \text{Ne}^+ + \text{H}$	$10^{-16}$	Afrosimov <i>et al.</i> [1969]	0.2	1.6
Si	$\text{Si} + h\nu \rightarrow \text{Si}^+ + e$		McGuire [1968]	60	45
Ar	$\text{Ar} + h\nu \rightarrow \text{Ar}^+ + e$		Cairns and Samson [1965]; Rustgi [1964]; Madden <i>et al.</i> [1969]	2.8	
	$\text{Ar} + \text{H}^+ \rightarrow \text{Ar}^+ + \text{H}$	$10^{-15}$	Koopman [1967]	2	3.6
Fe	$\text{Fe} + h\nu \rightarrow \text{Fe}^+ + e$		McGuire [1968]	2.4	
	$\text{Fe} + \text{H}^+ \rightarrow \text{Fe}^+ + \text{H}$	$< 10^{-16}$	Lee and Hasted [1965]		1.8

solar Lyman  $\alpha$  flux results in  $\mu$  being of order unity, and hence the effects of radiation pressure are very important [Wilson, 1960; Brandt, 1961; Tinsley, 1971], which is contrary to the conclusion of Fahr [1968a]. However, for other species  $\mu \ll 1$ , and hence solar gravity determines their dynamic behavior. In a more accurate treatment it would be necessary to take into account the variation of  $\mu$  with position resulting from Doppler shifts and the reduction in the intensity of the solar radiation resulting from scattering. It should also be noted that the solar Lyman  $\alpha$  flux varies with solar activity especially at the center of the line where 100 percent variations can occur [Blamont and Madjar, 1971].

If we neglect the thermal velocities of interstellar atoms ( $\leq 1 \text{ km sec}^{-1}$  if  $T_I \approx 100^\circ \text{ K}$ ) in comparison with the bulk velocity of the gas relative to the sun ( $V \approx 20 \text{ km sec}^{-1}$ ), then the trajectory of every atom lies in the plane determined by its velocity vector at infinity and the sun. Since the mean free path for atom-atom collisions is very large ( $\sim 10^{16}$ – $10^{17}$  cm), and the most

important collisions with solar wind particles are ionizing, it is appropriate to make use of a free particle treatment allowing for losses associated with ionization, with loss coefficients as given in table 1. Taking polar coordinates ( $r, \theta'$ ) in any such plane, it can readily be shown that the trajectories are hyperbolae with the sun as focus, given by

$$\frac{A}{r} = 1 + B \sin(\theta' + \alpha) \quad (42)$$

with

$$u_r = \pm \left[ V^2 + \frac{2(1-\mu)GM}{r} - \frac{p^2}{r^2} \right]^{1/2} \quad (43)$$

$$u_\theta = \frac{p}{r} \quad (44)$$

where  $\theta' = 0$  is antiparallel to the incident flow velocity  $\mathbf{V}$ ,  $p$  is the angular momentum of the atom about the sun,  $u_r, u_\theta$  are velocity components in the  $r, \theta'$  directions,  $M$  is the mass of the sun, and

$$A = \frac{p^2}{(1-\mu)GM} \quad (45)$$

$$B = \left(1 + \frac{V^2 A^2}{p^2}\right)^{1/2} \quad (46)$$

$$\sin \alpha = -\frac{1}{B} \quad (47)$$

In general, any point in the plane  $(r, \theta')$  is a point of intersection of two trajectories having angular momenta given by

$$p_1, p_2 = \frac{1}{2} V \left\{ r \sin \theta' \pm \left[ r^2 \sin^2 \theta' + \frac{4r(1 - \cos \theta')}{C} \right]^{1/2} \right\} \quad (48)$$

where  $C = V^2/(1 - \mu)GM$ , and the plus sign is associated with  $p_1$  and the minus sign with  $p_2$ . As indicated in figure 11,  $p_1 > 0, p_2 < 0$  if  $\mu < 1$ , and  $p_1 > 0, p_2 > 0$  if  $\mu > 1$ . In the case  $\mu < 1$ , some particles may be lost by striking the sun. In the case  $\mu > 1$ , the stream of particles cannot enter the region defined by

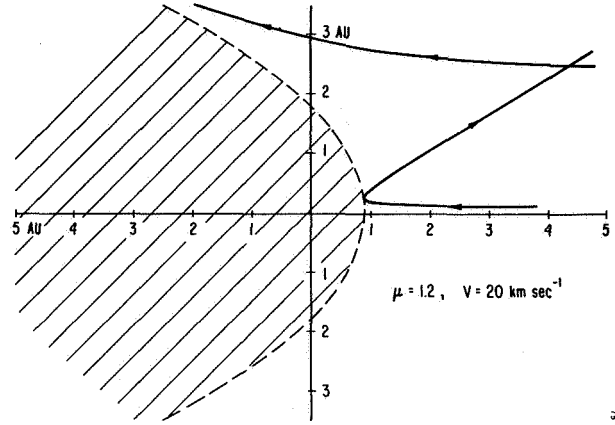


Figure 11(b) Same as (a), but with the effects of radiation pressure exceeding gravity. A parabolic forbidden region (hatched) is produced with the sun at the focus.

$$r(1 + \cos \theta') \leq \left(\frac{4GM}{V^2}\right) (\mu - 1) \quad (49)$$

since the angular momenta given by equation (48) become imaginary. In the case  $\mu = 1$ , the trajectories are straight lines parallel to  $\theta' = 0$  and  $p_2 = 0$ .

The number density  $n$  of a particular species in interplanetary space can be calculated from the equation of continuity, with the trajectories (42) being treated as streamlines. We use an orthogonal coordinate system  $(\xi, \Psi, \phi)$  such that  $\hat{e}_\xi = \mathbf{u}/u$ , and  $\phi$  is the azimuthal coordinate relative to the axis  $\theta' = 0$ . Thus

$$\text{div}(n\mathbf{u}) = \frac{1}{h_\xi h_\Psi h_\phi} \frac{\partial}{\partial \xi} (n u h_\Psi h_\phi) = -\beta n \quad (50)$$

with  $\beta$  as given in table 1, and

$$\int_{-\infty}^{\xi} d [\ln(n u h_\Psi h_\phi)] = - \int_{-\infty}^{\xi} \left(\frac{\beta}{u}\right) h_\xi d\xi \quad (51)$$

If we take  $\Psi = p/V$ , then it can be shown that

$$h_\Psi = \frac{|2\Psi - r \sin \theta'|}{|\Psi|(1 + 2/rC)^{1/2}} = \frac{[r^2 \sin^2 \theta' + 4r(1 - \cos \theta')/C]^{1/2}}{|\Psi|(1 + 2/rC)^{1/2}} \quad (52)$$

Also, since the displacement  $d\xi$  is along a trajectory

$$h_\xi d\xi = \frac{ur d\theta'}{u\theta} \quad (53)$$

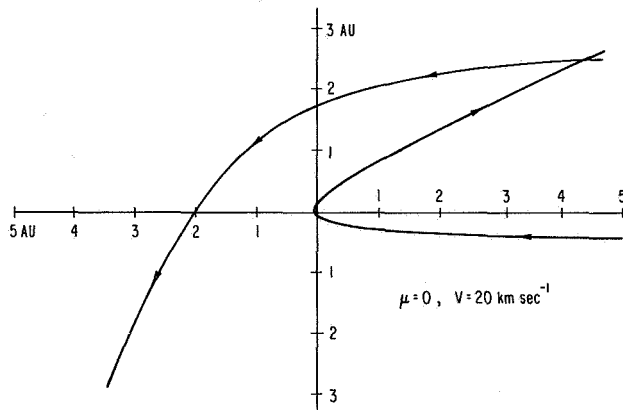


Figure 11(a) Examples of intersecting particle trajectories for a case of a cold interstellar wind approaching the sun (at the origin) from the right of the diagram at  $20 \text{ km sec}^{-1}$ , and with radiation pressure absent ( $\mu = 0$ ). Note that all trajectories cross the axis of symmetry on the downwind side of the sun.

Hence on putting  $h_\phi = r|\sin \theta'|$ , and taking  $\beta = \beta_0 r e^2 / r^2$ , we obtain from (51)

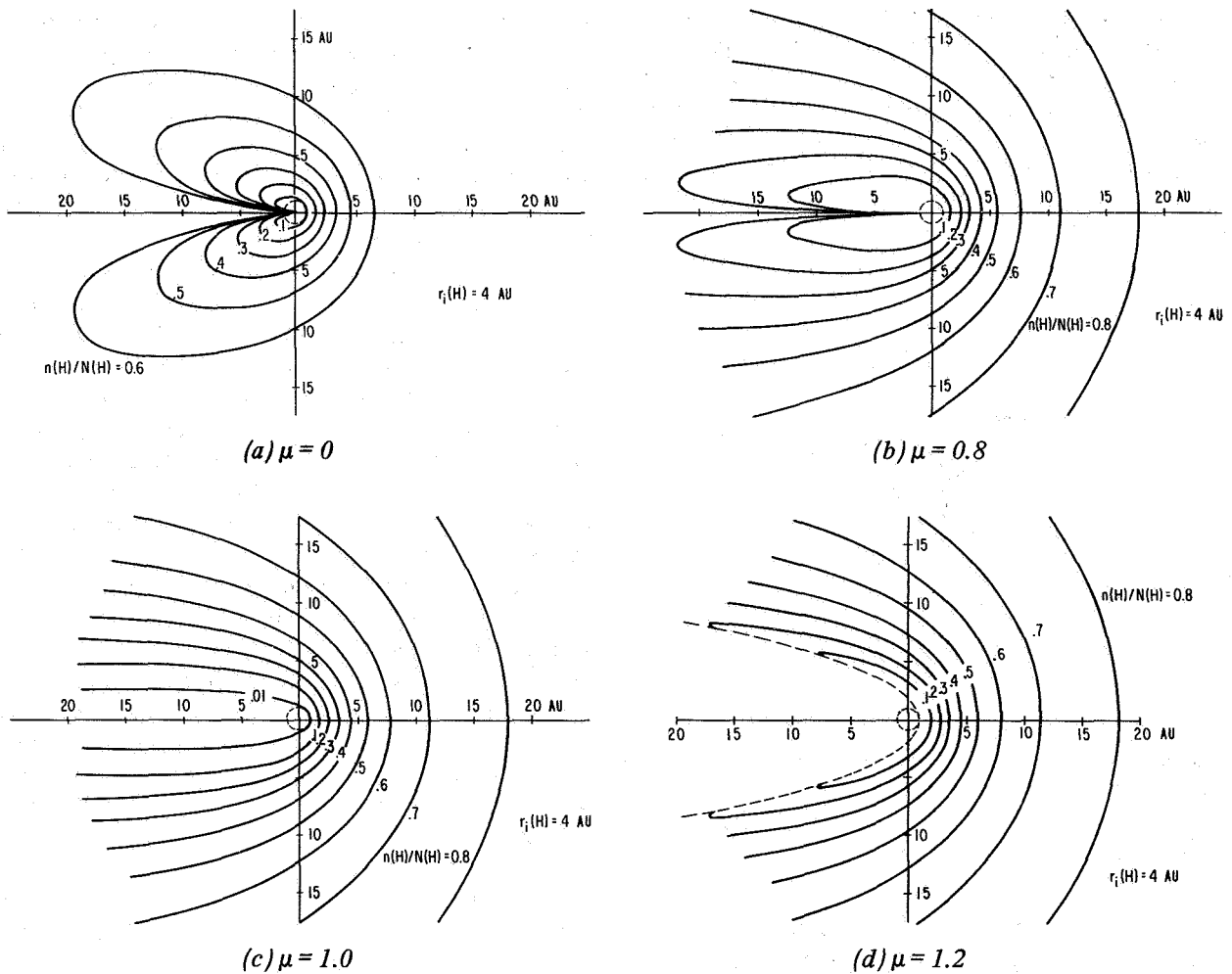
$$n(r, \theta) = \sum_j \frac{N p_j^2 \exp(-\beta_0 r e^2 \theta_j / |p_j|)}{V^2 r \sin \theta [r^2 \sin^2 \theta + 4r(1 - \cos \theta)/C]^{1/2}} \quad (54)$$

where  $\theta$  is the polar angle from the axis of symmetry ( $0 \leq \theta \leq \pi$  and  $|\sin \theta'| = \sin \theta$ ),  $N$  is the number density of the incident stream at infinity, and  $\theta_j = \theta$  if  $p_j > 0$ ,  $\theta_j = (2\pi - \theta)$  if  $p_j < 0$ . If either of the trajectories that

intersect at  $(r, \theta')$  strikes the sun before reaching the point, its contribution to  $n$  must be discounted. Note that if  $\mu \rightarrow 1$ ,  $C \rightarrow \infty$ , then  $u = V$ ,  $b_1 = Vr \sin \theta'$ ,  $p_2 = 0$ , and (54) reduces to the simple result

$$n(r, \theta) = N \exp\left(\frac{-\beta_0 r e^2 \theta}{Vr \sin \theta}\right) \quad (55)$$

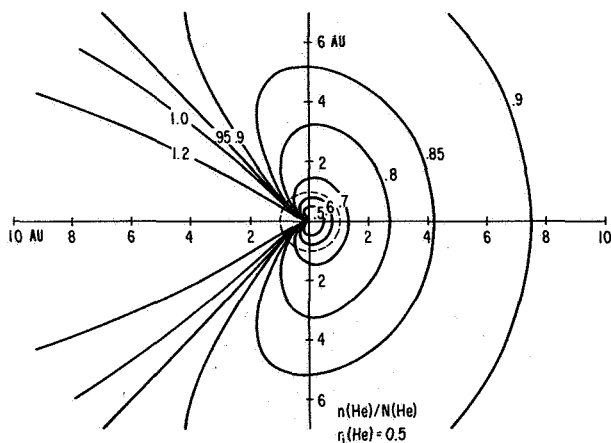
Equal number density contours for hydrogen and helium have been calculated with  $\mu = 0, 0.8, 1.0$ , and  $1.2$  for the case of hydrogen (figs. 12(a)–(d)) and with  $\mu = 0$



**Figure 12** Contours of equal density of neutral interstellar hydrogen. The sun is at the center of each diagram and the orbit of earth is shown as a dashed line. The plane of the diagram is the plane containing the velocity vector of the interstellar wind and the sun. The three-dimensional contours are of course axisymmetric. Note the high density on the axis of symmetry ( $\theta = \pi$ ) for  $\mu < 1$ , and the paraboloidal void which appears when  $\mu$  exceeds 1.

for helium (fig. 13). Note that  $n(r, \theta)$  is finite on  $\theta = 0$  in each case, but if  $\mu < 1$ ,  $n(r, \theta) \rightarrow \infty$  as  $\theta \rightarrow \pi$  as shown in a slightly different context by *Danby and Camm* [1957]. This singularity disappears if one relaxes the assumption that the incident stream of atoms has no thermal velocities [*Danby and Bray*, 1967]. For  $\mu \geq 1$ ,  $n(r, \pi) = 0$ , and for  $\mu > 1$  an empty region develops in the wake of the sun. In the upstream direction the interstellar neutral gas penetrates to a heliocentric distance of order  $r_i = \beta_0 r_e^2 / V$ , as argued previously, and hence there are likely to be observable effects that permit us to determine  $N(\text{H})$ ,  $N(\text{He})$ , and  $V$ .

*Fahr* [1968a,b; 1969] has examined the possibility that the local fluxes of neutral interstellar gas and of neutral hydrogen produced in the solar wind by charge exchange should be sufficient to cause changes in the structure of the upper atmosphere. However, on taking reasonable values for the various parameters concerned, one finds that it is unlikely that observable effects can be produced. *Holzer and Axford* [1971] have argued that accretion of interstellar gas could be an important



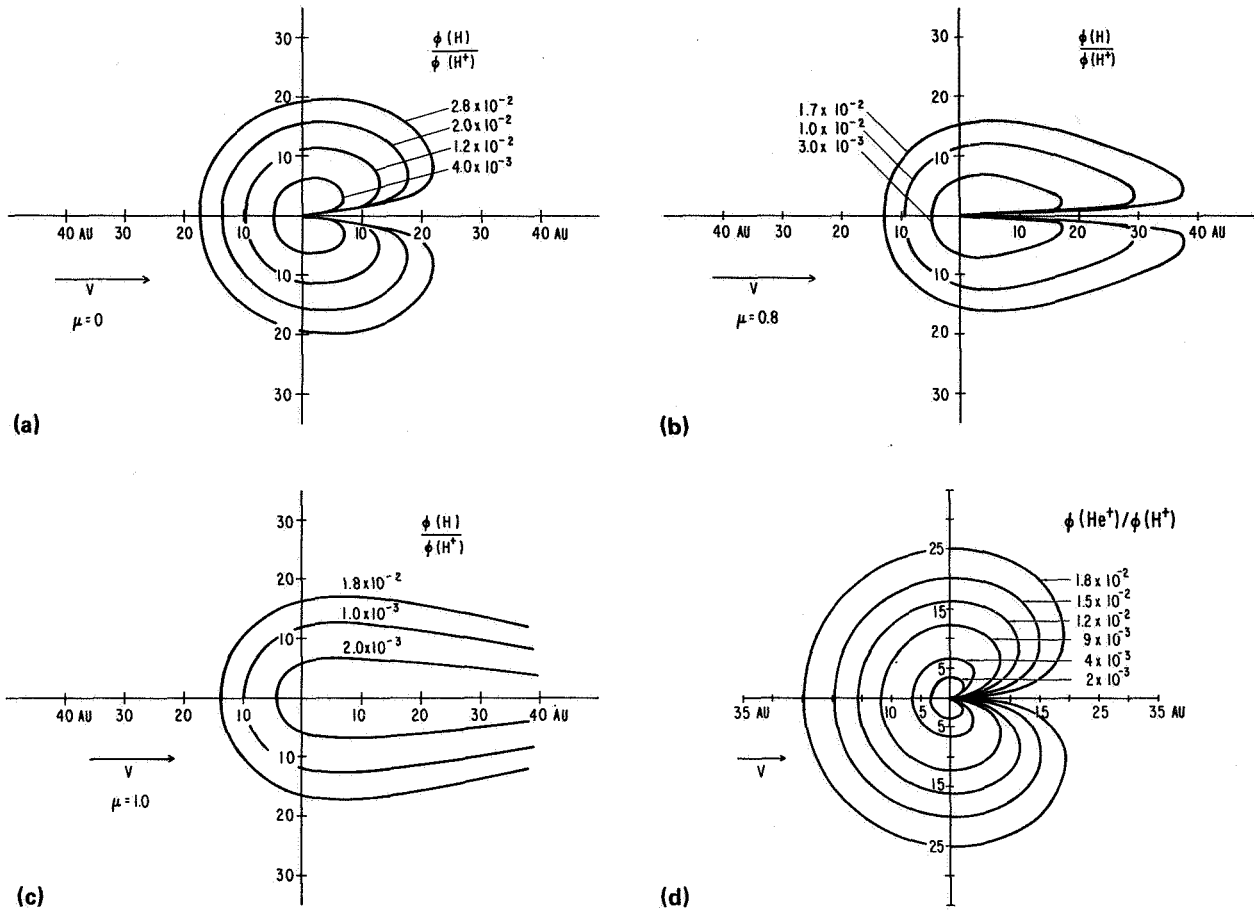
**Figure 13** Contours of equal number density of interstellar helium in the plane containing the sun and the velocity vector of the interstellar gas. The orbit of the earth is shown as a dashed line.

item in the terrestrial budget of  ${}^3\text{He}$  but not of other gases unless conditions were vastly different in the past. It is evident from the calculations described above that the number density of neutral helium near the earth is only slightly less ( $\sim 25$  percent) than it is in the interstellar gas. If we assume that  $[{}^4\text{He}]:[{}^3\text{He}] \approx 3000:1$  [*Cameron*, 1968], it is estimated that the average flux of interstellar  ${}^3\text{He}$  atoms accreted by the earth is approximately  $50 N(\text{H})$  atoms  $\text{cm}^{-2} \text{sec}^{-1}$ . According to

*Johnson and Axford* [1969], the average rate of loss of atmospheric  ${}^3\text{He}$  by evaporation is approximately  $7$  atoms  $\text{cm}^{-2} \text{sec}^{-1}$ ; hence, allowing for contributions from other sources, we find that  $N(\text{H}) \approx 0.05\text{--}0.1 \text{ cm}^{-3}$ . At certain times of the year, the relative velocity between the earth and the interstellar gas can be as high as  $80 \text{ km sec}^{-1}$ . This is sufficient for heavier atoms to be trapped in a target foil, thus raising the possibility that the isotopic composition of the interstellar gas (especially neon and argon) might be measured directly [*Geiss*, private communication].

It might also be possible to estimate the density of the neutral interstellar gas in the vicinity of the solar system from observations of the state of ionization of the solar wind. For example, charge exchange between solar wind protons and interstellar hydrogen atoms produces a neutral hydrogen component of the solar wind; similarly, photoionization of interstellar helium atoms, together with other less important processes, results in the appearance of  $\text{He}^+$  ions in the solar wind (fig. 14). The hydrogen flux in the solar wind is estimated to be less than  $10^{-4}$  of the proton flux if  $N(\text{H}) = 0.1 \text{ cm}^{-3}$ , and is probably too small to be easily measured. The expected flux of  $\text{He}^+$  ions in the solar wind is shown in figure 14(d) for the case  $N(\text{H}) = 1 \text{ cm}^{-3}$ . There have been reports of a singly ionized helium component of the solar wind [*Bame et al.*, 1968; *Wolfe et al.*, 1966], with a flux of the order of  $10^{-3}$  times that of  $\text{He}^{+2}$  ions. On the basis of these results, *Holzer and Axford* [1971] have estimated that  $N(\text{H}) \approx 0.1 \text{ cm}^{-3}$ , which is consistent with the estimate based on the terrestrial  ${}^3\text{He}$  budget. More recent observations by *Bame et al.* [1970] showed no evidence for the presence of  ${}^4\text{He}^+$  ions in the solar wind possibly because they were masked by other ions with the same charge-mass ratio ( $\text{Si}^{+7}$ ,  $\text{S}^{+8}$ ,  $\text{A}^{+9}$ ,  $\text{Fe}^{+14}$ ) or because they had a bulk flow velocity and temperature significantly different from those of other ions and could not be easily identified in an energy-per-unit-charge spectrum. There is clearly a need for further observations using a detector which can identify  ${}^4\text{He}^+$  ions unambiguously [*Ogilvie et al.*, 1968; *Ogilvie and Wilkerson*, 1969].

The interstellar gas can be detected directly by observations of resonant scattering of solar photons, notably Lyman  $\alpha$  ( $\lambda 1216 \text{ H}\alpha$ ) and  $\lambda 584 \text{ HeI}$  [*Morton and Purcell*, 1962; *Kurt*, 1965, 1967; *Kurt and Dostovalov*, 1968; *Kurt and Syunyaev*, 1968; *Young et al.*, 1968; *Chambers et al.*, 1970; *Mange and Meier*, 1970; *Thomas and Krassa*, 1971; *Bertaux and Blamont*, 1971; *Wallace*, 1969; *Tinsley*, 1969; *Reay and Ring*, 1969; *Barth*, 1970a,b; *Barth et al.*, 1967, 1968; *Metzger and Clark*, 1970; *Byram et al.*, 1961; *Bowyer et al.*, 1968; *Johnson*



**Figure 14** Contours of equal flux of hydrogen in the solar wind resulting from charge exchange with interstellar hydrogen, relative to the solar wind proton flux (assumed to be  $2 \times 10^8 \text{ cm}^{-2} \text{ sec}^{-1}$  at 1 AU). The plane of the diagram is defined by the velocity vector of the interstellar gas and the sun. There is an enhancement of solar wind hydrogen along the downwind axis of symmetry in (a) and (b) where  $\mu = 0.0$  and  $0.8$ , respectively, but not in (c) where  $\mu = 1$ .

The flux of  $\text{He}^+$  ions in the solar wind resulting from ionization of the interstellar gas, relative to the solar wind proton flux, is shown in (d). The interstellar gas density has been assumed to be  $1 \text{ cm}^{-3}$  in these calculations, with  $N(\text{H}) = 0.92 \text{ cm}^{-3}$ , and  $N(\text{He}) = 0.08 \text{ cm}^{-3}$ . For other values of  $N(\text{H})$  and  $N(\text{He})$  the figures should be rescaled appropriately.

*et al.*, 1971; Ogawa and Tohmatsu, 1971]. From such observations, we can in principle deduce the composition and density of neutral interstellar gas flowing past the solar system, the velocity vector, and also the temperature. Accordingly, they are of great significance for our understanding of the behavior of the solar wind at great distances from the sun. Interpretations of these observations in terms of various models of the interaction between the solar wind and the interstellar medium have been given by Patterson *et al.* [1963], Brandt [1964b, 1970], Hundhausen [1968b], Kurt and

Germogenova [1967], Blum and Fahr [1969, 1970b,c, 1971], Tohmatsu [1970], Bowers [1970], Tinsley [1971], Holzer [1971], Thomas [1971], and Wallis [1971].

Let us consider a simple model for the scattering of solar radiation by neutral atoms in the interplanetary medium. The flux  $J(r, \theta, \nu)$  of solar photons in the frequency range  $(\nu, \nu + d\nu)$  satisfies the equation

$$\frac{1}{r^2} \frac{\partial}{\partial r} (r^2 J) = -\alpha n J \quad (56)$$

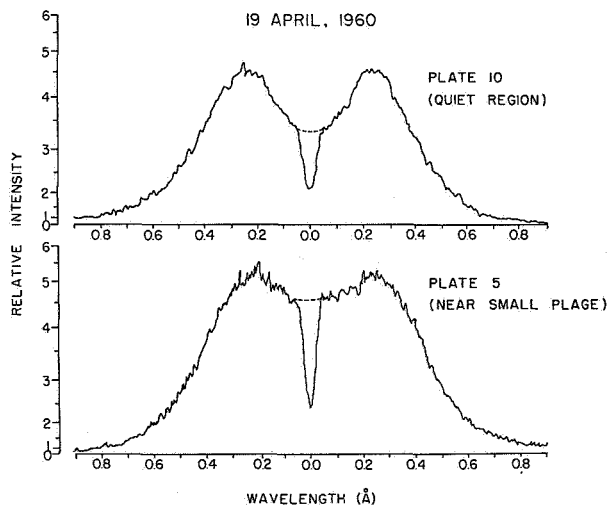
where  $\alpha(r, \theta; \nu)$  is the absorption coefficient, and we have neglected multiply scattered photons. If  $\mathbf{r}, \mathbf{r}'$  are the position vectors of a point in space relative to the sun and earth, respectively, then the intensity of singly scattered photons in a fixed direction  $\hat{\mathbf{r}}'$  is given by

$$J'(\nu) = \frac{1}{4\pi} \int_0^\infty \alpha(\mathbf{r}; \nu) n(\mathbf{r}) J(\mathbf{r}; \nu) dr' \quad (57)$$

where the integration is carried out along the line of sight from the earth,  $\nu$  refers to the frequency before scattering takes place, and absorption of the scattered photons is neglected. The total intensity of singly scattered photons from a given solar emission line is therefore

$$I = 4\pi \times 10^6 \int_{-\infty}^{\infty} J'(\nu) d\nu \quad (\text{Rayleighs}) \quad (58)$$

It does not matter that the frequency of the scattered photons need not be the same as that of the absorbed photons (in the observer's frame) since observations are usually carried out with broadband detectors. However it might be important in some cases to allow for Doppler shifts in calculating the absorption coefficient if the solar emission line is not broad and featureless. In the case of Lyman  $\alpha$  for example (see fig. 15), the intensity



**Figure 15** Solar Lyman  $\alpha$  profiles for two regions on the sun obtained by Meier and Prinz [1970]. The central core is produced by the earth's hydrogen corona, and the dashed line indicates the expected unattenuated intensity.

at the center of the line is only 70 percent of the maximum intensity in quiet solar conditions, and the maxima occur at  $\pm 0.25 \text{ \AA}$  from the center (corresponding to Doppler shifts such that  $|u_r| \approx 60 \text{ km sec}^{-1}$ ). If it is considered that the above analysis is unnecessarily complicated in view of the fact that the solar emission line is quite variable, and that multiple scattering has been neglected, a simplification can be achieved by assuming that the medium is optically thin. In this case the right hand side of equation (56) is equated to zero, so that instead of

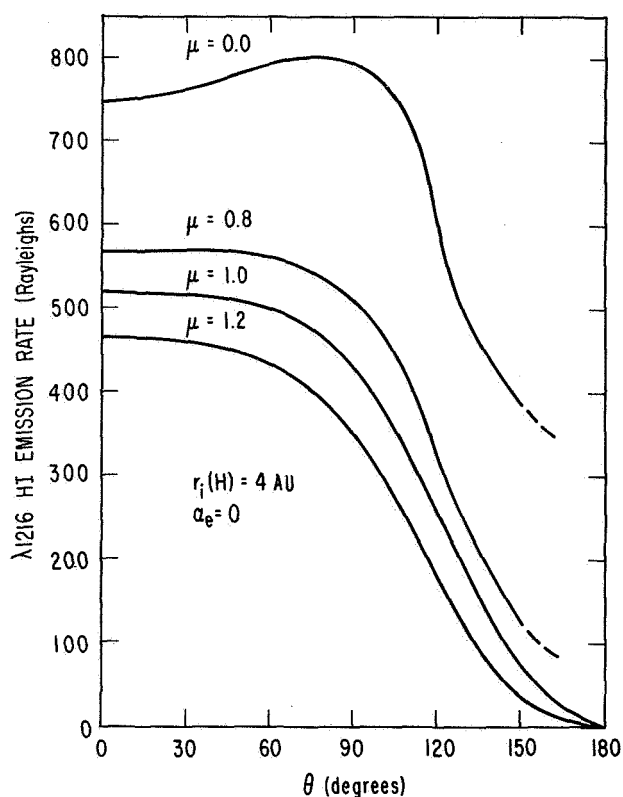
$$J(\mathbf{r}; \nu) = \frac{r_e^2}{r^2} J(r_e; \nu) \exp \left[ - \int_{r_e}^r \alpha(\mathbf{r}; \nu) n(\mathbf{r}) dr \right] \quad (59)$$

with the integration being carried out along the radius vector from the sun, we neglect the exponential term and simply use

$$J(\mathbf{r}; \nu) = \frac{r_e^2}{r^2} J(r_e; \nu) \quad (60)$$

in (57). In any case, these calculations will usually tend to overestimate the intensity of the scattered light for given  $N$ , as a result of the neglect of multiple scattering.

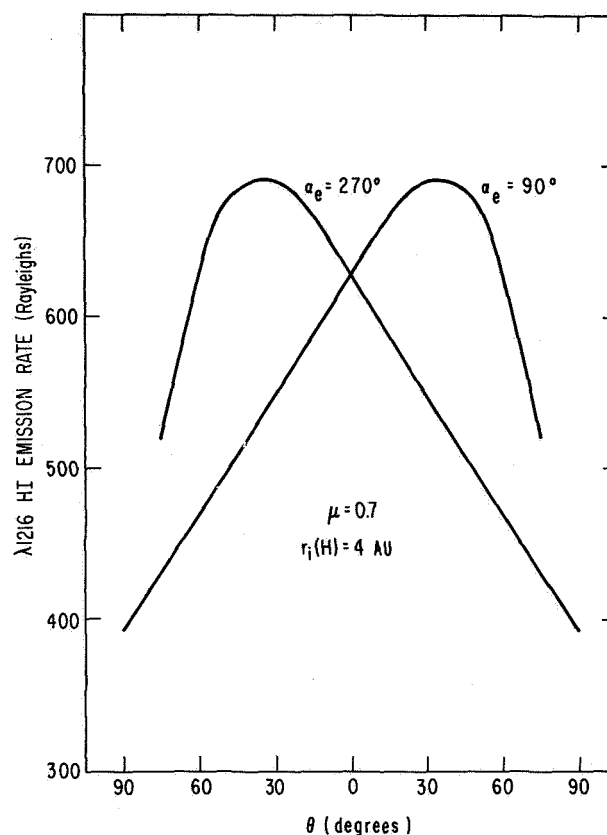
Examples of calculated total intensity profiles of scattered solar radiation from neutral hydrogen ( $\lambda 1216 \text{ H I}$ ) are shown in figures 16(a) and (b) and from neutral helium ( $\lambda 584 \text{ He I}$ ) in figures 16(c) and (d). In figures 16(a) and (c) the earth is shown situated on the upstream axis of symmetry ( $\alpha_e = 0$ ), and in figures 16(b) and (d) it is shown situated at  $90^\circ$  from the axis of symmetry ( $\alpha_e = 90^\circ, 270^\circ$ ). We have not attempted to obtain an exact fit between the models and the observations (fig. 17), but instead have simply taken  $N(\text{H}) = 0.1 \text{ cm}^{-3}$ ,  $N(\text{He}) = 0.008 \text{ cm}^{-3}$ , and  $V = 20 \text{ km sec}^{-1}$ , with the interstellar wind vector in the plane of the ecliptic; this choice provides a reasonable match to the observations if  $\mu \approx 1$ . The direction of the interstellar wind is determined by the direction of maximum Lyman  $\alpha$  intensity, although as pointed out by Blum and Fahr [1971], some distortion may be produced as a result of asymmetries in the solar Lyman  $\alpha$  emission. The velocity of the interstellar wind is determined by the parallax effect shown in figure 16(b) (see also figs. 17(a)–(c)). The value of  $N(\text{H})$  is determined from the maximum intensity of scattered Lyman  $\alpha$ , although it should be noted that there is some ambiguity since it is also necessary to account for the observed minimum intensity of  $\sim 250 R$  [Thomas, 1971]. Note that for small values of  $\mu$  the peak Lyman  $\alpha$  emission



**Figure 16(a)** Calculated scattered intensity of Lyman  $\alpha$  ( $\lambda 1216$  HI) corresponding to the results shown in figure 12 for various values of  $\mu$ , with  $N(\text{H}) = 0.1 \text{ cm}^{-3}$  and  $V = 20 \text{ km sec}^{-1}$ . The earth is on the axis of symmetry on the upstream side of the sun ( $\alpha_e = 0$ ). For  $\mu < 1.0$  there is a singularity at  $\theta = 180^\circ$  corresponding to the singularities on the axis of symmetry shown in figures 12(a) and (b).

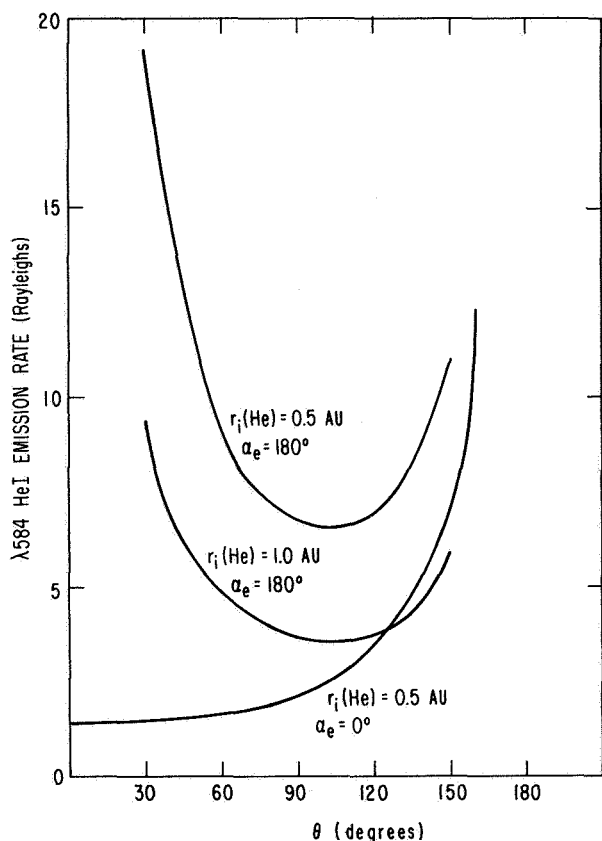
occurs at  $\theta \approx 90^\circ$ , and there would not be a single maximum as observed (fig. 17). If  $\mu \geq 1$ , the minimum intensity is zero according to our calculations, which are based on the assumption that  $T_I = 0$ .

The observed minimum intensity of  $\sim 250 R$  can be accounted for in any of three ways: (1) the effect of radiation pressure is such that  $\mu < 1$ ; (2) there may be a uniform galactic background of Lyman  $\alpha$  [Kurt and Syunyaev, 1968; Tinsley, 1969, 1971; Adams, 1971]; or (3) the interstellar hydrogen has a relatively high temperature ( $T_I \approx 10^4 \text{ K}$ ) as discussed earlier [Thomas, 1971]. If  $T_I$  is small and the effects of radiation pressure do not exceed those of gravity ( $\mu \approx 0.7$ ), then a small bright patch should occur near the center of the region of low intensity as a result of the high neutral hydrogen density in the vicinity of the axis of symmetry [Blum and Fahr, 1970b]. However, the bright patch may not



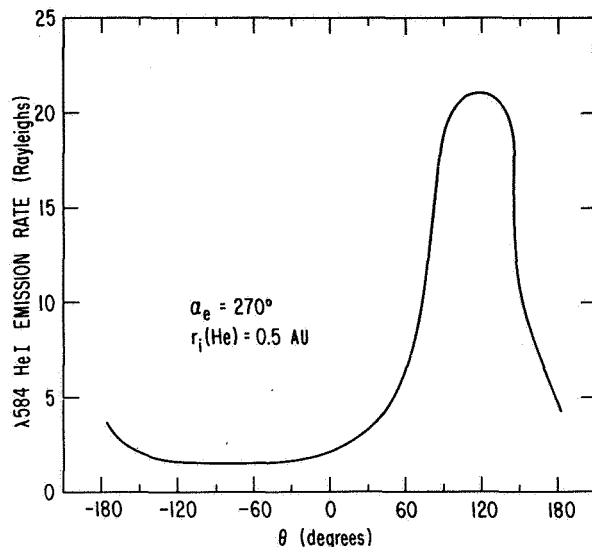
**Figure 16(b)** The same as (a) but with the earth at  $\pm 90^\circ$  from the axis of symmetry (i.e.,  $\alpha_e = 90^\circ, 270^\circ$ ) showing the effect of parallax. With  $\mu = 0.7$ , and the same values assumed for the various parameters involved, the direction of the region of maximum emission intensity can vary by about  $60^\circ$  throughout the year.

be very prominent unless observations are made exactly along the axis of symmetry ( $\alpha_e = \theta = 180^\circ$ ). Preliminary calculations indicate that for  $\alpha_e \neq 180^\circ$  the secondary intensity maximum is not at all pronounced and could be easily missed by observations made with wide-angle detectors [Johnson, 1971]. If the minimum intensity represents galactic Lyman  $\alpha$ , then this should be distinguishable from the scattered solar Lyman  $\alpha$  since the line width is expected to be considerably greater. Furthermore, as pointed out by Blum and Fahr [1970c], galactic and local components of the diffuse Lyman  $\alpha$  radiation can be distinguished by the fact that the former must be constant in time, while the latter must reflect changes in the solar Lyman  $\alpha$  flux, especially the 27-day variations [Meier, 1969]. Observations of such time variations could remove these uncertainties, as could observations made at greater distances from the sun (beyond the orbit of Jupiter) where the galactic

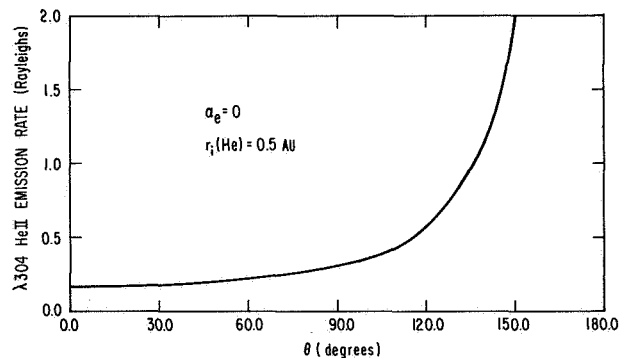


**Figure 16(c)** Intensity of scattered  $\lambda 584$  HeI; we have used the same parameters as in (a) and (b), and assumed that the interstellar gas contains 8 percent He. Note that there is a maximum in the direction of the sun as well as in the direction of the downstream axis of symmetry. The former maximum occurs in the case of helium but not hydrogen because the helium is easily able to penetrate to within the orbit of earth. The effect of varying  $r_i(\text{He})$  from 0.5 to 1.0 is shown for the case  $\alpha_e = 180^\circ$ . The solar line width is assumed to be  $0.023 \text{ \AA}$  [e.g., Donahue and Kumer, 1971] which is probably too small, however the scattered intensity varies approximately inversely with the line width, and for other values the scattered intensity can be obtained by simply rescaling this diagram.

component should be dominant. The suggestion by Thomas [1971] that  $T_I$  is relatively large is consistent with theoretical work on the intercloud component of a neutral interstellar gas. This is certainly a possibility if the background soft X-ray flux is sufficient to heat the interstellar gas [Silk and Werner, 1969; Werner et al., 1970], but probably not if it is necessary to rely on heating by low-energy cosmic rays. There are at least



**Figure 16(d)** The same as (c), but with  $\alpha_e = 270^\circ$ , showing the displacement of region of maximum intensity.



**Figure 16(e)** Intensity of scattered  $\lambda 304$  HeII resulting from the presence of singly ionized helium in the solar wind for  $\alpha_e = 0^\circ$ , and  $r_i(\text{He}) = 0.5$ . Most of the scattered light comes from the direction of the sun. The scattered intensity is approximately inversely proportional to the assumed solar line width, which in this case has been taken to be  $0.06 \text{ \AA}$ .

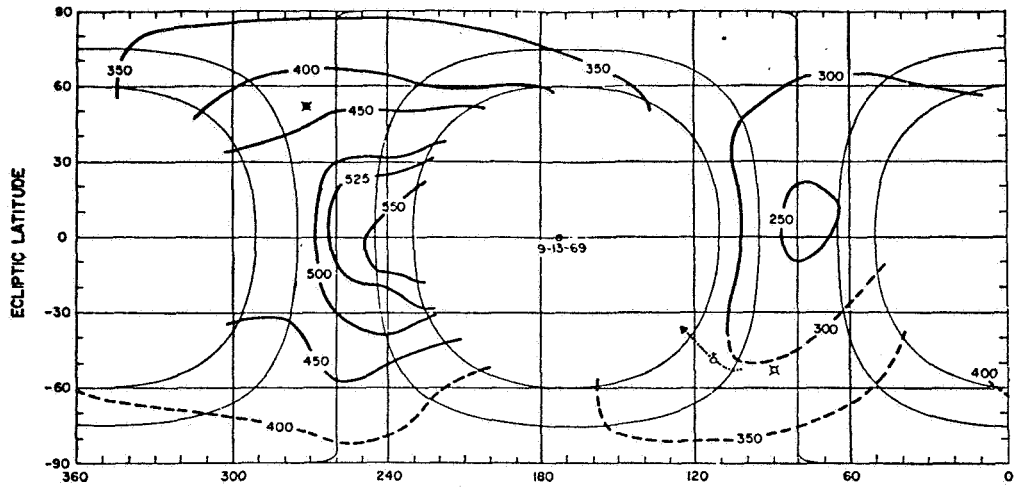
two ways of determining whether or not the temperature of the interstellar gas is large: (1) from measurements of the intensity of scattered  $\lambda 584$  HeI, which should show a very pronounced maximum in the direction of the axis of symmetry  $\alpha_e = 180^\circ$ , and to some extent for other values of  $\alpha_e$  if  $T_I$  is small (figs. 16(c) and (d)); and (2) from measurements of the width of the scattered solar Lyman  $\alpha$  line, made when  $\alpha_e = 90^\circ, 270^\circ$ , and away from the sun ( $\theta = 90^\circ, 270^\circ$ ), where scattering



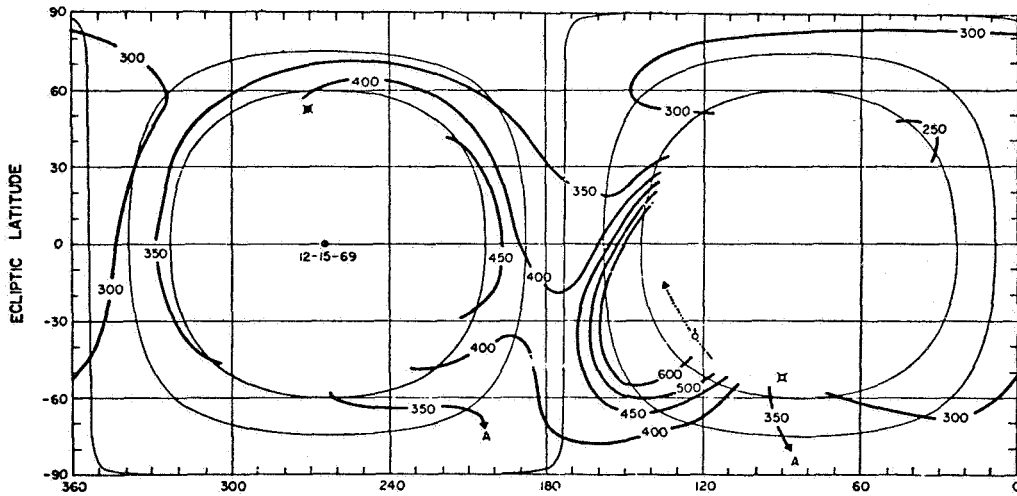
should take place in the line center if  $T_I$  is small. In this case, a hydrogen absorption cell should have a pronounced effect on the observed radiation unless there is a substantial galactic component [Blamont, private communication, 1971].

The resonantly scattered helium radiation ( $\lambda 584 \text{ HeI}$ ) is of particular interest since helium atoms penetrate easily to within the orbit of earth, and hence there is always a maximum in the direction of the sun. The

intensity minimum occurs in the direction away from the sun except when  $\alpha_e \approx 180^\circ$  (figs. 16(c) and (d)). These effects could also be found in the case of Lyman  $\alpha$  for observations made in the region  $r \geq 5 \text{ AU}$ . In our calculations we have adopted a solar line width of  $0.023 \text{ \AA}$  [Donahue and Kumer, 1971]; this line width may be too small, in which case the expected scattered intensity should be reduced proportionately downward from the values shown in figures 16(c) and (d). There

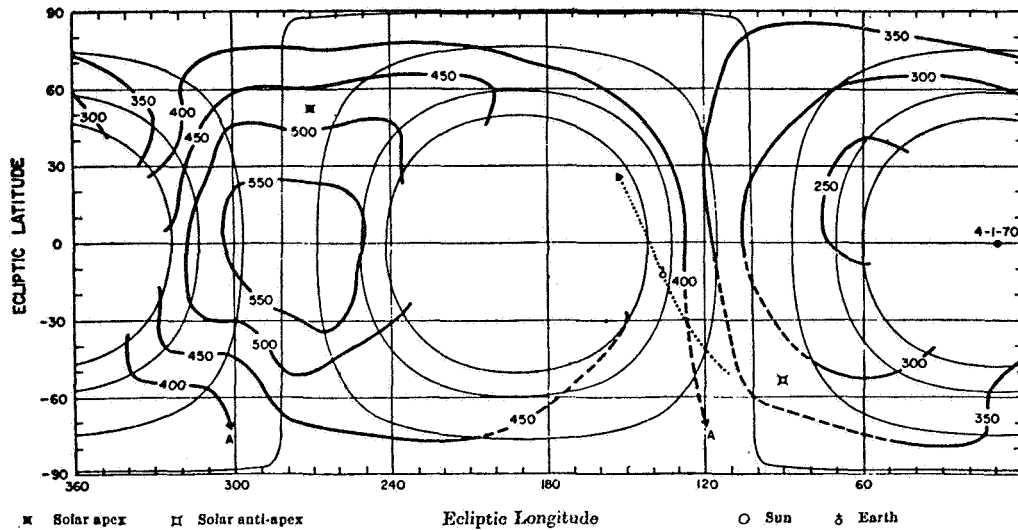


(a) SU 1 on 13 September 1969



(b) SU 2 on 15 December 1969

**Figure 17** Contour maps of the solar Lyman  $\alpha$  background in ecliptic coordinates for the three spinups (SU's) of OGO 5: (a) SU 1 on 13 September 1969; (b) SU 2 on 15 December 1969; and (c) SU 3 on 1 April 1970. These figures have been taken from Thomas and Krassa [1971]. Similar diagrams have been given by Bertaux and Blamont [1971]. (d) Contour map of scattered  $\lambda 304 \text{ HeII}$  radiation based on the observations of Johnson et al. [1971], and taken from Ogawa and Tohmatsu [1971].



(c) SU 3 on 1 April 1970

Figure 17 Continued.

have been only a few observations of the diffuse helium radiation to date; these indicate an upper limit of  $\sim 2 R$  for the intensity of the diffuse  $584\text{\AA}$  radiation from extraterrestrial neutral helium in a direction away from the sun [Young *et al.*, 1968; Johnson *et al.*, 1971; Ogawa and Tohmatsu, 1971]. We suggest that these observations be pursued for various combinations of values of  $\alpha_e$  and  $\theta$ , and also outside the influence of the neutral helium envelope of the earth.

There must be diffuse Lyman  $\alpha$  and  $\lambda 304$  HeII radiation resulting from the presence of neutral hydrogen and singly ionized helium in the solar wind as indicated in figure 14. The Lyman  $\alpha$  produced in this way can be distinguished from that described above since it should be red-shifted by about  $1.5\text{\AA}$  from the center of the solar line. However, calculations by Gregory [1971] indicate that for  $\mu = 0.8$ ,  $N(\text{H}) = 0.1 \text{ cm}^{-3}$ , and  $\alpha_e = 0$ , the intensity of the scattered Lyman  $\alpha$  from this source is only  $\sim 3.5 R$  in the direction  $\theta = 0$ , which is probably too small to be distinguished from the galactic background. The intensity of scattered  $304\text{\AA}$  radiation is shown in figure 16(e) for the case  $\alpha_e = 0$ ; as in the case of radiation scattered by neutral helium, maximum emission occurs in the direction of the sun. For  $\theta \approx 120^\circ$  to  $150^\circ$ , the intensity of the scattered radiation is  $\sim 1 R$ , which is consistent with an observation of  $1.0 \pm 0.2 R$  reported by Ogawa and Tohmatsu [1971].

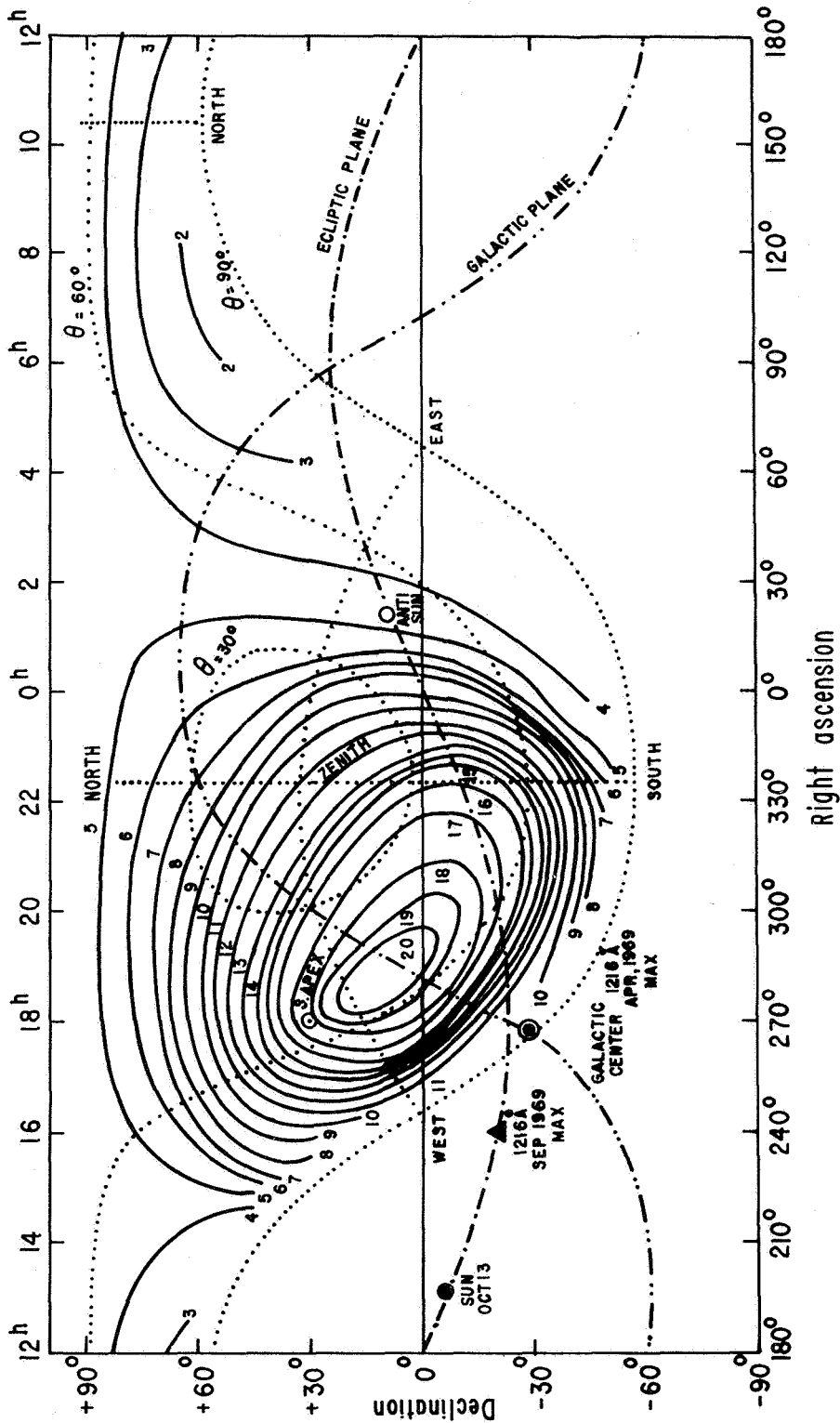
Another possible source of diffuse Lyman  $\alpha$  radiation is scattering from fast hydrogen atoms produced by charge exchange in the region of subsonic solar wind flow beyond the shock transition. In this case the emission should be centered at  $\sim 0.3\text{\AA}$  to the red side of the

center of the solar line, and have a half width of about  $1\text{\AA}$  as a result of the random velocities of the hydrogen atoms produced in this region. This emission has been considered by Patterson *et al.* [1963] and Hundhausen [1968b] in an attempt to account for an observation of  $\sim 540 R$  of Doppler-broadened Lyman  $\alpha$  reported by Morton and Purcell [1962]. However, this observation showed only that there is more or less isotropic emission outside  $\pm 0.04\text{\AA}$  from the center of the line, which is easily accounted for by scattering from interstellar hydrogen, since it is moving at velocities exceeding  $20 \text{ km sec}^{-1}$ , and will in general produce Lyman  $\alpha$  emission displaced about  $0.1\text{\AA}$  from the line center. The calculations of Patterson *et al.* [1963] and Hundhausen [1968b] indicate that the isotropically moving hydrogen atoms must be produced in the region  $r = 10$  to  $20 \text{ AU}$  to explain the observed emission intensity. However, since it seems likely that as noted, the transition to subsonic flow does not occur within  $50 \text{ AU}$ , this should not be an important source of diffuse Lyman  $\alpha$ .

It would be of interest to extend the calculations described in this section to include other emissions. Undoubtedly other hydrogen and helium lines are present in the diffuse radiation with intensities proportional to those of the  $\lambda 1216 \text{ HI}$  and  $\lambda 584 \text{ HeI}$  emissions [Reay and Ring, 1969; Tohmatsu, 1970]. Furthermore, the possibility of scattering by other species is also of interest, and on the basis of table 1 it would appear that neon in particular might produce a detectable emission, since  $r_i(\text{Ne})$  is small and neon is a relatively abundant element.

He<sup>+</sup> 304Å isophote map projected  
into celestial coordinates

(Multiply 0.36 to get  
brightness in Rayleighs)



(d) Contour map of scattered  $\lambda 304$  HeII radiation based on the observations of Johnson et al. [1971], and taken from Ogawa and Tohmatsu [1971].

Figure 17 Concluded.

## INTERACTION OF THE SOLAR WIND WITH NEUTRAL INTERSTELLAR GAS

In this section we consider the effect on the solar wind of the neutral component of the interstellar gas. Various aspects of this interaction have been considered by several authors [Axford *et al.*, 1963; Patterson *et al.*, 1963; Axford and Newman, 1965; Dessler, 1967; Kern and Semar, 1968; Hundhausen, 1968a; Fahr, 1968a,b, 1969, 1970; Blum and Fahr, 1969, 1970a,b; Semar, 1970; Holzer, 1970, 1971; Holzer and Axford, 1971; Wallis, 1971; Bhatnagar and Fahr, 1971]. In this discussion of the problem, we shall follow the treatment given by Holzer [1971], which is similar to the work of Wallis [1971] but somewhat more detailed.

It has been shown that the interstellar neutral gas penetrates to within a few astronomical units of the sun before becoming significantly affected by losses due to photoionization and charge exchange. Since the solar wind is expected to extend to a heliocentric distance of the order of 100 AU in the absence of any interaction with neutral interstellar gas, it is evident that as a first approximation we can treat the solar wind as if it were flowing through a uniform background of neutral gas with density  $N$ , temperature  $T_n$ , and velocity  $\mathbf{V}$  relative to the sun. Even with this assumption, the problem is very difficult since there must be nonradial flow in the region of supersonic solar wind flow as well as in the subsonic region; furthermore, the effects of the interplanetary magnetic field should not be ignored. However, a simplification can be achieved if we consider only the directions parallel and antiparallel to the velocity vector of the interstellar gas, since the flow can then be treated as being approximately radial. In this case, as noted earlier, the azimuthal component of the interplanetary magnetic field is dominant in  $r \gtrsim 5$  AU and accordingly we may assume that  $B_r \approx 0$  and  $B \approx B_\phi \propto (ur)^{-1}$ .

If we represent the solar wind as a steady, radial, spherically symmetric flow of a proton-electron plasma through an atomic hydrogen gas, then neglecting viscosity and heat conduction, the equations of motion can be formulated as follows:

$$\frac{1}{r^2} \frac{d}{dr} (nur^2) = q_p \quad (61)$$

$$\begin{aligned} \frac{1}{r^2} \frac{d}{dr} (nu^2 r^2) = & -\frac{1}{\gamma} \frac{d}{dr} (nc_s^2) - \frac{G\eta}{r^2} n \\ & + \frac{1}{mc} (\mathbf{j} \times \mathbf{B})_r + Q_p^m + Q_c^m \end{aligned} \quad (62)$$

$$\frac{1}{r^2} \frac{d}{dr} \left[ nur^2 \left( \frac{1}{2} u^2 + \frac{1}{\gamma-1} c_s^2 \right) \right] = -\frac{G\eta}{r^2} nu + \frac{\mathbf{j} \cdot \mathbf{E}}{m} + Q_p^e + Q_c^e \quad (63)$$

Here  $c_s (= \sqrt{\gamma p / \rho})$  is the plasma sound speed,  $m$  is the proton mass, and  $c$  is the speed of light. The rates of mass, momentum, and energy production are represented by  $q$ ,  $Q^m$ , and  $Q^e$ , per proton mass per unit volume, respectively, with the subscripts  $p$  and  $c$  referring to the processes of photoionization and charge exchange. Thus

$$q_p = q_0 N \left( \frac{r_0}{r} \right)^2 \exp \left( -\sigma_p \int_{r_0}^r N dr' \right) \quad (64)$$

$$Q_p^m = q_p V \quad (65)$$

$$Q_p^e = q_p \left( \frac{1}{2} V^2 + \frac{3}{2} \frac{kT_n}{m} + \frac{\mathcal{E}}{m} \right) \quad (66)$$

$$Q_c^m = \nu n (V - u) \quad (67)$$

$$Q_c^e = \nu n \left( \frac{1}{2} V^2 + \frac{3}{2} \frac{kT_n}{m} - \frac{1}{2} u^2 - \frac{\alpha}{\gamma-1} \frac{kT}{m} \right) \quad (68)$$

$$\nu = \sigma_c N \left[ \frac{128k}{9\pi m} (\alpha T + T_n) + (u - V)^2 \right]^{1/2} \quad (69)$$

where  $\sigma_p$  is a mean photoionization cross section,  $\mathcal{E}$  is the average energy of a photoelectron produced in the photoionization process,  $T (= T_e + T_p)$  is the plasma temperature,  $\alpha T$  is the proton temperature, and  $\sigma_c$  is the resonant charge exchange cross section. The velocity of the interstellar neutral gas ( $\mathbf{V}$ ) is taken to be radial.

The electric field ( $\mathbf{E}$ ), the current ( $\mathbf{j}$ ), and the magnetic field satisfy the equations

$$\nabla \times \mathbf{B} = \frac{4\pi}{c} \mathbf{j} \quad (70)$$

$$\mathbf{E} = -\frac{1}{c} \mathbf{u} \times \mathbf{B} \quad (71)$$

Thus, with the assumption that the magnetic field is azimuthal, we find that

$$\frac{1}{c} (\mathbf{j} \times \mathbf{B})_r = -\frac{d}{dr} \left( \frac{B^2}{8\pi} \right) - \frac{B^2}{4\pi r} \quad (72)$$

and

$$\mathbf{j} \cdot \mathbf{E} = -u \frac{d}{dr} \left( \frac{B^2}{8\pi} \right) - u \frac{B^2}{4\pi r} \quad (73)$$

We can now write the equations of motion in the form

$$\frac{1}{u} \frac{du}{dr} (u^2 - c_s^2 - c_A^2) = \frac{2}{r} c_s^2 - \frac{Gm}{r^2} + \mathfrak{Q}_1 \quad (74)$$

$$\frac{dc_s^2}{dr} = (\gamma - 1) \left( -\frac{2}{r} c_s^2 - \frac{c_s^2}{u} \frac{du}{dr} + \mathfrak{Q}_2 \right) \quad (75)$$

with the following definitions:

$$\mathfrak{Q}_1 = -\left( \frac{q_p}{\mathfrak{F}} + \frac{v}{u} \right) \left[ \frac{1}{2} u^2 + \frac{\gamma}{2} (u - V)^2 - \frac{1}{2} V^2 + \frac{3}{2} (\gamma - 1) \frac{kT_n}{m} \right] + \frac{v}{u} \frac{\alpha}{\gamma} c_s^2 - \frac{q_p}{\mathfrak{F}} (\gamma - 1) \frac{\mathfrak{E}}{m} \quad (76)$$

$$\mathfrak{Q}_2 = \gamma \left( \frac{q_p}{\mathfrak{F}} + \frac{v}{u} \right) \left[ \frac{1}{2} (u - V)^2 + \frac{3}{2} \frac{kT_n}{m} - \frac{\alpha}{\gamma(\gamma - 1)} c_s^2 \right] + \frac{q_p}{\mathfrak{F}} \left( \frac{\alpha - 1}{\gamma - 1} c_s^2 + \frac{\gamma \mathfrak{E}}{m} \right) \quad (77)$$

$$\mathfrak{F} = nu = \frac{1}{r^2} \left( n_o u_o r_o^2 + \int_{r_o}^r r'^2 q_p dr' \right) \quad (78)$$

$$c_A^2 = \frac{B^2}{4\pi m} = \frac{B_o^2 u_o^2 r_o^2}{4\pi m \mathfrak{F} r^2 u} \quad (79)$$

where the subscript  $o$  denotes quantities evaluated at a point  $r = r_o$  close to the sun.

In the special case where  $B = G = V = T_n = \mathfrak{E} = 0$ , equations (74) and (75) reduce to a single first-order differential equation in terms of the Mach number  $M = u/c_s$ :

$$\frac{1}{M} \frac{dM}{dr} (M^2 - 1) = \frac{\gamma + 1}{r} + \frac{\gamma - 1}{r} (M^2 - 1)$$

$$-\frac{q_p}{\mathfrak{F}} \left( \frac{\gamma^2 - \gamma}{4} M^4 + \frac{3\gamma - 1}{4} M^2 + \frac{1}{2} \right)$$

$$-\frac{v}{u} \left( \frac{\gamma^2 - \gamma}{4} M^4 + \frac{3\gamma - 2\alpha + 1}{4} M^2 - \frac{\alpha}{2\gamma} \right) \quad (80)$$

Note that  $v/u$  is a function only of  $M$ , since in this special case (69) reduces to

$$v = \sigma_c Nu \left( 1 + \frac{128\alpha}{9\pi\gamma} \frac{1}{M^2} \right)^{1/2} \quad (81)$$

Many features of the solutions of the more general equations (74) and (75) can be understood from an examination of the solutions of (80). In effect, this is the problem considered by *Semar* [1970], who carried out a numerical integration of the equations of motion (61), (62), and (63), for this case taking  $\gamma = 2$ ,  $\alpha = 1$ , and omitting the term enclosed in the bracket in (81). Unfortunately, the existence of a singular point at  $M = 1$  was overlooked in Semar's analysis, which consequently implies that a shock-free ("transonic") transition to subsonic flow will always occur. In fact, as pointed out by *Wallis* [1971] and *Holzer* [1971], this is not necessarily the case.

Equation (80) has a singular point at which  $(M^2 - 1)$  and the right-hand side of (80) vanish simultaneously. If this point is defined to be at  $r = r_c$ , then

$$r_c = \frac{1}{4f_c} \left\{ 3 - \gamma - 2Rf_c + [4R^2 f_c^2 + (20 + 4\gamma)Rf_c + (\gamma - 3)^2]^{1/2} \right\} \quad (82)$$

where, using (64) and (69), and assuming that the neutral gas is optically thin in the region  $r_o < r < r_c$ , we have

$$\frac{q_p}{\mathfrak{F}} = \frac{1}{R + r} \quad (83)$$

$$R = \frac{n_0 u_0}{q_0 N} - r_0 \quad (84)$$

$$f_c = \left( \frac{\gamma+1}{2} - \frac{\alpha}{\gamma} \right) \sigma_c N \left( \frac{128\alpha}{9\pi\gamma} + 1 \right)^{1/2} \quad (85)$$

Note that under typical solar wind conditions and with  $0.05 \leq N \leq 1.0 \text{ cm}^{-3}$ ,  $r_c \propto 1/N$ .

The form of the characteristics passing through the singular point can be determined by expanding (80) about  $M = 1$ ,  $r = r_c$ . Defining  $\lambda = M - 1$  and  $\xi = (r/r_c) - 1$ , we obtain to first order in  $\lambda$  and  $\xi$

$$\frac{d\lambda}{d\xi} = a \frac{\xi}{\lambda} + b \quad (86)$$

where

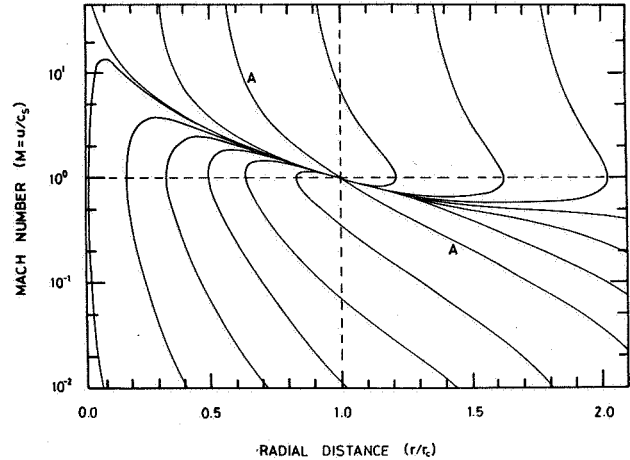
$$a = \frac{(\gamma+1)^2}{8} \left( \frac{r_c}{R+r_c} \right)^2 - \frac{\gamma+1}{2} \quad (87)$$

$$b = \gamma - 1 - \frac{(2\gamma-1)(\gamma+1)}{4} \frac{r_c}{r_c+R} - \frac{\gamma+1}{4} r_c f_c \cdot \left[ - \left( \frac{128\alpha}{9\pi\gamma} \right) \left( \frac{128\alpha}{9\pi\gamma} + 1 \right)^{-1} + \frac{4\gamma^2 - 2\gamma + \frac{4\gamma}{\gamma+1}(1-\alpha)}{\gamma^2 + \gamma - 2\alpha} \right] \quad (88)$$

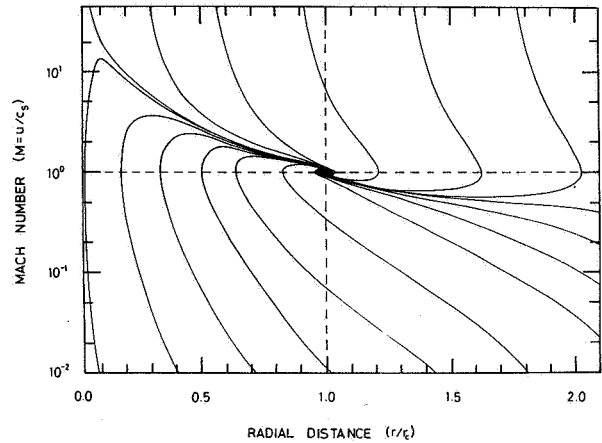
A characteristic passing through the singular point has a slope at the singular point given by  $S = \lim_{\xi \rightarrow 0} (\lambda/\xi)$ . Hence  $S$  can take one of the two values

$$S_{\pm} = \frac{1}{2} \left( b \pm \sqrt{b^2 + 4a} \right) \quad (89)$$

If  $b^2 + 4a > 0$ , the characteristics passing through the singular point can have slopes  $S_+$  or  $S_-$ . If  $b^2 + 4a = 0$ , all characteristics passing through the singular point have slope  $S_+ = S_- = b/2$ . If  $b^2 + 4a < 0$ , the characteristics in the vicinity of the singular point are spirals and the corresponding solutions are multivalued in  $M$ . A family of solutions of (80) for which  $b^2 + 4a > 0$  is shown in figure 18(a) and a family for which  $b^2 + 4a < 0$  is shown in figure 18(b).



(a)  $b^2 + 4a > 0$



(b)  $b^2 + 4a < 0$

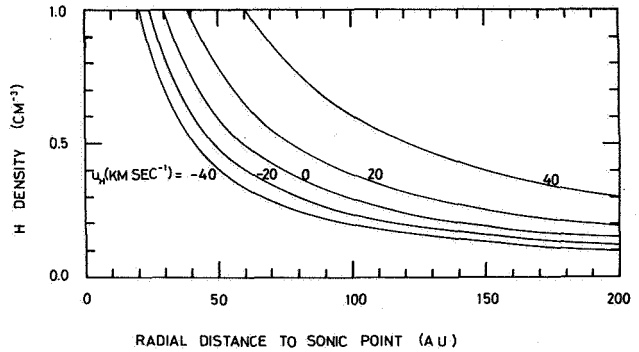
Figure 18 Characteristics of equation (58) [from Holzer, 1971]. Note that a transonic solution is possible in (a) but not in (b) where the singular point is a focus.

On examination of the possible solutions displayed in figures 18(a) and (b) one finds that only one characteristic leads to infinity in each case, and that these are such that the pressure  $p \rightarrow 0$  as  $r \rightarrow \infty$ ; there are no solutions that yield a finite pressure at infinity. For the case of moderate and low interstellar densities, the characteristics are as shown in figure 18(a), and it is always possible to find a solution starting with suitable conditions at  $r = 5 \text{ AU}$ , say, which contains a smooth transition to subsonic flow and eventually has vanishing pressure at infinity. For somewhat higher interstellar densities ( $N \gtrsim 10 \text{ cm}^{-3}$ , depending on the value chosen for other parameters), the characteristics are likely to be as shown in figure 18(b); in this case, again it is possible

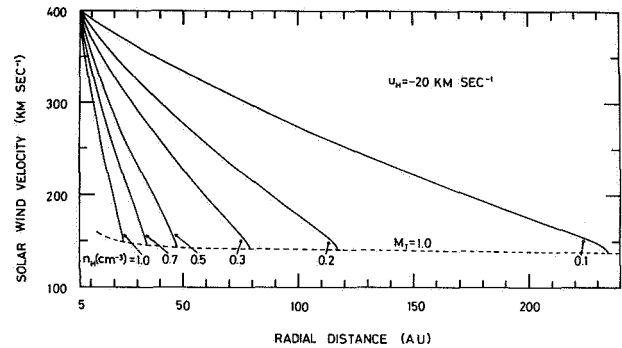
to find a solution starting with suitable conditions at  $r = 5$  AU, and with vanishing pressure at infinity, but it is necessary to insert a shock at a correctly determined location near the singular point to make the solution single valued. In the numerical treatment carried out by Semar [1970] these complexities have passed unnoticed, although the results obtained are probably a fairly good representation of the solution except in the vicinity of the singular point. It should be noted, however, that the form for the collision frequency  $\nu$  used by Semar is inadequate if the Mach number is not large, and the former has an important effect on the properties of the characteristics in the subsonic region.

The solutions of equation (80) are useful in that they suggest what we can expect in the more general case involving a pair of differential equations – namely, (74) and (75) – that must be solved simultaneously for two unknowns  $u$  and  $c_s$ . Holzer [1971] has treated this problem by a straightforward integration of (74) and (75), having assigned values for  $u$ ,  $\rho$ ,  $T$ , and  $B$  at a point relatively close to the sun ( $r = 5$  AU) where the solar wind can be expected to be essentially unaffected by the presence of neutral interstellar gas. The integration proceeds in the direction of increasing  $r$ , until the Mach number  $M_T = u/(c_s^2 + c_A^2)^{1/2}$  decreases to unity, or (if a shock transition is inserted) until the solutions approach some asymptotic form that can be recognized. In this procedure, there is some danger that singular points might be missed and that the solutions might be unstable; however, the results obtained appear to be satisfactory. Examples of solutions of equations (74) and (75) obtained in this manner are shown in figures 19(a) and (b) and 20(a)–(c). The initial conditions have been taken to be  $u_0 = 400$  km sec $^{-1}$ ,  $n_0 = 0.2$  cm $^{-3}$ ,  $c_{s0} = 15$  km sec $^{-1}$ ,  $B_0 = 0.7 \times 10^{-5}$  gauss at  $r = r_0 = 5$  AU, together with a range of values for the density ( $N$ ) and velocity ( $V$ ) of the interstellar neutral gas.

The location of the sonic point ( $M = 1$ ;  $r = r_c$ ) is shown in figure 19(a) for a range of values of  $N$  and  $V$ ; this yields an outer limit for the position of any possible shock transition in the flow. Note that the location of the sonic point is quite sensitive to the density of the neutral interstellar gas, varying roughly as  $N^{-1}$ . Furthermore, there is a substantial difference between the values of  $r_c$  on the upwind ( $V < 0$ ) and downwind ( $V > 0$ ) sides of the sun, which should produce a distinct asymmetry in the region of supersonic solar wind flow – for example, for  $N = 0.1$  cm $^{-3}$  and  $V = 20, -20$  km sec $^{-1}$ ,  $r_c = 250$  AU, 400 AU, respectively. The variation of solar wind speed with distance is shown in figure 19(b) for  $V = -20$  km sec $^{-1}$  and various values of  $N$ . If we



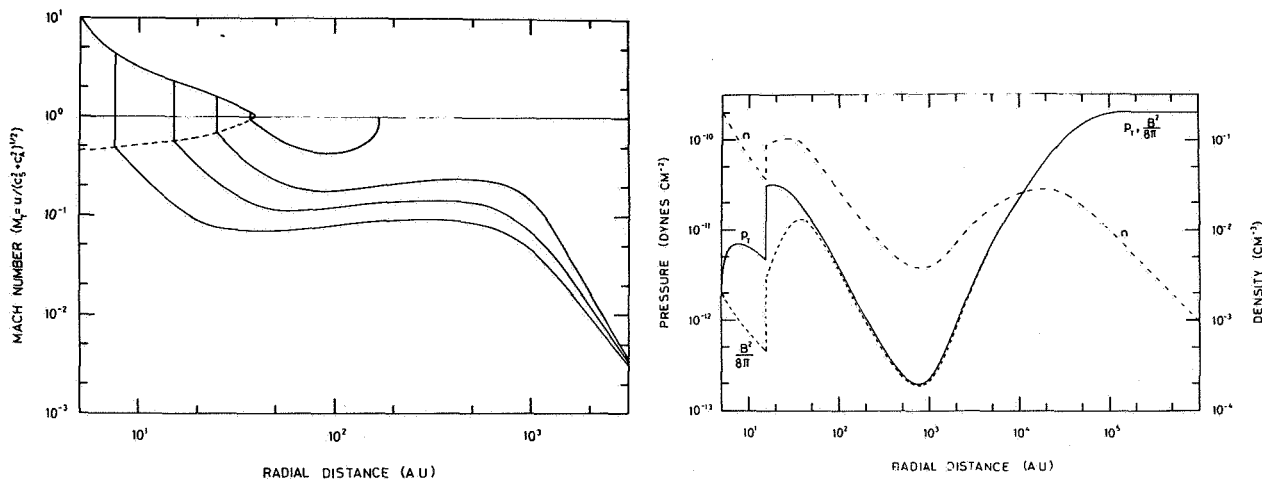
(a) Radial distance to the sonic point (see figs. 16(a), (b)) for various assumed values of the relative velocity of the interstellar gas, and interstellar hydrogen densities in the range  $0.0$  to  $1.0$  cm $^{-3}$ .



(b) Solar wind velocity as a function of radial distance from the sun for the case in which the interstellar gas has a velocity of  $20$  km sec $^{-1}$  towards the sun, and for various assumed values of the interstellar hydrogen density. Note that for the preferred value ( $0.1$  cm $^{-3}$ ) the solar wind velocity is reduced to  $< 300$  km sec $^{-1}$  at a distance of  $100$  AU where the shock transition might be expected to occur (see fig. 7).

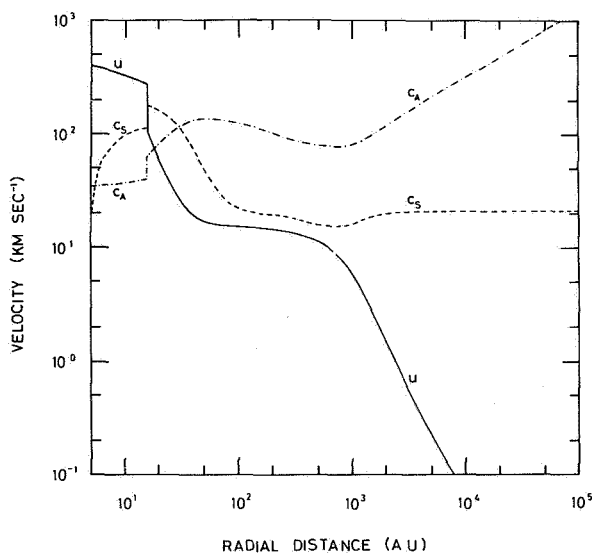
Figure 19 Effect of interstellar neutral gas hydrogen on the solar wind [from Holzer, 1971].

assume that  $N = 0.1$  cm $^{-3}$  and  $V = -20$  km sec $^{-1}$ , as suggested by the observations described in the preceding section, it can be seen that the solar wind speed is reduced from  $400$  km sec $^{-1}$  at  $5$  AU, to about  $270$  km sec $^{-1}$  at  $100$  AU, which we have estimated to be the likely position of the shock transition. Since photoionization is a relatively unimportant process the mass flux in the solar wind is essentially unaffected by the deceleration and hence the momentum flux (or ram pressure) is reduced in proportion to the velocity. This result can also be deduced easily by noting that the



(a) Variation of the Mach number with radial distance for various assumed positions of the shock transition. Note that the solutions terminate at a finite distance from the sun if the shock is inserted too close to the critical point.

(b) Variation of the plasma density  $n$ , total pressure  $p_T$ , and magnetic field pressure  $B^2/8\pi$ , as a function of radial distance for the case where the shock is inserted at 15 AU.



(c) Variation of the solar wind speed  $u$ , the sound speed  $c_s$ , and the Alfvén speed  $c_A$ , with radial distance for the case in which the shock transition is inserted at 15 AU.

**Figure 20** Variation of solar wind parameters with distance for the case  $V = 20 \text{ km/sec}^{-1}$ , and  $N = 1.0 \text{ cm}^{-3}$  [from Holzer, 1971]. Note that the solutions are somewhat similar to those shown in figure 7 for distances less than a few hundred AU. At very large radial distances the solutions may not be at all realistic; however, it is interesting that the asymptotic forms create a balance between the stresses associated with the magnetic field and the frictional interaction between the plasma and the neutral interstellar wind.



mean free path of solar wind protons against charge exchange is approximately 300 AU if  $N = 0.1 \text{ cm}^{-3}$ , and hence on reaching a heliocentric distance of 100 AU, the plasma must lose  $(1 - e^{-1/3}) \approx 1/3$  of its momentum per unit mass. Formally, this is equivalent to making the approximation  $M_T^2 \gg 1$  in (74) and putting  $\mathcal{G}_1 = -[(\gamma + 1)/2]vu$ . Thus we see that loss of momentum due to charge exchange within the region of supersonic solar wind is likely to have a significant effect on the location of the shock transition (in the sense that  $r_s$  might be reduced by 10 to 15 percent from the value estimated previously).

Solutions of equations (74) and (75) for the postshock flow have also been considered by *Holzer* [1971], again with the assumption that the flow is strictly radial; an example with  $V = 20 \text{ km sec}^{-1}$  and  $N = 1 \text{ cm}^{-3}$  is shown in figures 20(a)–(c). There appear to be no solutions that extend to infinity in the upwind direction ( $V < 0$ ); in the downwind direction ( $V > 0$ ), however, such solutions exist, provided the transition to subsonic flow takes place within a certain critical radius ( $r = r_1$ ). The Mach number is shown as a function of radial distance in figure 20(a). Note that if the shock location is such that  $r_s > r_1$ , the solution in the subsonic region bends upward, intersecting the line  $M_T = 1$  with infinite slope, and does not extend to  $r \rightarrow \infty$ . In cases where  $r_s < r_1$  the solutions in the subsonic region asymptotically approach the same curve, which is of the form  $M_T r^{3/2} = \text{constant}$ . The behavior of the other dependent variables for the case  $r_s = 15 \text{ AU} < r_1$  is shown in figures 20(b) and (c). The flow in the subsonic region can be divided into three parts: (1) in  $15 \text{ AU} < r < 50 \text{ AU}$ , the plasma is hot but is rapidly cooled as a result of charge exchange, thus causing the velocity to decrease and the magnetic field strength to increase; (2) in  $50 \text{ AU} < r < 10^3 \text{ AU}$ , the magnetic field dominates the total pressure, but the velocity is controlled by photoionization and charge exchange and is approximately equal to  $V$ ; (3) in  $r > 10^3 \text{ AU}$ , the magnetic field strength increases and the velocity decreases so that the asymptotic state is controlled by a balance between the tension stresses of the magnetic field and the frictional drag due to photoionization and charge exchange.

It is evident from the scales involved that we do not have to take these last results too seriously. Nevertheless, they do demonstrate rather clearly the complexity of the interaction that can be expected in more realistic situations when nonradial flow is important. We see, for example, that in the subsonic region on the upwind side of the heliosphere the most important effect of charge

exchange is to cool the plasma, thus permitting the magnetic field strength to grow more rapidly than it would otherwise (fig. 8). Charge exchange should not be important in the upwind subsonic region as far as the pressure/momentum balance is concerned since the streaming velocities are low. However, the increase of magnetic field strength enhances the inward force due to the tension stress associated with the field, and as noted earlier, this could produce a small but significant radial pressure gradient in the subsonic region. This effect, together with the loss of solar wind momentum due to charge exchange, could easily render our previous estimate of  $r_s = 100 \text{ AU}$  for the location of the shock transition too large by perhaps 20 to 30 percent [*Kern and Semar*, 1968]. However, a better self-consistent treatment is required before we can be sure that this is the case.

On the downwind side of the sun (in the “tail” of the heliosphere) we can expect the solar wind in the supersonic region to lose momentum due to charge exchange, so that the shock transition (if any) is not as far from the sun as it would be otherwise. In the subsonic region, the plasma should at first be cooled by charge exchange until  $\beta$  drops to such low values that the magnetic field has an important influence in controlling the flow. Momentum exchange due to photoionization and charge exchange will maintain the velocity of the flow at approximately that of the interstellar neutral gas. Similarly, the temperature of the plasma should ultimately be controlled by the input from photoelectrons and by the temperature of the interstellar gas. There is no strong reason for believing that the magnetic field will eventually increase as indicated in figure 20(b) since at the radial distances involved ( $r > 10^3 \text{ AU}$ ) in the actual heliosphere the magnetic field will certainly not be azimuthal as assumed in the calculations. Indeed, it should be expected that at distances of the order of a few hundred astronomical units the tail of the heliosphere should gradually deflate and collapse as the thermal pressure is removed from the plasma as a result of charge exchange. As the  $\beta$  of the plasma decreases to small values the magnetic structure of the tail should disintegrate due to field line reconnection at any surviving neutral sheets. Eventually, the field must become completely connected to the interstellar magnetic field and the plasma will disperse into the interstellar medium along the field lines. Thus we do not expect the tail of the heliosphere to be very long; indeed, after the first few hundred astronomical units, the term “wake” would be more appropriate. Finally, it should be noted that as a result of the very low densities involved, the plasma in the tail and wake is unlikely to be rapidly neutralized by

recombination unless the temperature of the interstellar neutral gas is relatively low ( $T_I \approx 10^2$  °K).

### THE INTERACTION BETWEEN GALACTIC COSMIC RAYS AND THE SOLAR WIND

Although galactic cosmic rays must pass through the outer regions of the heliosphere to reach the earth, they do not appear to carry much information about these regions. Nevertheless, it is useful to consider various aspects of the behavior of galactic cosmic rays within the heliosphere, especially as it is likely that the situation will change when observations from deep space probes become available.

At very high particle energies ( $\geq 200$  GeV), it is found that the solar wind and the interplanetary magnetic field have no effect on the mean cosmic ray intensity observed at the earth in the sense that there is no solar cycle modulation or evidence for Forbush decreases. It might be expected, therefore, that if the cosmic ray "gas," including these particles, has a velocity  $V_{cr}$  relative to the solar system, then this should be detectable as a sidereal diurnal variation of the intensity. That is, the differential intensity in the kinetic energy range ( $T, T + dT$ ) should have the form

$$j(T, t) = j_0(T) [1 + \xi(T) \cos \phi(t)] \quad (90)$$

where  $t$  is the time,  $\phi(t)$  is the angle between the detector acceptance direction and  $V_{cr}$ , and  $\xi(T)$  is the anisotropy given by

$$\xi(T) = \frac{3CV_{cr}}{\nu} \quad (91)$$

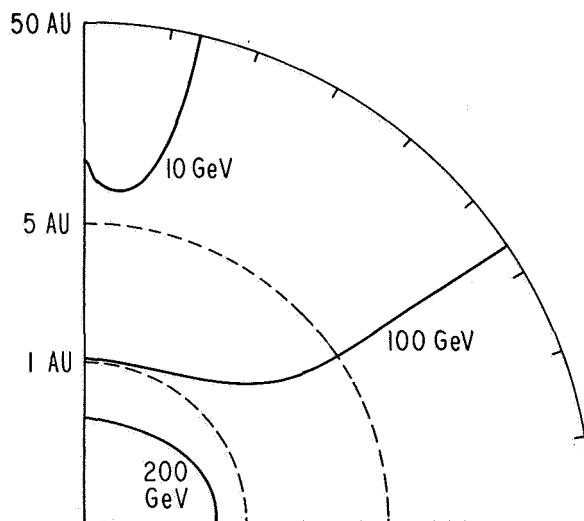
where  $\nu$  is the particle speed corresponding to kinetic energy  $T$ , and  $C$  is the Compton-Getting factor:

$$C(T) = 1 - \frac{1}{3U} \frac{\partial}{\partial T} (\alpha TU) \quad (92)$$

where  $\alpha = (T + 2E_0)/(T + E_0)$ ,  $E_0$  is the particle rest energy, and  $U(T) = 4\pi j(T)/\nu$  is the differential number density in ( $T, T + dT$ ) [Gleeson and Axford, 1968a; Forman, 1970]. At high energies ( $T \gg E_0$ ), it is a good approximation to take  $\alpha = 1$ ,  $\nu = c$ , and  $j(T) \propto T^{-\mu}$  where  $\mu \approx 2.5$ . Thus  $C \approx (2 + \mu)/3 \approx 1.5$ , and if  $V_{cr} \approx V \approx 20$  km sec<sup>-1</sup>, we should expect that  $\xi \approx 0.03$  percent, in principle an observable value.

Unfortunately, the situation is not as simple as this analysis suggests, since although the irregular component

of the interplanetary magnetic field does not significantly affect particles with energies of the order of 100 GeV and higher, the regular (Archimedes spiral) field can bend the particle trajectories so that any anisotropy becomes obscured. This is evident in figure (21), which also shows contours on which particles have gyroradii in the local mean interplanetary magnetic field equal to the scale length of the field ( $B/\nabla B$ ). Within each contour, the trajectories of particles with energies less than the designated energy can be completely turned by the magnetic field. McCracken [unpublished, but see



**Figure 21** Contour diagrams similar to those shown in figure 3 indicating regions of the interplanetary medium in which cosmic rays of a given energy have a gyroradius in the local magnetic field which is less than the characteristic scale of the field ( $B/\nabla B$ ). The diagram is somewhat misleading in the low latitude region beyond the few astronomical units since it does not take into account the sector structure of the interplanetary magnetic field. Since the sectors have a characteristic scale of only a few astronomical units, the trajectories of particles with gyroradii much larger than this will be essentially unaffected by the field.

Antonucci et al., 1970] has examined the nature of the sidereal variations to be expected in the energy range 50–500 GeV (the range appropriate to underground muon detectors). He has shown that diurnal and semi-diurnal intensity variations are to be expected, with the diurnal variation varying in amplitude throughout the year in such a manner that sidebands in the modulation should occur at 364 and 368 cycles/yr.

There is some evidence for the existence of a sidereal anisotropy obtained from detectors at 60 to 80 m.w.e. [Elliot *et al.*, 1970; Antonucci *et al.*, 1970]; however, it is not wholly convincing. For example, underground muon detectors at depths less than about 165 m.w.e. are sensitive to particles having energies less than 100 GeV [Ahluwalia, 1971], and the solar diurnal modulation (to which such particles are clearly subject) can produce pseudosidereal effects that can contaminate any genuine sidereal variation [Swinson, 1971]. It is probably necessary to make use of extensive air shower observations to obtain a good value for the cosmic ray anisotropy, since the particles involved have energies in excess of  $10^{12}$  eV and should not be noticeably affected by the interplanetary magnetic field or solar modulation. Unfortunately, the intensity of cosmic rays with energies  $\geq 10^{12}$  eV is low, and so far it has been possible only to place an upper limit of about 0.1 percent on the anisotropy.

At energies less than 100 GeV, galactic cosmic rays are modulated in intensity in a variety of ways by their interaction with the solar wind and interplanetary magnetic field; Jokipii [1971] has reviewed the theory of some of these effects. In particular, the cosmic rays undergo a solar cycle modulation that appears to be the result of a reduction of intensity in the inner solar system due to outward transport of the particles by the solar wind with associated energy changes [Parker, 1963, 1965b; Gleeson and Axford, 1967; Gleeson, 1969; Jokipii and Parker, 1970]. The equations describing the behavior of the differential number density  $U$  and current density  $S$ , assuming that the solar wind is steady and radial, and taking only radial diffusion into account, are

$$\frac{1}{r^2} \frac{\partial}{\partial r} (r^2 S) = -\frac{1}{3} u \frac{\partial^2}{\partial r \partial T} (\alpha T U) \quad (93)$$

$$S = CuU - \kappa \frac{\partial U}{\partial r} \quad (94)$$

where  $u$  is the solar wind speed and  $\kappa(r, T)$  the effective radial diffusion coefficient for cosmic rays in the (irregular) interplanetary magnetic field.

It is rather difficult to obtain solutions of equations (93) and (94) with the boundary conditions appropriate to the modulation problem ( $U \rightarrow U_\infty(T)$  as  $r \rightarrow \infty$ ,  $r^2 S \rightarrow 0$  as  $r \rightarrow 0$ ), although classes of exact solutions exist if it is assumed that  $\alpha$  can be treated as a constant [Fisk and Axford, 1969]. Purely numerical treatments of the problem such as those of Fisk [1971a], Gleeson and Urch [1971b], Lezniak and Webber, [1971], and

Urch [1971] have been helpful; however, for many purposes it is more convenient to use various approximate forms of equations (93) and (94) such as those of Fisk and Axford [1969] and Gleeson *et al.*, [1971] that yield asymptotically valid solutions. Gleeson and Axford [1967, 1968b] and Fisk and Axford [1969] have shown that an adequate approximation for  $T \geq 200$  MeV/nucleon at the earth can be achieved by neglecting the term  $S$  on the left of equation (94); the resulting equation

$$CuU = \kappa \frac{\partial U}{\partial r} \quad (95)$$

is termed the *force-field* equation.

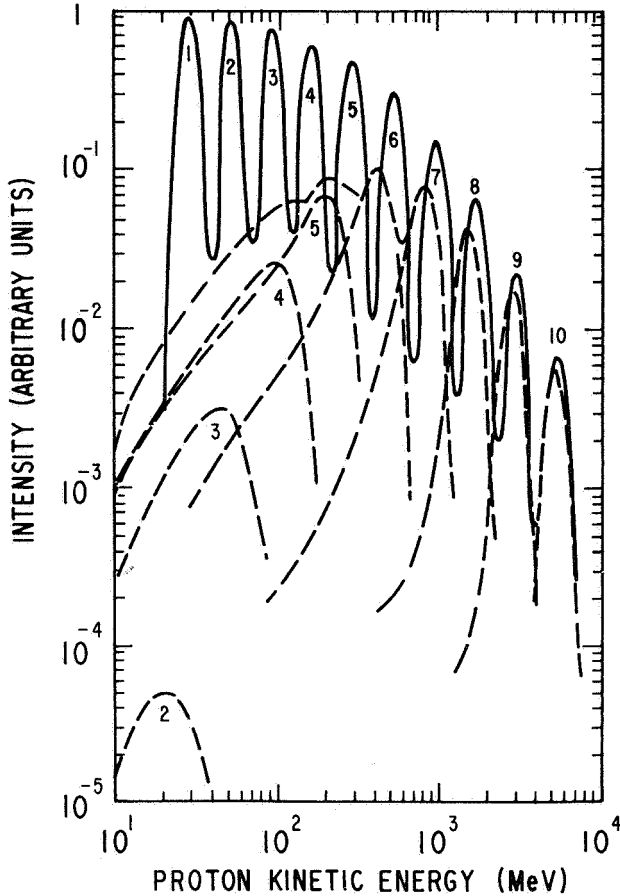
If  $\kappa(r, T)$  is a separable function of  $r$  and  $T$  — that is,  $\kappa(r, T) = \kappa_1(r)\kappa_2(T)$  — this equation can be integrated to yield a result similar to Liouville's theorem:

$$\frac{j(r, E)}{E^2 - E_0^2} = \frac{j(\infty, E + \Phi)}{(E + \Phi)^2 - E_0^2} \quad (96)$$

where  $E = T + E_0$  is the total energy of the particles, and  $\Phi$  can be regarded as a "potential" associated with the (apparent) force exerted on the cosmic ray distribution. In particular, for the case in which  $\kappa_2 \propto Pv/c = \alpha T v/c$ , which appears to be a reasonable choice in the vicinity of the earth for rigidities  $P \geq 1$  Gv [Jokipii and Coleman, 1968],  $\Phi = |Ze| \phi(r)$ , where

$$\phi(r) = \frac{1}{3} \int_r^\infty \frac{u(r')}{\kappa_1(r')} dr' \quad (97)$$

It is found that equations (96) and (97) provide a very good description of the (11-yr) solar modulation of protons,  $\alpha$  particles, and heavier nuclei for energies greater than 100–200 MeV/nucleon. The "potential difference" between the earth and infinity is typically found to be in the range 150–500 MV, and the modulation shows the predicted  $Z$  dependence [Gleeson and Axford, 1968b; Lezniak and Webber, 1971]. Goldstein *et al.* [1970b] and Gleeson and Urch [1971a] have found from numerical solutions of the full equations (93) and (94) that galactic cosmic rays with initial energies less than 100–200 MeV/nucleon are effectively excluded from the interplanetary medium at the earth's orbit (fig. 22), which is consistent with the idea that the modulation can be described in terms of a force field. Clearly it should be considered a prime task of any deep space mission to measure the spectra of various species



**Figure 22** A series of essentially monoenergetic proton spectra in interstellar space (solid line) and the corresponding modulated spectra at earth (dashed lines) obtained from numerical solutions of equations (93) and (94) [from Goldstein et al., 1970b]. The “force-field” solution (eq. (96)) provides a very good fit to the envelope of the modulated spectra for energies above about  $10^2$  MeV. It is important to note that particles with energies  $\leq 200$  MeV in interstellar space (i.e., unmodulated peaks 1-3) make a negligible contribution to the spectrum at earth, where this energy range is dominated by particles having higher energies in interstellar space (i.e., unmodulated peaks 4-6) and which have lost energy as a result of the modulating process. In effect, galactic cosmic rays with energies less than 100 MeV are unobservable at earth.

of cosmic rays as a function of radial distance from the sun as a basis for determining the unmodulated spectra and the variation of the diffusion coefficient with distance.

The radial gradient of the cosmic ray density or intensity at energies greater than  $\sim 200$  MeV/nucleon is given

directly by (97) as

$$\frac{1}{U} \frac{\partial U}{\partial r} = \frac{1}{j} \frac{\partial j}{\partial r} = \frac{Cu}{\kappa} \quad (98)$$

On taking a value for the diffusion coefficient consistent with that obtained by Jokipii and Coleman [1968], one finds that the gradient is of the order of 20–30 percent/AU for 1 GeV protons, and decreases at somewhat higher energies approximately as  $1/P$ . There is some evidence that gradients of this general magnitude exist, at least for  $P \gtrsim 1$  GV, from spacecraft observations [O’Gallagher and Simpson, 1967; O’Gallagher, 1967], measurements of radio activity in meteorites [Forman et al., 1971], and observations of the associated cosmic ray anisotropy perpendicular to the ecliptic [Yoshida et al., 1971].

If such gradients were to exist throughout the region in which the solar wind is supersonic (say,  $r \lesssim 50$  AU) then the total energy density of galactic cosmic rays outside the heliosphere would be enormously larger than that observed at the earth. In fact, it seems unlikely that the unmodulated spectrum for  $T \gtrsim 1$  GeV has a steeper slope than a spectrum with  $j(T) \propto T^{-\mu}$  with  $\mu \approx 2.5$ . This spectrum matches the (apparently unmodulated) observed spectrum in  $T \gtrsim 10^2$  GeV. It would require that the energy density of galactic cosmic rays be greater by only a factor of 2 or 3 outside the heliosphere than near the earth for  $T \gtrsim 1$  GeV, and hence that the radial gradient cannot be maintained at the value quoted above for more than a few AU from the sun. This argument is essentially the same as that of Gleeson and Axford [1968b], who for convenience assumed that  $\kappa_1(r) \propto e^{r/r_0}$  in (97), and found that if the “potential difference” between the earth and infinity is 100–200 MV, then  $r_0$  must be of the order of 1 AU.

Additional confirmation that the modulation of galactic cosmic rays with  $T \gtrsim 1$  GeV occurs in a region that is effectively contained within a few AU of the sun arises from comparisons of the solar cycle variation of the cosmic ray intensity (measured by neutron monitors, for example) and various indices of solar activity [Simpson, 1962; Simpson and Wang, 1967, 1970; Hatton et al., 1968; Guschina et al., 1970; Kolomeets et al., 1970; Wang, 1970]. It is argued that the lag obtained from a cross correlation analysis involving these quantities should provide a rough estimate of the time required for the solar wind to traverse the modulating region. A cross correlation between cosmic ray intensity and the geomagnetic activity index  $K_p$  yields a lag of the order of 6 to 12 months, which suggests that the radius of the modulating region might be as large as

50 to 80 AU [Dorman and Dorman, 1966]. However, it has been found that if a cross correlation is made between the coronal green line ( $\lambda$  Fe XIV 5303), the lag is only of the order of 1 month, which yields a radius of  $\sim 7$  AU for the modulating region of particles detected by neutron monitors [Simpson and Wang, 1967; Barker and Hatton, 1970; Kolomeets et al., 1970].

It is not possible to draw similar conclusions for the low energy end of the galactic cosmic ray spectrum, simply because the degree of modulation at low energies is expected to be so large that we are completely ignorant of the form of the unmodulated spectrum (fig. 21). Furthermore, at the lowest energies, the spectrum observed near the earth appears to consist mostly of particles of solar origin [Axford, 1970]. The effects of adiabatic deceleration associated with the expansion of the solar wind dominate the behavior of these particles.

It seems likely that galactic cosmic ray protons and heavier nuclei with energies of the order of 1–10 MeV/nucleon are to a large extent excluded from the region of supersonic solar wind flow, although they may penetrate the region of subsonic flow more easily since the effects of convection in this region are less important. At the shock transition separating these regions it is possible for significant acceleration of low-energy particles to occur, thus producing, in a sense, a local "source" of cosmic rays [Jokipii, 1968]. This effect can be demonstrated by means of appropriate solutions of equations (93) and (94). Let us suppose that the effective radial diffusion coefficient is small ( $\kappa \ll ur_s$ ) and that the solar wind convects energetic particles of solar origin toward the shock in such a manner that  $U(r, T) \rightarrow U_0(T) = AT^{-\mu}$  for  $(r_s - r)\mu/\kappa \rightarrow \infty$ . In these circumstances, the effects of spherical divergence can be neglected in  $r < r_s$ , and we find that equations (93) and (94) can be replaced by

$$S = u_1 U_0 - \frac{1}{3} u_1 \frac{\partial}{\partial T} (\alpha T U) \quad (99)$$

$$u_1 (U - U_0) = \kappa_1 \frac{\partial U}{\partial r} \quad (100)$$

having put  $u = u_1$  and  $(\partial/\partial r)(r^2 S) \approx r^2 (\partial S/\partial r)$ , and integrating (93). Thus we find that if  $\kappa = \kappa_1$  is assumed to be independent of  $r$  and  $T$ , and  $\alpha$  is taken to be constant, then

$$U = \left\{ A + B \exp \left[ \frac{u_1}{\kappa_1} (r - r_s) \right] \right\} T^{-\mu} \quad (101)$$

$$S = u_1 \left\{ \left[ 1 + \frac{1}{3} \alpha (\mu - 1) \right] A + \frac{1}{3} \alpha (\mu - 1) B \exp \left[ \frac{u_1}{\kappa_1} (r - r_s) \right] \right\} T^{-\mu} \quad (102)$$

where  $B$  is a constant obtained in the integration of (100), and it is assumed that  $U \propto T^{-\mu}$  everywhere. Beyond the shock transition (in  $r > r_s$ ), we can treat the flow as if it were incompressible to a first approximation, so that  $u = (1/4)u_1(r_s/r)^2$ ; hence, equations (93) and (94) become

$$S = \frac{1}{4} u_1 \left[ C(T) - \frac{1}{3} \frac{\partial}{\partial T} (\alpha T U) \right] \left( \frac{r_s}{r} \right)^2 \quad (103)$$

$$\frac{1}{4} u_1 [U - C(T)] \left( \frac{r_s}{r} \right)^2 = \kappa_2 \frac{\partial U}{\partial r} \quad (104)$$

where  $C(T) = CT^{-\mu}$  arises from the integration of (93). The appropriate solutions of these equations are such that  $U, S \rightarrow 0$  as  $r \rightarrow \infty$ :

$$U = CT^{-\mu} \left[ 1 - \exp \left( \frac{-4\kappa_2}{u_1 r} \right) \right] \approx \frac{4\kappa_2 CT^{-\mu}}{u_1 r} \quad (105)$$

$$S \approx \frac{1}{4} u_1 CT^{-\mu} \left( \frac{r_s}{r} \right)^2 + O \left( \frac{\kappa_2}{u_1 r_s} \right) \quad (106)$$

Provided there is no source of particles within the shock itself, both  $U$  and  $S$  must be continuous at the shock [Gleeson and Axford, 1967], and hence the constants  $B$  and  $C$  can be determined:

$$B \approx \frac{3A [1 - (\alpha/3)(\mu - 1)]}{\alpha(\mu - 1)} \quad C \approx \frac{3u_1 r_s A}{4\kappa_2 \alpha(\mu - 1)} \quad (107)$$

Note that the enhancement of the cosmic ray density resulting from the presence of the shock ( $C/A$ ) depends on the value of the diffusion coefficient in the subsonic region, and may be very large if  $\kappa_2/u_1 r_s \ll 1$ . The cosmic ray intensity near the earth is not significantly affected by the presence of this enhancement since if  $\kappa \ll ur$  the particles are convection dominated and downstream boundary conditions have little influence. It is possible to solve equations (93) and (94) exactly with the solar wind distribution assumed in the above analysis, provided  $\alpha$  is taken to be constant,  $\kappa$  is independent

of  $T$ , and  $U \propto T^{-\mu}$  [Fisk, 1969]. The solutions are consistent with those obtained here in the limit  $ur_s/\kappa \gg 1$ ; they also show that it is possible to produce an enhancement of the intensity of galactic cosmic rays in the vicinity of the shock transition under suitable conditions. On this basis, therefore, it should be expected that a low-energy cosmic ray enhancement similar to those associated with propagating shocks [Fisk, 1971b] is associated with the shock transition terminating the supersonic solar wind, and this may provide useful confirmation of the presence of the transition.

The possibility that the solar wind itself might be significantly affected by cosmic rays has been considered by several authors [Axford, 1965; Axford and Newman, 1965; Dorman and Dorman, 1968; Modisette and Snyder, 1968; Souk and Lenchek, 1969; Wallis, 1971]. In the early analyses it was assumed that there is no exchange of energy between the solar wind and the cosmic rays, and that the cosmic ray pressure  $\pi$  satisfies the convection-diffusion equation

$$K \frac{d\pi}{dr} = u\pi \quad (108)$$

where  $K(r)$  is the "effective" diffusion coefficient and

$$\pi = \frac{1}{3} \int_0^\infty \alpha T U dT \quad (109)$$

In more recent treatments [Souk and Lenchek, 1969; Wallis, 1971], which take the energy exchange into account, equation (108) is used together with the following equations for the conservation of mass, momentum and energy of the solar wind plasma:

$$\frac{d}{dr} (\rho u r^2) = 0 \quad (110)$$

$$\rho u \frac{du}{dr} = -\frac{dp}{dr} - \frac{G\lambda\rho}{r^2} - \frac{d\pi}{dr} \quad (111)$$

$$\frac{1}{r^2} \frac{d}{dr} \left[ \rho u r^2 \left( \frac{1}{2} u^2 + \frac{\gamma}{\gamma+1} \frac{p}{\rho} + \frac{G\lambda}{r} \right) \right] = u \frac{d\pi}{dr} \quad (112)$$

On combining equations (110)–(112), we can show that  $p/\rho^\gamma = \text{constant}$ . The right-hand side of equation (112) is easily shown from (93) to be given by

$$\frac{1}{r^2} \frac{d}{dr} \left( r^2 \int_0^\infty ST dT \right) = u \frac{d\pi}{dr} \quad (113)$$

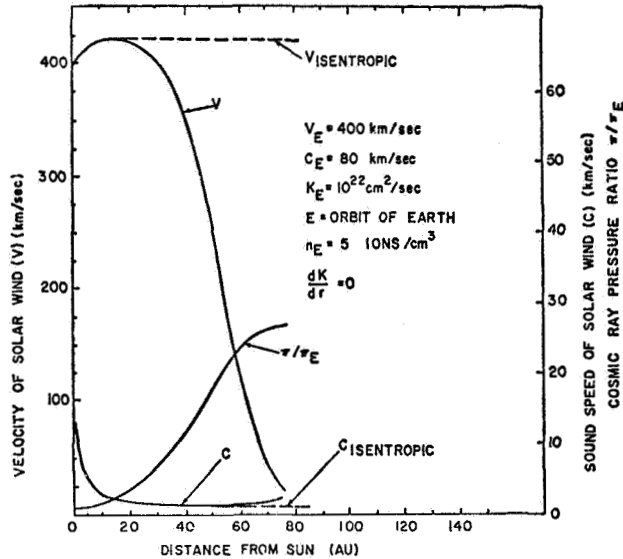
where  $\int_0^\infty ST dT$  is the net radial flux of energy in cosmic rays; since  $u d\pi/dr > 0$ , it is evident that there is a net transfer of energy from the solar wind to the cosmic rays [cf. Jokipii and Parker, 1967].

In the treatment of the problem by Axford and Newman [1965] and others, the right-hand side of (112) was omitted; since this term represents an effective heat sink for the solar wind, the results obtained by these authors are such that the Mach number decreases toward unity too rapidly with increasing radial distance. Wallis [1971] has pointed out that when equations (109)–(112) are reduced to a single equation for the Mach number in terms of radial distance, the characteristics of the equation have properties similar to those described in the preceding section for the case of interaction with interstellar neutral gas. In particular, there is a singular point at a large radial distance, the nature of which depends on the values assumed for the various parameters involved. It is found, however, that if the interaction is sufficiently strong that a significant effect is produced on the solar wind, then the cosmic ray pressure required in the interstellar medium is unacceptably high (more than 10 times the value observed at the position of the earth). An example of a solution obtained by Souk and Lenchek [1969] for the case where  $K$  is independent of  $r$  is shown in figure 23; it is evident that quite unreasonable cosmic ray pressures are necessary in this case to reduce the solar wind speed by as much as 25 percent. As a corollary to calculations of this sort, it is found that the cosmic ray pressure cannot be prevented from becoming excessive unless the net diffusion coefficient  $K$  increases more strongly than linear with radial distance. This is consistent with the conclusion of Simpson and Wang [1967] and others that the dimensions of the modulating region must be relatively small ( $\sim 7$  AU).

Cosmic rays are affected by the regular component of the interplanetary magnetic field as well as by irregularities, and as a consequence they tend to rotate with the magnetic field about the sun. The resulting anisotropy is observed at the earth as a solar diurnal variation of the cosmic ray intensity, which is of the order of 0.3 to 0.4 percent, given approximately by

$$\xi_\phi(T) = \frac{C(T)\Omega r \sin \theta}{v} \quad (114)$$

where  $\Omega$  is the angular velocity of the sun [Ahluwalia and Dessler, 1962; Parker, 1964; Axford, 1965]. This anisotropy has yet to be detected at low energies ( $T \lesssim 2$  GeV) from spacecraft; it is possible that it is absent at energies less than about 200 MeV/nucleon



**Figure 23** Variation of the solar wind speed  $V$ , sound speed  $C$ , and cosmic ray pressure  $\pi$ , with distance from the sun for the case in which the effective diffusion coefficient  $K$  is constant [from Sousk and Lenchek, 1969]. It should be noted that in order for the solar wind speed to drop to  $300 \text{ km sec}^{-1}$ , the cosmic ray pressure must rise by a factor of 10 over its value at the orbit of earth, which seems unacceptably large. The solutions have not been carried through the singular point of the equations where the solar wind and the sound speed are equal [cf. Wallis, 1971].

where  $\chi(T) \approx 0$  [Gleeson and Axford, 1968a]. It is difficult to escape the conclusion that this anisotropy must increase with increasing heliocentric distance, and become very large indeed at distances of the order of 50 AU. However, the anisotropy can be suppressed in two ways: by (1) a gradient of the intensity perpendicular to the ecliptic, and (2) isotropy of the diffusion tensor. The enormous intensity gradients necessary for any significant effect in this respect are difficult to accept, but the second possibility may well be important. A more accurate form of equation (114) is

$$\xi_{\phi}(T) = \frac{3C\Omega r \sin \theta}{\nu} \frac{\kappa_{\parallel} - \kappa_{\perp}}{\kappa_{\parallel} + \kappa_{\perp} \tan^2 \phi} \quad (115)$$

where  $\kappa_{\parallel}$  and  $\kappa_{\perp}$  are the diffusion coefficients parallel and perpendicular to the mean magnetic field direction, respectively. It has been pointed out by Jokipii [1966b, 1971] and Jokipii and Parker [1969] that as a result of the wandering of magnetic field lines with respect to the direction of the mean field it is possible for  $\kappa_{\perp} \rightarrow \kappa_{\parallel}$ , in

which case the anisotropy given by (115) must disappear. This effect is probably not as pronounced at the orbit of earth as suggested by Jokipii and Parker [1969] [Subramanian, 1971]; however, it is expected to increase in importance with increasing heliocentric distance and ultimately may be capable of keeping  $\xi_{\phi}$  within reasonable limits. A breakup of the interplanetary magnetic field sector structure as described earlier would serve the same purpose. It should be noted that in the presence of a large value of  $\xi_{\phi}$ , the medium comprising the solar wind plasma and the cosmic ray gas would be liable to streaming instabilities [Wentzel, 1969], which in turn would tend to reduce both  $\kappa_{\parallel}$  and  $\kappa_{\perp}$  and thus increase the overall modulation.

The problem of how cosmic rays penetrate the region occupied by the solar wind and interplanetary magnetic field is of some interest. In the absence of direct connection between the interplanetary and interstellar magnetic fields it is difficult to understand how low-energy electrons, for example, could enter the interplanetary region with any reasonable efficiency. Parker [1968] has suggested that the effect of field line wandering described above might be adequate to bring any given field line sufficiently close to the interface between the solar plasma and interstellar region to allow it to receive its full quota of cosmic rays, regardless of where the field line intersects the surface of the sun. Alternatively, we would argue that the access of cosmic rays can take place most easily if the interplanetary field is connected directly to the interstellar medium. There is little reason for believing that this is not so, and in the case of the interplanetary magnetic field and the geomagnetic field, for example, the evidence for interconnection is very compelling [Akasofu and Axford, 1971].

Schatten and Wilcox [1969, 1970] have suggested that interconnection of the interplanetary and interstellar magnetic fields could explain the 20-year cycle of the diurnal variation of the cosmic ray intensity at the earth reported by Forbush [1967, 1969]. It is argued that the effect is related to the 20-year solar magnetic cycle, and that the access of cosmic rays is controlled to some extent according to whether or not the solar magnetic field is favorably directed so that cosmic rays have easy access to the heliosphere. In fact, the situation is quite complex, and it is not obvious that this is the correct explanation. However, it should be noted that a similar situation exists in the case of access of anisotropic fluxes of solar energetic particles into the earth's magnetosphere, where the direction of the interplanetary magnetic field can lead to a pronounced asymmetry in the particle fluxes observed at low altitudes in the polar magnetosphere [Reid and Sauer,

1967; Engelman *et al.*, 1971; Van Allen *et al.*, 1971]. The possibility that interconnection of the interplanetary and interstellar magnetic fields might affect the intensity of low-energy cosmic ray electrons has been discussed by Fisk and Van Hollebeke [1971] in an attempt to explain the "quiettime increases" of these particles [Simnett *et al.*, 1971]. Kovar and Dessler [1967] have suggested that the sidereal anisotropy of galactic cosmic rays might be related to the asymmetry of the outer heliosphere. As noted previously, however, the particles that can be expected to show a sidereal anisotropy must have such high energies that they pass unaffected through the complex field structure of the outer heliosphere. As a result of the configuration of the interplanetary magnetic field, any effect associated with the asymmetry of the heliosphere will lead to spatial variations of the mean intensity of cosmic rays rather than a sidereal anisotropy.

#### APPENDIX: A HYDRAULIC ANALOGY TO THE SOLAR WIND

Consider the flow resulting from a jet of liquid incident on a horizontally held dinner plate. Under steady conditions, the total mass flux

$$\rho Q = 2\pi r h u \quad (\text{A1})$$

is constant, where  $\rho$  is the density of the liquid,  $r$  is the radial distance from the center of the plate,  $h(r)$  is the depth, and  $u(r)$  the mean radial velocity of the liquid. It can be shown that the flow pattern divides in general into a supercritical region ( $r < r_j$ ) and a subcritical region ( $r_j < r < R = \text{radius of the plate}$ ), in which the Froude number  $F = u/(gh)^{1/2}$  is greater than or less than unity, respectively.

Conservation of radial momentum requires that

$$\left(u^2 + \frac{1}{2}gh\right)h = \text{constant} = \frac{1}{2}gH^2 \quad (\text{A2})$$

where  $H$  is the "total head." Accordingly, if  $F \gg 1$ ,  $u$  is approximately constant and  $h(r) \propto 1/r$ ; if  $F \ll 1$ ,  $h$  is approximately constant and  $u \propto 1/r$ . In the case of the solar wind, where the Mach number plays the same role as the Froude number, these results are analogous to the constancy of  $u$  when  $M \gg 1$ , and of  $p$  when  $M \ll 1$ .

The regions of supercritical and subcritical flow are separated by a hydraulic jump at  $r = r_j$ , across which conservation of mass and momentum require that

$$h_1 u_1 = h_2 u_2 = \frac{Q}{2\pi r_j} \quad (\text{A3})$$

$$\left(u_1^2 + \frac{1}{2}gh_1\right)h_1 = \left(u_2^2 + \frac{1}{2}gh_2\right)h_2 = \frac{1}{2}gH^2 \quad (\text{A4})$$

where subscripts 1 and 2 refer to upstream and downstream conditions, respectively. For given values of  $Q$  and  $H$ , these equations are sufficient to determine  $u(r)$ ,  $h(r)$ , and  $r_j$ , provided we also specify conditions at  $r = R$ .

#### ACKNOWLEDGEMENTS

The author wishes to thank P. M. Banks, C. A. Barth, J. E. Blamont, W. H. Chambers, C. W. Cranfill, C. T. Gregory, T. E. Holzer, H. E. Johnson, T. N. L. Patterson, B. J. Rickett, F. Scherb, G. E. Thomas, B. A. Tinsley, M. P. Ulmer, and M. Wallis for their assistance in preparing this review.

This work was supported by the National Aeronautics and Space Administration under Contract NGR-05-009-081.

#### REFERENCES

- Adams, T. F.: On Lyman-Alpha Emission From the Galaxy. *Astron. Astrophys.*, Vol. 12, 1971, p. 280.
- Afrosimov, V. V.; Mamaev, Yu. A.; Panov, M. N.; and Fedorenko, N. V.: Coincidence Method for Studying Charge-Exchange in Proton-Inert Gas Interactions. *Sov. Phys. - Tech. Phys.*, Vol. 14, 1969, p. 109.
- Ahluwalia, H. S.: Median Primary Energy of Response of a Cosmic Ray Telescope Underground. *J. Geophys. Res.*, Vol. 76, 1971, p. 5358.
- Ahluwalia, H. S.; and Dessler, A. J.: Diurnal Variation of Cosmic Radiation Intensity Produced by a Solar Wind. *Planet. Space Sci.*, Vol. 9, 1962, p. 195.
- Akasofu, S.-I.: The Neutral Hydrogen Flux in the Solar Plasma Flow-I. *Planet. Space Sci.*, Vol. 12, 1964, p. 905.
- Akasofu, S.-I.; and Axford, W. I.: Magnetospheric Substorms: A Review. In preparation, 1971.
- Alexander, J. K.; Brown, L. W.; Clark, T. A.; Stone, R. G.; and Weber, R. R.: The Spectrum of the Cosmic Radio Background Between 0.4 and 6.5 MHz. *Astrophys. J.*, Vol. 157, 1969, p. L163.
- Allen, C. W.: *Astrophysical Quantities*. Athlone Press, London, 1963.
- Antonucci, E.; Castagnoli, G. C.; and Doderio, M. A.: On the Diurnal Variations of the Cosmic Ray Intensity Observed 70 m.w.e. Underground. *Proc. 11th Int. Conf. on Cosmic Rays*, Budapest, 1970, p. 157.
- Axford, W. I.: Anisotropic Diffusion of Solar Cosmic Rays. *Planet. Space Sci.*, Vol. 13, 1965, p. 1301.
- Axford, W. I.: The Interaction Between the Solar Wind and the Magnetosphere. *Aurora and Airglow*, B. M. McCormac, ed., Reinhold Publishing Co., New York, 1967, p. 409.
- Axford, W. I.: Observations of the Interplanetary Plasma. *Space Sci. Rev.*, Vol. 8, 1968, p. 331.



- Axford, W. I.: Helium in the Atmosphere, Aurora and Solar Wind. *Atmospheric Emissions*. B. M. McCormac and Anders Omholt, eds., Reinhold Publishing Co., New York, 1969, p. 317.
- Axford, W. I.: A Review of Theoretical Work on the Effects of Solar Wind Transport on Energetic Solar Particles. Presented at USSR Academy of Sciences Seminar on Cosmic Ray Generation on the Sun, Leningrad, 1970 (to be published).
- Axford, W. I.; Dessler, A. J.; and Gottlieb, B.: Termination of Solar Wind and Solar Magnetic Field. *Astrophys. J.*, Vol. 137, 1963, p. 1268.
- Axford, W. I.; and Newman, R. C.: The Effect of Cosmic Ray Friction on the Solar Wind. *Proc. 9th Int. Conf. Cosmic Rays, Phys. Soc.*, London, 1965, p. 173.
- Bame, S. J.; Hundhausen, A. J.; Asbridge, J. R.; and Strong, I. B.: Solar Wind Ion Composition. *Phys. Rev. Letters*, Vol. 20, 1968, p. 393.
- Bame, S. J.; Asbridge, J. R.; Hundhausen, A. J.; and Montgomery, M. D.: Solar Wind Ions:  $^{56}\text{Fe}^{+8}$  to  $^{56}\text{Fe}^{+12}$ ,  $^{28}\text{S}^{+7}$ ,  $^{28}\text{S}^{+8}$ ,  $^{28}\text{S}^{+9}$ , and  $^{16}\text{C}^{+6}$ . *J. Geophys. Res.*, Vol. 75, 1970, p. 6360.
- Bandermann, L. W.; and Singer, S. F.: Neutral Hydrogen in Interplanetary Gas. *Trans. Amer. Geophys. Union*, Vol. 46, 1965, p. 133.
- Banks, P. M.: Interplanetary Hydrogen and Helium From Cosmic Dust and the Solar Wind. *J. Geophys. Res.*, Vol. 76, 1971, p. 4341.
- Banks, P. M.; and Kockarts, G.: *Aeronomy*, Academic Press, to be published, 1972.
- Baranov, V. B.; Krasnobayev, K. V.; and Kulikovskiy, A. G.: A Model of the Interaction Between the Solar Wind and an Interstellar Medium. GSFC Tech. Trans. of "Model vzaimodeystviya solnechnogo vetra s mezhzvezdnoy sredoy," *Dokl. Akad. Nauk SSSR*, Vol. 194, 1970, p. 41.
- Barker, M. C.; and Hatton, C. J.: The Yearly Variation of the Cosmic Ray Intensity From 1963-67 and Its Relation to the Observed Variation of Solar Activity With Heliolatitude and Time. *Proc. 11th Int. Conf. Cosmic Rays*, Budapest, 1970, p. 177.
- Barnes, A.: Collisionless Heating of the Solar-Wind Plasma, 1. Theory of the Heating of Collisionless Plasma by Hydromagnetic Waves. *Astrophys. J.*, Vol. 154, 1968, p. 751.
- Barnes, A.: Collisionless Heating of the Solar Wind Plasma, 2. Application of the Theory of Plasma Heating by Hydromagnetic Waves. *Astrophys. J.*, Vol. 155, 1969, p. 311.
- Barth, C. A.: Mariner 6 Measurements of the Lyman  $\alpha$  Sky Background. *Astrophys. J.*, Vol. 161, 1970a, p. L181.
- Barth, C. A.: Mariner 5 Measurements of Ultraviolet Emission From the Galaxy. *Ultraviolet Stellar Spectra and Ground-Based Observations*. I.A.U. Symp. No. 36, L. Houziaux and H. E. Butler, eds., Reidel Pub. Co., Dordrecht, 1970b, p. 28.
- Barth, C. A.; Pearce, J. B.; Kelly, K. K.; Wallace, L.; and Fastie, W. G.: Ultraviolet Emissions Observed Near Venus From Mariner 5. *Science*, Vol. 158, 1967, p. 1675.
- Barth, C. A.; Wallace, L.; and Pearce, J. B.: Mariner 5 Measurement of Lyman-Alpha Radiation Near Venus. *J. Geophys. Res.*, Vol. 73, 1968, p. 2541.
- Barua, S. N.: A Source in a Rotating Fluid. *Quart. J. Mech. Appl. Math.*, Vol. VIII, Pt. 1, 1955, p. 22.
- Berge, G. L.; and Seielstad, G. A.: New Determinations of the Faraday Rotation for Extragalactic Radio Sources. *Astrophys. J.*, Vol. 148, 1967, p. 367.
- Bergeron, J.; and Souffrin, S.: Heating of HI Regions by Hard UV Radiation: Physical State of the Interstellar Matter. *Astron. Astrophys.*, Vol. 11, 1971, p. 40.
- Bertaux, J. L.; and Blamont, J. E.: Evidence for a Source of an Extraterrestrial Hydrogen Lyman-Alpha Emission: The Interstellar Wind. *Astron. Astrophys.*, Vol. 11, 1971, p. 200.
- Bhatnagar, V. P.; and Fahr, H. J.: Solar Wind Expansion Beyond the Heliosphere. Preprint, 1971.
- Biskamp, D.; Sagdeev, R. Z.; and Schindler, K.: Non-linear Evolution of the Tearing Instability in the Geomagnetic Tail. *Cosmic Electrodyn.*, Vol. 1, 1970, p. 297.
- Blamont, J. E.; and Madjar, A. V.: Monitoring of the Lyman-Alpha Emission Line of the Sun During the Year 1969. *J. Geophys. Res.*, Vol. 76, 1971, p. 4311.
- Blum, P. W.; and Fahr, H. J.: Solar Wind Tail and the Anisotropic Production of Fast Hydrogen Atoms. *Nature*, Vol. 223, 1969, p. 936.
- Blum, P. W.; and Fahr, H. J.: Interaction Between Interstellar Hydrogen and the Solar Wind. *Astron. Astrophys.*, Vol. 4, 1970a, p. 280.
- Blum, P. W.; and Fahr, H. J.: The Distribution of Interplanetary Hydrogen. *Astrophys. Letters*, Vol. 5, 1970b, p. 127.
- Blum, P. W.; and Fahr, H. J.: Lyman- $\alpha$  Scattering During the Solar Rotation Period. *Astron. Astrophys.*, Vol. 8, 1970c, p. 236.
- Blum, P. W.; and Fahr, H. J.: Interpretation of Extraterrestrial Lyman-Alpha Observations. *Nature*, Vol. 231, 1971, p. 171.
- Bowers, B.: Galactic Lyman-Alpha and the Interstellar Shock Wave. *Nature*, Vol. 228, 1970, p. 1182.

- Bowyer, C. S.; and Field, G. B.: The Intensity of the Soft X-ray Background Flux. *Nature*, Vol. 223, 1969, p. 573.
- Bowyer, C. S.; Livingston, P. M.; and Price, R. D.: Upper Limits to the 304- and 584-A Night Helium Glow. *J. Geophys. Res.*, Vol. 73, 1968, p. 1107.
- Brandt, J. C.: Interplanetary Gas, IV. Neutral Hydrogen in a Model Solar Corona. *Astrophys. J.*, Vol. 133, 1961, p. 688.
- Brandt, J. C.: Interplanetary Gas, IX. Effects on the Local Interstellar Medium. *Icarus*, Vol. 3, 1964a, p. 253.
- Brandt, J. C.: On Diffuse Galactic Lyman  $\alpha$  in the Night Sky. *Planet. Space Sci.*, Vol. 12, 1964b, p. 650.
- Brandt, J. C.: *Introduction to the Solar Wind*. G. Burbidge and M. Burbidge, eds., W. H. Freeman and Co., San Francisco, Calif., 1970.
- Brandt, J. C.; and Michie, R. W.: Semiempirical Model of the Interplanetary Medium. *Phys. Rev. Letters*, Vol. 8, 1962, p. 195.
- Brandt, J. C.; and Hunten, D. M.: On Ejection of Neutral Hydrogen From the Sun and the Terrestrial Consequences. *Planet. Space Sci.*, Vol. 14, 1966, p. 95.
- Brandt, J. C.; Stecher, T. P.; Crawford, D. L.; and Maran, S. P.: The Gum Nebula: Fossil Strömgren Sphere of the Vela X Supernova. *Astrophys. J.*, Vol. 163, 1971, p. L99.
- Brengauz, V. D.: Radiation by Magnetosonic Waves Generated in a Stellar Wind. *Soviet Astron.—AJ*, Vol. 13, 1969, p. 37.
- Bridle, A. H.: Spectra of Extended Extragalactic Radio Sources. *Nature*, Vol. 224, 1969, p. 889.
- Bridle, A. H.; and Venugopal, V. R.: Distribution and Temperature of Interstellar Electron Gas. *Nature*, Vol. 224, 1969, p. 545.
- Bunner, A. N.; Coleman, P. C.; Kraushaar, W. L.; McCammon, D.; Palmieri, T. M.; Shilepsky, A.; and Ulmer, M.: Soft X-ray Background Flux. *Nature*, Vol. 223, 1969, p. 1222.
- Burbidge, G. R.: The Galactic Magnetic Field. *Comments Astrophys. Space Phys.*, Vol. 1, 1969, p. 25.
- Burton, W. B.: Galactic Structure Derived From Neutral Hydrogen Observations Using Kinematic Models Based on the Density Wave Theory. *Astron. Astrophys.*, Vol. 10, 1971, p. 76.
- Byram, E. T.; Chubb, T. A.; and Friedman, H.: Attempt to Measure Night Helium Glow — Evidence for Metastable Molecules in the Night Ionosphere. *J. Geophys. Res.*, Vol. 66, 1961, p. 2095.
- Cahill, L. J.; and Amazeen, P. G.: The Boundary of the Geomagnetic Field. *J. Geophys. Res.*, Vol. 68, 1963, p. 1835.
- Cairns, R. B.; and Samson, J. A. R.: Absorption and Photoionization Cross Sections of CO<sub>2</sub>, CO, Ar, and He at Intense Solar Emission Lines. *J. Geophys. Res.*, Vol. 70, 1965, p. 99.
- Cameron, A. G. W.: A New Table of Abundances of the Elements in the Solar System, in *Origin and Distribution of the Elements*. L. H. Ahrens, ed., Pergamon Press, New York, 1968, p. 125.
- Carruthers, G. R.: An Upper Limit on the Concentration of Molecular Hydrogen in Interstellar Space. *Astrophys. J.*, Vol. 148, 1967, p. L141.
- Carruthers, G. R.: Far-Ultraviolet Spectroscopy and Photometry of Some Early-Type Stars. *Astrophys. J.*, Vol. 151, 1968, p. 269.
- Carruthers, G. R.: Observation of the Lyman-Alpha Interstellar Absorption Line in Theta Orionis. *Astrophys. J.*, Vol. 156, 1969, p. L97.
- Carruthers, G. R.: Atomic and Molecular Hydrogen in Interstellar Space. *Space Sci. Rev.*, Vol. 10, 1970a, p. 459.
- Carruthers, G. R.: Rocket Observation of Interstellar Molecular Hydrogen. *Astrophys. J.*, Vol. 161, 1970b, p. L81.
- Chambers, W. H.; Fehlan, P. E.; Fuller, J. C.; and Kunz, W. E.: Anisotropic Atomic Hydrogen Distribution in Interplanetary Space. *Nature*, Vol. 225, 1970, p. 713.
- Clark, B. G.: An Interferometer Investigation of the 21-centimeter Hydrogen-Line Absorption. *Astrophys. J.*, Vol. 142, 1965, p. 1398.
- Clauser, F.: Johns Hopkins Univ. Lab. Rep. AFOSRTN 60-1386, 1960.
- Cloutier, P. A.: A Comment on 'The Neutral Hydrogen Flux in the Solar Plasma Flow' by S.-I. Akasofu. *Planet. Space Sci.*, Vol. 14, 1966, p. 809.
- Cranfill, C.: Ph.D. Dissertation, Univ. of Calif., San Diego, 1971.
- Danby, J. M. A.; and Camm, G. L.: Statistical Dynamics and Accretion. *M.N.R.A.S.*, Vol. 117, 1957, p. 50.
- Danby, J. M. A.; and Bray, T. A.: Density of Interstellar Matter Near a Star. *Astron. J.*, Vol. 72, 1967, p. 219.
- Davidson, K.; and Terzian, Y.: Dispersion Measures of Pulsars. *Astron. J.*, Vol. 74, 1969, p. 849.
- Davies, R. D.: Distance of Pulsars and the Interstellar Electron Gas. *Nature*, Vol. 223, 1969, p. 355.
- Davies, J. G.; Horton, P. W.; Lyne, A. G.; Rickett, B. J.; and Smith, F. G.: Pulsating Radio Source at  $\alpha = 19^{\text{h}}19^{\text{m}}$ ,  $\delta = +22^{\circ}$ . *Nature*, Vol. 217, 1968, p. 910.
- Davis, L., Jr.: Interplanetary Magnetic Fields and Cosmic Rays. *Phys. Rev.*, Vol. 100, 1955, p. 1440.

- Davis, L., Jr.: The Effect of Solar Disturbances and the Galactic Magnetic Field on the Interplanetary Gas. *J. Phys. Soc., Japan*, Vol. 17, A-II, 1962, p. 543.
- Davis, L., Jr.: The Configuration of the Interplanetary Magnetic Field. Leningrad STP Symp. Paper No. II-2, 1970.
- Davis, L., Jr.; and Greenstein, J. L.: The Polarization of Starlight by Aligned Dust Grains. *Astrophys. J.*, Vol. 114, 1951, p. 206.
- de Jager, G.; Lyne, A. G.; Pointon, L.; and Ponsonby, J. E. B.: Measurement of the Distance of Pulsar CP 0328. *Nature*, Vol. 220, 1968, p. 128.
- Dennison, P. A.; and Hewish, A.: The Solar Wind Outside the Plane of the Ecliptic. *Nature*, Vol. 213, 1967, p. 343.
- Dessler, A. J.: Solar Wind and Interplanetary Magnetic Field. *Rev. Geophys.*, Vol. 5, 1967, p. 1.
- Dokuchaev, V. P.: Mission of Magnetoacoustic Waves in the Motion of Stars and Cosmic Space. *Sov. Astron.-AJ*, Vol. 8, 1964, p. 23.
- Donahue, T. M.; and Kumer, J. B.: An Observation of the Helium I 548-Å Day-Glow Radiation Between 400 and 1000 km. *J. Geophys. Res.*, Vol. 76, 1971, p. 145.
- Dorman, I. V.; and Dorman, L. I.: The Importance of the Solar System Geometry in the Cosmic Ray Variations Observed on the Earth. *Geomagn. Aeron. (USSR)*, Vol. 6, 1966, p. 231.
- Dorman, I. V.; and Dorman, L. I.: Cosmic Rays and the Dynamics of Solar Wind, 1. *Geomagn. Aeron. (USSR)*, Vol. 8, 1968, p. 652.
- Dungey, J. W.: Interplanetary Magnetic Field and the Auroral Zones. *Phys. Rev. Letters*, Vol. 6, 1961, p. 407.
- Ederer, D. L.; and Tomboulion, D. H.: Photoionization Cross Section of Neon in the 80 to 600 Å Region. *Phys. Rev.*, Vol. 133, 1964, p. A1525.
- Egidi, A.; Formisano, V.; Palmiotto, F.; Saraceno, P.; and Moreno, G.: Solar Wind and Location of Shock Front and Magnetopause at the 1969 Solar Maximum. *J. Geophys. Res.*, Vol. 75, 1970, p. 6999.
- Ekers, R. D.; Lequeux, J.; Moffet, A. T.; and Seielstad, G. A.: A Measurement of the Galactic Magnetic Field Using the Pulsating Radio Source PSR 0833-45. *Astrophys. J.*, Vol. 156, 1969, p. L21.
- Elliot, H.; Thambyahpillai, T.; and Peacock, D. S.: Search for a Sidereal Anisotropy at 60 m.w.e. Depth. *Acta Phys. Acad. Sci. Hungar.*, Vol. 29, Suppl. 1, 1970, p. 491.
- Ellis, G. R. A.; and Hamilton, P. A.: Ionized Hydrogen in the Plane of the Galaxy. *Astrophys. J.*, Vol. 146, 1966, p. 78.
- Engelmann, J.; Hynds, R. J.; Morfill, G.; Axisa, F.; Bewick, A.; Durney, A. C.; and Koch, L.: Penetration of Solar Protons Over the Polar Cap During the February 25, 1969 Event. *J. Geophys. Res.*, Vol. 76, 1971, p. 4245.
- Eviatar, A.; and Schulz, M.: Ion-Temperature Anisotropies and the Structure of the Solar Wind. *Planet. Space Sci.*, Vol. 18, 1970, p. 321.
- Fahr, H. J.: On the Influence of Neutral Interstellar Matter on the Upper Atmosphere. *Astrophys. Space Sci.*, Vol. 2, 1968a, p. 474.
- Fahr, H. J.: Neutral Corpuscular Energy Flux by Charge-Transfer Collisions in the Vicinity of the Sun. *Astrophys. Space Sci.*, Vol. 2, 1968b, p. 496.
- Fahr, H. J.: Influence of Interstellar Matter on the Density of Atmospheric Hydrogen. *Ann. Geophys.*, Vol. 25, 1969, p. 475.
- Fahr, H. J.: Interstellar Hydrogen Densities in the Surroundings of the Solar System. *Nature*, Vol. 226, 1970, p. 435.
- Faus, A. A.: Solar Wind Beyond the Earth's Orbit. The Transition Zone. *Planet. Space Sci.*, Vol. 14, 1966, p. 143.
- Felton, J. E.: Radio Electrons and Magnetic Fields in the Galactic Halo. *Astrophys. J.*, Vol. 145, 1966, p. 589.
- Field, G. B.: Thermal Instabilities in the Interstellar Medium. *Interstellar Matter in Galaxies*, L. Woltjer, ed., W. A. Benjamin, Inc., New York, 1962, p. 183.
- Field, G. B.; Goldsmith, D. W.; and Habing, H. J.: Cosmic-Ray Heating of the Interstellar Gas. *Astrophys. J.*, Vol. 155, 1969, p. L149.
- Fischel, D.; and Stecher, T. P.: On the Interstellar Hydrogen Density. *Astrophys. J.*, Vol. 150, 1967, p. L51.
- Fisk, L. A.: Ph.D. Dissertation, Univ. Calif., San Diego, 1969.
- Fisk, L. A.: Solar Modulation of Galactic Cosmic Rays, 2. *J. Geophys. Res.*, Vol. 76, 1971a, p. 221.
- Fisk, L. A.: Increases in the Low-Energy Cosmic Ray Intensity at the Front of Propagating Interplanetary Shock Waves. *J. Geophys. Res.*, Vol. 76, 1971b, p. 1662.
- Fisk, L. A.; and Axford, W. I.: Solar Modulation of Galactic Cosmic Rays, 1. *J. Geophys. Res.*, Vol. 74, 1969, p. 4973.
- Fisk, L. A.; and Van Hollebeke, M.: Quiet-Time Electron Increases, A Measure of Conditions in the Outer Solar System. Submitted to *J. Geophys. Res.*, 1971.
- Fite, W. L.; Smith, A. C. H.; and Stebbings, R. F.: Charge Transfer in Collisions Involving Symmetric and Asymmetric Resonance. *Proc. Roy. Soc. (London)*, Vol. A-268, 1962, p. 527.

- Forbush, S. E.: A Variation, With a Period of Two Solar Cycles, in the Cosmic-Ray Diurnal Anisotropy. *J. Geophys. Res.*, Vol. 72, 1967, p. 4937.
- Forbush, S. E.: Variation With a Period of Two Solar Cycles in the Cosmic-Ray Diurnal Anisotropy and the Superposed Variations Correlated With Magnetic Activity. *J. Geophys. Res.*, Vol. 74, 1969, p. 3451.
- Forman, M. A.: The Compton-Getting Effect for Cosmic-Ray Particles and Photons and the Lorentz-Invariance of Distribution Functions. *Planet. Space Sci.*, Vol. 18, 1970, p. 25.
- Forman, M. A.; Stoenner, R. W.; and Davis, R., Jr.: Cosmic Ray Gradient Measured by the Argon-37/Argon-39 Ratio in the Lost City Meteorite. *J. Geophys. Res.*, Vol. 76, 1971, p. 4109.
- Forslund, D. W.: Instabilities Associated With Heat Conduction in the Solar Wind and Their Consequences. *J. Geophys. Res.*, Vol. 75, 1970, p. 17.
- Fowler, W. A.; Reeves, H.; and Silk, J.: Spallation Limits on Interstellar Fluxes of Low-Energy Cosmic Rays and Nuclear Gamma Rays. *Astrophys. J.*, Vol. 162, 1970, p. 49.
- Fritz, G.; Meekins, J. F.; Henry, R. C.; Byram, E. T.; and Friedman, H.: Soft X-rays From Scorpius XR-1. *Astrophys. J.*, Vol. 153, 1968, p. L199.
- Gardner, F. F.; and Davies, R. D.: Faraday Rotation of the Emission From Linearly Polarized Radio Sources. *Austral. J. Phys.*, Vol. 19, 1966, p. 129.
- Gardner, F. F.; and Whiteoak, J. B.: The Polarization of Cosmic Radio Waves. *Ann. Rev. Astron. Astrophys.*, Vol. 4, 1966, p. 245.
- Gardner, F. F.; Whiteoak, J. B.; and Morris, D.: Evidence for an Association Between Magnetic Field and Gas Outflow From a Spiral Arm. *Nature*, Vol. 214, 1967, p. 371.
- Geiss, J.; Hirt, P.; and Lentwylser, H.: On Acceleration and Motion of Ions in Corona and Solar Wind. *Solar Phys.*, Vol. 13, 1970a, p. 183.
- Geiss, J.; Eberhardt, P.; Bühler, F.; Meister, J.; and Signer, P.: Apollo 11 and 12 Solar Wind Composition Experiments: Fluxes of He and Ne Isotopes. *J. Geophys. Res.*, Vol. 75, 1970b, p. 5972.
- Gleeson, L. J.: The Equations Describing the Cosmic-Ray Gas in the Interplanetary Region. *Planet. Space Sci.*, Vol. 17, 1969, p. 31.
- Gleeson, L. J.; and Axford, W. I.: Cosmic Rays in the Interplanetary Medium. *Astrophys. J.*, Vol. 149, 1967, p. L115.
- Gleeson, L. J.; and Axford, W. I.: The Compton-Getting Effect. *Astrophys. Space Sci.*, Vol. 2, 1968a, p. 431.
- Gleeson, L. J.; and Axford, W. I.: Solar Modulation of Galactic Cosmic Rays. *Astrophys. J.*, Vol. 154, 1968b, p. 1011.
- Gleeson, L. J.; and Urch, I. H.: Energy Losses and Modulation of Galactic Cosmic Rays. *Astrophys. Space Sci.*, Vol. 11, 1971a, p. 288.
- Gleeson, L. J.; and Urch, I. H.: Solar Sources and the Cosmic Ray Transport Equation. *J. Geophys. Res.*, Vol. 76, 1971b, p. 2510.
- Gleeson, L. J.; Krimigis, S. M.; and Axford, W. I.: Low-Energy Cosmic Rays Near Earth. *J. Geophys. Res.*, Vol. 76, 1971, p. 2228.
- Goldstein, S. J., Jr.; and MacDonald, D. D.: Observations of the 21-cm Hydrogen Line Toward High-Latitude Stars. *Astrophys. J.*, Vol. 157, 1969, p. 1101.
- Goldstein, S. J.; and Meisel, D. D.: Frequency Dependence of Polarization of Pulsar CP0328. *Science*, Vol. 163, 1969, p. 810.
- Goldstein, M. L.; Ramaty, R.; and Fisk, L. A.: Interstellar Cosmic Ray Spectra From the Nonthermal Radio Background From 0.4 to 400 Mhz. *Phys. Rev. Letters*, Vol. 24, 1970a, p. 1193.
- Goldstein, M. L.; Fisk, L. A.; and Ramaty, R.: Energy Loss of Cosmic Rays in the Interplanetary Medium. *Phys. Rev. Letters*, Vol. 25, 1970b, p. 832.
- Gordon, C. P.; Gordon, K. J.; and Shalloway, A. M.: Estimates of Pulsar Distances From Neutral Hydrogen Absorption. *Nature*, Vol. 222, 1969, p. 129.
- Gordon, K. J.; and Gordon, C. P.: Measurements of Neutral-Hydrogen Absorption in the Spectra of Four Pulsars. *Astrophys. J.*, Vol. 5, 1970, p. L153.
- Gorenstein, P.; Giacconi, R.; and Gursky, H.: The Spectra of Several X-ray Sources in Cygnus and Scorpio. *Astrophys. J.*, Vol. 150, 1967, p. L85.
- Gorenstein, P.; Kellogg, E. M.; and Gursky, H.: The Spectrum of Diffuse Cosmic X-rays, 1-13 keV. *Astrophys. J.*, Vol. 156, 1968, p. 315.
- Gould, R. J.: Pulsar Dispersion Measures and the Mean and Mean-Squared Interstellar Electron Density. *Astrophys. Space Sci.*, Vol. 10, 1971, p. 265.
- Gould, R. J.; and Salpeter, E. E.: The Interstellar Abundance of the Hydrogen Molecule, I. *Astrophys. J.*, Vol. 138, 1963, p. 393.
- Gould, R. J.; Gold, T.; and Salpeter, E. E.: The Interstellar Abundance of the Hydrogen Molecule, II. Galactic Abundance and Distribution. *Astrophys. J.*, Vol. 138, 1963, p. 408.
- Grader, R. J.; Hill, R. W.; Seward, F. D.; and Hiltner, W. A.: The Soft X-ray Spectra of Three Cosmic Sources and Simultaneous Optical Observations of SCO XR-1. *Astrophys. J.*, Vol. 159, 1970, p. 201.

- Green, D. W.; Wilson, B. G.; and Baxter, A. J.: A Spectral Measurement of the Cosmic X-ray Background Down to 2 keV. in *Space Research IX*. K. S. W. Champion, P. A. Smith, and R. L. Rose-Smith, eds., North-Holland Pub. Co., Amsterdam, 1968, p. 222.
- Greenberg, D. W.: A Radio Observational Test for Low-Energy Cosmic Rays in the Galaxy. *Astrophys. J.*, Vol. 155, 1969, p. L51.
- Gregory, C. T.: Ph.D. Dissertation, Univ. Calif., San Diego, 1971.
- Grewing, M.; and Walmsley, M.: On the Interpretation of the Pulsar Dispersion Measure. *Astron. Astrophys.*, Vol. 11, 1971, p. 65.
- Guelin, M.; Guibert, J.; Huchtmeier, W.; and Weliachew, L.: Measurement of Pulsar Distances by Galactic Hydrogen Absorption. *Nature*, Vol. 221, 1969, p. 249.
- Guschina, R. T.; Dorman, I. V.; Dorman, L. I.; and Pimenov, I. A.: Correlation of Solar Activity With Cosmic Ray Intensity and Solar Wind Properties. *Acta Phys. Acad. Sci. Hungar.*, Vol. 29, Suppl. 2, 1970, p. 219.
- Habing, H. J.; and Goldsmith, D. W.: Heating of the Interstellar Medium by X-rays and by Cosmic Rays. *Astrophys. J.*, Vol. 166, 1971, p. 525.
- Habing, H. J.; and Pottasch, S. R.: Low-Energy Cosmic Rays and the Electron Density in H<sub>I</sub> Regions. *Astrophys. J.*, Vol. 149, 1967, p. L119.
- Habing, H. J.; and Pottasch, S. R.: Distances to the Pulsating Radio Sources. *Nature*, Vol. 219, 1968, p. 1137.
- Hartle, R. E.; and Sturrock, P. A.: Two-Fluid Model of the Solar Wind. *Astrophys. J.*, Vol. 151, 1968, p. 1155.
- Hatton, C. J.; Marsden, P. L.; and Willetts, A. C.: Rigidity Dependence and the Correlation With Solar Activity of the 11-Year Variation. *Can. J. Phys.*, Vol. 46, 1968, p. S915.
- Hayakawa, S.; Nishimura, S.; and Takayanagi, K.: Radiation From the Interstellar Hydrogen Atoms. *Publ. Astron. Soc. Jap.*, Vol. 13, 1961, p. 184.
- Hayes, W. D.; and Probstein, R. F.: *Hypersonic Flow Theory*. Academic Press, New York, 1966.
- Henry, R. J. W.: Photoionization Cross Sections for N and O. *J. Chem. Phys.*, Vol. 48, 1968, p. 3635.
- Hertel, G. R.; and Koski, W. S.: Cross Sections for the Single Charge Transfer of Doubly-Charged Rare-Gas Ions in Their Own Gases. *J. Chem. Phys.*, Vol. 40, 1964, p. 3452.
- Hewish, A.: Pulsars. *Ann. Rev. Astron. Astrophys.*, Vol. 8, 1970, p. 265.
- Hewish, A.; and Wyndham, J. D.: The Solar Corona in Interplanetary Space. *Mon. Not. Roy. Astron. Soc.*, Vol. 126, 1963, p. 469.
- Hinteregger, H. E.: Extreme Ultraviolet Solar Spectrum and Its Variation During a Solar Cycle. *Ann. Geophys.*, Vol. 26, 1970, p. 547.
- Hjellming, R. M.; Gordon, C. P.; and Gordon, K. J.: Properties of Interstellar Clouds and the Inter-Cloud Medium. *Astron. Astrophys.*, Vol. 2, 1969, p. 202.
- Hollenbach, D. J.; Werner, M. W.; and Salpeter, E. E.: Molecular Hydrogen in H<sub>I</sub> Regions. *Astrophys. J.*, Vol. 163, 1971, p. 165.
- Hollweg, J. V.; and Völk, H. J.: New Plasma Instabilities in the Solar Wind. *J. Geophys. Res.*, Vol. 75, 1970, p. 5297.
- Holzer, T. E.: Stellar Winds and Related Flows. Ph.D. Thesis, Univ. Calif., San Diego, 1970.
- Holzer, T. E.: In preparation, 1971.
- Holzer, T. E.; and Axford, W. I.: The Theory of Stellar Winds and Related Flows. *Ann. Rev. Astron. Astrophys.*, Vol. 8 1970a, p. 31.
- Holzer, T. E.; and Axford, W. I.: Solar Wind Ion Composition. *J. Geophys. Res.*, Vol. 75, 1970b, p. 6354.
- Holzer, T. E.; and Axford, W. I.: The Interaction Between Interstellar Helium and the Solar Wind. To appear in *J. Geophys. Res.*, 1971.
- Huffman, R. E.: Absorption Cross-Sections of Atmospheric Gases for Use in Aeronomy. *Can. J. Chem.*, Vol. 47, 1969, p. 1823.
- Humphreys, R. M.: Streaming Motions in the Carina-Centaurus Region. *Astrophys. J.*, Vol. 163, 1971, p. L111.
- Hundhausen, A. J.: Direct Observations of Solar-Wind Particles. *Space Sci. Rev.*, Vol. 8, 1968a, p. 690.
- Hundhausen, A. J.: Interplanetary Neutral Hydrogen and the Radius of the Heliosphere. *Planet. Space Sci.*, Vol. 16, 1968b, p. 783.
- Hundhausen, A. J.: Composition and Dynamics of the Solar Wind Plasma. *Rev. Geophys. Space Phys.*, Vol. 8, 1970, p. 729.
- Hundhausen, A. J.; Bame, S. J.; and Ness, N. F.: Solar Wind Thermal Anisotropies: Vela 3 and IMP 3. *J. Geophys. Res.*, Vol. 72, 1967, p. 5265.
- Hundhausen, A. J.; Gilbert, H. E.; and Bame, S. J.: Ionization State of the Interplanetary Plasma. *J. Geophys. Res.*, Vol. 73, 1968, p. 5485.
- Ioffe, Z. M.: Comets in the Solar Wind. *Soviet Astron. - AJ*, Vol. 10, 1966a, p. 138.
- Ioffe, Z. M.: Comets in the Solar Wind, 2. *Soviet Astron. - AJ*, Vol. 10, 1966b, p. 517.
- Ioffe, Z. M.: Some Magnetohydrodynamic Effects in Comets. *Soviet Astron. - AJ*, Vol. 11, 1968, p. 1044.

- Jenkins, E. B.: Observations of Interstellar Lyman- $\alpha$  Absorption, in *Ultraviolet Stellar Spectra and Ground-Based Observations*. I.A.U. Symp. No. 36, L. Houziaux and H. E. Butler, eds., D. Reidel Pub. Co., Dordrecht, 1970.
- Jenkins, E. B.; and Morton, D. C.: Far Ultra-Violet Spectra of Orion Stars. *Nature*, Vol. 215, 1967, p. 1257.
- Jenkins, E. B.; Morton, D. C.; and Matilsky, T. A.: Interstellar  $L\alpha$  Absorption in  $\beta^1$ ,  $\delta$ , and  $\pi$  Scorpii. *Astrophys. J.*, Vol. 158, 1969, p. 473.
- Johnson, C. Y.; Young, J. M.; and Holmes, J. C.: Magnetoglow, A New Geophysical Resource. *Science*, Vol. 171, 1971, p. 379.
- Johnson, H. E.: Ph.D. Thesis, Univ. Calif., San Diego, 1971.
- Johnson, H. E.; and Axford, W. I.: Production and Loss of  $He^3$  in the Earth's Atmosphere. *J. Geophys. Res.*, Vol. 74, 1969, p. 2433.
- Jokipii, J. R.: Effects of Diffusion on the Composition of the Solar Corona and the Solar Wind, in *The Solar Wind*. R. J. Mackin, Jr., and M. Neugebauer, eds., Pergamon Press, New York, 1966a, p. 215.
- Jokipii, J. R.: Cosmic-Ray Propagation, I. Charged Particles in a Random Magnetic Field. *Astrophys. J.*, Vol. 146, 1966b, p. 480.
- Jokipii, J. R.: Acceleration of Cosmic Rays at the Solar-Wind Boundary. *Astrophys. J.*, Vol. 152, 1968, p. 799.
- Jokipii, J. R.: Propagation of Cosmic Rays in the Solar Wind. *Rev. Geophys. Space Phys.*, Vol. 9, 1971, p. 27.
- Jokipii, J. R.; and Coleman, P. J., Jr.: Cosmic-Ray Diffusion Tensor and Its Variation Observed With Mariner 4. *J. Geophys. Res.*, Vol. 73, 1968, p. 5495.
- Jokipii, J. R.; and Parker, E. N.: Energy Changes of Cosmic Rays in the Solar System. *Planet. Space Sci.*, Vol. 15, 1967, p. 1375.
- Jokipii, J. R.; and Parker, E. N.: Stochastic Aspects of Magnetic Lines of Force With Application to Cosmic-Ray Propagation. *Astrophys. J.*, Vol. 155, 1969, p. 777.
- Jokipii, J. R.; and Parker, E. N.: On the Convection, Diffusion, and Adiabatic Deceleration of Cosmic Rays in the Solar Wind. *Astrophys. J.*, Vol. 160, 1970, p. 735.
- Kennel, C. F.; and Scarf, F. L.: Thermal Anisotropies and Electromagnetic Instabilities in the Solar Wind. *J. Geophys. Res.*, Vol. 73, 1968, p. 6149.
- Kern, J. W.; and Semar, C. L.: Solar-Wind Termination and the Interstellar Medium. *Trans. Amer. Geophys. Union*, Vol. 49, 1968, p. 203.
- Kerr, F. J.: Radio-Line Emission and Absorption by the Interstellar Gas. *Nebulae and Interstellar Matter*. B. M. Middlehurst and L. H. Aller, eds., Univ. Chicago Press, 1968, p. 575.
- Kerr, F. J.: The Large-Scale Distribution of Hydrogen in the Galaxy. *Ann. Rev. Astron. Astrophys.*, Vol. 7, 1969, p. 39.
- Kerr, F. J.; and Westerhout, G.: Distribution of Interstellar Hydrogen. *Stars Stellar Sys.*, Vol. V, 1965, p. 167.
- Kolomeets, E. V.; Shakhova, Y. A.; and Zusmanovich, A. J.: Solar Activity and Dimension of Modulation Region. *Acta Phys. Acad. Sci. Hungar.*, Vol. 29, Suppl. 2, 1970, p. 305.
- Koopman, D. W.: Charge Exchange of  $H^+$  and  $H_2^+$  in Atmospheric Constituents. *Fifth Intern. Conf. Phys. Electron. Atomic Collisions*, I. P. Flaks, ed., Nauka, Leningrad, 1967, p. 410.
- Kovar, R. P.; and Dessler, A. J.: On the Anisotropy of Galactic Cosmic Rays. *Astrophys. Letters*, Vol. 1, 1967, p. 15.
- Kurt, V. G.: Measurement of Scattered  $L\alpha$ -Radiation in the Vicinity of the Earth and in Interplanetary Space. *Trans. All Union Conf. Space Phys., NASA-TTF*, Vol. 389, 1965, p. 769.
- Kurt, V. G.: Observations of Scattered Lyman- $\alpha$  Radiation in the Earth's Neighborhood. *Cosmic Res.*, Vol. 5, 1967, p. 770.
- Kurt, V. G.; and Germogenova, T. A.: Scattering of Solar Lyman- $\alpha$  Radiation by Galactic Hydrogen. *Soviet Astron.*, Vol. 11, 1967, p. 278.
- Kurt, V. G.; and Dostovalov, S. B.: For Ultraviolet Radiation From the Milky Way. *Nature*, Vol. 218, 1968, p. 258.
- Kurt, V. G.; and Syunyaev, R. A.: Observations and Interpretation of the Ultraviolet Radiation of the Galaxy. *Soviet Astron.*, Vol. 11, 1968, p. 928.
- Lanzerotti, L. J.; and Schulz, M.: Interaction Between the Boundary of the Heliosphere and the Magnetosphere of Jupiter. *Nature*, Vol. 222, 1969, p. 1054.
- Lee, A. R.; and Hasted, J. B.: Calculations of Atomic Asymmetric Charge Transfer. *Proc. Phys. Soc. (London)*, Vol. 85, 1965, p. 673.
- Leer, A.; and Axford, W. I.: A Two-Fluid Solar Wind Model with Anisotropic Proton Temperature. To be submitted to *Solar Phys.*, 1971.
- Lenchek, A. M.: The Solar HII Region and the Radio Spectrum of the Non-Thermal Radiation of the Galaxy. *Ann. Astrophys.*, Vol. 27, 1964, p. 219.
- Levy, R. H.; Petschek, H. E.; and Siscoe, G. L.: Aerodynamic Aspects of the Magnetospheric Flow. *AIAA J.*, Vol. 2, 1964, p. 2065.

- Lezniak, J. A.; and Webber, W. R.: Solar Modulation of Cosmic Ray Protons, Helium Nuclei, and Electrons. *J. Geophys. Res.*, Vol. 76, 1971, p. 1605.
- Liepmann, H. W.; and Roshko, A.: *Elements of Gas-dynamics*. John Wiley and Sons, Inc., New York, 1957.
- Lin, C. C.; Yuau, C.; and Shu, F. H.: On the Spiral Structure of Disk Galaxies, III. Comparison With Observations. *Astrophys. J.*, Vol. 155, 1969, p. 721.
- Lowry, J. F.; Tomboulian, D. H.; and Ederer, D. L.: Photoionization Cross Section of Helium in the 100- to 250-Å Region. *Phys. Rev.*, Vol. 137, 1965, No. 54, A1057.
- Lüst, R.: The Properties of Interplanetary Space, in *Solar Terrestrial Physics*, J. W. King and W. S. Newman, eds., Academic Press, London, 1967, p. 1.
- Lyne, A. G.; and Rickett, B. J.: Measurements of the Pulse Shape and Spectrum of the Pulsating Radio Sources. *Nature*, Vol. 218, 1968, p. 326.
- McCrea, W. H.: Shock Waves in Steady Radial Motion Under Gravity. *Astrophys. J.*, Vol. 124, 1956, p. 461.
- McGuire, E. J.: Photoionization Cross Sections of the Elements Helium to Xenon. *Phys. Rev.*, Vol. 175, 1968, p. 20.
- Madden, R. P.; Ederer, D. L.; and Codling, K.: Resonances in the Photo-Ionization Continuum of Ar I (20–150eV). *Phys. Rev.*, Vol. 177, 1969, p. 136.
- Mange, P.; and Meier, R. R.: Ogo 3 Observations of the Lyman-Alpha Intensity and the Hydrogen Concentration Beyond 5 R<sub>E</sub>. *J. Geophys. Res.*, Vol. 75, 1970, p. 1837.
- Mathewson, D. S.: The Local Galactic Magnetic Field and the Nature of the Radio Spurs. *Astrophys. J.*, Vol. 153, 1968, p. L47.
- Mathewson, D. S.; and Milne, D. K.: A Linear Polarization Survey of the Southern Sky at 408 Mc/s. *Austral. J. Phys.*, Vol. 18, 1965, p. 635.
- Mathewson, D. S.; and Nicholls, D. C.: The Local Spiral-Arm Magnetic Field. *Astrophys. J.*, Vol. 154, 1968, p. L11.
- Meier, R. R.: Temporal Variations of Solar Lyman Alpha. *J. Geophys. Res.*, Vol. 74, 1969, p. 6487.
- Meier, R. R.; and Prinz, D. K.: Absorption of the Solar Lyman Alpha Line by Geocoronal Atomic Hydrogen. *J. Geophys. Res.*, Vol. 75, 1970, p. 6969.
- Metzger, P. H.; and Clark, M. A.: On the Diurnal Variation of the Exospheric Neutral Hydrogen Temperature. *J. Geophys. Res.*, Vol. 75, 1970, p. 5587.
- Mills, B. Y.: Pulsar Distances, Spiral Structure and the Interstellar Medium. *Nature*, Vol. 224, 1969, p. 504.
- Milne, D. K.: Radio Emission From the Supernova Remnant Vela-X. *Austral. J. Phys.*, Vol. 21, 1968, p. 201.
- Modisette, J. L.; and Snyder, J. W.: Interaction of the Solar Wind With the Interstellar Medium (Abstract). *Trans. Amer. Geophys. Union*, Vol. 49, 1968, p. 263.
- Morris, D.; and Berge, G. L.: Direction of the Galactic Magnetic Field in the Vicinity of the Sun. *Astrophys. J.*, Vol. 139, 1964, p. 1388.
- Morton, D. C.: The Far-Ultraviolet Spectra of Six Stars in Orion. *Astrophys. J.*, Vol. 147, 1967, p. 1017.
- Morton, D. C.; and Purcell, J. D.: Observations of the Extreme Ultraviolet Radiation in the Night Sky Using an Atomic Hydrogen Filter. *Planet. Space Sci.*, Vol. 9, 1962, p. 455.
- Morton, D. C.; Jenkins, E. B.; and Brooks, N. H.: Far-Ultraviolet Spectra of Zeta Puppis and  $\gamma^2$  Velorum. *Astrophys. J.*, Vol. 155, 1969, p. 875.
- Munch, G.: Interstellar Absorption Lines, in *Nebulae and Interstellar Matter*. B. M. Middlehurst and L. H. Aller, eds., Univ. Chicago Press, 1968, p. 365.
- Ness, N. F.: Observations of the Interaction of the Solar Wind With the Geomagnetic Field During Quiet Conditions, in *Solar Terrestrial Physics*. J. W. King and W. S. Newman, eds., Academic Press, London, 1967, p. 57.
- Ness, N. F.: Observed Properties of the Interplanetary Plasma. *Ann. Rev. Astron. Astrophys.*, Vol. 6, 1968, p. 79.
- Newkirk, G. A.; Warwick, J. W.; and Zirin, H.: Backscatter of Cosmic Rays by the Sun's Hill Sphere. *J. Geophys. Res.*, Vol. 65, 1960, p. 2540.
- Newman, R. C.; and Axford, W. I.: Recombination Fronts in Stellar-Wind Flows. *Astrophys. J.*, Vol. 151, 1968, p. 1145.
- Nishida, A.: Thermal State and Effective Collision Frequency in the Solar Wind Plasma. *J. Geophys. Res.*, Vol. 74, 1969, p. 5155.
- O'Gallagher, J. J.: Cosmic-Ray Radial Density Gradient and Its Rigidity Dependence Observed at Solar Minimum on Mariner IV. *Astrophys. J.*, Vol. 150, 1967, p. 675.
- O'Gallagher, J. J.; and Simpson, J. A.: The Heliocentric Intensity Gradients of Cosmic-Ray Protons and Helium During Minimum Solar Modulation. *Astrophys. J.*, Vol. 147, 1967, p. 819.
- Ogawa, T.; and Tohmatsu, T.: Sounding Rocket Observation of Helium 304Å and 584Å Glow. To appear in *J. Geophys. Res.*, 1971.
- Ogilvie, K. W.; Burlaga, L. F.; and Wilkerson, T. D.: Plasma Observations on Explorer 34. *J. Geophys. Res.*, Vol. 73, 1968, p. 6809.

- Ogilvie, K. W.; and Wilkerson, T. D.: Helium Abundance on the Solar Wind. *Solar Phys.*, Vol. 8, 1969, p. 435.
- Parker, E. N.: Dynamics of the Interplanetary Gas and Magnetic Fields. *Astrophys. J.*, Vol. 128, 1958, p. 664.
- Parker, E. N.: The Stellar-Wind Regions. *Astrophys. J.*, Vol. 134, 1961, p. 20.
- Parker, E. N.: *Interplanetary Dynamical Processes*. Interscience, New York, 1963.
- Parker, E. N.: Theory of Streaming of Cosmic Rays and the Diurnal Variation. *Planet. Space Sci.*, Vol. 12, 1964, p. 735.
- Parker, E. N.: Dynamical Theory of the Solar Wind. *Space Sci. Rev.*, Vol. 4, 1965a, p. 666.
- Parker, E. N.: The Passage of Energetic Charged Particles Through Interplanetary Space. *Planet. Space Sci.*, Vol. 13, 1965b, p. 9.
- Parker, E. N.: The Role of Stochastic Fields in Admitting Low-Energy Galactic Cosmic Rays to the Solar System. *J. Geophys. Res.*, Vol. 73, 1968, p. 6842.
- Parker, E. N.: Theoretical Studies of the Solar Wind Phenomenon. *Space Sci. Rev.*, Vol. 9, 1969, p. 325.
- Patterson, T. N. L.; Johnson, F. S.; and Hanson, W. B.: The Distribution of Interplanetary Hydrogen. *Planet. Space Sci.*, Vol. 11, 1963, p. 767.
- Pikel'ner, S. B.: Ionization and Heating of the Interstellar Gas by Subcosmic Rays, and the Formation of Clouds. *Soviet Astron.*, Vol. 11, 1968, p. 737.
- Pilkington, J. D. H.; Hewish, A.; Bell, S. J.; and Cole, T. W.: Observations of Some Further Pulsed Radio Sources. *Nature*, Vol. 218, 1968, p. 126.
- Prentice, A. J. R.; and Ter Haar, D.: HII Regions and the Distances to Pulsars. *Nature*, Vol. 222, 1969a, p. 964.
- Prentice, A. J. R.; and Ter Haar, D.: On HII Regions and Pulsar Distances. *M.N.R.A.S.*, Vol. 146, 1969b, p. 423.
- Radhakrishnan, V.; and Murray, J. D.: The Spin Temperature of Interstellar Neutral Hydrogen. *Proc. Astron. Soc. Austral.*, Vol. 1, 1969, p. 215.
- Radhakrishnan, V.; Cooke, D. J.; Komesaroff, M. M.; and Morris, D.: Evidence in Support of a Rotational Model for the Pulsar PSR 0833-45. *Nature*, Vol. 221, 1969, p. 443.
- Rappaport, S.; Bradt, H. V.; and Mayer, W.: Interstellar Absorption of 10-Å X-rays. *Astrophys. J.*, Vol. 157, 1969, p. L21.
- Reay, N. K.; and Ring, J.: Radial Velocity and Intensity Measurements of the Night Sky H $\beta$  Emission Line. *Planet. Space Sci.*, Vol. 17, 1969, p. 561.
- Reid, G. C.; and Sauer, H. H.: Evidence for Nonuniformity of Solar-Proton Precipitation Over the Polar Caps. *J. Geophys. Res.*, Vol. 72, 1967, p. 4383.
- Reiffel, L.: Low-Energy X-rays From Interplanetary Space. *Nature*, Vol. 185, 1960, p. 229.
- Riegel, K. W.; and Jennings, M. C.: Observations of an Unusual Cold Cloud in the Galaxy. *Astrophys. J.*, Vol. 157, 1969, p. 563.
- Robbins, D. E.; Hundhausen, A. J.; and Bame, S. J.: Helium in the Solar Wind. *J. Geophys. Res.*, Vol. 75, 1970, p. 1178.
- Rohlfs, K.: On the Structure of Interstellar Matter, I. Kinematics of the Interstellar Gas and the Brightness Temperature of the 21 cm Line Emission. *Astron. Astrophys.*, Vol. 12, 1971, p. 43.
- Rustgi, O. P.: Absorption Cross Sections of Argon and Methane Between 600 and 170Å. *J. Opt. Soc. Amer.*, Vol. 54, 1964, p. 464.
- Sakashita, S.: Interaction of Stars and Interstellar Gas. Preprint, 1970.
- Samson, J. A. R.: Photoionization Cross Sections of Neon From Threshold to 200Å. *J. Opt. Soc. Amer.*, Vol. 55, 1965, p. 935.
- Schatten, K. H.; and Wilcox, J. M.: Direction of the Nearby Galactic Magnetic Field Inferred From a Cosmic-Ray Diurnal Anisotropy. *J. Geophys. Res.*, Vol. 74, 1969, p. 4157.
- Schatten, K. H.; and Wilcox, J. M.: Solar Modulation of Galactic Cosmic Rays With a Twenty-Year Period: Interpretation and Inferences. *Acta Phys. Acad. Sci. Hungar.*, Vol. 29, Suppl. 2, 1970, p. 279.
- Semar, C. L.: Effect of Interstellar Neutral Hydrogen on the Termination of the Solar Wind. *J. Geophys. Res.*, Vol. 75, 1970, p. 6892.
- Silk, J.; and Werner, M. W.: Heating of H $\text{I}$  Regions by Soft X-rays. *Astrophys. J.*, Vol. 158, 1969, p. 185.
- Silk, J.; and Brown, R. L.: On the Ultraviolet Absorption-Line Spectra Produced by H $\text{I}$  Regions. *Astrophys. J.*, Vol. 163, 1971, p. 495.
- Simnett, G. M.; Cline, T. L.; and McDonald, F. B.: The Multifarious Temporal Variations of Low Energy, Relativistic Cosmic Ray Electrons. Submitted to *J. Geophys. Res.*, 1971.
- Simpson, J. A.: Recent Investigations of the Low Energy Cosmic and Solar Particle Radiations, *Semaine d'Étude sur le Problème du Rayonnement Cosmique dans L'Éspace Interplanétaire*, Pontifical Acad. Sci., Vatican City, Vol. 281, 1962, p. 323.
- Simpson, J. A.; and Wang, J. R.: Dimension of the Cosmic Ray Modulation Region. *Astrophys. J.*, Vol. 149, 1967, p. L73.



- Simpson, J. A.; and Wang, J. R.: The Eleven-Year and Residual Solar Modulation of Cosmic Rays (1952–1969). *Astrophys. J.*, Vol. 161, 1970, p. 265.
- Slee, O. B.: The Outer Solar Corona During the Declining Portion of the Solar Activity Cycle. *Planet. Space Sci.*, Vol. 14, 1966, p. 255.
- Smith, A. M.: Rocket Spectrographic Observations of  $\alpha$  Virginis. *Astrophys. J.*, Vol. 156, 1969, p. 93.
- Smith, F. G.: Cosmic Radio Noise as Measured in the Satellite Ariel II. Pt. II, Analysis of the Observed Sky Brightness. *Mon. Notic. Roy. Astron. Soc.*, Vol. 131, 1965, p. 145.
- Smith, F. G.: Measurement of the Interstellar Magnetic Field. *Nature*, Vol. 218, 1968a, p. 325.
- Smith, F. G.: Faraday Rotation of Radio Waves From the Pulsars. *Nature*, Vol. 220, 1968b, p. 891.
- Snyder, C. W.; and Neugebauer, M.: Interplanetary Solar-Wind Measurements by Mariner II. *Space Res.*, Vol. 4, 1964, p. 89.
- Solomon, P. M.: and Werner, M. W.: In preparation, 1970.
- Sousk, S. F.; and Lenchek, A. M.: The Effect of Galactic Cosmic Rays Upon the Dynamics of the Solar Wind. *Astrophys. J.*, Vol. 158, 1969, p. 781.
- Spitzer, L., Jr.: Dynamics of Interstellar Matter and the Formation of Stars. *Nebulae and Interstellar Matter*. B. M. Middlehurst and L. H. Aller, eds., Univ. Chicago Press, 1968a, p. 1.
- Spitzer, L., Jr.: *Diffuse Matter in Space*. Interscience, New York, 1968b.
- Spitzer, L., Jr., and Tomasko, M. G.: Heating of H<sub>I</sub> Regions by Energetic Particles. *Astrophys. J.*, Vol. 152, 1968, p. 971.
- Staelin, D. H.; and Riefenstein, E. C., III: Faraday Rotation in Pulsars. *Astrophys. J.*, Vol. 156, 1969, p. L121.
- Stebbins, R. F.; Fite, W. L.; and Hummer, D. G.: Charge Transfer Between Atomic Hydrogen and N<sup>+</sup> and O<sup>+</sup>. *J. Chem. Phys.*, Vol. 33, 1960, p. 1226.
- Storer, S. H.; and Sciama, D. W.: Is Interstellar Hydrogen Capable of Maser Action at 21 Centimeters? *Nature*, Vol. 217, 1968, p. 1237.
- Subramanian, G.: Amplitude of Diurnal Anisotropy of Cosmic Ray Intensity. *J. Geophys. Res.*, Vol. 76, 1971, p. 1093.
- Sunyaev, R. A.: Interaction of the Ionizing Background Radiation With Galaxies, and Limits on the Inter-galactic Gas Density. *Astron. Zh.*, Vol. 46, 1969, p. 929.
- Swinson, D. B.: Solar Modulation Origin of 'Sidereal' Cosmic Ray Anisotropies. *J. Geophys. Res.*, Vol. 76, 1971, p. 4217.
- Thomas, G. E.: Properties of Nearby Interstellar Hydrogen Deduced From Lyman Alpha Sky Background Measurements. Presented at the Solar Wind Conf., Asilomar, Pacific Grove, Calif., March 21–26, 1971.
- Thomas, G. E.; and Krassa, R. F.: OGO 5 Measurements of the Lyman Alpha Sky Background. *Astron. Astrophys.*, Vol. 11, 1971, p. 218.
- Tinsley, B. A.: Anisotropic Galactic Emissions at Lyman Alpha and Nearby Wavelengths. *J. Geophys. Res.*, Vol. 9, 1969, p. 2327.
- Tinsley, B. A.: Extraterrestrial Lyman Alpha. *Rev. Geophys. Space Phys.*, Vol. 9, 1971, p. 89.
- Tohmatsu, T.: The Hydrogen and Helium Ultraviolet Glow, Its Origins and Aeronomical Significance. *Space Res.*, Vol. 10, 1970, p. 608.
- Toichi, T.: Thermal Properties of the Solar Wind Plasma. To be published in *Solar Phys.*, Vol. 15, 1971.
- Urch, I. H.: Ph.D. Dissertation, Univ. Adelaide, Australia, 1971.
- Van Allen, J. A.; Fennell, J. F.; and Ness, N. F.: Asymmetric Access of Energetic Solar Protons to the Earth's North and South Polar Caps. *J. Geophys. Res.*, Vol. 76, 1971, p. 4262.
- van de Hulst, H. C.: Observing the Galactic Magnetic Field. *Ann. Rev. Astron. Astrophys.*, 1967, p. 167.
- Verschuur, G. L.: Positive Determination of an Interstellar Magnetic Field by Measurement of the Zeeman Splitting of the 21 cm Hydrogen Line. *Phys. Rev. Letters*, Vol. 21, 1968, p. 775.
- Verschuur, G. L.: Measurements of Magnetic Fields in Interstellar Clouds of Neutral Hydrogen. *Astrophys. J.*, Vol. 156, 1969a, p. 861.
- Verschuur, G. L.: Further Measurements of Magnetic Fields in Interstellar Clouds of Neutral Hydrogen. *Nature*, Vol. 223, 1969b, p. 140.
- Verschuur, G. L.: Magnetic Fields in Interstellar Neutral-Hydrogen Clouds. *Astrophys. J.*, Vol. 155, 1969c, p. L149.
- Verschuur, G. L.: Further Measurements of the Zeeman Effect at 21 Centimeters and Their Limitations. *Astrophys. J.*, Vol. 161, 1970, p. 867.
- Wallace, L.: Analysis of the Lyman-Alpha Observations of Venus Made From Mariner 5. *J. Geophys. Res.*, Vol. 74, 1969, p. 115.
- Wallis, M.: Transonic Deceleration of the Solar Wind Via Planetary, Cometary or Interstellar Gas. Preprint, 1971.
- Wang, J. R.: Dynamics of the Eleven-Year Modulation of Galactic Cosmic Rays. *Astrophys. J.*, Vol. 160, 1970, p. 261.

- Wax, R. L.; Simpson, W. R.; and Bernstein, W.: Large Fluxes of 1-keV Atomic Hydrogen at 800 km. *J. Geophys. Res.*, Vol. 75, 1970, p. 6390.
- Webber, W. R.: On the Relationship Between Recent Measurements of Cosmic Ray Electrons, Nonthermal Radio Emission From the Galaxy, and the Solar Modulation of Cosmic Rays. *Austral. J. Phys.*, Vol. 21, 1968, p. 845.
- Weber, E. J.; and Davis, L., Jr.: The Angular Momentum of the Solar Wind. *Astrophys. J.*, Vol. 148, 1967, p. 217.
- Wentzel, D. G.: The Propagation and Anisotropy of Cosmic Rays, 1. Theory for Steady Streaming. *Astrophys. J.*, Vol. 156, 1969, p. 303.
- Werner, M. W.; and Harwit, M.: Observational Evidence for the Existence of Dense Clouds of Interstellar Molecular Hydrogen. *Astrophys. J.*, Vol. 154, 1968, p. 881.
- Werner, M. W.; Silk, J., and Rees, M. J.: Heating of H<sub>I</sub> Regions by Soft X-rays, II. The Effect of Galactic Soft X-ray Sources. *Astrophys. J.*, Vol. 161, 1970, p. 965.
- Weymann, R.: Coronal Evaporation as a Possible Mechanism for Mass Loss in Red Giants. *Astrophys. J.*, Vol. 132, 1960, p. 380.
- Wilcox, J. M.: The Interplanetary Magnetic Field, Solar Origin and Terrestrial Effects. *Space Sci. Rev.*, Vol. 8, 1968, p. 258.
- Wilcox, J. M.; and Ness, N. F.: Quasi-Stationary Corotating Structure in the Interplanetary Medium. *J. Geophys. Res.*, Vol. 70, 1965, p. 5793.
- Williams, R. E.: The Size of a Solar HII Region. *Astrophys. J.*, Vol. 142, 1965, p. 314.
- Wilson, O. C.: A Suggested Mechanism for the Ejection of Matter From M-Type Stars. *Astrophys. J.*, Vol. 131, 1960, p. 75.
- Wilson, R.; and Boksenberg, A.: Ultraviolet Astronomy. *Ann. Rev. Astron. Astrophys.*, Vol. 7, 1969, p. 421.
- Wolfe, J. H.; Silva, R. W.; and Myers, M. A.: Observations of the Solar Wind During the Flight of Imp 1. *J. Geophys. Res.*, Vol. 71, 1966, p. 1319.
- Yoshida, S.; Ogita, N.; and Akasofu, S.-I.: Cosmic Ray Variation and the Interplanetary Sector Structures. Submitted to *J. Geophys. Res.*, 1971.
- Young, J. M.; Carruthers, G. R.; Holmes, J. C.; Johnson, C. Y.; and Patterson, N. P.: Detection of Lyman- $\beta$  and Helium Resonance Radiation in the Night Sky. *Science*, Vol. 160, 1968, p. 990.

## DISCUSSION

*C. P. Sonett* For the distant solar wind the energy density decreases as  $1/r^2$  at least. At great distance, say a hundred astronomical units, a simple calculation suggests that the galactic cosmic ray energy density exceeds that of the solar wind. The cosmic ray gas is, of course, an extremely hot gas and it is hard to visualize a supersonic flow in such a gas. Now, for the mixture of these two gases (solar wind and cosmic rays) is it still likely that one can talk about some kind of shock transition?

*W. I. Axford* I think it is quite reasonable to treat the two gases separately at least as a first approximation, since the coupling is not very strong. One sees plenty of shock waves in the interplanetary medium moving through the cosmic ray gas. A strong shock does affect the cosmic rays noticeably, but I do not think the shock wave itself is much affected. I described these effects briefly at the end of my talk: as the termination of the supersonic solar wind flow is approached we expect that the intensity of cosmic rays will gradually increase to the interstellar level and then remain roughly constant in the subsonic region. There may be some acceleration of low energy cosmic rays at the shock as discussed by Jokipii [*Astrophys. J.*, 152, 799, 1968], but the more energetic cosmic rays do not seem to be noticeably affected. If this acceleration of low energy particles is significant and the unmodulated energy density of low energy cosmic rays is much larger than observed near the earth (which is possible) then one definitely would have to take into account the effect of the cosmic rays on the shock wave. Nevertheless there should still be a shock wave of sorts even if it is somewhat smeared out.

*C. P. Sonett* It's true from a structural standpoint, since the gyroradii are larger than the solar system, but there are still JXB forces so I'm not sure that one can completely ignore the fact that the cosmic ray gas has an enormous temperature.

Another question is in relation to Geiss' comment regarding the ratio  $^4\text{He}/^3\text{He}$ . The values that he showed for the Apollo samples were 1860–2720, while the value for

certain classes of meteorites was about 4000. I wonder, in view of what you said this morning, whether the  $^3\text{He}$  gradient might be such that the density is higher farther out. This class of meteorites have spent most of their lives outside 1 AU and perhaps that would account for the concentration.

*W. I. Axford* I think that the  $^3\text{He}$  concentration in meteorites could be expected to differ from that found in the lunar samples, since the latter are saturated with solar wind gases, whereas meteorites have the outer layers (which should also contain solar wind material) ablated away. Presumably the  $^3\text{He}$  concentration in meteorites is affected by cosmic ray implantation and spallation, and any other  $^3\text{He}$  deep within the meteorites must be primordial in some sense. There is a radial gradient in the density of interstellar  $^3\text{He}$ , but the density within 10 AU is less than that of the solar wind, and of course the particle energy is very much less. I doubt that interstellar  $^3\text{He}$  could be important as far as the interior of meteorites is concerned, and it seems unlikely that it could have much effect on the concentrations in lunar dust.

*C. P. Sonett* Also, there's the component from charge exchange.

*W. I. Axford* With the presently accepted values for the density of interstellar gas near the sun, I doubt that this could double the  $^3\text{He}$  content anywhere in the solar wind within 100 AU from the sun.

*J. R. Jokipii* I would like to comment on Dr. Sonett's point and then ask a question. It seems to me that if there are regions where the pressure of the cosmic rays is great enough, then the cosmic rays will indeed affect the supersonic or the subsonic nature of the gas. I'm not sure whether this will ever happen or not.

*W. I. Axford* Yes, it can in principle (see p. 645), but the answer depends upon how well the cosmic ray gas is coupled to the solar wind gas, and we have no way of determining this without actually exploring the termination region.

*J. R. Jokipii* Then one must consider the effect of sound waves actually being propagated through the cosmic ray gas. The sound speed is essentially the total pressure divided by the density, provided only that the wavelengths are long enough that the cosmic rays and plasma are coupled. We're talking about 0.01 to 0.1 AU, which is the cyclotron radius of a typical cosmic ray and this is small on this scale. Anyway, that's just the comment. The question I have concerns the interstellar density of hydrogen. Presumably your value is not intended to be an average for the interstellar density of hydrogen. It seems to me from some work of Parker and perhaps previous work of others that there is trouble with the virial theorem if the density of matter is too low.

*W. I. Axford* That is a problem and, of course, people have been searching for the extra mass for many years. But the mass of neutral hydrogen would not be enough even if the number density was as much as  $1\text{ cm}^{-3}$ . My assumed value of  $0.1\text{ cm}^{-3}$  is not necessarily the general density, but it appears to be very close to the local value (within  $\sim 100\text{ pc}$ ). As far as the "missing mass" is concerned, there simply is not enough atomic hydrogen in the galaxy to matter, and there are observations which suggest that the total amount of molecular hydrogen is also not significant in this respect. The only suggestion that seems to work is that the missing mass is in the form of black holes – which has the nice feature of being almost impossible to reject on observational grounds. As far as the confinement of cosmic rays within the galaxy is concerned, I think we must begin to revise our models for the behavior of cosmic rays, perhaps by considering "galactic wind" type models in which there is more emphasis on "flow" rather than "leakage" of the cosmic ray gas out of the galaxy.

*J. C. Brandt* About the mass of the galaxy, that has been missing for decades, I don't think that it's time to get too worried about it. But there are large areas in the galaxy where the number density is apparently  $0.1/\text{cm}^3$  and I think we just have to live with that.

*M. Dryer* I have a question about the term “shock wave.” Whenever we hear the term we think of Rankine-Hugoniot conditions, and we happily make comparisons between these conditions, including magnetic effects, and observations. Are we still talking about the same kind of thin layer in this context, that is, need we worry about these things on this scale, or will the meaning of the word “shock wave” be less well-specified in this context?

*W. I. Axford* I don't see why there should be any problem at all. The scale of the system is very large – 100 AU. As long as there is some mechanism which will make the shock look “thin” on this scale the Rankine-Hugoniot conditions must be satisfied. Since these represent conservation of mass, momentum and energy, there can hardly be much wrong with them. However, one might worry about the effective value of the ratio of specific heats, which appears prominently in the Rankine-Hugoniot relations. I doubt that the number of degrees of freedom can differ significantly from 3 per particle, but electron heat conduction could have a noticeable effect on the transition, as it presumably does in the case of shocks observed in the vicinity of the earth.

*C. P. Sonett* Would you care to comment on the time-dependent problem, for example, the time-dependent problem that would arise because of the motion of the heliosphere through the local arm. This part of the galaxy is very spotty with clouds and as the solar system moves through it, the background density varies, the field direction changes, and so on. Specifically, how does the information on a change in boundary then propagate back into the solar system or heliosphere?

*W. I. Axford* The “relaxation” time for the system to reach equilibrium is of the order of the time the solar wind takes to get to the terminating shock wave. Since the solar wind travels an astronomical unit every 4 days, the time scale for the system to reach equilibrium is about a year. This is short compared with any possible time scale for changes occurring outside the solar system. At a number density of  $0.1 \text{ cm}^{-3}$ , the mean free path is about  $10^{17}$  cm. At 20 km/sec, which is roughly the velocity of the interstellar gas past the sun, an interval of  $5 \cdot 10^{10}$  sec is required for a “cloud” with a scale size equal to one mean free path to go past the solar system. So a cloud which is only one mean free path across takes about 2000 years to go past the sun at this speed. If you take 1000 mean free paths for the size of an interstellar cloud, one sees that the heliosphere should be stationary over time scales of a million years.

*C. P. Sonett* Is that true also for the wave field? Supposing there were a wave field on the outside, as we suspect there probably is.

*W. I. Axford* Well, the waves that I would imagine to be important are Alfvén waves. The Alfvén speed is also quite small, something like 30 km/sec, so the time scale is still going to be of the order of  $10^6$  years if the wavelengths are comparable to cloud dimensions.