

**NASA TECHNICAL
MEMORANDUM**

NASA TM X-64682

**A MECHANICAL PROPERTY AND STRESS
CORROSION EVALUATION OF CUSTOM
455 STAINLESS STEEL ALLOY**

By J. W. Montano
Astronautics Laboratory

August 2, 1972

**CASE FILE
COPY**

NASA

*George C. Marshall Space Flight Center
Marshall Space Flight Center, Alabama*

1. REPORT NO. NASA TM X-64682		2. GOVERNMENT ACCESSION NO.		3. RECIPIENT'S CATALOG NO.	
4. TITLE AND SUBTITLE A Mechanical Property and Stress Corrosion Evaluation of Custom 455 Stainless Steel Alloy				5. REPORT DATE August 2, 1972	
				6. PERFORMING ORGANIZATION CODE	
7. AUTHOR(S) J. W. Montano				8. PERFORMING ORGANIZATION REPORT #	
9. PERFORMING ORGANIZATION NAME AND ADDRESS Marshall Space Flight Center Marshall Space Flight Center, AL 35812				10. WORK UNIT NO.	
				11. CONTRACT OR GRANT NO.	
				13. TYPE OF REPORT & PERIOD COVERED Technical Memorandum	
12. SPONSORING AGENCY NAME AND ADDRESS National Aeronautics and Space Administration Washington, DC 20546				14. SPONSORING AGENCY CODE	
15. SUPPLEMENTARY NOTES Work Performed by Astronautics Laboratory, Science and Engineering					
16. ABSTRACT <p>This report is a continuation of the work reported in NASA-TMX-53665, dated October 20, 1967. Presented in this report are the mechanical and stress corrosion properties of vacuum melted Custom 455 stainless steel alloy bar [1.0-inch (2.54 cm) diameter] and sheet [0.083-inch (0.211 cm) thick] material aged at 950°F (510°C), 1000°F (538°C), and 1050°F (566°C). Low temperature mechanical properties were determined at temperatures of 80°F (26.7°C), 0°F (-17.8°C), -100°F (-73°C), and -200°F (-129°C).</p> <p>For all three aging treatments, the ultimate tensile and 0.2 percent offset yield strengths increased with decreasing test temperatures while the elongation held fairly constant down to -100°F (-73°C) and decreased at -200°F (-129°C). Reduction in Area decreased moderately with decreasing temperature for the longitudinal round [0.250-inch (0.635 cm) diameter] specimens. Notched tensile strength and charpy V-notched impact strength decreased with decreasing test temperature.</p> <p>For all three aging treatments, no failures were observed in the unstressed specimens or the specimens stressed to 50, 75, and 100 percent of their yield strengths for 180 days of alternate immersion testing in a 3.5 percent NaCl solution. As indicated by the results of tensile tests performed after alternate immersion testing, the mechanical properties of Custom 455 alloy were not affected by stress or exposure under the conditions of this evaluation.</p>					
17. KEY WORDS Cryogenic Temperature Alternate Immersion			18. DISTRIBUTION STATEMENT Unclassified - unlimited <i>J. W. Montano</i>		
19. SECURITY CLASSIF. (of this report) U		20. SECURITY CLASSIF. (of this page) U		21. NO. OF PAGES 59	22. PRICE \$3.00

ACKNOWLEDGEMENT

Acknowledgement is given to the following personnel of the Astronautics Laboratory:

Mr. Wendel Deweese, Brown Engineering Company
Metallography

Mr. Samuel H. Hunter, S&E-ASTN-MMP, NASA
Assistance in tensile and impact testing

Mr. Daniel S. Kinkle, Jr., S&E-ASTN-MMA, NASA
Mr. Gordon R. Marsh, S&E-ASTN-MMA, NASA
Fractography

Mr. T. L. King, Brown Engineering Company
Mr. James R. Sandlin, S&E-ASTN-MMA, NASA
Photography

Mr. Eli Nelson, S&E-ASTN-MMC
Stress Corrosion

TABLE OF CONTENTS

	Page
SUMMARY	1
INTRODUCTION	2
EQUIPMENT AND TEST SPECIMENS	3
RESULTS AND DISCUSSION	3
CONCLUSIONS	5
REFERENCES	7

LIST OF TABLES

Table	Page	
I.	Chemical Composition of Custom 455 Alloy Sheet and Bar Stock	9
II.	Low Temperature Mechanical Properties of Custom 455 Stainless Steel Longitudinal Round Tensile Specimens [0.250-Inch (0.635cm)] Diameter	10
III.	Low Temperature Mechanical Properties of Custom 455 Stainless Steel Longitudinal Flat Tensile Specimens [0.083-Inch (0.211cm)] Thick	11
IV.	Low Temperature Mechanical Properties of Custom 455 Stainless Steel Transverse Flat Tensile Specimens [0.083-Inch (0.211cm)] Thick	12
V.	Charpy V-Notched Impact Test Data for Custom 455 Alloy Bar	13
VI.	Mechanical Properties of Custom 455 Stainless Steel Aged at 950 ^o F (510 ^o C) Bar [0.1250-Inch (0.3175cm) Diameter] and Sheet [0.083-Inch (0.211cm) Thick] Tensile Specimens After 180 Days of Alternate Immersion Testing in a 3.5 Percent NaCl Solution	14
VII.	Mechanical Properties of Custom 455 Stainless Steel Aged at 1000 ^o F (538 ^o C) Bar [0.1250-Inch (0.3175cm) Diameter] and Sheet [0.083-Inch (0.211cm) Thick] Tensile Specimens After 180 Days of Alternate Immersion Testing in a 3.5 Percent NaCl Solution	15
VIII.	Mechanical Properties of Custom 455 Stainless Steel Aged at 1050 ^o F (566 ^o C) Bar [0.1250-Inch (0.3175cm) Diameter] and Sheet [0.083-Inch (0.211cm) Thick] Tensile Specimens After 180 Days of Alternate Immersion Testing in a 3.5 Percent NaCl Solution	16

LIST OF ILLUSTRATIONS

Figure	Title	Page
1A	Flat Tensile Test Specimen Configuration	17
1B	Flat Tensile V-Notch Specimen Configuration	18
2A	Round Smooth Tensile Specimen Configuration	19
2B	Round V-Notch Tensile Specimen Configuration	20
3	Round Tensile Specimen Configuration for Stress Corrosion Test	21
4	Flat Tensile Specimen Configuration for Stress Corrosion Test	22
5	'C' -Ring Stress Corrosion Specimen	22
6	Low Temperature Mechanical Properties of Custom 455 Stainless Steel Tensile Specimens [0.250-Inch (0.635cm) Diameter] Aged at 950 ^o F (510 ^o C)	23
7	Low Temperature Mechanical Properties of Custom 455 Stainless Steel Tensile Specimens [0.250-Inch (0.635cm) Diameter] Aged at 1000 ^o F (538 ^o C)	24
8	Low Temperature Mechanical Properties of Custom 455 Stainless Steel Tensile Specimens [0.0250-Inch (0.635cm) Diameter] Aged at 1050 ^o F (566 ^o C)	25
9	Low Temperature Notched Properties of Custom 455 Stainless Bar Longitudinal Tensile Specimens and Charpy Impact Specimens	26
10	Low Temperature Mechanical Properties of Custom 455 Stainless Steel Flat Tensile Specimens [0.083-Inch (0.211cm) Thick] Aged at 950 ^o F (510 ^o C)	27
11	Low Temperature Mechanical Properties of Custom 455 Stainless Steel Flat Tensile Specimens [0.083-Inch (0.211cm) Thick] Aged at 1000 ^o F (538 ^o C)	28
12	Low Temperature Mechanical Properties of Custom 455 Stainless Steel Flat Tensile Specimens [0.083-Inch (0.211cm) Thick] Aged at 1050 ^o F (566 ^o C)	29
13	Low Temperature Notched Tensile Properties of Custom 455 Stainless Longitudinal Sheet [0.083-Inch (0.211cm) Thick] Specimens	30

LIST OF ILLUSTRATIONS

Figure	Title	Page
14	Low Temperature Notched Tensile Properties of Custom 455 Stainless Transverse Sheet Specimens [0.083-Inch (0.211cm) Thick]	31
15	Alternate Immersion Bath	32
16	Custom 455 Stainless Steel C-Ring Specimen and Longitudinal Round Tensile Specimen Aged to 950 ^o F (510 ^o C) and Stressed to 90% of the Yield Strength	33
17	Custom 455 Stainless Steel Flat Tensile Specimens Aged at 950 ^o F (510 ^o C) and Stressed to 90% of the 0.2% Yield Strength	34
18A	Microstructure of Custom 455 Stainless Steel Alloy Bar Aged at 950 ^o F (510 ^o C) Etchant: HCl-Nitric Acid-Glycerine Mixture	35
18B	Microstructure of Custom 455 Stainless Steel Alloy Sheet Aged at 950 ^o F (510 ^o C) Etchant: HCl-Nitric Acid-Glycerine Mixture	36
19A	Microstructure of Custom 455 Stainless Steel Alloy Bar Aged at 1000 ^o F (538 ^o C) Etchant: HCl-Nitric Acid-Glycerine Mixture	37
19B	Microstructure of Custom 455 Stainless Steel Alloy Sheet Aged at 1000 ^o F (538 ^o C) Etchant: HCl-Nitric Acid-Glycerine Mixture	38
20A	Microstructure of Custom 455 Stainless Steel Alloy Bar Aged at 1050 ^o F (566 ^o C) Etchant: HCl-Nitric Acid-Glycerine Mixture	39
20B	Microstructure of Custom 455 Stainless Steel Alloy Sheet Aged at 950 ^o F (510 ^o C) Etchant: HCl-Nitric Acid-Glycerine Mixture	40
21A	TEM Fractographs of Custom 455 Stainless Steel Alloy Aged at 950 ^o F (510 ^o C) Smooth Bar Tensile Fractures 3150 X Mag.	41
21B	TEM Fractographs of Custom 455 Stainless Steel Alloy Aged at 950 ^o F (510 ^o C) V-Notch Bar Tensile Fractures 3150 X Mag.	42
21C	TEM Fractographs of Custom 455 Stainless Steel Alloy Aged at 950 ^o F (510 ^o C) Charpy V-Notched Impact Bar Specimen Fractures 3150 X Mag.	43
22A	TEM Fractographs of Custom 455 Stainless Steel Alloy Aged at 1000 ^o F (538 ^o C) Smooth Bar Tensile Fracture 3150 X Mag.	44
22B	TEM Fractographs of Custom 455 Stainless Steel Alloy Aged at 1000 ^o F (538 ^o C) V-Notch Bar Tensile Fractures 3150 X Mag.	45
22C	TEM Fractographs of Custom 455 Stainless Steel Alloy Aged at 1000 ^o F (538 ^o C) Charpy V-Notched Impact Bar Specimen Fractures 3150 X Mag.	46

LIST OF ILLUSTRATIONS

Figure	Title	Page
23A	TEM Fractographs of Custom 455 Stainless Steel Alloy Aged at 1050 ^o F (566 ^o C) Smooth Bar Tensile Fractures 3150X Mag.	47
23B	TEM Fractographs of Custom 455 Stainless Steel Alloy Aged at 1050 ^o F (566 ^o C) V-Notch Bar Tensile Fractures 3150 X Mag.	48
23C	TEM Fractographs of Custom 455 Stainless Steel Alloy Aged at 1050 ^o F (566 ^o C) Charpy V-Notched Impact Bar Specimen Fractures 3150X Mag.	49

SUMMARY

This report presents the mechanical and stress corrosion properties of Custom 455 stainless steel alloy bar and sheet material aged at 950°F (510°C), 1000°F (538°C) and 1050°F (566°C). The mechanical properties were evaluated at temperatures from +80°F (+26.7°C) to -200°F (-129°C). The tensile test data indicate both increasing ultimate tensile strength and 0.2 percent offset yield strength with decreasing temperature. Elongation held fairly constant to -100°F (-73°C) and indicated a slight decrease at -200°F (-129°C). Reduction in area, measured in the longitudinal round tensile specimens, indicated a moderate decrease with decreasing temperatures. Notched tensile strength and charpy V-notched impact strength decreased with decreasing temperatures.

Results of the 180-day alternate immersion stress corrosion tests in a 3.5 percent NaCl solution indicated that the longitudinal and transverse sheet specimens, the longitudinal bar specimens, and the transverse "C" -ring bar specimens were not susceptible to stress corrosion cracking, even when stressed as high as 90 percent of the 0.2 percent yield strength. Tensile tests made on the specimens after exposure to the stress corrosion media indicated that the alloy was not affected by the stress or the exposure.

The data presented in this text is a continuation of work reported in NASA-TMX 53665, dated October 20, 1967. Test results and conclusions reported herein have not been made available through any other source prior to this publication.

INTRODUCTION

Carpenter Custom 455 stainless steel alloy has previously been investigated by the Materials Division, Astronautics Laboratory, of MSFC and the test data, derived from vacuum melted material from Carpenter heat number Z80128, was reported in NASA-TMX-53665, dated October 20, 1967. Our conclusions at that time were that additional cryogenic temperature mechanical testing was needed for several heats of material. We also indicated that for future evaluations, round smooth tensile and round V-notched specimens of at least 0.50-inch (1.27 cm) diameter would be preferable to the small [0.1250-inch (0.3175 cm)] diameter specimens used in that evaluation. At the time of reporting the previous data we suspected that our vacuum furnace temperature indicator was indicating a plus 50^oF (28^oC) error at the aging temperatures. Further investigation has confirmed our suspicions and an errata sheet will be published correcting the temperature to indicate aging at 950^oF (510^oC), 1050^oF (566^oC), and 1100^oF (593^oC).

The Materials Division of MSFC also performed a second evaluation of Custom 455 alloy and reported this data in a letter to the Carpenter Steel Company, on April 15, 1969. Numerous failures occurred, in less than 30 days, in the transverse flat tensile specimen and in the transverse "C" -ring specimens aged at 900^oF (482^oC) and 950^oF (510^oC) and exposed to alternate immersion testing in a 3.5 percent NaCl solution. It was determined that the bar material from heat number 85215 and the sheet material from heat number 86032, used in that evaluation, had been air melted and contained stringers, probably titanium carbonitrides, and banding. The Carpenter Steel Company took immediate steps to remove from their inventory all of the material which they felt had any tendency toward this condition. A change in the method of manufacturing Custom 455 materials was also made at that time to limit the production of Custom 455 to vacuum melting only and a recommendation that a minimum aging temperature of 1000^oF (538^oC) be used when service in environments containing chlorides is contemplated.

Our present investigation of Custom 455 alloy utilized vacuum melted bar [1.0-inch (2.54 cm) diameter] and sheet [0.083-inch (0.211 cm) thick] material from Carpenter Technology's heat number 88832.

EQUIPMENT AND TEST SPECIMENS

Cryogenic tensile properties were determined by utilizing a conventional screw powered, universal testing machine with liquid nitrogen as the cooling medium and controlled by a recorder-controller actuated by a chromel-alumel thermocouple. An additional thermocouple attached to a potentiometer was employed for accuracy checks. Cryogenic tensile testing utilized a special extensometer which attaches directly to the specimen gage length. Impact testing at low temperatures utilized the same recorder-controller thermocouple-actuated set-up. A second thermocouple was attached to the specimen V-notch and temperature measurements were made with a potentiometer. A special cover was used on the impact tester for temperature stabilization. The impact specimens were machined from bar stock to the Federal Standard No. 151 configuration. Tensile test specimen configurations appear in Figures 1A, 1B, 2A and 2B, and the chemical composition of the test material is shown in Table 1.

The equipment used in the stress corrosion testing is described in a report by Williamson (Ref. 1). Appendix I describes the "Method for Stressing "C" Ring Stress Corrosion Specimen." Figures 3-5 illustrate the stress corrosion test specimen configurations. The "C" -ring specimens were stressed in the transverse direction to 50, 75, and 90 percent of the 0.2 percent longitudinal yield strength and placed in the 3.5 percent NaCl solution for 180 days of alternate immersion testing (10 minutes in solution, 50 minutes above solution). Longitudinal and transverse flat tensile specimens of 0.083-inch (0.211 cm) diameter were stressed to 0, 50, 75, and 90 percent of their yield strengths, respectively, and subjected to the same stress corrosion test.

RESULTS AND DISCUSSION

The tensile test data and Charpy V-notched impact test results of the ambient-through-cryogenic-temperature mechanical properties evaluation are tabulated in Tables II - V, and these properties are plotted in Figures 6- 14.

Table II contains test data on longitudinal round tensile specimens [0.250-inch (0.635 cm) diameter] machined from 1.0 inch (2.54 cm) diameter bar and age hardened at 950^oF (510^oC), 1000^oF (538^oC), and 1050^oF (566^oC). As indicated in these test data, there is an increase in ultimate tensile (U. T. S.) and 0.2 percent yield strengths (Y. S.) with decreasing temperature. Elongation, measured in 2.00-inches (5.08 cm) held fairly constant to -100^oF (-73^oC) and indicated a slight drop at -200^oF (-129^oC). Reduction in area (R. A.) measured in the longitudinal round specimens decreased moderately with decreasing temperatures. Notched tensile strength (N. T. S.) decreased with decreasing test temperature. The notched to unnotched tensile ratio (stress concentration factor $K_t = 7.5$) indicated excellent notched tensile strength for the longitudinal round tensile specimens aged at 1000^oF (538^oC) and 1050^oF (566^oC). The notched tensile strength of the 950^oF (510^oC) aged round tensile specimens dropped considerably at -200^oF (-129^oC).

Tables III and IV, respectively, contain test data on longitudinal and on transverse flat tensile specimens [0.083-inch (0.211 cm) thick] machined from sheet material and age hardened at 950°F (510°C), 1000°F (538°C), and 1050°F (566°C). These test data indicate the same trends in properties as the longitudinal round tensile specimen data contained in Table II, except for the notched to unnotched tensile ratio which is considerably lower for the flat specimens. This is due, possibly, to the difference between round V-notched specimens and flat V-notched specimens and the greater stress concentration factor in the flat specimens. These data indicate the resistance of the material, aged at 1000°F (538°C) and 1050°F (566°C), to the adverse effects of notches when tested at temperatures down to -100°F (-73°C). However, at -200°F (-129°C), the notched to unnotched tensile ratio decreased abruptly, indicating a notched sensitive condition. This notch sensitive condition shows up more quickly and more severely in the 950°F (510°C) aged material, as indicated by the rapid drop in notched tensile strength at -100°F (-73°C).

Table V contains charpy V-notched impact test data on specimens machined from 1.0 inch (2.54 cm) diameter bar, age hardened at 950°F (510°C), 1000°F (538°C), and 1050°F (566°C). These data indicate reasonable impact values for the 1000°F (538°C), and 1050°F (566°C) aged material at temperatures down to -100°F (-73°C). At -200°F (-129°C) the impact energy is relatively low. The test specimens aged at 950°F (510°C) indicated considerably lower impact values at all testing temperatures.

The mechanical properties of the test specimens, after 180 days of alternate immersion exposure in a 3.5 percent NaCl solution, are reported in Tables VI, VII, and VIII. These data indicate the mechanical properties of the longitudinal round and longitudinal and transverse flat tensile specimens age hardened at 950°F (510°C), 1000°F (538°C), and 1050°F (566°C), respectively. These test data represent mechanical properties that are so consistent that they indicate no adverse effects of stress (up to 90 percent of the Y.S.) or environment (3.5 percent NaCl solution). Therefore, only the averages of the specimens stressed to 0, 50, 75, and 90 percent of the Y.S. have been converted to the metric equivalent.

No failures were observed in the unstressed or the stressed longitudinal bar specimens or the transverse "C" -ring bar specimens or the longitudinal or transverse sheet specimens during or after the 180 days of alternate immersion testing in a 3.5 percent NaCl solution.

Figures 6-8 illustrate the cryogenic mechanical properties, as tabulated in Table II, of the longitudinal round tensile specimens age hardened at 950°F (510°C), 1000°F (538°C), and 1050°F (566°C), respectively. As indicated in these figures, the reduction in area does not drop below 50 percent for any of the cryogenic temperatures employed in this investigation.

Figure 9 illustrates the notched properties, including notched tensile, notched to unnotched tensile ratio, and charpy V-notched impact strength for longitudinal round bar material age hardened at 950°F (510°C), 1000°F (538°C), and 1050°F (566°C).

Figures 10-12 illustrate the cryogenic mechanical properties, as tabulated in Tables 3 and 4, of the longitudinal and transverse flat tensile specimens age hardened at 950°F (510°C), 1000°F (538°C), and 1050°F (566°C) respectively.

Figures 13 and 14 represent the notched tensile strength and notched to unnotched tensile ratios for the longitudinal and transverse flat specimens respectively, age hardened at 950°F (510°C), 1000°F (538°C) and 1050°F (566°C). The 1050°F (566°C) age hardened material specimens illustrated the superior notched properties.

Figure 15 illustrates the alternate immersion bath which was utilized in the stress corrosion evaluation of Custom 455 alloy material.

Figures 16 and 17 illustrate representative samples of the 950°F (510°C) age hardened test specimens prior to, and after, 180 days of alternate immersion testing in a 3.5 percent NaCl solution. The excellent corrosion resistance properties of Custom 455 stainless steel alloy are enhanced by the protective oxide coating which forms on the test specimens immediately upon exposure to the chloride environment.

Figures 18A-20B illustrate the longitudinal and transverse microstructure of the three age hardened conditions as revealed by a hydrochloric-nitric acid-glycerine etchant. The aging treatments make very little difference on the microstructure of this material. There is also very little difference in the microstructure of the material rolled in either the longitudinal or transverse directions. However, there is a marked difference between the microstructure of the bar and sheet material. The orientation of stringers is indicated in the microstructure of the longitudinal bar material. The sheet material microstructure indicates a considerable increase in grain size as compared to the bar material grain size. The strengthening mechanism of the alloy is the precipitation of intermetallic compounds containing titanium and copper, brought about by age hardening. The microstructure of the material does not reveal this strengthening mechanism. The presence of compounds containing titanium, possibly titanium carbonitrides, can be identified, but the degree to which they affect the strength of the material cannot readily be determined by observation of the microstructure. Hardness testing is a non-destructive method which can be used to determine the strengthening effect of age hardening in Custom 455 alloy.

Figures 21A-23C illustrate fractographs taken by Transmission Electron Microscopy (TEM) at 3150X magnification. These fractographs were made on smooth and V-notched round tensile specimens and on charpy V-notched impact specimens aged at 950°F (510°C), 1000°F (538°C), and 1050°F (566°C), and tested at temperatures from ambient to -200°F (-129°C). The susceptibility toward brittleness is increased with increasing strength and decreasing temperature.

CONCLUSIONS

Based upon the results of this evaluation and other evaluations of Custom 455 alloy made by the Materials Division, Astronautics Laboratory of MSFC, the following conclusions are drawn:

(1) Custom 455 alloy has a relatively simple heat treatment which consists of a solution treatment at 1500°F (816°C) for 1 1/2 hours, followed by water quenching and age hardening at 950°F (510°C) or 1000°F (538°C) or 1050°F (566°C) for four hours and air cooling.

(2) The only recommended method of melting Custom 455 alloy is the vacuum melting process. Air melting introduces inclusions and stringers which have a detrimental effect on stress corrosion properties, notched properties, and low temperature mechanical properties.

(3) Custom 455 alloy has a higher yield strength, derived from heat treatment, than any 300 series stainless steels and most precipitation hardenable stainless steels, and marks a significant advancement in the area of precipitation hardening alloys. A yield strength of 200 KSI (1.3796 CN/m²) can be realized without adversely affecting the stress corrosion properties of the alloy.

(4) Longitudinal round tensile specimens have fairly stable and consistent reduction in area and elongation values at test temperatures down to -200°F (-129°C). The notched to unnotched tensile ratio ($K_t = 7.5$) is greater than 1.0 for the bar material aged at 1000°F (538°C) and 1050°F (566°C) and tested at temperatures down to -200°F (-129°C).

(5) The longitudinal sheet material mechanical properties such as U. T. S., Y.S., and elongation were good down to -200°F (-129°C) for all three aging treatments. However, the notched to unnotched tensile ratio (Avg. $K_t = 12$) of the sheet material declined sharply at temperatures below 0°F (-17.8°C).

(6) A fair degree of toughness is obtained for all three heat treatments as reflected in the charpy V-notched impact strength at test temperatures down to 0°F (-17.8°C). The 1000°F (538°C) and the 1050°F (566°C) aged materials indicate good impact strength down to -100°F (-73.0°C).

(7) Considering the overall mechanical properties obtained in our evaluation of vacuum melted material, it would be reasonable to consider either sheet or bar material aged at 950°F (510°C), 1000°F (538°C), and 1050°F (566°C) for tension application down to 0°F (-17.8°C). Bar material, stressed in the longitudinal direction, could probably be utilized at temperatures down to -100°F (-73°C).

(8) Custom 455 alloy, produced by vacuum melting and aged at 950°F (510°C), 1000°F (538°C), and 1050°F (566°C), is not affected by stresses up to 90 percent of the 0.2 percent yield strength when exposed to a 3.5 percent NaCl solution for 180 days of alternate immersion testing.

REFERENCE

1. Williamson, J. G. : "Stress Corrosion Studies of AM-355 Stainless Steel," NASA TMX-53317, August 1961.

APPENDIX I

METHOD FOR STRESSING "C" -RING STRESS CORROSION SPECIMENS

The following is a procedure for stressing "C" -ring stress corrosion specimens:

1. Measure with a micrometer to the nearest 1/1000 of an inch the outside parallel to the stressing crew (averaging the two ends of the ring) and the wall thickness.

2. Set up a table to calculate the final diameter (OD_f) required to give the desired stress using the following equations:

$$OD_f = OD - \Delta$$

$$= \frac{f \cdot \pi \cdot D^2}{4 \cdot E \cdot t \cdot Z}$$

where

- Δ = Change of OD giving desired stress, inches
- f = Desired stress, psi
- OD = Outside diameter, inches
- t = Wall thickness, inches
- D = Mean diameter (OD-t), inches
- E = Modulus of elasticity
- Z = Constant (function of ring D/t)
- OD_f = Final outside diameter of stress "C" -ring, inches

3. To simplify calculations, certain terms in the above equation may be combined into a constant that will be applicable for a group of rings of the same alloy and size.

$$\text{Let } \frac{4 \cdot E}{\pi} = K, \text{ a constant}$$

$$\text{Then } \Delta = \frac{f \cdot D^2}{K \cdot t \cdot Z}$$

TABLE I
CHEMICAL COMPOSITION OF CUSTOM 455 ALLOY SHEET AND BAR STOCK

	Fe	Cr	Ni	Cu	Ti	Cb + Ta	C	Mn	Mo	Si	S	P
Nominal	11-12.50	7.5-9.50	1.5-2.50	0.8-1.40	0.1-0.50	0.05max	0.50max	0.07	0.07	0.025max	0.025max	0.025max
* Sheet & Bar	11.47	8.23	2.14	1.23	0.25	0.010	0.11	0.07	0.07	0.005	0.005	0.010
** Sheet	11.43	8.22	1.90	1.30	0.38	0.010	0.04	0.10	0.10	0.006	0.006	0.017
** Bar	11.46	8.22	1.90	1.25	0.38	0.013	0.04	0.10	0.10	0.006	0.006	0.014

* Carpenter Technology Analysis-Heat No. 88832.

** MSFC Analysis-Heat No. 88832.

TABLE II

Low Temperature Mechanical Properties of Custom 455 Stainless Steel
Longitudinal Round Tensile Specimens 0.025-Inch (0.635cm) Diameter

Test Temperature °F (°C)	Aged Condition °F (°C)	Hardness Rockwell C	Ultimate Tensile Strength		Yield Strength 0.2% offset Ksi (GN/m ²)	Elongation in 2.0 Inches Percent		R.A. %	Modulus x10 ⁻⁶		*N/U Tensile Ratio
			Ksi (GN/m ²)	(GN/m ²)		Psi (GN/m ²)	(GN/m ²)				
80 (+26.7)	950 (510)	48	221.0 (1.524)	217.1 (1.497)	225.8 (1.557)	14.6	56.9	27.8 (0.192)	27.1 (0.187)	1.564	
0 (-17.8)			229.9 (1.585)	230.3 (1.588)	238.1 (1.642)	15.0	55.4	27.1 (0.187)	26.8 (0.185)	1.487	
-100 (-73.0)			237.8 (1.640)	238.1 (1.642)		14.5	54.0	26.8 (0.185)	27.4 (0.189)	0.997	
-200 (-129.0)			246.5 (1.700)			13.9	51.2	27.4 (0.189)		0.654	
80 (+26.7)	1000 (538)	43	207.0 (1.427)	198.8 (1.371)	203.7 (1.404)	15.8	59.9	28.3 (0.195)	28.5 (0.196)	1.641	
0 (-17.8)			211.7 (1.460)	212.3 (1.464)	219.1 (1.510)	16.8	60.1	28.5 (0.196)	28.6 (0.197)	1.610	
-100 (-73.0)			220.0 (1.517)	227.2 (1.566)		15.6	58.2	28.6 (0.197)	28.5 (0.196)	1.560	
-200 (-129.0)			227.2 (1.566)			12.9	55.7	28.5 (0.196)		1.448	
80 (+26.7)	1050 (566)	42	195.1 (1.345)	181.3 (1.250)	188.5 (1.300)	17.5	60.0	28.8 (0.197)	27.7 (0.191)	1.625	
0 (-17.8)			202.9 (1.399)	201.4 (1.388)	212.1 (1.462)	17.4	60.3	27.7 (0.191)	29.5 (0.203)	1.588	
-100 (-73.0)			215.9 (1.488)	212.1 (1.462)		17.0	57.6	29.5 (0.203)	28.2 (0.194)	1.507	
-200 (-129.0)			226.0 (1.558)			16.2	54.4	28.2 (0.194)		1.326	

Average of 4 tests at each temperature for each aged condition.

*Average stress concentration factor $K_t=7.5$.

TABLE III

Low Temperature Mechanical Properties of Custom 455 Stainless Steel
Longitudinal Flat Tensile Specimens 0.083-Inch (0.211cm) Thick

Test Temperature °F (°C)	Aged Condition °F (°C)	Hardness Rockwell C	Ultimate Tensile Strength		Yield Strength		Elongation		Modulus		*N/U Tensile Ratio
			Ksi	(GN/m ²)	0.2% offset Ksi	(GN/m ²)	in 2.0 Inches Percent	Psi x10 ⁻⁶	(GN/m ²)		
80 (+26.7)	950 (510)	45	227.2	(1.566)	220.8	(1.522)	6.2	29.1	(0.200)	1.021	
0 (-17.8)			236.3	(1.629)	(230.0)	(1.586)	5.8	-	-	0.875	
-100 (-73.0)			242.6	(1.673)	236.8	(1.633)	5.9	29.0	(0.200)	0.485	
-200 (-129.0)			254.7	(1.756)	249.7	(1.722)	4.8	29.7	(0.205)	0.376	
80 (+26.7)	1000 (538)	43	199.6	(1.376)	191.1	(1.317)	9.4	28.2	(0.194)	1.175	
0 (-17.8)			206.1	(1.421)	197.6	(1.362)	8.8	27.5	(0.190)	0.885	
-100 (-73.0)			209.2	(1.442)	199.7	(1.377)	9.2	28.2	(0.194)	0.770	
-200 (-129.0)			221.5	(1.527)	214.3	(1.477)	7.8	28.3	(0.195)	0.435	
80 (+26.7)	1050 (566)	38	196.6	(1.355)	183.3	(1.264)	9.2	30.4	(0.210)	1.094	
0 (-17.8)			203.9	(1.406)	189.6	(1.307)	10.5	29.7	(0.205)	1.089	
-100 (-73.0)			212.9	(1.468)	197.9	(1.364)	11.2	30.1	(0.207)	0.883	
-200 (-129.0)			229.8	(1.584)	219.3	(1.512)	10.4	30.5	(0.210)	0.565	

Average of 4 tests at each temperature for each aged condition.

*Average stress concentration factor $K_t=11.5$.

(()) Yield strength approximated at 0°F (-17.8°C) due to cryogenic extensometer malfunction. [950°F (510°C) Aged specimens only.]

TABLE IV

Low Temperature Mechanical Properties of Custom 455 Stainless Steel
Transverse Flat Tensile Specimens 0.083-Inch (0.211cm) Thick

Test Temperature °F (°C)	Aged Condition °F (°C)	Hardness Rockwell C	Ultimate Tensile Strength		Yield Strength 0.2% offset Ksi (GN/m ²)	Elongation in 2.0 Inches Percent	Modulus x10 ⁻⁶		*N/U Tensile Ratio
			Ksi (GN/m ²)	(GN/m ²)			Psi (GN/m ²)	(GN/m ²)	
80 (+26.7)	950 (510)	45	230.9	(1.592)	224.6 (1.548)	5.0	29.5	(0.203)	0.969
0 (-17.8)			244.1	(1.683)	((238.0)) (1.641)	5.7	29.8	(0.205)	0.757
-100 (-73.0)			251.9	(1.737)	244.8 (1.688)	4.9	30.1	(0.207)	0.484
-200 (-129.0)			256.7	(1.770)	251.5 (1.734)	4.5			0.396
80 (+26.7)	1000 (538)	43	203.6	(1.404)	194.7 (1.342)	8.5	28.3	(0.195)	1.154
0 (-17.8)			210.2	(1.449)	202.3 (1.395)	7.5	28.9	(0.199)	0.958
-100 (-73.0)			214.3	(1.477)	204.2 (1.408)	9.3	28.4	(0.196)	0.682
-200 (-129.0)			231.7	(1.597)	225.0 (1.551)	6.7	29.0	(0.200)	0.444
80 (+26.7)	1050 (566)	38	200.5	(1.382)	187.8 (1.295)	9.2	31.0	(0.207)	1.087
0 (-17.8)			209.1	(1.442)	196.8 (1.357)	10.4	29.3	(0.202)	1.063
-100 (-73.0)			218.7	(1.508)	206.4 (1.423)	10.5	30.5	(0.210)	0.766
-200 (-129.0)			225.4	(1.554)	212.6 (1.466)	10.4	30.9	(0.213)	0.640

Average of 4 tests at each temperature for each aged condition.

*Average stress concentration factor $K_t=12.0$.

(()) Yield strength approximated for 950°F (510°C) aged specimens tested at 0°F (-17.8°C).

TABLE V
Charpy V-Notched Impact Test Data For Custom 455 Alloy Bar

Test Temperature °F (°C)	Aging Temperature °F (°C)	Average Impact Energy		Impact Energy Range		Number of Tests
		Ft-Lb	(Joules)	Ft-Lb	(Joules)	
80 (+26.7)	950 (510)	11.4	(13.6)	10.5-12.5	(14.2-16.9)	3
0 (-17.8)		5.6	(7.6)	4.8-7.0	(6.5-9.5)	4
-100 (-73.0)		3.1	(4.2)	2.8-3.8	(3.8-5.2)	4
-200 (-129.0)		2.3	(3.1)	2.0-2.5	(2.7-3.4)	4
80 (+26.7)	1000 (538)	23.2	(31.4)	21.8-25.0	(29.6-33.9)	5
0 (-17.8)		15.9	(21.6)	15.0-17.0	(20.3-23.0)	4
-100 (-73.0)		7.3	(9.9)	6.8-8.0	(9.2-10.8)	4
-200 (-129.0)		3.0	(4.1)	2.5-3.5	(3.4-4.7)	4
80 (+26.7)	1050 (566)	35.0	(47.4)	34.5-35.8	(46.8-48.5)	3
0 (-17.8)		25.5	(34.6)	23.5-27.0	(31.9-36.6)	4
-100 (-73.0)		10.8	(14.6)	10.0-11.3	(13.6-15.3)	4
-200 (-129.0)		6.0	(8.1)	4.0-8.3	(5.4-11.2)	4

TABLE VI

Mechanical Properties of Custom 455 Stainless Steel Aged at 950° F (510° C)
 Bar [0.1250-Inch (0.3175cm) Diameter] and Sheet [0.083-Inch (0.211cm) Thick] Tensile Specimens
 After 180 Days of Alternate Immersion Testing in a 3.5 Percent NaCl Solution

Ultimate Tensile Strength			0.2% Offset Yield Strength			Elongation			R. A.	Stress
(Ksi)			(Ksi)			(2.0")			(%)	% of
Long	Trans	Long	Long	Trans	Long	Long	Trans	(1/2")	Long	0.2%
Flat	Flat	Bar	Flat	Flat	Bar	Flat	Flat	Long	Bar	Y.S.
225.2	228.2	230.0	218.2	221.0	223.9	8.1	7.4	13.25	55.1	0
224.1	228.6	226.4	217.0	221.0	220.8	8.2	7.5	13.25	56.6	50
223.4	229.4	225.3	217.2	222.1	220.4	7.6	6.5	12.70	56.5	75
224.3	228.5	227.7	217.8	222.0	220.9	8.4	7.1	13.75	56.0	90
224.2	228.7	227.4	217.6	221.5	221.5	8.1	7.1	13.24	56.0	AVG.
*(1.546) (1.577) (1.568)			(1.500) (1.527) (1.527)			**	**	***		

* GN/m²

** Elongation in 2.00-Inches (4.08cm)

*** Elongation in 0.50-Inch (1.27cm)

Each numerical value represents an average of 4 tests.

The average of 0, 50, 75, and 90% stressed specimens is 16 tests for each direction of Bar and Sheet.

TABLE VII

Mechanical Properties of Custom 455 Stainless Steel Aged at 1000°F (538°C)
 Bar [0.1250-Inch (0.3175cm) Diameter] and Sheet [0.083-Inch (0.211 cm) Thick] Tensile Specimens
 After 180 Days of Alternate Immersion Testing in a 3.5 Percent NaCl Solution

Ultimate Tensile Strength (Ksi)			0.2% Offset Yield Strength (Ksi)			Elongation (2.0")			Elongation (1/2")			R. A. (%)		Applied Stress
Long	Trans	Long	Long	Trans	Long	Long	Trans	Flat	Long	Long	Long	Bar	Bar	Y.S.
Flat	Flat	Bar	Flat	Flat	Bar	Flat	Flat	Bar	Flat	Bar	Bar	Bar	Bar	% of 0.2%
212.3	214.2	208.2	201.8	204.7	202.8	9.4	9.0	17.3	60.9	0				
214.2	219.1	210.2	205.6	211.1	204.8	9.7	7.9	17.7	60.0	50				
215.1	216.7	208.1	206.7	208.1	200.5	9.1	9.4	18.0	60.6	75				
210.4	213.6	211.4	200.7	204.0	203.8	10.0	10.0	17.5	60.2	90				
213.0	215.9	209.5	203.7	207.0	203.0	9.6	9.1	17.6	60.4	AVG.				

* (1.468) (1.488) (1.444)

** (1.404) (1.427) (1.400)

* GN/m²

** Elongation in 2.00 Inches (4.08cm)

*** Elongation in 0.50 Inches (1.27cm)

Each numerical value represents an average of 4 tests.

The average of 0, 50, 75, and 90% stressed specimens is 16 tests for each direction of Bar and Sheet.

TABLE VIII

Mechanical Properties of Custom 455 Stainless Steel Aged at 1050^oF (566^oC)
 Bar [0.1250-Inch (0.3175cm) Diameter] and Sheet [0.083-Inch (0.211cm) Thick] Tensile Specimens
 After 180 Days of Alternate Immersion Testing in a 3.5 Percent NaCl Solution:

Ultimate Tensile Strength (Ksi)			0.2% Offset Yield Strength (Ksi)						Elongation (2.0") (1/2")						R. A. %		Applied Stress % of 0.2% Y.S.
Long Flat	Trans Flat	Long Bar	Long Flat	Trans Flat	Long Bar	Long Flat	Trans Flat	Long Bar	Long Flat	Trans Flat	Long Bar	Long Flat	Trans Flat	Long Bar	Long Bar	Applied Stress % of 0.2% Y.S.	
																	Long Flat
199.3	202.5	197.0	187.4	190.6	183.4	10.9	11.4	18.0	62.0	0							
198.6	203.9	198.4	186.3	192.4	185.9	11.1	11.3	20.9	62.4	50							
197.5	202.3	200.2	184.6	190.2	186.6	10.6	11.0	18.7	62.2	75							
199.1	200.7	201.1	186.8	188.2	186.6	11.6	10.7	18.9	61.6	90							
198.6	202.3	199.2	186.3	190.3	185.6	11.0	11.1	19.1	62.0	AVG.							

*(1.369) (1.395) (1.373)

*(1.284) (1.312) (1.280)

**

**

GN/m²

Elongation in 2.00-Inches (4.08cm)

Elongation in 0.50-Inches (1.27cm)

Each numerical value represents an average of 4 tests

The average of 0, 50, 75, and 90% stressed specimens is 16 tests for each direction of Bar and Sheet

*

**

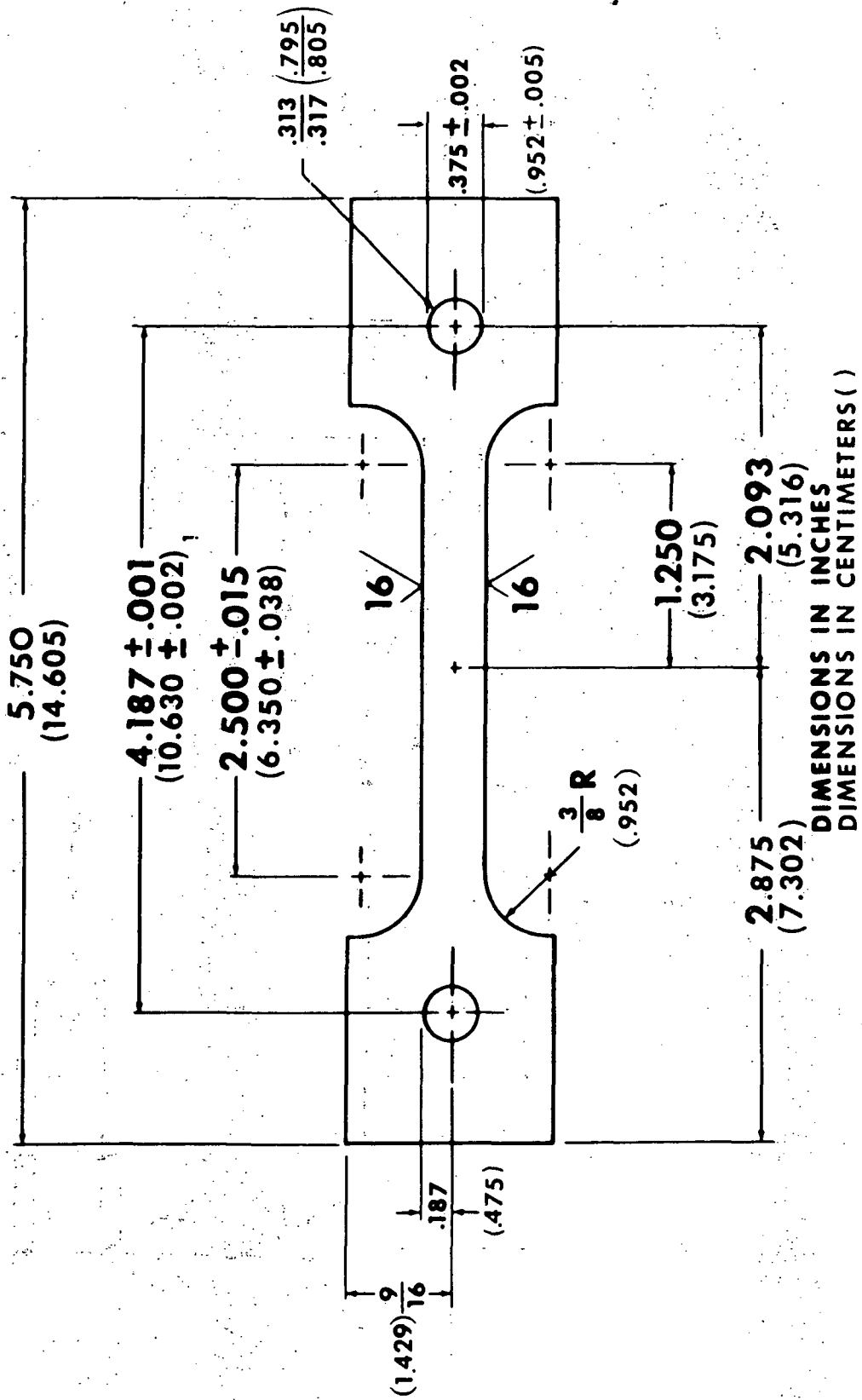
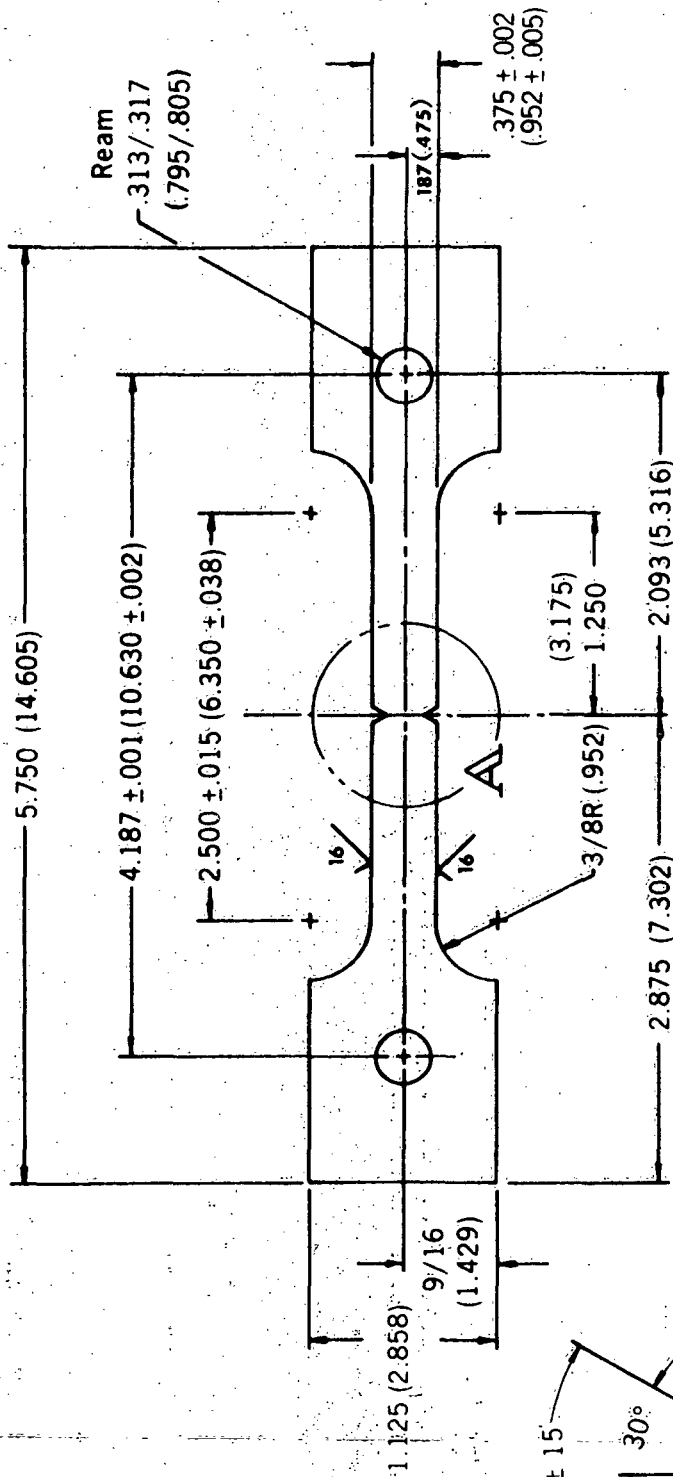

FIGURE 1A - FLAT TENSILE TEST SPECIMEN CONFIGURATION



Dimensions in Inches
 Dimensions in Centimeters ()

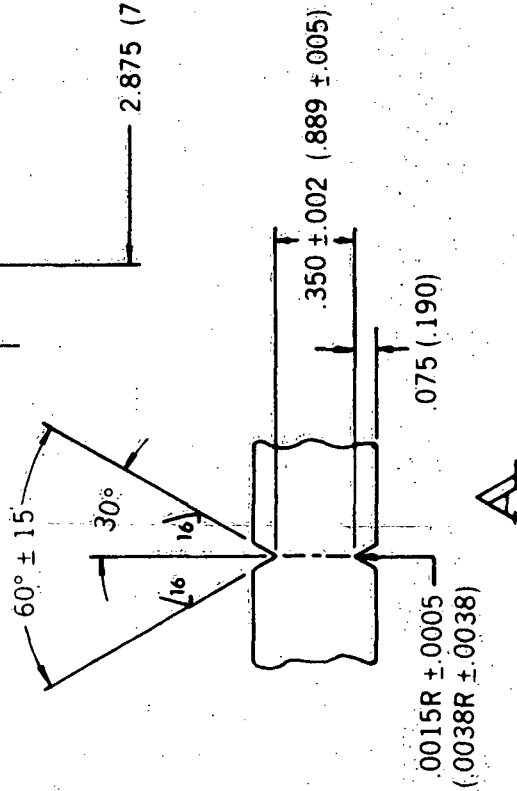

FIGURE 1B - FLAT TENSILE V-NOTCH SPECIMEN CONFIGURATION

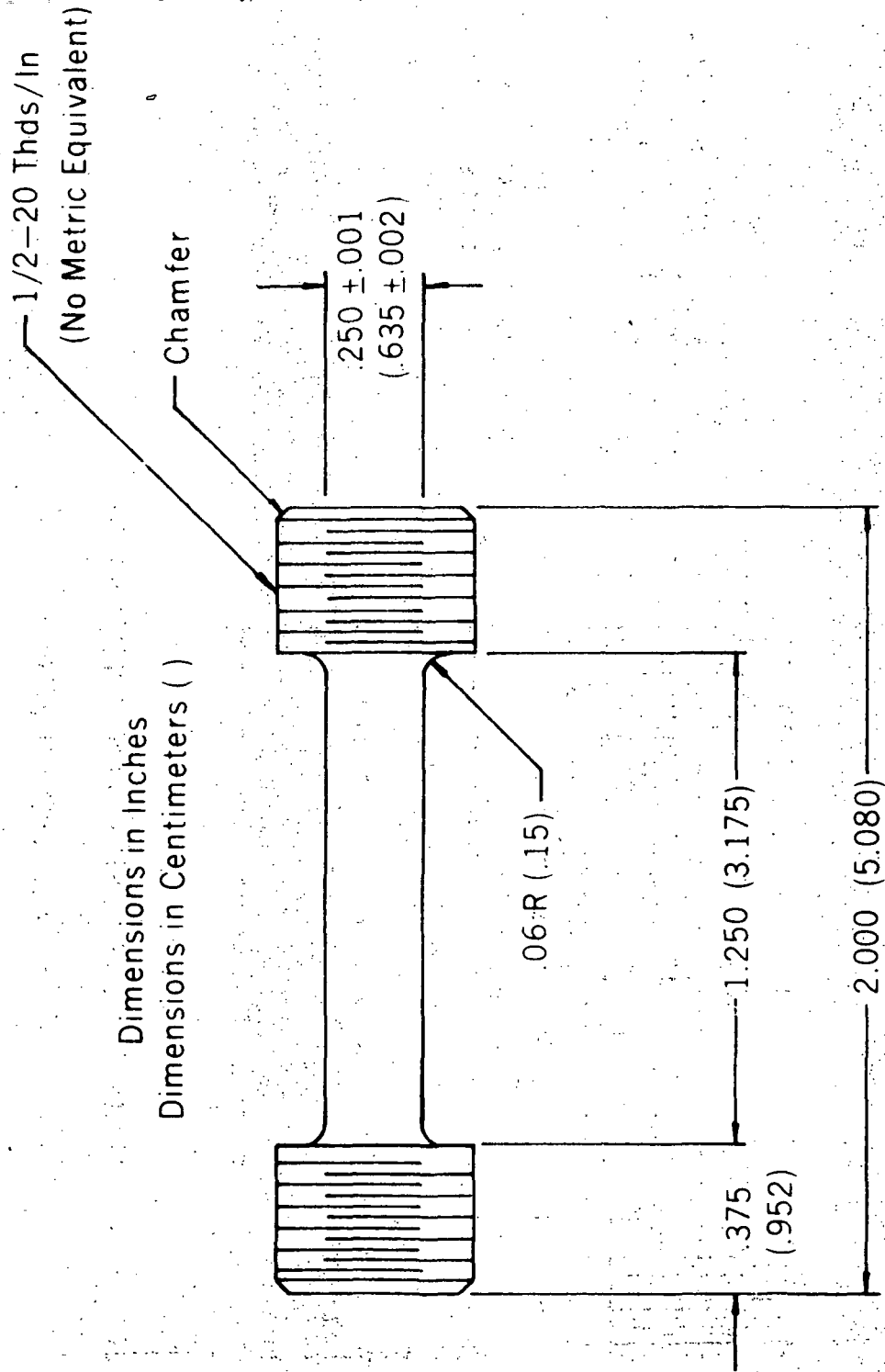

FIGURE 2A - ROUND SMOOTH TENSILE SPECIMEN CONFIGURATION

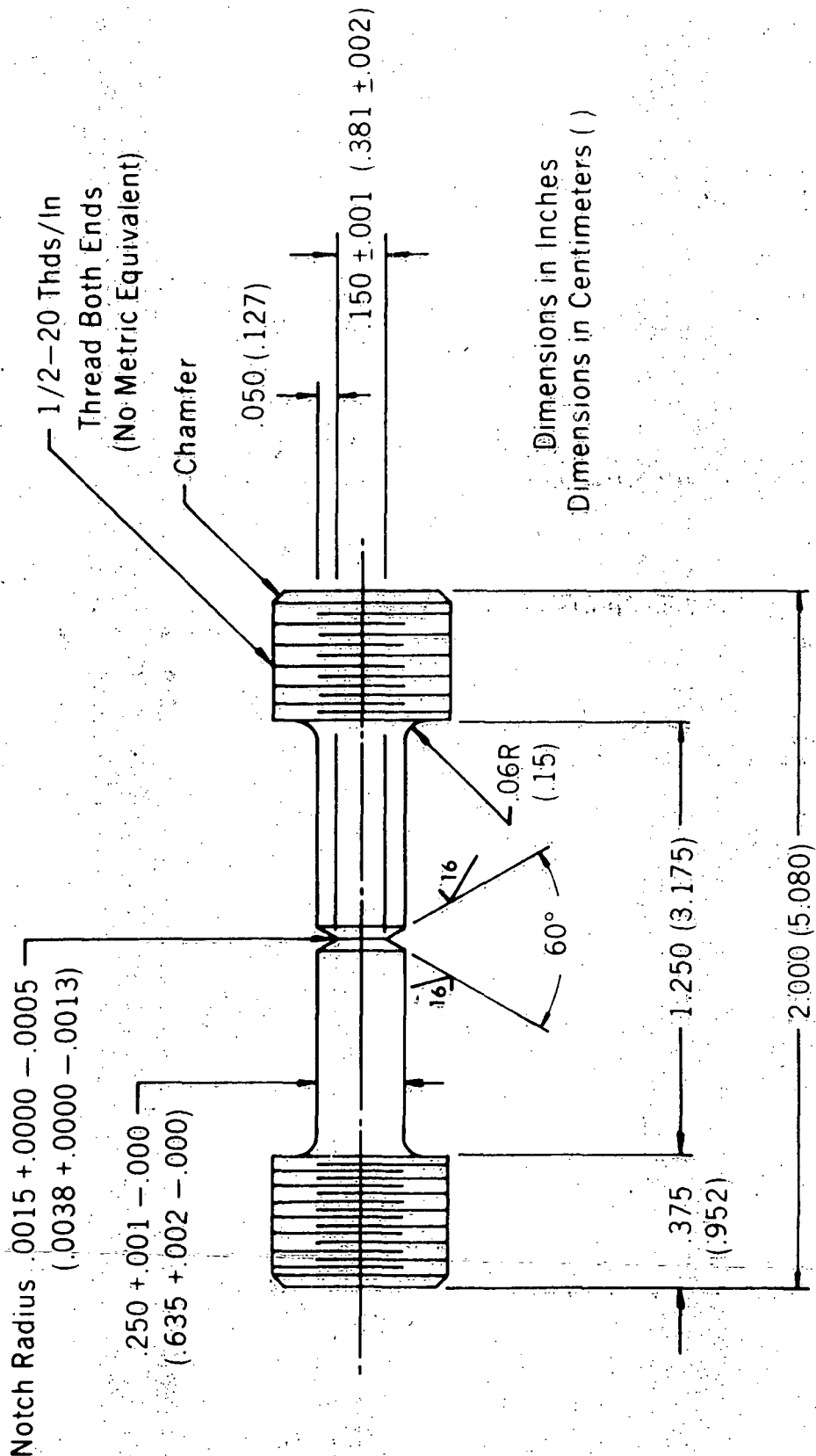

FIGURE 2B · ROUND V-NOTCH TENSILE SPECIMEN CONFIGURATION

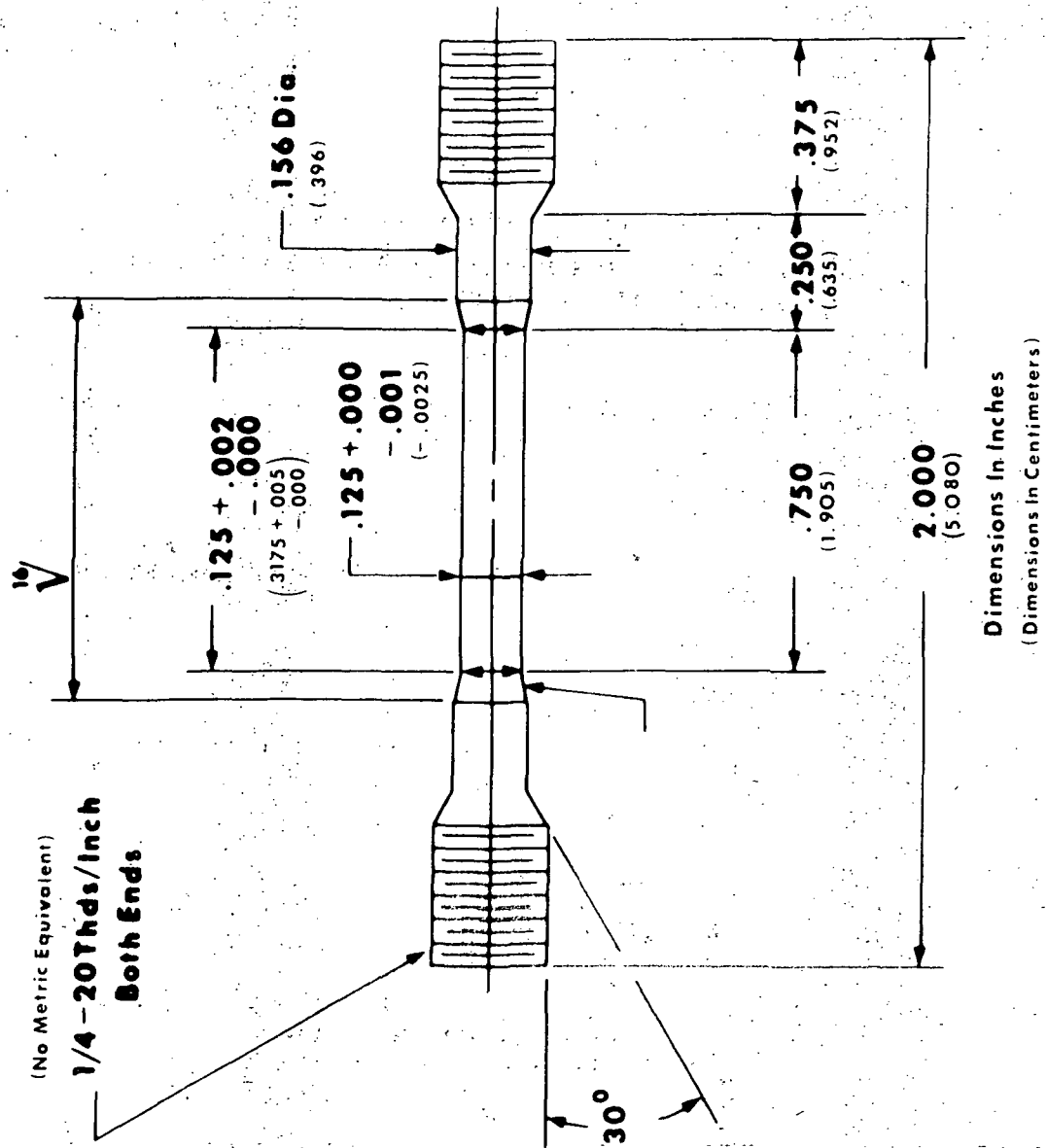

FIGURE 3 - ROUND TENSILE SPECIMEN CONFIGURATION FOR STRESS CORROSION TEST

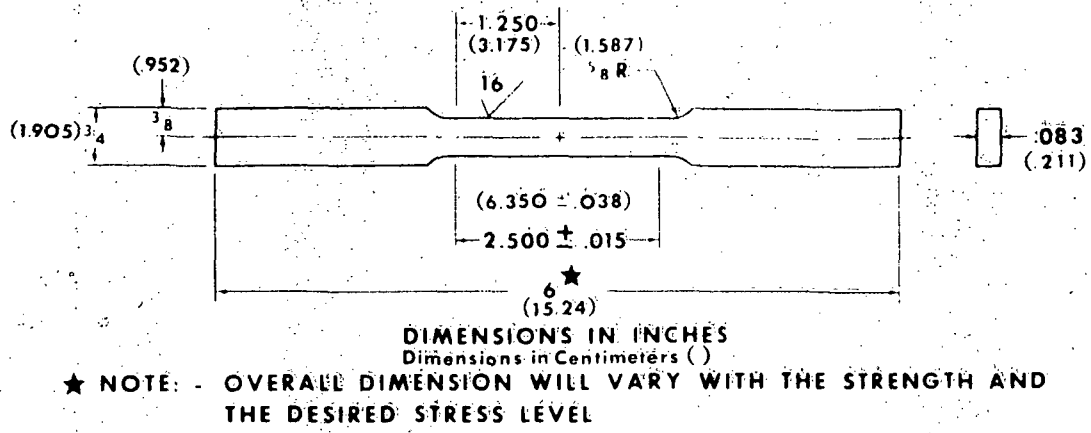

FIGURE 4 - FLAT TENSILE SPECIMEN CONFIGURATION FOR STRESS CORROSION TEST

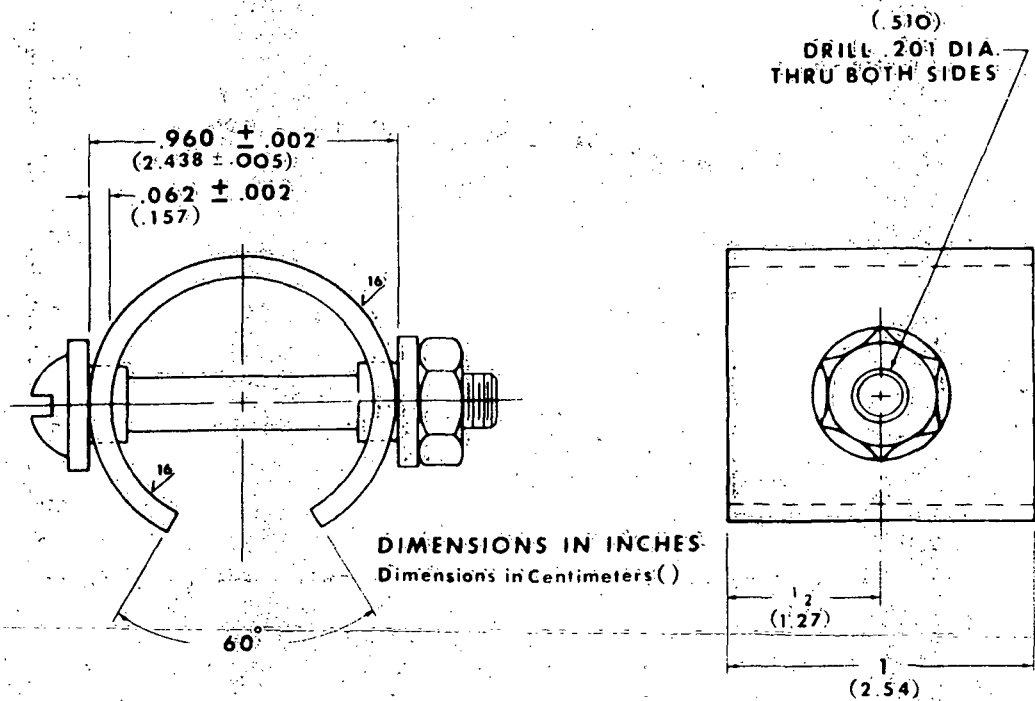

FIGURE 5 - 'C' - RING STRESS CORROSION SPECIMEN

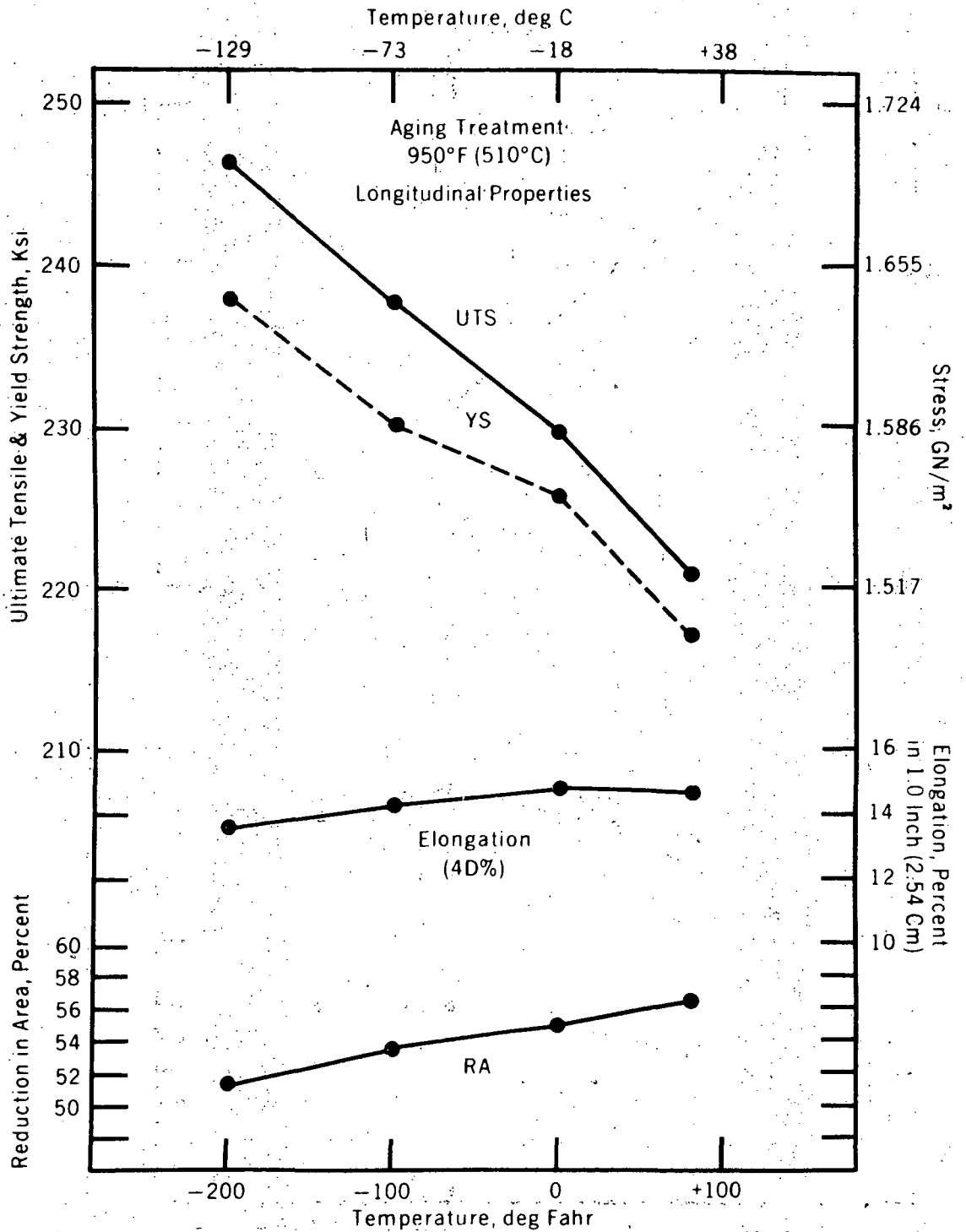

FIGURE 6 - LOW TEMPERATURE MECHANICAL PROPERTIES OF CUSTOM 455 STAINLESS STEEL TENSILE SPECIMENS [0.250-INCH (0.635 CM) DIAMETER] AGED AT 950°F (510°C)

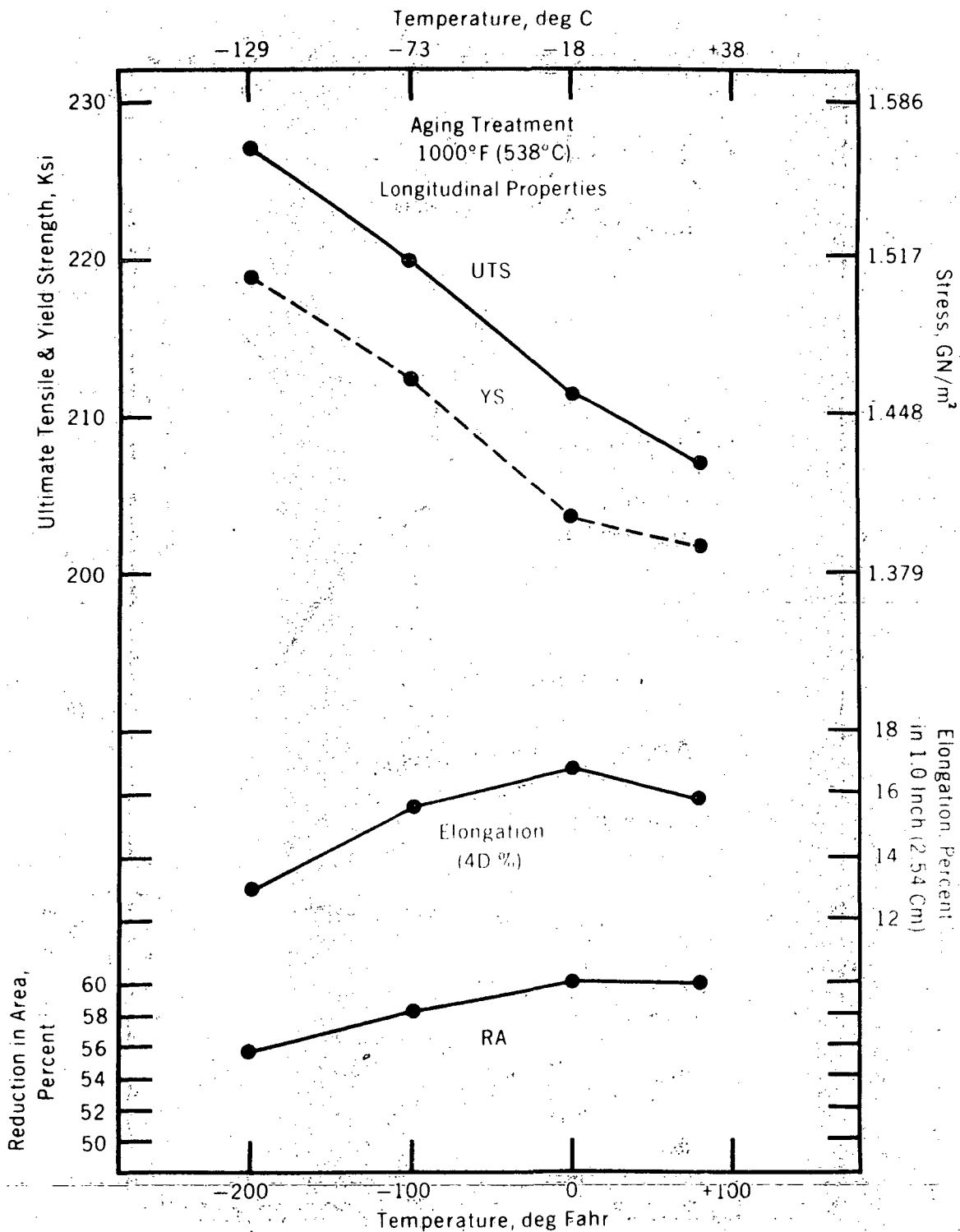

FIGURE 7 · LOW TEMPERATURE MECHANICAL PROPERTIES OF CUSTOM 455 STAINLESS STEEL TENSILE SPECIMENS [0.250-INCH (0.635 CM) DIAMETER] AGED AT 1000°F (538°C)

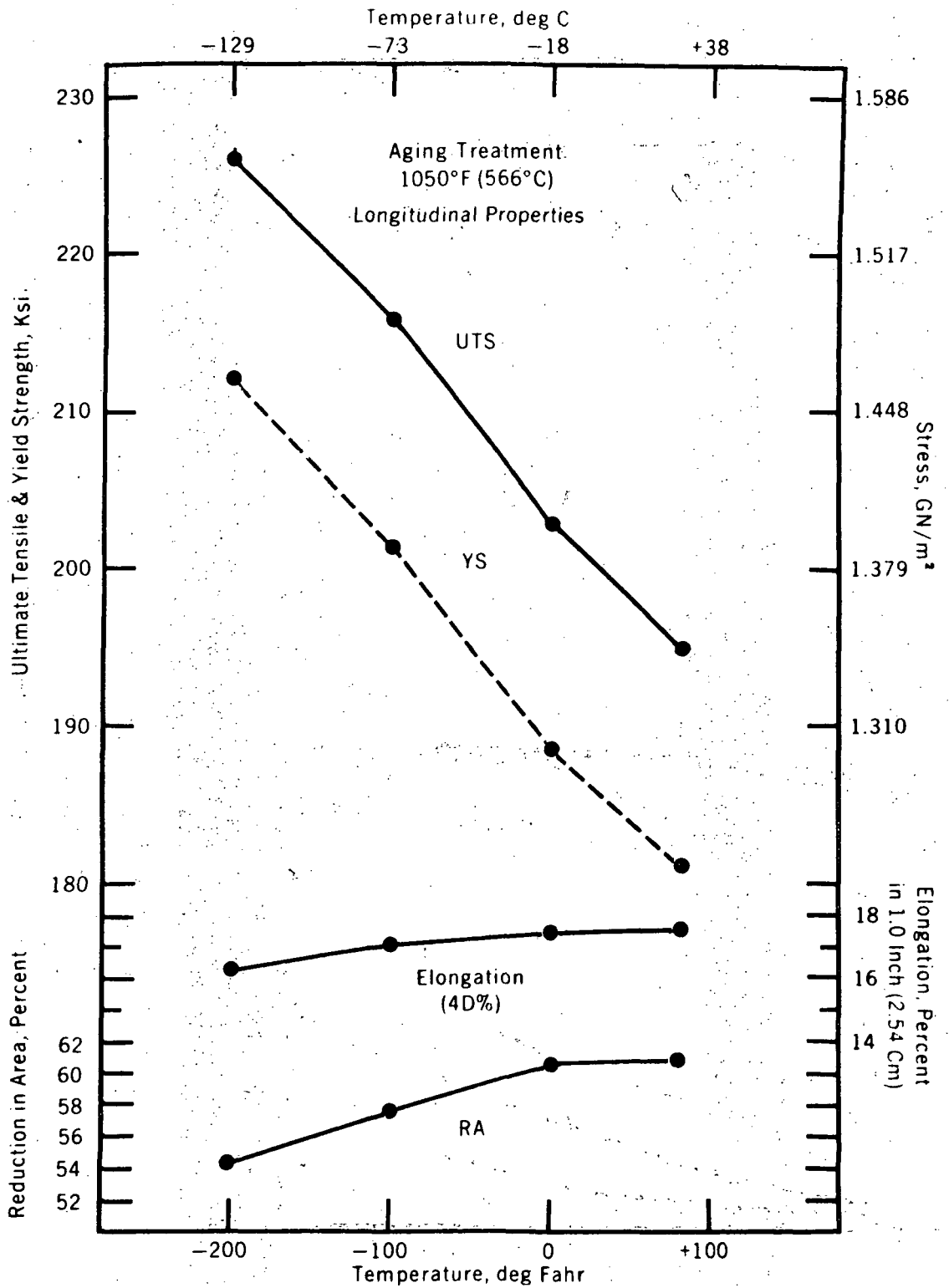

FIGURE 8 - LOW TEMPERATURE MECHANICAL PROPERTIES OF CUSTOM 455 STAINLESS STEEL TENSILE SPECIMENS [0.250-INCH (0.635 CM) DIAMETER] AGED AT 1050°F (566°C)

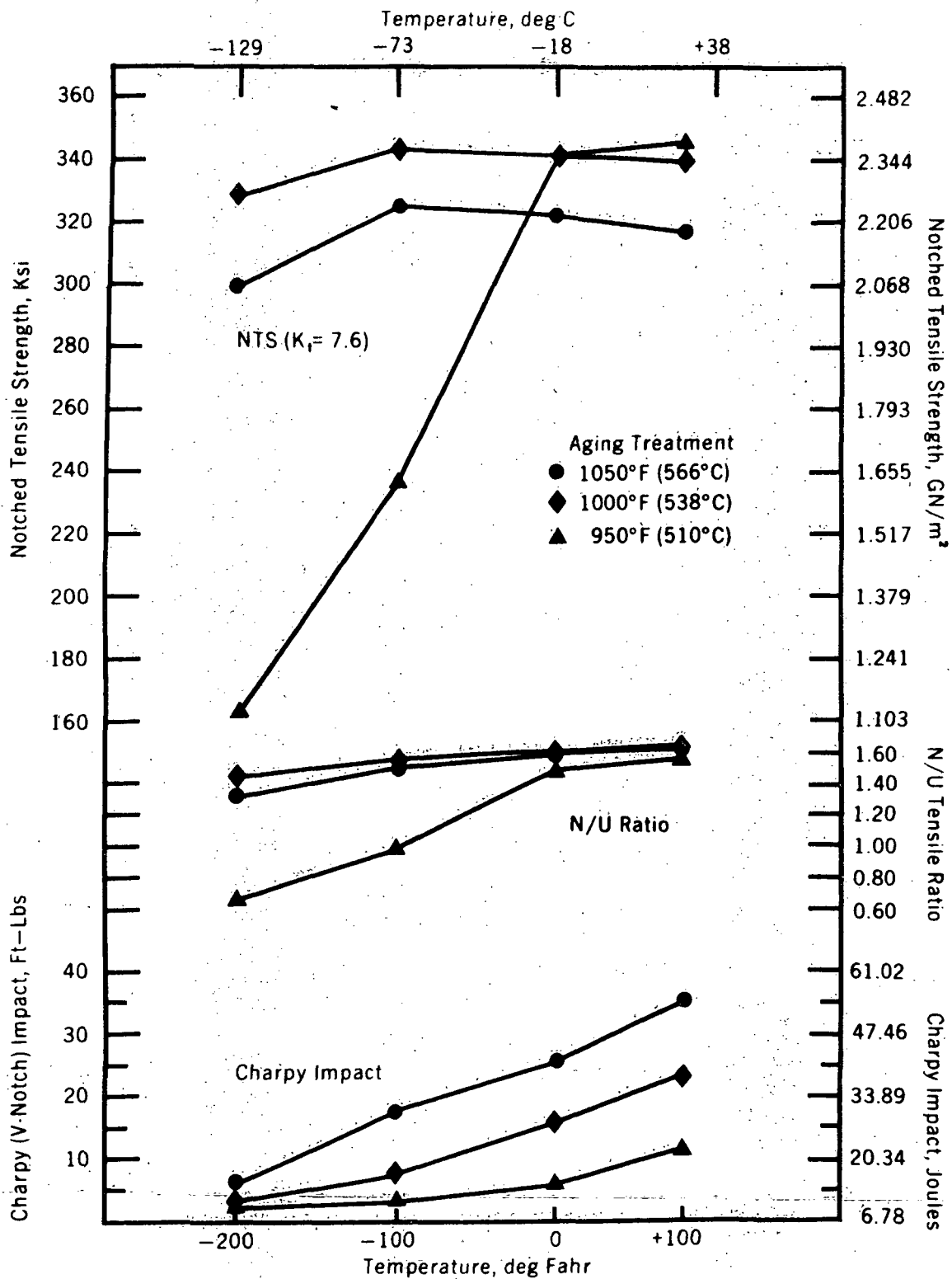

FIGURE 9. LOW TEMPERATURE NOTCHED PROPERTIES OF CUSTOM 455 STAINLESS BAR LONGITUDINAL TENSILE SPECIMENS AND CHARPY IMPACT SPECIMENS

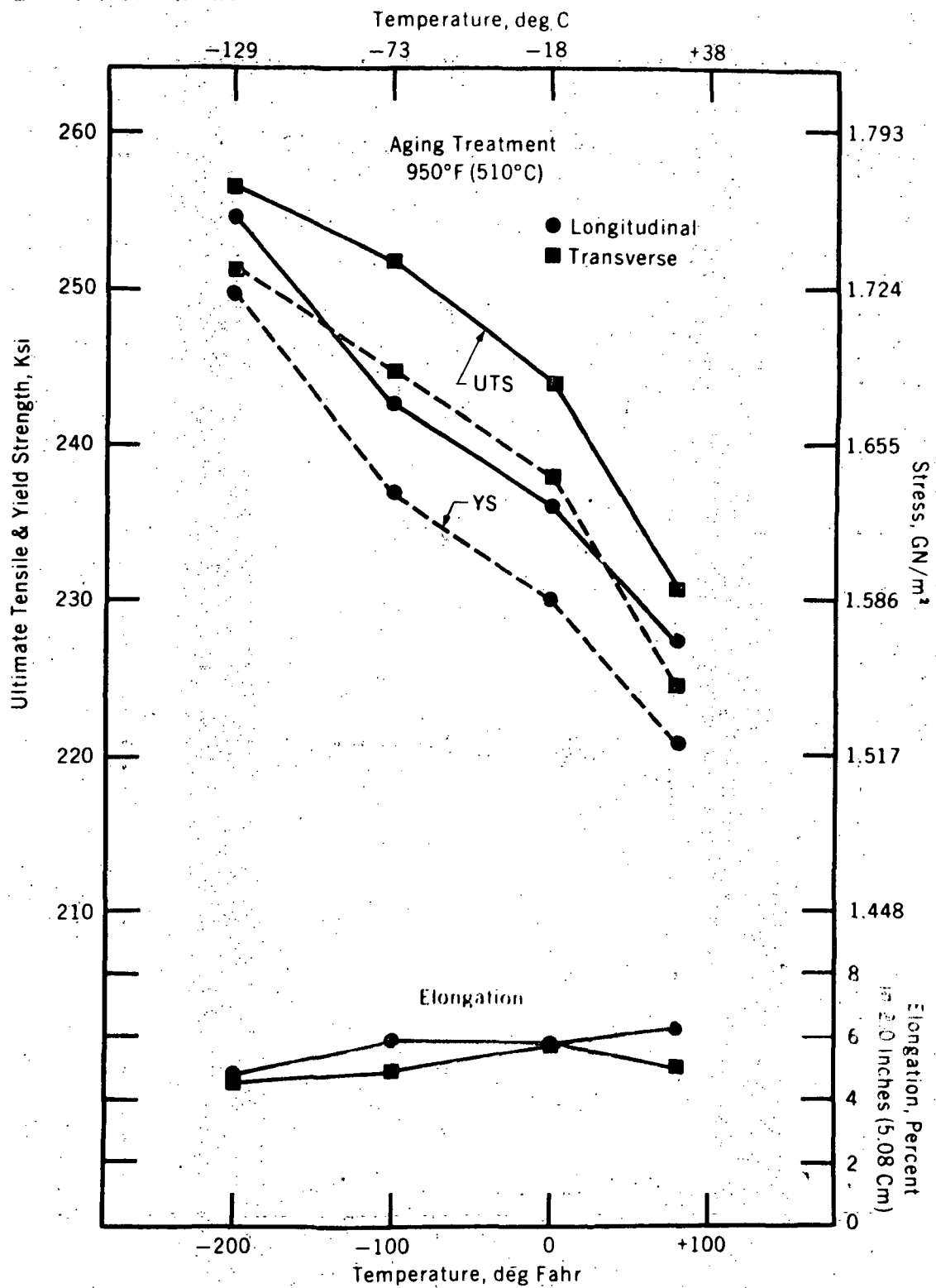

FIGURE 10 - LOW TEMPERATURE MECHANICAL PROPERTIES OF CUSTOM 455 STAINLESS STEEL FLAT TENSILE SPECIMENS [0.083-INCH (0.211 CM) THICK] AGED AT 950°F (510°C)

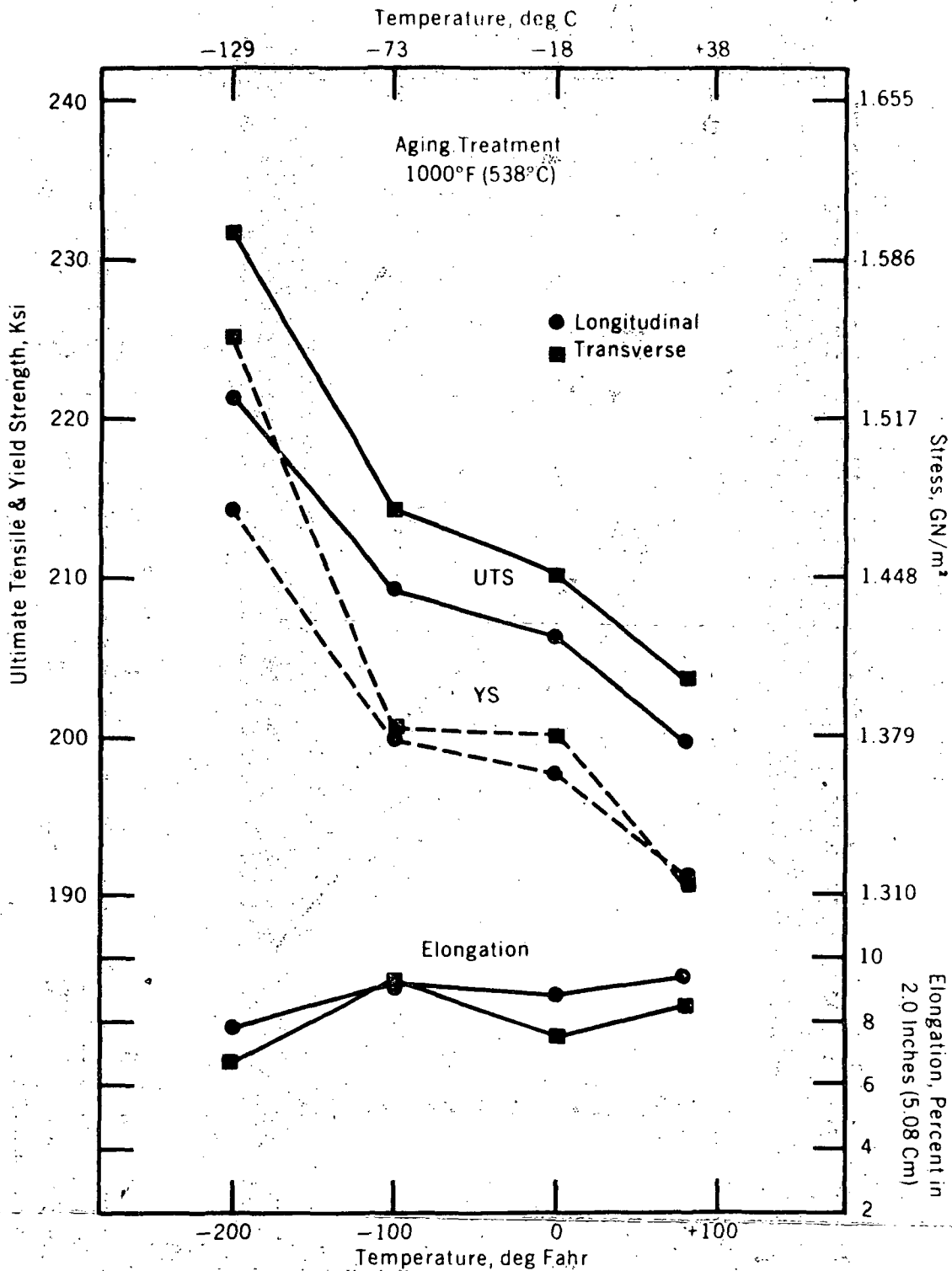

FIGURE 11 - LOW TEMPERATURE MECHANICAL PROPERTIES OF CUSTOM 455 STAINLESS STEEL FLAT TENSILE SPECIMENS [0.083-INCH (0.211 CM) THICK] AGED AT 1000°F (538°C)

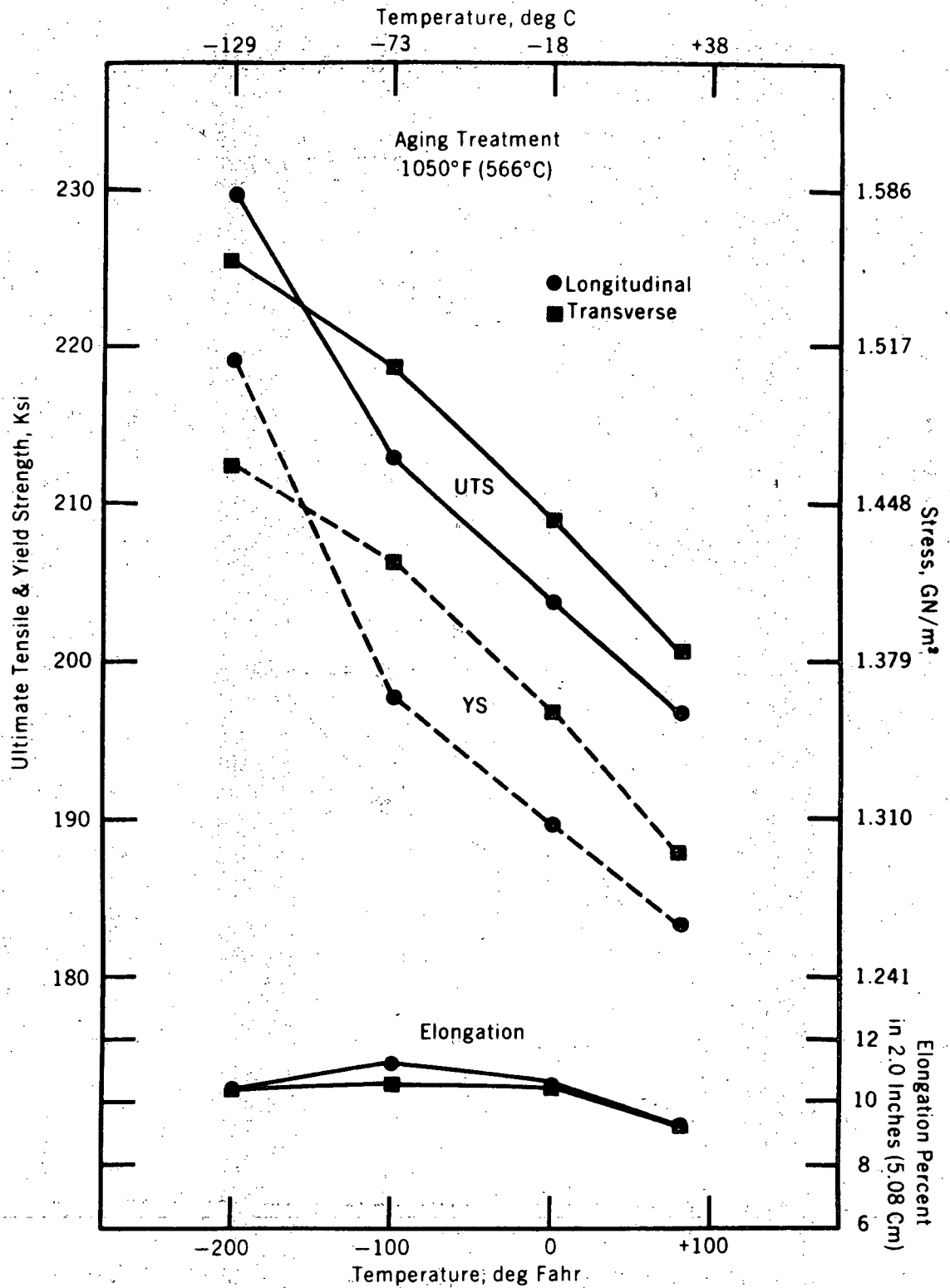

FIGURE 12 - LOW TEMPERATURE MECHANICAL PROPERTIES OF CUSTOM 455 STAINLESS STEEL FLAT TENSILE SPECIMENS [0.083-INCH (0.211 CM) THICK] AGED AT 1050°F (566°C)

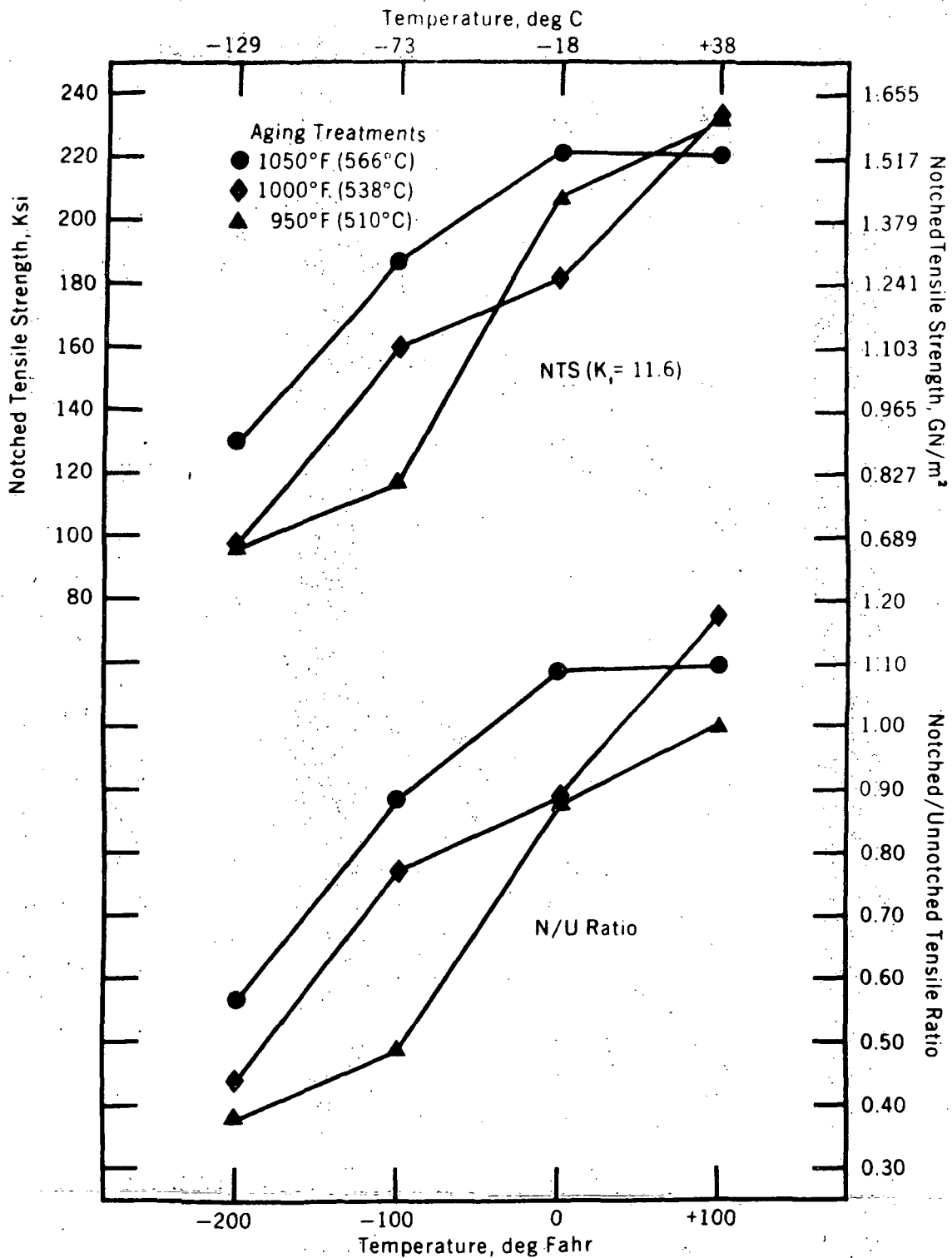

FIGURE 13 - LOW TEMPERATURE NOTCHED TENSILE PROPERTIES OF CUSTOM 455 STAINLESS LONGITUDINAL SHEET [0.083-INCH (0.211 CM) THICK] SPECIMENS

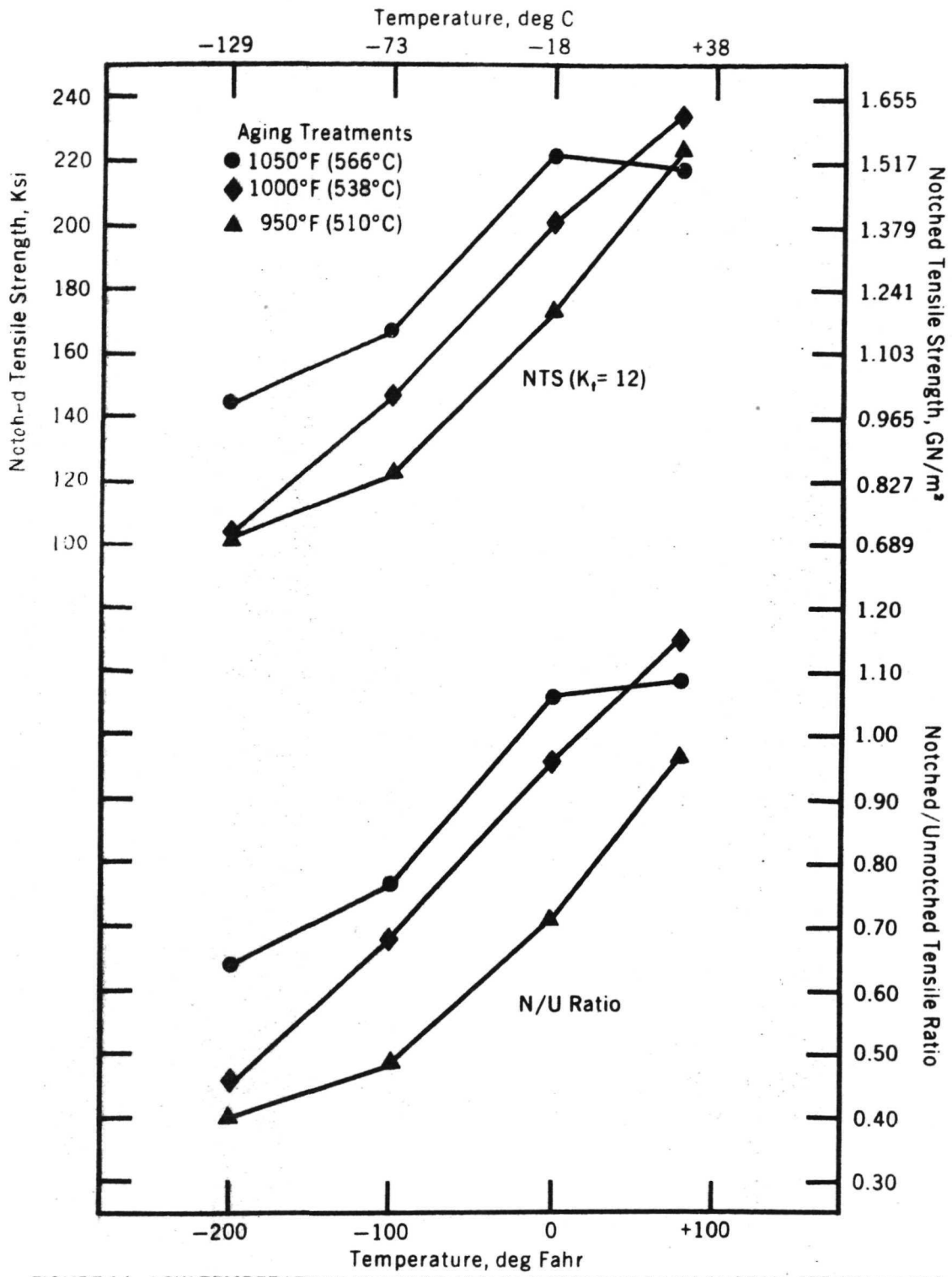

FIGURE 14 - LOW TEMPERATURE NOTCHED TENSILE PROPERTIES OF CUSTOM 455 STAINLESS TRANSVERSE SHEET SPECIMENS [0.083-INCH (0.211 CM) THICK]

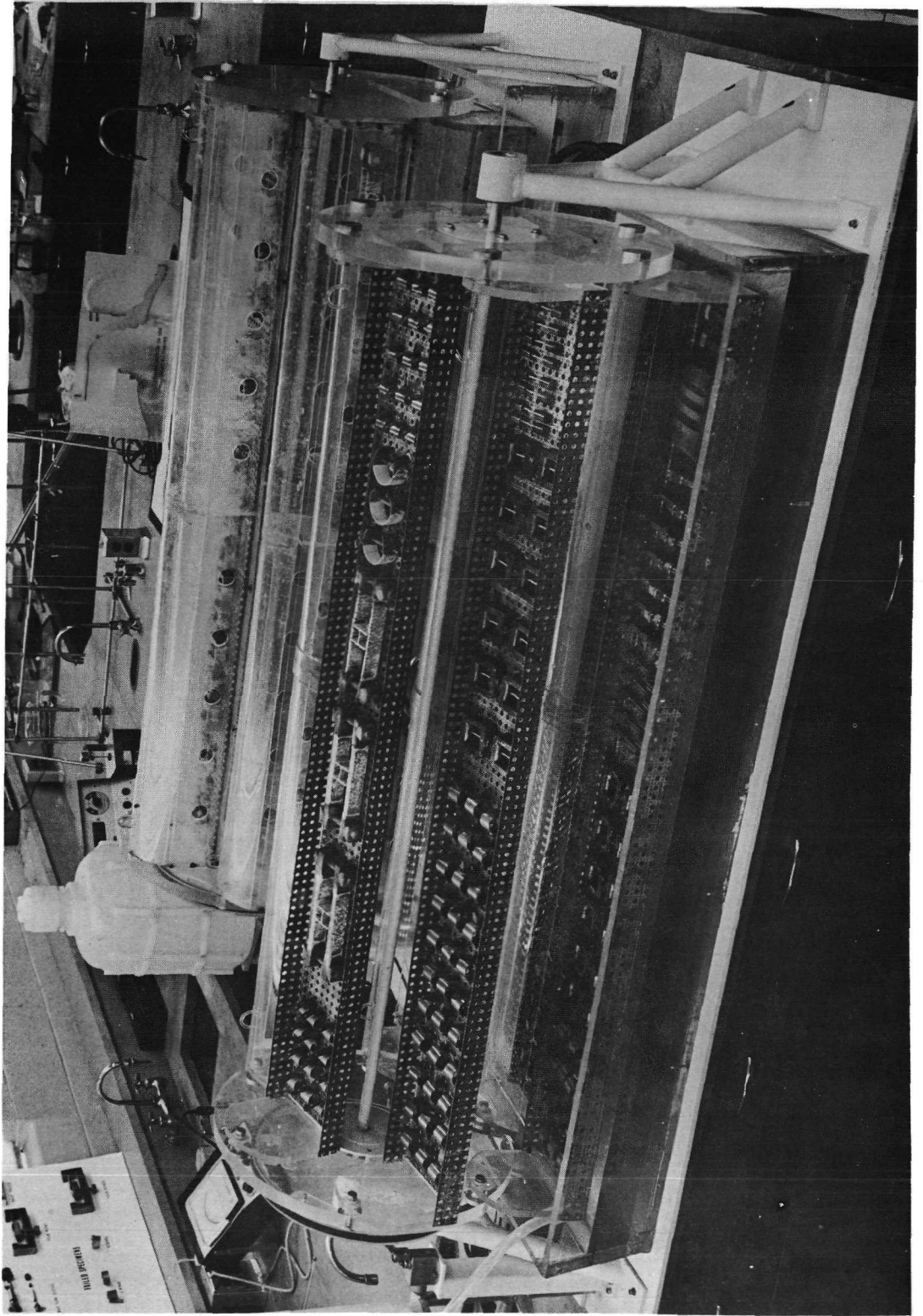
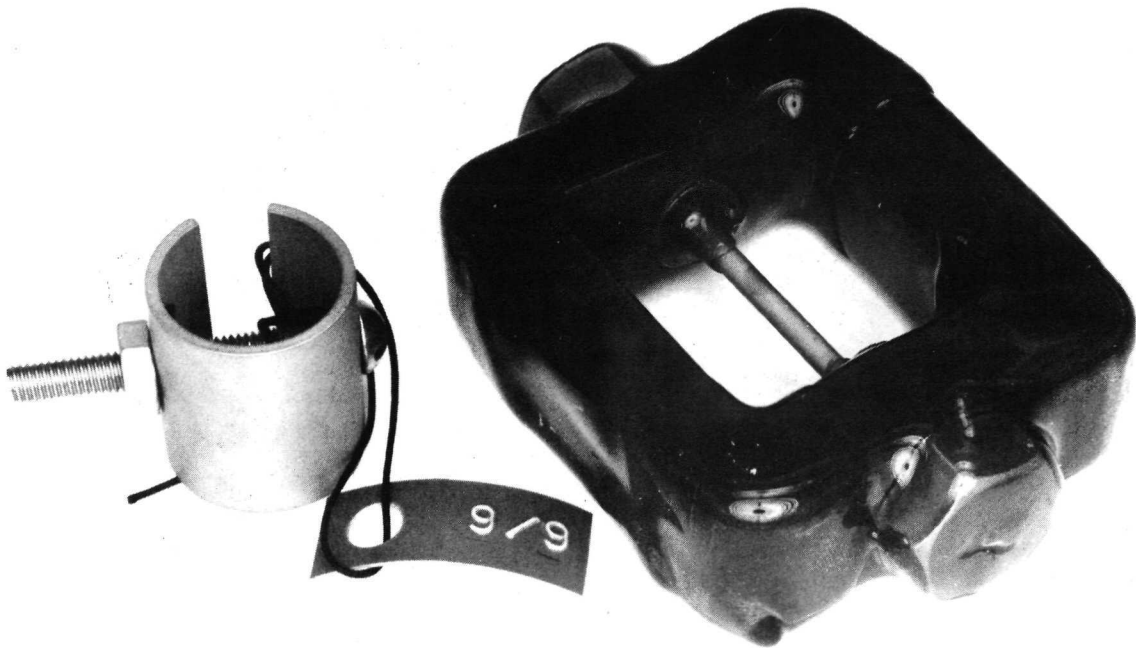
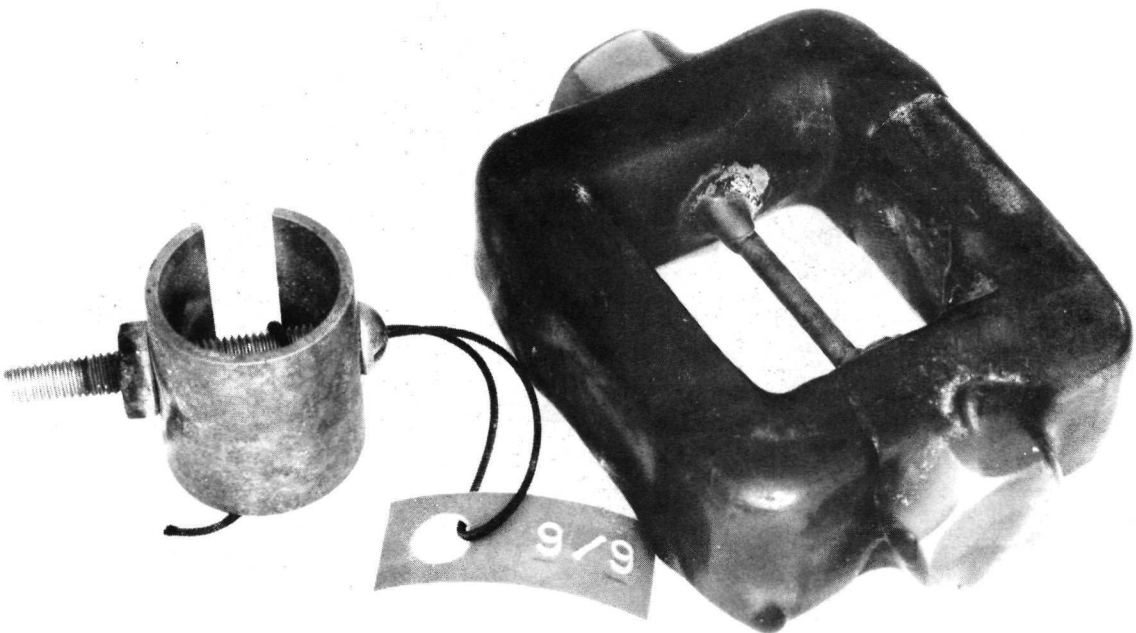

FIGURE 15-ALTERNATE IMMERSION BATH



Prior to Testing



After 180 Day Test

FIGURE 16 - CUSTOM 455 STAINLESS C-RING SPECIMEN AND LONGITUDINAL ROUND TENSILE SPECIMEN AGED AT 950°F (510°C) AND STRESSED TO 90% OF THE 0.2% YIELD

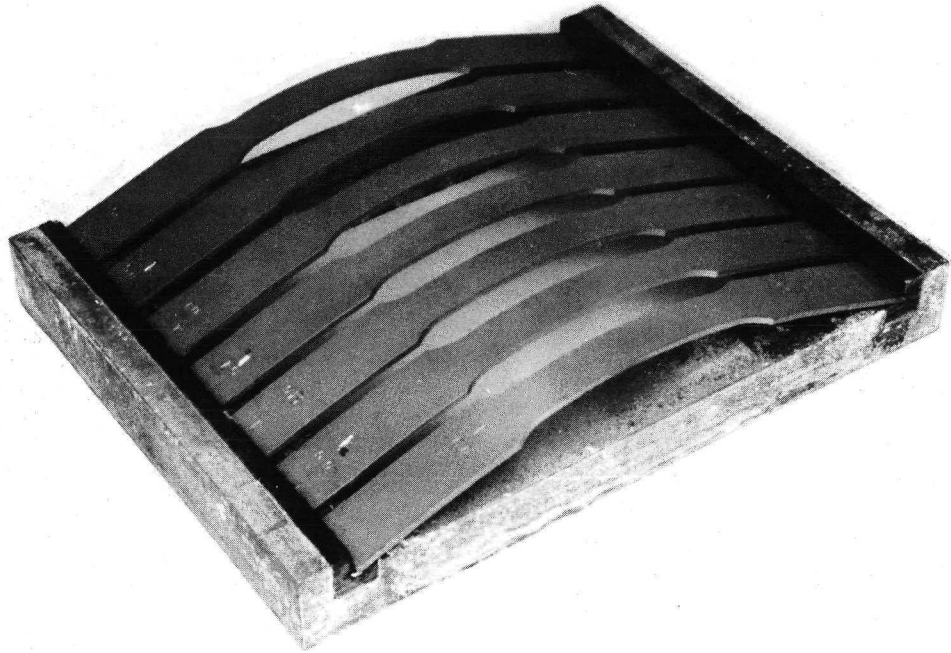

Prior to Testing

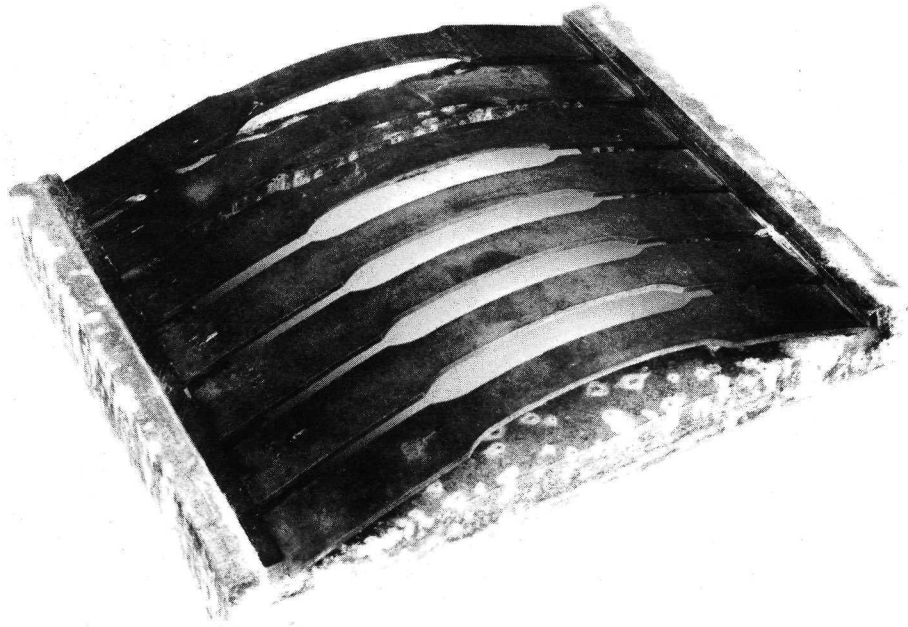

After 180 Day Test

FIGURE 17 - CUSTOM 455 STAINLESS STEEL FLAT TENSILE SPECIMENS AGED AT 950°F (510°C) AND STRESSED TO 90% OF THE 0.2% YIELD STRENGTH

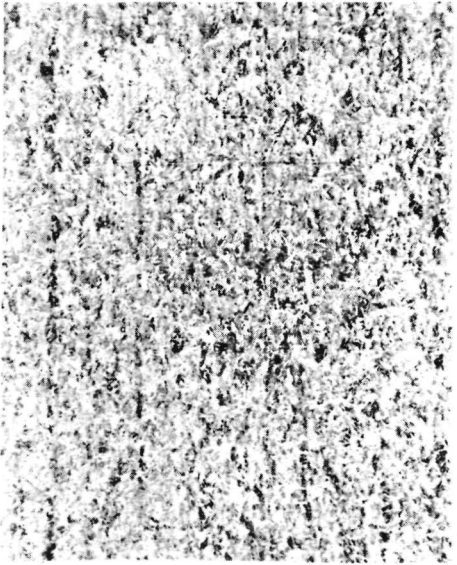

MAG 100X

Longitudinal



MAG 500X

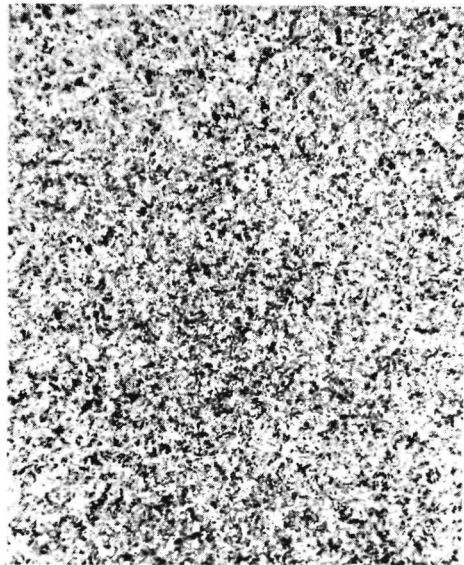

MAG 100X

Transverse



MAG 500X

FIGURE 18A - MICROSTRUCTURE OF CUSTOM 455 STAINLESS STEEL ALLOY BAR AGED AT 950°F (510°C)
Etchant: HCl-Nitric Acid-Glycerine Mixture



MAG 100X

Longitudinal



MAG 500X



MAG 100X

Transverse



MAG 500X

FIGURE 18B - MICROSTRUCTURE OF CUSTOM 455 STAINLESS STEEL ALLOY SHEET AGED AT 950°F (510°C)

Etchant: HCl-Nitric Acid-Glycerine Mixture



MAG 100X

Longitudinal



MAG 500X



MAG 100X

Transverse



MAG 500X

FIGURE 19A - MICROSTRUCTURE OF CUSTOM 455 STAINLESS STEEL ALLOY BAR AGED AT 1000°F (538°C)
Etchant: HCl-Nitric Acid-Glycerine Mixture



MAG 100X

Longitudinal



MAG 500X



MAG 100X

Transverse



MAG 500X

FIGURE 19B - MICROSTRUCTURE OF CUSTOM 455 STAINLESS STEEL ALLOY SHEET AGED AT 1000°F (538°C)

Etchant: HCl-Nitric Acid-Glycerine Mixture

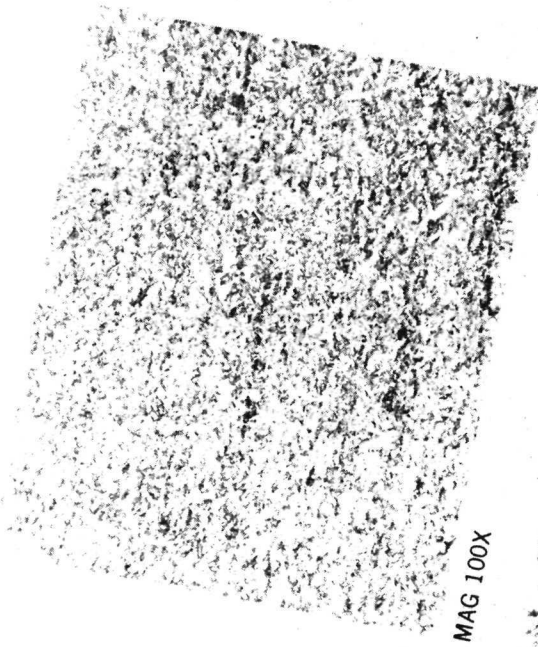

MAG 100X

Longitudinal

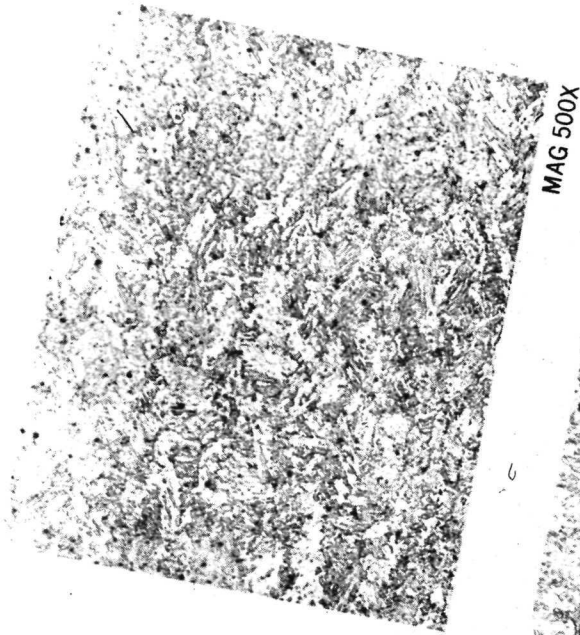

MAG 500X

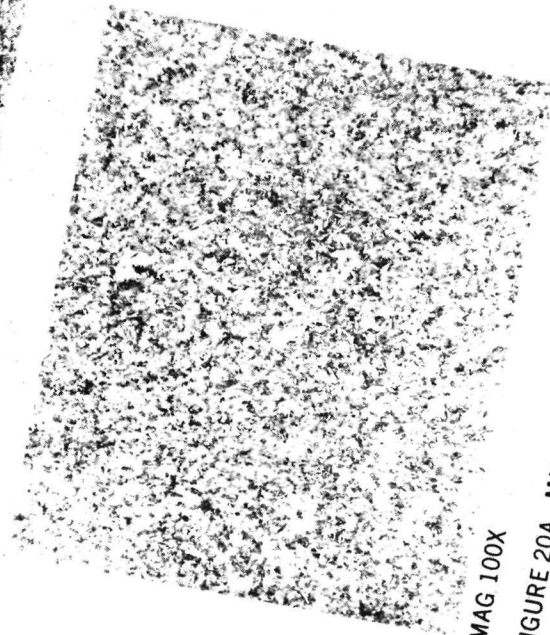

MAG 100X

Transverse

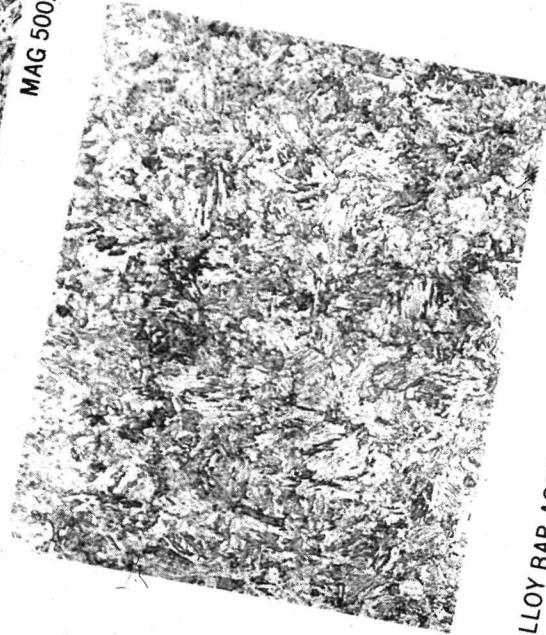

MAG 500X

FIGURE 20A - MICROSTRUCTURE OF CUSTOM 455 STAINLESS STEEL ALLOY BAR AGED AT 1050°F (566°C)
Etchant: HCl-Nitric Acid-Glycerine Mixture



MAG 100X

Longitudinal



MAG 500X



MAG 100X

Transverse



MAG 500X

FIGURE 20B - MICROSTRUCTURE OF CUSTOM 455 STAINLESS STEEL ALLOY SHEET AGED AT 1050°F (566°C)
Etchant: HCl-Nitric Acid-Glycerine Mixture

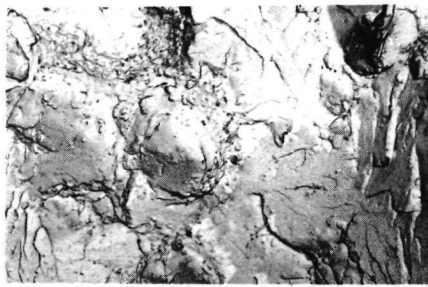

Edge

+80°F (+26.7°C)

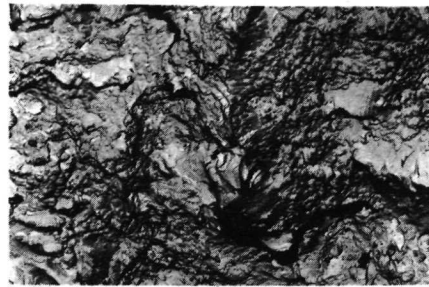

Center

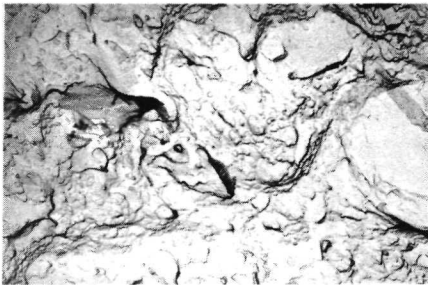

Edge

0°F (-17.8°C)

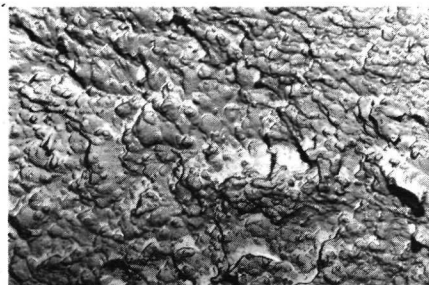

Center

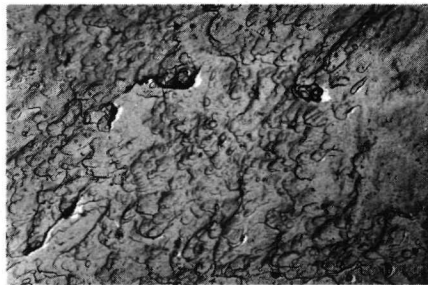

Edge

-100°F (-73°C)

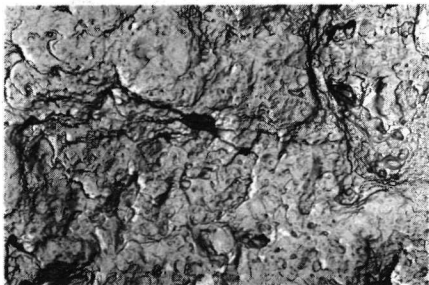

Center



Edge

-200°F (-129°C)

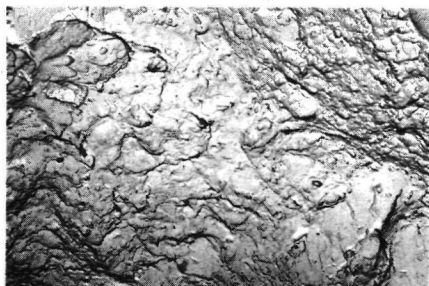

Center

FIGURE 21A - TEM FRACTOGRAPHS OF CUSTOM 455 STAINLESS STEEL ALLOY AGED AT 950°F (510°C)
SMOOTH BAR TENSILE FRACTURES
3150X Mag



Edge

+80°F (+26.7°C)

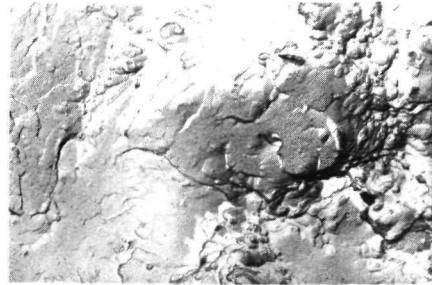

Center

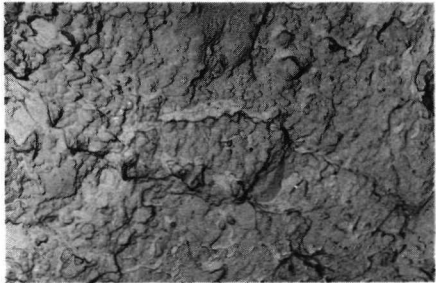

Edge

0°F (-17.8°C)

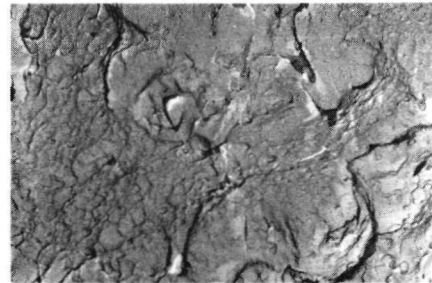

Center

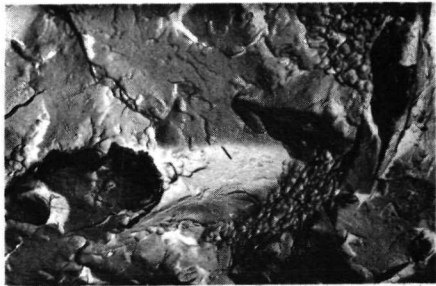

Edge

-100°F (-73°C)

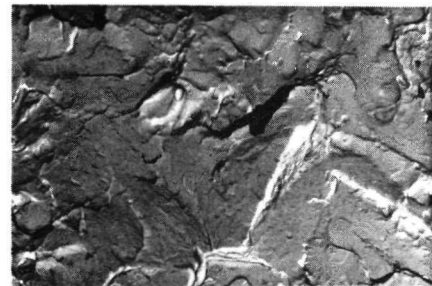

Center



Edge

-200°F (-129°C)



Center

FIGURE 21B · TEM FRACTOGRAPHS OF CUSTOM 455 STAINLESS STEEL ALLOY AGED AT 950°F (510°C)
V-NOTCH BAR TENSILE FRACTURES 3150X Mag

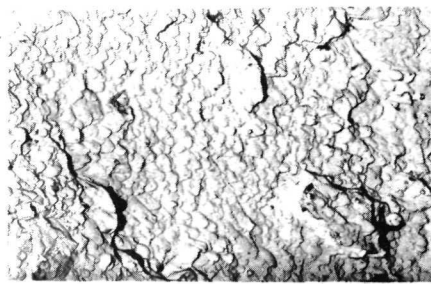

Edge

+80°F (+26.7°C)

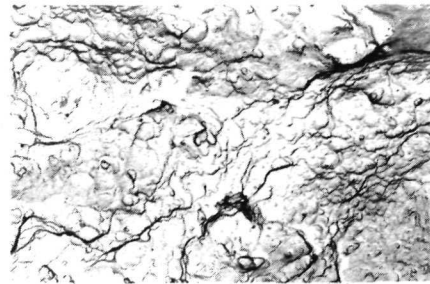

Center

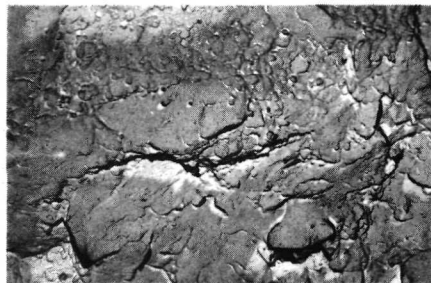

Edge

0°F (-17.8°C)

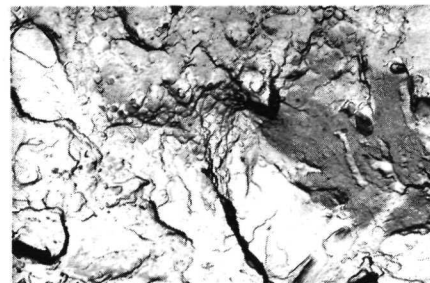

Center

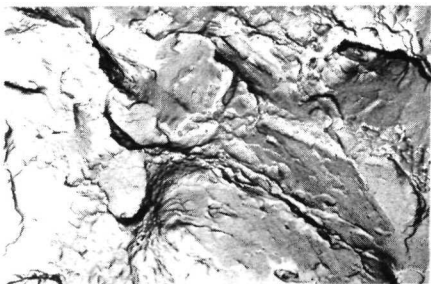

Edge

-100°F (-73°C)

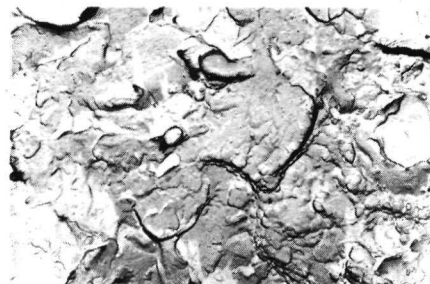

Center

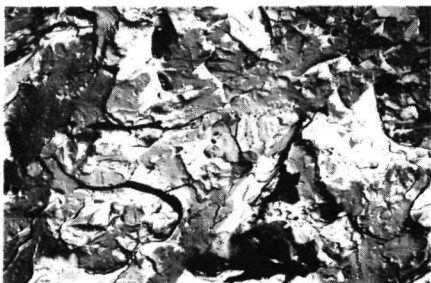

Edge

-200°F (-129°C)

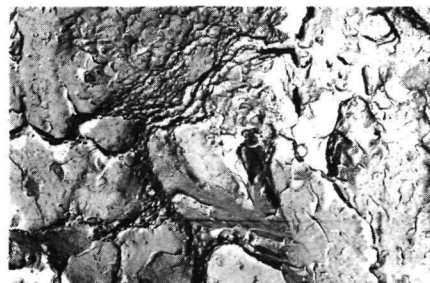

Center

FIGURE 21C - TEM FRACTOGRAPHS OF CUSTOM 455 STAINLESS STEEL ALLOY AGED AT 950°F (510°C)
CHARPY V-NOTCHED IMPACT BAR SPECIMEN FRACTURES 3150X Mag

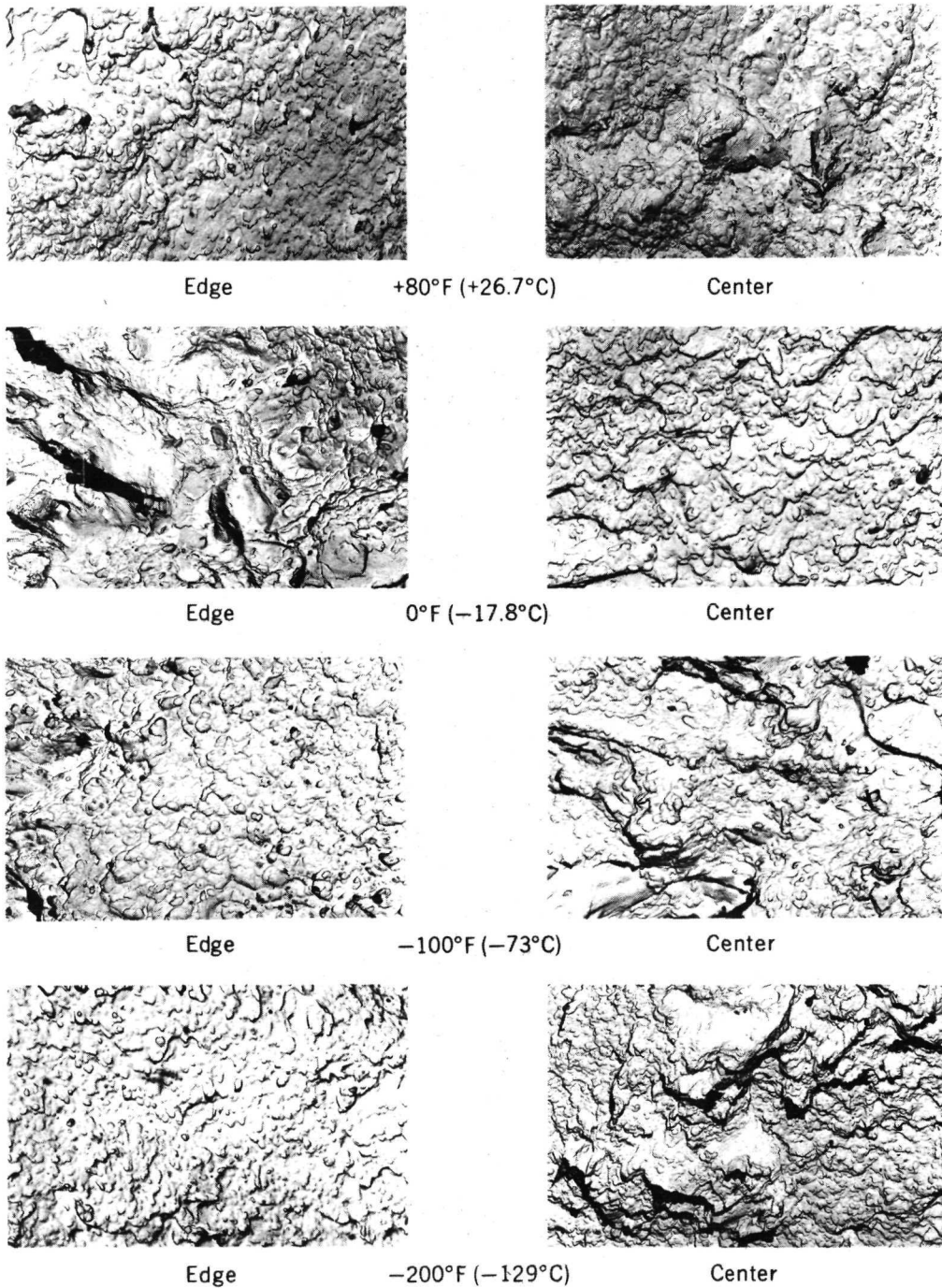
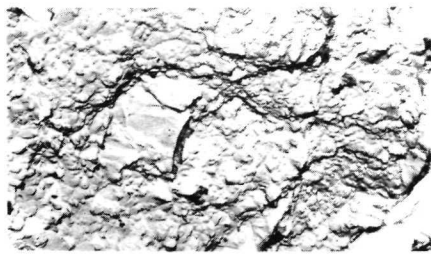
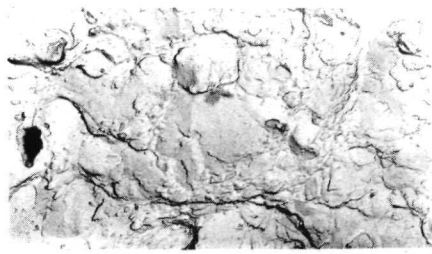

FIGURE 22A - TEM FRACTOGRAPHS OF CUSTOM 455 STAINLESS STEEL ALLOY AGED AT 1000°F (538°C)
 SMOOTH BAR TENSILE FRACTURES 3150X Mag



Edge

+80°F (+26.7°C)



Center

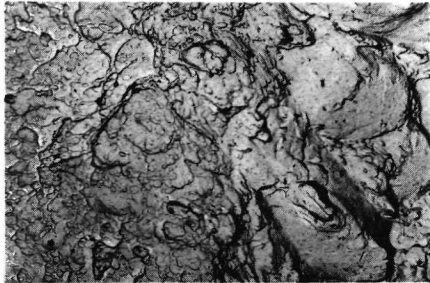

Edge

0°F (-17.8°C)

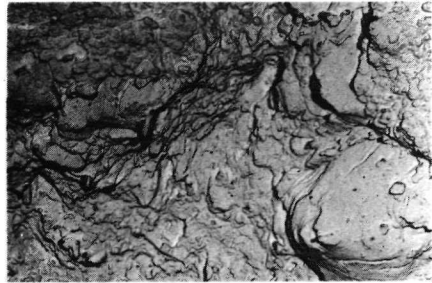

Center

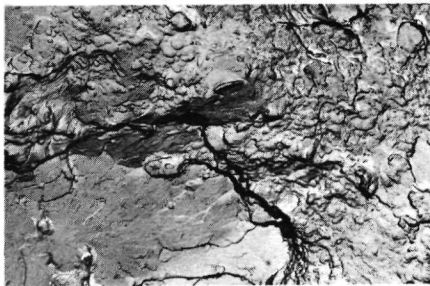

Edge

-100°F (-73°C)

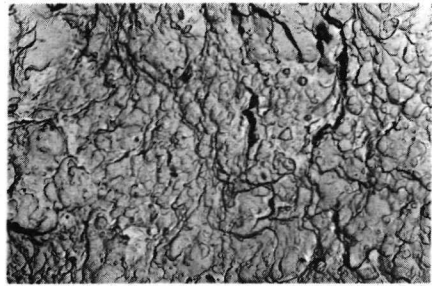

Center

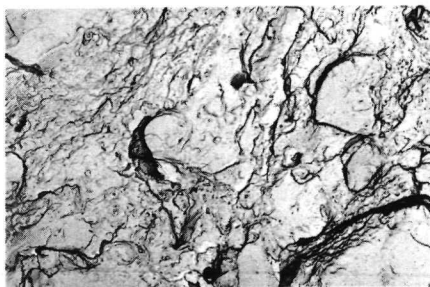

Edge

-200°F (-129°C)

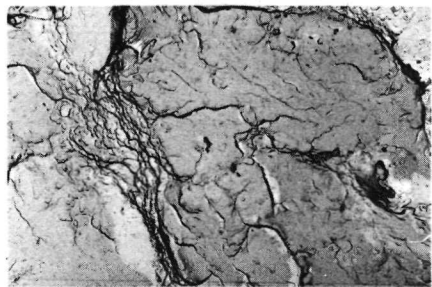

Center

FIGURE 22B - TEM FRACTOGRAPHS OF CUSTOM 455 STAINLESS STEEL ALLOY AGED AT 1000°F (538°C)
V-NOTCH BAR TENSILE FRACTURES

3150X Mag

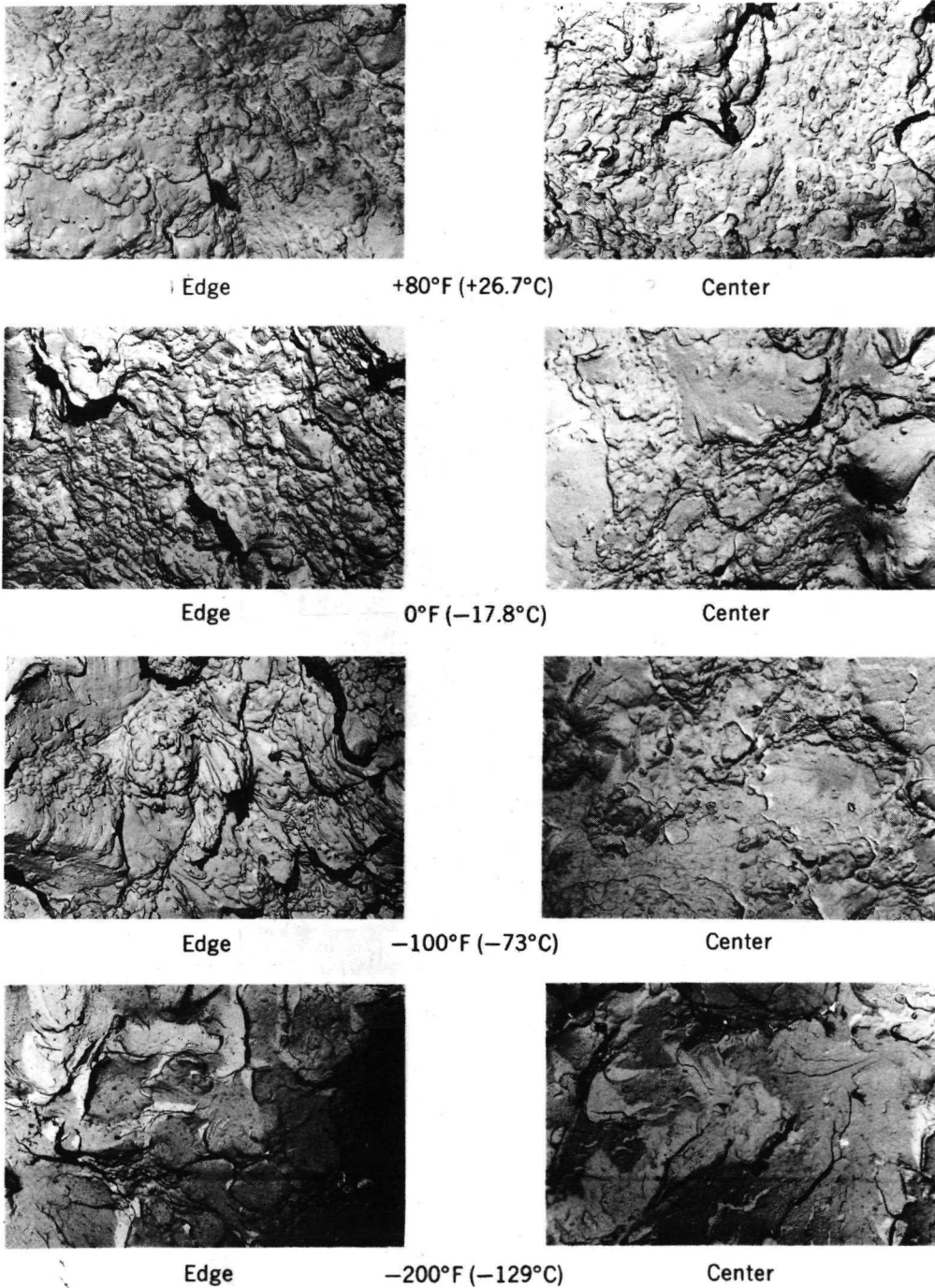

FIGURE 22C TEM FRACTOGRAPHS OF CUSTOM 455 STAINLESS STEEL ALLOY AGED AT 1000°F (538°C)
 CHARPY V-NOTCHED IMPACT BAR SPECIMEN FRACTURES 3150X Mag

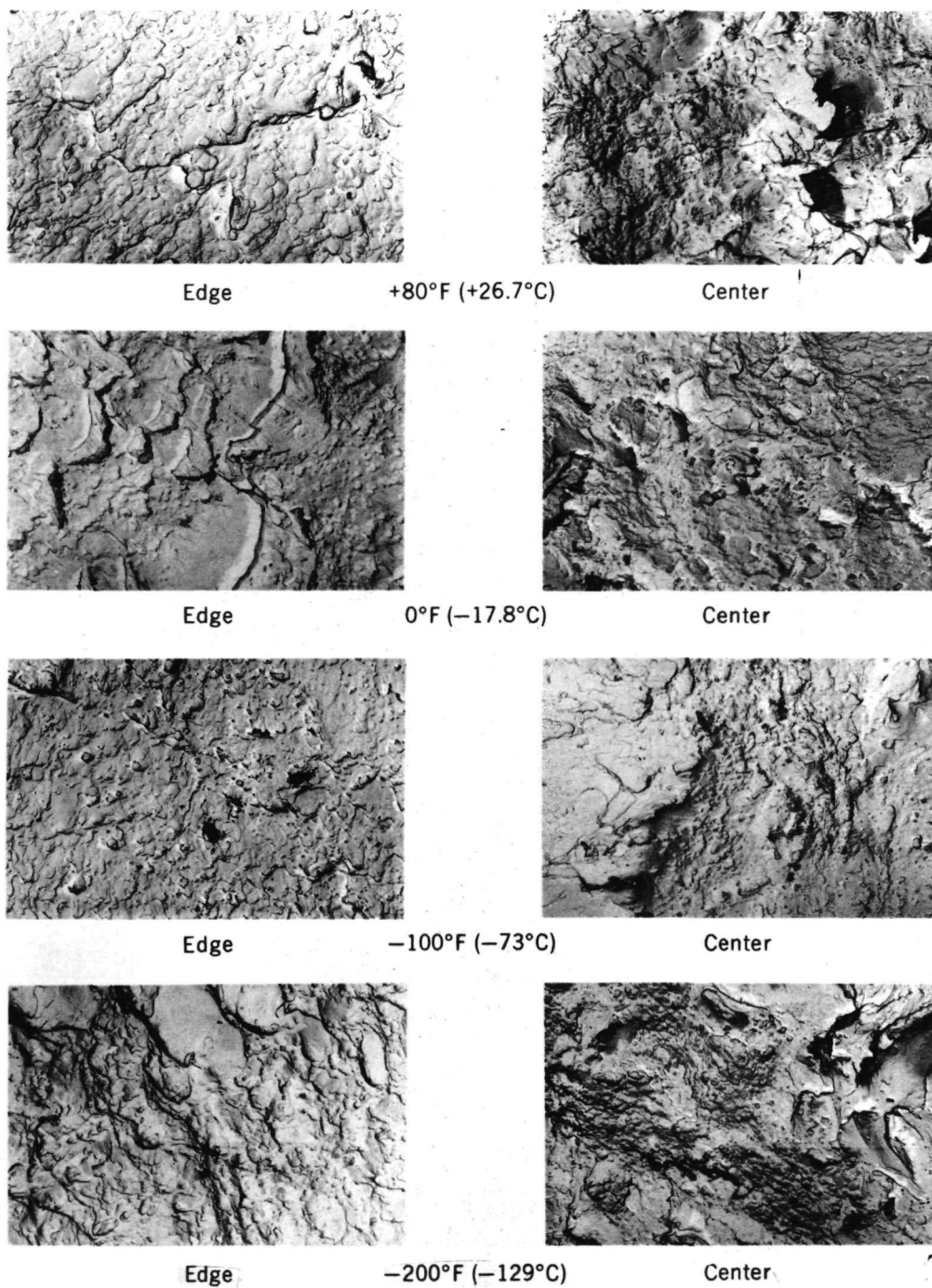
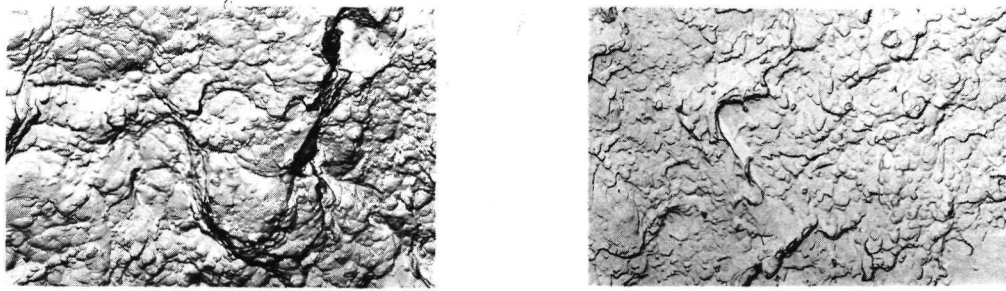

FIGURE 23A - TEM FRACTOGRAPHS OF CUSTOM 455 STAINLESS STEEL ALLOY AGED AT 1050°F (566°C)
 SMOOTH BAR TENSILE FRACTURES 3150X Mag



Edge

+80°F (+26.7°C)

Center

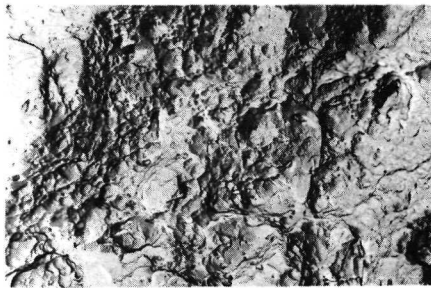

Edge

0°F (-17.8°C)

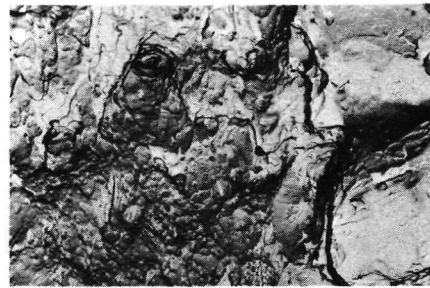

Center

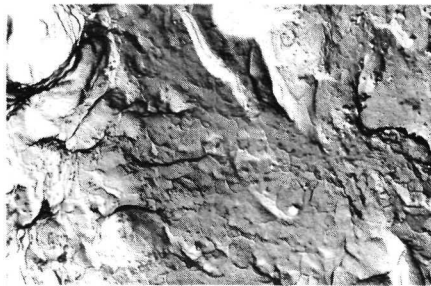

Edge

-100°F (-73°C)

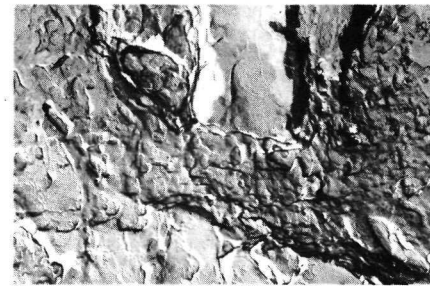

Center

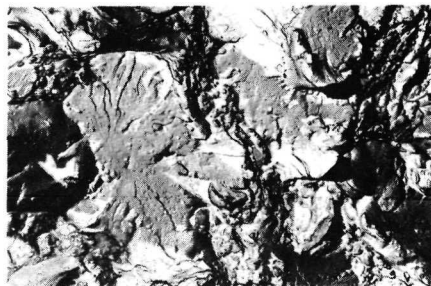

Edge

-200°F (-129°C)

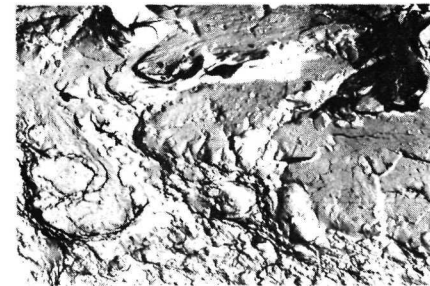

Center

FIGURE 23B - TEM FRACTOGRAPHS OF CUSTOM 455 STAINLESS STEEL ALLOY AGED AT 1050°F (566°C)
V-NOTCH BAR TENSILE FRACTURES

3150X Mag

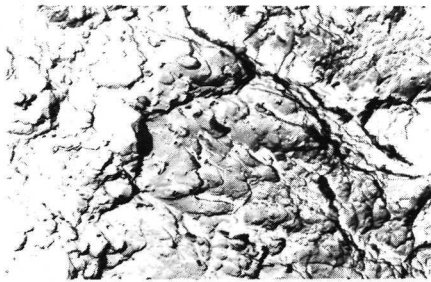

Edge

+80°F (+26.7°C)

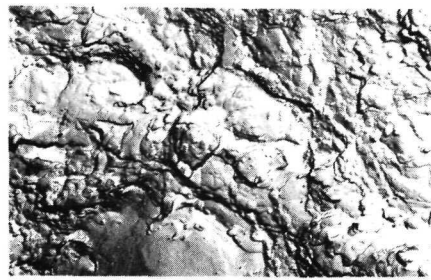

Center

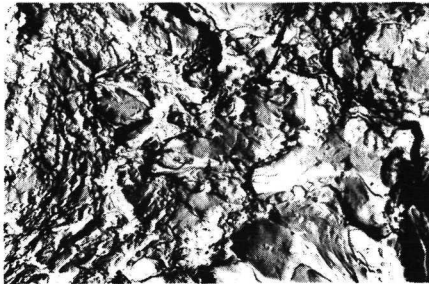

Edge

0°F (-17.8°C)



Center

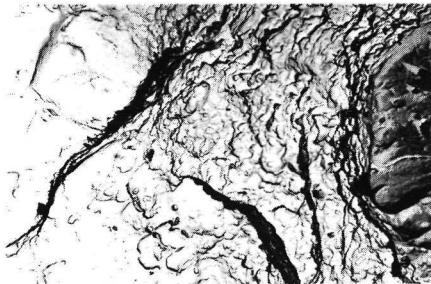

Edge

-100°F (-73°C)

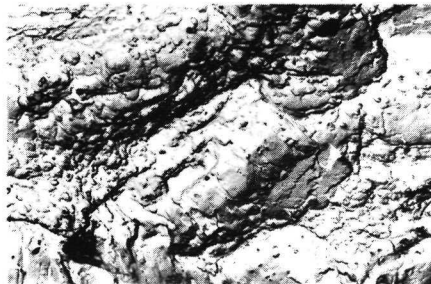

Center

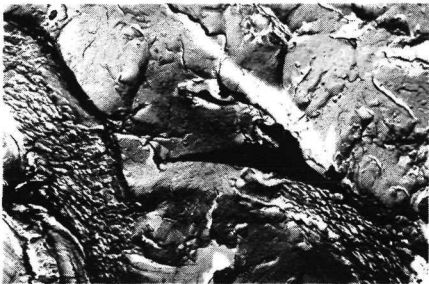

Edge

-200°F (-129°C)

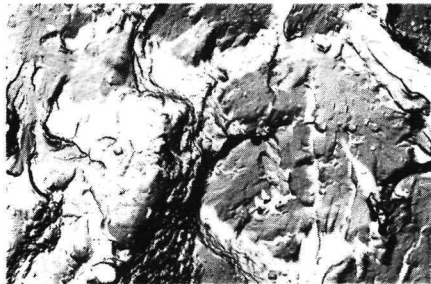

Center

FIGURE 23C - TEM FRACTOGRAPHS OF CUSTOM 455 STAINLESS STEEL ALLOY AGED AT 1050°F (566°C)
CHARPY V-NOTCHED IMPACT BAR SPECIMEN FRACTURES

3150X Mag

APPROVAL

A MECHANICAL PROPERTY AND STRESS CORROSION
EVALUATION OF CUSTOM 455 STAINLESS STEEL ALLOY

By

J. W. Montano

The information in this report has been reviewed for security classification. Review of any information concerning Department of Defense or Atomic Energy Commission programs has been made by the MSFC Security Classification Officer. This report, in its entirety, has been determined to be unclassified.

This document has also been reviewed and approved for technical accuracy.

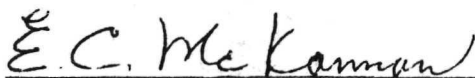

E. C. McKannan
Chief, Metallic Materials Branch

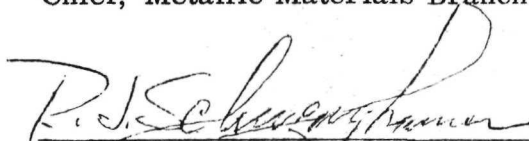

R. J. Schwingamer
Chief, Materials Division

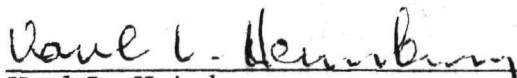

Karl L. Heimburg
Director, Astronautics Laboratory

DISTRIBUTION

DEP-T	Dr. Lucas
S&E-ASTN-DIR	Mr. Kingsbury
S&E-PE-DIR	Dr. Siebel
S&E-ASTR-DIR	Mr. Moore
S&E-QUAL-DIR	Mr. Grau
S&E-CSE-DIR	Dr. Haeussermann
S&E-CSE-S	Mr. Aberg
S&E-ASTN-M	Mr. Schwinghamer
S&E-ASTN-MX	Mr. Uptagrafft
S&E-ASTN-MX	Mr. Holmes
S&E-ASTN-MR	Mr. Welzyn (3)
S&E-ASTN-P	Mr. Paul
S&E-ASTN-E	Mr. Kroll
S&E-ASTN-MC	Mr. Nunnelley/Krupnick
S&E-ASTN-MM	Mr. McKannan
S&E-ASTN-MN	Mr. Curry
S&E-ASTN-MMM	Mr. Hess
S&E-ASTN-MMA	Mr. Kinkle
S&E-ASTN-MMA	Mr. Gilmore
S&E-ASTN-MMA	Mr. Marsh
S&E-ASTN-MMC	Mr. Williamson
S&E-ASTN-MMC	Mr. Nelson
S&E-ASTN-MMP	Mr. Montano (50)
S&E-ASTN-MMP	Mr. Morgan
S&E-ASTN-MMP	Mr. Hunter
S&E-ASTN-RM	Mrs. Thompson
S&E-ASTN-ASV	Mr. Hurford
S&E-ASTN-S	Mr. Verble
S&E-ASTN-EA	Mr. Prasthofer
S&E-ASTN-EAA	Mr. Genter
S&E-ASTN-ESP	Mr. Franz
S&E-ASTN-SA	Mr. Engler
S&E-PE-D	Mr. Eisenhardt
S&E-QUAL-ARM	Mr. Neuschaefer
S&E-PE-MW	Mr. Parks
S&E-PE-MWP	Mr. Wood
A&TS-MS-H	Mr. Akens
A&TS-PAT	Mr. Wofford
A&TS-TU	Mr. Higgins
A&TS-MS-IP	Mr. Remer (2)
A&TS-MS-IL	Miss Robertson (8)

Scientific and Technical Inf. Facility (25)

P. O. Box 33
College Park, MD 20740