

2nd Data Management Copy #5
Lee Lucas

DMS-DR-1222
CR-120,034
JANUARY 1973

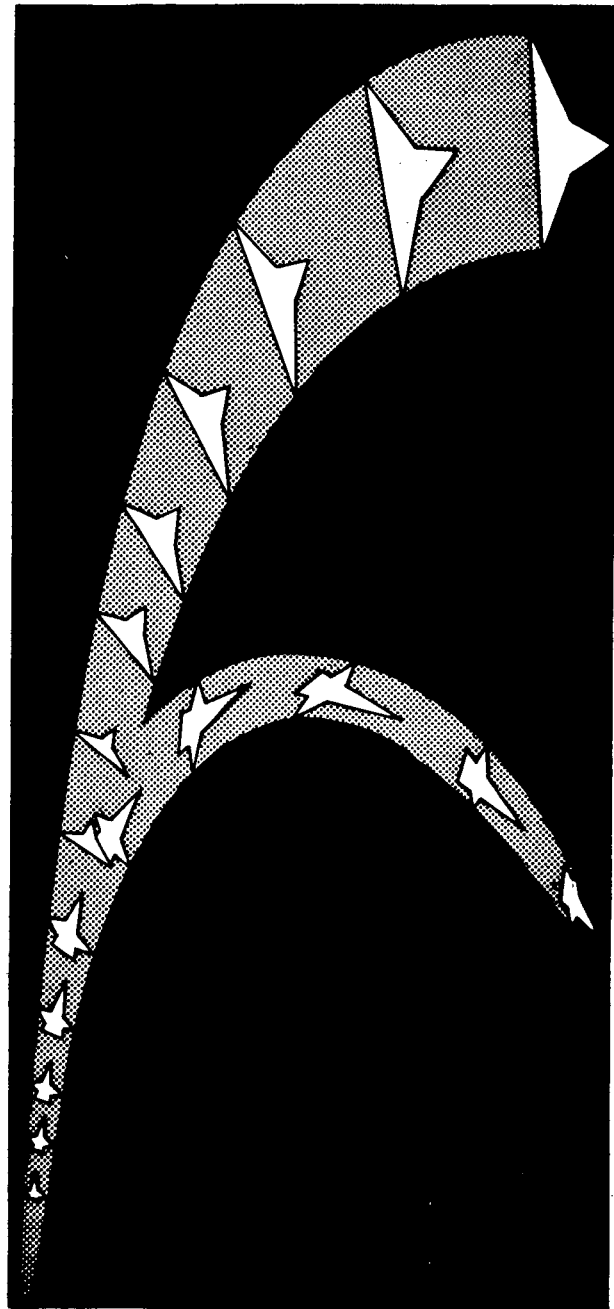

—SPACE SHUTTLE—
PRESSURE INVESTIGATION OF
A SPACE SHUTTLE LAUNCH
CONFIGURATION CONSISTING
OF A DELTA-WING ORBITER
AND A SWEEP-WING BOOSTER
WITH CANARD AND TIP FINS

(M=0.6 TO 1.3)

Volume 1-Part A
Booster Data

by

J.M. Rampy, NSI
K.L. Blackwell, MSFC
G.R. Gomillion, ARO

4-FOOT TRANSONIC
PROPULSION WIND
TUNNEL

Arnold Engineering
Development Center

SADSAC SPACE SHUTTLE
AEROTHERMODYNAMIC
DATA MANAGEMENT SYSTEM

CONTRACT NAS8-4016
MARSHALL SPACE FLIGHT CENTER



This document should
be referenced as
NASA CR-120,034

NASA-CR-120034-Vol-1-1-Pt-A) SPACE SHUTTLE:
PRESSURE INVESTIGATION OF A SPACE SHUTTLE
LAUNCH CONFIGURATION CONSISTING OF A
DELTA-WING ORBITER AND A (Chrysler Corp.)
560 p HC \$30.00
CSCI 22B G3/31
Unclas 67094
N73-20891

NASA Series Number: P-1001

DMS-DR-1222
Volume I - Part A
CR-120,034

SADSAC/SPACE SHUTTLE

WIND TUNNEL TEST DATA REPORT

CONFIGURATION: MDAC Orbiter and Booster Shuttle Models; 0.00556 Scale

TEST PURPOSE: Experimental Pressure Investigation of Space Shuttle Launch
Vehicle at Mach Numbers of 0.6 to 1.3

TEST FACILITY: AEDC-PWT Tunnel 4-T

TESTING AGENCY: MSFC/AEDC

TEST NO. & DATE: AEDC TC174 (PC1154); 11 through 13 October, 1971

FACILITY COORDINATOR: L. L. Trimmer, ARO; J. F. Weaver, MSFC

PROJECT ENGINEER(S): J. M. Rampy, NSI
K. L. Blackwell, MSFC
G. R. Gomillion, ARO

DATA MANAGEMENT SERVICES

LIAISON: *HC Zimmerle* DATA OPERATIONS: *HC Zimmerle*
for V. W. Sparks H. C. Zimmerle

RELEASE APPROVAL: *J. Y. Kelly*
for D. Kemp Supervisor
Aero Thermo Data Group

CONTRACT NAS 8-4016

AMENDMENT 182

DRL 297 - 84a

This report has been prepared by Chrysler Corporation Space Division under a Data Management Contract to the NASA. Chrysler assumes no responsibility for the data presented herein other than its display characteristics.

FACILITY COORDINATORS:

Mr. L. L. Trimmer
VKF - SH
ARO, Inc.
Arnold Air Force Station,
Tennessee 37389

Phone: (615) 455-2611-X7377

Mr. J. F. Weaver
Marshall Space Flight Center
Mail Stop S&E-AERO-AAE
Huntsville, Alabama 35801

Phone: (205) 453-2519

PROJECT ENGINEERS:

Mr. J. M. Rampy
Northrop Services, Inc.
Department 9241
P. O. Box 1484
Huntsville, Alabama 35801

Phone: (205) 837-0580, X208

Mr. K. L. Blackwell
Marshall Space Flight Center
Mail Stop S&E-AERO-AAE
Huntsville, Alabama 35801

Phone: (205) 453-2517

Mr. G. R. Gomillion
PWT-4T Project Branch
ARO, Inc.
Arnold Air Force Station,
Tennessee 37349

Phone: (615) 455-2611-X7181

SADSAC LIAISON:

Mr. Wayne Sparks
Chrysler Corporation - Huntsville Division
102 Wynn Drive, Department 4820
Huntsville, Alabama 35805

Phone: (205) 895-1560

SADSAC OPERATIONS:

Mr. H. C. Zimmerle
Chrysler Corporation Space Division
P. O. Box 29200, Department 2780
New Orleans, Louisiana 70189

Phone: (504) 255-2327

TABLE OF CONTENTS

| | <u>PAGE NUMBER</u> |
|--------------------------------------|------------------------|
| SUMMARY | 1 |
| NOMENCLATURE | 3 |
| APPARATUS AND MODELS | 5 |
| TEST FACILITY DESCRIPTION | 6 |
| DATA REDUCTION | 6 |
| REFERENCES | 7 |
| TABLES | |
| I. TEST CONDITIONS | 8 |
| II. DATASET COLLATION SHEETS | 9 |
| III. ORBITER PRESSURE TAP LOCATIONS | 10 |
| IV. BOOSTER PRESSURE TAP LOCATIONS | 11 |
| V. DIMENSIONAL DATA | 14 |
| VI INDEX OF MODEL FIGURES | 21 |
| VII. INDEX OF DATA FIGURES | 22 |
| FIGURES | |
| MODEL | 24 |
| DATA | 31 |

PRESSURE INVESTIGATION OF A SPACE SHUTTLE
LAUNCH CONFIGURATION CONSISTING OF A DELTA-WING ORBITER
AND A SWEPT-WING BOOSTER WITH CANARD AND TIP FINS
(M = 0.6 TO 1.3)

By J. M. Rampy, K. L. Blackwell, and G. R. Gomillion

S U M M A R Y

This report presents pressure data obtained from a wind tunnel test sponsored by the Marshall Space Flight Center (MSFC) and conducted in the FWT-4T facility of the Arnold Engineering Development Center (AEDC) from October 11 through October 13, 1971. The models tested were 0.00556 scale models of the McDonnell-Douglas orbiter and booster configurations. Pressure data were obtained for the combined orbiter and booster and for the booster alone at Mach numbers from 0.6 to 1.3, angles of attack from -8° to $+10^{\circ}$, and sideslip angles from -6° to $+6^{\circ}$. Pressure data was also obtained for the booster alone without canard at Mach numbers of 0.9 and 1.1 (nominal). The pressure taps were distributed primarily over the booster upper surface and the orbiter lower surface.

The models were mounted on individual stings which allowed various incidence angles and longitudinal positions of the orbiter relative to the booster. Orbiter incidence angles of 0° , 1.9° , and 3.8° were obtained at the most aft position of the orbiter, and **three** longitudinal positions were obtained at 0° incidence. The vertical separation distance between the orbiter lower

SUMMARY (Concluded)

surface and the booster upper surface was nominally zero. These test results supplement the data presented in references 1 and 2.

Plotted data for this test is published under one report number (DMS-DR-1222) in two volumes: volume 1, parts A and B, contains the plotted data for the booster alone and in the presence of the orbiter, and volume 2 contains the plotted data for the orbiter in the presence of the booster.

NOMENCLATURE

AEDC TC 174

| <u>SYMBOL</u> | <u>SADSAC SYMBOL</u> | <u>DEFINITION</u> |
|---------------|--------------------------|--|
| a | | Speed of sound; m/sec, ft/sec |
| b/2 | | Vehicle wing semi-span; in. |
| c | | Local airfoil chord; in. |
| c.g. | | Center of gravity |
| CP | CP | Pressure coefficient, $\frac{P_l - P_\infty}{q}$ |
| L | L | Body length; in. |
| M_∞ | ML | Free stream Mach number; V/a |
| P_l | | Local static pressure; psia |
| P_o | | Free stream total pressure; psia |
| P_∞ | | Free stream static pressure; psia |
| q | | Dynamic pressure; psi |
| RN/L | | Unit Reynolds number; per foot |
| T_o | | Freestream total temperature, °F |
| V | | Velocity; m/sec, ft/sec |
| x | | Distance from vehicle nose; in. |
| x/c | X/C | Local chordwise position/local chord length |
| x/L | X/L | Longitudinal position/body length |
| y | | Distance from lateral centerline, in. |
| y/b/2 | Y/B | Local spanwise position/wing semi-span |

NOMENCLATURE (Concluded)

AEDC TC 174

| <u>SYMBOL</u> | <u>SADSAC SYMBOL</u> | <u>DEFINITION</u> |
|---------------|--------------------------|---|
| α_B | ALFB | Booster angle of attack; degrees |
| α_0 | ALF0 | Orbiter angle of attack; degrees |
| i | I | Incidence angle between the orbiter and booster, $I = \alpha_0 - \alpha_B$; degrees |
| β | BETA | Angle of sideslip; degrees |
| θ | THETA | Angle measured from vehicle top center-line; degrees |
| $\Delta x/L$ | DX/L | Distance between the c.g. of the orbiter and booster measured parallel to the longitudinal axis of the booster, positive when the orbiter c.g. is forward of the booster c.g., the distance has been normalized with respect to the booster fuselage length (16.184 inches) |

APPARATUS AND MODELS

The models tested were .00556 scale models of the MDAC orbiter and booster, figures 3 and 4, respectively. The orbiter is basically the configuration illustrated on MDAC drawing number 255BJ0050. Modifications made on the orbiter to allow for installation of the nozzle assembly are shown in figure 3.

The booster configuration is basically the configuration designated 19A by MDAC (drawing number 256-19-0001). The body, wing, and canard of the booster model are that of configuration 19A except that the body does not have a base flare or boattail, figure 4. The vertical tails are those which were designed for the configuration designated 17 (drawing number 256-17-001).

The booster model was tested alone with and without canard, and the complete booster and orbiter models were tested together. The orbiter and booster models were mounted on individual stings as shown by figures 6 and 7. The orbiter could be moved fore and aft with respect to the booster and small variations of the orbiter/booster relative incidence angle could be obtained. The vertical separation distance (minimum gap) between the orbiter lower surface and the booster upper surface was nominally zero. The **values** of the relative incidence angle, I , and the longitudinal separation variable, DX/L , are listed in Table II entitled "Pressure Dataset Collation Sheets".

Dimensional data for both vehicles are shown in Table V. The pressure tap layout is shown in figures 1 and 2, and the exact tap locations are given in tables III and IV.

TEST FACILITY DESCRIPTION

The 4-Foot Transonic Propulsion Wind Tunnel (PWT-4T) is a closed-loop, continuous flow, variable density facility with a 4- by 4-foot square test section and a Mach number range of 0.1 to 1.4. The tunnel has a stagnation pressure range of 300 to 1700 psf, and a stagnation temperature range of 80° to 130°F. The test section is equipped with variable porosity walls with an available porosity range of 0 to 10 percent open area. A complete description of the PWT-4T tunnel can be found in reference 3.

DATA REDUCTION

The longitudinal separation variable DX/L is referenced to nominal center of gravity locations on the orbiter and booster and to the booster body axis system. The orbiter model c.g. was located 4.917 inches aft of the orbiter model nose, and the booster model c.g. was located 7.528 inches aft of the booster model nose. The DX/L distance is measured parallel to the longitudinal axis of the booster and between the nominal center of gravity points on the orbiter and booster, as illustrated in figure 5. The value of DX/L is positive when the orbiter c.g. is forward of the booster c.g. DX/L is normalized using the booster fuselage length of 16.184 inches.

REFERENCES

1. Strike, W. T. Jr., "Abort Separation Pressure Distributions on McDonnell-Douglas Space Shuttle Configurations at Mach Numbers 2.3 and 5", AEDC-TR-72-46, May 1972.
2. "Space Shuttle Abort Separation Pressure Investigation", NASA CR-120,008, June 1972.
3. "Test Facilities Handbook", Arnold Engineering Development Center, December 1969.
4. Lane, David G., "Pretest Information For A Proposed Space Shuttle Launch Configuration Pressure Investigation To Be Conducted At AEDC PWT-4T", MSFC Pretest Report, July 1971.

TABLE I
TEST CONDITIONS
TEST TC 174

| MACH NUMBER | REYNOLDS NUMBER per unit length | DYNAMIC PRESSURE (pounds/sq. foot) | STAGNATION TEMPERATURE (degrees Fahrenheit) |
|-------------|------------------------------------|---------------------------------------|--|
| 0.6 | 2.0×10^6 | 238 | |
| 0.9 | 2.4×10^6 | 402 | |
| 1.0 | 2.5×10^6 | 441 | |
| 1.1 | 2.5×10^6 | 478 | |
| 1.2 | 2.5×10^6 | 498 | |
| 1.3 | 2.5×10^6 | 510 | |
| | | | 80° to 110° F |
| | | | (overall range) |
| | | | |
| | | | |
| | | | |
| | | | |
| | | | |
| | | | |
| | | | |
| | | | |
| | | | |
| | | | |
| | | | |
| | | | |

BALANCE UTILIZED: _____

CAPACITY:

NF _____
 SF _____
 AF _____
 PM _____
 YM _____
 RM _____

ACCURACY:

**COEFFICIENT
 TOLERANCE:**

COMMENTS:

TABLE II
 TEST AEDC TC 174 PRESSURE DATASET COLLATION SHEET

PRETEST
 POSTTEST

| DATASET IDENTIFIER | CONFIGURATION | MODEL SECTION | GEO. CONFIG. | SCHD. | | PARAMETER/VALUES | | NO. OF RUNS | MACH NUMBERS | | | | | | | | | | | |
|--------------------|----------------------------|---------------|--------------|----------|---------|------------------|--------------|-------------|--------------|----|-----|-----|-----|-----|--|--|--|--|--|--|
| | | | | α | β | λ | $\Delta x/l$ | | .6 | .9 | 1.0 | 1.1 | 1.2 | 1.3 | | | | | | |
| TC001 | BOOSTER/ORBITER | A through I | | A | O | | O | | | | | | | | | | | | | |
| TC002 | | | | O | B | | | | | | | | | | | | | | | |
| TC003 | | | | -6 | C | | | | | | | | | | | | | | | |
| TC004 | | | | +6 | B | | | | | | | | | | | | | | | |
| TC005 | | | | A | O | | | | | | | | | | | | | | | |
| TC006 | | | | O | B | | | | | | | | | | | | | | | |
| TC007 | | | | -6 | D | | | | | | | | | | | | | | | |
| TC008 | | | | +6 | D | | | | | | | | | | | | | | | |
| TC009 | | | | A | O | | | | | | | | | | | | | | | |
| TC010 | | | | A | O | | | | | | | | | | | | | | | |
| TC011 | | | | A | O | | | | | | | | | | | | | | | |
| TC012 | BOOSTER ALONE | A, B, C, D, E | | A | O | | | | | | | | | | | | | | | |
| TC013 | BOOSTER ALONE / CANARD OFF | A, B, C, E | | O | B | | | | | | | | | | | | | | | |
| TC014 | | | | A | O | | | | | | | | | | | | | | | |

NOTE (1): First character of each dataset identifier denotes model section: A through I refer to booster body, upper wing, lower wing, canard, base, and orbiter body, upper wing, lower wing, respectively.

α OR β SCHEDULES
 A(α)=-8,-6,-4,-2, 0,+2,+4,+6,+8,+10 degrees
 B(β)=-6,-4,-2, 0,+2,+4,+6 degrees
 C(β)=-4,-2, 0,+2,+4 degrees
 P(α)=partial schedule A

D(β)=-4,+4 degrees (plotted data includes $\beta=0$ at $\alpha=-6$ or $+6$ from corresponding α -variant dataset)

TABLE III
ORBITER PRESSURE TAP LOCATIONS

| Tap No. | TAP LOCATION | | | Tap No. | TAP LOCATION | | |
|---------|--------------|-------------|------------|---------|--------------|-------------|------------|
| | $(x/L)_o$ | $(y/b/2)_o$ | Surface | | $(x/L)_o$ | $(y/b/2)_o$ | Surface |
| 1 | 0 | 0 | Lower Body | 28 | .498 | .231 | Lower Wing |
| 2 | .019 | ↓ | ↓ | 29 | .586 | ↓ | ↓ |
| 3 | .066 | ↓ | ↓ | 30 | .674 | ↓ | ↓ |
| 4 | .145 | ↓ | ↓ | 31 | .762 | ↓ | ↓ |
| 5 | .233 | ↓ | ↓ | 32 | .854 | ↓ | ↓ |
| 6 | .321 | ↓ | ↓ | 33 | .944 | ↓ | ↓ |
| 7 | .409 | ↓ | ↓ | 34 | .674 | .400 | ↓ |
| 8 | .498 | ↓ | ↓ | 35 | .762 | ↓ | ↓ |
| 9 | .586 | ↓ | ↓ | 36 | .854 | ↓ | ↓ |
| 10 | .676 | ↓ | ↓ | 37 | .942 | ↓ | ↓ |
| 11 | .765 | ↓ | ↓ | 38 | .764 | .569 | ↓ |
| 12 | .854 | ↓ | ↓ | 39 | .854 | ↓ | ↓ |
| 13 | .943 | ↓ | ↓ | 40 | .942 | ↓ | ↓ |
| 14 | .981 | ↓ | ↓ | 41 | .852 | .738 | ↓ |
| 15 | .149 | .077 | ↓ | 42 | .942 | ↓ | ↓ |
| 16 | .233 | ↓ | ↓ | 43 | ↓ | 0 | Upper Base |
| 17 | .321 | ↓ | ↓ | 44 | ↓ | .138 | Lower Base |
| 18 | .409 | ↓ | ↓ | 45 | .981 | -.007 | Upper Wing |
| 19 | .498 | ↓ | ↓ | 46 | .981 | .289 | ↓ |
| 20 | .586 | ↓ | ↓ | 47 | .939 | ↓ | ↓ |
| 25 | .233 | .191 | ↓ | 48 | .851 | ↓ | ↓ |
| 26 | .321 | .221 | ↓ | 49 | .981 | .400 | ↓ |
| 27 | .409 | .231 | Lower Wing | 50 | .939 | ↓ | ↓ |

x = Distance from orbiter nose

y = Distance from orbiter centerline

L = Orbiter length 27.153 cm (10.690 in.)

b/2 = Orbiter wing semi-span 8.255 cm (3.250 in.)

TABLE IV

BOOSTER PRESSURE TAP LOCATIONS

| Tap No. | TAP LOCATION | | | Tap No. | TAP LOCATION | | |
|---------|--------------|-------------|---|---------|--------------|-------------|----------------------------|
| | $(x/L)_B$ | $(y/b/2)_B$ | Surface | | $(x/L)_B$ | $(y/b/2)_B$ | Surface |
| 1 | .004 | 0 | Body \mathcal{C} , $\theta = 0^\circ$ | 30 | .243 | .092 | Body, $\theta = 24^\circ$ |
| 2 | .014 | ↓ | ↓ | 31 | .305 | ↓ | ↓ |
| 3 | .025 | ↓ | ↓ | 32 | .367 | ↓ | ↓ |
| 4 | .062 | ↓ | ↓ | 33 | .490 | ↓ | ↓ |
| 5 | .120 | ↓ | ↓ | 34 | .613 | ↓ | ↓ |
| 6 | .181 | ↓ | ↓ | 35 | .737 | ↓ | ↓ |
| 7 | .243 | ↓ | ↓ | 36 | .798 | ↓ | ↓ |
| 8 | .305 | ↓ | ↓ | 37 | .860 | ↓ | ↓ |
| 9 | .366 | ↓ | ↓ | 38 | .921 | ↓ | ↓ |
| 10 | .490 | ↓ | ↓ | 39 | .983 | ↓ | ↓ |
| 11 | .613 | ↓ | ↓ | 40 | .062 | .155 | Body, $\theta = 45^\circ$ |
| 12 | .737 | ↓ | ↓ | 41 | .124 | ↓ | ↓ |
| 13 | .799 | ↓ | ↓ | 42 | .185 | ↓ | ↓ |
| 14 | .859 | ↓ | ↓ | 43 | .247 | ↓ | ↓ |
| 15 | .921 | ↓ | ↓ | 44 | .309 | ↓ | ↓ |
| 16 | .983 | ↓ | ↓ | 45 | .371 | ↓ | ↓ |
| 17 | .062 | .018 | Nose Section | 46 | .494 | ↓ | ↓ |
| 18 | .120 | .037 | ↓ | 47 | .618 | ↓ | ↓ |
| 19 | .181 | .046 | ↓ | 48 | .741 | ↓ | ↓ |
| 20 | .243 | ↓ | ↓ | 49 | .988 | .220 | Body, $\theta = 90^\circ$ |
| 21 | .309 | .220 | Body, $\theta = 90^\circ$ | 93 | .998 | 0 | Base, $\theta = 0^\circ$ |
| 22 | .371 | ↓ | ↓ | 94 | ↓ | .193 | 90° |
| 23 | .494 | ↓ | ↓ | 95 | ↓ | -.193 | 270° |
| 24 | .618 | ↓ | ↓ | 96 | ↓ | 0 | 180° |
| 25 | .741 | ↓ | ↓ | 97 | .803 | ↓ | Body, $\theta = 180^\circ$ |
| 26 | .803 | ↓ | ↓ | 98 | .865 | ↓ | ↓ |
| 27 | .851 | ↓ | ↓ | 99 | .927 | ↓ | ↓ |
| 28 | .896 | ↓ | ↓ | 100 | .988 | ↓ | ↓ |
| 29 | .942 | ↓ | ↓ | | | ↓ | ↓ |

x = Distance from booster nose

y = Distance from booster centerline

L = Booster length 41.107 cm (16.184 in.)

$b/2$ = Booster semi-span 13.805 cm (5.435 in.)

TABLE IV (Continued)

BOOSTER PRESSURE TAP LOCATIONS

| Tap No. | TAP LOCATION | | | Tap No. | TAP LOCATION | | | |
|---------|--------------|-------------|------------|---------|--------------|-------------|------------|--------------|
| | $(x/c)_B$ | $(y/b/2)_B$ | Surface | | $(x/c)_B$ | $(y/b/2)_B$ | Surface | |
| 53 | .098 | .221 | Upper Wing | 71 | .718 | .635 | Upper Wing | |
| 54 | .320 | ↓ | | 72 | .926 | ↓ | | |
| 55 | .542 | ↓ | | 73 | .066 | .773 | | |
| 56 | .763 | ↓ | | 74 | .275 | ↓ | | |
| 57 | .985 | ↓ | | 75 | .484 | ↓ | | |
| 58 | .101 | .359 | | 76 | .696 | ↓ | | Upper Canard |
| 59 | .320 | ↓ | | 77 | .896 | ↓ | | |
| 60 | .542 | ↓ | | 83 | .195 | .565 | | |
| 61 | .762 | ↓ | | 84 | .716 | ↓ | | |
| 62 | .970 | ↓ | | 85 | .195 | .879 | | |
| 63 | .103 | .497 | | 86 | .716 | ↓ | | Lower Wing |
| 64 | .319 | ↓ | | 87 | .514 | .230 | | |
| 65 | .528 | ↓ | | 88 | .737 | ↓ | | |
| 66 | .741 | ↓ | | 89 | .960 | ↓ | | |
| 67 | .948 | ↓ | | 90 | .496 | .368 | | |
| 68 | .081 | .635 | | 91 | .718 | ↓ | | |
| 69 | .292 | ↓ | | 92 | .940 | ↓ | | |
| 70 | .507 | ↓ | | | | | | |

x = Distance from airfoil leading edge

y = Distance from booster centerline

c = Local airfoil chord

b/2 = Booster wing semi-span 13,805 cm (5.435 in.) for wing taps

b/2 = Booster canard semi-span 6.071 cm (2.390 in.) for canard taps

TABLE IV (Concluded)
BOOSTER PRESSURE TAP LOCATIONS

| Surface | $(y/b/2)_B$ | Local Chord, cm | Local Chord, in. |
|-------------------------------|-------------|-----------------|------------------|
| Wing ↓ ↓ Canard ↓ | .221 | 8.387 | 3.302 |
| | .359 | 7.640 | 3.008 |
| | .497 | 6.962 | 2.741 |
| | .635 | 6.116 | 2.408 |
| | .773 | 5.301 | 2.087 |
| | .230 | 8.336 | 3.282 |
| | .368 | 7.564 | 2.978 |
| | .565 | 4.877 | 1.923 |
| | .879 | 4.877 | 1.923 |

TABLE V. DIMENSIONAL DATA

MODEL COMPONENT: BODY - MDAC Orbiter

GENERAL DESCRIPTION: Basic fuselage contours including canopy with modified aft fuselage cross sections; cross-sectional shape constant from station 1500 to end of fuselage - model scale 1/120.

DRAWING NUMBER: 255 BJ 00060, Rev. B

DIMENSIONS:

| | <u>FULL-SCALE</u> | <u>MODEL SCALE</u> |
|----------------------|-------------------|--------------------|
| Length | <u>156.4</u> | <u>.869</u> |
| Max. Width | <u>27.1</u> | <u>.150</u> |
| Max. Depth | <u>30.3</u> | <u>.168</u> |
| Fineness Ratio | <u> </u> | <u> </u> |
| Area | <u> </u> | <u> </u> |
| Max. Cross-Sectional | <u> </u> | <u> </u> |
| Planform | <u> </u> | <u> </u> |
| Wetted | <u> </u> | <u> </u> |
| Base | <u> </u> | <u> </u> |

TABLE V. (CONTINUED)

MODEL COMPONENT: Wing - NDAC Orbiter

GENERAL DESCRIPTION: Model Scale 1/180

DRAWING NUMBER: 255 BJ 00050, Rev. B

DIMENSIONS:

FULL-SCALE

MODEL SCALE

TOTAL DATA

| | | |
|------------------------------|---------|---------|
| Area, ft ² | | |
| Planform | | |
| Wetted | 5330.0 | .164 |
| Span (equivalent), ft | 97.5 | .542 |
| Aspect Ratio | 1.79 | 1.79 |
| Rate of Taper | | |
| Taper Ratio | .230 | .230 |
| Diehedral Angle, degrees | 10.0 | 10.0 |
| Incidence Angle, degrees | 2.0 | 2.0 |
| Aerodynamic Twist, degrees | 0 | 0 |
| Sweep Back Angles, degrees | | |
| Leading Edge | 55.0 | 55.0 |
| Trailing Edge | 0 | 0 |
| 0.25 Element Line | 47.0 | 47.0 |
| Chords: | | |
| Root (Wing Sta. 0.0), INCHES | 1021.8 | 6.027 |
| Tip, (equivalent), INCHES | 219.6 | 1.337 |
| MAC, inches | 754.3 | 4.193 |
| Fus. Sta. of .25 MAC | | |
| W.P. of .25 MAC | | |
| Airfoil Section | | |
| Root (B.L. 162) | 0010-64 | 0010-64 |
| Tip (B.L. 540) | 0009-64 | 0009-64 |

EXPOSED DATA

| | | |
|------------------------|--------|-------|
| Area, ft ² | 3147.3 | .097 |
| Span, (equivalent), ft | 70.5 | .392 |
| Aspect Ratio | 1.53 | 1.53 |
| Taper Ratio | | |
| Chords | | |
| Root, inches | 855.0 | 4.750 |
| Tip, inches | 219.6 | 1.337 |
| MAC | 607.2 | 3.373 |
| Fus. Sta. of .25 MAC | | |
| W.P. of .25 MAC | | |

TABLE V. (CONTINUED)

MODEL COMPONENT: Vertical Tail - MDAC Orbiter

GENERAL DESCRIPTION: Model Scale 1/180

DRAWING NUMBER: 255 BJ 00050, Rev. B

DIMENSIONS: FULL-SCALE MODEL SCALE

TOTAL DATA

| | | |
|----------------------------|----------------|----------------|
| Area, ft ² | | |
| Planform | <u>580.0</u> | <u>.013</u> |
| Wetted | | |
| Span (equivalent), ft. | <u>27.5</u> | <u>.153</u> |
| Aspect Ratio | | |
| Rate of Taper | | |
| Taper Ratio | <u>.638</u> | <u>.633</u> |
| Diehedral Angle, degrees | | |
| Incidence Angle, degrees | | |
| Aerodynamic Twist, degrees | | |
| Toe-In Angle | | |
| Cant Angle | | |
| Sweep Back Angles, degrees | | |
| Leading Edge | <u>30.0</u> | <u>30.0</u> |
| Trailing Edge | <u>13.1</u> | <u>13.1</u> |
| 0.25 Element Line | <u>26.2</u> | <u>26.2</u> |
| Chords: | | |
| Root, inches | <u>309.6</u> | <u>1.720</u> |
| Tip, (equivalent), inches | <u>196.3</u> | <u>1.093</u> |
| MAC, inches | <u>21.4</u> | <u>.119</u> |
| Fus. Sta. of .25 MAC | | |
| W.P. of .25 MAC | | |
| Airfoil Section | | |
| Root | <u>0009-64</u> | <u>0009-64</u> |
| Tip | <u>0009-64</u> | <u>0009-64</u> |

EXPOSED DATA

| | | |
|------------------------|--------------|--------------|
| Area, ft ² | <u>580.0</u> | <u>.018</u> |
| Span, (equivalent), ft | <u>27.5</u> | <u>.153</u> |
| Aspect Ratio | | |
| Taper Ratio | <u>.638</u> | <u>.638</u> |
| Chords: | | |
| Root, inches | <u>309.6</u> | <u>1.720</u> |
| Tip, inches | <u>196.3</u> | <u>1.093</u> |
| MAC, inches | <u>21.4</u> | <u>.119</u> |
| Fus. Sta. of .25 MAC | | |
| W.P. of .25 MAC | | |

TABLE V. (CONTINUED)

MODEL COMPONENT: BODY - MDAC Booster

GENERAL DESCRIPTION: Configuration 19A fuselage without base flare and boattail
Model Scale 1/180

DRAWING NUMBER: 256-19-0001, Rev. A

DIMENSIONS:

| | <u>FULL-SCALE</u> | <u>MODEL SCALE</u> |
|----------------------|-------------------|--------------------|
| Length (Ft) | <u>241.7</u> | <u>1.343</u> |
| Max. Width (Ft) | <u>34.0</u> | <u>.189</u> |
| Max. Depth (Ft) | <u>34.0</u> | <u>.189</u> |
| Fineness Ratio | <u> </u> | <u> </u> |
| Area | <u> </u> | <u> </u> |
| Max. Cross-Sectional | <u> </u> | <u> </u> |
| Planform | <u> </u> | <u> </u> |
| Wetted | <u> </u> | <u> </u> |
| Base | <u> </u> | <u> </u> |

TABLE V. (CONTINUED)

MODEL COMPONENT: Wing - MDAC Booster

GENERAL DESCRIPTION: Configuration 19A Wing

Model Scale 1/180

DRAWING NUMBER: _____

DIMENSIONS:

FULL-SCALE

MODEL SCALE

TOTAL DATA

| | | |
|------------------------------|---------|---------|
| Area, ft ² | | |
| Planform | 6020.0 | .136 |
| Wetted | | |
| Span (equivalent), ft. | 146.0 | .811 |
| Aspect Ratio | 3.54 | 3.54 |
| Rate of Taper | | |
| Taper Ratio | .435 | .435 |
| Dihedral Angle, degrees | 7.67 | 7.67 |
| Incidence Angle, degrees | 3.0 | 3.0 |
| Aerodynamic Twist, degrees | 0 | 0 |
| Sweep Back Angles, degrees | | |
| Leading Edge | 44.0 | 44.0 |
| Trailing Edge | | |
| 0.25 Element Line | | |
| Chords: | | |
| Root (Wing Sta. 0.0), inches | 690.0 | 3.833 |
| Tip, (equivalent) | 300.0 | 1.667 |
| MAC, inches | 520.0 | 2.889 |
| Fus. Sta. of .25 MAC, inches | 3625 | 20.139 |
| W.P. of .25 MAC, inches | | |
| B.L. of .25 MAC, inches | 380 | 2.111 |
| Airfoil Section | | |
| Root | 0010-64 | 0010-64 |
| Tip | 0010-64 | 0010-64 |

EXPOSED DATA

| | | |
|-------------------------|--------|-------|
| Area, ft ² | 4190.0 | .129 |
| Span, (equivalent), ft. | | |
| Aspect Ratio | | |
| Taper Ratio | | |
| Chords: | | |
| Root, inches | 594.0 | 3.300 |
| Tip, inches | 300.0 | 1.667 |
| MAC | | |
| Fus. Sta. of .25 MAC | | |
| W.P. of .25 MAC | | |

TABLE V. (CONTINUED)

MODEL COMPONENT: Canard - MDAC Booster

GENERAL DESCRIPTION: Configuration 19A Canard

Model Scale 1/180

DRAWING NUMBER: 256-19-001, Rev. A

DIMENSIONS:

| | <u>FULL-SCALE</u> | <u>MODEL SCALE</u> |
|------------------------------|-------------------|--------------------|
| Theo. Area, Ft ² | <u>1660</u> | <u>.051</u> |
| Exp Area, Ft ² | <u>1215</u> | <u>.038</u> |
| Aspect Ratio | <u>3.0</u> | <u>3.0</u> |
| Chord (Incl. Flap), Ft | <u>23.625</u> | <u>.131</u> |
| Airfoil (360 In. Theo Chord) | <u>63-018</u> | <u>63-018</u> |

NACA

NACA

TABLE VI. INDEX OF MODEL FIGURES

| FIGURE | | PAGE |
|--------|---|------|
| 1. | Pressure Tap Layout-Orbiter | 24 |
| 2. | Pressure Tap Layout-Booster | 25 |
| 3. | Modifications to Orbiter Model | 26 |
| 4. | Modifications to Booster Model | 27 |
| 5. | Model Separation Variables | 28 |
| 6. | Rear View of Models and Test Apparatus | 29 |
| 7. | Front View of Models and Test Apparatus | 30 |

TABLE VII. INDEX OF DATA FIGURES
 VOLUME I - PARTS A AND B

| TITLE | VEHICLE SECTION | TYPE OF PLOT | CONDITIONS VARYING | PAGES |
|---|-----------------|--------------|------------------------------|----------|
| (1) | | | | |
| <u>PART A</u> | | | | |
| Longitudinal Distribution of Booster Fuselage Pressures | Fuselage | CP vs. X/L | ALFB or BETA, THETA, MACH | 1-417 |
| Radial Distribution of Booster Base Pressures | Fuselage Base | CP vs. THETA | ALFB or BETA, MACH | 418-556 |
| <u>PART B</u> | | | | |
| Chordwise Distribution of Booster Canard Pressures | Canard | CP vs. X/C | ALFB or BETA, Y/B, MACH | 557-691 |
| Chordwise Distribution of Booster Upper and Lower Wing Pressures | Wing | CP vs. X/C | ALFB or BETA, Y/B, MACH | 692-1108 |

- Notes: (1) Conditions listed are those which vary in each dataset plotted.
 A complete list of configurations and varying parameters is given in Table II, "Pressure Dataset Collation Sheets".
- (2) Dataset plotting order for each section is numerical sequence of dataset identifier as listed in Table II.
- (3) The varying legend dimension for the fuselage, THETA, and for the canard, wing upper surface, and wing lower surface, Y/B, is plotted two values per page on side-by-side plot grids. The first value listed in the legend table under the dimension name corresponds to the data plotted on the left plot grid.

TABLE VII. INDEX OF DATA FIGURES

VOLUME II

| TITLE | VEHICLE SECTION | TYPE OF PLOT | CONDITIONS VARYING | PAGES |
|---|----------------------|---------------------|-------------------------|---------|
| Longitudinal Distribution of Orbiter Fuselage Pressures | Fuselage, Lower Wing | CP vs. X/L | ALFB or BETA, Y/B, MACH | 1-333 |
| | | | | |
| Longitudinal Distribution of Orbiter Upper Wing Pressures | Upper Wing | CP vs. X/L | ALFB or BETA, Y/B, MACH | 334-444 |
| | | | | |
| | Base | CP vs. ALFB or BETA | ALFB or BETA, MACH | 445-510 |

Notes: (1) Conditions listed are those which vary in each dataset plotted.

A complete list of configurations and varying parameters is given in Table II, "Pressure Dataset Collation Sheets".

(2) Dataset plotting order for fuselage and lower wing sections is FTCCOOL, HTCCOOL, FTCCO02, HTCCO02, etc., in **numerical sequence up to 11 datasets** for each section. Dataset plotting order for upper wing and base sections, individually, is numerical sequence of dataset identifier as listed in Table II.

(3) The varying legend dimension, Y/B, for the fuselage, lower wing, and upper wing sections is plotted two values per page on side-by-side plot grids. The first value listed in the legend table under the dimension name corresponds to the data plotted on the left plot grid.

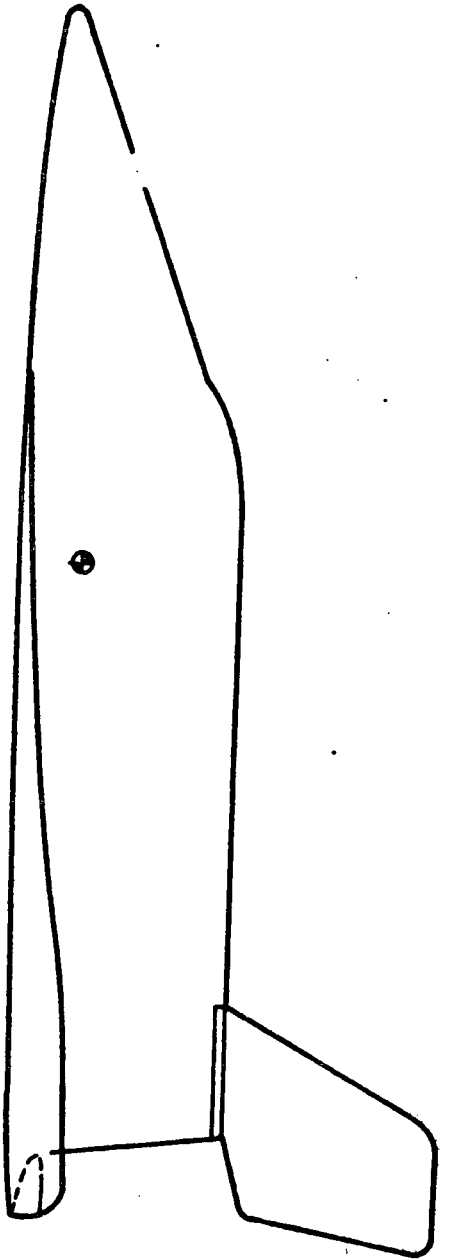

NOTE: Tap numbers in parentheses with solid symbols are on upper side of wing.

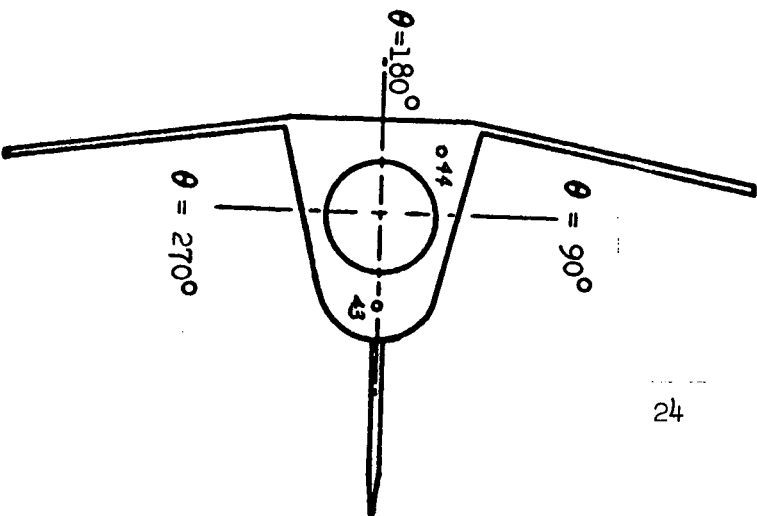
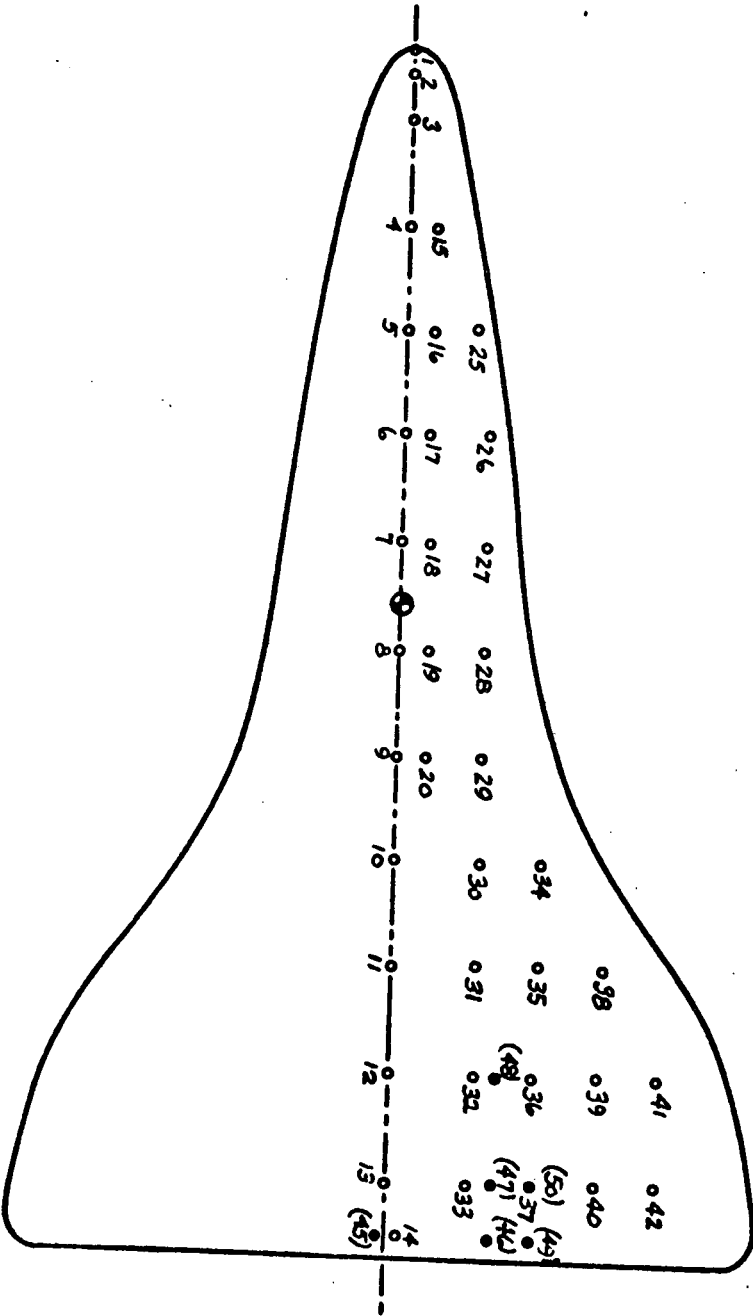

Fig. 1.- Pressure Tap Layout - Orbiter

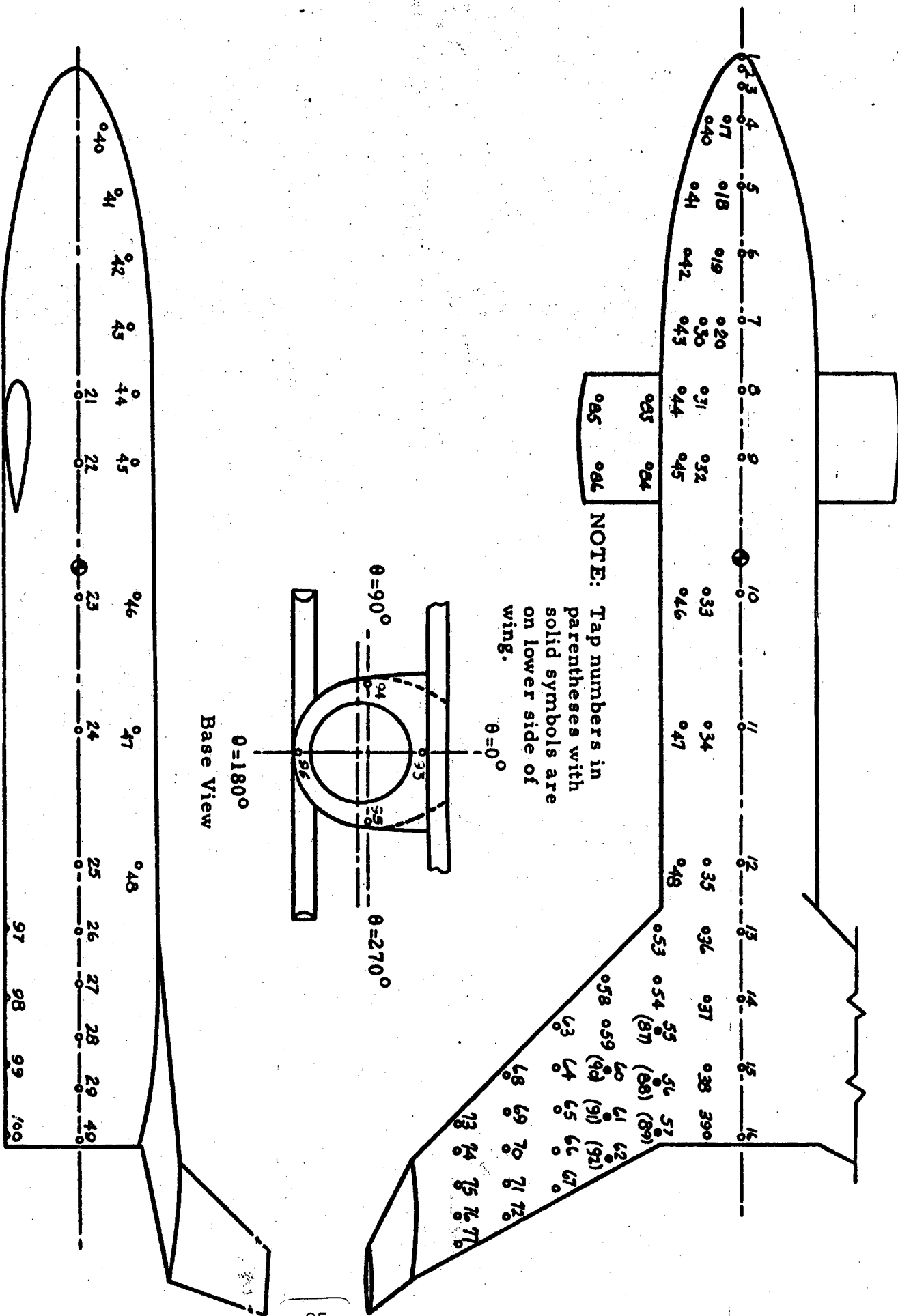

Fig. 2 - Pressure Tap Layout - Booster

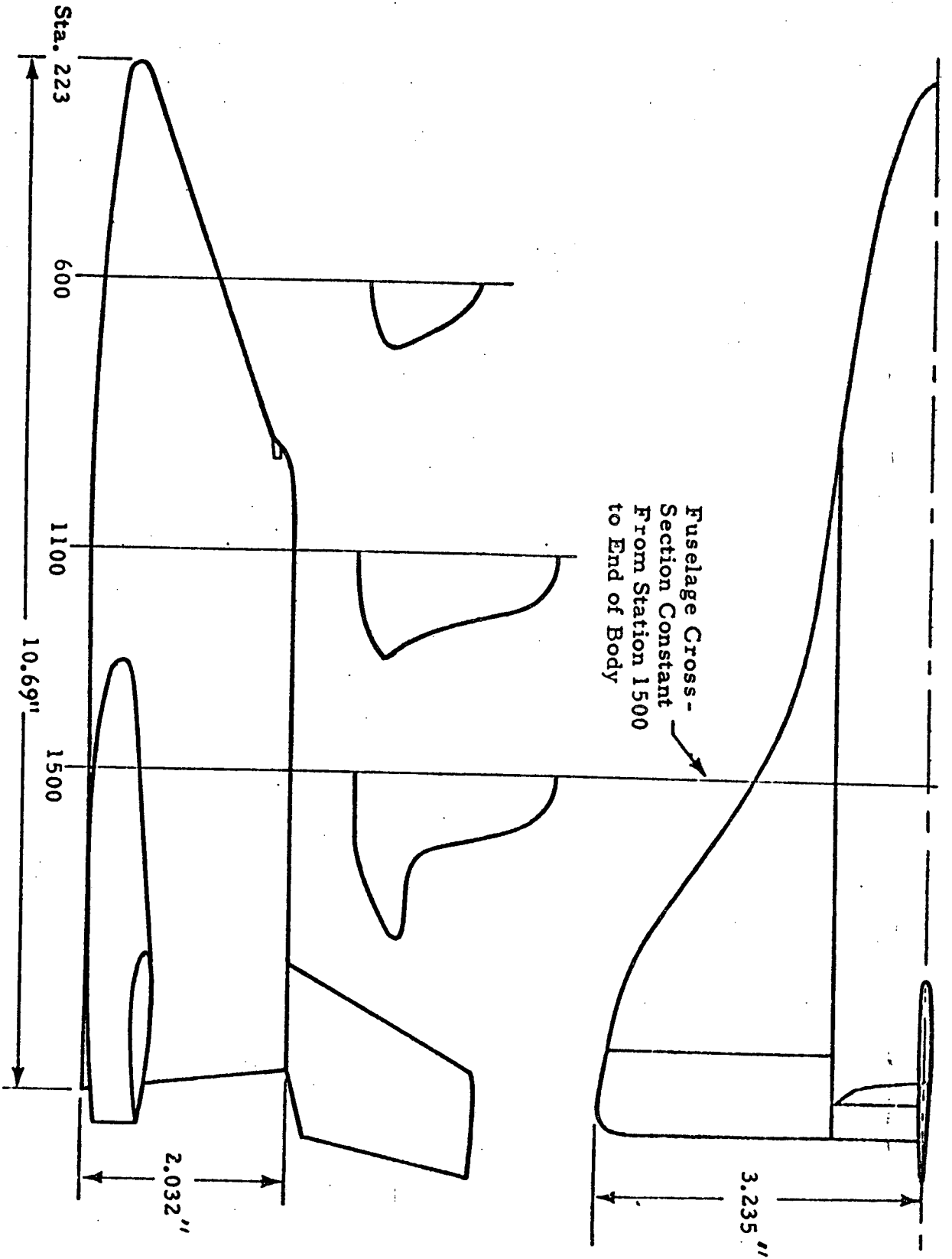

Fig. 3 - Modifications to Orbiter Model

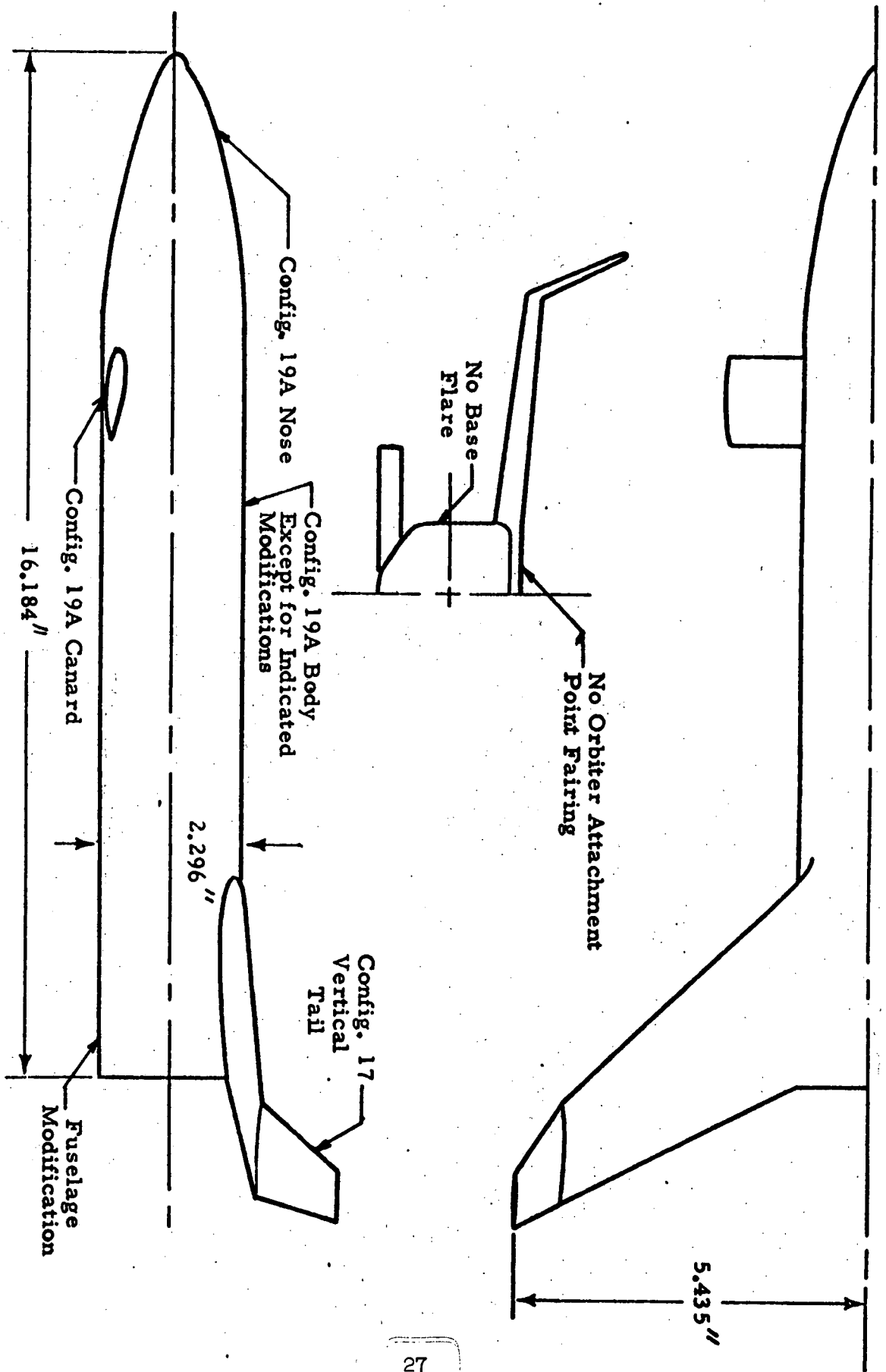

Fig. 4 - Modifications to Booster Model

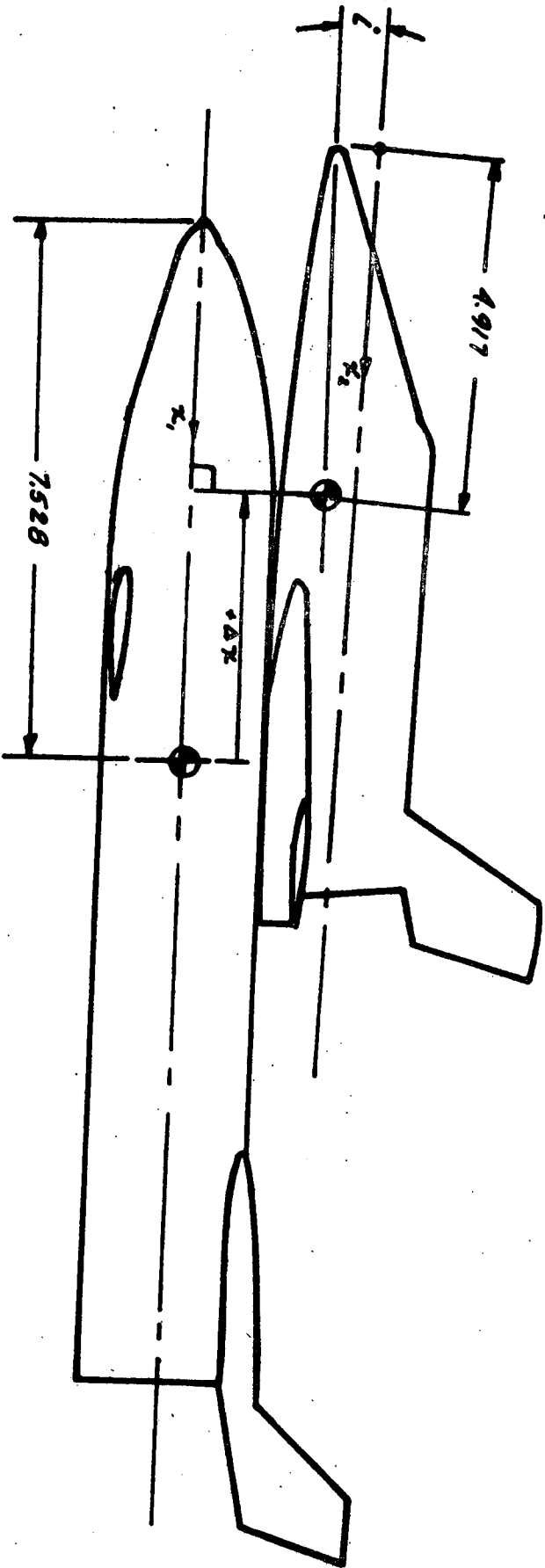
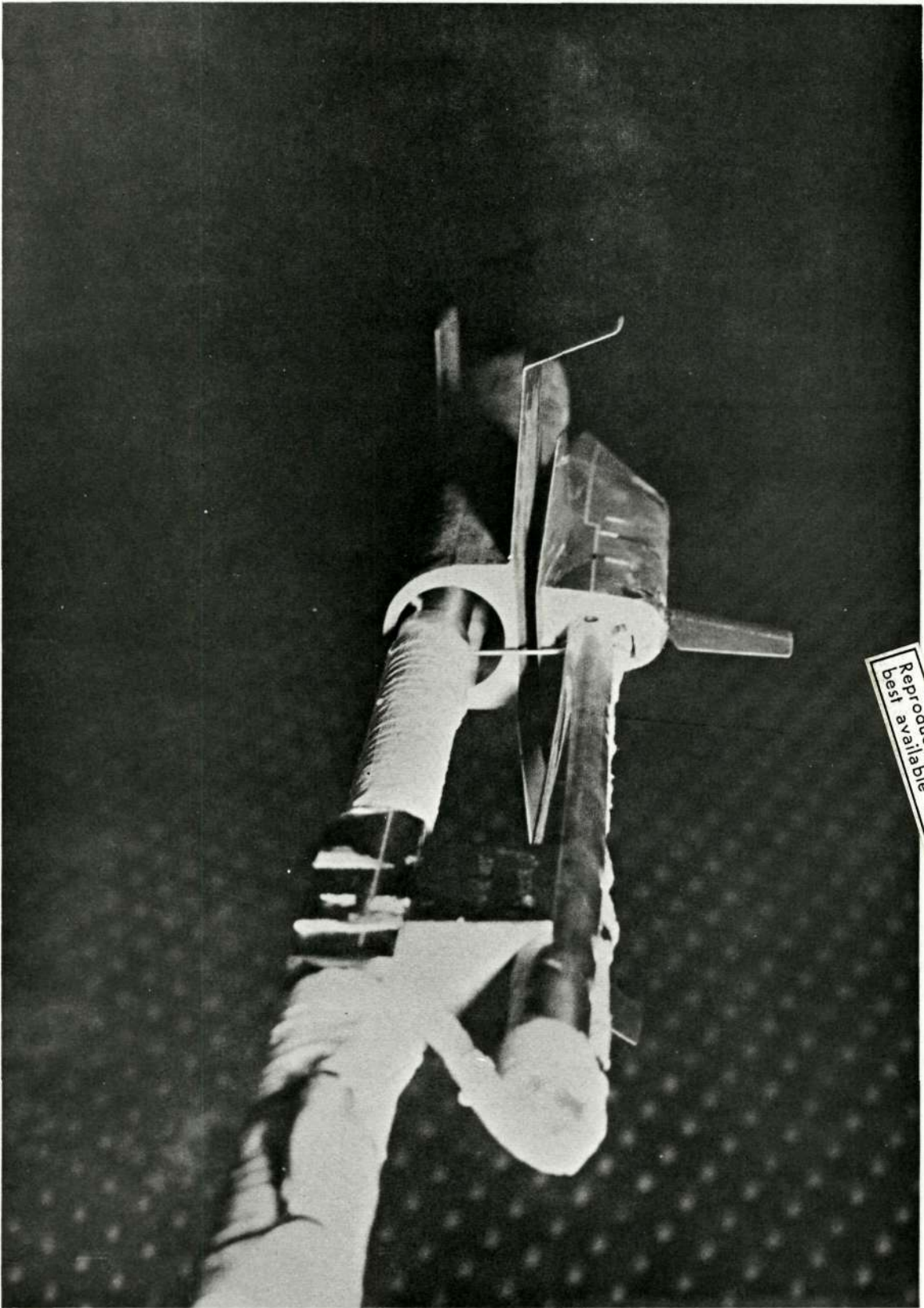

Figure 5: Model Separation Variables



Reproduced from
best available copy.

Figure 6. Rear View of Models and Test Apparatus



Figure 7. Front View of Models and Test Apparatus

D A T A F I G U R E S

Tabulations of the plotted data and corresponding source data are available from SADSAC Operations.

Preceding page blank

LONGITUDINAL DISTRIBUTION OF BOOSTER FUSELAGE PRESSURES

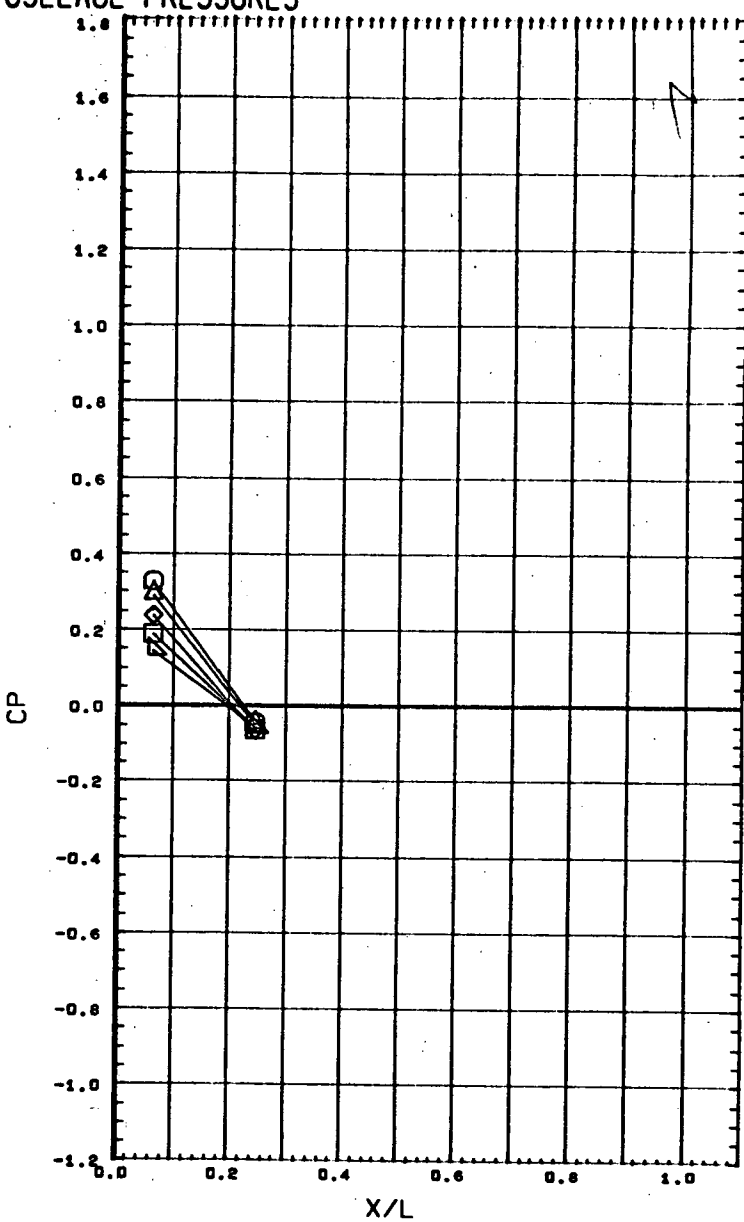
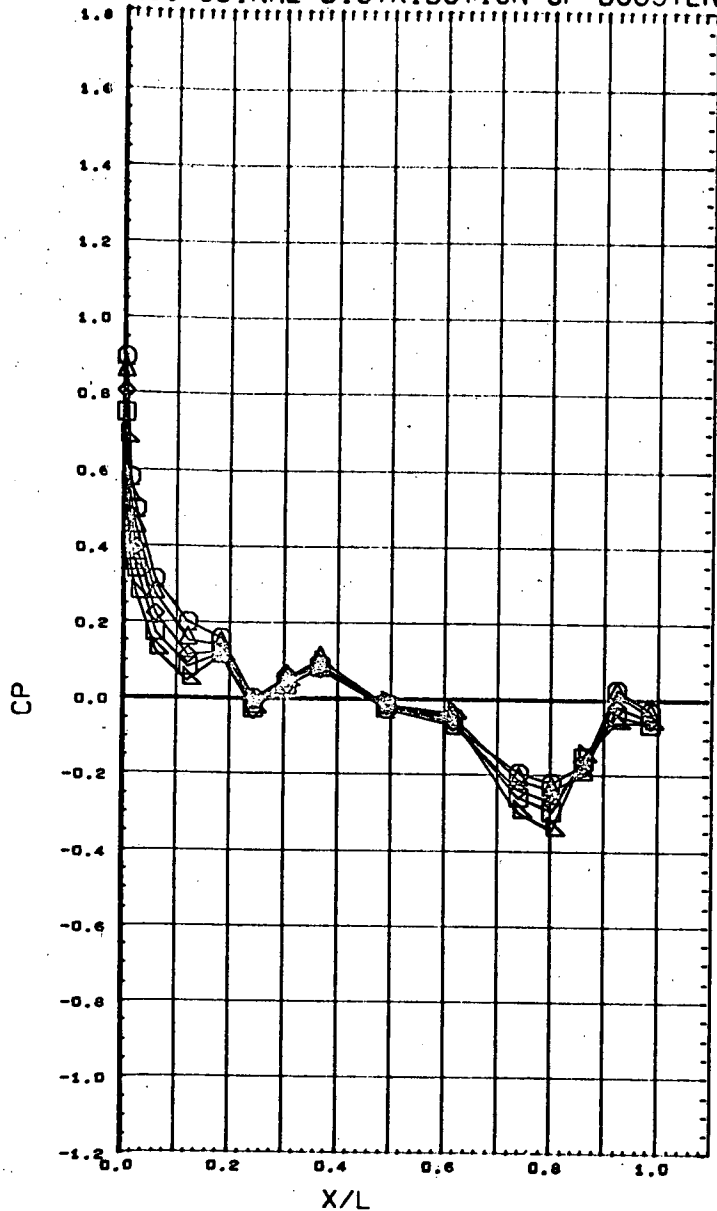

| SYMBOL | ALFB | THETA | M1 |
|--------|---------|--------|-------|
| ○ | - 7.935 | 0.000 | 0.600 |
| ◇ | - 5.896 | 15.000 | |
| △ | - 4.415 | | |
| □ | - 2.278 | | |
| ◇ | 0.122 | | |

REFERENCE FILE

| PARAMETRIC VALUES | | | |
|-------------------|-------|------|-------|
| BETA | 0.000 | DX/L | 0.000 |
| I | 0.000 | | |

AEDC TC174 MDAC BOOSTER NEAR ORBITER (BODY)

(ATC001)

PAGE 1

PRECEDING PAGE BLANK NOT FILMED

LONGITUDINAL DISTRIBUTION OF BOOSTER FUSELAGE PRESSURES

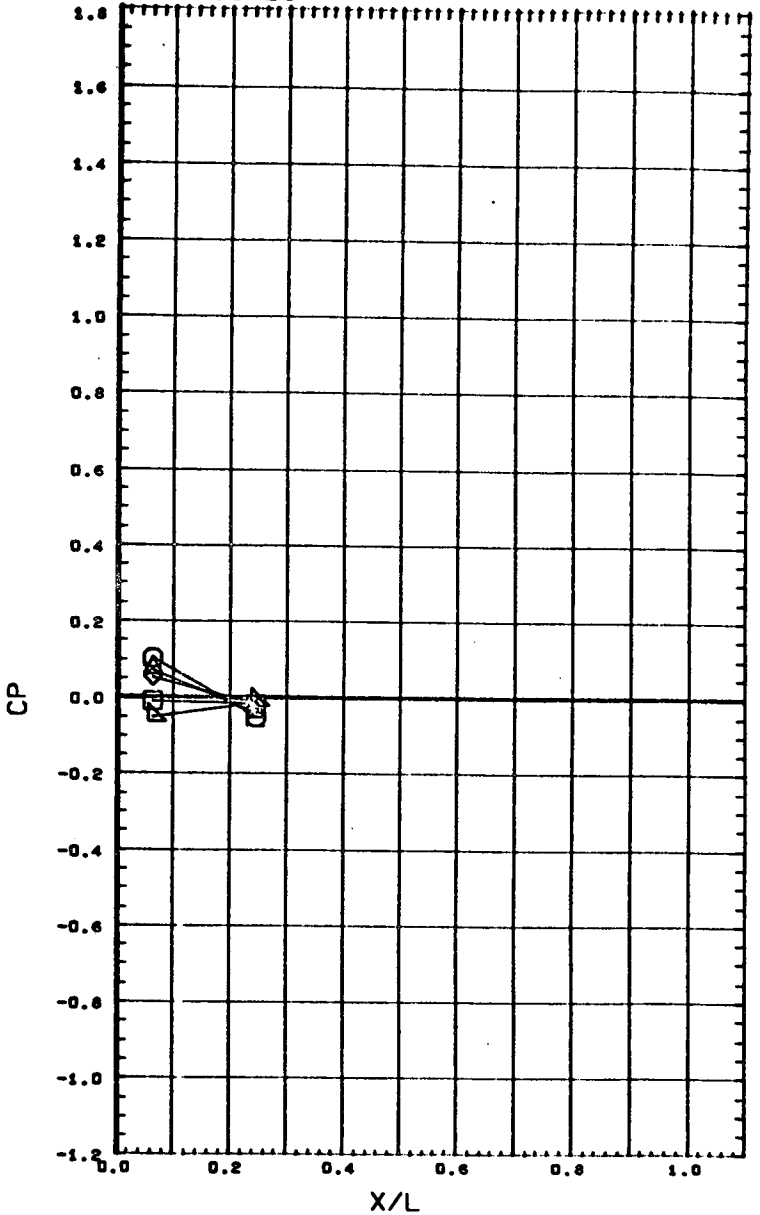
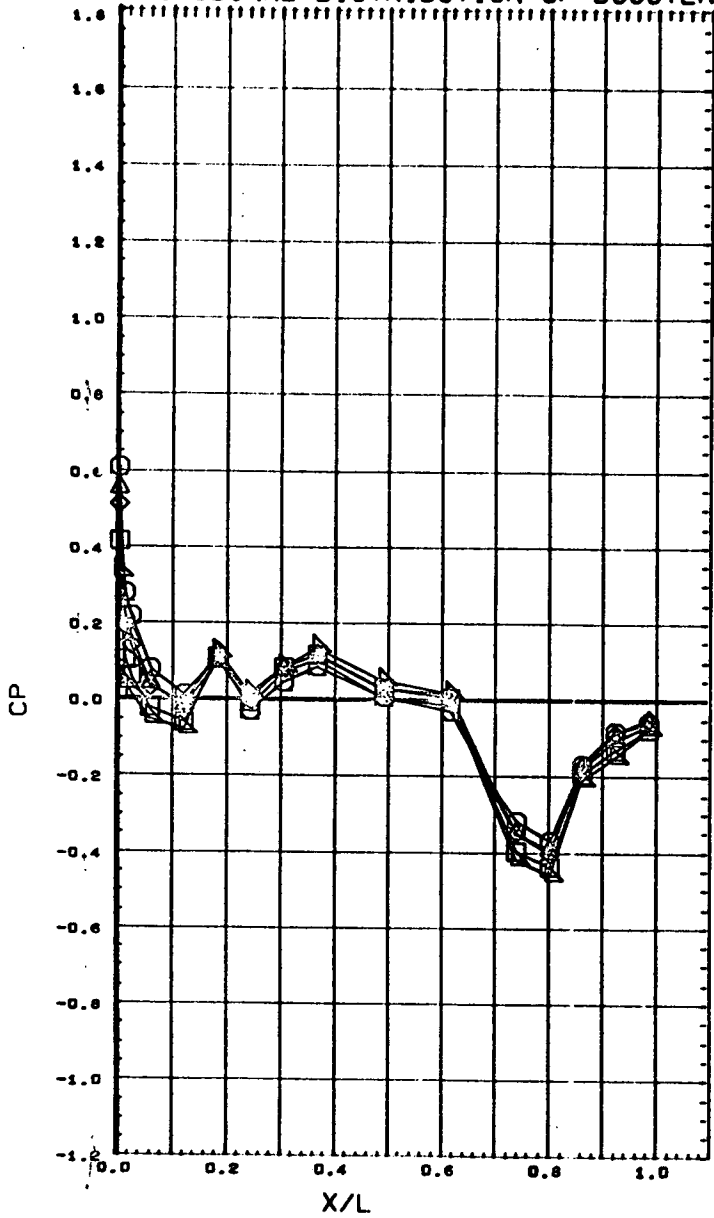

| SYMBOL | ALFB | THETA | M1 |
|--------|--------|--------|-------|
| ○ | 2.077 | 0.000 | 0.600 |
| △ | 4.089 | 15.000 | |
| ◇ | 5.583 | | |
| □ | 8.037 | | |
| ▽ | 10.078 | | |

REFERENCE FILE

| PARAMETRIC VALUES | | |
|-------------------|-------|-------|
| BETA | 0.000 | 0.000 |
| I | 0.000 | |

LONGITUDINAL DISTRIBUTION OF BOOSTER FUSELAGE PRESSURES

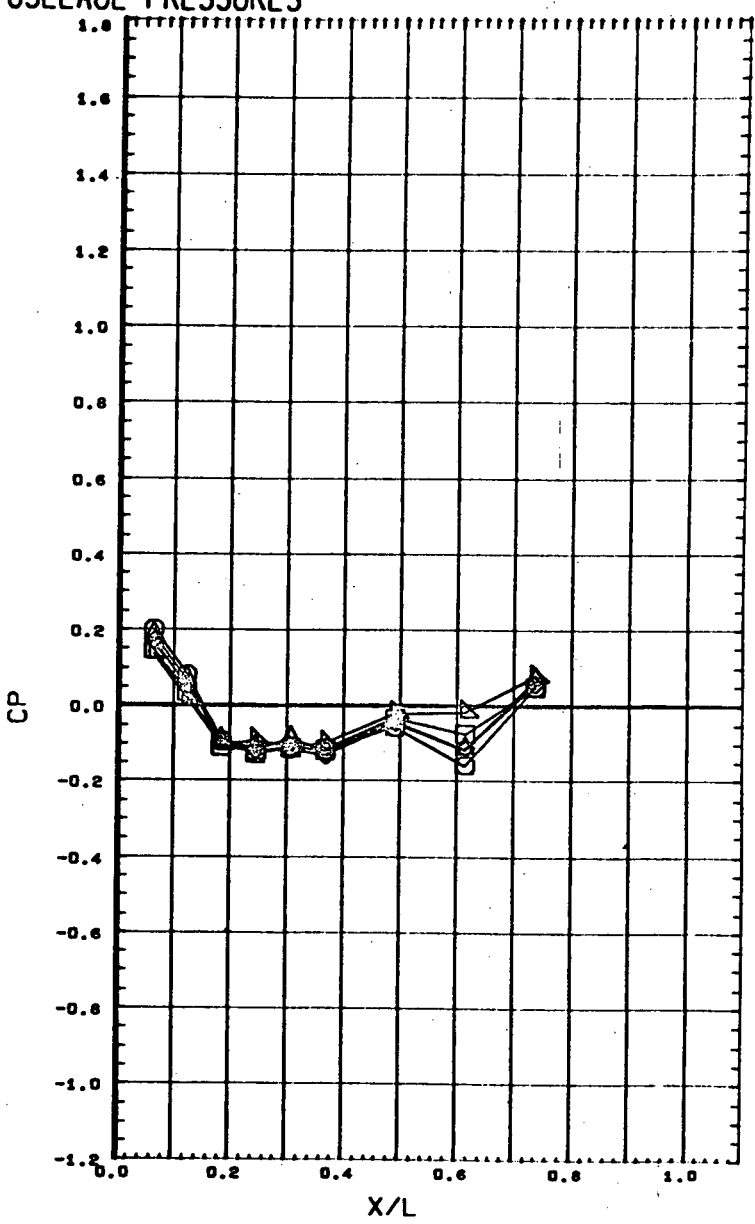
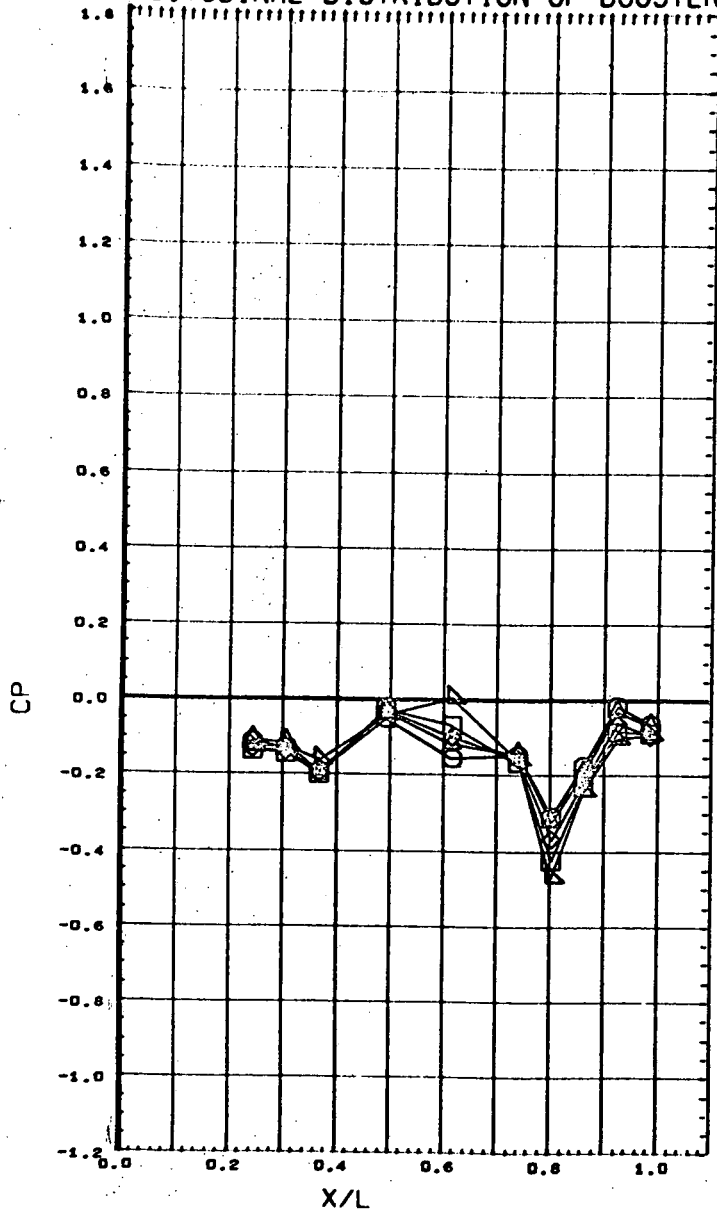

| SYMBOL | ALFB | THETA | M1 |
|--------|-------|--------|-------|
| ○ | 7.935 | 24.000 | 0.600 |
| △ | 5.896 | 45.000 | |
| ◇ | 4.415 | | |
| □ | 2.278 | | |
| ◇ | 0.122 | | |

| PARAMETRIC VALUES | | |
|-------------------|-------|-------|
| BETA | 0.000 | DX/L |
| I | 0.000 | 0.000 |

REFERENCE FILE

LONGITUDINAL DISTRIBUTION OF BOOSTER FUSELAGE PRESSURES

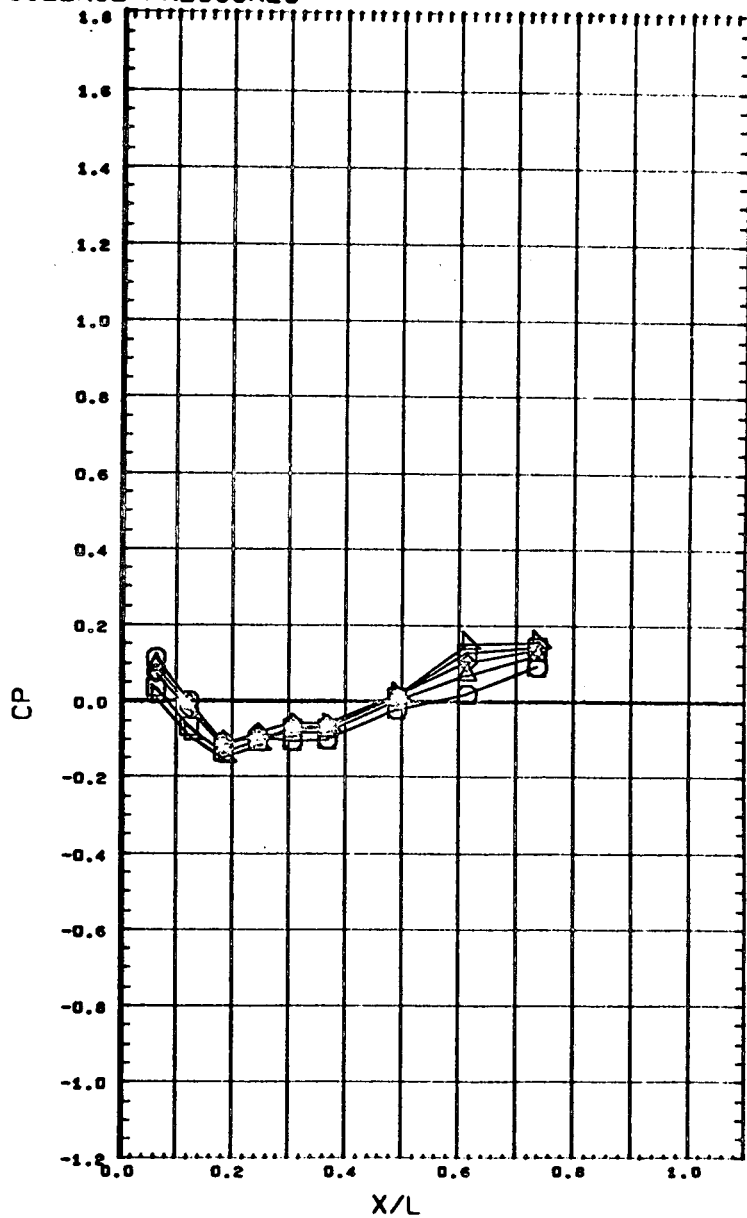
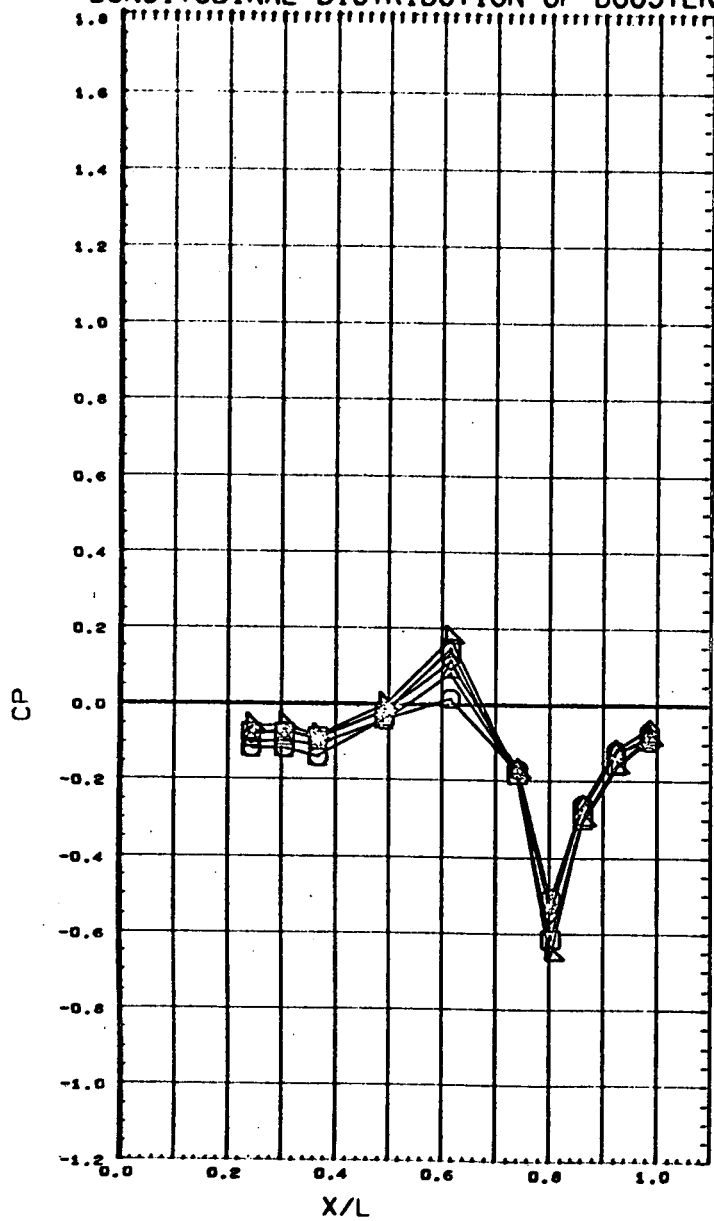

| SYMBOL | ALFB | THETA | M1 |
|--------|--------|--------|-------|
| ○ | 2.077 | 24.000 | 0.600 |
| ◇ | 4.089 | 45.000 | |
| △ | 5.583 | | |
| □ | 8.037 | | |
| ▽ | 10.078 | | |

| PARAMETRIC VALUES | | |
|-------------------|-------|-------|
| BETA | 0.000 | DX/L |
| I | 0.000 | 0.000 |

REFERENCE FILE

LONGITUDINAL DISTRIBUTION OF BOOSTER FUSELAGE PRESSURES

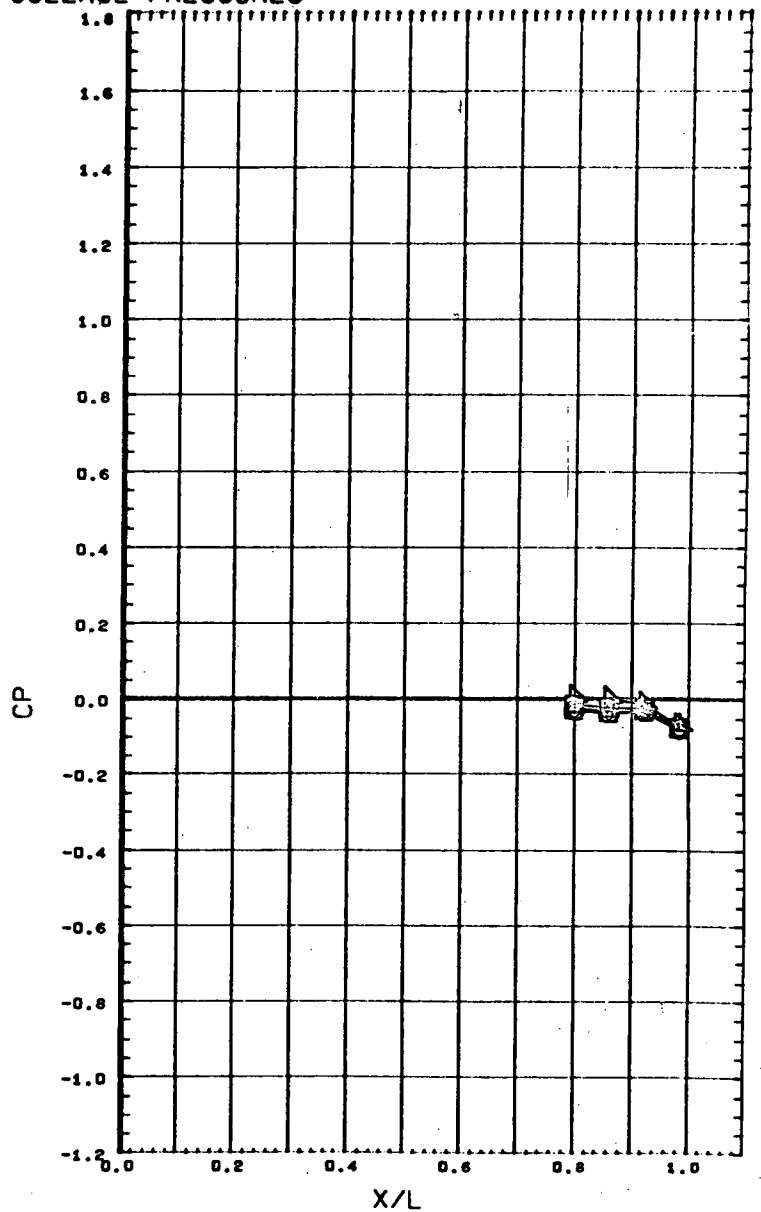
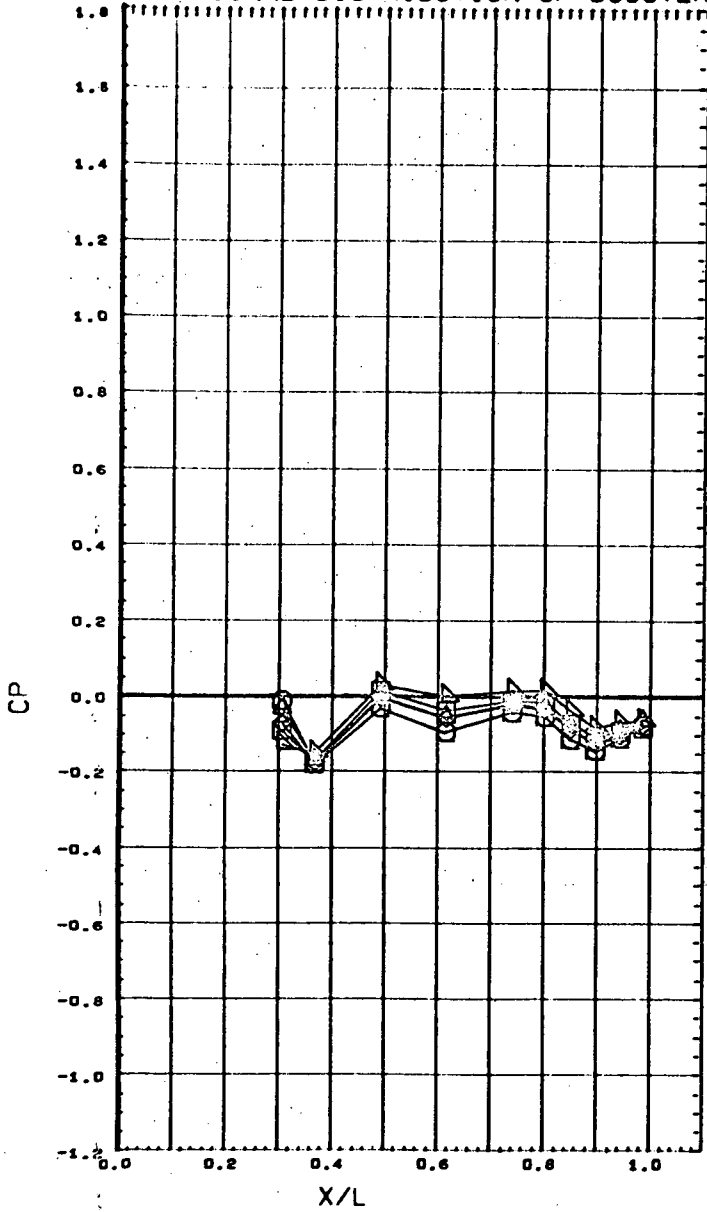

| SYMBOL | ALFB | THETA | M1 |
|--------|-------|---------|-------|
| ○ | 7.935 | 90.000 | 0.600 |
| △ | 5.896 | 180.000 | |
| ◇ | 4.415 | | |
| □ | 2.278 | | |
| ▽ | 0.122 | | |

| PARAMETRIC VALUES | | | |
|-------------------|-------|------|-------|
| BETA | 0.000 | OX/L | 0.000 |
| I | 0.000 | | |

REFERENCE FILE

LONGITUDINAL DISTRIBUTION OF BOOSTER FUSELAGE PRESSURES

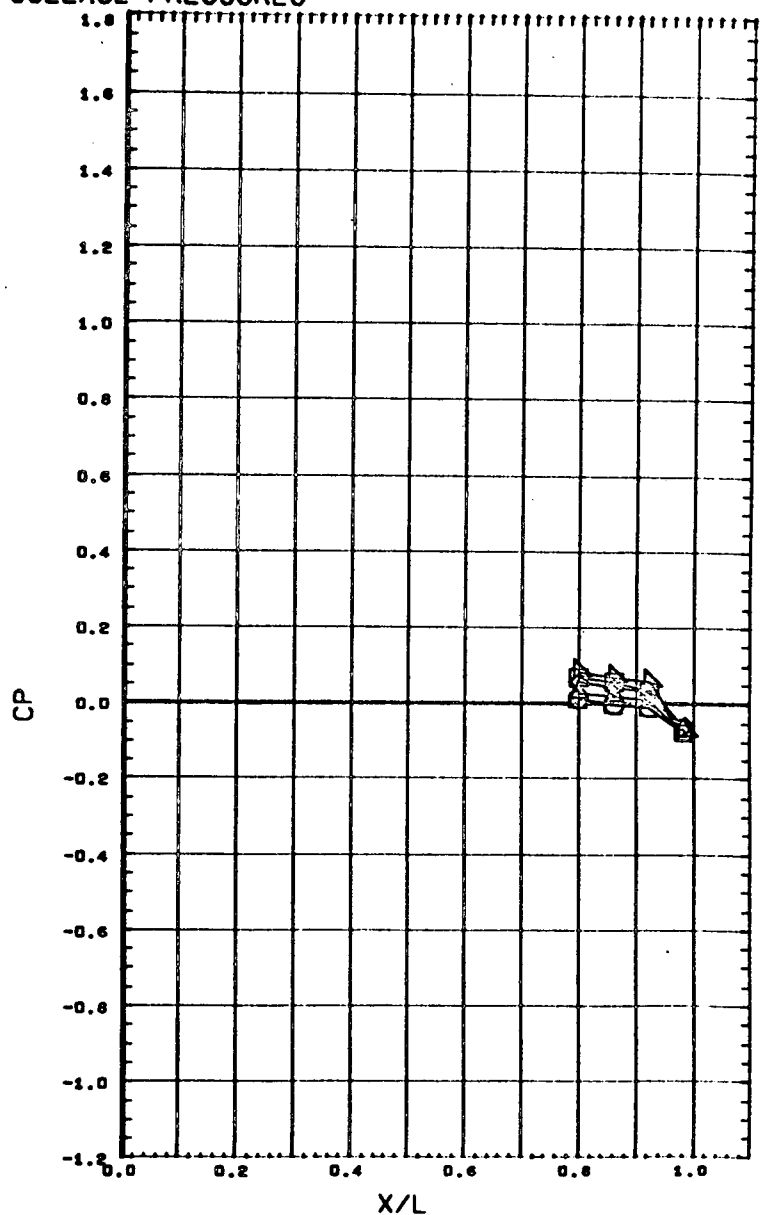
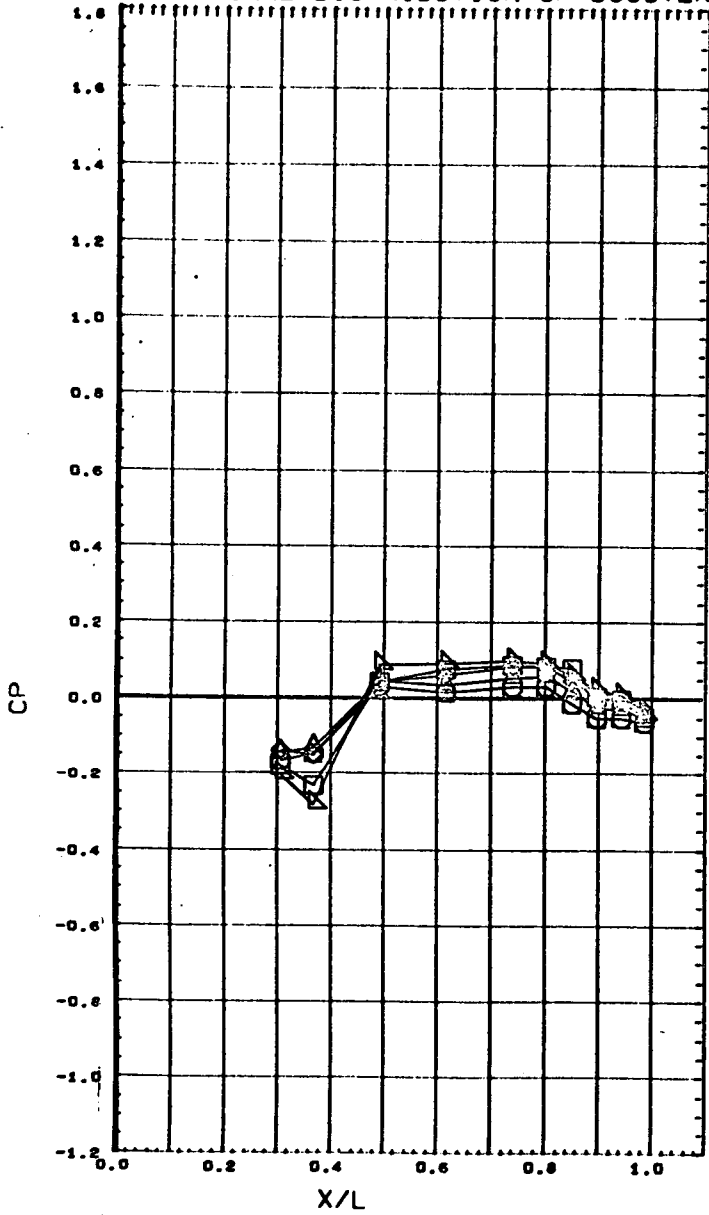

| SYMBOL | ALFB | THETA | M1 |
|--------|--------|---------|-------|
| ○ | 2.077 | 90.000 | 0.600 |
| ◇ | 4.069 | 180.000 | |
| △ | 5.583 | | |
| □ | 6.037 | | |
| ○ | 10.078 | | |

REFERENCE FILE

| PARAMETRIC VALUES | | | |
|-------------------|-------|------|-------|
| BETA | 0.000 | DX/L | 0.000 |
| I | 0.000 | | |

LONGITUDINAL DISTRIBUTION OF BOOSTER FUSELAGE PRESSURES

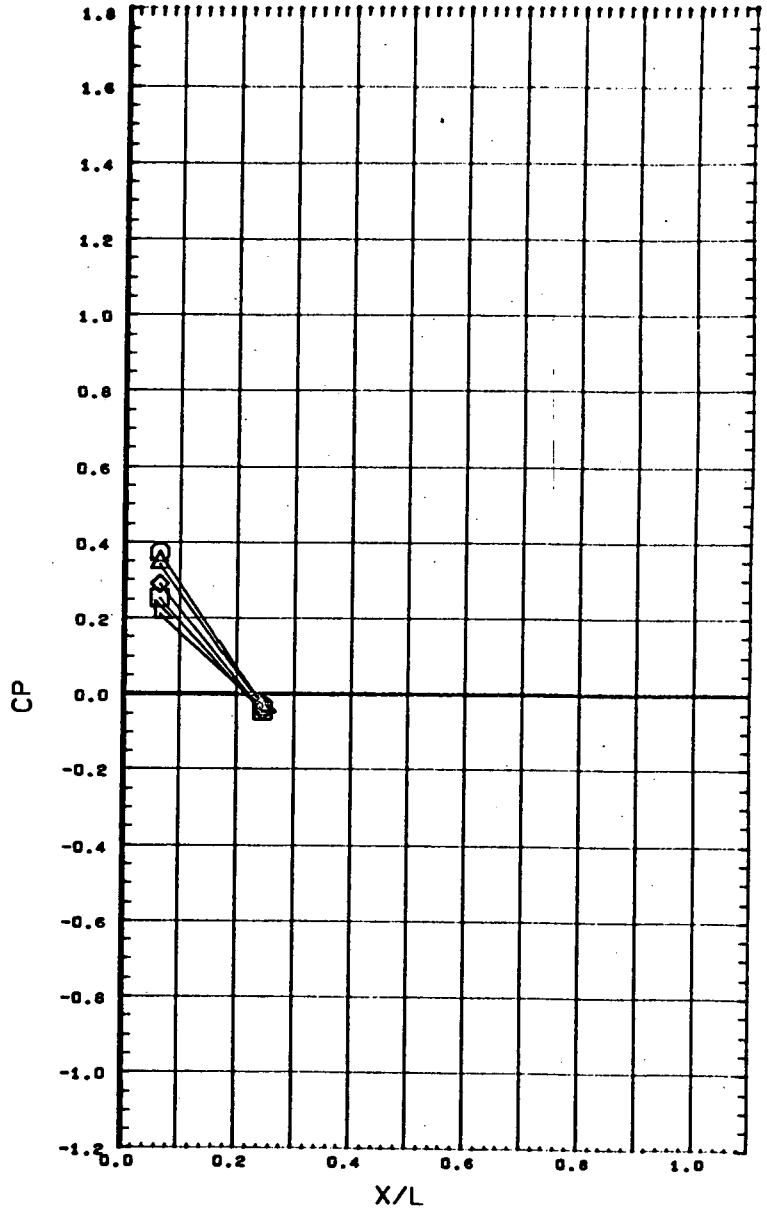
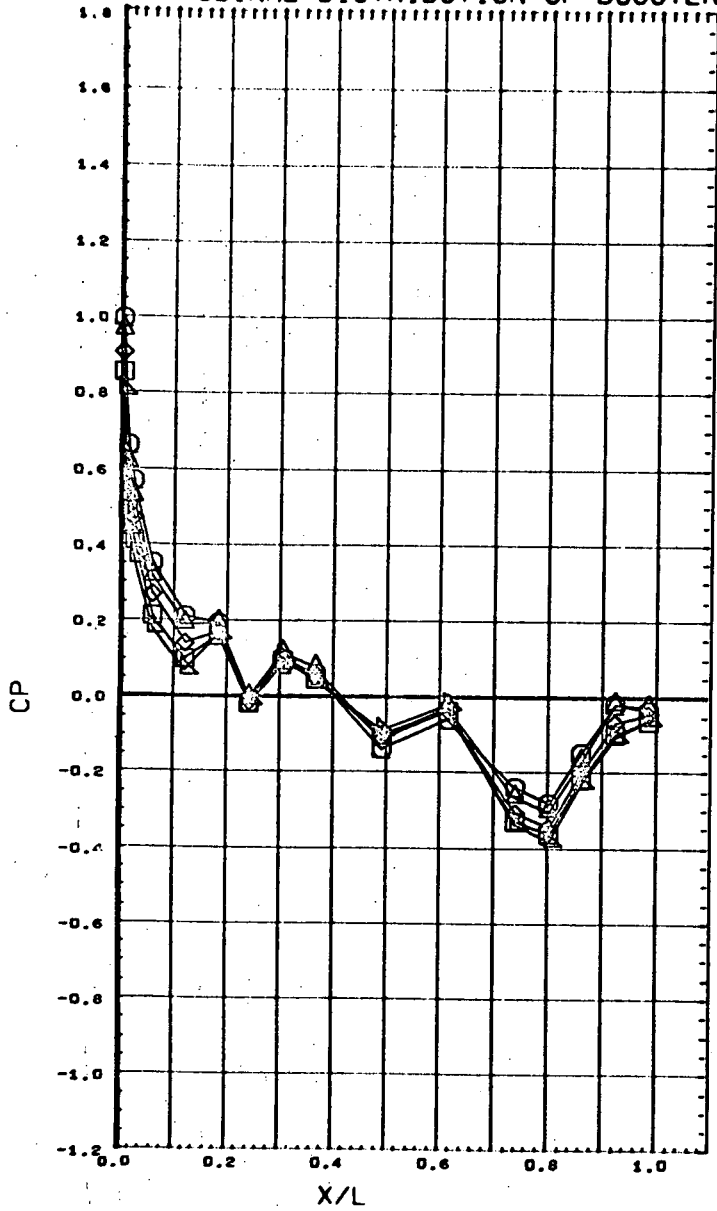

| SYMBOL | ALFB | THETA | M1 |
|--------|-------|--------|-------|
| ○ | 8.137 | 0.000 | 0.894 |
| △ | 5.856 | 15.000 | |
| ◇ | 3.631 | | |
| □ | 1.836 | | |
| ◇ | 0.154 | | |

| PARAMETRIC VALUES | | | |
|-------------------|-------|------|-------|
| BETA | 0.000 | DX/L | 0.000 |
| I | 0.000 | | |

REFERENCE FILE

AEDC TC174 MDAC BOOSTER NEAR ORBITER (BODY)

(ATC001)

PAGE 7

LONGITUDINAL DISTRIBUTION OF BOOSTER FUSELAGE PRESSURES

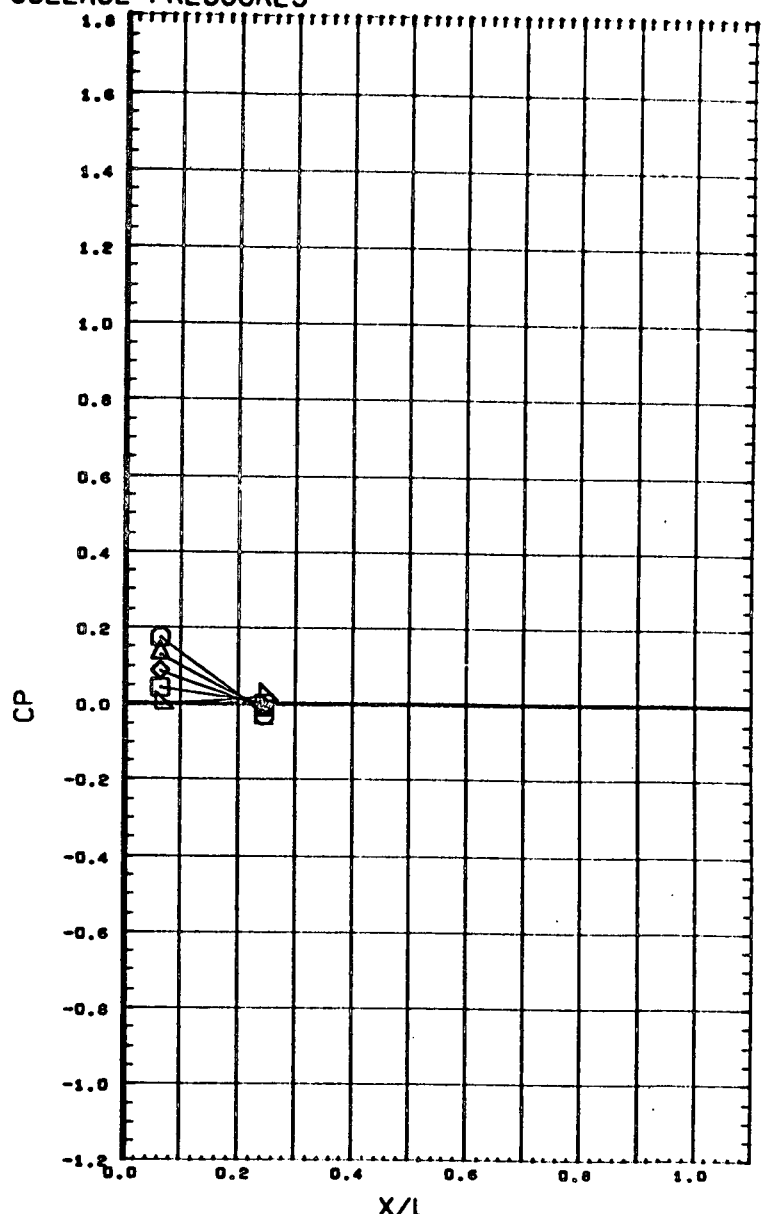
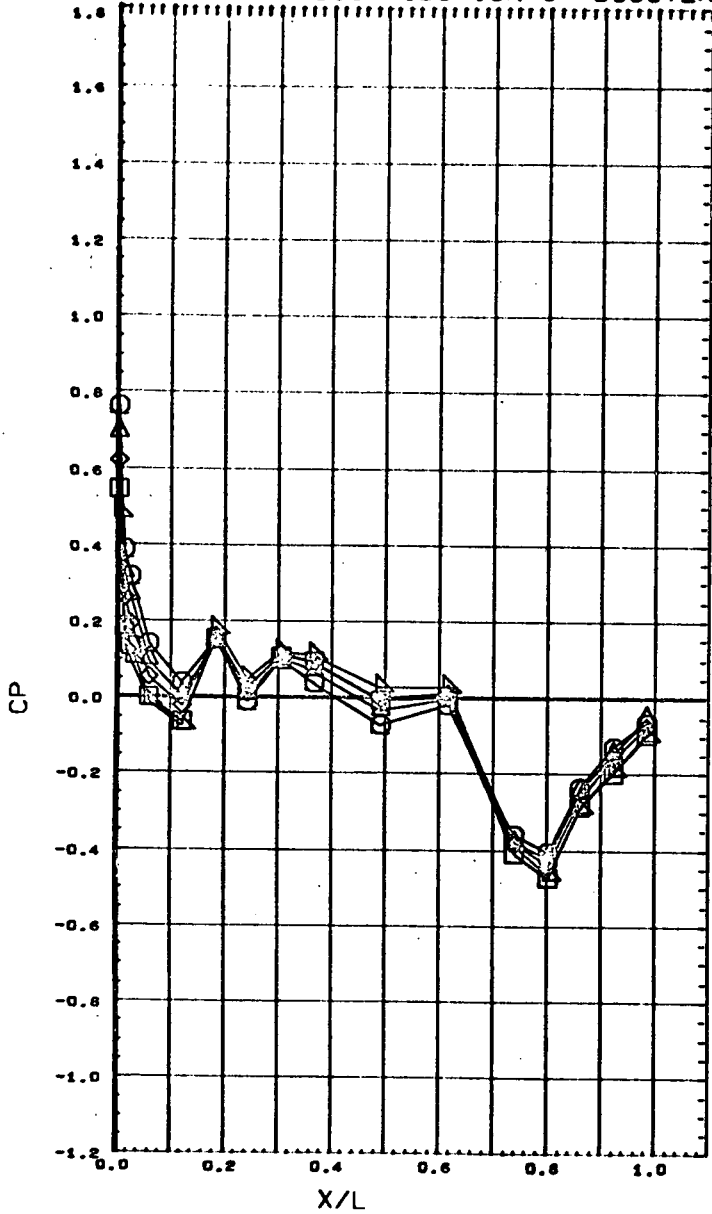

| SYMBOL | ALFB | THETA | M1 |
|--------|--------|--------|-------|
| ○ | 1.547 | 0.000 | 0.894 |
| △ | 3.746 | 15.000 | |
| ◇ | 6.129 | | |
| □ | 8.138 | | |
| ▽ | 10.120 | | |

| PARAMETRIC VALUES | | | |
|-------------------|-------|------|-------|
| BETA | 0.000 | DX/L | 0.000 |
| I | 0.000 | | |

REFERENCE FILE

LONGITUDINAL DISTRIBUTION OF BOOSTER FUSELAGE PRESSURES

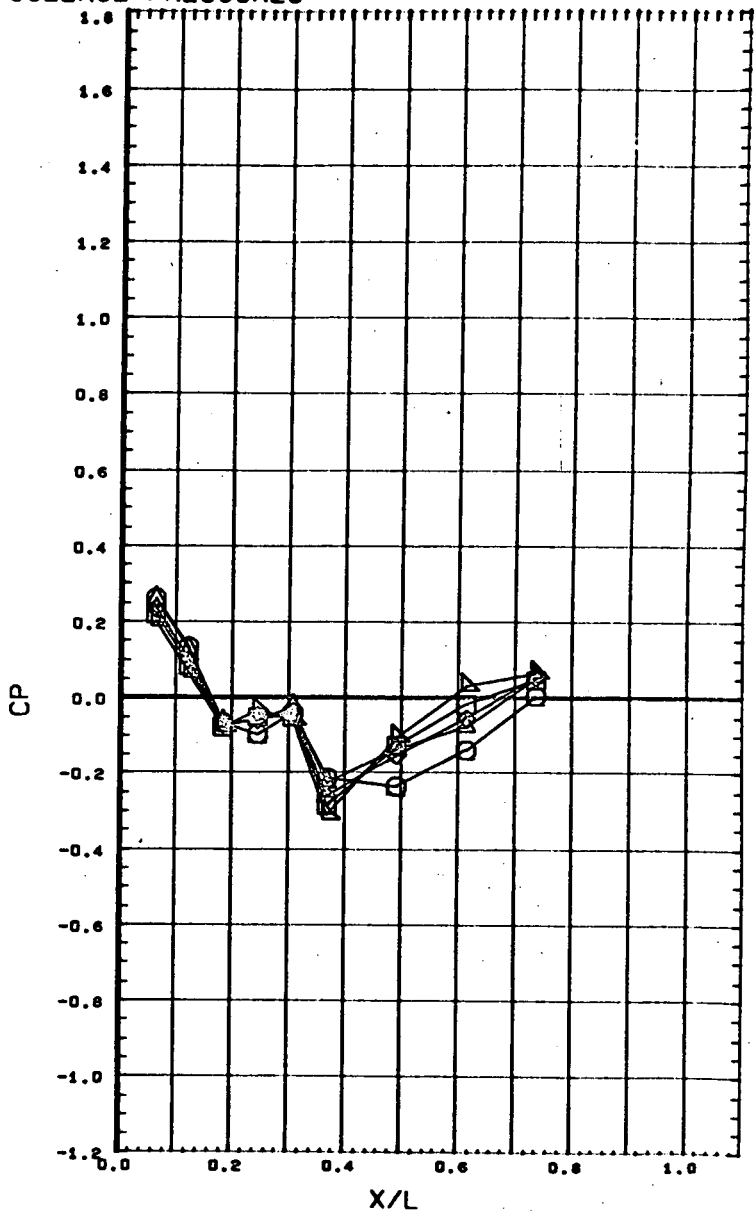
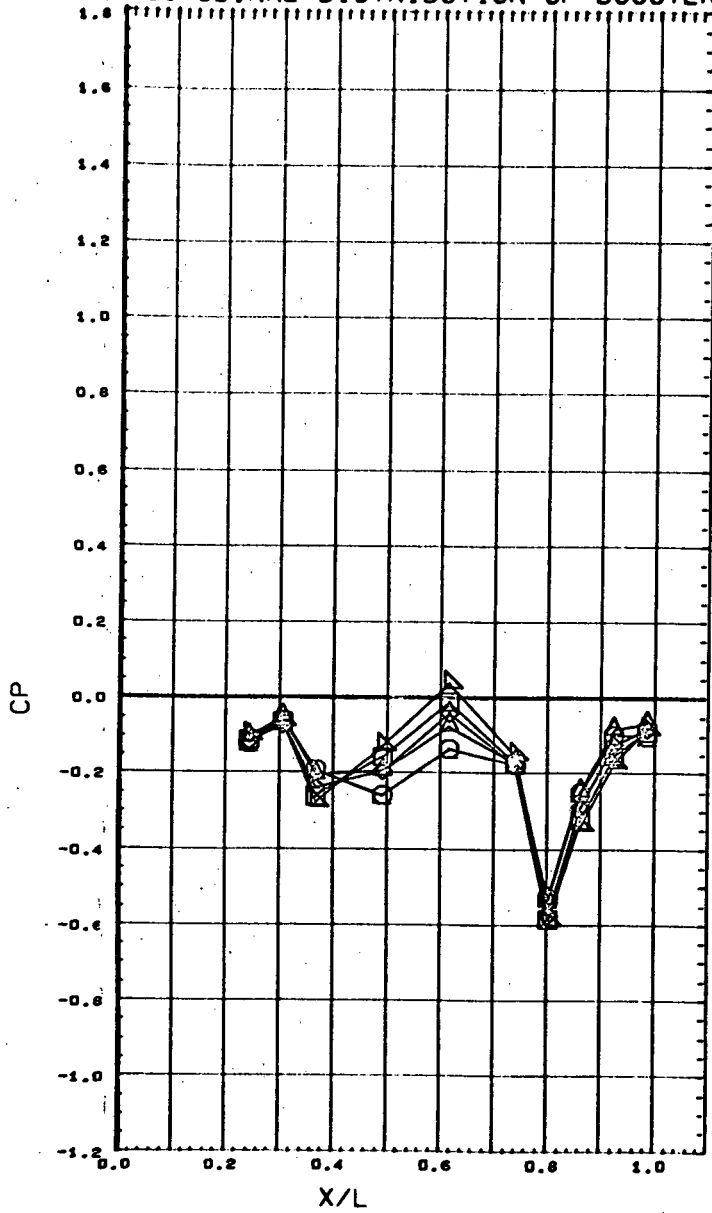

| SYMBOL | ALFB | THETA | M1 |
|--------|-------|--------|-------|
| ○ | 8.137 | 24.000 | 0.894 |
| ◇ | 5.806 | 45.000 | |
| △ | 3.831 | | |
| □ | 1.836 | | |
| ○ | 0.154 | | |

REFERENCE FILE

| PARAMETRIC VALUES | | | |
|-------------------|-------|------|-------|
| BETA | 0.000 | OX/L | 0.000 |
| I | 0.000 | | |

LONGITUDINAL DISTRIBUTION OF BOOSTER FUSELAGE PRESSURES

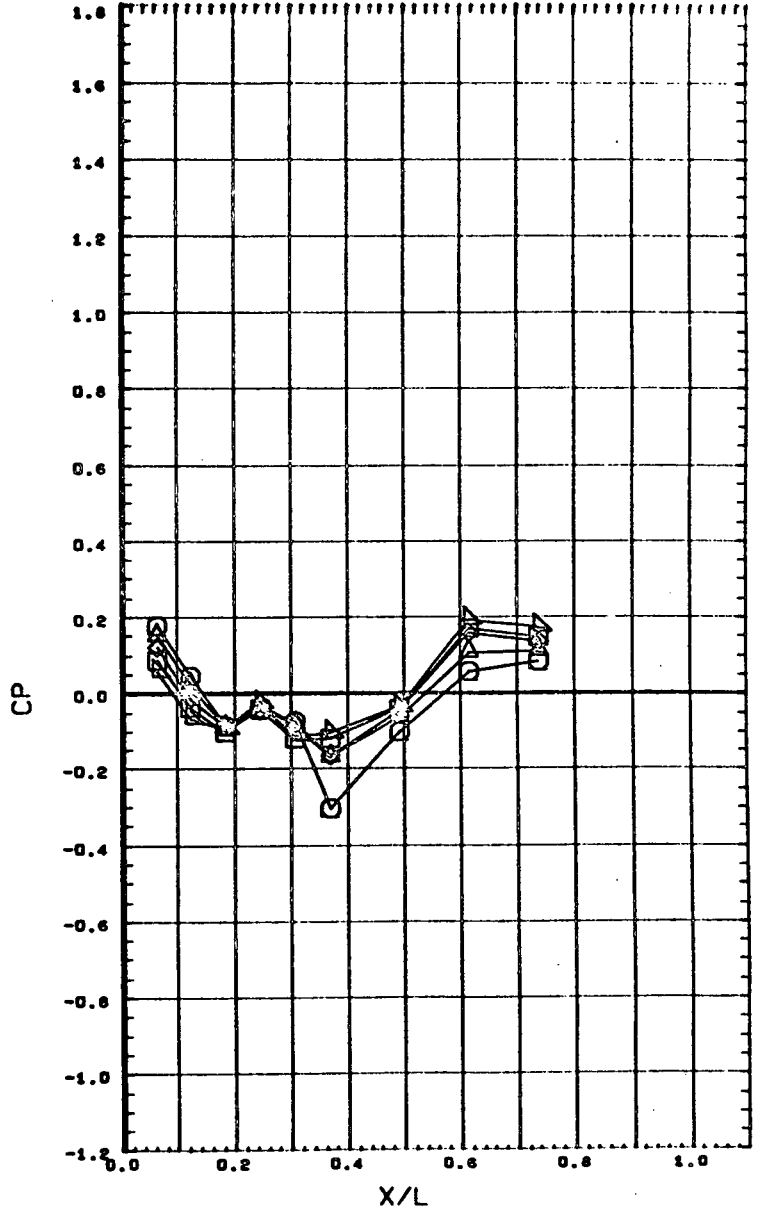
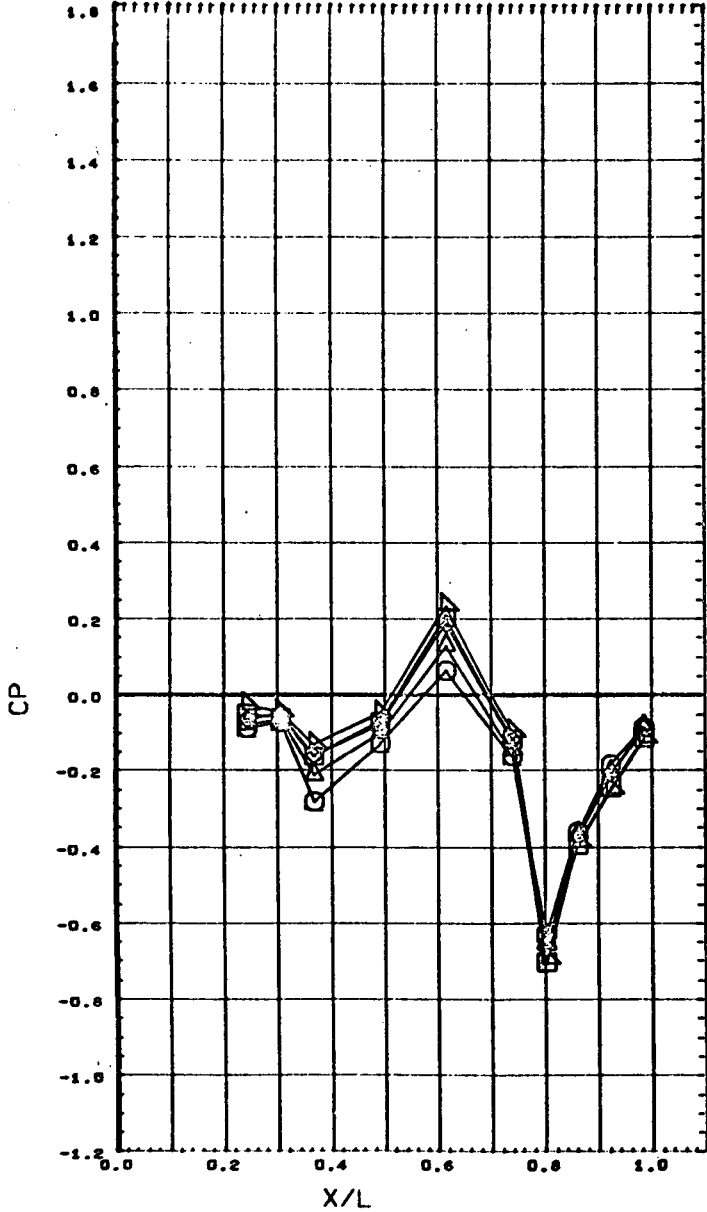

| SYMBOL | ALFB | THETA | M1 |
|--------|--------|--------|-------|
| ◇ | 1.547 | 24.000 | 0.894 |
| ◇ | 3.746 | 45.000 | |
| ◇ | 6.129 | | |
| ◇ | 8.138 | | |
| ◇ | 10.120 | | |

| PARAMETRIC VALUES | | |
|-------------------|-------|-------|
| BETA | 0.000 | DX/L |
| I | 0.000 | 0.000 |

REFERENCE FILE

LONGITUDINAL DISTRIBUTION OF BOOSTER FUSELAGE PRESSURES

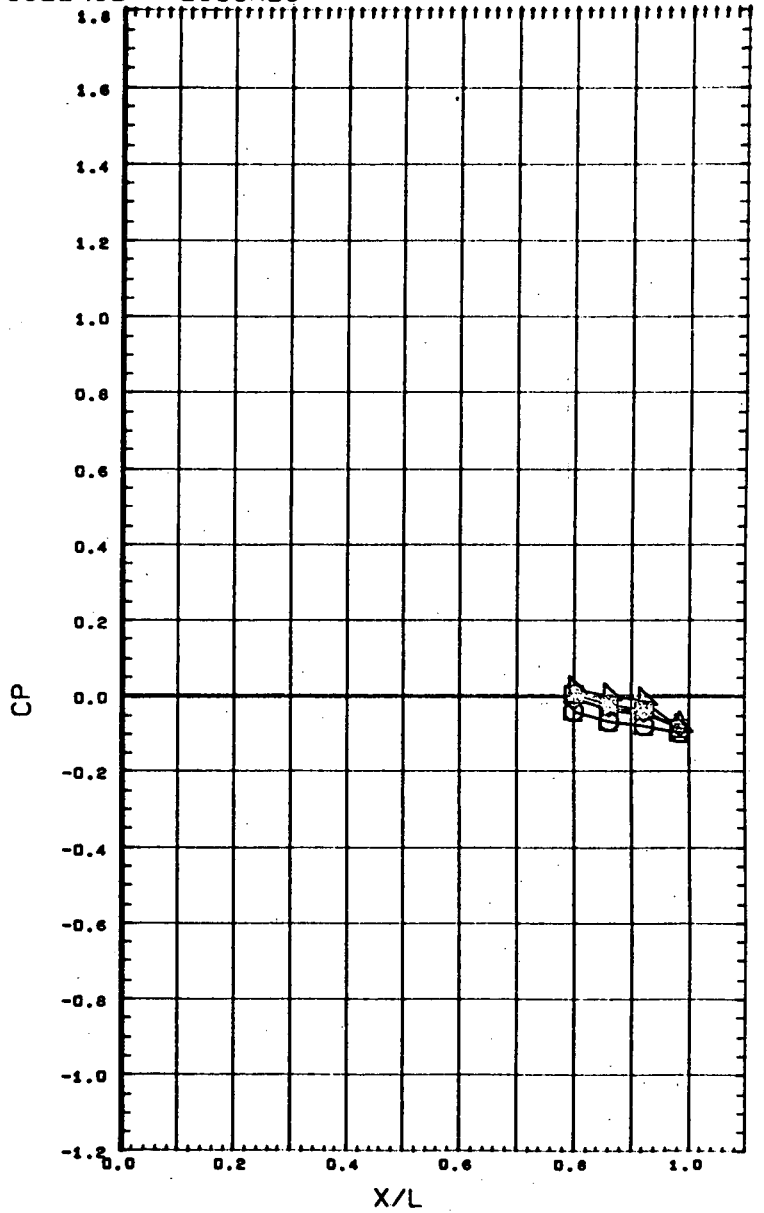
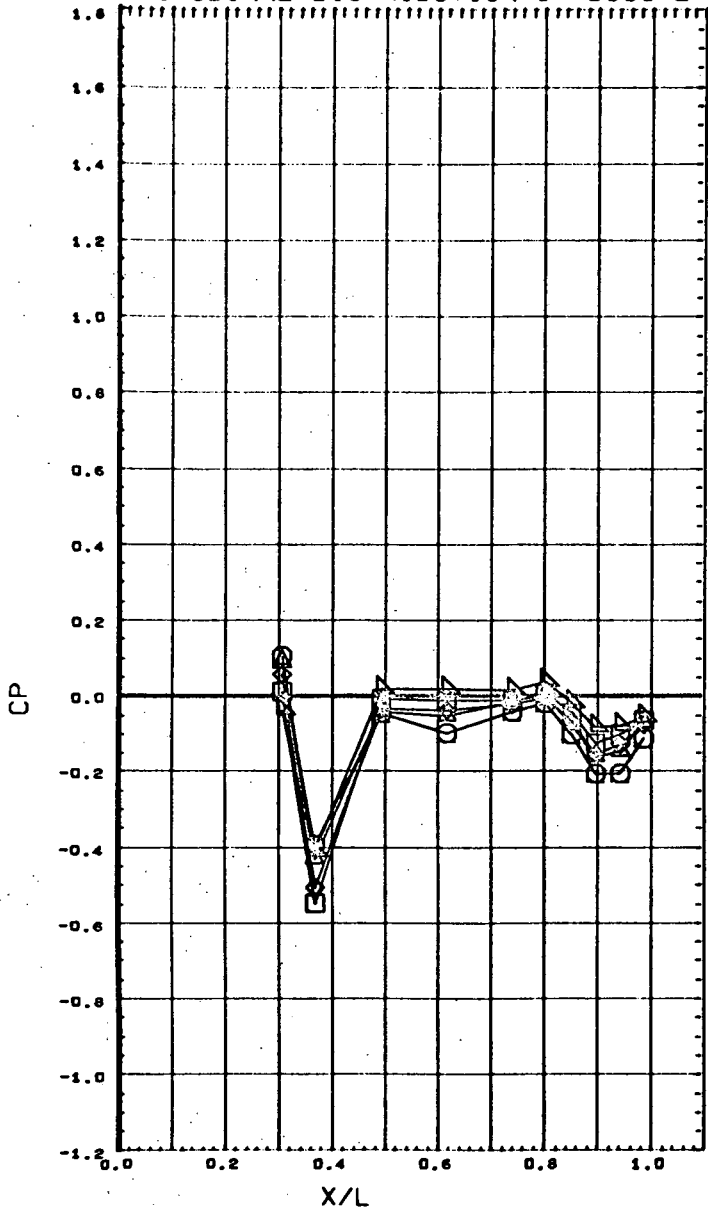

| SYMBOL | ALFB | THETA | M1 |
|--------|-------|---------|-------|
| ○ | 6.137 | 90.000 | 0.894 |
| △ | 5.806 | 180.000 | |
| ◇ | 3.831 | | |
| □ | 1.836 | | |
| ▽ | 0.154 | | |

| PARAMETRIC VALUES | | |
|-------------------|-------|-------|
| BETA | 0.000 | 0.000 |
| I | 0.000 | |

REFERENCE FILE

LONGITUDINAL DISTRIBUTION OF BOOSTER FUSELAGE PRESSURES

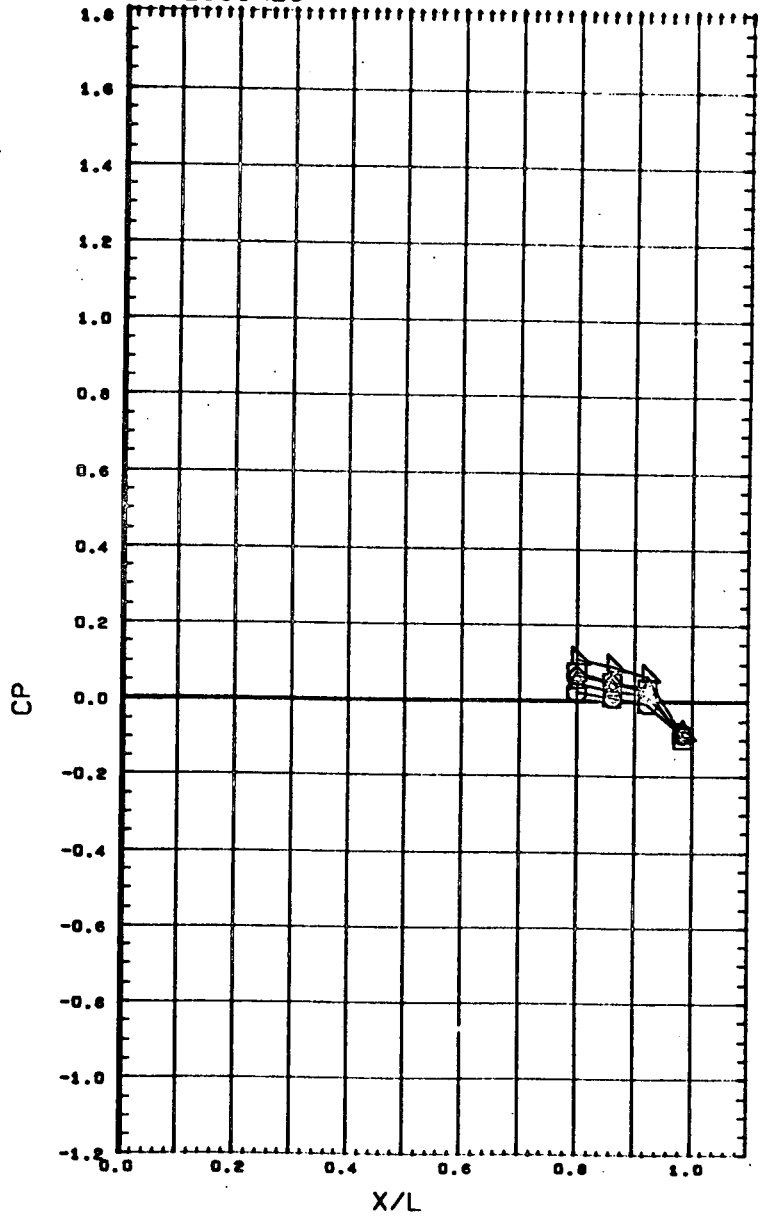
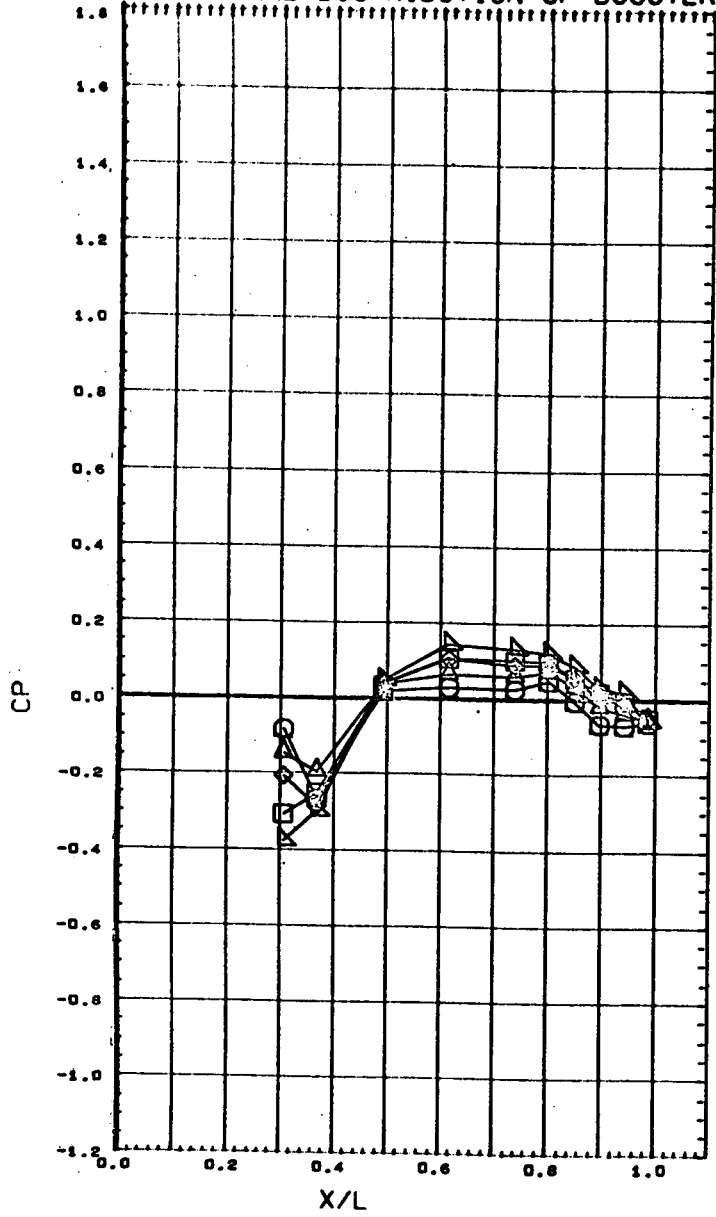

| SYMBOL | ALFB | THETA | M1 |
|--------|--------|---------|-------|
| ○ | 1.547 | 90.000 | 0.894 |
| △ | 3.746 | 180.000 | |
| ◇ | 6.129 | | |
| □ | 8.138 | | |
| ○ | 10.120 | | |

REFERENCE FILE

| PARAMETRIC VALUES | | | |
|-------------------|-------|------|-------|
| BETA | 0.000 | DX/L | 0.000 |
| I | 0.000 | | |

LONGITUDINAL DISTRIBUTION OF BOOSTER FUSELAGE PRESSURES

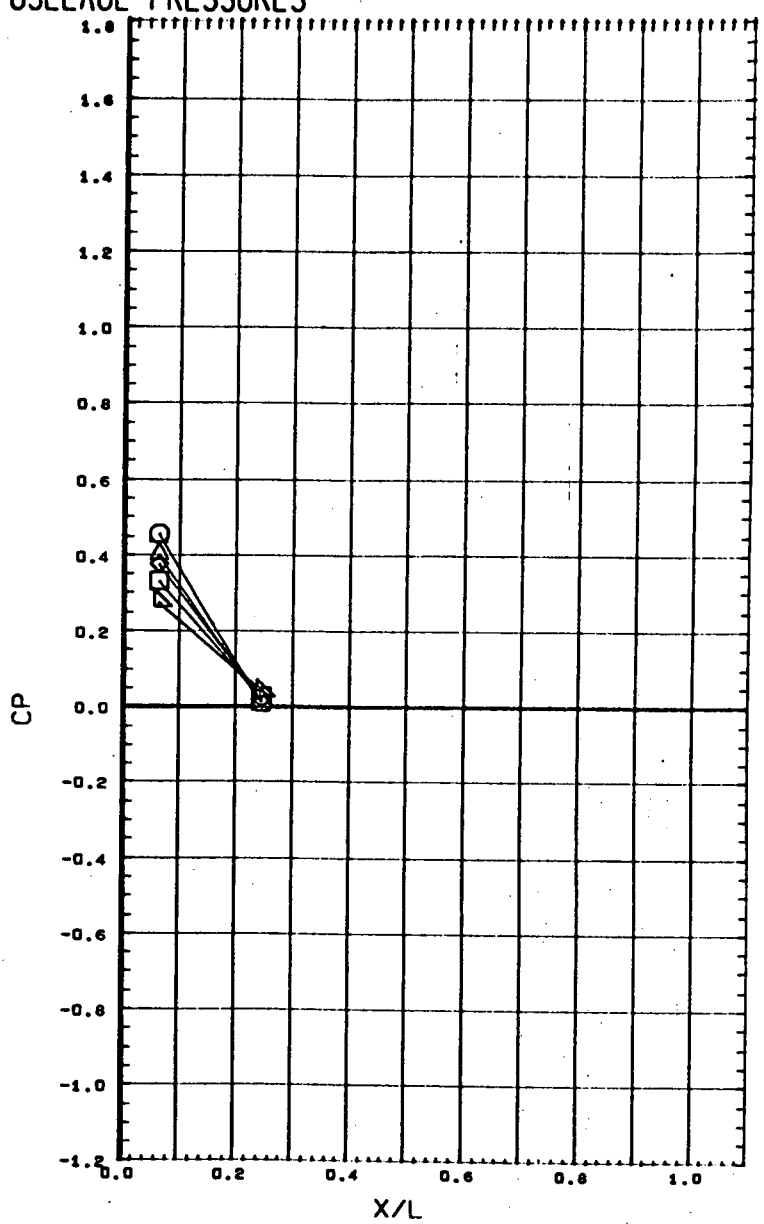
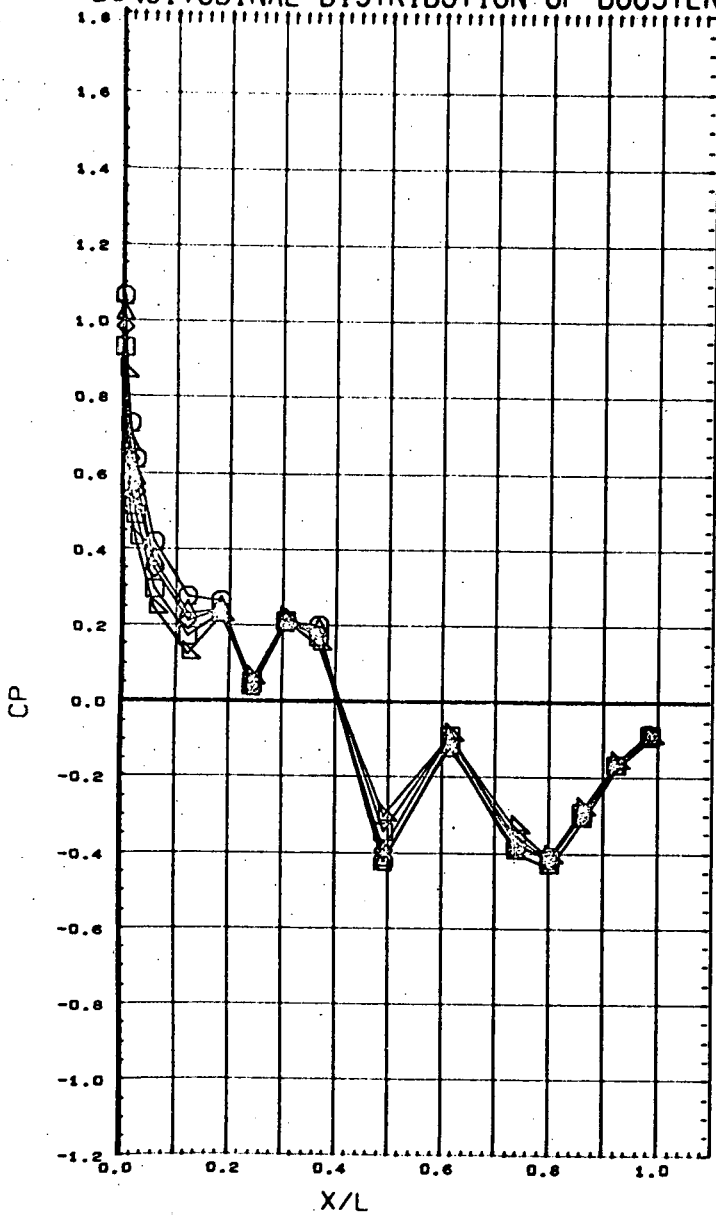

| SYMBOL | ALFB | THETA | M1 |
|--------|-------|--------|-------|
| ◇ | 7.922 | 0.000 | 1.000 |
| ◇ | 5.773 | 15.000 | |
| ◇ | 4.421 | | |
| ◇ | 2.227 | | |
| ◇ | 0.197 | | |

REFERENCE FILE

| PARAMETRIC VALUES | | | |
|-------------------|-------|------|-------|
| BETA | 0.000 | OX/L | 0.000 |
| I | 0.000 | | |

LONGITUDINAL DISTRIBUTION OF BOOSTER FUSELAGE PRESSURES

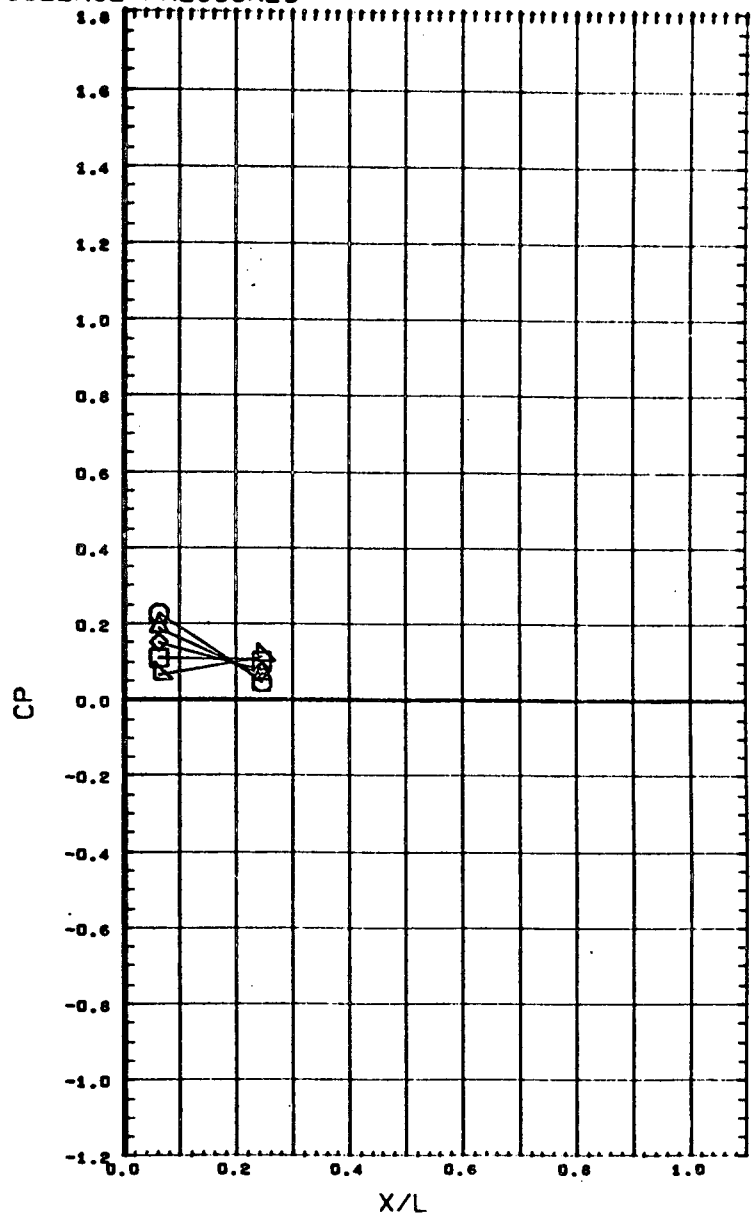
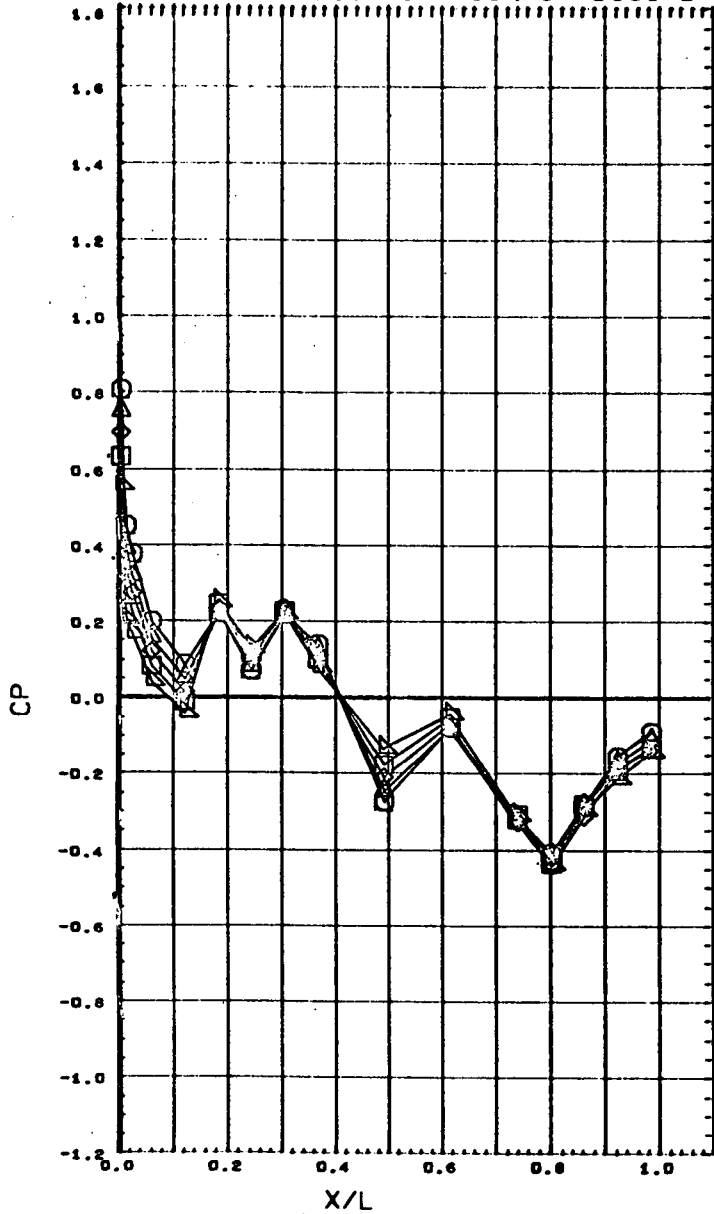

| SYMBOL | ALFB | THETA | M1 |
|--------|--------|--------|-------|
| ○ | 2.153 | 0.000 | 1.000 |
| △ | 4.142 | 15.000 | |
| ◇ | 6.073 | | |
| □ | 8.175 | | |
| × | 10.285 | | |

| PARAMETRIC VALUES | | | |
|-------------------|-------|------|-------|
| BETA | 0.000 | DX/L | 0.000 |
| I | 0.000 | | |

REFERENCE FILE

LONGITUDINAL DISTRIBUTION OF BOOSTER FUSELAGE PRESSURES

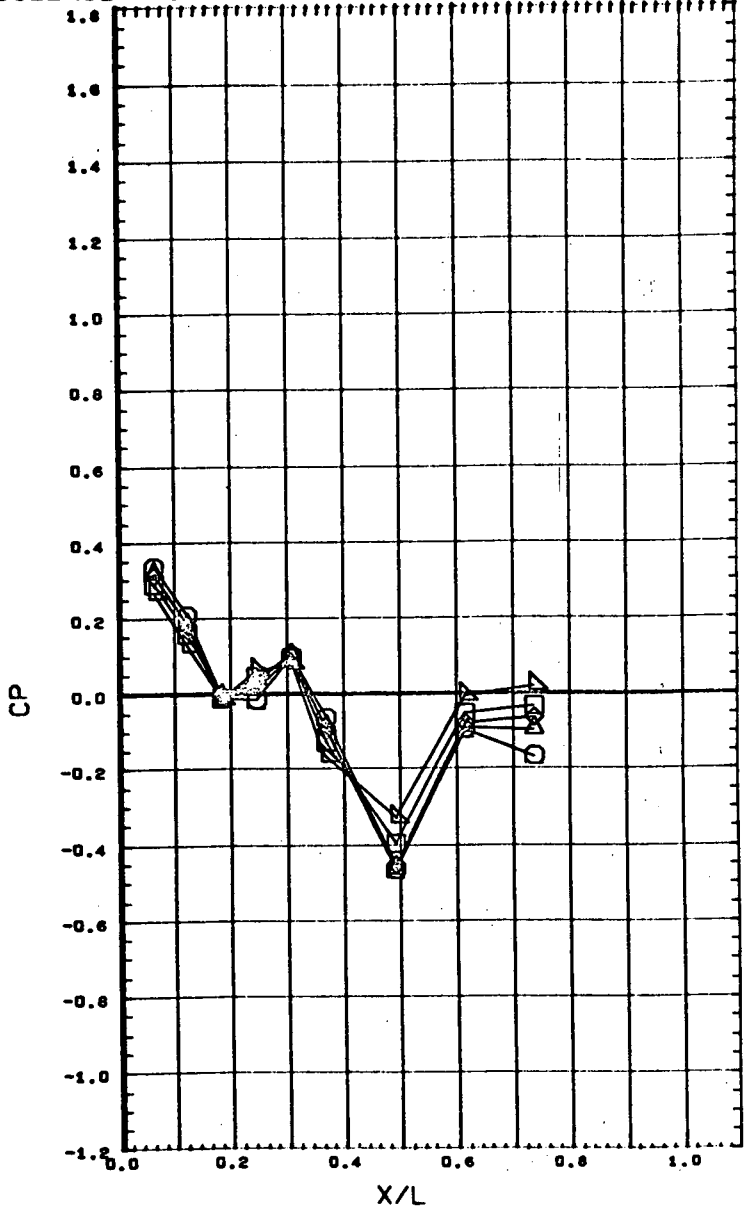
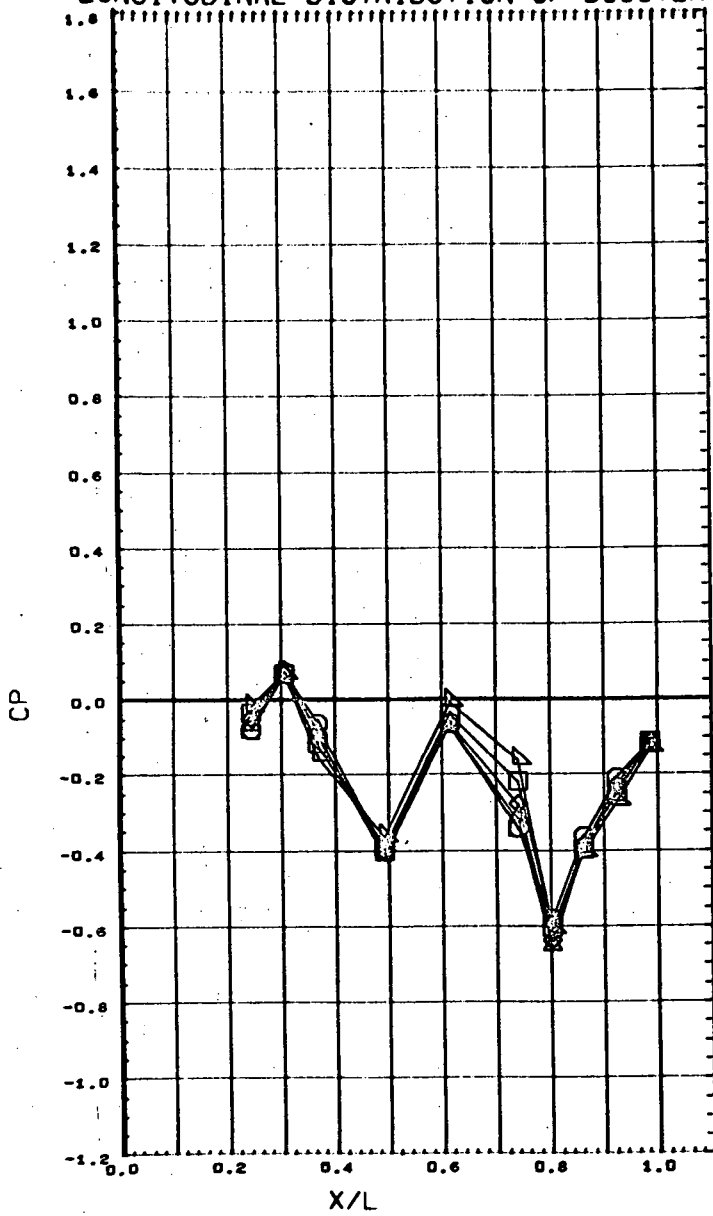

| SYMBOL | ALFB | THETA | M1 |
|--------|-------|--------|-------|
| ○ | 7.922 | 24.000 | 1.000 |
| △ | 5.773 | 45.000 | |
| ◇ | 4.421 | | |
| □ | 2.227 | | |
| ◇ | 0.197 | | |

REFERENCE FILE

| PARAMETRIC VALUES | | |
|-------------------|-------|------------|
| BETA | 0.000 | DX/L 0.000 |
| I | 0.000 | |

LONGITUDINAL DISTRIBUTION OF BOOSTER FUSELAGE PRESSURES

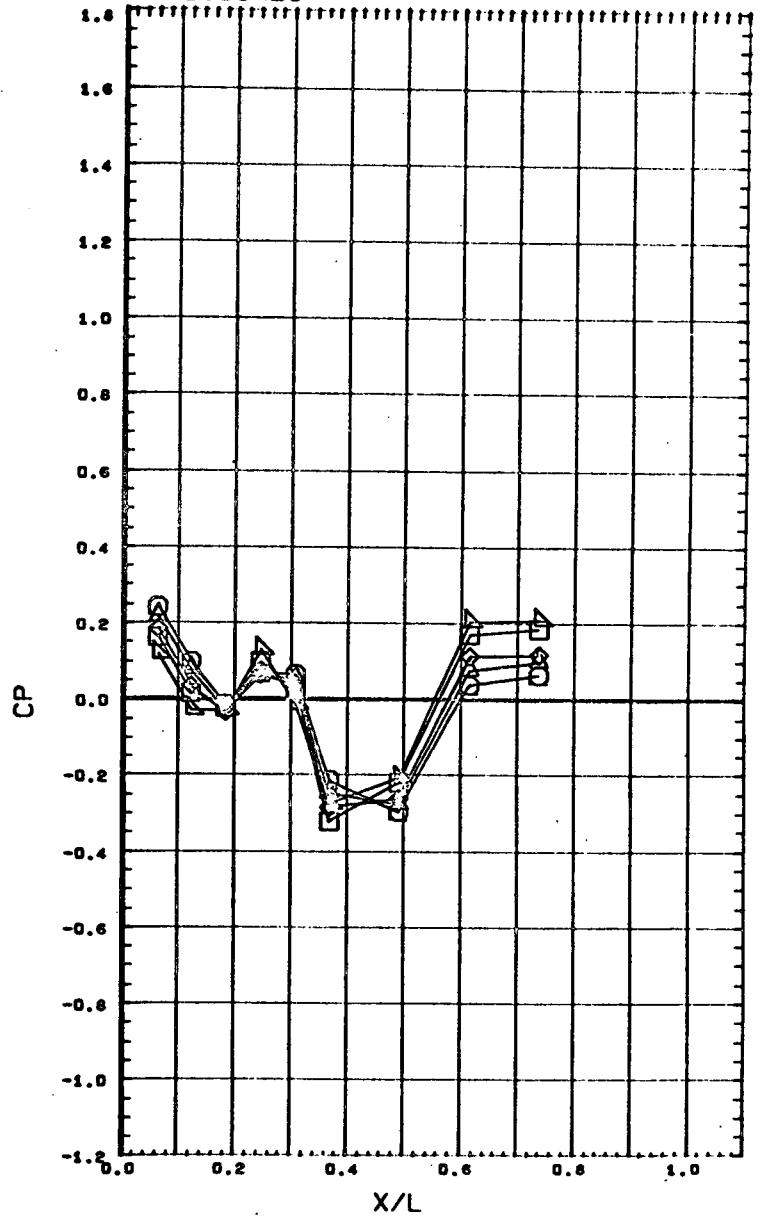
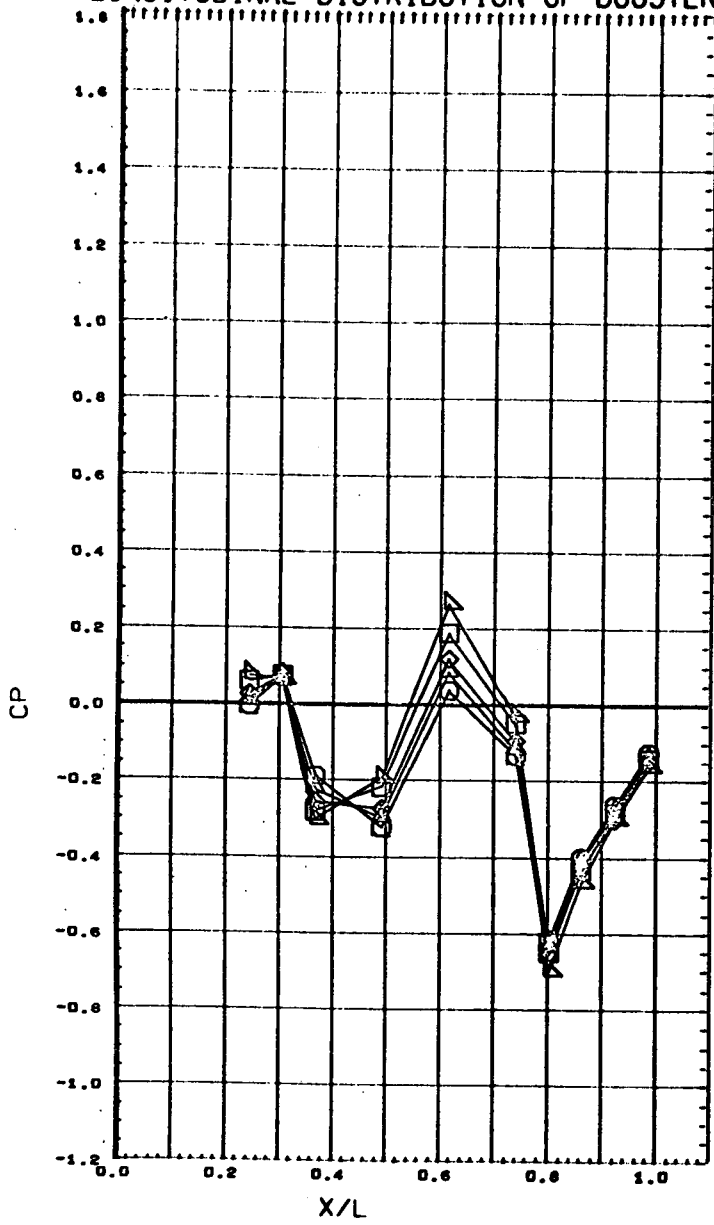

| SYMBOL | ALFB | THETA | M1 |
|--------|--------|--------|-------|
| ○ | 2.153 | 24.000 | 1.000 |
| ◇ | 4.142 | 45.000 | |
| ◇ | 6.073 | | |
| □ | 8.175 | | |
| △ | 10.285 | | |

| PARAMETRIC VALUES | | |
|-------------------|-------|-------|
| BETA | 0.000 | DX/L |
| I | 0.000 | 0.000 |

REFERENCE FILE

LONGITUDINAL DISTRIBUTION OF BOOSTER FUSELAGE PRESSURES

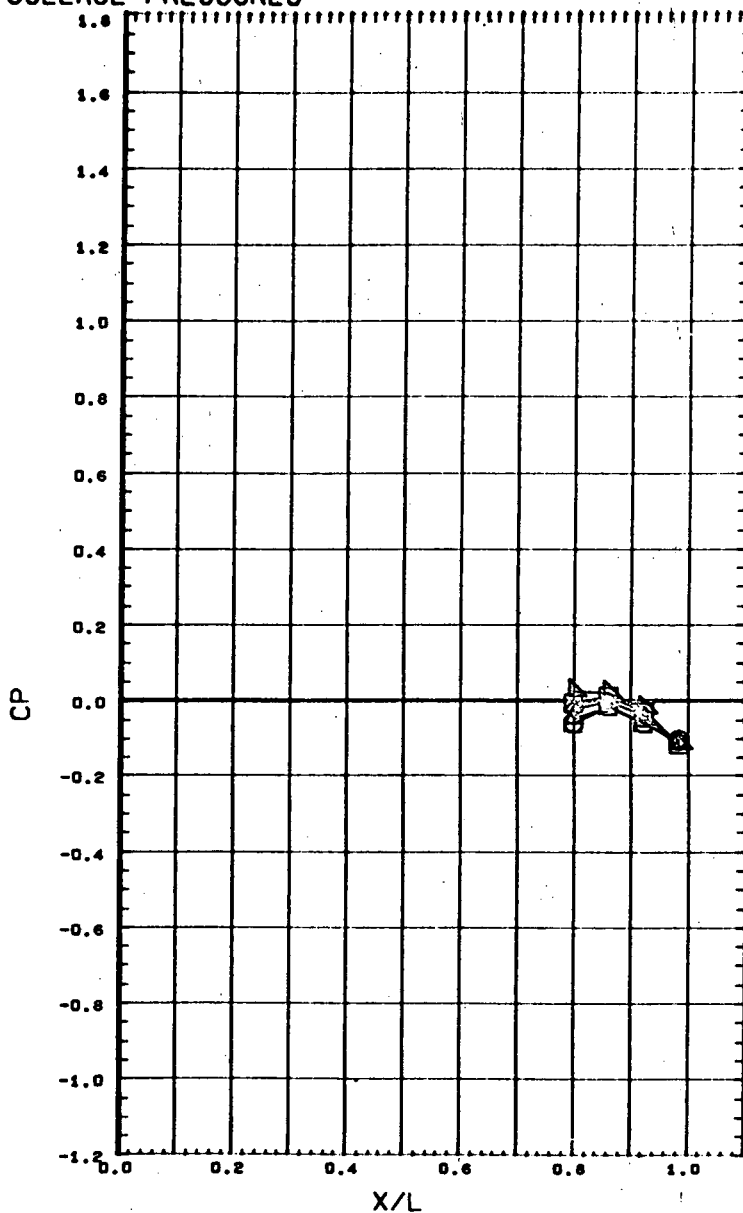
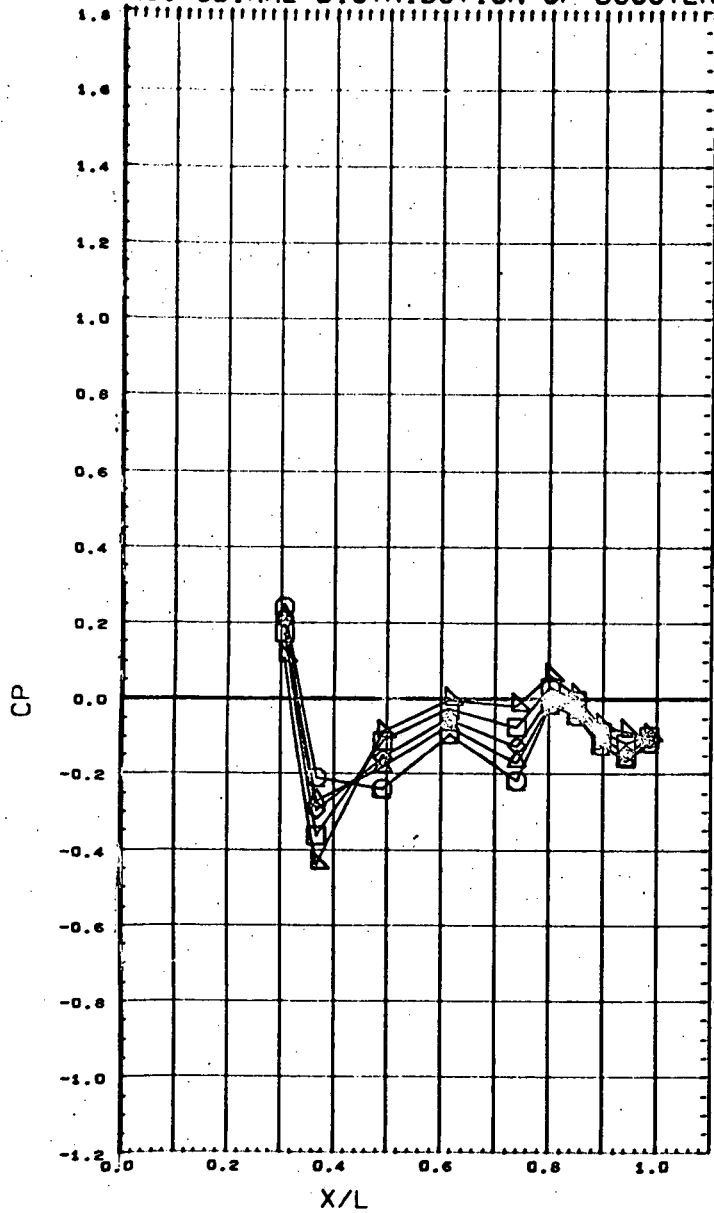

| SYMBOL | ALFB | THETA | M1 |
|--------|---------|---------|-------|
| ○ | - 7.922 | 90.000 | 1.000 |
| ◇ | - 5.773 | 180.000 | |
| ◇ | - 4.421 | | |
| □ | - 2.227 | | |
| ▽ | 0.197 | | |

| PARAMETRIC VALUES | | | |
|-------------------|-------|------|-------|
| BETA | 0.000 | OX/L | 0.000 |
| I | 0.000 | | |

REFERENCE FILE

LONGITUDINAL DISTRIBUTION OF BOOSTER FUSELAGE PRESSURES

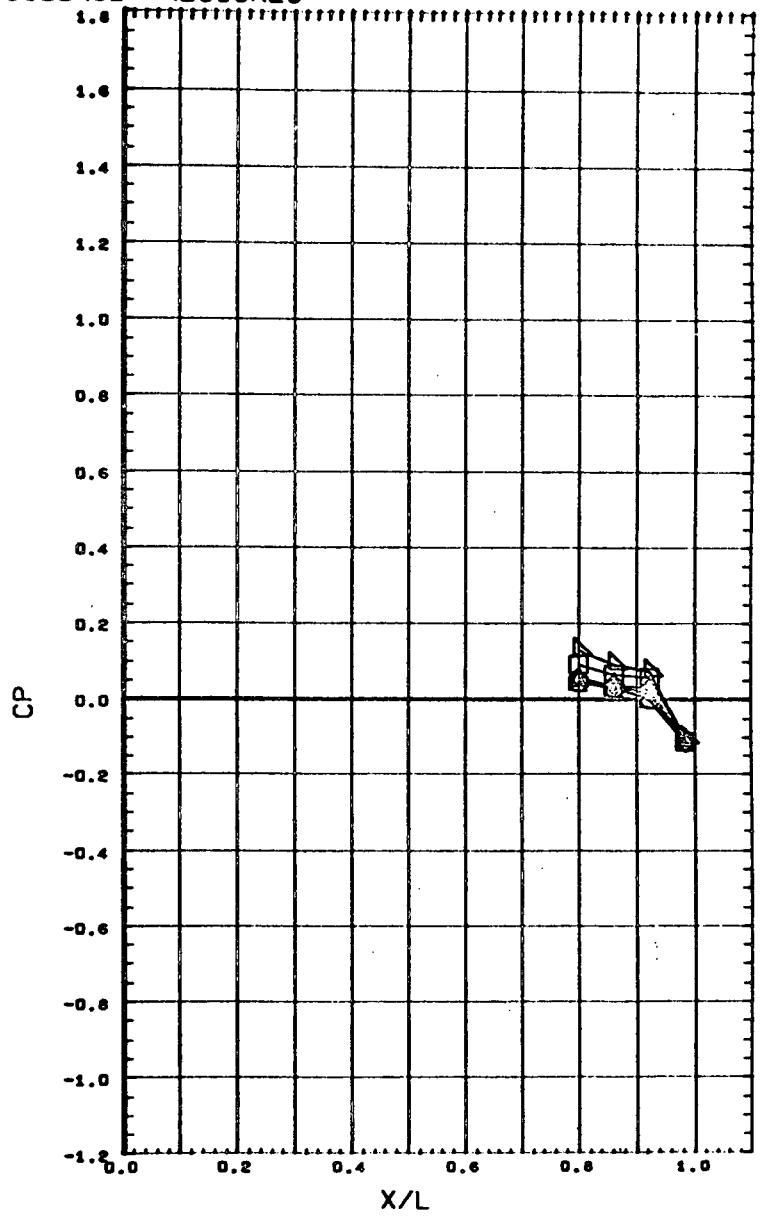
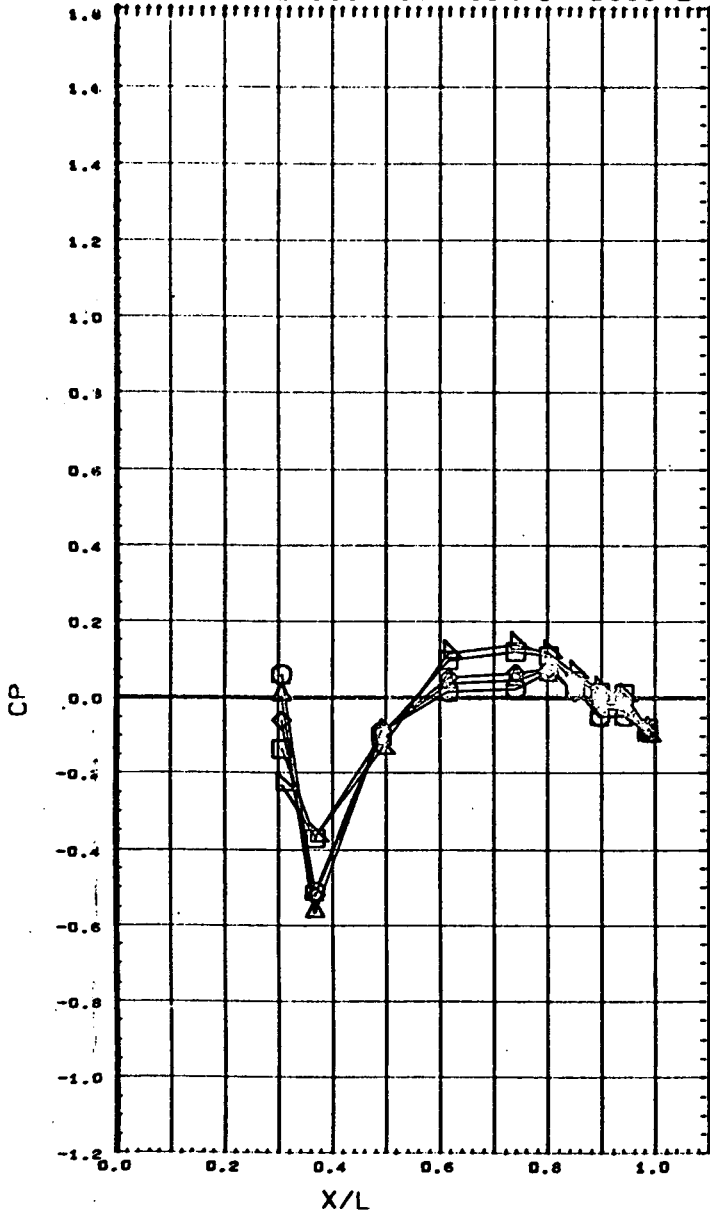

| SYMBOL | ALFD | THETA | M1 |
|--------|--------|---------|-------|
| ○ | 2.153 | 90.000 | 1.000 |
| ◇ | 4.142 | 180.000 | |
| ◇ | 6.073 | | |
| □ | 8.175 | | |
| △ | 10.285 | | |

REFERENCE FILE

| PARAMETRIC VALUES | | |
|-------------------|-------|-------|
| BETA | 0.000 | DX/L |
| I | 0.000 | 0.000 |

LONGITUDINAL DISTRIBUTION OF BOOSTER FUSELAGE PRESSURES

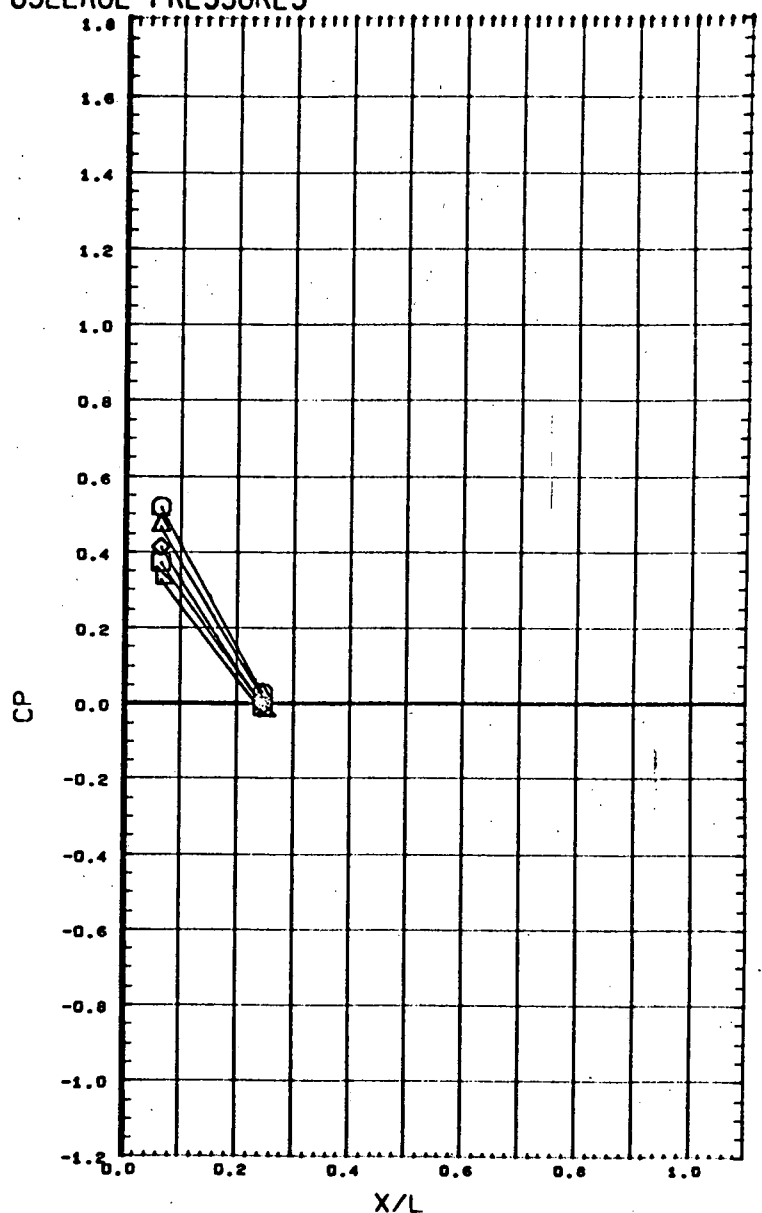
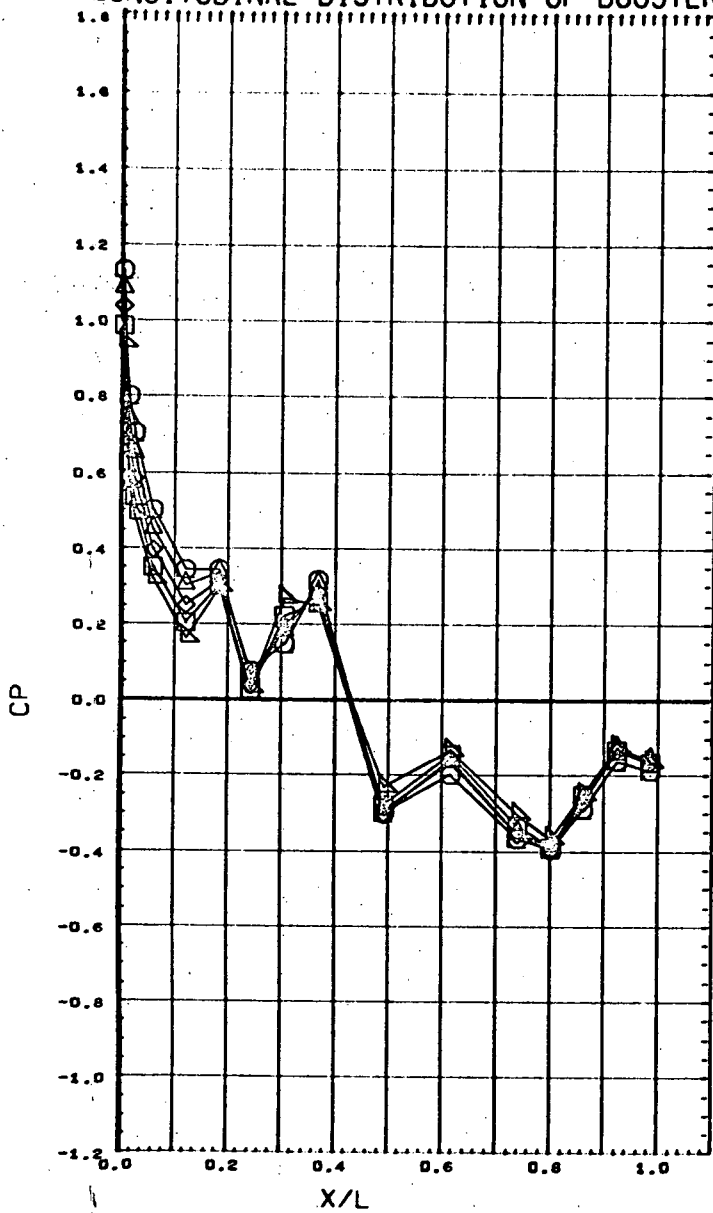

| SYMBOL | ALFD | THETA | M1 |
|--------|-------|--------|-------|
| △ | 8.282 | 0.000 | 1.100 |
| ◇ | 5.772 | 15.000 | |
| □ | 3.796 | | |
| ○ | 1.825 | | |
| ○ | 0.182 | | |

REFERENCE FILE

| PARAMETRIC VALUES | | | |
|-------------------|-------|------|-------|
| BETA | 0.000 | OX/L | 0.000 |
| I | 0.000 | | |

LONGITUDINAL DISTRIBUTION OF BOOSTER FUSELAGE PRESSURES

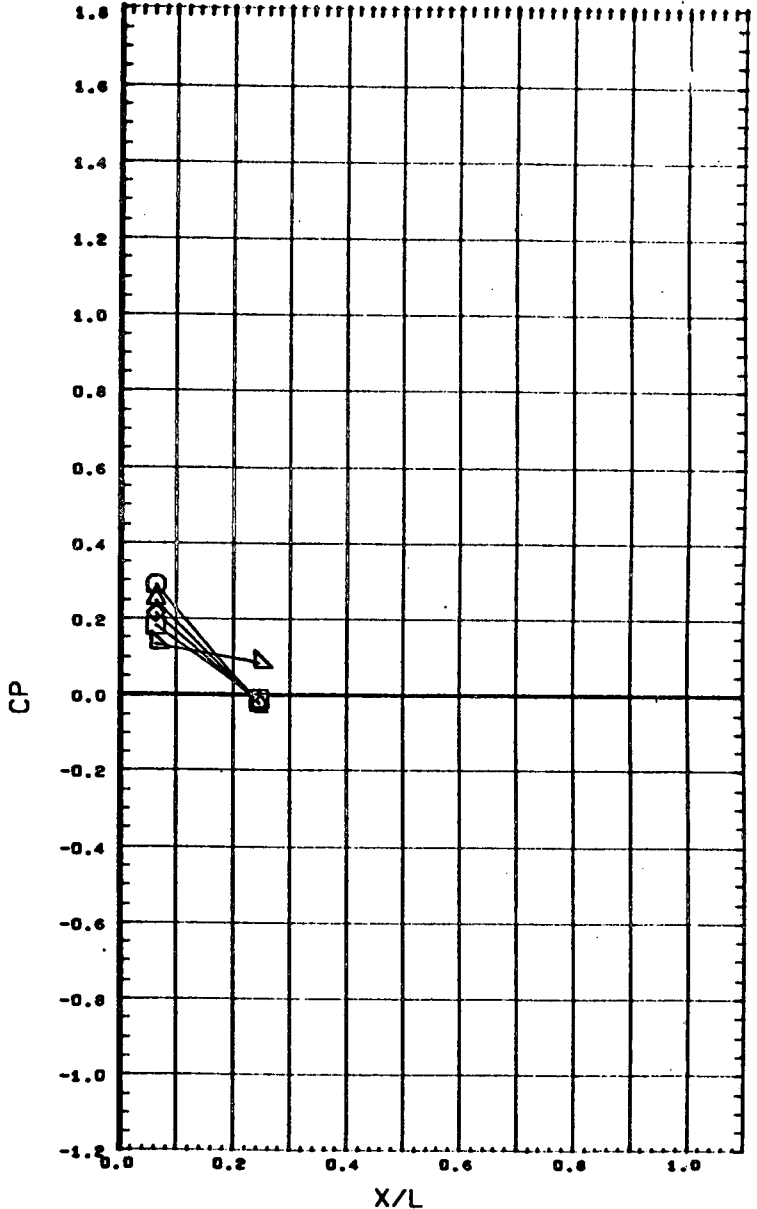
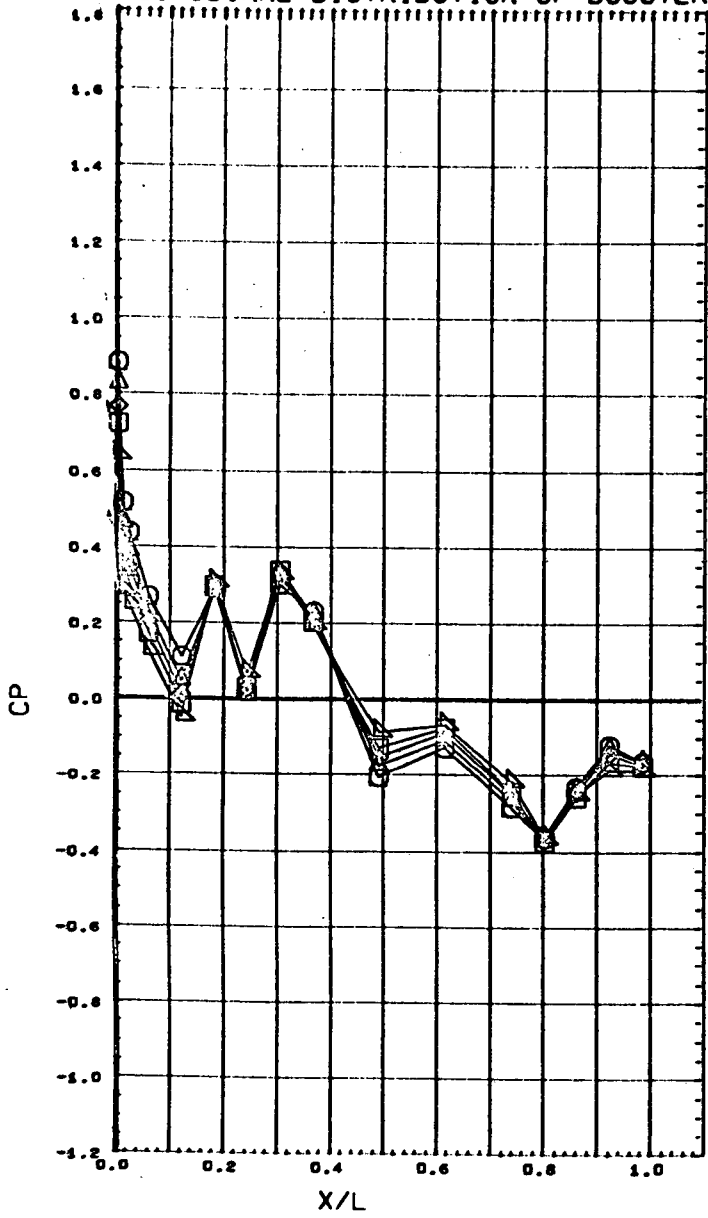

| SYMBOL | ALFD | THETA | M1 |
|--------|--------|--------|-------|
| ○ | 2.160 | 0.000 | 1.100 |
| △ | 4.320 | 15.000 | |
| ◇ | 6.003 | | |
| □ | 7.758 | | |
| ◇ | 10.193 | | |

| PARAMETRIC VALUES | | | |
|-------------------|-------|------|-------|
| BETA | 0.000 | DX/L | 0.000 |
| I | 0.000 | | |

REFERENCE FILE

LONGITUDINAL DISTRIBUTION OF BOOSTER FUSELAGE PRESSURES

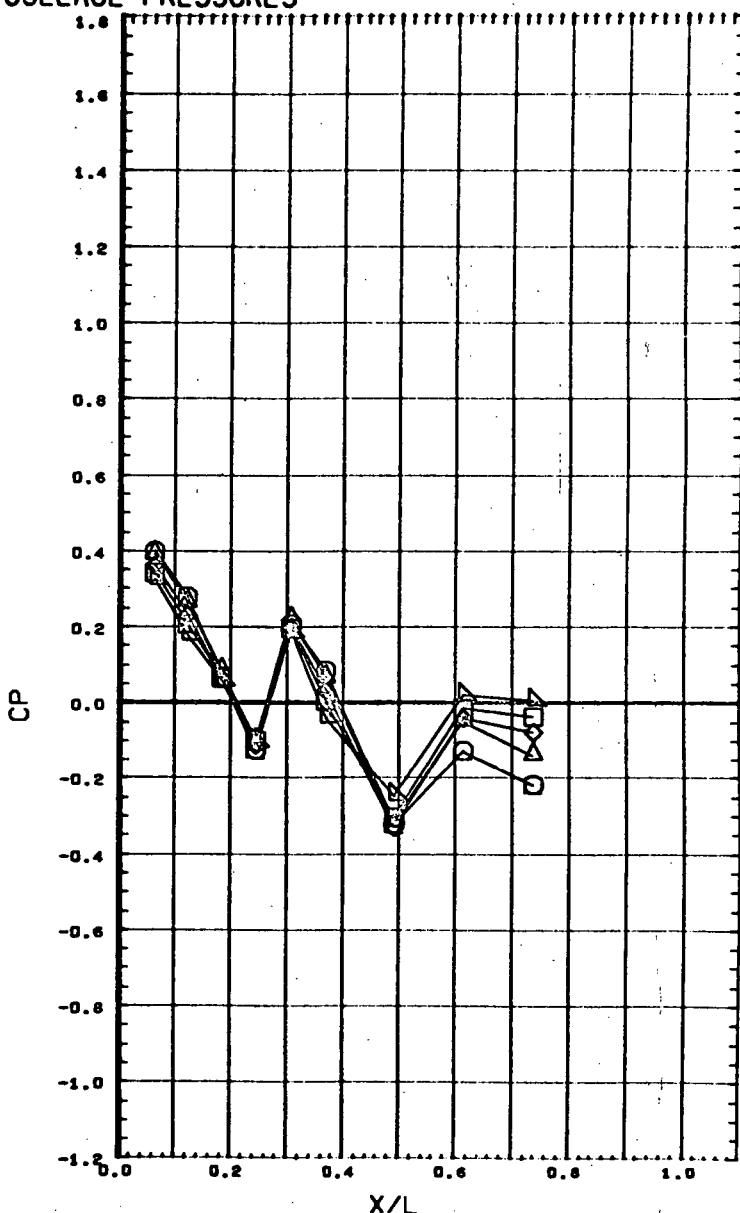
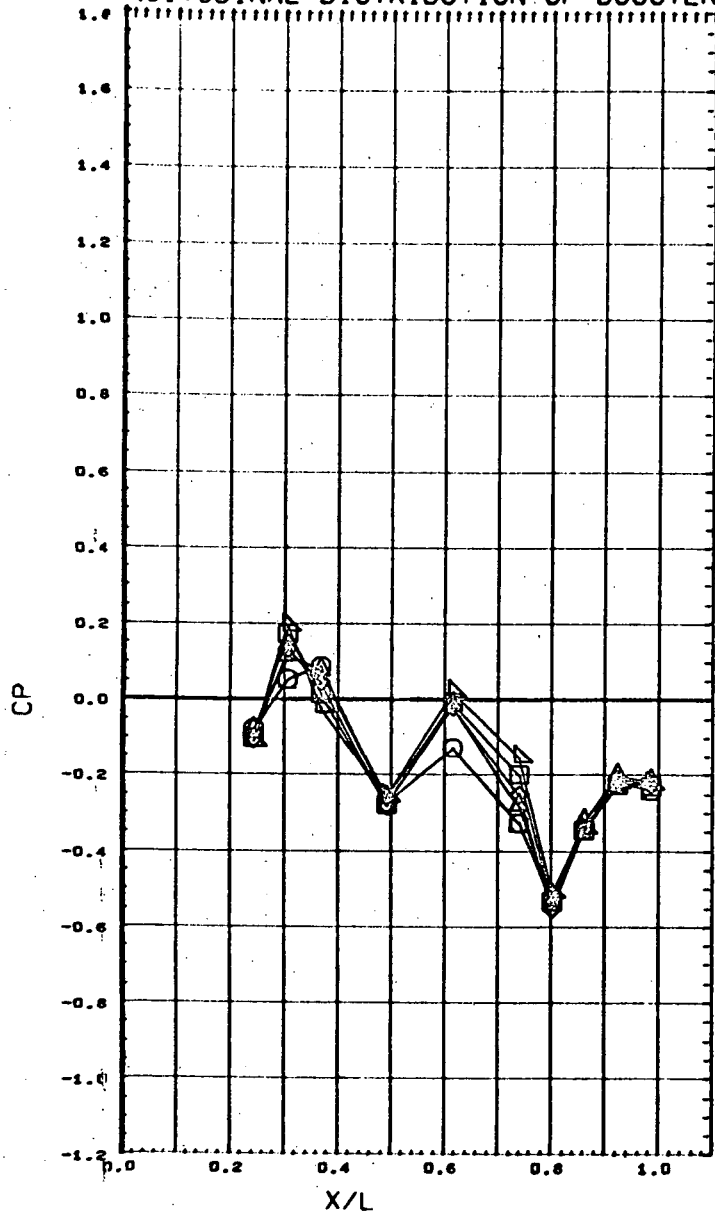

| SYMBOL | ALFB | THETA | M1 |
|--------|---------|--------|-------|
| ○ | - 8.282 | 24.000 | 1.100 |
| △ | - 5.772 | 45.000 | |
| ◇ | - 3.796 | | |
| □ | - 1.825 | | |
| ▽ | 0.182 | | |

| PARAMETRIC VALUES | | | |
|-------------------|-------|------|-------|
| BETA | 0.000 | DX/L | 0.000 |
| I | 0.000 | | |

REFERENCE FILE

LONGITUDINAL DISTRIBUTION OF BOOSTER FUSELAGE PRESSURES

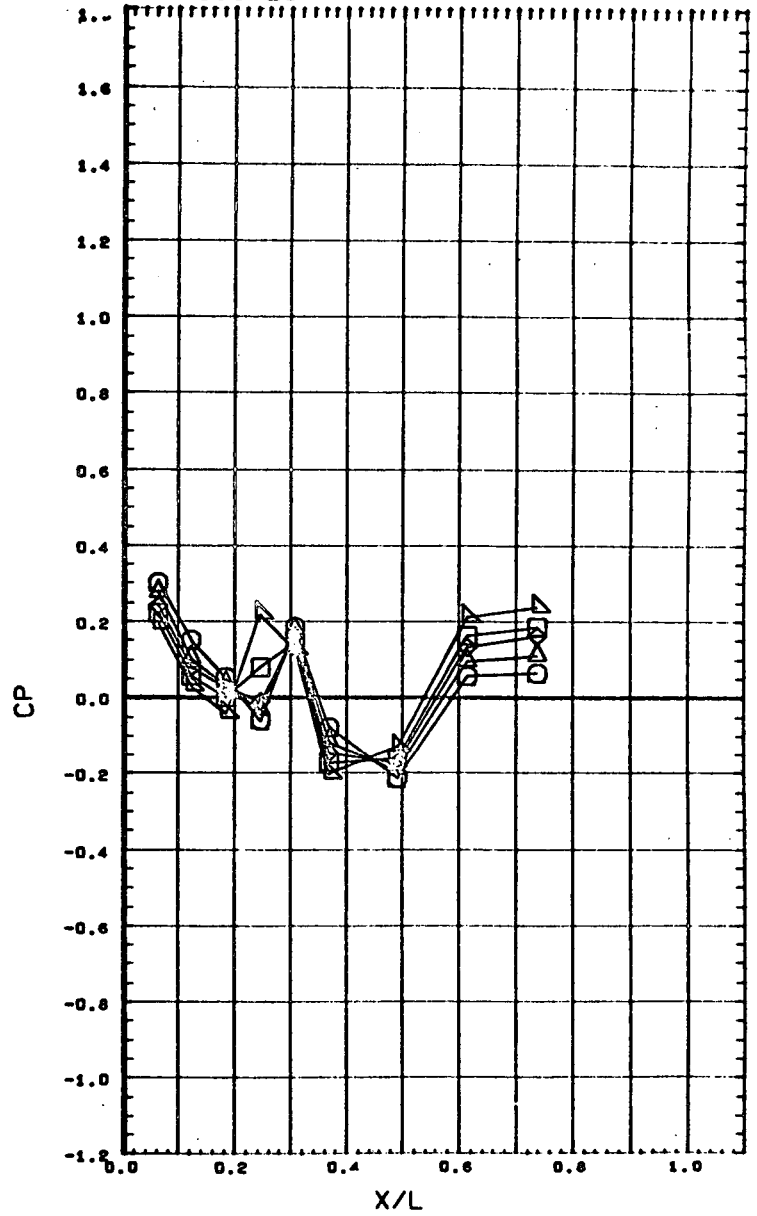
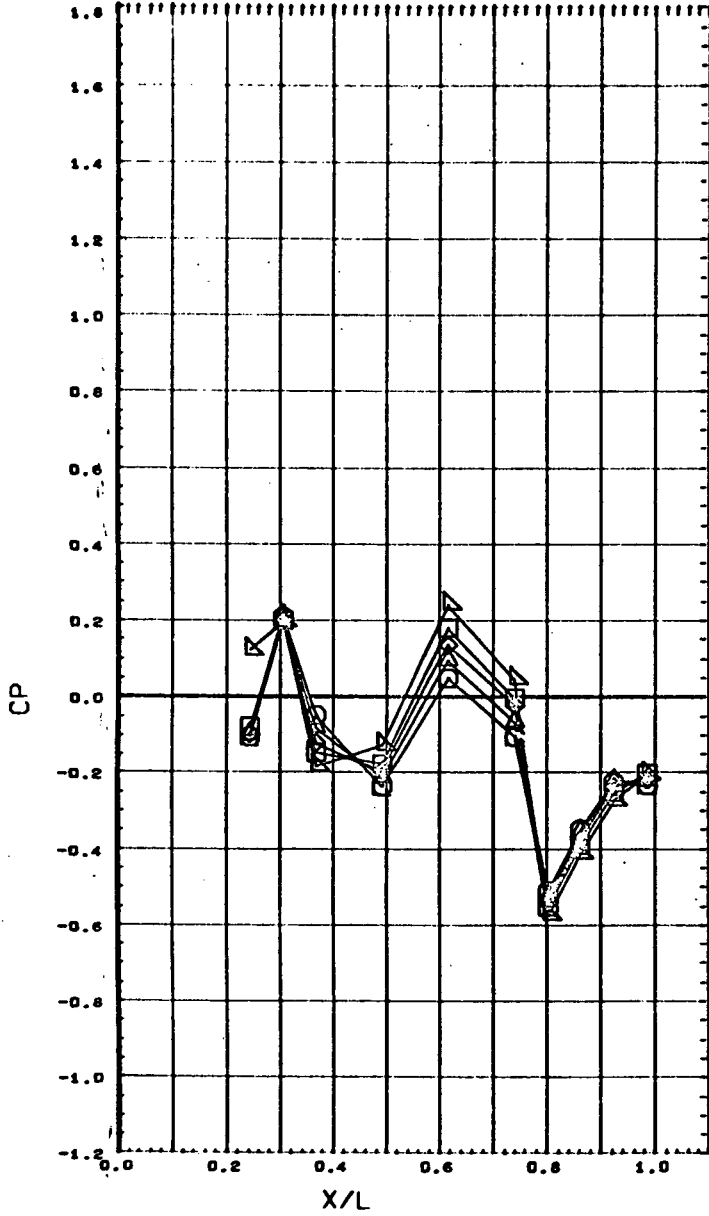

| SYMBOL | ALFB | THETA | M1 |
|--------|--------|--------|-------|
| ○ | 2.160 | 24.000 | 1.100 |
| ◇ | 4.170 | 45.000 | |
| △ | 6.083 | | |
| □ | 7.758 | | |
| ○ | 10.193 | | |

| PARAMETRIC VALUES | | | |
|-------------------|-------|------|-------|
| BETA | 0.000 | DX/L | 0.000 |
| I | 0.000 | | |

REFERENCE FILE

LONGITUDINAL DISTRIBUTION OF BOOSTER FUSELAGE PRESSURES

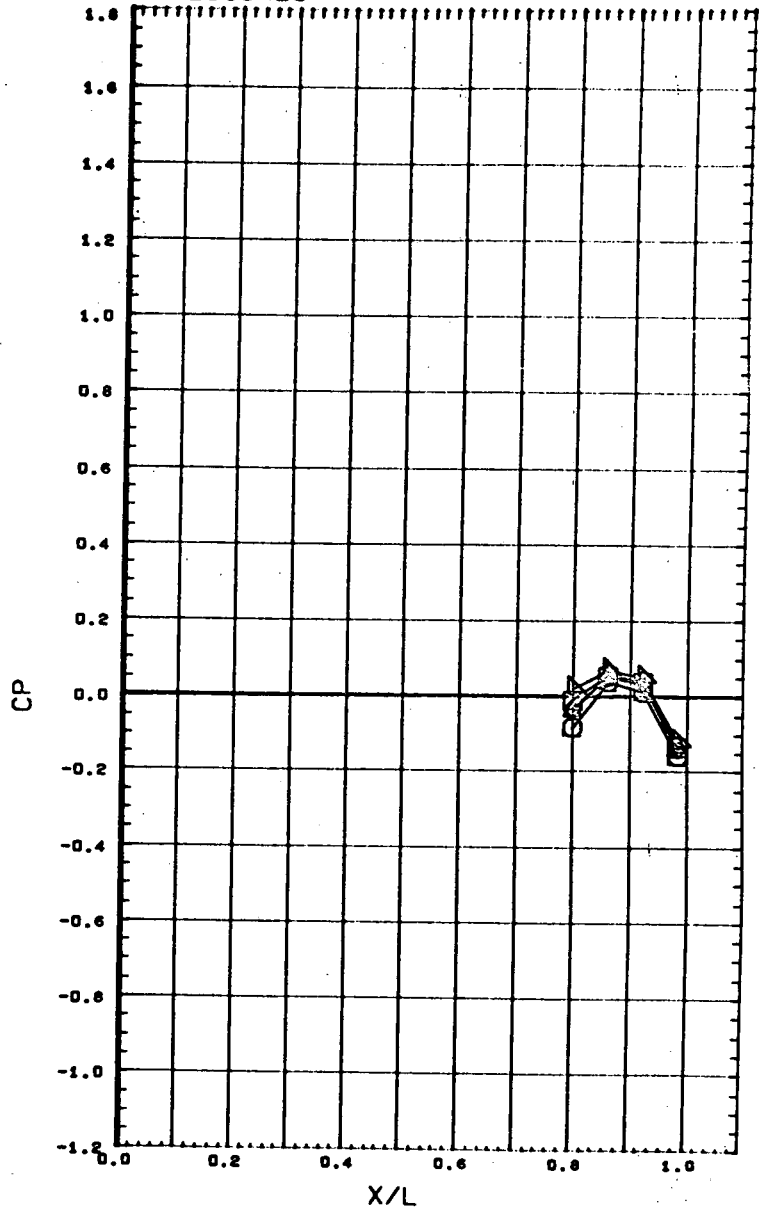
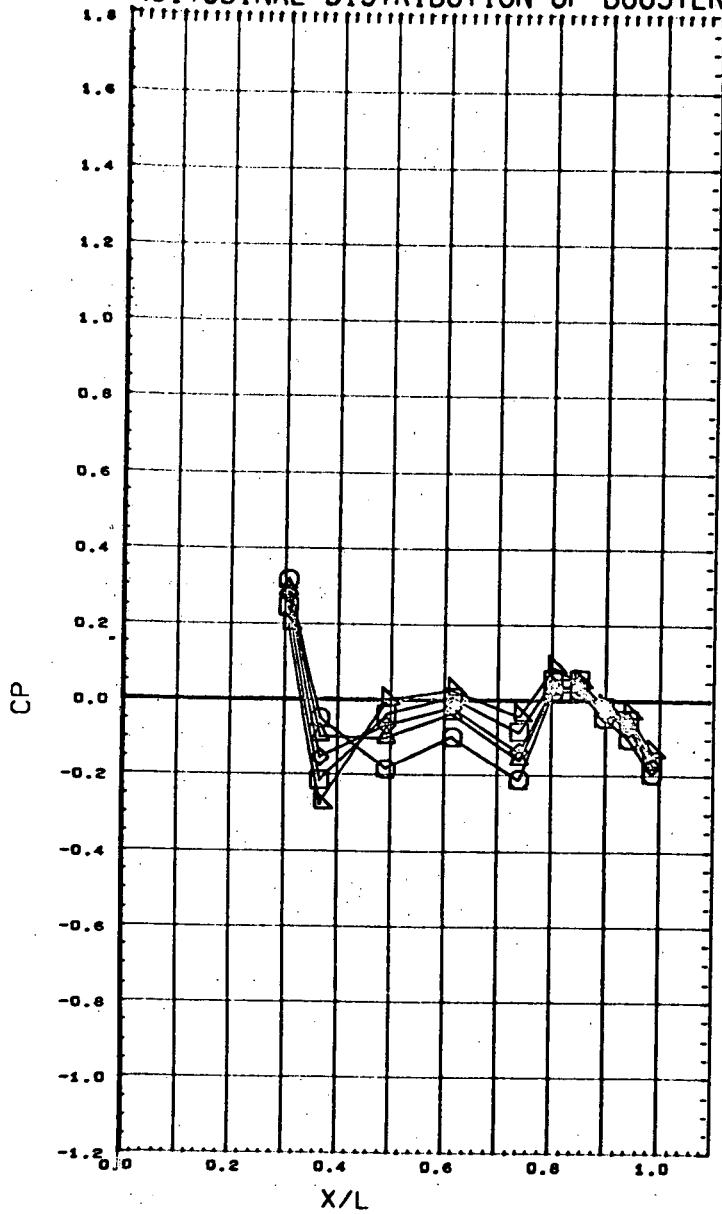

| SYMBOL | ALFB | THETA | M1 |
|--------|---------|---------|-------|
| ○ | - 8.282 | 90.000 | 1.100 |
| △ | - 4.772 | 180.000 | |
| ◇ | - 3.796 | | |
| □ | - 1.825 | | |
| ◇ | 0.182 | | |

REFERENCE FILE

| PARAMETRIC VALUES | | | |
|-------------------|-------|------|-------|
| BETA | 0.000 | DX/L | 0.000 |
| I | 0.000 | | |

LONGITUDINAL DISTRIBUTION OF BOOSTER FUSELAGE PRESSURES

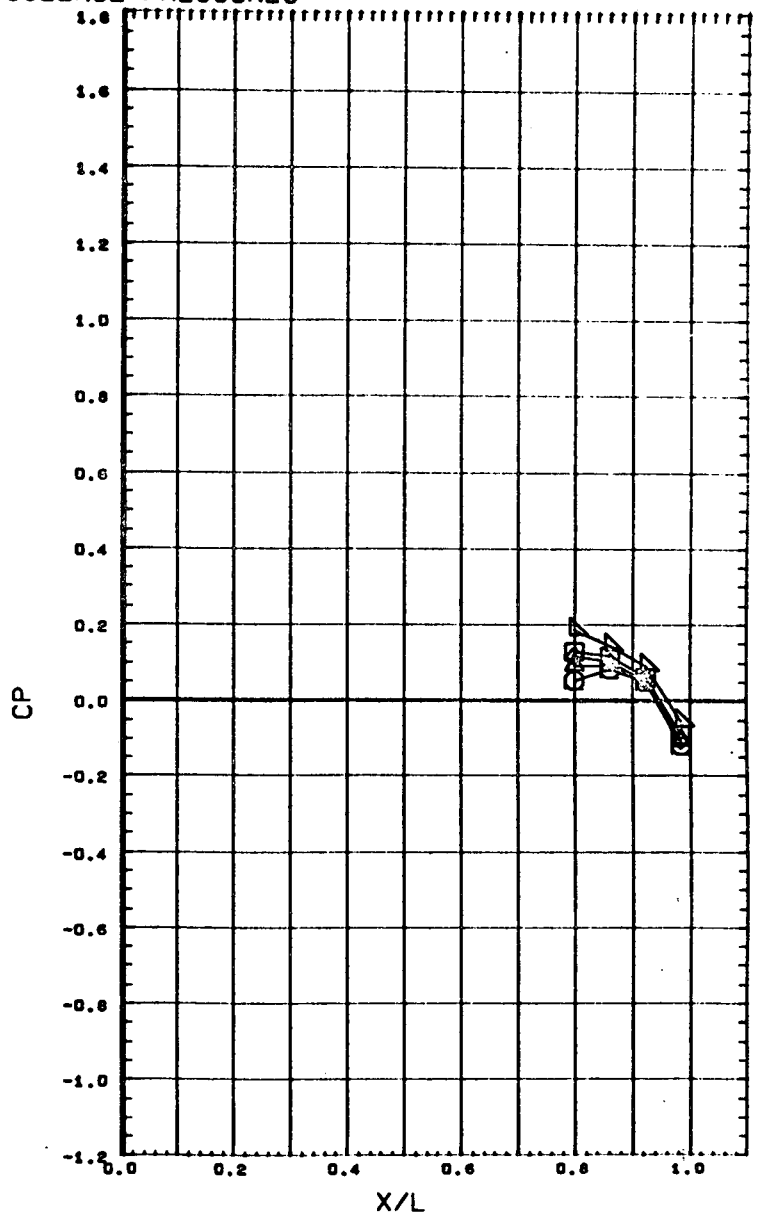
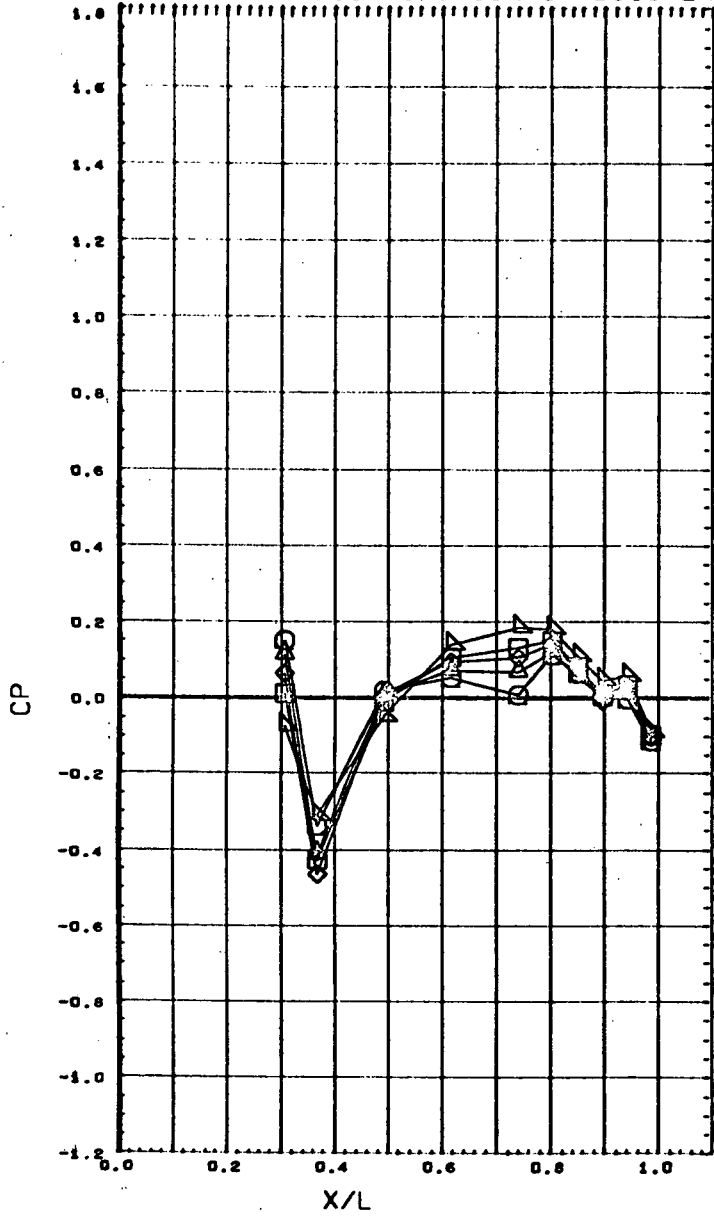

| SYMBOL | ALFB | THETA | M1 |
|--------|--------|---------|-------|
| □ | 2.160 | 90.000 | 1.100 |
| ◇ | 4.170 | 180.000 | |
| △ | 6.083 | | |
| ○ | 7.758 | | |
| ◇ | 10.193 | | |

| PARAMETRIC VALUES | | | |
|-------------------|-------|------|-------|
| BETA | 0.000 | DX/L | 0.000 |
| Z | 0.000 | | |

REFERENCE FILE

LONGITUDINAL DISTRIBUTION OF BOOSTER FUSELAGE PRESSURES

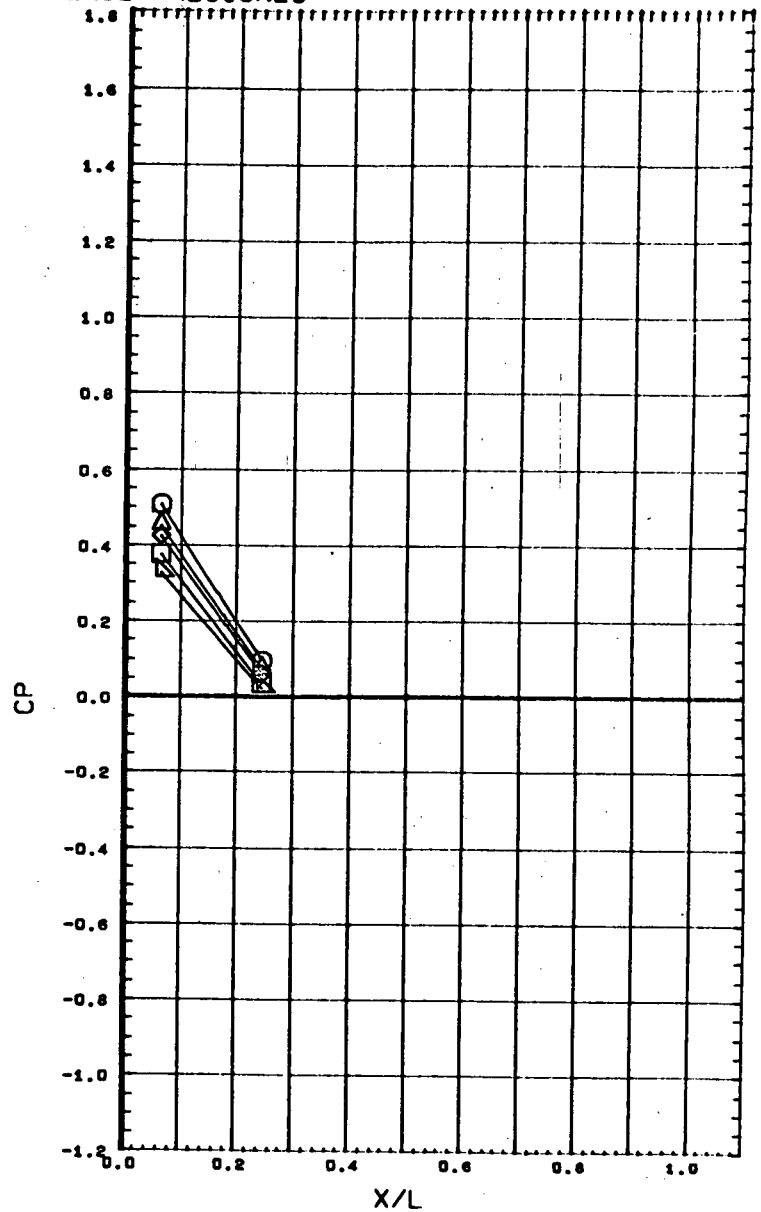
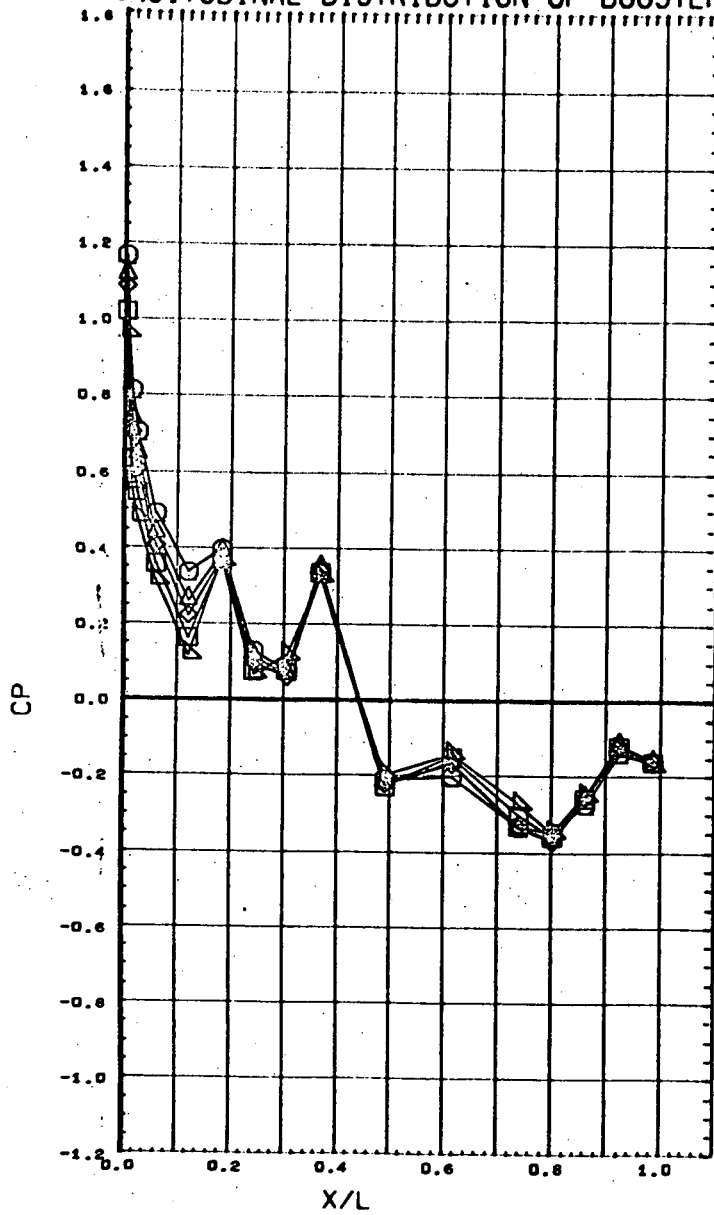

| SYMBOL | ALFB | THETA | M1 |
|--------|-------|--------|-------|
| ○ | 8.312 | 0.000 | 1.199 |
| ◇ | 5.768 | 15.000 | |
| △ | 4.439 | | |
| □ | 2.103 | | |
| ○ | 0.215 | | |

REFERENCE FILE

| BETA | PARAMETRIC VALUES | DX/L |
|-------|-------------------|-------|
| 0.000 | | 0.000 |
| 1 | 0.000 | |

LONGITUDINAL DISTRIBUTION OF BOOSTER FUSELAGE PRESSURES

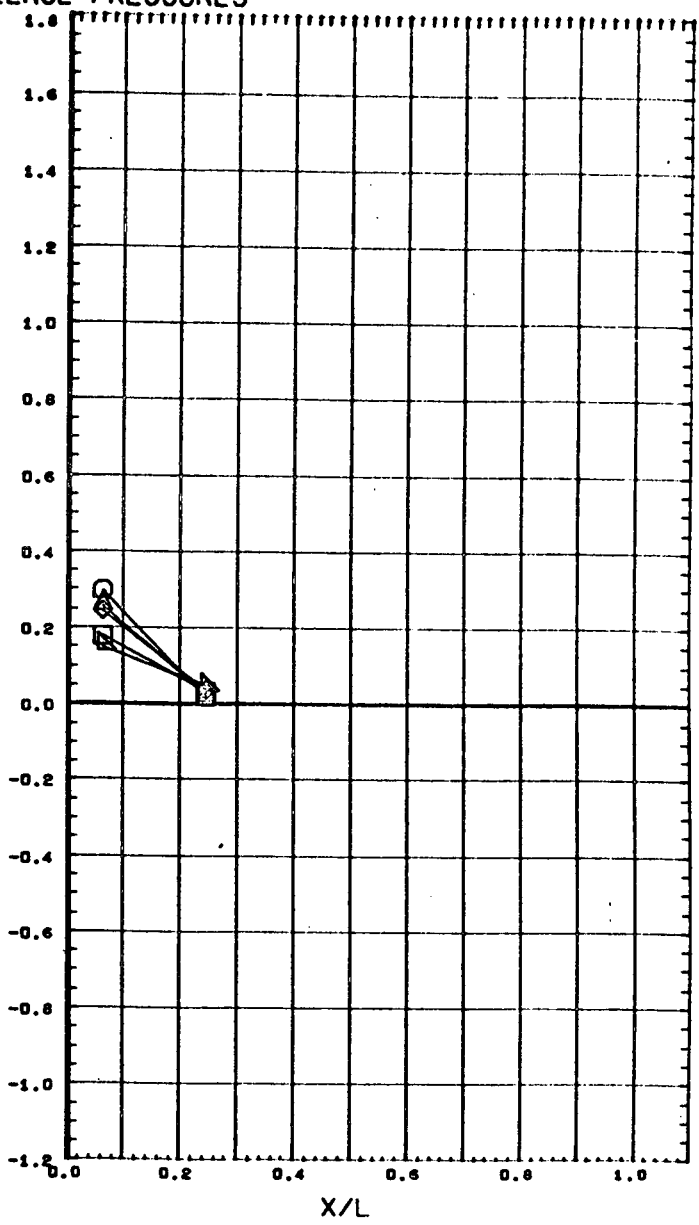
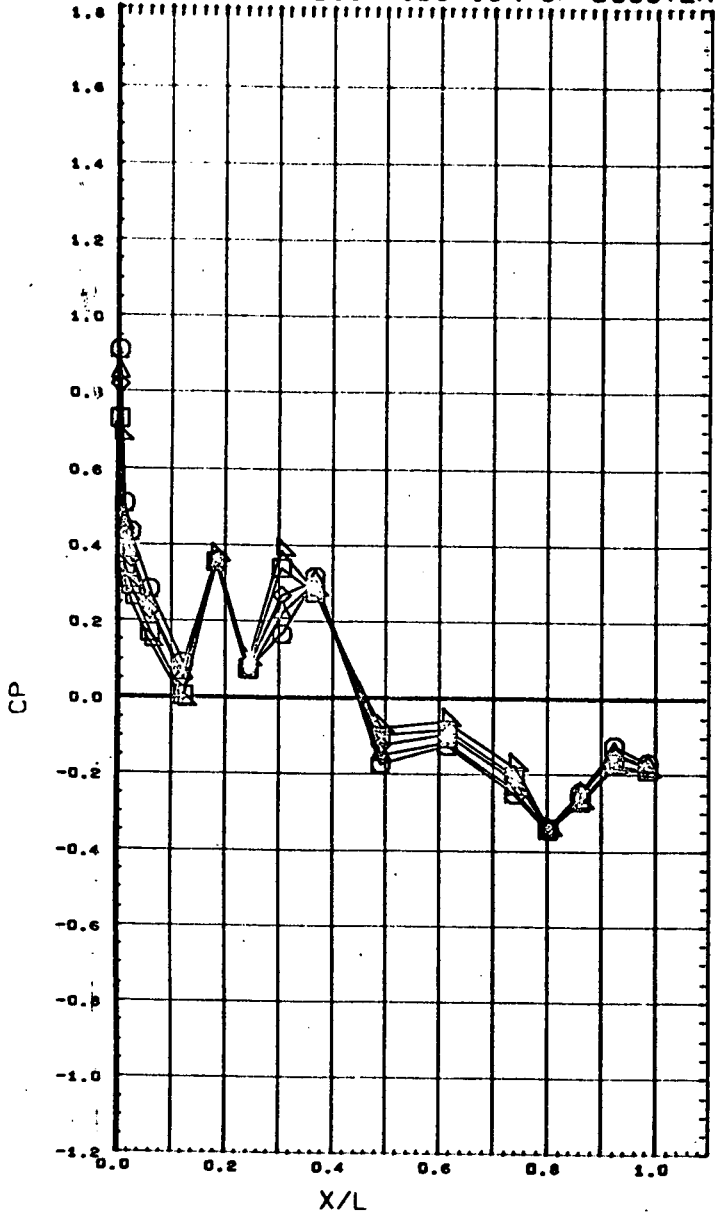

| SYMBOL | ALFB | THETA | M1 |
|--------|--------|--------|-------|
| ○ | 2.170 | 0.000 | 1.199 |
| △ | 4.167 | 15.000 | |
| ◇ | 5.540 | | |
| □ | 8.201 | | |
| ▽ | 10.161 | | |

| PARAMETRIC VALUES | | |
|-------------------|-------|-------|
| BETA | 0.000 | DX/L |
| I | 0.000 | 0.000 |

REFERENCE FILE

LONGITUDINAL DISTRIBUTION OF BOOSTER FUSELAGE PRESSURES

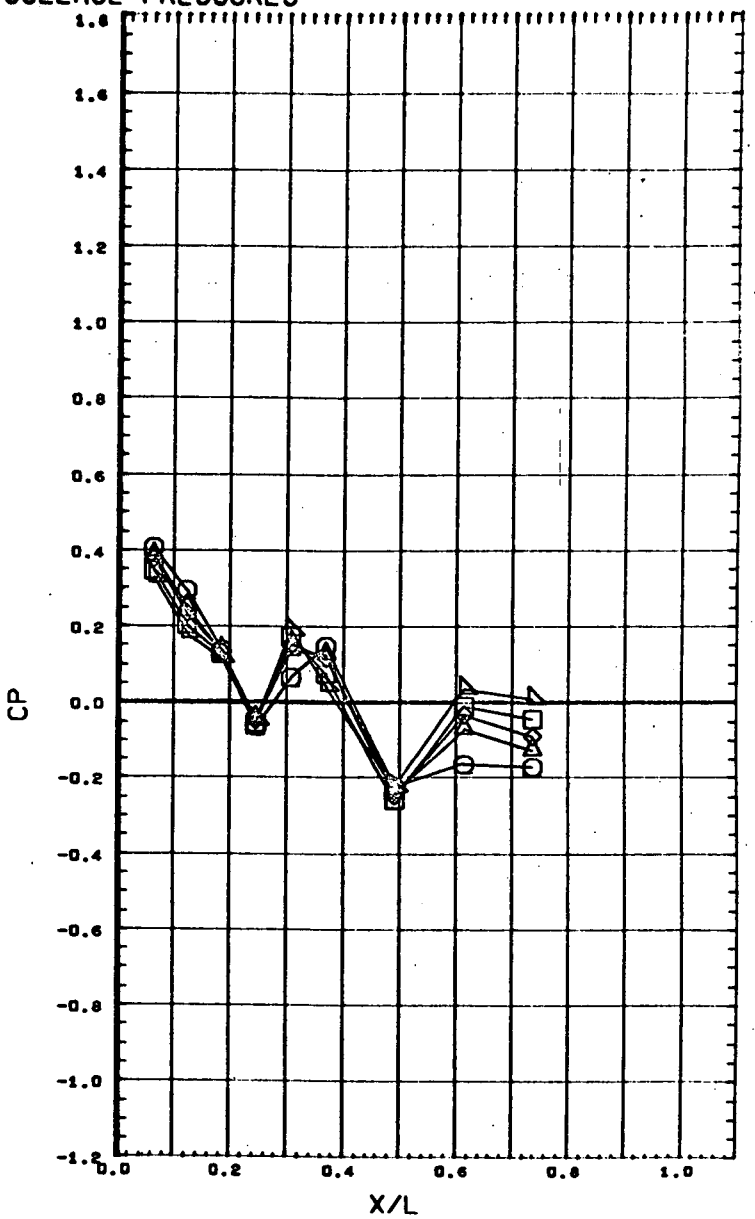
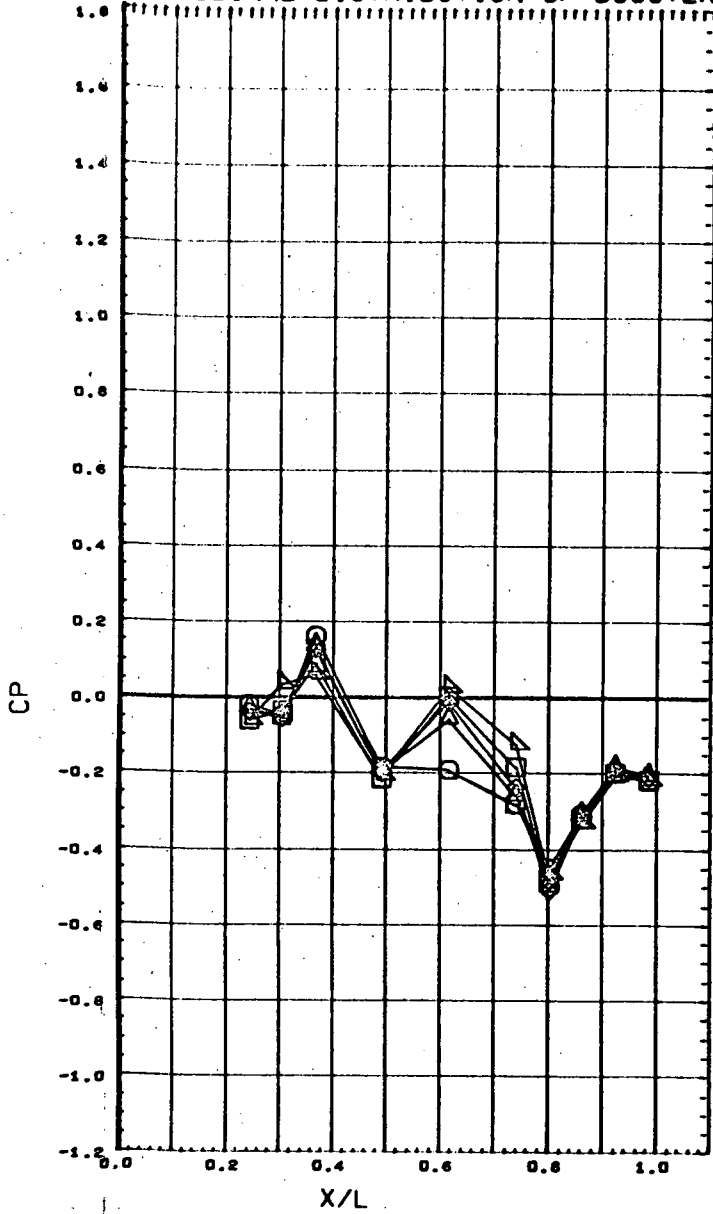

| SYMBOL | ALFB | THETA | M1 |
|--------|-------|--------|-------|
| ○ | 8.312 | 24.000 | 1.199 |
| ◇ | 5.768 | 45.000 | |
| △ | 4.439 | | |
| □ | 2.183 | | |
| ▽ | 0.215 | | |

| PARAMETRIC VALUES | | |
|-------------------|-------|------------|
| BETA | 0.000 | DX/L 0.000 |
| I | 0.000 | |

REFERENCE FILE

LONGITUDINAL DISTRIBUTION OF BOOSTER FUSELAGE PRESSURES

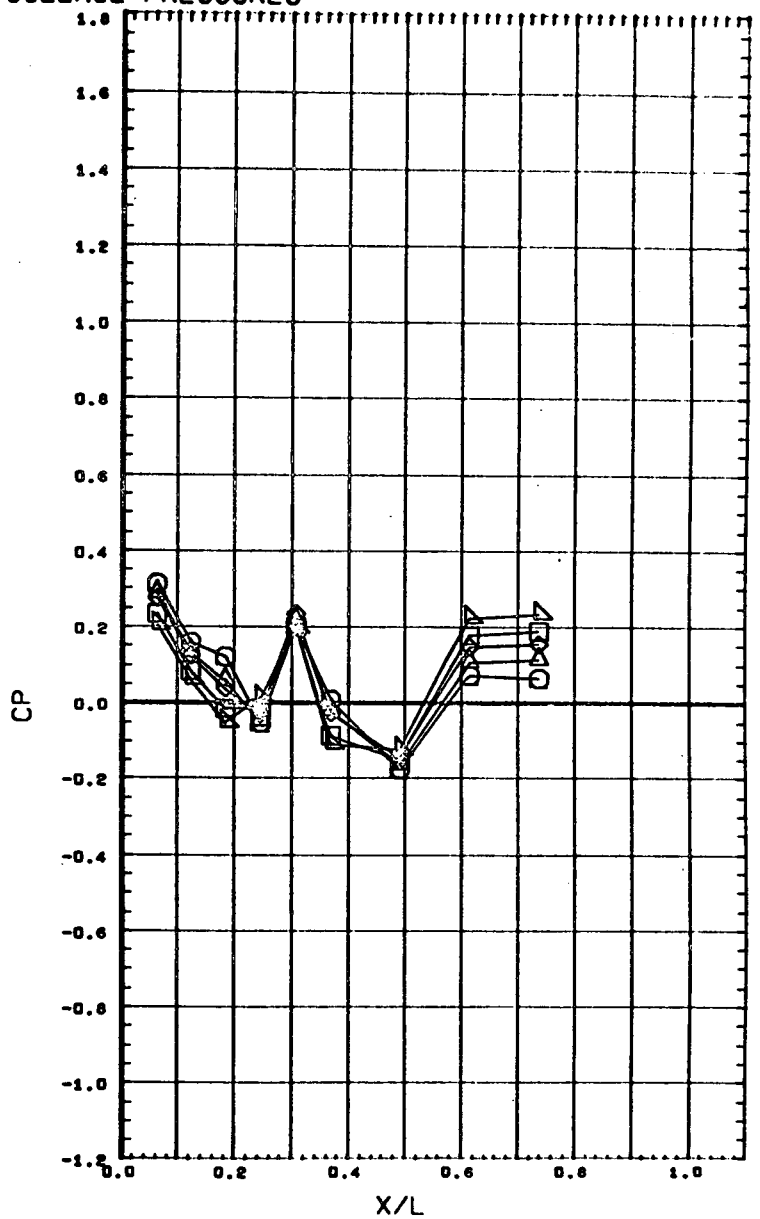
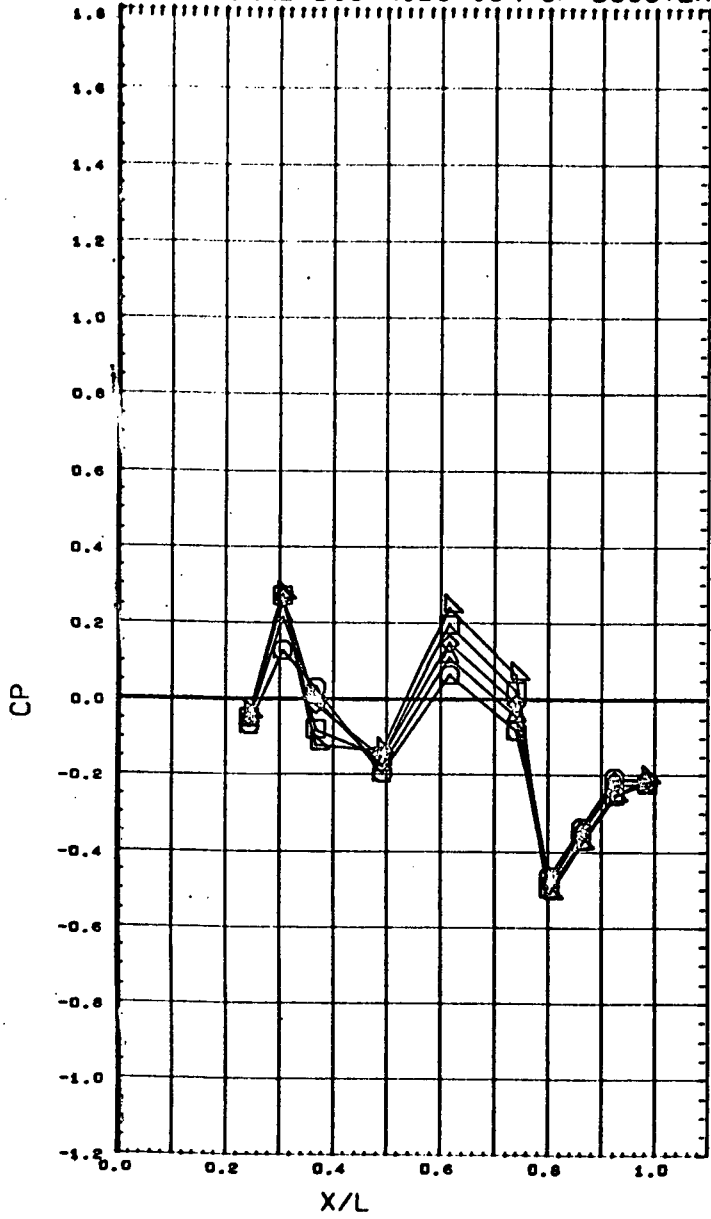

| SYMBOL | ALFB | THETA | M1 |
|--------|--------|--------|-------|
| ○ | 2.170 | 24.000 | 1.199 |
| △ | 4.167 | 45.000 | |
| ◇ | 5.540 | | |
| □ | 8.201 | | |
| ◇ | 10.161 | | |

REFERENCE FILE

| PARAMETRIC VALUES | | |
|-------------------|-------|-------|
| BETA | 0.000 | DX/L |
| I | 0.000 | 0.000 |

LONGITUDINAL DISTRIBUTION OF BOOSTER FUSELAGE PRESSURES

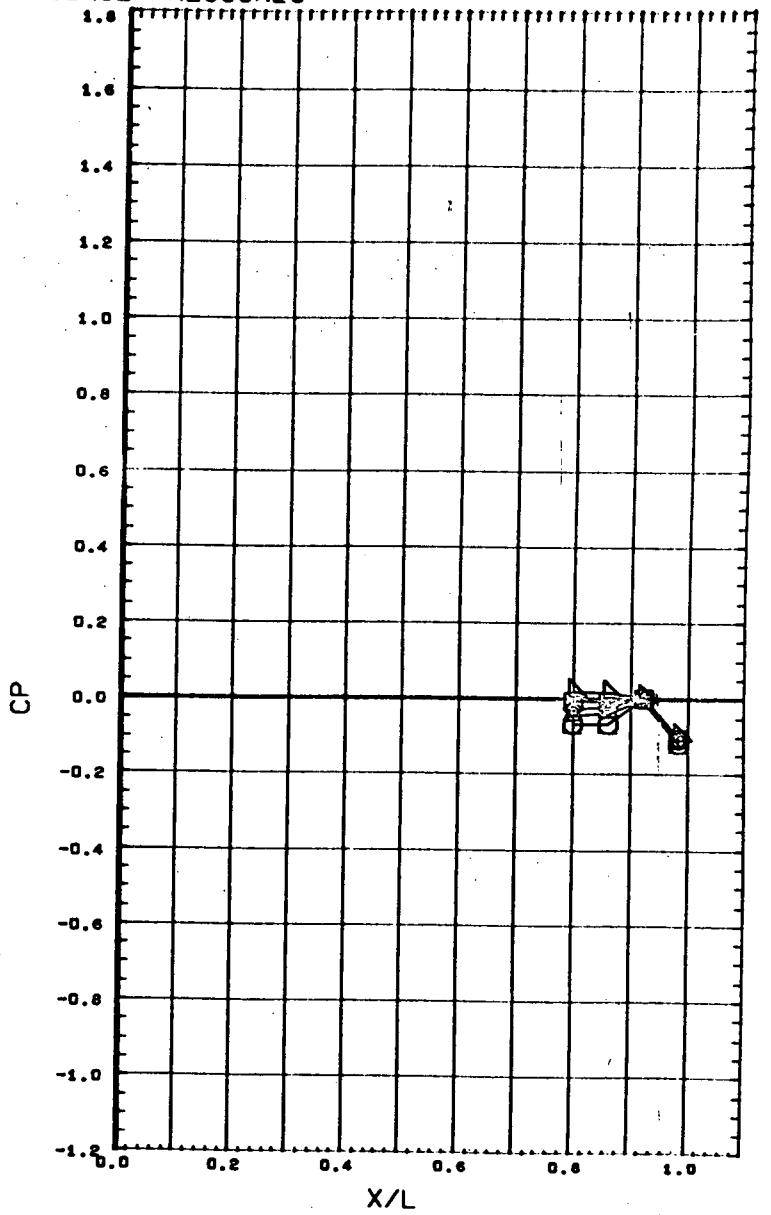
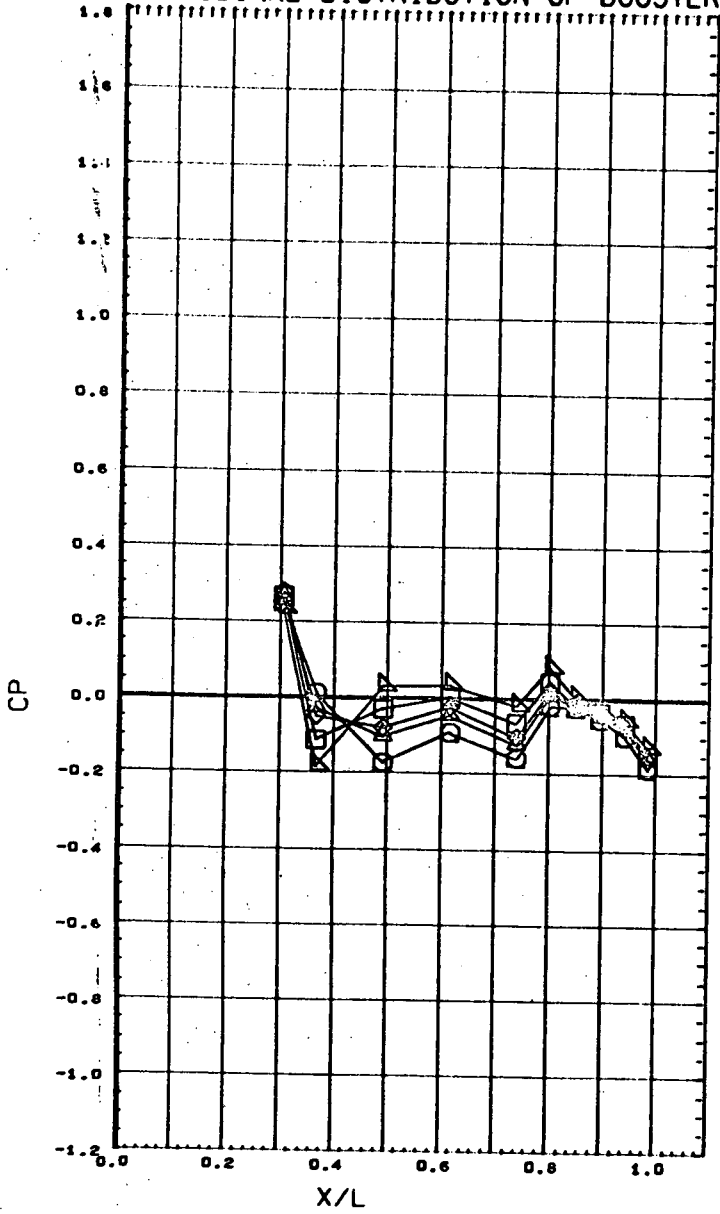

| SYMBOL | ALPB | THETA | M1 |
|--------|-------|---------|-------|
| ○ | 0.312 | 90.000 | 1.199 |
| ◇ | 5.768 | 180.000 | |
| △ | 4.439 | | |
| □ | 2.183 | | |
| ▽ | 0.215 | | |

REFERENCE FILE

| PARAMETRIC VALUES | | |
|-------------------|-------|-------|
| BETA | 0.000 | OX/L |
| I | 0.000 | 0.000 |

LONGITUDINAL DISTRIBUTION OF BOOSTER FUSELAGE PRESSURES

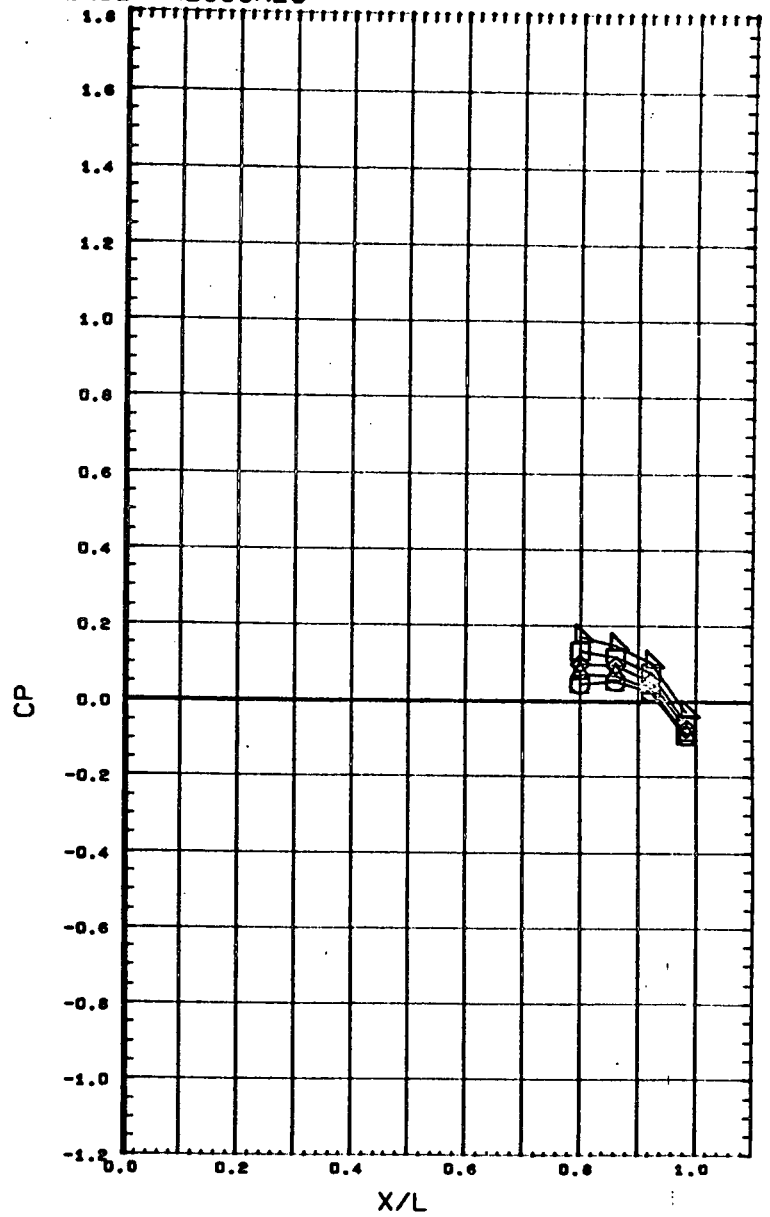
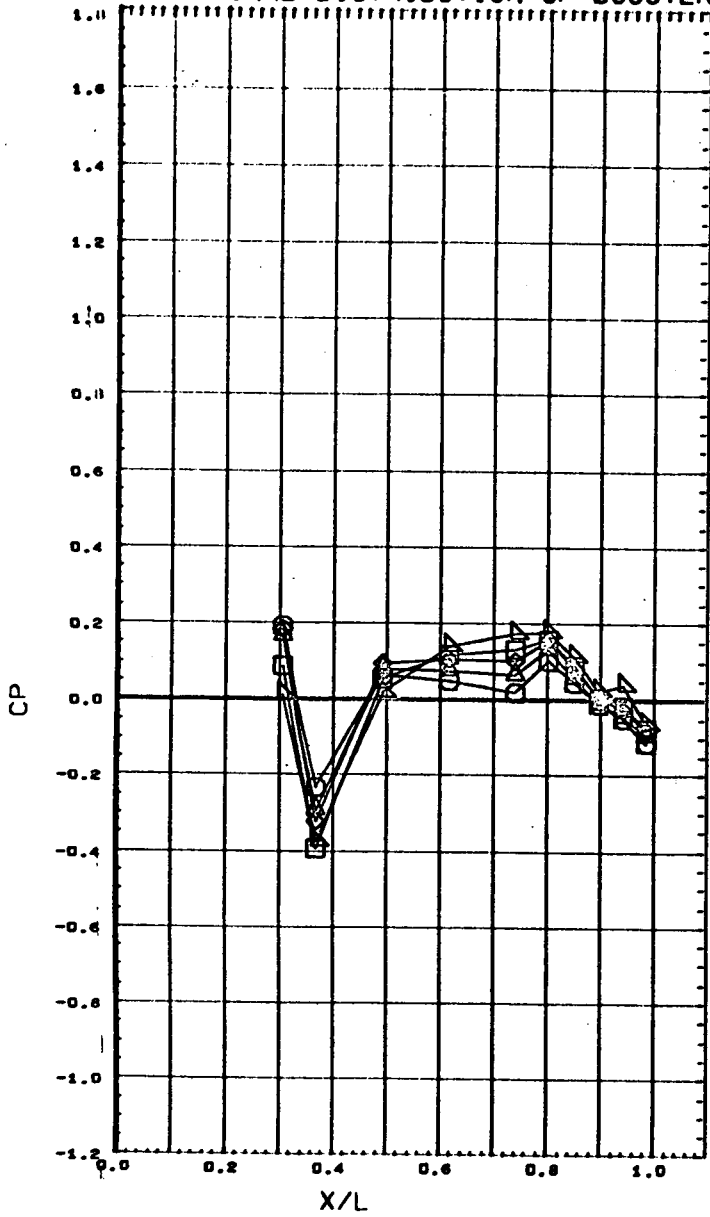

| SYMBOL | ALFB | THETA | M1 |
|--------|--------|---------|-------|
| ○ | 2.170 | 90.000 | 1.199 |
| △ | 4.167 | 180.000 | |
| ◇ | 5.540 | | |
| □ | 8.201 | | |
| ▽ | 10.161 | | |

| PARAMETRIC VALUES | | | |
|-------------------|-------|------|-------|
| BETA | 0.000 | OX/L | 0.000 |
| I | 0.000 | | |

REFERENCE FILE

LONGITUDINAL DISTRIBUTION OF BOOSTER FUSELAGE PRESSURES

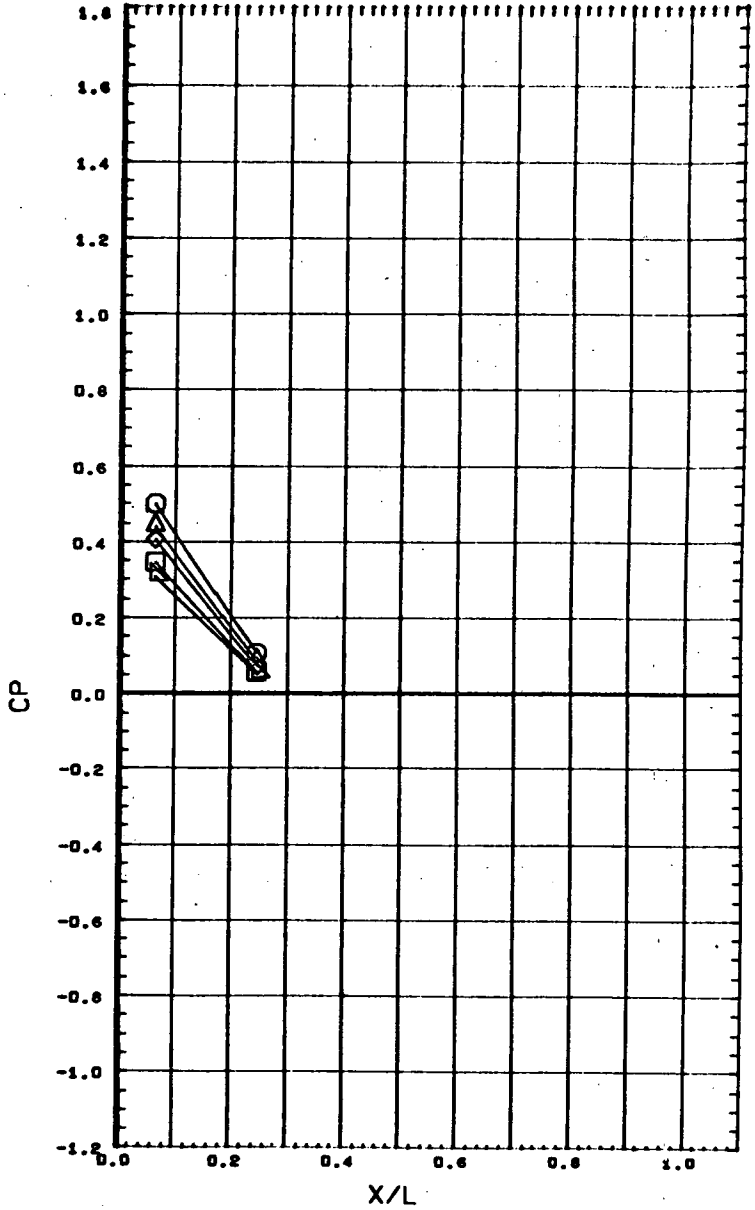
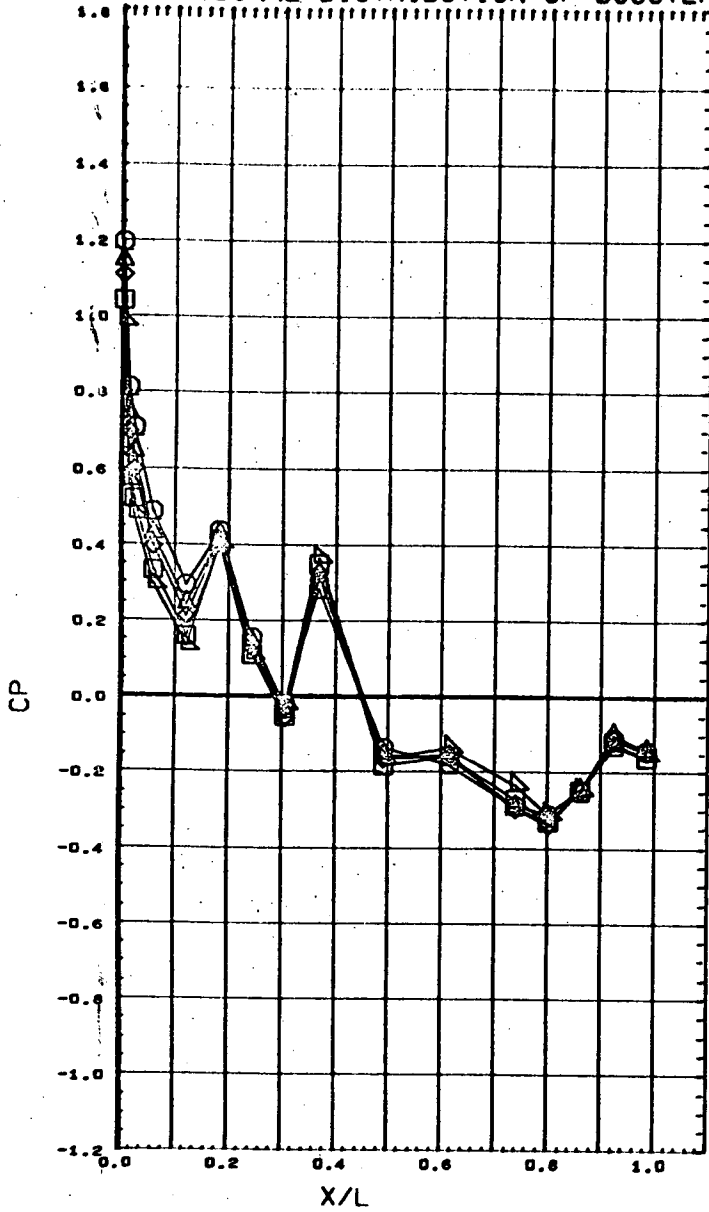

| SYMBOL | ALFB | THETA | M1 |
|--------|-------|--------|-------|
| △ | 8.330 | 0.000 | 1.300 |
| ○ | 5.772 | 15.000 | |
| ◇ | 4.443 | | |
| □ | 1.778 | | |
| ▽ | 0.181 | | |

REFERENCE FILE

| PARAMETRIC VALUES | | |
|-------------------|-------|-------|
| BETA | 0.000 | DX/L |
| I | 0.000 | 0.000 |

LONGITUDINAL DISTRIBUTION OF BOOSTER FUSELAGE PRESSURES

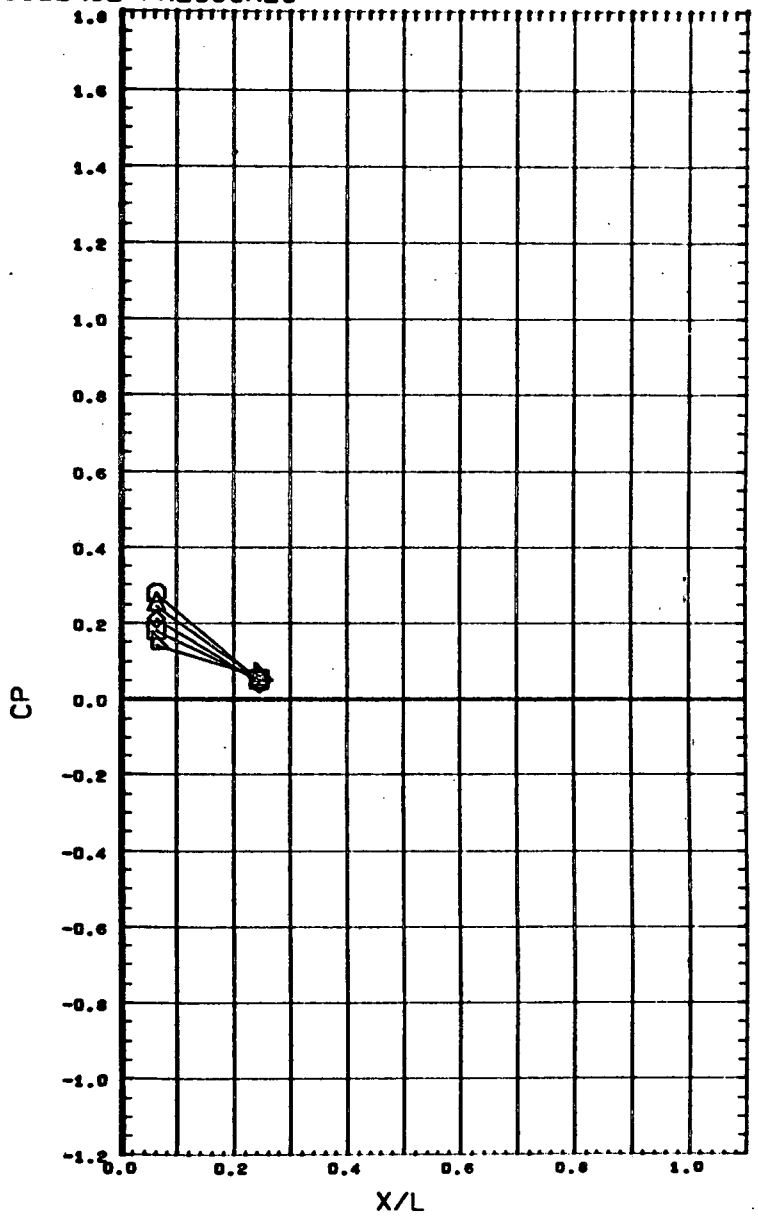
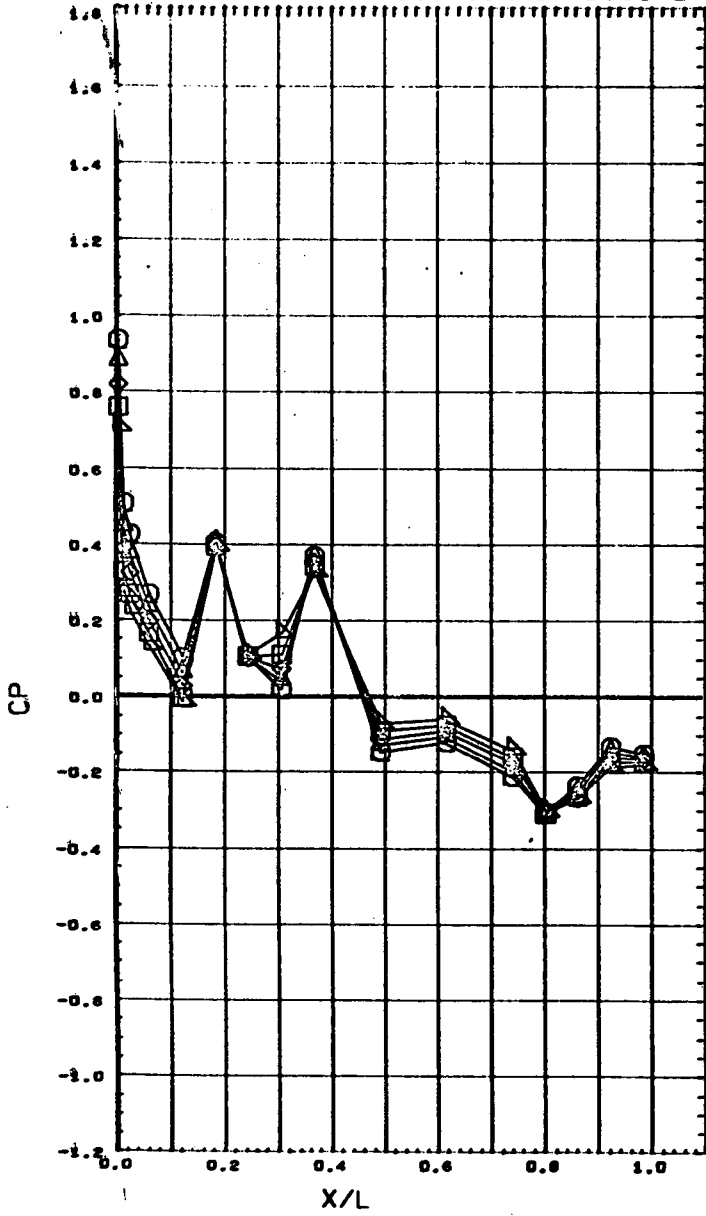

| SYMBOL | ALFB | THETA | M1 |
|--------|--------|--------|-------|
| ○ | 2.169 | 0.000 | 1.300 |
| △ | 4.179 | 15.000 | |
| ◇ | 6.168 | | |
| □ | 8.177 | | |
| ▽ | 10.171 | | |

| PARAMETRIC VALUES | | | |
|-------------------|-------|------|-------|
| BETA | 0.000 | OX/L | 0.000 |
| I | 0.000 | | |

REFERENCE FILE

LONGITUDINAL DISTRIBUTION OF BOOSTER FUSELAGE PRESSURES

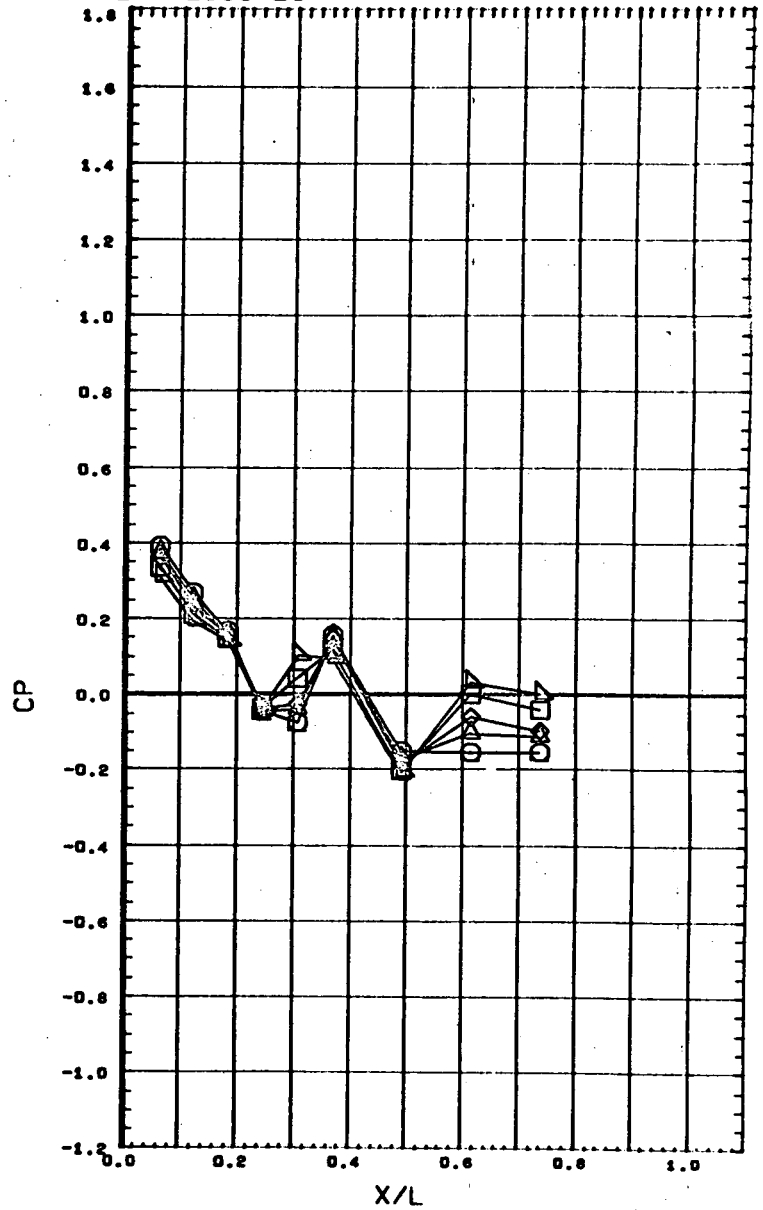
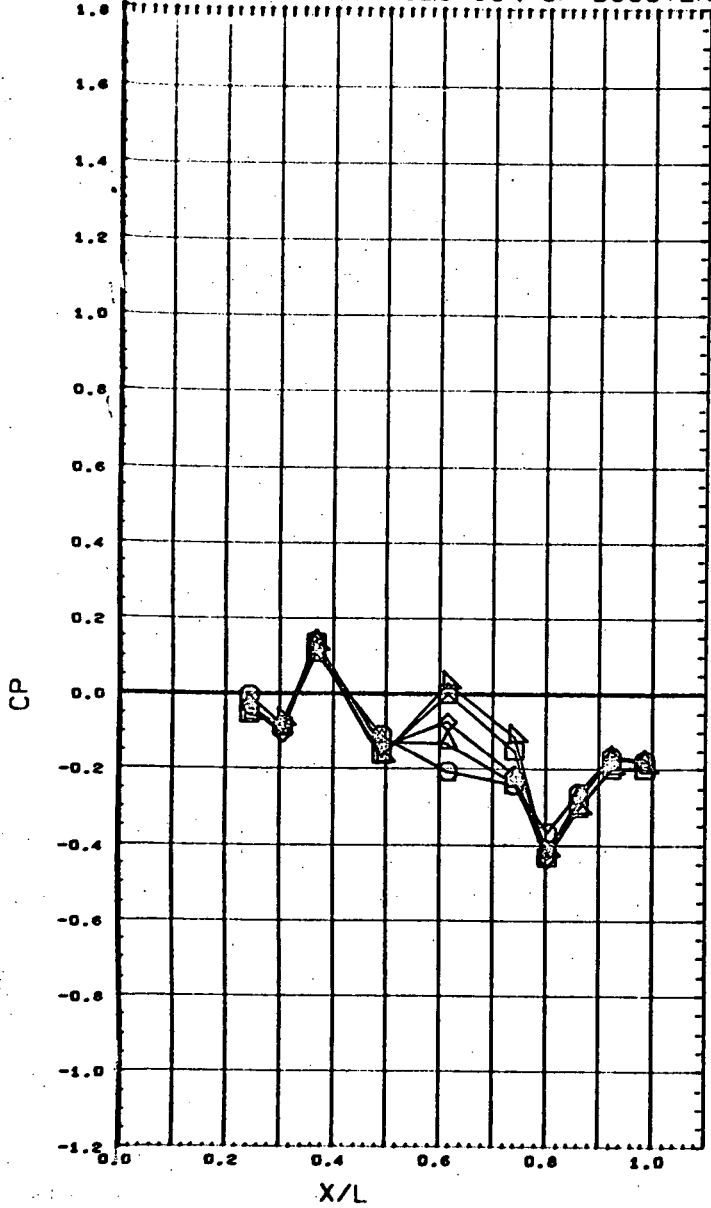

| SYMBOL | ALFB | THETA | M1 |
|--------|-------|--------|-------|
| ○ | 8.330 | 24.000 | 1.300 |
| ◇ | 5.772 | 45.000 | |
| △ | 4.443 | | |
| □ | 1.778 | | |
| ▽ | 0.181 | | |

| PARAMETRIC VALUES | | |
|-------------------|-------|-------|
| BETA | 0.000 | 0.000 |
| I | 0.000 | 0.000 |

REFERENCE FILE

LONGITUDINAL DISTRIBUTION OF BOOSTER FUSELAGE PRESSURES

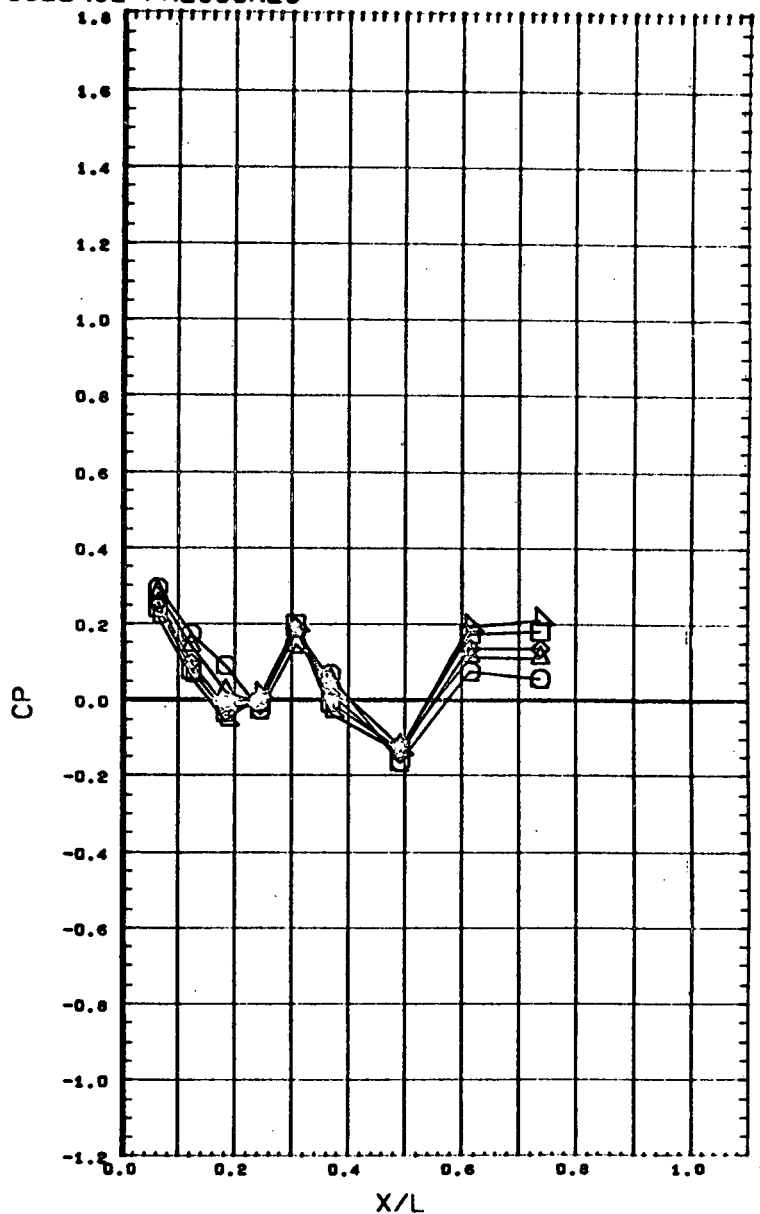
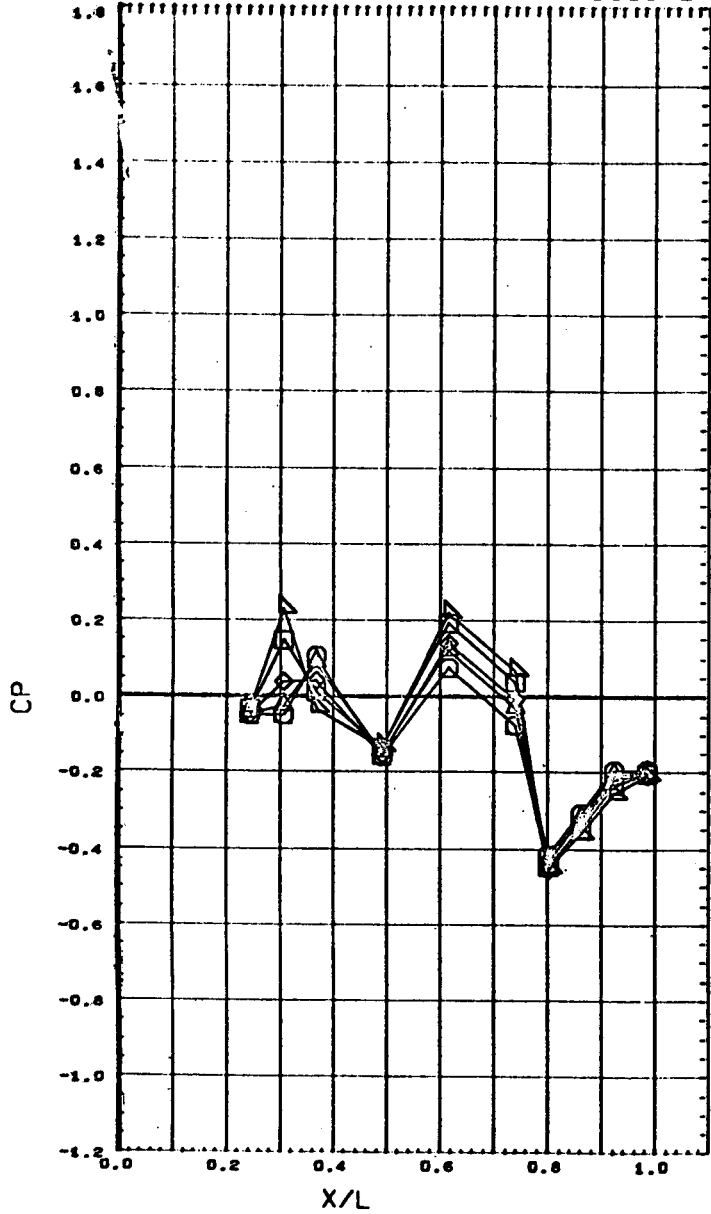

| SYMBOL | AL/B | THETA | M1 |
|--------|--------|--------|-------|
| □ | 2.169 | 24.000 | 1.300 |
| ◇ | 4.179 | 45.000 | |
| △ | 6.168 | | |
| ○ | 8.177 | | |
| ▽ | 10.171 | | |

| PARAMETRIC VALUES | | | |
|-------------------|-------|------|-------|
| BETA | 0.000 | OX/L | 0.000 |
| I | 0.000 | | |

REFERENCE FILE

LONGITUDINAL DISTRIBUTION OF BOOSTER FUSELAGE PRESSURES

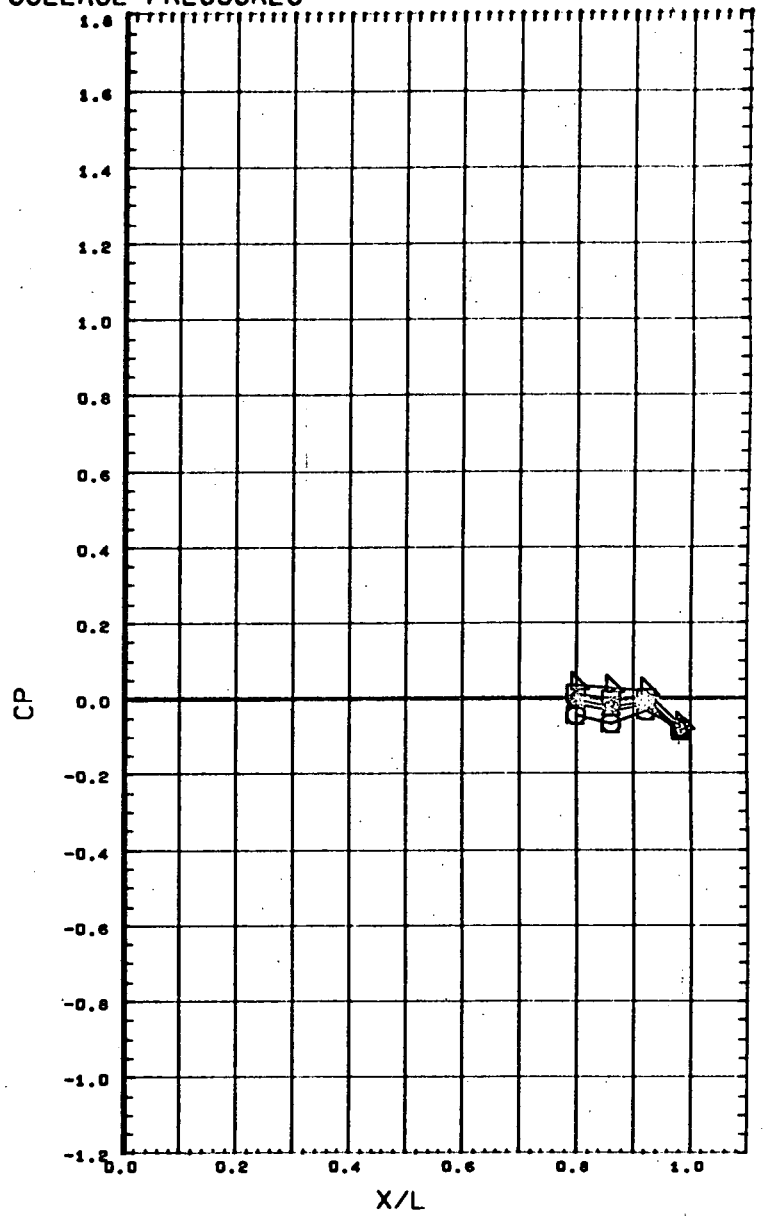
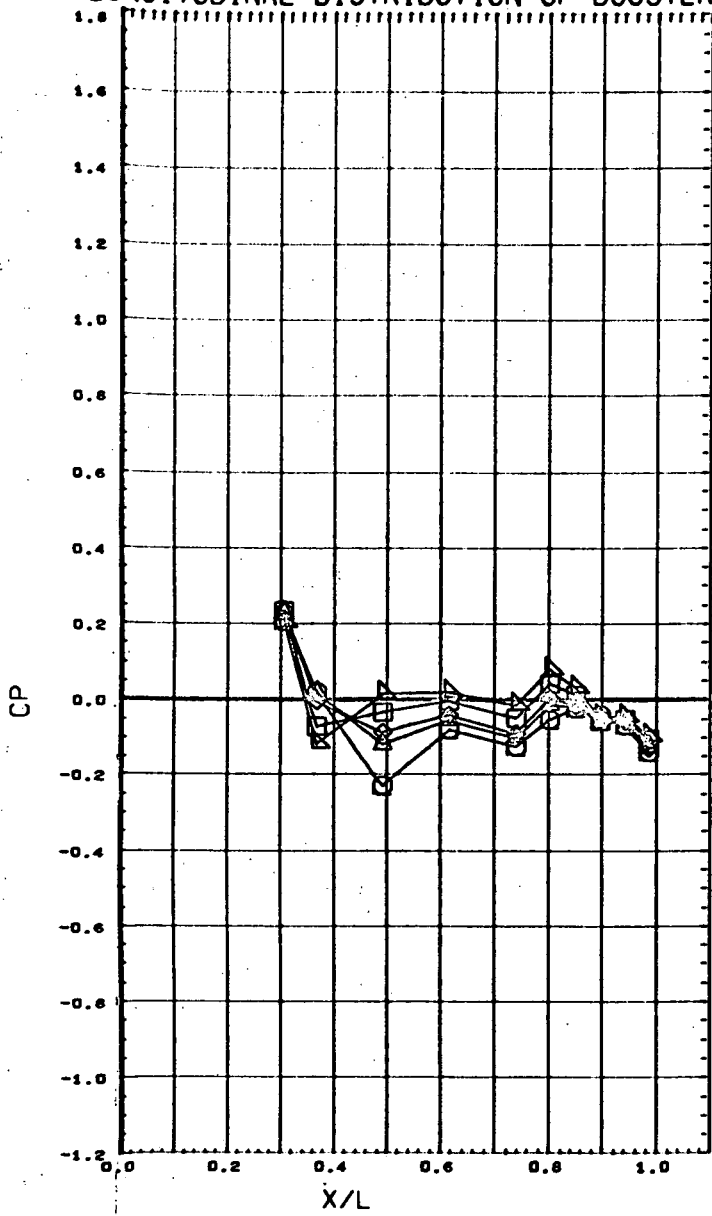

| SYMBOL | ALFB | THETA | M1 |
|--------|---------|---------|-------|
| ○ | - 8.330 | 90.000 | 1.300 |
| △ | - 5.772 | 180.000 | |
| ◇ | - 4.443 | | |
| □ | - 3.776 | | |
| ▽ | 0.181 | | |

| PARAMETRIC VALUES | | | |
|-------------------|-------|------|-------|
| BETA | 0.000 | OX/L | 0.000 |
| i | 0.000 | | |

REFERENCE FILE

LONGITUDINAL DISTRIBUTION OF BOOSTER FUSELAGE PRESSURES

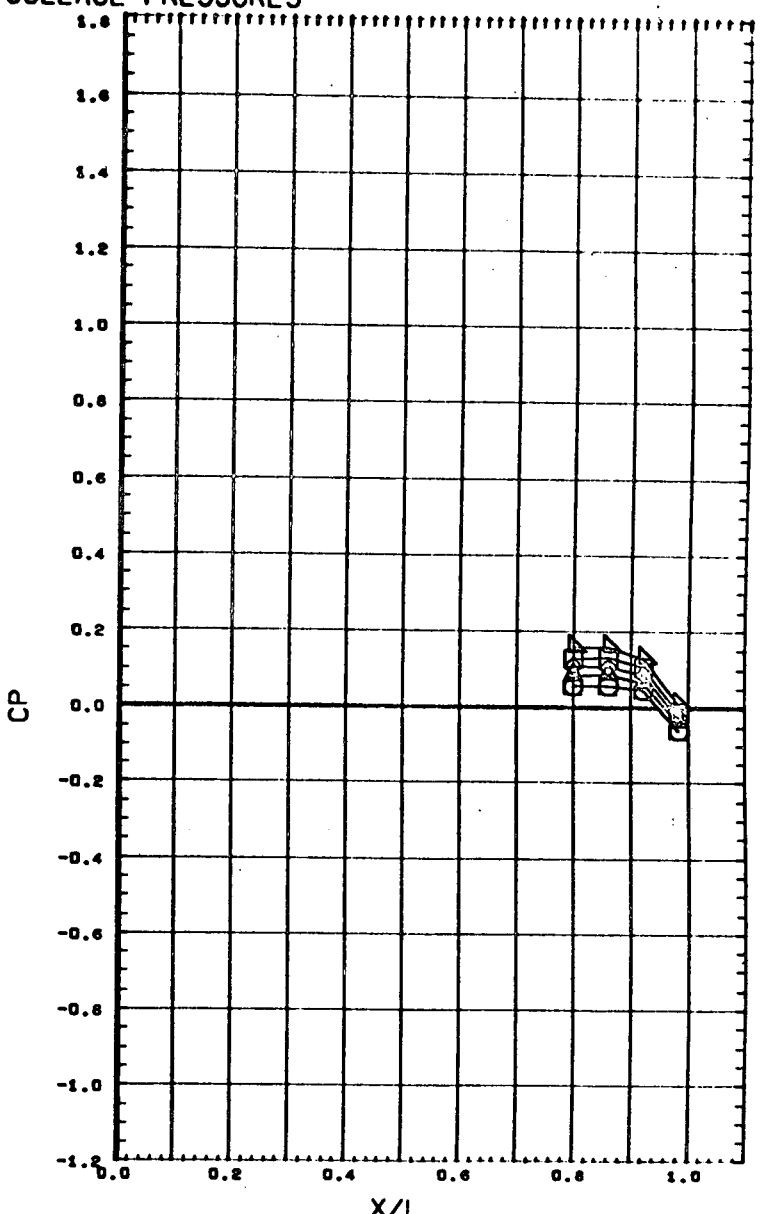
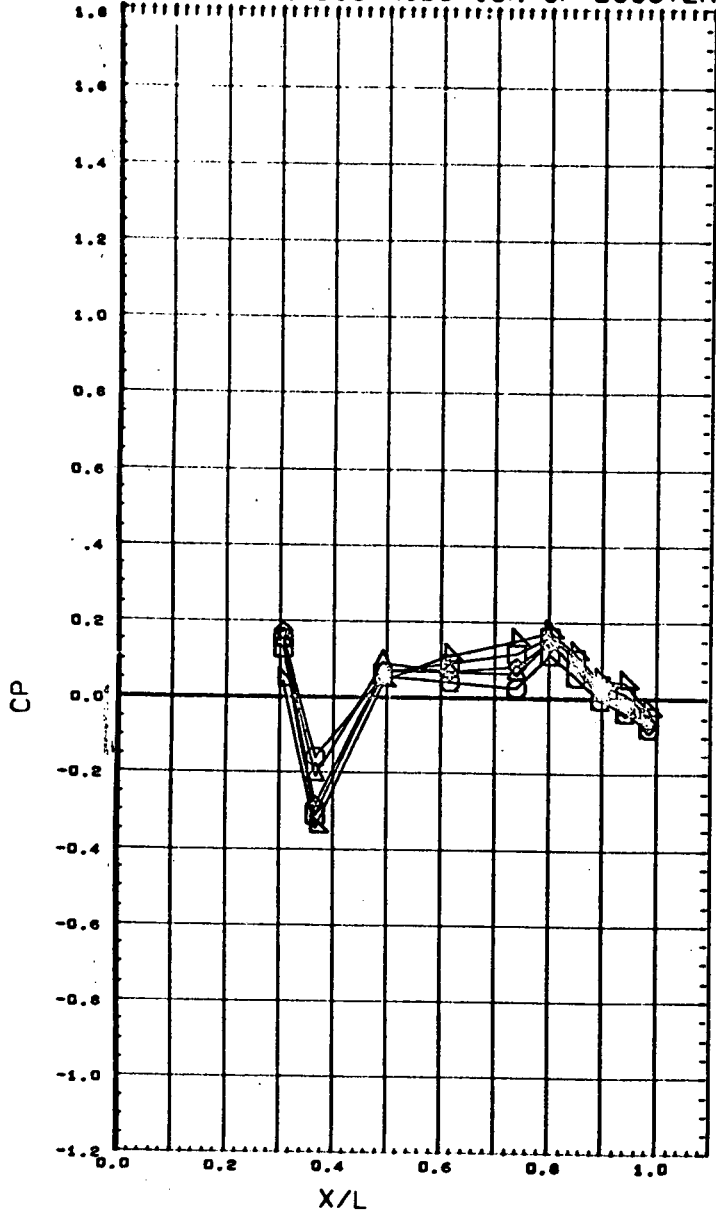

| SYMBOL | ALFB | THETA | M1 |
|--------|--------|---------|-------|
| □ | 2.169 | 90.000 | 1.300 |
| ◇ | 4.179 | 180.000 | |
| △ | 6.168 | | |
| ○ | 8.177 | | |
| ◇ | 10.171 | | |

| PARAMETRIC VALUES | | |
|-------------------|-------|-------|
| BETA | 0.000 | DX/L |
| I | 0.000 | 0.000 |

REFERENCE FILE

LONGITUDINAL DISTRIBUTION OF BOOSTER FUSELAGE PRESSURES

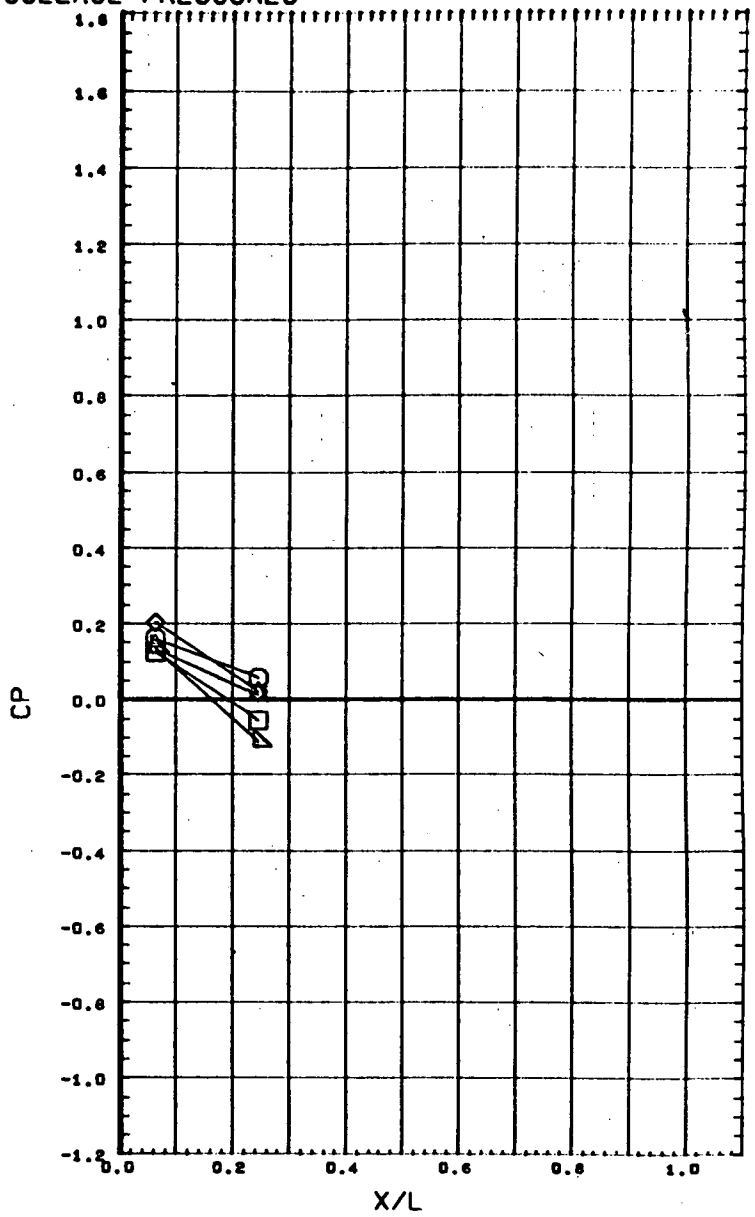
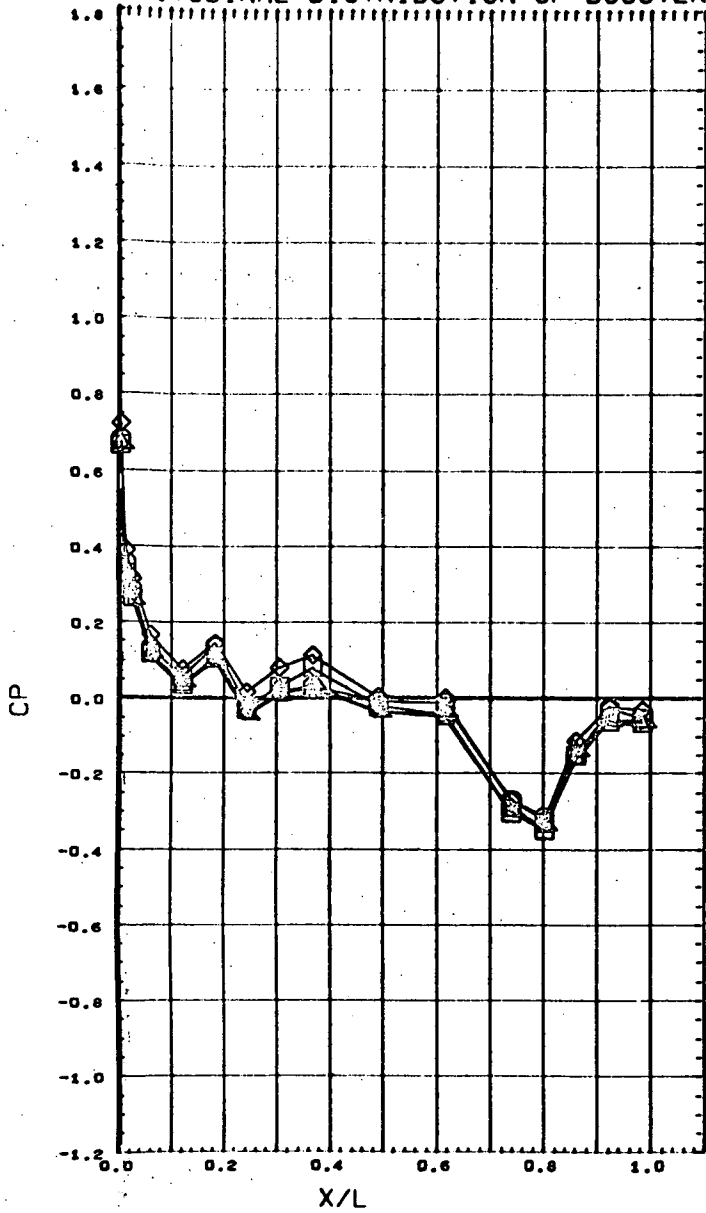

| SYMBOL | BETA | THETA | M1 |
|--------|-------|--------|-------|
| ○ | 5.991 | 0.000 | 0.600 |
| △ | 4.085 | 15.000 | |
| ◇ | 2.108 | | |
| □ | 0.293 | | |
| ○ | 1.955 | | |

REFERENCE FILE

| PARAMETRIC VALUES | | |
|-------------------|-------|------------|
| ALFB | 0.000 | OX/L 0.000 |
| I | 0.000 | |

LONGITUDINAL DISTRIBUTION OF BOOSTER FUSELAGE PRESSURES

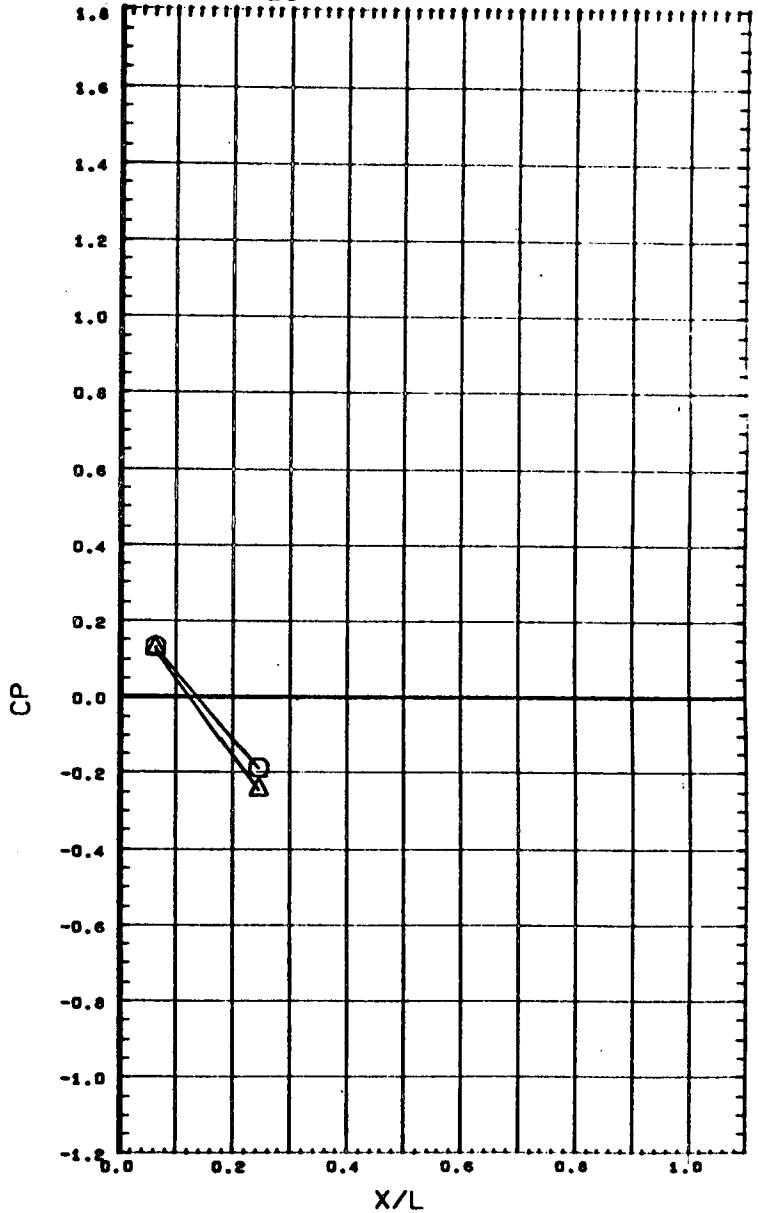
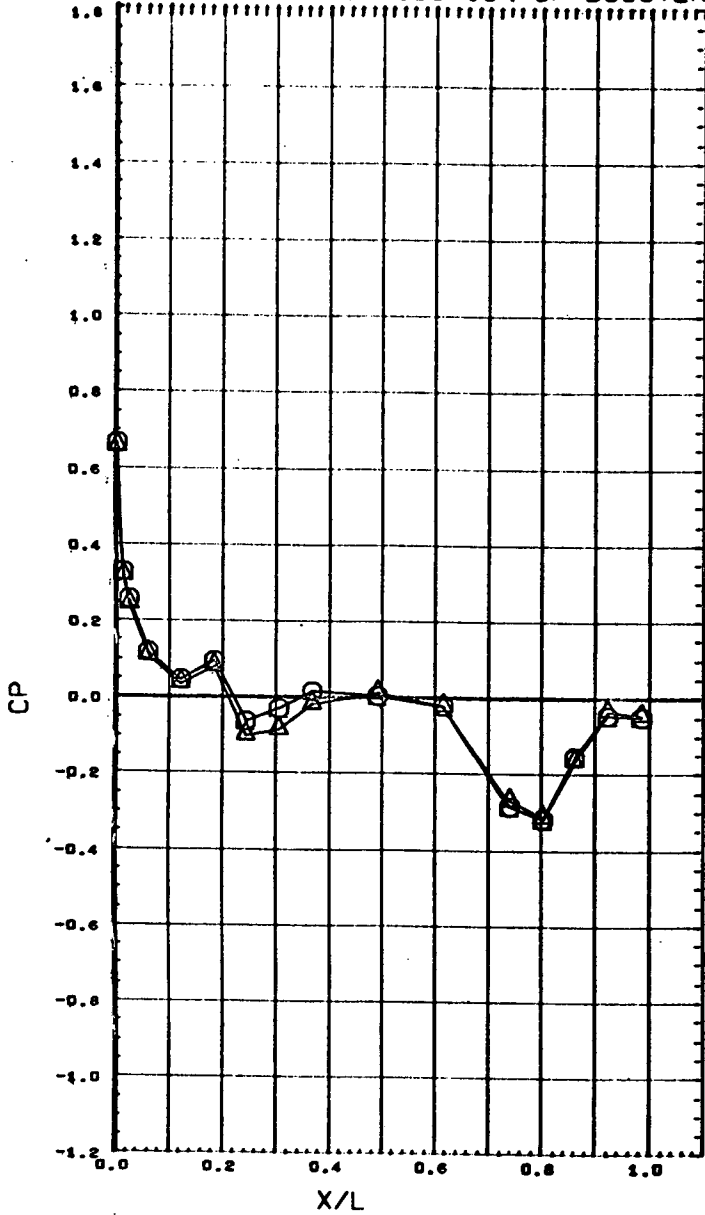

| SYMBOL | BETA | THETA | M1 |
|--------|-------|--------|-------|
| ○ | 4.018 | 0.000 | 0.600 |
| △ | 9.878 | 15.000 | |

| PARAMETRIC VALUES | | | |
|-------------------|-------|------|-------|
| ALFB | 0.000 | OX/L | 0.000 |
| I | 0.000 | | |

REFERENCE FILE

LONGITUDINAL DISTRIBUTION OF BOOSTER FUSELAGE PRESSURES

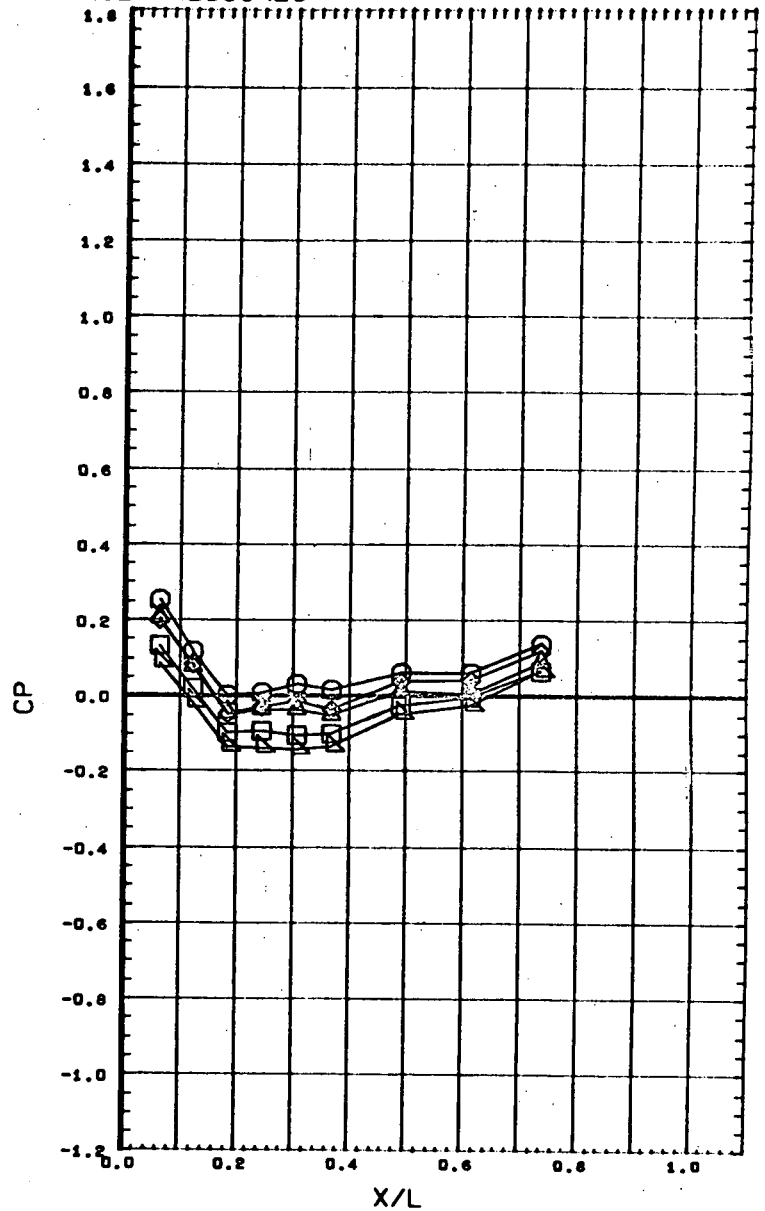
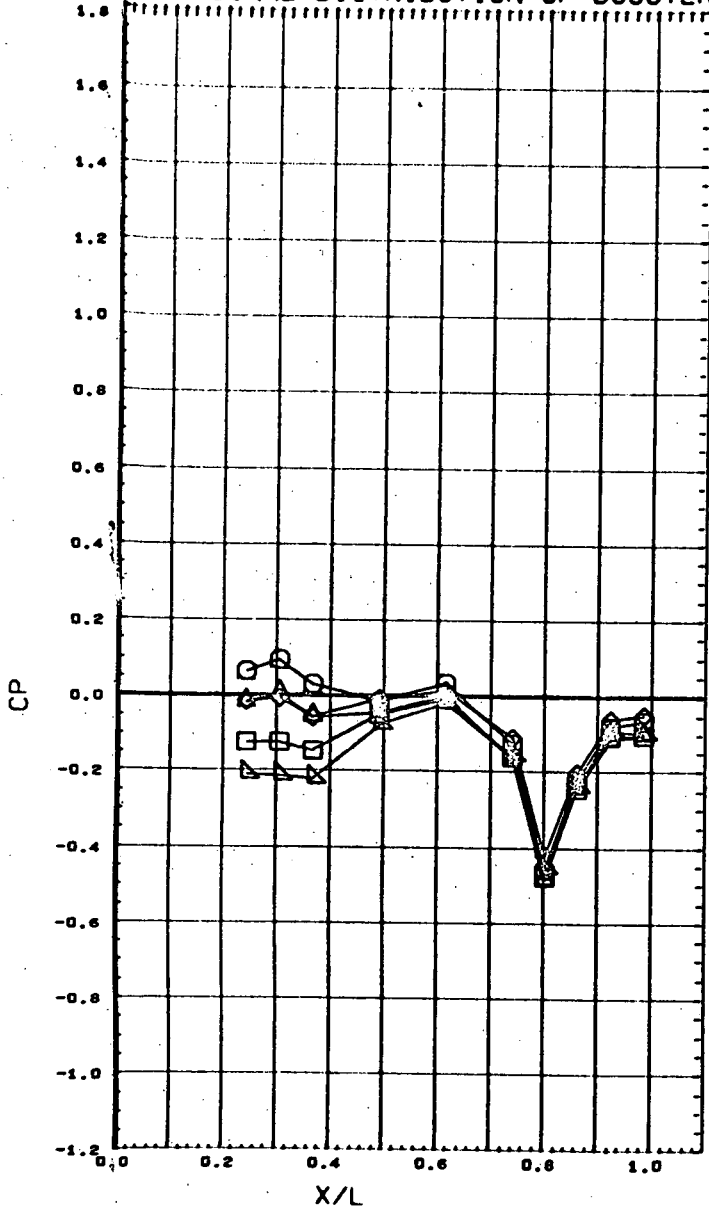

| SYMBOL | BETA | THETA | M1 |
|--------|-------|--------|-------|
| ○ | 5.991 | 24.000 | 0.600 |
| ◇ | 4.085 | 45.000 | |
| △ | 2.108 | | |
| □ | 0.293 | | |
| ▽ | 1.955 | | |

REFERENCE FILE

| PARAMETRIC VALUES | | |
|-------------------|-------|-------|
| ALFB | 0.000 | OX/L |
| I | 0.000 | 0.000 |

LONGITUDINAL DISTRIBUTION OF BOOSTER FUSELAGE PRESSURES

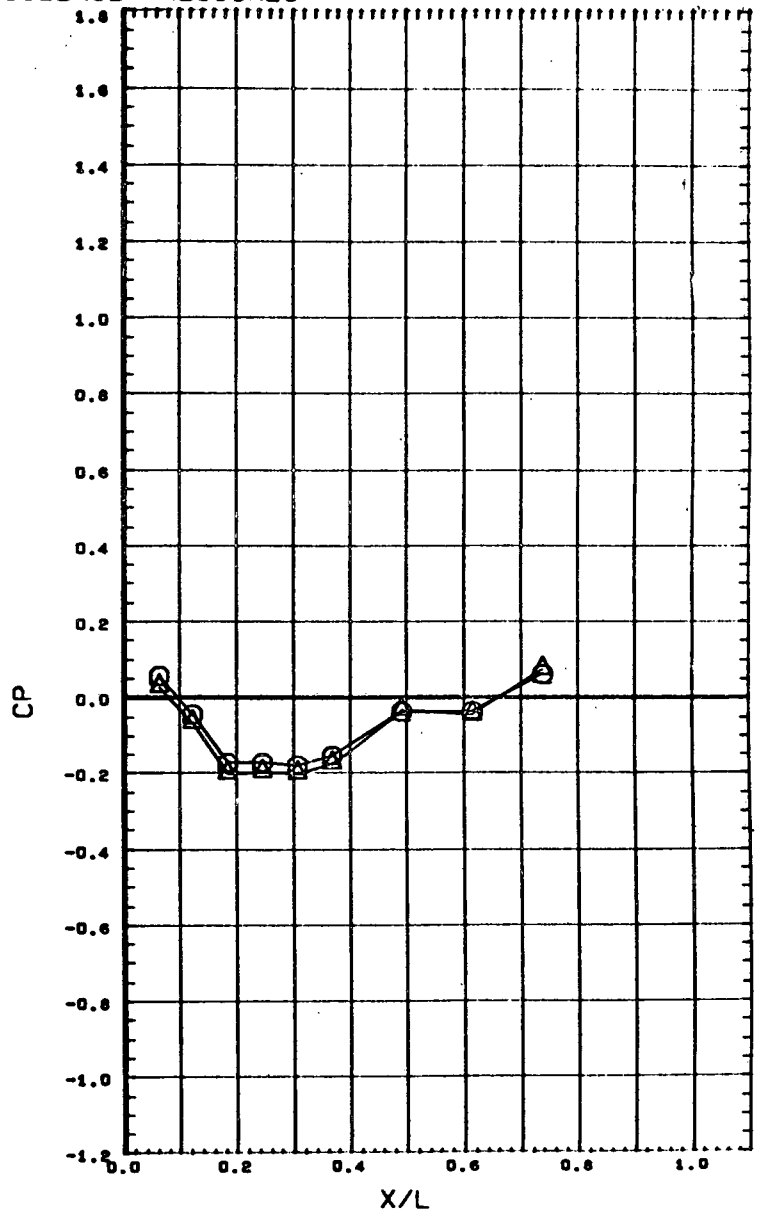
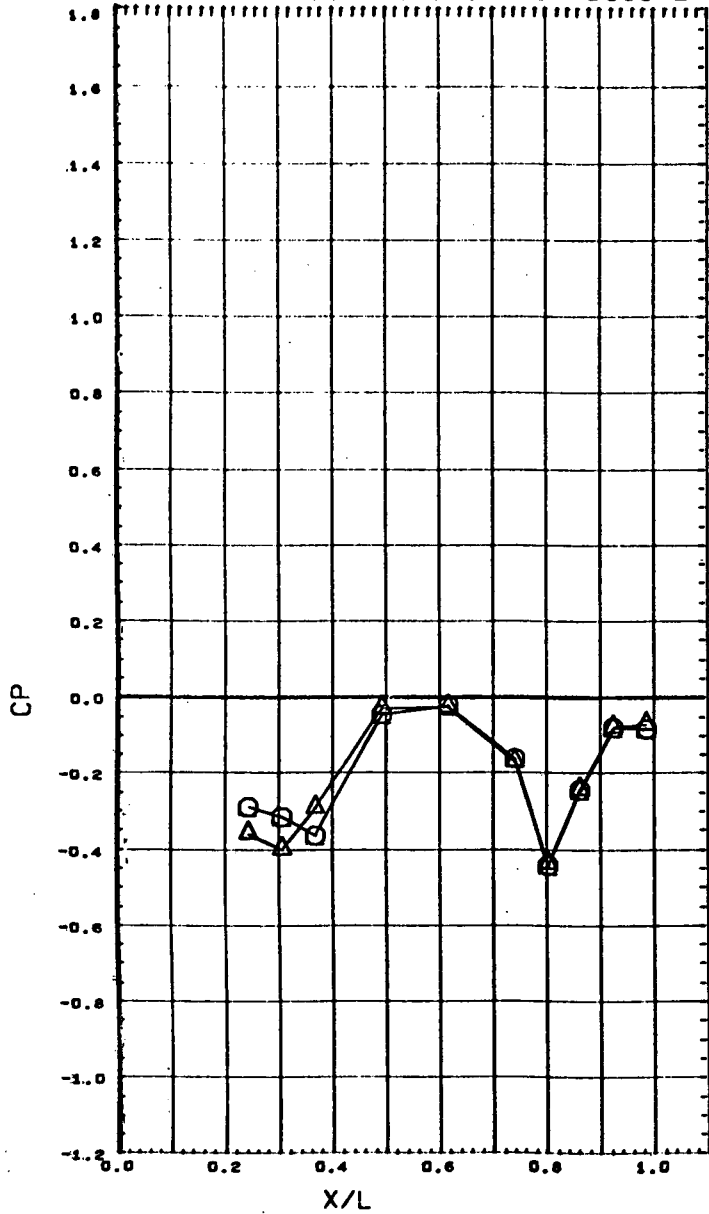

| SYMBOL | BETA | THETA | M1 |
|--------|-------|--------|-------|
| ○ | 4.018 | 24.000 | 0.600 |
| △ | 5.878 | 45.000 | |

| PARAMETRIC VALUES | | | |
|-------------------|-------|------|-------|
| ALFB | 0.000 | DX/L | 3.000 |
| I | 0.000 | | |

REFERENCE FILE

LONGITUDINAL DISTRIBUTION OF BOOSTER FUSELAGE PRESSURES

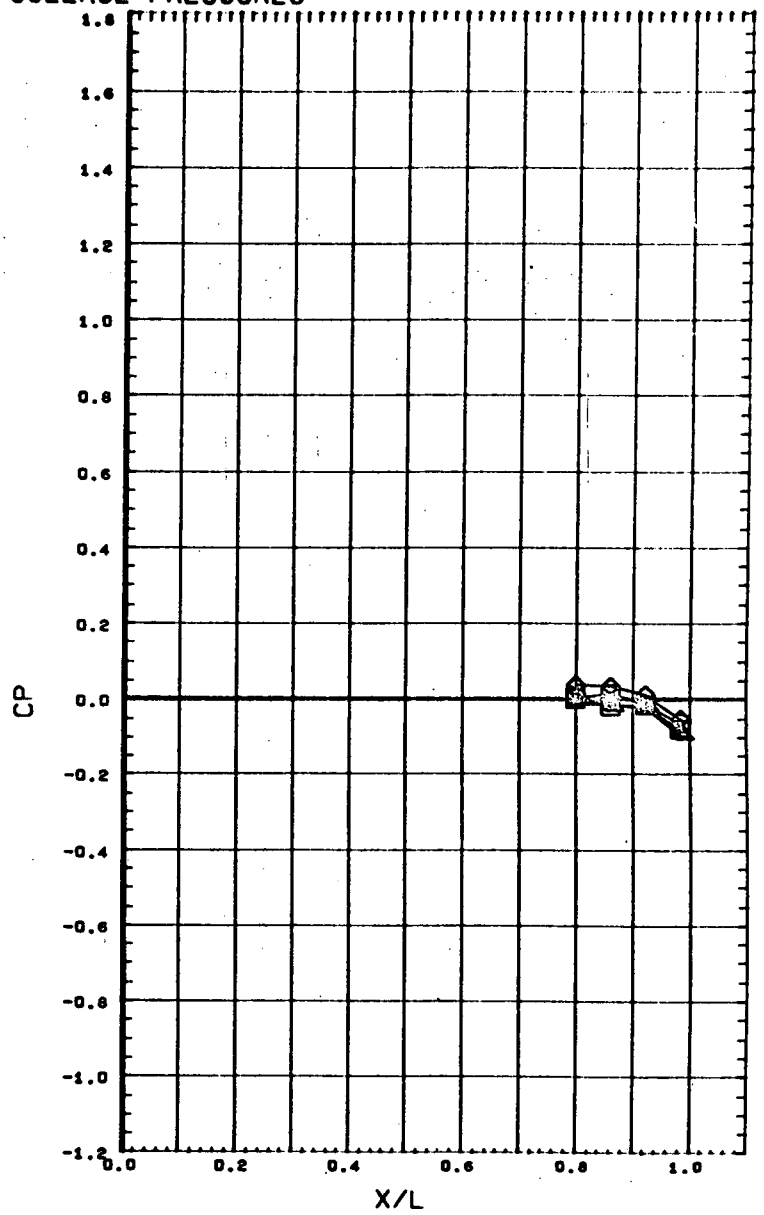
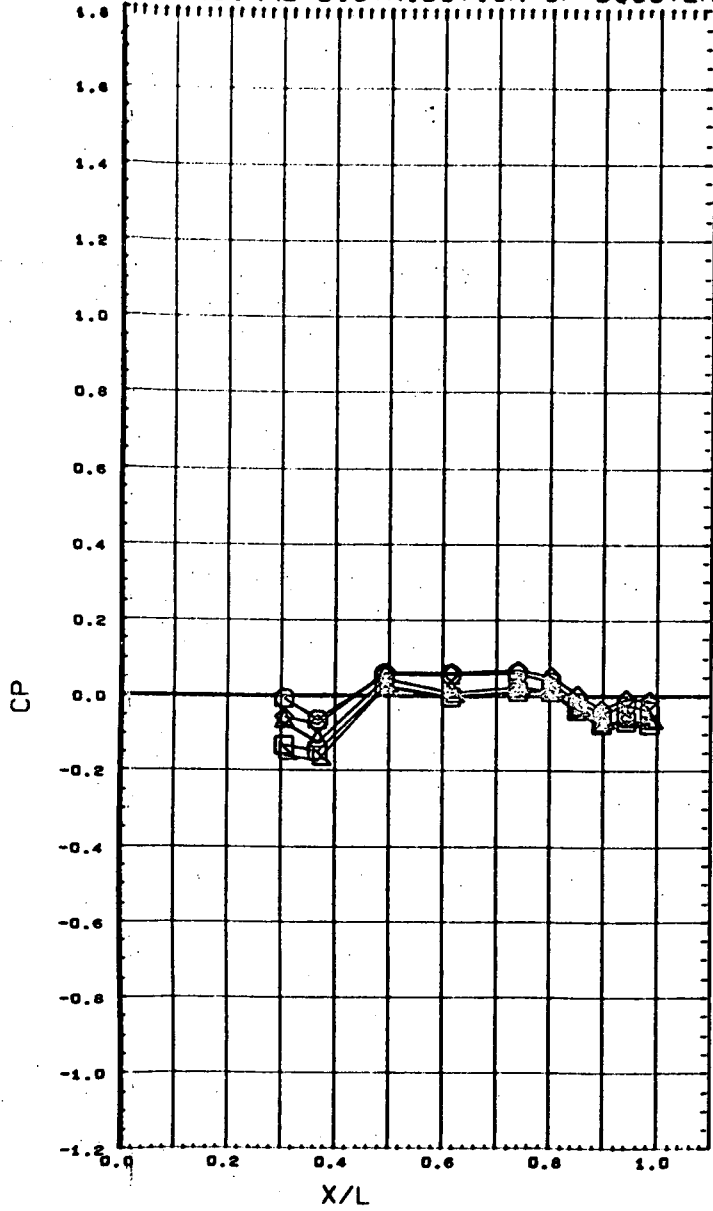

| SYMBOL | BETA | THETA | M1 |
|--------|-------|---------|-------|
| □ | 5.991 | 90.000 | 0.600 |
| ◇ | 4.085 | 180.000 | |
| △ | 2.108 | | |
| ○ | 0.293 | | |
| ◇ | 1.955 | | |

REFERENCE FILE

| PARAMETRIC VALUES | | |
|-------------------|-------|-------|
| ALFB | 0.000 | DX/L |
| I | 0.000 | 0.000 |

LONGITUDINAL DISTRIBUTION OF BOOSTER FUSELAGE PRESSURES

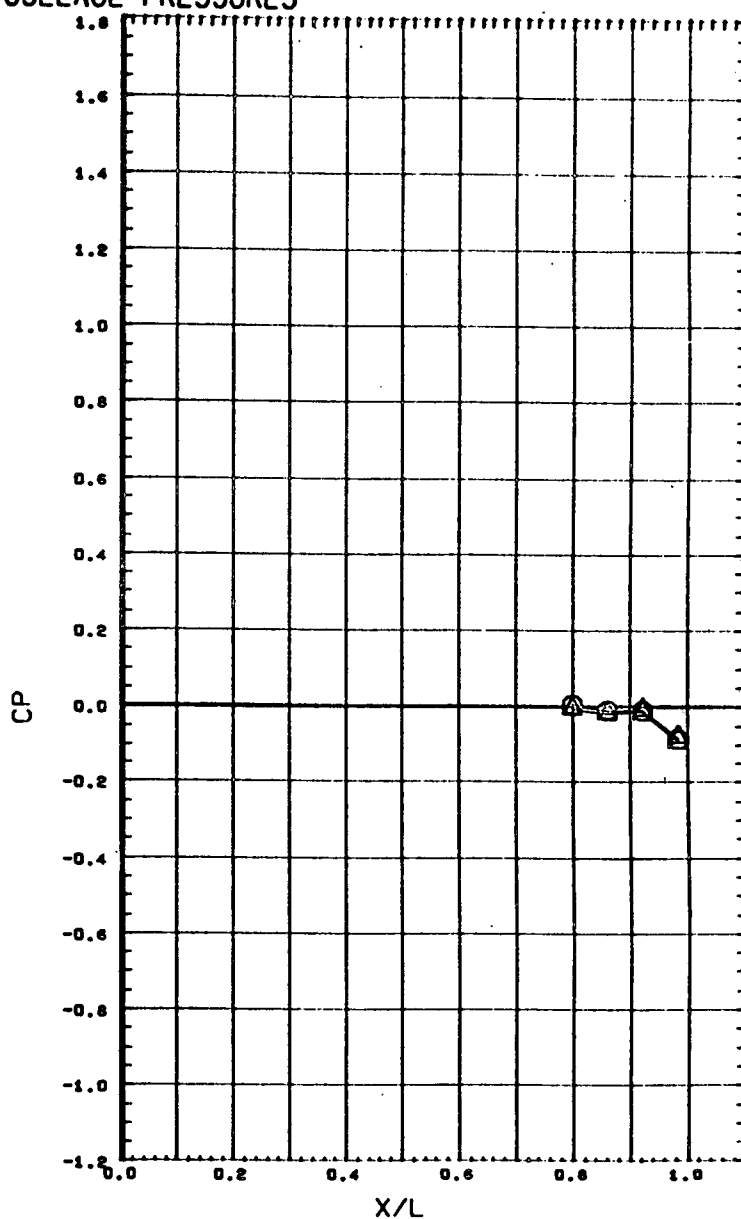
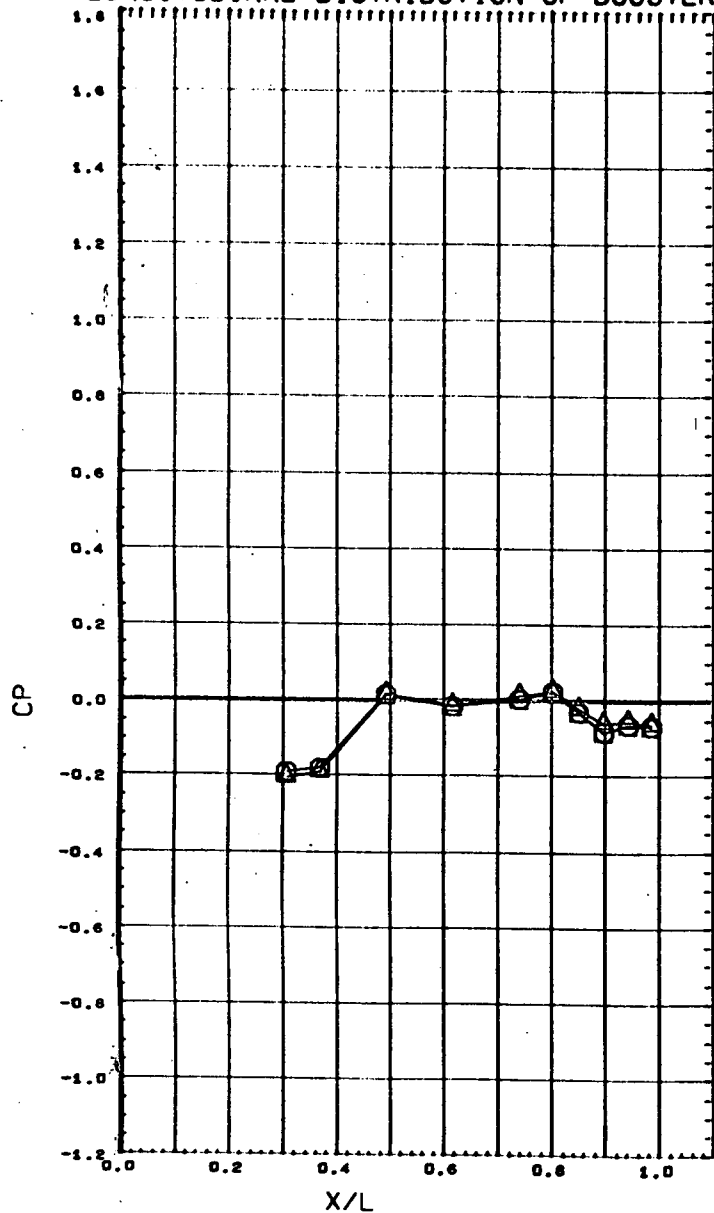

| SYMBOL | BETA | THETA | M1 |
|--------|-------|---------|-------|
| ○ | 4.018 | 90.000 | 0.600 |
| △ | 5.878 | 180.000 | |

| PARAMETRIC VALUES | | |
|-------------------|-------|-------|
| ALFB | dx/L | |
| I | 0.000 | 0.000 |

REFERENCE FILE

LONGITUDINAL DISTRIBUTION OF BOOSTER FUSELAGE PRESSURES

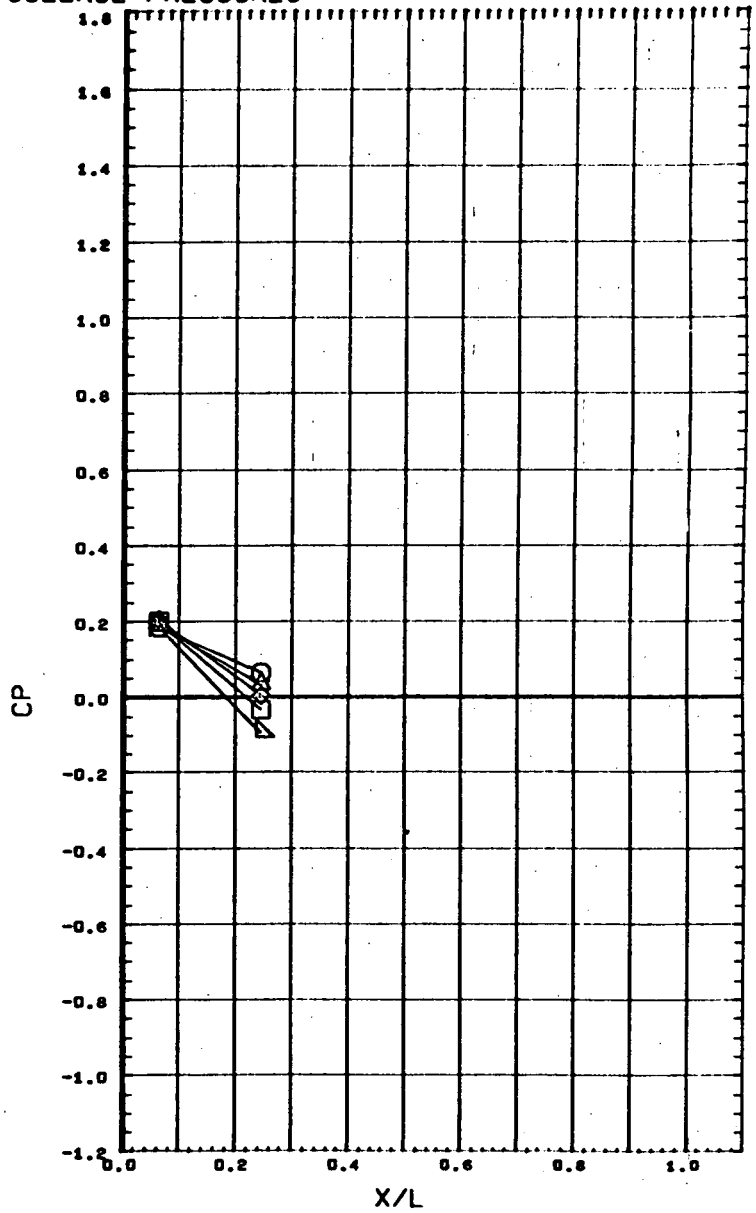
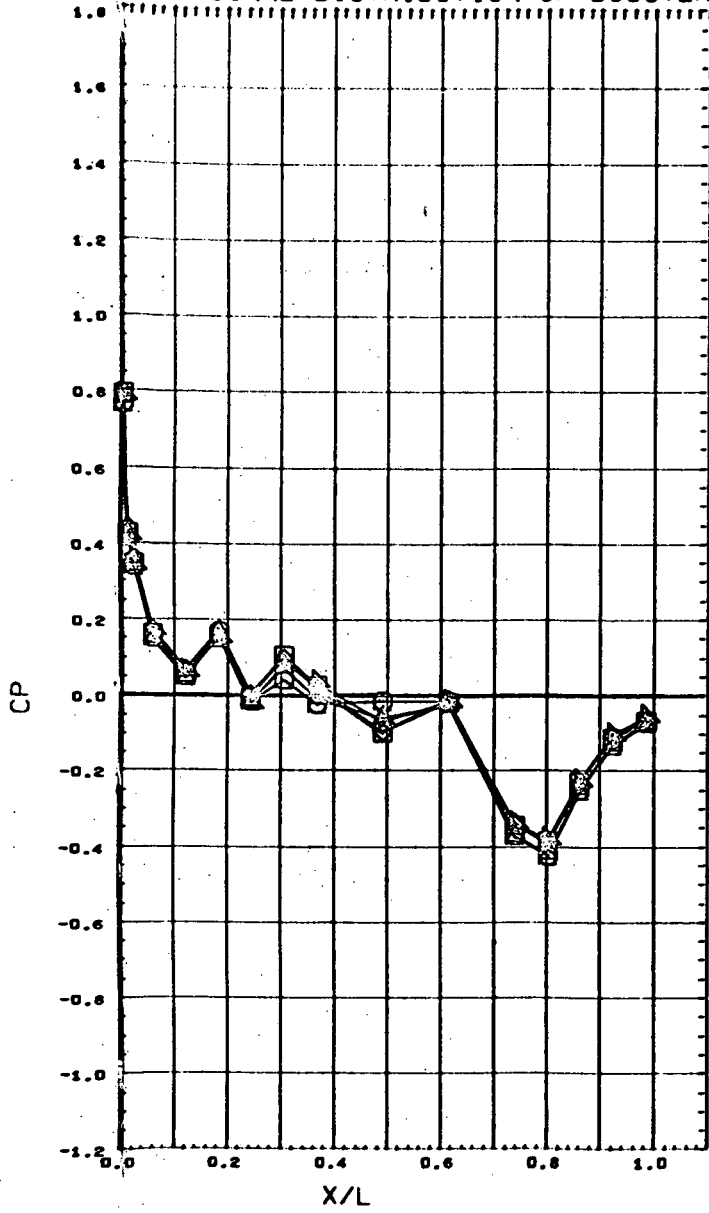

| SYMBOL | BETA | THETA | M1 |
|--------|-------|--------|-------|
| □ | 6.014 | 0.000 | 0.898 |
| ◇ | 4.113 | 15.000 | |
| △ | 2.146 | | |
| ○ | 0.287 | | |
| ▽ | 2.007 | | |

| PARAMETRIC VALUES | | |
|-------------------|-------|-------|
| ALFB | 0.000 | DX/L |
| I | 0.000 | 0.000 |

REFERENCE FILE

LONGITUDINAL DISTRIBUTION OF BOOSTER FUSELAGE PRESSURES

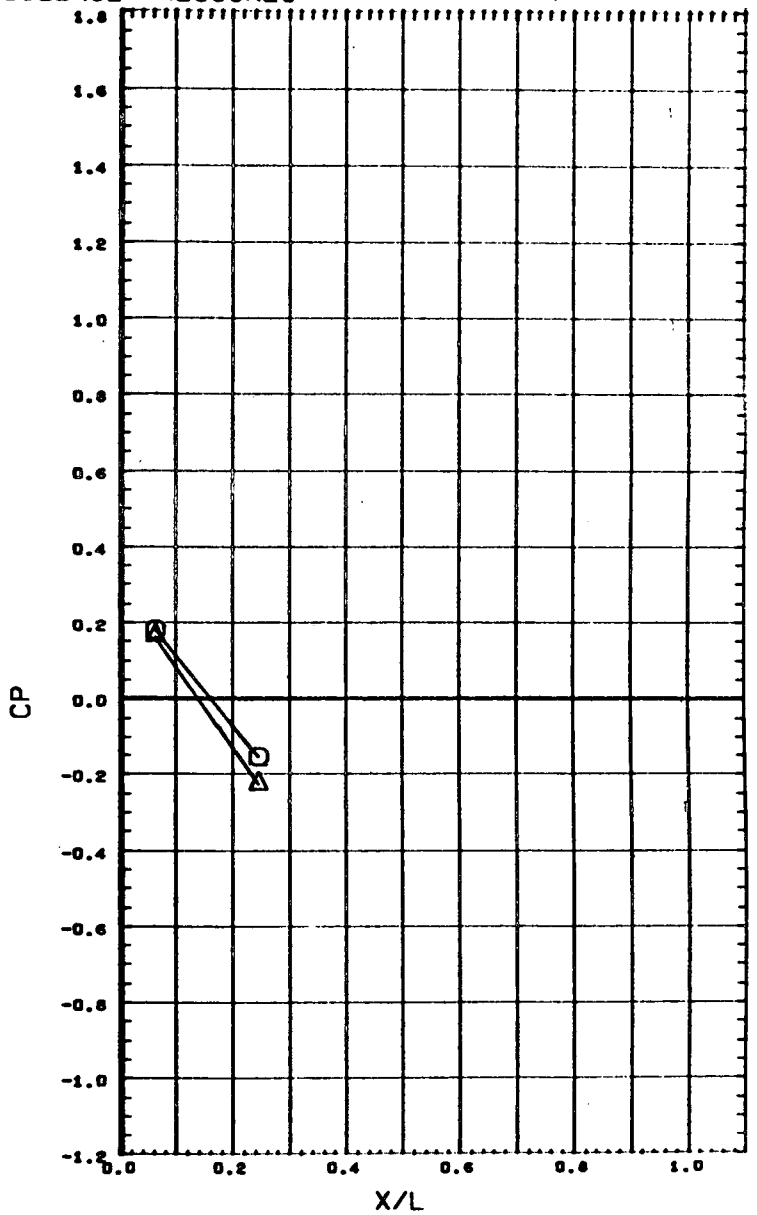
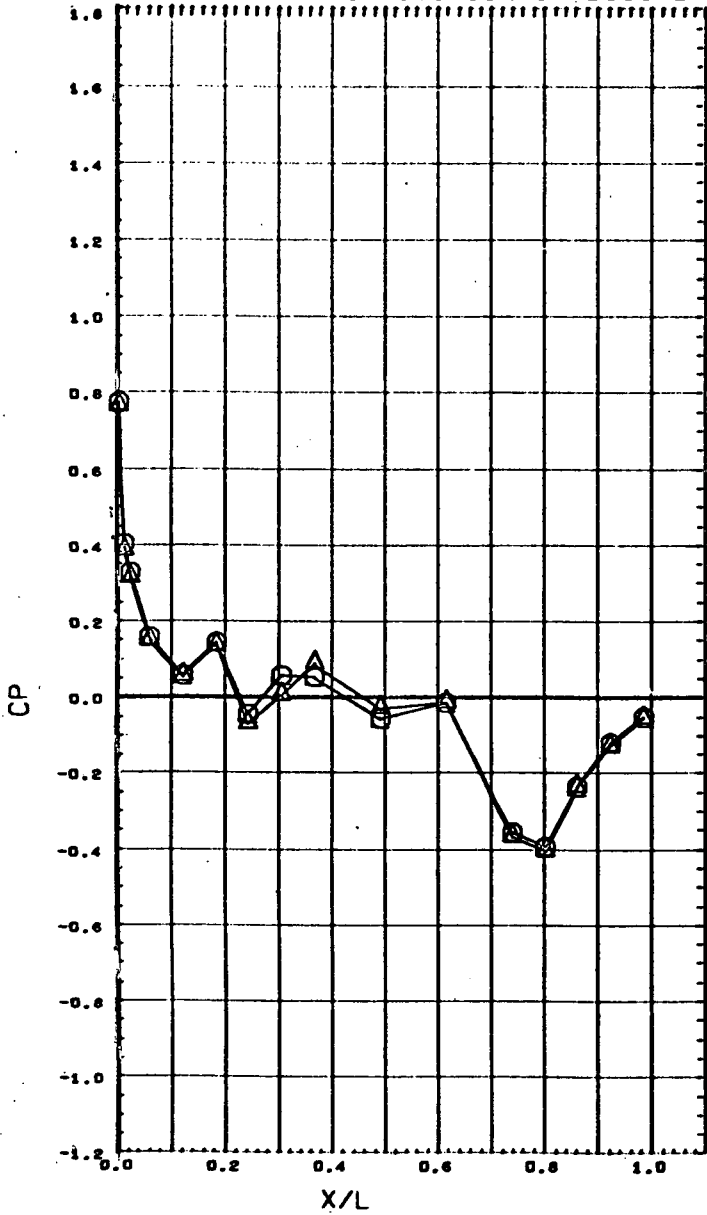

| SYMBOL | BETA | THETA | M1 |
|--------|-------|--------|-------|
| ○ | 4.094 | 0.000 | 0.898 |
| △ | 5.964 | 15.000 | |

| ALFB | PARAMETRIC VALUES | |
|------|-------------------|------------|
| I | 0.000 | DX/L 0.000 |
| | 0.000 | |

REFERENCE FILE

LONGITUDINAL DISTRIBUTION OF BOOSTER FUSELAGE PRESSURES

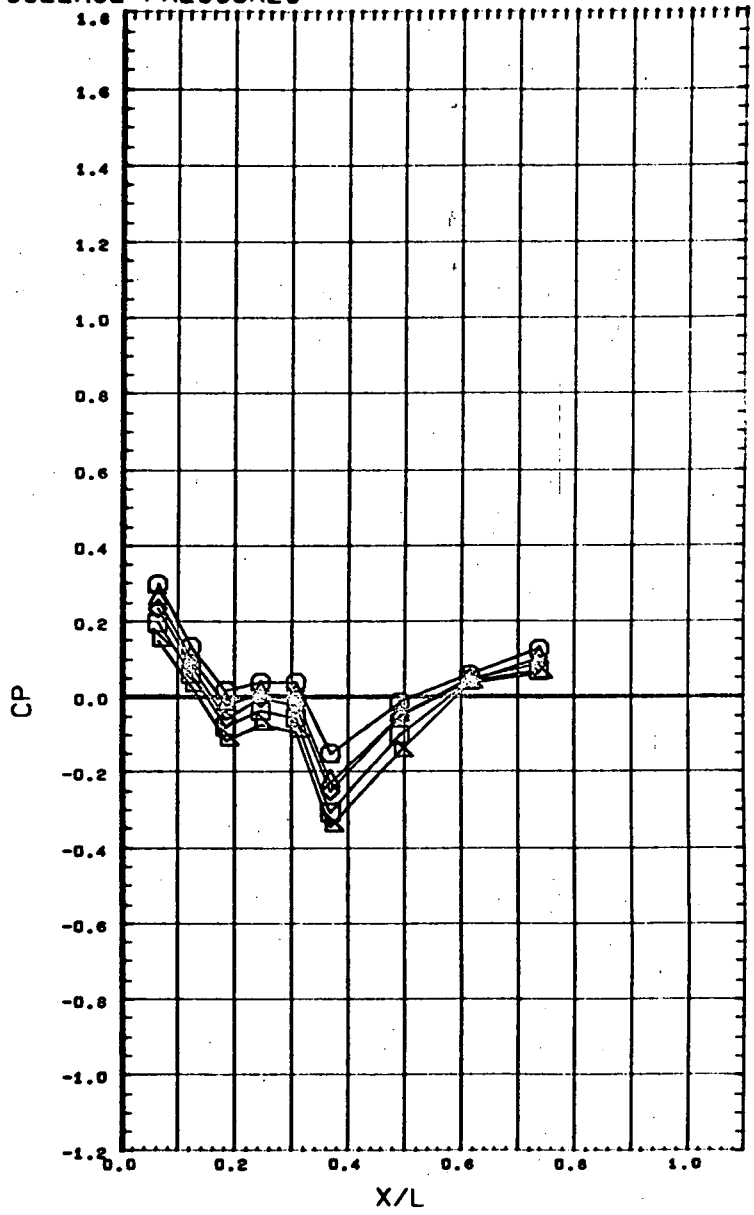
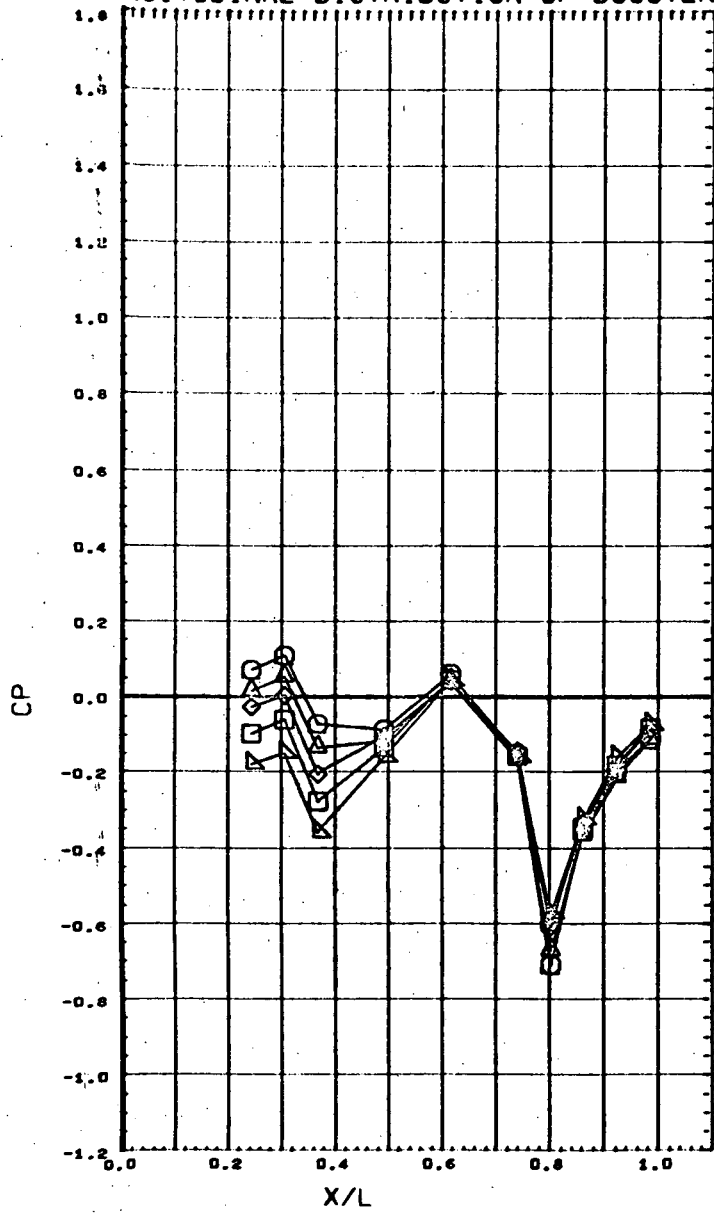

| SYMBOL | BETA | THETA | M1 |
|--------|---------|--------|-------|
| ○ | - 6.014 | 24.000 | 0.898 |
| △ | - 4.113 | 45.000 | |
| ◇ | - 2.146 | | |
| □ | - 0.287 | | |
| ▽ | 2.007 | | |

REFERENCE FILE

| PARAMETRIC VALUES | | |
|-------------------|-------|------------|
| ALFB | 0.000 | DX/L 0.000 |
| I | 0.000 | |

LONGITUDINAL DISTRIBUTION OF BOOSTER FUSELAGE PRESSURES

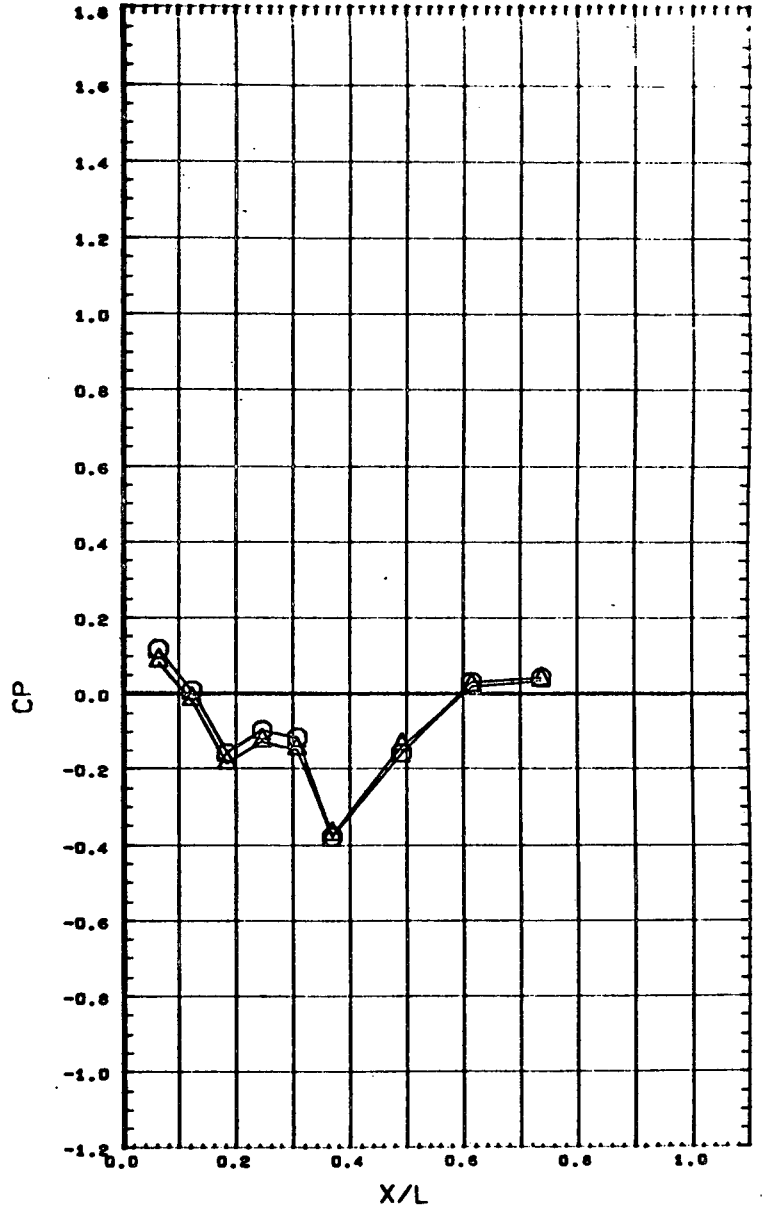
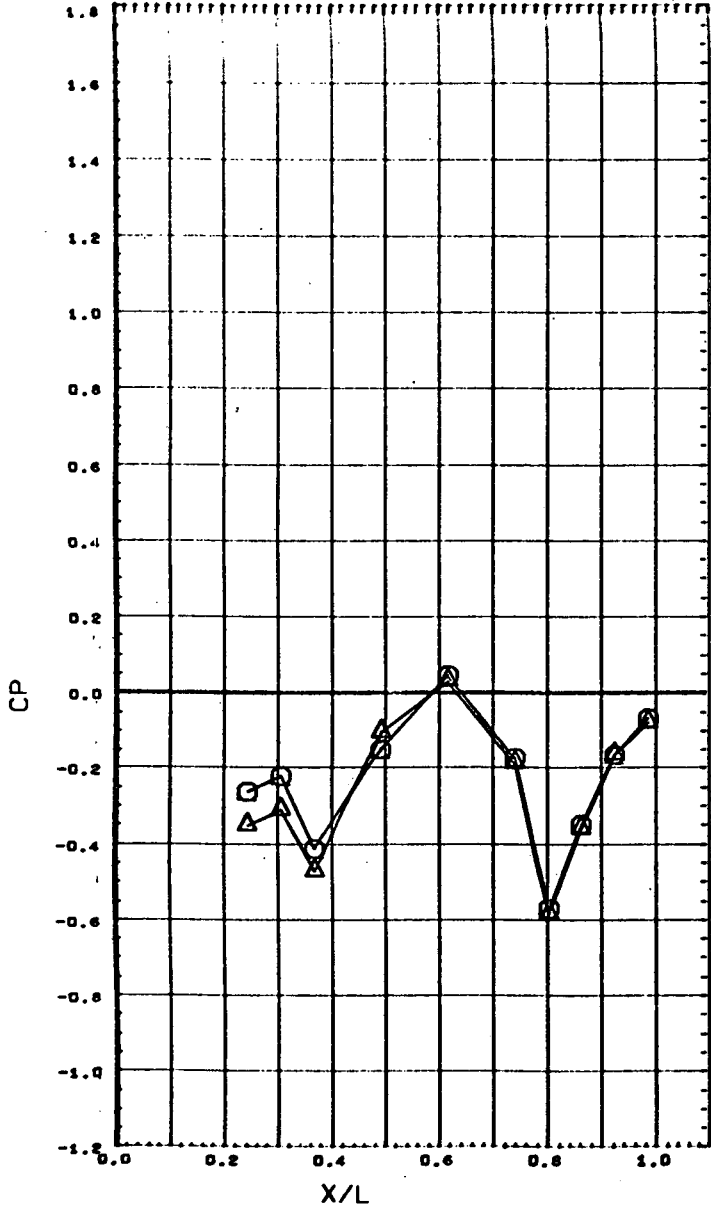

| SYMBOL | BETA | THETA | M1 |
|--------|-------|--------|-------|
| ○ | 4.094 | 24.000 | 0.898 |
| △ | 5.964 | 45.000 | |

| PARAMETRIC VALUES | | |
|-------------------|-------|-------|
| ALFB | 0.000 | DX/L |
| 1 | 0.000 | 0.000 |

REFERENCE FILE

LONGITUDINAL DISTRIBUTION OF BOOSTER FUSELAGE PRESSURES

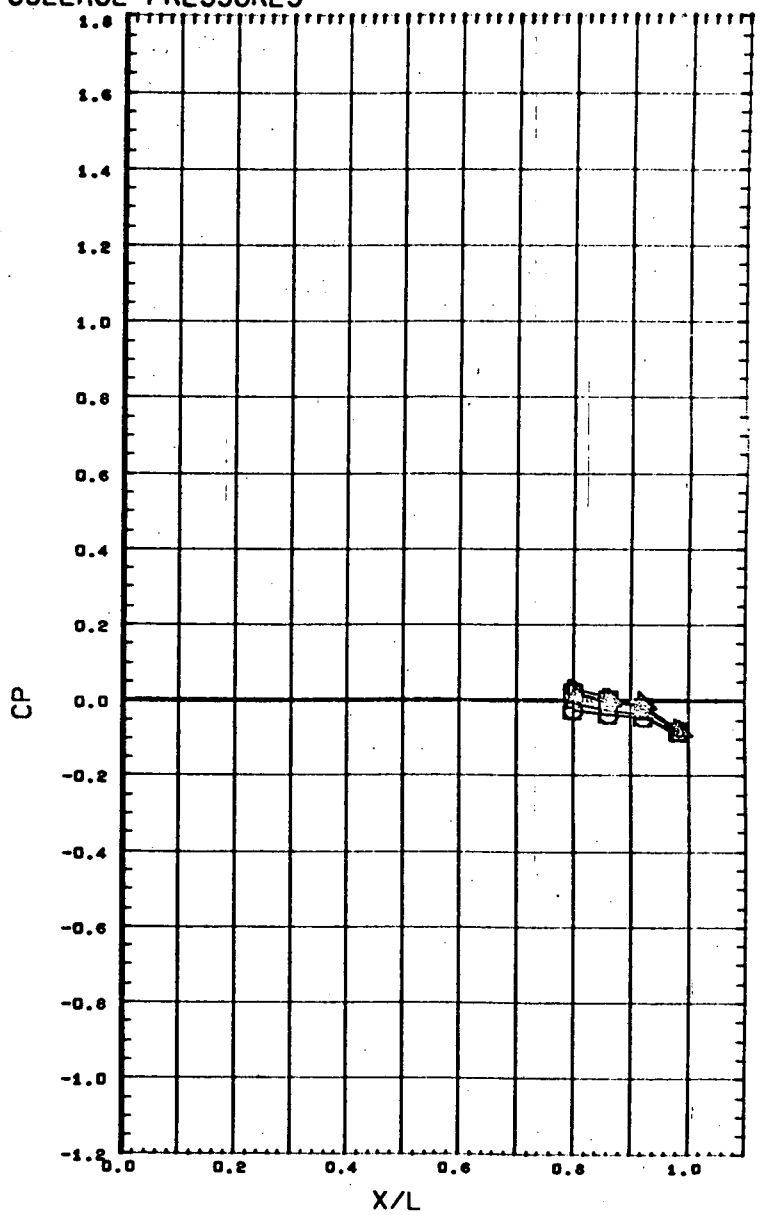
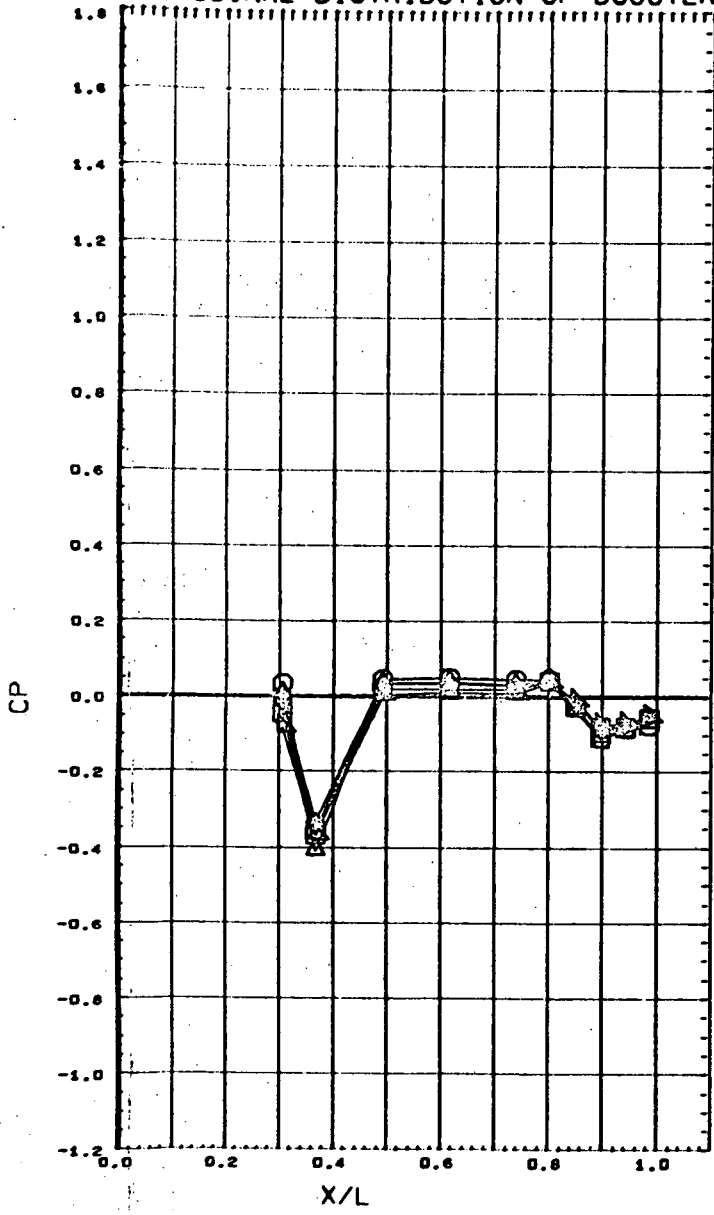

| SYMBOL | BETA | THETA | M1 |
|--------|-------|---------|-------|
| ○ | 6.014 | 90.000 | 0.898 |
| △ | 4.113 | 180.000 | |
| ◇ | 2.146 | | |
| □ | 0.287 | | |
| ◇ | 2.007 | | |

REFERENCE FILE

| PARAMETRIC VALUES | | |
|-------------------|-------|------------|
| ALFB | 0.000 | DX/L 0.000 |
| I | 0.000 | |

LONGITUDINAL DISTRIBUTION OF BOOSTER FUSELAGE PRESSURES

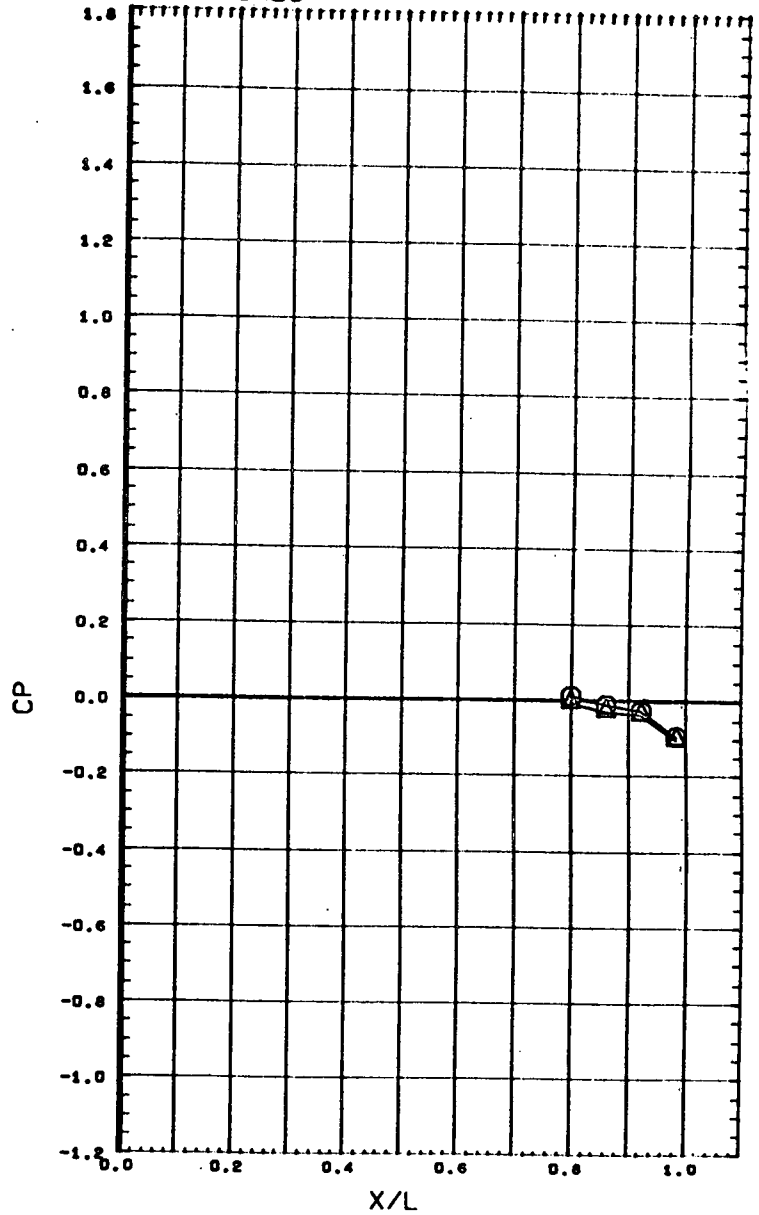
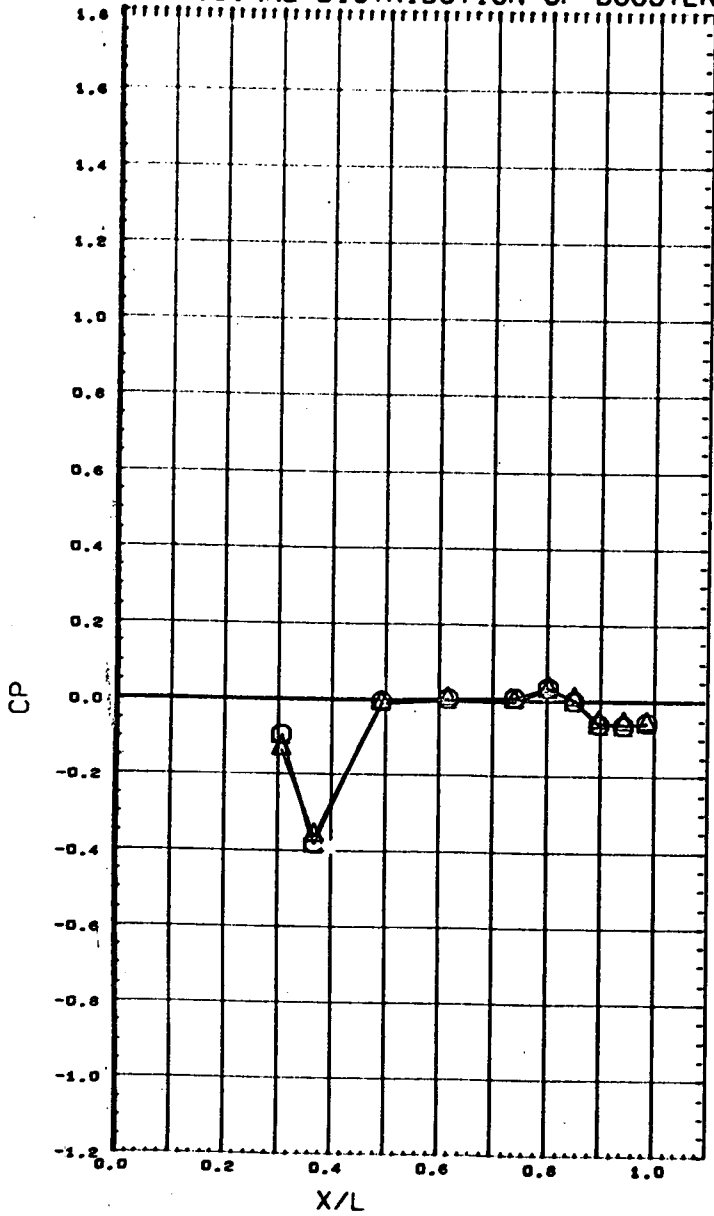

| SYMBOL | BETA | THETA | M1 |
|--------|-------|---------|-------|
| ○ | 4.094 | 90.000 | 0.898 |
| △ | 5.964 | 180.000 | |

| PARAMETRIC VALUES | | |
|-------------------|-------|-------|
| ALFB | 0.000 | OX/L |
| I | 0.000 | 0.000 |

REFERENCE FILE

LONGITUDINAL DISTRIBUTION OF BOOSTER FUSELAGE PRESSURES

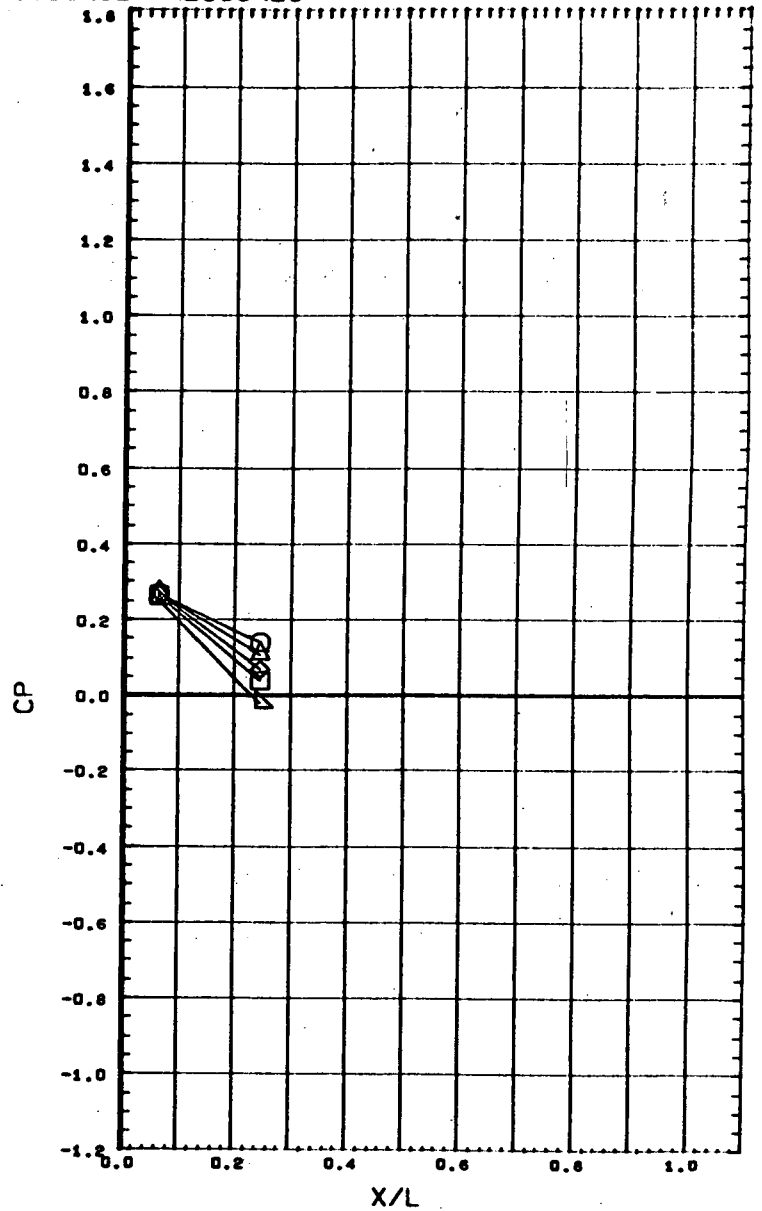
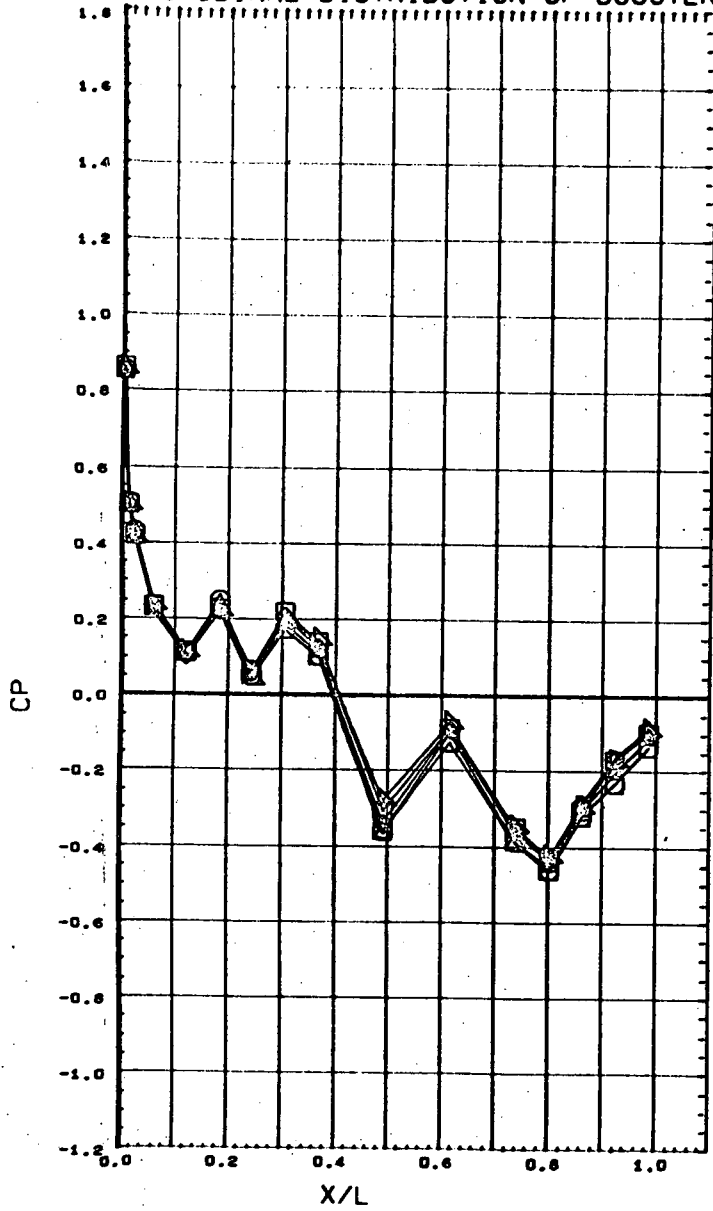

| SYMBOL | BETA | THETA | M1 |
|--------|-------|--------|-------|
| ◇ | 6.082 | 0.000 | 1.010 |
| ◇ | 4.150 | 15.000 | |
| ◇ | 2.153 | | |
| ◇ | 0.281 | | |
| ◇ | 2.037 | | |

| PARAMETRIC VALUES | | |
|-------------------|-------|--------------|
| ALFB | 0.000 | DX/L : 0.000 |
| I | 0.000 | |

REFERENCE FILE

LONGITUDINAL DISTRIBUTION OF BOOSTER FUSELAGE PRESSURES

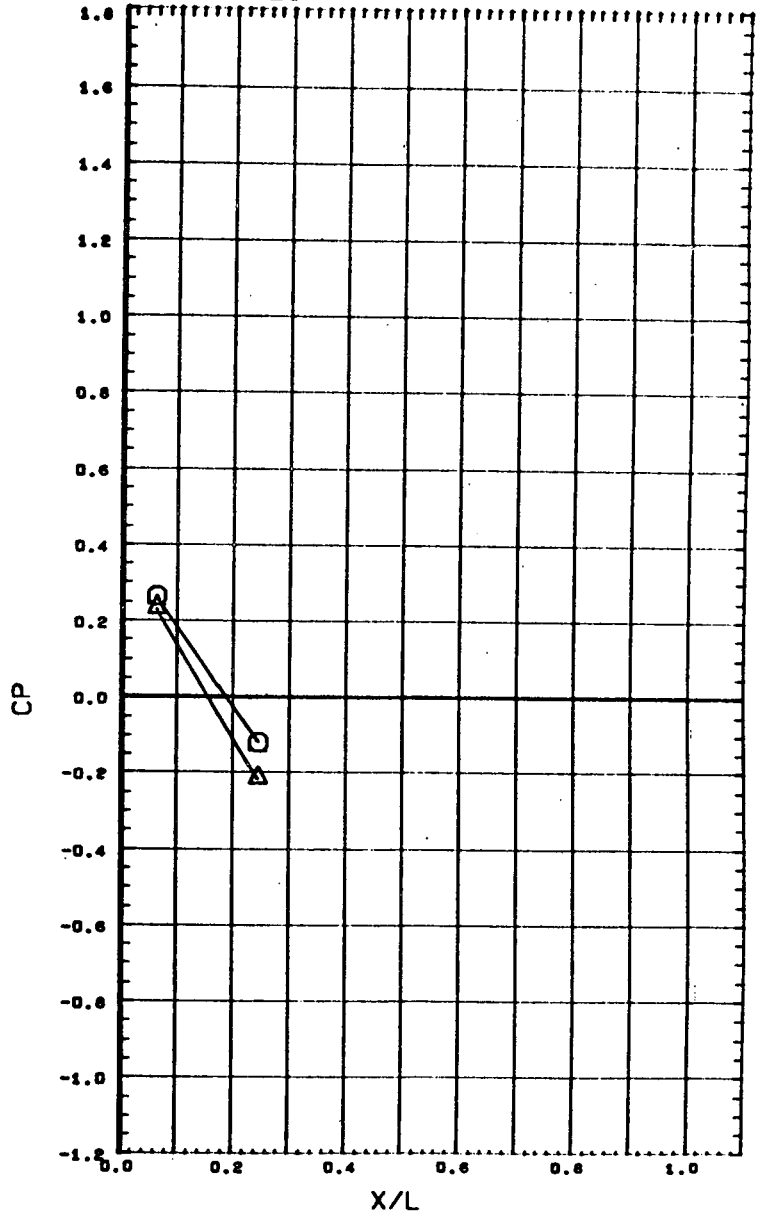
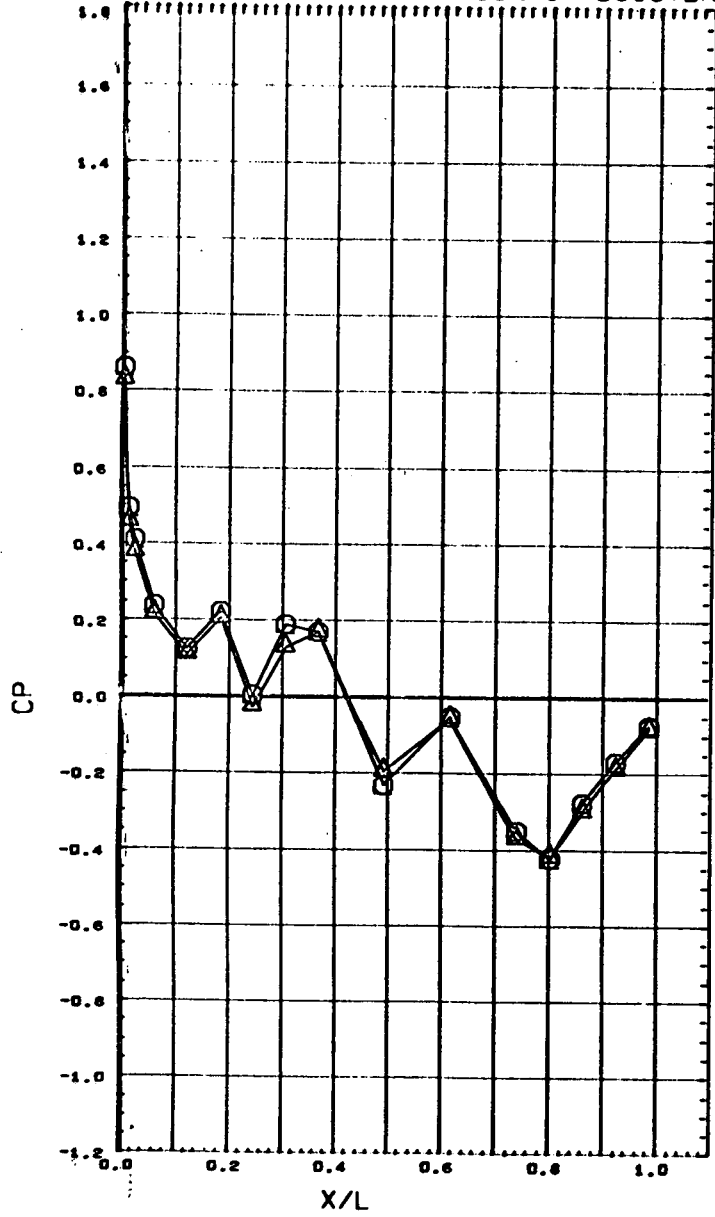

| SYMBOL | BETA | THETA | M1 |
|--------|-------|--------|-------|
| ○ | 4.071 | 0.000 | 1.010 |
| △ | 6.041 | 15.000 | |

| PARAMETRIC VALUES | | | |
|-------------------|-------|------|-------|
| ALFB | 0.000 | DX/L | 0.000 |
| I | 0.000 | | |

REFERENCE FILE

LONGITUDINAL DISTRIBUTION OF BOOSTER FUSELAGE PRESSURES

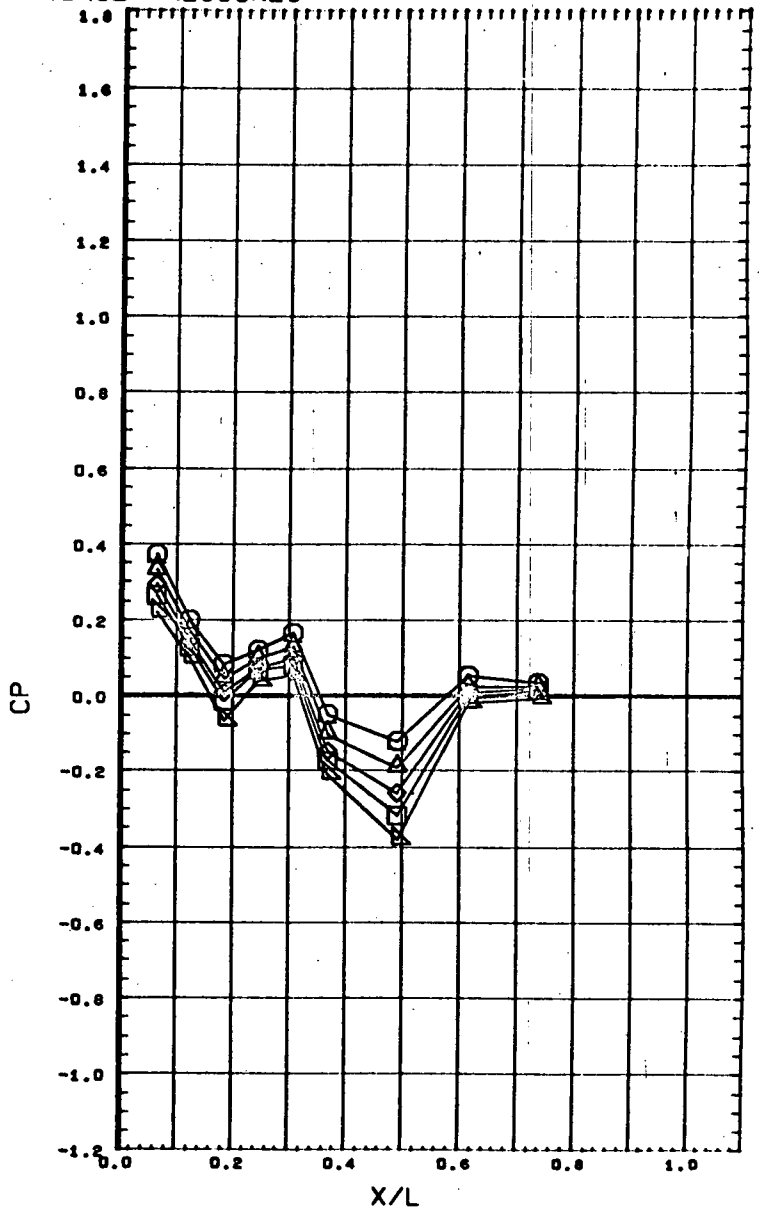
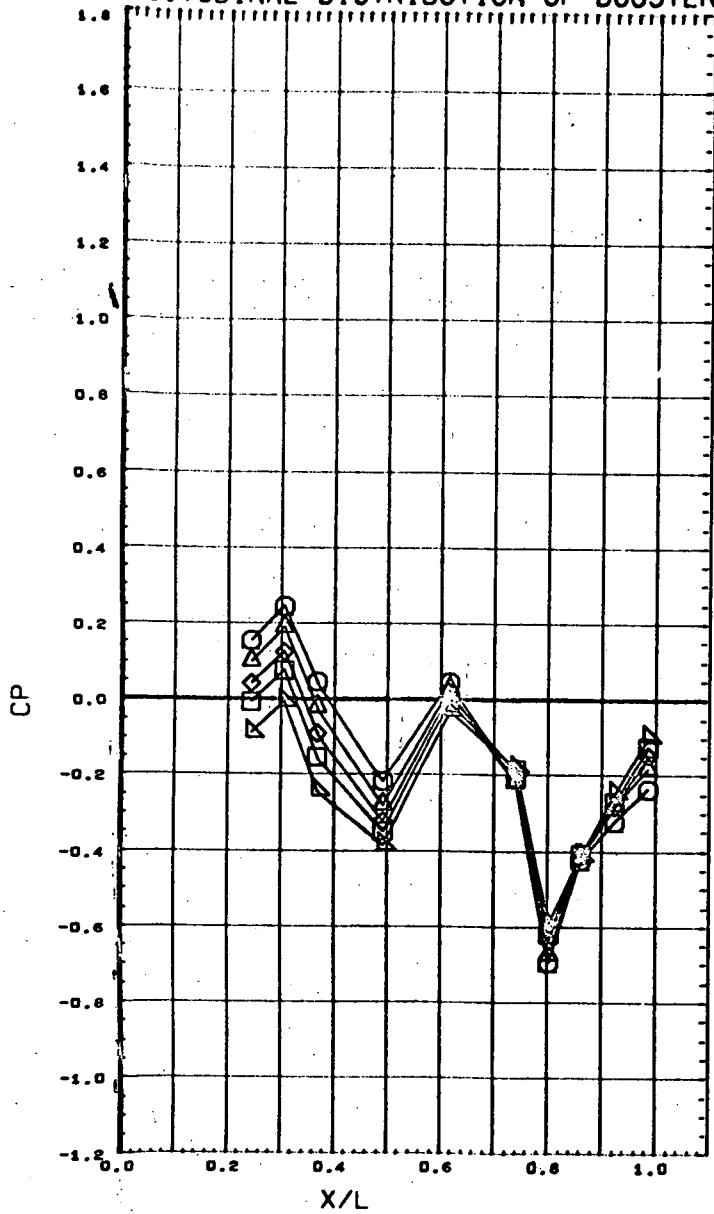

| SYMBOL | BETA | THETA | M1 |
|--------|-------|--------|-------|
| ○ | 6.082 | 24.000 | 1.010 |
| △ | 4.150 | 45.000 | |
| ◇ | 2.153 | | |
| □ | 0.281 | | |
| ○ | 2.037 | | |

REFERENCE FILE

| PARAMETRIC VALUES | | |
|-------------------|-------|-------|
| ALFB | 0.000 | DX/L |
| I | 0.000 | 0.000 |

LONGITUDINAL DISTRIBUTION OF BOOSTER FUSELAGE PRESSURES

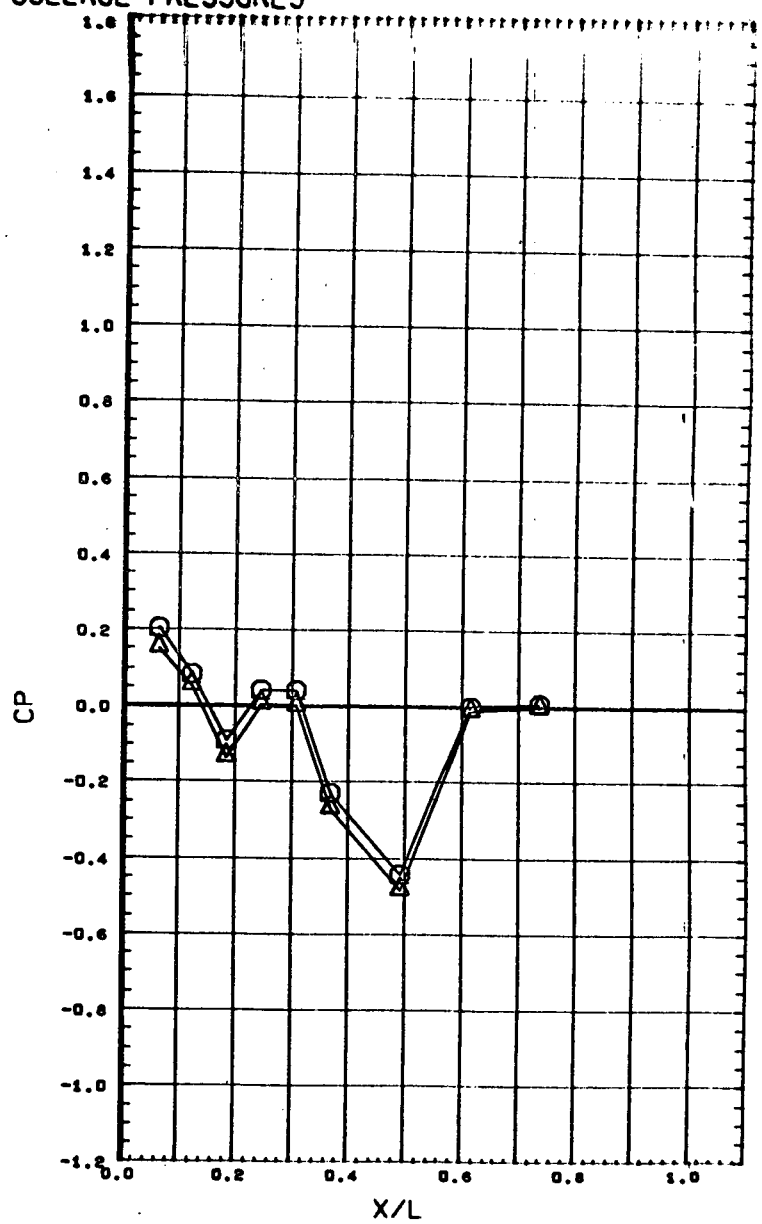
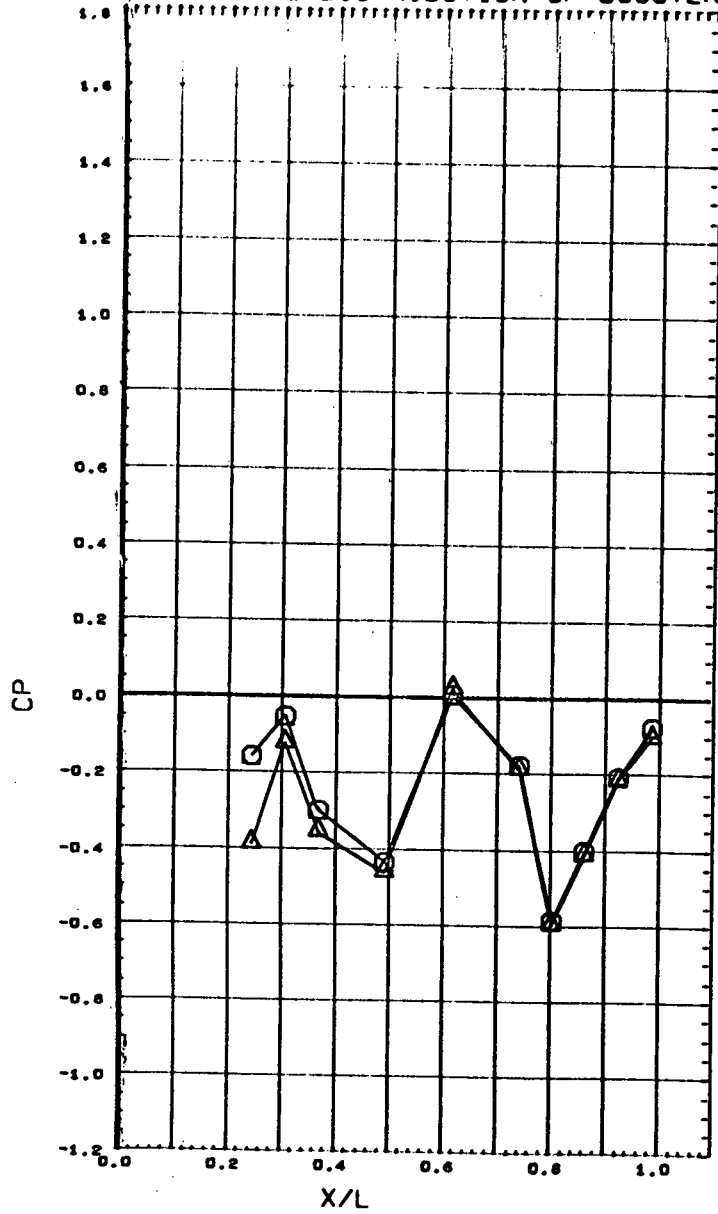

| SYMBOL | BETA | THETA | M1 |
|--------|-------|--------|-------|
| ○ | 4.071 | 24.000 | 1.010 |
| △ | 6.041 | 45.000 | |

| PARAMETRIC VALUES | | | |
|-------------------|-------|------|-------|
| ALFB | 0.000 | DX/L | 0.000 |
| I | 0.000 | | |

REFERENCE FILE

LONGITUDINAL DISTRIBUTION OF BOOSTER FUSELAGE PRESSURES

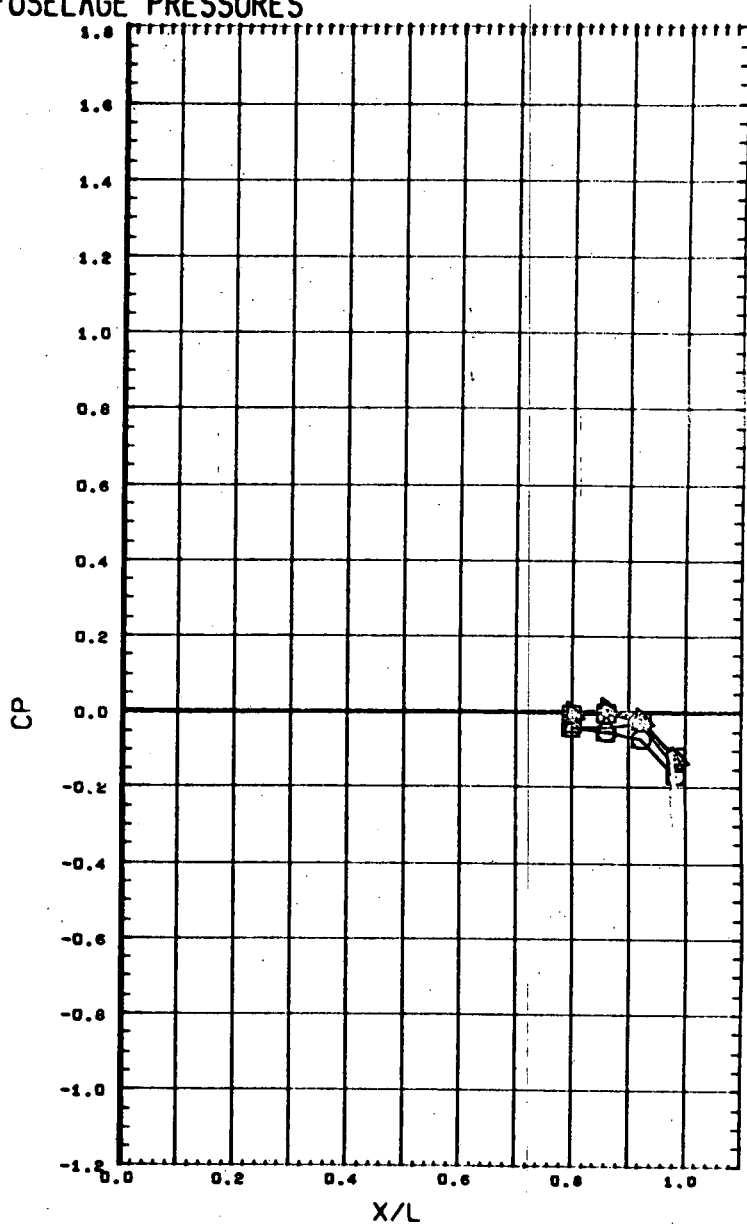
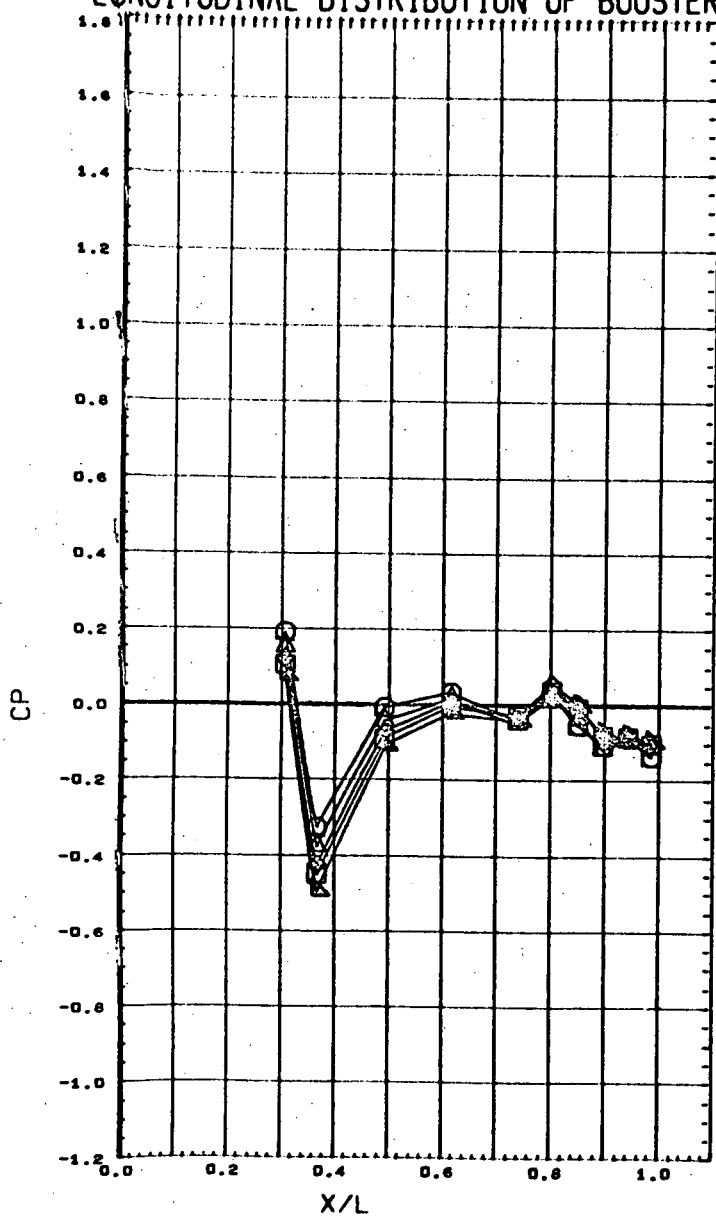

| SYMBOL | BETA | THETA | M1 |
|--------|-------|---------|-------|
| ○ | 6.082 | 90.000 | 1.010 |
| △ | 4.150 | 180.000 | |
| ◇ | 2.153 | | |
| □ | 0.281 | | |
| ○ | 2.037 | | |

REFERENCE FILE

| PARAMETRIC VALUES | | |
|-------------------|-------|-------|
| ALFB | DX/L | |
| 1 | 0.000 | 0.000 |
| | 0.000 | |

LONGITUDINAL DISTRIBUTION OF BOOSTER FUSELAGE PRESSURES

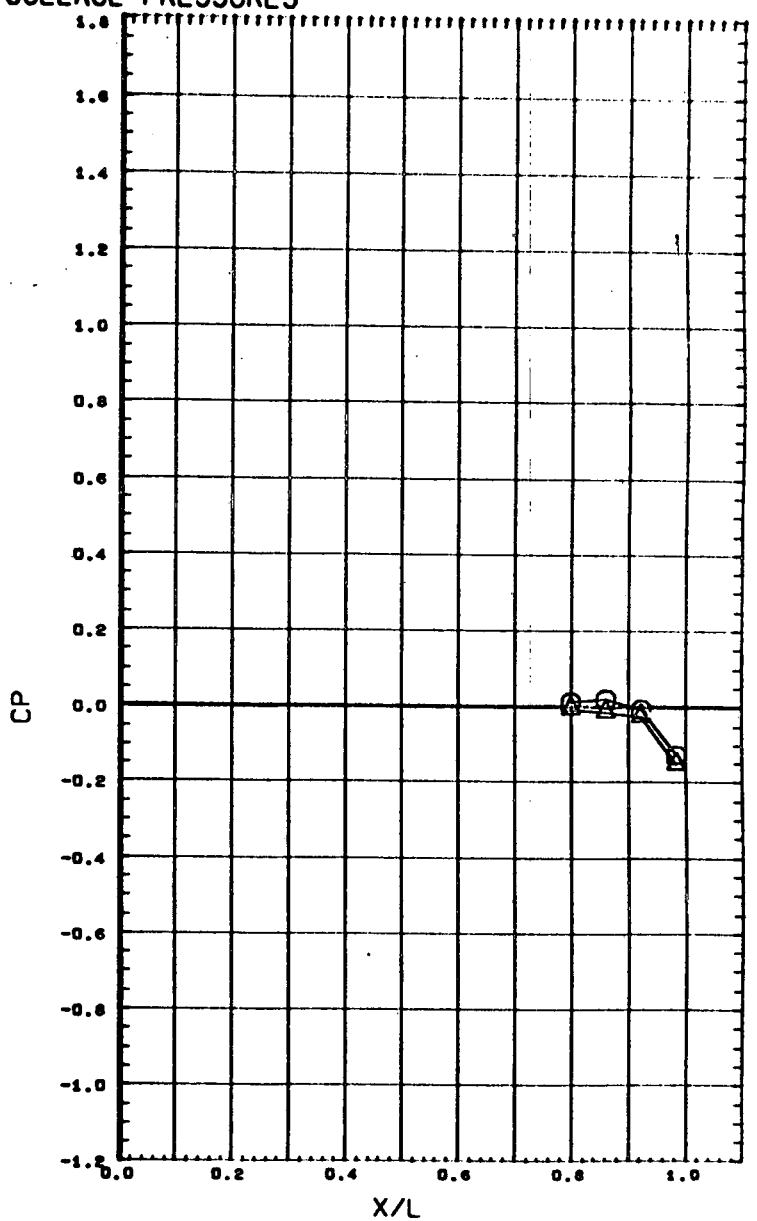
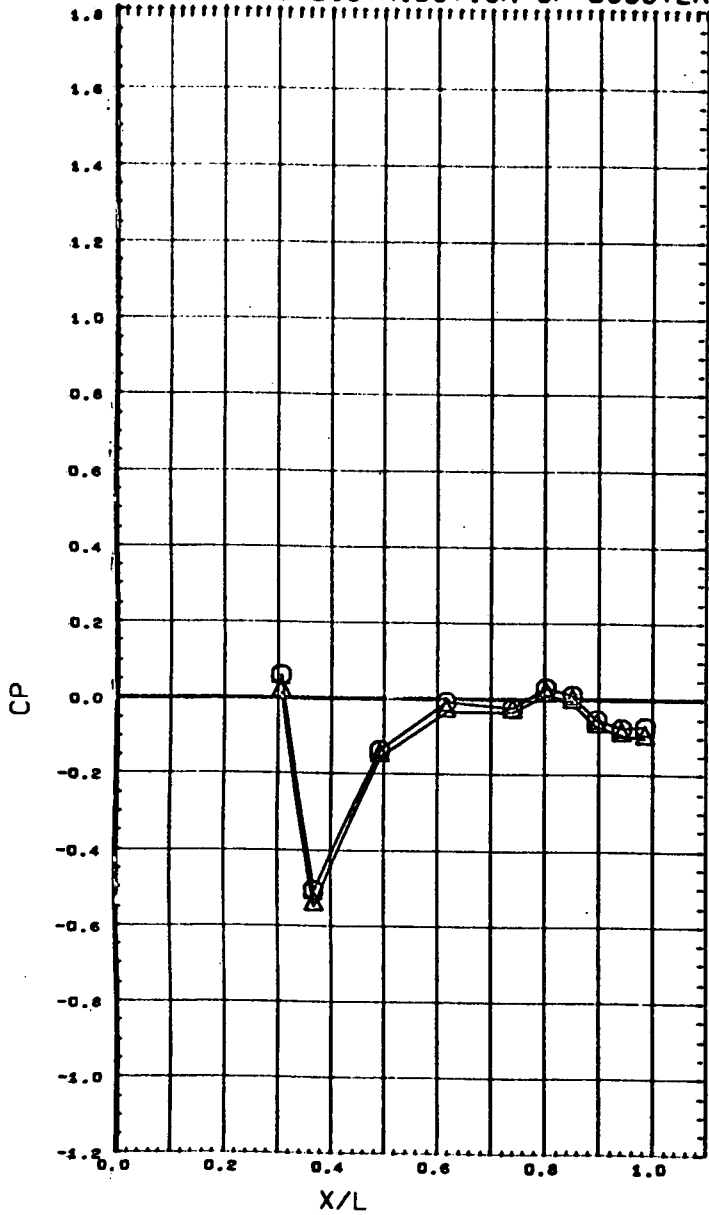

| SYMBOL | BETA | THETA | M1 |
|--------|-------|---------|-------|
| ○ | 4.071 | 90.000 | 1.010 |
| △ | 6.041 | 180.000 | |

| ALFB | PARAMETRIC VALUES | |
|------|-------------------|-------|
| I | 0.000 | 0.000 |
| | 0.000 | 0.000 |

REFERENCE FILE

LONGITUDINAL DISTRIBUTION OF BOOSTER FUSELAGE PRESSURES

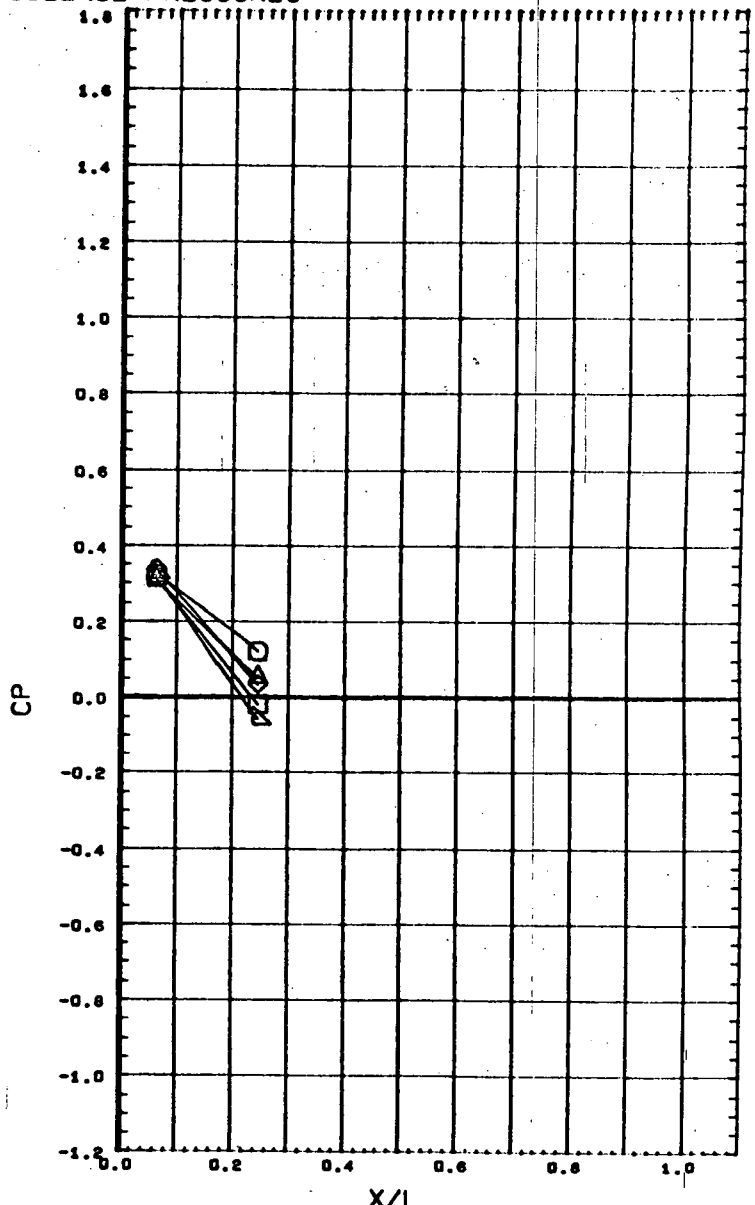
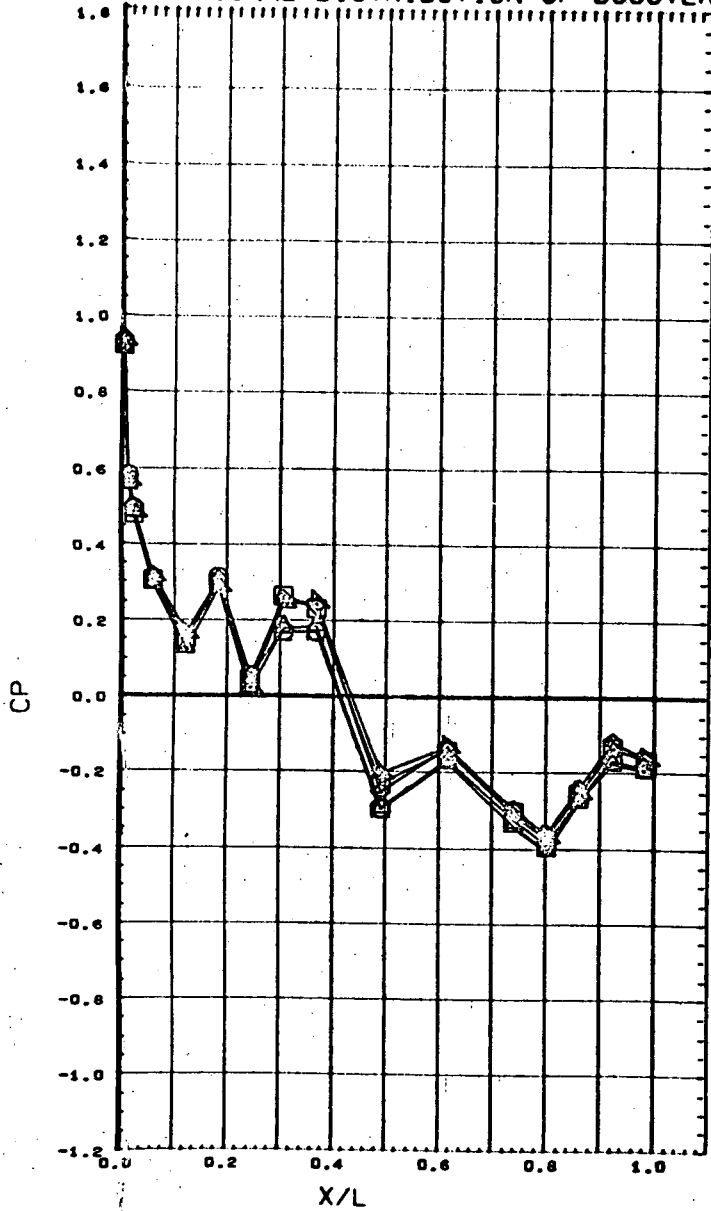

| SYMBOL | BETA | THETA | M1 |
|--------|-------|--------|-------|
| ◇ | 6.306 | 0.000 | 1.101 |
| △ | 4.084 | 15.000 | |
| ○ | 2.015 | | |
| □ | 0.247 | | |
| ○ | 1.831 | | |

| PARAMETRIC VALUES | | |
|-------------------|-------|-------|
| ALFB | 0.000 | DX/L |
| 1 | 0.000 | 0.000 |

REFERENCE FILE

LONGITUDINAL DISTRIBUTION OF BOOSTER FUSELAGE PRESSURES

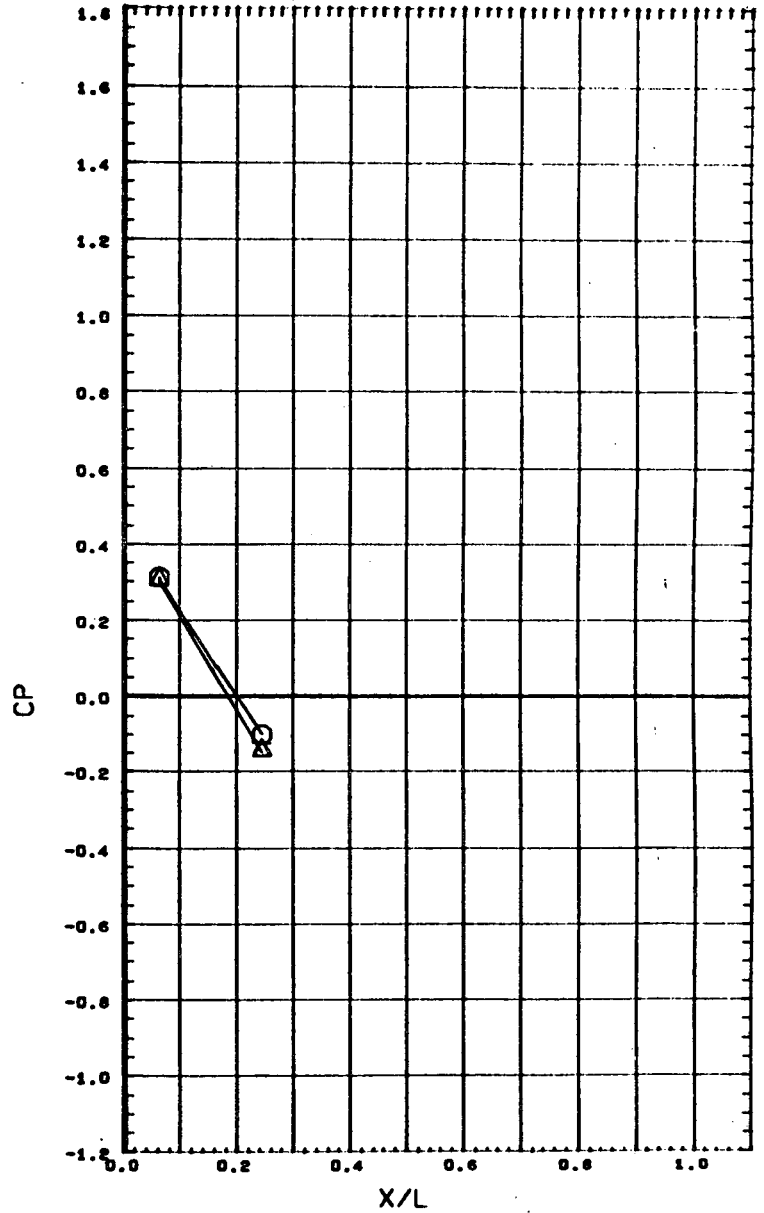
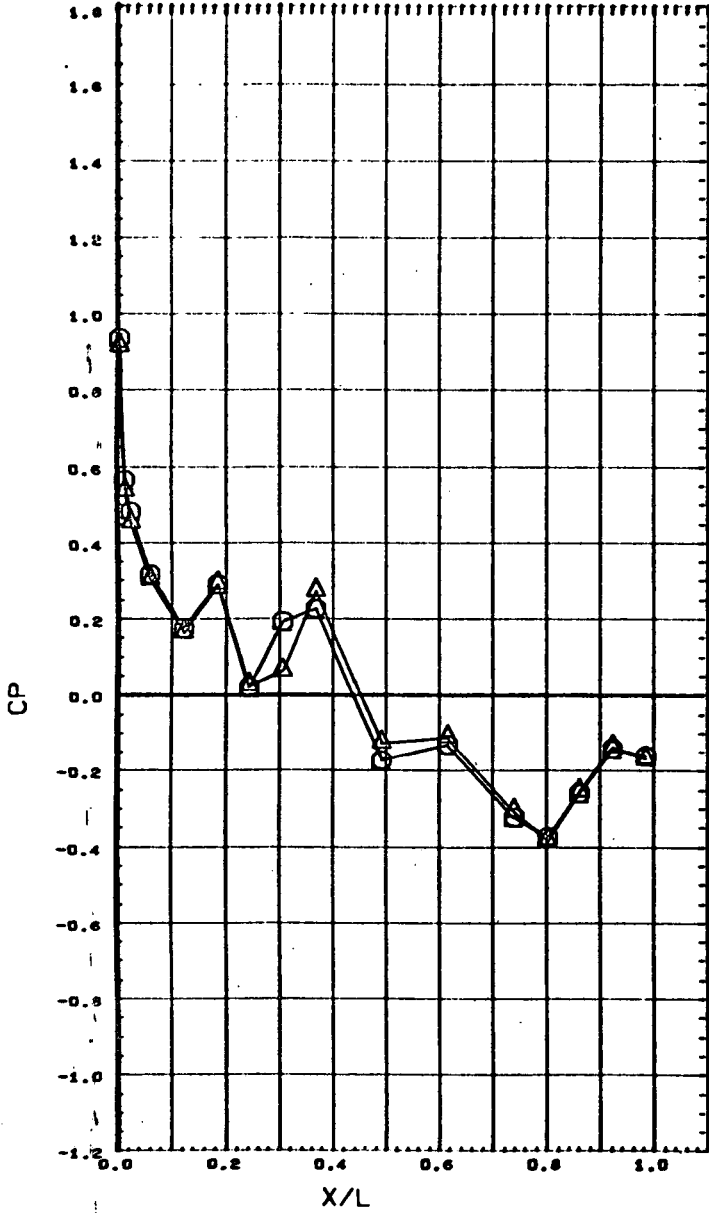

| SYMBOL | BETA | THETA | M1 |
|--------|-------|--------|-------|
| ○ | 3.893 | 0.000 | 1.101 |
| △ | 6.209 | 15.000 | |

| PARAMETRIC VALUES | | | |
|-------------------|-------|------|-------|
| ALFB | 0.000 | DX/L | 0.000 |
| 1 | 0.000 | | |

REFERENCE FILE

LONGITUDINAL DISTRIBUTION OF BOOSTER FUSELAGE PRESSURES

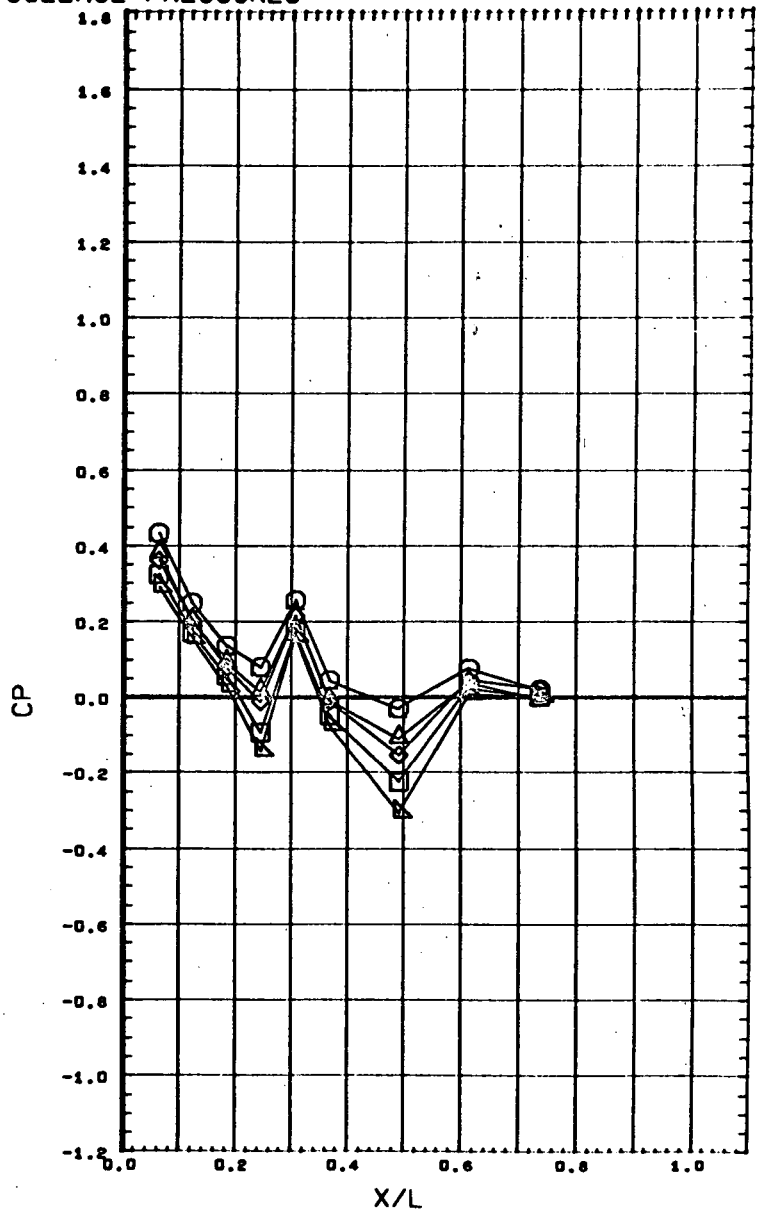
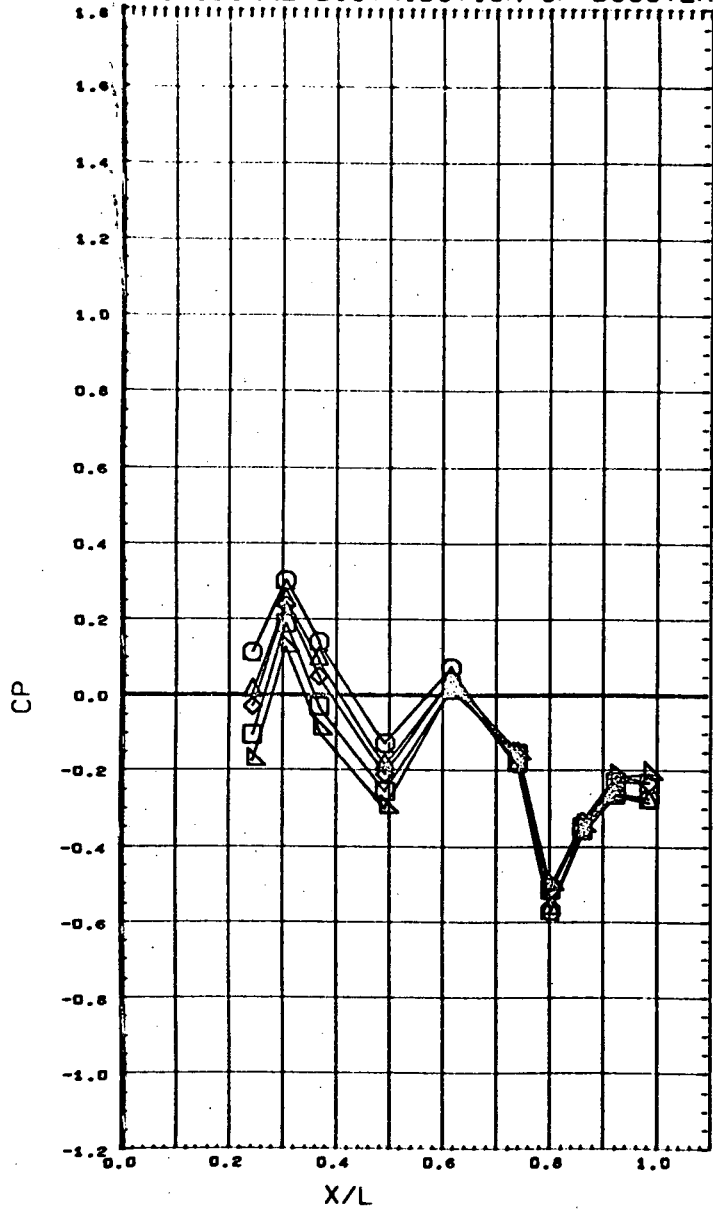

| SYMBOL | BETA | THETA | M1 |
|--------|-------|--------|-------|
| ○ | 6.306 | 24.000 | 1.101 |
| ◇ | 4.084 | 45.000 | |
| △ | 2.015 | | |
| □ | 0.247 | | |
| ▽ | 1.831 | | |

| PARAMETRIC VALUES | | |
|-------------------|-------|-------|
| ALFB | 0.000 | DX/L |
| I | 0.000 | 0.000 |

REFERENCE FILE

LONGITUDINAL DISTRIBUTION OF BOOSTER FUSELAGE PRESSURES

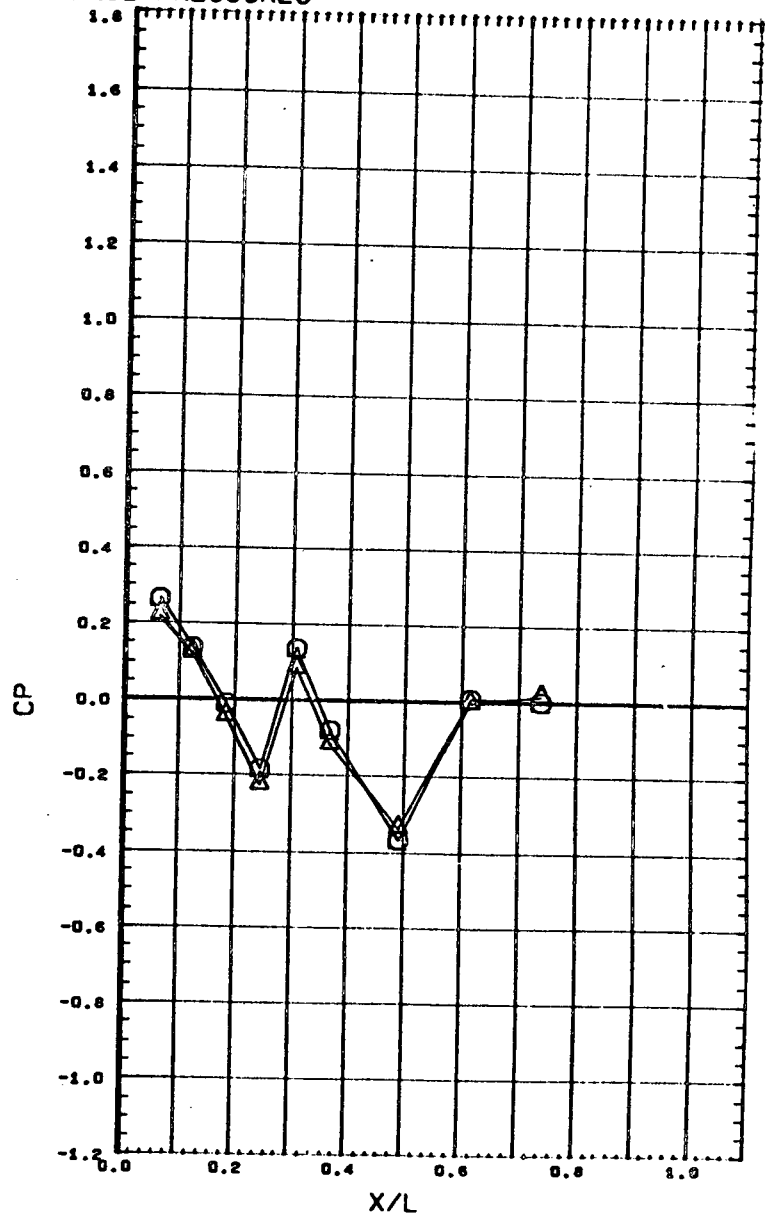
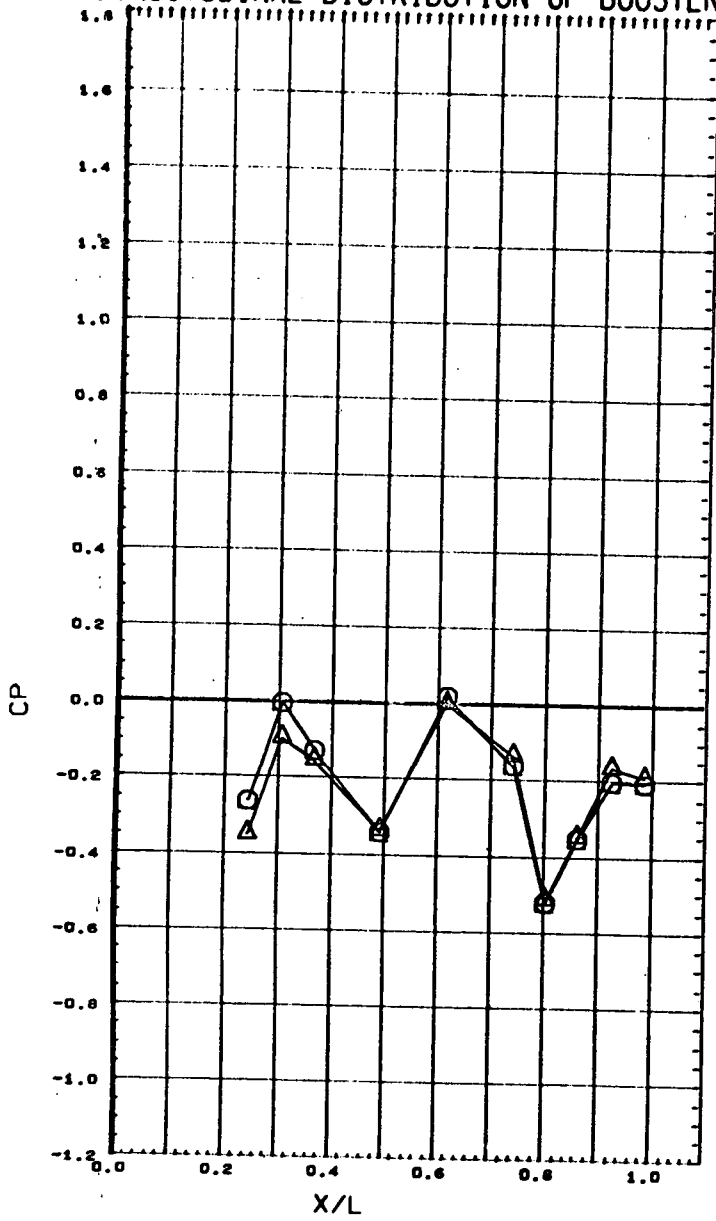

| SYMBOL | BETA | THETA | M1 |
|--------|-------|--------|-------|
| ○ | 3.893 | 24.000 | 1.101 |
| △ | 6.209 | 45.000 | |

| PARAMETRIC VALUES | | |
|-------------------|-------|-------|
| ALFB | 0.000 | DX/L |
| i | 0.000 | 0.000 |

REFERENCE FILE

AEDC TC174 MDAC BOOSTER NEAR ORBITER (BODY)

(ATC002)

PAGE 58

LONGITUDINAL DISTRIBUTION OF BOOSTER FUSELAGE PRESSURES

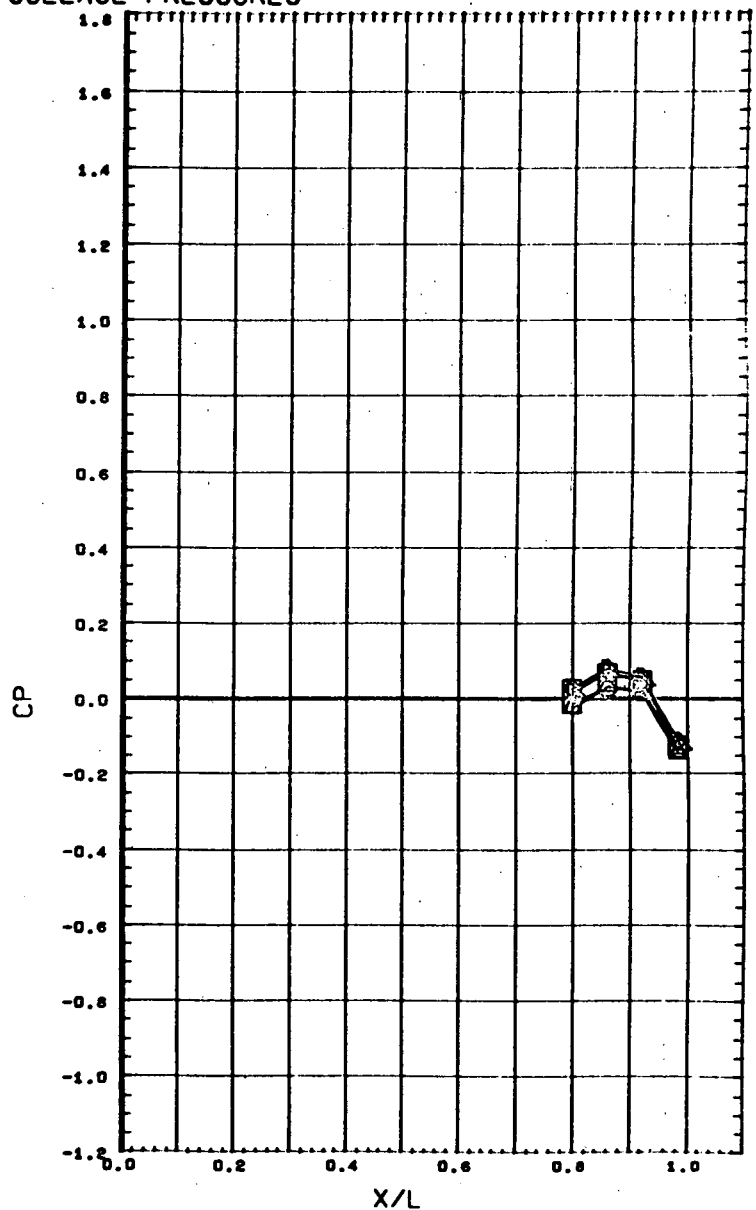
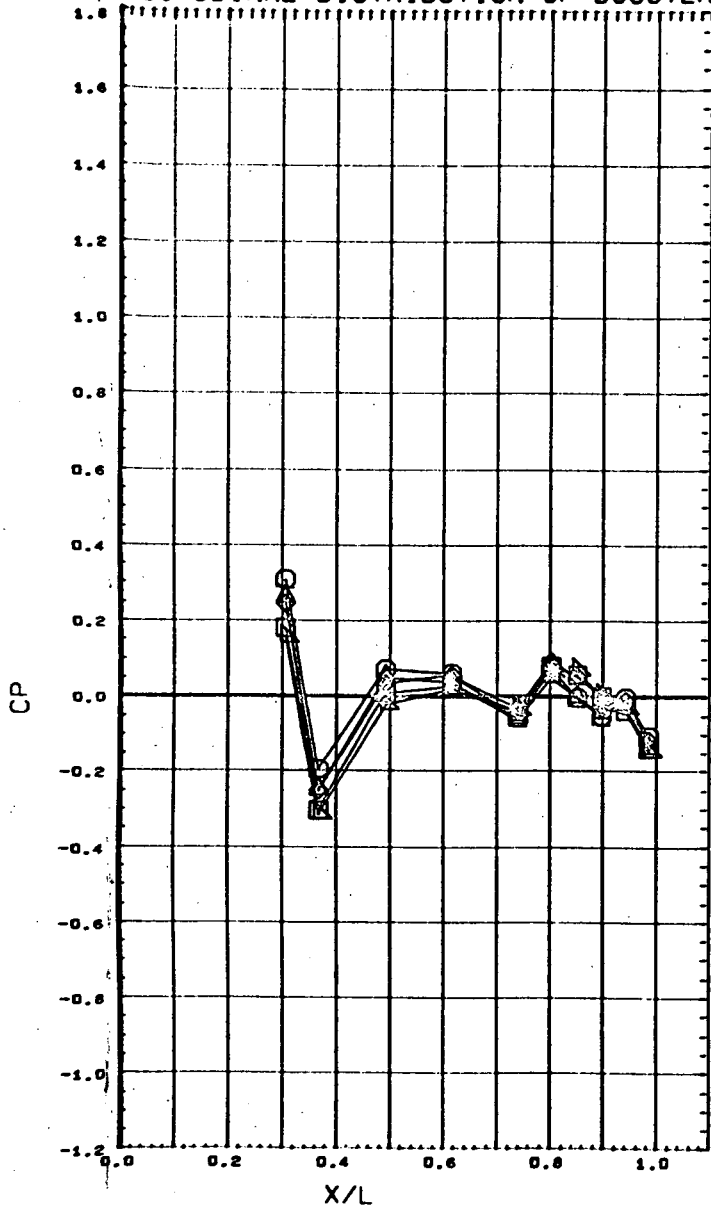

| SYMBOL | BETA | THETA | M1 |
|--------|-------|---------|-------|
| ○ | 6.306 | 90.000 | 1.101 |
| ◇ | 4.084 | 180.000 | |
| △ | 2.015 | | |
| □ | 0.247 | | |
| ▽ | 1.831 | | |

| PARAMETRIC VALUES | | | |
|-------------------|-------|------|-------|
| ALFB | 0.000 | DX/L | 0.000 |
| I | 0.000 | | |

REFERENCE FILE

LONGITUDINAL DISTRIBUTION OF BOOSTER FUSELAGE PRESSURES

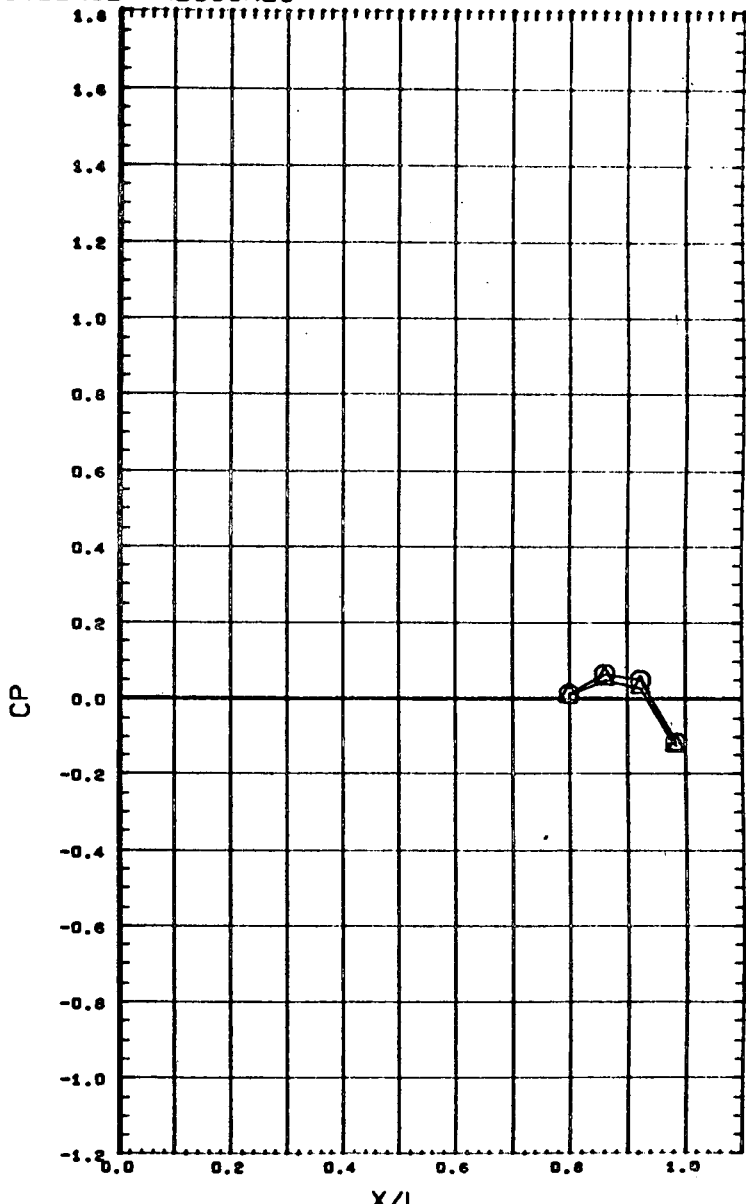
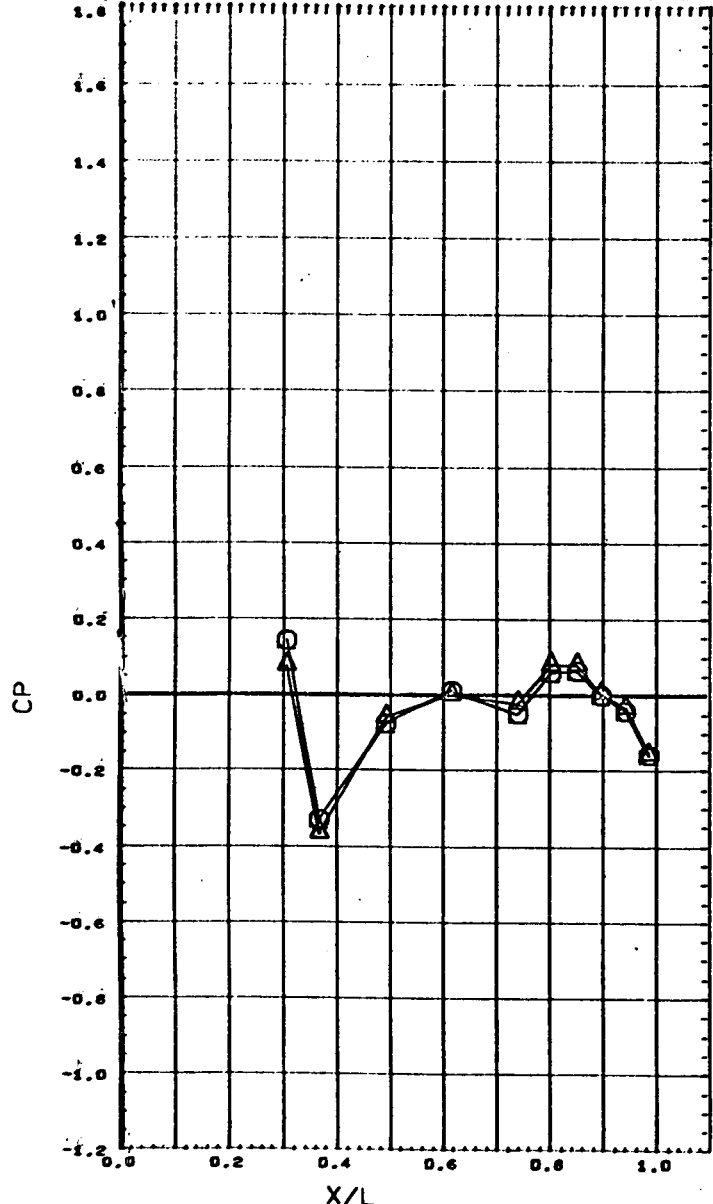

| SYMBOL | BETA | THETA | M1 |
|--------|-------|---------|-------|
| ○ | 3.893 | 90.000 | 1.101 |
| △ | 6.209 | 180.000 | |

| PARAMETRIC VALUES | | | |
|-------------------|-------|------|-------|
| ALFB | 0.000 | DX/L | 0.000 |
| I | 0.000 | | |

REFERENCE FILE

LONGITUDINAL DISTRIBUTION OF BOOSTER FUSELAGE PRESSURES

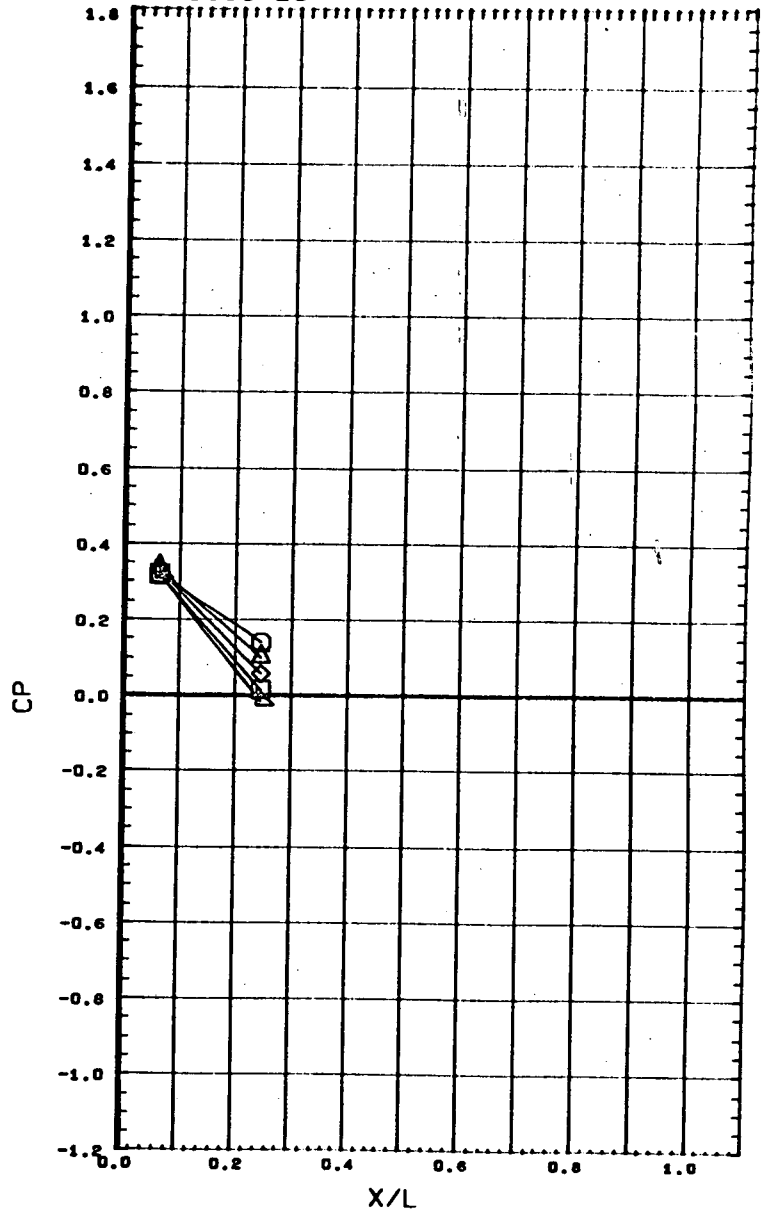
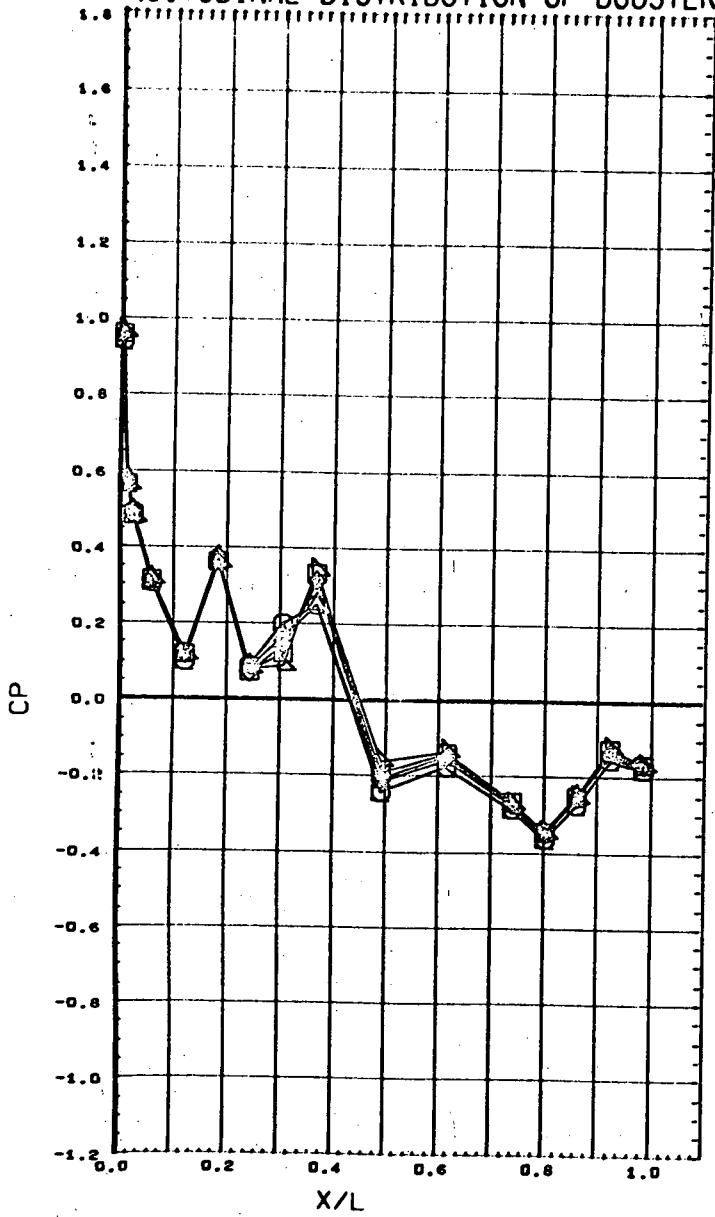

| SYMBOL | BETA | THETA | M1 |
|--------|-------|--------|-------|
| ○ | 6.196 | 0.000 | 1.201 |
| △ | 4.116 | 15.000 | |
| ◇ | 2.016 | | |
| □ | 0.241 | | |
| ○ | 2.057 | | |

REFERENCE FILE

| PARAMETRIC VALUES | | | |
|-------------------|-------|------|-------|
| ALFB | 0.000 | DX/L | 0.000 |
| I | 0.000 | | |

LONGITUDINAL DISTRIBUTION OF BOOSTER FUSELAGE PRESSURES

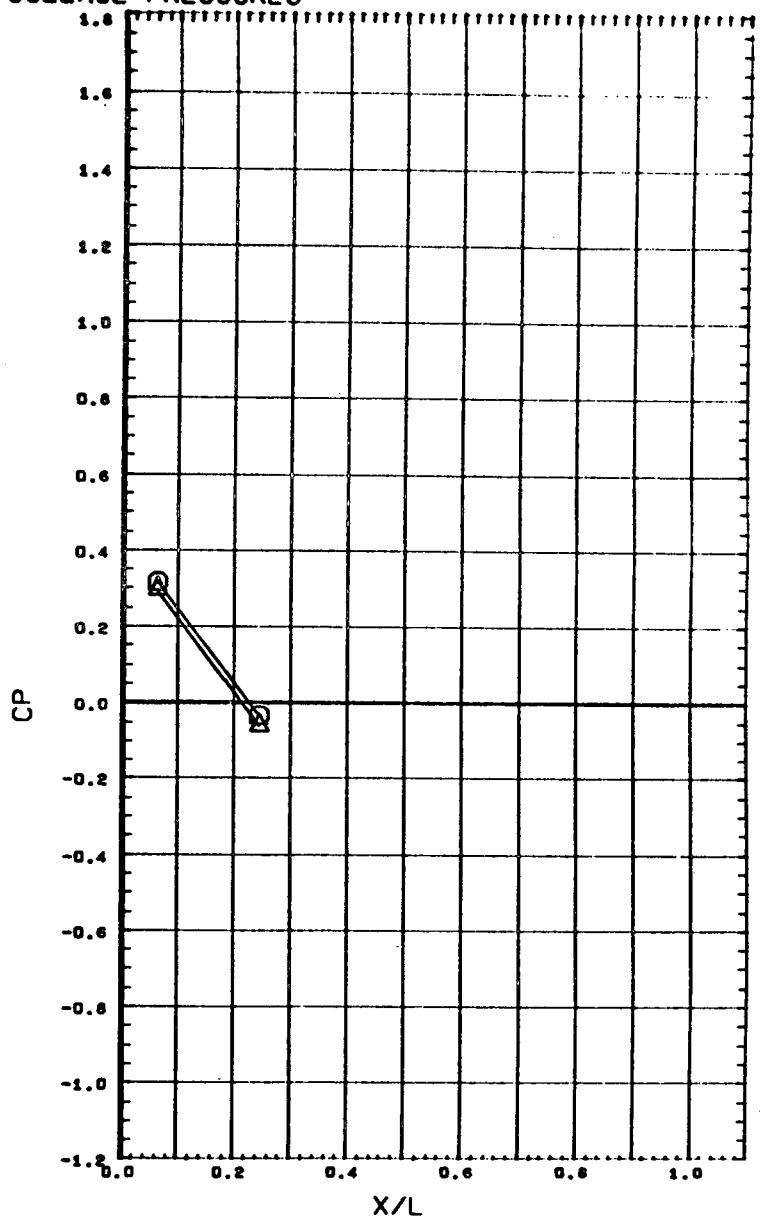
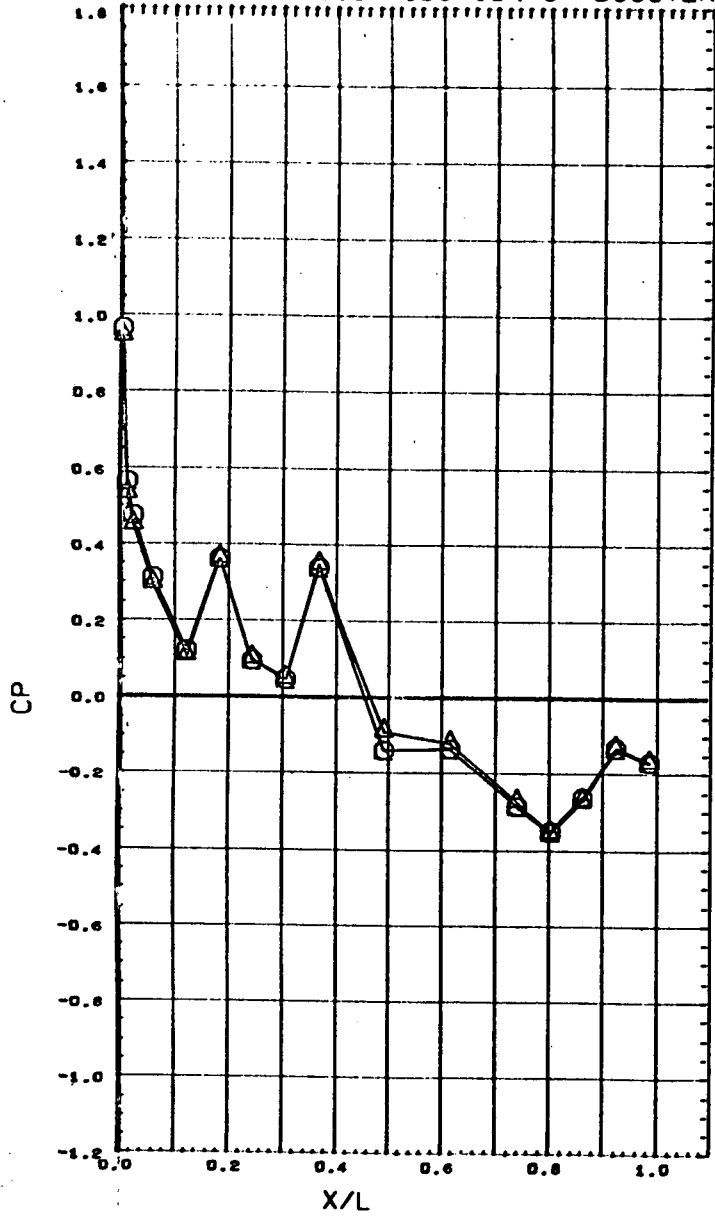

| SYMBOL | BETA | THETA | M1 |
|--------|-------|--------|-------|
| O | 5.912 | 0.000 | 1.201 |
| Δ | 5.999 | 15.000 | |

| PARAMETRIC VALUES | | | |
|-------------------|-------|------|-------|
| ALFB | 0.000 | DX/L | 0.000 |
| I | 0.000 | | |

REFERENCE FILE

LONGITUDINAL DISTRIBUTION OF BOOSTER FUSELAGE PRESSURES

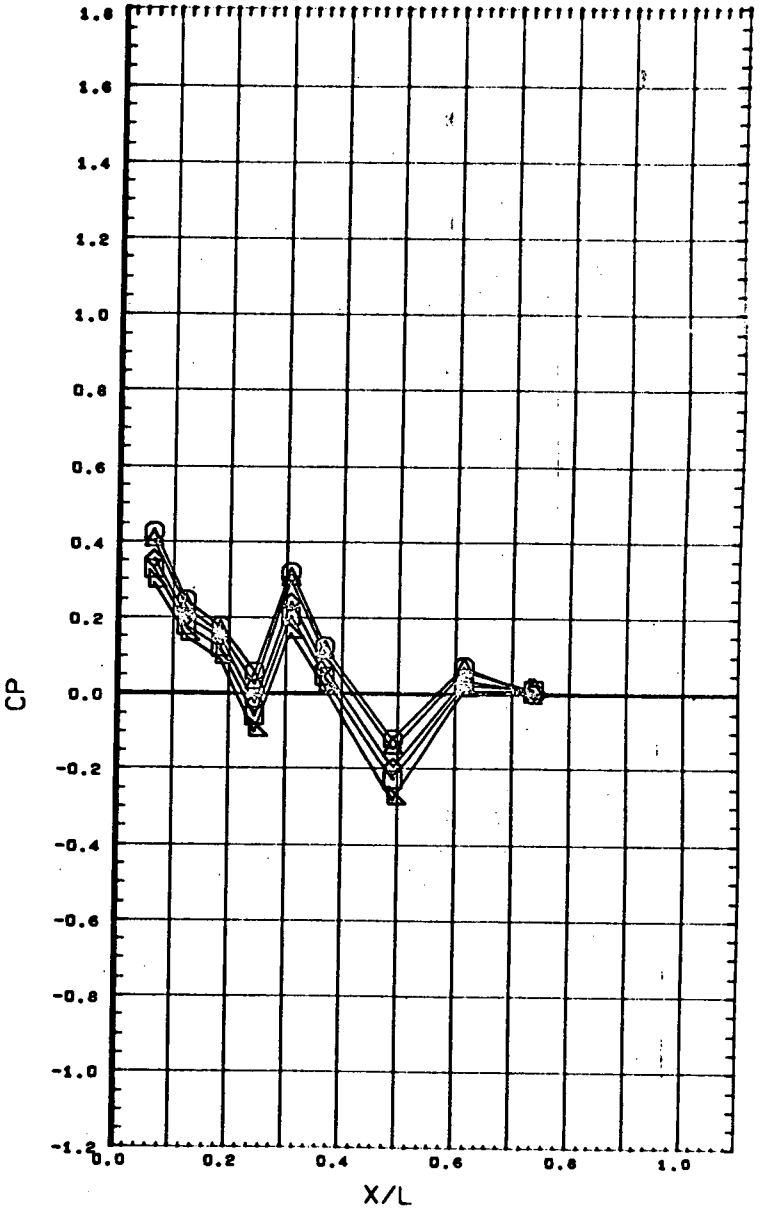
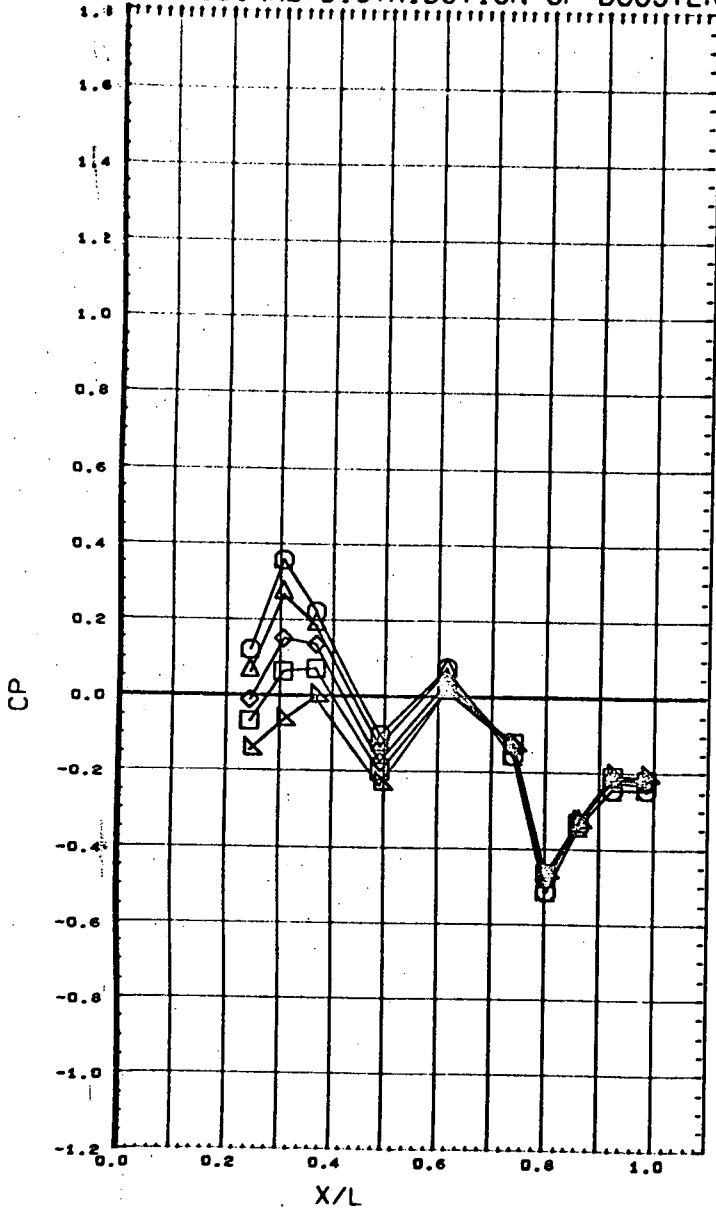

| SYMBOL | BETA | THETA | M1 |
|--------|-------|--------|-------|
| ○ | 6.196 | 24.000 | 1.201 |
| △ | 4.116 | 45.000 | |
| ◇ | 2.016 | | |
| □ | 0.241 | | |
| ◇ | 2.057 | | |

REFERENCE FILE

| PARAMETRIC VALUES | | | |
|-------------------|-------|------|-------|
| ALFB | 0.000 | DX/L | 0.000 |
| I | 0.000 | | |

AEDC TC174 MDAC BOOSTER NEAR ORBITER (BODY)

(ATC002)

PAGE 63

C-2

LONGITUDINAL DISTRIBUTION OF BOOSTER FUSELAGE PRESSURES

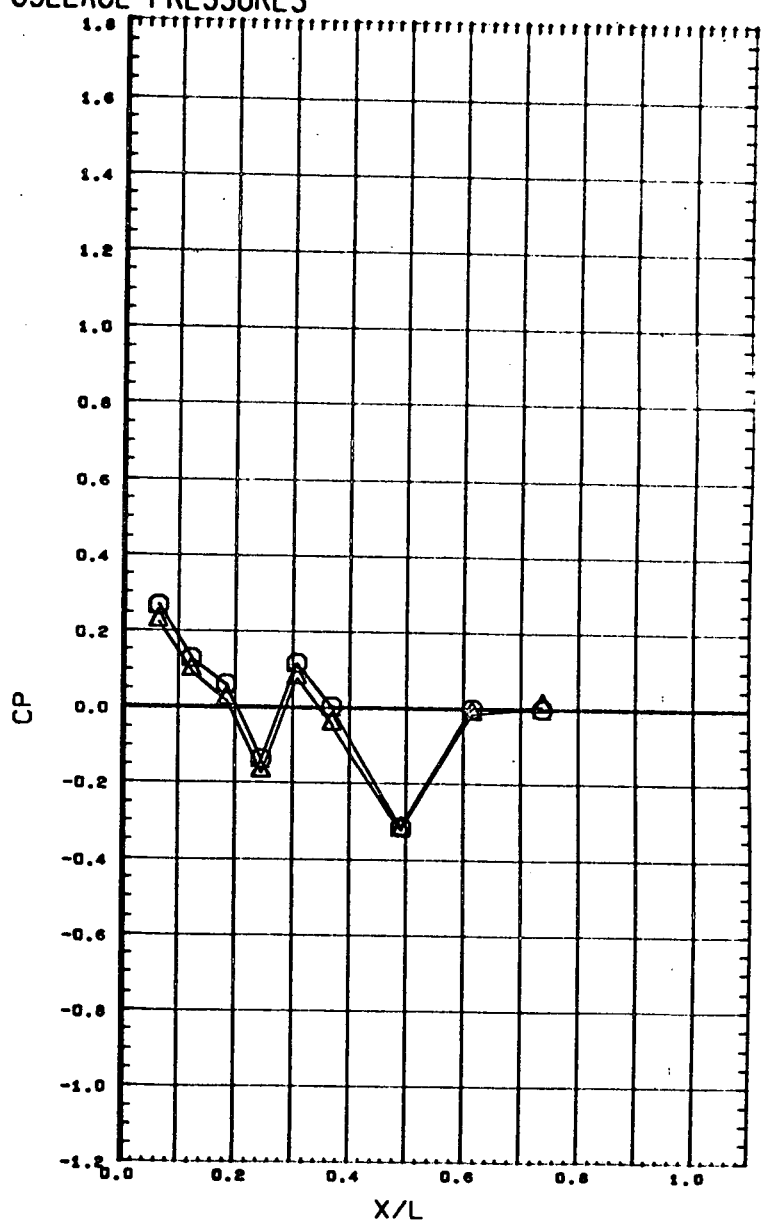
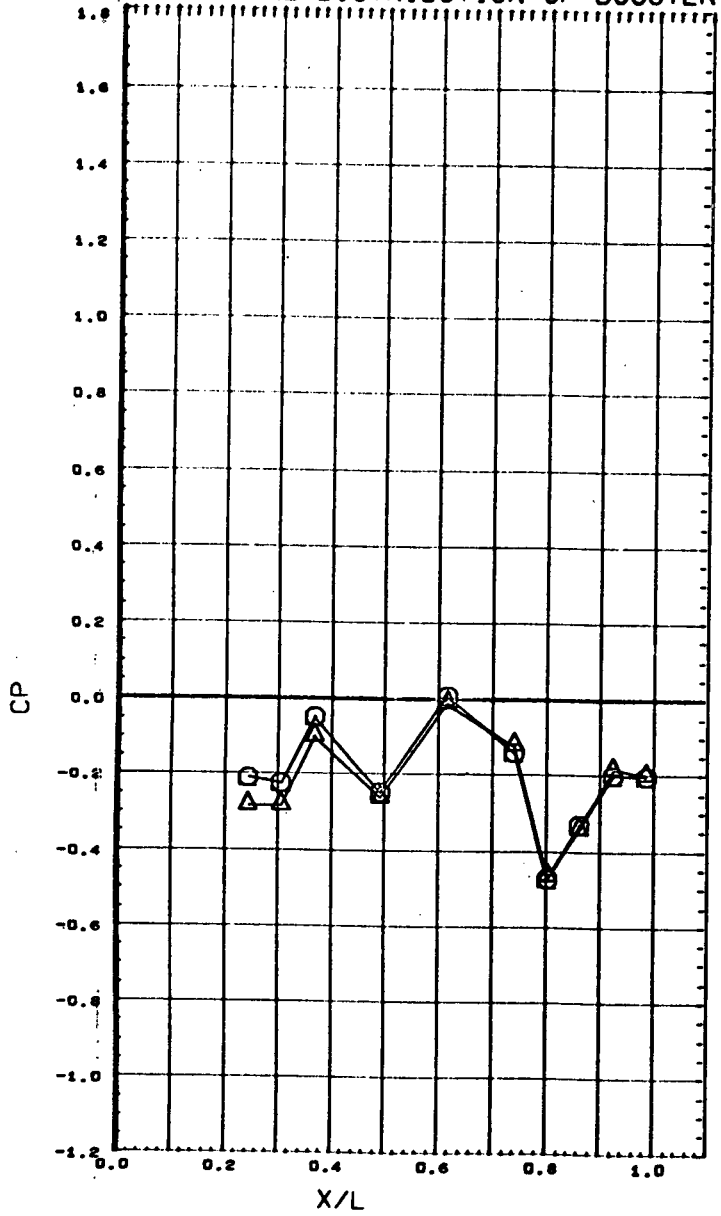

| SYMBOL | BETA | THETA | M1 |
|--------|-------|--------|-------|
| ○ | 3.912 | 24.000 | 1.201 |
| △ | 5.999 | 45.000 | |

| PARAMETRIC VALUES | | |
|-------------------|-------|-------|
| ALFB | 0.000 | 0.000 |
| I | 0.000 | 0.000 |

REFERENCE FILE

AEDC TC174 MDAC BOOSTER NEAR ORBITER (BODY)

(ATC002)

PAGE 64

LONGITUDINAL DISTRIBUTION OF BOOSTER FUSELAGE PRESSURES

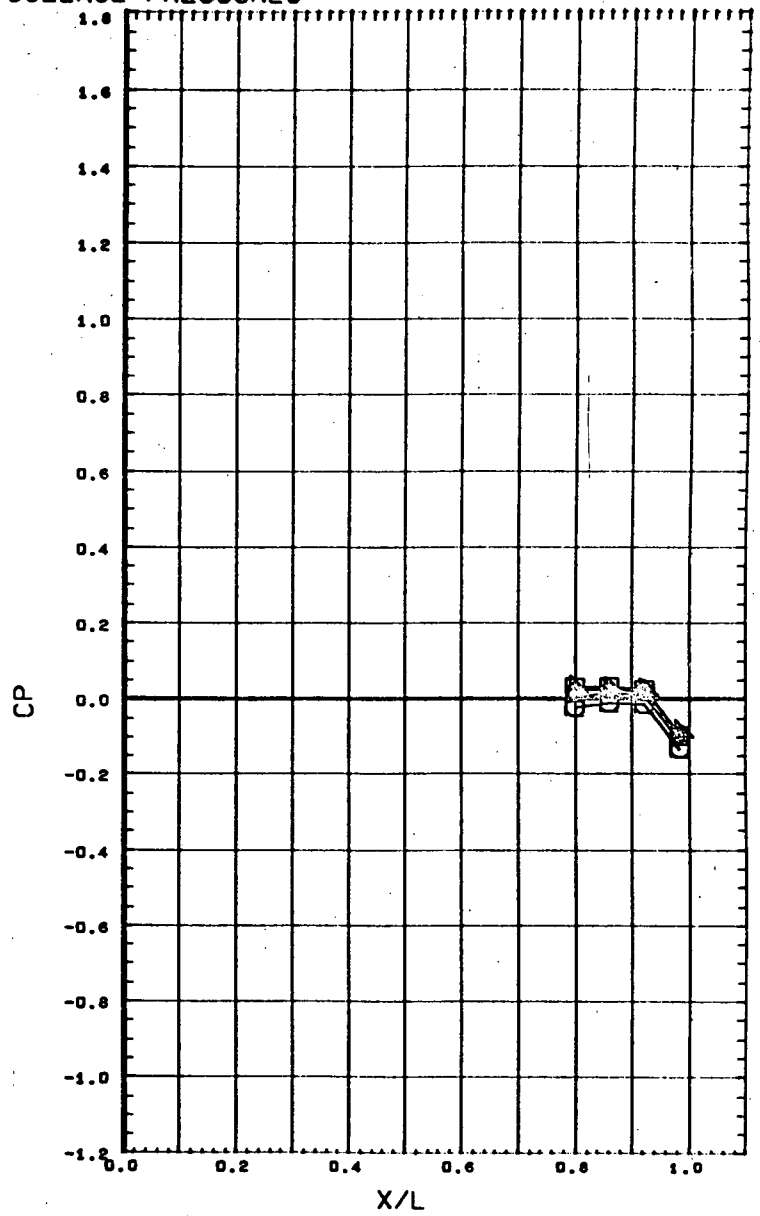
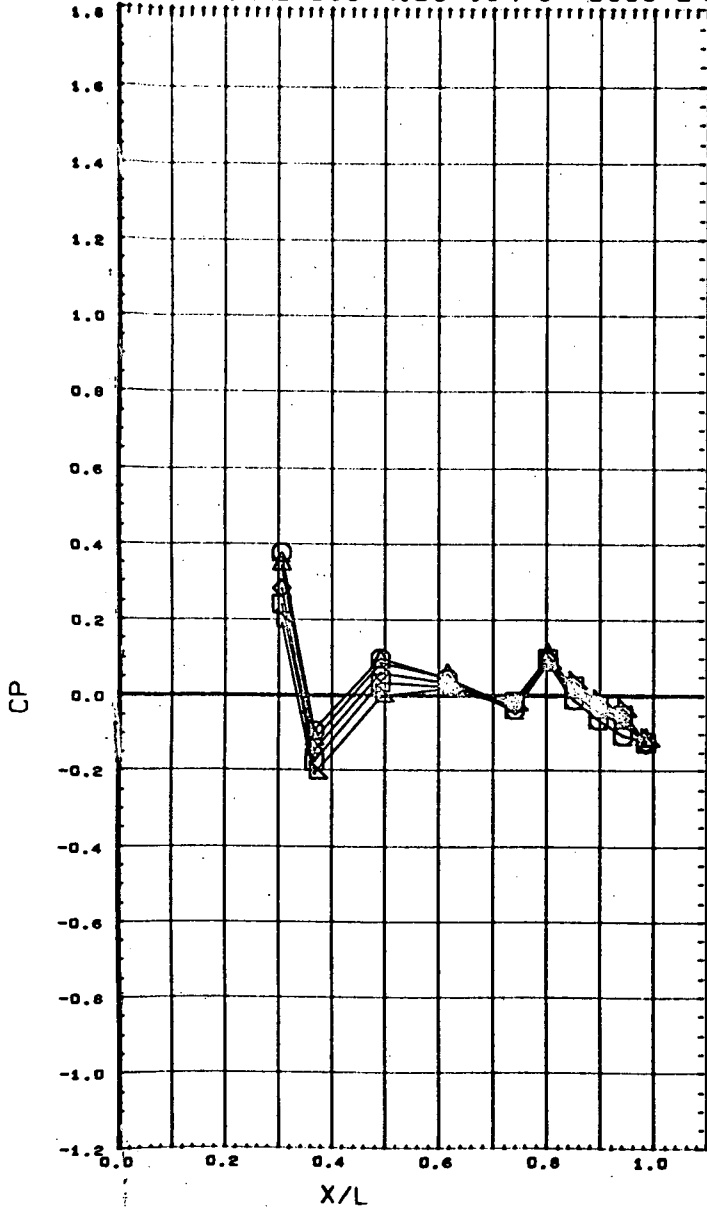

| SYMBOL | BETA | THETA | M1 |
|--------|-------|---------|-------|
| ○ | 6.196 | 90.000 | 1.201 |
| ◇ | 4.116 | 180.000 | |
| △ | 2.016 | | |
| □ | 0.241 | | |
| ▽ | 2.057 | | |

REFERENCE FILE

| PARAMETRIC VALUES | | | |
|-------------------|-------|------|-------|
| ALPB | 0.000 | OX/L | 0.000 |
| I | 0.000 | | |

LONGITUDINAL DISTRIBUTION OF BOOSTER FUSELAGE PRESSURES

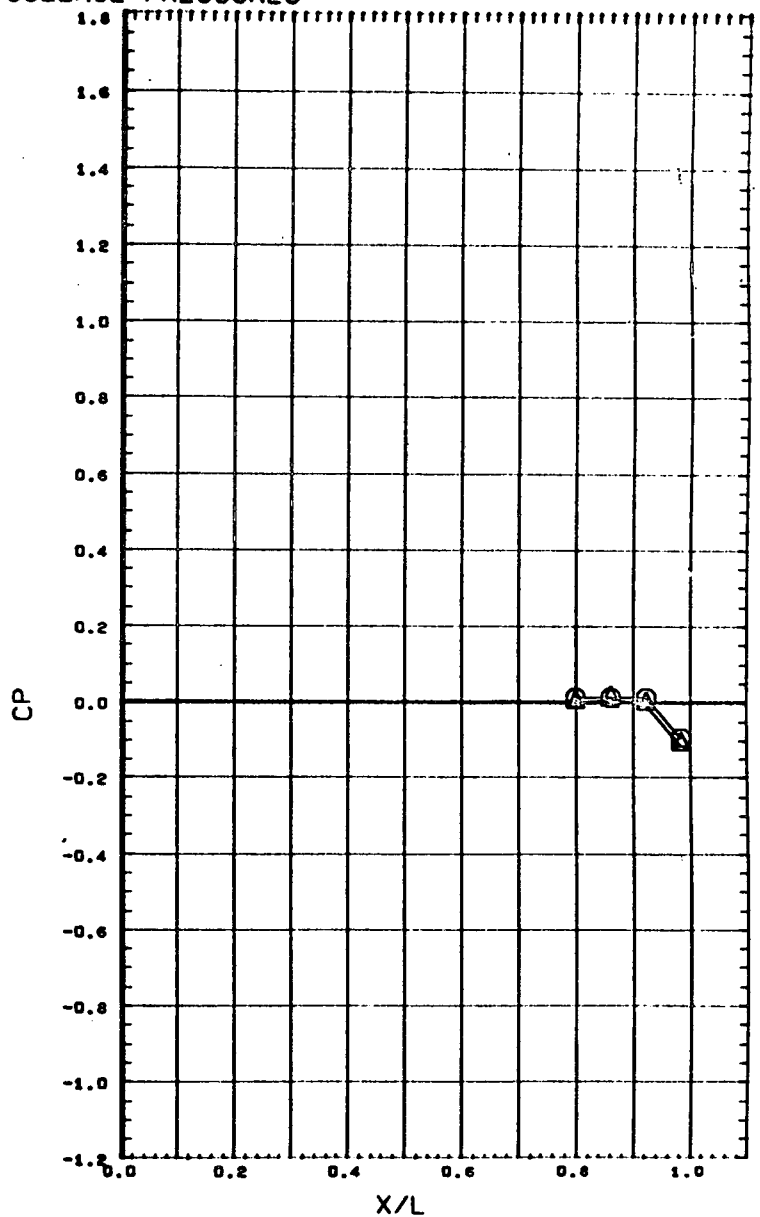
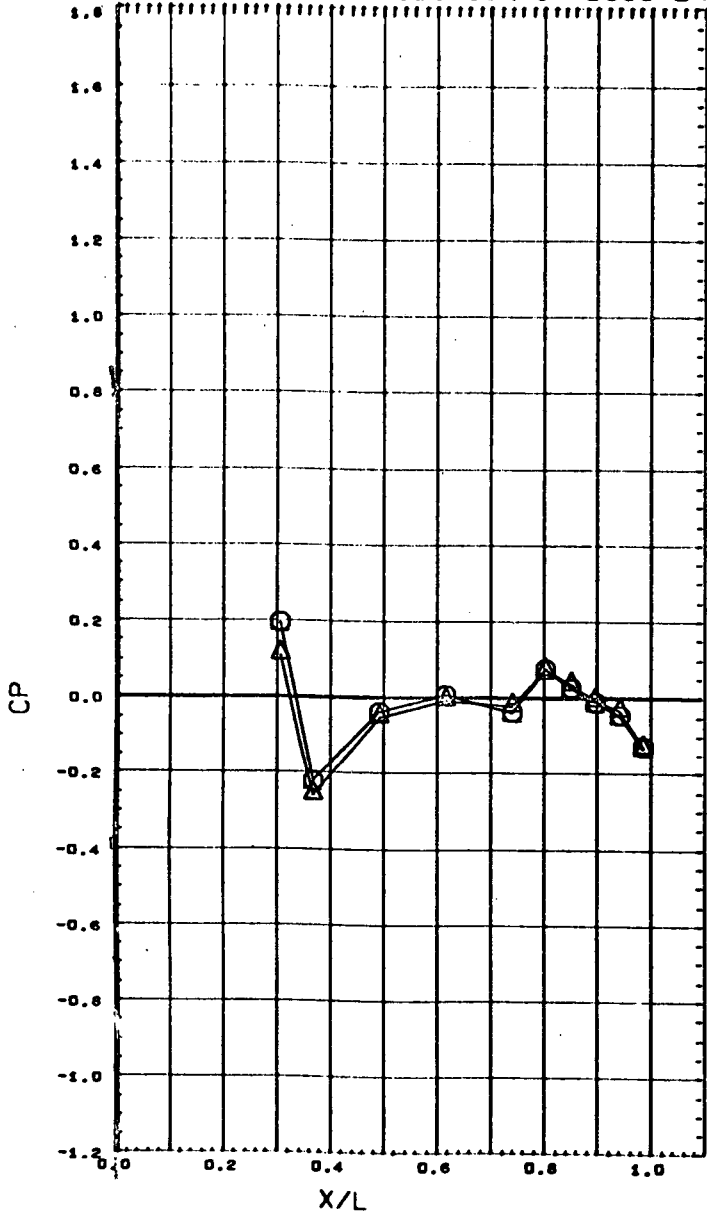

| SYMBOL | BETA | THETA | M1 |
|--------|-------|---------|-------|
| ○ | 3.912 | 90.000 | 1.201 |
| △ | 5.999 | 160.000 | |

| PARAMETRIC VALUES | | | |
|-------------------|-------|------|-------|
| ALFB | 0.000 | DX/L | 0.000 |
| I | 0.000 | | |

REFERENCE FILE

LONGITUDINAL DISTRIBUTION OF BOOSTER FUSELAGE PRESSURES

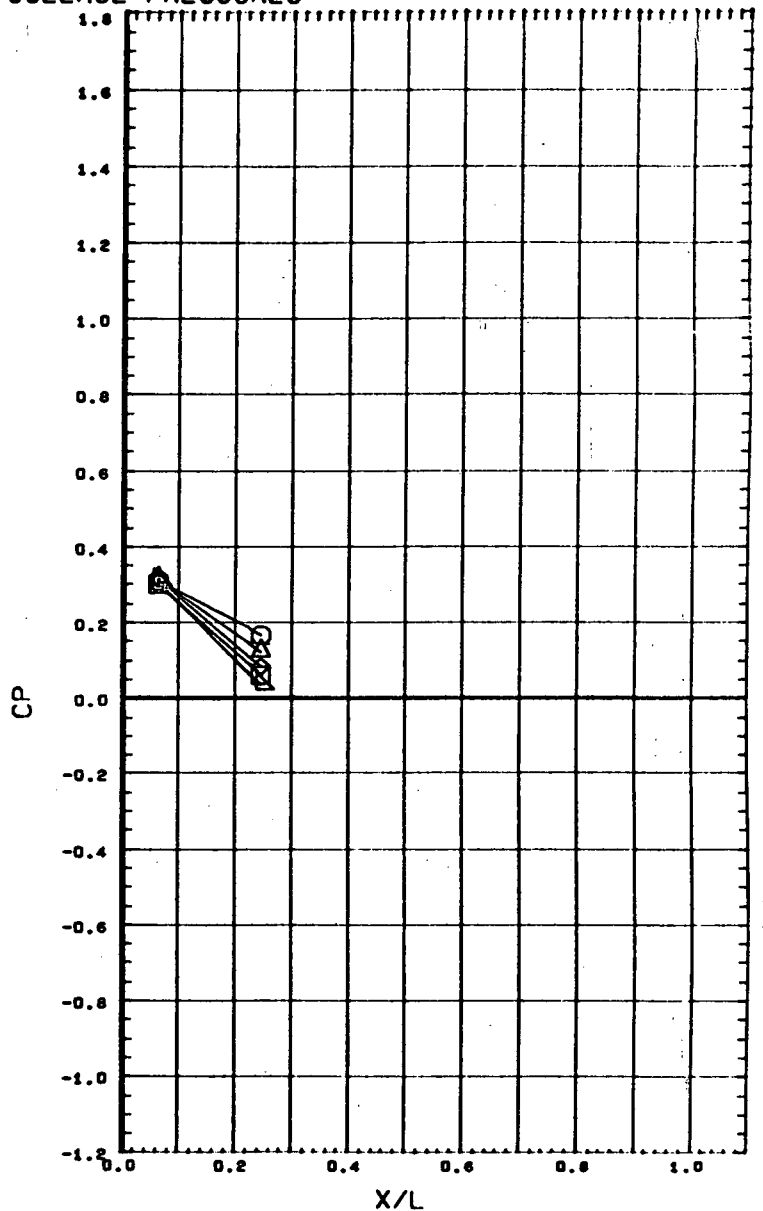
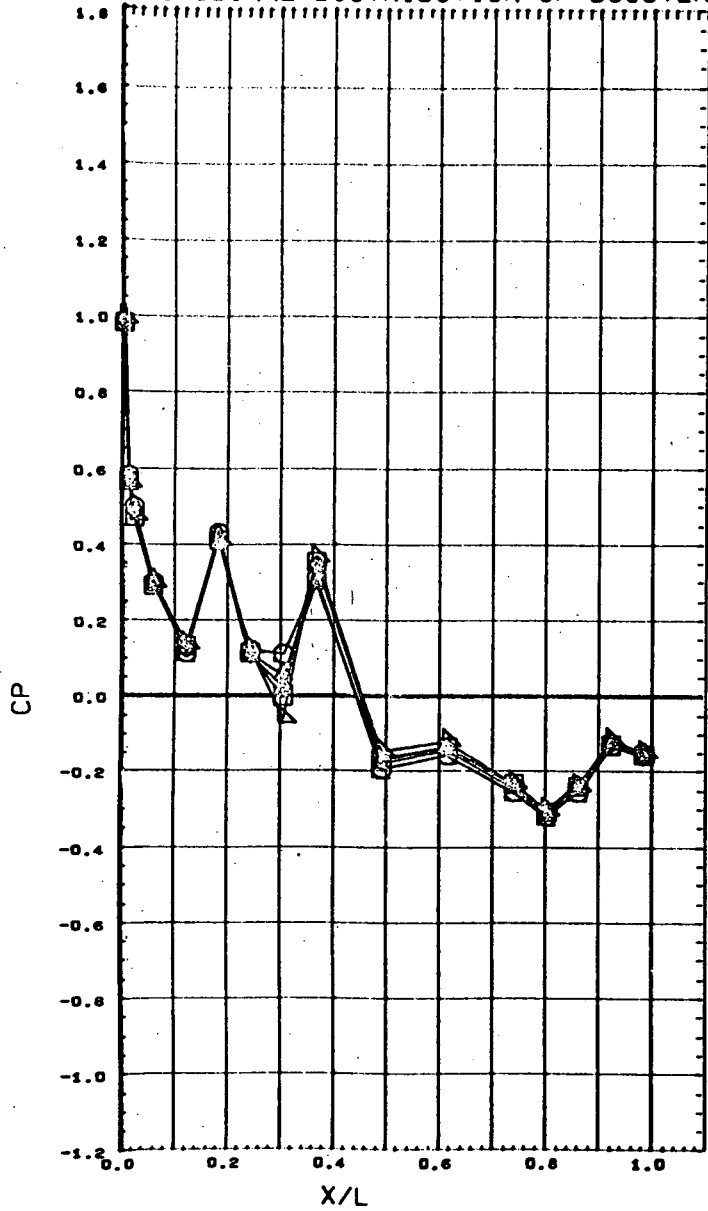

| SYMBOL | BETA | THETA | M1 |
|--------|-------|--------|-------|
| ○ | 6.203 | 0.000 | 1.302 |
| ◇ | 4.105 | 15.000 | |
| △ | 2.025 | | |
| □ | 0.252 | | |
| | 1.830 | | |

REFERENCE FILE

| PARAMETRIC VALUES | | | |
|-------------------|-------|------|-------|
| ALFB | 0.000 | OX/L | 0.000 |
| I | 0.000 | | |

LONGITUDINAL DISTRIBUTION OF BOOSTER FUSELAGE PRESSURES

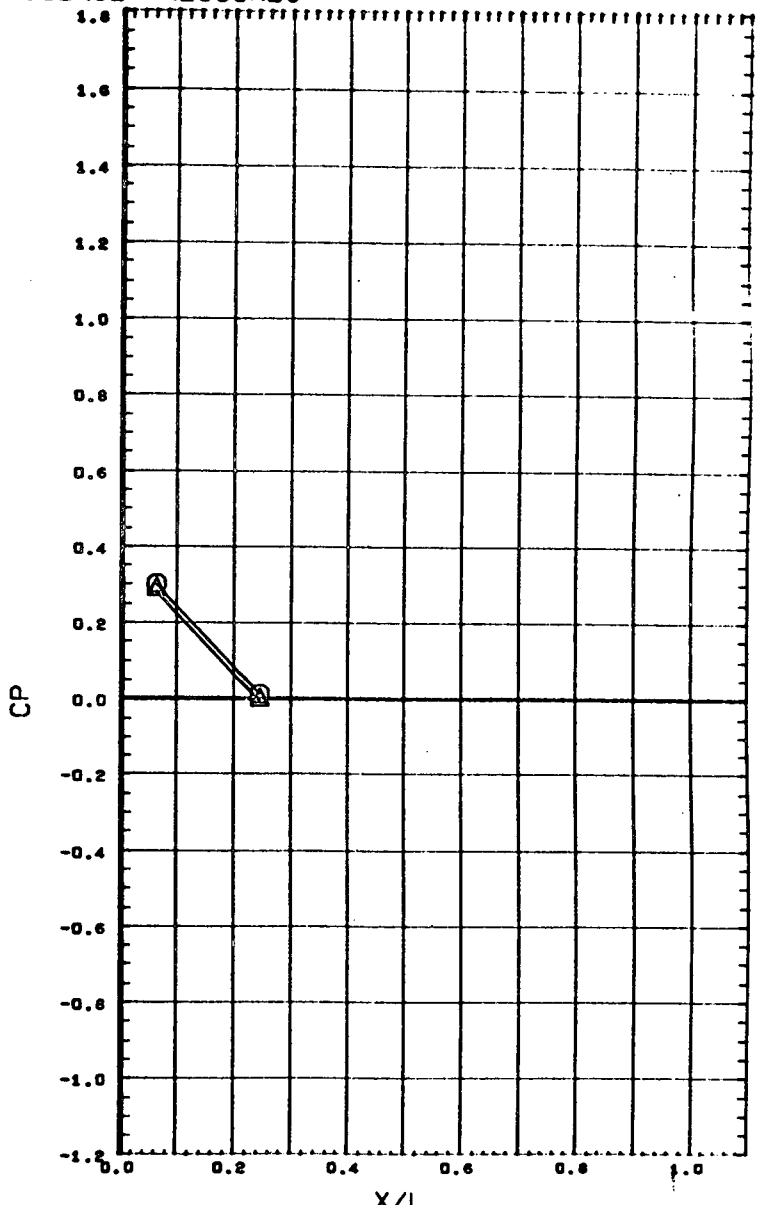
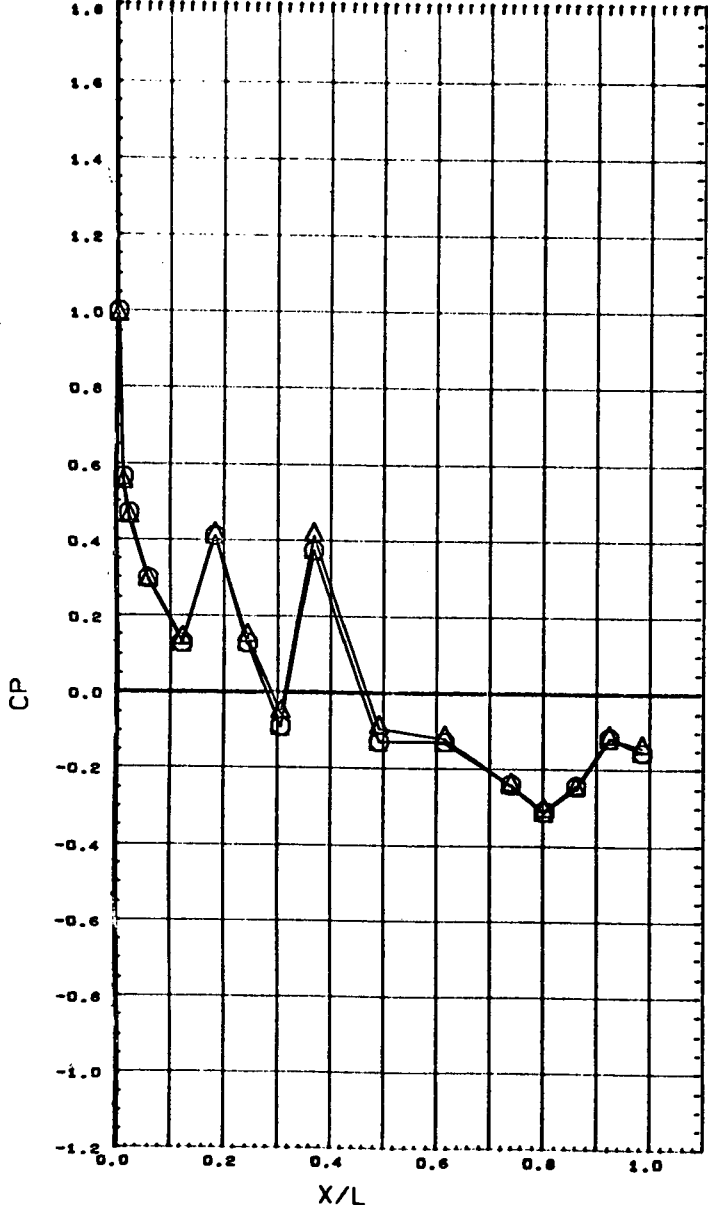

| SYMBOL | BETA | THETA | M1 |
|--------|-------|--------|-------|
| ○ | 5.890 | 0.000 | 1.302 |
| △ | 5.994 | 15.000 | |

| PARAMETRIC VALUES | | | |
|-------------------|-------|------|-------|
| ALFB | 0.000 | DX/L | 0.000 |
| I | 0.000 | | |

REFERENCE FILE

LONGITUDINAL DISTRIBUTION OF BOOSTER FUSELAGE PRESSURES

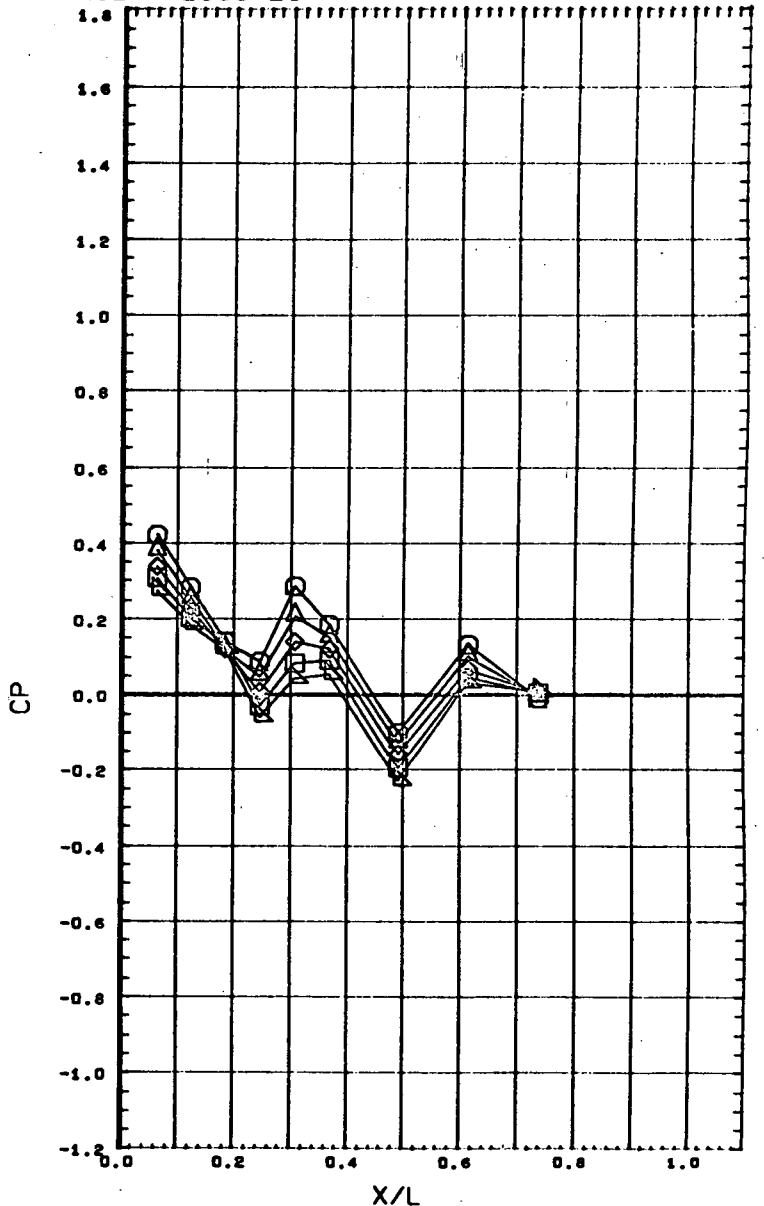
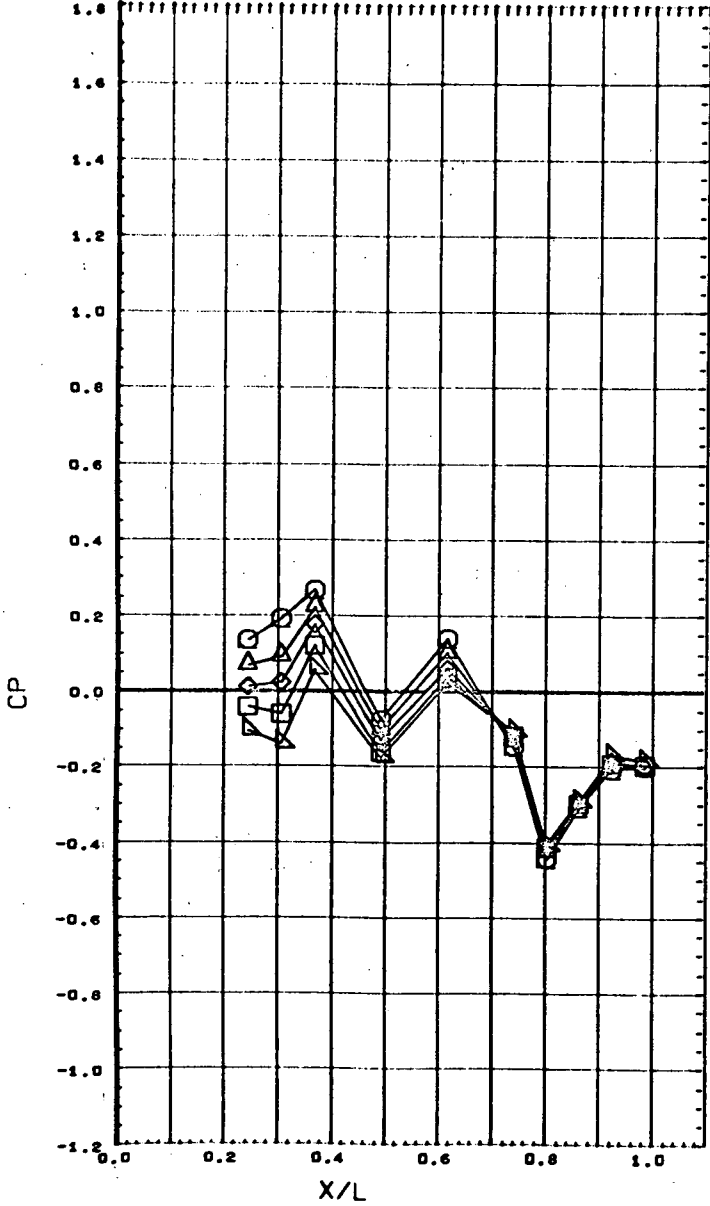

| SYMBOL | BETA | THETA | M1 |
|--------|-------|--------|-------|
| ○ | 6.203 | 24.000 | 1.302 |
| ◇ | 4.105 | 45.000 | |
| △ | 2.025 | | |
| □ | 0.252 | | |
| ○ | 1.830 | | |

| PARAMETRIC VALUES | | |
|-------------------|-------|-------|
| ALFB | 0.000 | DX/L |
| I | 0.000 | 0.000 |

REFERENCE FILE

LONGITUDINAL DISTRIBUTION OF BOOSTER FUSELAGE PRESSURES

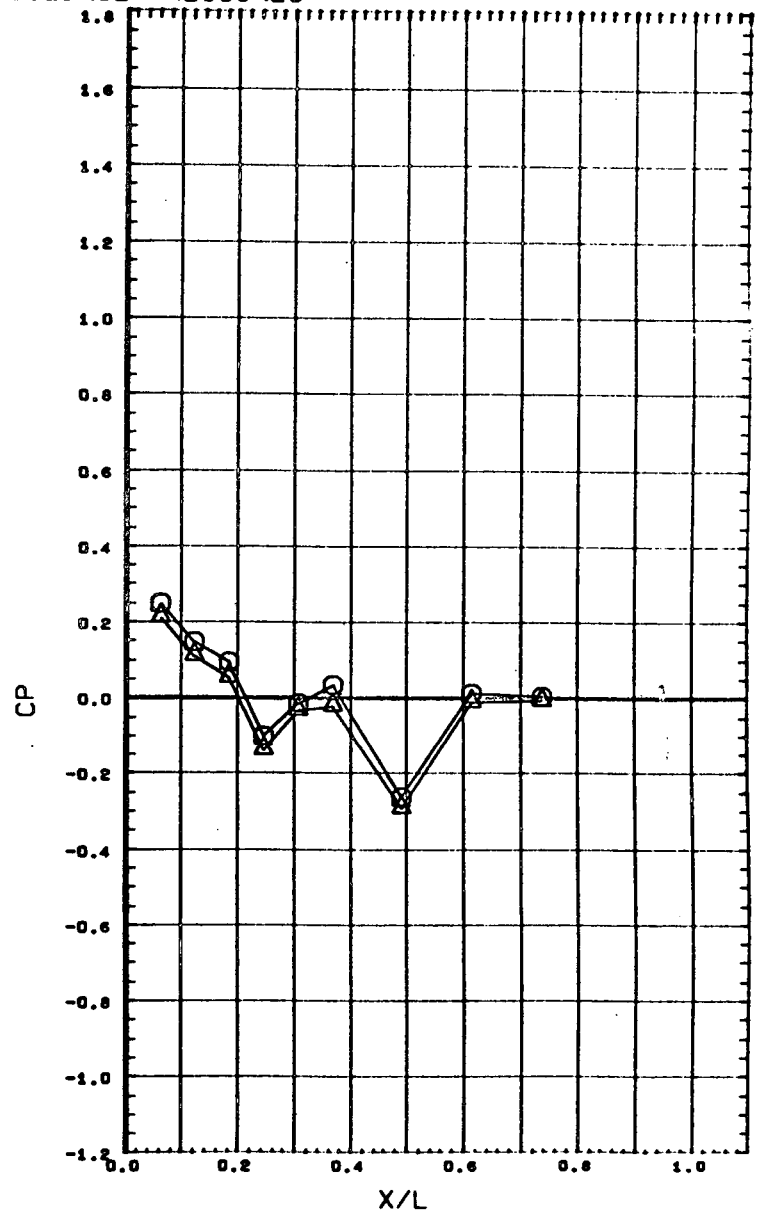
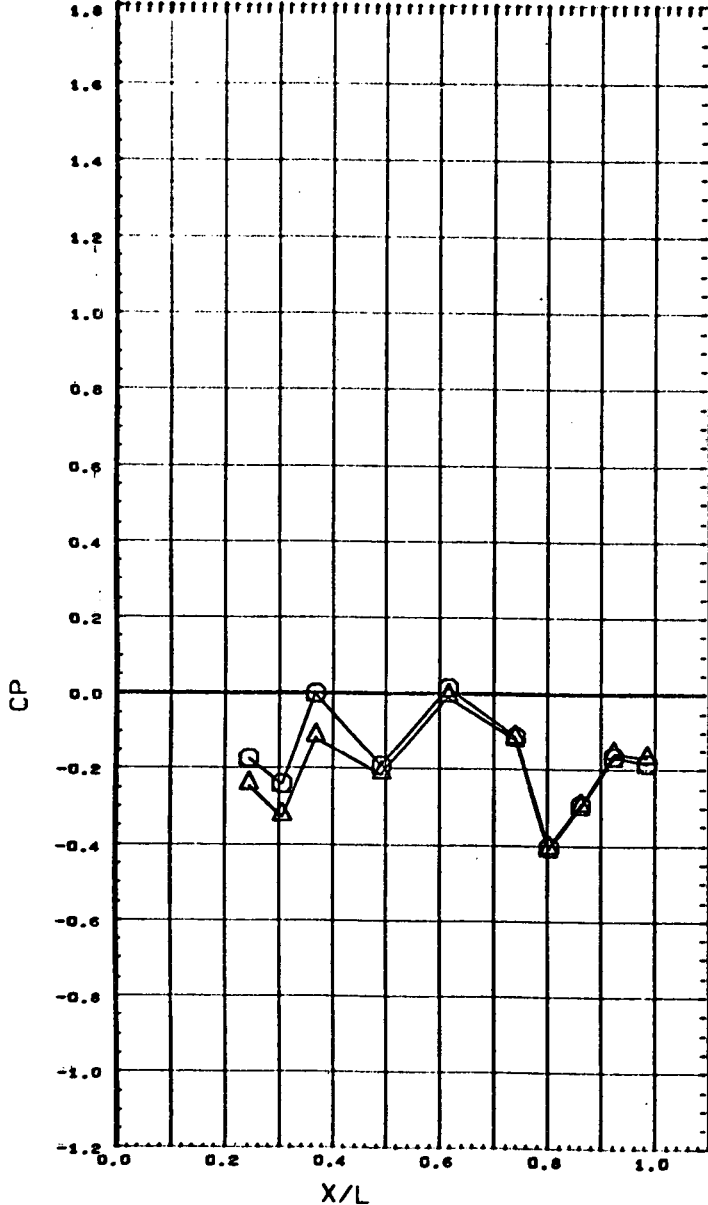

| SYMBOL | BETA | THETA | M1 |
|--------|-------|--------|-------|
| ○ | 3.895 | 24.000 | 1.302 |
| △ | 5.994 | 45.000 | |

| PARAMETRIC VALUES | | |
|-------------------|-------|-------|
| ALFB | 0.000 | DX/L |
| I | 0.000 | 0.000 |

REFERENCE FILE

LONGITUDINAL DISTRIBUTION OF BOOSTER FUSELAGE PRESSURES

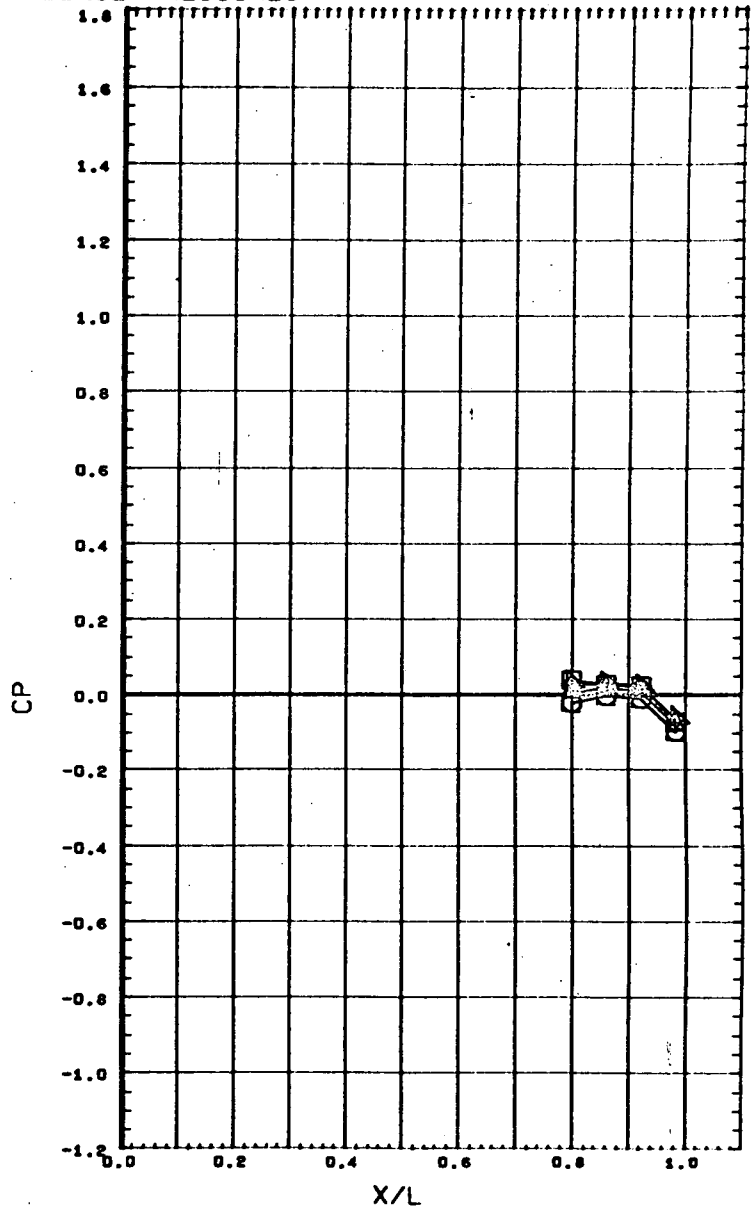
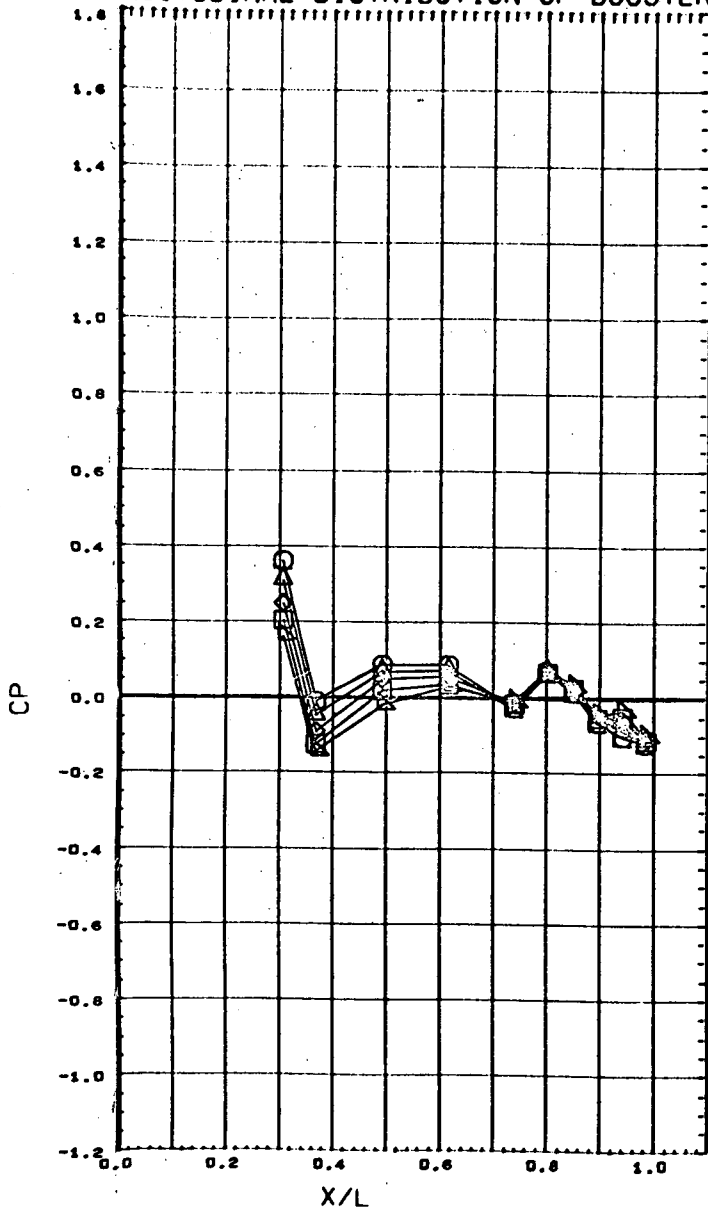

| SYMBOL | BETA | THETA | M1 |
|--------|-------|---------|-------|
| ○ | 6.203 | 90.000 | 1.302 |
| ◇ | 4.105 | 180.000 | |
| △ | 2.025 | | |
| □ | 0.252 | | |
| ▽ | 1.830 | | |

| PARAMETRIC VALUES | | | |
|-------------------|-------|------|-------|
| ALFB | 0.000 | DX/L | 0.000 |
| I | 0.000 | | |

REFERENCE FILE

LONGITUDINAL DISTRIBUTION OF BOOSTER FUSELAGE PRESSURES

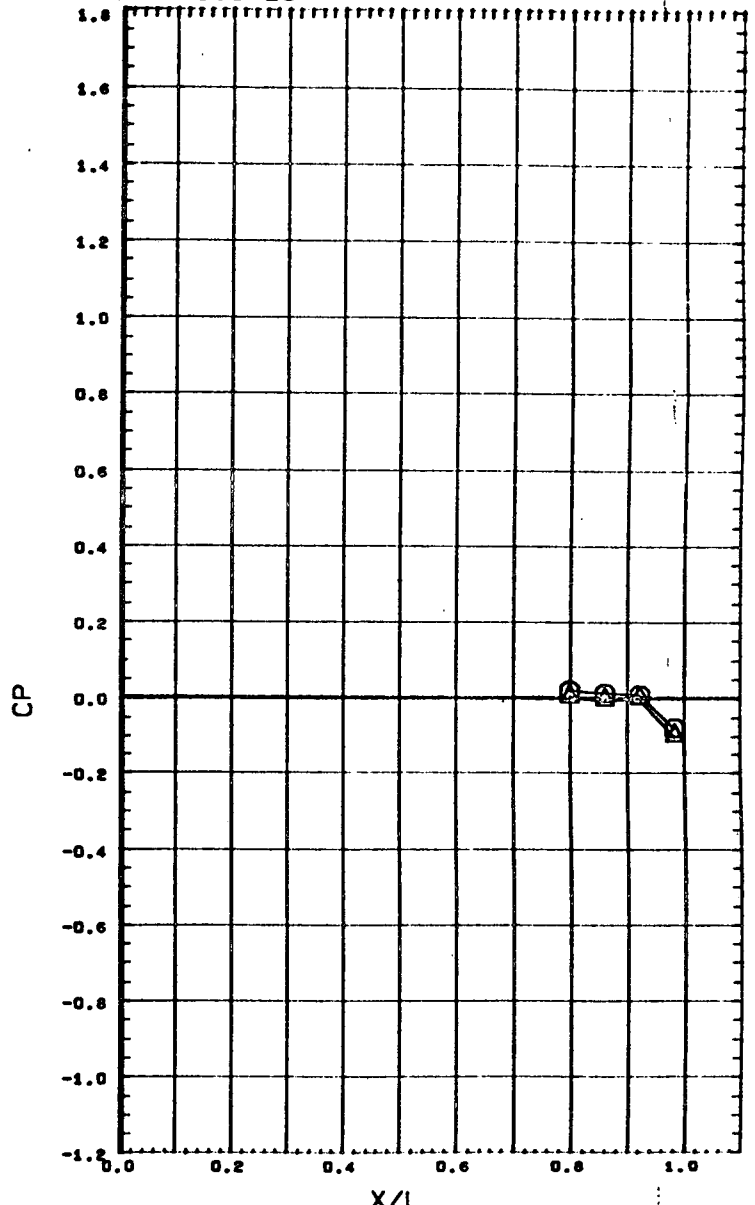
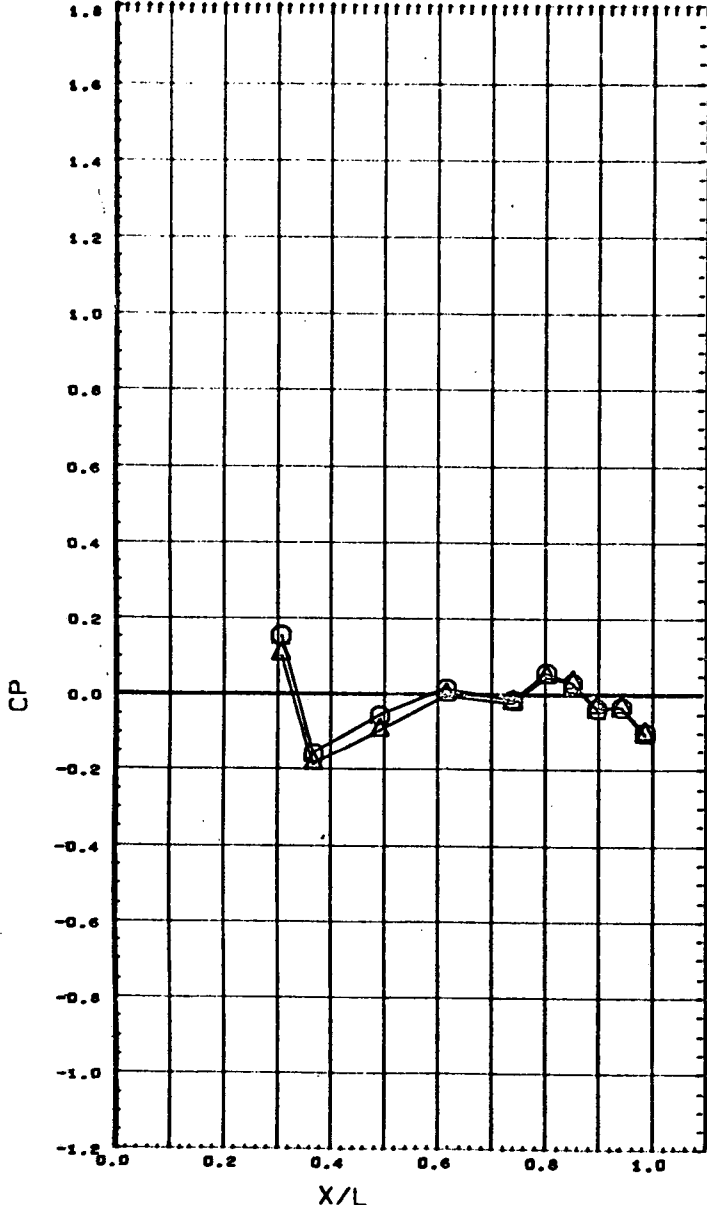

| SYMBOL | BETA | THETA | M1 |
|--------|-------|---------|-------|
| ○ | 3.890 | 90.000 | 1.302 |
| △ | 3.994 | 180.000 | |

| PARAMETRIC VALUES | | | |
|-------------------|-------|------|-------|
| ALFB | 0.000 | OX/L | 0.000 |
| I | 0.000 | | |

REFERENCE FILE

LONGITUDINAL DISTRIBUTION OF BOOSTER FUSELAGE PRESSURES

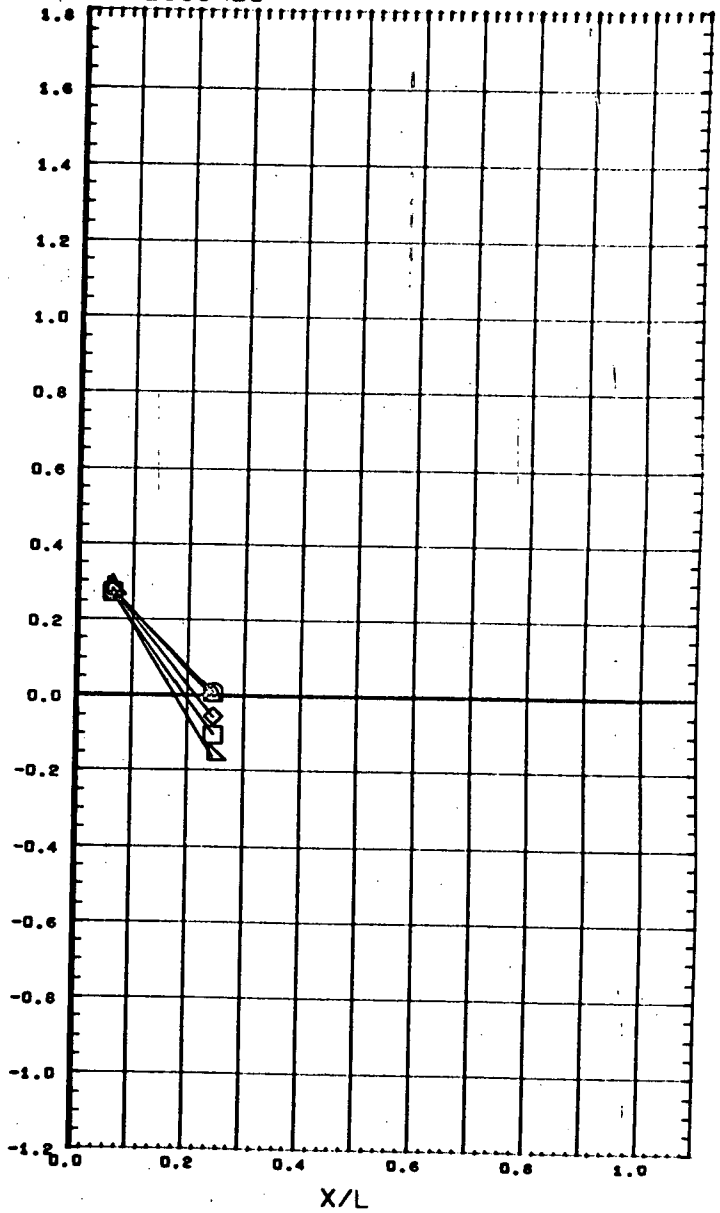
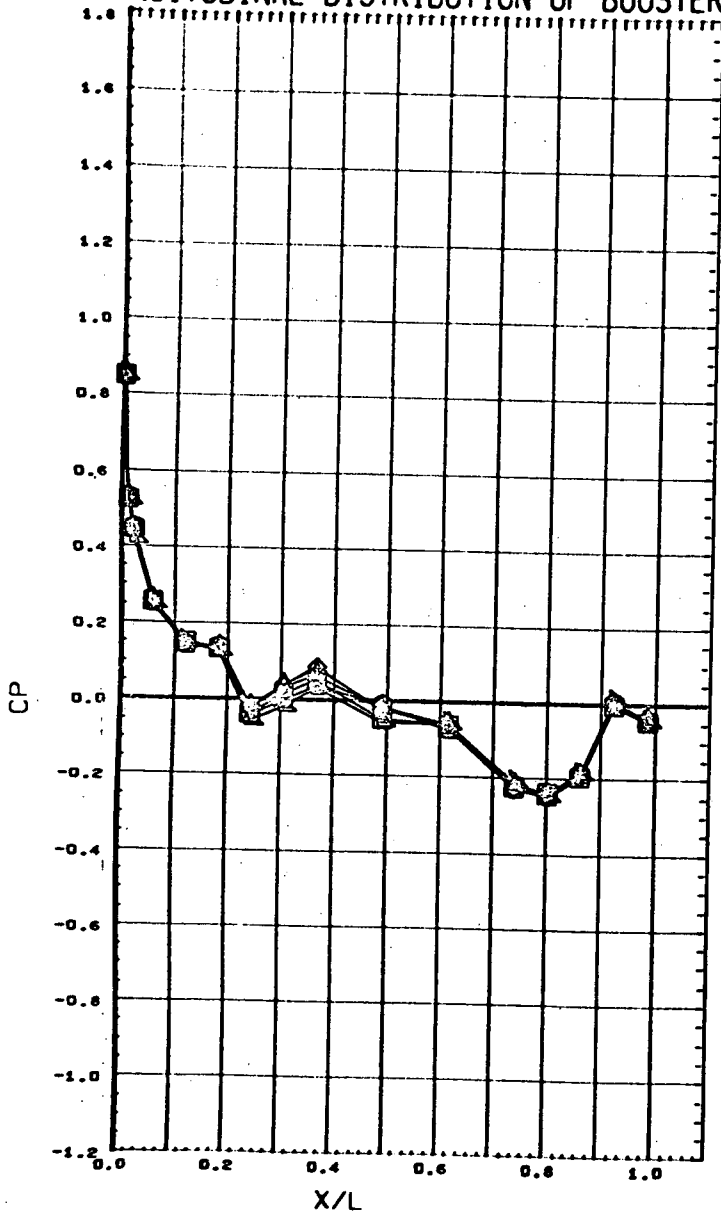

| SYMBOL | BETA | THETA | M1 |
|--------|-------|--------|-------|
| ○ | 3.954 | 0.000 | 0.599 |
| △ | 1.923 | 15.000 | |
| ◇ | 0.013 | | |
| □ | 1.958 | | |
| ▽ | 3.955 | | |

| PARAMETRIC VALUES | | |
|-------------------|-------|-------|
| ALFB | 6.000 | DX/L |
| I | 0.000 | 0.000 |

REFERENCE FILE

AEDC TC174 MDAC BOOSTER NEAR ORBITER (BODY)

(ATC003)

PAGE 73

LONGITUDINAL DISTRIBUTION OF BOOSTER FUSELAGE PRESSURES

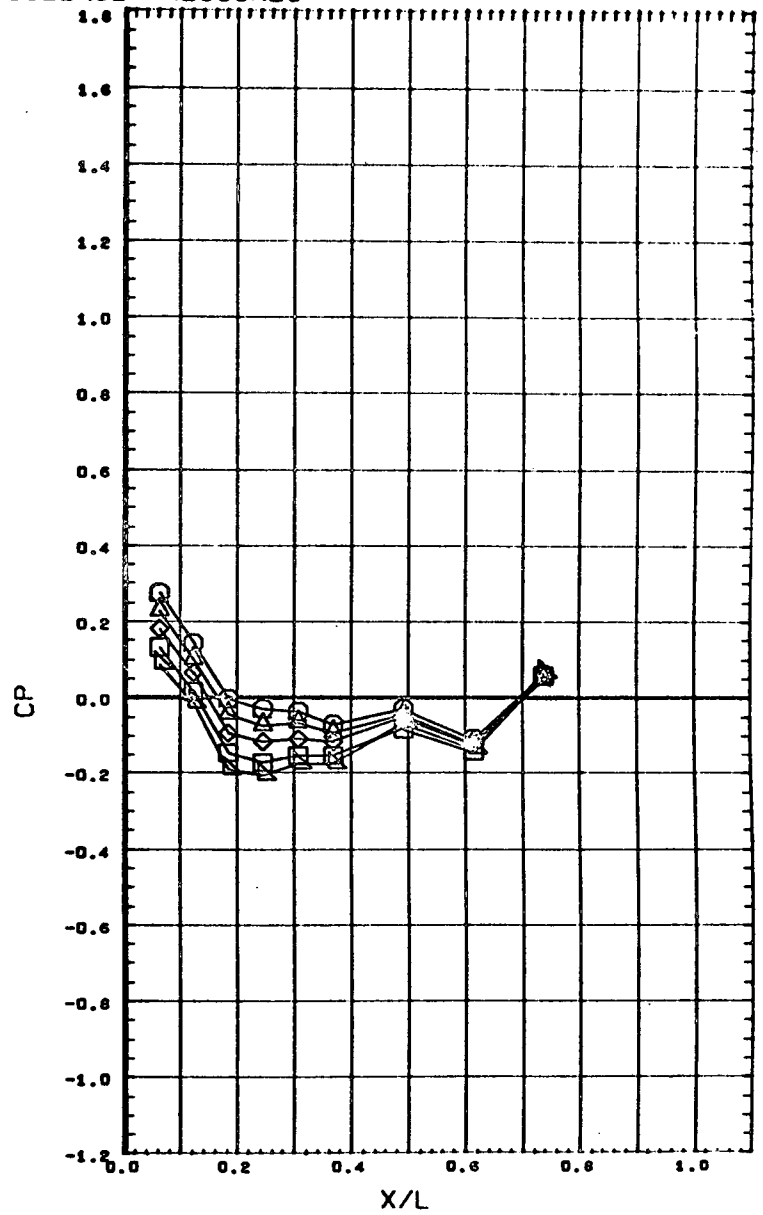
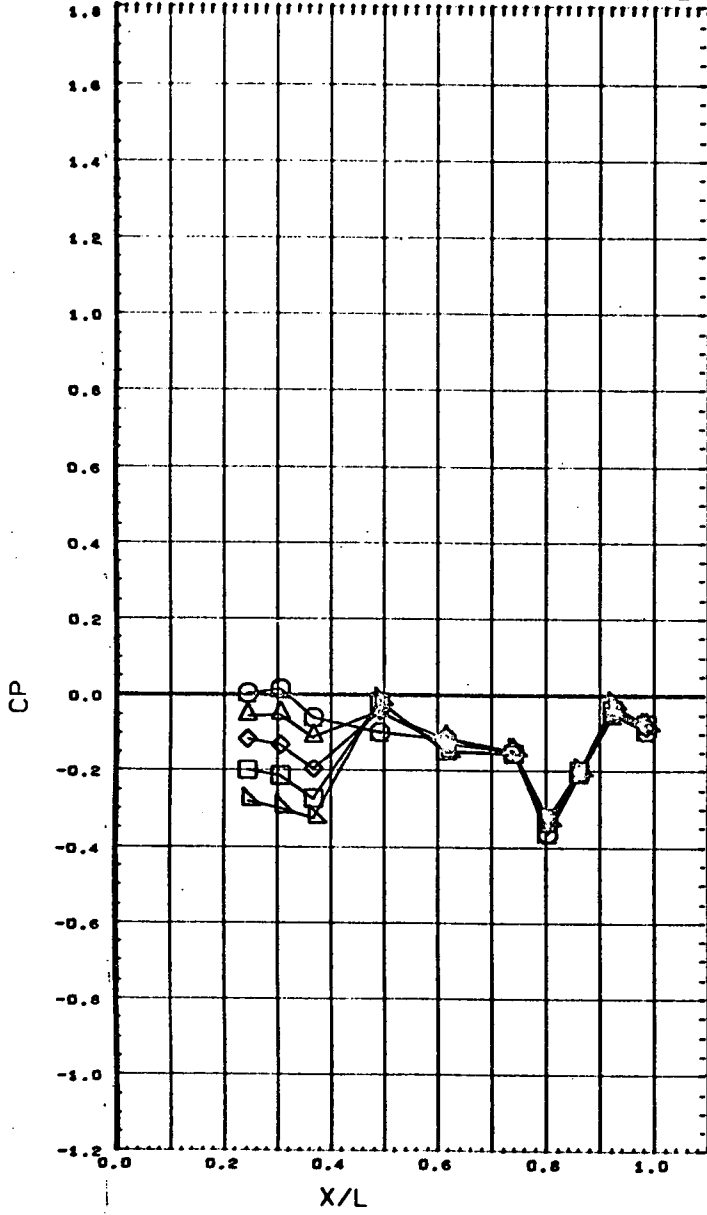

| SYMBOL | BETA | THETA | M1 |
|--------|-------|--------|-------|
| ○ | 3.904 | 24.000 | 0.599 |
| △ | 1.993 | 45.000 | |
| ◇ | 0.013 | | |
| □ | 1.958 | | |
| ▽ | 3.955 | | |

| PARAMETRIC VALUES | | |
|-------------------|---------|------------|
| ALPB | - 6.000 | OX/L 0.000 |
| I | 0.000 | |

REFERENCE FILE

LONGITUDINAL DISTRIBUTION OF BOOSTER FUSELAGE PRESSURES

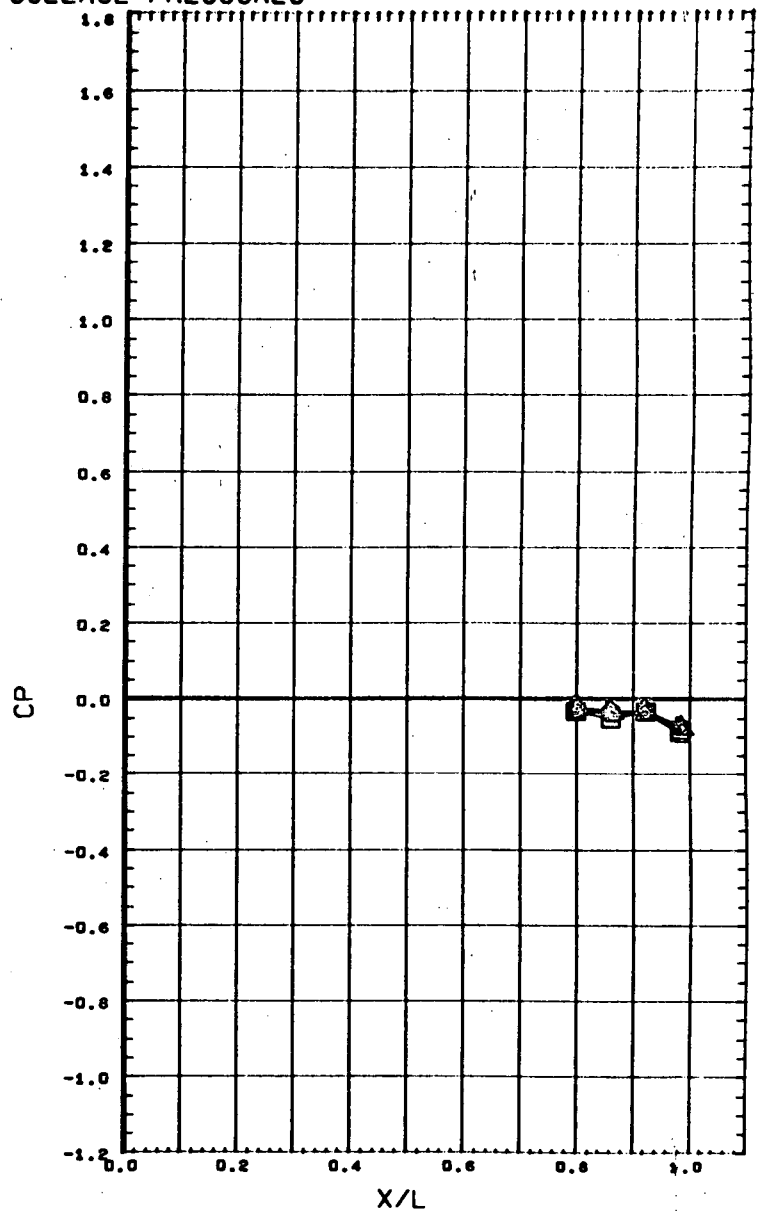
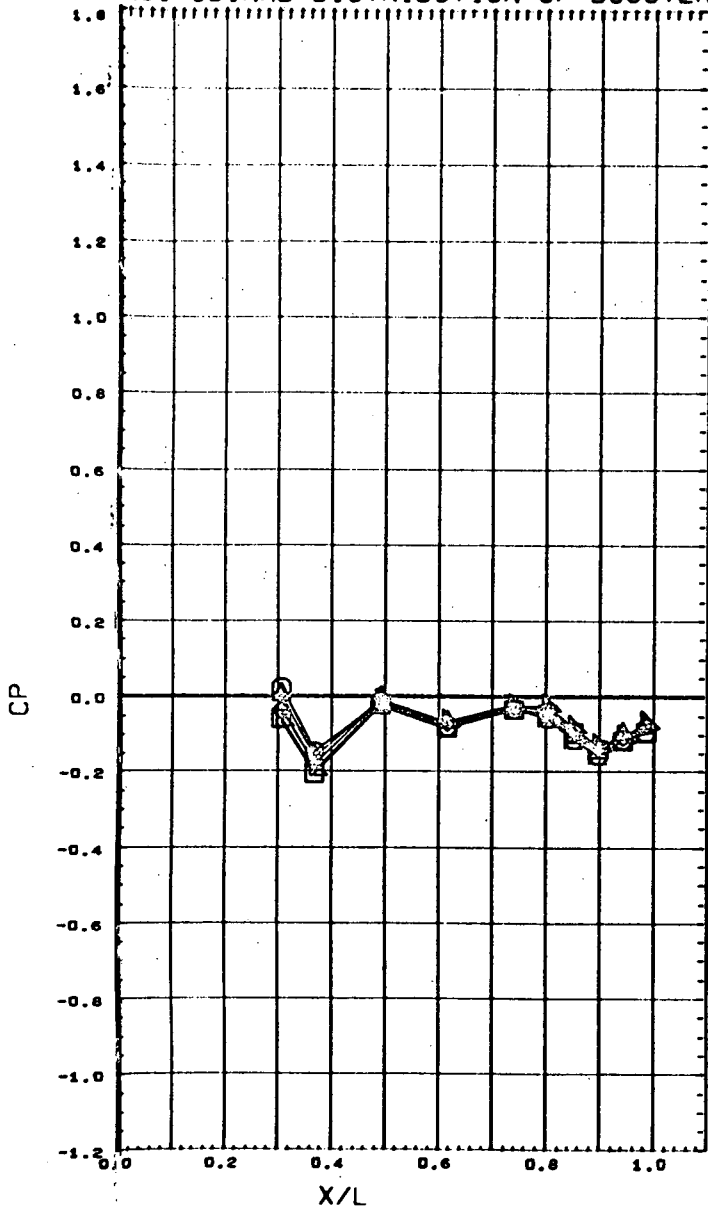

| SYMBOL | BETA | THETA | M1 |
|--------|-------|---------|-------|
| □ | 3.904 | 90.000 | 0.599 |
| ◇ | 1.993 | 180.000 | |
| ◇ | 0.013 | | |
| ◇ | 1.958 | | |
| ◇ | 3.955 | | |

REFERENCE FILE

| PARAMETRIC VALUES | | | |
|-------------------|---------|------|-------|
| ALFB | - 6.000 | DX/L | 0.000 |
| I | 0.000 | | |

LONGITUDINAL DISTRIBUTION OF BOOSTER FUSELAGE PRESSURES

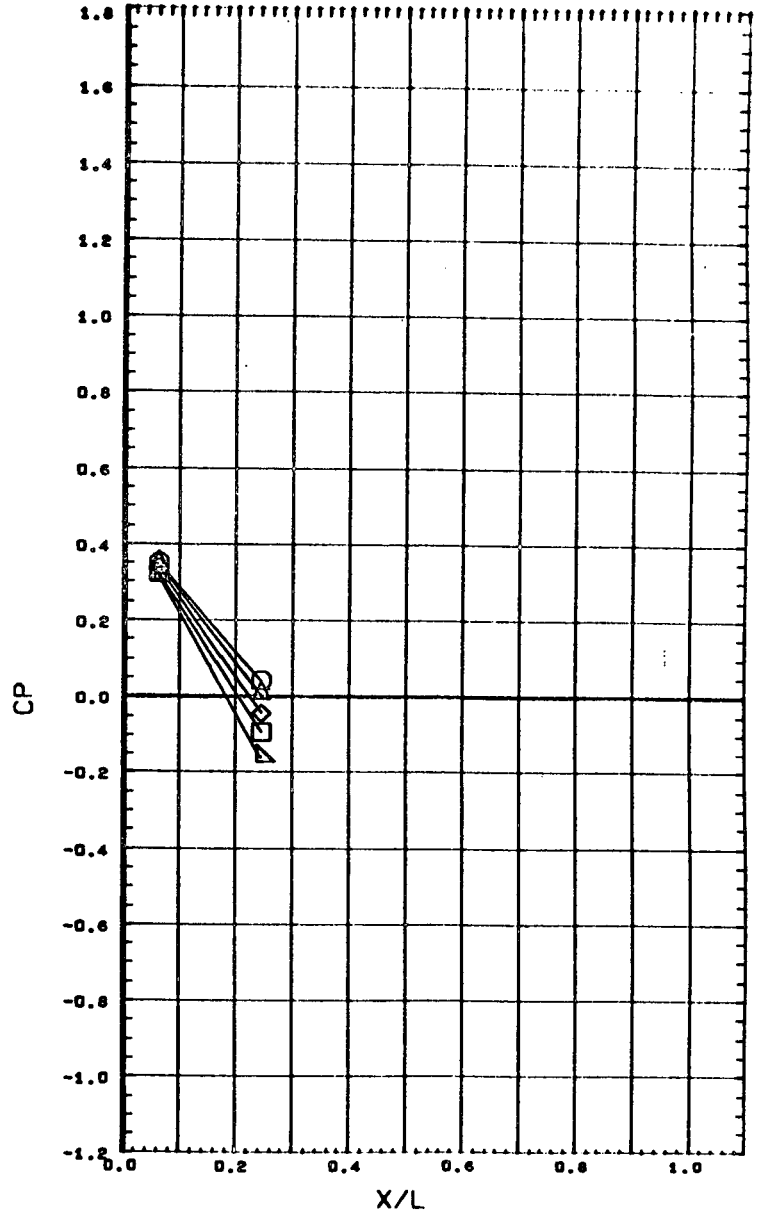
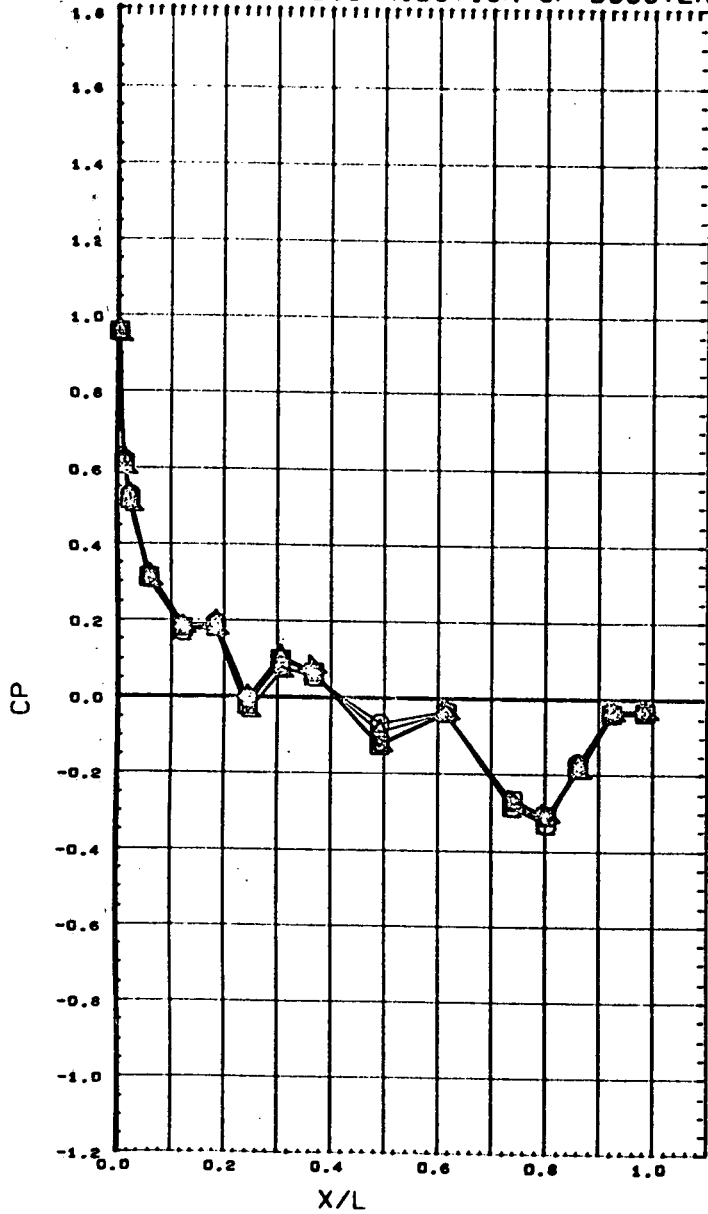

| SYMBOL | BETA | THETA | M1 |
|--------|-------|--------|-------|
| ○ | 3.957 | 0.000 | 0.900 |
| △ | 1.918 | 15.000 | |
| ◇ | 0.152 | | |
| □ | 2.081 | | |
| ▽ | 4.094 | | |

| PARAMETRIC VALUES | | | |
|-------------------|---------|------|-------|
| ALFB | - 6.000 | DX/L | 0.000 |
| I | 0.000 | | |

REFERENCE FILE

LONGITUDINAL DISTRIBUTION OF BOOSTER FUSELAGE PRESSURES

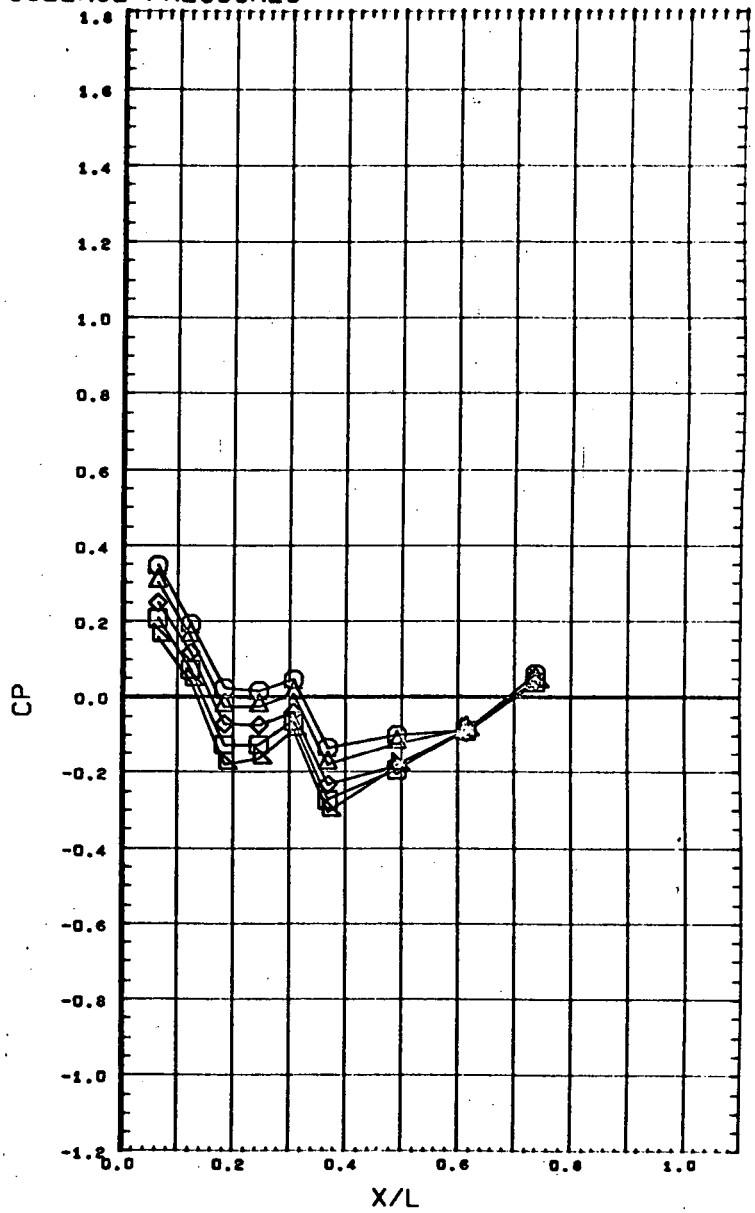
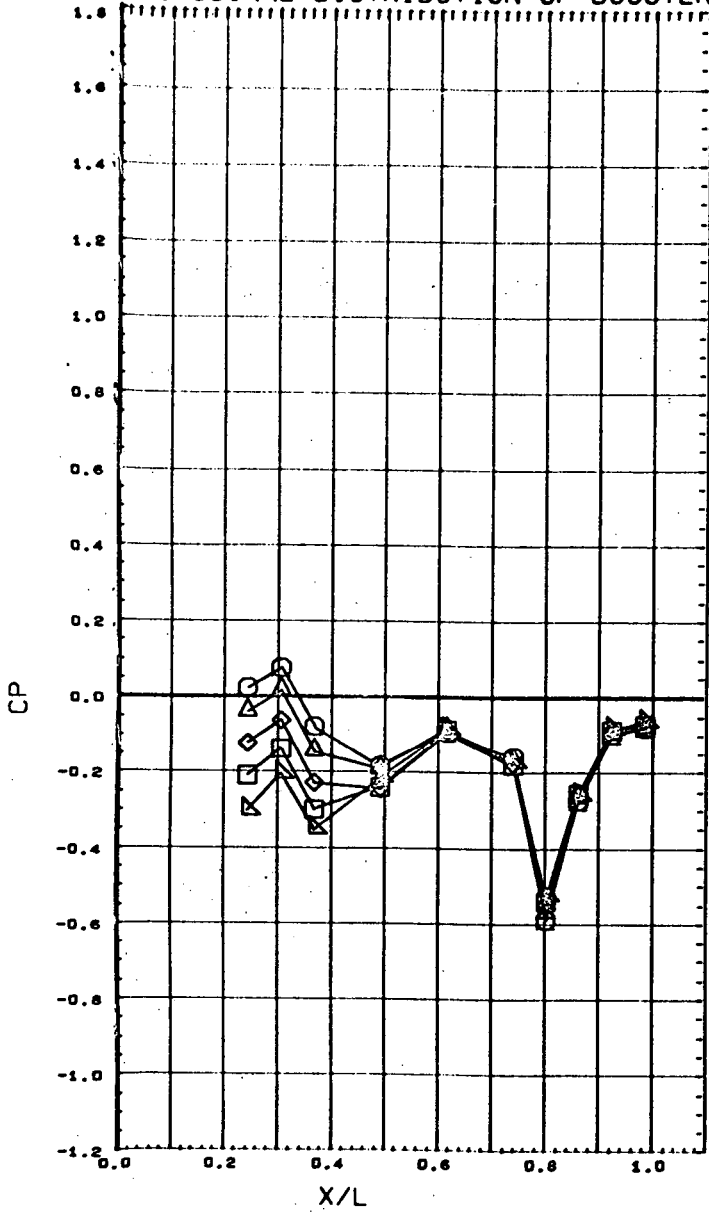

| SYMBOL | BETA | THETA | M1 |
|--------|---------|--------|-------|
| ○ | - 3.957 | 24.000 | 0.900 |
| △ | - 1.918 | 45.000 | |
| ◇ | 0.152 | | |
| □ | 2.081 | | |
| ▽ | 4.094 | | |

| PARAMETRIC VALUES | | |
|-------------------|---------|------------|
| ALFB | - 6.000 | DX/L 0.000 |
| I | 0.000 | |

REFERENCE FILE

LONGITUDINAL DISTRIBUTION OF BOOSTER FUSELAGE PRESSURES

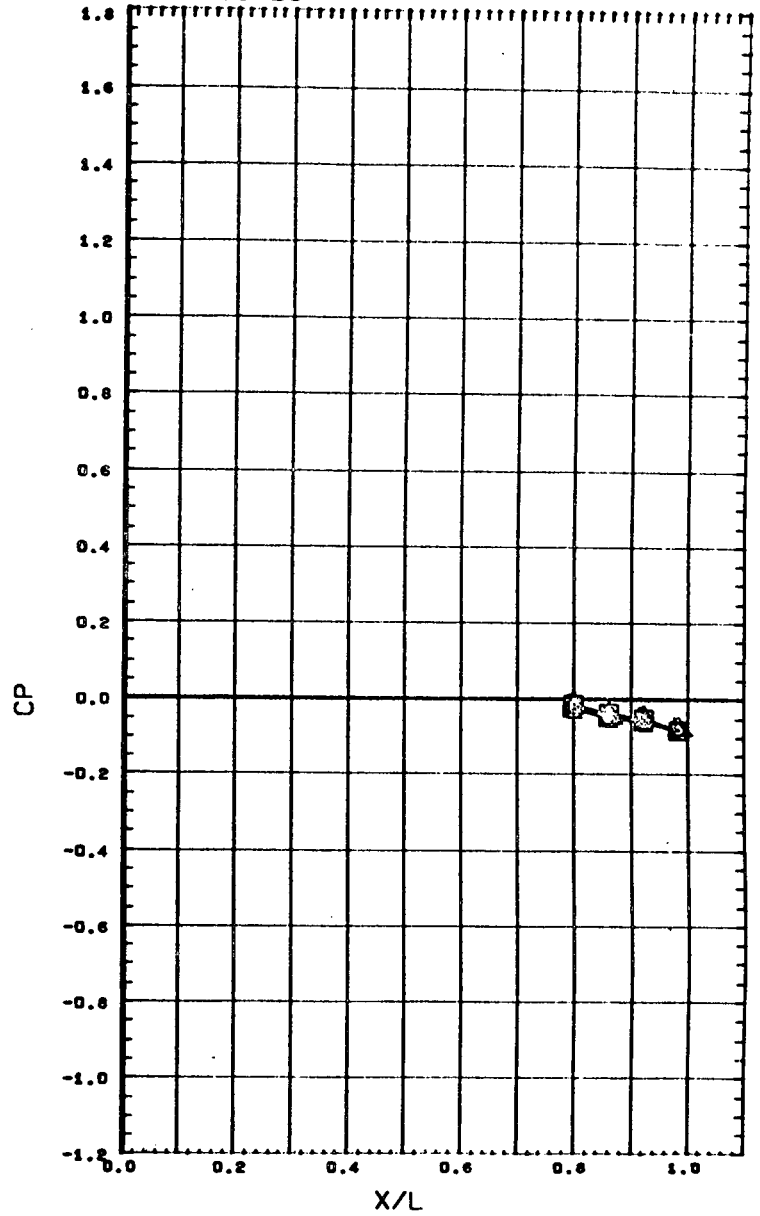
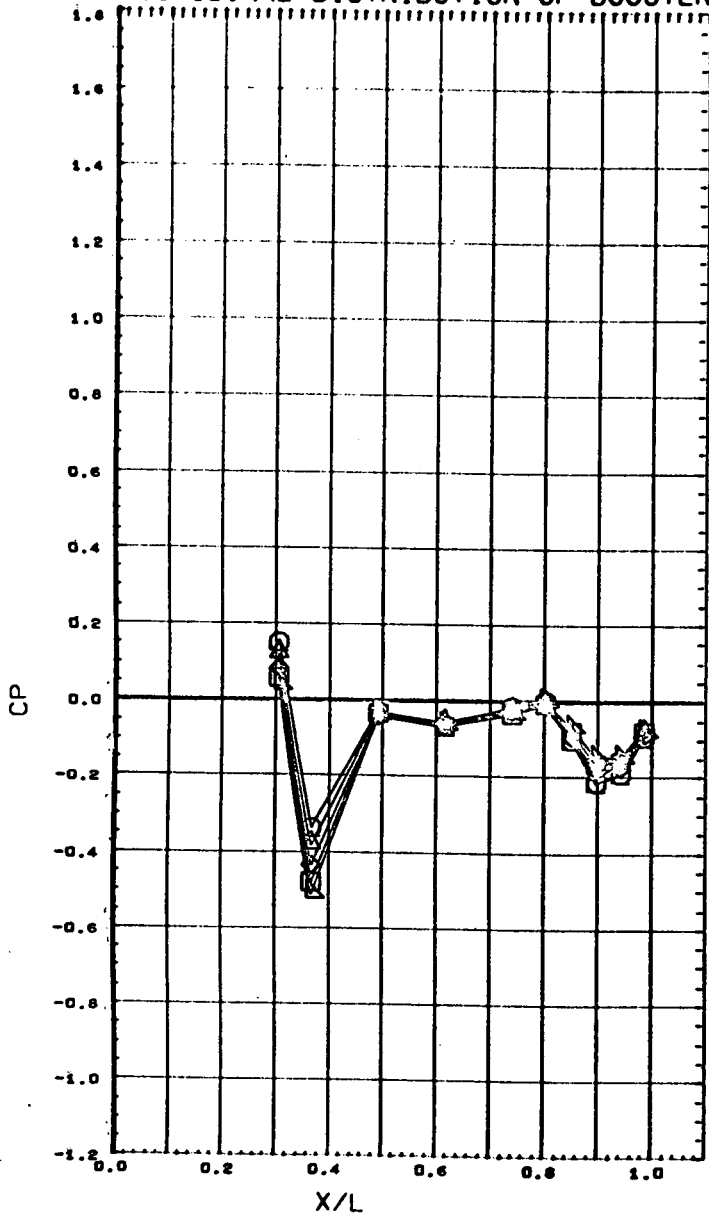

| SYMBOL | BETA | THETA | M1 |
|--------|-------|---------|-------|
| □ | 3.957 | 90.000 | 0.900 |
| ◇ | 1.918 | 180.000 | |
| △ | 0.152 | | |
| ○ | 2.081 | | |
| ○ | 4.094 | | |

REFERENCE FILE

| PARAMETRIC VALUES | | |
|-------------------|---------|------------|
| ALFB | - 6.000 | DX/L 0.000 |
| I | 0.000 | |

LONGITUDINAL DISTRIBUTION OF BOOSTER FUSELAGE PRESSURES

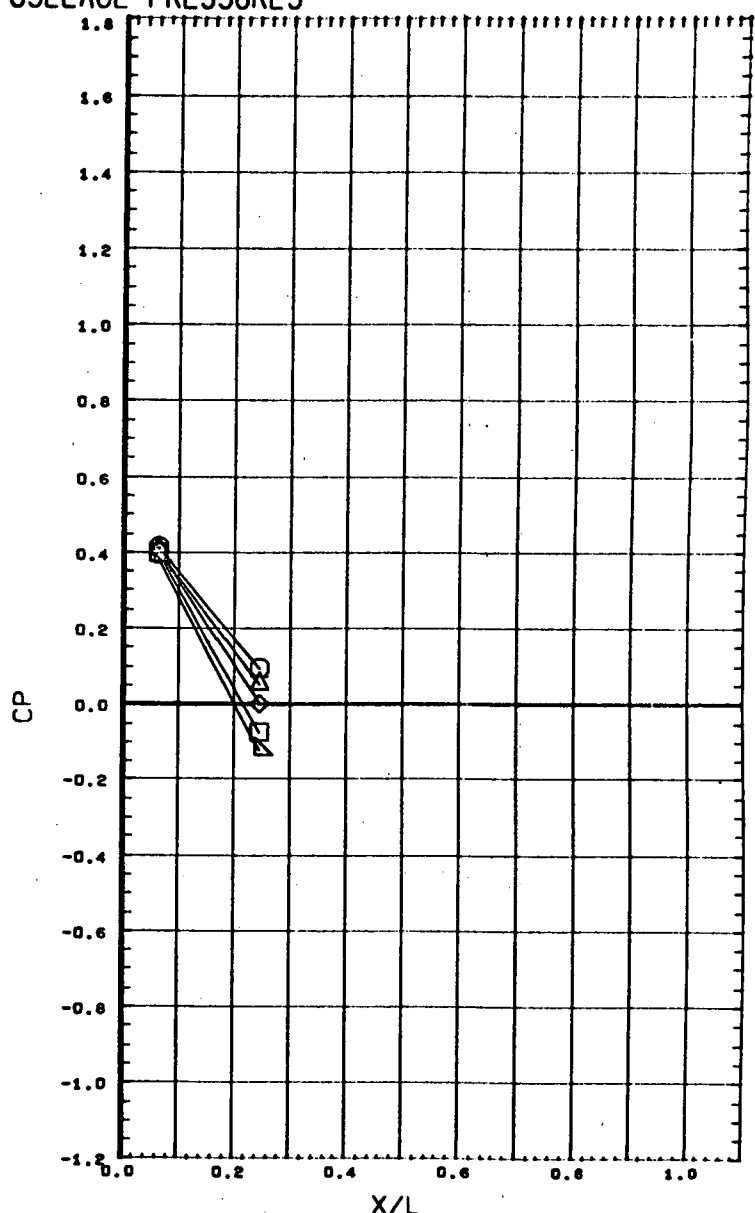
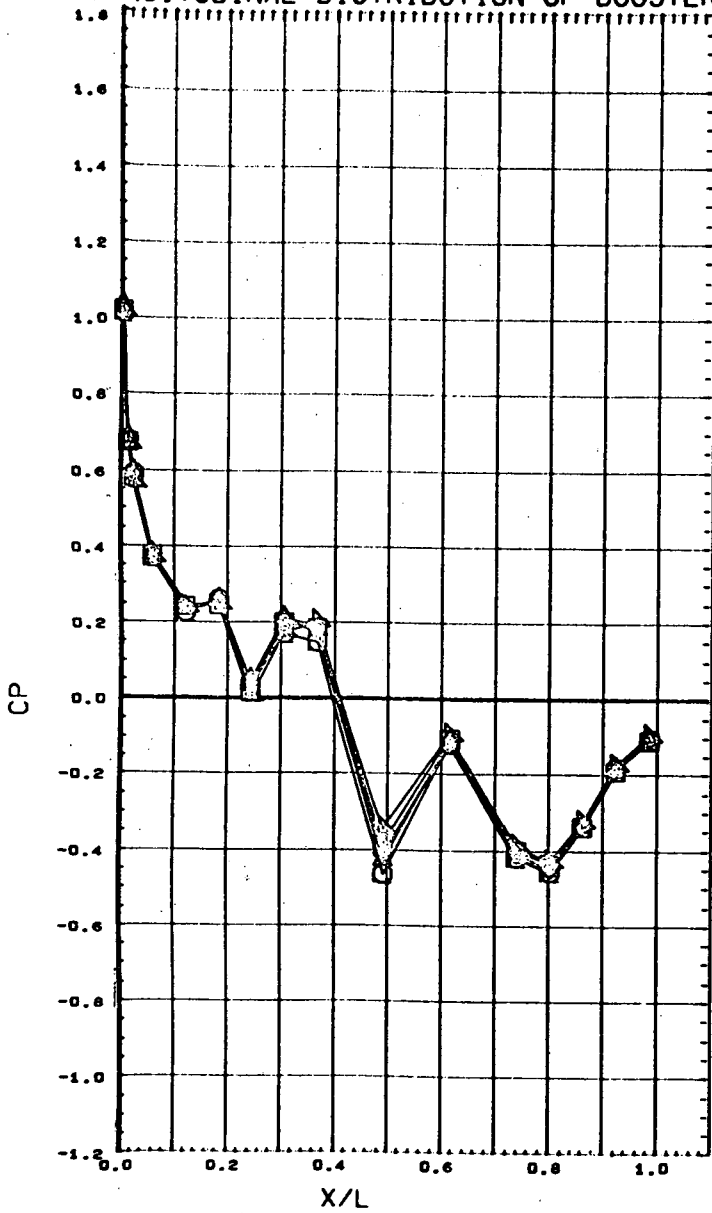

| SYMBOL | BETA | THETA | M1 |
|--------|---------|--------|-------|
| ○ | - 4.189 | 0.000 | 0.999 |
| △ | - 1.899 | 15.000 | |
| ◇ | 0.003 | | |
| □ | 2.143 | | |
| ▽ | 4.116 | | |

REFERENCE FILE

| PARAMETRIC VALUES | | | |
|-------------------|---------|------|-------|
| ALPB | - 6.000 | DX/L | 0.000 |
| I | 0.000 | | |

LONGITUDINAL DISTRIBUTION OF BOOSTER FUSELAGE PRESSURES

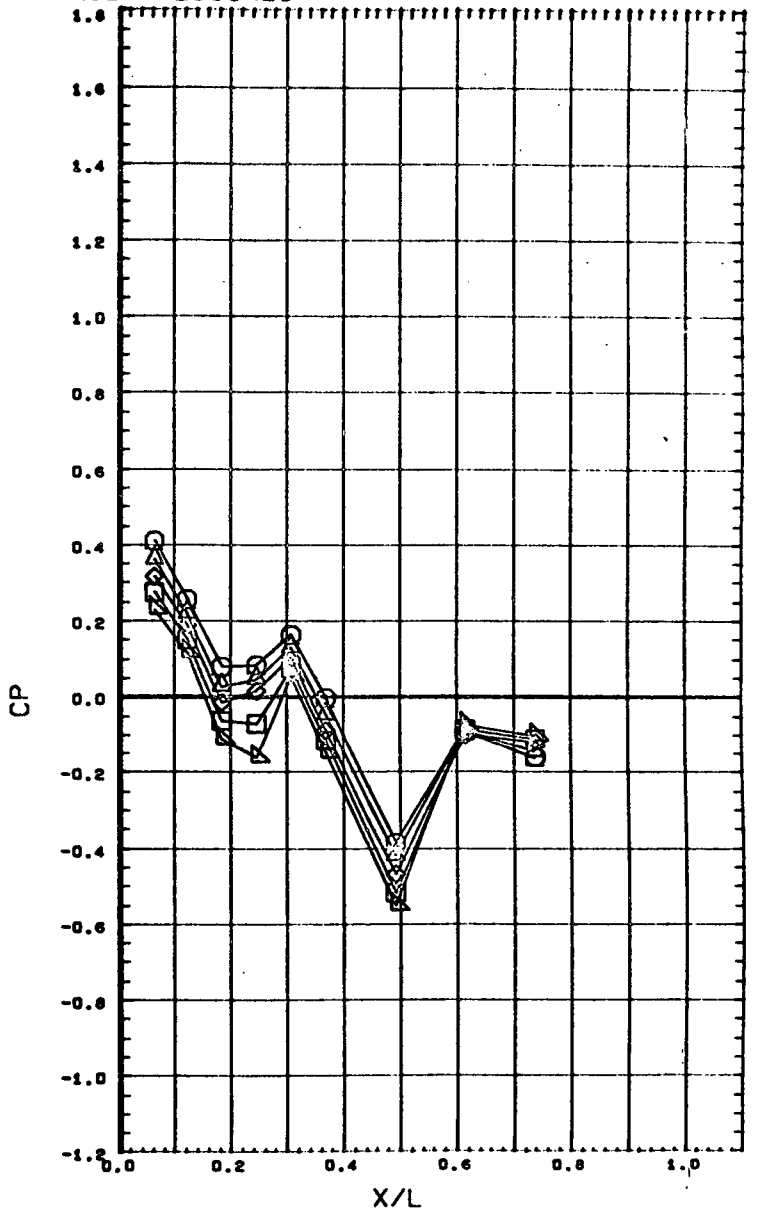
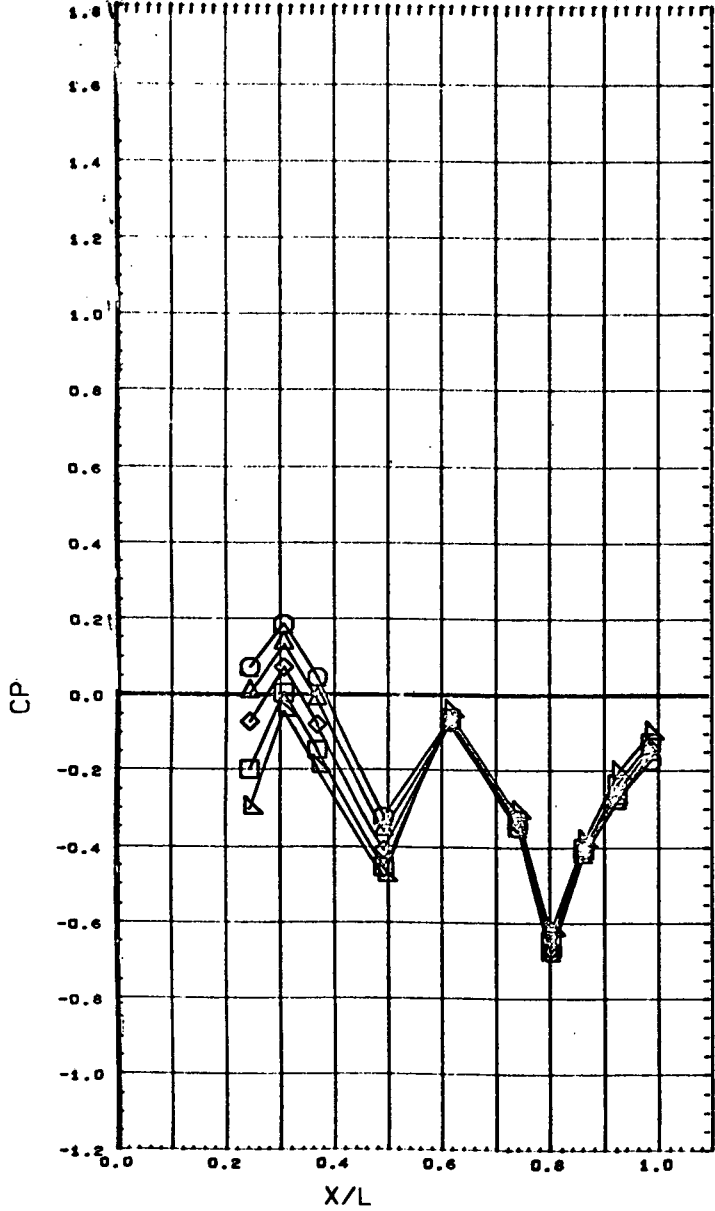

| SYMBOL | BETA | THETA | M1 |
|--------|---------|--------|-------|
| ○ | - 4.189 | 24.000 | 0.999 |
| ◇ | - 1.899 | 45.000 | |
| △ | 0.003 | | |
| □ | 2.143 | | |
| ▽ | 4.116 | | |

| PARAMETRIC VALUES | | |
|-------------------|---------|------------|
| ALFB | - 6.000 | OX/L 0.000 |
| I | 0.000 | |

REFERENCE FILE

LONGITUDINAL DISTRIBUTION OF BOOSTER FUSELAGE PRESSURES

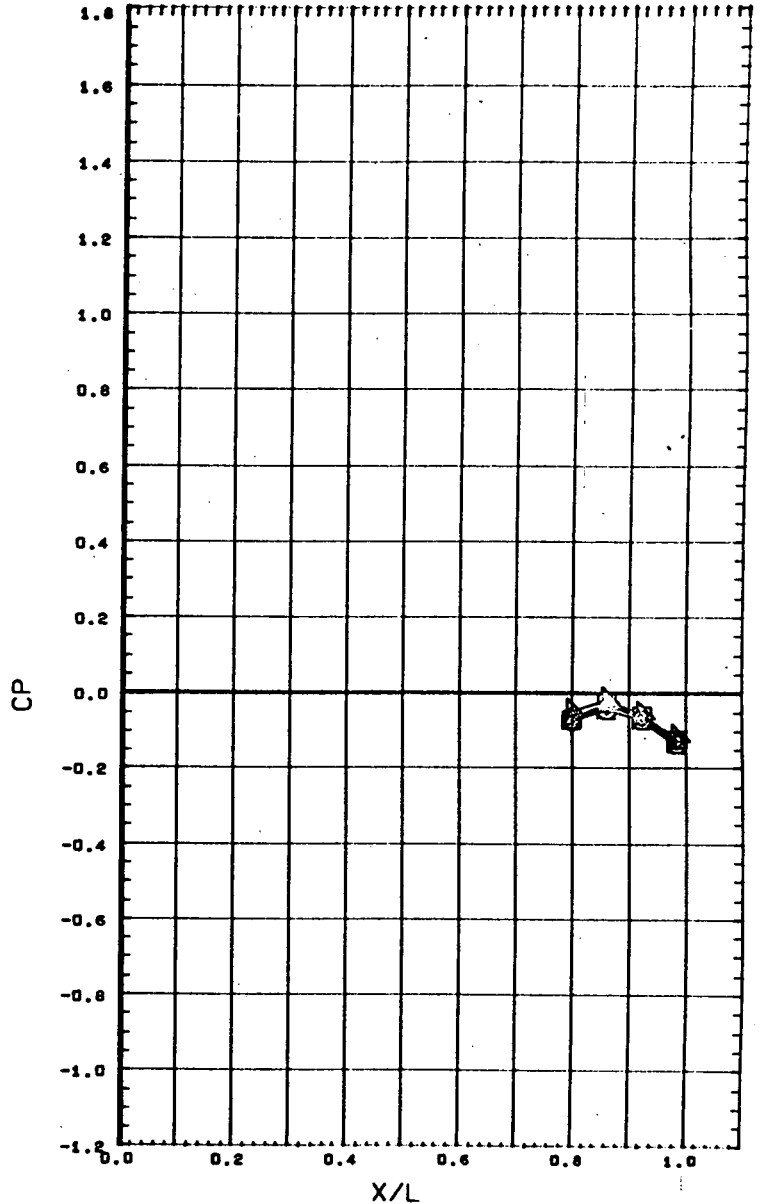
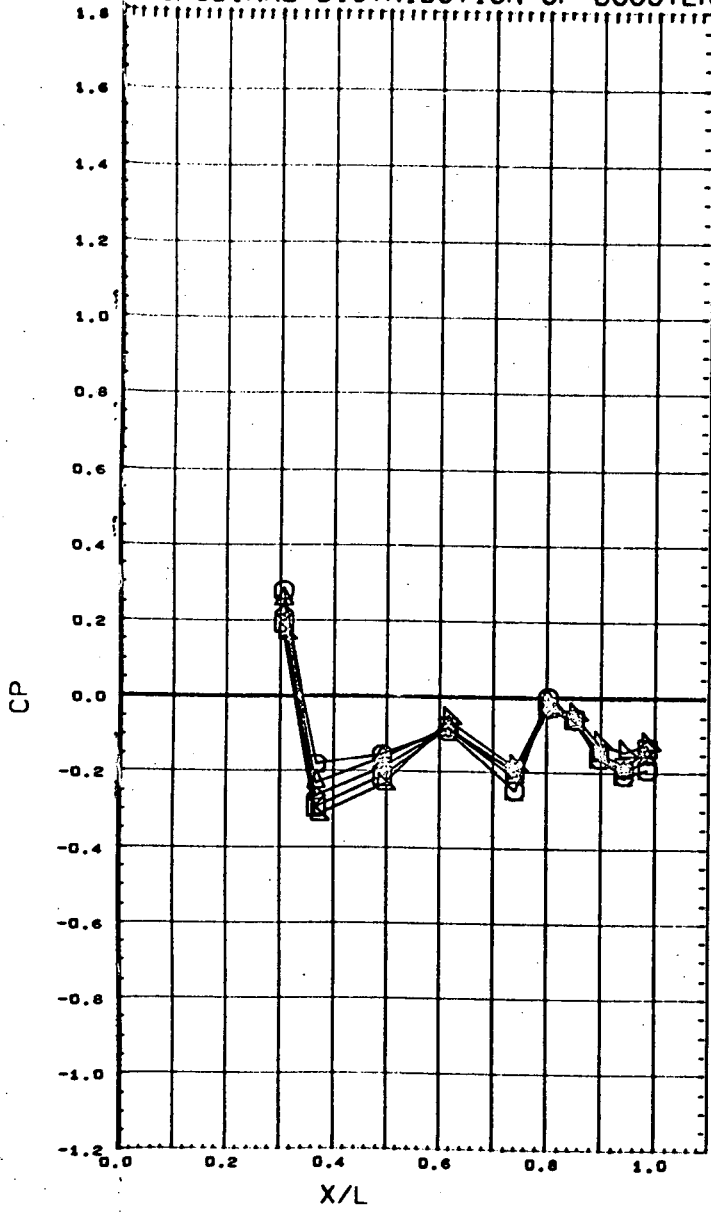

| SYMBOL | BETA | THETA | M1 |
|--------|-------|---------|-------|
| ○ | 1.189 | 90.000 | 0.999 |
| ◇ | 1.899 | 180.000 | |
| △ | 0.003 | | |
| □ | 2.143 | | |
| ○ | 4.116 | | |

| PARAMETRIC VALUES | | |
|-------------------|-------|------------|
| ALFB | 6.000 | OX/L 0.000 |
| I' | 0.000 | |

REFERENCE FILE

LONGITUDINAL DISTRIBUTION OF BOOSTER FUSELAGE PRESSURES

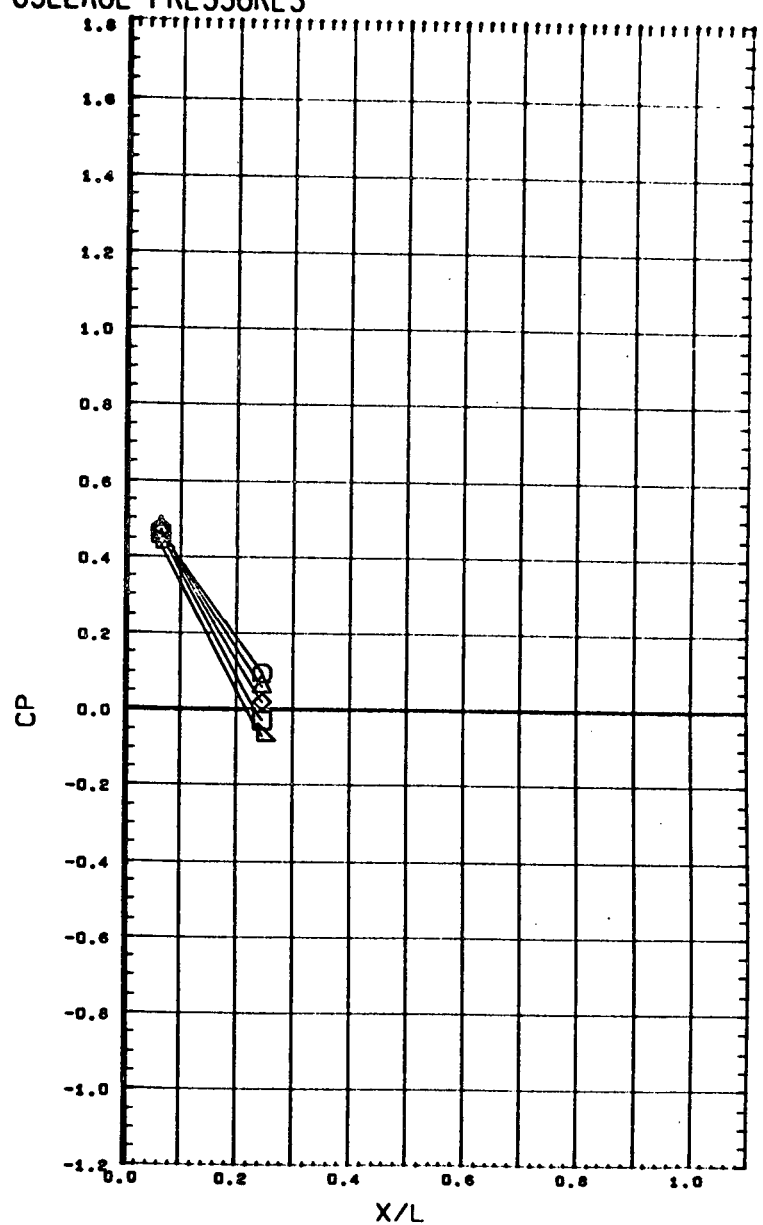
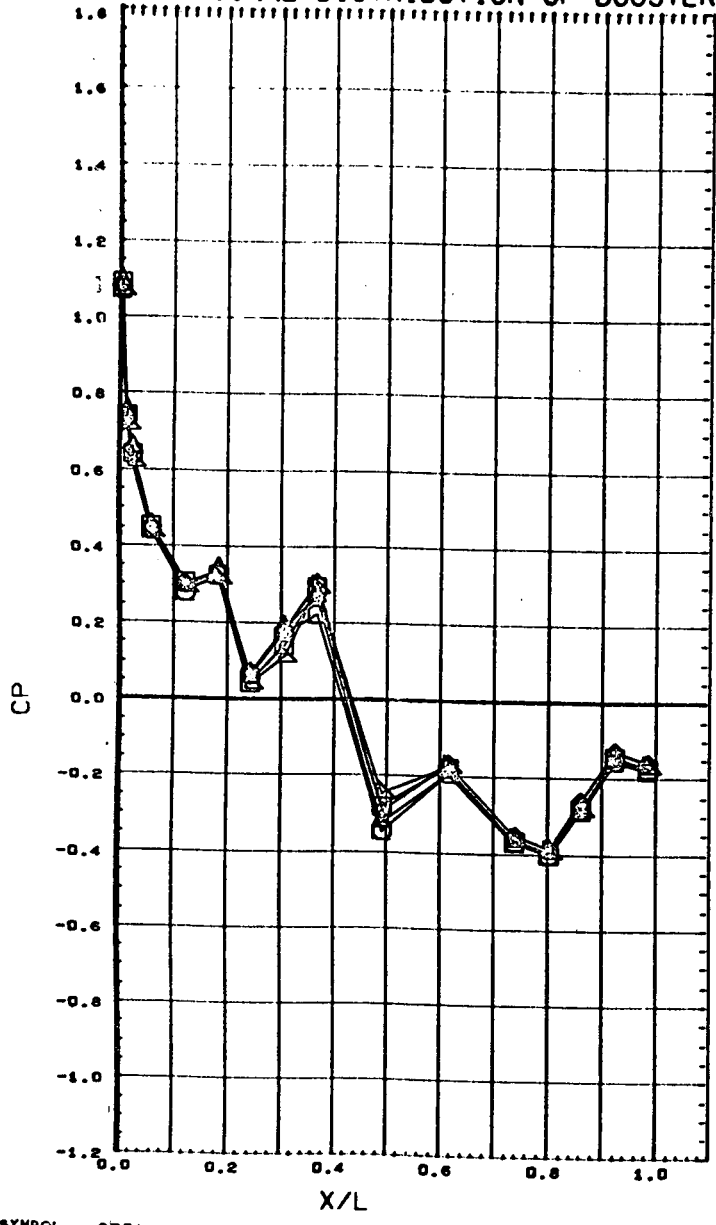

| SYMBOL | BETA | THETA | M1 |
|--------|---------|--------|-------|
| ○ | - 4.154 | 0.000 | 1.100 |
| △ | - 2.119 | 15.000 | |
| ◇ | 0.035 | | |
| □ | 2.286 | | |
| ▽ | 4.304 | | |

| PARAMETRIC VALUES | | |
|-------------------|---------|------------|
| ALFB | - 6.000 | DX/L 0.000 |
| I | 0.000 | |

REFERENCE FILE

LONGITUDINAL DISTRIBUTION OF BOOSTER FUSELAGE PRESSURES

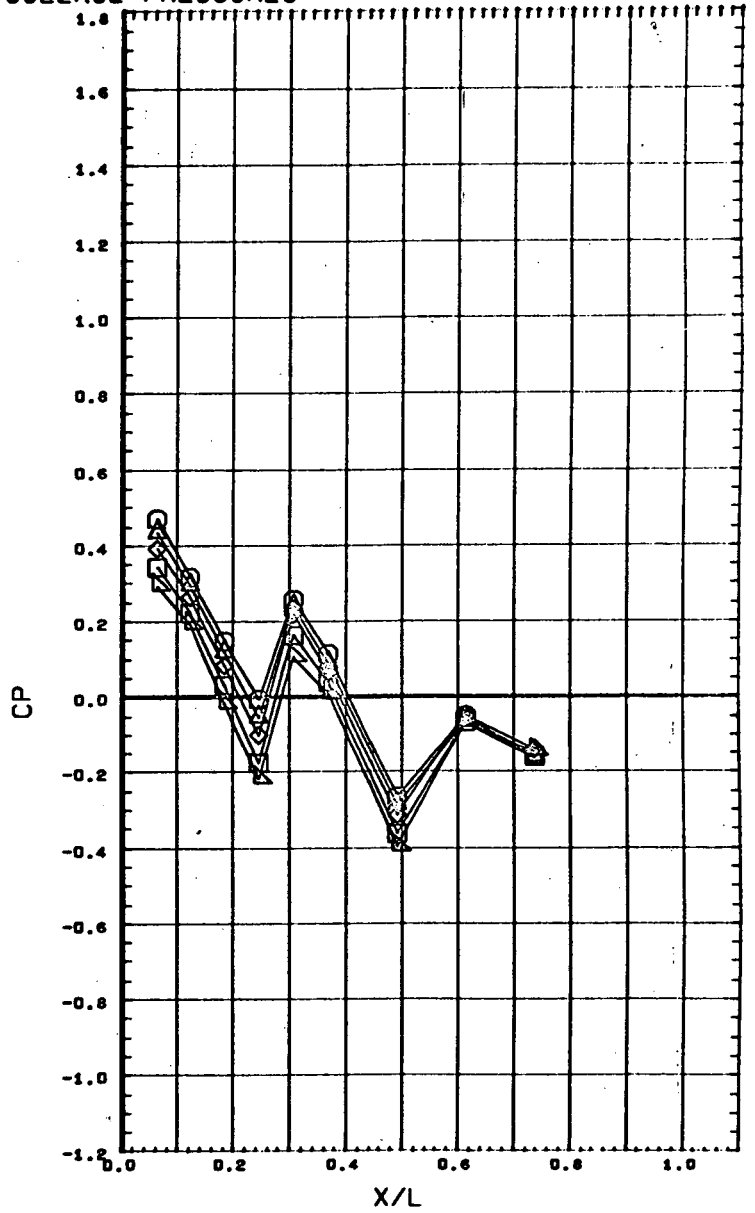
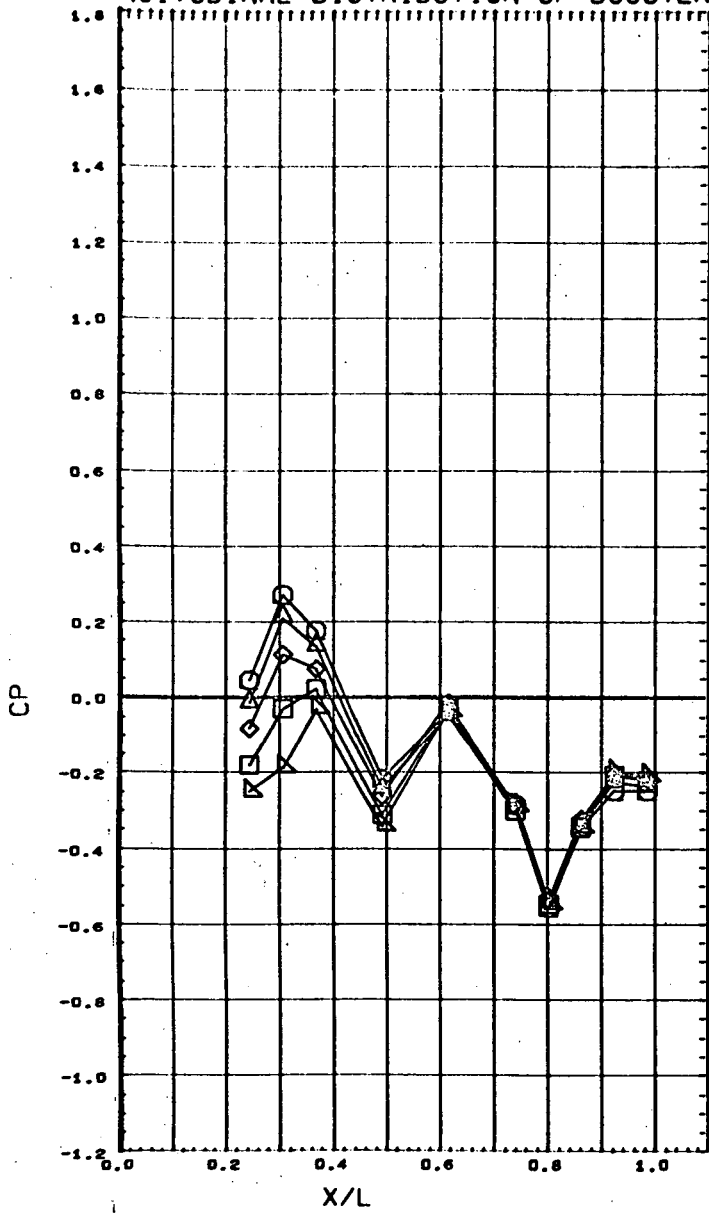

| SYMBOL | BETA | THETA | M1 |
|--------|-------|--------|-------|
| ○ | 4.154 | 24.000 | 1.100 |
| △ | 2.119 | 45.000 | |
| ◇ | 0.035 | | |
| □ | 2.266 | | |
| ▽ | 4.304 | | |

REFERENCE FILE

| PARAMETRIC VALUES | | | |
|-------------------|-------|------|-------|
| ALFB | 6.000 | DX/L | 0.000 |
| I | 0.000 | | |

LONGITUDINAL DISTRIBUTION OF BOOSTER FUSELAGE PRESSURES

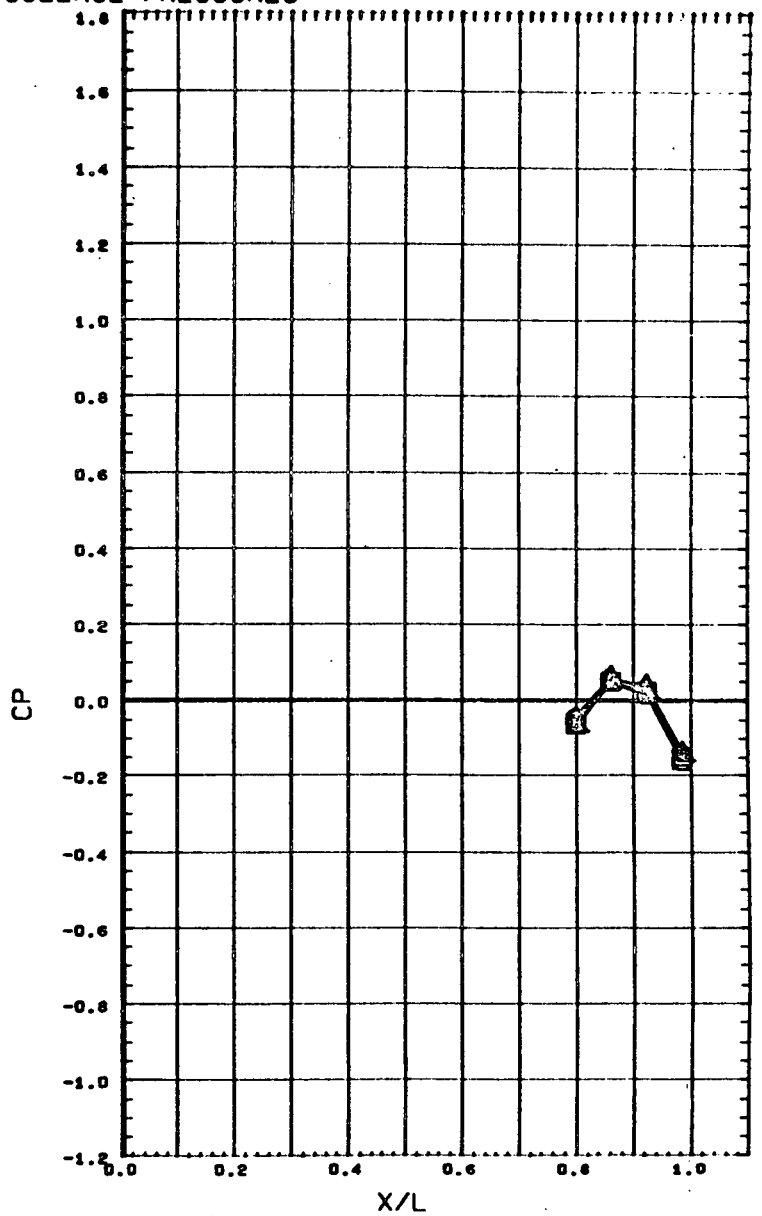
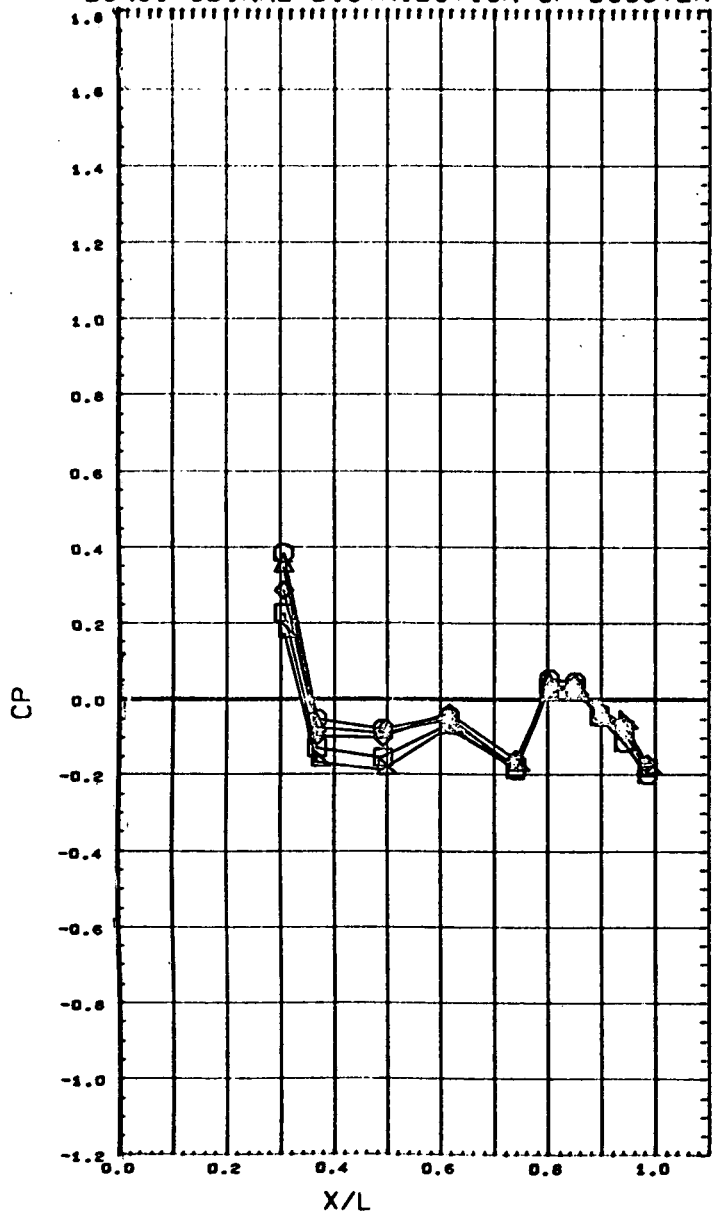

| SYMBOL | BETA | THETA | M1 |
|--------|-------|---------|-------|
| □ | 4.154 | 90.000 | 1.100 |
| ◇ | 2.119 | 180.000 | |
| △ | 0.035 | | |
| ○ | 2.286 | | |
| ◇ | 4.364 | | |

| PARAMETRIC VALUES | | | |
|-------------------|---------|------|-------|
| ALFB | - 6.000 | DX/L | 0.000 |
| I | 0.000 | | |

REFERENCE FILE

LONGITUDINAL DISTRIBUTION OF BOOSTER FUSELAGE PRESSURES

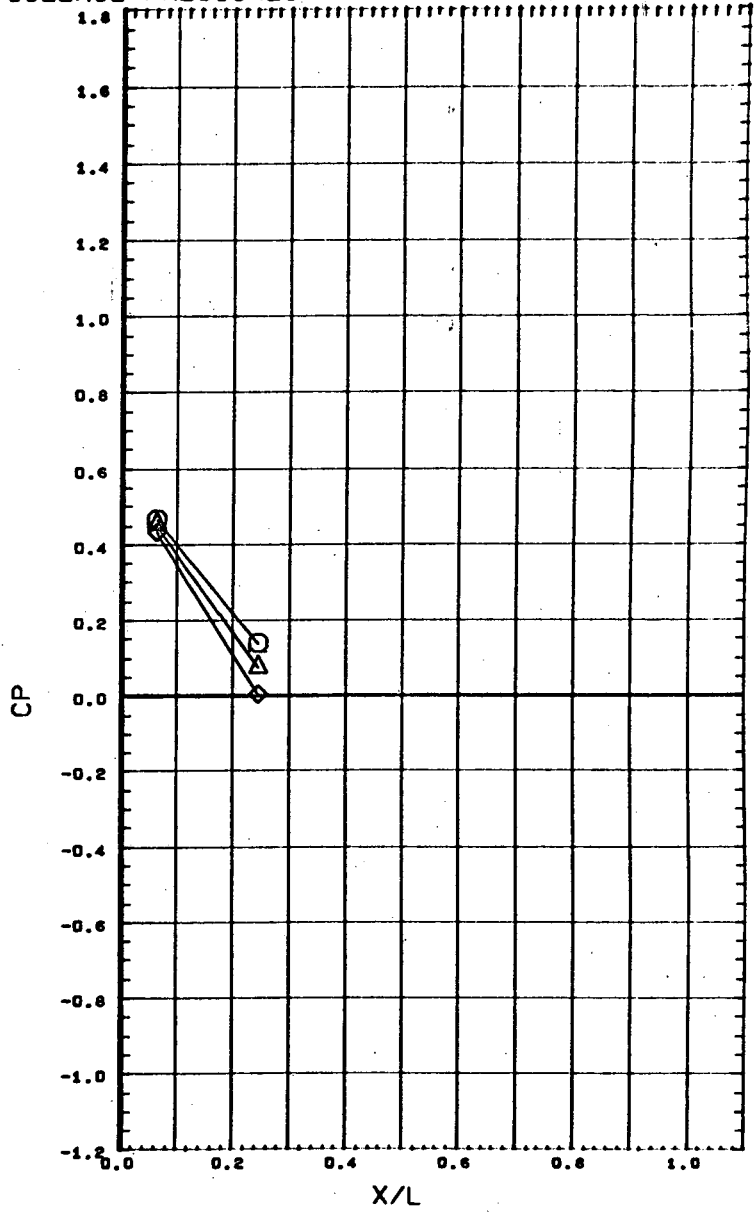
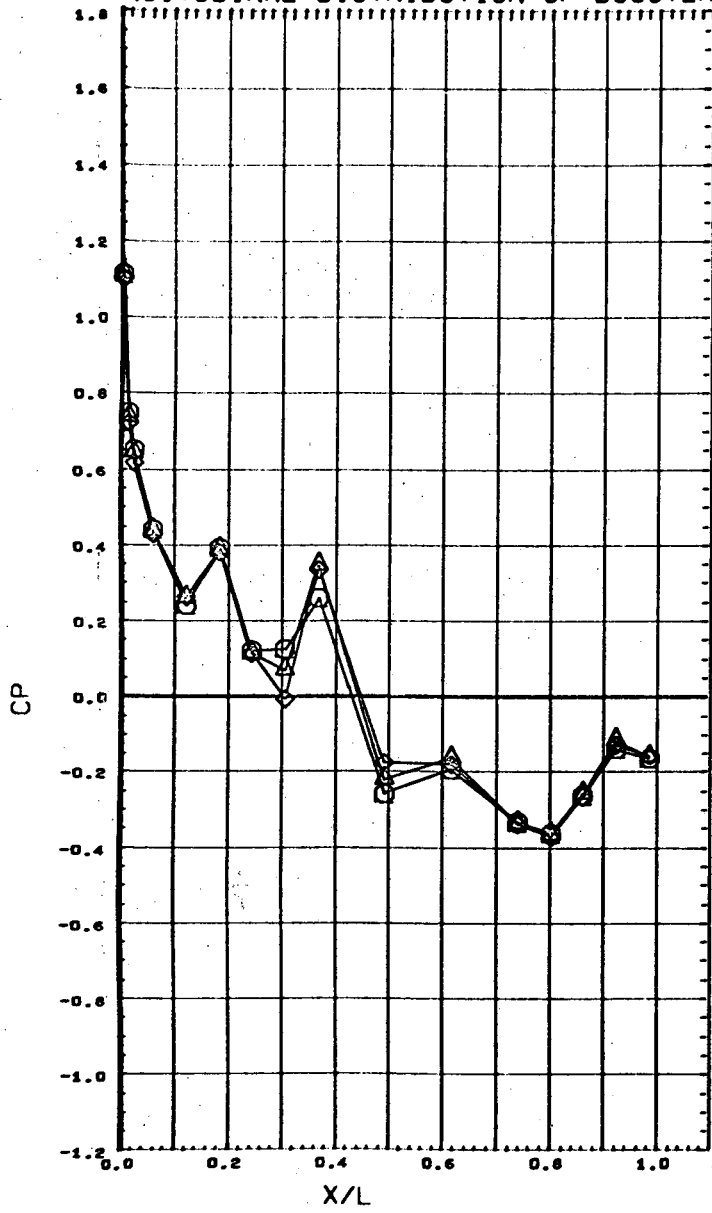

| SYMBOL | BETA | THETA | M1 |
|--------|-------|--------|-------|
| ○ | 4.187 | 0.000 | 1.201 |
| △ | 0.069 | 15.000 | |
| ◇ | 4.363 | | |

| PARAMETRIC VALUES | | |
|-------------------|-------|------------|
| ALFB | 6.000 | DX/L 0.000 |
| I | 0.000 | |

REFERENCE FILE

LONGITUDINAL DISTRIBUTION OF BOOSTER FUSELAGE PRESSURES

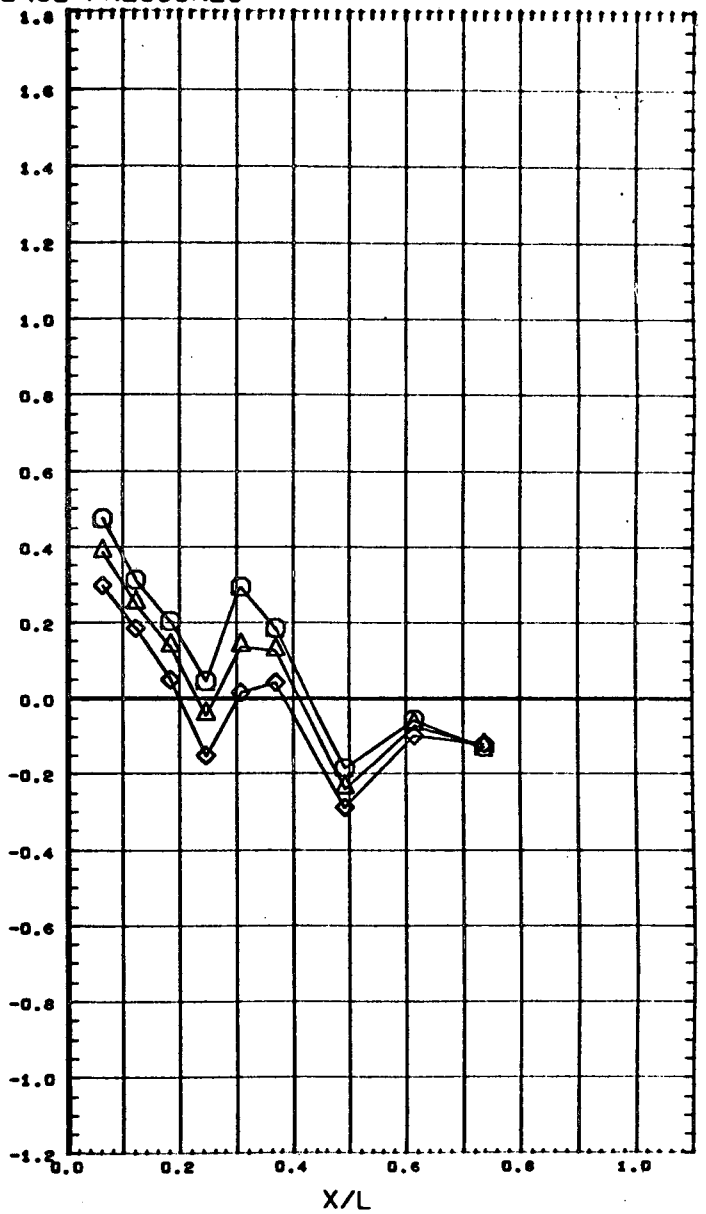
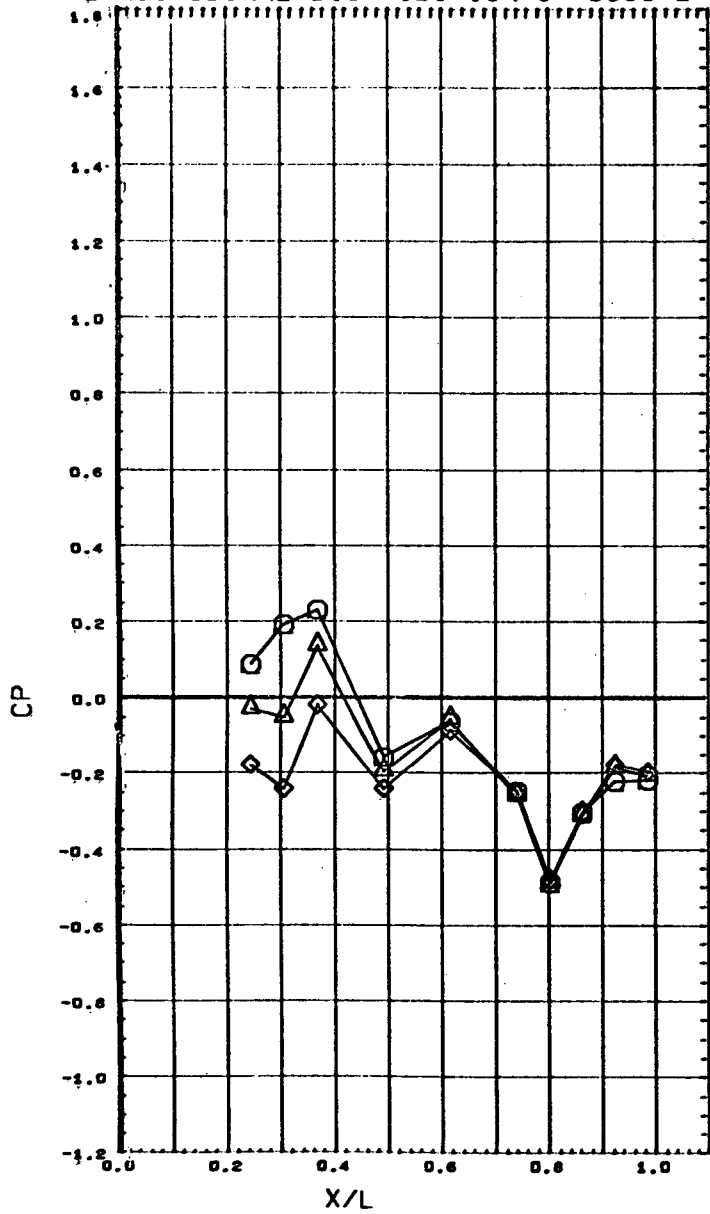

| SYMBOL | BETA | THETA | M1 |
|--------|-------|--------|-------|
| ○ | 4.187 | 24.000 | 1.201 |
| △ | 0.069 | 45.000 | |
| ◇ | 4.363 | | |

| PARAMETRIC VALUES | | | |
|-------------------|-------|------|-------|
| ALFB | 6.000 | DX/L | 0.000 |
| I | 0.000 | | |

REFERENCE FILE

LONGITUDINAL DISTRIBUTION OF BOOSTER FUSELAGE PRESSURES

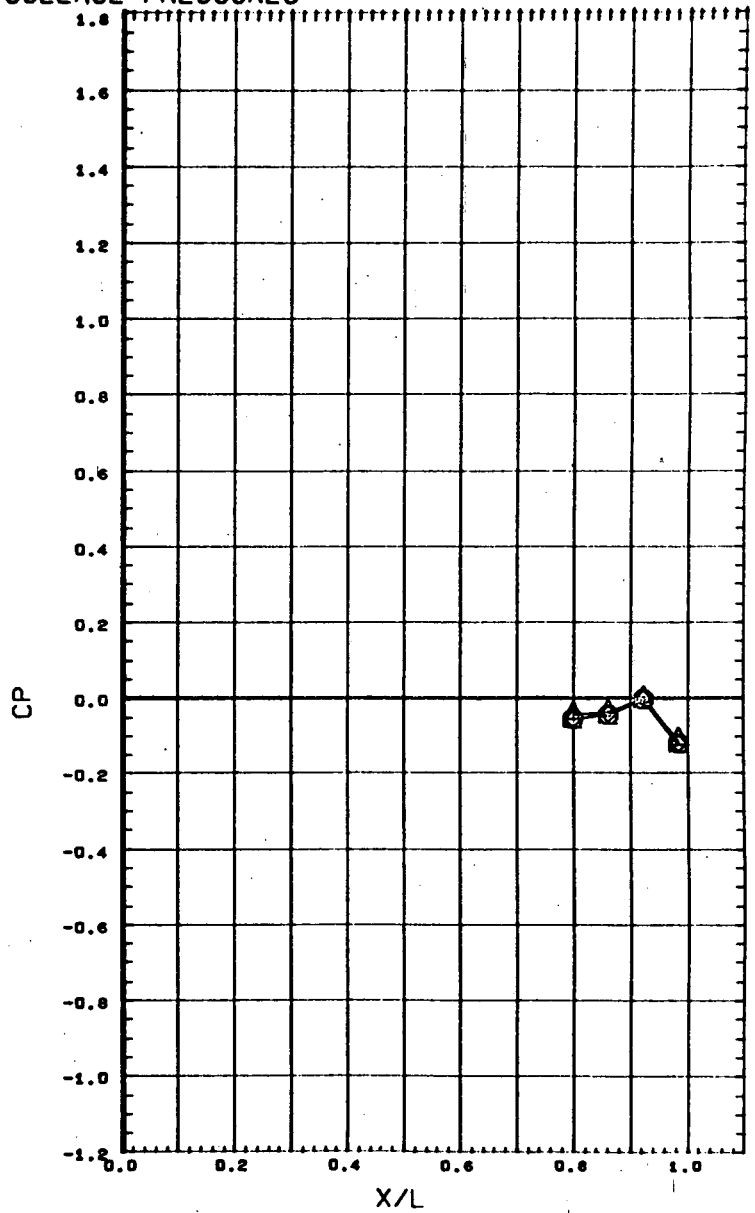
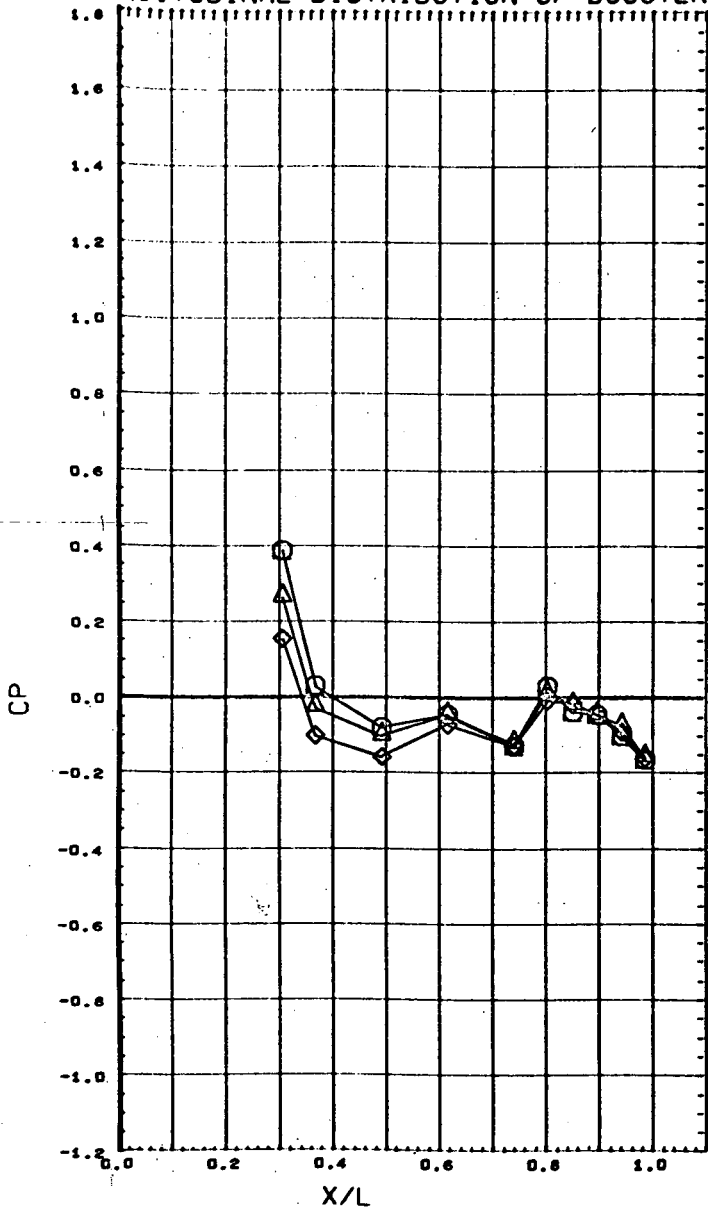

| SYMBOL | BETA | THETA | M1 |
|--------|-------|---------|-------|
| O | 4.187 | 90.000 | 1.201 |
| Δ | 0.069 | 180.000 | |
| ◇ | 4.363 | | |

| PARAMETRIC VALUES | | | |
|-------------------|-------|------|-------|
| ALFB | 6.000 | DX/L | 0.000 |
| I | 0.000 | | |

REFERENCE FILE

LONGITUDINAL DISTRIBUTION OF BOOSTER FUSELAGE PRESSURES

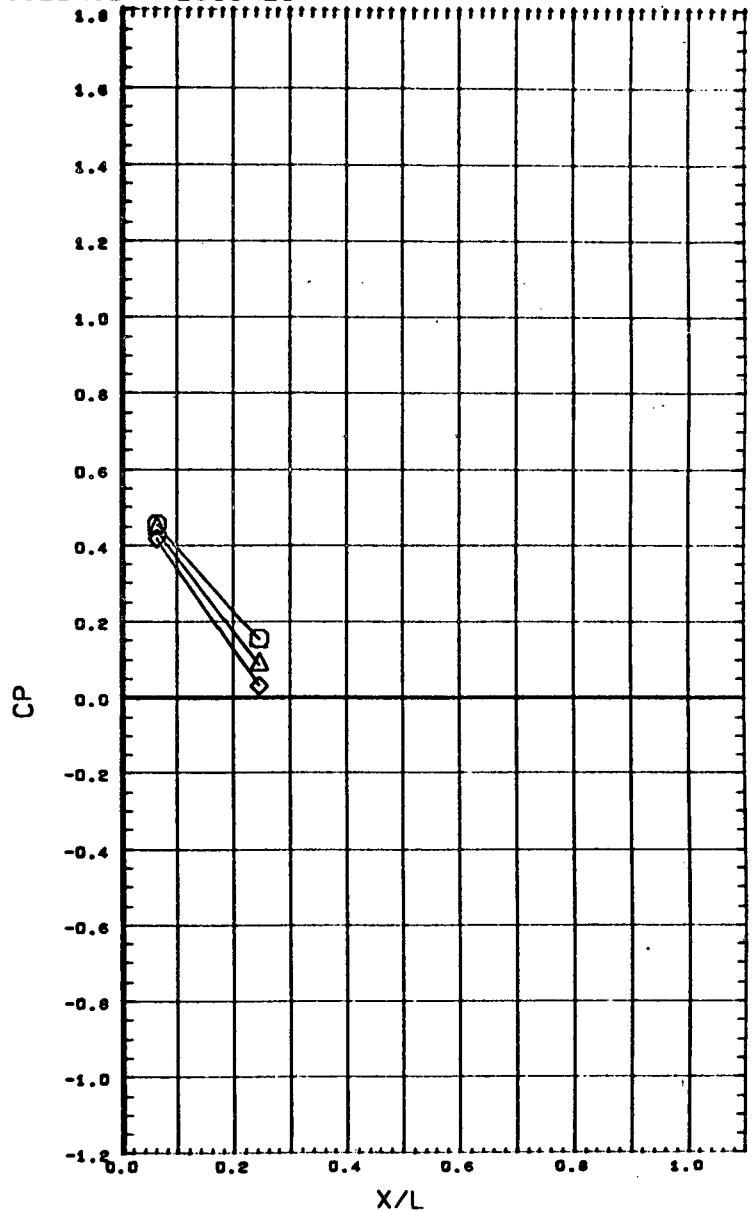
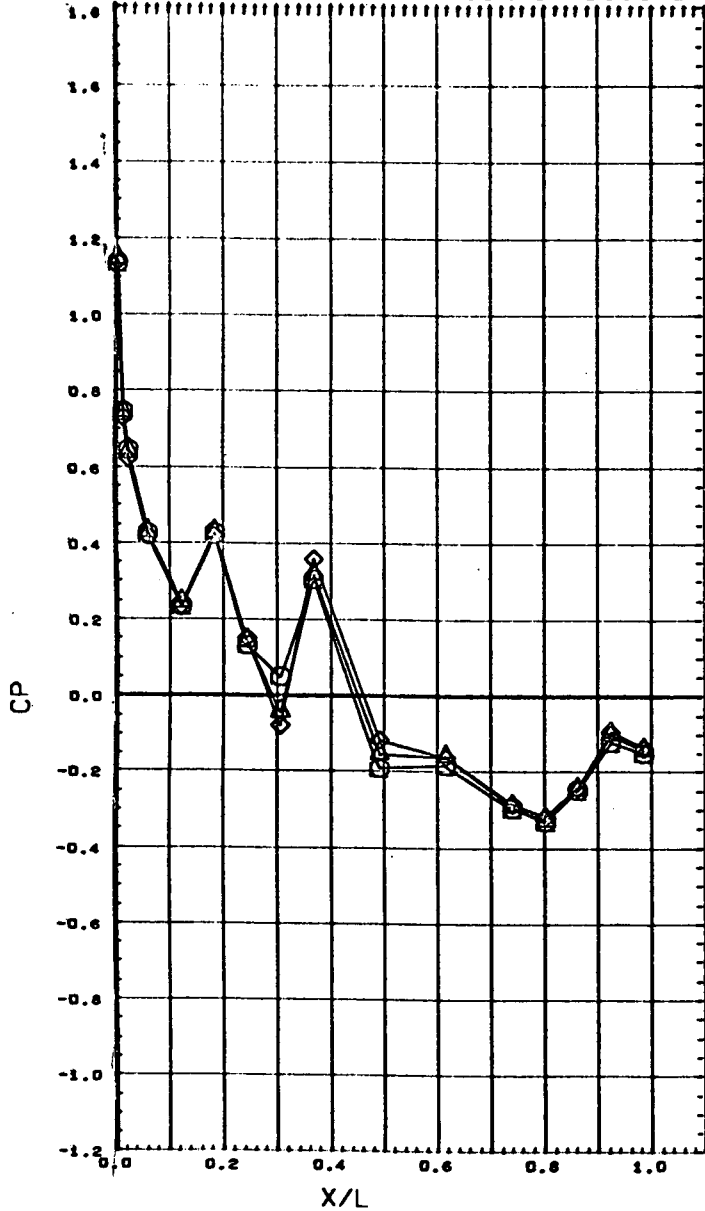

| SYMBOL | BETA | THETA | M1 |
|--------|-------|--------|-------|
| ○ | 4.197 | 0.000 | 1.300 |
| △ | 0.065 | 15.000 | |
| ◇ | 4.355 | | |

| PARAMETRIC VALUES | | | |
|-------------------|---------|------|-------|
| ALFB | - 6.000 | DX/L | 0.000 |
| I | 0.000 | | |

REFERENCE FILE

LONGITUDINAL DISTRIBUTION OF BOOSTER FUSELAGE PRESSURES

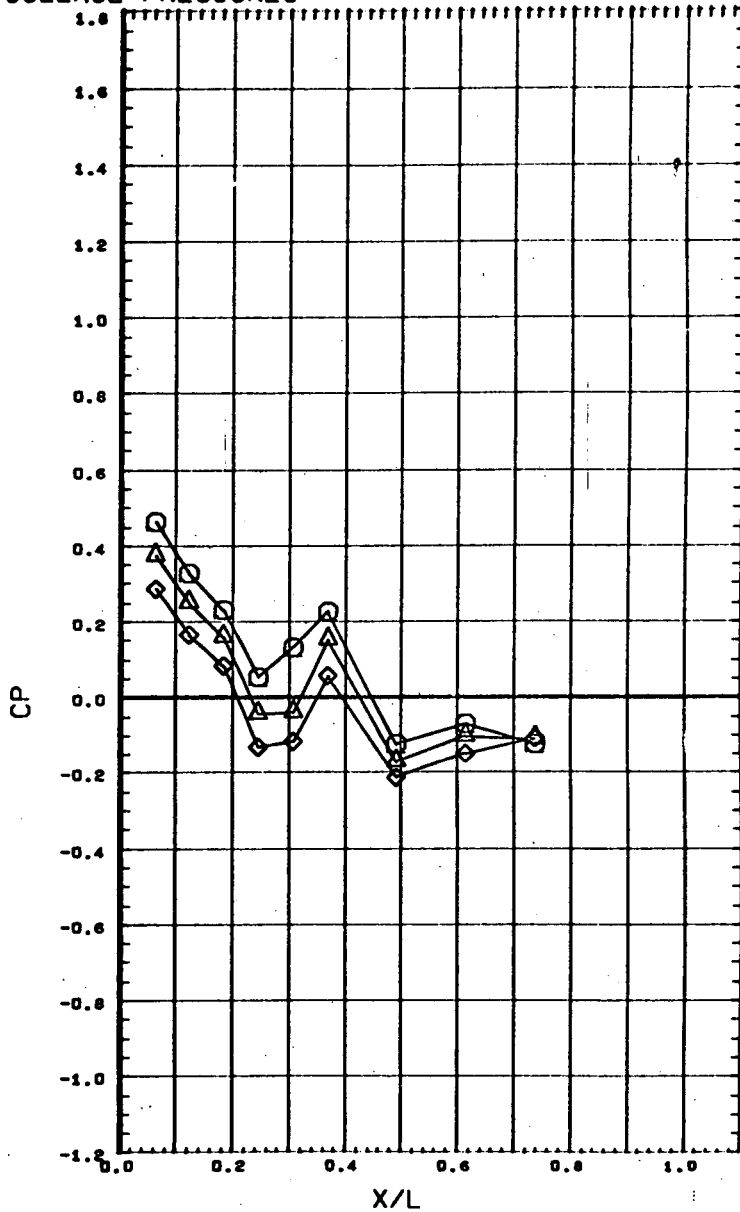
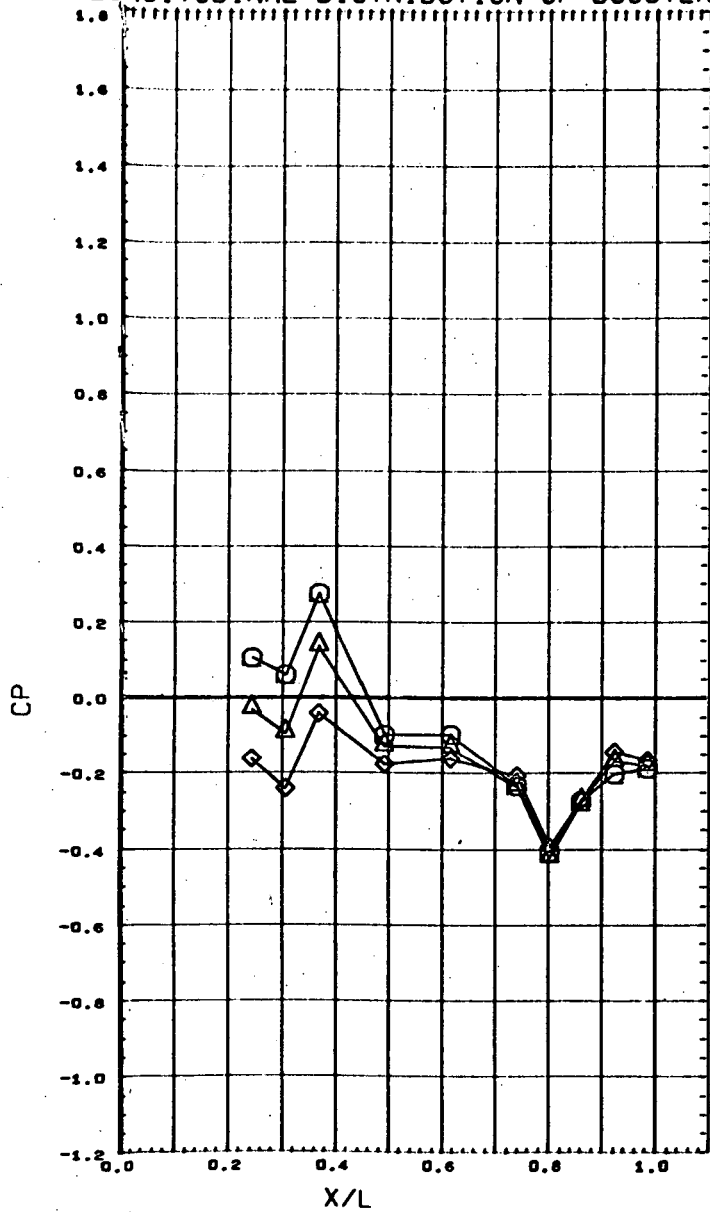

| SYMBOL | BETA | THETA | M1 |
|--------|-------|--------|-------|
| ○ | 4.197 | 24.000 | 1.300 |
| △ | 0.065 | 45.000 | |
| ◇ | 4.355 | | |

| PARAMETRIC VALUES | | |
|-------------------|-------|------------|
| ALPB | 6.000 | DX/L 0.000 |
| I | 0.000 | |

REFERENCE FILE

LONGITUDINAL DISTRIBUTION OF BOOSTER FUSELAGE PRESSURES

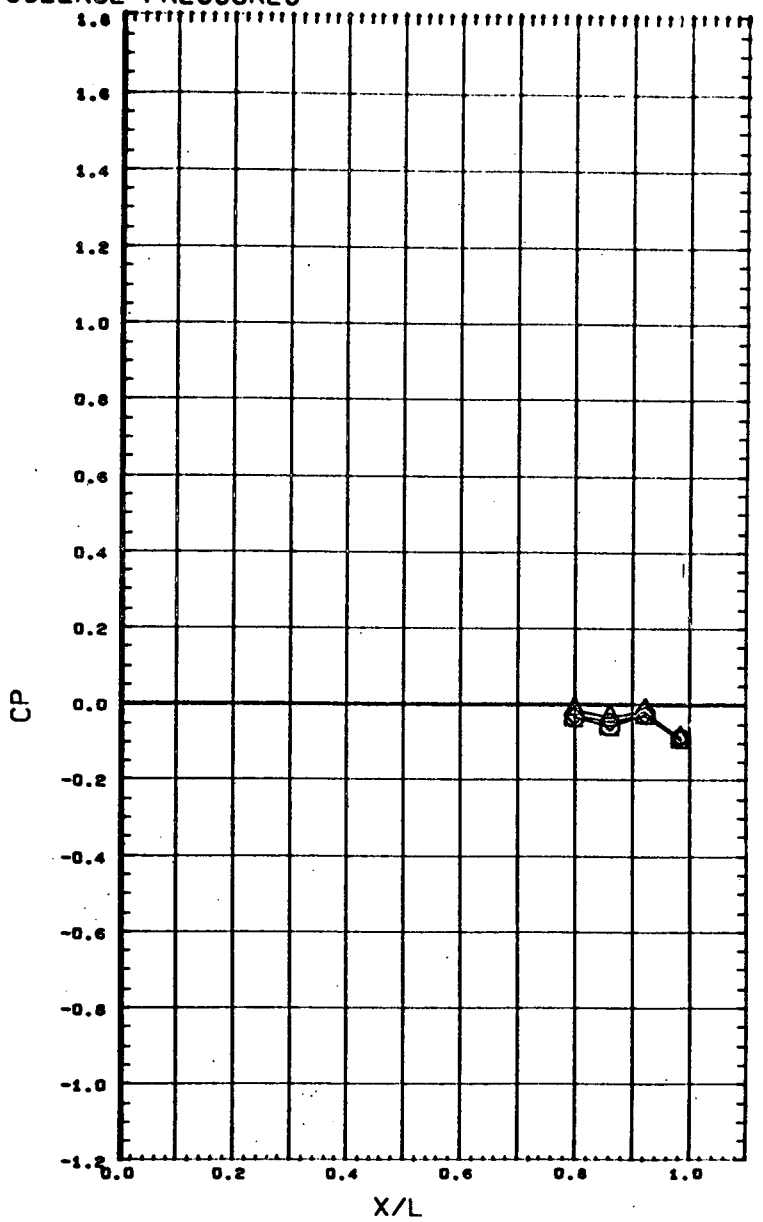
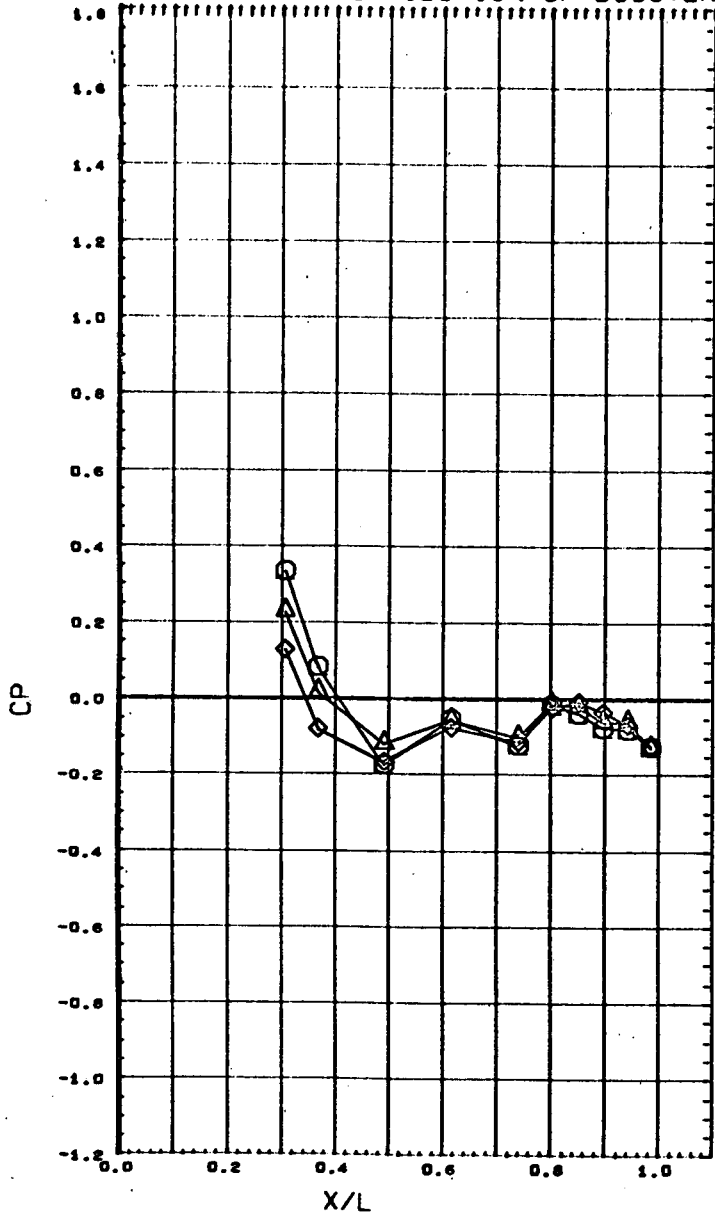

| SYMBOL | BETA | THETA | M1 |
|--------|-------|---------|-------|
| ○ | 4.197 | 90.000 | 1.300 |
| △ | 0.065 | 180.000 | |
| ◇ | 4.355 | | |

| PARAMETRIC VALUES | | | |
|-------------------|---------|------|-------|
| ALPB | - 6.000 | DX/L | 0.000 |
| I | 0.000 | | |

REFERENCE FILE

LONGITUDINAL DISTRIBUTION OF BOOSTER FUSELAGE PRESSURES

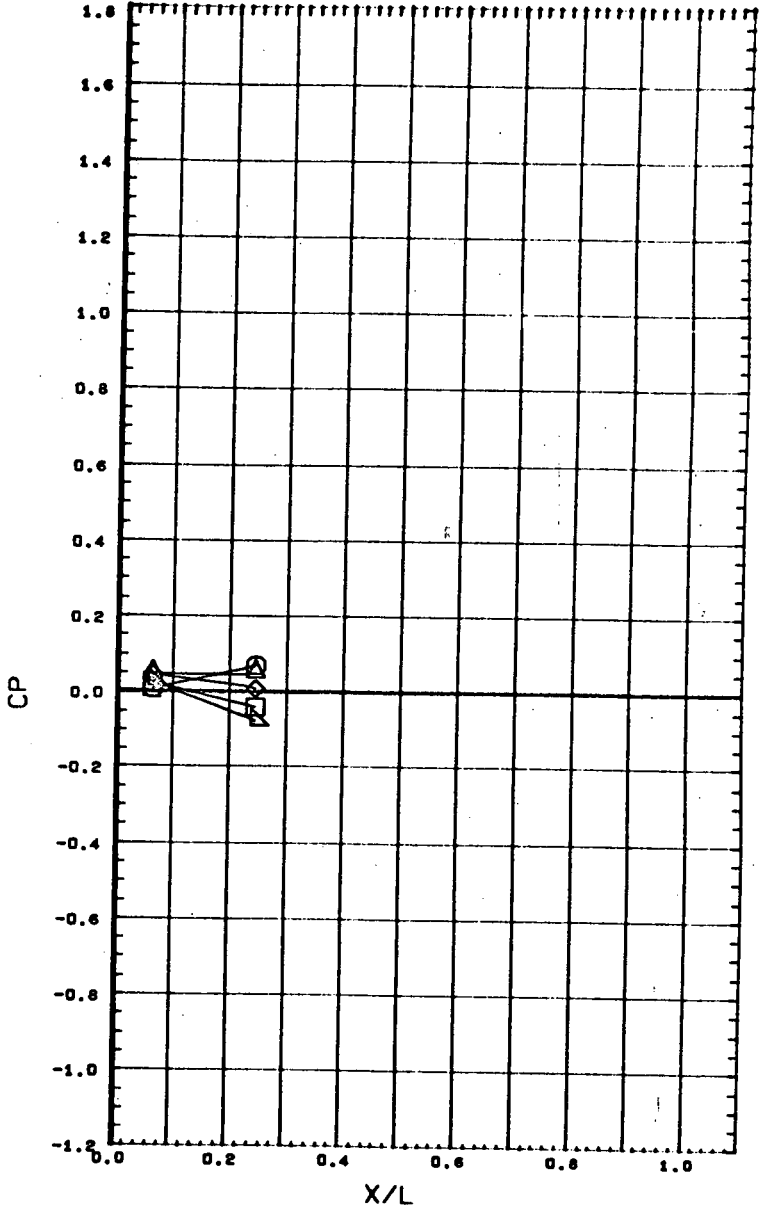
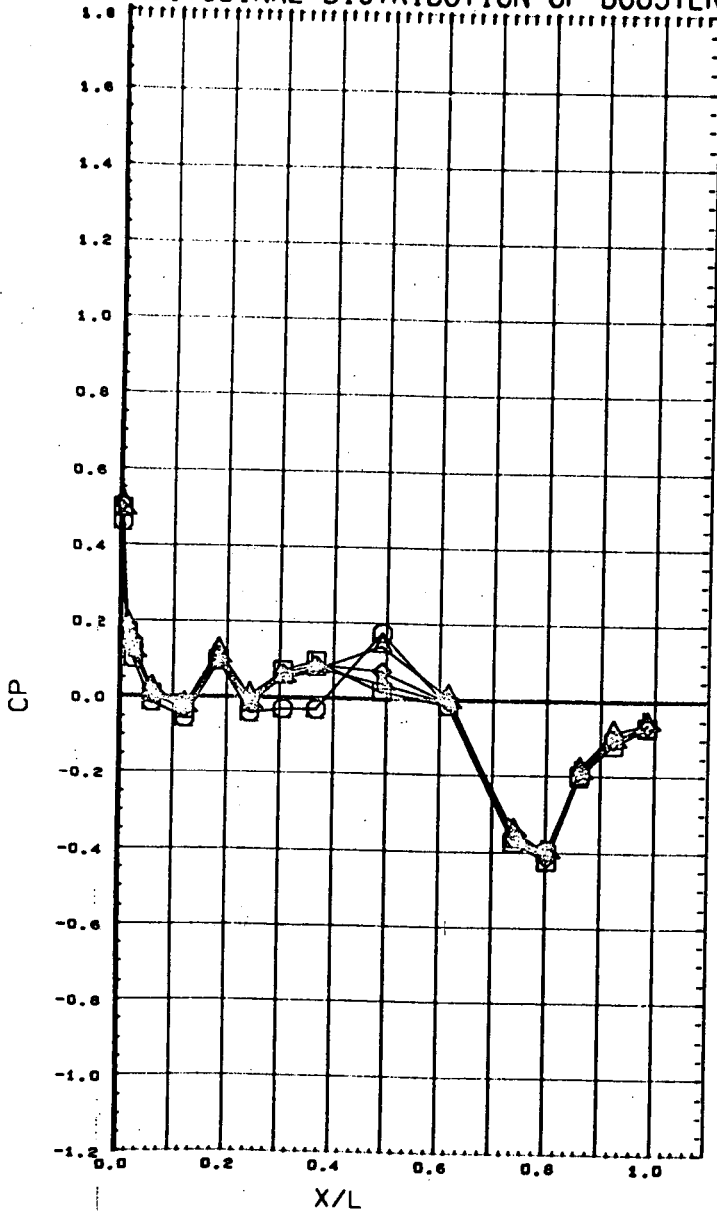

| SYMBOL | BETA | THETA | M1 |
|--------|-------|--------|-------|
| ○ | 6.197 | 0.000 | 0.598 |
| ◇ | 3.945 | 15.000 | |
| △ | 2.127 | | |
| □ | 0.034 | | |
| ○ | 1.761 | | |

REFERENCE FILE

| PARAMETRIC VALUES | | |
|-------------------|-------|------------|
| ALFB | 6.000 | DX/L 0.000 |
| I | 0.000 | |

LONGITUDINAL DISTRIBUTION OF BOOSTER FUSELAGE PRESSURES

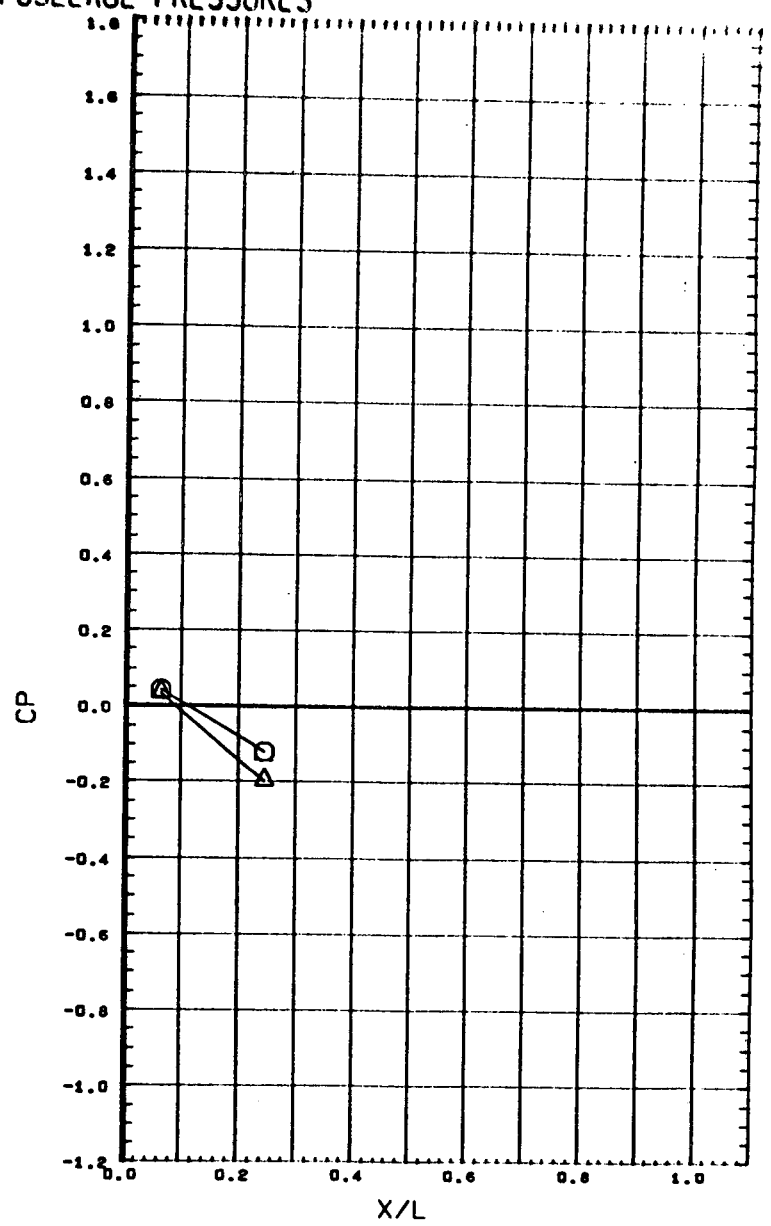
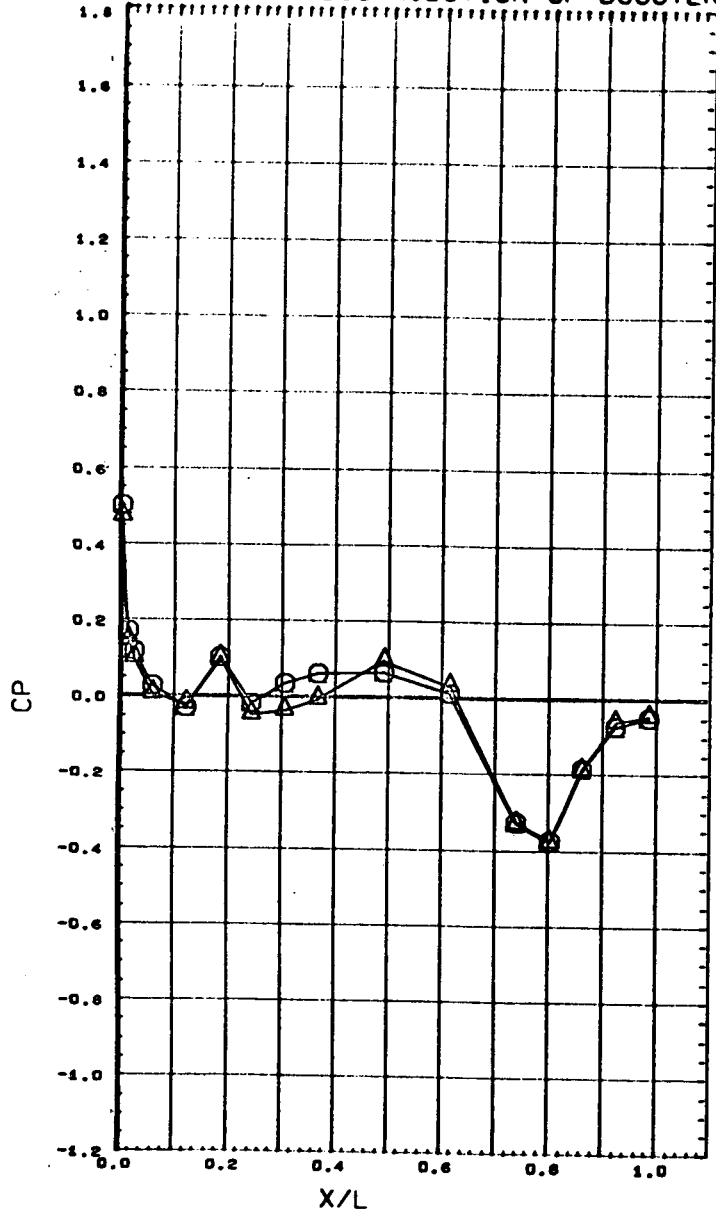

| SYMBOL | BETA | THETA | M1 |
|--------|-------|--------|-------|
| ○ | 3.766 | 0.000 | 0.598 |
| △ | 6.036 | 15.000 | |

| ALFB | PARAMETRIC VALUES | |
|------|-------------------|-------|
| I | 6.000 | 0.000 |
| | 0.000 | |

REFERENCE FILE

LONGITUDINAL DISTRIBUTION OF BOOSTER FUSELAGE PRESSURES

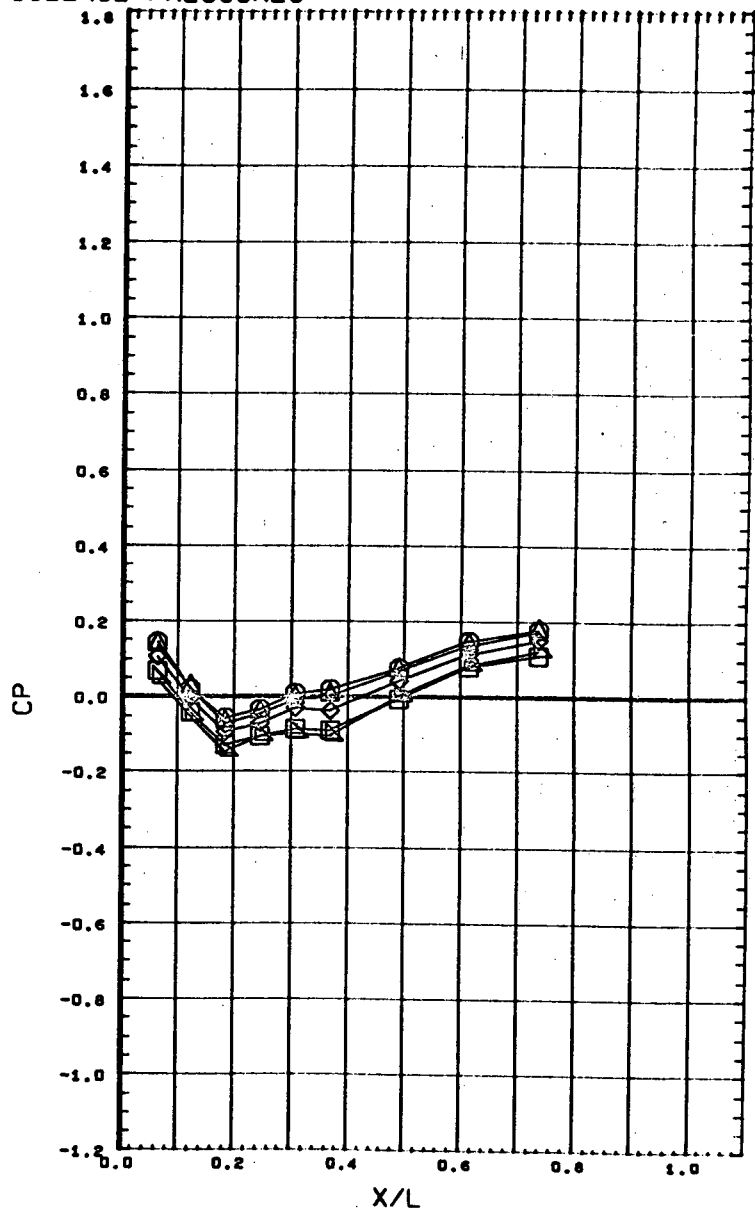
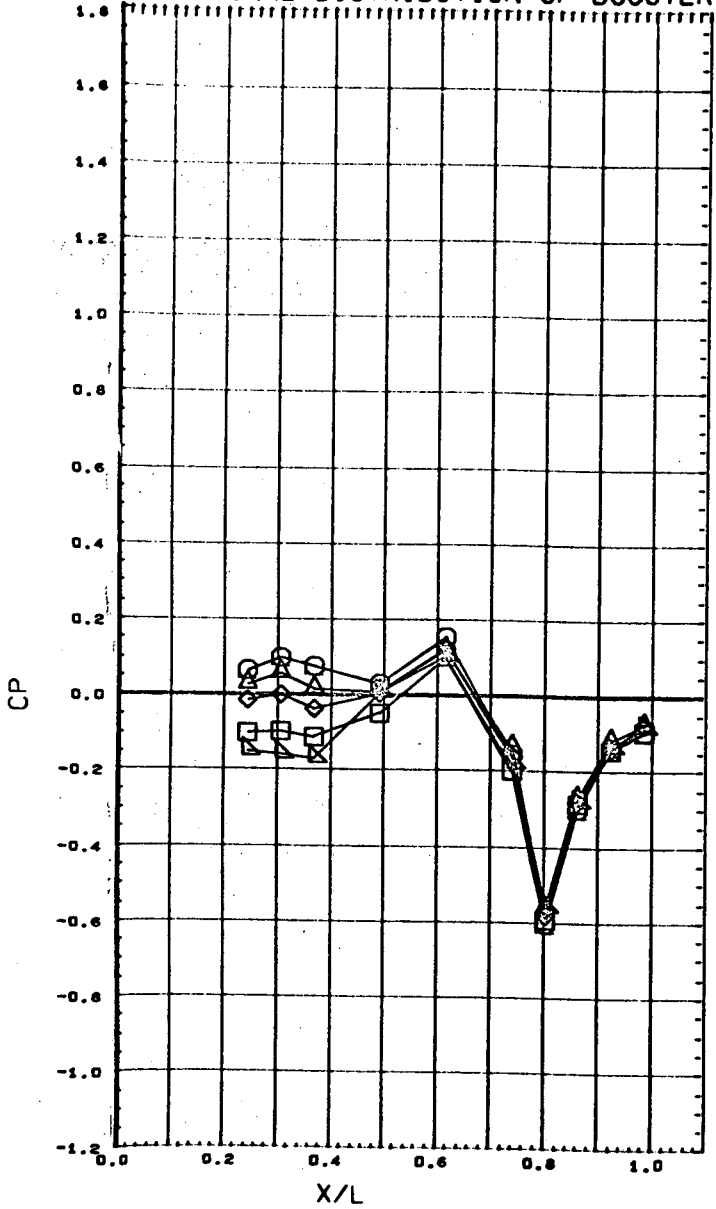

| SYMBOL | BETA | THETA | M1 |
|--------|-------|--------|-------|
| ○ | 3.197 | 24.000 | 0.598 |
| △ | 3.945 | 45.000 | |
| ◇ | 2.127 | | |
| □ | 0.034 | | |
| ▽ | 0.761 | | |

| PARAMETRIC VALUES | | |
|-------------------|-------|-------|
| ALFB | 6.000 | DX/L |
| I | 0.000 | 0.000 |

REFERENCE FILE

LONGITUDINAL DISTRIBUTION OF BOOSTER FUSELAGE PRESSURES

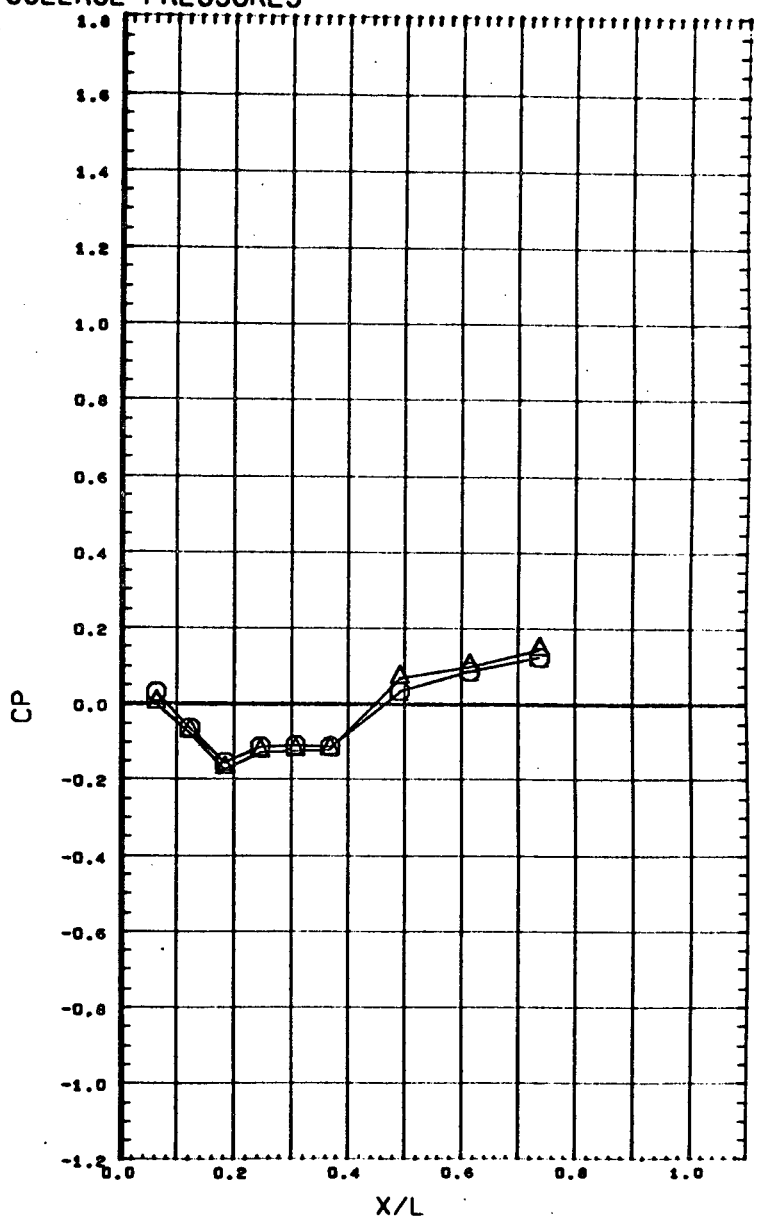
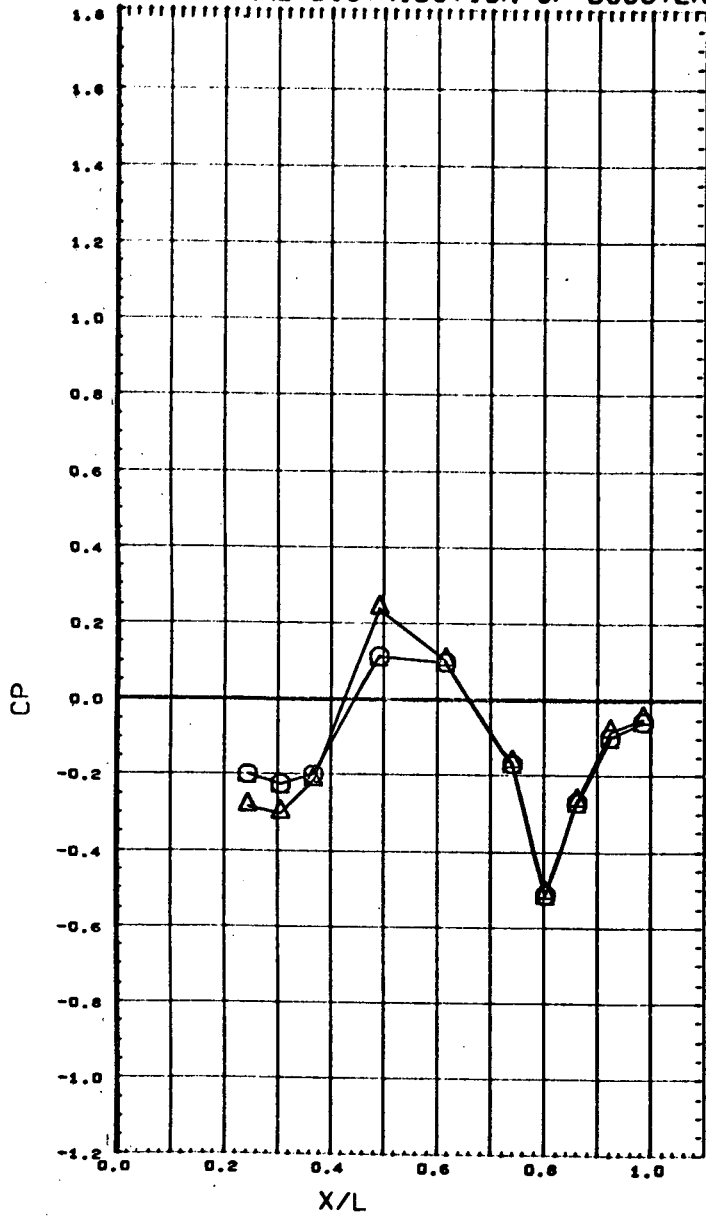

| SYMBOL | BETA | THETA | M1 |
|--------|-------|--------|-------|
| ○ | 3.766 | 24.000 | 0.598 |
| △ | 6.056 | 45.000 | |

| PARAMETRIC VALUES | | |
|-------------------|-------|-------|
| ALFB | 6.000 | DX/L |
| I | 0.000 | 0.000 |

REFERENCE FILE

LONGITUDINAL DISTRIBUTION OF BOOSTER FUSELAGE PRESSURES

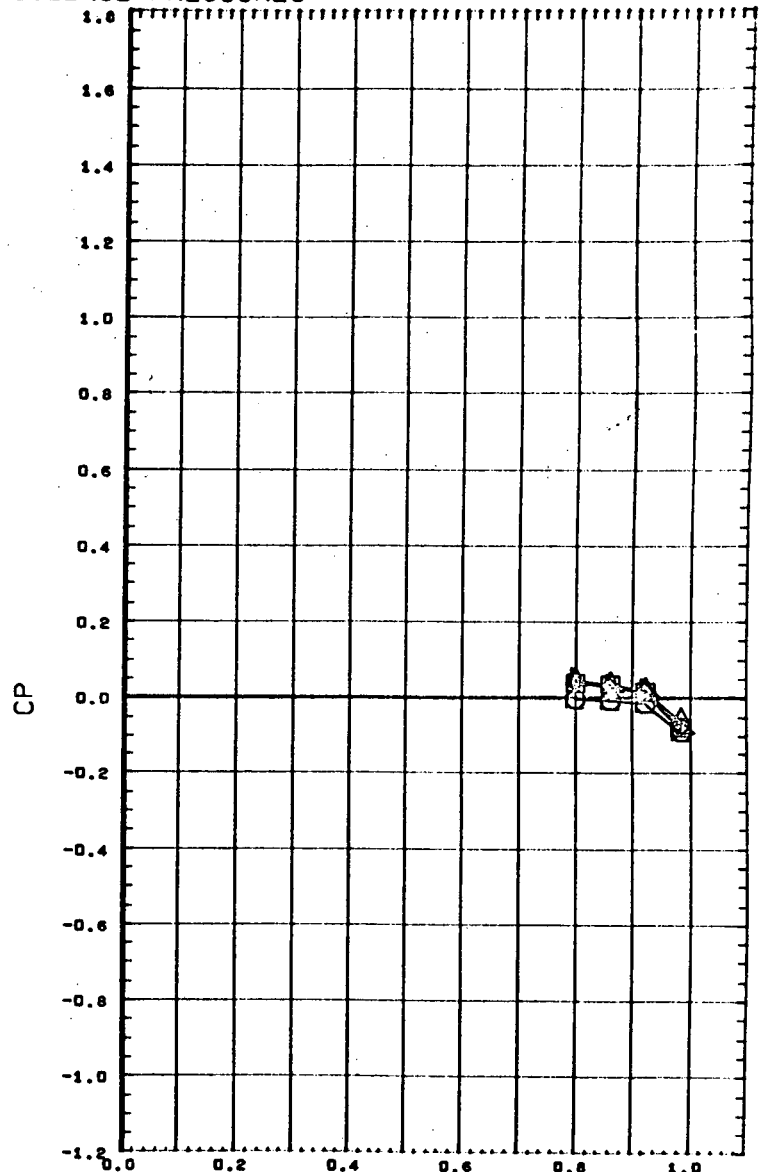
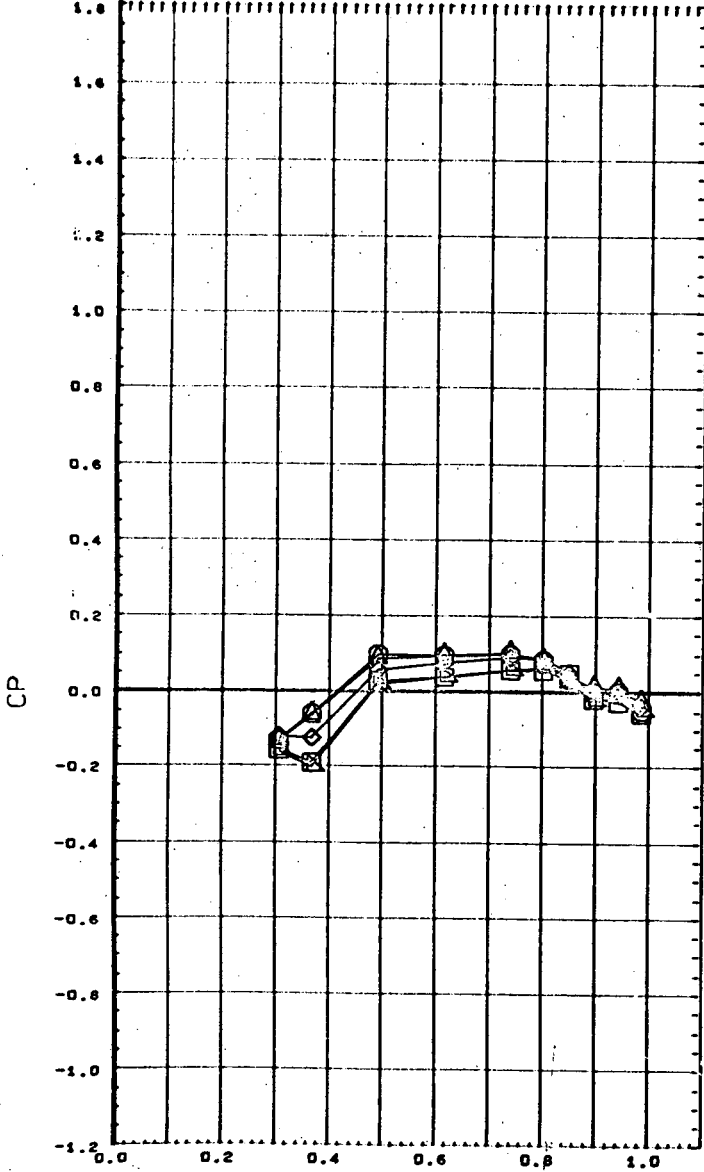

| SYMBOL | BETA | THETA | M1 |
|--------|---------|---------|-------|
| ◇ | - 6.197 | 90.000 | 0.598 |
| ◇ | - 3.945 | 180.000 | |
| ◇ | - 2.127 | | |
| ◇ | - 0.034 | | |
| ◇ | 1.761 | | |

REFERENCE FILE

| PARAMETRIC VALUES | | |
|-------------------|-------|-------|
| ALFB | 6.000 | DX/L |
| I | 0.000 | 0.000 |

LONGITUDINAL DISTRIBUTION OF BOOSTER FUSELAGE PRESSURES

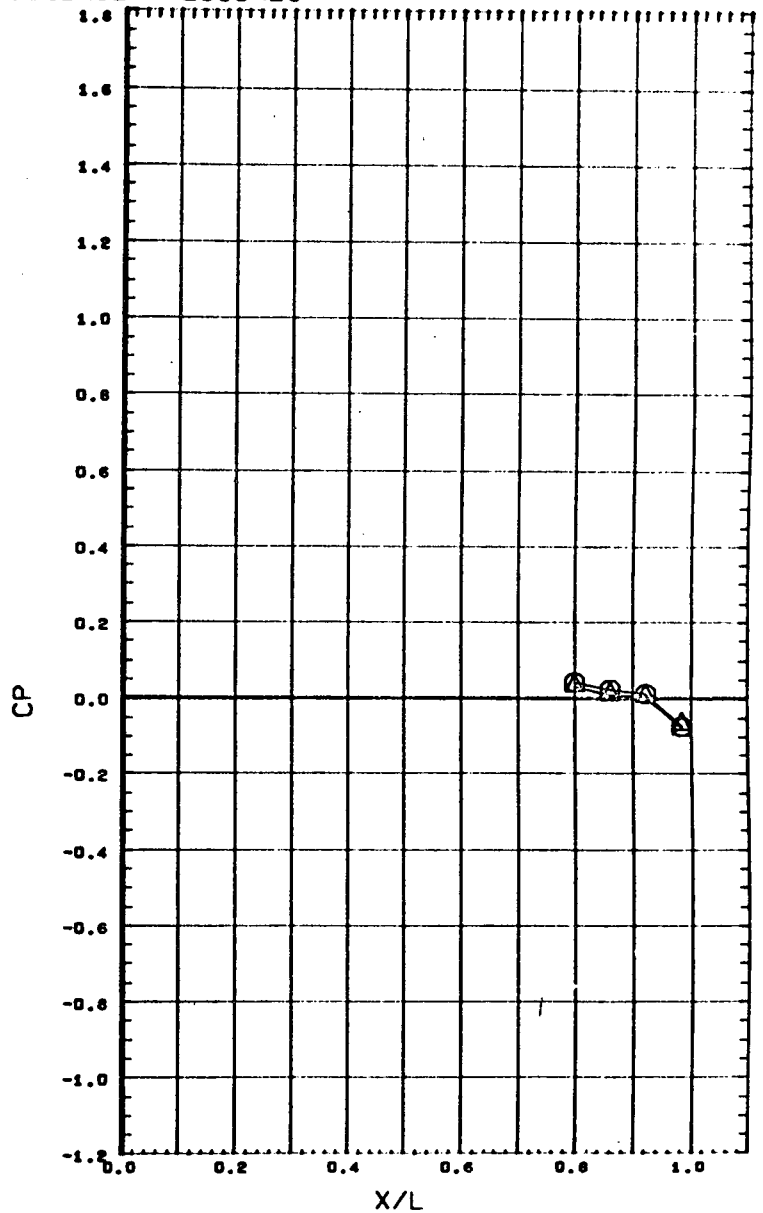
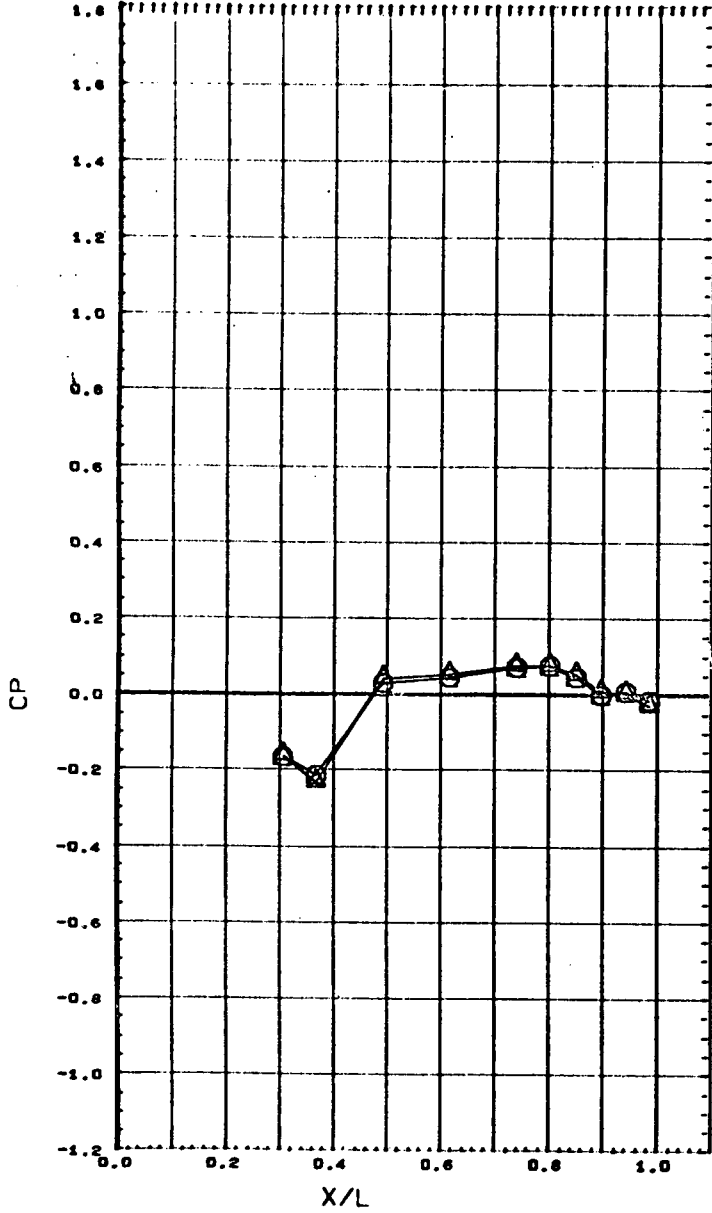

| SYMBOL | BETA | THETA | M1 |
|--------|-------|---------|-------|
| ○ | 3.766 | 90.000 | 0.598 |
| △ | 6.056 | 180.000 | |

| PARAMETRIC VALUES | | |
|-------------------|-------|-------|
| ALFB | 6.000 | DX/L |
| I | 0.000 | 0.000 |

REFERENCE FILE

LONGITUDINAL DISTRIBUTION OF BOOSTER FUSELAGE PRESSURES

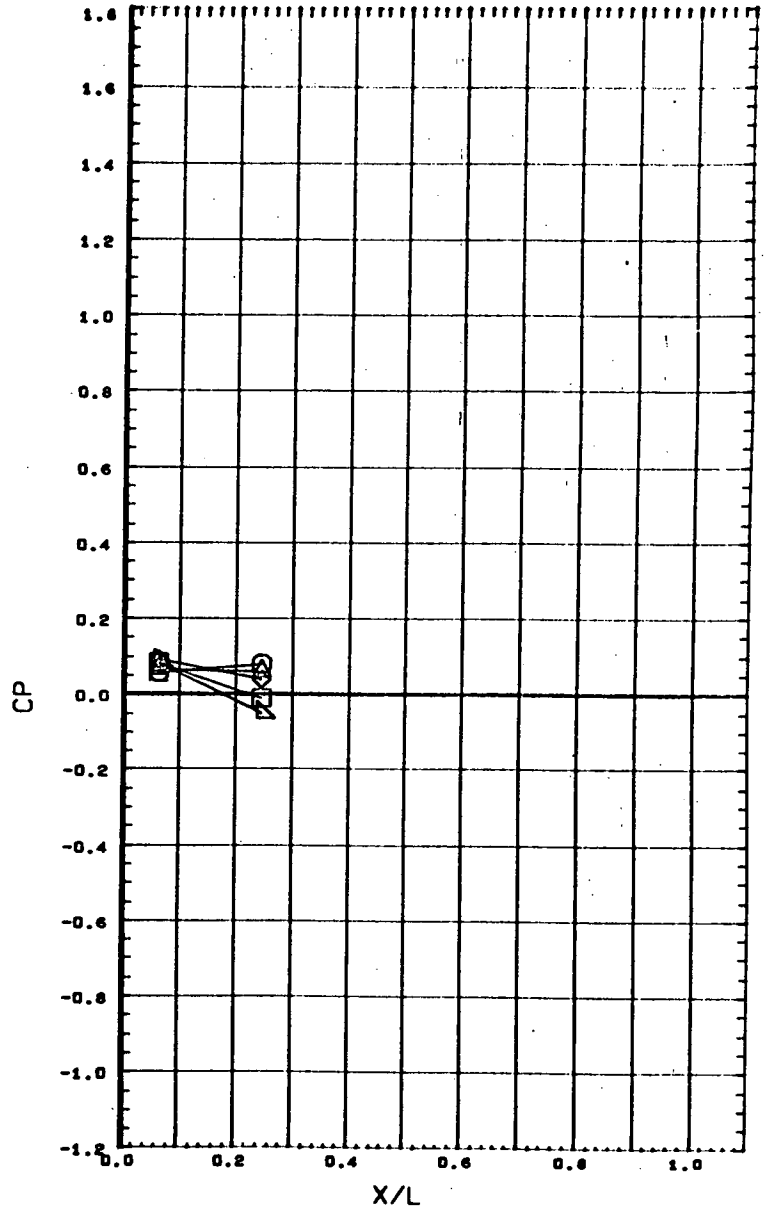
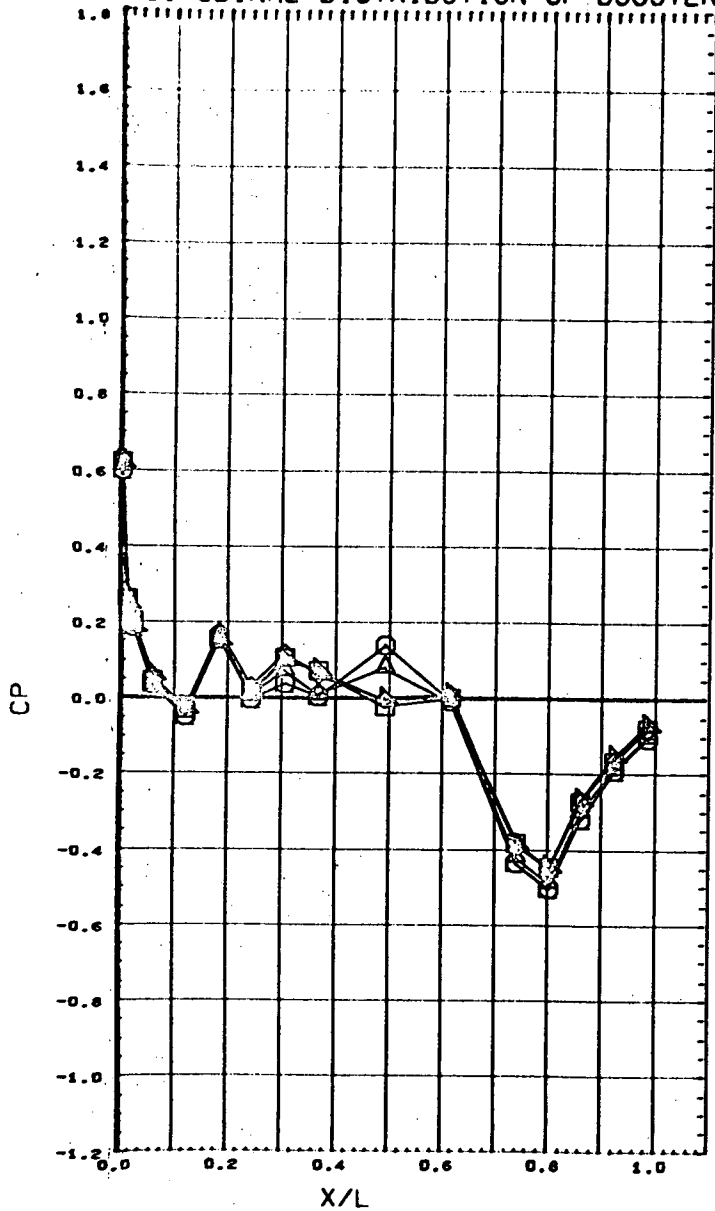

| SYMBOL | BETA | THETA | M1 |
|--------|-------|--------|-------|
| ○ | 5.928 | 0.000 | 0.903 |
| □ | 4.036 | 15.000 | |
| ◇ | 2.074 | | |
| △ | 0.007 | | |
| ▽ | 1.049 | | |

REFERENCE FILE

| PARAMETRIC VALUES | | | |
|-------------------|-------|------|-------|
| ALFB | 6.000 | DX/L | 0.000 |
| I | 0.000 | | |

LONGITUDINAL DISTRIBUTION OF BOOSTER FUSELAGE PRESSURES

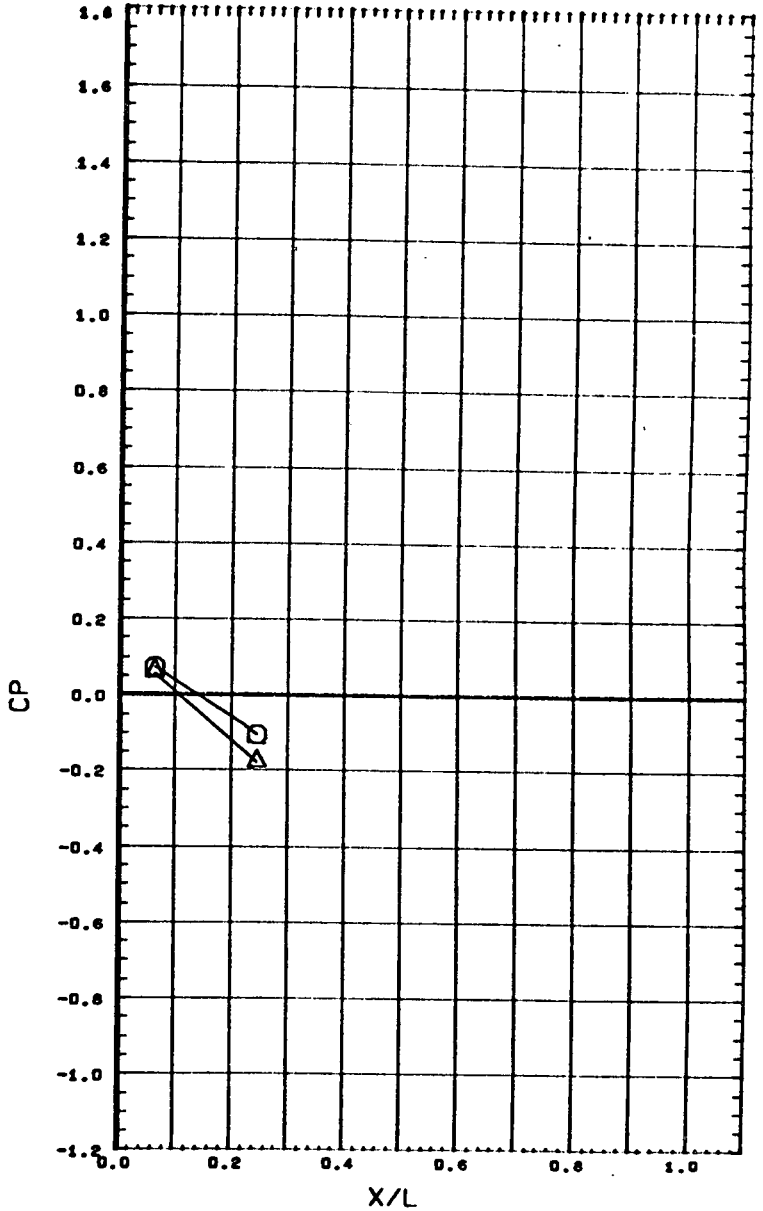
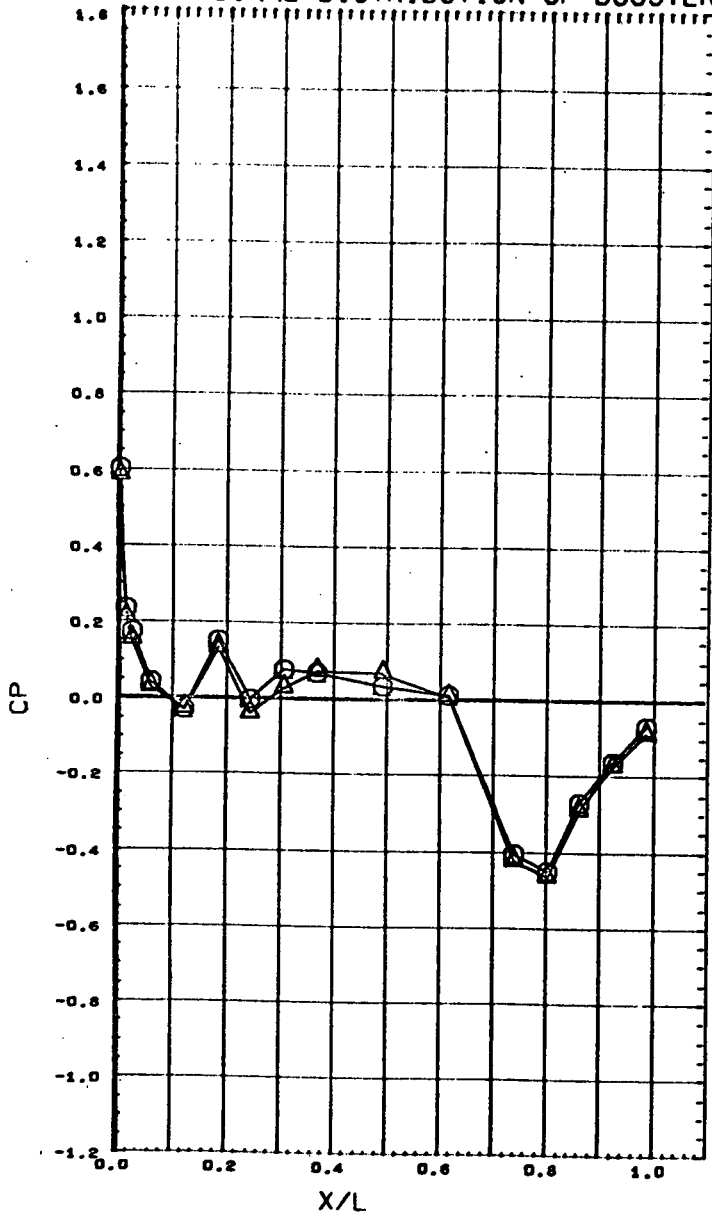

| SYMBOL | BETA | THETA | M1 |
|--------|-------|--------|-------|
| ○ | 5.870 | 0.000 | 0.903 |
| △ | 5.976 | 15.000 | |

| PARAMETRIC VALUES | | |
|-------------------|-------|-------|
| ALFB | 6.000 | DX/L |
| I | 0.000 | 0.000 |

REFERENCE FILE

AEDC TC174 MDAC BOOSTER NEAR ORBITER (BODY)

(ATC004)

PAGE 98

LONGITUDINAL DISTRIBUTION OF BOOSTER FUSELAGE PRESSURES

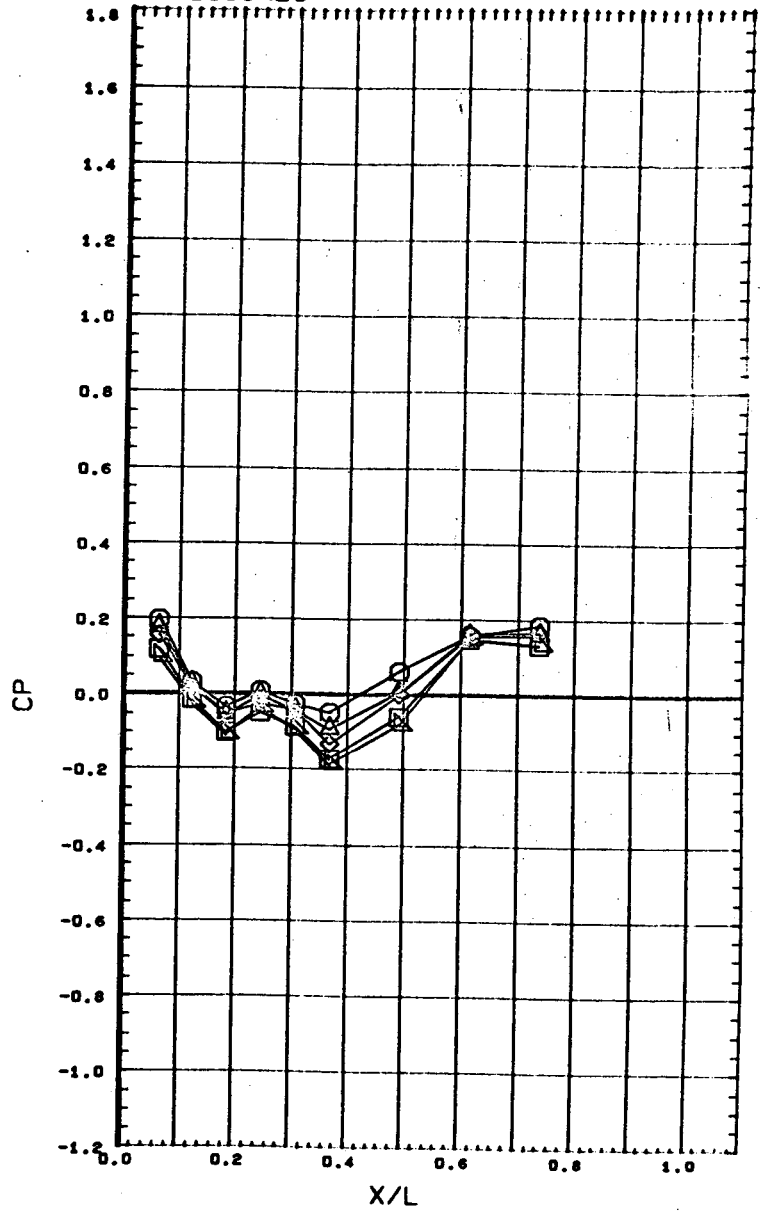
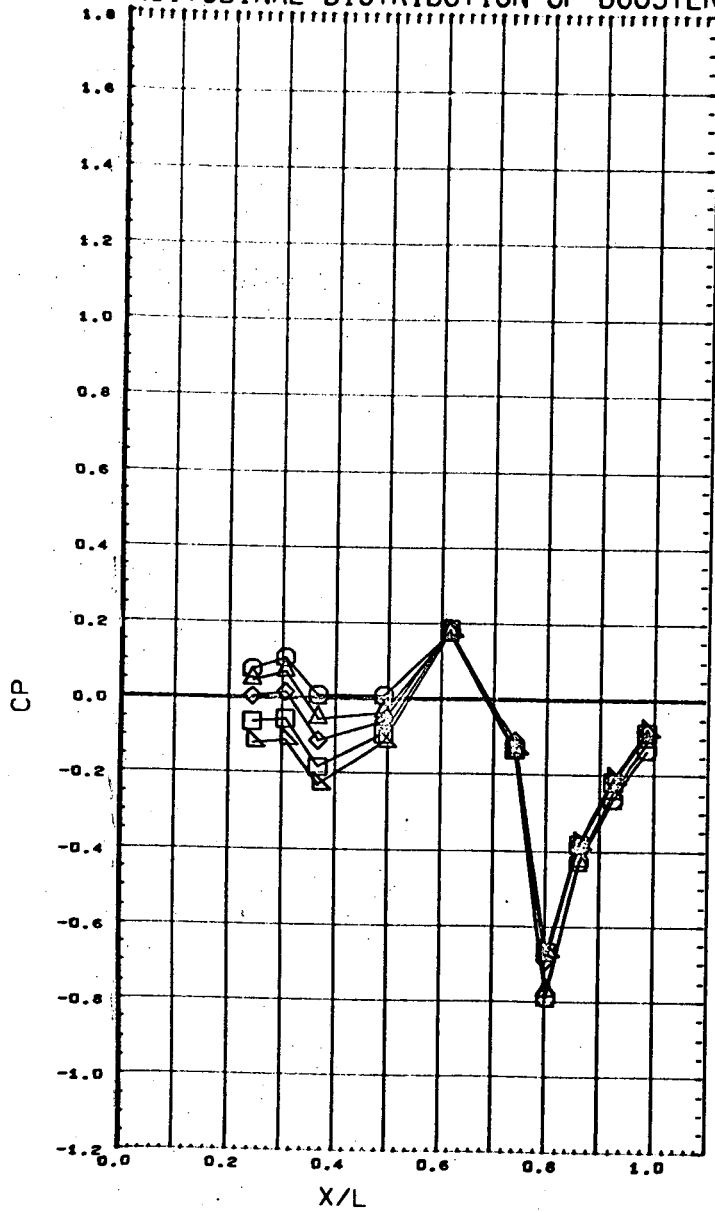

| SYMBOL | BETA | THETA | M1 |
|--------|---------|--------|-------|
| ○ | - 5.928 | 24.000 | 0.903 |
| ◇ | - 4.036 | 45.000 | |
| ◇ | - 2.074 | | |
| □ | - 0.007 | | |
| □ | 1.849 | | |

REFERENCE FILE

| PARAMETRIC VALUES | | |
|-------------------|-------|------------|
| ALFB | 6.000 | DX/L 0.000 |
| I | 0.000 | |

LONGITUDINAL DISTRIBUTION OF BOOSTER FUSELAGE PRESSURES

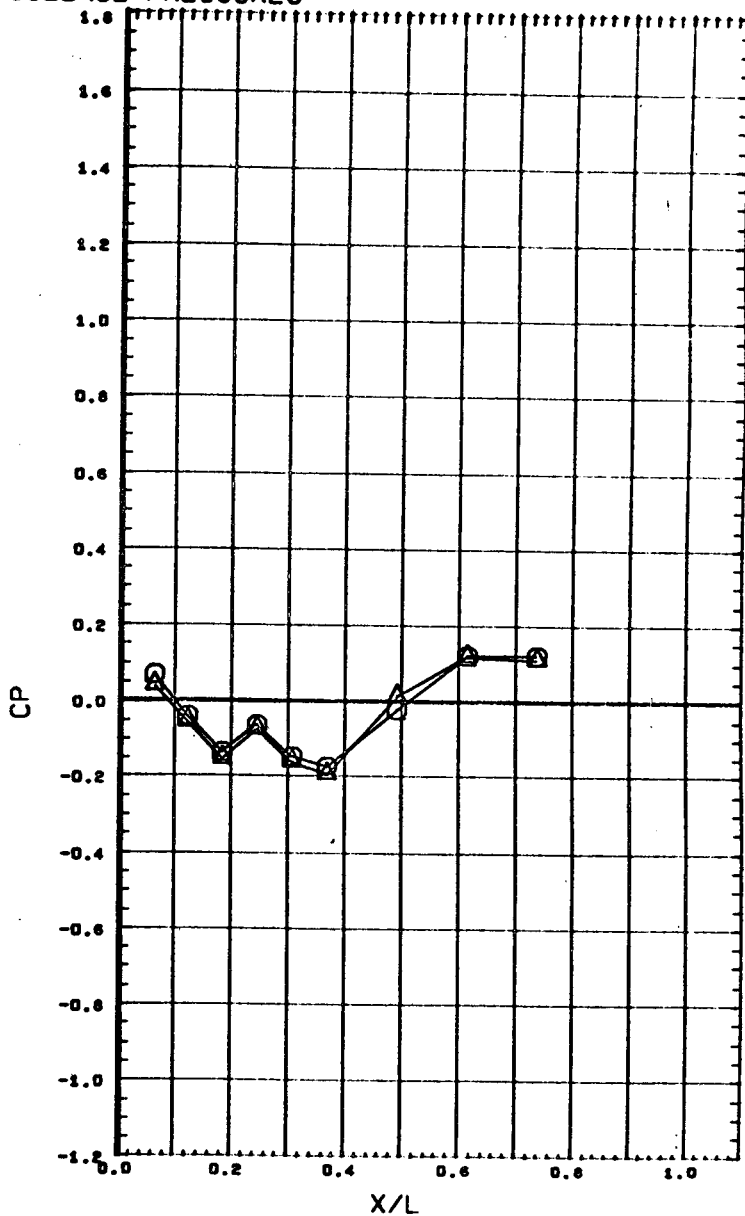
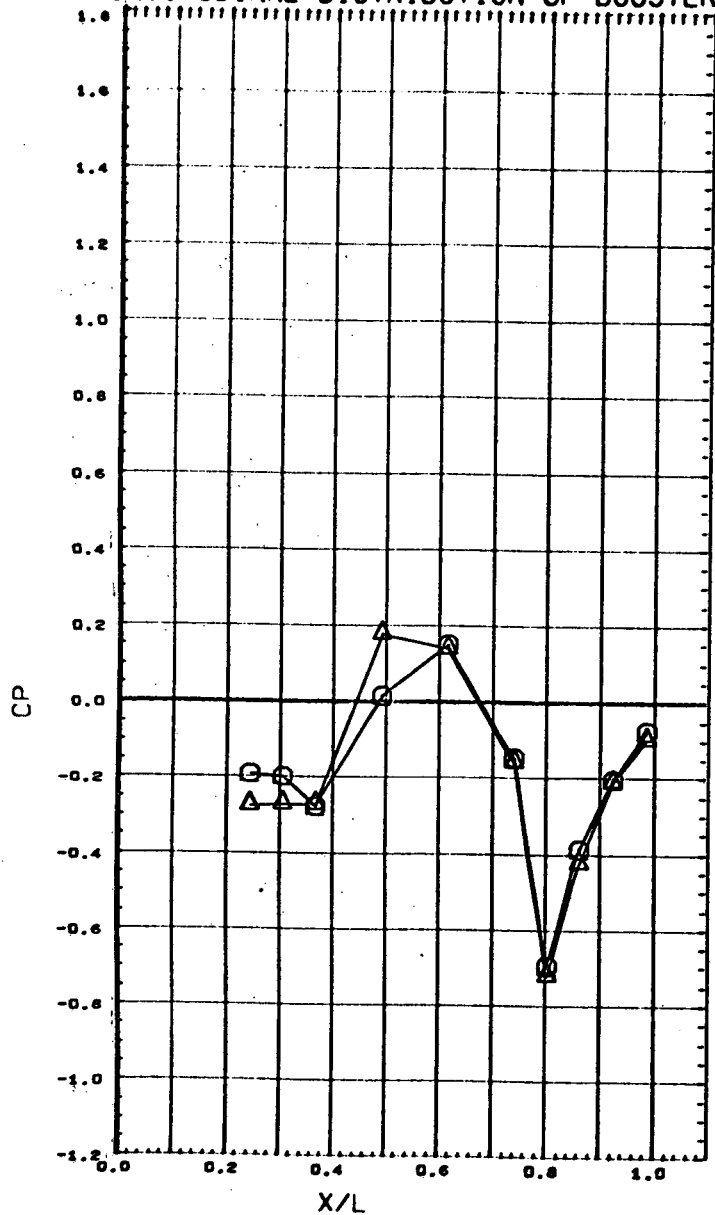

| SYMBOL | BETA | THETA | M1 |
|--------|-------|--------|-------|
| ○ | 3.870 | 24.000 | 0.903 |
| △ | 5.976 | 45.000 | |

| PARAMETRIC VALUES | | |
|-------------------|-------|------------|
| ALFB | 6.000 | OX/L 0.000 |
| I | 0.000 | |

REFERENCE FILE

LONGITUDINAL DISTRIBUTION OF BOOSTER FUSELAGE PRESSURES

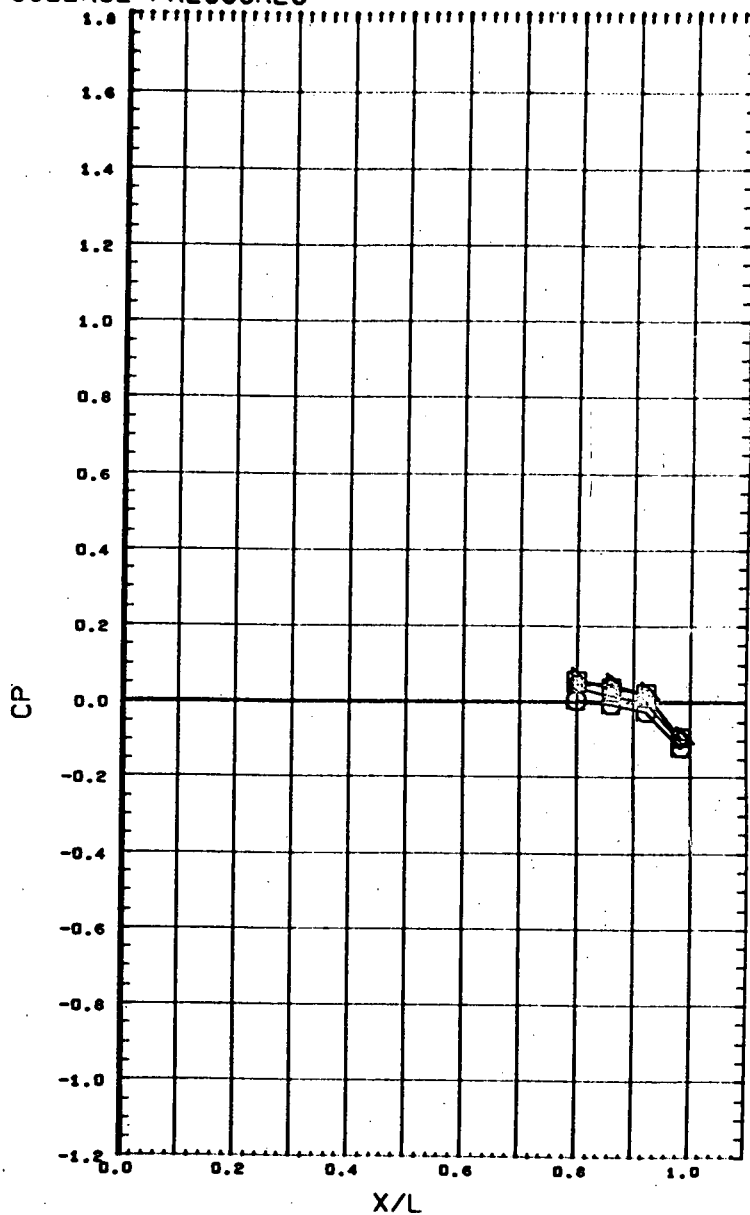
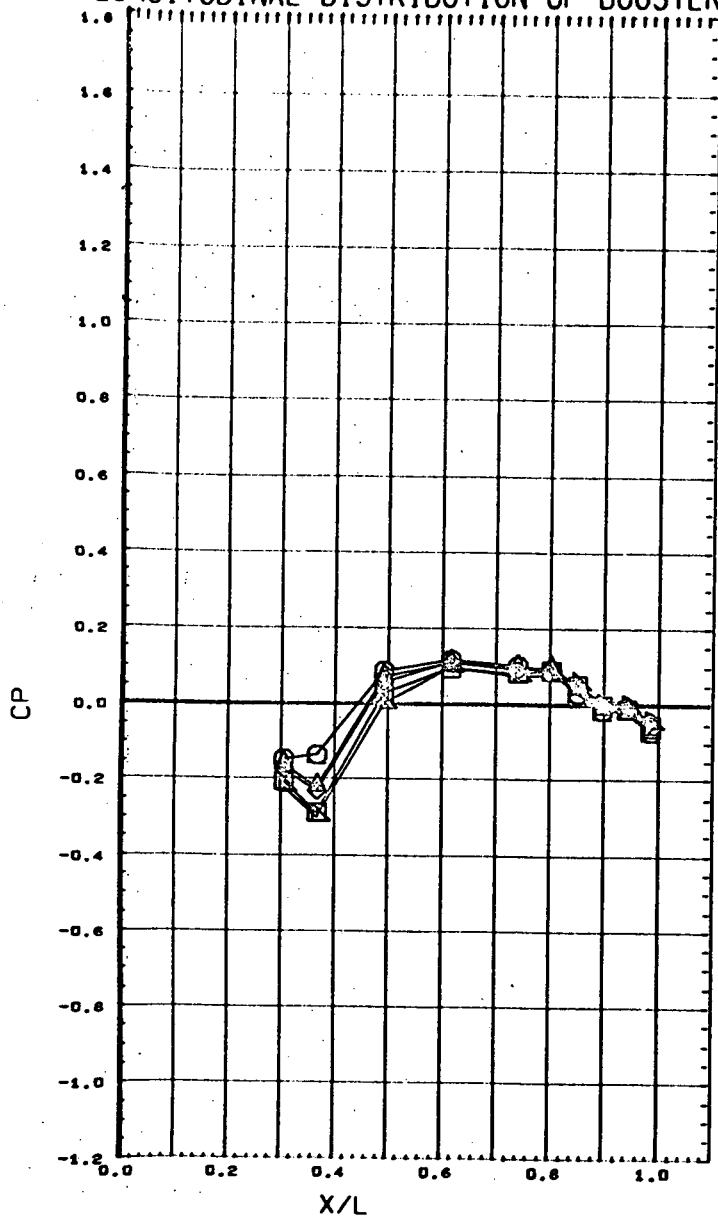

| SYMBOL | BETA | THETA | M1 |
|--------|-------|---------|-------|
| ○ | 5.928 | 90.000 | 0.903 |
| △ | 4.036 | 180.000 | |
| ◇ | 2.074 | | |
| □ | 0.007 | | |
| ▽ | 1.849 | | |

REFERENCE FILE

| PARAMETRIC VALUES | | |
|-------------------|-------|------------|
| ALFB | 6.000 | DX/L 0.000 |
| I | 0.000 | |

LONGITUDINAL DISTRIBUTION OF BOOSTER FUSELAGE PRESSURES

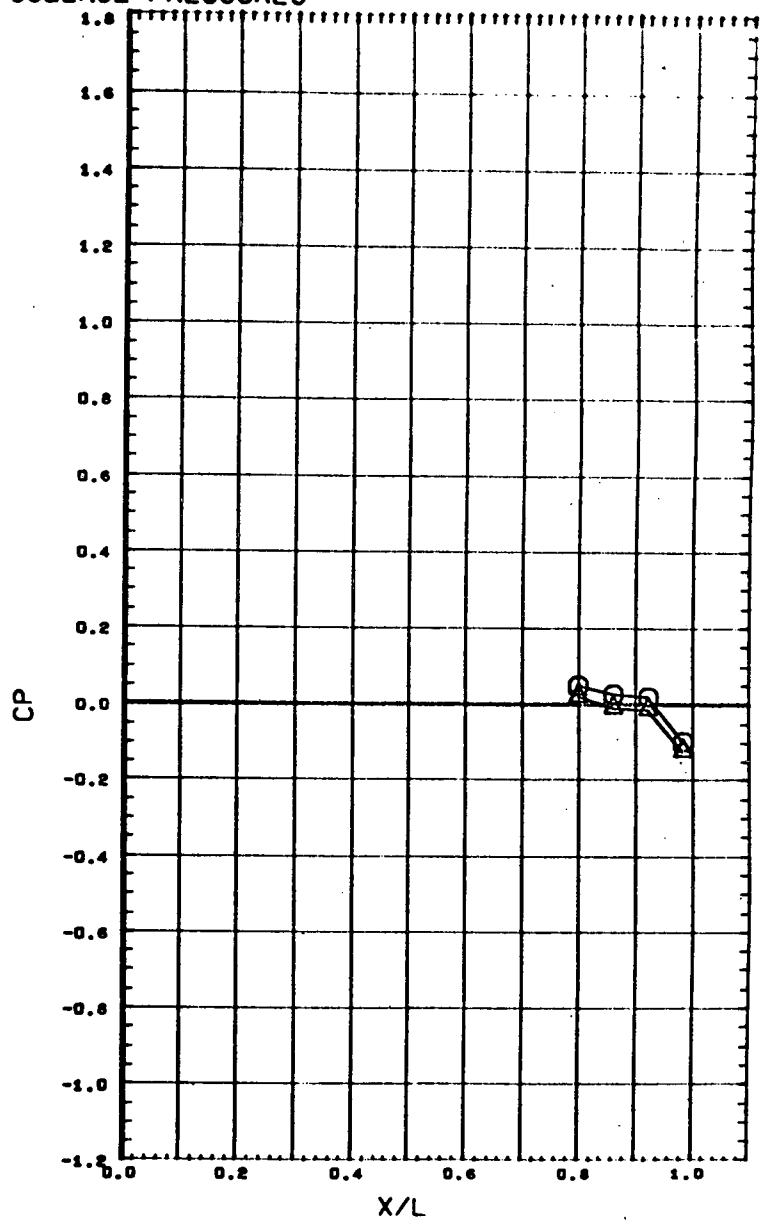
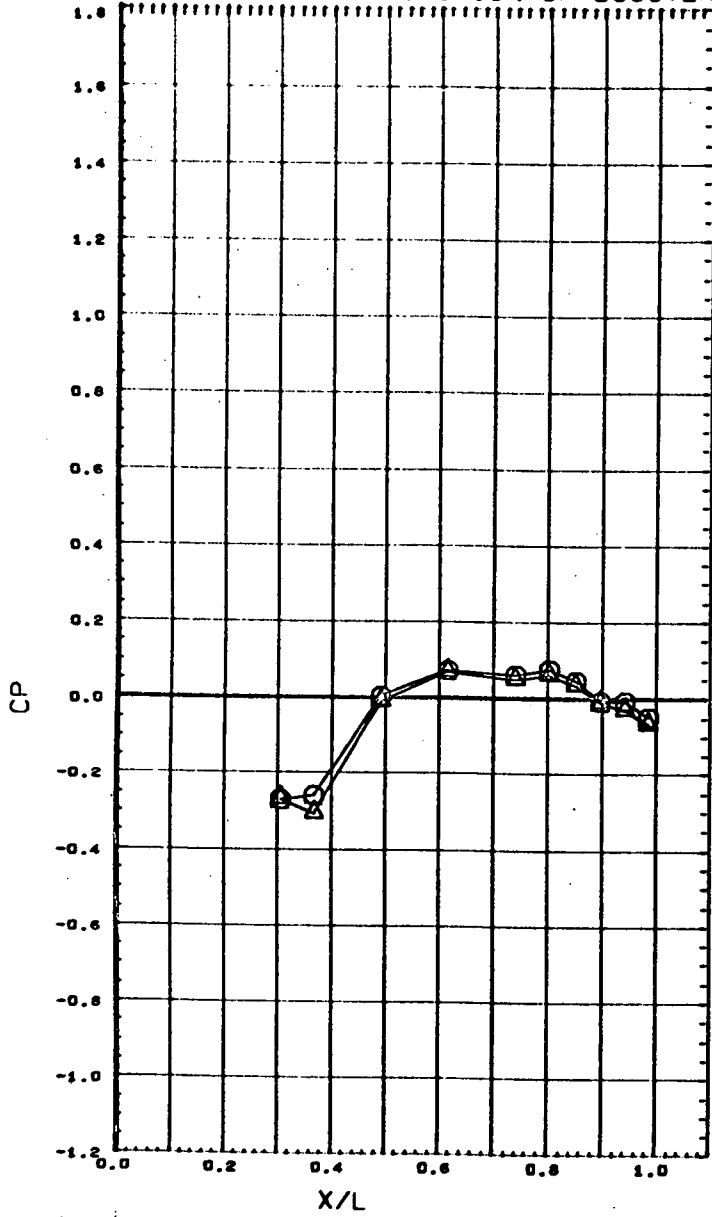

| SYMBOL | BETA | THETA | M1 |
|--------|-------|---------|-------|
| ○ | 3.870 | 90.000 | 0.903 |
| △ | 5.976 | 180.000 | |

| PARAMETRIC VALUES | | |
|-------------------|-------|-------|
| ALFB | 6.000 | OX/L |
| 1 | 0.000 | 0.000 |

REFERENCE FILE

LONGITUDINAL DISTRIBUTION OF BOOSTER FUSELAGE PRESSURES

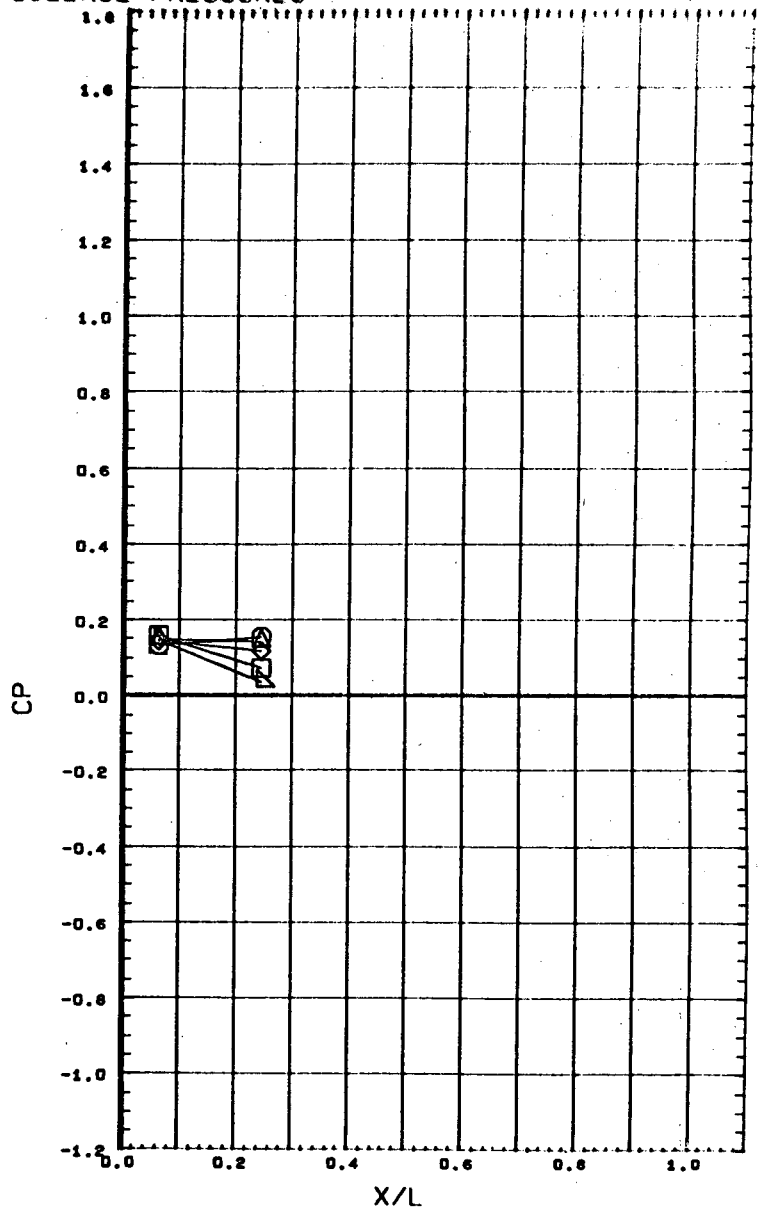
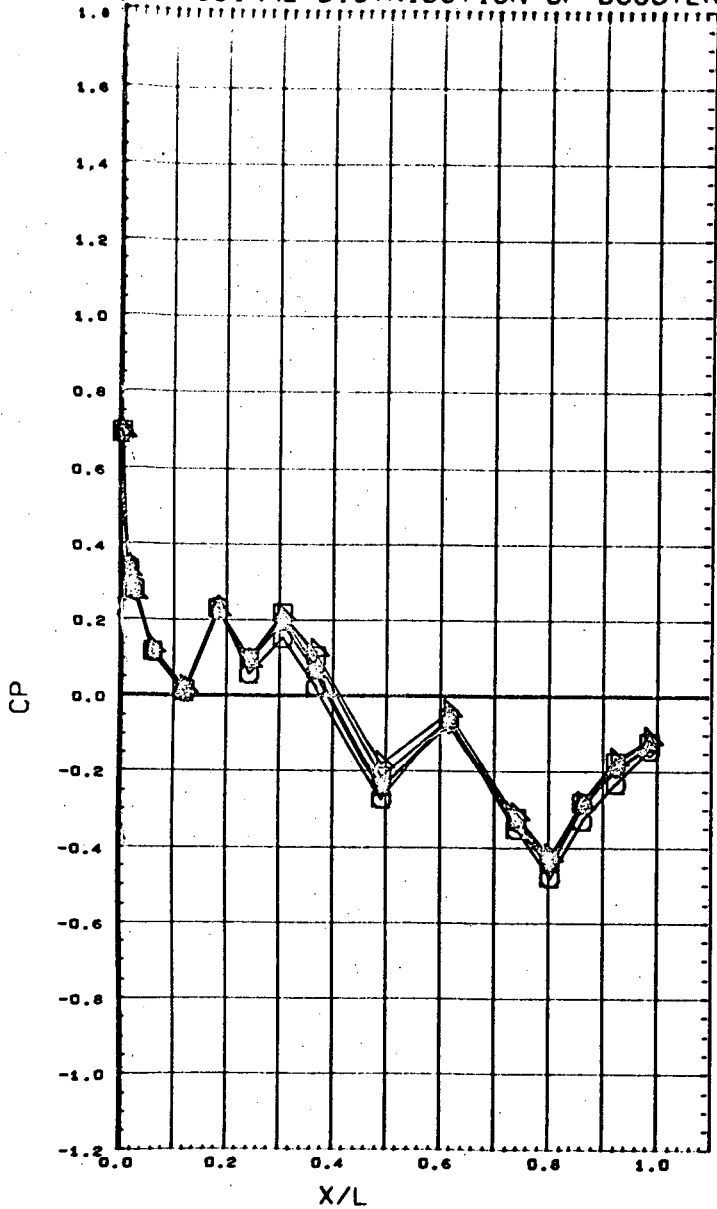

| SYMBOL | BETA | THETA | M1 |
|--------|-------|--------|-------|
| ○ | 5.831 | 0.000 | 1.001 |
| △ | 3.916 | 15.000 | |
| ◇ | 2.062 | | |
| □ | 0.023 | | |
| ◇ | 1.643 | | |

REFERENCE FILE

| PARAMETRIC VALUES | | | |
|-------------------|-------|------|-------|
| ALFB | 6.000 | DX/L | 0.000 |
| I | 0.000 | | |

LONGITUDINAL DISTRIBUTION OF BOOSTER FUSELAGE PRESSURES

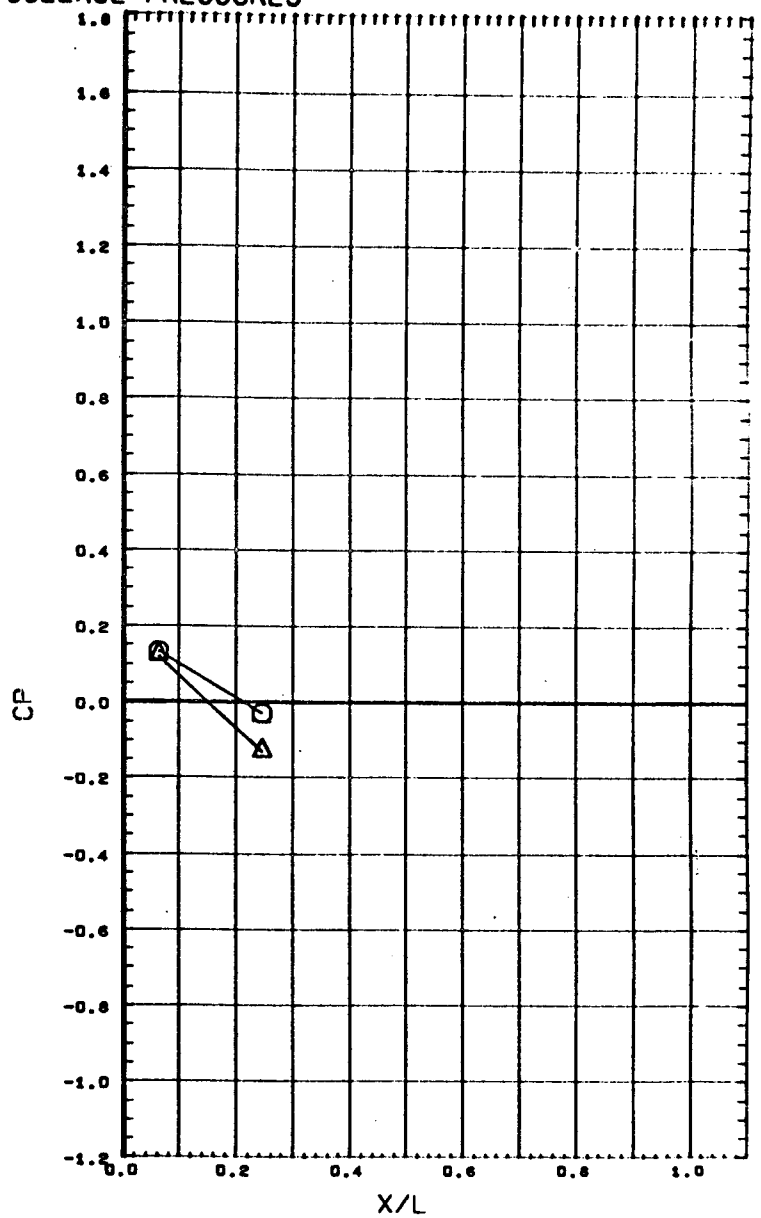
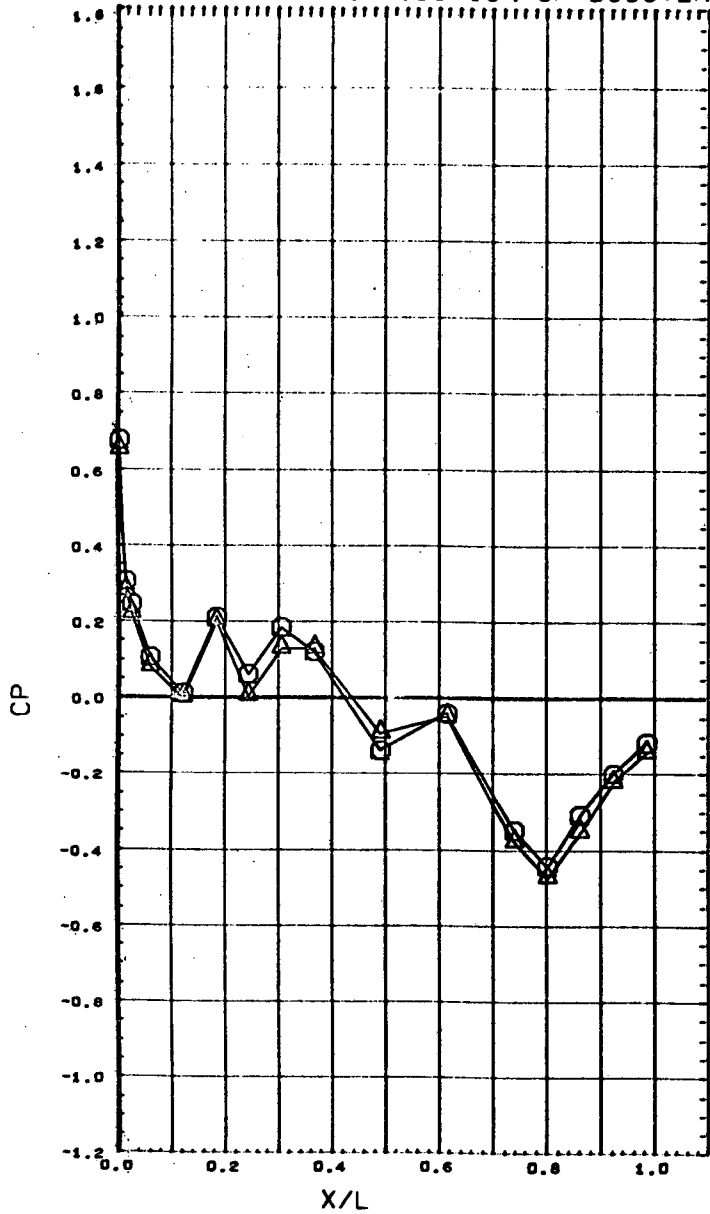

| SYMBOL | BETA | THETA | M1 |
|--------|-------|--------|-------|
| ○ | 3.879 | 0.000 | 1.001 |
| △ | 5.995 | 15.000 | |

| PARAMETRIC VALUES | | | |
|-------------------|-------|------|-------|
| ALFB | 6.000 | DX/L | 0.000 |
| I | 0.000 | | |

REFERENCE FILE

LONGITUDINAL DISTRIBUTION OF BOOSTER FUSELAGE PRESSURES

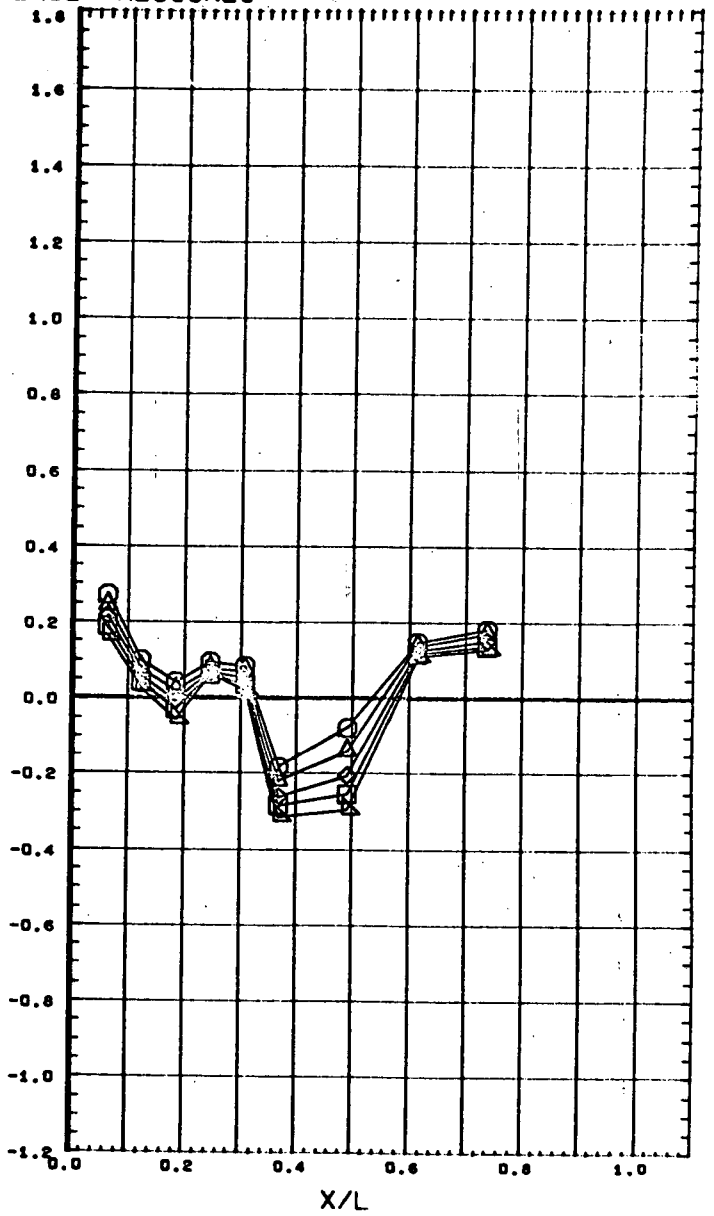
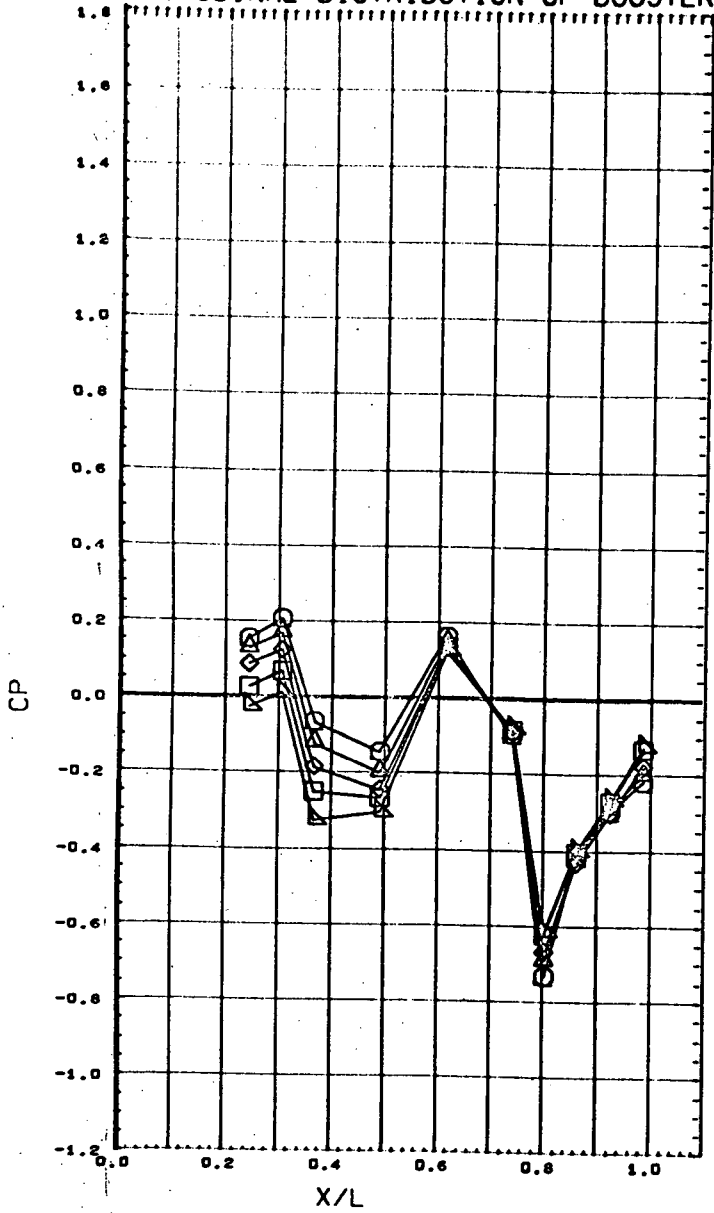

| SYMBOL | BETA | THETA | M1 |
|--------|-------|--------|-------|
| ○ | 5.831 | 24.000 | 1.001 |
| ◇ | 3.916 | 45.000 | |
| △ | 2.002 | | |
| □ | 0.023 | | |
| ○ | 1.843 | | |

REFERENCE FILE

| PARAMETRIC VALUES | | |
|-------------------|-------|-------|
| ALFB | 6.000 | DX/L |
| I | 0.000 | 0.000 |

LONGITUDINAL DISTRIBUTION OF BOOSTER FUSELAGE PRESSURES

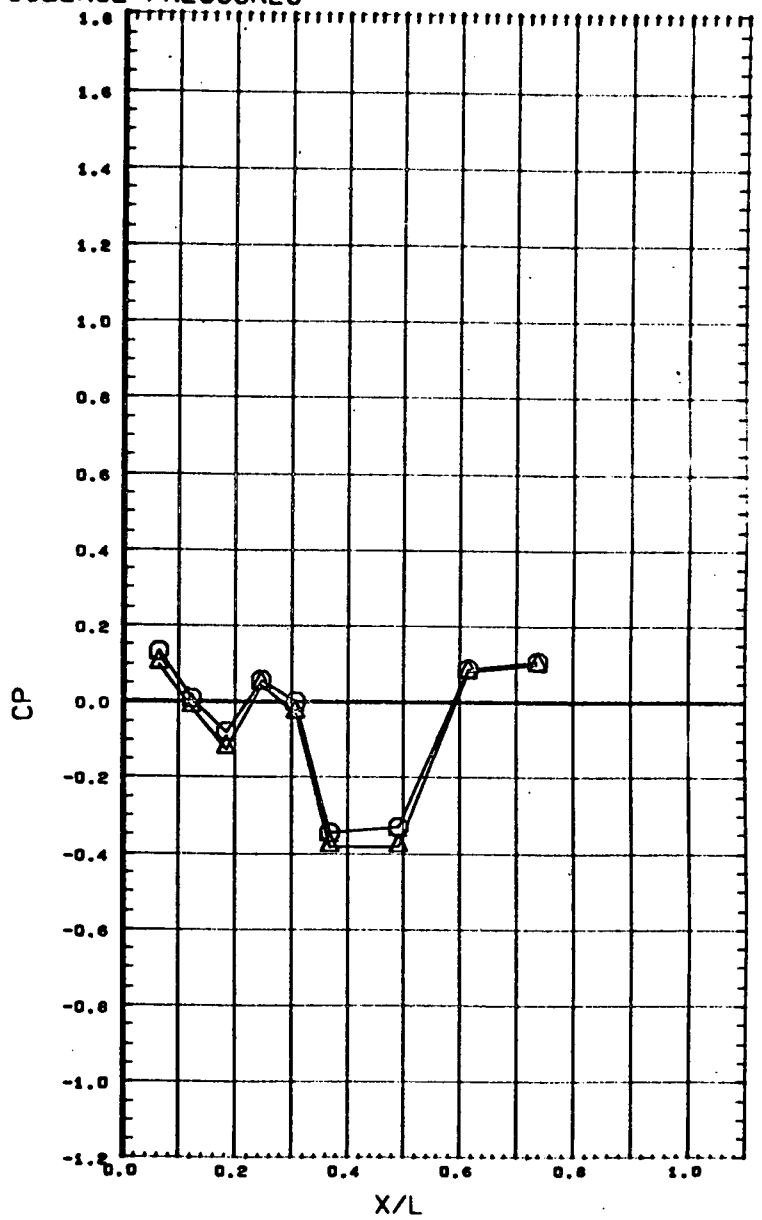
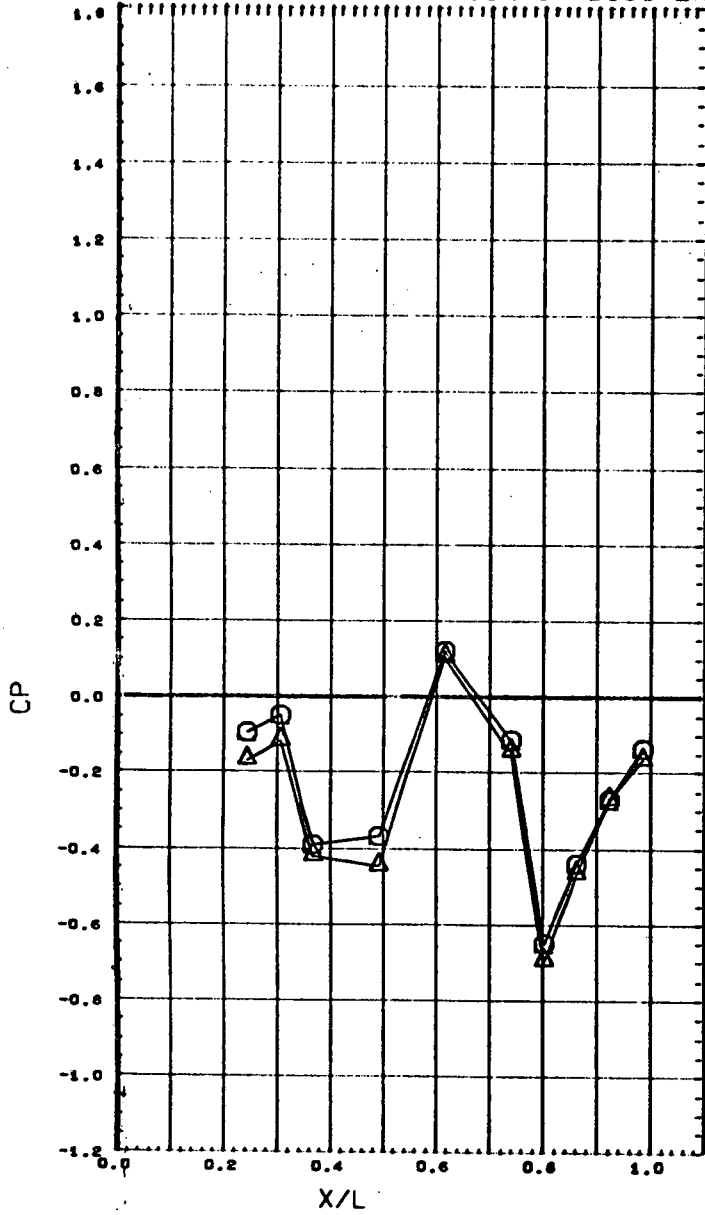

| SYMBOL | BETA | THETA | M1 |
|--------|-------|--------|-------|
| ○ | 3.879 | 24.000 | 1.001 |
| △ | 9.995 | 45.000 | |

| PARAMETRIC VALUES | | |
|-------------------|-------|-------|
| ALFB | 6.000 | DX/L |
| I | 0.000 | 0.000 |

REFERENCE FILE

LONGITUDINAL DISTRIBUTION OF BOOSTER FUSELAGE PRESSURES

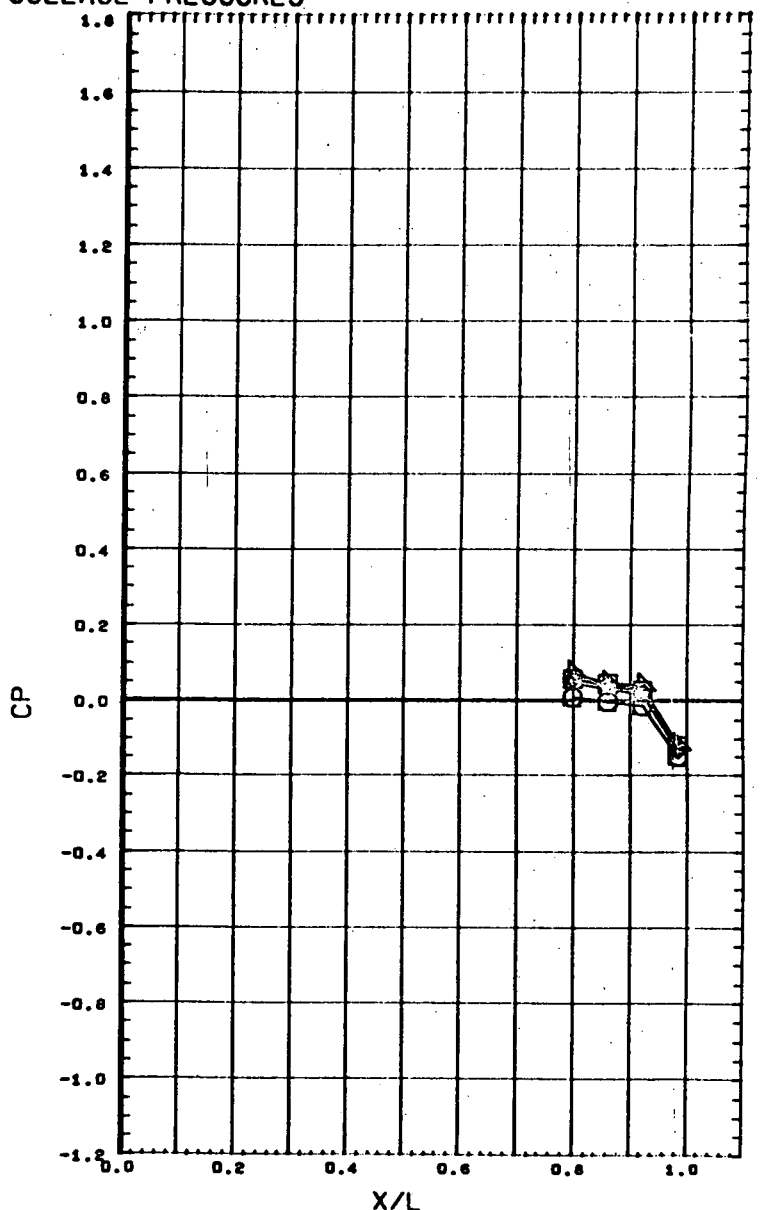
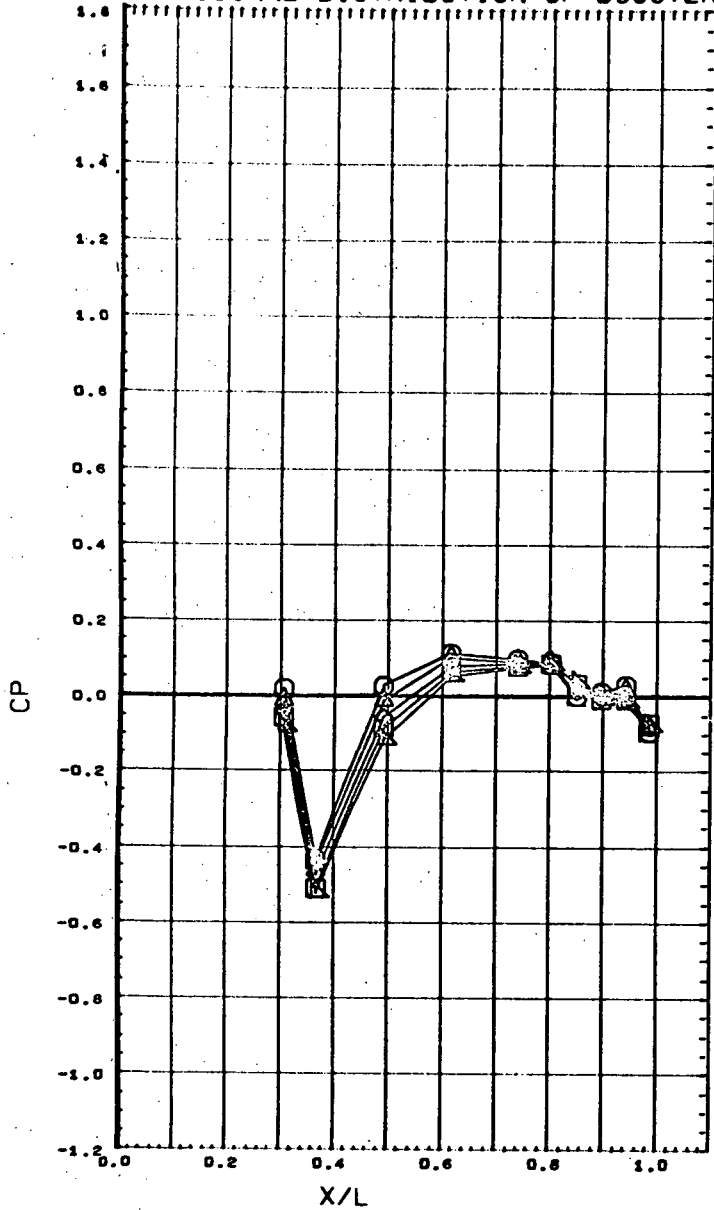

| SYMBOL | BETA | THETA | M1 |
|--------|---------|---------|-------|
| ○ | - 5.831 | 90.000 | 1.001 |
| ◇ | - 3.916 | 180.000 | |
| ◇ | - 2.062 | | |
| □ | - 0.023 | | |
| ◇ | 1.843 | | |

| PARAMETRIC VALUES | | |
|-------------------|-------|-------|
| ALFB | 6.000 | 0x/L |
| I | 0.000 | 0.000 |

REFERENCE FILE

LONGITUDINAL DISTRIBUTION OF BOOSTER FUSELAGE PRESSURES

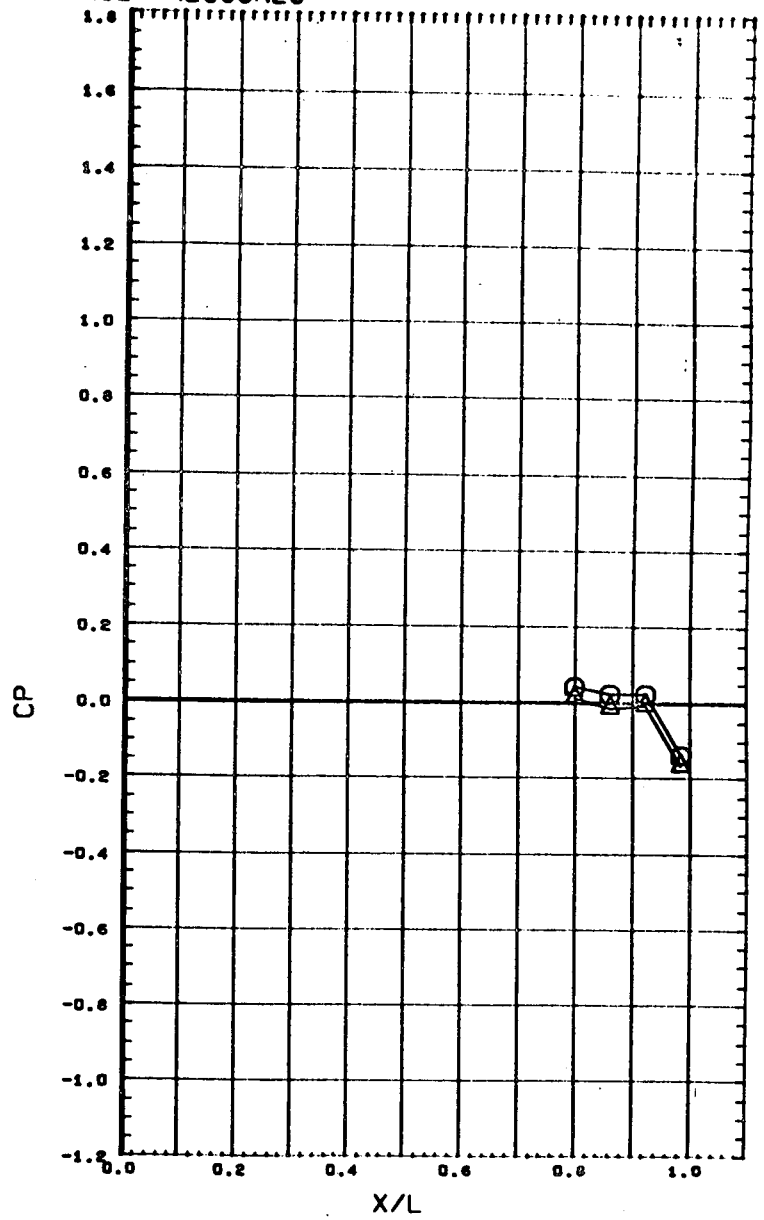
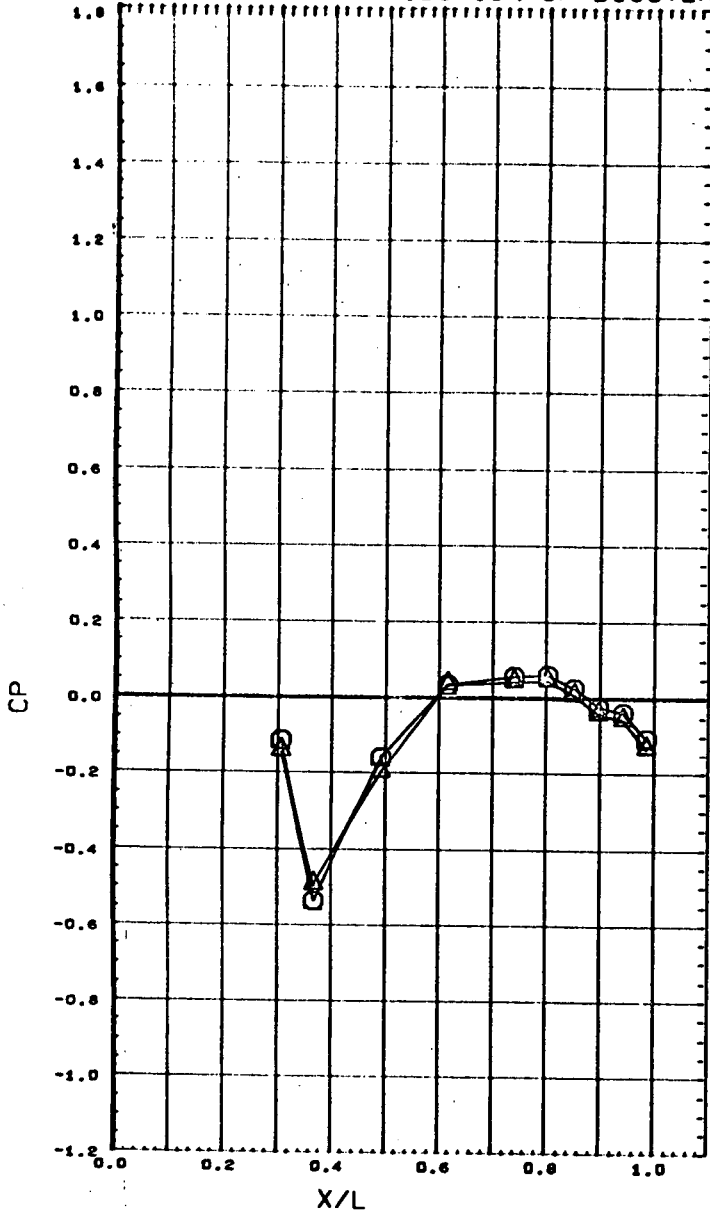

| SYMBOL | BETA | THETA | M1 |
|--------|-------|---------|-------|
| ○ | 3.879 | 90.000 | 1.001 |
| △ | 5.995 | 180.000 | |

| PARAMETRIC VALUES | | |
|-------------------|-------|-------|
| ALFB | 6.000 | DX/L |
| I | 0.000 | 0.000 |

REFERENCE FILE

LONGITUDINAL DISTRIBUTION OF BOOSTER FUSELAGE PRESSURES

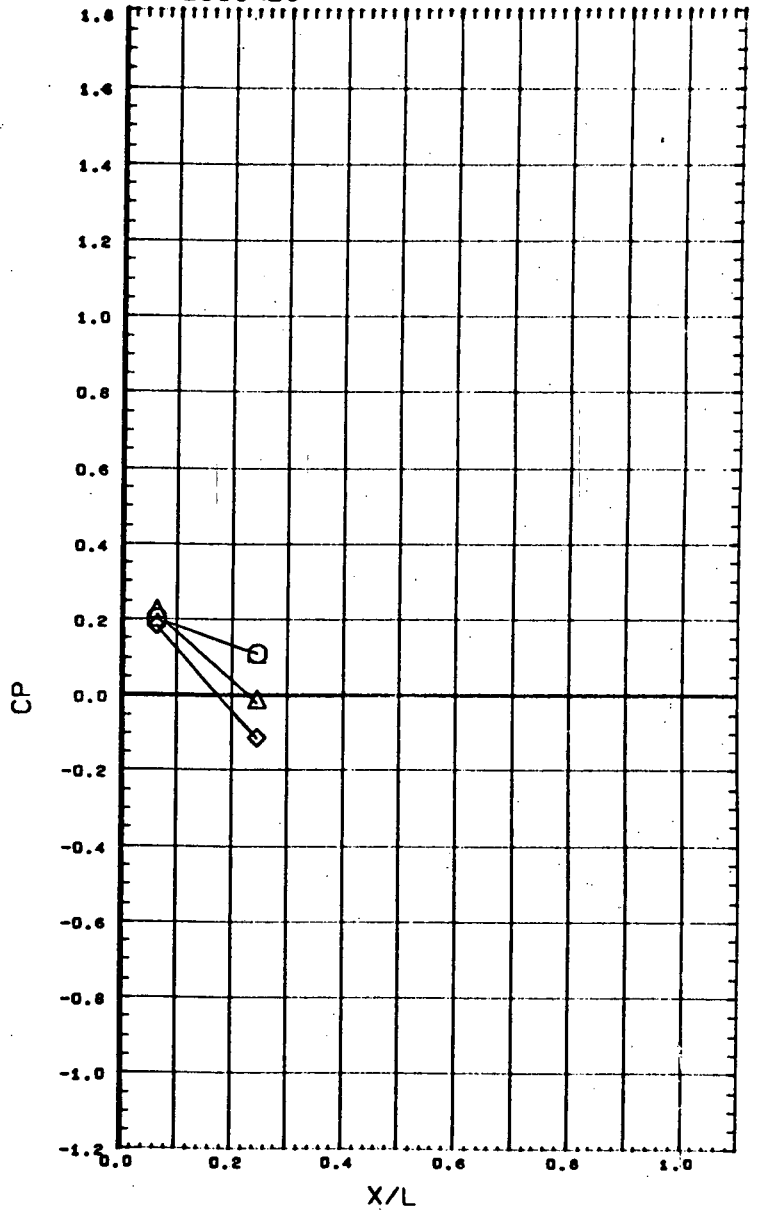
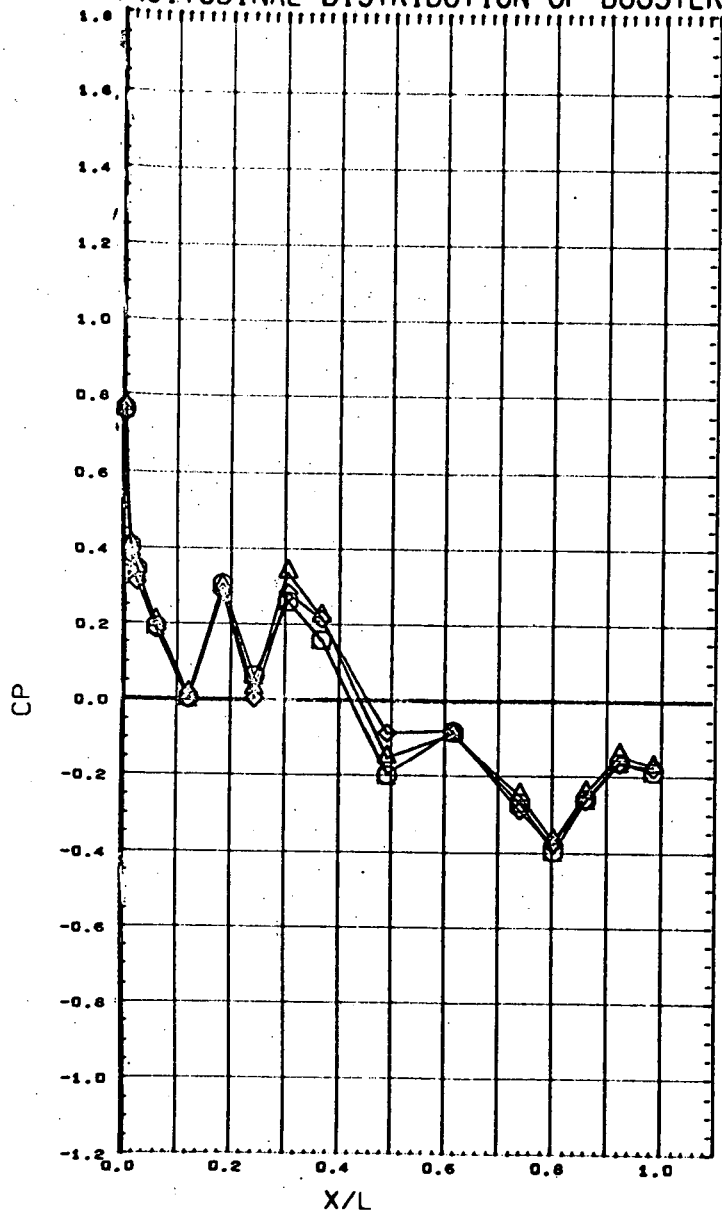

| SYMBOL | BETA | THETA | M1 |
|--------|---------|--------|-------|
| ○ | - 3.704 | 0.000 | 1.100 |
| △ | - 0.004 | 15.000 | |
| ◇ | 3.758 | | |

| PARAMETRIC VALUES | | |
|-------------------|-------|------------|
| ALFB | 6.000 | DX/L 0.000 |
| I | 0.000 | |

REFERENCE FILE

LONGITUDINAL DISTRIBUTION OF BOOSTER FUSELAGE PRESSURES

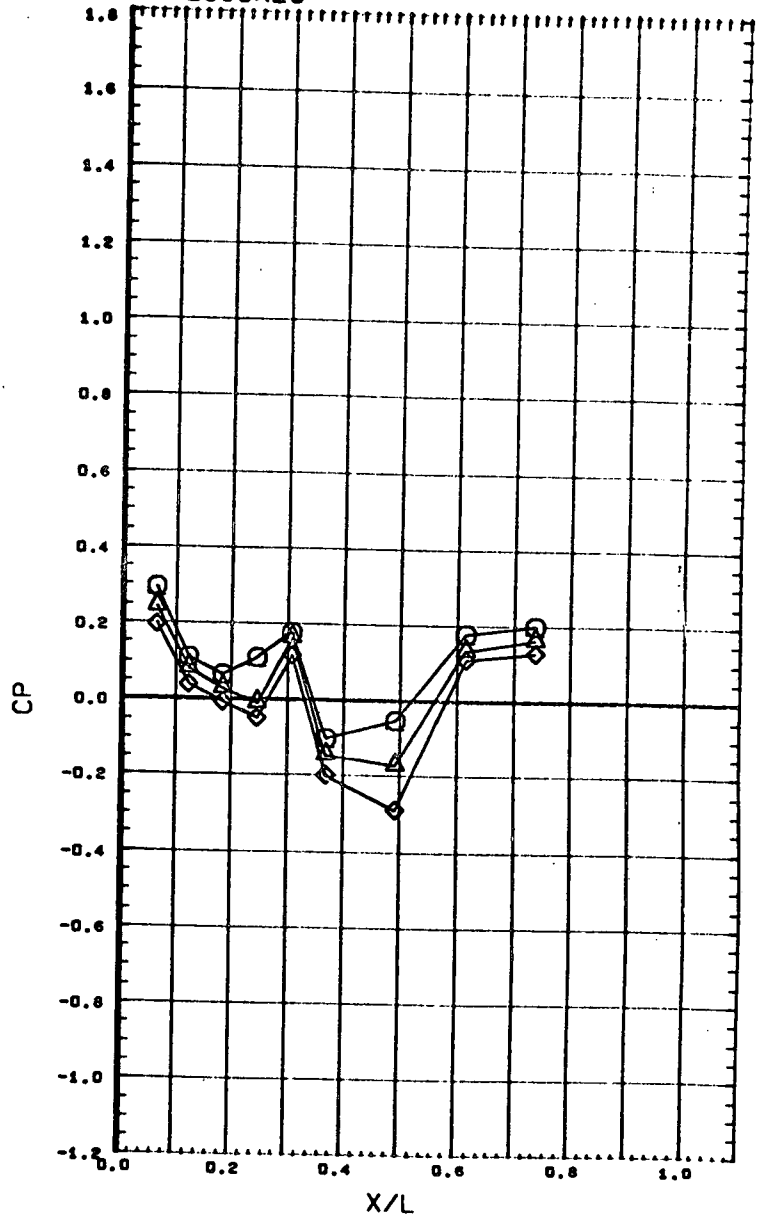
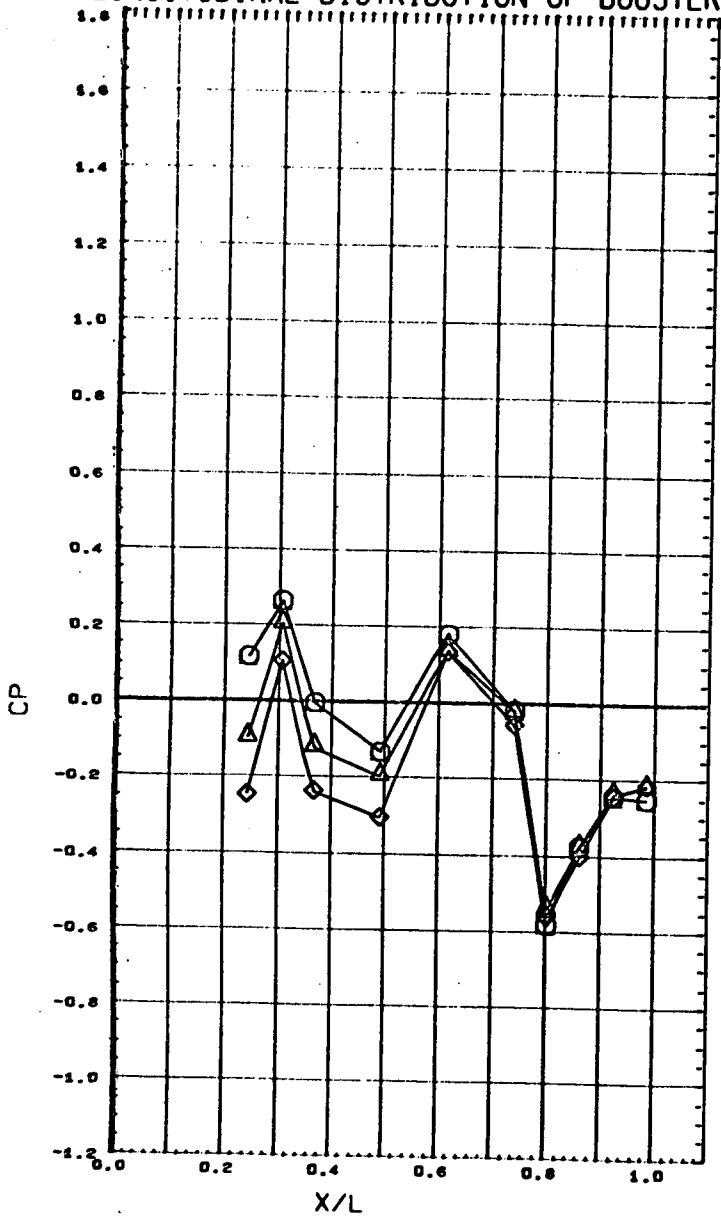

| SYMBOL | BETA | THETA | M1 |
|--------|---------|--------|-------|
| ○ | - 3.704 | 24.000 | 1.100 |
| △ | - 0.004 | 45.000 | |
| ◇ | 3.758 | | |

| PARAMETRIC VALUES | | |
|-------------------|-------|-------|
| ALFB | 6.000 | DX/L |
| I | 0.000 | 0.000 |

REFERENCE FILE

AEDC TC174 MDAC BOOSTER NEAR ORBITER (BODY)

(ATC004)

PAGE 110

LONGITUDINAL DISTRIBUTION OF BOOSTER FUSELAGE PRESSURES

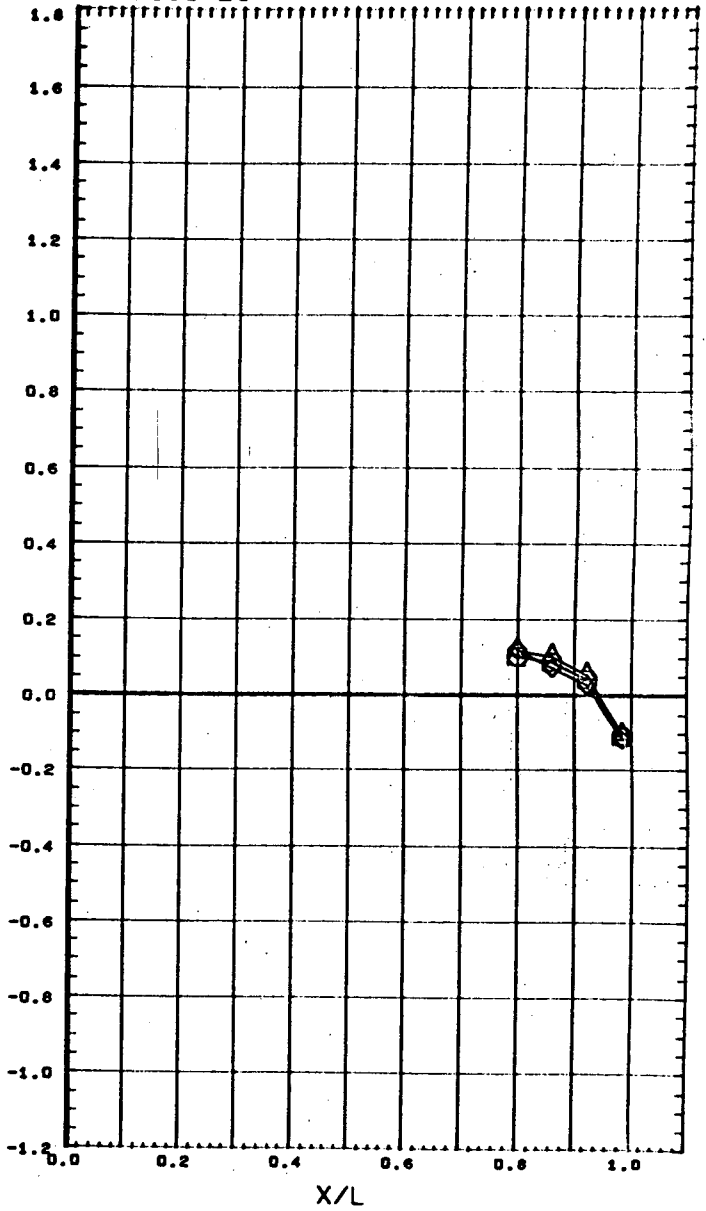
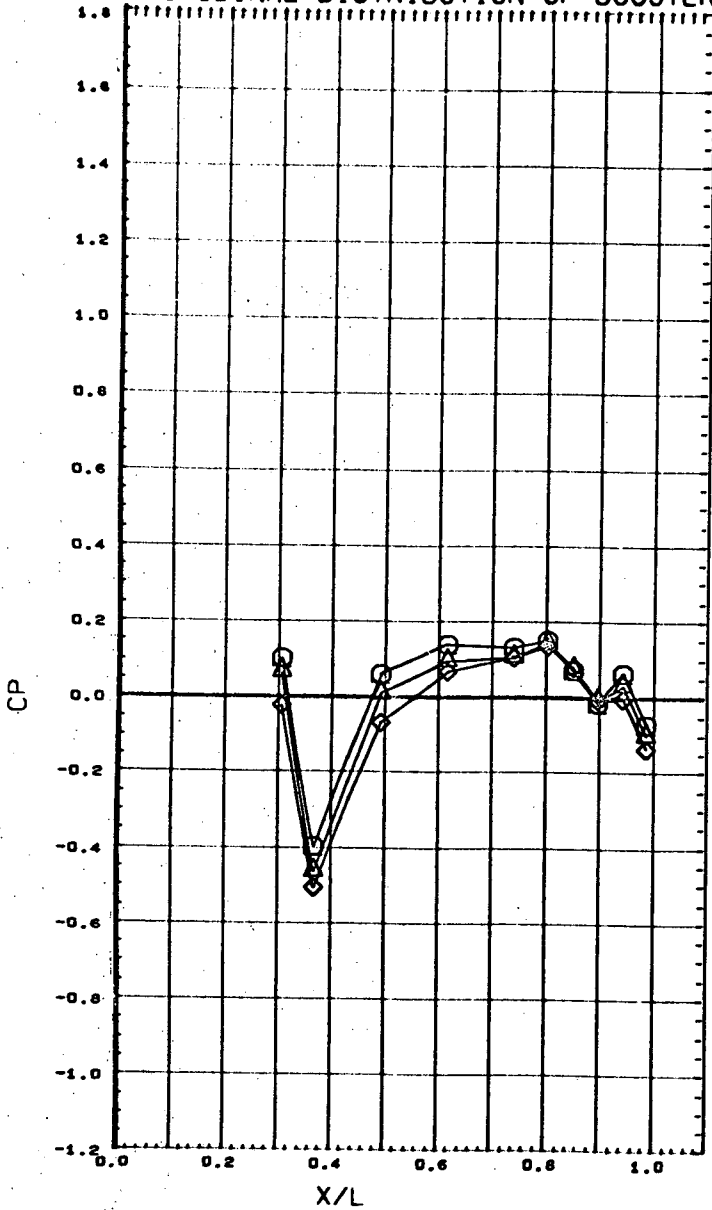

| SYMBOL | BETA | THETA | M1 |
|--------|---------|---------|-------|
| ○ | - 3.704 | 90.000 | 1.100 |
| △ | - 0.004 | 180.000 | |
| ◇ | 3.758 | | |

| PARAMETRIC VALUES | | | |
|-------------------|-------|------|-------|
| ALFB | 6.000 | DX/L | 0.000 |
| I | 0.000 | | |

REFERENCE FILE

LONGITUDINAL DISTRIBUTION OF BOOSTER FUSELAGE PRESSURES

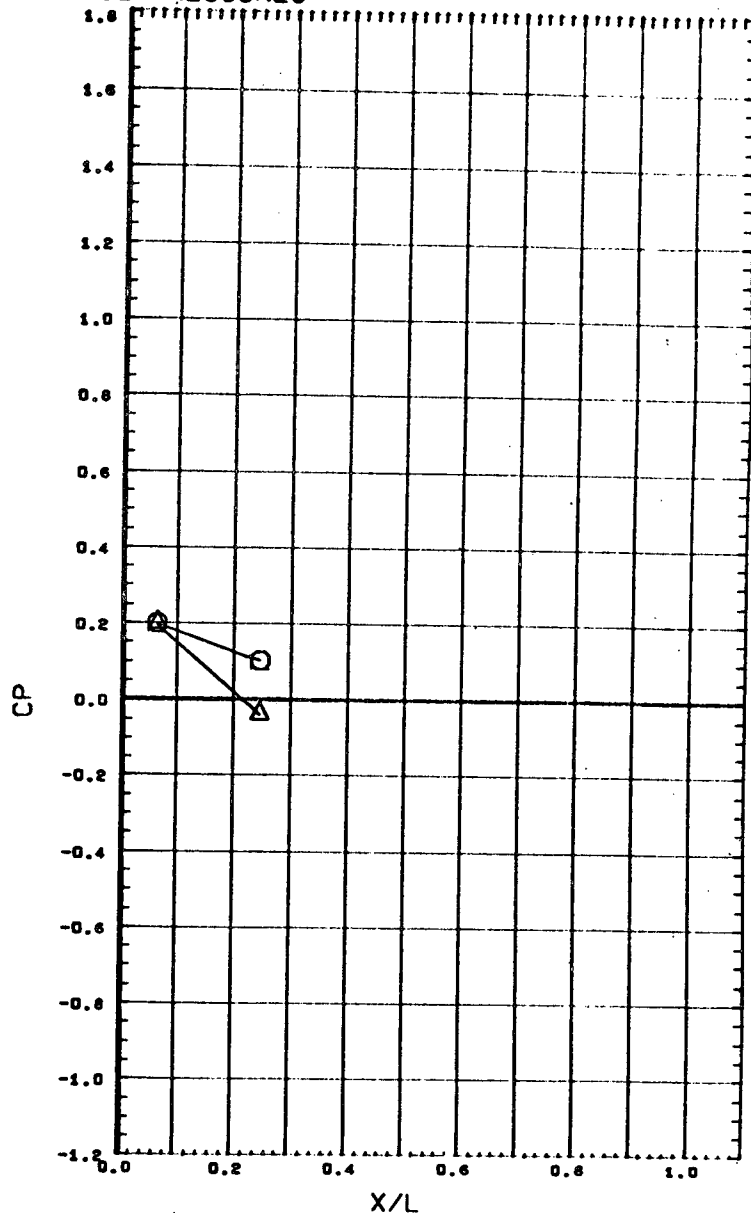
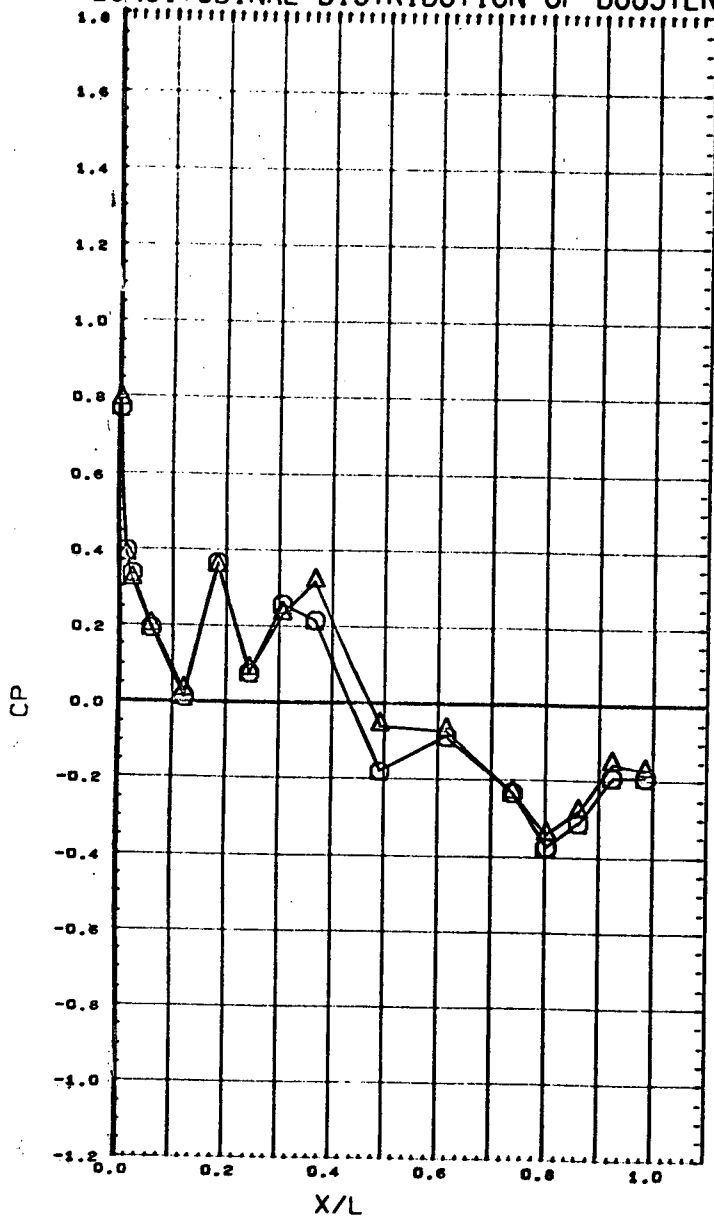

| SYMBOL | BETA | THETA | M1 |
|--------|-------|--------|-------|
| ○ | 3.879 | 0.000 | 1.202 |
| △ | 3.779 | 15.000 | |

| PARAMETRIC VALUES | | |
|-------------------|-------|-------|
| ALFB | 6.000 | DX/L |
| I | 0.000 | 0.000 |

REFERENCE FILE

LONGITUDINAL DISTRIBUTION OF BOOSTER FUSELAGE PRESSURES

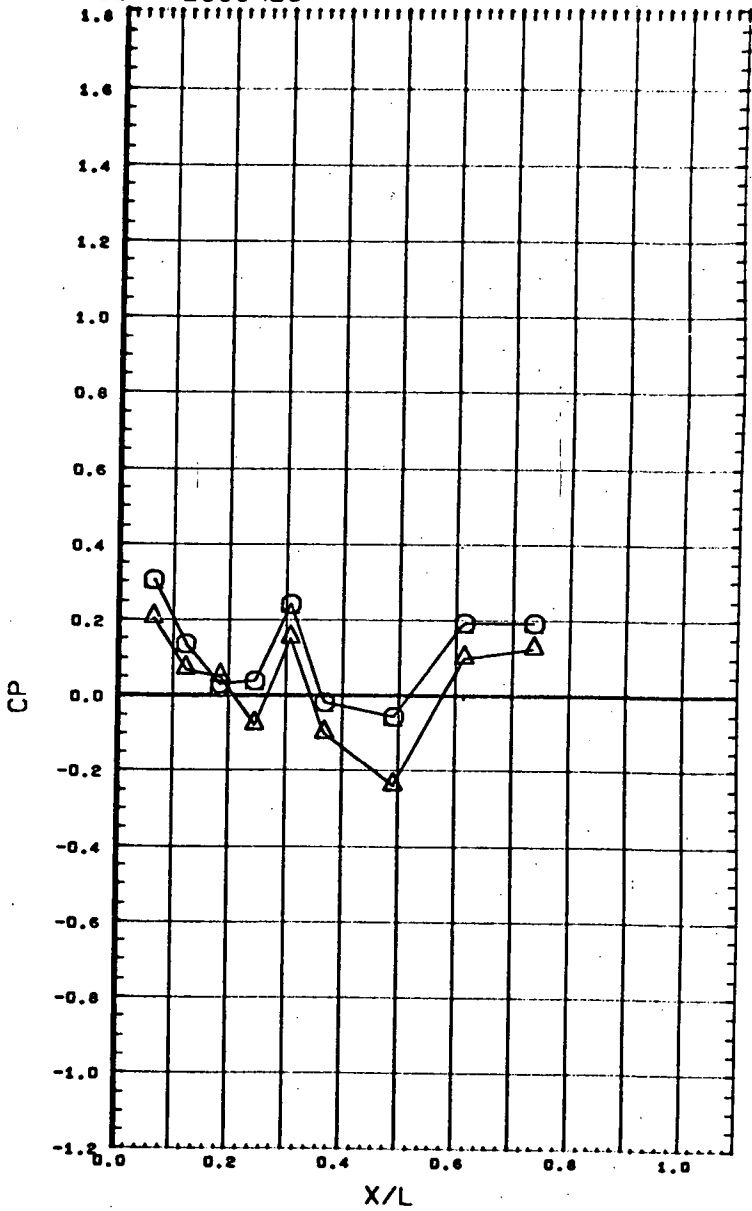
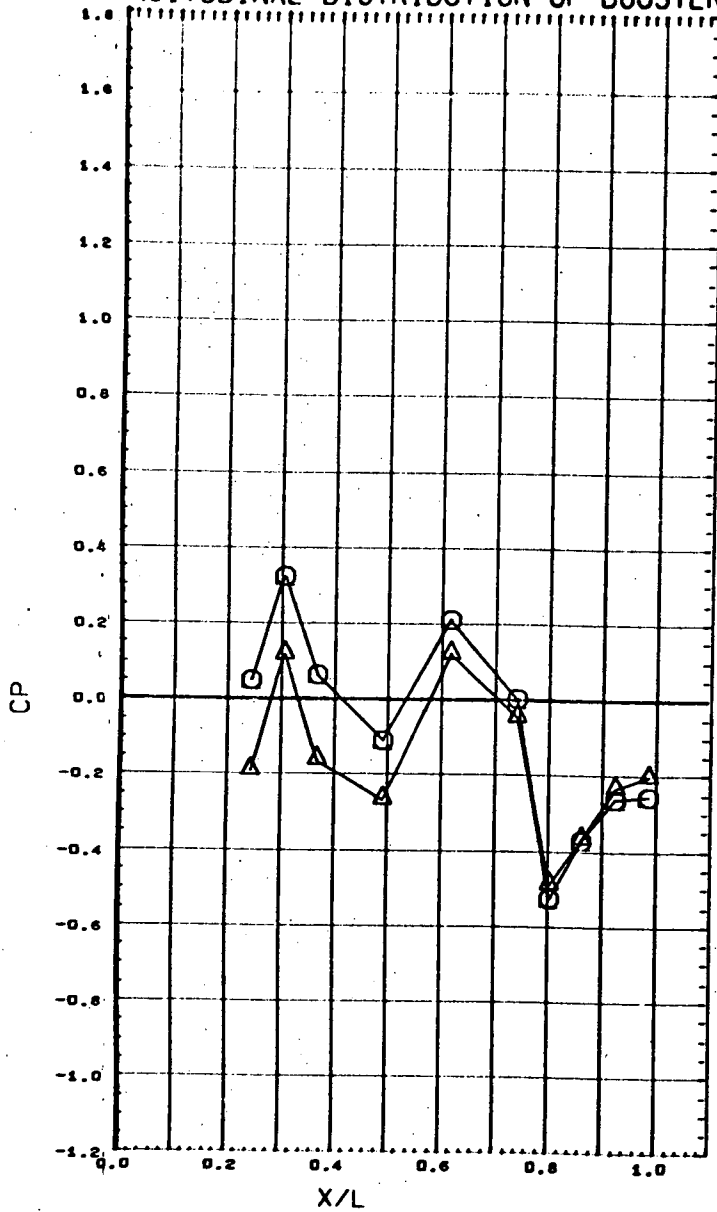

| SYMBOL | BETA | THETA | M1 |
|--------|-------|--------|-------|
| ○ | 3.879 | 24.000 | 1.202 |
| △ | 3.779 | 45.000 | |

| PARAMETRIC VALUES | | |
|-------------------|-------|-------|
| ALFB | 6.000 | DX/L |
| I | 0.000 | 0.000 |

REFERENCE FILE

LONGITUDINAL DISTRIBUTION OF BOOSTER FUSELAGE PRESSURES

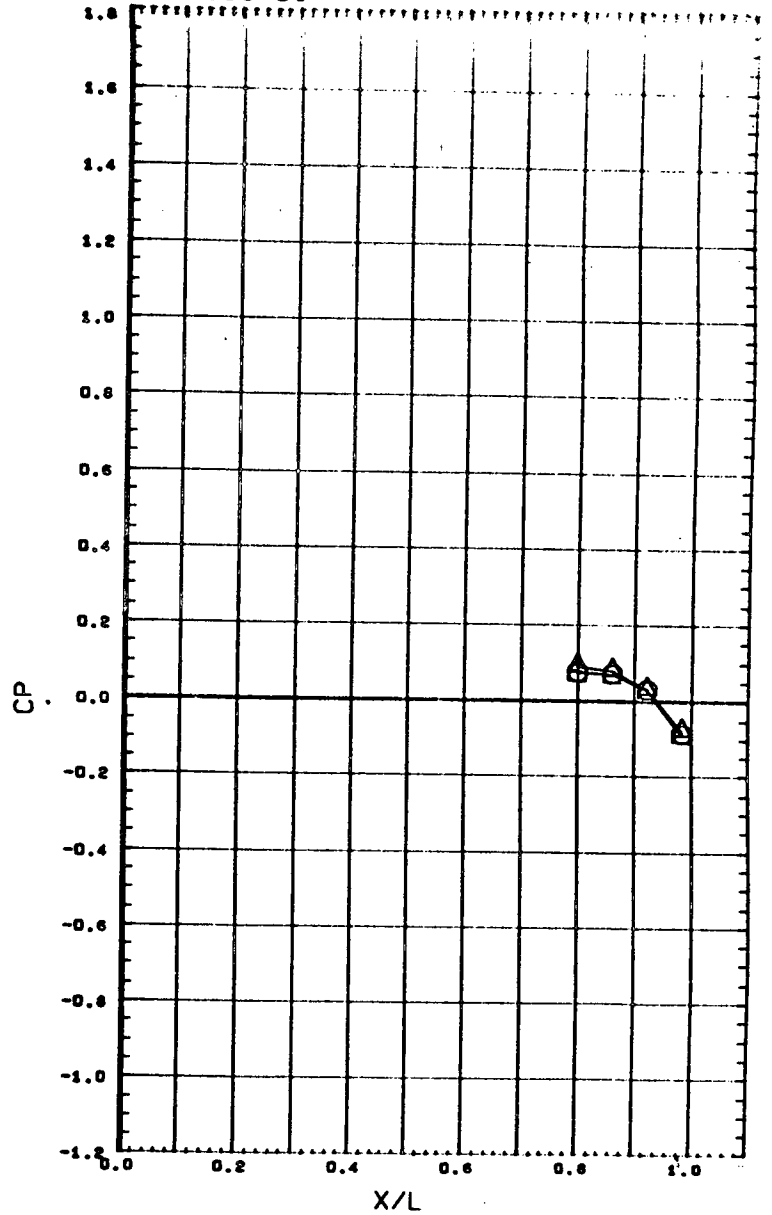
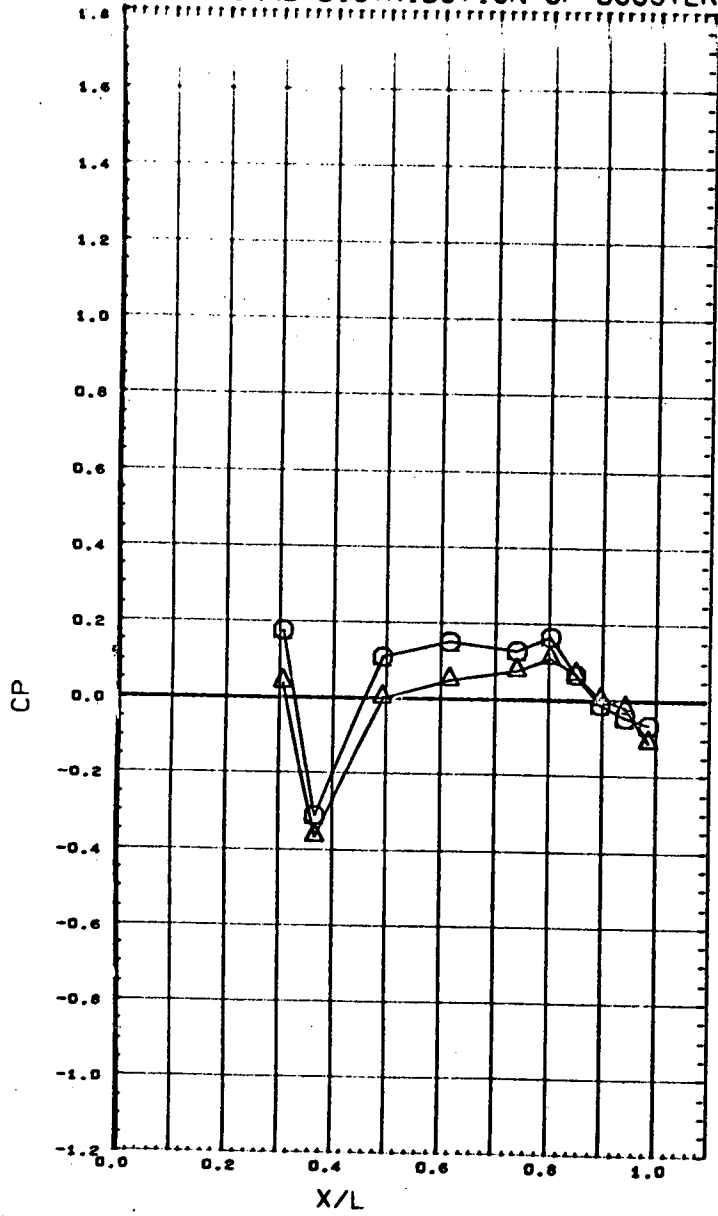

| SYMBOL | BETA | THETA | M1 |
|--------|-------|---------|-------|
| ○ | 3.879 | 99.000 | 1.202 |
| △ | 3.779 | 189.000 | |

| PARAMETRIC VALUES | | |
|-------------------|-------|------------|
| ALPB | 6.000 | CX/L 0.000 |
| I | 0.000 | |

REFERENCE FILE

LONGITUDINAL DISTRIBUTION OF BOOSTER FUSELAGE PRESSURES

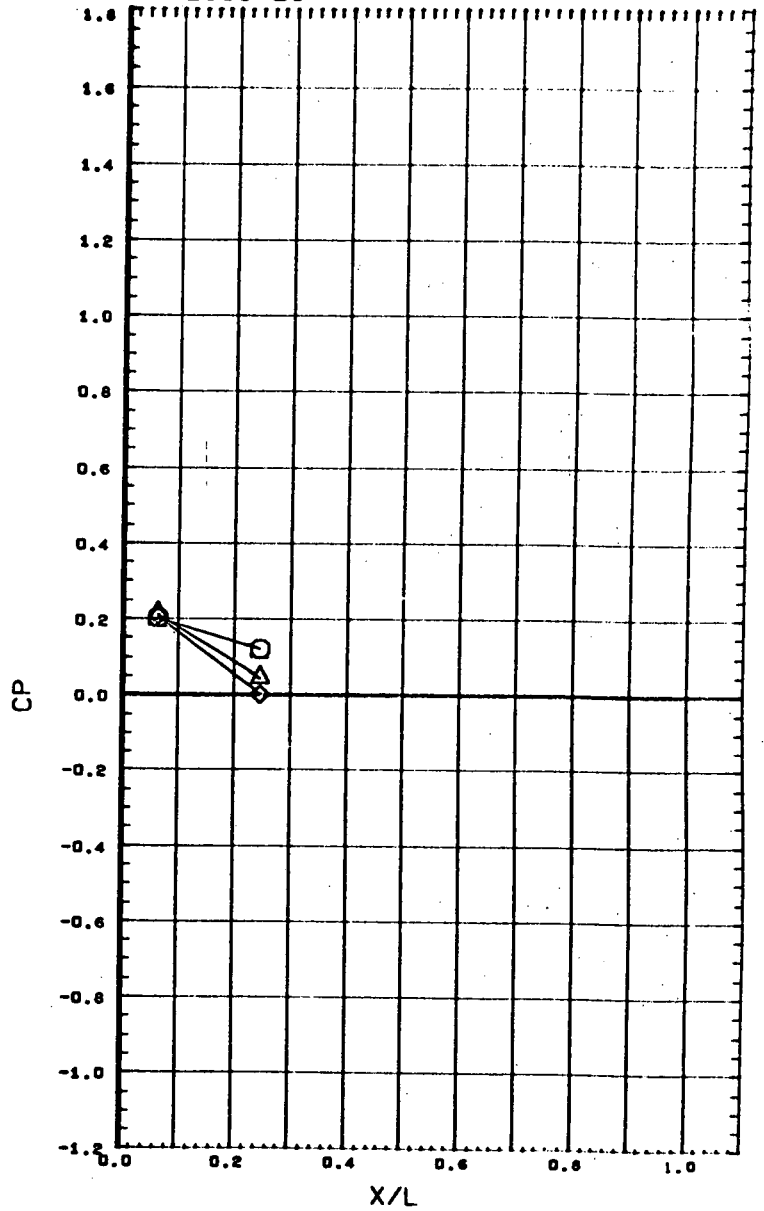
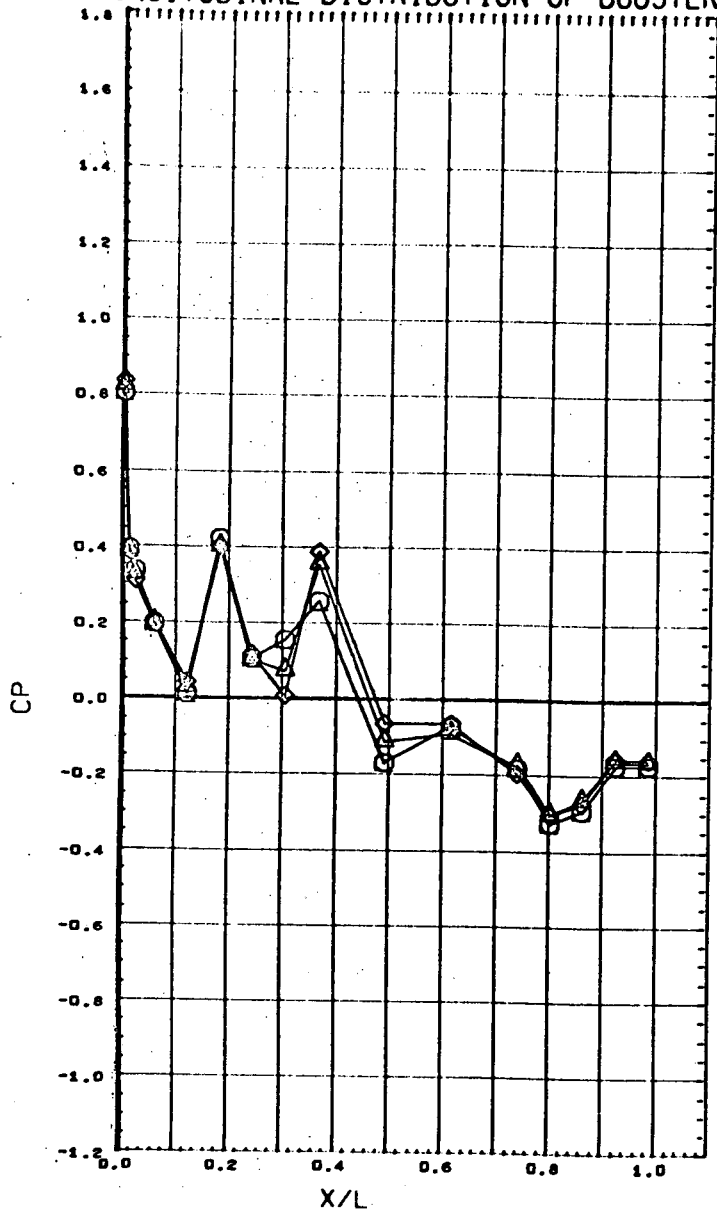

| SYMBOL | BETA | THETA | M1 |
|--------|-------|--------|-------|
| ○ | 3.842 | 0.000 | 1.298 |
| △ | 0.036 | 15.000 | |
| ◇ | 3.887 | | |

| PARAMETRIC VALUES | | | |
|-------------------|-------|------|-------|
| ALFB | 6.000 | DX/L | 0.000 |
| I | 0.000 | | |

REFERENCE FILE

AEDC TC174 MDAC BOOSTER NEAR ORBITER (BODY)

(ATC004)

PAGE 115

LONGITUDINAL DISTRIBUTION OF BOOSTER FUSELAGE PRESSURES

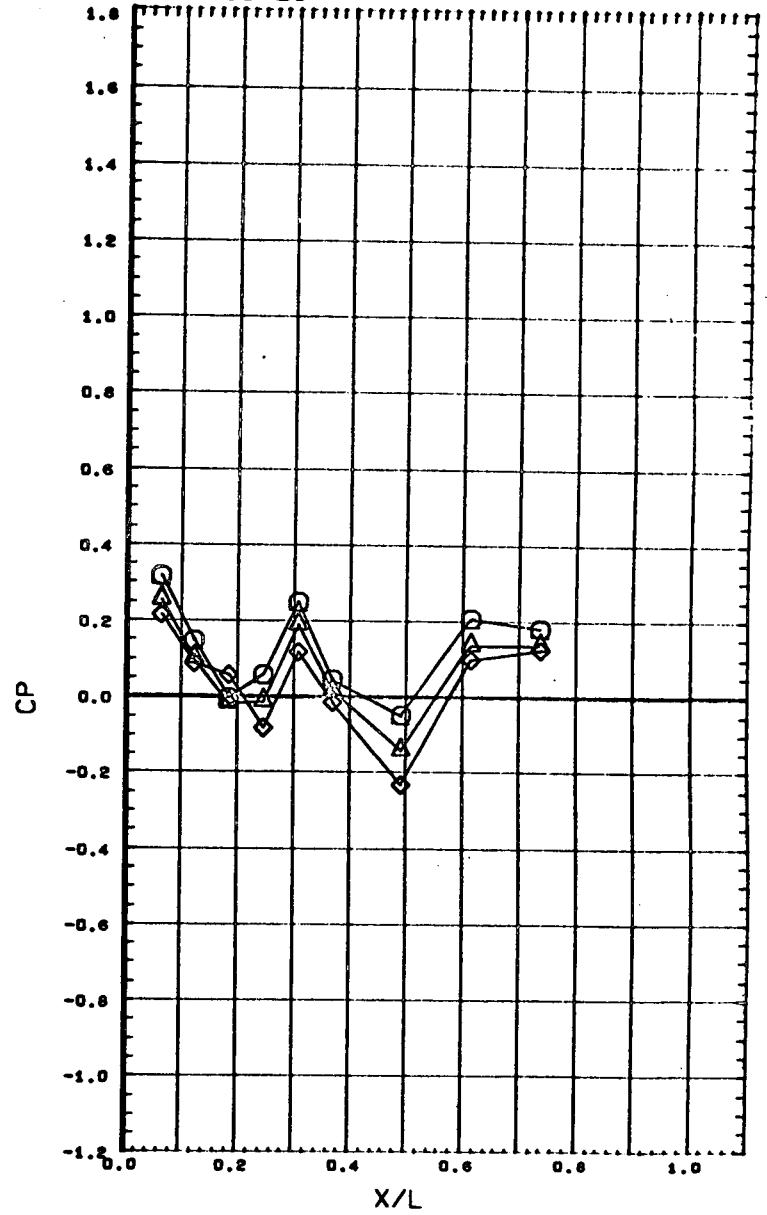
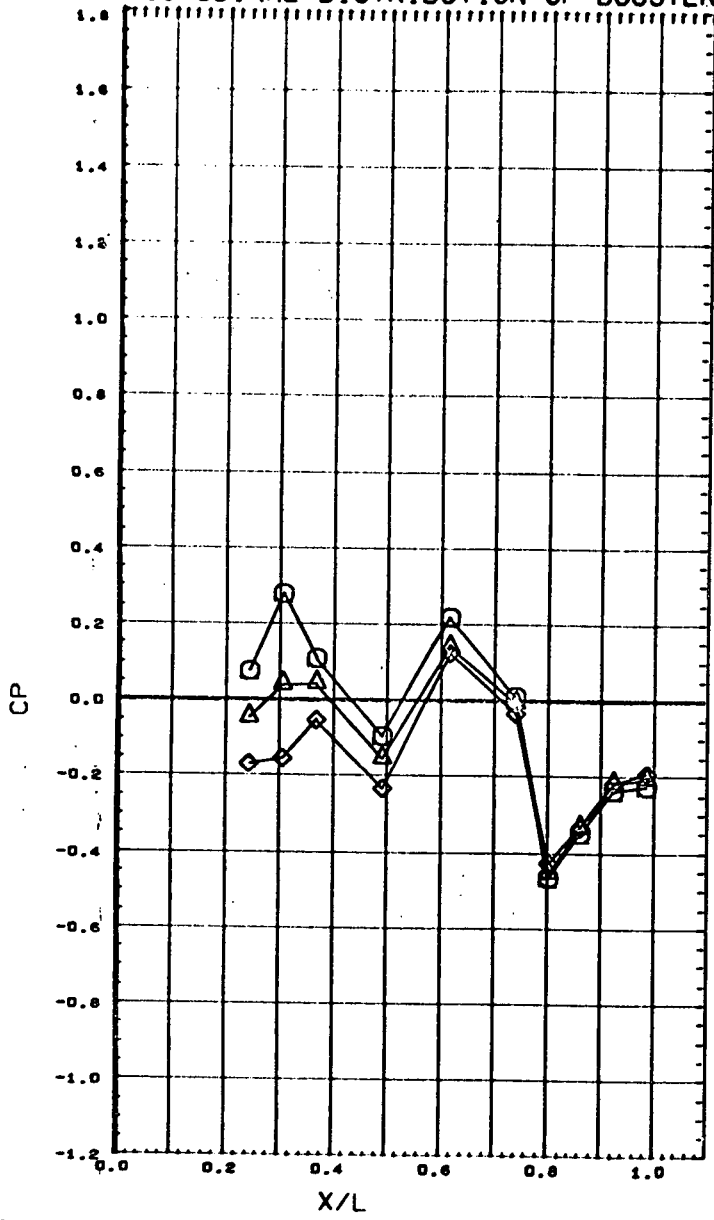

| SYMBOL | BETA | THETA | M1 |
|--------|-------|--------|-------|
| ○ | 3.642 | 24.000 | 1.298 |
| △ | 0.036 | 45.000 | |
| ◇ | 3.887 | | |

| PARAMETRIC VALUES | | |
|-------------------|-------|-------|
| ALPB | 6.000 | 0x/L |
| I | 0.000 | 0.000 |

REFERENCE FILE

LONGITUDINAL DISTRIBUTION OF BOOSTER FUSELAGE PRESSURES

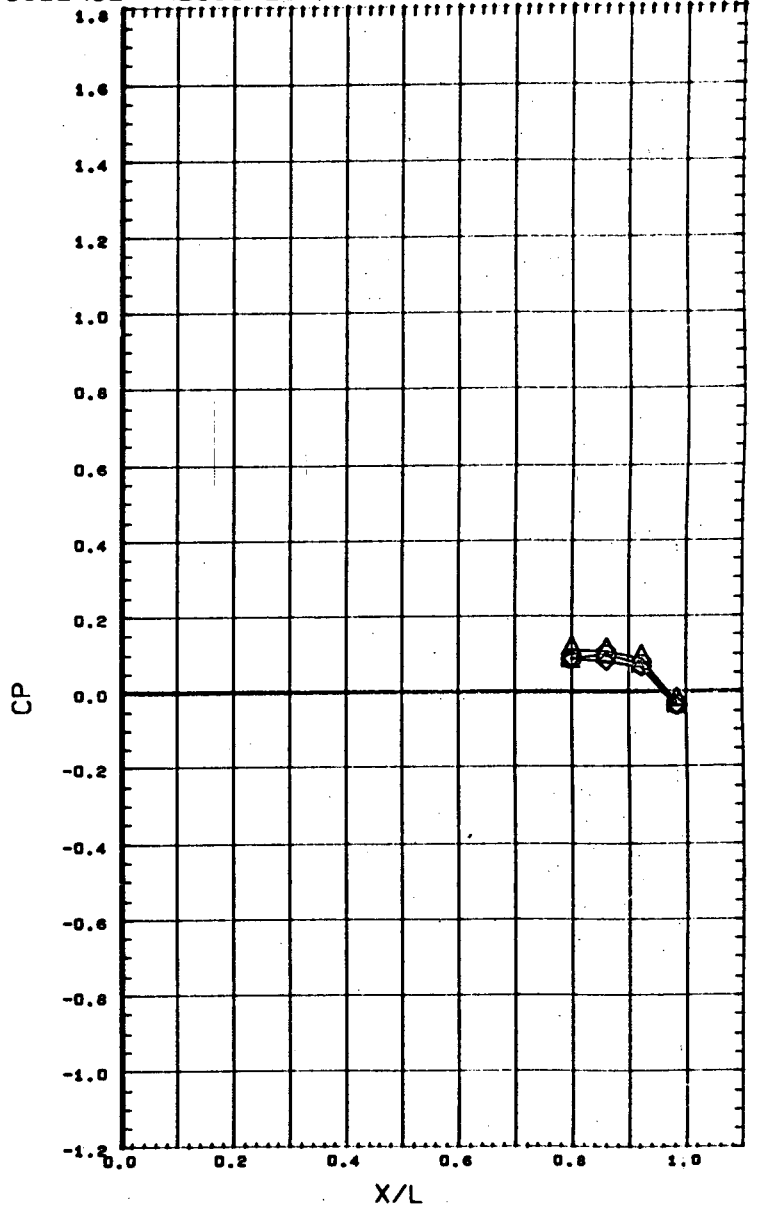
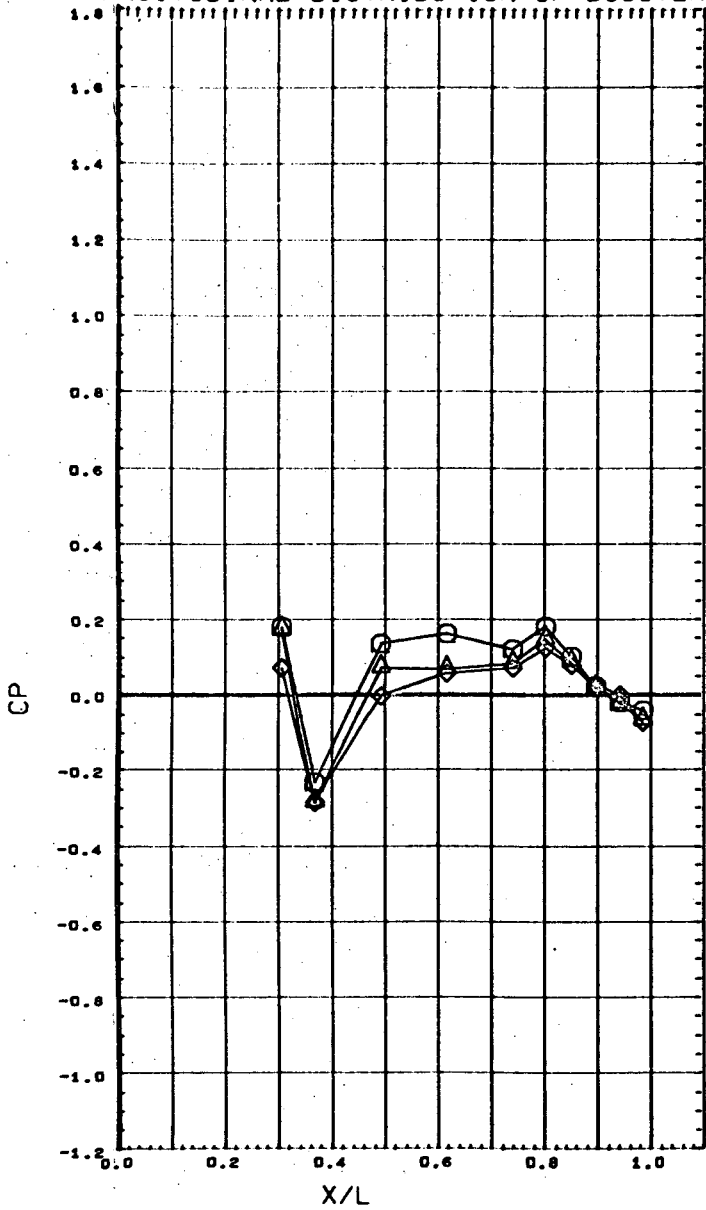

| SYMBOL | BETA | THETA | M1 |
|--------|-------|---------|-------|
| ○ | 3.842 | 90.000 | 1.298 |
| △ | 0.036 | 180.000 | |
| ◇ | 3.887 | | |

| PARAMETRIC VALUES | | | |
|-------------------|-------|------|-------|
| ALFB | 6.000 | DX/L | 0.000 |
| I | 0.000 | | |

REFERENCE FILE

LONGITUDINAL DISTRIBUTION OF BOOSTER FUSELAGE PRESSURES

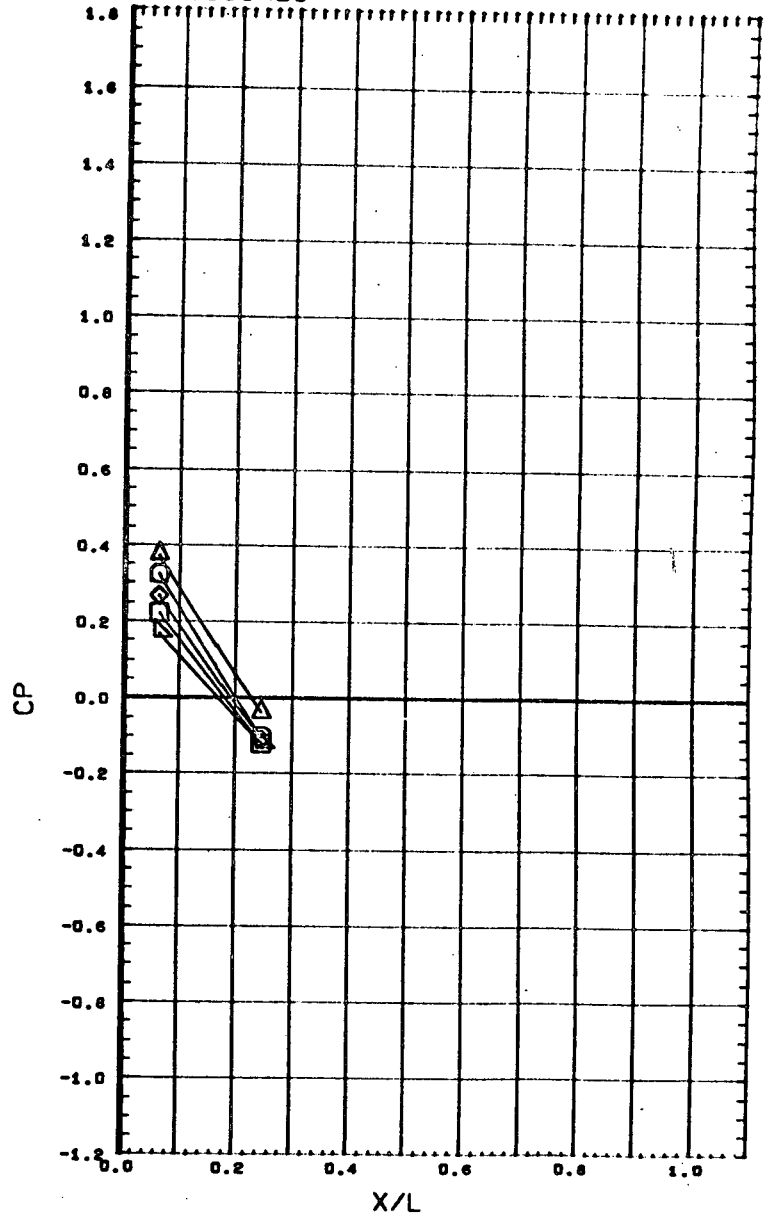
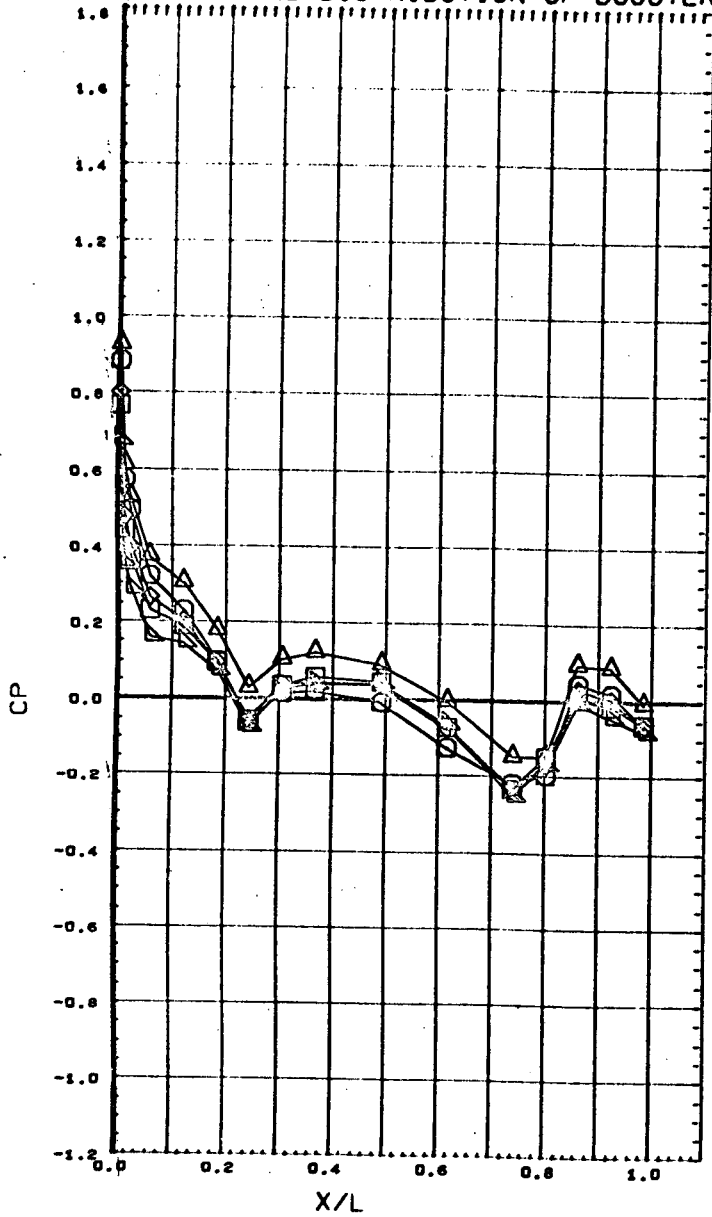

| SYMBOL | ALFB | THETA | M1 |
|--------|-------|--------|-------|
| ○ | 8.140 | 0.000 | 0.597 |
| △ | 5.877 | 15.050 | |
| ◇ | 3.890 | | |
| □ | 2.290 | | |
| ▽ | 0.129 | | |

REFERENCE FILE

| PARAMETRIC VALUES | | | |
|-------------------|-------|------|-------|
| BETA | 0.000 | DX/L | 0.036 |
| I | 0.000 | | |

LONGITUDINAL DISTRIBUTION OF BOOSTER FUSELAGE PRESSURES

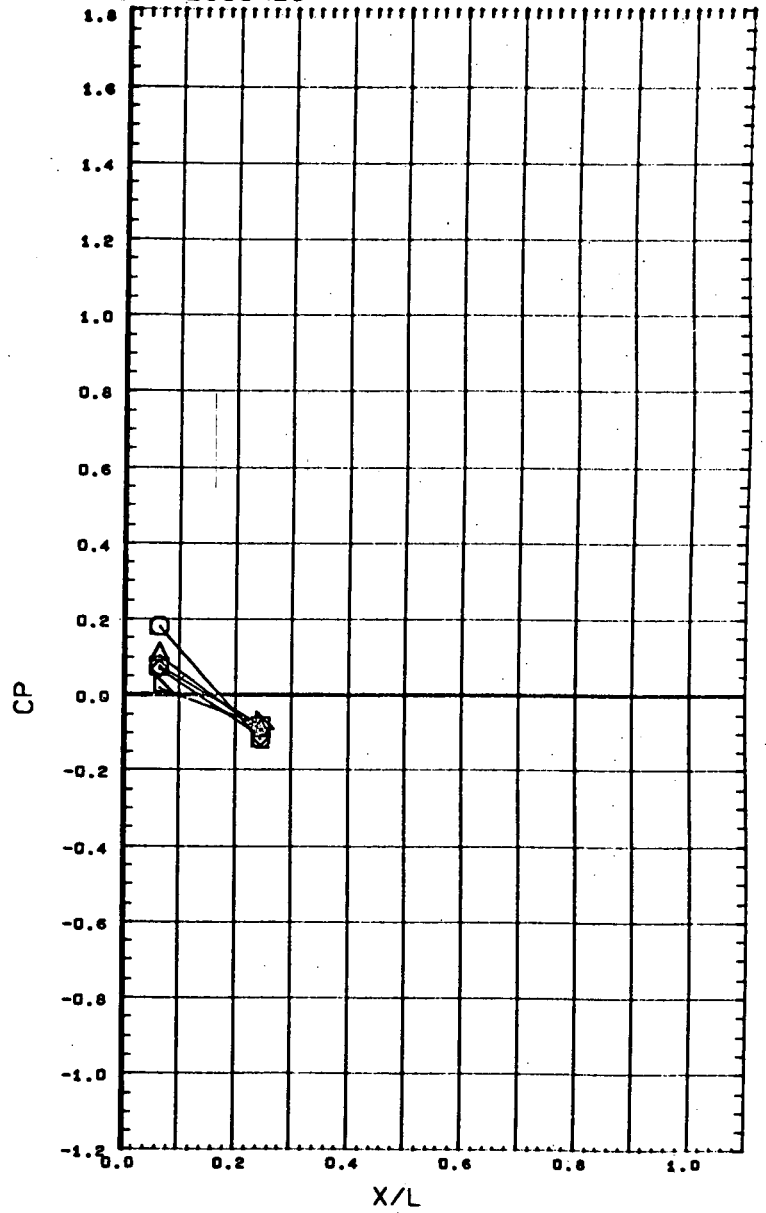
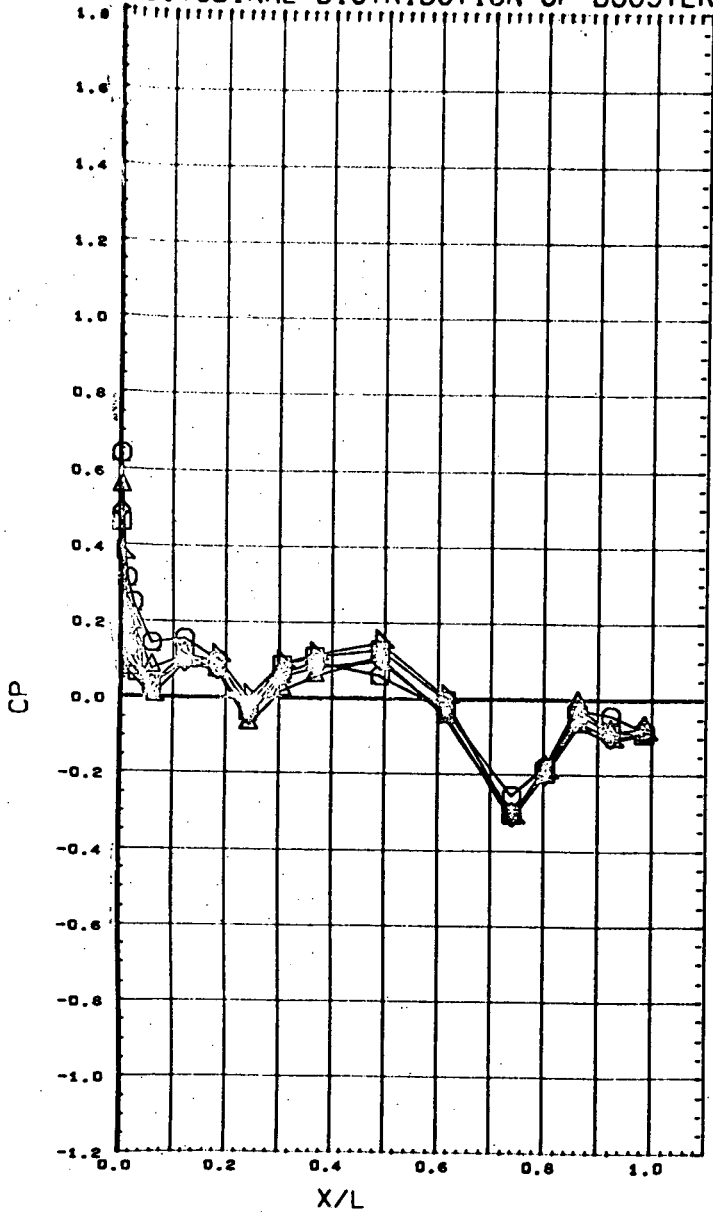

| SYMBOL | ALFO | THETA | M1 |
|--------|--------|--------|-------|
| ○ | 2.108 | 0.000 | 0.597 |
| ◇ | 3.102 | 15.000 | |
| △ | 5.080 | | |
| □ | 7.688 | | |
| ○ | 10.114 | | |

REFERENCE FILE

| PARAMETRIC VALUES | | |
|-------------------|-------|------------|
| BETA | 0.000 | DX/L 0.036 |
| I | 0.000 | |

LONGITUDINAL DISTRIBUTION OF BOOSTER FUSELAGE PRESSURES

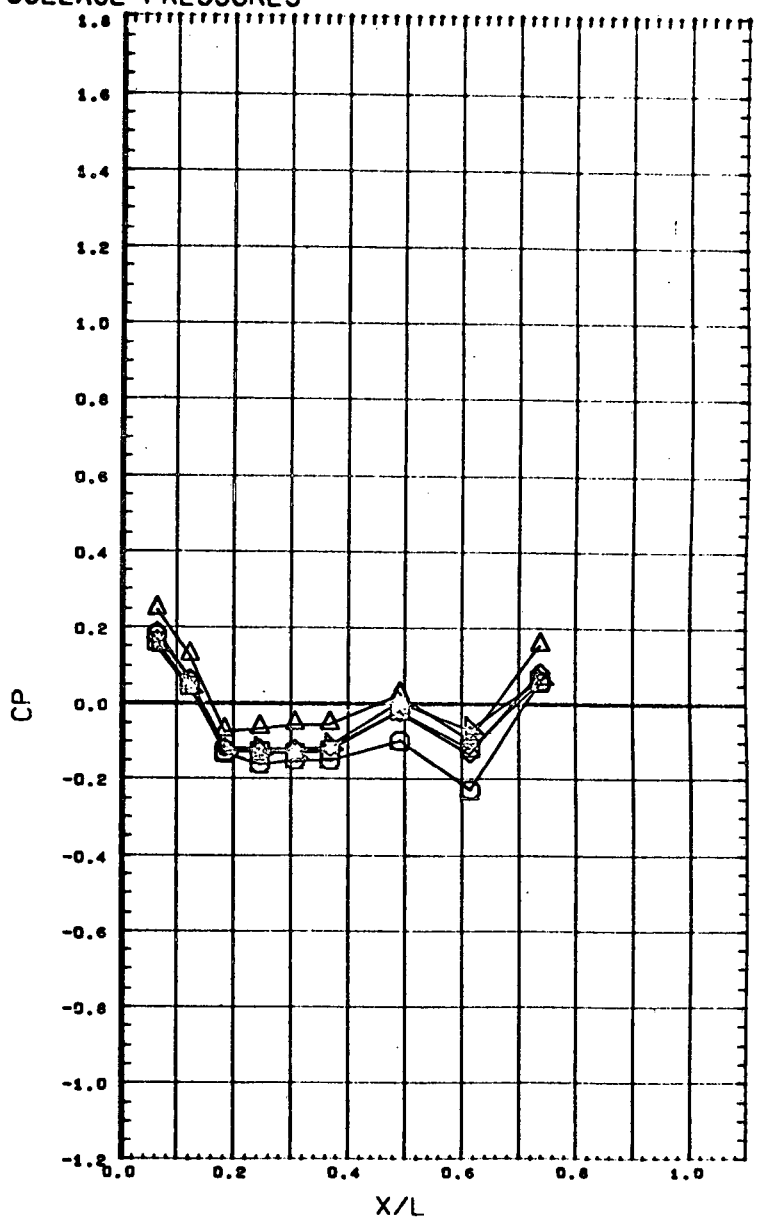
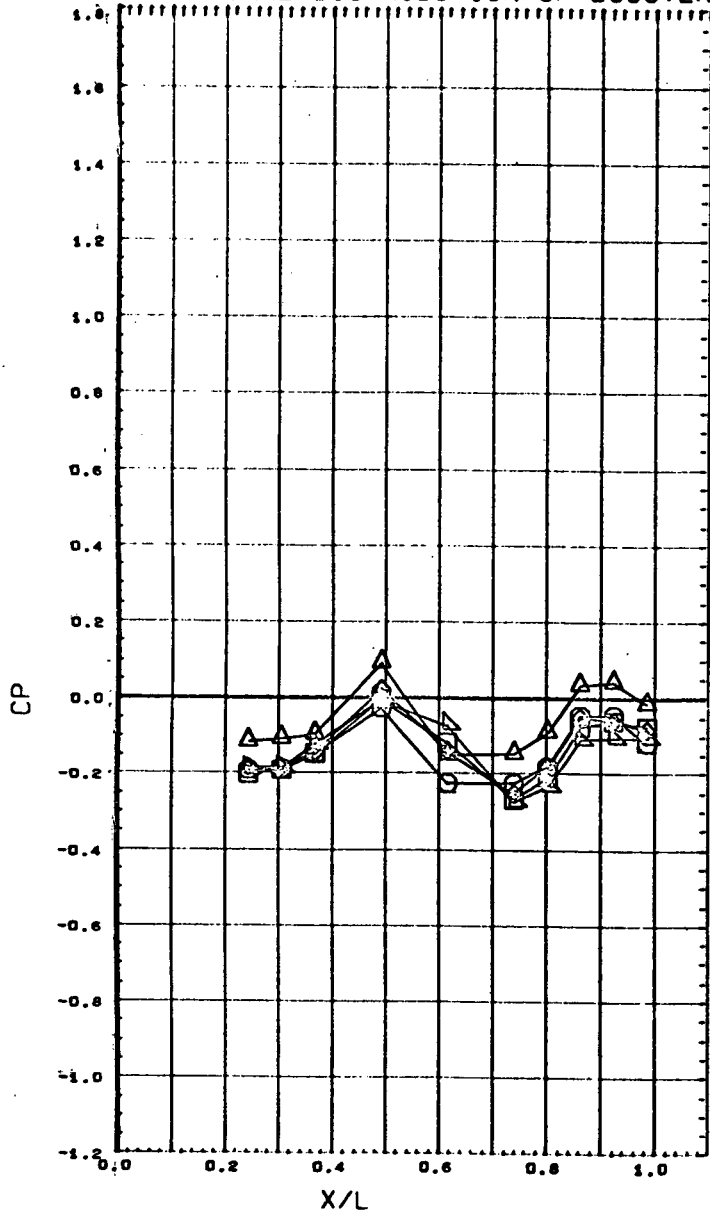

| SYMBOL | ALFD | THETA | H1 |
|--------|-------|--------|-------|
| △ | 8.140 | 24.000 | 0.597 |
| ◇ | 5.877 | 45.000 | |
| ○ | 5.890 | | |
| □ | 2.290 | | |
| ○ | 0.129 | | |

REFERENCE FILE

| PARAMETRIC VALUES | | |
|-------------------|-------|------------|
| BETA | 0.000 | DX/L 0.036 |
| I | 0.000 | |

LONGITUDINAL DISTRIBUTION OF BOOSTER FUSELAGE PRESSURES

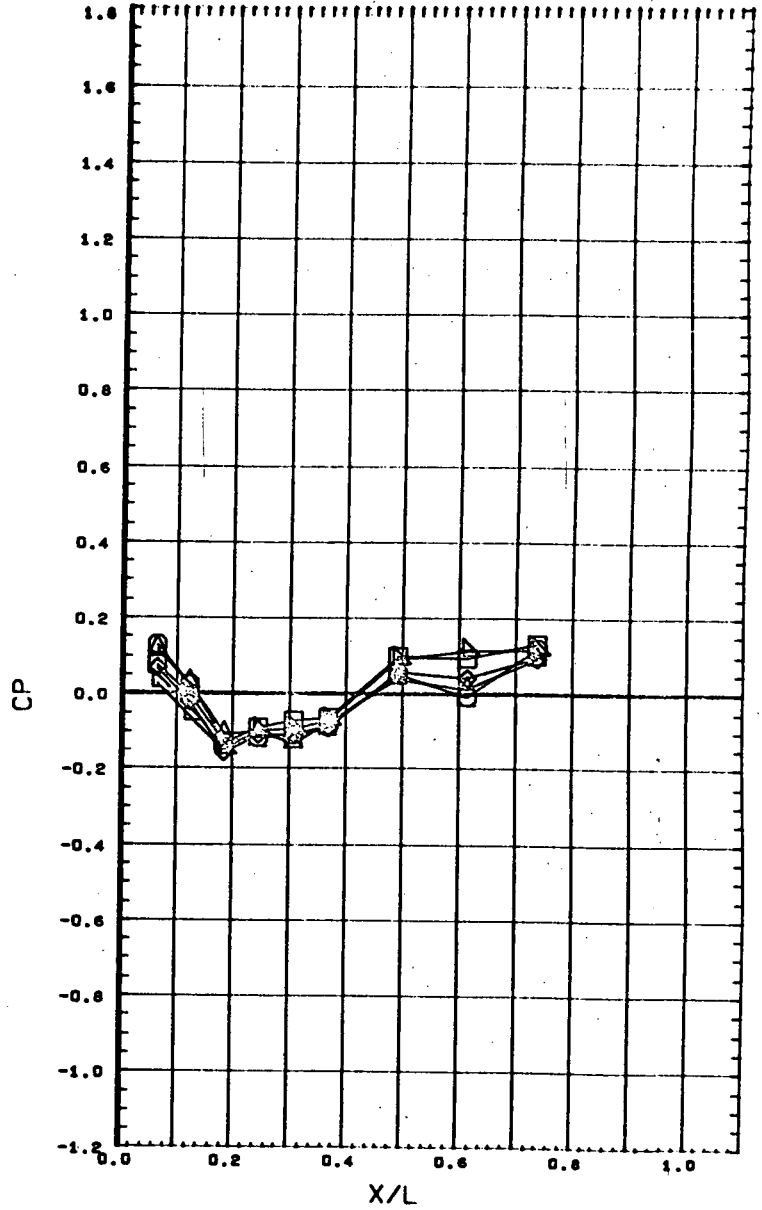
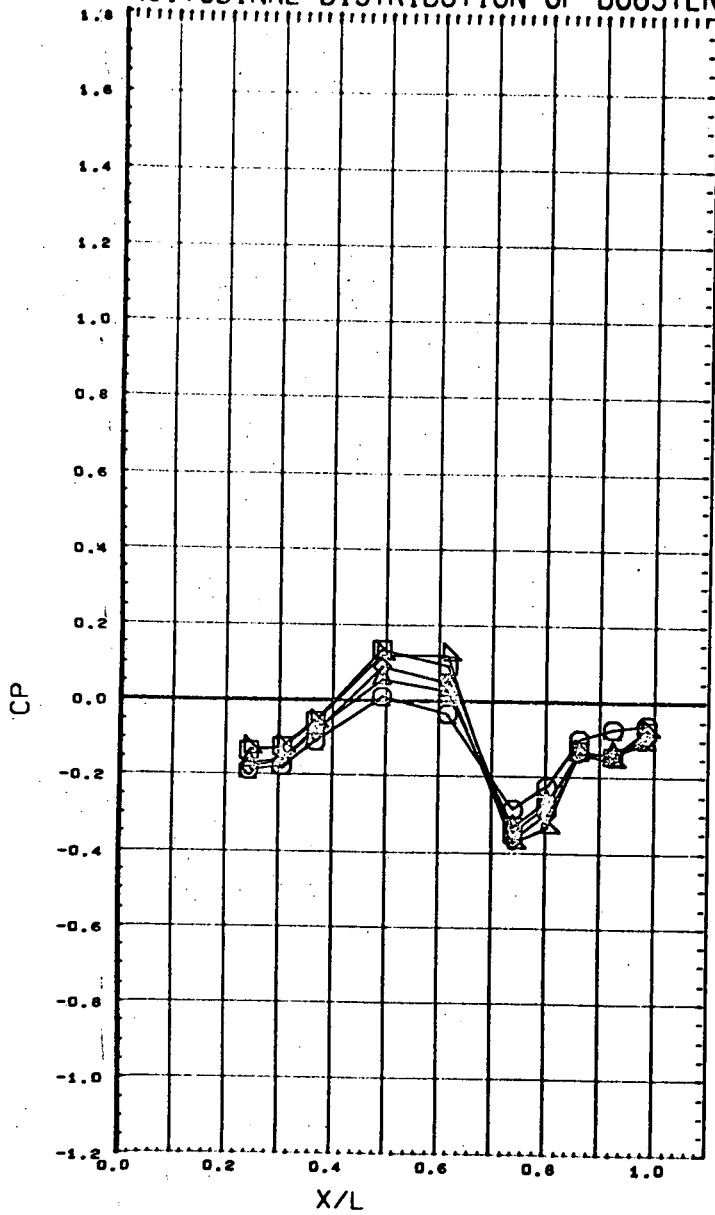

| SYMBOL | ALFB | THETA | M1 |
|--------|--------|--------|-------|
| ○ | 2.108 | 24.000 | 0.597 |
| ◇ | 4.102 | 45.000 | |
| △ | 6.080 | | |
| □ | 7.688 | | |
| ◇ | 10.114 | | |

REFERENCE FILE

| PARAMETRIC VALUES | | |
|-------------------|-------|-------|
| BETA | 0.000 | OX/L |
| I | 0.000 | 0.936 |

LONGITUDINAL DISTRIBUTION OF BOOSTER FUSELAGE PRESSURES

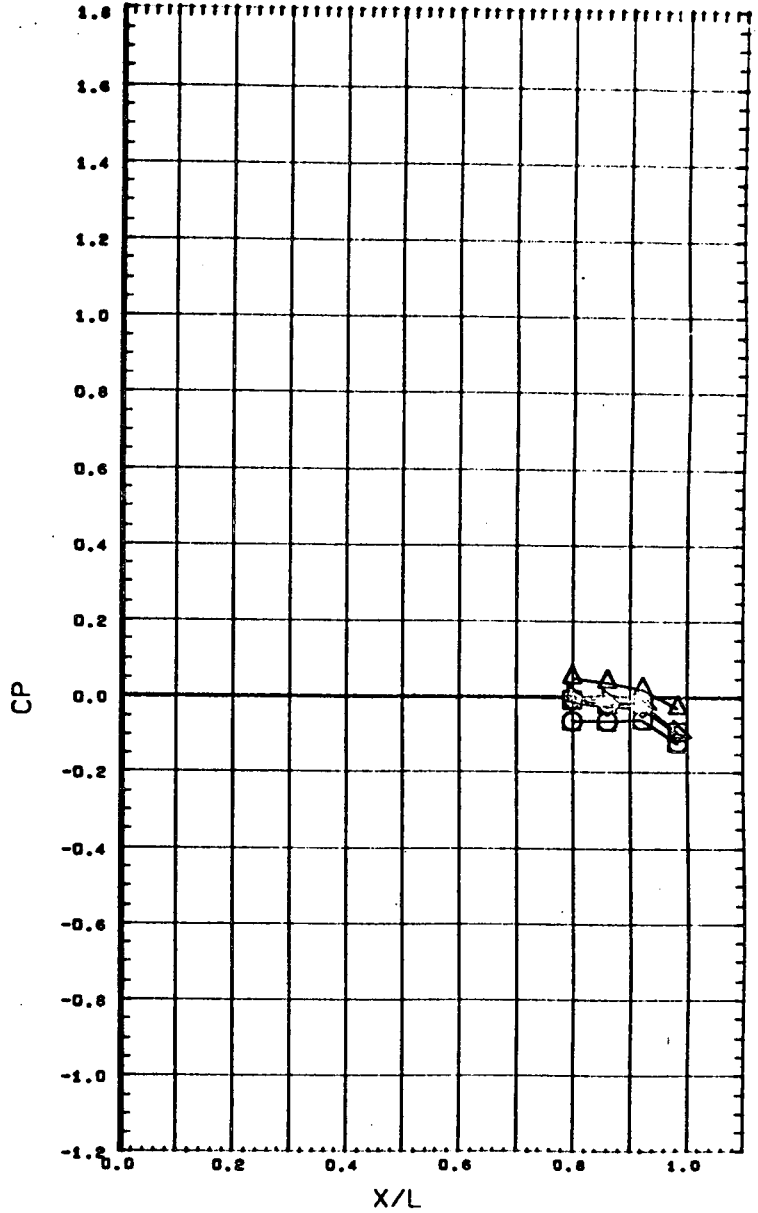
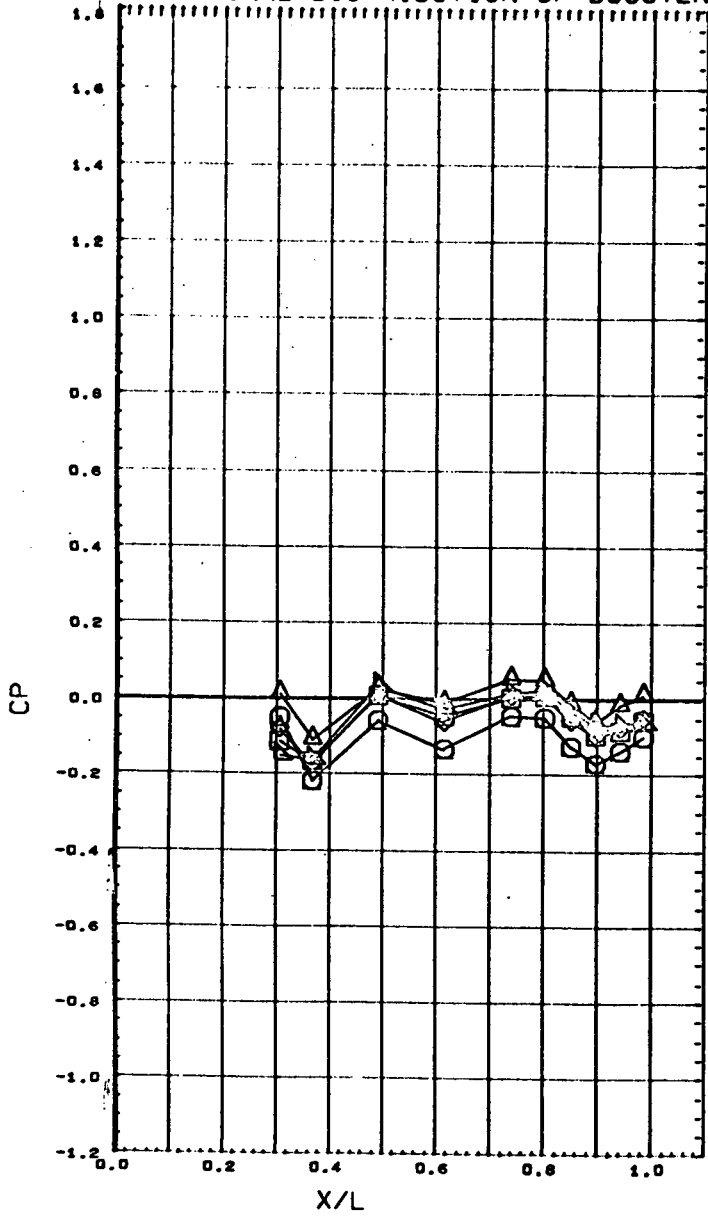

| SYMBOL | ALFB | THETA | M1 |
|--------|-------|---------|-------|
| ○ | 8.140 | 90.000 | 0.597 |
| ◇ | 5.877 | 180.000 | |
| △ | 3.890 | | |
| □ | 2.290 | | |
| ○ | 0.129 | | |

| PARAMETRIC VALUES | | | |
|-------------------|-------|------|-------|
| BETA | 0.000 | DX/L | 0.036 |
| I | 0.000 | | |

REFERENCE FILE

LONGITUDINAL DISTRIBUTION OF BOOSTER FUSELAGE PRESSURES

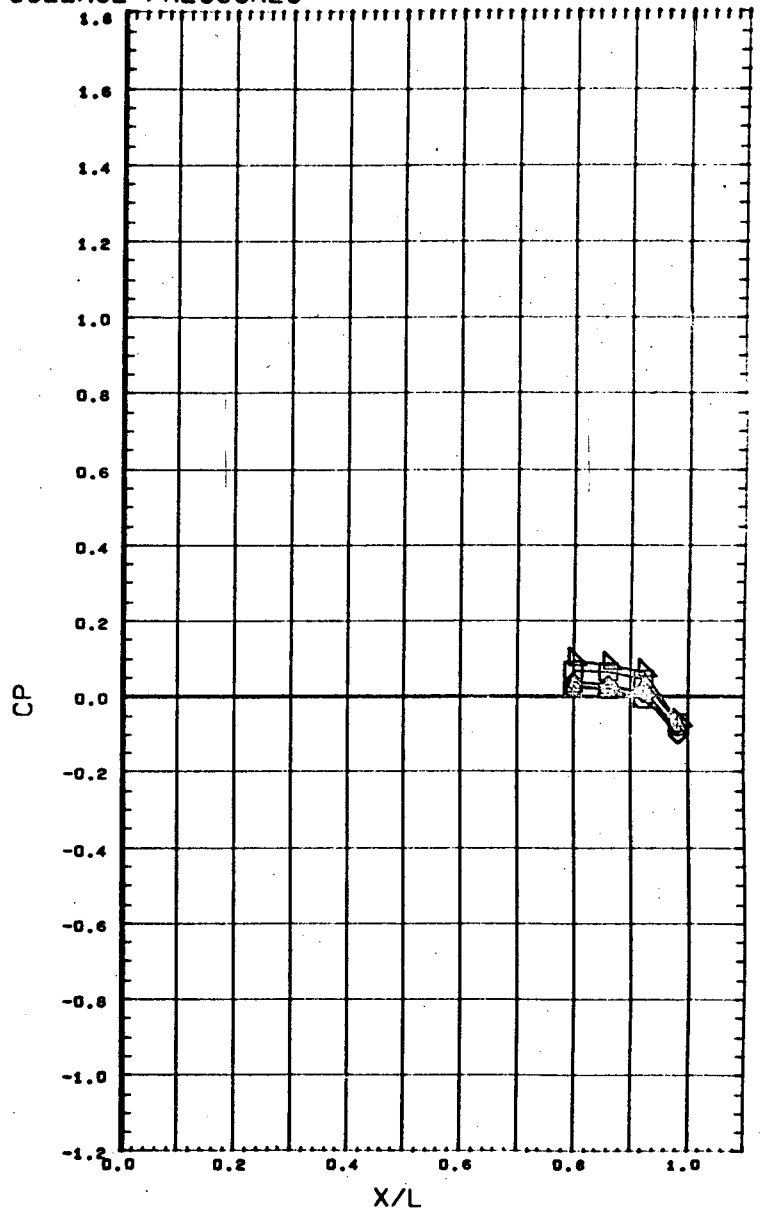
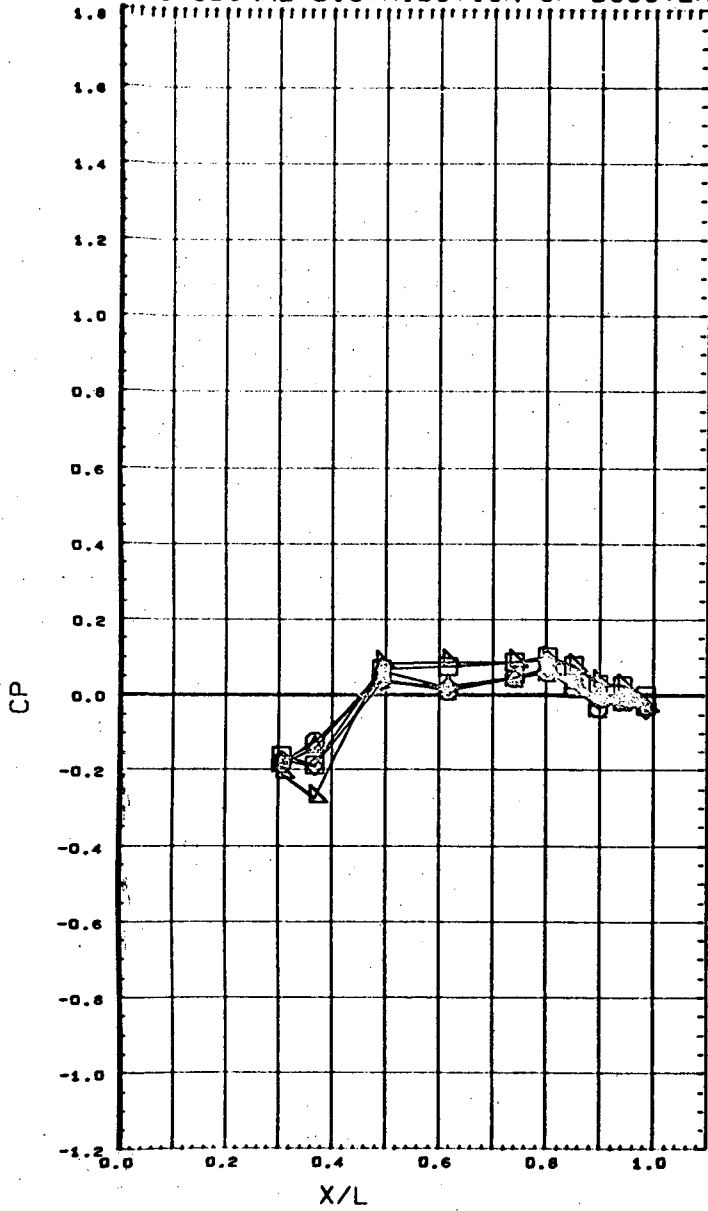

| SYMBOL | ALFB | THETA | M1 |
|--------|--------|---------|-------|
| ○ | 2.108 | 90.000 | 0.597 |
| ◇ | 4.102 | 180.000 | |
| ◇ | 6.080 | | |
| ◇ | 7.688 | | |
| ◇ | 10.114 | | |

| PARAMETRIC VALUES | | | |
|-------------------|-------|------|-------|
| BETA | 0.000 | DX/L | 0.036 |
| I | 0.000 | | |

REFERENCE FILE

LONGITUDINAL DISTRIBUTION OF BOOSTER FUSELAGE PRESSURES

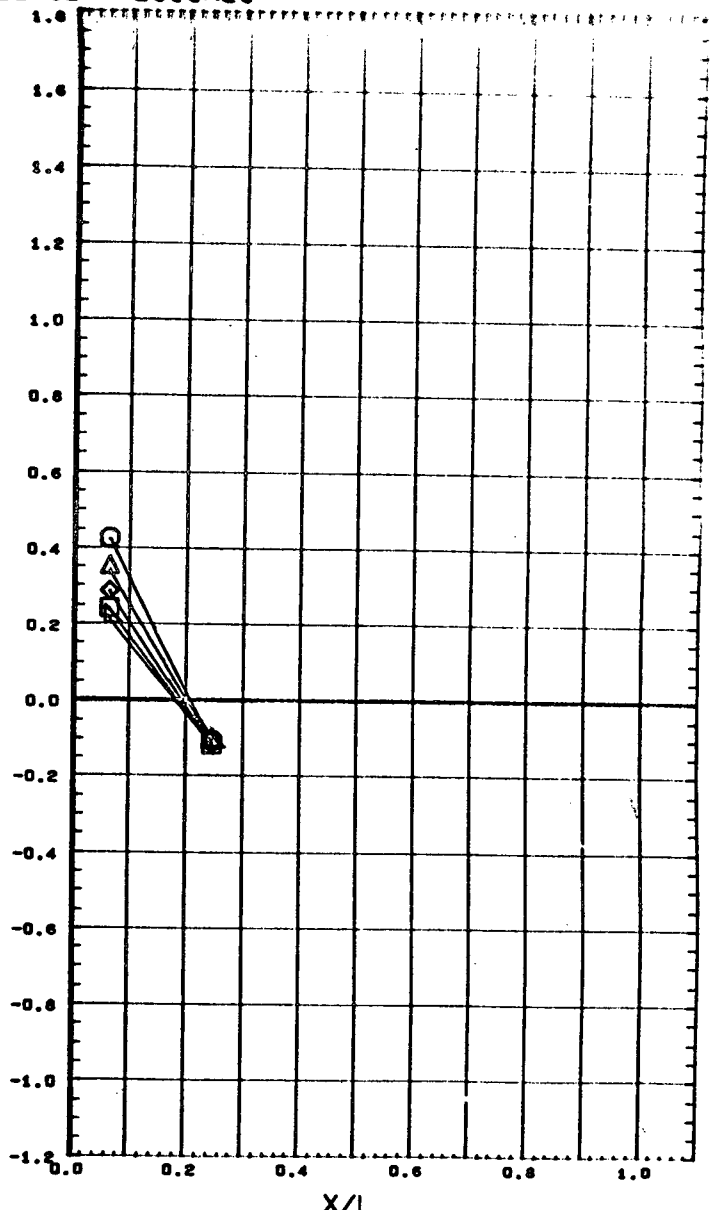
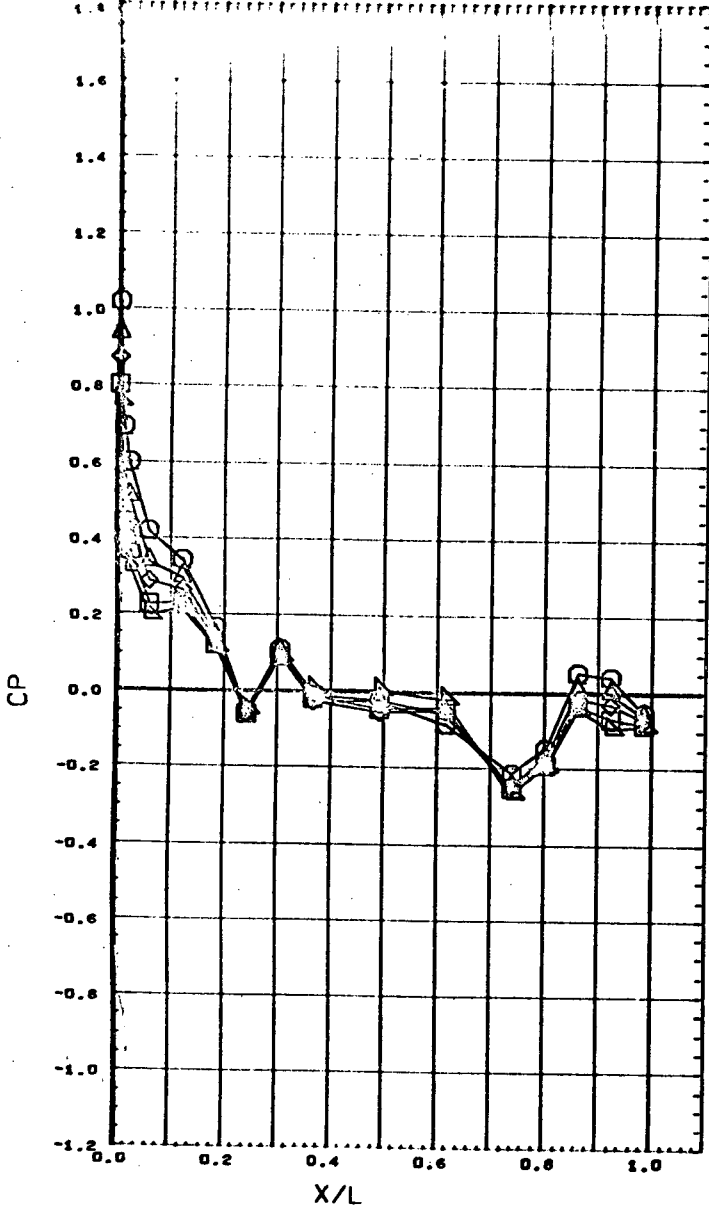

| SYMBOL | ALFB | THETA | M1 |
|--------|-------|--------|-------|
| □ | 8.280 | 0.000 | 0.899 |
| ◇ | 4.452 | 15.000 | |
| △ | 2.200 | | |
| ○ | 0.193 | | |
| ● | 2.085 | | |

| PARAMETRIC VALUES | | | |
|-------------------|-------|------|-------|
| BETA | 0.000 | DX/L | 0.036 |
| I | 0.000 | | |

REFERENCE FILE

LONGITUDINAL DISTRIBUTION OF BOOSTER FUSELAGE PRESSURES

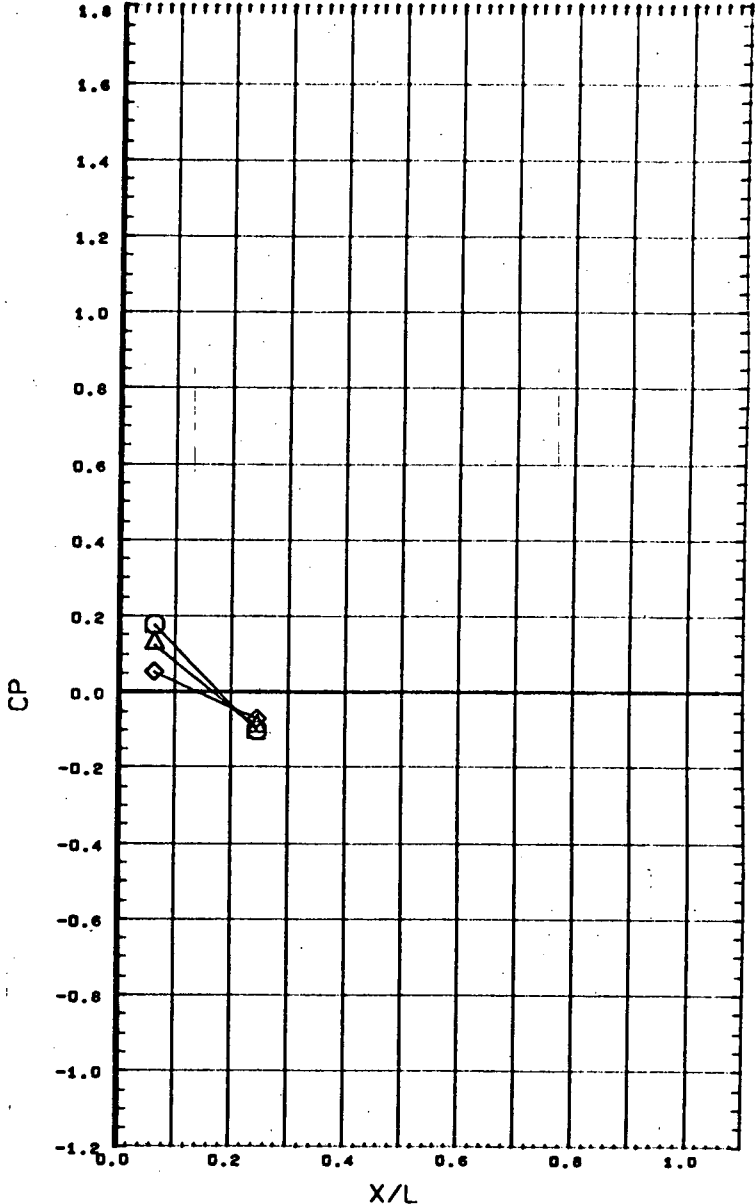
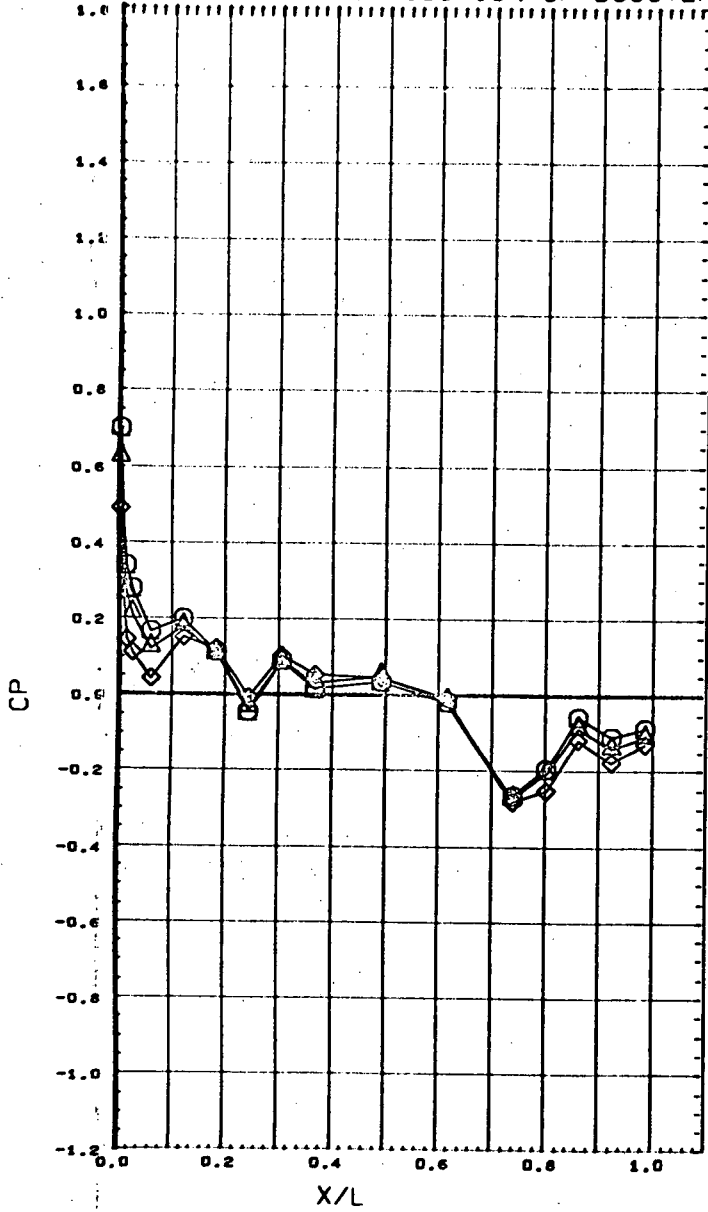

| SYMBOL | ALFB | THETA | M1 |
|--------|--------|--------|-------|
| ○ | 3.719 | 0.000 | 0.899 |
| △ | 6.154 | 15.000 | |
| ◇ | 10.121 | | |

| PARAMETRIC VALUES | | |
|-------------------|-------|-------|
| BETA | 0.000 | OX/L |
| I | 0.000 | 0.036 |

REFERENCE FILE

LONGITUDINAL DISTRIBUTION OF BOOSTER FUSELAGE PRESSURES

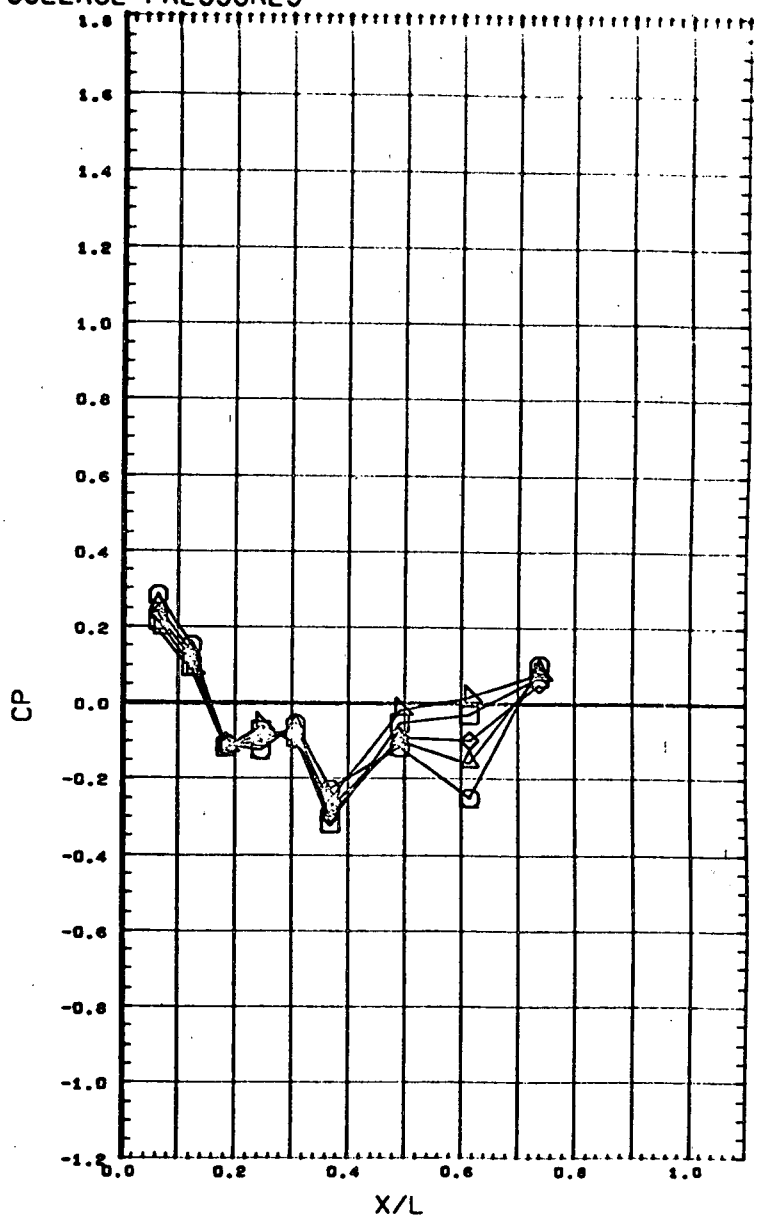
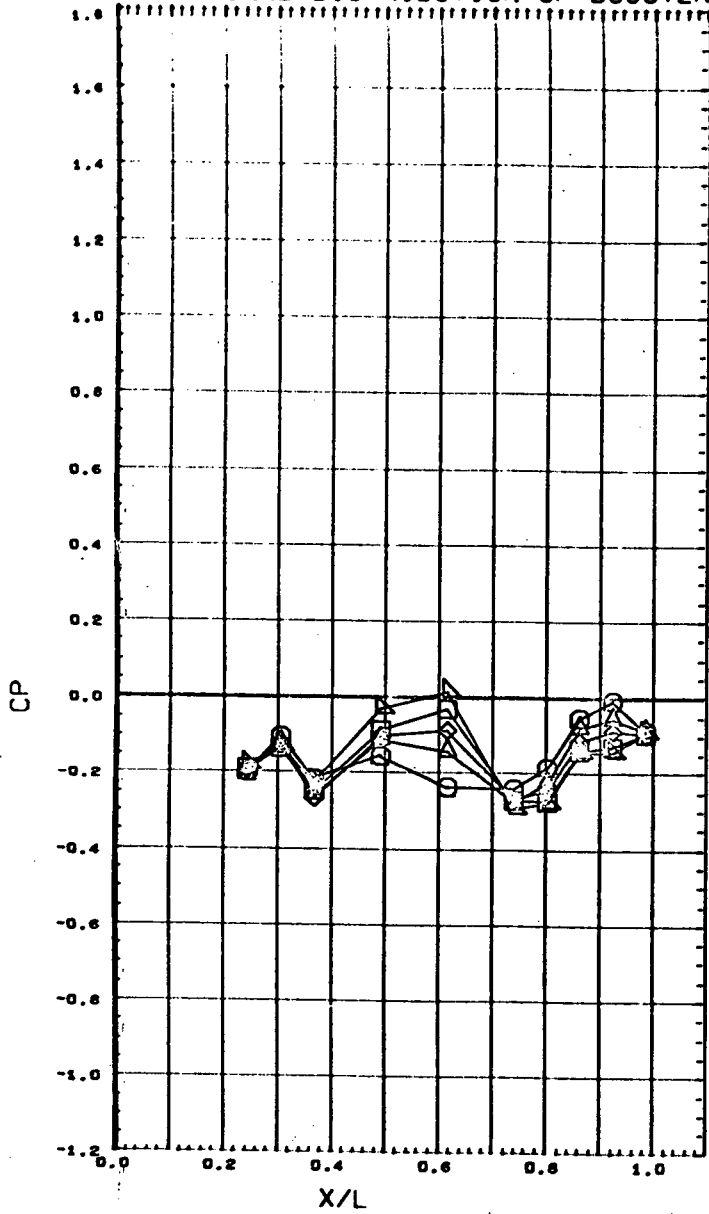

| SYMBOL | ALFB | THETA | M1 |
|--------|-------|--------|-------|
| ○ | 8.280 | 24.000 | 0.899 |
| △ | 4.452 | 45.000 | |
| ◇ | 2.200 | | |
| □ | 0.193 | | |
| ○ | 2.085 | | |

| PARAMETRIC VALUES | | |
|-------------------|-------|-------|
| BETA | 0.000 | OX/L |
| I | 0.000 | 0.036 |

REFERENCE FILE

LONGITUDINAL DISTRIBUTION OF BOOSTER FUSELAGE PRESSURES

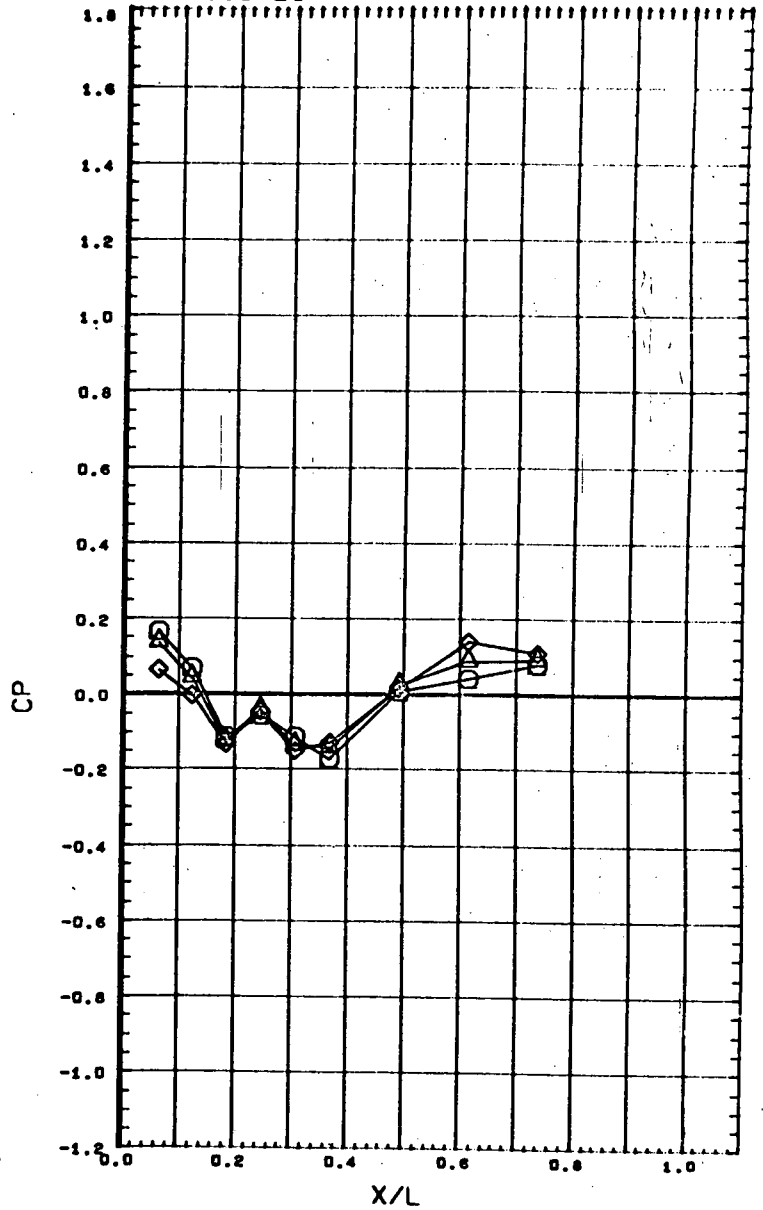
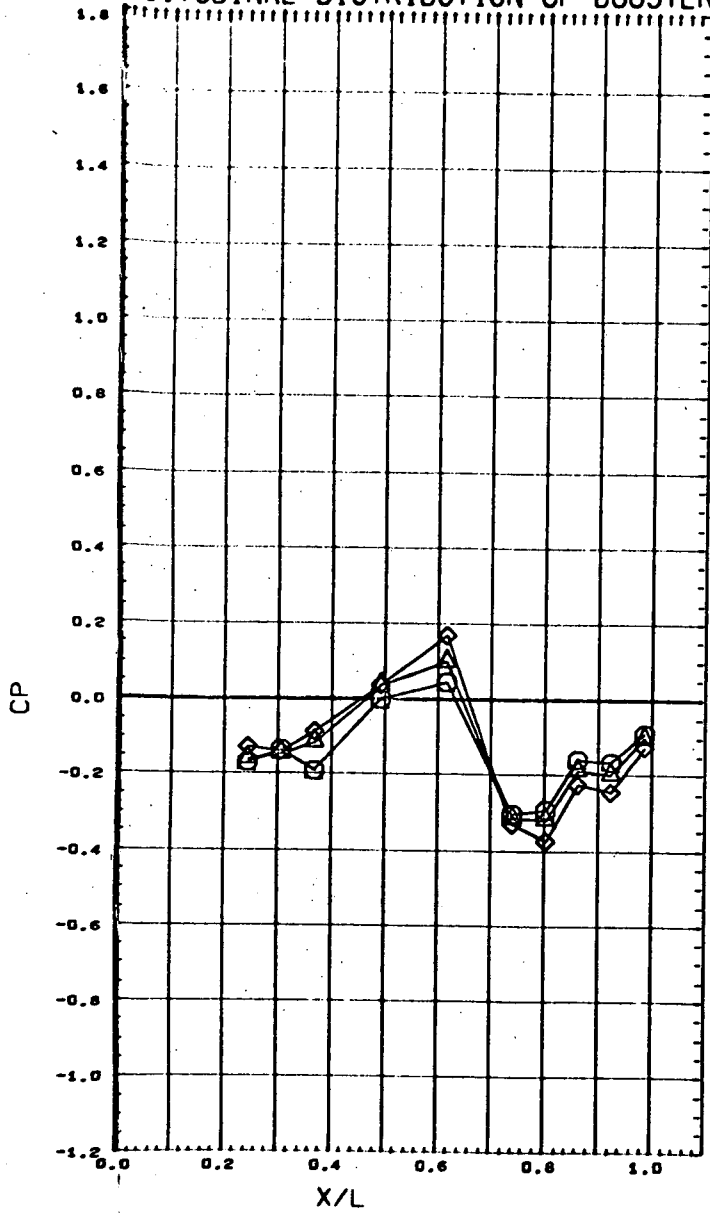

| SYMBOL | ALFB | THETA | M1 |
|--------|--------|--------|-------|
| ○ | 3.719 | 24.000 | 0.899 |
| △ | 6.154 | 45.000 | |
| ◇ | 10.121 | | |

| PARAMETRIC VALUES | |
|-------------------|-------|
| BETA | 0.000 |
| I | 0.000 |
| DX/L | 0.036 |

REFERENCE FILE

LONGITUDINAL DISTRIBUTION OF BOOSTER FUSELAGE PRESSURES

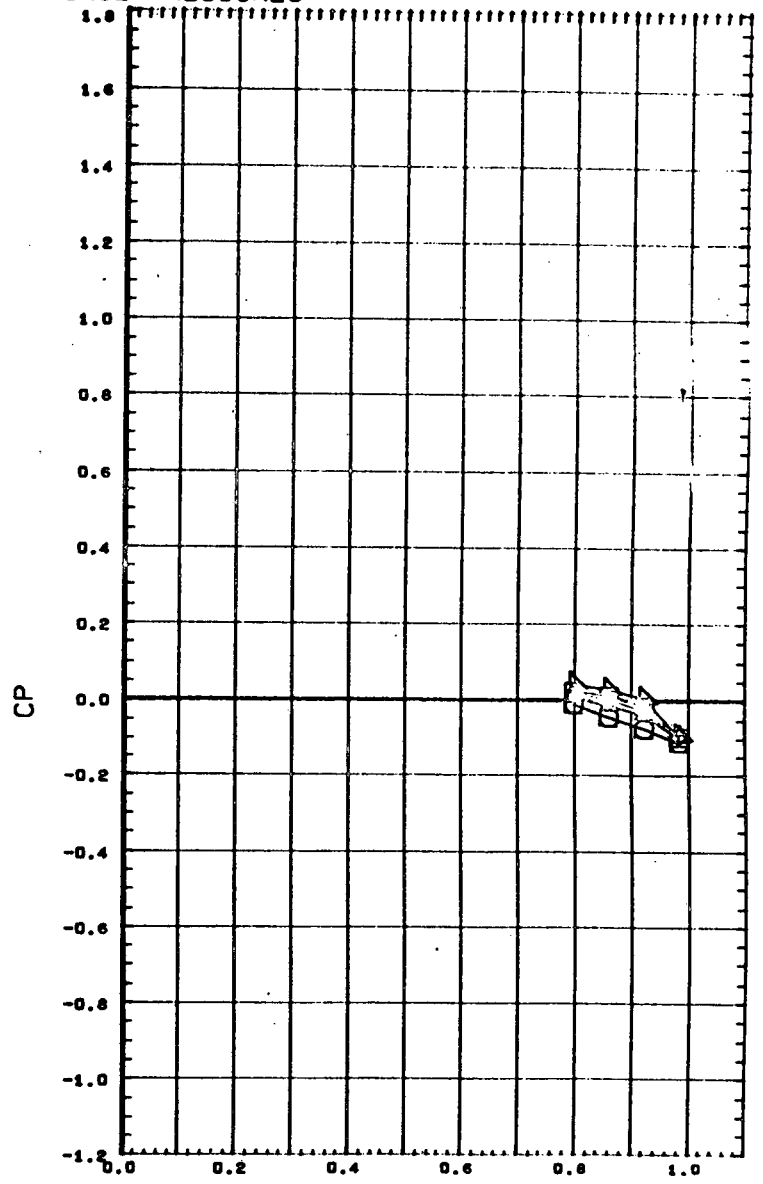
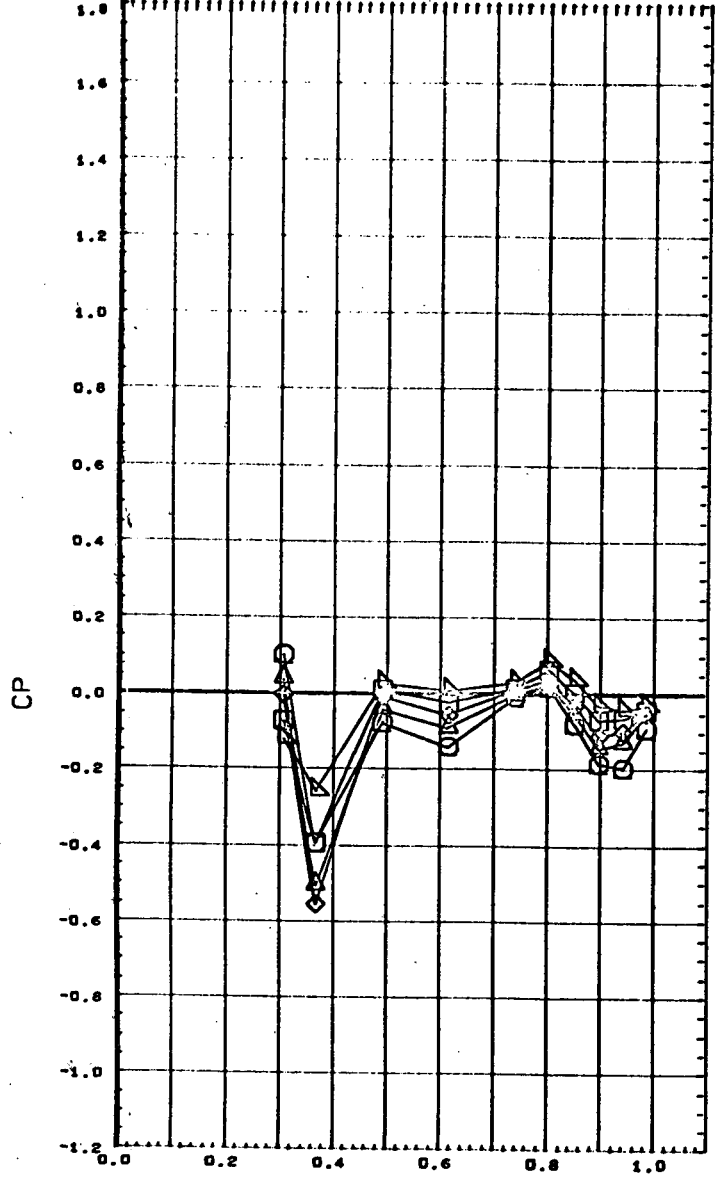

| SYMBOL | ALFB | THETA | M1 |
|--------|-------|---------|-------|
| □ | 8.280 | 90.000 | 0.899 |
| ◇ | 4.452 | 180.000 | |
| △ | 2.200 | | |
| ○ | 0.193 | | |
| ◇ | 2.085 | | |

| PARAMETRIC VALUES | | | |
|-------------------|-------|------|-------|
| BETA | 0.000 | DX/L | 0.036 |
| I | 0.000 | | |

REFERENCE FILE

LONGITUDINAL DISTRIBUTION OF BOOSTER FUSELAGE PRESSURES

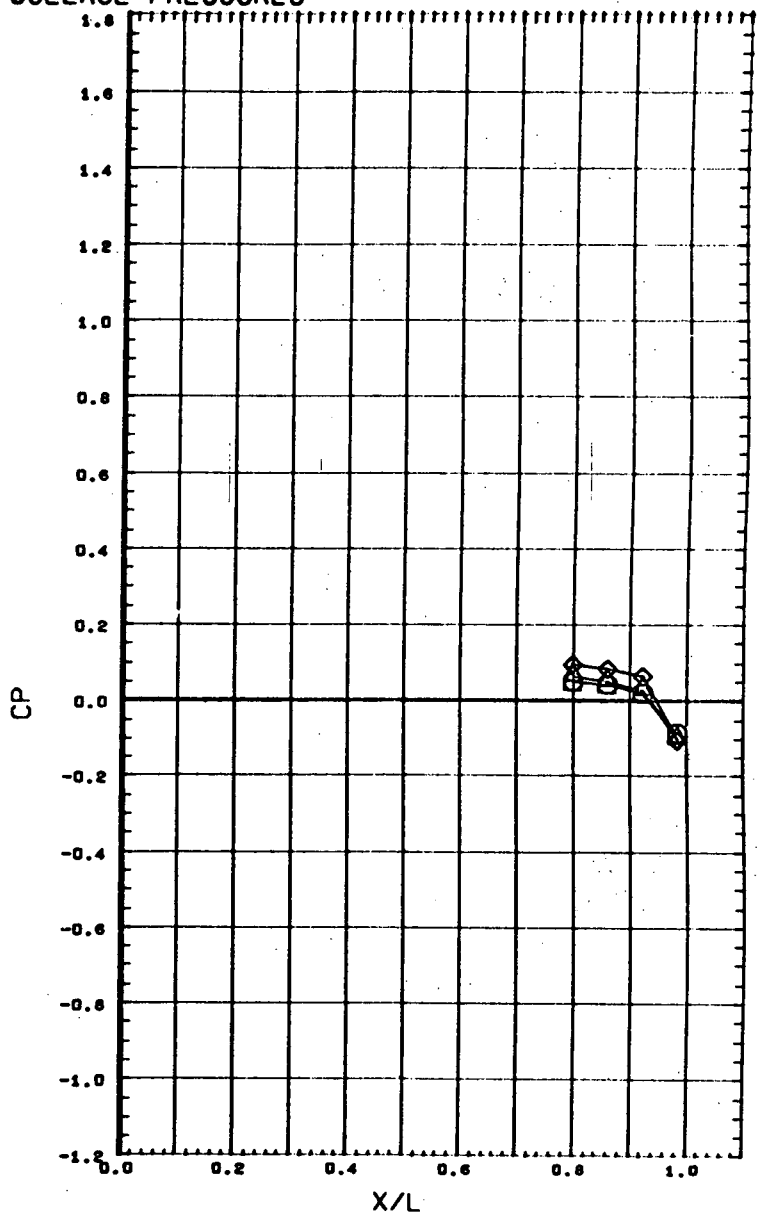
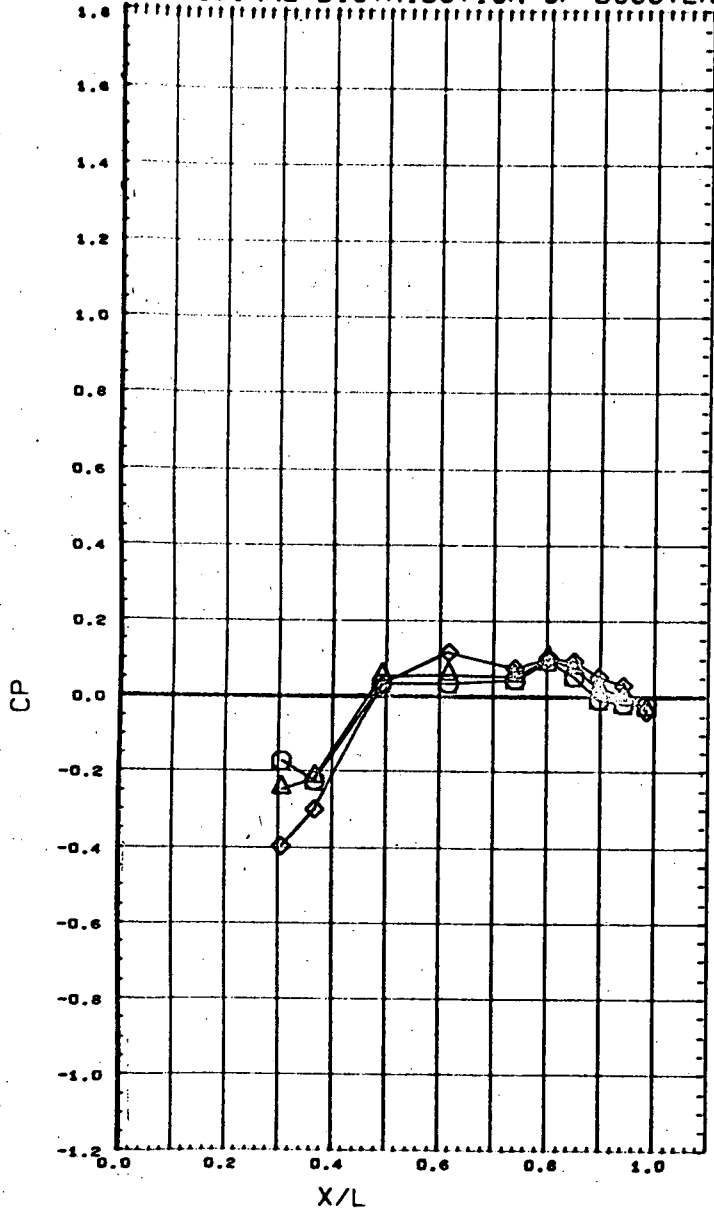

| SYMBOL | ALFB | THETA | M1 |
|--------|--------|---------|-------|
| ○ | 3.719 | 90.000 | 0.899 |
| △ | 6.154 | 180.000 | |
| ◇ | 10.121 | | |

| PARAMETRIC VALUES | | |
|-------------------|-------|-------|
| BETA | 0.000 | DX/L |
| I | 0.000 | 0.036 |

REFERENCE FILE

LONGITUDINAL DISTRIBUTION OF BOOSTER FUSELAGE PRESSURES

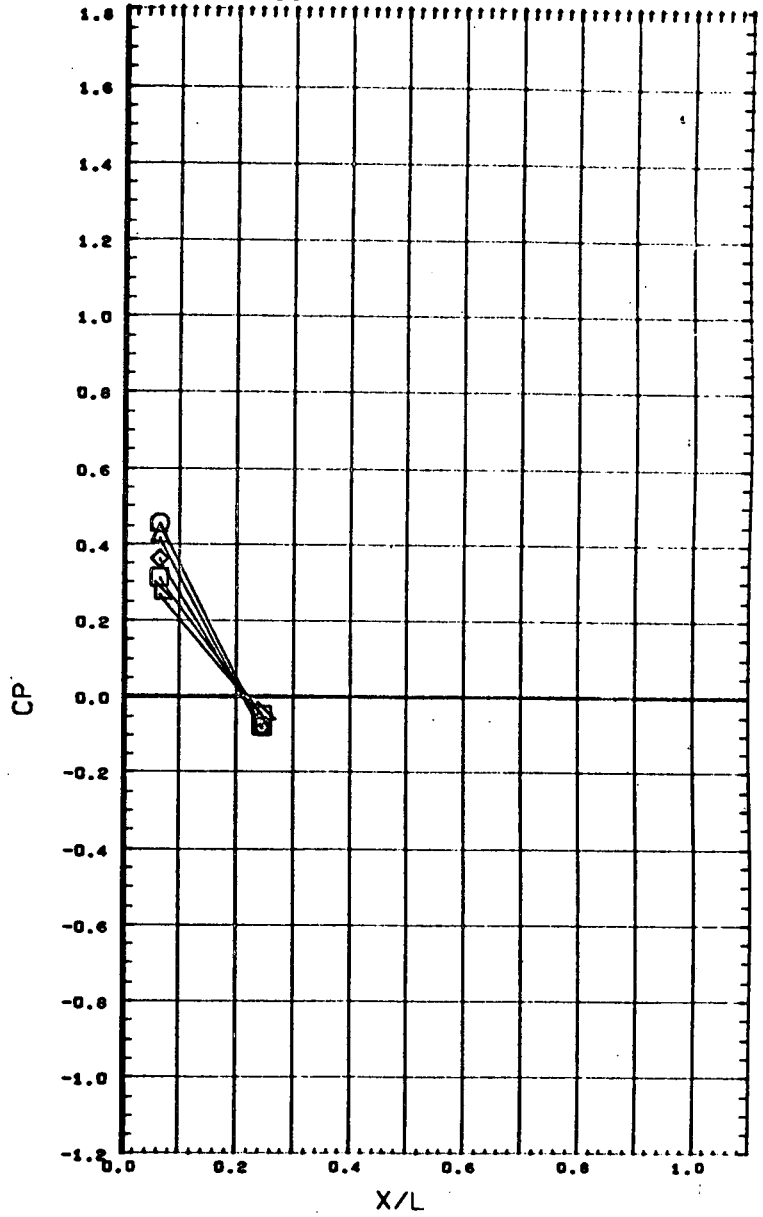
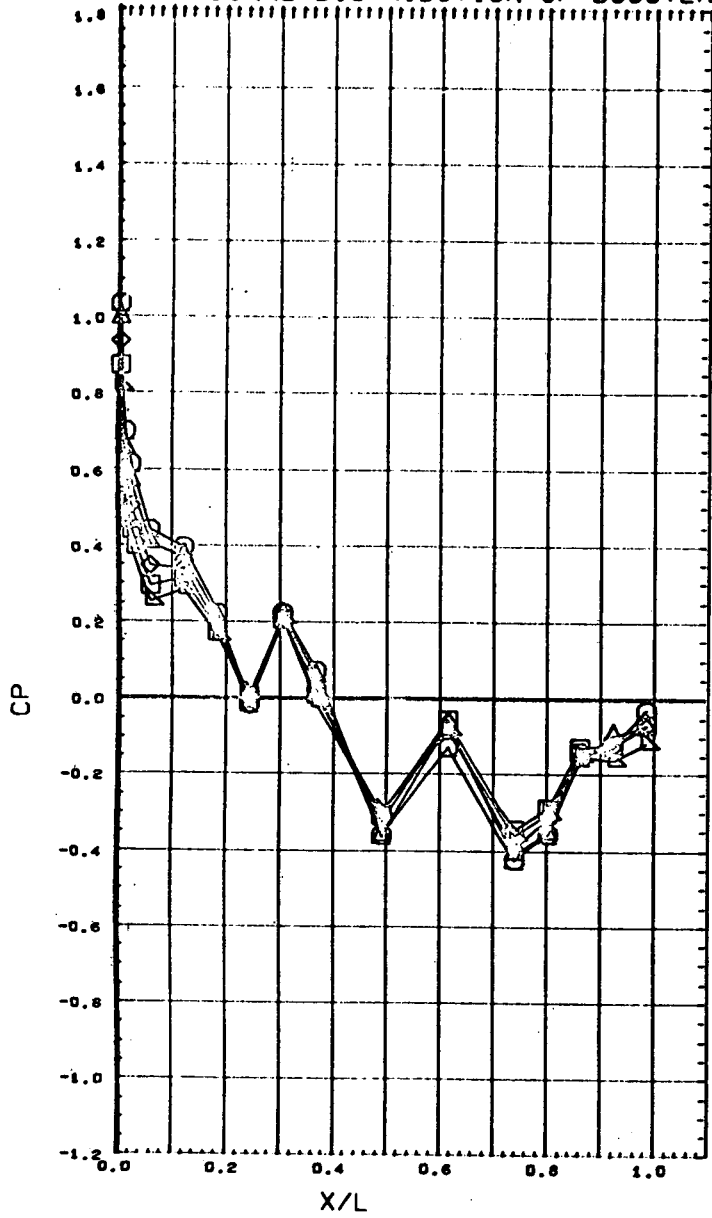

| SYMBOL | ALFB | THETA | M1 |
|--------|-------|--------|-------|
| □ | 6.158 | 0.000 | 0.995 |
| ◇ | 4.439 | 15.000 | |
| △ | 2.197 | | |
| ○ | 0.217 | | |
| ○ | 2.165 | | |

| PARAMETRIC VALUES | | | |
|-------------------|-------|------|-------|
| BETA | 0.000 | DX/L | 0.036 |
| I | 0.000 | | |

REFERENCE FILE

LONGITUDINAL DISTRIBUTION OF BOOSTER FUSELAGE PRESSURES

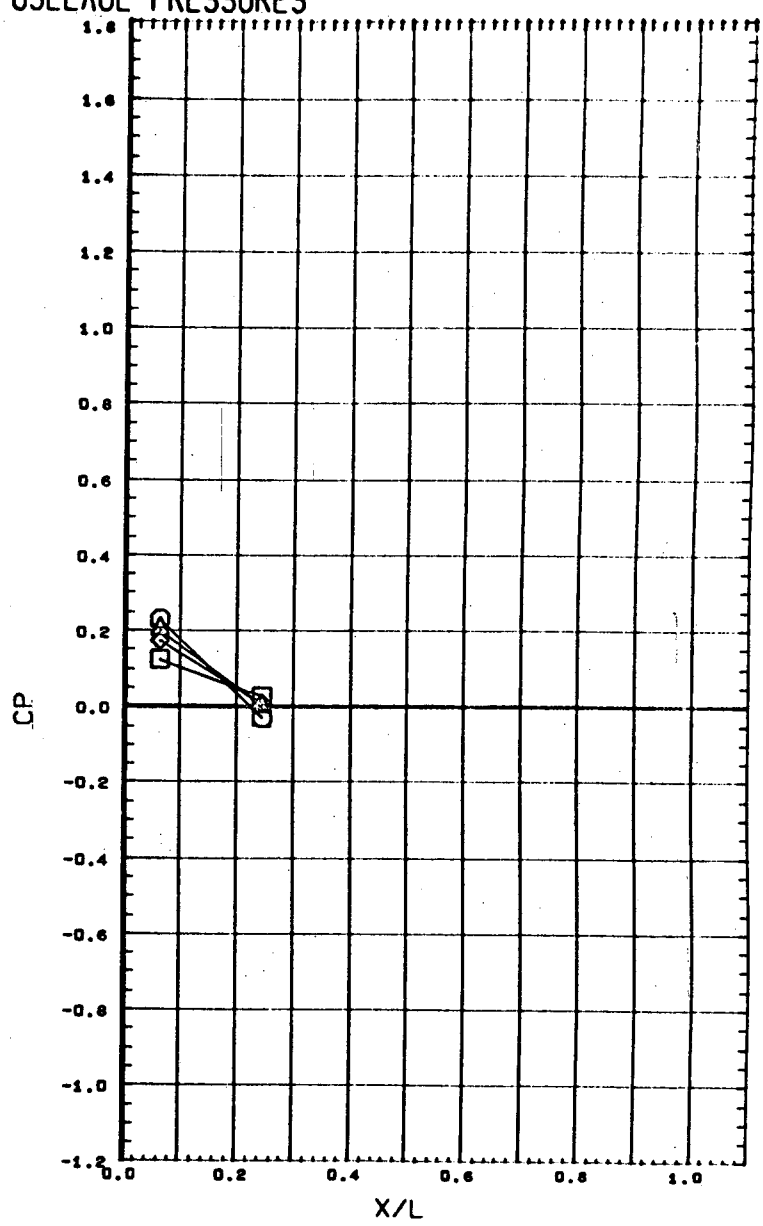
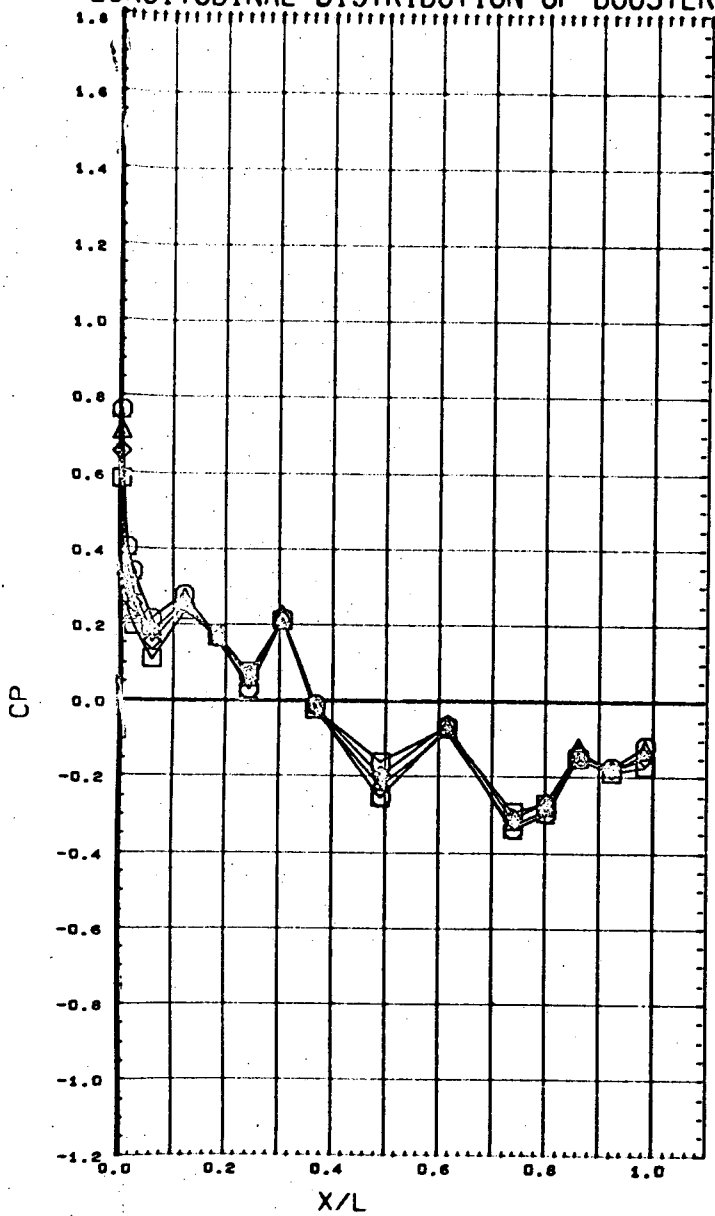

| SYMBOL | ALFB | THETA | M1 |
|--------|-------|--------|-------|
| ○ | 4.157 | 0.000 | 0.995 |
| △ | 6.136 | 15.000 | |
| ◇ | 7.548 | | |
| □ | 9.756 | | |

| PARAMETRIC VALUES | | |
|-------------------|-------|------------|
| BETA | 0.000 | OX/L 0.036 |
| I | 0.000 | |

REFERENCE FILE

LONGITUDINAL DISTRIBUTION OF BOOSTER FUSELAGE PRESSURES

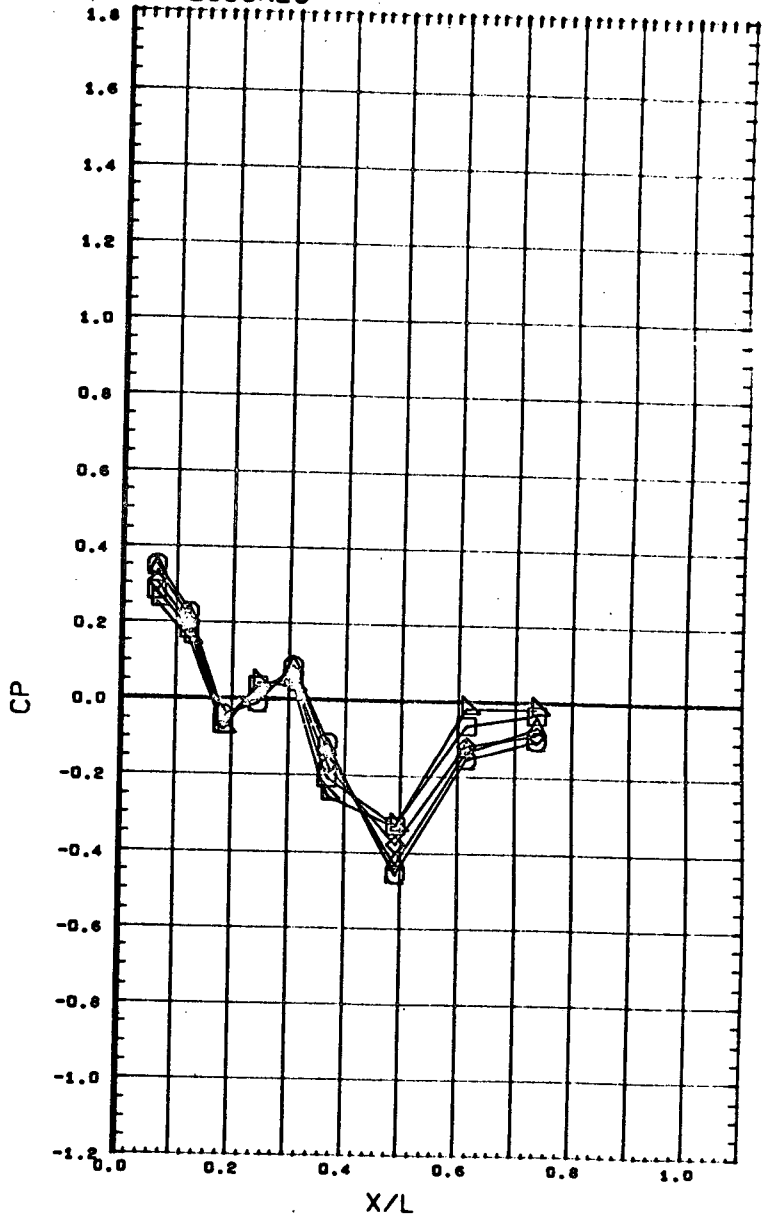
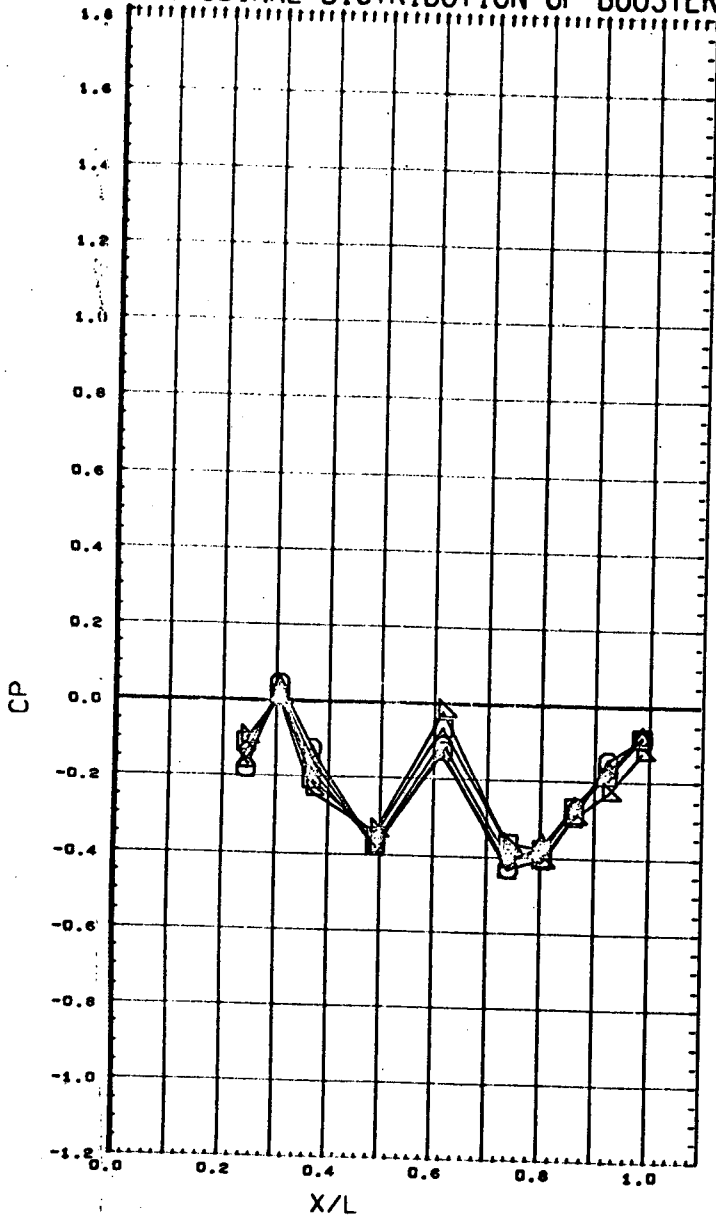

| SYMBOL | ALFB | THETA | M1 |
|--------|-------|--------|-------|
| ○ | 6.158 | 24.000 | 0.995 |
| △ | 4.439 | 45.000 | |
| □ | 2.197 | | |
| ◇ | 0.217 | | |
| ○ | 2.165 | | |

REFERENCE FILE

| PARAMETRIC VALUES | | |
|-------------------|-------|-------|
| BETA | 0.000 | DX/L |
| I | 0.000 | 0.036 |

LONGITUDINAL DISTRIBUTION OF BOOSTER FUSELAGE PRESSURES

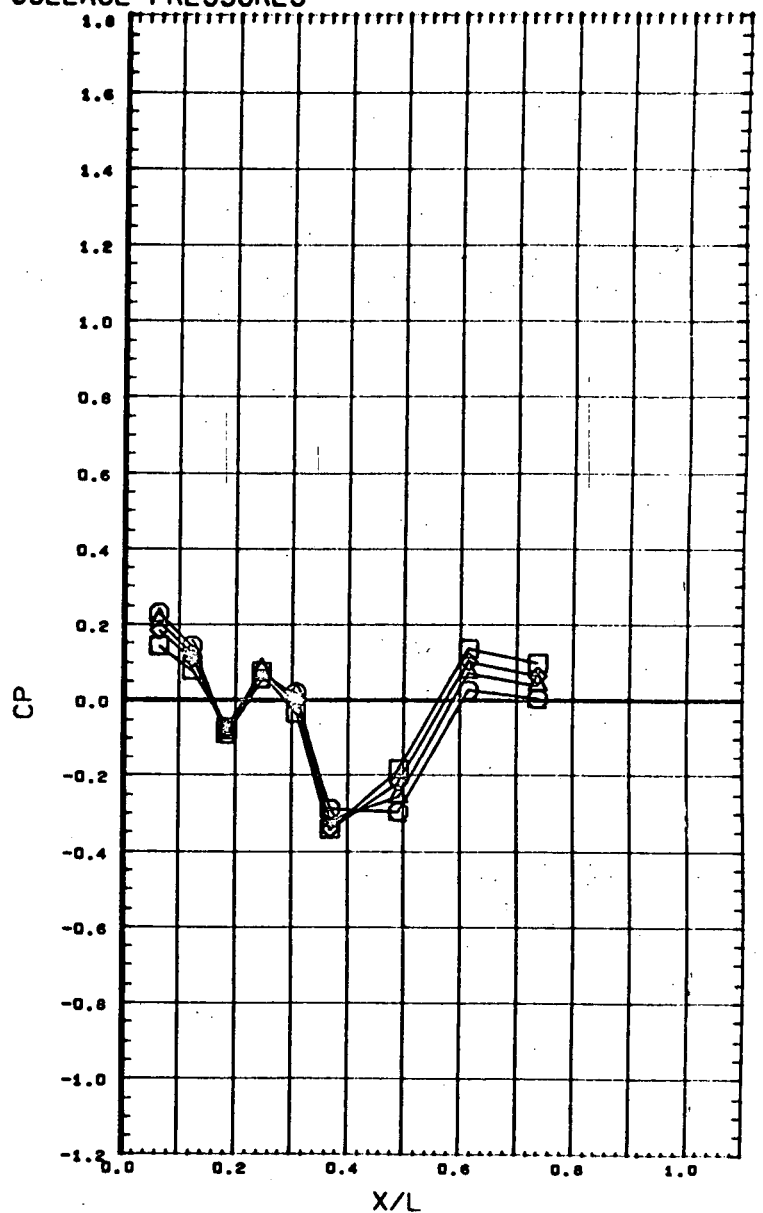
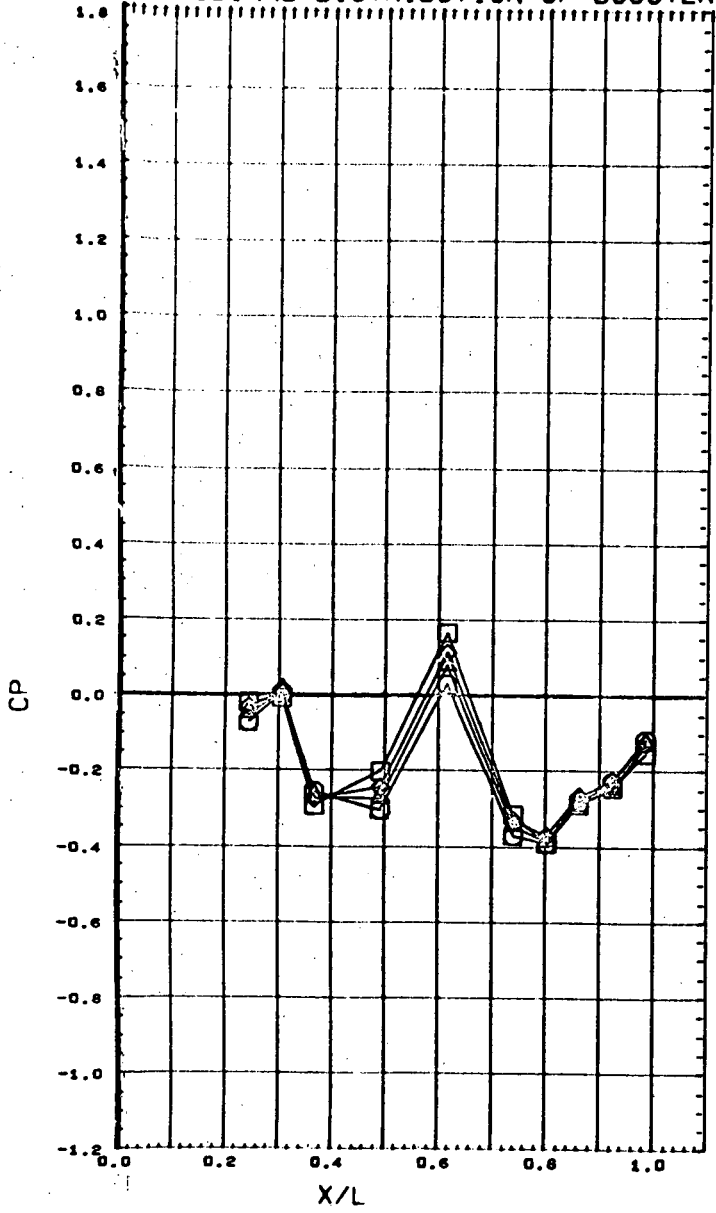

| SYMBOL | ALFD | THETA | M1 |
|--------|-------|--------|-------|
| ○ | 4.157 | 24.000 | 0.995 |
| △ | 6.136 | 45.000 | |
| ◇ | 7.548 | | |
| □ | 9.756 | | |

| PARAMETRIC VALUES | | | |
|-------------------|-------|------|-------|
| BETA | 0.000 | OX/L | 0.036 |
| I | 0.000 | | |

REFERENCE FILE

LONGITUDINAL DISTRIBUTION OF BOOSTER FUSELAGE PRESSURES

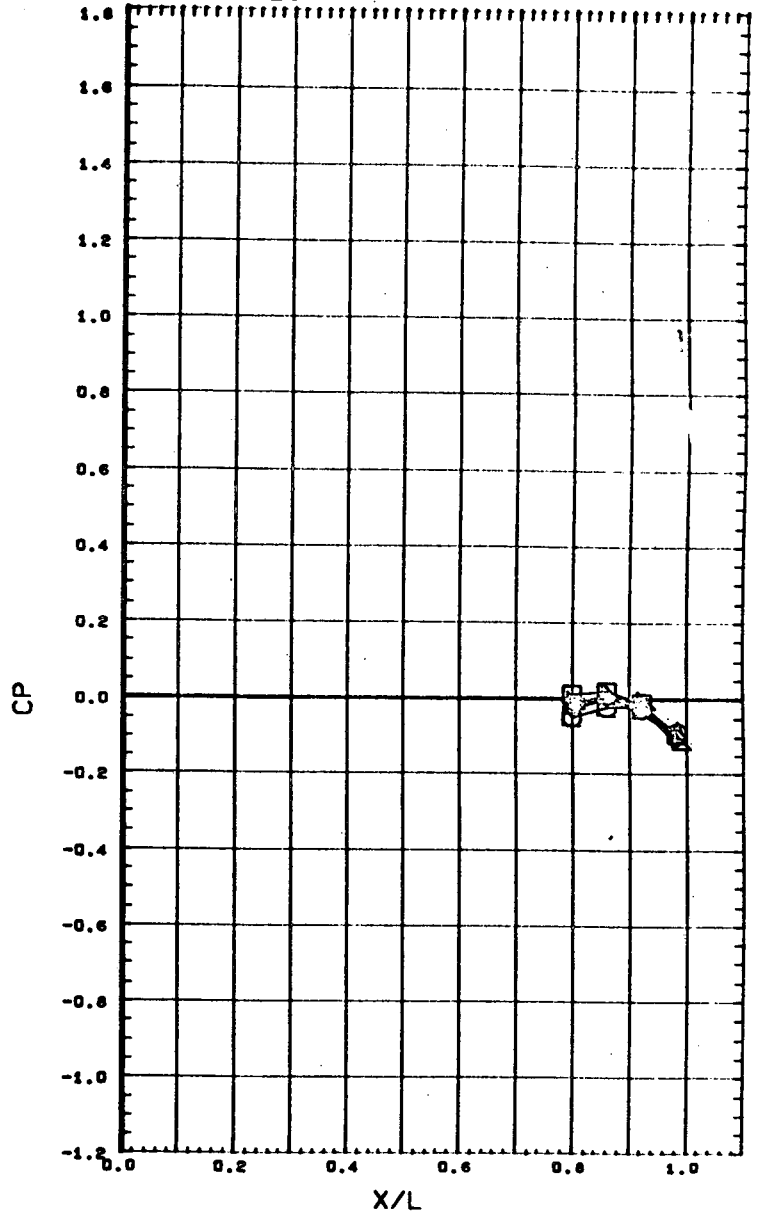
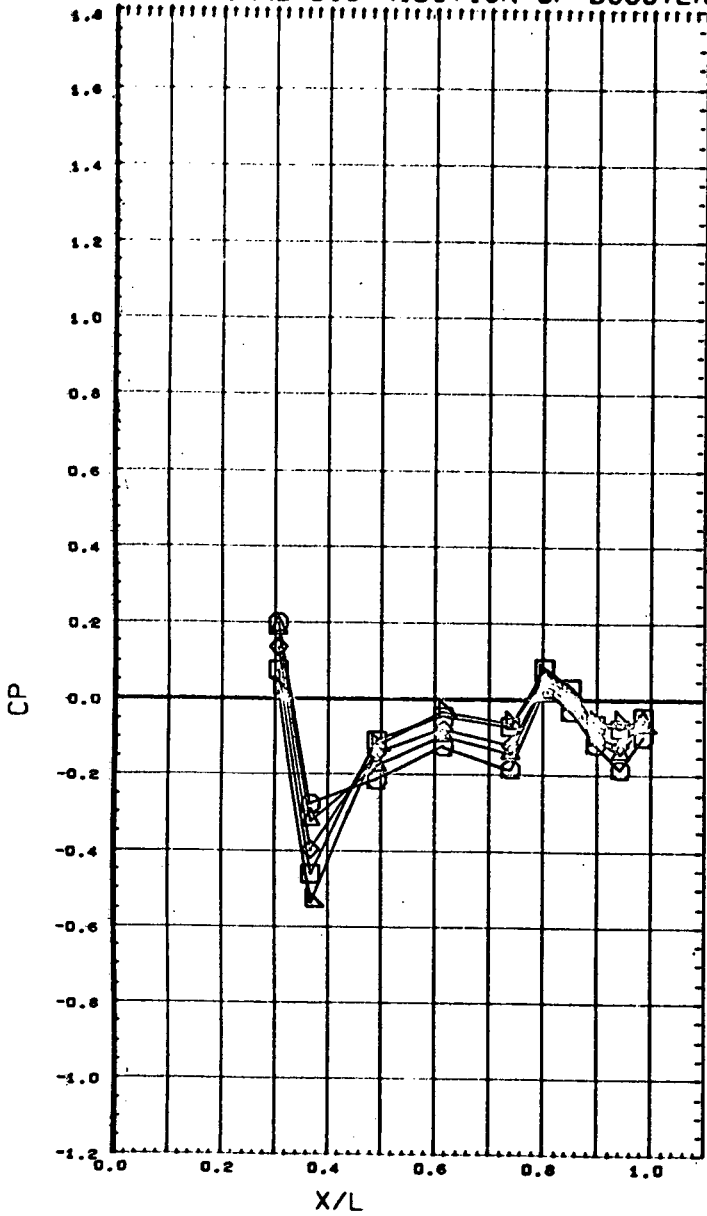

| SYMBOL | ALFB | THETA | M1 |
|--------|-------|---------|-------|
| ○ | 6.158 | 90.000 | 0.995 |
| △ | 4.439 | 180.000 | |
| ◇ | 2.197 | | |
| □ | 0.217 | | |
| ○ | 2.165 | | |

REFERENCE FILE

| PARAMETRIC VALUES | | | |
|-------------------|-------|------|-------|
| BETA | 0.000 | DX/L | 0.036 |
| I | 0.000 | | |

LONGITUDINAL DISTRIBUTION OF BOOSTER FUSELAGE PRESSURES

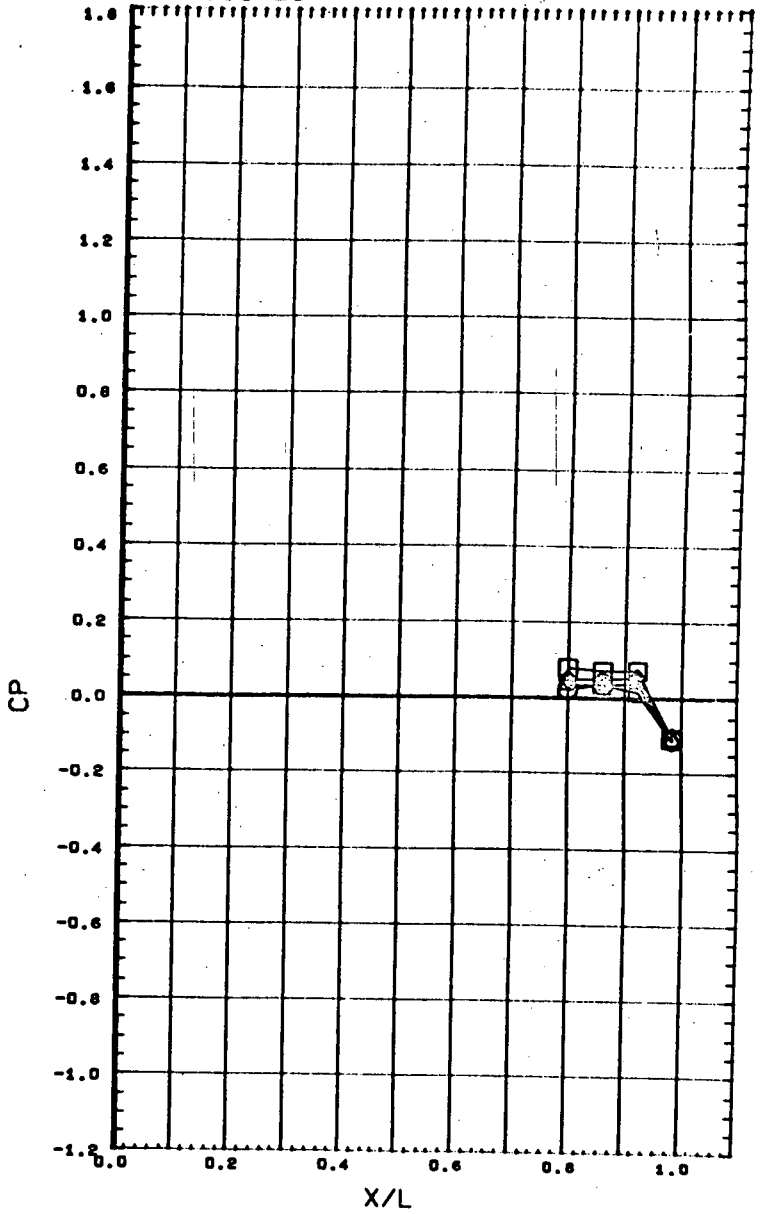
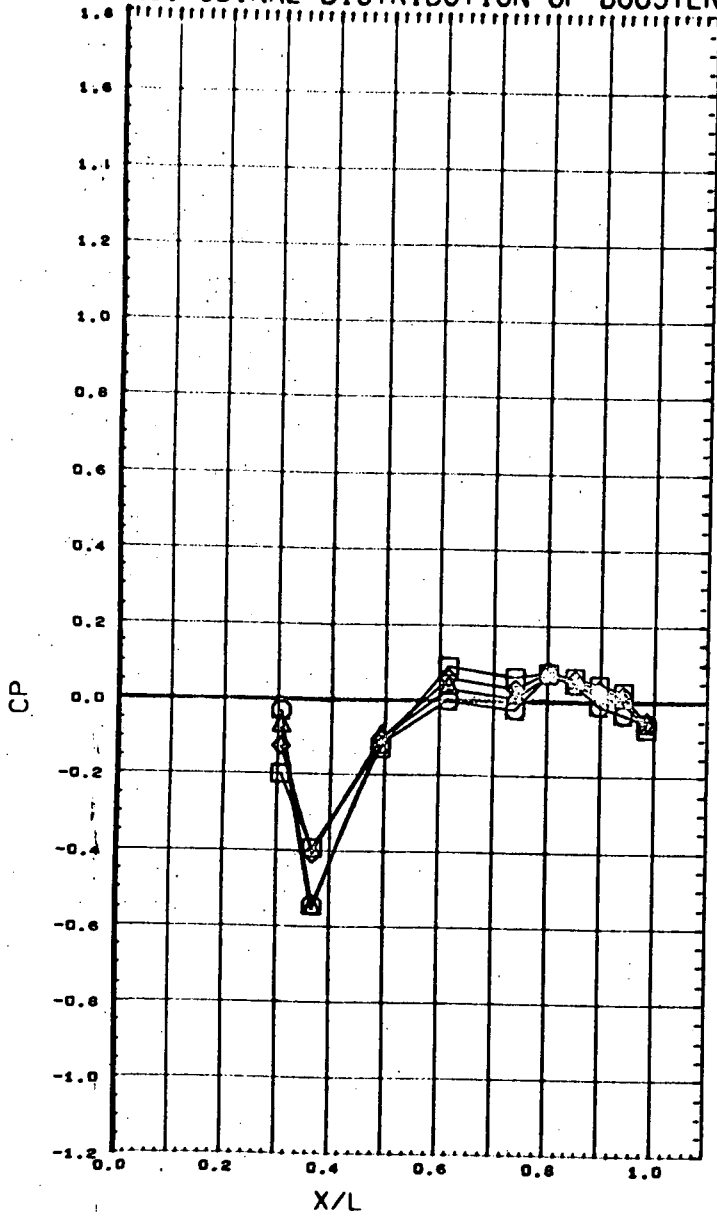

| SYMBOL | ALFB | THETA | M1 |
|--------|-------|---------|-------|
| ○ | 4.157 | 90.000 | 0.995 |
| △ | 6.136 | 180.000 | |
| ◇ | 7.548 | | |
| □ | 9.756 | | |

| PARAMETRIC VALUES | | | |
|-------------------|-------|------|-------|
| BETA | 0.000 | DX/L | 0.036 |
| I | 0.000 | | |

REFERENCE FILE

LONGITUDINAL DISTRIBUTION OF BOOSTER FUSELAGE PRESSURES

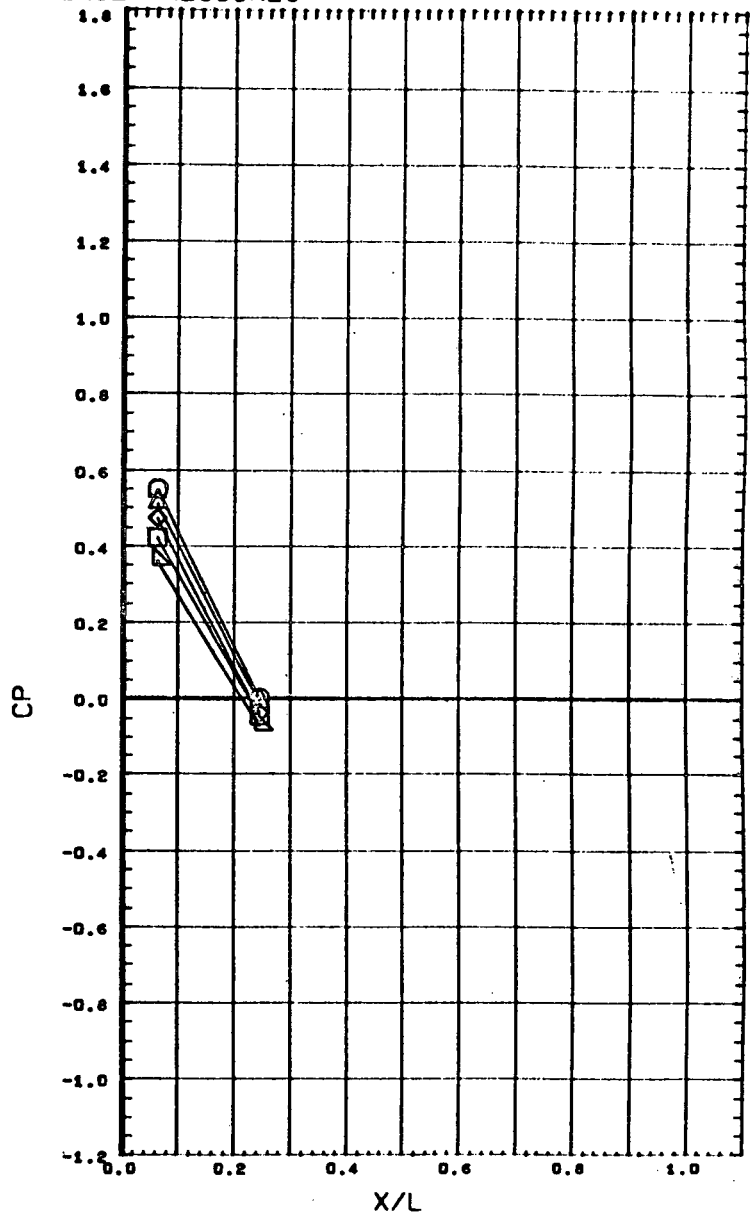
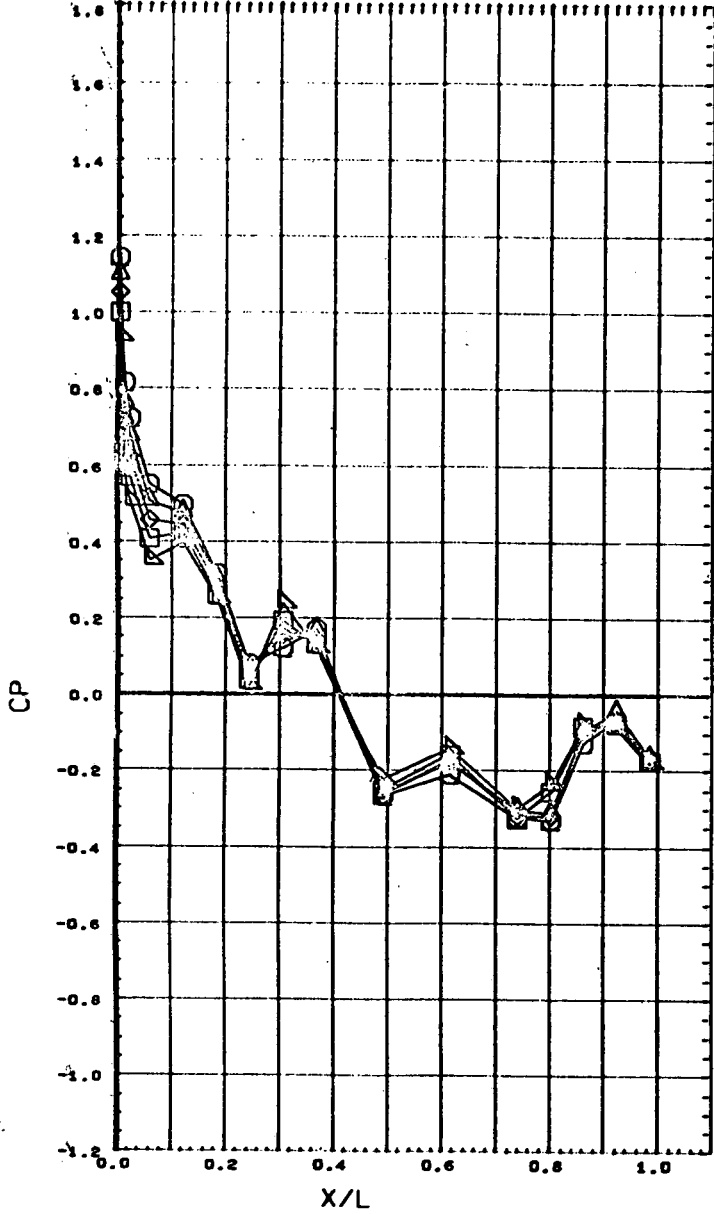

| SYMBOL | ALFB | THETA | M1 |
|--------|-------|--------|-------|
| ○ | 8.325 | 0.000 | 1.101 |
| ◇ | 6.165 | 15.000 | |
| △ | 4.458 | | |
| □ | 2.183 | | |
| ▽ | 0.223 | | |

| PARAMETRIC VALUES | | | |
|-------------------|-------|------|-------|
| BETA | 0.000 | DX/L | 0.036 |
| I | 0.000 | | |

REFERENCE FILE

LONGITUDINAL DISTRIBUTION OF BOOSTER FUSELAGE PRESSURES

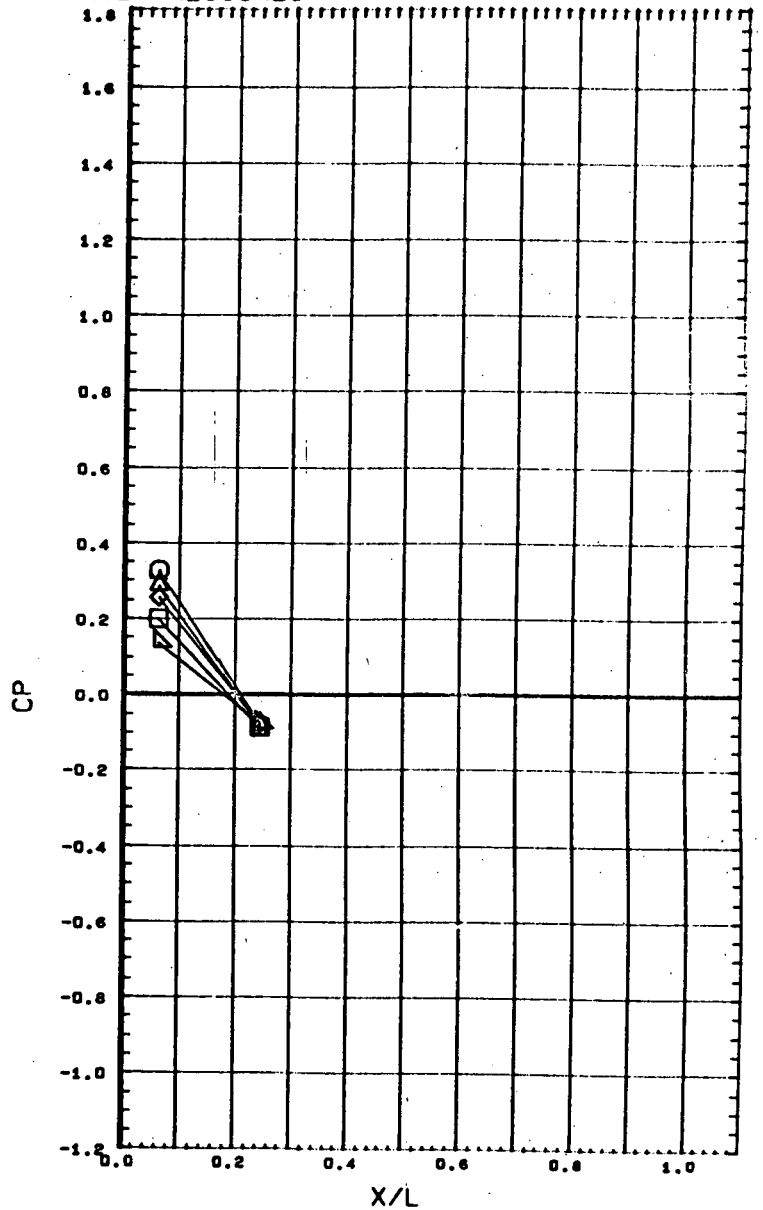
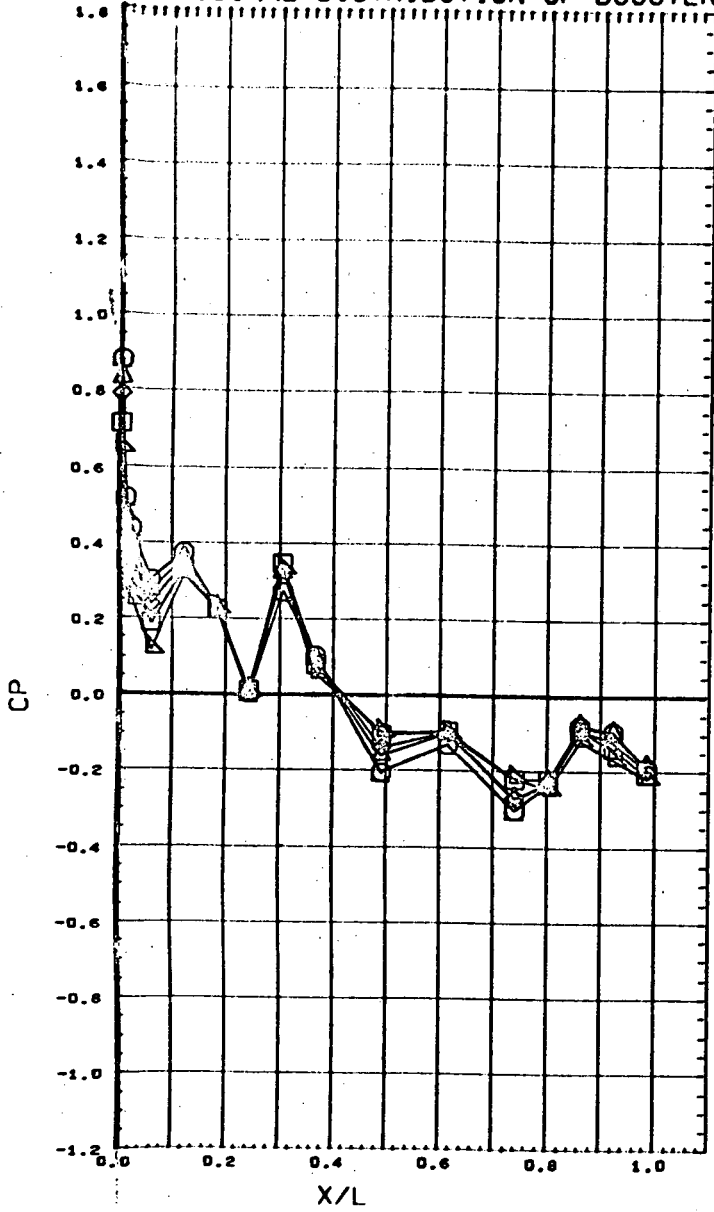

| SYMBOL | ALFD | THETA | M1 |
|--------|--------|--------|-------|
| ○ | 2.164 | 0.000 | 1.101 |
| ◇ | 4.173 | 15.000 | |
| △ | 5.536 | | |
| □ | 8.188 | | |
| ▽ | 10.145 | | |

| PARAMETRIC VALUES | | |
|-------------------|-------|-------|
| BETA | 0.000 | OX/L |
| I | 0.000 | 0.036 |

REFERENCE FILE

LONGITUDINAL DISTRIBUTION OF BOOSTER FUSELAGE PRESSURES

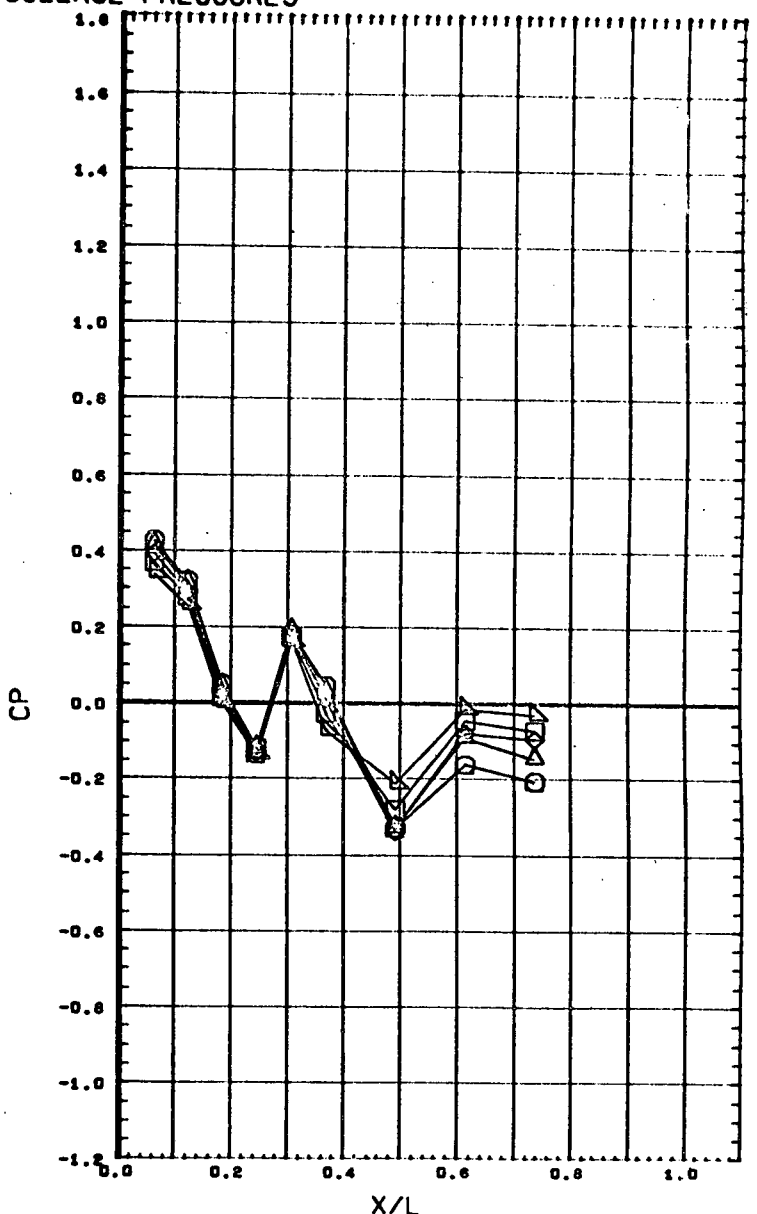
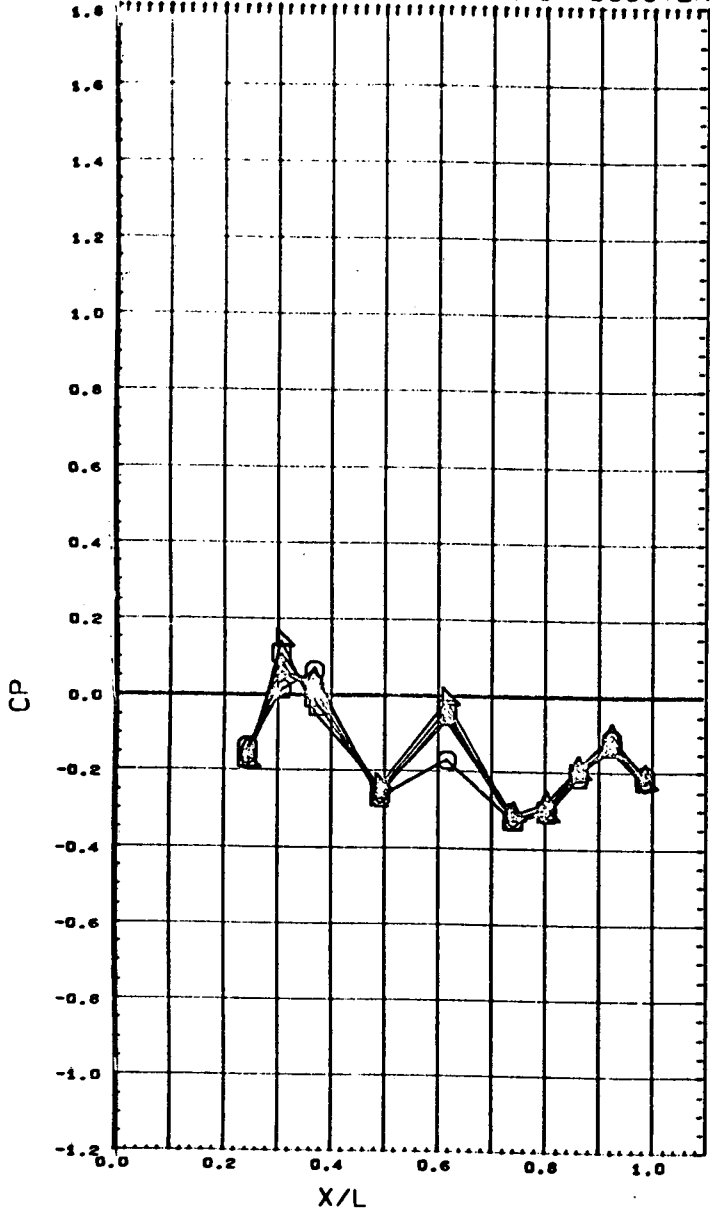

| SYMBOL | ALFD | THETA | M1 |
|--------|-------|--------|-------|
| ○ | 0.325 | 24.000 | 1.101 |
| ◇ | 6.165 | 45.000 | |
| △ | 4.458 | | |
| □ | 2.183 | | |
| ◇ | 0.223 | | |

| PARAMETRIC VALUES | | | |
|-------------------|-------|------|-------|
| BETA | 0.000 | DX/L | 0.036 |
| I | 0.000 | | |

REFERENCE FILE

LONGITUDINAL DISTRIBUTION OF BOOSTER FUSELAGE PRESSURES

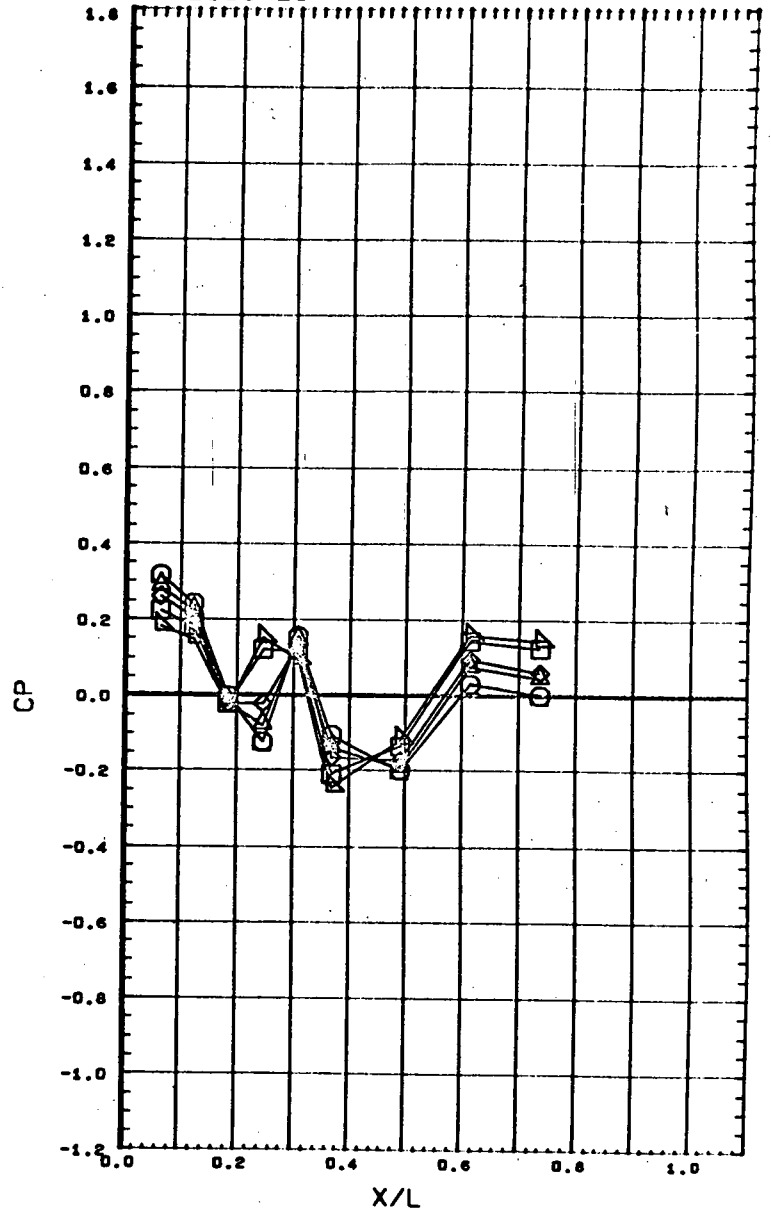
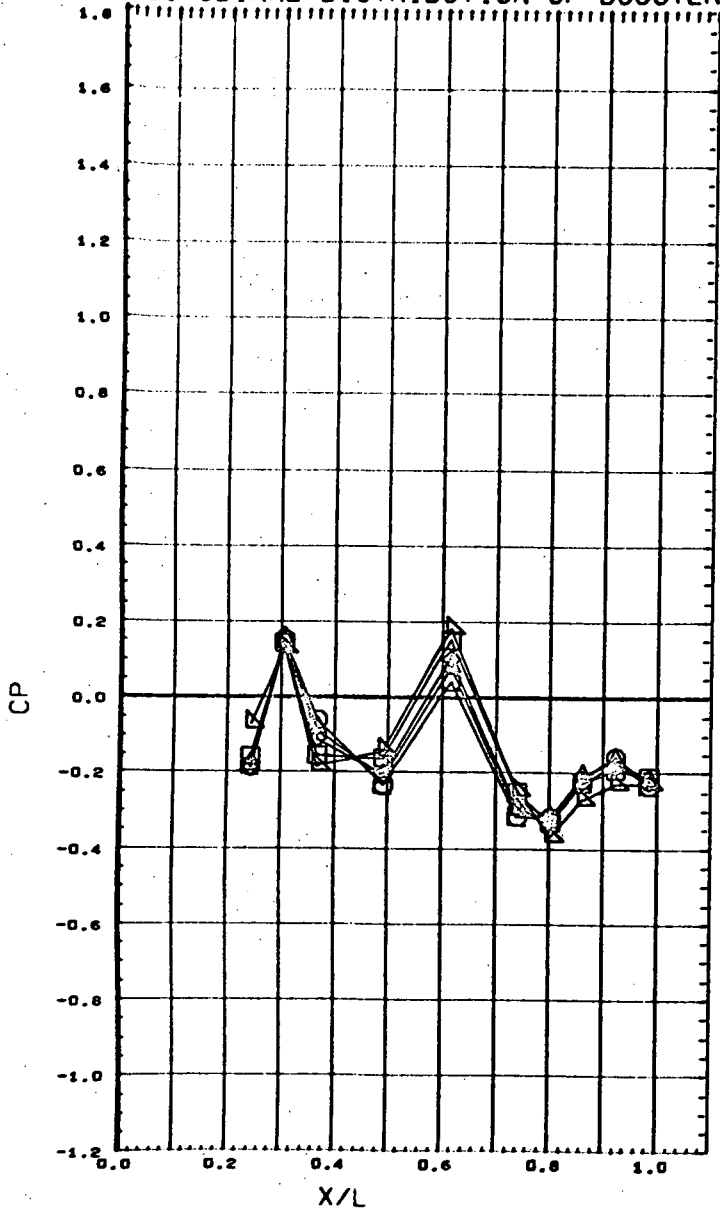

| SYMBOL | ALFB | THETA | M1 |
|--------|--------|--------|-------|
| □ | 2.164 | 24.000 | 1.101 |
| ◇ | 4.173 | 45.000 | |
| △ | 5.536 | | |
| ○ | 6.188 | | |
| ○ | 10.145 | | |

REFERENCE FILE

| PARAMETRIC VALUES | | | |
|-------------------|-------|------|-------|
| BETA | 0.000 | DX/L | 0.036 |
| I | 0.000 | | |

LONGITUDINAL DISTRIBUTION OF BOOSTER FUSELAGE PRESSURES

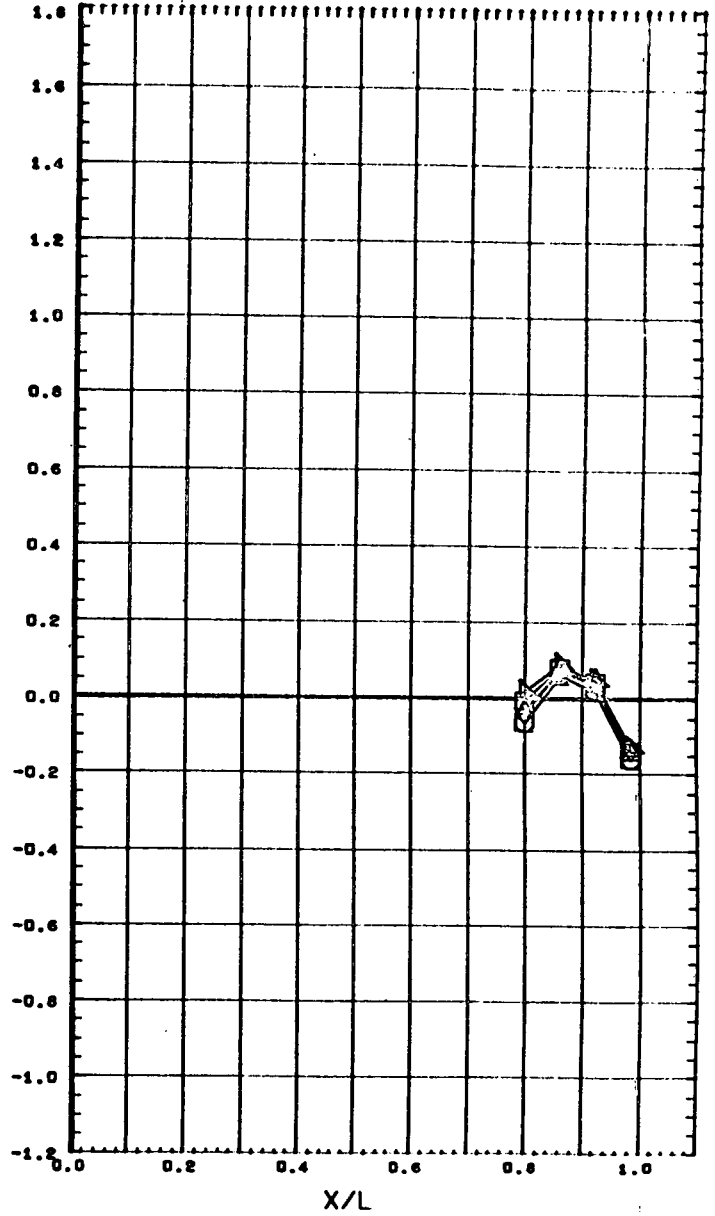
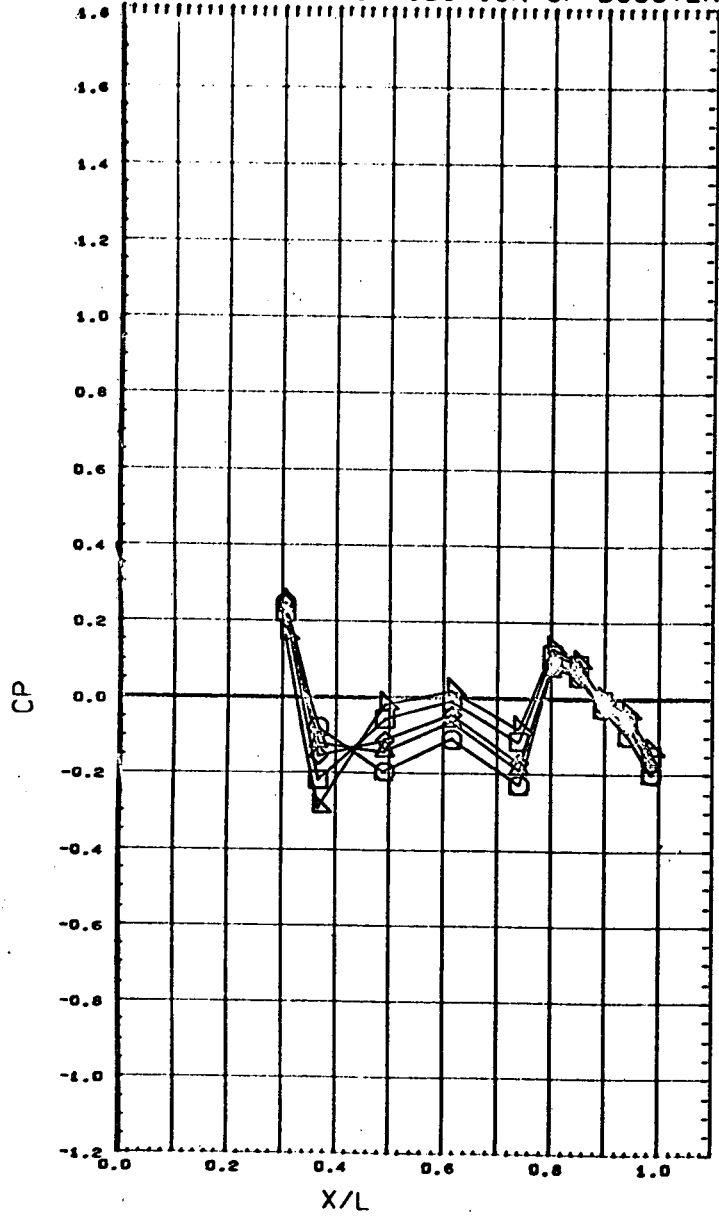

| SYMBOL | ALFB | THETA | M1 |
|--------|-------|---------|-------|
| □ | 8.325 | 90.000 | 1.101 |
| ◇ | 6.165 | 180.000 | |
| △ | 4.458 | | |
| ○ | 2.183 | | |
| ○ | 0.223 | | |

| PARAMETRIC VALUES | | | |
|-------------------|-------|------|-------|
| BETA | 0.000 | DX/L | 0.036 |
| I | 0.000 | | |

REFERENCE FILE

LONGITUDINAL DISTRIBUTION OF BOOSTER FUSELAGE PRESSURES

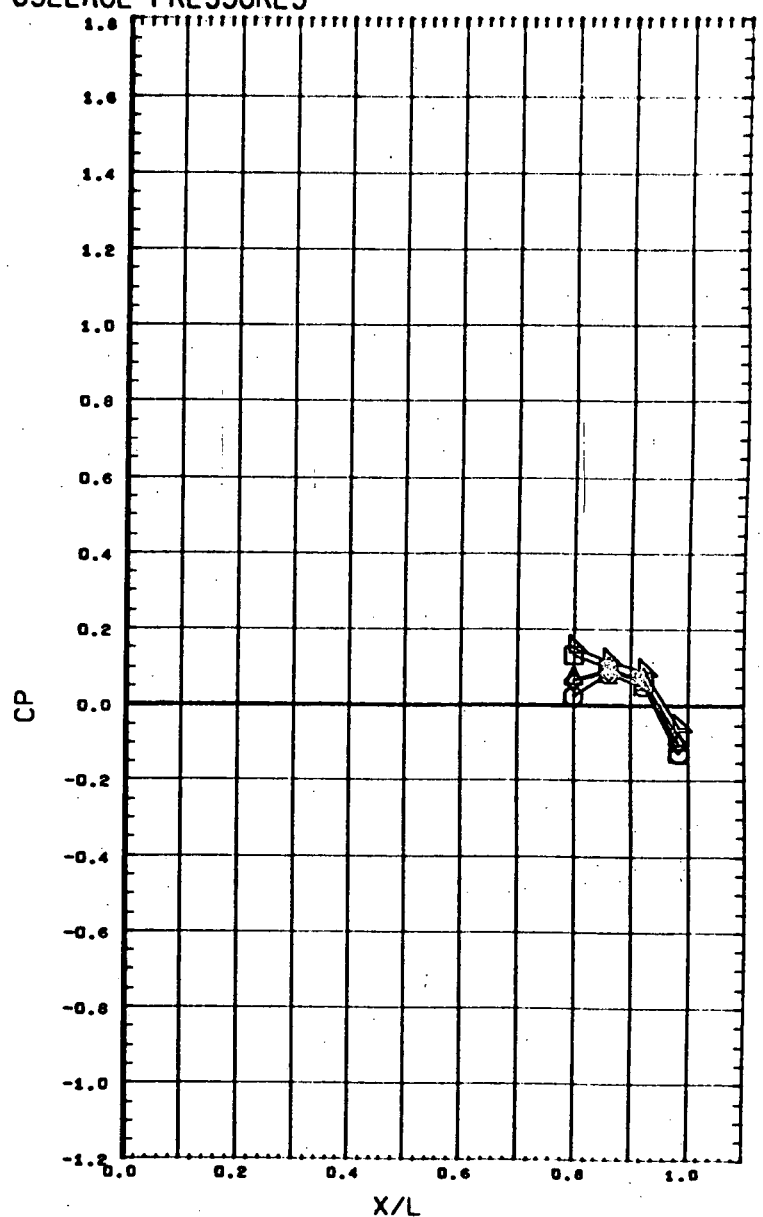
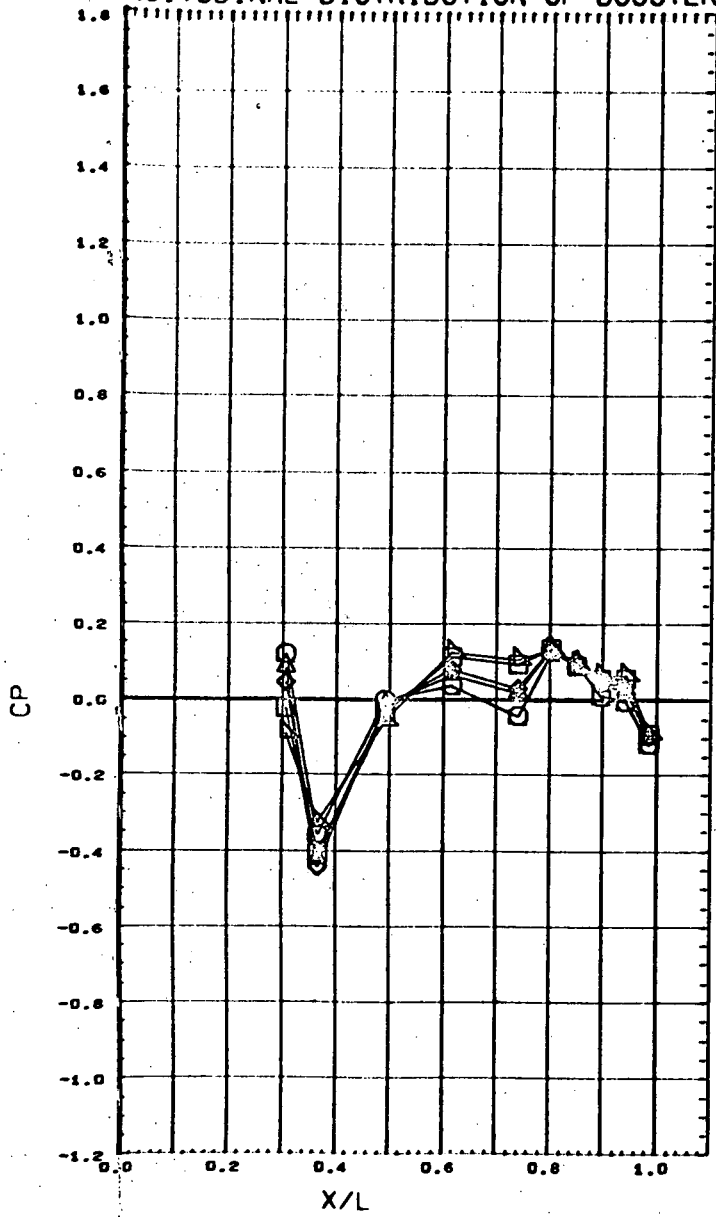

| SYMBOL | ALFD | THETA | M1 |
|--------|--------|---------|-------|
| ◇ | 2.164 | 90.000 | 1.101 |
| ◇ | 4.173 | 180.000 | |
| ◇ | 5.536 | | |
| ◇ | 8.188 | | |
| ◇ | 10.145 | | |

REFERENCE FILE

| PARAMETRIC VALUES | | |
|-------------------|-------|------------|
| BETA | 0.000 | DX/L 0.036 |
| I | 0.000 | |

LONGITUDINAL DISTRIBUTION OF BOOSTER FUSELAGE PRESSURES

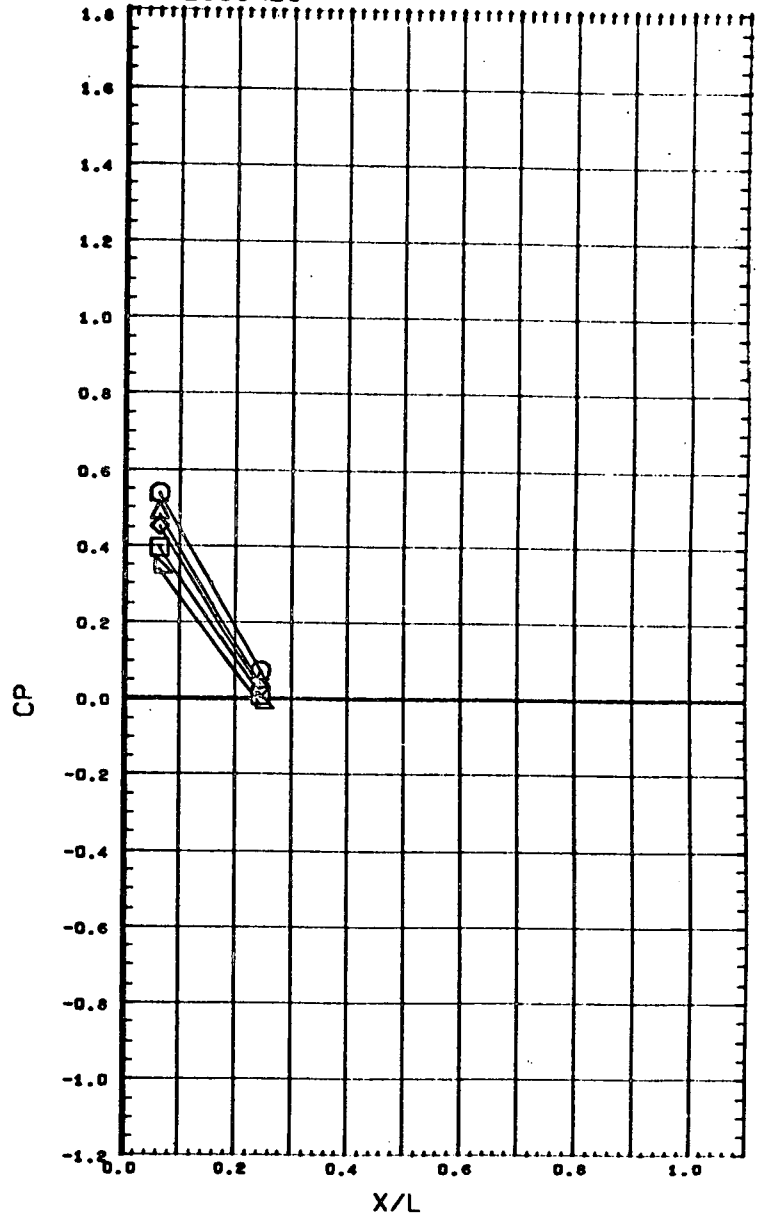
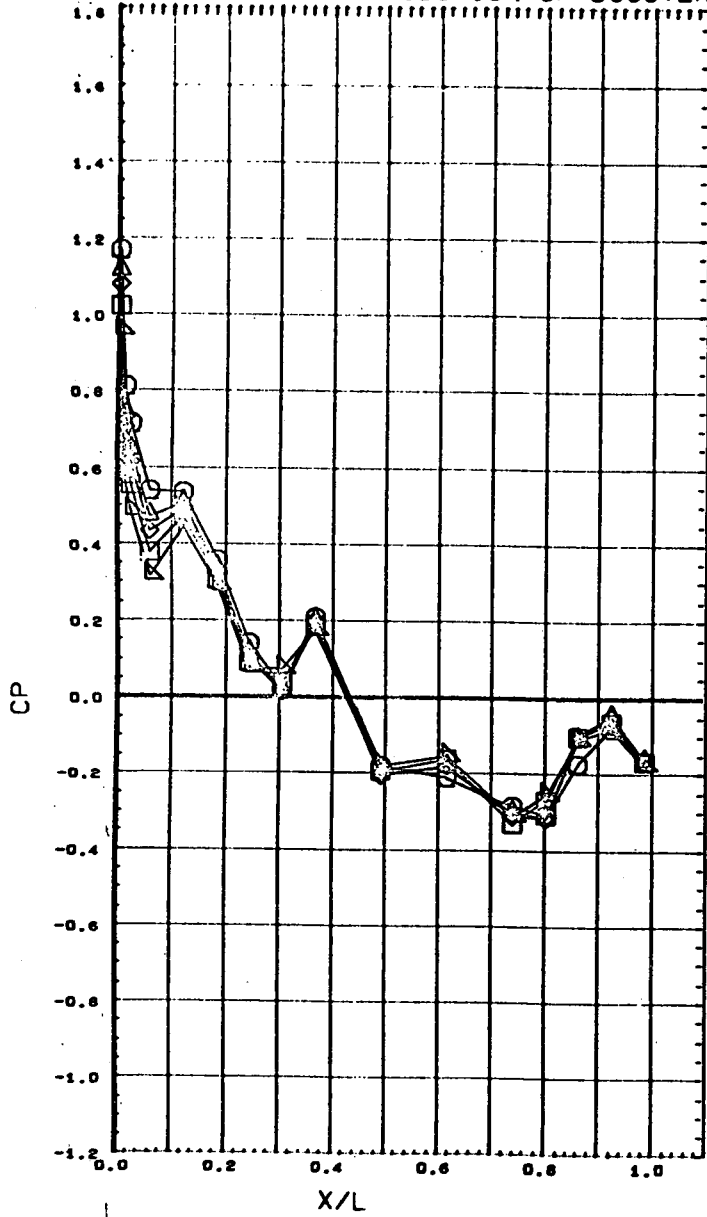

| SYMBOL | ALFD | THETA | M1 |
|--------|-------|--------|-------|
| ○ | 8.517 | 0.000 | 1.200 |
| △ | 5.757 | 15.000 | |
| ◇ | 4.430 | | |
| □ | 2.200 | | |
| ◇ | 0.220 | | |

REFERENCE FILE

| PARAMETRIC VALUES | | | |
|-------------------|-------|------|-------|
| BETA | 0.000 | DX/L | 0.036 |
| I | 0.000 | | |

LONGITUDINAL DISTRIBUTION OF BOOSTER FUSELAGE PRESSURES

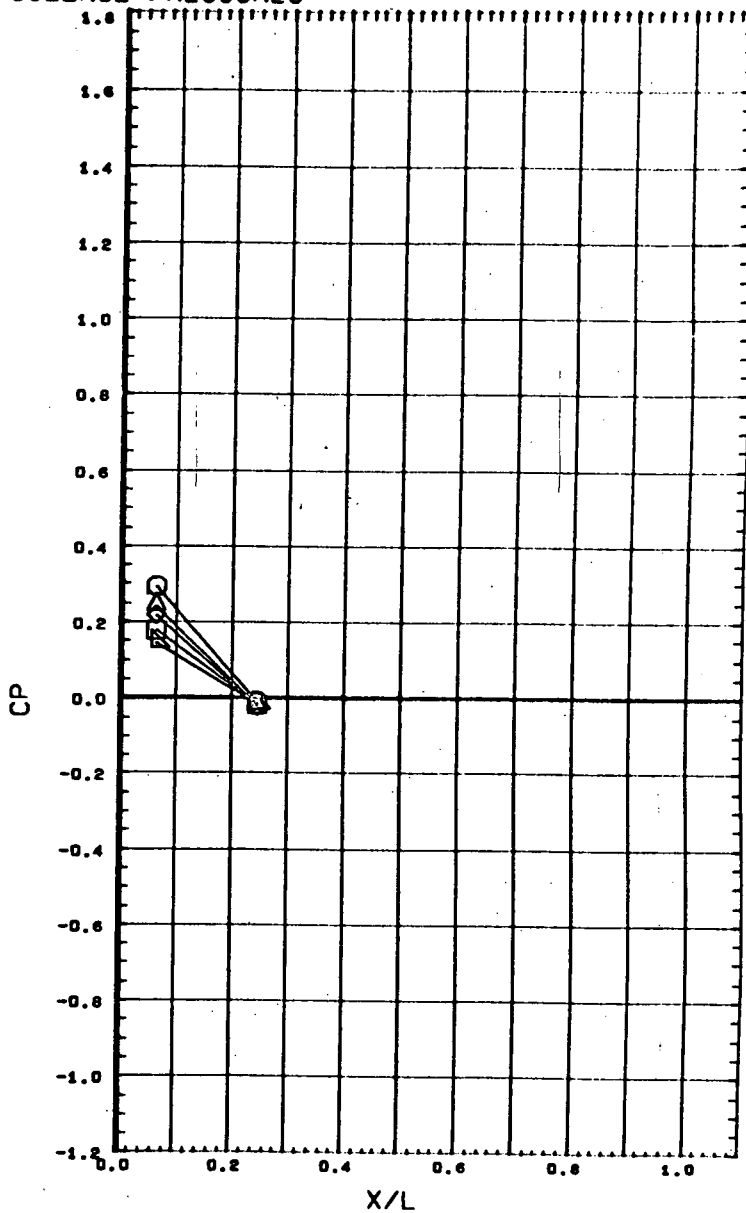
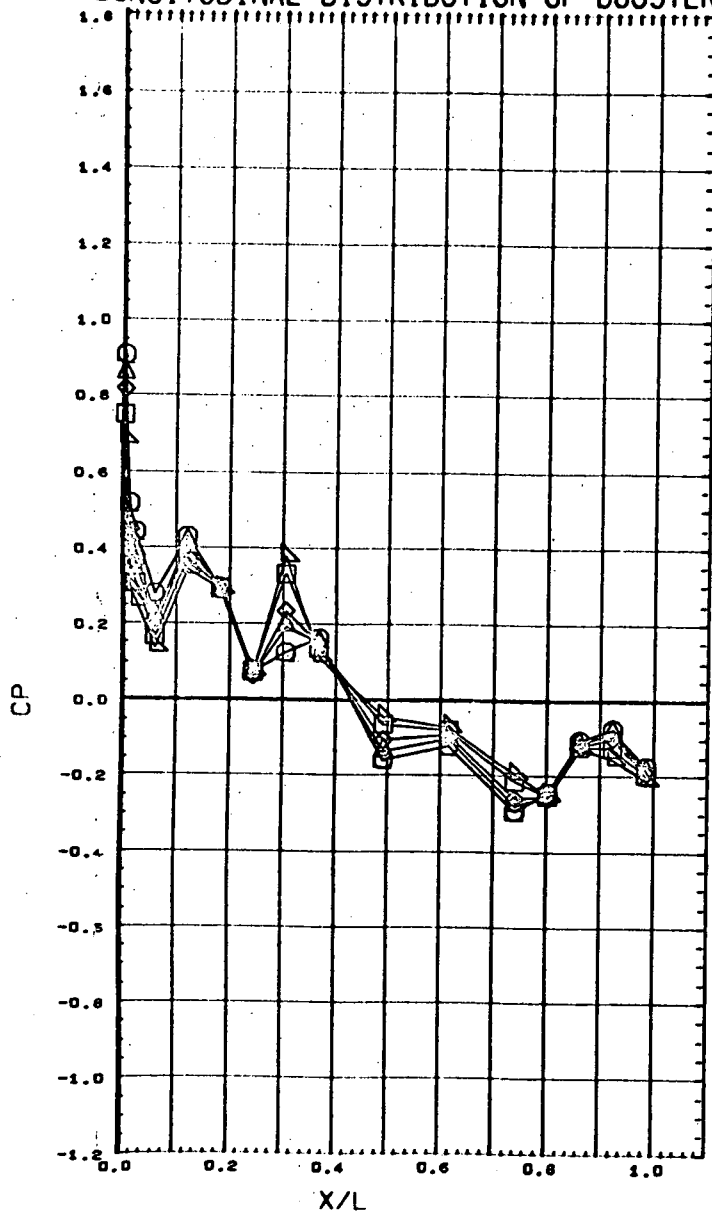

| SYMBOL | ALFB | THETA | M1 |
|--------|--------|--------|-------|
| ○ | 2.166 | 0.000 | 1.200 |
| ◇ | 4.173 | 15.000 | |
| △ | 5.534 | | |
| □ | 8.199 | | |
| ◇ | 10.165 | | |

REFERENCE FILE

| PARAMETRIC VALUES | | |
|-------------------|-------|-------|
| BETA | 0.000 | DX/L |
| I | 0.000 | 0.036 |

LONGITUDINAL DISTRIBUTION OF BOOSTER FUSELAGE PRESSURES

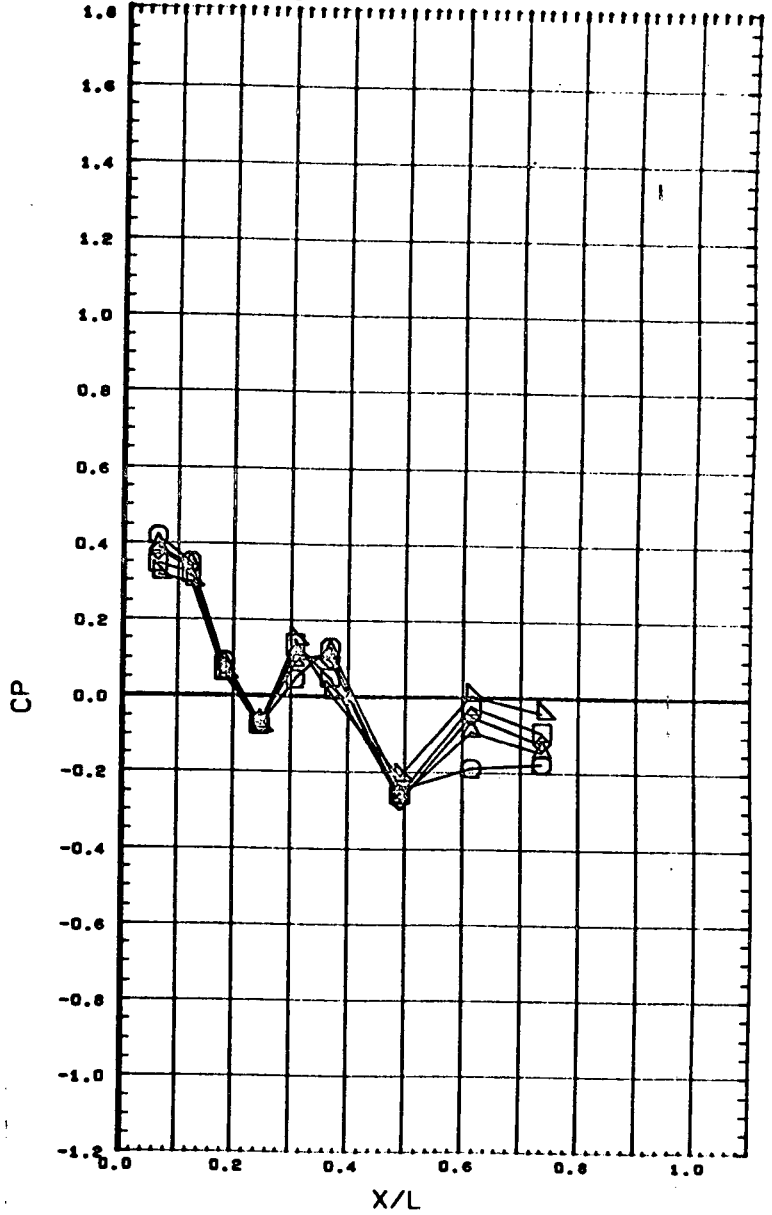
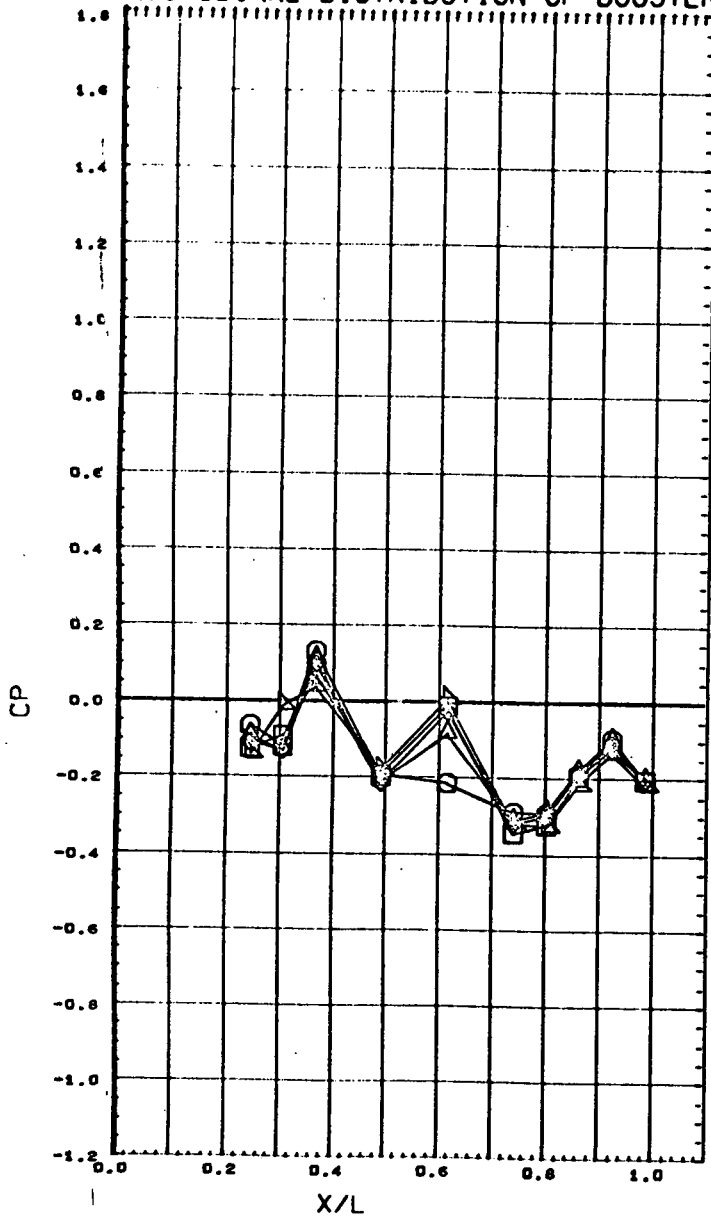

| SYMBOL | ALFB | THETA | M1 |
|--------|-------|--------|-------|
| ○ | 8.317 | 24.000 | 1.200 |
| ◇ | 5.757 | 45.000 | |
| △ | 4.430 | | |
| □ | 2.200 | | |
| ○ | 0.220 | | |

| PARAMETRIC VALUES | | |
|-------------------|-------|-------|
| BETA | 0.000 | OX/L |
| I | 0.000 | 0.036 |

REFERENCE FILE

LONGITUDINAL DISTRIBUTION OF BOOSTER FUSELAGE PRESSURES

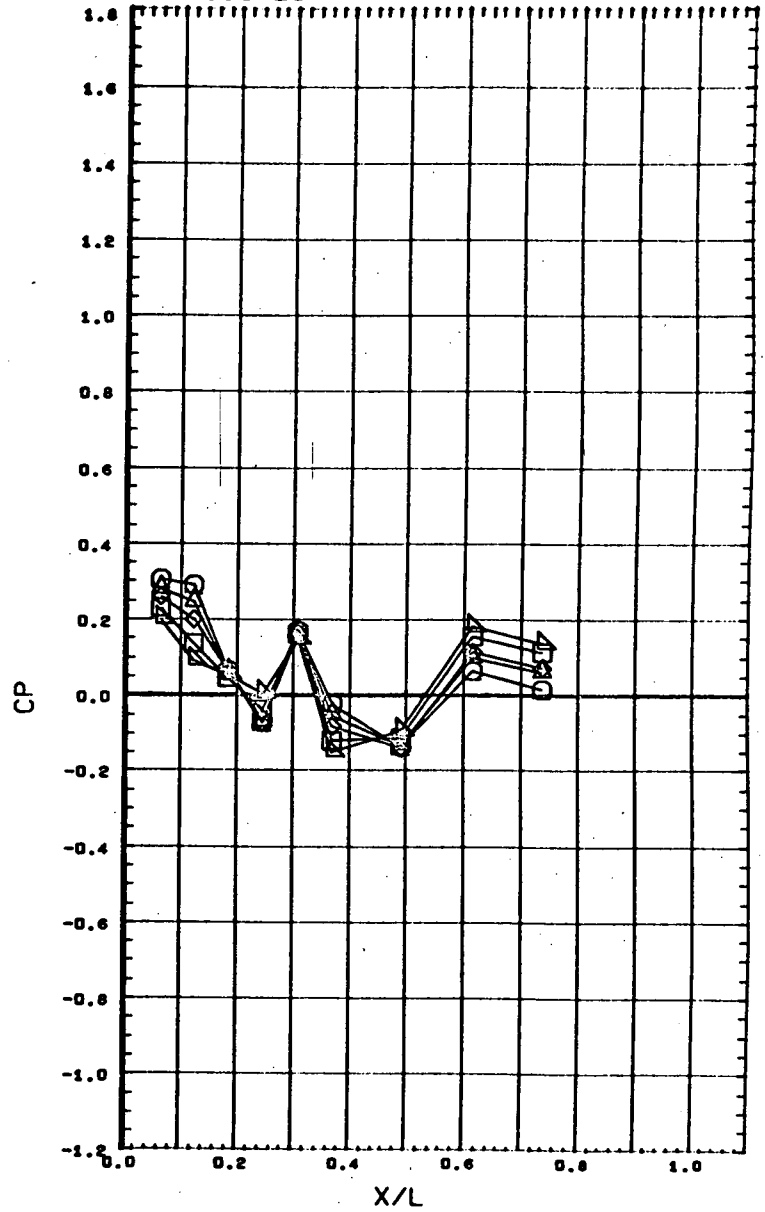
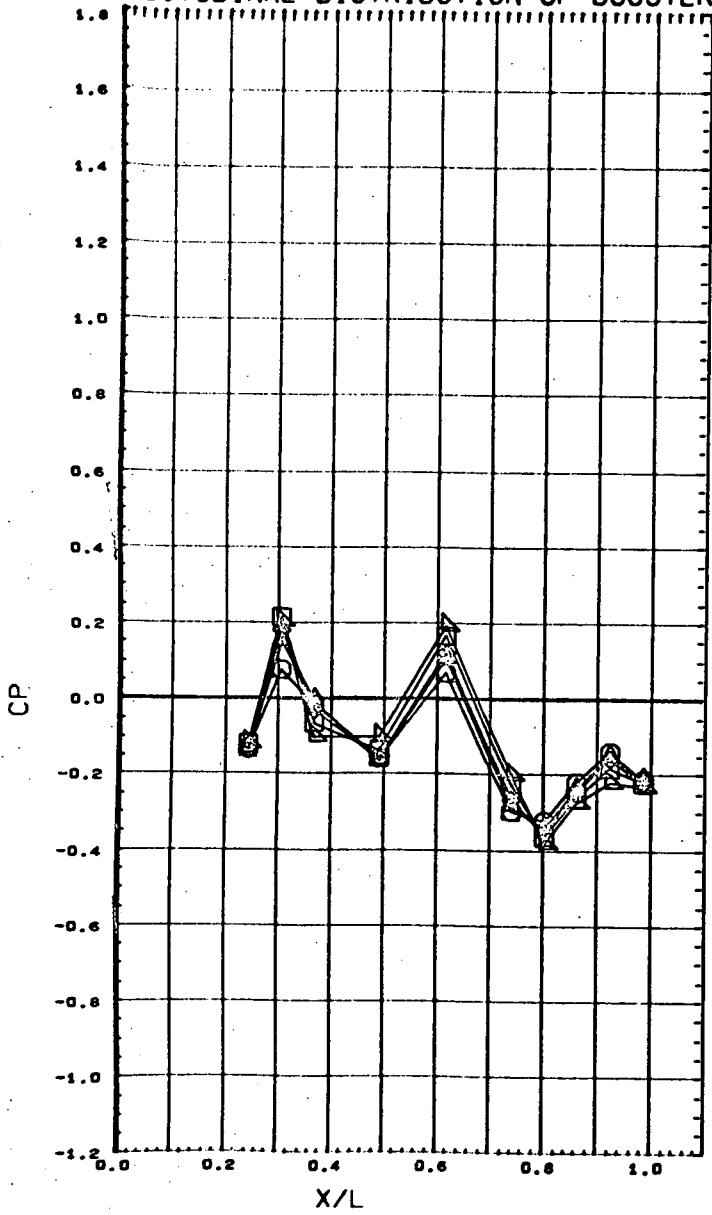

| SYMBOL | ALFB | THETA | M1 |
|--------|--------|--------|-------|
| ○ | 2.166 | 24.000 | 1.200 |
| △ | 4.173 | 45.000 | |
| ◇ | 5.534 | | |
| □ | 6.199 | | |
| ▽ | 10.165 | | |

REFERENCE FILE

| PARAMETRIC VALUES | | | |
|-------------------|-------|------|-------|
| BETA | 0.000 | DX/L | 0.036 |
| I | 0.000 | | |

LONGITUDINAL DISTRIBUTION OF BOOSTER FUSELAGE PRESSURES

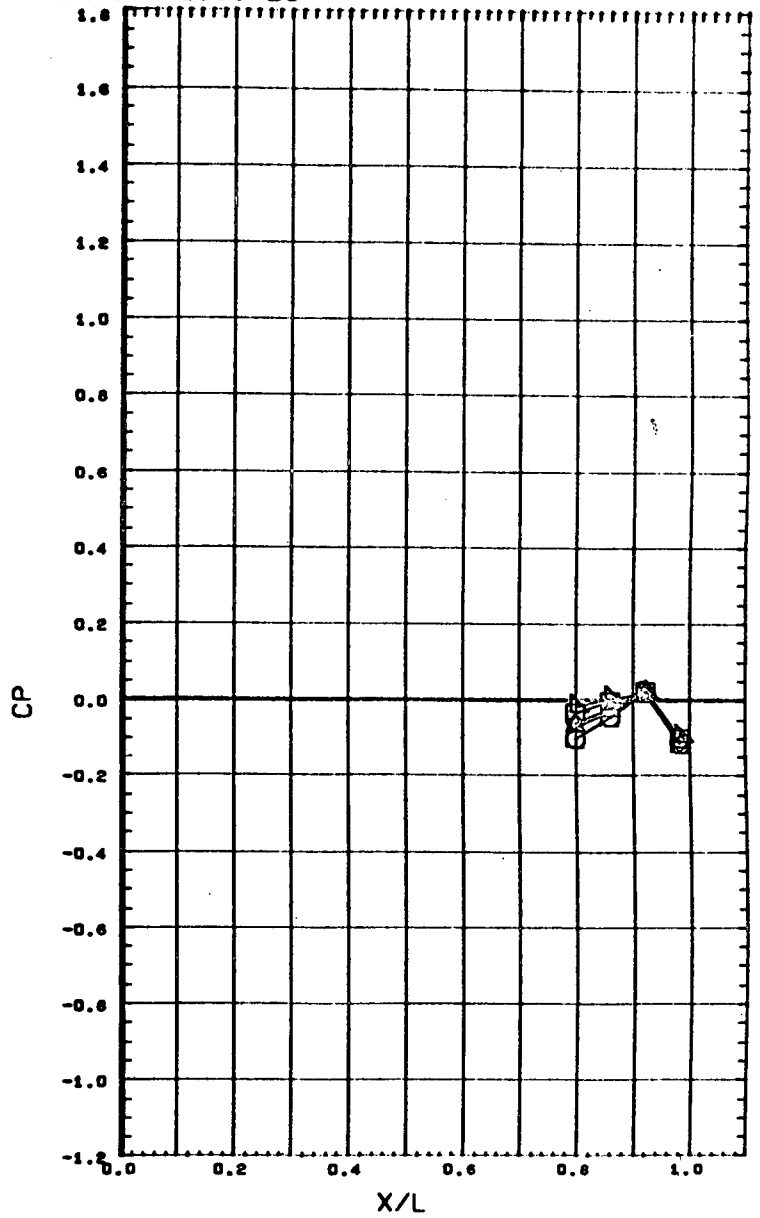
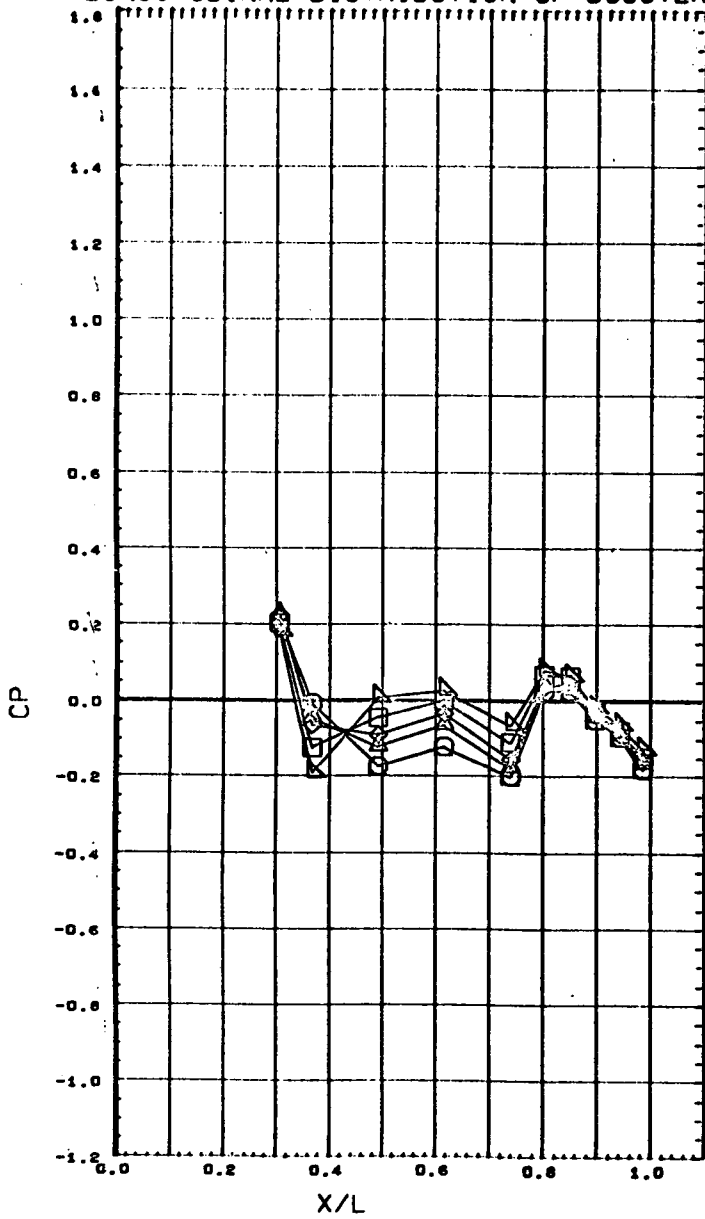

| SYMBOL | ALFB | THETA | M1 |
|--------|-------|---------|-------|
| ○ | 8.317 | 90.000 | 1.200 |
| ◇ | 5.757 | 180.000 | |
| △ | 4.430 | | |
| □ | 2.200 | | |
| ▽ | 0.220 | | |

| PARAMETRIC VALUES | | | |
|-------------------|-------|------|-------|
| BETA | 0.000 | OX/L | 0.036 |
| I | 0.000 | | |

REFERENCE FILE

LONGITUDINAL DISTRIBUTION OF BOOSTER FUSELAGE PRESSURES

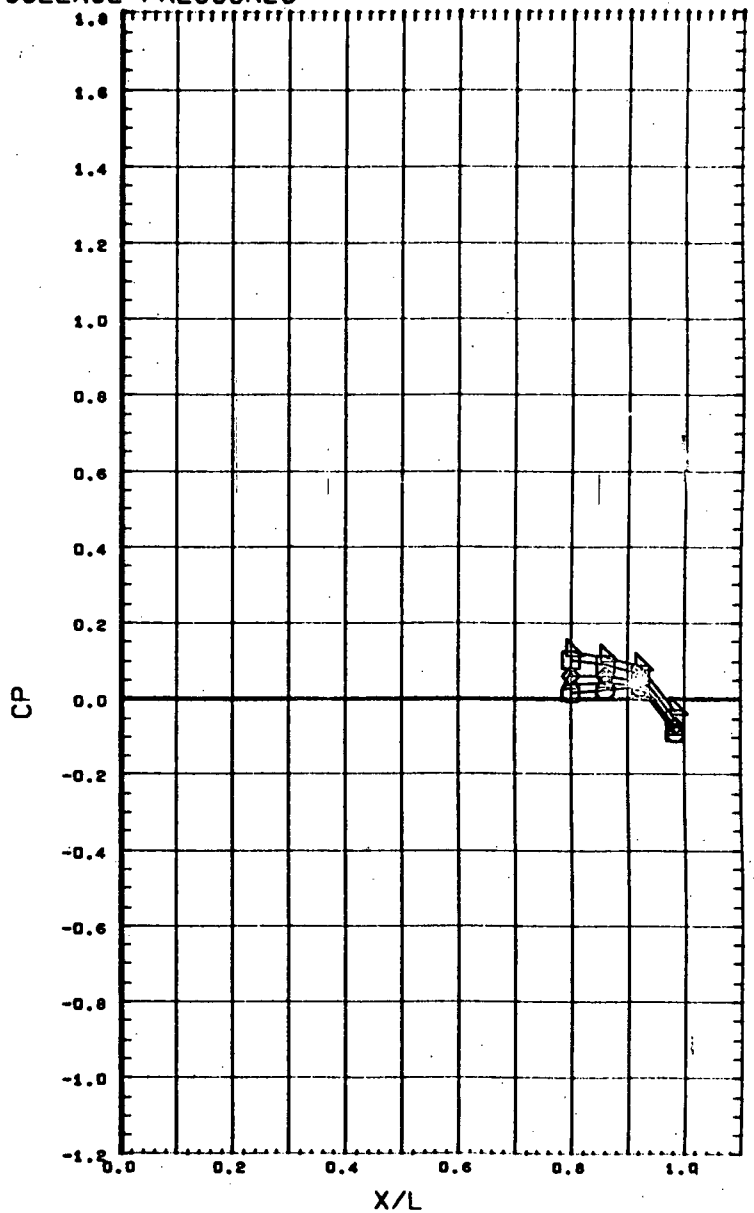
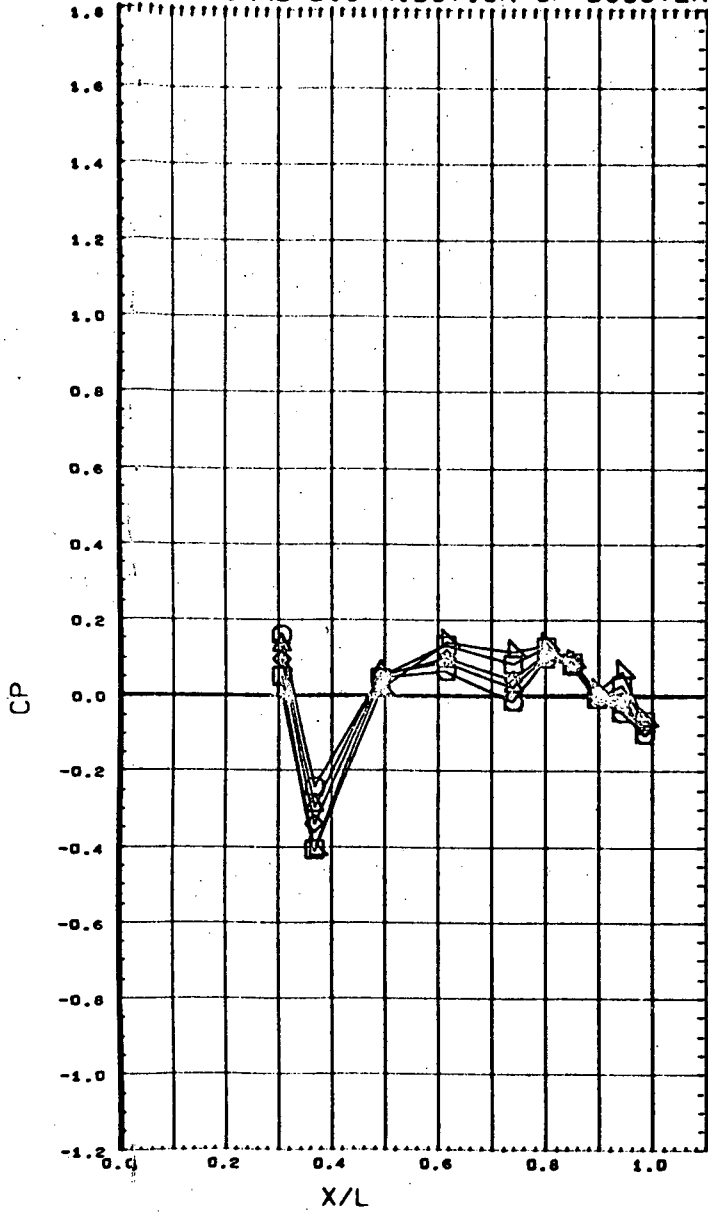

| SYMBOL | ALFB | THETA | M1 |
|--------|--------|---------|-------|
| ○ | 2.166 | 90.000 | 1.200 |
| △ | 4.173 | 180.000 | |
| ◇ | 5.534 | | |
| □ | 8.199 | | |
| ▽ | 10.165 | | |

REFERENCE FILE

| PARAMETRIC VALUES | | | |
|-------------------|-------|------|-------|
| BETA | 0.000 | OX/L | 0.036 |
| I | 0.000 | | |

LONGITUDINAL DISTRIBUTION OF BOOSTER FUSELAGE PRESSURES

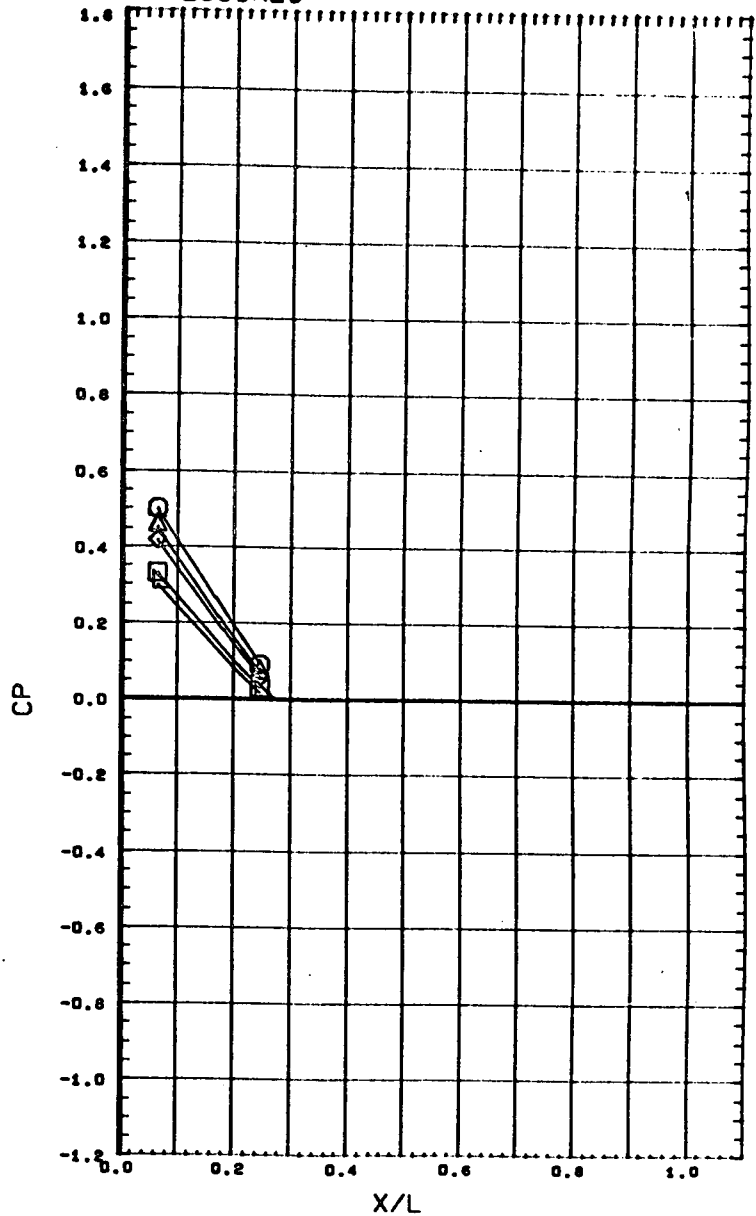
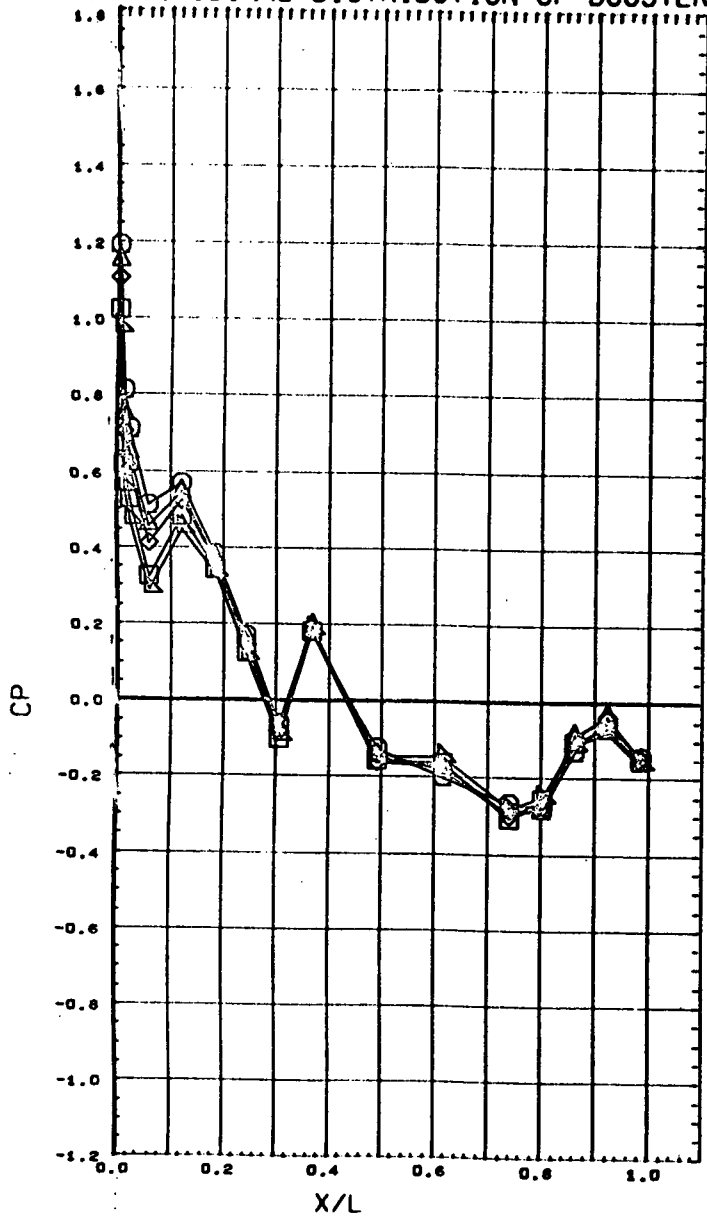

| SYMBOL | ALFB | THETA | M1 |
|--------|-------|--------|-------|
| ○ | 8.324 | 0.000 | 1.300 |
| △ | 5.757 | 15.000 | |
| ◇ | 4.435 | | |
| □ | 1.782 | | |
| | 0.167 | | |

| PARAMETRIC VALUES | | | |
|-------------------|-------|------|-------|
| BETA | 0.000 | DX/L | 0.036 |
| I | 0.000 | | |

REFERENCE FILE

LONGITUDINAL DISTRIBUTION OF BOOSTER FUSELAGE PRESSURES

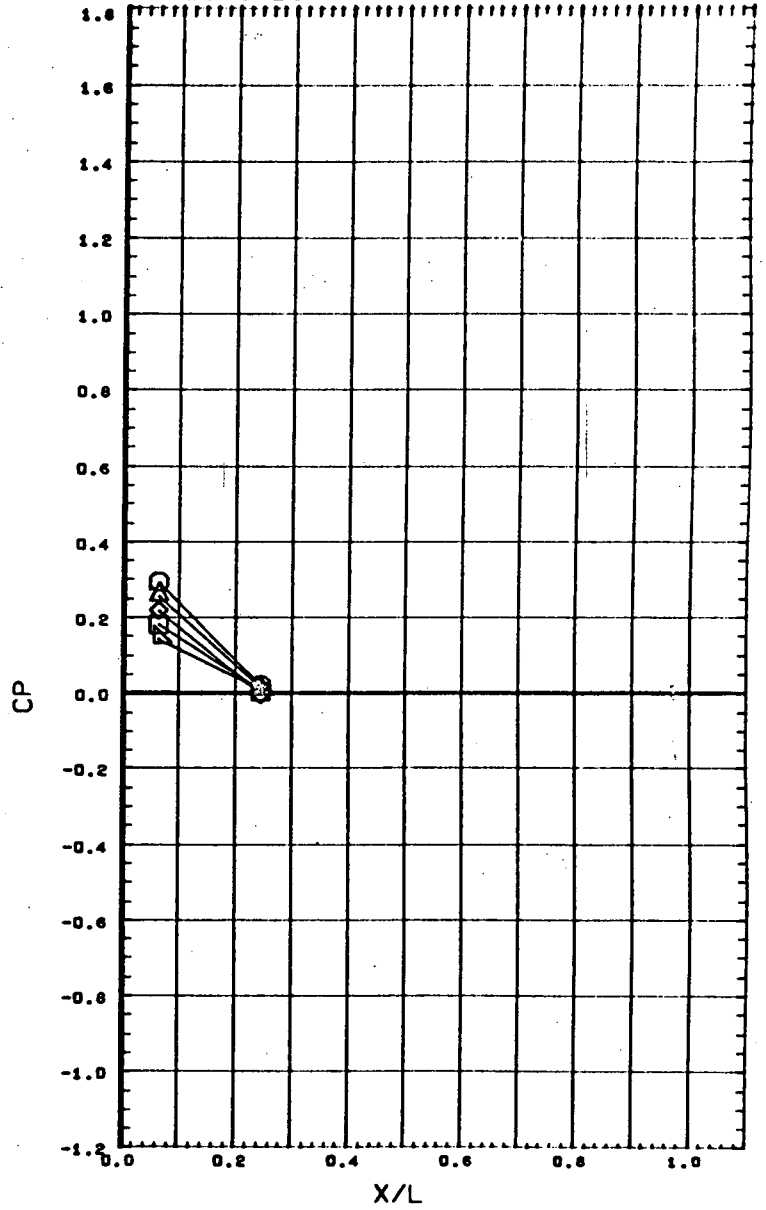
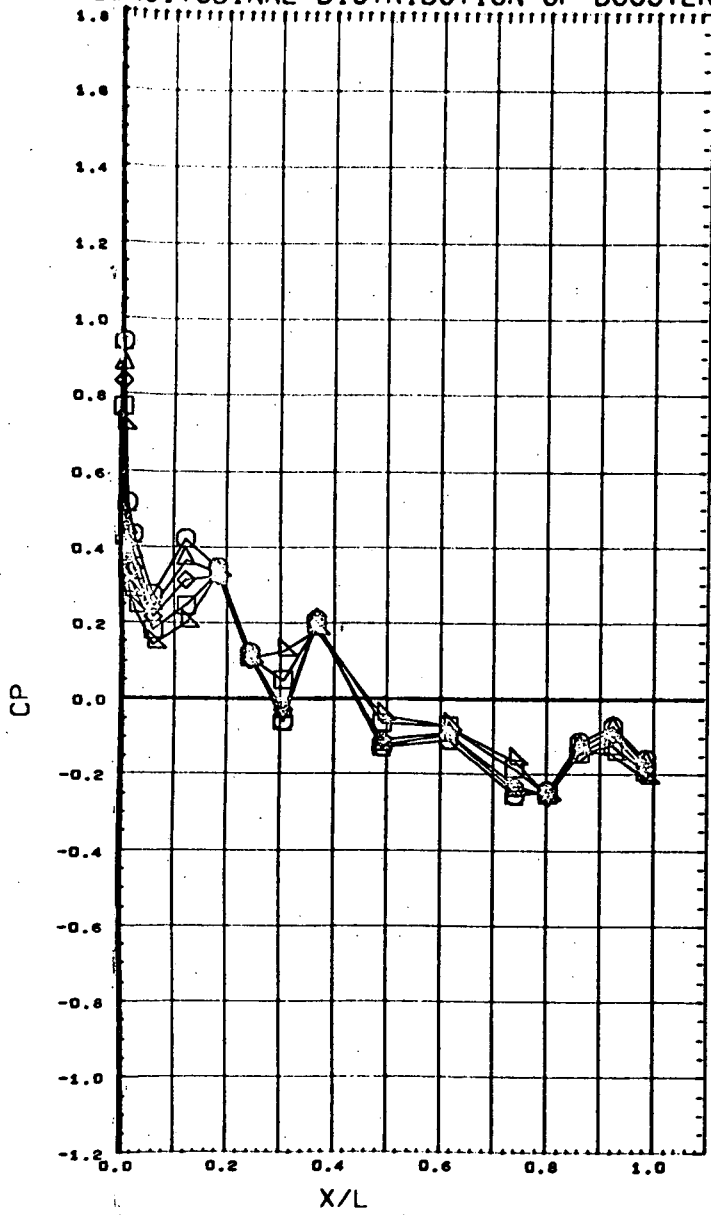

| SYMBOL | ALFB | THETA | M1 |
|--------|--------|--------|-------|
| ○ | 2.176 | 0.000 | 1.300 |
| ◇ | 4.176 | 15.000 | |
| △ | 9.526 | | |
| □ | 6.201 | | |
| ▽ | 10.165 | | |

| PARAMETRIC VALUES | | |
|-------------------|-------|-------|
| BETA | 0.000 | OX/L |
| I | 0.000 | 0.036 |

REFERENCE FILE

LONGITUDINAL DISTRIBUTION OF BOOSTER FUSELAGE PRESSURES

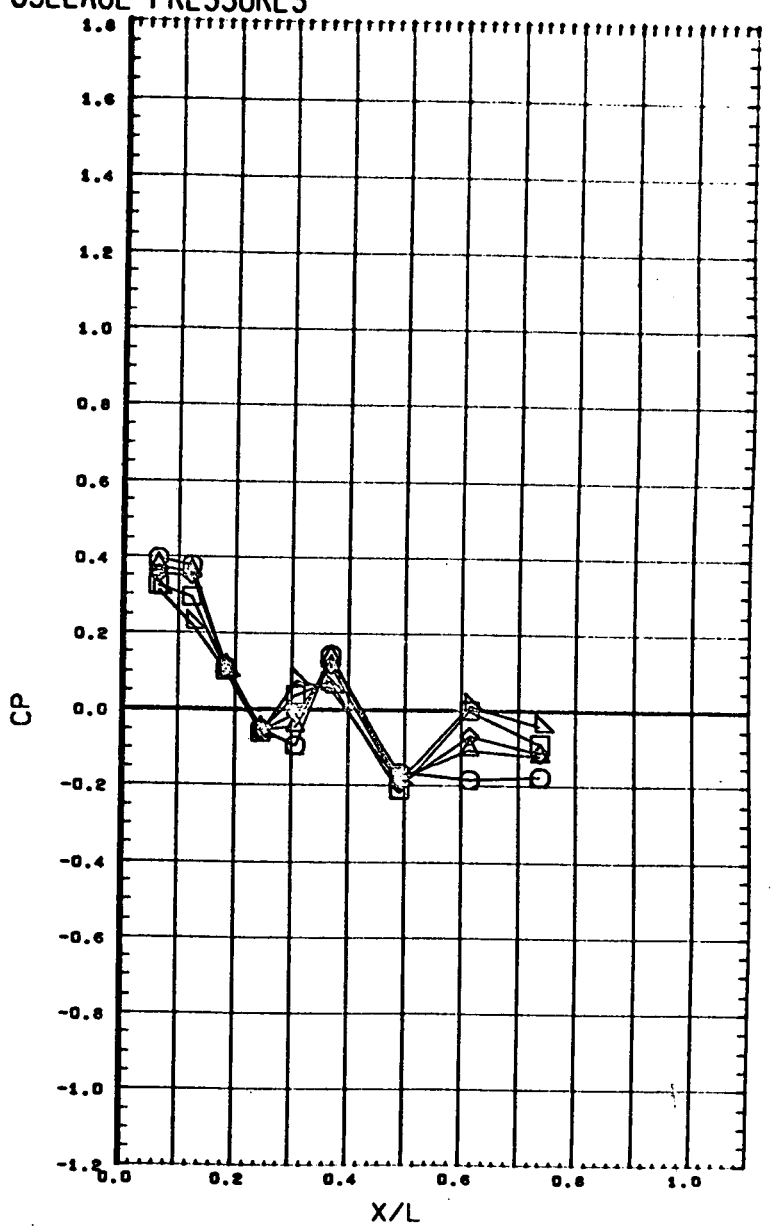
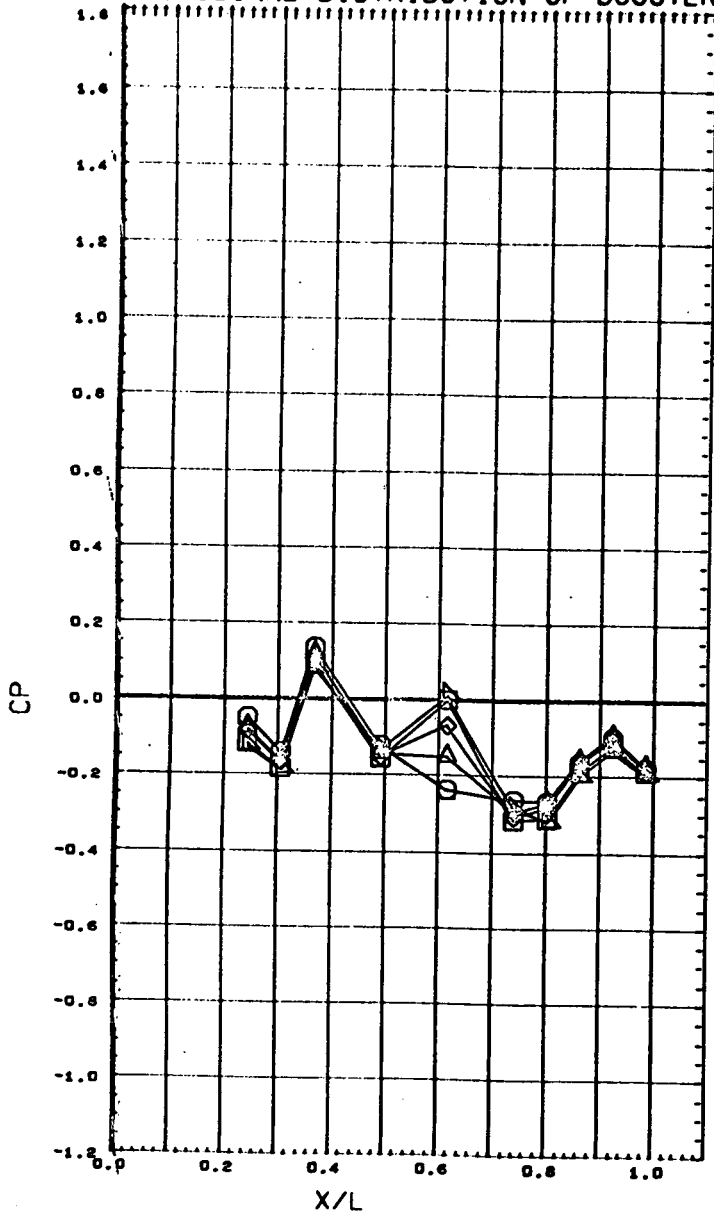

| SYMBOL | ALFB | THETA | M1 |
|--------|-------|--------|-------|
| ○ | 8.324 | 24.000 | 1.300 |
| △ | 9.757 | 45.000 | |
| ◇ | 4.435 | | |
| □ | 1.782 | | |
| ○ | 0.167 | | |

REFERENCE FILE

| PARAMETRIC VALUES | | | |
|-------------------|-------|------|-------|
| BETA | 0.000 | OX/L | 0.036 |
| I | 0.000 | | |

LONGITUDINAL DISTRIBUTION OF BOOSTER FUSELAGE PRESSURES

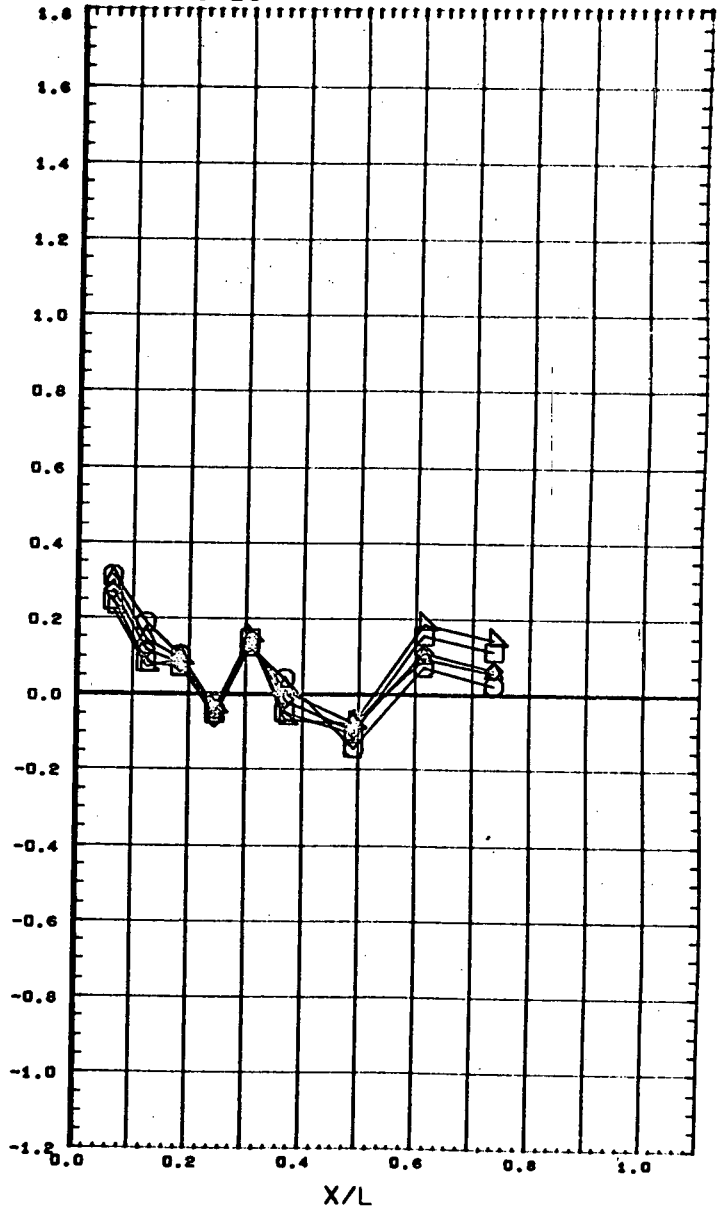
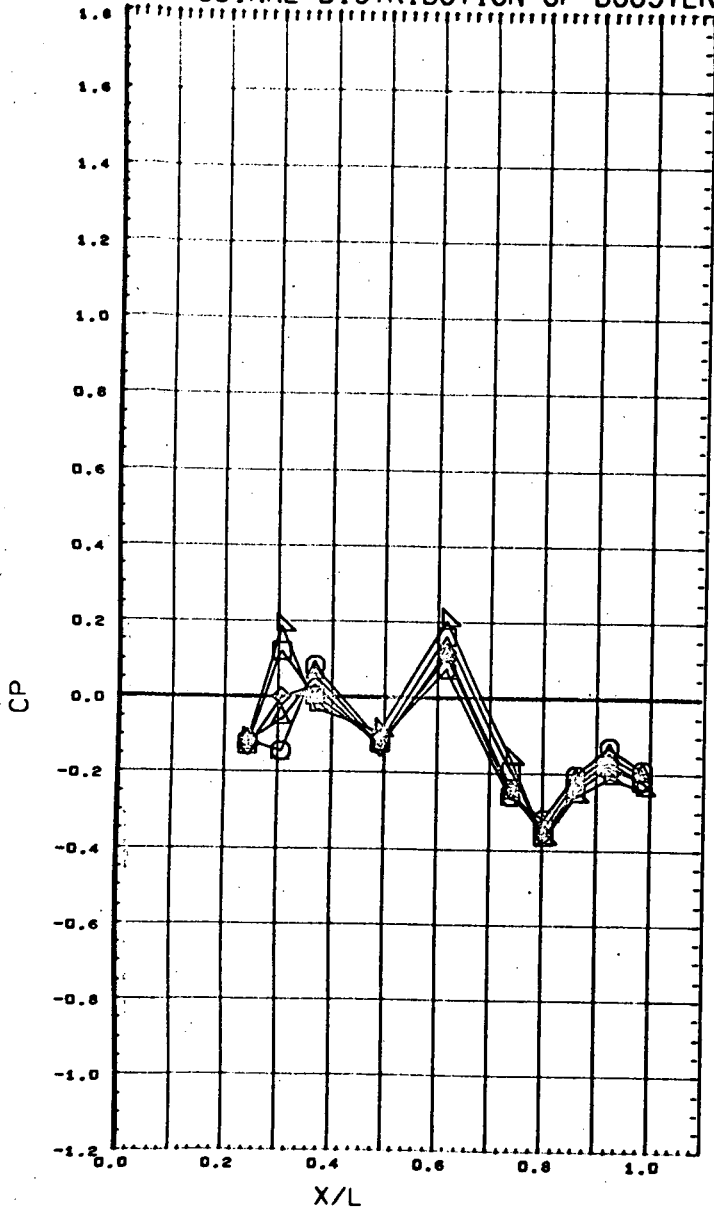

| SYMBOL | ALFB | THETA | M1 |
|--------|--------|--------|-------|
| ○ | 2.176 | 24.000 | 1.300 |
| △ | 4.176 | 45.000 | |
| ◇ | 5.526 | | |
| □ | 6.201 | | |
| ▽ | 10.165 | | |

| PARAMETRIC VALUES | | |
|-------------------|-------|-------|
| BETA | 0.000 | DX/L |
| I | 0.000 | 0.036 |

REFERENCE FILE

LONGITUDINAL DISTRIBUTION OF BOOSTER FUSELAGE PRESSURES

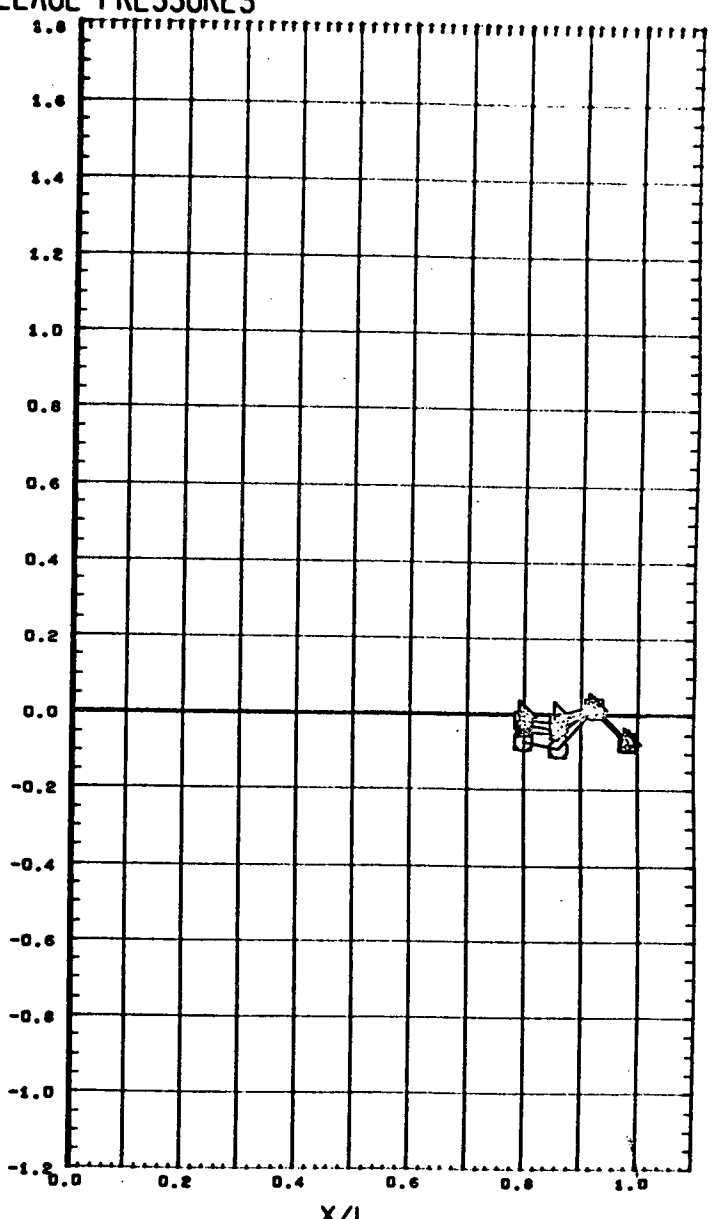
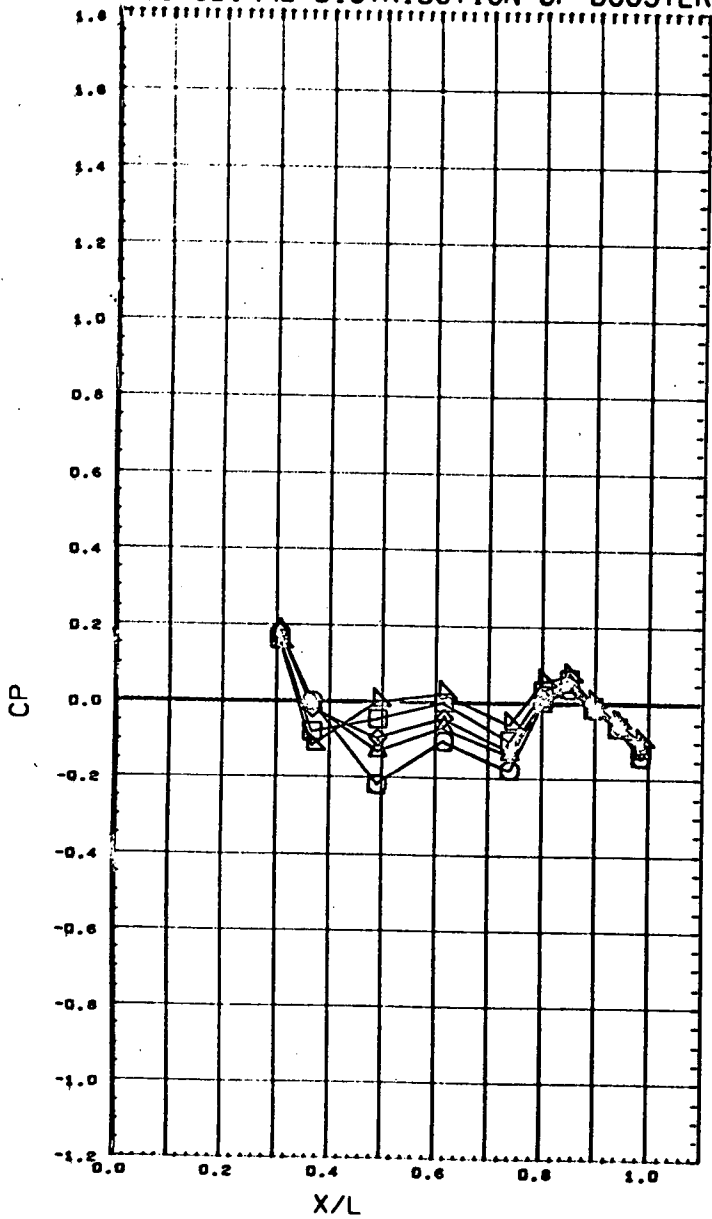

| SYMBOL | ALFB | THETA | M1 |
|--------|-------|---------|-------|
| □ | 6.324 | 90.000 | 1.300 |
| ◇ | 5.757 | 180.000 | |
| △ | 4.435 | | |
| ○ | 1.782 | | |
| ◇ | 0.167 | | |

REFERENCE FILE

| PARAMETRIC VALUES | | | |
|-------------------|-------|------|-------|
| BETA | 0.000 | DX/L | 0.036 |
| I | 0.000 | | |

LONGITUDINAL DISTRIBUTION OF BOOSTER FUSELAGE PRESSURES

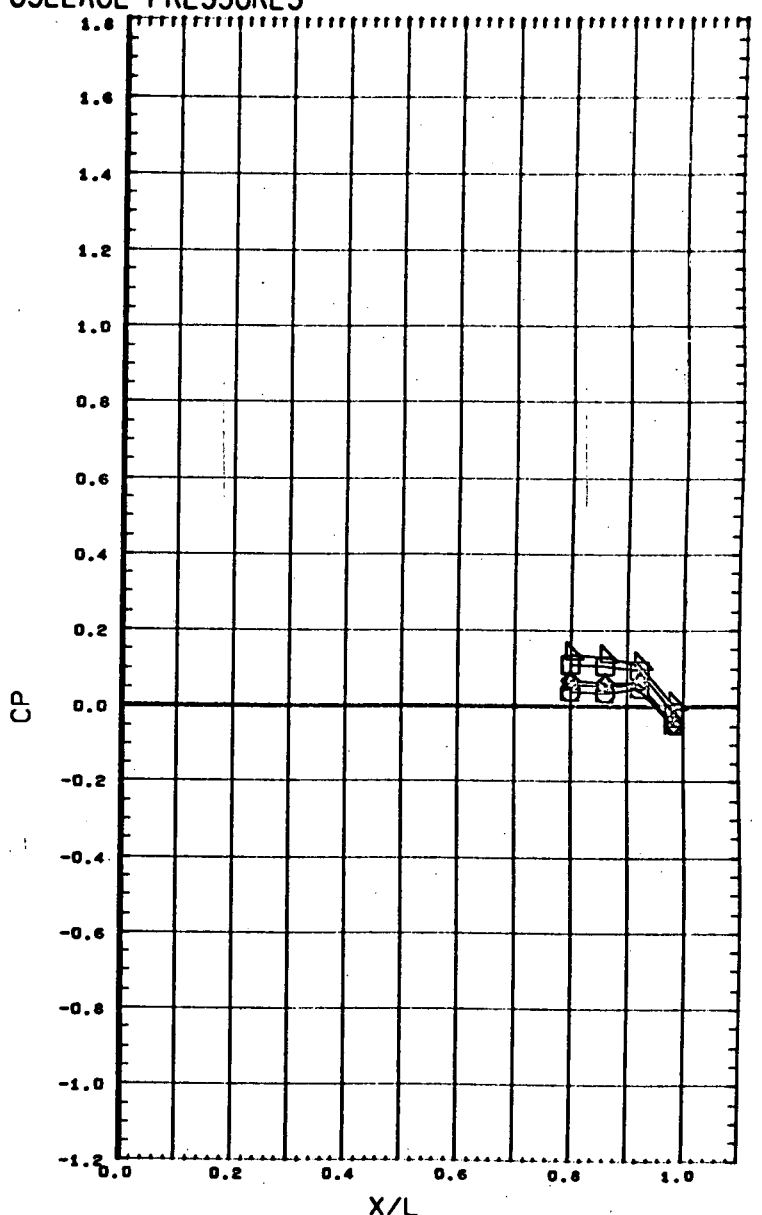
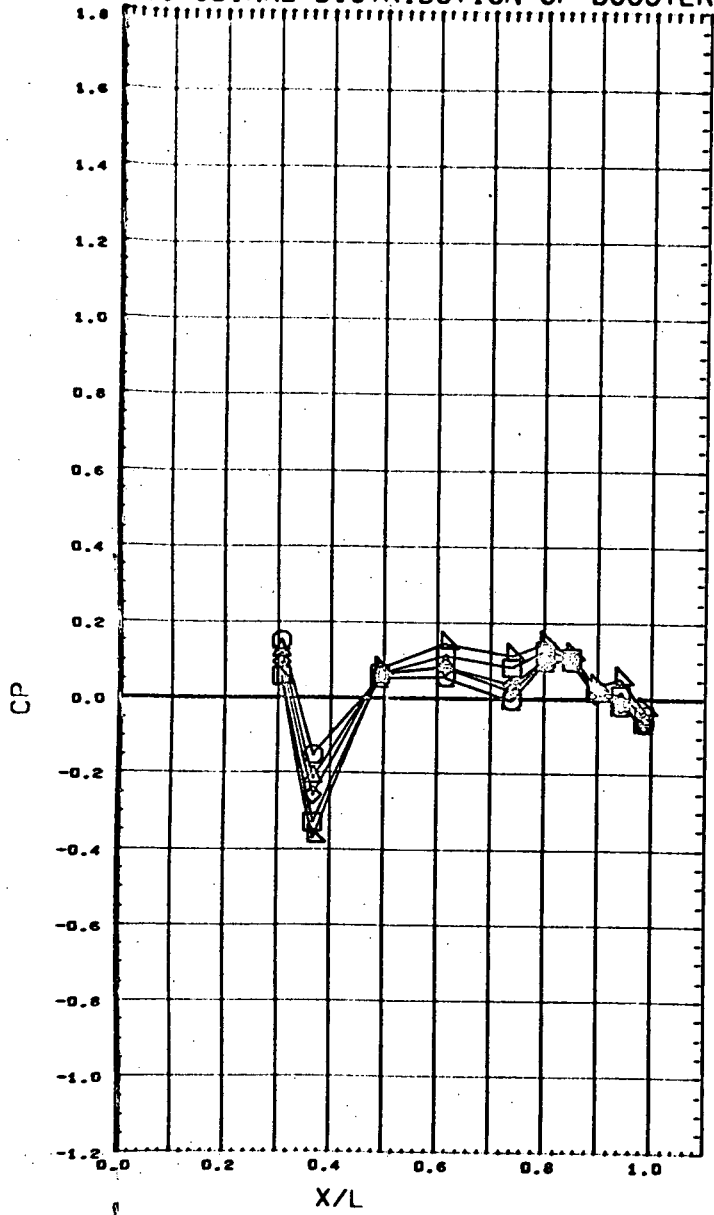

| SYMBOL | ALFB | THETA | M1 |
|--------|--------|---------|-------|
| ○ | 2.176 | 90.000 | 1.300 |
| △ | 4.176 | 180.000 | |
| ◇ | 5.526 | | |
| □ | 6.201 | | |
| ○ | 10.165 | | |

REFERENCE FILE

| PARAMETRIC VALUES | | |
|-------------------|-------|------------|
| BETA | 0.000 | DX/L 0.036 |
| I | 0.000 | |

LONGITUDINAL DISTRIBUTION OF BOOSTER FUSELAGE PRESSURES

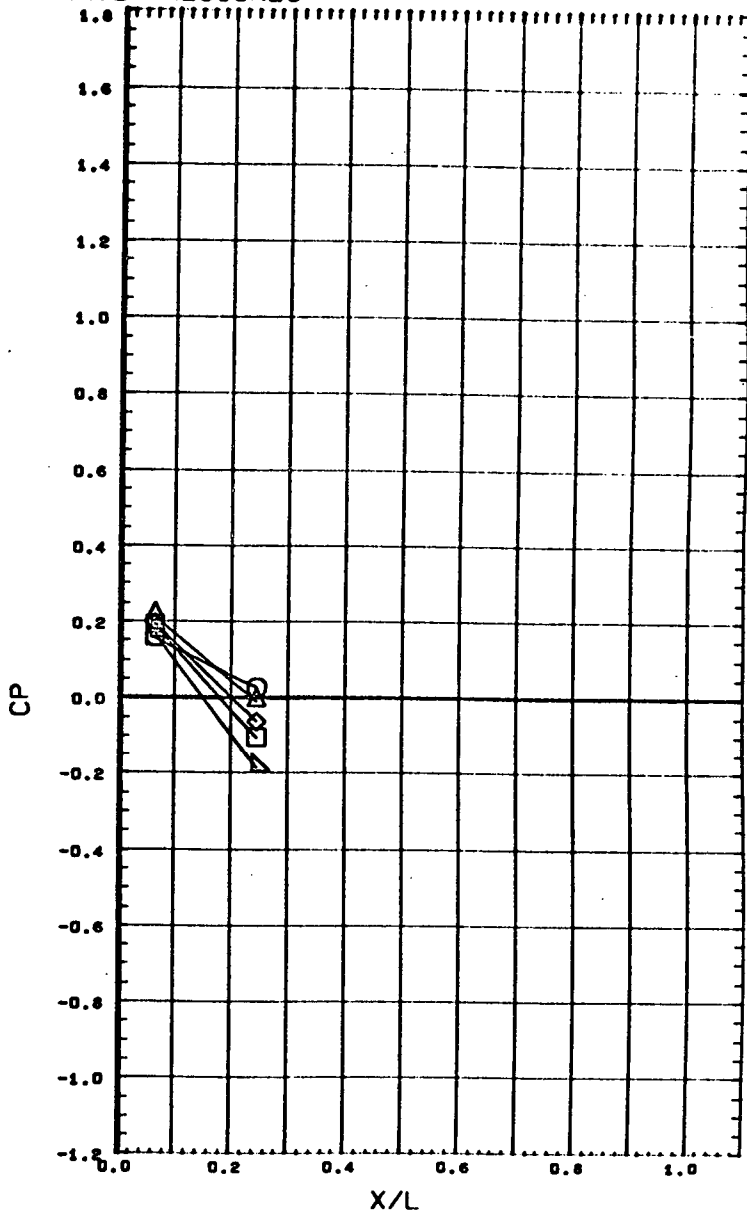
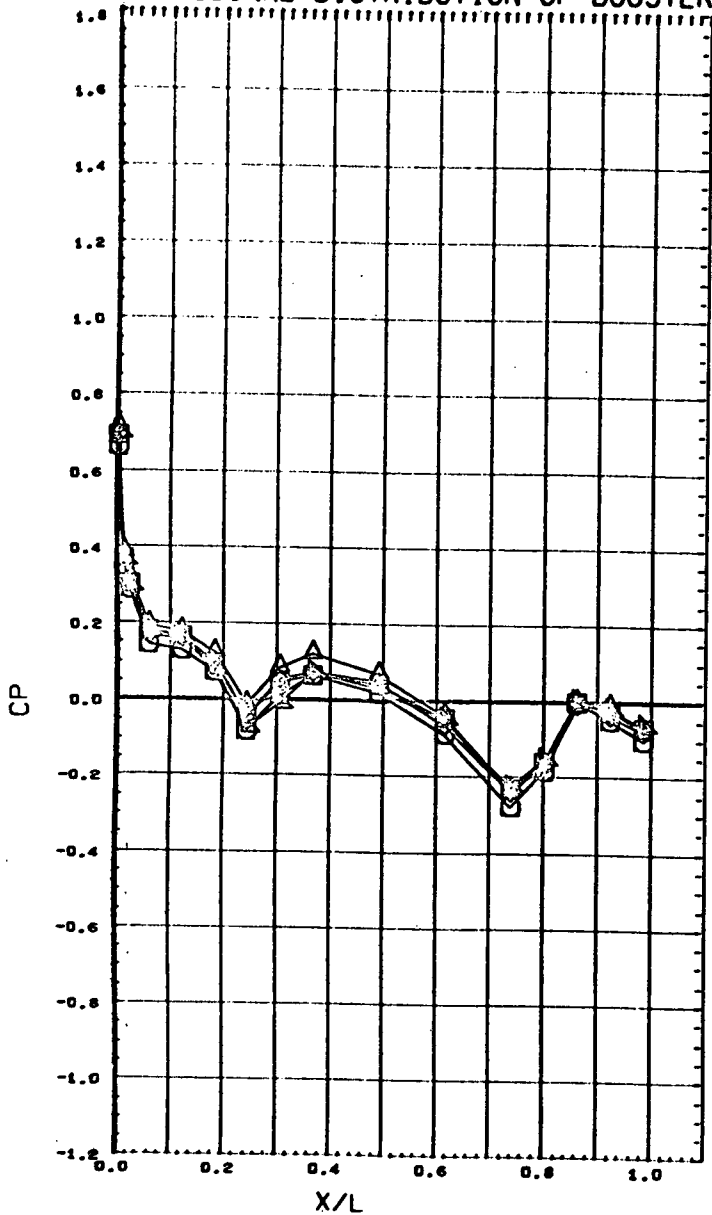

| SYMBOL | BETA | THETA | M1 |
|--------|-------|--------|-------|
| ○ | 6.037 | 0.000 | 0.599 |
| △ | 4.023 | 15.000 | |
| ◇ | 1.978 | | |
| □ | 0.265 | | |
| ○ | 1.756 | | |

| PARAMETRIC VALUES | | |
|-------------------|-------|-------|
| ALPB | 0.000 | DX/L |
| I | 0.000 | 0.036 |

REFERENCE FILE

LONGITUDINAL DISTRIBUTION OF BOOSTER FUSELAGE PRESSURES

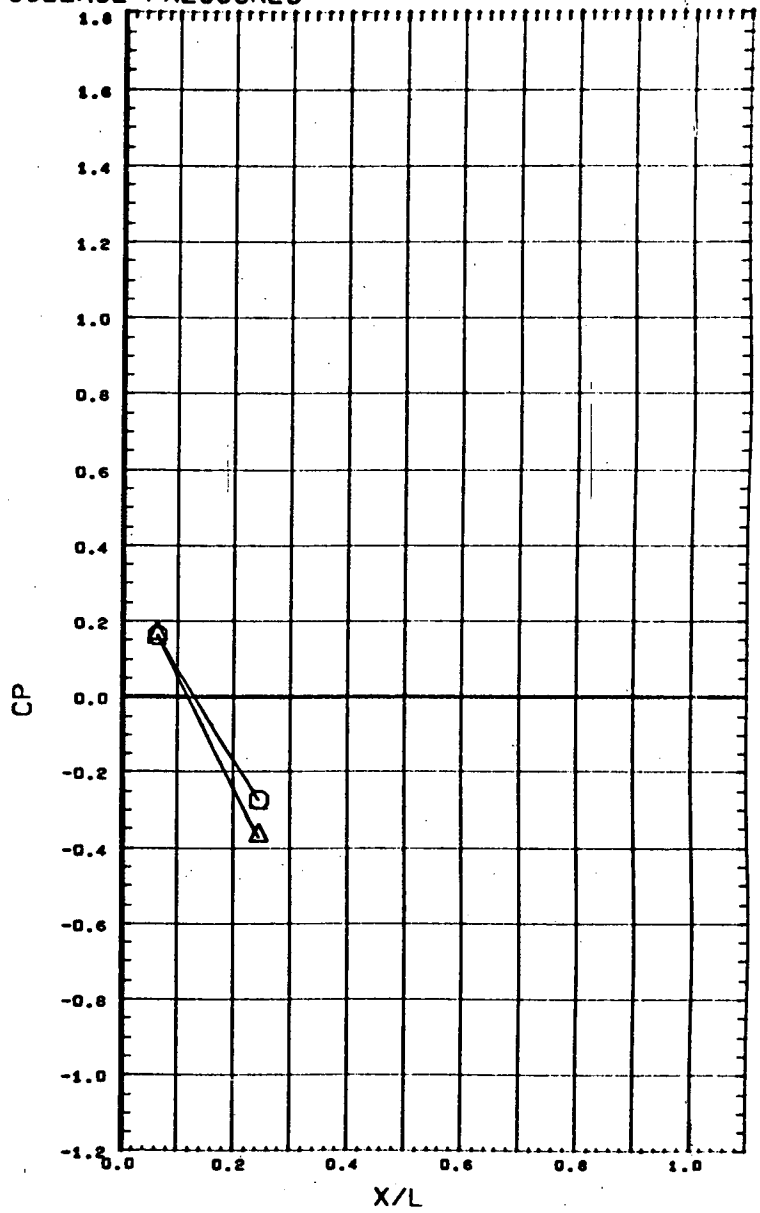
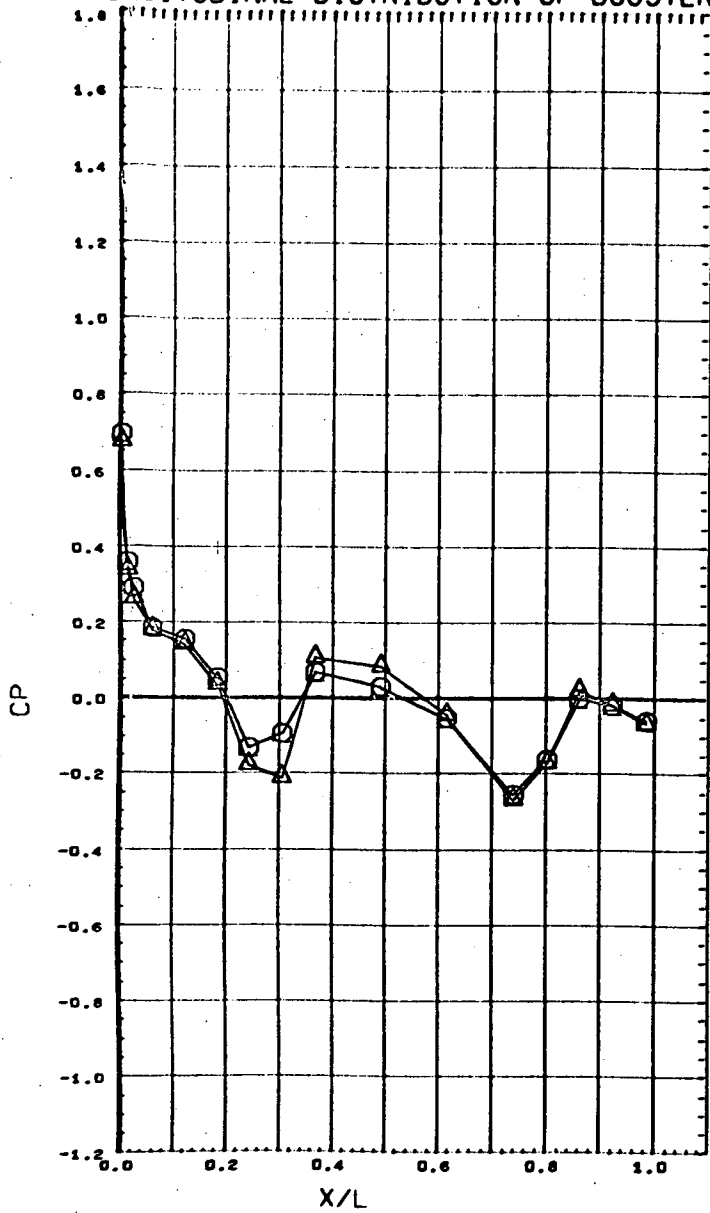

| SYMBOL | BETA | THETA | M1 |
|--------|-------|--------|-------|
| ○ | 3.761 | 0.000 | 0.599 |
| △ | 5.835 | 15.000 | |

| PARAMETRIC VALUES | | | |
|-------------------|-------|------|-------|
| ALFB | 0.000 | DX/L | 0.036 |
| I | 0.000 | | |

REFERENCE FILE

LONGITUDINAL DISTRIBUTION OF BOOSTER FUSELAGE PRESSURES

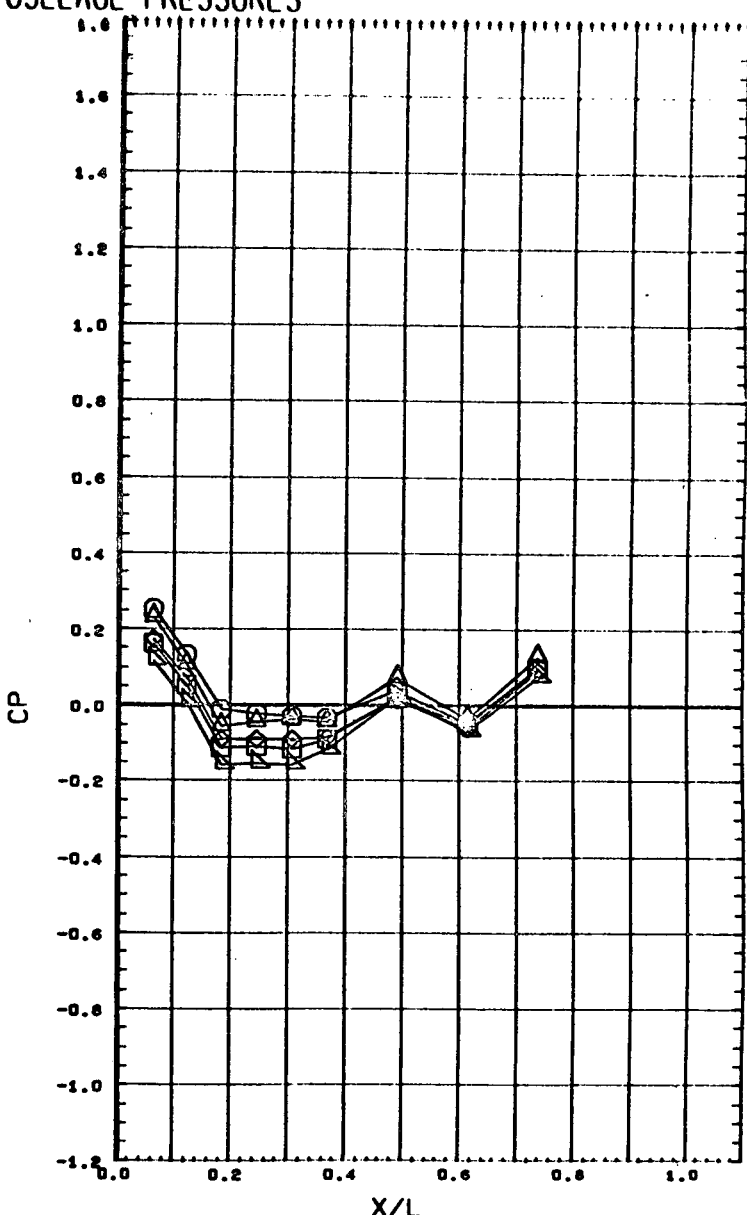
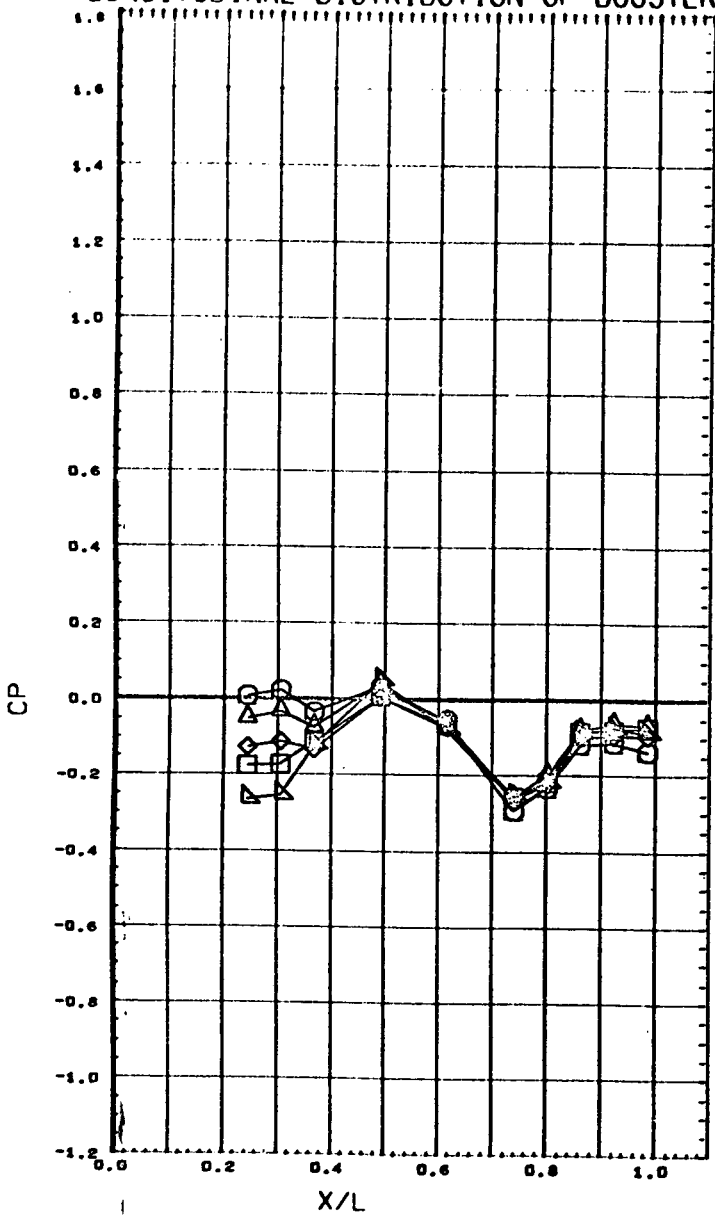

| SYMBOL | BETA | THETA | M1 |
|--------|-------|--------|-------|
| ○ | 6.037 | 24.000 | 0.599 |
| △ | 4.023 | 45.000 | |
| ◇ | 1.978 | | |
| □ | 0.265 | | |
| ▽ | 1.756 | | |

| PARAMETRIC VALUES | | | |
|-------------------|-------|------|-------|
| ALFB | 0.000 | DX/L | 0.036 |
| I | 0.000 | | |

REFERENCE FILE

LONGITUDINAL DISTRIBUTION OF BOOSTER FUSELAGE PRESSURES

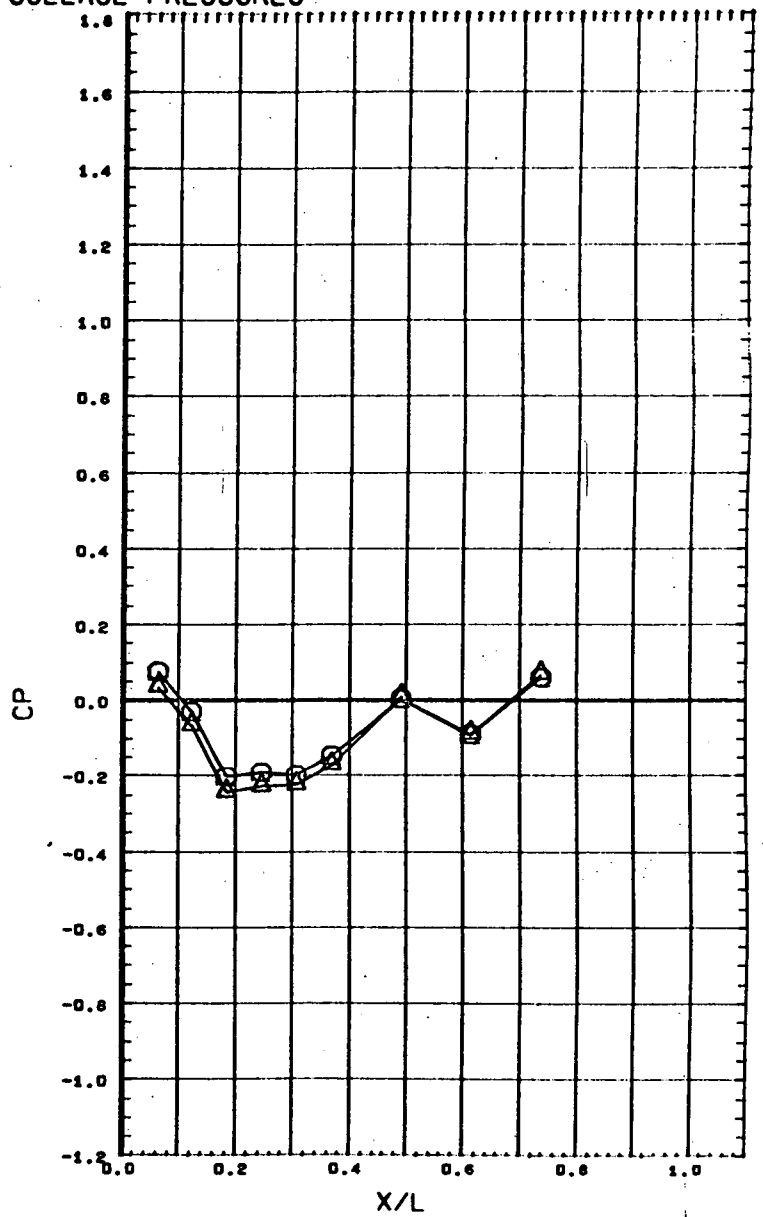
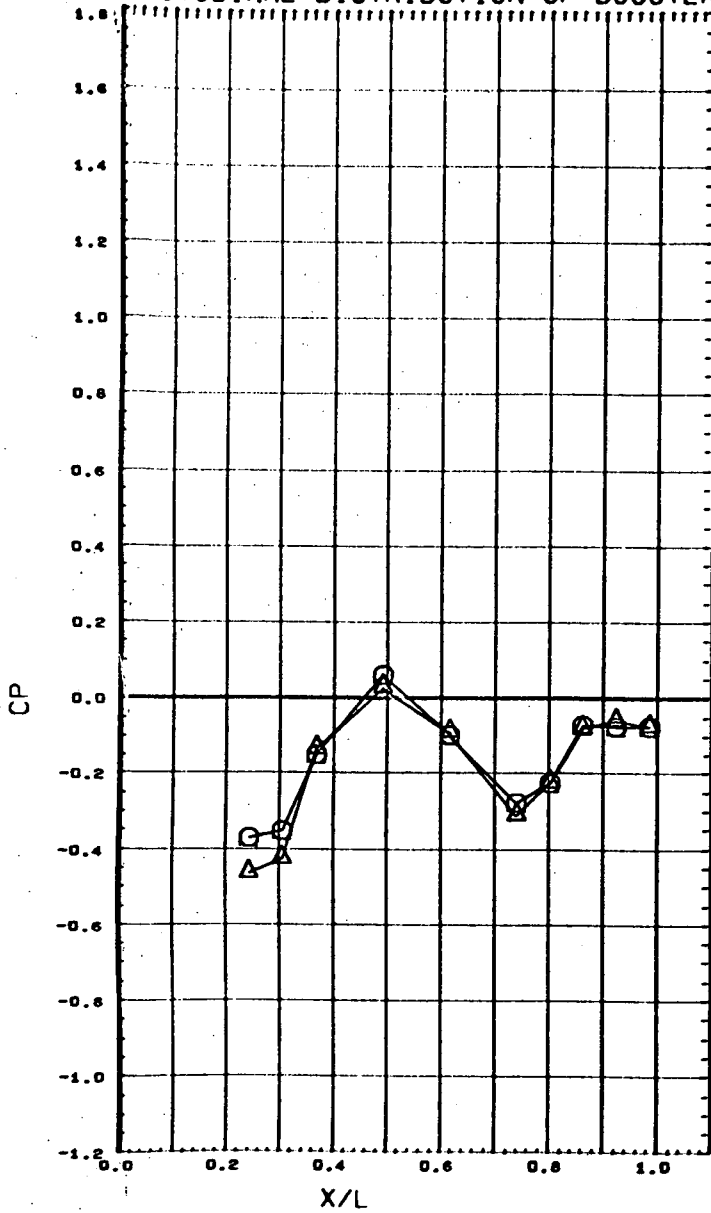

| SYMBOL | BETA | THETA | M1 |
|--------|-------|--------|-------|
| O | 3.761 | 24.000 | 0.599 |
| Δ | 5.835 | 45.000 | |

| PARAMETRIC VALUES | | |
|-------------------|-------|-------|
| ALFB | 0.000 | DX/L |
| I | 0.000 | 0.036 |

REFERENCE FILE

LONGITUDINAL DISTRIBUTION OF BOOSTER FUSELAGE PRESSURES

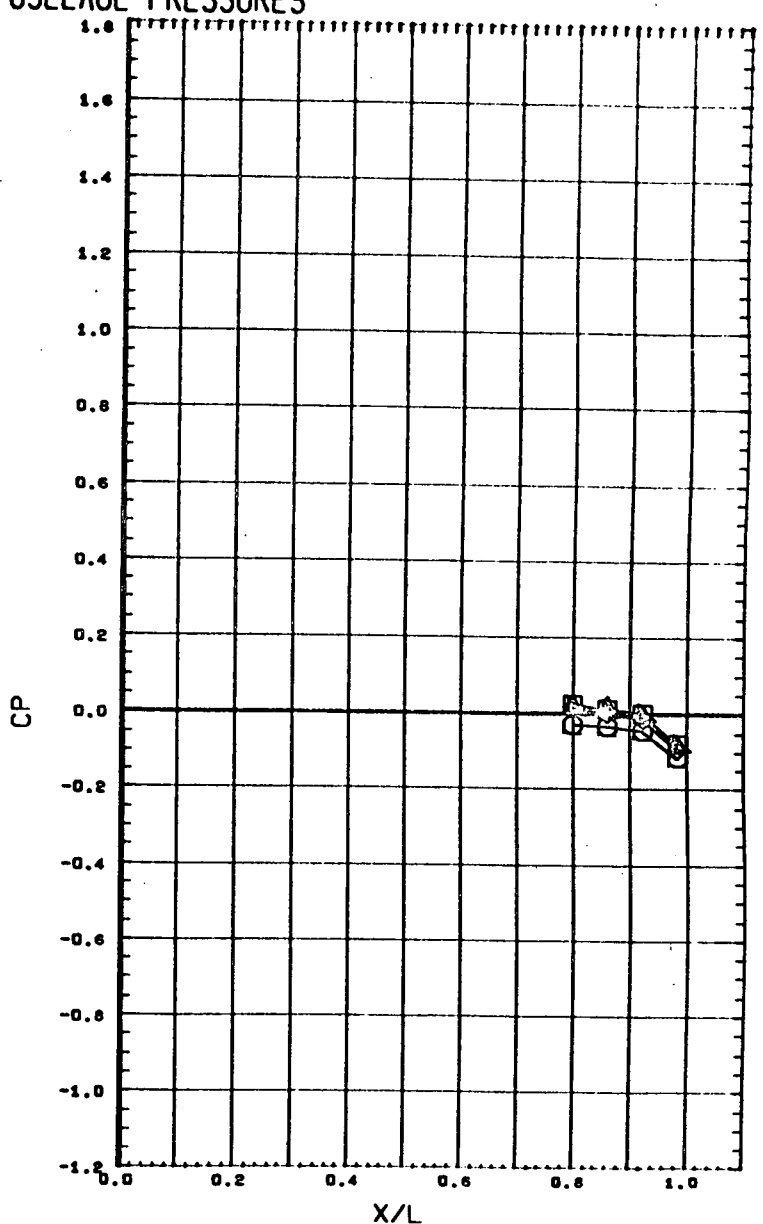
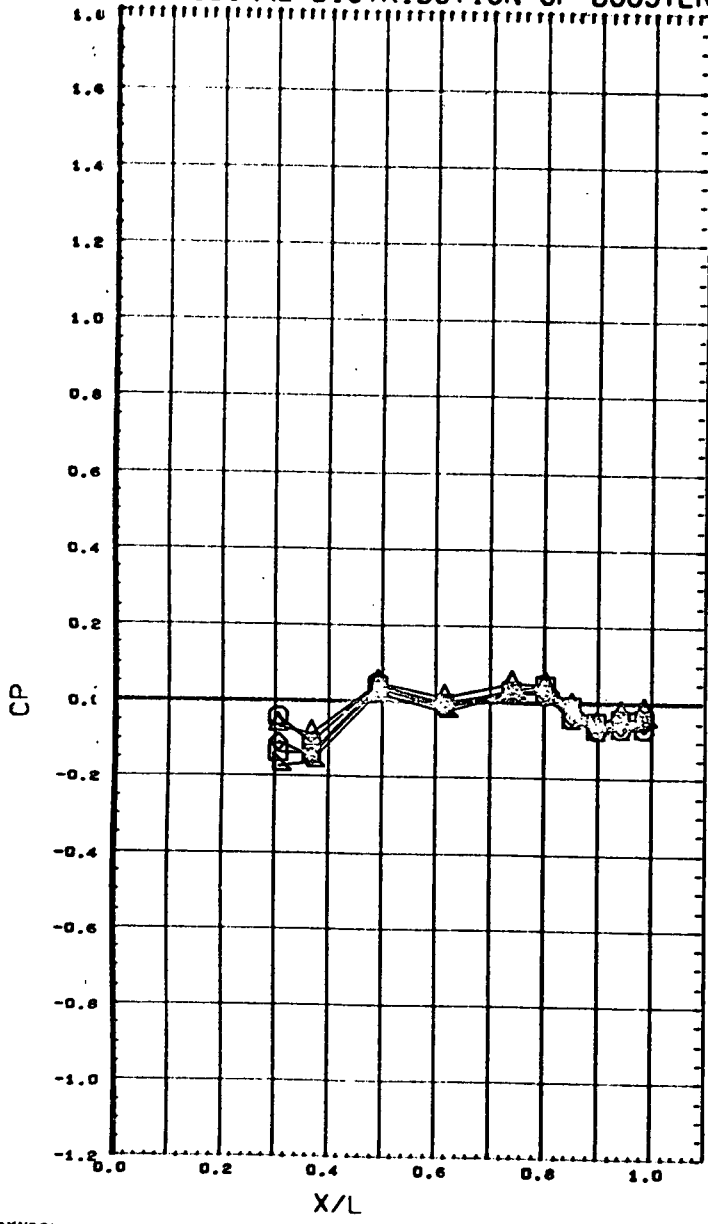

| SYMBOL | BETA | THETA | M1 |
|--------|-------|---------|-------|
| ○ | 6.037 | 90.000 | 0.599 |
| △ | 4.023 | 180.000 | |
| ◇ | 1.978 | | |
| □ | 0.265 | | |
| ▽ | 1.756 | | |

| PARAMETRIC VALUES | | | |
|-------------------|-------|------|-------|
| ALFB | 0.000 | DX/L | 0.036 |
| I | 0.000 | | |

REFERENCE FILE

LONGITUDINAL DISTRIBUTION OF BOOSTER FUSELAGE PRESSURES

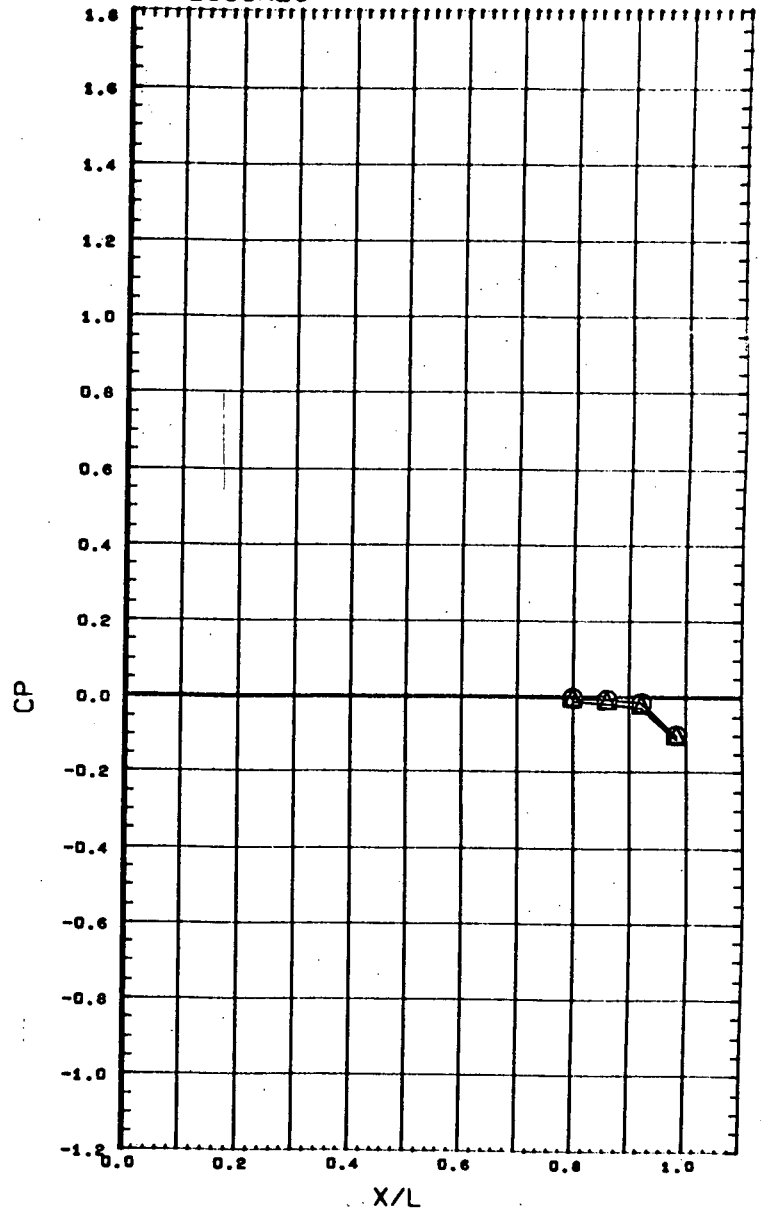
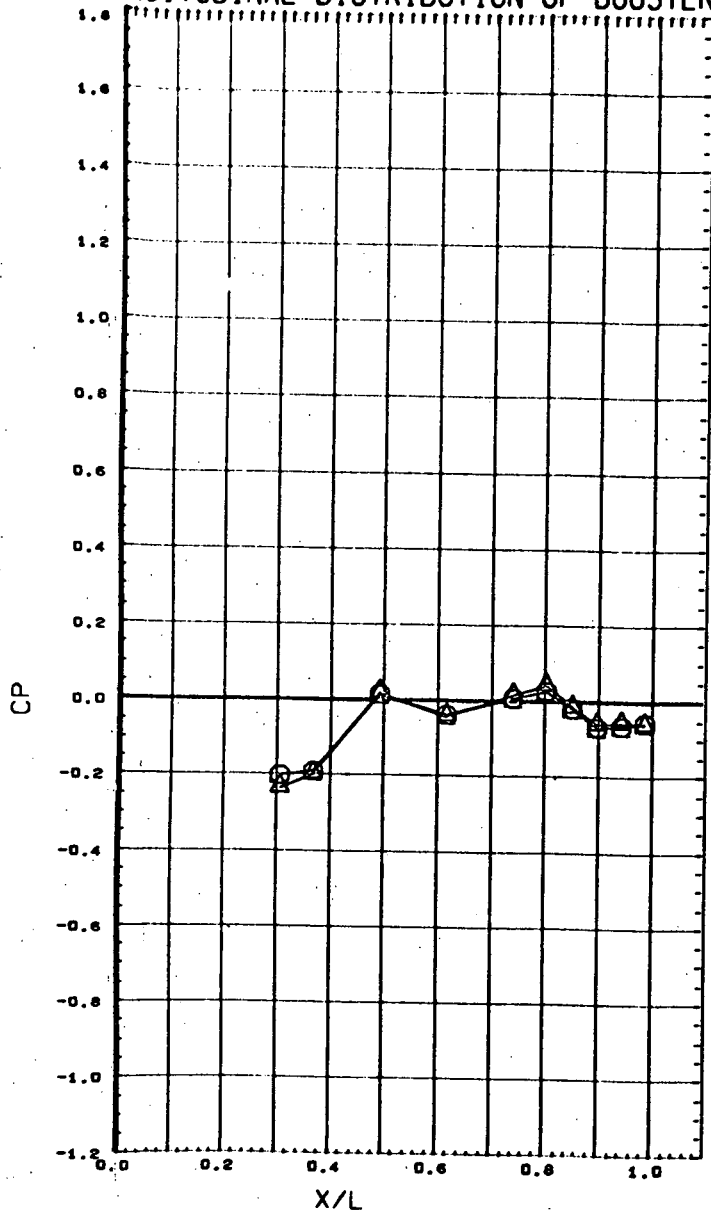

| SYMBOL | BETA | THETA | M1 |
|--------|-------|---------|-------|
| ○ | 3.761 | 90.000 | 0.599 |
| △ | 4.835 | 180.000 | |

| PARAMETRIC VALUES | | |
|-------------------|-------|-------|
| ALFB | 0.000 | DX/L |
| I | 0.000 | 0.036 |

REFERENCE FILE

LONGITUDINAL DISTRIBUTION OF BOOSTER FUSELAGE PRESSURES

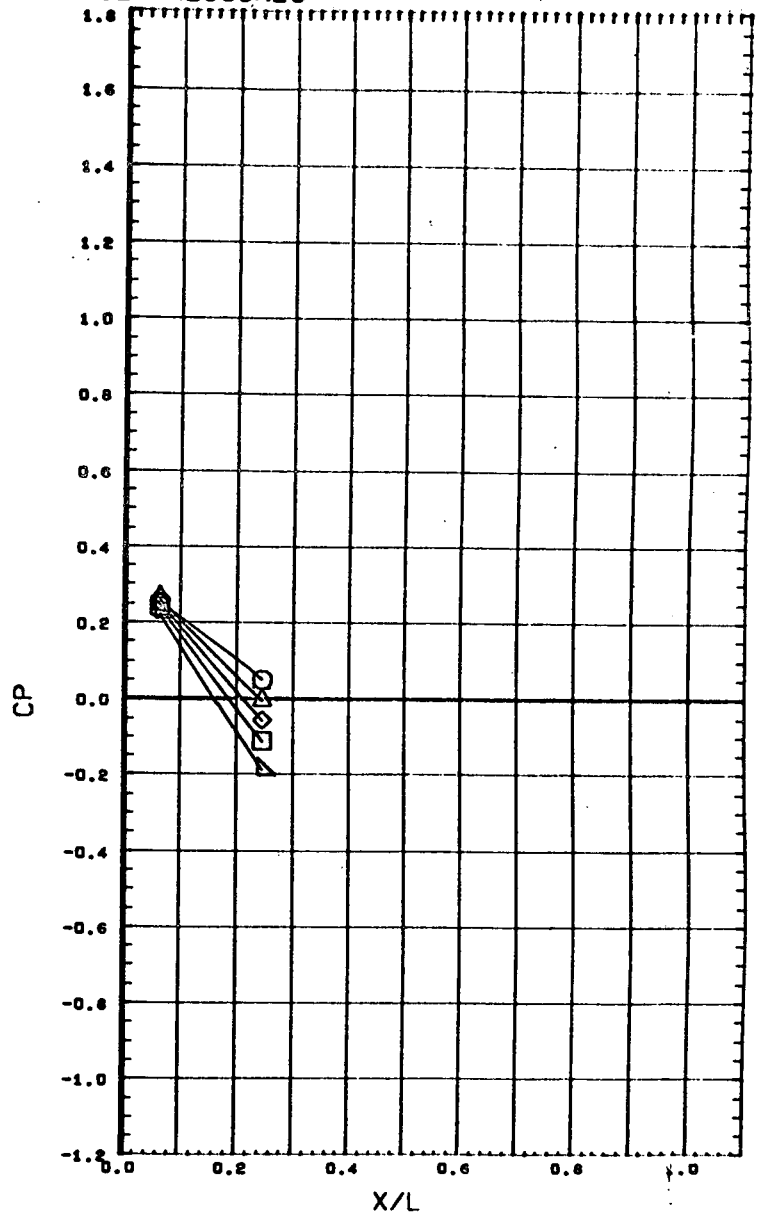
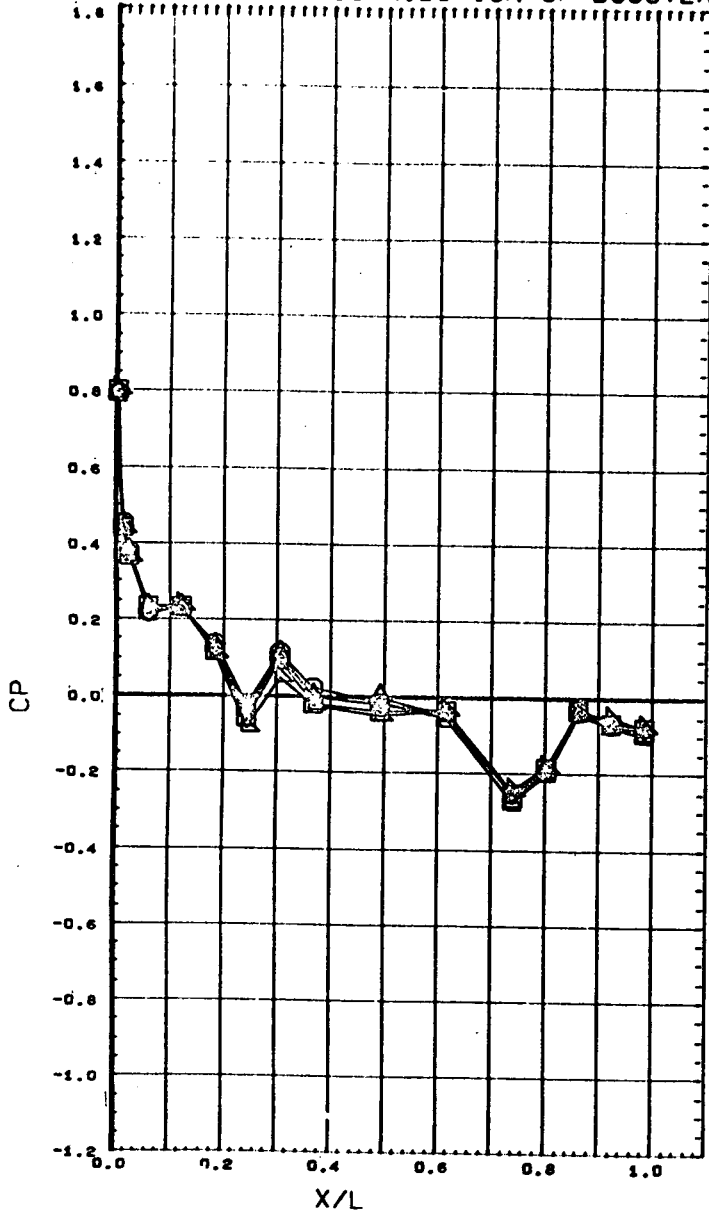

| SYMBOL | BETA | THETA | M1 |
|--------|-------|--------|-------|
| ○ | 6.113 | 0.000 | 0.899 |
| △ | 4.054 | 15.000 | |
| ◇ | 2.068 | | |
| □ | 0.259 | | |
| ○ | 1.804 | | |

REFERENCE FILE

| PARAMETRIC VALUES | | | |
|-------------------|-------|------|-------|
| ALFB | 0.000 | OX/L | 0.036 |
| I | 0.000 | | |

C-3

LONGITUDINAL DISTRIBUTION OF BOOSTER FUSELAGE PRESSURES

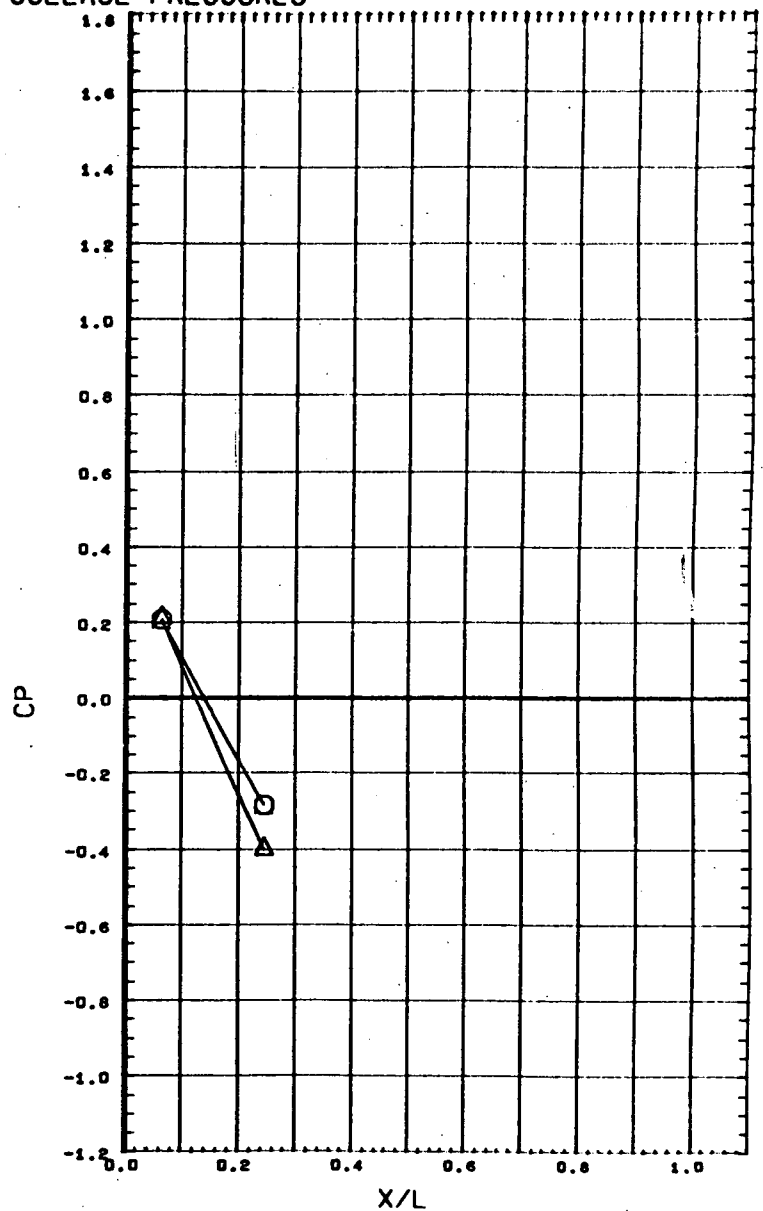
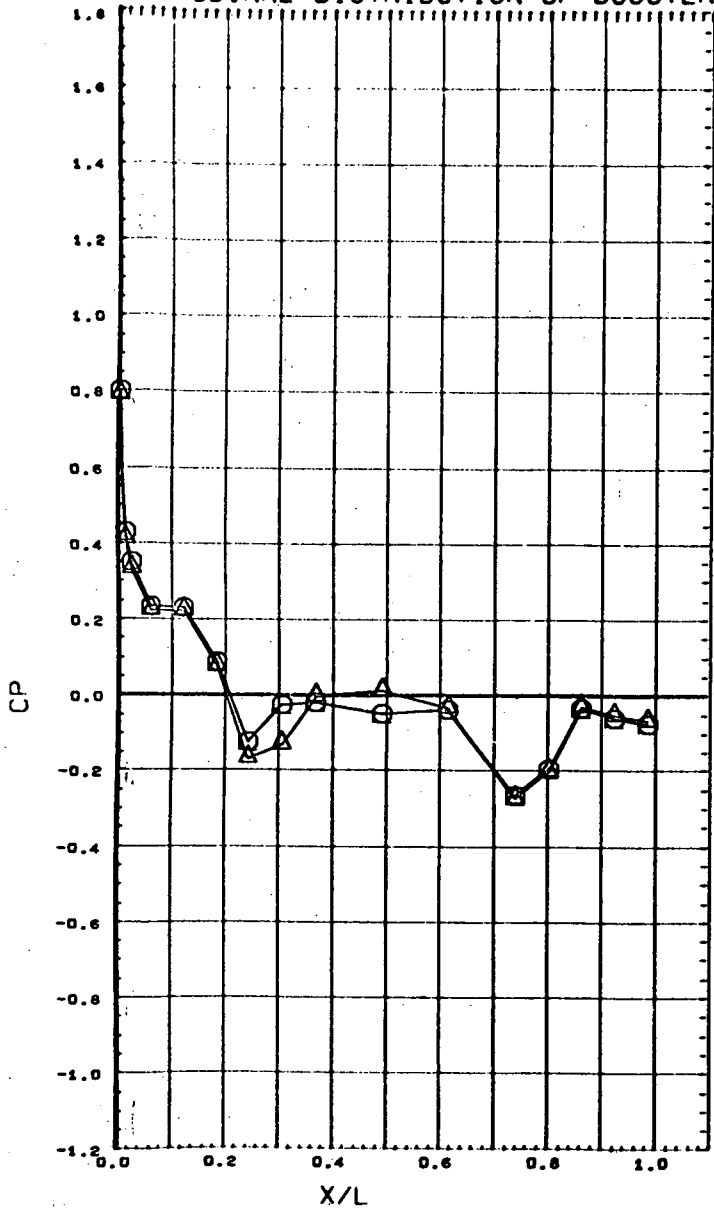

| SYMBOL | BETA | THETA | M1 |
|--------|-------|--------|-------|
| ○ | 3.845 | 0.000 | 0.899 |
| △ | 5.924 | 15.000 | |

| PARAMETRIC VALUES | | |
|-------------------|-------|-------|
| ALFB | 0.000 | OX/L |
| I | 0.000 | 0.036 |

REFERENCE FILE

LONGITUDINAL DISTRIBUTION OF BOOSTER FUSELAGE PRESSURES

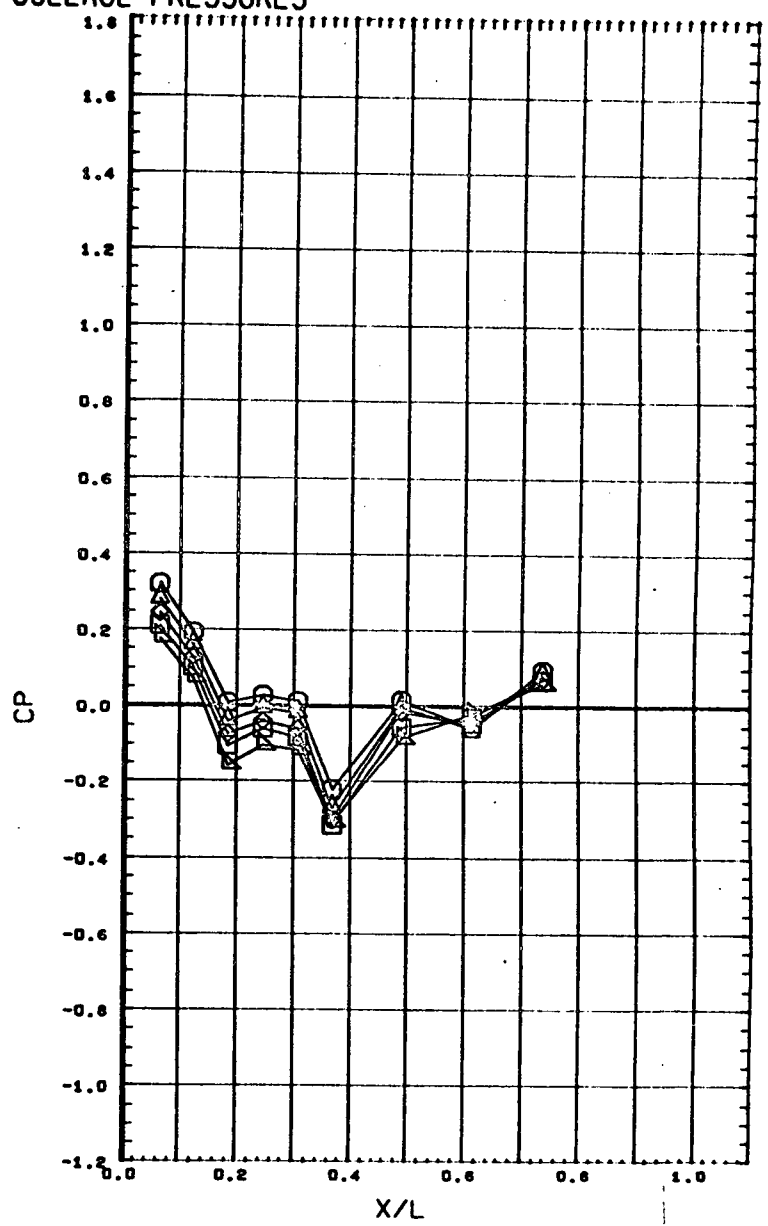
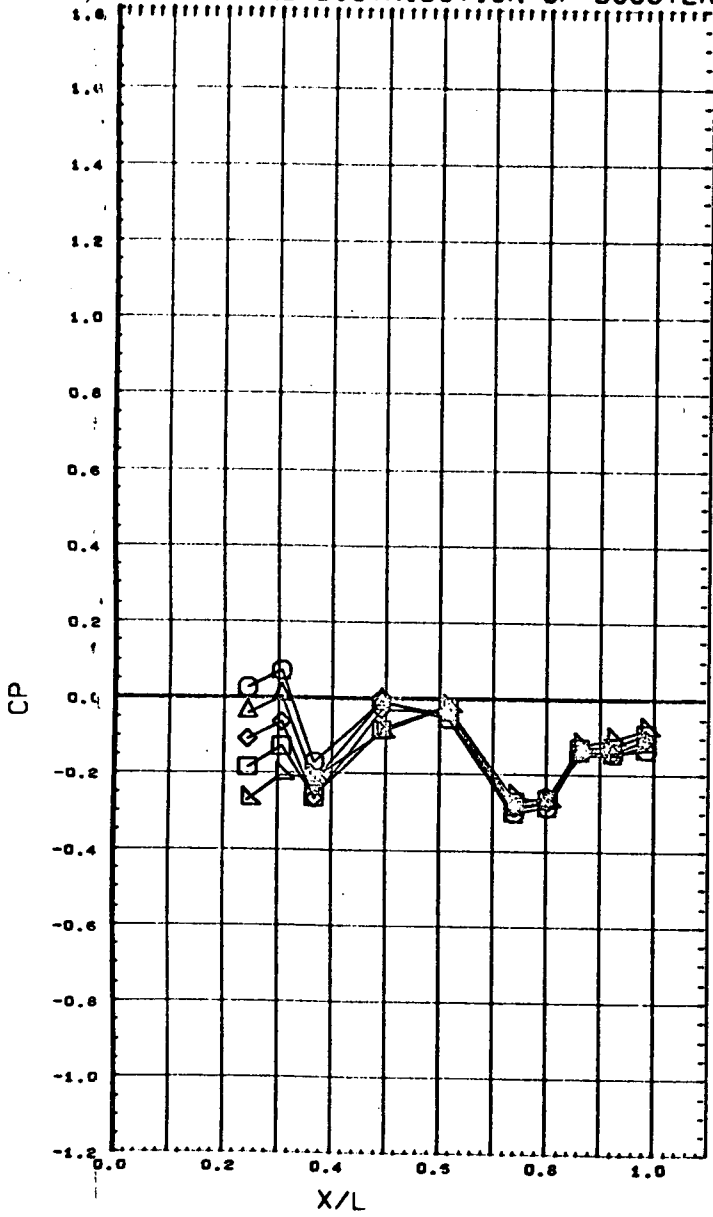

| SYMBOL | BETA | THETA' | M1 |
|--------|---------|--------|-------|
| ○ | - 6.113 | 24.000 | 0.899 |
| △ | - 4.054 | 45.000 | |
| ◇ | - 2.008 | | |
| □ | - 0.259 | | |
| ○ | 1.804 | | |

REFERENCE FILE

| PARAMETRIC VALUES | | | |
|-------------------|-------|------|-------|
| ALFB | 0.000 | DX/L | 0.036 |
| I | 0.000 | | |

LONGITUDINAL DISTRIBUTION OF BOOSTER FUSELAGE PRESSURES

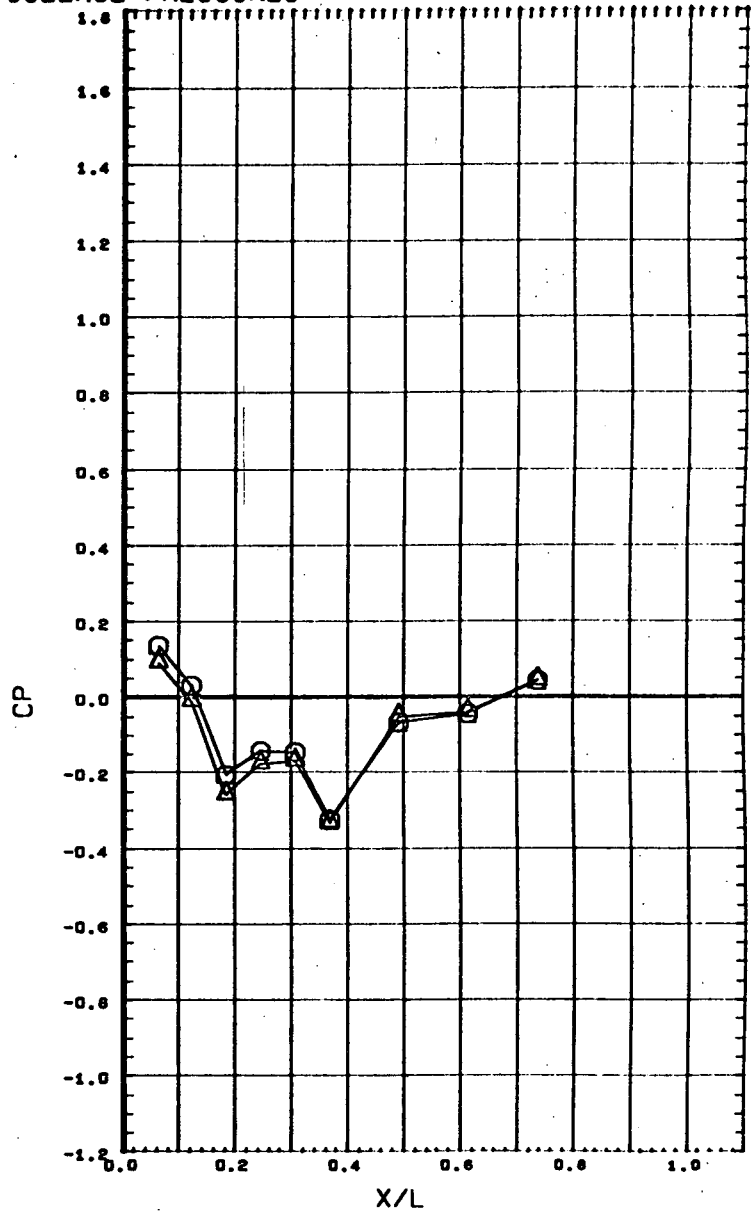
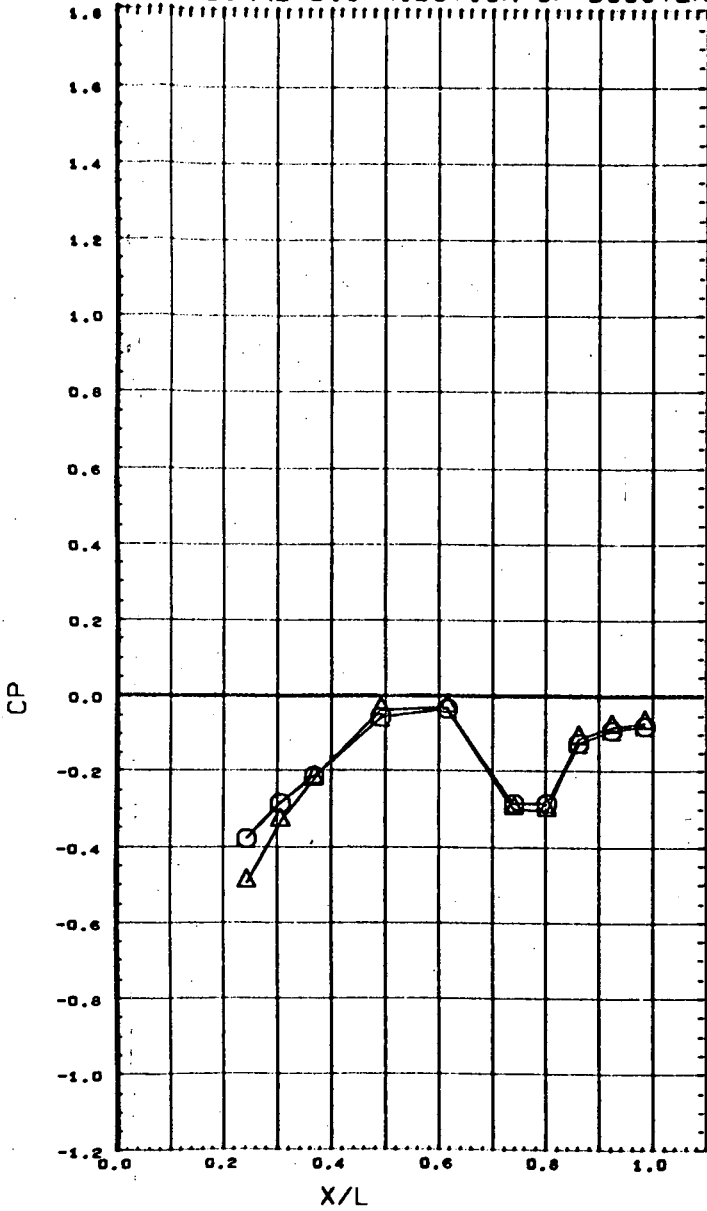

| SYMBOL | BETA | THETA | M1 |
|--------|-------|--------|-------|
| ○ | 3.845 | 24.000 | 0.899 |
| △ | 5.924 | 45.000 | |

| PARAMETRIC VALUES | | | |
|-------------------|-------|------|-------|
| ALFB | 0.000 | DX/L | 0.036 |
| J | 0.000 | | |

REFERENCE FILE

LONGITUDINAL DISTRIBUTION OF BOOSTER FUSELAGE PRESSURES

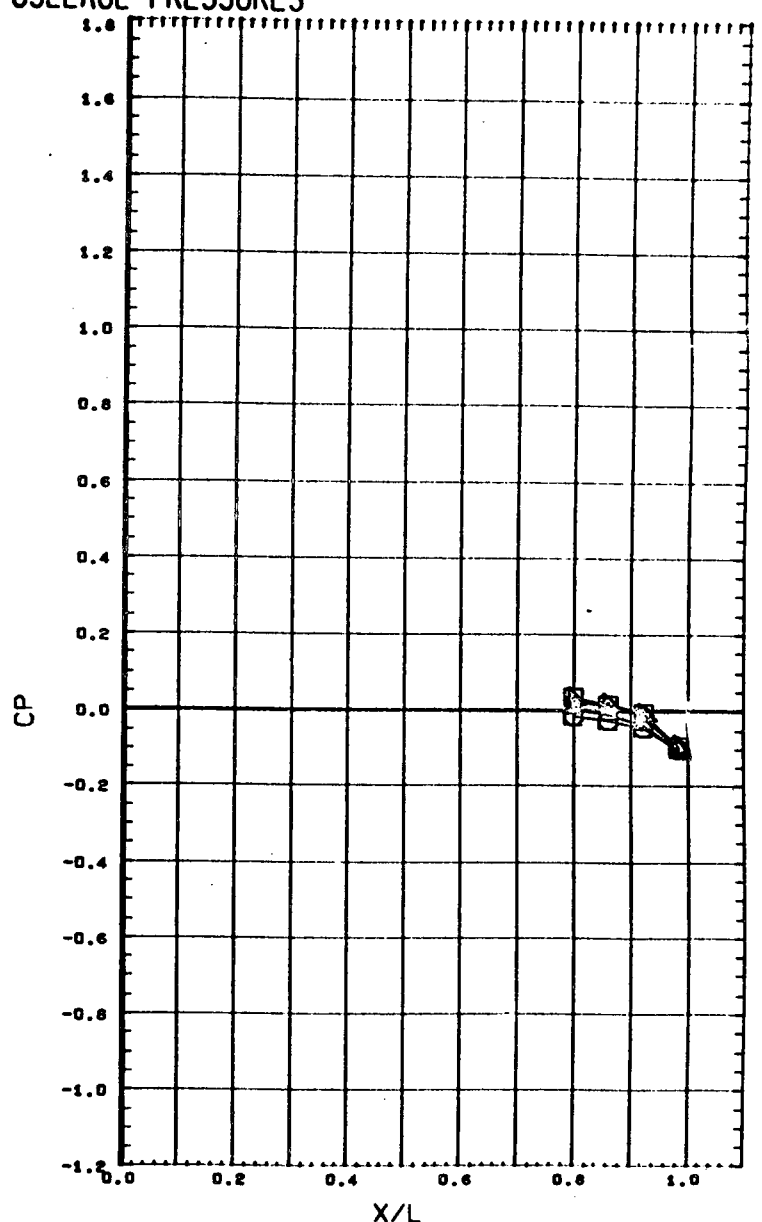
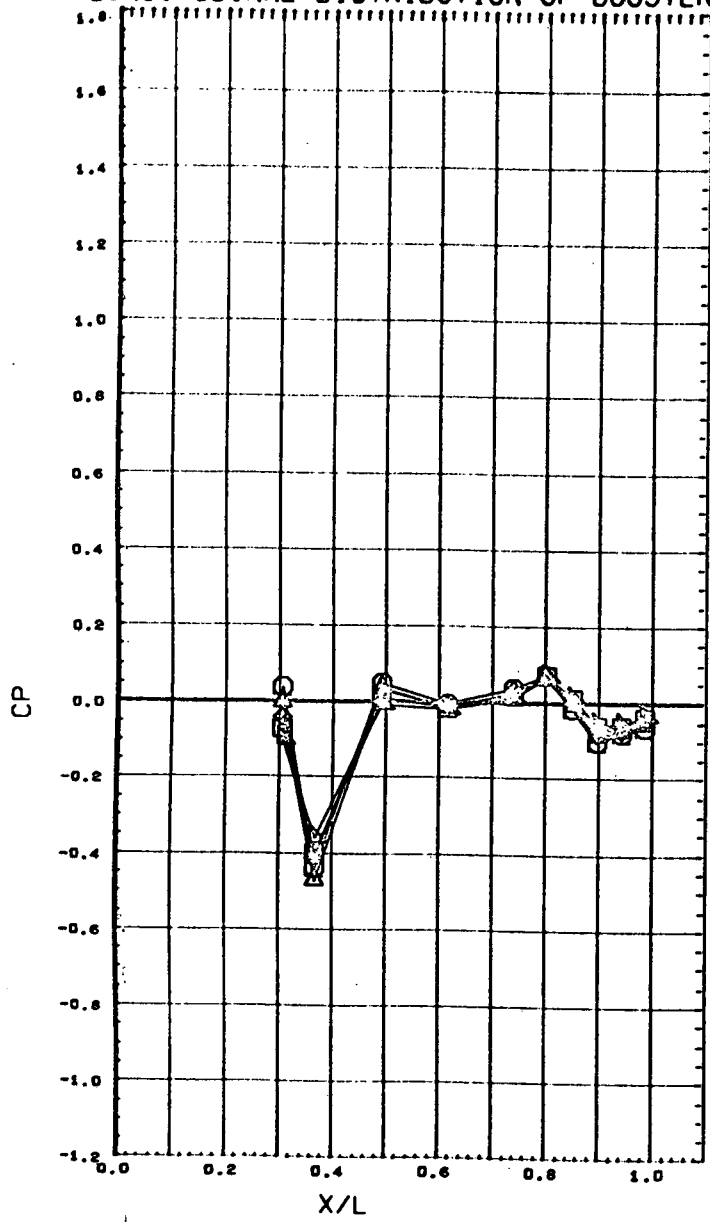

| SYMBOL | BETA | THETA | M1 |
|--------|-------|---------|-------|
| □ | 6.113 | 90.000 | 0.899 |
| ◇ | 4.054 | 180.000 | |
| △ | 2.000 | | |
| ○ | 0.259 | | |
| ○ | 1.804 | | |

REFERENCE FILE

| PARAMETRIC VALUES | | |
|-------------------|-------|------------|
| ALFB | 0.000 | DX/L 0.036 |
| I | 0.000 | |

LONGITUDINAL DISTRIBUTION OF BOOSTER FUSELAGE PRESSURES

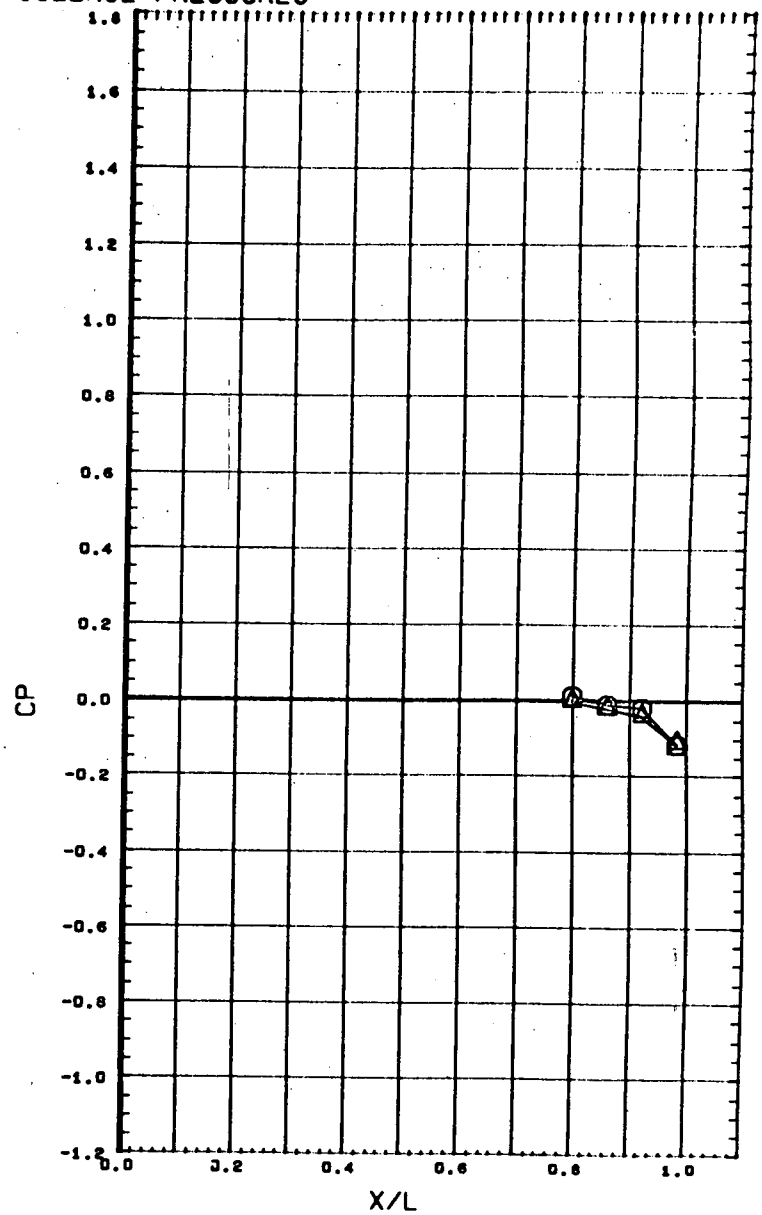
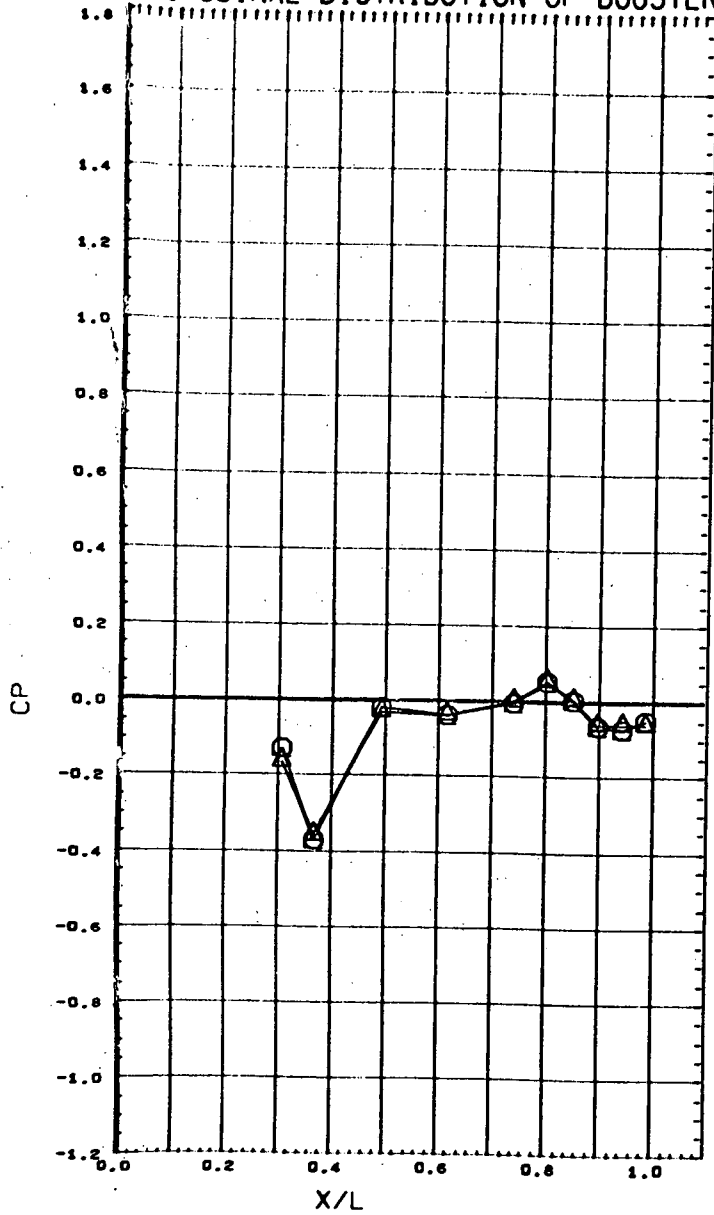

| SYMBOL | BETA | THETA | M1 |
|--------|-------|---------|-------|
| ○ | 3.845 | 90.000 | 0.899 |
| △ | 5.924 | 180.000 | |

| PARAMETRIC VALUES | | | |
|-------------------|-------|------|-------|
| ALFB | 0.000 | DX/L | 0.036 |
| I | 0.000 | | |

REFERENCE FILE

LONGITUDINAL DISTRIBUTION OF BOOSTER FUSELAGE PRESSURES

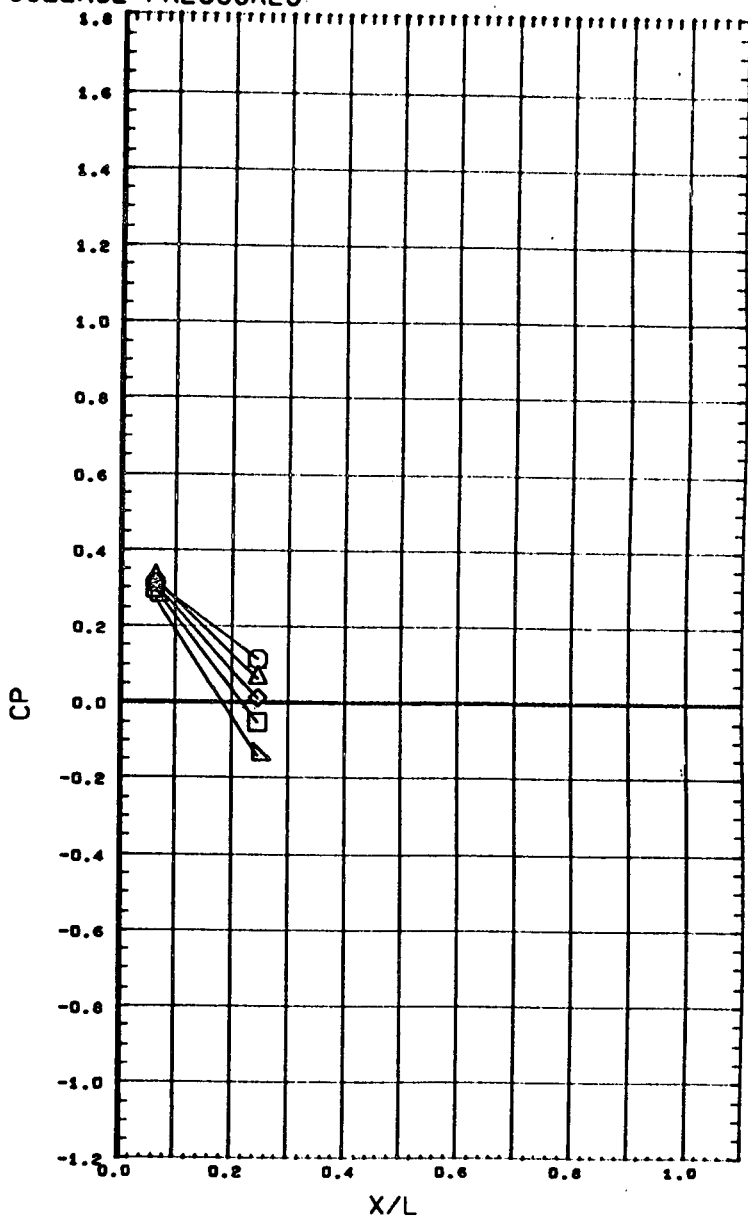
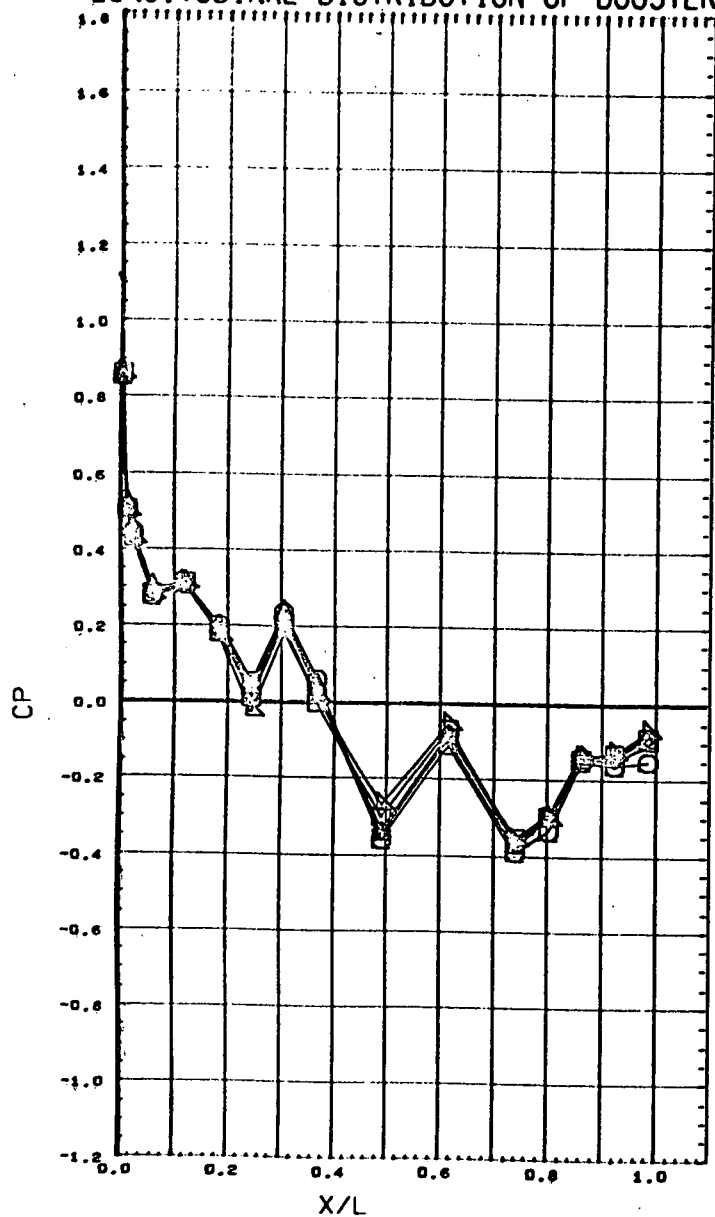

| SYMBOL | BETA | THETA | M1 |
|--------|-------|--------|-------|
| □ | 5.858 | 0.000 | 1.004 |
| ◇ | 3.758 | 15.000 | |
| △ | 1.727 | | |
| ○ | 0.370 | | |
| ○ | 2.147 | | |

| PARAMETRIC VALUES | | |
|-------------------|-------|-------|
| ALFB | 0.000 | 0.036 |
| I | 0.000 | |

REFERENCE FILE

LONGITUDINAL DISTRIBUTION OF BOOSTER FUSELAGE PRESSURES

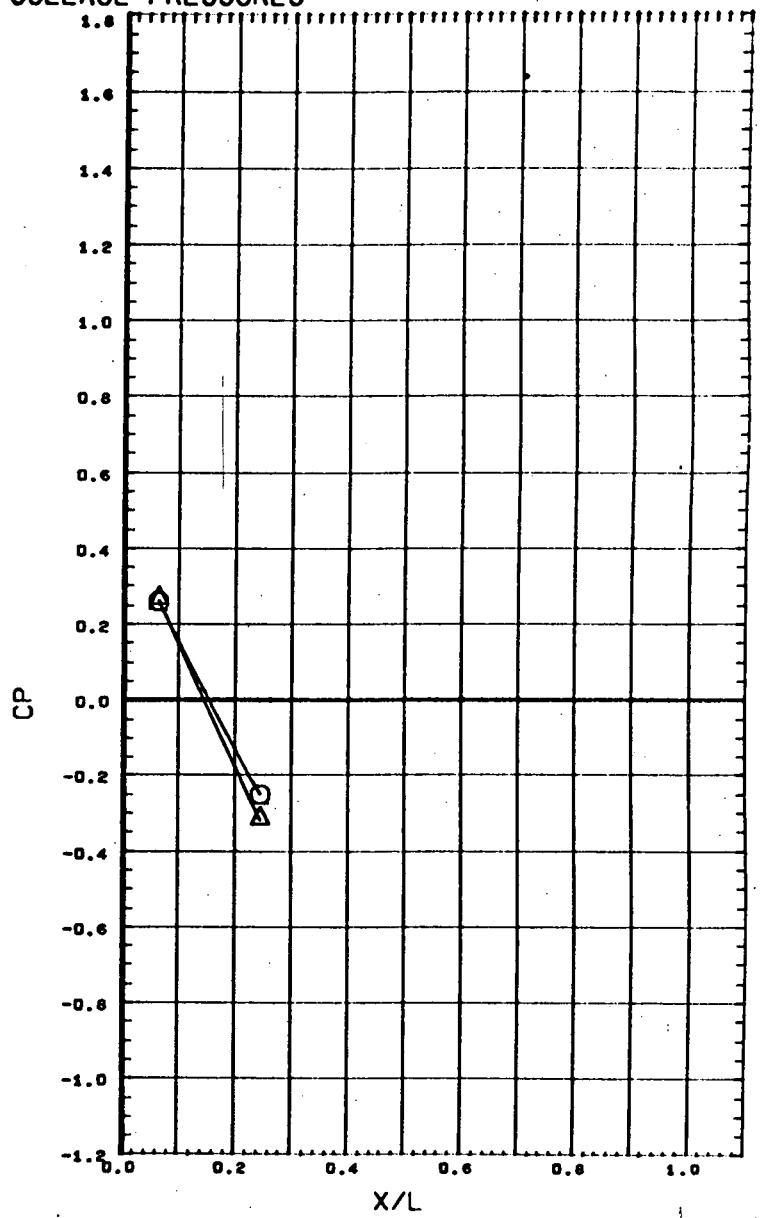
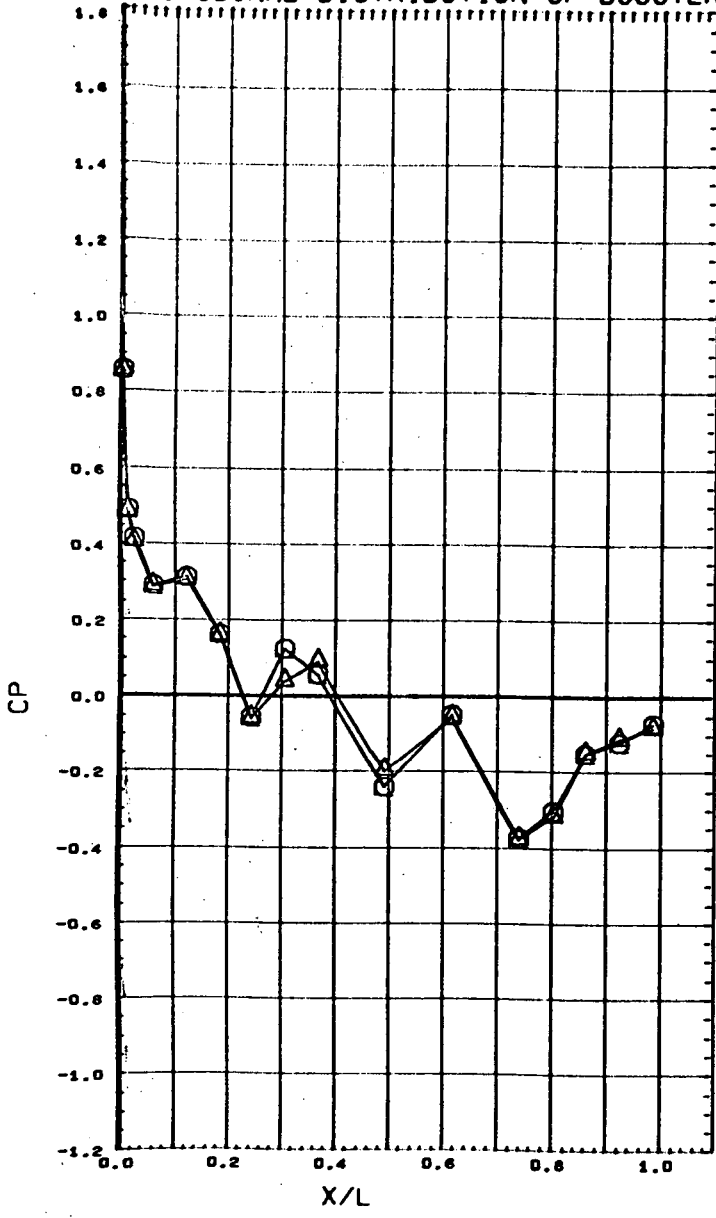

| SYMBOL | BETA | THETA | M1 |
|--------|-------|--------|-------|
| ○ | 4.227 | 0.000 | 1.004 |
| △ | 6.297 | 15.000 | |

| PARAMETRIC VALUES | | |
|-------------------|-------|-------|
| ALFB | 0.000 | DX/L |
| I | 0.000 | 0.036 |

REFERENCE FILE

LONGITUDINAL DISTRIBUTION OF BOOSTER FUSELAGE PRESSURES

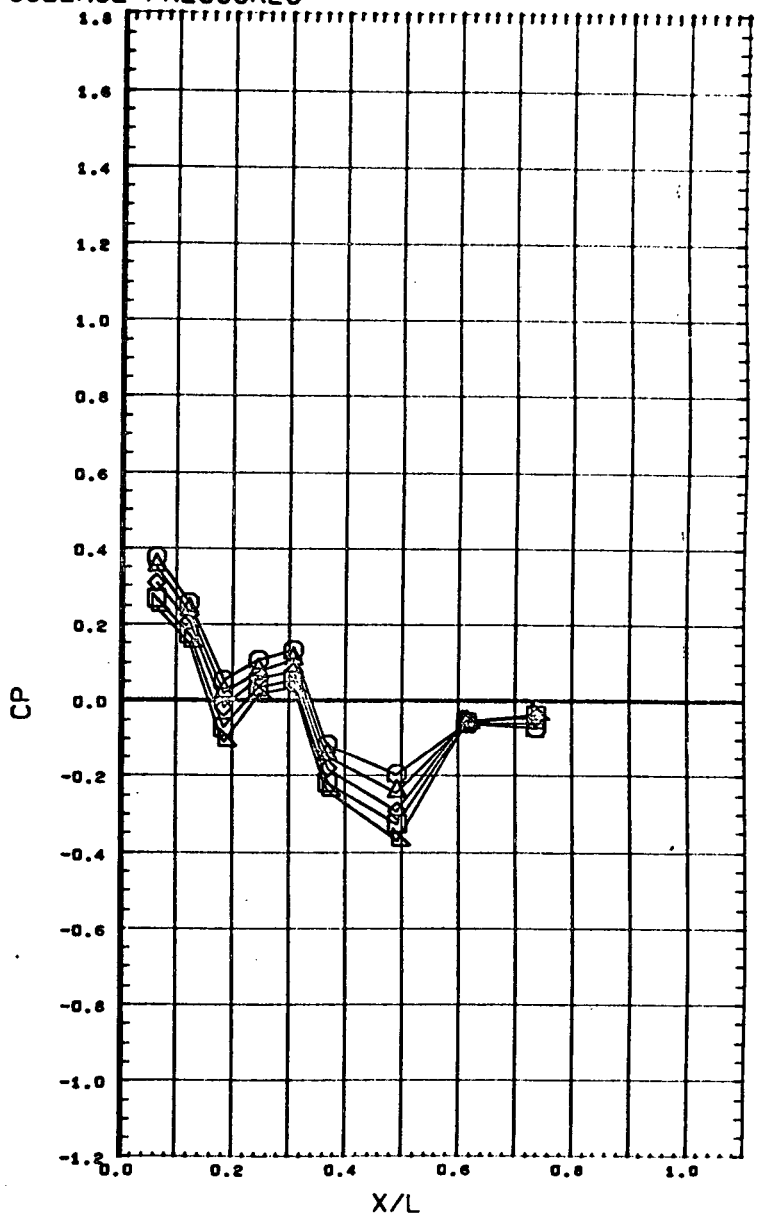
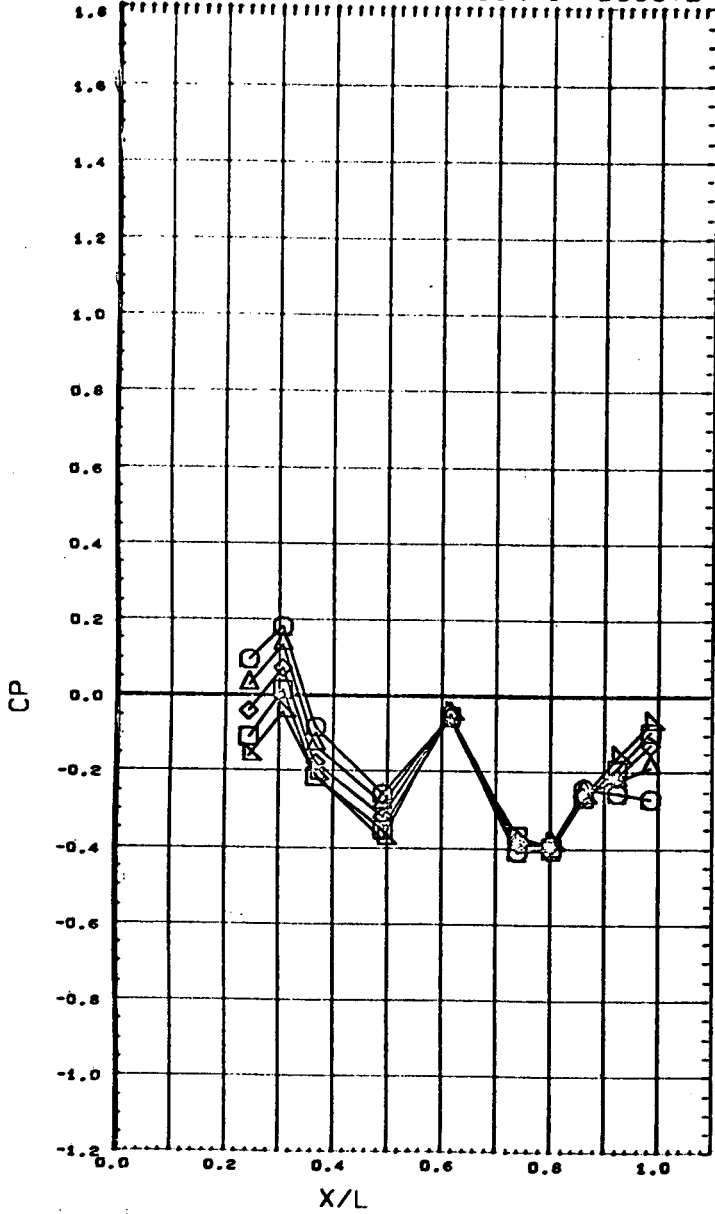

| SYMBOL | BETA | THETA | M1 |
|--------|-------|--------|-------|
| ○ | 5.858 | 24.000 | 1.004 |
| △ | 3.758 | 45.000 | |
| ◇ | 1.727 | | |
| □ | 0.370 | | |
| ▽ | 2.147 | | |

| PARAMETRIC VALUES | | | |
|-------------------|-------|------|-------|
| ALFB | 0.000 | DX/L | 0.036 |
| I | 0.000 | | |

REFERENCE FILE

LONGITUDINAL DISTRIBUTION OF BOOSTER FUSELAGE PRESSURES

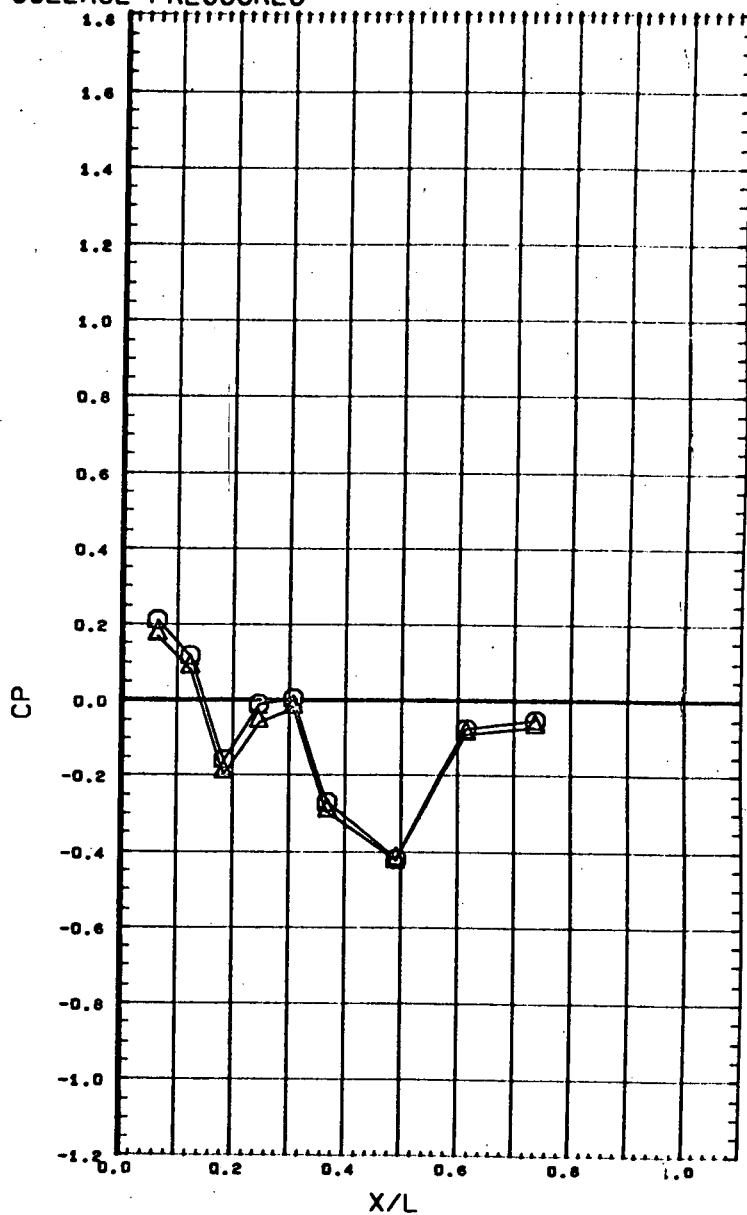
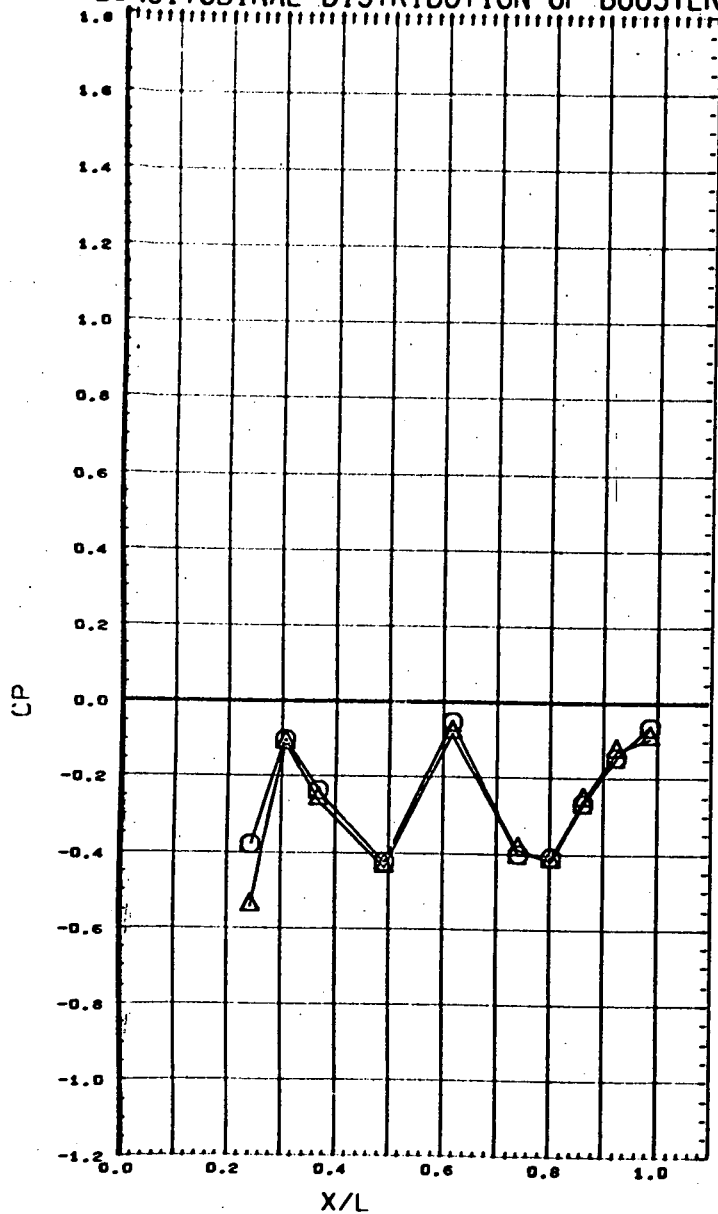

| SYMBOL | BETA | THETA | M1 |
|--------|-------|--------|-------|
| ○ | 4.227 | 24.000 | 1.004 |
| △ | 6.297 | 45.000 | |

| PARAMETRIC VALUES | | |
|-------------------|-------|-------|
| ALFB | 0.000 | DX/L |
| I | 0.000 | 0.036 |

REFERENCE FILE

LONGITUDINAL DISTRIBUTION OF BOOSTER FUSELAGE PRESSURES

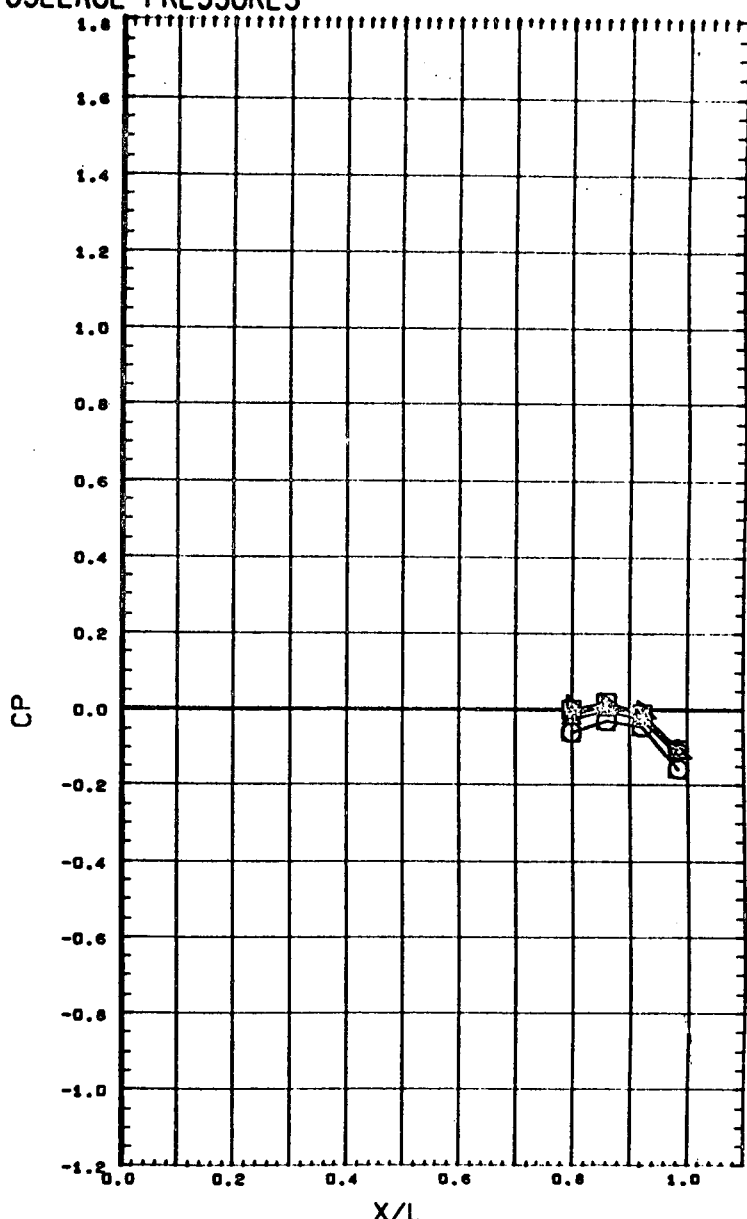
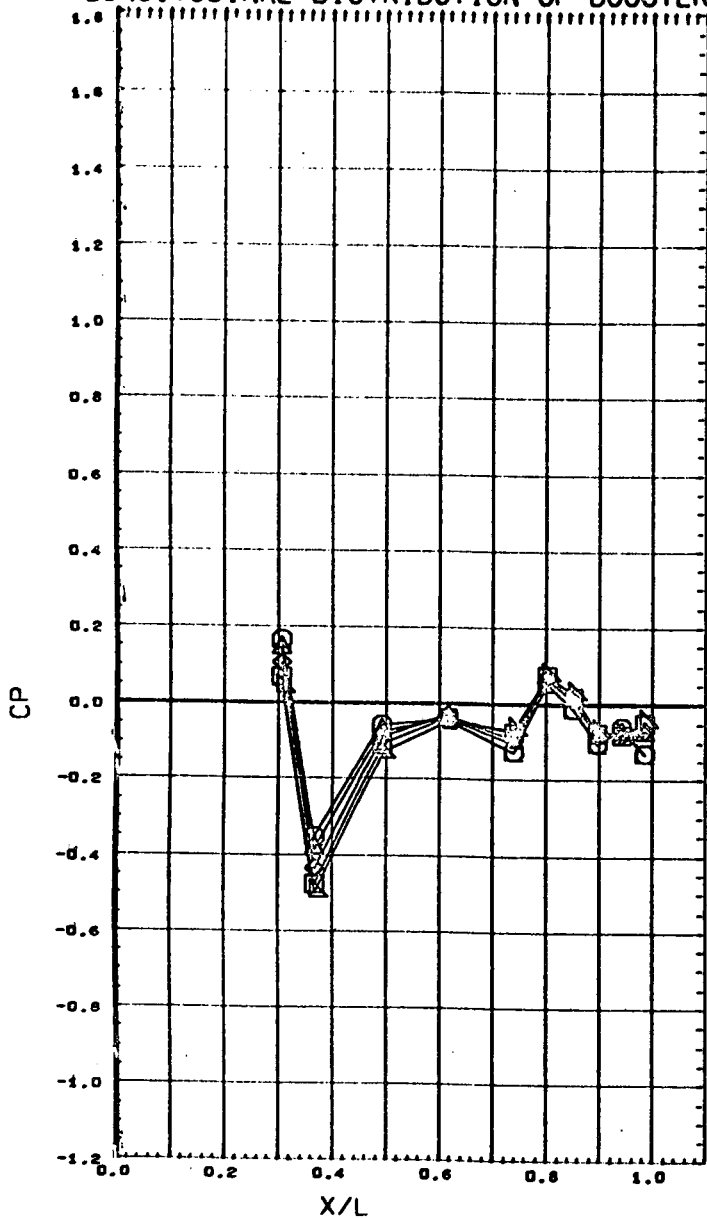

| SYMBOL | BETA | THETA | M1 |
|--------|---------|---------|-------|
| ○ | - 5.858 | 90.000 | 1.004 |
| ◇ | - 3.758 | 180.000 | |
| △ | - 1.727 | | |
| □ | 0.370 | | |
| ◇ | 2.147 | | |

| PARAMETRIC VALUES | | | |
|-------------------|-------|------|-------|
| ALFB | 0.000 | OX/L | 0.036 |
| I | 0.000 | | |

REFERENCE FILE

LONGITUDINAL DISTRIBUTION OF BOOSTER FUSELAGE PRESSURES

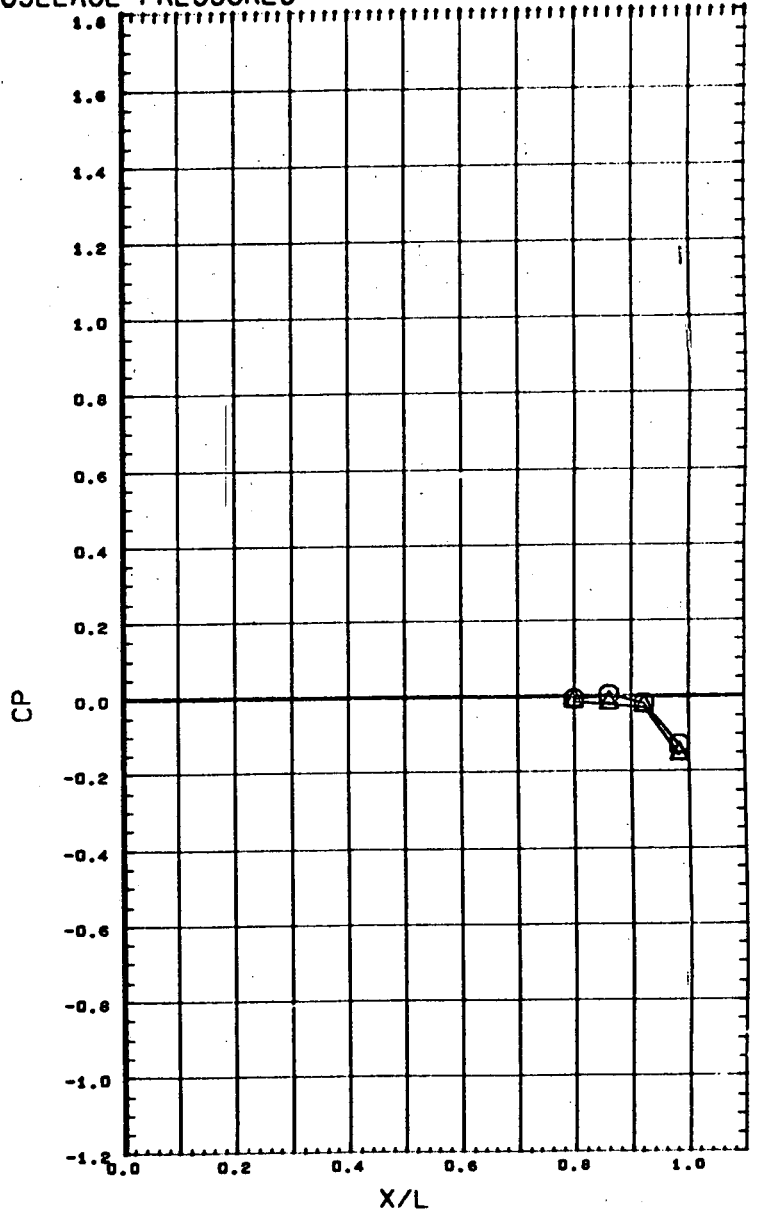
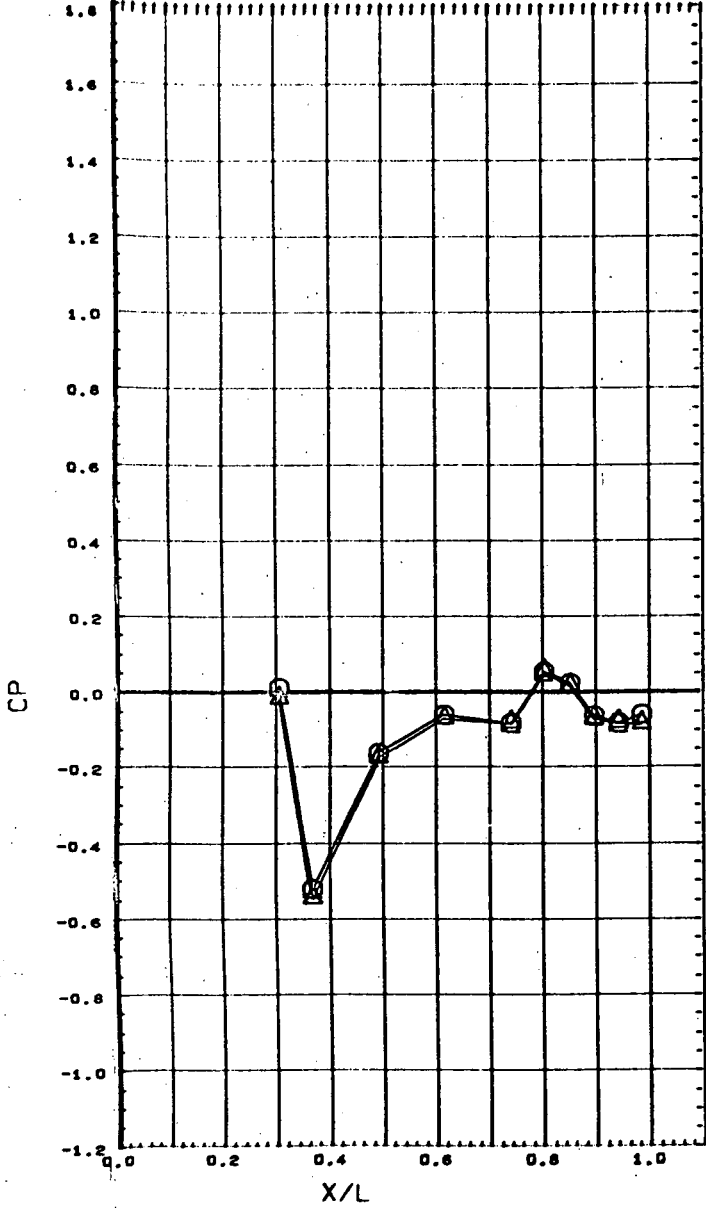

| SYMBOL | BETA | THETA | M1 |
|--------|-------|---------|-------|
| ○ | 4.227 | 90.000 | 1.004 |
| △ | 6.297 | 180.000 | |

| PARAMETRIC VALUES | | |
|-------------------|-------|-------|
| ALFB | 0.000 | 0.036 |
| I | 0.000 | |

REFERENCE FILE

LONGITUDINAL DISTRIBUTION OF BOOSTER FUSELAGE PRESSURES

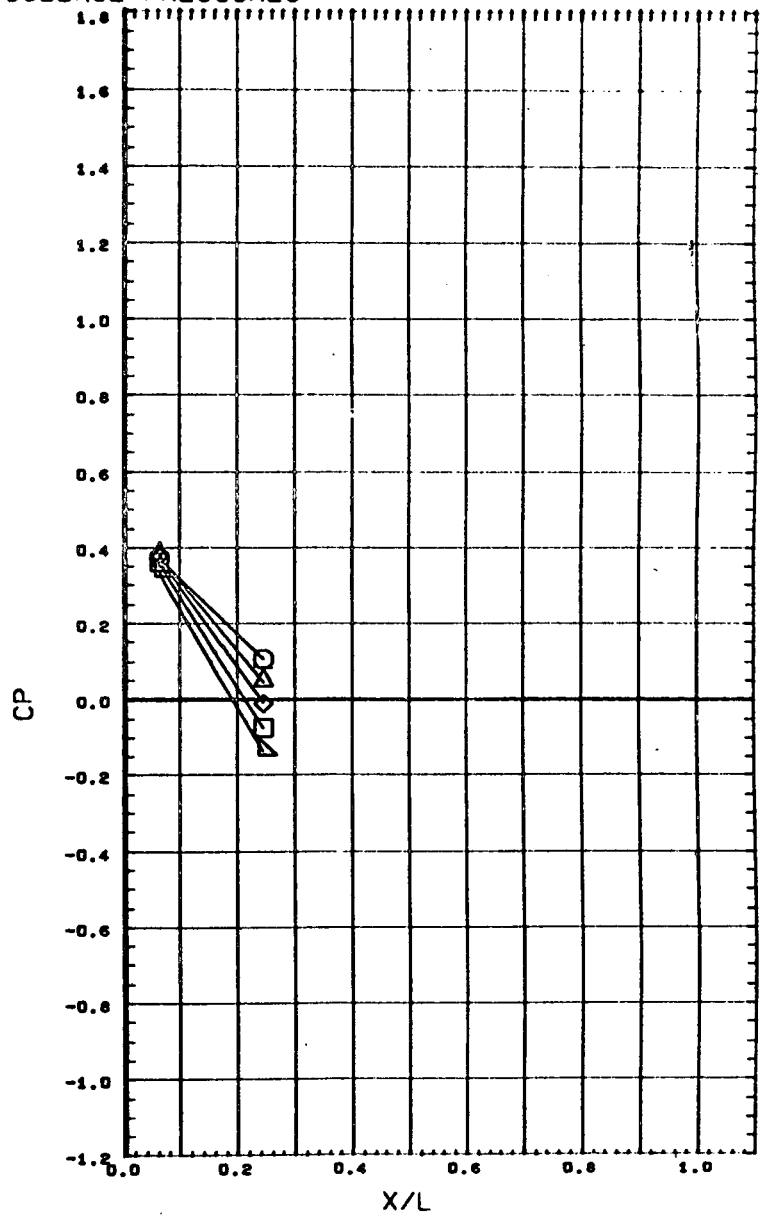
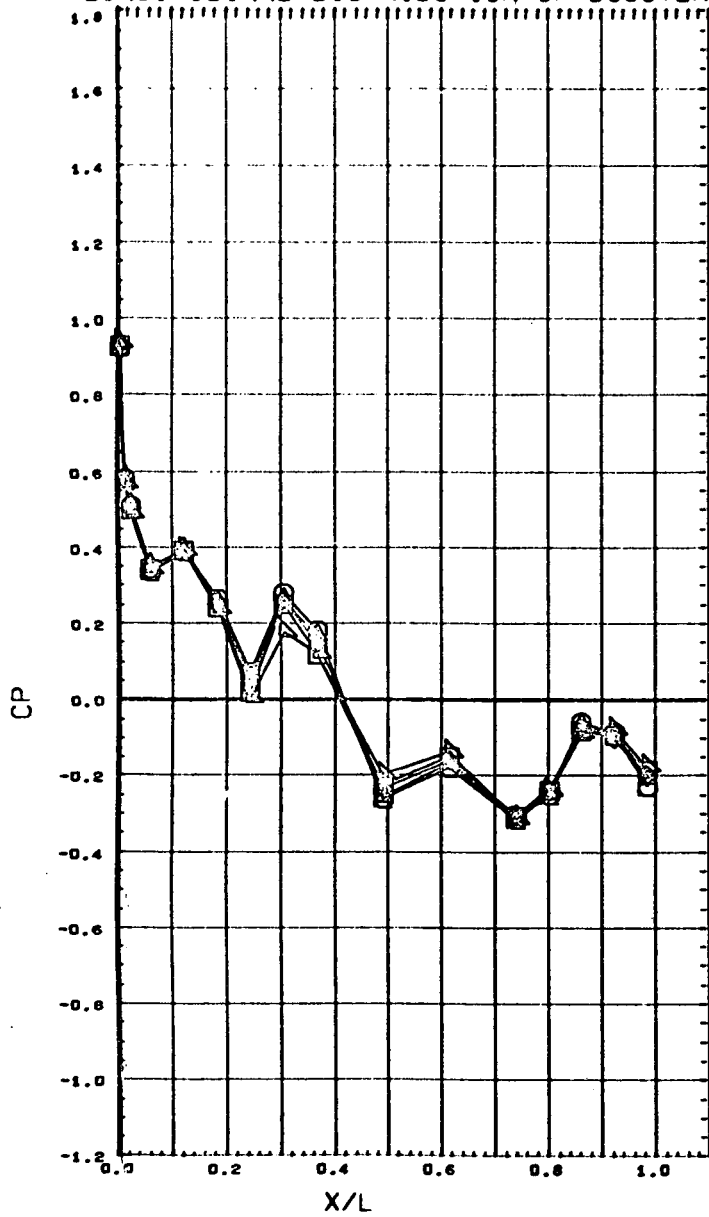

| SYMBOL | BETA | THETA | M1 |
|--------|---------|--------|-------|
| ○ | - 6.178 | 0.000 | 1.099 |
| ◇ | - 4.110 | 15.000 | |
| △ | - 2.033 | | |
| □ | - 0.268 | | |
| ○ | 1.827 | | |

| PARAMETRIC VALUES | | | |
|-------------------|-------|------|-------|
| ALFB | 0.000 | CX/L | 0.036 |
| I | 0.000 | | |

REFERENCE FILE

LONGITUDINAL DISTRIBUTION OF BOOSTER FUSELAGE PRESSURES

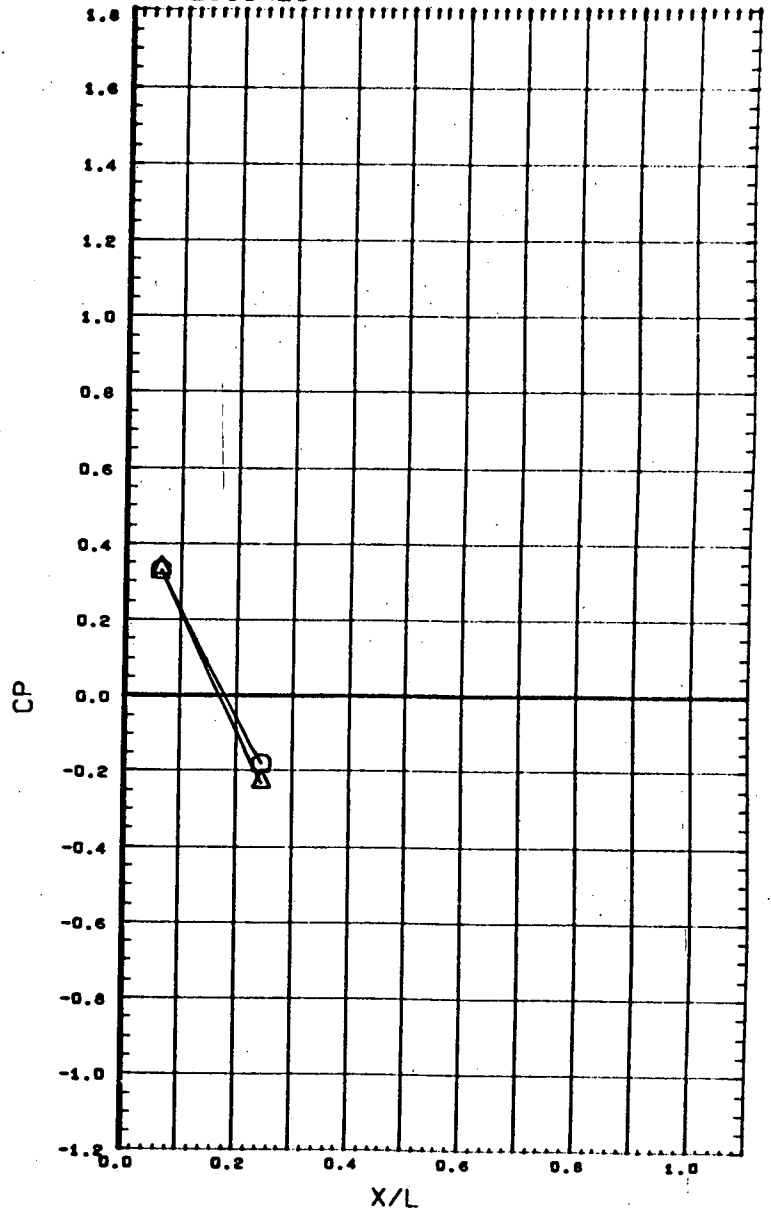
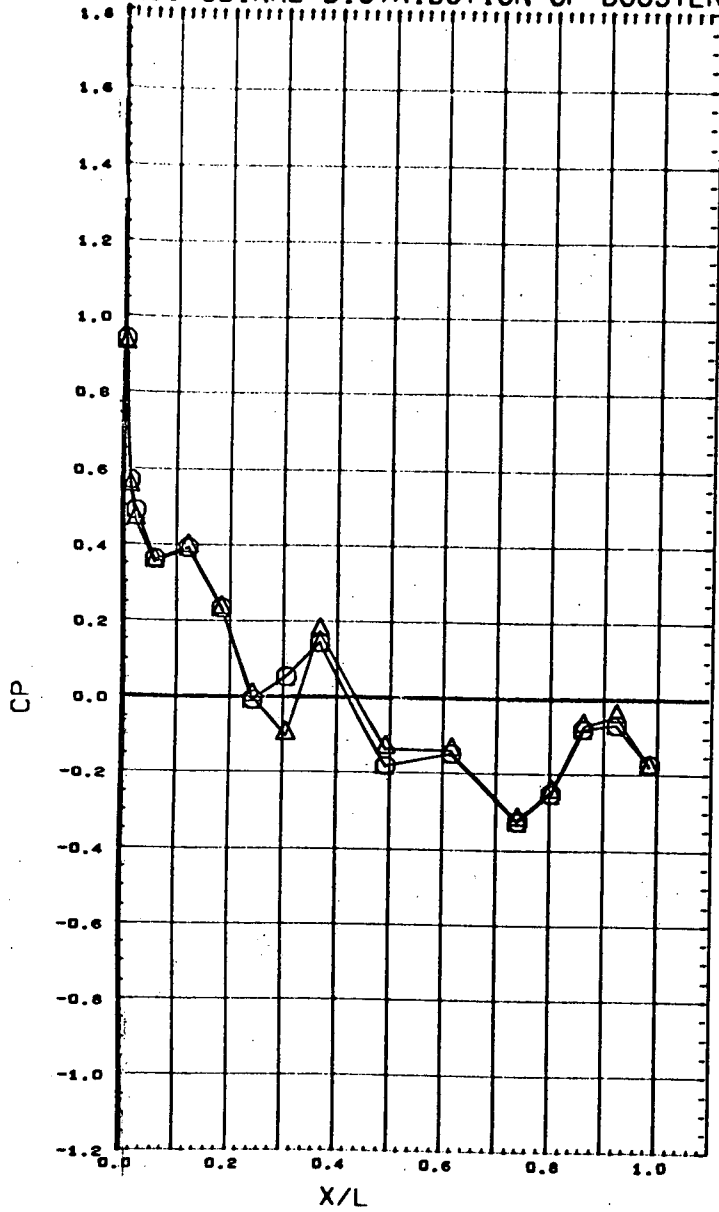

| SYMBOL | BETA | THETA | M1 |
|--------|-------|--------|-------|
| ○ | 3.902 | 0.000 | 1.099 |
| △ | 5.993 | 15.000 | |

| PARAMETRIC VALUES | | |
|-------------------|-------|------------|
| ALFB | 0.000 | DX/L 0.036 |
| I | 0.000 | |

REFERENCE FILE

LONGITUDINAL DISTRIBUTION OF BOOSTER FUSELAGE PRESSURES

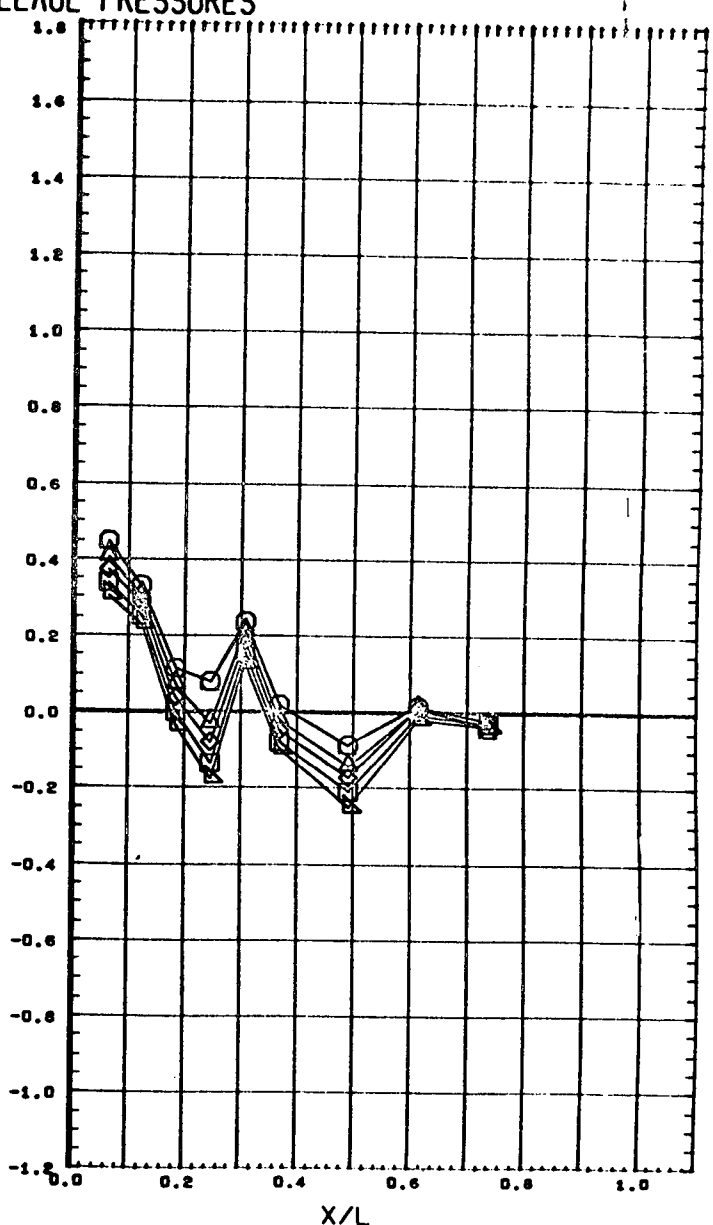
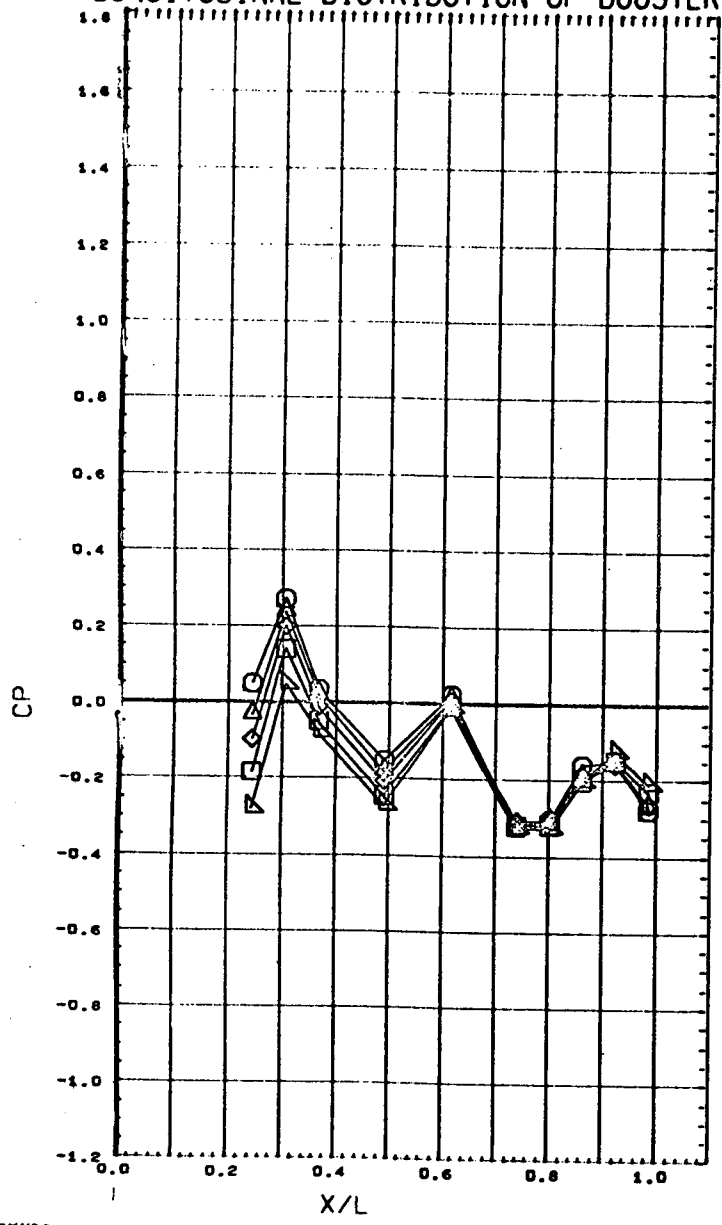

| SYMBOL | BETA | THETA | M1 |
|--------|-------|--------|-------|
| ○ | 6.178 | 24.000 | 1.099 |
| △ | 4.110 | 45.000 | |
| ◇ | 2.033 | | |
| □ | 0.268 | | |
| ○ | 1.027 | | |

| PARAMETRIC VALUES | | | |
|-------------------|-------|------|-------|
| ALFB | 0.000 | DX/L | 0.036 |
| I | 0.000 | | |

REFERENCE FILE

LONGITUDINAL DISTRIBUTION OF BOOSTER FUSELAGE PRESSURES

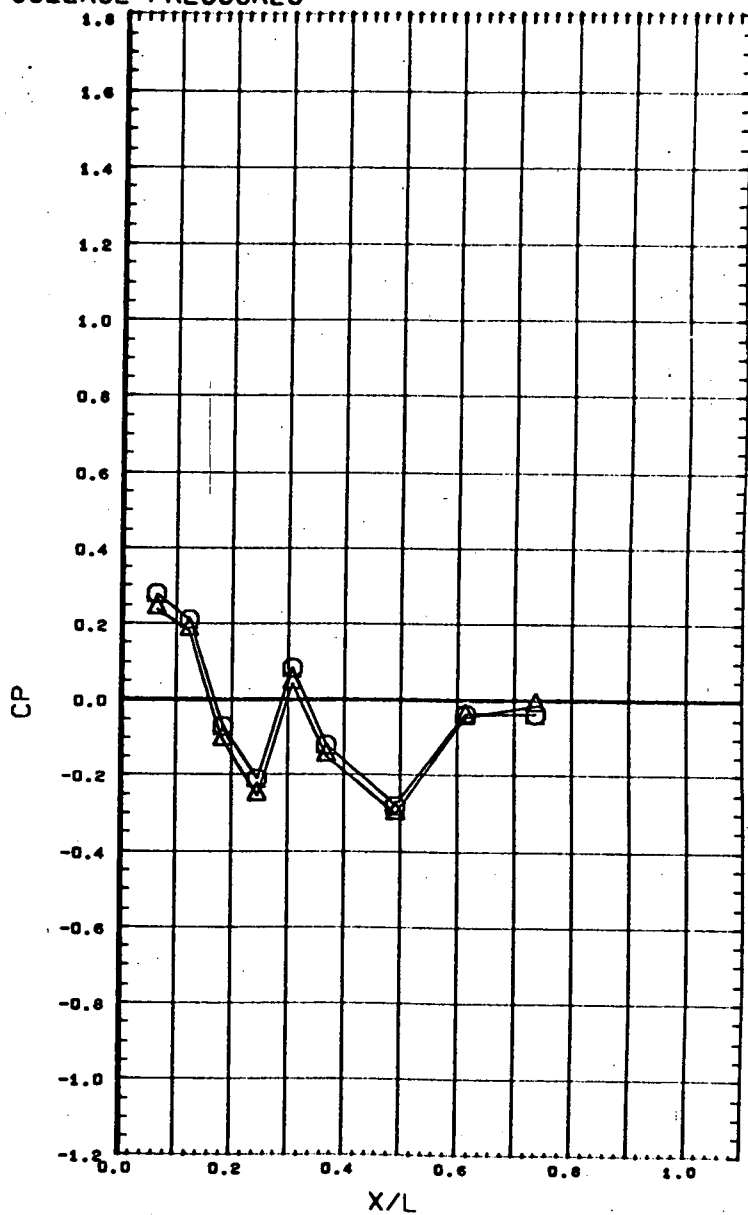
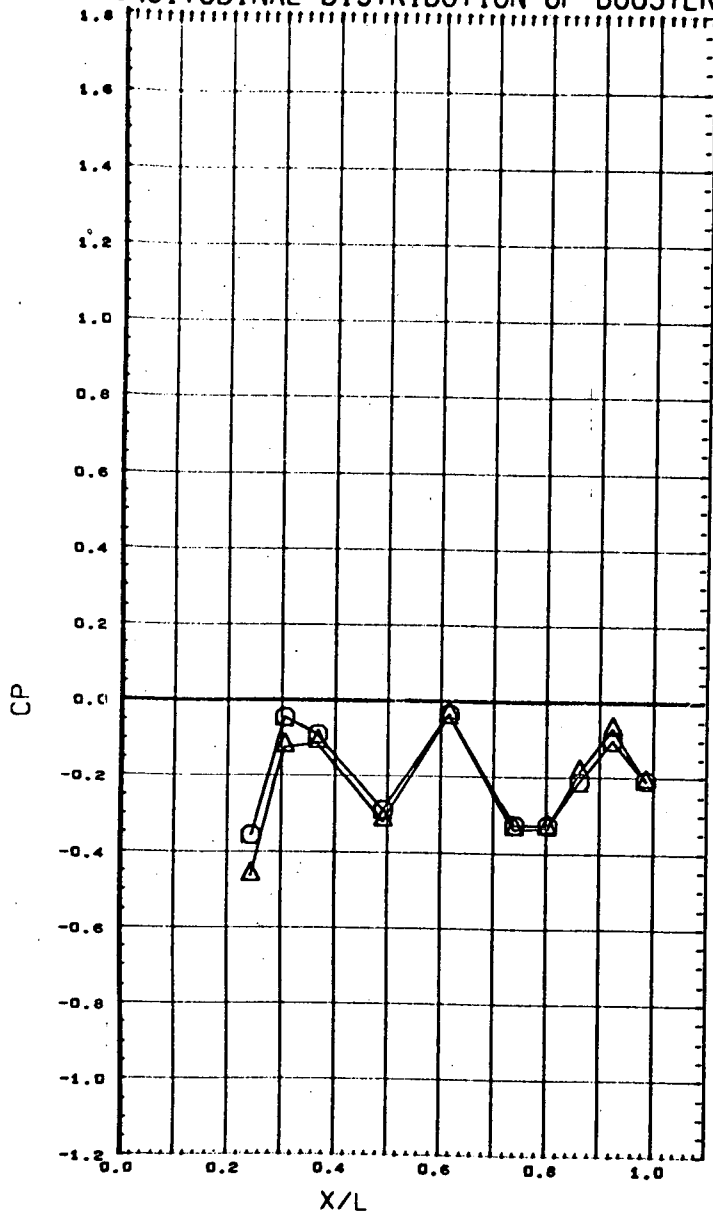

| SYMBOL | BETA | THETA | M1 |
|--------|-------|--------|-------|
| ○ | 3.902 | 24.000 | 1.099 |
| △ | 5.993 | 45.000 | |

| PARAMETRIC VALUES | | |
|-------------------|-------|-------|
| ALFB | 0.000 | 0.036 |
| I | 0.000 | |

REFERENCE FILE

AEDC TC174 MDAC BOOSTER NEAR ORBITER (BODY)

(ATC006)

PAGE 175

LONGITUDINAL DISTRIBUTION OF BOOSTER FUSELAGE PRESSURES

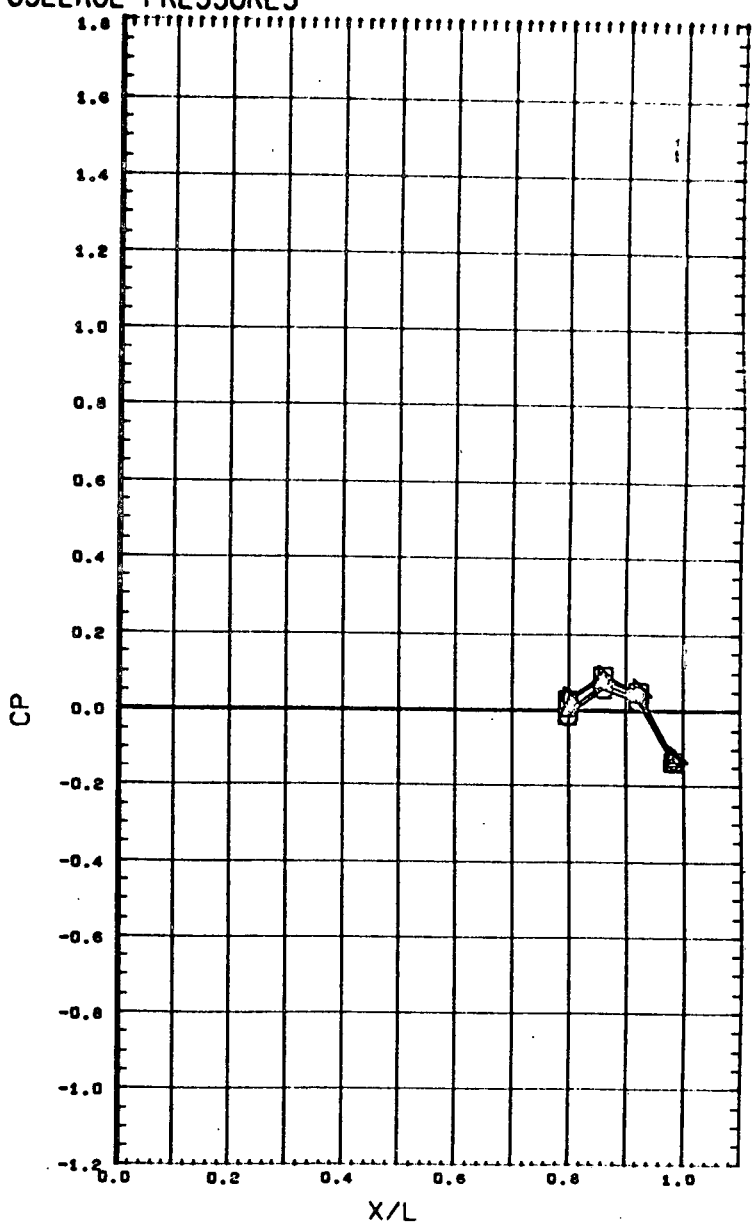
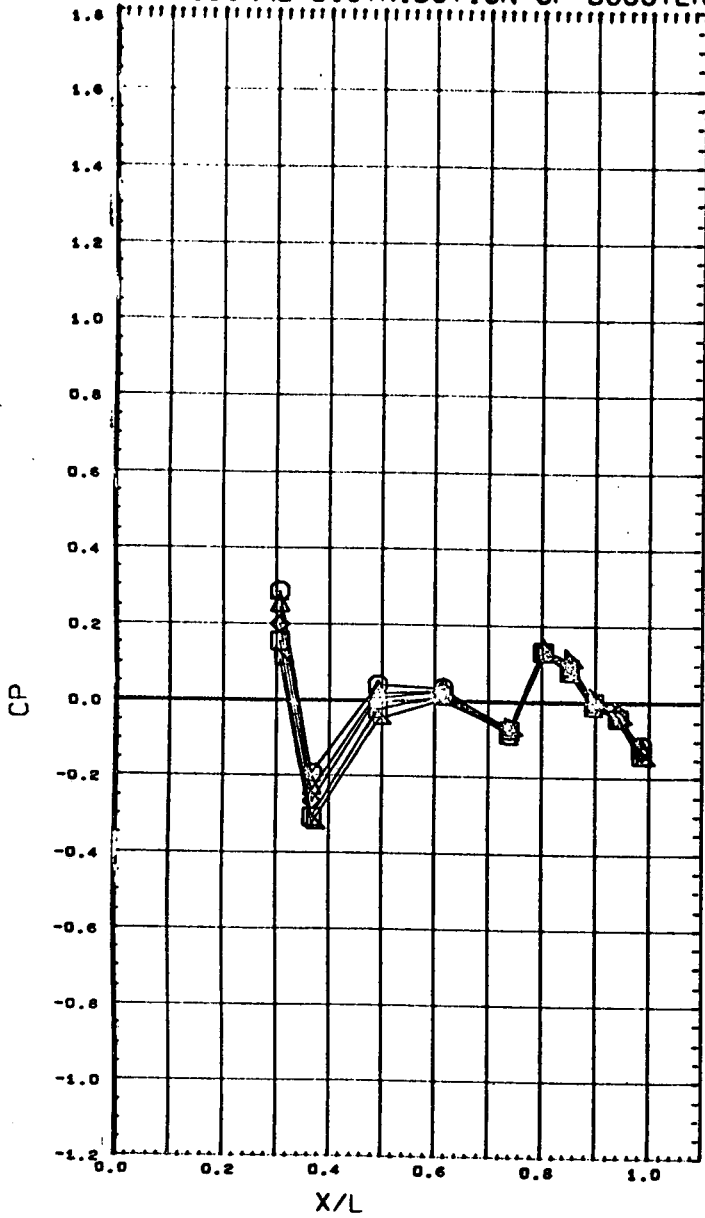

| SYMBOL | BETA | THETA | M1 |
|--------|-------|---------|-------|
| ○ | 6.178 | 90.000 | 1.099 |
| ◇ | 4.110 | 180.000 | |
| △ | 2.033 | | |
| □ | 0.268 | | |
| ◇ | 1.627 | | |

REFERENCE FILE

| PARAMETRIC VALUES | | | |
|-------------------|-------|------|-------|
| ALFB | 0.000 | DX/L | 0.036 |
| I | 0.000 | | |

LONGITUDINAL DISTRIBUTION OF BOOSTER FUSELAGE PRESSURES

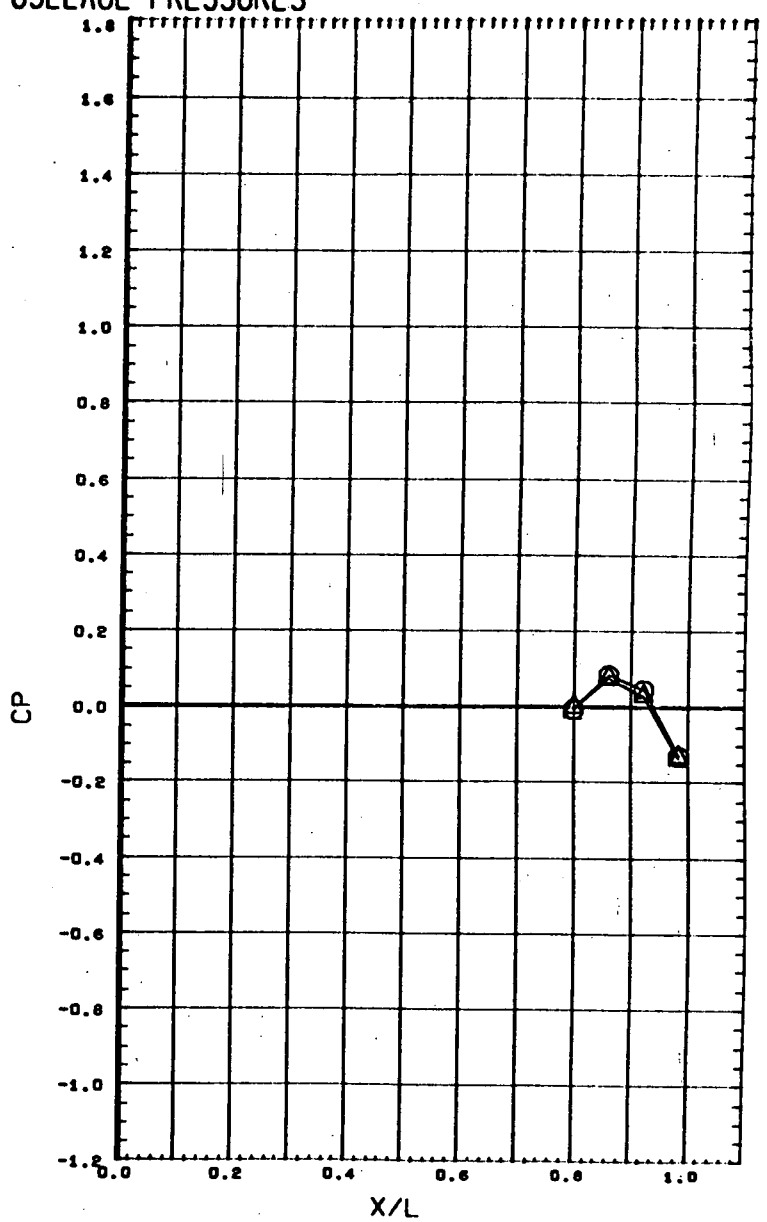
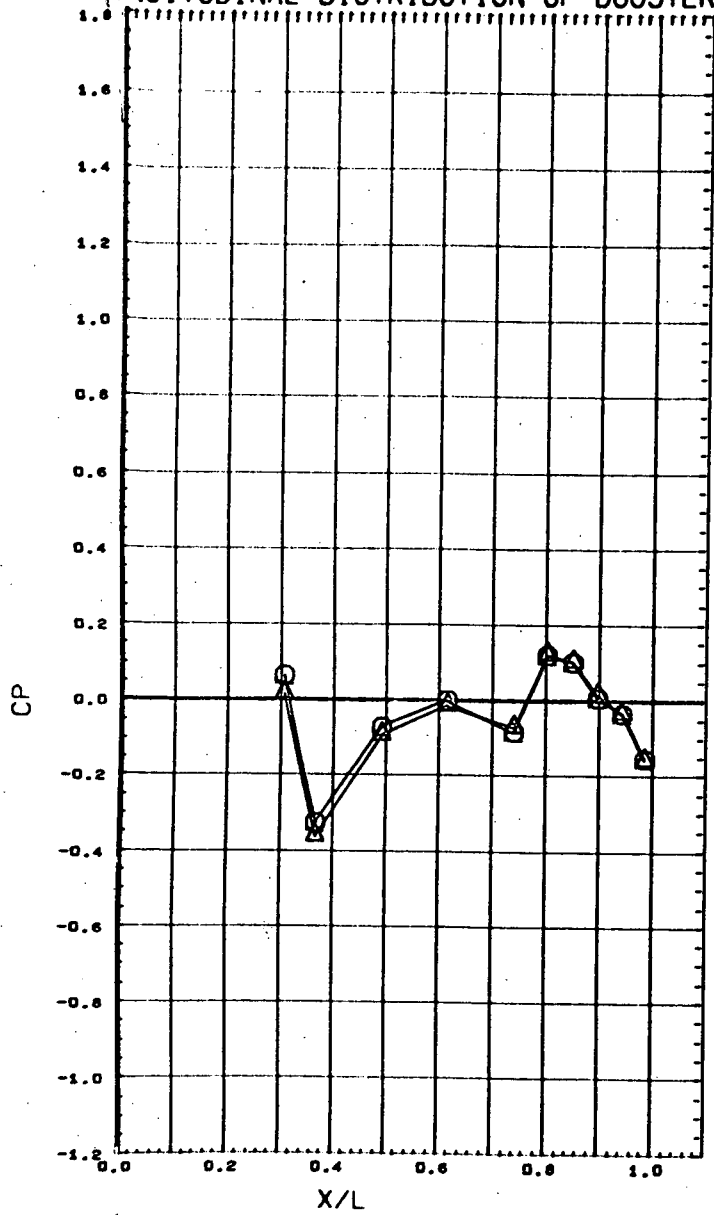

| SYMBOL | BETA | THETA | M1 |
|--------|-------|---------|-------|
| ○ | 3.902 | 90.000 | 1.099 |
| △ | 3.993 | 180.000 | |

| PARAMETRIC VALUES | | | |
|-------------------|-------|------|-------|
| ALFB | 0.000 | DA/L | 0.036 |
| I | 0.000 | | |

REFERENCE FILE

LONGITUDINAL DISTRIBUTION OF BOOSTER FUSELAGE PRESSURES

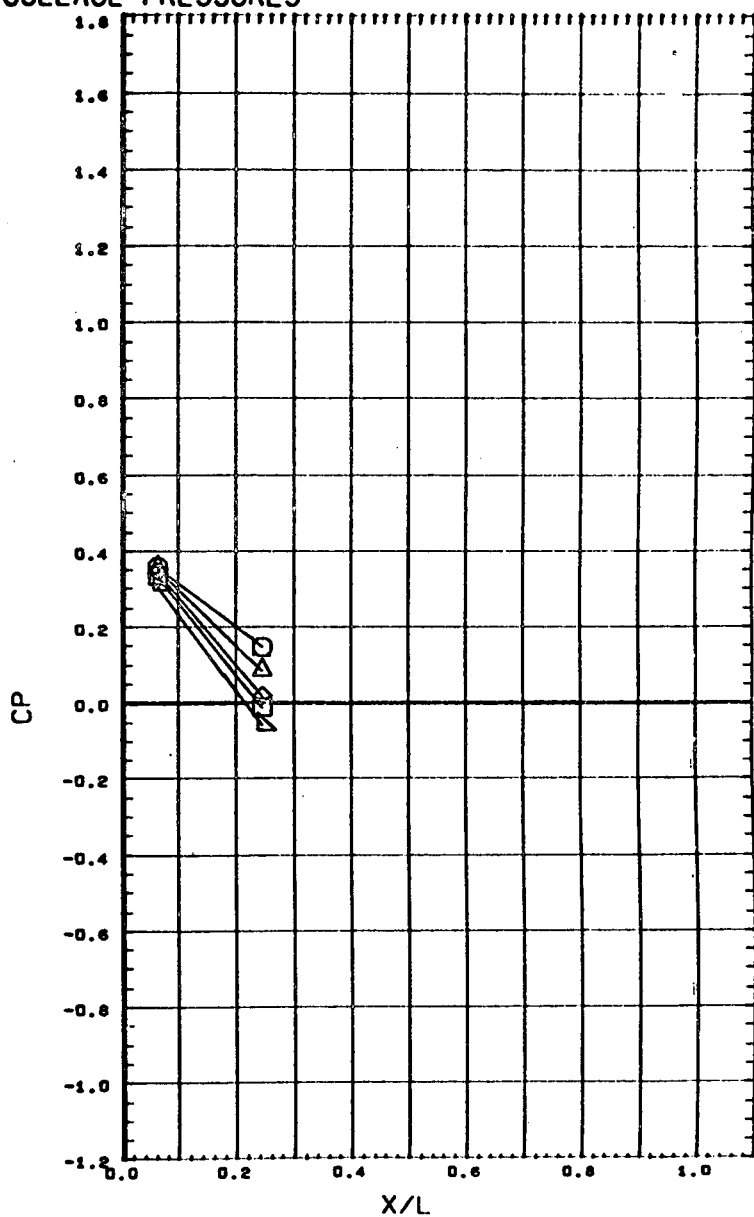
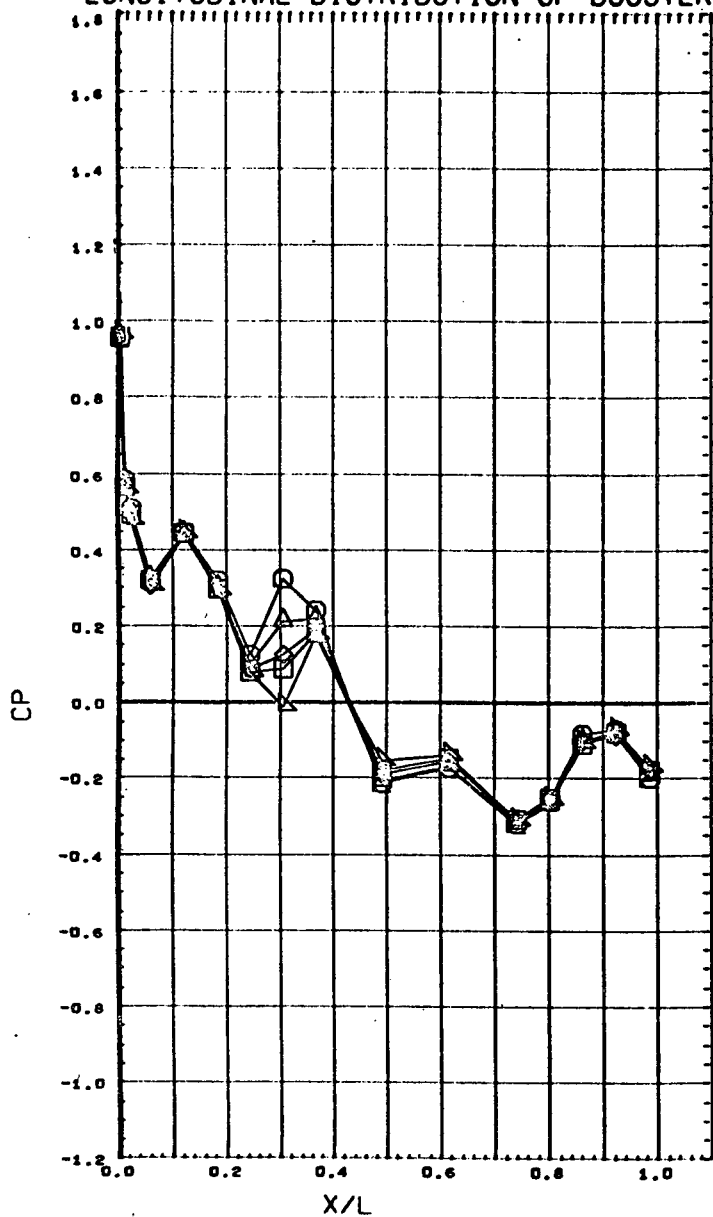

| SYMBOL | BETA | THETA | M1 |
|--------|-------|--------|-------|
| ○ | 6.194 | 0.000 | 1.201 |
| ◇ | 4.117 | 15.000 | |
| ◇ | 1.825 | | |
| □ | 0.517 | | |
| △ | 1.830 | | |

REFERENCE FILE

| PARAMETRIC VALUES | | | |
|-------------------|-------|------|-------|
| ALFB | 0.000 | OX/L | 0.036 |
| I | 0.000 | | |

LONGITUDINAL DISTRIBUTION OF BOOSTER FUSELAGE PRESSURES

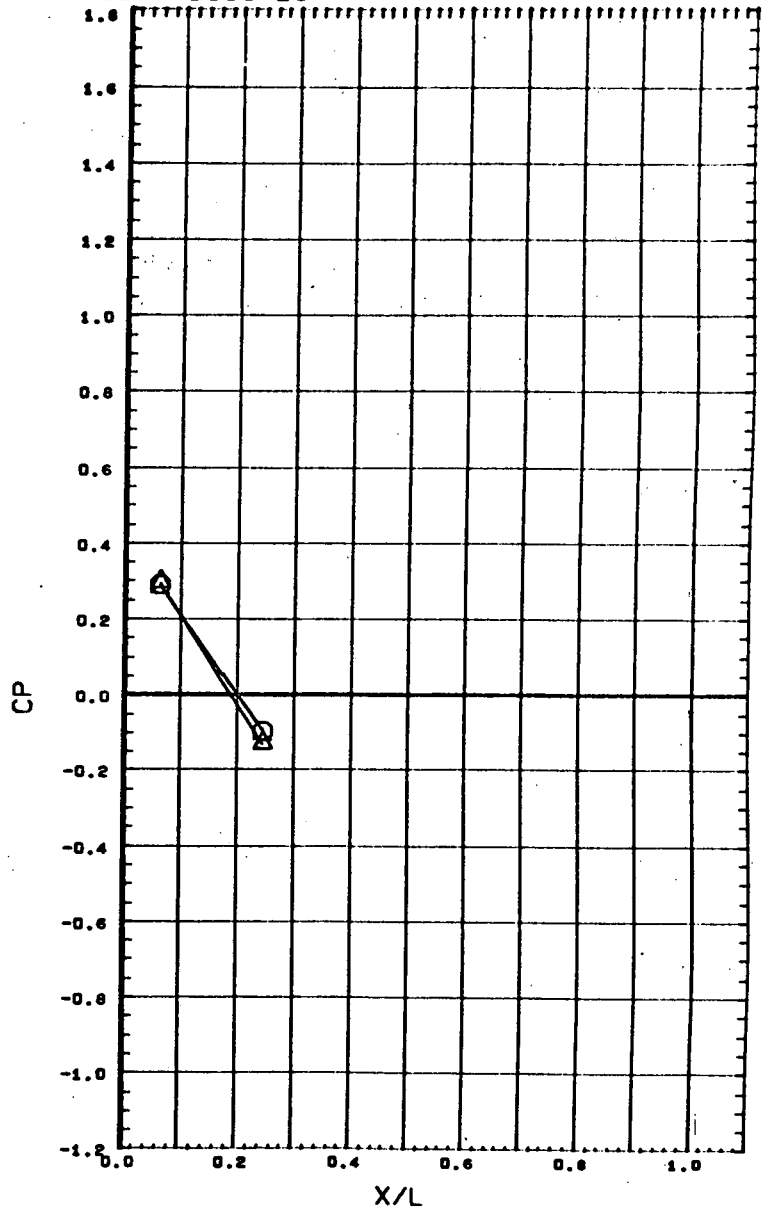
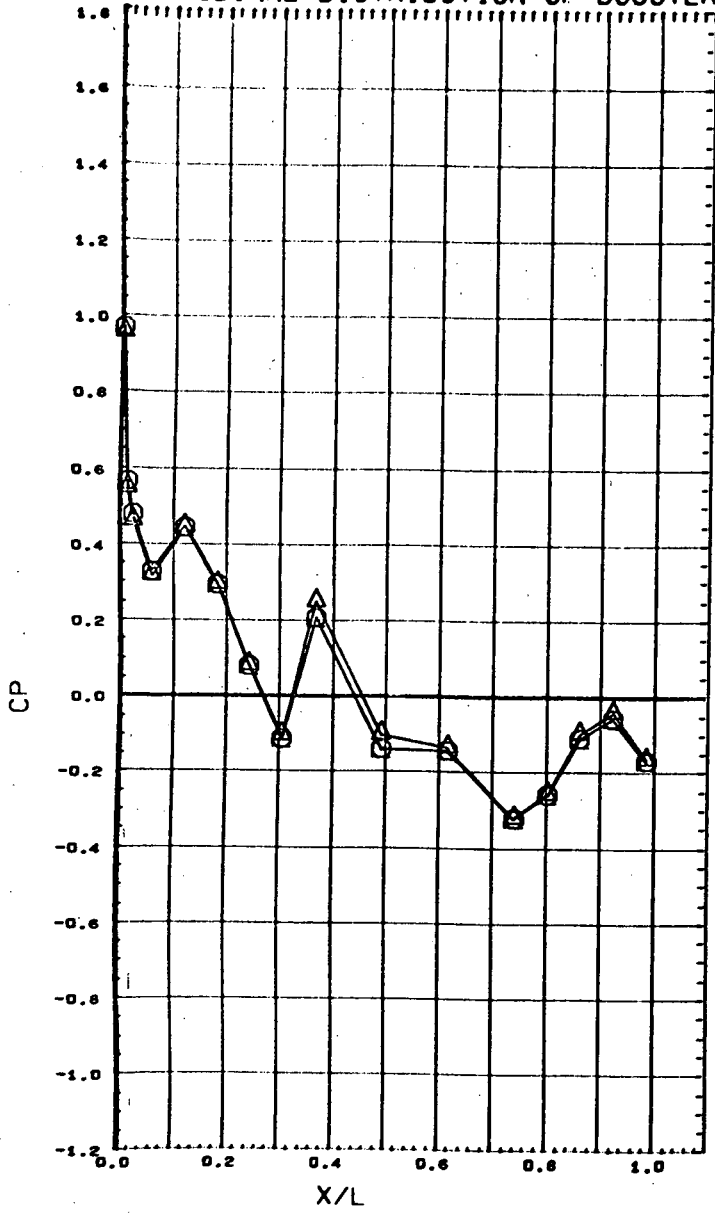

| SYMBOL | BETA | THETA | M1 |
|--------|-------|--------|-------|
| ○ | 3.904 | 0.000 | 1.201 |
| △ | 5.997 | 15.000 | |

| PARAMETRIC VALUES | | | |
|-------------------|-------|------|-------|
| ALFB | 0.000 | DX/L | 0.036 |
| I | 0.000 | | |

REFERENCE FILE

LONGITUDINAL DISTRIBUTION OF BOOSTER FUSELAGE PRESSURES

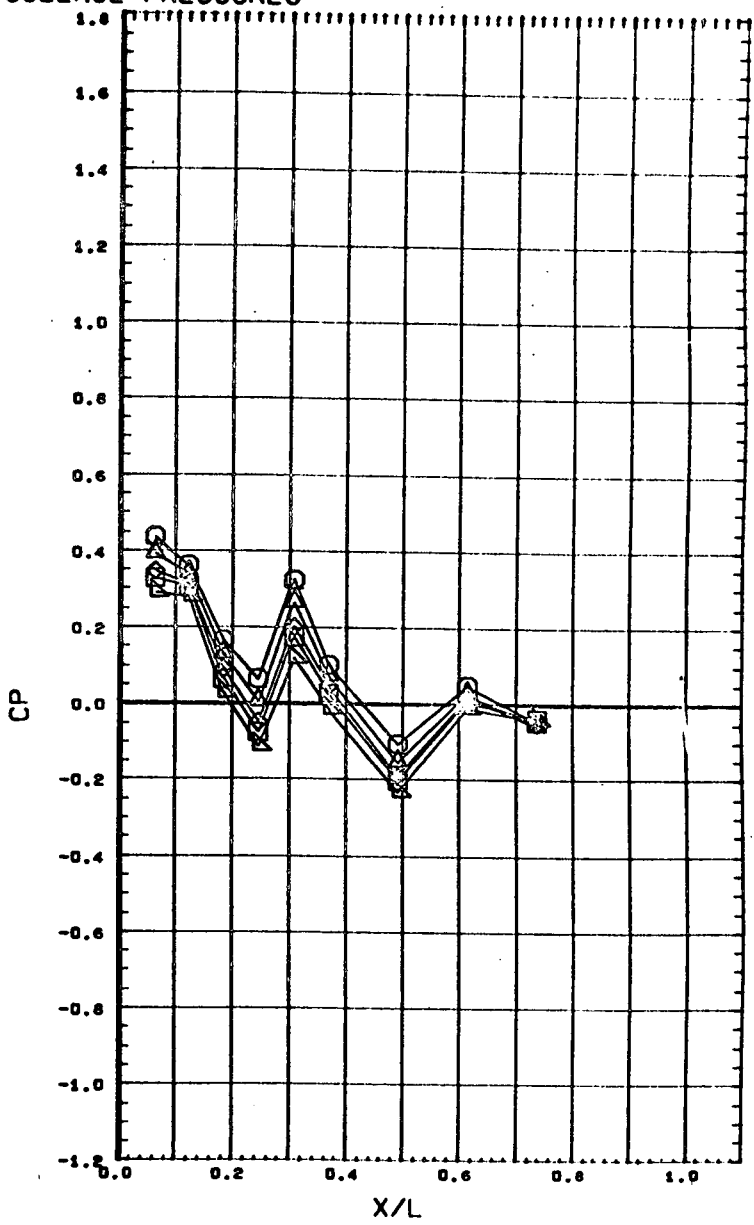
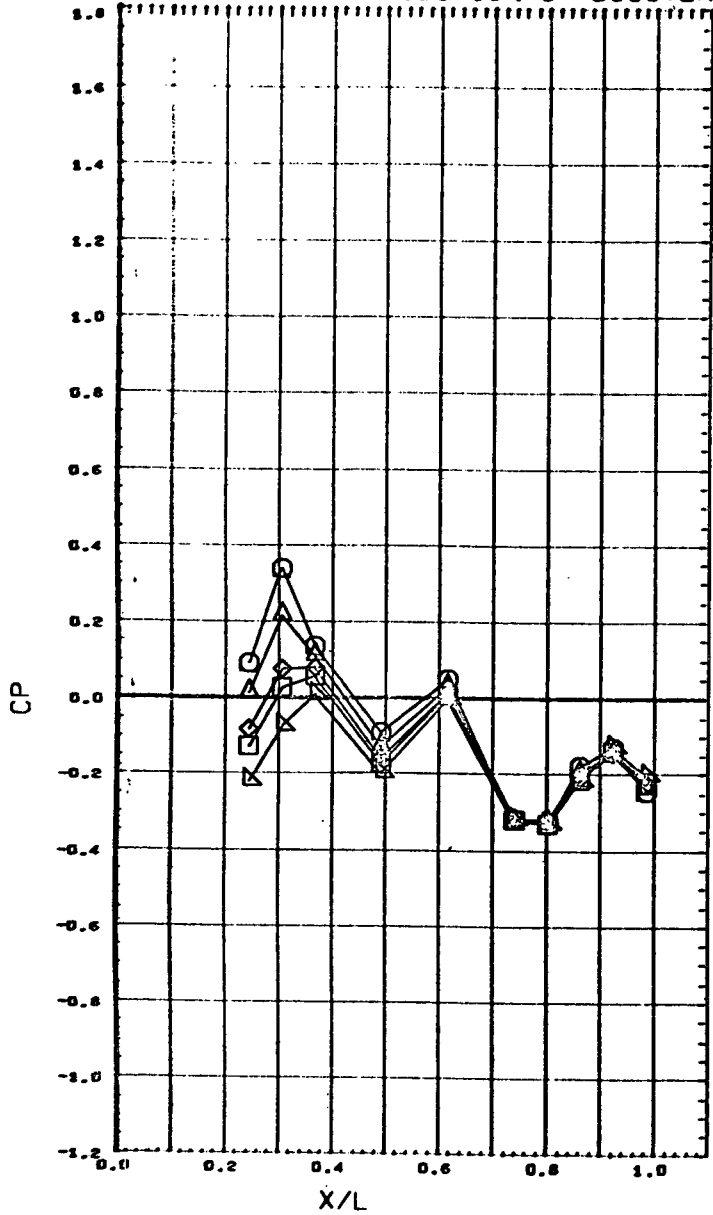

| SYMBOL | BETA | THETA | M1 |
|--------|-------|--------|-------|
| ○ | 6.194 | 24.000 | 1.201 |
| △ | 4.117 | 45.000 | |
| ◇ | 1.825 | | |
| □ | 0.517 | | |
| ▽ | 1.830 | | |

| PARAMETRIC VALUES | | | |
|-------------------|-------|------|-------|
| ALFB | 0.000 | OX/L | 0.036 |
| I | 0.000 | | |

REFERENCE FILE

LONGITUDINAL DISTRIBUTION OF BOOSTER FUSELAGE PRESSURES

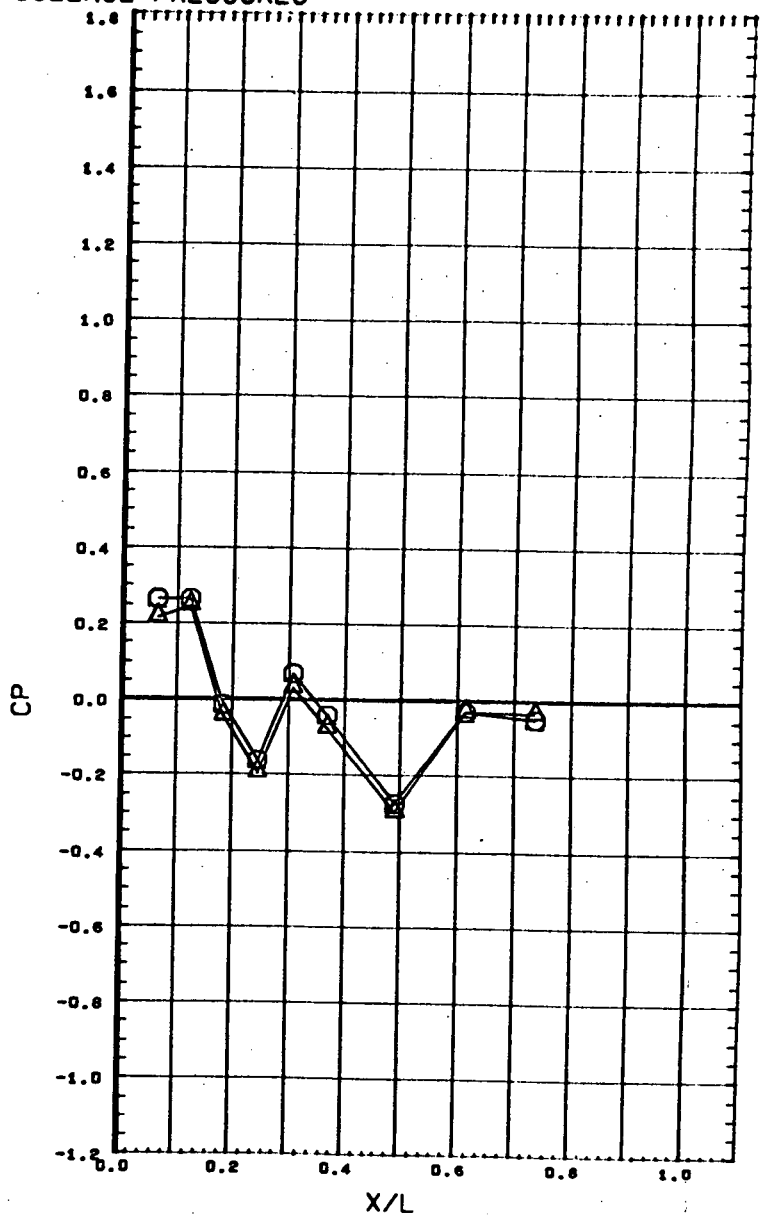
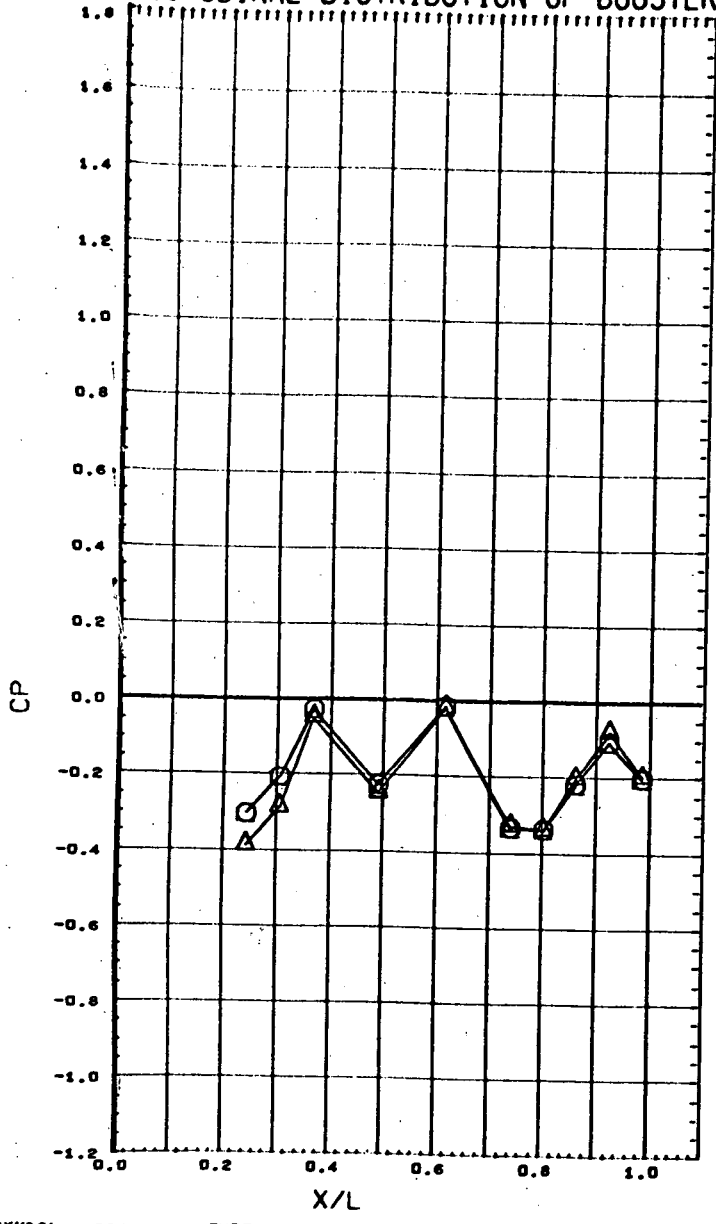

| SYMBOL | BETA | THETA | M1 |
|--------|-------|--------|-------|
| ○ | 3.904 | 24.000 | 1.201 |
| △ | 5.997 | 45.000 | |

| PARAMETRIC VALUES | | |
|-------------------|-------|-------|
| ALFB | 0.000 | DX/L |
| I | 0.000 | 0.036 |

REFERENCE FILE

LONGITUDINAL DISTRIBUTION OF BOOSTER FUSELAGE PRESSURES

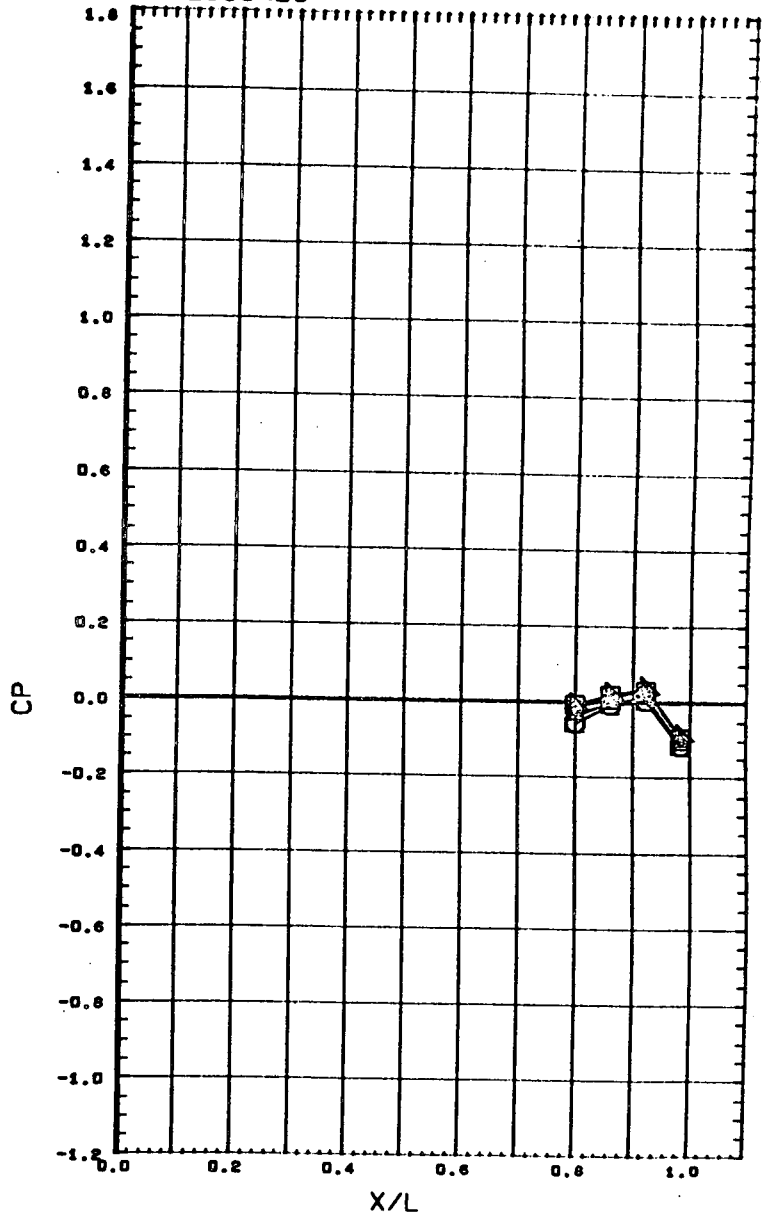
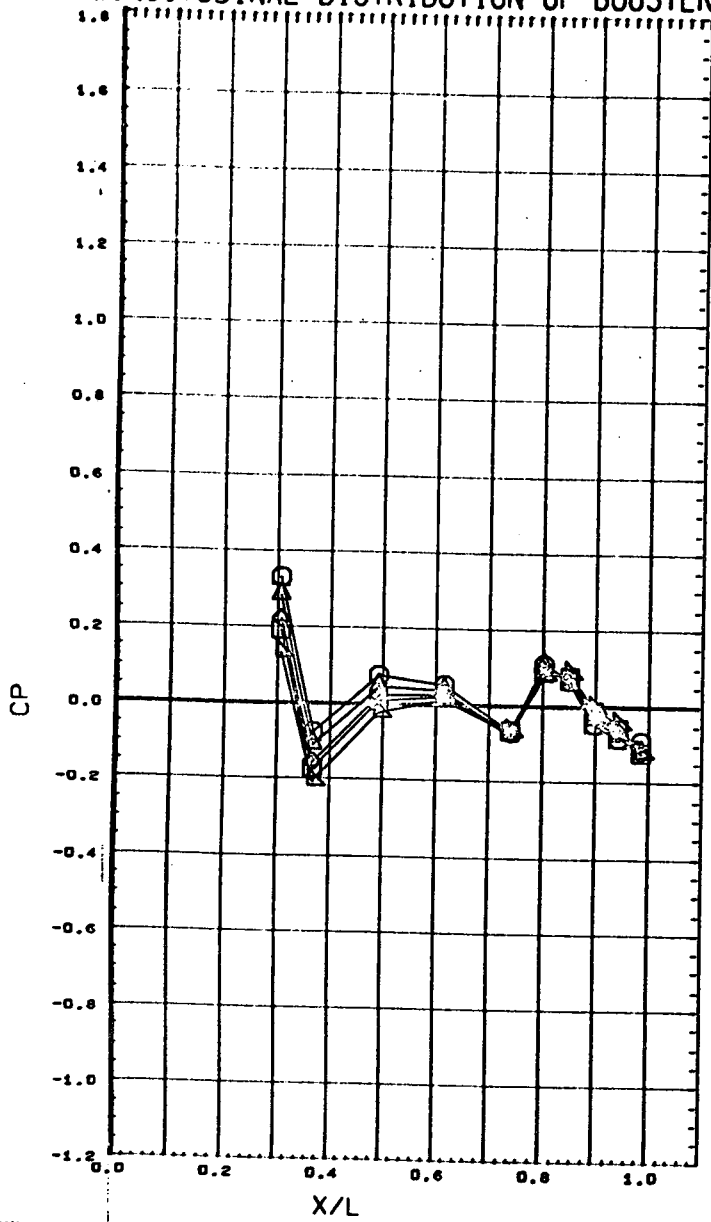

| SYMBOL | BETA | THETA | M1 |
|--------|-------|---------|-------|
| ○ | 6.194 | 90.000 | 1.201 |
| △ | 4.117 | 180.000 | |
| ◇ | 1.825 | | |
| □ | 0.517 | | |
| ○ | 1.830 | | |

REFERENCE FILE

| PARAMETRIC VALUES | | | |
|-------------------|-------|------|-------|
| ALFB | 0.000 | DX/L | 0.036 |
| I | 0.000 | | |

LONGITUDINAL DISTRIBUTION OF BOOSTER FUSELAGE PRESSURES

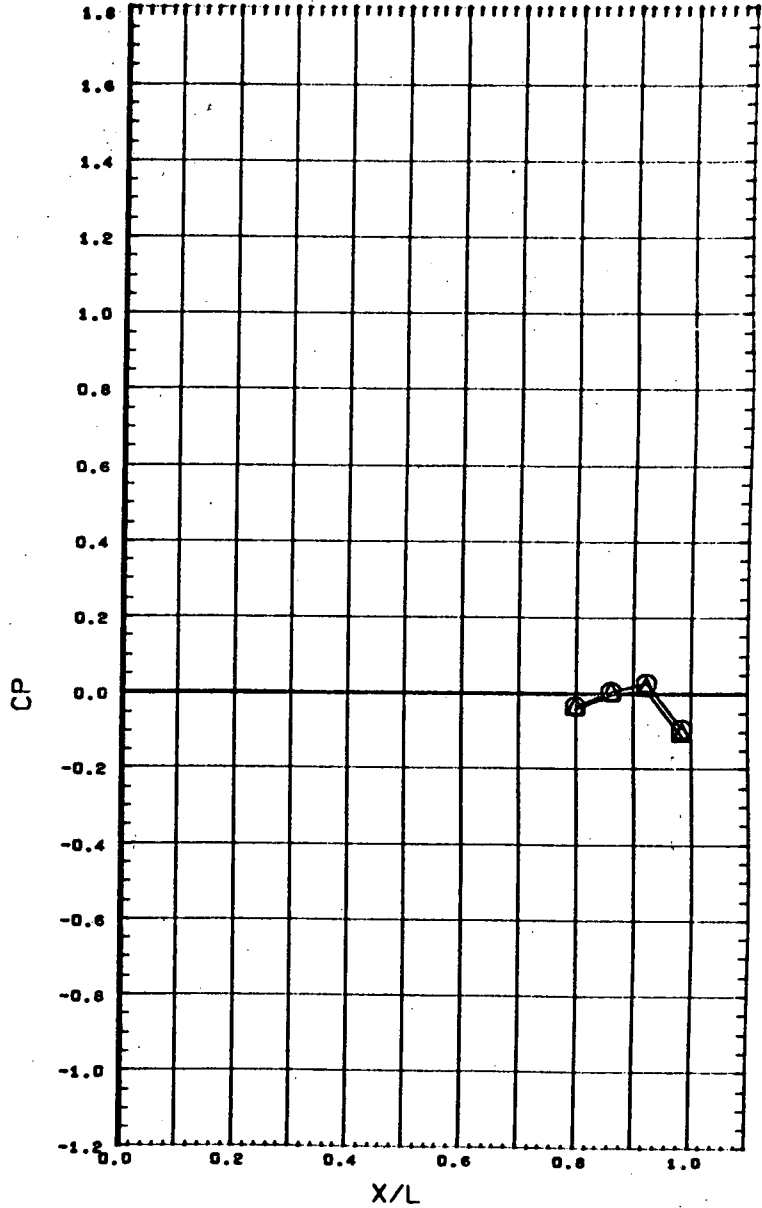
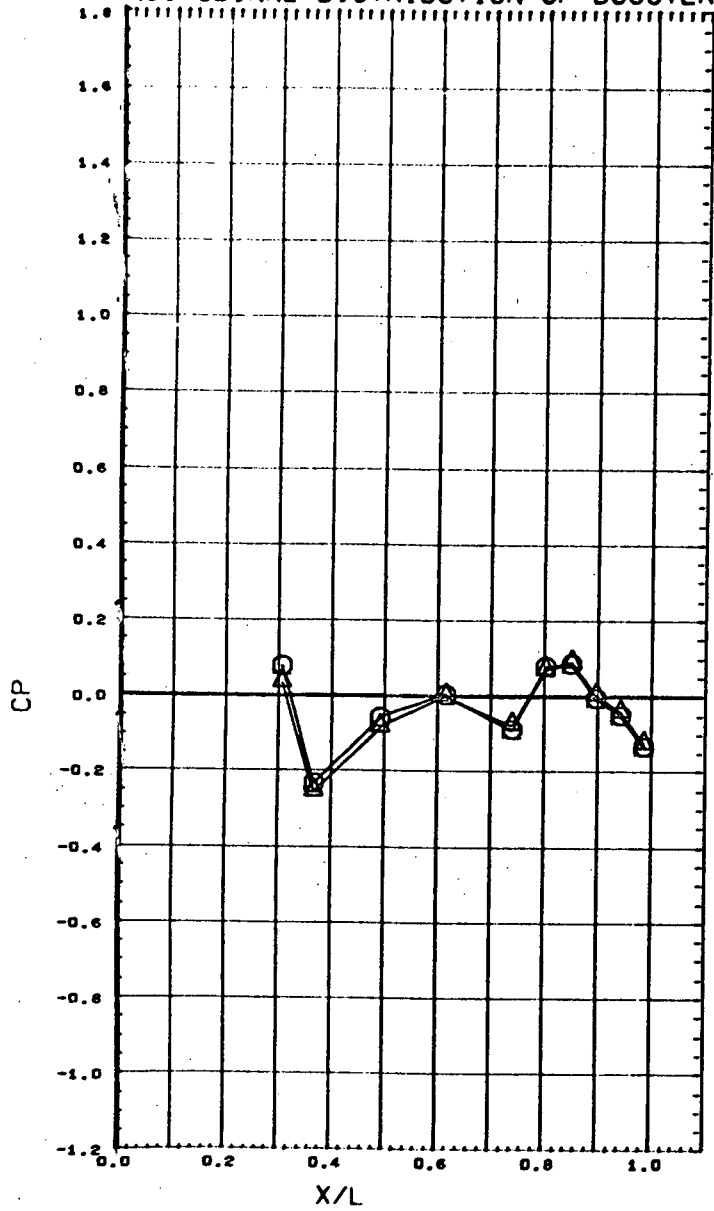

| SYMBOL | BETA | THETA | M1 |
|--------|-------|---------|-------|
| ○ | 3.904 | 90.000 | 1.201 |
| △ | 5.997 | 180.000 | |

| PARAMETRIC VALUES | | |
|-------------------|-------|-------|
| ALFB | 0.000 | DX/L |
| I | 0.000 | 0.036 |

REFERENCE FILE

LONGITUDINAL DISTRIBUTION OF BOOSTER FUSELAGE PRESSURES

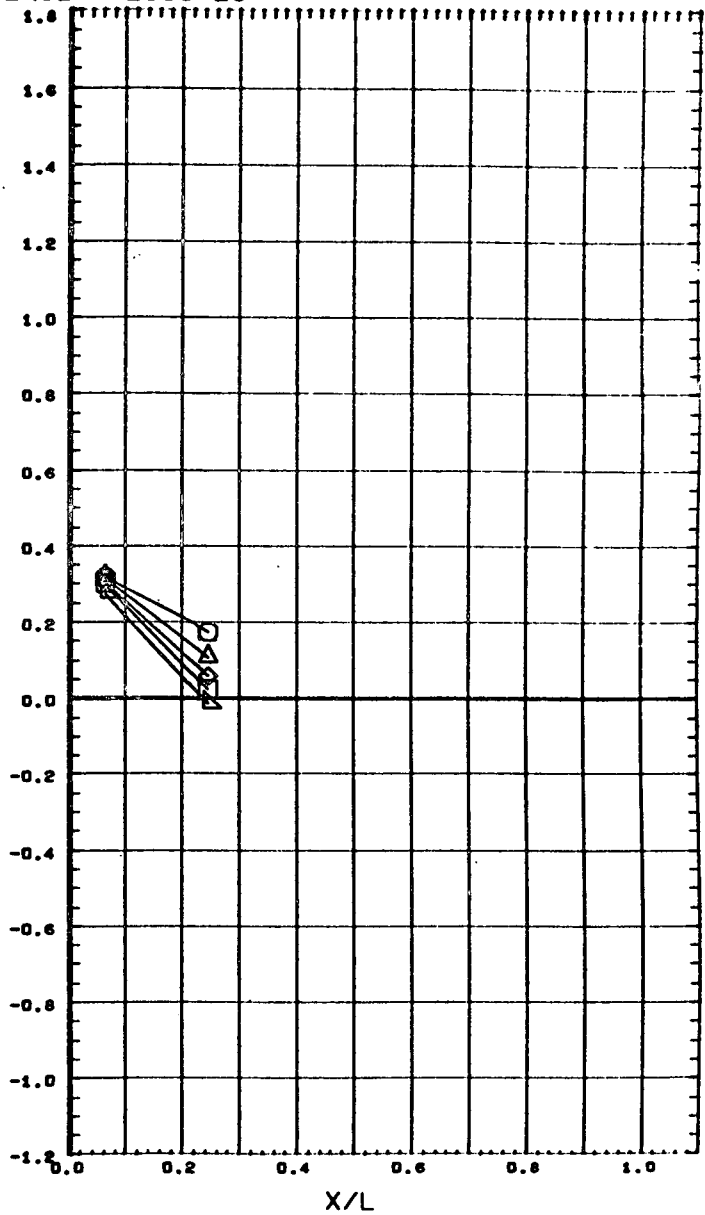
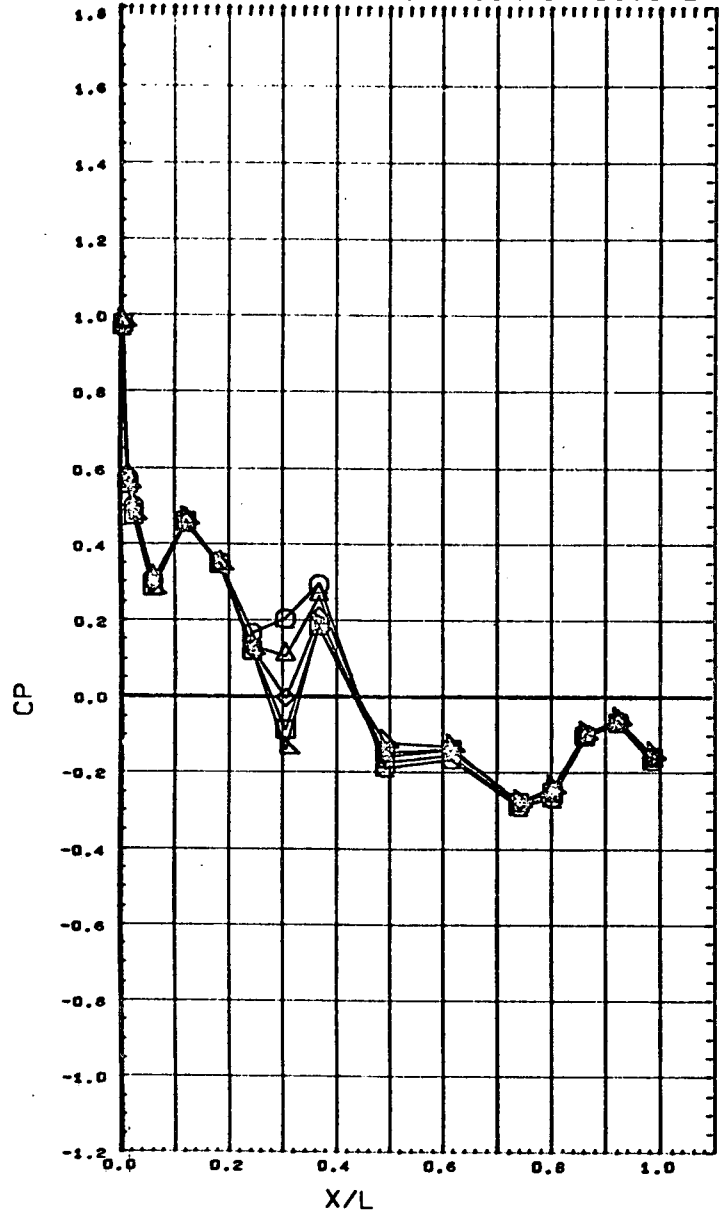

| SYMBOL | BETA | THETA | M1 |
|--------|---------|--------|-------|
| ○ | - 6.217 | 0.000 | 1.299 |
| △ | - 4.137 | 15.000 | |
| ◇ | - 2.051 | | |
| □ | - 0.275 | | |
| ▽ | 1.816 | | |

| PARAMETRIC VALUES | | | |
|-------------------|-------|------|-------|
| ALFB | 0.000 | DX/L | 0.036 |
| I | 0.000 | | |

REFERENCE FILE

LONGITUDINAL DISTRIBUTION OF BOOSTER FUSELAGE PRESSURES

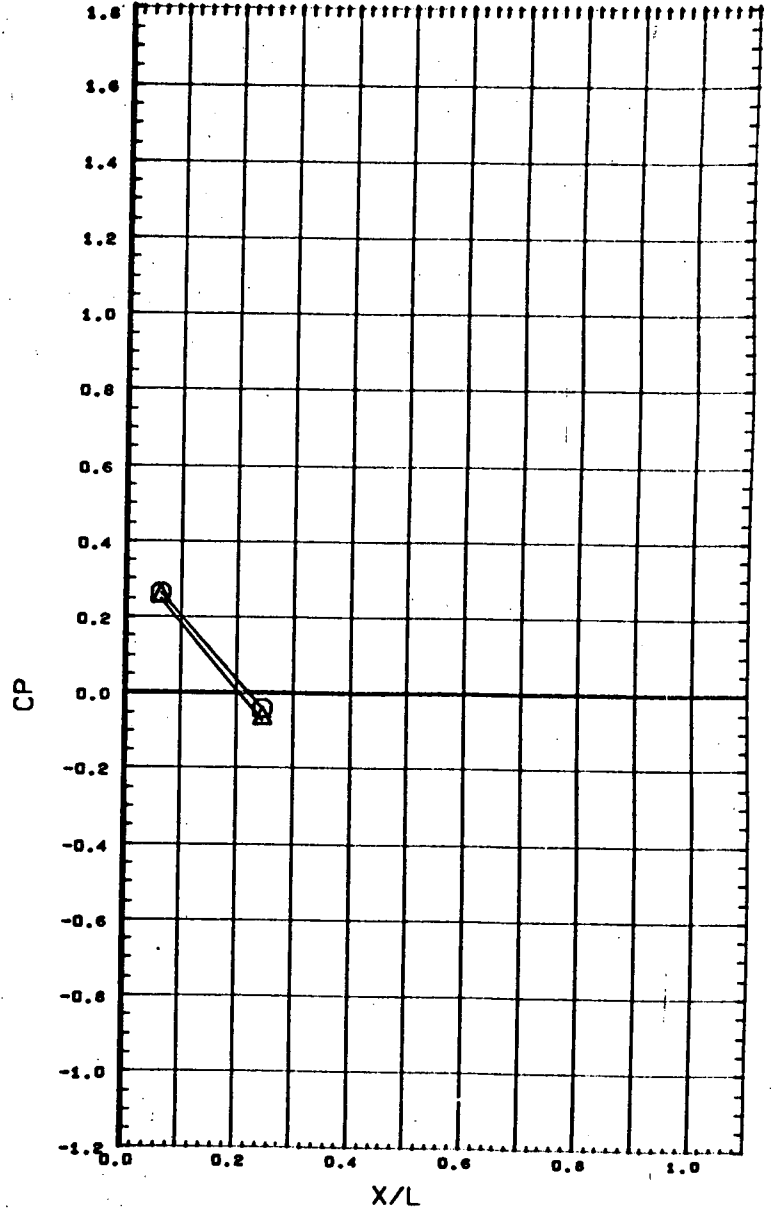
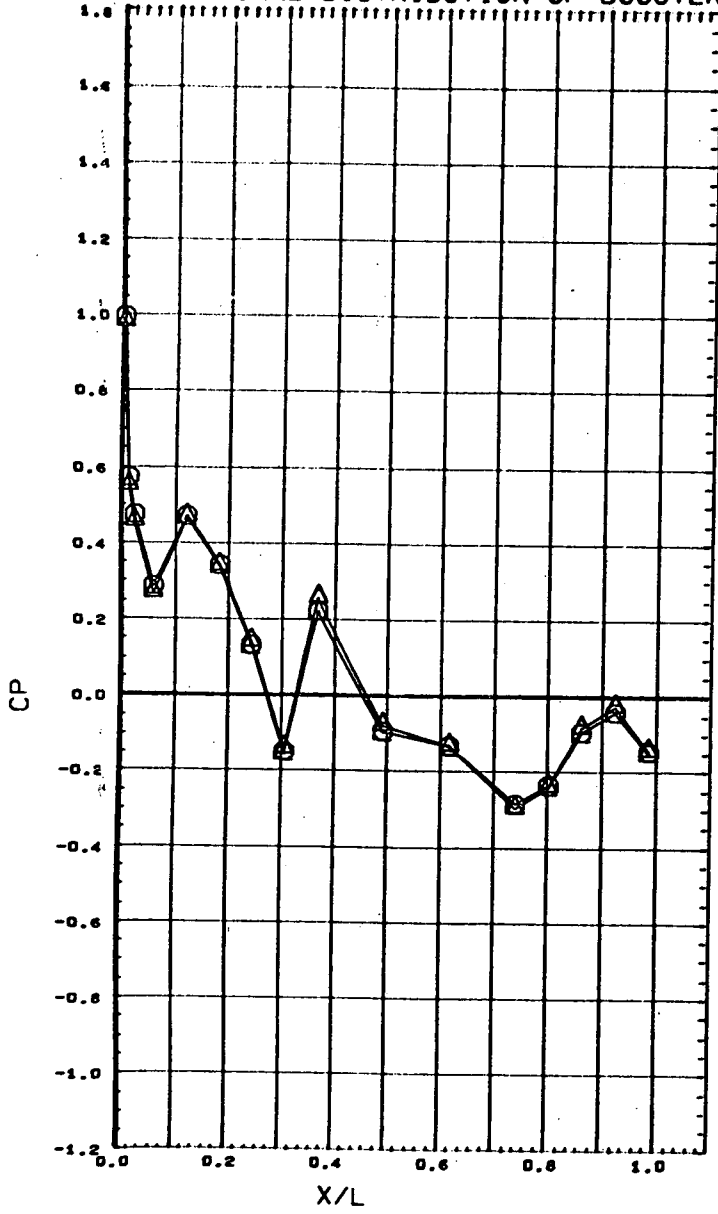

| SYMBOL | BETA | THETA | M1 |
|--------|-------|--------|-------|
| ○ | 3.882 | 0.000 | 1.299 |
| △ | 5.985 | 15.000 | |

| PARAMETRIC VALUES | | |
|-------------------|-------|-------|
| ALFB | 0.000 | DX/L |
| I | 0.000 | 0.036 |

REFERENCE FILE

AEDC TC174 MDAC BOOSTER NEAR ORBITER (BODY)

(ATC006)

PAGE 185

LONGITUDINAL DISTRIBUTION OF BOOSTER FUSELAGE PRESSURES

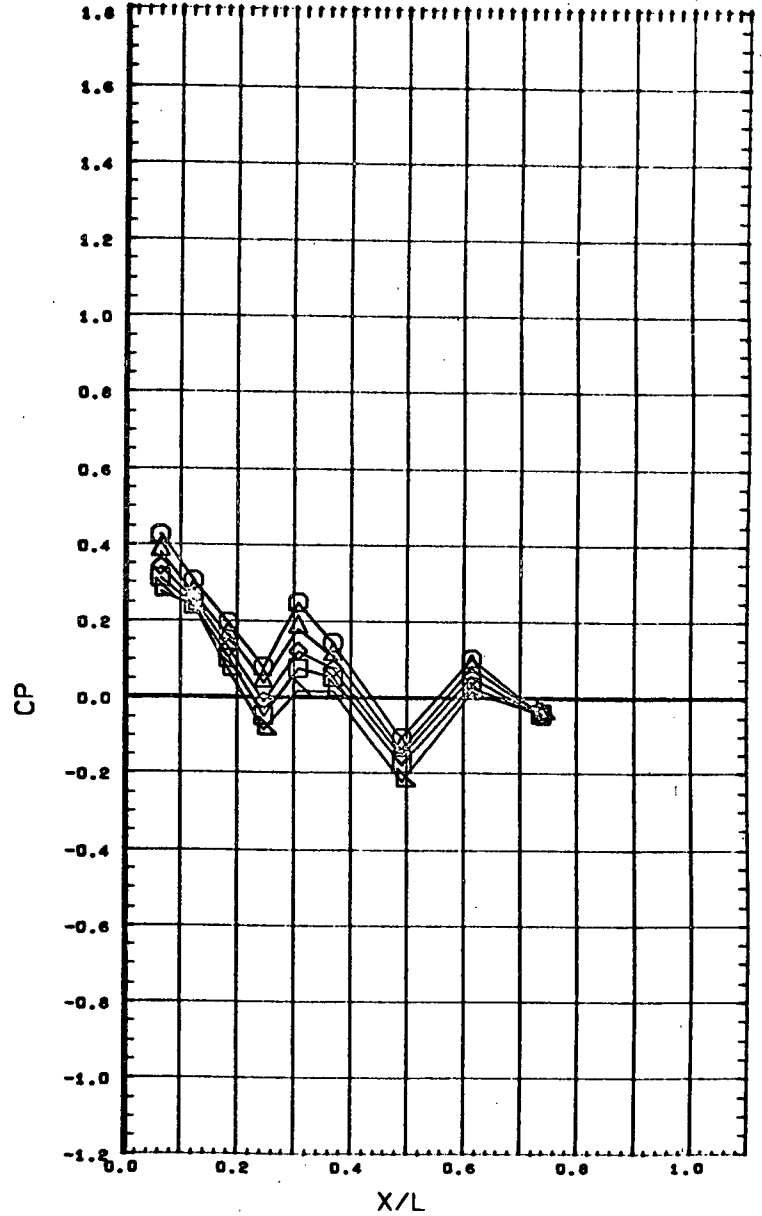
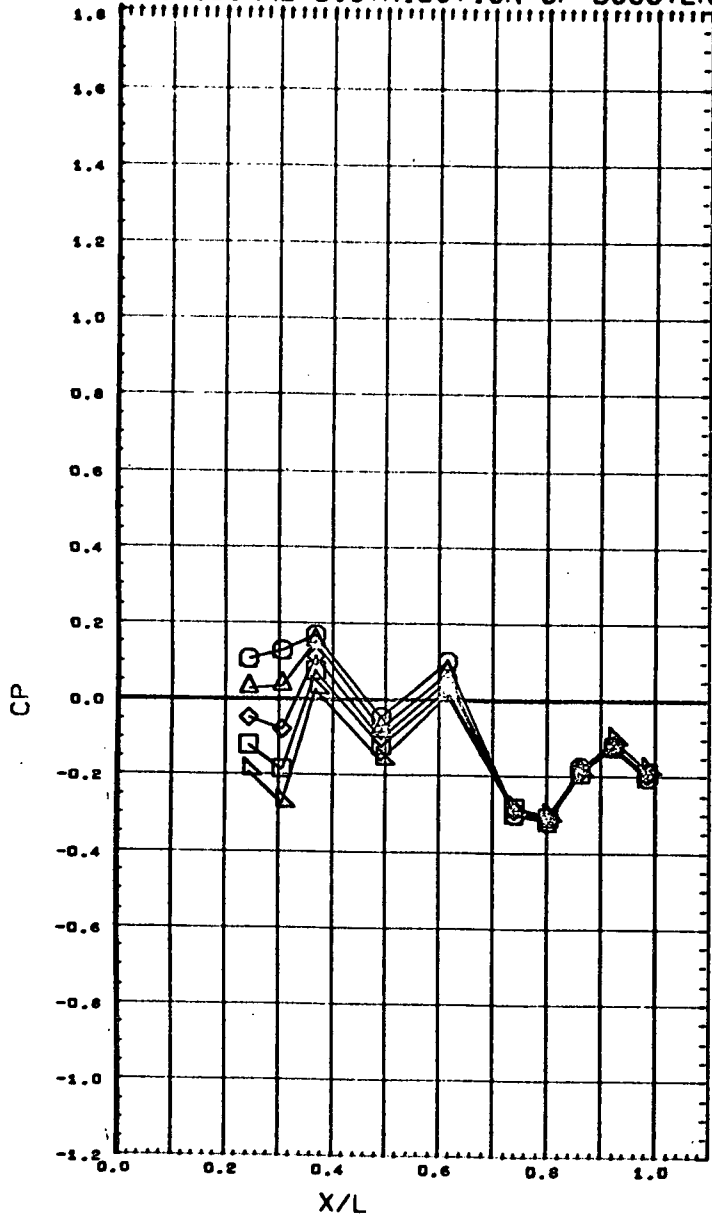

| SYMBOL | BETA | THETA | M1 |
|--------|---------|--------|-------|
| ○ | - 6.217 | 24.000 | 1.299 |
| △ | - 4.137 | 45.000 | |
| ◇ | - 2.051 | | |
| □ | - 0.270 | | |
| ▽ | 1.816 | | |

REFERENCE FILE

| PARAMETRIC VALUES | | | |
|-------------------|-------|------|-------|
| ALFB | 0.000 | DX/L | 0.036 |
| I | 0.000 | | |

LONGITUDINAL DISTRIBUTION OF BOOSTER FUSELAGE PRESSURES

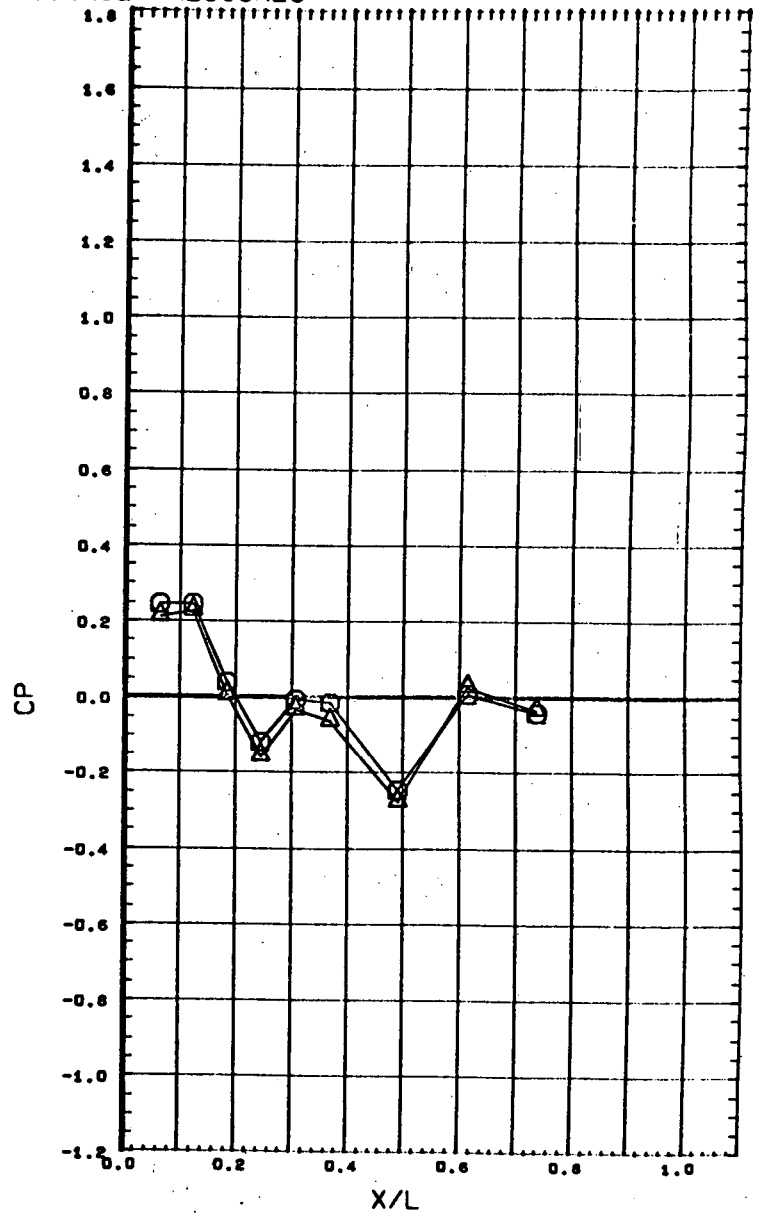
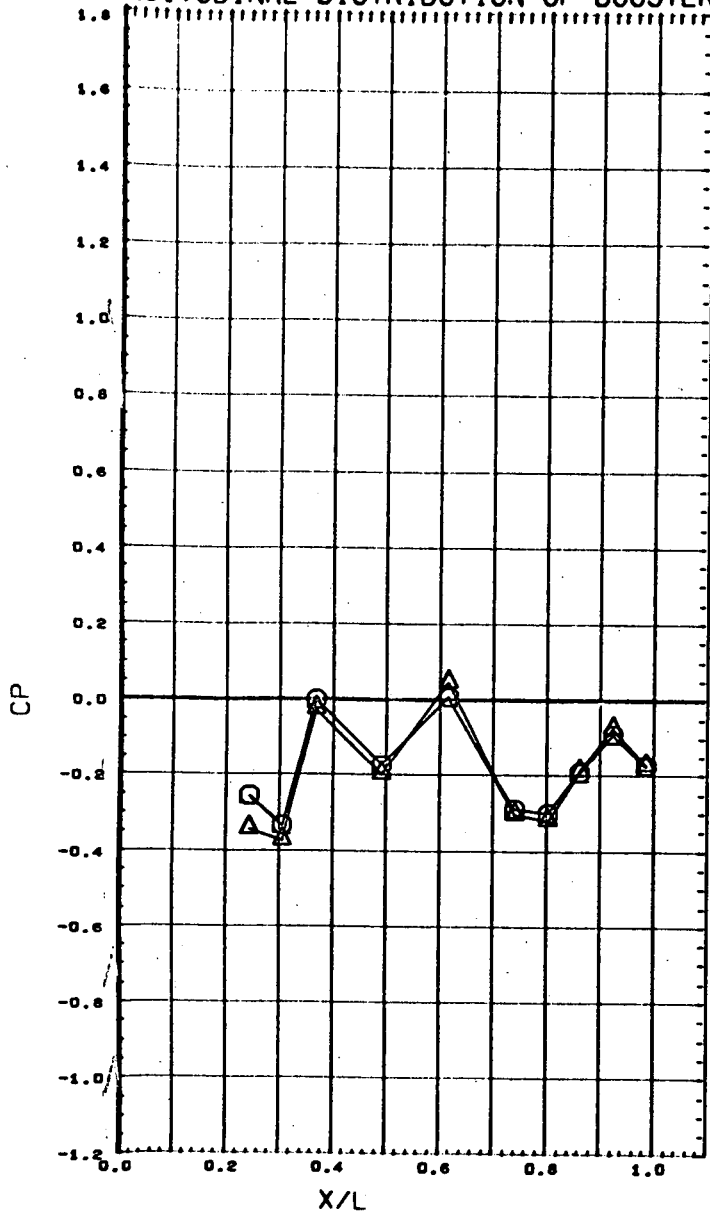

| SYMBOL | BETA | THETA | M1 |
|--------|-------|--------|-------|
| ○ | 3.682 | 24.000 | 1.299 |
| △ | 5.980 | 45.000 | |

| PARAMETRIC VALUES | | |
|-------------------|-------|------------|
| ALFB | 0.000 | DX/L 0.036 |
| I | 0.000 | |

REFERENCE FILE

LONGITUDINAL DISTRIBUTION OF BOOSTER FUSELAGE PRESSURES

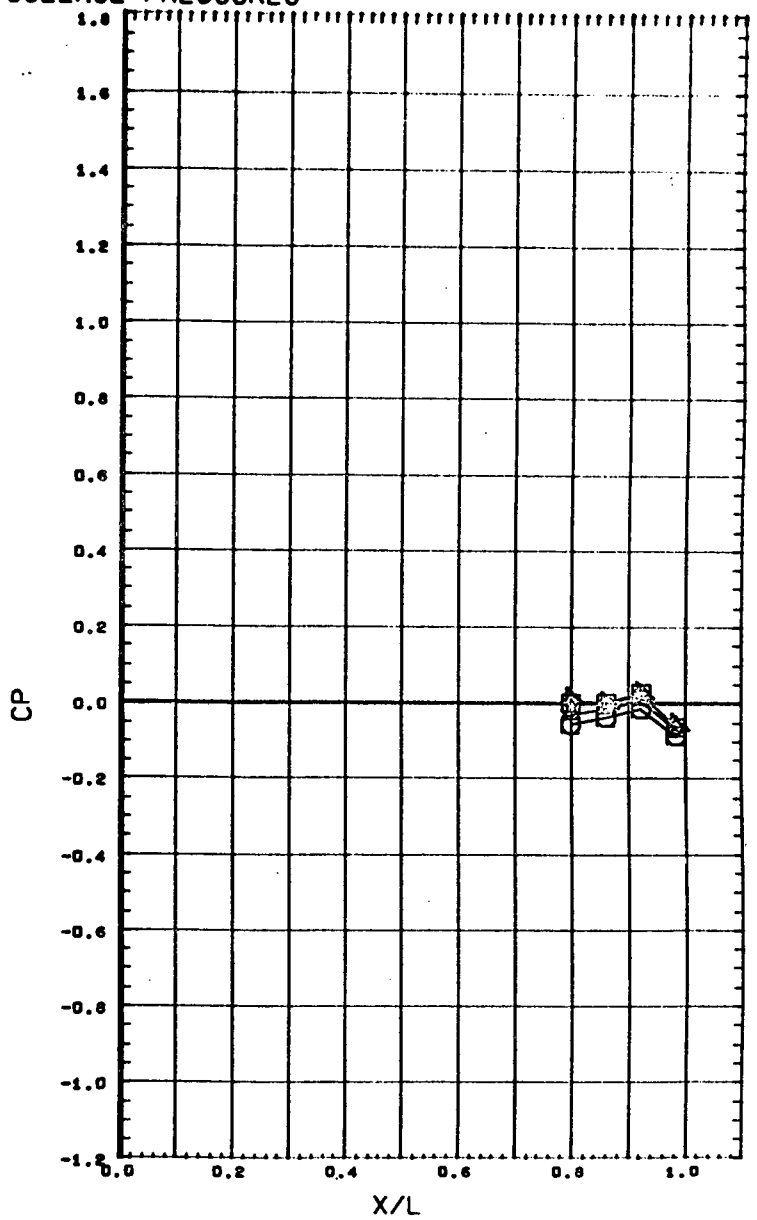
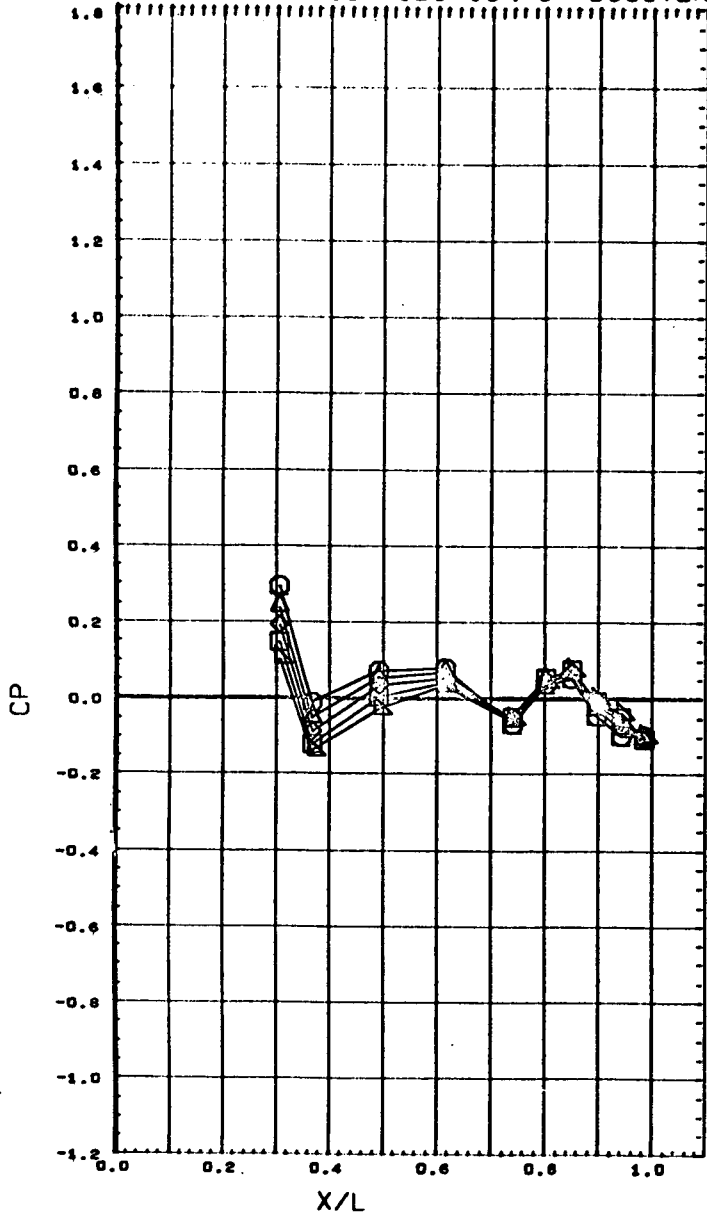

| SYMBOL | BETA | THETA | M1 |
|--------|-------|---------|-------|
| ○ | 6.217 | 90.000 | 1.299 |
| △ | 4.137 | 180.000 | |
| ◇ | 2.051 | | |
| □ | 0.270 | | |
| ○ | 1.816 | | |

| PARAMETRIC VALUES | | | |
|-------------------|-------|------|-------|
| ALFB | 0.000 | DX/L | 0.036 |
| I | 0.000 | | |

REFERENCE FILE

LONGITUDINAL DISTRIBUTION OF BOOSTER FUSELAGE PRESSURES

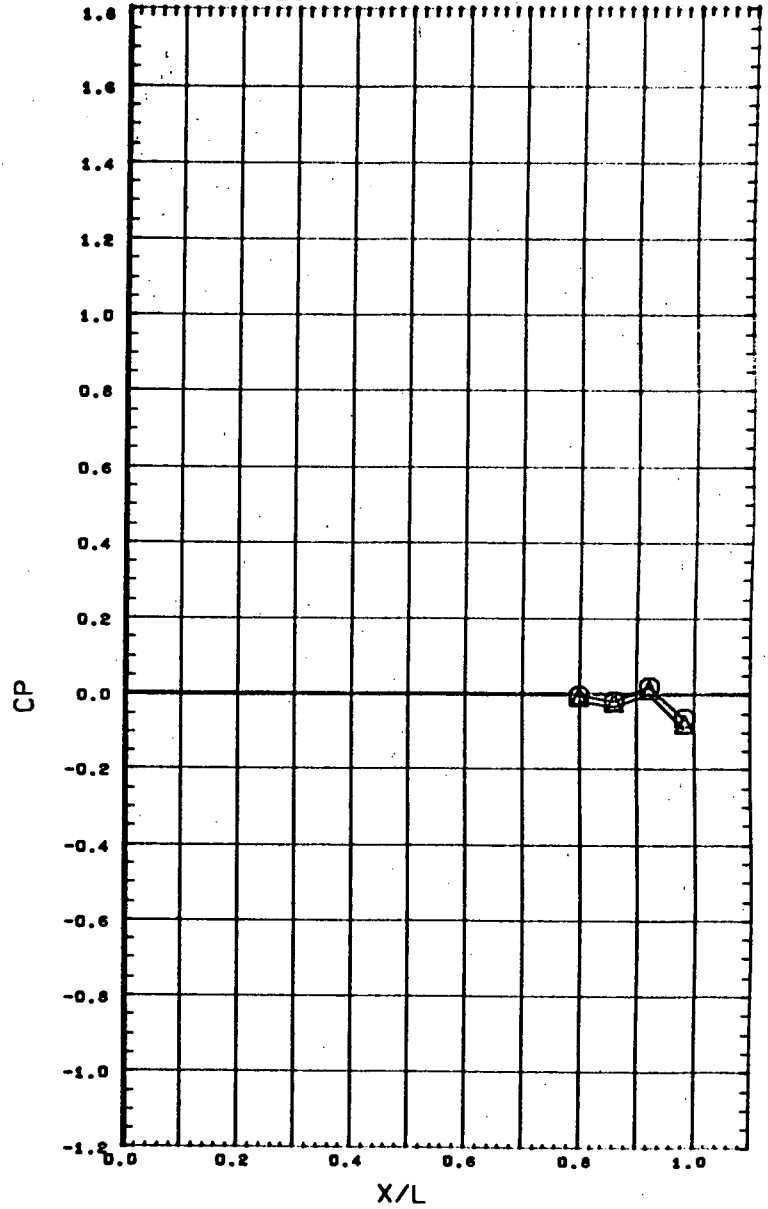
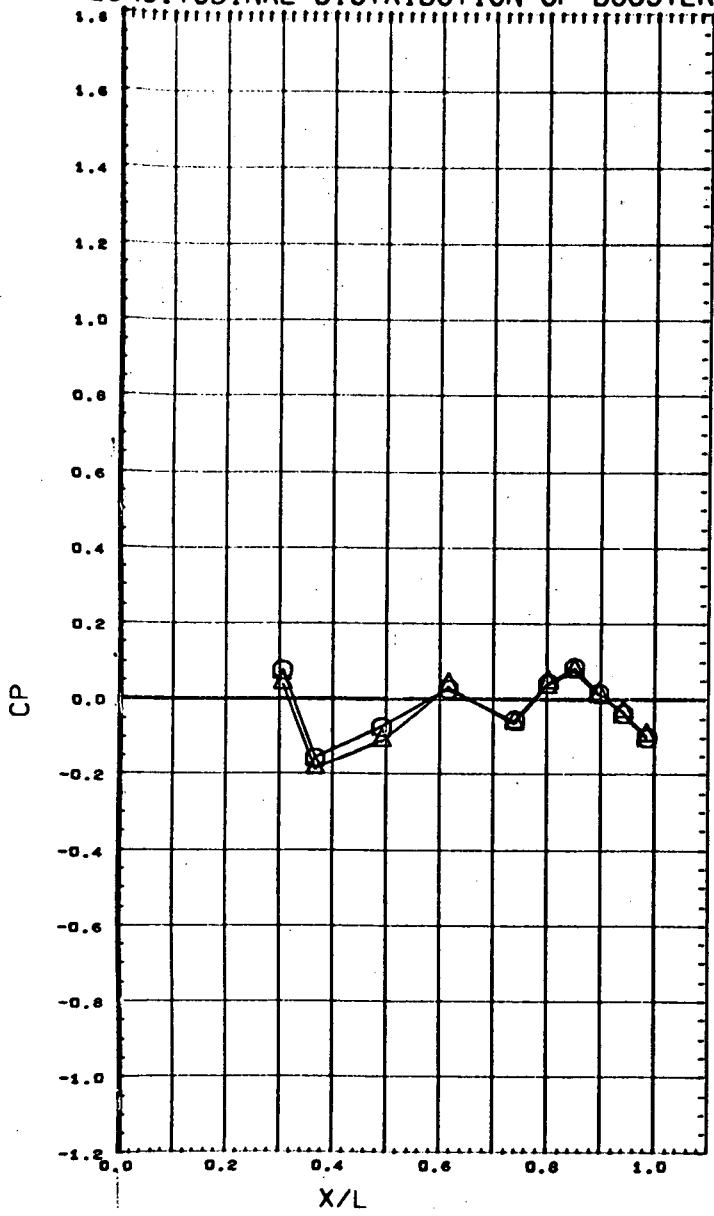

| SYMBOL | BETA | THETA | M1 |
|--------|-------|---------|-------|
| ○ | 3.882 | 90.000 | 1.299 |
| △ | 5.980 | 180.000 | |

| PARAMETRIC VALUES | | | |
|-------------------|-------|------|-------|
| ALFB | 0.000 | DX/L | 0.036 |
| I | 0.000 | | |

REFERENCE FILE

LONGITUDINAL DISTRIBUTION OF BOOSTER FUSELAGE PRESSURES

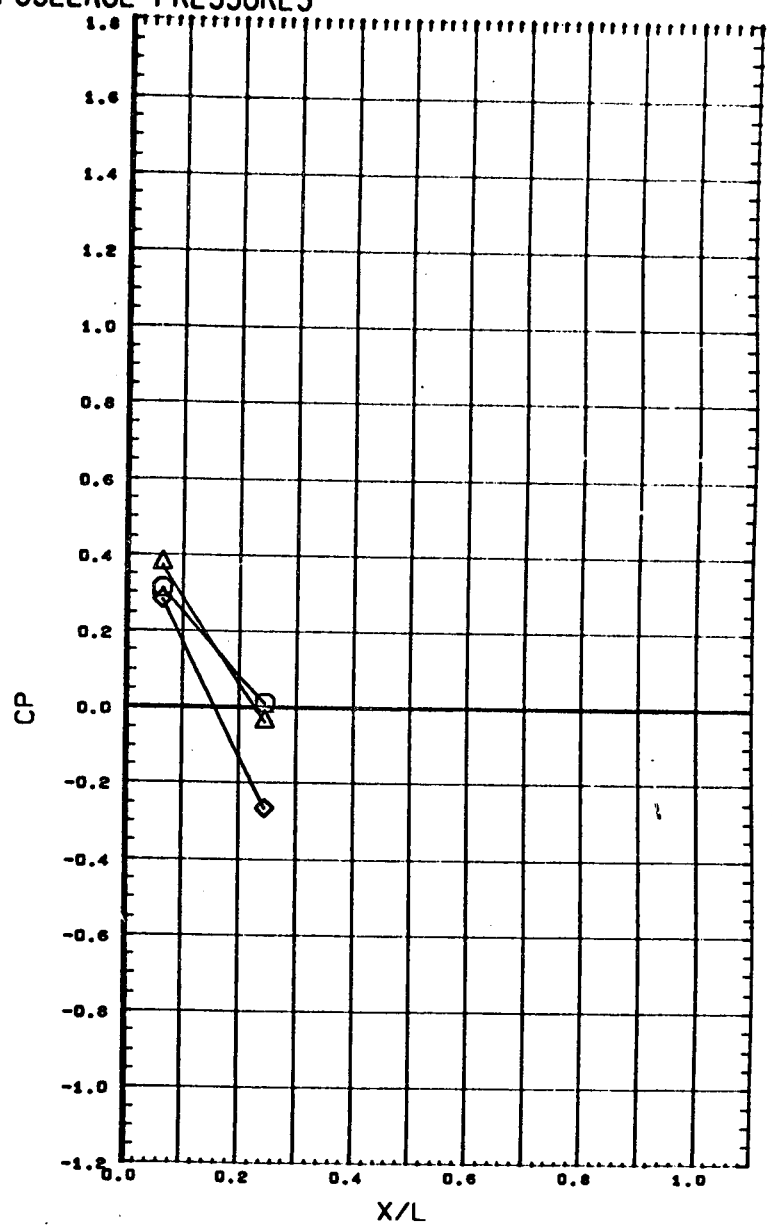
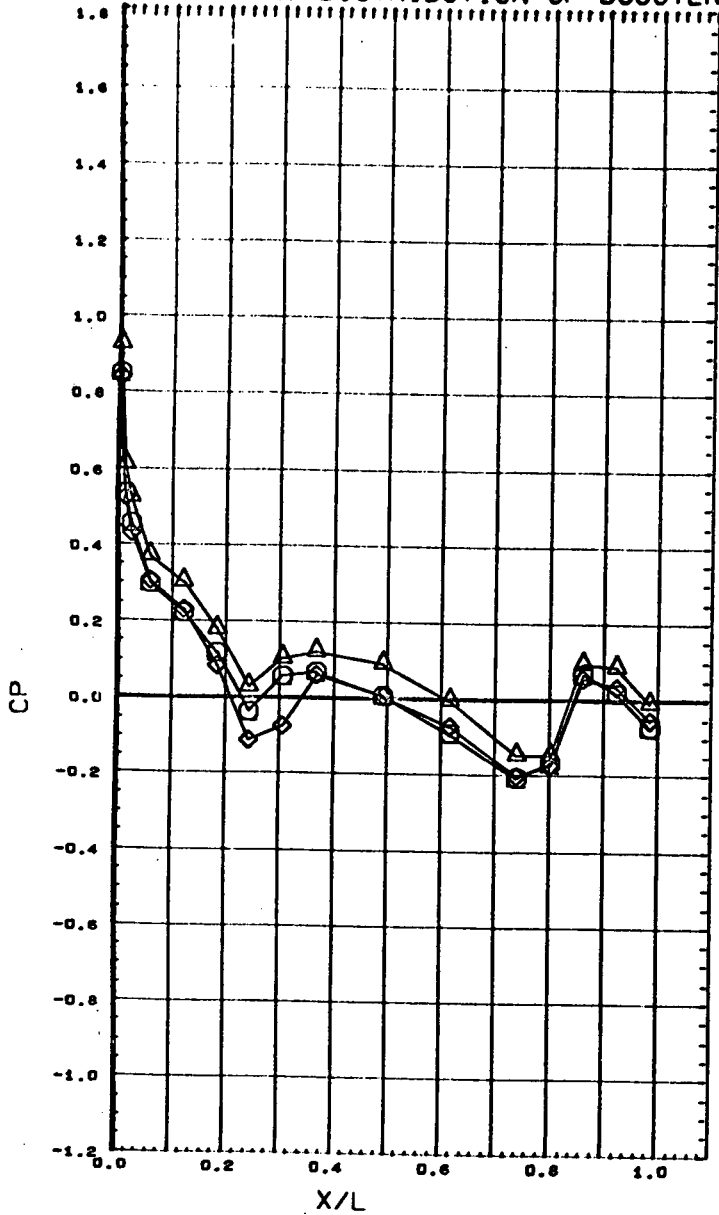

| SYMBOL | BETA | THETA | M1 |
|--------|-------|--------|-------|
| ○ | 4.097 | 0.000 | 0.599 |
| △ | 0.032 | 15.000 | |
| ◇ | 4.299 | | |

| PARAMETRIC VALUES | | | |
|-------------------|-------|------|-------|
| ALFB | 6.000 | DX/L | 0.036 |
| I | 0.000 | | |

REFERENCE FILE

LONGITUDINAL DISTRIBUTION OF BOOSTER FUSELAGE PRESSURES

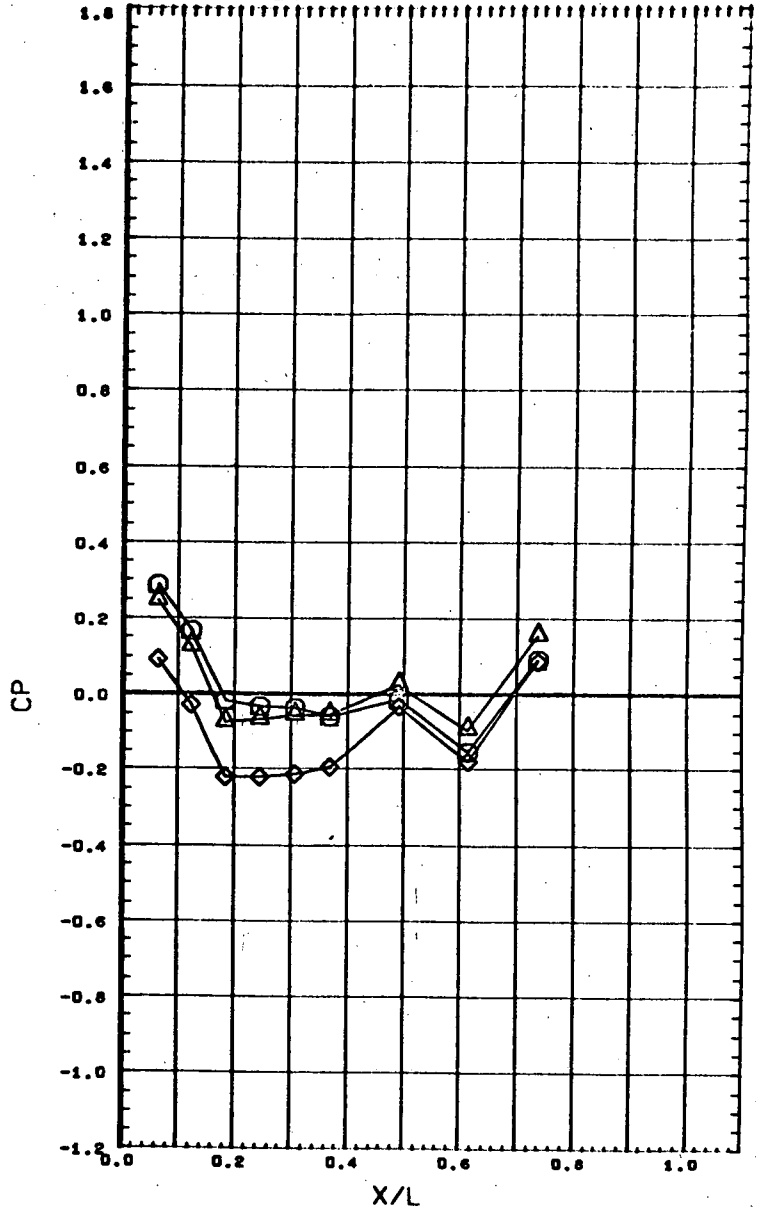
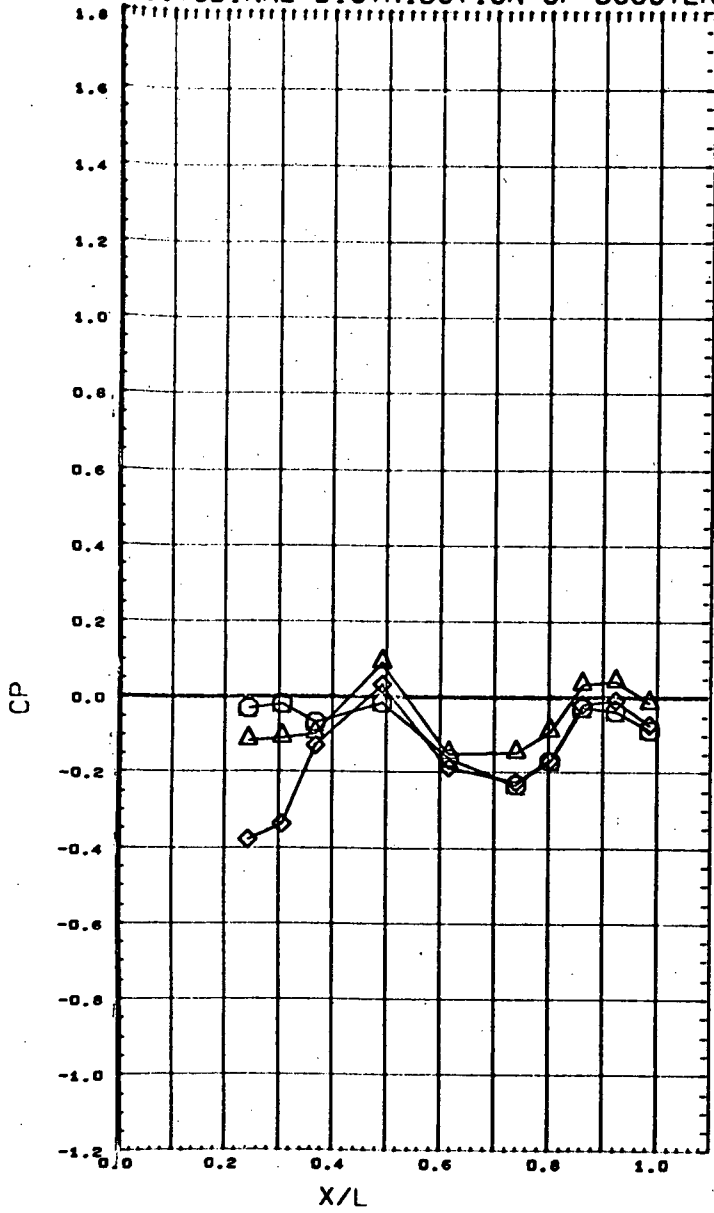

| SYMBOL | BETA | THETA | M1 |
|--------|-------|--------|-------|
| ○ | 0.097 | 24.000 | 0.599 |
| △ | 0.032 | 45.000 | |
| ◇ | 4.299 | | |

| PARAMETRIC VALUES | | |
|-------------------|-------|-------|
| ALPB | 6.000 | DX/L |
| I | 0.000 | 0.036 |

REFERENCE FILE

LONGITUDINAL DISTRIBUTION OF BOOSTER FUSELAGE PRESSURES

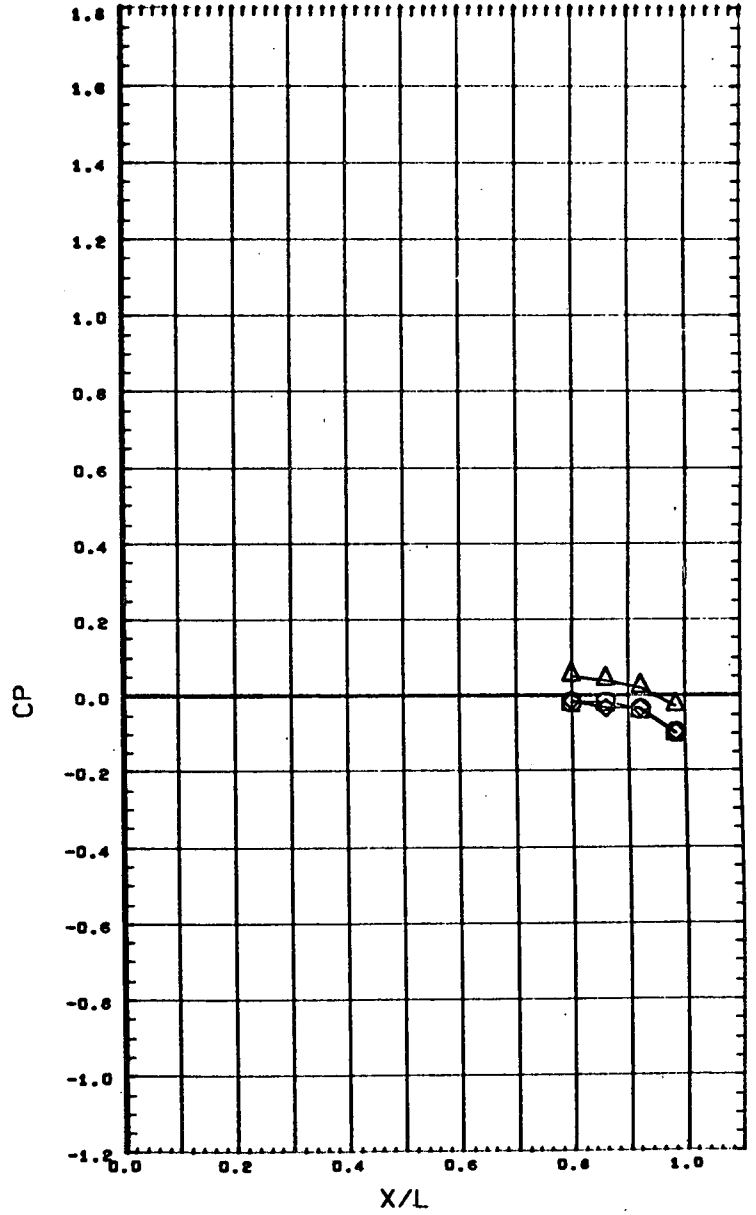
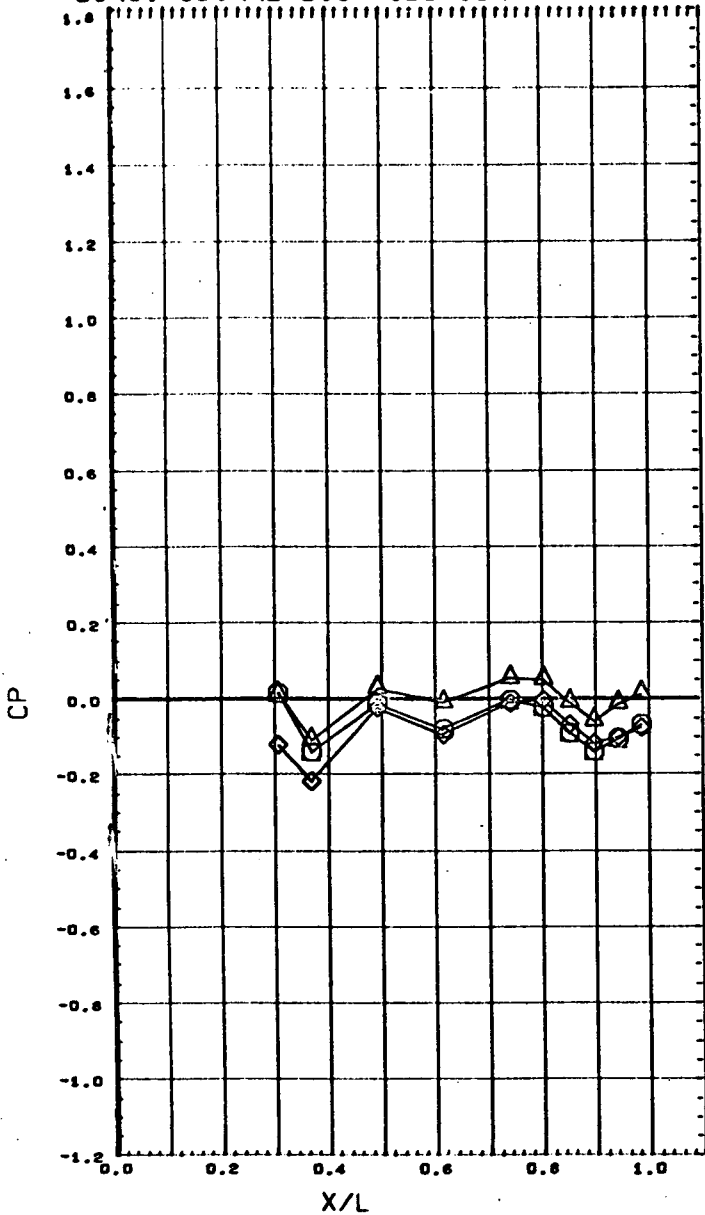

| SYMBOL | BETA | THETA | M1 |
|--------|-------|---------|-------|
| ○ | 4.097 | 90.000 | 0.599 |
| △ | 0.032 | 180.000 | |
| ◇ | 4.299 | | |

| PARAMETRIC VALUES | | |
|-------------------|-------|-------|
| ALFB | 6.000 | 0X/L |
| I | 0.000 | 0.036 |

REFERENCE FILE

LONGITUDINAL DISTRIBUTION OF BOOSTER FUSELAGE PRESSURES

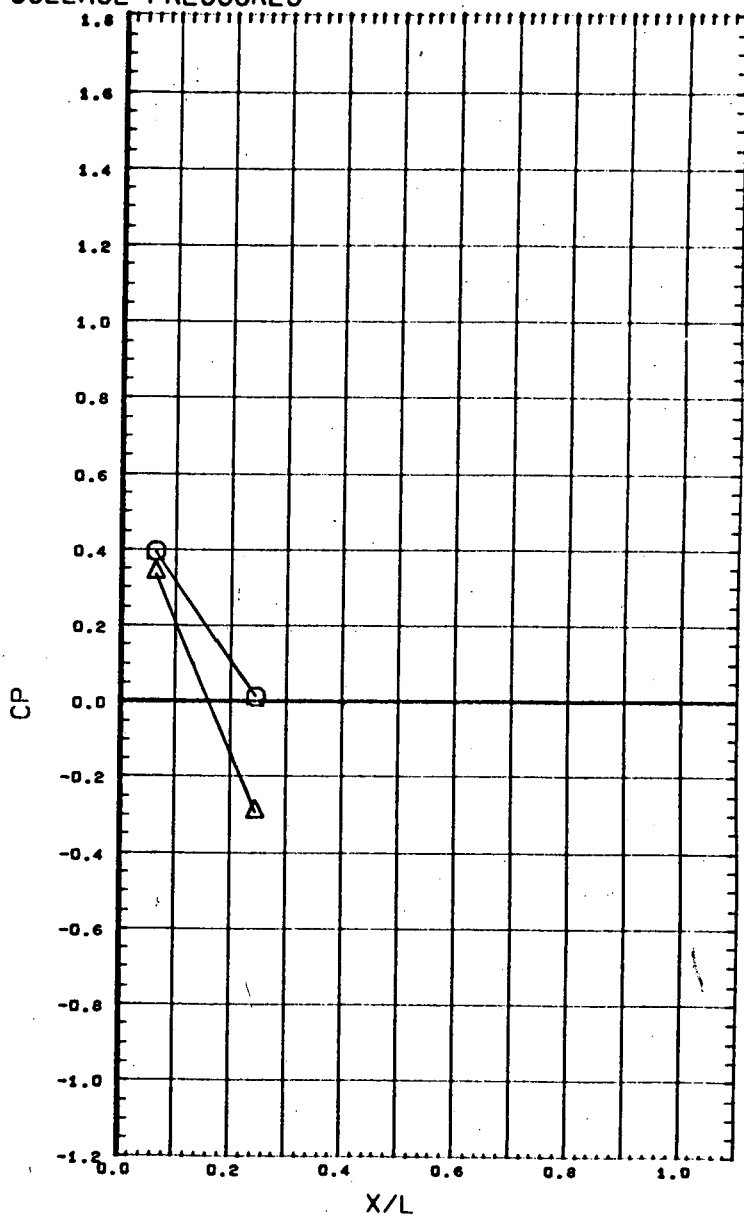
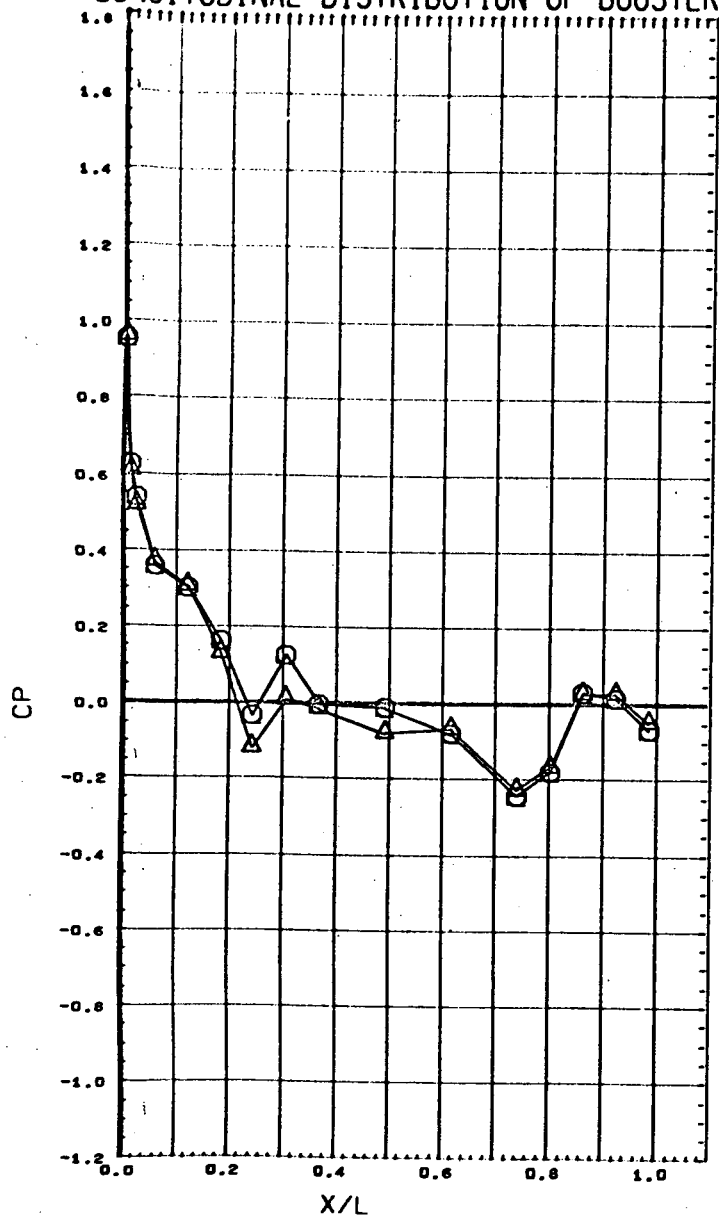

| SYMBOL | BETA | THETA | M1 |
|--------|-------|--------|-------|
| ○ | 4.138 | 0.000 | 0.901 |
| △ | 4.250 | 15.000 | |

| PARAMETRIC VALUES | | |
|-------------------|---------|------------|
| ALFB | - 6.000 | OX/L 0.036 |
| I | 0.000 | |

REFERENCE FILE

LONGITUDINAL DISTRIBUTION OF BOOSTER FUSELAGE PRESSURES

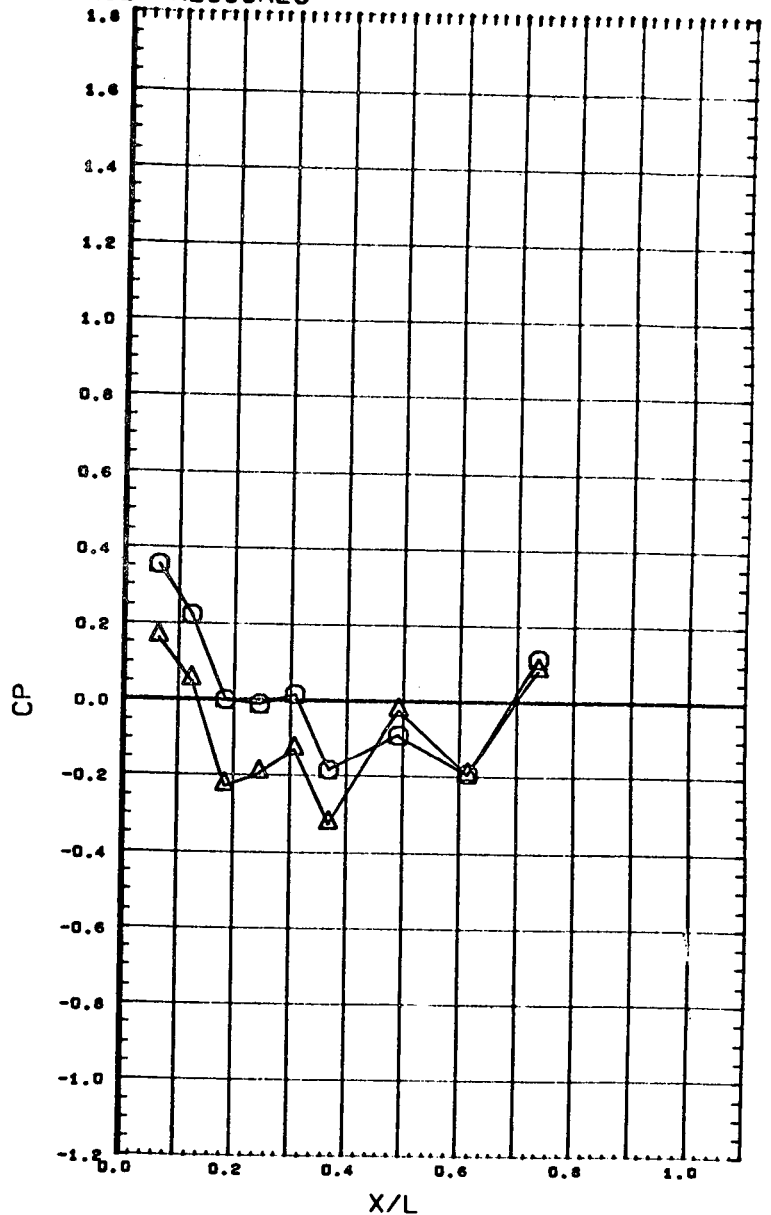
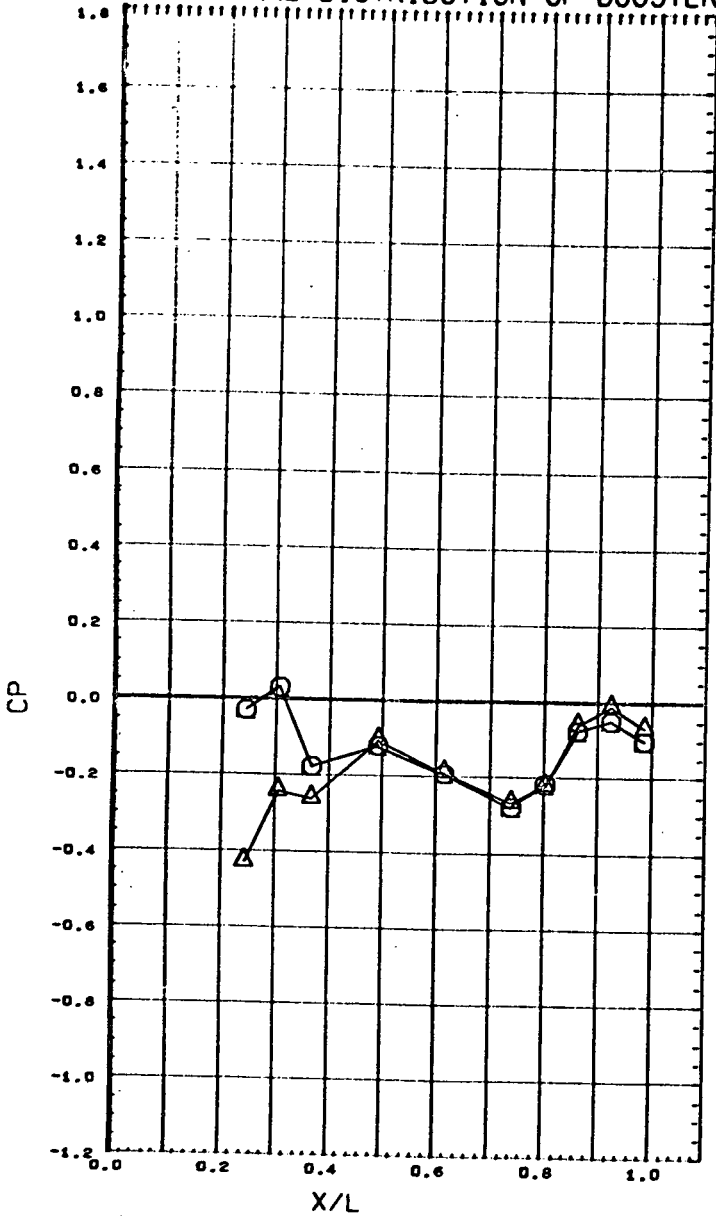

| SYMBOL | BETA | THETA | M1 |
|--------|-------|--------|-------|
| ○ | 4.138 | 24.000 | 0.901 |
| △ | 4.250 | 45.000 | |

| PARAMETRIC VALUES | | |
|-------------------|-------|------------|
| ALFB | 6.000 | DX/L 0.036 |
| I | 0.000 | |

REFERENCE FILE

LONGITUDINAL DISTRIBUTION OF BOOSTER FUSELAGE PRESSURES

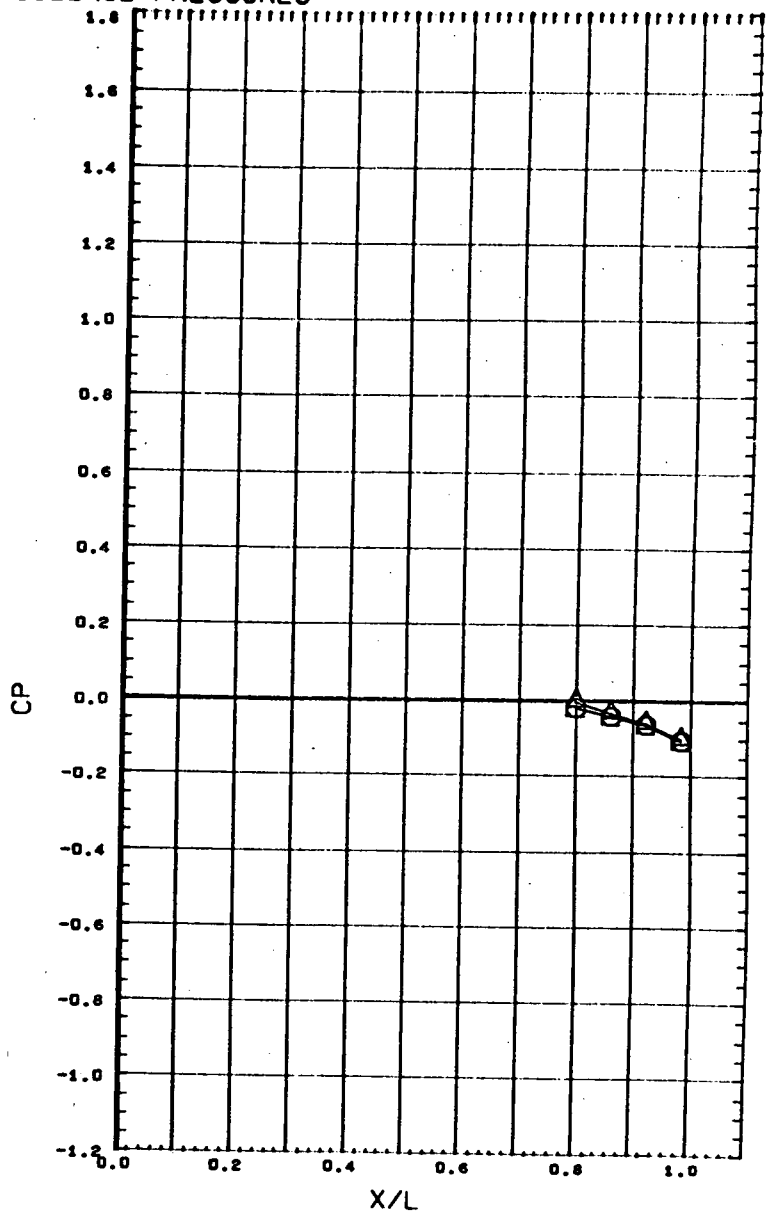
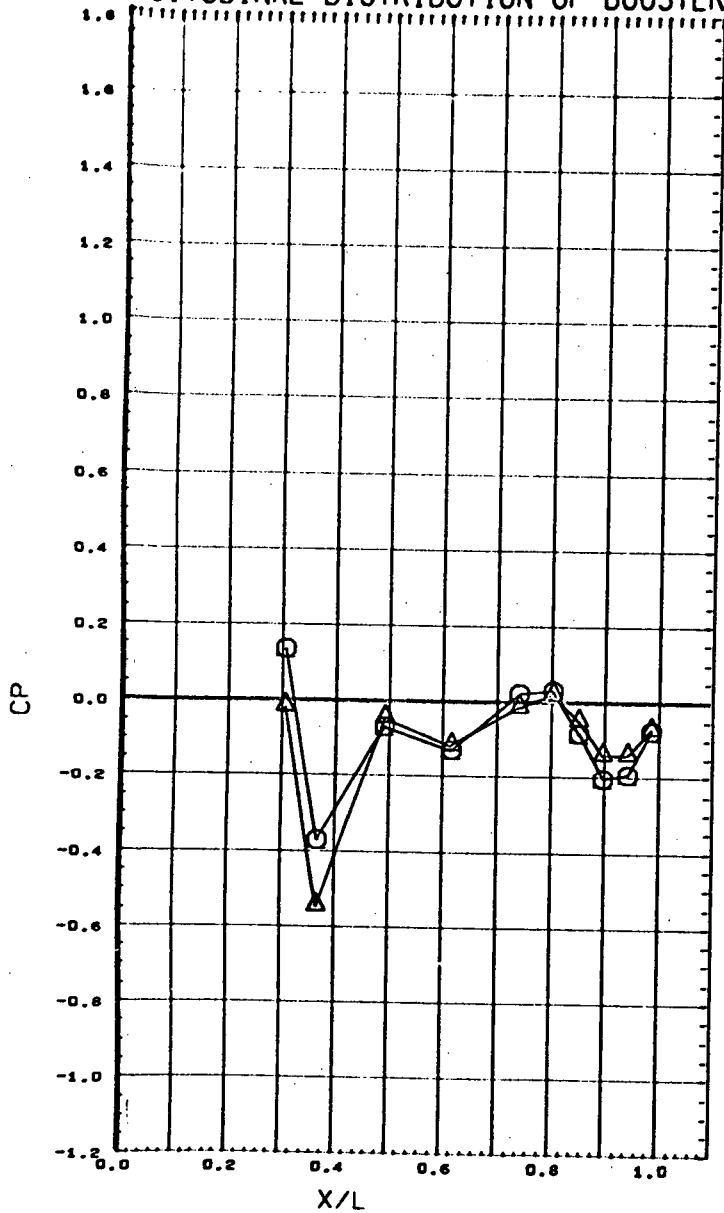

| SYMBOL | BETA | THETA | M1 |
|--------|-------|---------|-------|
| ○ | 4.138 | 90.000 | 0.901 |
| △ | 4.250 | 180.000 | |

| PARAMETRIC VALUES | | | |
|-------------------|-------|------|-------|
| ALFB | 6.000 | DX/L | 0.036 |
| I | 0.000 | | |

REFERENCE FILE

LONGITUDINAL DISTRIBUTION OF BOOSTER FUSELAGE PRESSURES

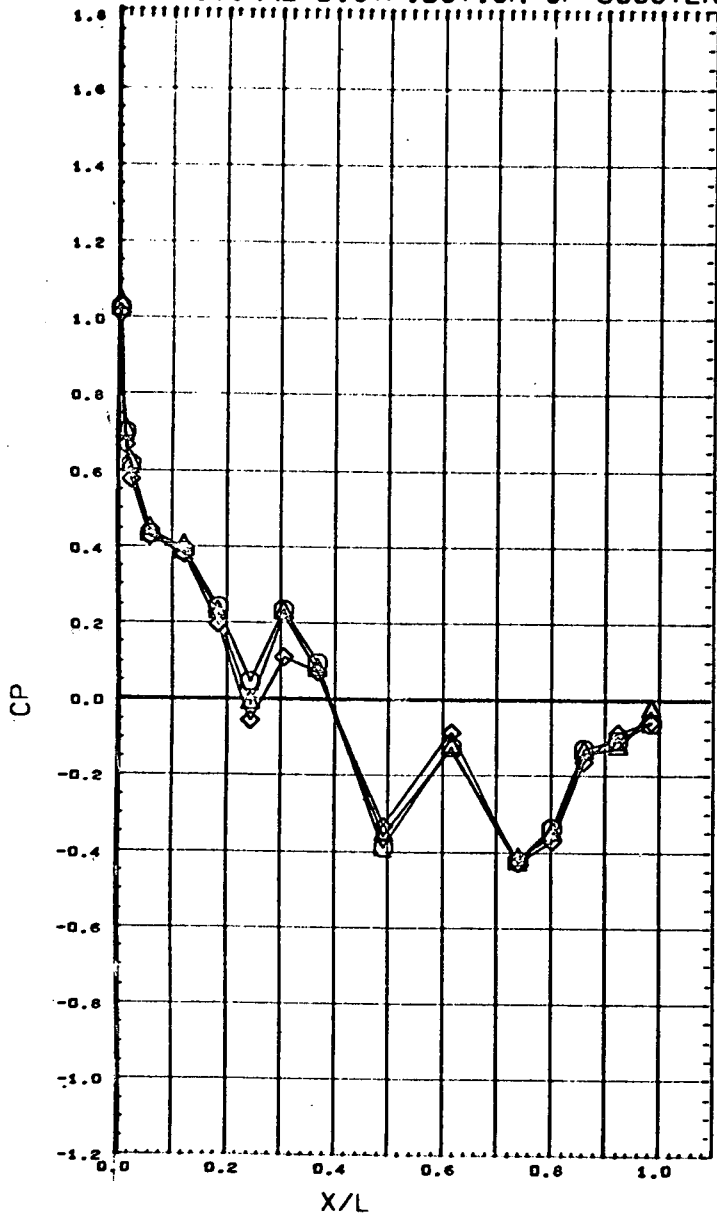

| SYMBOL | BETA | THETA | M1 |
|--------|-------|--------|-------|
| ○ | 4.168 | 0.000 | 0.995 |
| △ | 0.062 | 15.000 | |
| ◇ | 4.315 | | |

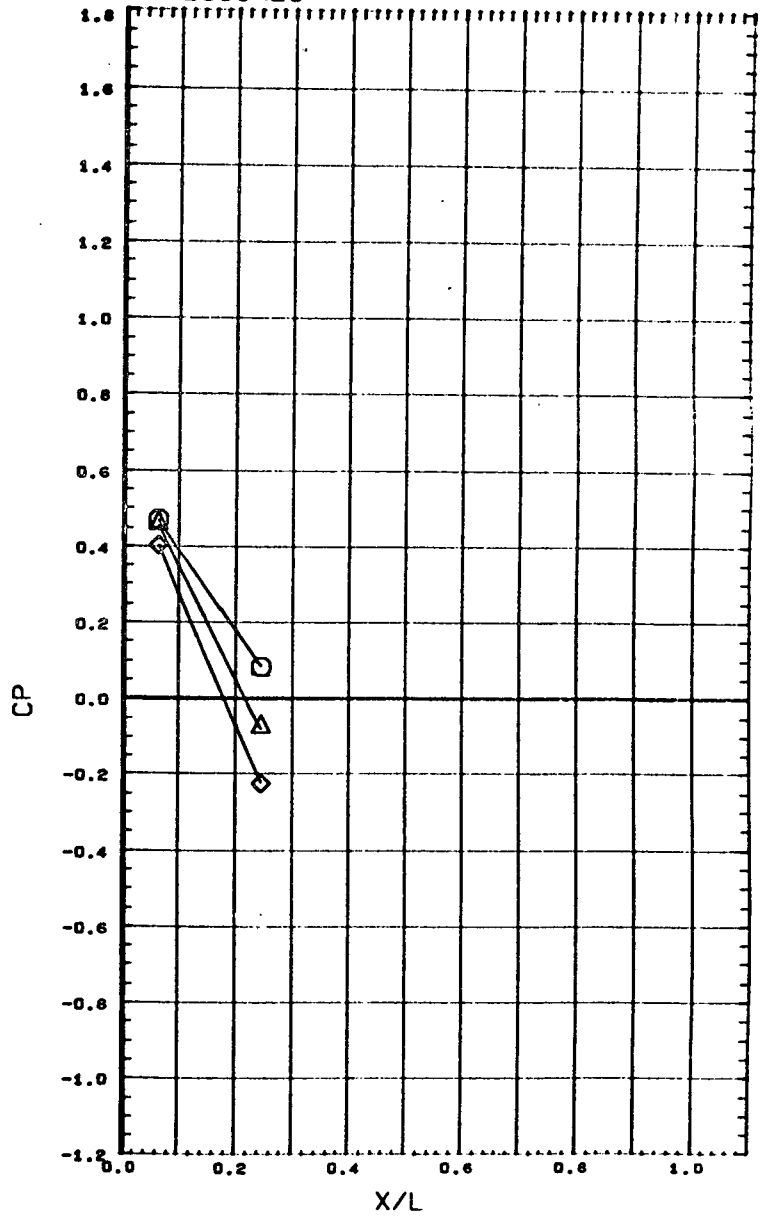

| PARAMETRIC VALUES | | | |
|-------------------|-------|------|-------|
| ALFB | 6.000 | DX/L | 0.036 |
| I | 0.000 | | |

REFERENCE FILE

AEDC TC174 MDAC BOOSTER NEAR ORBITER (BODY)

(ATC007)

PAGE 196

LONGITUDINAL DISTRIBUTION OF BOOSTER FUSELAGE PRESSURES

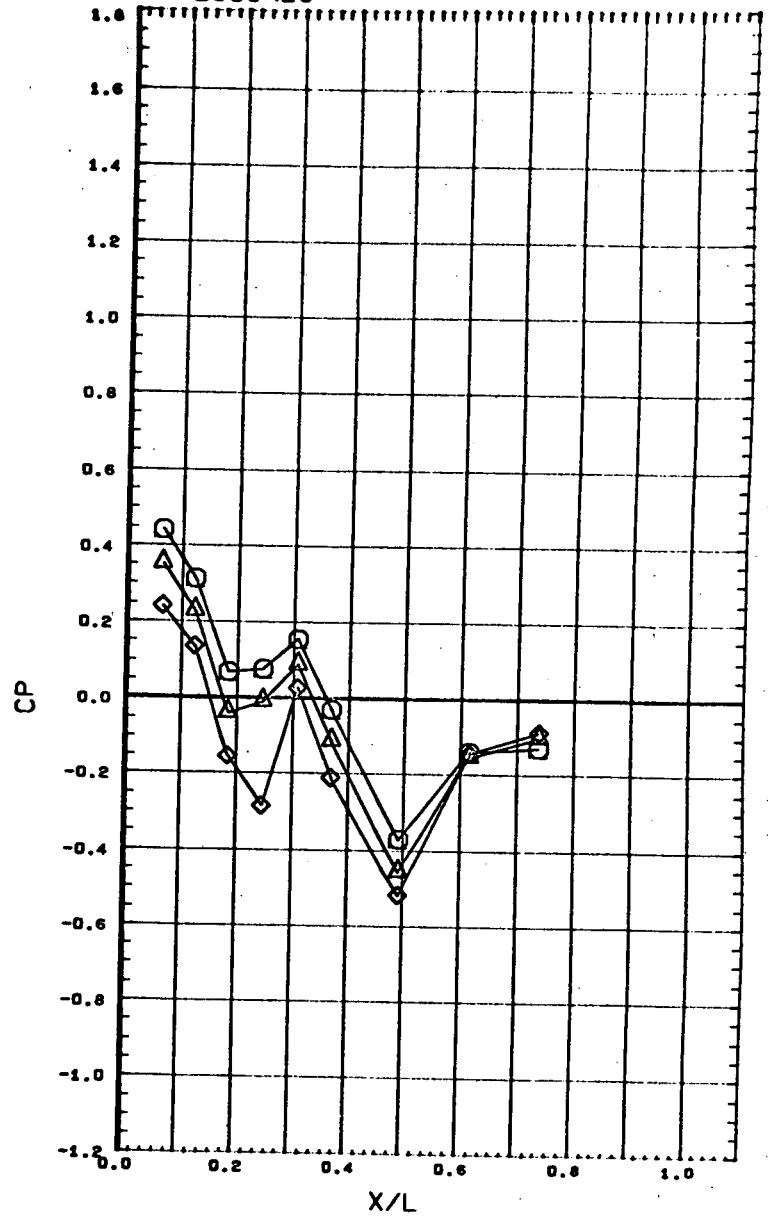
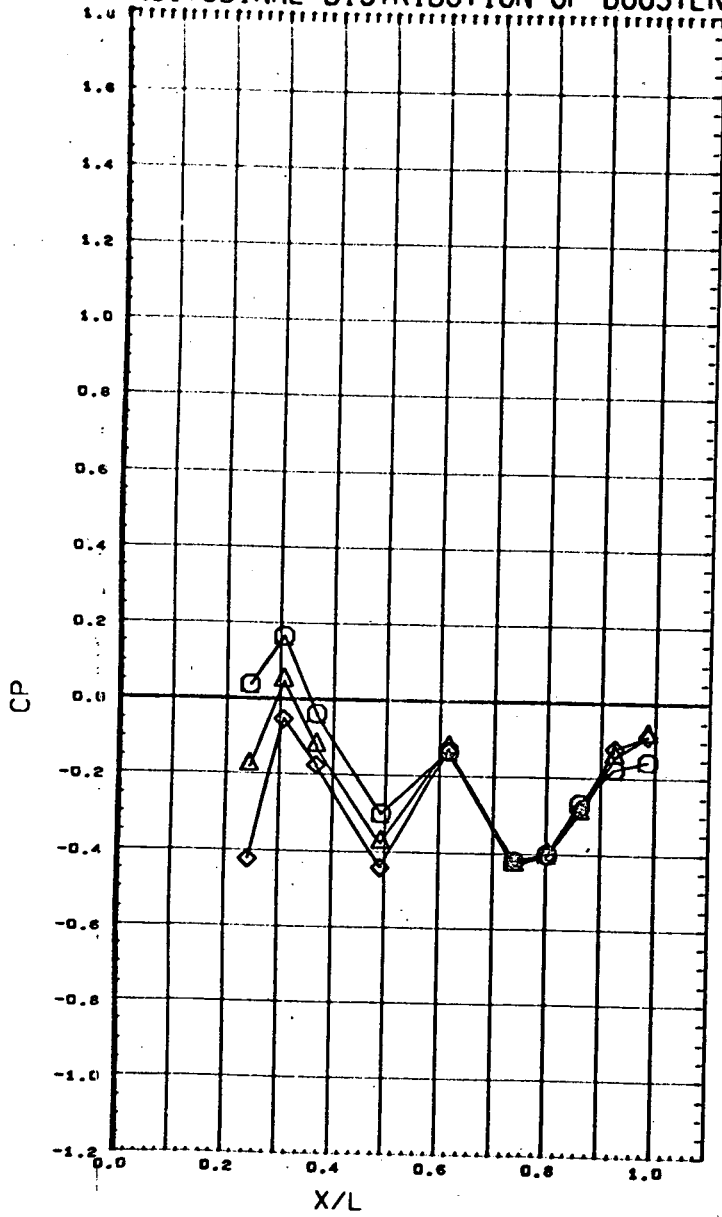

| SYMBOL | BETA | THETA | M1 |
|--------|-------|--------|-------|
| ○ | 4.168 | 24.000 | 0.995 |
| △ | 0.062 | 45.000 | |
| ◇ | 4.315 | | |

| PARAMETRIC VALUES | | |
|-------------------|---------|------------|
| ALFB | - 6.000 | DX/L 0.036 |
| I | 0.000 | |

REFERENCE FILE

AEDC TC174 MDAC BOOSTER NEAR ORBITER (BODY)

(ATC007)

PAGE 197

LONGITUDINAL DISTRIBUTION OF BOOSTER FUSELAGE PRESSURES

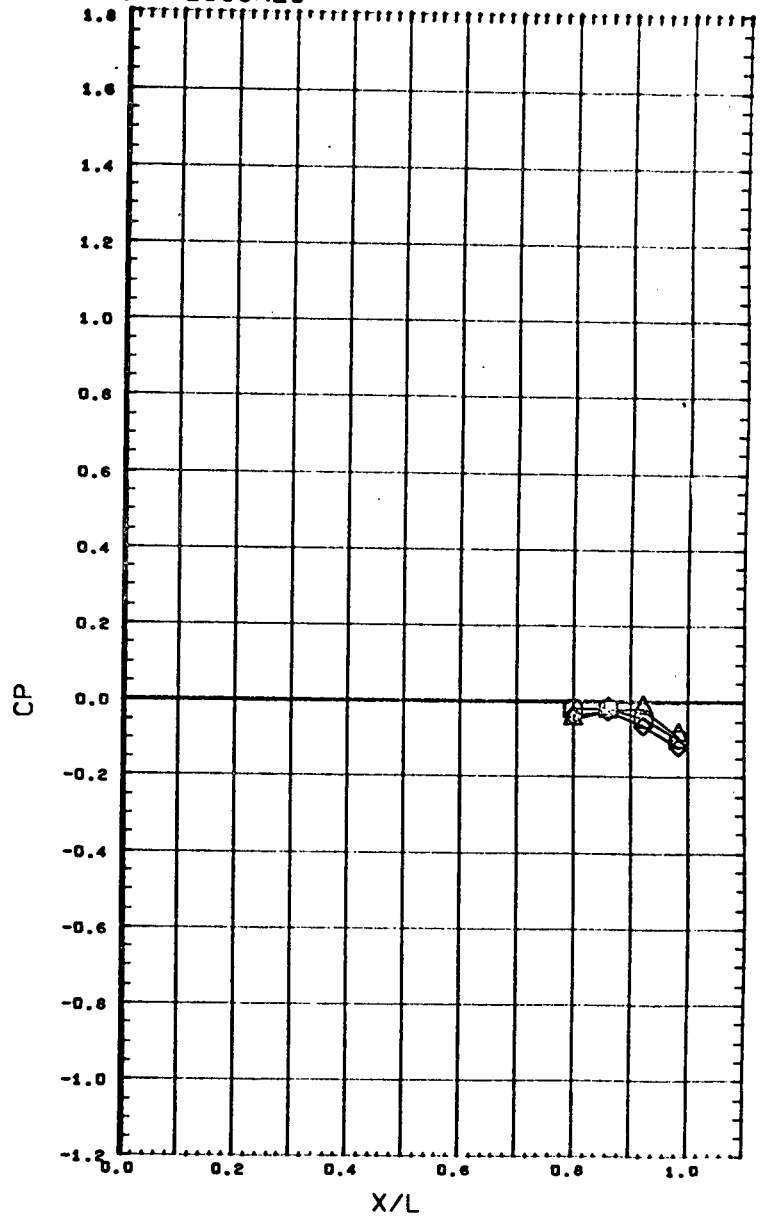
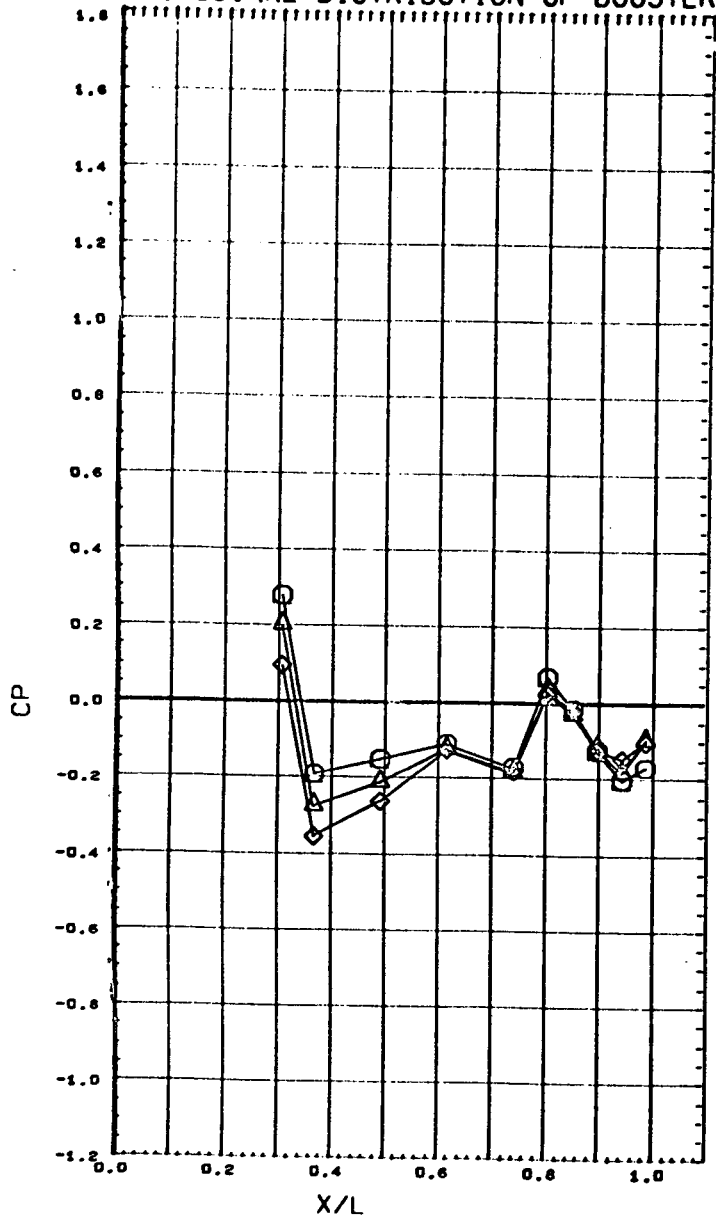

| SYMBOL | DELTA | THETA | M1 |
|--------|-------|---------|-------|
| ○ | 4.168 | 90.000 | 0.995 |
| △ | 0.062 | 160.000 | |
| ◇ | 4.315 | | |

| PARAMETRIC VALUES | | | |
|-------------------|---------|------|-------|
| ALPB | - 6.000 | DX/L | 0.036 |
| I | 0.000 | | |

REFERENCE FILE

LONGITUDINAL DISTRIBUTION OF BOOSTER FUSELAGE PRESSURES

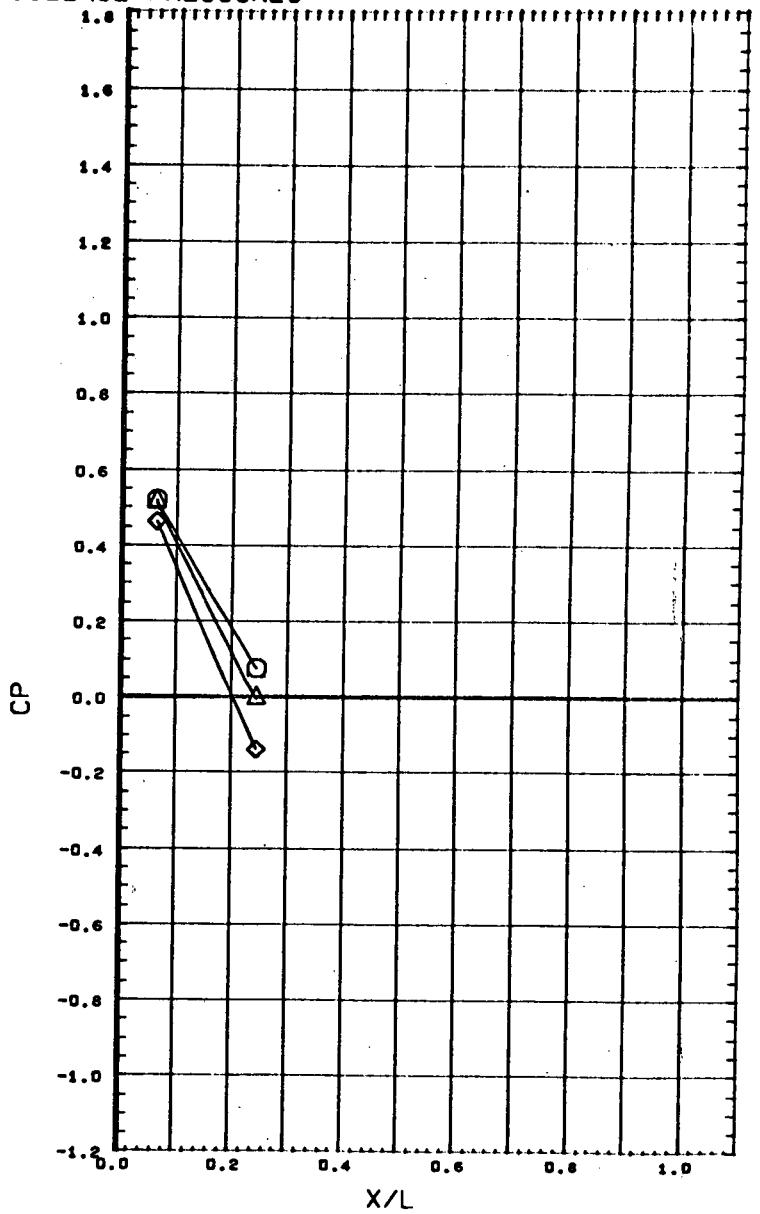
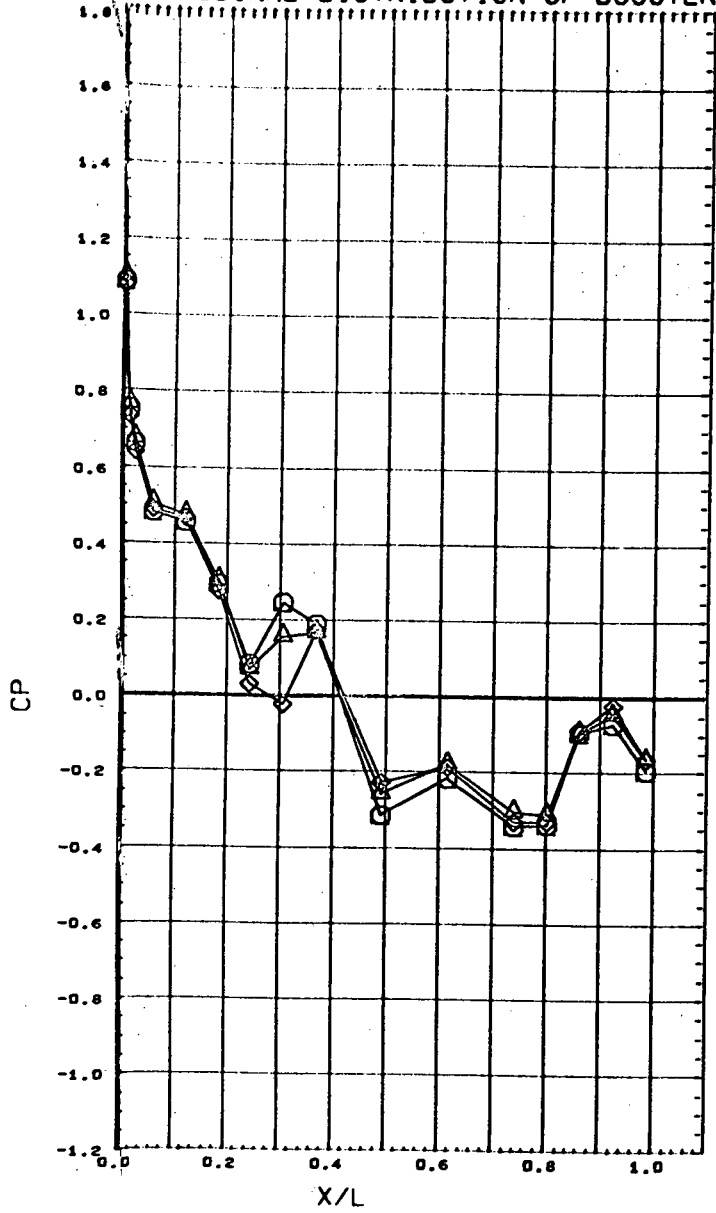

| SYMBOL | BETA | THETA | M1 |
|--------|-------|--------|-------|
| ○ | 4.195 | 0.000 | 1.100 |
| △ | 0.061 | 15.000 | |
| ◇ | 4.344 | | |

| PARAMETRIC VALUES | | |
|-------------------|-------|------------|
| ALFB | 6.000 | DX/L 0.036 |
| I | 0.000 | |

REFERENCE FILE

LONGITUDINAL DISTRIBUTION OF BOOSTER FUSELAGE PRESSURES

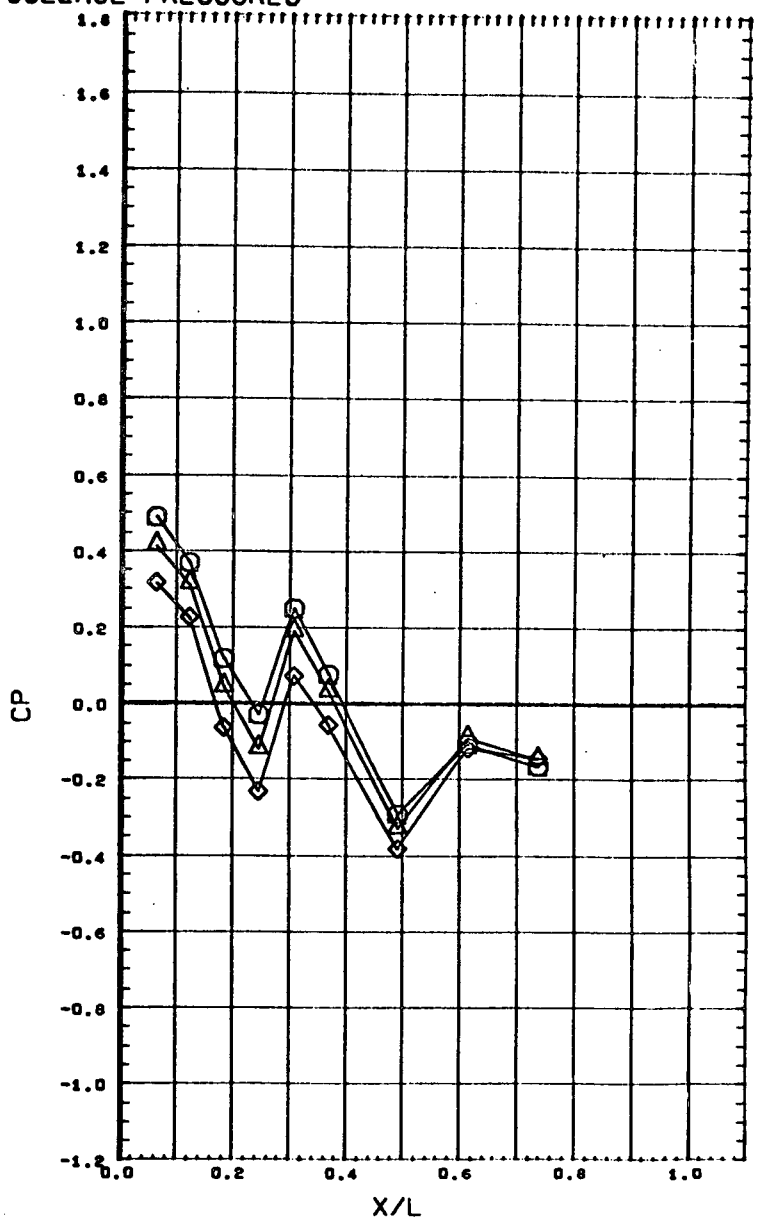
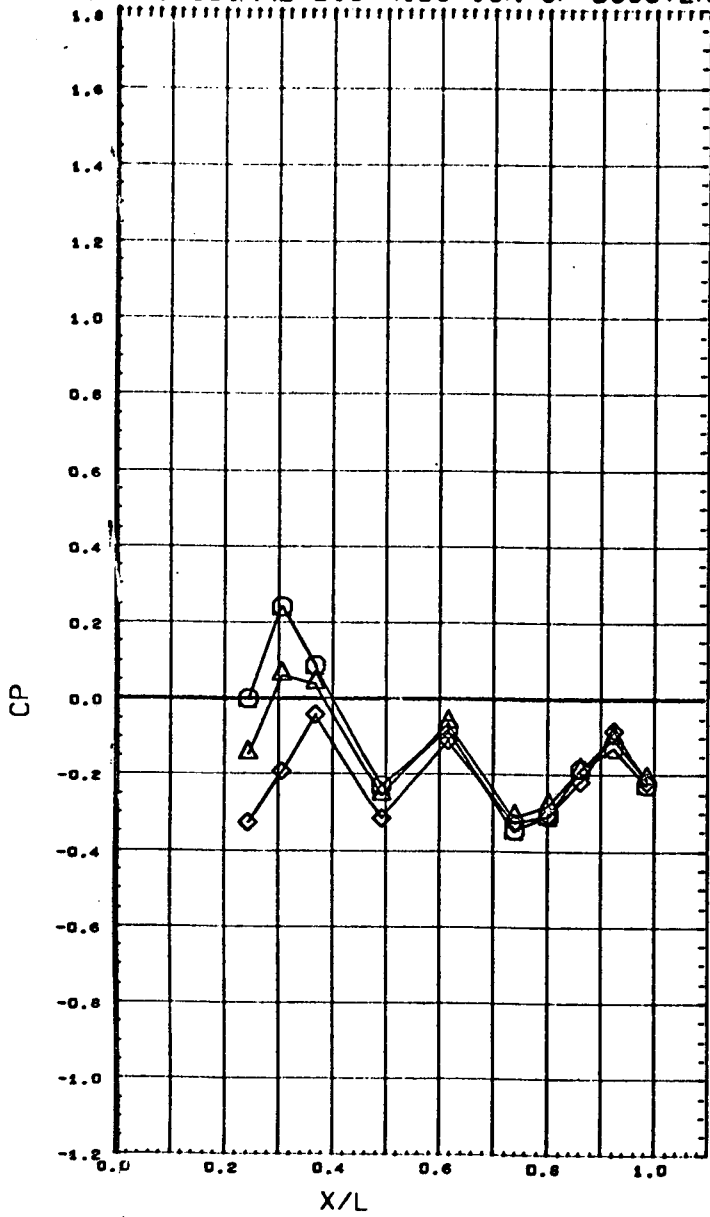

| SYMBOL | BETA | THETA | M1 |
|--------|-------|--------|-------|
| ○ | 4.195 | 24.000 | 1.100 |
| △ | 0.061 | 45.000 | |
| ◇ | 4.344 | | |

| PARAMETRIC VALUES | | |
|-------------------|---------|------------|
| ALF8 | - 6.000 | DX/L 0.036 |
| I | 0.000 | |

REFERENCE FILE

LONGITUDINAL DISTRIBUTION OF BOOSTER FUSELAGE PRESSURES

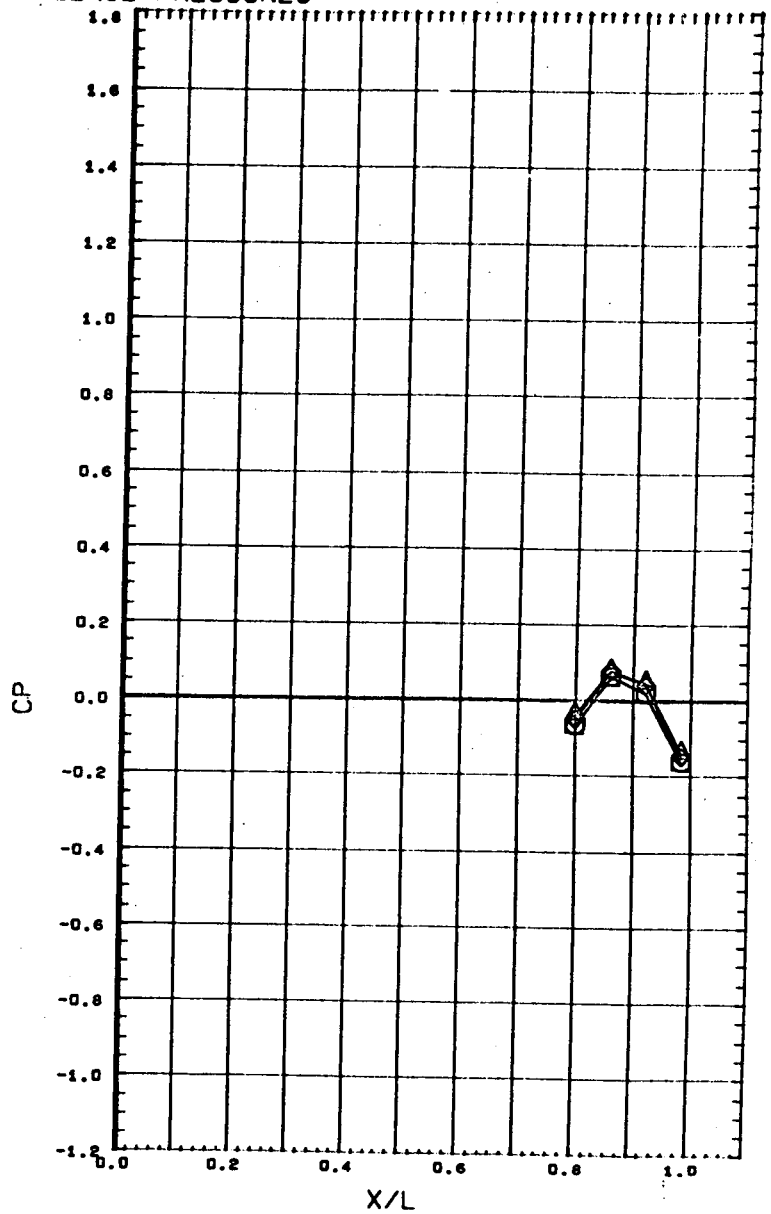
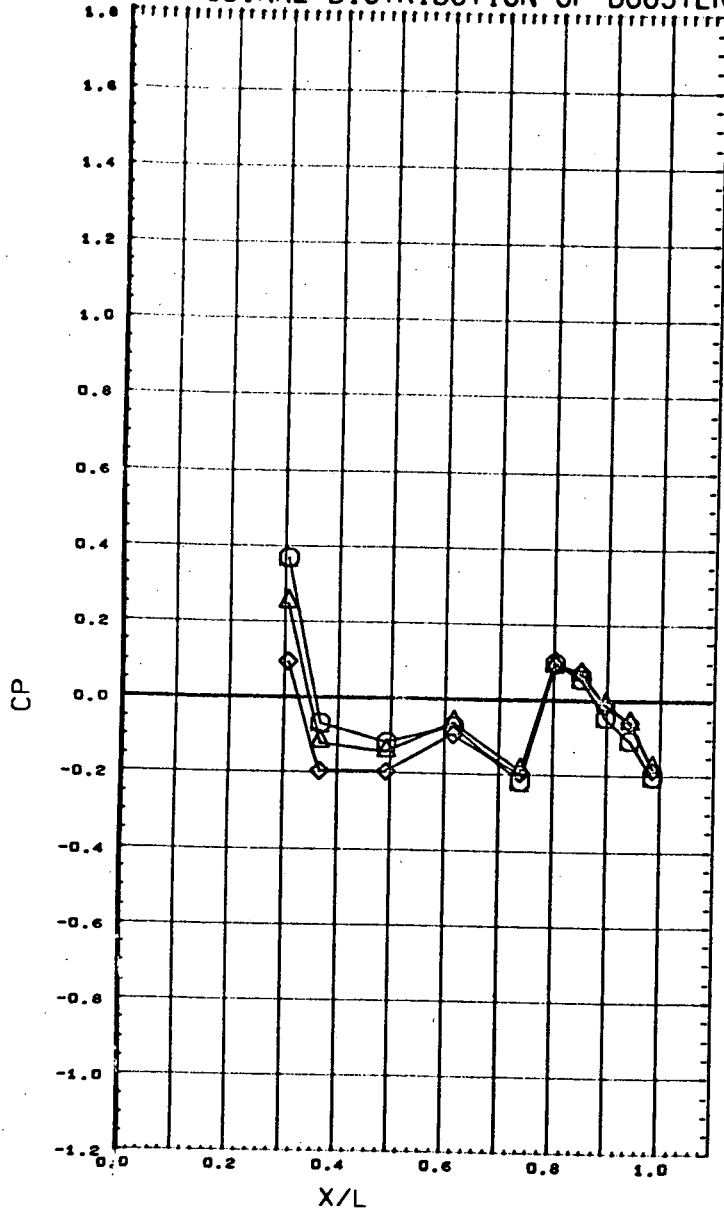

| SYMBOL | BETA | THETA | M1 |
|--------|-------|---------|-------|
| ○ | 4.195 | 90.000 | 1.100 |
| △ | 0.061 | 180.000 | |
| ◇ | 4.344 | | |

| PARAMETRIC VALUES | | | |
|-------------------|---------|------|-------|
| ALFB | - 6.000 | DX/L | 0.036 |
| I | 0.000 | | |

REFERENCE FILE

LONGITUDINAL DISTRIBUTION OF BOOSTER FUSELAGE PRESSURES

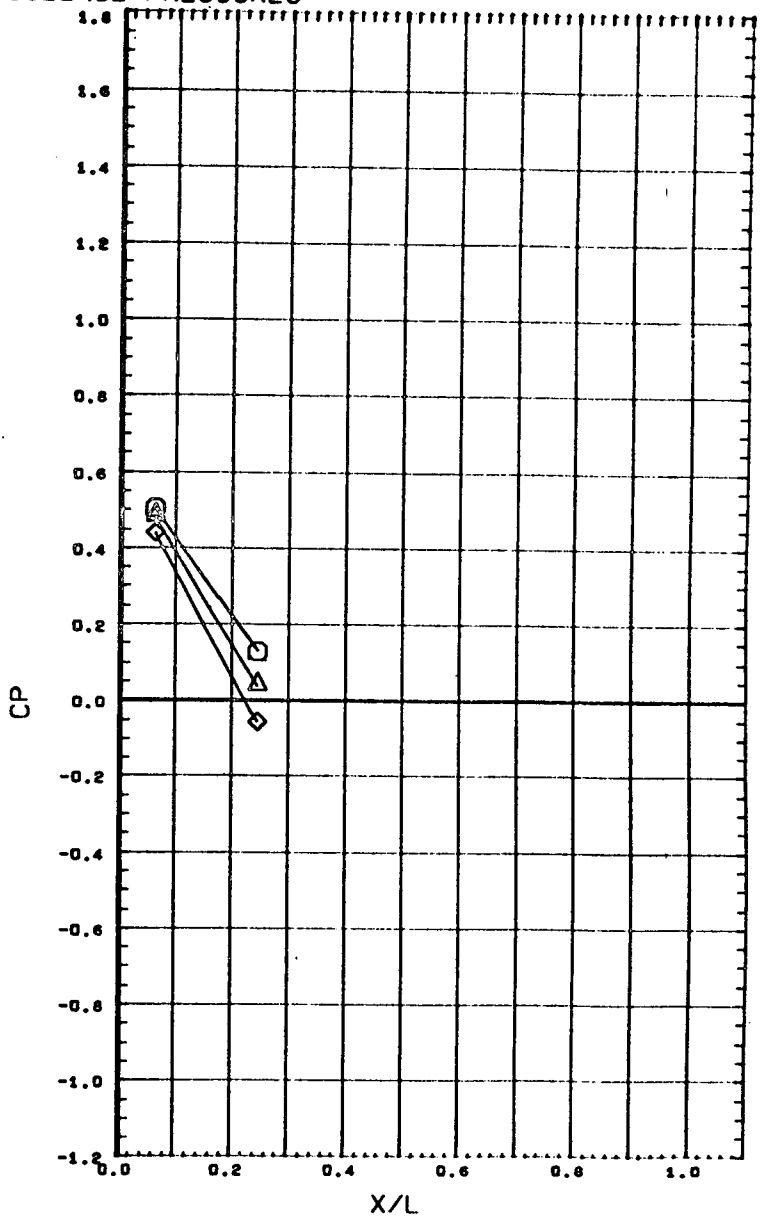
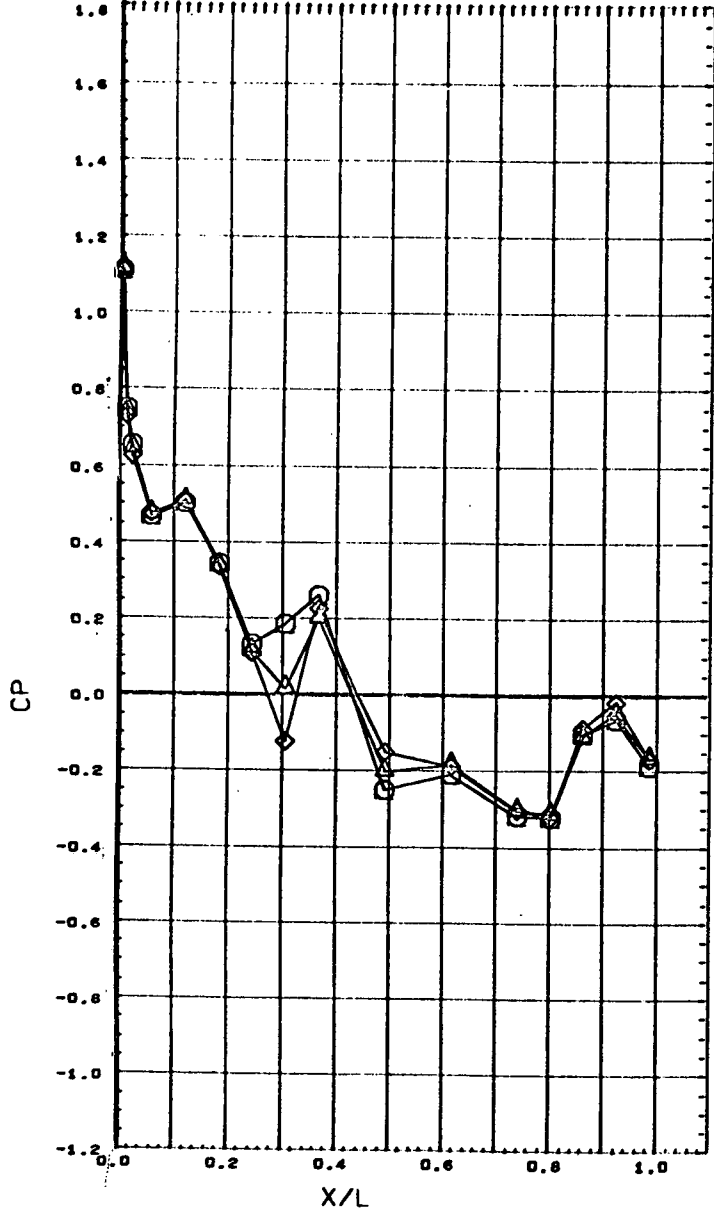

| SYMBOL | BETA | THETA | M1 |
|--------|-------|--------|-------|
| ○ | 4.213 | 0.000 | 1.199 |
| △ | 0.048 | 15.000 | |
| ◇ | 4.359 | | |

| PARAMETRIC VALUES | | |
|-------------------|-------|------------|
| ALPB | 6.000 | DX/L 0.036 |
| I | 0.000 | |

REFERENCE FILE

LONGITUDINAL DISTRIBUTION OF BOOSTER FUSELAGE PRESSURES

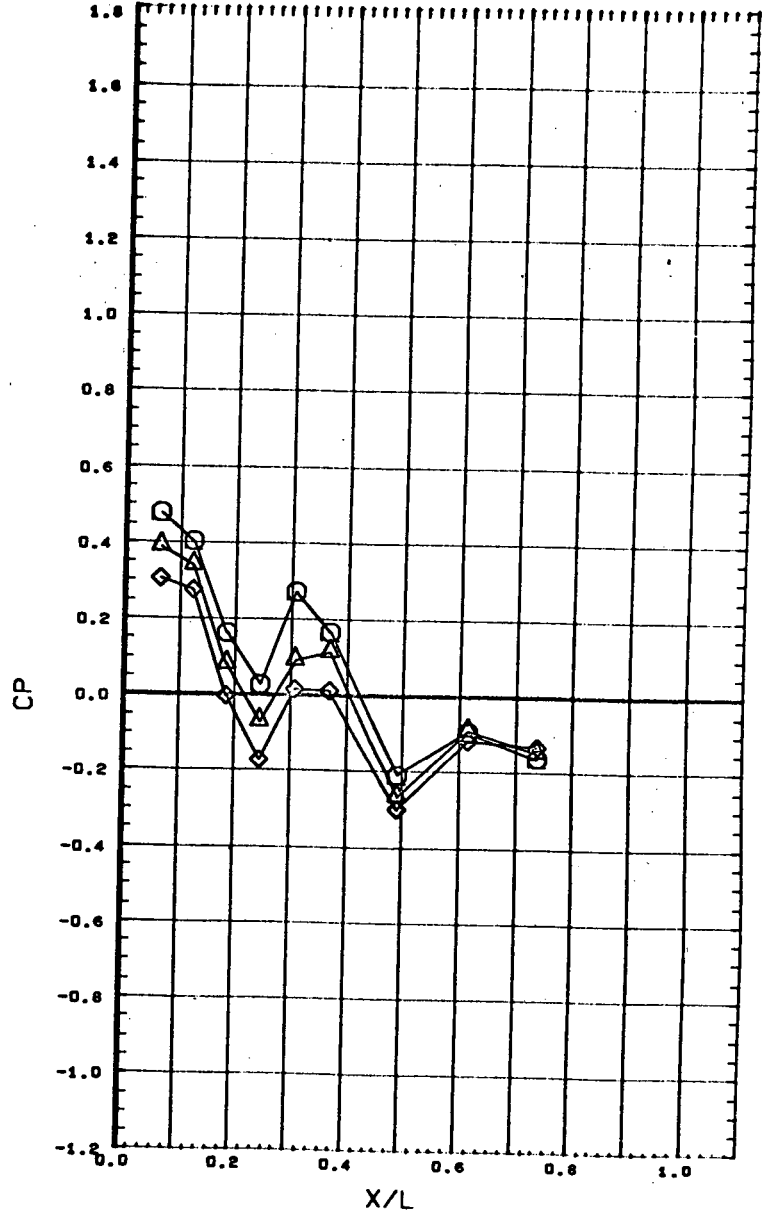
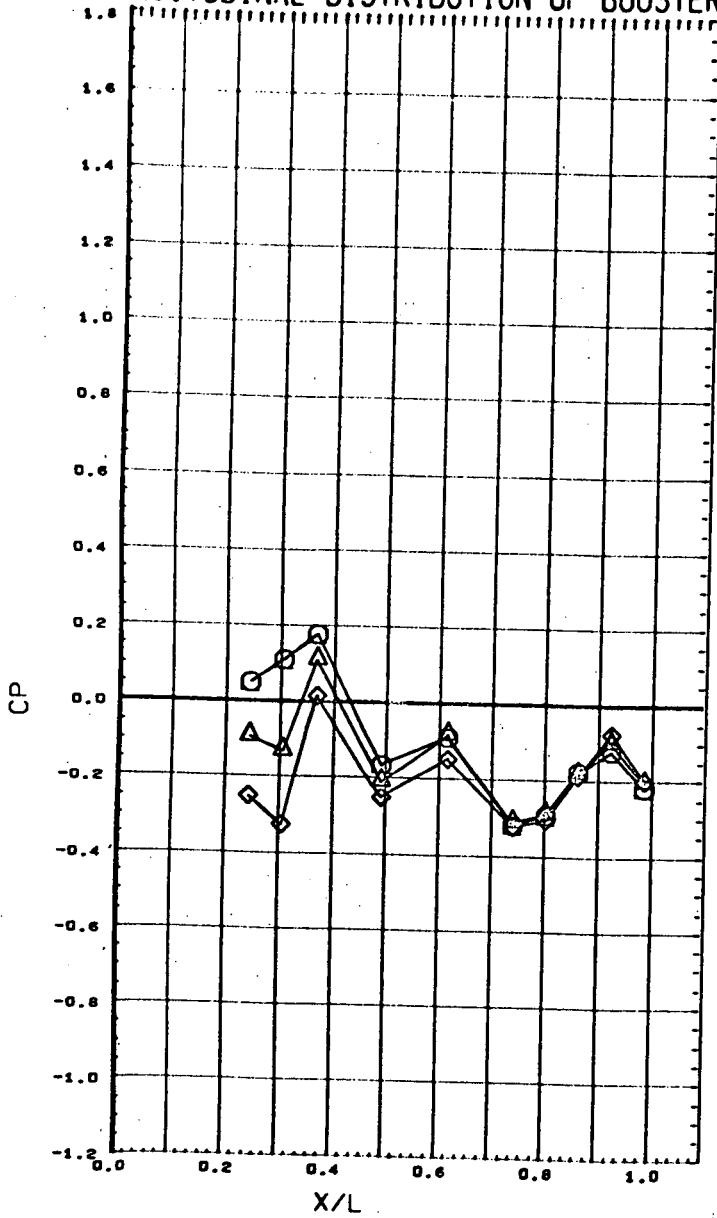

| SYMBOL | BETA | THETA | M1 |
|--------|-------|--------|-------|
| ○ | 4.213 | 24.000 | 1.199 |
| △ | 0.048 | 45.000 | |
| ◇ | 4.359 | | |

| PARAMETRIC VALUES | | |
|-------------------|---------|------------|
| ALFB | - 6.000 | DX/L 0.036 |
| I | 0.000 | |

REFERENCE FILE

AEDC TC174 MDAC BOOSTER NEAR ORBITER (BODY)

(ATC007)

PAGE 203

LONGITUDINAL DISTRIBUTION OF BOOSTER FUSELAGE PRESSURES

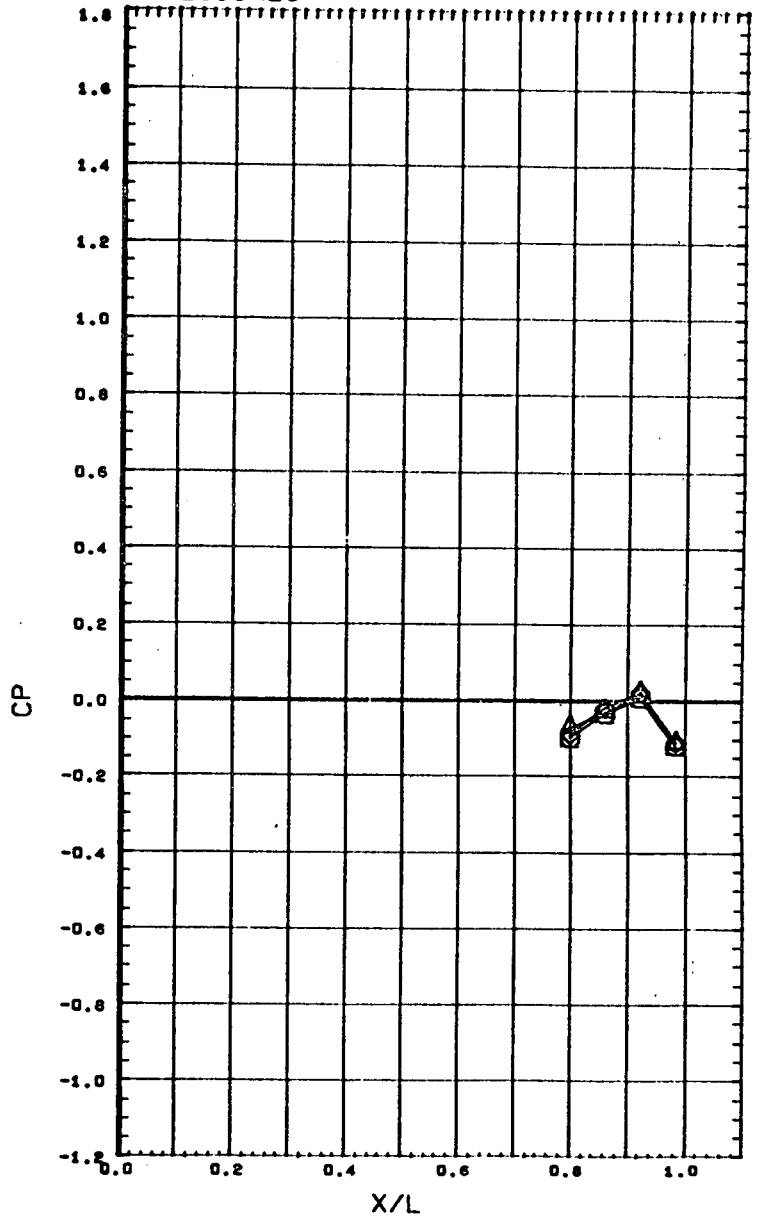
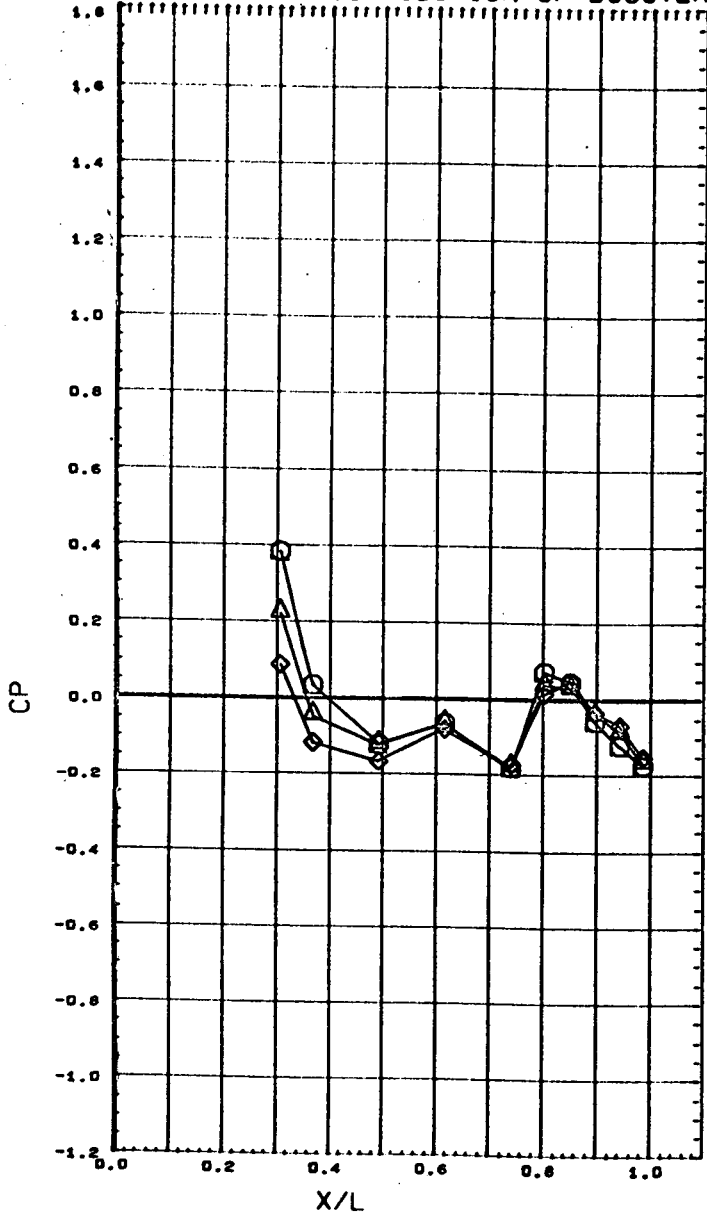

| SYMBOL | BETA | THETA | M1 |
|--------|-------|---------|-------|
| ○ | 4.213 | 90.000 | 1.199 |
| △ | 0.048 | 180.000 | |
| ◇ | 4.359 | | |

| PARAMETRIC VALUES | | | |
|-------------------|-------|------|-------|
| ALFB | 6.000 | DX/L | 0.036 |
| I | 0.000 | | |

REFERENCE FILE

LONGITUDINAL DISTRIBUTION OF BOOSTER FUSELAGE PRESSURES

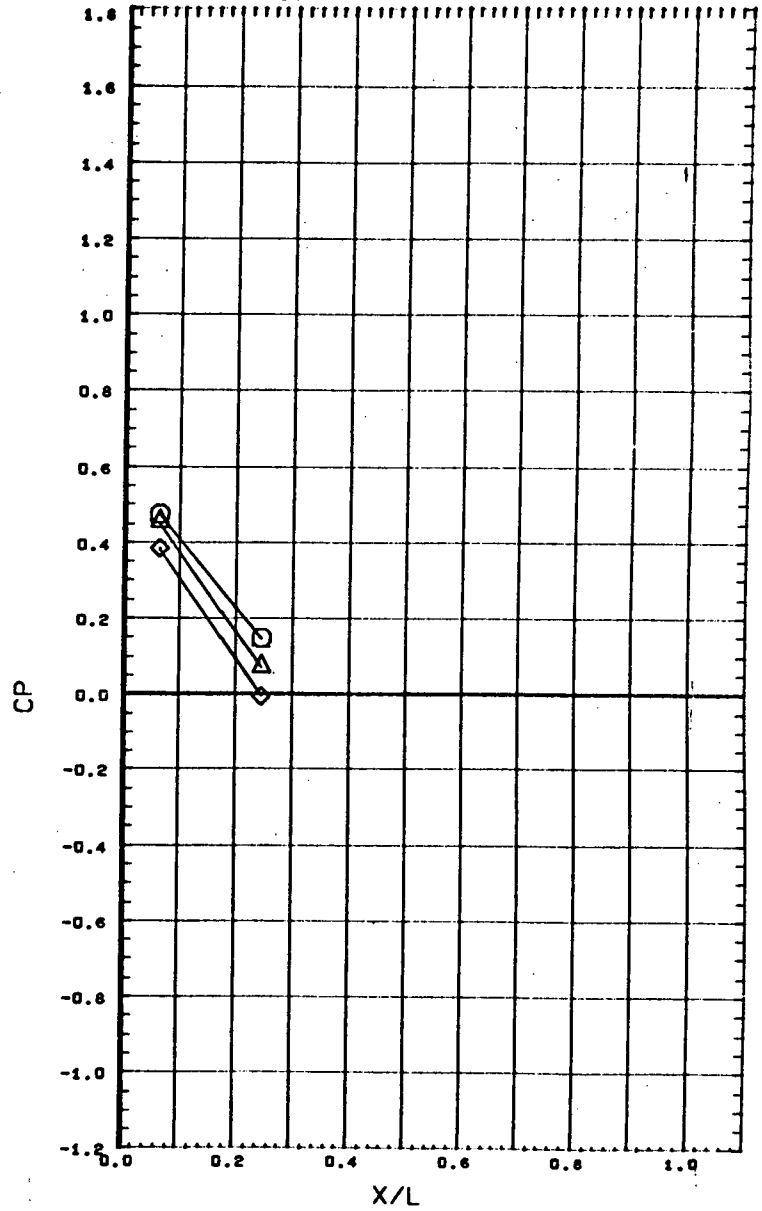
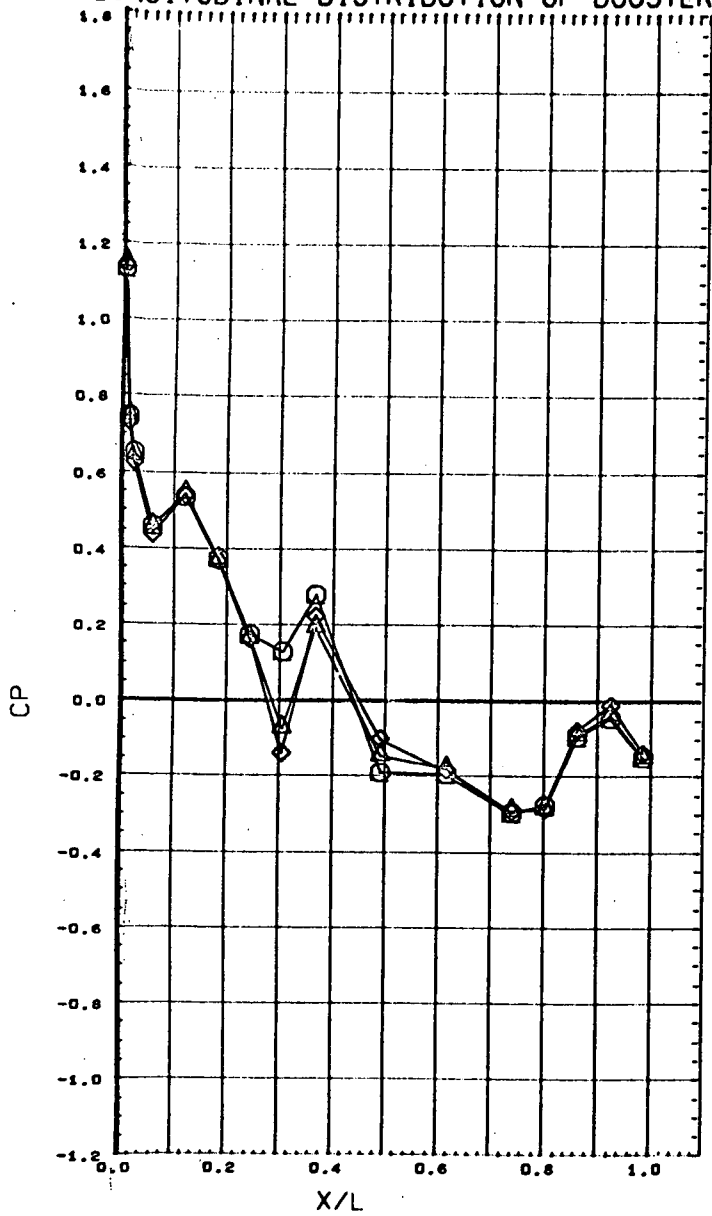

| SYMBOL | BETA | THETA | M1 |
|--------|-------|--------|-------|
| ○ | 4.204 | 0.000 | 1.297 |
| △ | 0.035 | 15.000 | |
| ◇ | 4.318 | | |

| PARAMETRIC VALUES | | | |
|-------------------|---------|------|-------|
| ALFB | - 6.000 | DX/L | 0.036 |
| I | 0.000 | | |

REFERENCE FILE

LONGITUDINAL DISTRIBUTION OF BOOSTER FUSELAGE PRESSURES

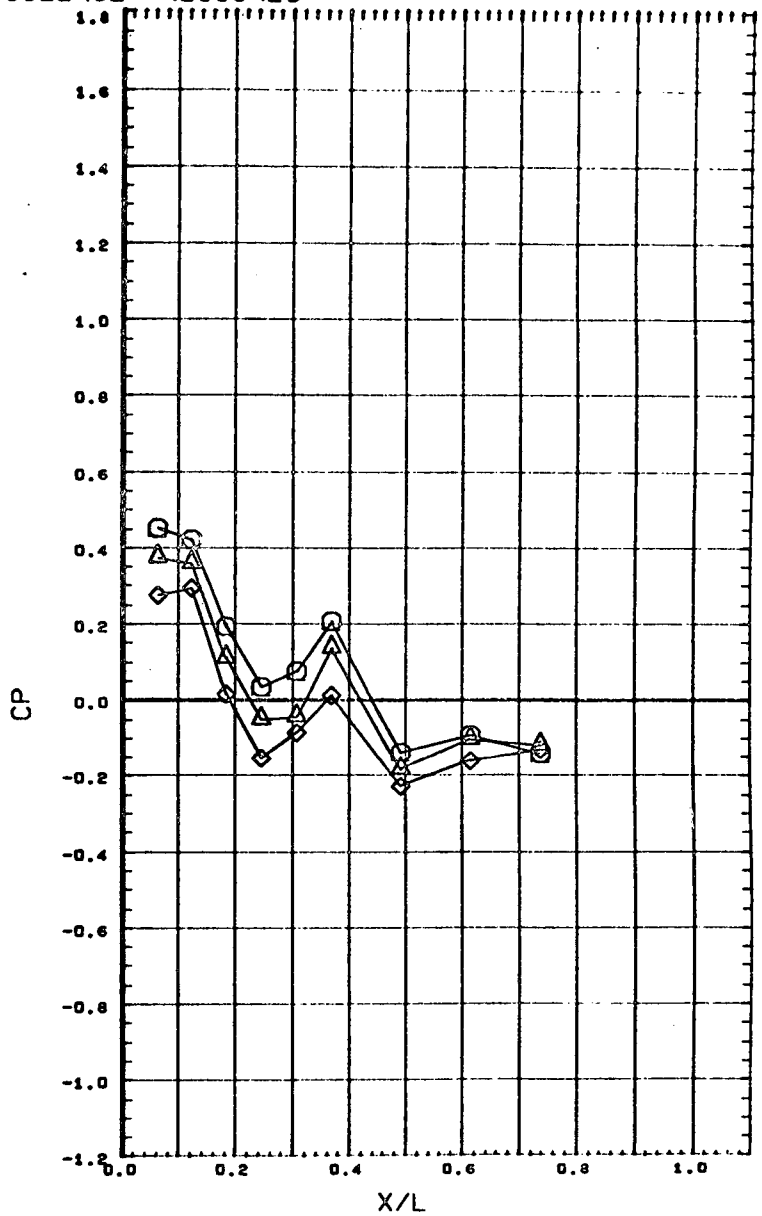
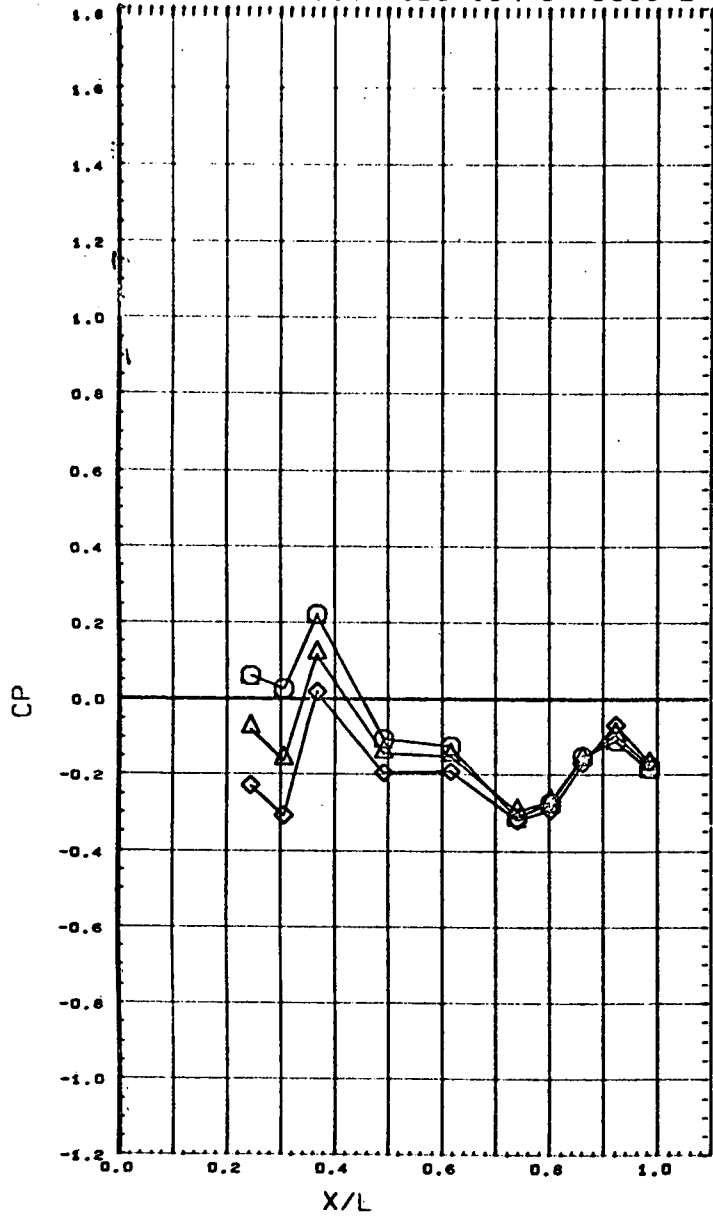

| SYMBOL | BETA | THETA | M1 |
|--------|-------|--------|-------|
| ○ | 4.204 | 24.000 | 1.297 |
| △ | 0.035 | 45.000 | |
| ◇ | 4.318 | | |

| PARAMETRIC VALUES | | | |
|-------------------|-------|------|-------|
| ALFB | 6.000 | DX/L | 0.036 |
| I | 0.000 | | |

REFERENCE FILE

LONGITUDINAL DISTRIBUTION OF BOOSTER FUSELAGE PRESSURES

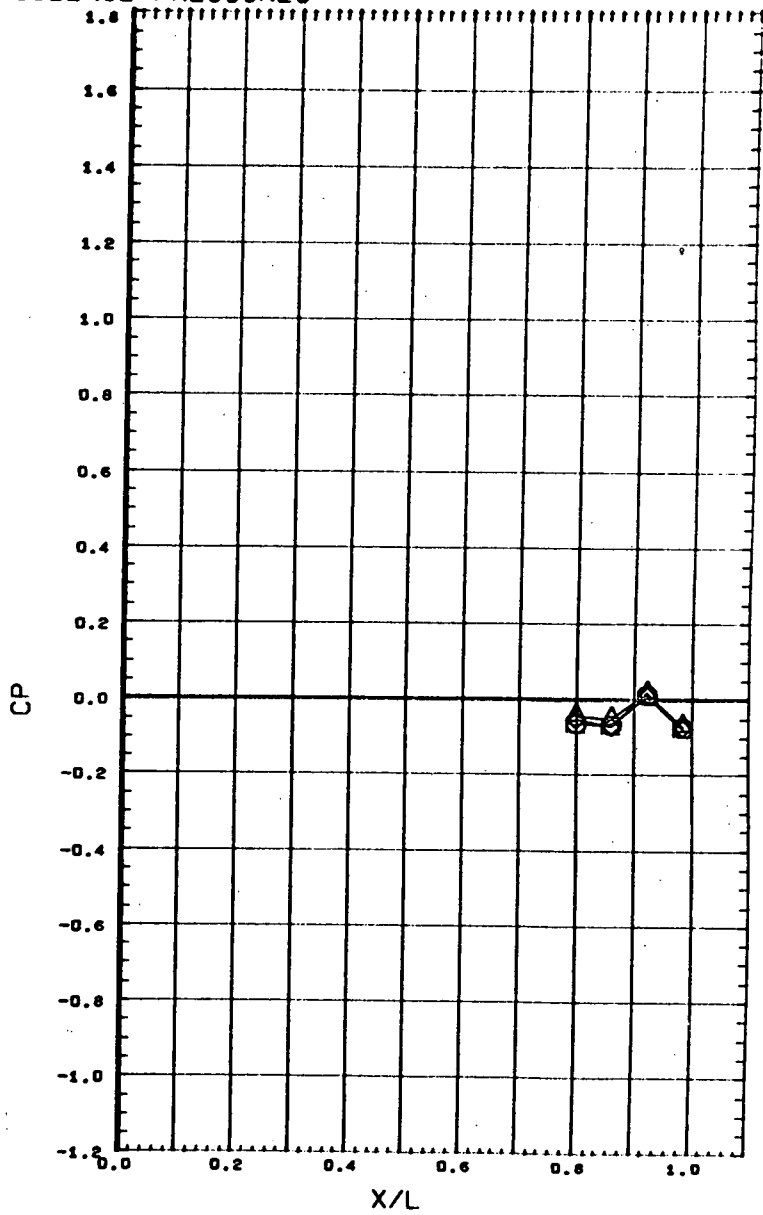
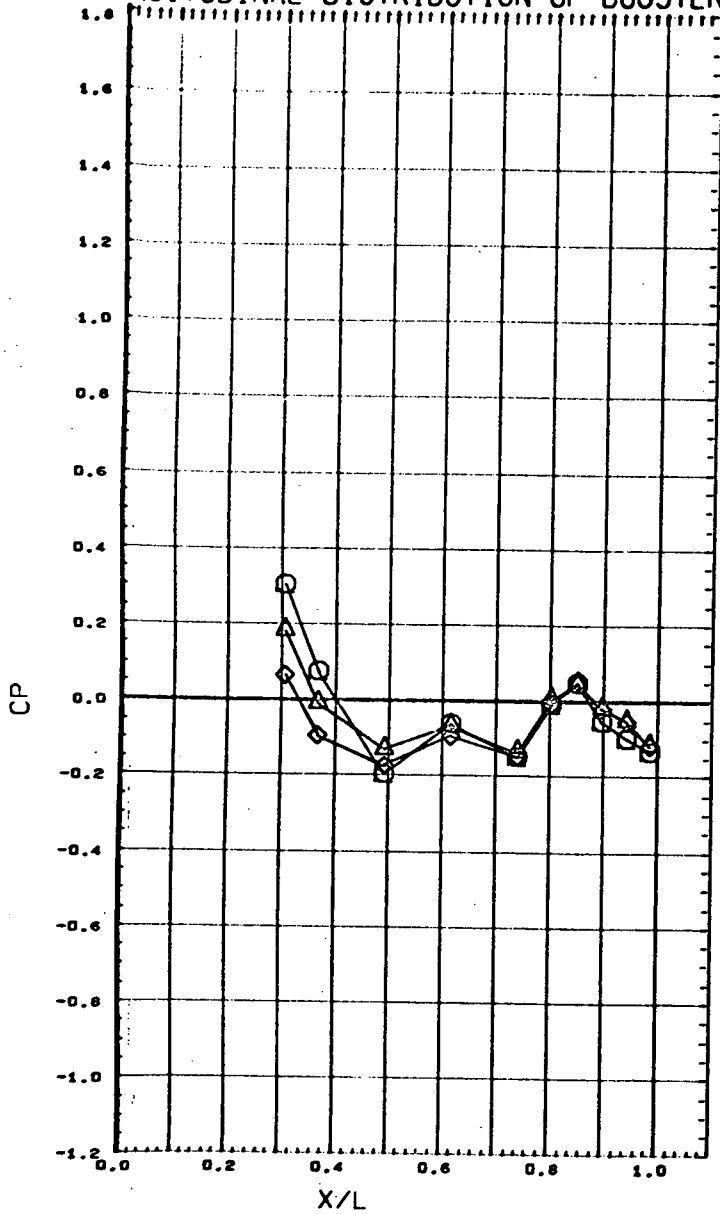

| SYMBOL | BETA | THETA | M1 |
|--------|-------|---------|-------|
| ○ | 4.254 | 90.000 | 1.297 |
| △ | 0.035 | 180.000 | |
| ◇ | 4.318 | | |

| PARAMETRIC VALUES | | | |
|-------------------|---------|------|-------|
| ALFB | - 6.000 | DX/L | 0.036 |
| I | 0.000 | | |

REFERENCE FILE

LONGITUDINAL DISTRIBUTION OF BOOSTER FUSELAGE PRESSURES

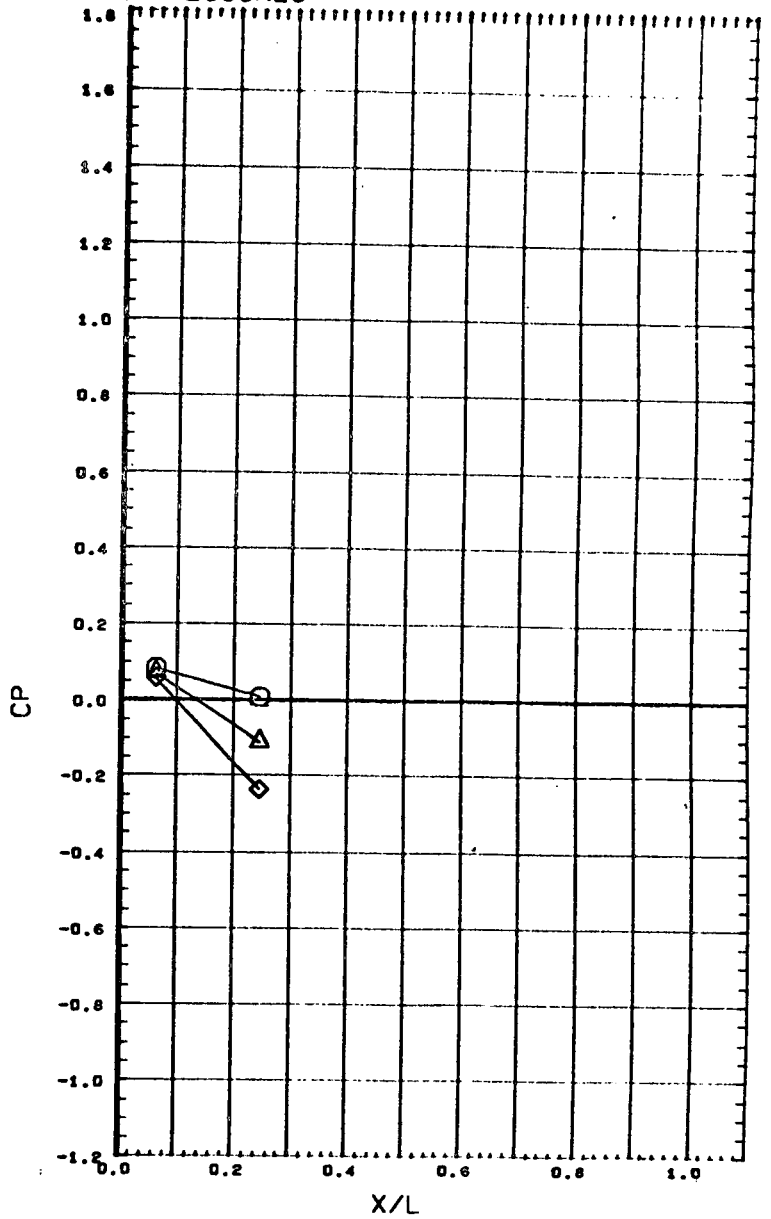
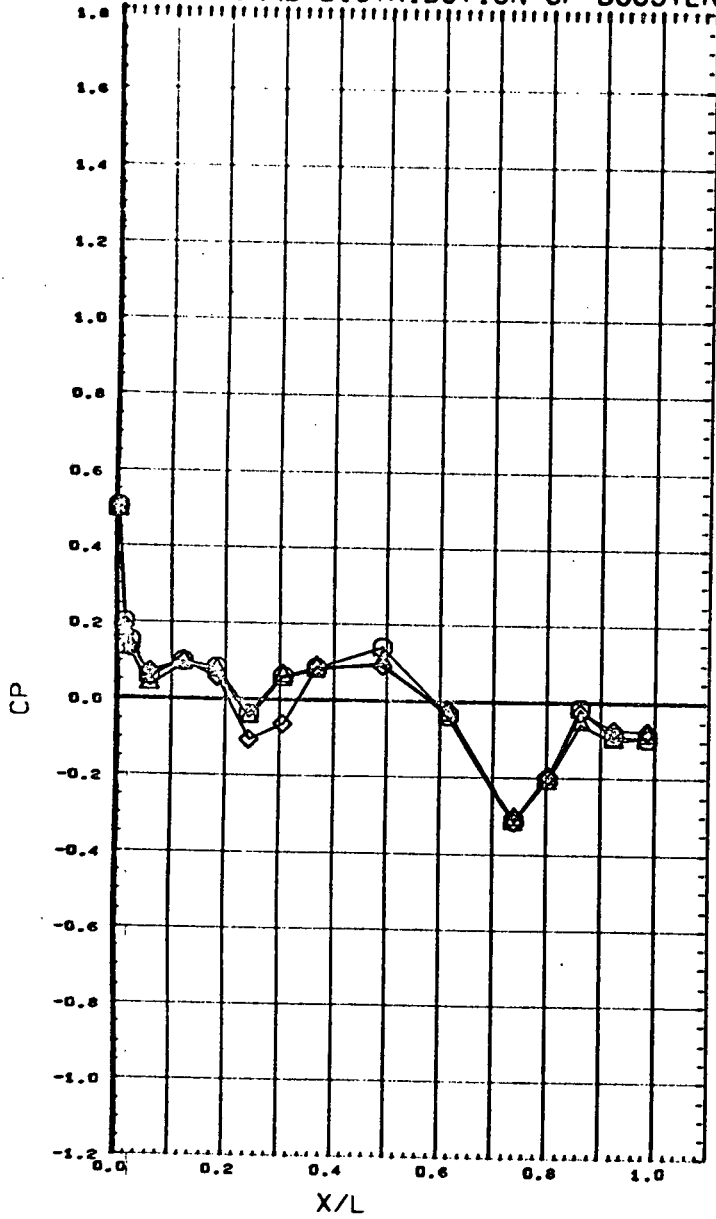

| SYMBOL | BETA | THETA | M ₁ |
|--------|-------|--------|----------------|
| ○ | 3.664 | 0.000 | 0.600 |
| △ | 0.026 | 15.000 | |
| ◇ | 3.735 | | |

| PARAMETRIC VALUES | | |
|-------------------|-------|------------|
| ALFB | 6.000 | DX/L 0.036 |
| I | 0.000 | |

REFERENCE FILE

LONGITUDINAL DISTRIBUTION OF BOOSTER FUSELAGE PRESSURES

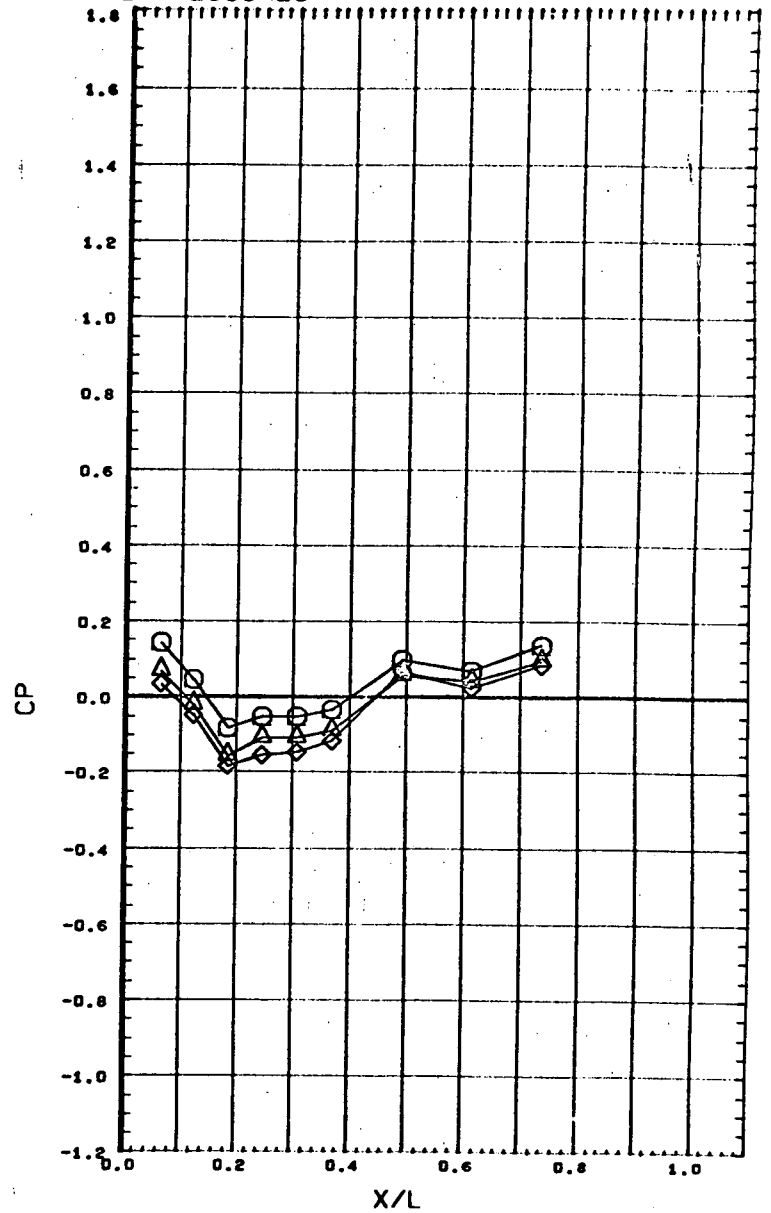
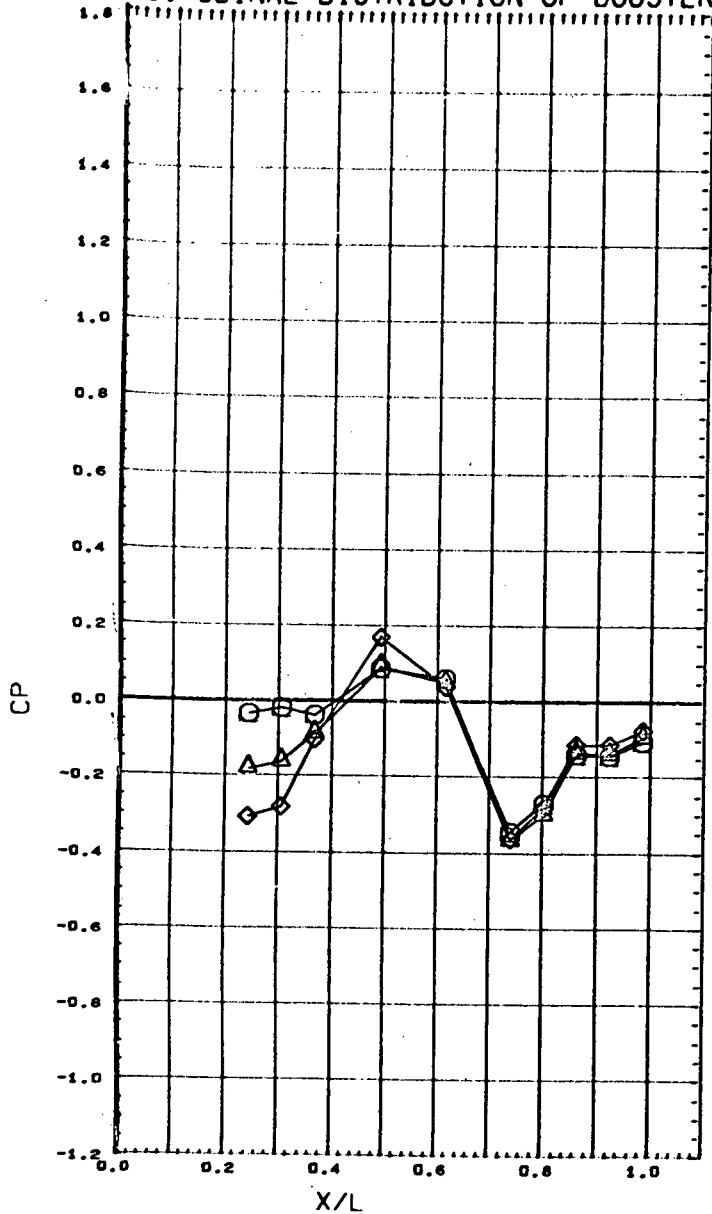

| SYMBOL | BETA | THETA | M1 |
|--------|-------|--------|-------|
| ○ | 3.664 | 24.000 | 0.600 |
| △ | 0.026 | 45.000 | |
| ◇ | 3.735 | | |

| PARAMETRIC VALUES | | |
|-------------------|-------|------------|
| ALFB | 6.000 | DX/L 0.036 |
| I | 0.000 | |

REFERENCE FILE

LONGITUDINAL DISTRIBUTION OF BOOSTER FUSELAGE PRESSURES

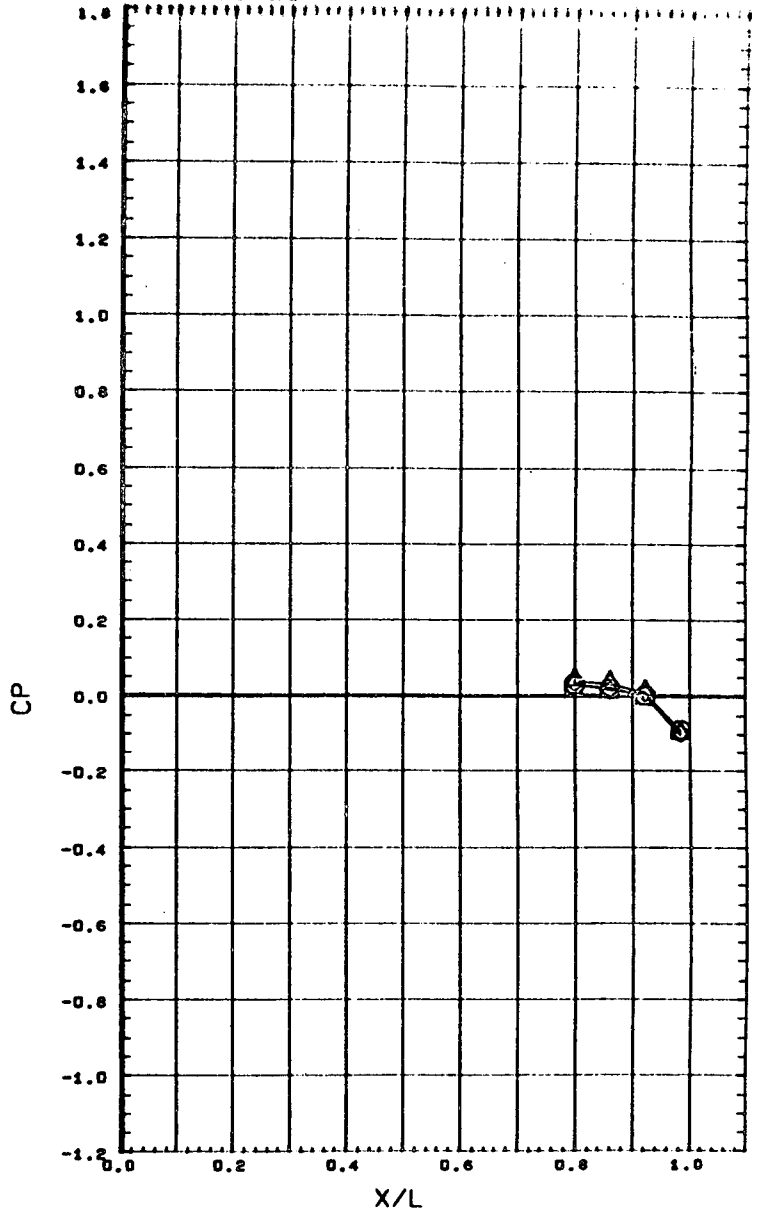
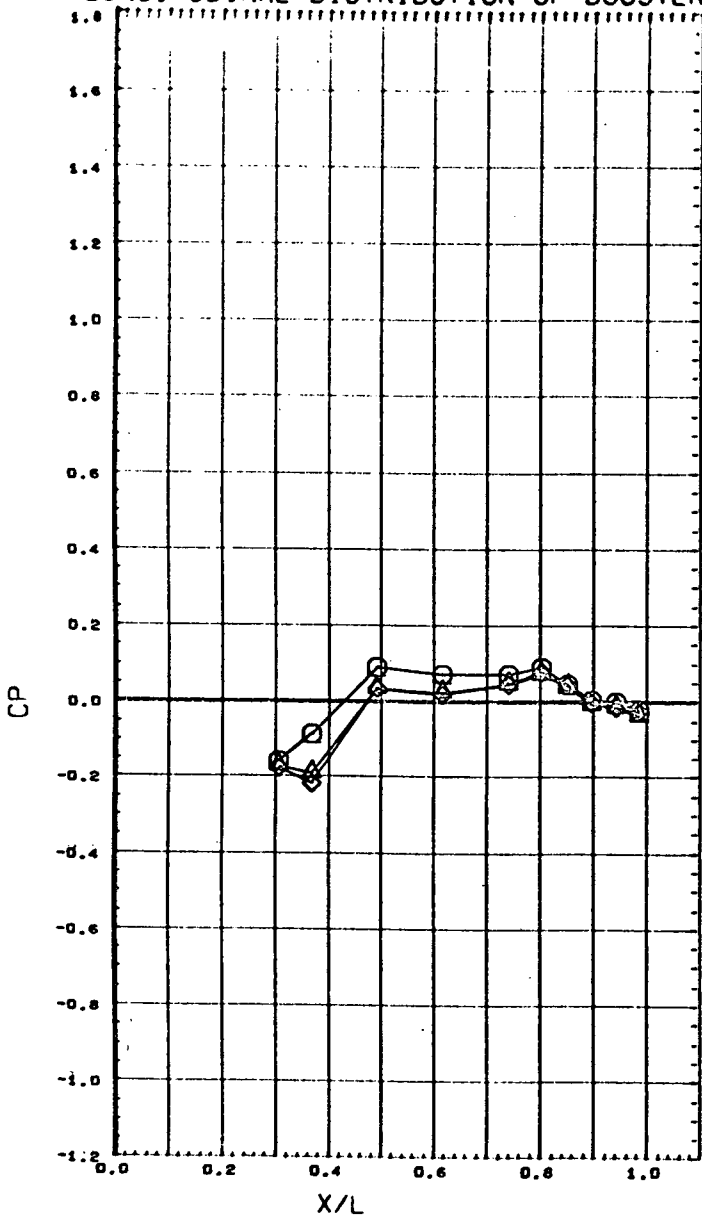

| SYMBOL | BETA | THETA | M1 |
|--------|-------|---------|-------|
| ○ | 3.664 | 90.000 | 0.600 |
| △ | 0.026 | 180.000 | |
| ◇ | 3.735 | | |

| PARAMETRIC VALUES | | | |
|-------------------|-------|------|-------|
| ALFB | 6.000 | DX/L | 0.036 |
| I | 0.000 | | |

REFERENCE FILE

LONGITUDINAL DISTRIBUTION OF BOOSTER FUSELAGE PRESSURES

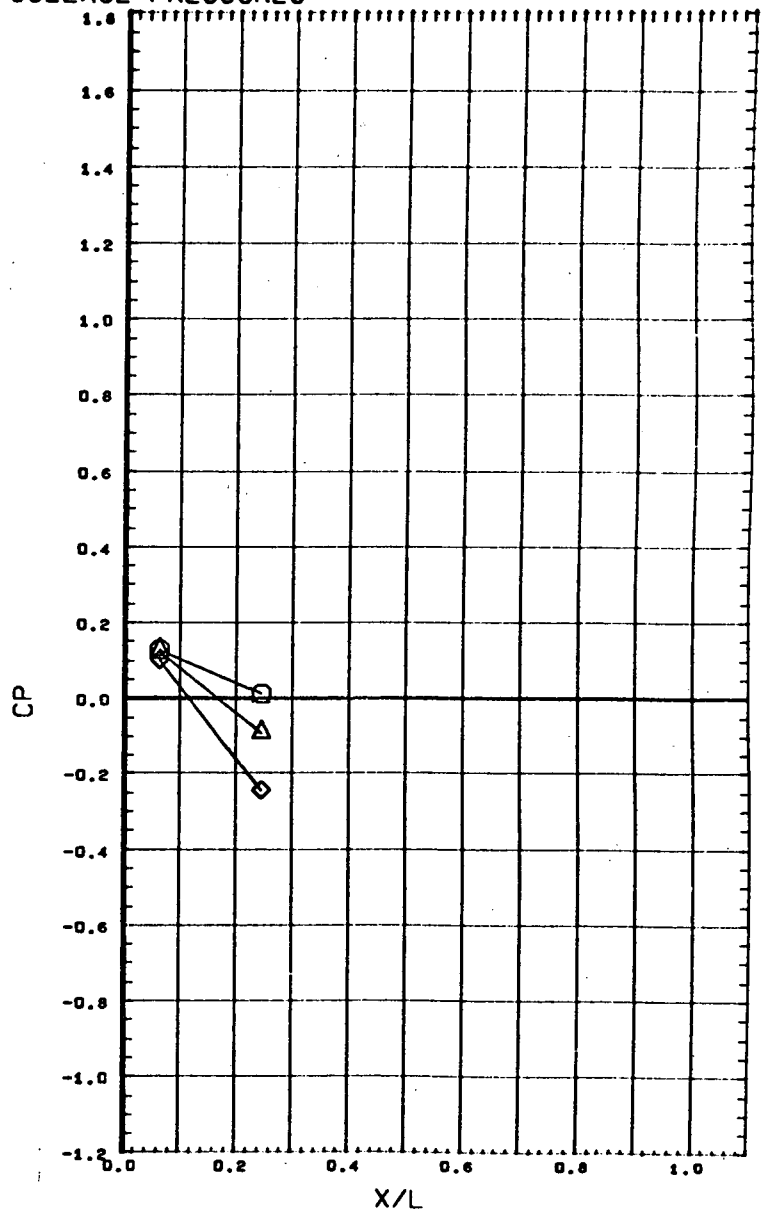
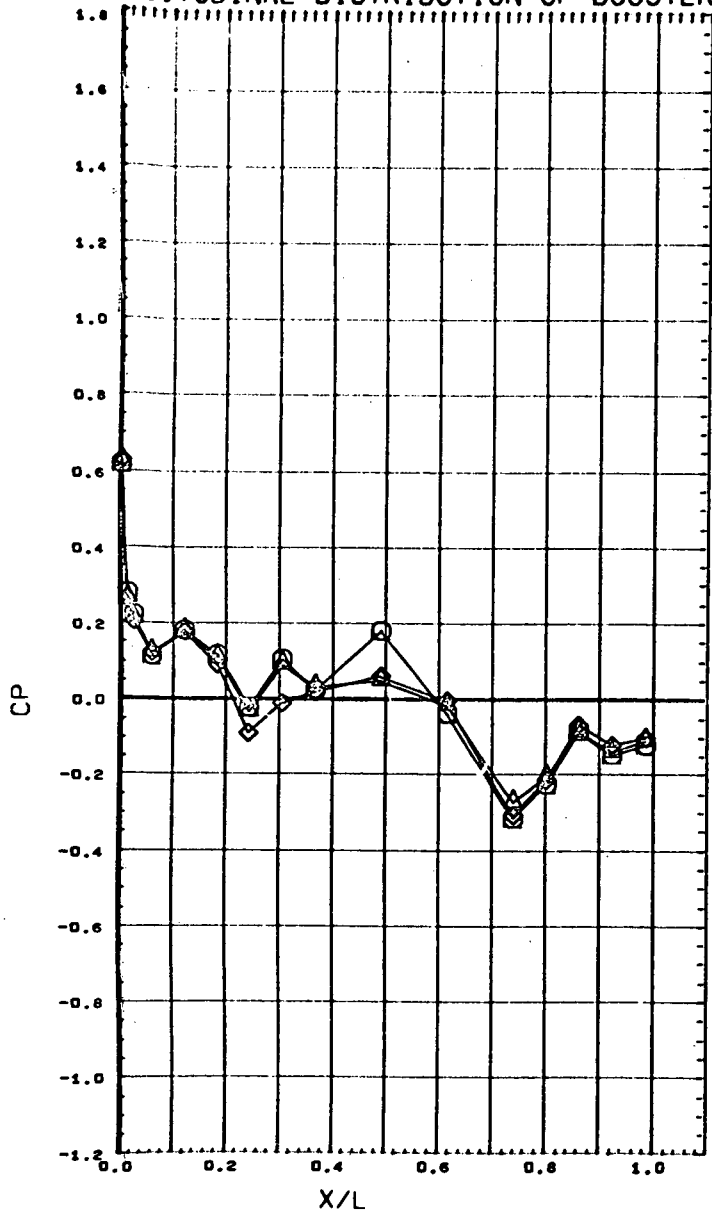

| SYMBOL | BETA | THETA | M1 |
|--------|-------|--------|-------|
| ○ | 3.711 | 0.000 | 0.901 |
| △ | 0.038 | 15.000 | |
| ◇ | 3.785 | | |

| PARAMETRIC VALUES | | |
|-------------------|-------|-------|
| ALFB | 6.000 | DX/L |
| I | 0.000 | 0.036 |

REFERENCE FILE

LONGITUDINAL DISTRIBUTION OF BOOSTER FUSELAGE PRESSURES

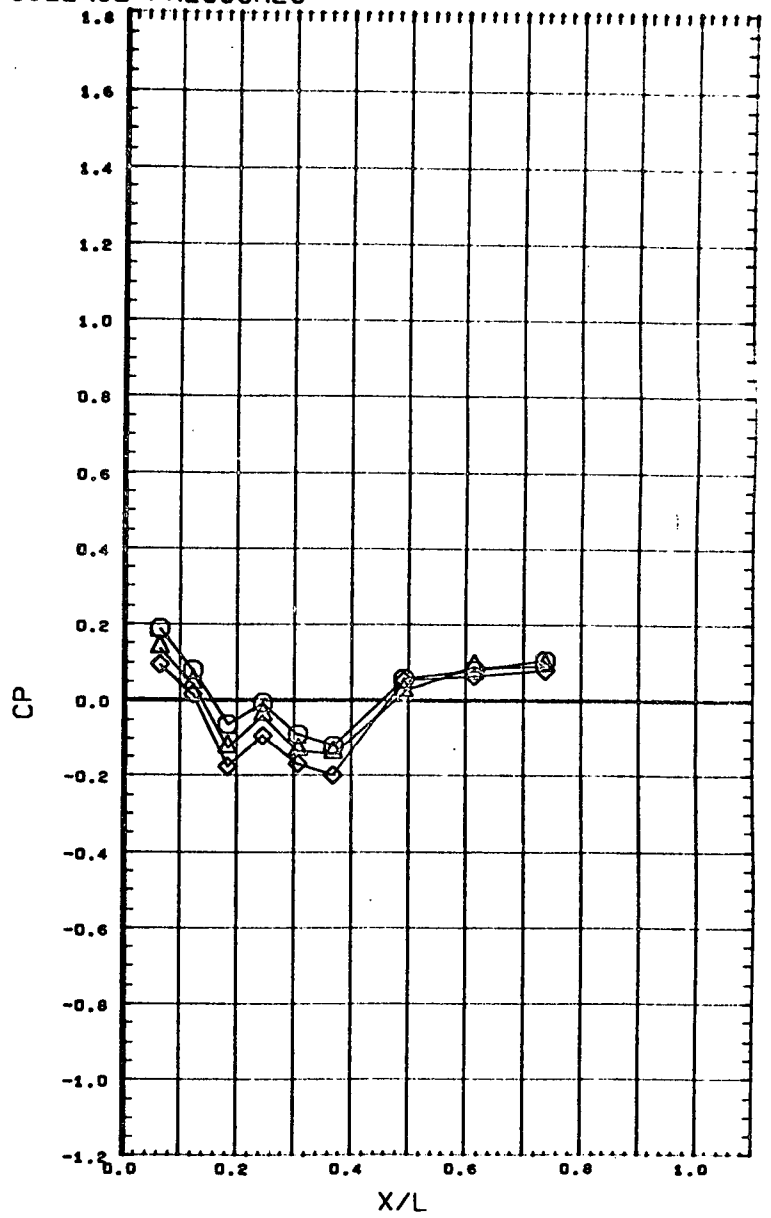
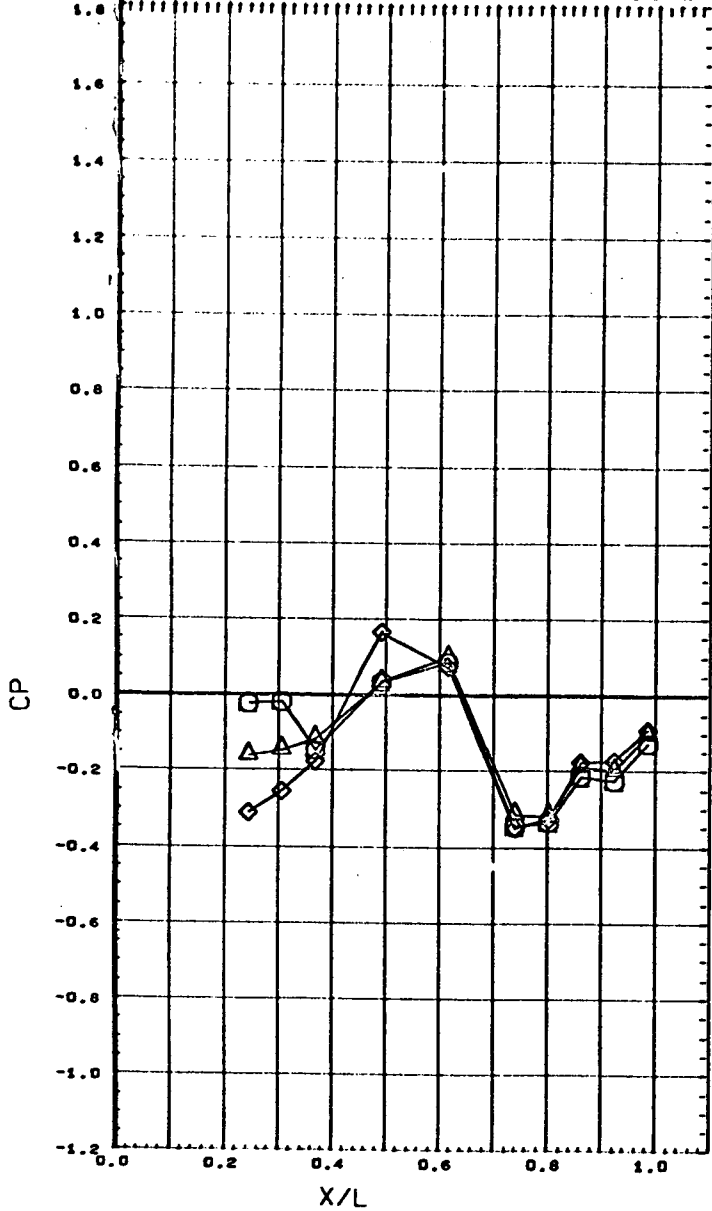

| SYMBOL | BETA | THETA | M1 |
|--------|-------|--------|-------|
| ○ | 8.711 | 24.000 | 0.901 |
| △ | 0.030 | 45.000 | |
| ◇ | 3.785 | | |

| PARAMETRIC VALUES | | |
|-------------------|-------|------------|
| ALFB | 6.000 | DX/L 0.036 |
| I | 0.000 | |

REFERENCE FILE

LONGITUDINAL DISTRIBUTION OF BOOSTER FUSELAGE PRESSURES

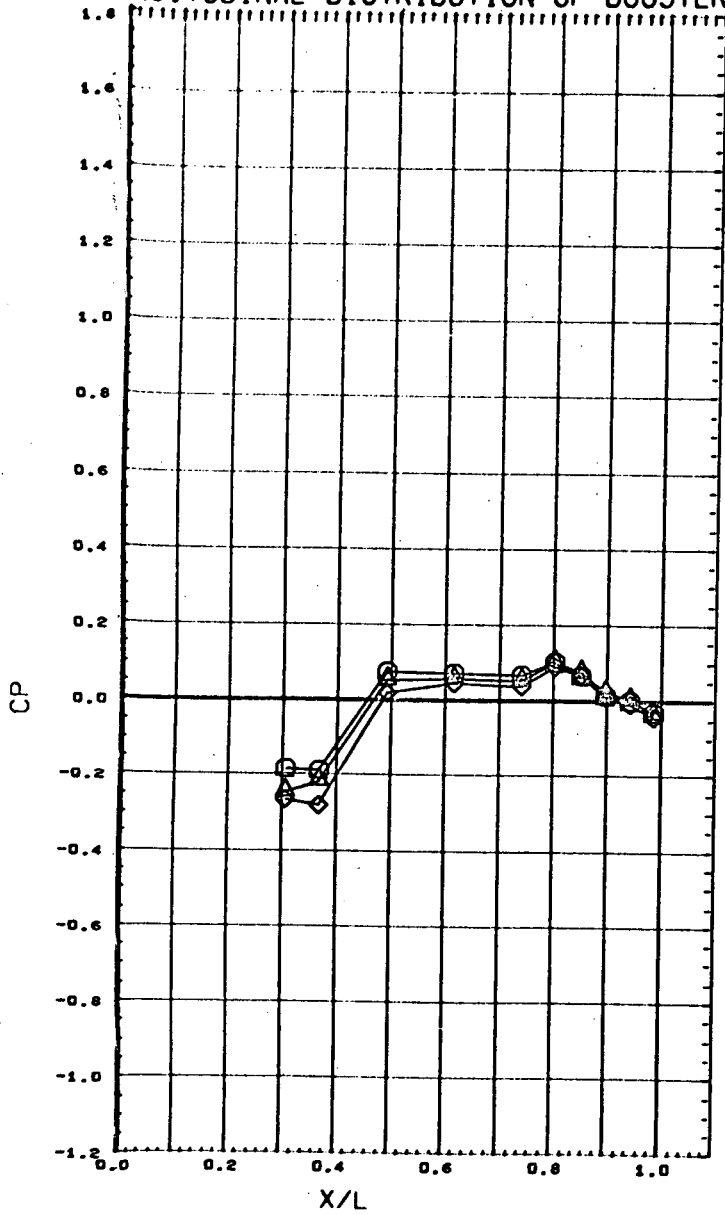

| SYMBOL | BETA | THETA | M1 |
|--------|-------|---------|-------|
| ○ | 3.711 | 90.000 | 0.901 |
| △ | 0.038 | 180.000 | |
| ◇ | 3.785 | | |

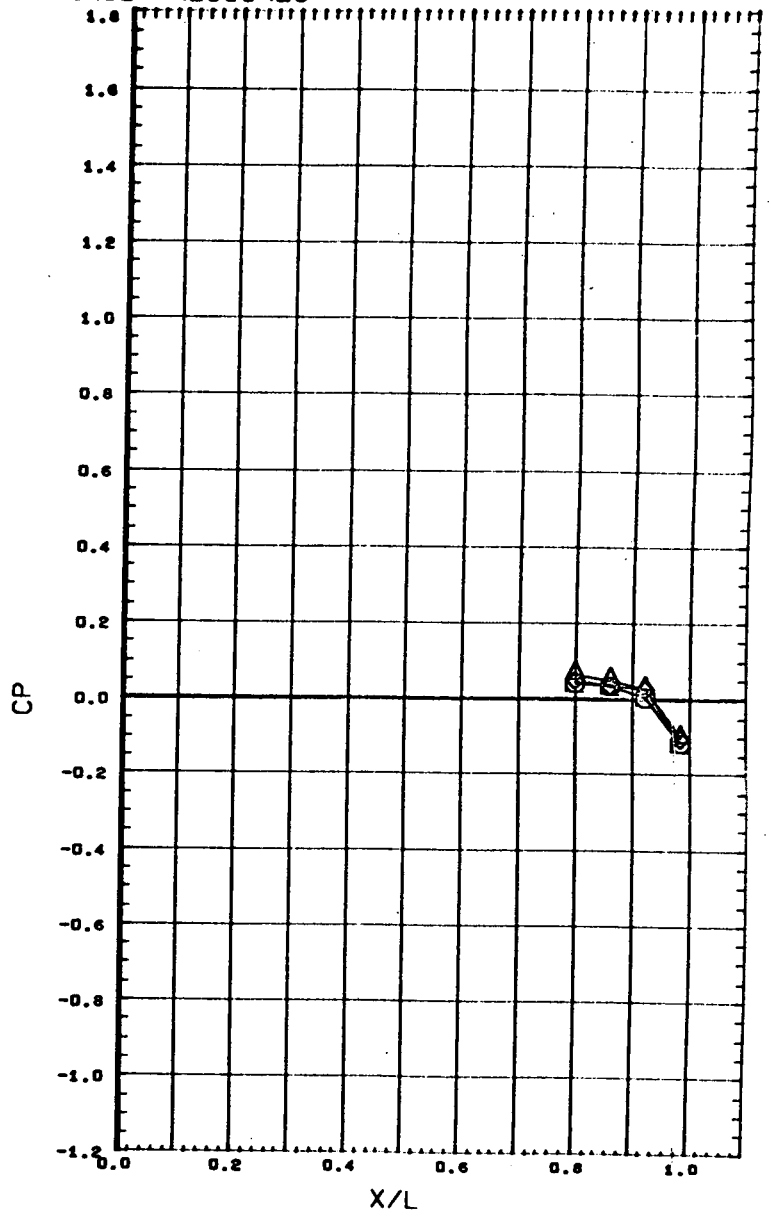

| PARAMETRIC VALUES | | | |
|-------------------|-------|------|-------|
| ALFB | 6.000 | DX/L | 0.036 |
| I | 0.000 | | |

REFERENCE FILE

AEDC TC174 MDAC BOOSTER NEAR ORBITER (BODY)

(ATC008)

PAGE 213

LONGITUDINAL DISTRIBUTION OF BOOSTER FUSELAGE PRESSURES

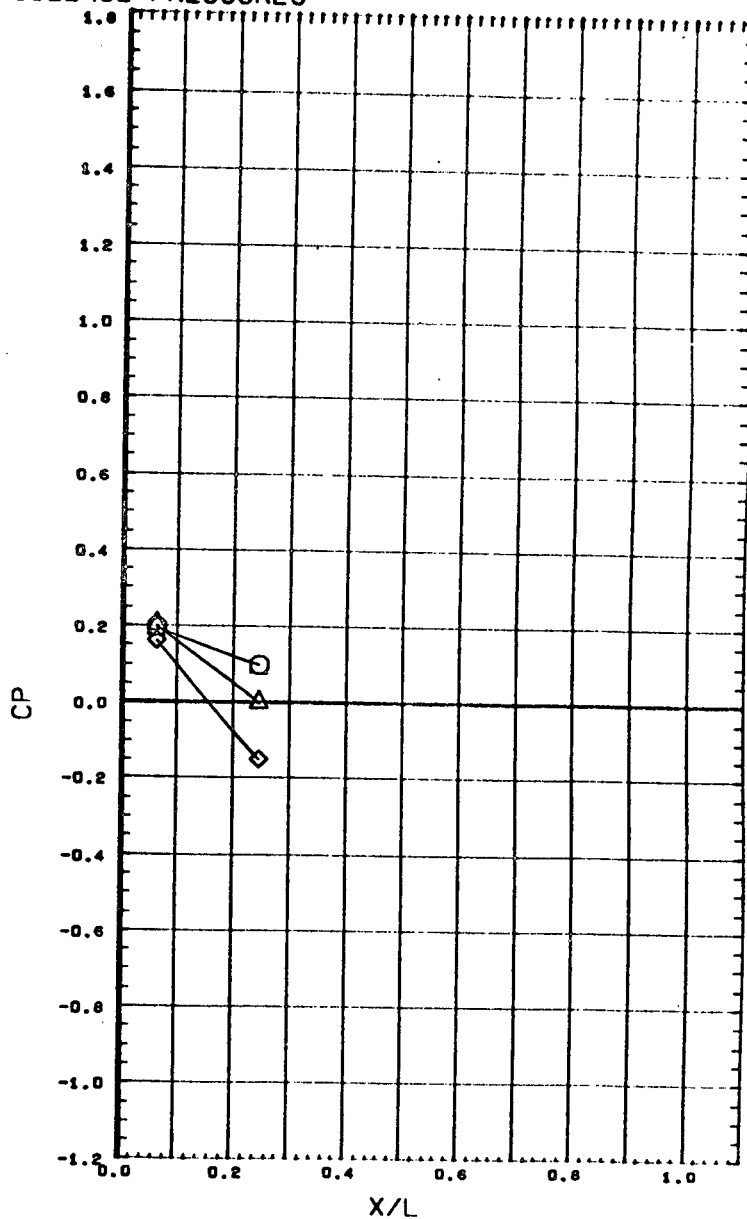
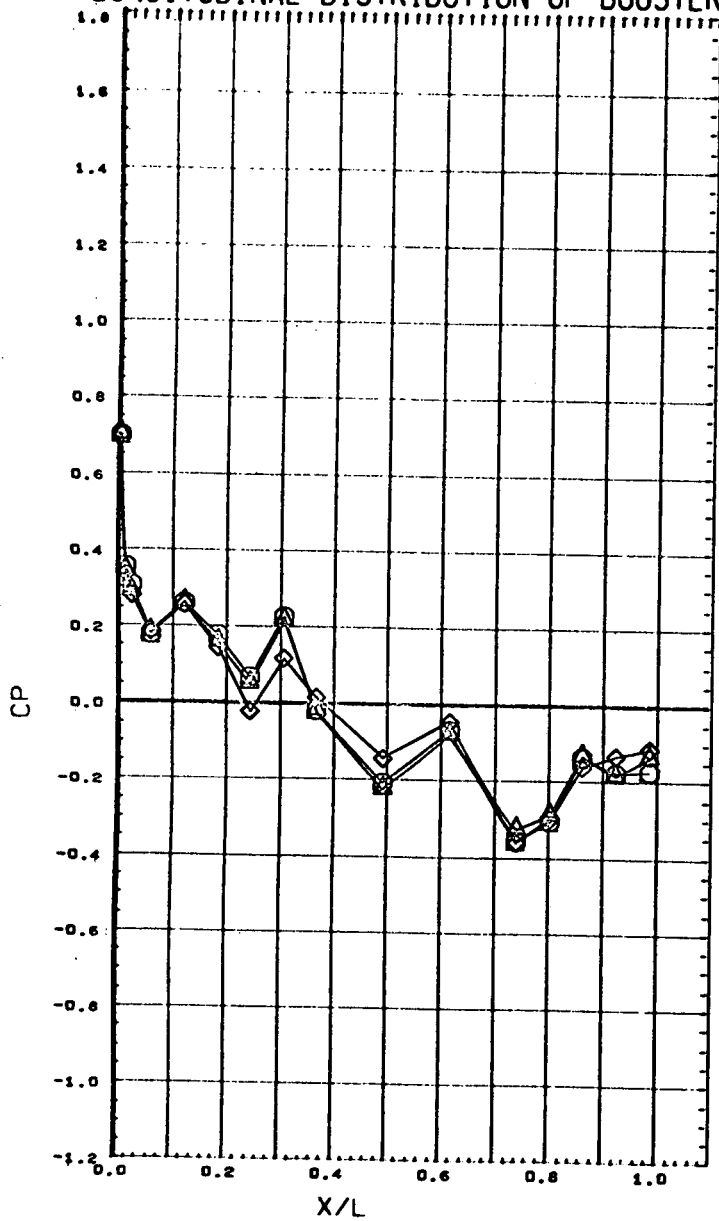

| SYMBOL | BETA | THETA | M1 |
|--------|-------|--------|-------|
| ○ | 3.742 | 0.000 | 1.002 |
| △ | 0.036 | 15.000 | |
| ◇ | 3.842 | | |

| PARAMETRIC VALUES | | | |
|-------------------|-------|------|-------|
| ALFB | 6.000 | DX/L | 0.036 |
| I | 0.000 | | |

REFERENCE FILE

LONGITUDINAL DISTRIBUTION OF BOOSTER FUSELAGE PRESSURES

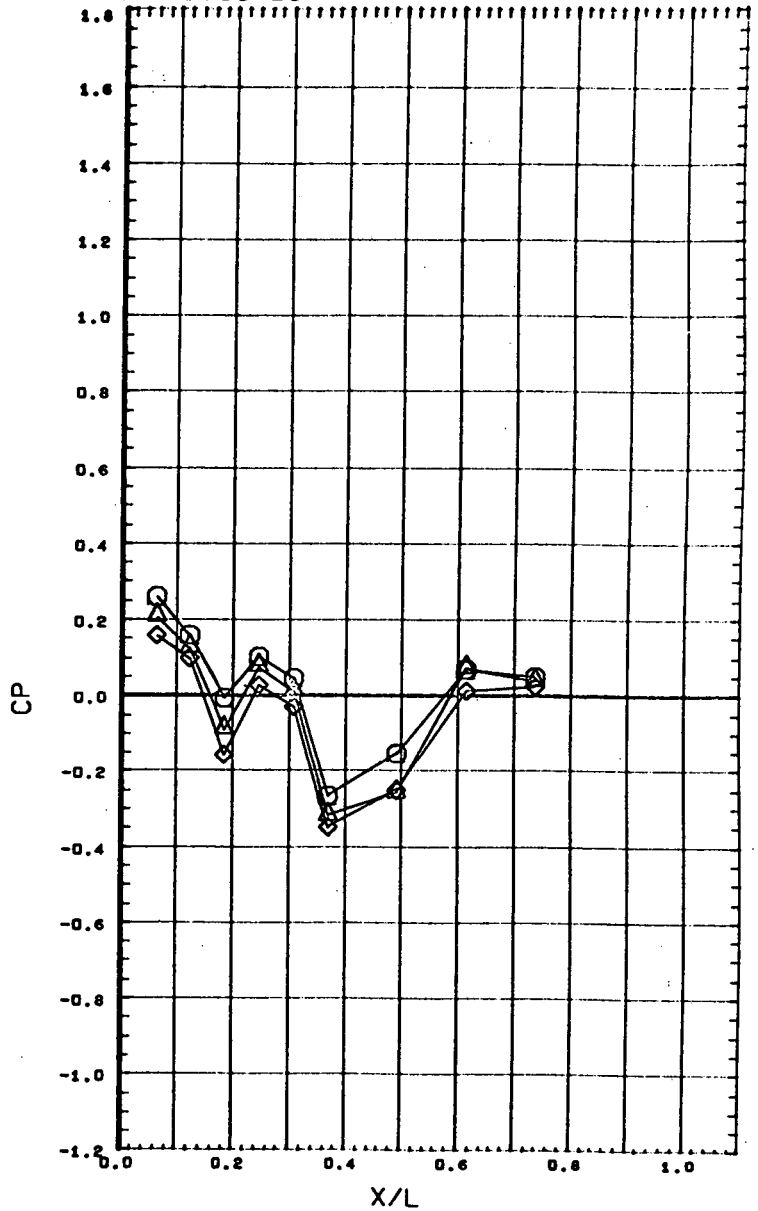
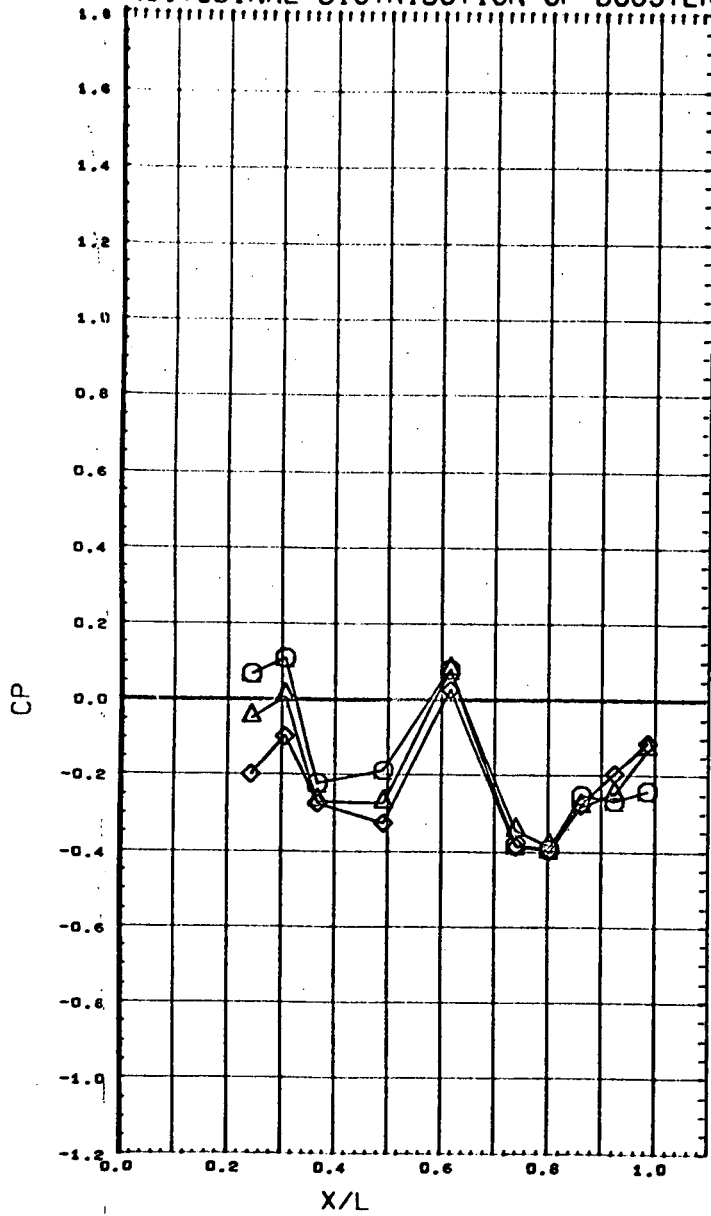

| SYMBOL | BETA | THETA | M1 |
|--------|-------|--------|-------|
| ○ | 3.742 | 24.000 | 1.002 |
| △ | 0.036 | 45.000 | |
| ◇ | 3.842 | | |

| PARAMETRIC VALUES | | |
|-------------------|-------|-------|
| ALFB | 6.000 | DX/L |
| I | 0.000 | 0.036 |

REFERENCE FILE

LONGITUDINAL DISTRIBUTION OF BOOSTER FUSELAGE PRESSURES

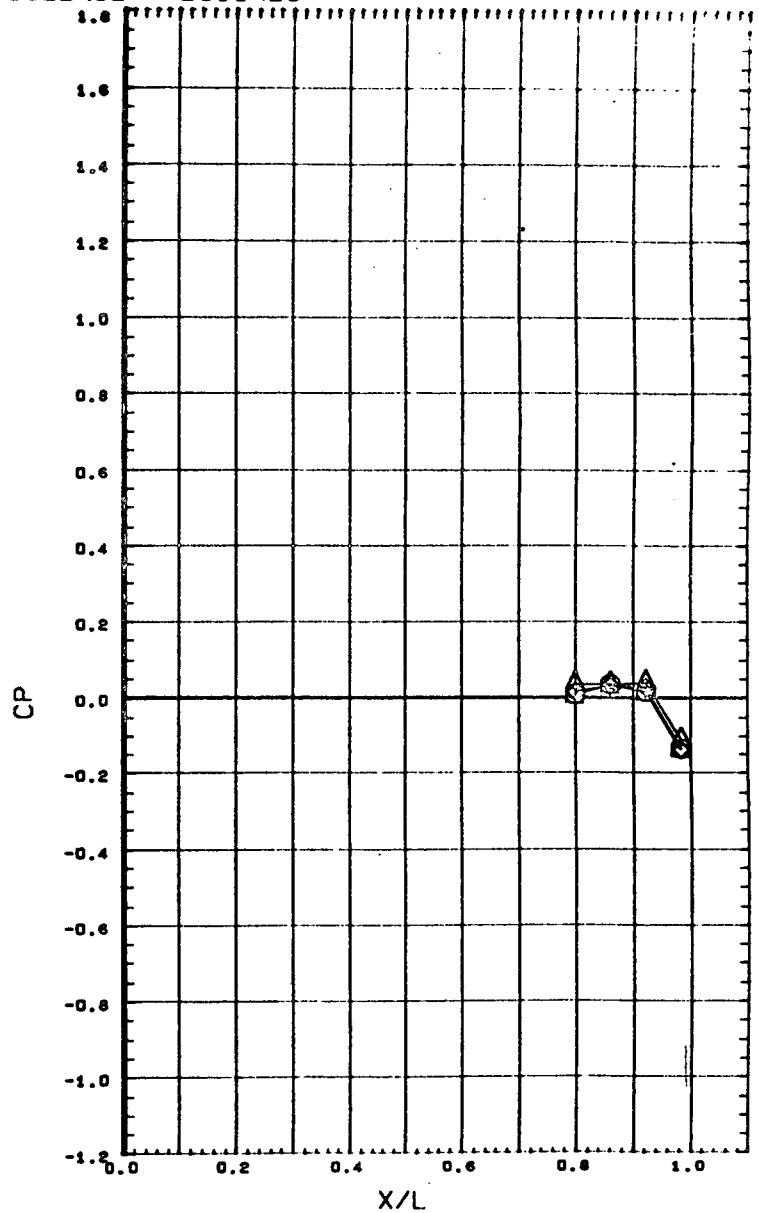
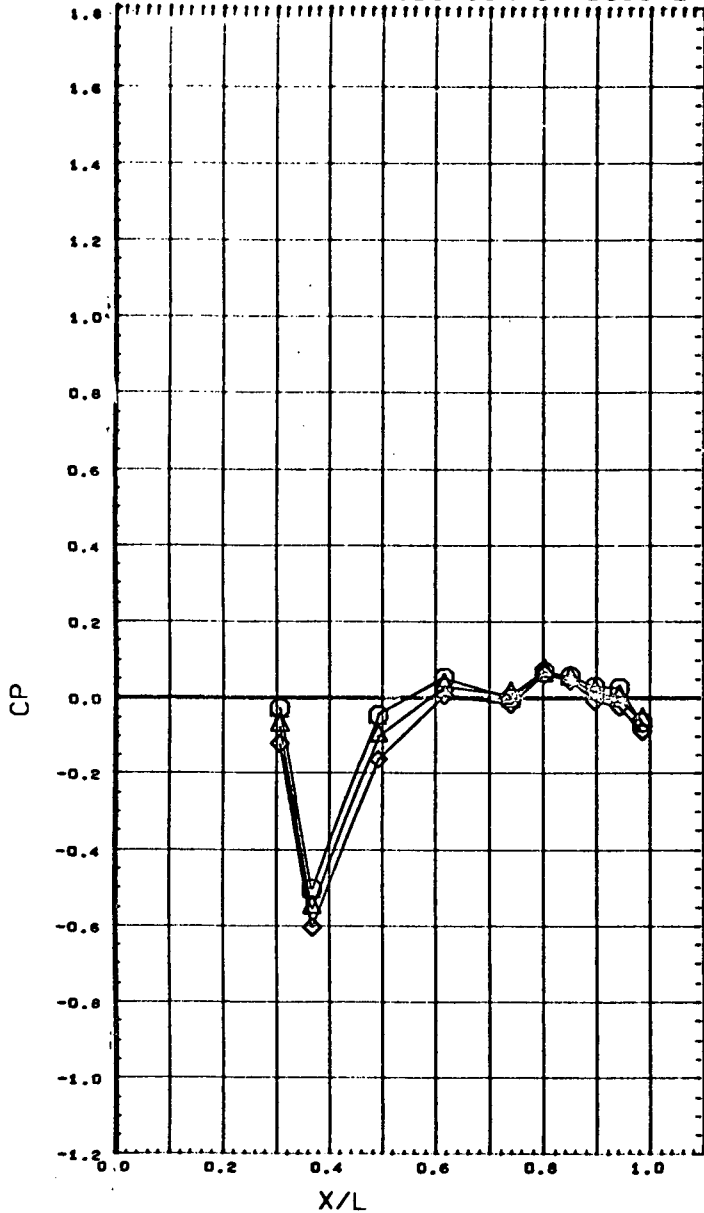

| SYMBOL | BETA | THETA | M1 |
|--------|-------|---------|-------|
| ○ | 3.742 | 90.000 | 1.002 |
| △ | 0.036 | 180.000 | |
| ◇ | 3.842 | | |

| PARAMETRIC VALUES | | |
|-------------------|-------|------------|
| ALFB | 6.000 | DX/L 0.036 |
| I | 0.000 | |

REFERENCE FILE

LONGITUDINAL DISTRIBUTION OF BOOSTER FUSELAGE PRESSURES

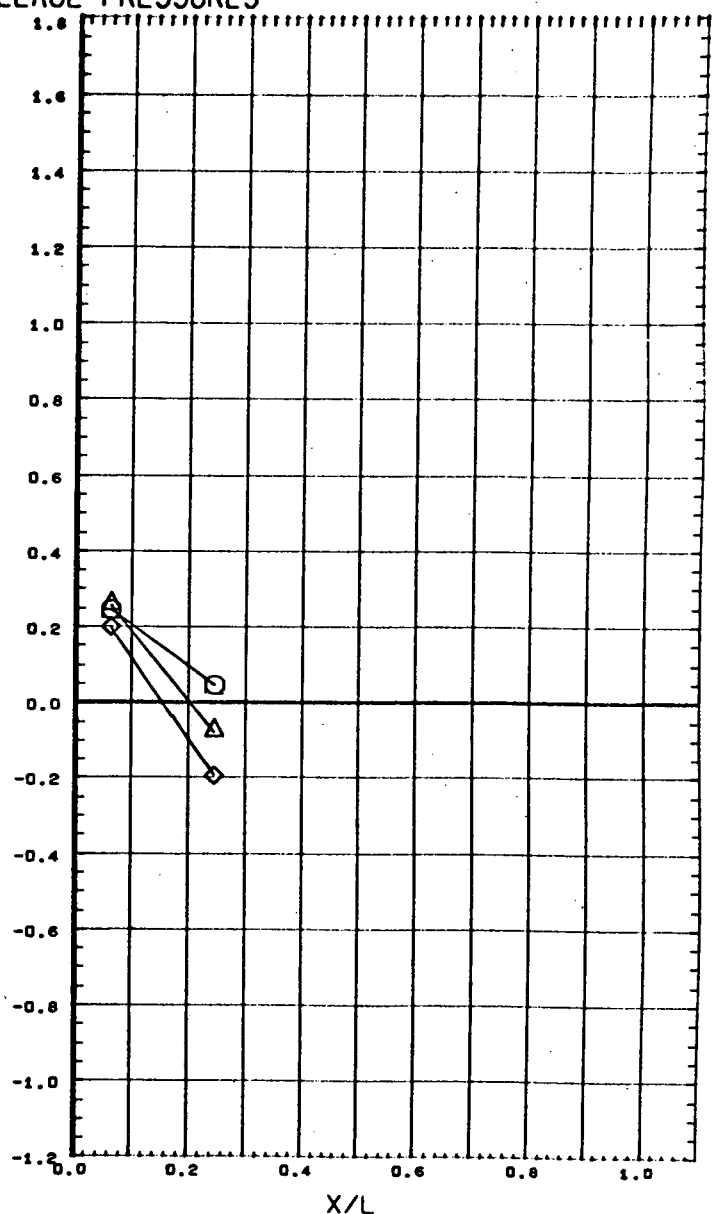
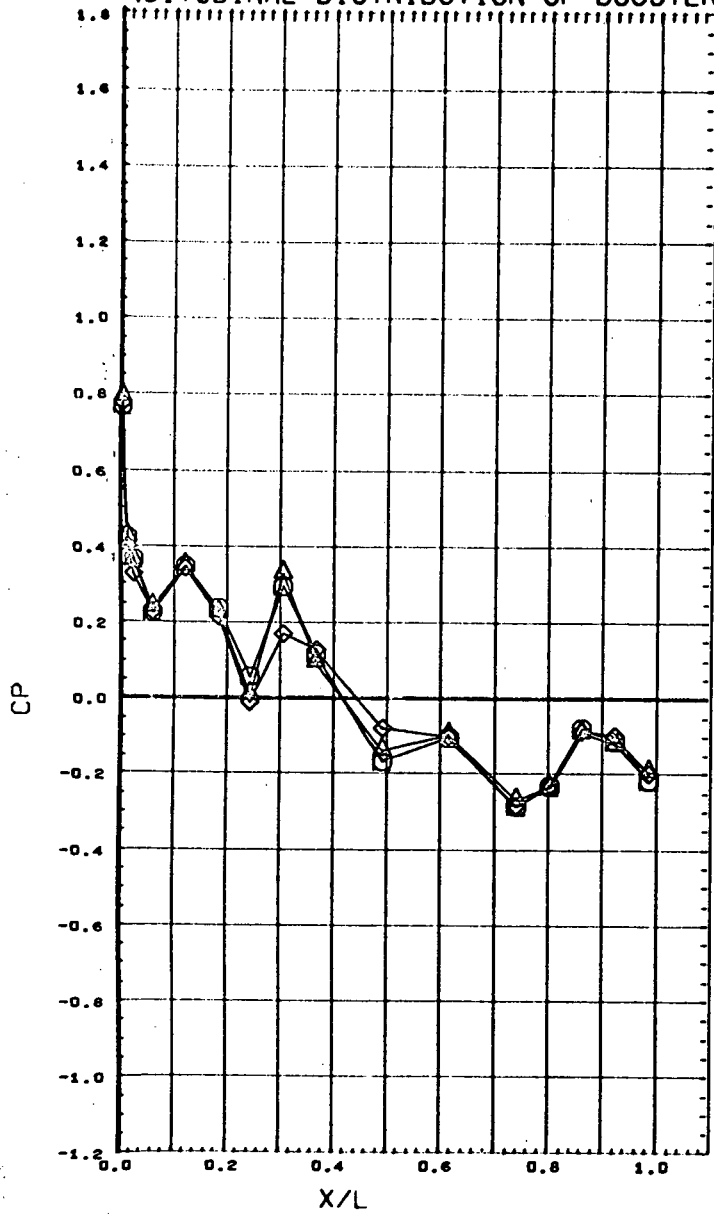

| SYMBOL | BETA | THETA | M1 |
|--------|-------|--------|-------|
| ○ | 3.747 | 0.000 | 1.100 |
| △ | 0.027 | 15.000 | |
| ◇ | 3.836 | | |

| PARAMETRIC VALUES | | |
|-------------------|-------|-------|
| ALFB | 6.000 | DX/L |
| I | 0.000 | 0.036 |

REFERENCE FILE

LONGITUDINAL DISTRIBUTION OF BOOSTER FUSELAGE PRESSURES

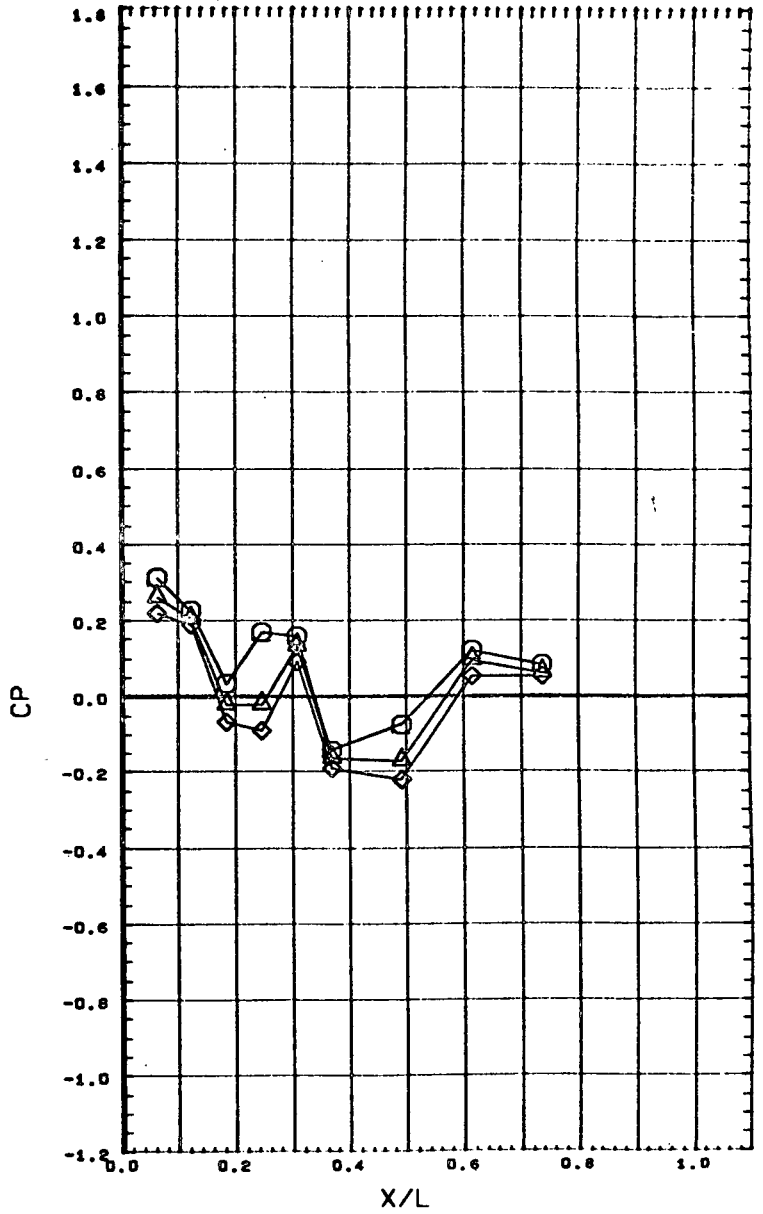
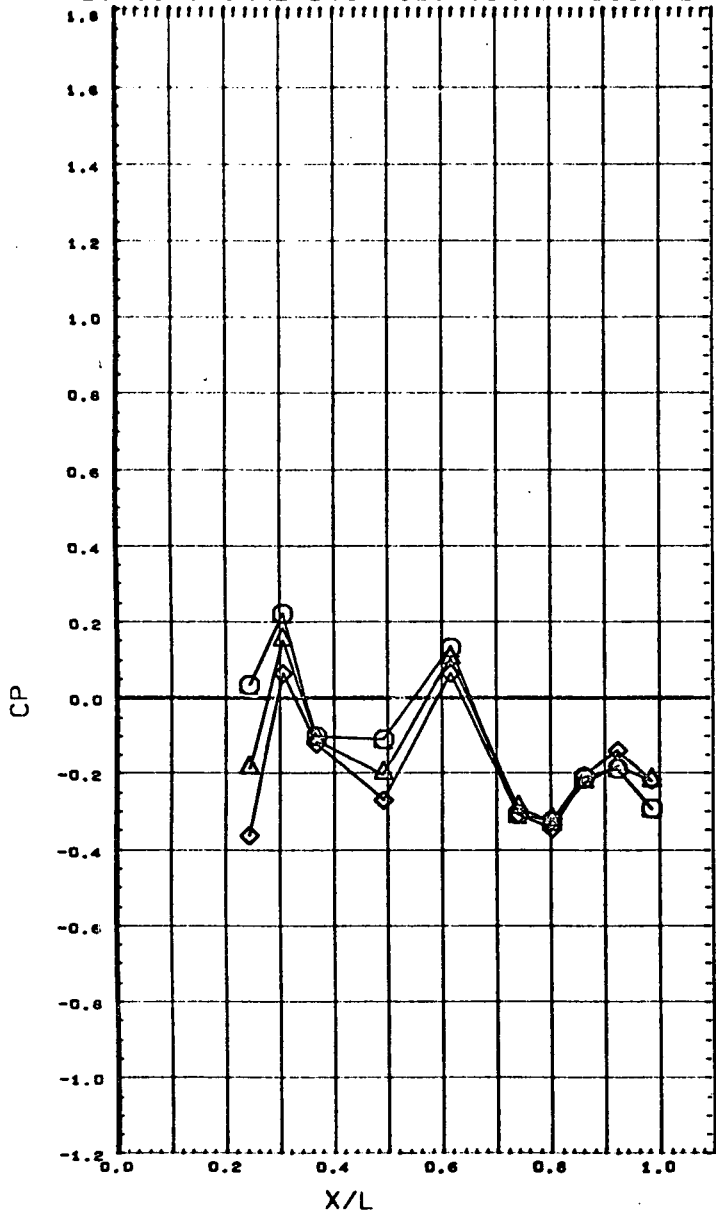

| SYMBOL | BETA | THETA | M1 |
|--------|-------|--------|-------|
| ○ | 3.747 | 24.000 | 1.100 |
| △ | 0.027 | 45.000 | |
| ◇ | 3.836 | | |

| PARAMETRIC VALUES | | |
|-------------------|-------|------------|
| ALFB | 6.000 | DX/L 0.036 |
| I | 0.000 | |

REFERENCE FILE

LONGITUDINAL DISTRIBUTION OF BOOSTER FUSELAGE PRESSURES

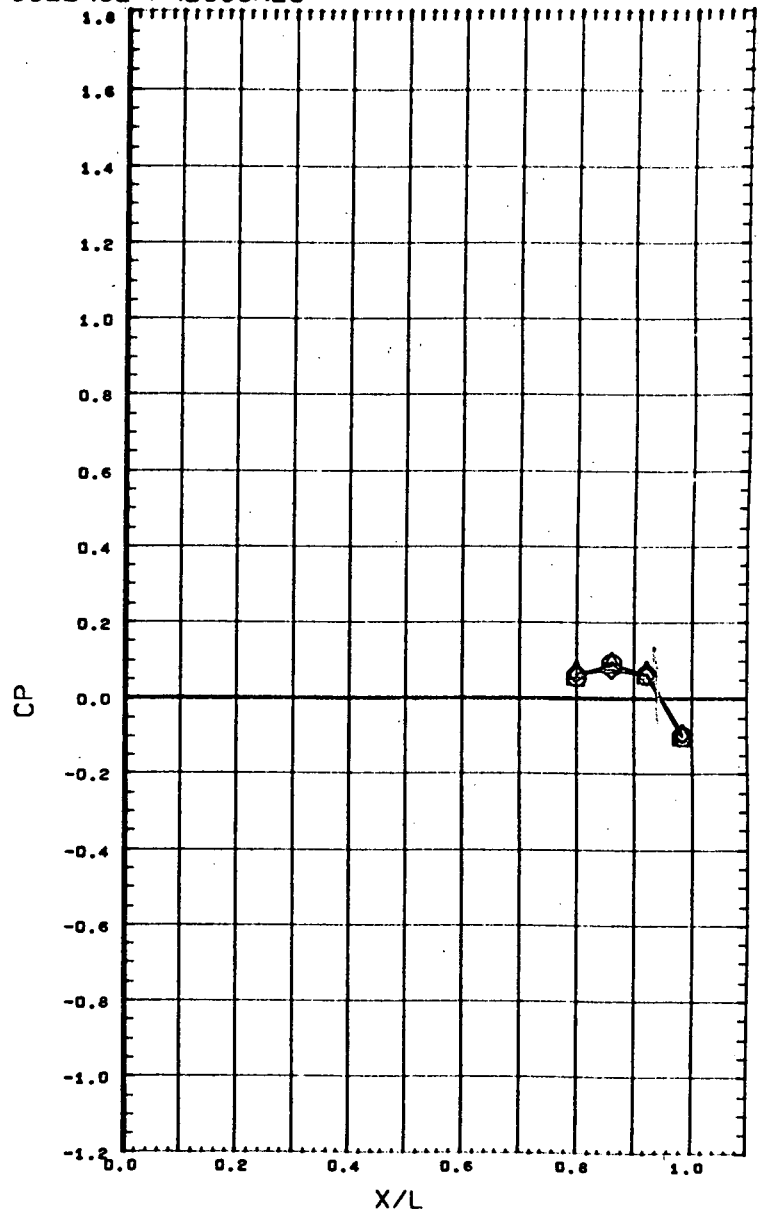
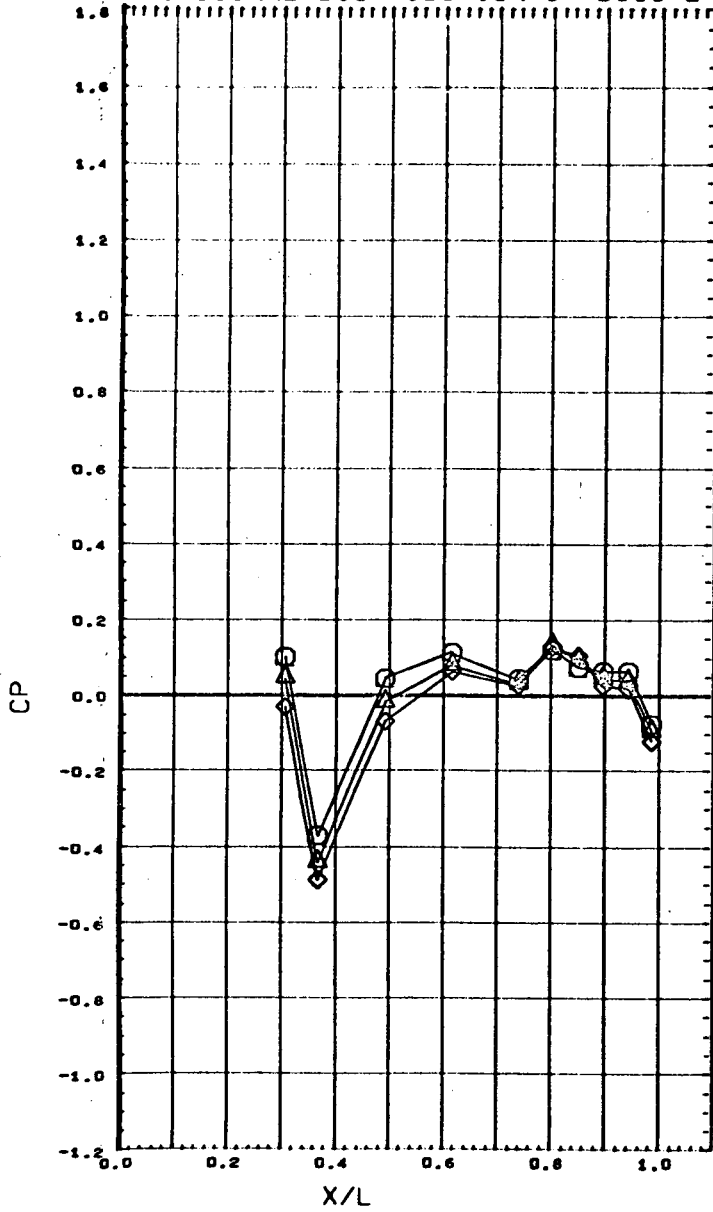

| SYMBOL | BETA | THETA | M1 |
|--------|-------|---------|-------|
| ○ | 3.747 | 90.000 | 1.100 |
| △ | 0.027 | 180.000 | |
| ◇ | 3.836 | | |

| PARAMETRIC VALUES | | | |
|-------------------|-------|------|-------|
| ALFB | 6.000 | DX/L | 0.036 |
| I | 0.000 | | |

REFERENCE FILE

LONGITUDINAL DISTRIBUTION OF BOOSTER FUSELAGE PRESSURES

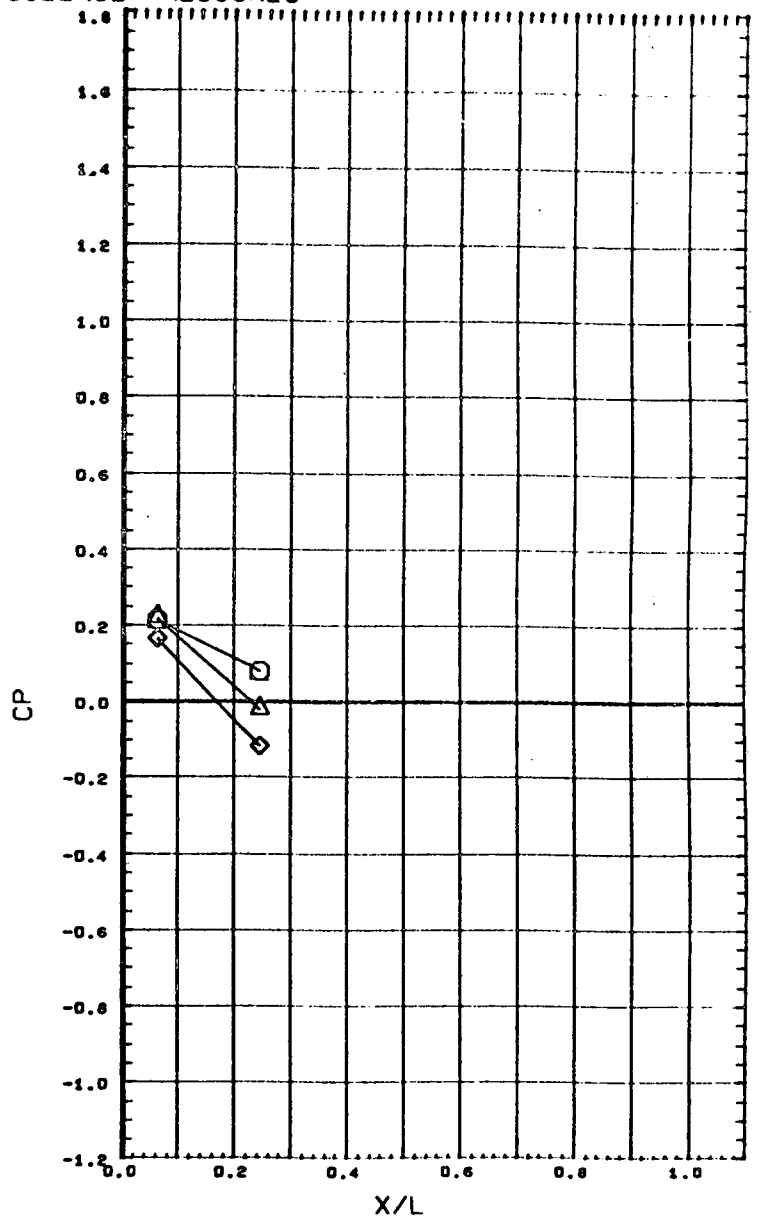
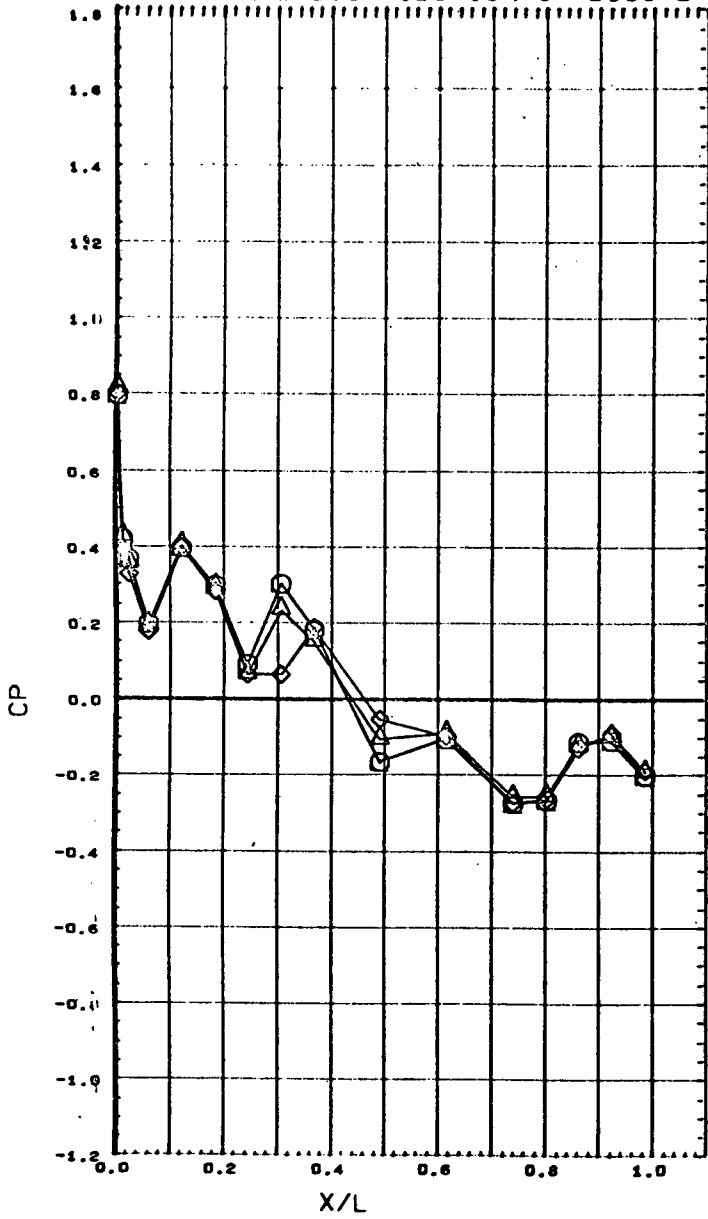

| SYMBOL | BETA | THETA | M1 |
|--------|-------|--------|-------|
| ○ | 3.783 | 0.000 | 1.201 |
| △ | 0.017 | 15.000 | |
| ◇ | 3.843 | | |

| PARAMETRIC VALUES | | | |
|-------------------|-------|------|-------|
| ALFB | 6.000 | DX/L | 0.036 |
| I | 0.000 | | |

REFERENCE FILE

LONGITUDINAL DISTRIBUTION OF BOOSTER FUSELAGE PRESSURES

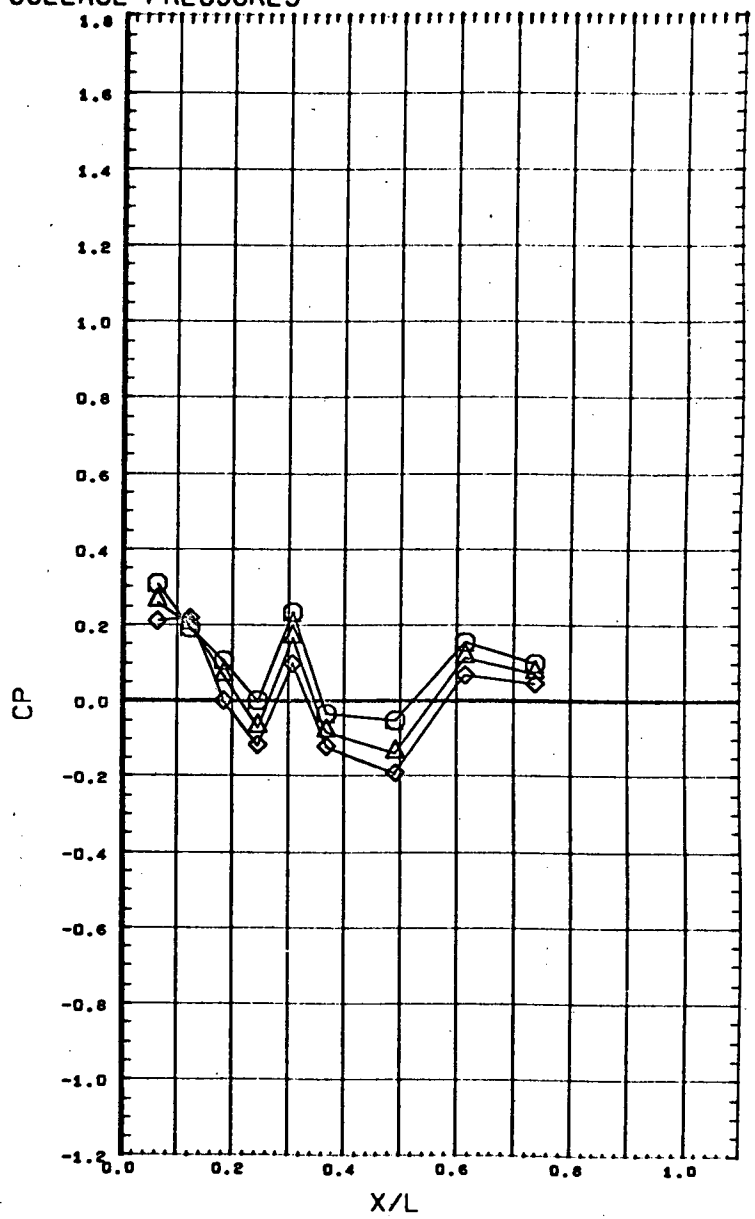
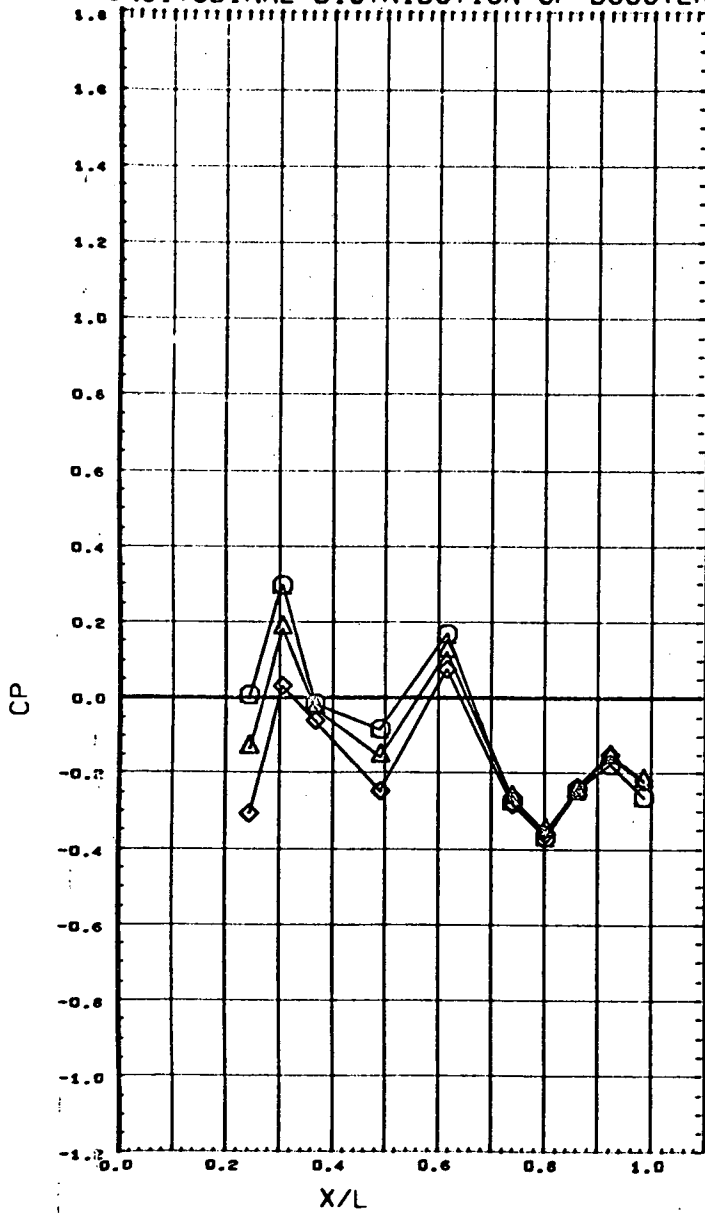

| SYMBOL | BETA | THETA | M1 |
|--------|-------|--------|-------|
| ○ | 3.783 | 24.000 | 1.201 |
| △ | 0.017 | 45.000 | |
| ◇ | 3.843 | | |

| PARAMETRIC VALUES | | |
|-------------------|-------|------------|
| ALFB | 6.000 | DX/L 0.036 |
| I | 0.000 | |

REFERENCE FILE

LONGITUDINAL DISTRIBUTION OF BOOSTER FUSELAGE PRESSURES

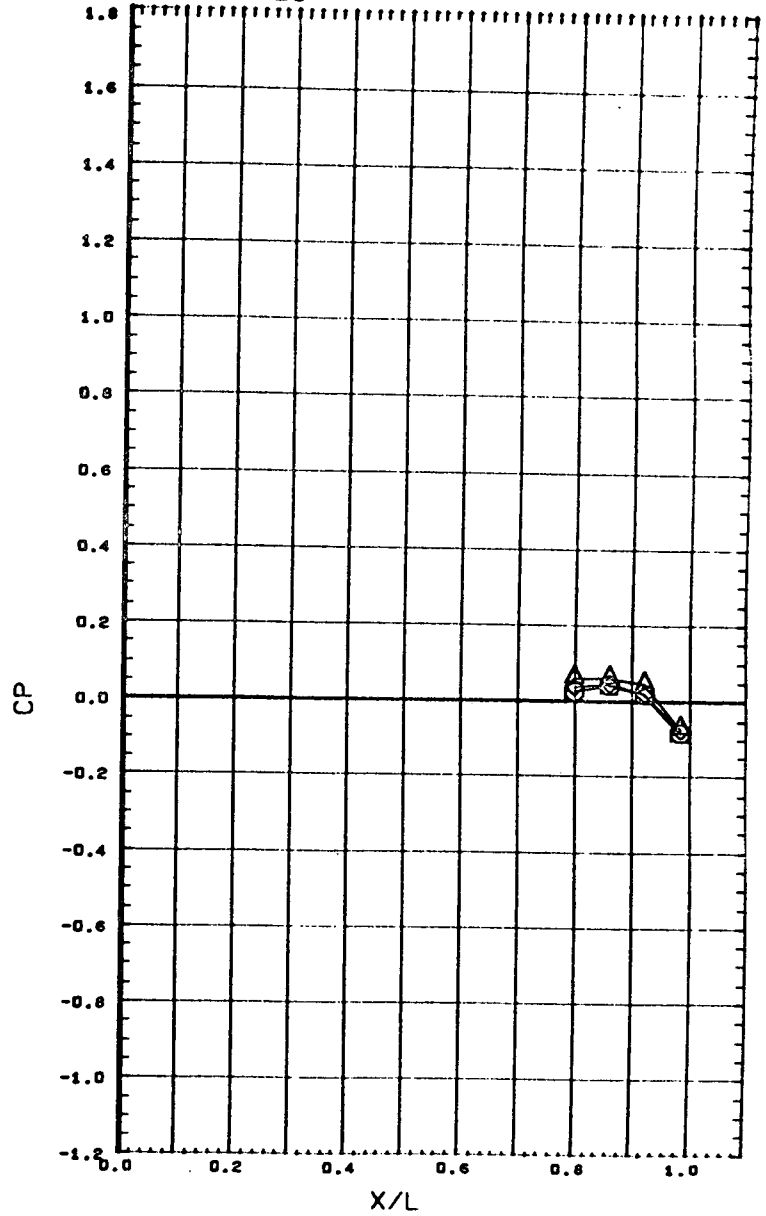
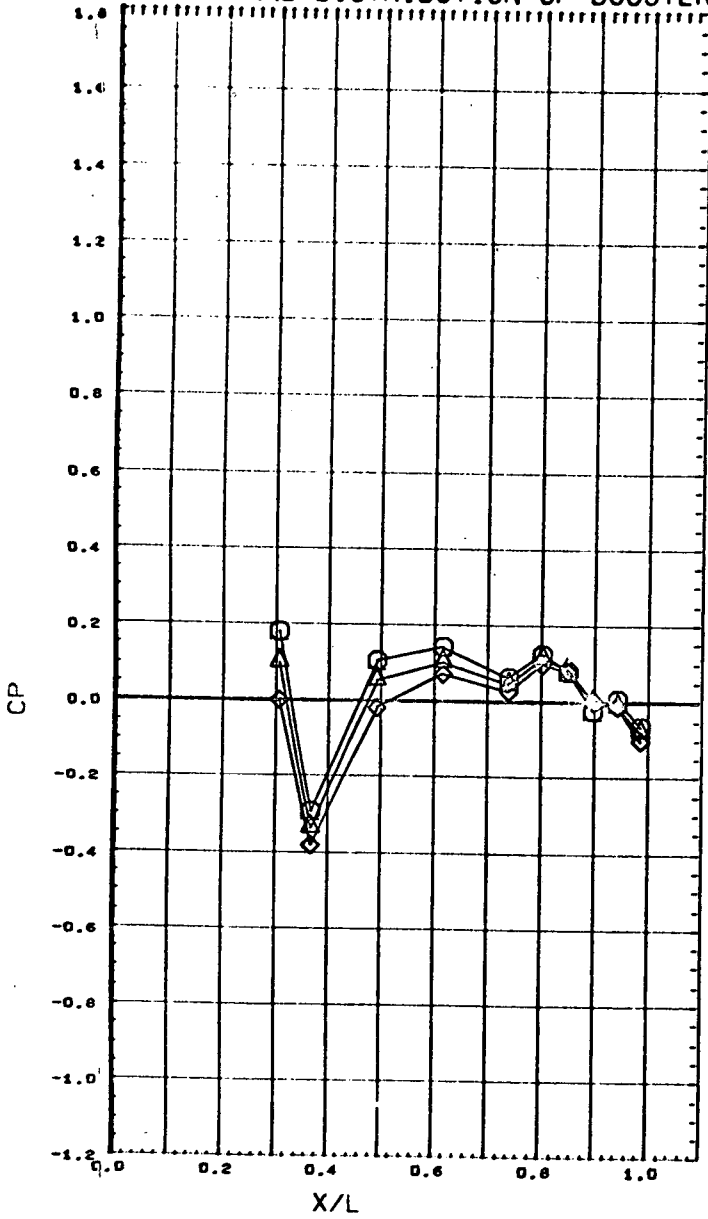

| SYMBOL | BETA | THETA | M1 |
|--------|-------|---------|-------|
| ○ | 3.783 | 90.000 | 1.201 |
| △ | 0.017 | 180.000 | |
| ◇ | 3.843 | | |

| PARAMETRIC VALUES | | |
|-------------------|-------|------------|
| ALFB | 6.000 | DX/L 0.036 |
| I | 0.000 | |

REFERENCE FILE

LONGITUDINAL DISTRIBUTION OF BOOSTER FUSELAGE PRESSURES

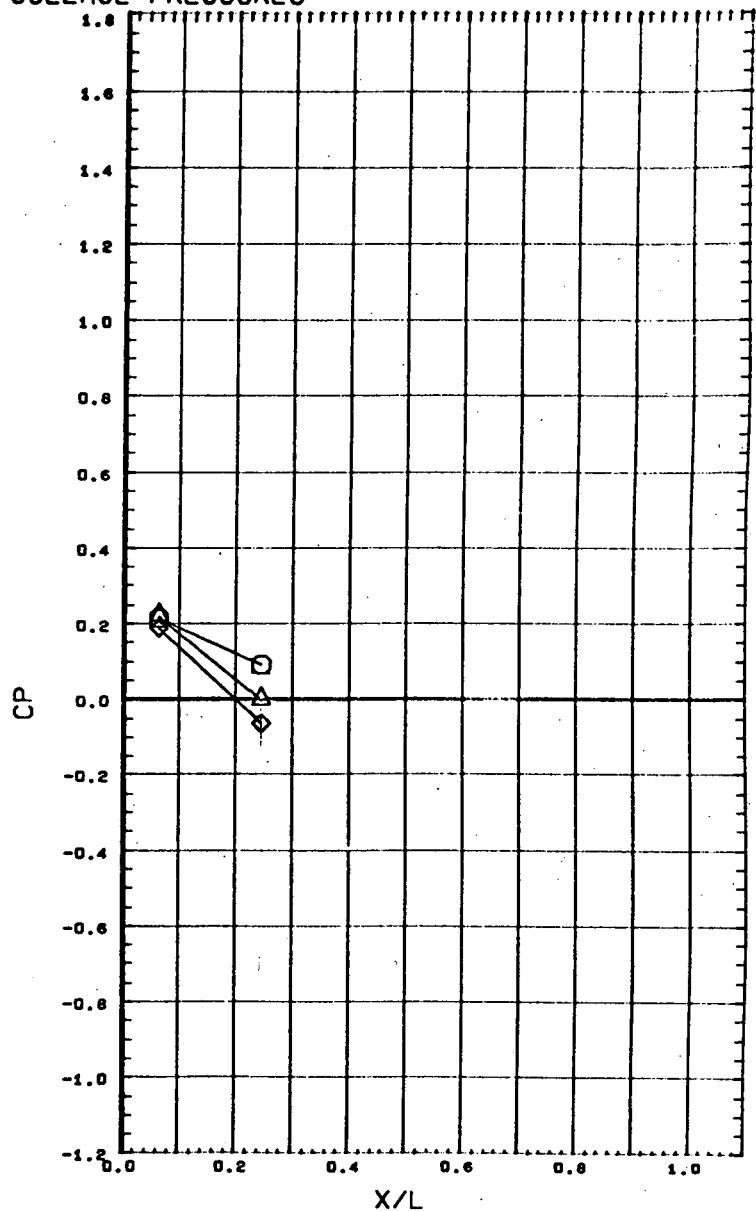
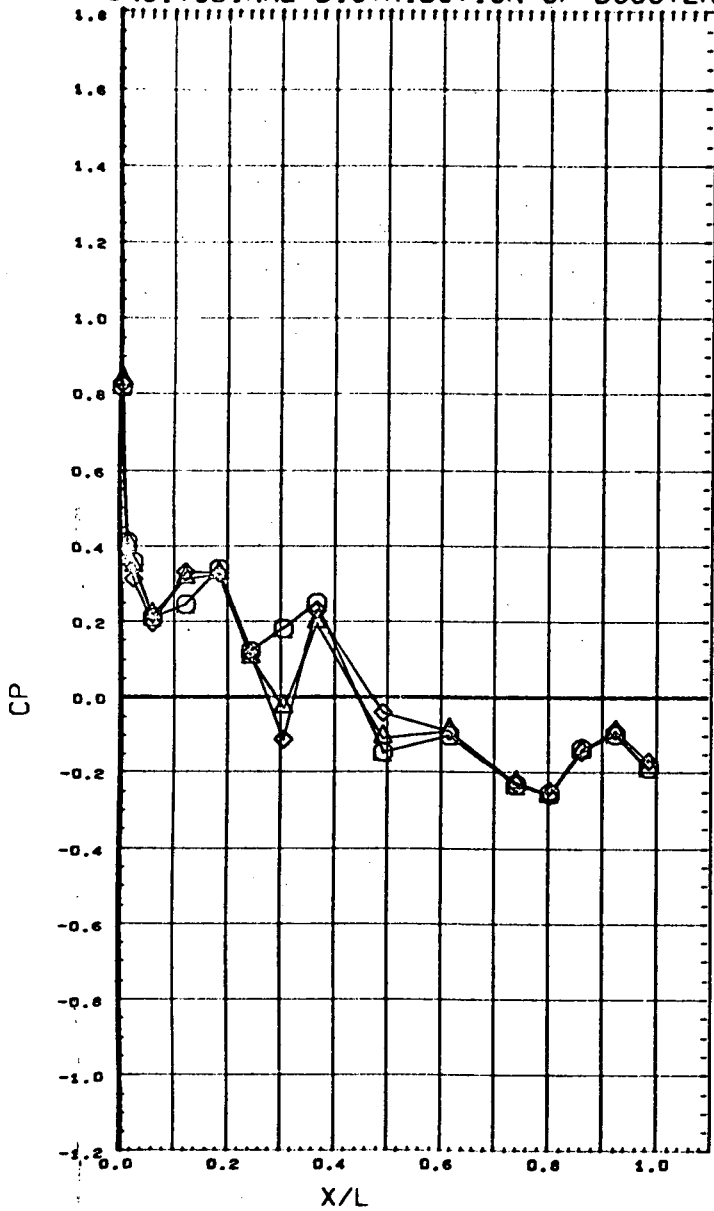

| SYMBOL | BETA | THETA | M1 |
|--------|-------|--------|-------|
| ○ | 3.787 | 0.000 | 1.299 |
| △ | 0.024 | 15.000 | |
| ◇ | 3.637 | | |

| PARAMETRIC VALUES | | | |
|-------------------|-------|------|-------|
| ALFB | 6.000 | DX/L | 0.036 |
| I | 0.000 | | |

REFERENCE FILE

LONGITUDINAL DISTRIBUTION OF BOOSTER FUSELAGE PRESSURES

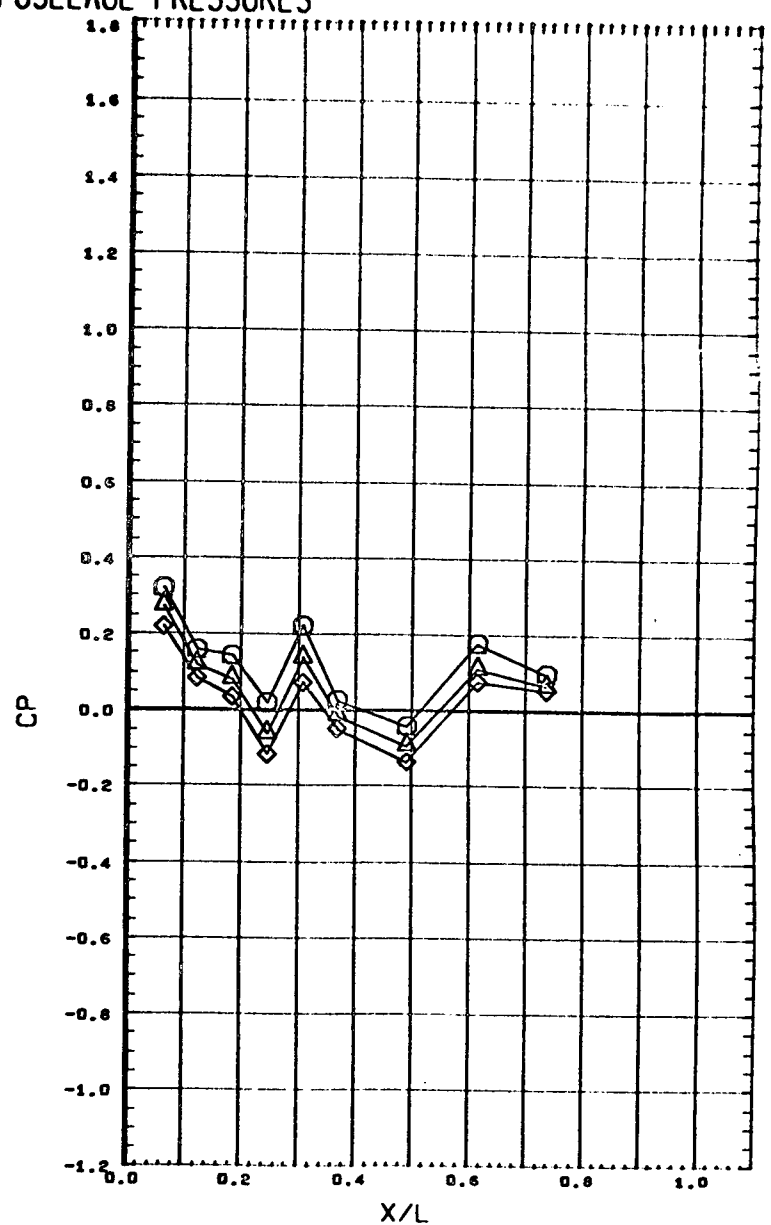
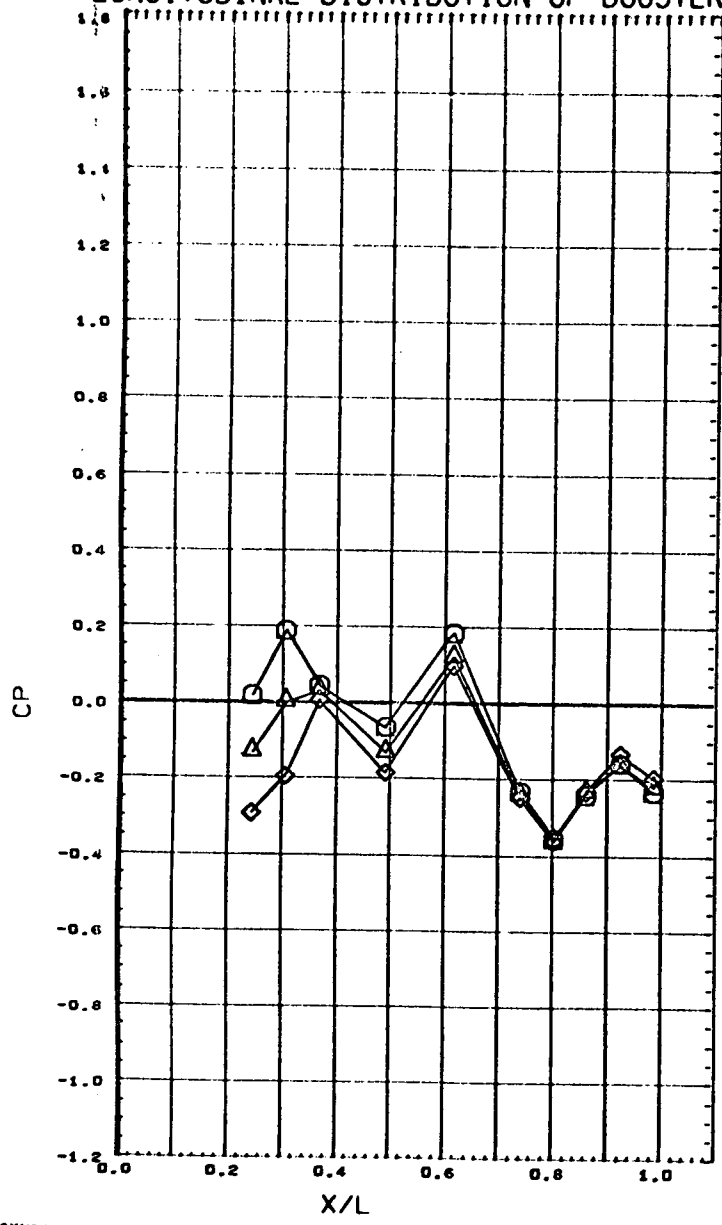

| SYMBOL | BETA | THETA | M1 |
|--------|-------|--------|-------|
| ○ | 3.787 | 24.000 | 1.299 |
| △ | 0.024 | 45.000 | |
| ◇ | 3.837 | | |

| PARAMETRIC VALUES | | |
|-------------------|-------|------------|
| ALFB | 6.000 | DX/L 0.036 |
| I | 0.000 | |

REFERENCE FILE

LONGITUDINAL DISTRIBUTION OF BOOSTER FUSELAGE PRESSURES

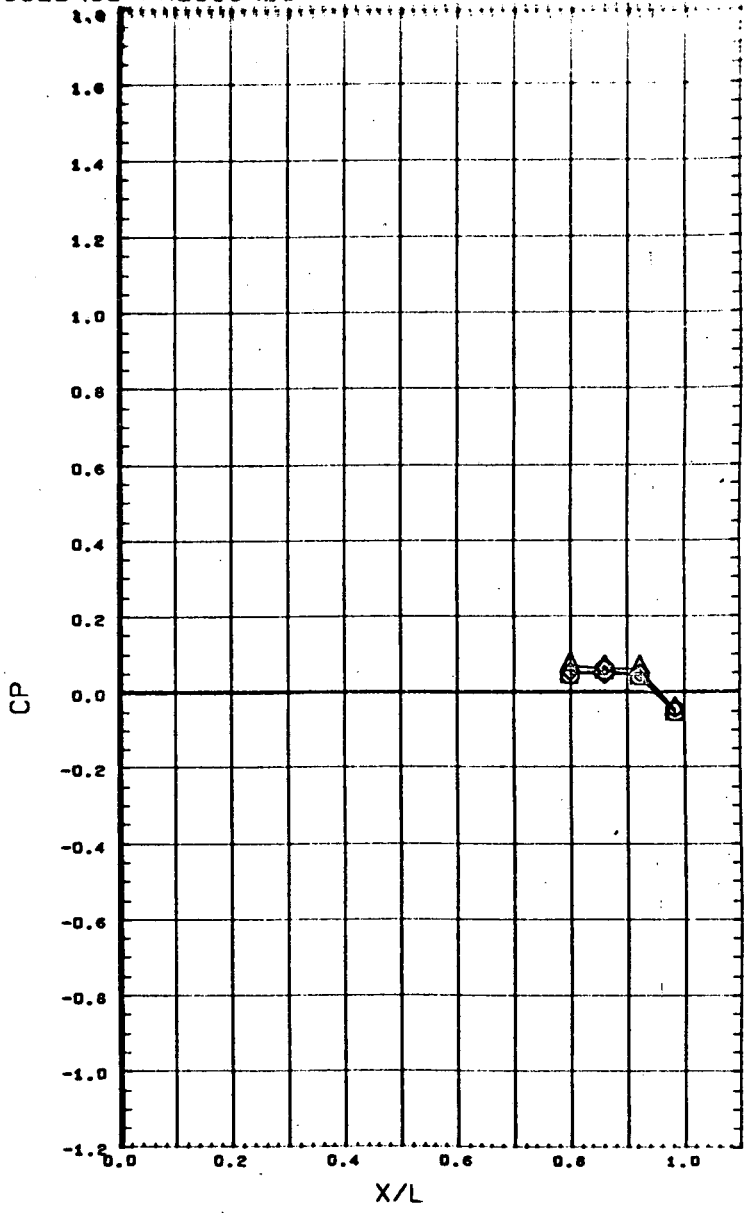
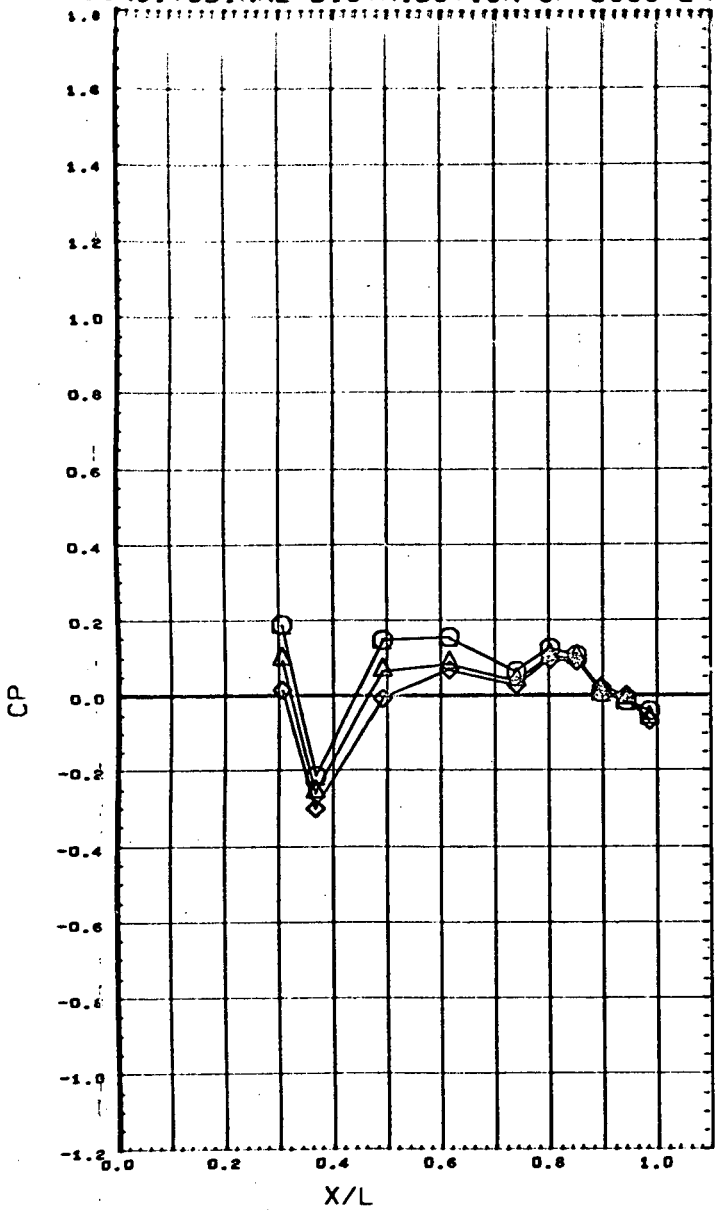

| SYMBOL | BETA | THETA | M1 |
|--------|-------|---------|-------|
| ○ | 3.787 | 90.000 | 1.299 |
| △ | 0.024 | 180.000 | |
| ◇ | 3.837 | | |

| PARAMETRIC VALUES | | |
|-------------------|-------|-------|
| ALFB | 6.000 | DX/L |
| I | 0.000 | 0.036 |

REFERENCE FILE

LONGITUDINAL DISTRIBUTION OF BOOSTER FUSELAGE PRESSURES

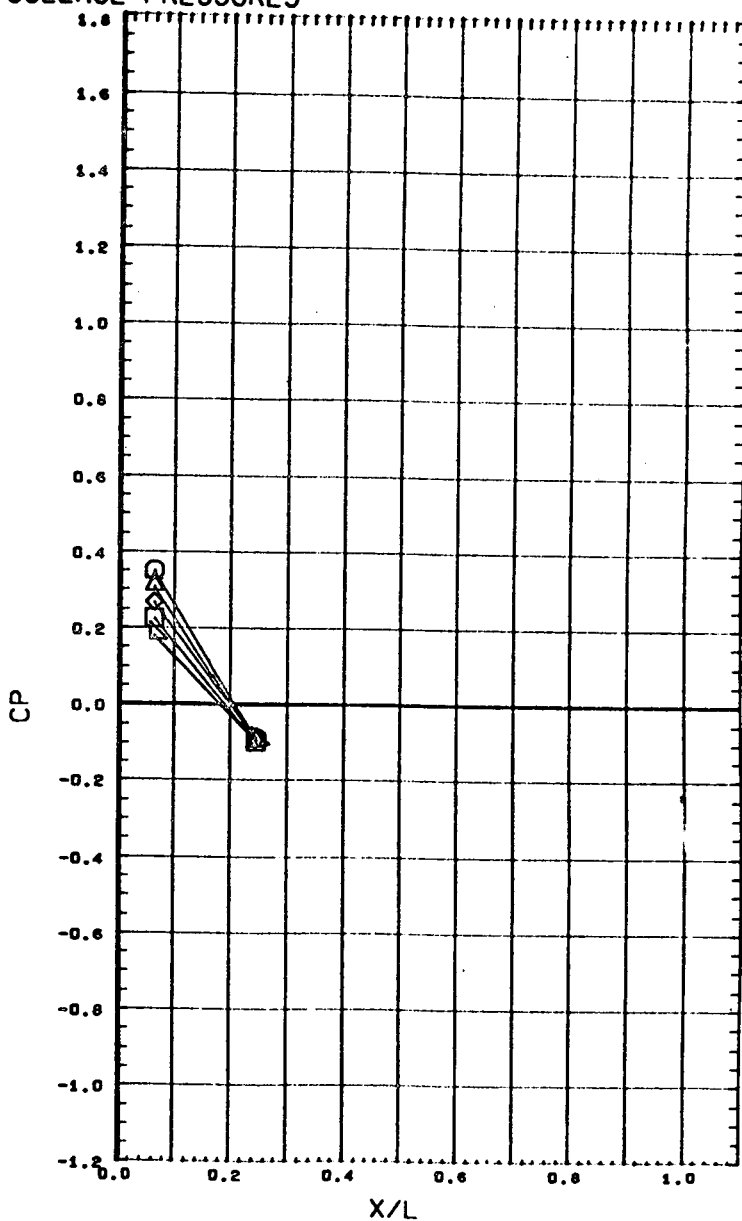
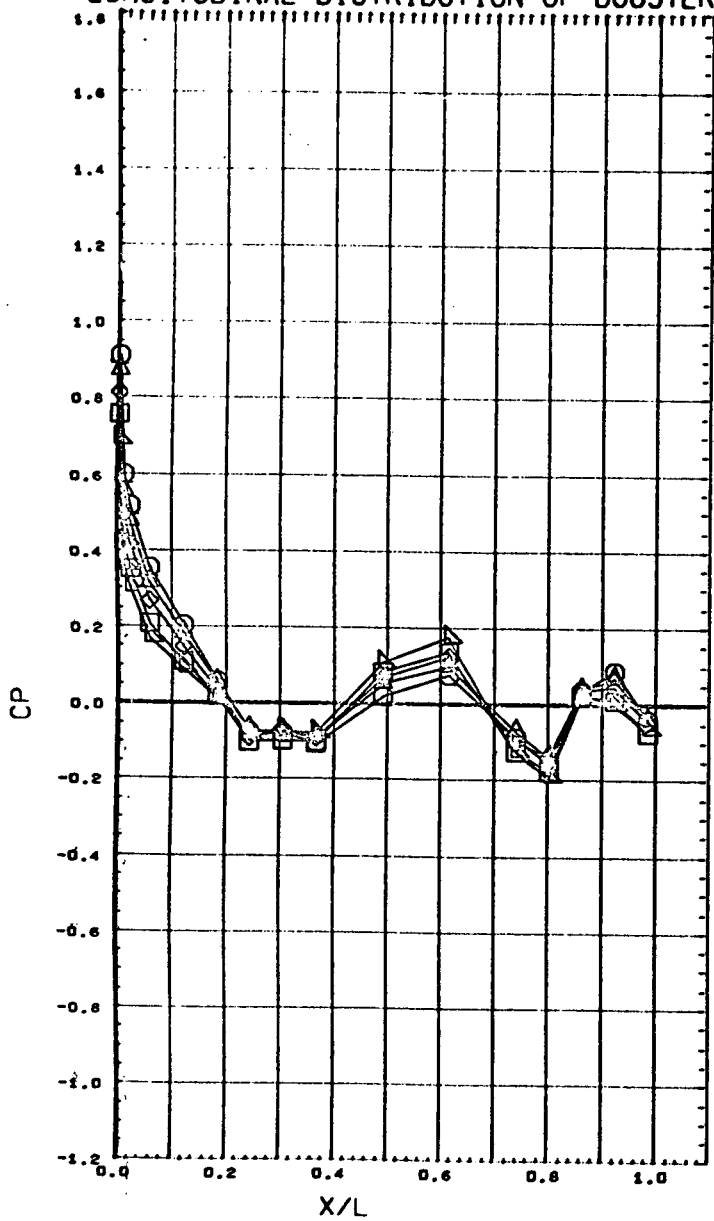

| SYMBOL | ALFA | THETA | M1 |
|--------|-------|--------|-------|
| ○ | 8.148 | 0.000 | 0.601 |
| ◇ | 6.084 | 15.000 | |
| △ | 4.017 | | |
| □ | 1.949 | | |
| | 0.119 | | |

| PARAMETRIC VALUES | | | |
|-------------------|-------|------|-------|
| BETA | 0.000 | DX/L | 0.036 |
| I | 1.900 | | |

REFERENCE FILE

LONGITUDINAL DISTRIBUTION OF BOOSTER FUSELAGE PRESSURES

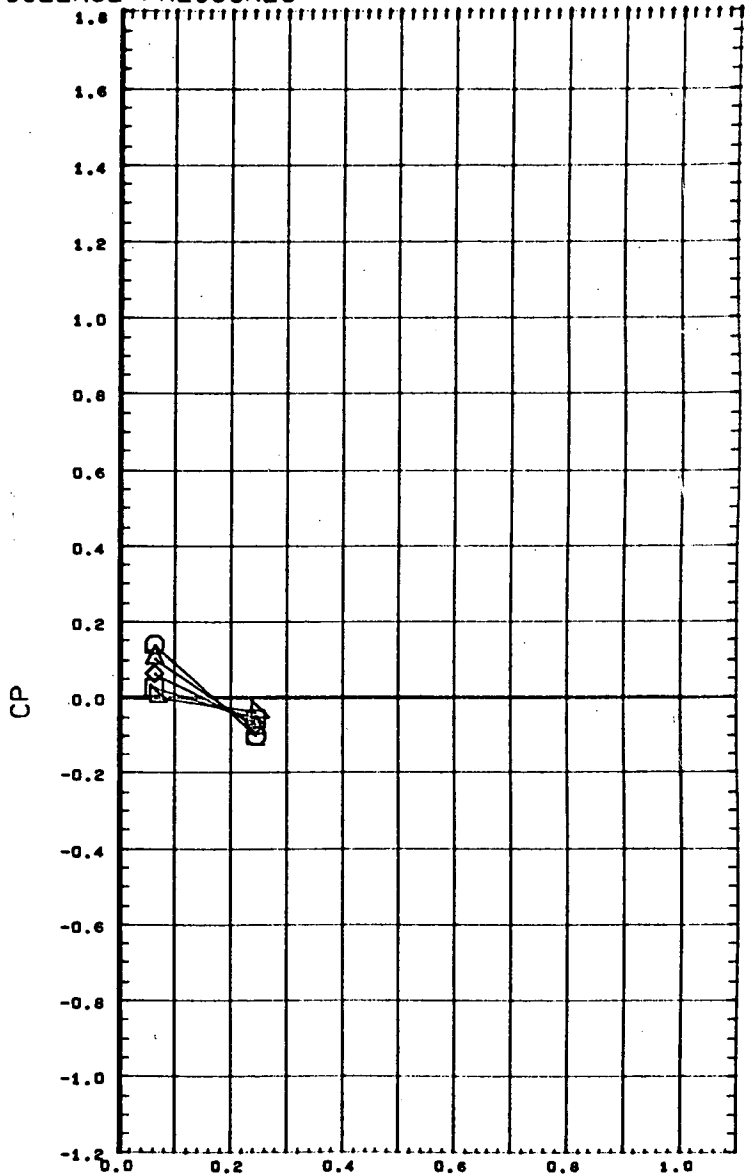
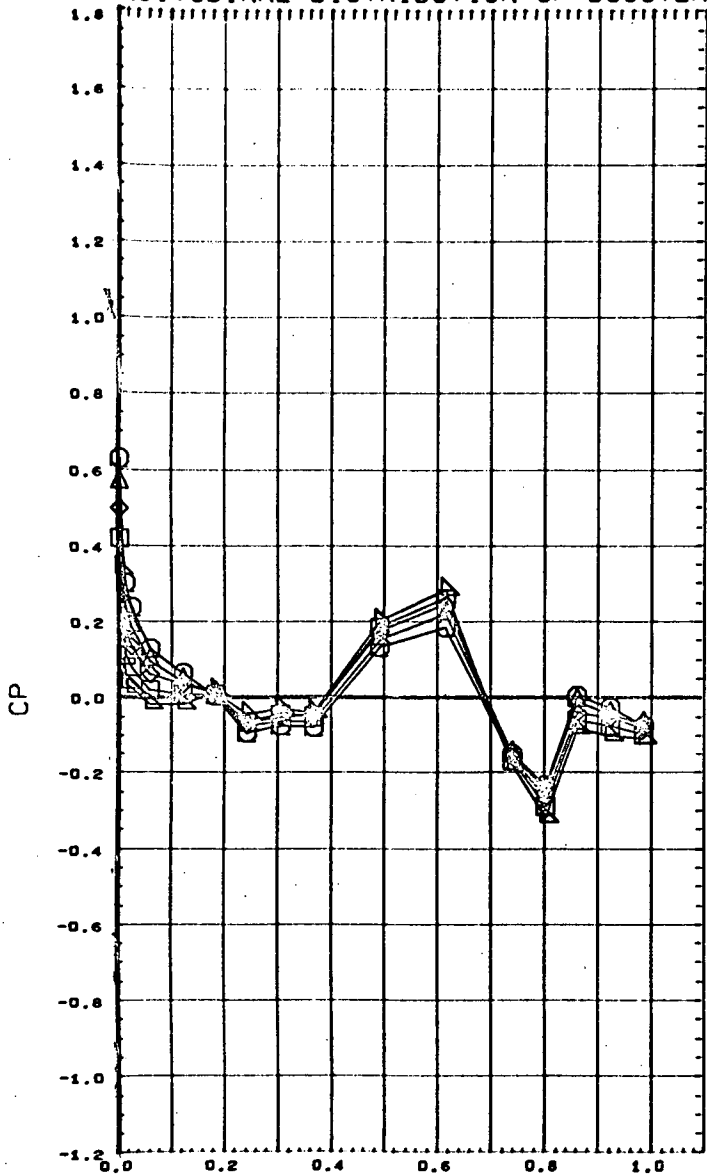

| SYMBOL | ALFB | THETA | M1 |
|--------|--------|--------|-------|
| ○ | 2.172 | 0.000 | 0.601 |
| ◇ | 4.250 | 15.000 | |
| △ | 6.291 | | |
| □ | 8.362 | | |
| ◇ | 10.431 | | |

| PARAMETRIC VALUES | | |
|-------------------|-------|-------|
| BETA | 0.000 | DX/L |
| I | 1.900 | 0.036 |

REFERENCE FILE

LONGITUDINAL DISTRIBUTION OF BOOSTER FUSELAGE PRESSURES

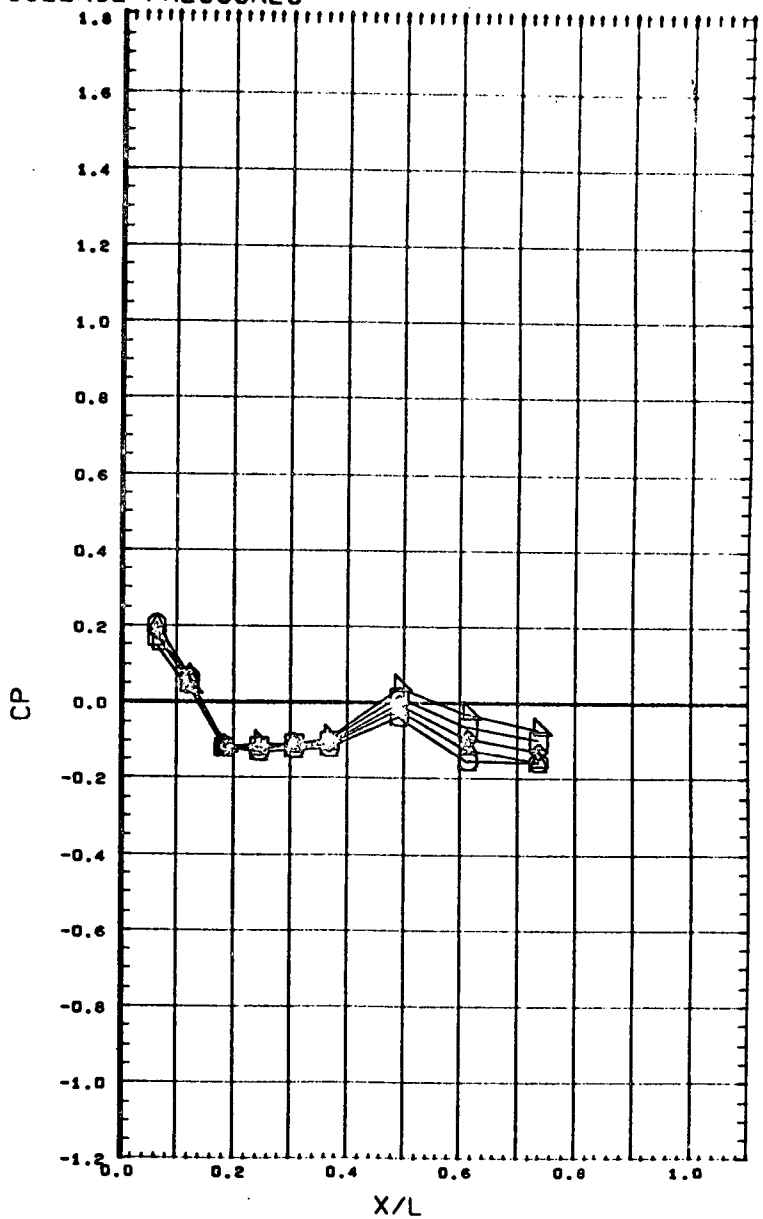
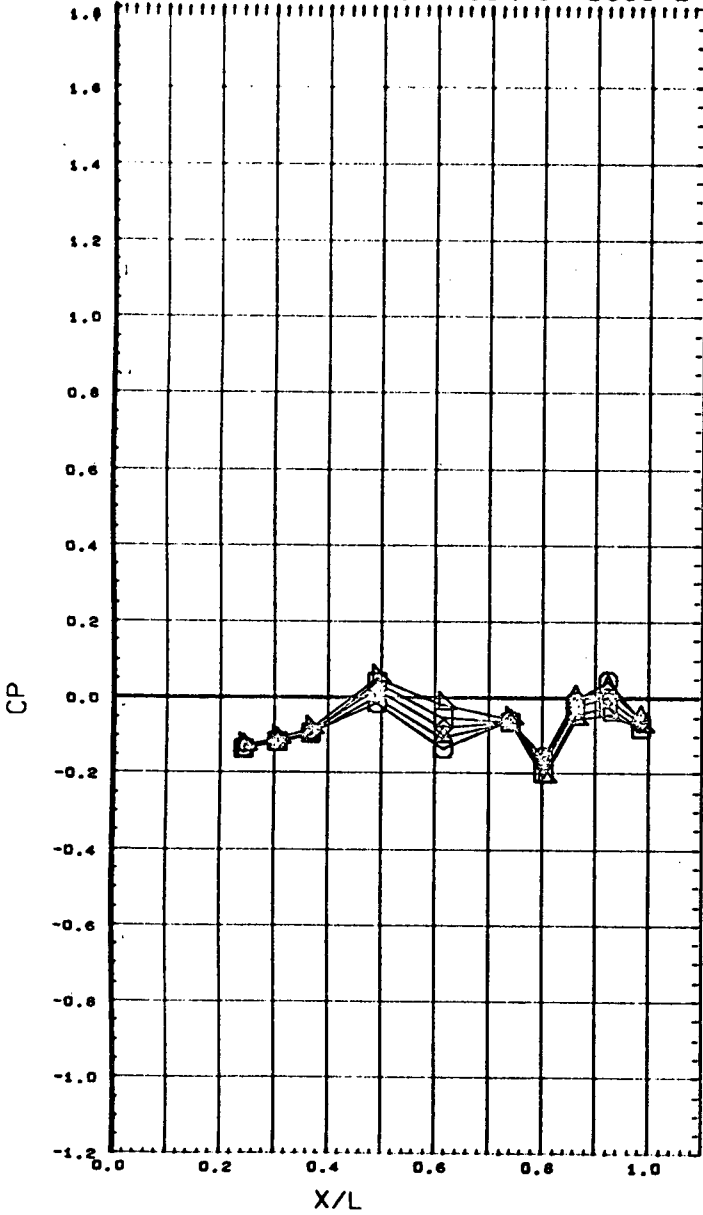

| SYMBOL | ALFB | THETA | M1 |
|--------|-------|--------|-------|
| ◇ | 8.148 | 24.000 | 0.601 |
| ◇ | 6.084 | 45.000 | |
| ◇ | 4.017 | | |
| ◇ | 1.949 | | |
| ◇ | 0.119 | | |

| PARAMETRIC VALUES | | |
|-------------------|-------|-------|
| BETA | 0.000 | DX/L |
| I | 1.900 | 0.036 |

REFERENCE FILE

LONGITUDINAL DISTRIBUTION OF BOOSTER FUSELAGE PRESSURES

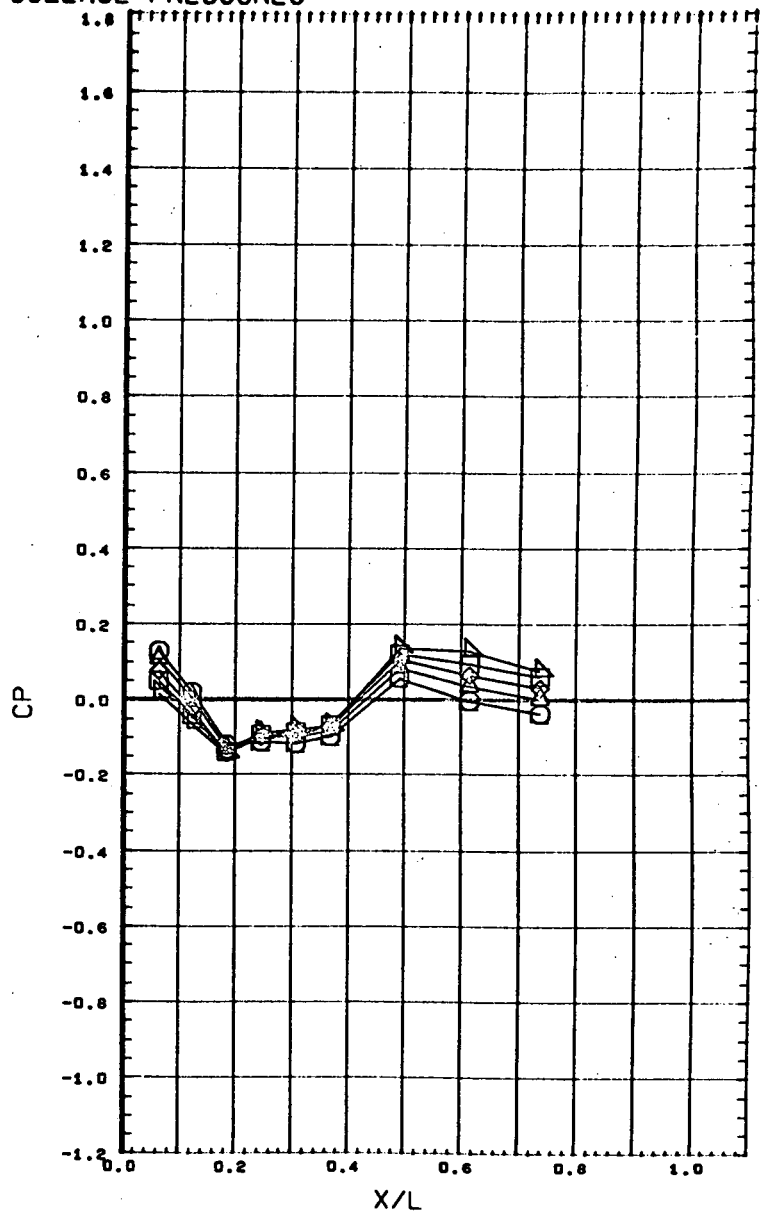
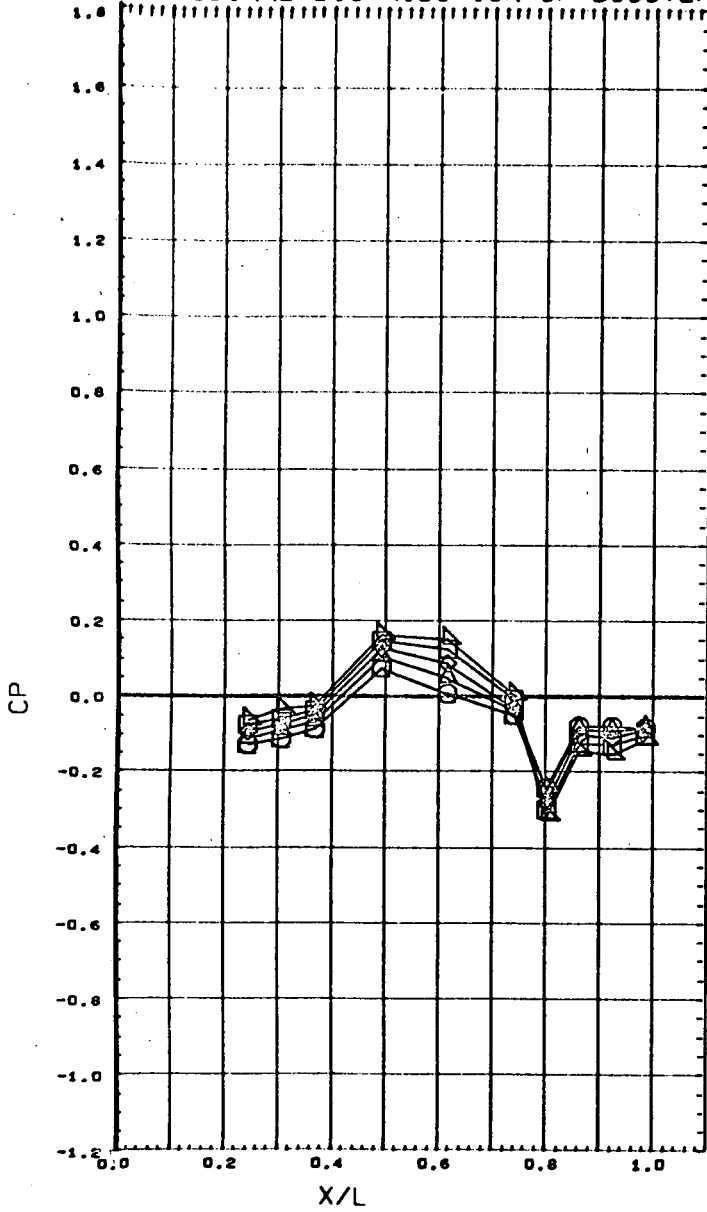

| SYMBOL | ALFB | THETA | M1 |
|--------|--------|--------|-------|
| ○ | 2.172 | 24.000 | 0.601 |
| ◇ | 4.250 | 45.000 | |
| △ | 6.291 | | |
| □ | 8.362 | | |
| ◇ | 10.431 | | |

| PARAMETRIC VALUES | | |
|-------------------|-------|-------|
| BETA | 0.000 | DX/L |
| I | 1.900 | 0.036 |

REFERENCE FILE

LONGITUDINAL DISTRIBUTION OF BOOSTER FUSELAGE PRESSURES

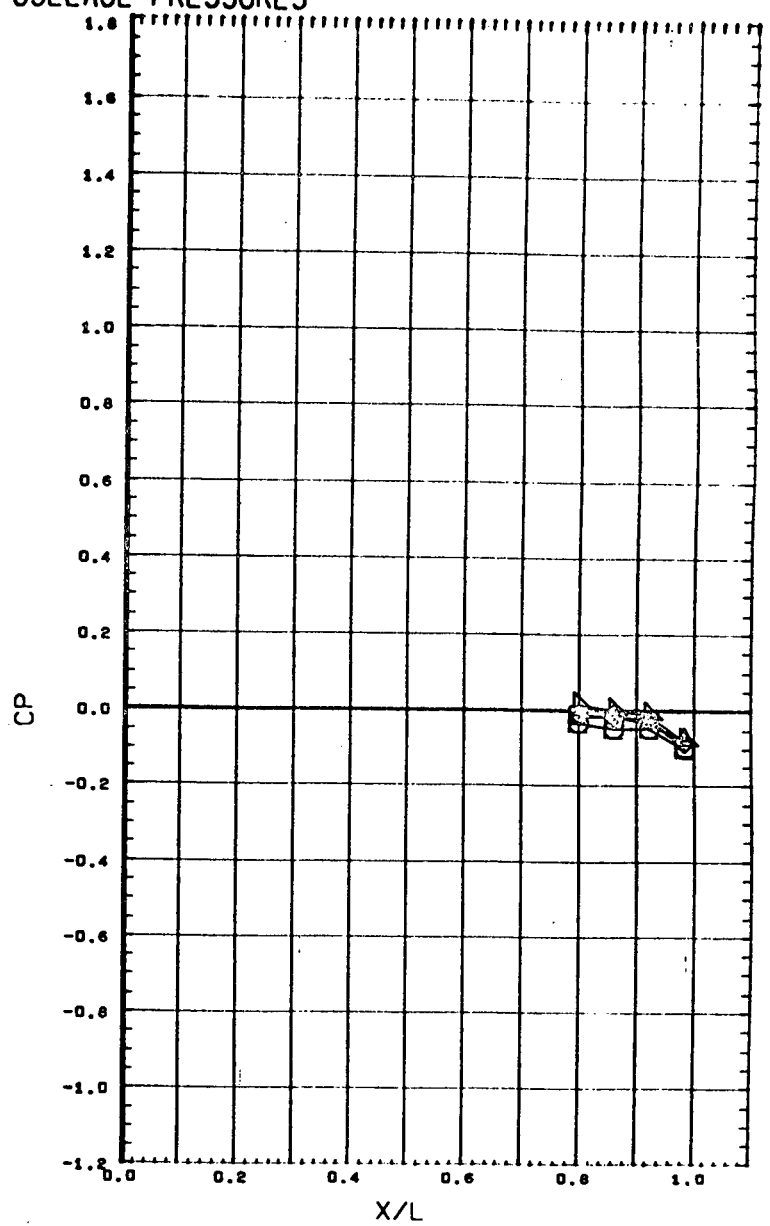
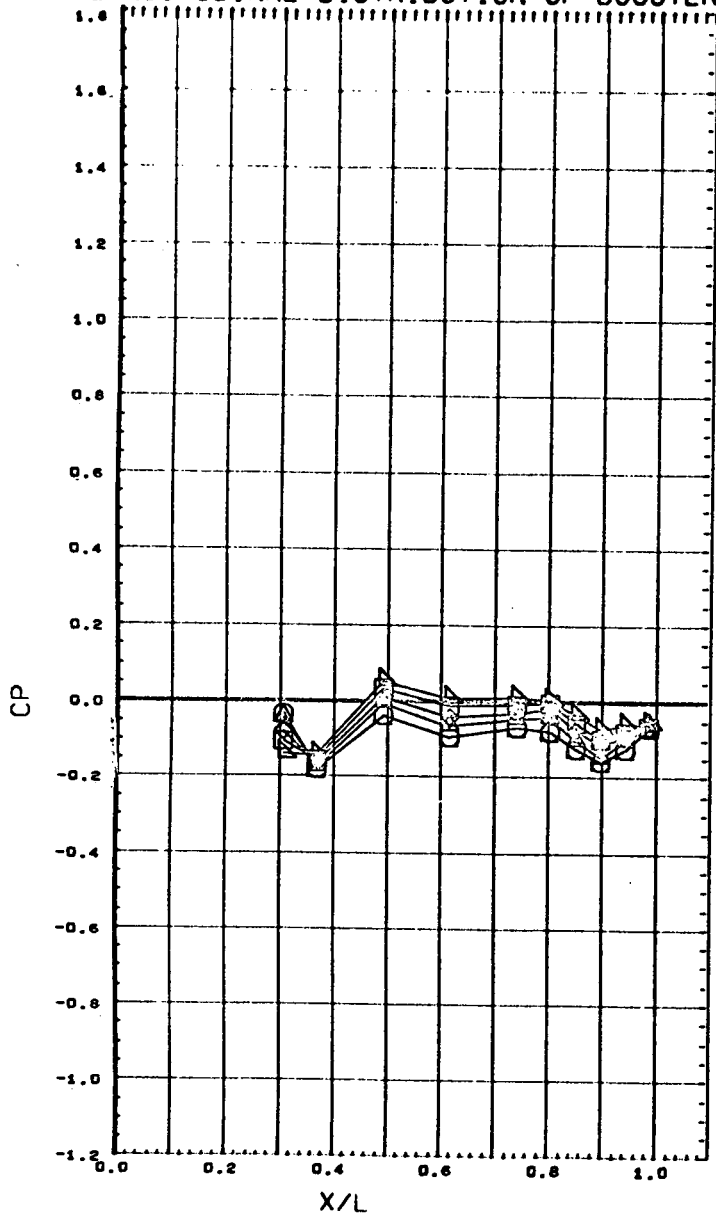

| SYMBOL | ALFB | THETA | M1 |
|--------|-------|---------|-------|
| ○ | 8.148 | 90.000 | 0.601 |
| △ | 6.084 | 180.000 | |
| ◇ | 4.017 | | |
| □ | 1.949 | | |
| ▽ | 0.119 | | |

REFERENCE FILE

| PARAMETRIC VALUES | | | |
|-------------------|-------|------|-------|
| BETA | 0.000 | DX/L | 0.036 |
| I | 1.900 | | |

LONGITUDINAL DISTRIBUTION OF BOOSTER FUSELAGE PRESSURES

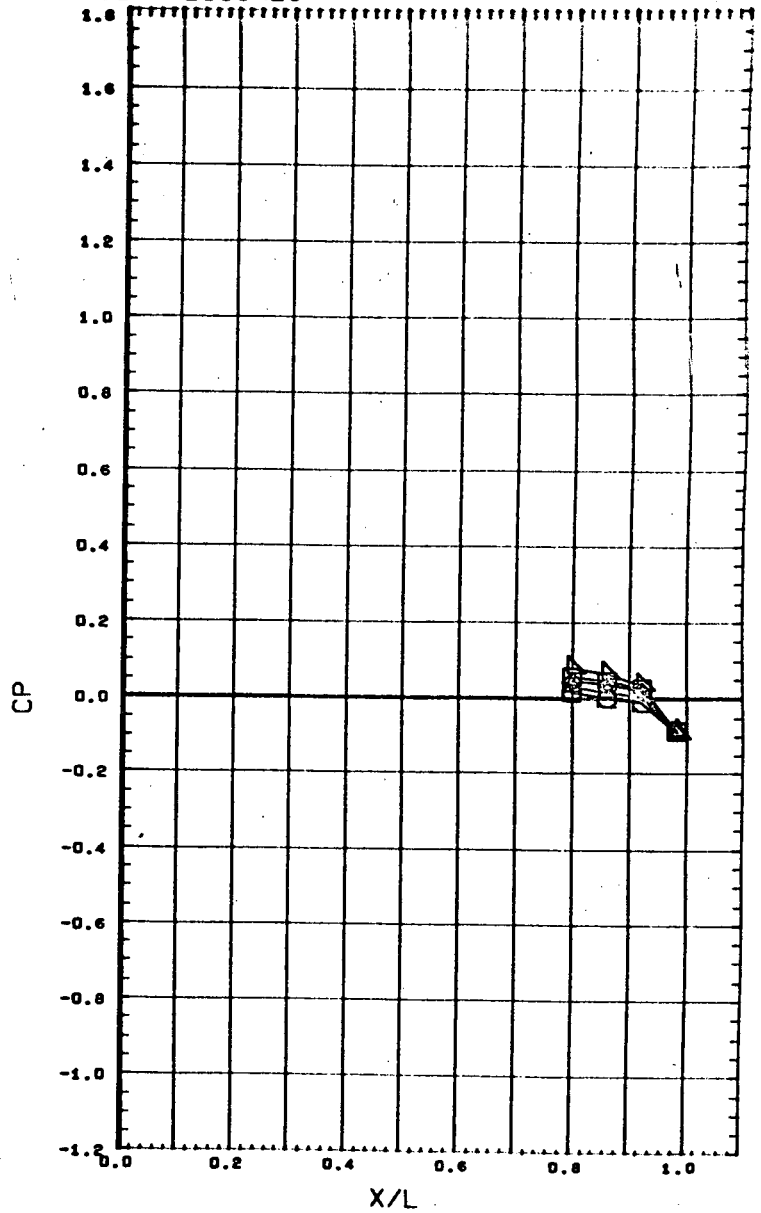
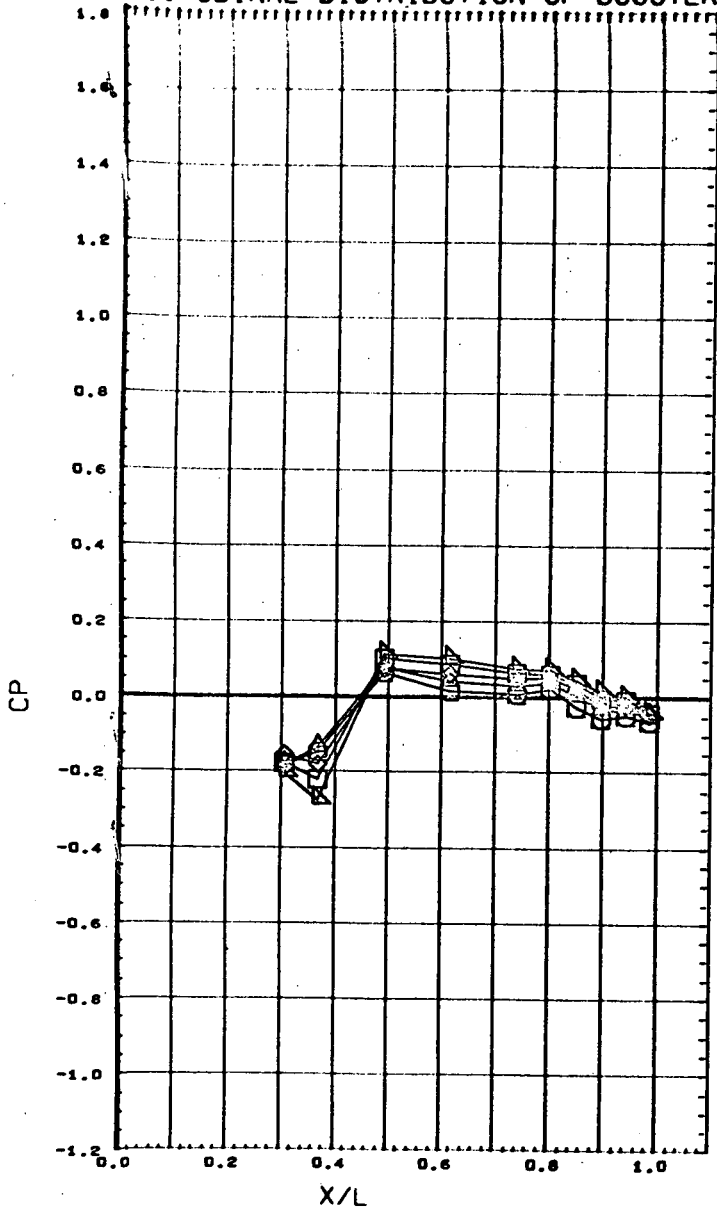

| SYMBOL | ALFB | THETA | M1 |
|--------|--------|---------|-------|
| ○ | 2.172 | 90.000 | 0.601 |
| ◇ | 4.250 | 180.000 | |
| △ | 6.291 | | |
| □ | 8.362 | | |
| ◇ | 10.431 | | |

REFERENCE FILE

| PARAMETRIC VALUES | | |
|-------------------|-------|-------|
| BETA | 0.000 | DX/L |
| I | 1.900 | 0.036 |

LONGITUDINAL DISTRIBUTION OF BOOSTER FUSELAGE PRESSURES

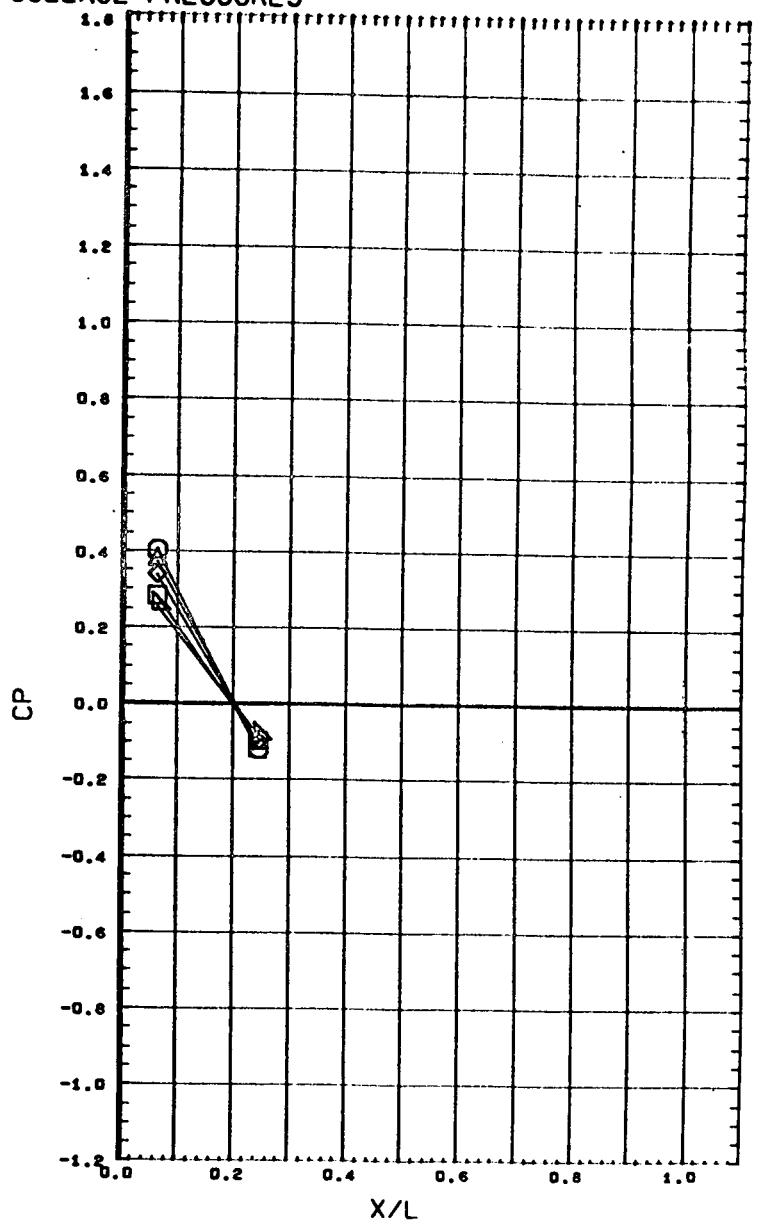
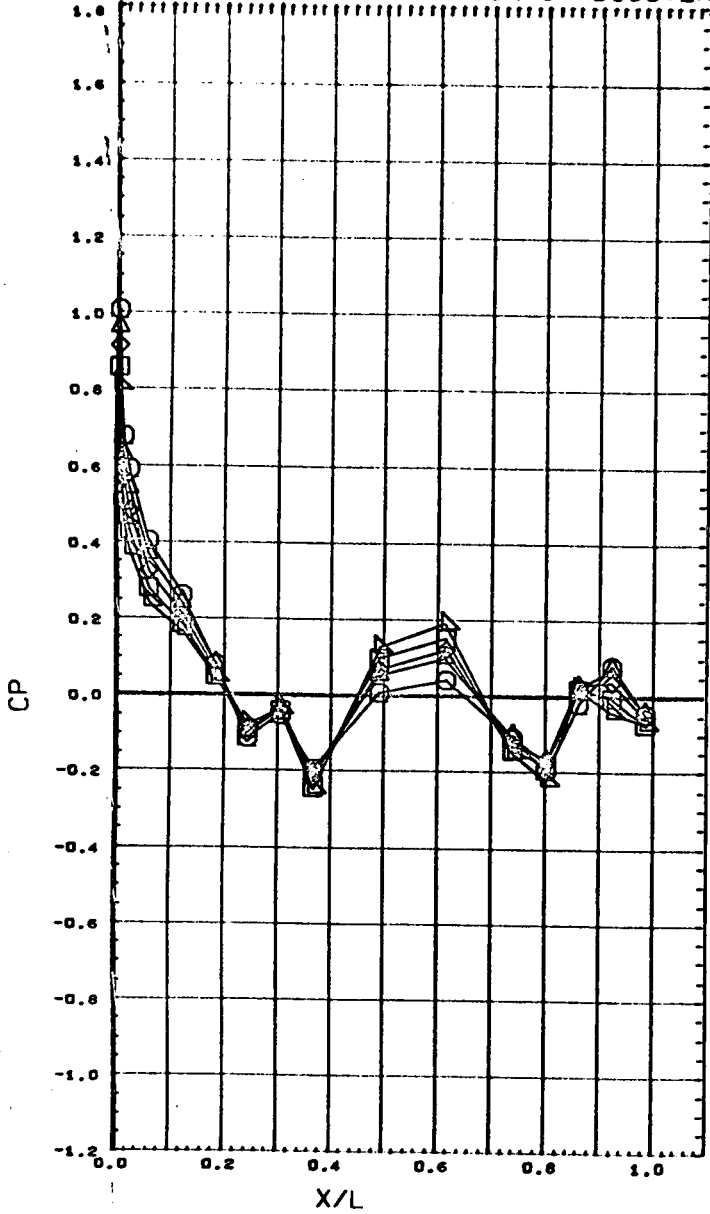

| SYMBOL | ALFB | THETA | M1 |
|--------|-------|--------|-------|
| ○ | 8.279 | 0.000 | 0.903 |
| ◇ | 5.812 | 15.000 | |
| △ | 3.826 | | |
| □ | 1.834 | | |
| ▽ | 0.163 | | |

| PARAMETRIC VALUES | | | |
|-------------------|-------|------|-------|
| BETA | 0.000 | DX/L | 0.036 |
| I | 1.900 | | |

REFERENCE FILE

LONGITUDINAL DISTRIBUTION OF BOOSTER FUSELAGE PRESSURES

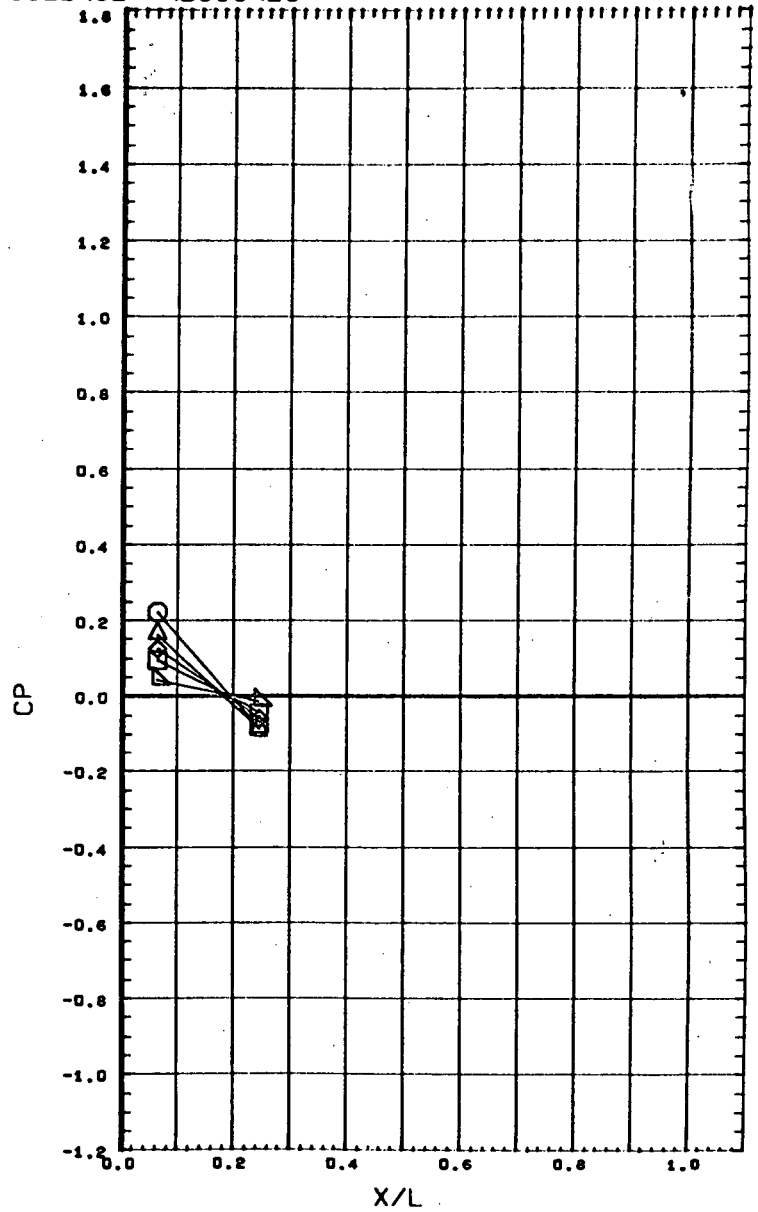
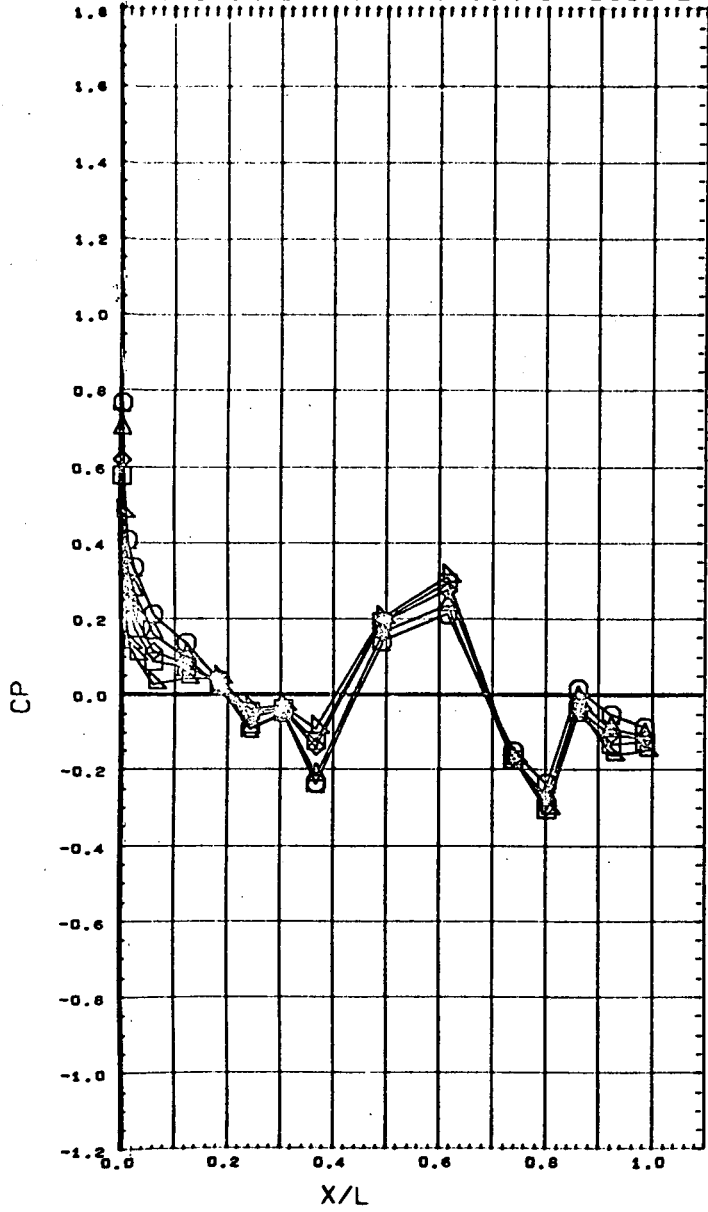

| SYMBOL | ALFB | THETA | M1 |
|--------|--------|--------|-------|
| ○ | 1.553 | 0.000 | 0.903 |
| △ | 3.751 | 15.000 | |
| ◇ | 6.149 | | |
| □ | 7.558 | | |
| ▽ | 10.169 | | |

| PARAMETRIC VALUES | | | |
|-------------------|-------|------|-------|
| BETA | 0.000 | DX/L | 0.036 |
| I | 1.900 | | |

REFERENCE FILE

LONGITUDINAL DISTRIBUTION OF BOOSTER FUSELAGE PRESSURES

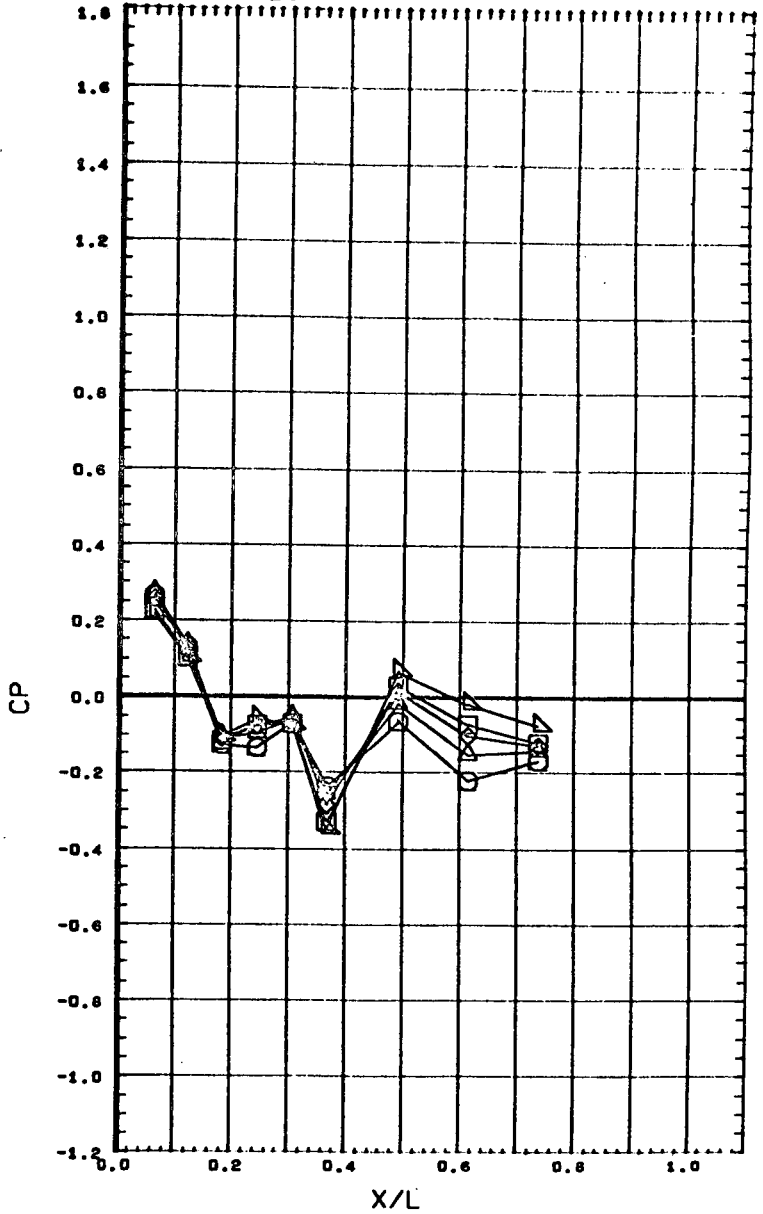
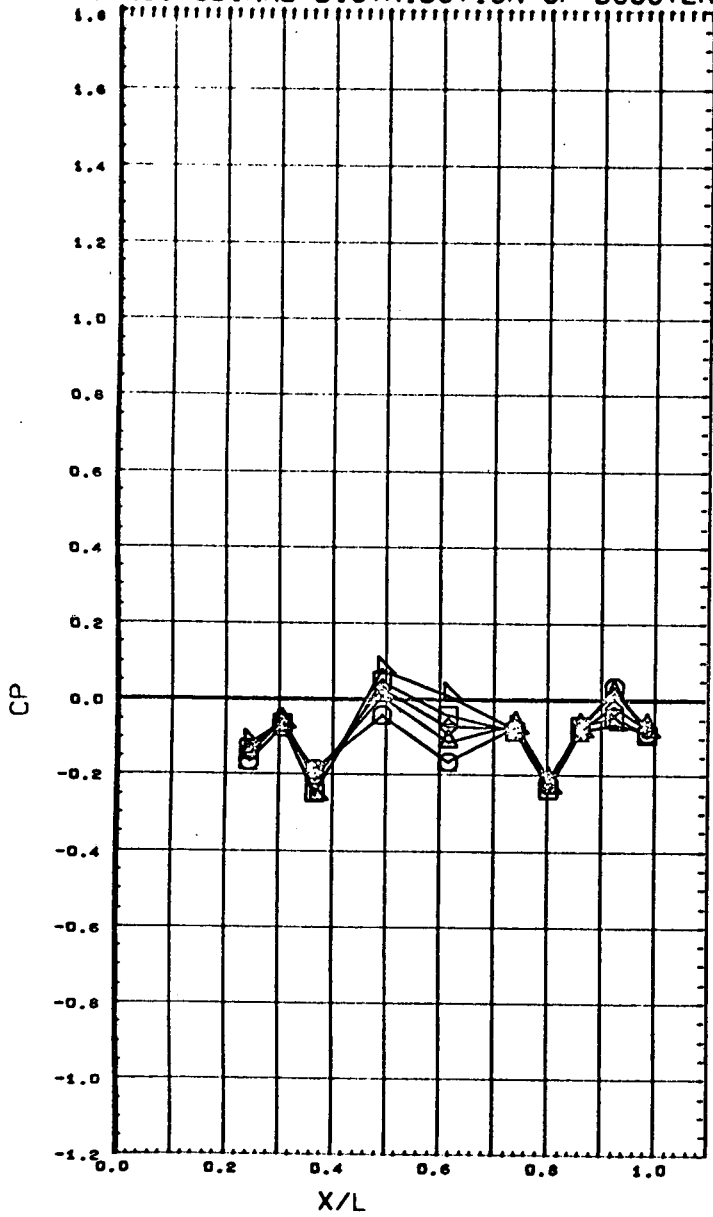

| SYMBOL | ALFB | THETA | M1 |
|--------|---------|--------|-------|
| ○ | - 8.279 | 24.000 | 0.903 |
| △ | - 5.812 | 45.000 | |
| ◇ | - 3.826 | | |
| □ | - 1.834 | | |
| ▽ | 0.163 | | |

| PARAMETRIC VALUES | | | |
|-------------------|-------|------|-------|
| BETA | 0.000 | DX/L | 0.036 |
| I | 1.900 | | |

REFERENCE FILE

LONGITUDINAL DISTRIBUTION OF BOOSTER FUSELAGE PRESSURES

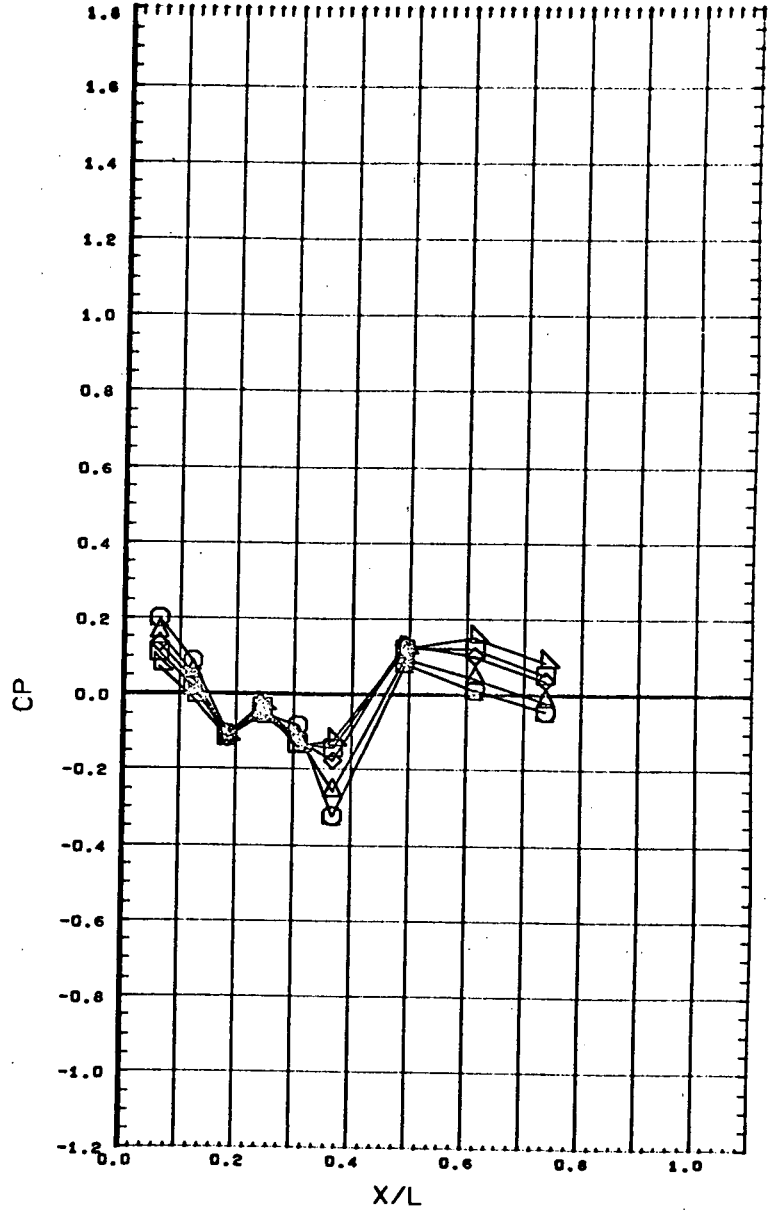
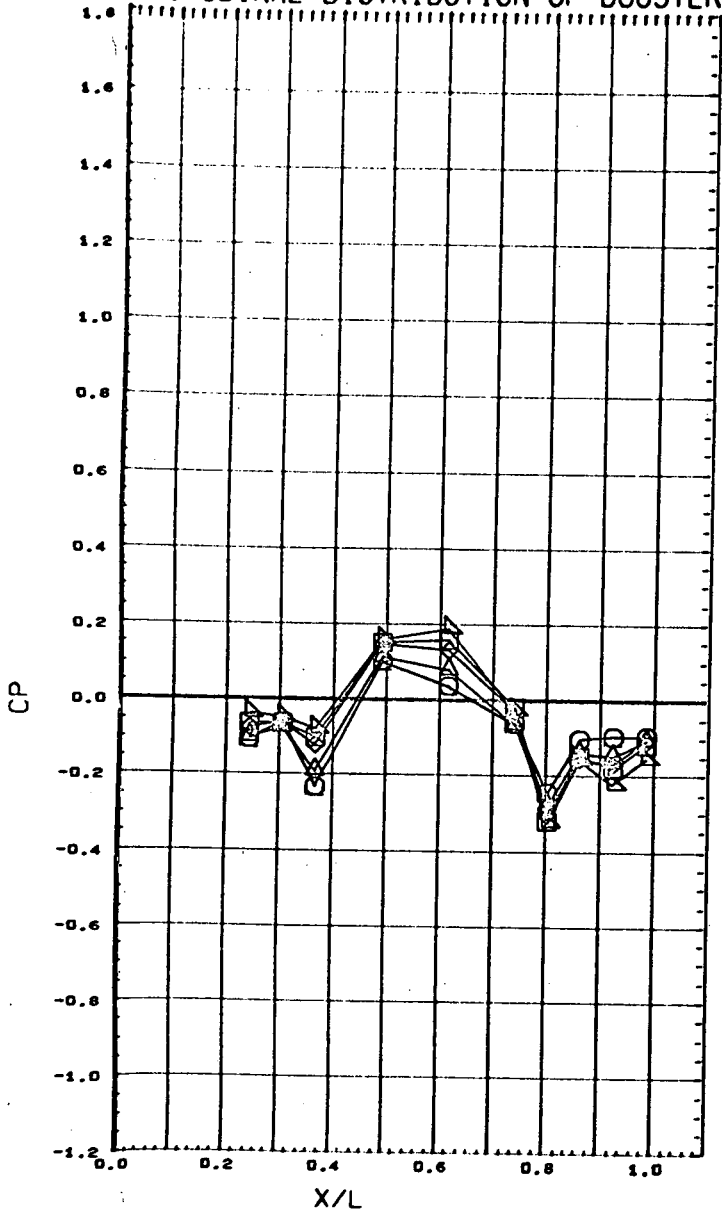

| SYMBOL | ALFB | THETA | M1 |
|--------|--------|--------|-------|
| ○ | 11.553 | 24.000 | 0.903 |
| △ | 3.751 | 45.000 | |
| ◇ | 6.149 | | |
| □ | 7.558 | | |
| ○ | 10.169 | | |

REFERENCE FILE

| PARAMETRIC VALUES | | |
|-------------------|-------|-------|
| BETA | 0.000 | 0X/L |
| I | 1.900 | 0.036 |

LONGITUDINAL DISTRIBUTION OF BOOSTER FUSELAGE PRESSURES

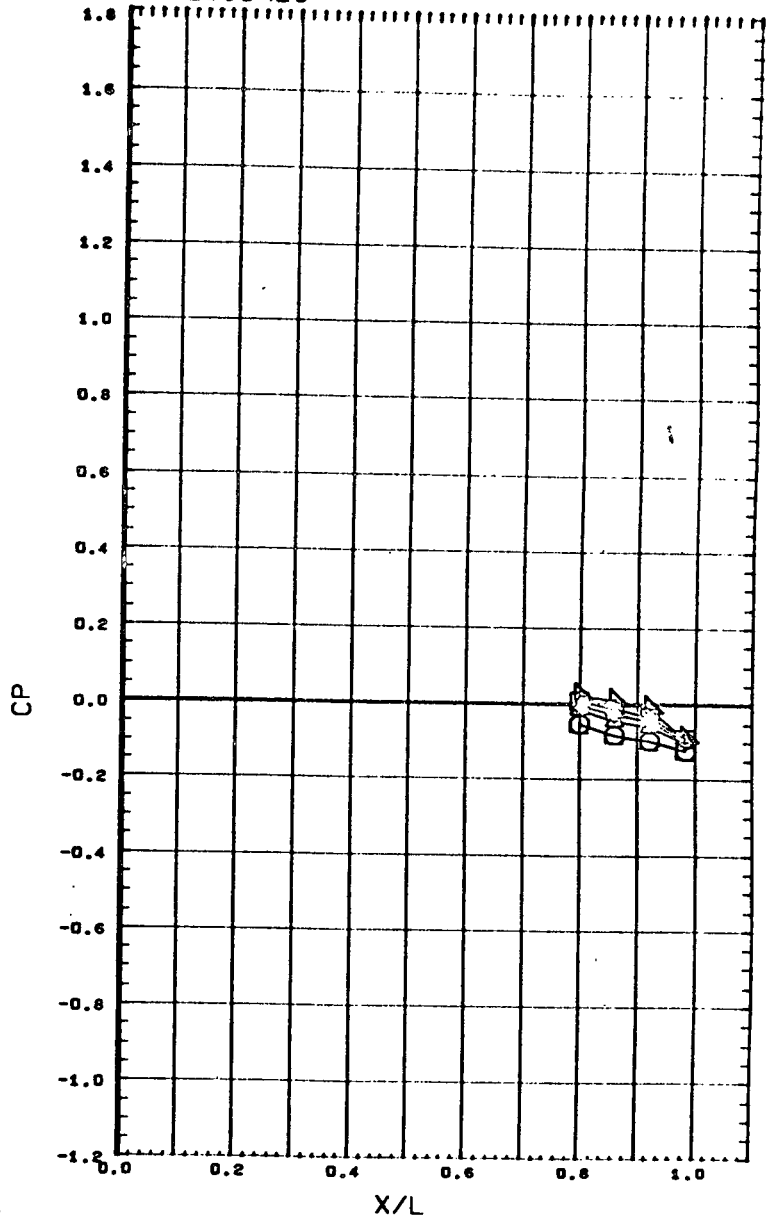
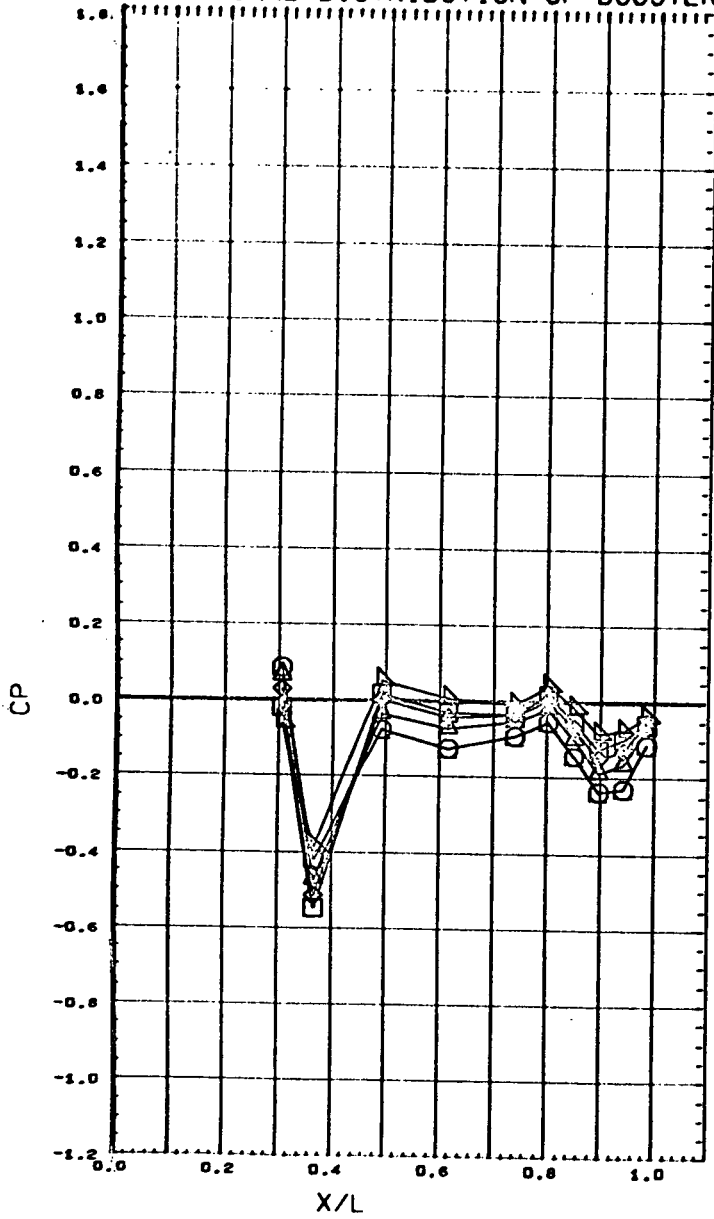

| SYMBOL | ALFB | THETA | M1 |
|--------|-------|---------|-------|
| ○ | 8.279 | 90.000 | 0.903 |
| ◇ | 5.812 | 180.000 | |
| △ | 3.826 | | |
| □ | 1.834 | | |
| ▽ | 0.163 | | |

| PARAMETRIC VALUES | | | |
|-------------------|-------|------|-------|
| BETA | 0.000 | DX/L | 0.036 |
| I | 1.900 | | |

REFERENCE FILE

LONGITUDINAL DISTRIBUTION OF BOOSTER FUSELAGE PRESSURES

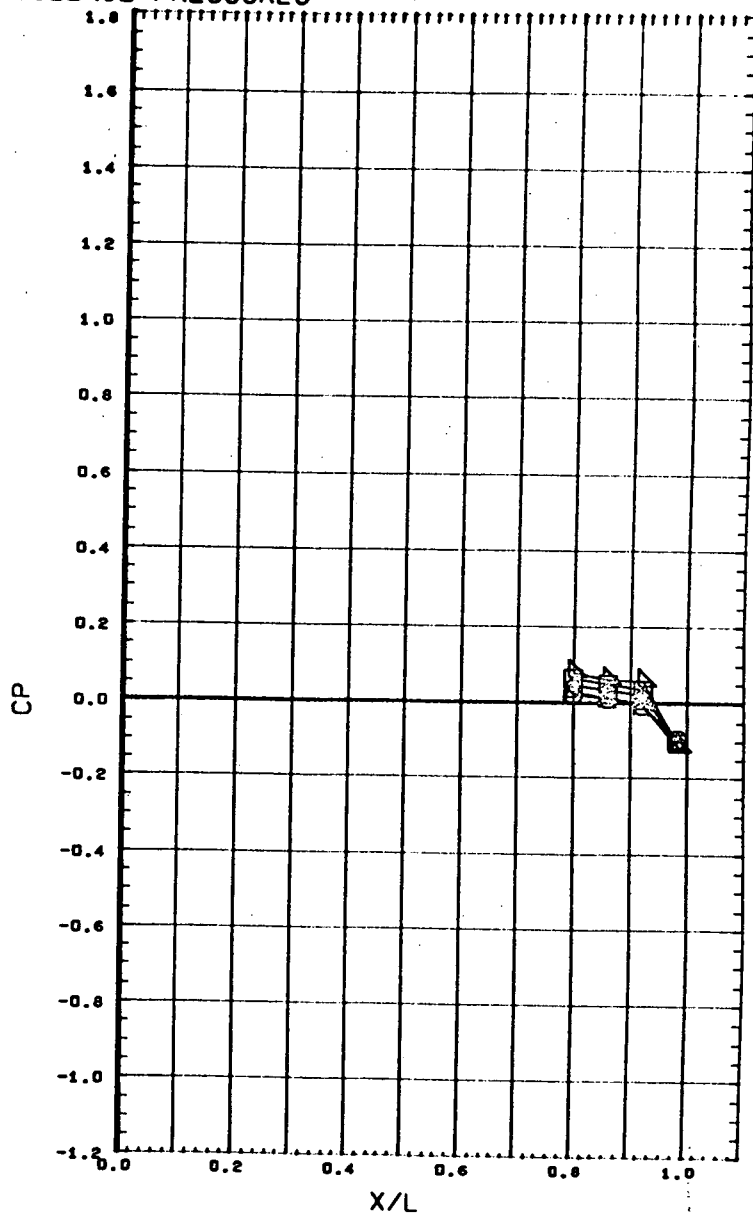
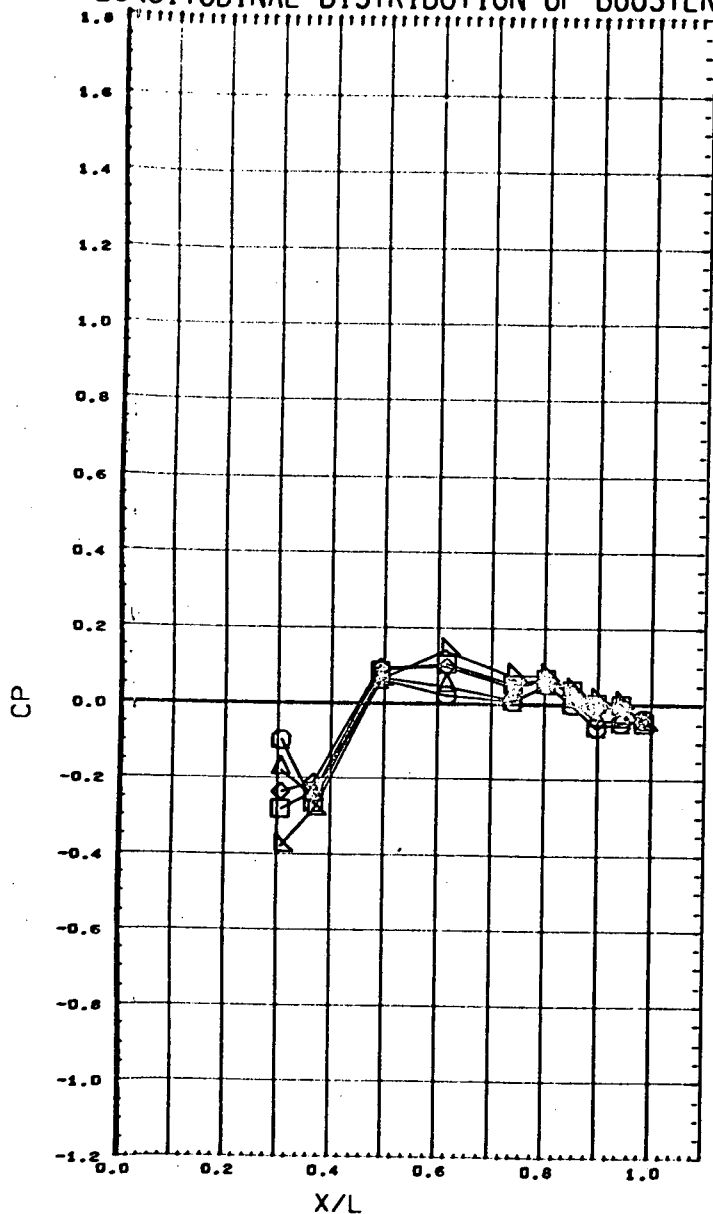

| SYMBOL | ALFB | THETA | M1 |
|--------|--------|---------|-------|
| ○ | 1.553 | 90.000 | 0.903 |
| ◇ | 3.751 | 180.000 | |
| △ | 6.149 | | |
| □ | 7.558 | | |
| ▽ | 10.169 | | |

REFERENCE FILE

| PARAMETRIC VALUES | | | |
|-------------------|-------|------|-------|
| BETA | 0.000 | DX/L | 0.036 |
| I | 1.900 | | |

LONGITUDINAL DISTRIBUTION OF BOOSTER FUSELAGE PRESSURES

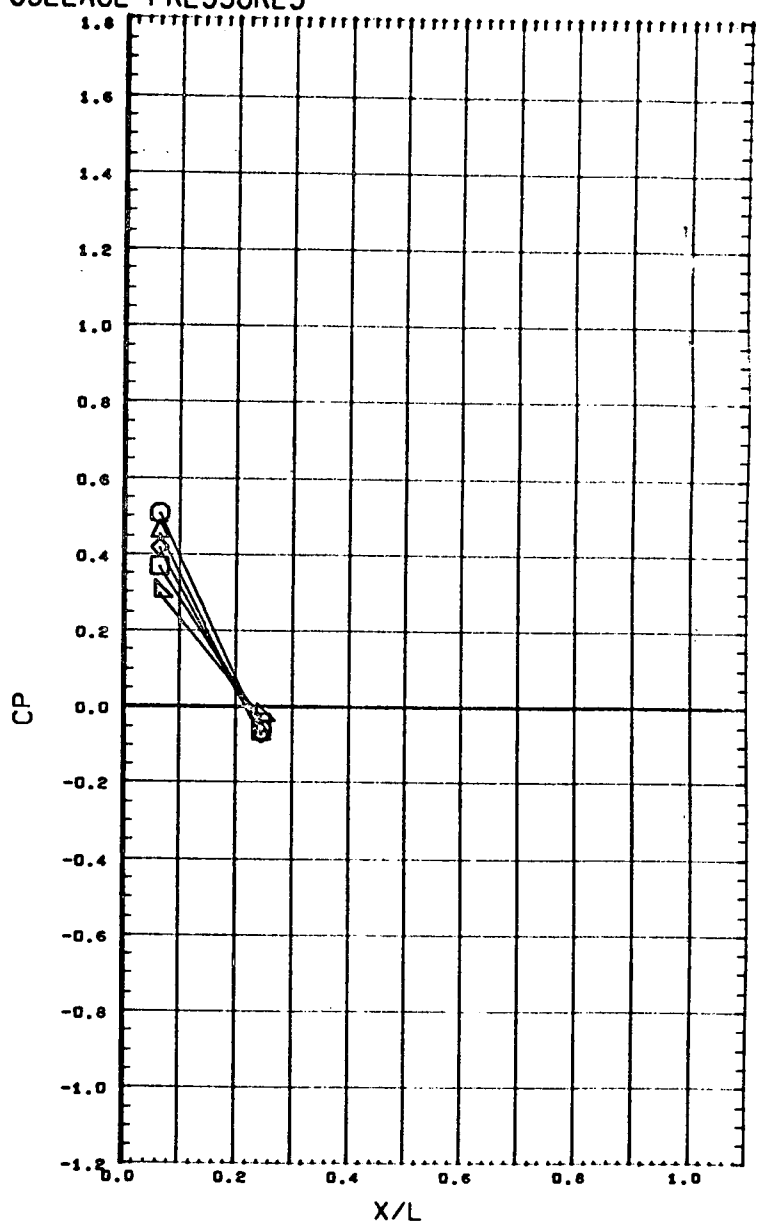
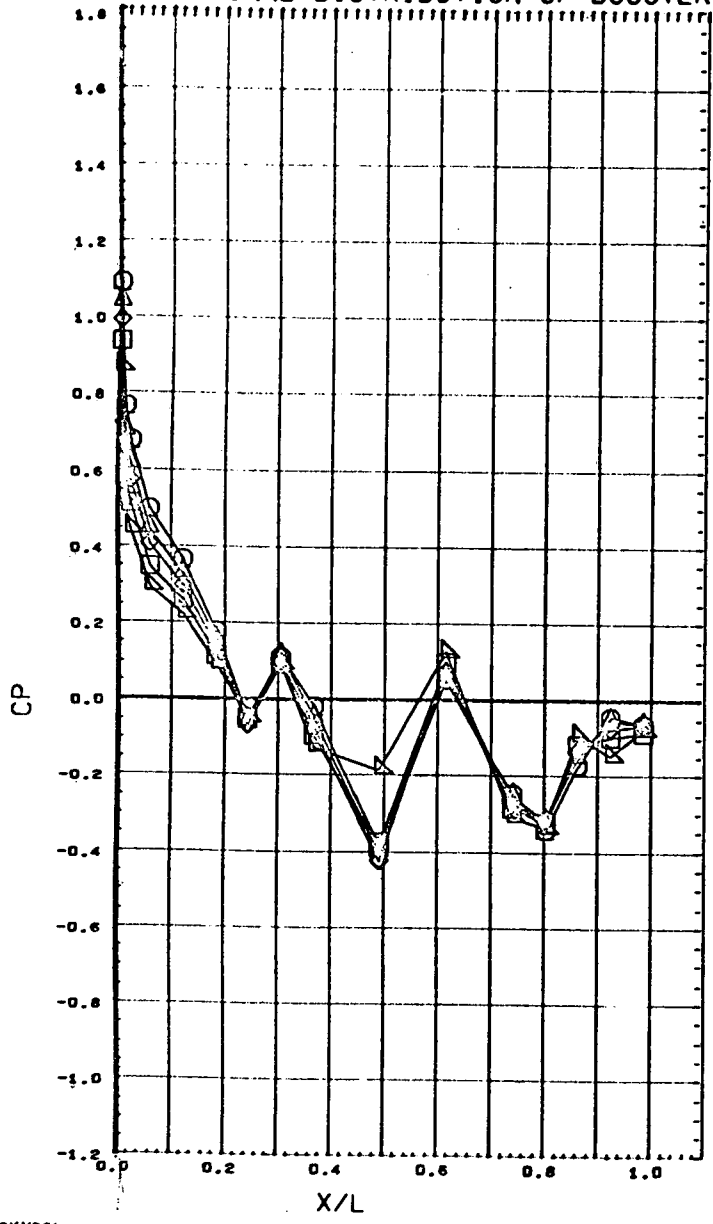

| SYMBOL | ALFB | THETA | M1 |
|--------|---------|--------|-------|
| ○ | - 7.909 | 0.000 | 1.004 |
| △ | - 5.810 | 15.000 | |
| ◇ | - 4.434 | | |
| □ | - 2.210 | | |
| ○ | 0.226 | | |

| PARAMETRIC VALUES | | | |
|-------------------|-------|------|-------|
| BETA | 0.000 | DX/L | 0.036 |
| I | 1.900 | | |

REFERENCE FILE

LONGITUDINAL DISTRIBUTION OF BOOSTER FUSELAGE PRESSURES

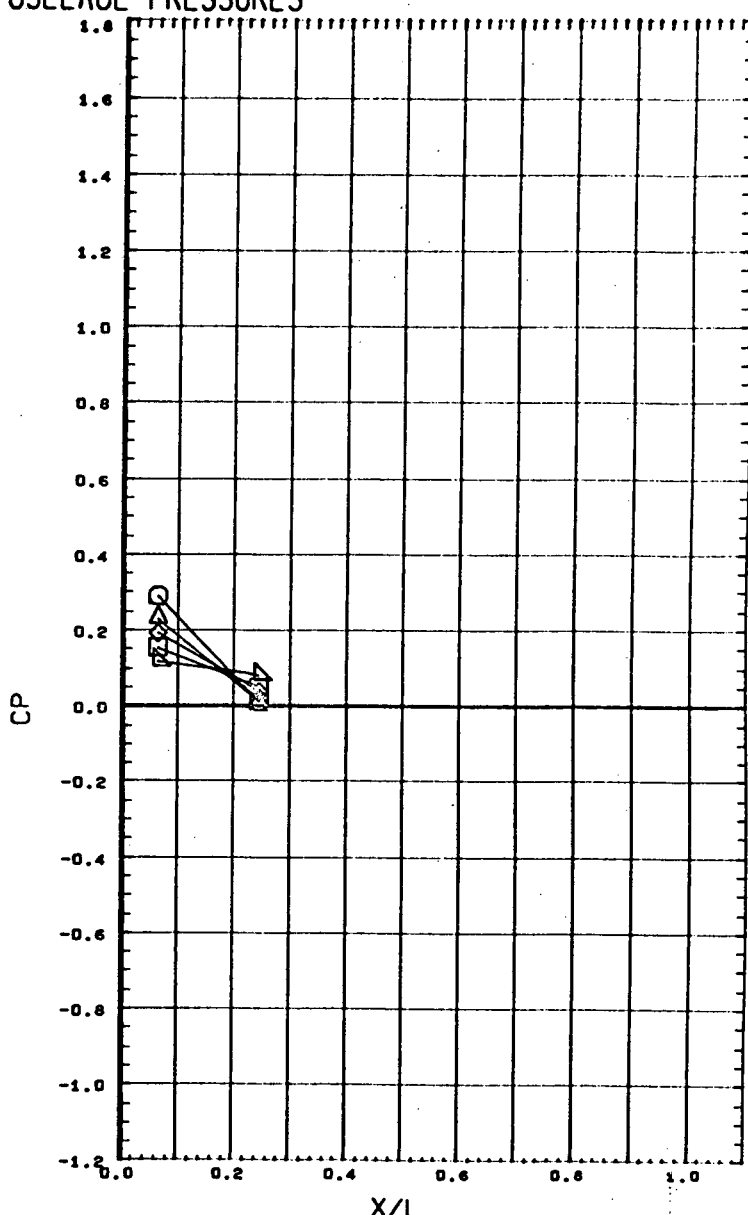
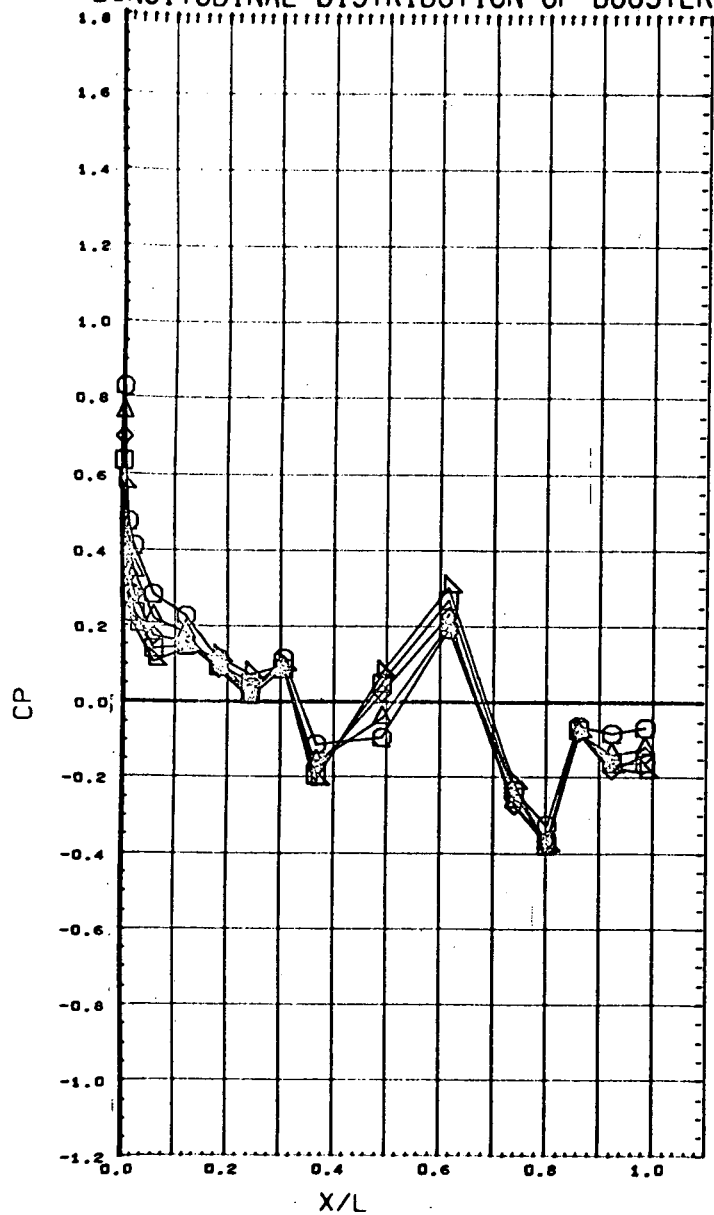

| SYMBOL | ALFB | THETA | M1 |
|--------|--------|--------|-------|
| ○ | 2.167 | 0.000 | 1.004 |
| △ | 4.154 | 15.000 | |
| ◇ | 6.134 | | |
| □ | 8.144 | | |
| ◇ | 10.153 | | |

REFERENCE FILE

| PARAMETRIC VALUES | | | |
|-------------------|-------|------|-------|
| BETA | 0.000 | DX/L | 0.036 |
| I | 1.900 | | |

LONGITUDINAL DISTRIBUTION OF BOOSTER FUSELAGE PRESSURES

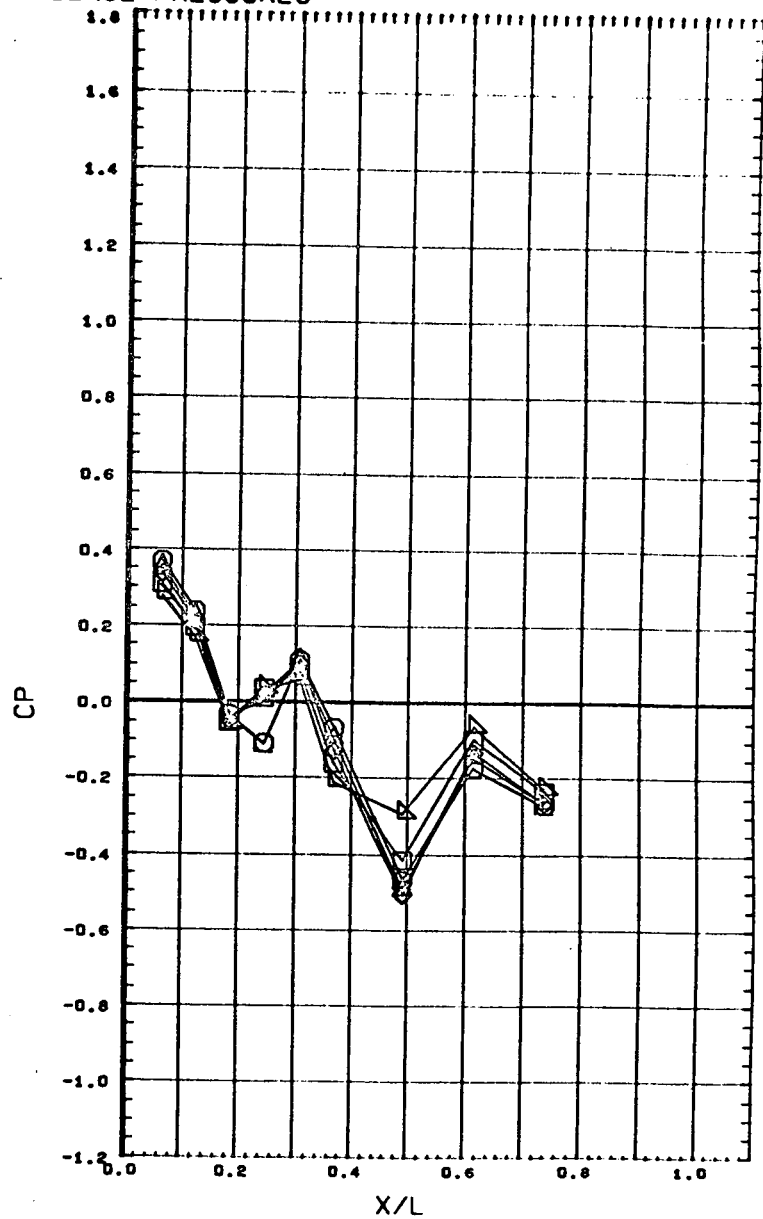
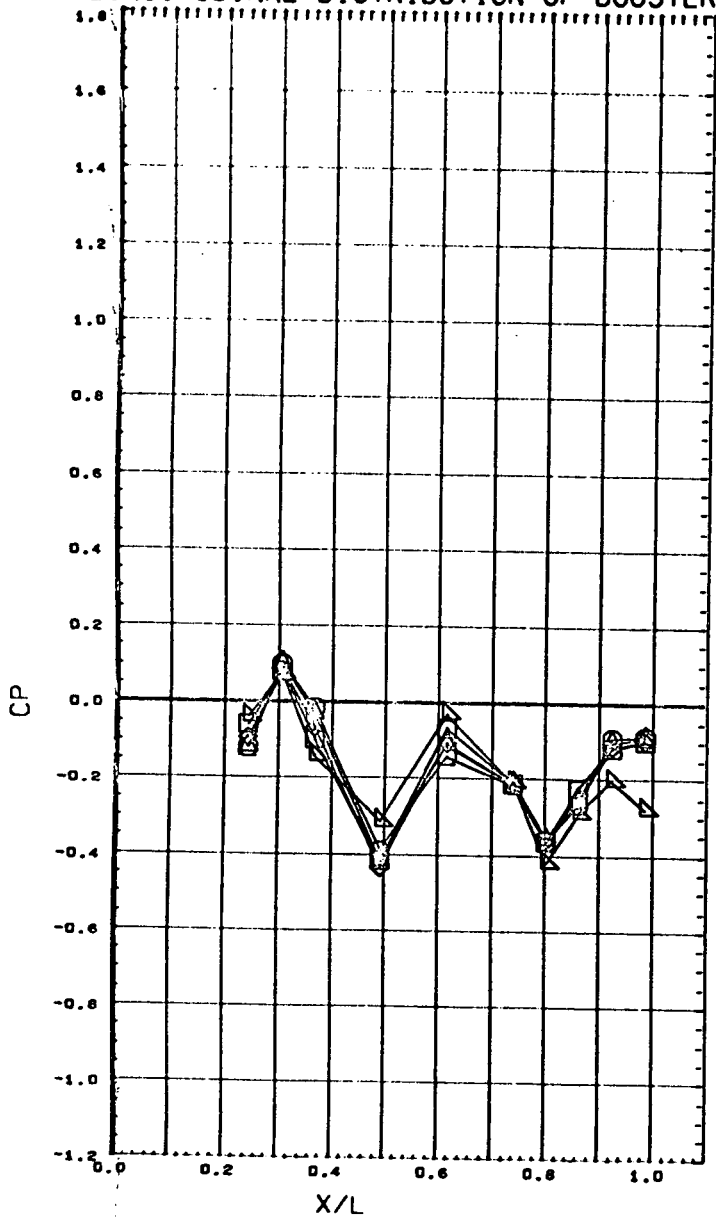

| SYMBOL | ALFB | THETA | M1 |
|--------|-------|--------|-------|
| ○ | 7.999 | 24.000 | 1.004 |
| △ | 5.810 | 45.000 | |
| ◇ | 4.434 | | |
| □ | 2.210 | | |
| ○ | 0.226 | | |

| PARAMETRIC VALUES | | | |
|-------------------|-------|------|-------|
| BETA | 0.000 | DX/L | 0.036 |
| I | 1.900 | | |

REFERENCE FILE

LONGITUDINAL DISTRIBUTION OF BOOSTER FUSELAGE PRESSURES

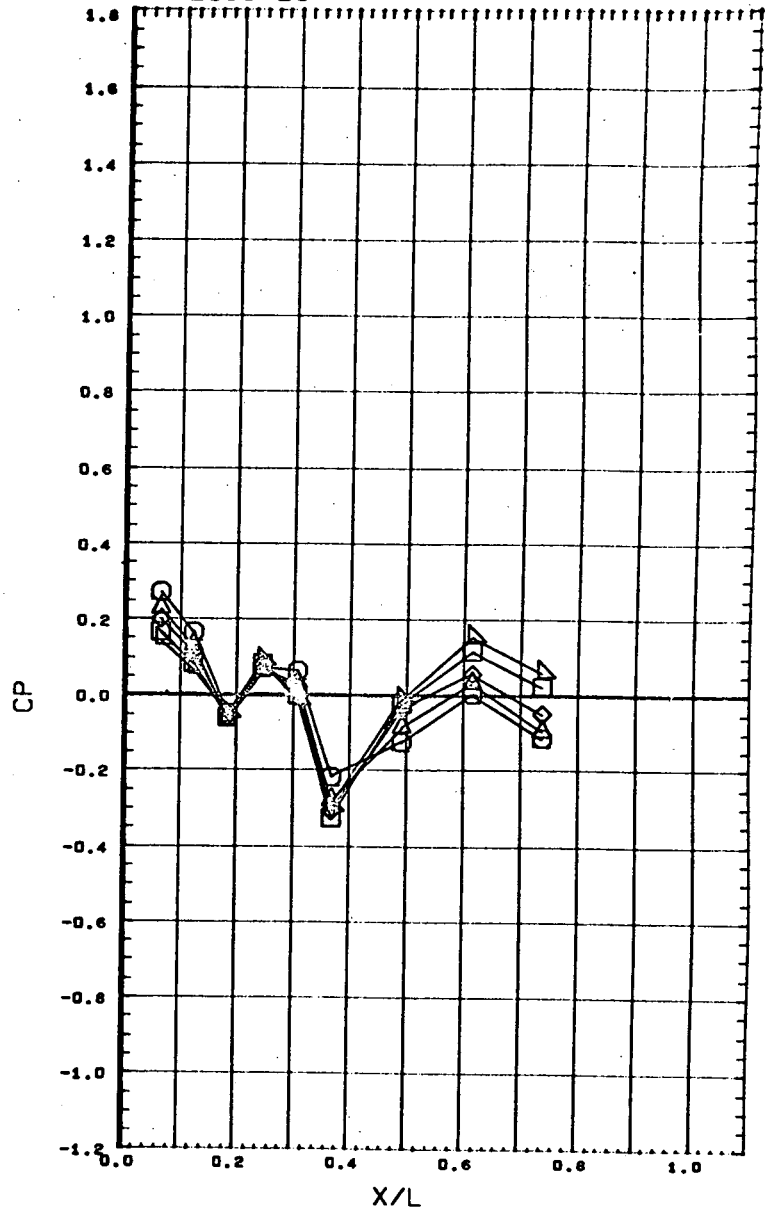
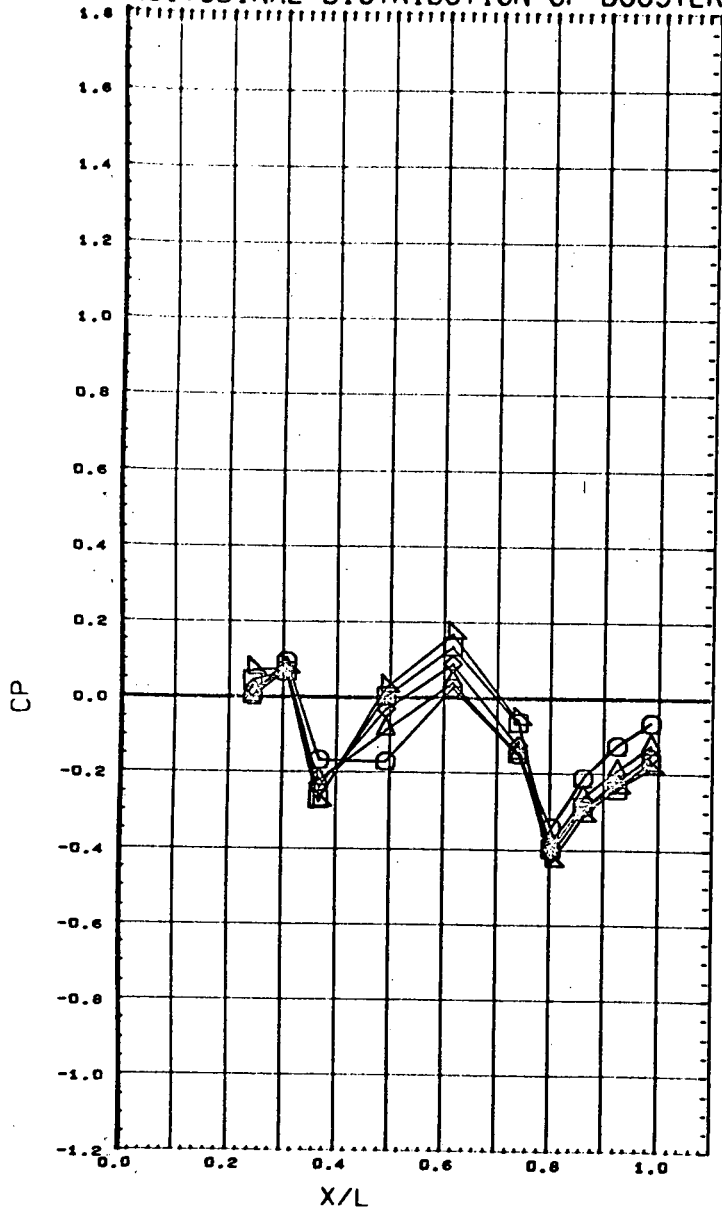

| SYMBOL | ALFB | THETA | M1 |
|--------|--------|--------|-------|
| ○ | 2.167 | 24.000 | 1.004 |
| △ | 4.154 | 45.000 | |
| ◇ | 6.134 | | |
| ◻ | 8.144 | | |
| ◼ | 10.153 | | |

REFERENCE FILE

| PARAMETRIC VALUES | | |
|-------------------|-------|------------|
| BETA | 0.000 | DX/L 0.036 |
| I | 1.900 | |

LONGITUDINAL DISTRIBUTION OF BOOSTER FUSELAGE PRESSURES

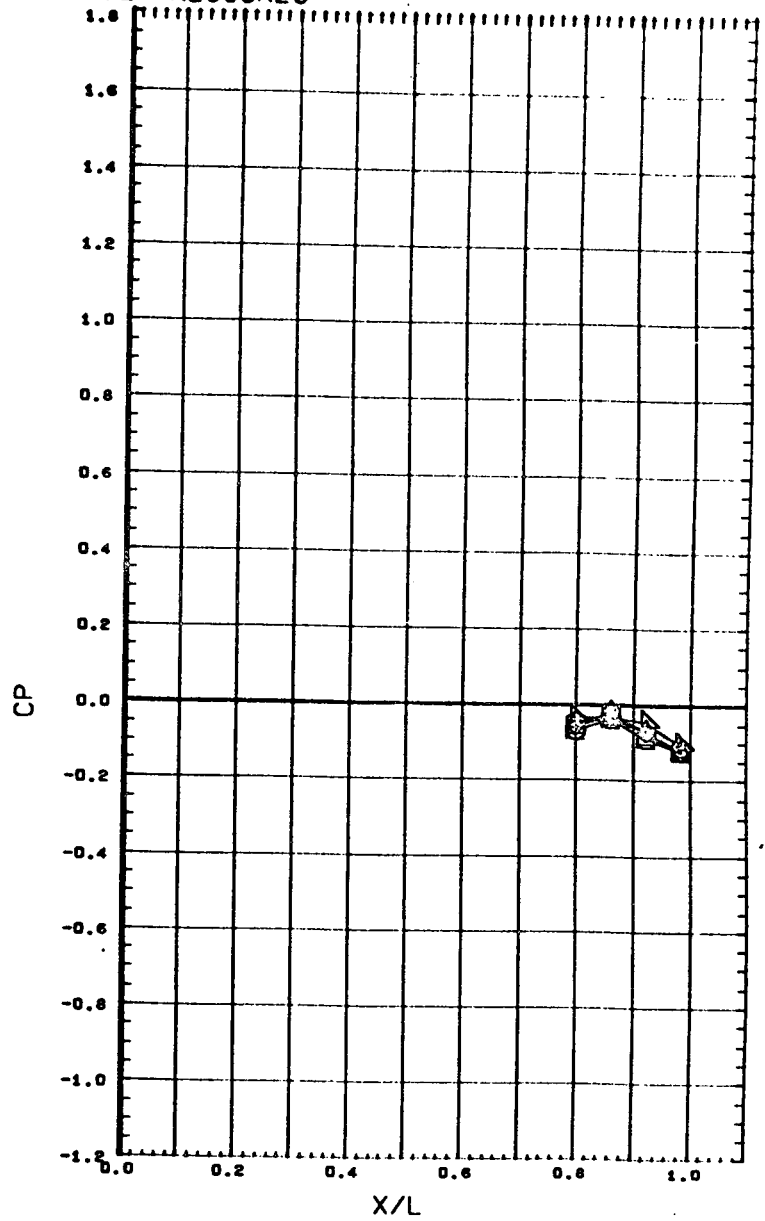
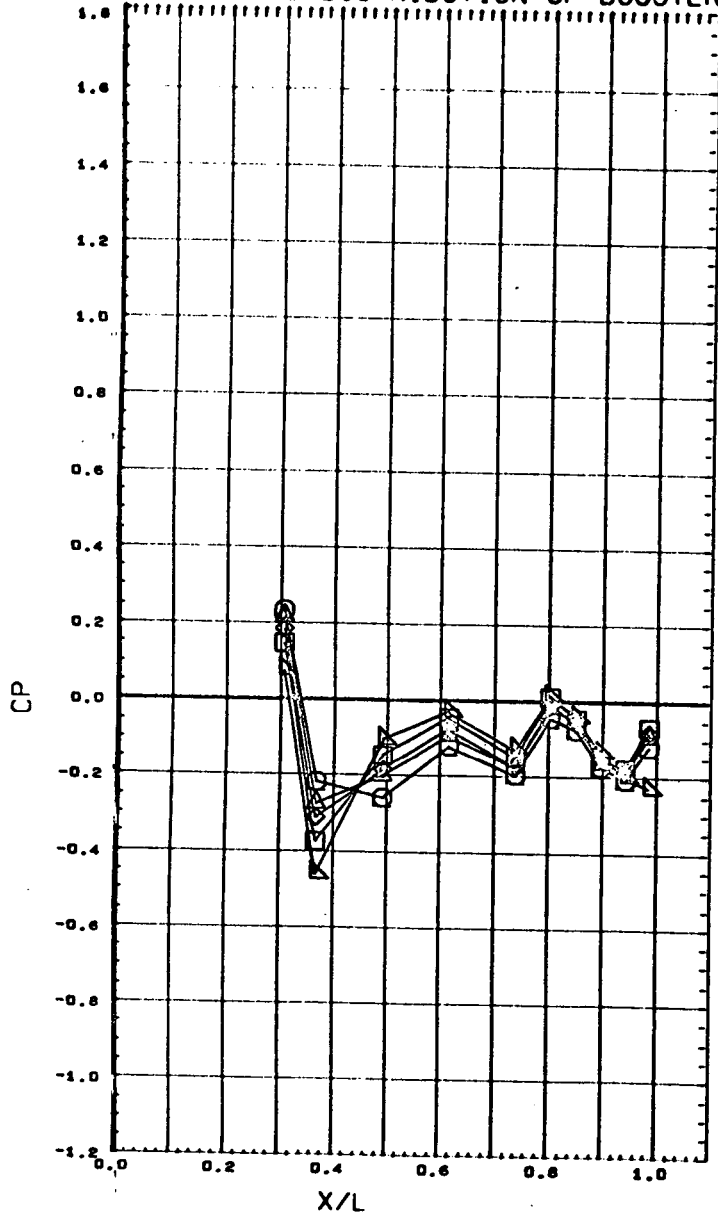

| SYMBOL | ALFB | THETA | M1 |
|--------|-------|---------|-------|
| ○ | 7.909 | 90.000 | 1.004 |
| ◇ | 5.810 | 180.000 | |
| △ | 4.434 | | |
| □ | 2.210 | | |
| ▽ | 0.226 | | |

REFERENCE FILE

| PARAMETRIC VALUES | | | |
|-------------------|-------|------|-------|
| BETA | 0.000 | DX/L | 0.036 |
| I | 1.900 | | |

LONGITUDINAL DISTRIBUTION OF BOOSTER FUSELAGE PRESSURES

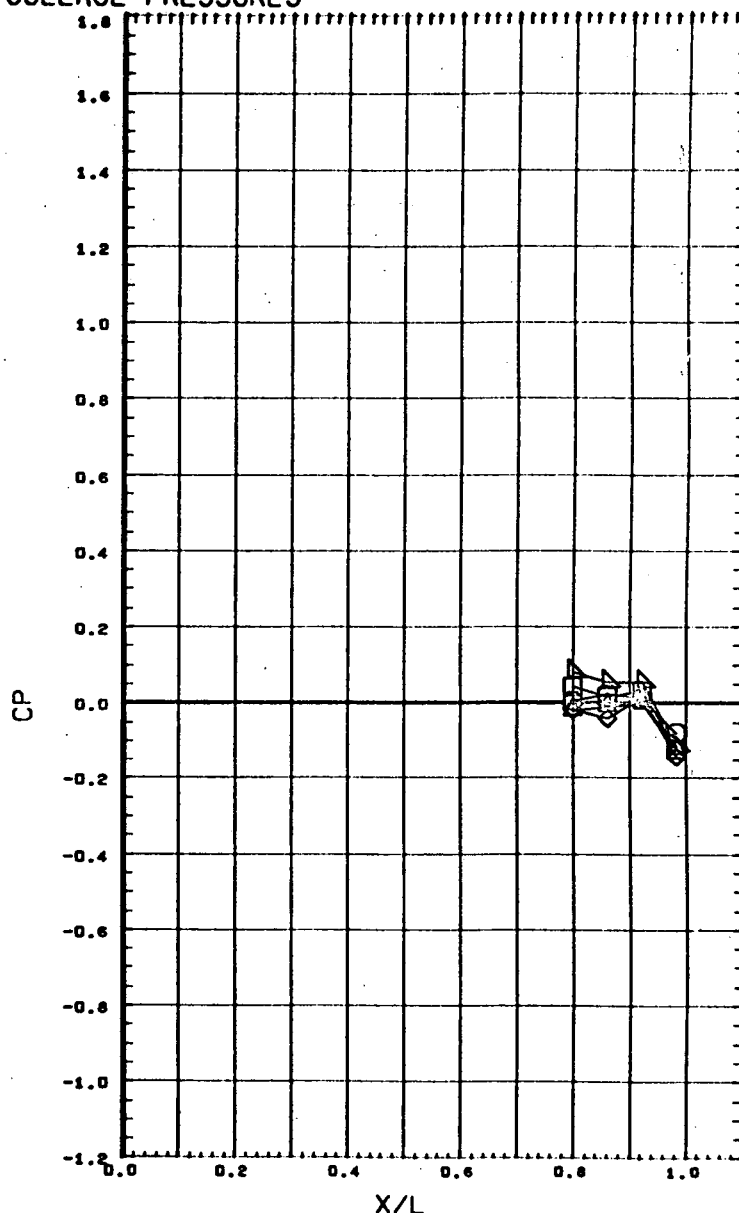
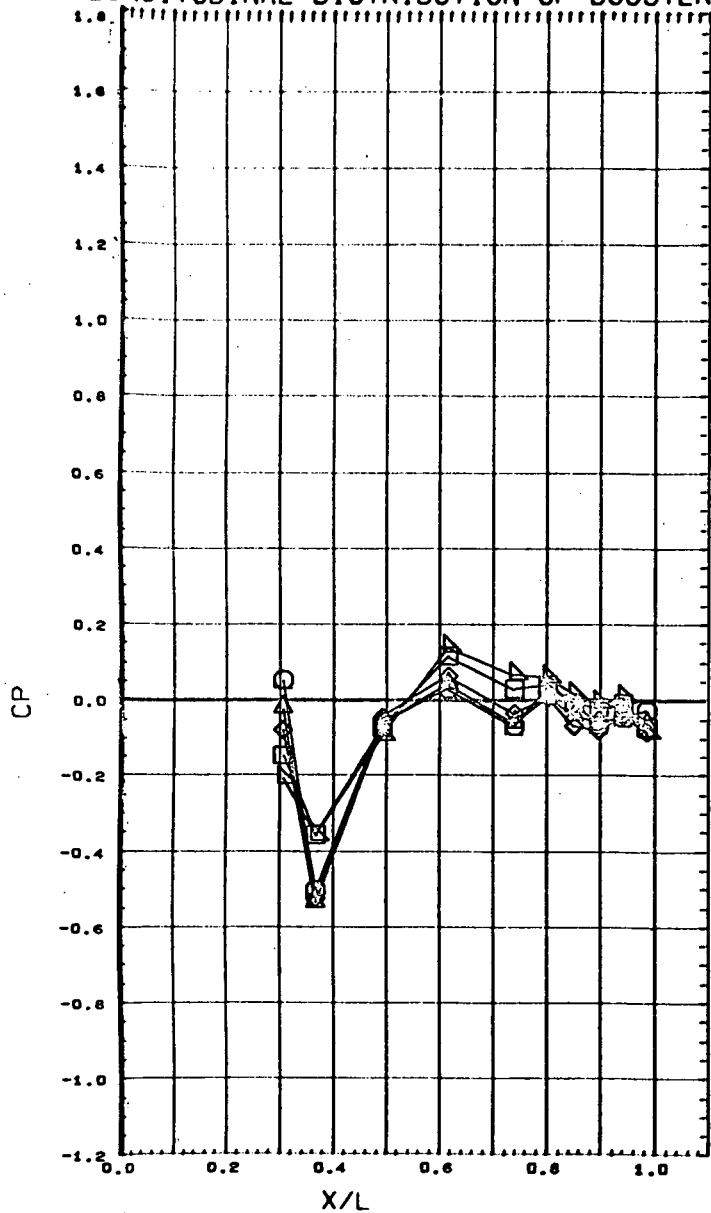

| SYMBOL | ALFB | THETA | M1 |
|--------|--------|---------|-------|
| ○ | 2.167 | 90.000 | 1.004 |
| ◇ | 4.154 | 180.000 | |
| △ | 6.134 | | |
| □ | 8.144 | | |
| ◇ | 10.153 | | |

REFERENCE FILE

| PARAMETRIC VALUES | | |
|-------------------|-------|-------|
| BETA | 0.000 | 0.036 |
| I | 1.900 | |

LONGITUDINAL DISTRIBUTION OF BOOSTER FUSELAGE PRESSURES

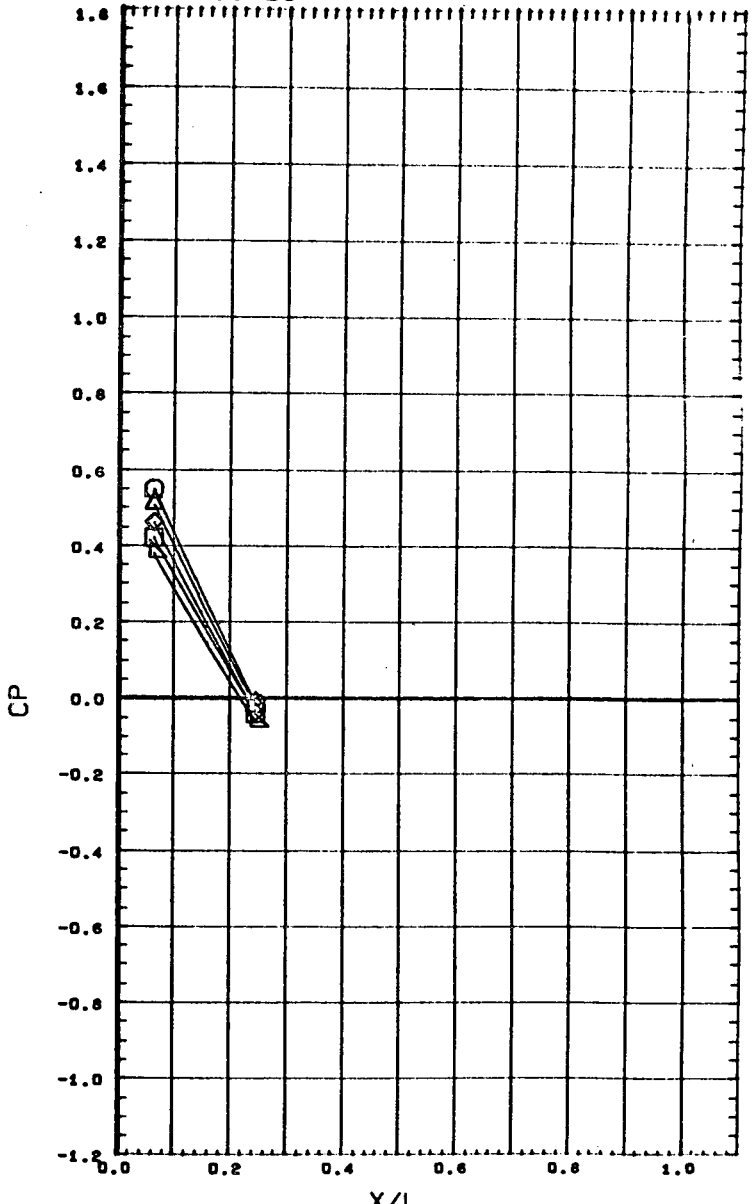
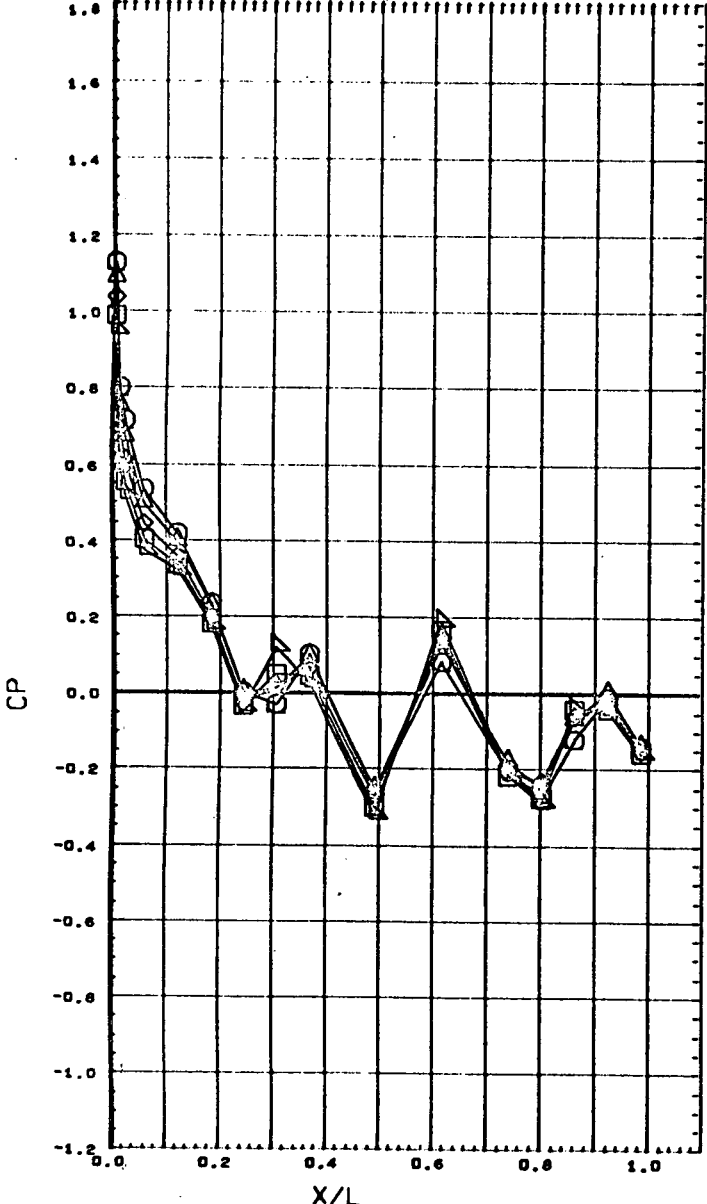

| SYMBOL | ALFB | THETA | M1 |
|--------|-------|--------|-------|
| ○ | 7.920 | 0.000 | 1.100 |
| ◇ | 5.788 | 15.000 | |
| △ | 3.610 | | |
| □ | 1.812 | | |
| ▽ | 0.381 | | |

| PARAMETRIC VALUES | | | |
|-------------------|-------|------|-------|
| BETA | 0.000 | DX/L | 0.036 |
| I | 1.900 | | |

REFERENCE FILE

LONGITUDINAL DISTRIBUTION OF BOOSTER FUSELAGE PRESSURES

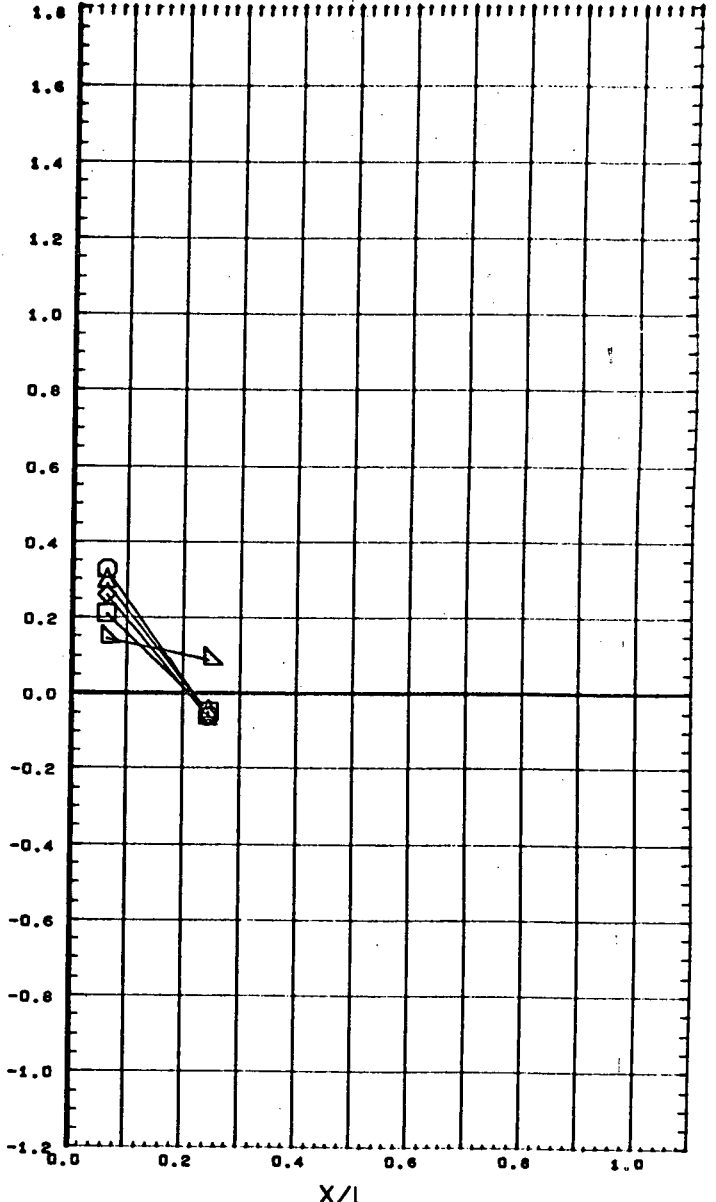
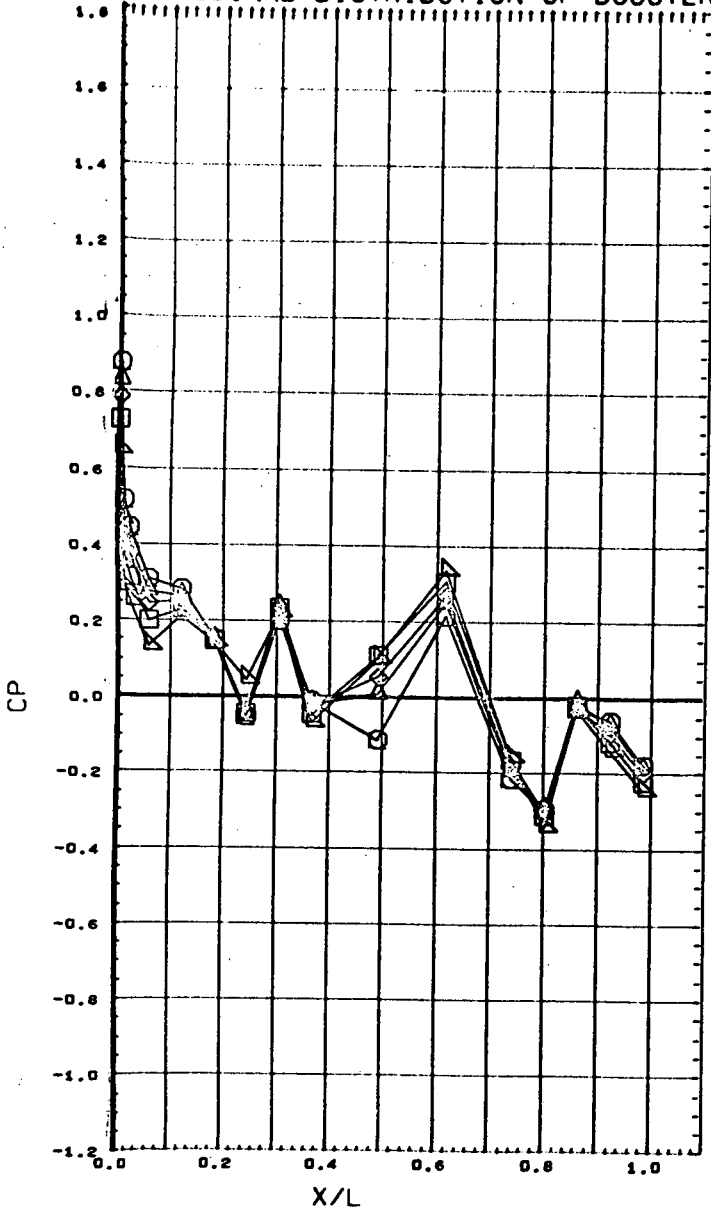

| SYMBOL | ALFB | THETA | M1 |
|--------|--------|--------|-------|
| ○ | 2.224 | 0.000 | 1.100 |
| ◇ | 4.163 | 15.000 | |
| ◇ | 6.935 | | |
| □ | 7.787 | | |
| ▽ | 10.190 | | |

| PARAMETRIC VALUES | | | |
|-------------------|-------|------|-------|
| BETA | 0.000 | DX/L | 0.036 |
| I | 1.900 | | |

REFERENCE FILE

LONGITUDINAL DISTRIBUTION OF BOOSTER FUSELAGE PRESSURES

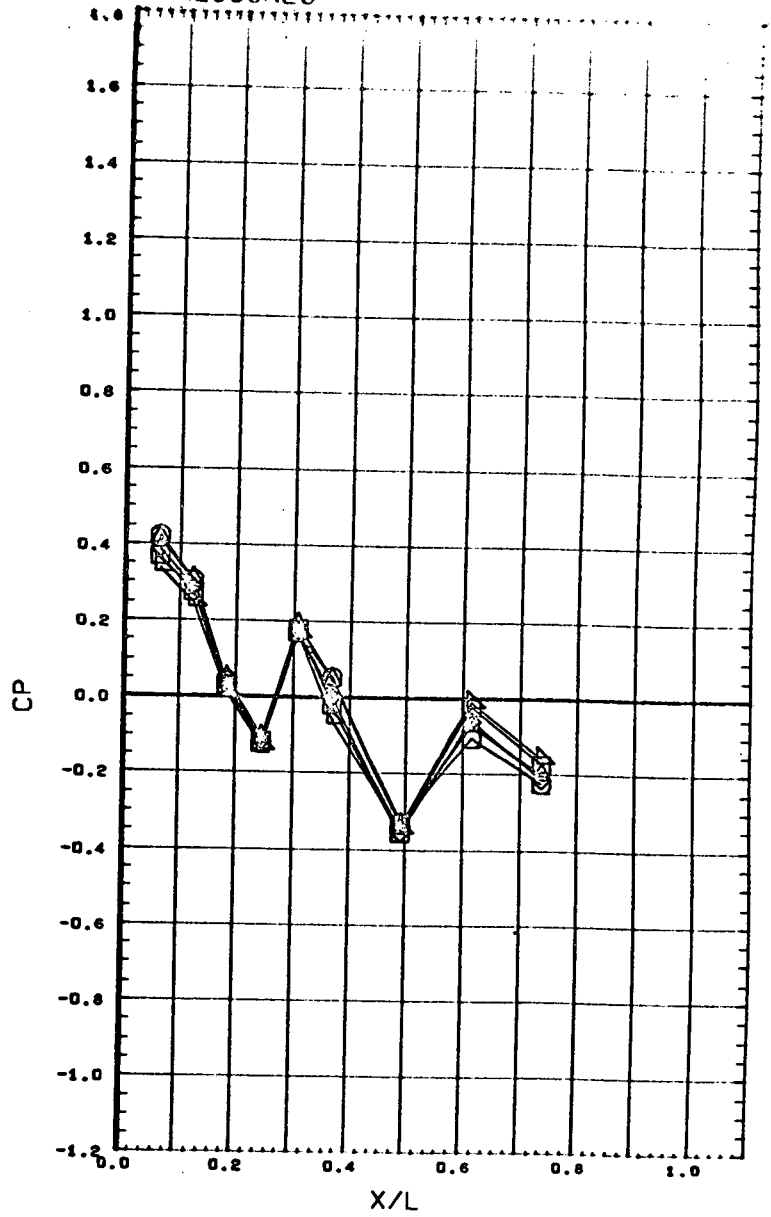
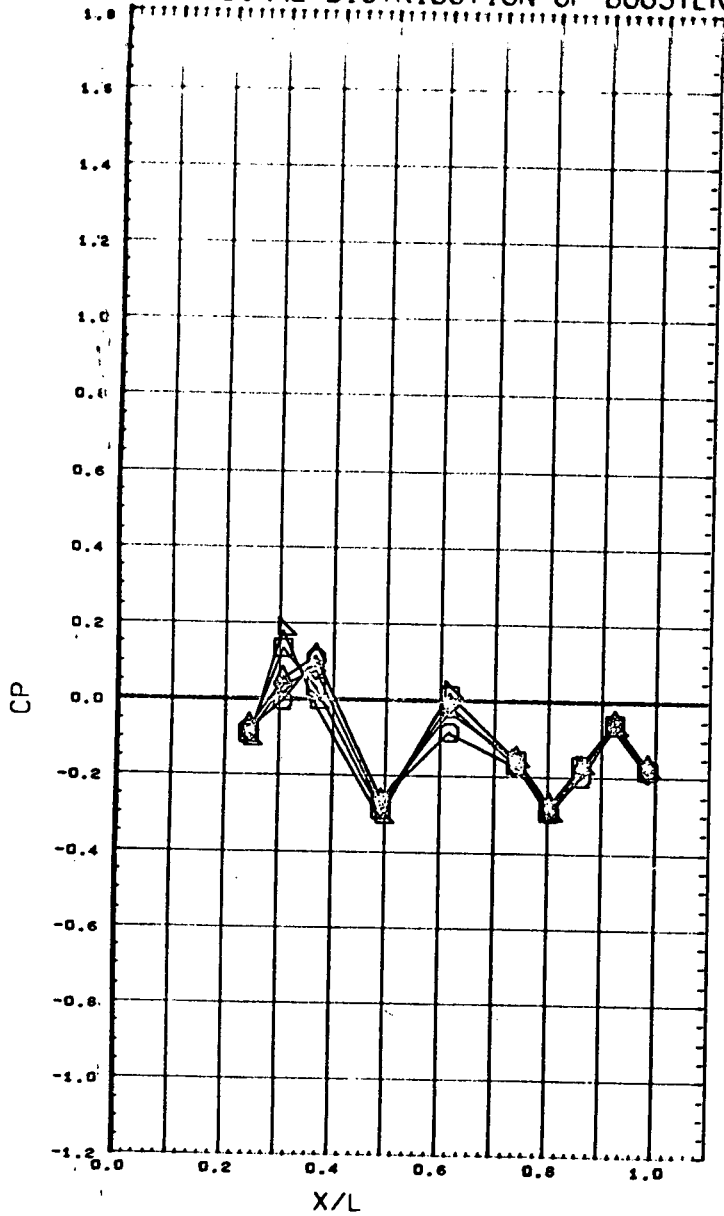

| SYMBOL | ALFA | THETA | M1 |
|--------|-------|--------|-------|
| ○ | 7.920 | 24.000 | 1.100 |
| ◇ | 5.788 | 45.000 | |
| △ | 3.610 | | |
| □ | 1.612 | | |
| ▽ | 0.381 | | |

REFERENCE FILE

| PARAMETRIC VALUES | | |
|-------------------|-------|------------|
| BETA | 0.000 | DX/L 0.036 |
| I | 1.900 | |

LONGITUDINAL DISTRIBUTION OF BOOSTER FUSELAGE PRESSURES

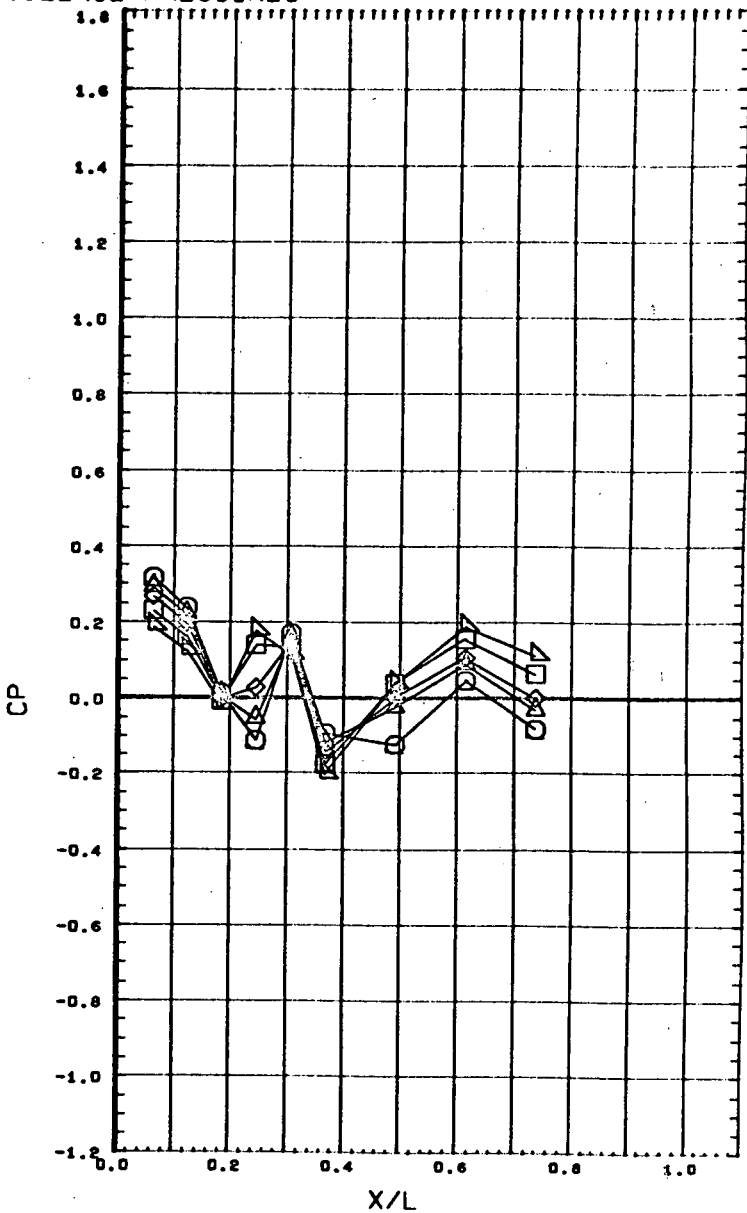
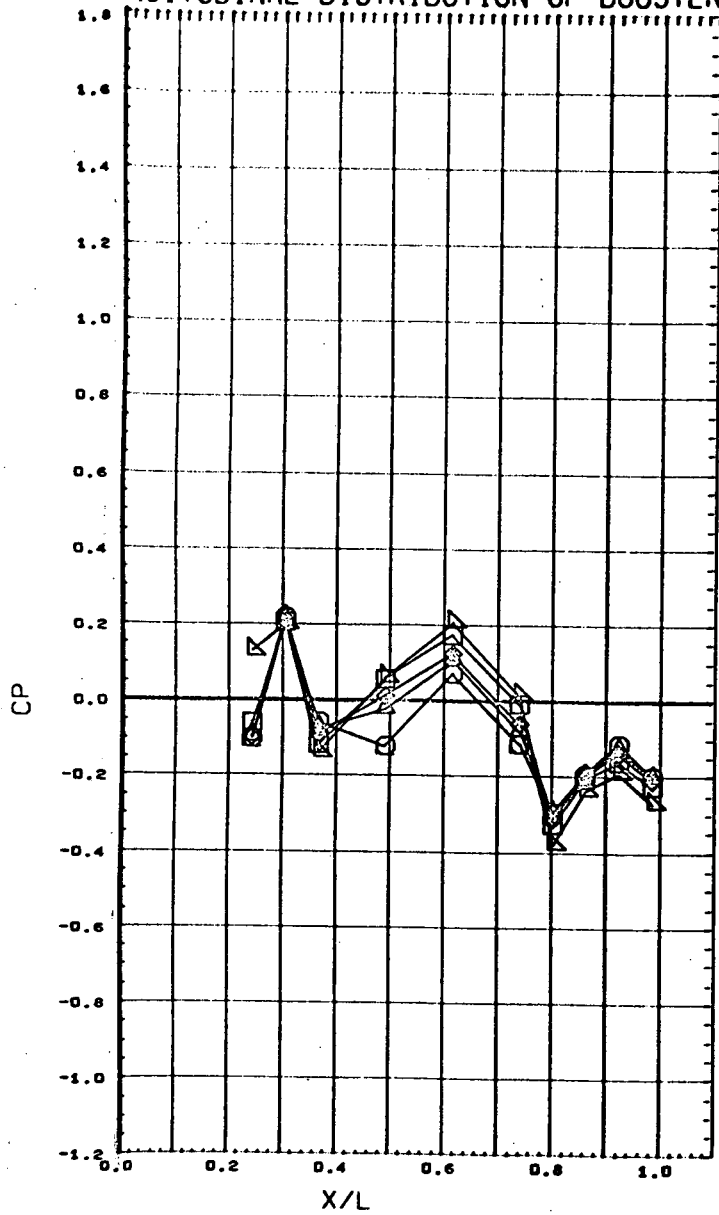

| SYMBOL | ALFB | THETA | M1 |
|--------|--------|--------|-------|
| ○ | 2.224 | 24.000 | 1.100 |
| ◇ | 4.163 | 45.000 | |
| △ | 5.535 | | |
| □ | 7.787 | | |
| ○ | 10.190 | | |

REFERENCE FILE

| PARAMETRIC VALUES | | |
|-------------------|-------|------------|
| BETA | 0.000 | DX/L 0.036 |
| I | 1.900 | |

LONGITUDINAL DISTRIBUTION OF BOOSTER FUSELAGE PRESSURES

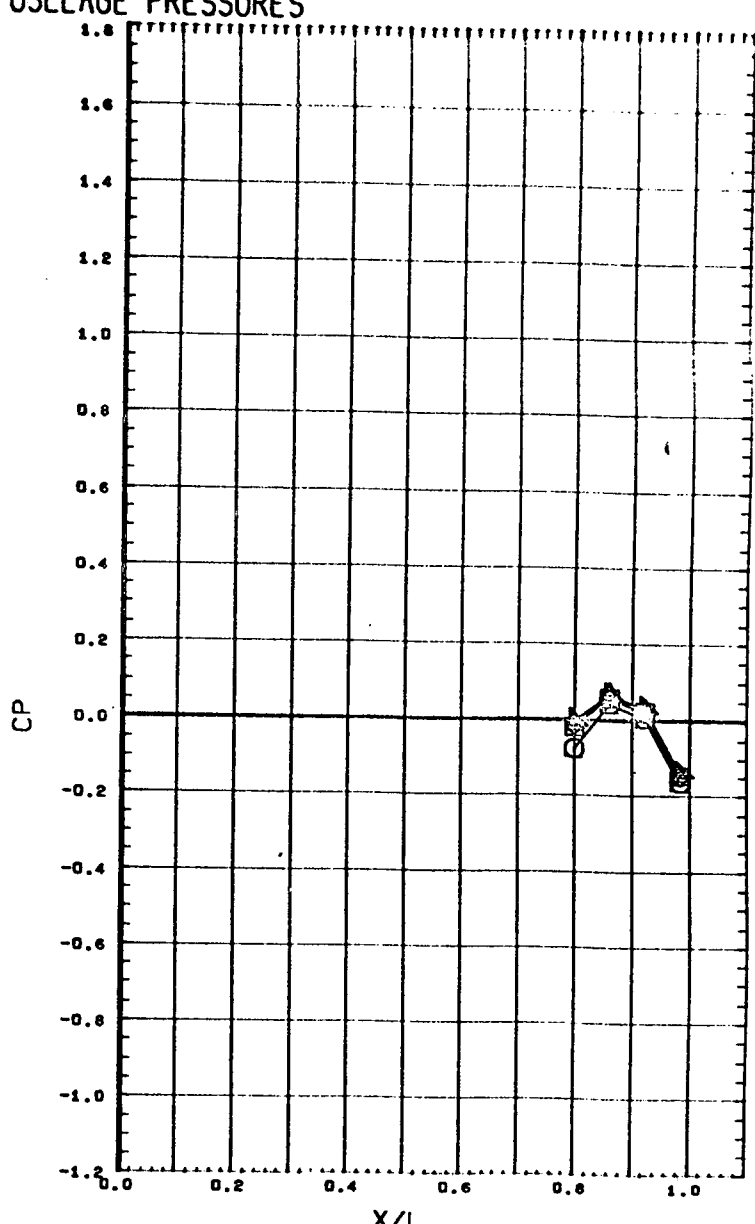
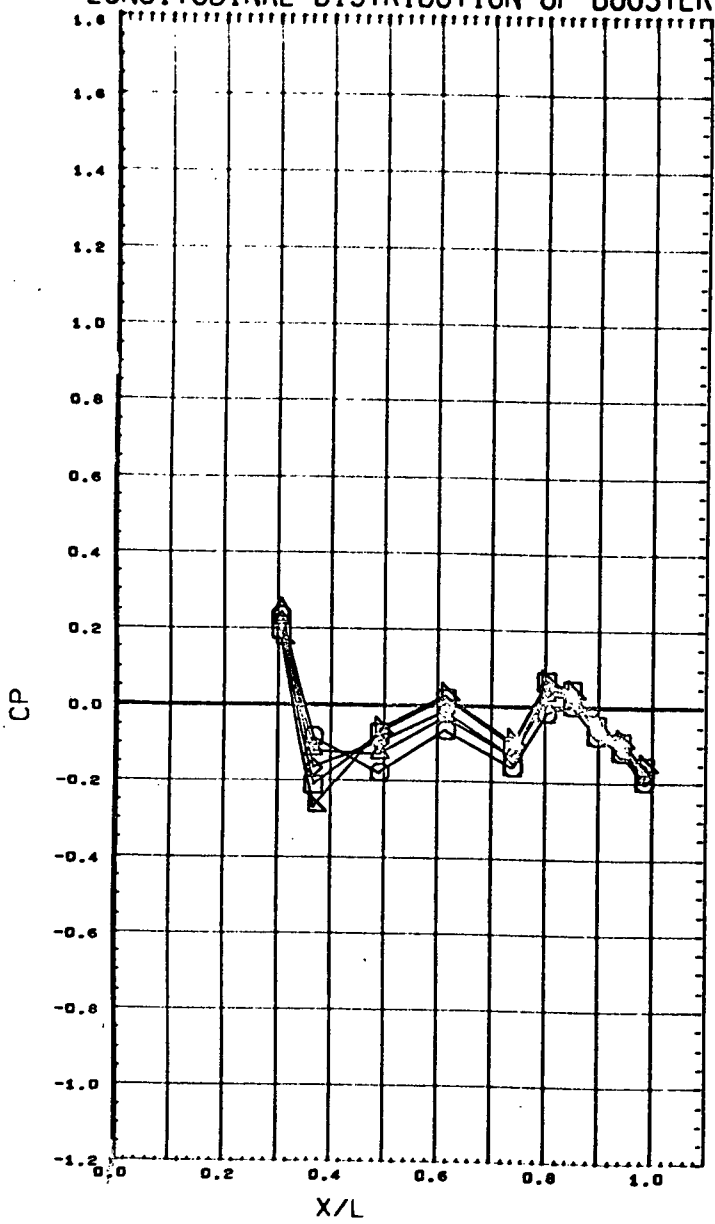

| SYMBOL | ALFB | THETA | M3 |
|--------|-------|---------|-------|
| ○ | 7.920 | 90.000 | 1.100 |
| ◇ | 9.788 | 180.000 | |
| △ | 3.810 | | |
| □ | 1.812 | | |
| ▽ | 0.381 | | |

REFERENCE FILE

| PARAMETRIC VALUES | | | |
|-------------------|-------|------|-------|
| BETA | 0.000 | DX/L | 0.036 |
| I | 1.900 | | |

LONGITUDINAL DISTRIBUTION OF BOOSTER FUSELAGE PRESSURES

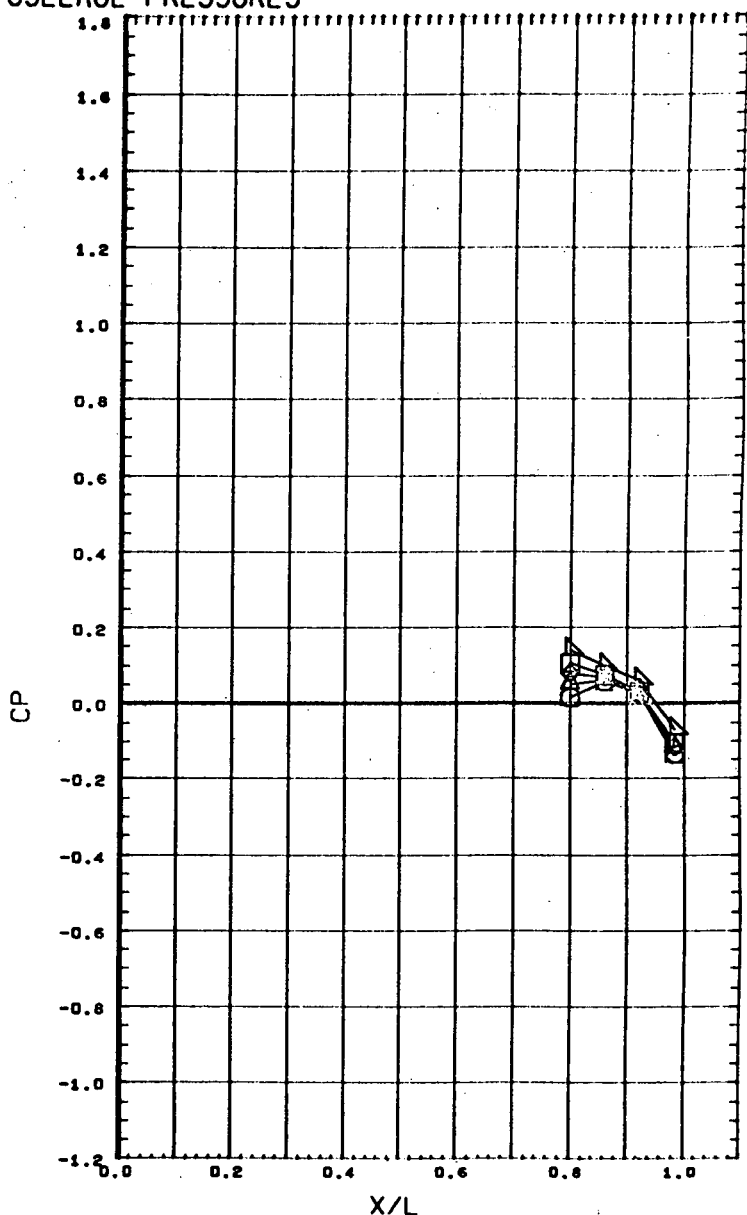
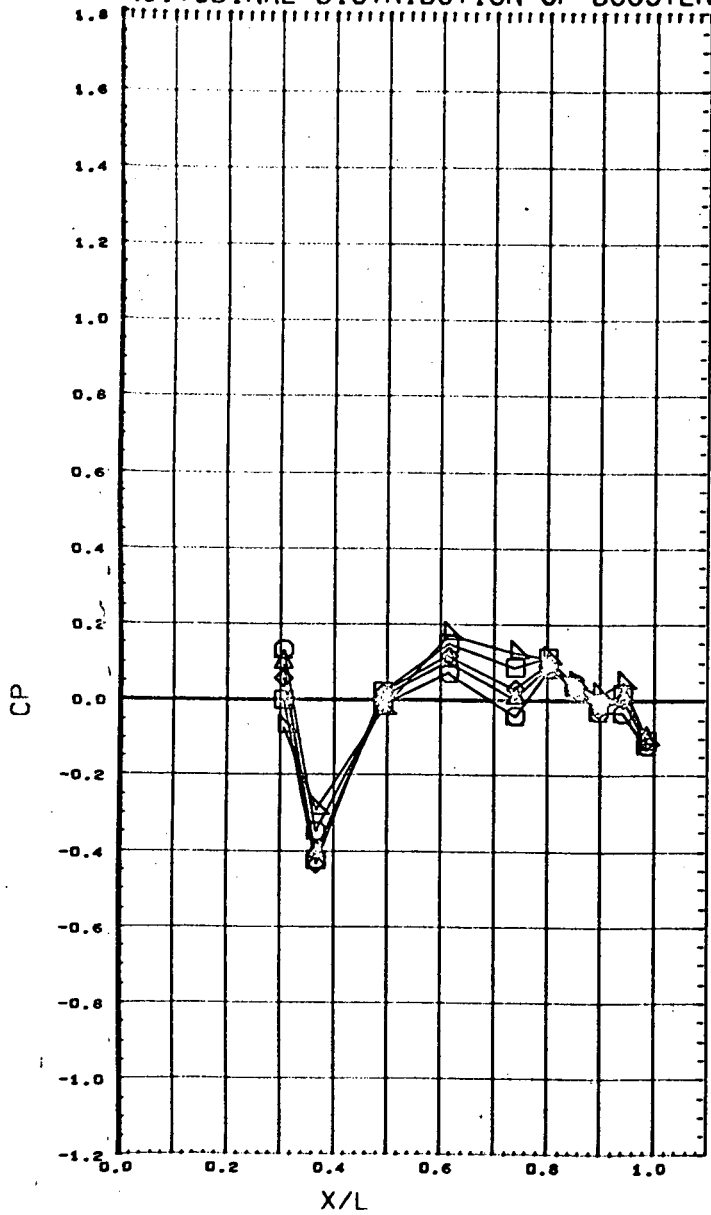

| SYMBOL | ALFB | THETA | M1 |
|--------|--------|---------|-------|
| ○ | 2.224 | 90.000 | 1.100 |
| ◇ | 4.163 | 180.000 | |
| △ | 5.535 | | |
| □ | 7.787 | | |
| ▽ | 10.190 | | |

REFERENCE FILE

| PARAMETRIC VALUES | | | |
|-------------------|-------|------|-------|
| BETA | 0.000 | DX/L | 0.036 |
| I | 1.900 | | |

LONGITUDINAL DISTRIBUTION OF BOOSTER FUSELAGE PRESSURES

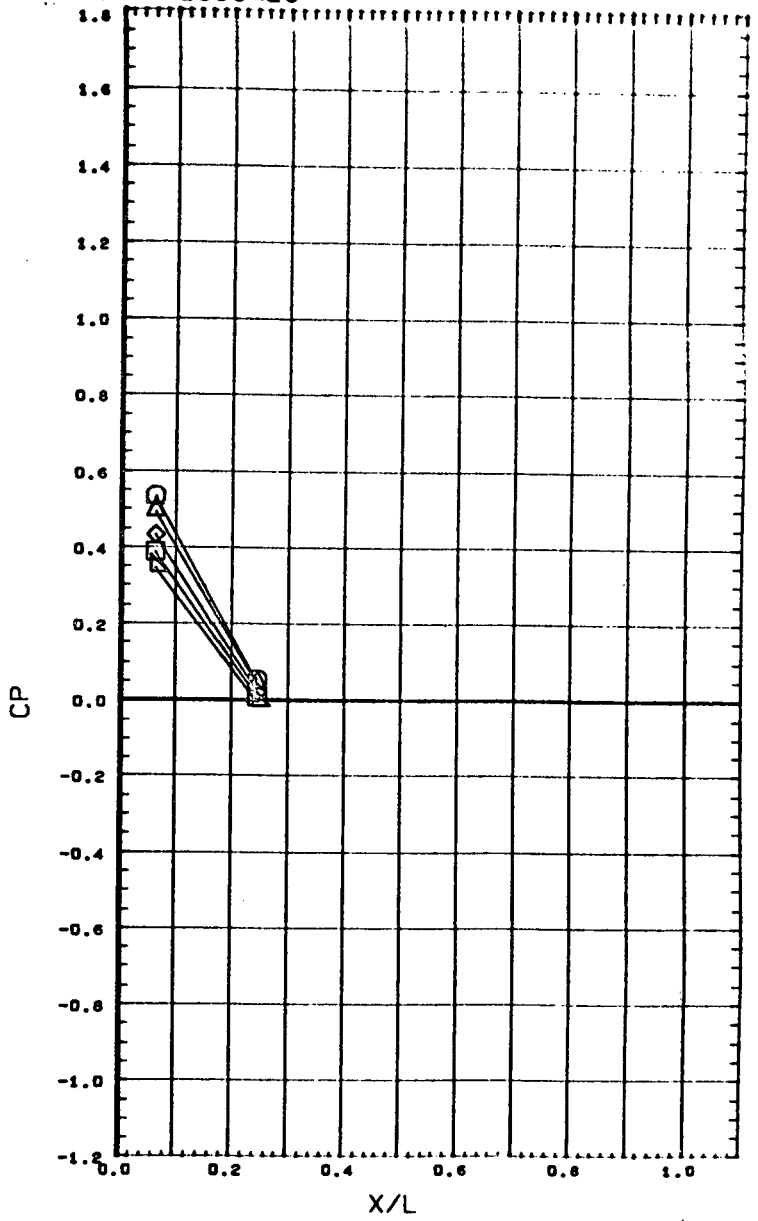
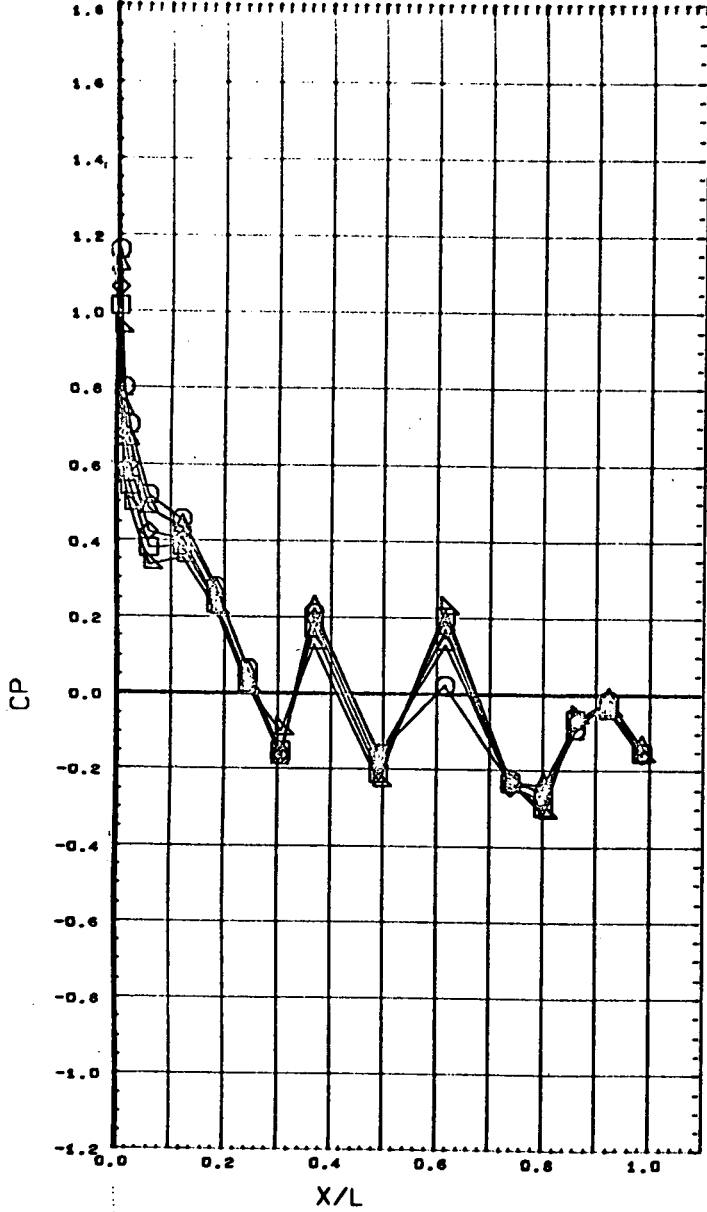

| SYMBOL | ALFB | THETA | M1 |
|--------|---------|--------|-------|
| ○ | - 7.918 | 0.000 | 1.201 |
| ◇ | - 5.800 | 15.000 | |
| △ | - 3.805 | | |
| □ | - 1.810 | | |
| ▽ | 0.192 | | |

| PARAMETRIC VALUES | | | |
|-------------------|-------|------|-------|
| BETA | 0.000 | DX/L | 0.036 |
| I | 1.900 | | |

REFERENCE FILE

LONGITUDINAL DISTRIBUTION OF BOOSTER FUSELAGE PRESSURES

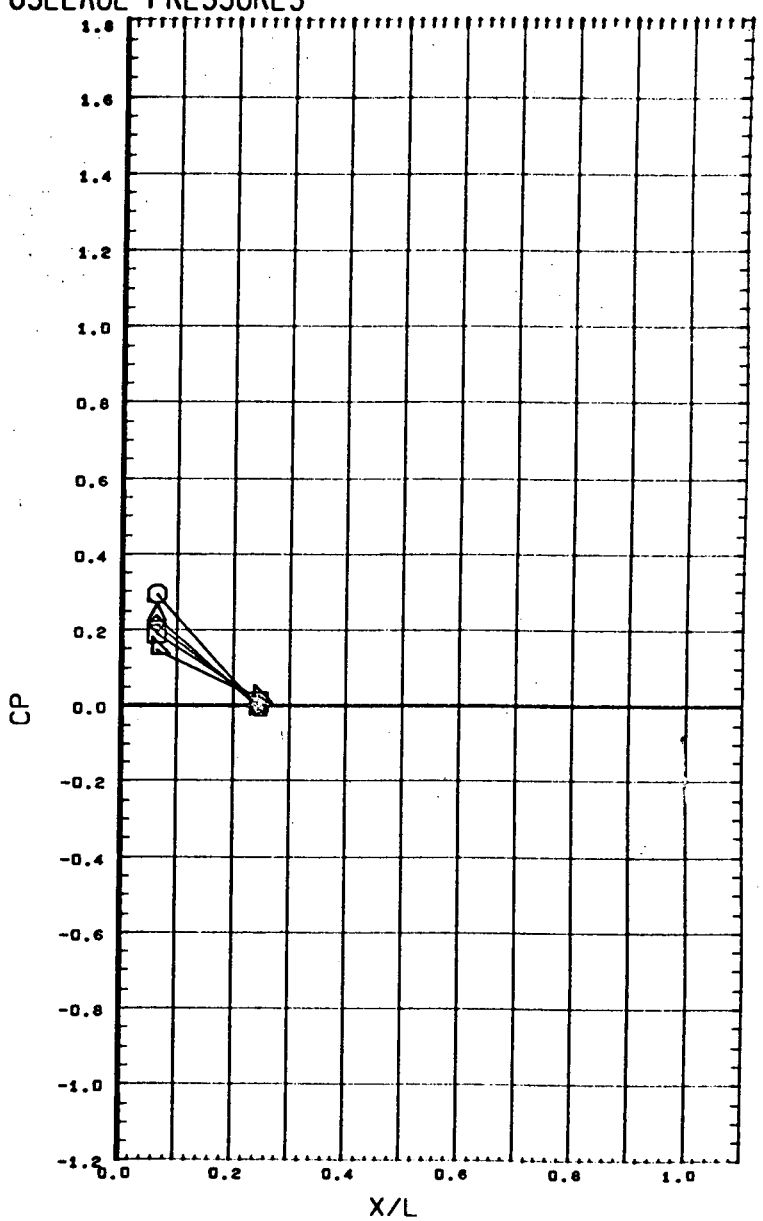
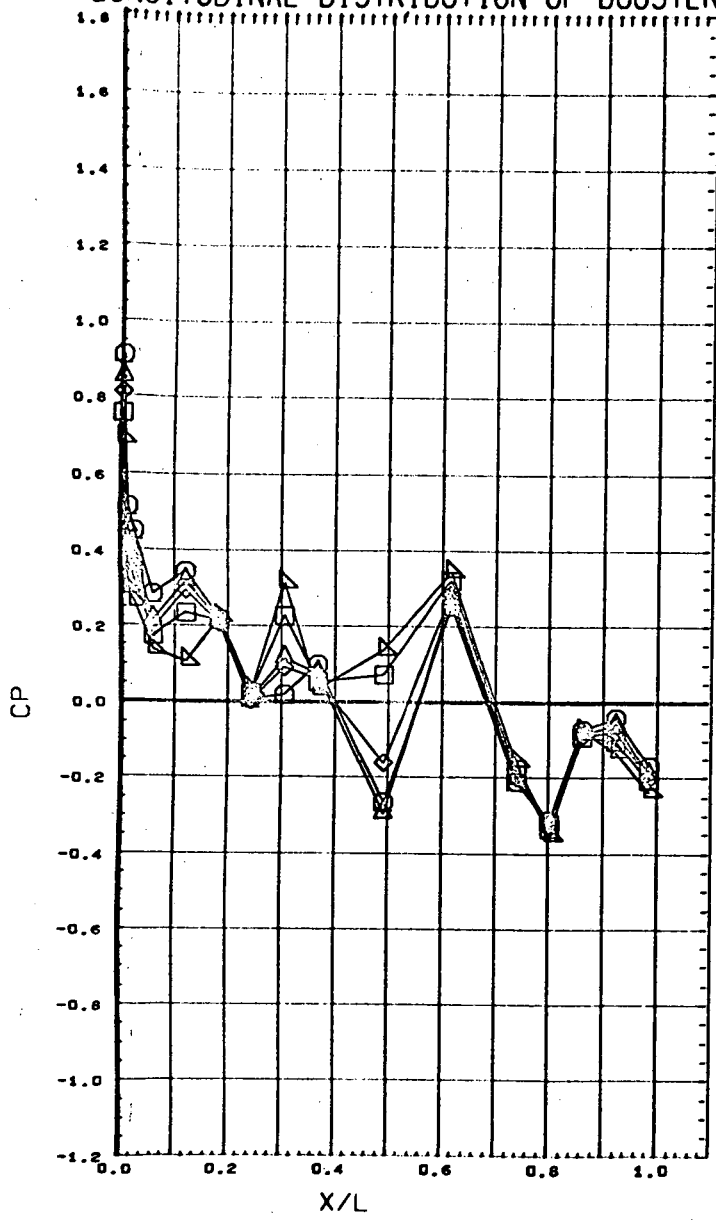

| SYMBOL | ALFB | THETA | M1 |
|--------|--------|--------|-------|
| ○ | 2.165 | 0.000 | 1.201 |
| ◇ | 4.175 | 15.000 | |
| △ | 5.542 | | |
| □ | 7.781 | | |
| ▽ | 10.179 | | |

REFERENCE FILE

| PARAMETRIC VALUES | | |
|-------------------|-------|------------|
| BETA | 0.000 | DX/L 0.036 |
| I | 1.900 | |

LONGITUDINAL DISTRIBUTION OF BOOSTER FUSELAGE PRESSURES

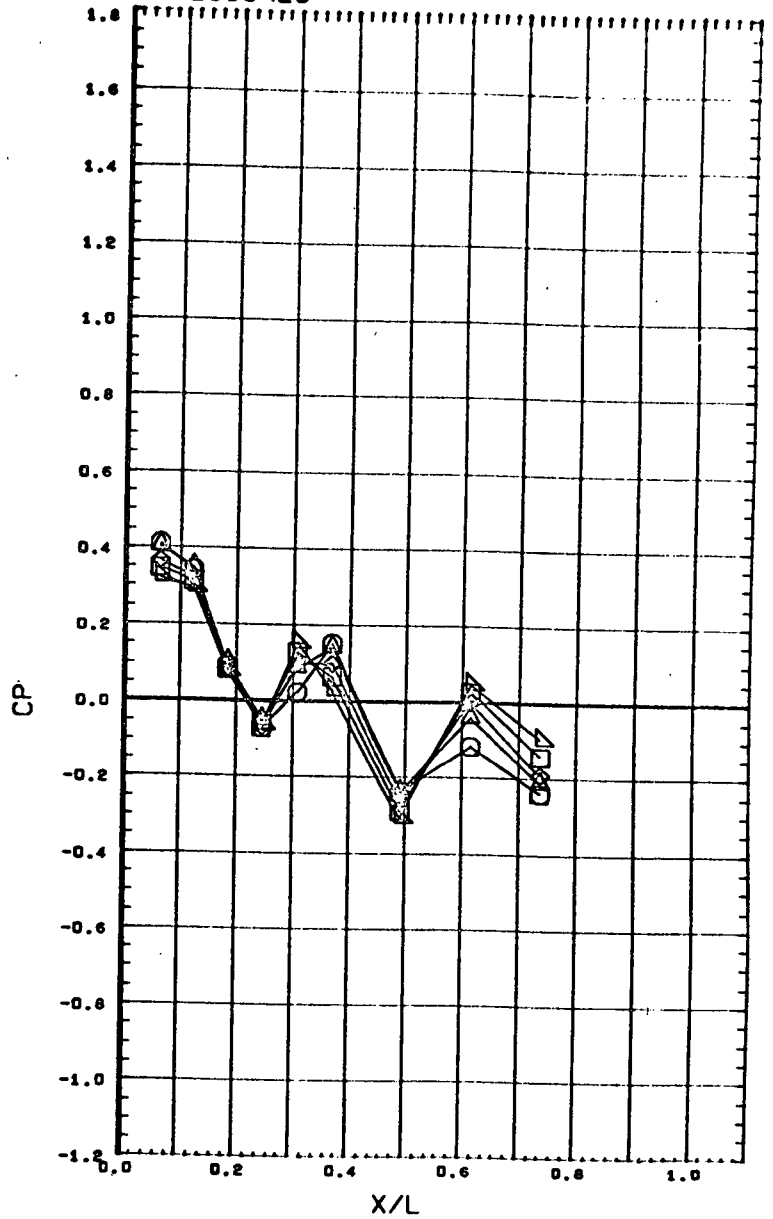
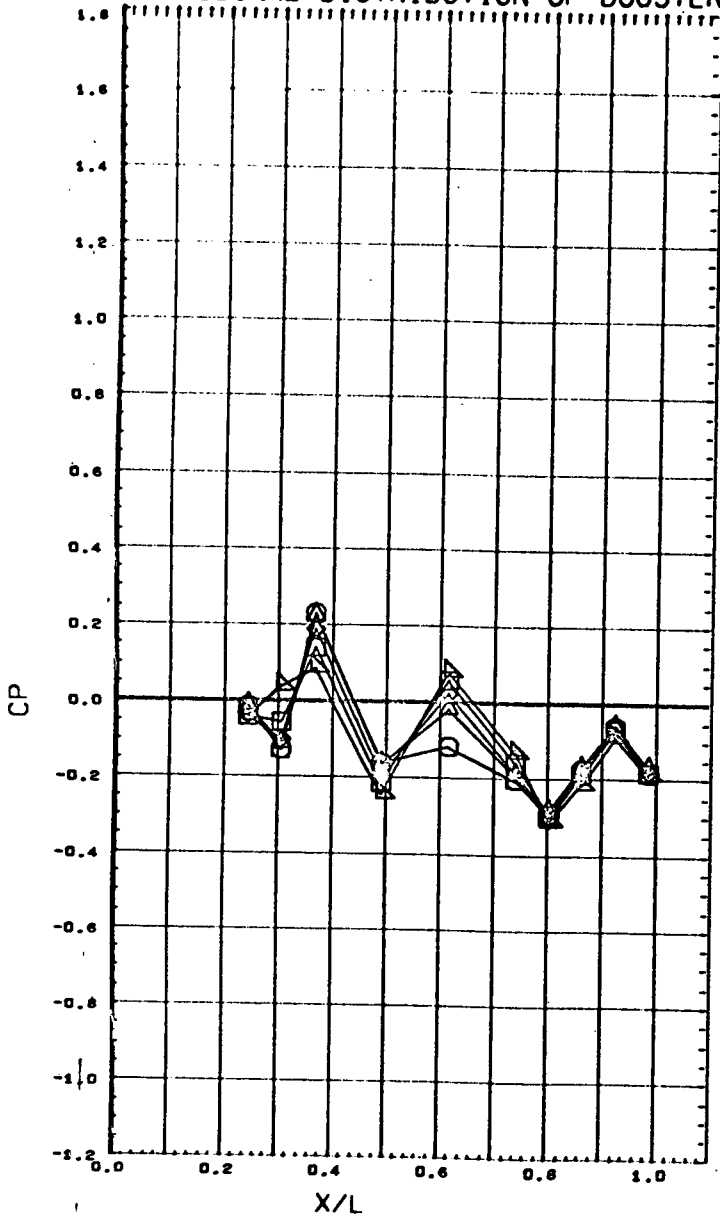

| SYMBOL | ALFD | THETA | M1 |
|--------|-------|--------|-------|
| ○ | 7.918 | 24.000 | 1.201 |
| ◇ | 5.800 | 45.000 | |
| △ | 3.805 | | |
| □ | 1.810 | | |
| ◇ | 0.192 | | |

REFERENCE FILE

| PARAMETRIC VALUES | | |
|-------------------|-------|-------|
| BETA | 0.000 | DX/L |
| I | 1.900 | 0.036 |

LONGITUDINAL DISTRIBUTION OF BOOSTER FUSELAGE PRESSURES

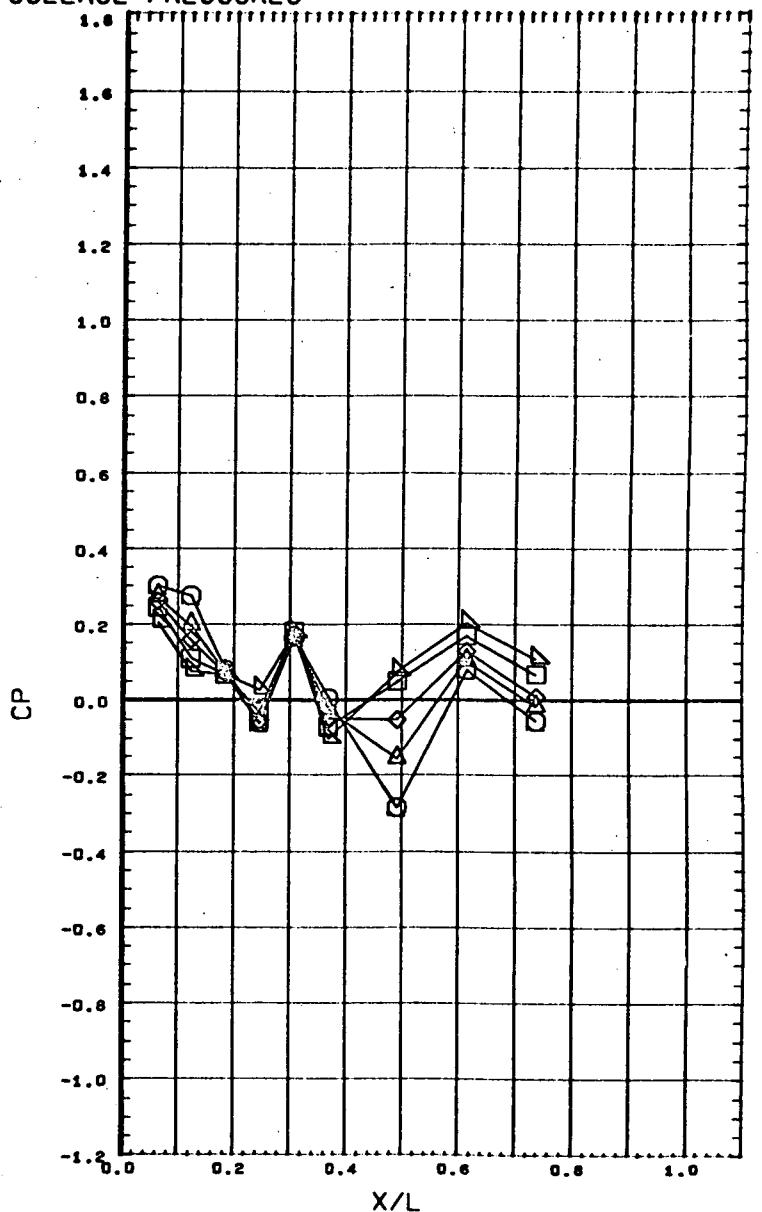
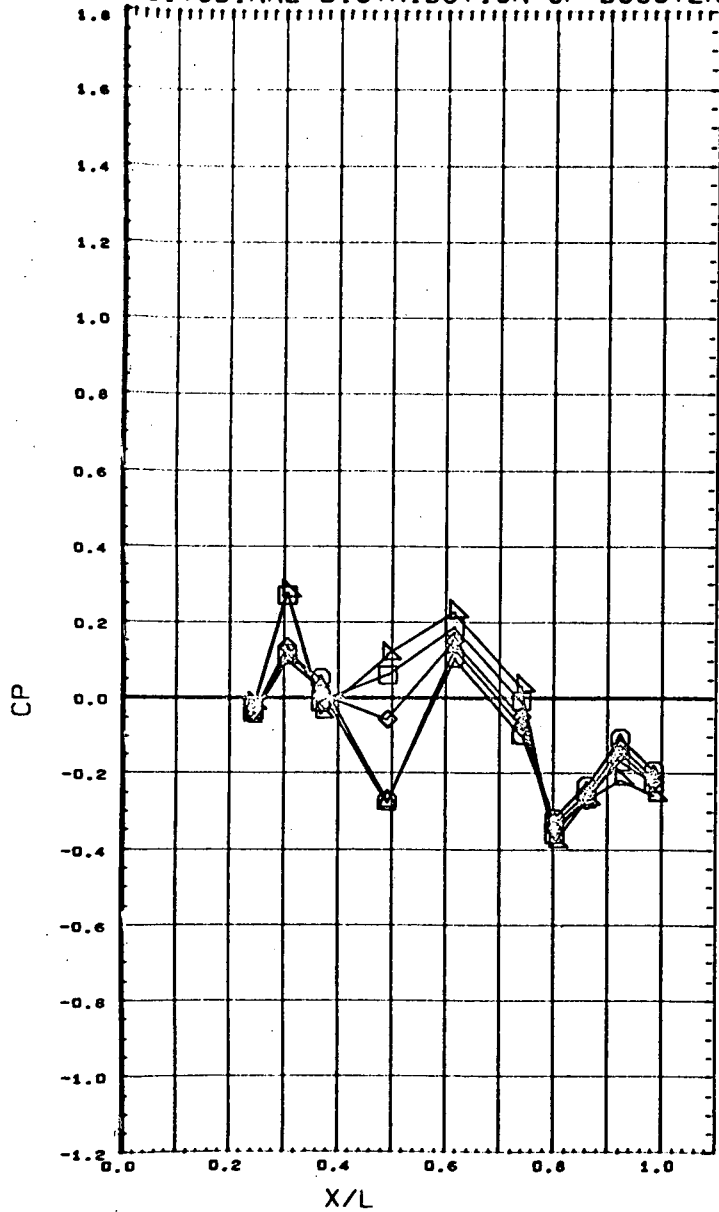

| SYMBOL | ALFB | THETA | M1 |
|--------|--------|--------|-------|
| ○ | 2.165 | 24.000 | 1.201 |
| ◇ | 4.175 | 45.000 | |
| △ | 5.542 | | |
| □ | 7.781 | | |
| ◇ | 10.179 | | |

REFERENCE FILE

| PARAMETRIC VALUES | | |
|-------------------|-------|-------|
| BETA | 0.000 | DX/L |
| I | 1.900 | 0.036 |

LONGITUDINAL DISTRIBUTION OF BOOSTER FUSELAGE PRESSURES

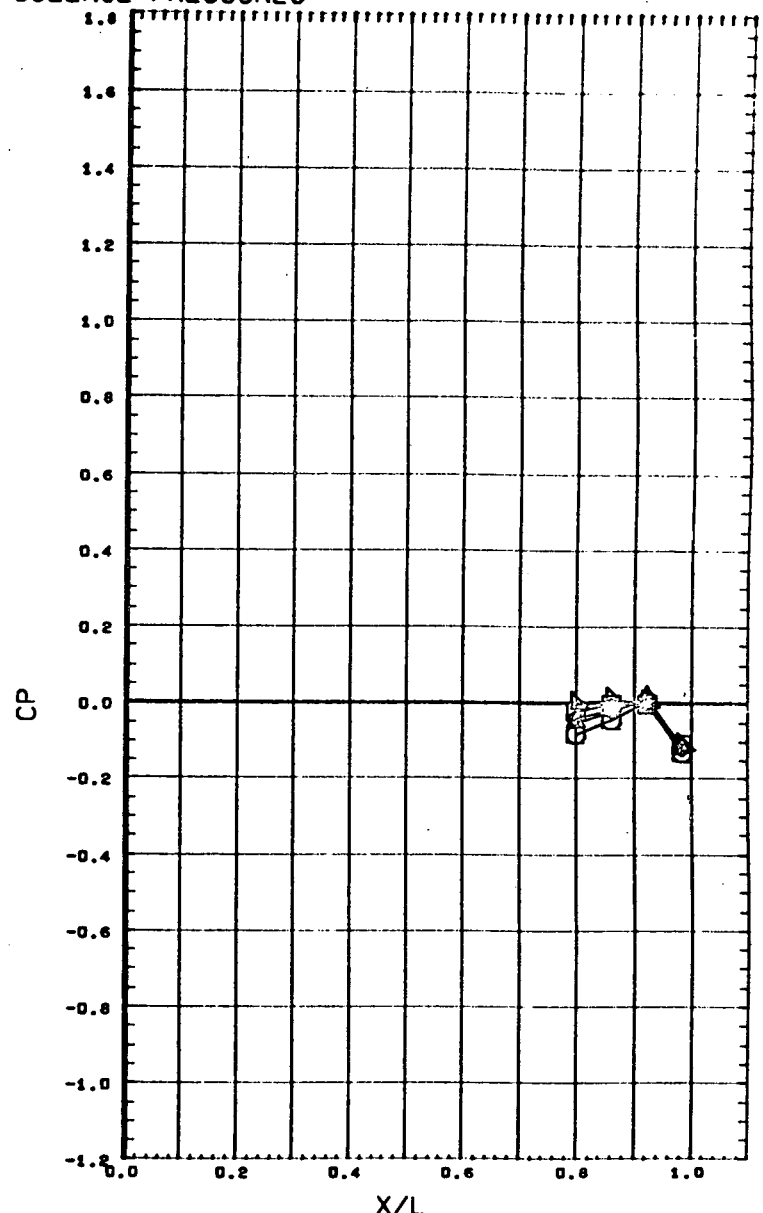
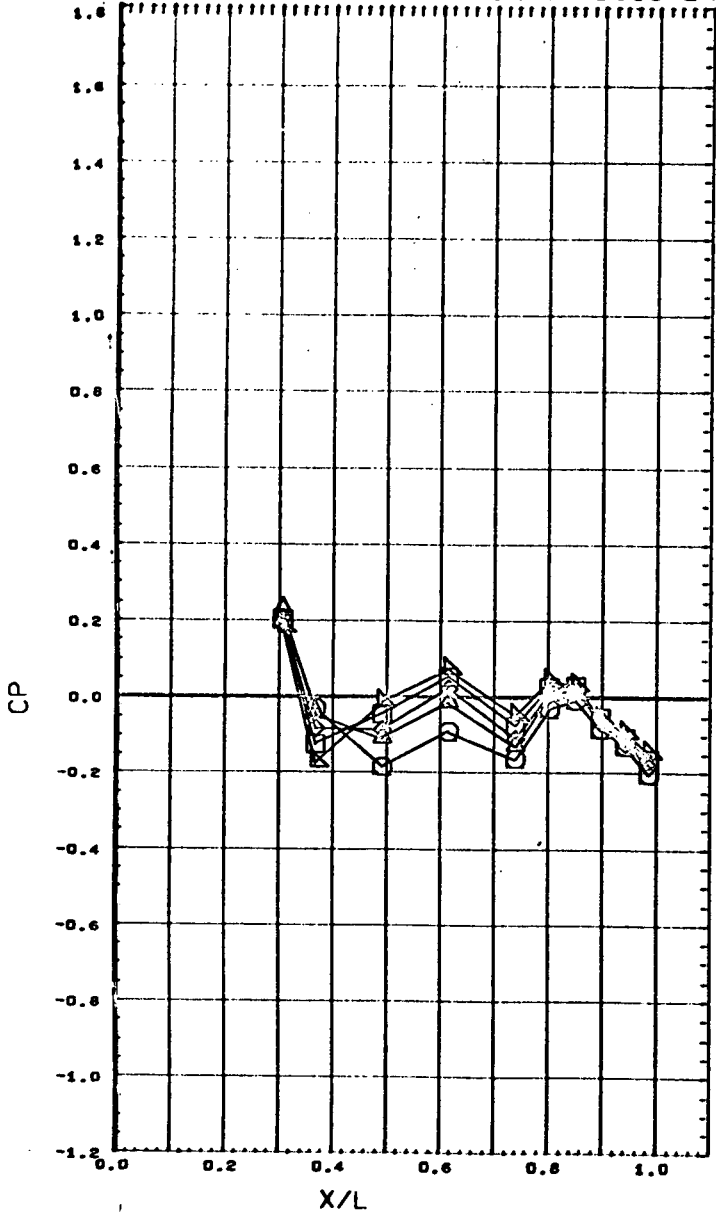

| SYMBOL | ALFB | THETA | M1 |
|--------|-------|---------|-------|
| ○ | 7.918 | 90.000 | 1.201 |
| ◇ | 5.800 | 180.000 | |
| △ | 3.805 | | |
| □ | 1.810 | | |
| ◇ | 0.192 | | |

| PARAMETRIC VALUES | | | |
|-------------------|-------|------|-------|
| BETA | 0.000 | OX/L | 0.036 |
| I | 1.900 | | |

REFERENCE FILE

LONGITUDINAL DISTRIBUTION OF BOOSTER FUSELAGE PRESSURES

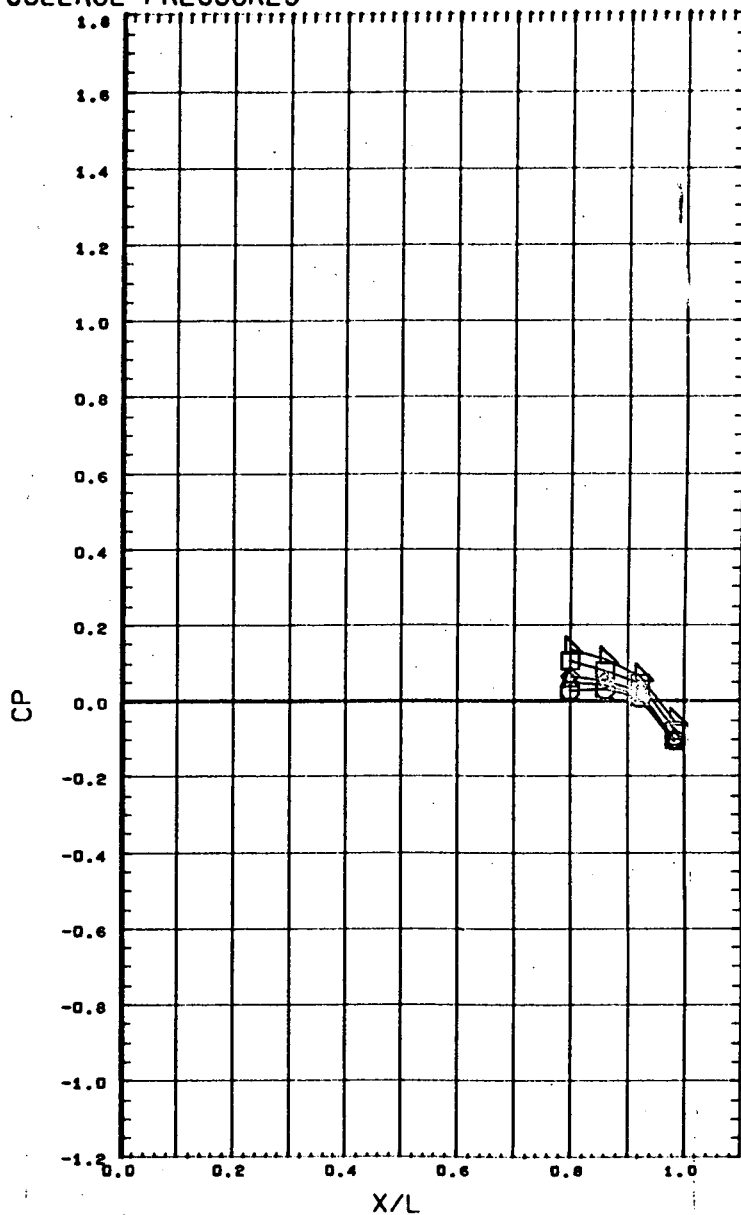
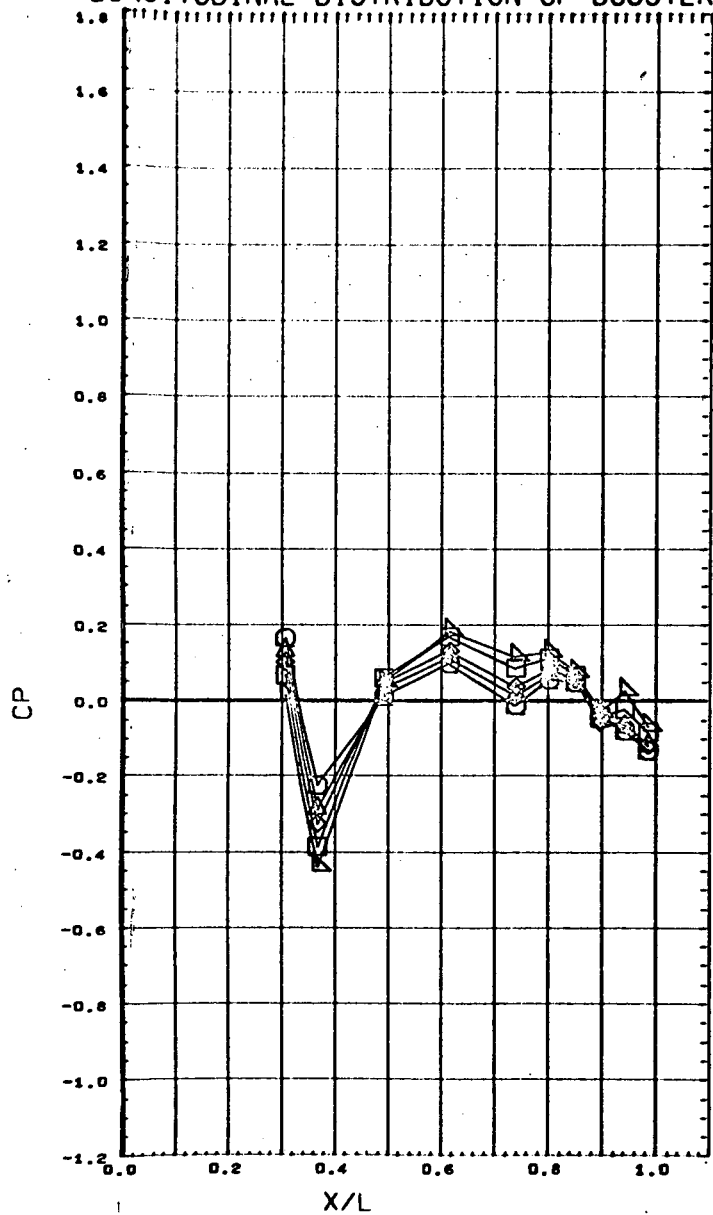

| SYMBOL | ALFB | THETA | M1 |
|--------|--------|---------|-------|
| ○ | 2.165 | 90.000 | 1.201 |
| ◇ | 4.175 | 180.000 | |
| △ | 5.542 | | |
| □ | 7.781 | | |
| ○ | 10.179 | | |

REFERENCE FILE

| PARAMETRIC VALUES | | | |
|-------------------|-------|------|-------|
| BETA | 0.000 | CX/L | 0.036 |
| I | 1.900 | | |

LONGITUDINAL DISTRIBUTION OF BOOSTER FUSELAGE PRESSURES

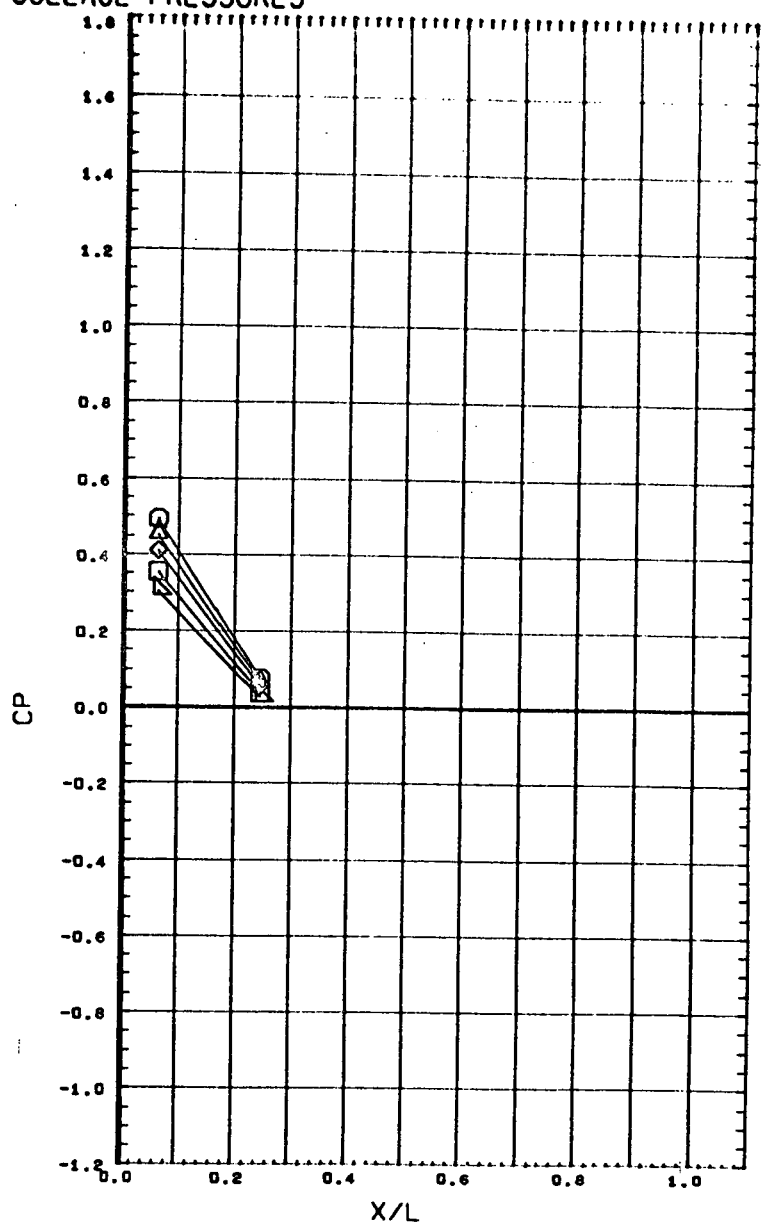
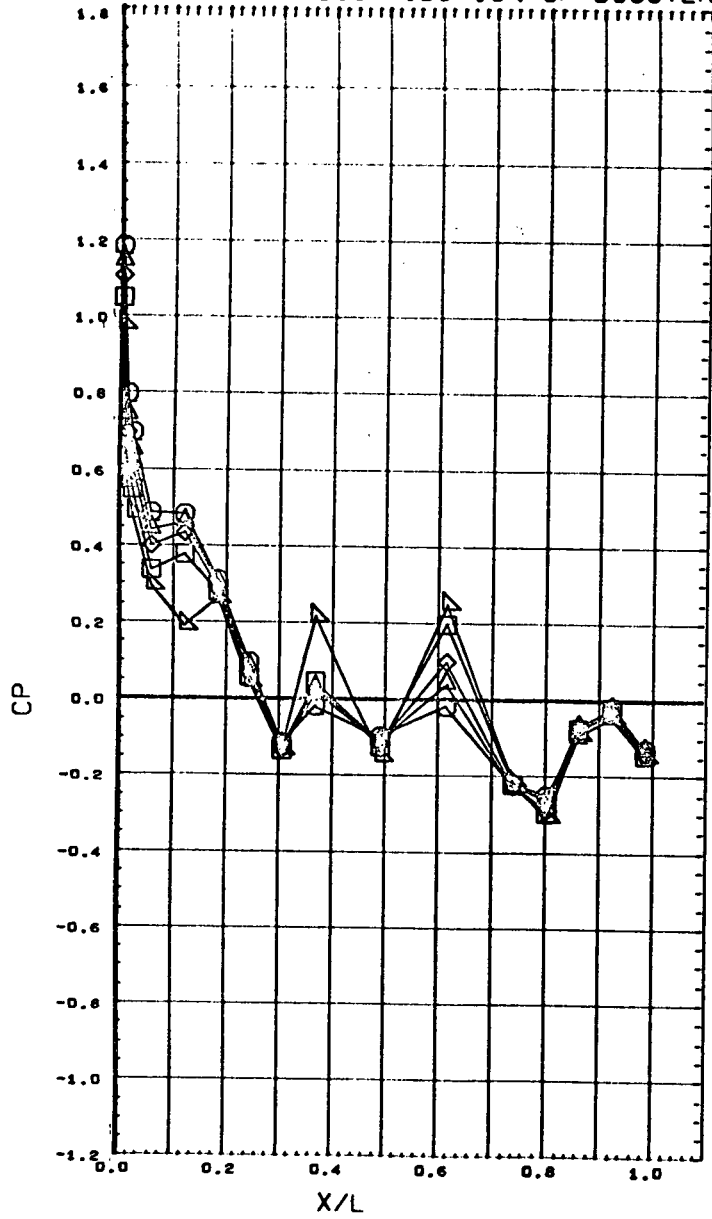

| SYMBOL | ALFB | THETA | M1 |
|--------|-------|--------|-------|
| ○ | 7.919 | 0.000 | 1.299 |
| ◇ | 5.804 | 15.000 | |
| △ | 4.443 | | |
| □ | 2.184 | | |
| ○ | 0.212 | | |

REFERENCE FILE

| PARAMETRIC VALUES | | |
|-------------------|-------|-------|
| BETA | 0.000 | OX/L |
| I | 1.900 | 0.036 |

LONGITUDINAL DISTRIBUTION OF BOOSTER FUSELAGE PRESSURES

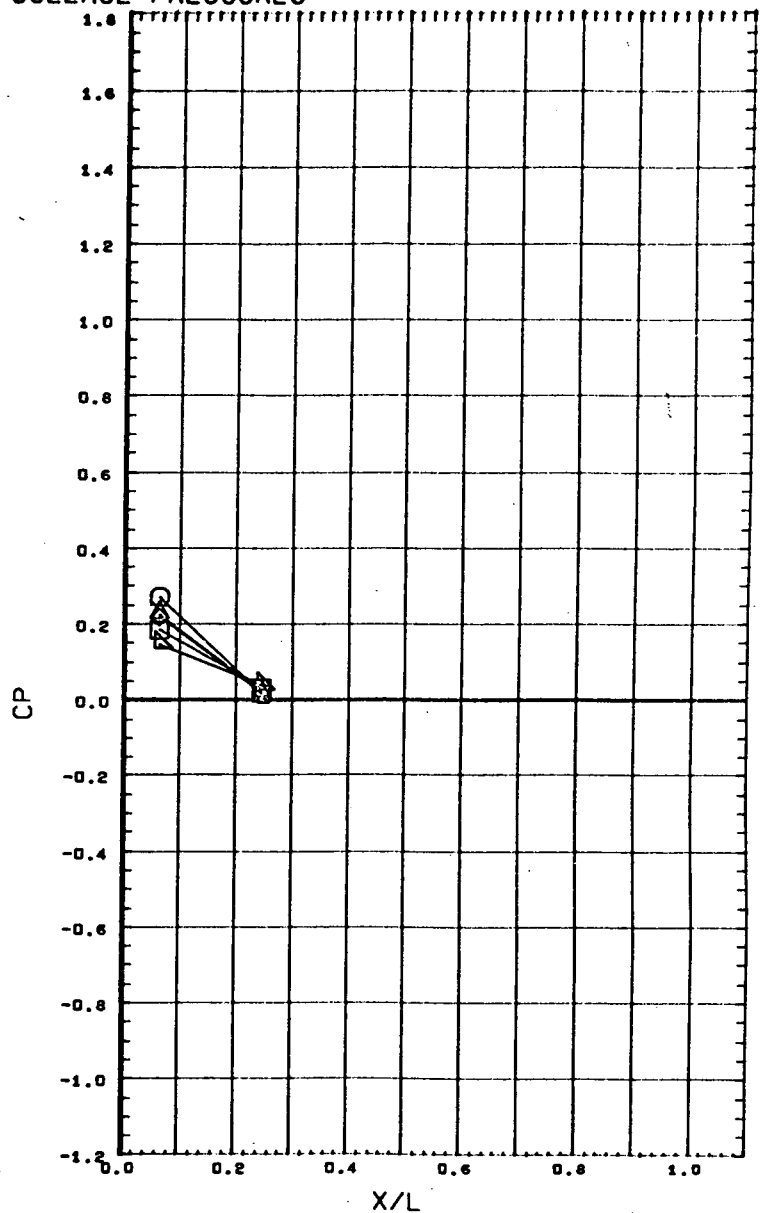
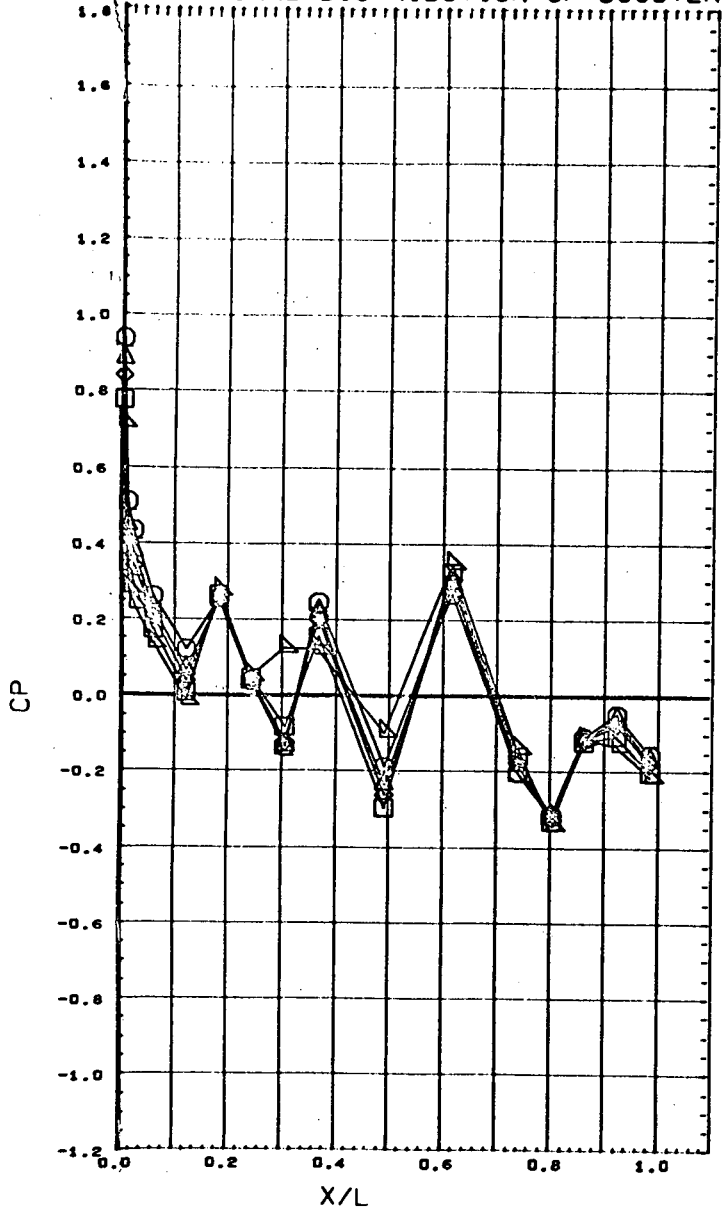

| SYMBOL | ALFB | THETA | M1 |
|--------|--------|--------|-------|
| ○ | 1.918 | 0.000 | 1.299 |
| △ | 4.204 | 15.000 | |
| ◇ | 5.543 | | |
| □ | 7.781 | | |
| ▽ | 10.179 | | |

| PARAMETRIC VALUES | | | |
|-------------------|-------|------|-------|
| BETA | 0.000 | DX/L | 0.036 |
| I | 1.900 | | |

REFERENCE FILE

AEDC TC174 MDAC BOOSTER NEAR ORBITER (BODY)

(ATC009)

PAGE 257

C-4

LONGITUDINAL DISTRIBUTION OF BOOSTER FUSELAGE PRESSURES

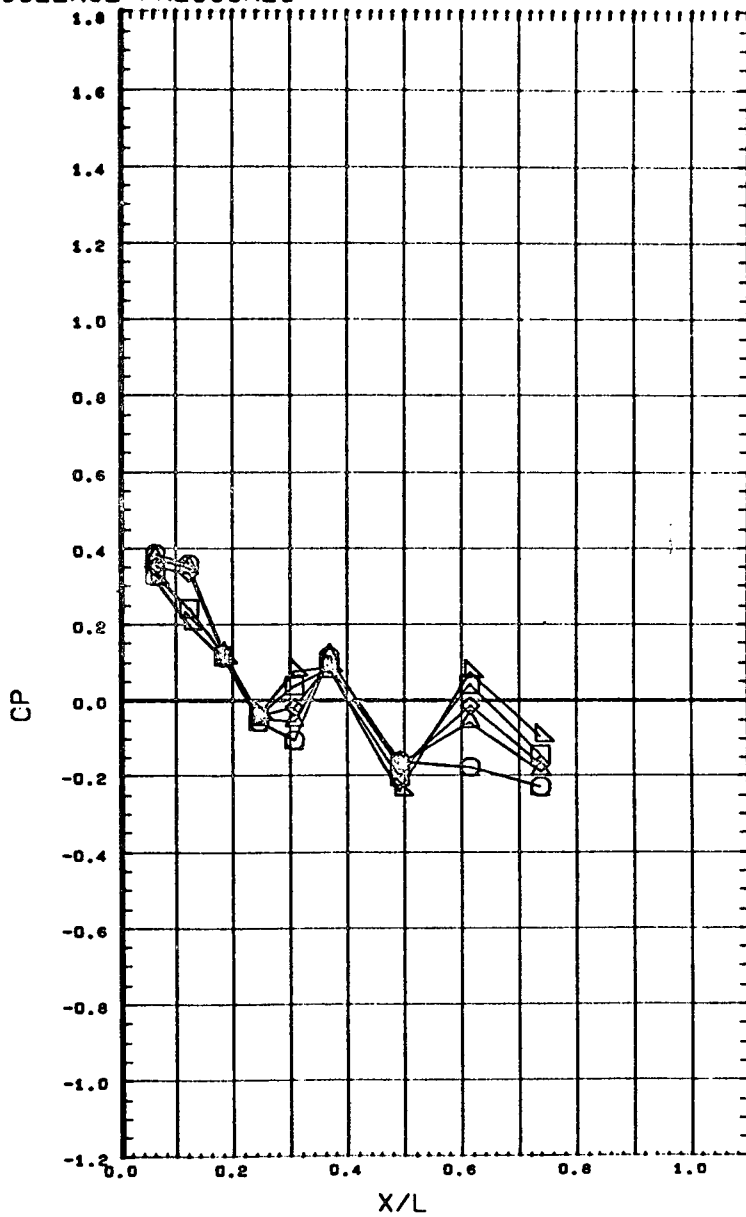
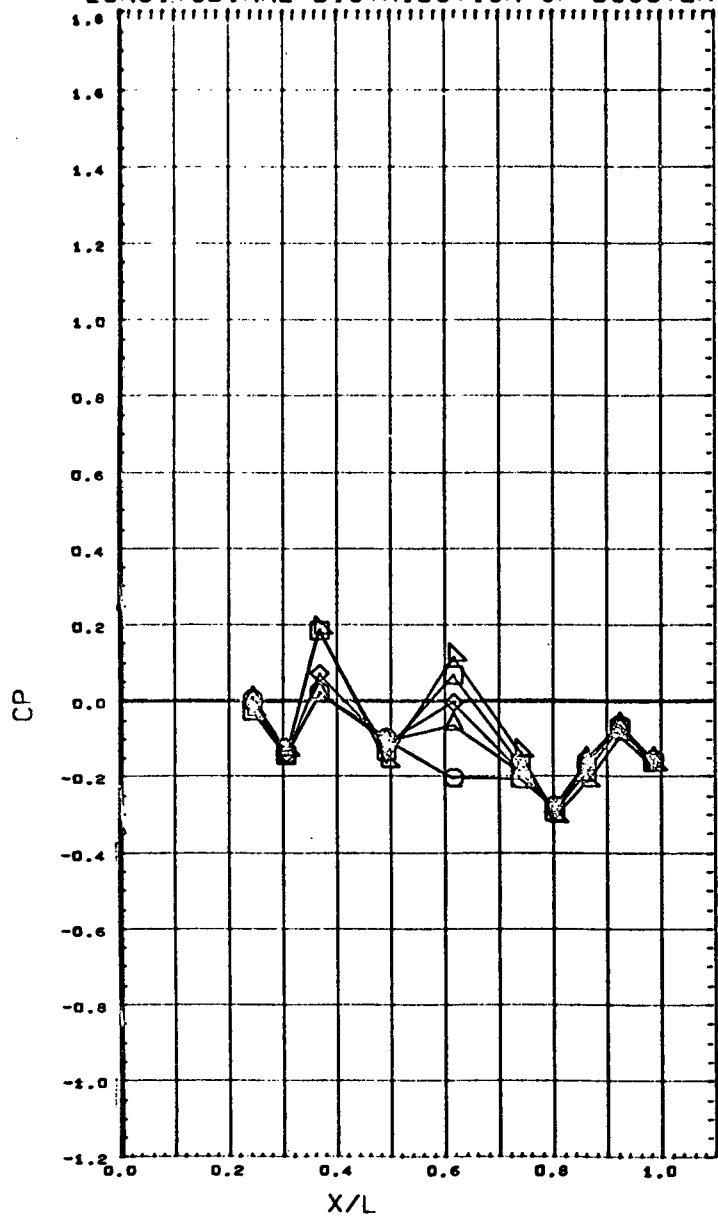

| SYMBOL | ALFB | THETA | M1 |
|--------|---------|--------|-------|
| ○ | - 7.919 | 24.000 | 1.299 |
| ◇ | - 5.804 | 45.000 | |
| △ | - 4.443 | | |
| □ | - 2.184 | | |
| ▽ | P.212 | | |

| PARAMETRIC VALUES | | |
|-------------------|-------|-------------|
| BETA | 0.000 | OX/L 10.036 |
| I | 1.900 | |

REFERENCE FILE

LONGITUDINAL DISTRIBUTION OF BOOSTER FUSELAGE PRESSURES

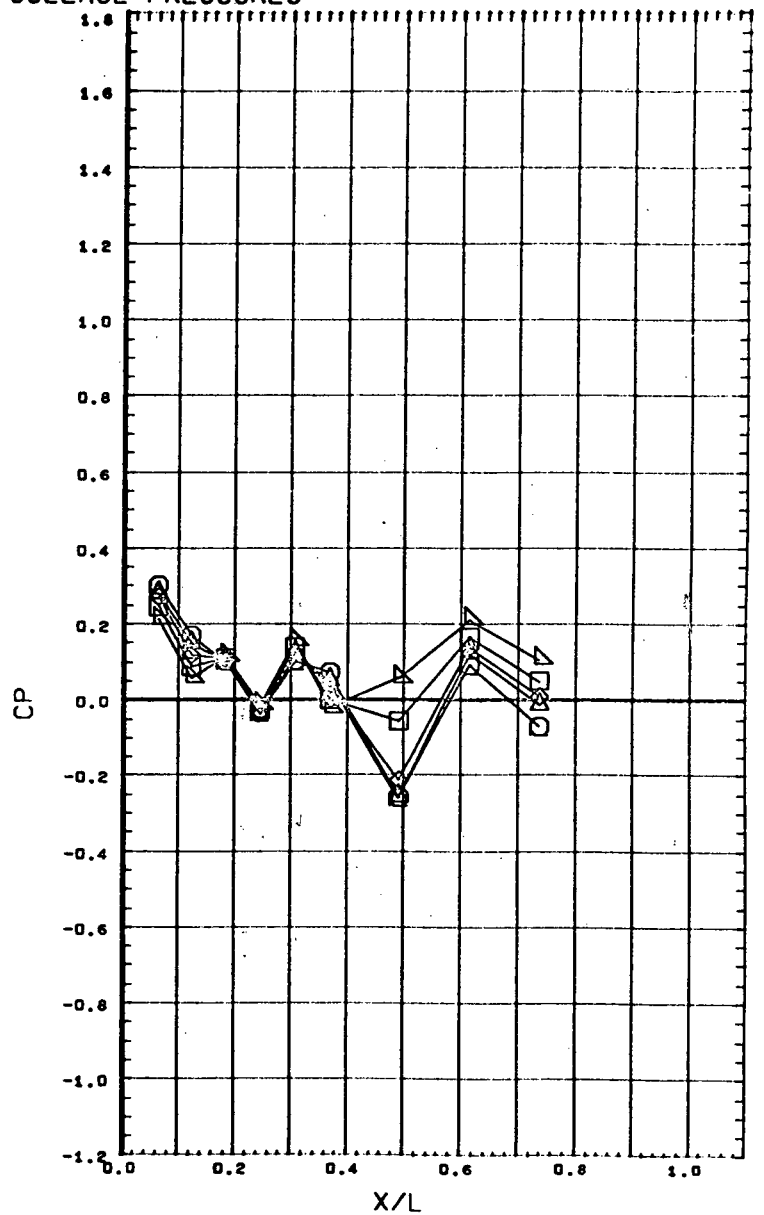
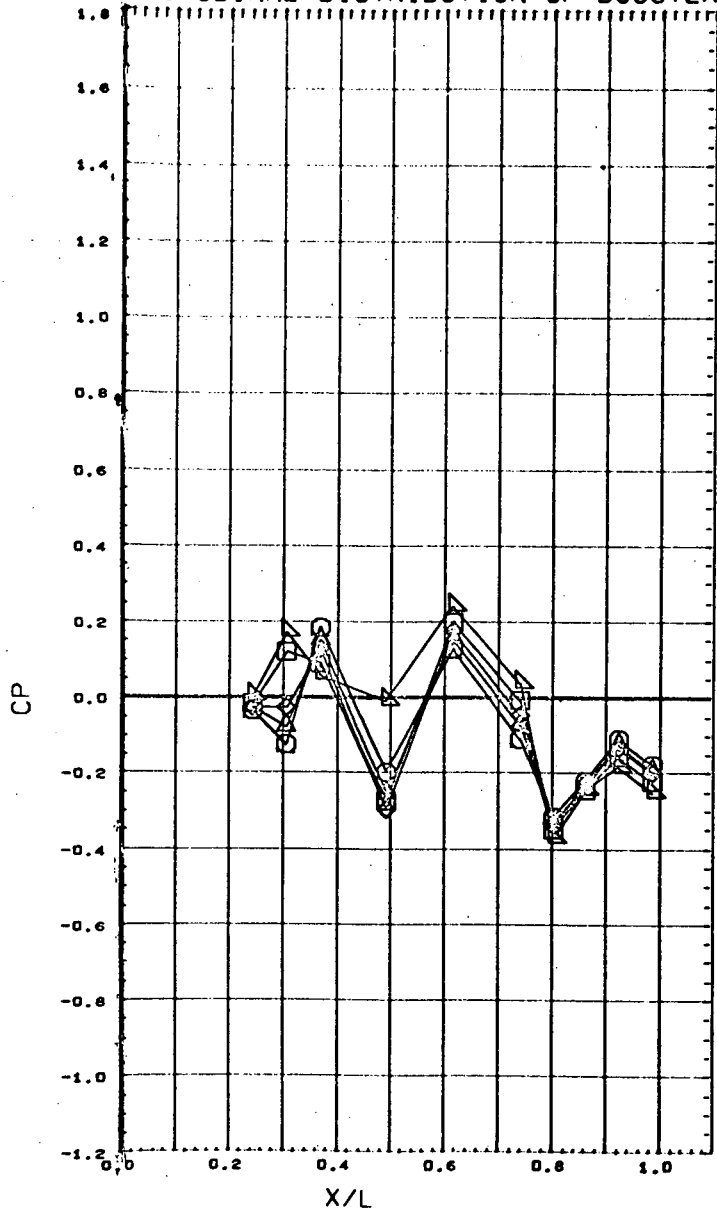

| SYMBOL | ALFB | THETA | M1 |
|--------|--------|--------|-------|
| ○ | 1.918 | 24.000 | 1.299 |
| △ | 4.204 | 45.000 | |
| ◇ | 5.543 | | |
| □ | 7.781 | | |
| ○ | 10.179 | | |

REFERENCE FILE

| PARAMETRIC VALUES | | |
|-------------------|-------|-------|
| BETA | 0.000 | DX/L |
| I | 1.900 | 0.036 |

LONGITUDINAL DISTRIBUTION OF BOOSTER FUSELAGE PRESSURES

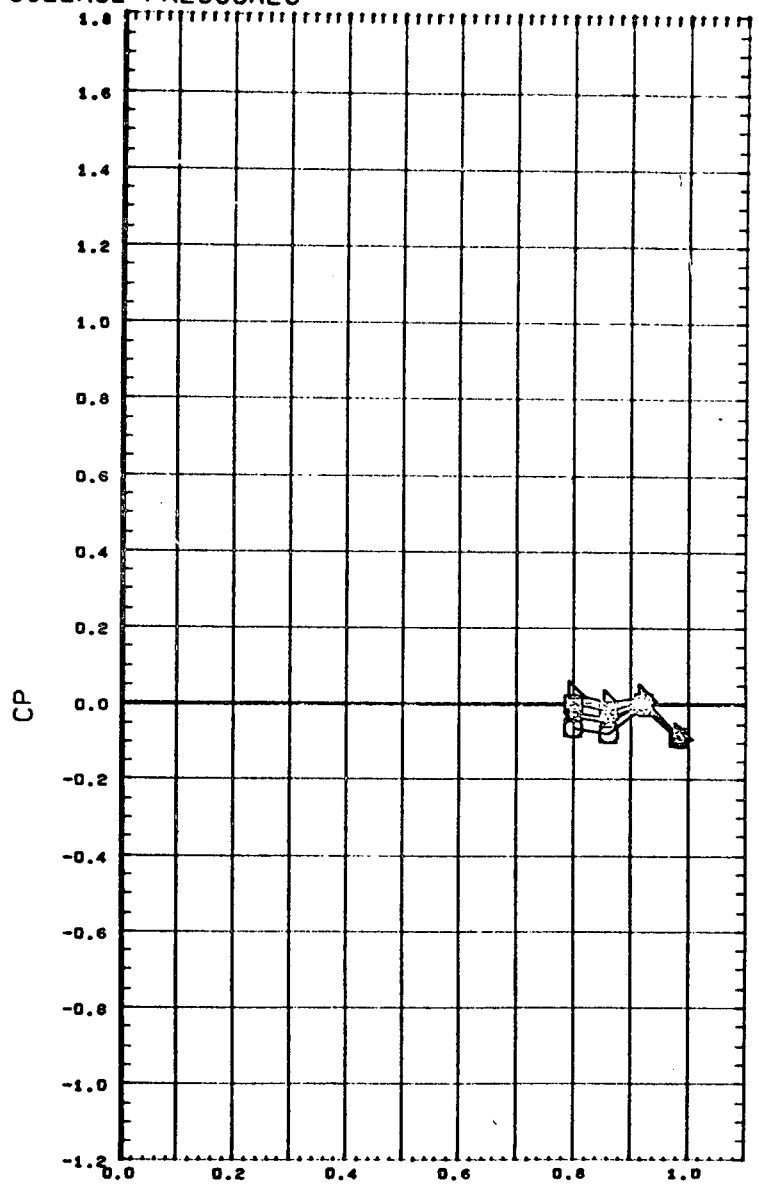
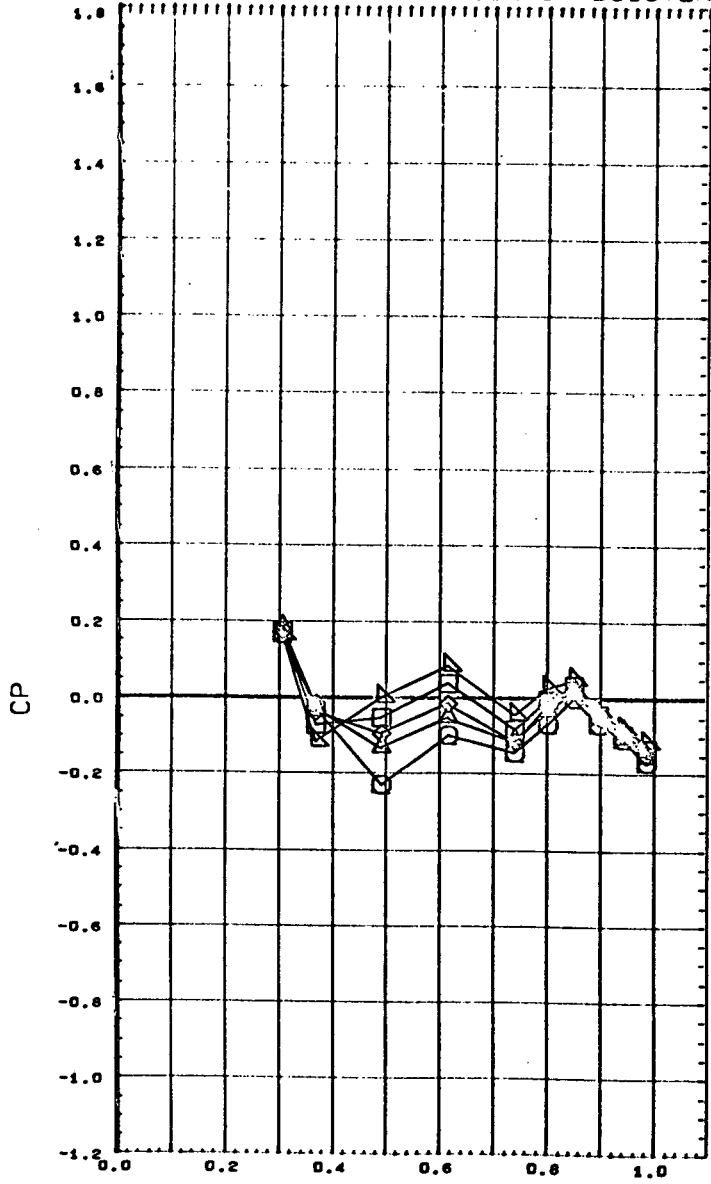

| SYMBOL | ALFB | THETA | M1 |
|--------|---------|---------|-------|
| ○ | - 7.919 | 90.000 | 1.299 |
| ◇ | - 5.804 | 180.000 | |
| △ | - 4.443 | | |
| □ | - 2.184 | | |
| ▽ | 0.212 | | |

| PARAMETRIC VALUES | | | |
|-------------------|-------|------|-------|
| BETA | 0.000 | αX/L | 0.036 |
| I | 1.900 | | |

REFERENCE FILE

LONGITUDINAL DISTRIBUTION OF BOOSTER FUSELAGE PRESSURES

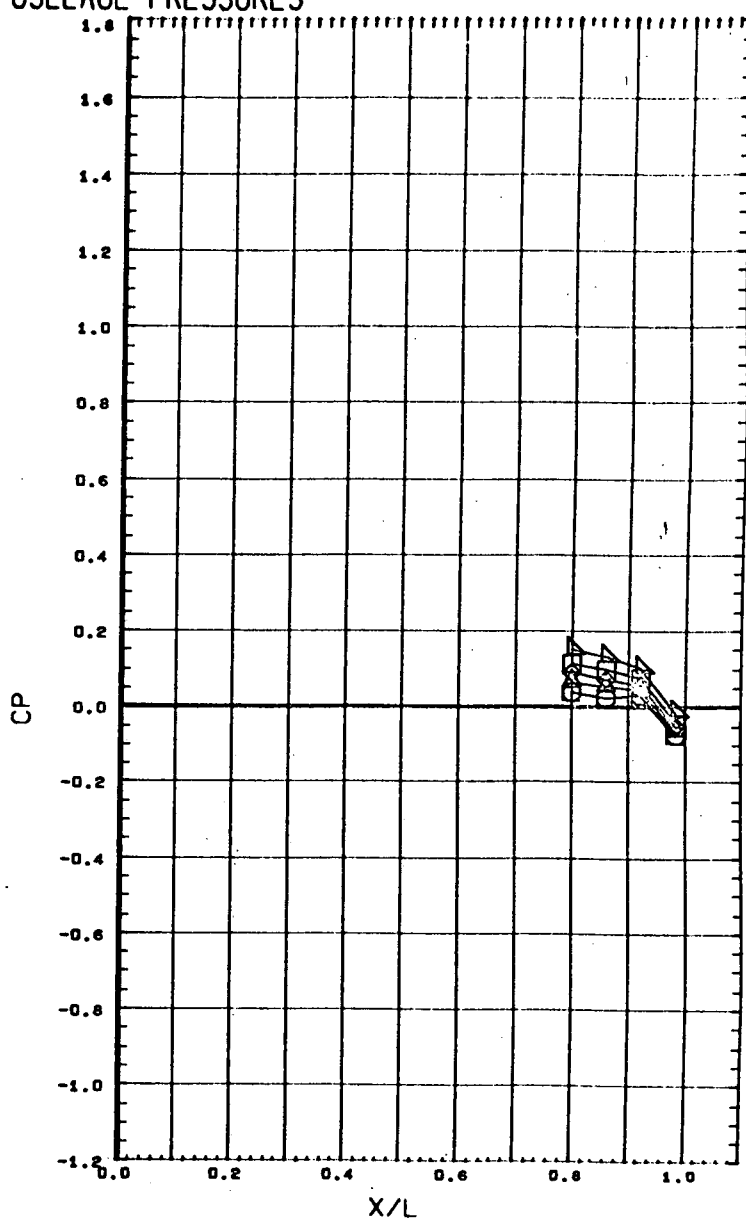
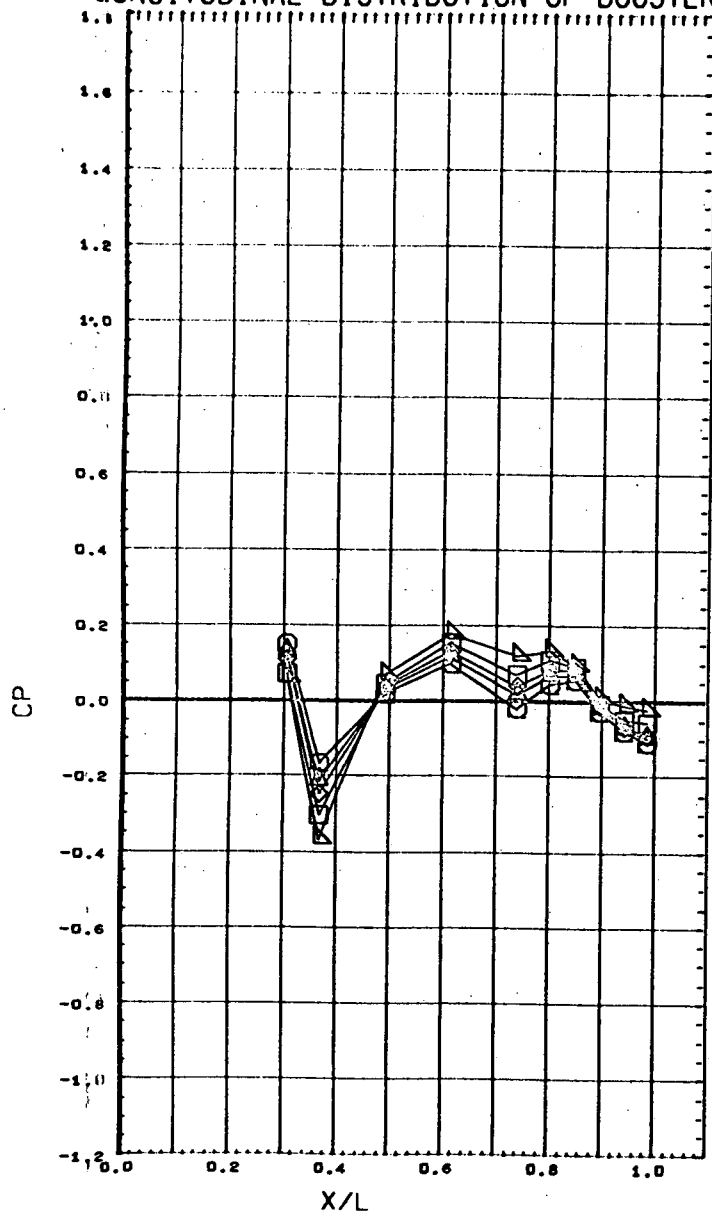

| SYMBOL | ALFB | THETA | M1 |
|--------|--------|---------|-------|
| ○ | 1.918 | 90.000 | 1.299 |
| △ | 4.204 | 180.000 | |
| ◇ | 5.543 | | |
| □ | 7.781 | | |
| ◇ | 10.179 | | |

REFERENCE FILE

| PARAMETRIC VALUES | | |
|-------------------|-------|-------|
| BETA | 0.000 | OX/L |
| I | 1.900 | 0.036 |

LONGITUDINAL DISTRIBUTION OF BOOSTER FUSELAGE PRESSURES

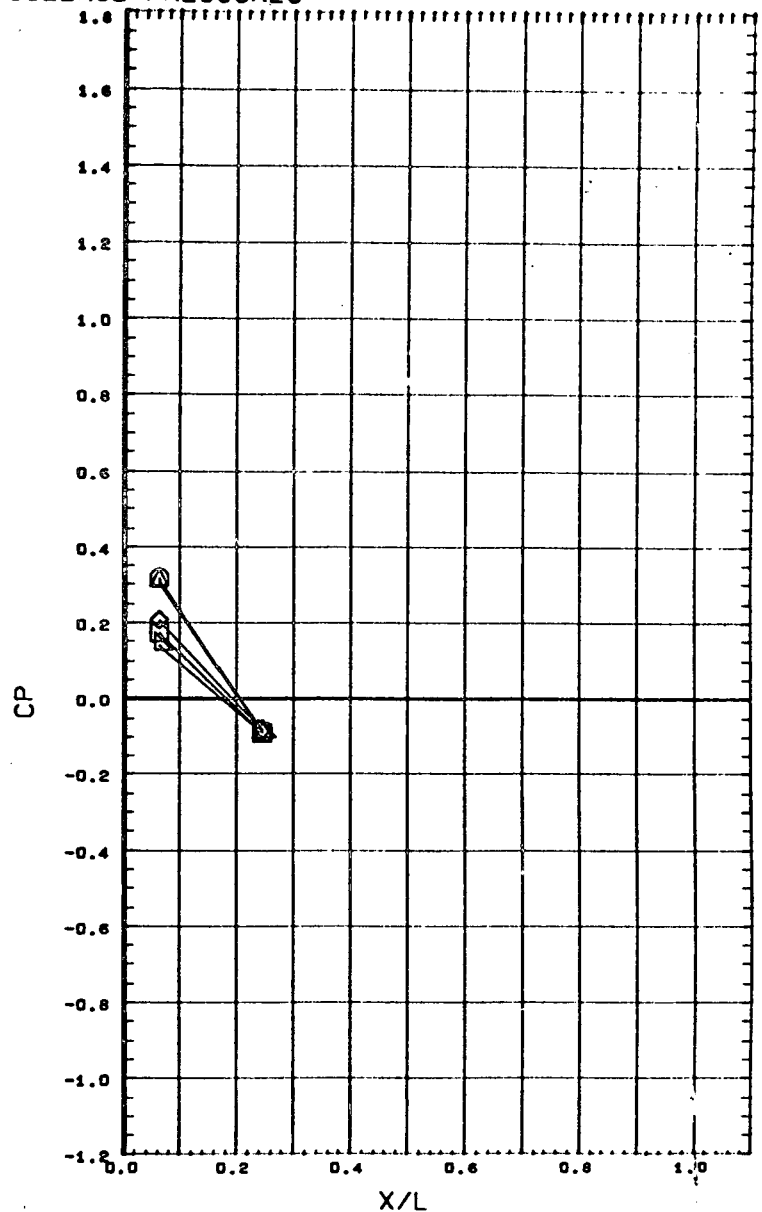
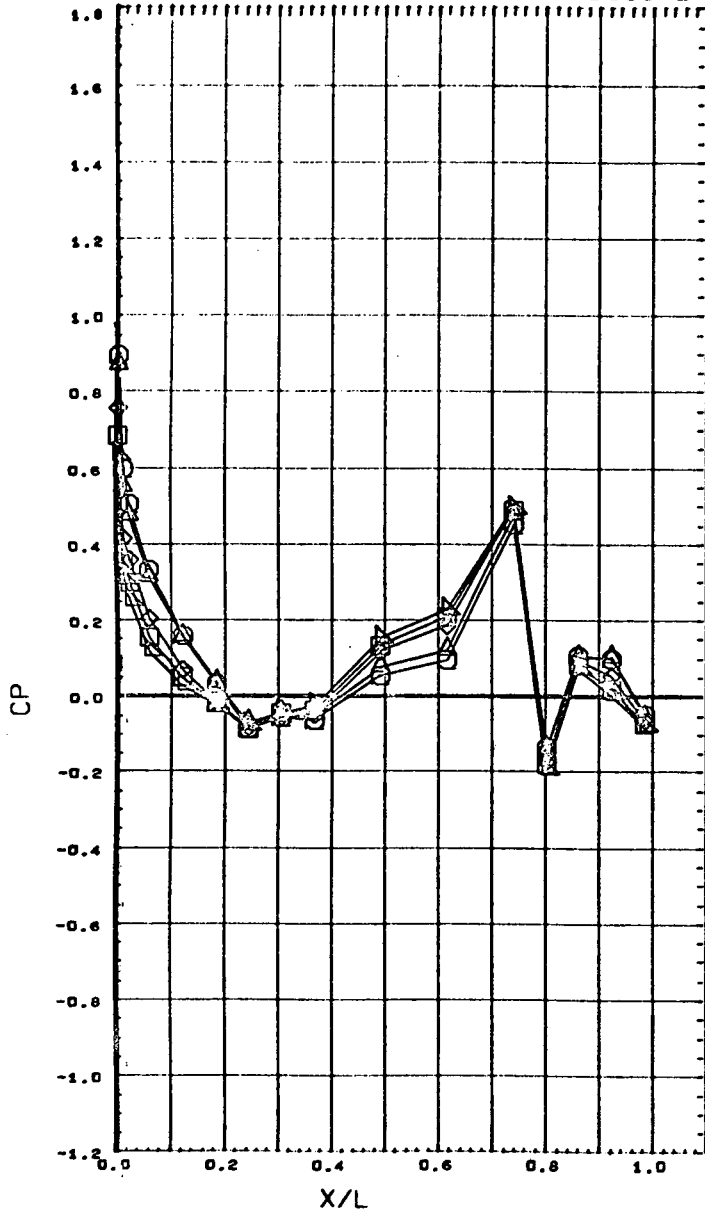

| SYMBOL | ALFB | THETA | M1 |
|--------|-------|--------|-------|
| ○ | 8.145 | 0.000 | 0.602 |
| ◇ | 6.431 | 15.000 | |
| △ | 1.866 | | |
| □ | 0.118 | | |
| ◇ | 2.110 | | |

| PARAMETRIC VALUES | | | |
|-------------------|-------|------|-------|
| BETA | 0.000 | DX/L | 0.036 |
| I | 3.800 | | |

REFERENCE FILE

LONGITUDINAL DISTRIBUTION OF BOOSTER FUSELAGE PRESSURES

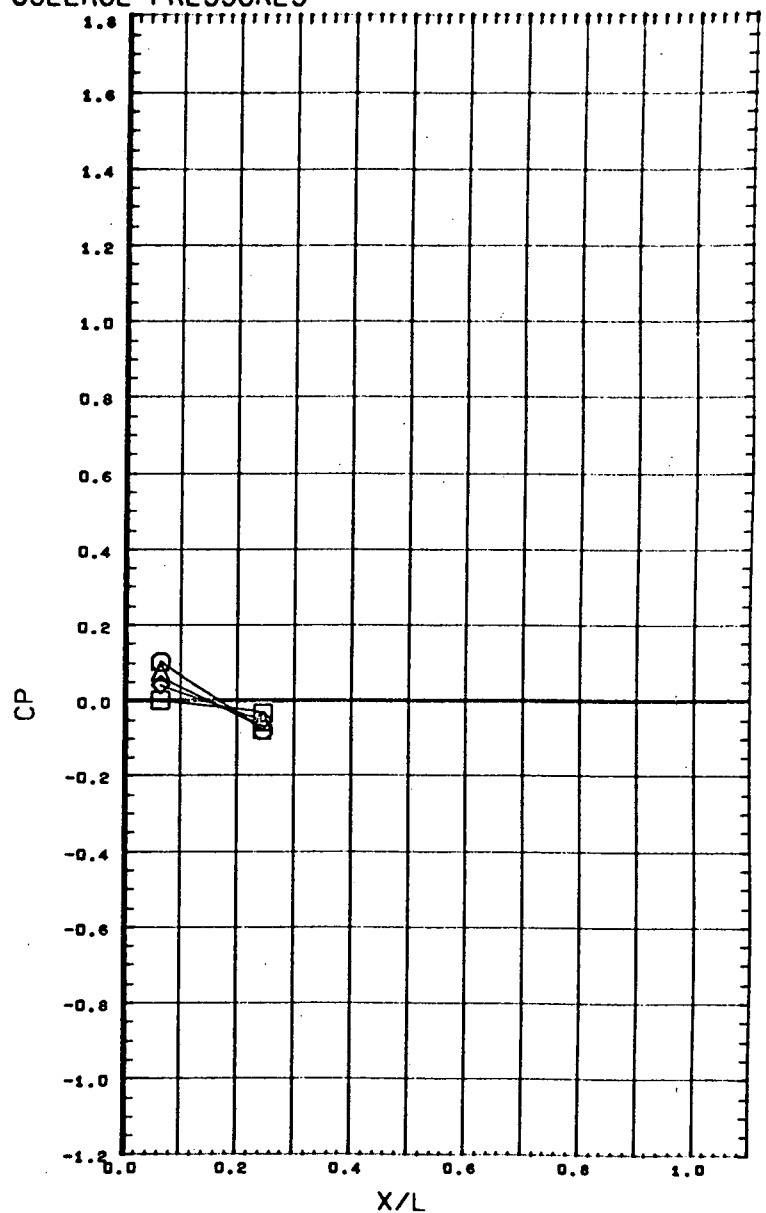
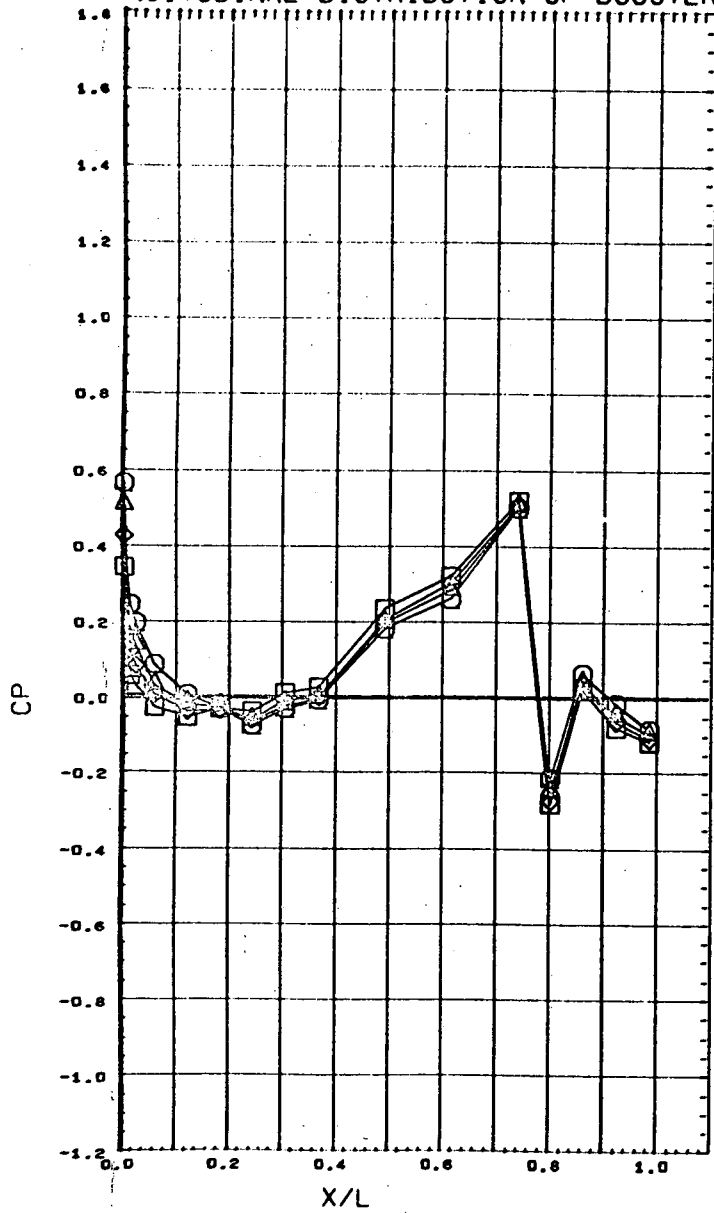

| SYMBOL | ALFB | THETA | M1 |
|--------|--------|--------|-------|
| ○ | 4.101 | 0.000 | 0.662 |
| △ | 6.690 | 15.000 | |
| ◇ | 7.692 | | |
| □ | 10.115 | | |

| PARAMETRIC VALUES | | | |
|-------------------|-------|------|-------|
| BETA | 0.000 | DX/L | 0.036 |
| I | 3.600 | | |

REFERENCE FILE

LONGITUDINAL DISTRIBUTION OF BOOSTER FUSELAGE PRESSURES

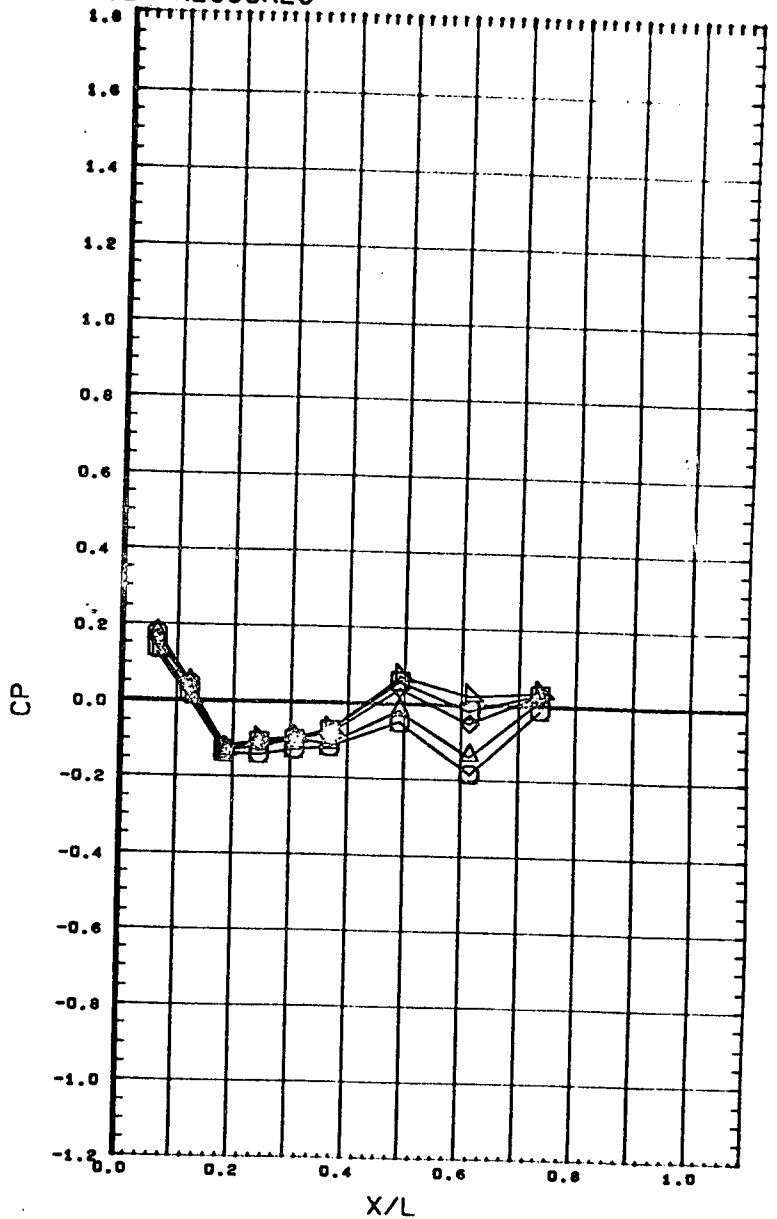
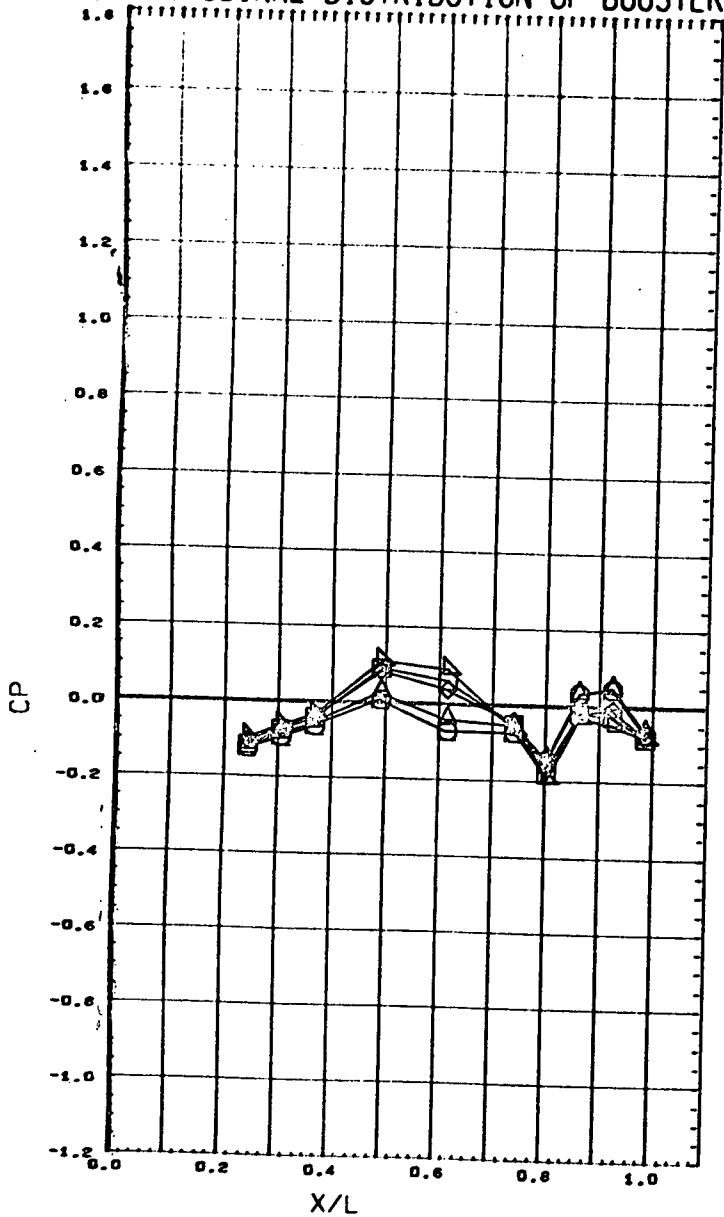

| SYMBOL | ALFB | THETA | M1 |
|--------|-------|--------|-------|
| ◻ | 8.145 | 24.000 | 0.602 |
| ◊ | 6.431 | 45.000 | |
| ◈ | 1.886 | | |
| ◉ | 0.118 | | |
| ◊ | 2.110 | | |

| PARAMETRIC VALUES | | | |
|-------------------|-------|------|-------|
| BETA | 0.000 | DX/L | 0.036 |
| I | 3.800 | | |

REFERENCE FILE

AEDC TC174 MDAC BOOSTER NEAR ORBITER (BODY)

(ATC010)

PAGE 264

LONGITUDINAL DISTRIBUTION OF BOOSTER FUSELAGE PRESSURES

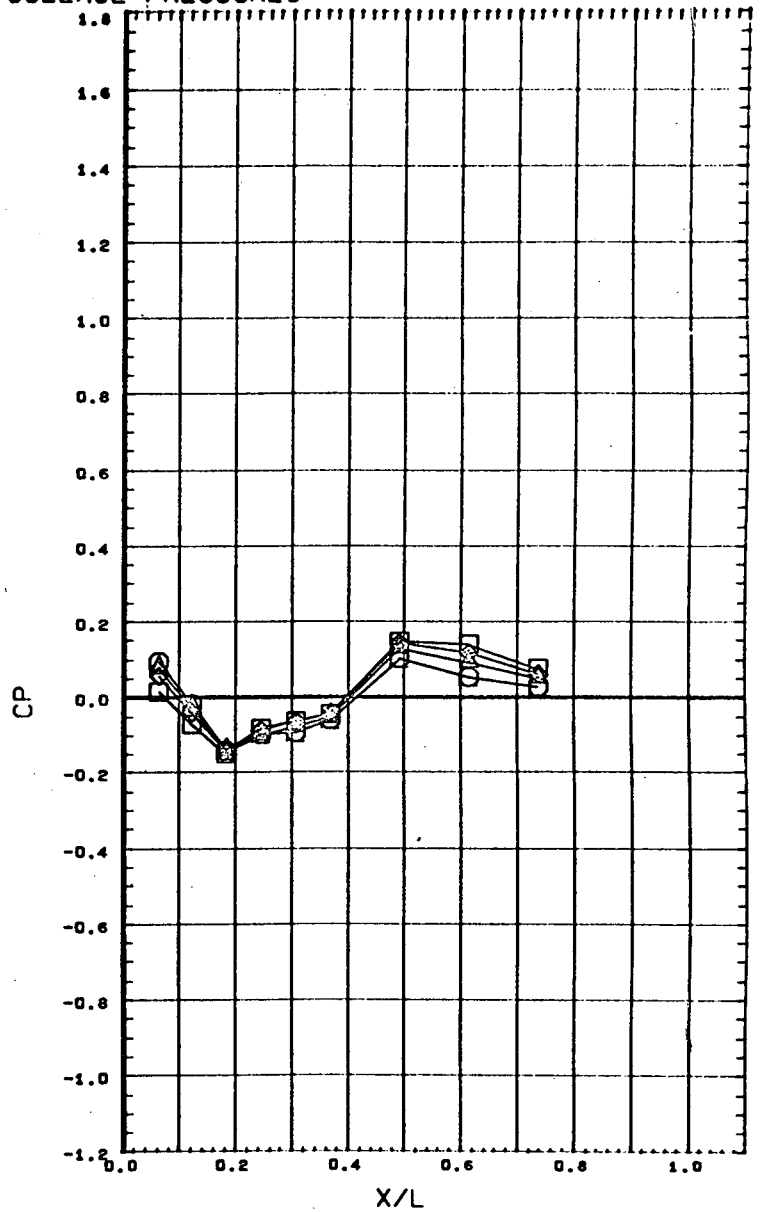
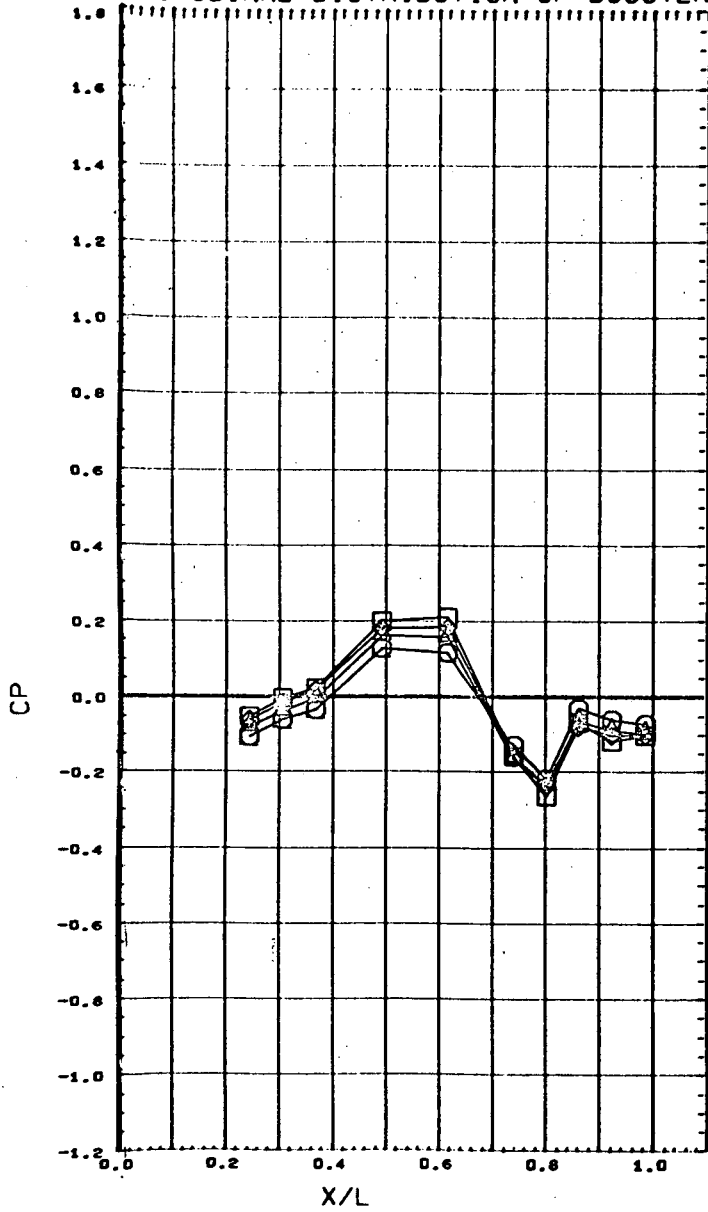

| SYMBOL | ALFB | THETA | M1 |
|--------|--------|--------|-------|
| ○ | 4.161 | 24.000 | 0.602 |
| △ | 6.095 | 45.000 | |
| ◇ | 7.692 | | |
| □ | 10.115 | | |

| PARAMETRIC VALUES | | | |
|-------------------|-------|------|-------|
| BETA | 0.000 | DX/L | 0.036 |
| I | 3.800 | | |

REFERENCE FILE

LONGITUDINAL DISTRIBUTION OF BOOSTER FUSELAGE PRESSURES

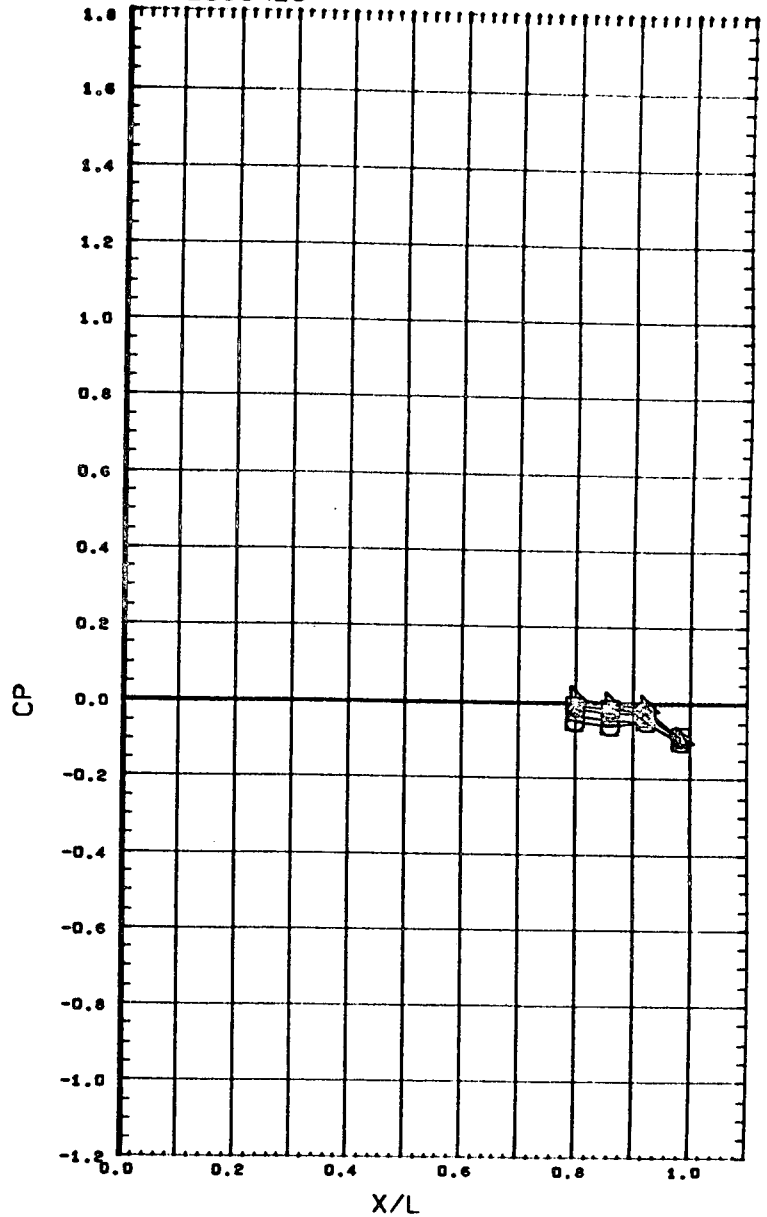
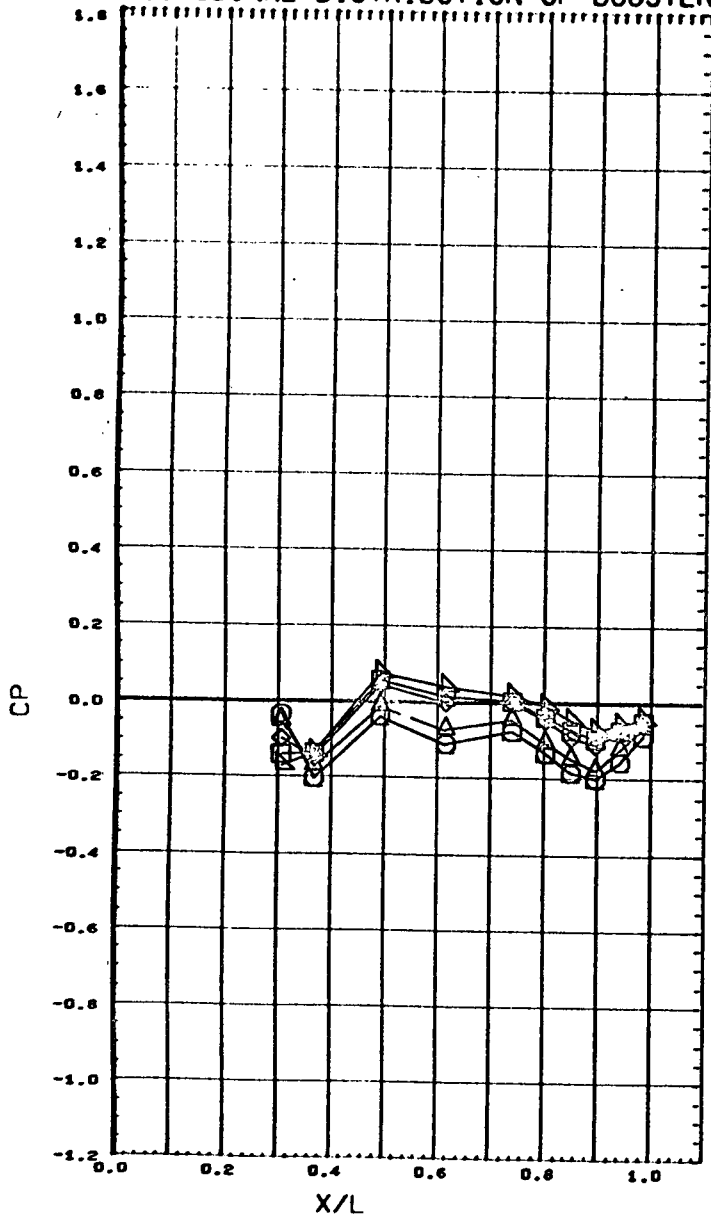

| SYMBOL | ALFA | THETA | M1 |
|--------|-------|---------|-------|
| ○ | 8.145 | 90.000 | 0.602 |
| △ | 6.431 | 180.000 | |
| ◇ | 1.886 | | |
| □ | 0.118 | | |
| ○ | 2.110 | | |

| PARAMETRIC VALUES | | | |
|-------------------|-------|------|-------|
| BETA | 0.000 | DX/L | 0.036 |
| I | 3.800 | | |

REFERENCE FILE

LONGITUDINAL DISTRIBUTION OF BOOSTER FUSELAGE PRESSURES

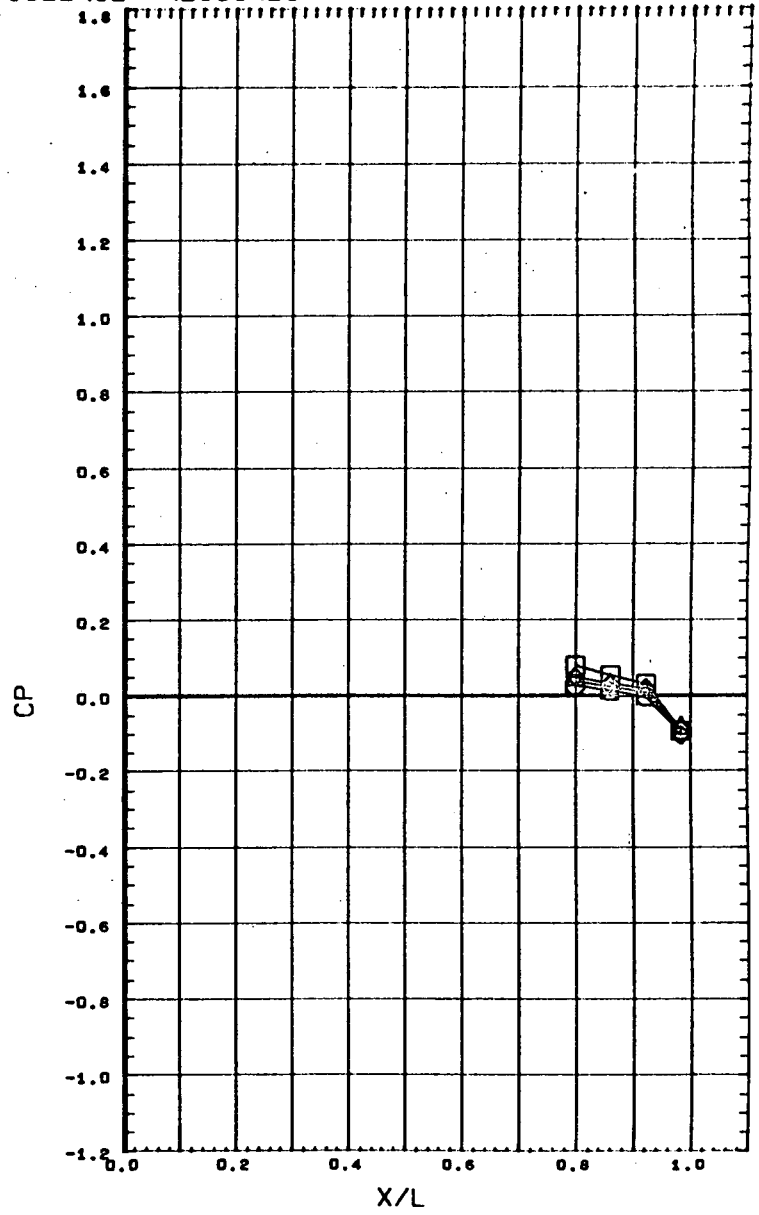
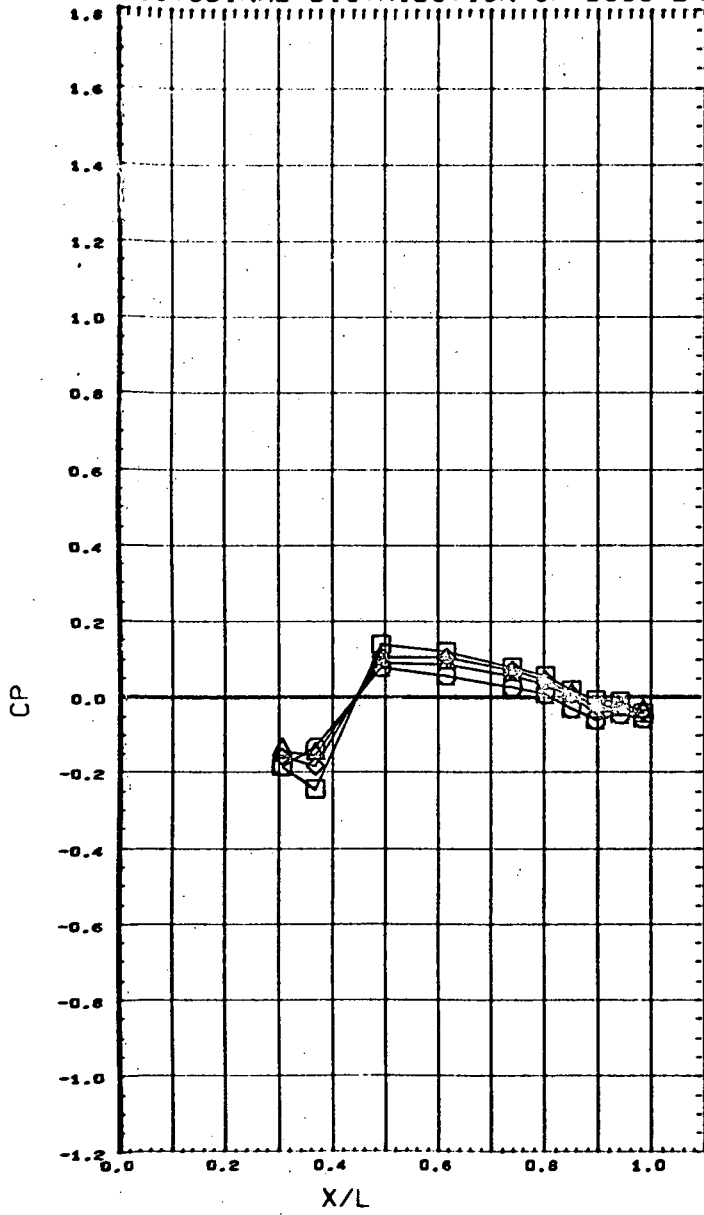

| SYMBOL | ALFB | THETA | M1 |
|--------|--------|---------|-------|
| ○ | 4.101 | 95.000 | 0.602 |
| ◇ | 6.090 | 185.000 | |
| ◇ | 7.692 | | |
| □ | 10.115 | | |

| PARAMETRIC VALUES | | |
|-------------------|-------|-------|
| BETA | 0.000 | DX/L |
| I | 3.800 | 0.036 |

REFERENCE FILE

LONGITUDINAL DISTRIBUTION OF BOOSTER FUSELAGE PRESSURES

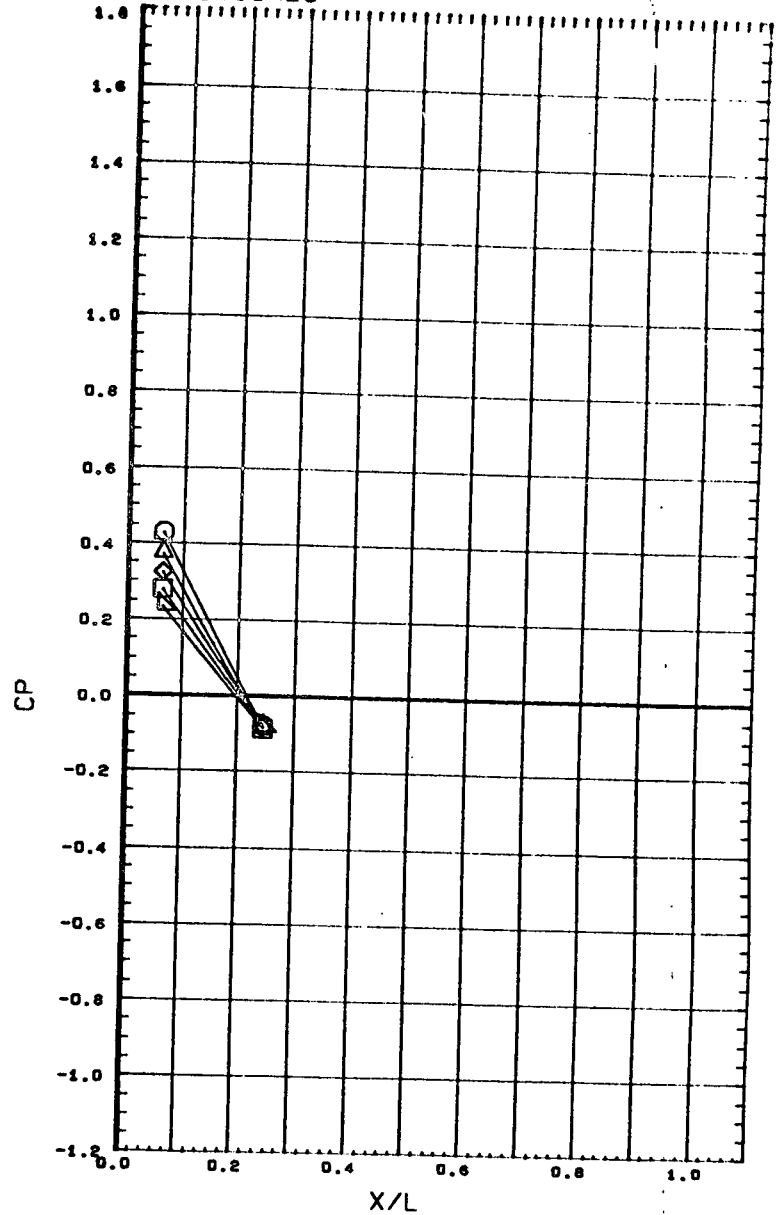
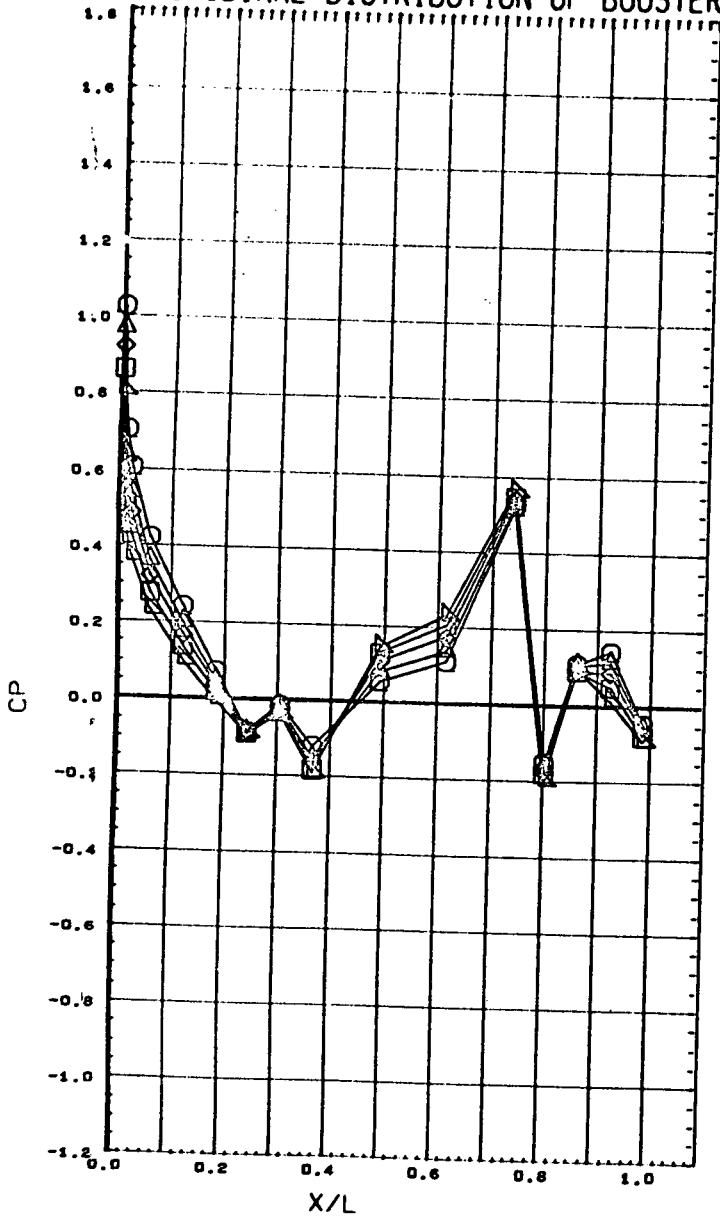

| SYMBOL | ALFB | THETA | M1 |
|--------|-------|--------|-------|
| ○ | 8.247 | 0.000 | 0.902 |
| ◇ | 5.623 | 15.000 | |
| △ | 3.825 | | |
| □ | 1.848 | | |
| ○ | 0.126 | | |

| PARAMETRIC VALUES | | | |
|-------------------|-------|------|-------|
| BETA | 0.000 | DX/L | 0.036 |
| I | 3.600 | | |

REFERENCE FILE

AEDC TC174 MDAC BOOSTER NEAR ORBITER (BODY)

(ATC010)

PAGE 268

LONGITUDINAL DISTRIBUTION OF BOOSTER FUSELAGE PRESSURES

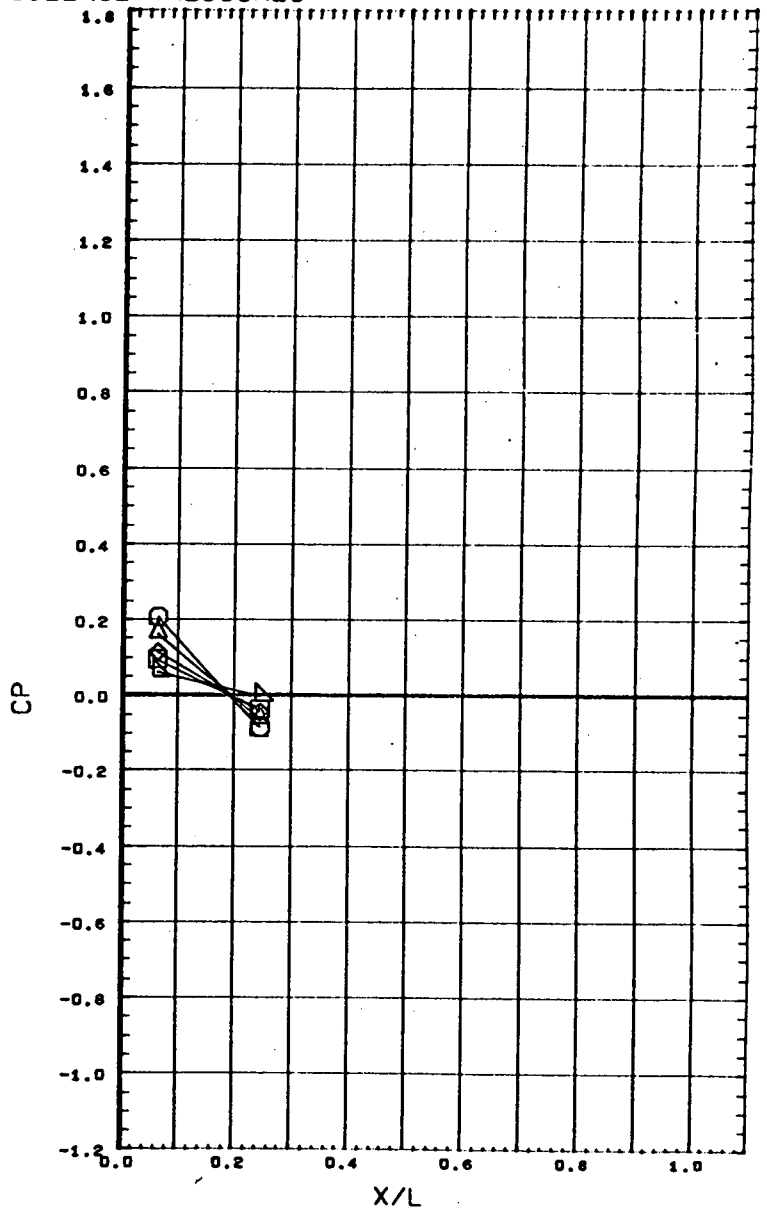
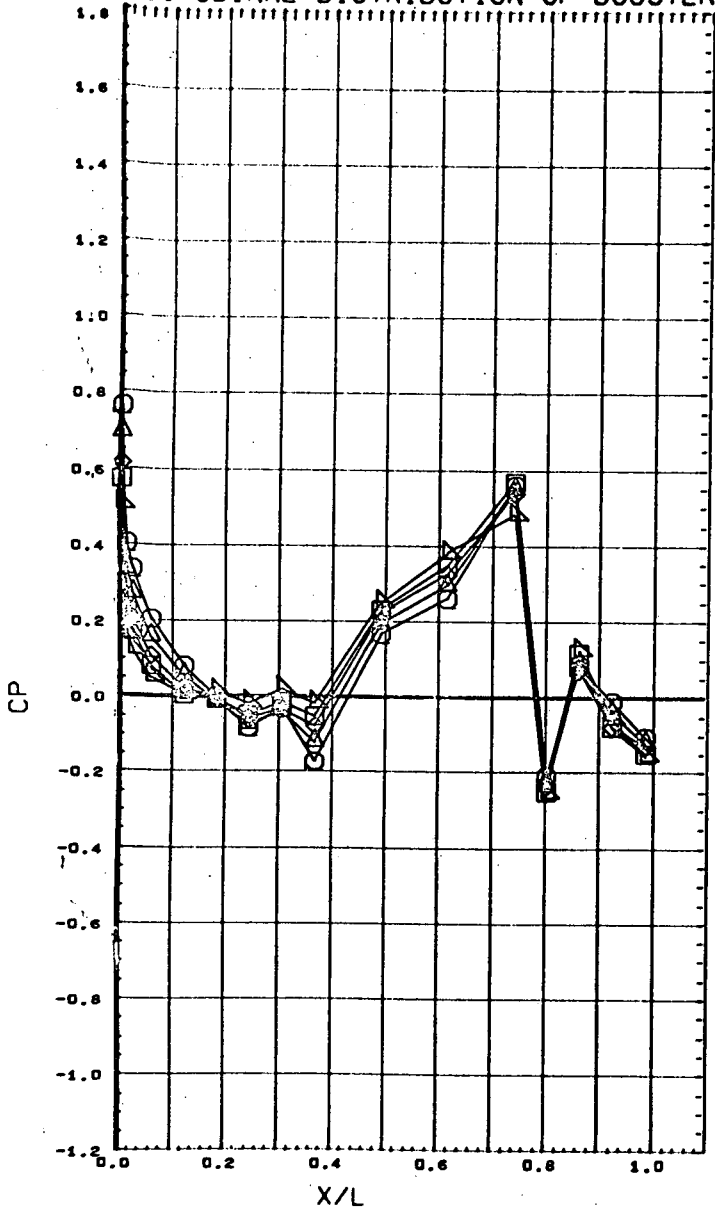

| SYMBOL | ALFB | THETA | M1 |
|--------|-------|--------|-------|
| ○ | 1.552 | 0.000 | 0.902 |
| △ | 3.765 | 15.000 | |
| ◇ | 6.165 | | |
| □ | 7.507 | | |
| ▽ | 9.767 | | |

REFERENCE FILE

| PARAMETRIC VALUES | | | |
|-------------------|-------|------|-------|
| BETA | 0.000 | DX/L | 0.036 |
| I | 3.800 | | |

LONGITUDINAL DISTRIBUTION OF BOOSTER FUSELAGE PRESSURES

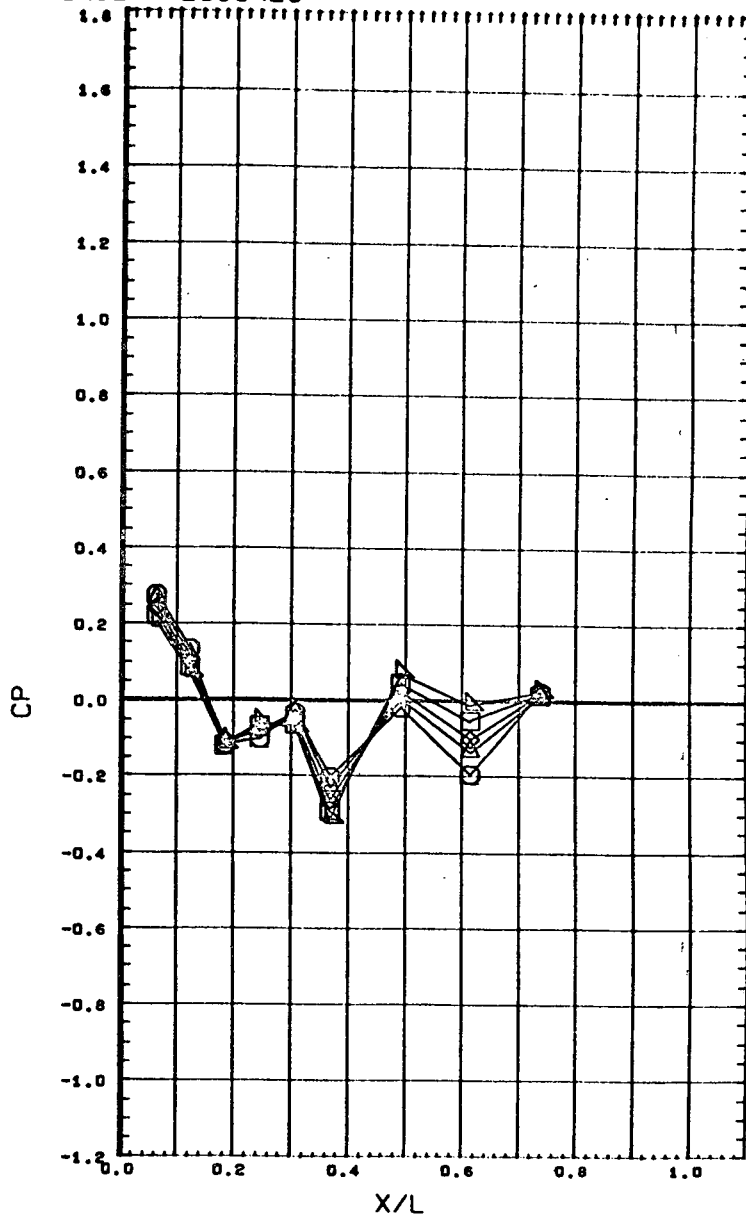
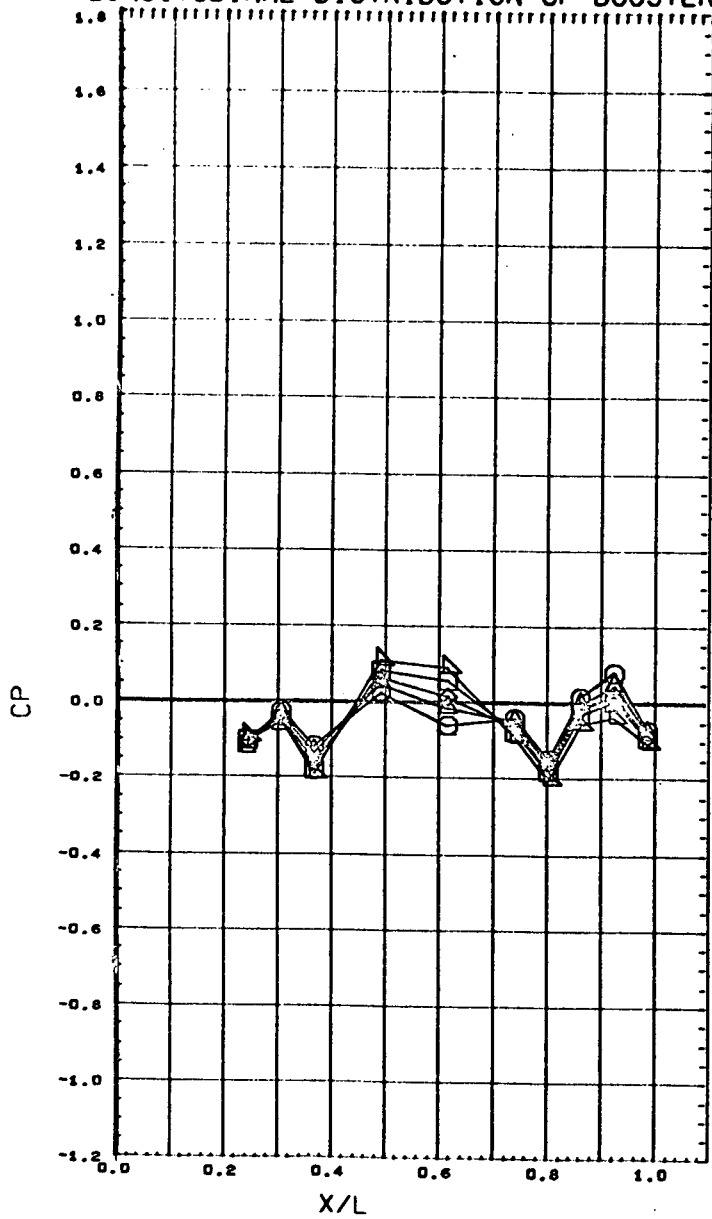

| SYMBOL | ALFB | THETA | M1 |
|--------|-------|--------|-------|
| □ | 8.247 | 24.000 | 0.902 |
| ◇ | 5.823 | 45.000 | |
| △ | 3.835 | | |
| ○ | 1.848 | | |
| ○ | 0.126 | | |

REFERENCE FILE

| PARAMETRIC VALUES | | |
|-------------------|-------|------------|
| BETA | 0.000 | DX/L 0.036 |
| I | 3.800 | |

LONGITUDINAL DISTRIBUTION OF BOOSTER FUSELAGE PRESSURES

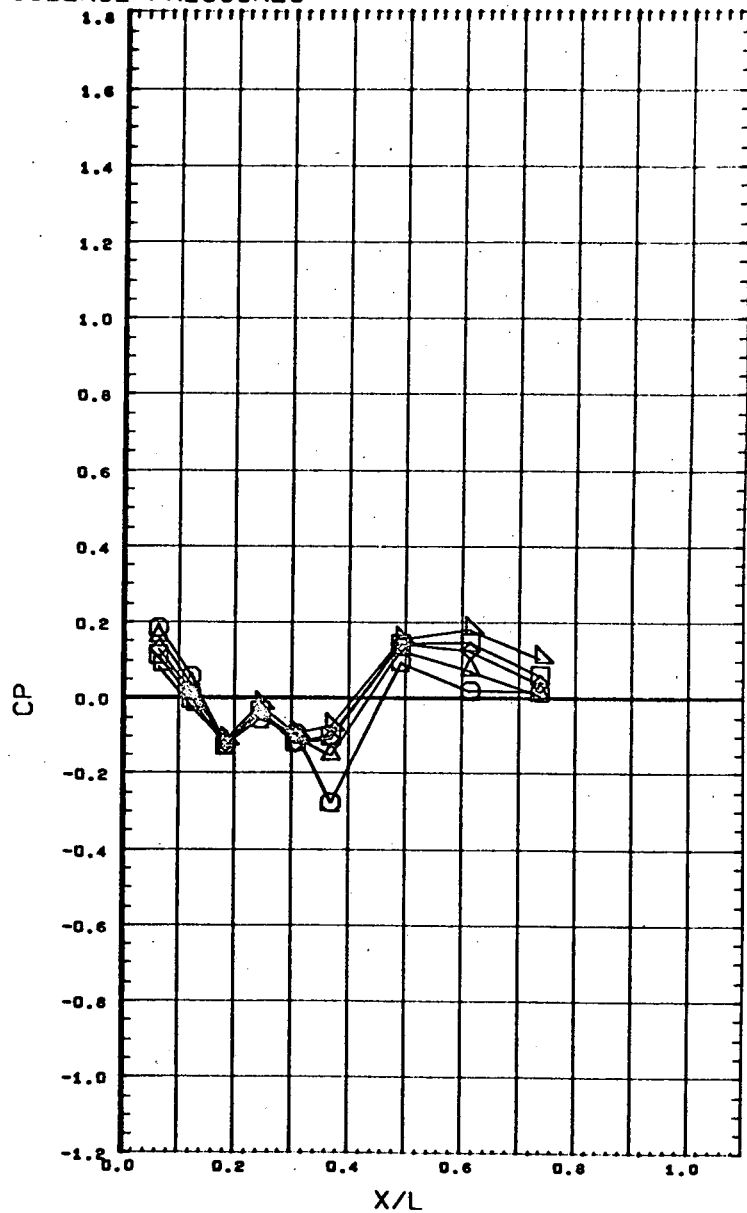
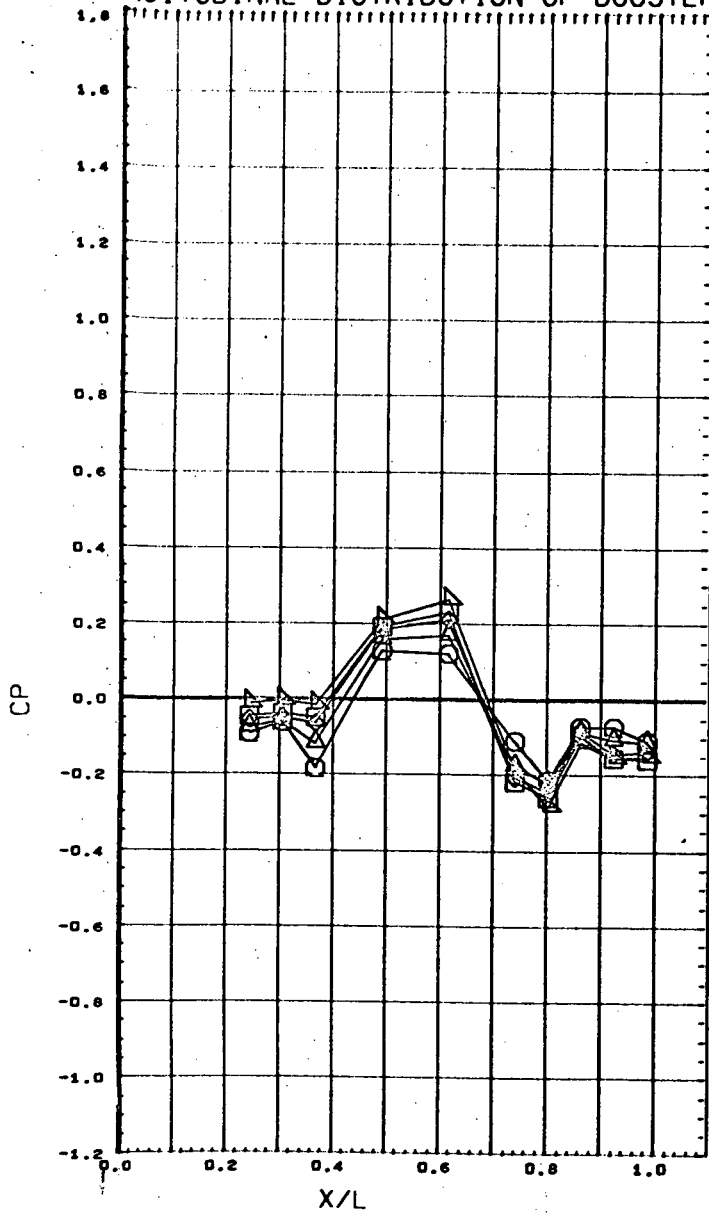

| SYMBOL | ALFB | THETA | M1 |
|--------|-------|--------|-------|
| □ | 1.552 | 24.000 | 0.902 |
| ◇ | 3.765 | 45.000 | |
| △ | 6.165 | | |
| ○ | 7.507 | | |
| ◊ | 9.767 | | |

REFERENCE FILE

| PARAMETRIC VALUES | | |
|-------------------|-------|-------|
| BETA | 0.000 | DX/L |
| I | 3.600 | 0.036 |

LONGITUDINAL DISTRIBUTION OF BOOSTER FUSELAGE PRESSURES

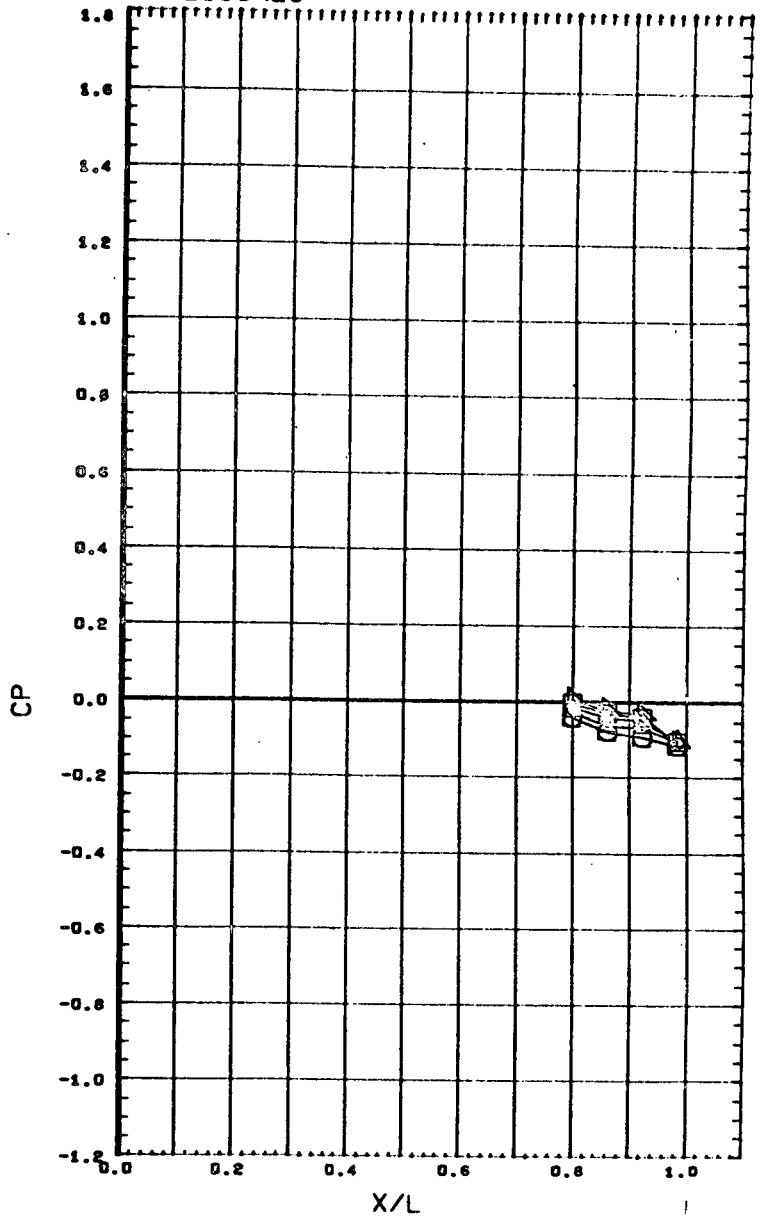
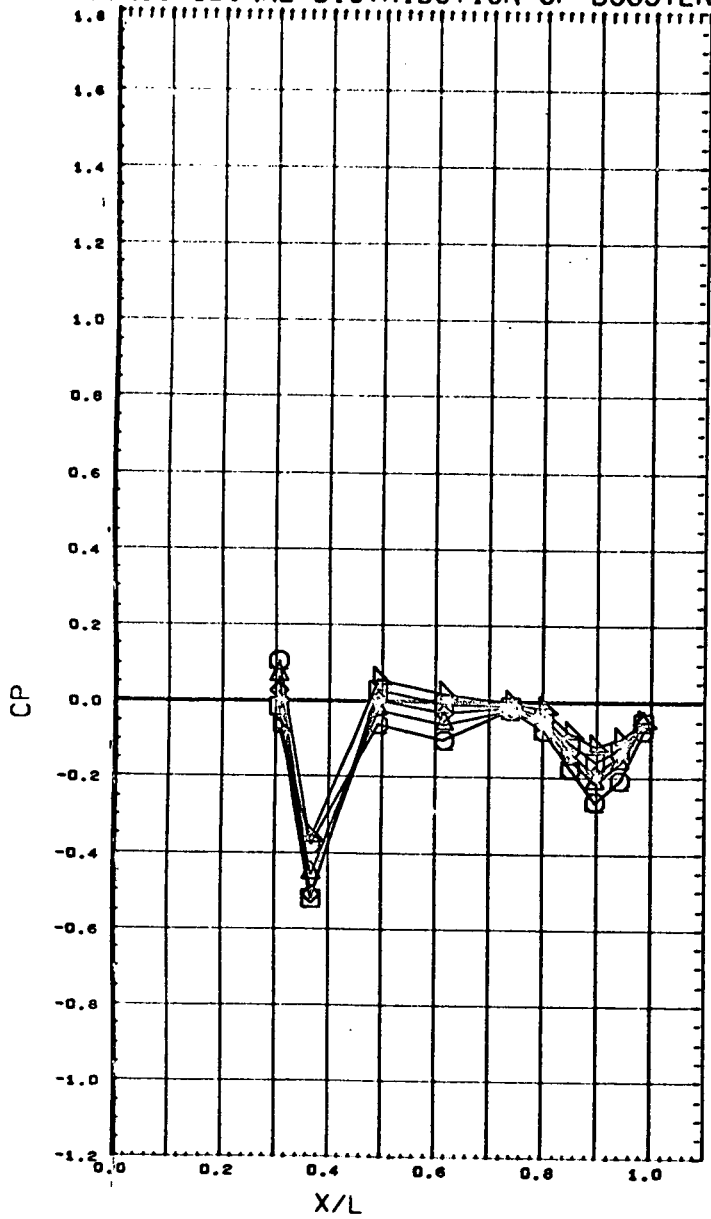

| SYMBOL | ALFB | THETA | M1 |
|--------|-------|---------|-------|
| ○ | 8.247 | 90.000 | 0.902 |
| △ | 8.823 | 180.000 | |
| ◇ | 3.835 | | |
| □ | 1.848 | | |
| ▽ | 0.126 | | |

| PARAMETRIC VALUES | | |
|-------------------|-------|-------|
| BETA | 0.000 | DX/L |
| I | 3.800 | 0.036 |

REFERENCE FILE

LONGITUDINAL DISTRIBUTION OF BOOSTER FUSELAGE PRESSURES

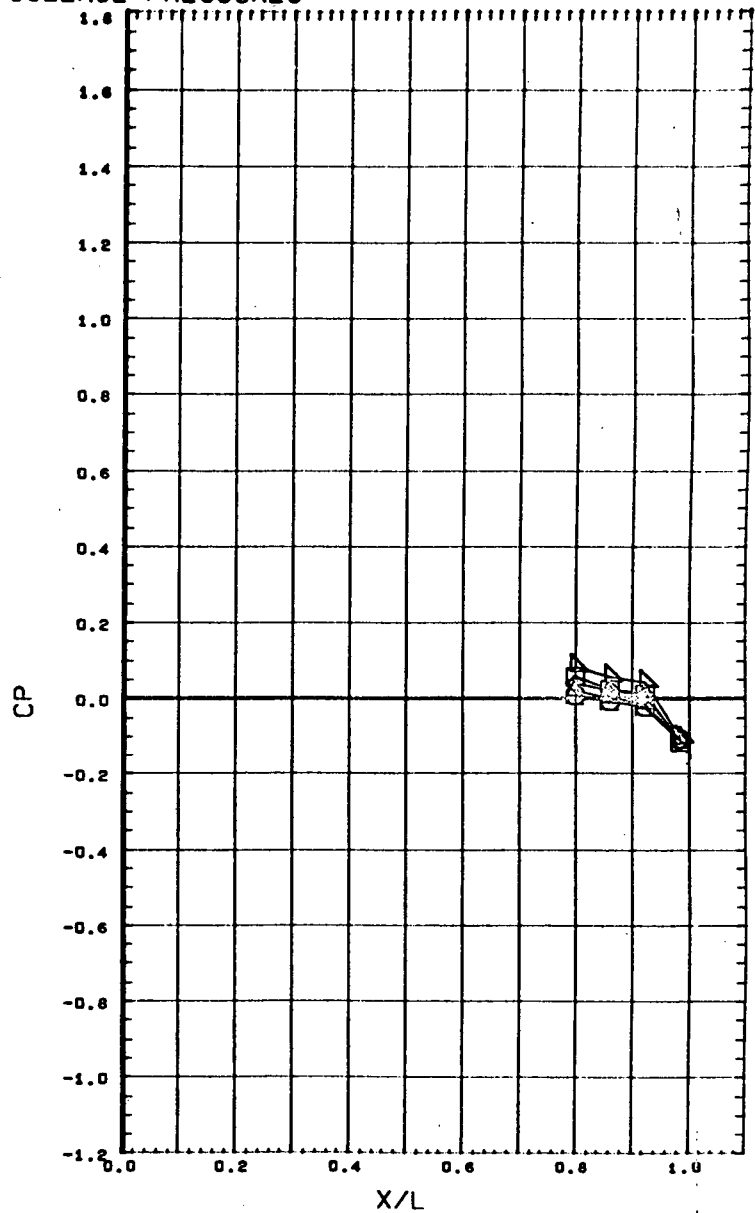
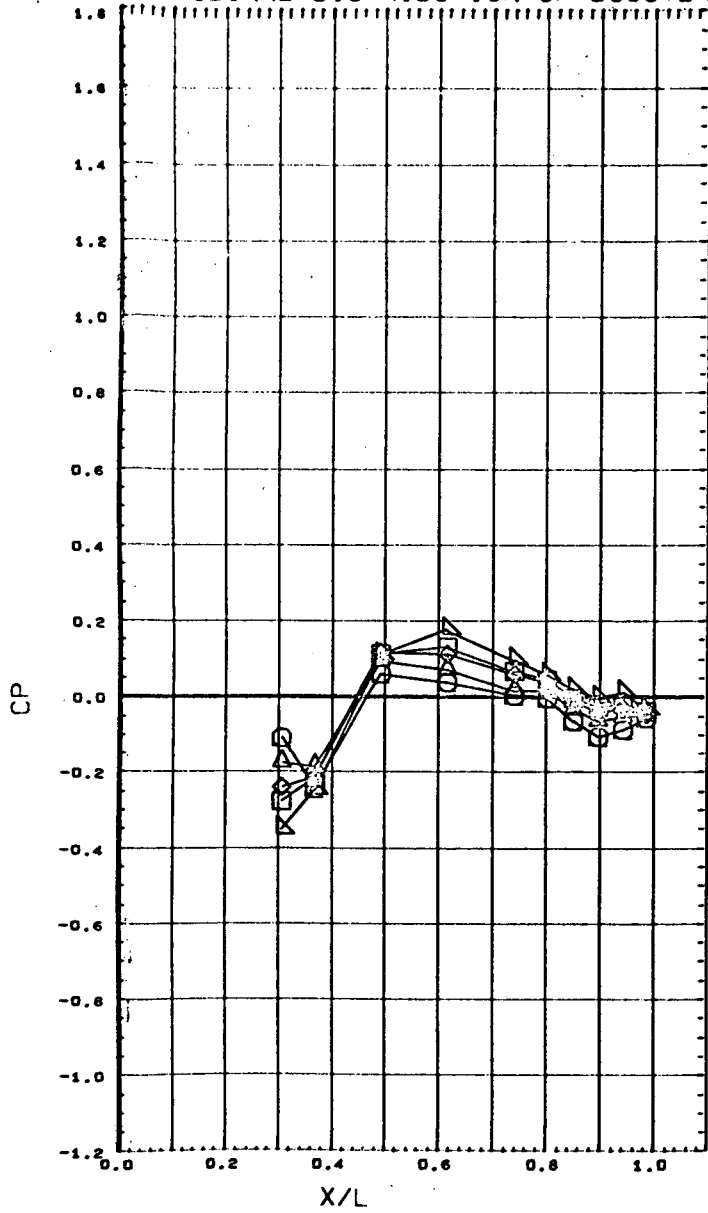

| SYMBOL | ALFB | THETA | M1 |
|--------|-------|---------|-------|
| ○ | 1.552 | 90.000 | 0.902 |
| ◇ | 3.765 | 180.000 | |
| △ | 6.165 | | |
| □ | 7.507 | | |
| ▽ | 9.767 | | |

REFERENCE FILE

| PARAMETRIC VALUES | | |
|-------------------|-------|------------|
| BETA | 0.000 | DX/L 0.036 |
| I | 3.800 | |

LONGITUDINAL DISTRIBUTION OF BOOSTER FUSELAGE PRESSURES

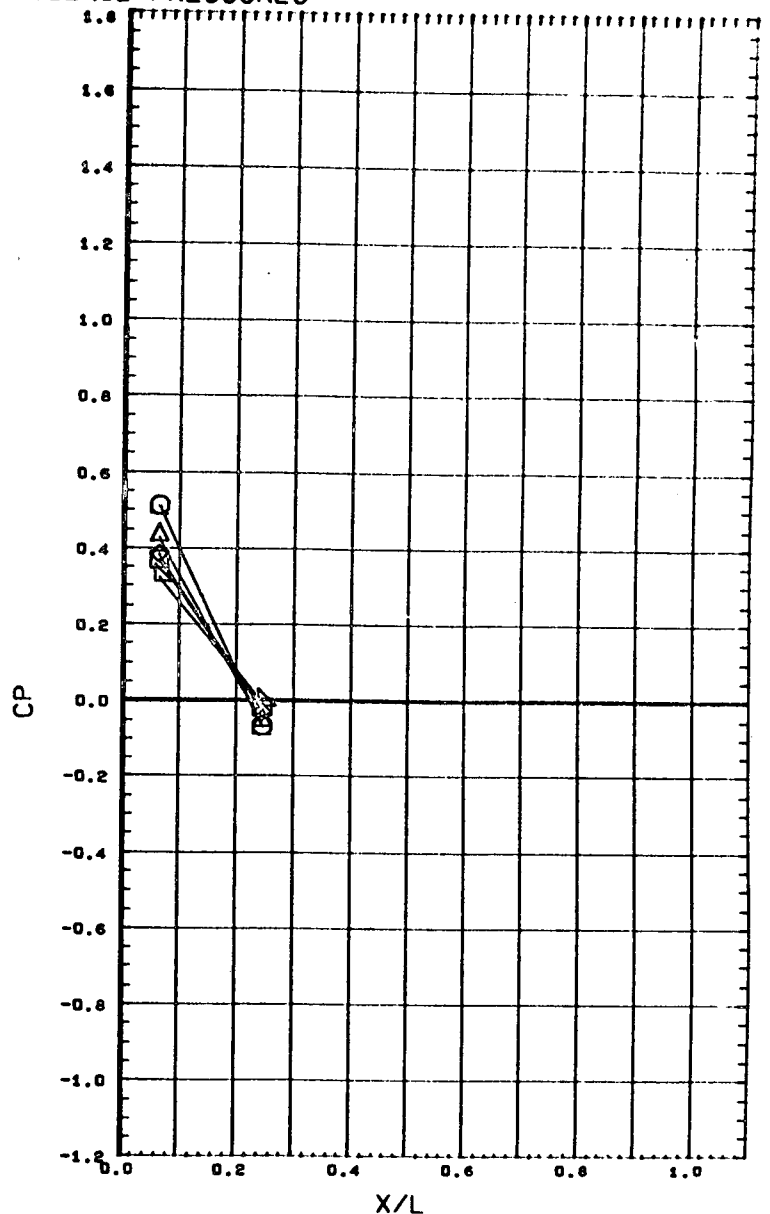
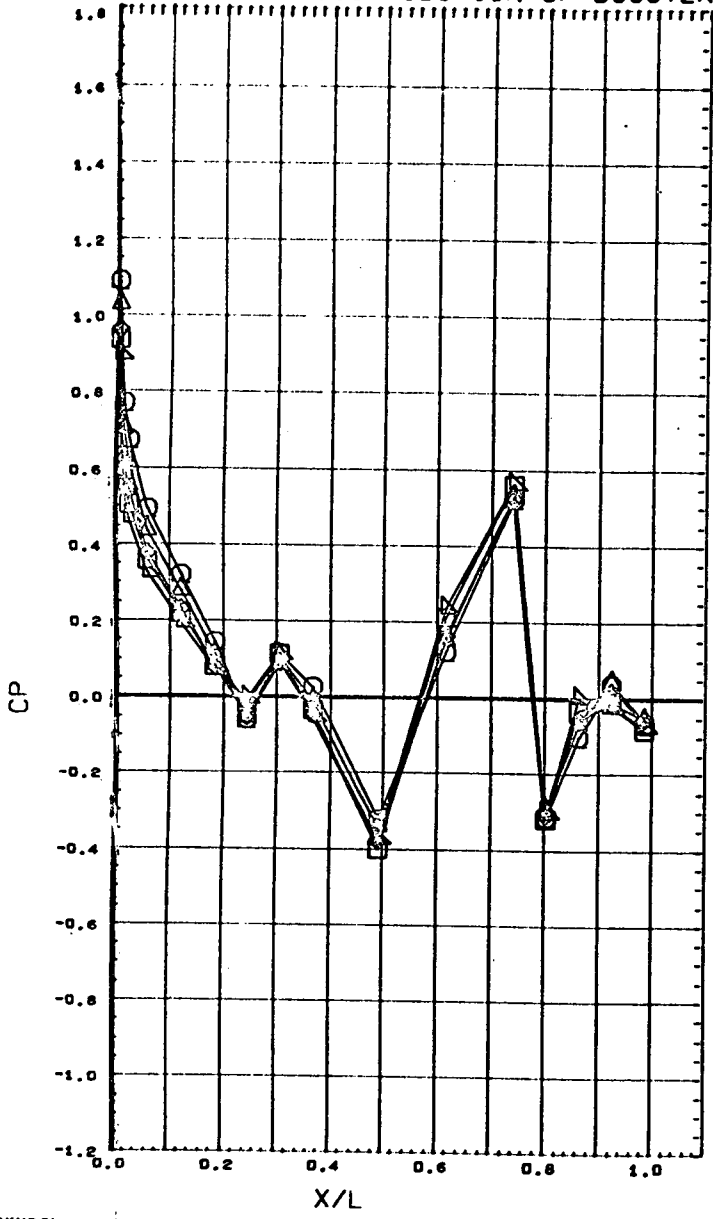

| SYMBOL | ALFB | THETA | M1 |
|--------|-------|--------|-------|
| ○ | 8.294 | 0.000 | 1.002 |
| ◇ | 5.781 | 15.000 | |
| △ | 3.822 | | |
| □ | 1.824 | | |
| ◇ | 0.452 | | |

| PARAMETRIC VALUES | | | |
|-------------------|-------|------|-------|
| BETA | 0.000 | DX/L | 0.036 |
| I | 3.800 | | |

REFERENCE FILE

LONGITUDINAL DISTRIBUTION OF BOOSTER FUSELAGE PRESSURES

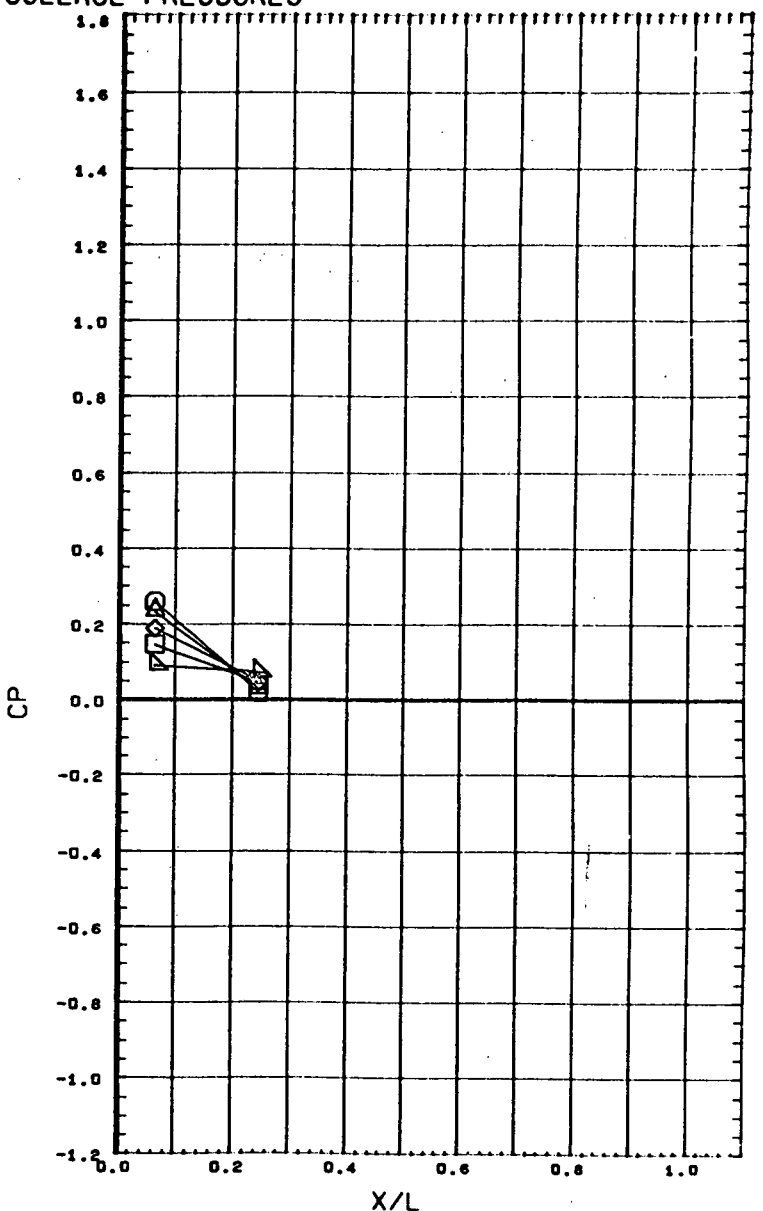
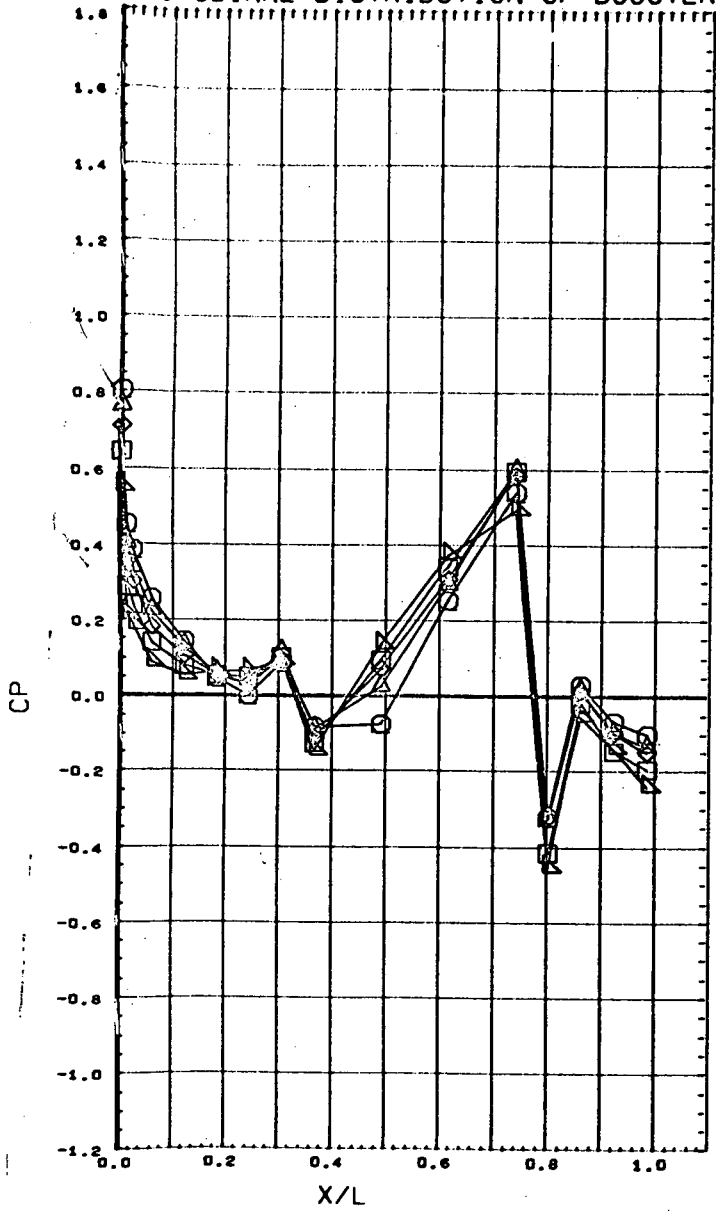

| SYMBOL | ALFB | THETA | M1 |
|--------|--------|--------|-------|
| ○ | 2.116 | 0.000 | 1.002 |
| ◇ | 4.156 | 15.000 | |
| △ | 5.934 | | |
| □ | 7.374 | | |
| ▽ | 10.204 | | |

| PARAMETRIC VALUES | | | |
|-------------------|-------|------|-------|
| BETA | 0.000 | DX/L | 0.036 |
| I | 3.600 | | |

REFERENCE FILE

LONGITUDINAL DISTRIBUTION OF BOOSTER FUSELAGE PRESSURES

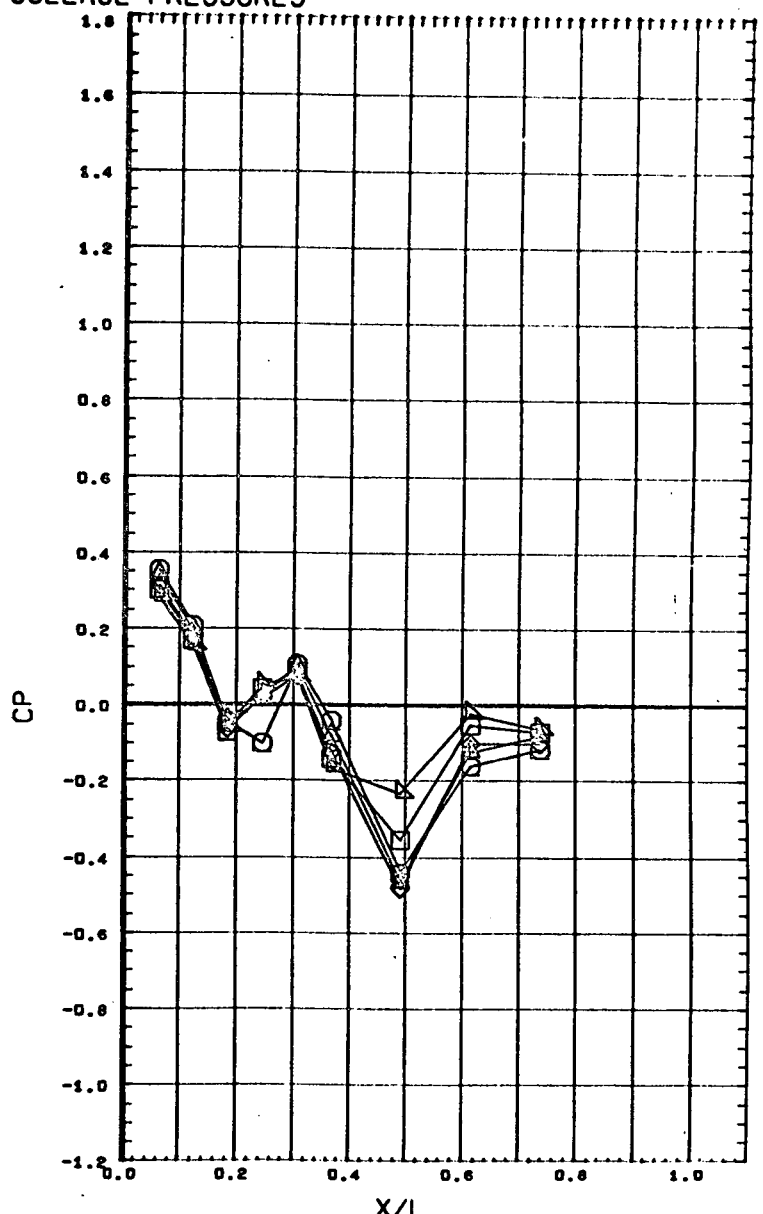
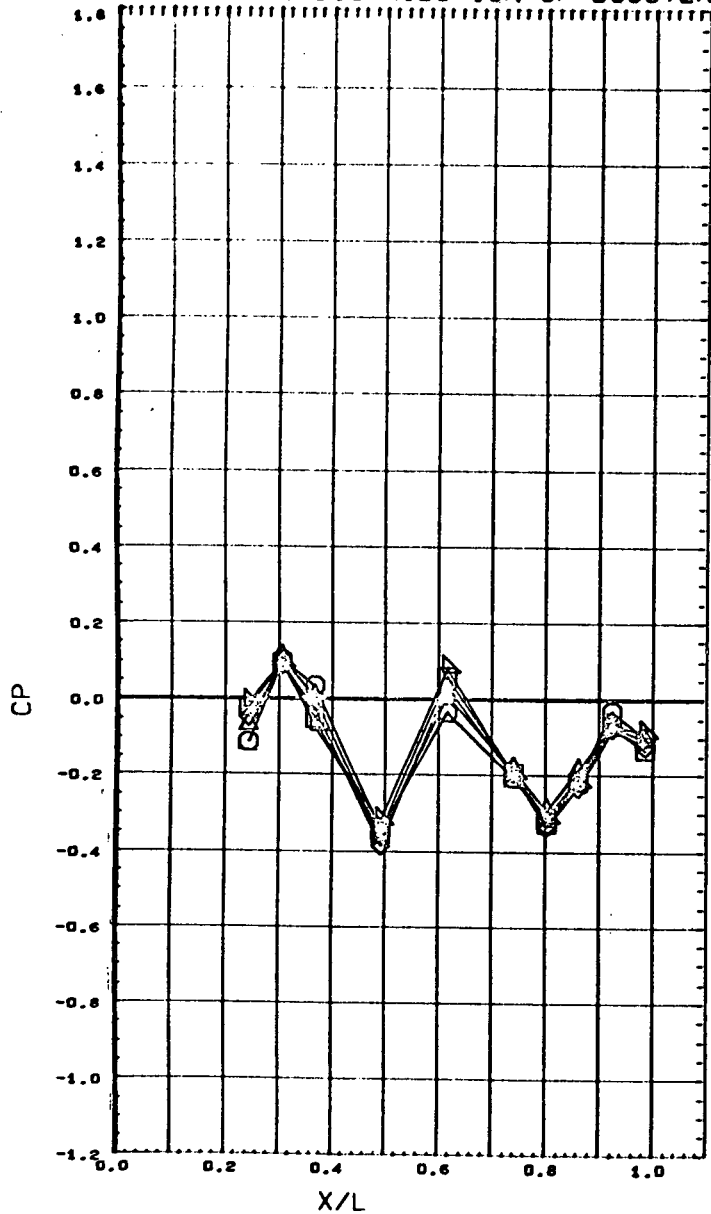

| SYMBOL | ALFB | THETA | M1 |
|--------|-------|--------|-------|
| ○ | 8.294 | 24.000 | 1.002 |
| ◇ | 5.781 | 45.000 | |
| ◇ | 3.822 | | |
| □ | 3.824 | | |
| △ | 0.452 | | |

| PARAMETRIC VALUES | | |
|-------------------|-------|------------|
| BETA | 0.000 | DX/L 0.036 |
| I | 3.800 | |

REFERENCE FILE

LONGITUDINAL DISTRIBUTION OF BOOSTER FUSELAGE PRESSURES

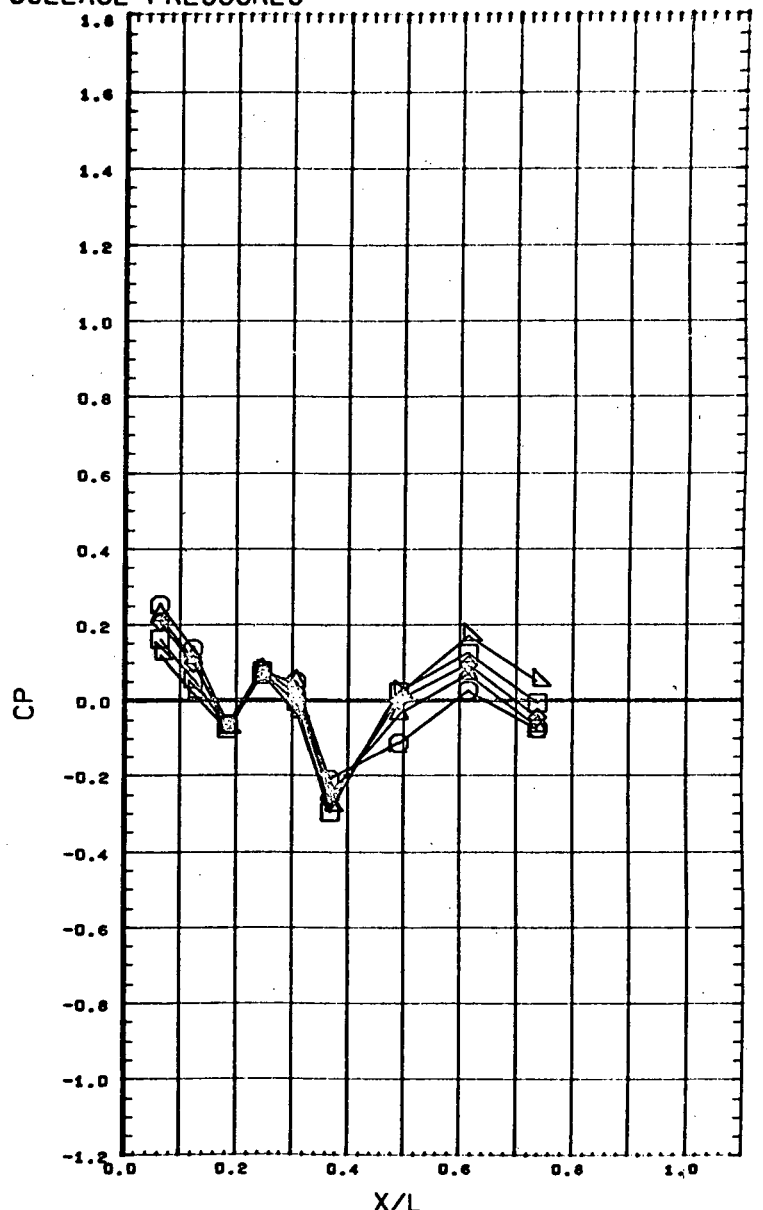
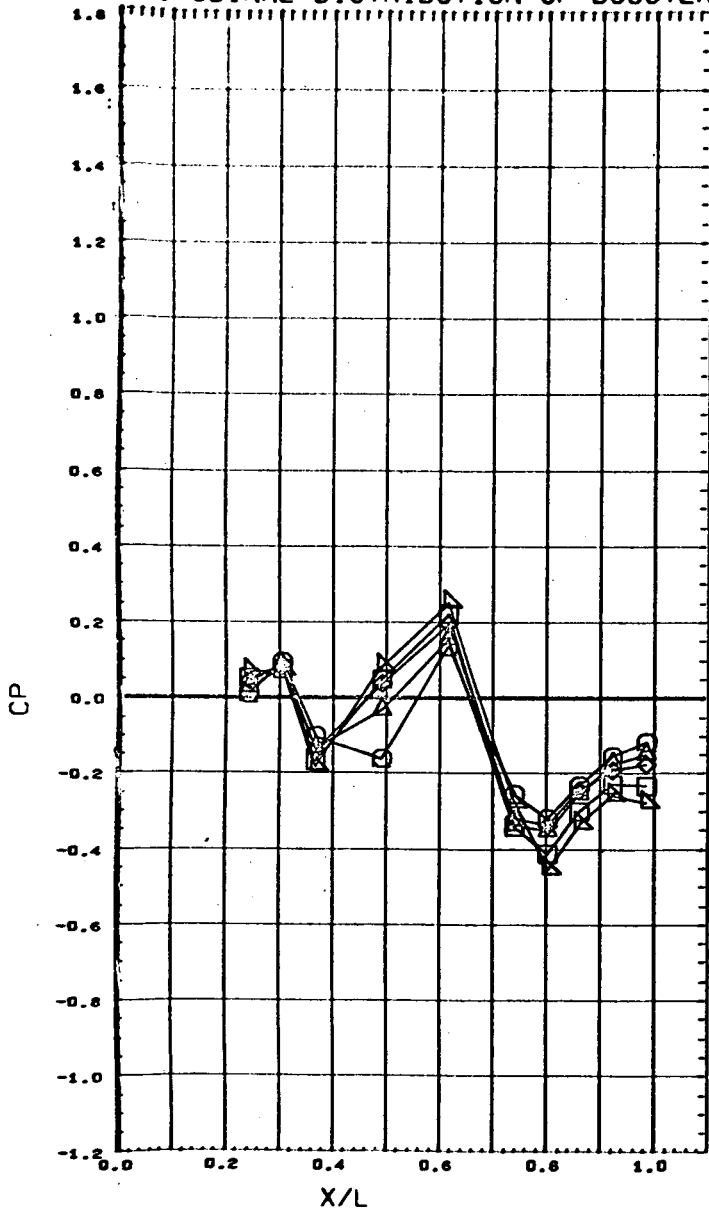

| SYMBOL | ALFB | THETA | M1 |
|--------|--------|--------|-------|
| ○ | 2.116 | 24.000 | 1.002 |
| ◇ | 4.156 | 45.000 | |
| △ | 5.934 | | |
| □ | 7.374 | | |
| ▽ | 10.204 | | |

| PARAMETRIC VALUES | | | |
|-------------------|-------|------|-------|
| BETA | 0.000 | OX/L | 0.036 |
| I | 3.600 | | |

REFERENCE FILE

LONGITUDINAL DISTRIBUTION OF BOOSTER FUSELAGE PRESSURES

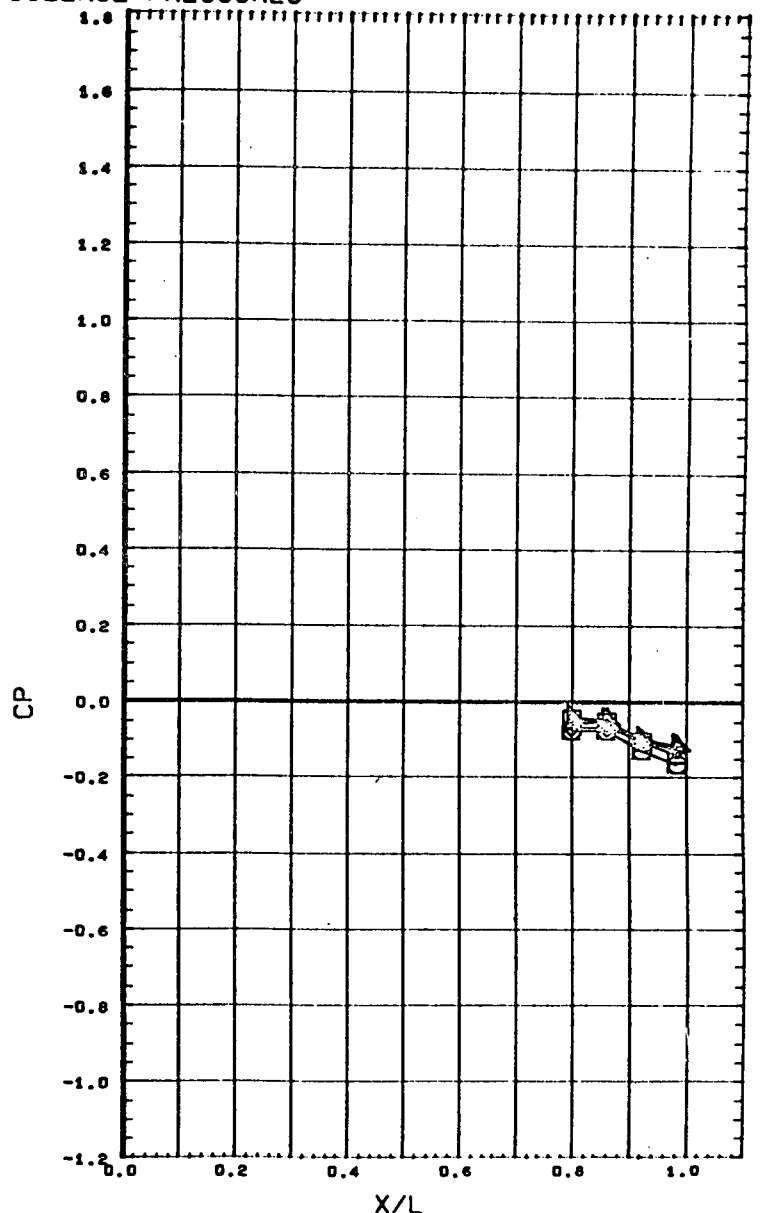
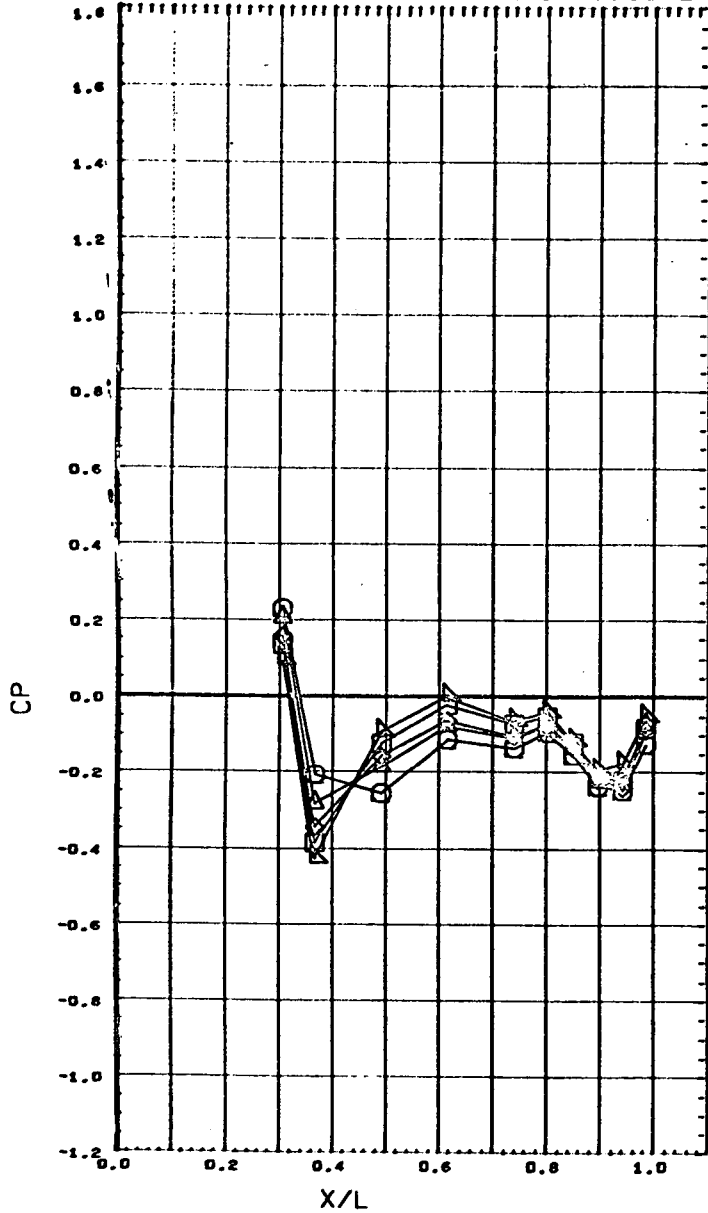

| SYMBOL | A/FB | THETA | M1 |
|--------|-------|---------|-------|
| ○ | 8.294 | 90.000 | 1.002 |
| ◇ | 5.781 | 180.000 | |
| ◇ | 3.822 | | |
| □ | 1.824 | | |
| △ | 0.452 | | |

| PARAMETRIC VALUES | | | |
|-------------------|-------|------|-------|
| BETA | 0.000 | DX/L | 0.036 |
| I | 3.800 | | |

REFERENCE FILE

LONGITUDINAL DISTRIBUTION OF BOOSTER FUSELAGE PRESSURES

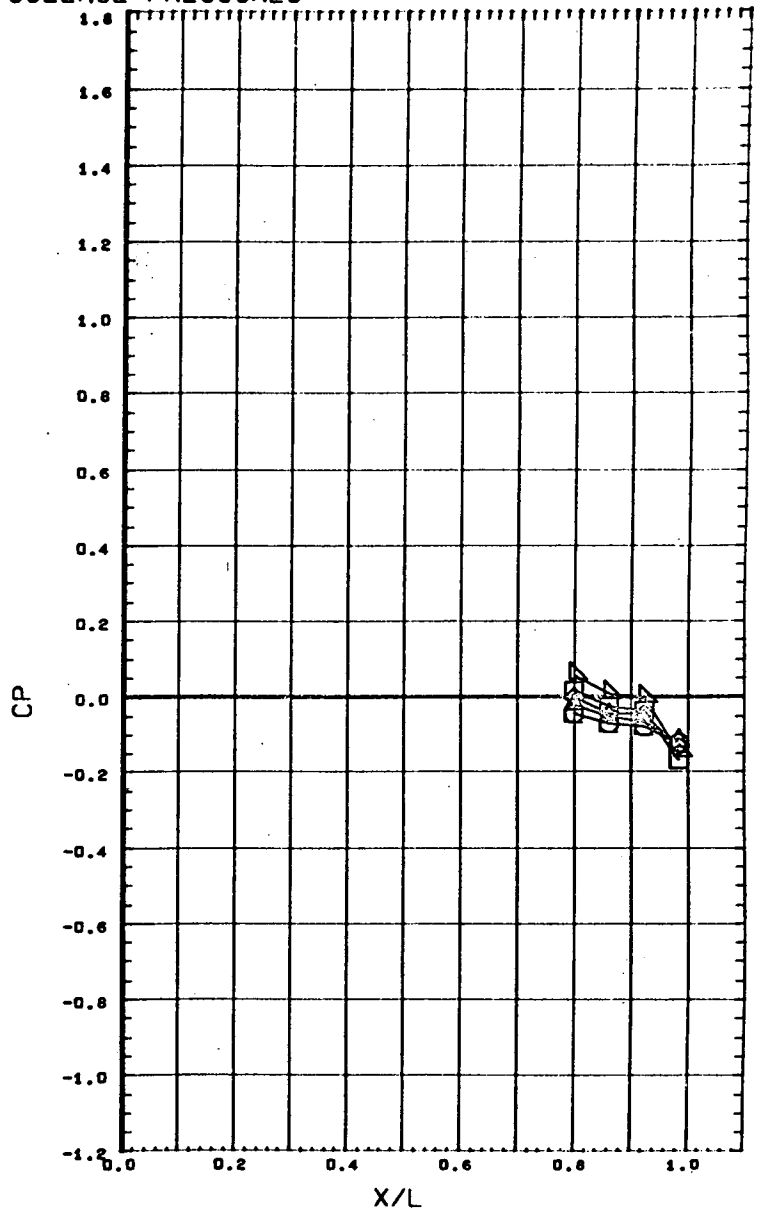
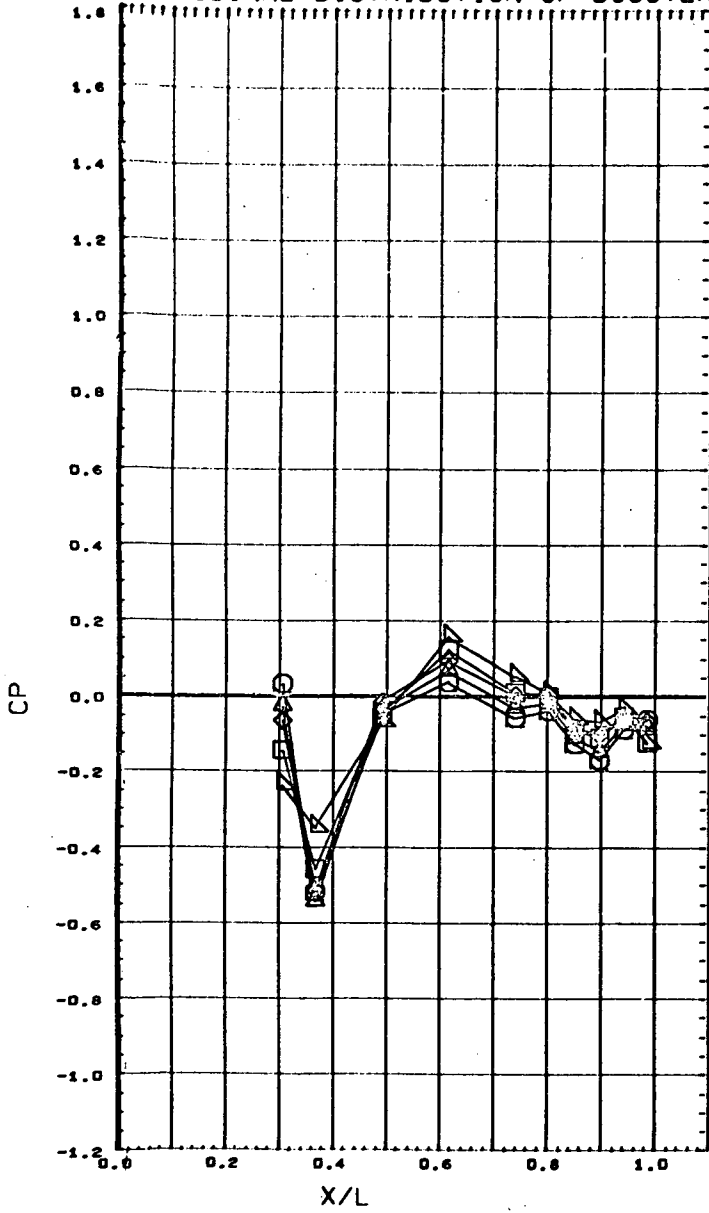

| SYMBOL | ALFB | THETA | M1 |
|--------|--------|---------|-------|
| □ | 2.116 | 90.000 | 1.002 |
| ◇ | 4.156 | 180.000 | |
| △ | 5.934 | | |
| ▽ | 7.374 | | |
| ○ | 10.204 | | |

REFERENCE FILE

| PARAMETRIC VALUES | | | |
|-------------------|-------|------|-------|
| BETA | 0.000 | DX/L | 0.036 |
| I | 3.800 | | |

LONGITUDINAL DISTRIBUTION OF BOOSTER FUSELAGE PRESSURES

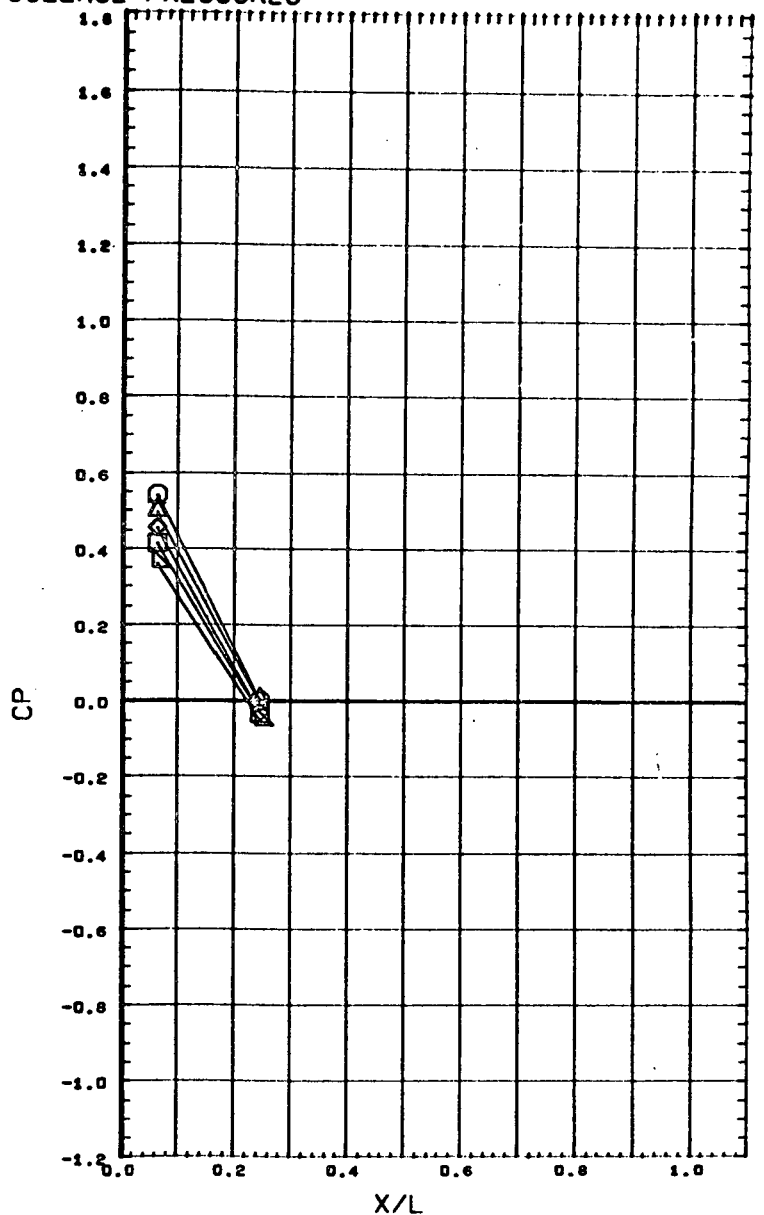
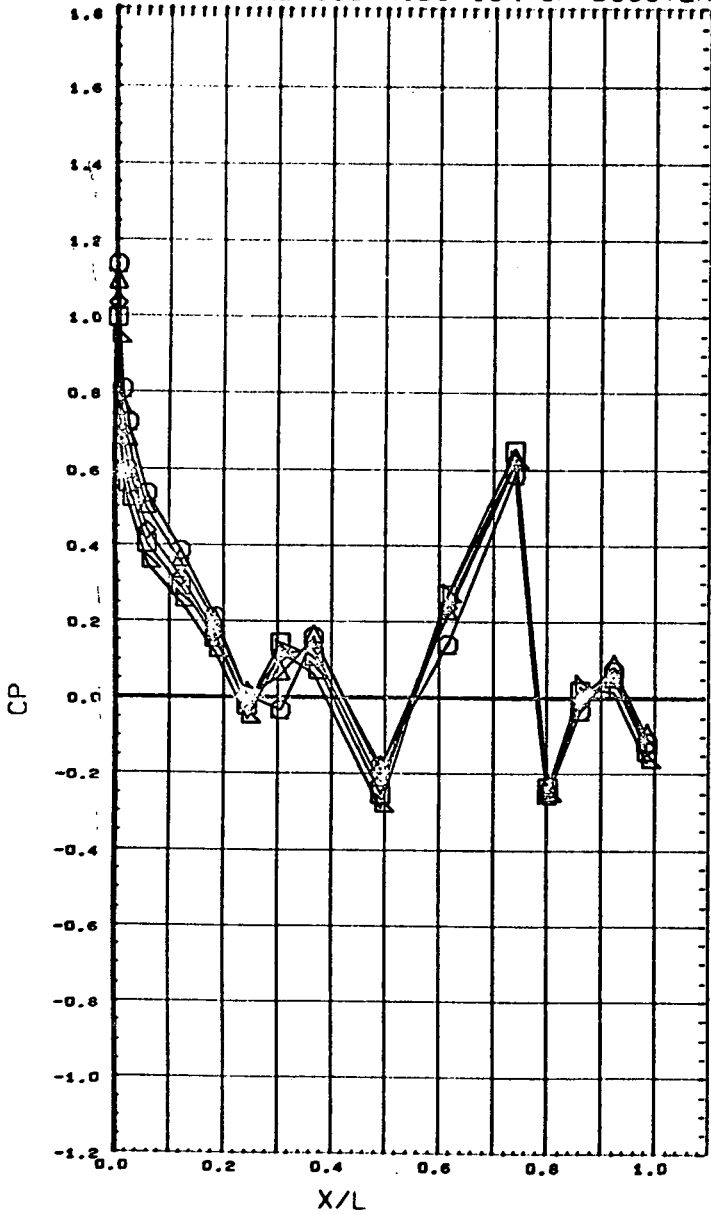

| SYMBOL | ALFB | THETA | M1 |
|--------|---------|--------|-------|
| ○ | - 8.281 | 0.000 | 1.099 |
| △ | - 5.784 | 15.000 | |
| ◇ | - 3.817 | | |
| □ | - 1.823 | | |
| ▽ | - 0.455 | | |

REFERENCE FILE

| PARAMETRIC VALUES | | | |
|-------------------|-------|------|-------|
| BETA | 0.000 | DX/L | 0.036 |
| I | 3.800 | | |

LONGITUDINAL DISTRIBUTION OF BOOSTER FUSELAGE PRESSURES

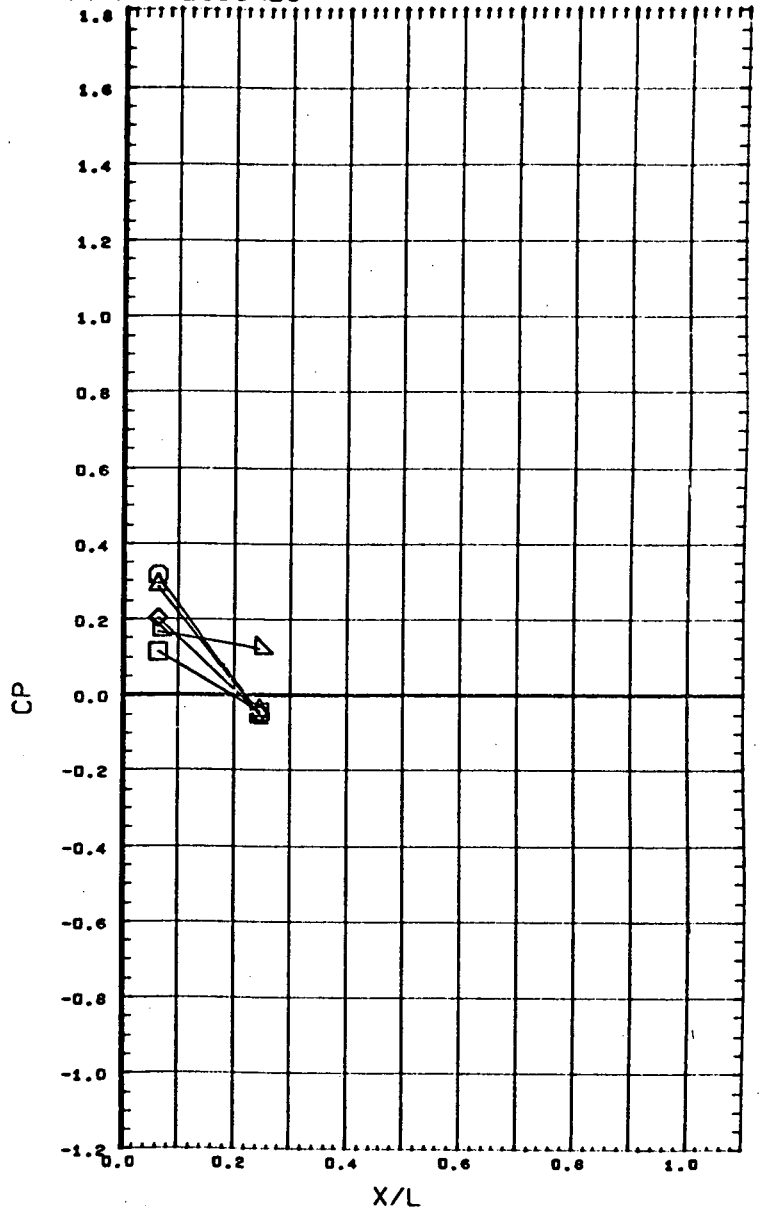
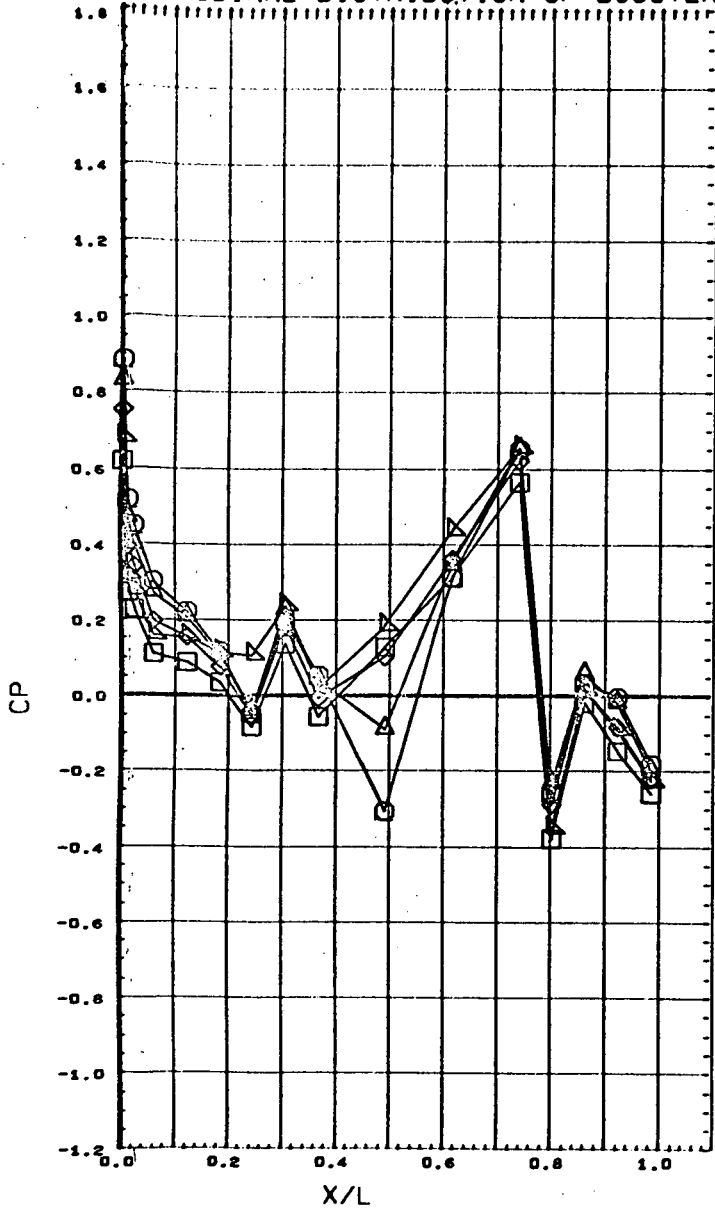

| SYMBOL | ALFB | THETA | M1 |
|--------|-------|--------|-------|
| ○ | 2.207 | 0.000 | 1.099 |
| △ | 4.159 | 15.000 | |
| ◇ | 6.174 | | |
| □ | 8.149 | | |
| ▽ | 9.546 | | |

REFERENCE FILE

| PARAMETRIC VALUES | | |
|-------------------|-------|------------|
| BETA | 0.000 | DX/L 0.036 |
| I | 3.600 | |

LONGITUDINAL DISTRIBUTION OF BOOSTER FUSELAGE PRESSURES

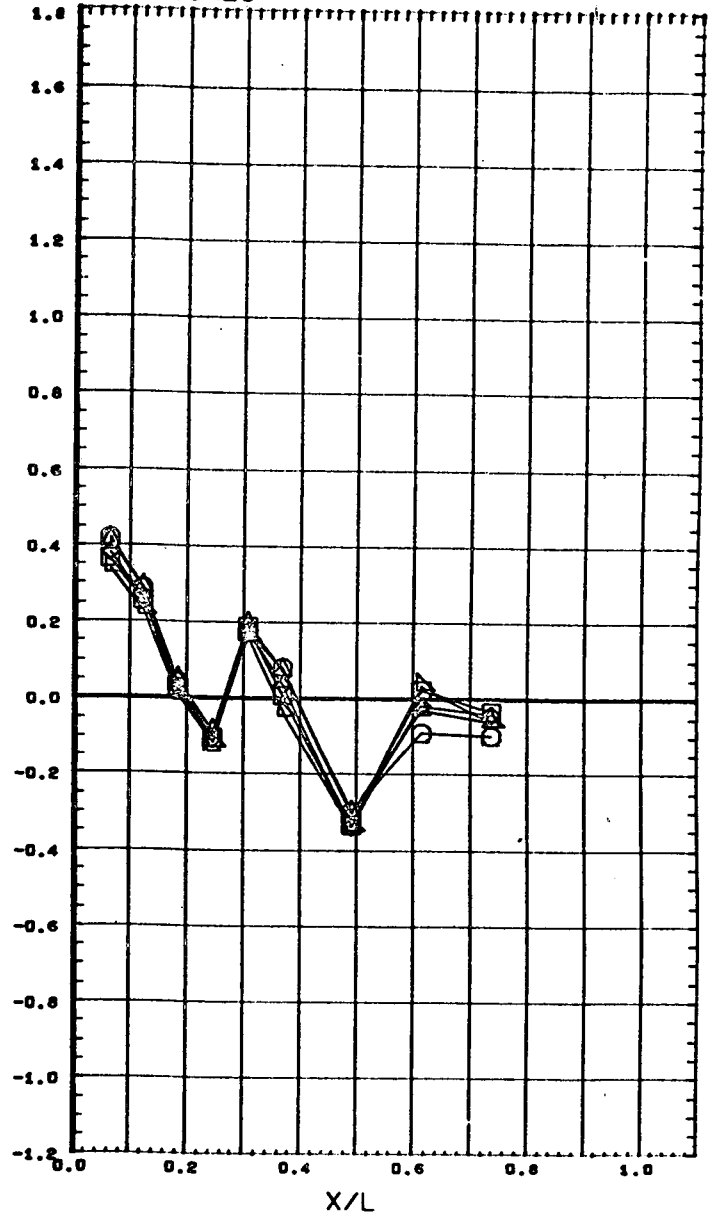
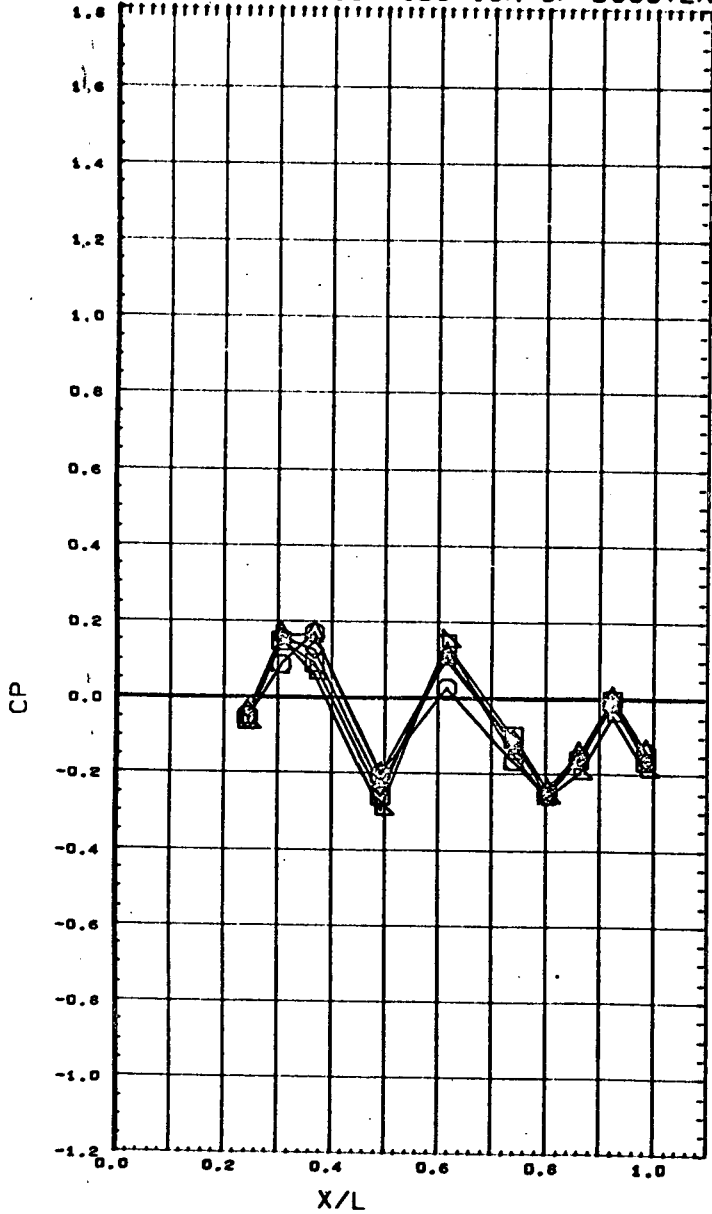

| SYMBOL | ALFB | THETA | M1 |
|--------|-------|--------|-------|
| ○ | 8.281 | 24.000 | 1.099 |
| ◇ | 5.784 | 45.000 | |
| △ | 3.817 | | |
| □ | 1.823 | | |
| ▽ | 0.455 | | |

| PARAMETRIC VALUES | | |
|-------------------|-------|------------|
| BETA | 0.000 | OX/L 0.036 |
| I | 3.800 | |

REFERENCE FILE

LONGITUDINAL DISTRIBUTION OF BOOSTER FUSELAGE PRESSURES

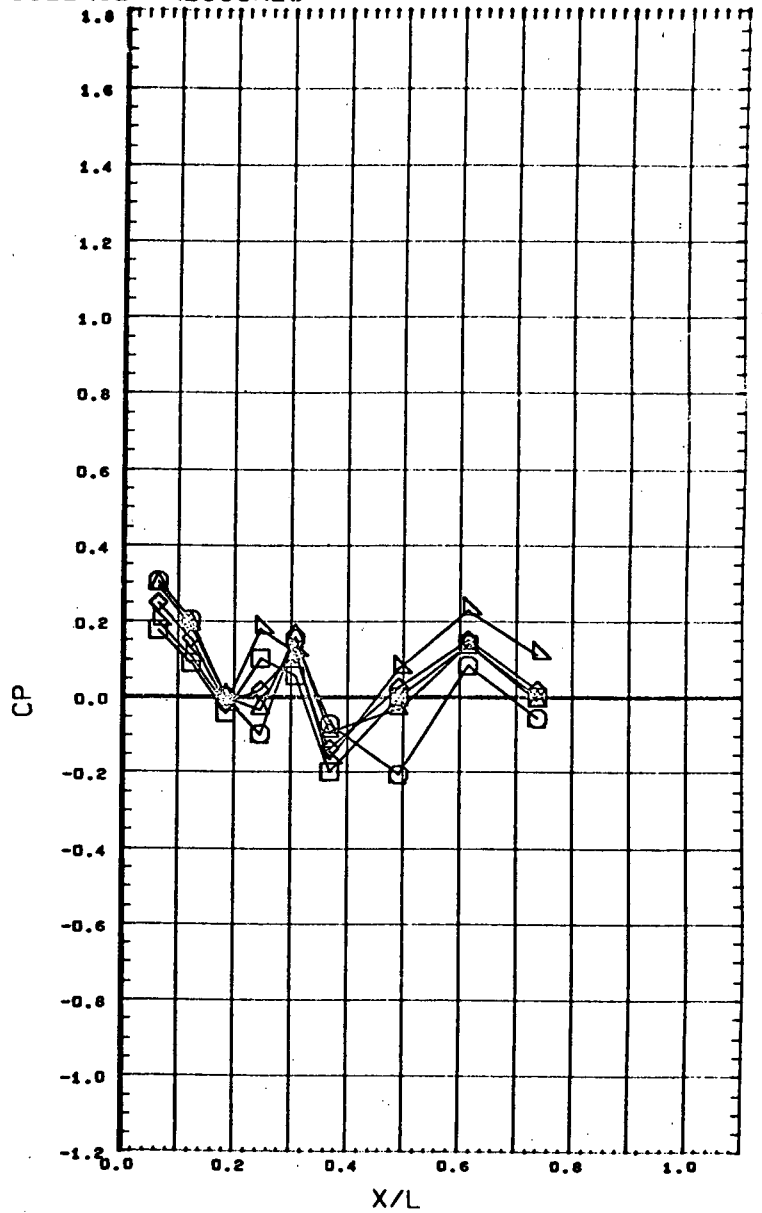
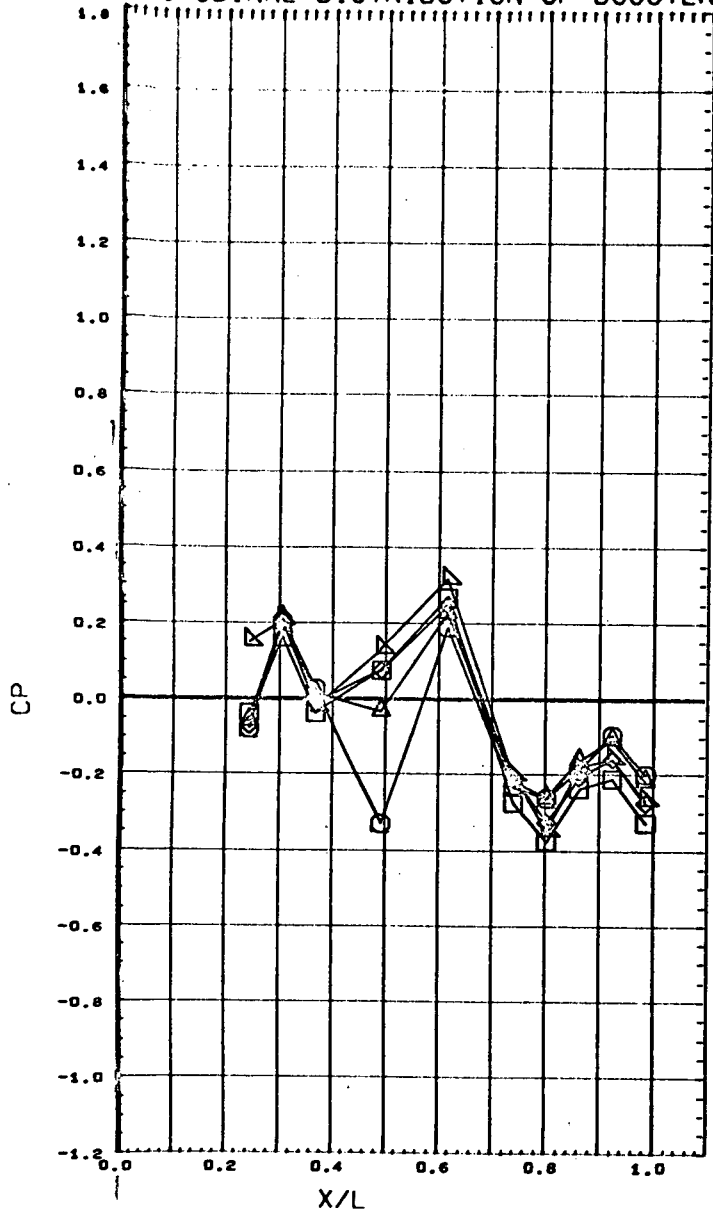

| SYMBOL | ALFB | THETA | M1 |
|--------|-------|--------|-------|
| ○ | 2.207 | 24.000 | 1.099 |
| △ | 4.159 | 45.000 | |
| ◇ | 6.174 | | |
| □ | 8.149 | | |
| ▽ | 9.546 | | |

REFERENCE FILE

| PARAMETRIC VALUES | | |
|-------------------|-------|-------|
| BETA | 0.000 | OX/L |
| I | 3.800 | 0.036 |

LONGITUDINAL DISTRIBUTION OF BOOSTER FUSELAGE PRESSURES

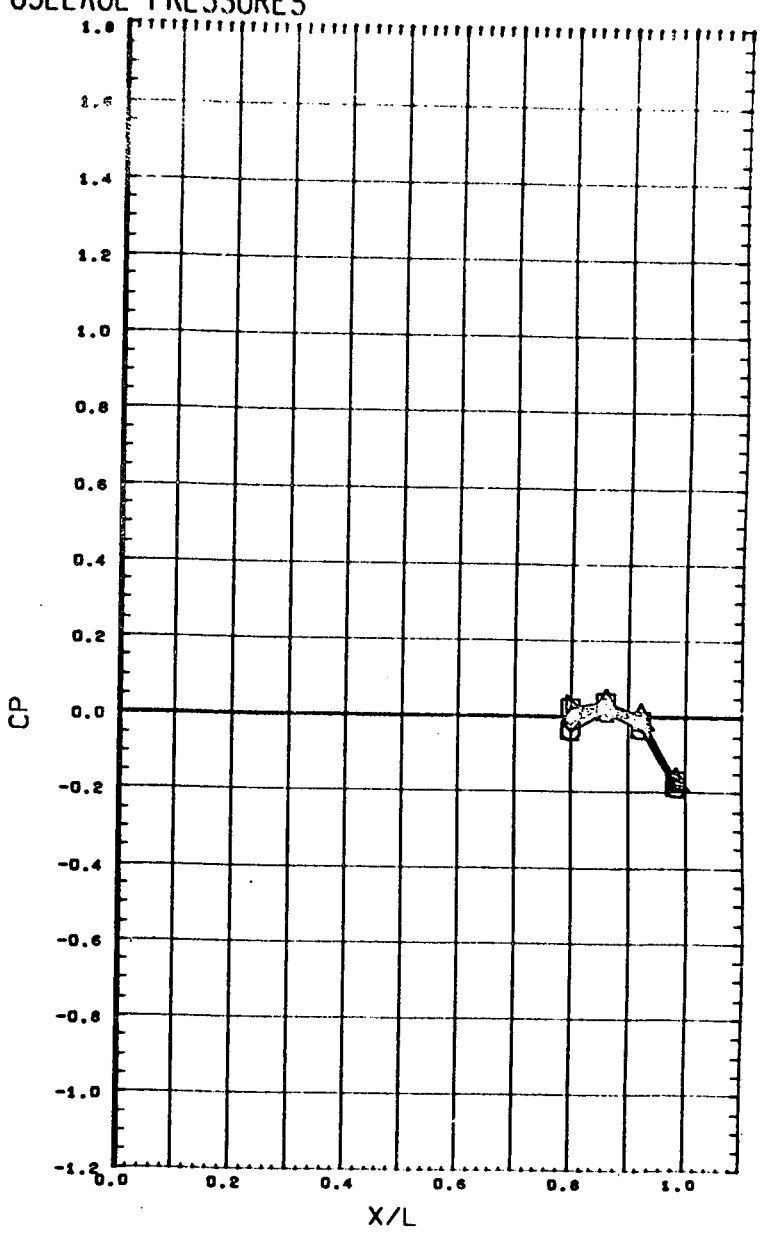
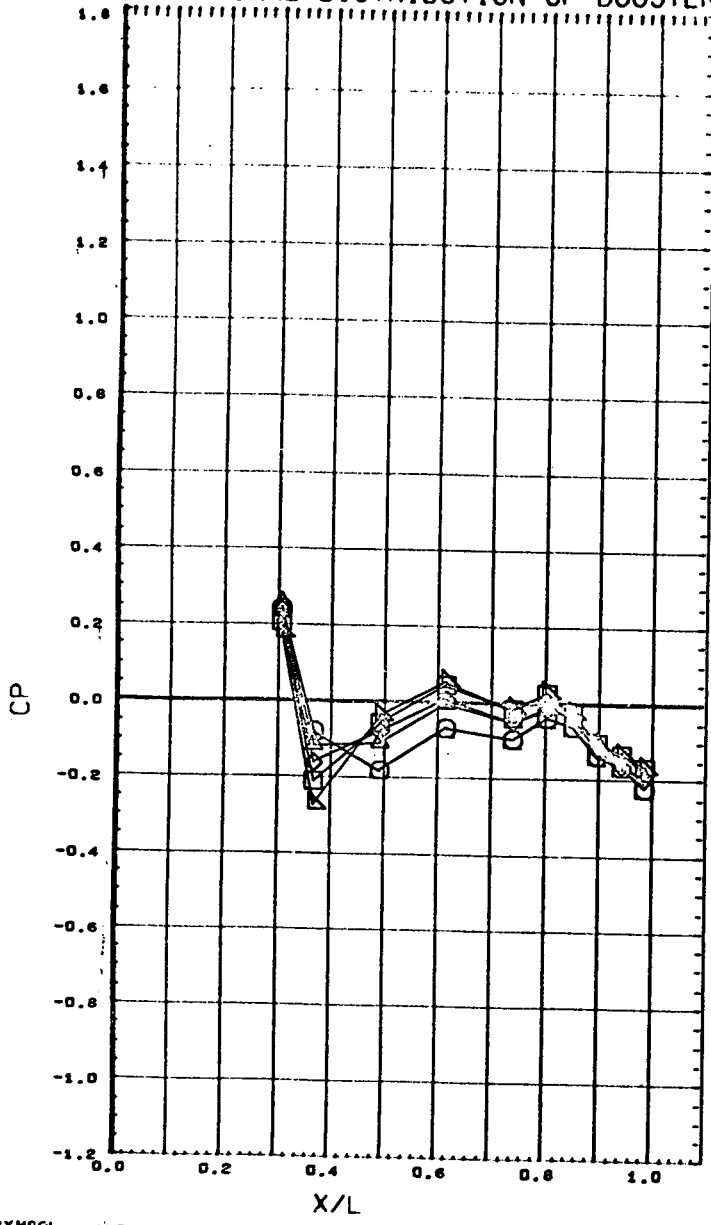

| SYMBOL | ALFB | THETA | M1 |
|--------|-------|---------|-------|
| ○ | 8.281 | 90.000 | 1.099 |
| △ | 5.784 | 180.000 | |
| ◇ | 3.817 | | |
| □ | 1.823 | | |
| ▽ | 0.455 | | |

| PARAMETRIC VALUES | | |
|-------------------|-------|-------|
| BETA | 0.000 | DX/L |
| I | 3.800 | 0.036 |

REFERENCE FILE

LONGITUDINAL DISTRIBUTION OF BOOSTER FUSELAGE PRESSURES

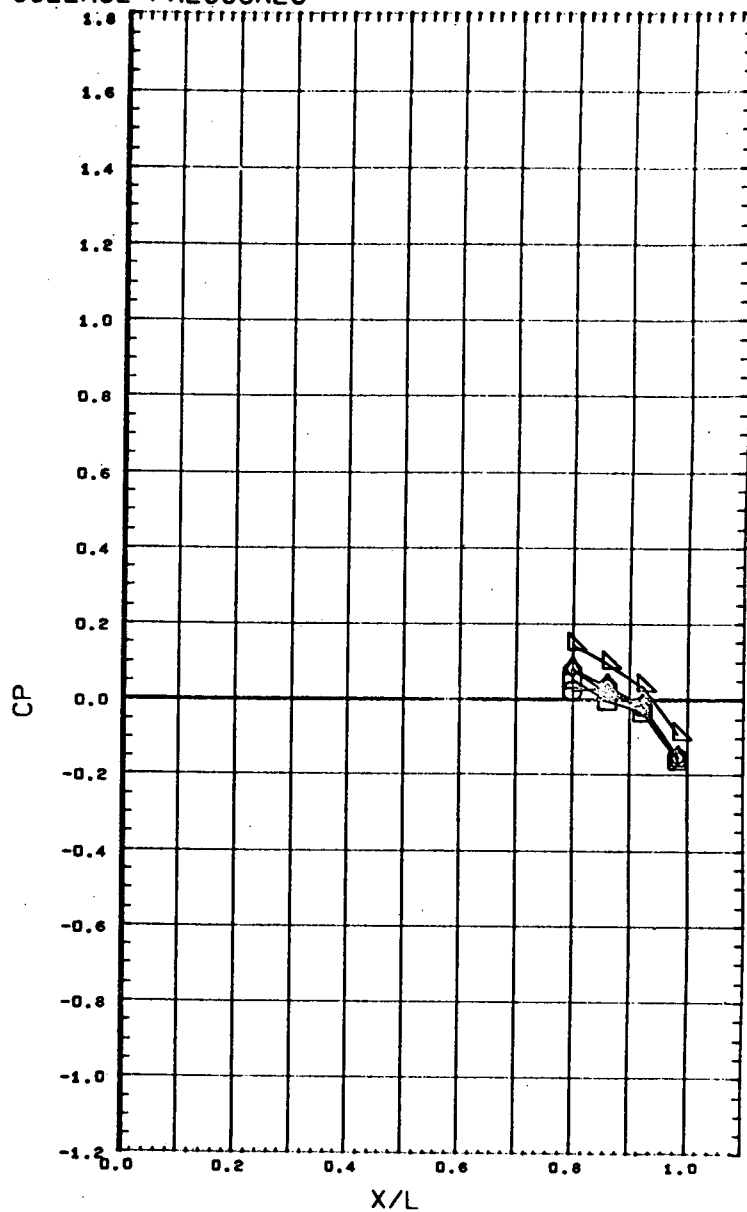
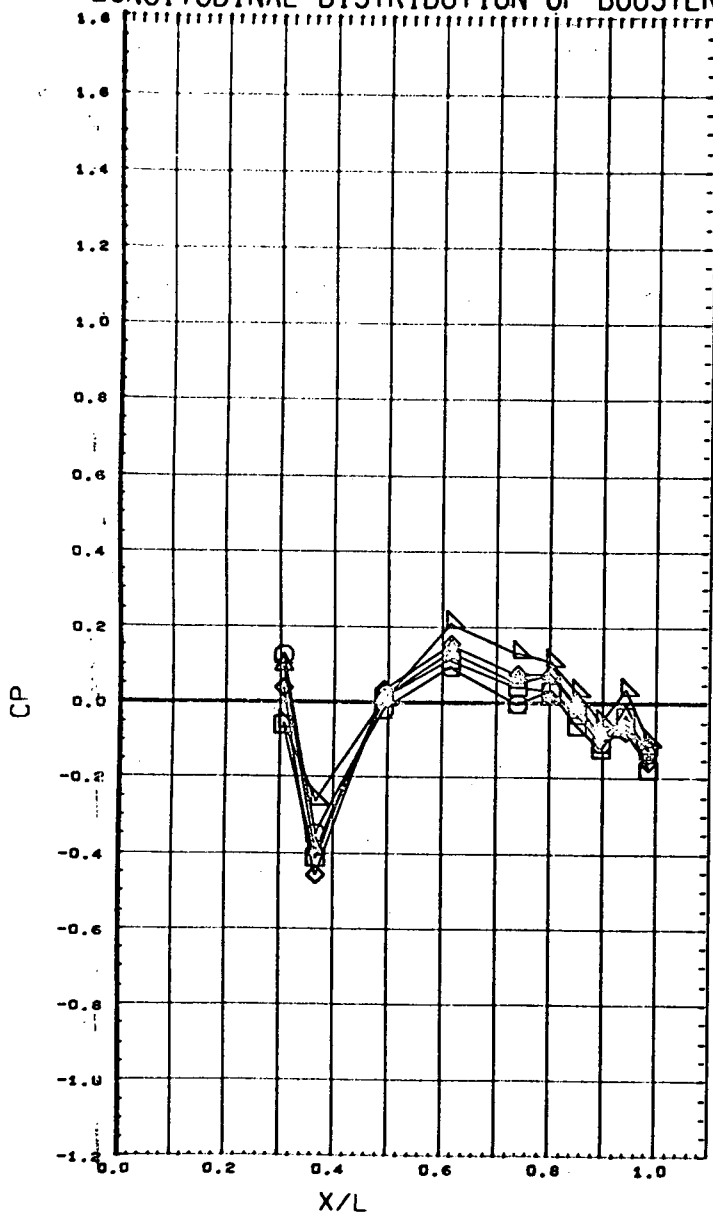

| SYMBOL | ALFB | THETA | M1 |
|--------|-------|---------|-------|
| □ | 2.207 | 90.000 | 1.099 |
| ◇ | 4.159 | 180.000 | |
| △ | 6.174 | | |
| ○ | 8.149 | | |
| ◇ | 9.546 | | |

REFERENCE FILE

| PARAMETRIC VALUES | | | |
|-------------------|-------|------|-------|
| BETA | 0.000 | DX/L | 0.036 |
| I | 3.800 | | |

LONGITUDINAL DISTRIBUTION OF BOOSTER FUSELAGE PRESSURES

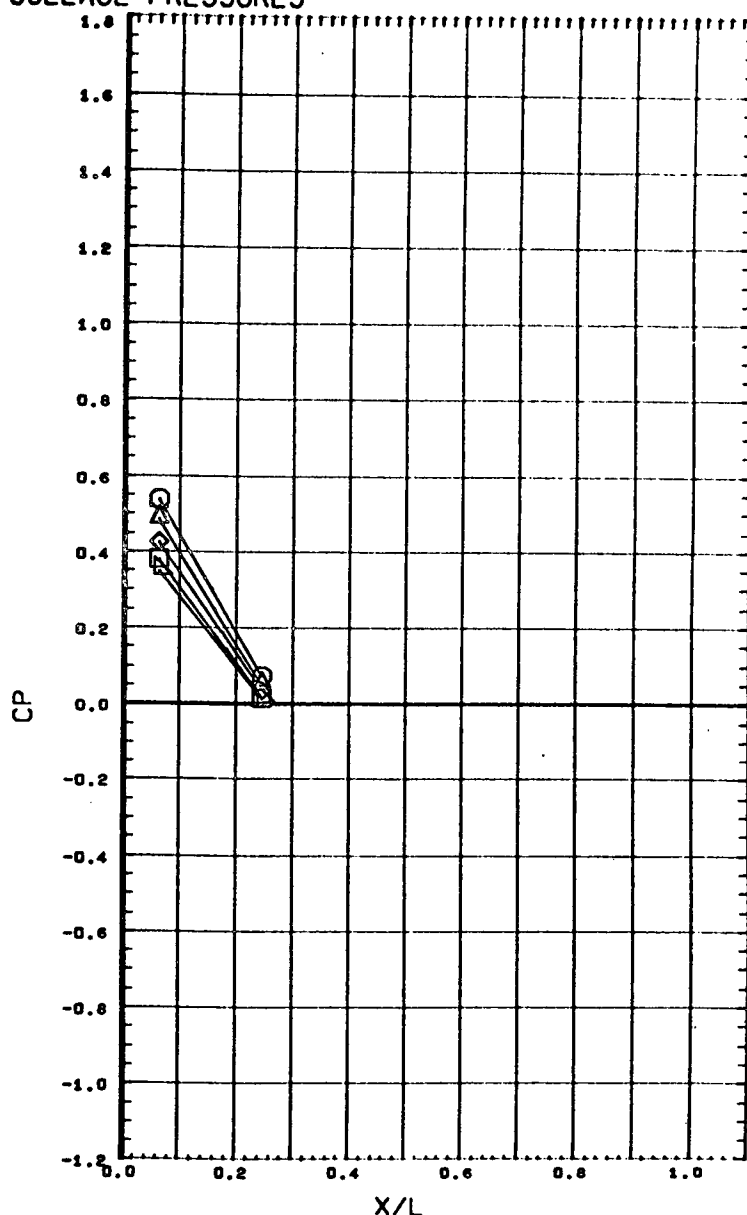
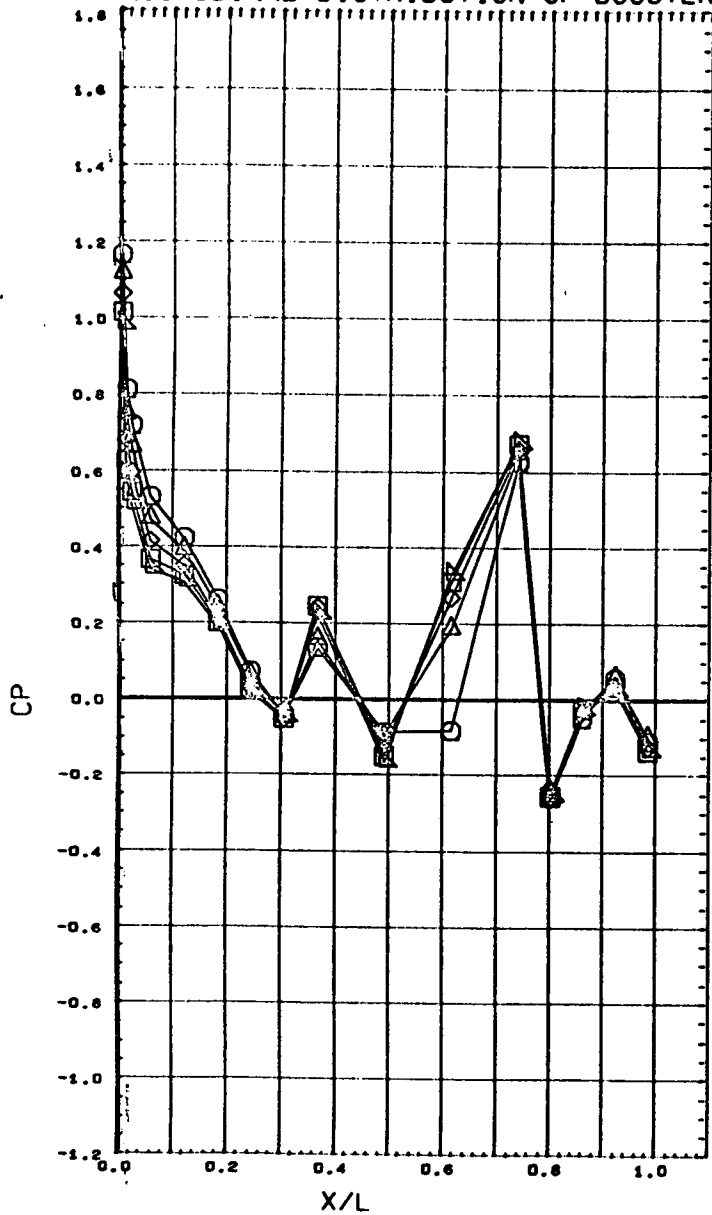

| SYMBOL | ALFB | THETA | M1 |
|--------|-------|--------|-------|
| ○ | 8.310 | 0.000 | 1.199 |
| □ | 5.780 | 15.000 | |
| ◇ | 5.815 | | |
| △ | 1.813 | | |
| ▽ | 0.450 | | |

REFERENCE FILE

| PARAMETRIC VALUES | | |
|-------------------|-------|-------|
| BETA | 0.000 | QX/L |
| 1 | 3.800 | 4.036 |

LONGITUDINAL DISTRIBUTION OF BOOSTER FUSELAGE PRESSURES

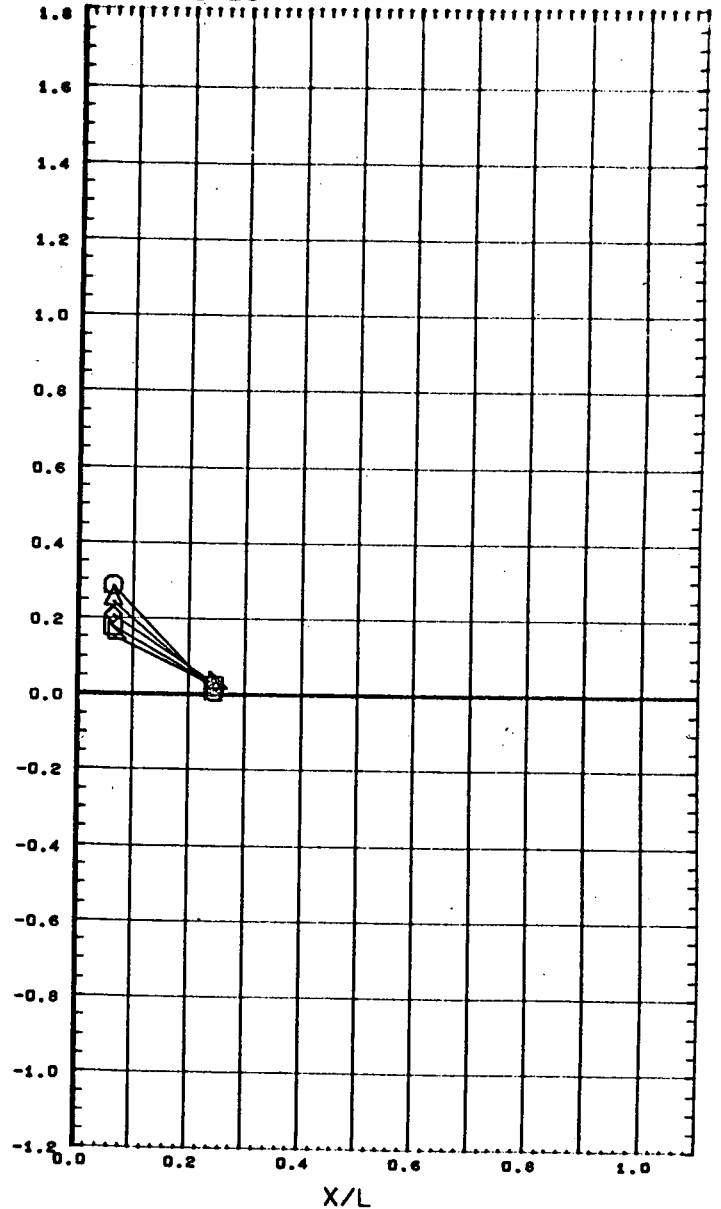
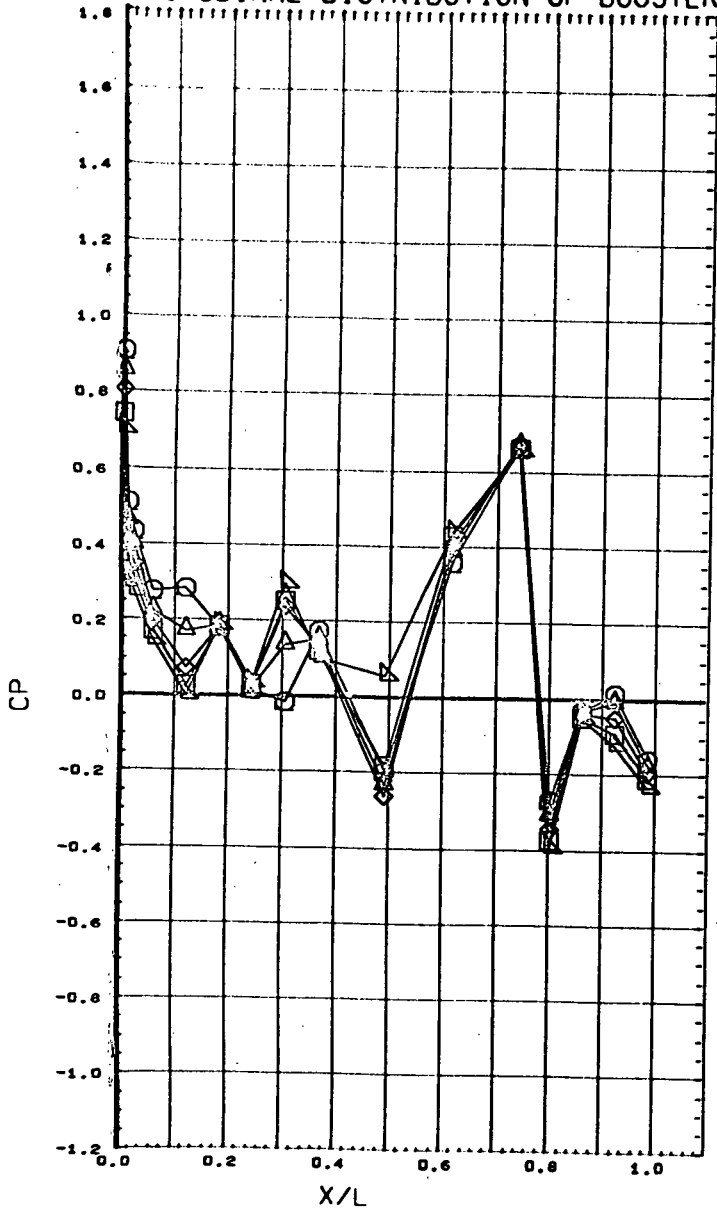

| SYMBOL | ALFB | THETA | M1 |
|--------|-------|--------|-------|
| ○ | 2.219 | 0.000 | 1.199 |
| △ | 4.179 | 15.000 | |
| ◇ | 6.175 | | |
| □ | 8.168 | | |
| ▽ | 9.532 | | |

REFERENCE FILE

| PARAMETRIC VALUES | | | |
|-------------------|-------|------|-------|
| BETA | 0.000 | OX/L | 0.036 |
| I | 3.800 | | |

LONGITUDINAL DISTRIBUTION OF BOOSTER FUSELAGE PRESSURES

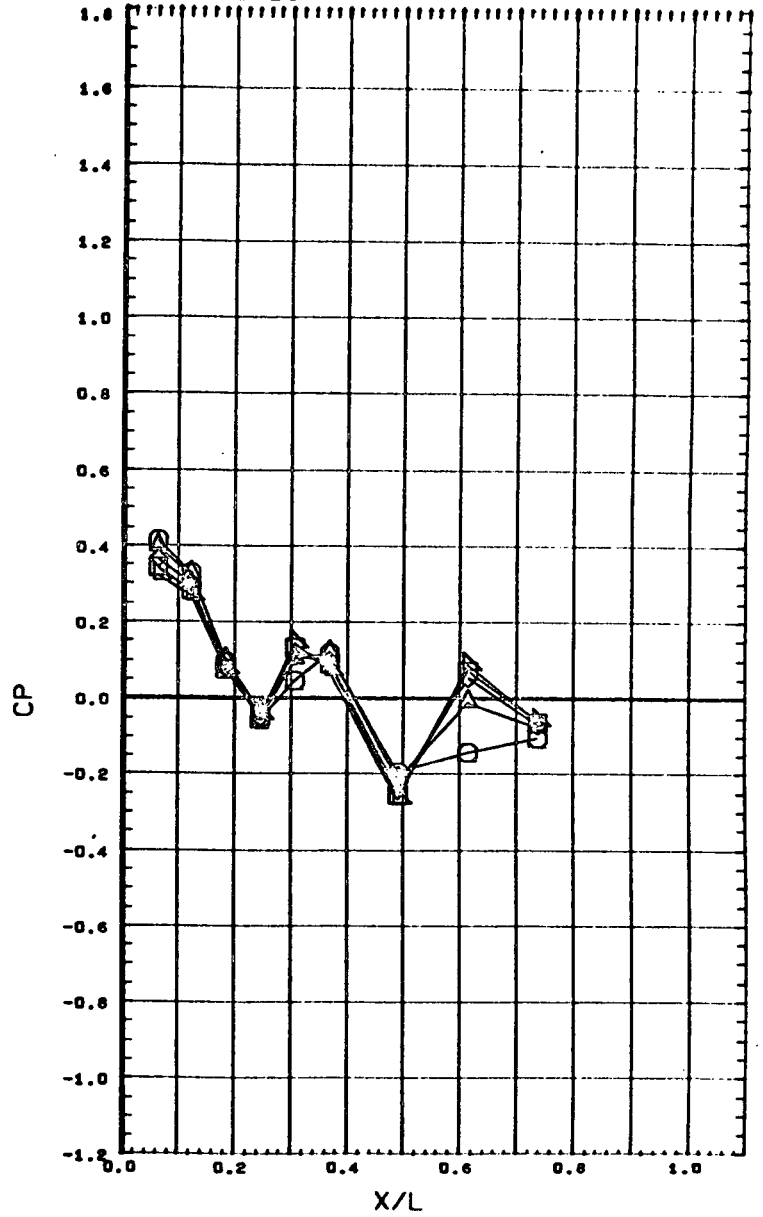
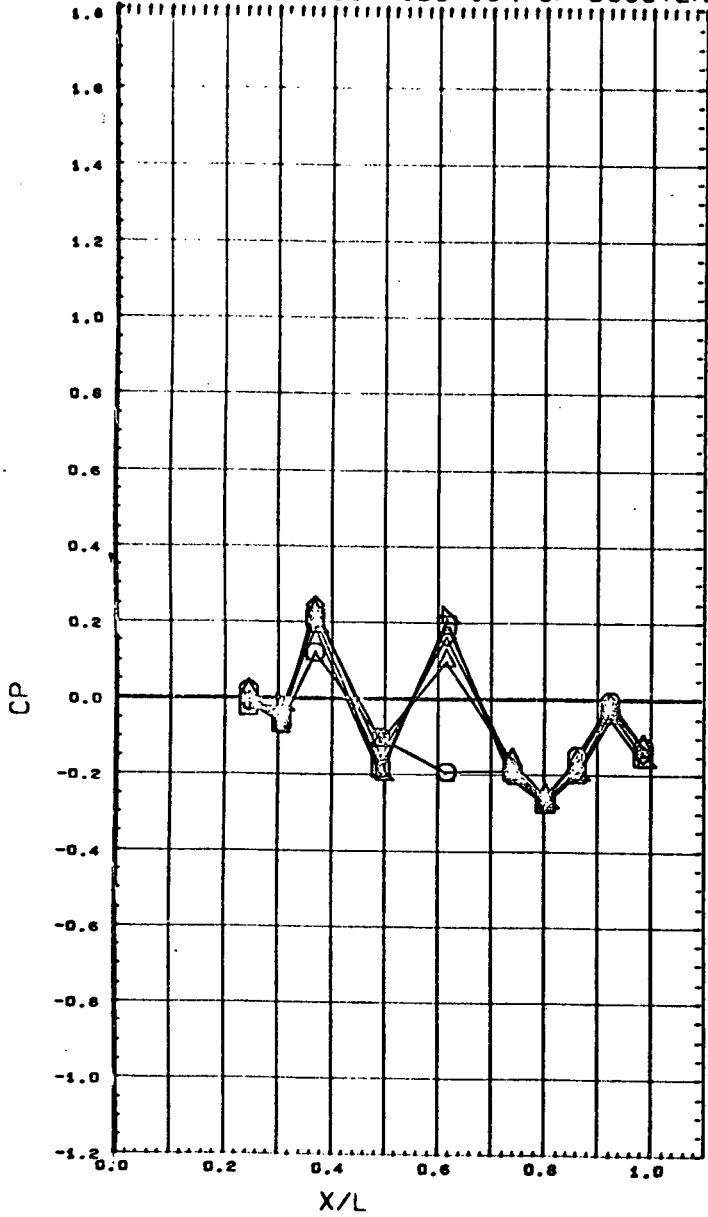

| SYMBOL | ALFB | THETA | M1 |
|--------|-------|--------|-------|
| ○ | 0.310 | 24.000 | 1.199 |
| △ | 1.780 | 45.000 | |
| ◇ | 3.815 | | |
| □ | 1.813 | | |
| ○ | 0.450 | | |

REFERENCE FILE

| PARAMETRIC VALUES | | |
|-------------------|-------|-------|
| BETA | 0.000 | DX/L |
| I | 3.800 | 0.036 |

LONGITUDINAL DISTRIBUTION OF BOOSTER FUSELAGE PRESSURES

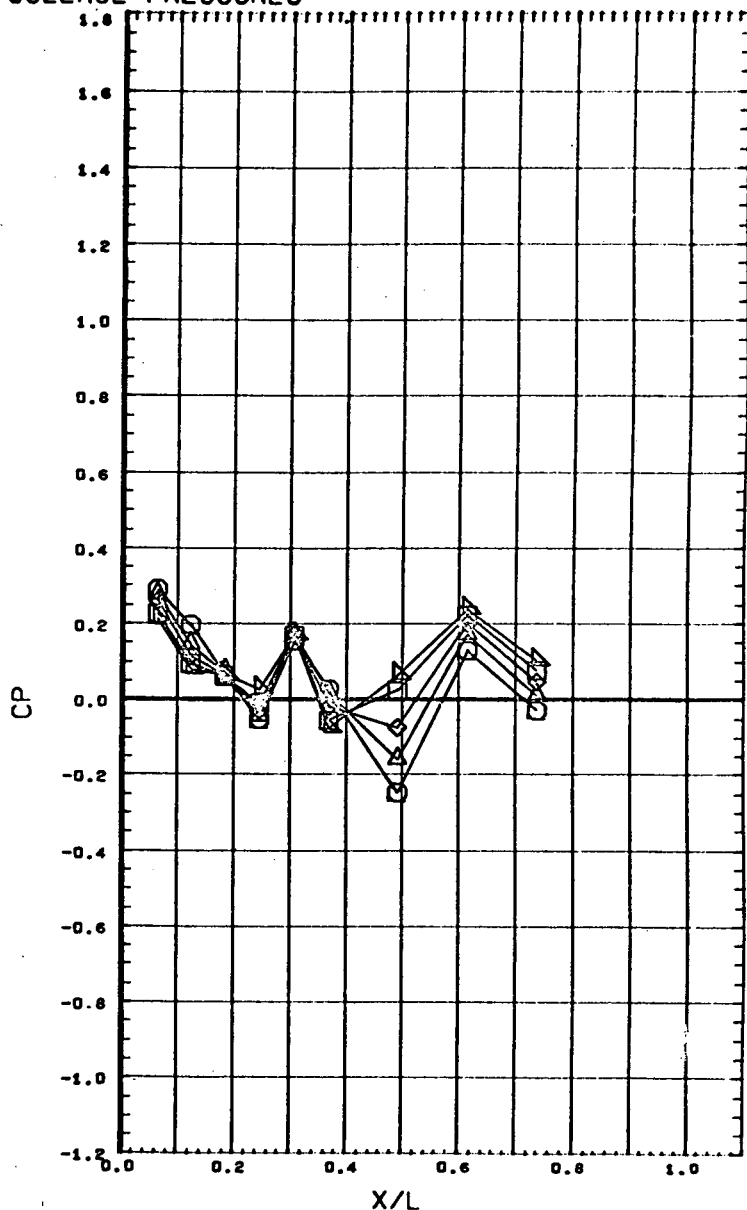
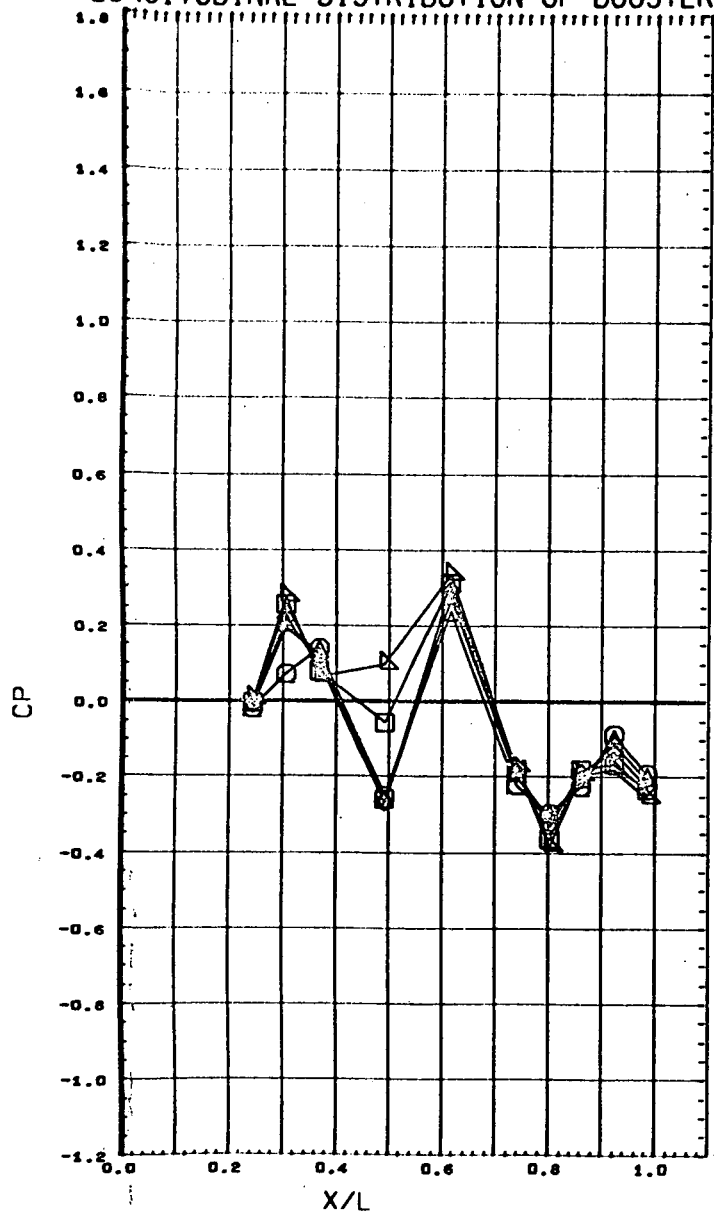

| SYMBOL | ALFB | THETA | M1 |
|--------|-------|--------|-------|
| ○ | 2.219 | 24.000 | 1.199 |
| ◇ | 4.179 | 45.000 | |
| △ | 6.175 | | |
| □ | 8.168 | | |
| ▽ | 9.532 | | |

REFERENCE FILE

| PARAMETRIC VALUES | | | |
|-------------------|-------|------|-------|
| BETA | 0.000 | DX/L | 0.036 |
| I | 3.800 | | |

LONGITUDINAL DISTRIBUTION OF BOOSTER FUSELAGE PRESSURES

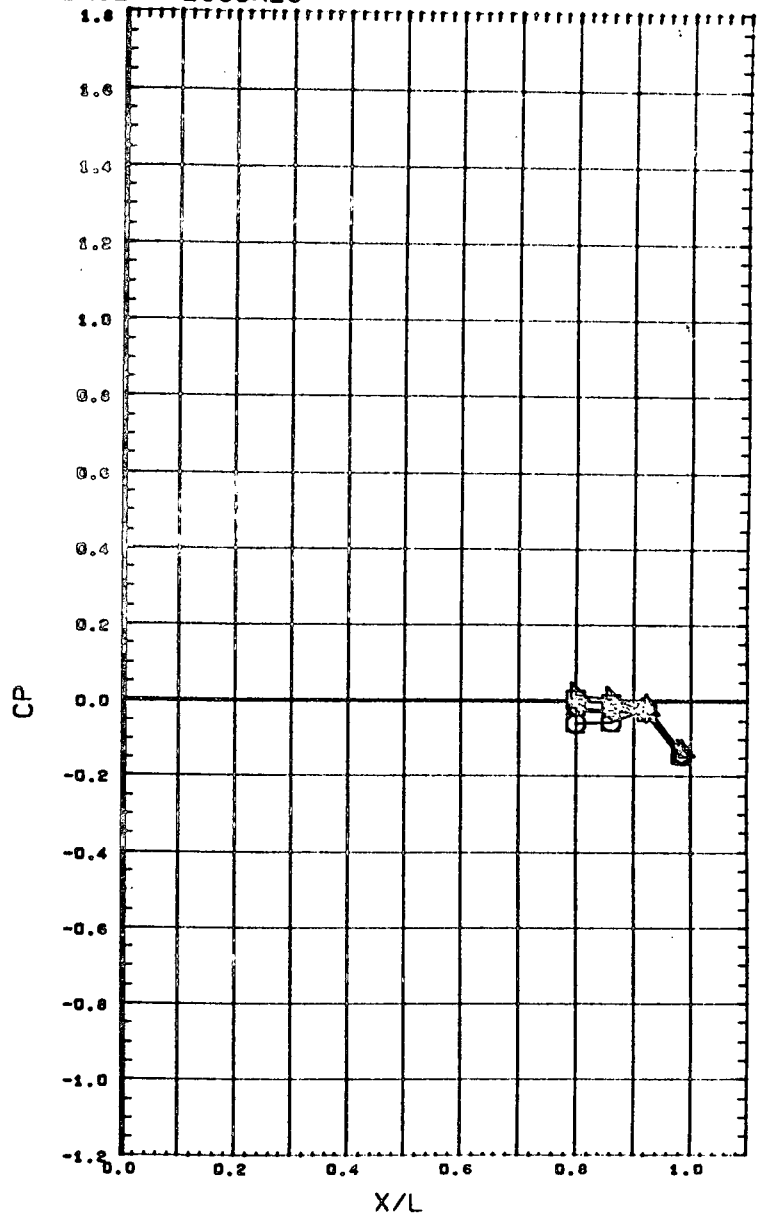
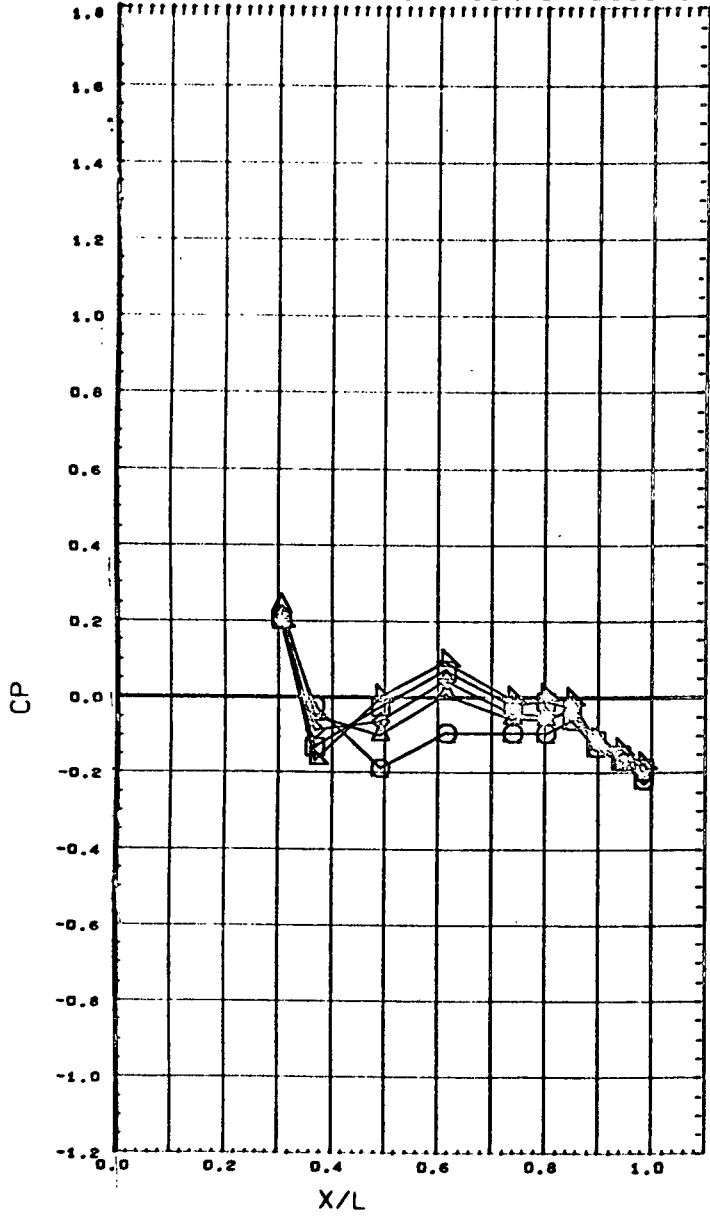

| SYMBOL | ALFB | THETA | M1 |
|--------|-------|---------|-------|
| ○ | 8.310 | 90.000 | 1.199 |
| ◇ | 5.780 | 180.000 | |
| △ | 3.815 | | |
| □ | 1.813 | | |
| ◇ | 0.450 | | |

REFERENCE FILE

| PARAMETRIC VALUES | | |
|-------------------|-------|-------|
| BETA | 0.000 | DX/L |
| z | 3.800 | 0.036 |

LONGITUDINAL DISTRIBUTION OF BOOSTER FUSELAGE PRESSURES

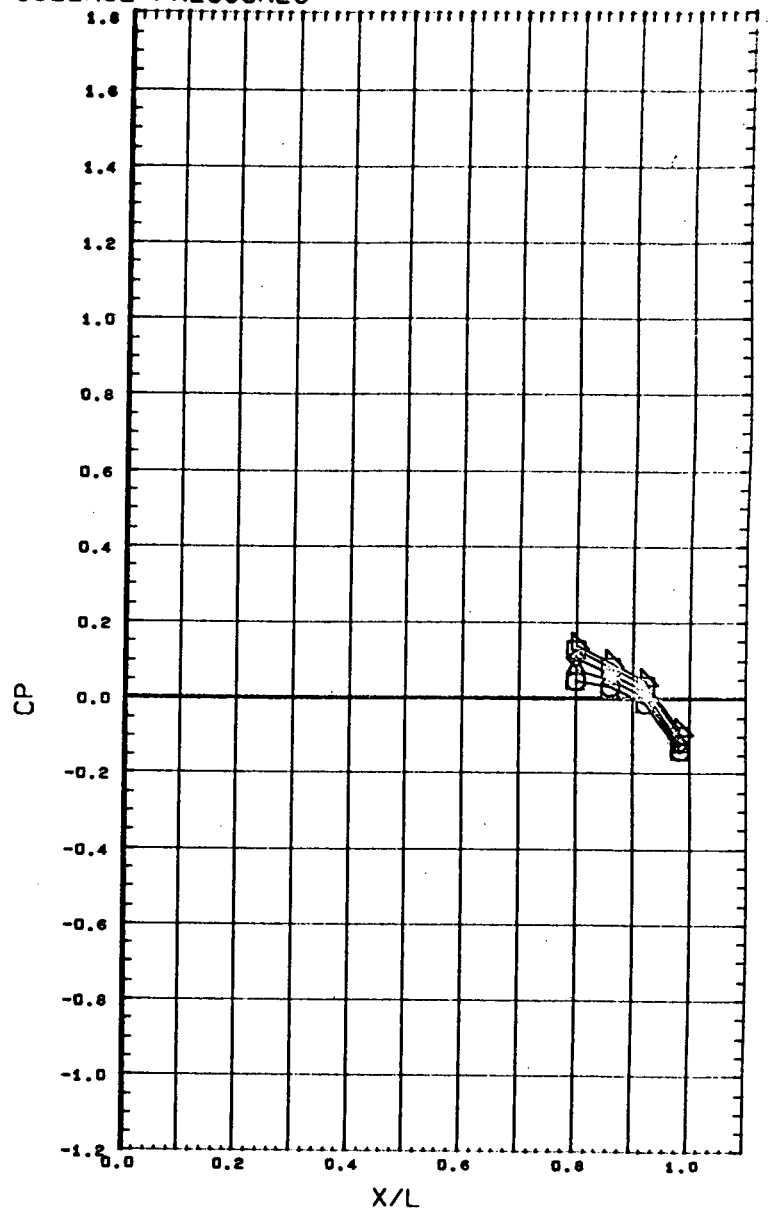
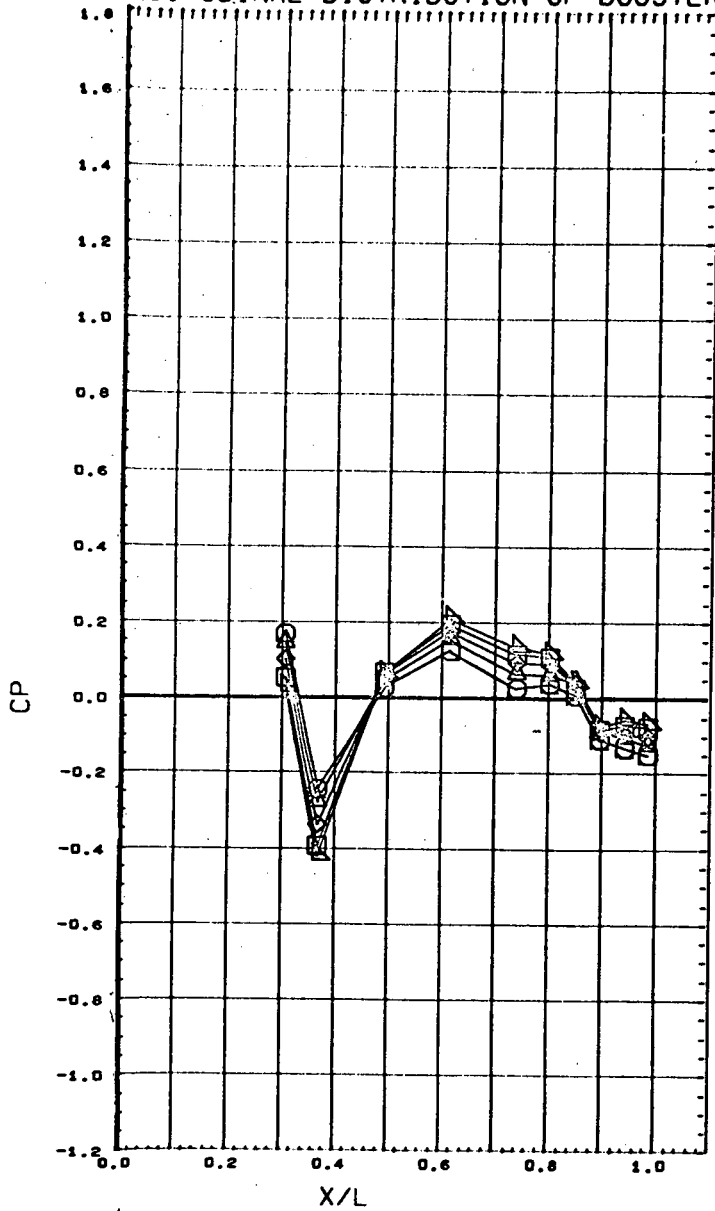

| SYMBOL | ALFB | THETA | M1 |
|--------|-------|---------|-------|
| ○ | 2.219 | 90.000 | 1.199 |
| ◇ | 4.179 | 180.000 | |
| ◇ | 6.175 | | |
| ◇ | 8.168 | | |
| ◇ | 9.532 | | |

REFERENCE FILE

| PARAMETRIC VALUES | | | |
|-------------------|-------|------|-------|
| BETA | 0.000 | DX/L | 0.036 |
| I | 3.800 | | |

LONGITUDINAL DISTRIBUTION OF BOOSTER FUSELAGE PRESSURES

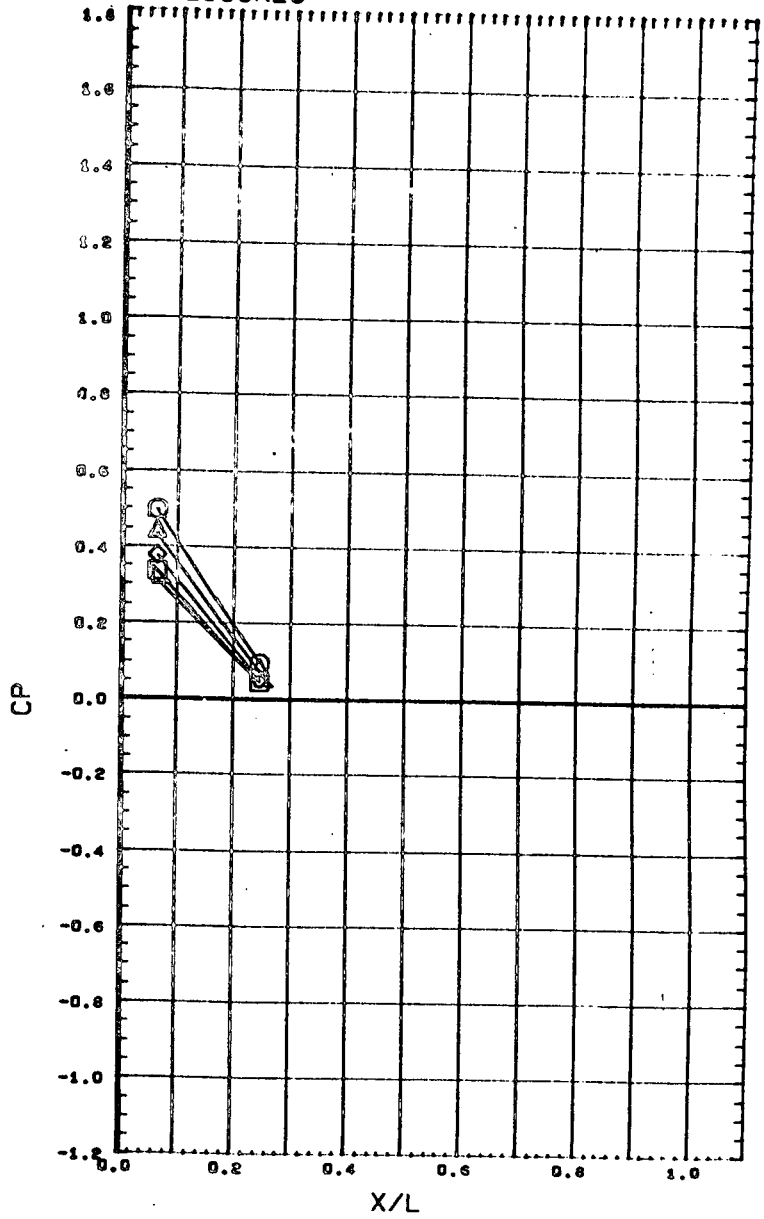
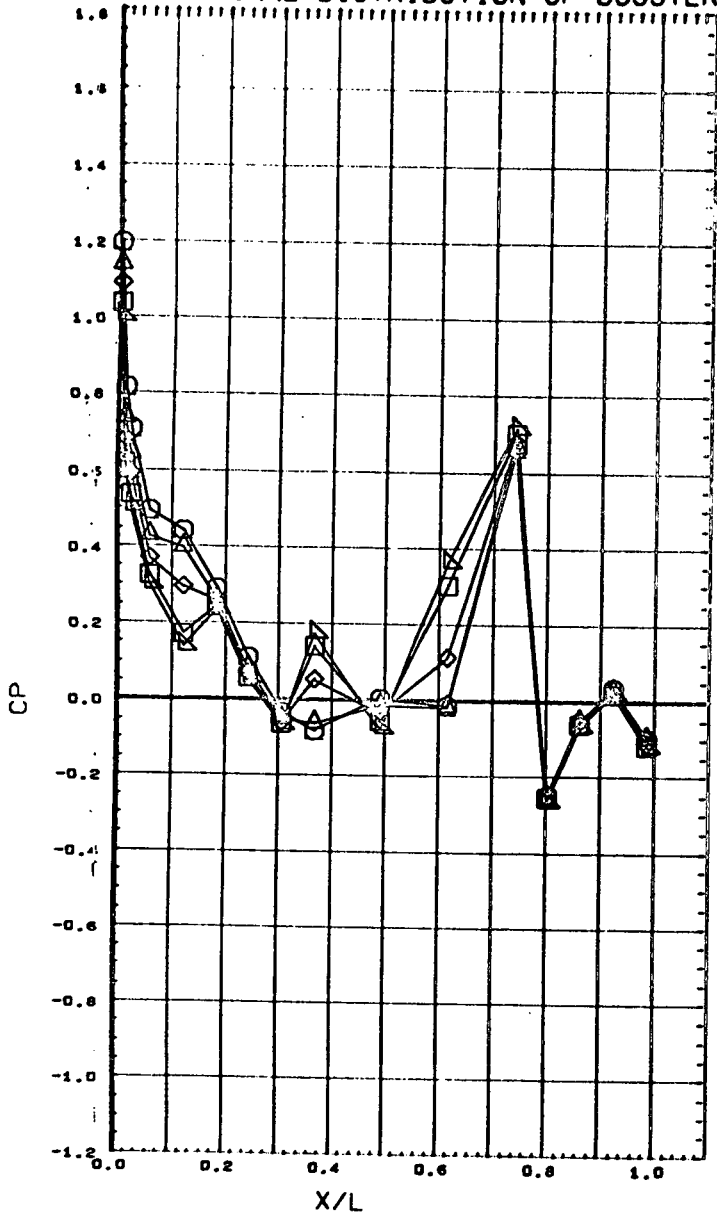

| SYMBOL | ALFB | THETA | M1 |
|--------|-------|--------|-------|
| ○ | 8.317 | 0.000 | 1.297 |
| △ | 5.788 | 15.000 | |
| ◇ | 3.823 | | |
| □ | 1.808 | | |
| ▽ | 0.447 | | |

| PARAMETRIC VALUES | | | |
|-------------------|-------|------|-------|
| BETA | 0.000 | DX/L | 0.036 |
| I | 3.800 | | |

REFERENCE FILE

LONGITUDINAL DISTRIBUTION OF BOOSTER FUSELAGE PRESSURES

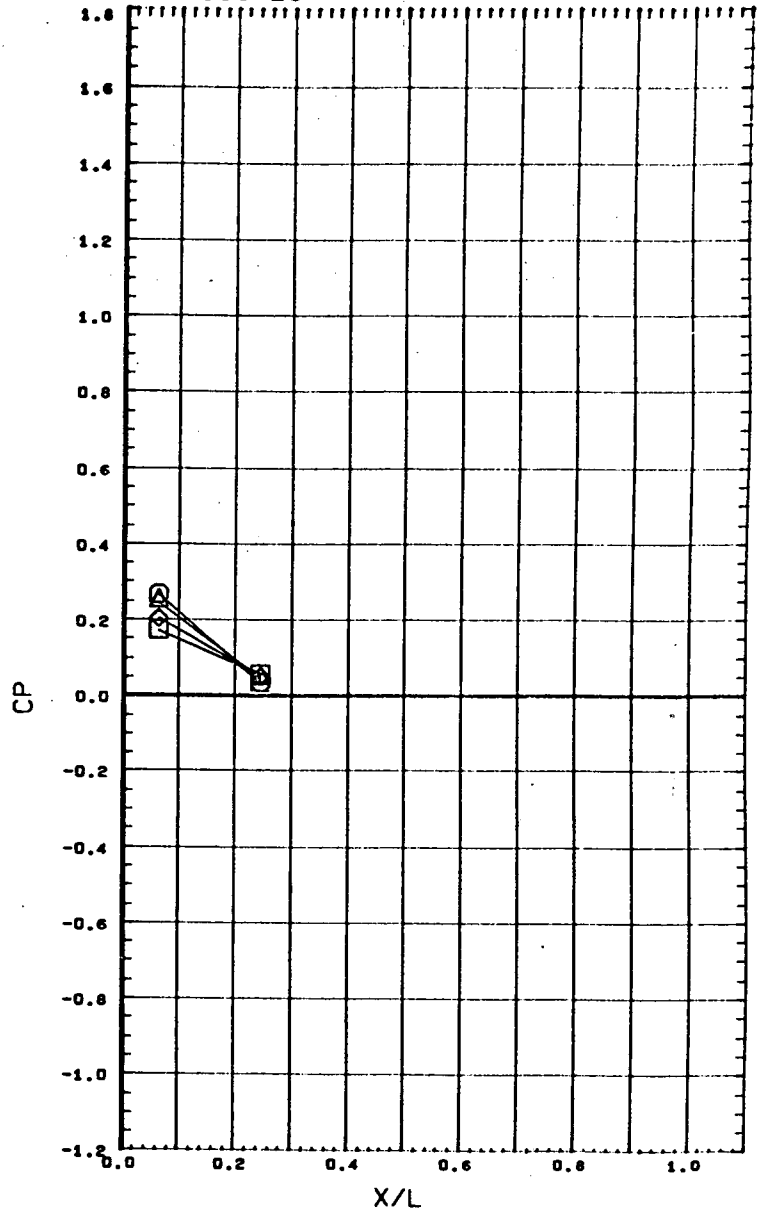
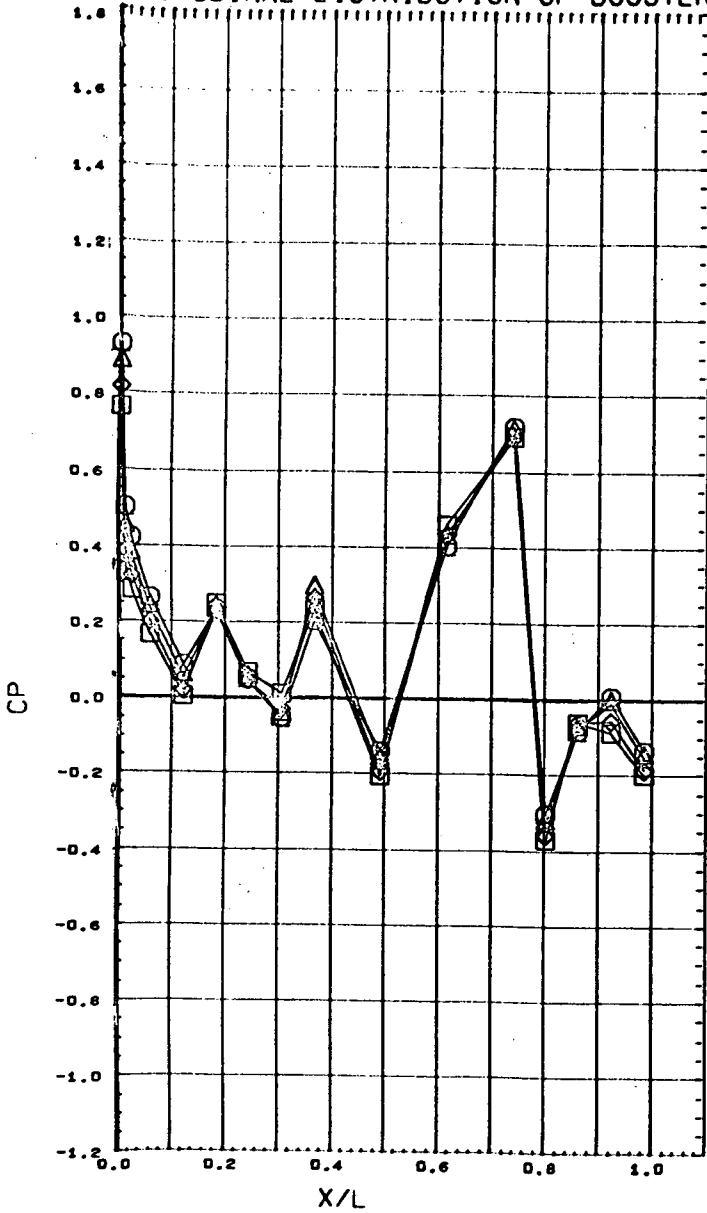

| SYMBOL | ALFB | THETA | M1 |
|--------|-------|--------|-------|
| ○ | 2.215 | 0.000 | 1.297 |
| △ | 4.170 | 15.000 | |
| ◇ | 6.162 | | |
| □ | 8.160 | | |

| PARAMETRIC VALUES | | | |
|-------------------|-------|------|-------|
| BETA | 0.000 | DX/L | 0.036 |
| I | 3.800 | | |

REFERENCE FILE

LONGITUDINAL DISTRIBUTION OF BOOSTER FUSELAGE PRESSURES

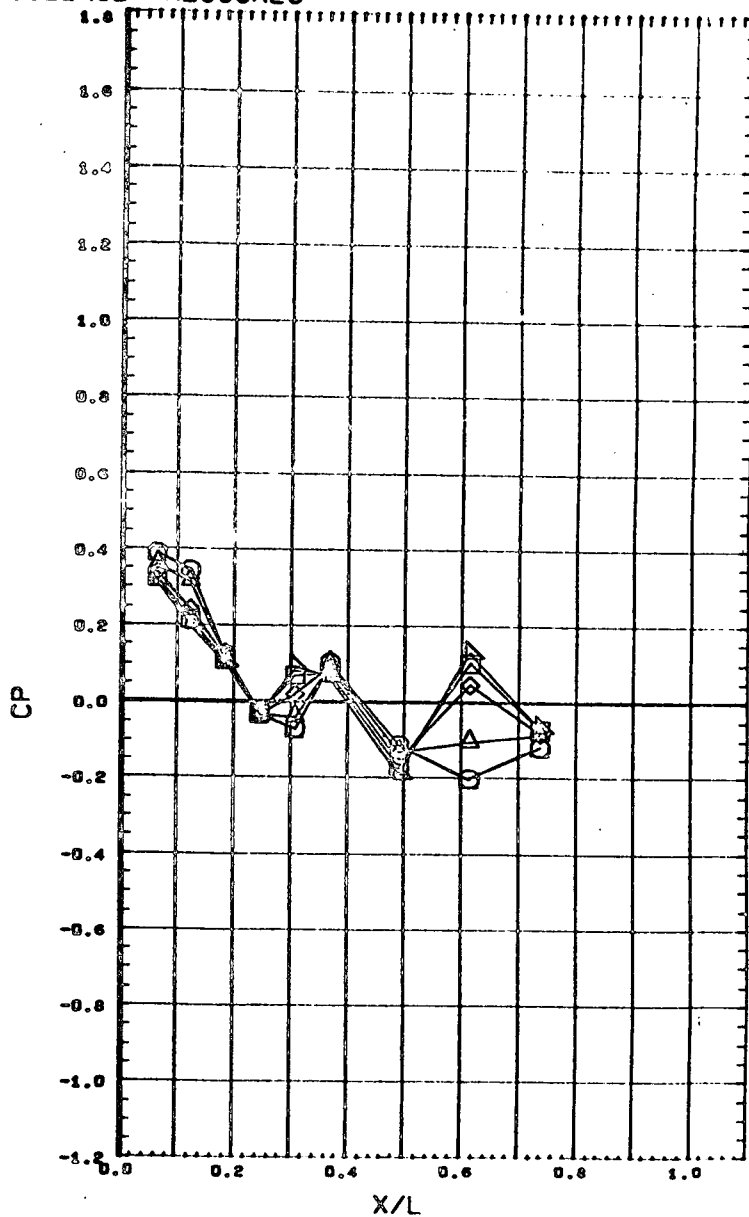
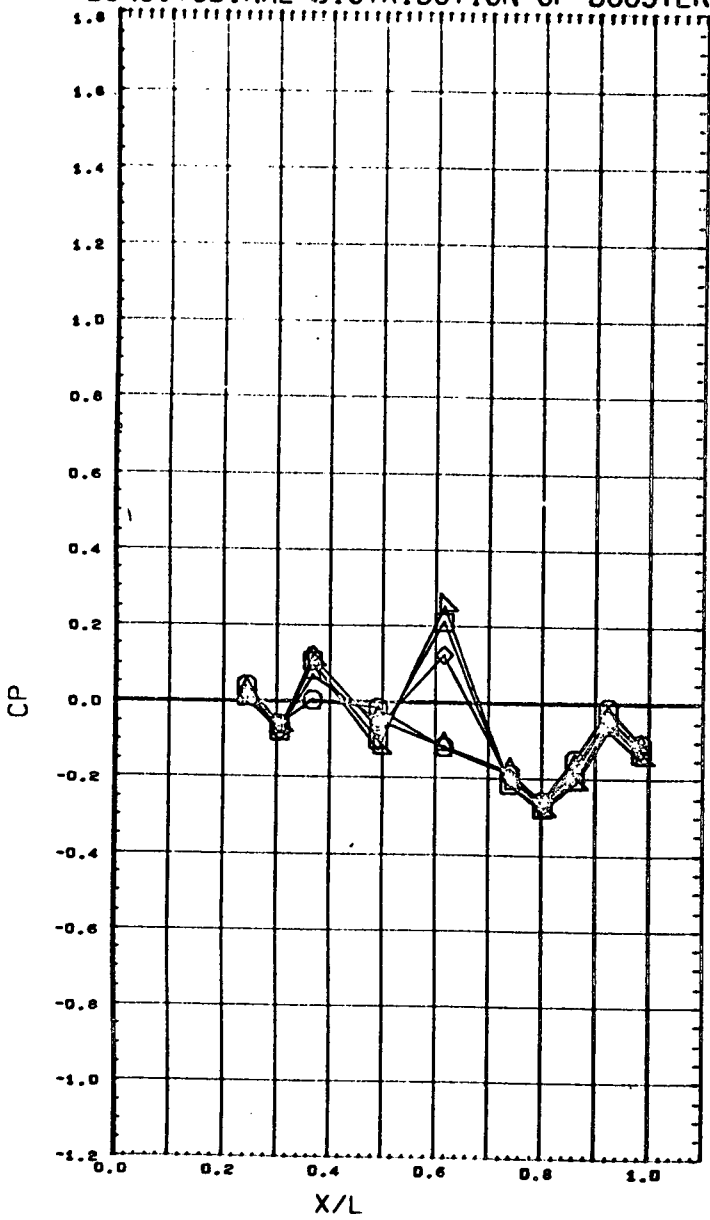

| SYMBOL | ALFD | THETA | M1 |
|--------|---------|--------|-------|
| ◇ | - 8.317 | 24.000 | 1.297 |
| ◇ | - 5.788 | 45.000 | |
| ◇ | - 3.623 | | |
| ◇ | - 1.808 | | |
| ◇ | - 0.447 | | |

| PARAMETRIC VALUES | | | |
|-------------------|-------|------|-------|
| BETA | 0.000 | DX/L | 0.036 |
| I | 3.800 | | |

REFERENCE FILE

LONGITUDINAL DISTRIBUTION OF BOOSTER FUSELAGE PRESSURES

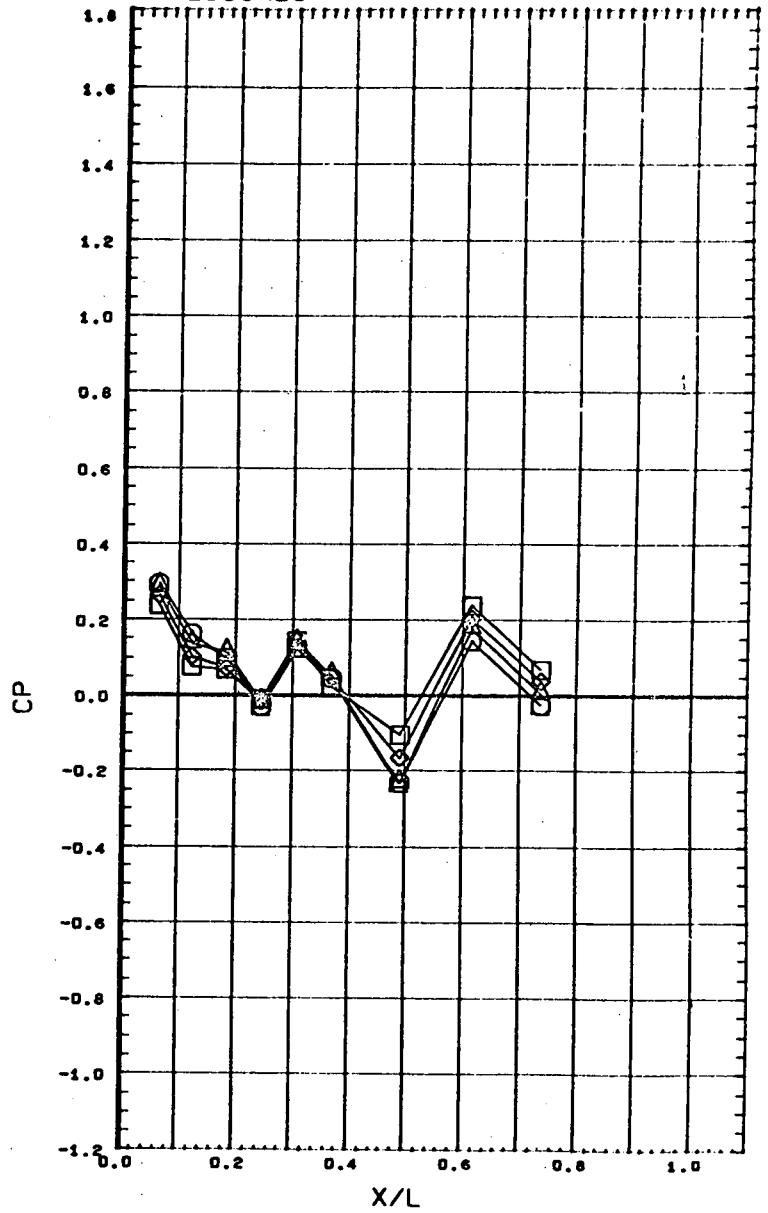
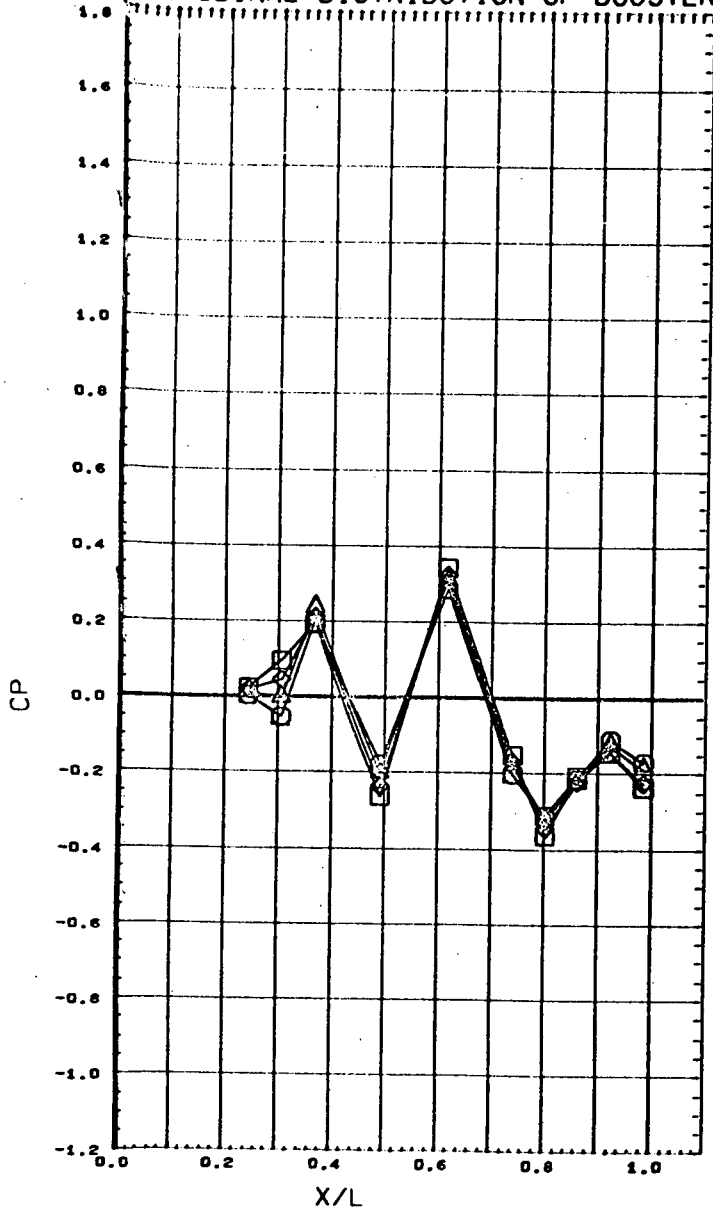

| SYMBOL | ALFB | THETA | M1 |
|--------|-------|--------|-------|
| ○ | 2.215 | 24.000 | 1.297 |
| △ | 4.170 | 45.000 | |
| ◇ | 6.162 | | |
| □ | 8.160 | | |

| PARAMETRIC VALUES | | |
|-------------------|-------|-------|
| BETA | 0.000 | OX/L |
| I | 3.800 | 0.036 |

REFERENCE FILE

LONGITUDINAL DISTRIBUTION OF BOOSTER FUSELAGE PRESSURES

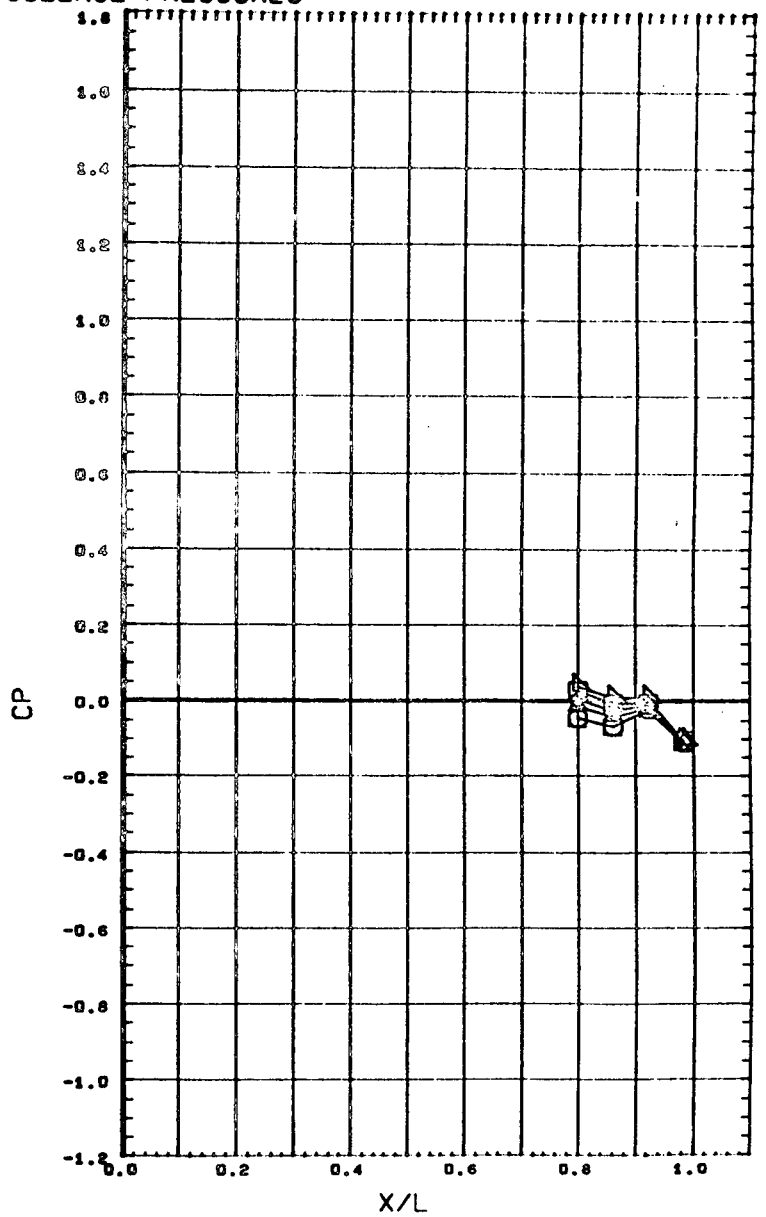
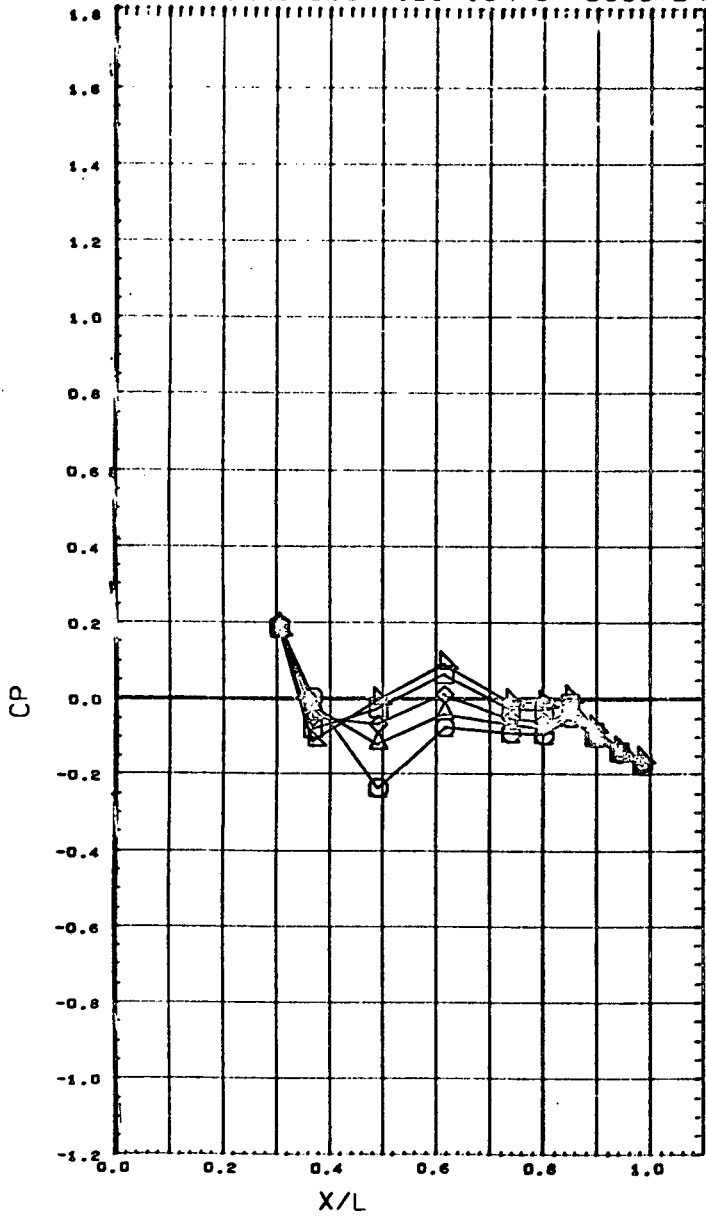

| SYMBOL | ALFB | THETA | M1 |
|--------|---------|---------|-------|
| ○ | - 8.317 | 90.000 | 1.297 |
| △ | - 5.788 | 180.000 | |
| ◇ | - 3.823 | | |
| □ | - 1.808 | | |
| ▽ | - 0.447 | | |

| PARAMETRIC VALUES | | |
|-------------------|-------|------------|
| BETA | 0.000 | DX/L 0.036 |
| I | 3.800 | |

REFERENCE FILE

LONGITUDINAL DISTRIBUTION OF BOOSTER FUSELAGE PRESSURES

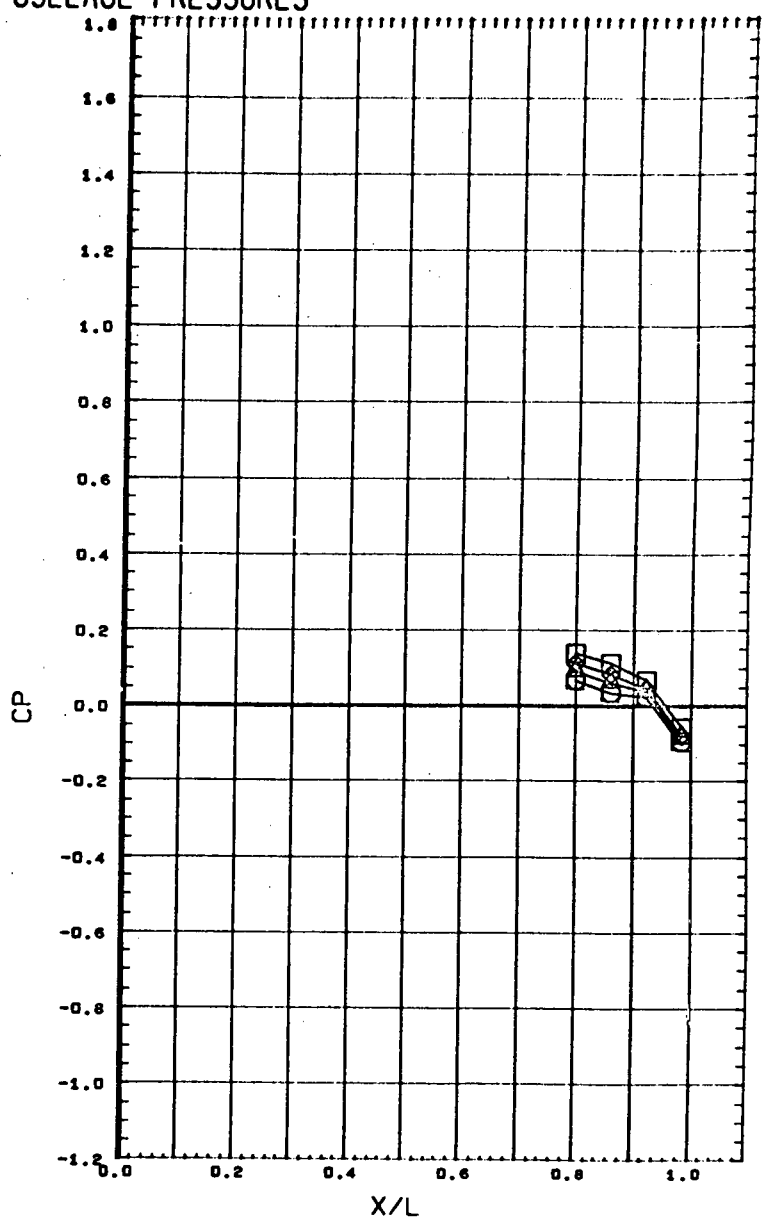
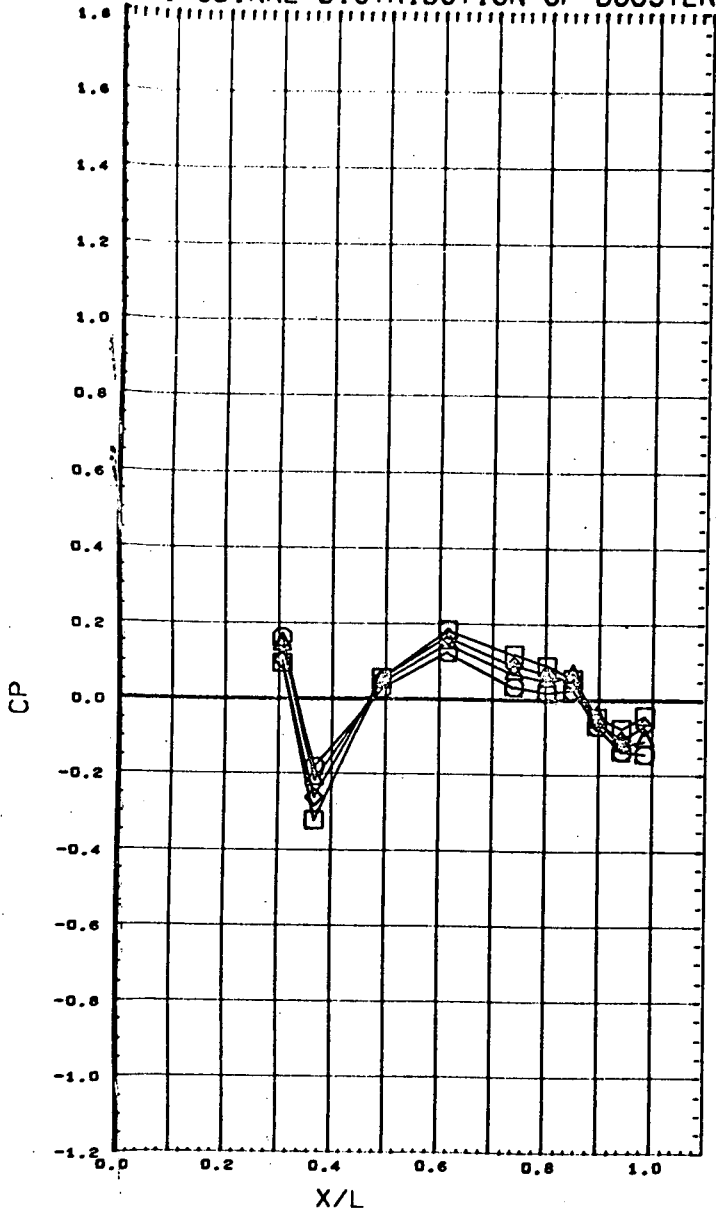

| SYMBOL | ALFB | THETA | M1 |
|--------|-------|---------|-------|
| ○ | 2.215 | 90.000 | 1.297 |
| △ | 4.170 | 180.000 | |
| ◇ | 6.162 | | |
| □ | 8.160 | | |

| PARAMETRIC VALUES | | | |
|-------------------|-------|------|-------|
| BETA | 0.000 | DX/L | 0.036 |
| I | 3.800 | | |

REFERENCE FILE

LONGITUDINAL DISTRIBUTION OF BOOSTER FUSELAGE PRESSURES

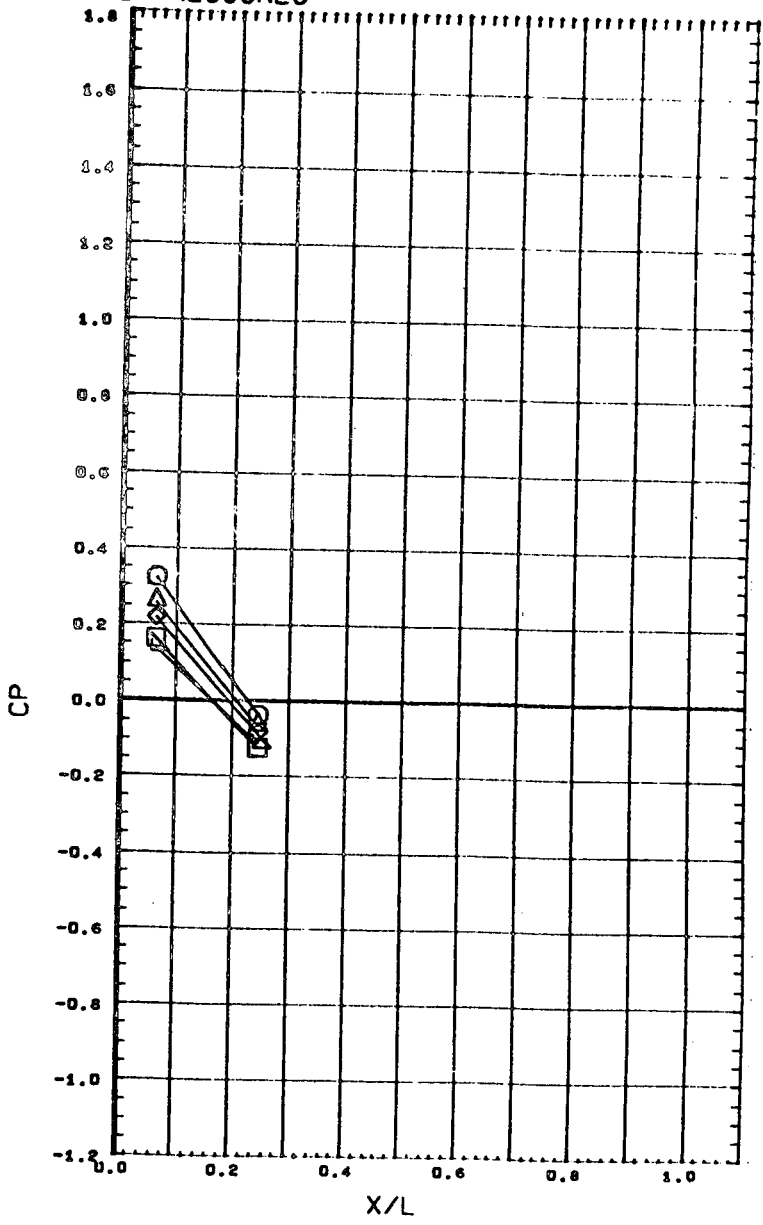
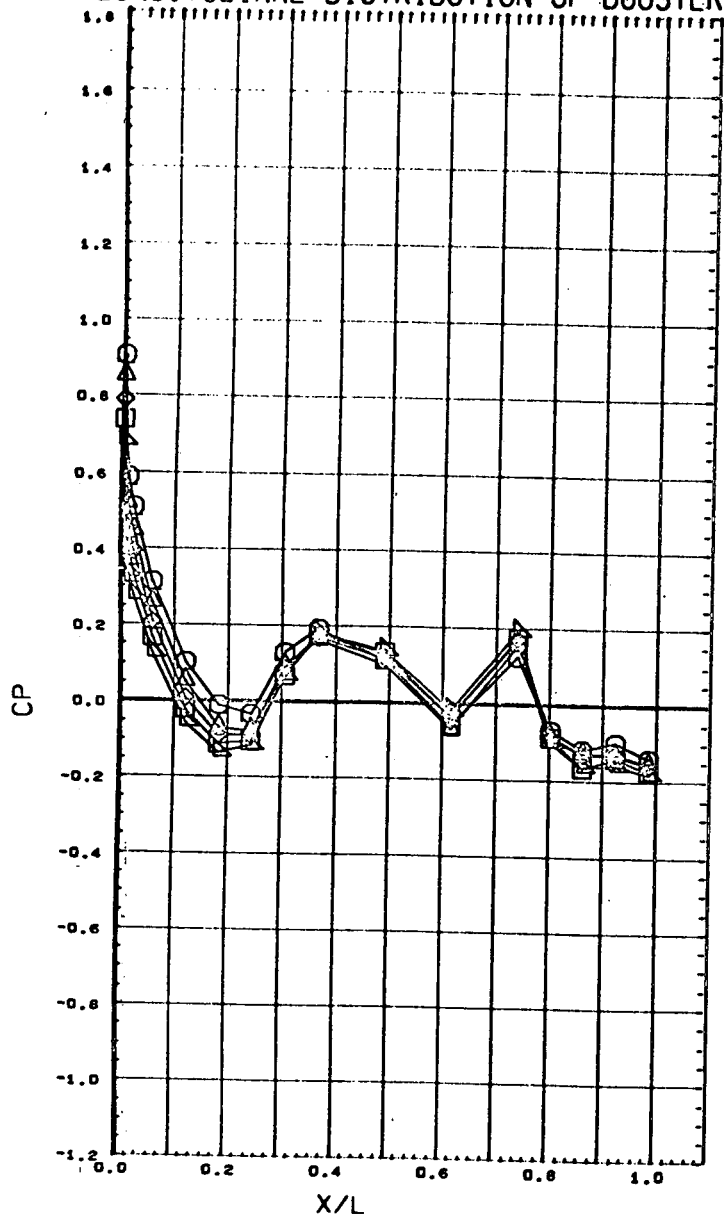

| SYMBOL | ALFB | THETA | M1 |
|--------|-------|--------|-------|
| ○ | 6.188 | 0.000 | 0.598 |
| ◇ | 5.890 | 15.000 | |
| △ | 3.880 | | |
| □ | 1.881 | | |
| ▽ | 0.100 | | |

| PARAMETRIC VALUES | | | |
|-------------------|-------|------|---------|
| BETA | 0.000 | DX/L | - 0.194 |
| I | 0.000 | | |

REFERENCE FILE

LONGITUDINAL DISTRIBUTION OF BOOSTER FUSELAGE PRESSURES

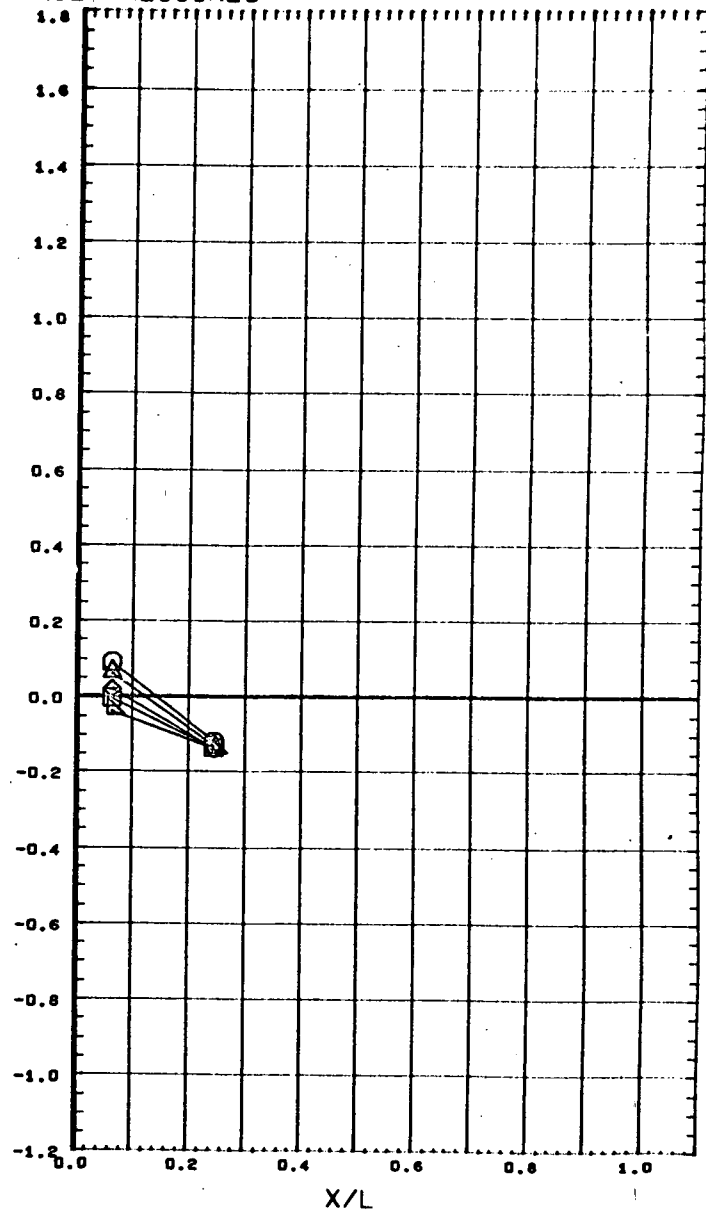
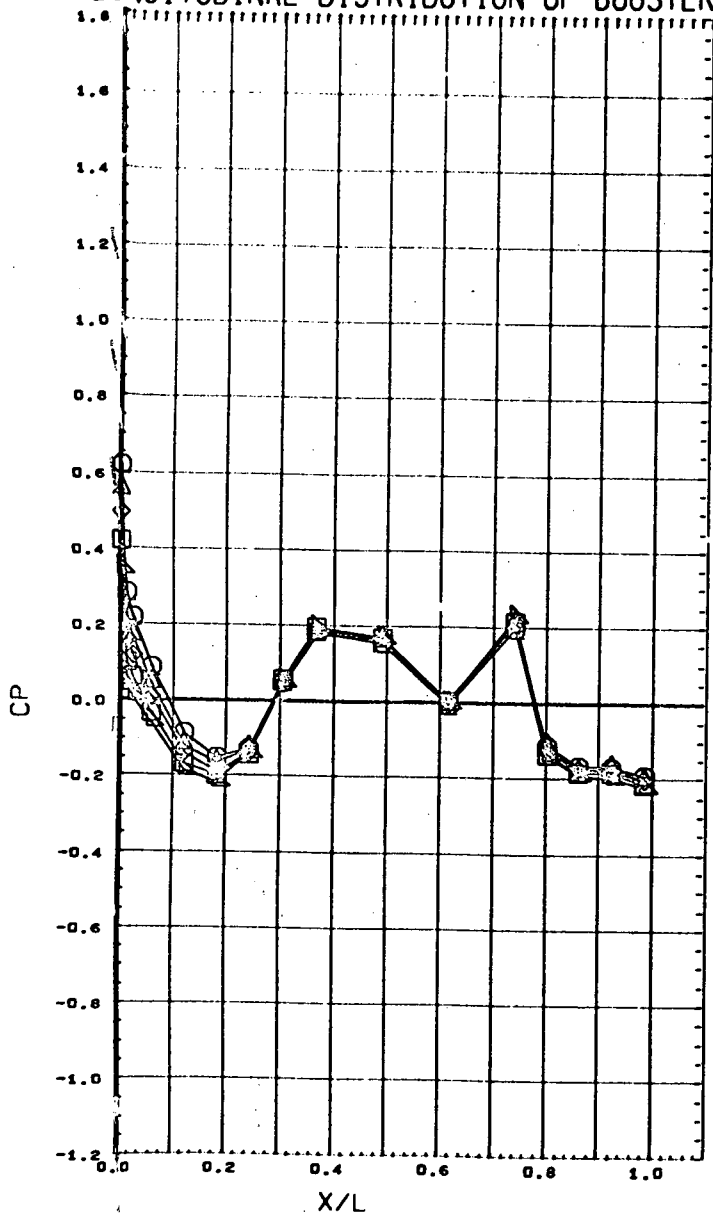

| SYMBOL | ALFB | THETA | M1 |
|--------|--------|--------|-------|
| ○ | 2.097 | 0.000 | 0.598 |
| ◇ | 4.096 | 15.000 | |
| △ | 6.063 | | |
| □ | 8.094 | | |
| ○ | 10.082 | | |

REFERENCE FILE

| PARAMETRIC VALUES | | | |
|-------------------|-------|------|---------|
| BETA | 0.000 | OX/L | - 0.194 |
| I | 0.000 | | |

LONGITUDINAL DISTRIBUTION OF BOOSTER FUSELAGE PRESSURES

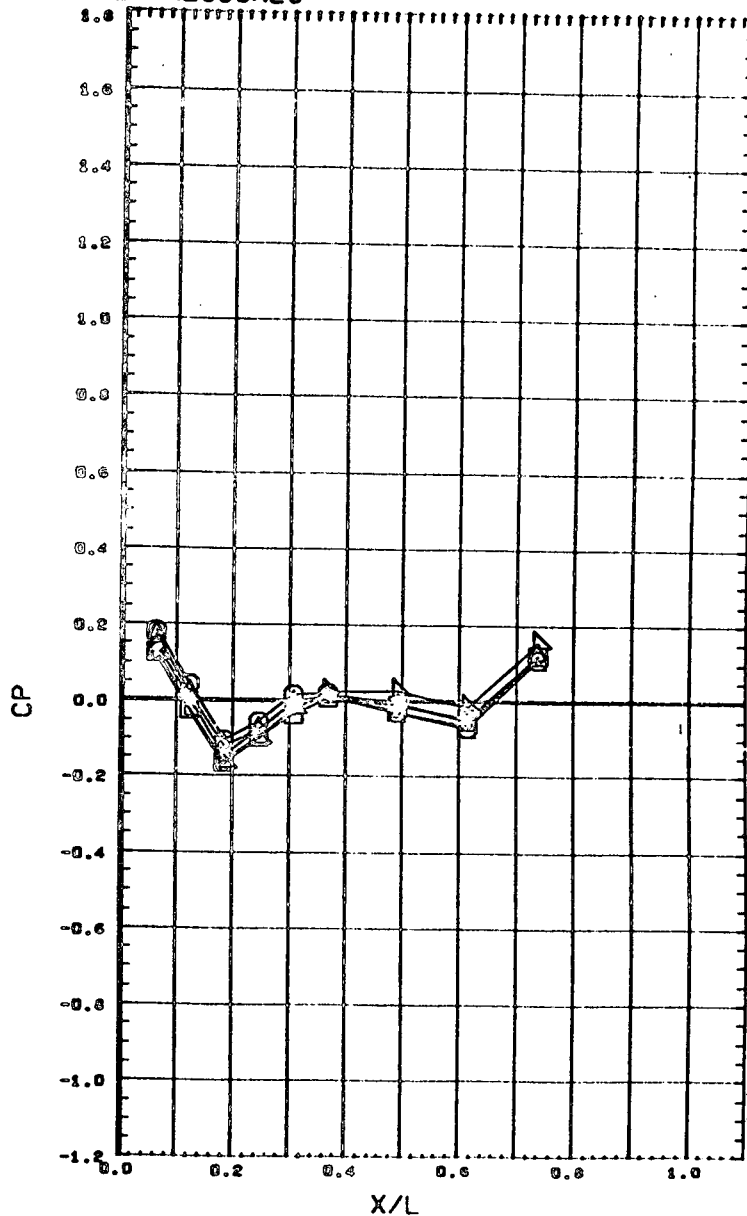
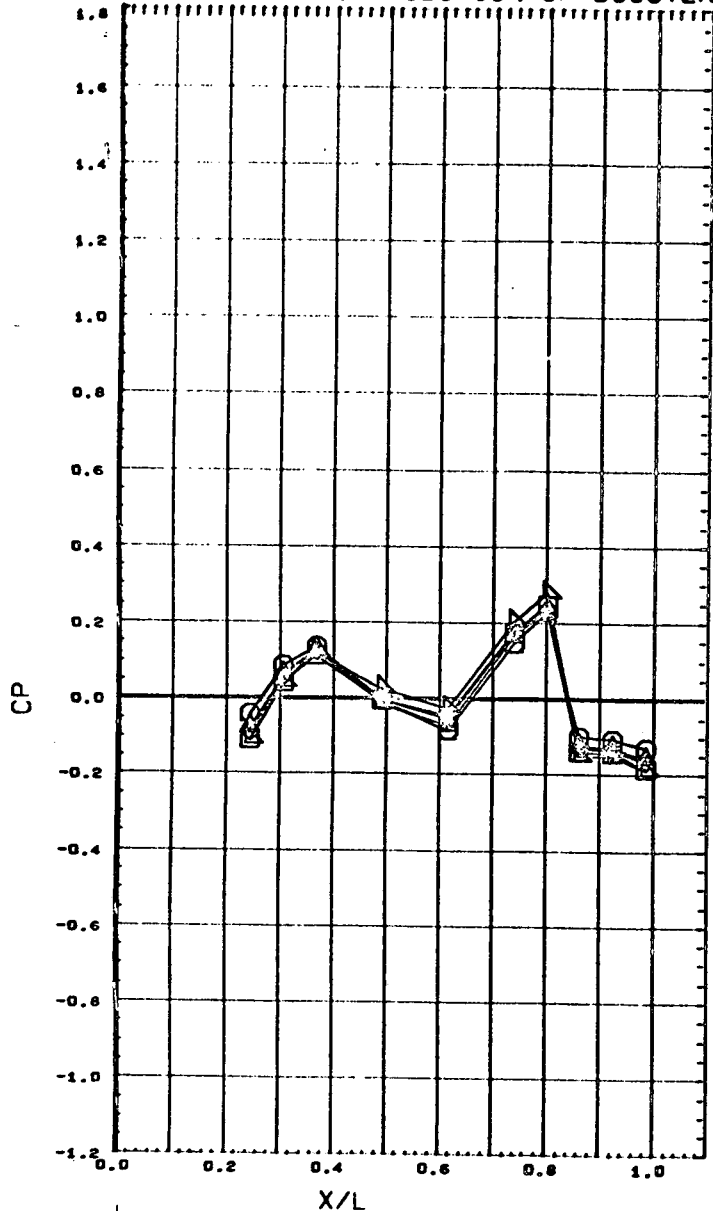

| SYMBOL | ALFB | THETA | M1 |
|--------|---------|--------|-------|
| ○ | - 8.188 | 24.000 | 0.598 |
| ◇ | - 5.890 | 45.000 | |
| △ | - 3.880 | | |
| □ | - 1.881 | | |
| ▽ | 0.100 | | |

| PARAMETRIC VALUES | | | |
|-------------------|-------|------|---------|
| BETA | 0.000 | OX/L | - 0.194 |
| I | 0.000 | | |

REFERENCE FILE

LONGITUDINAL DISTRIBUTION OF BOOSTER FUSELAGE PRESSURES

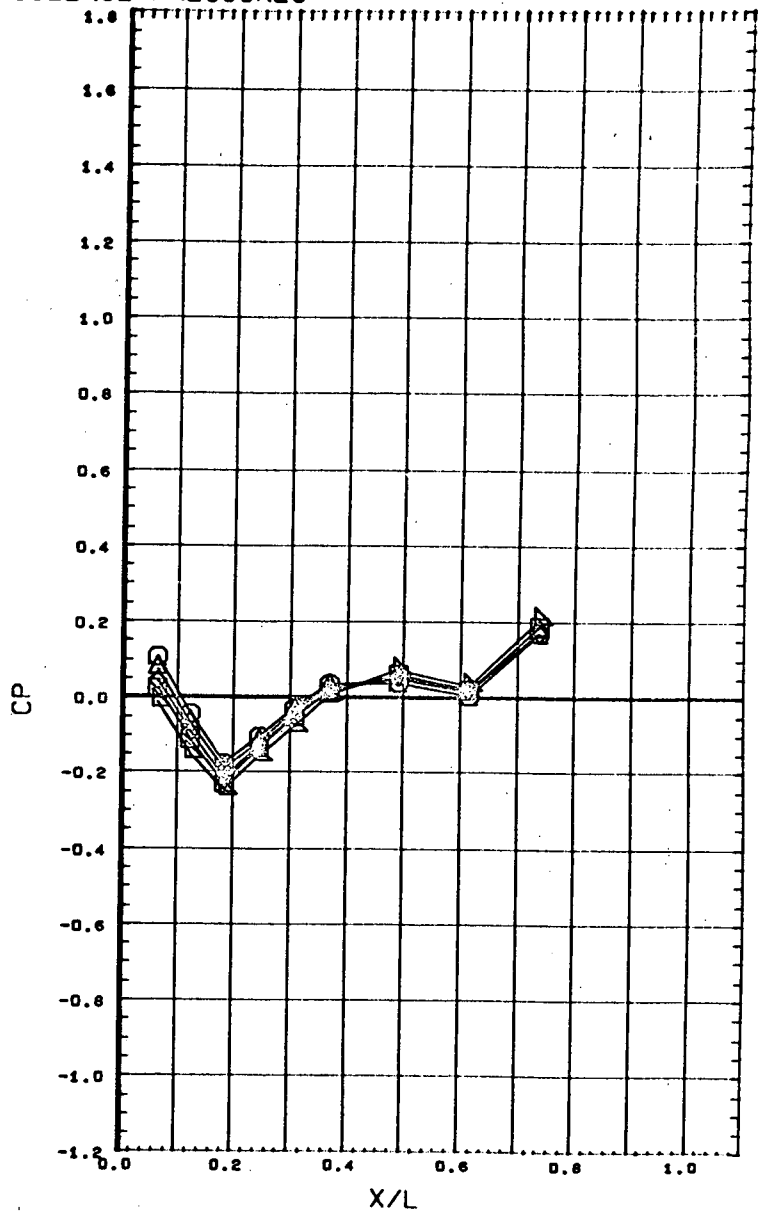
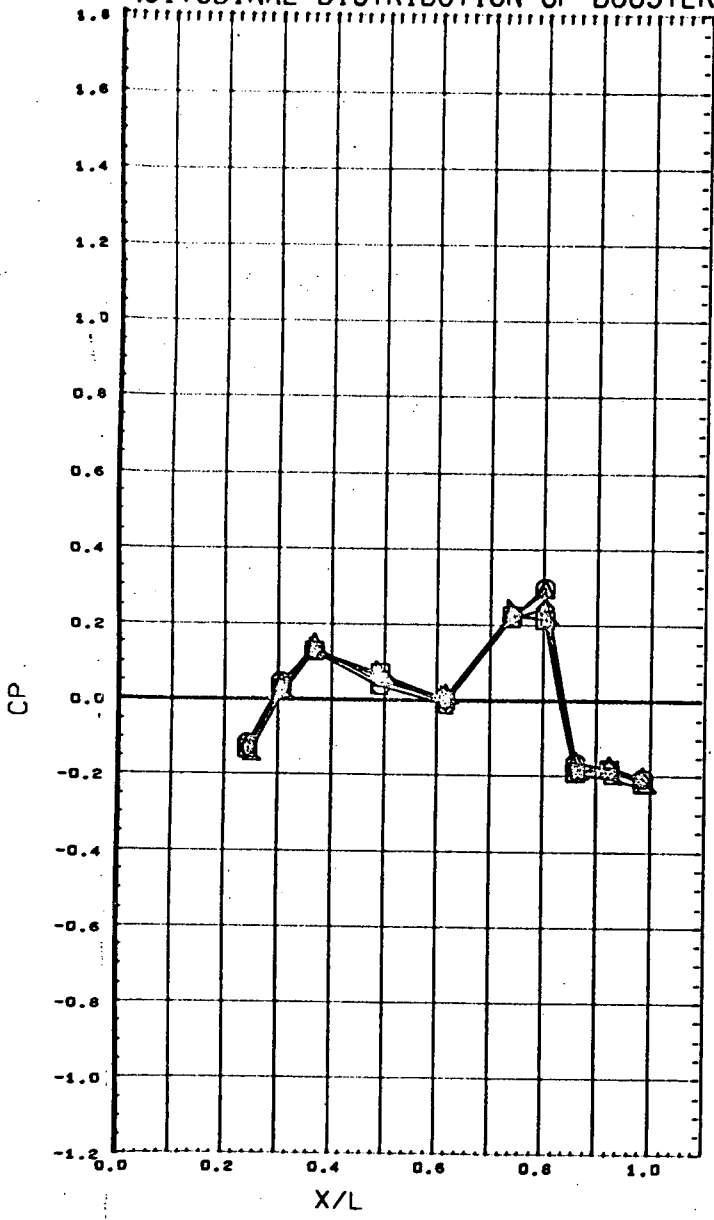

| SYMBOL | ALFD | THETA | M1 |
|--------|--------|--------|-------|
| □ | 2.097 | 24.000 | 0.598 |
| ◇ | 4.096 | 45.000 | |
| ◇ | 6.063 | | |
| ◇ | 8.094 | | |
| ◇ | 10.082 | | |

REFERENCE FILE

| PARAMETRIC VALUES | | | |
|-------------------|-------|------|---------|
| BETA | 0.000 | Ox/L | - 0.194 |
| I | 0.000 | | |

LONGITUDINAL DISTRIBUTION OF BOOSTER FUSELAGE PRESSURES

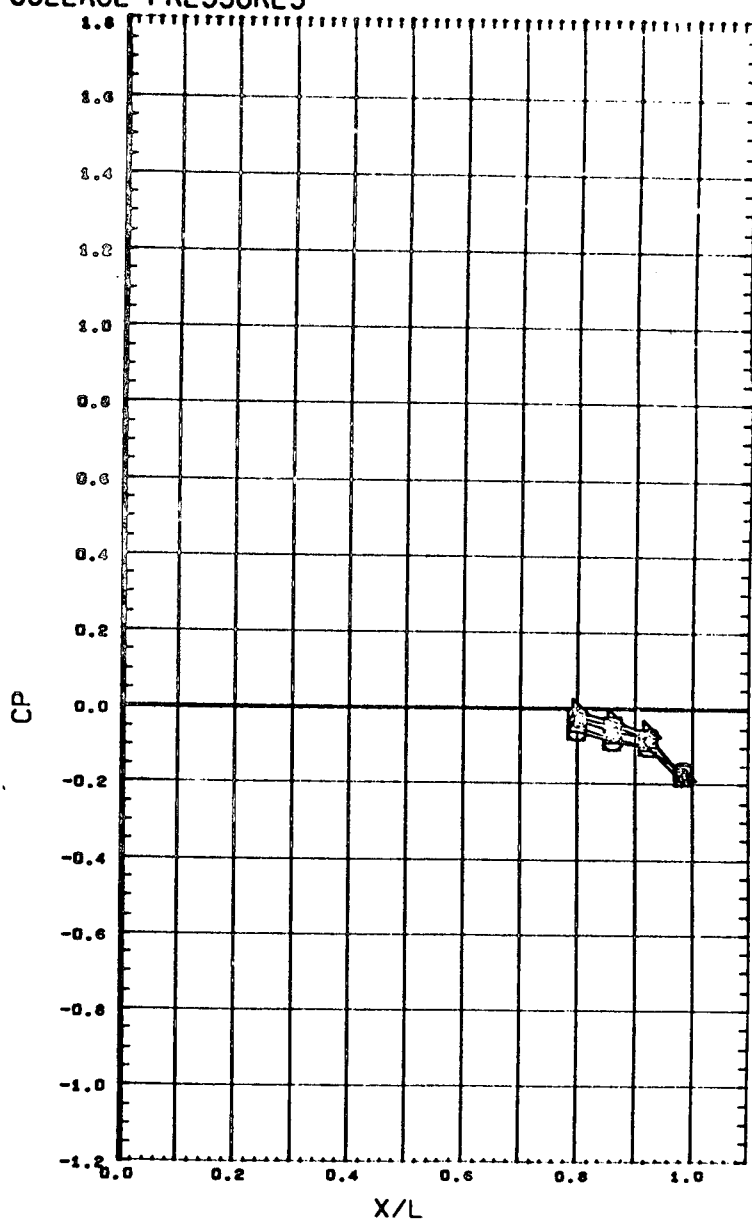
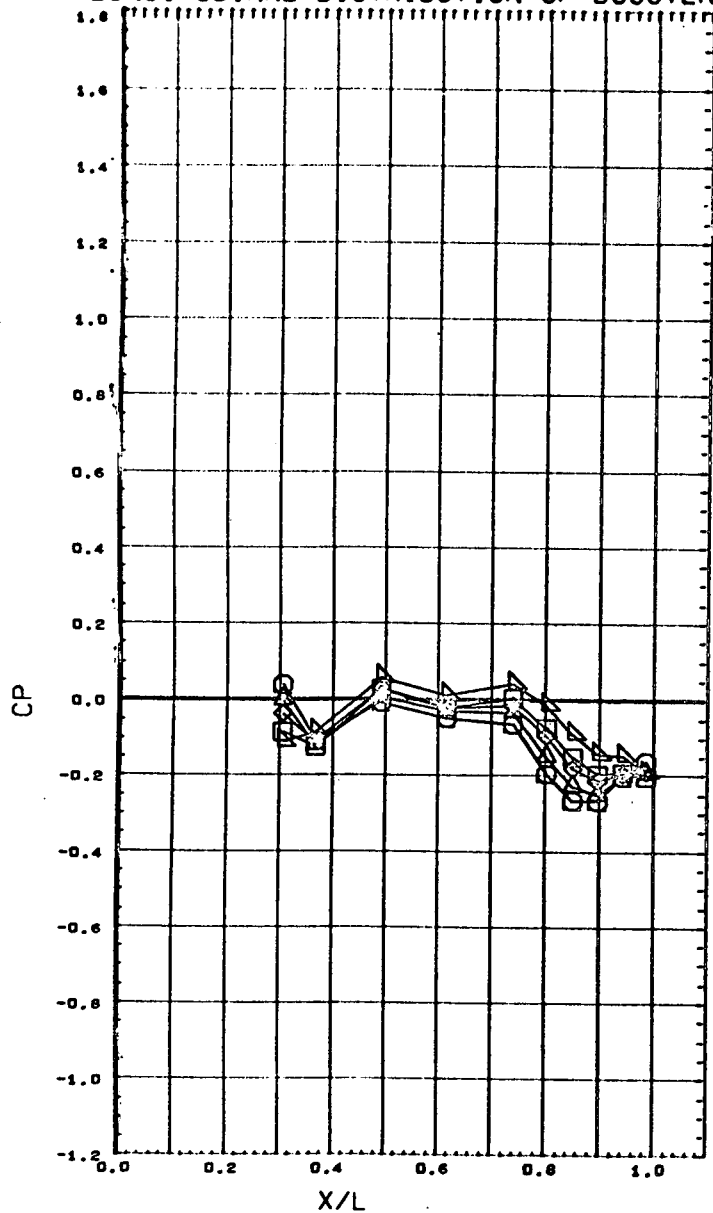

| SYMBOL | ALFB | THETA | M1 |
|--------|-------|---------|-------|
| ○ | 6.188 | 90.000 | 0.598 |
| △ | 5.890 | 180.000 | |
| ◇ | 3.880 | | |
| □ | 1.881 | | |
| ○ | 0.160 | | |

REFERENCE FILE

| PARAMETRIC VALUES | | |
|-------------------|-------|--------------|
| BETA | 0.000 | DX/L - 0.194 |
| z | 0.000 | |

LONGITUDINAL DISTRIBUTION OF BOOSTER FUSELAGE PRESSURES

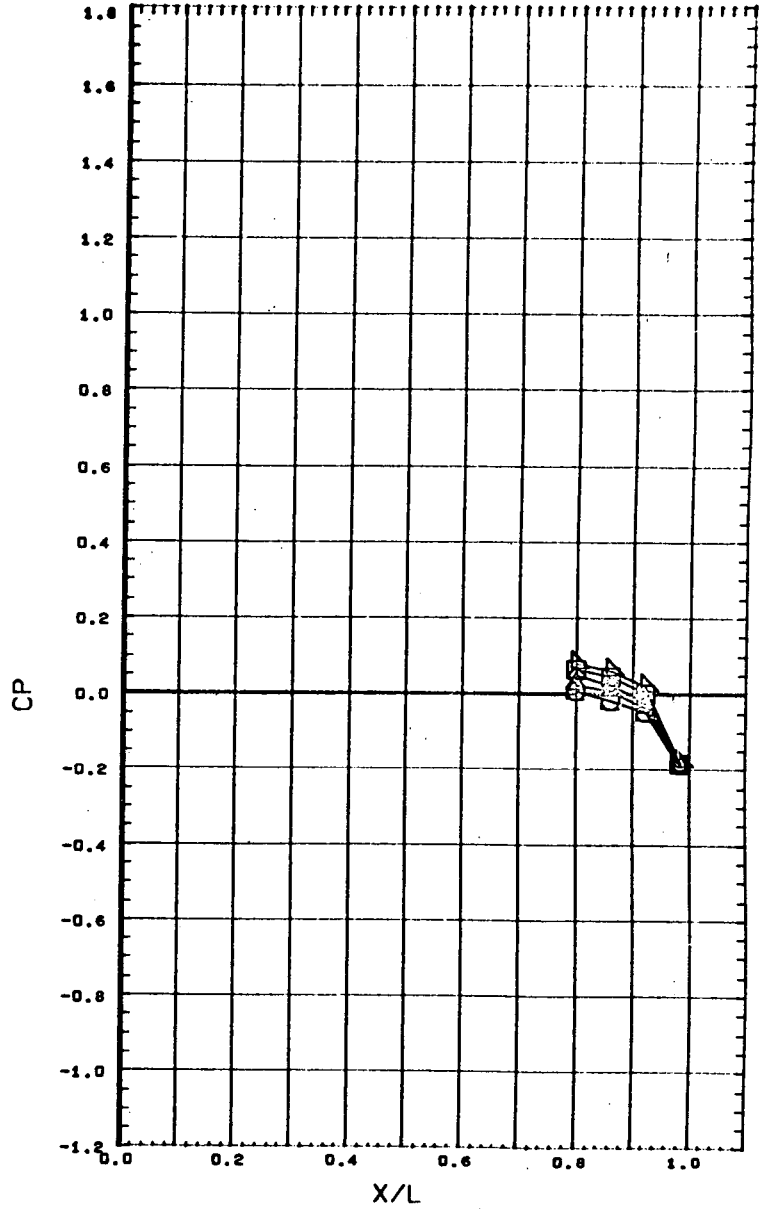
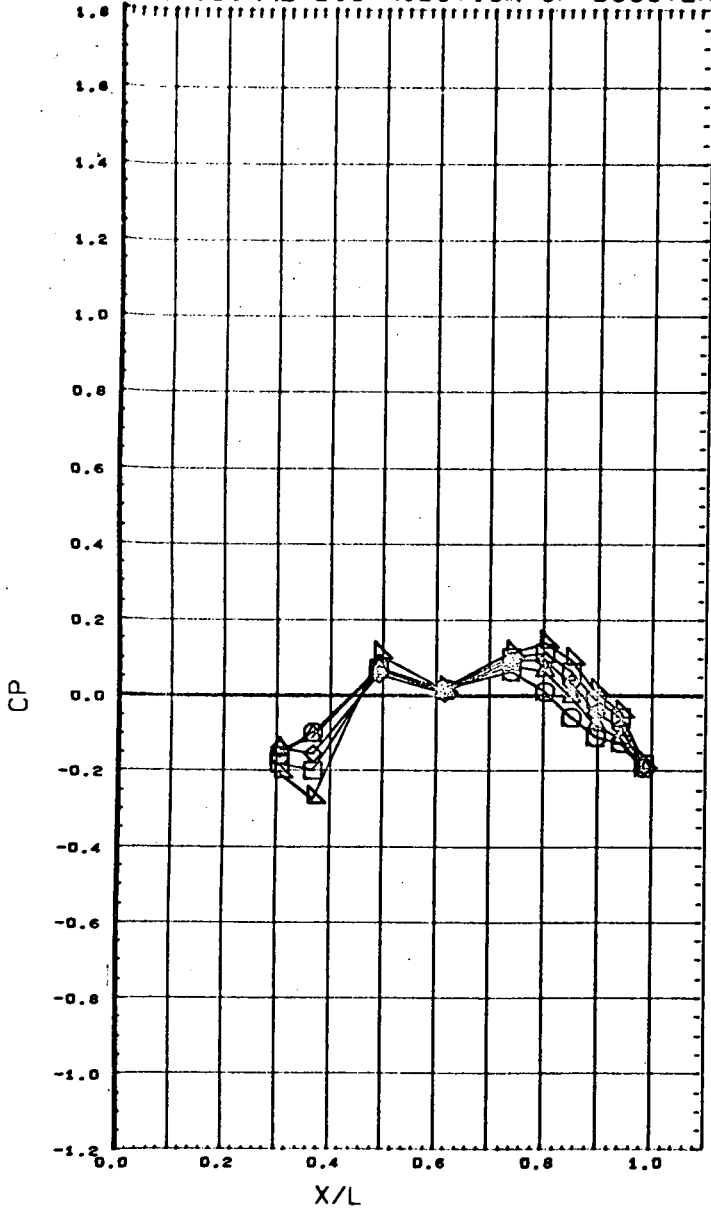

| SYMBOL | ALFB | THETA | M1 |
|--------|--------|---------|-------|
| ○ | 2.097 | 90.000 | 0.598 |
| △ | 4.096 | 180.000 | |
| ◇ | 6.063 | | |
| □ | 8.094 | | |
| ▽ | 10.082 | | |

REFERENCE FILE

| PARAMETRIC VALUES | | |
|-------------------|-------|--------------|
| BETA | 0.000 | DX/L - 0.194 |
| I | 0.000 | |

LONGITUDINAL DISTRIBUTION OF BOOSTER FUSELAGE PRESSURES

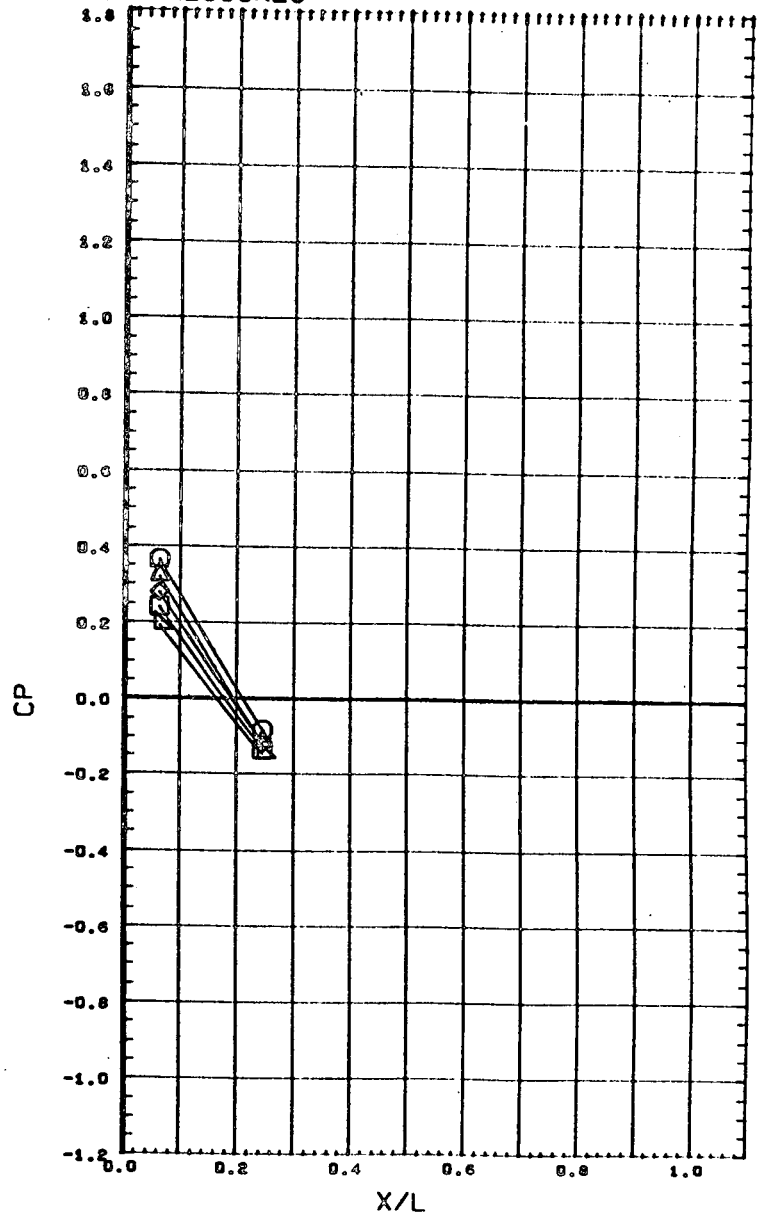
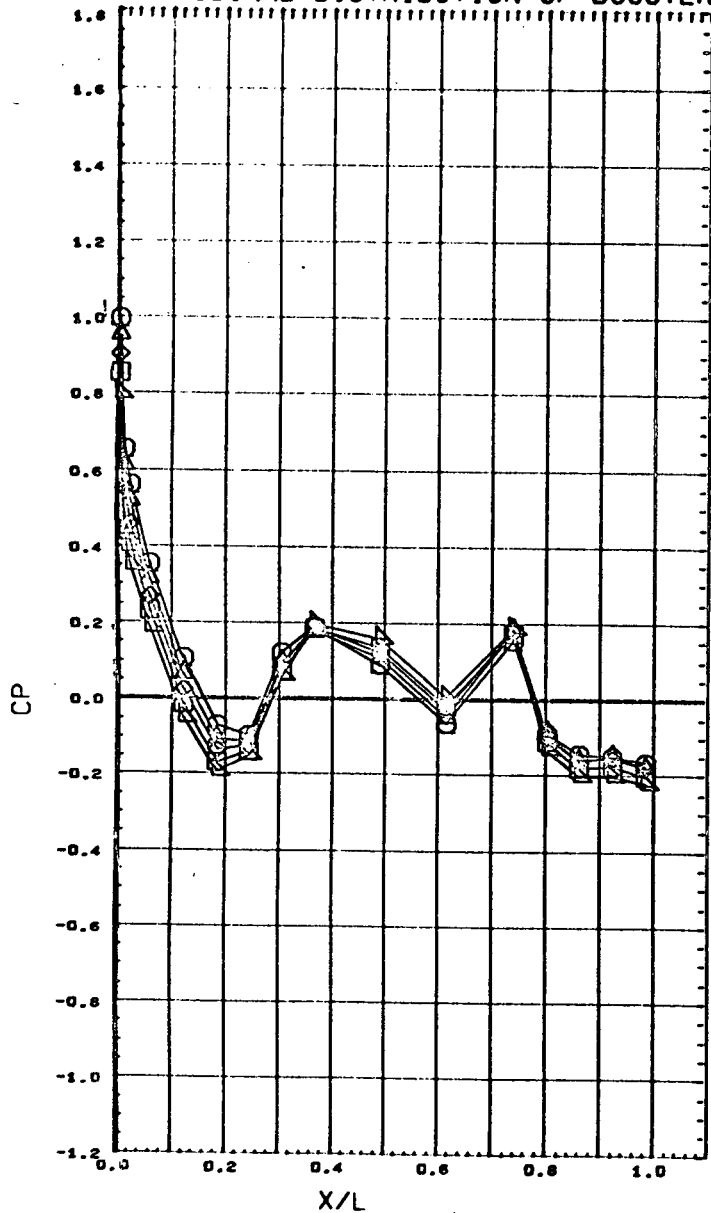

| SYMBOL | ALFB | THETA | M1 |
|--------|---------|--------|-------|
| ○ | - 7.940 | 0.000 | 0.900 |
| ◇ | - 5.847 | 15.000 | |
| ◊ | - 3.836 | | |
| □ | - 1.843 | | |
| △ | 0.144 | | |

| PARAMETRIC VALUES | | |
|-------------------|-------|--------------|
| BETA | 0.000 | DX/L - 0.194 |
| I | 0.000 | |

REFERENCE FILE

LONGITUDINAL DISTRIBUTION OF BOOSTER FUSELAGE PRESSURES

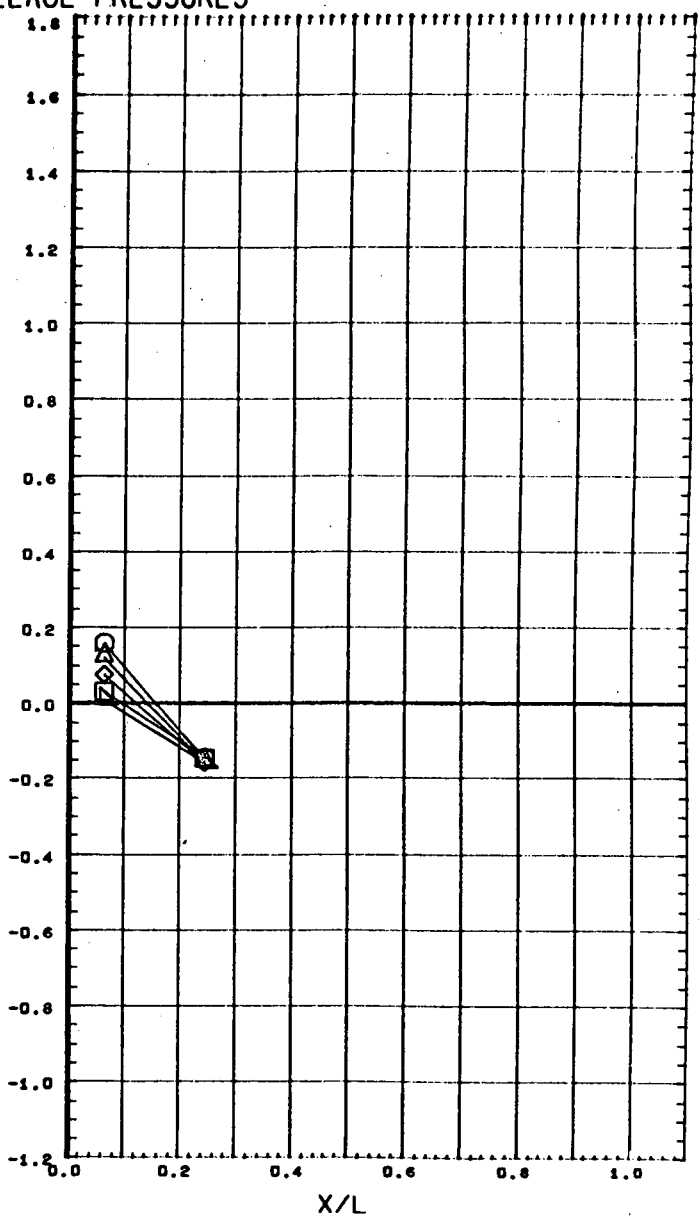
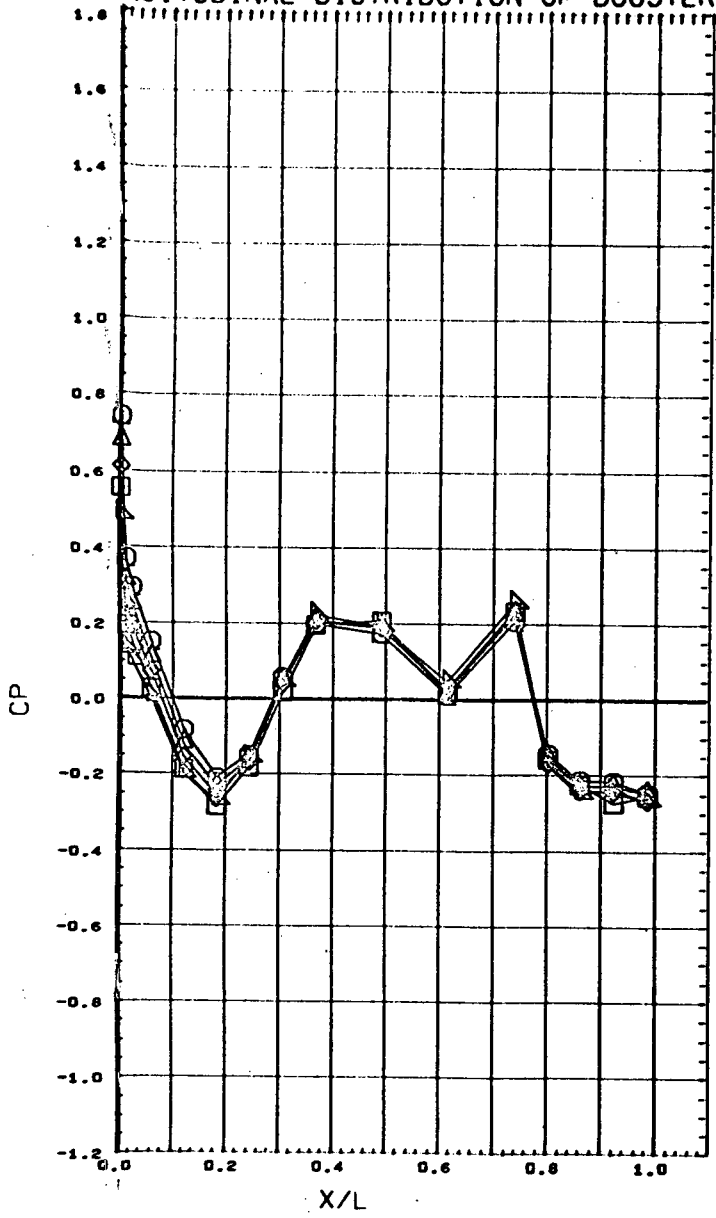

| SYMBOL | ALFB | THETA | M1 |
|--------|--------|--------|-------|
| ○ | 2.153 | 0.000 | 0.900 |
| ◇ | 4.141 | 15.000 | |
| ◇ | 6.125 | | |
| □ | 8.130 | | |
| △ | 10.089 | | |

| PARAMETRIC VALUES | | | |
|-------------------|-------|------|---------|
| BETA | 0.000 | DX/L | - 0.194 |
| I | 0.000 | | |

REFERENCE FILE

LONGITUDINAL DISTRIBUTION OF BOOSTER FUSELAGE PRESSURES

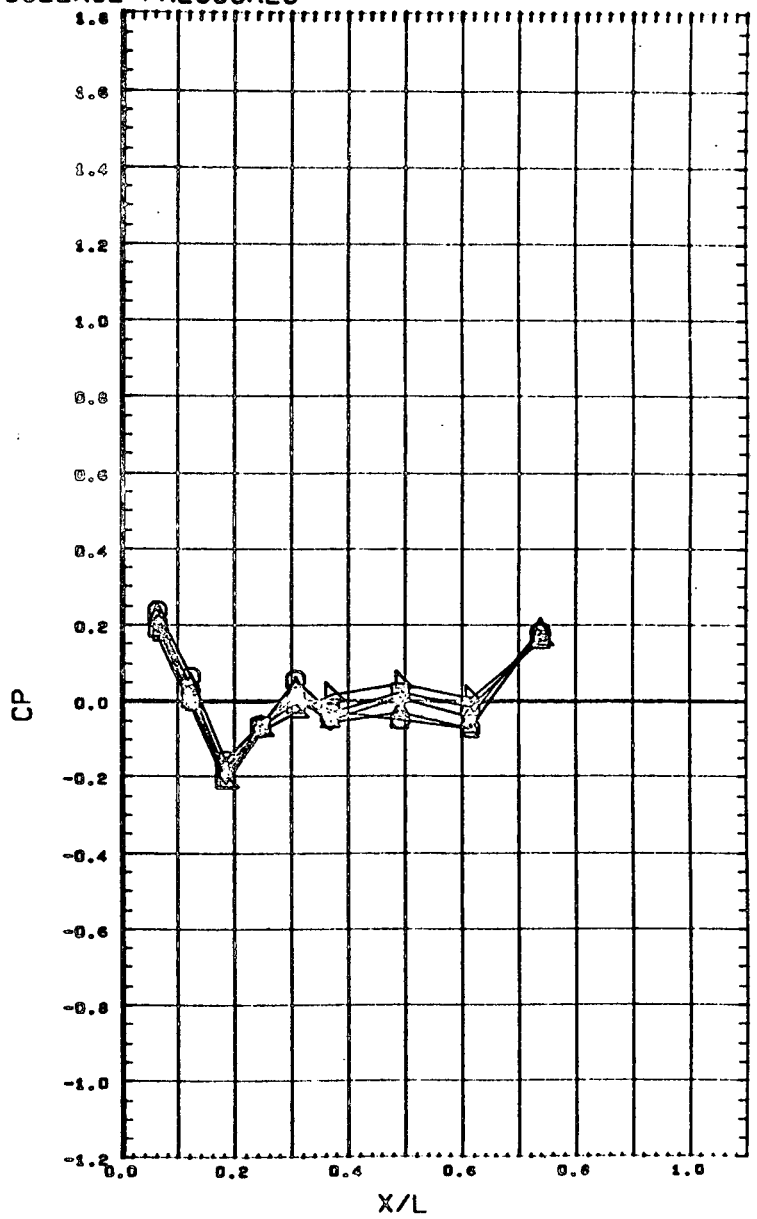
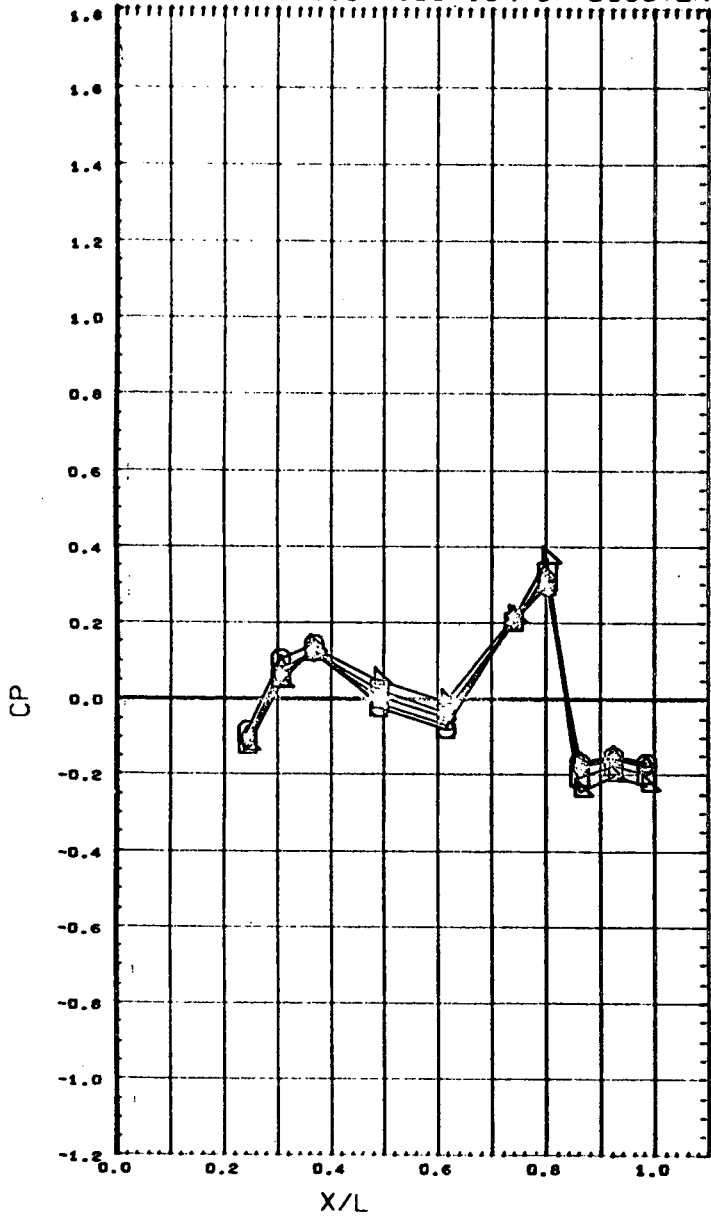

| SYMBOL | ALF3 | THETA | M1 |
|--------|-------|--------|-------|
| ○ | 7.940 | 24.000 | 0.900 |
| △ | 5.847 | 45.000 | |
| ◇ | 3.836 | | |
| □ | 1.843 | | |
| ▽ | 0.844 | | |

| PARAMETRIC VALUES | | | |
|-------------------|-------|------|---------|
| BETA | 0.000 | DX/L | - 0.194 |
| I | 0.000 | | |

REFERENCE FILE

LONGITUDINAL DISTRIBUTION OF BOOSTER FUSELAGE PRESSURES

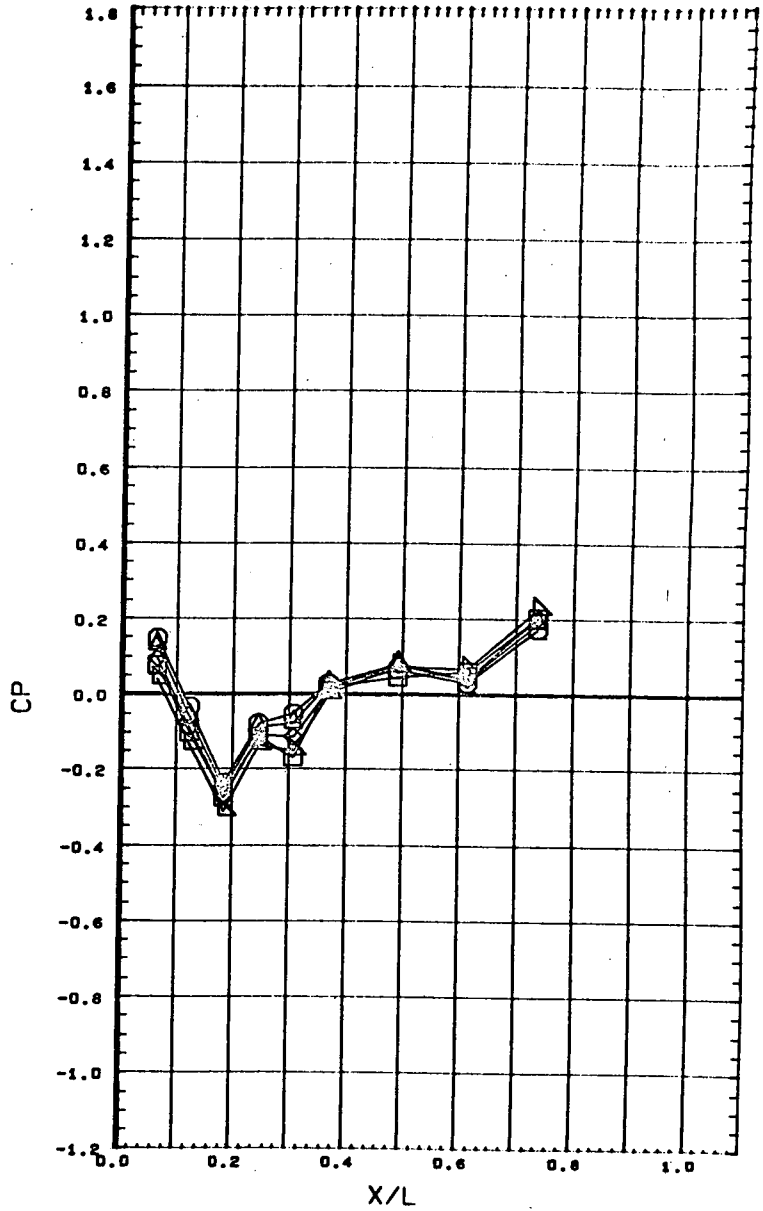
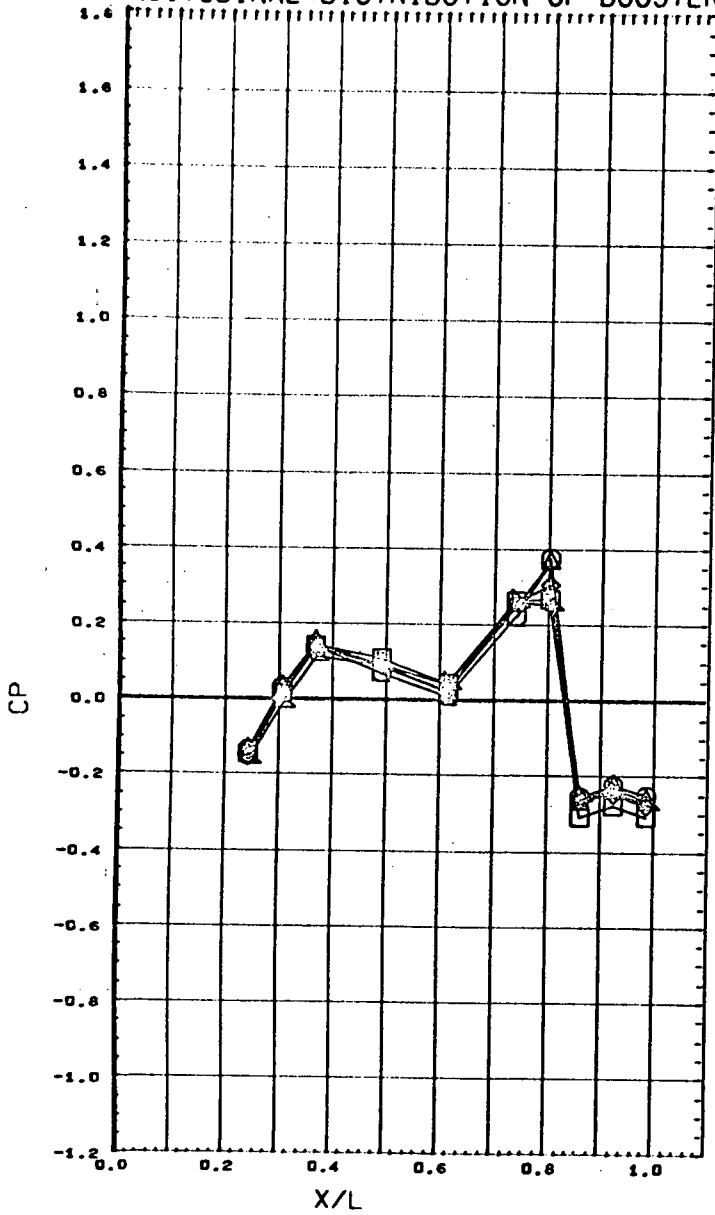

| SYMBOL | ALFA | THETA | M1 |
|--------|--------|--------|-------|
| ○ | 2.153 | 24.000 | 0.900 |
| ◇ | 4.141 | 45.000 | |
| △ | 6.125 | | |
| □ | 8.130 | | |
| ◇ | 10.089 | | |

| PARAMETRIC VALUES | | |
|-------------------|-------|--------------|
| BETA | 0.000 | DX/L - 0.194 |
| I | 0.000 | |

REFERENCE FILE

LONGITUDINAL DISTRIBUTION OF BOOSTER FUSELAGE PRESSURES

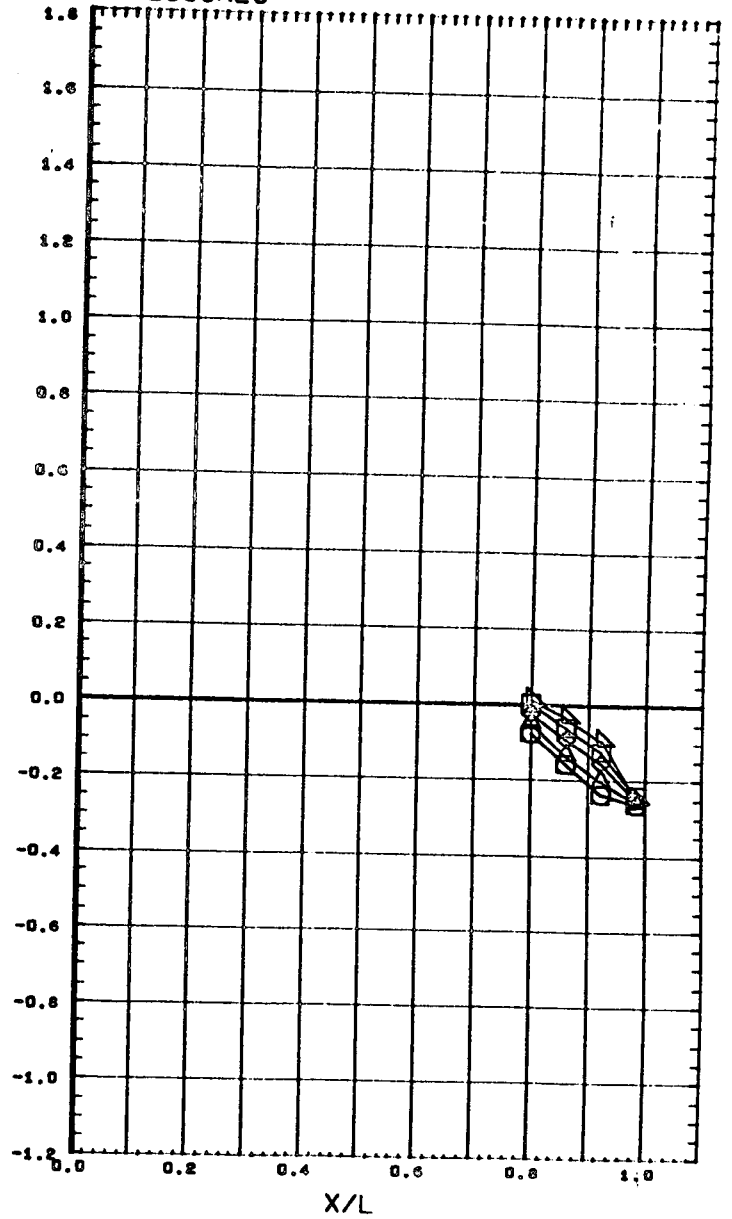
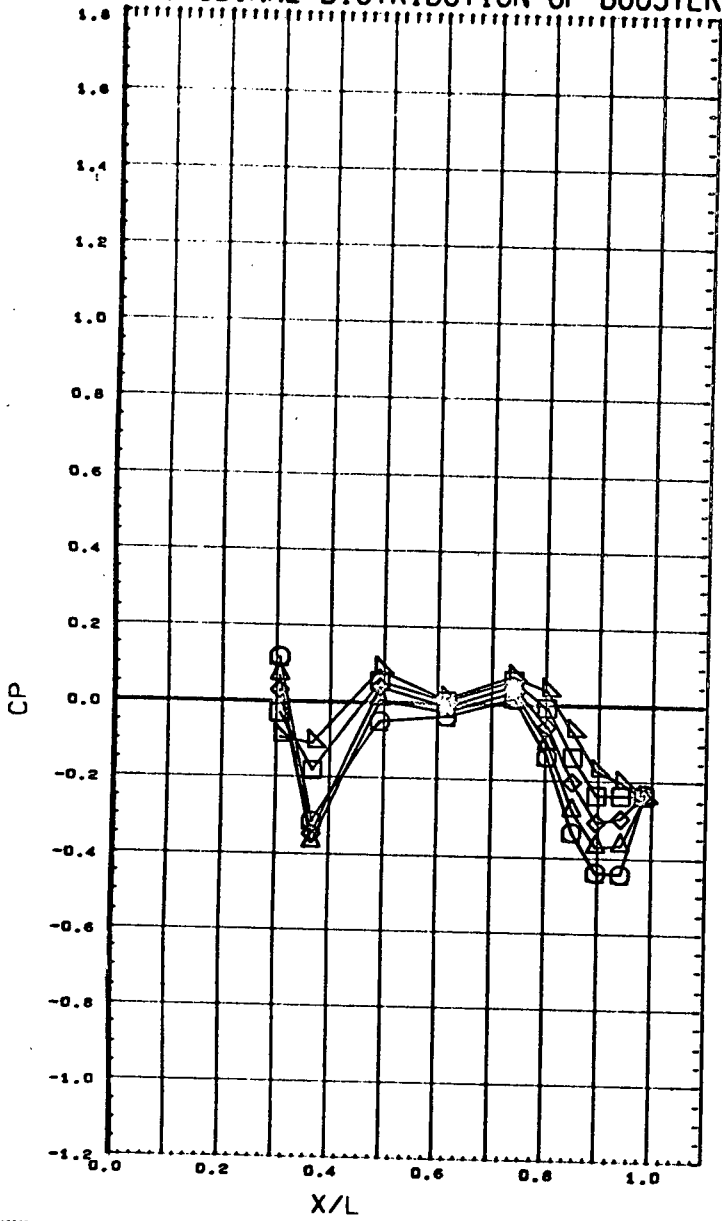

| SYMBOL | ALFD | THETA | M1 |
|--------|-------|---------|-------|
| ○ | 7.940 | 90.000 | 0.900 |
| △ | 5.847 | 180.000 | |
| ◇ | 3.836 | | |
| □ | 1.843 | | |
| ○ | 0.144 | | |

REFERENCE FILE

| PARAMETRIC VALUES | | |
|-------------------|-------|--------------|
| BETA | 0.000 | OX/L - 0.194 |
| I | 0.000 | |

LONGITUDINAL DISTRIBUTION OF BOOSTER FUSELAGE PRESSURES

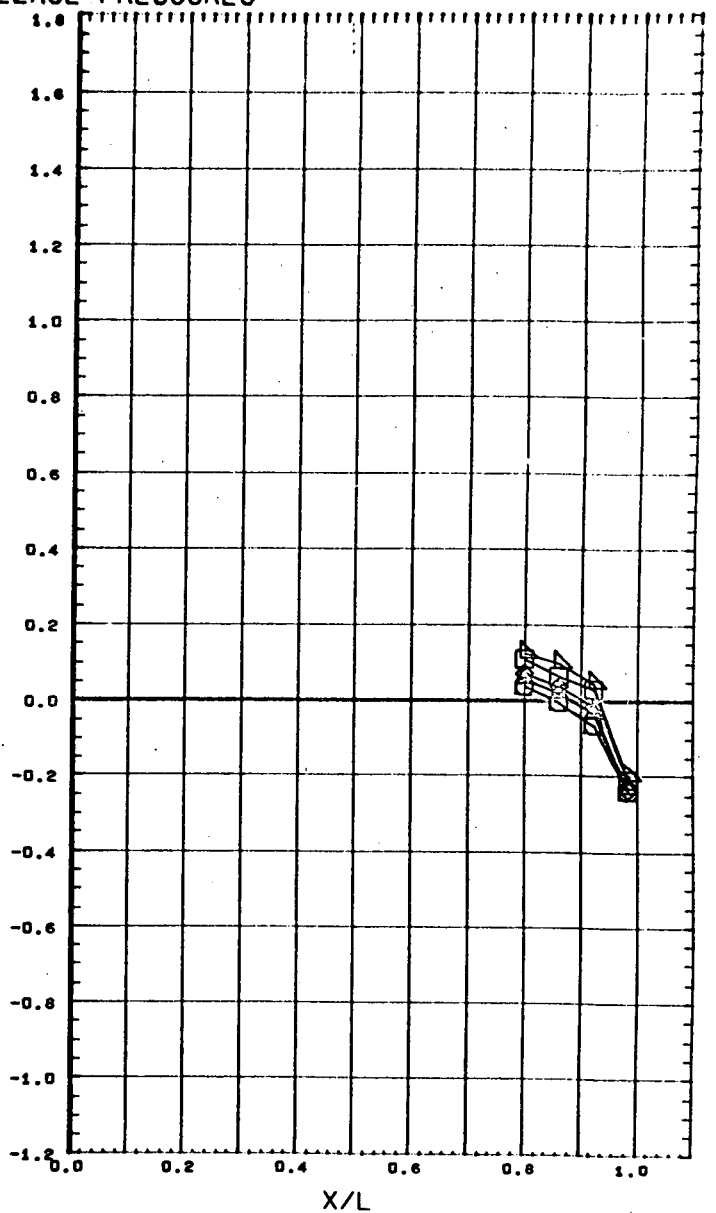
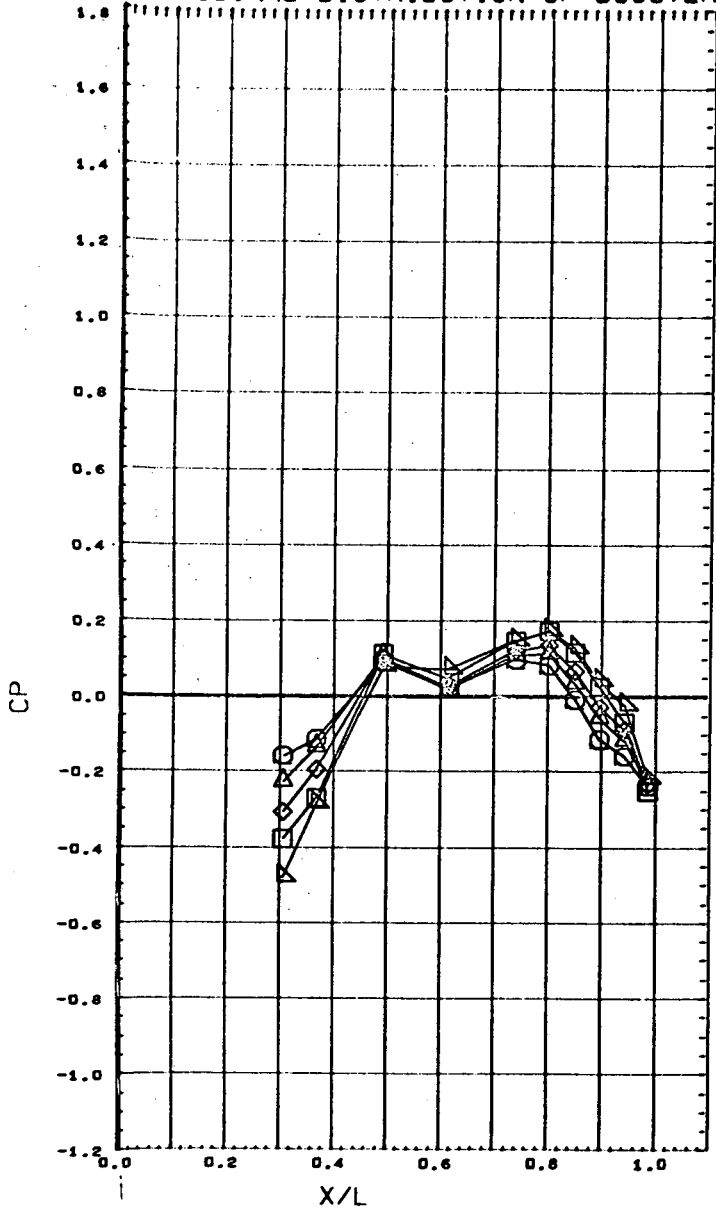

| SYMBOL | ALFB | THETA | M1 |
|--------|--------|---------|-------|
| ○ | 2.153 | 90.000 | 0.900 |
| ◇ | 4.141 | 180.000 | |
| △ | 6.125 | | |
| □ | 8.130 | | |
| ◇ | 10.089 | | |

REFERENCE FILE

| PARAMETRIC VALUES | | | |
|-------------------|-------|------|---------|
| BETA | 0.000 | DX/L | - 0.194 |
| I | 0.000 | | |

LONGITUDINAL DISTRIBUTION OF BOOSTER FUSELAGE PRESSURES

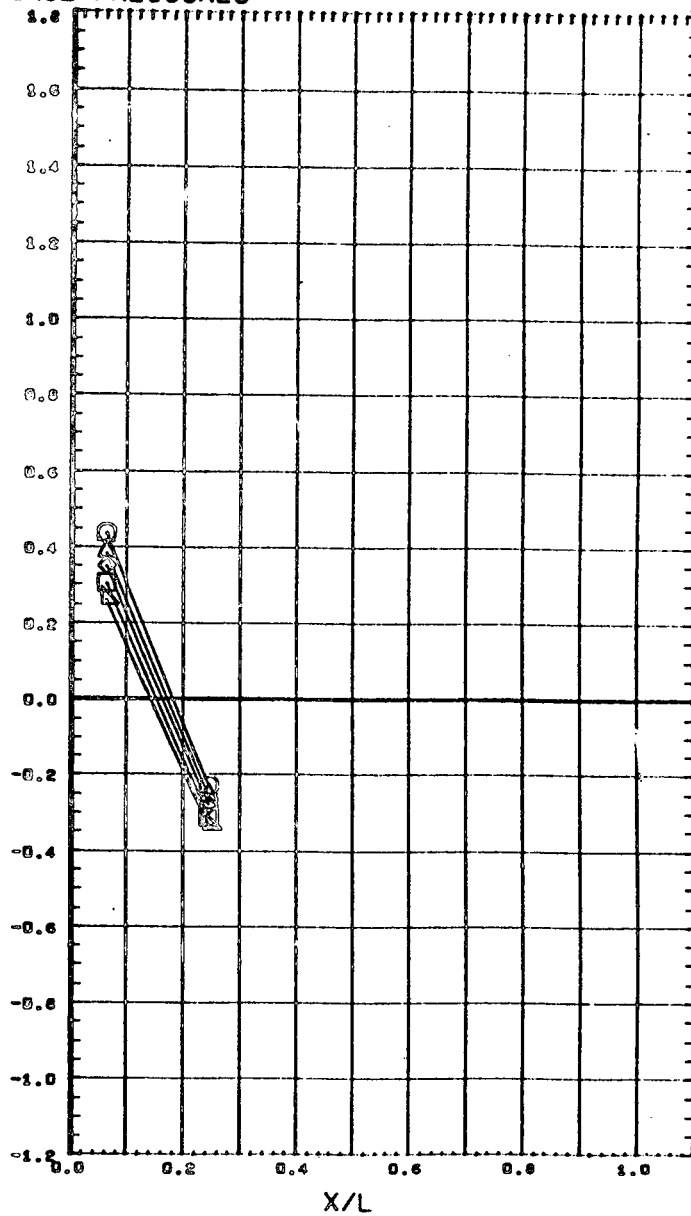
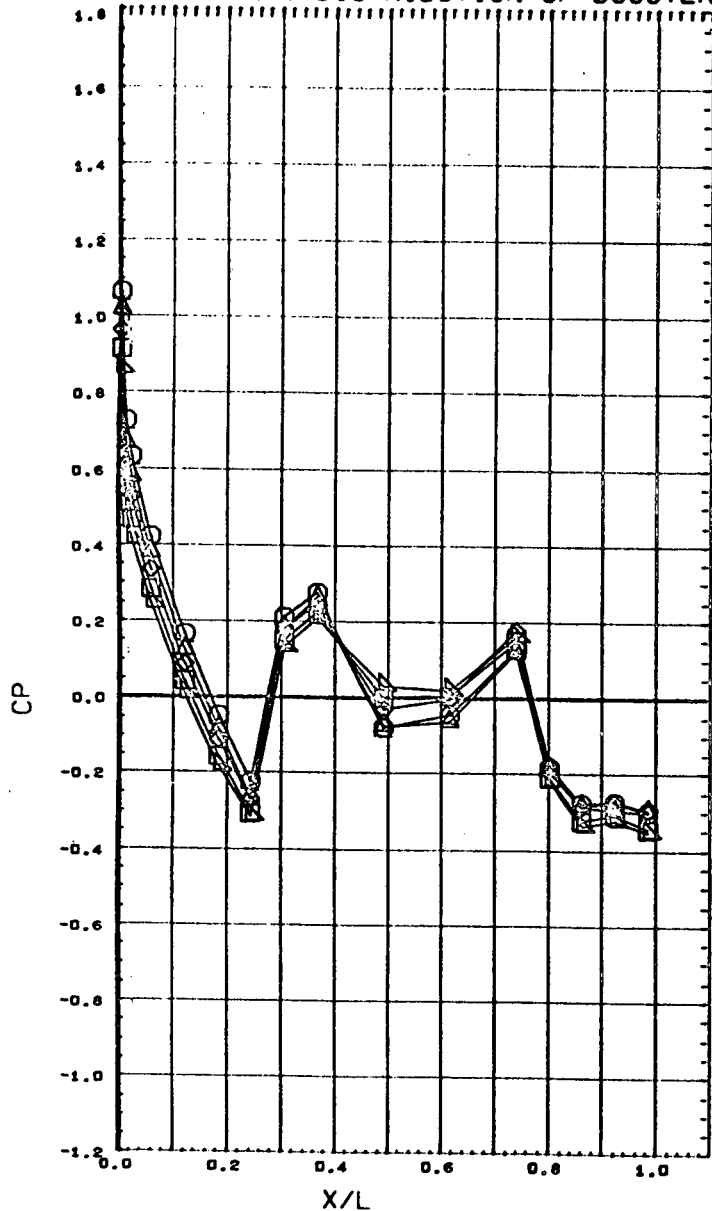

| SYMBOL | ALFB | THETA | M1 |
|--------|-------|--------|-------|
| ○ | 7.910 | 0.000 | 1.000 |
| ◇ | 5.806 | 15.000 | |
| △ | 3.814 | | |
| □ | 1.822 | | |
| ◇ | 0.152 | | |

| PARAMETRIC VALUES | | | |
|-------------------|-------|------|---------|
| BETA | 0.000 | DX/L | - 0.194 |
| I | 0.000 | | |

REFERENCE FILE

LONGITUDINAL DISTRIBUTION OF BOOSTER FUSELAGE PRESSURES

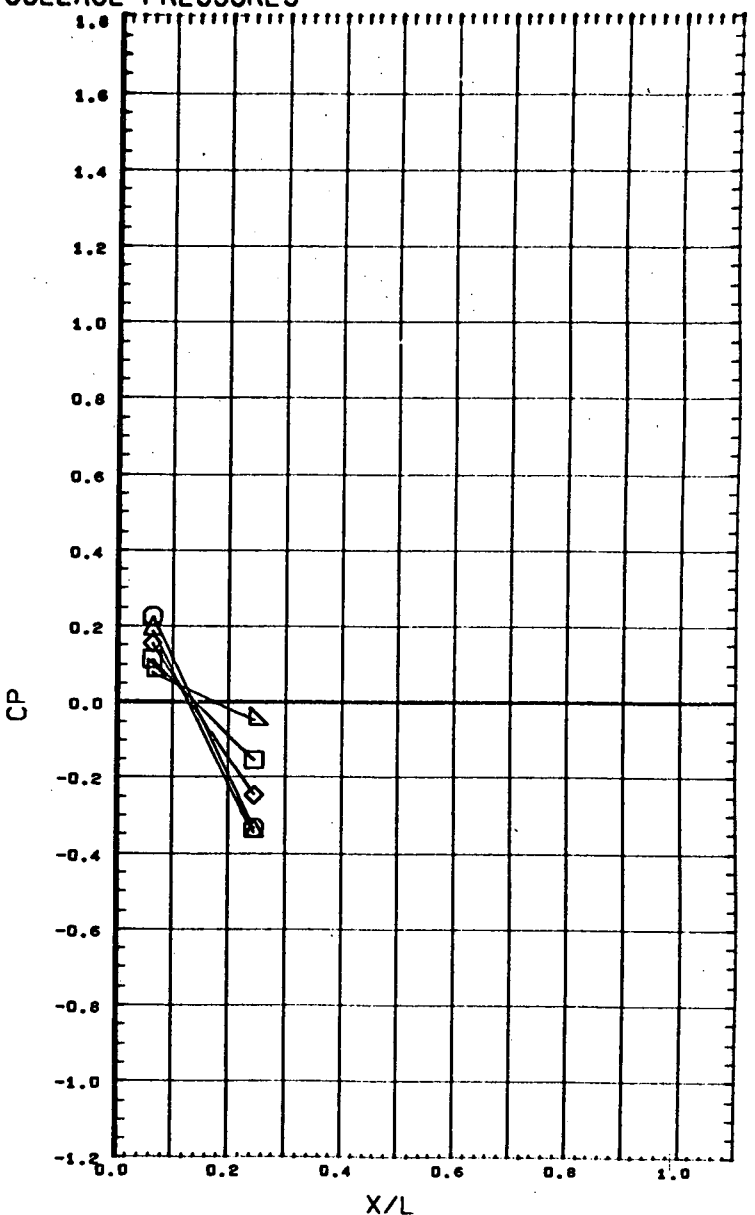
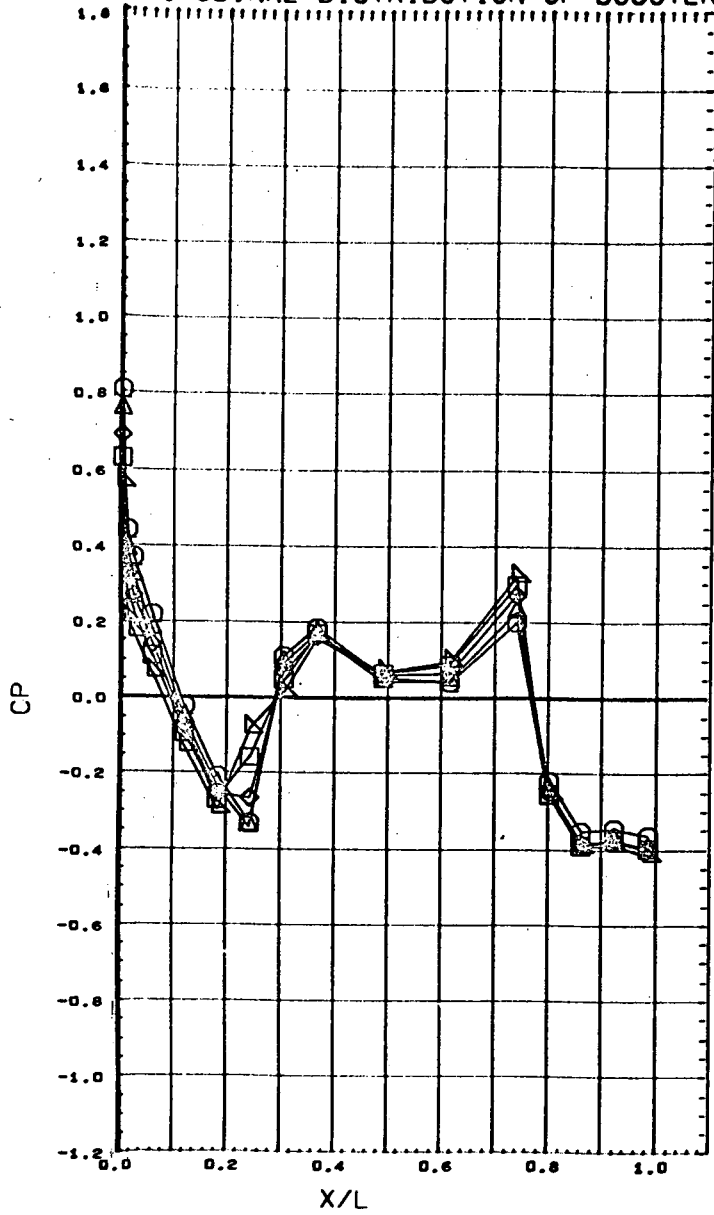

| SYMBOL | ALFD | THETA | M1 |
|--------|--------|--------|-------|
| ○ | 2.149 | 0.000 | 1.000 |
| △ | 4.157 | 15.000 | |
| ◇ | 6.143 | | |
| □ | 8.134 | | |
| ▽ | 10.121 | | |

REFERENCE FILE

| PARAMETRIC VALUES | | | |
|-------------------|-------|------|---------|
| BETA | 0.000 | DX/L | - 0.194 |
| I | 0.000 | | |

LONGITUDINAL DISTRIBUTION OF BOOSTER FUSELAGE PRESSURES

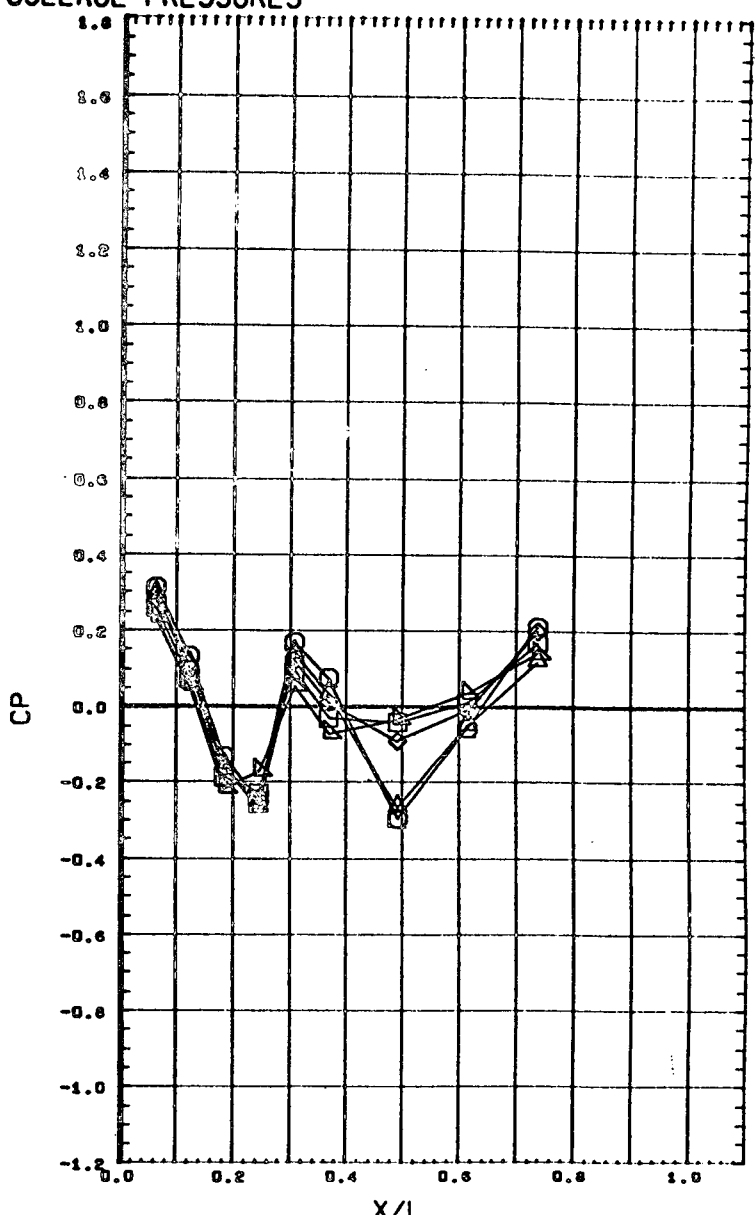
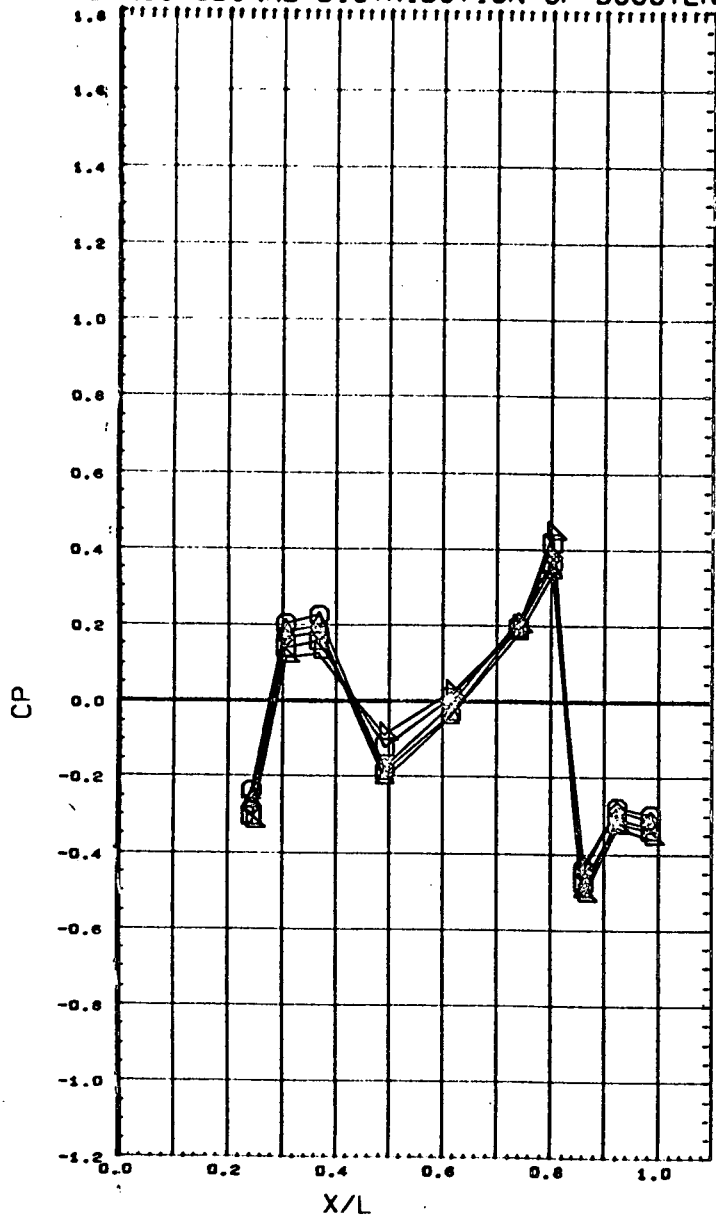

| SYMBOL | ALFB | THETA | M1 |
|--------|---------|--------|-------|
| ○ | - 7.910 | 24.000 | 1.000 |
| ◇ | - 5.806 | 45.000 | |
| △ | - 3.814 | | |
| □ | - 1.822 | | |
| ▽ | 0.152 | | |

REFERENCE FILE

| PARAMETRIC VALUES | | |
|-------------------|-------|--------------|
| BETA | 0.000 | OX/L - 0.194 |
| I | 0.000 | |

LONGITUDINAL DISTRIBUTION OF BOOSTER FUSELAGE PRESSURES

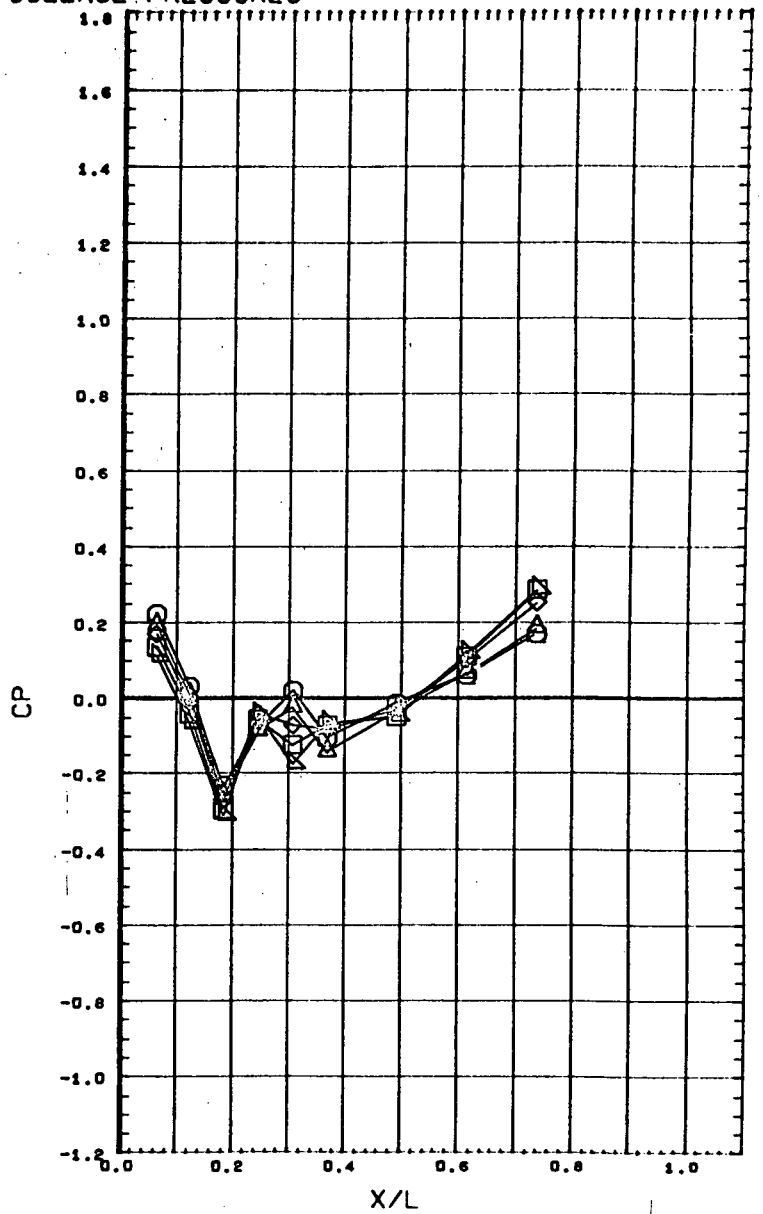
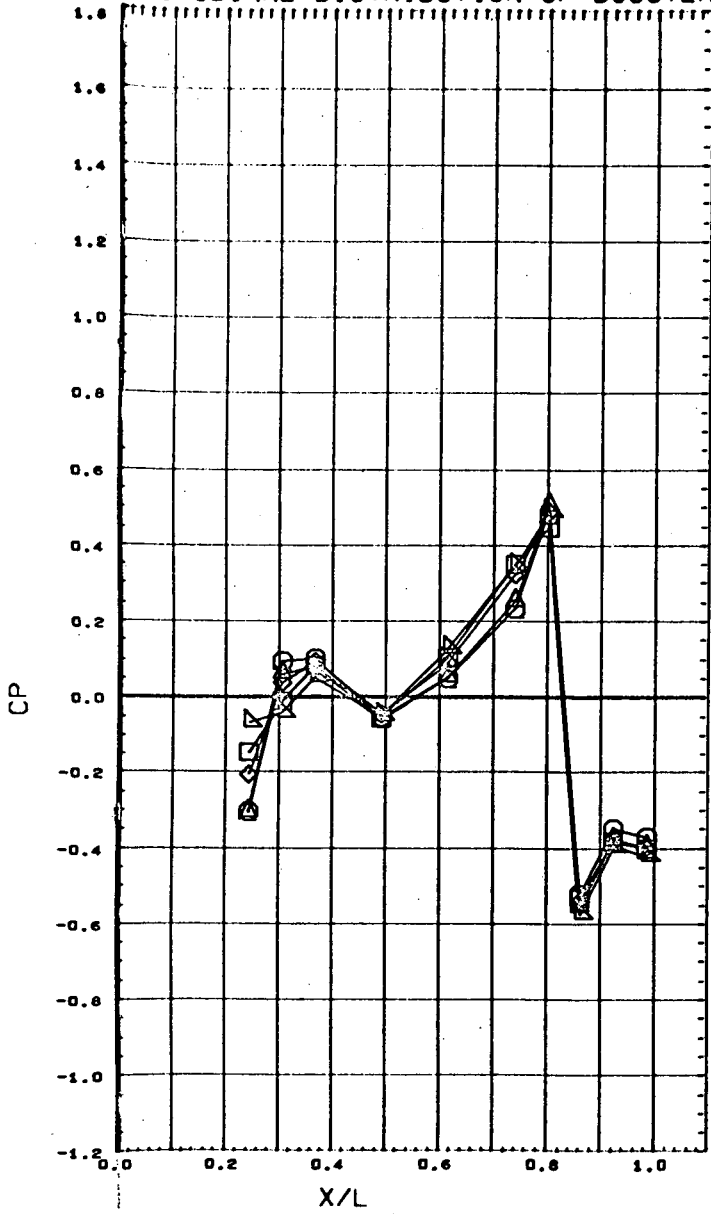

| SYMBOL | ALFB | THETA | M1 |
|--------|--------|--------|-------|
| ○ | 2.149 | 24.000 | 1.000 |
| ◇ | 4.157 | 45.000 | |
| △ | 6.143 | | |
| □ | 8.134 | | |
| ▽ | 10.121 | | |

| PARAMETRIC VALUES | | |
|-------------------|-------|--------------|
| BETA | 0.000 | DX/L - 0.194 |
| I | 0.000 | |

REFERENCE FILE

LONGITUDINAL DISTRIBUTION OF BOOSTER FUSELAGE PRESSURES

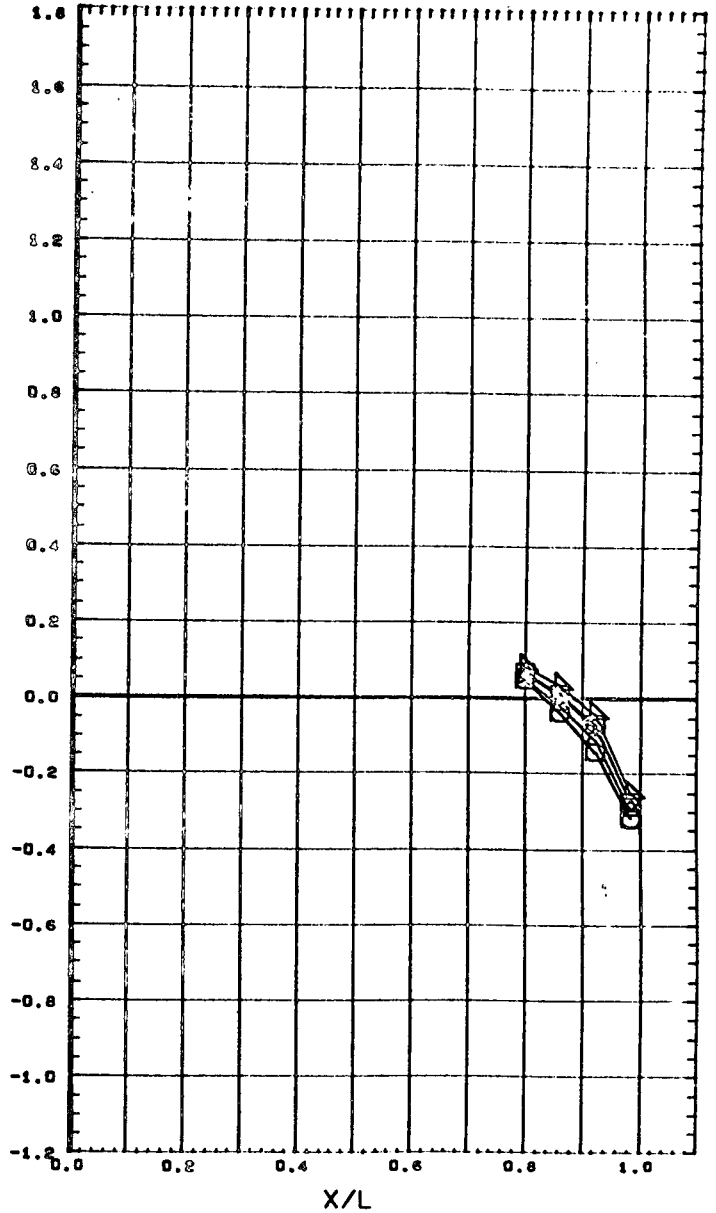
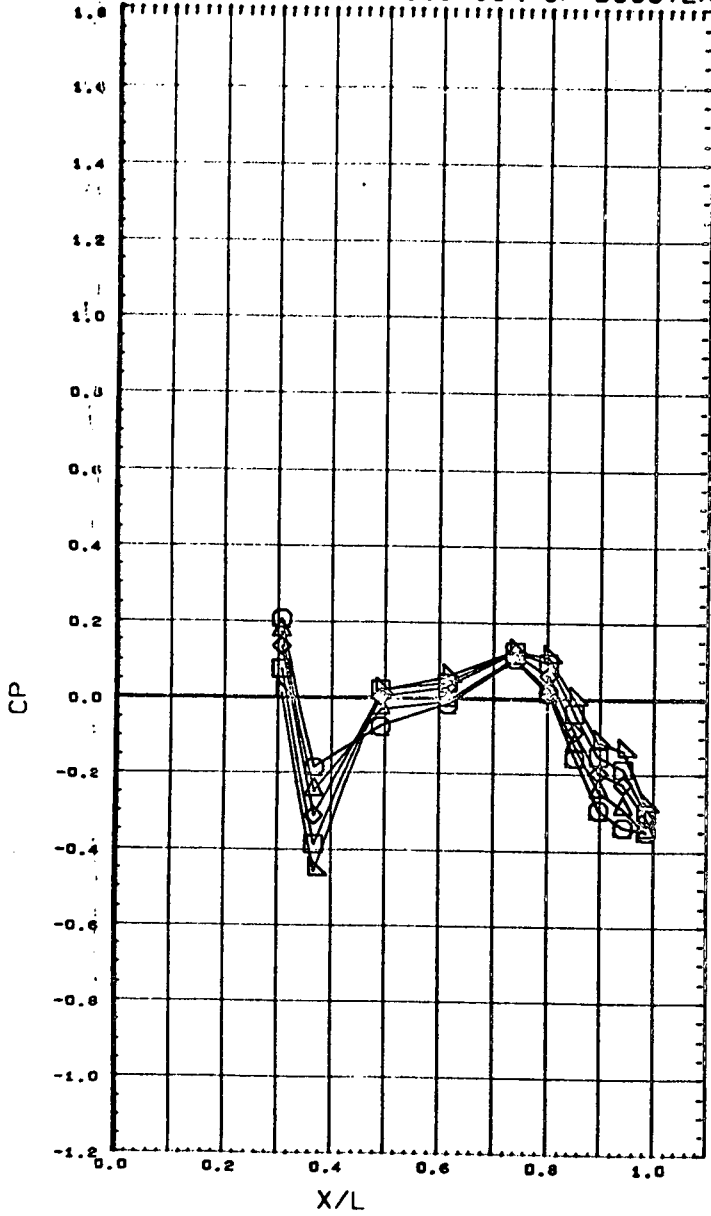

| SYMBOL | ALFB | THETA | M1 |
|--------|-------|---------|-------|
| □ | 7.910 | 90.000 | 1.000 |
| ◇ | 5.806 | 180.000 | |
| △ | 3.814 | | |
| ○ | 1.822 | | |
| ○ | 0.192 | | |

REFERENCE FILE

| PARAMETRIC VALUES | | | |
|-------------------|-------|------|---------|
| BETA | 0.000 | DX/L | - 0.194 |
| I | 0.000 | | |

LONGITUDINAL DISTRIBUTION OF BOOSTER FUSELAGE PRESSURES

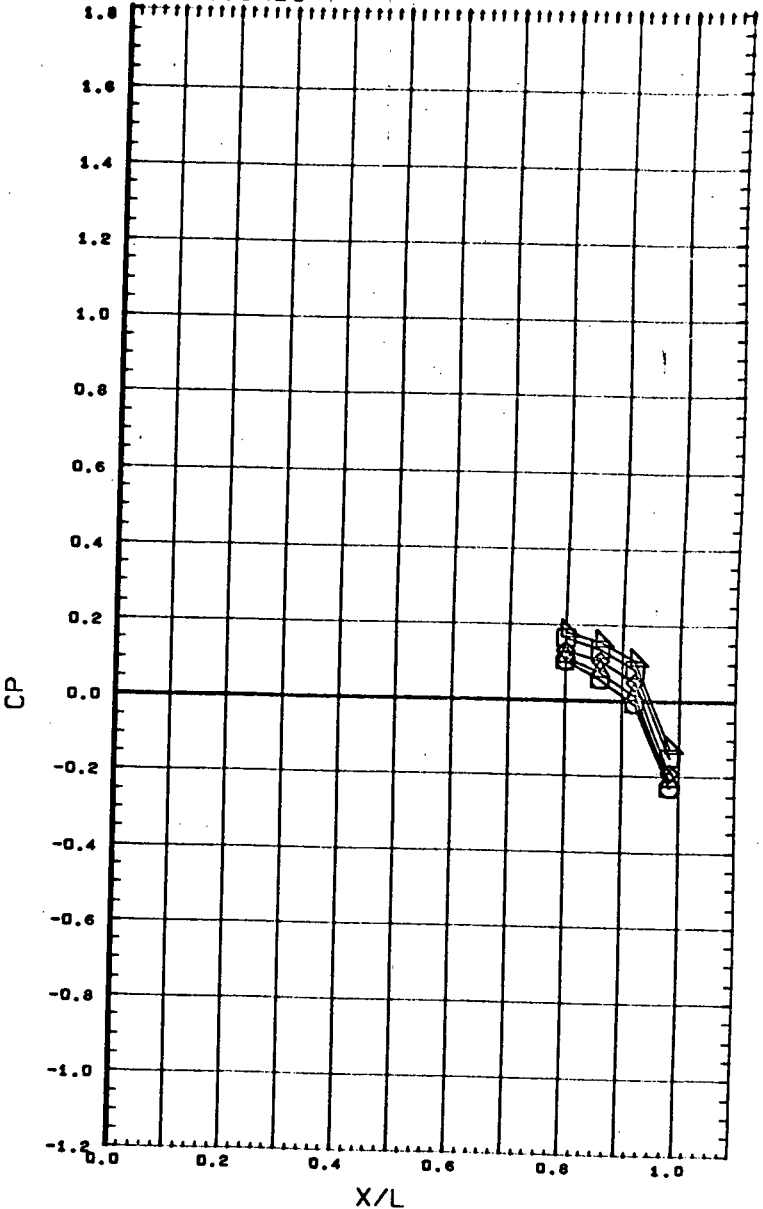
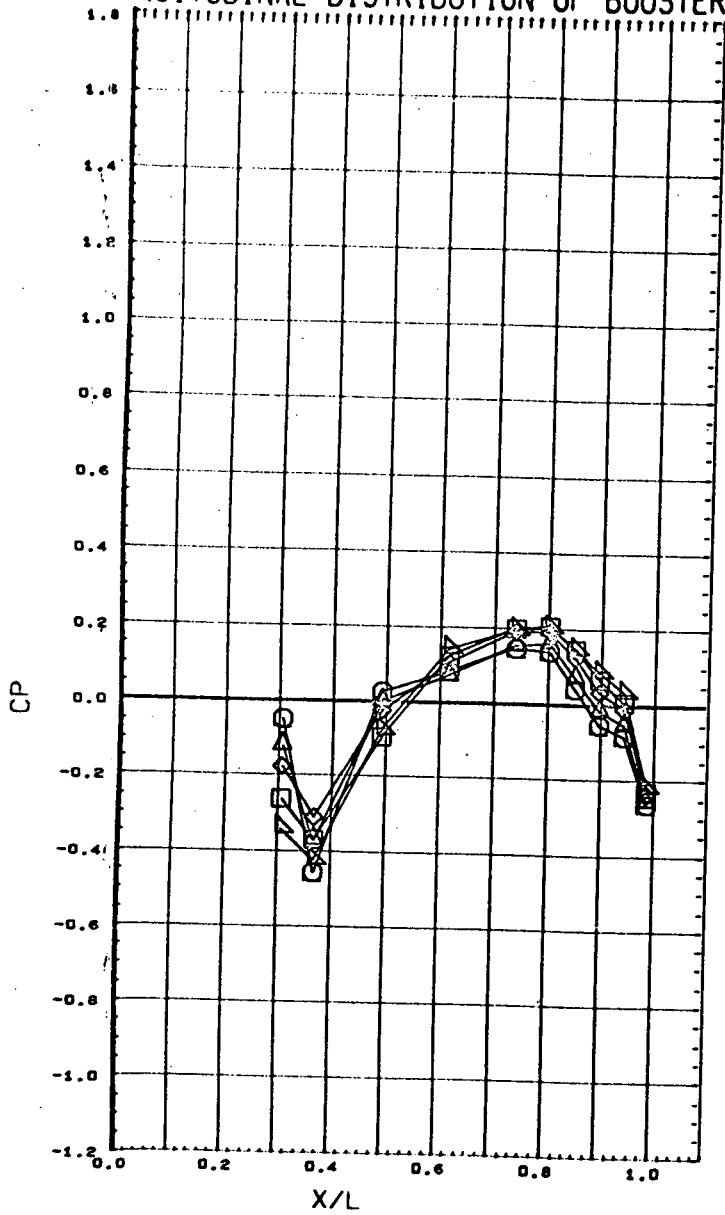

| SYMBOL | ALFB | THETA | M1 |
|--------|--------|---------|-------|
| ○ | 2.149 | 90.000 | 1.000 |
| △ | 4.157 | 180.000 | |
| ◇ | 6.143 | | |
| □ | 8.134 | | |
| ▽ | 10.121 | | |

REFERENCE FILE

| PARAMETRIC VALUES | | |
|-------------------|-------|--------------|
| BETA | 0.000 | DX/L - 0.194 |
| I | 0.000 | |

LONGITUDINAL DISTRIBUTION OF BOOSTER FUSELAGE PRESSURES

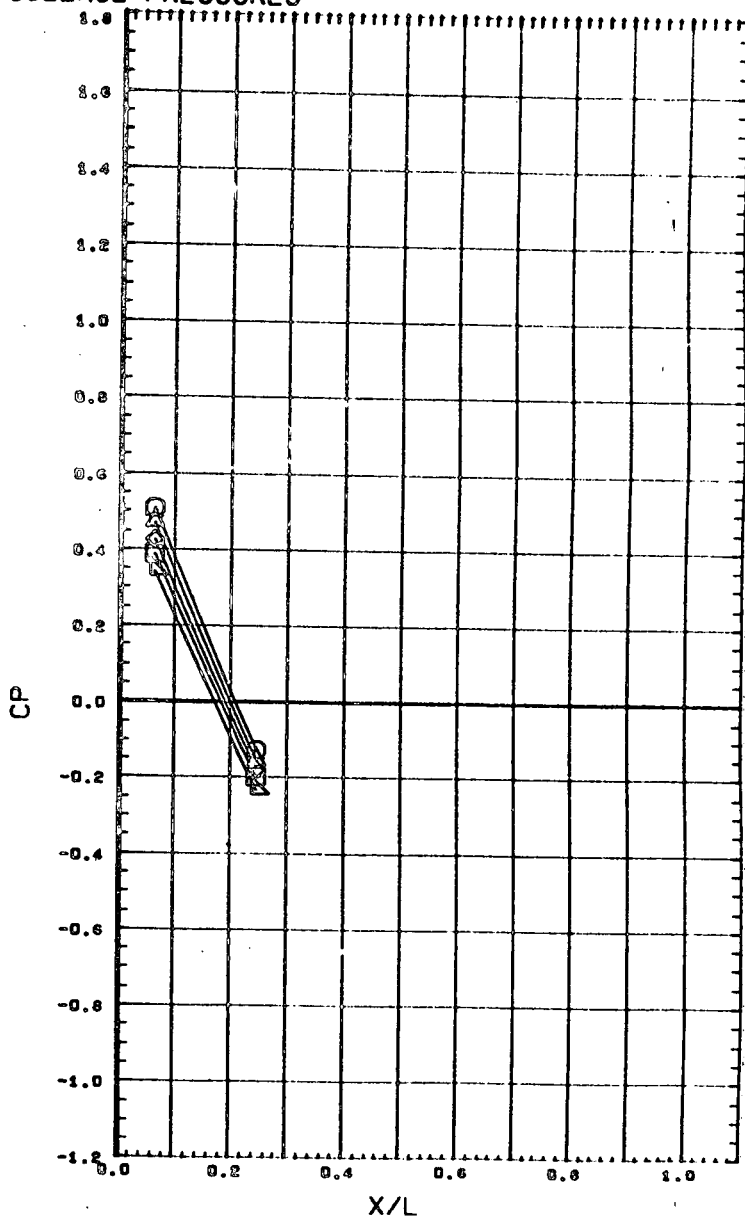
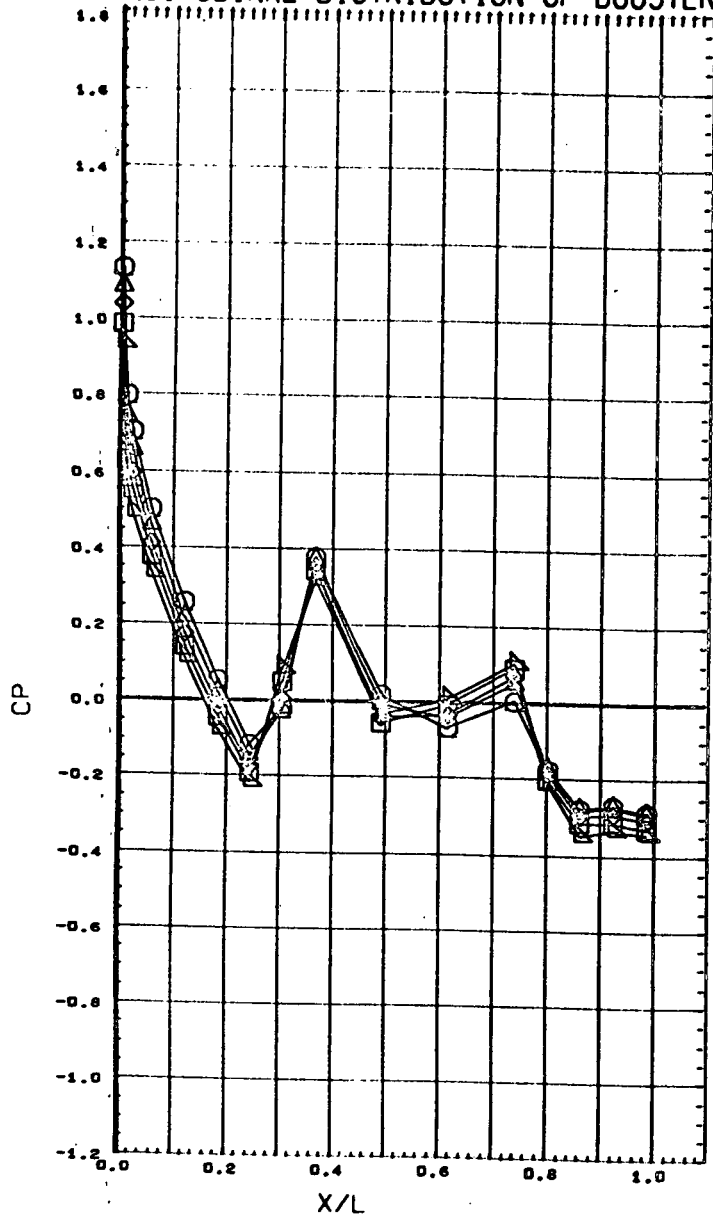

| SYMBOL | ALFD | THETA | M1 |
|--------|-------|--------|-------|
| ○ | 7.928 | 0.000 | 1.104 |
| ◇ | 5.803 | 15.000 | |
| △ | 3.824 | | |
| □ | 1.828 | | |
| | 0.154 | | |

| PARAMETRIC VALUES | | |
|-------------------|-------|--------------|
| BETA | 0.000 | OX/L - 0.194 |
| I | 0.000 | |

REFERENCE FILE

LONGITUDINAL DISTRIBUTION OF BOOSTER FUSELAGE PRESSURES

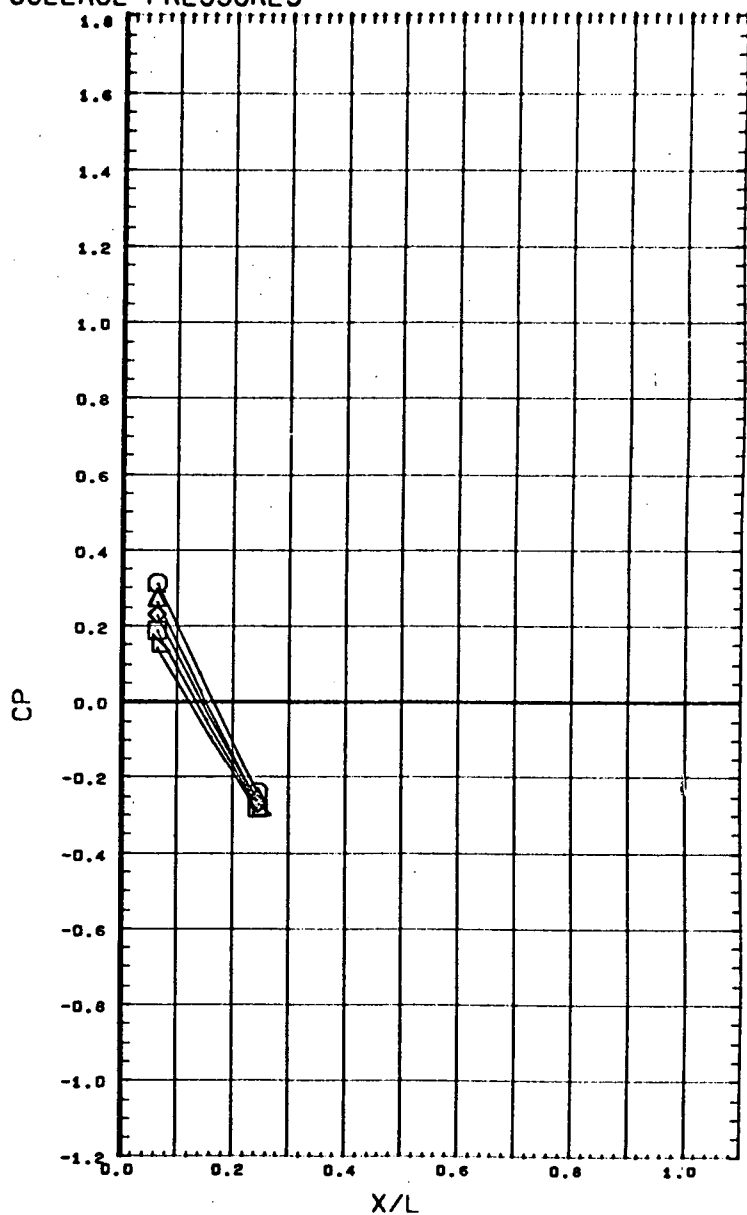
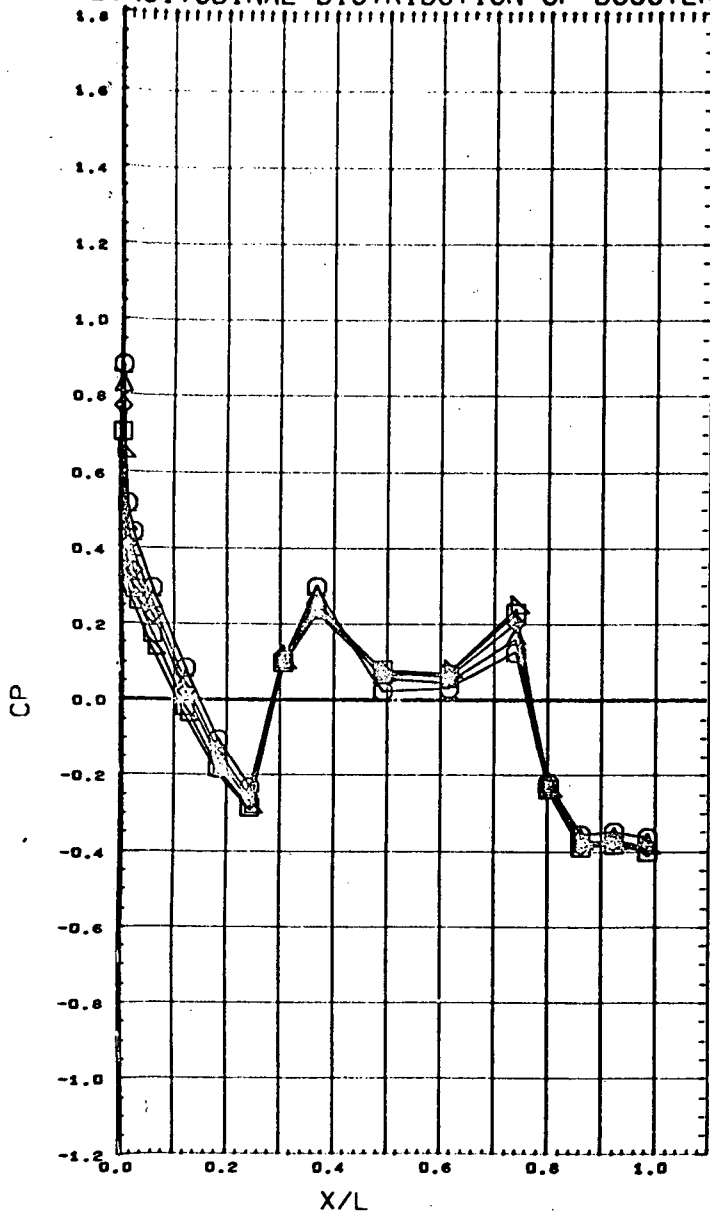

| SYMBOL | ALFB | THETA | M1 |
|--------|--------|--------|-------|
| ○ | 2.171 | 0.000 | 1.104 |
| ◇ | 4.158 | 15.000 | |
| △ | 6.148 | | |
| □ | 8.136 | | |
| ▽ | 10.122 | | |

REFERENCE FILE

| PARAMETRIC VALUES | | |
|-------------------|-------|--------------|
| BETA | 0.000 | DX/L - 0.194 |
| I | 0.000 | |

LONGITUDINAL DISTRIBUTION OF BOOSTER FUSELAGE PRESSURES

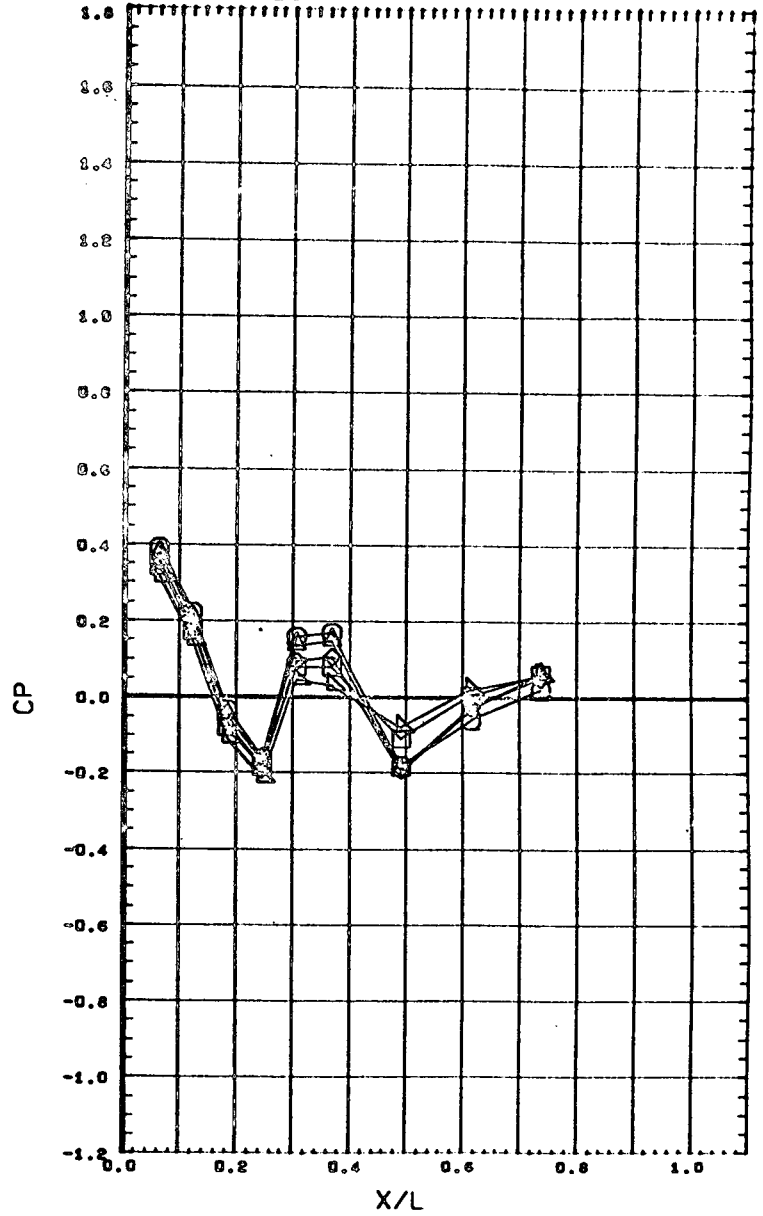
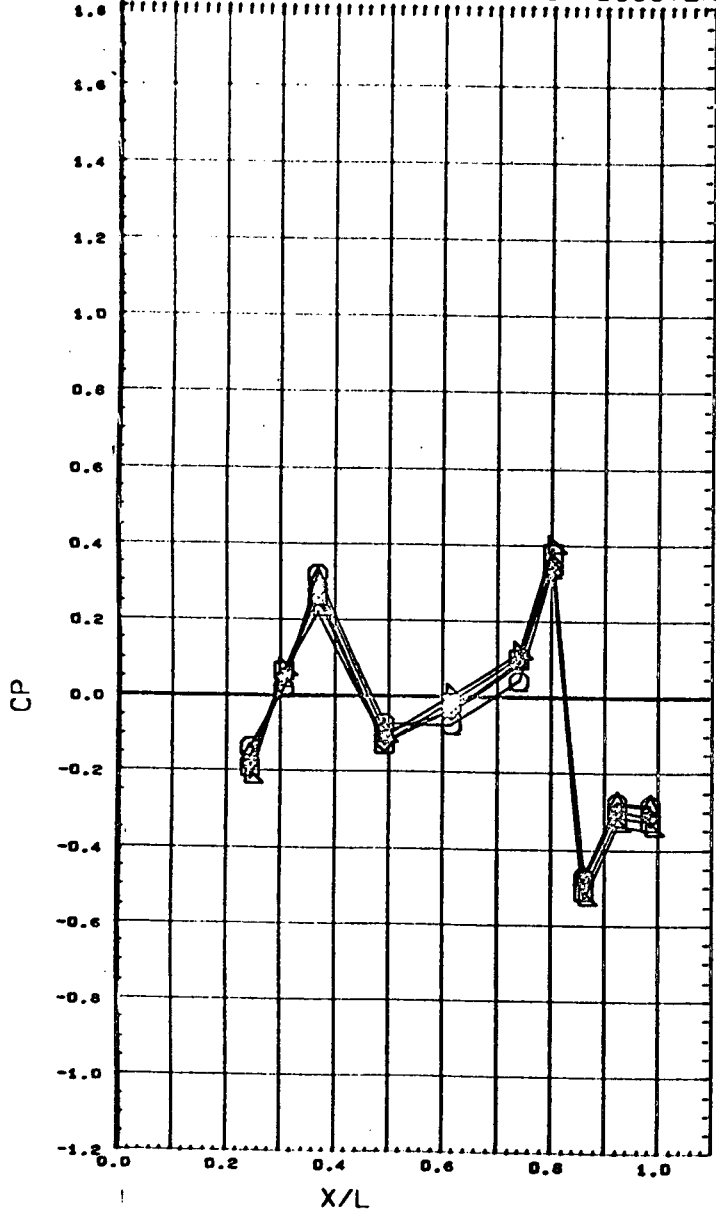

| SYMBOL | ALFB | THETA | M1 |
|--------|-------|--------|-------|
| ○ | 7.928 | 24.000 | 1.104 |
| ◇ | 5.803 | 45.000 | |
| □ | 3.824 | | |
| △ | 1.828 | | |
| | 0.154 | | |

| PARAMETRIC VALUES | | |
|-------------------|-------|--------------|
| BETA | 0.000 | DX/L - 0.194 |
| I | 0.000 | |

REFERENCE FILE

LONGITUDINAL DISTRIBUTION OF BOOSTER FUSELAGE PRESSURES

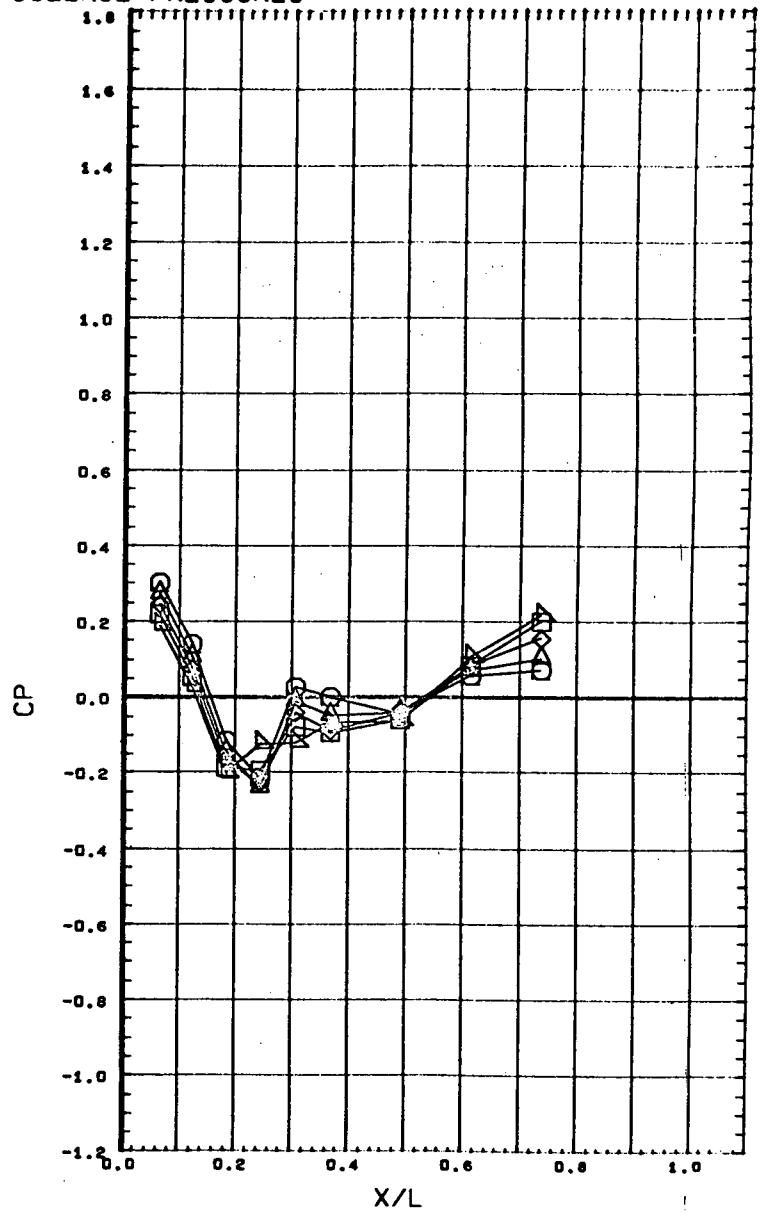
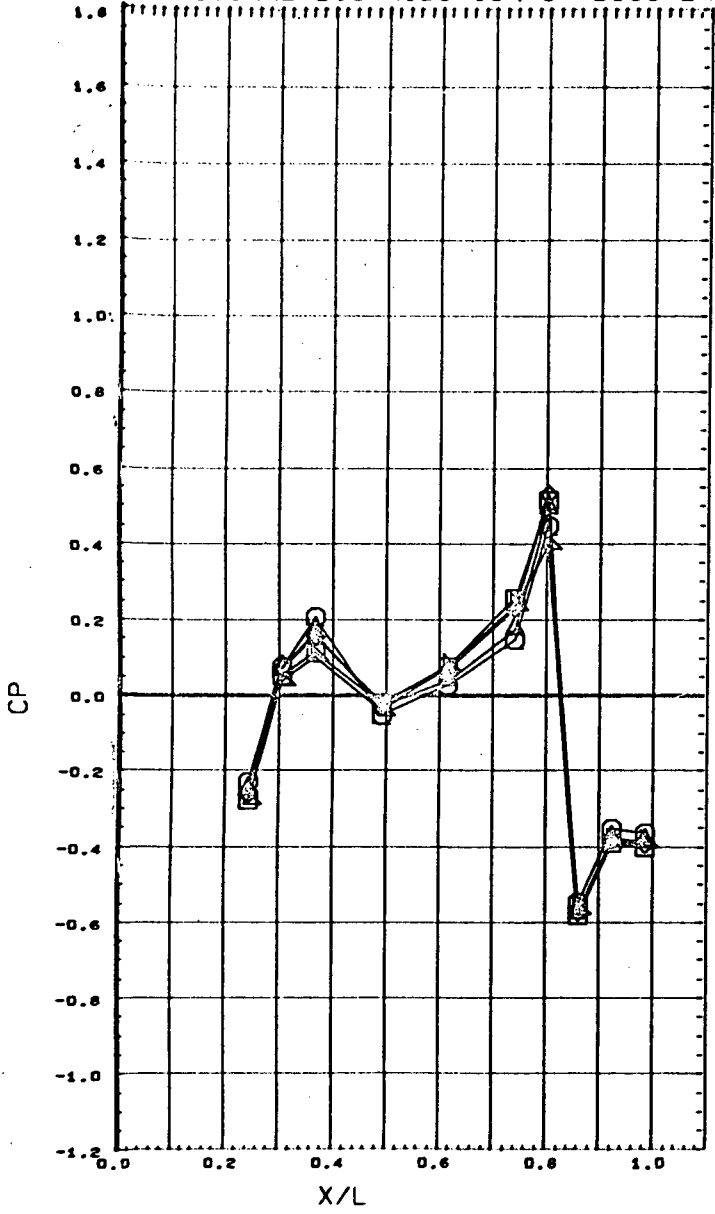

| SYMBOL | ALFB | THETA | M1 |
|--------|--------|--------|-------|
| ○ | 2.171 | 24.000 | 1.104 |
| ◇ | 4.158 | 45.000 | |
| ◇ | 6.148 | | |
| □ | 8.136 | | |
| ▽ | 10.122 | | |

| PARAMETRIC VALUES | | |
|-------------------|-------|--------------|
| BETA | 0.000 | DX/L - 0.194 |
| I | 0.000 | |

REFERENCE FILE

LONGITUDINAL DISTRIBUTION OF BOOSTER FUSELAGE PRESSURES

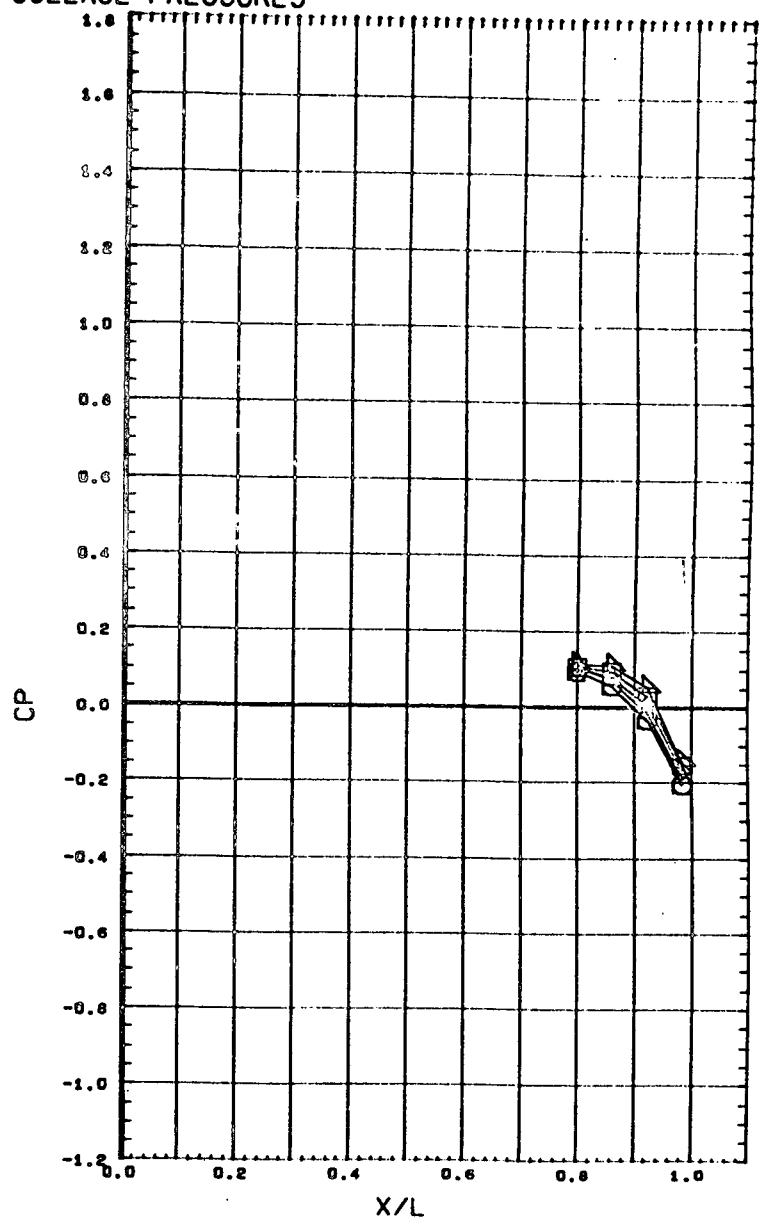
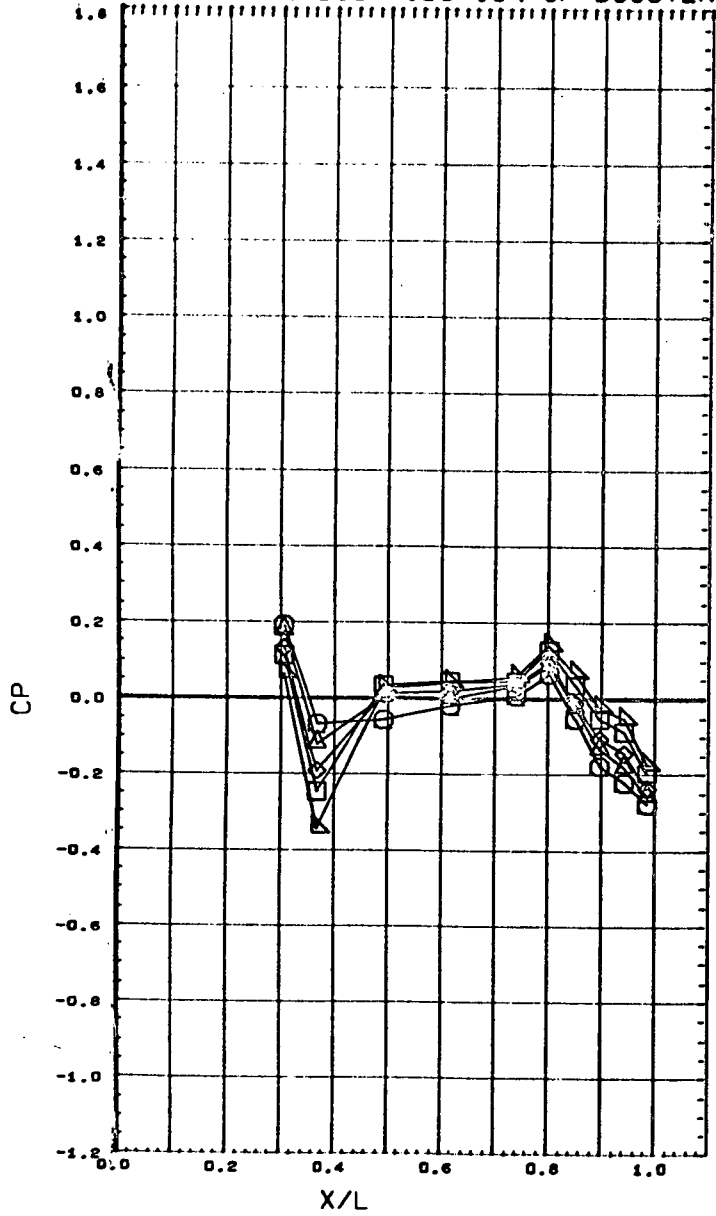

| SYMBOL | ALFD | THETA | M1 |
|--------|---------|---------|-------|
| ○ | - 7.928 | 90.000 | 1.104 |
| △ | - 5.803 | 180.000 | |
| ◇ | - 3.824 | | |
| □ | - 1.828 | | |
| ○ | 0.154 | | |

| PARAMETRIC VALUES | | |
|-------------------|-------|--------------|
| BETA | 0.000 | DX/L - 0.194 |
| I | 0.000 | |

REFERENCE FILE

LONGITUDINAL DISTRIBUTION OF BOOSTER FUSELAGE PRESSURES

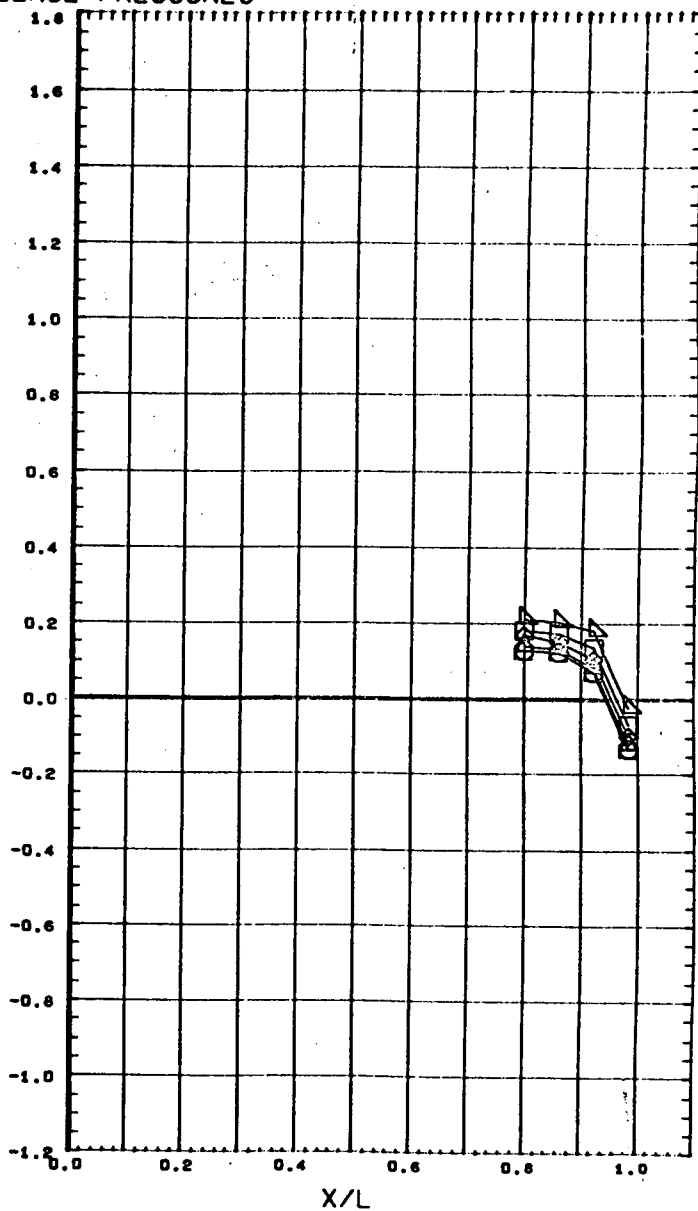
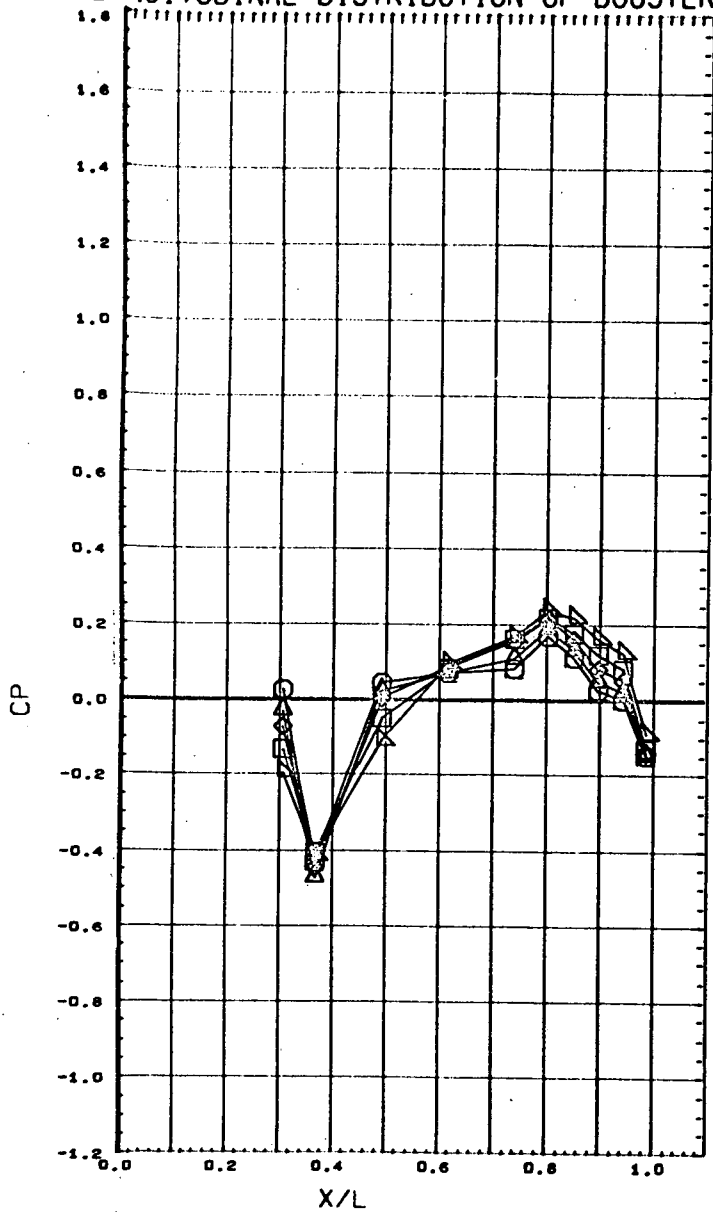

| SYMBOL | ALFB | THETA | M1 |
|--------|--------|---------|-------|
| ○ | 2.171 | 90.000 | 1.104 |
| ◇ | 4.158 | 180.000 | |
| ◇ | 6.148 | | |
| ◇ | 8.136 | | |
| ◇ | 10.122 | | |

REFERENCE FILE

| PARAMETRIC VALUES | | | |
|-------------------|-------|------|---------|
| BETA | 0.000 | DX/L | - 0.194 |
| I | 0.000 | | |

LONGITUDINAL DISTRIBUTION OF BOOSTER FUSELAGE PRESSURES

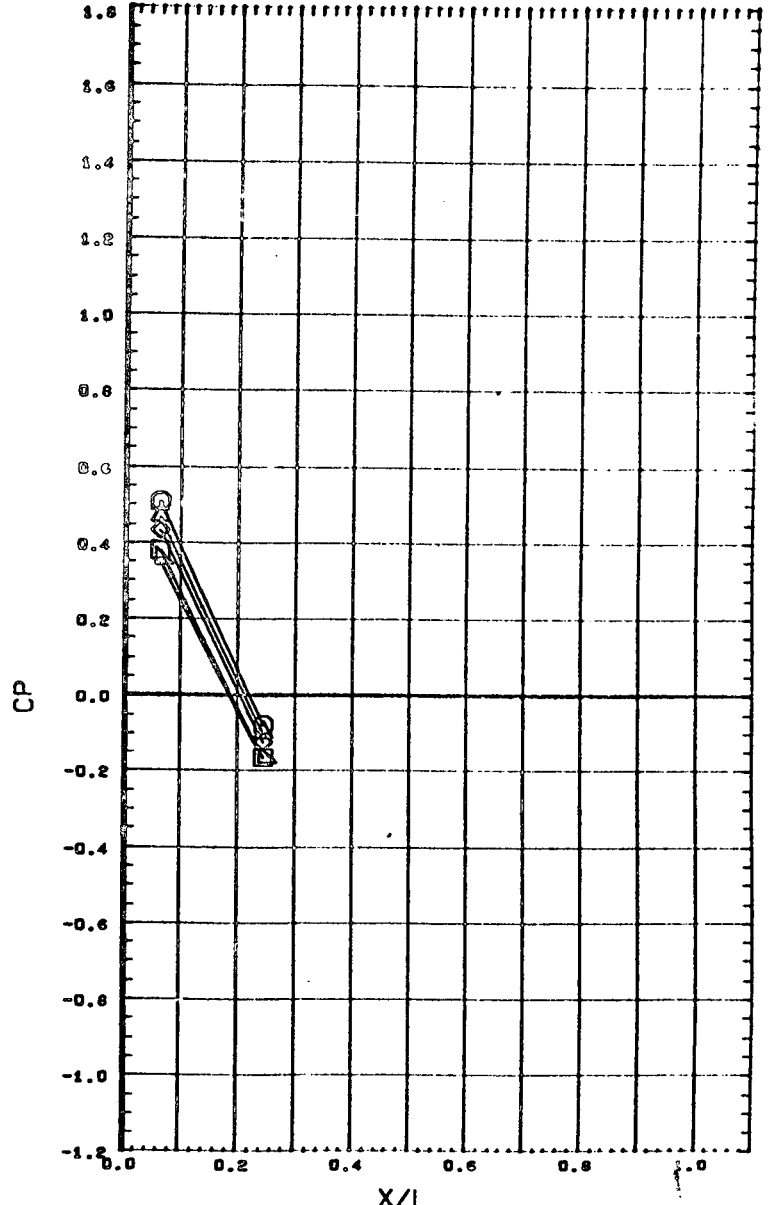
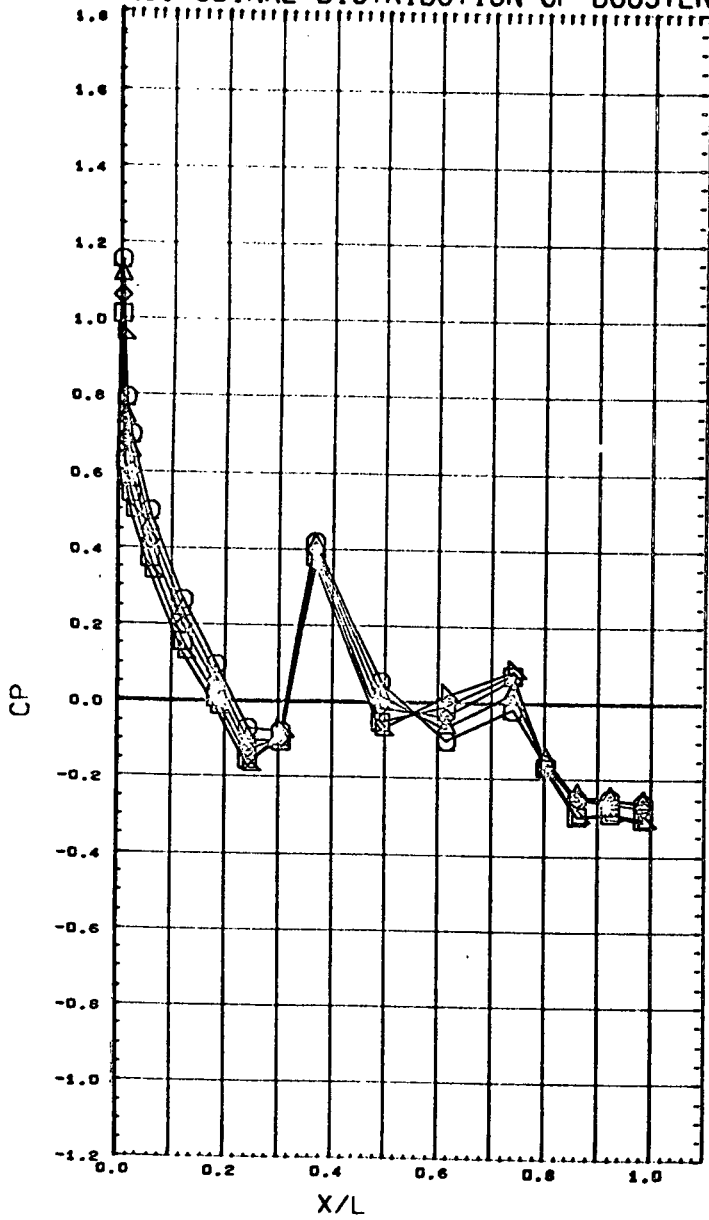

| SYMBOL | ALFB | THETA | M1 |
|--------|-------|--------|-------|
| ○ | 7.923 | 0.000 | 1.201 |
| ◇ | 5.815 | 15.000 | |
| △ | 3.827 | | |
| □ | 1.841 | | |
| ○ | 0.145 | | |

| PARAMETRIC VALUES | | |
|-------------------|-------|--------------|
| BETA | 0.000 | DX/L - 0.194 |
| δ | 0.000 | |

REFERENCE FILE

LONGITUDINAL DISTRIBUTION OF BOOSTER FUSELAGE PRESSURES

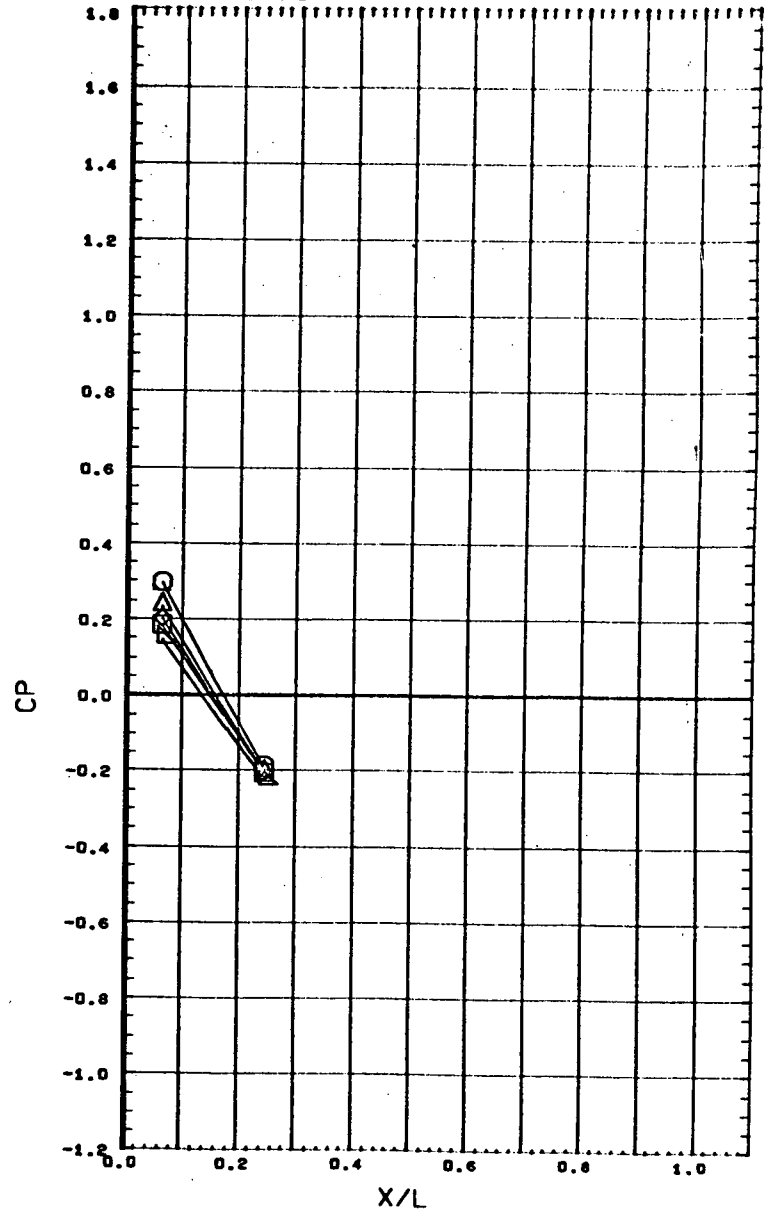
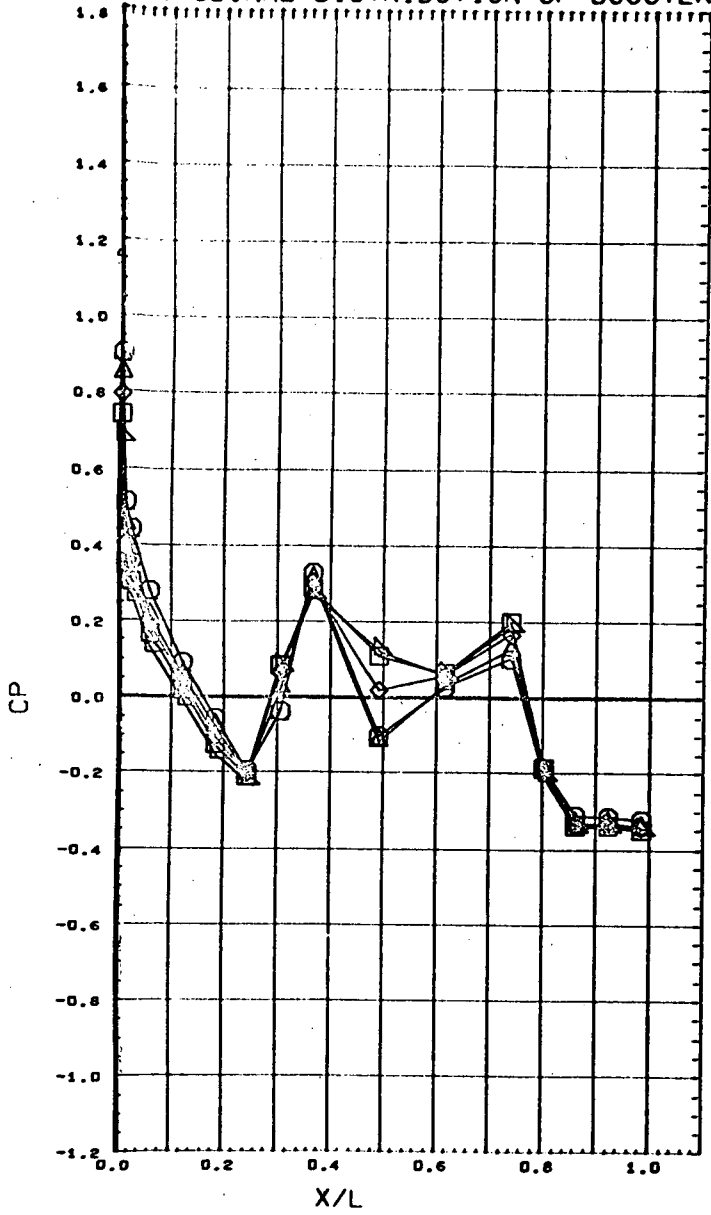

| SYMBOL | ALFB | THETA | M1 |
|--------|--------|--------|-------|
| ○ | 2.167 | 0.000 | 1.201 |
| ◇ | 4.166 | 15.000 | |
| △ | 6.147 | | |
| □ | 8.143 | | |
| ◇ | 10.117 | | |

REFERENCE FILE

| PARAMETRIC VALUES | | |
|-------------------|-------|--------------|
| BETA | 0.000 | DX/L - 0.194 |
| I | 0.000 | |

LONGITUDINAL DISTRIBUTION OF BOOSTER FUSELAGE PRESSURES

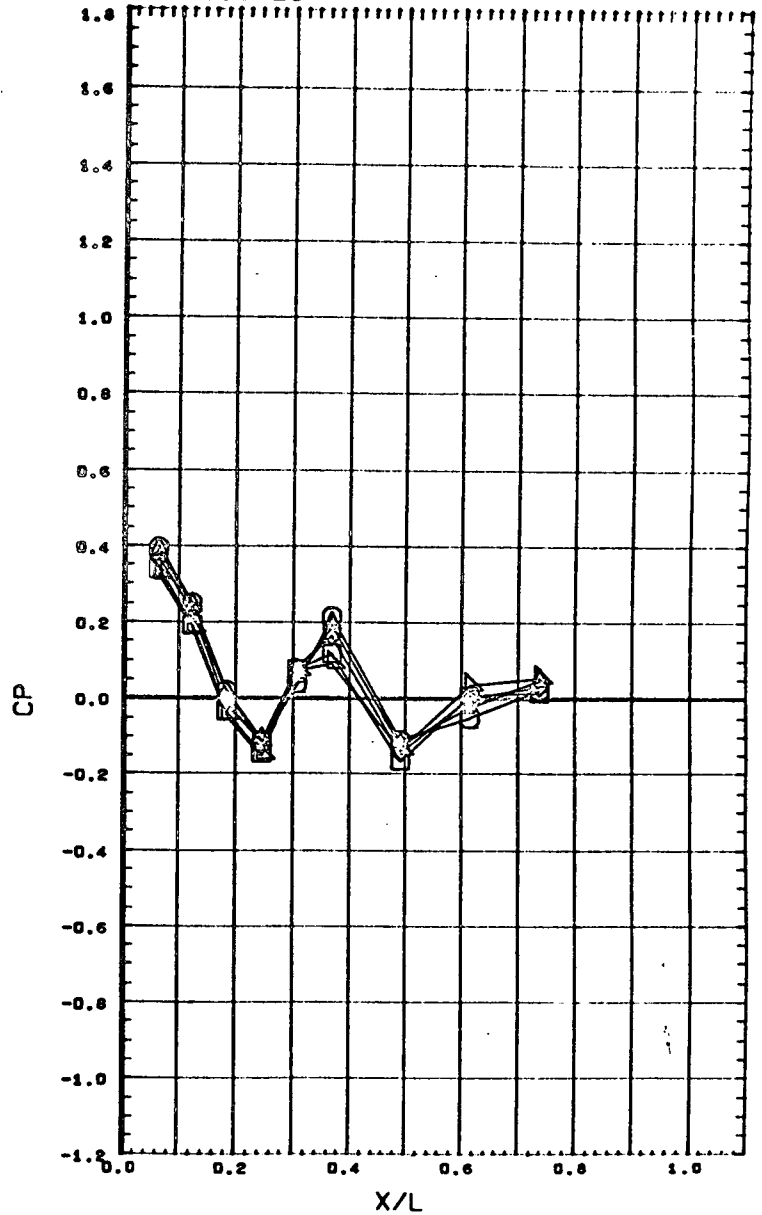
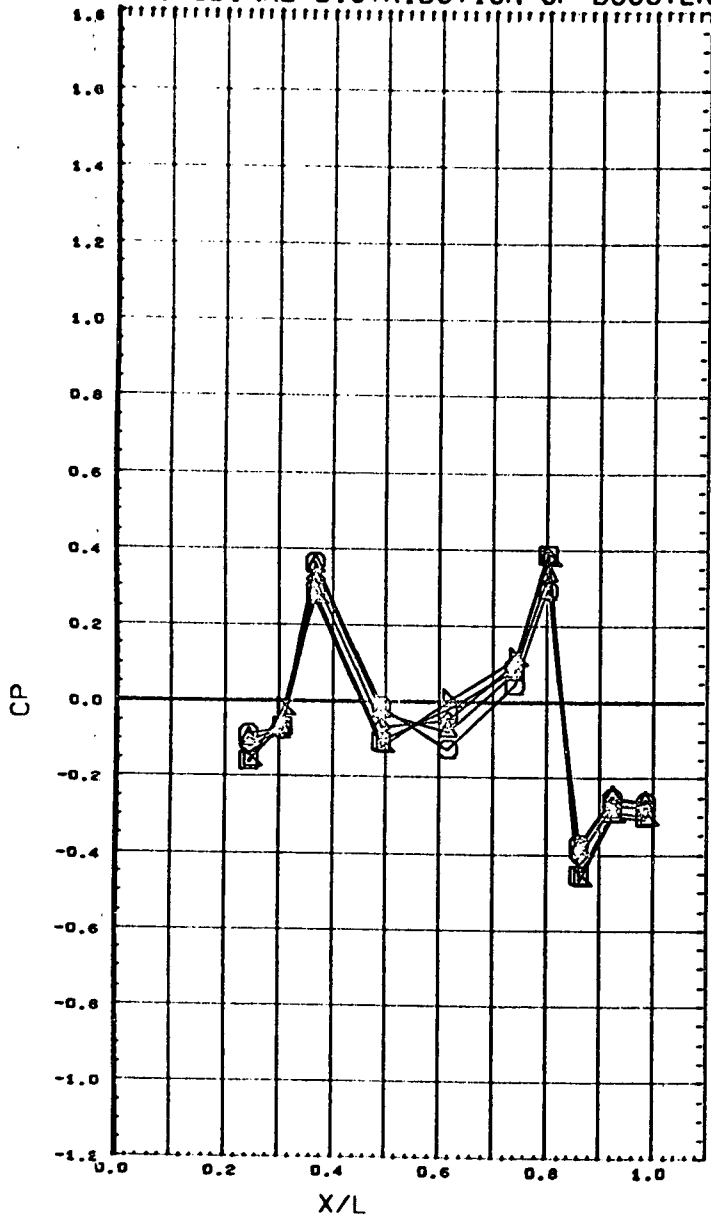

| SYMBOL | ALPB | THETA | M1 |
|--------|-------|--------|-------|
| ○ | 7.923 | 24.000 | 1.201 |
| △ | 5.815 | 45.000 | |
| ◇ | 3.827 | | |
| □ | 1.841 | | |
| ◇ | 0.145 | | |

REFERENCE FILE

| PARAMETRIC VALUES | | |
|-------------------|-------|--------------|
| BETA | 0.000 | DX/L - 0.194 |
| I | 0.000 | |

LONGITUDINAL DISTRIBUTION OF BOOSTER FUSELAGE PRESSURES

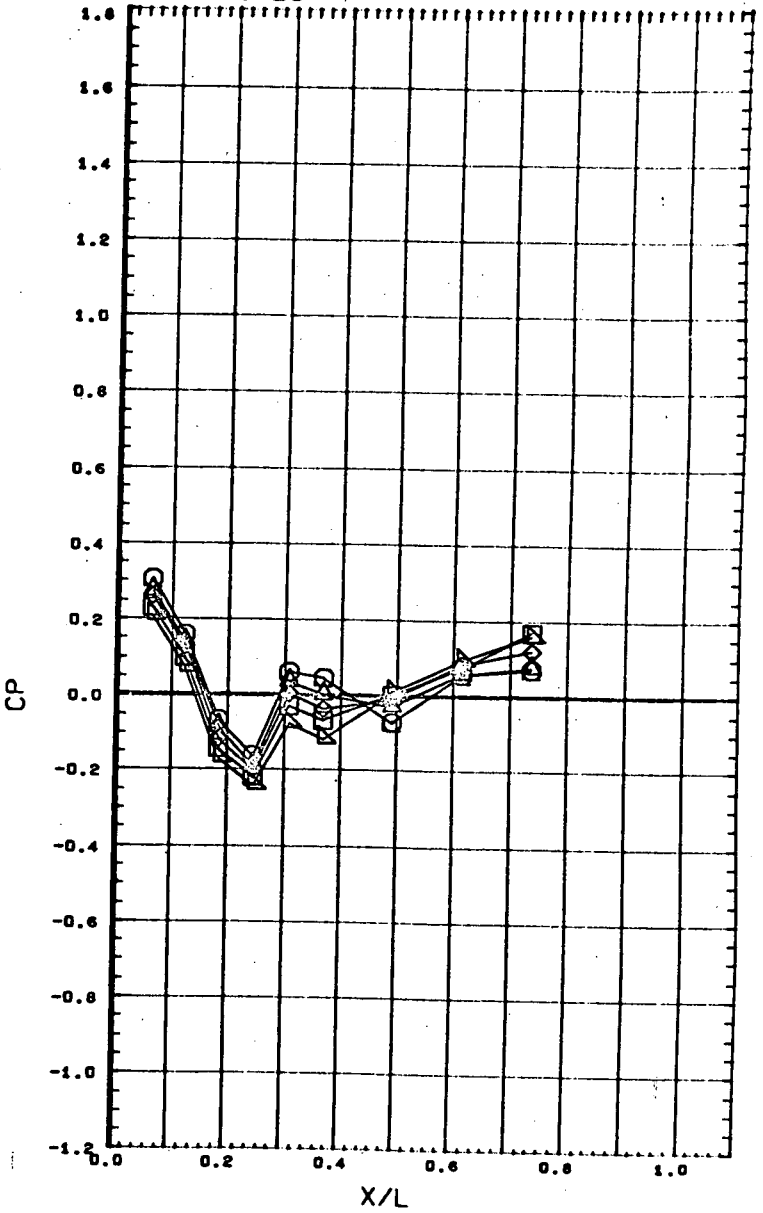
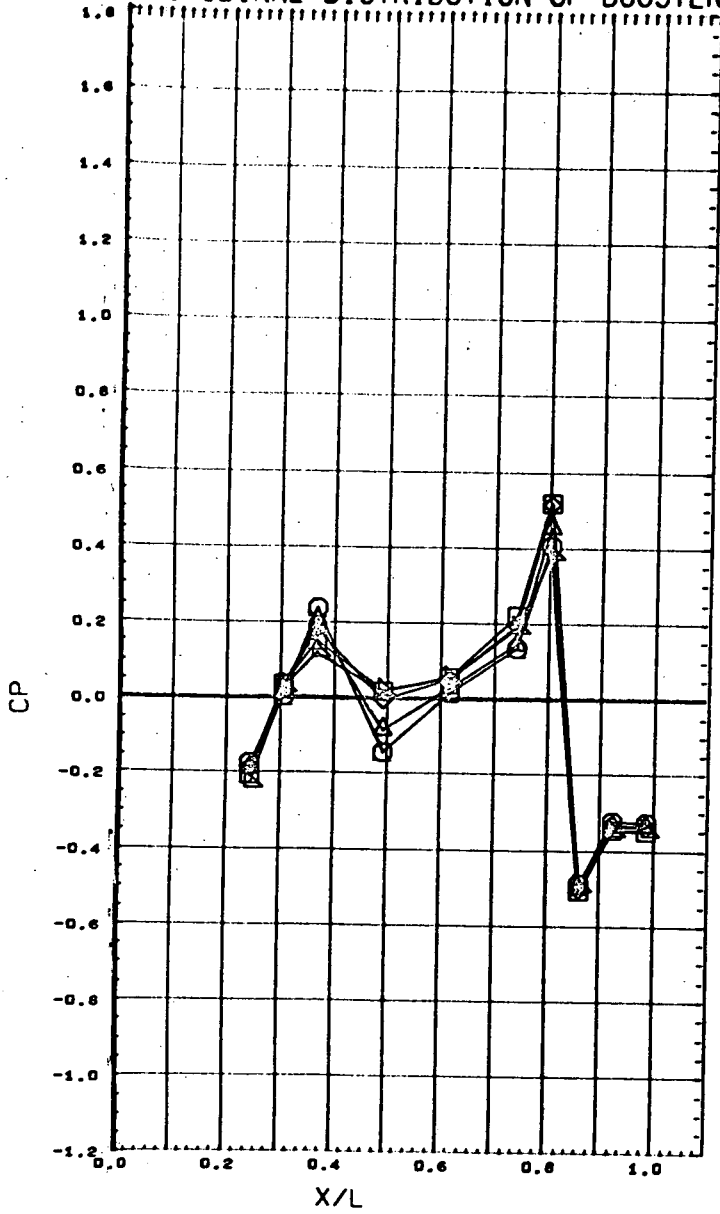

| SYMBOL | ALFB | THETA | M1 |
|--------|--------|--------|-------|
| ○ | 2.167 | 24.000 | 1.201 |
| △ | 4.166 | 45.000 | |
| ◇ | 6.147 | | |
| □ | 8.143 | | |
| ▽ | 10.117 | | |

REFERENCE FILE

| PARAMETRIC VALUES | | |
|-------------------|-------|--------------|
| BETA | 0.000 | DX/L - 0.194 |
| I | 0.000 | |

LONGITUDINAL DISTRIBUTION OF BOOSTER FUSELAGE PRESSURES

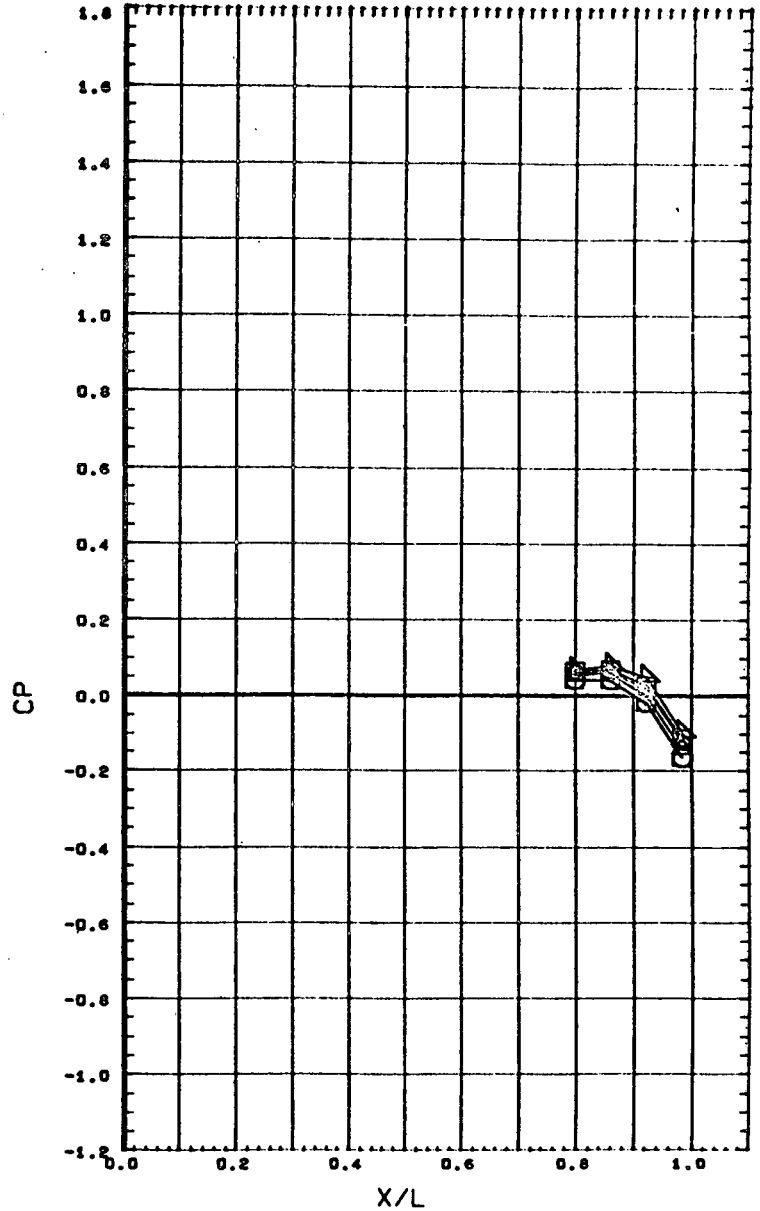
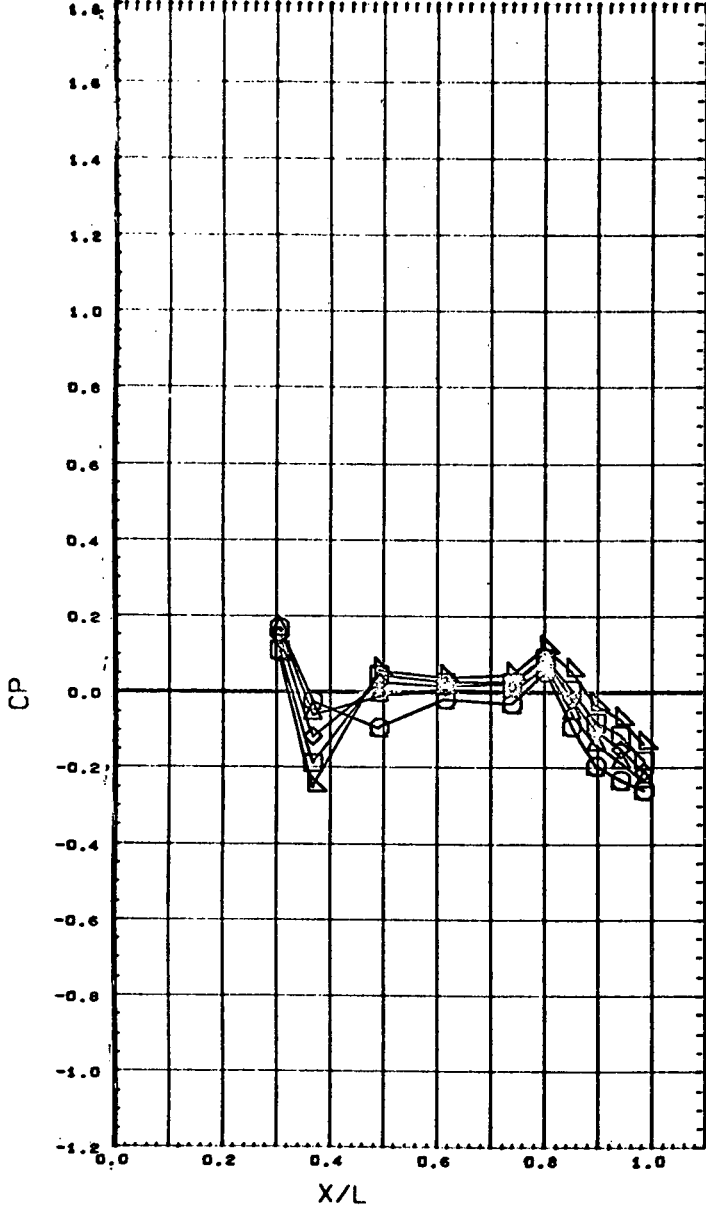

| SYMBOL | ALFB | THETA | M1 |
|--------|-------|---------|-------|
| ○ | 7.923 | 90.000 | 1.201 |
| ◇ | 9.815 | 180.000 | |
| △ | 9.827 | | |
| □ | 1.841 | | |
| ○ | 0.145 | | |

REFERENCE FILE

| PARAMETRIC VALUES | | | |
|-------------------|-------|------|---------|
| BETA | 0.000 | DX/L | - 0.194 |
| I | 0.000 | | |

LONGITUDINAL DISTRIBUTION OF BOOSTER FUSELAGE PRESSURES

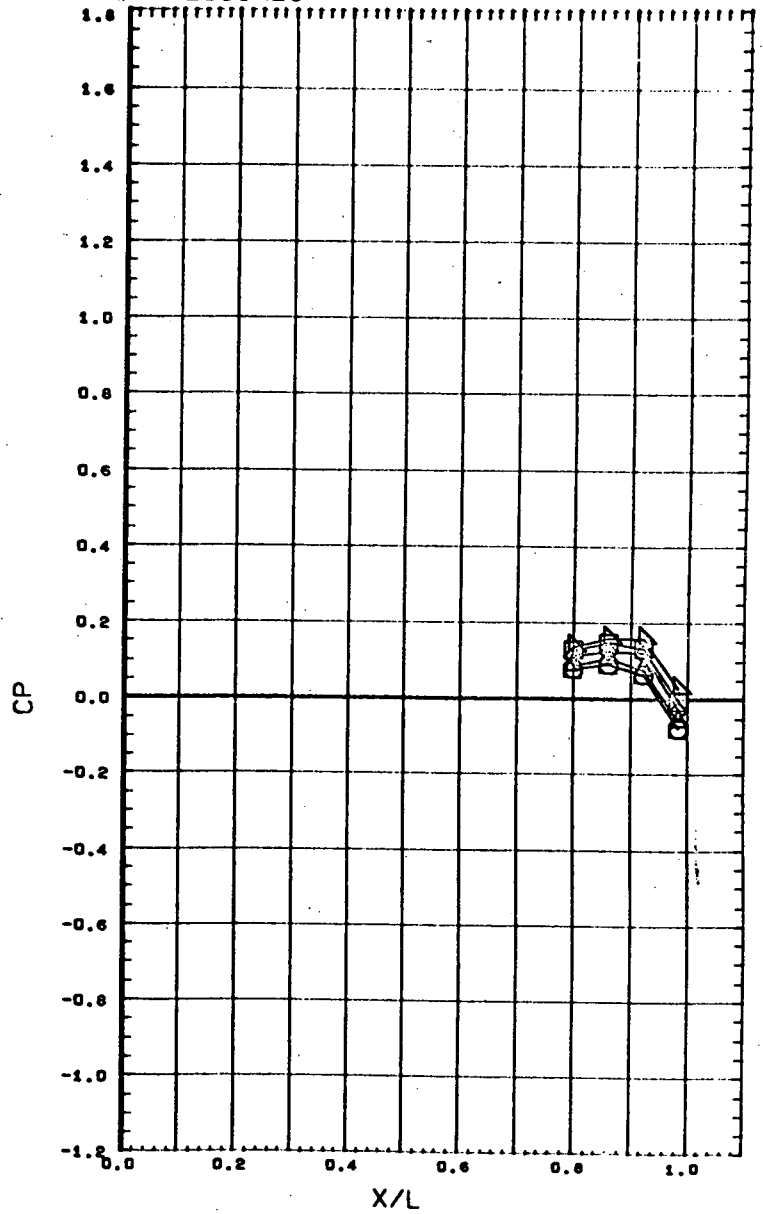
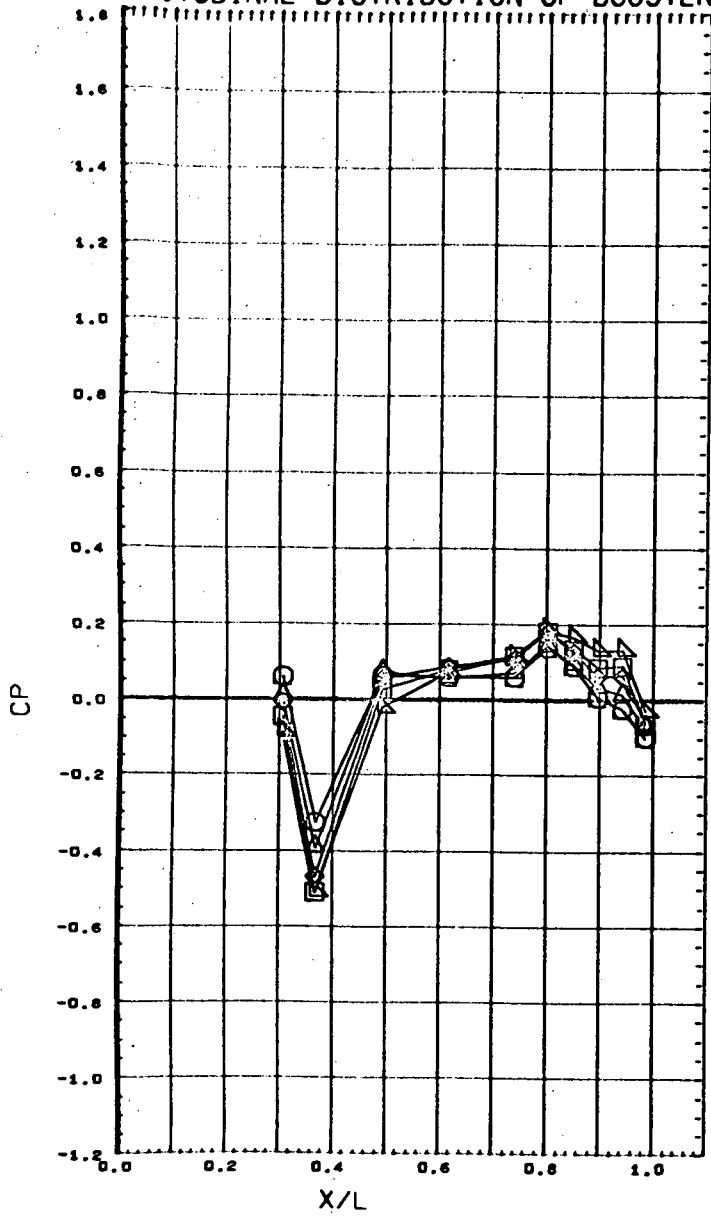

| SYMBOL | ALFB | THETA | M1 |
|--------|--------|---------|-------|
| ○ | 2.167 | 90.000 | 1.201 |
| ◇ | 4.166 | 180.000 | |
| △ | 6.147 | | |
| □ | 8.143 | | |
| ▽ | 10.117 | | |

REFERENCE FILE

| PARAMETRIC VALUES | | |
|-------------------|-------|--------------|
| BETA | 0.000 | DX/L - 0.194 |
| I | 0.000 | |

LONGITUDINAL DISTRIBUTION OF BOOSTER FUSELAGE PRESSURES

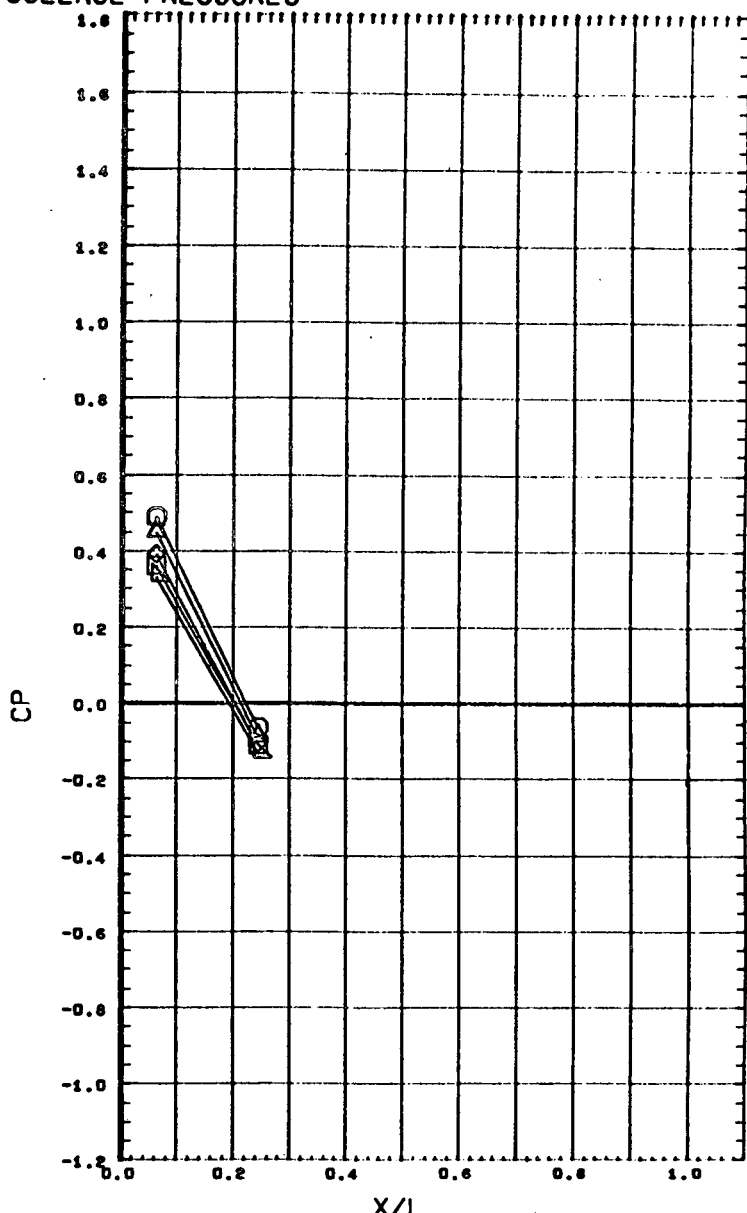
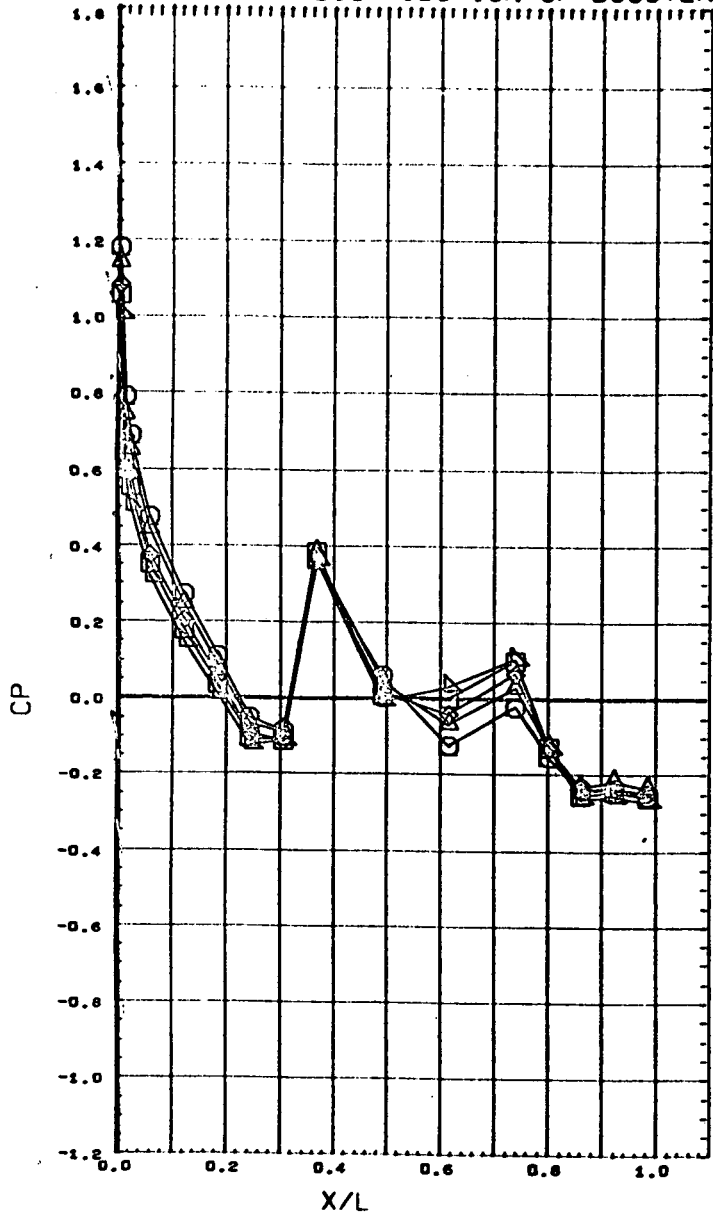

| SYMBOL | ALFD | THETA | M1 |
|--------|-------|--------|-------|
| ○ | 7.930 | 0.000 | 1.300 |
| ◇ | 5.834 | 19.000 | |
| △ | 3.852 | | |
| □ | 1.848 | | |
| ○ | 0.145 | | |

| PARAMETRIC VALUES | | | |
|-------------------|-------|------|---------|
| BETA | 0.000 | DX/L | - 0.194 |
| I | 0.000 | | |

REFERENCE FILE

LONGITUDINAL DISTRIBUTION OF BOOSTER FUSELAGE PRESSURES

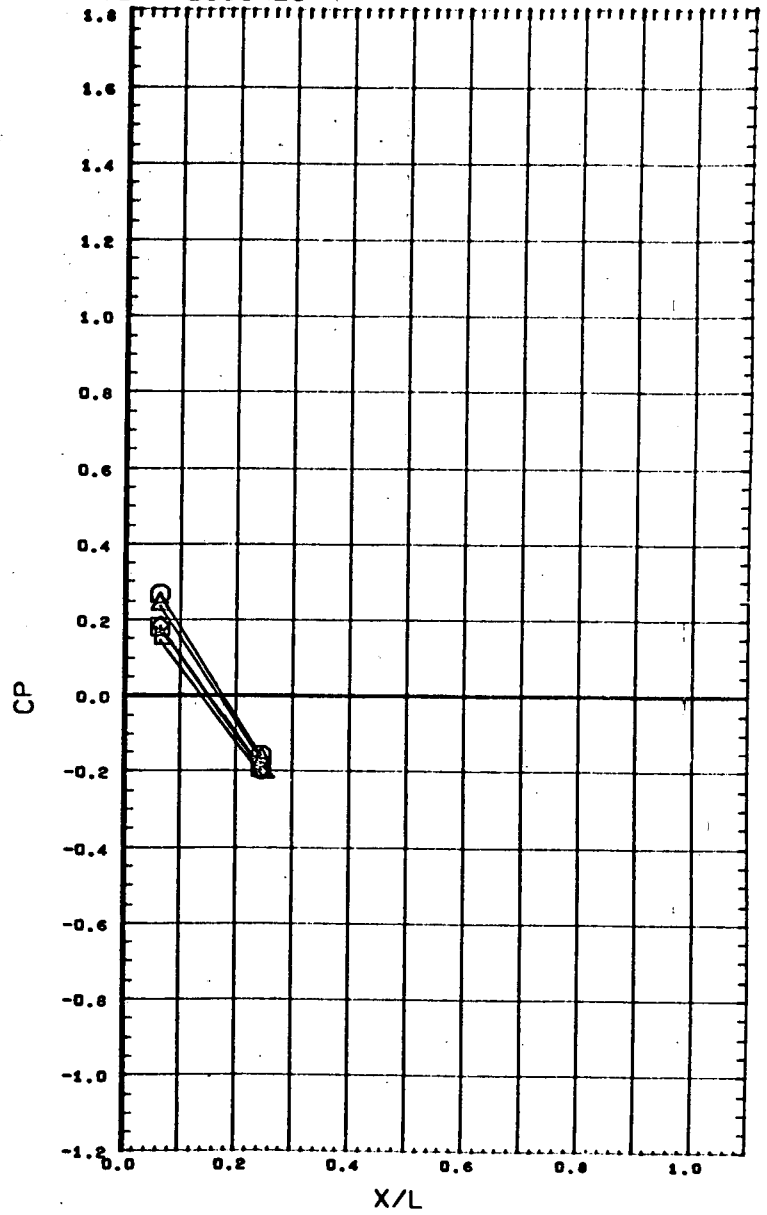
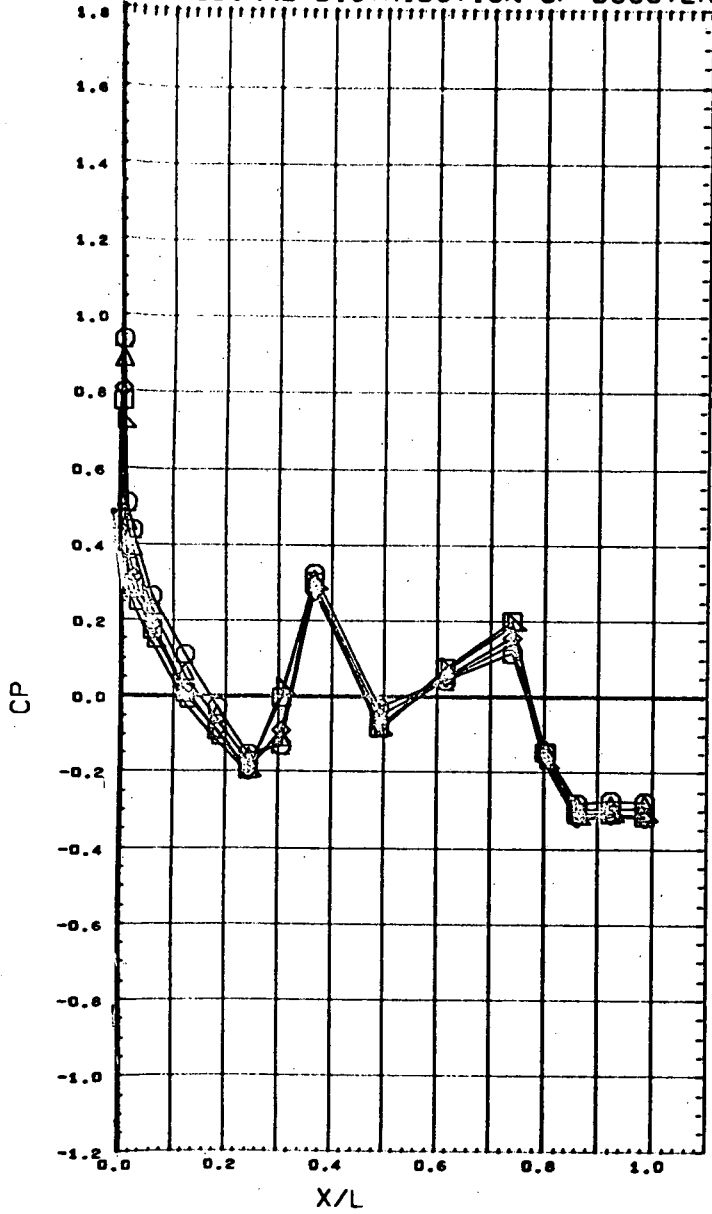

| SYMBOL | ALFB | THETA | M1 |
|--------|--------|--------|-------|
| ○ | 2.163 | 0.000 | 1.300 |
| ◇ | 4.164 | 15.000 | |
| △ | 6.136 | | |
| □ | 8.142 | | |
| ▽ | 10.136 | | |

REFERENCE FILE

| PARAMETRIC VALUES | | | |
|-------------------|-------|------|---------|
| BETA | 0.000 | DX/L | - 0.194 |
| I | 0.000 | | |

LONGITUDINAL DISTRIBUTION OF BOOSTER FUSELAGE PRESSURES

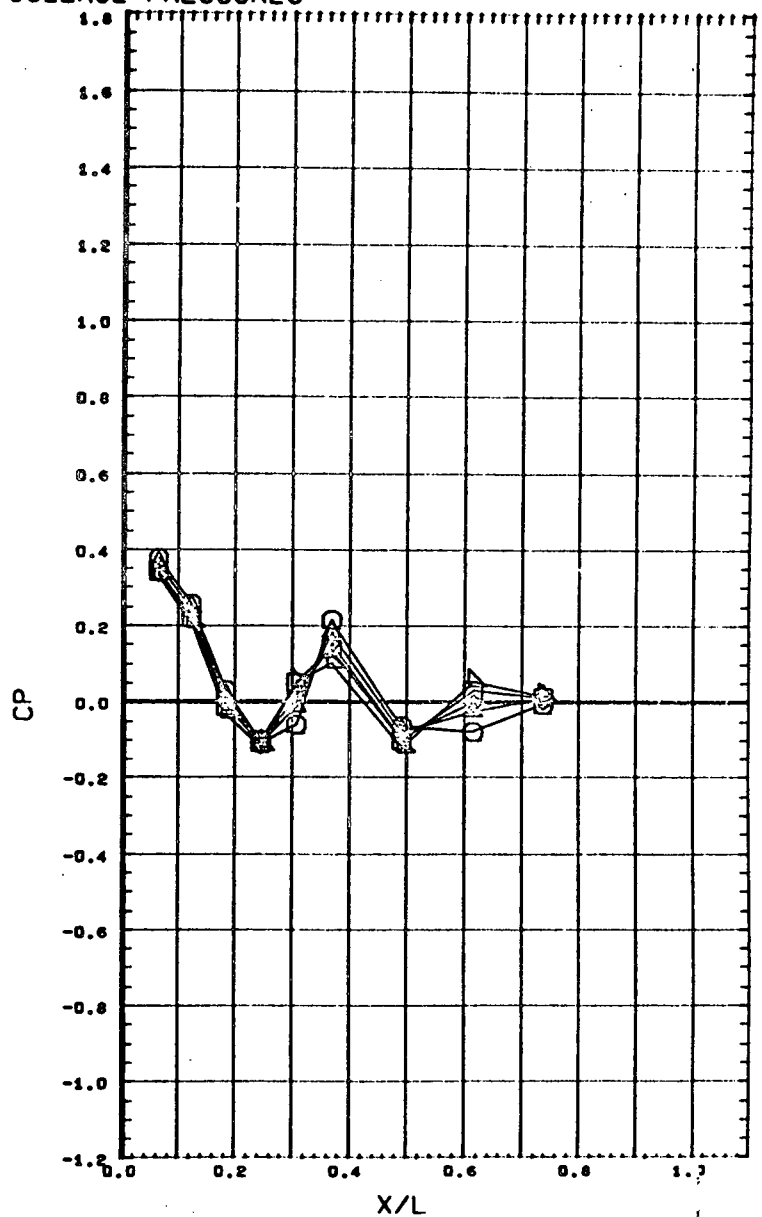
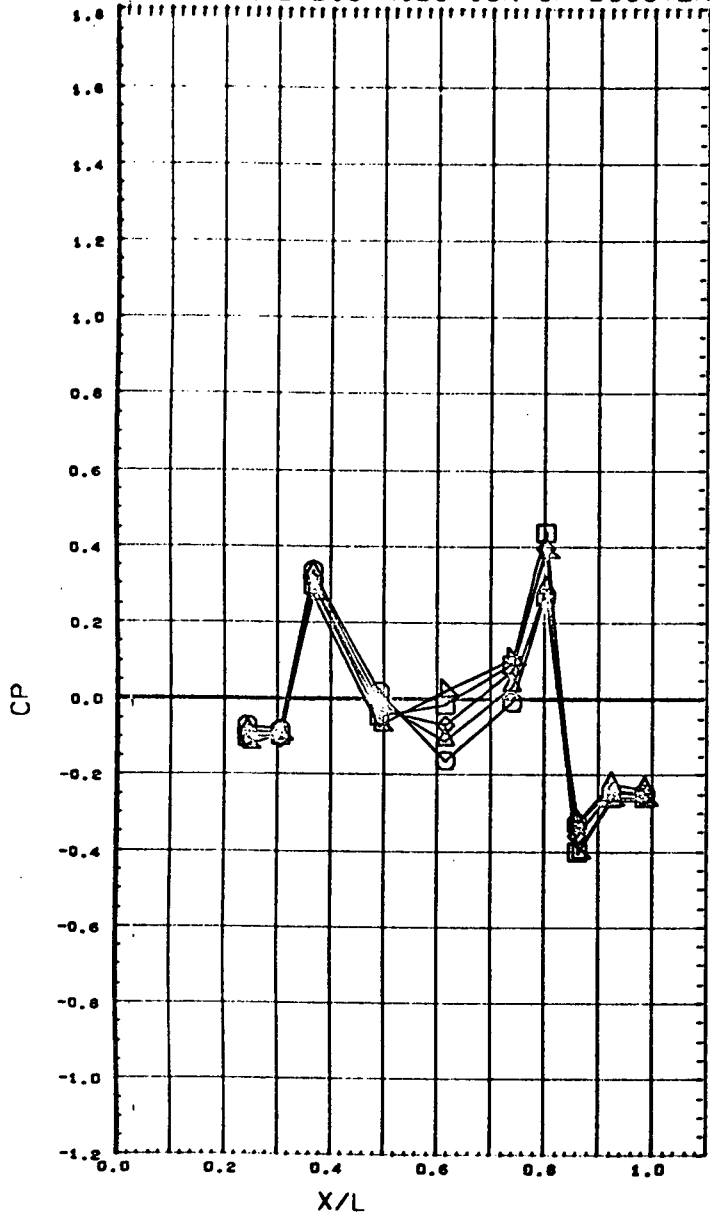

| SYMBOL | ALFB | THETA | M1 |
|--------|-------|--------|-------|
| ○ | 7.930 | 24.000 | 1.300 |
| ◇ | 5.834 | 45.000 | |
| △ | 3.852 | | |
| □ | 1.848 | | |
| ○ | 0.145 | | |

REFERENCE FILE

| PARAMETRIC VALUES | | |
|-------------------|-------|--------------|
| BETA | 0.000 | DX/L - 0.194 |
| I | 0.000 | |

LONGITUDINAL DISTRIBUTION OF BOOSTER FUSELAGE PRESSURES

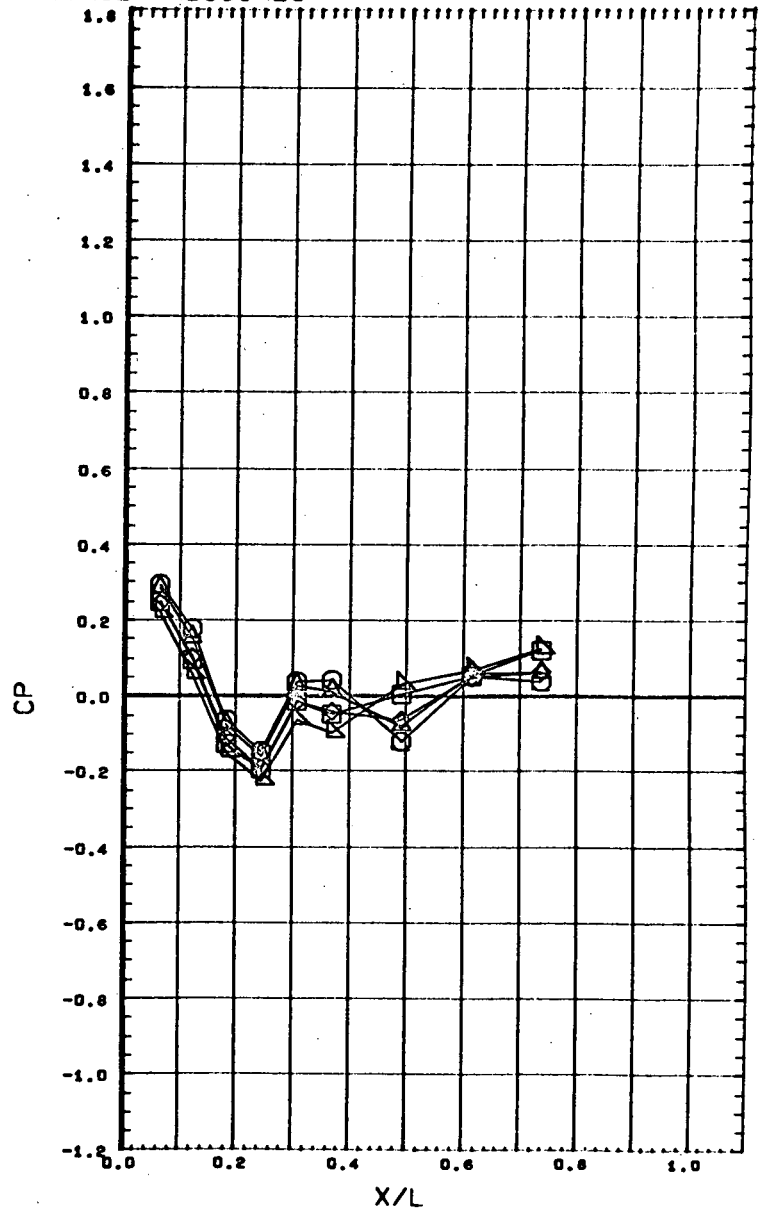
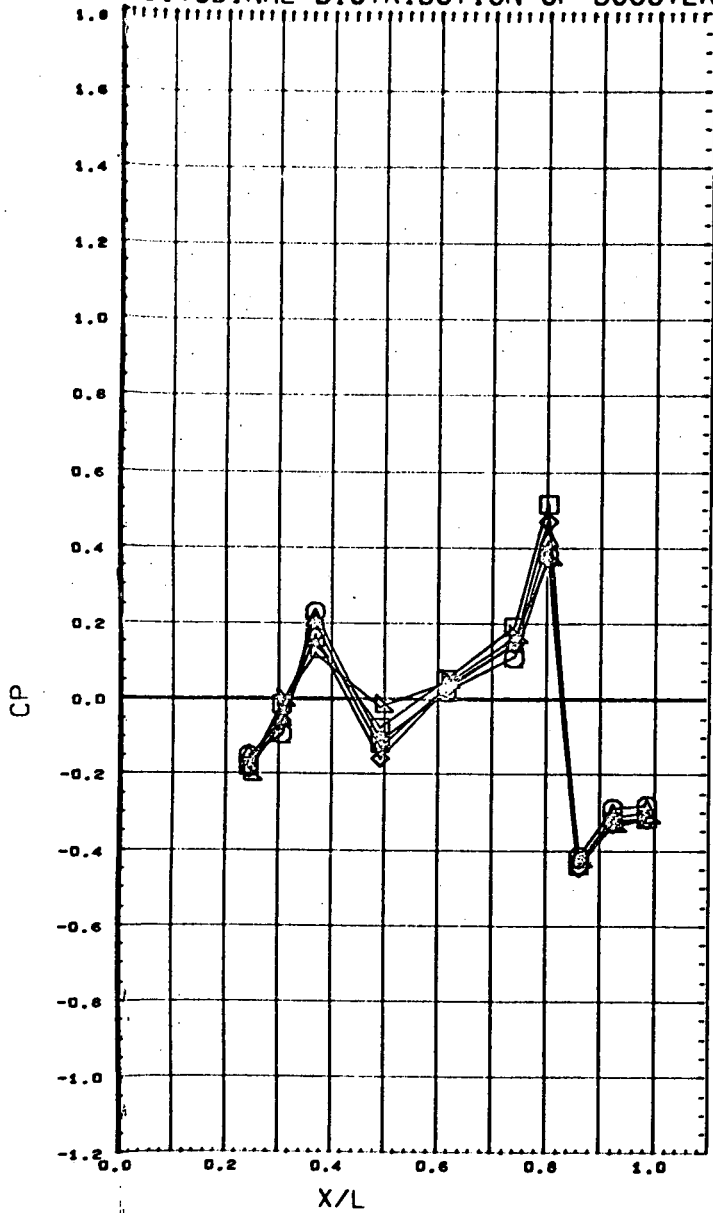

| SYMBOL | ALFB | THETA | M1 |
|--------|--------|--------|-------|
| ○ | 2.163 | 24.000 | 1.300 |
| △ | 4.164 | 45.000 | |
| ◇ | 6.136 | | |
| □ | 8.142 | | |
| ▽ | 10.136 | | |

REFERENCE FILE

| PARAMETRIC VALUES | | | |
|-------------------|-------|------|---------|
| BETA | 0.000 | DX/L | - 0.194 |
| I | 0.000 | | |

LONGITUDINAL DISTRIBUTION OF BOOSTER FUSELAGE PRESSURES

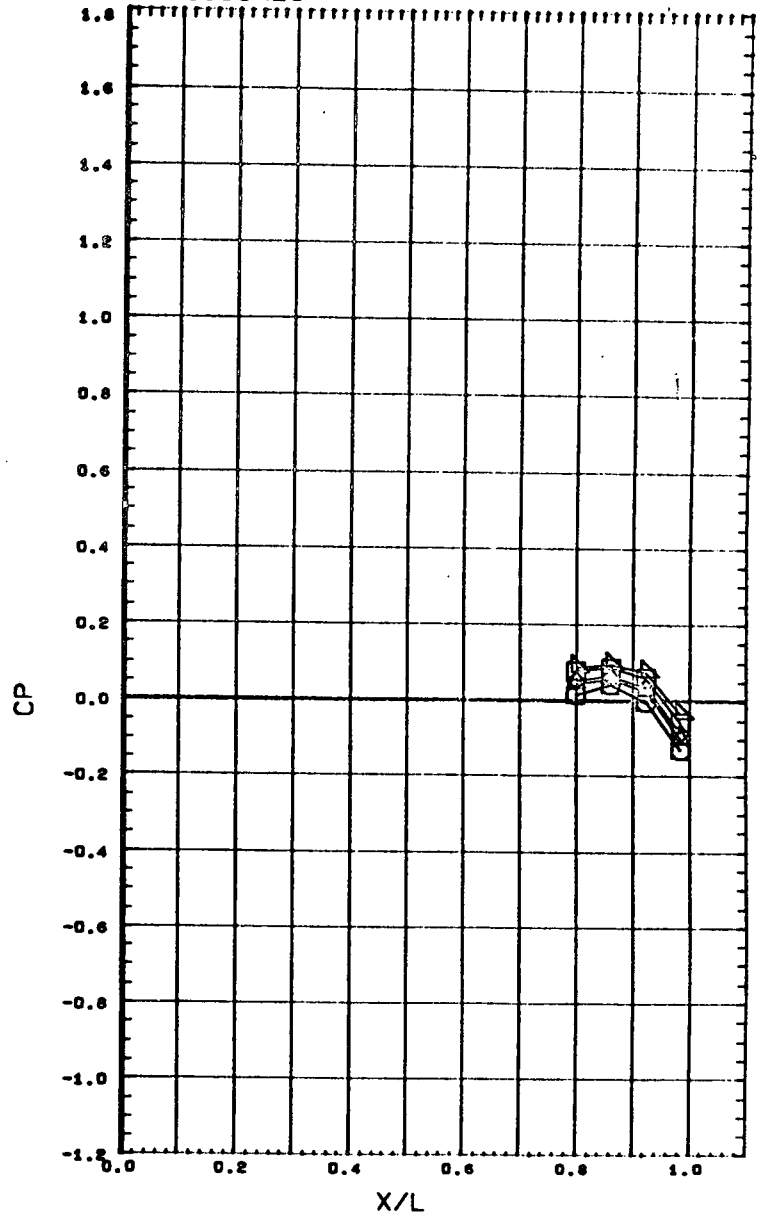
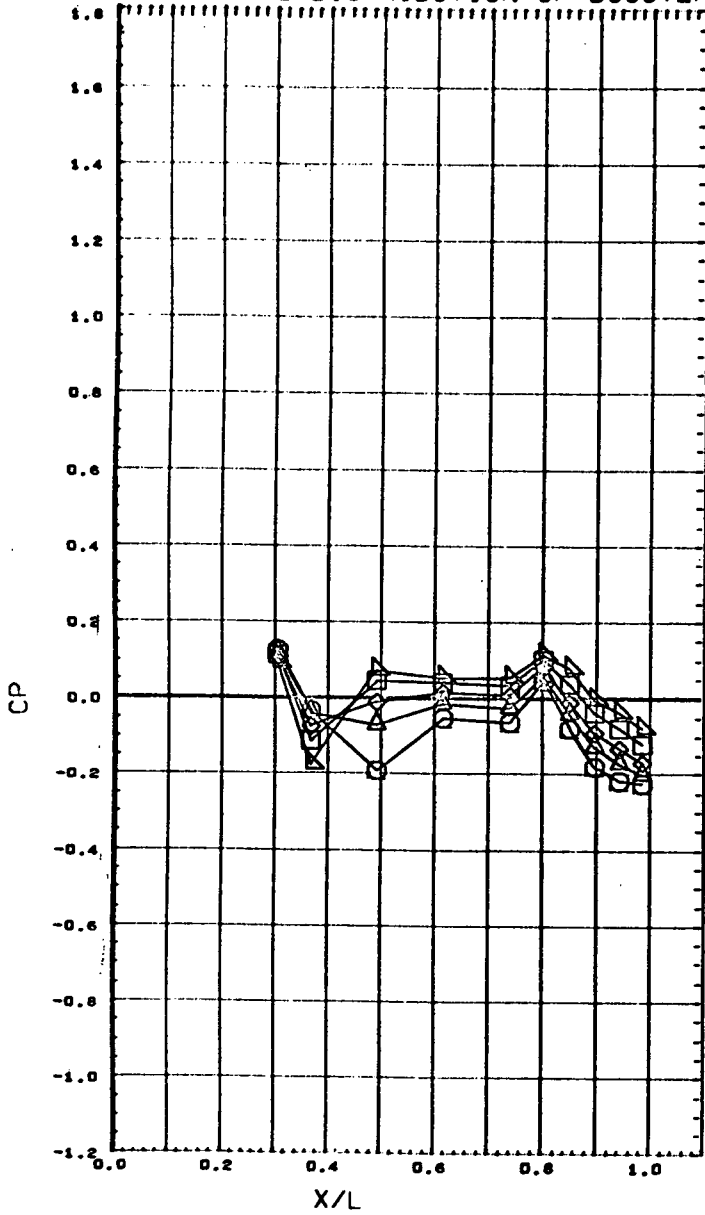

| SYMBOL | ALFB | THETA | M1 |
|--------|-------|---------|-------|
| ○ | 7.930 | 90.000 | 1.300 |
| △ | 5.834 | 180.000 | |
| ◇ | 3.852 | | |
| □ | 1.848 | | |
| ○ | 0.145 | | |

REFERENCE FILE

| PARAMETRIC VALUES | | |
|-------------------|-------|--------------|
| BETA | 0.000 | OX/L - 0.194 |
| I | 0.000 | |

LONGITUDINAL DISTRIBUTION OF BOOSTER FUSELAGE PRESSURES

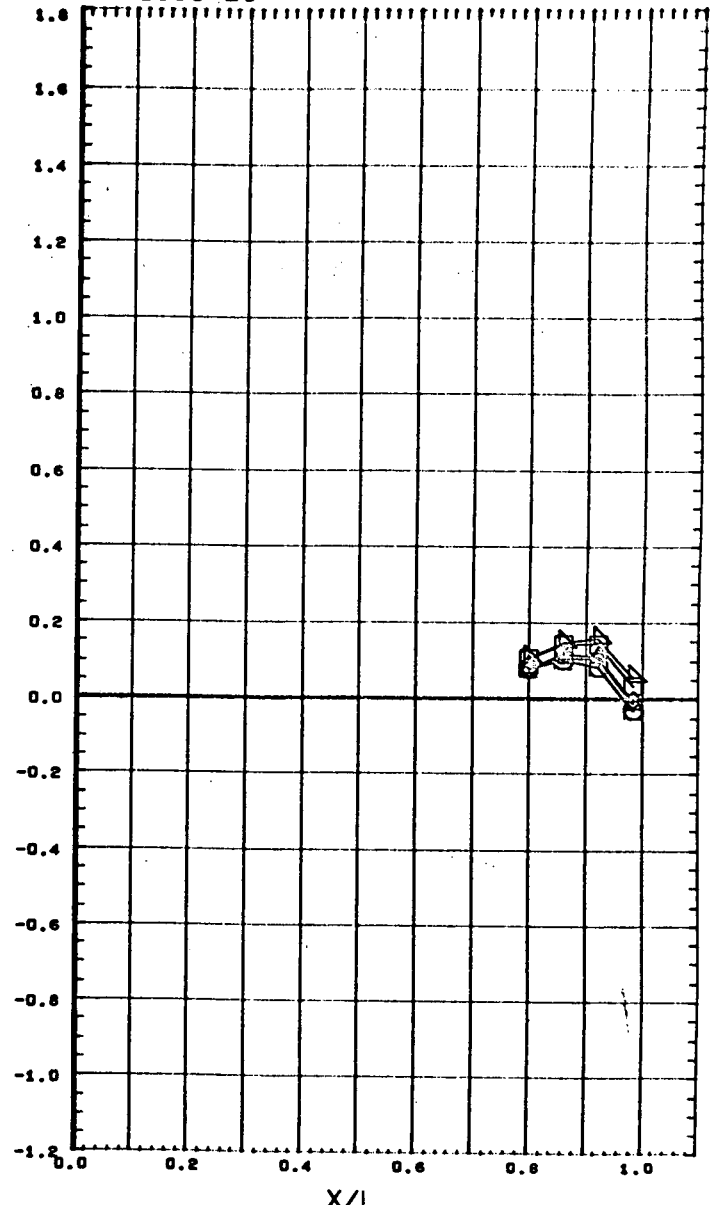
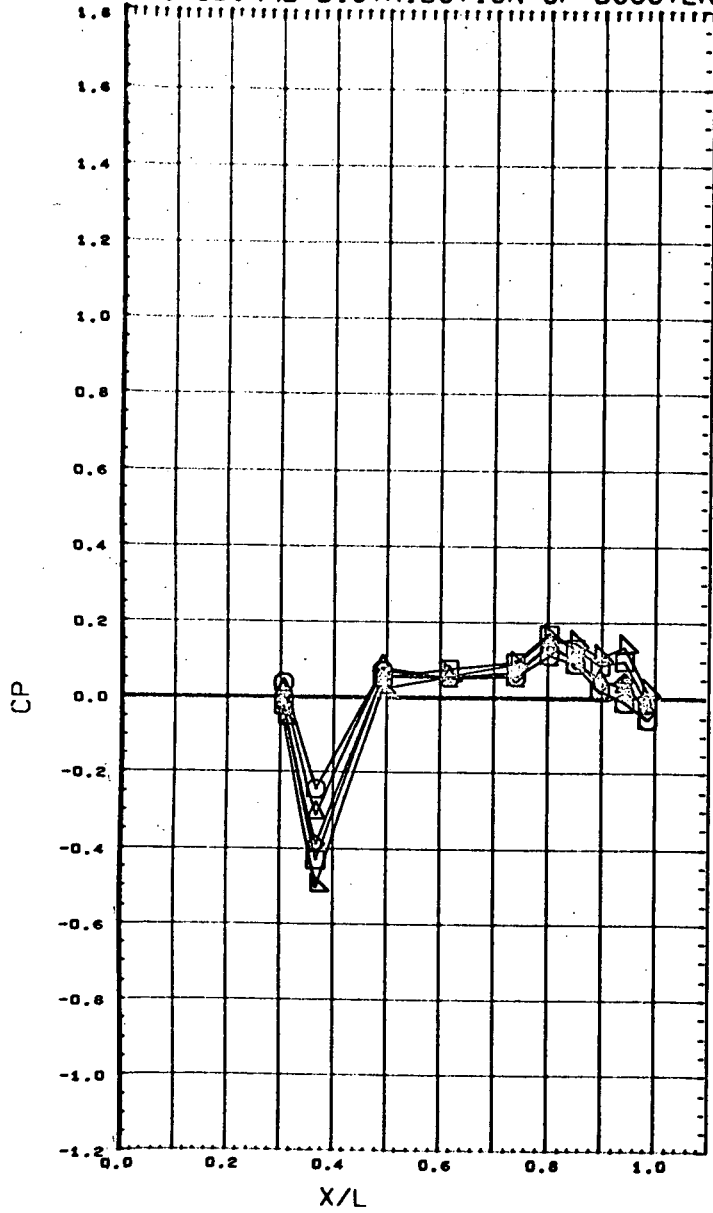

| SYMBOL | ALFB | THETA | M1 |
|--------|--------|---------|-------|
| ○ | 2.163 | 90.000 | 1.300 |
| △ | 4.164 | 180.000 | |
| ◇ | 6.136 | | |
| □ | 8.142 | | |
| ▽ | 10.136 | | |

| PARAMETRIC VALUES | | |
|-------------------|-------|--------------|
| BETA | 0.000 | OX/L - 0.194 |
| I | 0.000 | |

REFERENCE FILE

LONGITUDINAL DISTRIBUTION OF BOOSTER FUSELAGE PRESSURES

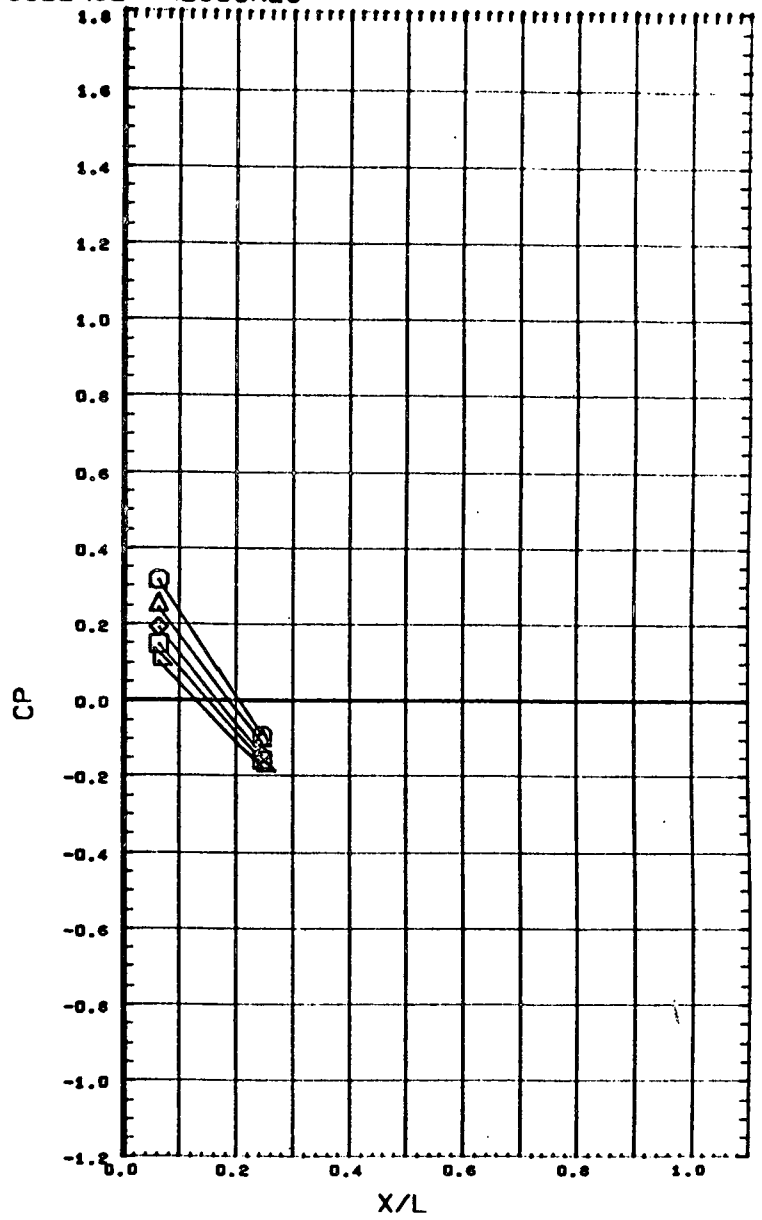
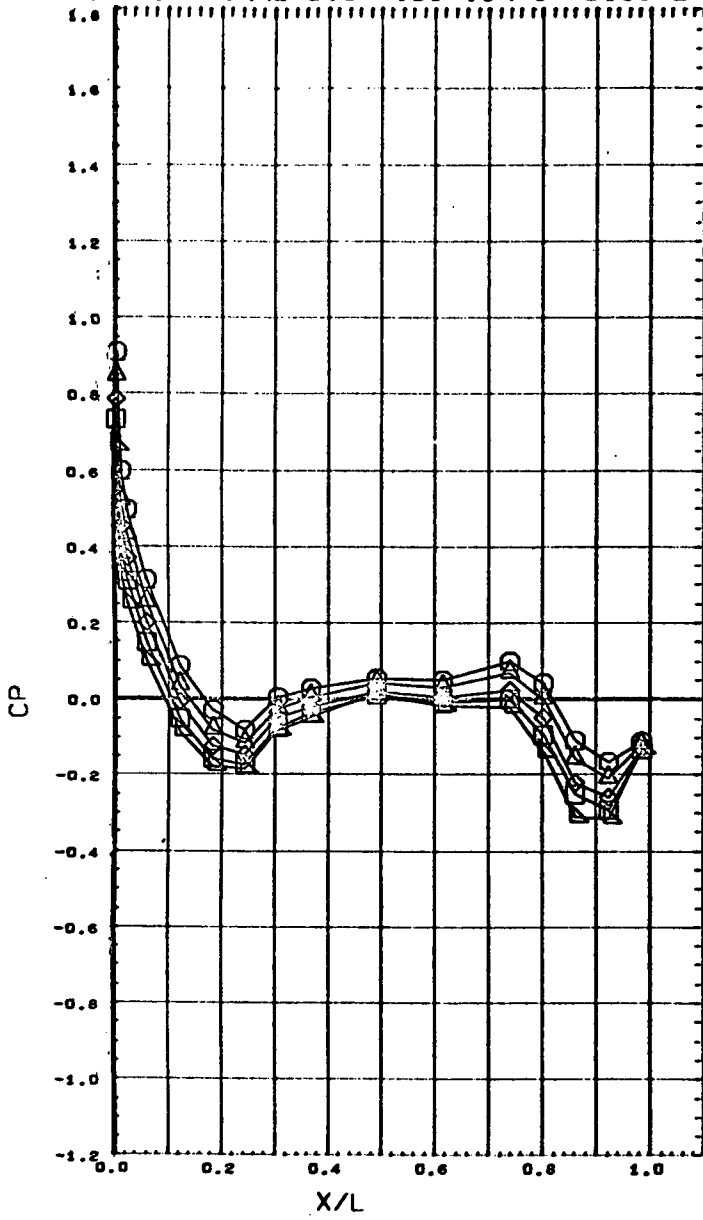

| SYMBOL | ALFB | THETA | M1 |
|--------|-------|--------|-------|
| ○ | 9.160 | 0.000 | 0.604 |
| △ | 5.879 | 15.000 | |
| ◇ | 3.899 | | |
| □ | 1.899 | | |
| ▽ | 0.093 | | |

REFERENCE FILE

BETA PARAMETRIC VALUES
0.000

LONGITUDINAL DISTRIBUTION OF BOOSTER FUSELAGE PRESSURES

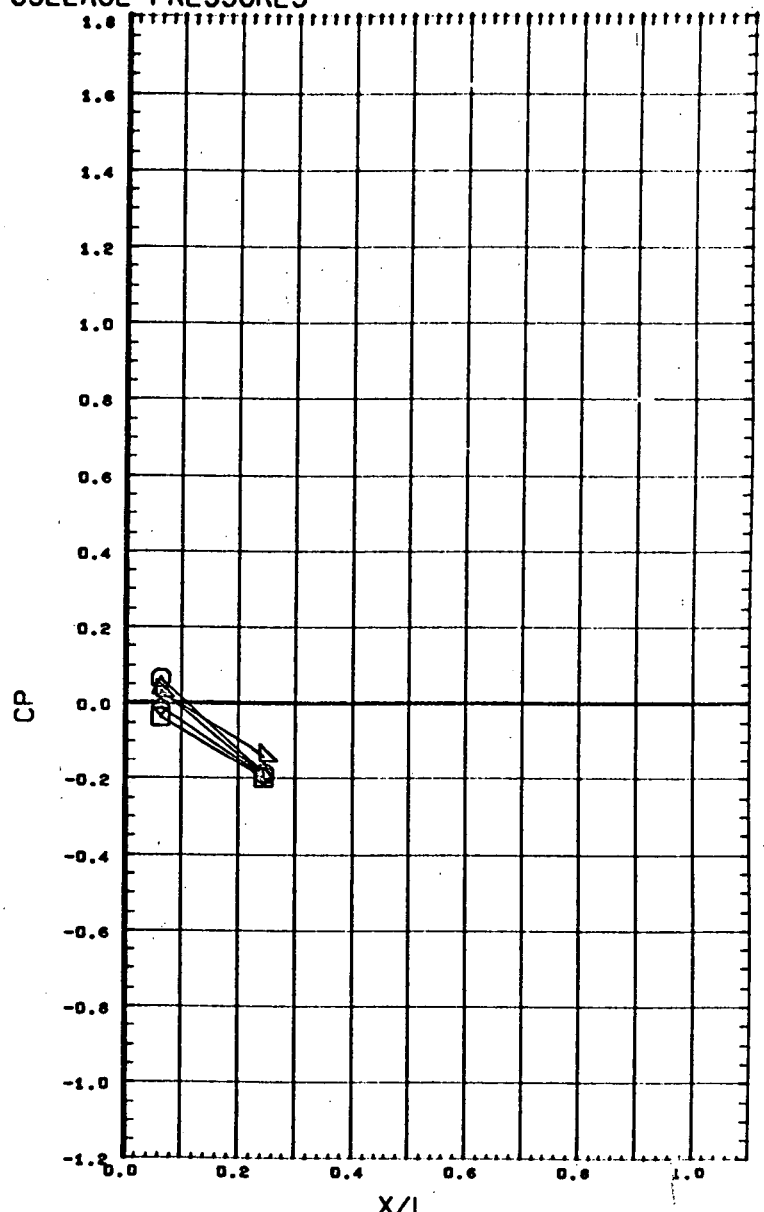
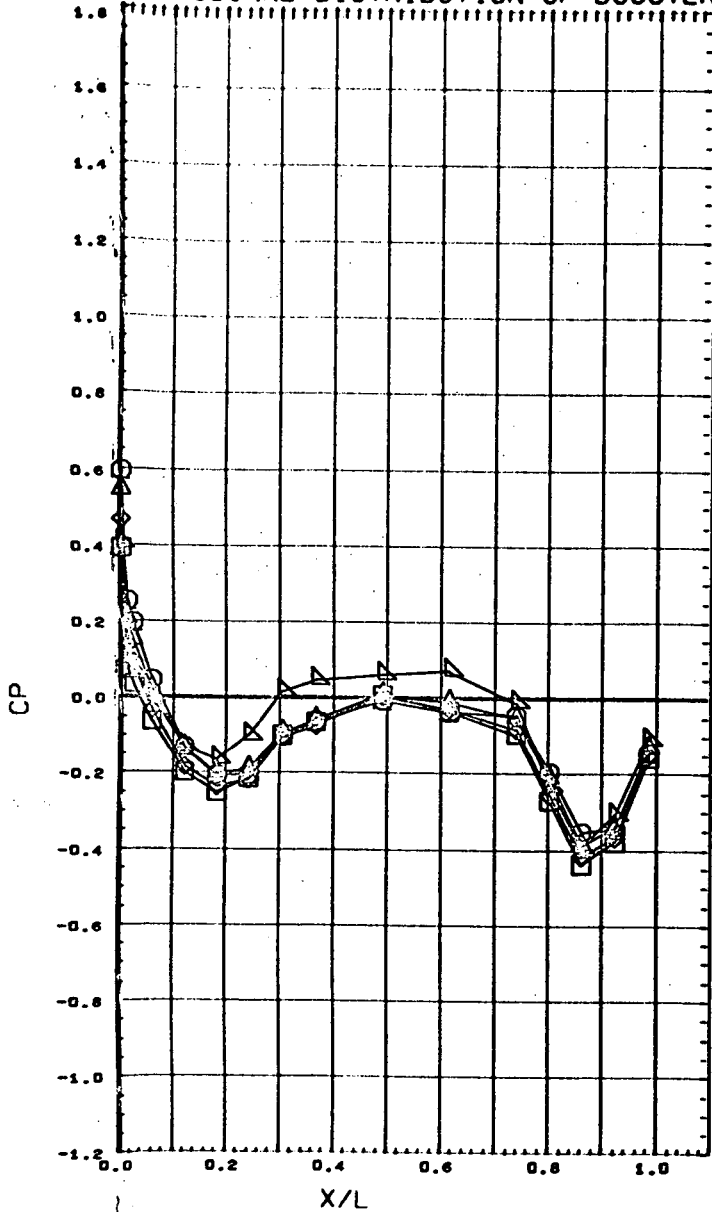

| SYMBOL | ALFB | THETA | M1 |
|--------|--------|--------|-------|
| ○ | 2.099 | 0.000 | 0.604 |
| △ | 4.077 | 15.000 | |
| ◇ | 6.072 | | |
| □ | 8.009 | | |
| ▽ | 10.065 | | |

PARAMETRIC VALUES
BETA 0.000

REFERENCE FILE

LONGITUDINAL DISTRIBUTION OF BOOSTER FUSELAGE PRESSURES

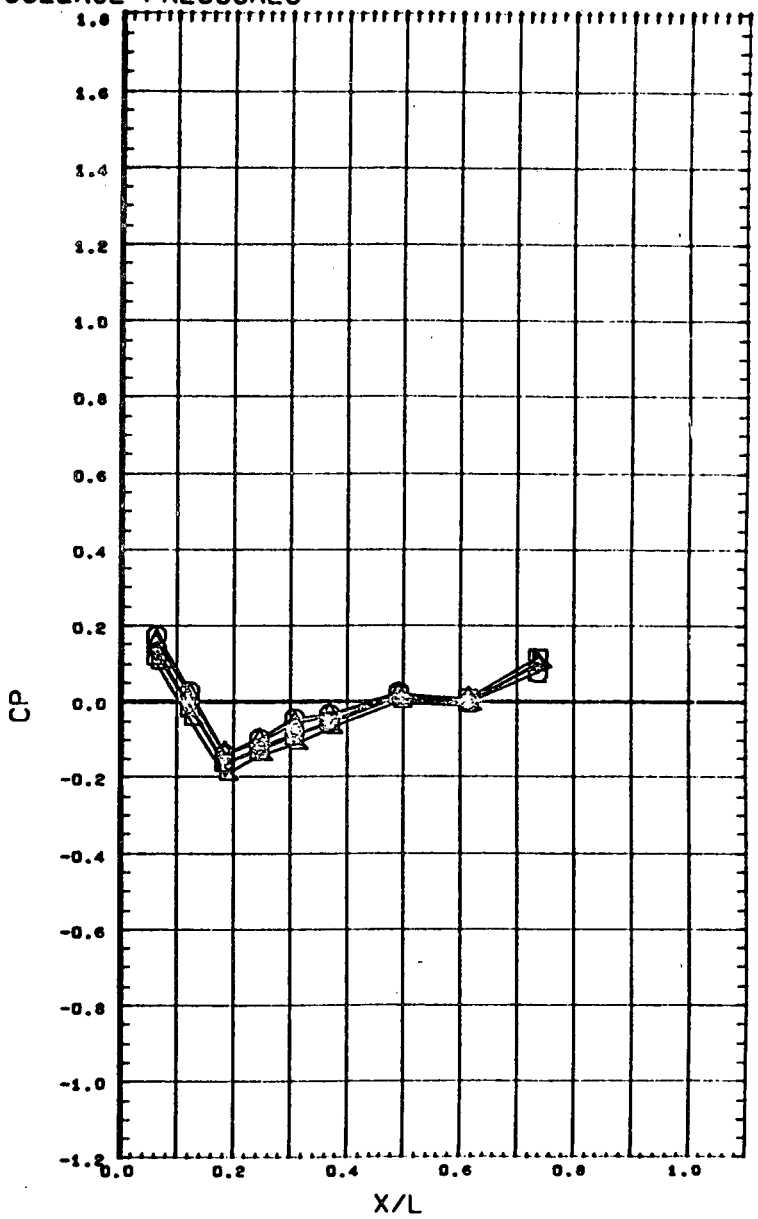
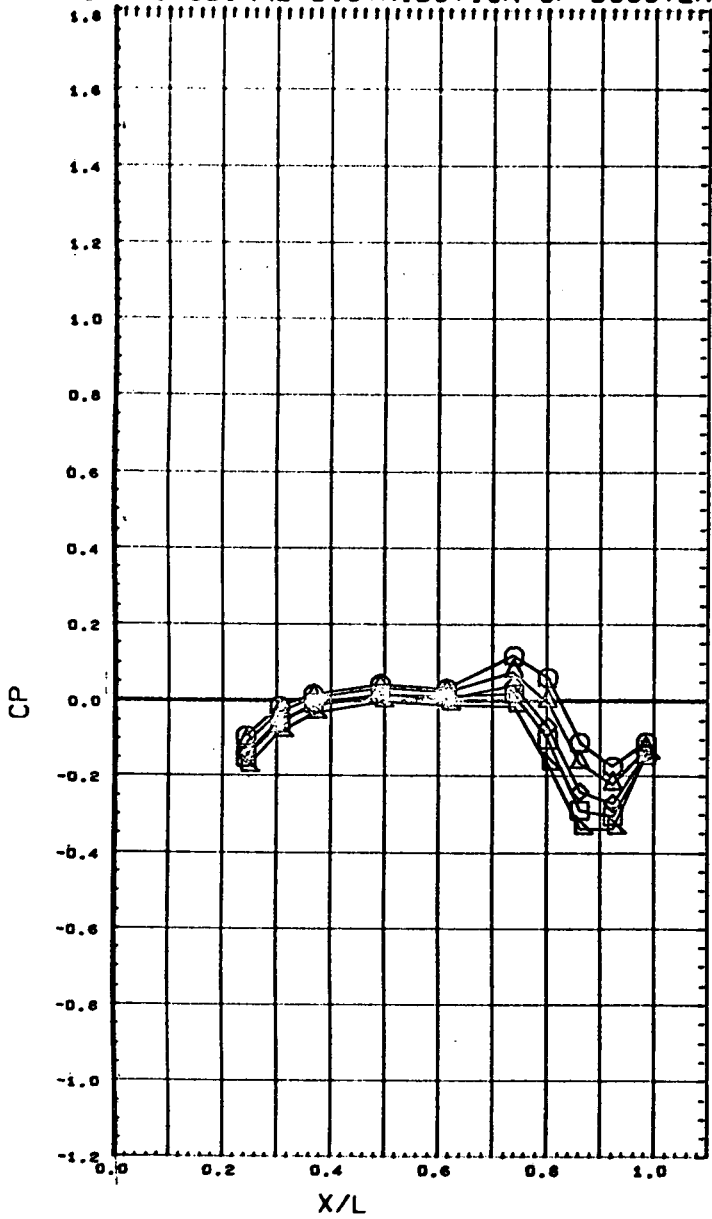

| SYMBOL | ALFB | THETA | M1 |
|--------|-------|--------|-------|
| ○ | 4.160 | 24.000 | 0.604 |
| ◇ | 5.879 | 45.000 | |
| △ | 3.899 | | |
| □ | 1.899 | | |
| ◇ | 0.093 | | |

PARAMETRIC VALUES
BETA 0.000

REFERENCE FILE

LONGITUDINAL DISTRIBUTION OF BOOSTER FUSELAGE PRESSURES

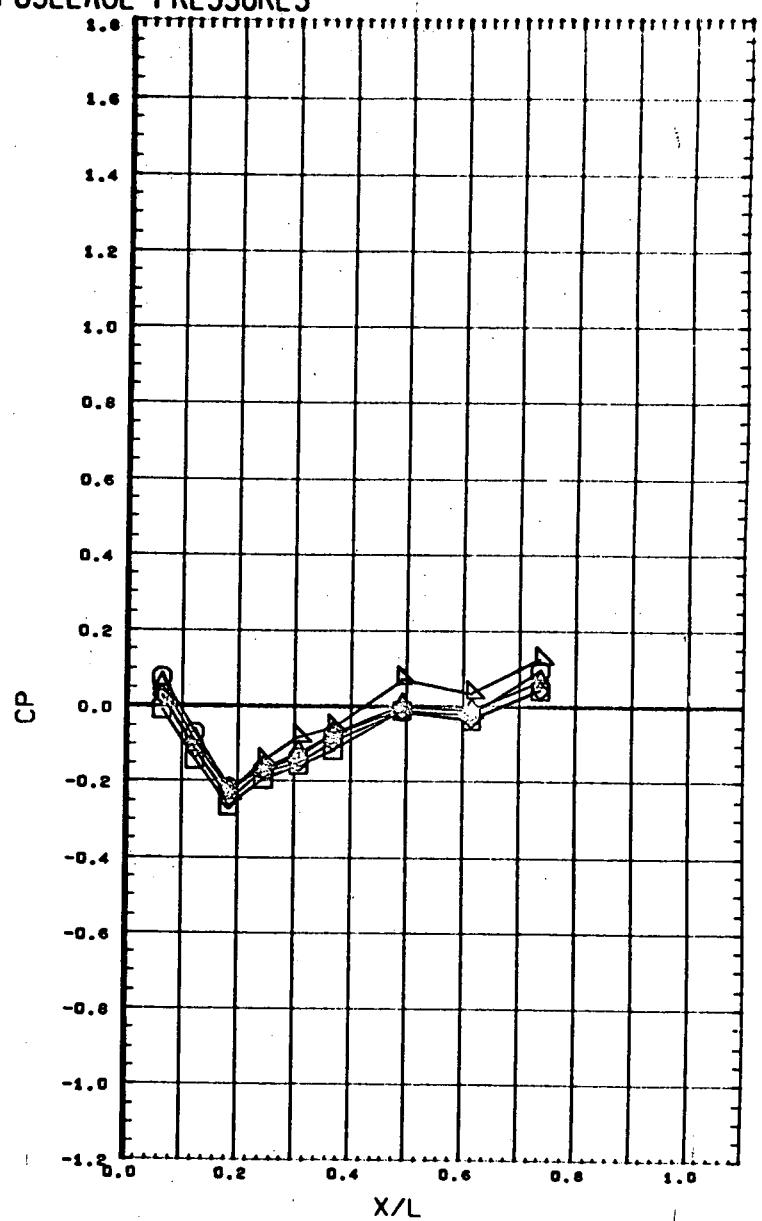
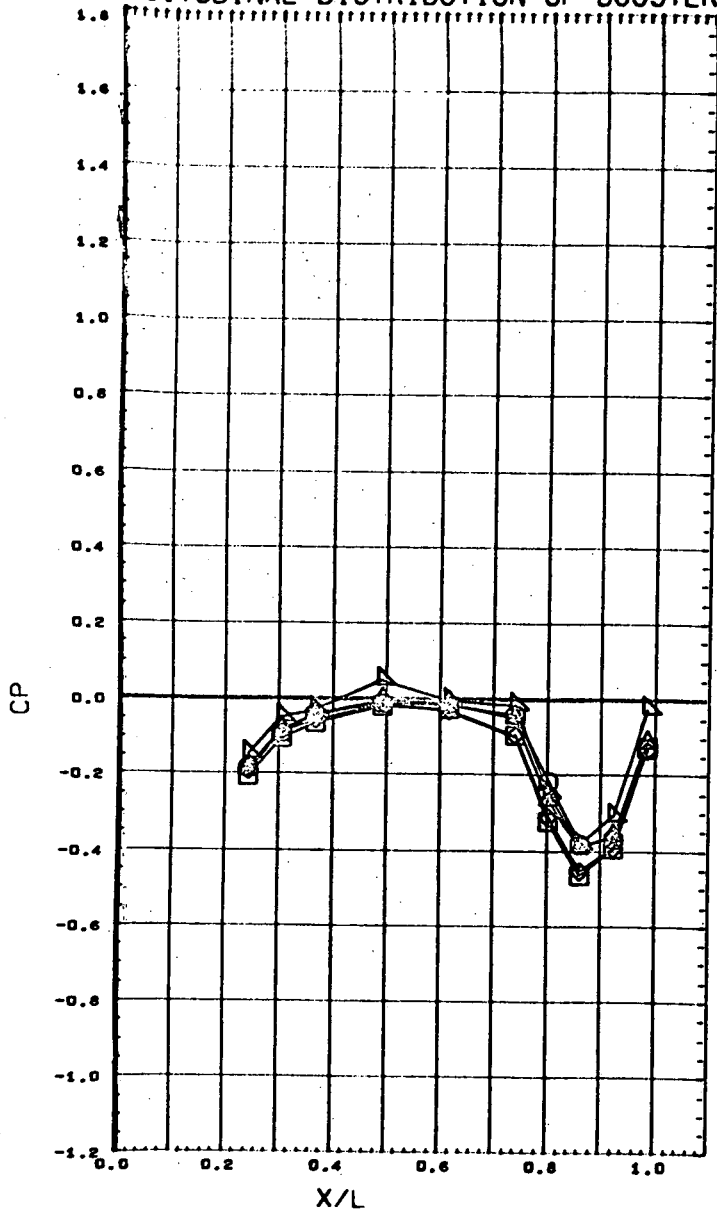

| SYMBOL | ALFB | THETA | M1 |
|--------|--------|--------|-------|
| ○ | 2.099 | 24.000 | 0.604 |
| △ | 4.077 | 45.000 | |
| ◇ | 6.072 | | |
| □ | 8.009 | | |
| ◇ | 10.065 | | |

REFERENCE FILE

PARAMETRIC VALUES
BETA 0.000

LONGITUDINAL DISTRIBUTION OF BOOSTER FUSELAGE PRESSURES

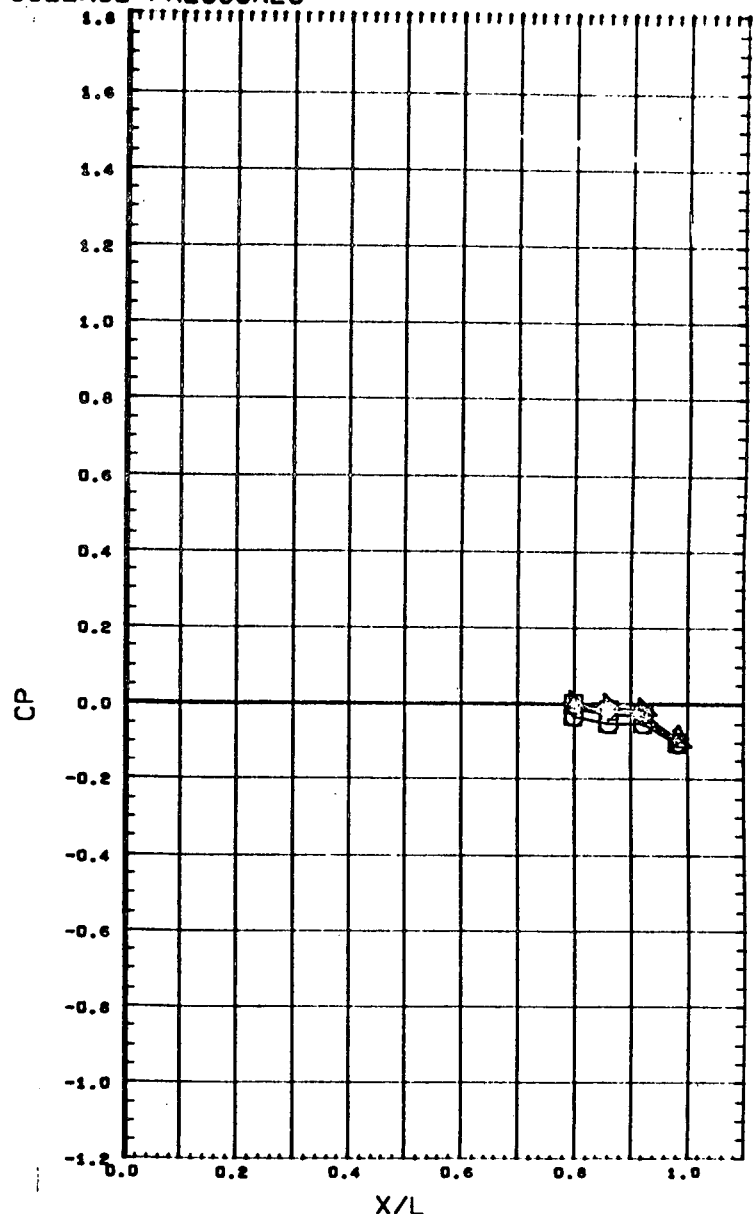
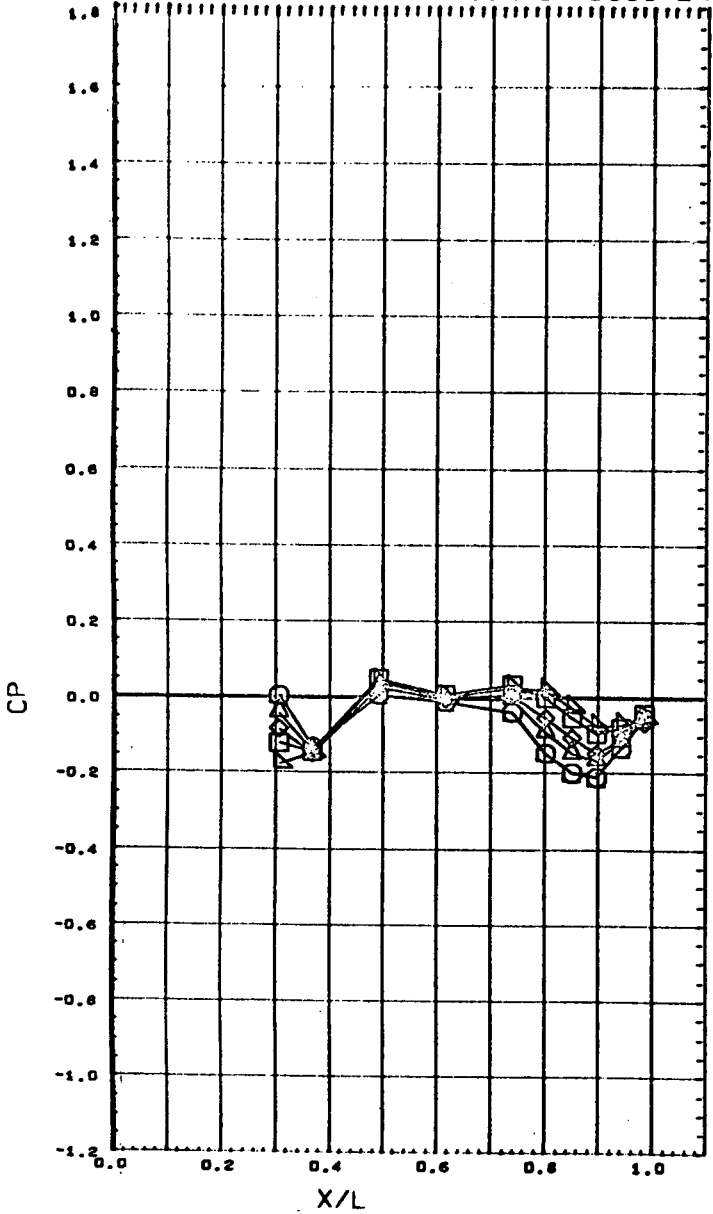

| SYMBOL | ALFB | THETA | M1 |
|--------|-------|---------|-------|
| ○ | 8.160 | 90.000 | 0.604 |
| ◇ | 5.879 | 180.000 | |
| △ | 3.899 | | |
| □ | 1.899 | | |
| | 0.093 | | |

PARAMETRIC VALUES
BETA 0.000

REFERENCE FILE

LONGITUDINAL DISTRIBUTION OF BOOSTER FUSELAGE PRESSURES

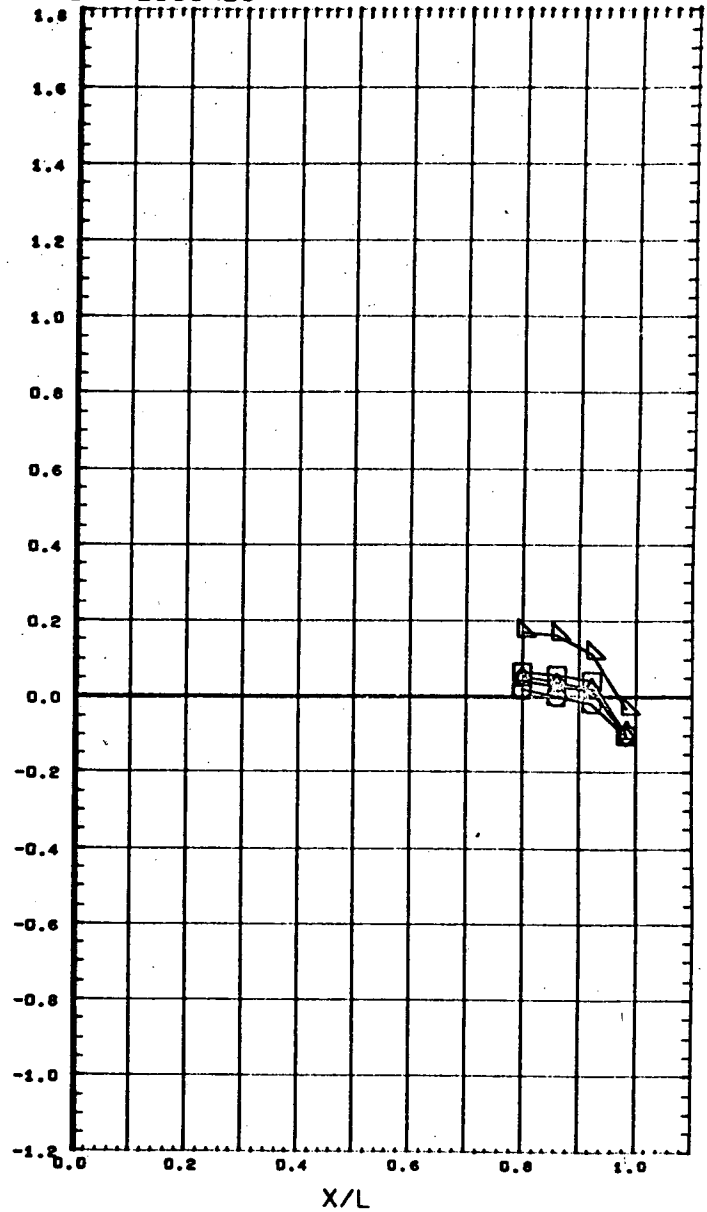
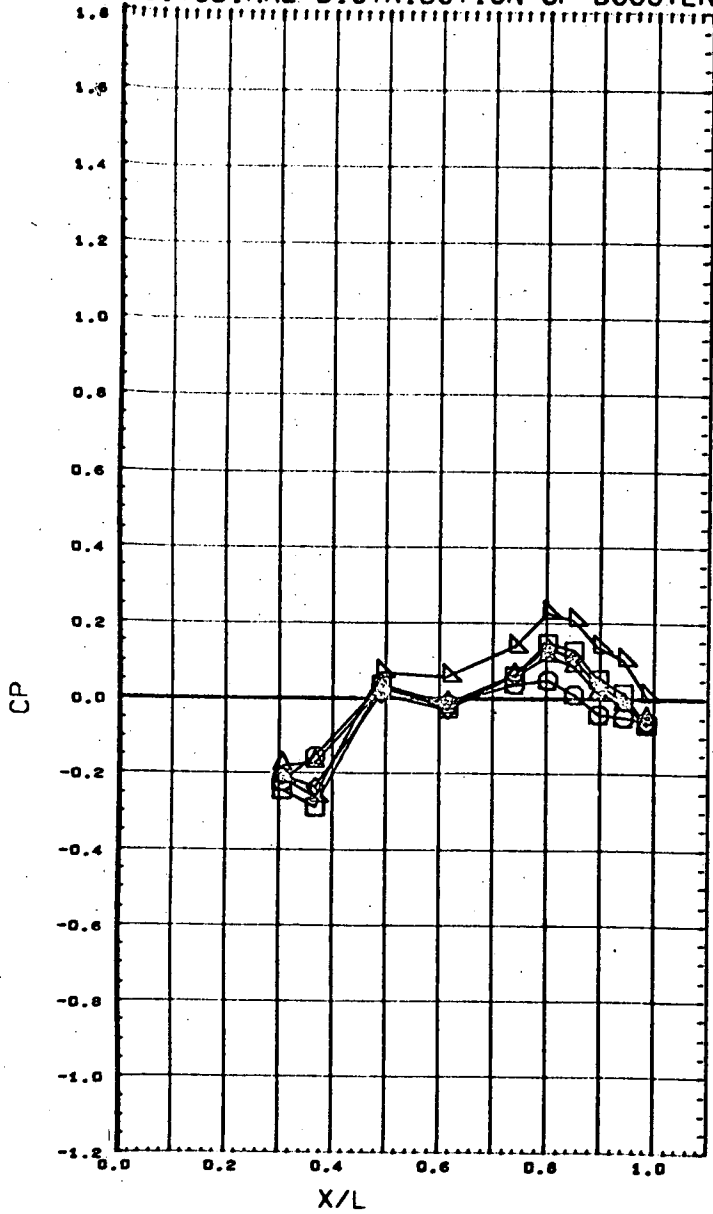

| SYMBOL | ALFB | THETA | M1 |
|--------|--------|---------|-------|
| ○ | 2.099 | 90.000 | 0.604 |
| ◇ | 4.077 | 180.000 | |
| △ | 6.072 | | |
| □ | 8.009 | | |
| ▽ | 10.065 | | |

PARAMETRIC VALUES
BETA 0.000

REFERENCE FILE

AEDC TC174 MDAC BOOSTER (BODY)

(ATC012)

PAGE 339

LONGITUDINAL DISTRIBUTION OF BOOSTER FUSELAGE PRESSURES

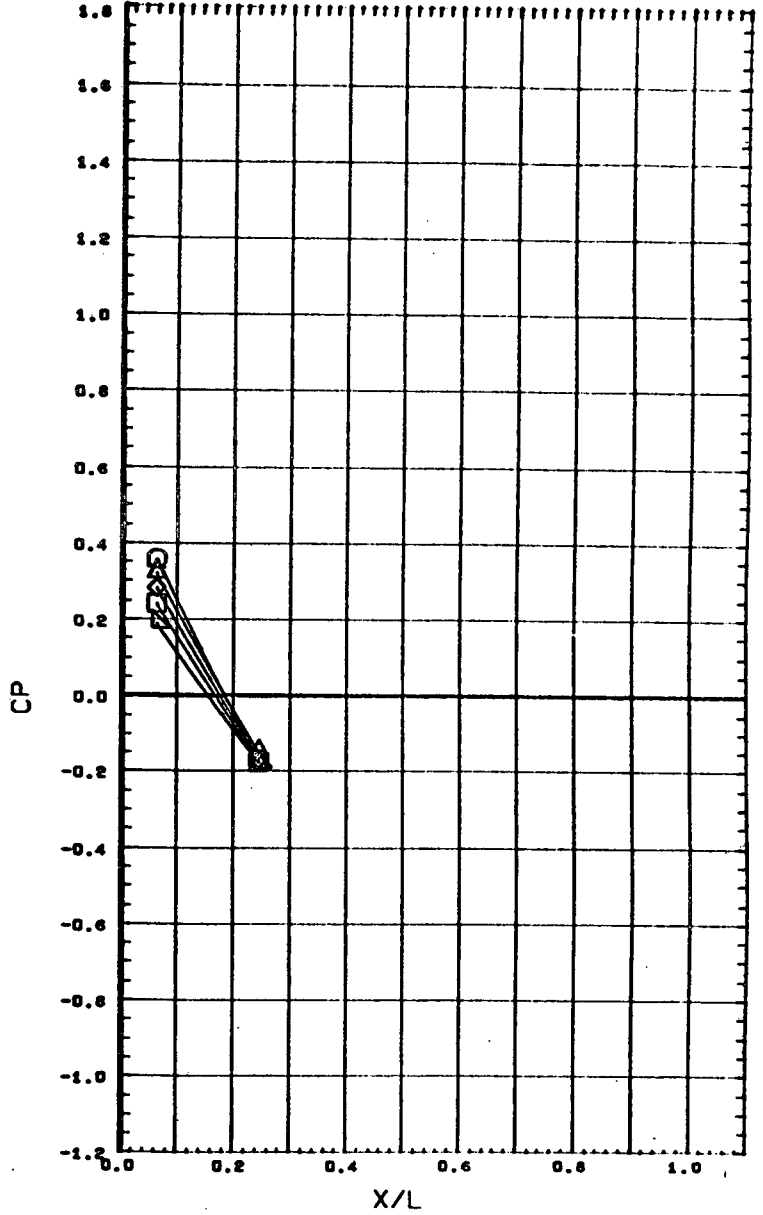
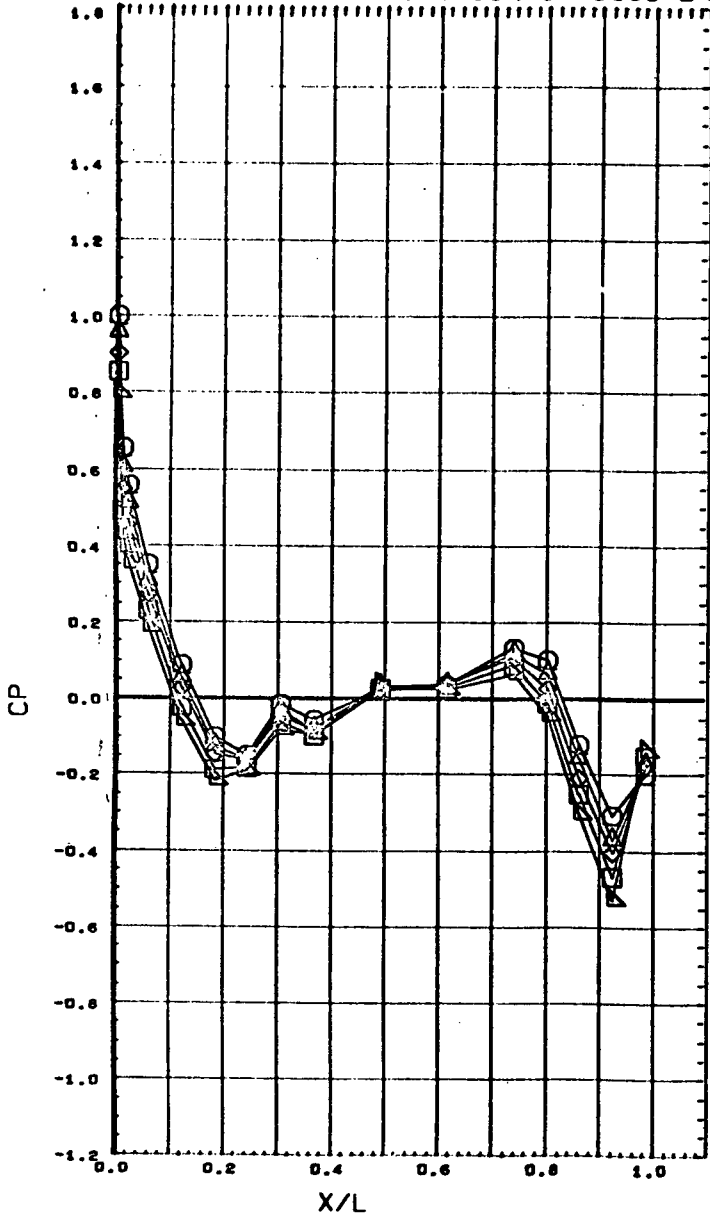

| SYMBOL | ALFB | THETA | M1 |
|--------|-------|--------|-------|
| ○ | 8.278 | 0.000 | 0.897 |
| ◇ | 5.834 | 15.000 | |
| △ | 3.850 | | |
| □ | 1.847 | | |
| ▽ | 0.155 | | |

BETA 0.000
PARAMETRIC VALUES

REFERENCE FILE

LONGITUDINAL DISTRIBUTION OF BOOSTER FUSELAGE PRESSURES

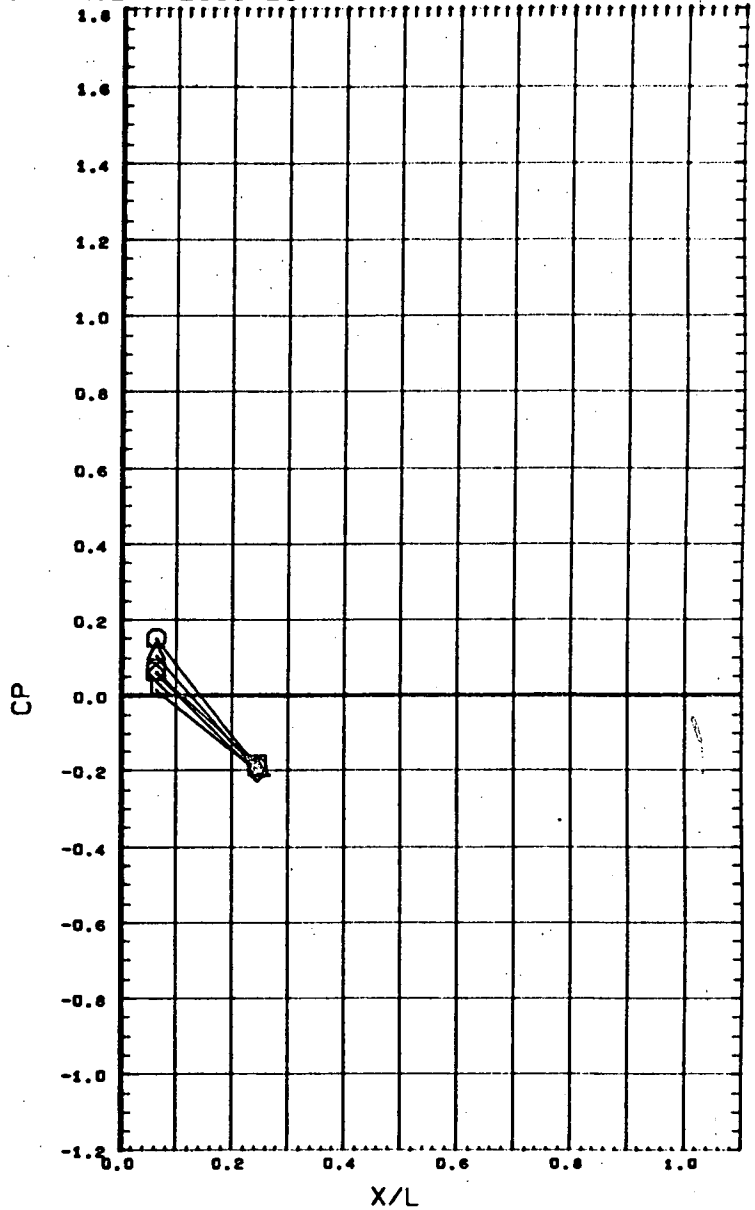
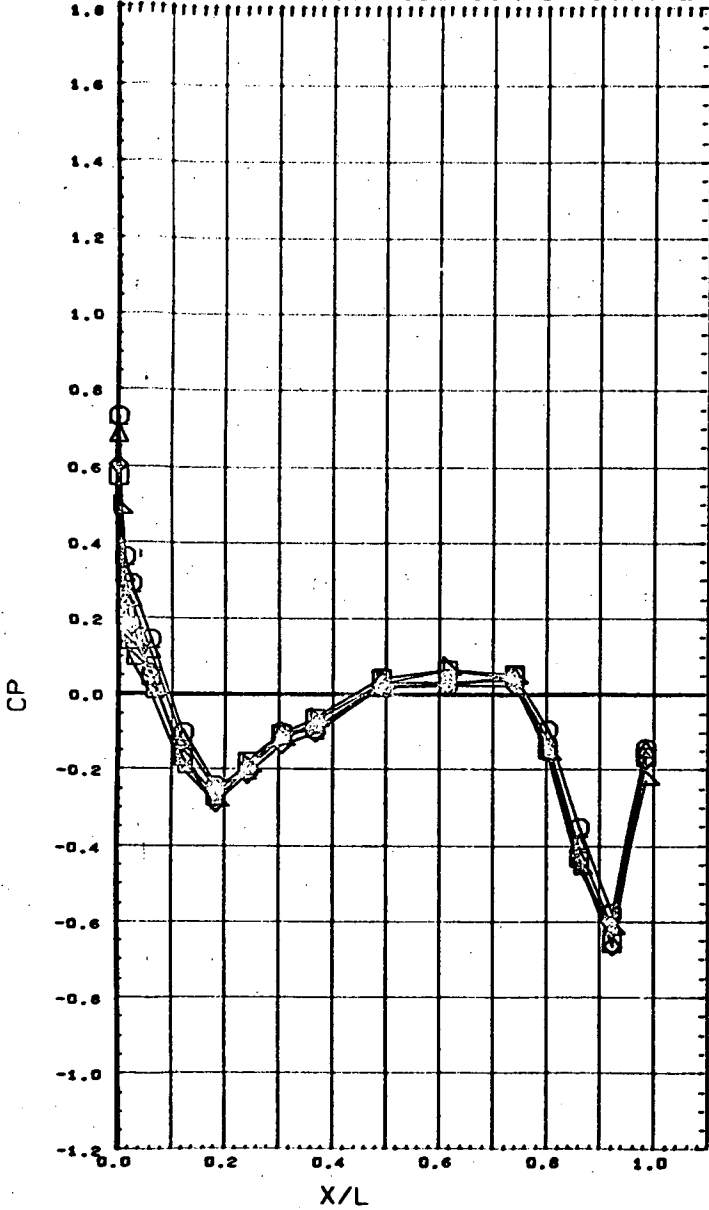

| SYMBOL | ALFB | THETA | M1 |
|--------|--------|--------|-------|
| ○ | 2.122 | 0.000 | 0.897 |
| ◇ | 4.086 | 15.000 | |
| △ | 6.078 | | |
| □ | 8.097 | | |
| ▽ | 10.093 | | |

REFERENCE FILE

PARAMETRIC VALUES
BETA 0.000

LONGITUDINAL DISTRIBUTION OF BOOSTER FUSELAGE PRESSURES

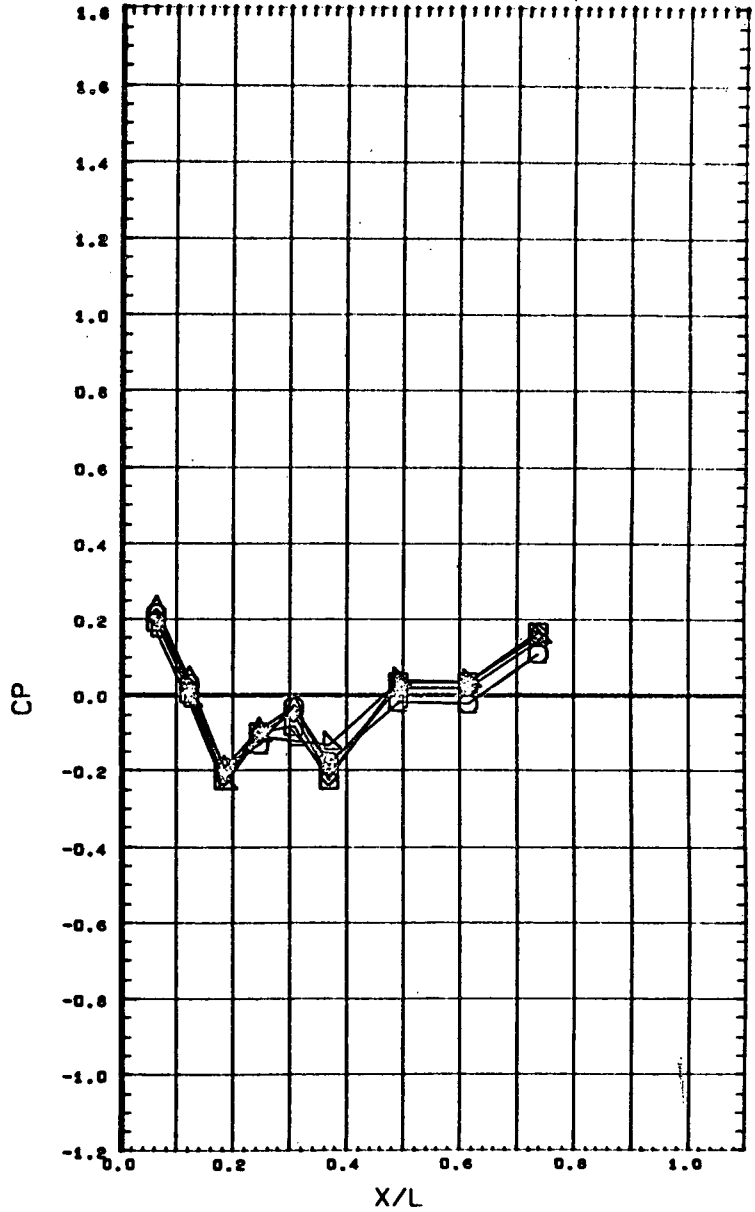
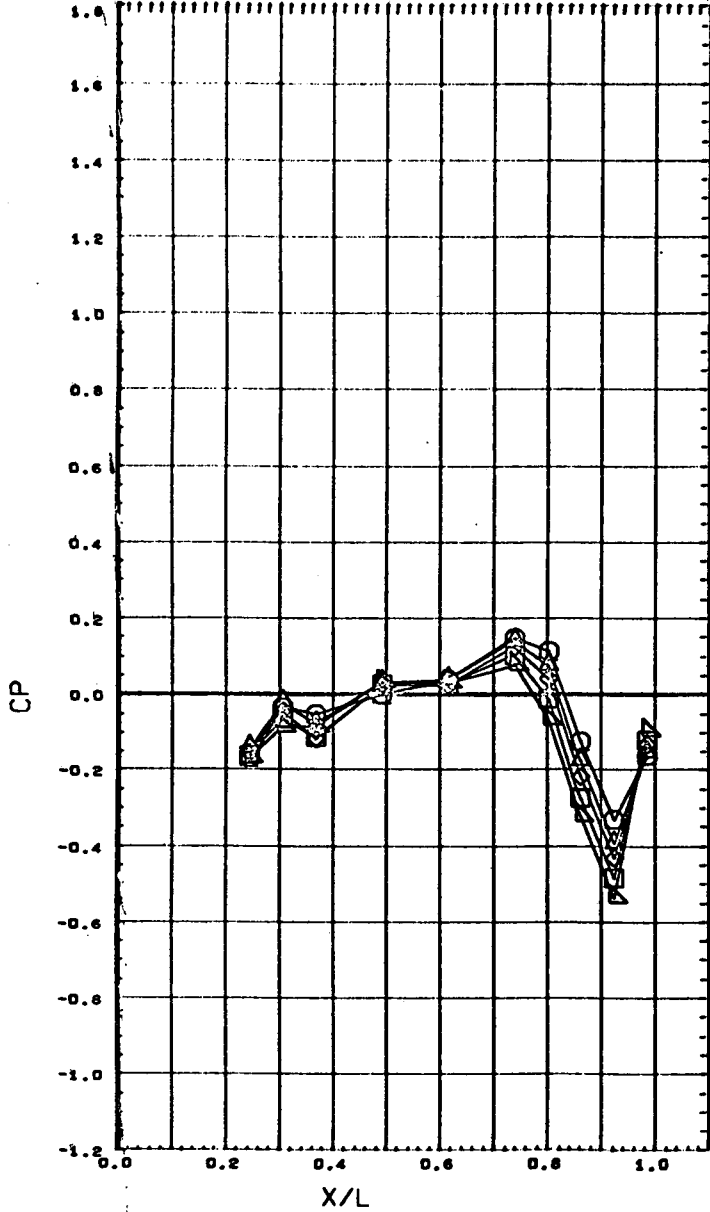

| SYMBOL | ALFB | THETA | M1 |
|--------|---------|--------|-------|
| ○ | - 8.278 | 24.000 | 0.897 |
| ◇ | - 5.834 | 45.000 | |
| △ | - 3.850 | | |
| □ | - 1.847 | | |
| ○ | 0.155 | | |

PARAMETRIC VALUES
BETA 0.000

REFERENCE FILE

LONGITUDINAL DISTRIBUTION OF BOOSTER FUSELAGE PRESSURES

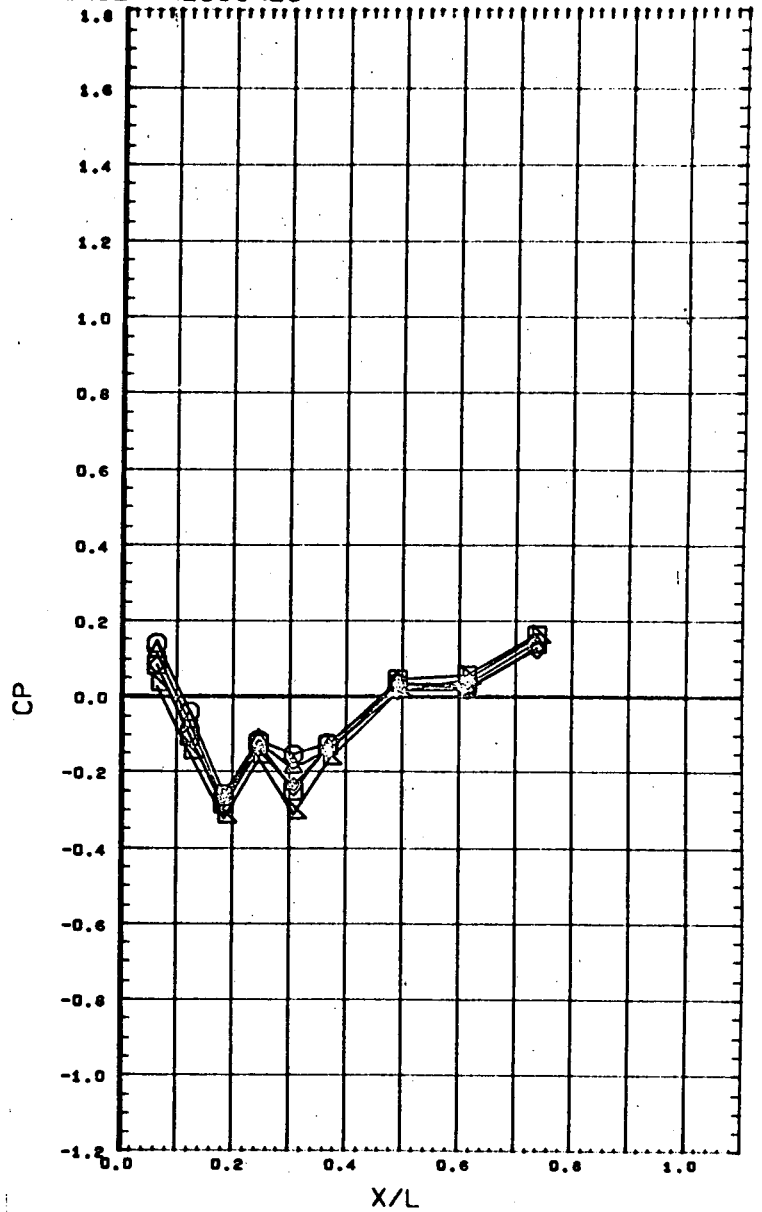
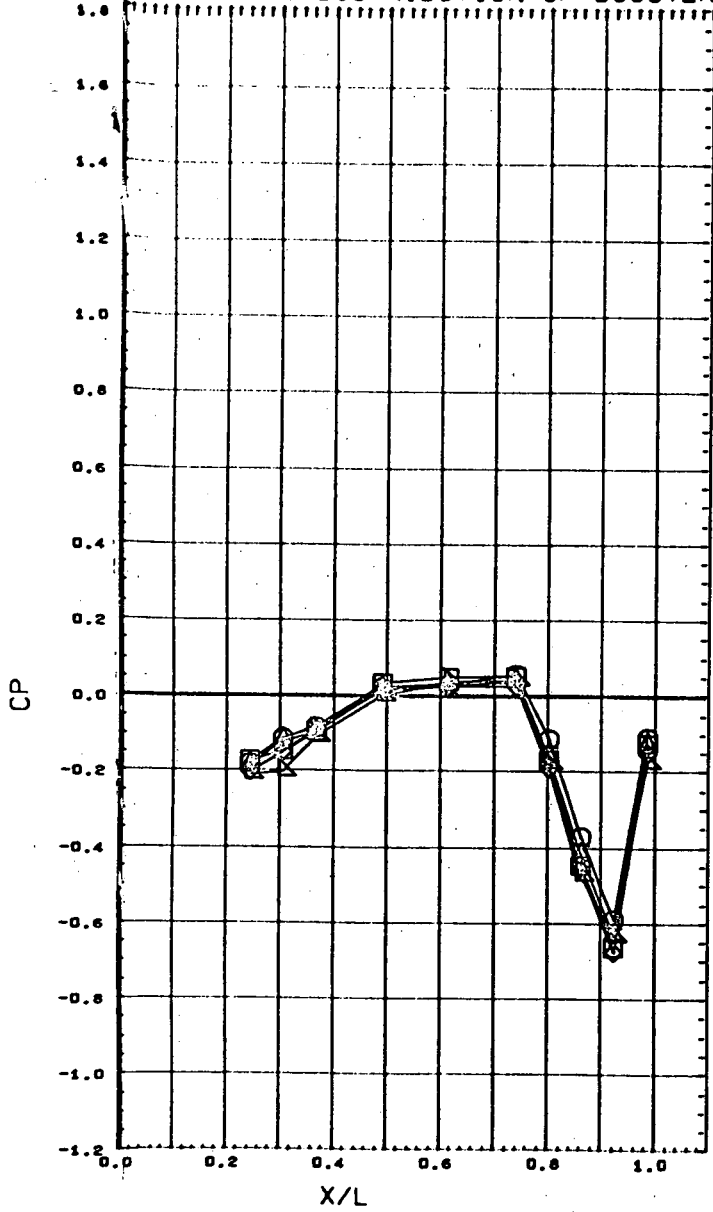

| SYMBOL | ALFB | THETA | M1 |
|--------|--------|--------|-------|
| ○ | 2.122 | 24.000 | 0.897 |
| ◇ | 4.086 | 45.000 | |
| △ | 6.078 | | |
| □ | 8.097 | | |
| ▽ | 10.093 | | |

REFERENCE FILE

PARAMETRIC VALUES
BETA 0.000

LONGITUDINAL DISTRIBUTION OF BOOSTER FUSELAGE PRESSURES

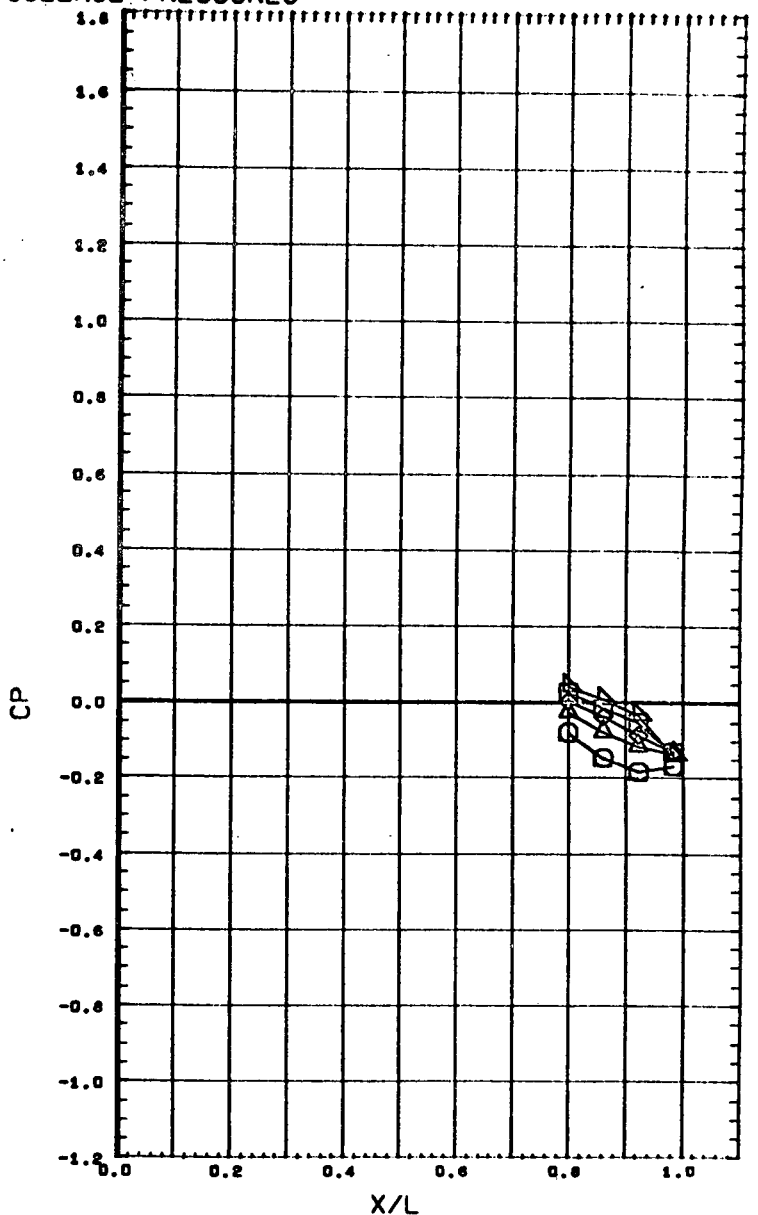
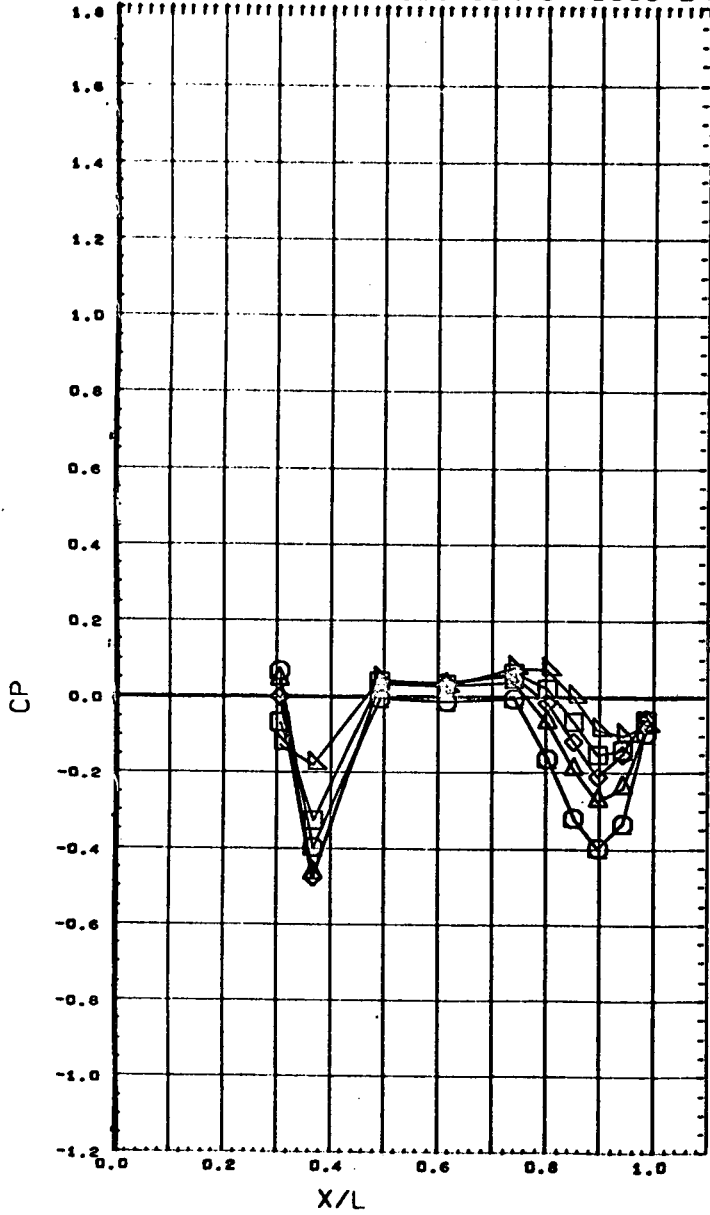

| SYMBOL | ALFB | THETA | M1 |
|--------|-------|---------|-------|
| ○ | 8.278 | 90.000 | 0.897 |
| △ | 5.834 | 180.000 | |
| ◇ | 3.850 | | |
| ▽ | 1.847 | | |
| | 0.155 | | |

REFERENCE FILE

PARAMETRIC VALUES
BETA 0.000

LONGITUDINAL DISTRIBUTION OF BOOSTER FUSELAGE PRESSURES

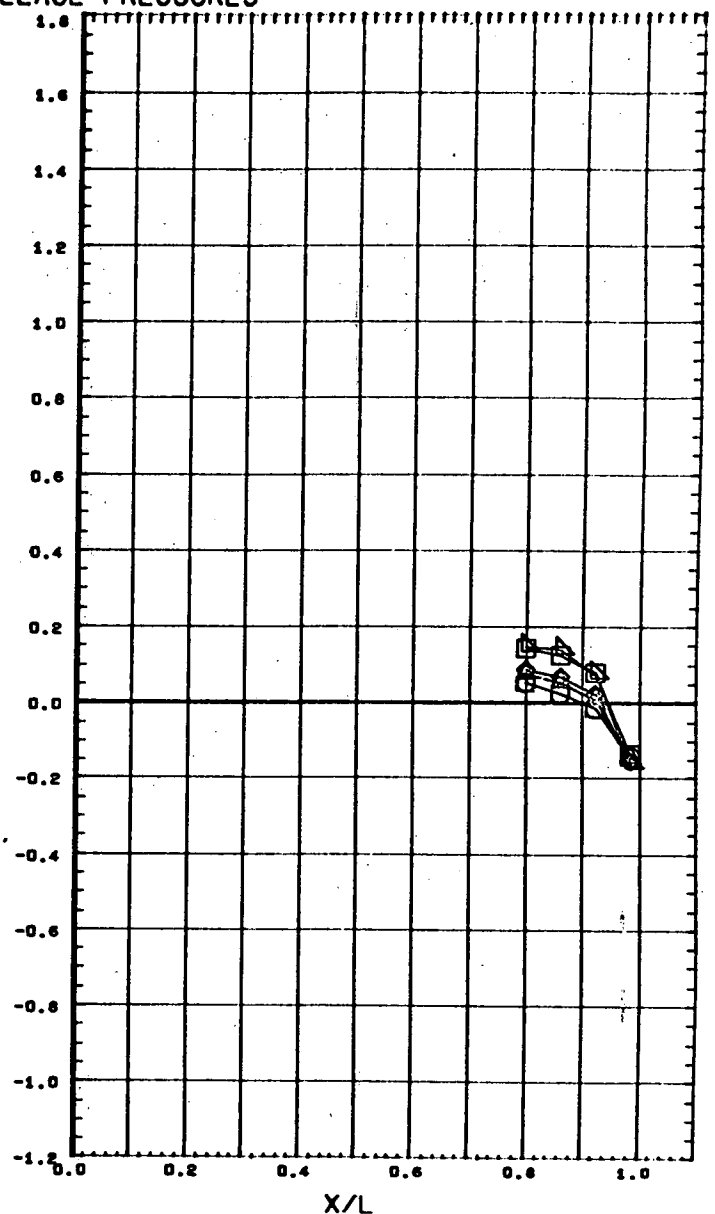
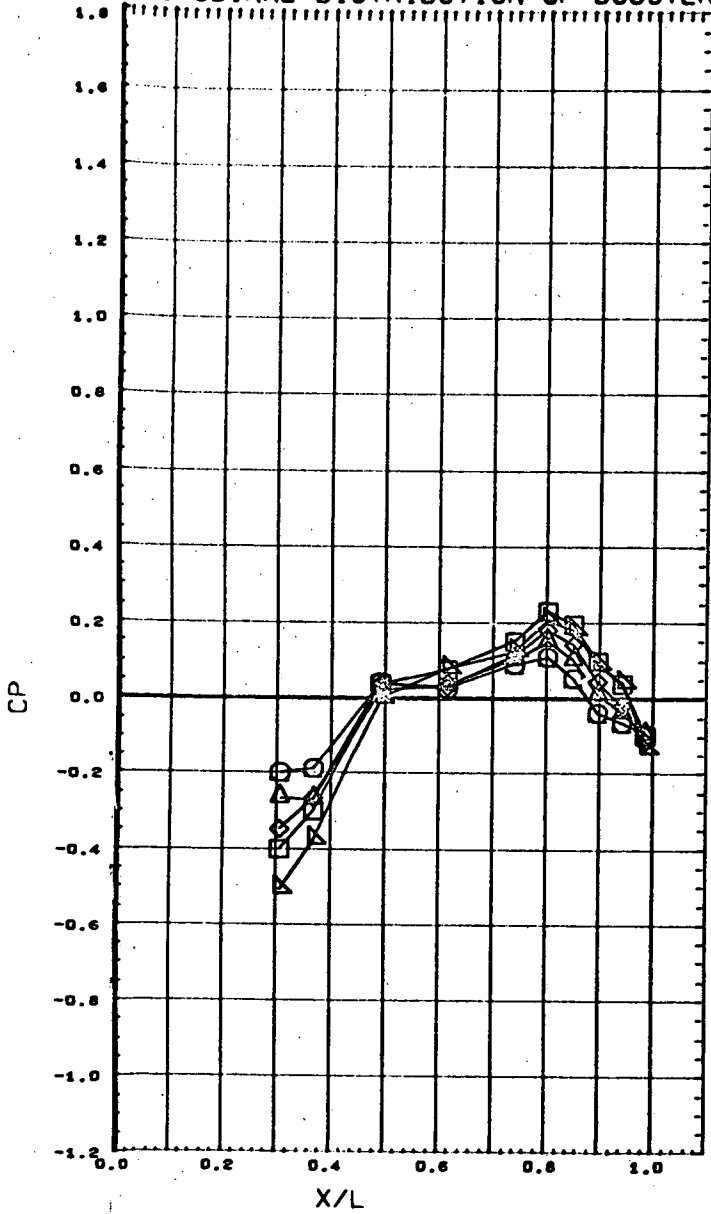

| SYMBOL | ALFB | THETA | M1 |
|--------|--------|---------|-------|
| ○ | 2.122 | 90.000 | 0.897 |
| ◇ | 4.086 | 180.000 | |
| △ | 6.078 | | |
| □ | 8.097 | | |
| ▽ | 10.093 | | |

BETA 0.000
PARAMETRIC VALUES

REFERENCE FILE

LONGITUDINAL DISTRIBUTION OF BOOSTER FUSELAGE PRESSURES

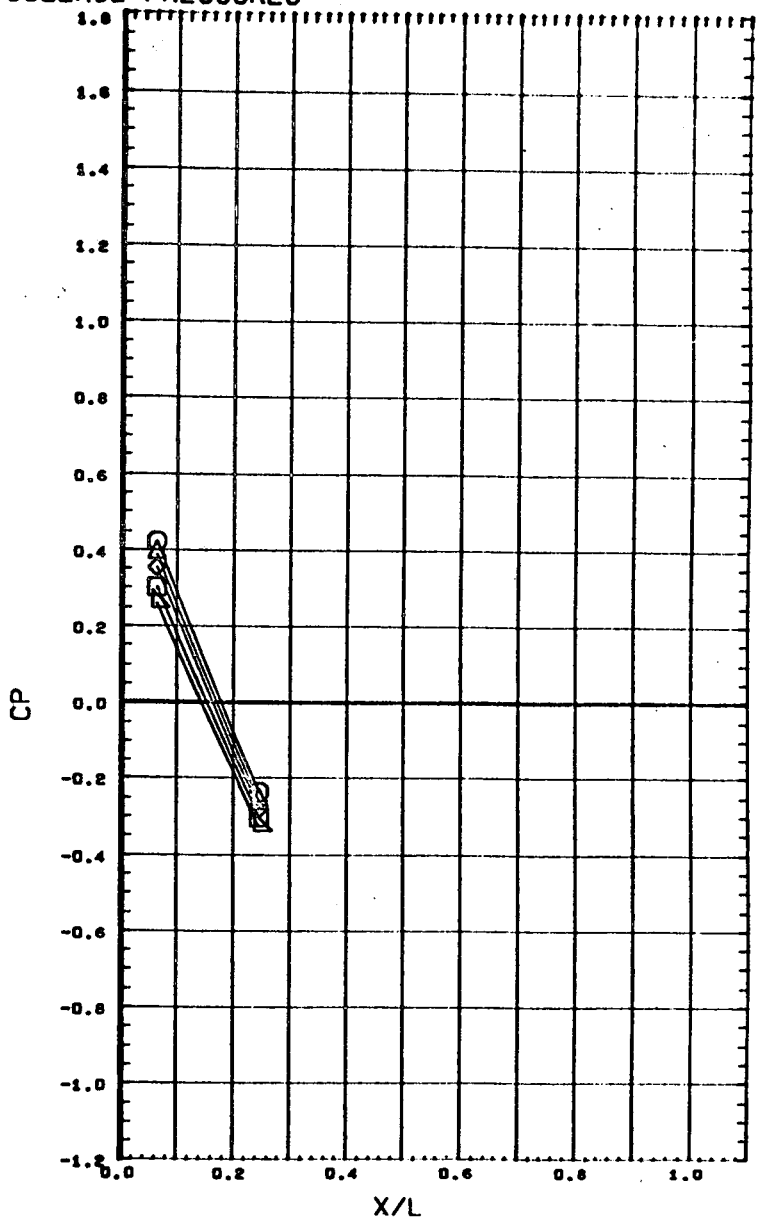
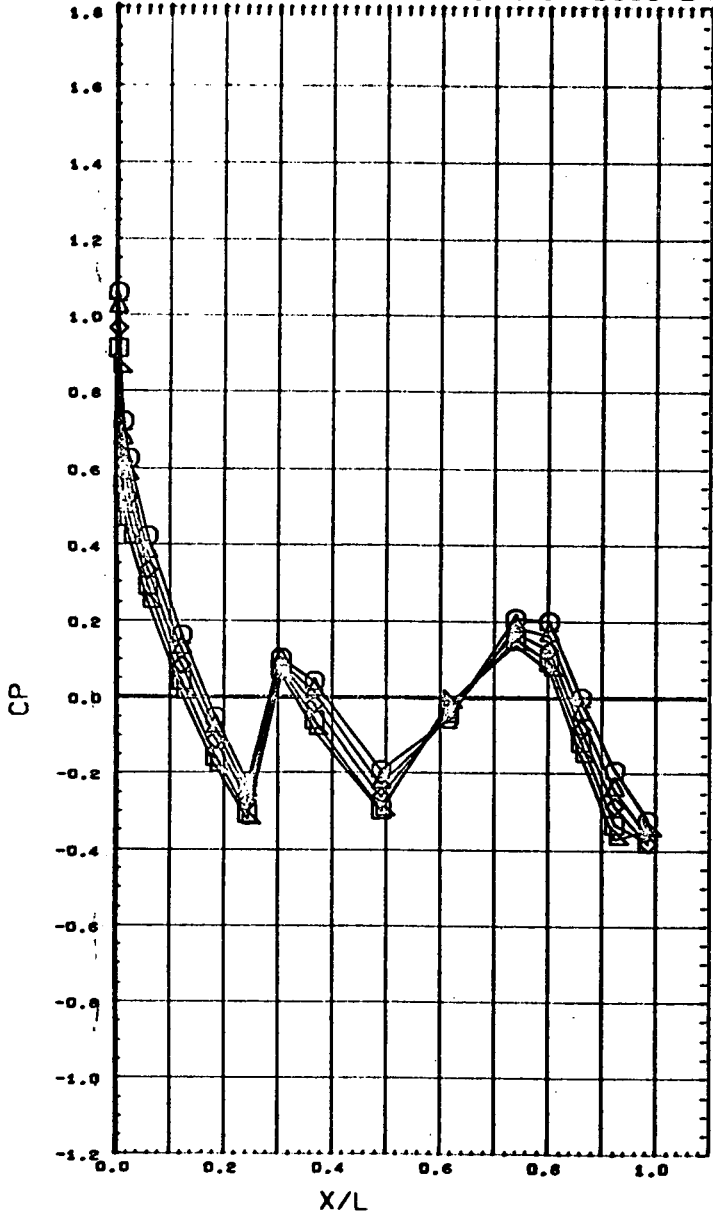

| SYMBOL | ALFB | THETA | M1 |
|--------|-------|--------|-------|
| ○ | 7.938 | 0.000 | 0.999 |
| ◇ | 5.832 | 15.000 | |
| △ | 3.830 | | |
| □ | 1.825 | | |
| ◇ | 0.148 | | |

BETA PARAMETRIC VALUES
0.000

REFERENCE FILE

LONGITUDINAL DISTRIBUTION OF BOOSTER FUSELAGE PRESSURES

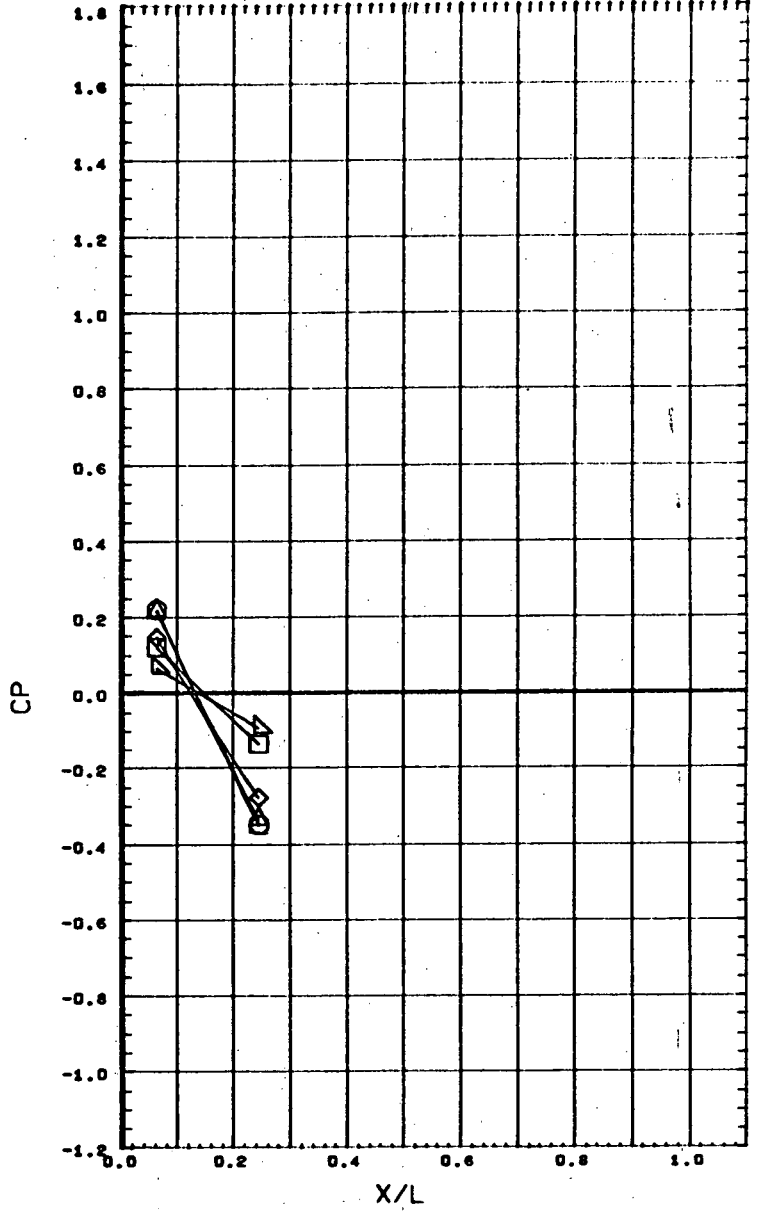
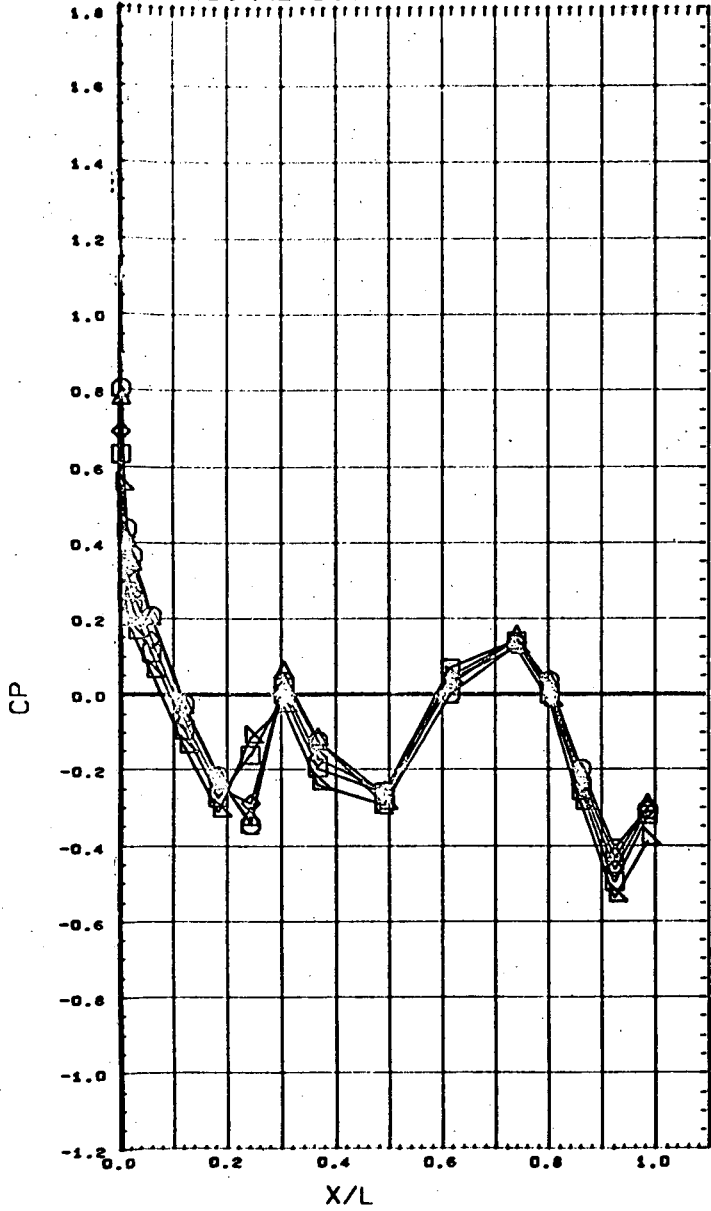

| SYMBOL | ALFB | THETA | M1 |
|--------|--------|--------|-------|
| ○ | 2.161 | 0.000 | 0.999 |
| ◇ | 4.143 | 15.000 | |
| △ | 6.134 | | |
| □ | 8.108 | | |
| ◇ | 10.097 | | |

REFERENCE FILE

PARAMETRIC VALUES
BETA 0.000

LONGITUDINAL DISTRIBUTION OF BOOSTER FUSELAGE PRESSURES

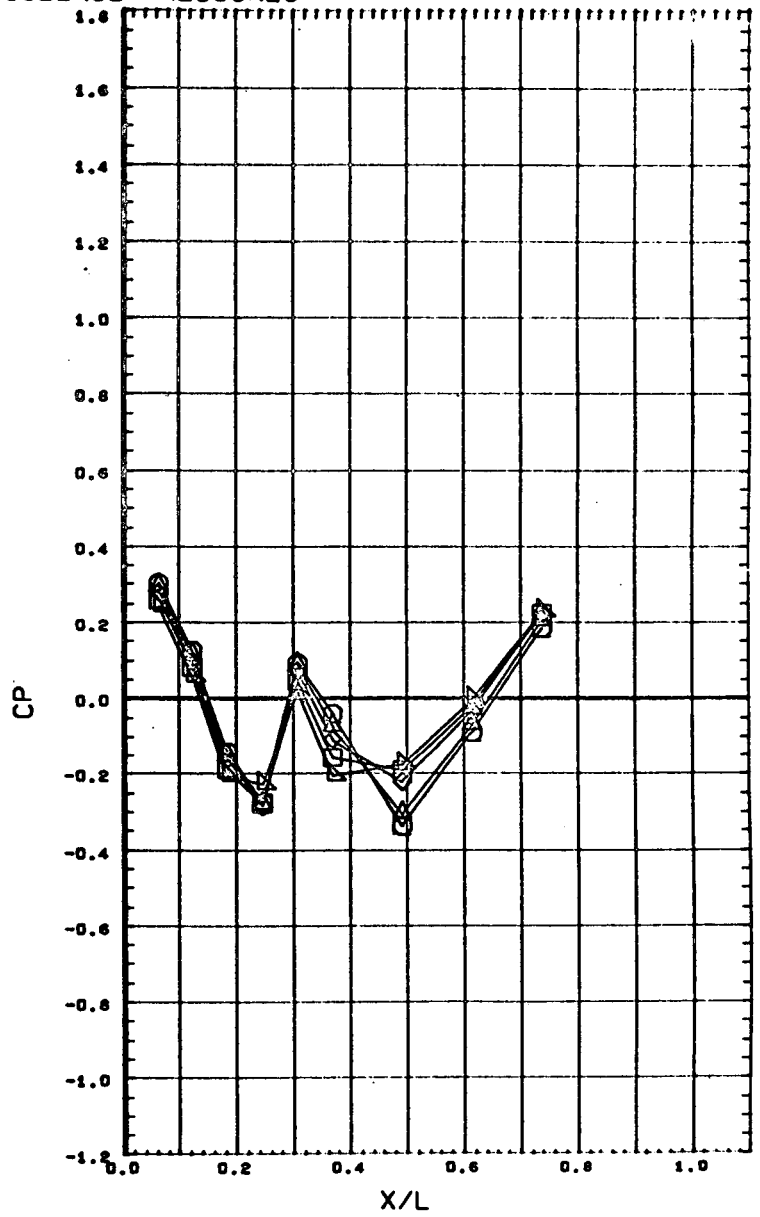
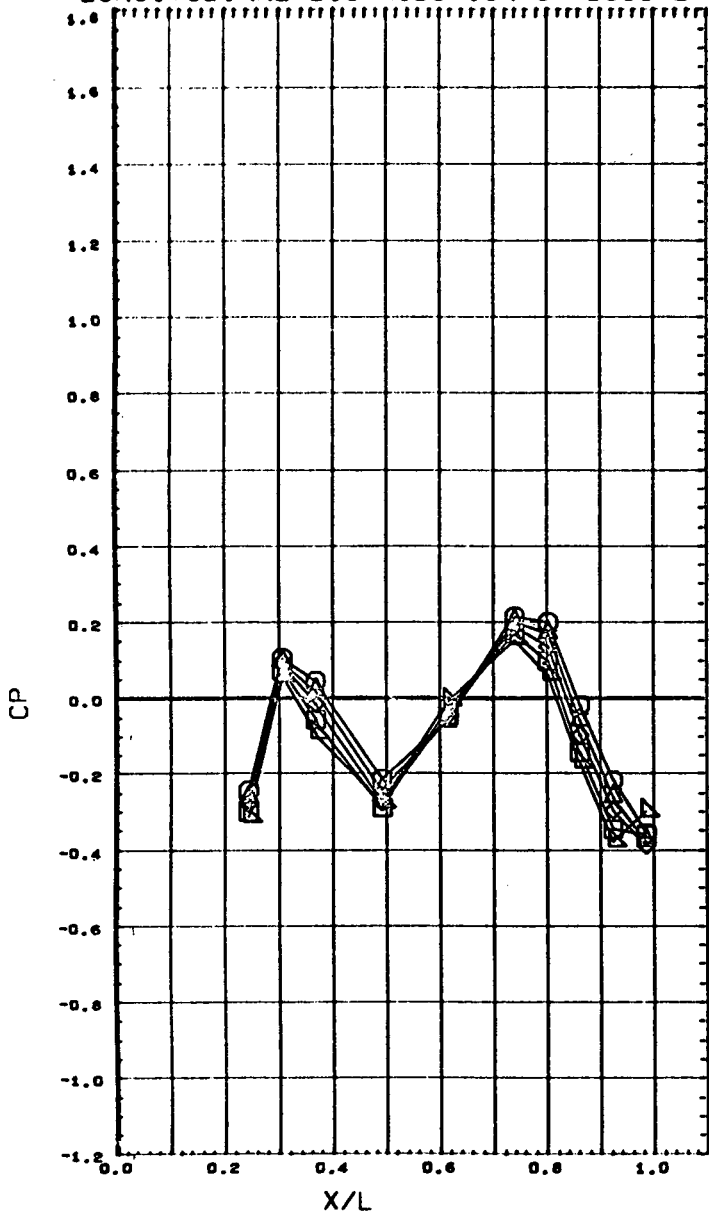

| SYMBOL | ALFB | THETA | M1 |
|--------|-------|--------|-------|
| ○ | 7.938 | 24.000 | 0.999 |
| ◇ | 5.832 | 45.000 | |
| △ | 3.430 | | |
| □ | 1.825 | | |
| ▽ | 0.148 | | |

PARAMETRIC VALUES
BETA 0.000

REFERENCE FILE

LONGITUDINAL DISTRIBUTION OF BOOSTER FUSELAGE PRESSURES

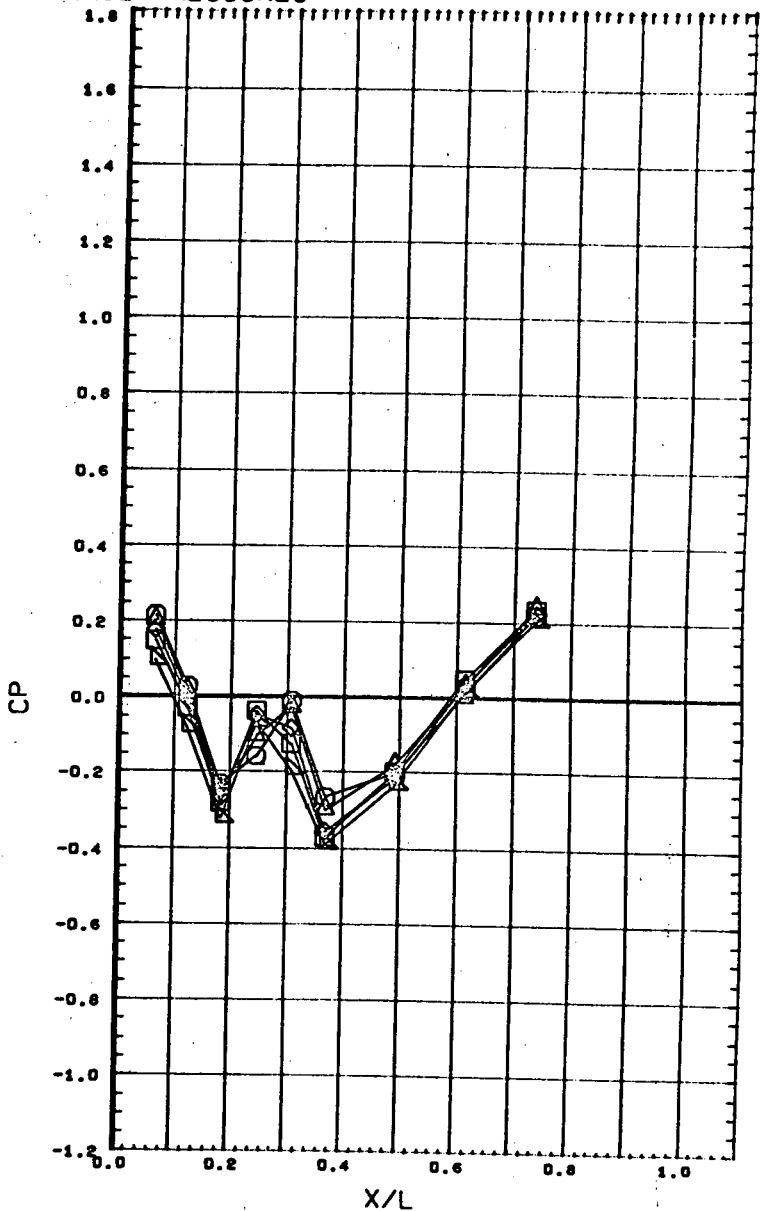
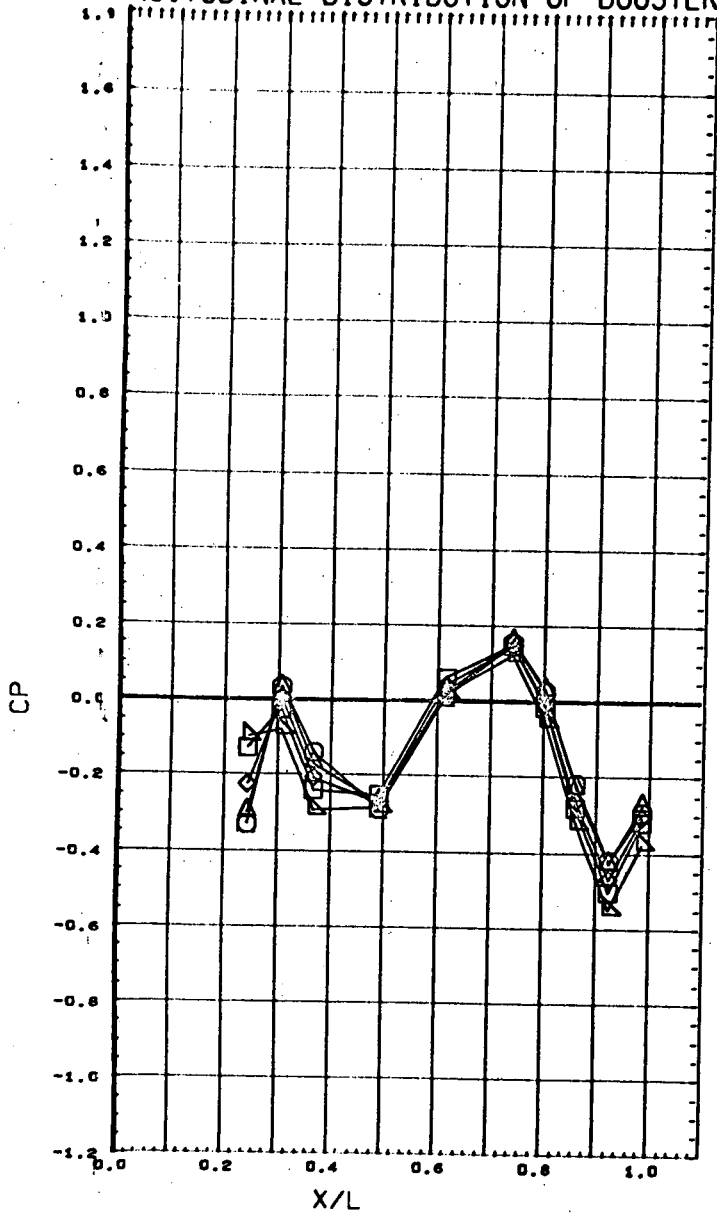

| SYMBOL | ALFB | THETA | M1 |
|--------|--------|--------|-------|
| ○ | 2.161 | 24.000 | 0.999 |
| △ | 4.143 | 45.000 | |
| ◇ | 6.134 | | |
| □ | 8.108 | | |
| ▽ | 10.097 | | |

REFERENCE FILE

PARAMETRIC VALUES
BETA 0.000

LONGITUDINAL DISTRIBUTION OF BOOSTER FUSELAGE PRESSURES

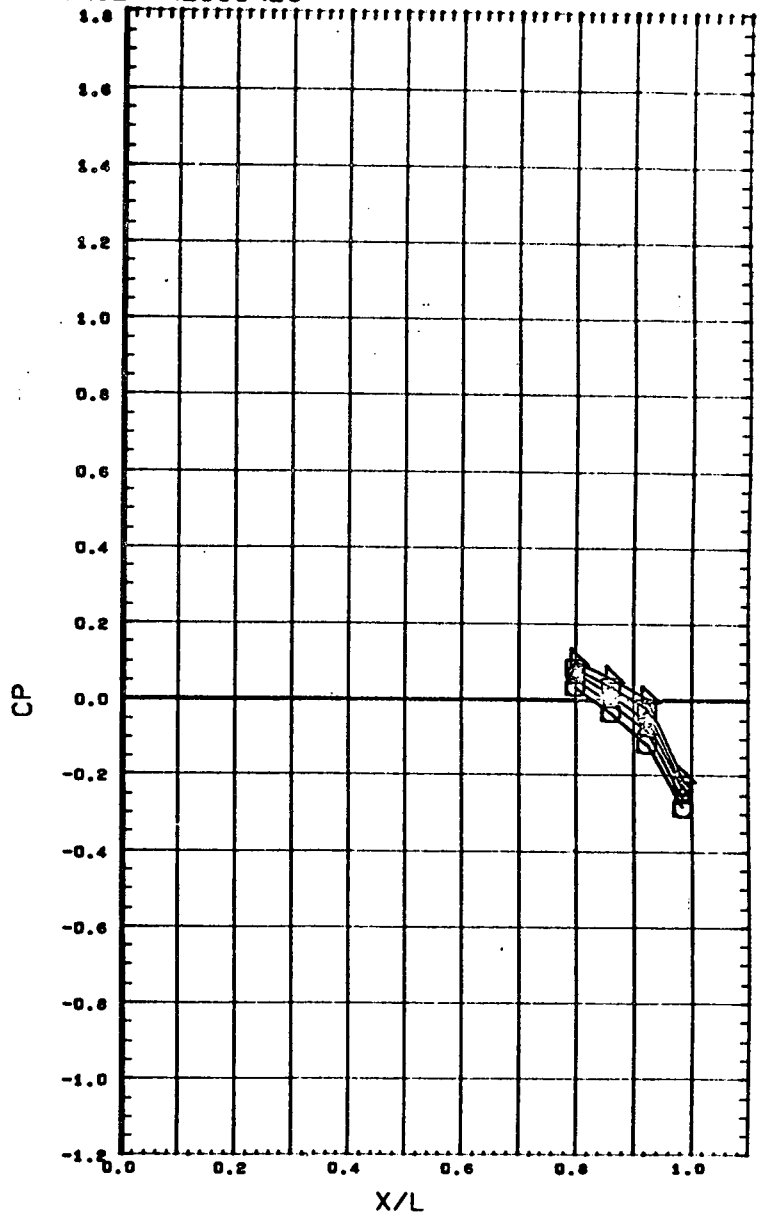
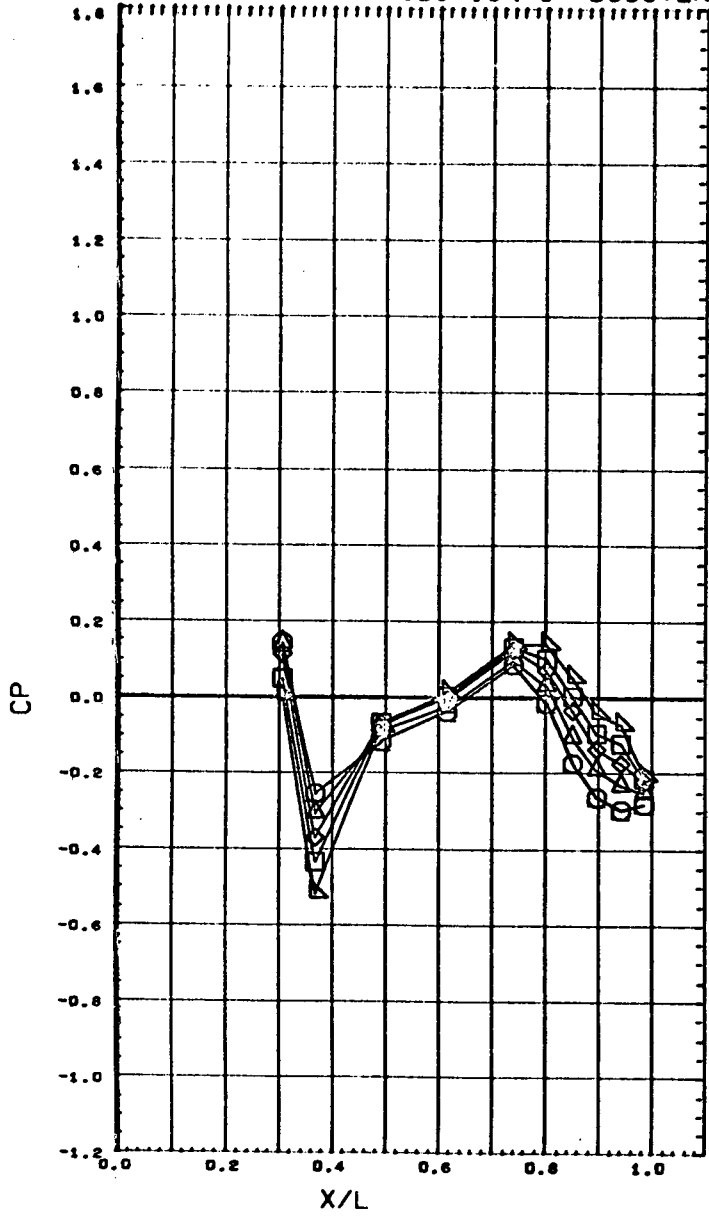

| SYMBOL | ALFB | THETA | M1 |
|--------|-------|---------|-------|
| ○ | 7.938 | 90.000 | 0.999 |
| △ | 5.832 | 180.000 | |
| ◇ | 3.830 | | |
| □ | 1.825 | | |
| ▽ | 0.148 | | |

REFERENCE FILE

PARAMETRIC VALUES
BETA 0.000

LONGITUDINAL DISTRIBUTION OF BOOSTER FUSELAGE PRESSURES

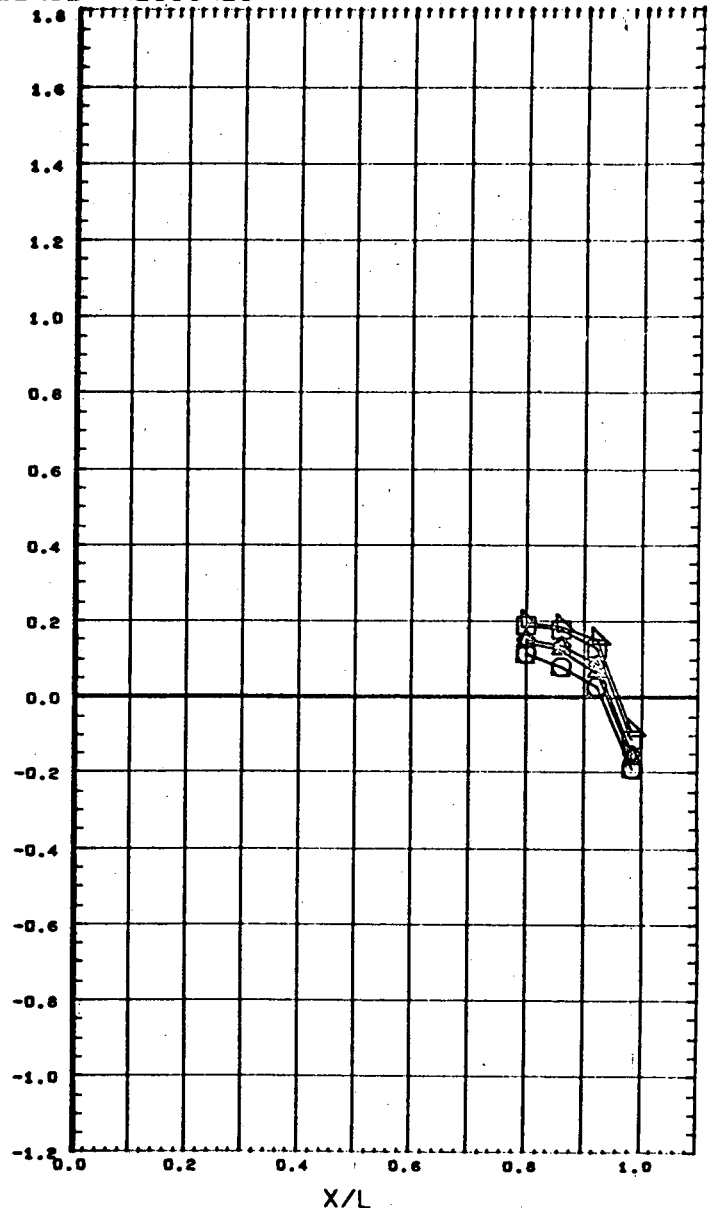
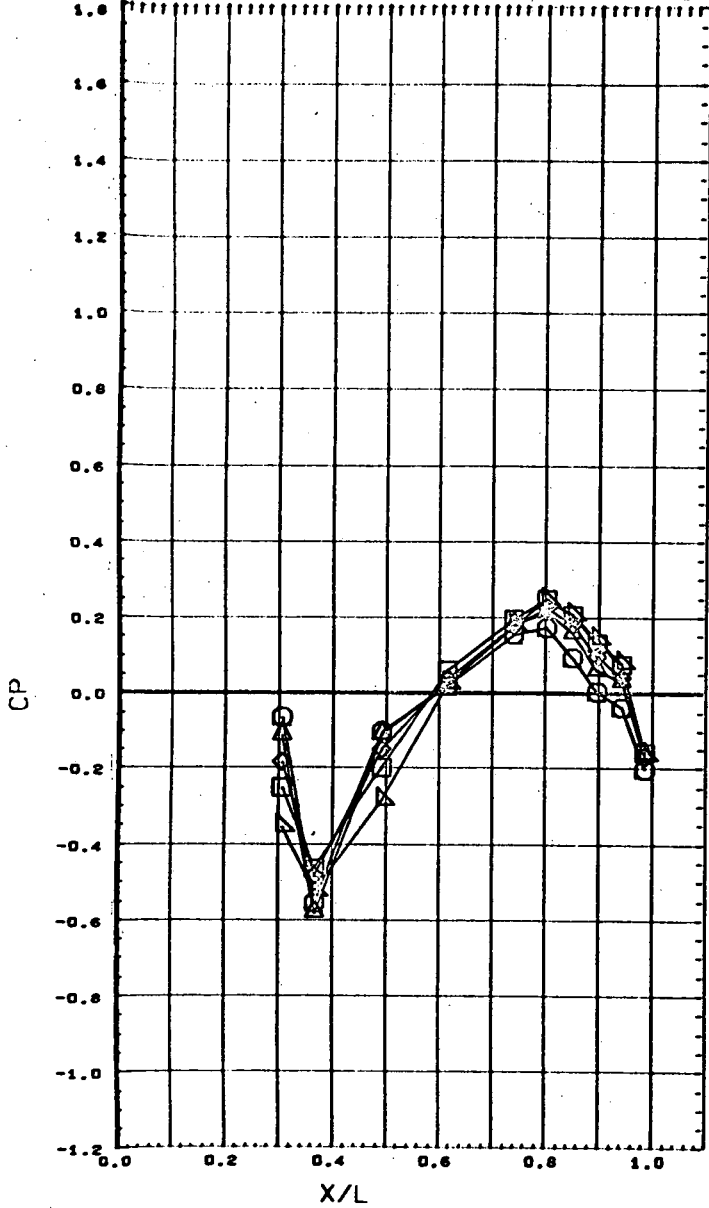

| SYMBOL | ALFB | THETA | M1 |
|--------|--------|---------|-------|
| ○ | 2.161 | 95.000 | 0.999 |
| △ | 4.143 | 185.000 | |
| ◇ | 6.134 | | |
| □ | 8.108 | | |
| ▽ | 10.097 | | |

REFERENCE FILE

PARAMETRIC VALUES
BETA 0.000

LONGITUDINAL DISTRIBUTION OF BOOSTER FUSELAGE PRESSURES

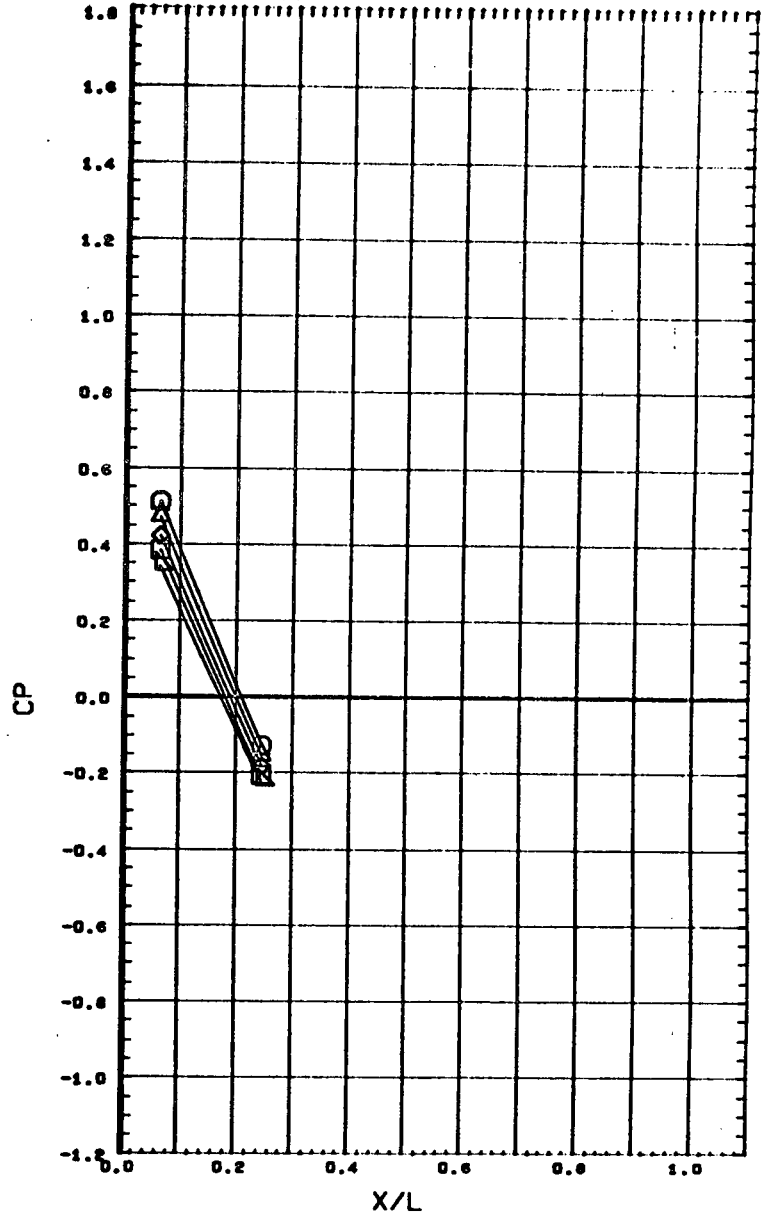
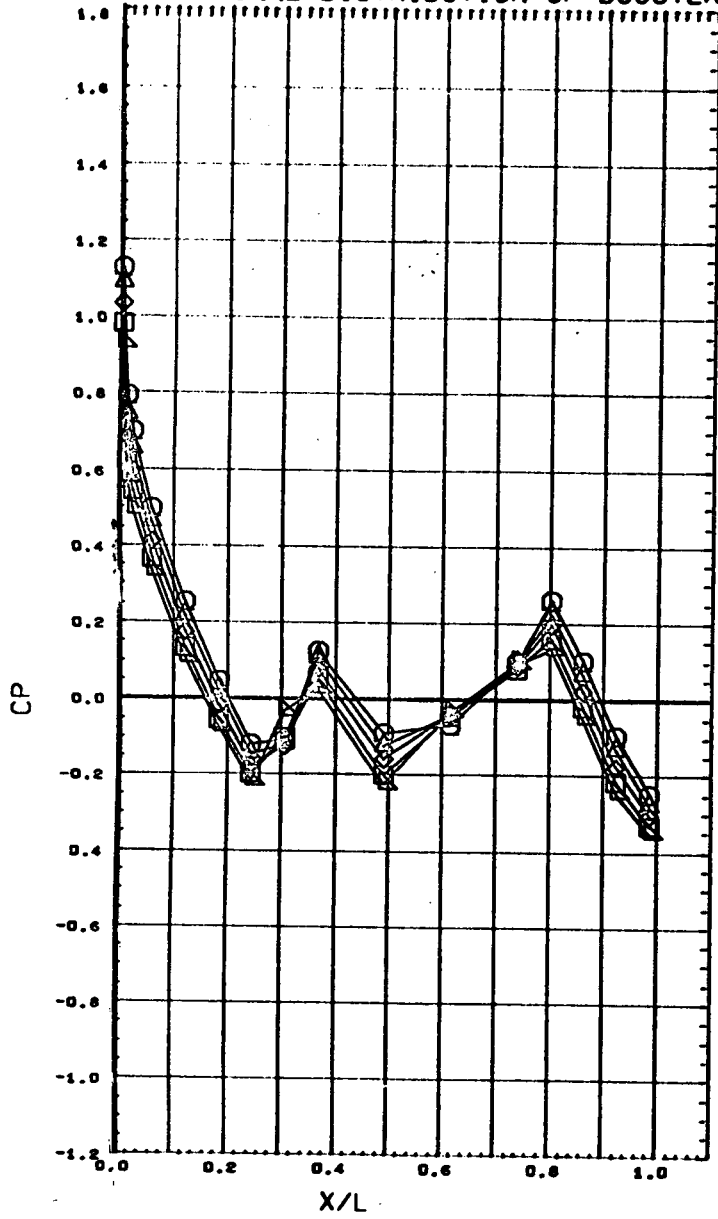

| SYMBOL | ALFB | THETA | M1 |
|--------|-------|--------|-------|
| ○ | 7.924 | 0.000 | 1.100 |
| ◇ | 7.825 | 15.000 | |
| △ | 7.839 | | |
| □ | 7.836 | | |
| ○ | 7.132 | | |

REFERENCE FILE

BETA PARAMETRIC VALUES
0.000

LONGITUDINAL DISTRIBUTION OF BOOSTER FUSELAGE PRESSURES

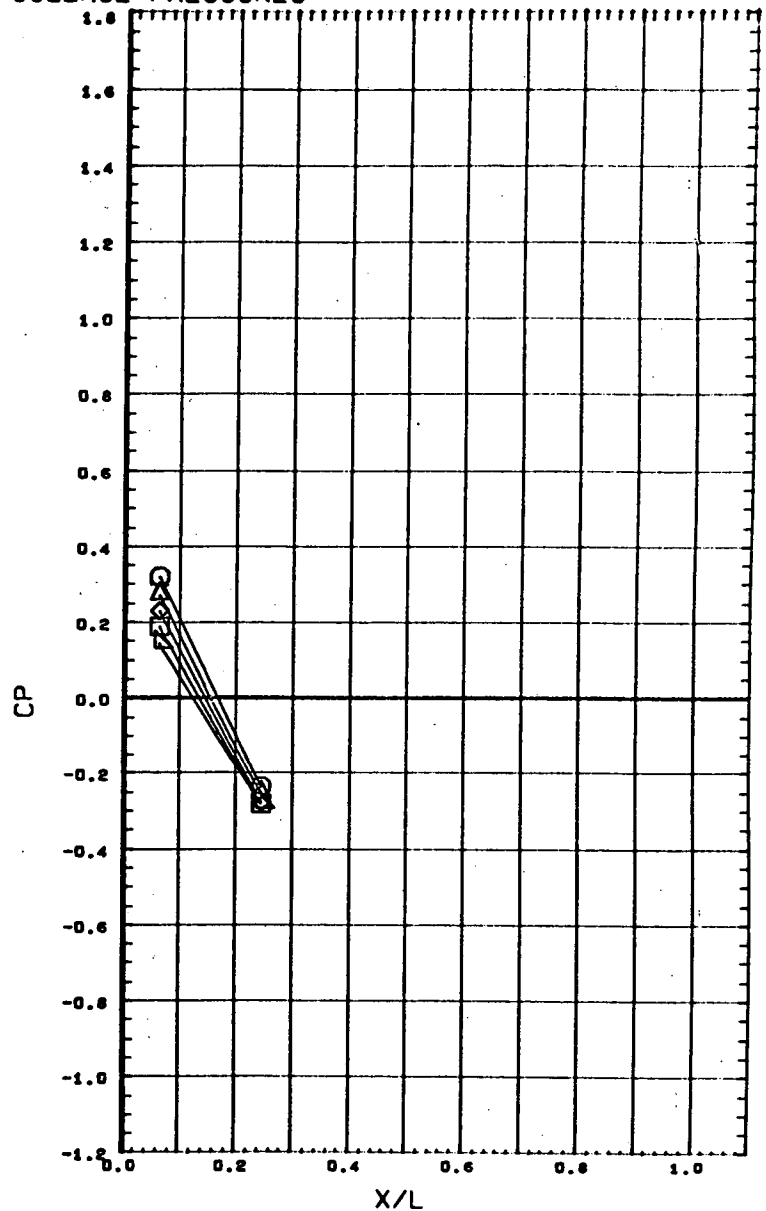
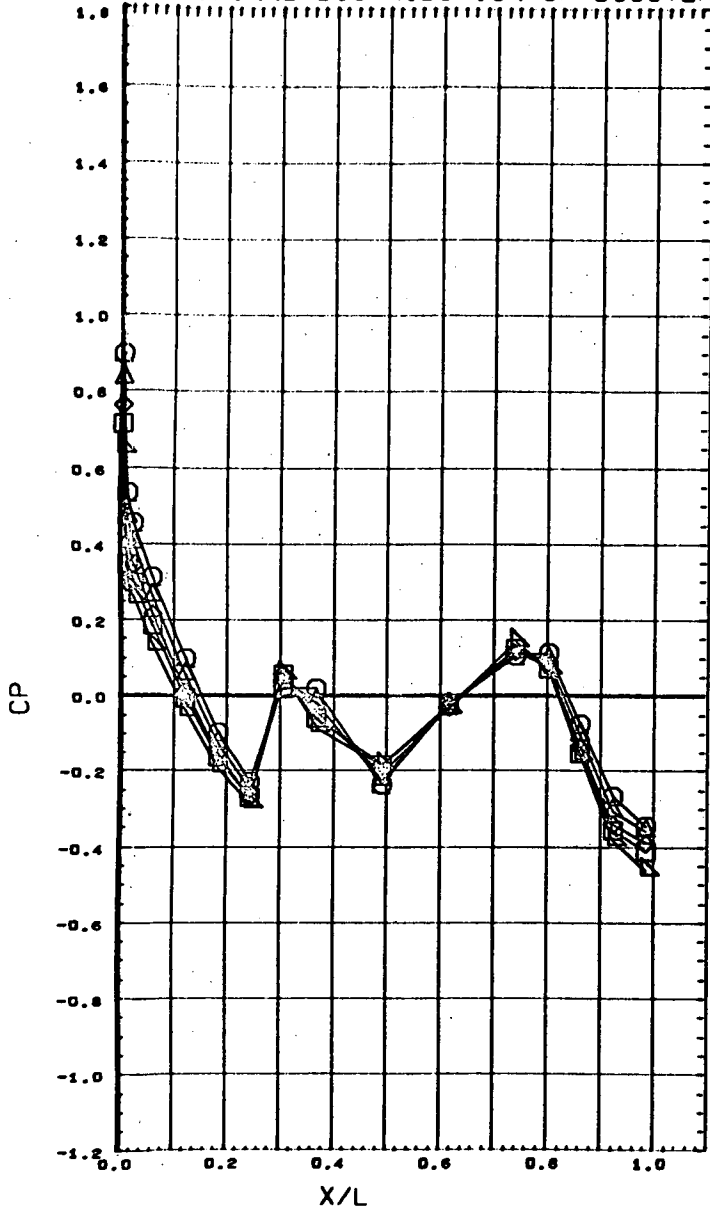

| SYMBOL | ALFB | THETA | M1 |
|--------|--------|--------|-------|
| ○ | 1.941 | 0.000 | 1.100 |
| △ | 4.070 | 15.000 | |
| ◇ | 6.179 | | |
| □ | 8.163 | | |
| ▽ | 10.138 | | |

REFERENCE FILE

PARAMETRIC VALUES
BETA 0.000

LONGITUDINAL DISTRIBUTION OF BOOSTER FUSELAGE PRESSURES

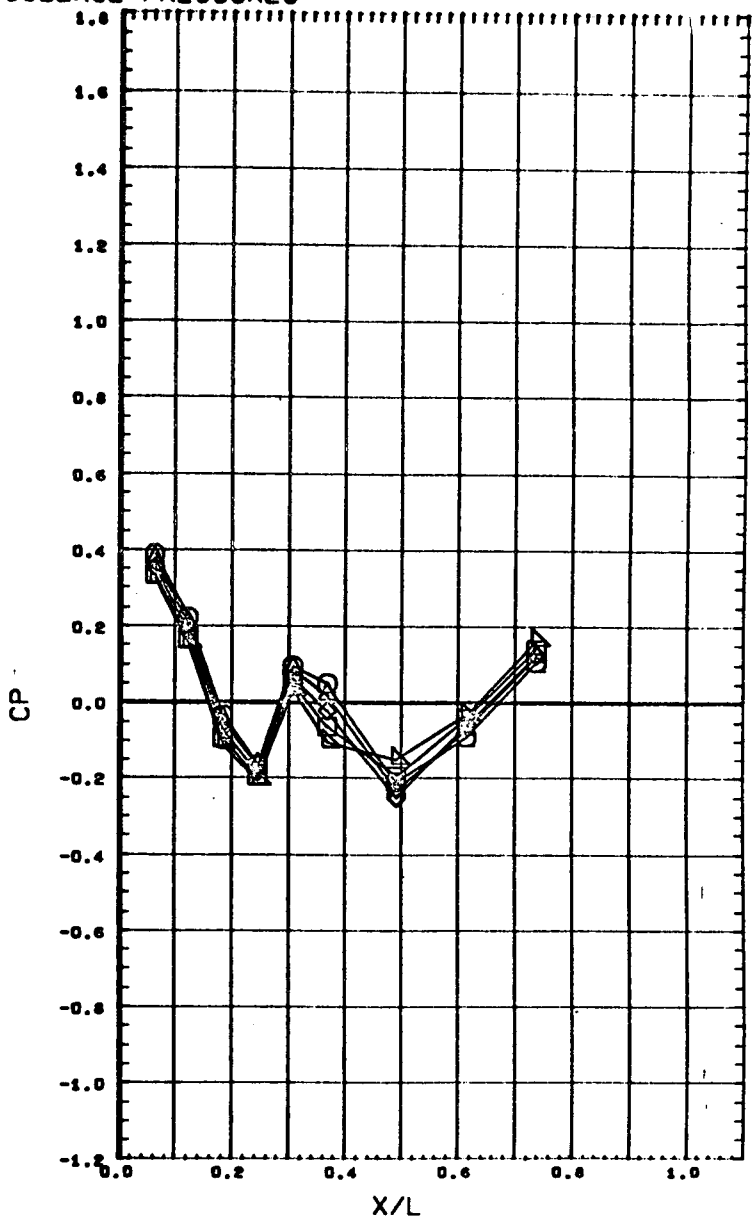
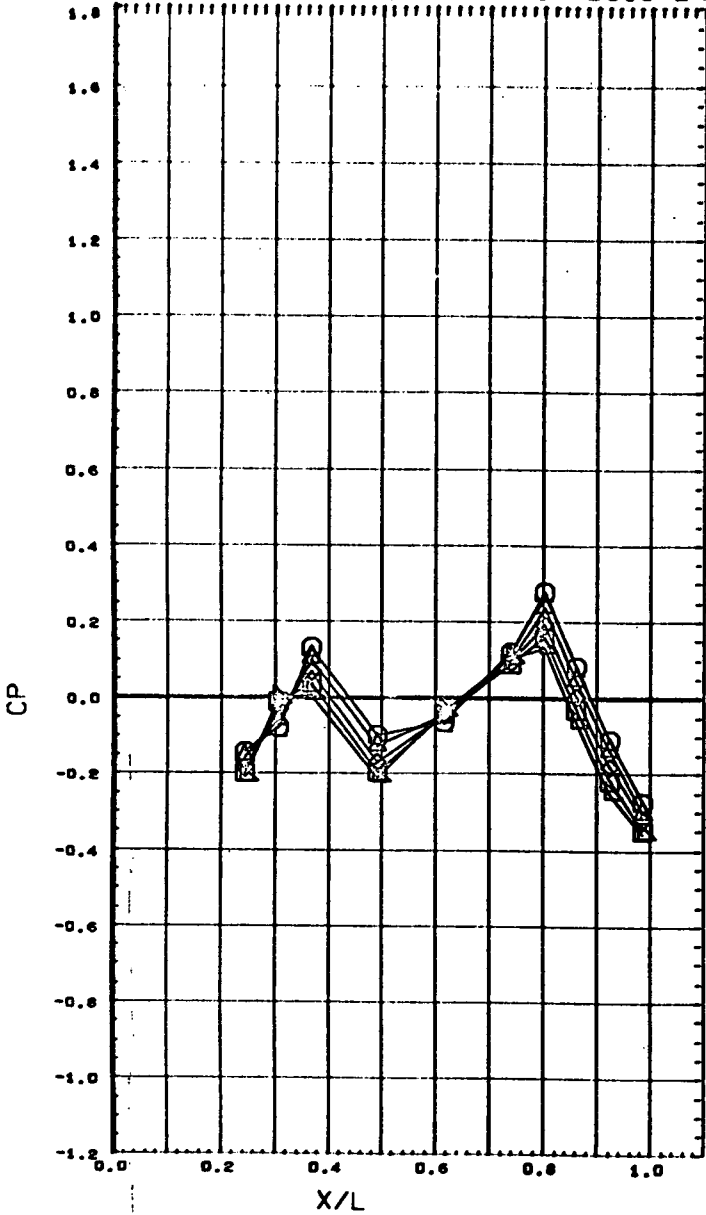

| SYMBOL | ALFB | THETA | M1 |
|--------|---------|--------|-------|
| ○ | - 7.924 | 24.000 | 1.100 |
| ◇ | - 5.825 | 45.000 | |
| ◇ | - 3.839 | | |
| ◇ | - 1.836 | | |
| ◇ | 0.132 | | |

PARAMETRIC VALUES
BETA 0.000

REFERENCE FILE

AEDC TC174 MDAC BOOSTER (BODY)

(ATC012)

PAGE 354

C-5

LONGITUDINAL DISTRIBUTION OF BOOSTER FUSELAGE PRESSURES

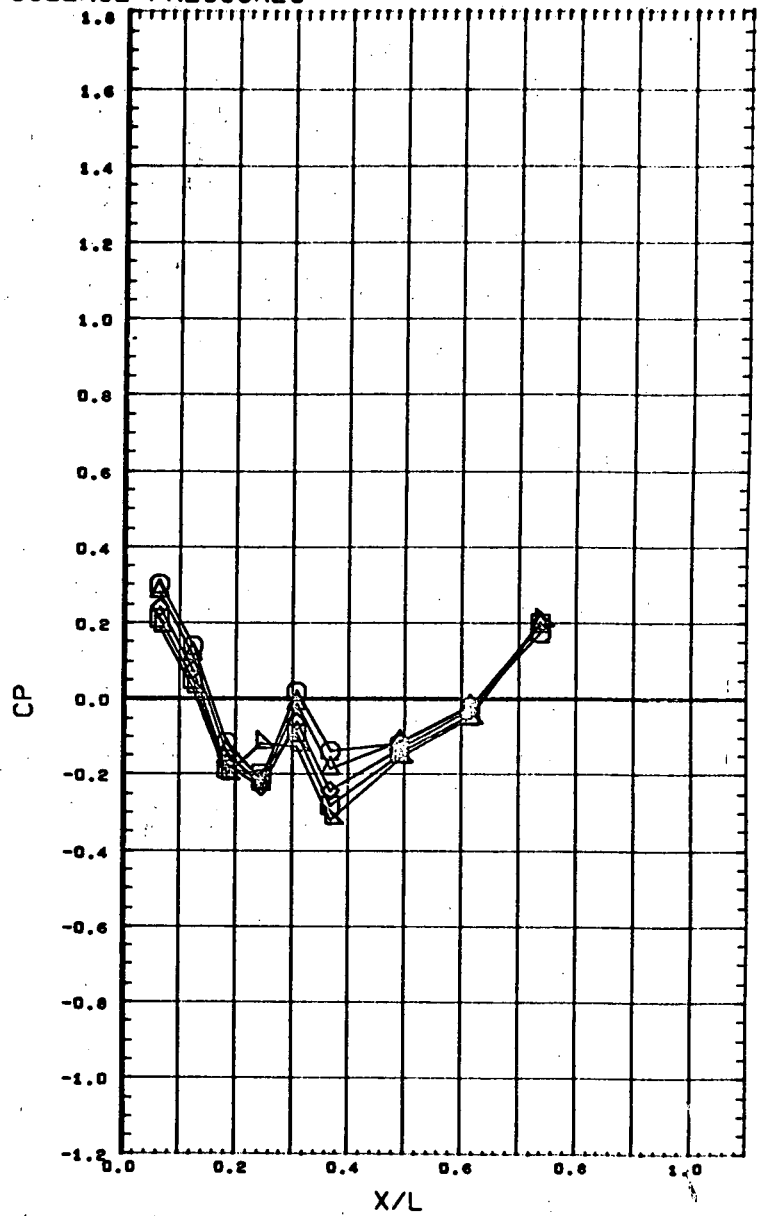
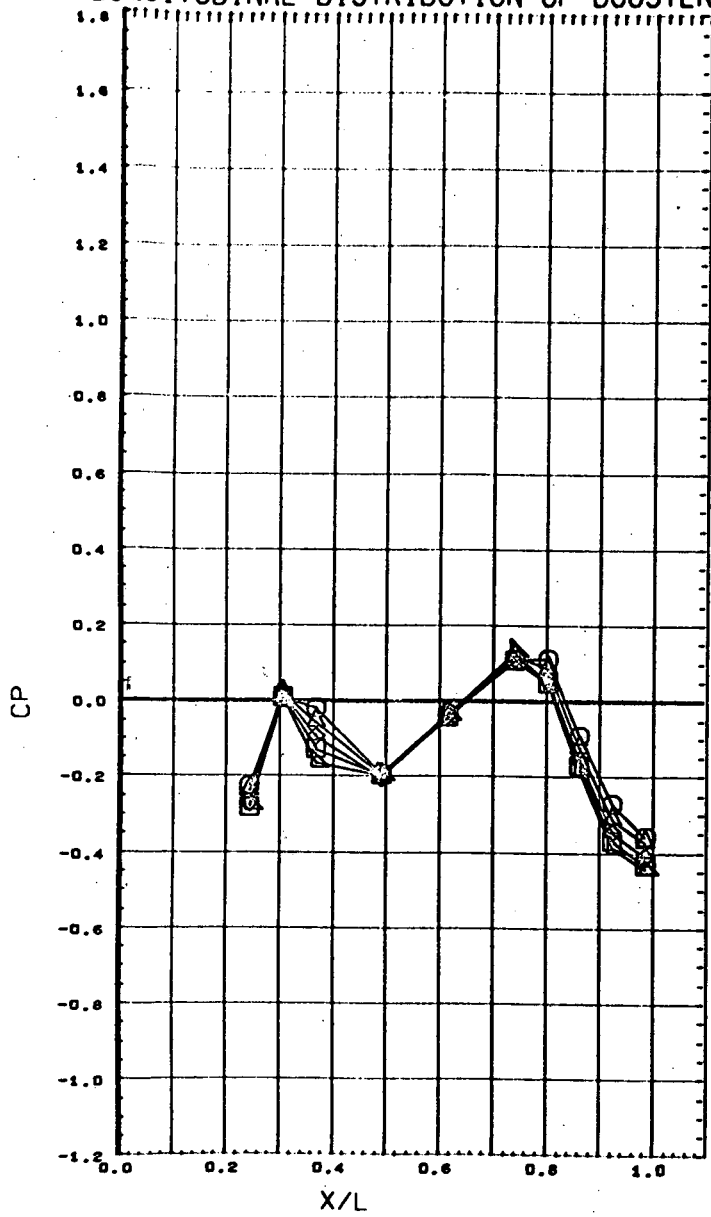

| SYMBOL | ALFB | THETA | M1 |
|--------|--------|--------|-------|
| ○ | 1.941 | 24.000 | 1.100 |
| △ | 4.070 | 45.000 | |
| ◇ | 6.179 | | |
| □ | 8.163 | | |
| ◇ | 10.138 | | |

REFERENCE FILE

BETA PARAMETRIC VALUES
0.000

LONGITUDINAL DISTRIBUTION OF BOOSTER FUSELAGE PRESSURES

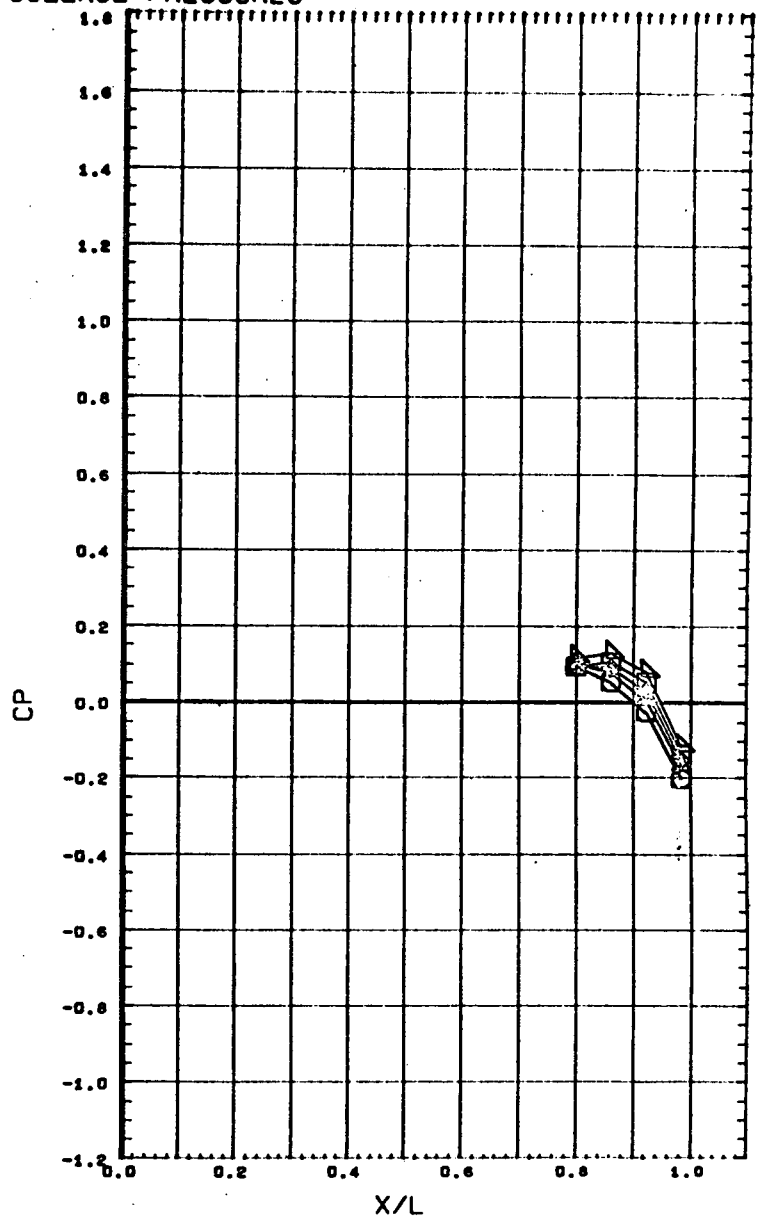
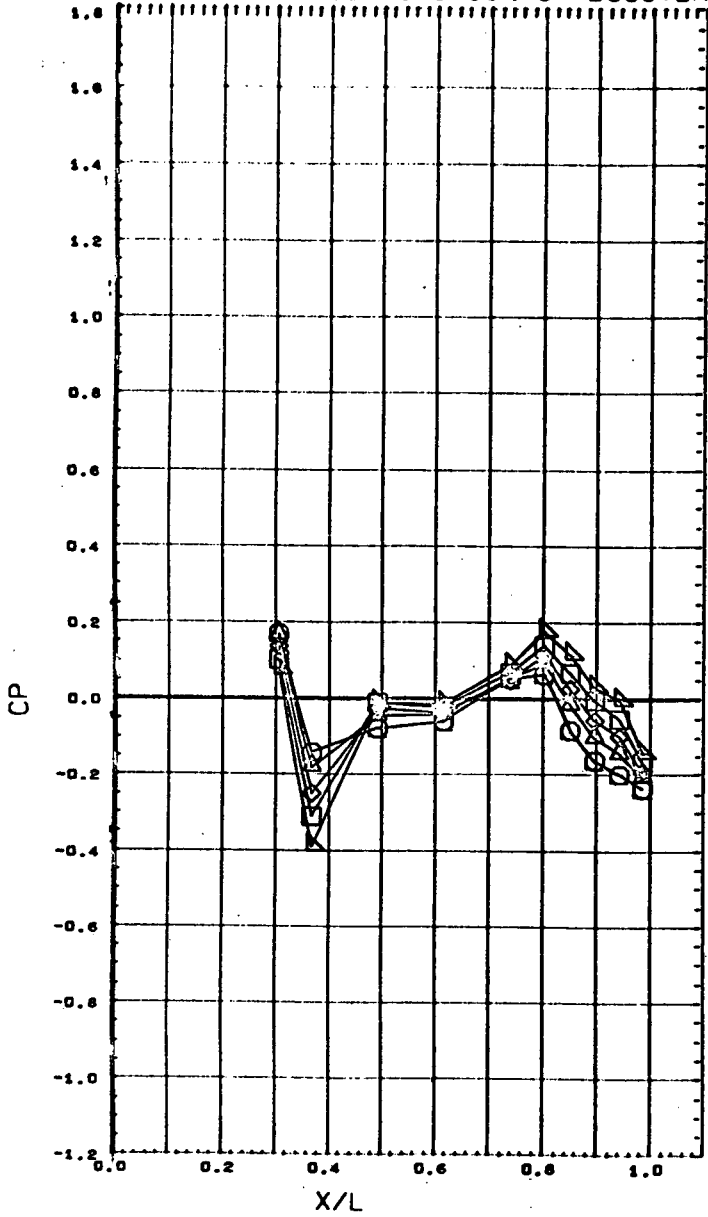

| SYMBOL | ALFB | THETA | M1 |
|--------|-------|---------|-------|
| ○ | 7.924 | 90.000 | 1.100 |
| △ | 5.625 | 180.000 | |
| ◇ | 3.839 | | |
| □ | 1.836 | | |
| ▽ | 0.132 | | |

REFERENCE FILE

BETA PARAMETRIC VALUES
0.000

LONGITUDINAL DISTRIBUTION OF BOOSTER FUSELAGE PRESSURES

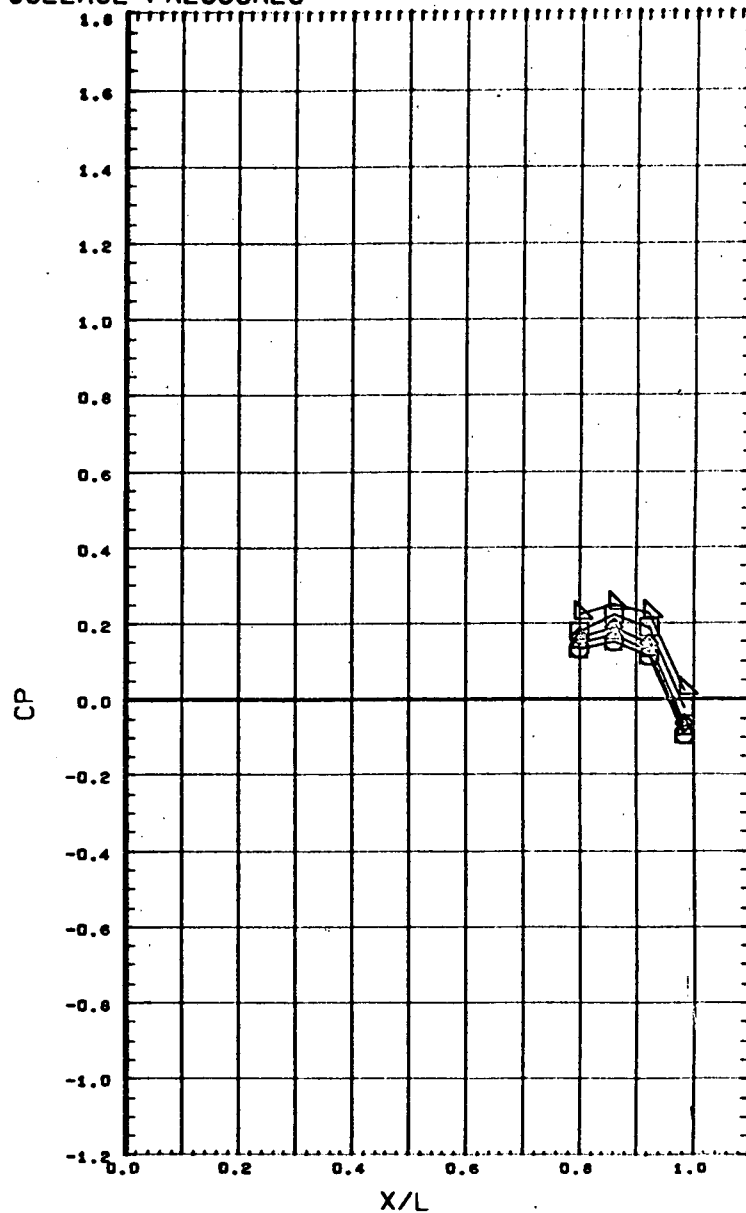
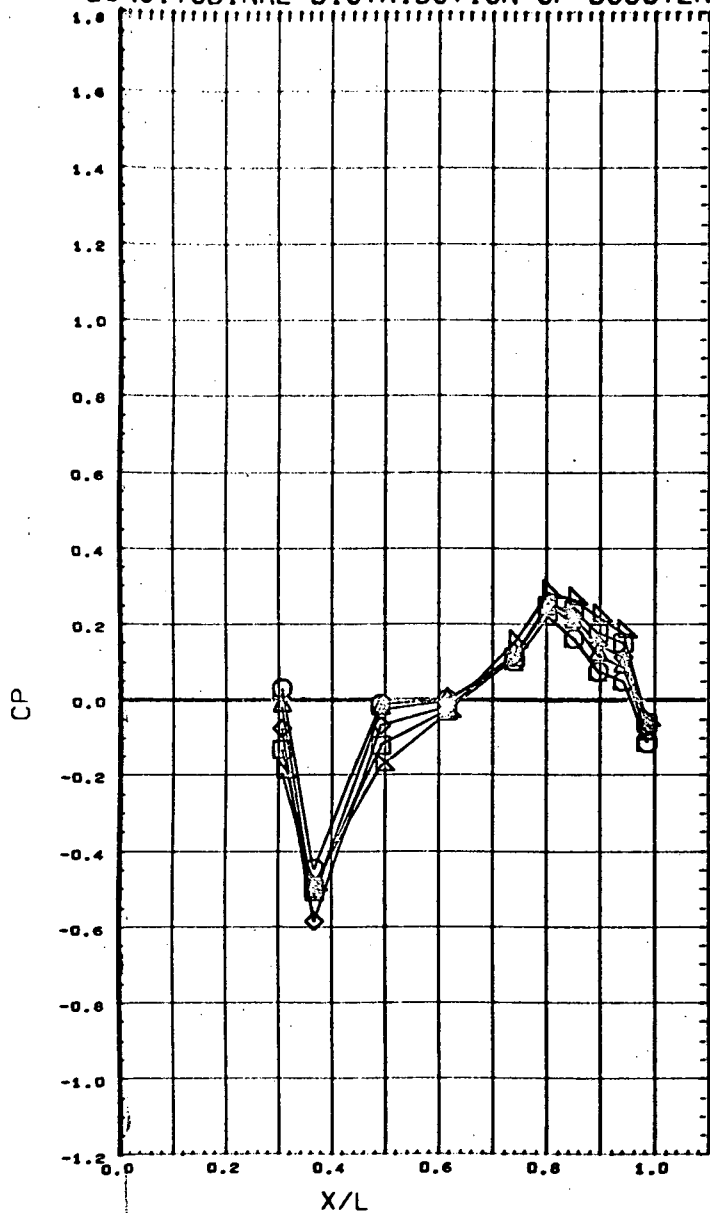

| SYMBOL | ALFB | THETA | M1 |
|--------|--------|---------|-------|
| ◇ | 1.941 | 90.000 | 1.100 |
| ◇ | 4.070 | 180.000 | |
| ◇ | 6.179 | | |
| ◇ | 8.163 | | |
| ◇ | 10.138 | | |

PARAMETRIC VALUES
BETA 0.000

REFERENCE FILE

LONGITUDINAL DISTRIBUTION OF BOOSTER FUSELAGE PRESSURES

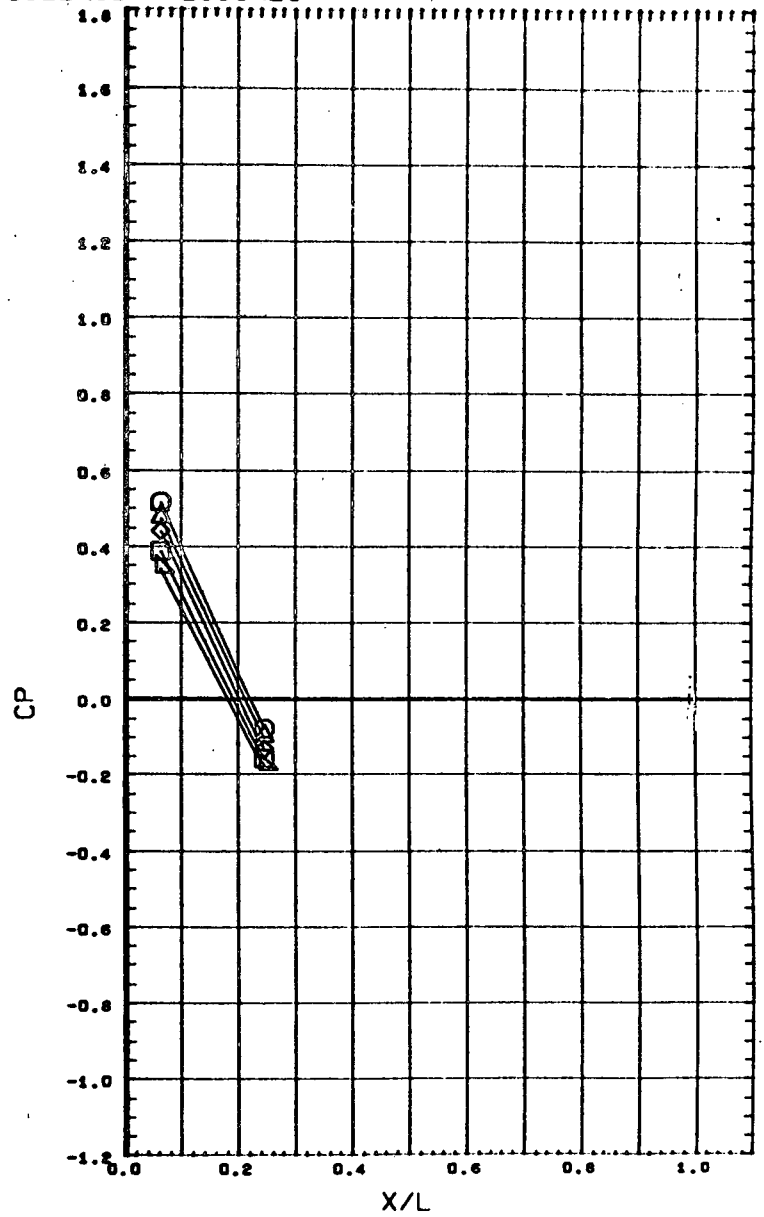
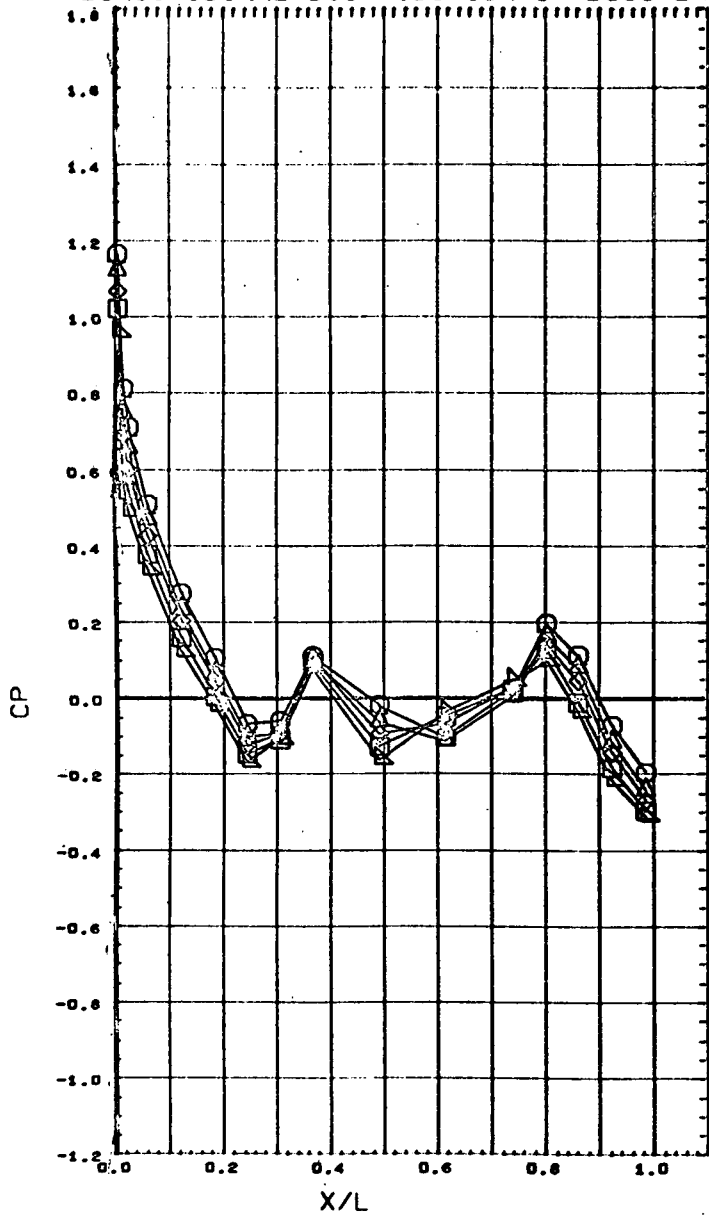

| SYMBOL | ALFB | THETA | M1 |
|--------|-------|--------|-------|
| ○ | 8.231 | 0.000 | 1.200 |
| △ | 6.153 | 15.000 | |
| ◇ | 4.135 | | |
| □ | 2.009 | | |
| ▽ | 0.120 | | |

REFERENCE FILE

PARAMETRIC VALUES
BETA 0.000

LONGITUDINAL DISTRIBUTION OF BOOSTER FUSELAGE PRESSURES

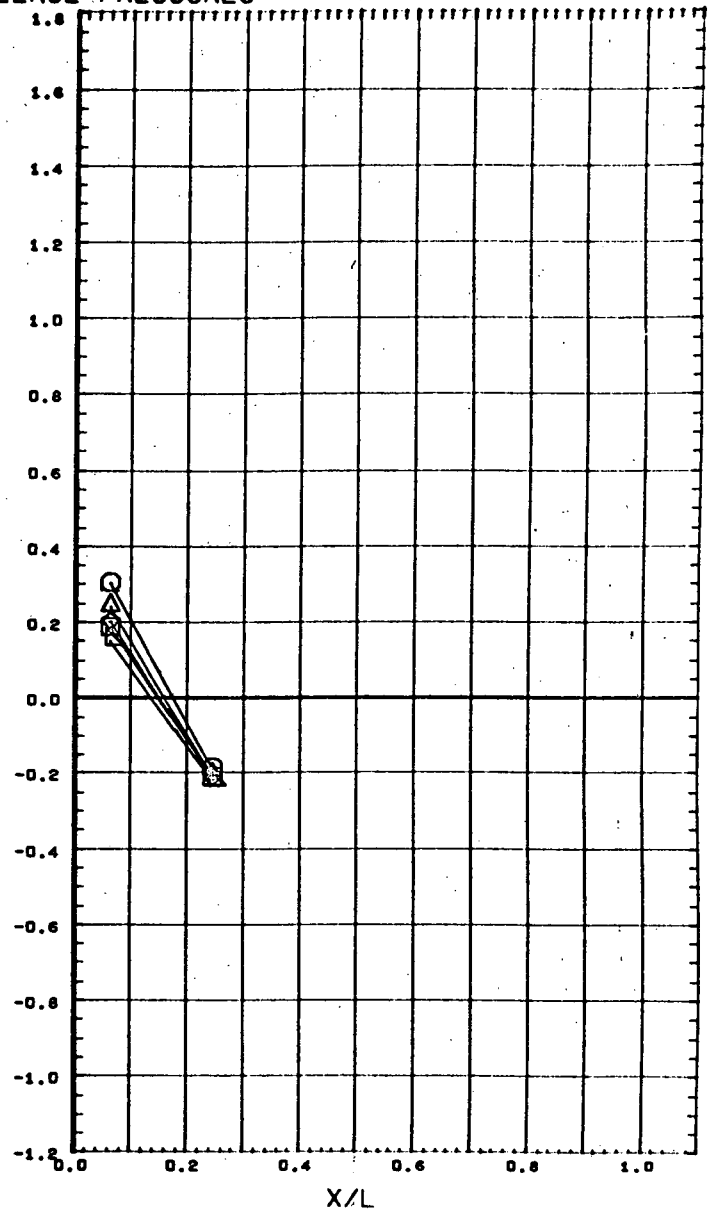
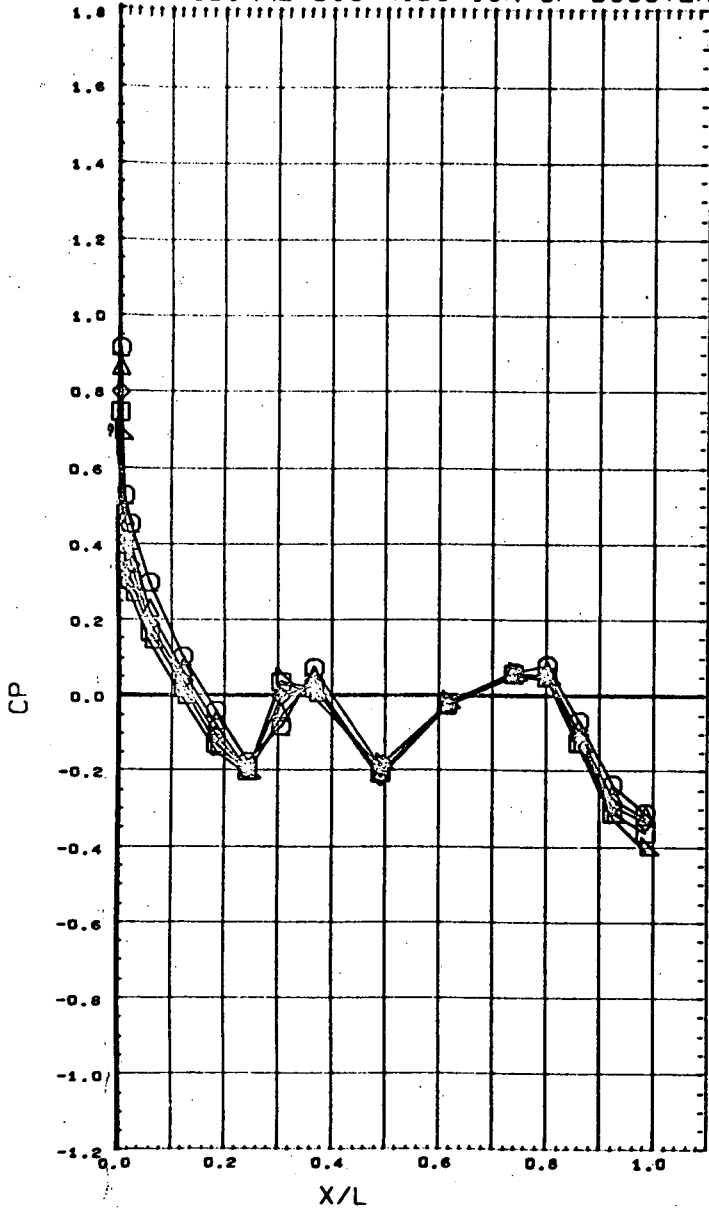

| SYMBOL | ALFB | THETA | M1 |
|--------|--------|--------|-------|
| ○ | 1.926 | 0.000 | 1.200 |
| ◇ | 4.054 | 15.000 | |
| △ | 6.166 | | |
| □ | 8.159 | | |
| ▽ | 10.141 | | |

REFERENCE FILE

PARAMETRIC VALUES
BETA 0.000

LONGITUDINAL DISTRIBUTION OF BOOSTER FUSELAGE PRESSURES

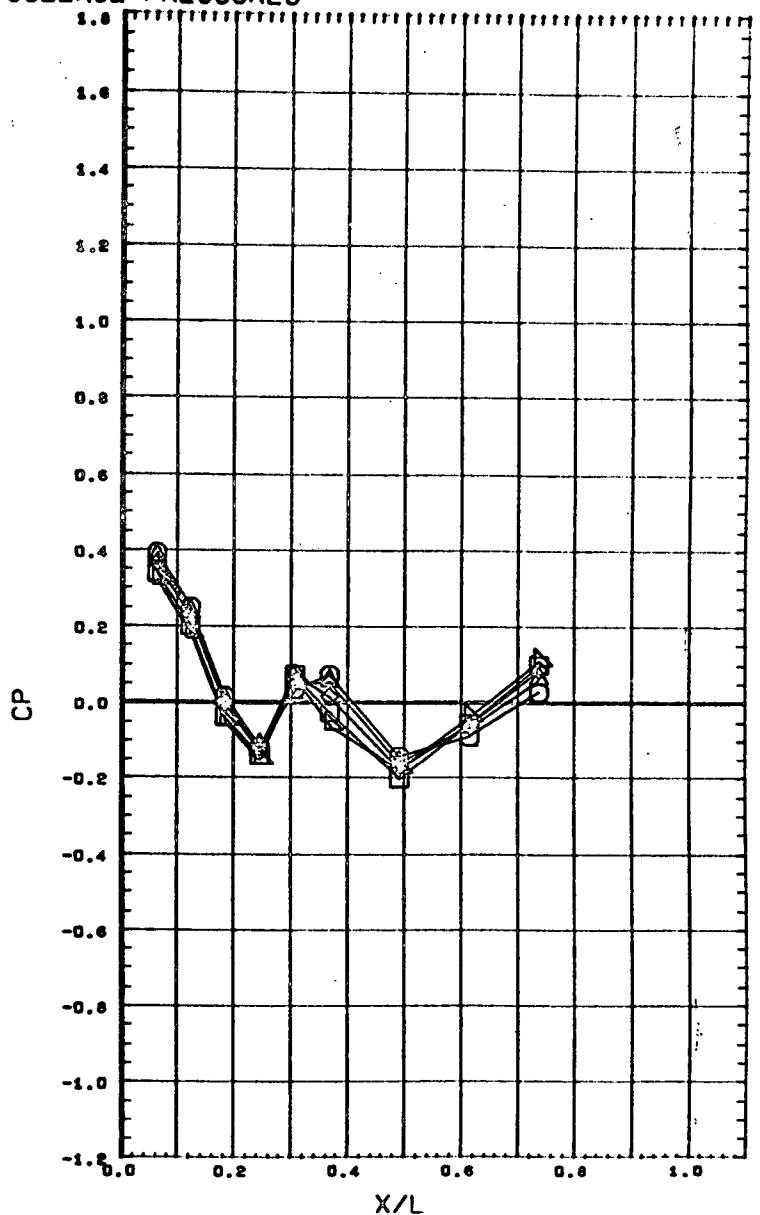
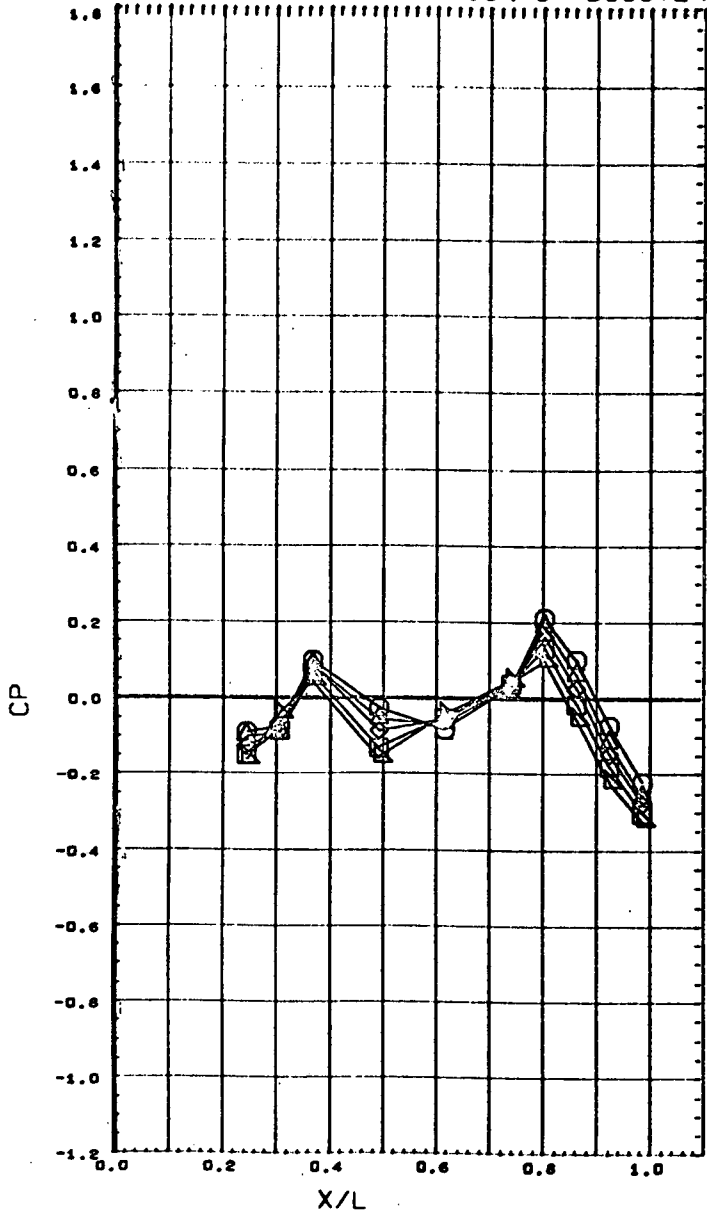

| SYMBOL | ALFB | THETA | M1 |
|--------|-------|--------|-------|
| ○ | 8.231 | 24.000 | 1.200 |
| ◇ | 6.153 | 45.000 | |
| △ | 4.135 | | |
| □ | 2.009 | | |
| ◇ | 0.120 | | |

REFERENCE FILE

PARAMETRIC VALUES
BETA 0.000

LONGITUDINAL DISTRIBUTION OF BOOSTER FUSELAGE PRESSURES

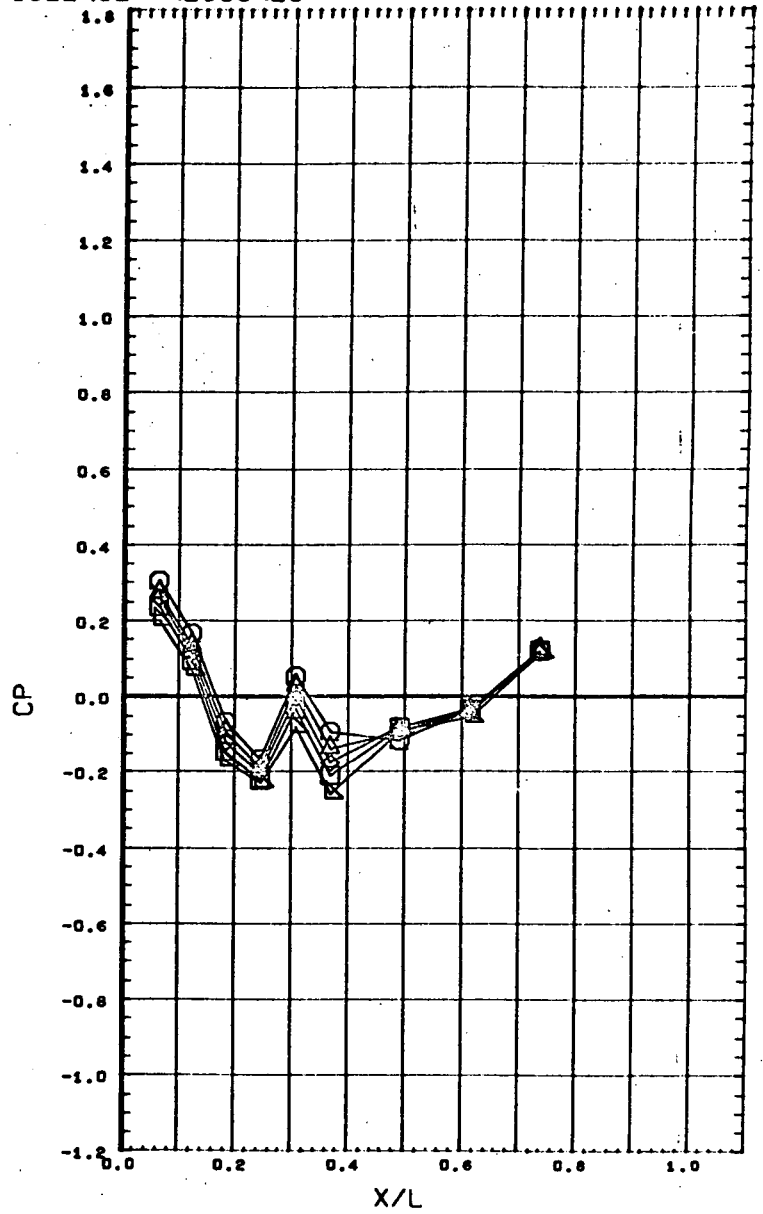
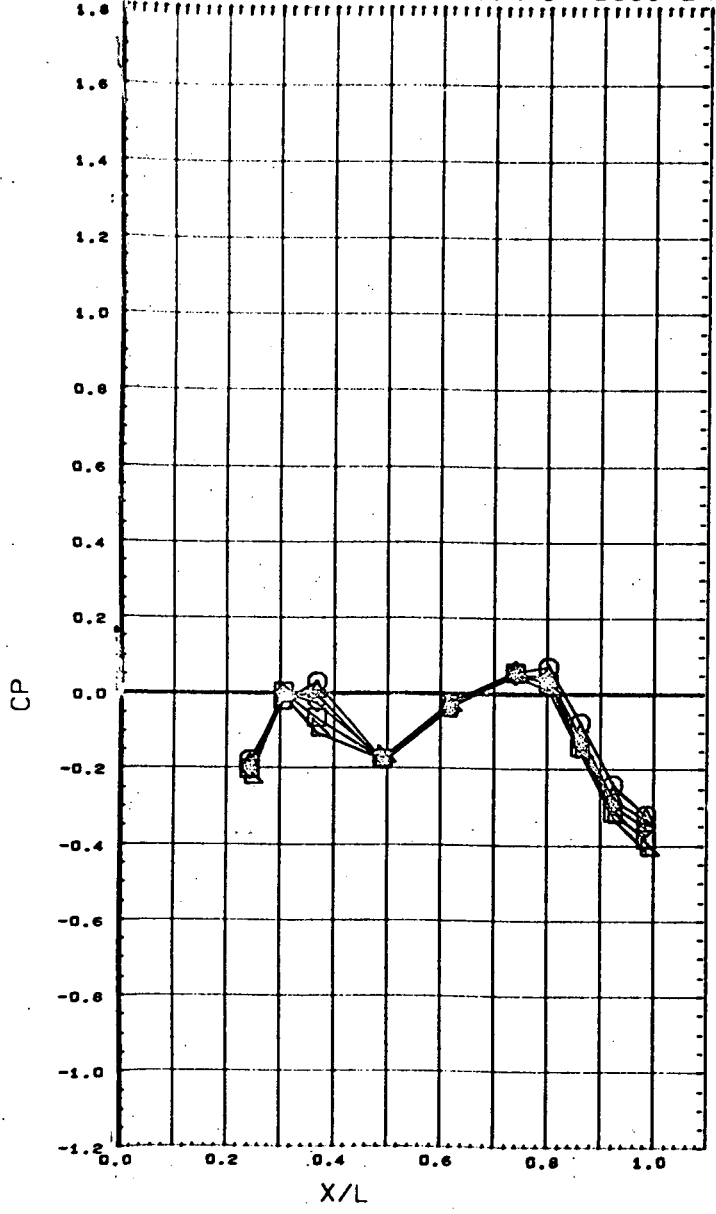

| SYMBOL | ALFB | THETA | M1 |
|--------|--------|--------|-------|
| ◇ | 1.926 | 24.000 | 1.200 |
| ◇ | 4.054 | 45.000 | |
| ◇ | 6.166 | | |
| ◇ | 8.159 | | |
| ◇ | 10.141 | | |

REFERENCE FILE

PARAMETRIC VALUES
BETA 0.000

LONGITUDINAL DISTRIBUTION OF BOOSTER FUSELAGE PRESSURES

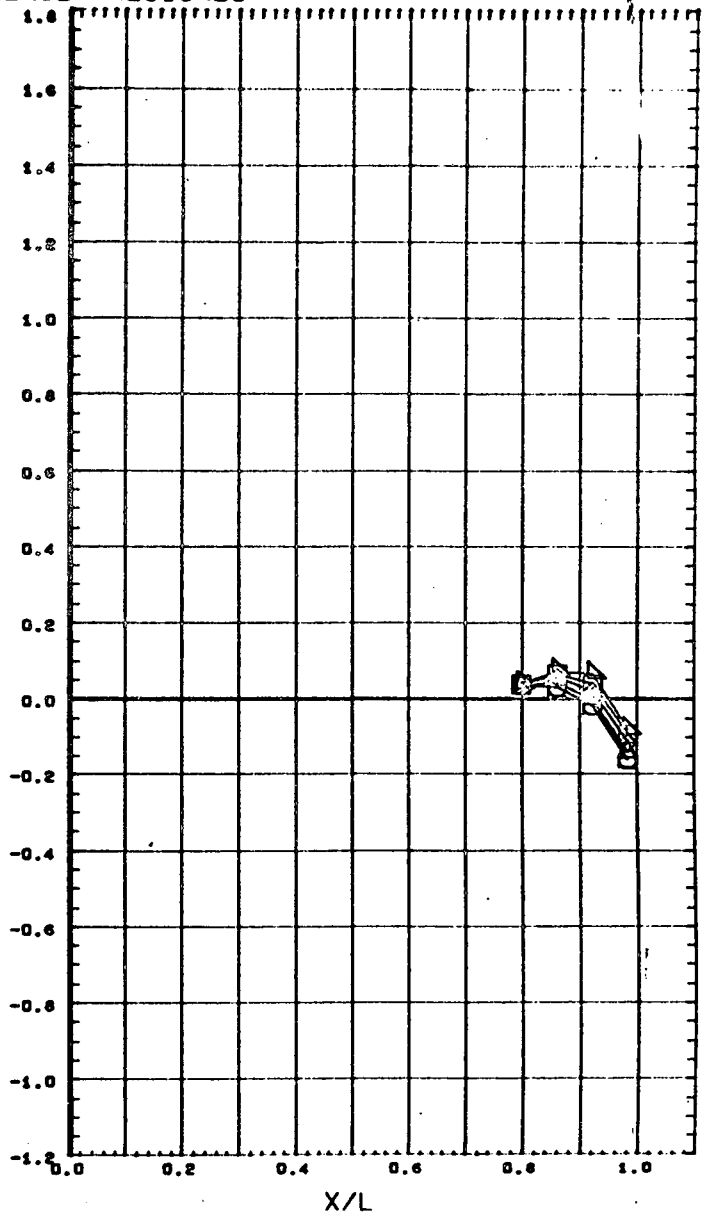
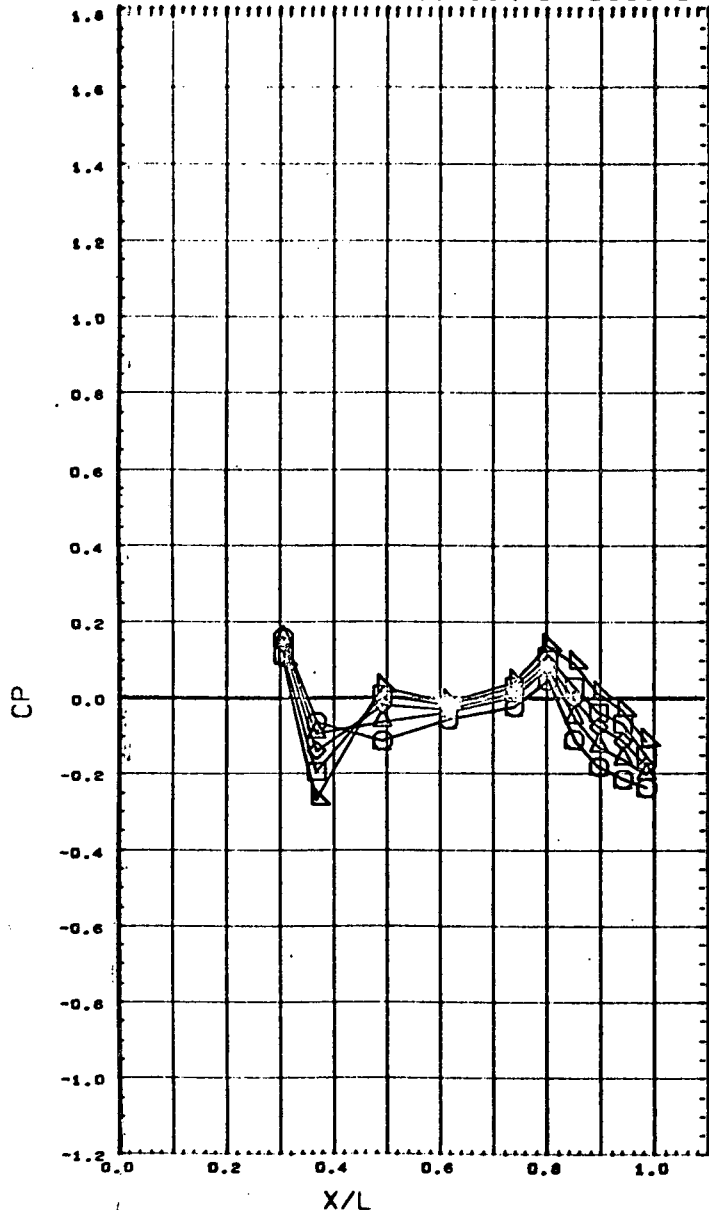

| SYMBOL | ALFB | THETA | M1 |
|--------|-------|---------|-------|
| ○ | 8.231 | 90.000 | 1.200 |
| △ | 6.153 | 180.000 | |
| ◇ | 4.135 | | |
| □ | 2.009 | | |
| ○ | 0.120 | | |

PARAMETRIC VALUES
BETA 0.000

REFERENCE FILE

LONGITUDINAL DISTRIBUTION OF BOOSTER FUSELAGE PRESSURES

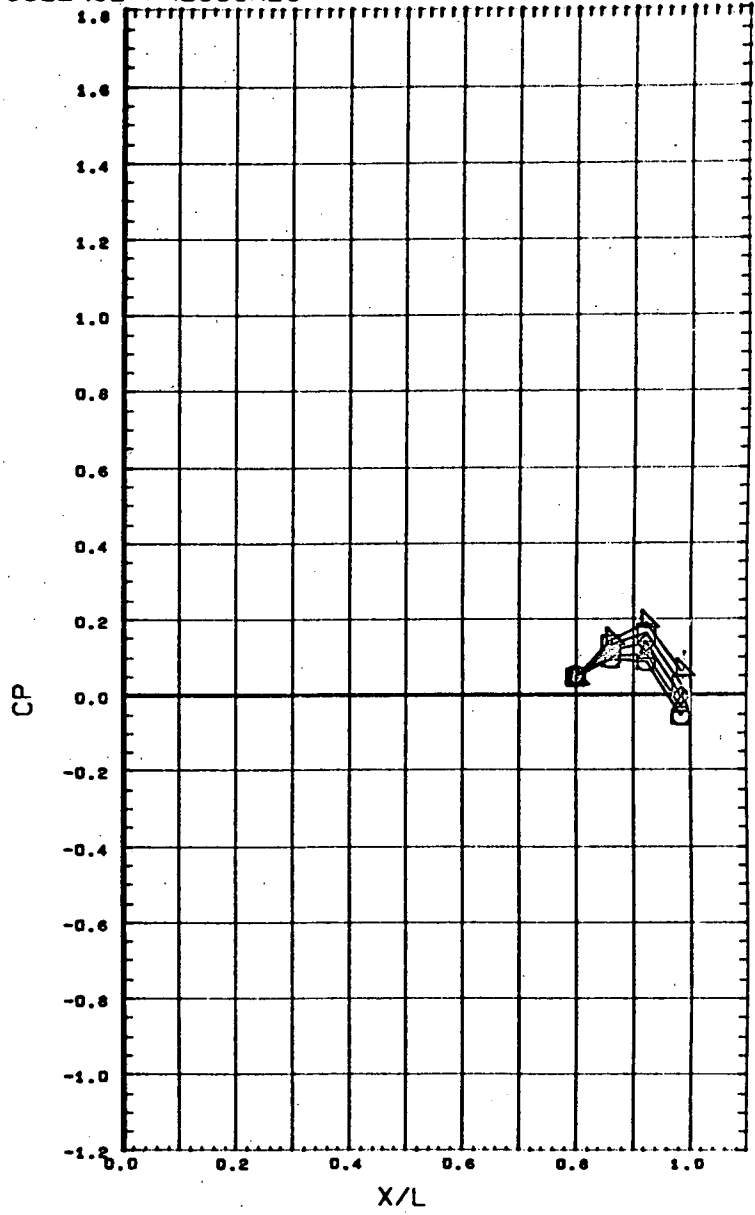
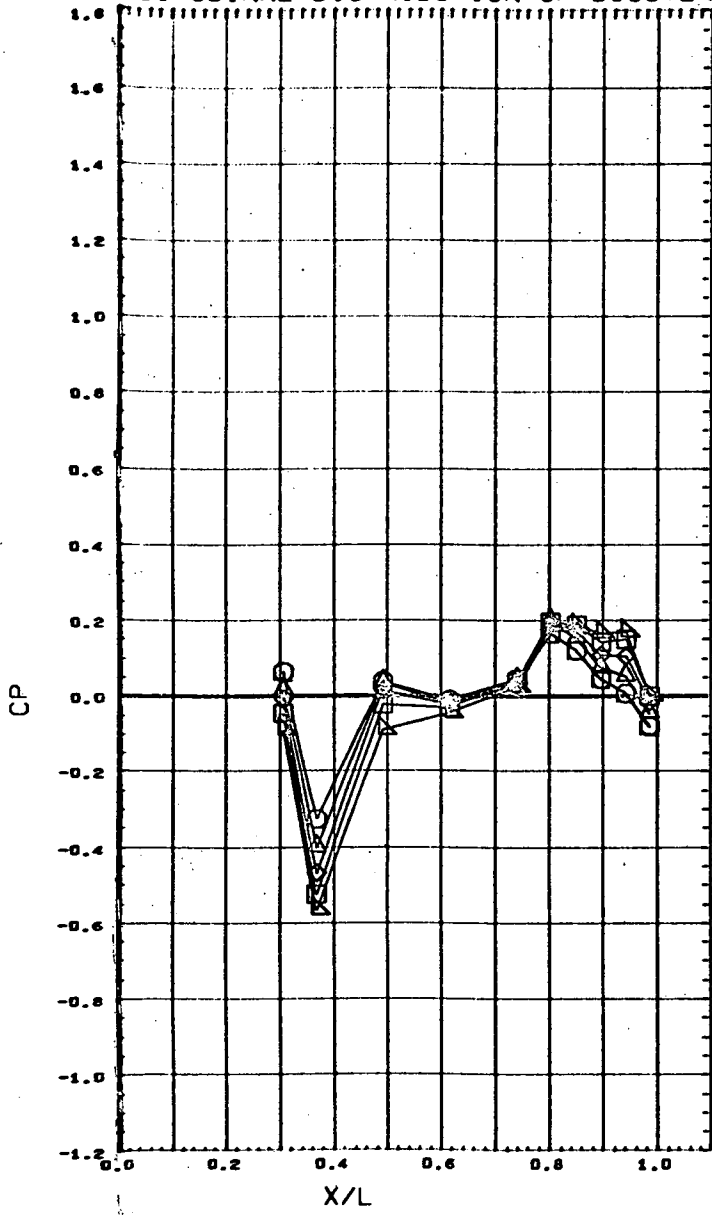

| SYMBOL | ALFD | THETA | M1 |
|--------|--------|---------|-------|
| ○ | 1.926 | 90.000 | 1.200 |
| ◇ | 4.054 | 180.000 | |
| ◇ | 6.166 | | |
| ◇ | 8.159 | | |
| ◇ | 10.141 | | |

REFERENCE FILE

PARAMETRIC VALUES
BETA 0.000

LONGITUDINAL DISTRIBUTION OF BOOSTER FUSELAGE PRESSURES

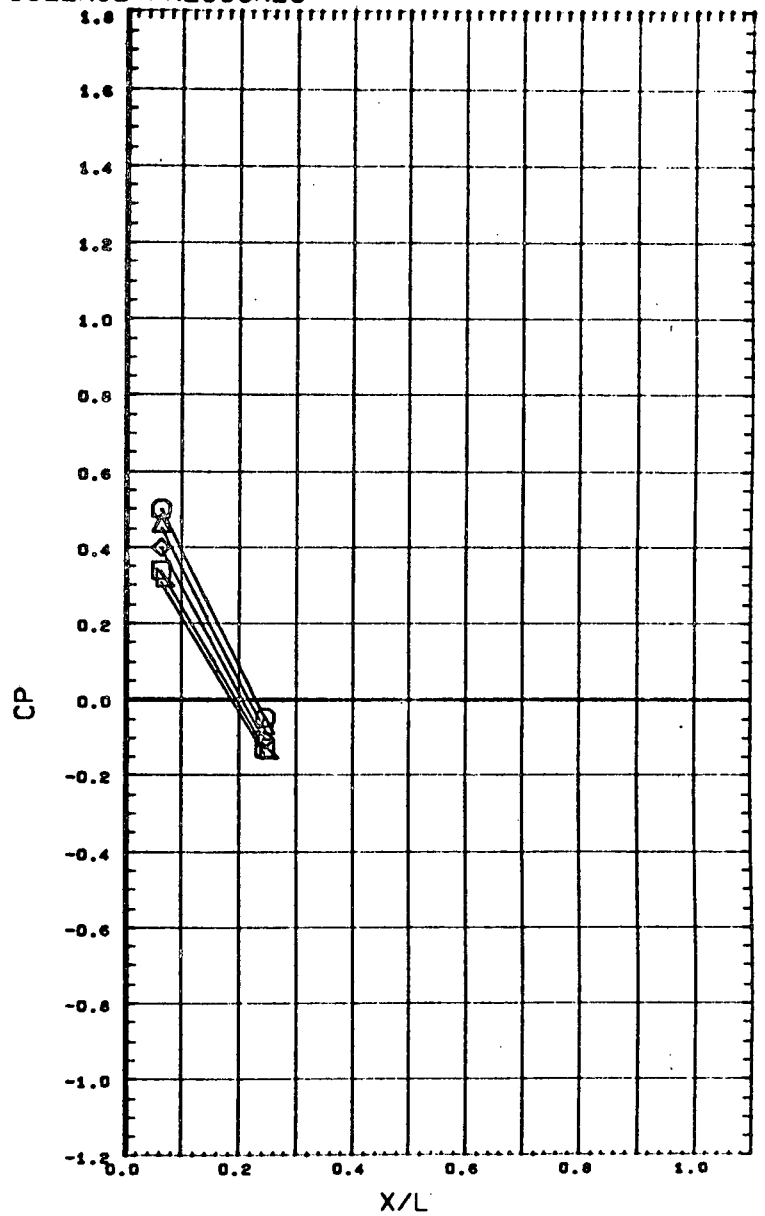
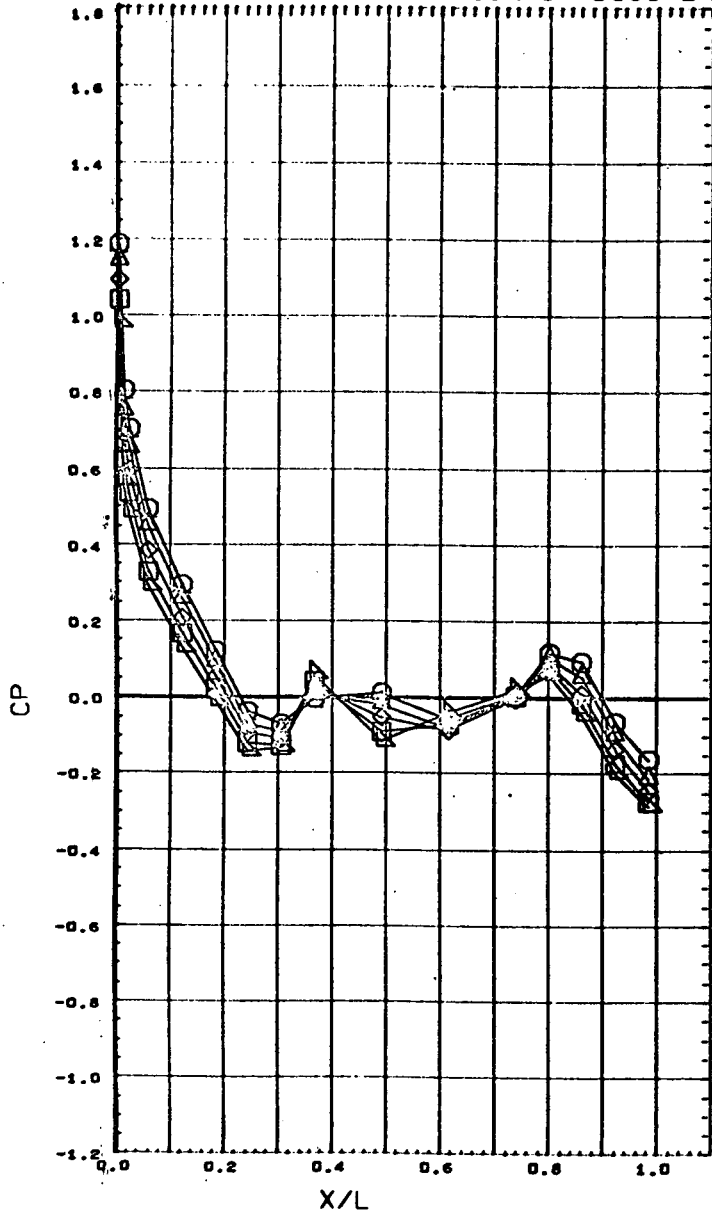

| SYMBOL | ALFB | THETA | M1 |
|--------|--------|--------|-------|
| ○ | 8.210 | 0.000 | 1.299 |
| ◇ | 16.139 | 15.000 | |
| △ | 4.129 | | |
| □ | 2.017 | | |
| ○ | 0.107 | | |

REFERENCE FILE

PARAMETRIC VALUES
BETA 0.000

LONGITUDINAL DISTRIBUTION OF BOOSTER FUSELAGE PRESSURES

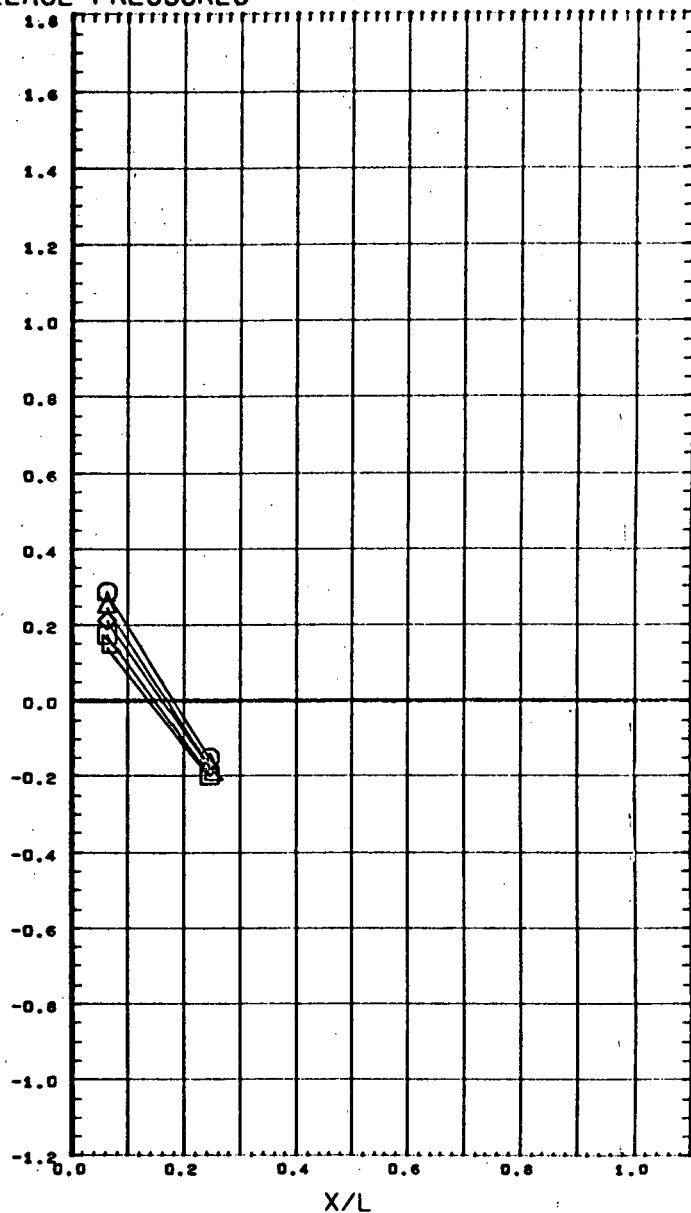
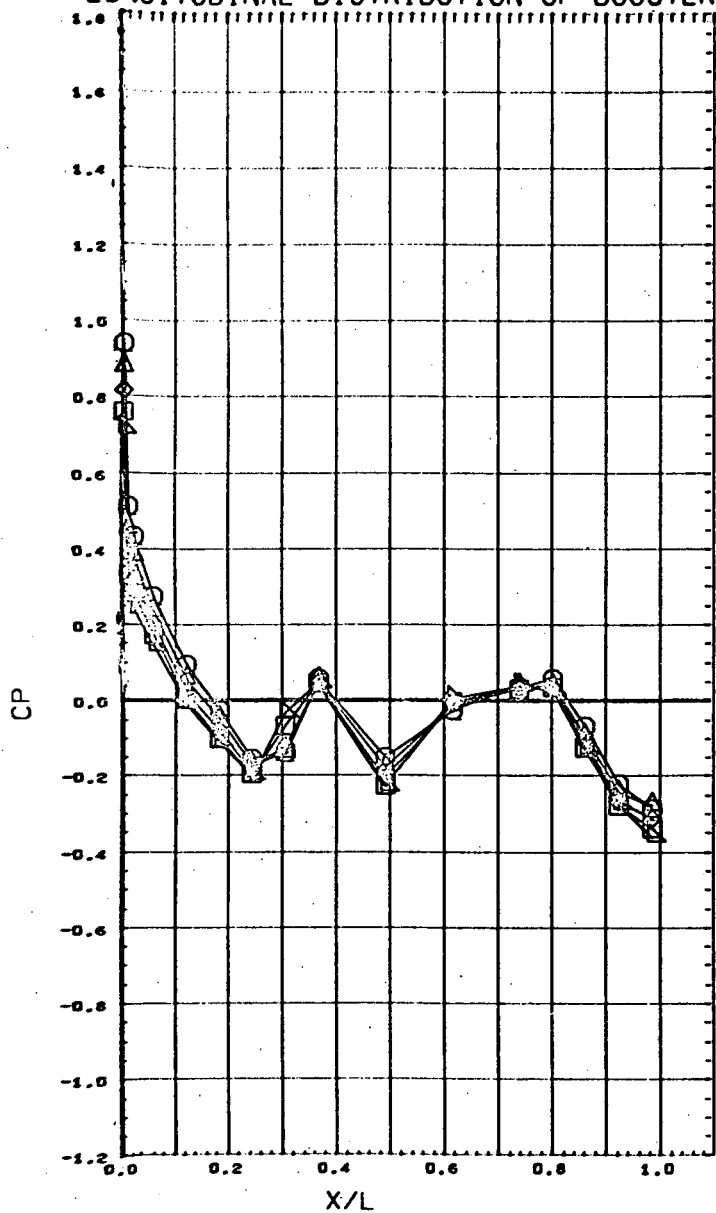

| SYMBOL | ALFB | THETA | M1 |
|--------|--------|--------|-------|
| ○ | 1.914 | 0.000 | 1.299 |
| △ | 4.038 | 15.000 | |
| ◇ | 6.150 | | |
| □ | 8.153 | | |
| ▽ | 10.147 | | |

PARAMETRIC VALUES
BETA 0.000

REFERENCE FILE

LONGITUDINAL DISTRIBUTION OF BOOSTER FUSELAGE PRESSURES

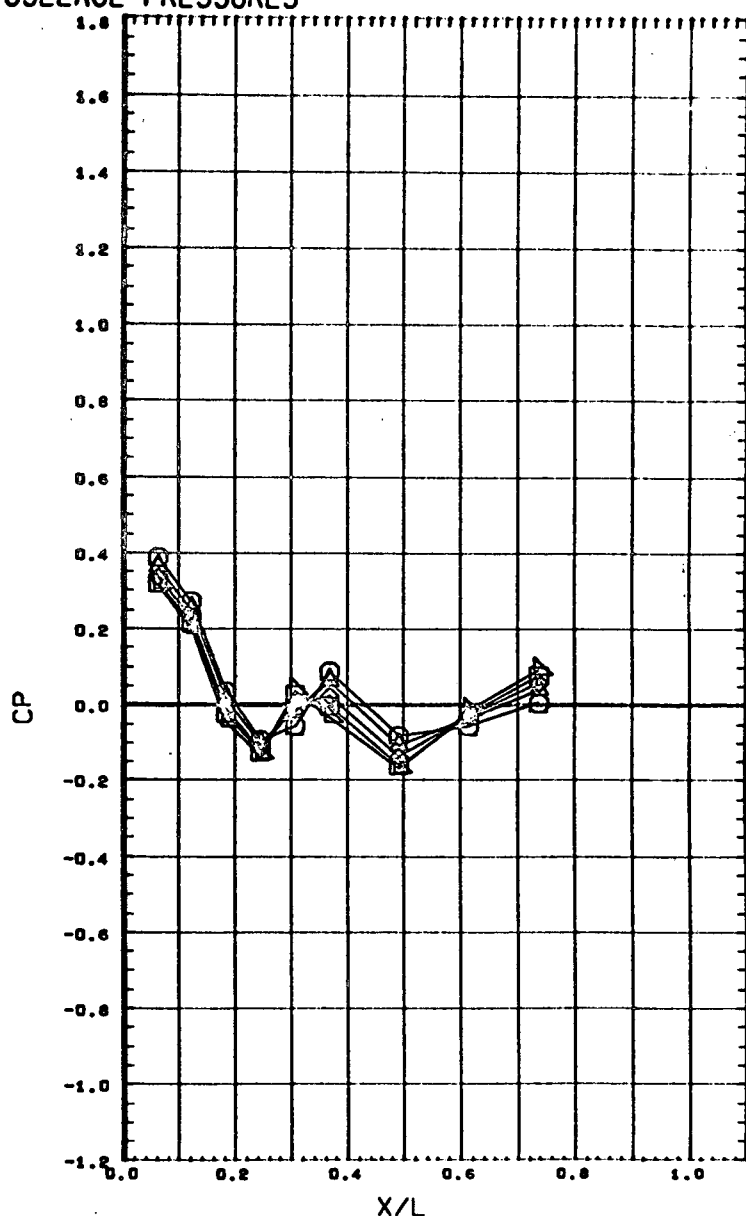
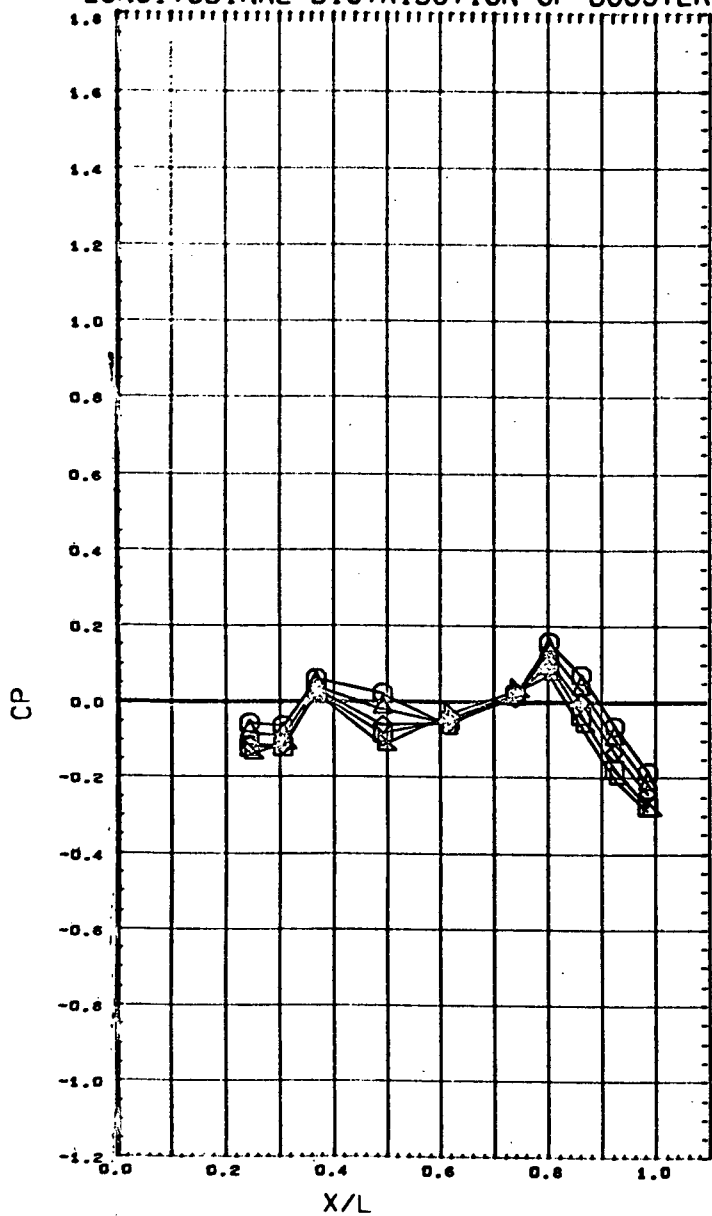

| SYMBOL | ALFB | THETA | M1 |
|--------|-------|--------|-------|
| ○ | 8.215 | 24.000 | 1.299 |
| △ | 6.139 | 45.000 | |
| ◇ | 4.129 | | |
| □ | 2.517 | | |
| ○ | 0.167 | | |

REFERENCE FILE

BETA PARAMETRIC VALUES
0.000

LONGITUDINAL DISTRIBUTION OF BOOSTER FUSELAGE PRESSURES

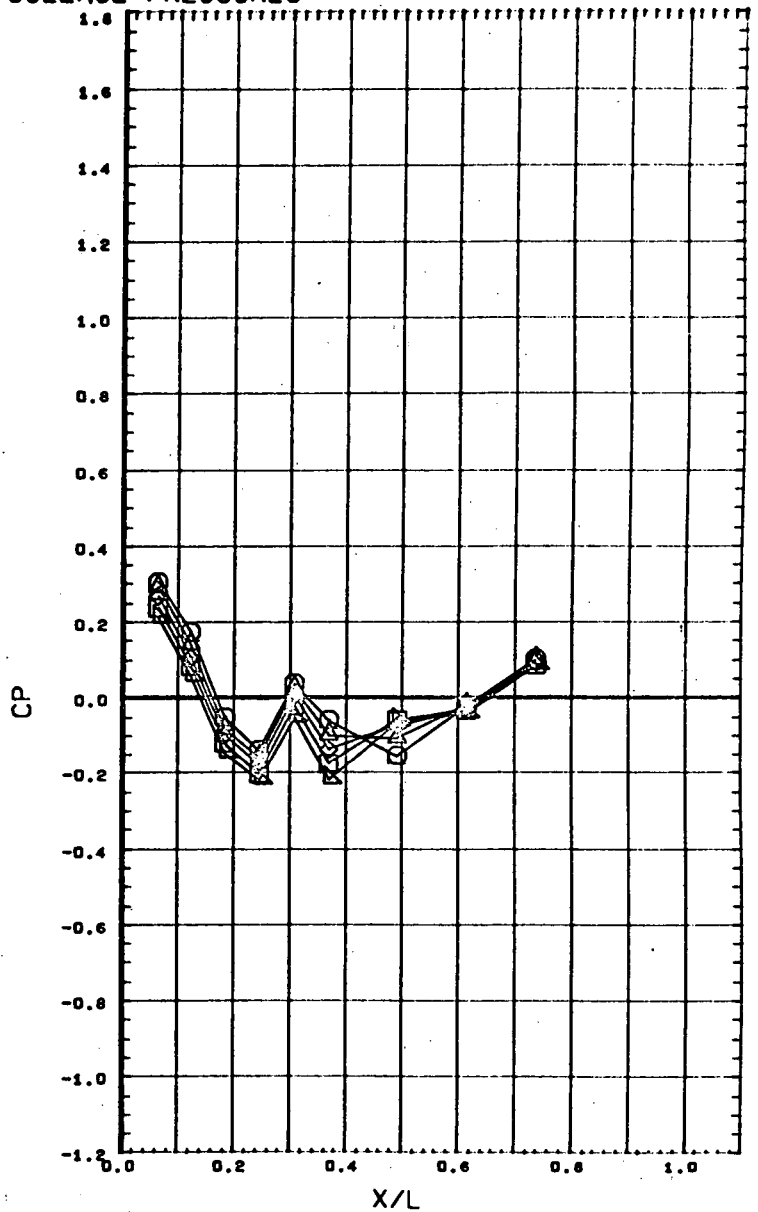
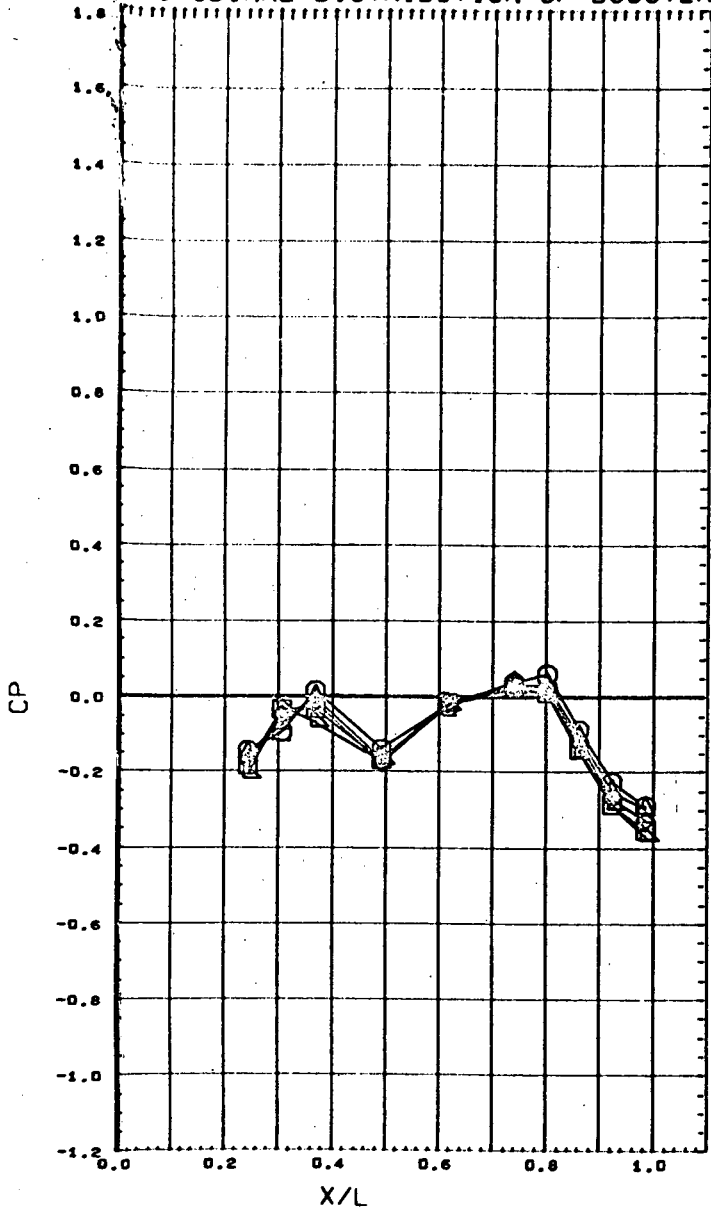

| SYMBOL | ALFB | THETA | M1 |
|--------|--------|--------|-------|
| ○ | 1.914 | 24.000 | 1.299 |
| ◇ | 4.038 | 45.000 | |
| △ | 6.150 | | |
| □ | 8.153 | | |
| ▽ | 10.147 | | |

REFERENCE FILE

PARAMETRIC VALUES
BETA 0.000

LONGITUDINAL DISTRIBUTION OF BOOSTER FUSELAGE PRESSURES

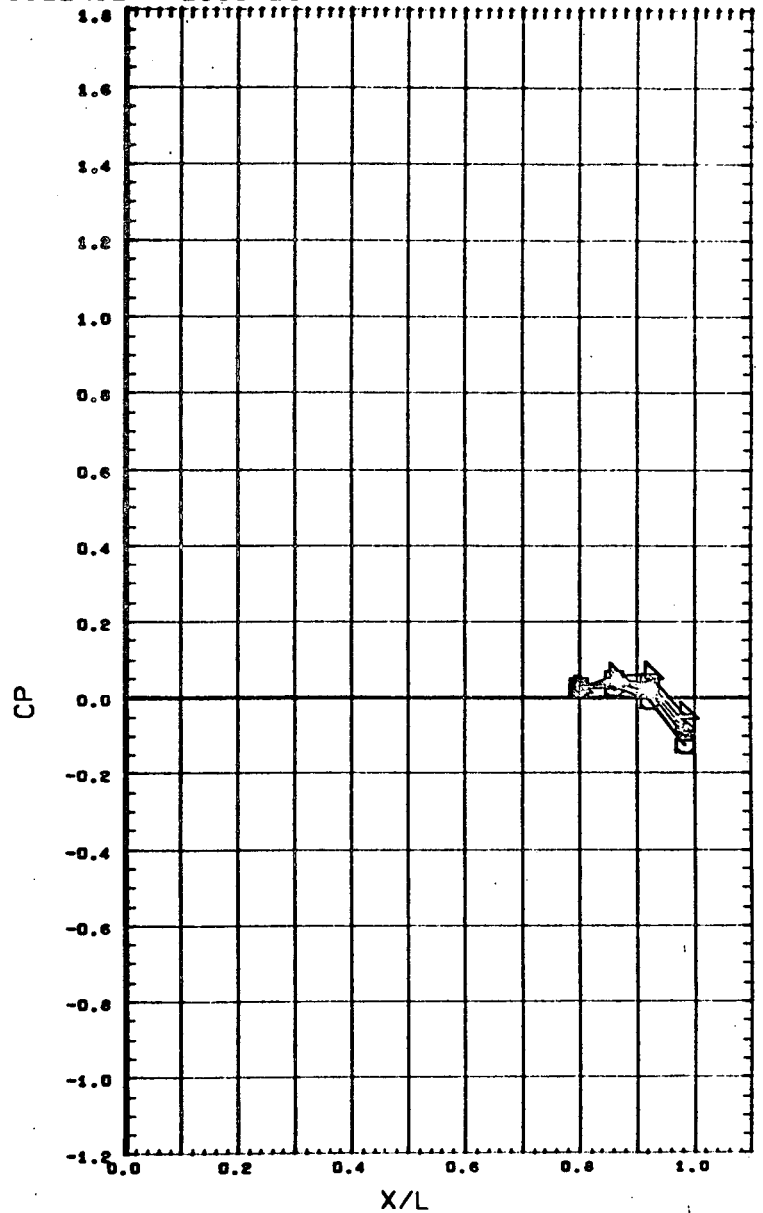
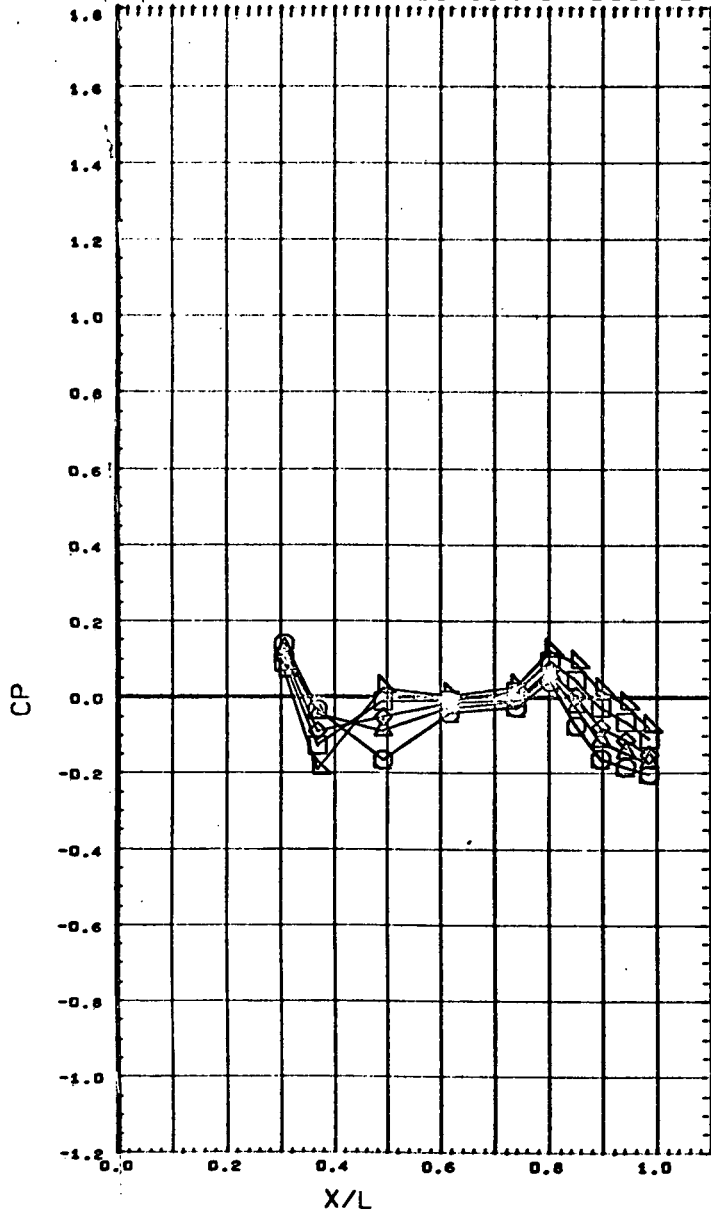

| SYMBOL | ALFB | THETA | M1 |
|--------|---------|---------|-------|
| ○ | - 8.210 | 90.000 | 1.299 |
| △ | - 6.139 | 180.000 | |
| ◇ | - 4.129 | | |
| □ | - 2.017 | | |
| ○ | 0.107 | | |

PARAMETRIC VALUES
BETA 0.000

REFERENCE FILE

LONGITUDINAL DISTRIBUTION OF BOOSTER FUSELAGE PRESSURES

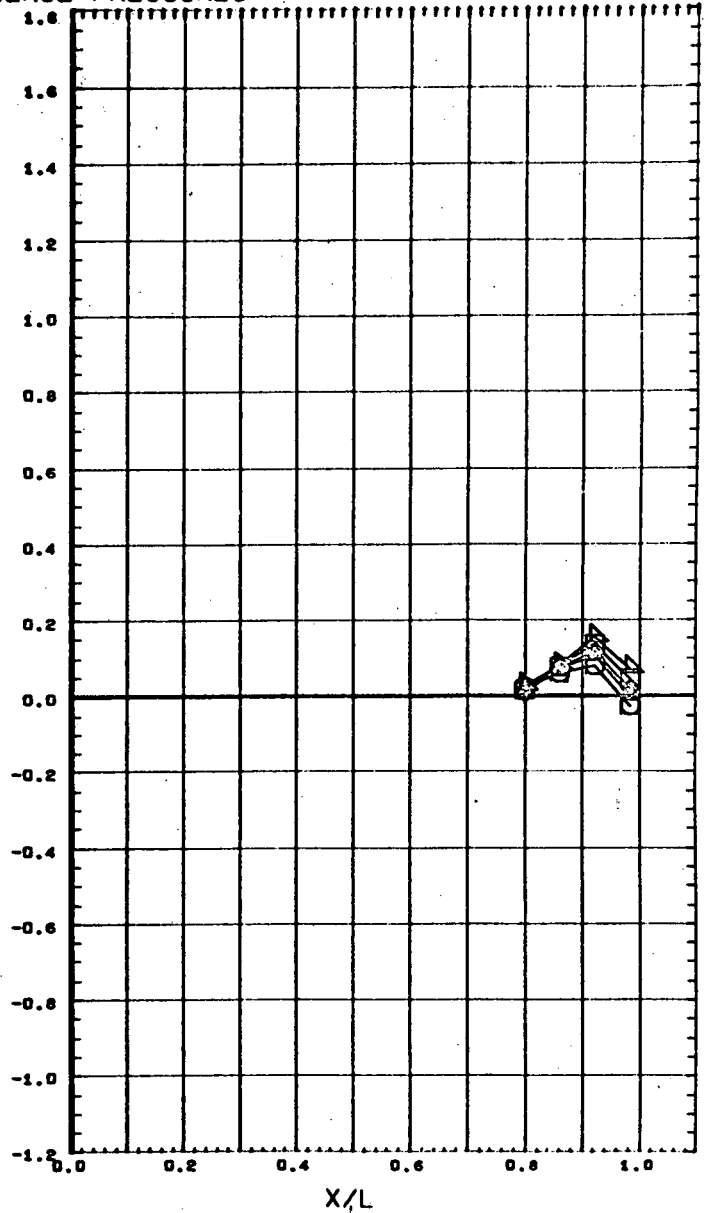
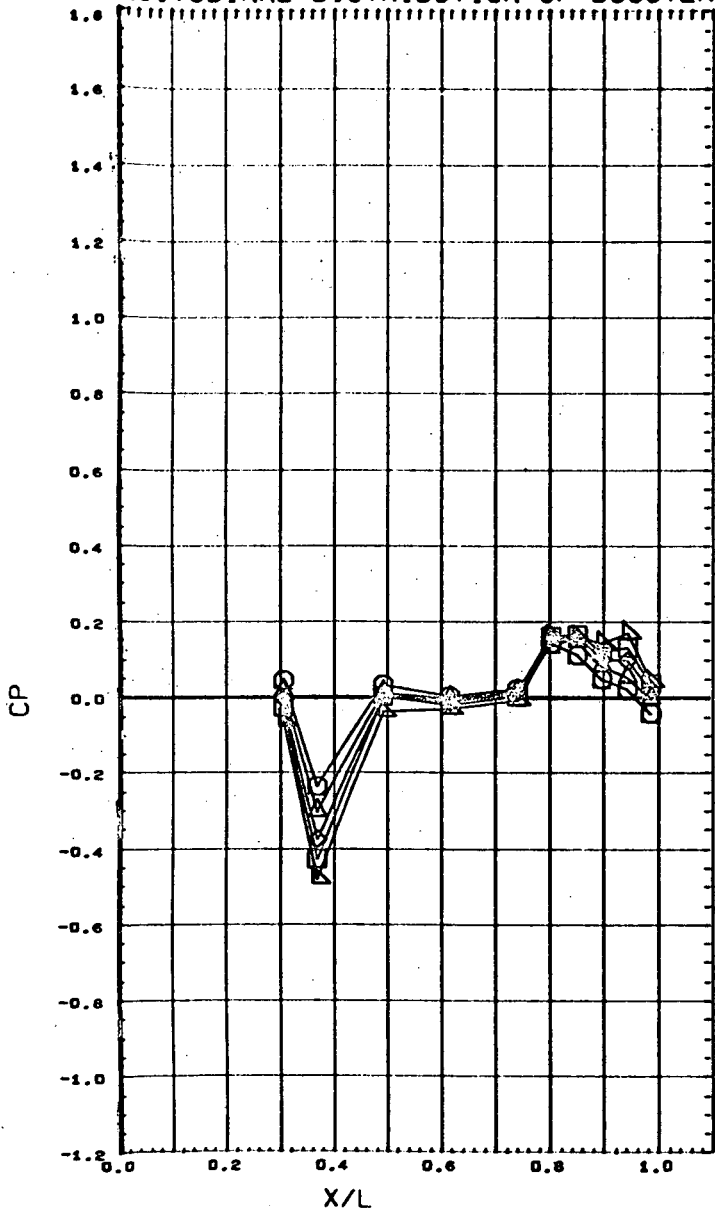

| SYMBOL | ALFB | THETA | M1 |
|--------|--------|---------|-------|
| □ | 1.914 | 90.000 | 1.299 |
| ◇ | 4.038 | 180.000 | |
| ◇ | 6.150 | | |
| ◇ | 8.153 | | |
| ◇ | 10.147 | | |

REFERENCE FILE

BETA PARAMETRIC VALUES
0.000

LONGITUDINAL DISTRIBUTION OF BOOSTER FUSELAGE PRESSURES

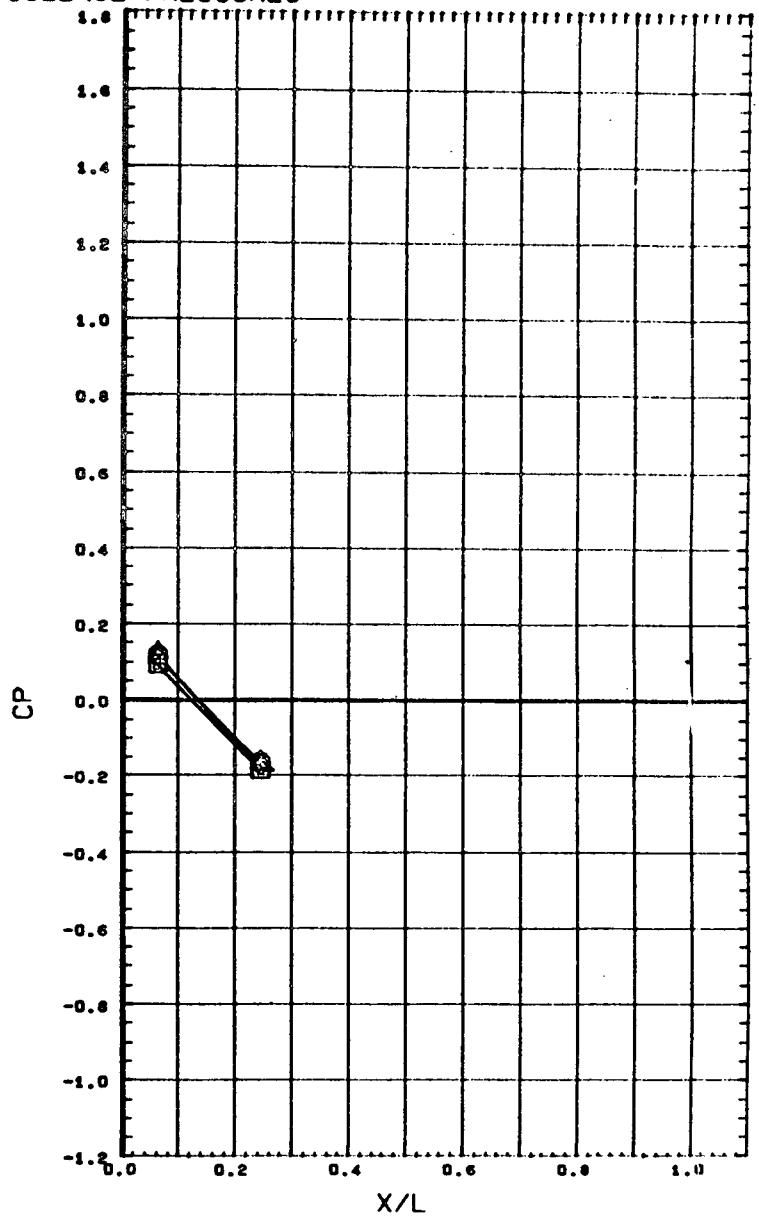
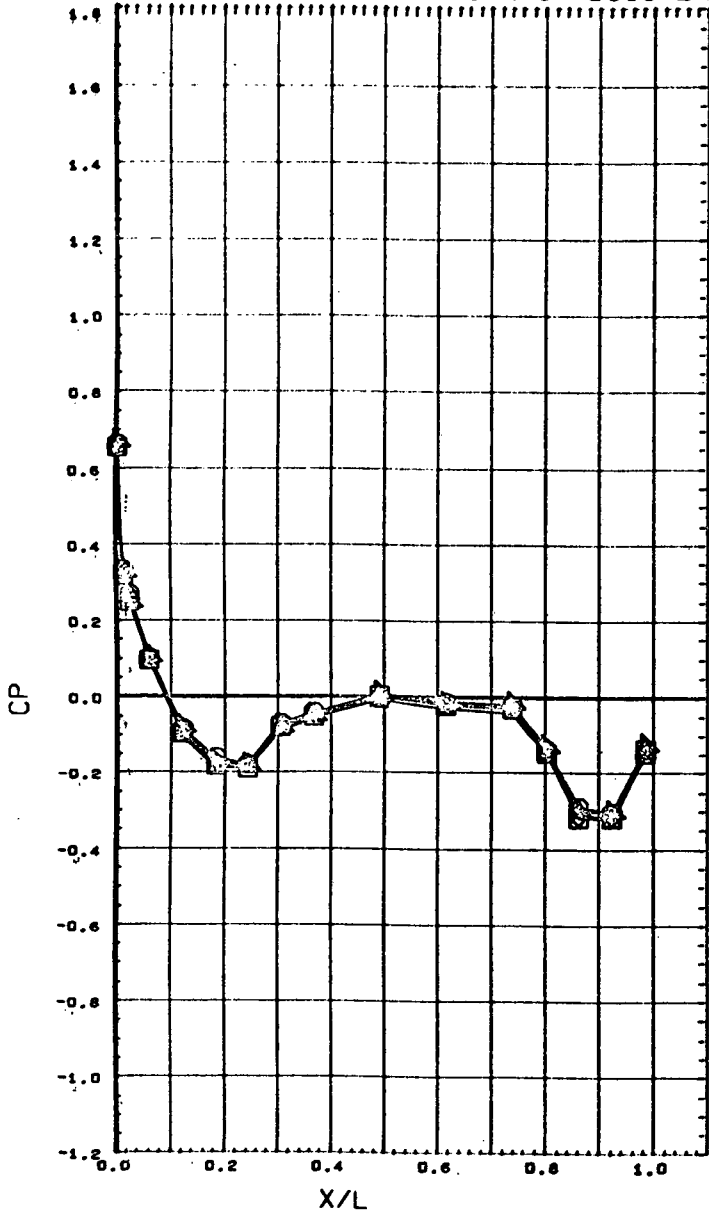

| SYMBOL | BETA | THETA | M1 |
|--------|-------|--------|-------|
| □ | 5.936 | 0.000 | 0.597 |
| ◇ | 3.933 | 15.000 | |
| △ | 1.925 | | |
| ○ | 0.211 | | |
| ◇ | 1.796 | | |

PARAMETRIC VALUES
ALFB 0.000

REFERENCE FILE

LONGITUDINAL DISTRIBUTION OF BOOSTER FUSELAGE PRESSURES

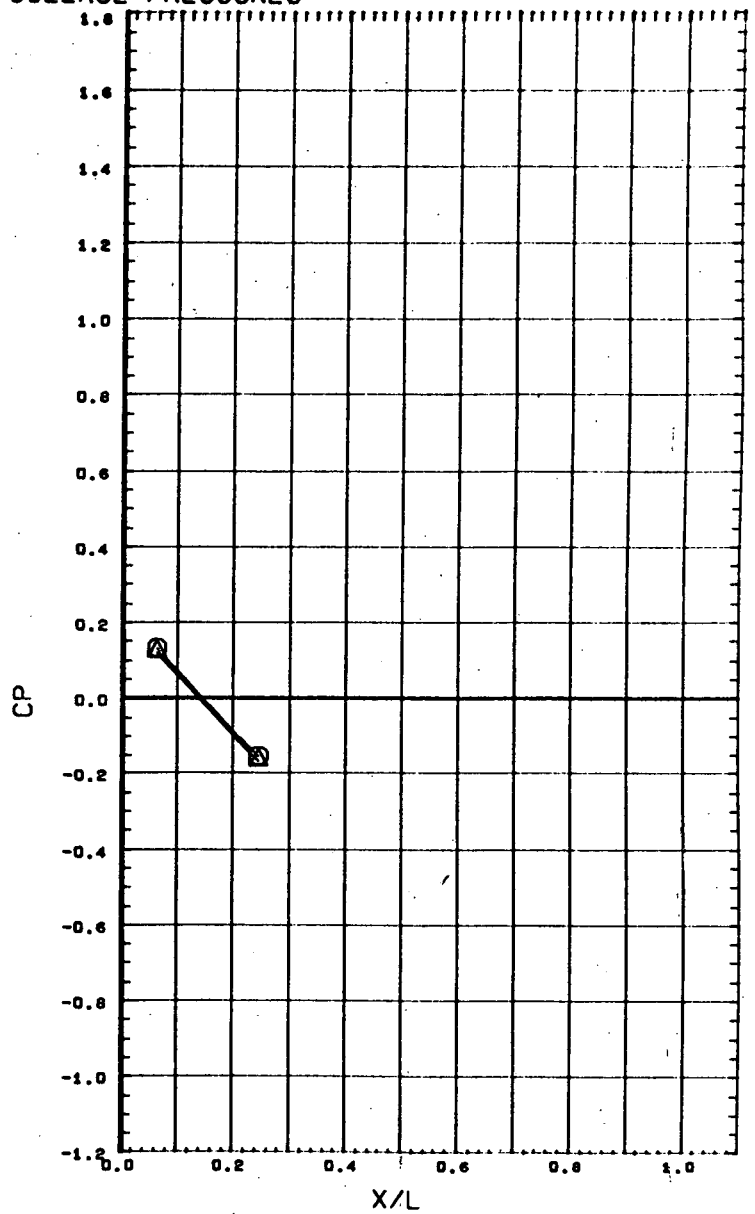
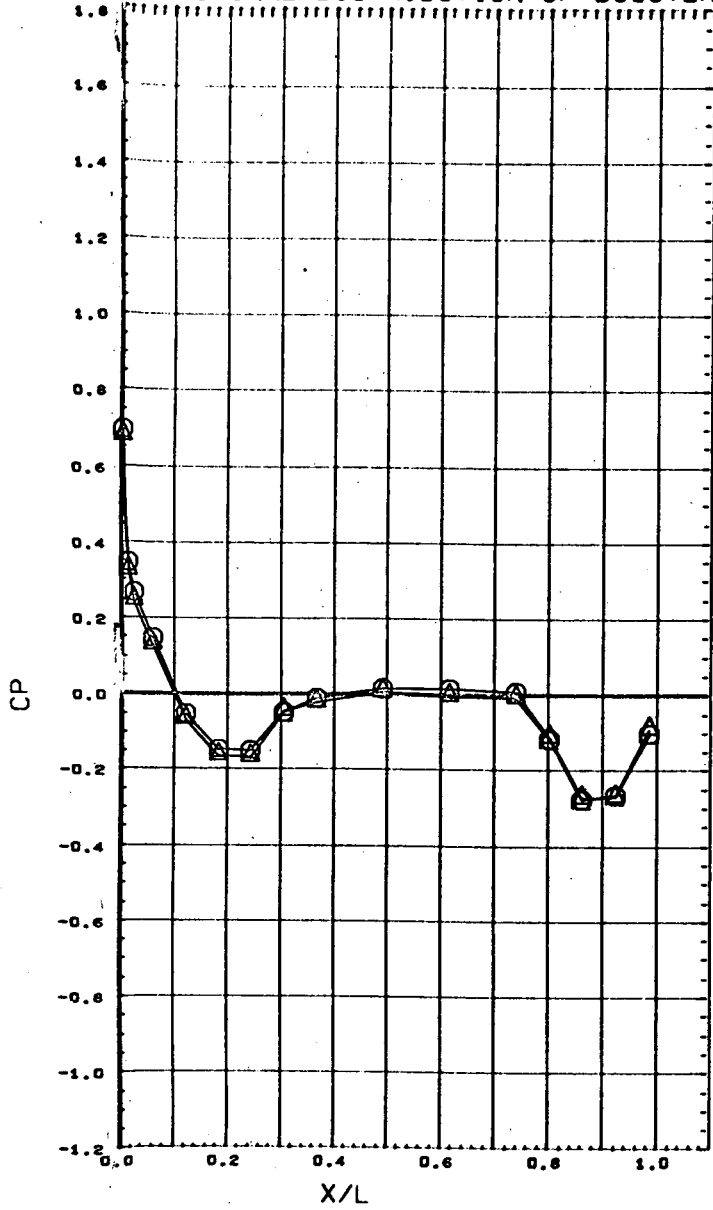

| SYMBOL | BETA | THETA | M1 |
|--------|-------|--------|-------|
| ○ | 3.795 | 0.000 | 0.597 |
| △ | 6.842 | 15.000 | |

PARAMETRIC VALUES
ALFB 0.000

REFERENCE FILE

AEDC C174 MDAC BOOSTER (BODY)

(ATC013)

PAGE 371

LONGITUDINAL DISTRIBUTION OF BOOSTER FUSELAGE PRESSURES

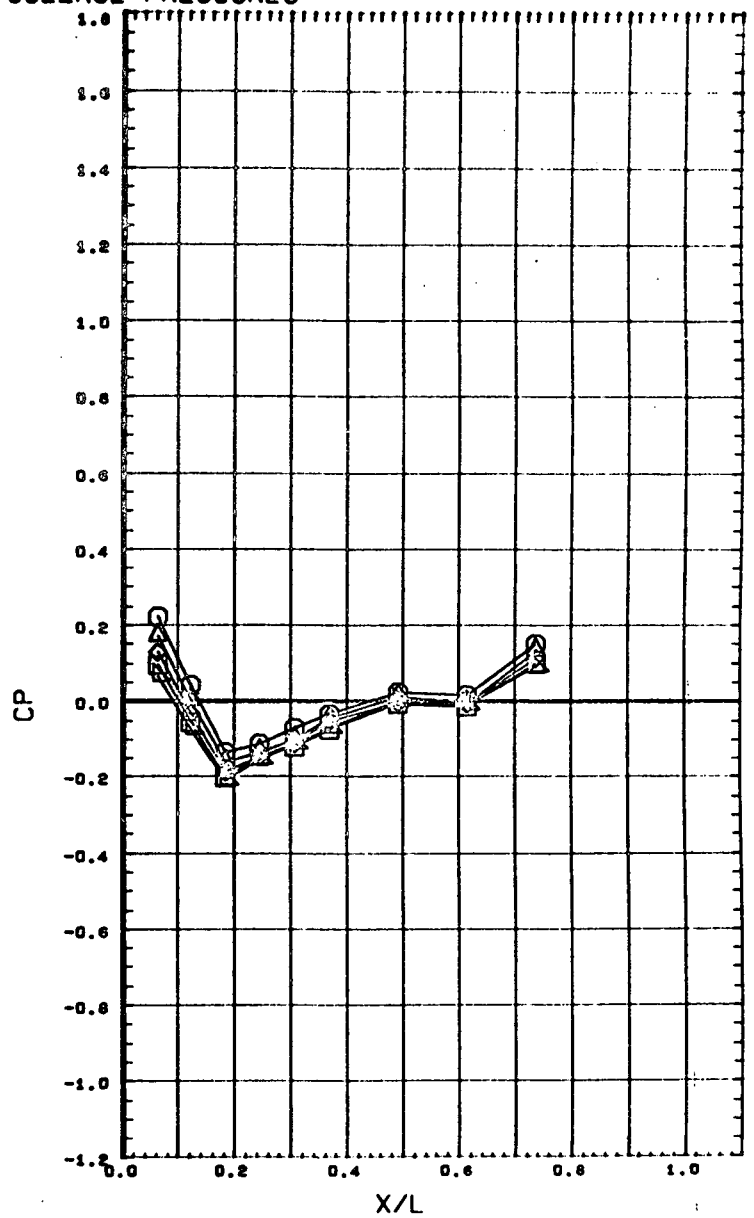
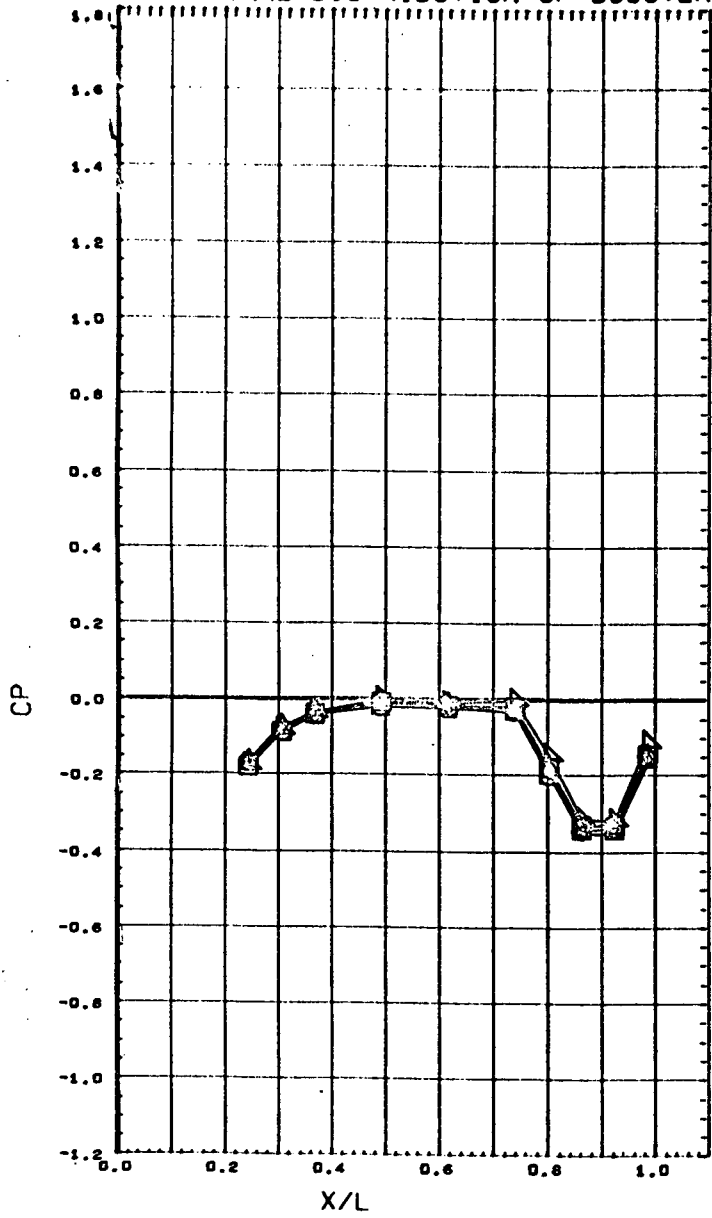

| SYMBOL | BETA | THETA | M1 |
|--------|-------|--------|-------|
| ○ | 5.936 | 24.000 | 0.597 |
| △ | 3.933 | 45.000 | |
| ◇ | 1.925 | | |
| □ | 0.211 | | |
| ▽ | 1.796 | | |

PARAMETRIC VALUES
ALFB 0.000

REFERENCE FILE

LONGITUDINAL DISTRIBUTION OF BOOSTER FUSELAGE PRESSURES

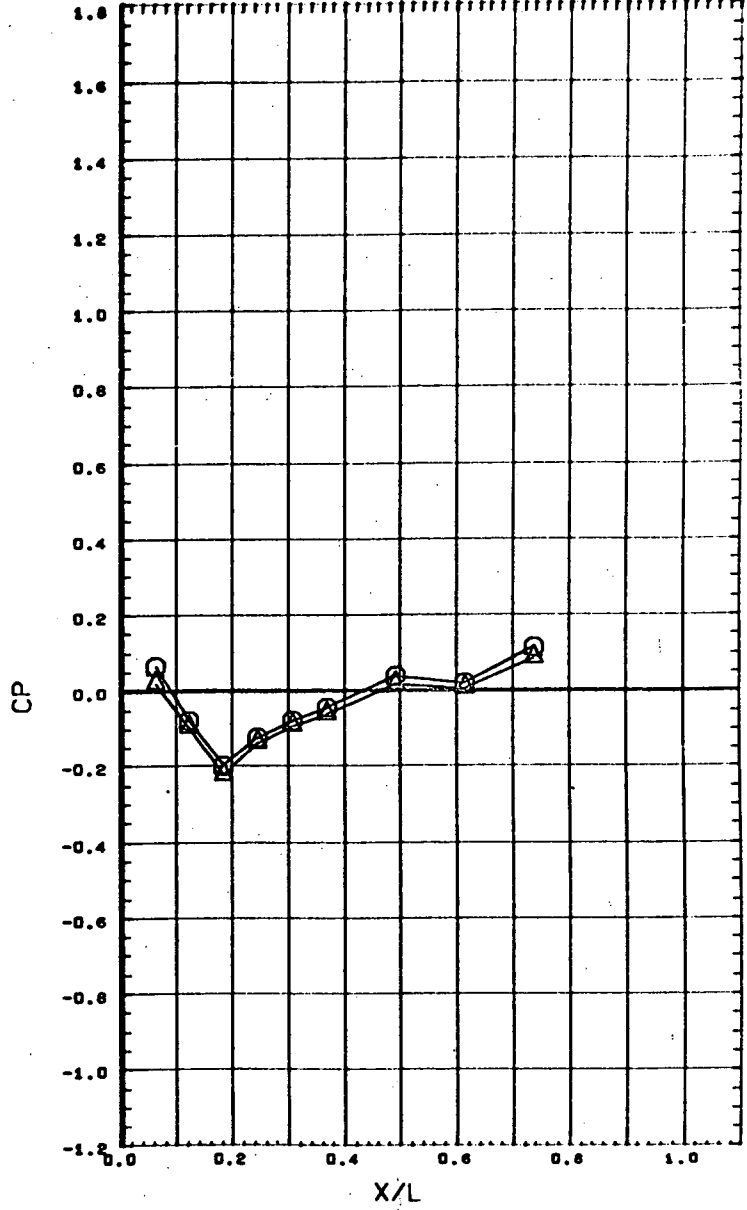
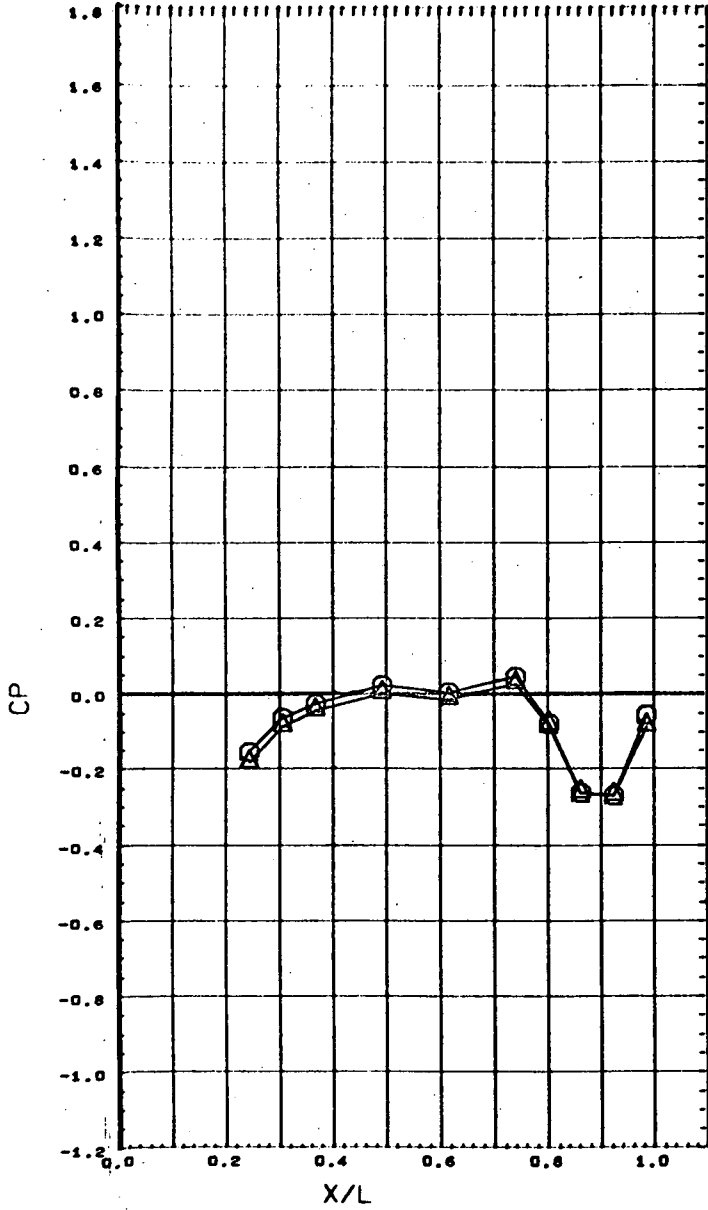

| SYMBOL | BETA | THETA | M1 |
|--------|-------|--------|-------|
| ○ | 3.795 | 24.000 | 0.597 |
| △ | 5.842 | 45.000 | |

ALFB PARAMETRIC VALUES
0.000

REFERENCE FILE

LONGITUDINAL DISTRIBUTION OF BOOSTER FUSELAGE PRESSURES

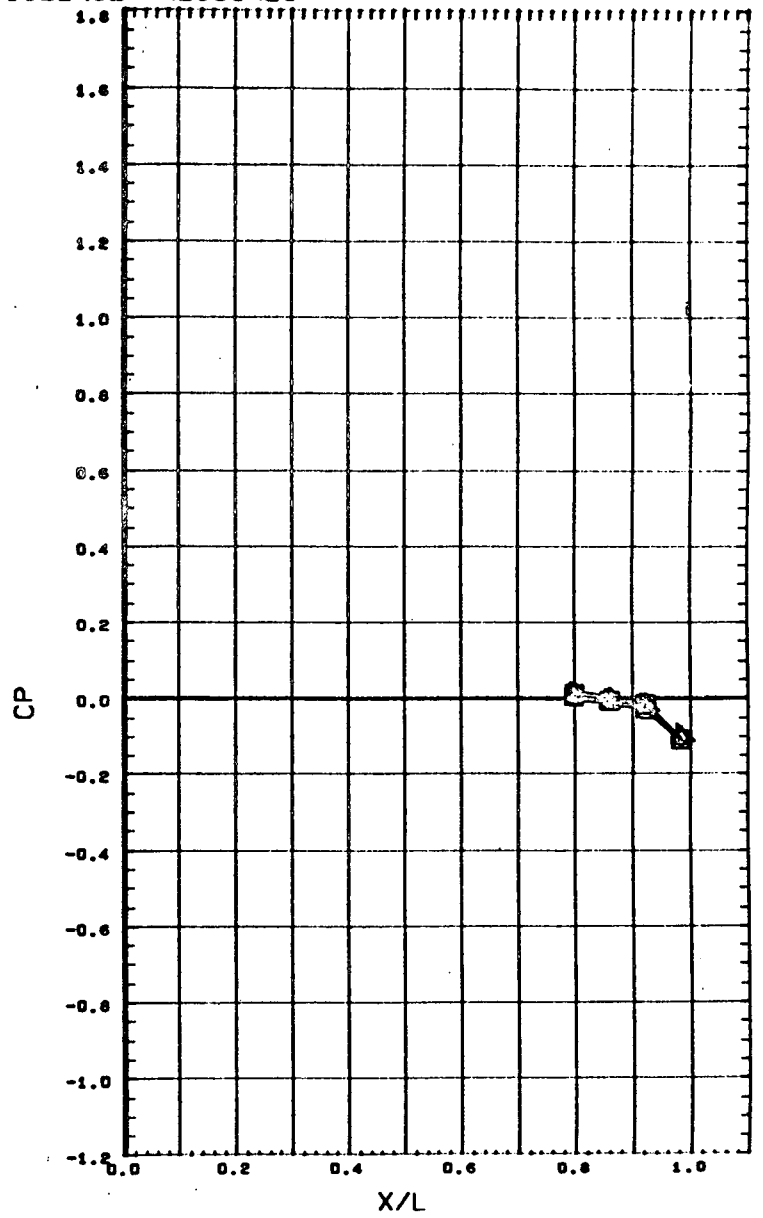
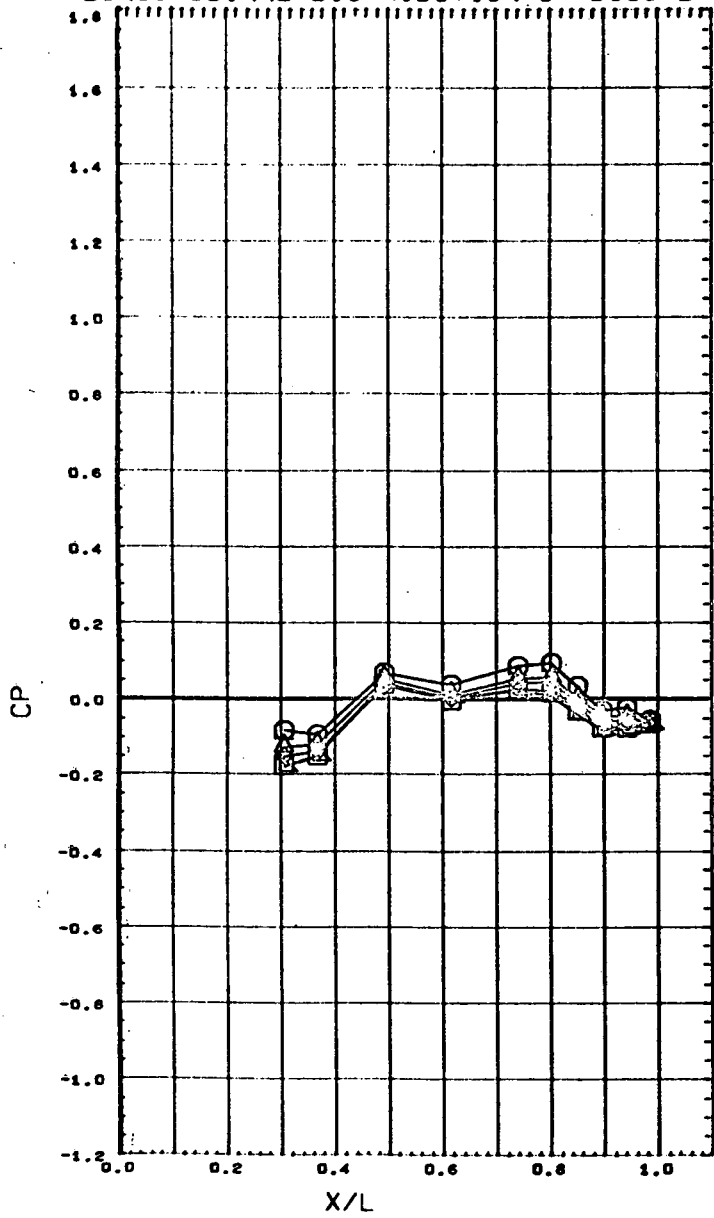

| SYMBOL | BETA | THETA | M1 |
|--------|-------|---------|-------|
| ○ | 5.936 | 90.000 | 0.597 |
| ◇ | 3.933 | 180.000 | |
| △ | 1.925 | | |
| □ | 0.211 | | |
| ▽ | 1.796 | | |

PARAMETRIC VALUES
ALFB 0.000

REFERENCE FILE

LONGITUDINAL DISTRIBUTION OF BOOSTER FUSELAGE PRESSURES

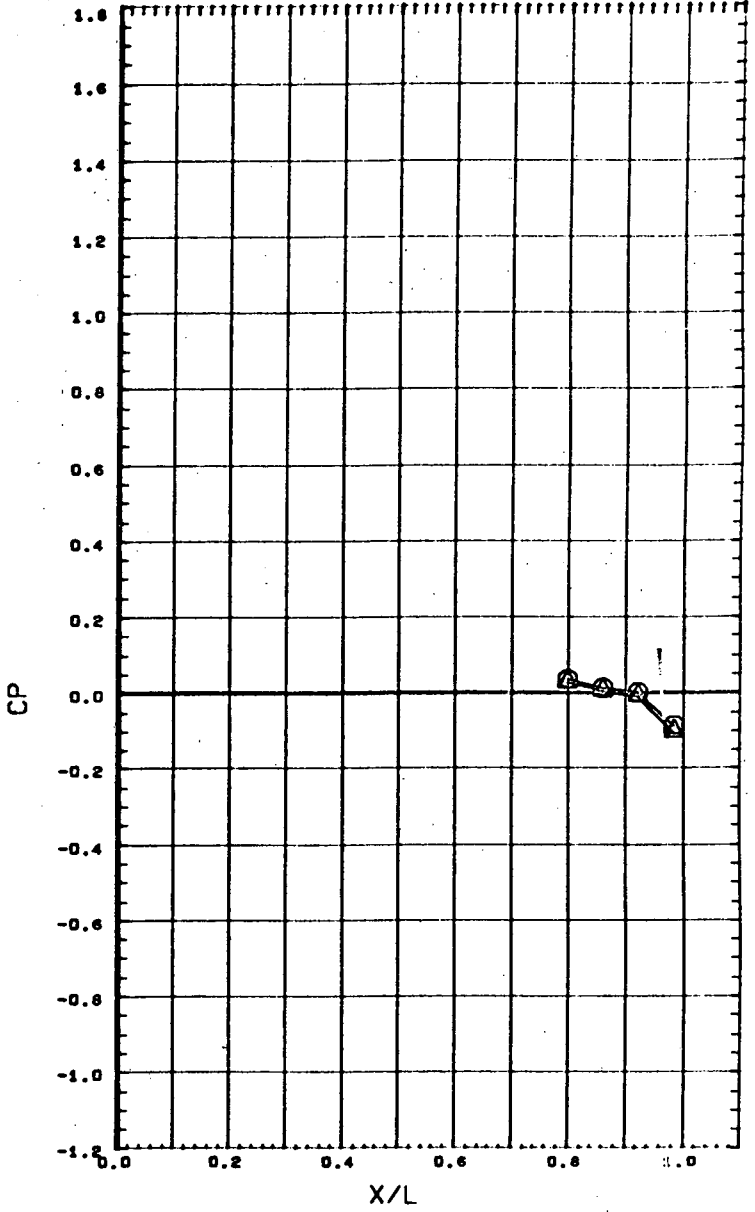
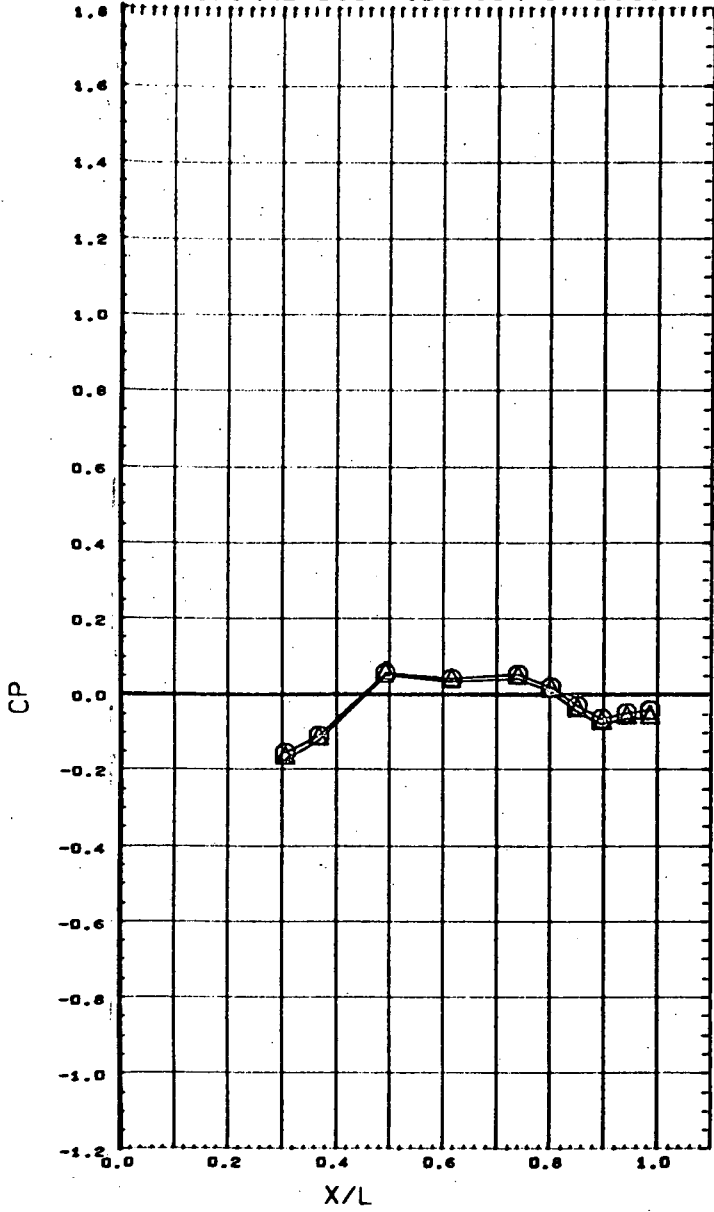

| SYMBOL | BETA | THETA | M1 |
|--------|-------|---------|-------|
| ○ | 5.795 | 90.000 | 0.597 |
| △ | 5.842 | 180.000 | |

PARAMETRIC VALUES
ALFB 0.000

REFERENCE FILE

AEDC TC174 MDAC BOOSTER (BODY)

(ATC013)

PAGE 375

LONGITUDINAL DISTRIBUTION OF BOOSTER FUSELAGE PRESSURES

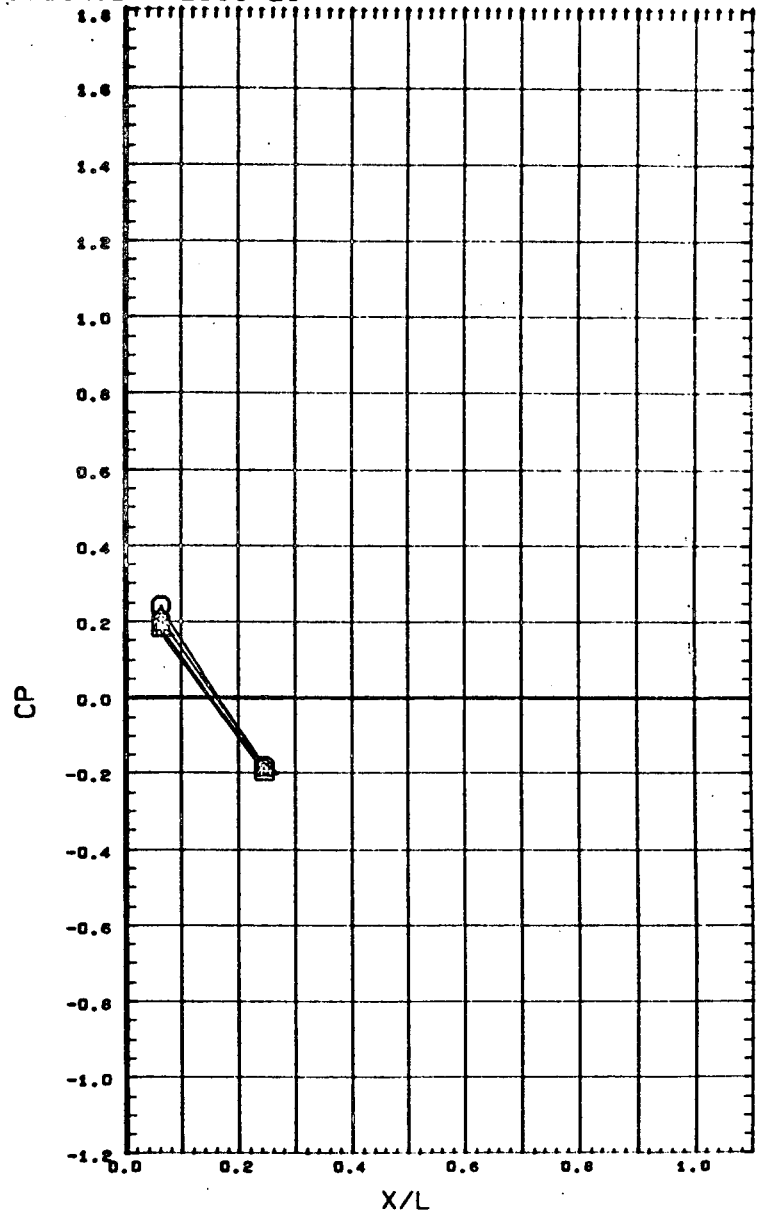
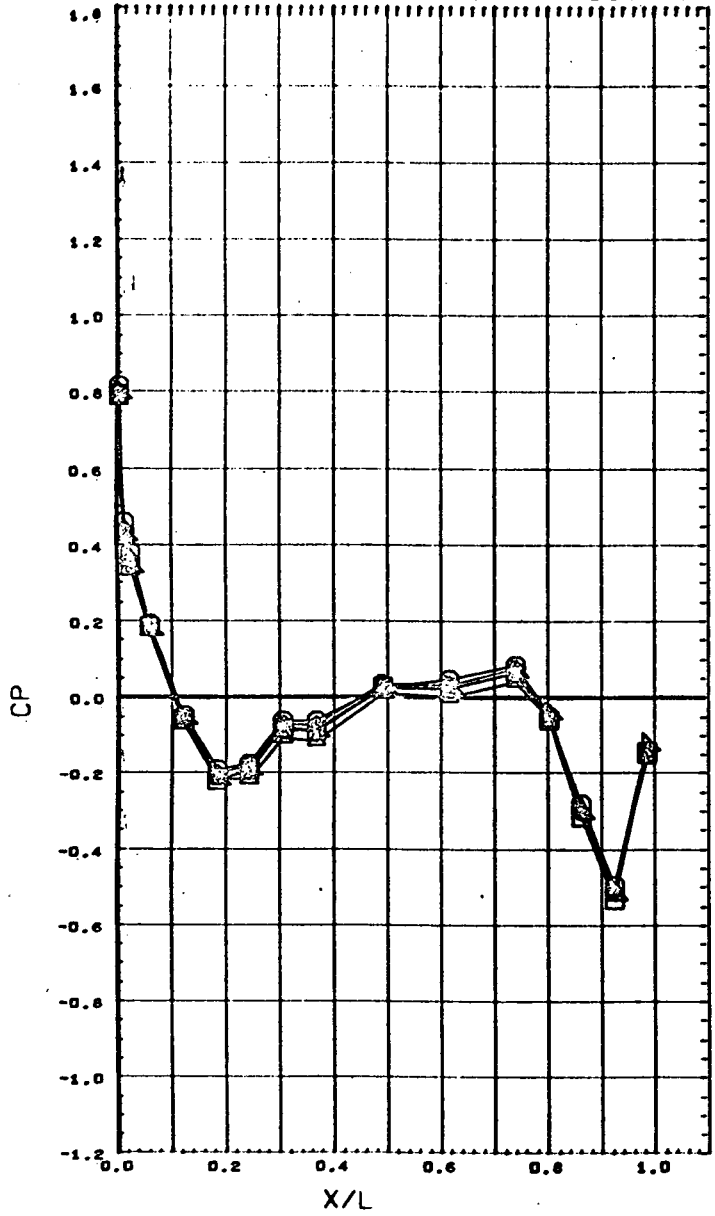

| SYMBOL | BETA | THETA | M1 |
|--------|-------|--------|-------|
| ○ | 5.965 | 0.000 | 0.900 |
| ◇ | 3.882 | 15.000 | |
| ◇ | 1.921 | | |
| ◇ | 0.216 | | |
| ◇ | 1.795 | | |

REFERENCE FILE

PARAMETRIC VALUES
ALFB 0.000

LONGITUDINAL DISTRIBUTION OF BOOSTER FUSELAGE PRESSURES

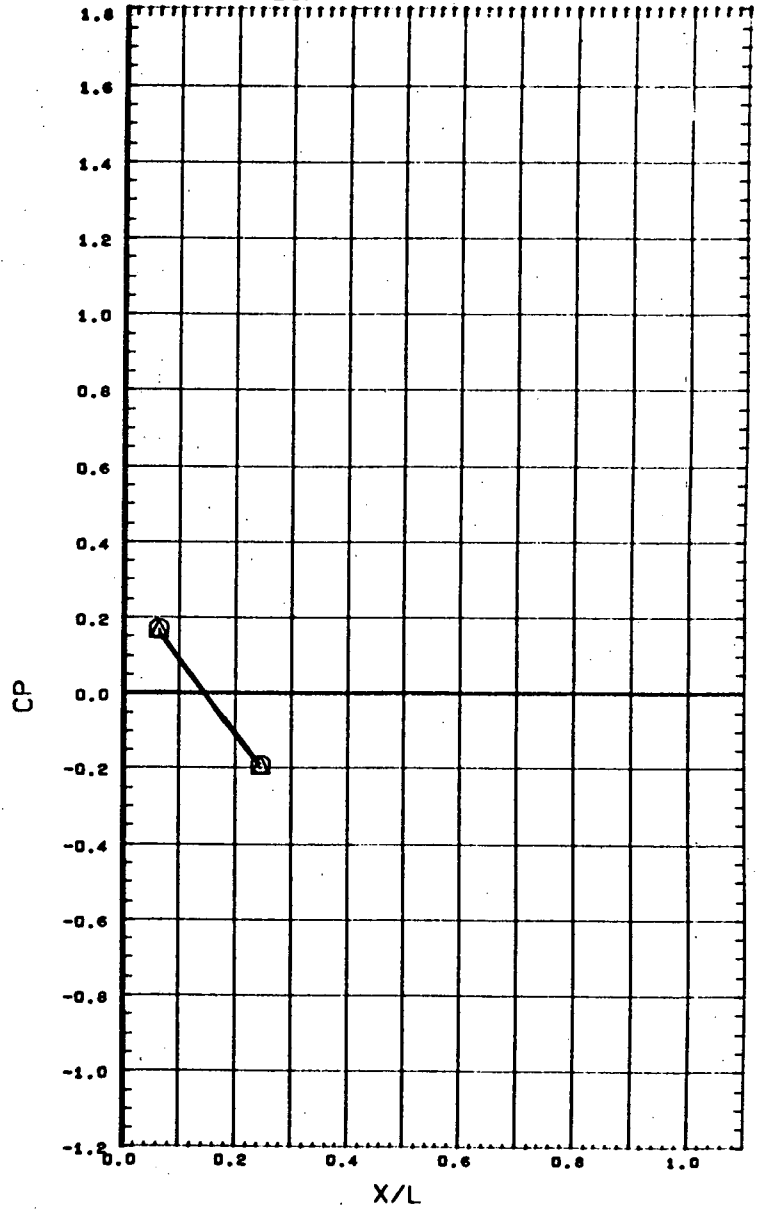
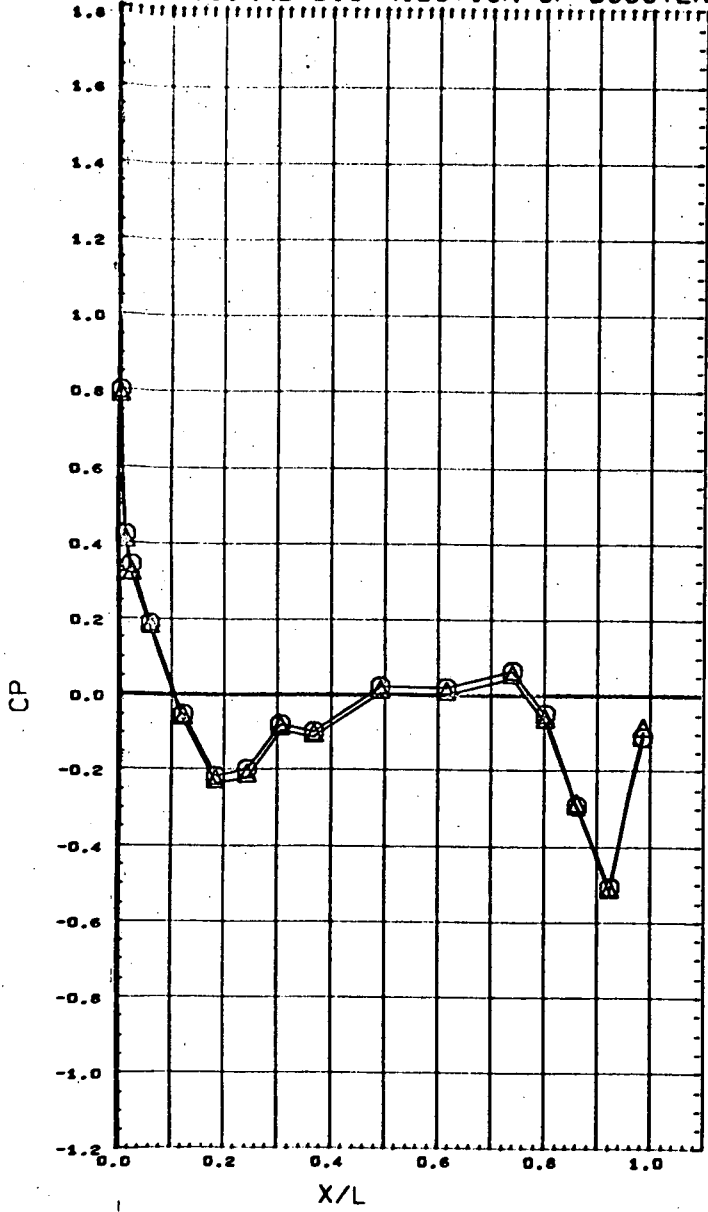

| SYMBOL | BETA | THETA | M1 |
|--------|-------|--------|-------|
| ○ | 3.785 | 0.000 | 0.900 |
| △ | 5.851 | 15.000 | |

PARAMETRIC VALUES
ALFB 0.000

REFERENCE FILE

AEDC TC174 MDAC BOOSTER (BODY)

(ATC013)

PAGE 377

LONGITUDINAL DISTRIBUTION OF BOOSTER FUSELAGE PRESSURES

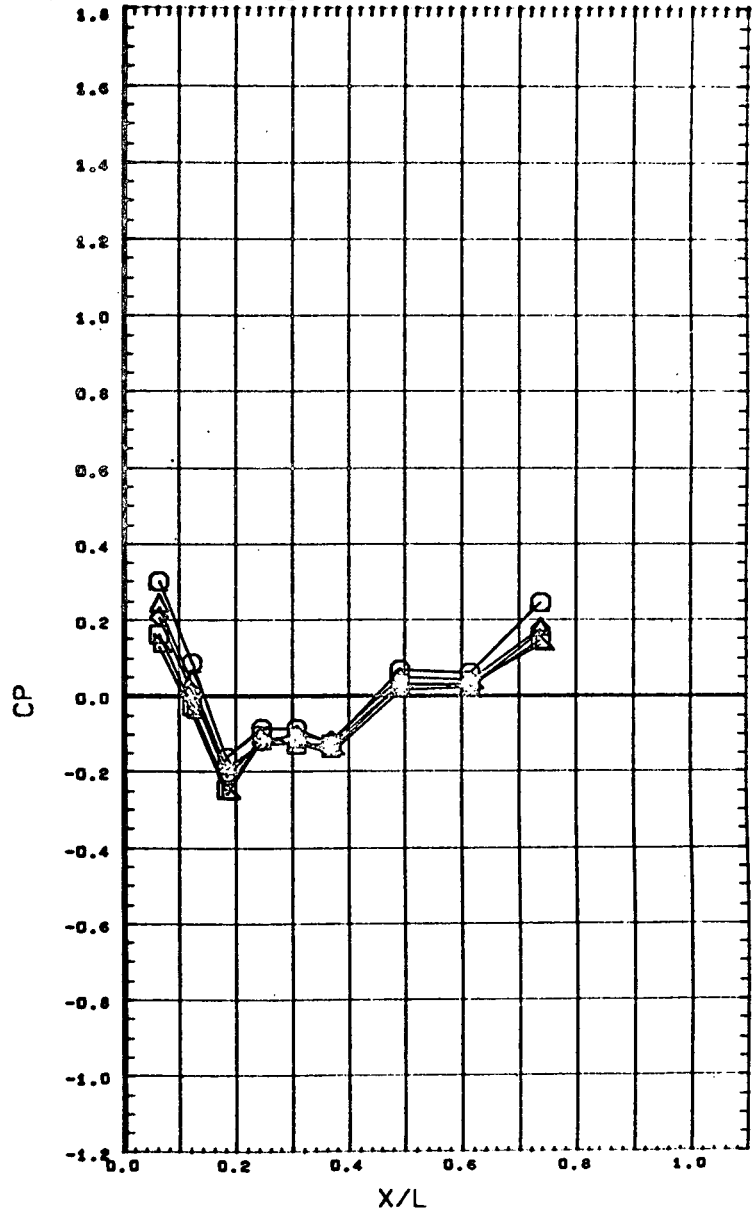
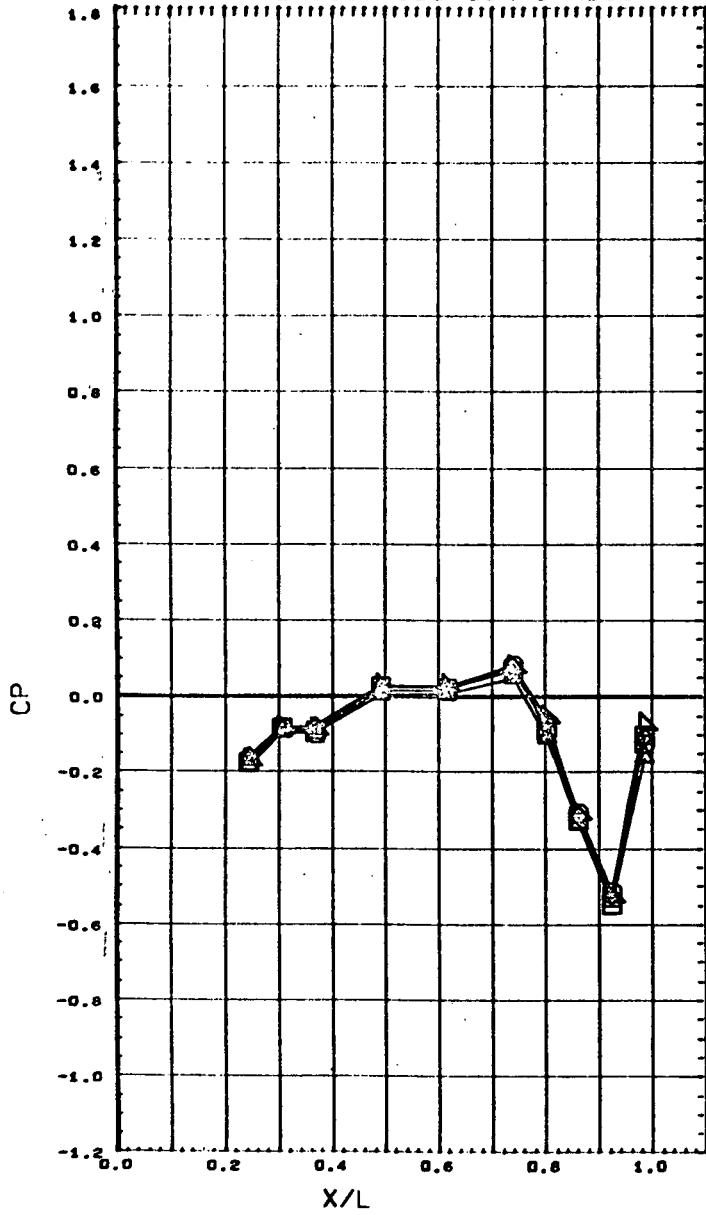

| SYMBOL | BETA | THETA | M1 |
|--------|-------|--------|-------|
| ○ | 5.965 | 24.000 | 0.900 |
| △ | 3.882 | 45.000 | |
| ◇ | 1.921 | | |
| □ | 0.218 | | |
| ▽ | 1.795 | | |

PARAMETRIC VALUES
ALFB 0.000

REFERENCE FILE

LONGITUDINAL DISTRIBUTION OF BOOSTER FUSELAGE PRESSURES

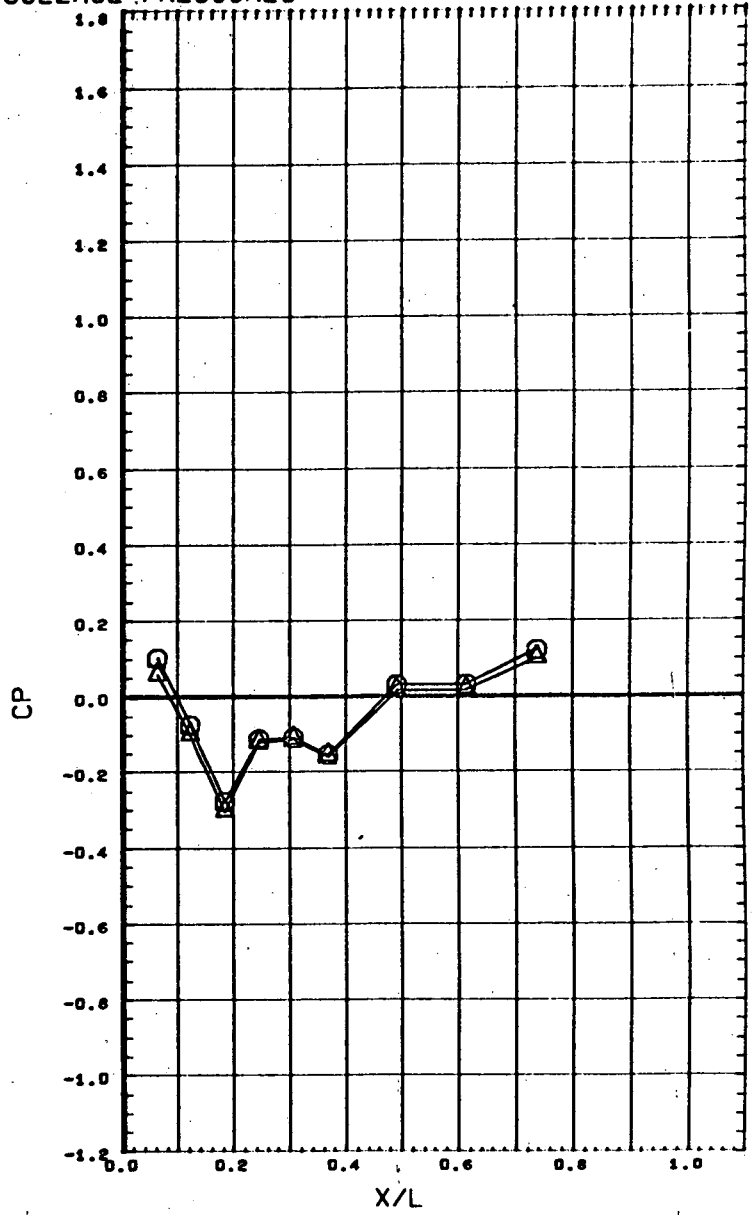
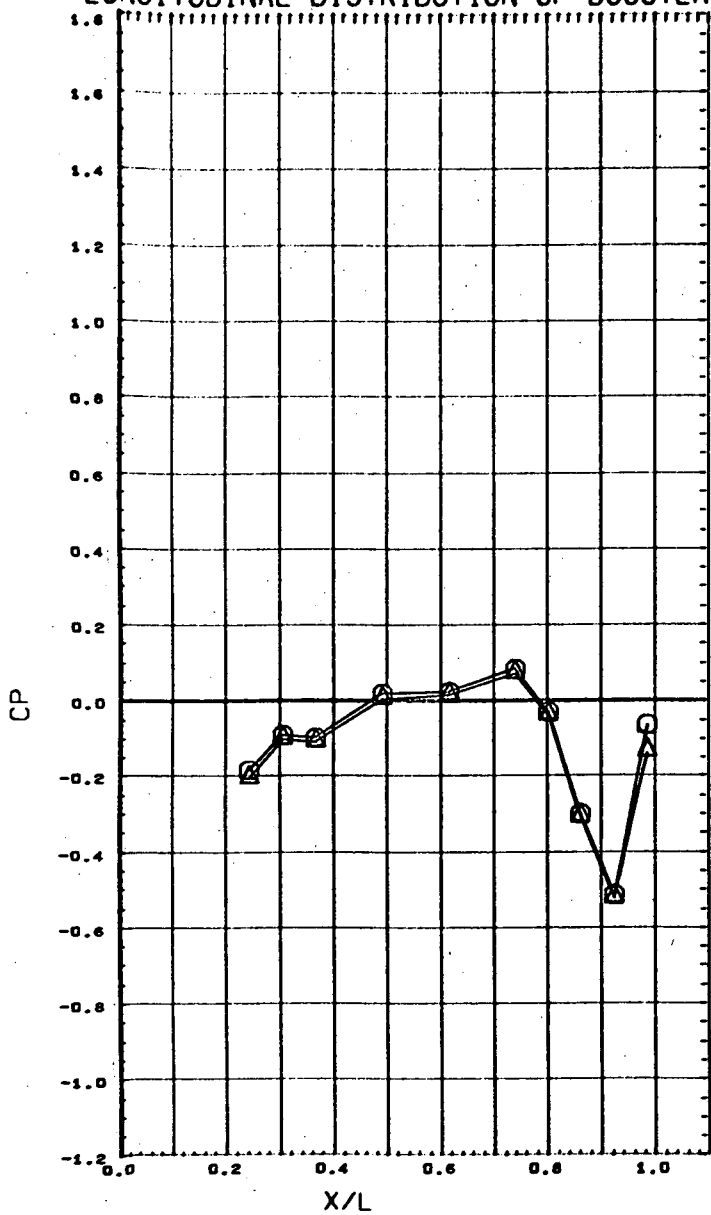

| SYMBOL | BETA | THETA | M1 |
|--------|-------|--------|-------|
| ○ | 3.785 | 24.000 | 0.900 |
| △ | 5.851 | 45.000 | |

PARAMETRIC VALUES
ALFB 0.000

REFERENCE FILE

LONGITUDINAL DISTRIBUTION OF BOOSTER FUSELAGE PRESSURES

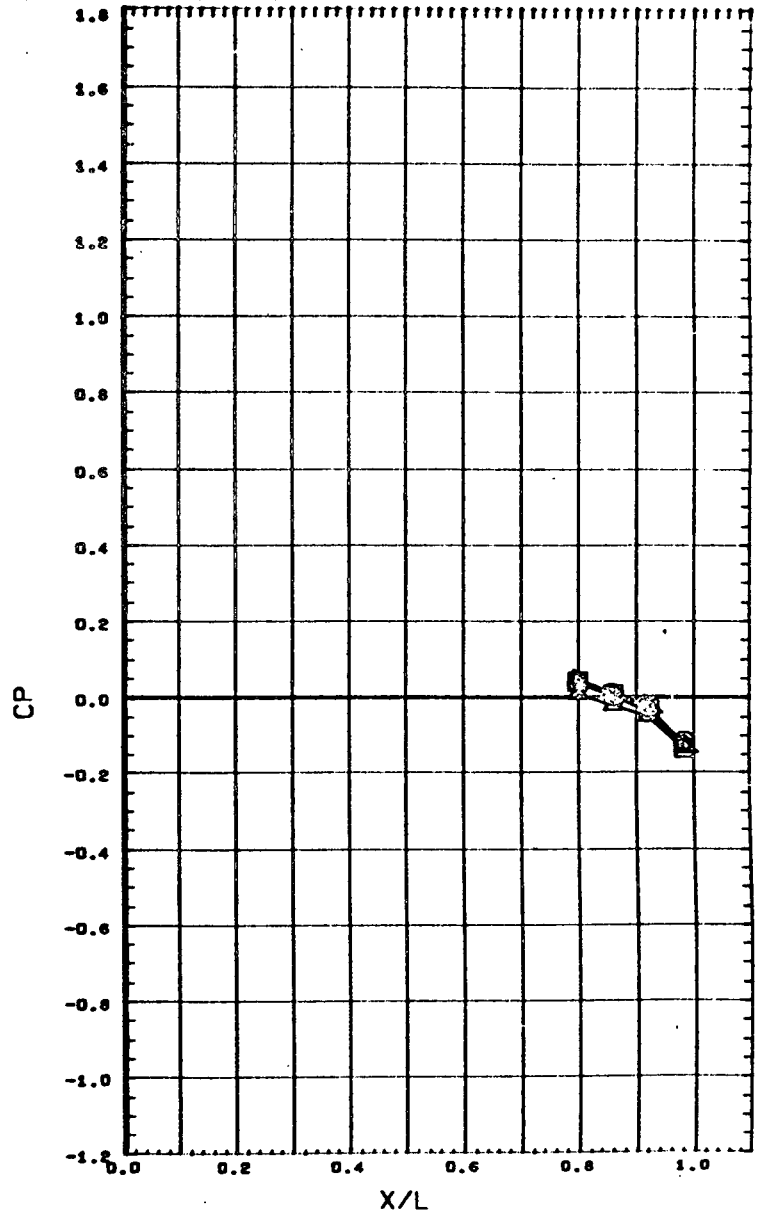
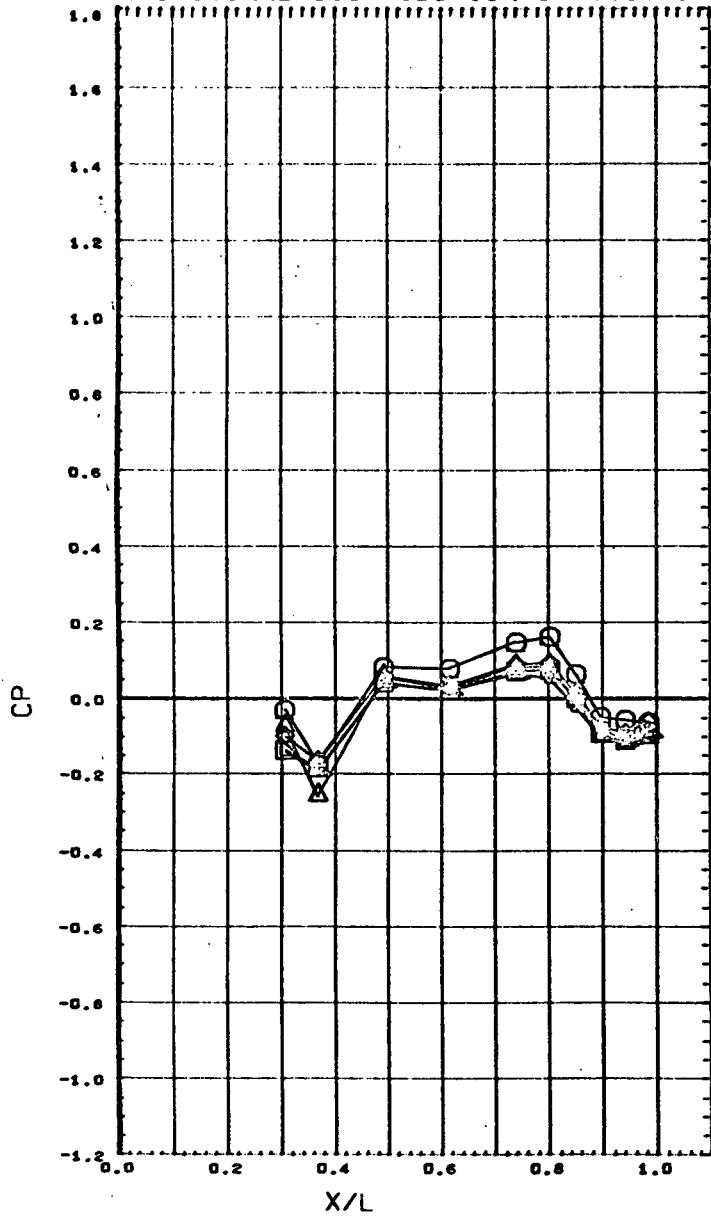

| SYMBOL | BETA | THETA | M1 |
|--------|-------|---------|-------|
| ○ | 3.965 | 90.000 | 0.900 |
| △ | 3.802 | 180.000 | |
| ◇ | 1.921 | | |
| □ | 0.218 | | |
| ▽ | 1.795 | | |

PARAMETRIC VALUES
ALFB 0.000

REFERENCE FILE

LONGITUDINAL DISTRIBUTION OF BOOSTER FUSELAGE PRESSURES

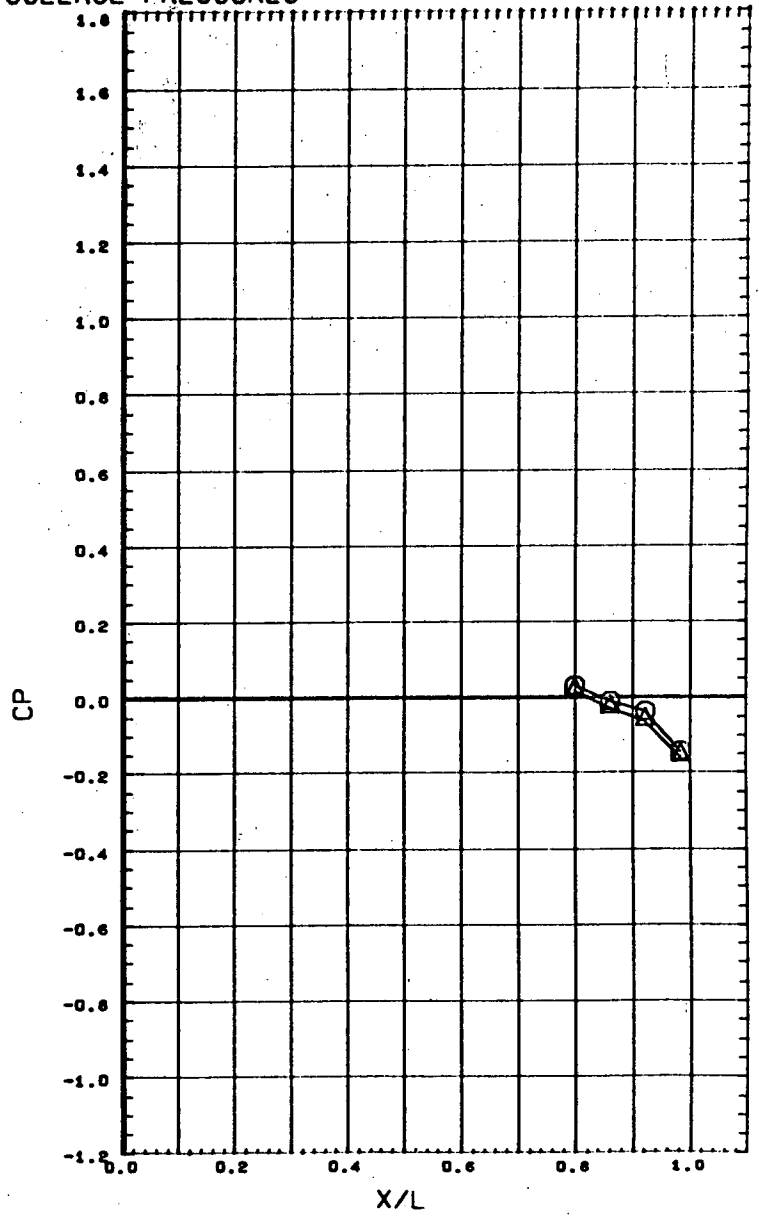
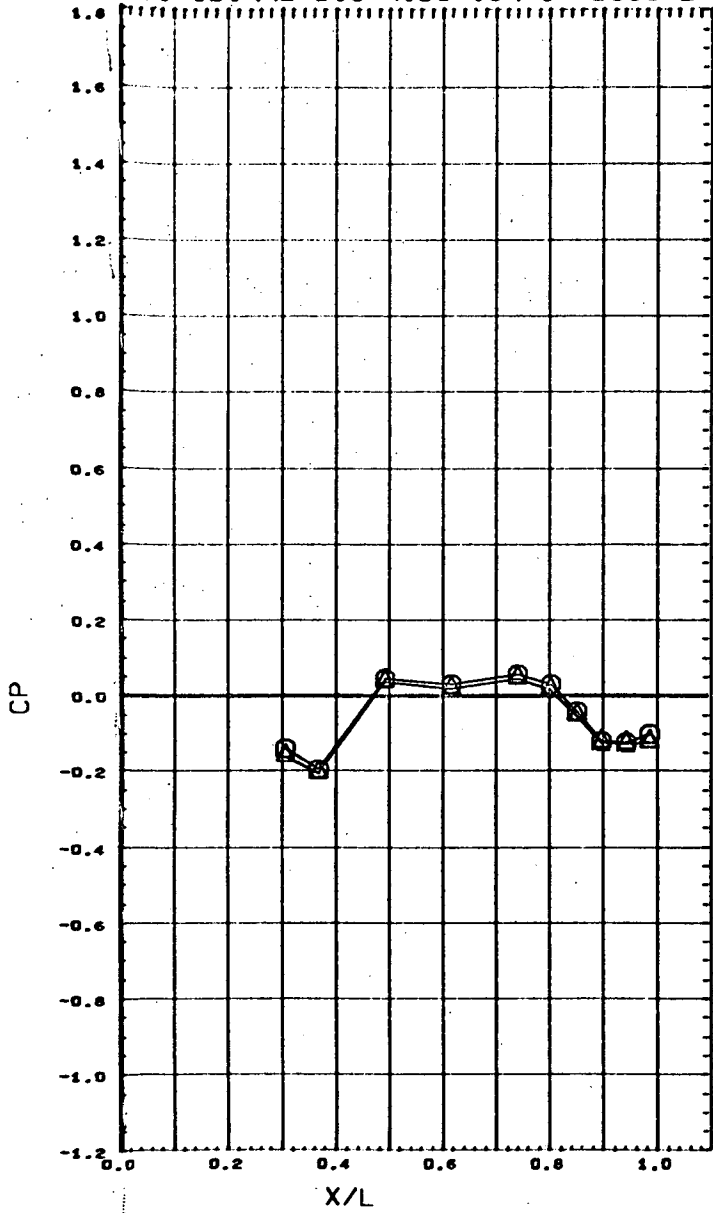

| SYMBOL | BETA | THETA | M1 |
|--------|-------|---------|-------|
| ○ | 4.785 | 90.000 | 0.900 |
| △ | 4.851 | 180.000 | |

| ALFB | PARAMETRIC VALUES |
|------|-------------------|
| | 0.000 |

REFERENCE FILE

AEDC TC174 MDAC BOOSTER (BODY)

(ATC013)

PAGE 381

LONGITUDINAL DISTRIBUTION OF BOOSTER FUSELAGE PRESSURES

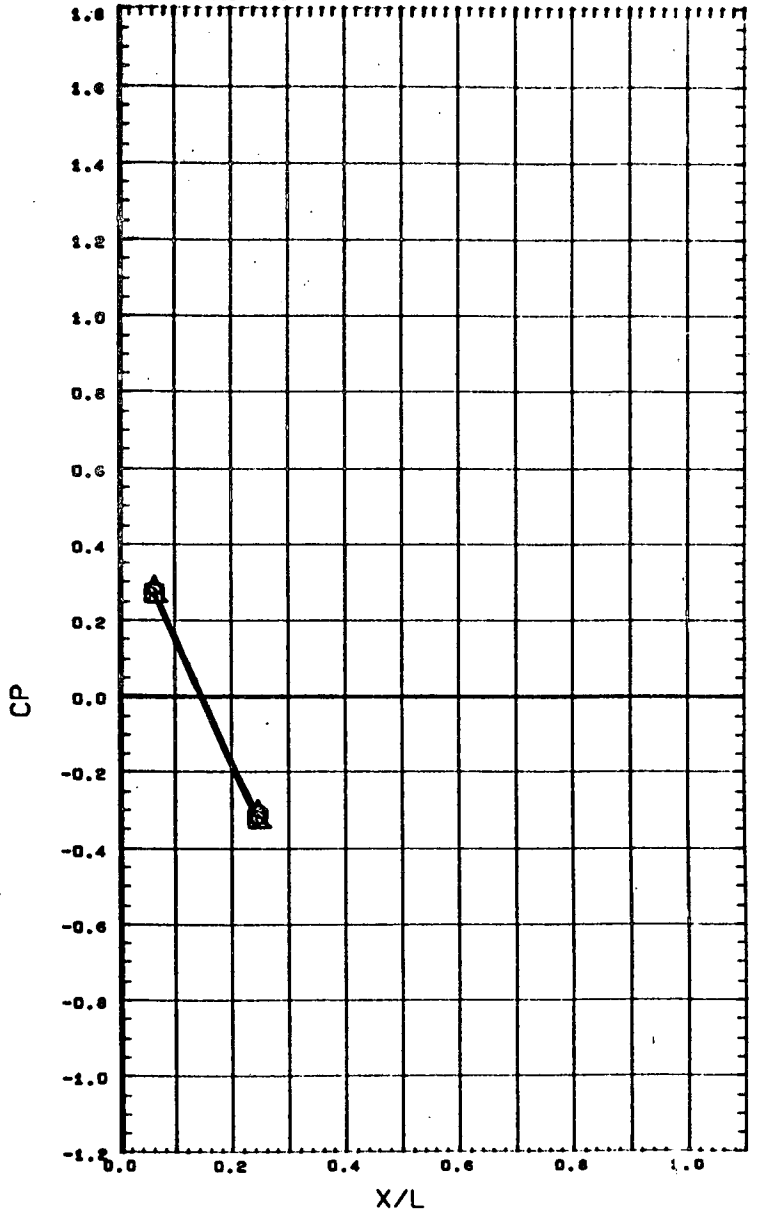
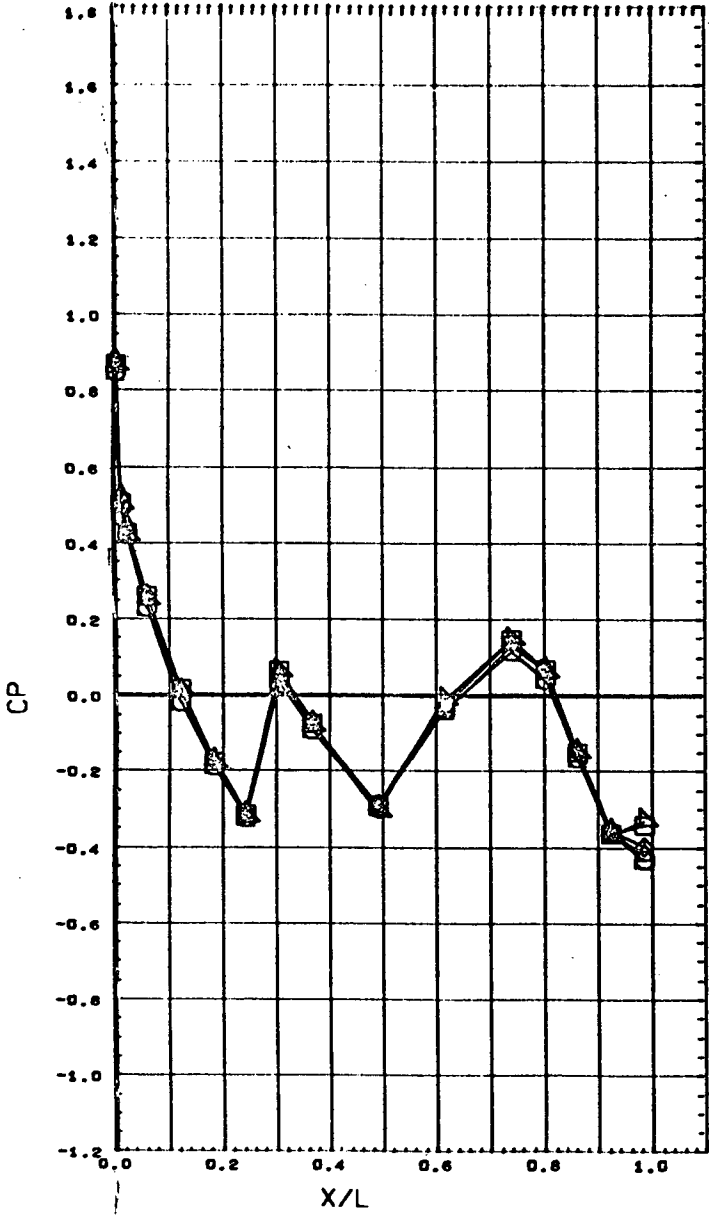

| SYMBOL | BETA | THETA | M1 |
|--------|-------|--------|-------|
| ○ | 6.013 | 0.000 | 1.000 |
| ◇ | 3.911 | 15.000 | |
| △ | 1.927 | | |
| □ | 0.219 | | |
| ◇ | 1.802 | | |

PARAMETRIC VALUES
ALFB 0.000

REFERENCE FILE

LONGITUDINAL DISTRIBUTION OF BOOSTER FUSELAGE PRESSURES

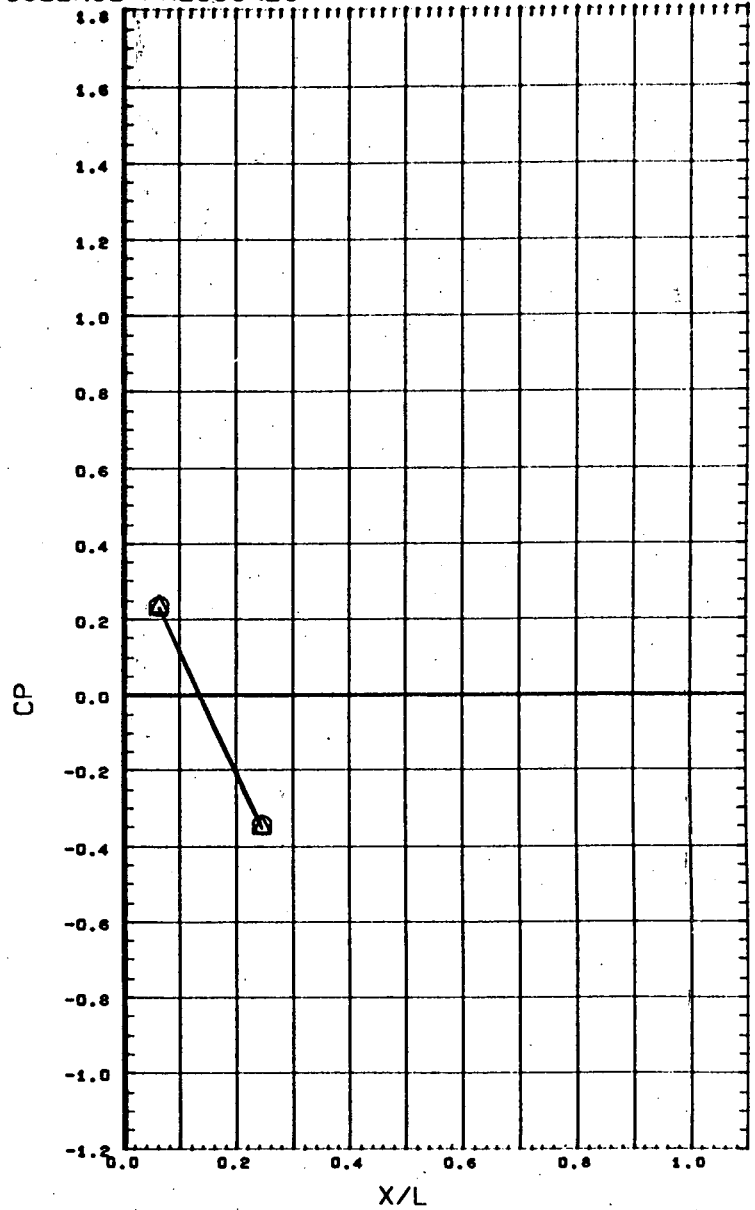
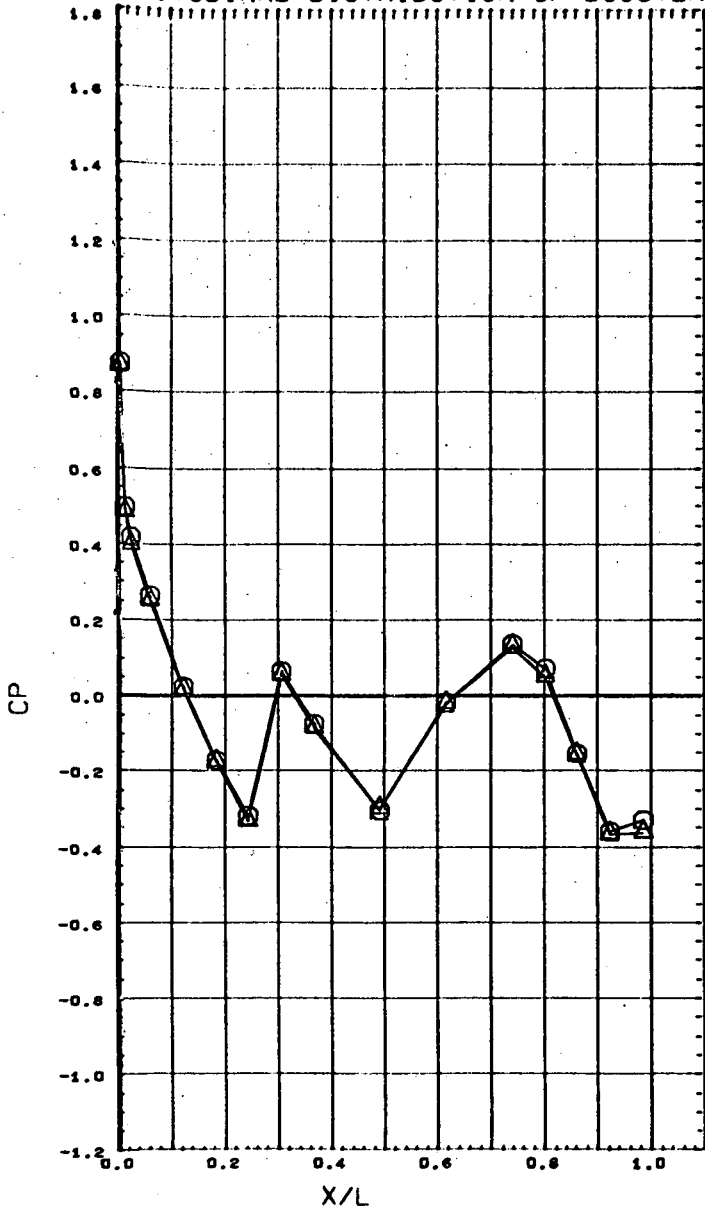

| SYMBOL | BETA | THETA | M1 |
|--------|-------|--------|-------|
| ○ | 3.868 | 0.000 | 1.000 |
| △ | 5.892 | 15.000 | |

PARAMETRIC VALUES
ALFB 0.000

REFERENCE FILE

AEDC TC174 MDAC BOOSTER (BODY)

(ATC013)

PAGE 383

LONGITUDINAL DISTRIBUTION OF BOOSTER FUSELAGE PRESSURES

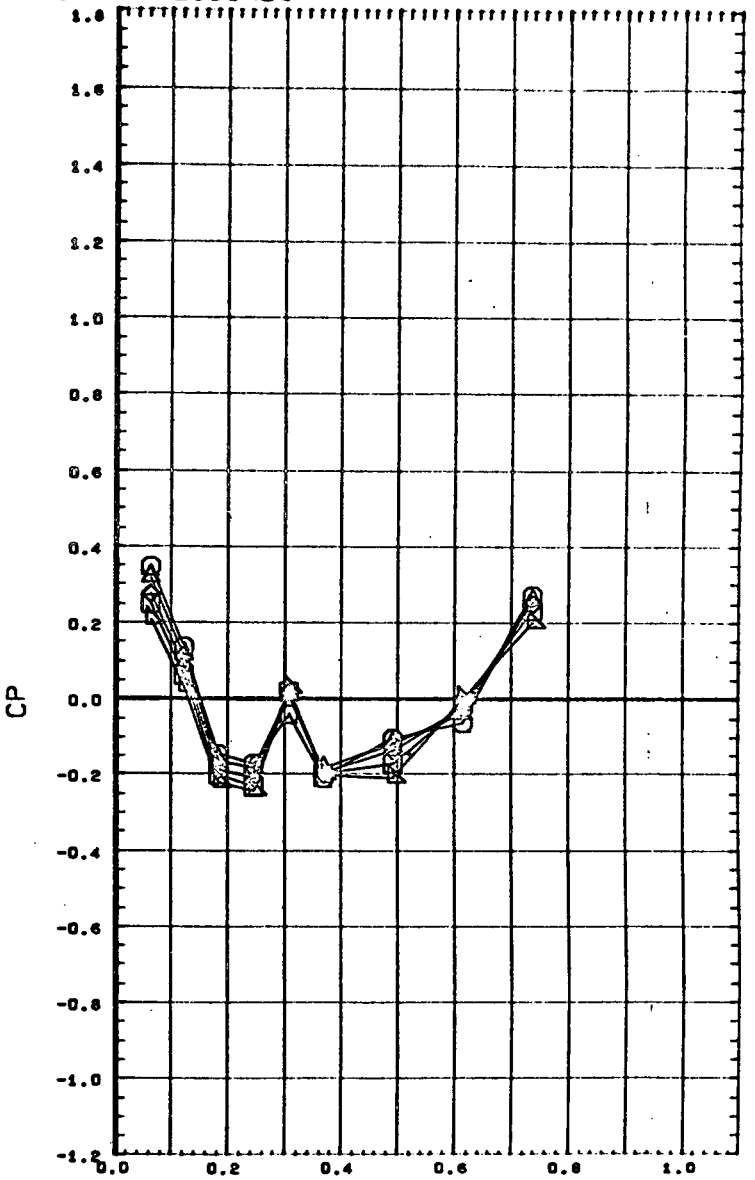
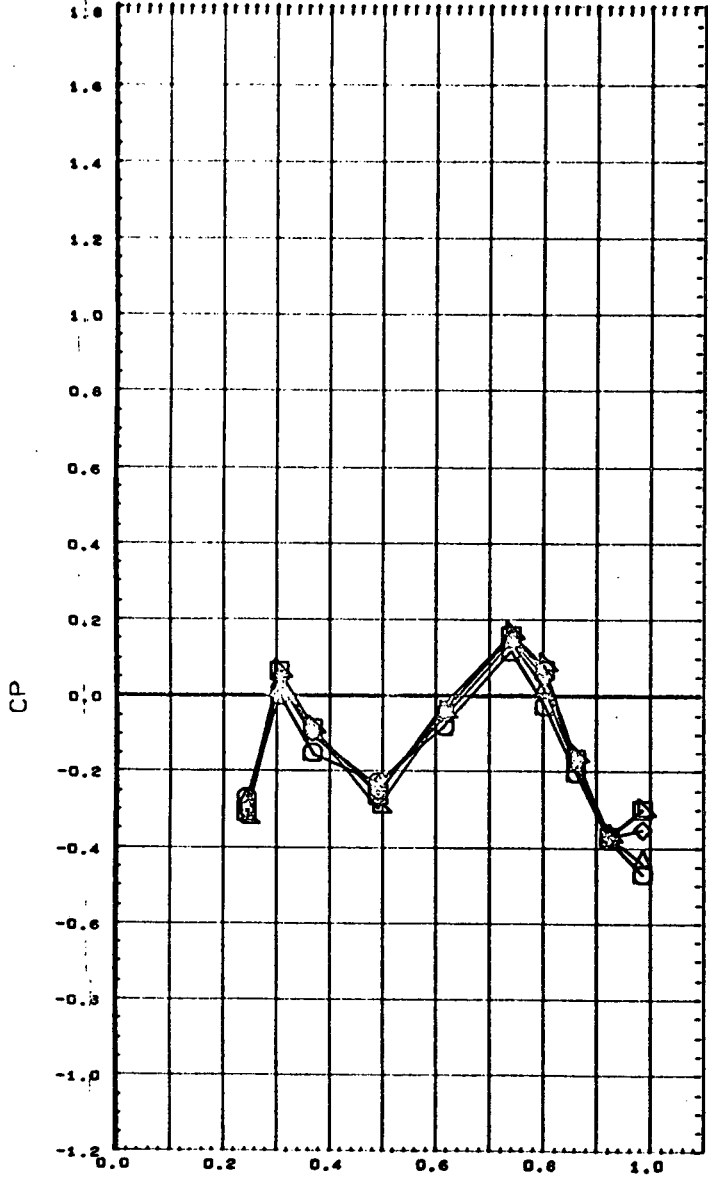

| SYMBOL | BETA | THETA | M1 |
|--------|-------|--------|-------|
| ○ | 6.013 | 24.000 | 1.000 |
| △ | 3.911 | 45.000 | |
| ◇ | 1.927 | | |
| □ | 0.219 | | |
| ▽ | 1.802 | | |

ALPB PARAMETRIC VALUES
 0.000

REFERENCE FILE

LONGITUDINAL DISTRIBUTION OF BOOSTER FUSELAGE PRESSURES

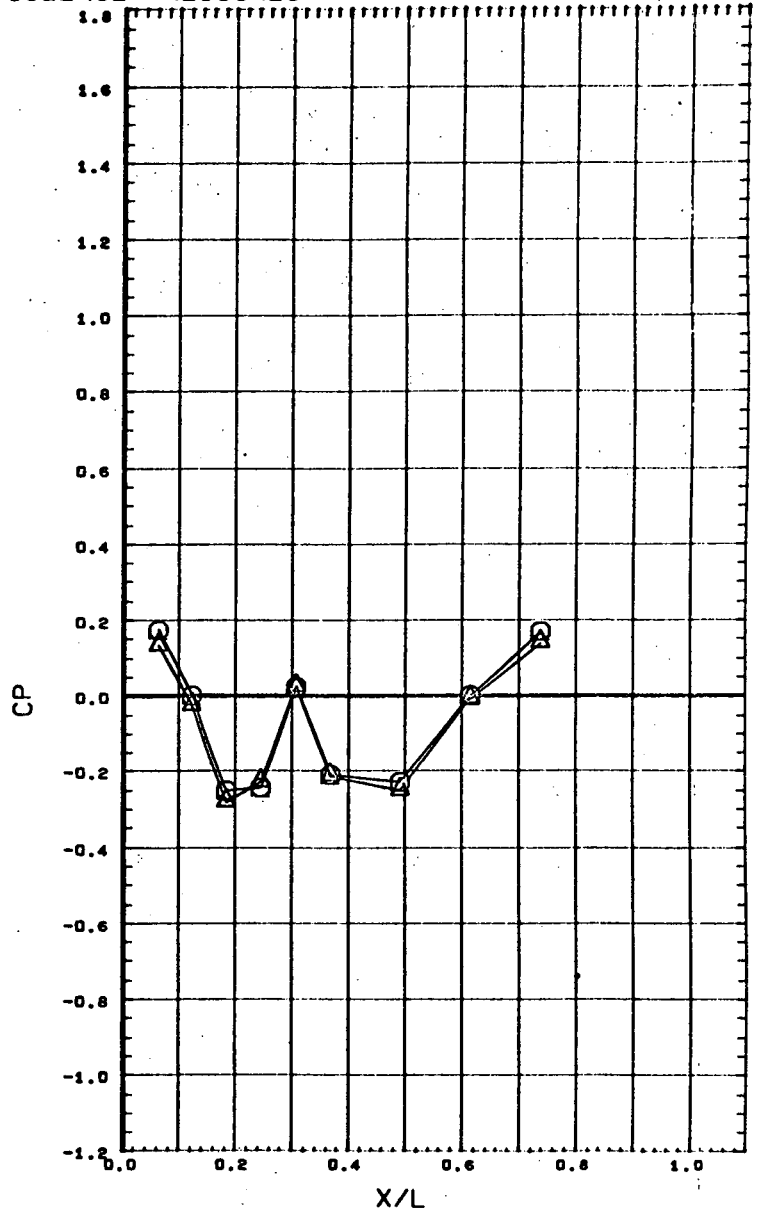
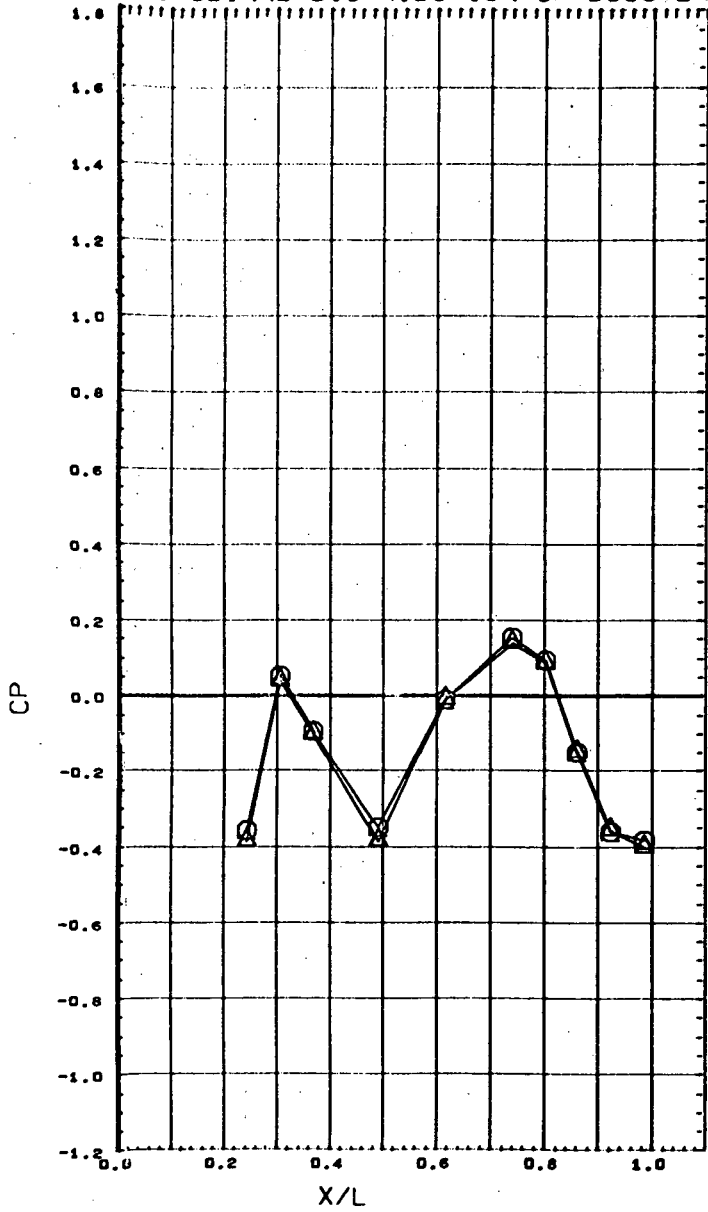

| SYMBOL | BETA | THETA | M1 |
|--------|-------|--------|-------|
| ○ | 3.808 | 24.000 | 1.000 |
| △ | 5.892 | 45.000 | |

PARAMETRIC VALUES
ALFB 0.000

REFERENCE FILE

AEDC TC174 MDAC BOOSTER (BODY)

(ATC013)

PAGE 385

LONGITUDINAL DISTRIBUTION OF BOOSTER FUSELAGE PRESSURES

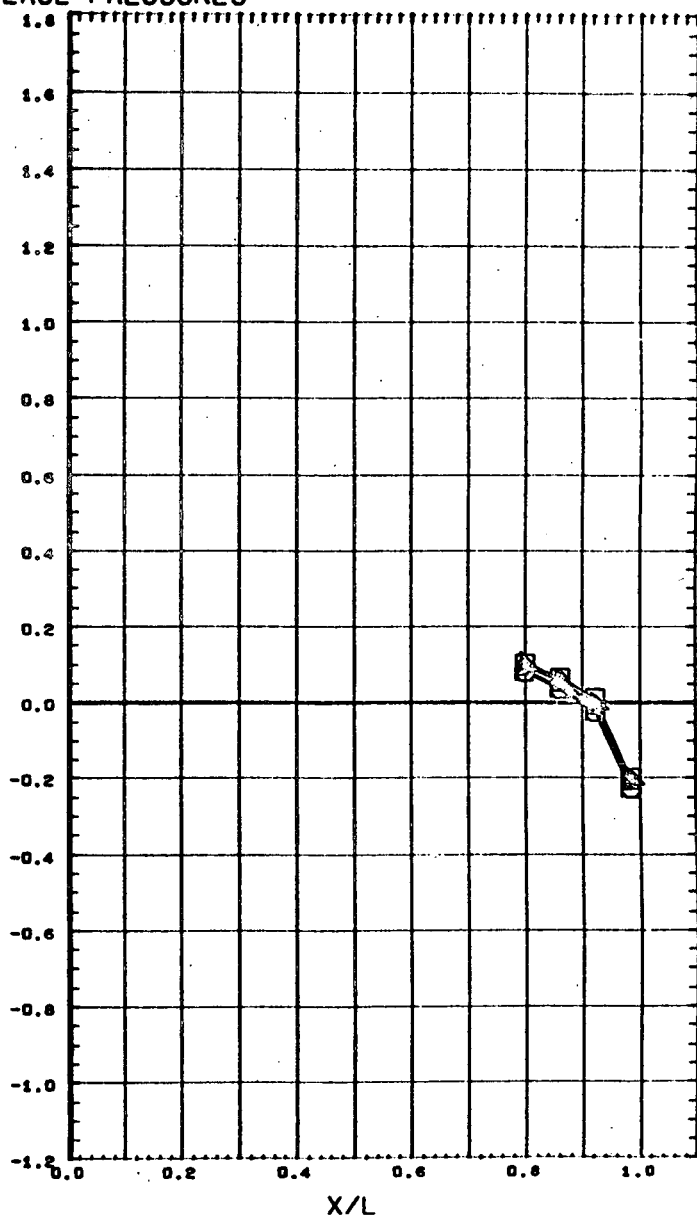
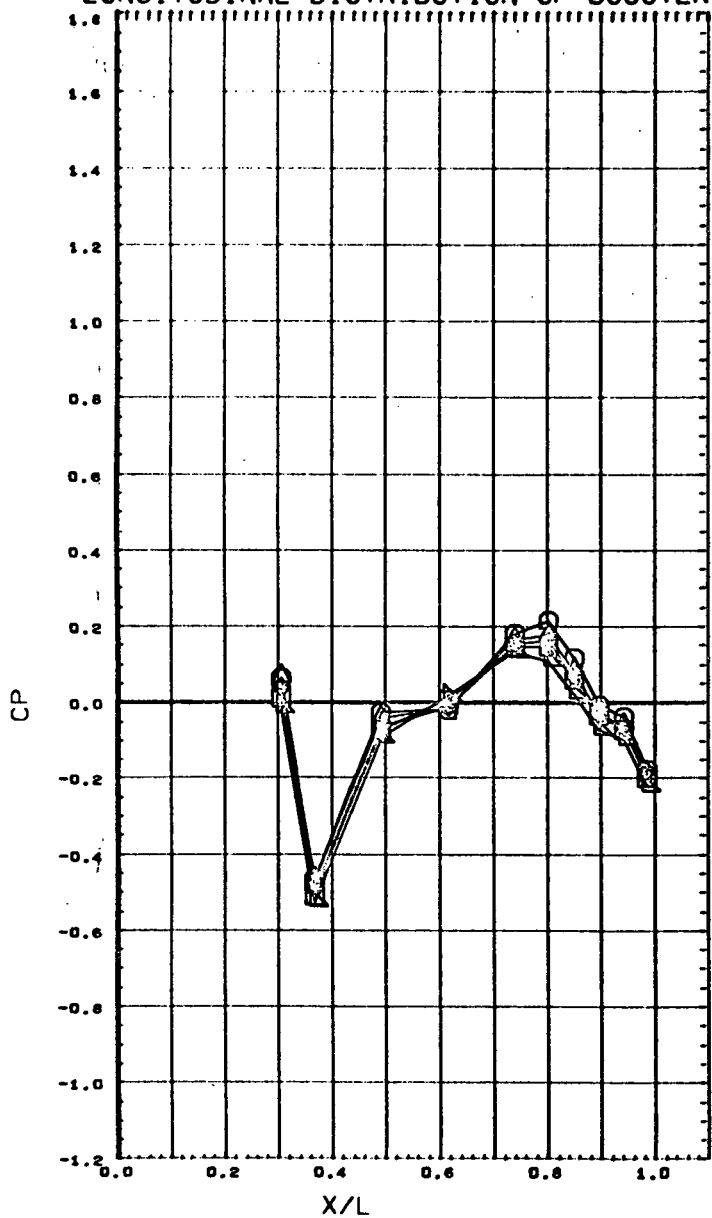

| SYMBOL | BETA | THETA | M1 |
|--------|-------|---------|-------|
| ○ | 6.013 | 90.000 | 1.000 |
| ◇ | 3.911 | 180.000 | |
| ◇ | 1.927 | | |
| □ | 0.219 | | |
| ○ | 1.802 | | |

REFERENCE FILE

PARAMETRIC VALUES
ALFB 0.000

LONGITUDINAL DISTRIBUTION OF BOOSTER FUSELAGE PRESSURES

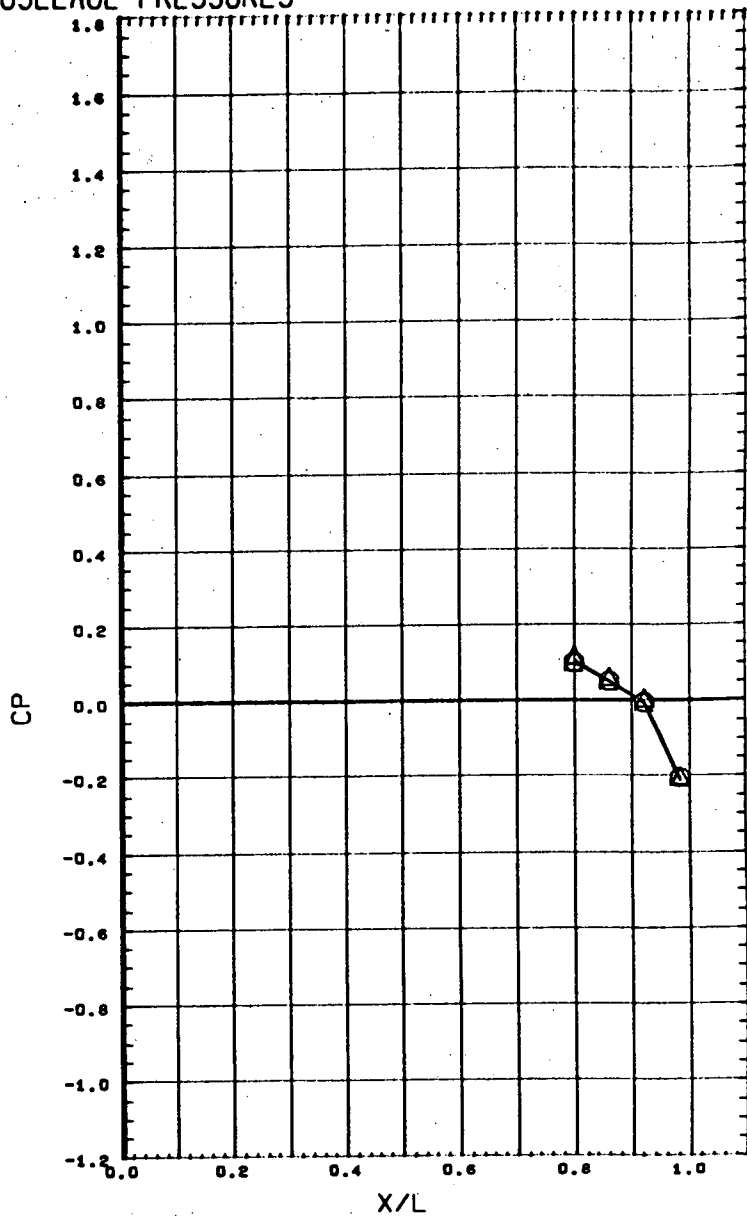
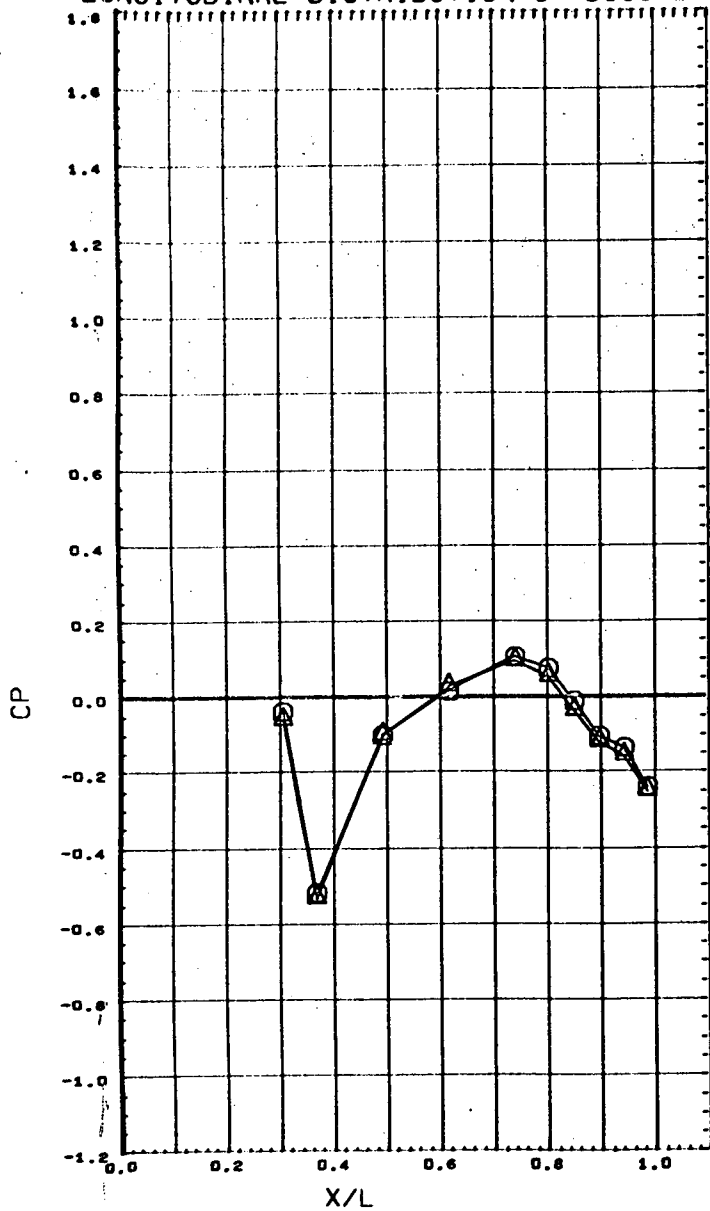

| SYMBOL | BETA | THETA | M1 |
|--------|-------|---------|-------|
| ○ | 3.808 | 90.000 | 1.000 |
| △ | 3.892 | 180.000 | |

PARAMETRIC VALUES
ALFB 0.000

REFERENCE FILE

AEDC TC174 MDAC BOOSTER (BODY)

(ATC013)

PAGE 387

LONGITUDINAL DISTRIBUTION OF BOOSTER FUSELAGE PRESSURES

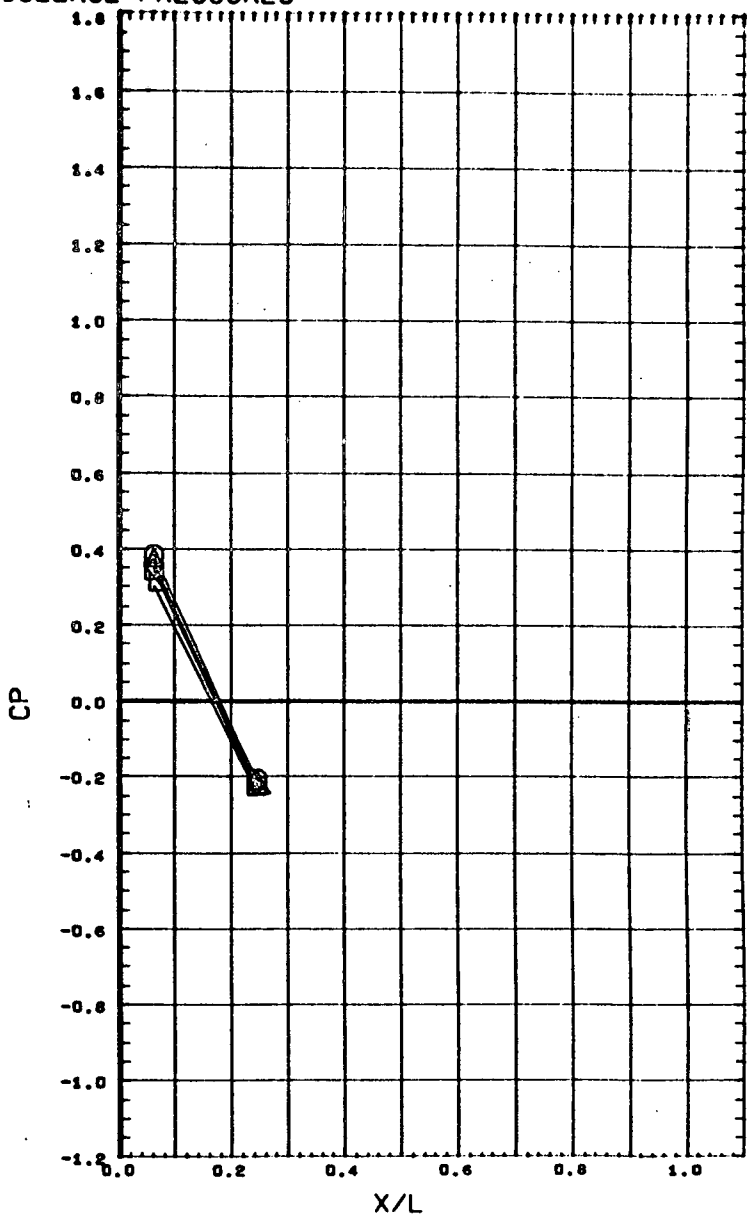
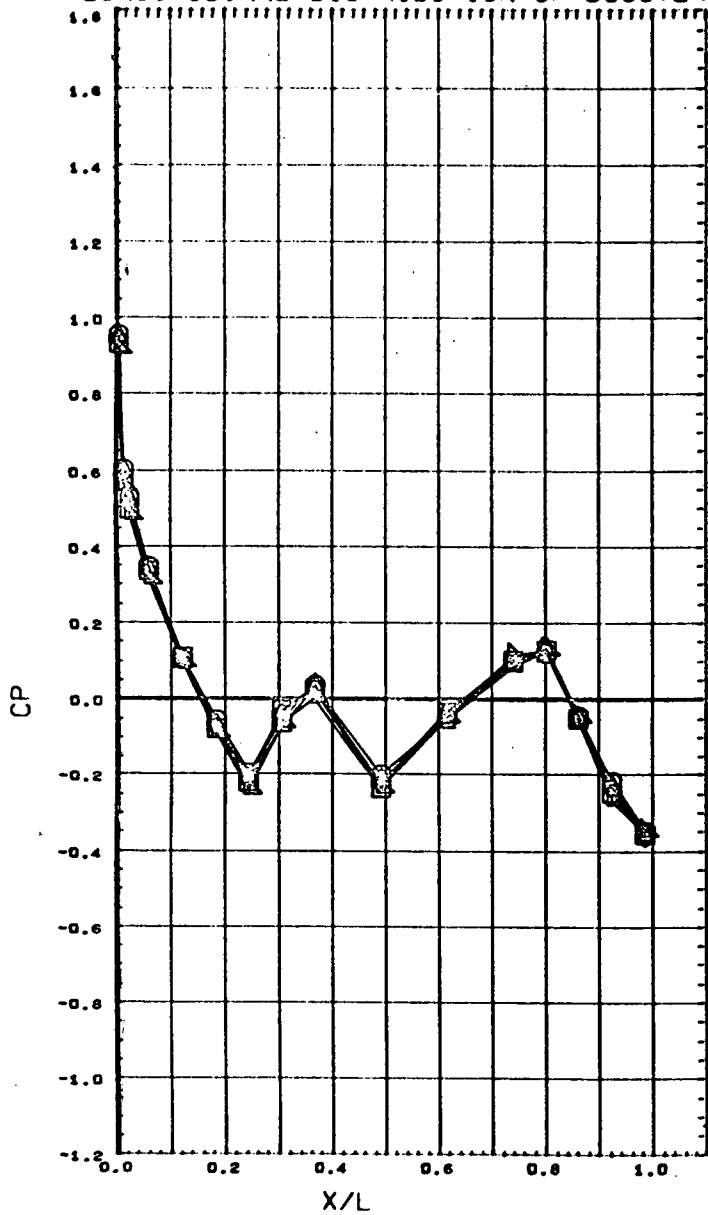

| SYMBOL | BETA | THETA | M1 |
|--------|---------|--------|-------|
| ○ | - 6.034 | 0.000 | 1.100 |
| △ | - 3.925 | 15.000 | |
| ◇ | - 1.934 | | |
| □ | - 0.220 | | |
| ◇ | 1.808 | | |

PARAMETRIC VALUES
ALFB 0.000

REFERENCE FILE

LONGITUDINAL DISTRIBUTION OF BOOSTER FUSELAGE PRESSURES

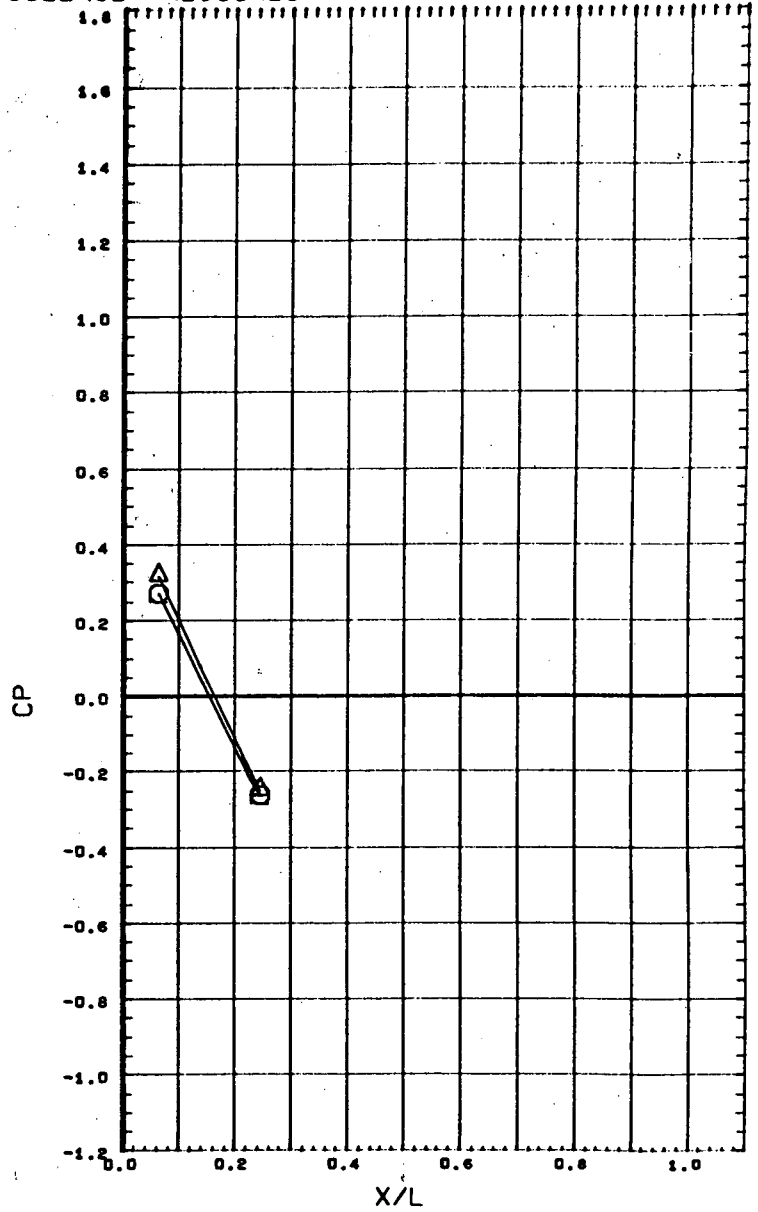
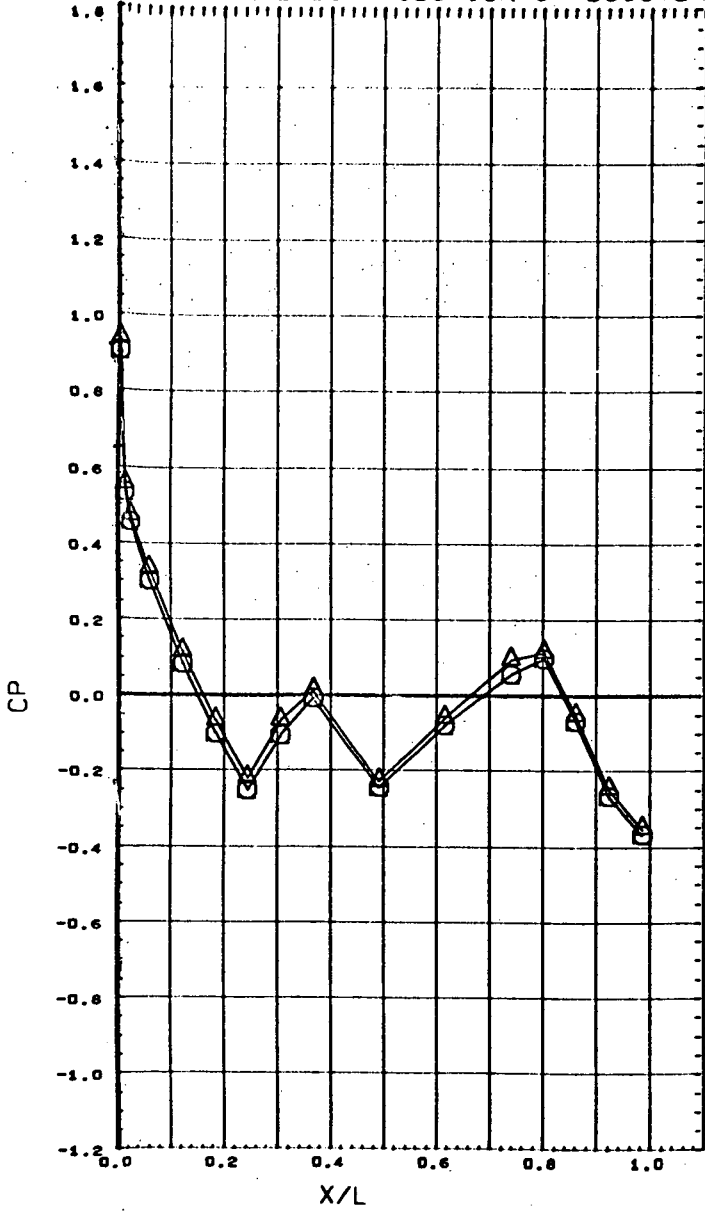

| SYMBOL | BETA | THETA | M1 |
|--------|-------|--------|-------|
| ○ | 3.812 | 0.000 | 1.100 |
| △ | 5.908 | 15.000 | |

PARAMETRIC VALUES
ALFB 0.000

REFERENCE FILE

LONGITUDINAL DISTRIBUTION OF BOOSTER FUSELAGE PRESSURES

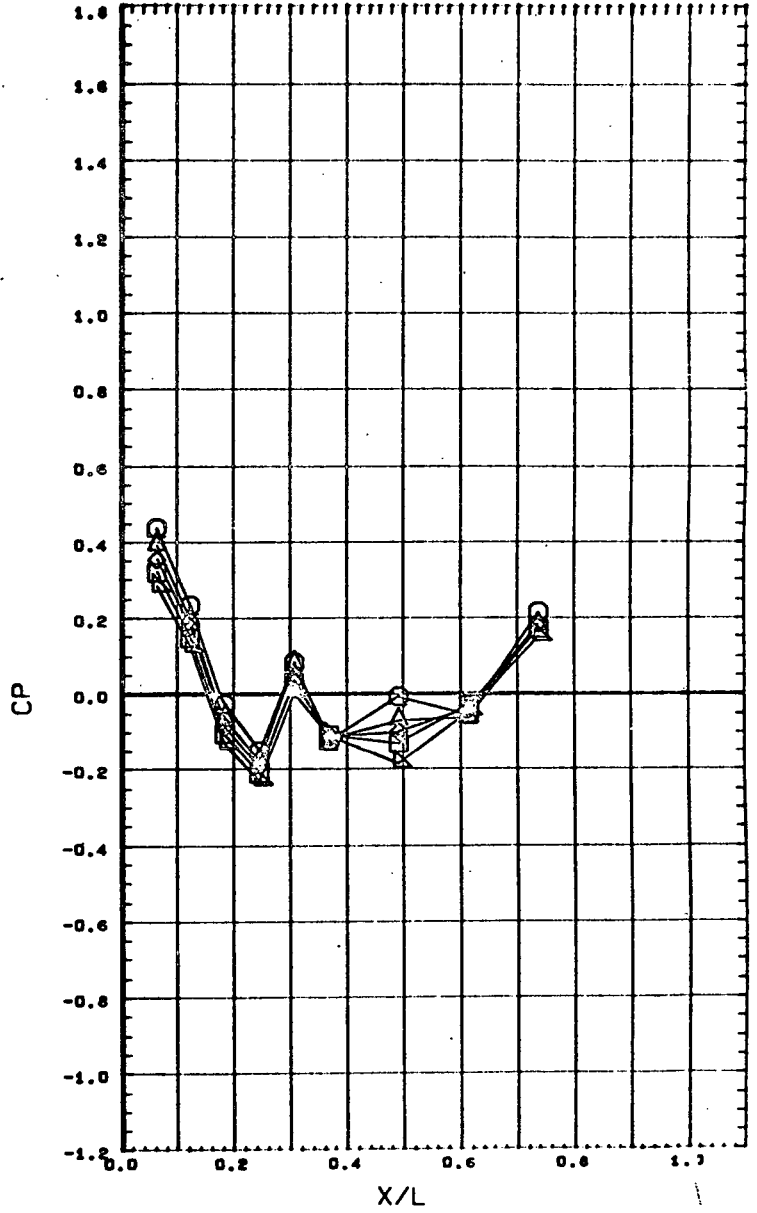
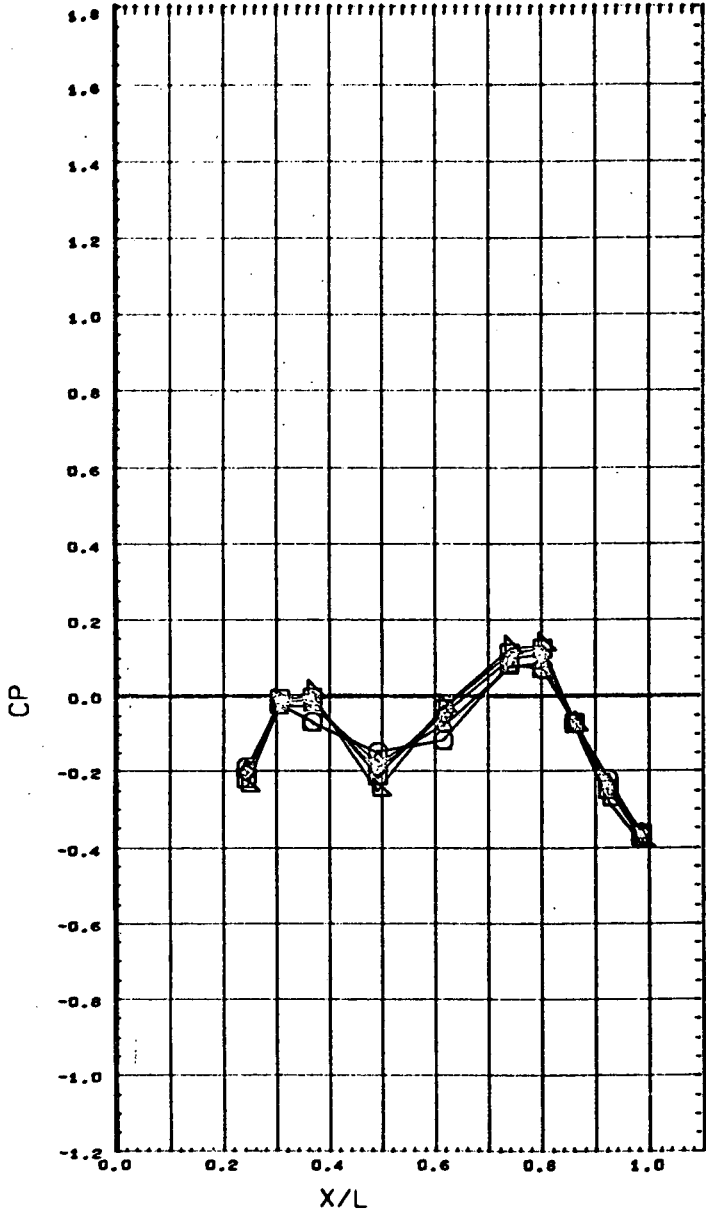

| SYMBOL | BETA | THETA | M1 |
|--------|-------|--------|-------|
| ○ | 6.034 | 24.000 | 1.100 |
| ◇ | 3.925 | 45.000 | |
| △ | 1.934 | | |
| □ | 0.220 | | |
| ▽ | 1.808 | | |

PARAMETRIC VALUES
ALFB 0.000

REFERENCE FILE

LONGITUDINAL DISTRIBUTION OF BOOSTER FUSELAGE PRESSURES

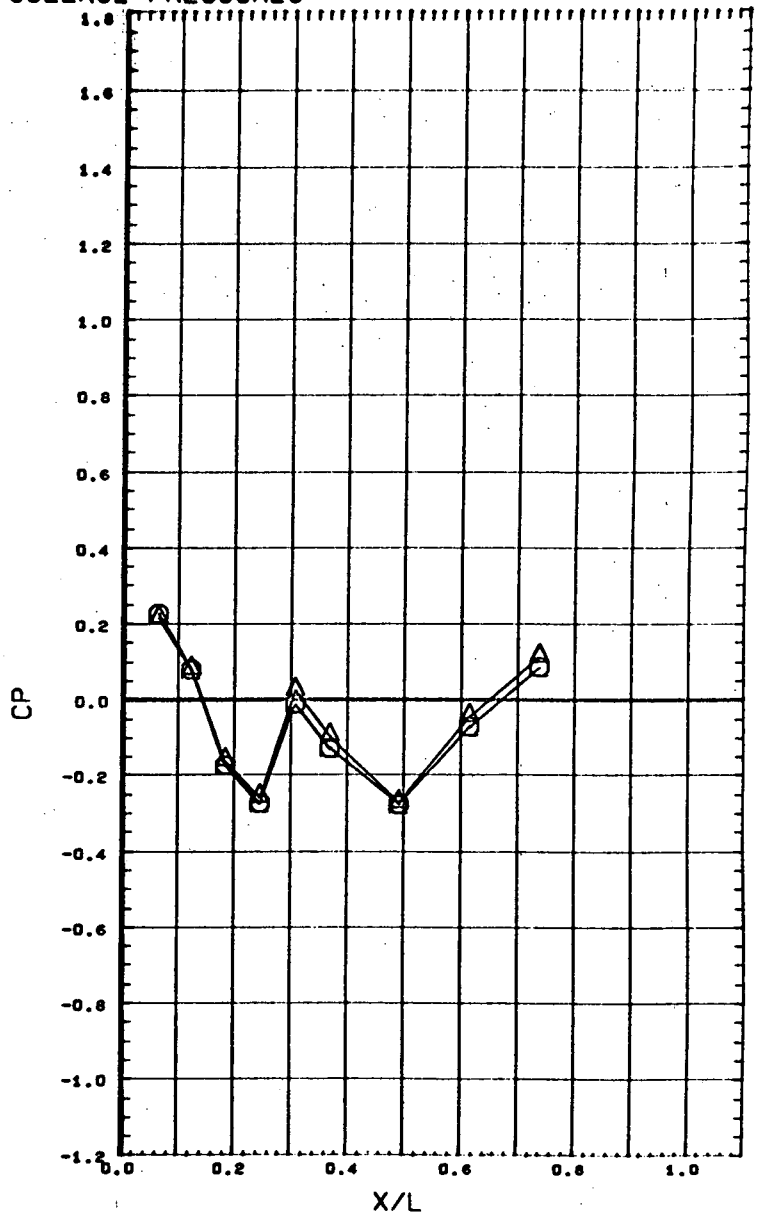
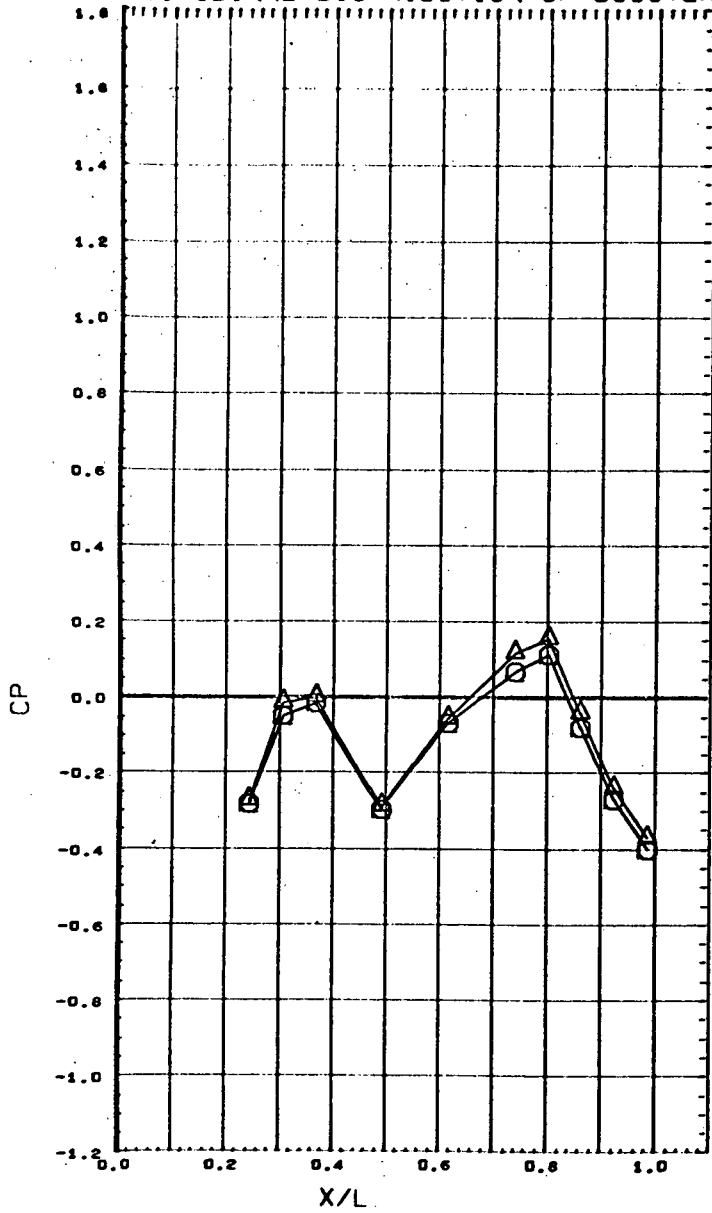

| SYMBOL | BETA | THETA | M1 |
|--------|-------|--------|-------|
| ○ | 3.812 | 24.000 | 1.100 |
| △ | 5.908 | 45.000 | |

PARAMETRIC VALUES
ALFB 0.000

REFERENCE FILE

LONGITUDINAL DISTRIBUTION OF BOOSTER FUSELAGE PRESSURES

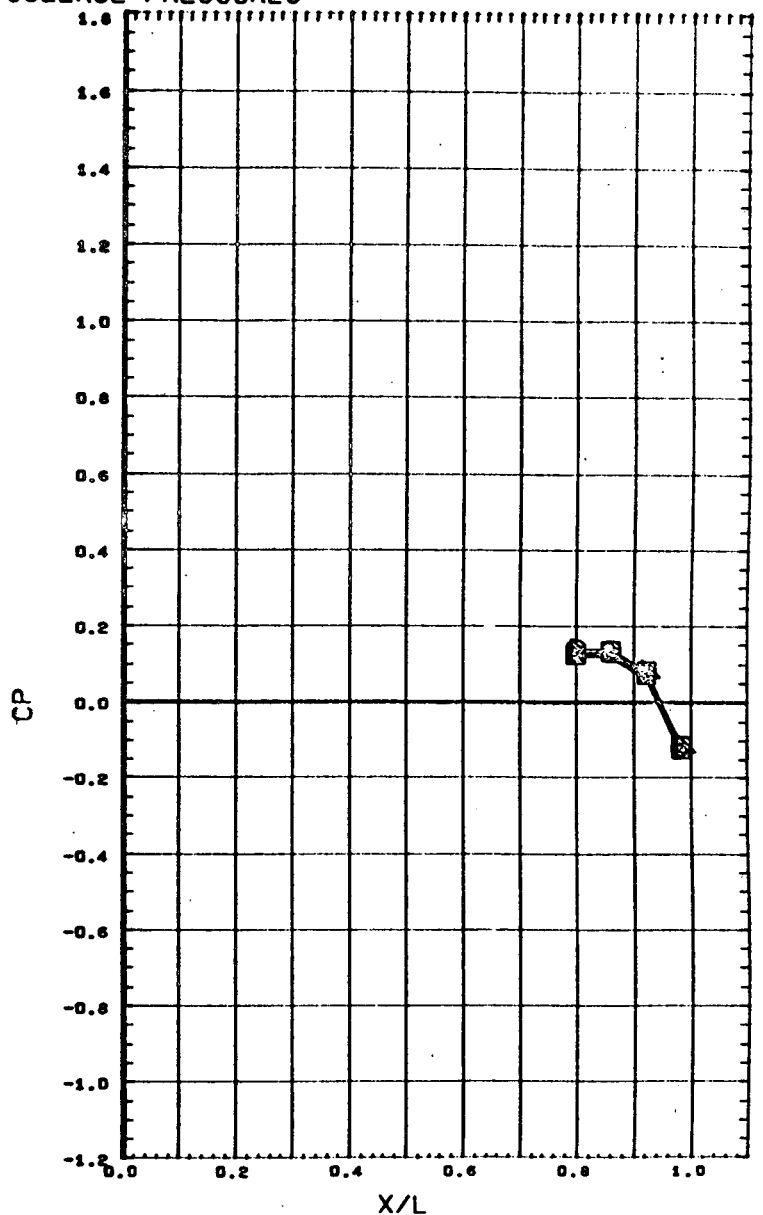
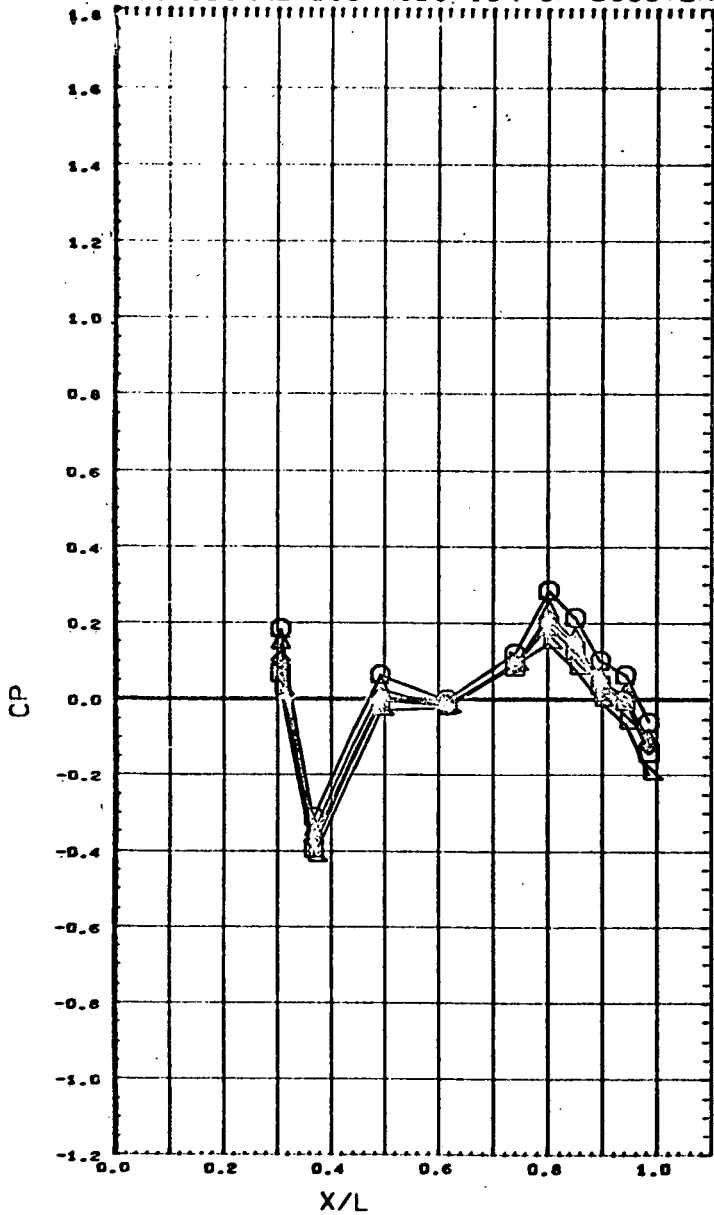

| SYMBOL | BETA | THETA | M1 |
|--------|-------|---------|-------|
| ○ | 6.034 | 90.000 | 1.100 |
| △ | 3.925 | 180.000 | |
| ◇ | 1.934 | | |
| □ | 0.225 | | |
| ▽ | 1.858 | | |

REFERENCE FILE

ALFB PARAMETRIC VALUES
0.000

LONGITUDINAL DISTRIBUTION OF BOOSTER FUSELAGE PRESSURES

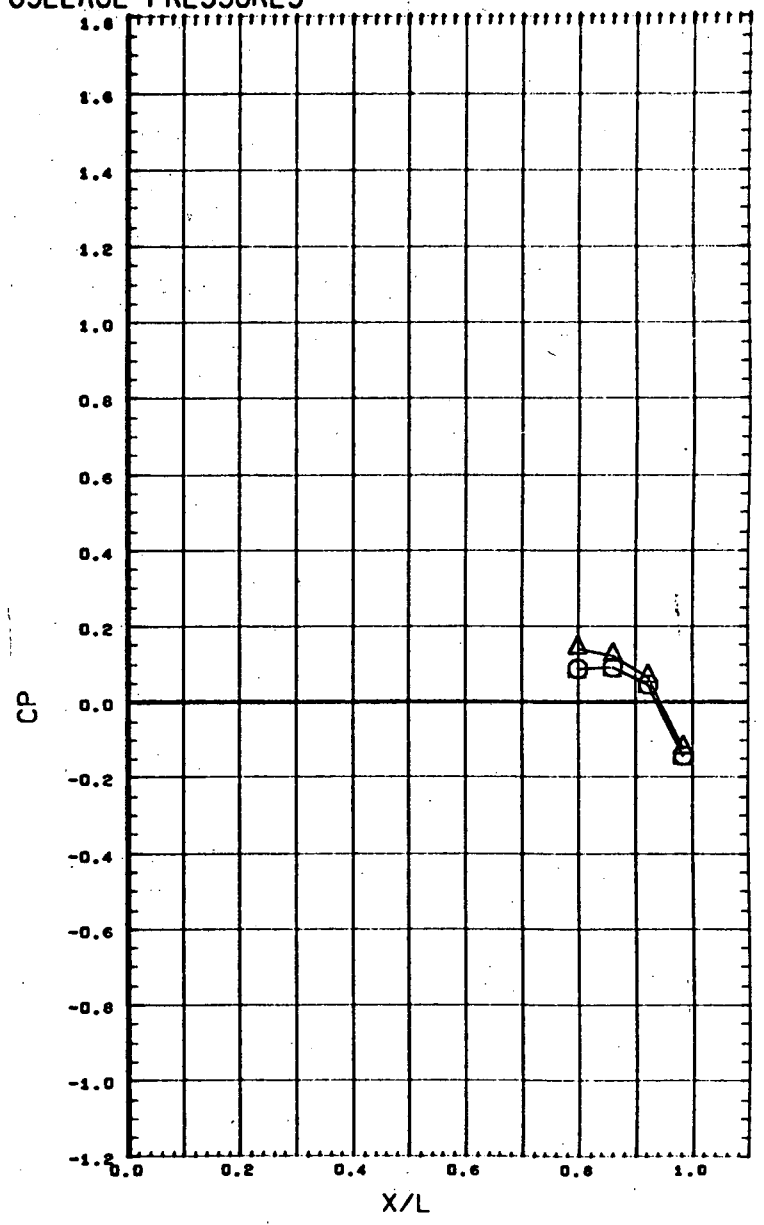
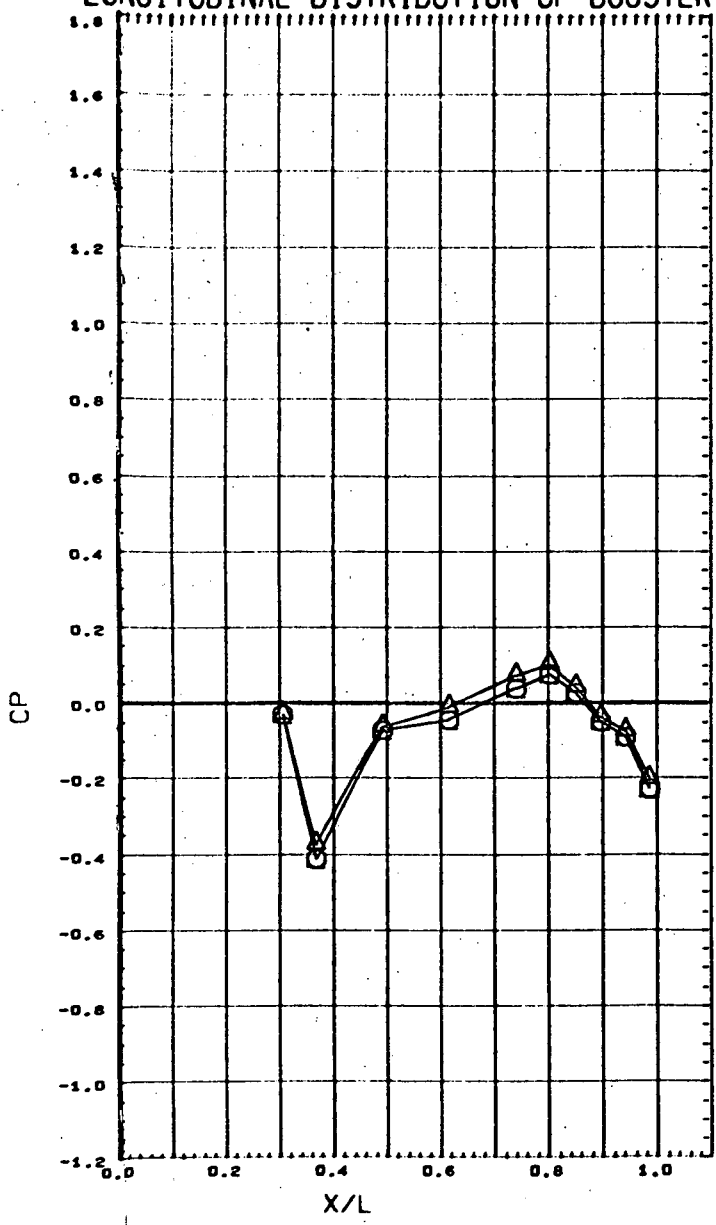

| SYMBOL | BETA | THETA | M1 |
|--------|-------|---------|-------|
| ○ | 3.812 | 90.000 | 1.100 |
| △ | 5.902 | 180.000 | |

PARAMETRIC VALUES
ALFB 0.000

REFERENCE FILE

LONGITUDINAL DISTRIBUTION OF BOOSTER FUSELAGE PRESSURES

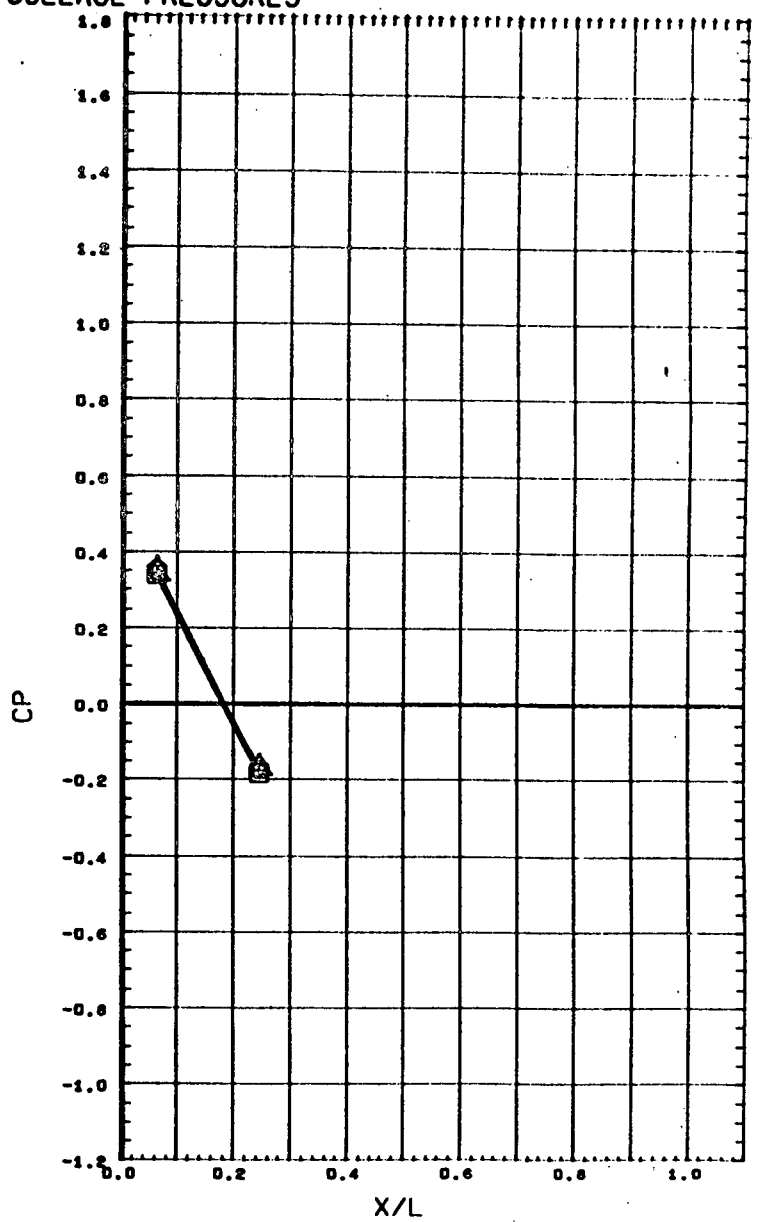
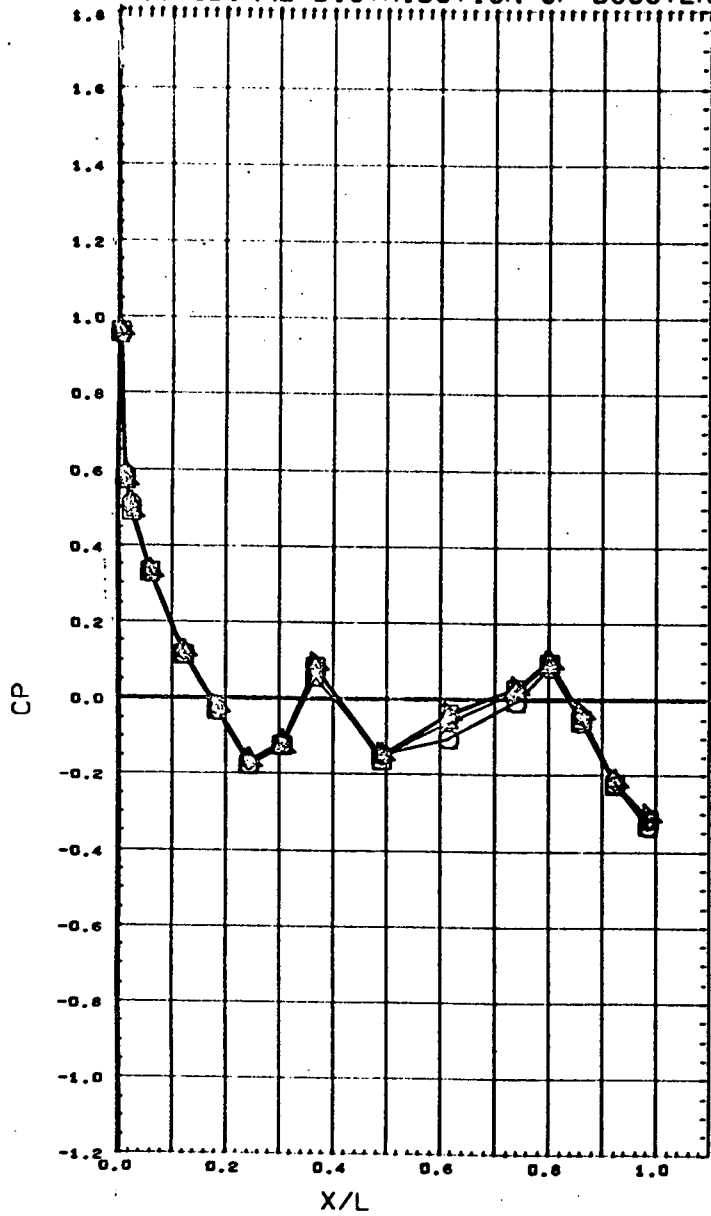

| SYMBOL | BETA | THETA | M1 |
|--------|-------|--------|-------|
| ○ | 6.044 | 0.000 | 1.201 |
| △ | 4.009 | 15.000 | |
| ◇ | 1.940 | | |
| □ | 0.223 | | |
| ▽ | 1.805 | | |

PARAMETRIC VALUES
ALFB 0.000

REFERENCE FILE

LONGITUDINAL DISTRIBUTION OF BOOSTER FUSELAGE PRESSURES

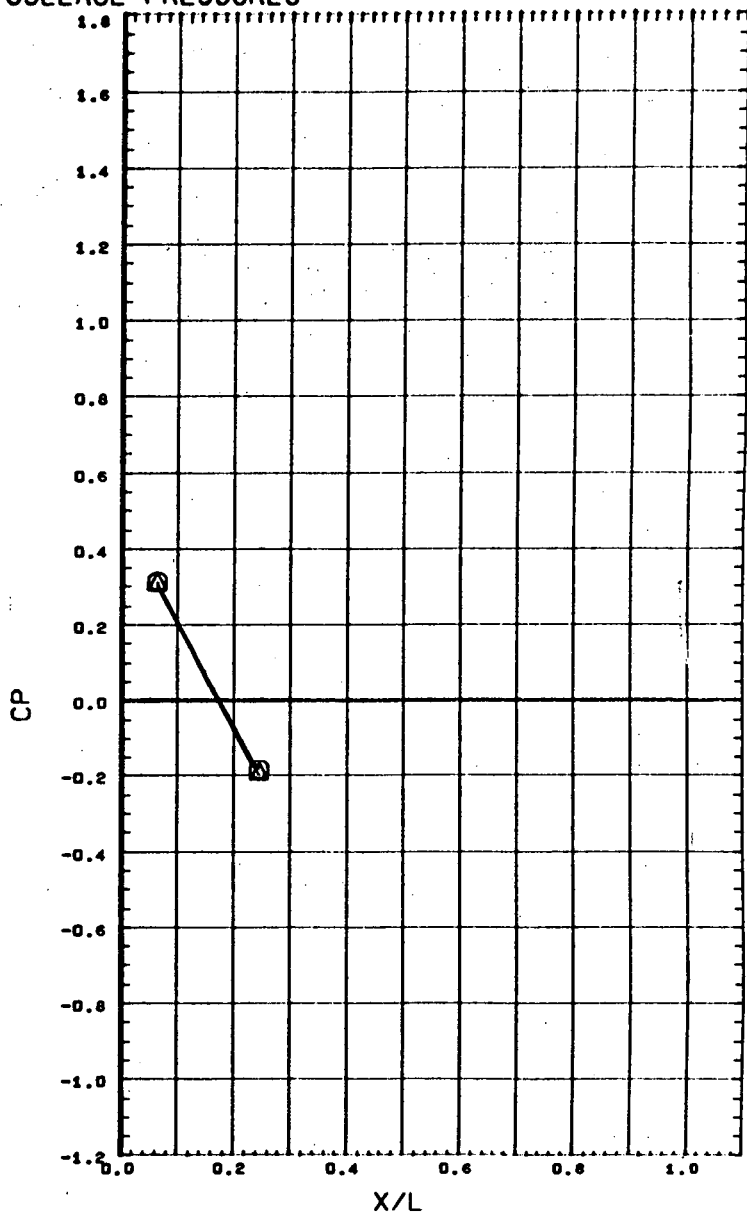
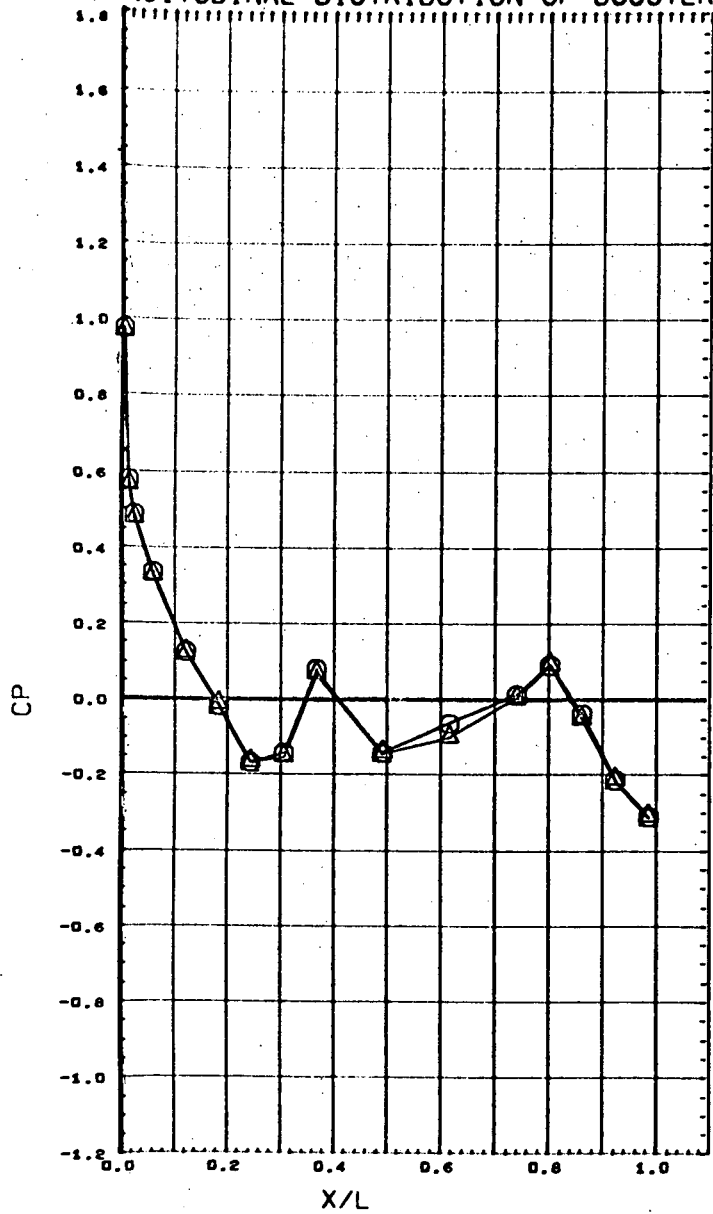

| SYMBOL | BETA | THETA | M1 |
|--------|-------|--------|-------|
| ○ | 3.819 | 0.000 | 1.201 |
| △ | 5.910 | 15.000 | |

PARAMETRIC VALUES
ALFB 0.000

REFERENCE FILE

LONGITUDINAL DISTRIBUTION OF BOOSTER FUSELAGE PRESSURES

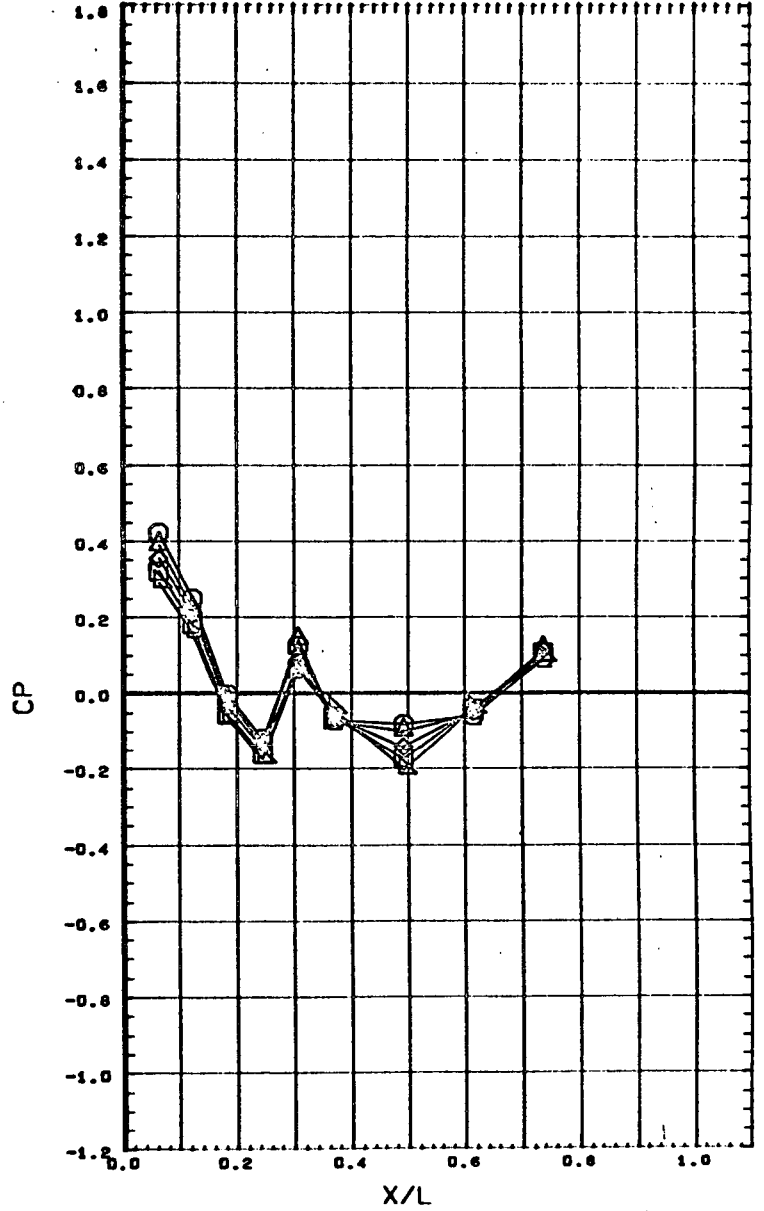
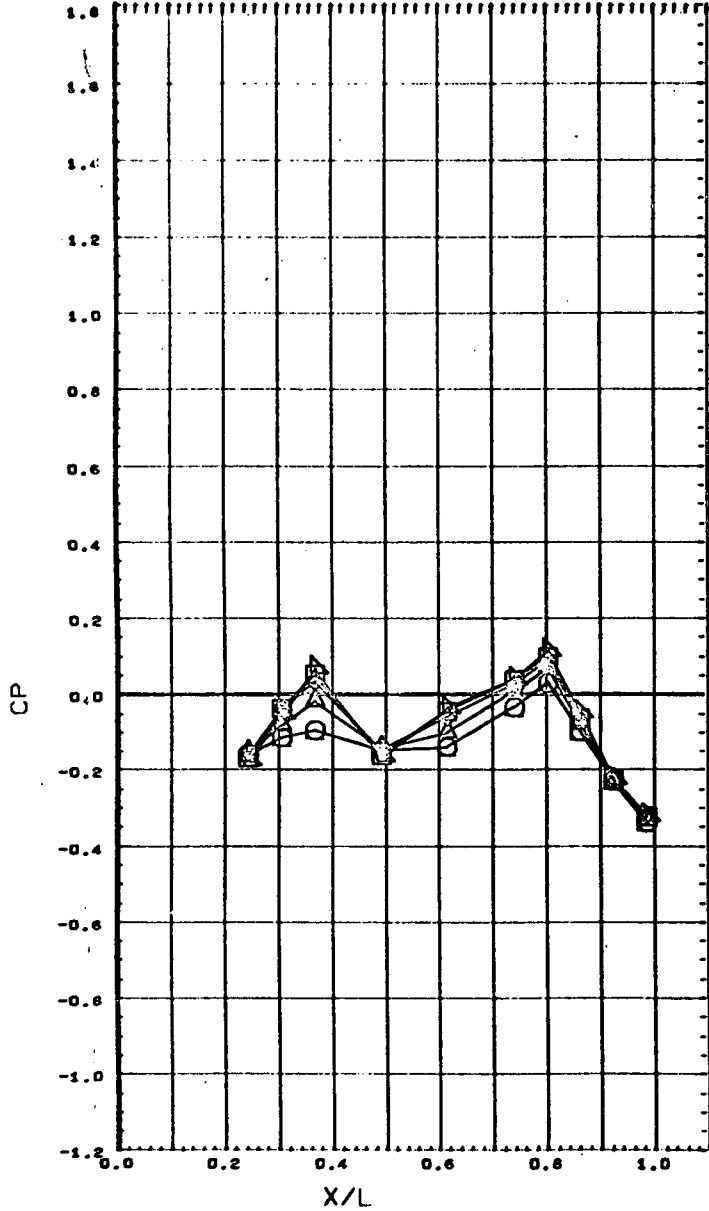

| SYMBOL | BETA | THETA | M1 |
|--------|-------|--------|-------|
| ○ | 6.044 | 24.000 | 1.201 |
| ◇ | 4.009 | 45.000 | |
| △ | 1.940 | | |
| □ | 0.223 | | |
| ▽ | 1.865 | | |

PARAMETRIC VALUES
ALFB 0.000

REFERENCE FILE

LONGITUDINAL DISTRIBUTION OF BOOSTER FUSELAGE PRESSURES

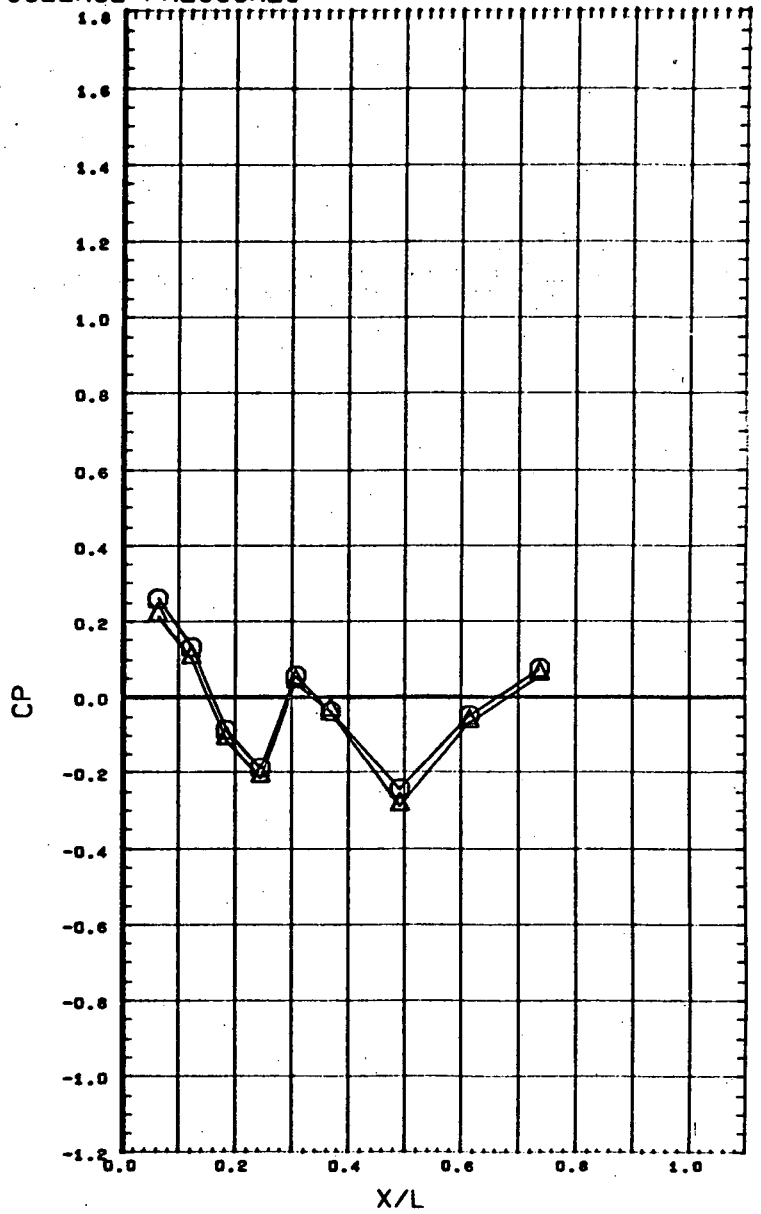
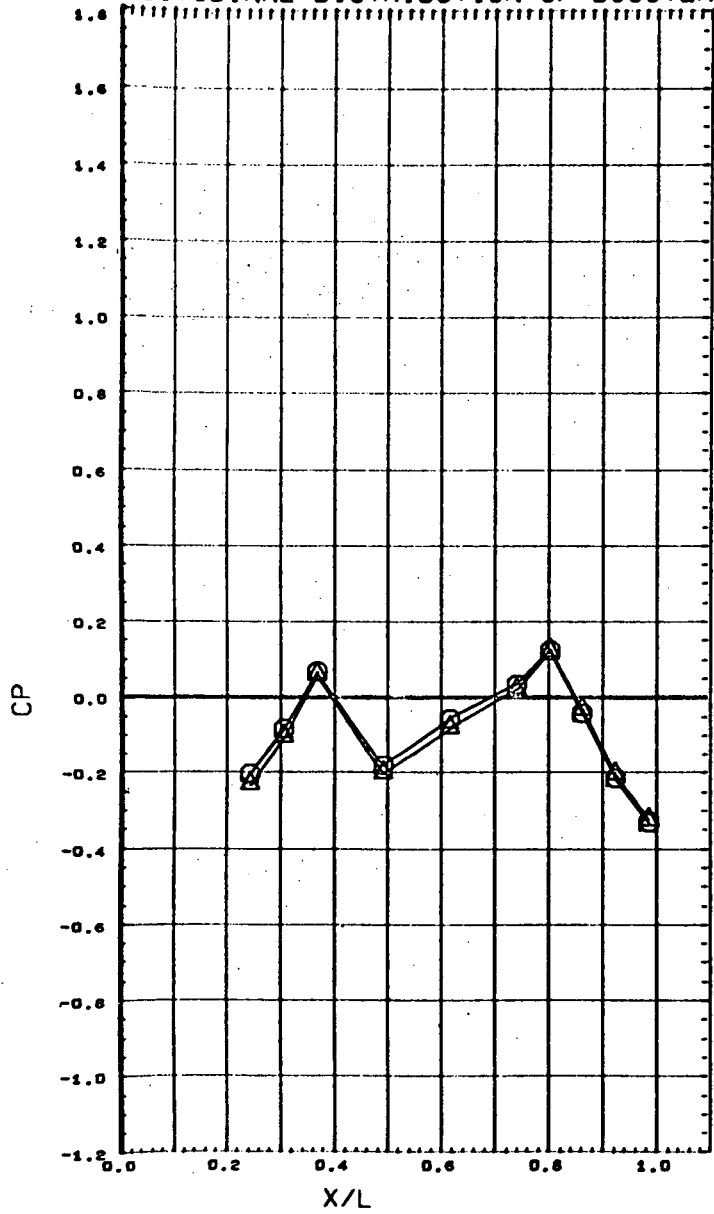

| SYMBOL | BETA | THETA | M1 |
|--------|-------|--------|-------|
| ○ | 3.819 | 24.000 | 1.201 |
| △ | 5.910 | 45.000 | |

PARAMETRIC VALUES
ALFB 0.000

REFERENCE FILE

AEDC TC174 MDAC BOOSTER (BODY)

(ATC013)

PAGE 397

LONGITUDINAL DISTRIBUTION OF BOOSTER FUSELAGE PRESSURES

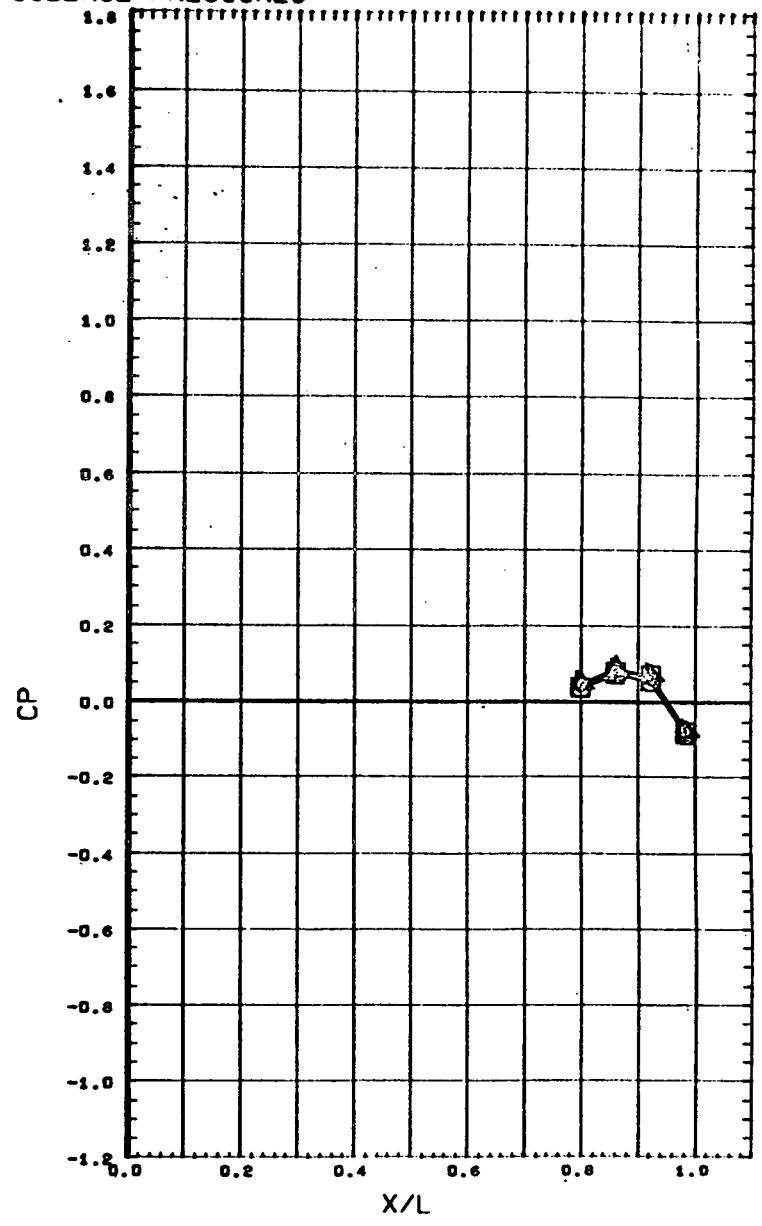
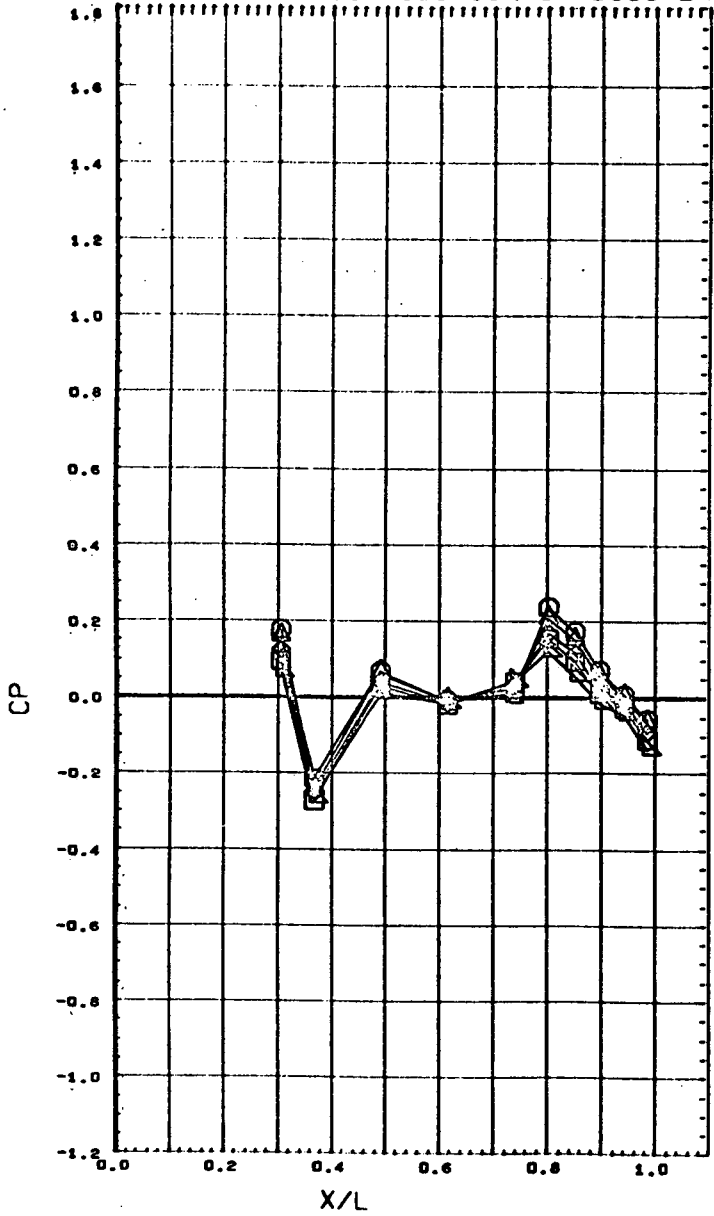

| SYMBOL | BETA | THETA | M1 |
|--------|-------|---------|-------|
| ○ | 6.044 | 90.000 | 1.201 |
| △ | 4.009 | 180.000 | |
| ◇ | 1.940 | | |
| □ | 0.223 | | |
| ▽ | 1.805 | | |

REFERENCE FILE

PARAMETRIC VALUES
ALFB 0.000

LONGITUDINAL DISTRIBUTION OF BOOSTER FUSELAGE PRESSURES

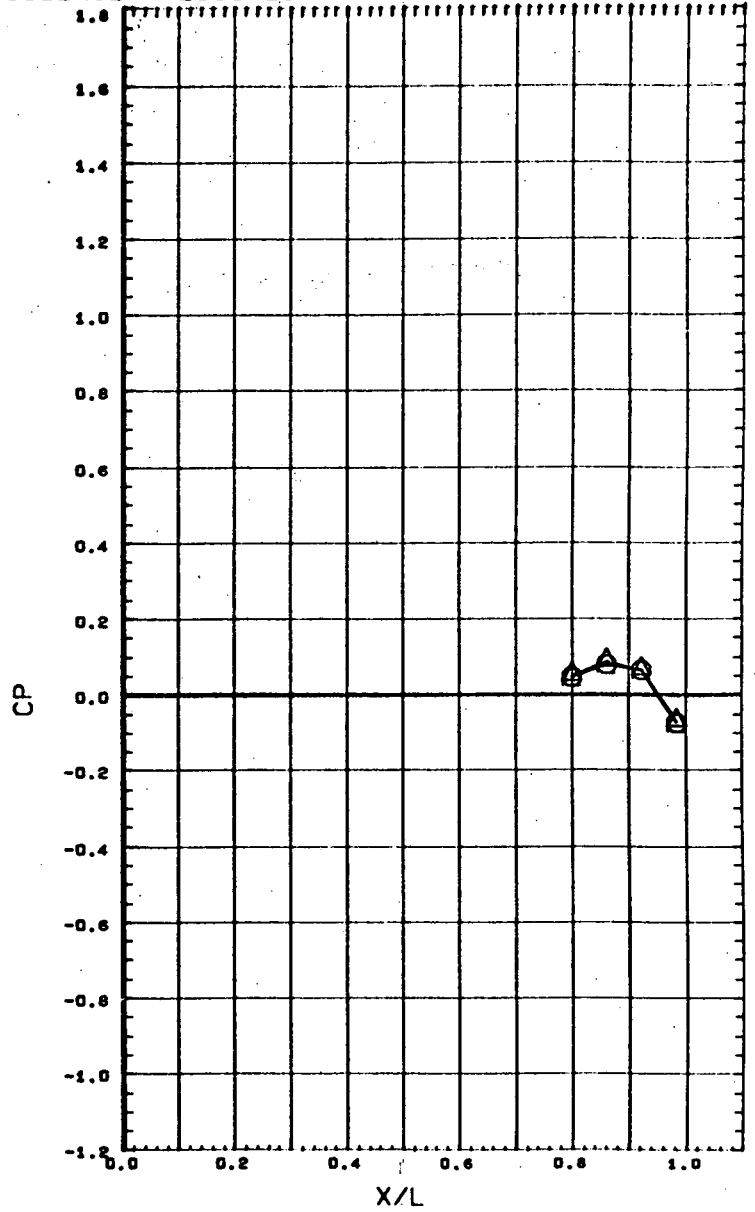
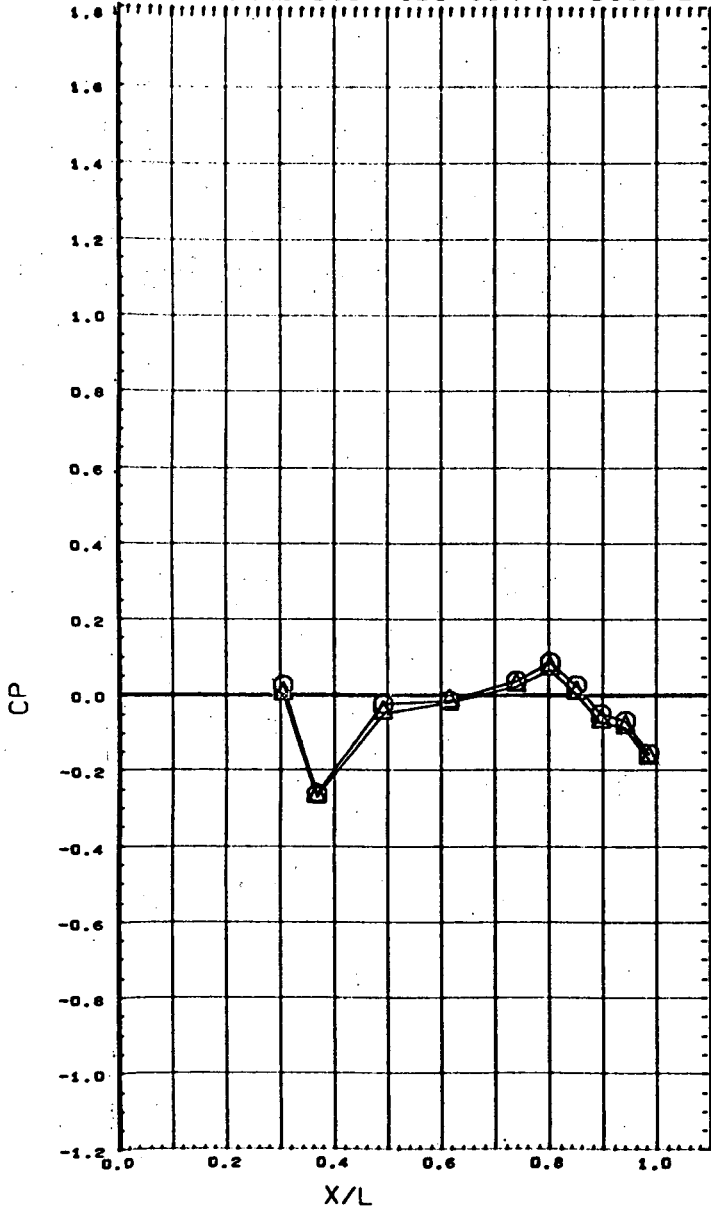

| SYMBOL | BETA | THETA | M1 |
|--------|-------|---------|-------|
| ○ | 3.819 | 90.000 | 1.201 |
| △ | 5.910 | 180.000 | |

PARAMETRIC VALUES
ALFB 0.000

REFERENCE FILE

LONGITUDINAL DISTRIBUTION OF BOOSTER FUSELAGE PRESSURES

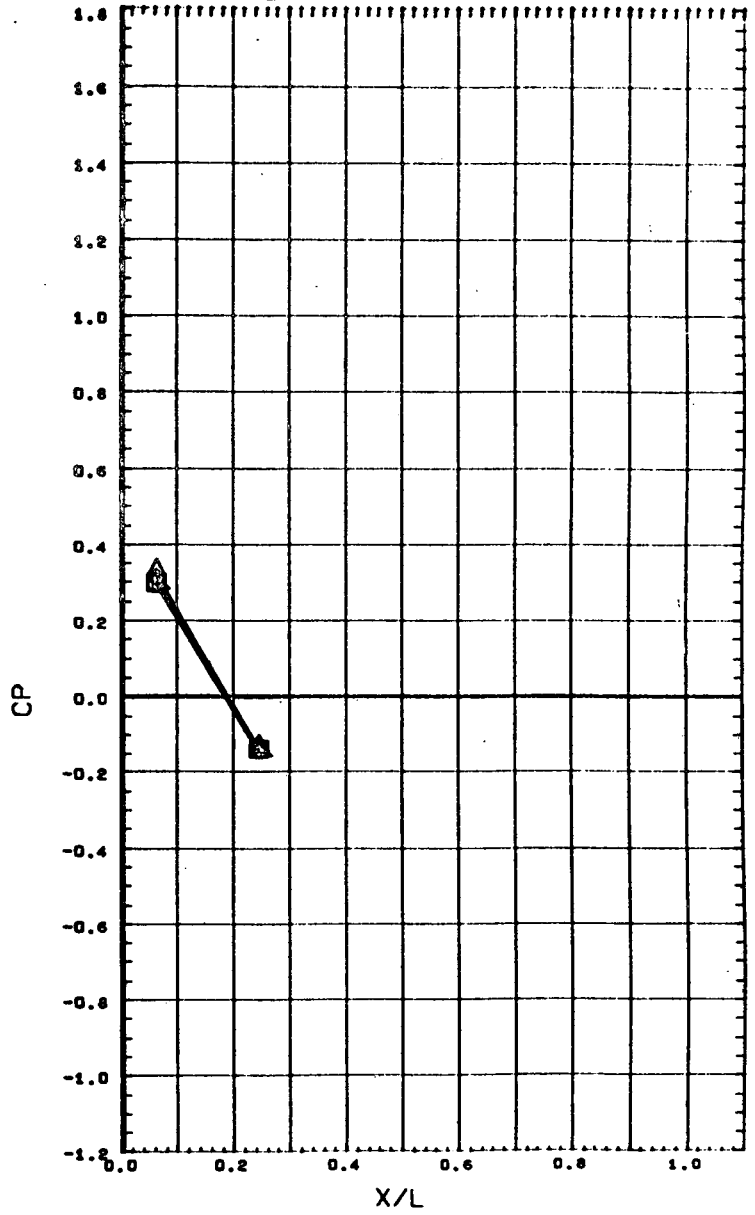
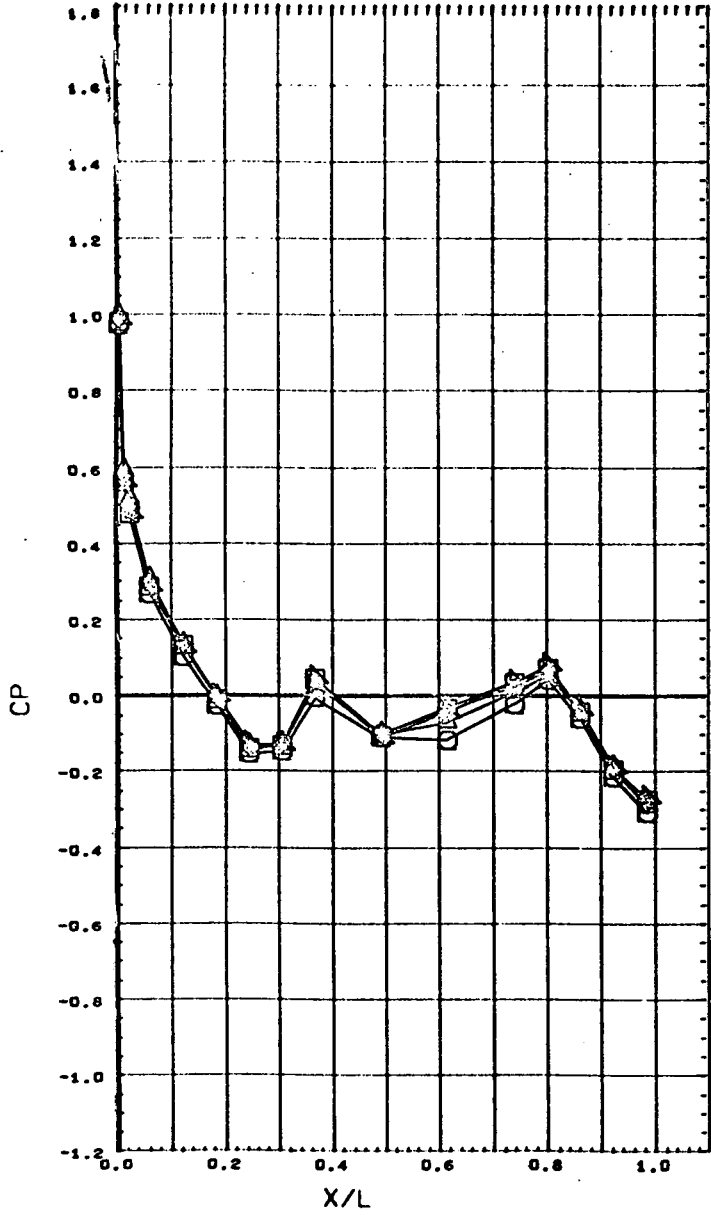

| SYMBOL | BETA | THETA | M1 |
|--------|-------|--------|-------|
| ○ | 5.041 | 0.000 | 1.299 |
| △ | 3.928 | 15.000 | |
| ◇ | 1.929 | | |
| □ | 0.215 | | |
| ▽ | 1.804 | | |

PARAMETRIC VALUES
ALFB 0.000

REFERENCE FILE

LONGITUDINAL DISTRIBUTION OF BOOSTER FUSELAGE PRESSURES

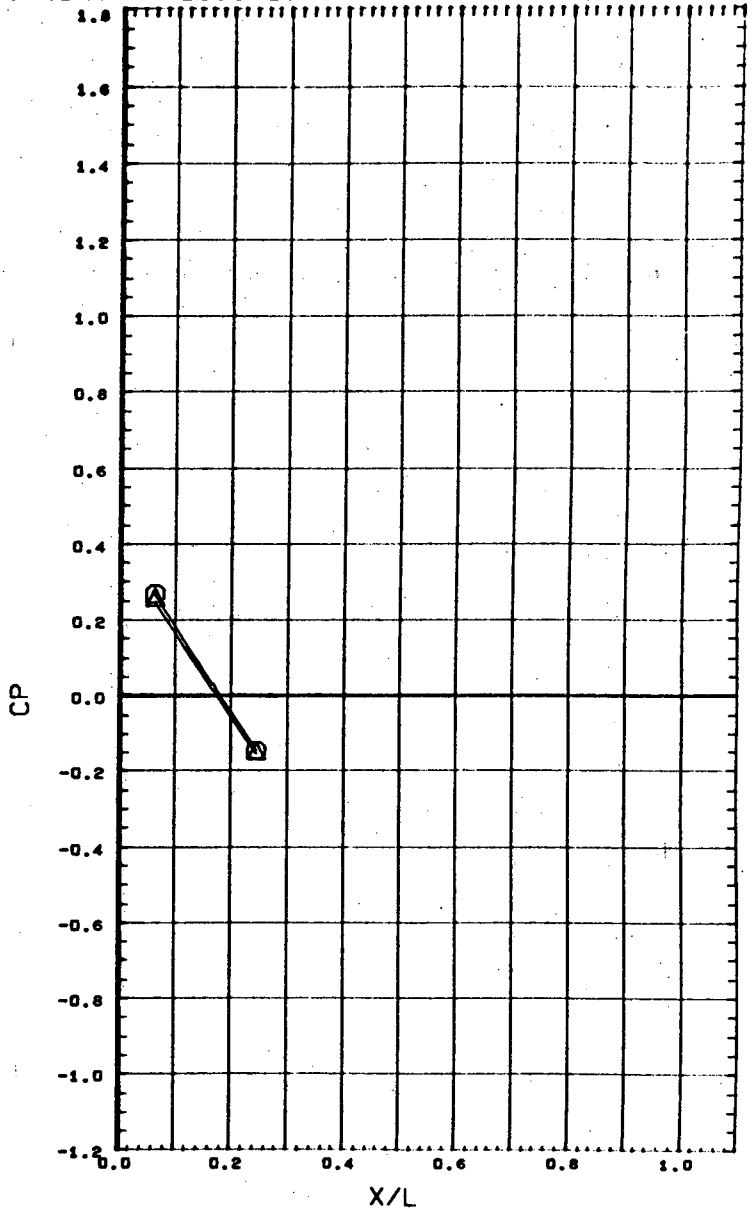
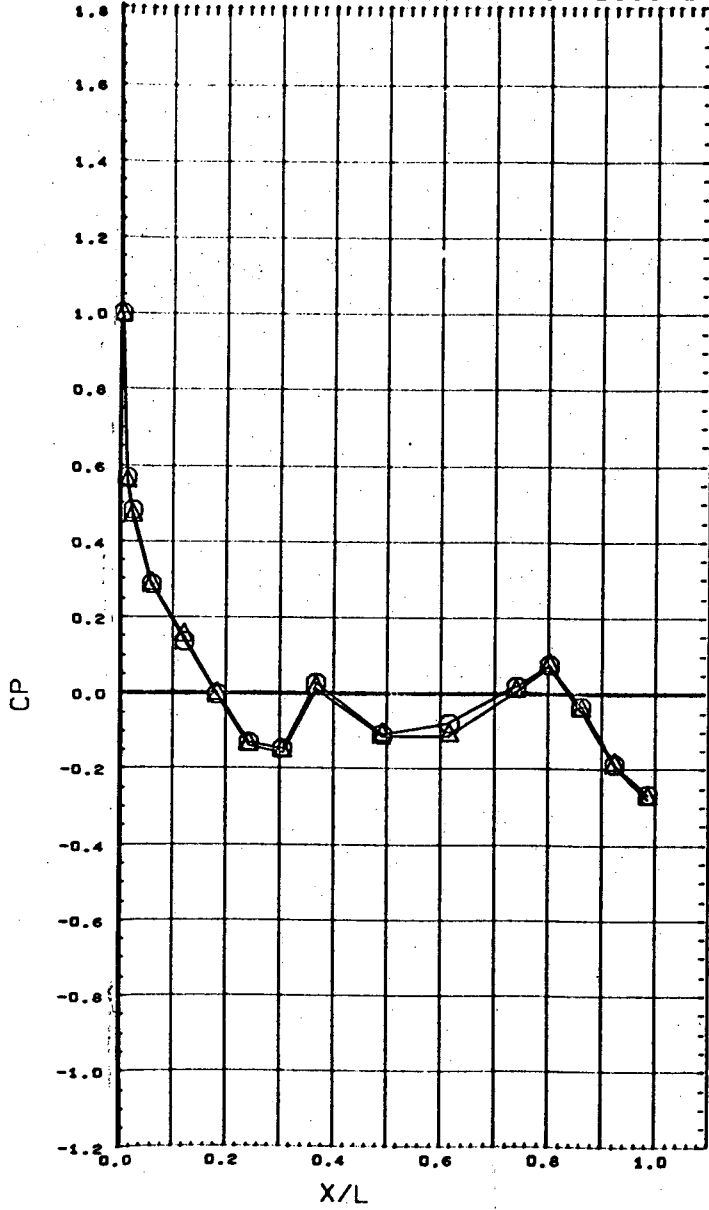

| SYMBOL | BETA | THETA | M1 |
|--------|-------|--------|-------|
| O | 3.812 | 0.000 | 1.299 |
| Δ | 5.896 | 15.000 | |

PARAMETRIC VALUES
ALFB 0.000

REFERENCE FILE

LONGITUDINAL DISTRIBUTION OF BOOSTER FUSELAGE PRESSURES

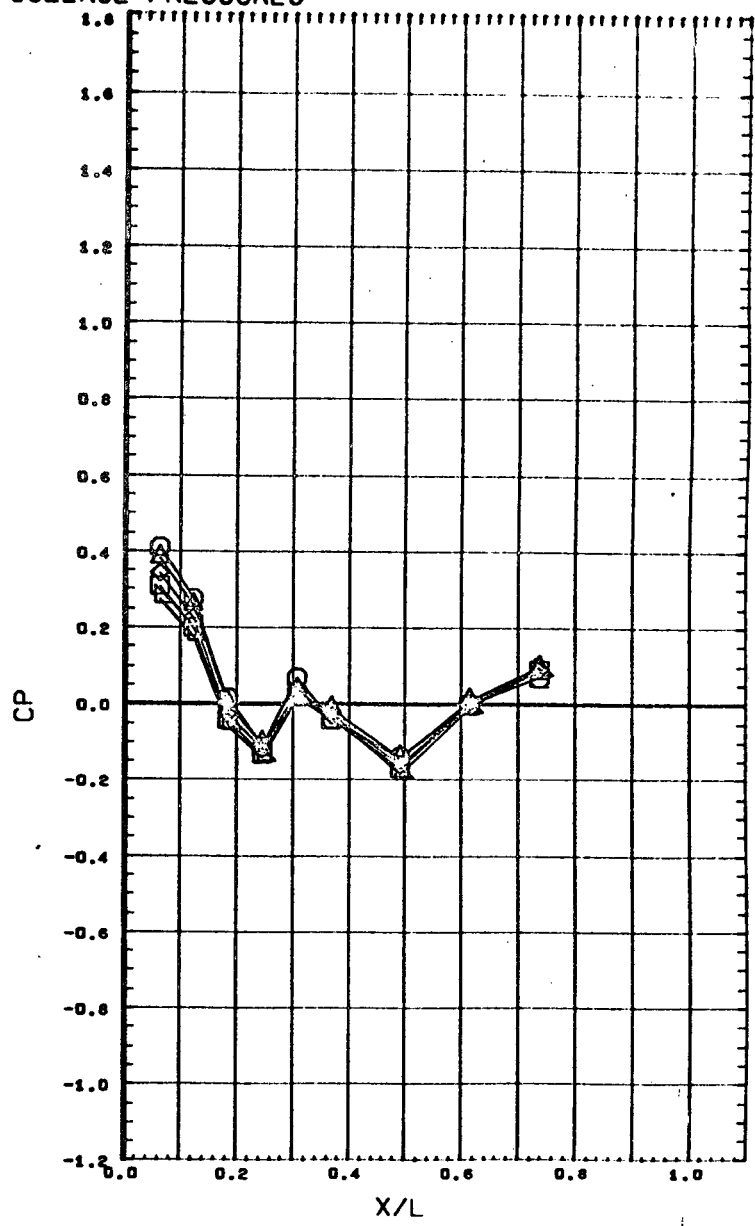
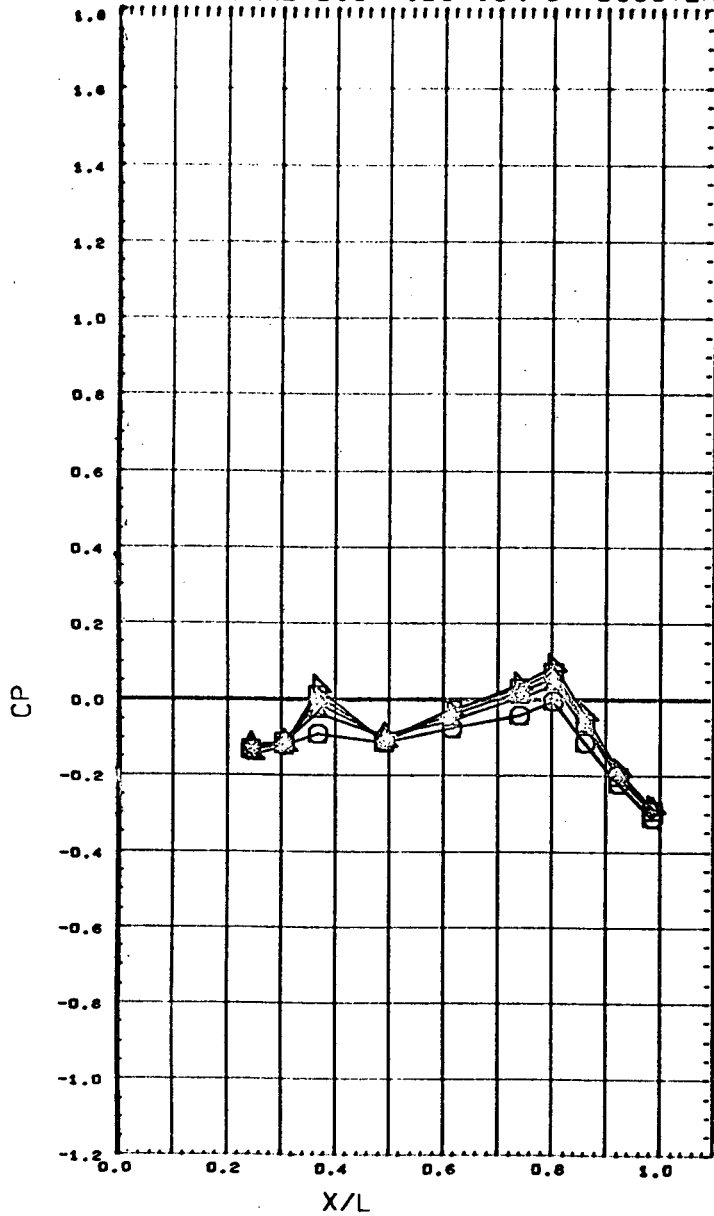

| SYMBOL | BETA | THETA | M1 |
|--------|-------|--------|-------|
| ○ | 4.041 | 24.000 | 1.299 |
| △ | 3.928 | 45.000 | |
| ◇ | 3.929 | | |
| □ | 0.215 | | |
| ▽ | 1.804 | | |

REFERENCE FILE

PARAMETRIC VALUES
ALFB 0.000

LONGITUDINAL DISTRIBUTION OF BOOSTER FUSELAGE PRESSURES

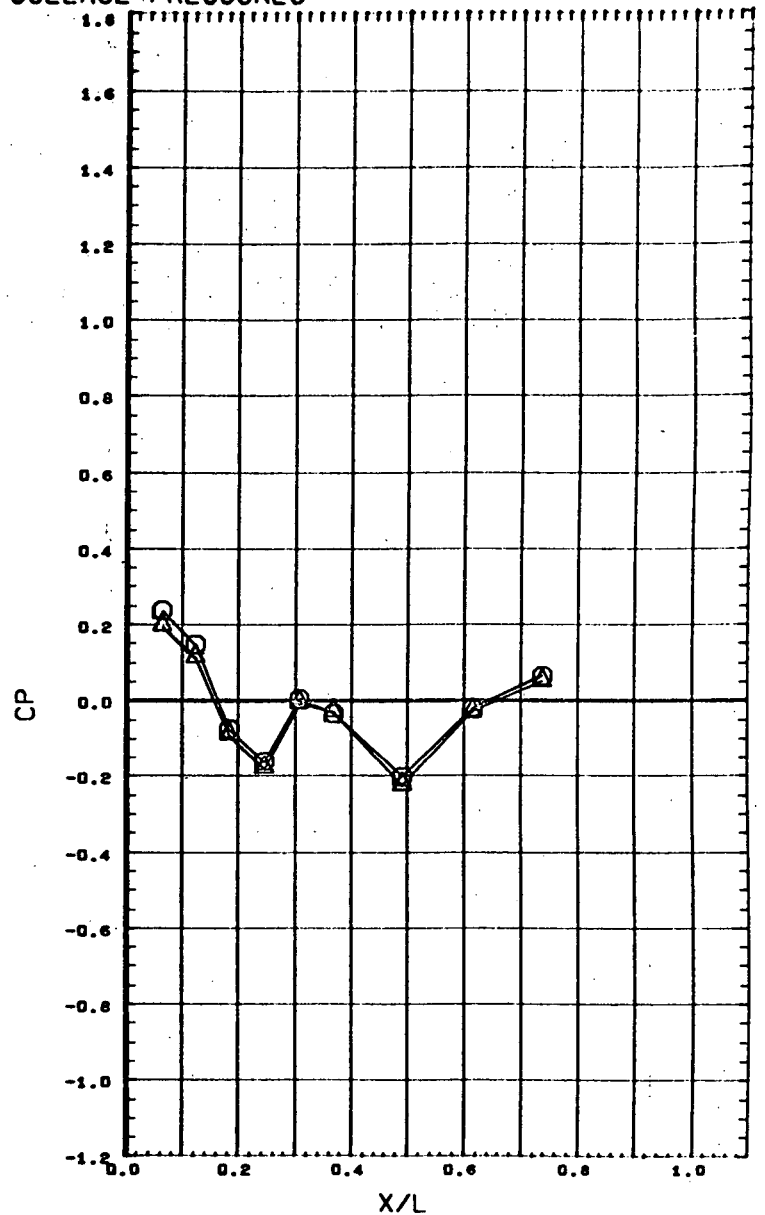
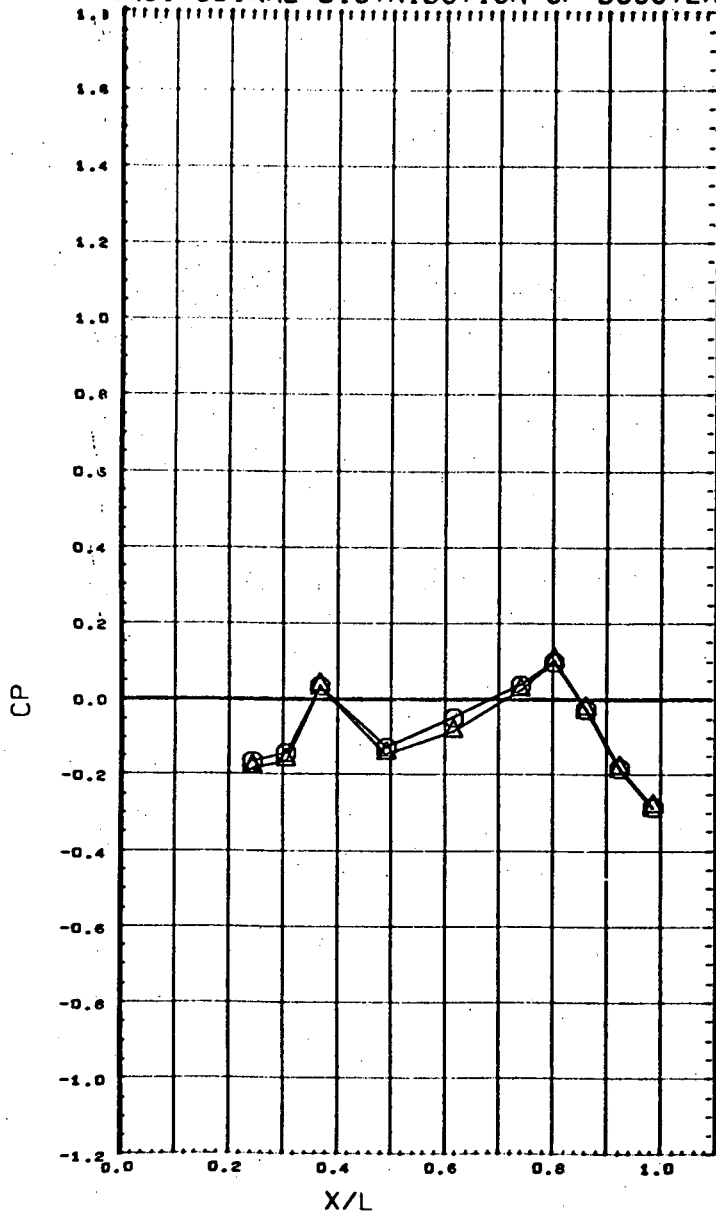

| SYMBOL | BETA | THETA | M1 |
|--------|-------|--------|-------|
| ○ | 3.812 | 24.000 | 1.299 |
| △ | 5.896 | 45.000 | |

PARAMETRIC VALUES
ALFB 0.000

REFERENCE FILE

LONGITUDINAL DISTRIBUTION OF BOOSTER FUSELAGE PRESSURES

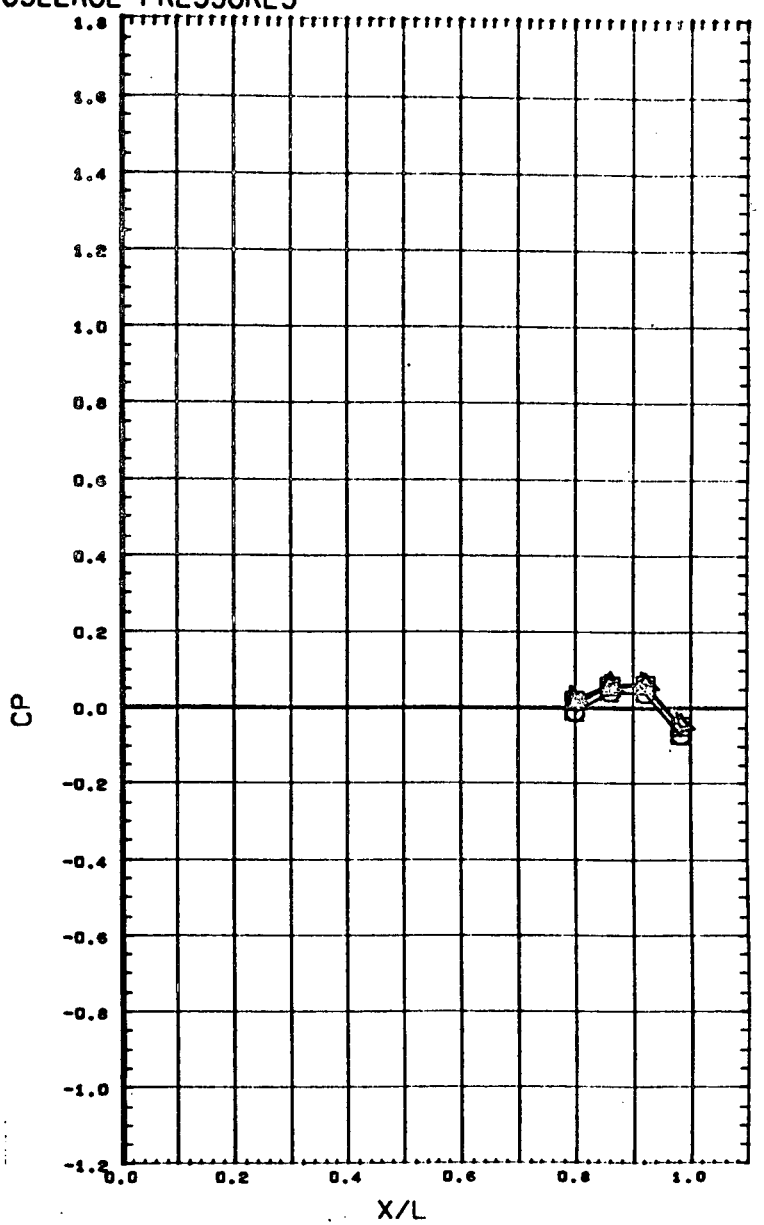
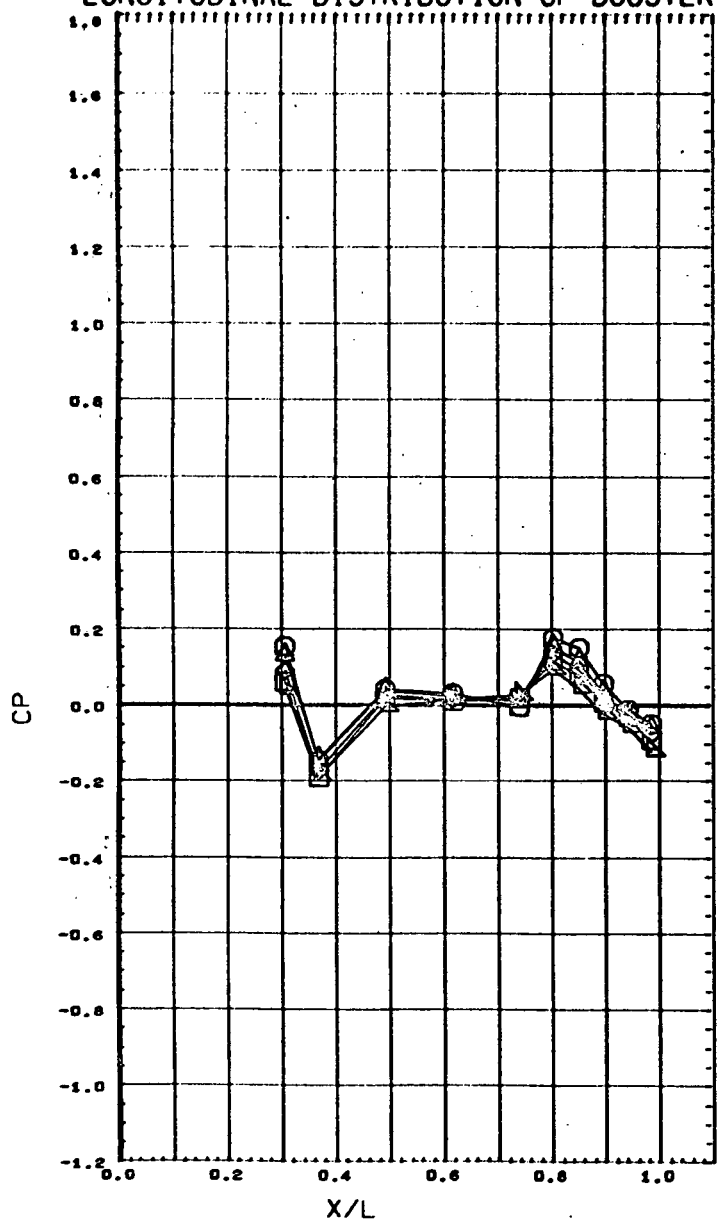

| SYMBOL | BETA | THETA | M1 |
|--------|---------|---------|-------|
| ○ | - 6.041 | 90.000 | 1.299 |
| △ | - 3.928 | 180.000 | |
| ◇ | - 1.929 | | |
| □ | - 0.215 | | |
| ▽ | 1.804 | | |

REFERENCE FILE

PARAMETRIC VALUES
ALFB 0.000

LONGITUDINAL DISTRIBUTION OF BOOSTER FUSELAGE PRESSURES

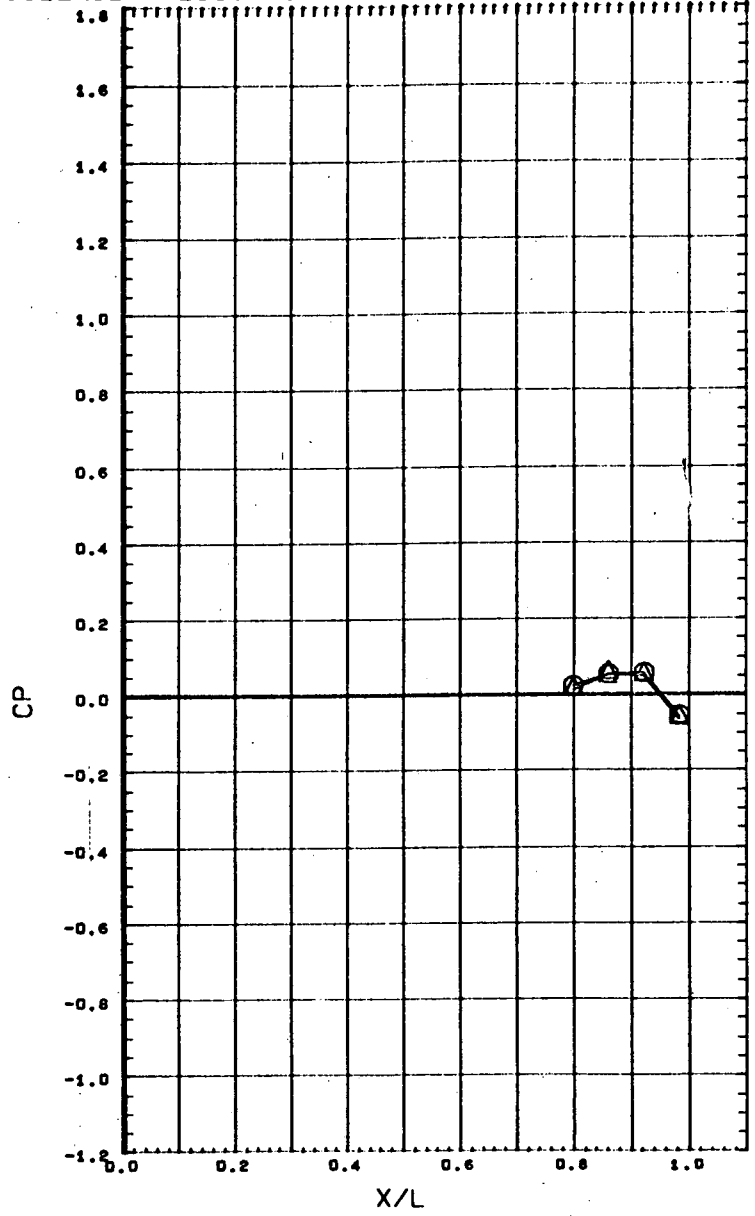
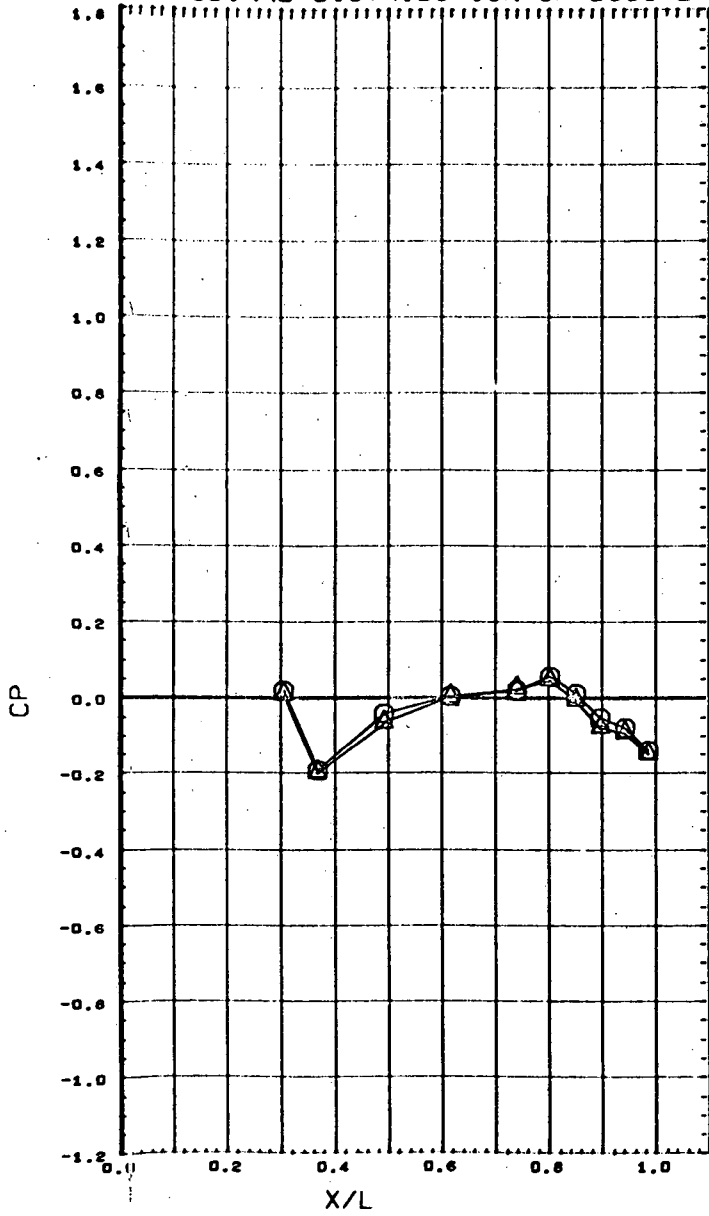

| SYMBOL | BETA | THETA | M1 |
|--------|-------|---------|-------|
| ○ | 3.812 | 90.000 | 1.299 |
| △ | 5.896 | 180.000 | |

PARAMETRIC VALUES
ALFB 0.000

REFERENCE FILE

LONGITUDINAL DISTRIBUTION OF BOOSTER FUSELAGE PRESSURES

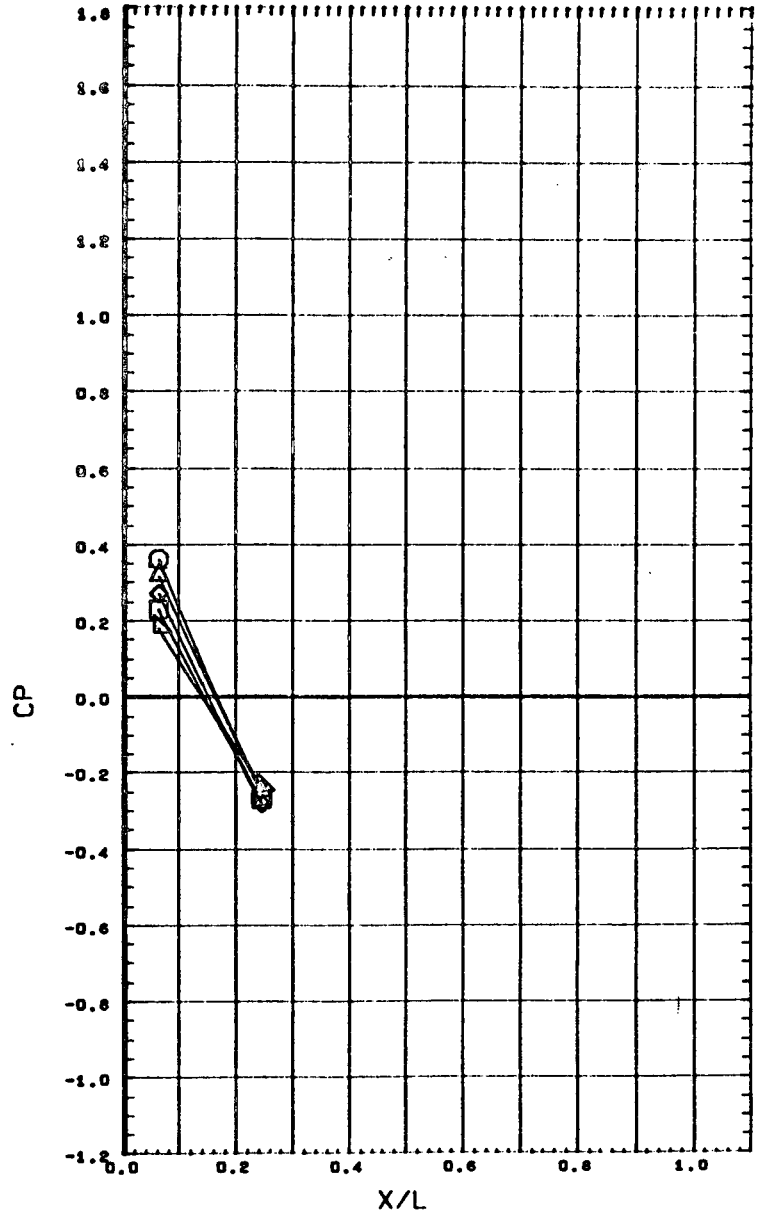
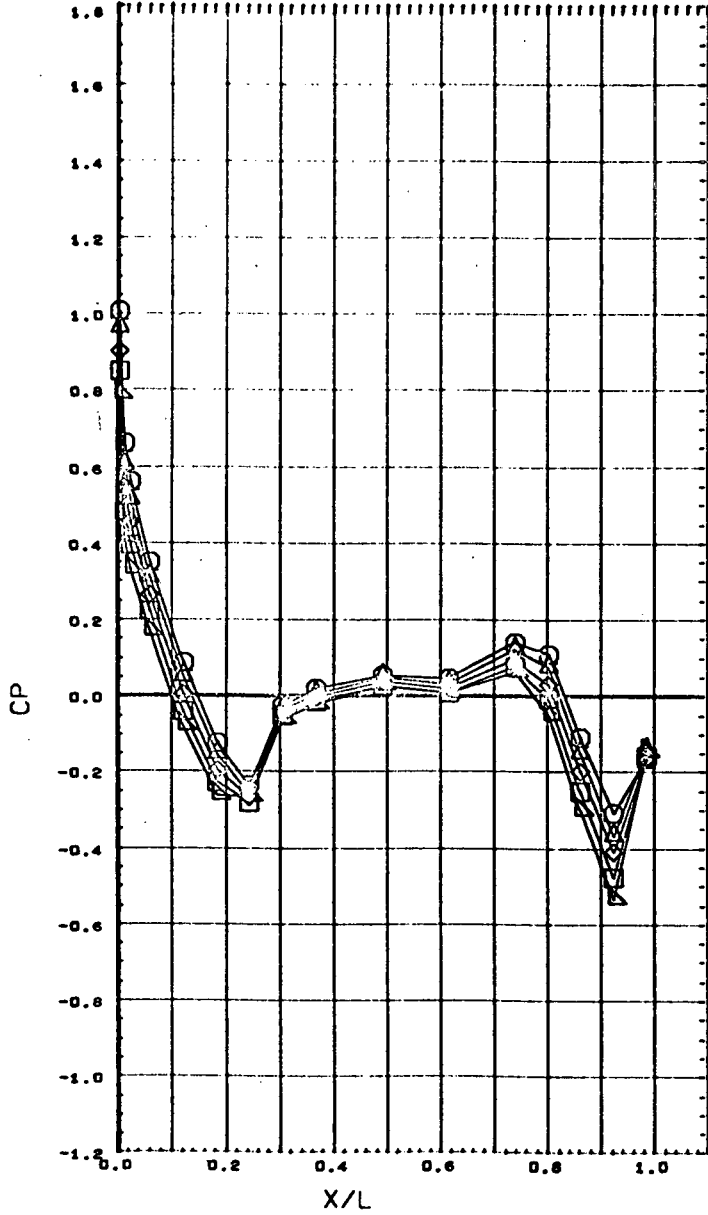

| SYMBOL | ALFB | THETA | M1 |
|--------|-------|--------|-------|
| ○ | 8.102 | 0.000 | 0.902 |
| ◇ | 6.057 | 15.000 | |
| ◇ | 4.060 | | |
| □ | 1.956 | | |
| ◇ | 0.154 | | |

PARAMETRIC VALUES
BETA 0.000

REFERENCE FILE

LONGITUDINAL DISTRIBUTION OF BOOSTER FUSELAGE PRESSURES

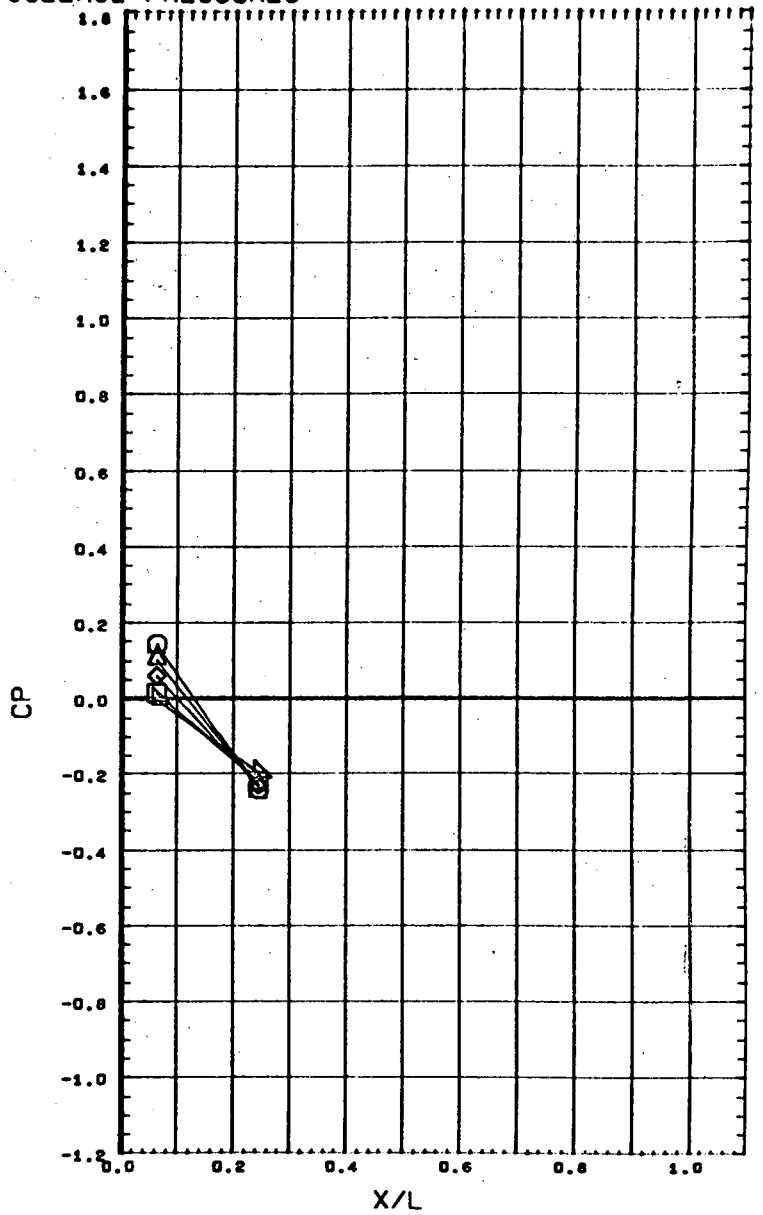
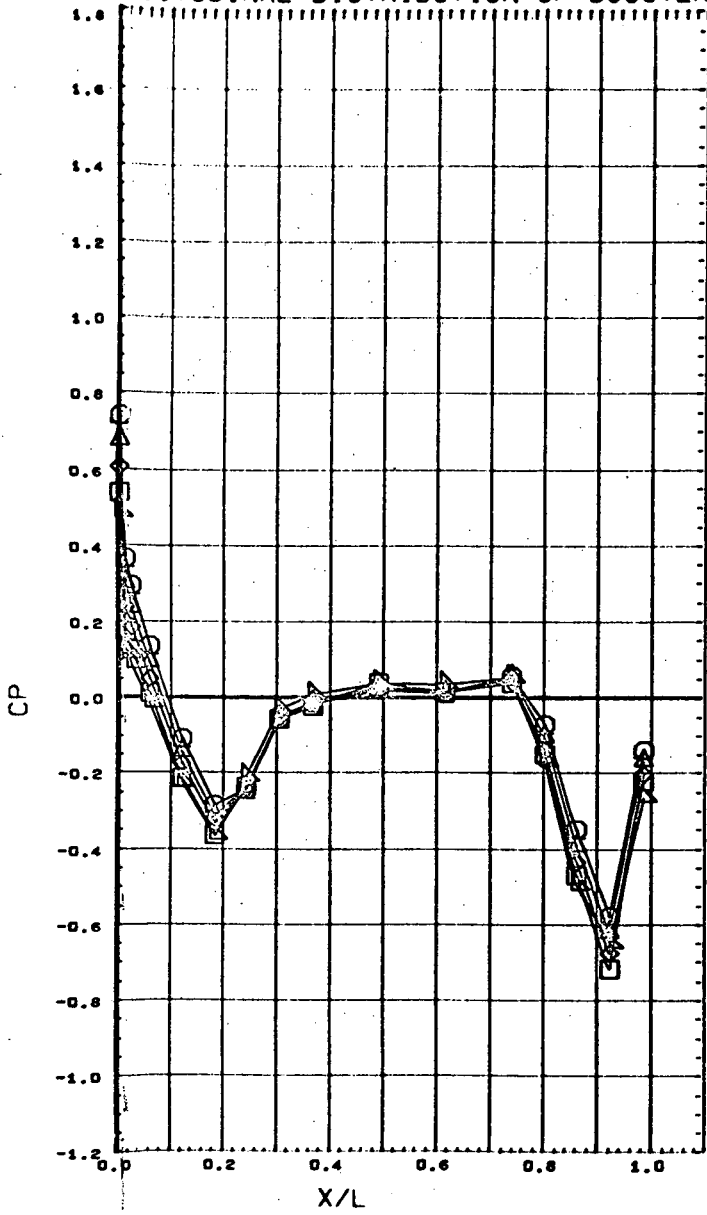

| SYMBOL | ALFB | THETA | M1 |
|--------|-------|--------|-------|
| ○ | 1.940 | 0.000 | 0.902 |
| ◇ | 3.993 | 15.000 | |
| △ | 6.033 | | |
| □ | 7.982 | | |
| ◇ | 9.932 | | |

REFERENCE FILE

PARAMETRIC VALUES
BETA 0.000

LONGITUDINAL DISTRIBUTION OF BOOSTER FUSELAGE PRESSURES

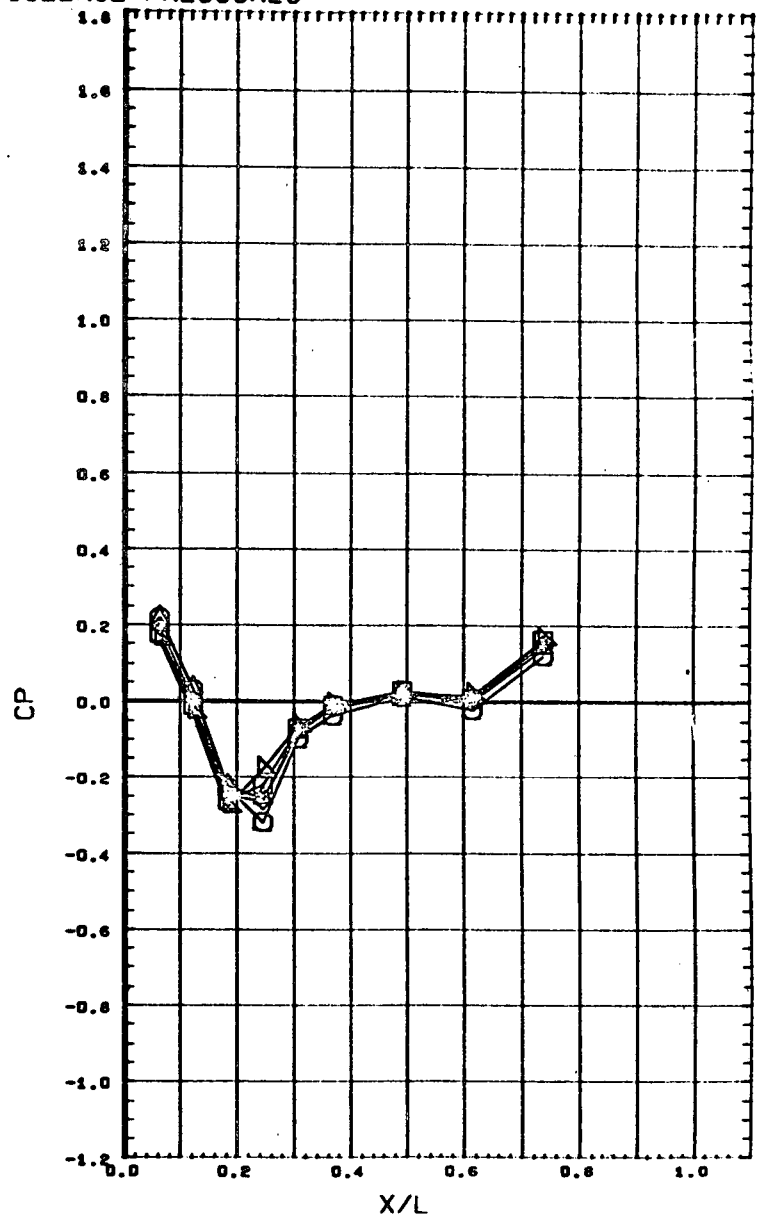
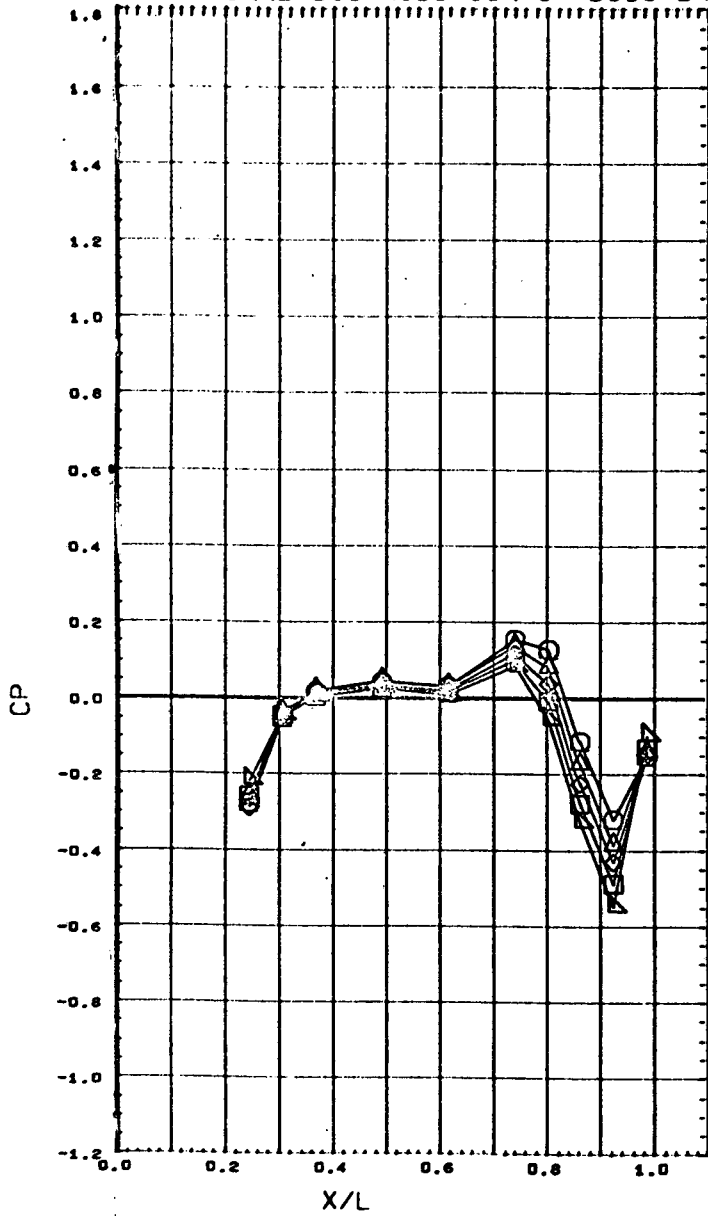

| SYMBOL | A/CFB | THETA | M1 |
|--------|-------|--------|-------|
| ○ | 8.102 | 24.000 | 0.902 |
| ◇ | 6.057 | 45.000 | |
| △ | 4.060 | | |
| □ | 1.956 | | |
| ▽ | 0.154 | | |

PARAMETRIC VALUES
BETA 0.000

REFERENCE FILE

LONGITUDINAL DISTRIBUTION OF BOOSTER FUSELAGE PRESSURES

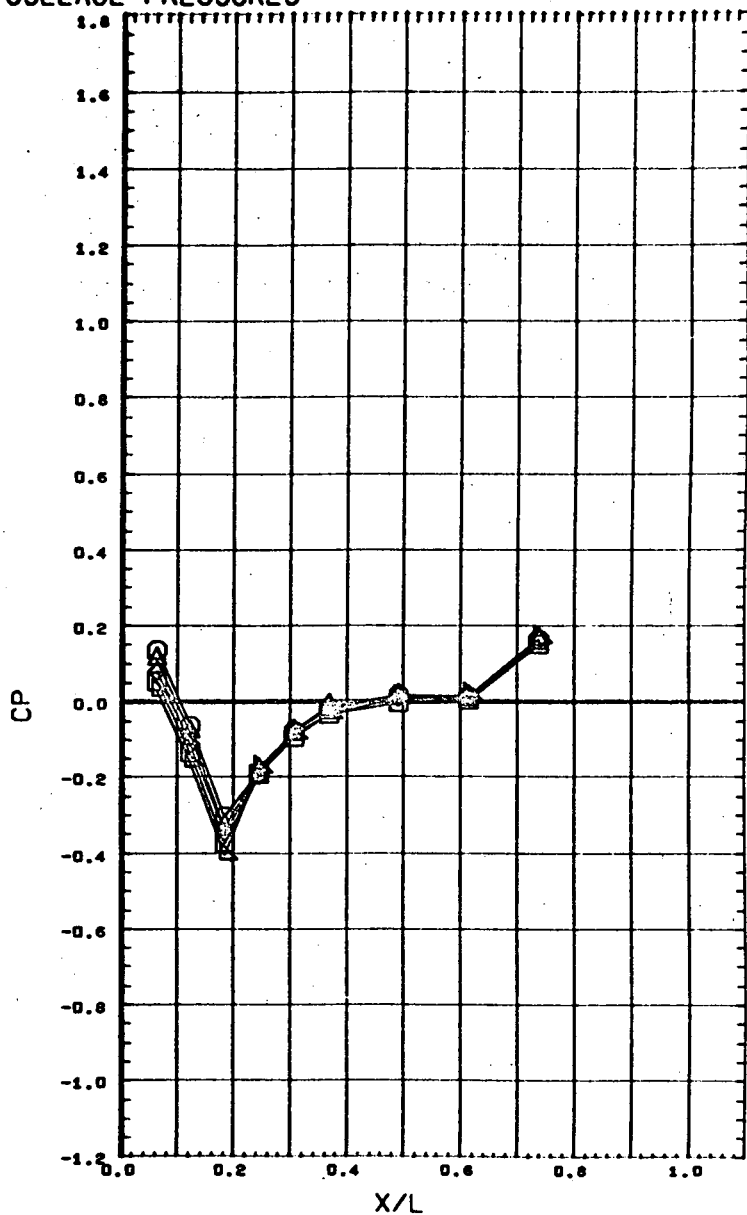
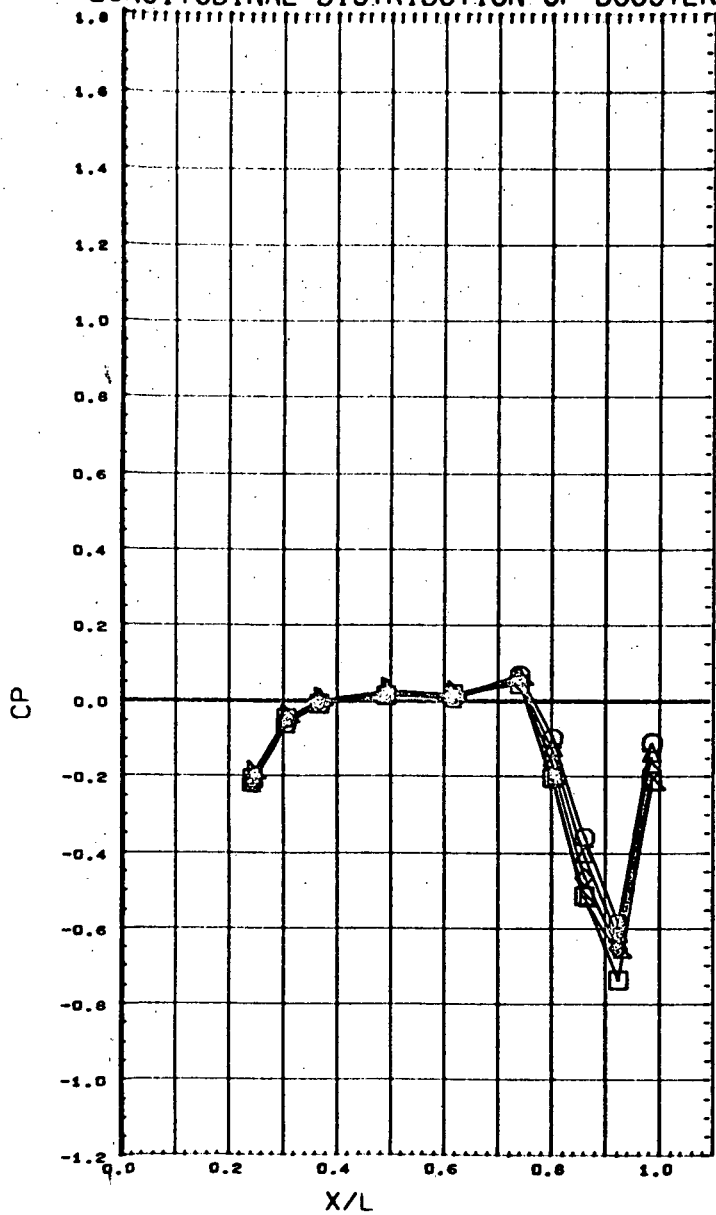

| SYMBOL | ALFD | THETA | M1 |
|--------|-------|--------|-------|
| ○ | 1.940 | 24.000 | 0.902 |
| ◇ | 3.993 | 45.000 | |
| △ | 6.033 | | |
| □ | 7.982 | | |
| ◇ | 9.932 | | |

REFERENCE FILE

PARAMETRIC VALUES
BETA 0.000

LONGITUDINAL DISTRIBUTION OF BOOSTER FUSELAGE PRESSURES

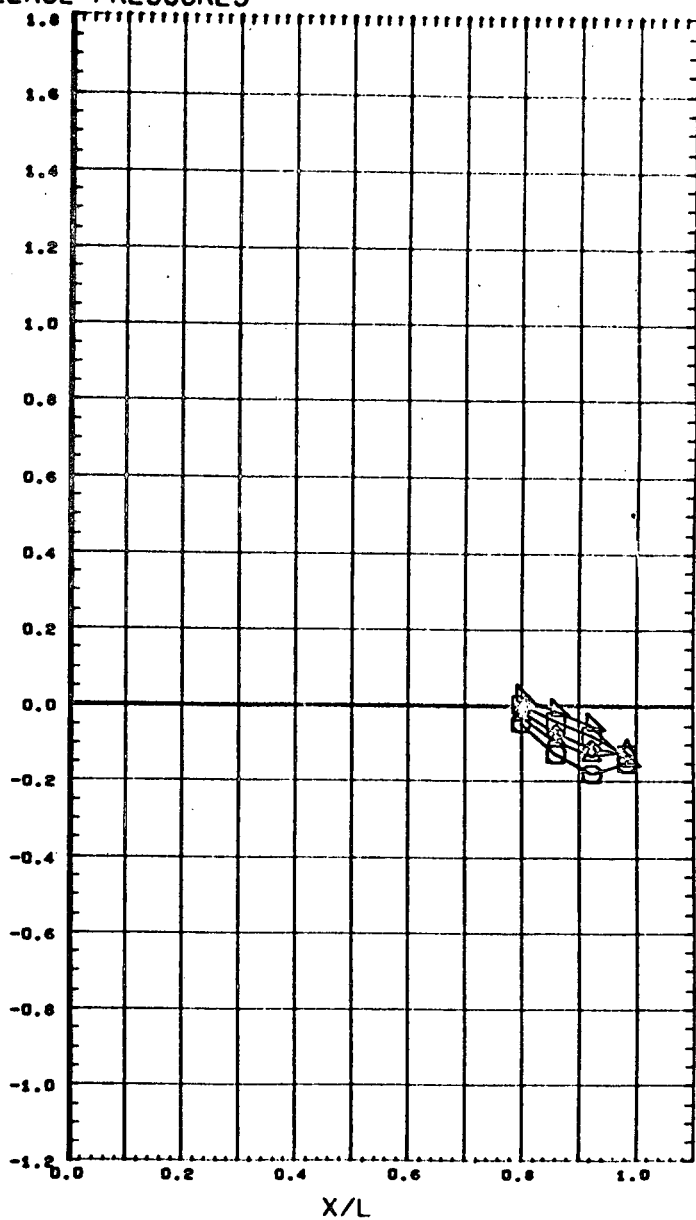
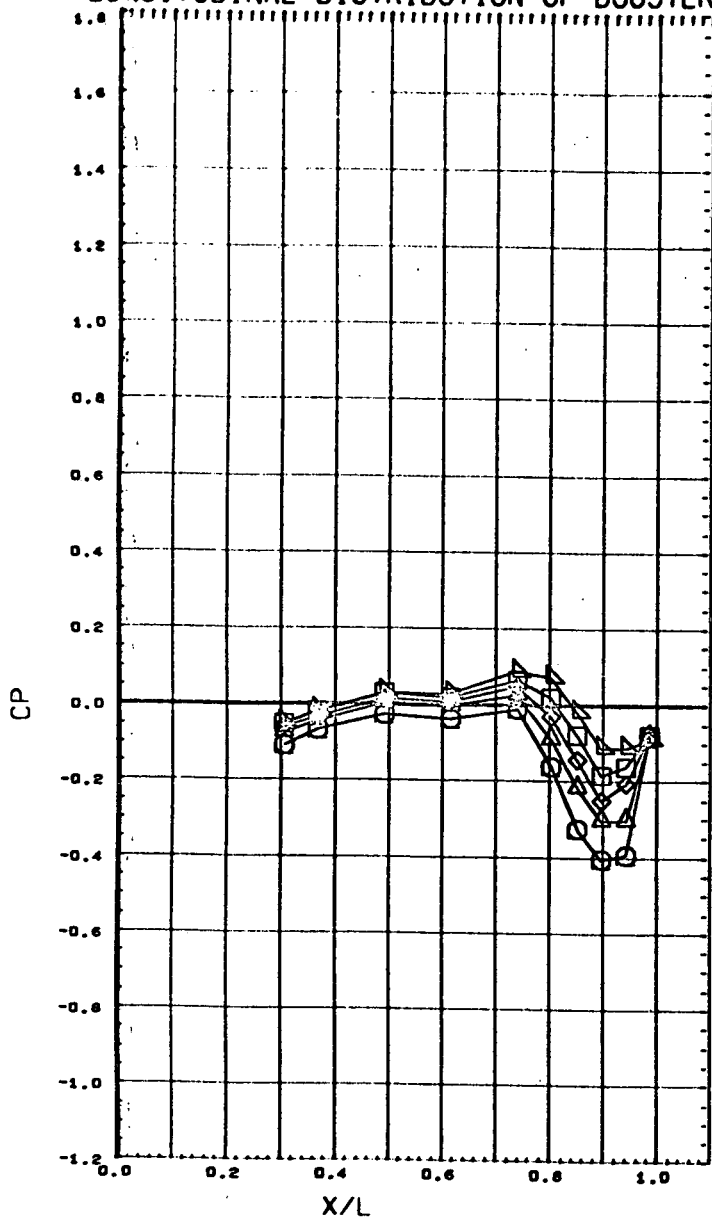

| SYMBOL | ALFB | THETA | M1 |
|--------|-------|---------|-------|
| ○ | 8.102 | 90.000 | 0.902 |
| △ | 6.057 | 180.000 | |
| □ | 4.060 | | |
| ◇ | 1.956 | | |
| ○ | 0.154 | | |

REFERENCE FILE

PARAMETRIC VALUES
BETA 0.000

LONGITUDINAL DISTRIBUTION OF BOOSTER FUSELAGE PRESSURES

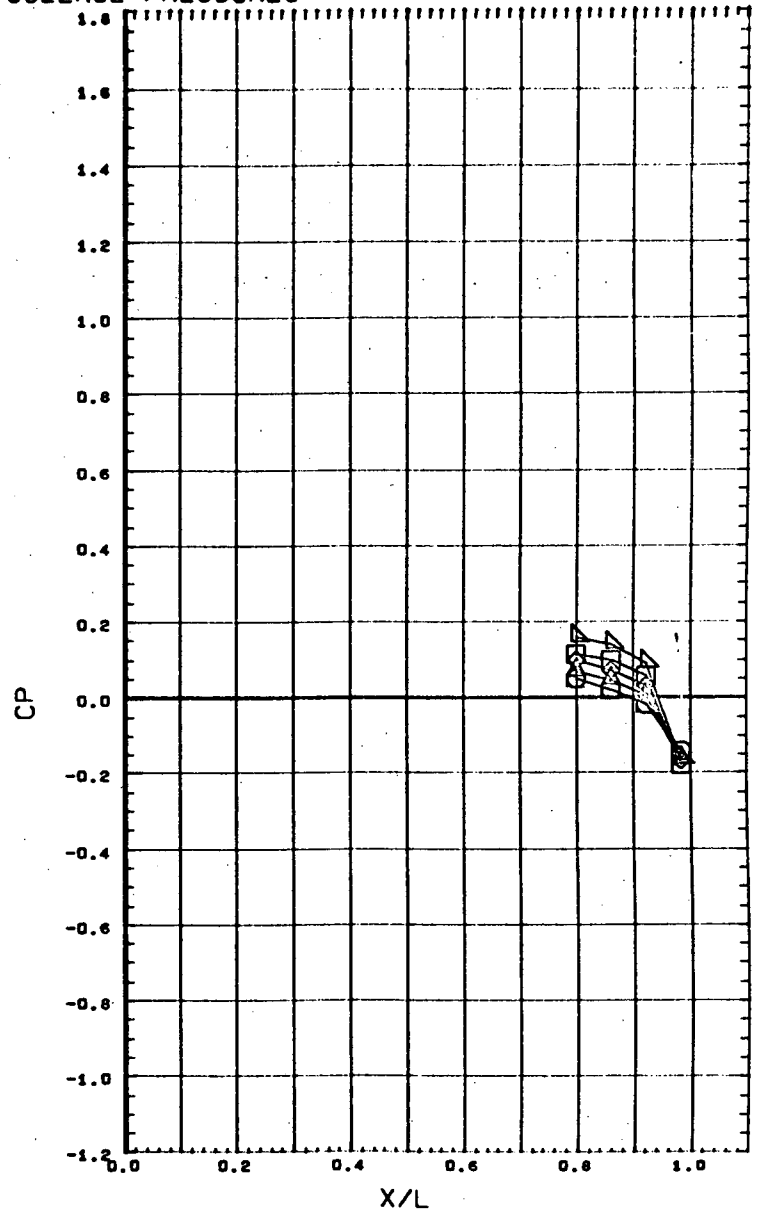
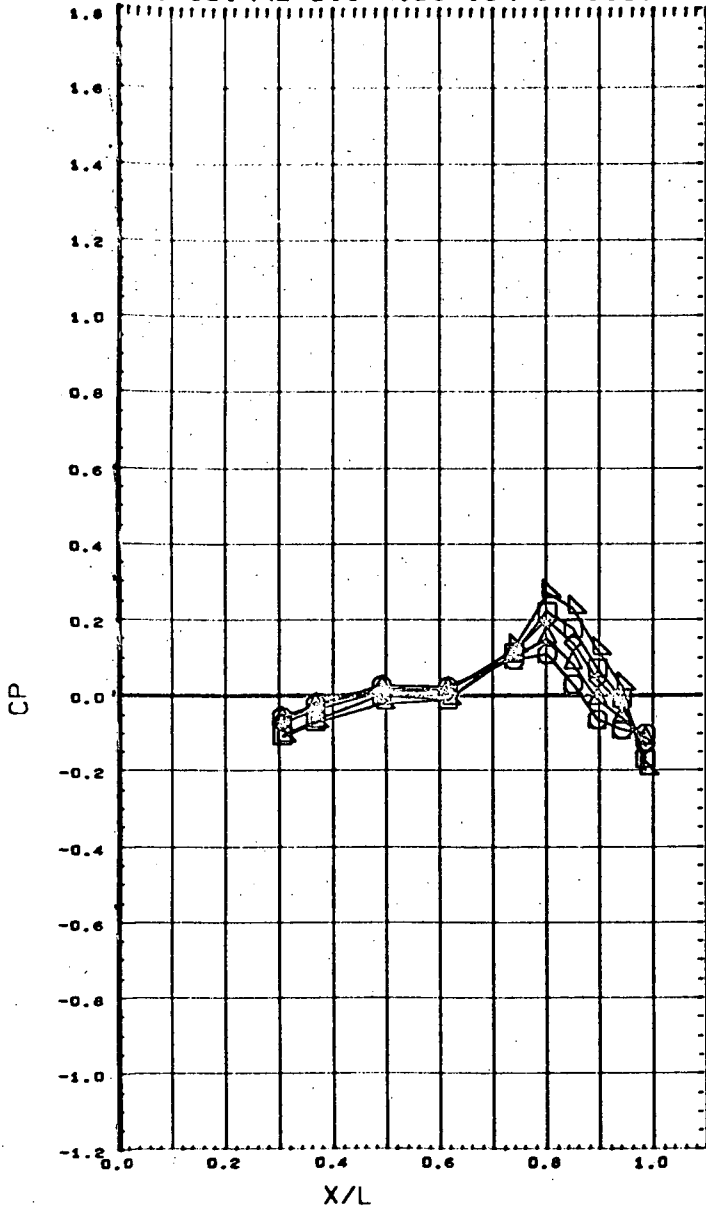

| SYMBOL | ALFA | THETA | M1 |
|--------|-------|---------|-------|
| ○ | 1.940 | 90.000 | 0.902 |
| ◇ | 3.993 | 180.000 | |
| ◇ | 6.033 | | |
| □ | 7.982 | | |
| ◇ | 9.932 | | |

REFERENCE FILE

BETA PARAMETRIC VALUES
0.000

LONGITUDINAL DISTRIBUTION OF BOOSTER FUSELAGE PRESSURES

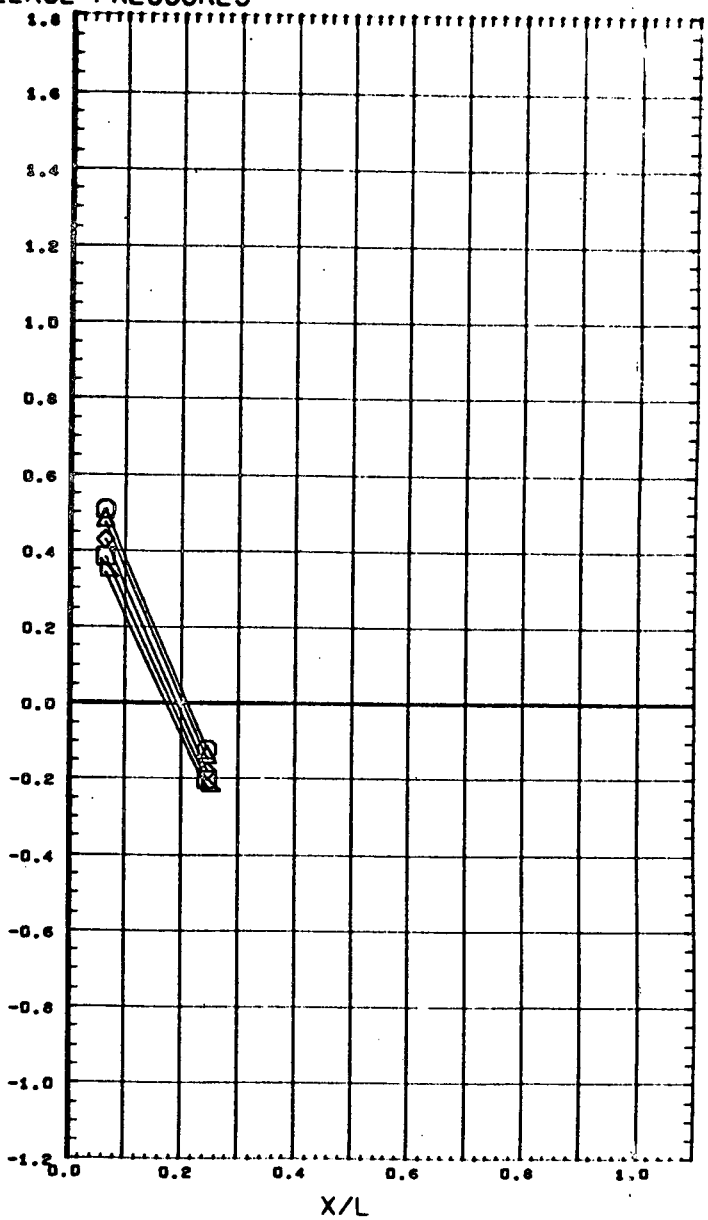
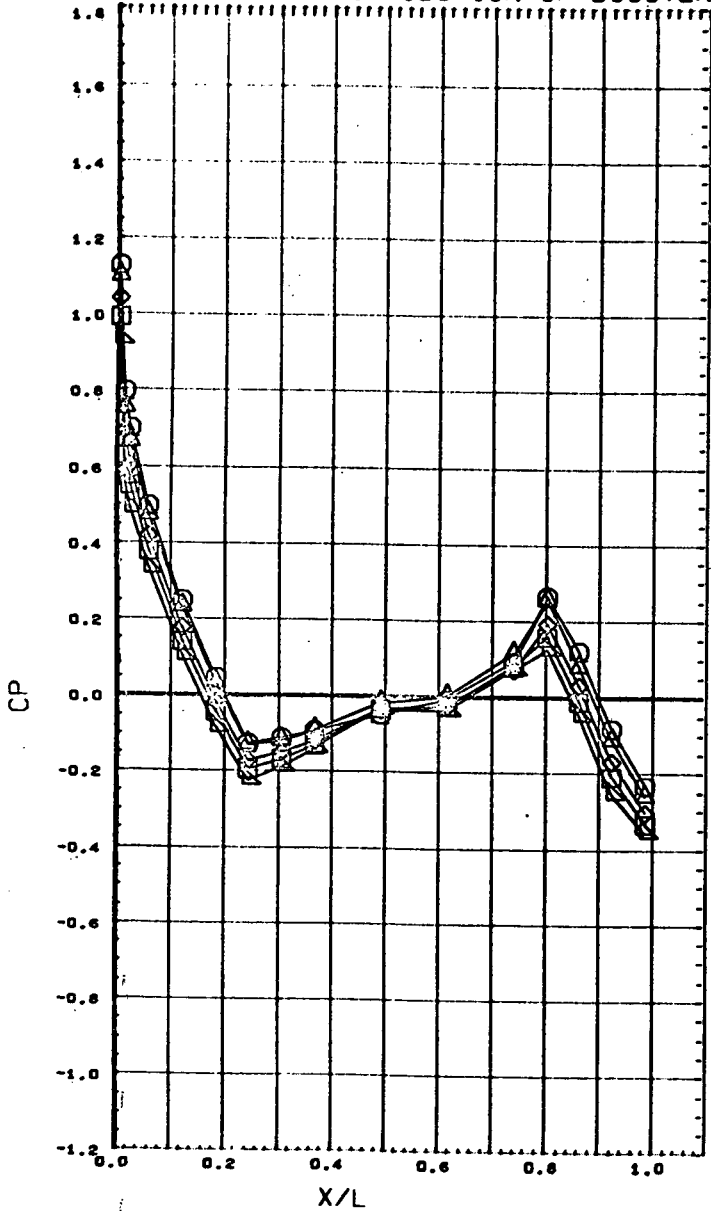

| SYMBOL | ALFB | THETA | M1 |
|--------|-------|--------|-------|
| ○ | 8.189 | 0.000 | 1.101 |
| △ | 6.122 | 15.000 | |
| ◇ | 4.119 | | |
| □ | 1.997 | | |
| ○ | 0.125 | | |

PARAMETRIC VALUES
BETA 0.000

REFERENCE FILE

LONGITUDINAL DISTRIBUTION OF BOOSTER FUSELAGE PRESSURES

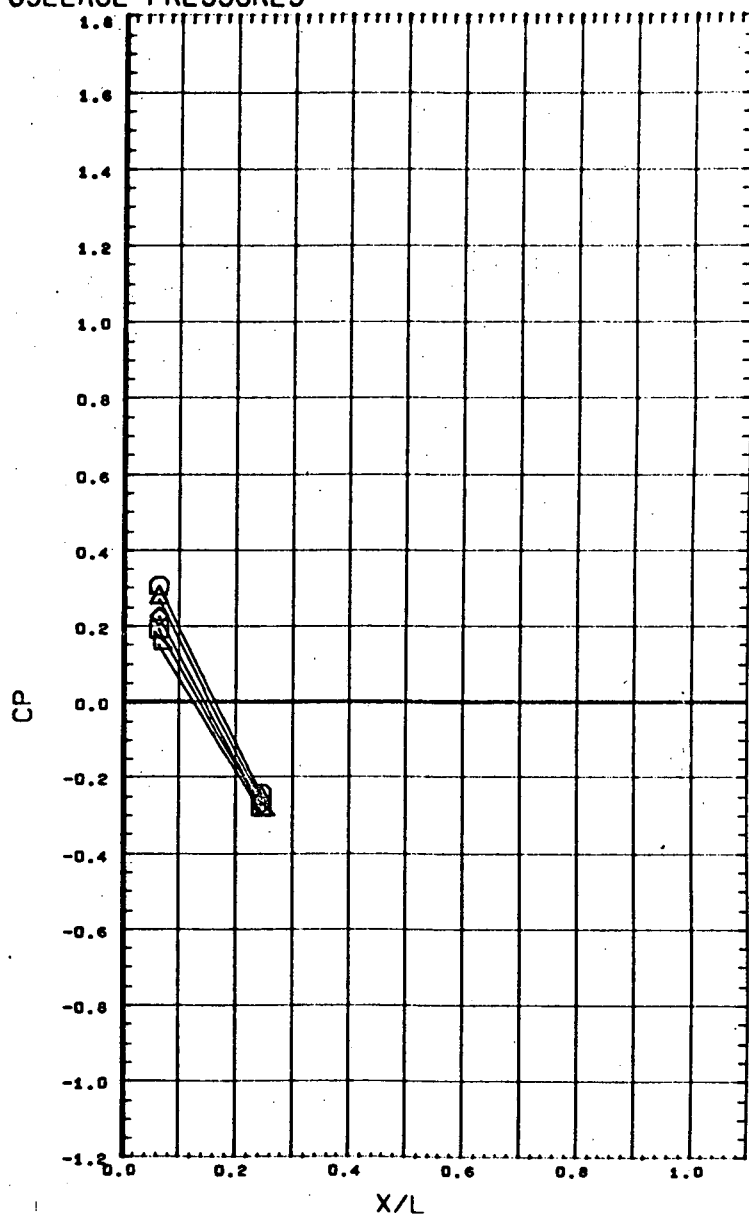
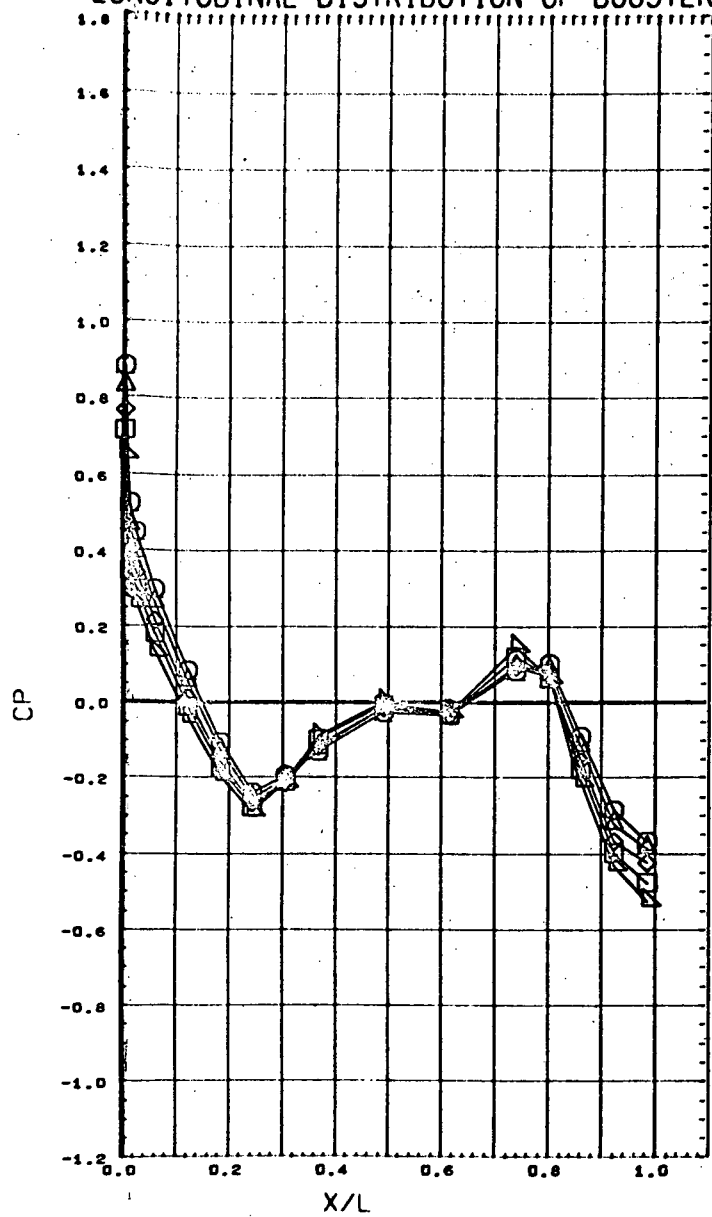

| SYMBOL | ALFB | THETA | M1 |
|--------|--------|--------|-------|
| ○ | 1.927 | 0.000 | 1.101 |
| ◇ | 4.042 | 15.000 | |
| △ | 6.146 | | |
| □ | 8.139 | | |
| ▽ | 10.123 | | |

PARAMETRIC VALUES
BETA 0.000

REFERENCE FILE

LONGITUDINAL DISTRIBUTION OF BOOSTER FUSELAGE PRESSURES

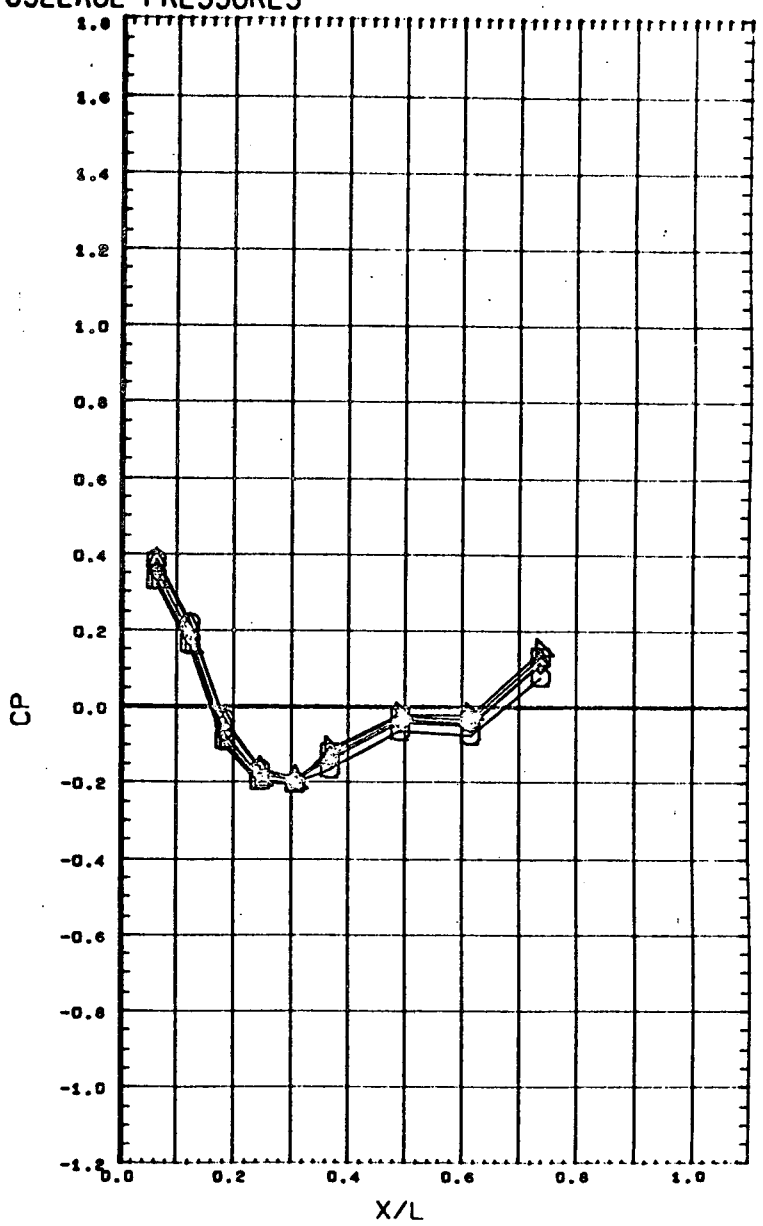
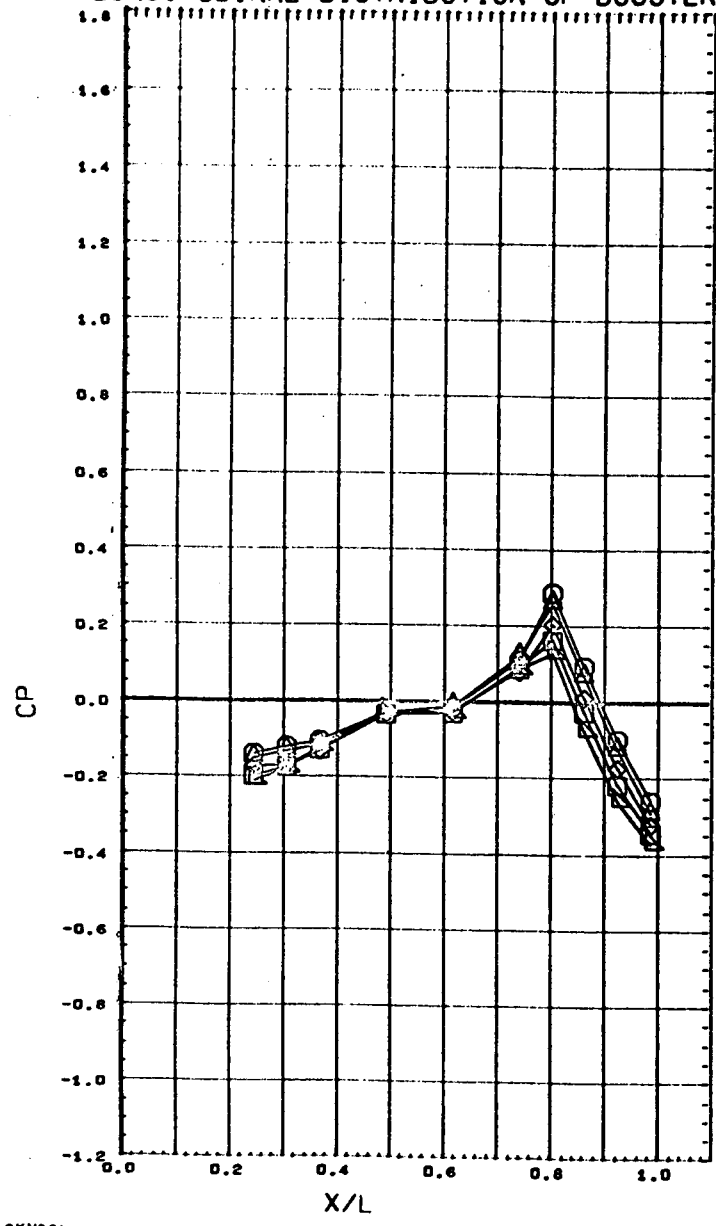

| SYMBOL | ALFB | THETA | M1 |
|--------|-------|--------|-------|
| ○ | 6.189 | 24.000 | 1.101 |
| △ | 6.122 | 45.000 | |
| ◇ | 4.119 | | |
| □ | 1.997 | | |
| ▽ | 0.125 | | |

PARAMETRIC VALUES
BETA 0.000

REFERENCE FILE

LONGITUDINAL DISTRIBUTION OF BOOSTER FUSELAGE PRESSURES

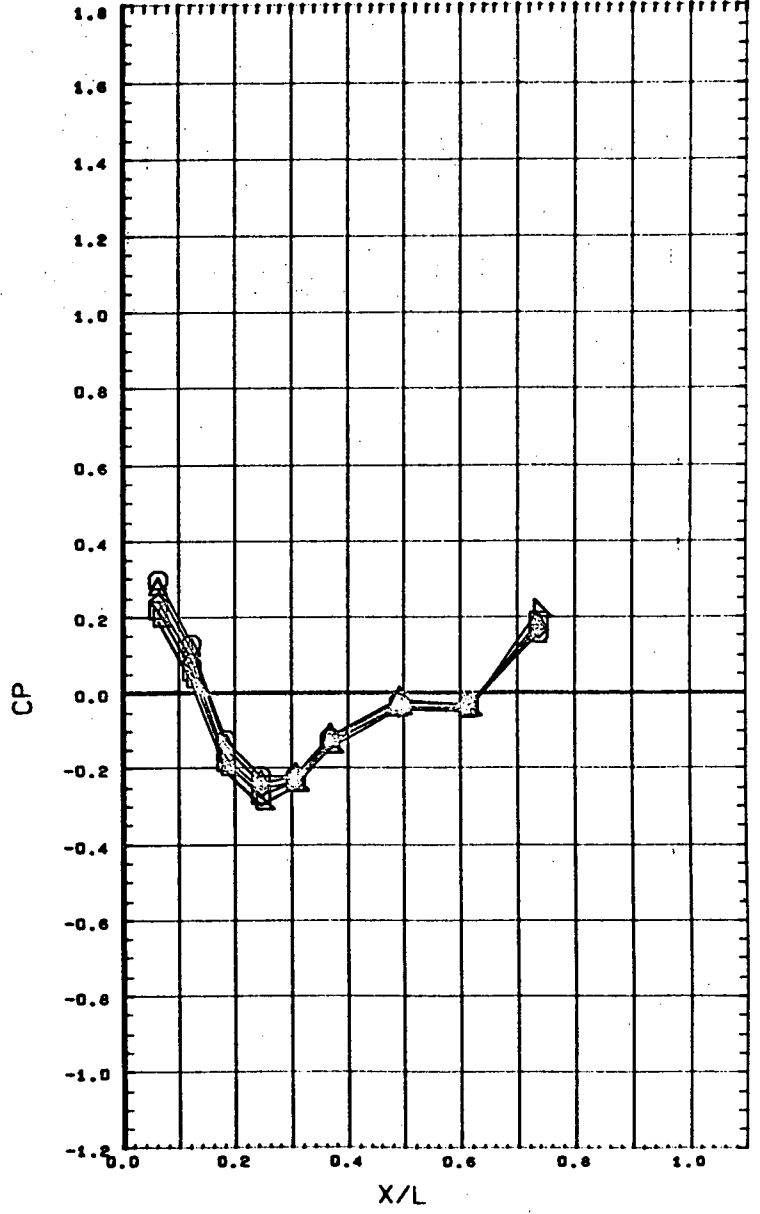
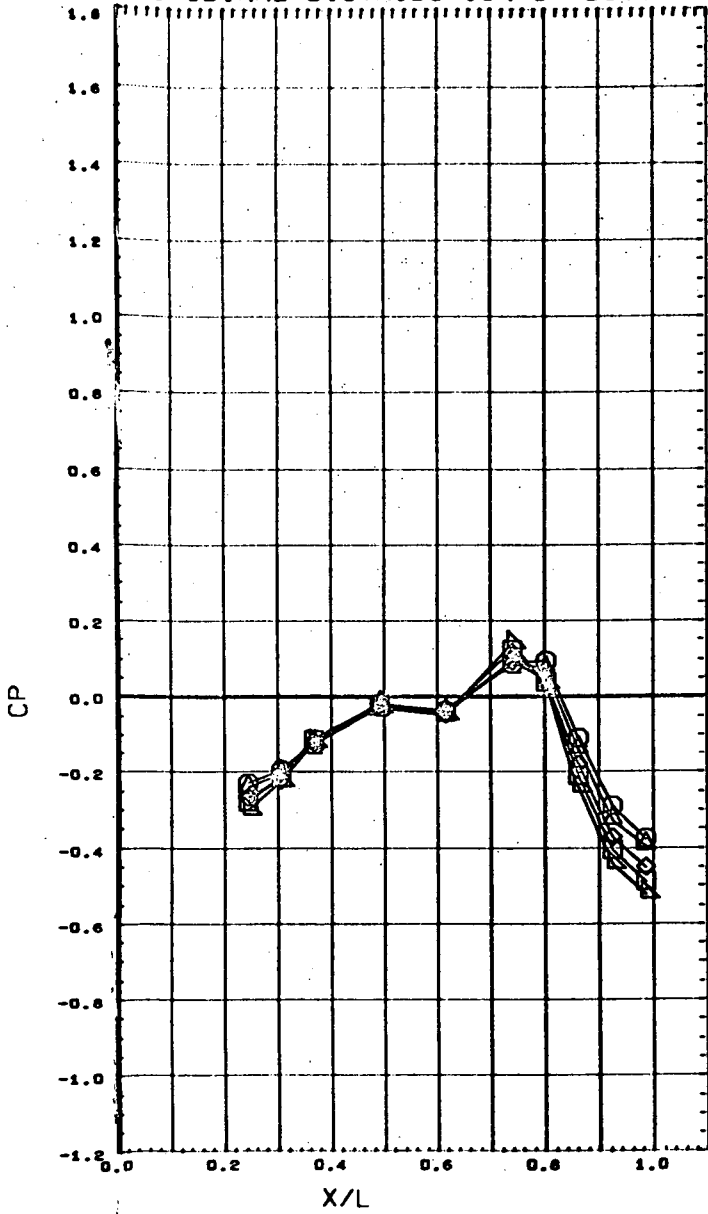

| SYMBOL | ALFB | THETA | M1 |
|--------|--------|--------|-------|
| ○ | 1.927 | 24.000 | 1.101 |
| ◇ | 4.042 | 45.000 | |
| ◇ | 6.146 | | |
| □ | 8.139 | | |
| □ | 10.123 | | |

PARAMETRIC VALUES
BETA 0.000

REFERENCE FILE

LONGITUDINAL DISTRIBUTION OF BOOSTER FUSELAGE PRESSURES

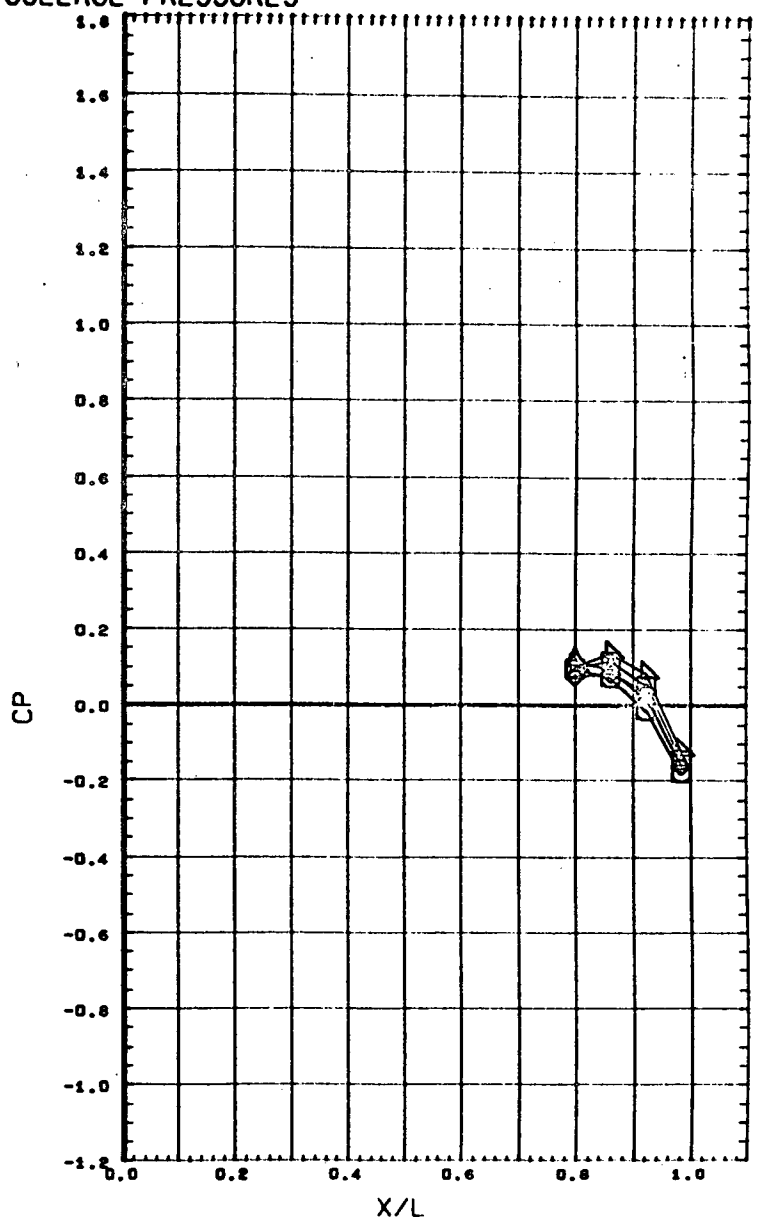
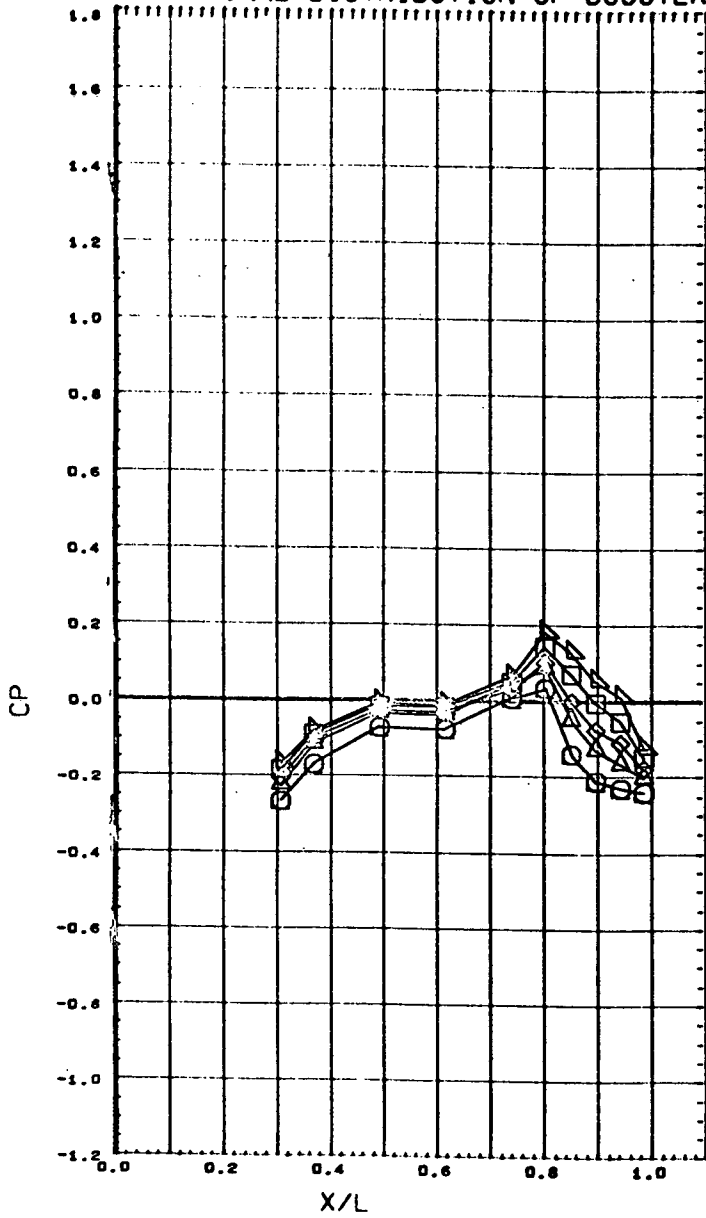

| SYMBOL | ALFB | THETA | M1 |
|--------|-------|---------|-------|
| □ | 8.189 | 90.000 | 1.101 |
| ◇ | 6.122 | 100.000 | |
| △ | 4.119 | | |
| ○ | 1.997 | | |
| ○ | 0.125 | | |

BETA PARAMETRIC VALUES
0.000

REFERENCE FILE

LONGITUDINAL DISTRIBUTION OF BOOSTER FUSELAGE PRESSURES

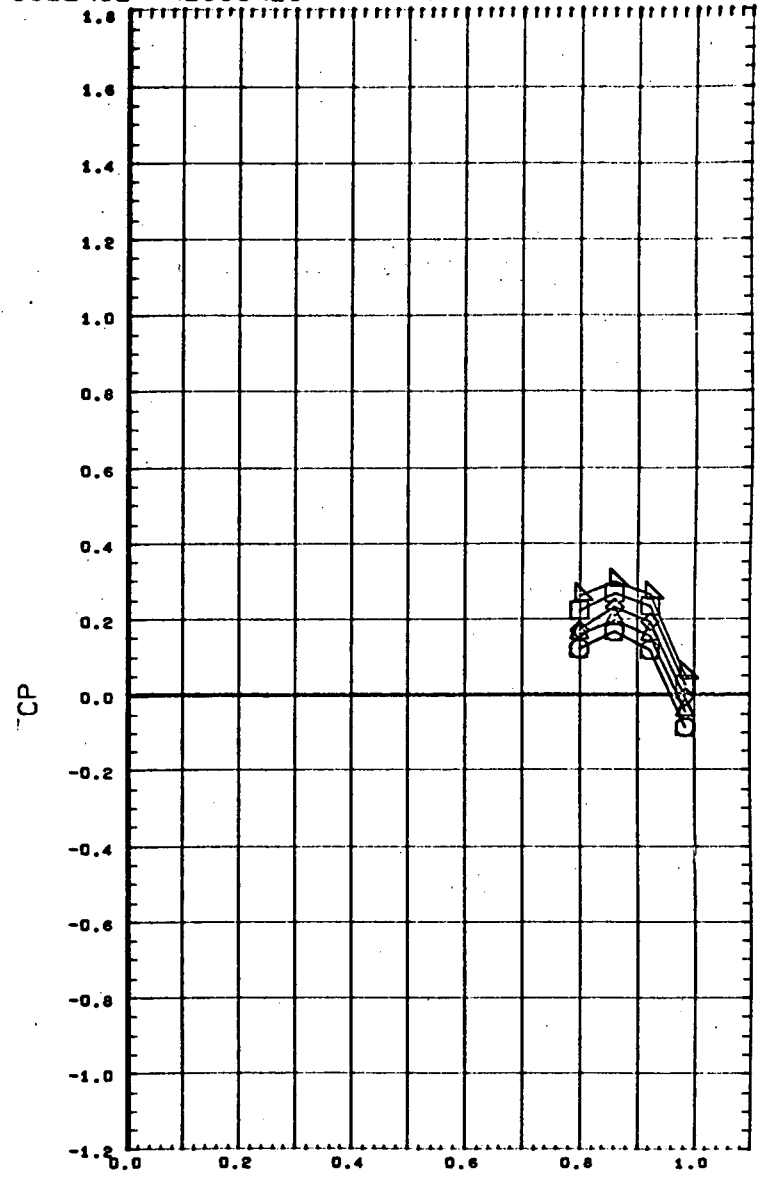
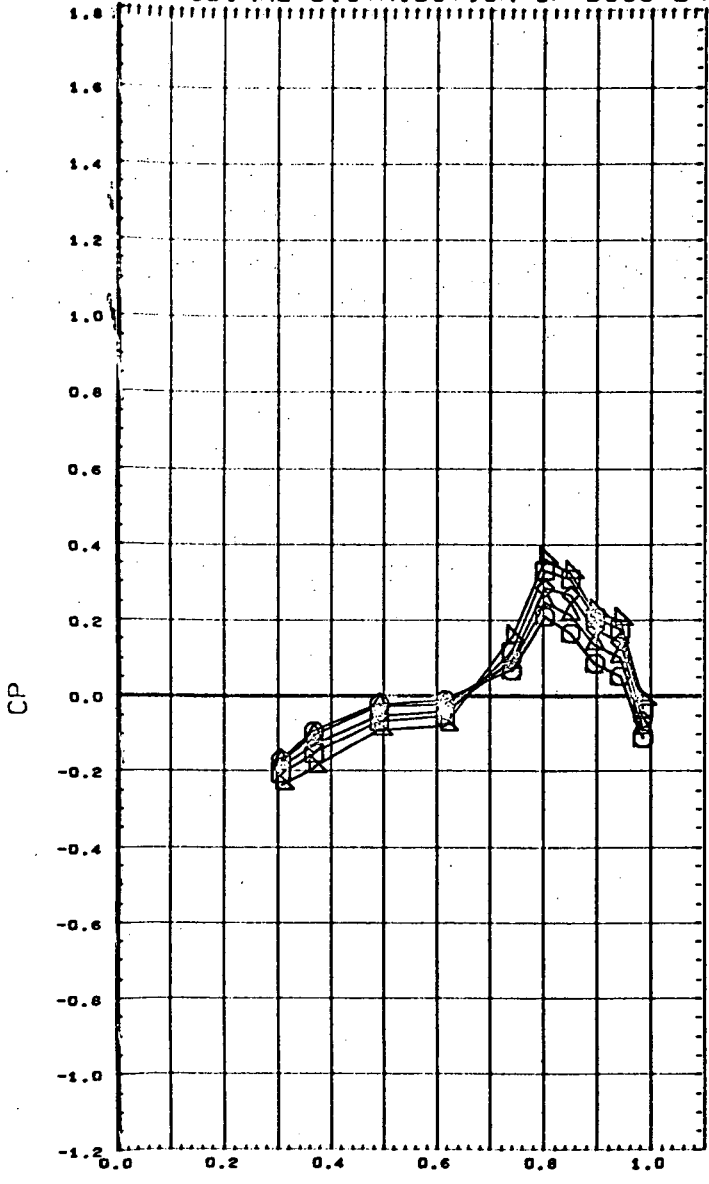

| SYMBOL | ALFB | THETA | M1 |
|--------|--------|---------|-------|
| □ | 1.927 | 90.000 | 1.101 |
| ◇ | 4.042 | 180.000 | |
| △ | 6.146 | | |
| ○ | 8.139 | | |
| ◇ | 10.123 | | |

REFERENCE FILE

PARAMETRIC VALUES
BETA 0.000

RADIAL DISTRIBUTION OF BOOSTER BASE PRESSURES

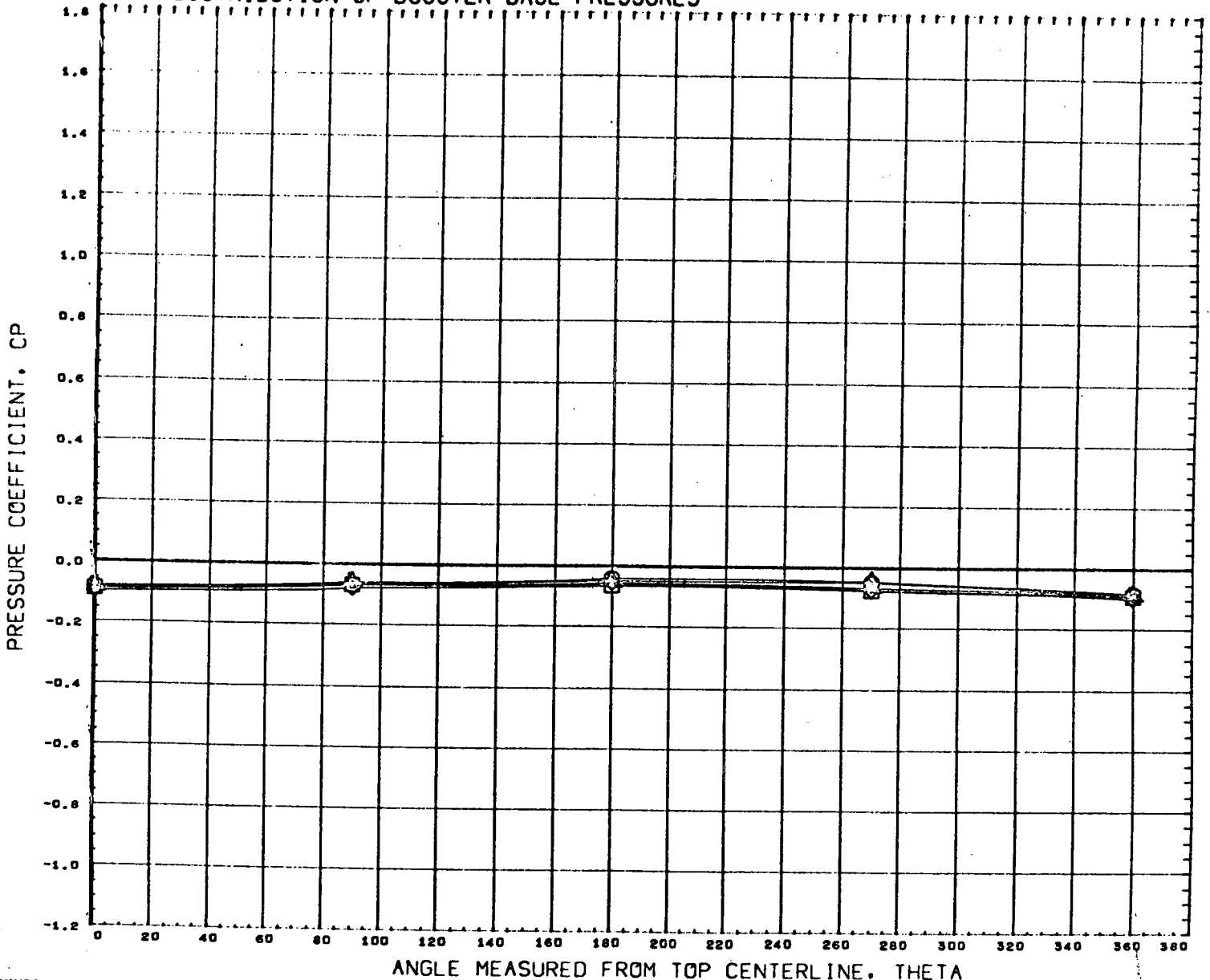

| SYMBOL | ALFB | X/L | M1 |
|--------|-------|-------|-------|
| ◇ | 7.935 | 1.000 | 0.600 |
| ◇ | 5.896 | | |
| ◇ | 4.415 | | |
| ◇ | 2.278 | | |
| ◇ | 0.122 | | |

| PARAMETRIC VALUES | | |
|-------------------|-------|-------|
| BETA | 0.000 | CX/L |
| I | 0.000 | 0.000 |

REFERENCE FILE

RADIAL DISTRIBUTION OF BOOSTER BASE PRESSURES

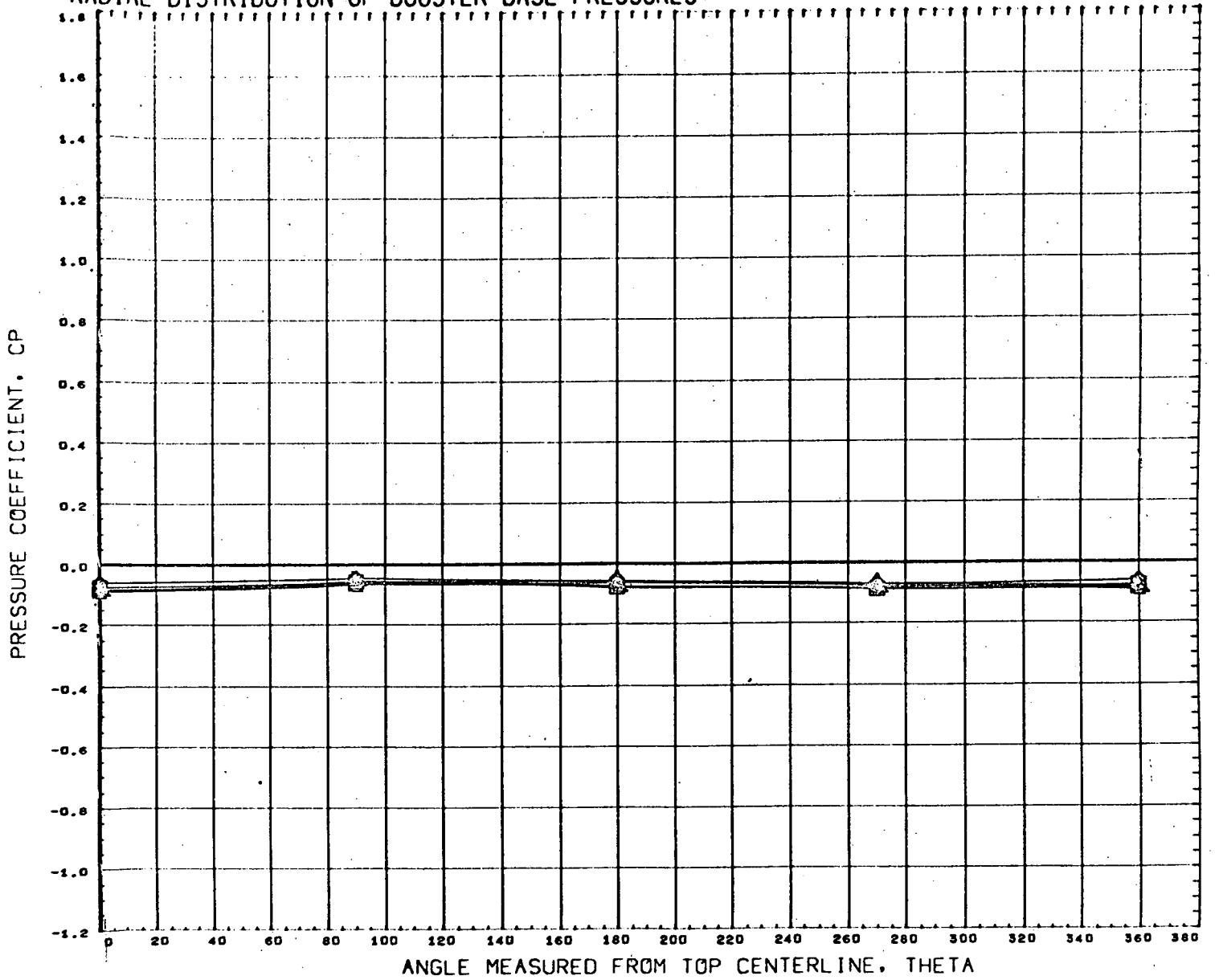

| SYMBOL | ALFB | X/L | M1 | PARAMETRIC VALUES | | |
|--------|--------|-------|-------|-------------------|-------|-------|
| | | | | BETA | DX/L | 0.000 |
| ◇ | 2.577 | 1.000 | 0.600 | I | 0.000 | 0.000 |
| ◇ | 4.089 | | | | | |
| ◇ | 5.583 | | | | | |
| ◇ | 6.037 | | | | | |
| ◇ | 10.078 | | | | | |

REFERENCE FILE

RADIAL DISTRIBUTION OF BOOSTER BASE PRESSURES

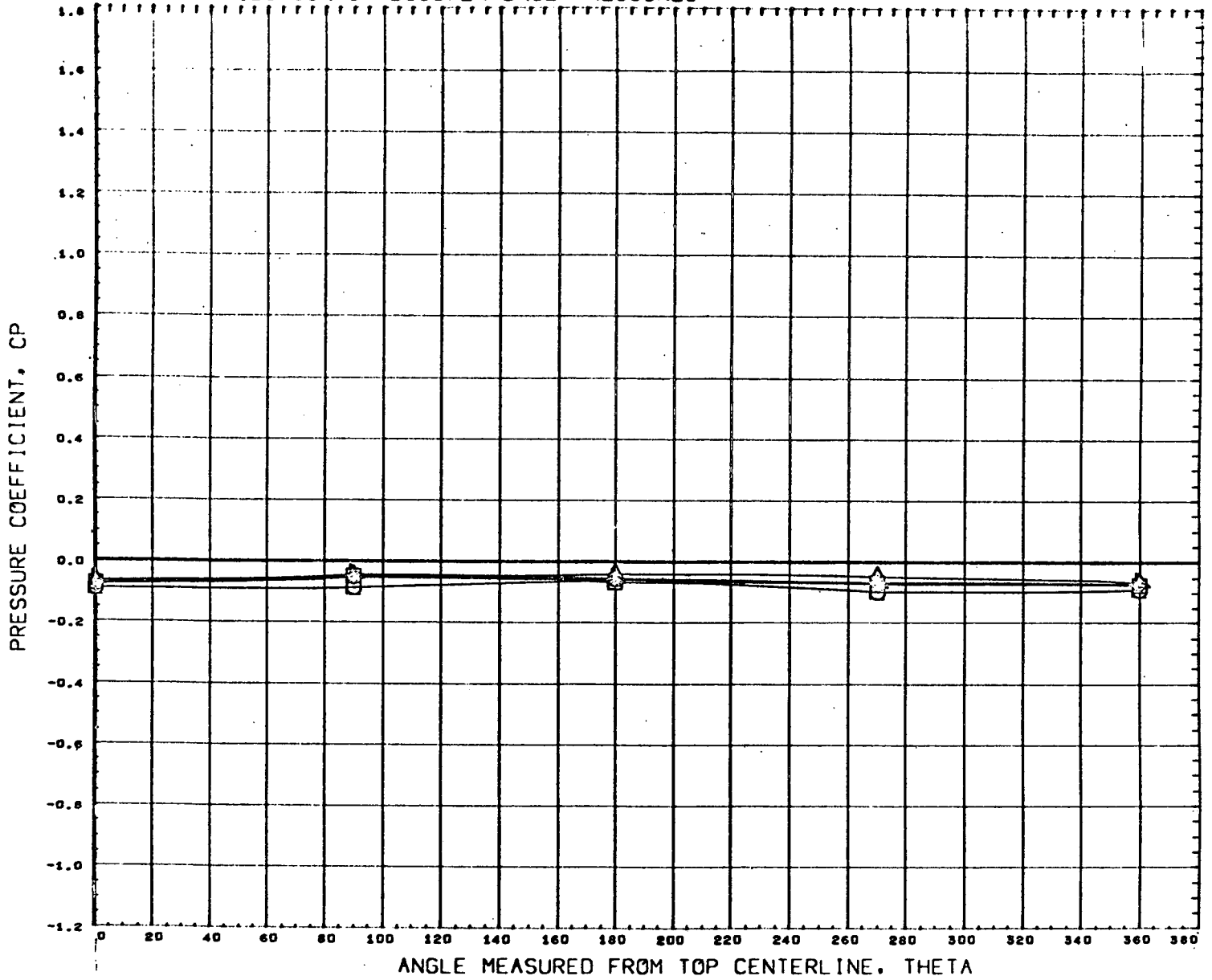

| SYMBOL | ALFB | X/L | M1 |
|--------|---------|-------|-------|
| ◇ | - 8.137 | 1.000 | 0.894 |
| ◇ | - 5.806 | | |
| ◇ | - 3.831 | | |
| ◇ | - 1.836 | | |
| ◇ | 0.154 | | |

| PARAMETRIC VALUES | | |
|-------------------|-------|-------|
| BETA | 0.000 | 0.000 |
| I | 0.000 | 0.000 |

REFERENCE FILE

RADIAL DISTRIBUTION OF BOOSTER BASE PRESSURES

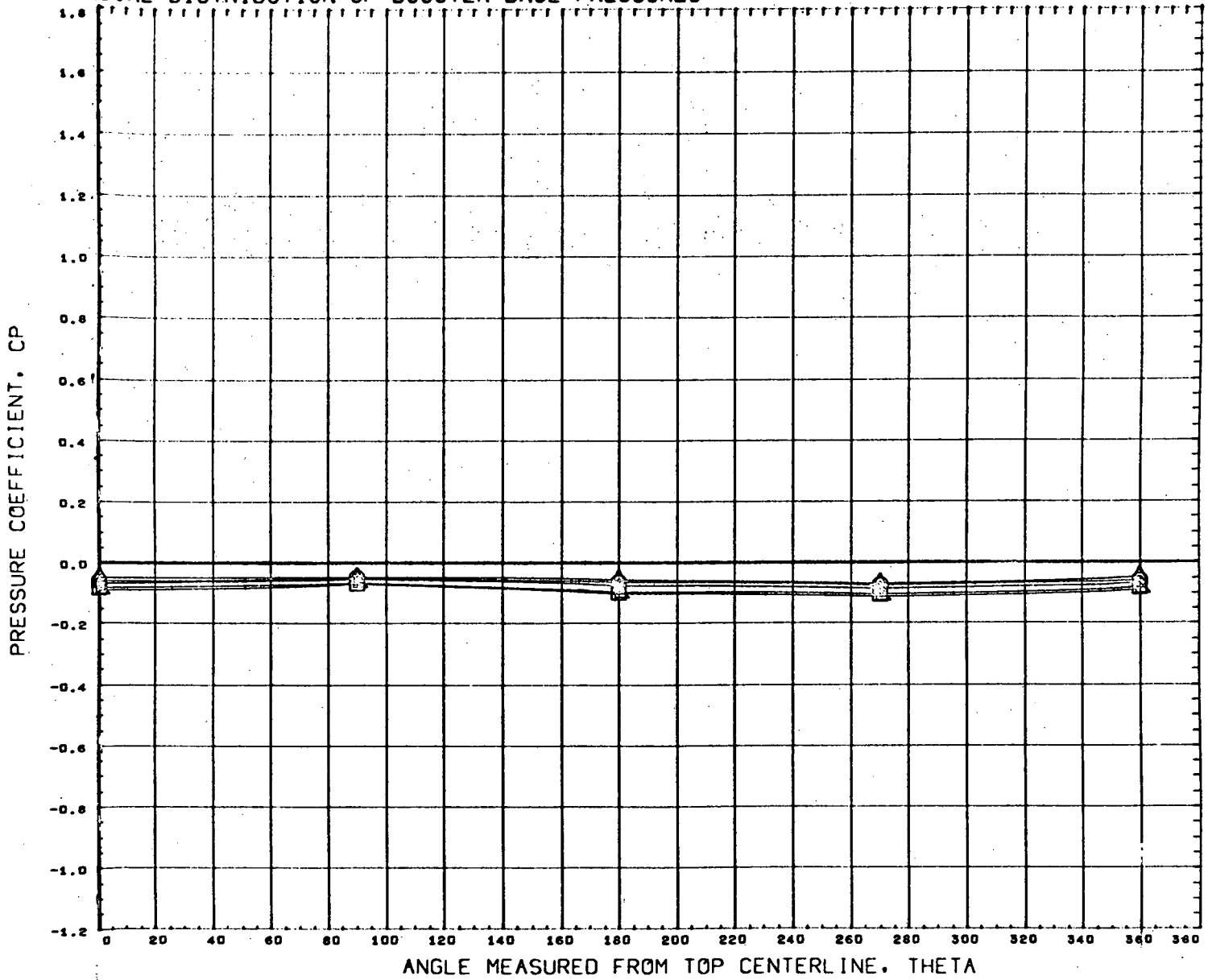

| SYMBOL | ALFB | X/L | M1 | PARAMETRIC VALUES | | | |
|--------|--------|-------|-------|-------------------|-------|------|-------|
| □ | 1.547 | 1.000 | 0.894 | BETA | 0.000 | DX/L | 0.000 |
| ◇ | 3.746 | | | I | 0.000 | | |
| ◇ | 6.129 | | | | | | |
| ◇ | 8.136 | | | | | | |
| ◇ | 10.120 | | | | | | |

REFERENCE FILE

RADIAL DISTRIBUTION OF BOOSTER BASE PRESSURES

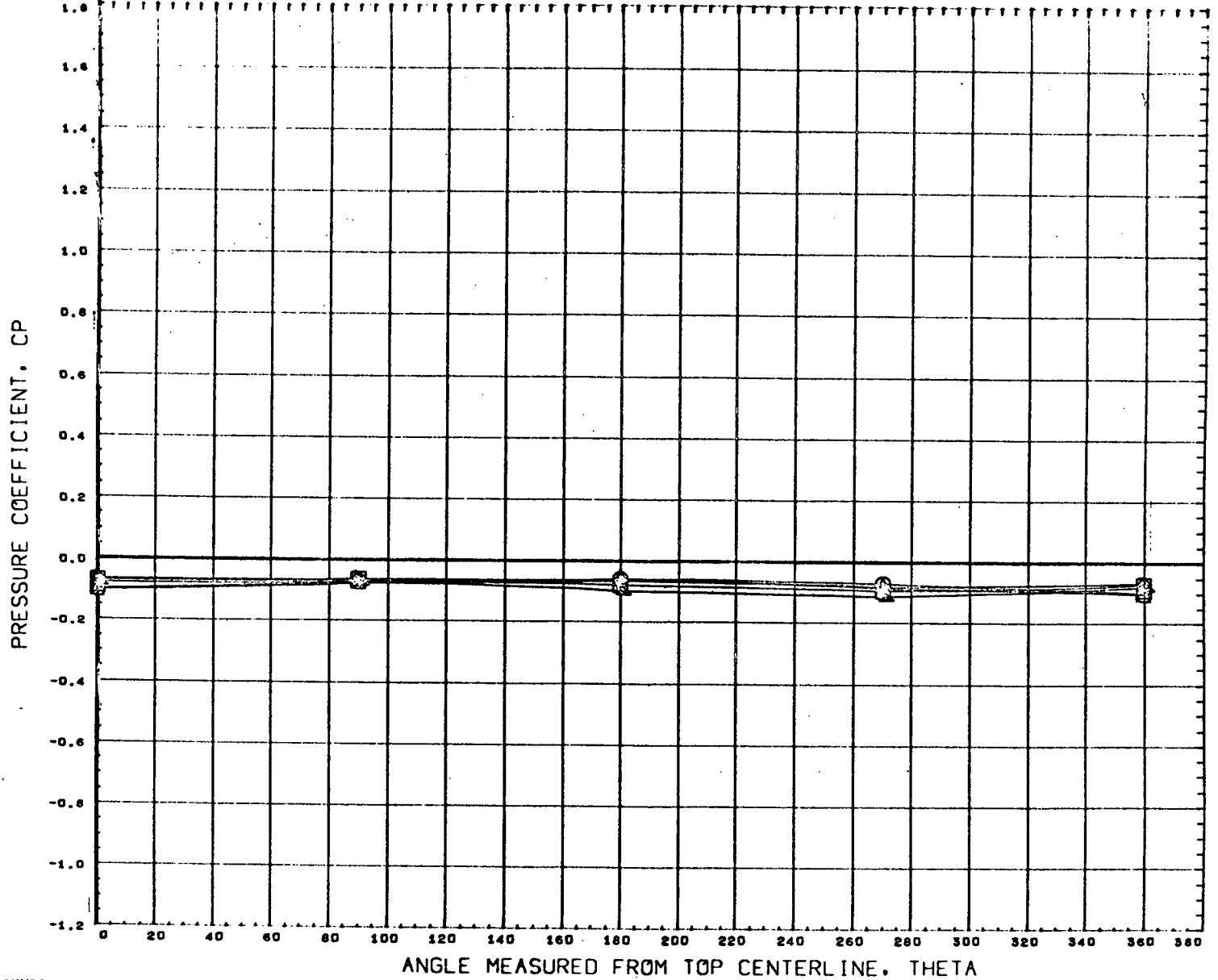

| | | | | | | |
|--------|---------|-------|-------|-------|-------------------|-------|
| SYMBOL | ALFB | X/L | H1 | BETA | PARAMETRIC VALUES | |
| ◇ | - 7.922 | 1.000 | 1.000 | 0.000 | DX/L | 0.000 |
| ◇ | - 5.773 | | | I | 0.000 | |
| ◇ | - 4.421 | | | | | |
| ◇ | - 2.227 | | | | | |
| ◇ | 0.197 | | | | | |

REFERENCE FILE

RADIAL DISTRIBUTION OF BOOSTER BASE PRESSURES

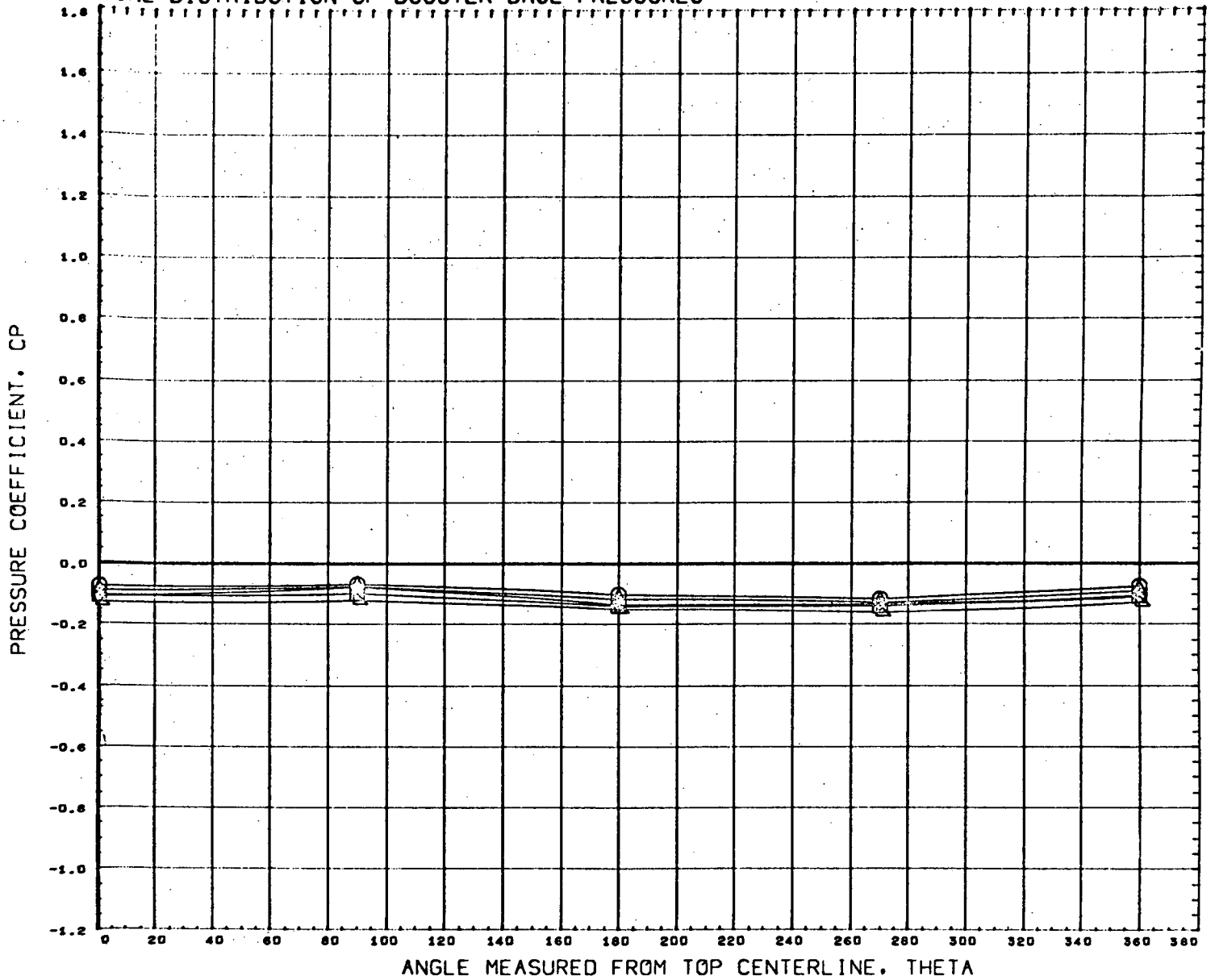

| SYMBOL | ALFB | X/L | M1 | PARAMETRIC VALUES | | |
|--------|--------|-------|-------|-------------------|------|-------|
| | | | | BETA | DX/L | 0.000 |
| ◇ | 2.153 | 1.000 | 1.000 | 0.000 | | |
| ◇ | 4.142 | | | 0.000 | | |
| ◇ | 6.073 | | | | | |
| ◇ | 8.175 | | | | | |
| ◇ | 10.285 | | | | | |

REFERENCE FILE

RADIAL DISTRIBUTION OF BOOSTER BASE PRESSURES

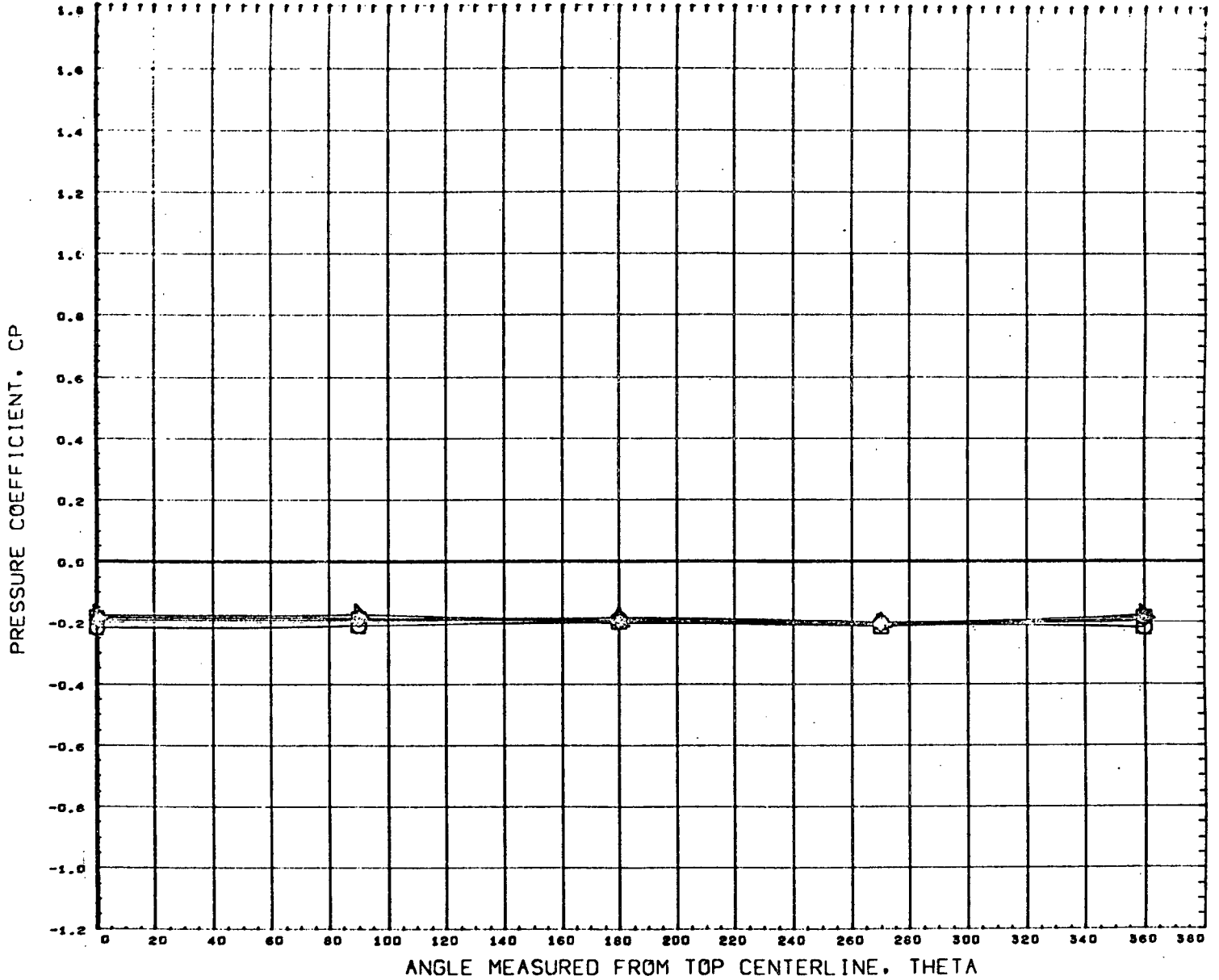

| SYMBOL | ALFB | X/L | M1 |
|--------|-------|-------|-------|
| ○ | 8.282 | 1.000 | 1.100 |
| △ | 5.772 | | |
| ◇ | 3.796 | | |
| □ | 1.825 | | |
| ◇ | 0.102 | | |

| PARAMETRIC VALUES | | |
|-------------------|-------|------------|
| BETA | 0.000 | DX/L 0.000 |
| I | 0.000 | |

REFERENCE FILE

RADIAL DISTRIBUTION OF BOOSTER BASE PRESSURES

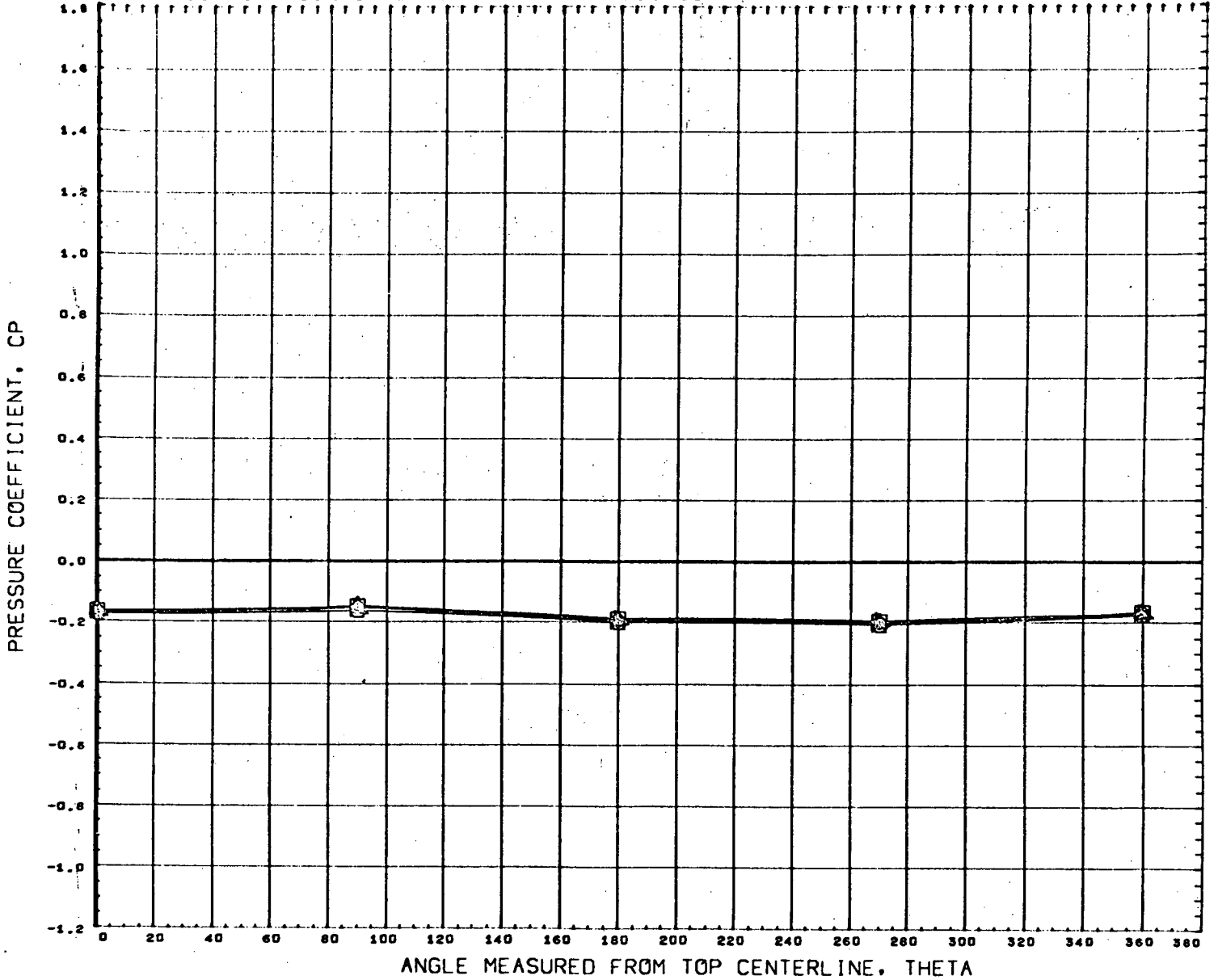

| | | | | | | | |
|--------|--------|-------|-------|-------------------|-------|------|-------|
| SYMBOL | ALFD | X/L | M1 | PARAMETRIC VALUES | | | |
| ○ | 2.160 | 1.000 | 1.100 | BETA | 0.000 | DX/L | 0.000 |
| ◇ | 4.170 | | | I | 0.000 | | |
| ◇ | 6.083 | | | | | | |
| □ | 7.758 | | | | | | |
| ◇ | 10.193 | | | | | | |

REFERENCE FILE

RADIAL DISTRIBUTION OF BOOSTER BASE PRESSURES

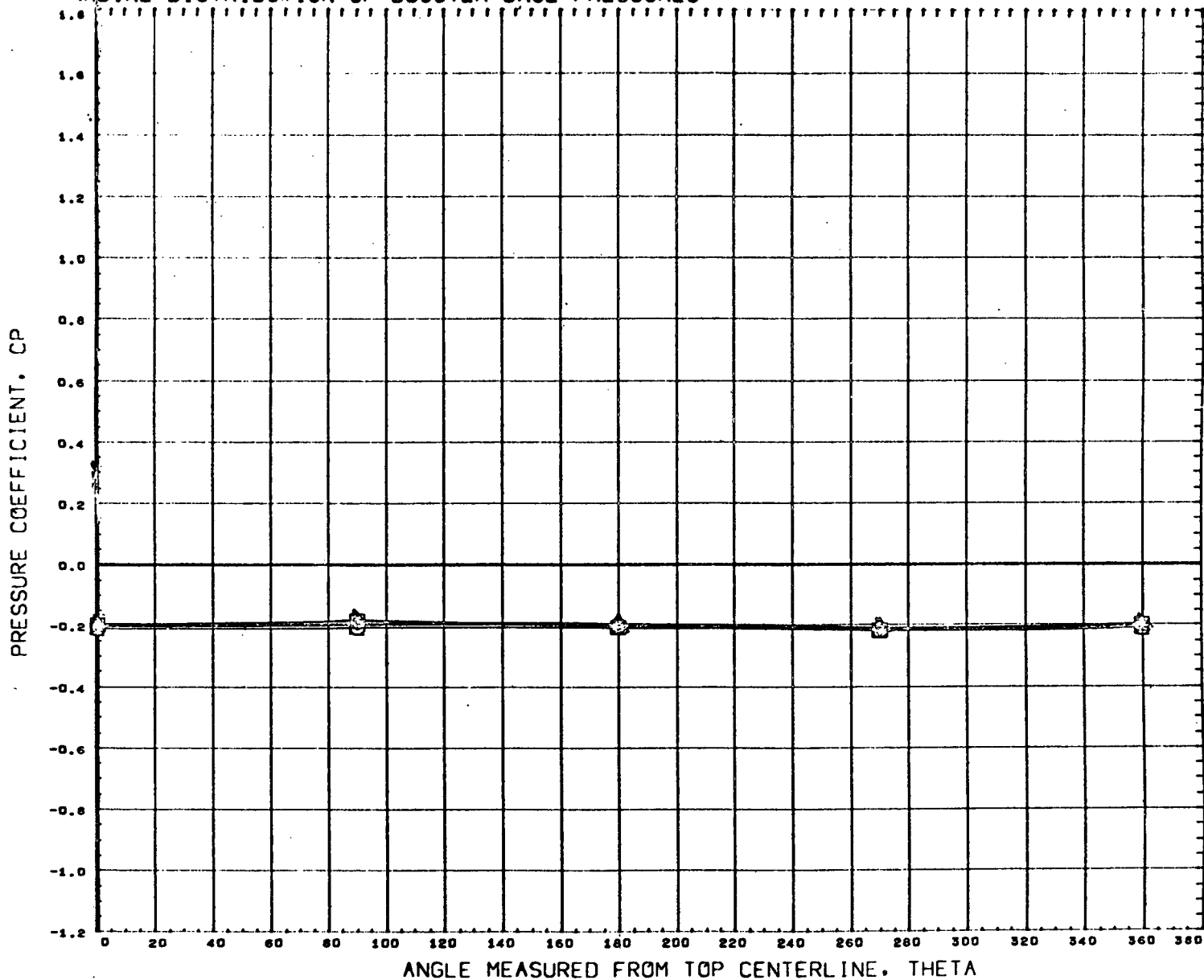

| SYMBOL | ALFB | X/L | M1 | BETA | PARAMETRIC VALUES | | |
|--------|-------|-------|-------|-------|-------------------|-------|-------|
| ◇ | 8.312 | 1.000 | 1.199 | 0.000 | 0.000 | 0.000 | 0.000 |
| ◇ | 5.768 | | | 0.000 | | | |
| ◇ | 4.439 | | | | | | |
| ◇ | 2.183 | | | | | | |
| ◇ | 0.215 | | | | | | |

REFERENCE FILE

RADIAL DISTRIBUTION OF BOOSTER BASE PRESSURES

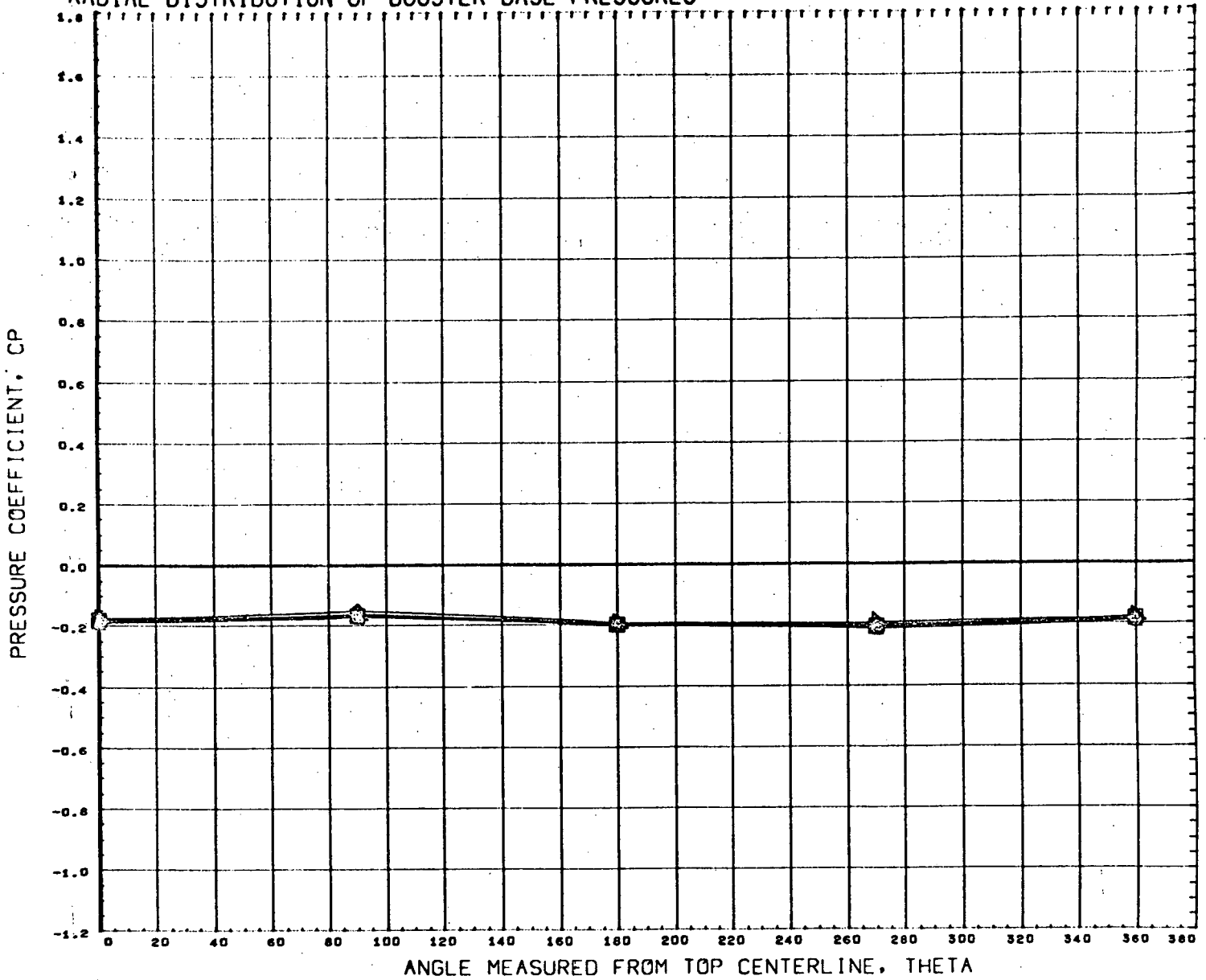

| SYMBOL | ALFB | X/L | M1 | PARAMETRIC VALUES | | |
|--------|--------|-------|-------|-------------------|-------|-------|
| | | | | BETA | OX/L | I |
| ◇ | 2.170 | 1.000 | 1.199 | 0.000 | 0.000 | 0.000 |
| ◇ | 4.167 | | | | | |
| ◇ | 5.540 | | | | | |
| ◇ | 8.201 | | | | | |
| ◇ | 10.161 | | | | | |

REFERENCE FILE

RADIAL DISTRIBUTION OF BOOSTER BASE PRESSURES

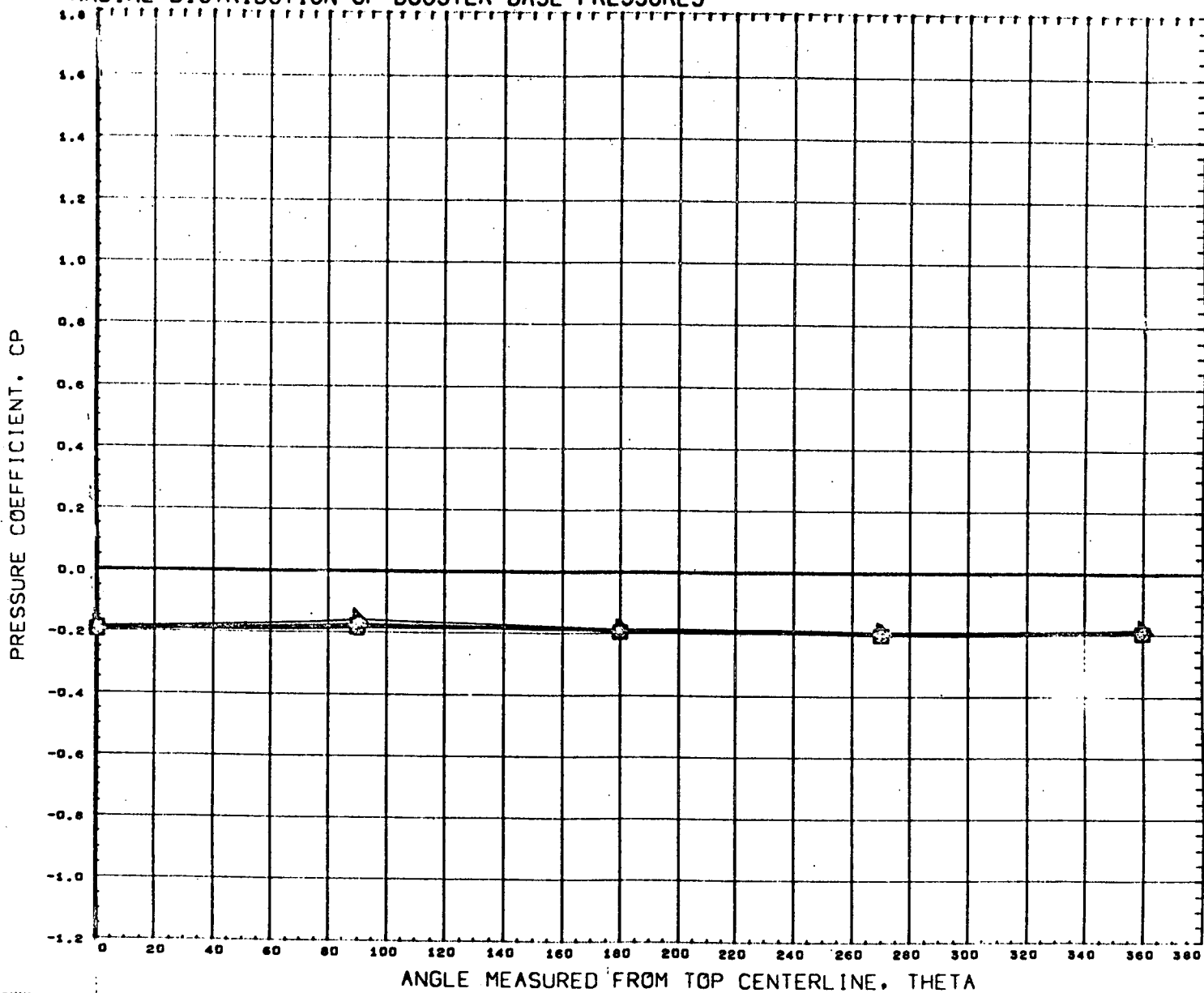

| SYMBOL | ALFB | X/L | M1 |
|--------|-------|-------|-------|
| ◇ | 0.330 | 1.000 | 1.300 |
| ◇ | 5.772 | | |
| ◇ | 4.443 | | |
| ◇ | 1.778 | | |
| ◇ | 0.181 | | |

| PARAMETRIC VALUES | | |
|-------------------|-------|------------|
| BETA | 0.000 | DX/L 0.000 |
| I | 0.000 | |

REFERENCE FILE

RADIAL DISTRIBUTION OF BOOSTER BASE PRESSURES

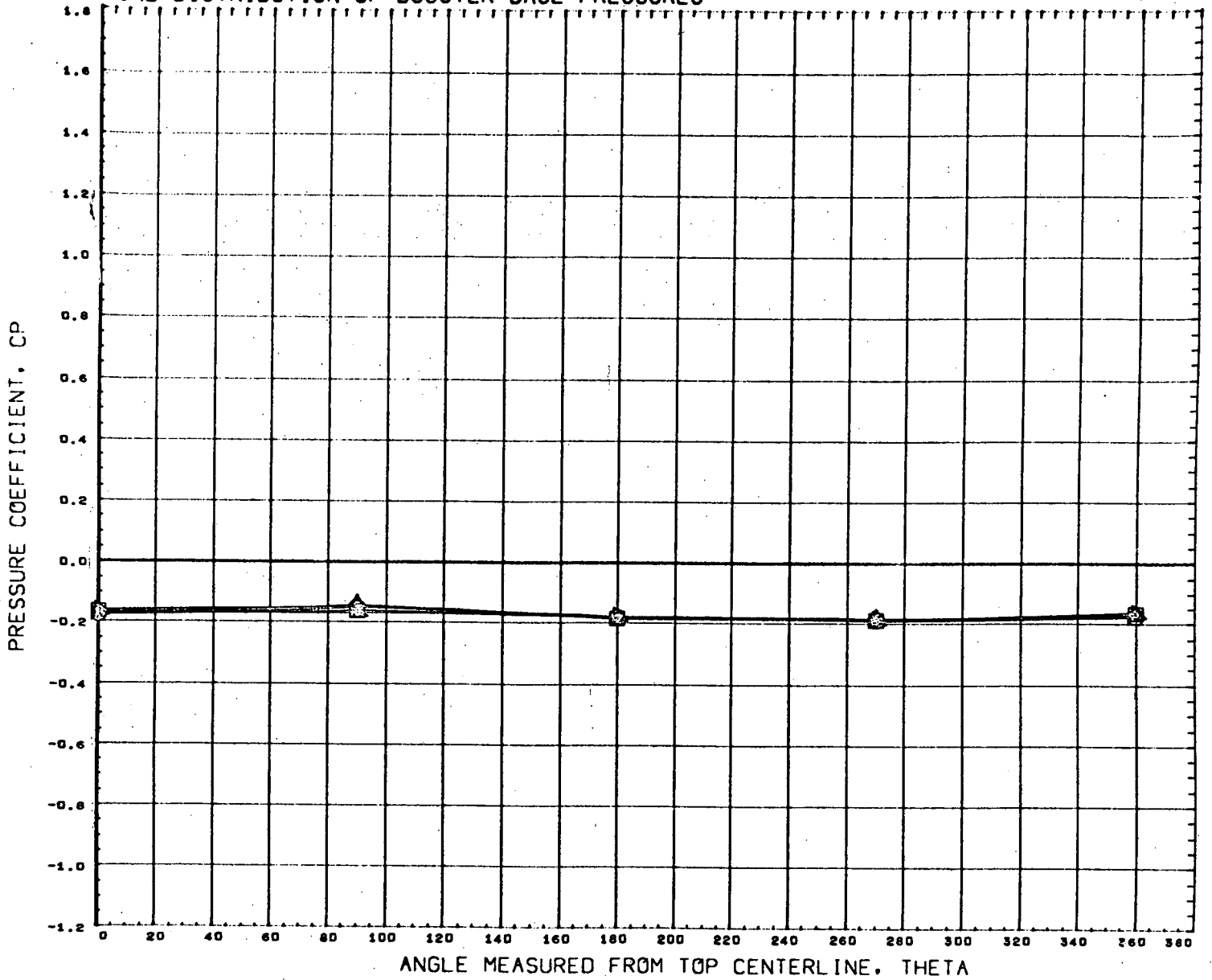

| SYMBOL | ALFB | X/L | M1 | PARAMETRIC VALUES | | | |
|--------|--------|-------|-------|-------------------|-------|------|-------|
| □ | 2.169 | 1.000 | 1.300 | BETA | 0.000 | DX/L | 0.000 |
| ◇ | 4.179 | | | 1 | 0.000 | | |
| ◇ | 6.168 | | | | | | |
| ◇ | 8.177 | | | | | | |
| ◇ | 10.171 | | | | | | |

REFERENCE FILE

RADIAL DISTRIBUTION OF BOOSTER BASE PRESSURES

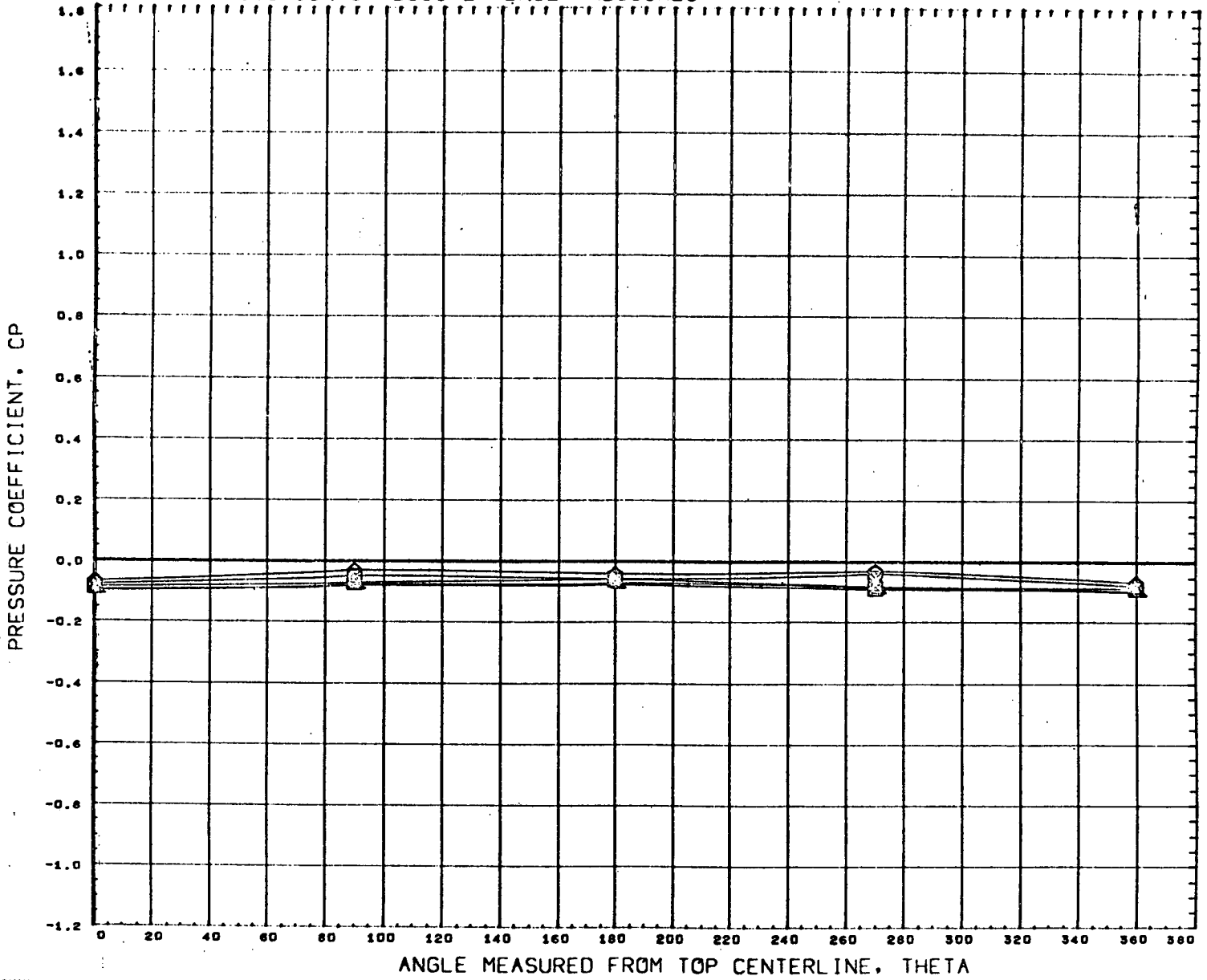

| SYMBOL | BETA | X/L | M1 | PARAMETRIC VALUES | | | |
|--------|-------|-------|-------|-------------------|-------|------|-------|
| □ | 5.991 | 1.000 | 0.600 | ALFB | 0.000 | DX/L | 0.000 |
| ◇ | 4.085 | | | I | 0.000 | | |
| △ | 2.108 | | | | | | |
| ○ | 0.293 | | | | | | |
| ◇ | 1.955 | | | | | | |

REFERENCE FILE

RADIAL DISTRIBUTION OF BOOSTER BASE PRESSURES

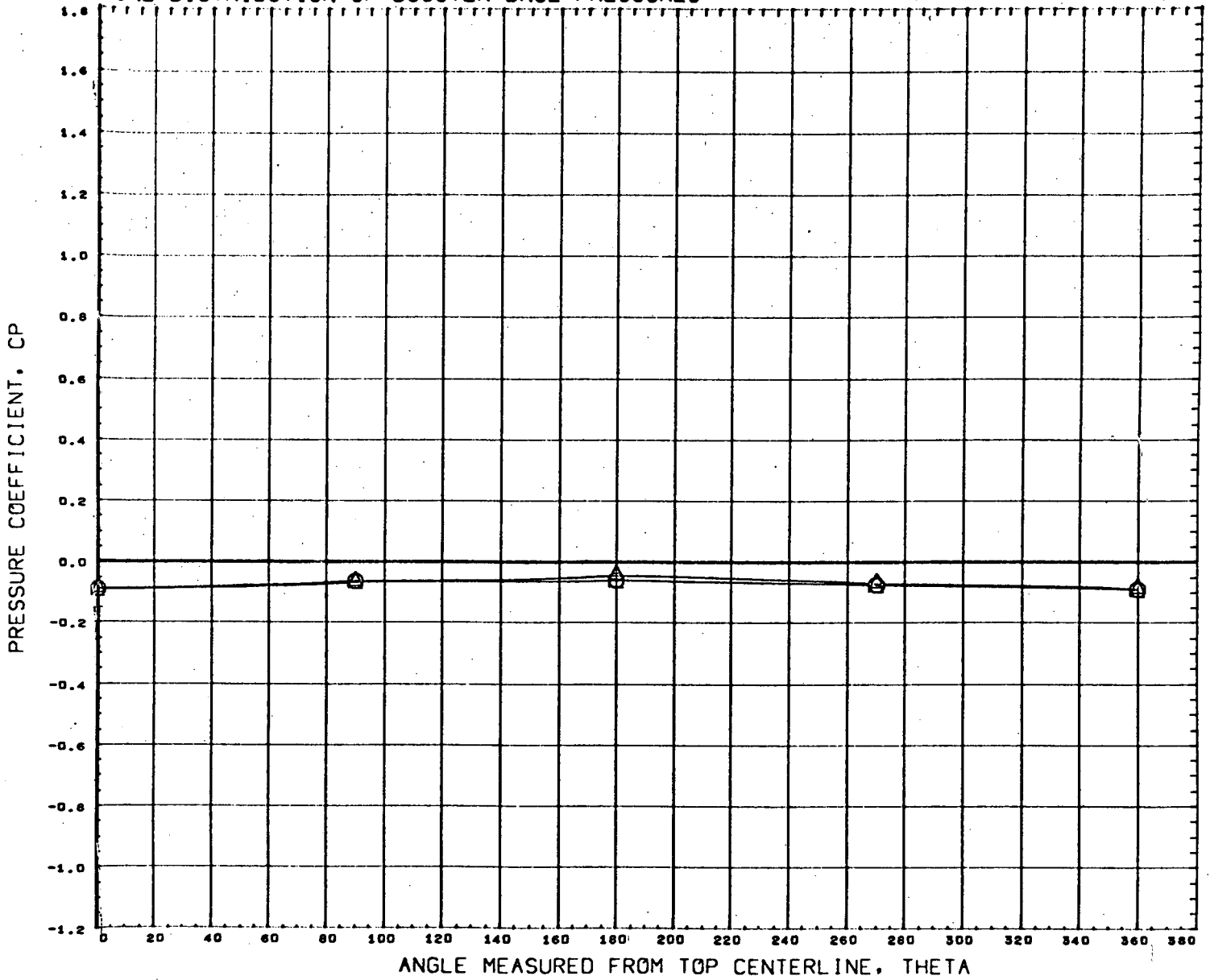

| SYMBOL | BETA | X/L | M1 | ALFB | PARAMETRIC VALUES | |
|--------|-------|-------|-------|-------|-------------------|-------|
| ○ | 4.018 | 1.000 | 0.600 | 0.000 | DX/L | 0.000 |
| △ | 5.878 | | | I | 0.000 | |

REFERENCE FILE

RADIAL DISTRIBUTION OF BOOSTER BASE PRESSURES

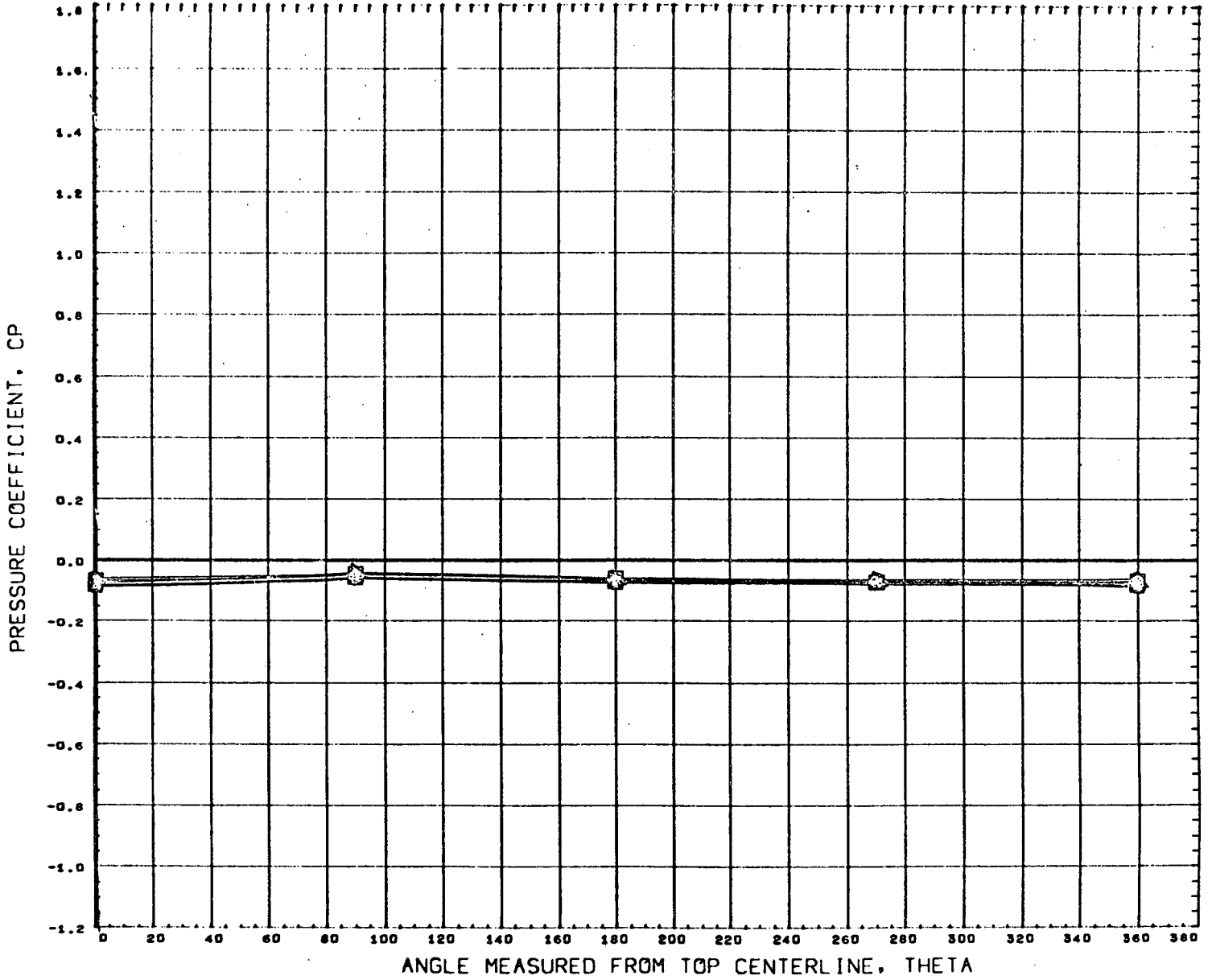

| SYMBOL | BETA | X/L | M1 | ALFB | PARAMETRIC VALUES | |
|--------|---------|-------|-------|-------|-------------------|-------|
| ○ | - 6.014 | 1.000 | 0.898 | 0.000 | DX/L | 0.000 |
| ◇ | - 4.113 | | | I | 0.000 | |
| ◇ | - 2.146 | | | | | |
| □ | - 0.287 | | | | | |
| ▽ | 2.007 | | | | | |

REFERENCE FILE

RADIAL DISTRIBUTION OF BOOSTER BASE PRESSURES

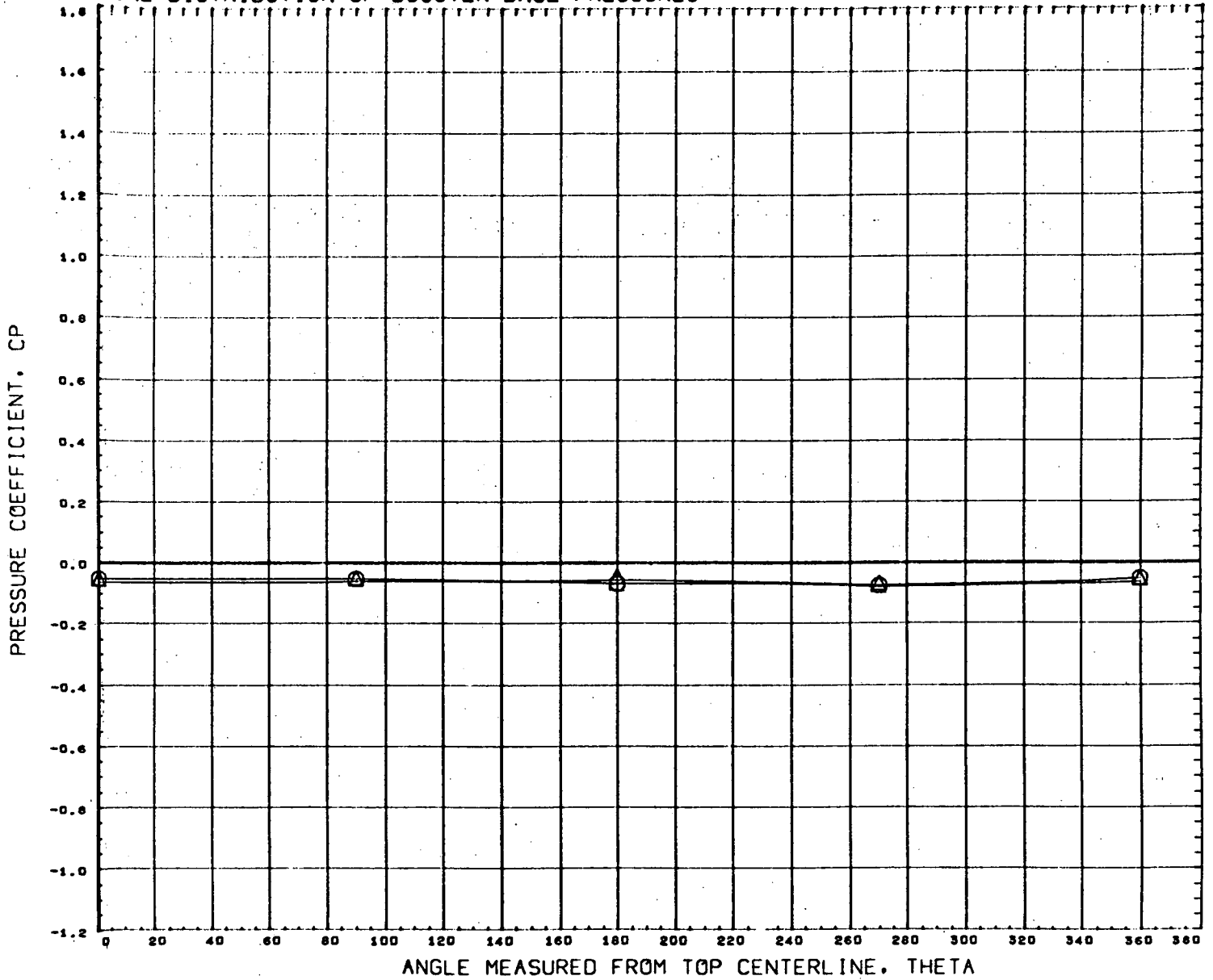

| SYMBOL | BETA | X/L | M1 | ALFB | PARAMETRIC VALUES | |
|--------|-------|-------|-------|-------|-------------------|-------|
| ○ | 4.094 | 1.000 | 0.898 | 0.000 | 0x/L | 0.000 |
| △ | 5.964 | | | I | 0.000 | |

REFERENCE FILE

RADIAL DISTRIBUTION OF BOOSTER BASE PRESSURES

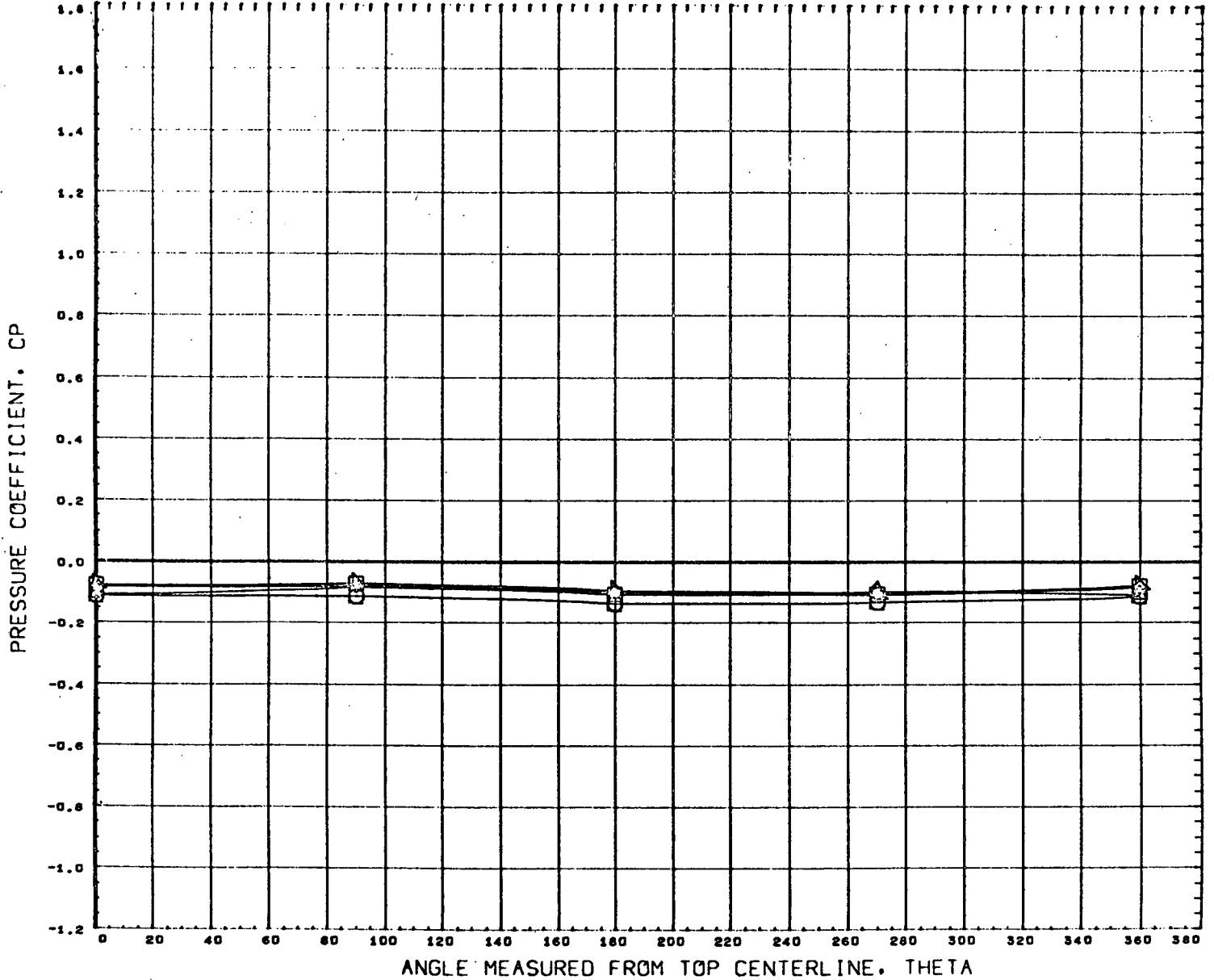

| SYMBOL | BETA | X/L | M1 | PARAMETRIC VALUES | | | |
|--------|---------|-------|-------|-------------------|-------|------|-------|
| ○ | - 6.082 | 1.000 | 1.010 | ALFB | 0.000 | OX/L | 0.000 |
| ◇ | - 4.150 | | | I | 0.000 | | |
| ◇ | - 2.153 | | | | | | |
| □ | - 0.281 | | | | | | |
| △ | 2.037 | | | | | | |

REFERENCE FILE

RADIAL DISTRIBUTION OF BOOSTER BASE PRESSURES

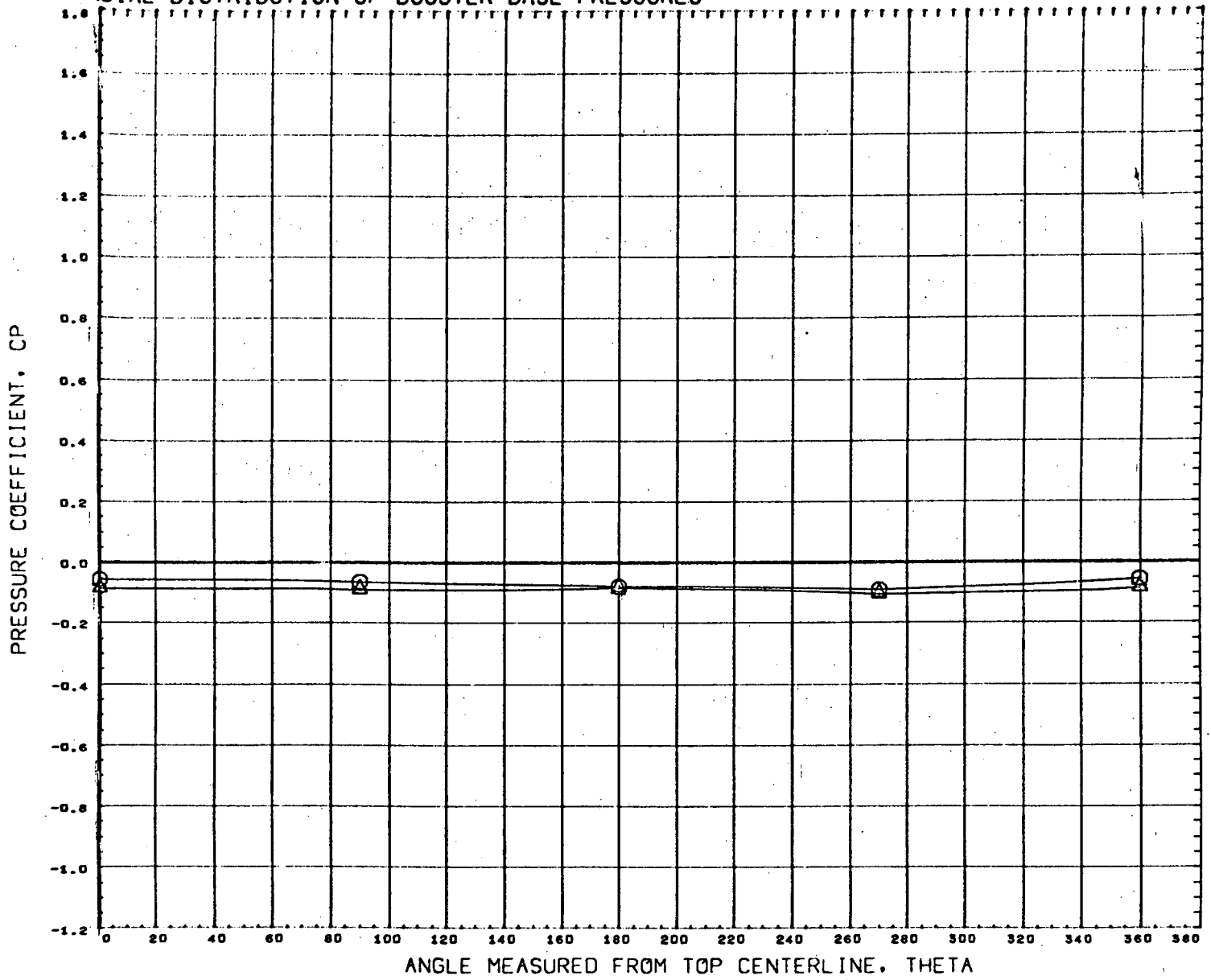

| | | | | | |
|--------|-------|-------|-------|------|-------------------|
| SYMBOL | BETA | X/L | M1 | | PARAMETRIC VALUES |
| ○ | 4.071 | 1.000 | 1.010 | ALFB | 0.000 DX/L 0.000 |
| △ | 6.041 | | | I | 0.000 |

REFERENCE FILE

RADIAL DISTRIBUTION OF BOOSTER BASE PRESSURES

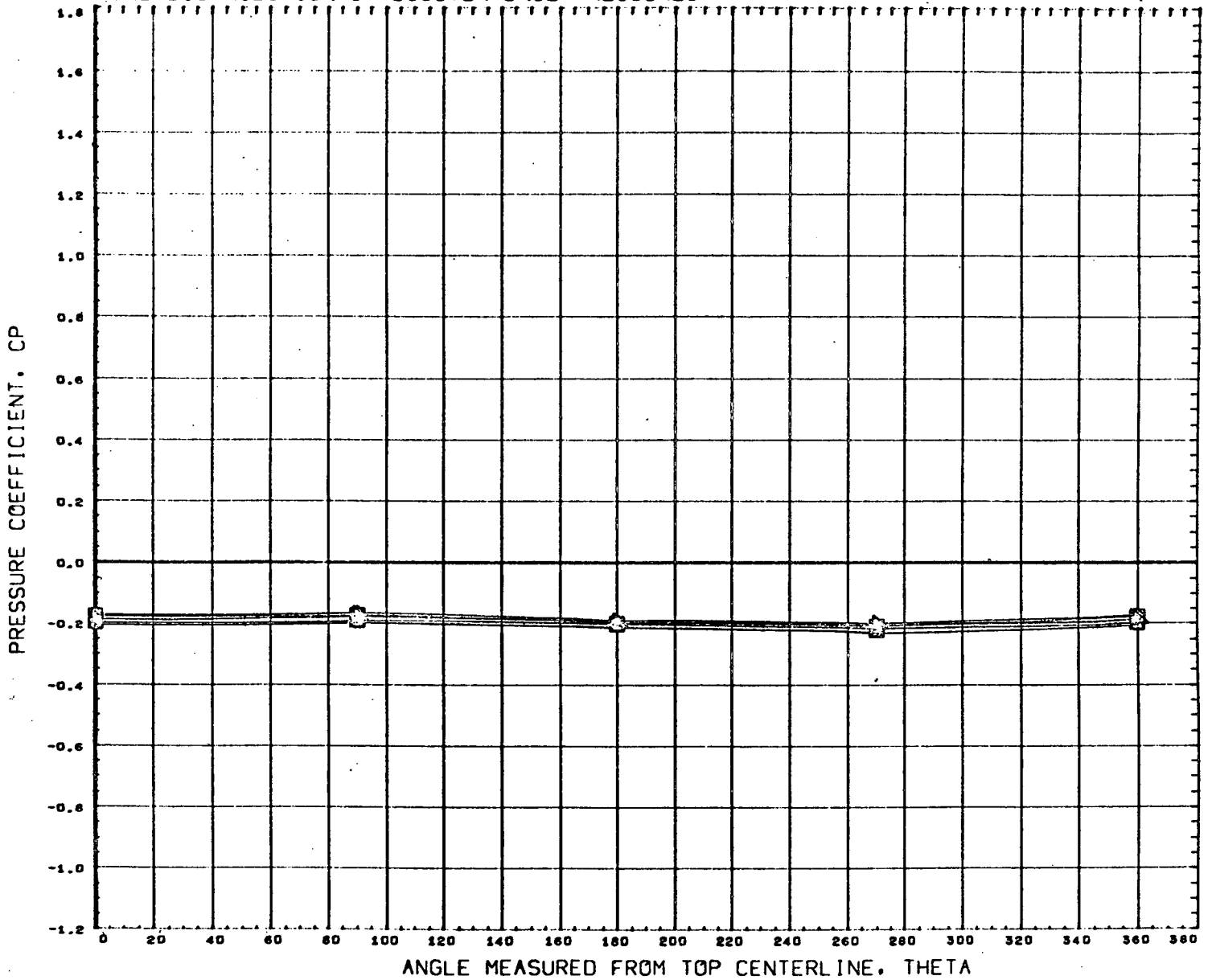

| SYMBOL | BETA | X/L | M1 | ALFB | PARAMETRIC VALUES | |
|--------|-------|-------|-------|-------|-------------------|-------|
| ○ | 6.396 | 1.000 | 1.101 | 0.000 | 0x/L | 0.000 |
| ◇ | 4.084 | | | I | 0.000 | |
| □ | 2.015 | | | | | |
| △ | 0.247 | | | | | |
| ▽ | 1.831 | | | | | |

REFERENCE FILE

RADIAL DISTRIBUTION OF BOOSTER BASE PRESSURES

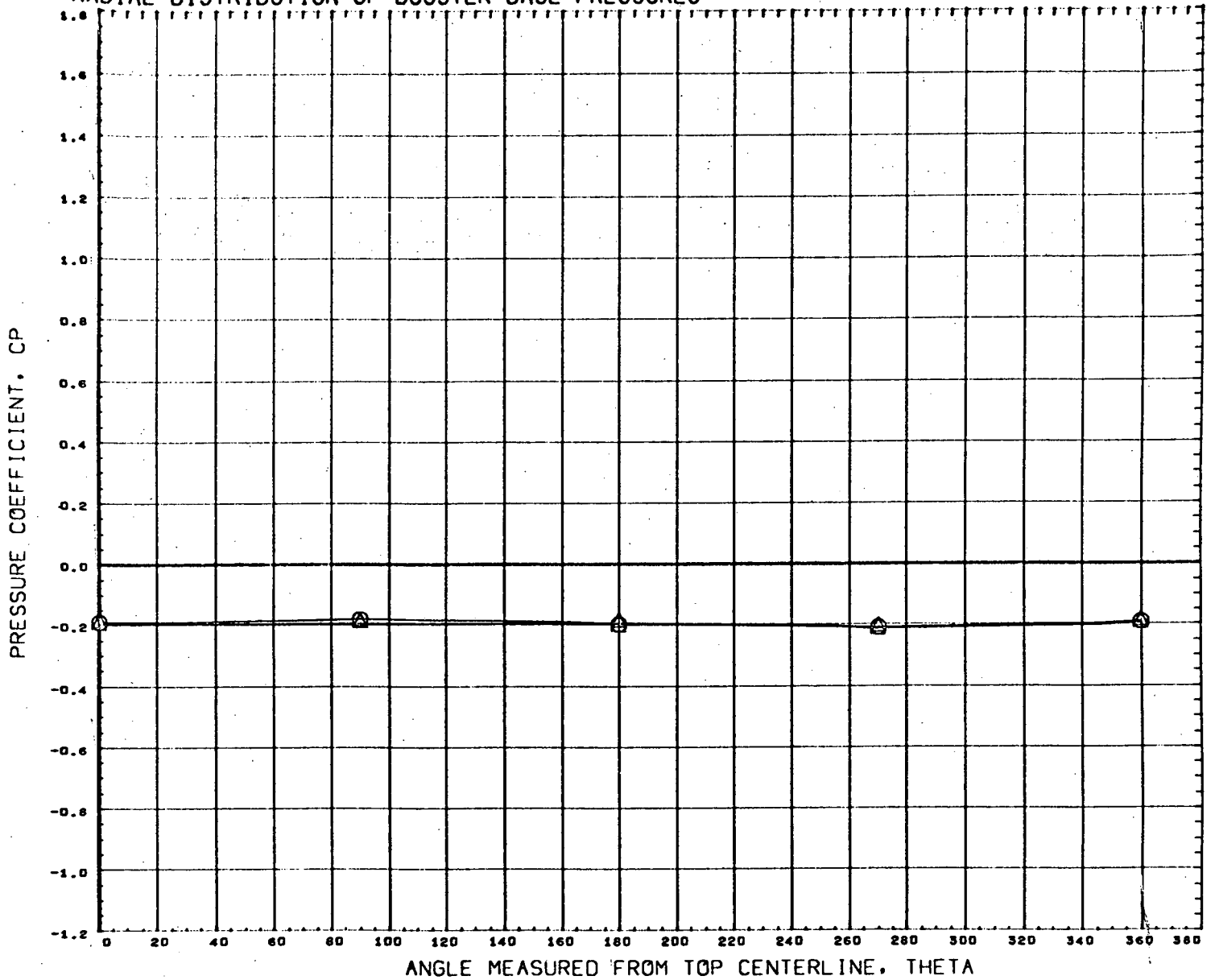

| SYMBOL | BETA | X/L | M1 | ALFB | PARAMETRIC VALUES | |
|--------|-------|-------|-------|-------|-------------------|-------|
| ○ | 3.893 | 1.000 | 1.101 | 0.000 | DX/L | 0.000 |
| △ | 6.269 | | | I | 0.000 | |

REFERENCE FILE

RADIAL DISTRIBUTION OF BOOSTER BASE PRESSURES

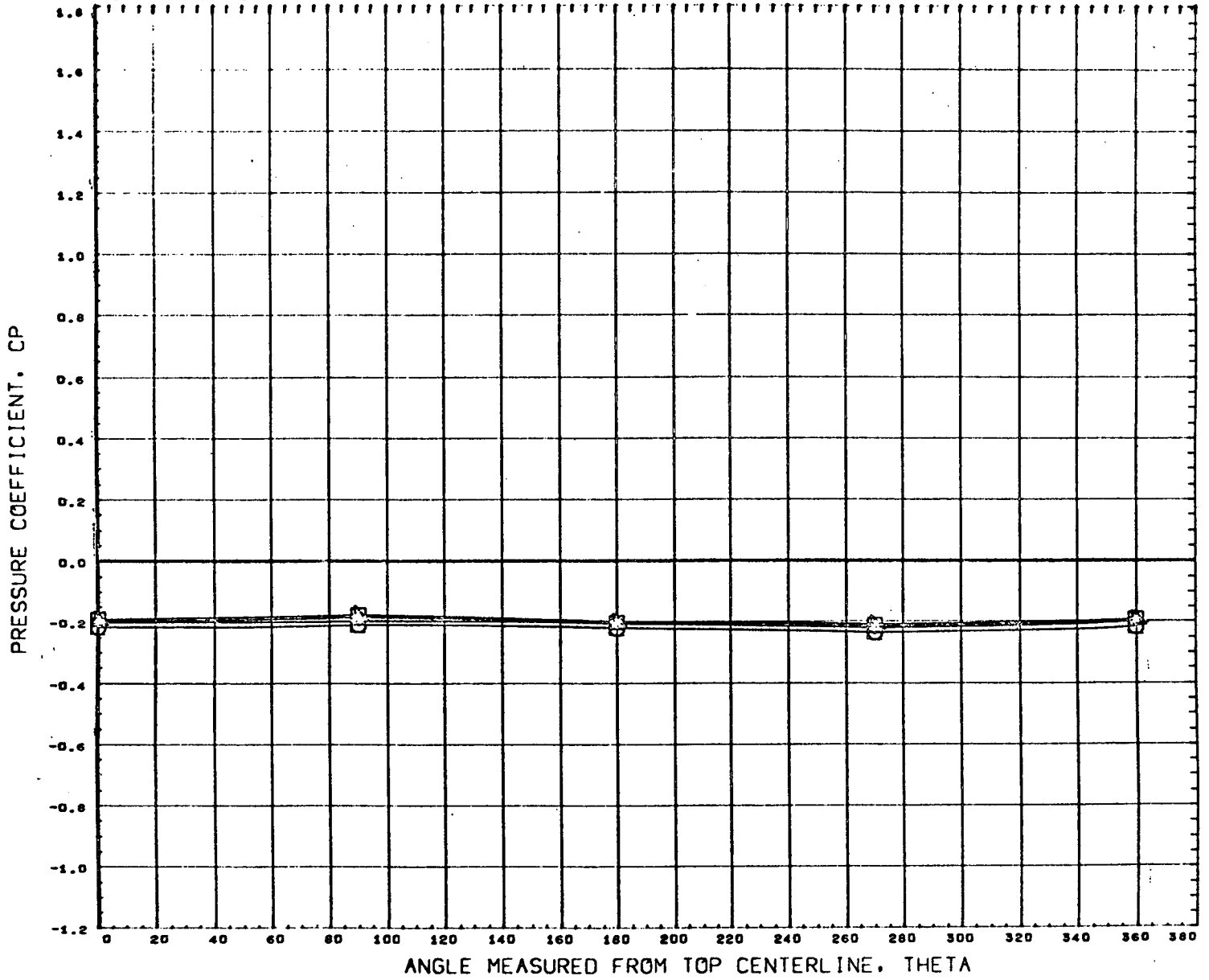

| SYMBOL | BETA | X/L | M1 | ALFB | PARAMETRIC VALUES | DX/L | |
|--------|-------|-------|-------|-------|-------------------|-------|--|
| ◇ | 6.196 | 1.000 | 1.201 | 0.000 | 0.000 | 0.000 | |
| ◇ | 4.116 | | | I | 0.000 | | |
| ◇ | 2.016 | | | | | | |
| ◇ | 0.241 | | | | | | |
| ◇ | 2.057 | | | | | | |

REFERENCE FILE

RADIAL DISTRIBUTION OF BOOSTER BASE PRESSURES

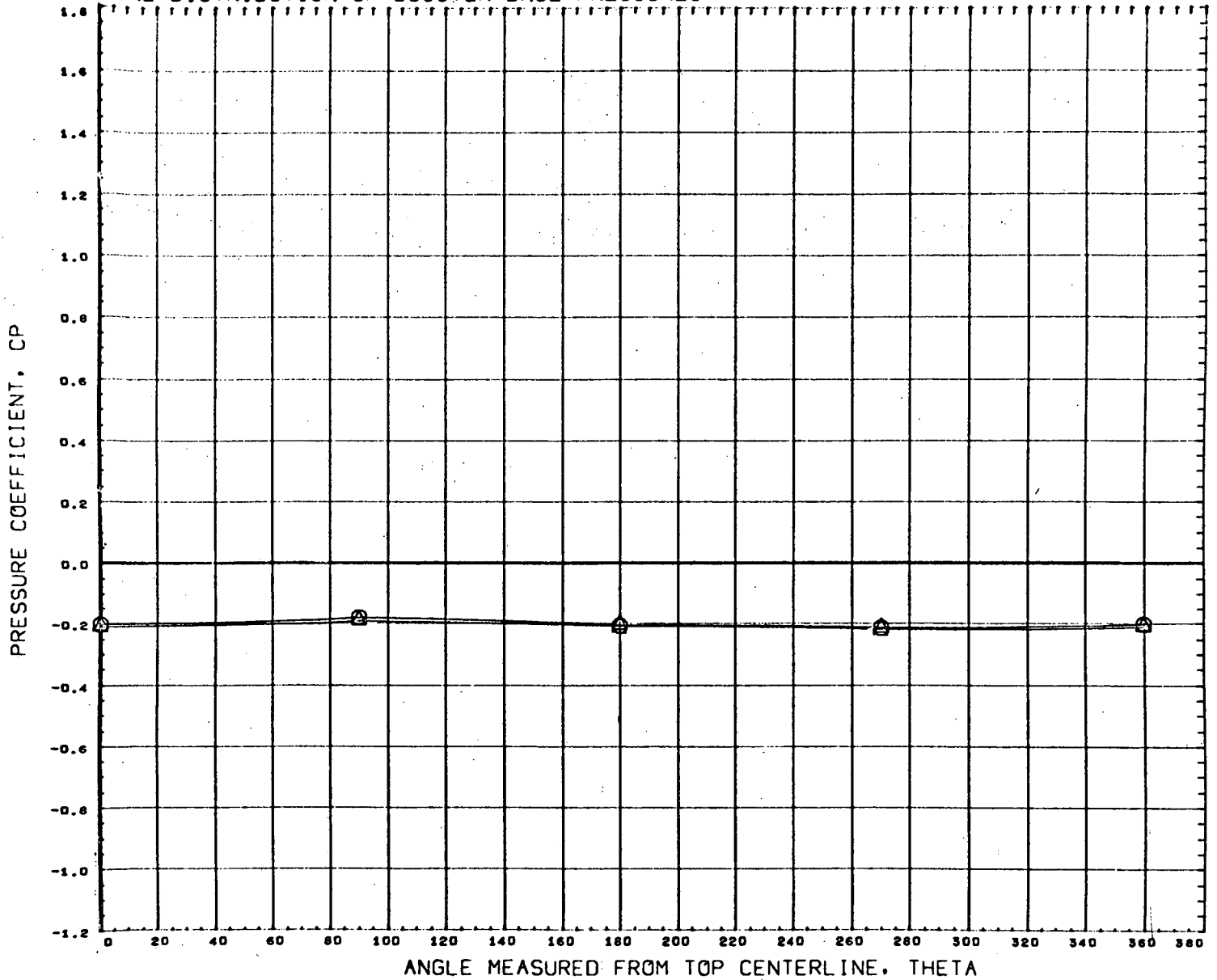

| SYMBOL | BETA | X/L | M1 | ALFB | PARAMETRIC VALUES | |
|--------|-------|-------|-------|-------|-------------------|-------|
| ○ | 5.912 | 1.000 | 1.201 | 0.000 | DX/L | 0.000 |
| △ | 5.999 | | | I | 0.000 | |

REFERENCE FILE

RADIAL DISTRIBUTION OF BOOSTER BASE PRESSURES

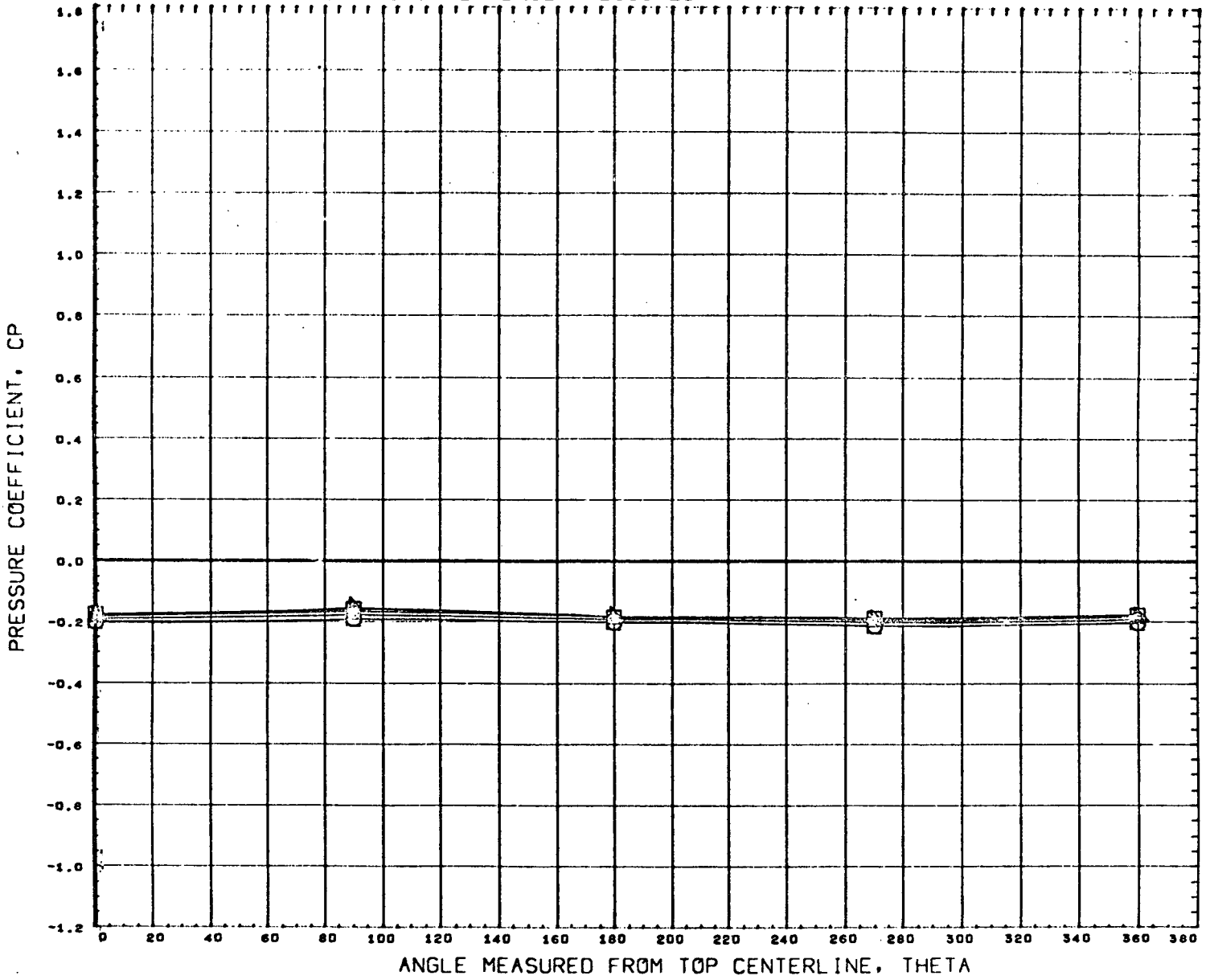

| SYMBOL | BETA | X/L | M1 | ALFB | PARAMETRIC VALUES | | |
|--------|-------|-------|-------|-------|-------------------|-------|--|
| ◇ | 6.203 | 1.000 | 1.302 | 0.000 | DX/L | 0.000 | |
| ◇ | 4.105 | | | I | 0.000 | | |
| ◇ | 2.025 | | | | | | |
| ◇ | 0.252 | | | | | | |
| ◇ | 1.830 | | | | | | |

REFERENCE FILE

RADIAL DISTRIBUTION OF BOOSTER BASE PRESSURES

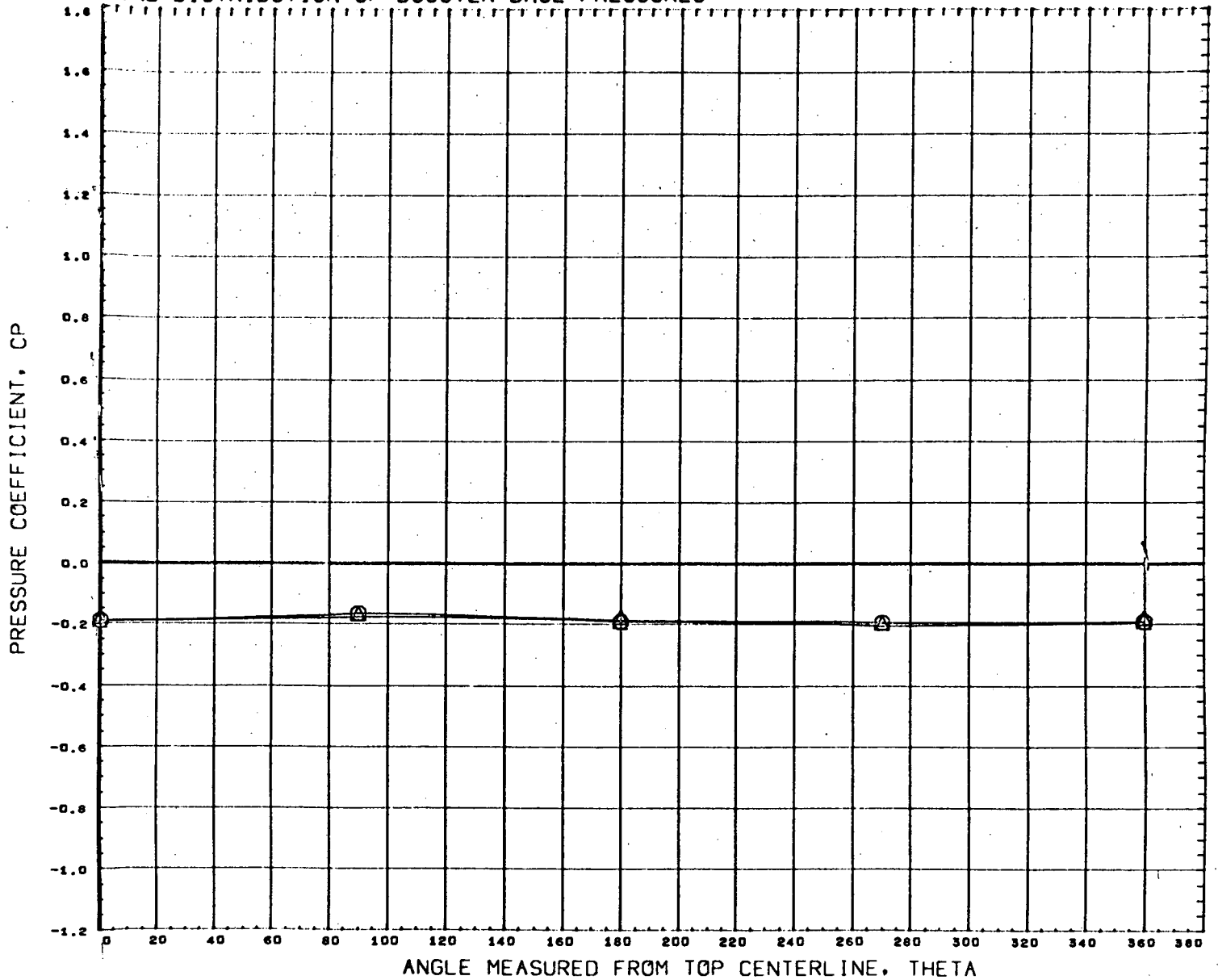

| SYMBOL | BETA | X/L | M1 | ALFB | PARAMETRIC VALUES | DX/L | |
|--------|-------|-------|-------|------|-------------------|------|-------|
| ○ | 3.890 | 1.000 | 1.302 | | 0.000 | | 0.000 |
| △ | 5.994 | | | I | 0.000 | | |

REFERENCE FILE

RADIAL DISTRIBUTION OF BOOSTER BASE PRESSURES

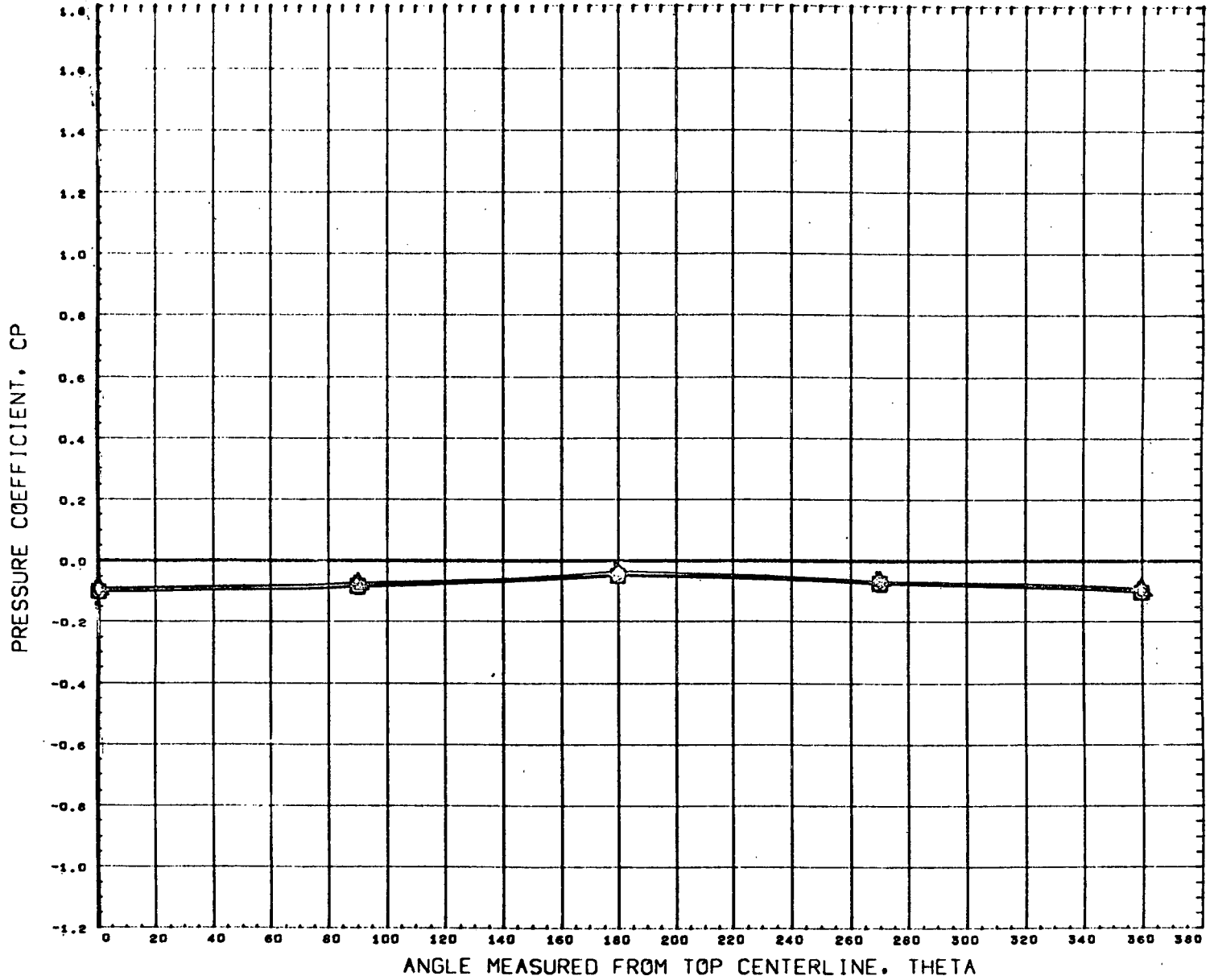

| | | | | | | |
|---------------------------------|---------|-------|-------|-------------------|---------|------------|
| SYMBOL □ ◇ ◇ ◇ ◇ | BETA | X/L | M1 | PARAMETRIC VALUES | | |
| | - 3.904 | 1.000 | 0.599 | ALFB | - 6.000 | DX/L 0.000 |
| | - 1.993 | | | I | 0.000 | |
| | - 0.013 | | | | | |
| | 1.956 | | | | | |
| | 3.955 | | | | | |

REFERENCE FILE

RADIAL DISTRIBUTION OF BOOSTER BASE PRESSURES

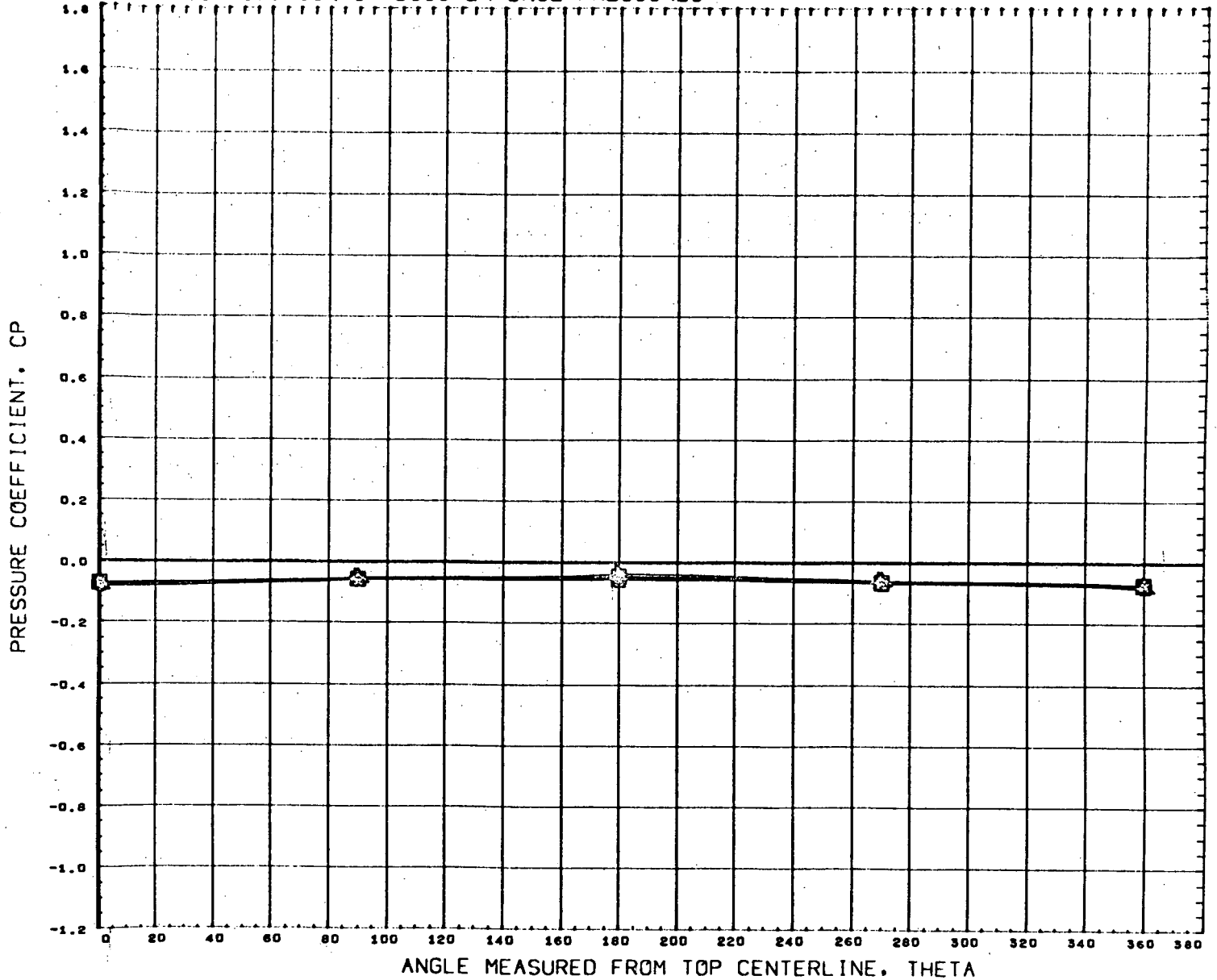

| SYMBOL | BETA | X/L | M1 |
|--------|-------|-------|-------|
| ◇ | 3.957 | 1.000 | 0.900 |
| ◇ | 1.918 | | |
| ◇ | 0.152 | | |
| ◇ | 2.081 | | |
| ◇ | 4.094 | | |

| PARAMETRIC VALUES | | |
|-------------------|---------|------------|
| ALFB | - 6.000 | DX/L 0.000 |
| I | 0.000 | |

REFERENCE FILE

RADIAL DISTRIBUTION OF BOOSTER BASE PRESSURES

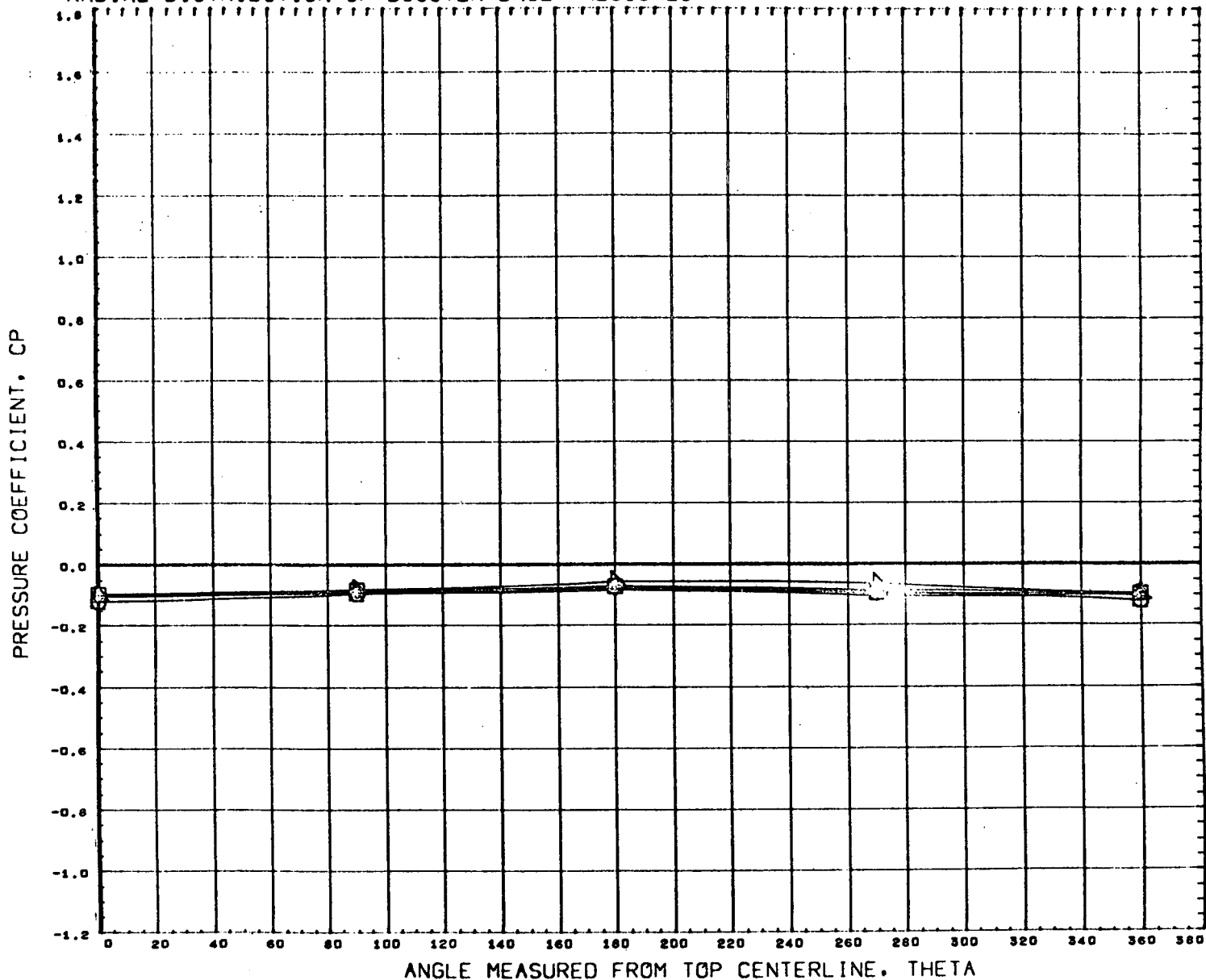

| SYMBOL | BETA | X/L | M1 | PARAMETRIC VALUES |
|--------|-------|-------|-------|-------------------------|
| ○ | 4.189 | 1.000 | 0.999 | ALFB - 6.000 DX/L 0.000 |
| △ | 1.899 | | | I 0.000 |
| ◇ | 0.003 | | | |
| □ | 2.143 | | | |
| ▽ | 4.116 | | | |

REFERENCE FILE

RADIAL DISTRIBUTION OF BOOSTER BASE PRESSURES

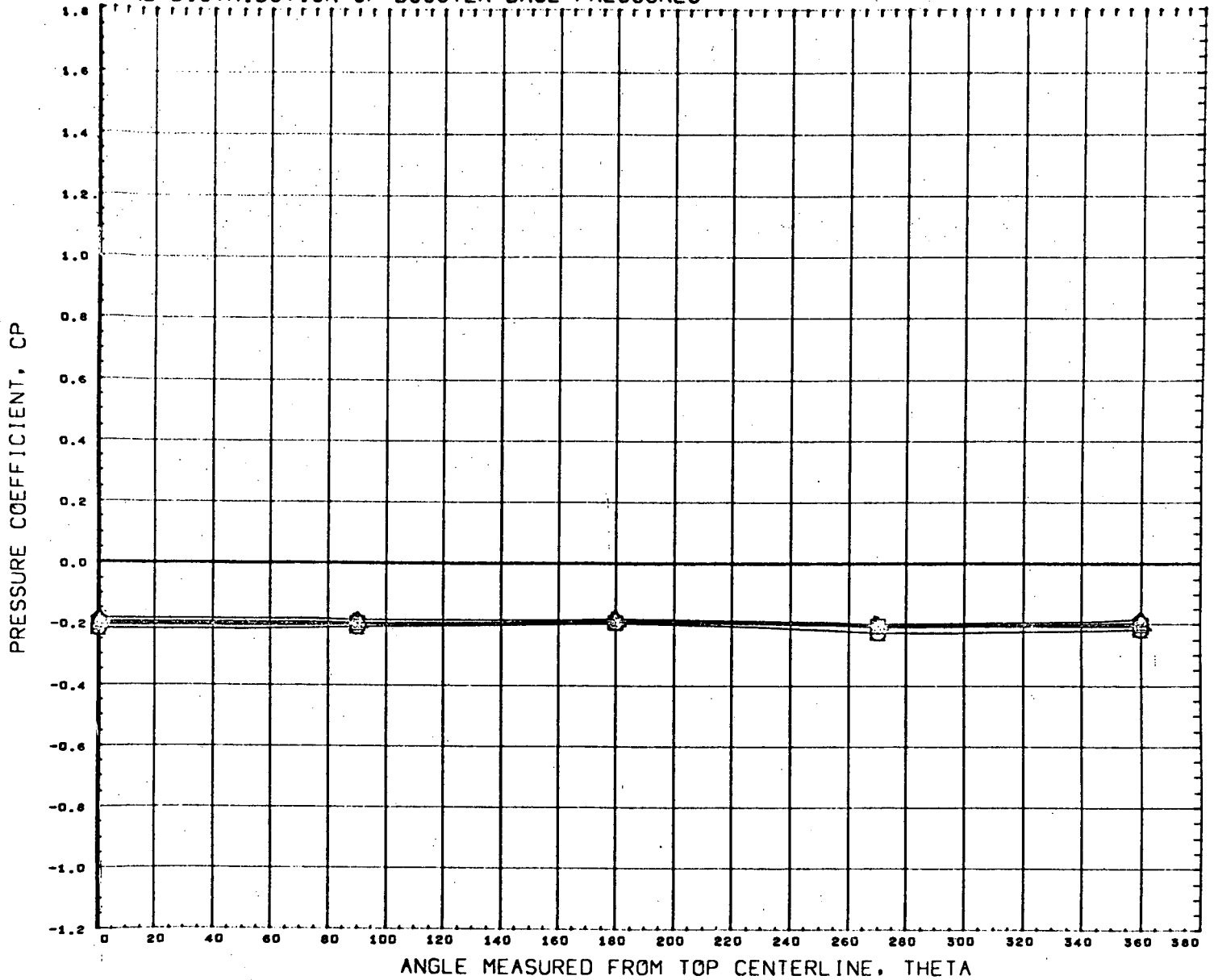

| SYMBOL | BETA | X/L | M1 |
|--------|-------|-------|-------|
| ◇ | 4.154 | 1.000 | 1.100 |
| △ | 2.119 | | |
| ○ | 0.035 | | |
| □ | 2.286 | | |
| ▽ | 4.304 | | |

| PARAMETRIC VALUES | | |
|-------------------|-------|------------|
| ALFB | 6.000 | DX/L 0.000 |
| I | 0.000 | |

REFERENCE FILE

RADIAL DISTRIBUTION OF BOOSTER BASE PRESSURES

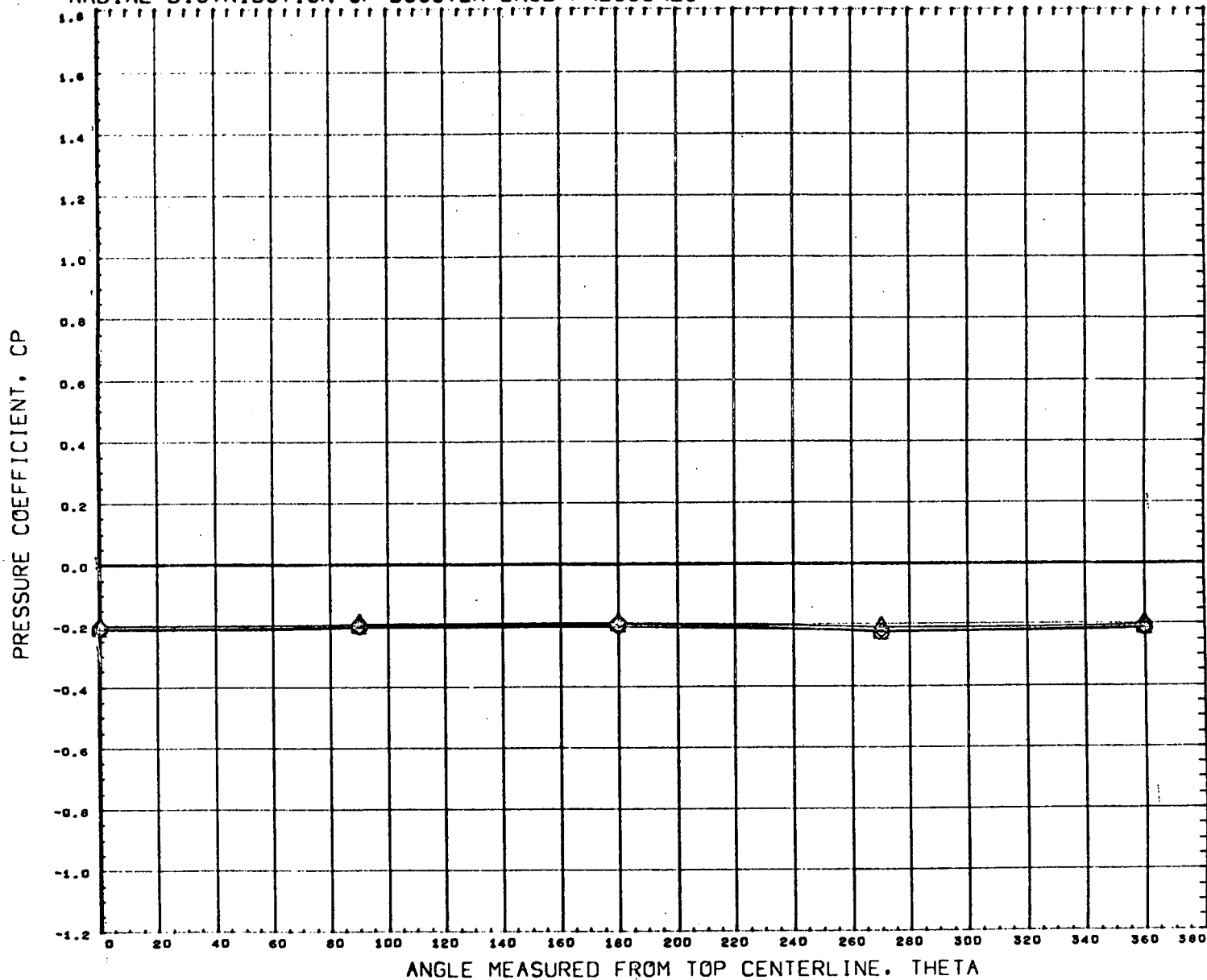

| SYMBOL | BETA | X/L | M1 |
|--------|-------|-------|-------|
| ○ | 4.187 | 1.050 | 1.201 |
| △ | 0.069 | | |
| ◇ | 4.363 | | |

| PARAMETRIC VALUES | | |
|-------------------|---------|------------|
| ALFB | - 6.000 | OX/L 0.000 |
| I | 0.000 | |

REFERENCE FILE

RADIAL DISTRIBUTION OF BOOSTER BASE PRESSURES

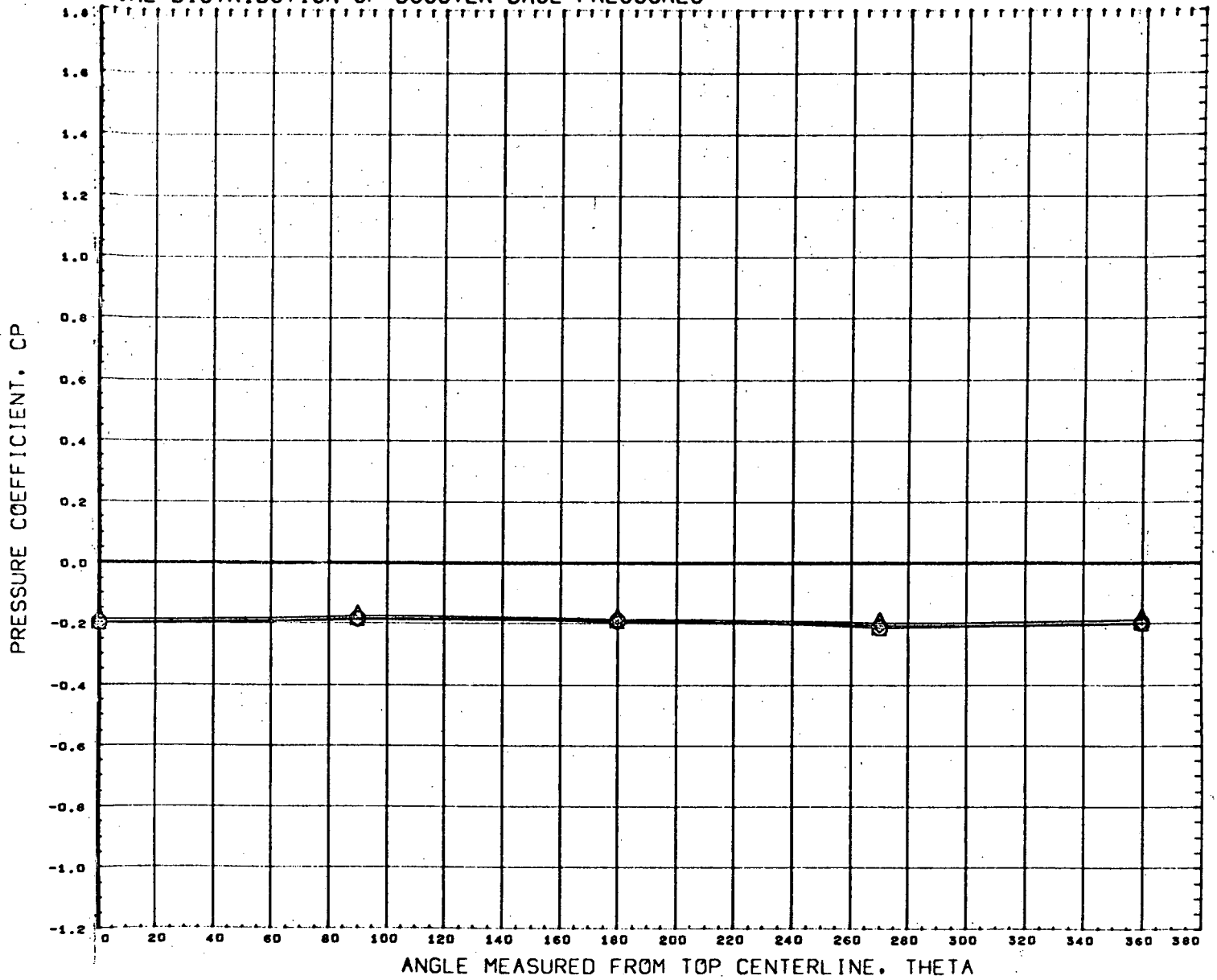

| SYMBOL | BETA | X/L | M1 |
|--------|-------|-------|-------|
| ○ | 4.197 | 1.000 | 1.300 |
| △ | 0.065 | | |
| ◇ | 4.355 | | |

| PARAMETRIC VALUES | | | |
|-------------------|---------|------|-------|
| ALFB | - 6.000 | DX/L | 0.000 |
| I | 0.000 | | |

REFERENCE FILE

RADIAL DISTRIBUTION OF BOOSTER BASE PRESSURES

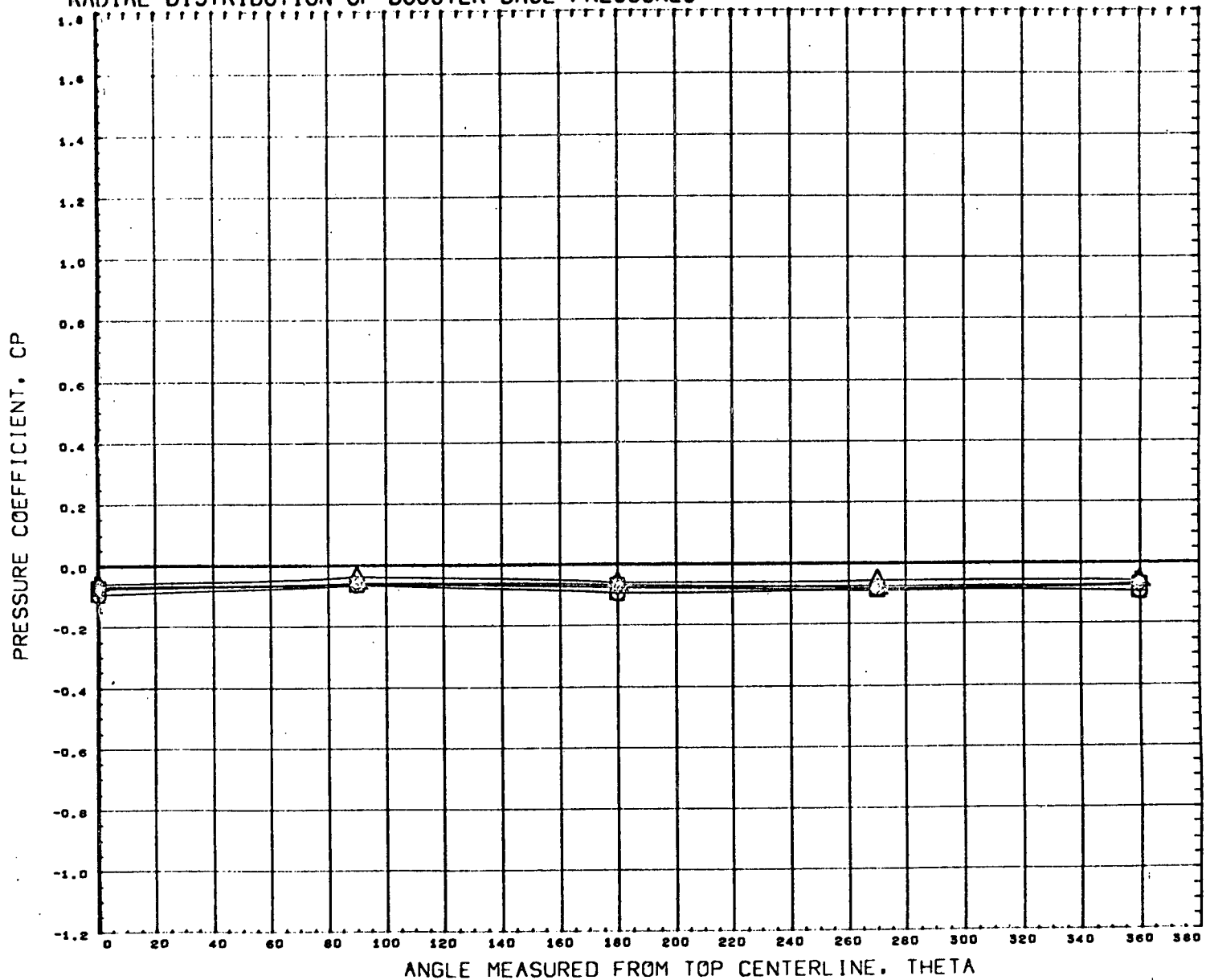

| SYMBOL | BETA | X/L | M1 | ALFB | PARAMETRIC VALUES | Dx/L | 0.000 |
|--------|-------|-------|-------|------|-------------------|-------|-------|
| ◇ | 6.197 | 1.000 | 0.598 | I | 6.000 | 0.000 | 0.000 |
| ◇ | 3.945 | | | | 0.000 | | |
| ◇ | 2.127 | | | | | | |
| ◇ | 0.034 | | | | | | |
| ◇ | 1.761 | | | | | | |

REFERENCE FILE

RADIAL DISTRIBUTION OF BOOSTER BASE PRESSURES

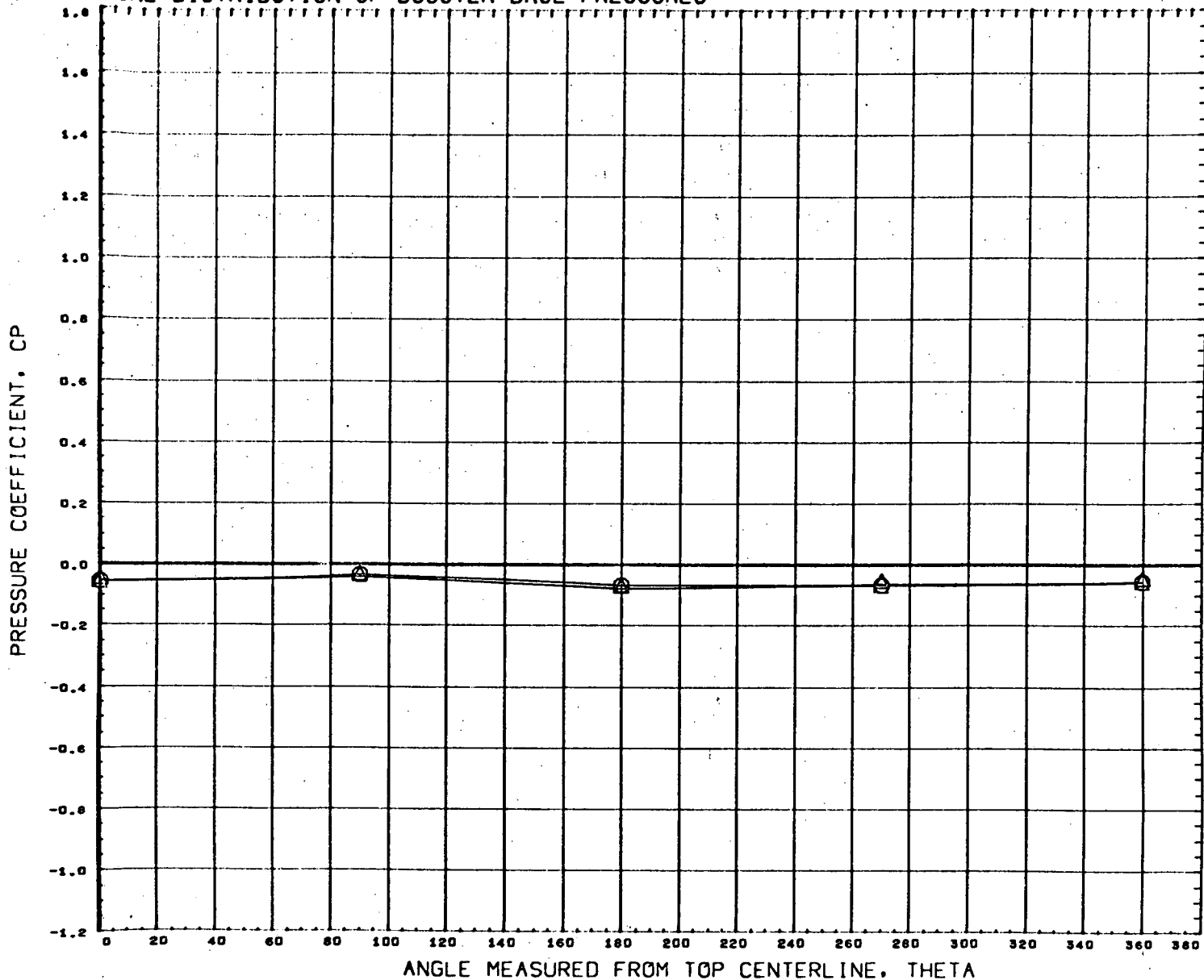

| | | | |
|--------|-------|-------|-------|
| SYMBOL | BETA | X/L | M1 |
| ○ | 3.766 | 1.000 | 0.598 |
| △ | 6.056 | | |

| | | | |
|-------------------|-------|------|-------|
| PARAMETRIC VALUES | | | |
| ALFB | 6.000 | DX/L | p.000 |
| I | 0.000 | | |

REFERENCE FILE

RADIAL DISTRIBUTION OF BOOSTER BASE PRESSURES

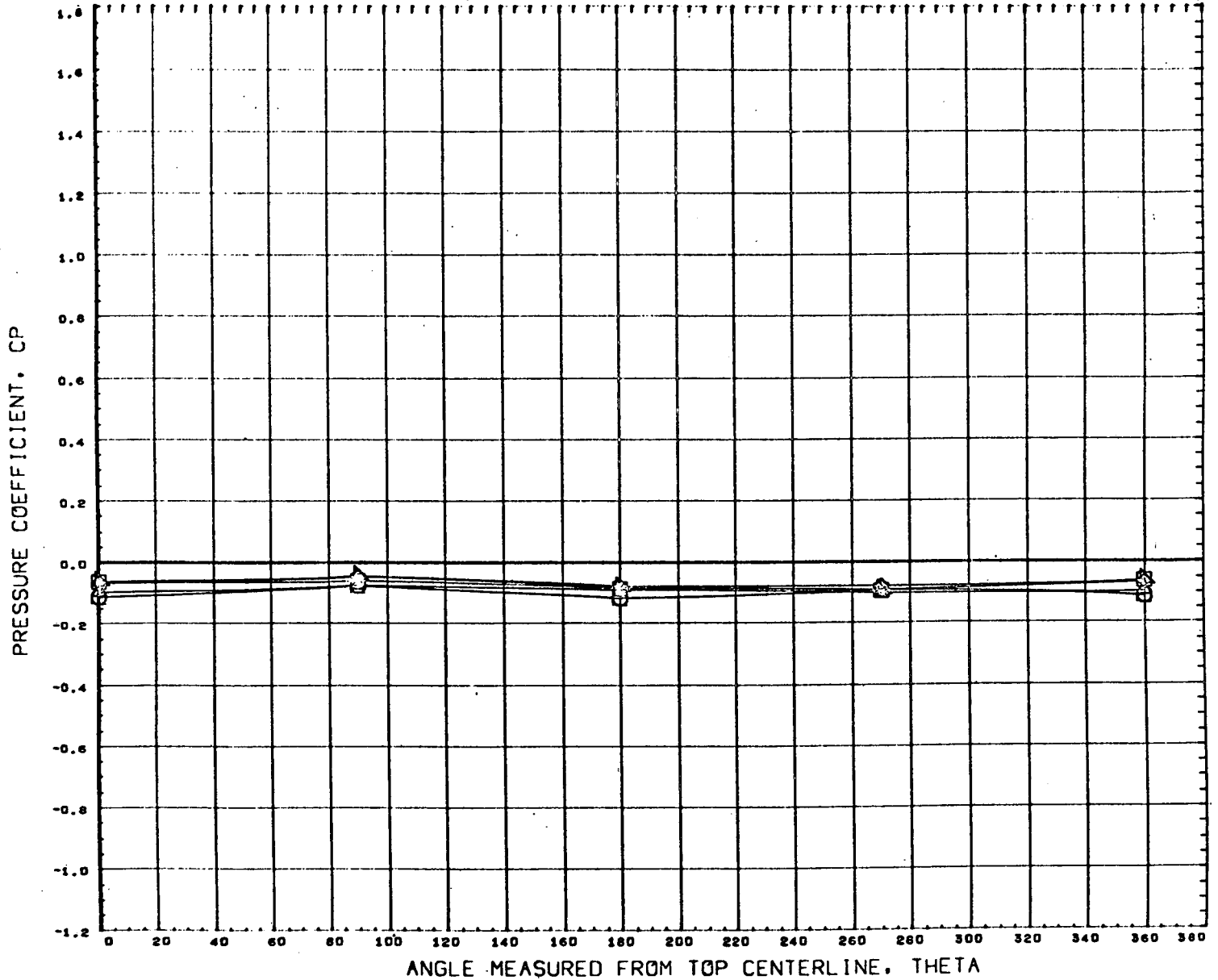

| SYMBOL | BETA | X/L | M1 | PARAMETRIC VALUES | | | |
|--------|---------|-------|-------|-------------------|-------|------|-------|
| ◇ | - 5.928 | 1.000 | 0.903 | ALFB | 6.000 | DX/L | 0.000 |
| ◇ | - 4.036 | | | I | 0.000 | | |
| ◇ | - 2.074 | | | | | | |
| ◇ | - 0.007 | | | | | | |
| ◇ | 1.849 | | | | | | |

REFERENCE FILE

RADIAL DISTRIBUTION OF BOOSTER BASE PRESSURES

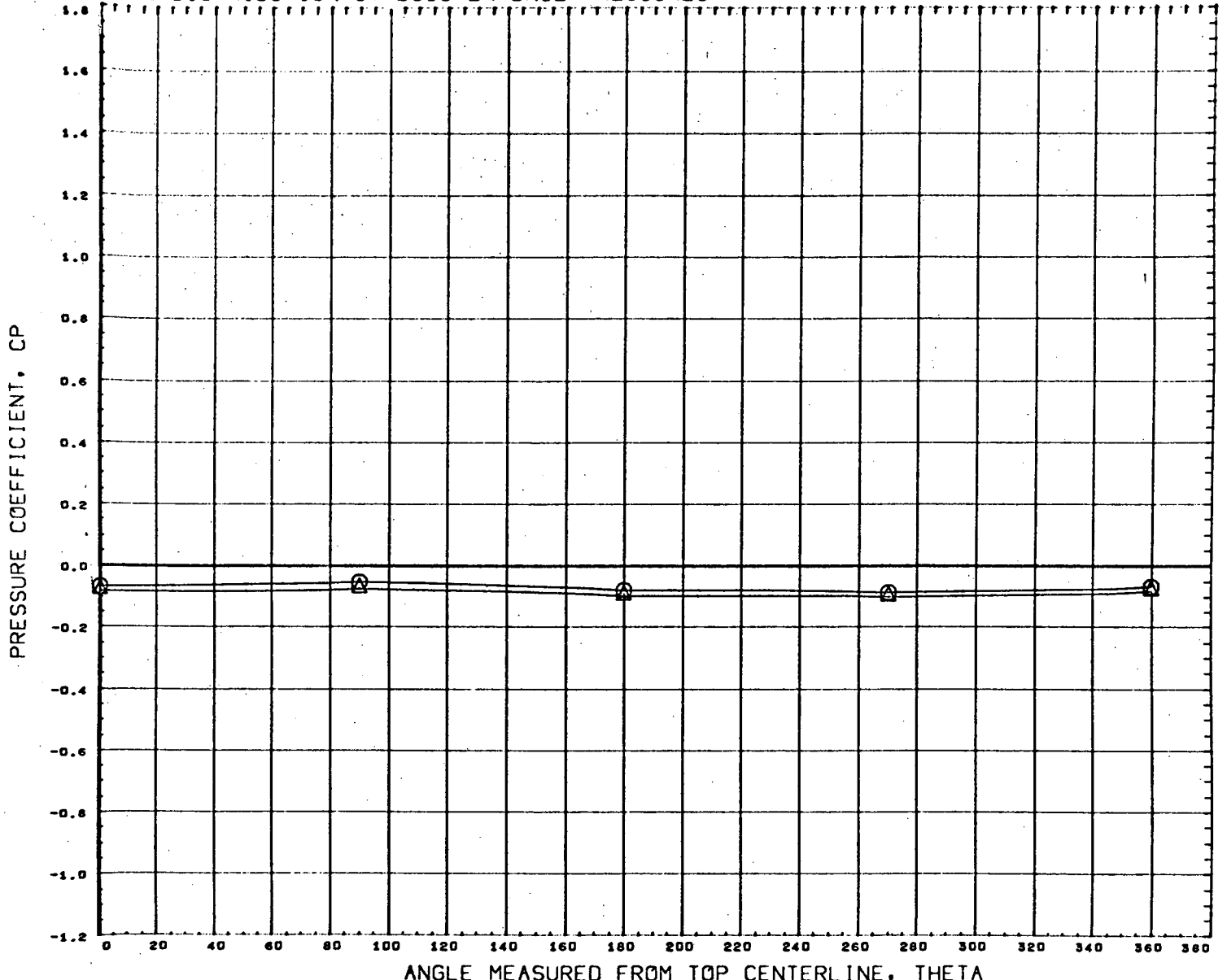

| | | | | | | | |
|--------|-------|-------|-------|-------------------|-------|------|-------|
| SYMBOL | BETA | X/L | M1 | PARAMETRIC VALUES | | | |
| ○ | 3.870 | 1.000 | 0.903 | ALFB | 6.000 | DX/L | 0.000 |
| △ | 5.976 | | | I | 0.000 | | |

REFERENCE FILE

AEDC TC174 MDAC BOOSTER NEAR ORBITER (BASE)

(ETC004)

PAGE 451

C-6

RADIAL DISTRIBUTION OF BOOSTER BASE PRESSURES

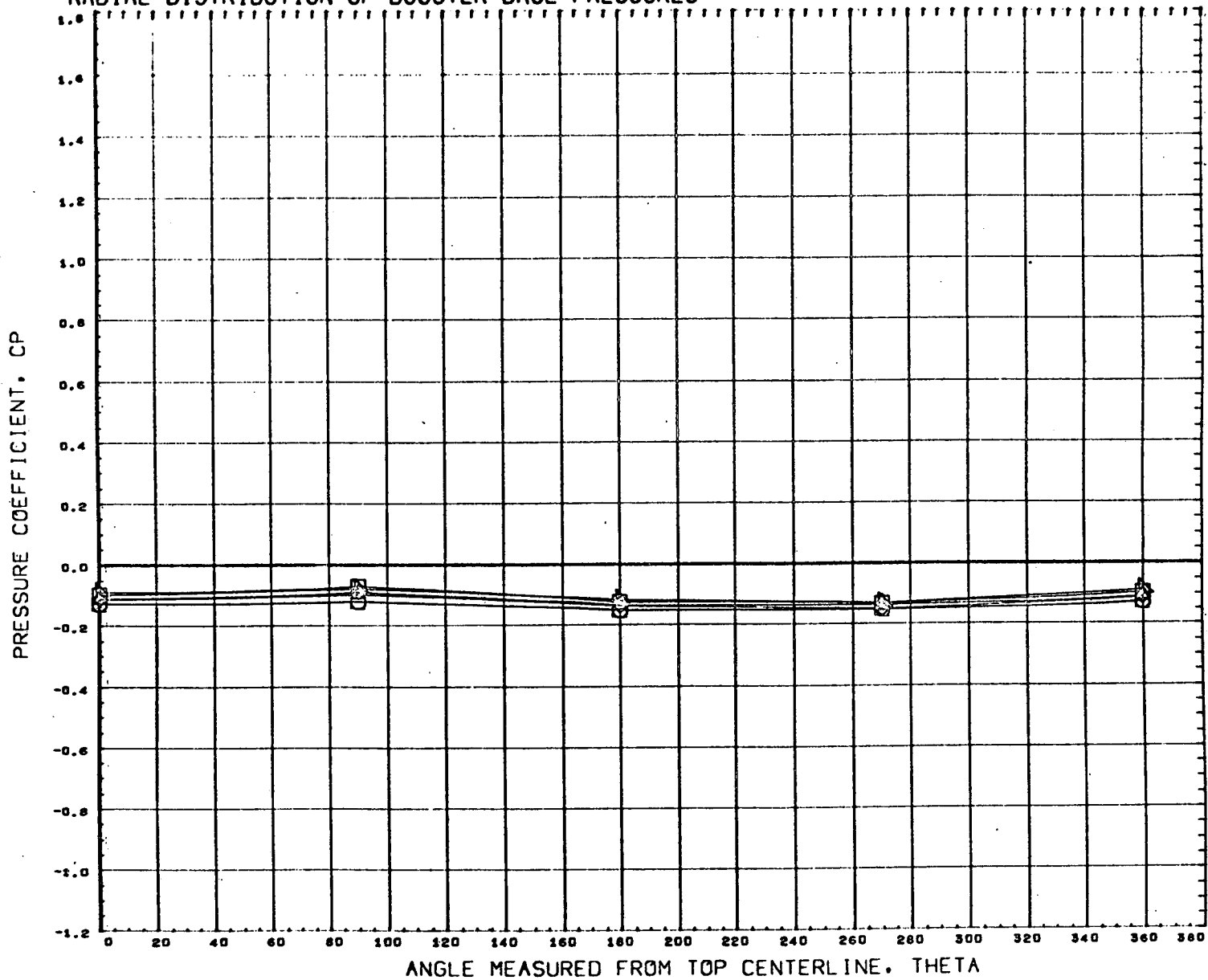

| SYMBOL | BETA | X/L | M1 | ALFB | PARAMETRIC VALUES | |
|--------|-------|-------|-------|-------|-------------------|-------|
| ◇ | 5.831 | 1.000 | 1.001 | 6.000 | 0.000 | 0.000 |
| □ | 3.916 | | | 0.000 | | |
| ○ | 2.062 | | | | | |
| △ | 0.023 | | | | | |
| ◻ | 1.843 | | | | | |

REFERENCE FILE

RADIAL DISTRIBUTION OF BOOSTER BASE PRESSURES

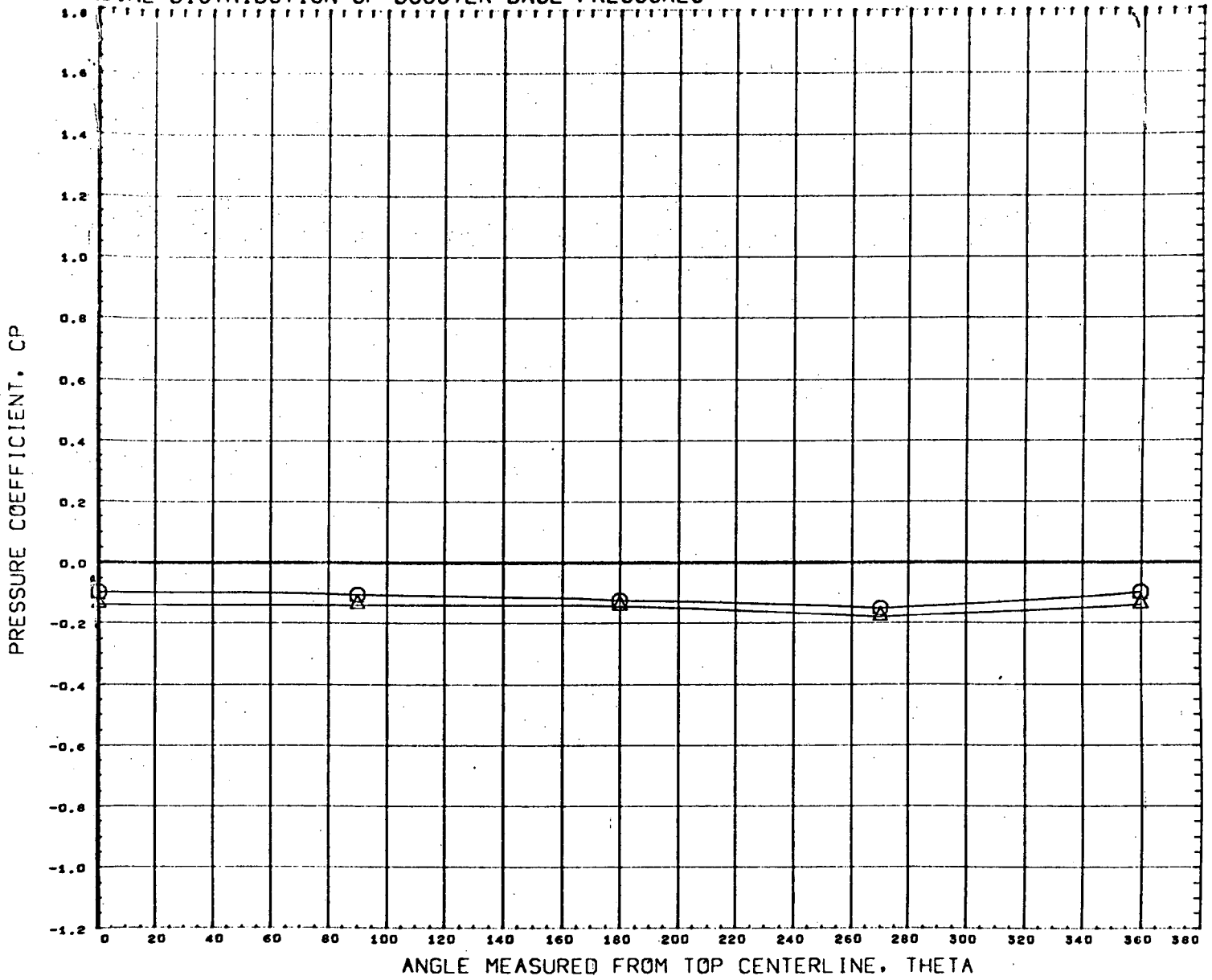

| | | | | | |
|--------|-------|-------|-------|------|-------------------|
| SYMBOL | BETA | X/L | M1 | | PARAMETRIC VALUES |
| ○ | 3.879 | 1.000 | 1.001 | ALFB | 6.000 DX/L 0.000 |
| △ | 5.995 | | | I | 0.000 |

REFERENCE FILE

RADIAL DISTRIBUTION OF BOOSTER BASE PRESSURES

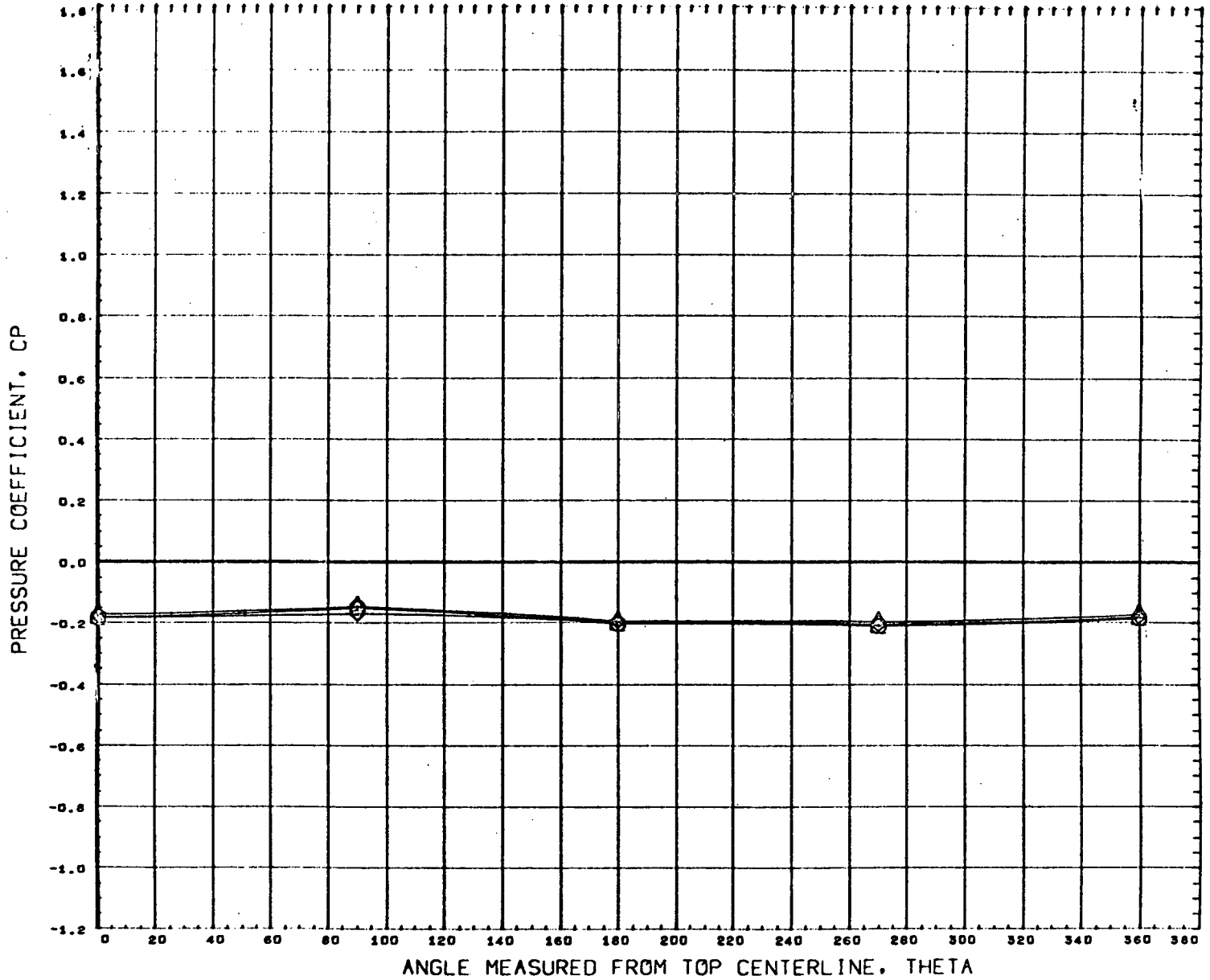

| SYMBOL | BETA | X/L | M1 |
|--------|---------|-------|-------|
| ○ | - 3.704 | 1.000 | 1.100 |
| △ | - 0.004 | | |
| ◇ | 3.758 | | |

| PARAMETRIC VALUES | | |
|-------------------|-------|------------|
| ALFB | 6.000 | DX/L 0.000 |
| I | 0.000 | |

REFERENCE FILE

RADIAL DISTRIBUTION OF BOOSTER BASE PRESSURES

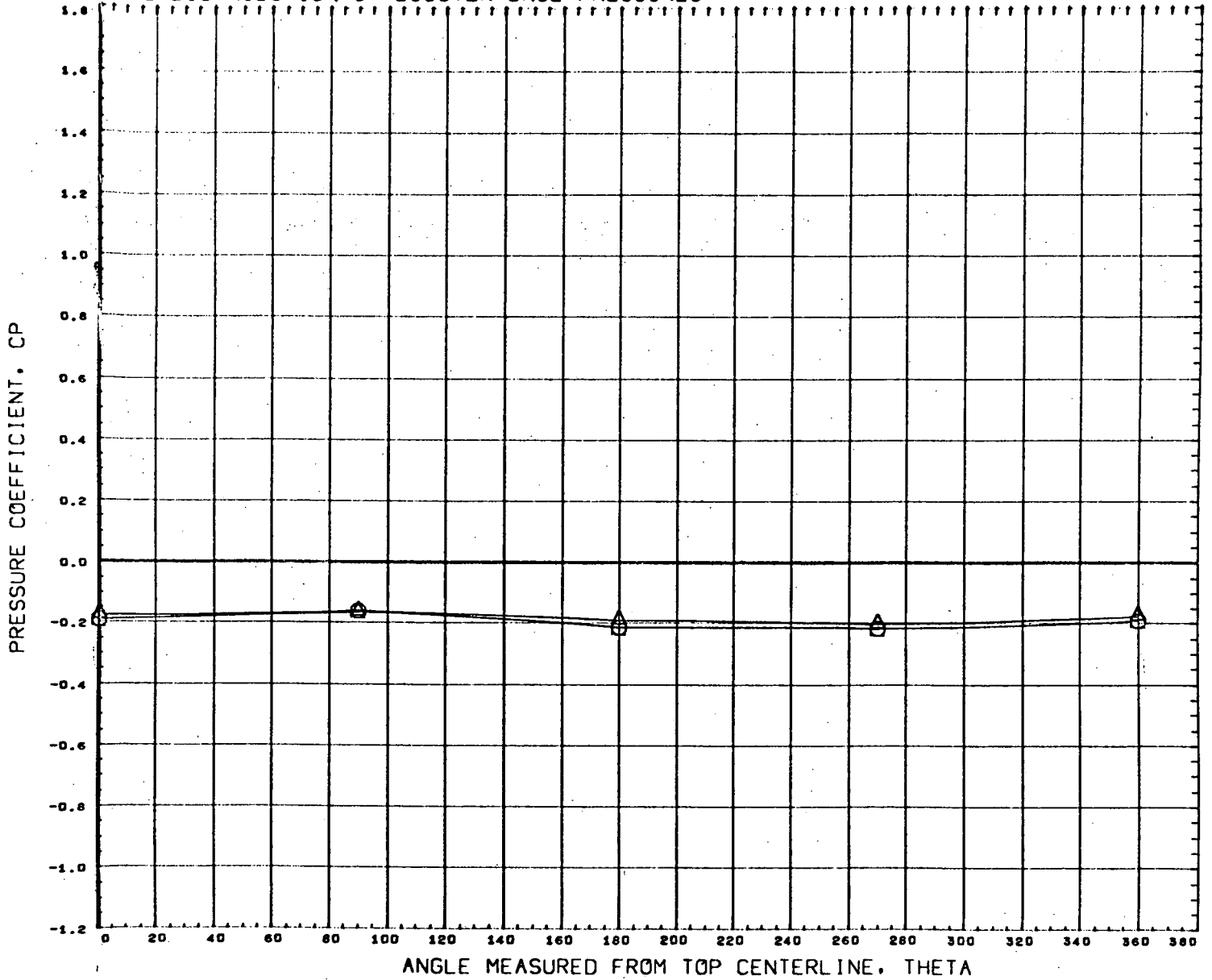

| SYMBOL | BETA | X/L | M1 | ALFB | PARAMETRIC VALUES | | |
|--------|-------|-------|-------|-------|-------------------|-------|--|
| ○ | 3.879 | 1.000 | 1.202 | 6.000 | DX/L | 0.000 | |
| △ | 3.779 | | | I | 0.000 | | |

REFERENCE FILE

RADIAL DISTRIBUTION OF BOOSTER BASE PRESSURES

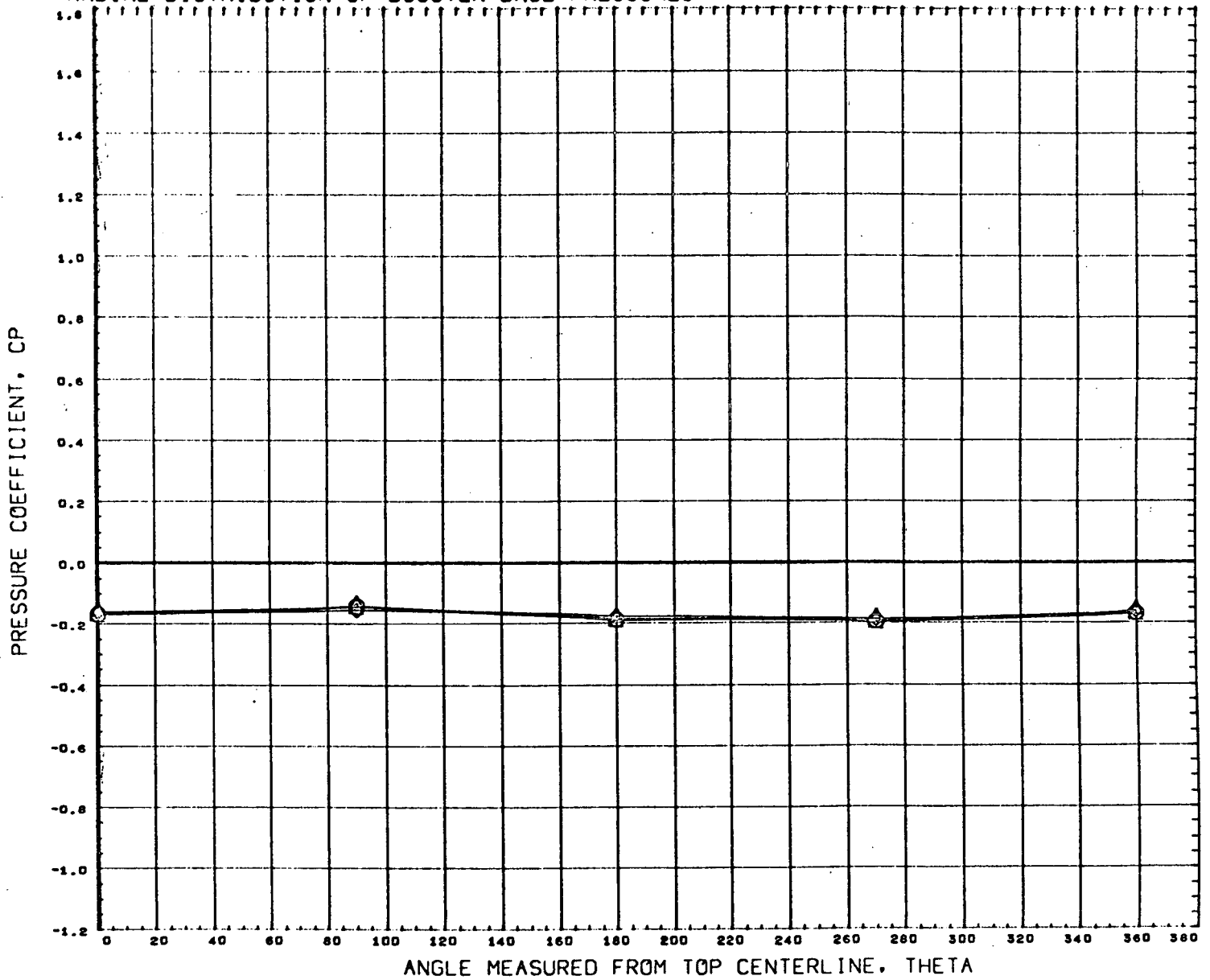

| SYMBOL | BETA | X/L | M1 | PARAMETRIC VALUES | | |
|--------|-------|-------|-------|-------------------|-------|-------|
| | | | | ALFB | DX/L | 0,000 |
| ○ | 3.842 | 1.000 | 1.298 | 6.000 | 0.000 | 0.000 |
| △ | 0.036 | | | | | |
| ◇ | 3.887 | | | | | |

REFERENCE FILE

RADIAL DISTRIBUTION OF BOOSTER BASE PRESSURES

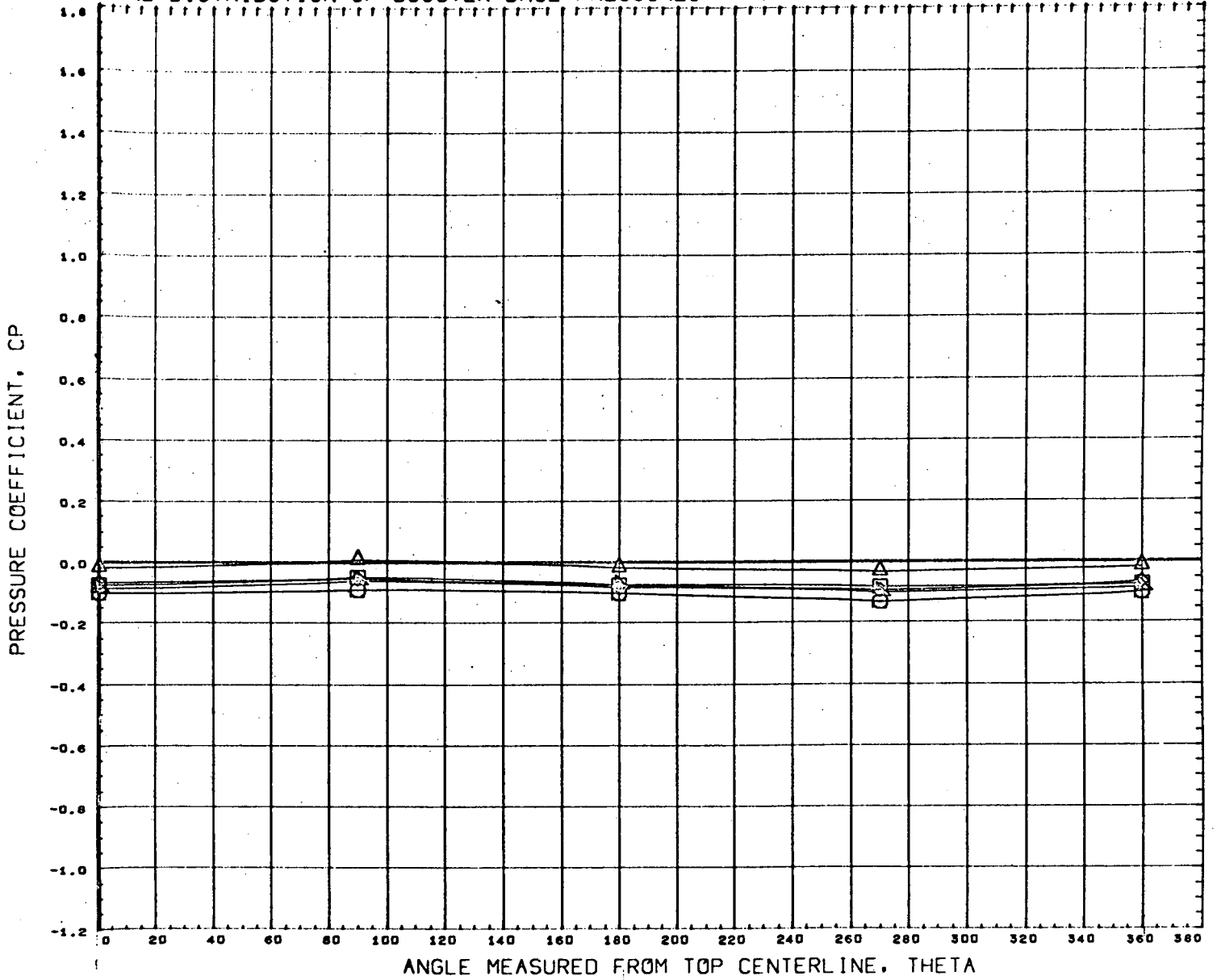

| SYMBOL | ALFB | X/L | M1 | PARAMETRIC VALUES | | |
|--------|-------|-------|-------|-------------------|-------|-------|
| △ | 6.140 | 1.000 | 0.597 | BETA | 0.000 | 0.036 |
| □ | 5.877 | | | I | 0.000 | |
| ◇ | 5.890 | | | | | |
| ○ | 2.290 | | | | | |
| | 0.129 | | | | | |

REFERENCE FILE

RADIAL DISTRIBUTION OF BOOSTER BASE PRESSURES

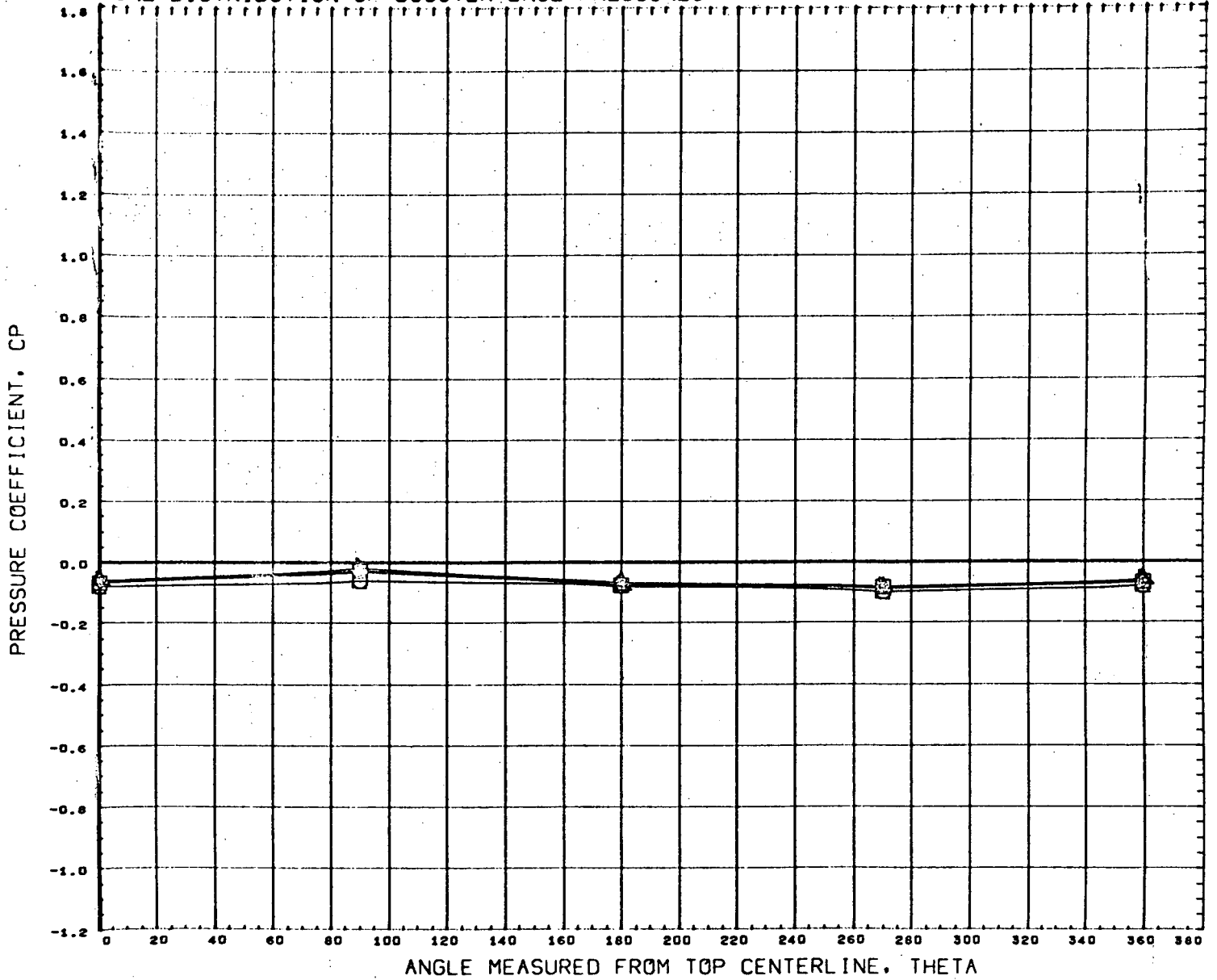

| | | | | | | |
|--------|---------|-------|-------|------|-------------------|-------|
| SYMBOL | ALFB | X/L | M1 | BETA | PARAMETRIC VALUES | |
| ◇ | - 8.280 | 1.000 | 0.899 | I | 0.000 | 0.036 |
| ◇ | - 4.452 | | | | 0.000 | |
| ◇ | - 2.200 | | | | | |
| ◇ | 0.193 | | | | | |
| ◇ | 2.085 | | | | | |

REFERENCE FILE

RADIAL DISTRIBUTION OF BOOSTER BASE PRESSURES

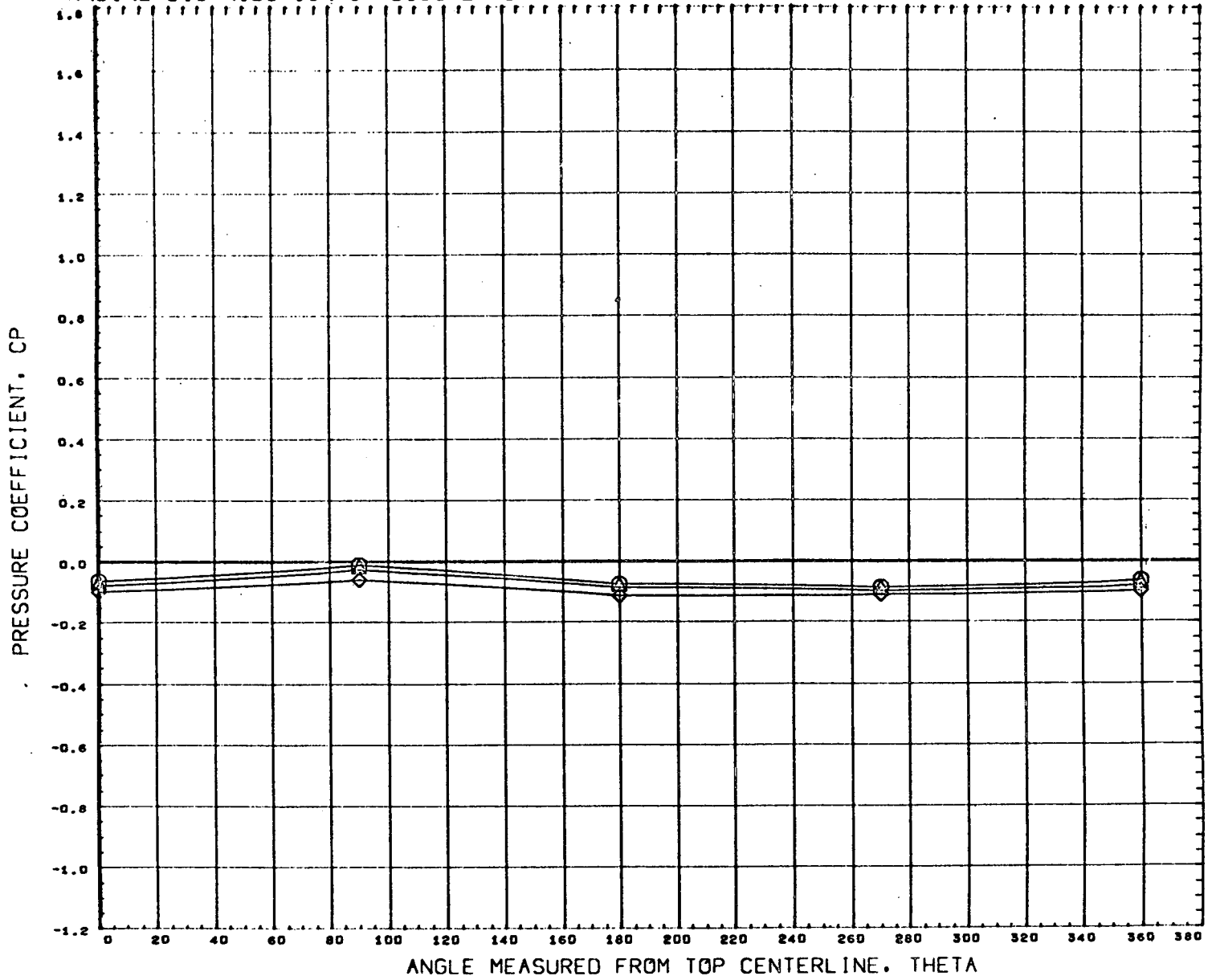

| SYMBOL | ALFB | X/L | M1 |
|--------|--------|-------|-------|
| ○ | 3.719 | 1.000 | 0.899 |
| △ | 6.154 | | |
| ◇ | 10.121 | | |

| PARAMETRIC VALUES | | |
|-------------------|-------|------------|
| BETA | 0.000 | DX/L 0.036 |
| I | 0.000 | |

REFERENCE FILE

RADIAL DISTRIBUTION OF BOOSTER BASE PRESSURES

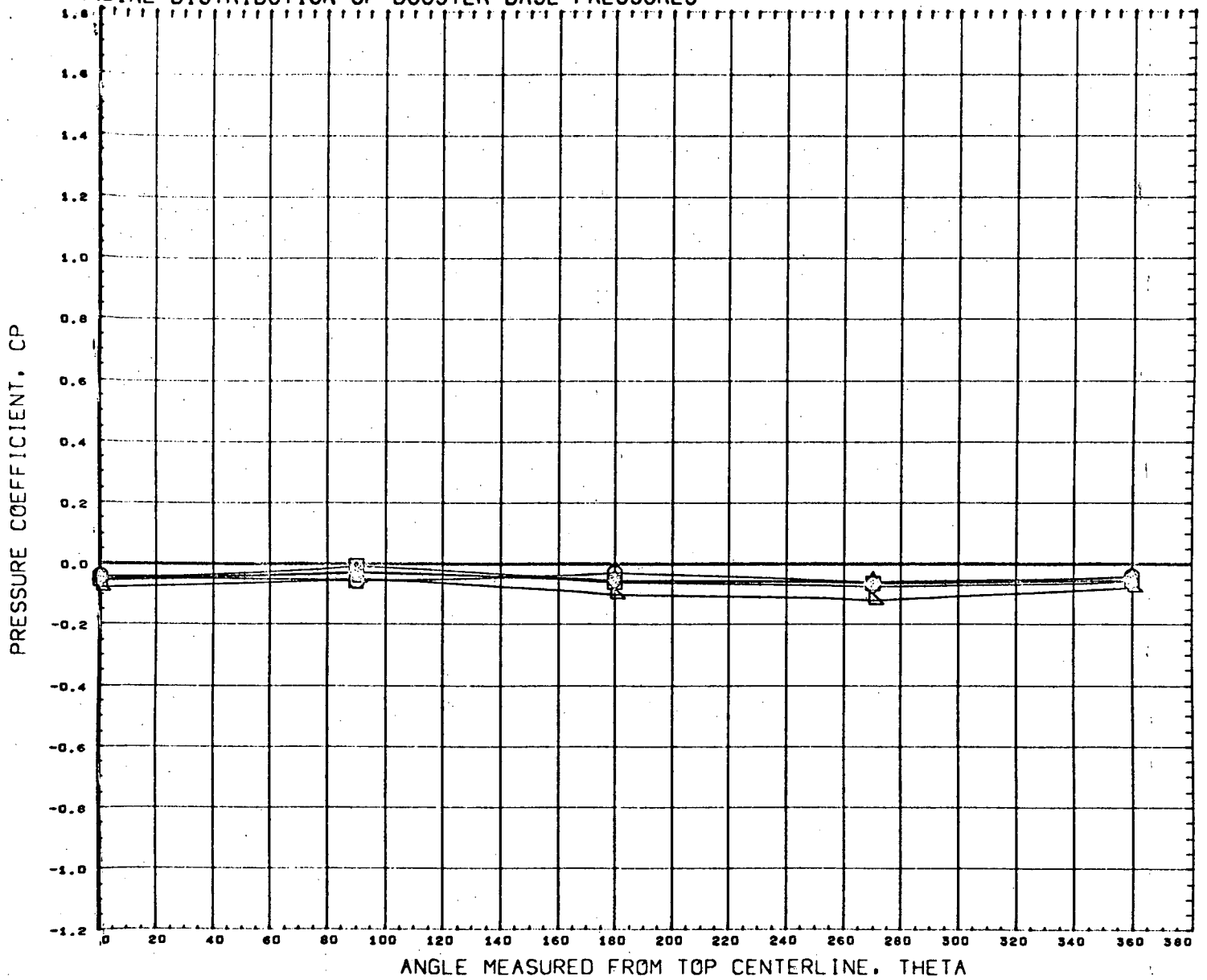

| SYMBOL | ALFB | X/L | M1 | BETA | PARAMETRIC VALUES | |
|--------|-------|-------|-------|-------|-------------------|-------|
| ○ | 6.158 | 1.000 | 0.995 | 0.000 | DX/L | 0.036 |
| ◇ | 4.439 | | | I | 0.000 | |
| △ | 2.197 | | | | | |
| □ | 0.217 | | | | | |
| ▽ | 2.165 | | | | | |

REFERENCE FILE

RADIAL DISTRIBUTION OF BOOSTER BASE PRESSURES

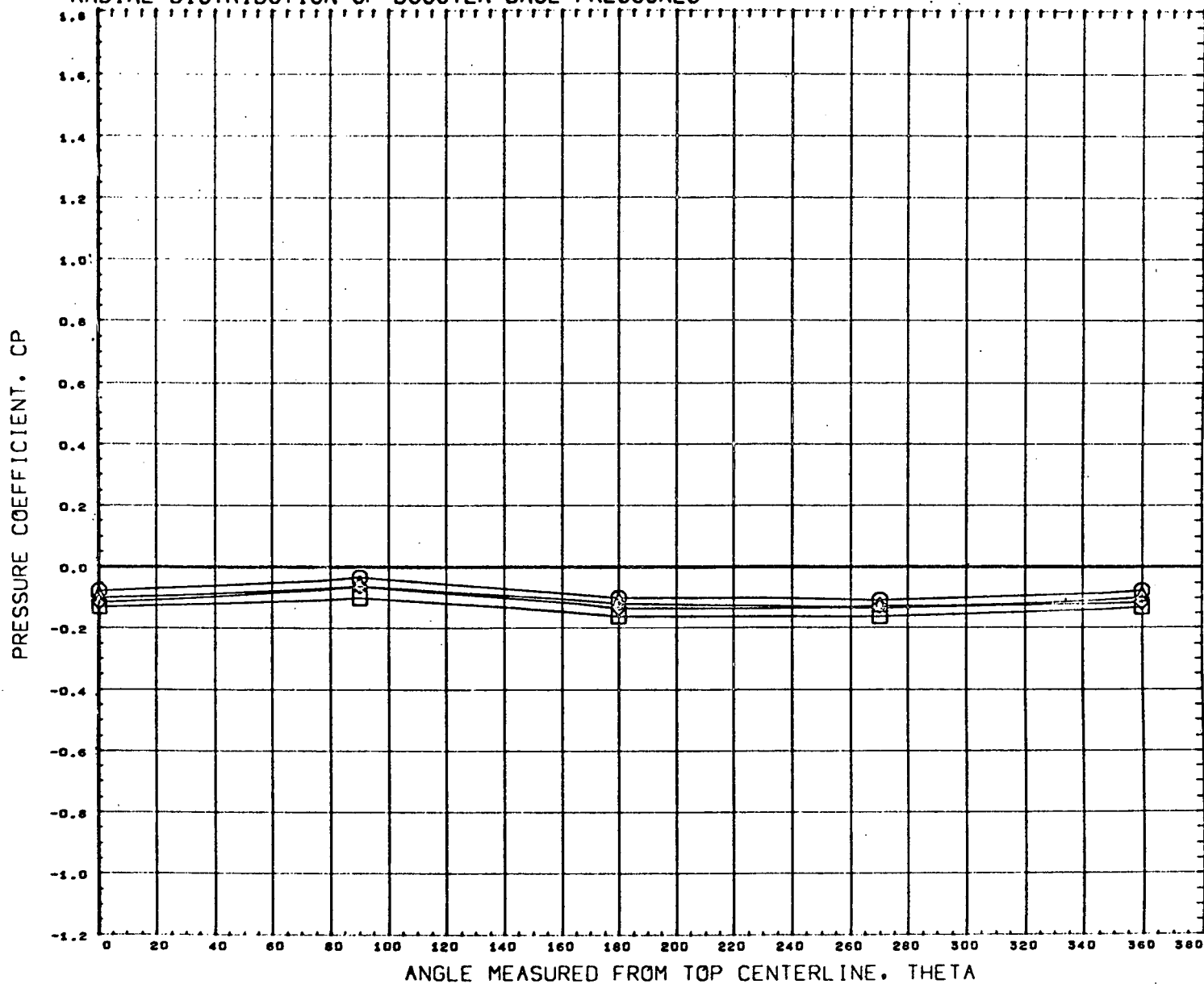

| SYMBOL | ALFB | X/L | M1 | BETA | PARAMETRIC VALUES | DX/L | |
|--------|-------|-------|-------|-------|-------------------|------|-------|
| ○ | 4.157 | 1.000 | 0.995 | 0.000 | | | 0.036 |
| △ | 6.136 | | | 0.000 | | | |
| ◇ | 7.548 | | | 0.000 | | | |
| □ | 9.756 | | | | | | |

REFERENCE FILE

RADIAL DISTRIBUTION OF BOOSTER BASE PRESSURES

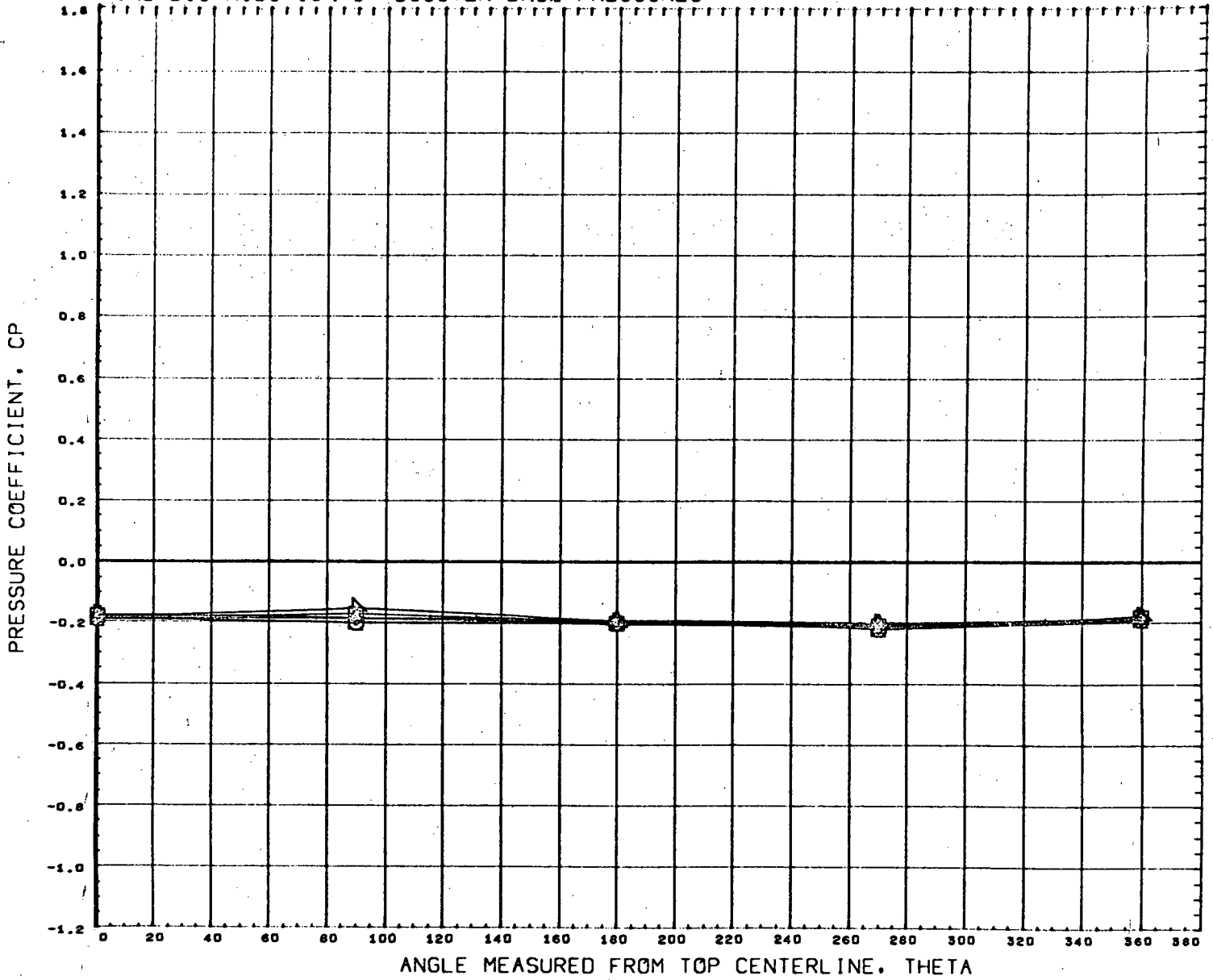

| | | | | | | |
|---------------------------------|---------|-------|-------|-------------------|-------|------------|
| SYMBOL ◊ ◊ ◊ ◊ ◊ | ALFB | X/L | M1 | PARAMETRIC VALUES | | |
| | - 8.325 | 1.000 | 1.101 | BETA | 0.000 | OX/L 0.036 |
| | - 6.165 | | | I | 0.000 | |
| | - 4.458 | | | | | |
| | - 2.183 | | | | | |
| | 0.223 | | | | | |

REFERENCE FILE

RADIAL DISTRIBUTION OF BOOSTER BASE PRESSURES

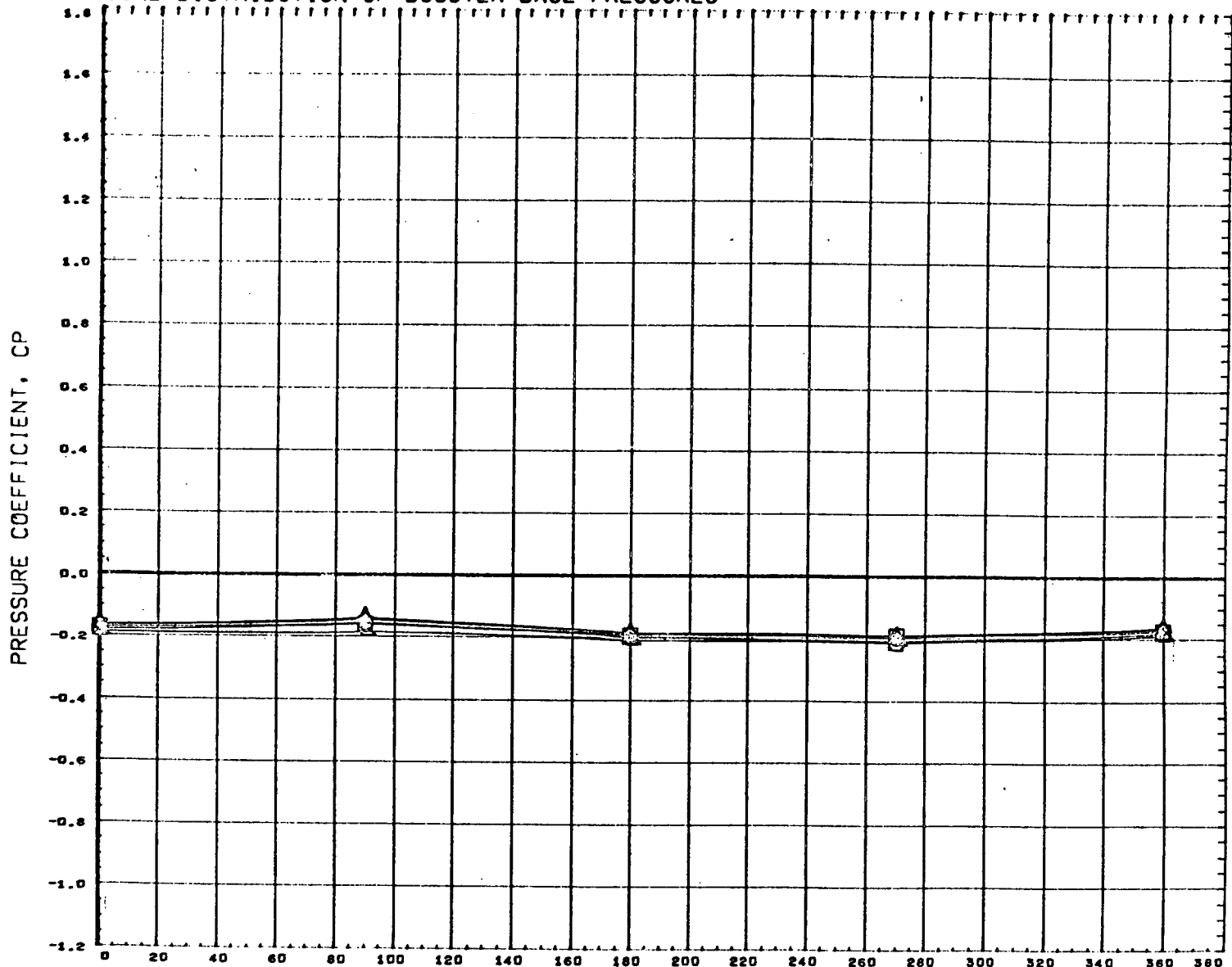

ANGLE MEASURED FROM TOP CENTERLINE, THETA

| SYMBOL | ALFB | X/L | M1 | PARAMETRIC VALUES | | | |
|--------|--------|-------|-------|-------------------|-------|------|-------|
| ◇ | 2.164 | 1.000 | 1.101 | BETA | 0.000 | DX/L | 0.036 |
| ◇ | 4.173 | | | I | 0.000 | | |
| ◇ | 5.536 | | | | | | |
| ◇ | 8.188 | | | | | | |
| ◇ | 10.145 | | | | | | |

REFERENCE FILE

RADIAL DISTRIBUTION OF BOOSTER BASE PRESSURES

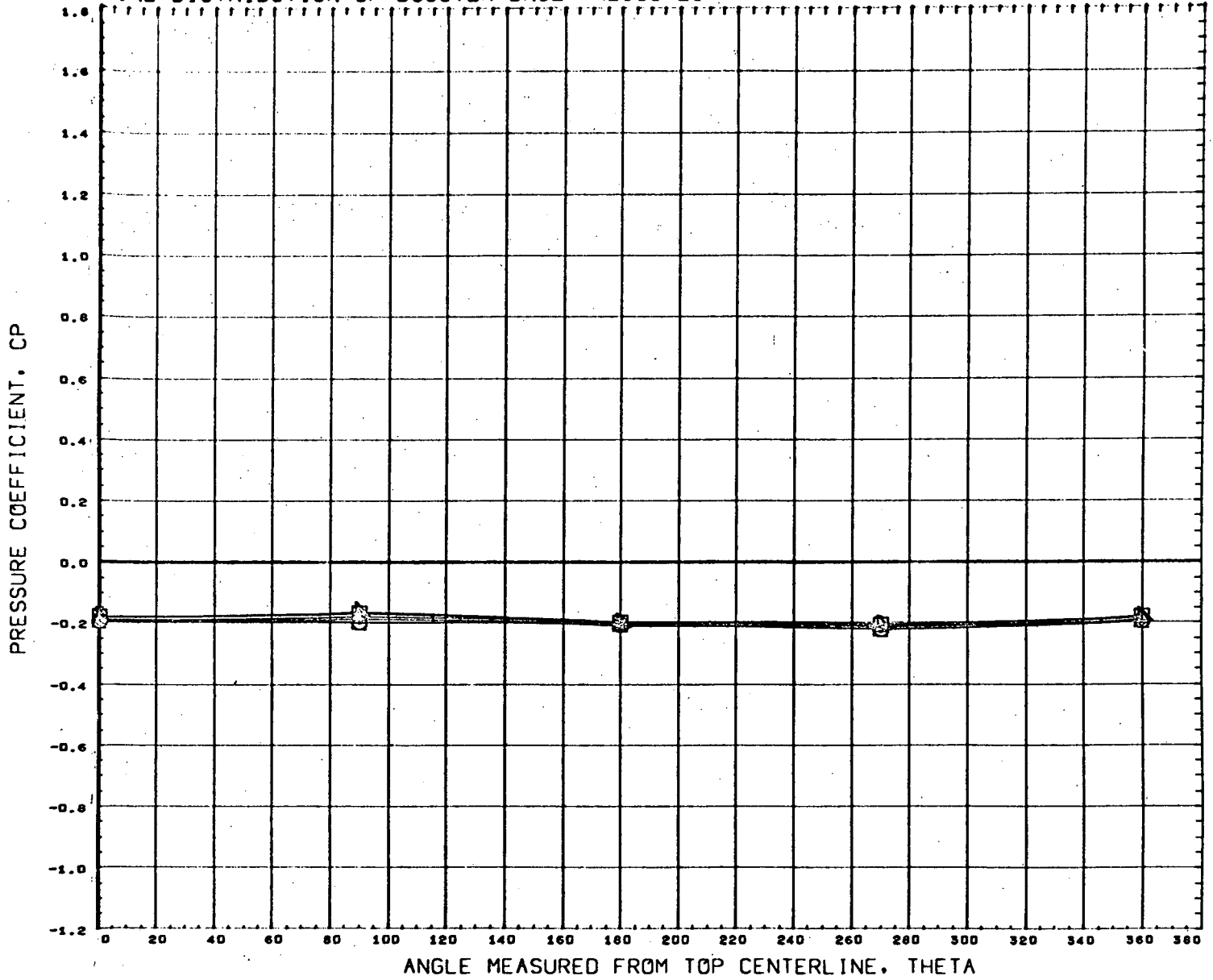

| SYMBOL | ALFB | X/L | M1 |
|--------|-------|-------|-------|
| ◇ | 8.317 | 1.000 | 1.200 |
| ◇ | 5.757 | | |
| ◇ | 4.430 | | |
| ◇ | 2.200 | | |
| ◇ | 0.220 | | |

| PARAMETRIC VALUES | | |
|-------------------|-------|-------|
| BETA | 0.000 | Dx/L |
| I | 0.000 | 0.036 |

REFERENCE FILE

RADIAL DISTRIBUTION OF BOOSTER BASE PRESSURES

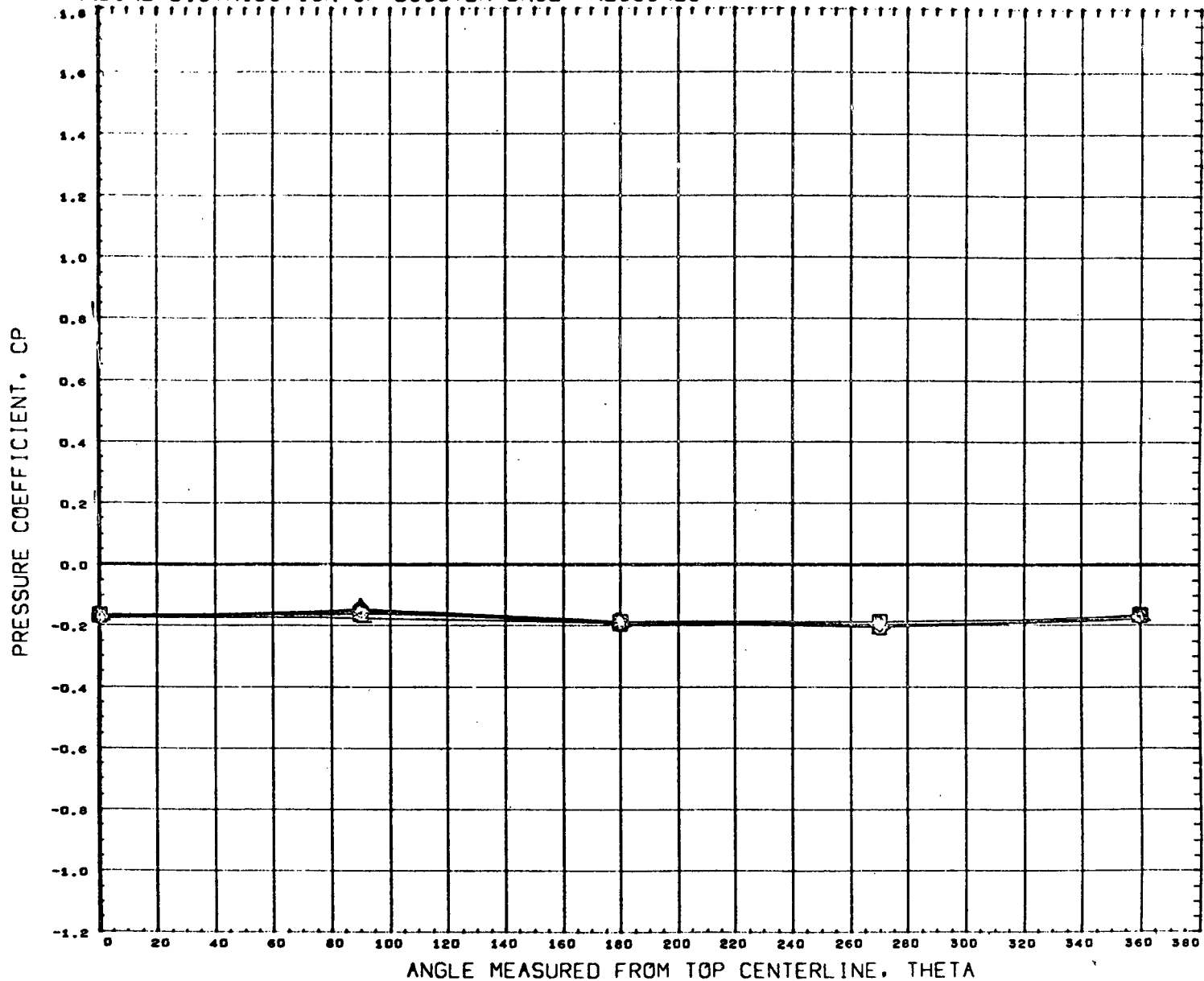

| SYMBOL | ALFB | X/L | M1 | BETA | PARAMETRIC VALUES | | |
|--------|--------|-------|-------|-------|-------------------|-------|--|
| ○ | 2.166 | 1.000 | 1.200 | 0.000 | DX/L | 0.036 | |
| ◇ | 4.173 | | | 0.000 | | | |
| ◇ | 5.534 | | | | | | |
| □ | 8.199 | | | | | | |
| ◇ | 10.165 | | | | | | |

REFERENCE FILE

RADIAL DISTRIBUTION OF BOOSTER BASE PRESSURES

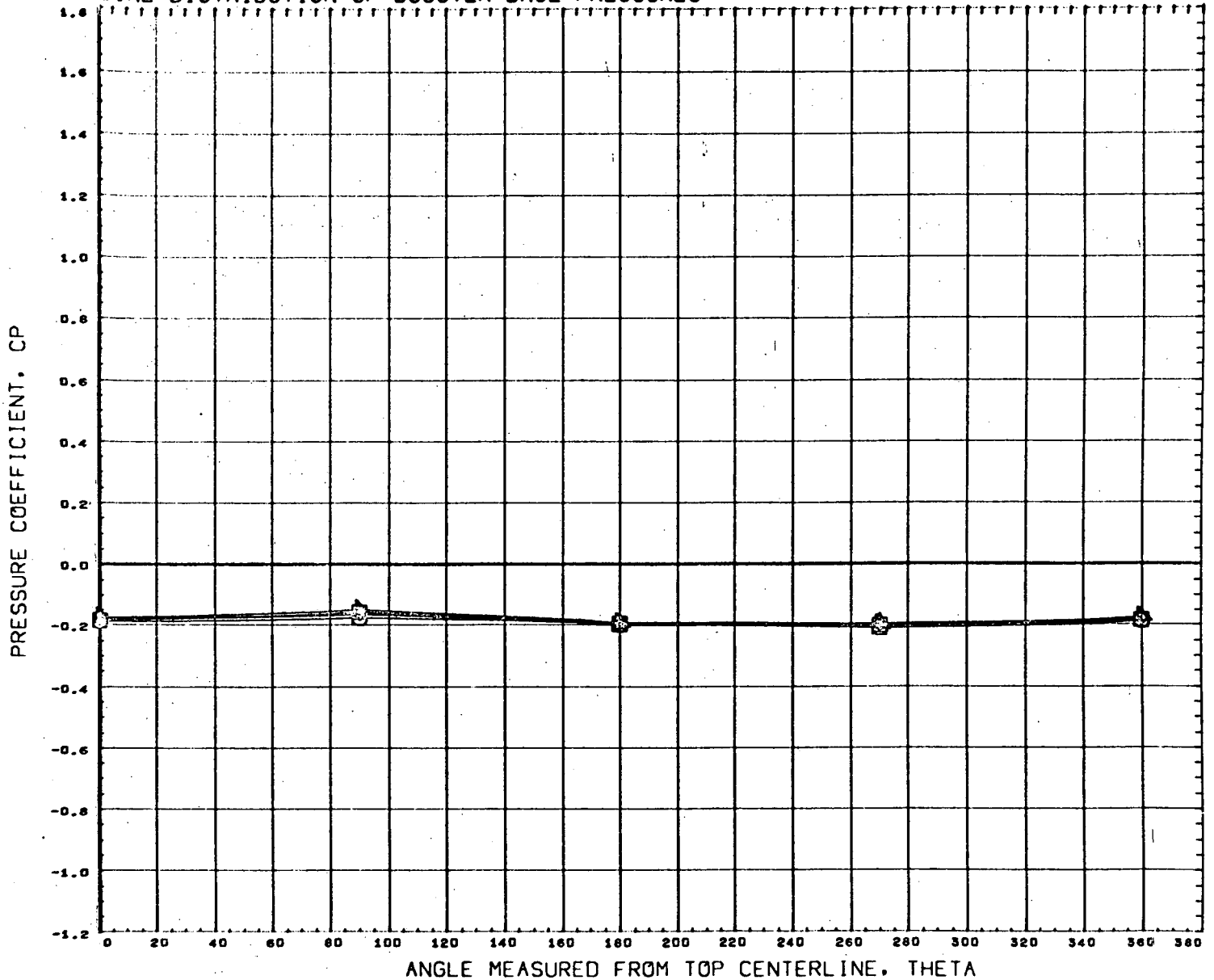

| SYMBOL | ALFB | X/L | M1 |
|--------|-------|-------|-------|
| ○ | 8.324 | 1.000 | 1.300 |
| ◇ | 5.757 | | |
| ◇ | 4.435 | | |
| ◇ | 1.782 | | |
| ◇ | 0.167 | | |

| PARAMETRIC VALUES | | |
|-------------------|-------|------------|
| BETA | 0.000 | DX/L 0.036 |
| I | 0.000 | |

REFERENCE FILE

RADIAL DISTRIBUTION OF BOOSTER BASE PRESSURES

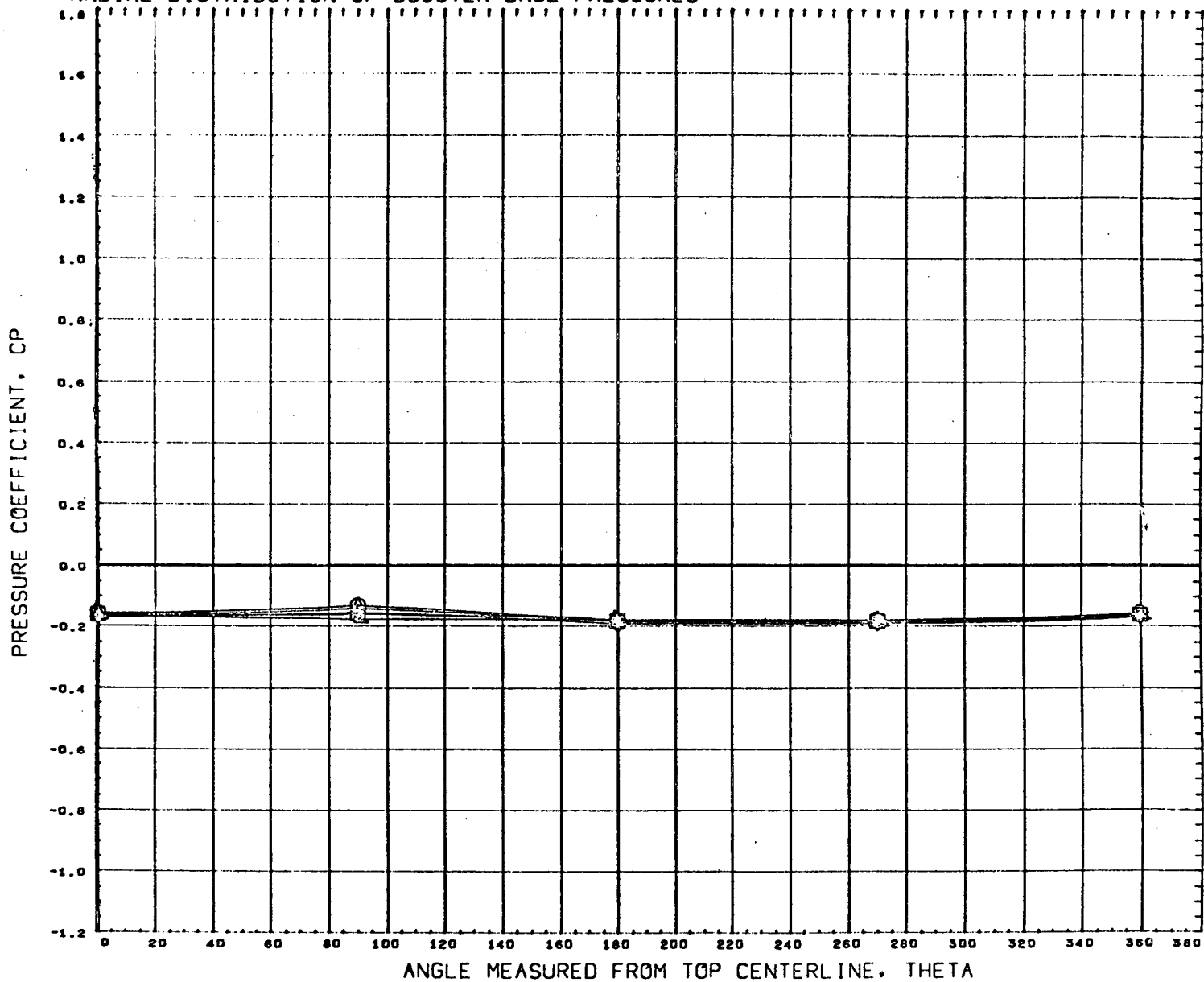

| SYMBOL | ALFB | X/L | H1 | BETA | PARAMETRIC VALUES | DX/L | |
|--------|--------|-------|-------|-------|-------------------|------|--|
| ◇ | 2.176 | 1.000 | 1.360 | 0.000 | 0.036 | | |
| ◇ | 4.176 | | | 0.000 | | | |
| ◇ | 5.526 | | | | | | |
| ◇ | 8.201 | | | | | | |
| ◇ | 10.165 | | | | | | |

REFERENCE FILE

RADIAL DISTRIBUTION OF BOOSTER BASE PRESSURES

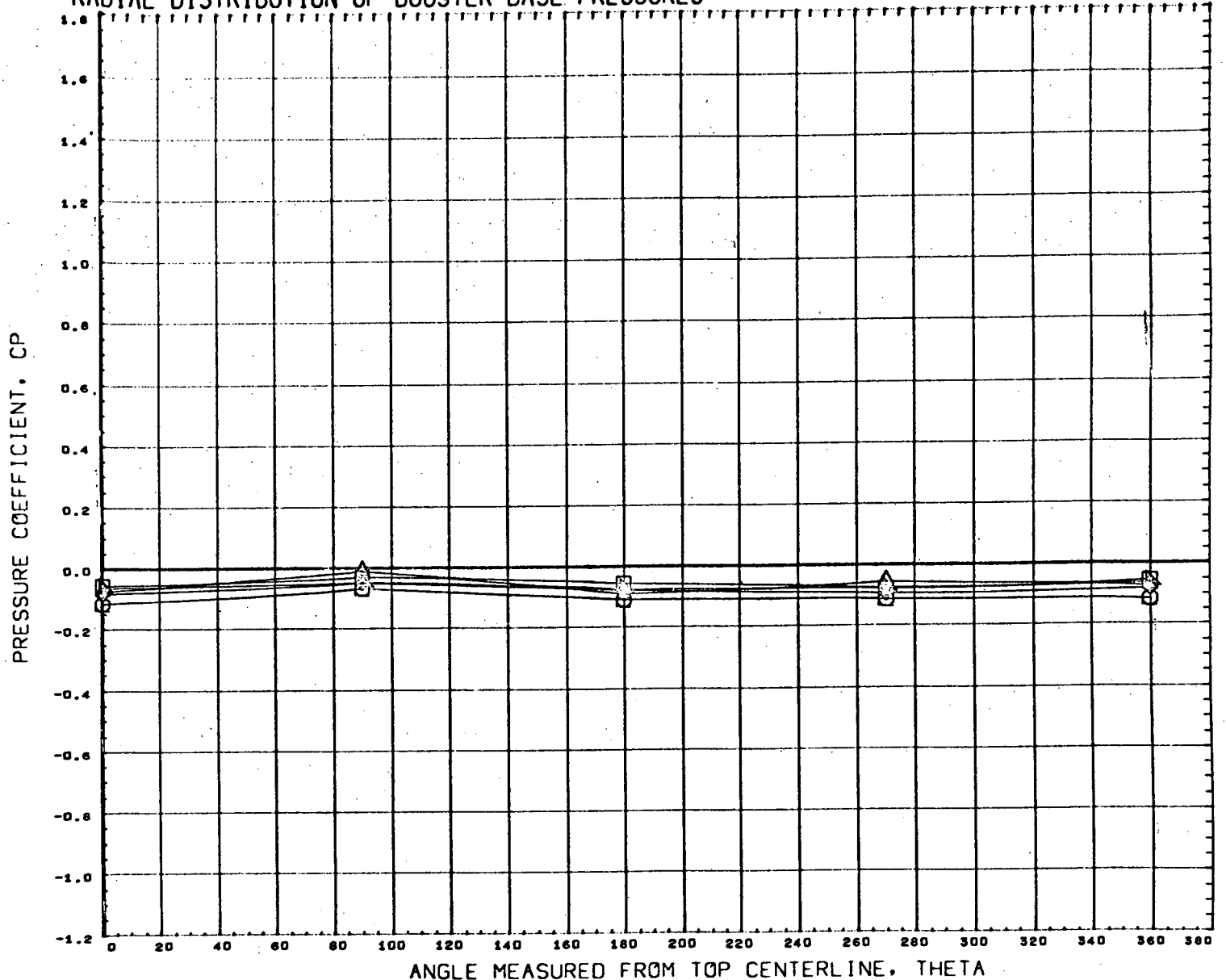

| | | | | | |
|--------|---------|-------|-------|------|-------------------|
| SYMBOL | BETA | X/L | M1 | | PARAMETRIC VALUES |
| ◇ | - 6.037 | 1.000 | 0.599 | ALFB | 0.000 DX/L 0.036 |
| □ | - 4.023 | | | I | 0.000 |
| △ | - 1.978 | | | | |
| ○ | - 0.265 | | | | |
| + | 1.756 | | | | |

REFERENCE FILE

RADIAL DISTRIBUTION OF BOOSTER BASE PRESSURES

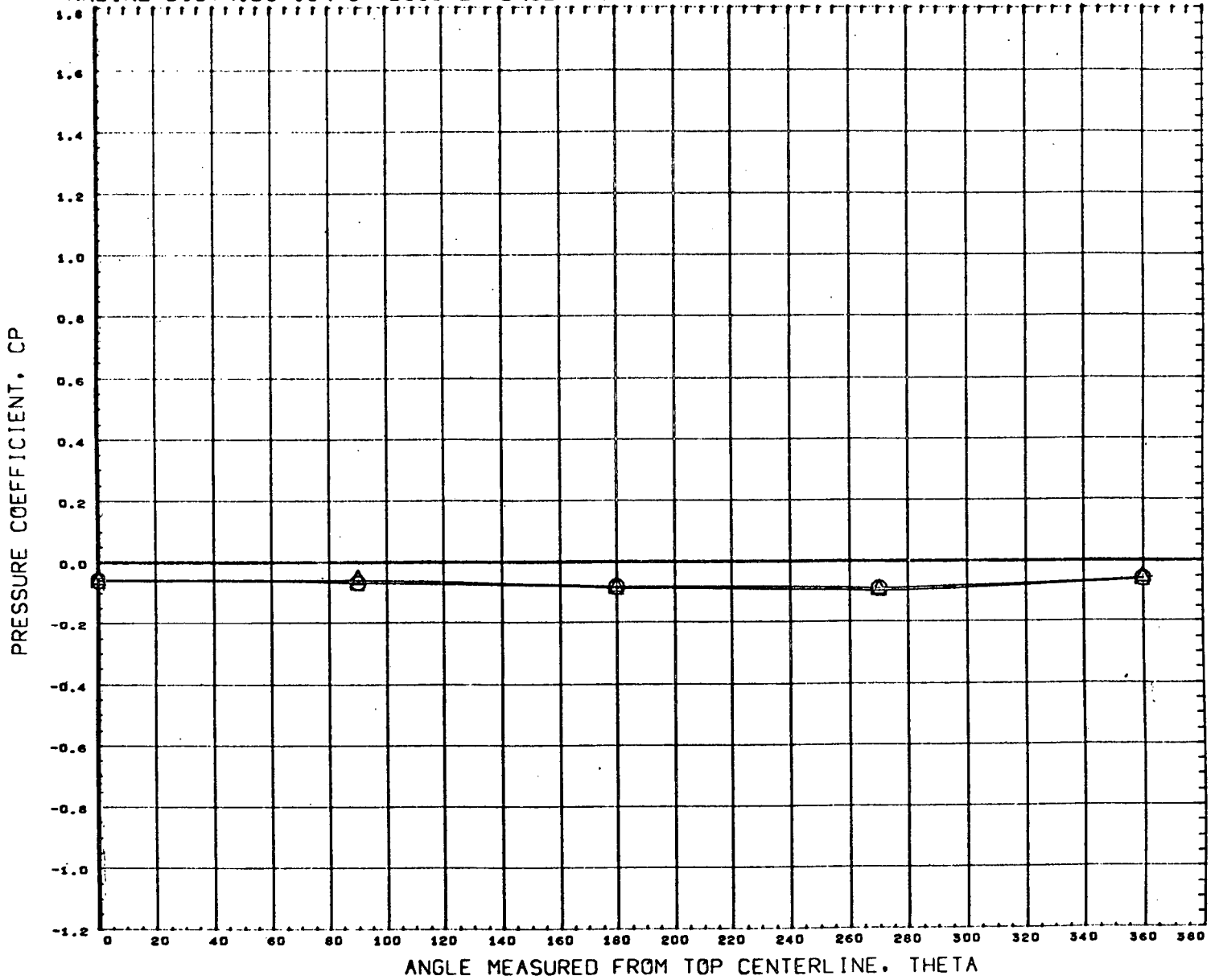

| | | | | | | |
|--------|-------|-------|-------|-------|-------------------|-------|
| SYMBOL | BETA | X/L | M1 | ALFB | PARAMETRIC VALUES | |
| ○ | 3.761 | 1.000 | 0.599 | 0.000 | DX/L | 0.036 |
| △ | 5.835 | | | I | 0.000 | |

REFERENCE FILE

RADIAL DISTRIBUTION OF BOOSTER BASE PRESSURES

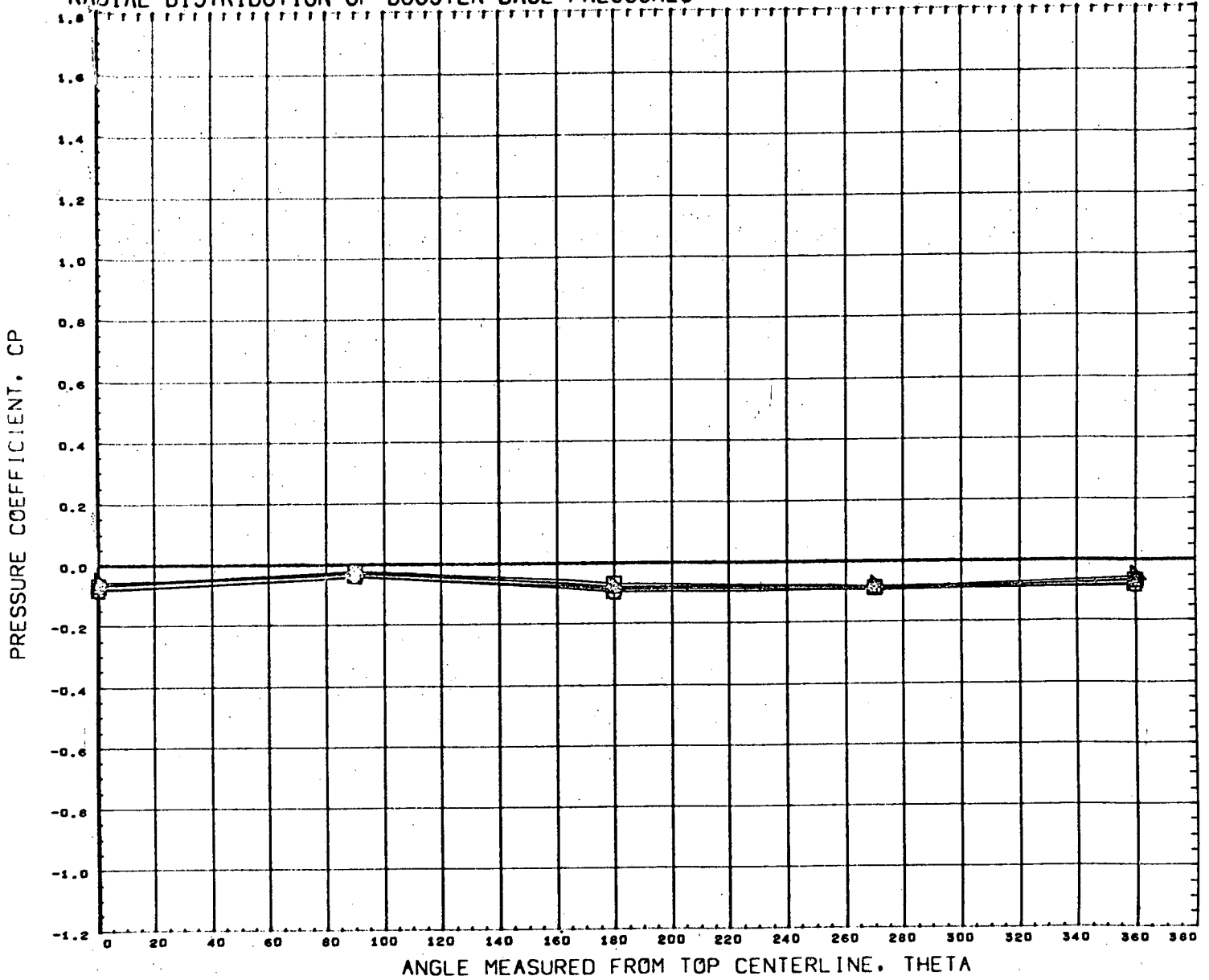

| SYMBOL | BETA | X/L | M1 | ALFB | PARAMETRIC VALUES | DX/L | |
|--------|-------|-------|-------|-------|-------------------|------|-------|
| ○ | 6.113 | 1.000 | 0.899 | 0.000 | | | 0.036 |
| ◇ | 4.054 | | | 0.000 | | | |
| ◇ | 2.008 | | | 0.000 | | | |
| □ | 0.259 | | | | | | |
| ▽ | 1.804 | | | | | | |

REFERENCE FILE

RADIAL DISTRIBUTION OF BOOSTER BASE PRESSURES

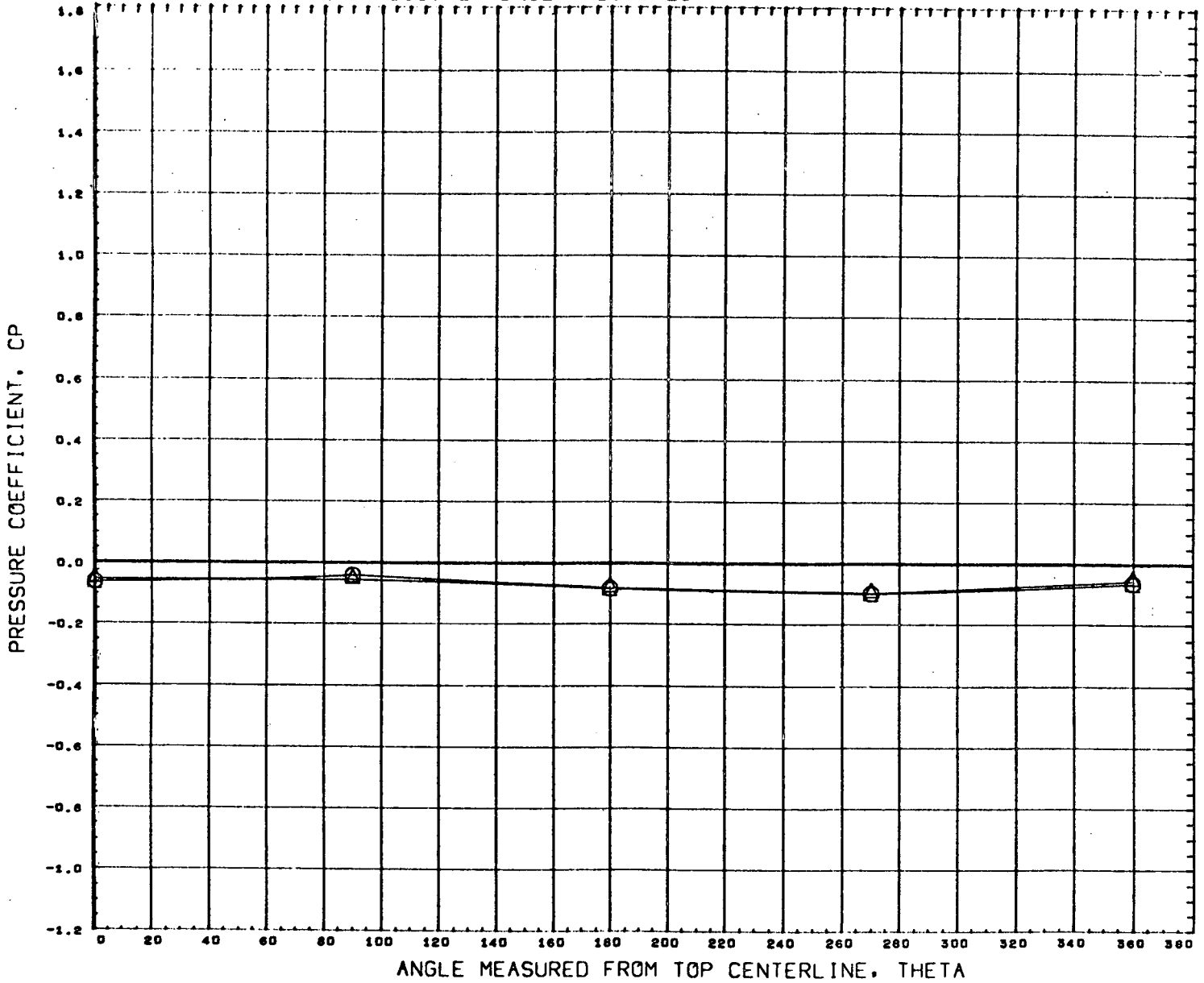

| | | | | | | | |
|--------|-------|-------|-------|-------------------|-------|------|-------|
| SYMBOL | BETA | X/L | M1 | PARAMETRIC VALUES | | | |
| ○ | 3.845 | 1.000 | 0.899 | ALFB | 0.000 | CX/L | 0.036 |
| △ | 5.924 | | | I | 0.000 | | |

REFERENCE FILE

RADIAL DISTRIBUTION OF BOOSTER BASE PRESSURES

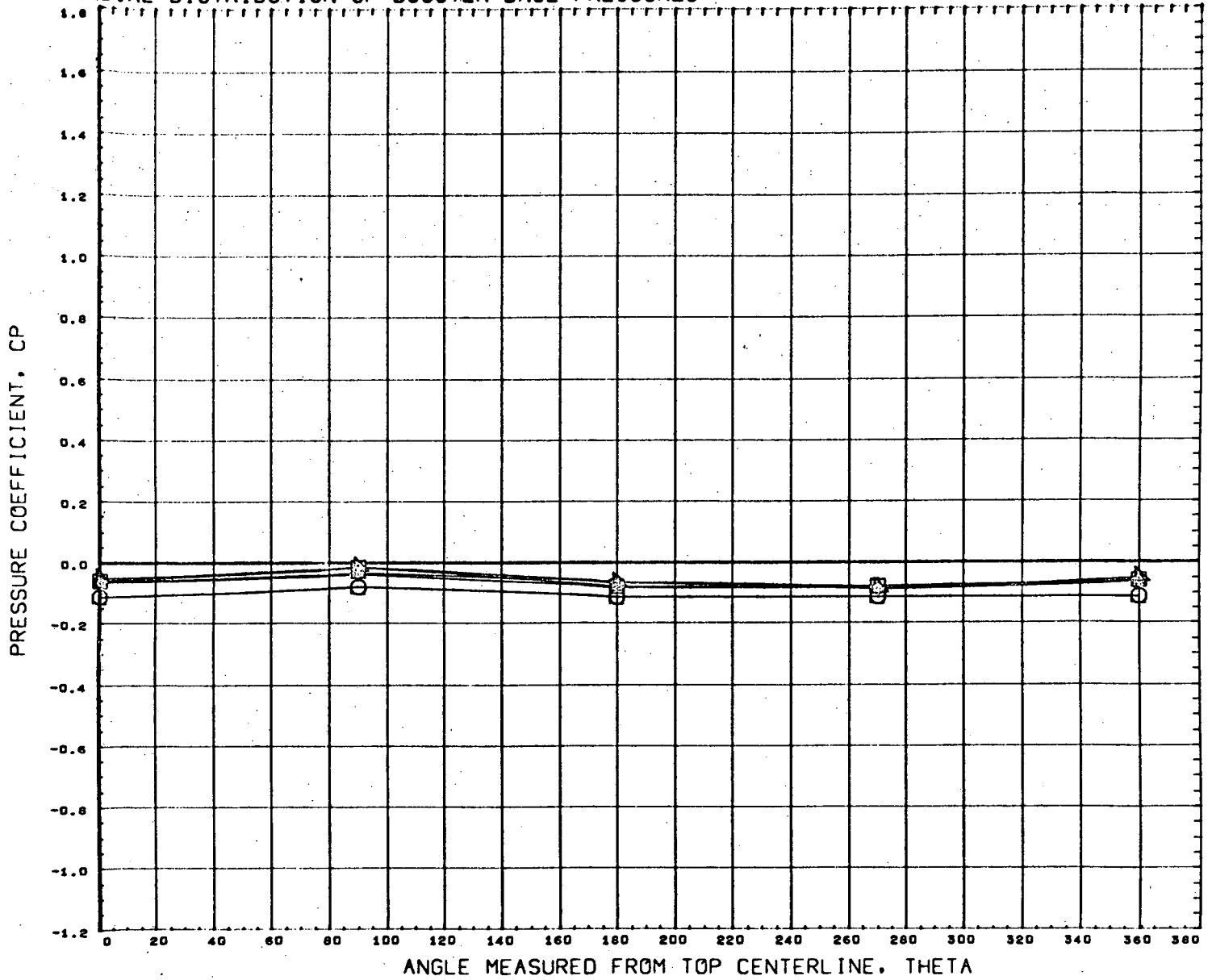

| SYMBOL | BETA | X/L | M1 | PARAMETRIC VALUES |
|--------|-------|-------|-------|-----------------------|
| ◇ | 5.858 | 1.000 | 1.064 | ALFB 0.000 DX/L 0.036 |
| ◇ | 3.758 | | | I 0.000 |
| ◇ | 1.727 | | | |
| ◇ | 0.370 | | | |
| ◇ | 2.147 | | | |

REFERENCE FILE

RADIAL DISTRIBUTION OF BOOSTER BASE PRESSURES

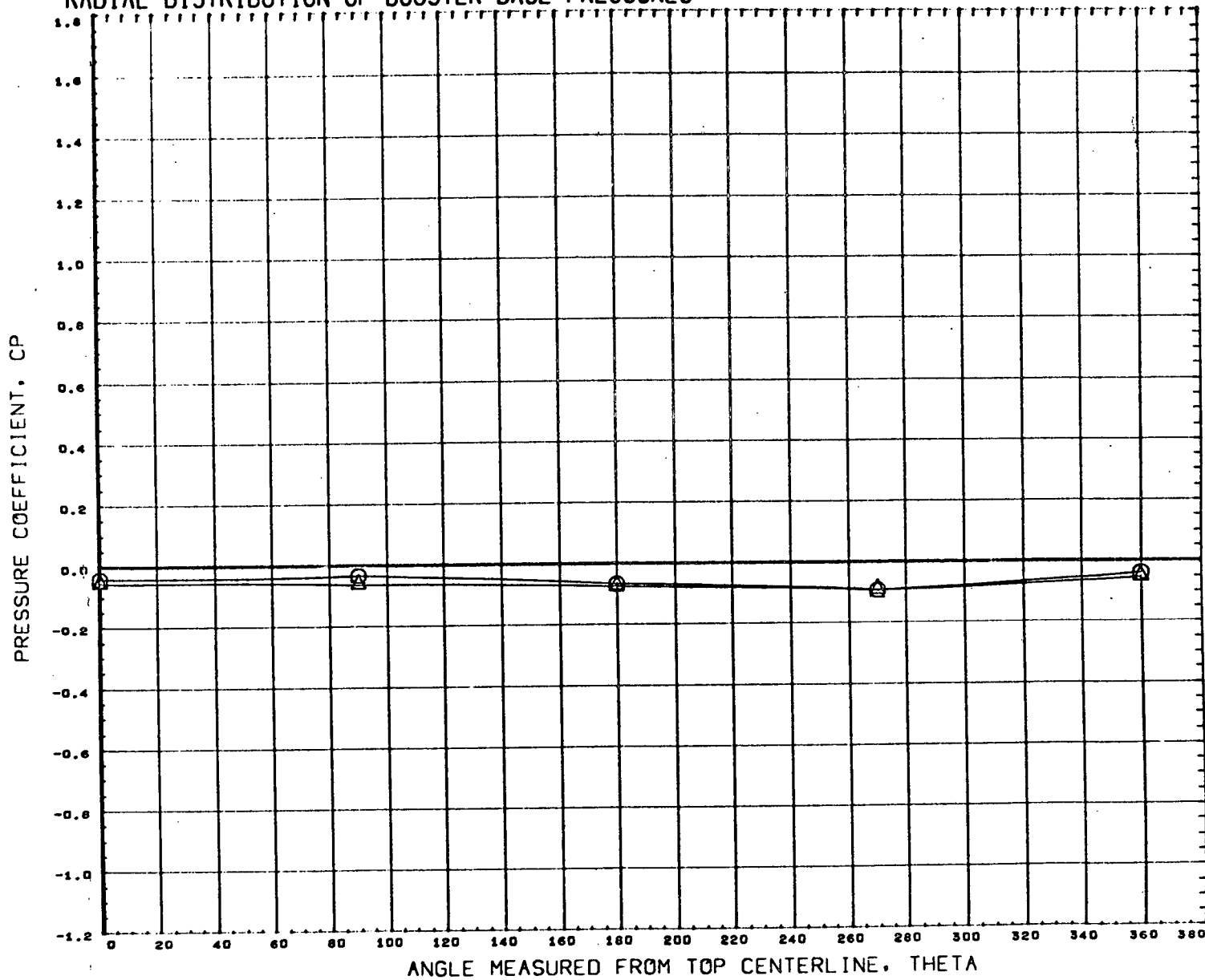

| SYMBOL | BETA | X/L | M1 |
|--------|-------|-------|-------|
| ○ | 4.227 | 1.000 | 1.004 |
| △ | 6.297 | | |

| PARAMETRIC VALUES | | |
|-------------------|-------|------------|
| ALFB | 0.000 | DX/L 0.036 |
| I | 0.000 | |

REFERENCE FILE

AEDC TC174 MDAC BOOSTER NEAR ORBITER (BASE)

(ETC006)

PAGE 474

RADIAL DISTRIBUTION OF BOOSTER BASE PRESSURES

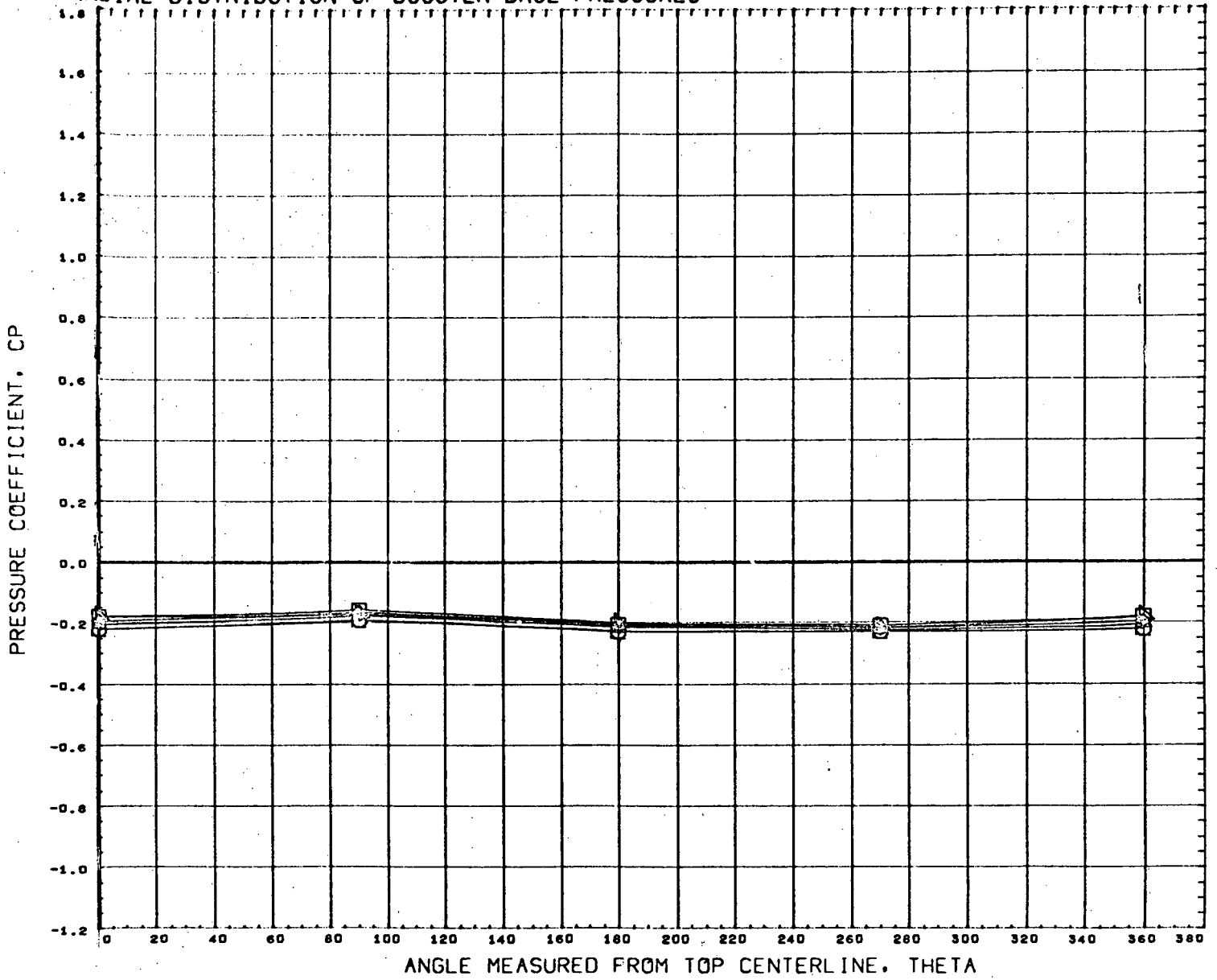

| SYMBOL | BETA | X/L | M1 | ALFB | PARAMETRIC VALUES | | |
|--------|-------|-------|-------|-------|-------------------|-------|--|
| ◇ | 6.178 | 1.000 | 1.099 | 0.000 | 0x/L | 0.036 | |
| ◇ | 4.110 | | | 0.000 | | | |
| ◇ | 2.033 | | | | | | |
| ◇ | 0.268 | | | | | | |
| ◇ | 1.827 | | | | | | |

REFERENCE FILE

RADIAL DISTRIBUTION OF BOOSTER BASE PRESSURES

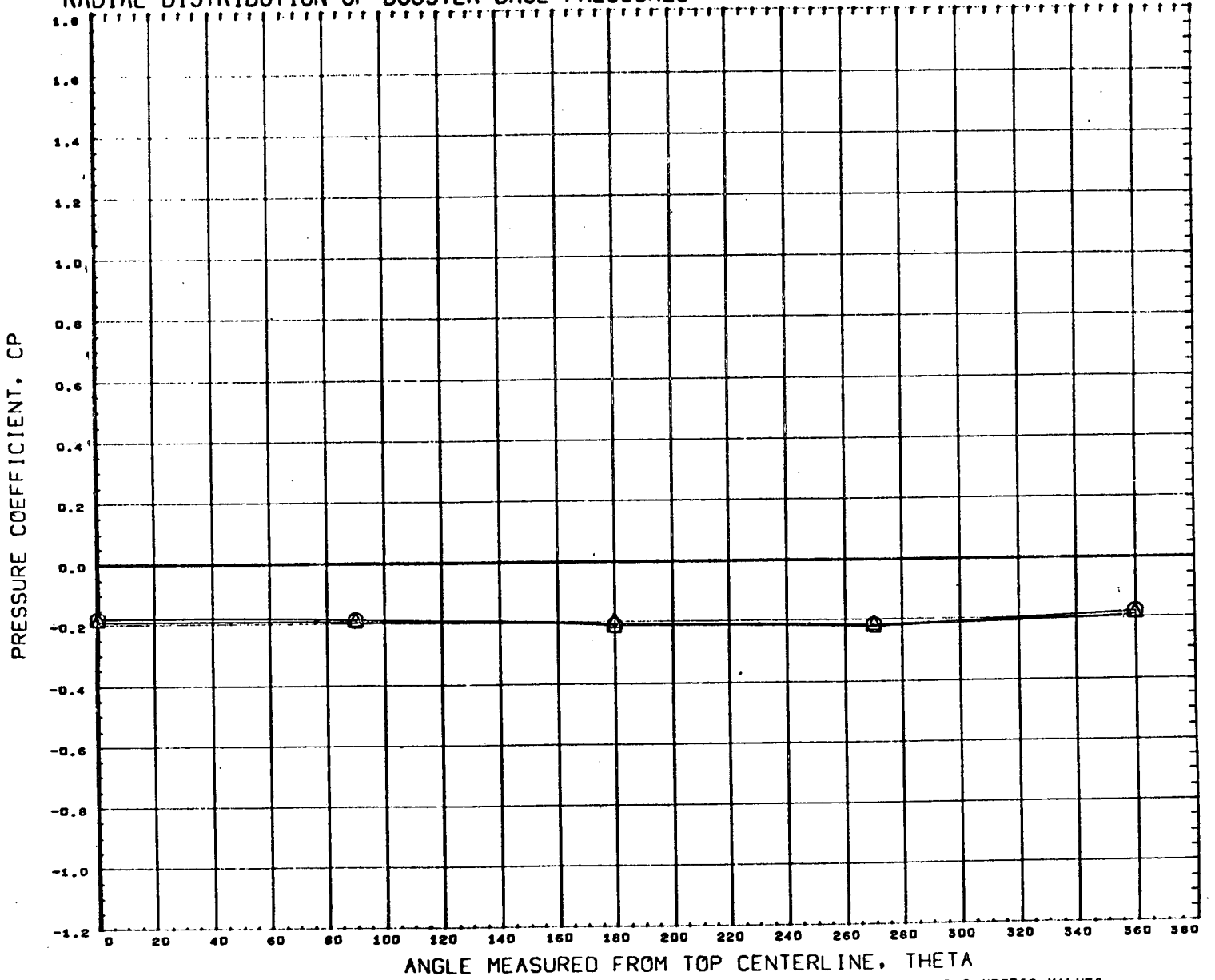

| SYMBOL | PARAMETRIC VALUES | | | PARAMETRIC VALUES | | |
|--------|-------------------|-------|-------|-------------------|------|-------|
| | BETA | X/L | M1 | ALFB | DX/L | |
| ○ | 3.902 | 1.000 | 1.099 | 0.000 | | 0.036 |
| △ | 5.993 | | | 0.000 | | |

REFERENCE FILE

RADIAL DISTRIBUTION OF BOOSTER BASE PRESSURES

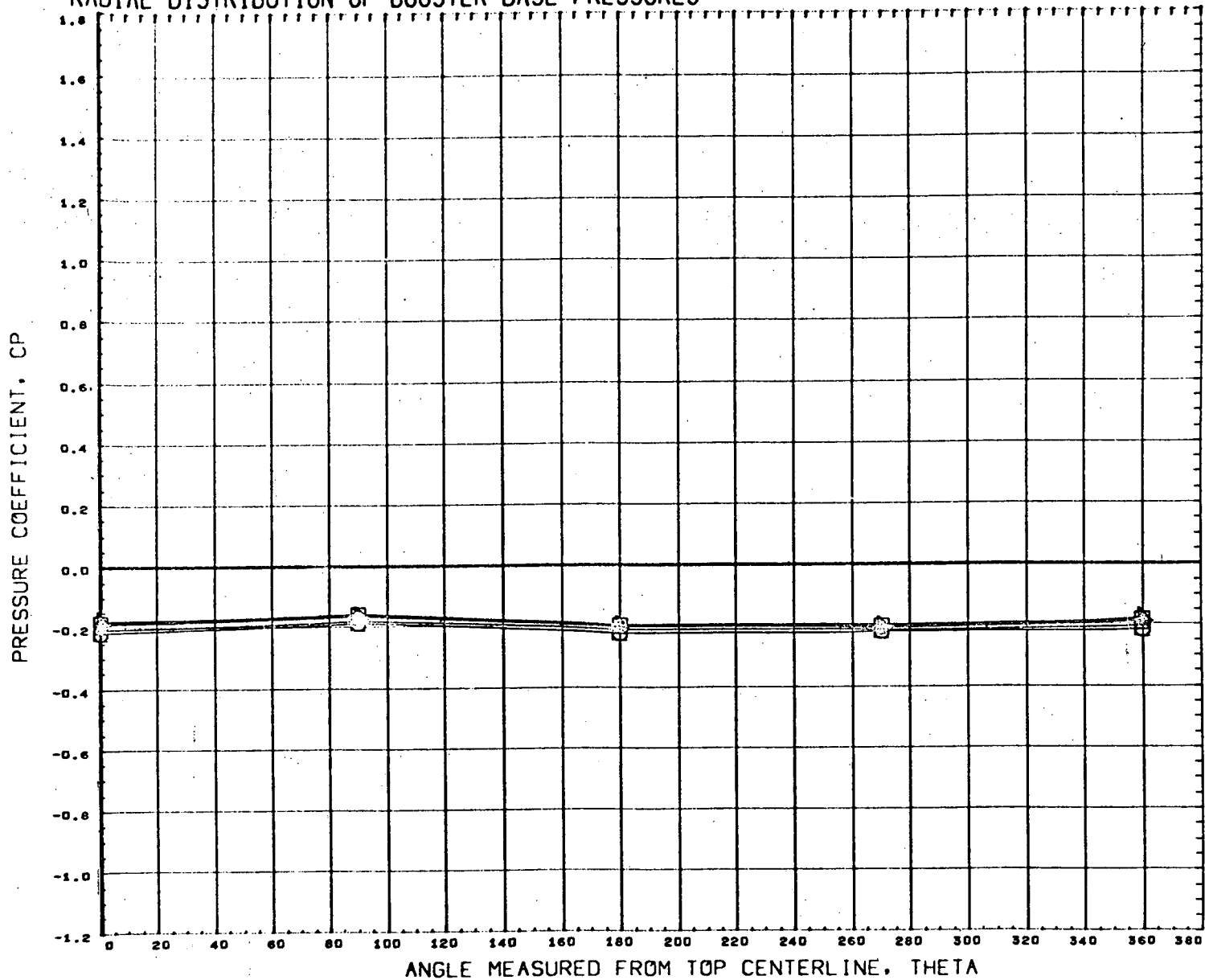

| SYMBOL | BETA | X/L | M1 | PARAMETRIC VALUES | | |
|--------|-------|-------|-------|-------------------|------|-------|
| | | | | ALFB | DX/L | 0.036 |
| ○ | 6.194 | 1.000 | 1.201 | 0.000 | | |
| △ | 4.117 | | | 0.000 | | |
| ◇ | 1.825 | | | | | |
| □ | 0.517 | | | | | |
| ▽ | 1.830 | | | | | |

REFERENCE FILE

RADIAL DISTRIBUTION OF BOOSTER BASE PRESSURES

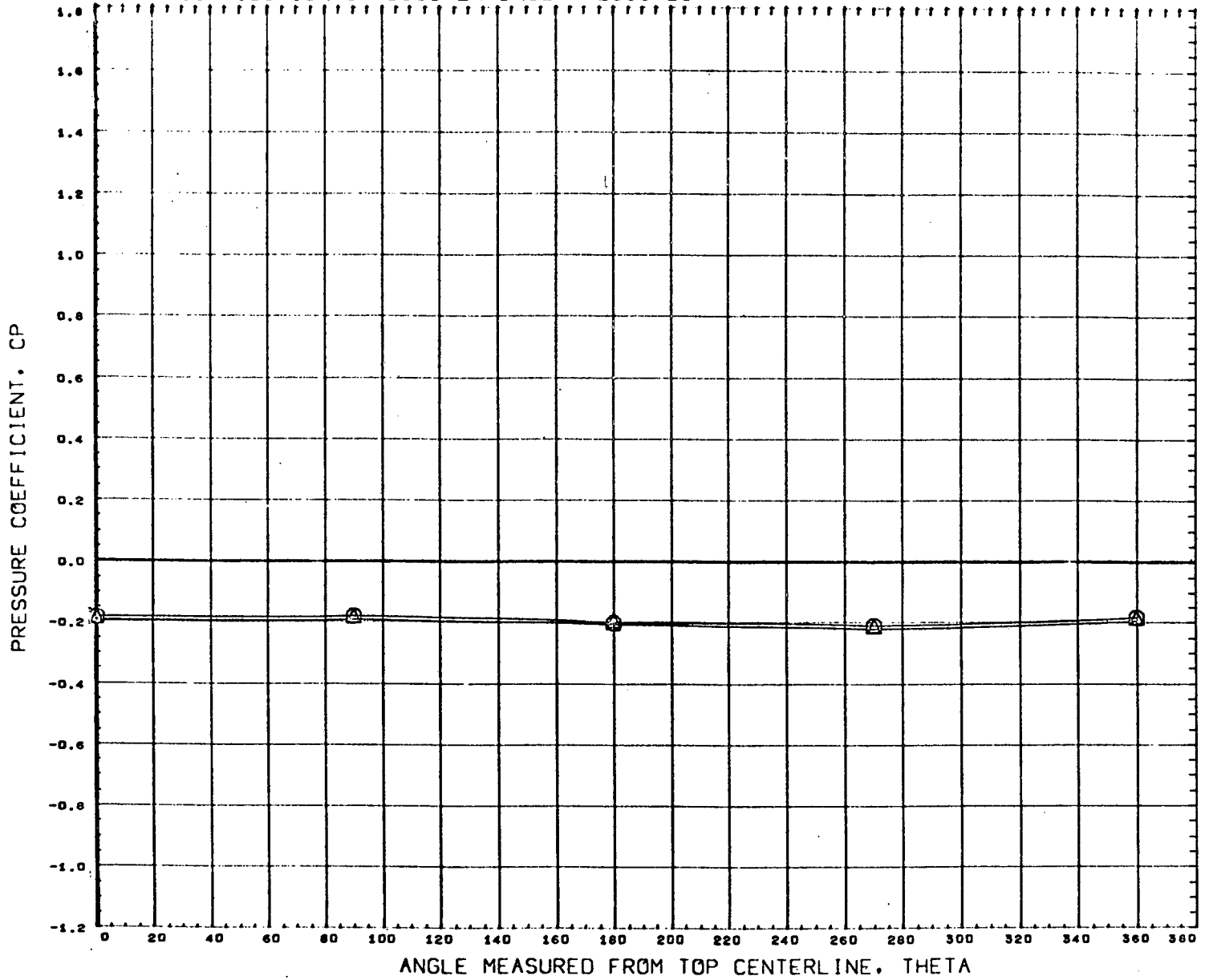

| | | | | | | |
|--------|-------|-------|-------|-------|-------------------|-------|
| SYMBOL | BETA | X/L | M1 | ALFB | PARAMETRIC VALUES | |
| ○ | 3.904 | 1.000 | 1.201 | 0.000 | OX/L | 0.036 |
| △ | 5.997 | | | 1 | 0.000 | |

REFERENCE FILE

RADIAL DISTRIBUTION OF BOOSTER BASE PRESSURES

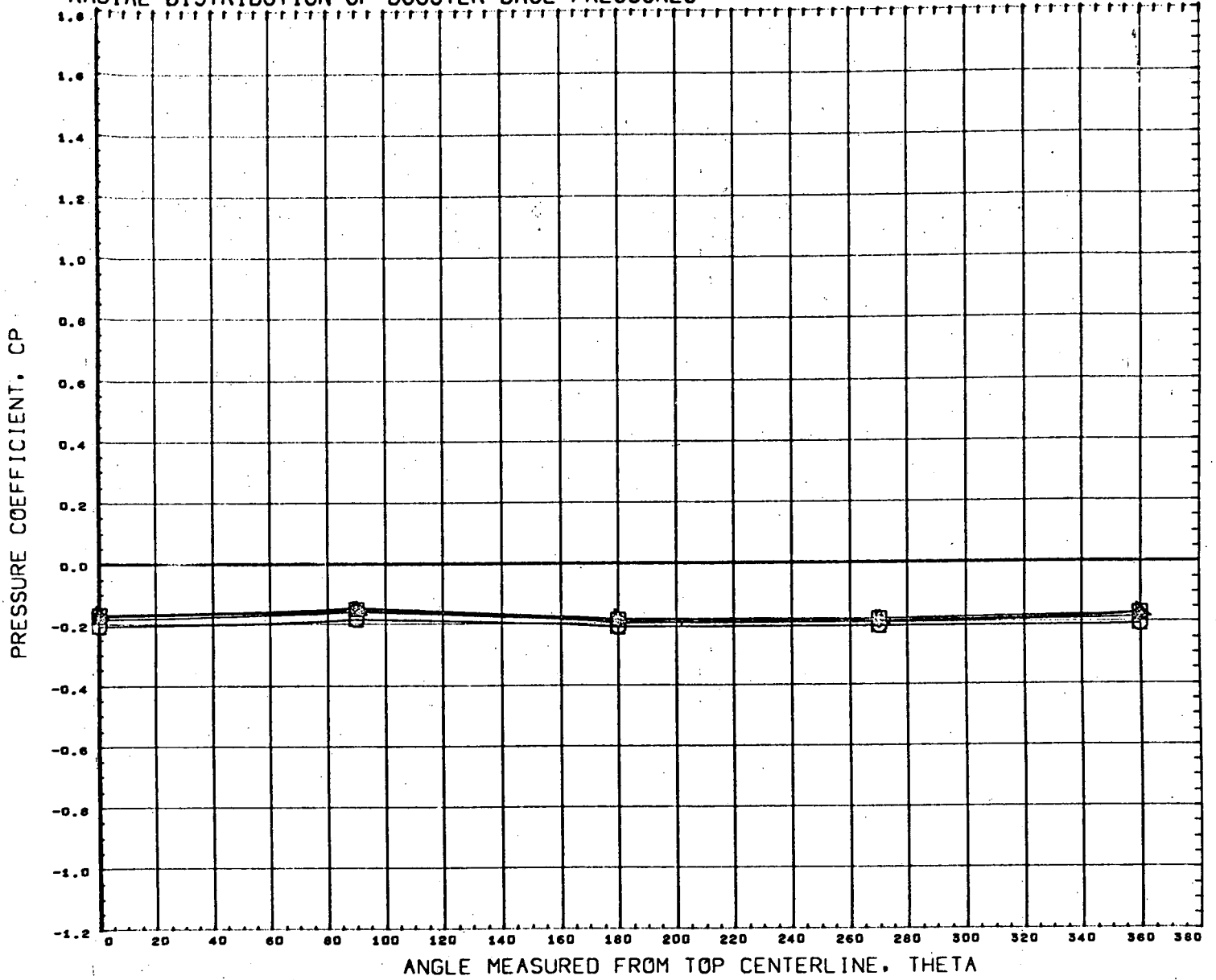

| SYMBOL | BETA | X/L | M1 | ALFB | PARAMETRIC VALUES | DX/L | |
|--------|---------|-------|-------|------|-------------------|------|-------|
| ○ | - 6.217 | 1.000 | 1.299 | | 0.000 | | 0.036 |
| △ | - 4.137 | | | I | 0.000 | | |
| ◇ | - 2.051 | | | | | | |
| □ | - 0.270 | | | | | | |
| ▽ | 1.816 | | | | | | |

REFERENCE FILE

RADIAL DISTRIBUTION OF BOOSTER BASE PRESSURES

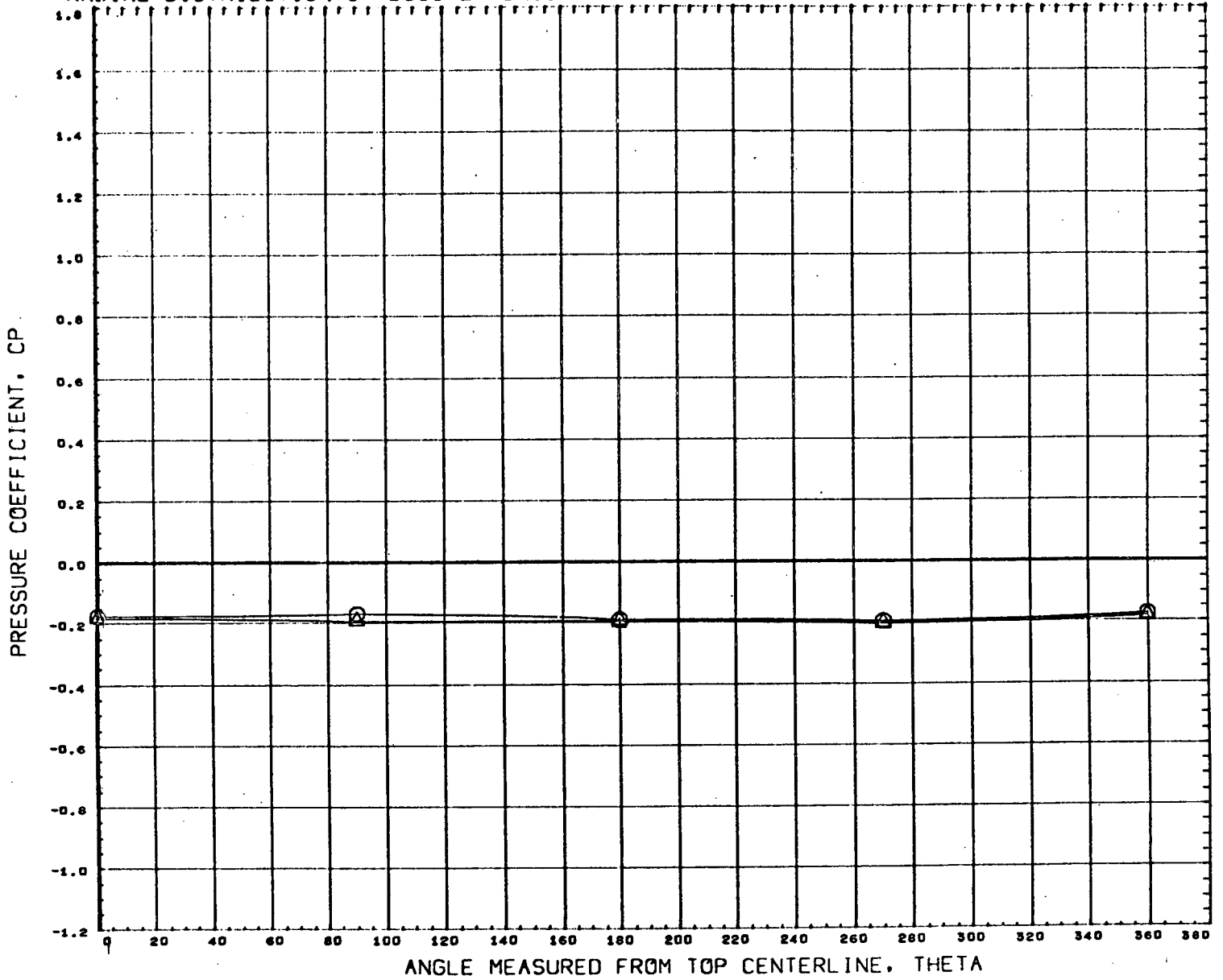

| | | | | | | | |
|--------|-------|-------|-------|-------------------|-------|------|-------|
| SYMBOL | BETA | X/L | M1 | PARAMETRIC VALUES | | | |
| ○ | 3.882 | 1.000 | 1.299 | ALFB | 0.000 | DX/L | 0.036 |
| △ | 5.980 | | | I | 0.000 | | |

REFERENCE FILE

RADIAL DISTRIBUTION OF BOOSTER BASE PRESSURES

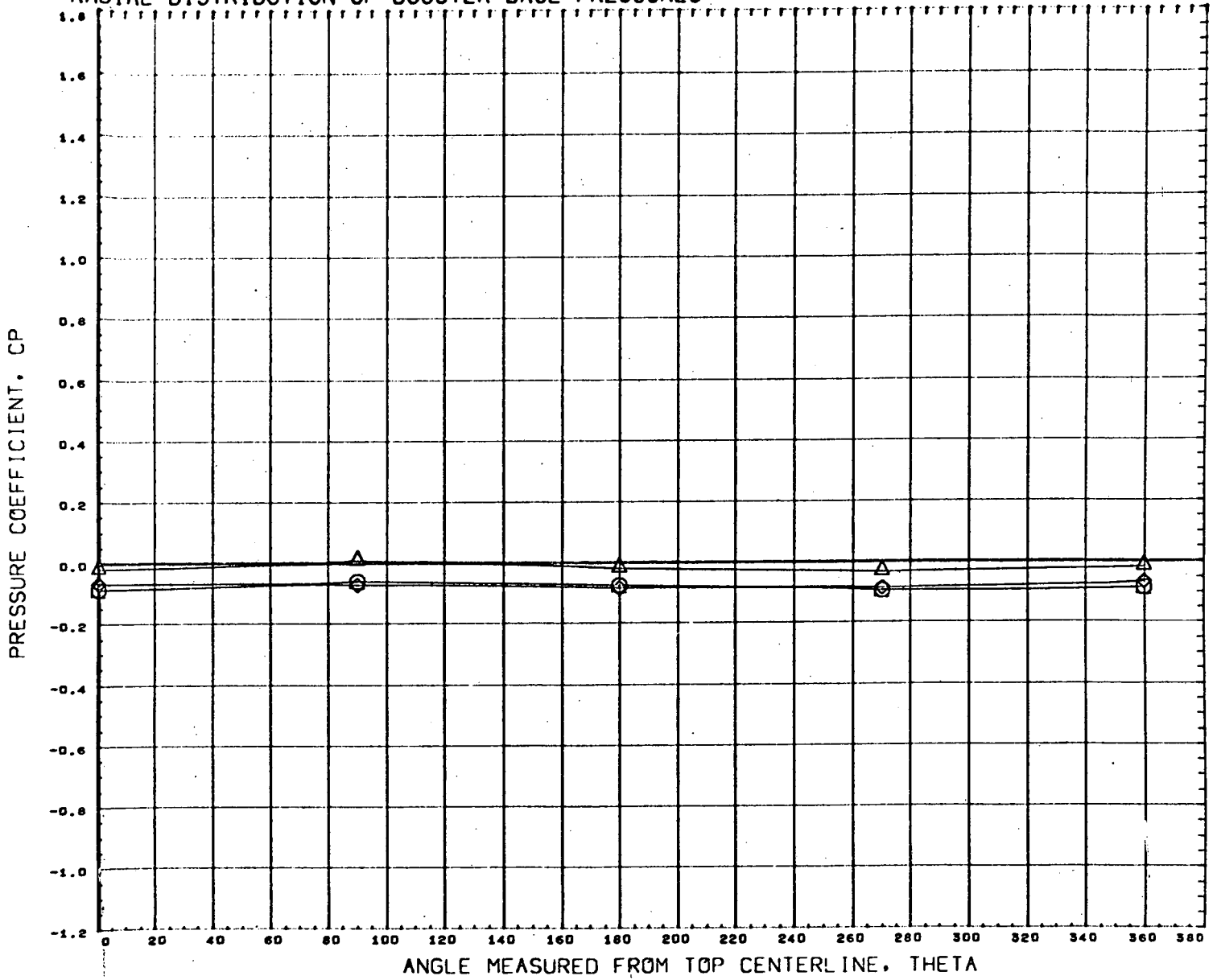

| SYMBOL | BETA | X/L | M1 |
|--------|-------|-------|-------|
| △ | 4.097 | 1.000 | 0.599 |
| ○ | 0.032 | | |
| ◇ | 4.299 | | |

| PARAMETRIC VALUES | | | |
|-------------------|-------|------|-------|
| ALFB | 6.000 | OX/L | 0.036 |
| I | 0.000 | | |

REFERENCE FILE

RADIAL DISTRIBUTION OF BOOSTER BASE PRESSURES

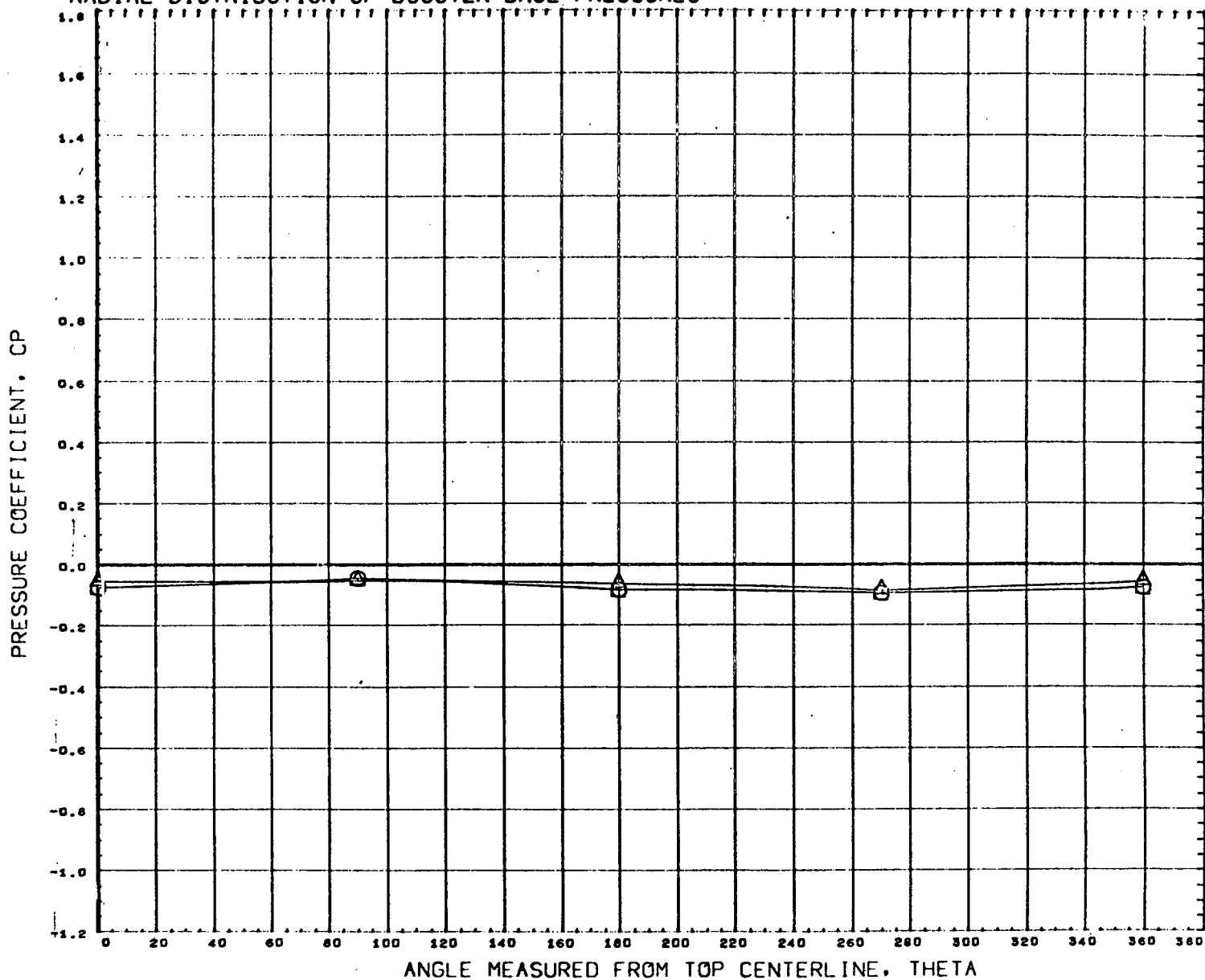

| SYMBOL | BETA | X/L | M1 |
|--------|-------|-------|-------|
| ○ | 4.138 | 1.000 | 0.901 |
| △ | 4.250 | | |

| PARAMETRIC VALUES | | |
|-------------------|-------|------------|
| ALFB | 6.000 | DX/L 0.036 |
| I | 0.000 | |

REFERENCE FILE

RADIAL DISTRIBUTION OF BOOSTER BASE PRESSURES

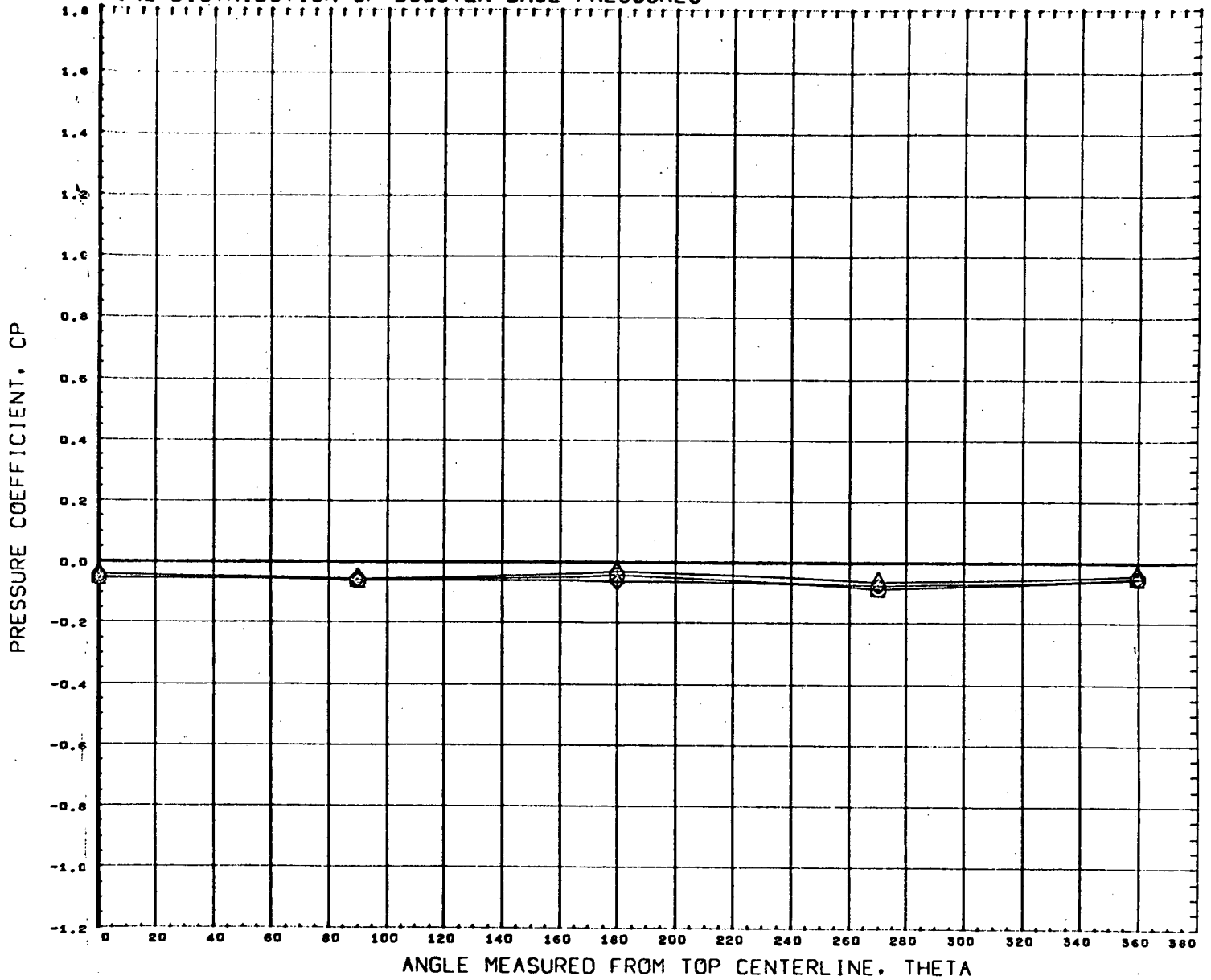

| | | | | | | |
|--------|-------|-------|-------|-------------------|-------|------------|
| SYMBOL | BETA | X/L | M1 | PARAMETRIC VALUES | | |
| ○ | 4.168 | 1.000 | 0.995 | ALFB | 6.000 | DX/L 0.036 |
| △ | 0.062 | | | I | 0.000 | |
| ◇ | 4.315 | | | | | |

REFERENCE FILE

RADIAL DISTRIBUTION OF BOOSTER BASE PRESSURES

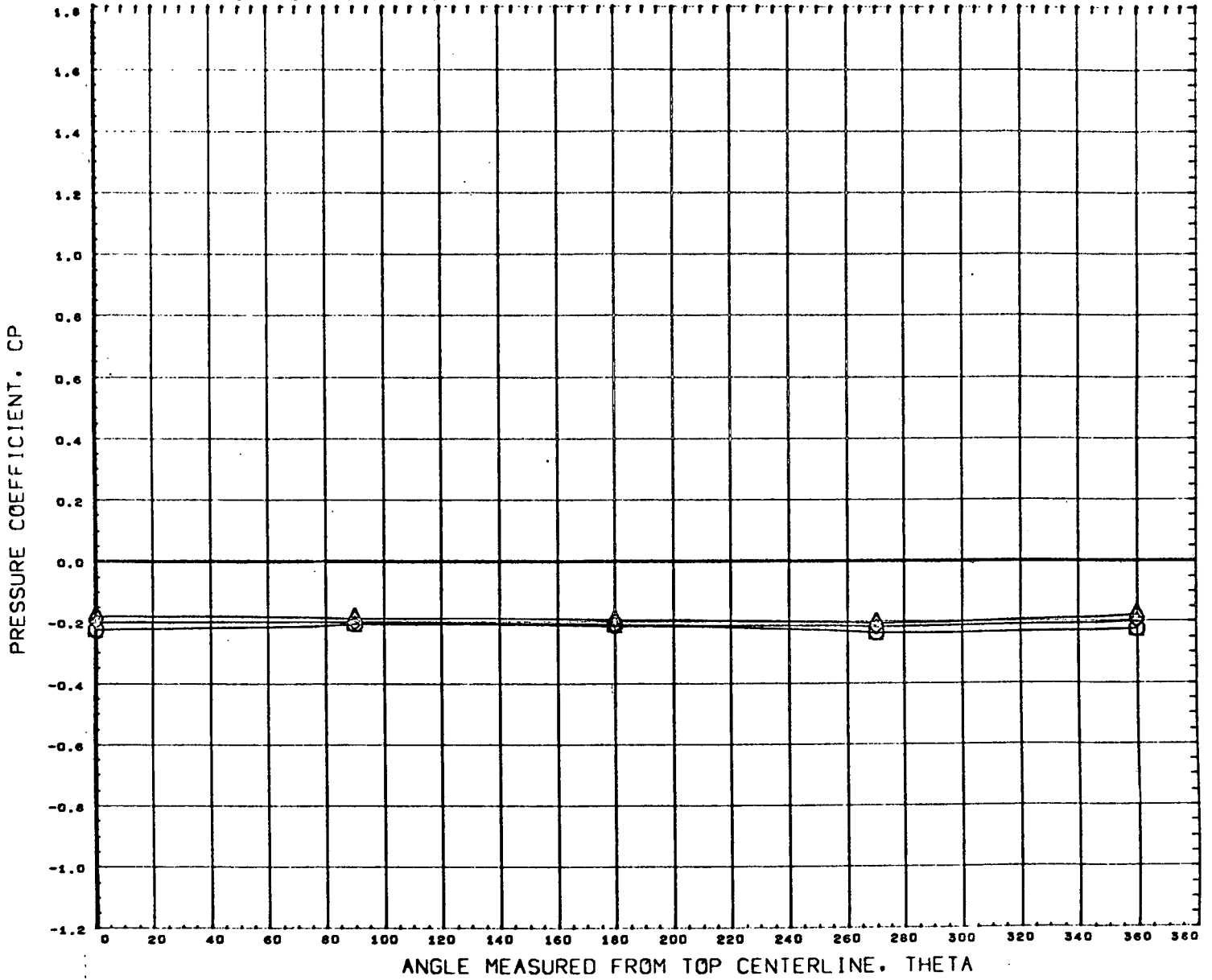

| | | | | |
|--------|-------|-------|-------|-------------------------|
| SYMBOL | BETA | X/L | M1 | PARAMETRIC VALUES |
| ○ | 4.195 | 1.000 | 1.100 | ALFB - 6.000 DX/L 0.036 |
| △ | 0.061 | | | I 0.000 |
| ◇ | 4.344 | | | |

REFERENCE FILE

RADIAL DISTRIBUTION OF BOOSTER BASE PRESSURES

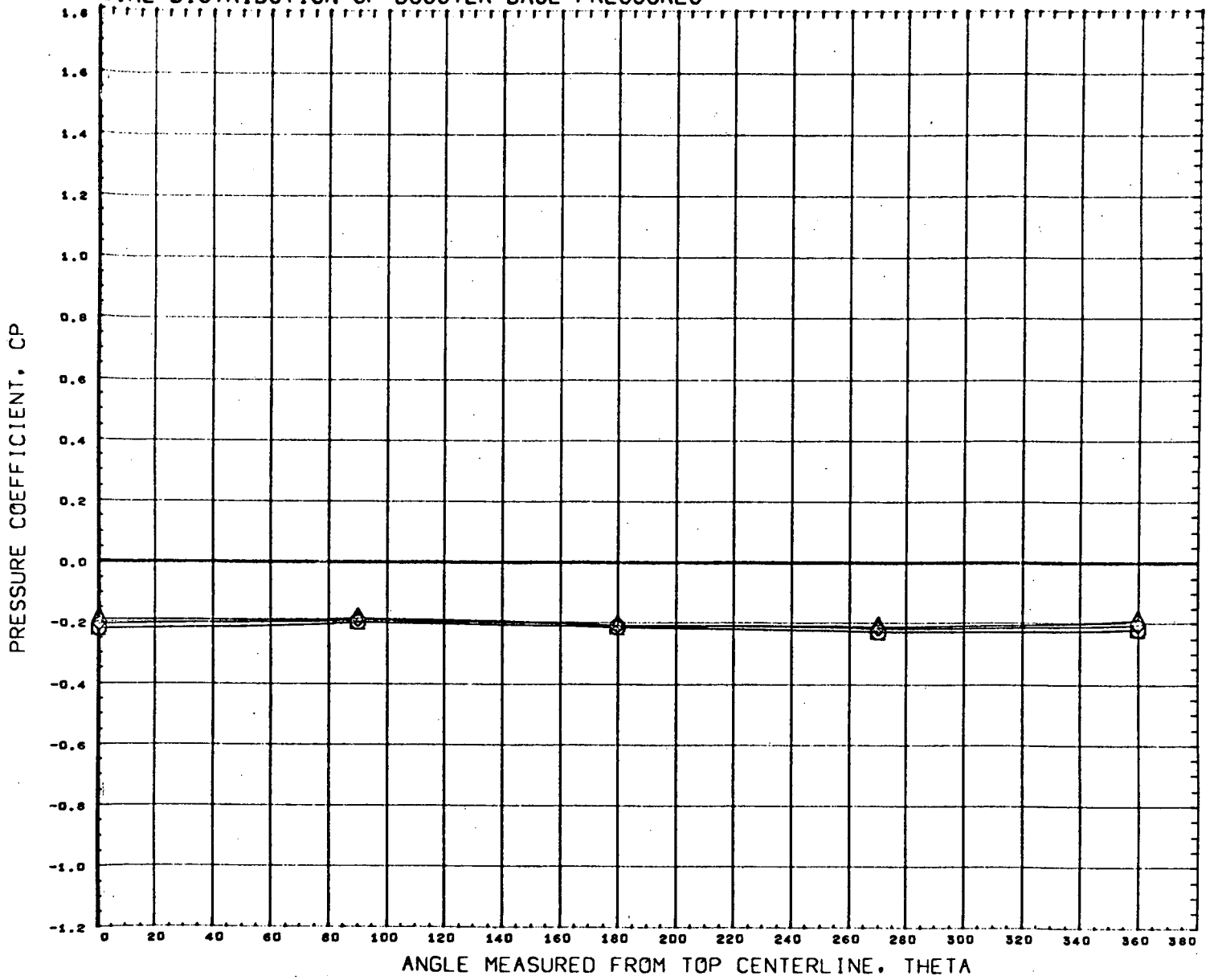

| SYMBOL | BETA | X/L | M1 |
|--------|-------|-------|-------|
| ○ | 4.213 | 1.000 | 1.199 |
| △ | 0.048 | | |
| ◇ | 4.359 | | |

| PARAMETRIC VALUES | | |
|-------------------|-------|------------|
| ALFB | 6.000 | DX/L 0.036 |
| I | 0.000 | |

REFERENCE FILE

RADIAL DISTRIBUTION OF BOOSTER BASE PRESSURES

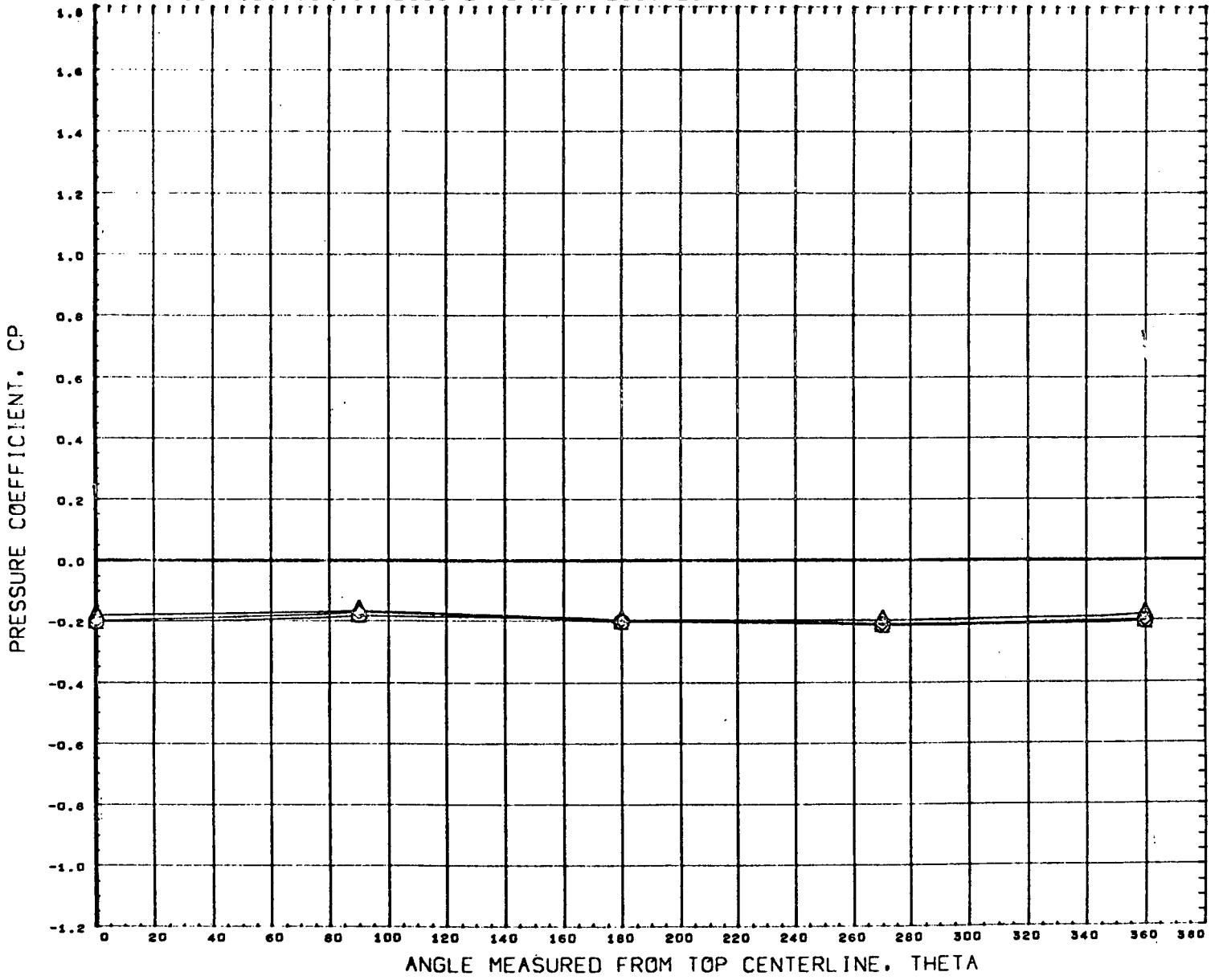

| SYMBOL | BETA | X/L | M1 |
|--------|-------|-------|-------|
| ○ | 4.204 | 1.000 | 1.297 |
| △ | 0.035 | | |
| ◇ | 4.318 | | |

| PARAMETRIC VALUES | | |
|-------------------|-------|------------|
| ALFB | 6.000 | DX/L 0.036 |
| I | 0.000 | |

REFERENCE FILE

RADIAL DISTRIBUTION OF BOOSTER BASE PRESSURES

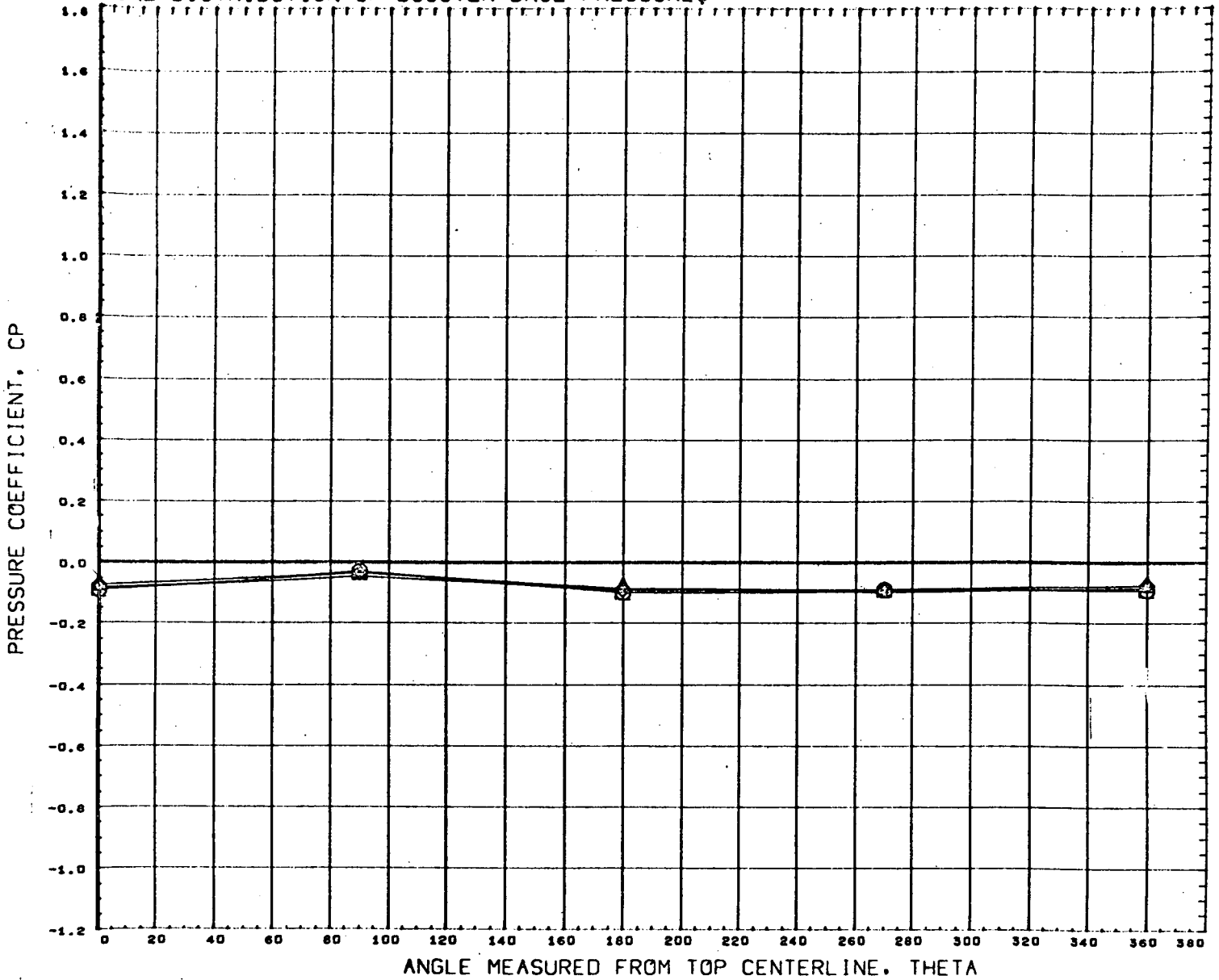

| SYMBOL | BETA | X/L | M1 | ALFB | PARAMETRIC VALUES | | |
|--------|-------|-------|-------|-------|-------------------|-------|--|
| ◇ | 3.664 | 1.000 | 0.600 | 6.000 | DX/L | 0.036 | |
| △ | 0.026 | | | 1 | 0.000 | | |
| ◇ | 3.735 | | | | | | |

REFERENCE FILE

RADIAL DISTRIBUTION OF BOOSTER BASE PRESSURES

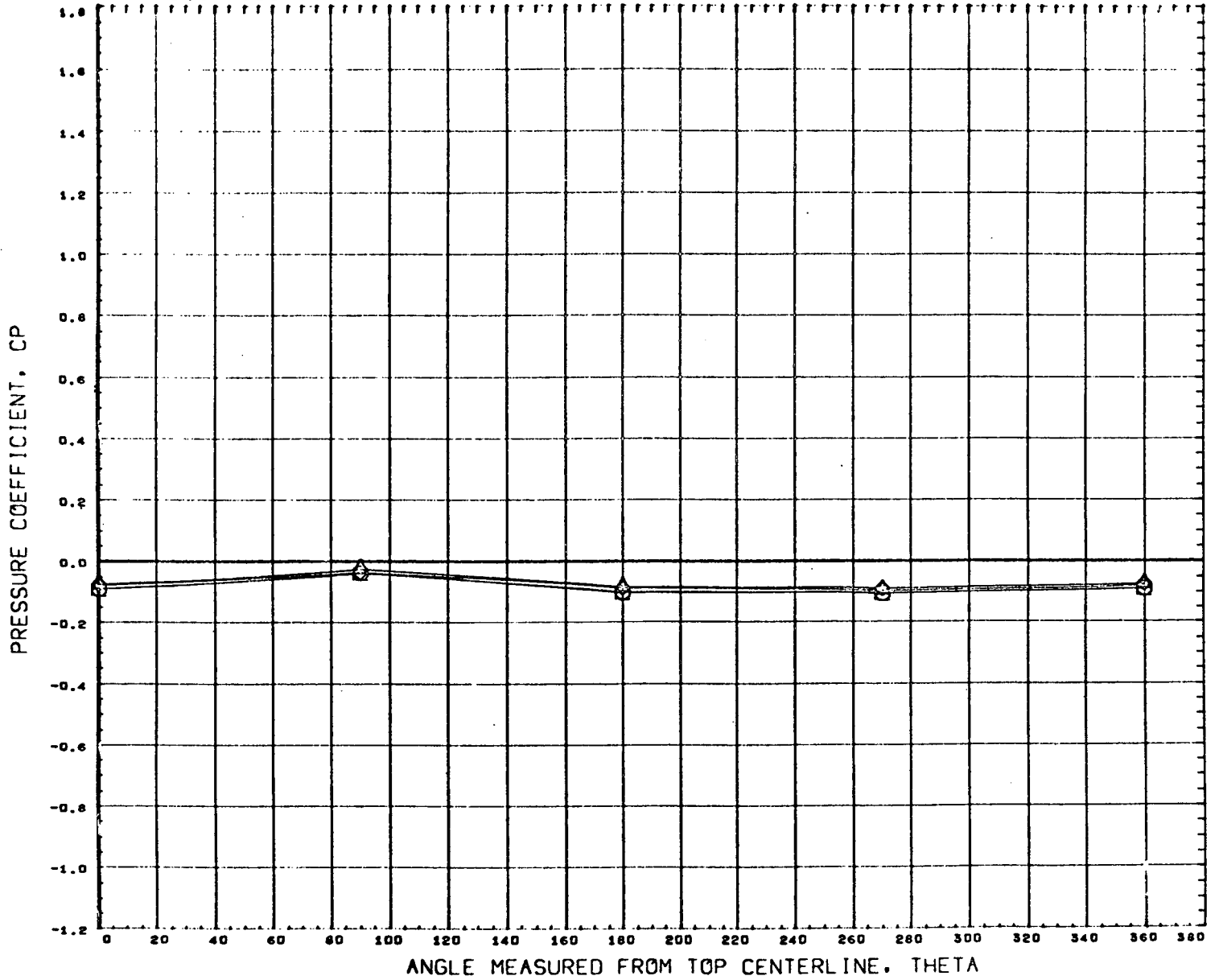

| | | | | |
|--------|-------|-------|-------|-----------------------|
| SYMBOL | BETA | X/L | M1 | PARAMETRIC VALUES |
| ○ | 5.711 | 1.000 | 0.991 | ALFB 6.000 DX/L 0.036 |
| △ | 0.038 | | | I 0.000 |
| ◇ | 3.785 | | | |

REFERENCE FILE

RADIAL DISTRIBUTION OF BOOSTER BASE PRESSURES

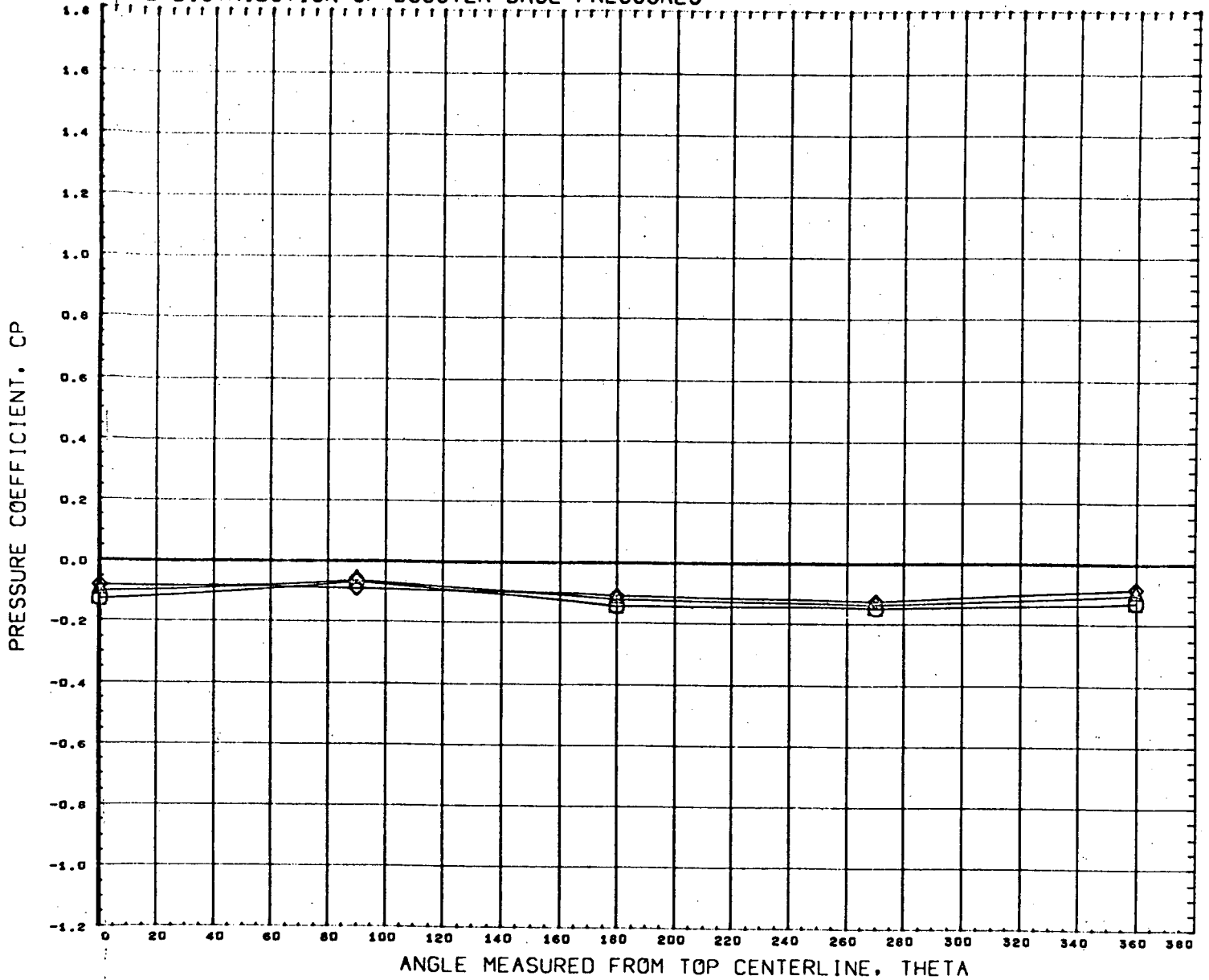

| SYMBOL | BETA | X/L | M1 | PARAMETRIC VALUES |
|--------|-------|-------|-------|-----------------------|
| ○ | 3.742 | 1.000 | 1.002 | ALFB 6.000 DX/L 0.036 |
| △ | 0.036 | | | I 0.000 |
| ◇ | 3.842 | | | |

REFERENCE FILE

RADIAL DISTRIBUTION OF BOOSTER BASE PRESSURES

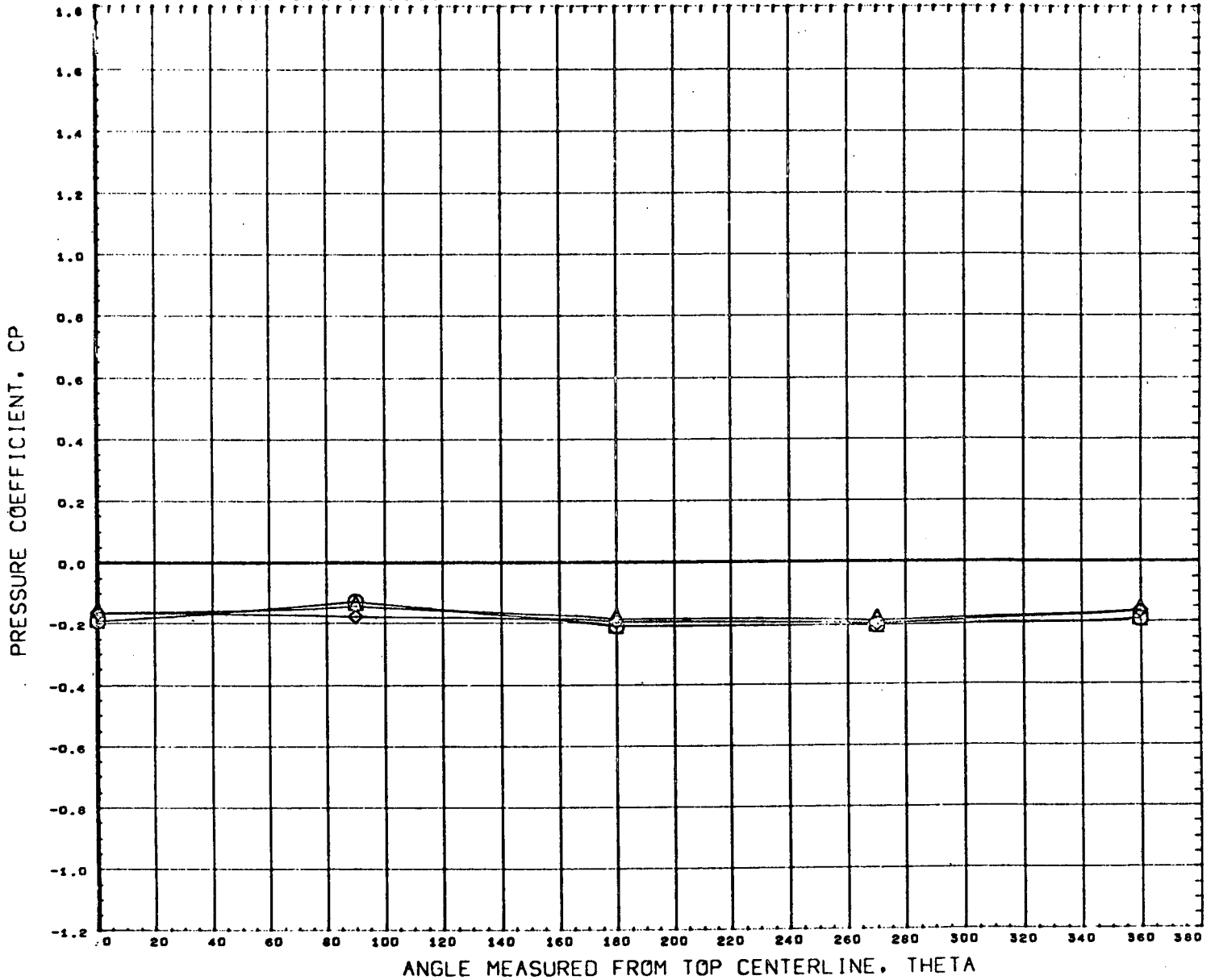

| SYMBOL | BETA | X/L | M1 | ALFB | PARAMETRIC VALUES | | |
|--------|-------|-------|-------|-------|-------------------|-------|--|
| ○ | 3.747 | 1.000 | 1.100 | 6.000 | Dx/L | 0.036 | |
| △ | 0.027 | | | 1 | 0.000 | | |
| ◇ | 3.836 | | | | | | |

REFERENCE FILE

RADIAL DISTRIBUTION OF BOOSTER BASE PRESSURES

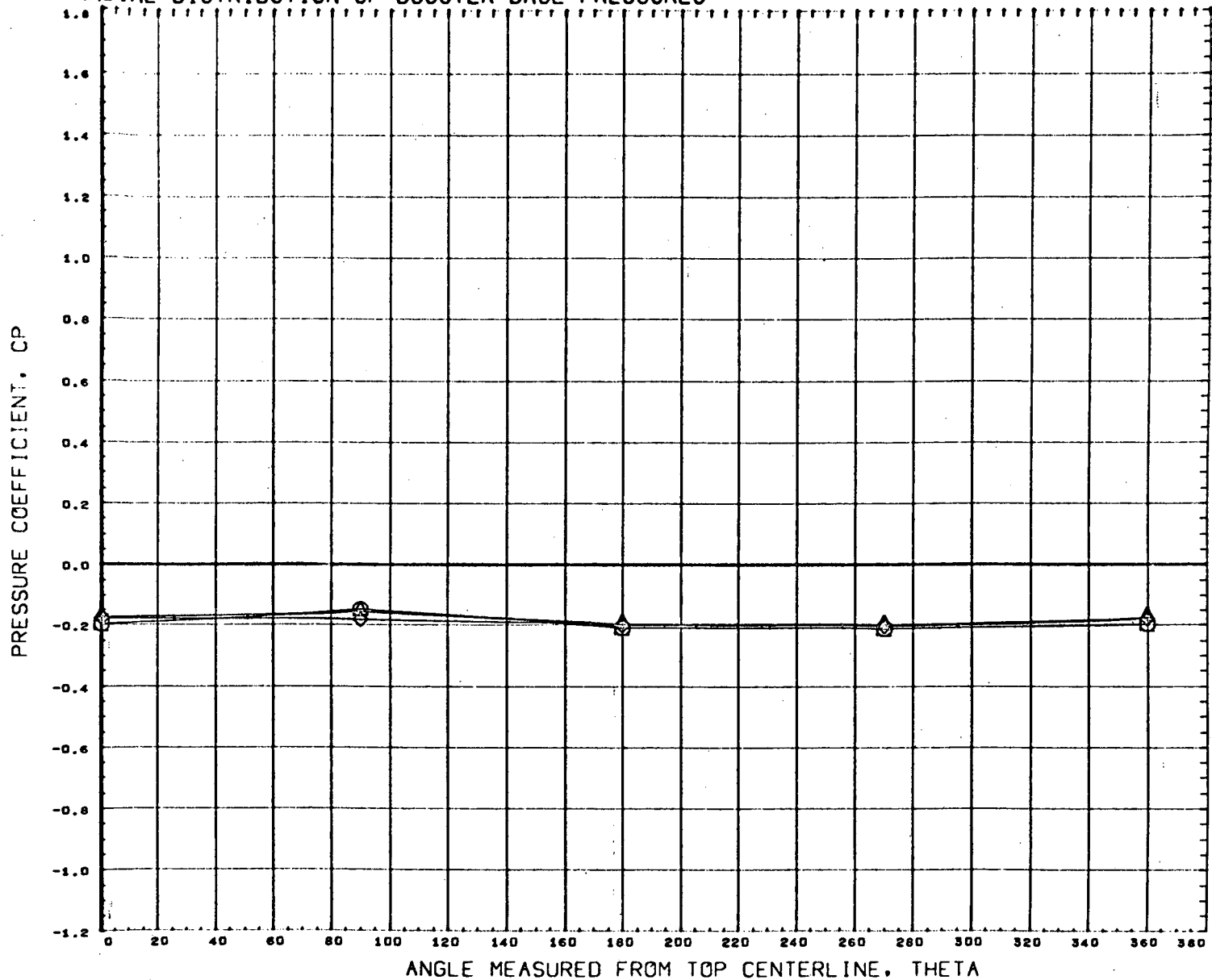

| | | | | |
|--------|-------|-------|-------|-----------------------|
| SYMBOL | DETA | X/L | M1 | PARAMETRIC VALUES |
| ○ | 3.783 | 1.000 | 1.201 | ALFB 6.000 DX/L 0.036 |
| △ | 0.017 | | | I 0.000 |
| ◇ | 3.843 | | | |

REFERENCE FILE

RADIAL DISTRIBUTION OF BOOSTER BASE PRESSURES

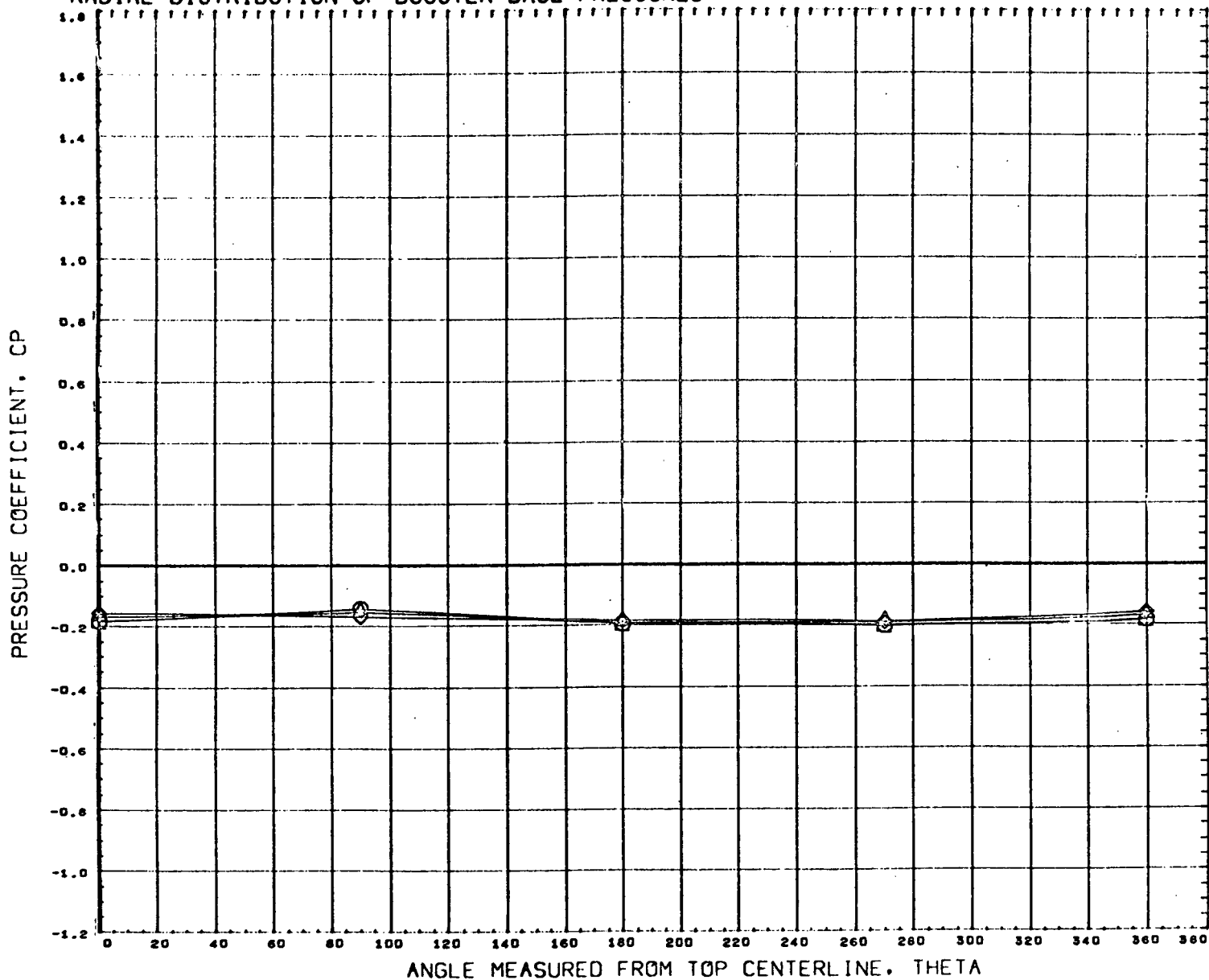

| SYMBOL | BETA | X/L | M1 | ALFB | PARAMETRIC VALUES | | |
|--------|-------|-------|-------|-------|-------------------|-------|--|
| ○ | 3.787 | 1.000 | 1.299 | 6.000 | DX/L | 0.036 | |
| △ | 0.024 | | | 0.000 | | | |
| ◇ | 3.837 | | | 1 | | | |

REFERENCE FILE

RADIAL DISTRIBUTION OF BOOSTER BASE PRESSURES

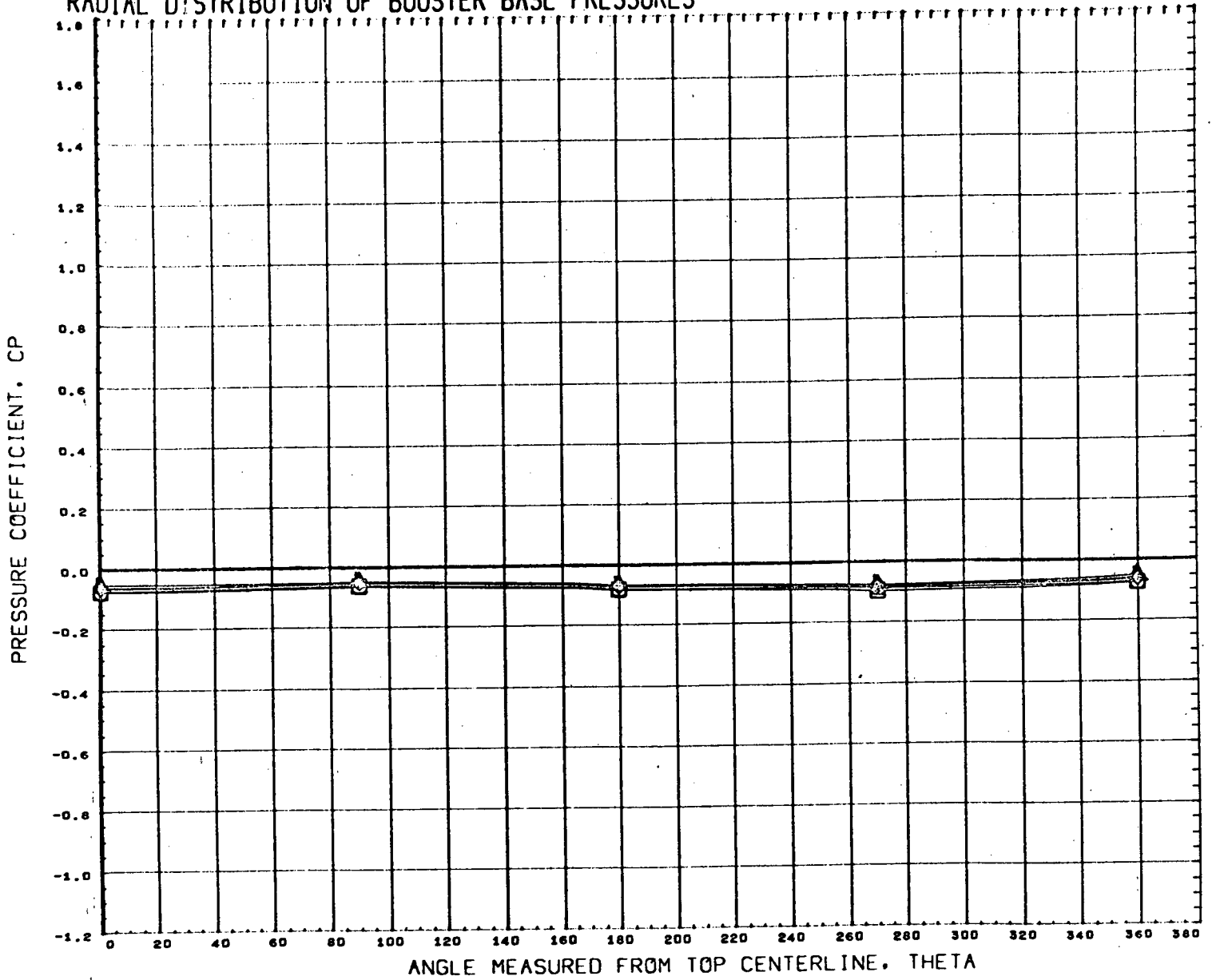

| SYMBOL | ALFB | X/L | M1 | BETA | PARAMETRIC VALUES | |
|--------|-------|-------|-------|-------|-------------------|-------|
| ◇ | 8.148 | 1.000 | 0.601 | 0.000 | DX/L | 0.036 |
| ◇ | 6.084 | | | I | 1.900 | |
| ◇ | 4.017 | | | | | |
| ◇ | 1.949 | | | | | |
| ◇ | 0.119 | | | | | |

REFERENCE FILE

RADIAL DISTRIBUTION OF BOOSTER BASE PRESSURES

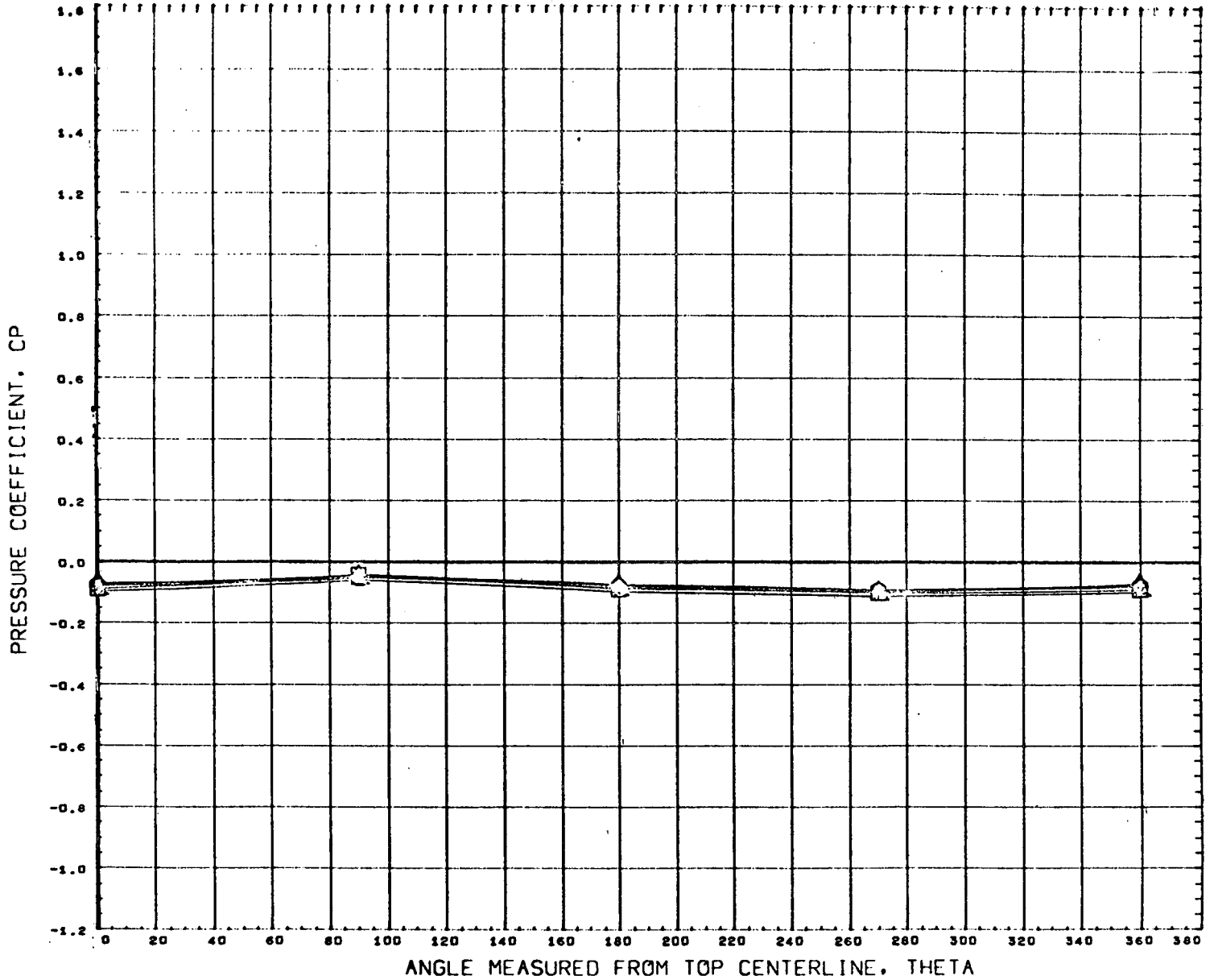

| SYMBOL | ALFB | X/L | M1 | BETA | PARAMETRIC VALUES | DX/L | 0.036 |
|--------|--------|-------|-------|-------|-------------------|------|-------|
| ◇ | 2.172 | 1.000 | 0.601 | 0.000 | | | |
| ◇ | 4.250 | | | 1.900 | | | |
| ◇ | 6.291 | | | | | | |
| ◇ | 8.362 | | | | | | |
| ◇ | 10.431 | | | | | | |

REFERENCE FILE

RADIAL DISTRIBUTION OF BOOSTER BASE PRESSURES

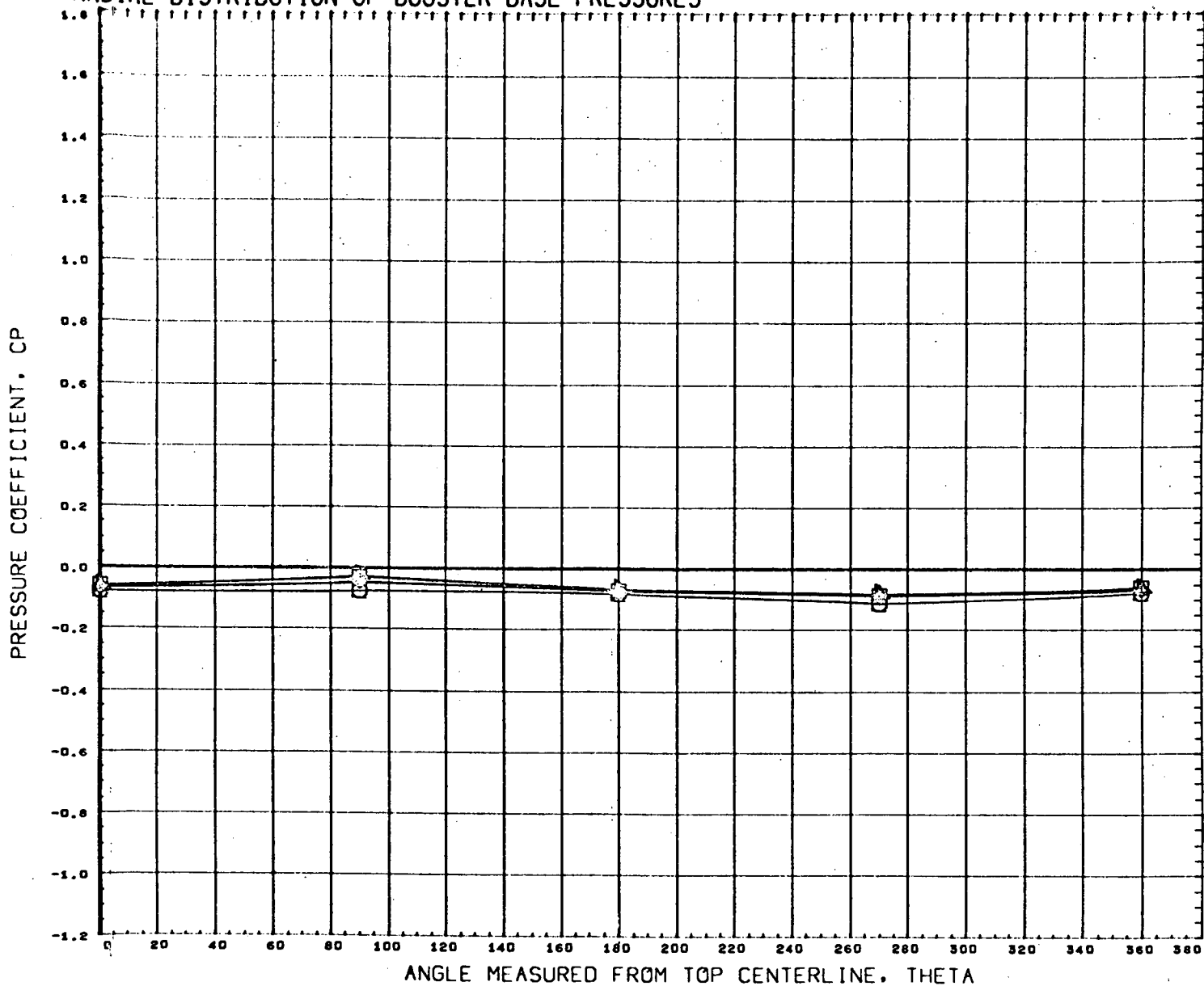

| SYMBOL | ALFB | X/L | M1 |
|--------|---------|-------|-------|
| ◇ | - 8.279 | 1.000 | 0.903 |
| ◇ | - 5.812 | | |
| ◇ | - 3.826 | | |
| ◇ | - 1.834 | | |
| ◇ | 0.163 | | |

| PARAMETRIC VALUES | | |
|-------------------|-------|------------|
| BETA | 0.000 | DX/L 0.036 |
| I | 1.900 | |

REFERENCE FILE

RADIAL DISTRIBUTION OF BOOSTER BASE PRESSURES

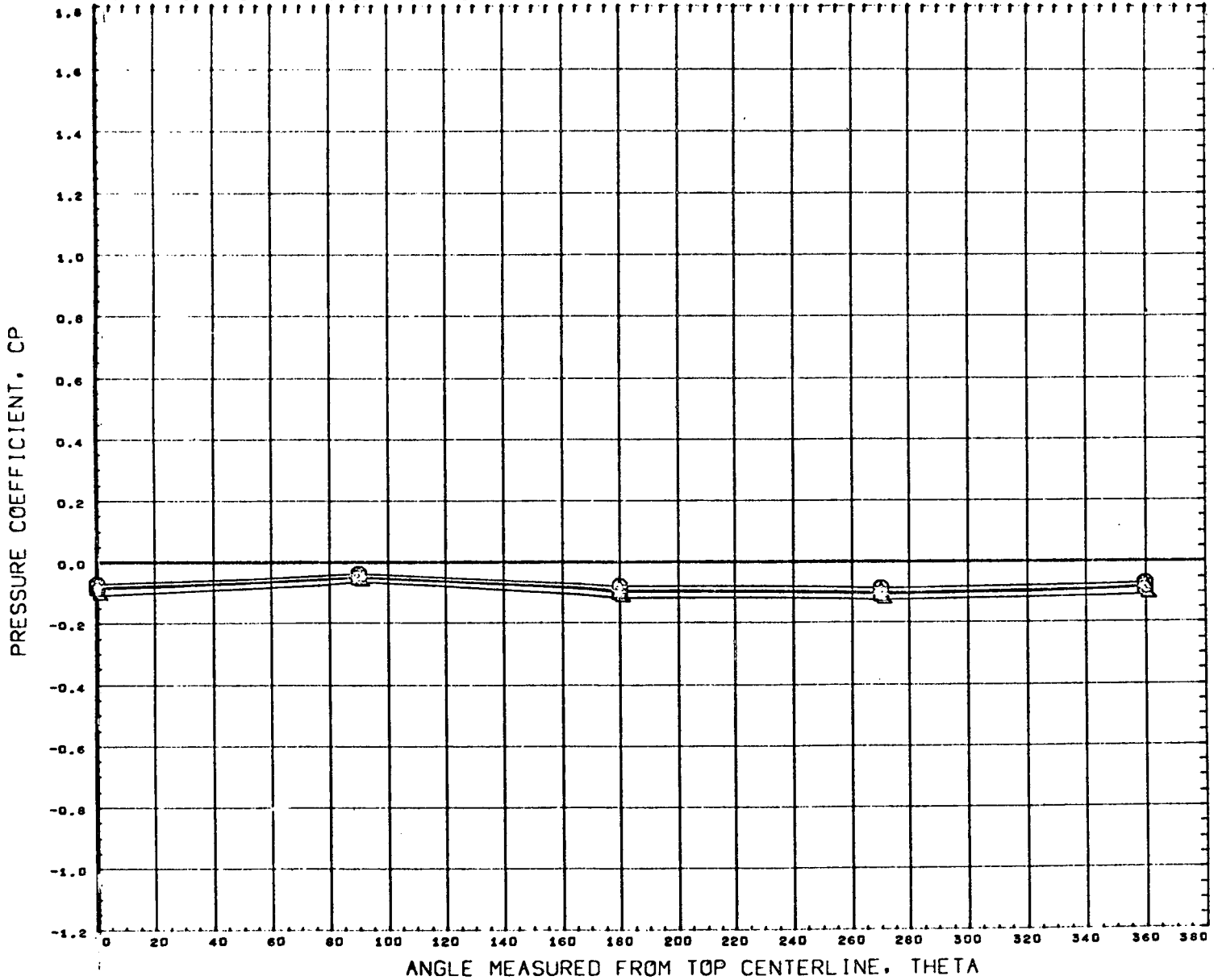

| | | | | | | | |
|---------------------------------|--------|-------|-------|-------------------|-------|------|-------|
| SYMBOL □ ◇ △ □ □ | ALFB | X/L | M1 | PARAMETRIC VALUES | | | |
| | 1.553 | 1.000 | 0.903 | BETA | 0.000 | DX/L | 0.036 |
| | 3.751 | | | I | 1.900 | | |
| | 6.149 | | | | | | |
| | 7.558 | | | | | | |
| | 10.169 | | | | | | |
| REFERENCE FILE | | | | | | | |

RADIAL DISTRIBUTION OF BOOSTER BASE PRESSURES

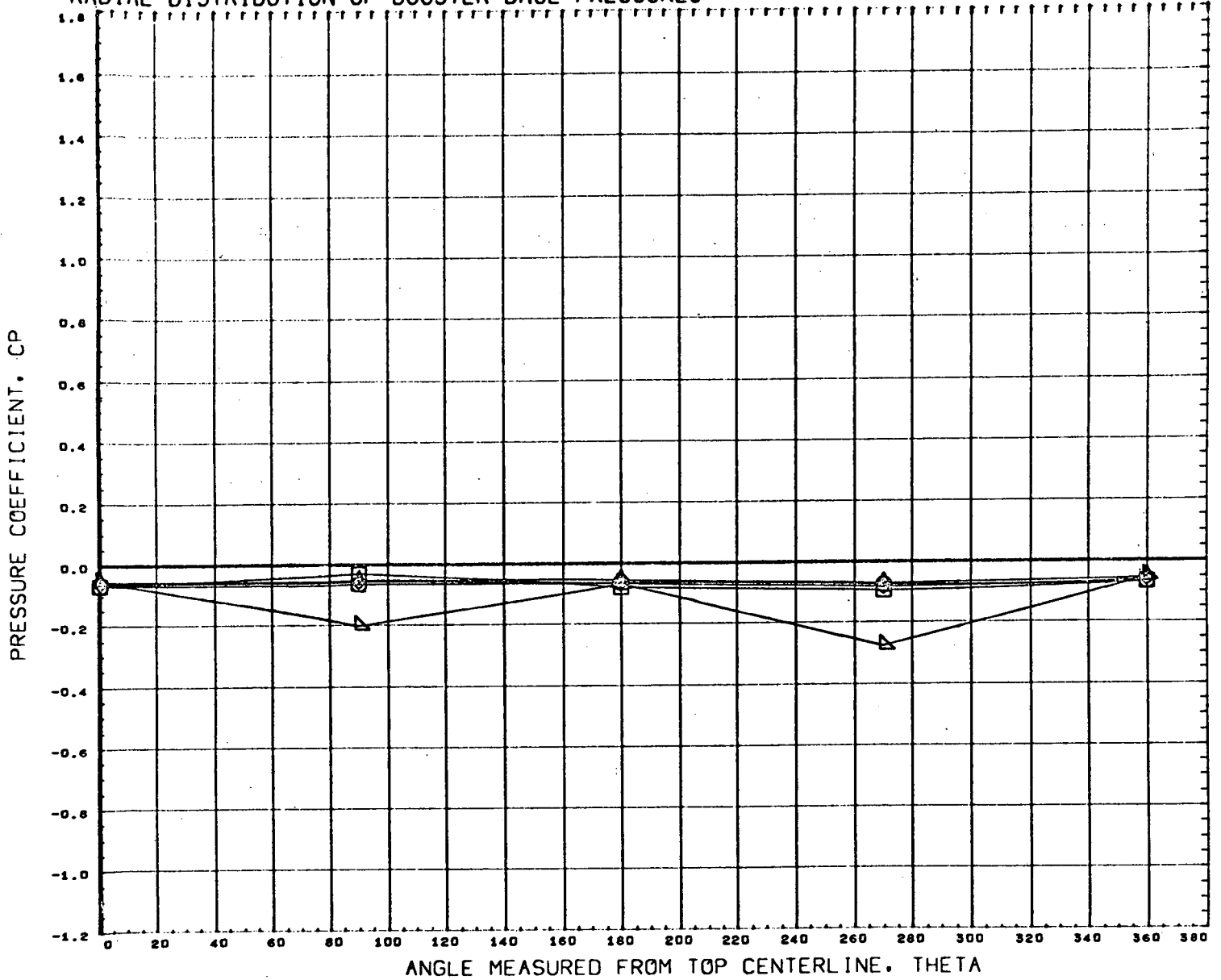

| SYMBOL | ALFB | X/L | M1 |
|--------|---------|-------|-------|
| ○ | - 7.909 | 1.000 | 1.004 |
| □ | - 5.810 | | |
| △ | - 4.434 | | |
| ◇ | - 2.210 | | |
| ▽ | 0.226 | | |

| PARAMETRIC VALUES | | |
|-------------------|-------|-------|
| BETA | 0.000 | DX/L |
| I | 1.900 | 0.036 |

REFERENCE FILE

RADIAL DISTRIBUTION OF BOOSTER BASE PRESSURES

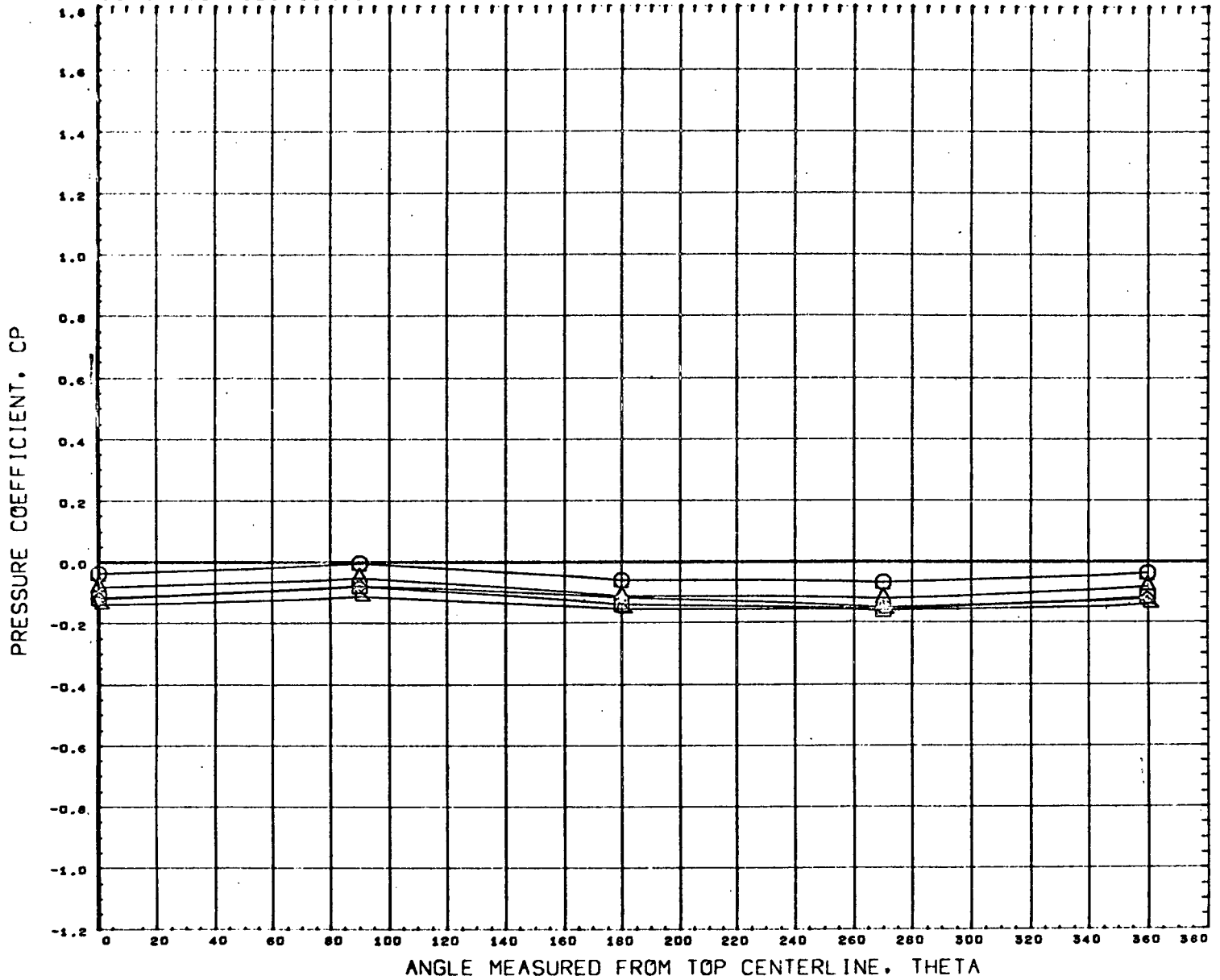

| SYMBOL | ALFB | X/L | M1 | PARAMETRIC VALUES | | |
|--------|--------|-------|-------|-------------------|-------|-------|
| | | | | BETA | DX/L | 0.036 |
| ○ | 2.167 | 1.000 | 1.004 | I | 1.900 | |
| △ | 4.154 | | | | | |
| ◇ | 6.134 | | | | | |
| □ | 8.144 | | | | | |
| ▽ | 10.153 | | | | | |

REFERENCE FILE

RADIAL DISTRIBUTION OF BOOSTER BASE PRESSURES

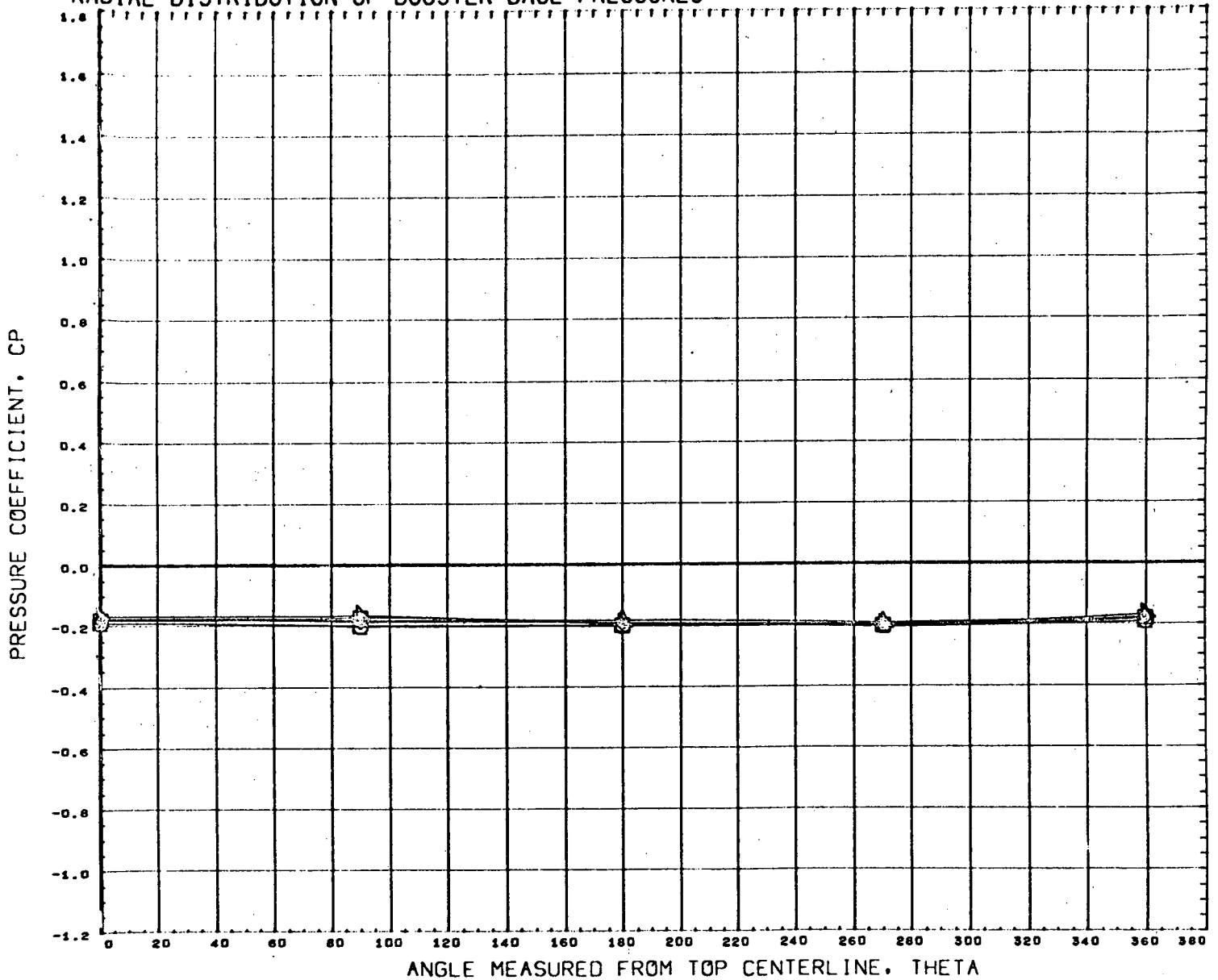

| SYMBOL | ALFB | X/L | M1 |
|--------|---------|-------|-------|
| ◇ | - 7.920 | 1.000 | 1.100 |
| ◇ | - 5.788 | | |
| ◇ | - 3.810 | | |
| ◇ | - 1.812 | | |
| ◇ | - 0.381 | | |

| PARAMETRIC VALUES | | |
|-------------------|-------|------------|
| BETA | 0.000 | DX/L 0.036 |
| I | 1.900 | |

REFERENCE FILE

RADIAL DISTRIBUTION OF BOOSTER BASE PRESSURES

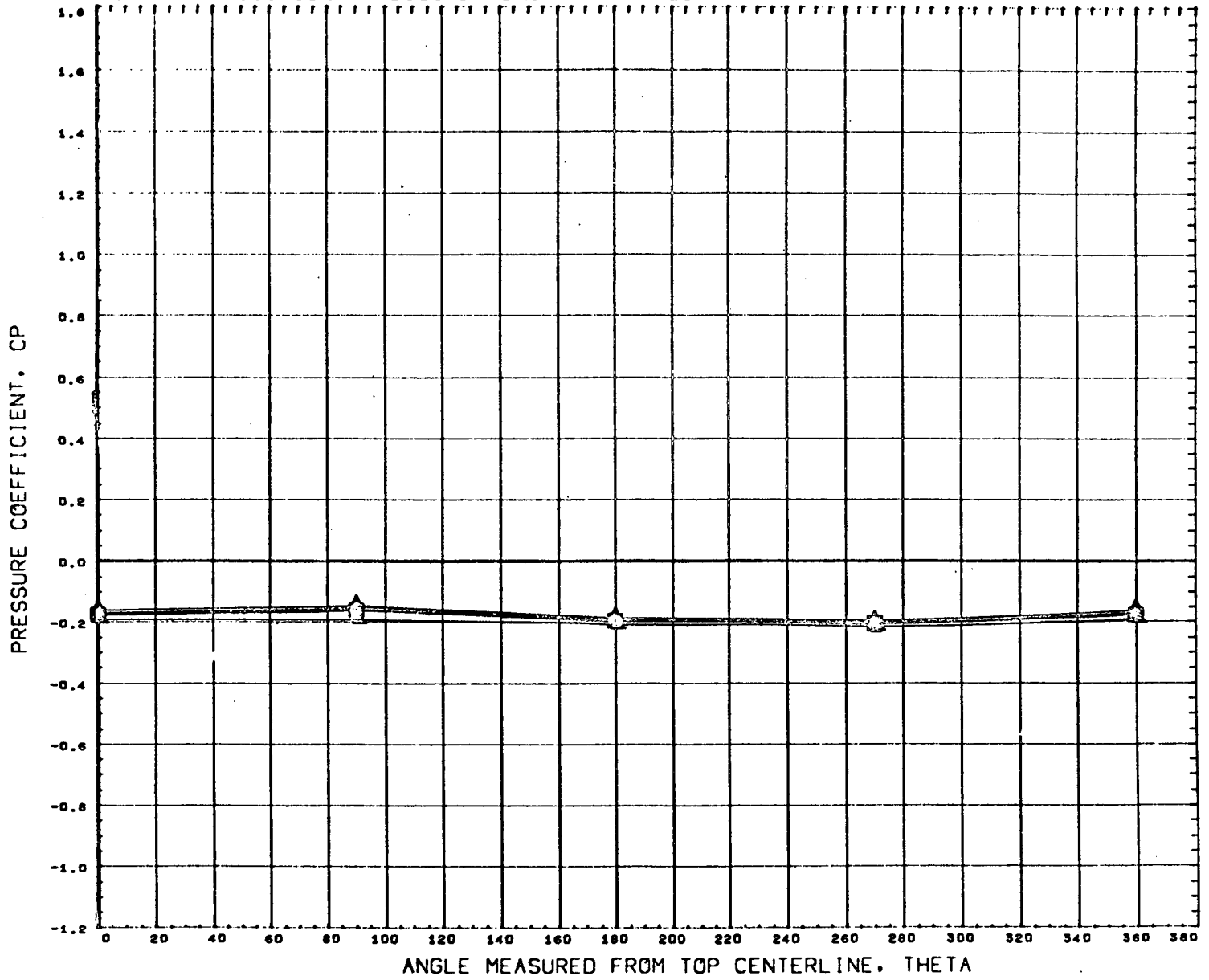

| SYMBOL | ALFB | X/L | M1 | PARAMETRIC VALUES | | |
|--------|--------|-------|-------|-------------------|------|-------|
| | | | | BETA | DX/L | |
| ◇ | 2.224 | 1.000 | 1.100 | 0.000 | | 0.036 |
| ◇ | 4.163 | | | 1.900 | | |
| ◇ | 5.535 | | | | | |
| ◇ | 7.787 | | | | | |
| ◇ | 10.190 | | | | | |

REFERENCE FILE

RADIAL DISTRIBUTION OF BOOSTER BASE PRESSURES

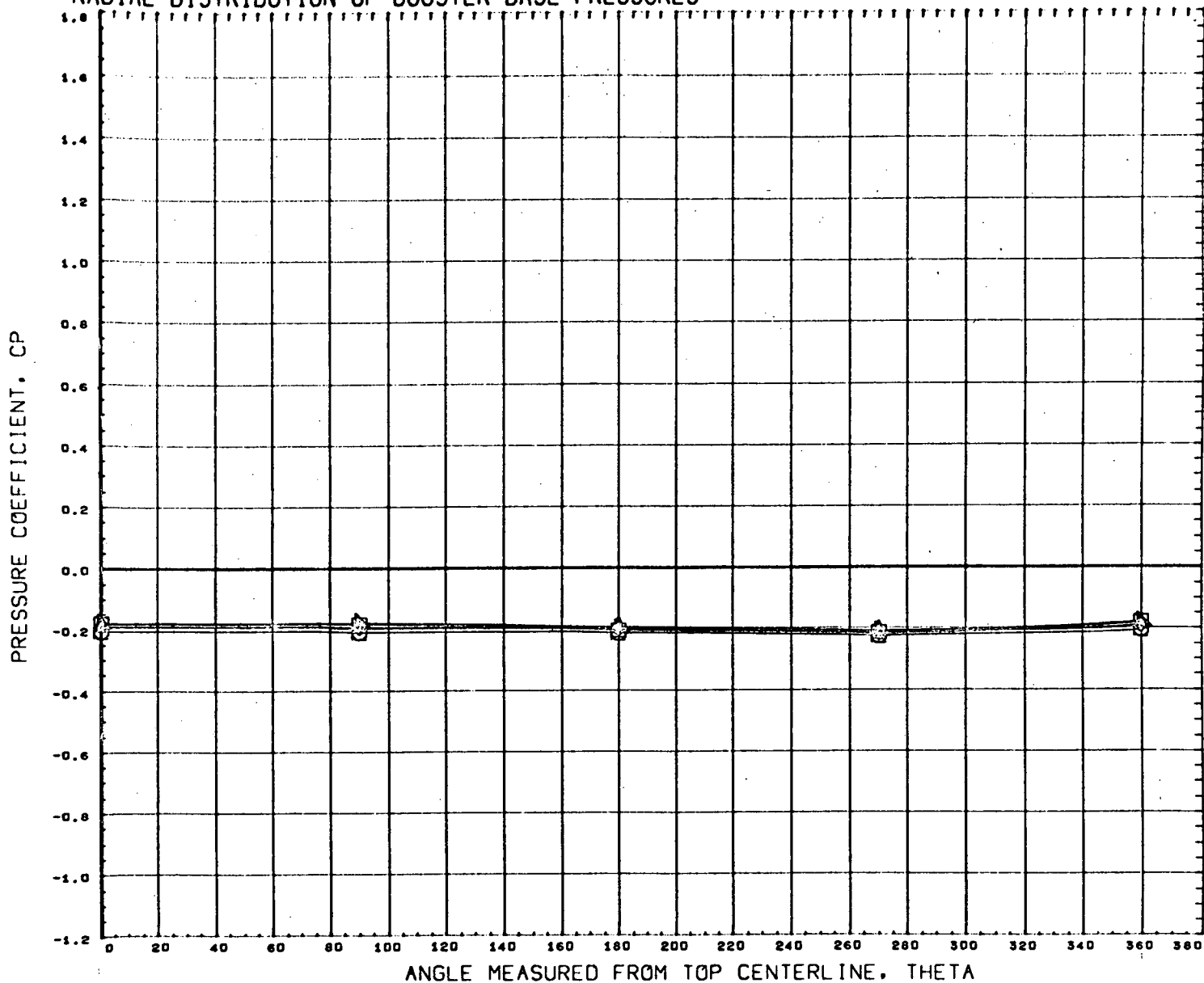

| SYMBOL | ALFB | X/L | M1 |
|--------|---------|-------|-------|
| ○ | - 7.918 | 1.000 | 1.201 |
| ◇ | - 5.800 | | |
| ◇ | - 3.805 | | |
| □ | - 1.810 | | |
| △ | 0.192 | | |

| PARAMETRIC VALUES | | |
|-------------------|-------|------------|
| BETA | 0.000 | DX/L 0.036 |
| I | 1.900 | |

REFERENCE FILE

RADIAL DISTRIBUTION OF BOOSTER BASE PRESSURES

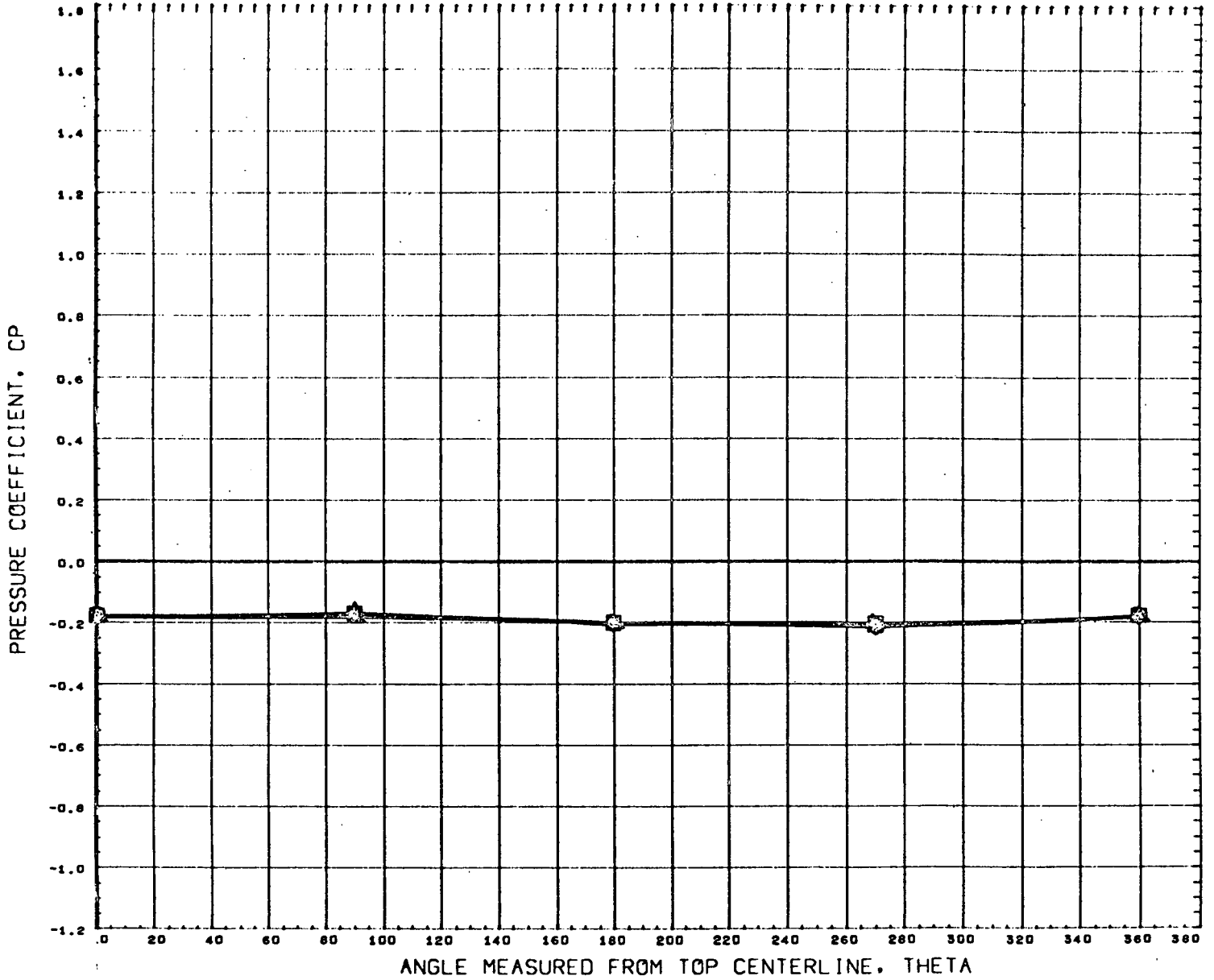

| SYMBOL | ALFB | X/L | M1 | PARAMETRIC VALUES | | | |
|--------|--------|-------|-------|-------------------|-------|------|-------|
| ◇ | 2.165 | 1.000 | 1.201 | BETA | 0.000 | DX/L | 0.036 |
| ◇ | 4.175 | | | I | 1.900 | | |
| ◇ | 5.542 | | | | | | |
| ◇ | 7.781 | | | | | | |
| ◇ | 10.179 | | | | | | |

REFERENCE FILE

RADIAL DISTRIBUTION OF BOOSTER BASE PRESSURES

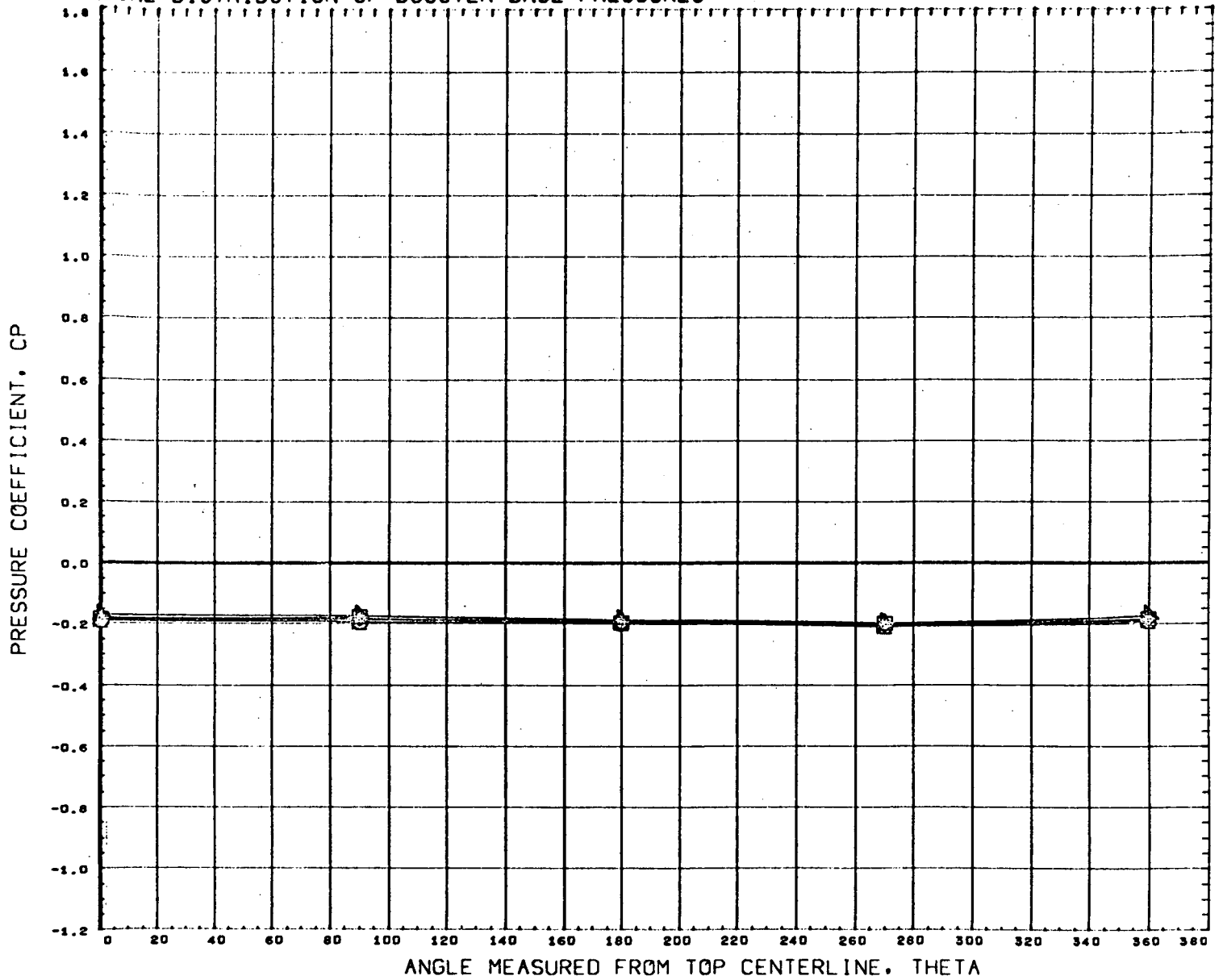

| SYMBOL | ALFB | X/L | M1 |
|--------|---------|-------|-------|
| ○ | - 7.919 | 1.000 | 1.299 |
| △ | - 5.804 | | |
| ◇ | - 4.443 | | |
| □ | - 2.184 | | |
| ▽ | 0.212 | | |

| PARAMETRIC VALUES | | | |
|-------------------|-------|------|-------|
| BETA | 0.000 | DX/L | 0.036 |
| I | 1.900 | | |

REFERENCE FILE

RADIAL DISTRIBUTION OF BOOSTER BASE PRESSURES

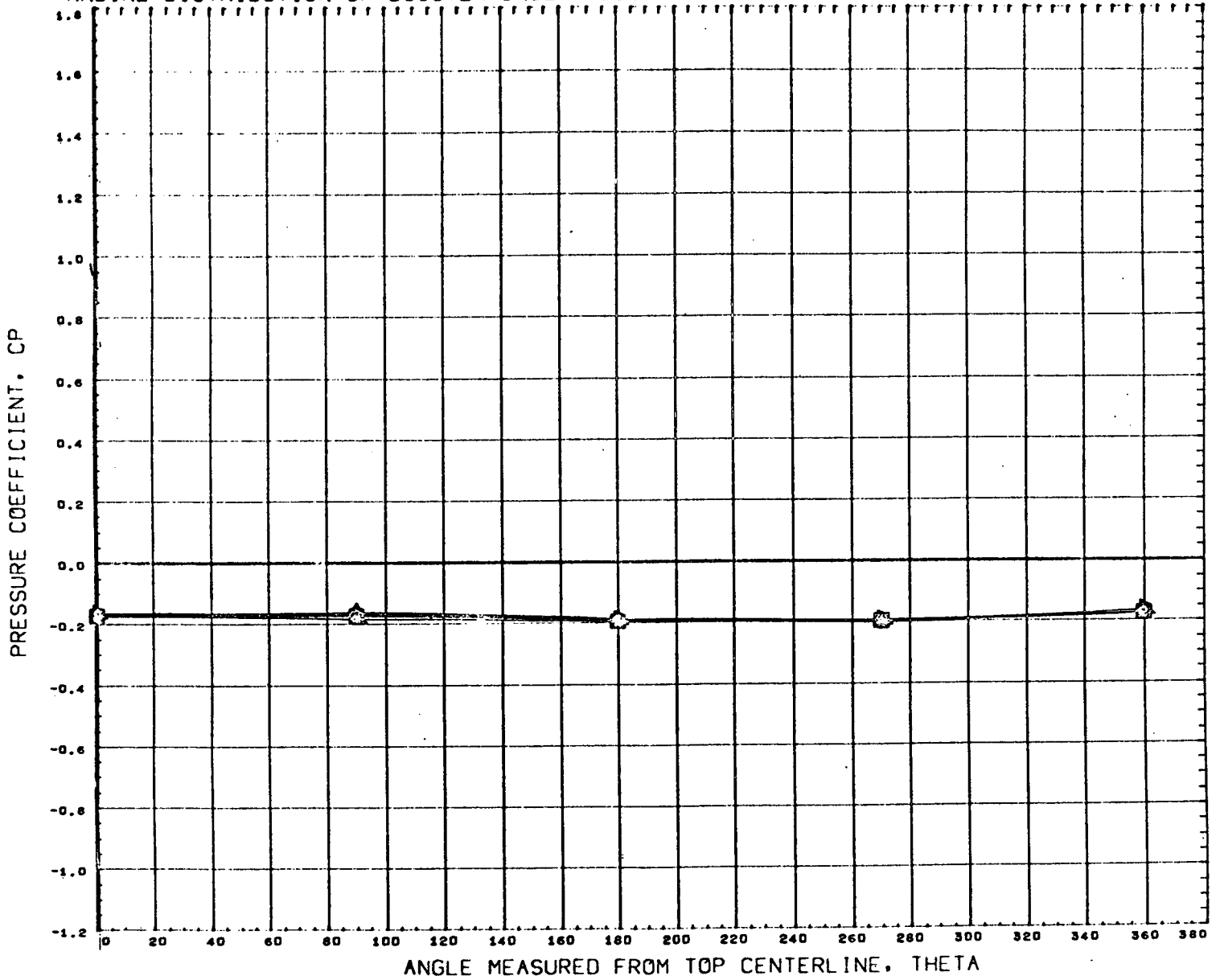

| SYMBOL | ALFB | X/L | M1 | PARAMETRIC VALUES | | | |
|--------|--------|-------|-------|-------------------|-------|------|-------|
| ◇ | 1.918 | 1.000 | 1.299 | BETA | 0.000 | DX/L | 0.036 |
| ◇ | 4.204 | | | I | 1.900 | | |
| ◇ | 5.543 | | | | | | |
| ◇ | 7.781 | | | | | | |
| ◇ | 10.179 | | | | | | |

REFERENCE FILE

RADIAL DISTRIBUTION OF BOOSTER BASE PRESSURES

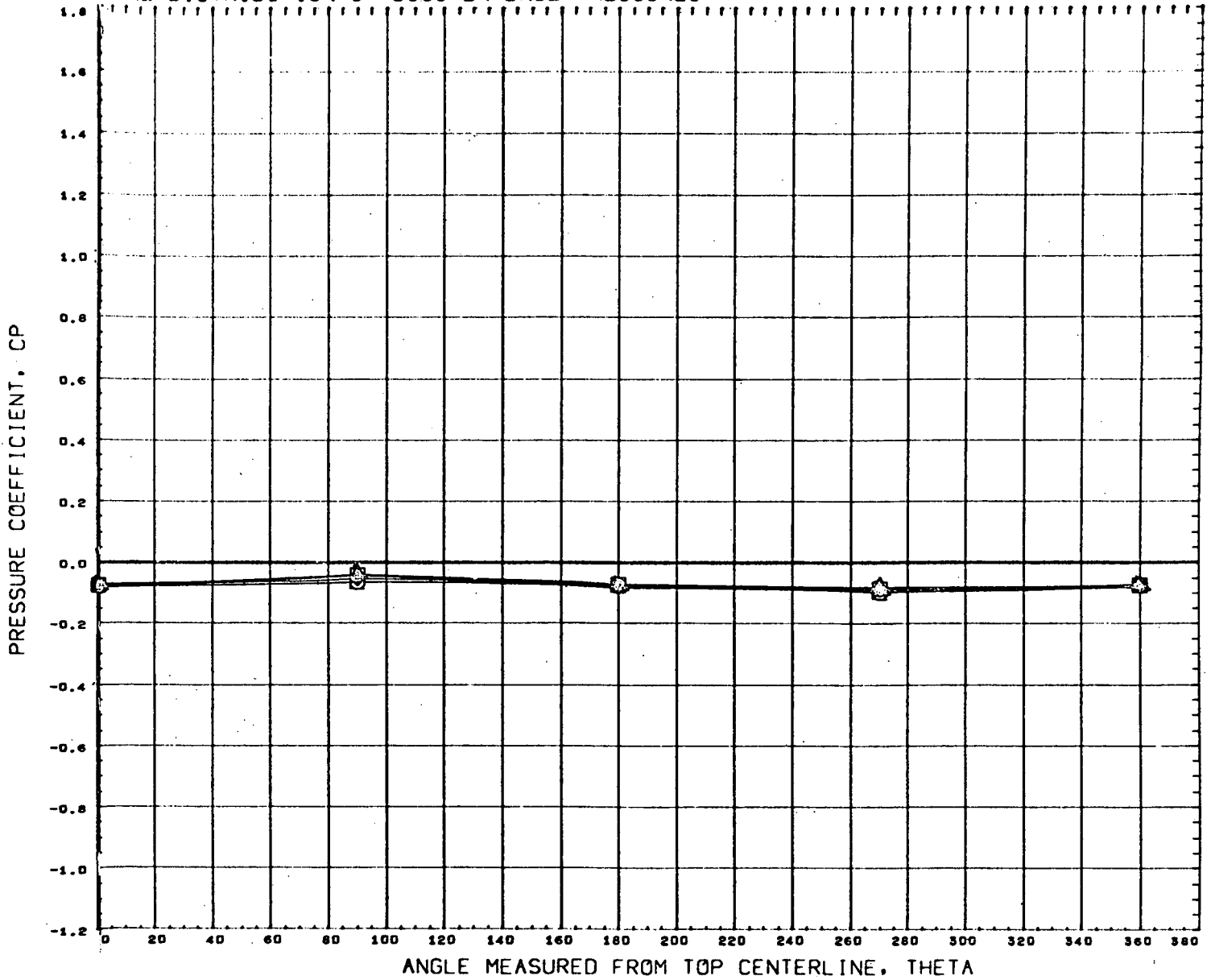

| SYMBOL | ALFD | X/L | M1 |
|--------|-------|-------|-------|
| ◇ | 8.145 | 1.000 | 0.602 |
| ◇ | 6.431 | | |
| ◇ | 1.886 | | |
| ◇ | 0.118 | | |
| ◇ | 2.110 | | |

| PARAMETRIC VALUES | | | |
|-------------------|-------|------|-------|
| BETA | 0.000 | DX/L | 0.036 |
| I | 3.800 | | |

REFERENCE FILE

RADIAL DISTRIBUTION OF BOOSTER BASE PRESSURES

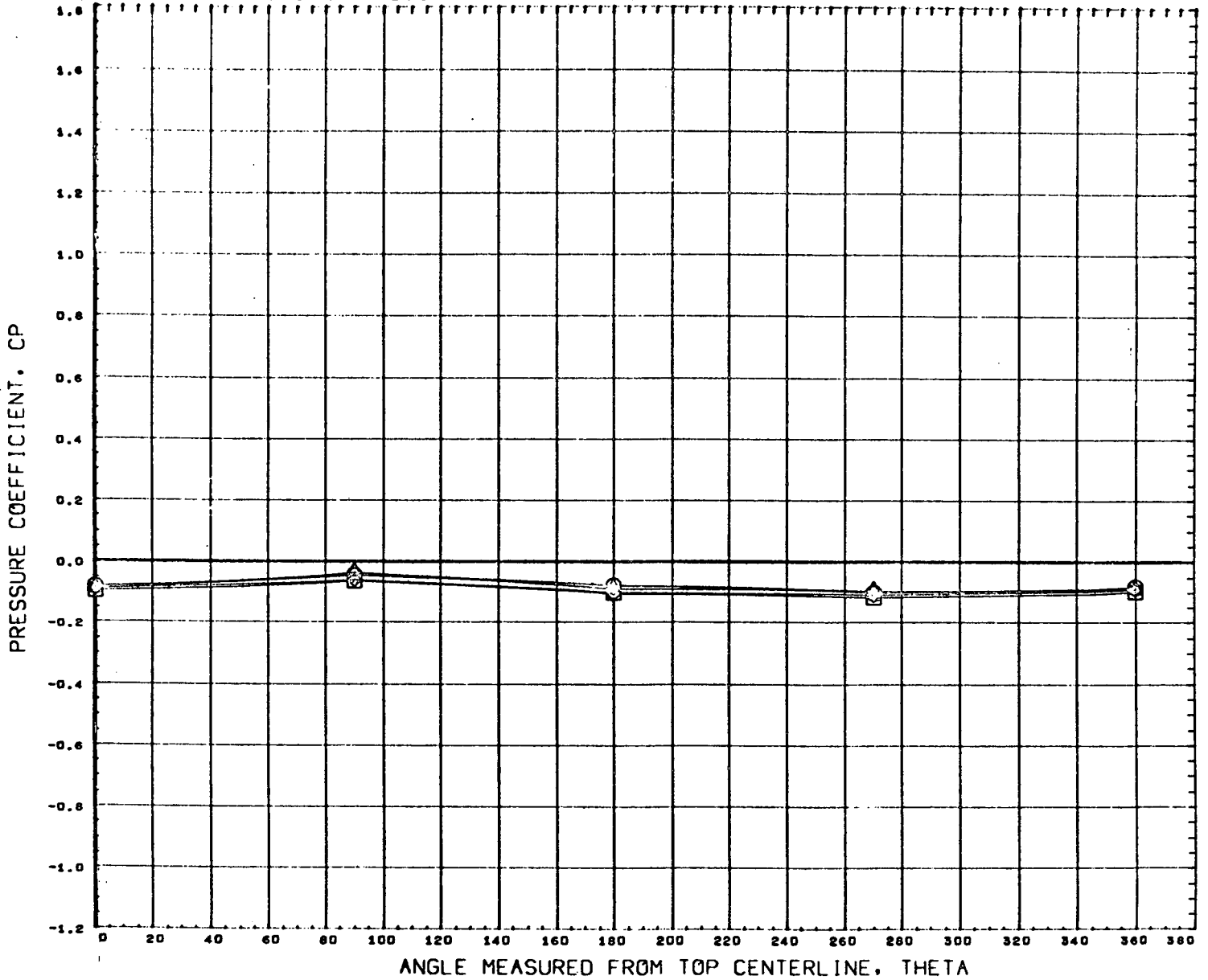

| SYMBOL | ALFB | X/L | M1 | BETA | PARAMETRIC VALUES | | |
|--------|--------|-------|-------|-------|-------------------|--|-------|
| ○ | 4.101 | 1.000 | 0.652 | 0.000 | OX/L | | 0.036 |
| △ | 6.090 | | | I | 3.800 | | |
| ◇ | 7.892 | | | | | | |
| □ | 10.115 | | | | | | |

REFERENCE FILE

RADIAL DISTRIBUTION OF BOOSTER BASE PRESSURES

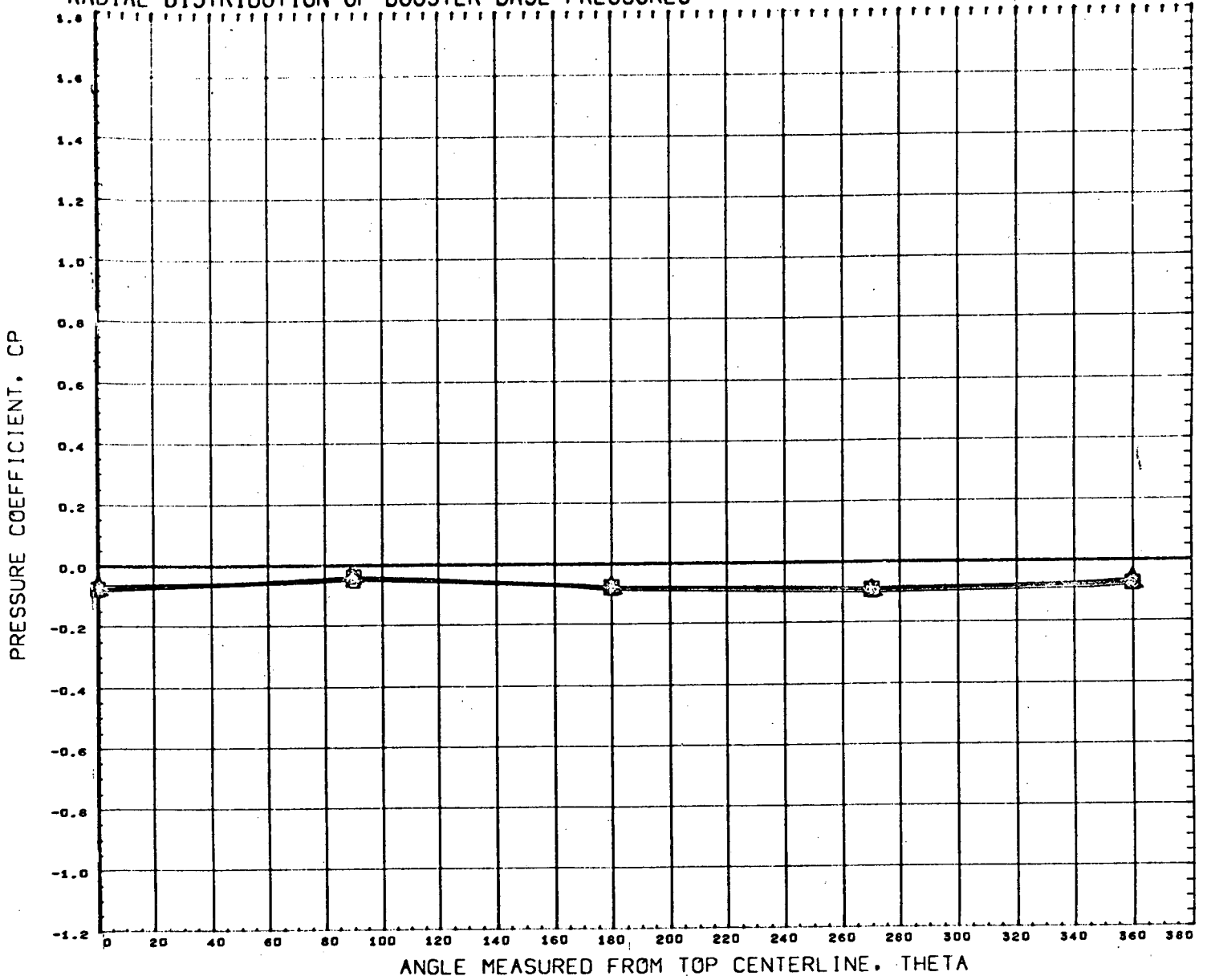

| SYMBOL | ALFB | X/L | M1 |
|--------|---------|-------|-------|
| ◇ | - 8.247 | 1.000 | 0.902 |
| ◇ | - 5.823 | | |
| ◇ | - 3.835 | | |
| ◇ | - 1.848 | | |
| ◇ | 0.126 | | |

| PARAMETRIC VALUES | | | |
|-------------------|-------|------|-------|
| BETA | 0.000 | DX/L | 0.036 |
| I | 3.800 | | |

REFERENCE FILE

RADIAL DISTRIBUTION OF BOOSTER BASE PRESSURES

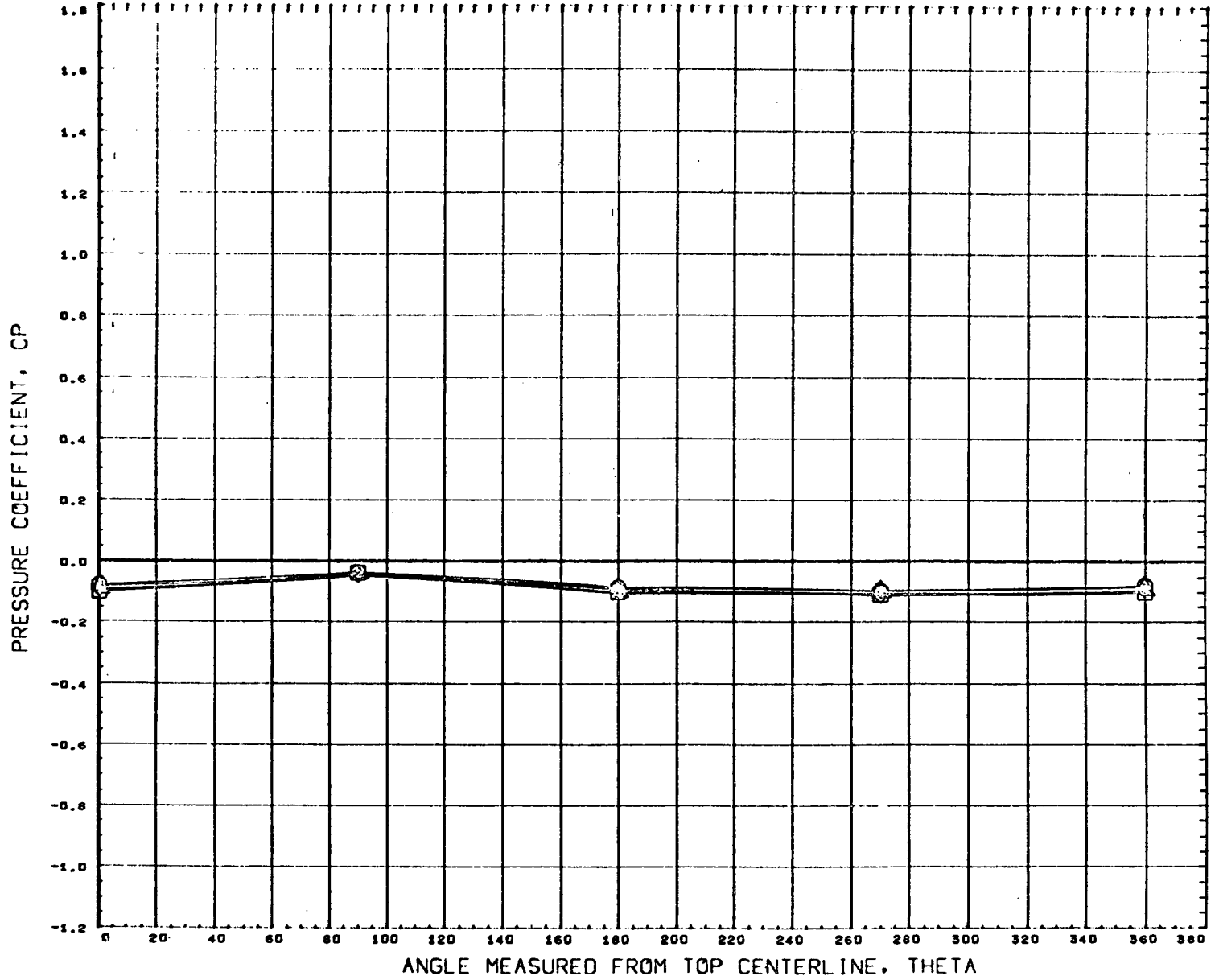

| SYMBOL | ALFD | X/L | M1 | PARAMETRIC VALUES | | | |
|--------|-------|-------|-------|-------------------|-------|------|-------|
| | | | | BETA | OX/L | | |
| ◇ | 1.552 | 1.000 | 0.902 | | | | |
| ◇ | 3.765 | | | | | | |
| ◇ | 6.165 | | | | | | |
| ◇ | 7.507 | | | | | | |
| ◇ | 9.767 | | | | | | |
| | | | | BETA | 0.000 | OX/L | 0.036 |
| | | | | I | 3.800 | | |

REFERENCE FILE

RADIAL DISTRIBUTION OF BOOSTER BASE PRESSURES

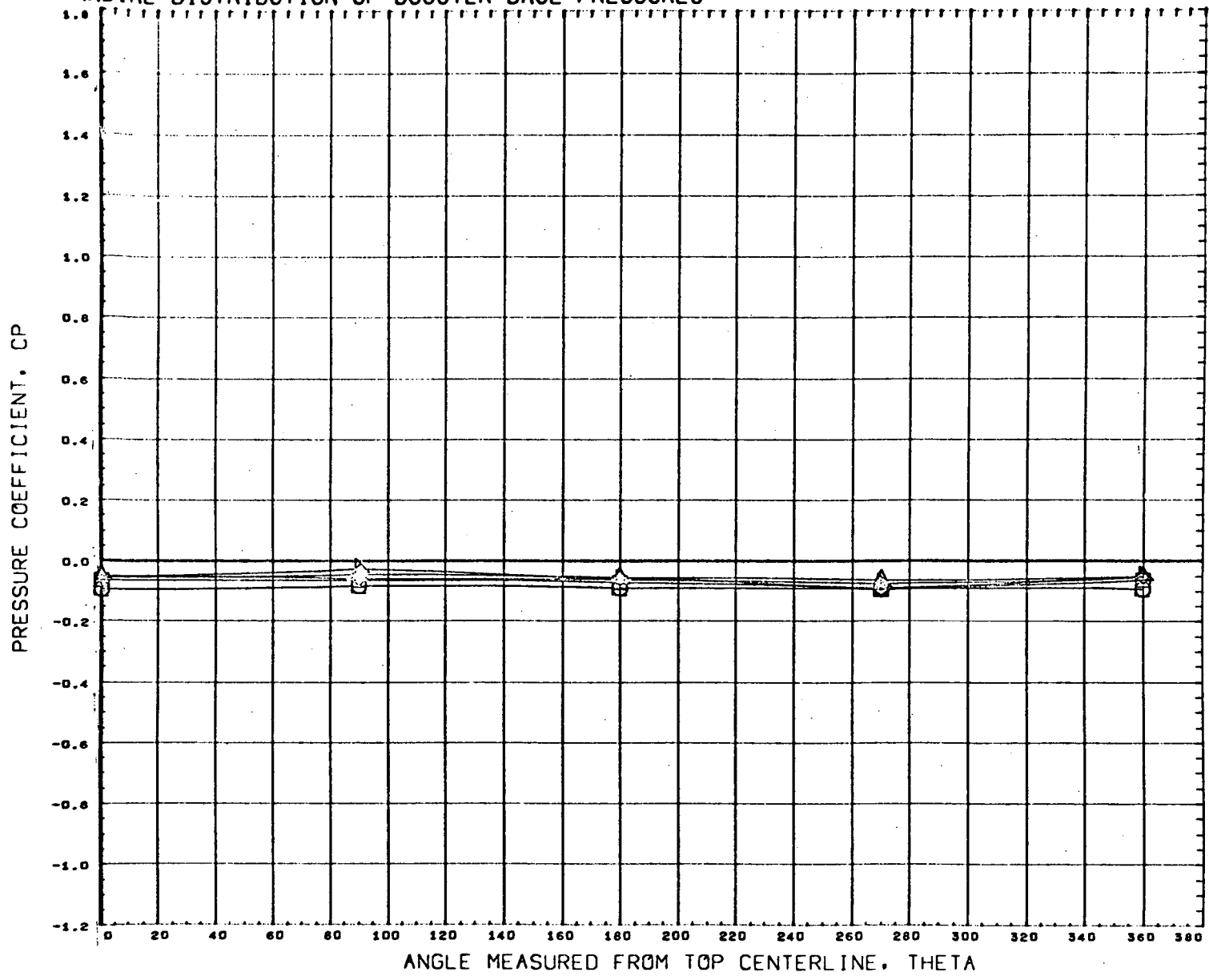

| SYMBOL | ALFB | X/L | M1 |
|--------|-------|-------|-------|
| ○ | 8.294 | 1.000 | 1.002 |
| ◇ | 5.781 | | |
| ◻ | 3.822 | | |
| △ | 1.824 | | |
| + | 0.452 | | |

| PARAMETRIC VALUES | | | |
|-------------------|-------|------|-------|
| BETA | 0.000 | DX/L | 0.036 |
| I | 3.800 | | |

REFERENCE FILE

RADIAL DISTRIBUTION OF BOOSTER BASE PRESSURES

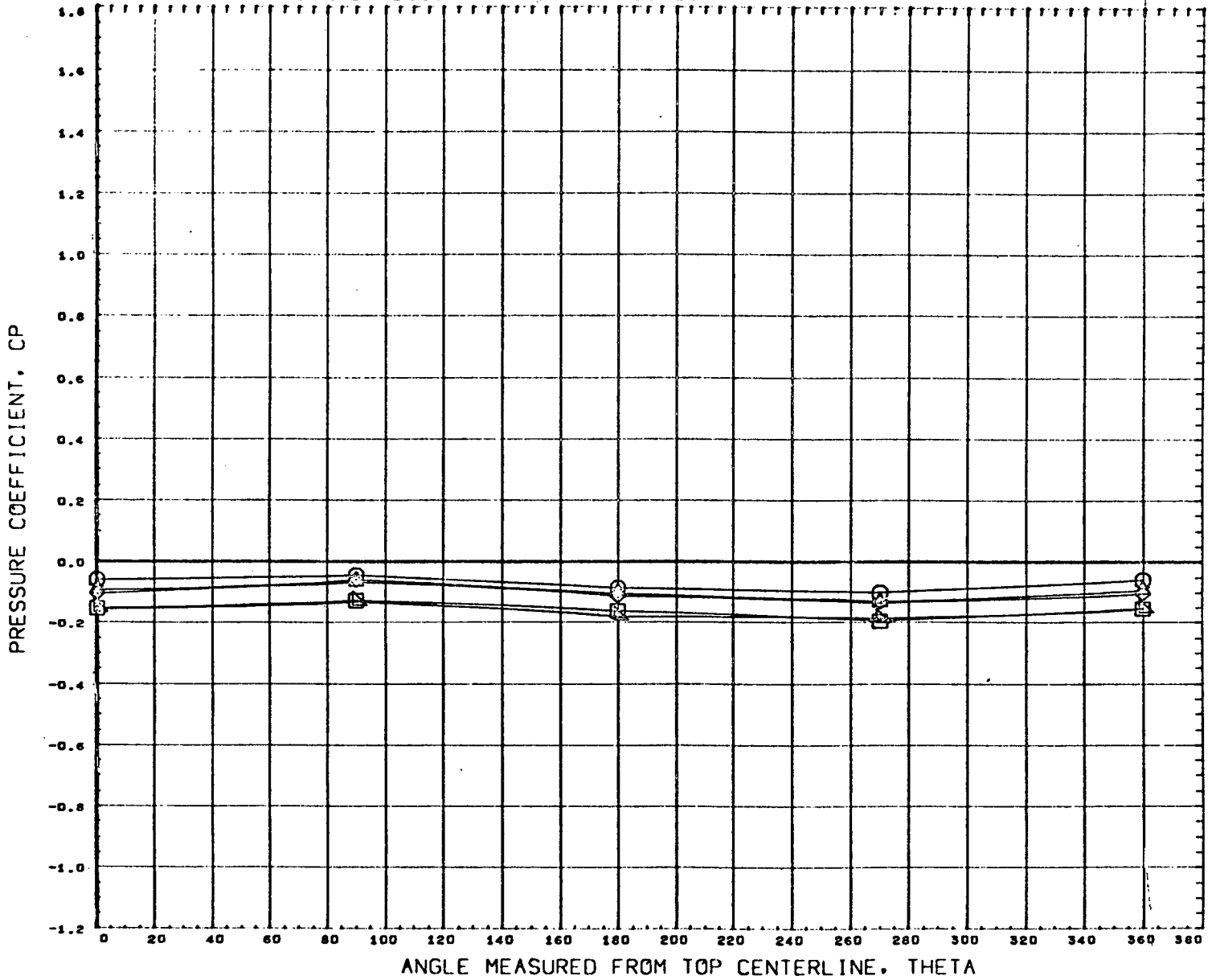

| SYMBOL | ALFD | X/L | M1 | PARAMETRIC VALUES | | | |
|--------|--------|-------|-------|-------------------|-------|------|-------|
| □ | 2.116 | 1.000 | 1.002 | BETA | 0.000 | DX/L | 0.036 |
| ◇ | 4.156 | | | I | 3.800 | | |
| ◇ | 5.934 | | | | | | |
| ◇ | 7.374 | | | | | | |
| ◇ | 10.204 | | | | | | |

REFERENCE FILE

RADIAL DISTRIBUTION OF BOOSTER BASE PRESSURES

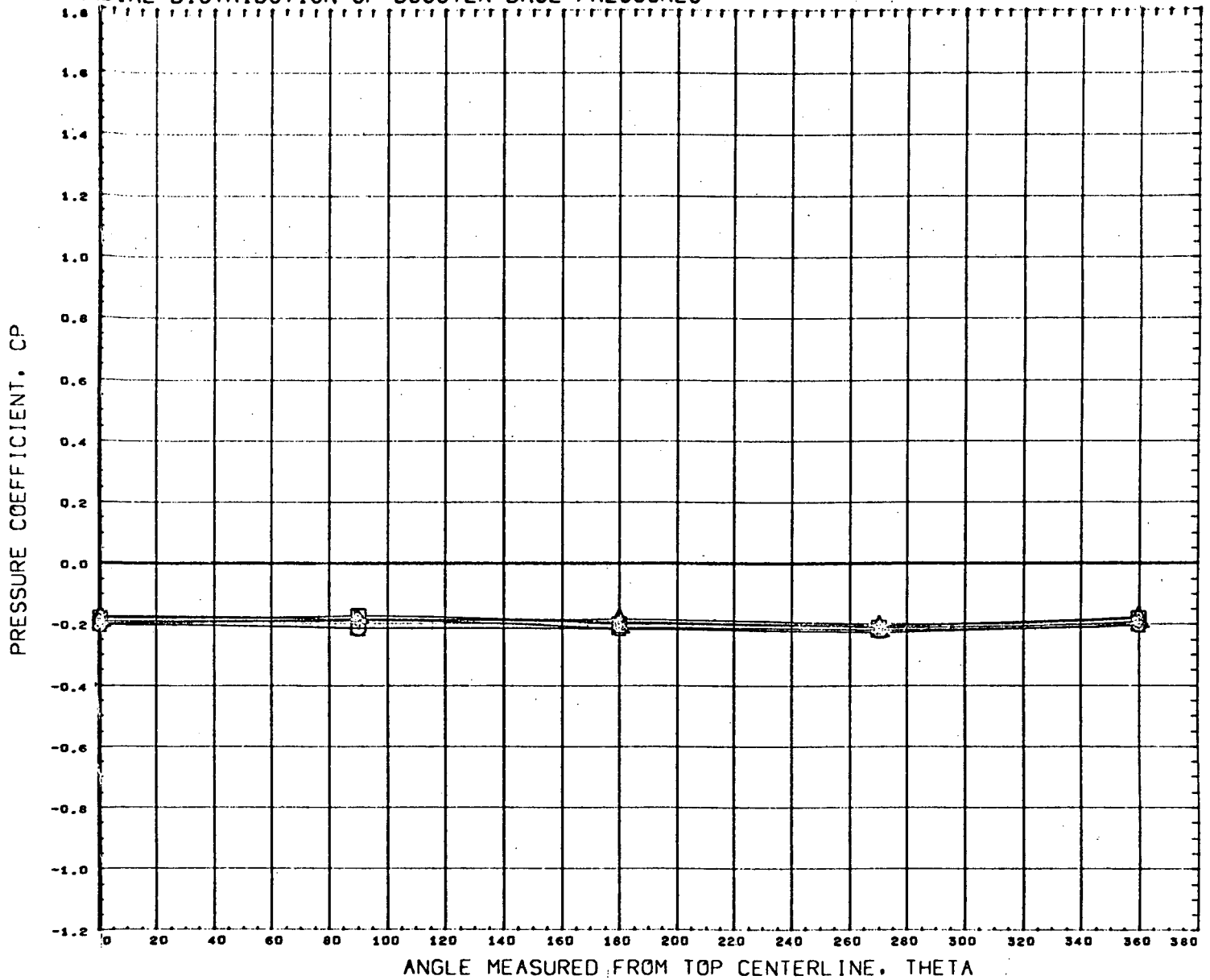

| SYMBOL | ALFB | X/L | M1 | BETA | PARAMETRIC VALUES | |
|--------|-------|-------|-------|-------|-------------------|-------|
| ○ | 8.281 | 1.000 | 1.099 | 0.000 | DX/L | 0.036 |
| ◇ | 5.784 | | | I | 3.800 | |
| ◊ | 3.817 | | | | | |
| □ | 1.823 | | | | | |
| ▽ | 0.455 | | | | | |

REFERENCE FILE

RADIAL DISTRIBUTION OF BOOSTER BASE PRESSURES

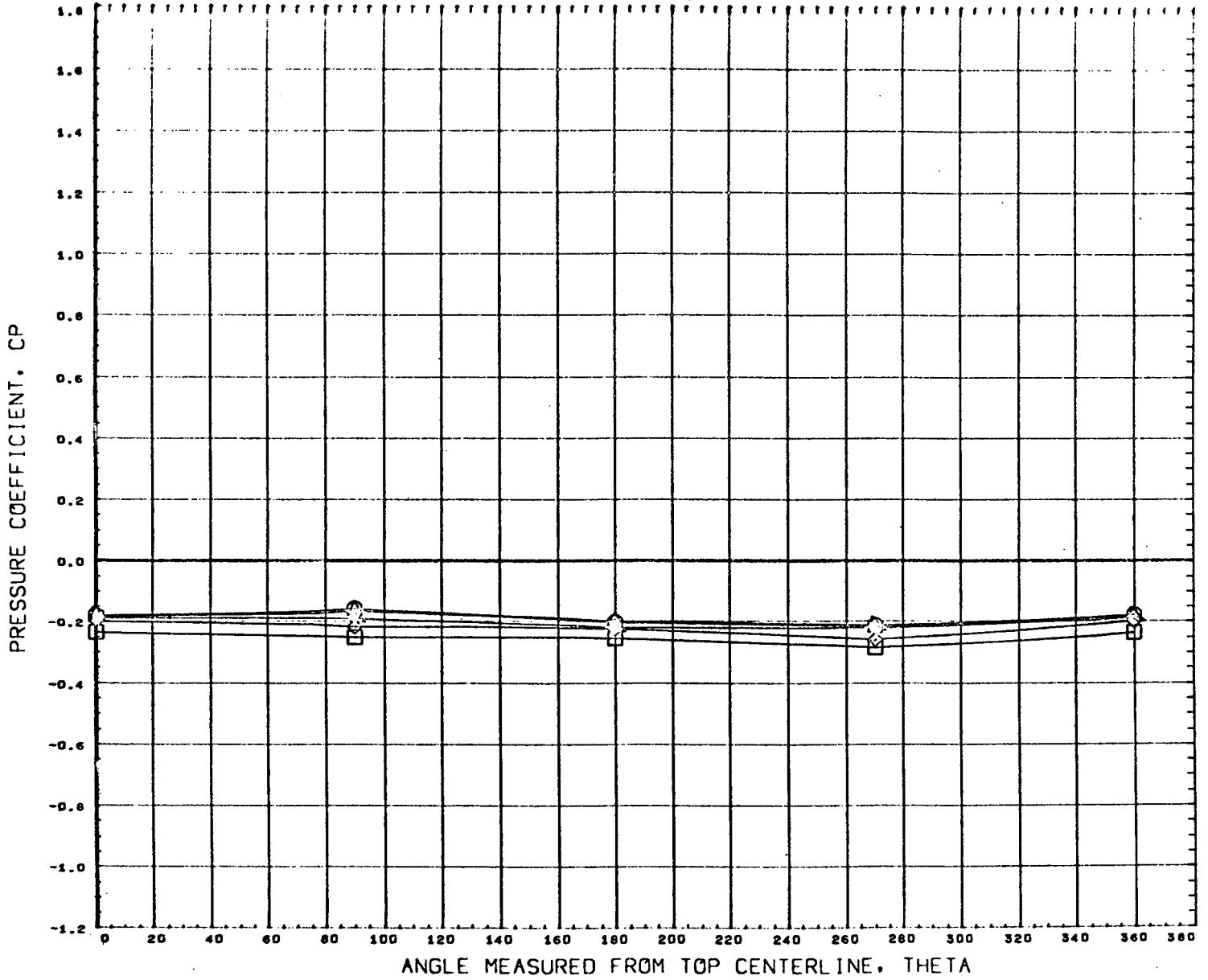

| SYMBOL | ALFB | X/L | M1 | BETA | PARAMETRIC VALUES | |
|--------|-------|-------|-------|-------|-------------------|-------|
| ◇ | 2.257 | 1.000 | 1.099 | 0.000 | DX/L | 0.036 |
| □ | 4.159 | | | I | 3.800 | |
| △ | 6.174 | | | | | |
| ○ | 8.149 | | | | | |
| ◻ | 9.546 | | | | | |

REFERENCE FILE

RADIAL DISTRIBUTION OF BOOSTER BASE PRESSURES

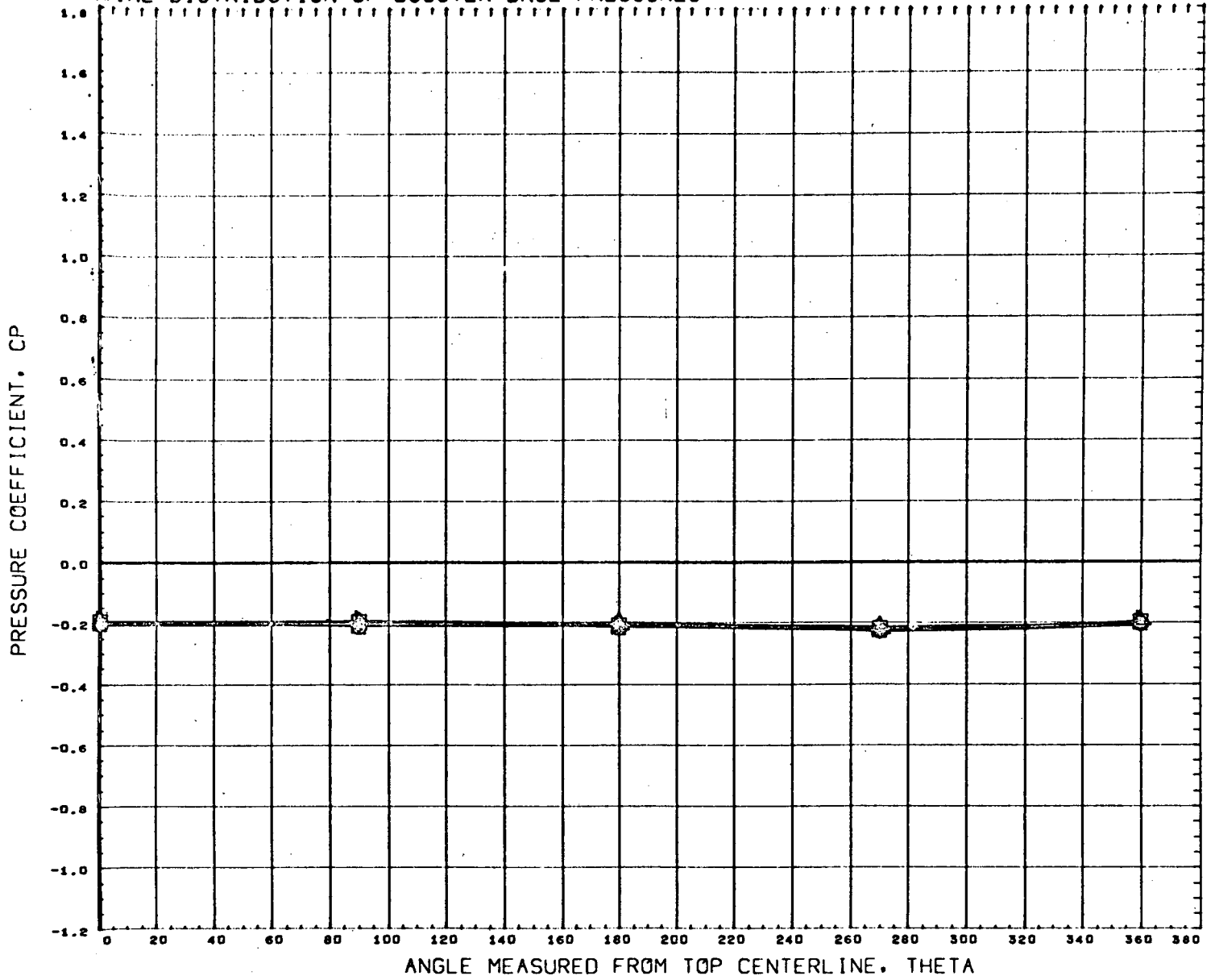

| SYMBOL | ALFB | X/L | M1 |
|--------|---------|-------|-------|
| ◇ | - 8.310 | 1.000 | 1.199 |
| ◇ | - 5.785 | | |
| ◇ | - 3.815 | | |
| ◇ | - 1.813 | | |
| ◇ | - 0.450 | | |

| PARAMETRIC VALUES | | |
|-------------------|-------|------------|
| BETA | 0.000 | DX/L 0.036 |
| I | 3.800 | |

REFERENCE FILE

RADIAL DISTRIBUTION OF BOOSTER BASE PRESSURES

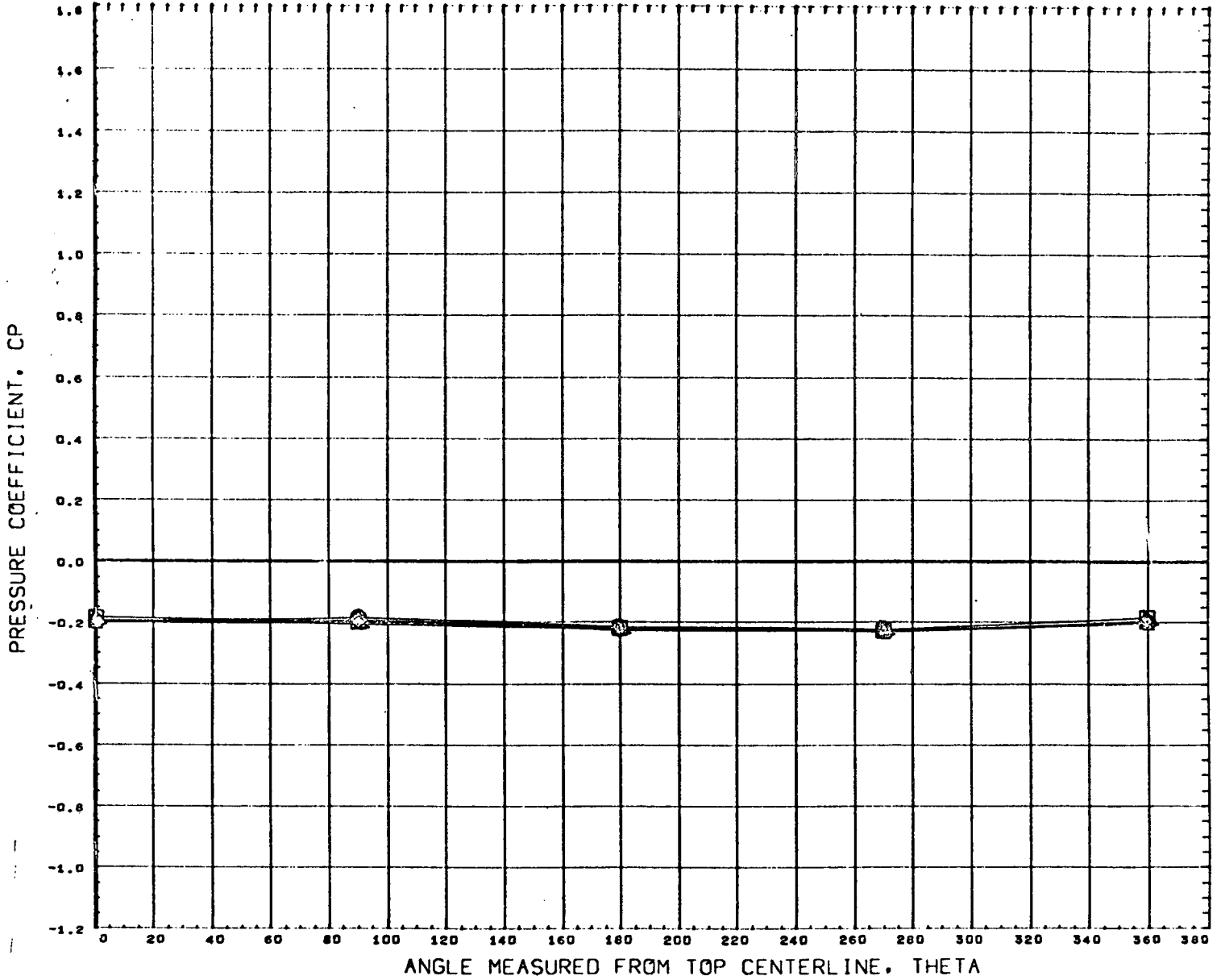

| | | | | | | |
|------------|-------|-------|-------|-------------------|-------|------------|
| SYMBOL | ALFB | X/L | M1 | PARAMETRIC VALUES | | |
| | 2.219 | 1.000 | 1.199 | BETA | 0.000 | DX/L 0.036 |
| | 4.179 | | | I | 3.800 | |
| | 6.175 | | | | | |
| | 8.168 | | | | | |
| | 9.532 | | | | | |

REFERENCE FILE

RADIAL DISTRIBUTION OF BOOSTER BASE PRESSURES

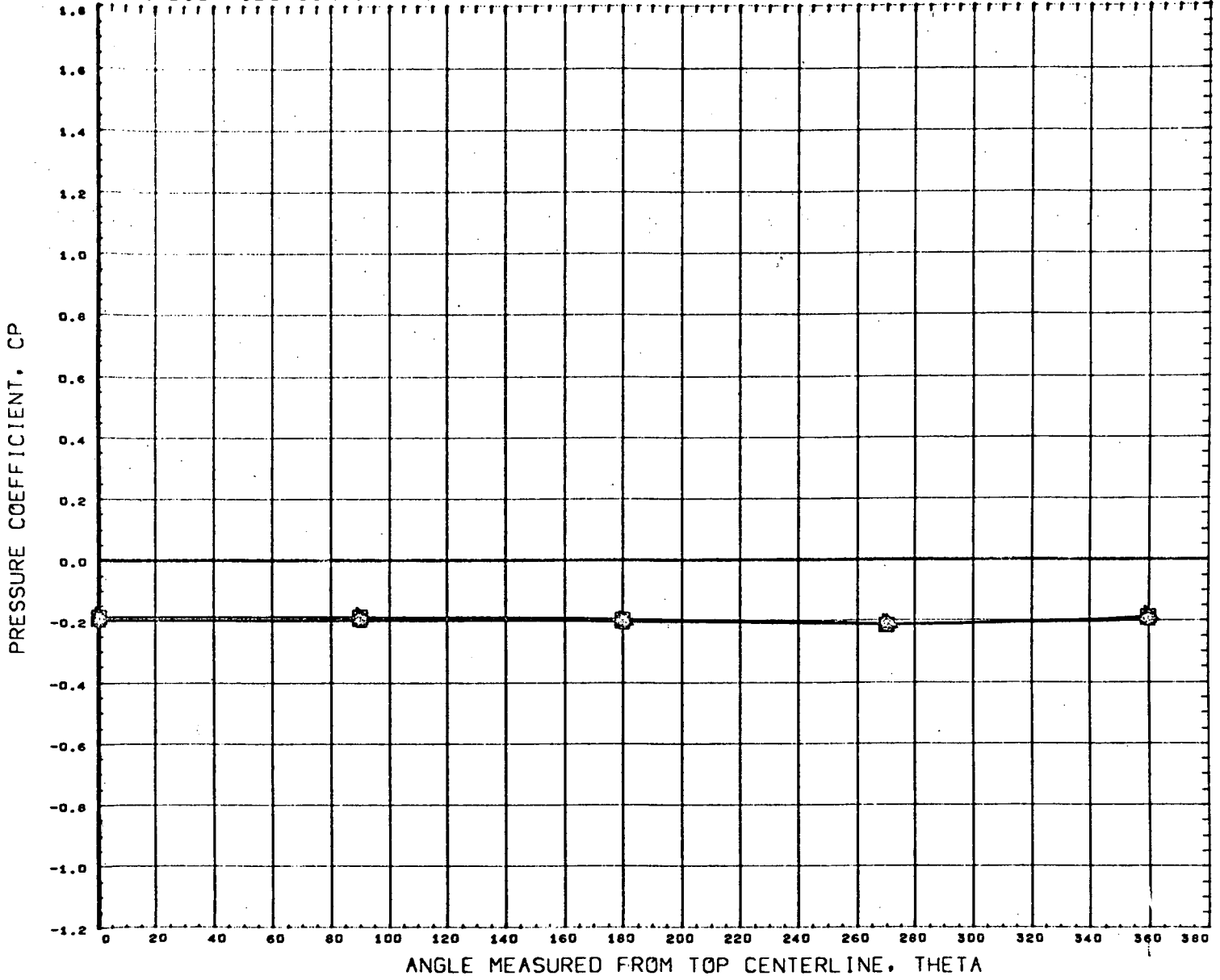

| SYMBOL | ALFB | X/L | M1 | PARAMETRIC VALUES | | | |
|--------|---------|-------|-------|-------------------|-------|------|-------|
| ◇ | - 8.317 | 1.000 | 1.297 | BETA | 0.000 | DX/L | 0.036 |
| ◇ | - 5.788 | | | I | 3.800 | | |
| ◇ | - 3.823 | | | | | | |
| ◇ | - 1.808 | | | | | | |
| ◇ | - 0.447 | | | | | | |

REFERENCE FILE

RADIAL DISTRIBUTION OF BOOSTER BASE PRESSURES

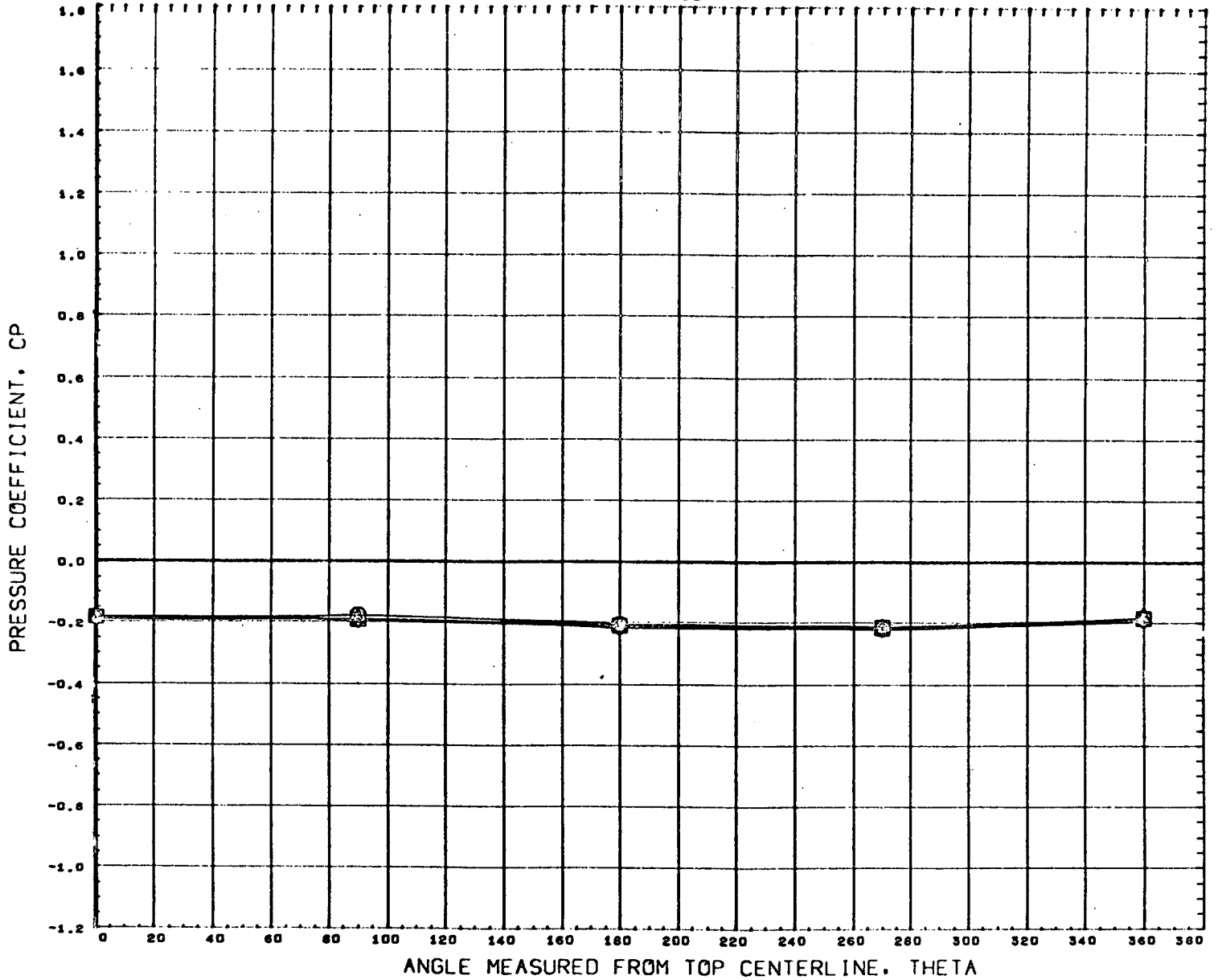

| SYMBOL | ALFB | X/L | M1 | PARAMETRIC VALUES | | | |
|--------|-------|-------|-------|-------------------|-------|------|-------|
| ○ | 2.215 | 1.000 | 1.297 | BETA | 0.000 | OX/L | 0.036 |
| ◇ | 4.170 | | | I | 3.800 | | |
| ◊ | 6.162 | | | | | | |
| □ | 8.160 | | | | | | |

REFERENCE FILE

RADIAL DISTRIBUTION OF BOOSTER BASE PRESSURES

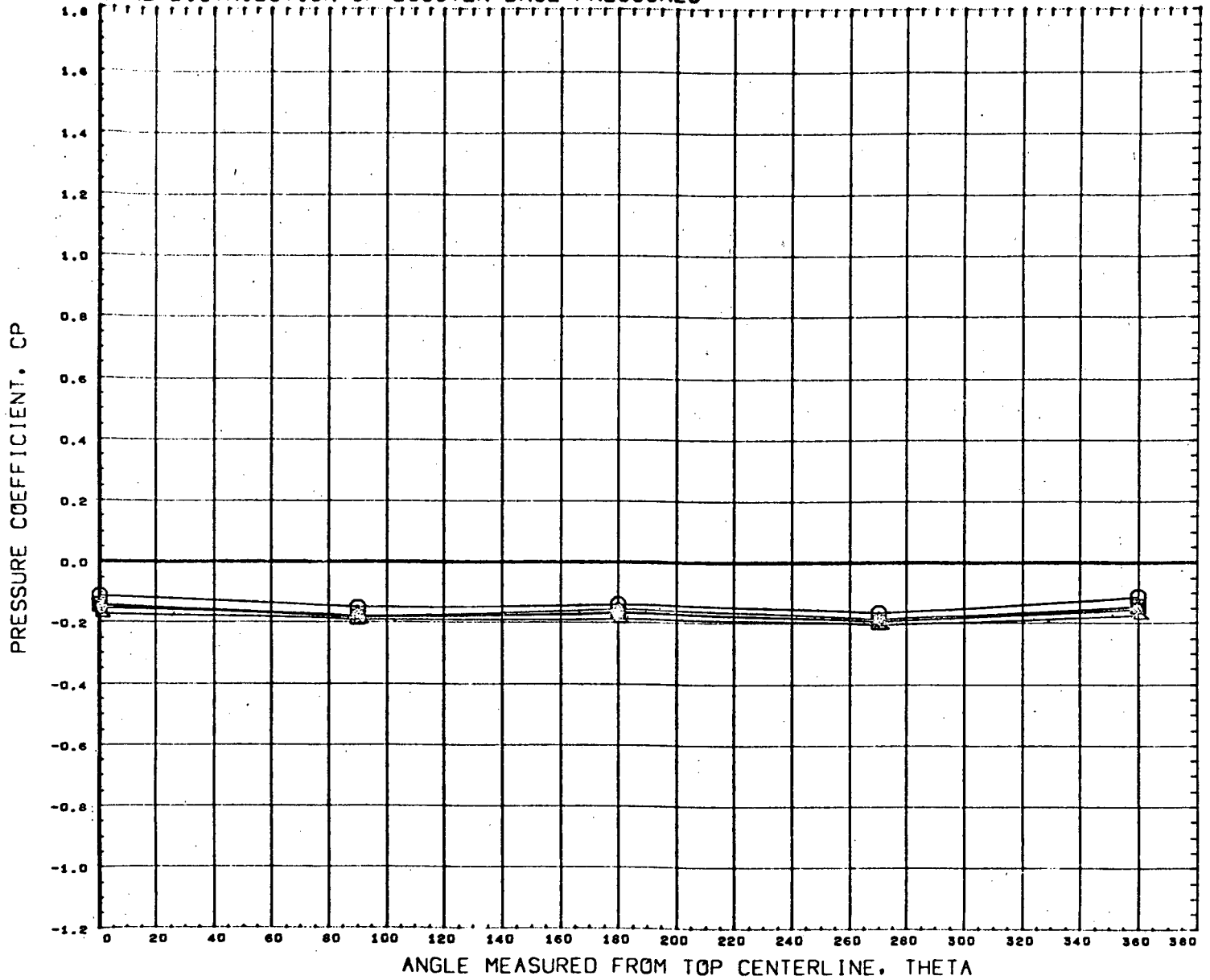

| SYMBOL | ALFB | X/L | M1 |
|--------|-------|-------|-------|
| ○ | 8.188 | 1.000 | 0.598 |
| ◇ | 5.890 | | |
| ◇ | 3.880 | | |
| □ | 1.881 | | |
| □ | 0.100 | | |

| PARAMETRIC VALUES | | | |
|-------------------|-------|------|---------|
| BETA | 0.000 | DX/L | - 0.194 |
| I | 0.000 | | |

REFERENCE FILE

RADIAL DISTRIBUTION OF BOOSTER BASE PRESSURES

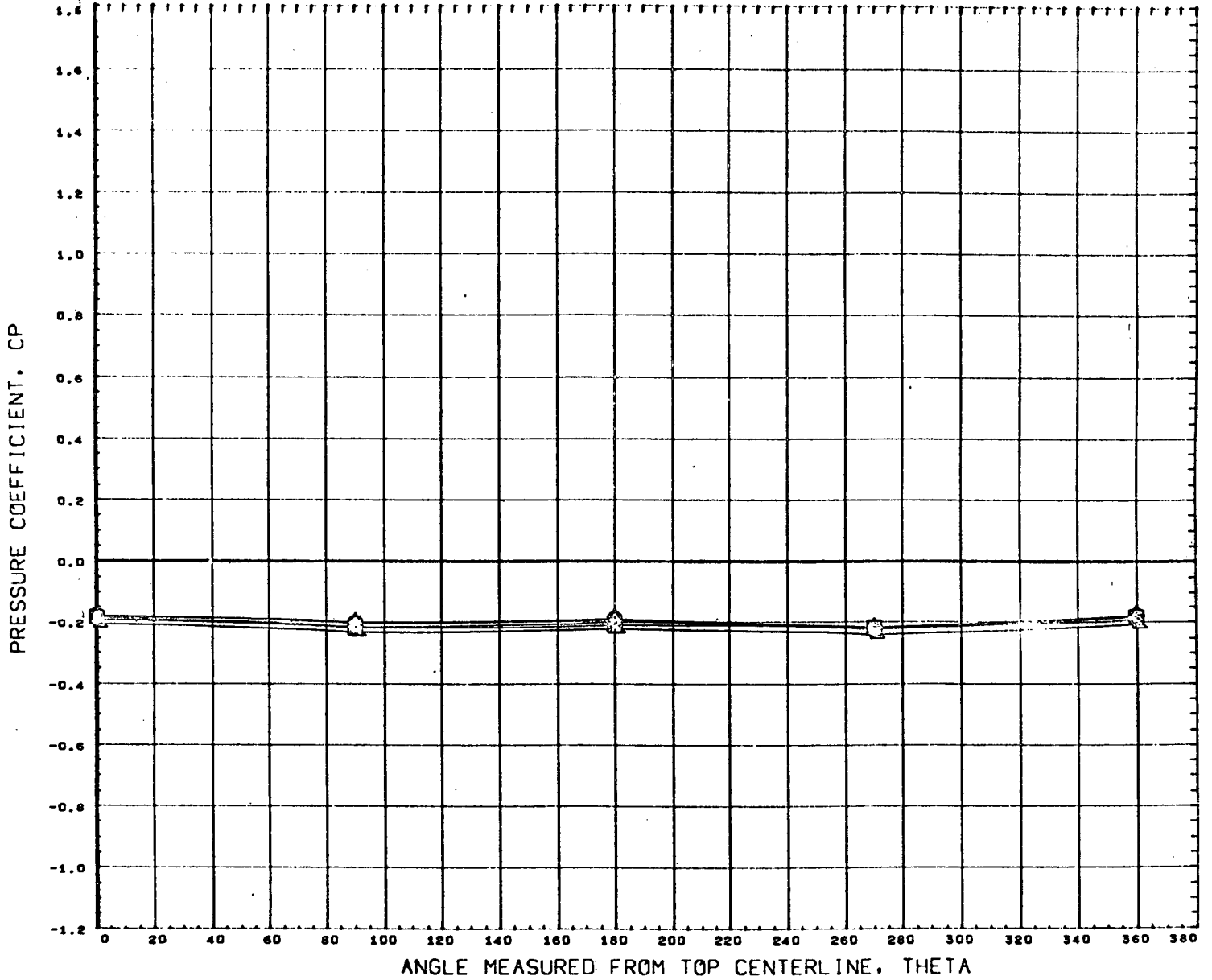

| SYMBOL | ALFB | X/L | M1 | BETA | PARAMETRIC VALUES | | |
|--------|--------|-------|-------|-------|-------------------|---|-------|
| ◇ | 2.097 | 1.000 | 0.598 | 0.000 | DX/L | - | 0.194 |
| ◇ | 4.096 | | | I | 0.000 | | |
| ◇ | 6.093 | | | | | | |
| ◇ | 8.094 | | | | | | |
| ◇ | 10.082 | | | | | | |

REFERENCE FILE

RADIAL DISTRIBUTION OF BOOSTER BASE PRESSURES

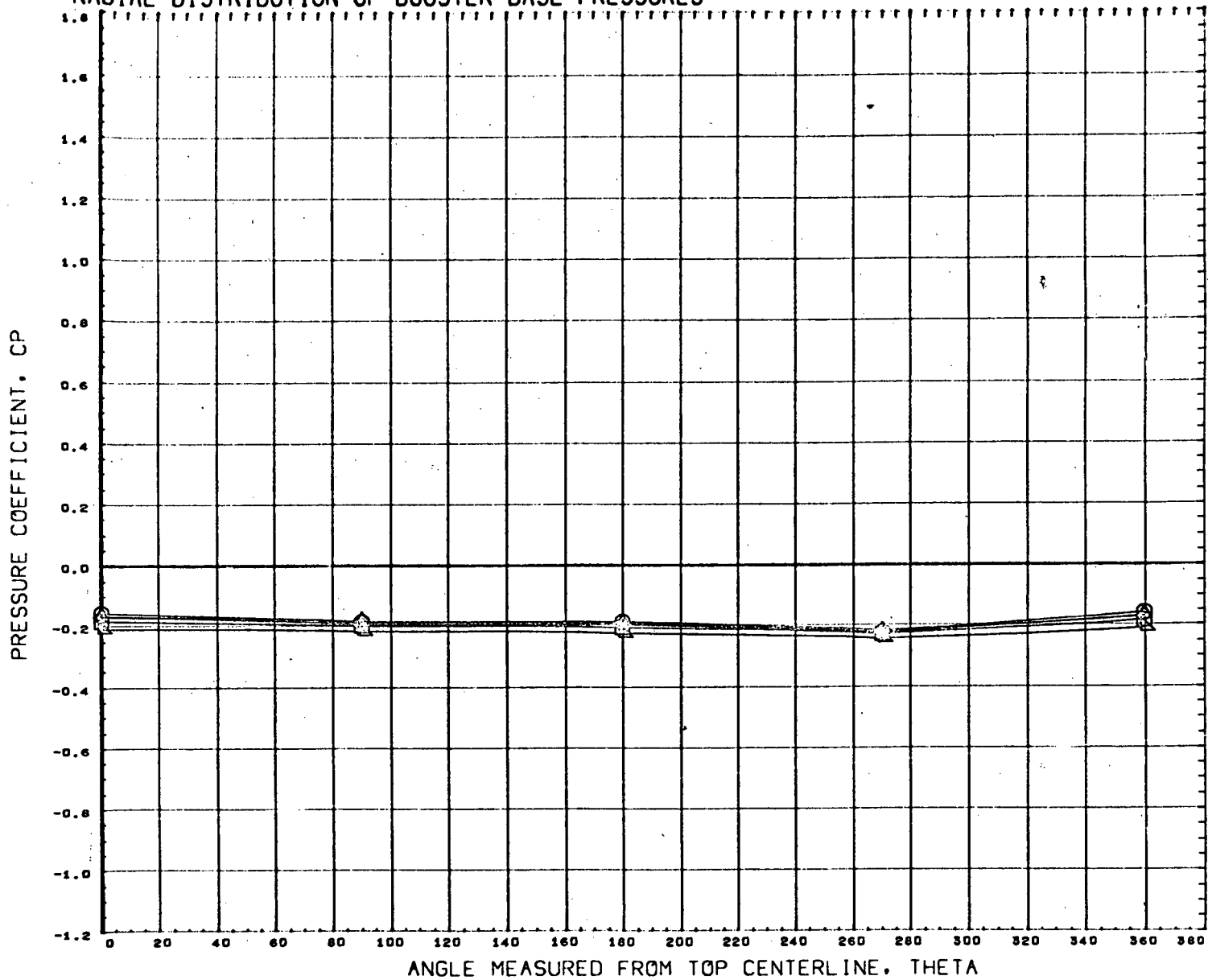

| | | | | | | | |
|--------|---------|-------|-------|------|-------------------|---------|--|
| SYMBOL | ALFB | X/L | M1 | BETA | PARAMETRIC VALUES | DX/L | |
| ◇ | - 7.940 | 1.000 | 0.900 | I | 0.000 | - 0.194 | |
| ◇ | - 5.847 | | | | 0.000 | | |
| ◇ | - 3.836 | | | | | | |
| ◇ | - 1.843 | | | | | | |
| ◇ | 0.144 | | | | | | |

REFERENCE FILE

RADIAL DISTRIBUTION OF BOOSTER BASE PRESSURES

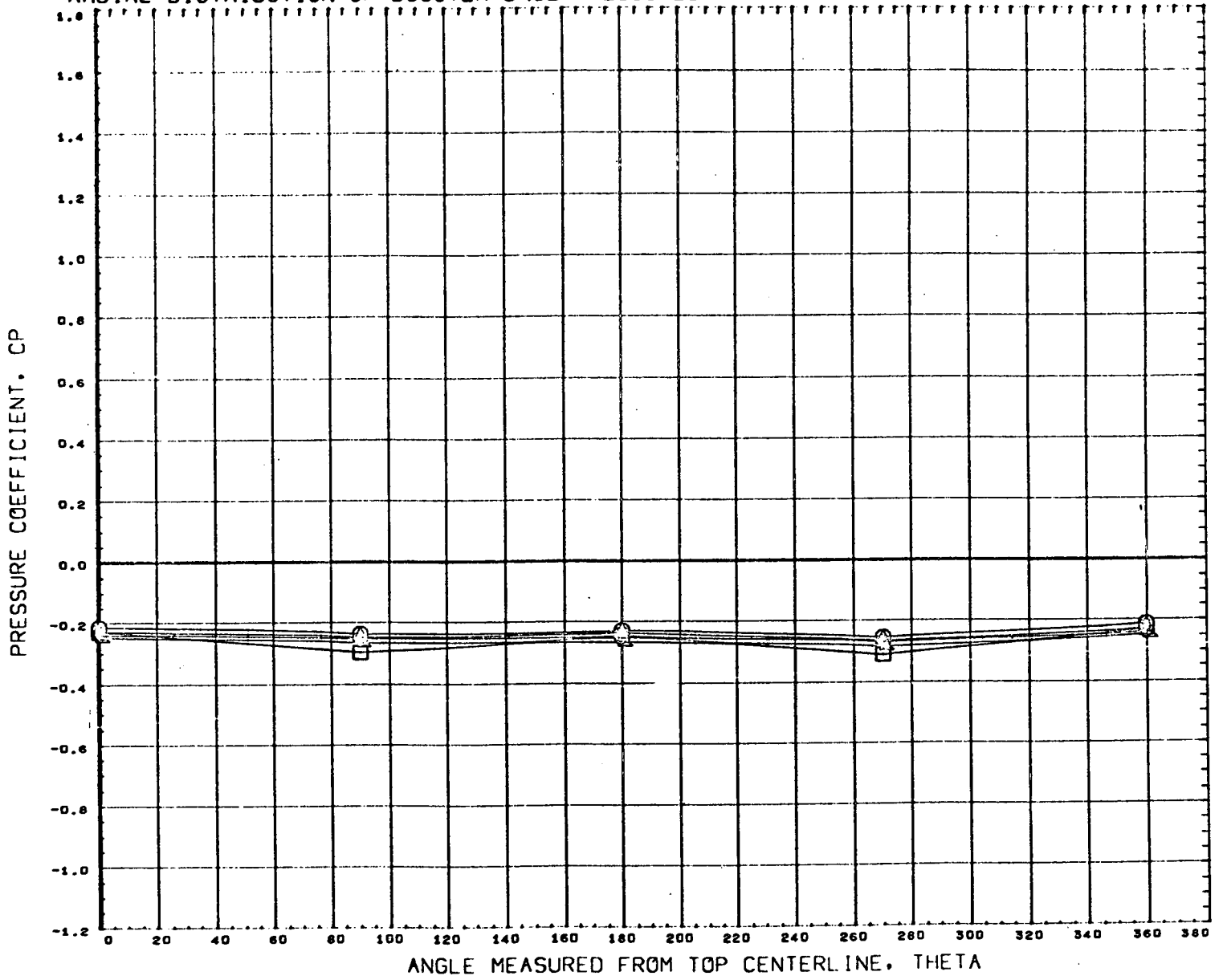

| SYMBOL | ALFB | X/L | M1 | BETA | PARAMETRIC VALUES | | |
|--------|--------|-------|-------|-------|-------------------|---|-------|
| ○ | 2.153 | 1.000 | 0.900 | 0.000 | DX/L | - | 0.194 |
| ◇ | 4.141 | | | I | 0.000 | | |
| △ | 6.125 | | | | | | |
| □ | 8.130 | | | | | | |
| ▽ | 10.089 | | | | | | |

REFERENCE FILE

RADIAL DISTRIBUTION OF BOOSTER BASE PRESSURES

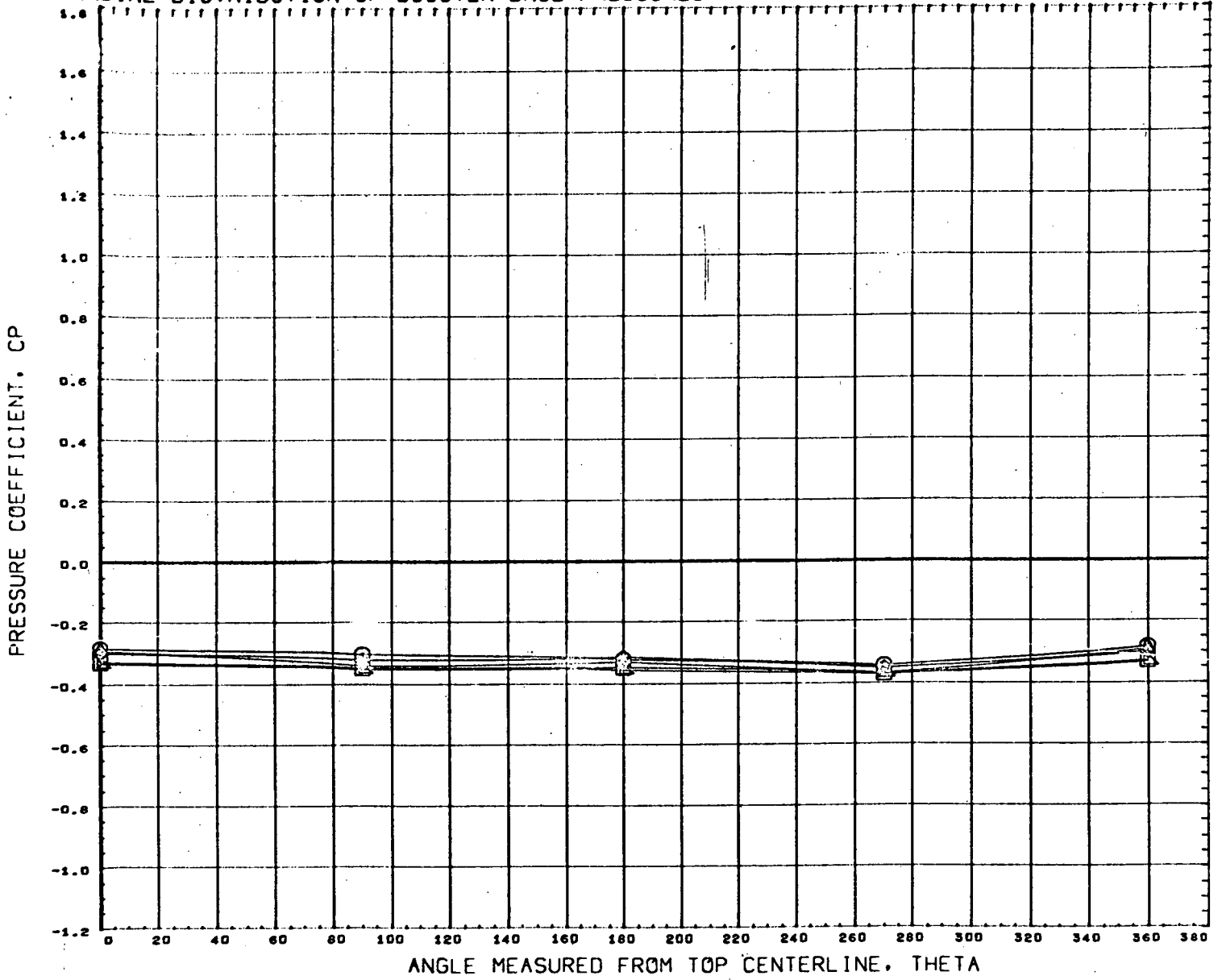

| SYMBOL | ALFB | X/L | M1 | PARAMETRIC VALUES | | |
|--------|---------|-------|-------|-------------------|-------|--------------|
| ○ | - 7.910 | 1.000 | 1.000 | BETA | 0.000 | DX/L - 0.194 |
| ◇ | - 5.806 | | | I | 0.000 | |
| ◇ | - 3.814 | | | | | |
| □ | - 1.822 | | | | | |
| ▽ | 0.152 | | | | | |

REFERENCE FILE

RADIAL DISTRIBUTION OF BOOSTER BASE PRESSURES

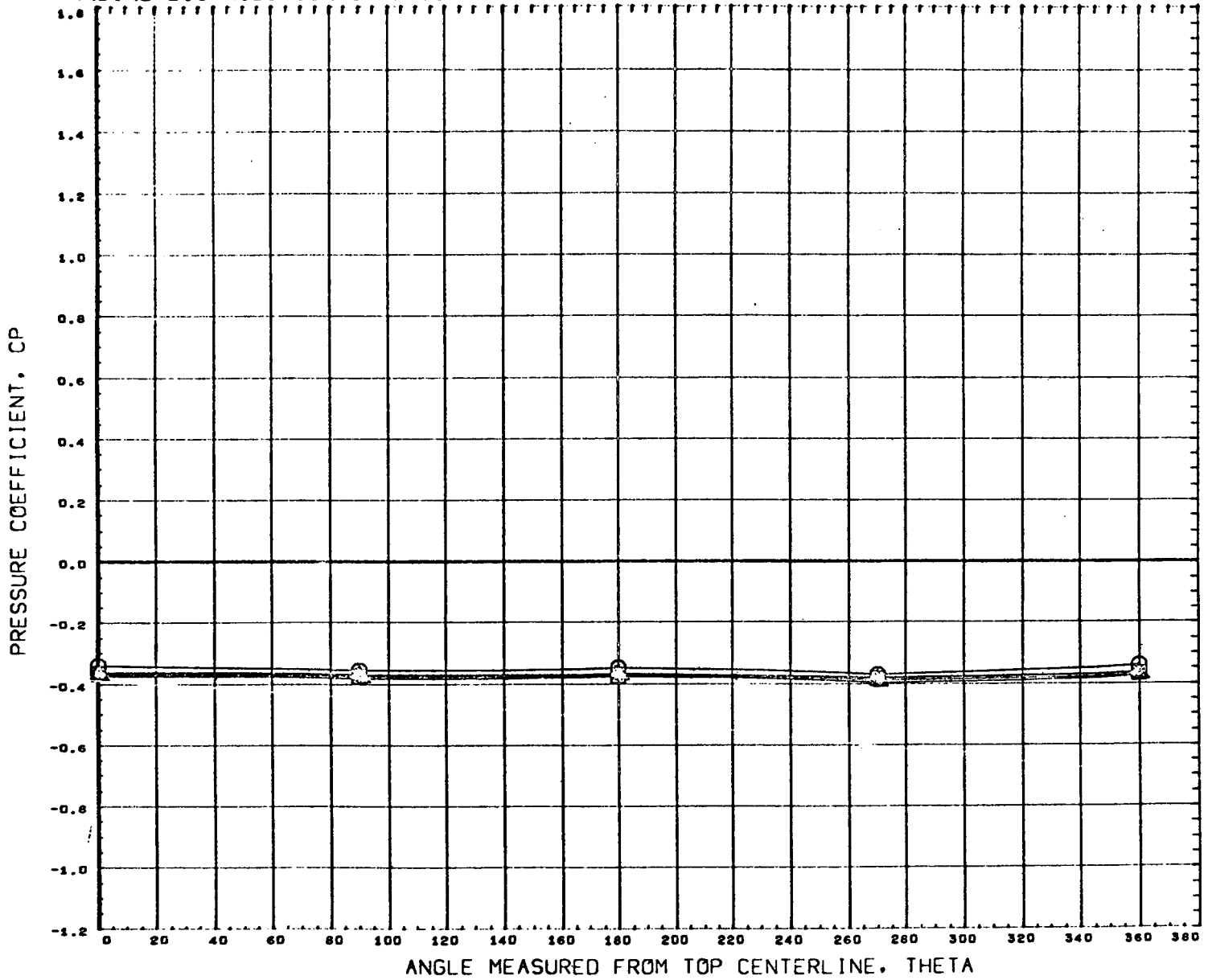

| SYMBOL | ALFB | X/L | M1 | BETA | PARAMETRIC VALUES | |
|--------|--------|-------|-------|-------|-------------------|---------|
| ◇ | 2.149 | 1.000 | 1.050 | 0.000 | OX/L | - 0.194 |
| ◇ | 4.157 | | | 0.000 | | |
| ◇ | 6.143 | | | | | |
| ◇ | 8.134 | | | | | |
| ◇ | 10.121 | | | | | |

REFERENCE FILE

RADIAL DISTRIBUTION OF BOOSTER BASE PRESSURES

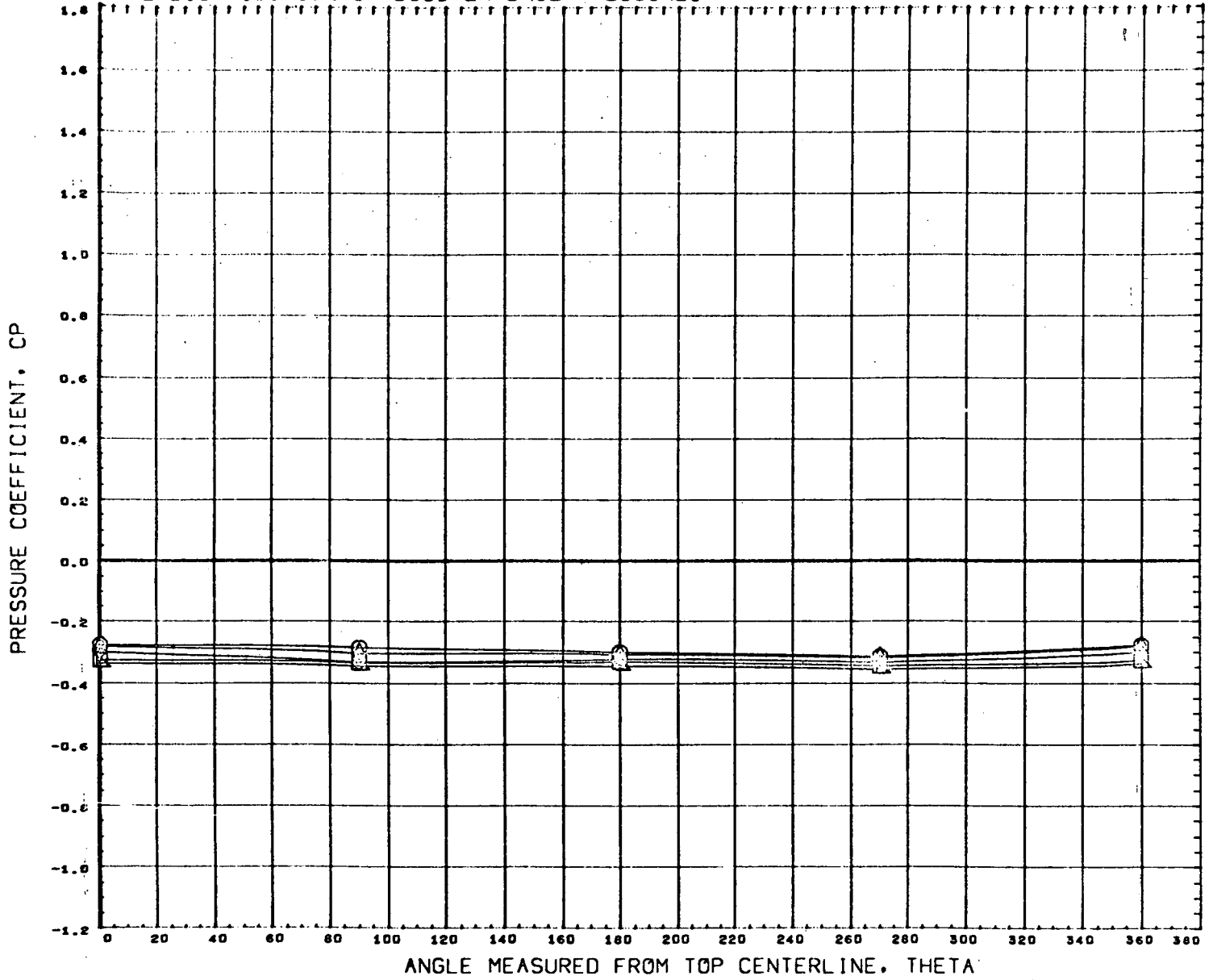

| | | | | | | | |
|--------|---------|-------|-------|--|-------|-------------------|---------|
| SYMBOL | ALFB | X/L | M1 | | BETA | PARAMETRIC VALUES | |
| ◇ | - 7.928 | 1.000 | 1.104 | | 0.000 | DX/L | - 0.194 |
| ◇ | - 5.803 | | | | I | 0.000 | |
| ◇ | - 3.824 | | | | | | |
| ◇ | - 1.828 | | | | | | |
| ◇ | 0.154 | | | | | | |

REFERENCE FILE

RADIAL DISTRIBUTION OF BOOSTER BASE PRESSURES

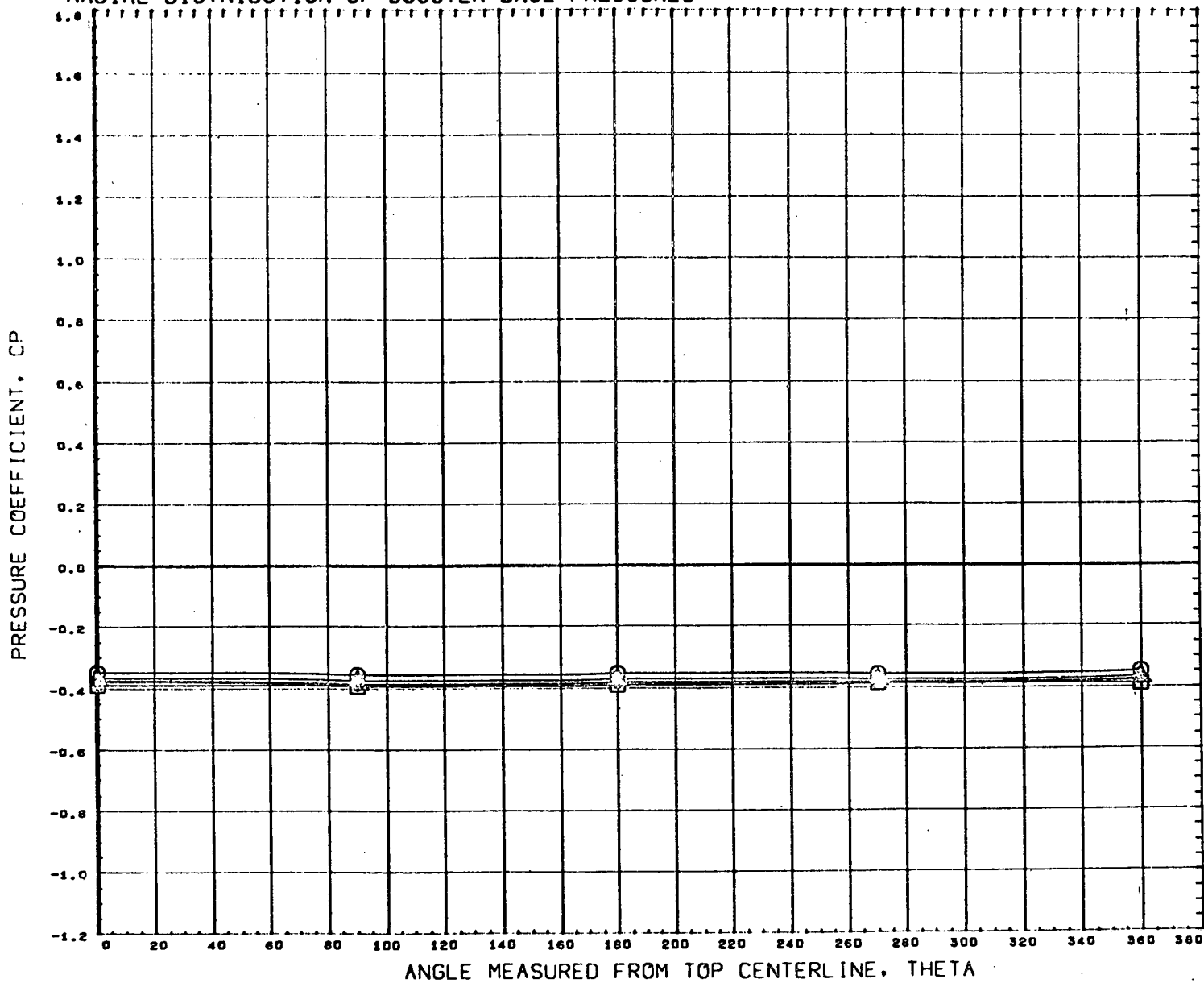

| SYMBOL | ALFB | X/L | M1 |
|--------|--------|-------|-------|
| ◇ | 2.171 | 1.000 | 1.104 |
| ◇ | 4.158 | | |
| ◇ | 6.148 | | |
| ◇ | 8.136 | | |
| ◇ | 10.122 | | |

| PARAMETRIC VALUES | | | |
|-------------------|-------|------|---------|
| BETA | 0.000 | DX/L | - 0.194 |
| I | 0.000 | | |

REFERENCE FILE

RADIAL DISTRIBUTION OF BOOSTER BASE PRESSURES

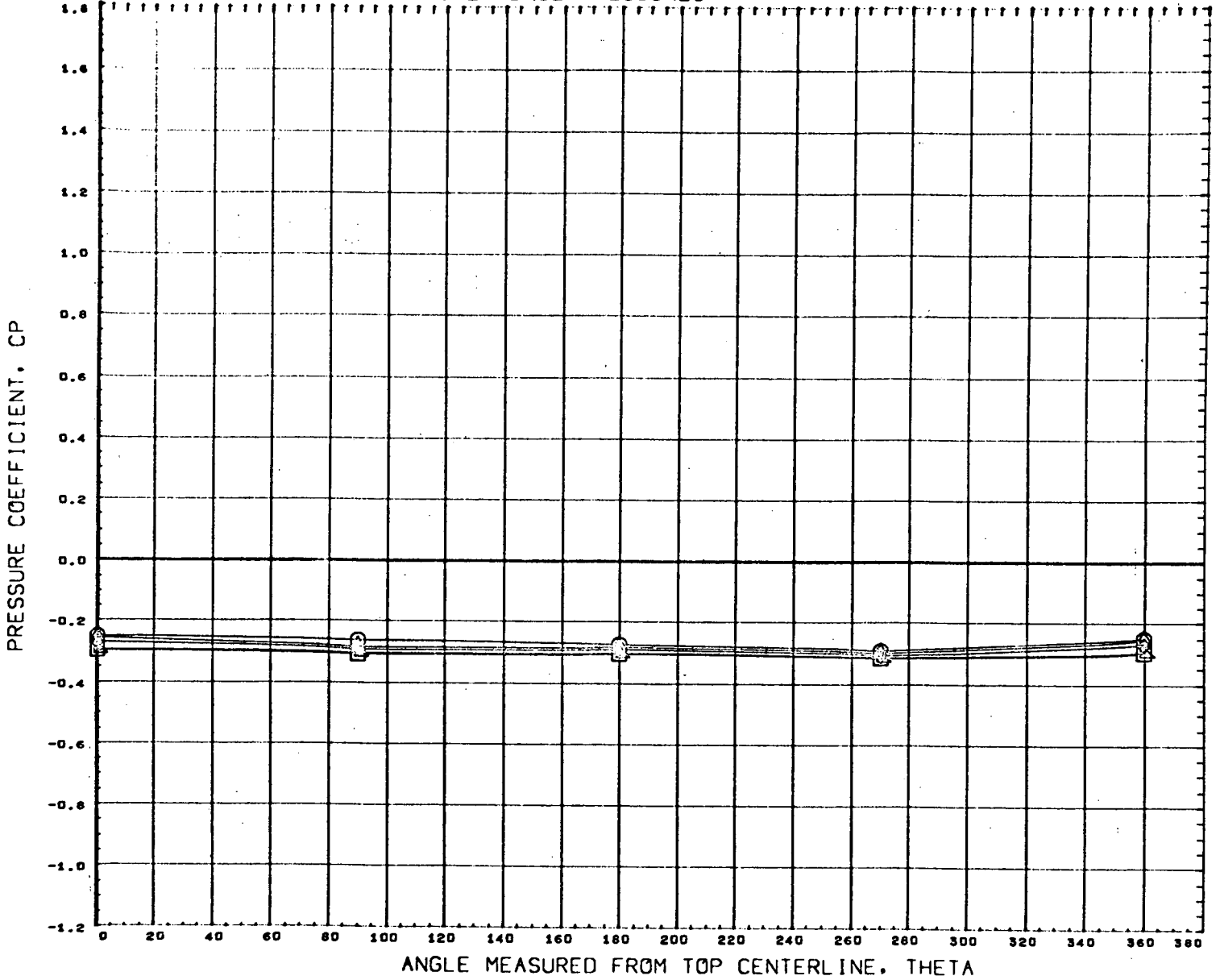

| SYMBOL | ALFB | X/L | M1 |
|--------|-------|-------|-------|
| ◇ | 7.923 | 1.000 | 1.201 |
| ◇ | 5.815 | | |
| ◇ | 3.827 | | |
| ◇ | 1.841 | | |
| ◇ | 0.145 | | |

| PARAMETRIC VALUES | | | |
|-------------------|-------|------|---------|
| BETA | 0.000 | DX/L | - 0.194 |
| I | 0.000 | | |

REFERENCE FILE

RADIAL DISTRIBUTION OF BOOSTER BASE PRESSURES

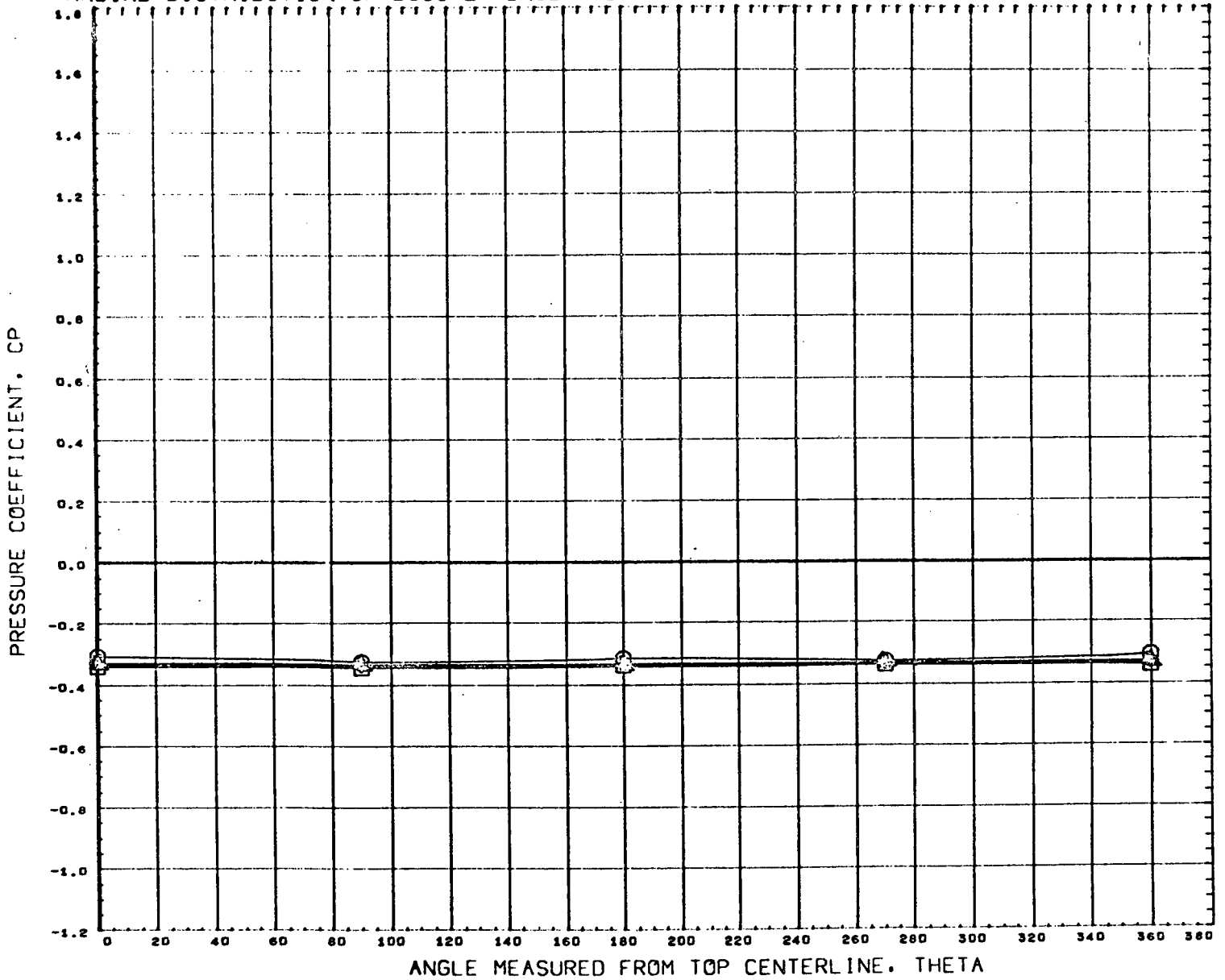

| | | | | | | |
|--------|--------|-------|-------|-------|-------------------|---------|
| SYMBOL | ALFB | X/L | M1 | BETA | PARAMETRIC VALUES | |
| ○ | 2.167 | 1.000 | 1.201 | 0.000 | DX/L | - 0.194 |
| ◇ | 4.166 | | | I | 0.000 | |
| ◇ | 6.147 | | | | | |
| □ | 8.143 | | | | | |
| ▽ | 10.117 | | | | | |

REFERENCE FILE

RADIAL DISTRIBUTION OF BOOSTER BASE PRESSURES

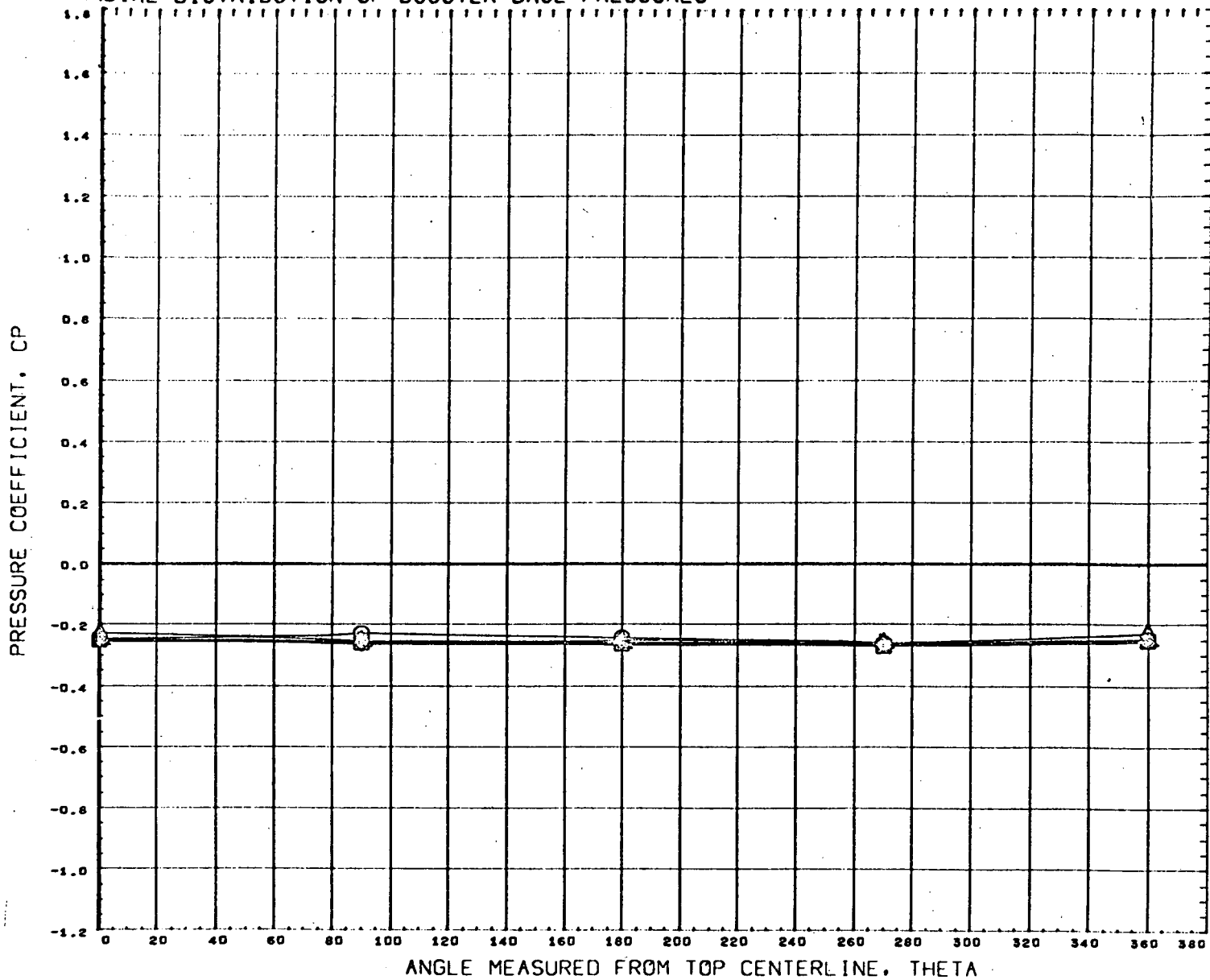

| SYMBOL | ALFB | X/L | M1 | PARAMETRIC VALUES | | |
|--------|---------|-------|-------|-------------------|-------|--------------|
| ◇ | - 7.930 | 1.000 | 1.300 | BETA | 0.000 | DX/L - 0.194 |
| ◇ | - 5.834 | | | I | 0.000 | |
| ◇ | - 3.852 | | | | | |
| ◇ | - 1.848 | | | | | |
| ◇ | 0.145 | | | | | |

REFERENCE FILE

RADIAL DISTRIBUTION OF BOOSTER BASE PRESSURES

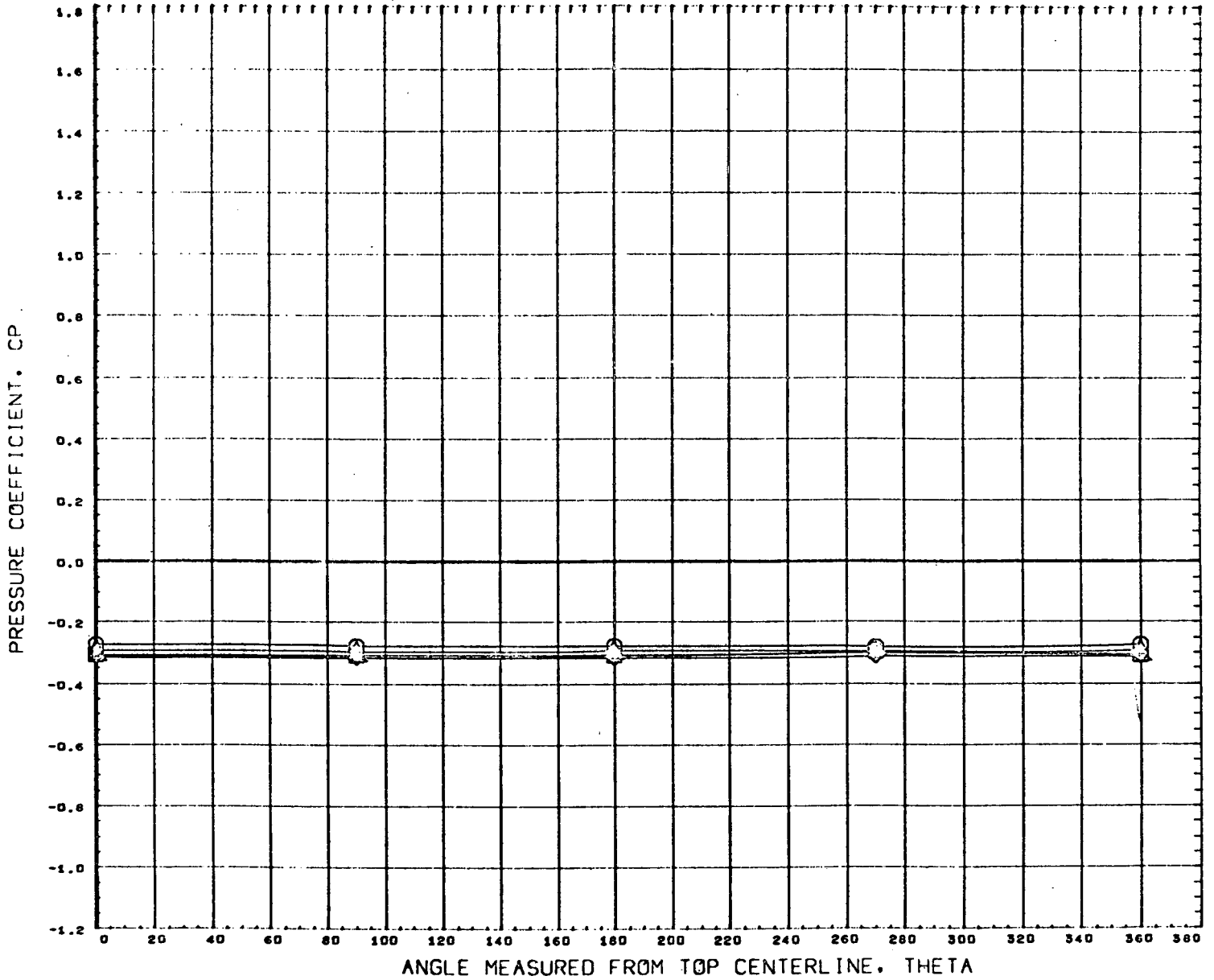

| SYMBOL | ALFB | X/L | M1 |
|--------|--------|-------|-------|
| ◇ | 2.163 | 1.000 | 1.300 |
| ◇ | 4.164 | | |
| ◇ | 6.136 | | |
| ◇ | 8.142 | | |
| ◇ | 10.136 | | |

| PARAMETRIC VALUES | | |
|-------------------|-------|--------------|
| BETA | 0.000 | DX/L - 0.194 |
| I | 0.000 | |

REFERENCE FILE

RADIAL DISTRIBUTION OF BOOSTER BASE PRESSURES

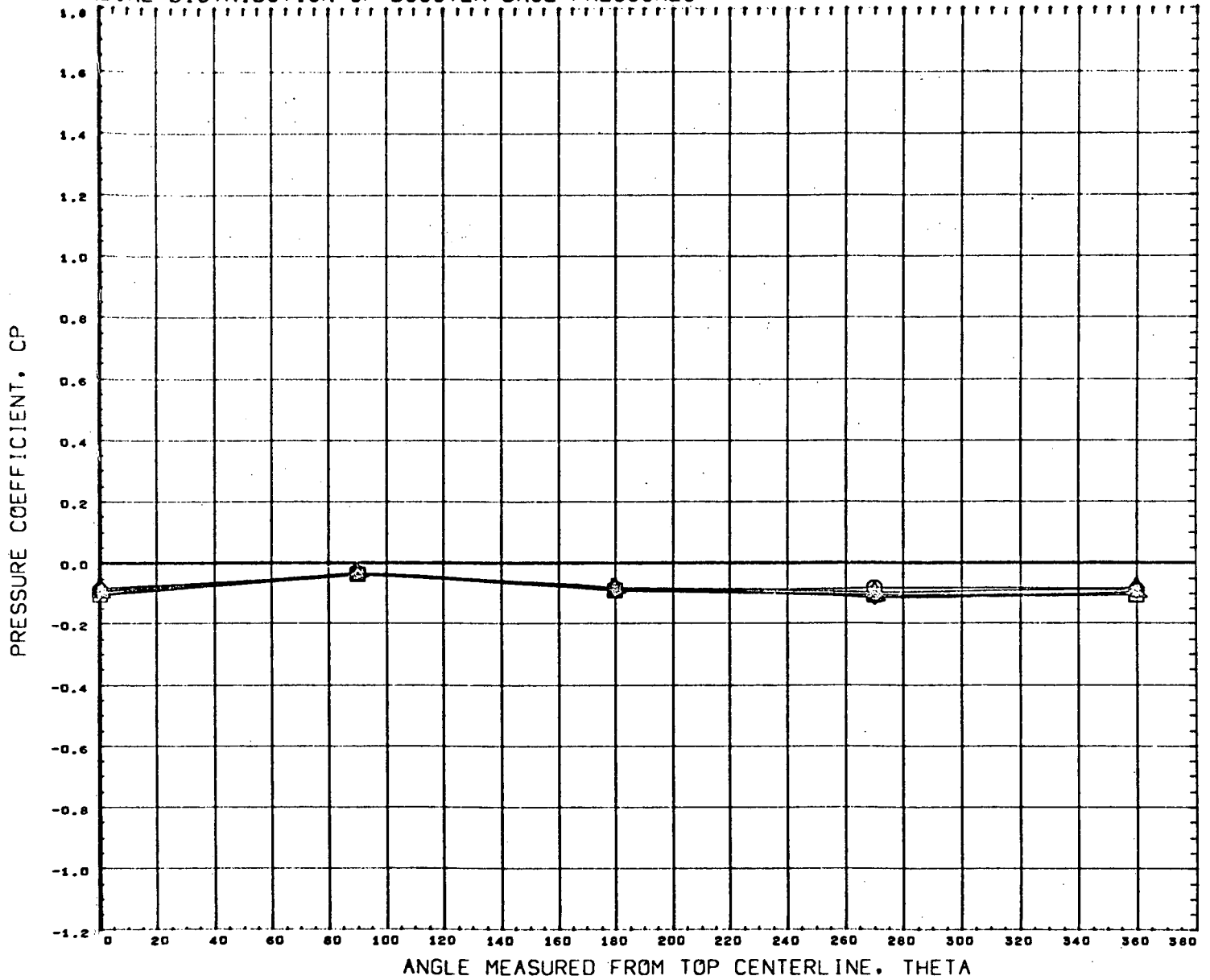

| SYMBOL | ALFB | X/L | M1 | BETA | PARAMETRIC VALUES |
|--------|---------|-------|-------|------|-------------------|
| ○ | - 8.160 | 1.000 | 0.604 | | 0.000 |
| ◇ | - 5.879 | | | | |
| ◇ | - 3.899 | | | | |
| ◇ | - 1.899 | | | | |
| ◇ | 0.093 | | | | |

REFERENCE FILE

RADIAL DISTRIBUTION OF BOOSTER BASE PRESSURES

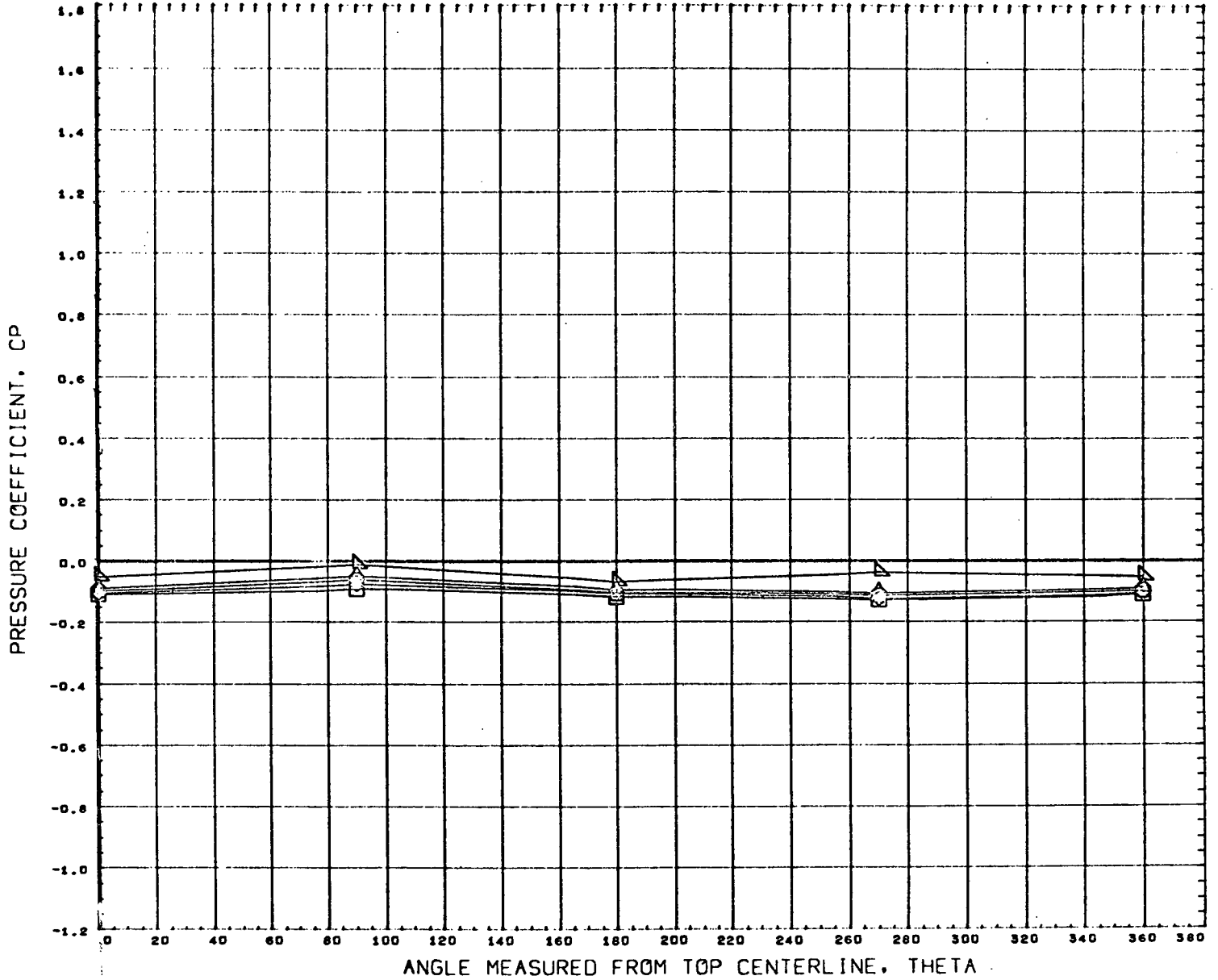

| SYMBOL | ALFB | X/L | M1 | BETA | PARAMETRIC VALUES |
|--------|--------|-------|-------|------|-------------------|
| ○ | 2.099 | 1.000 | 0.604 | | |
| ◇ | 4.077 | | | | |
| ◻ | 6.072 | | | | |
| △ | 8.009 | | | | |
| × | 10.065 | | | | |

REFERENCE FILE

RADIAL DISTRIBUTION OF BOOSTER BASE PRESSURES

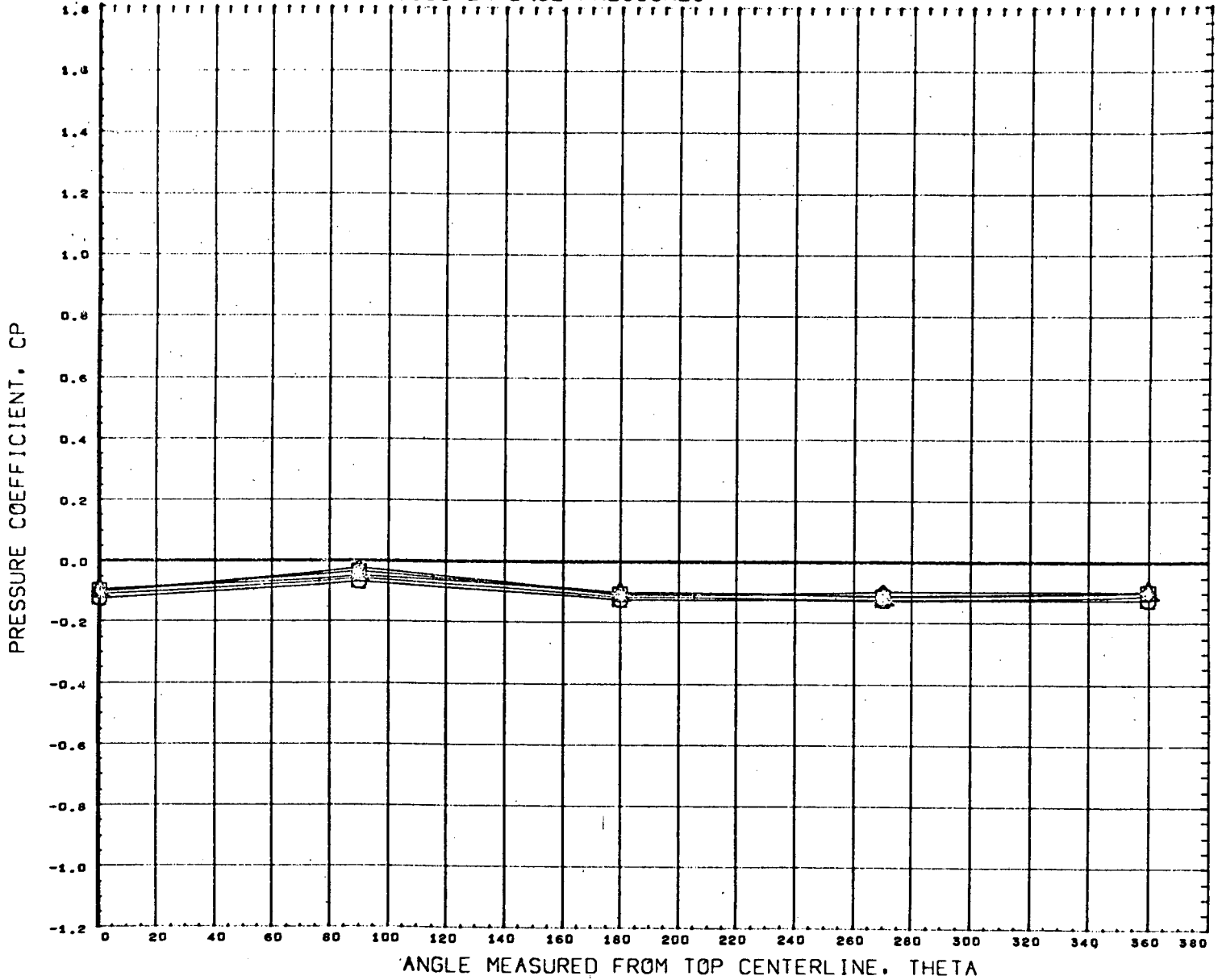

| SYMBOL | ALFB | X/L | M1 | BETA | PARAMETRIC VALUES |
|--------|-------|-------|-------|------|-------------------|
| ○ | 8.278 | 1.000 | 0.897 | | 0.000 |
| ◇ | 5.834 | | | | |
| ◇ | 3.850 | | | | |
| □ | 1.847 | | | | |
| ▽ | 0.155 | | | | |

REFERENCE FILE

RADIAL DISTRIBUTION OF BOOSTER BASE PRESSURES

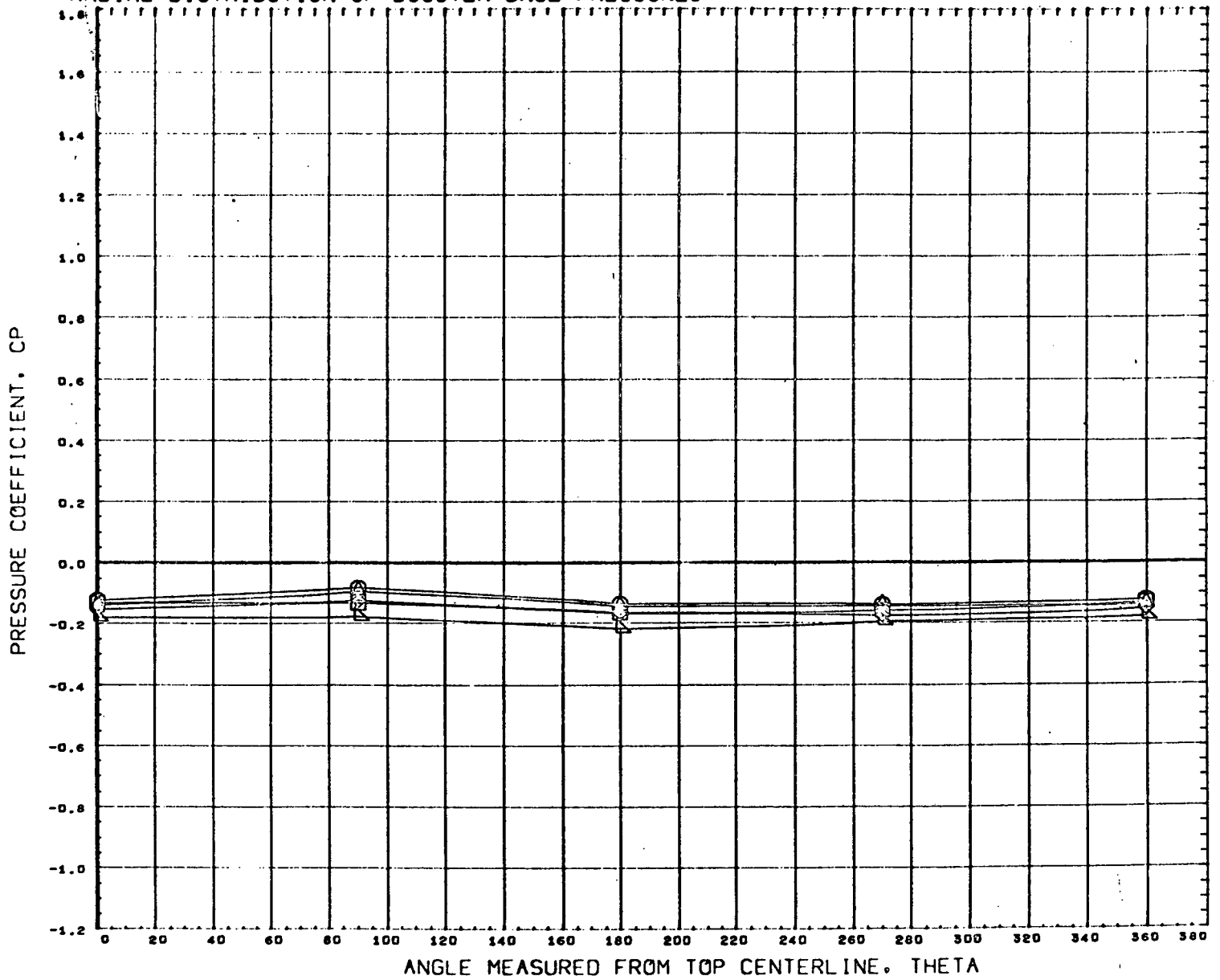

| SYMBOL | ALFD | X/L | M1 | BETA | PARAMETRIC VALUES |
|--------|--------|-------|-------|------|-------------------|
| ○ | 2.122 | 1.000 | 0.897 | | 0.000 |
| ◇ | 4.086 | | | | |
| □ | 6.078 | | | | |
| △ | 8.097 | | | | |
| + | 10.093 | | | | |

REFERENCE FILE

RADIAL DISTRIBUTION OF BOOSTER BASE PRESSURES

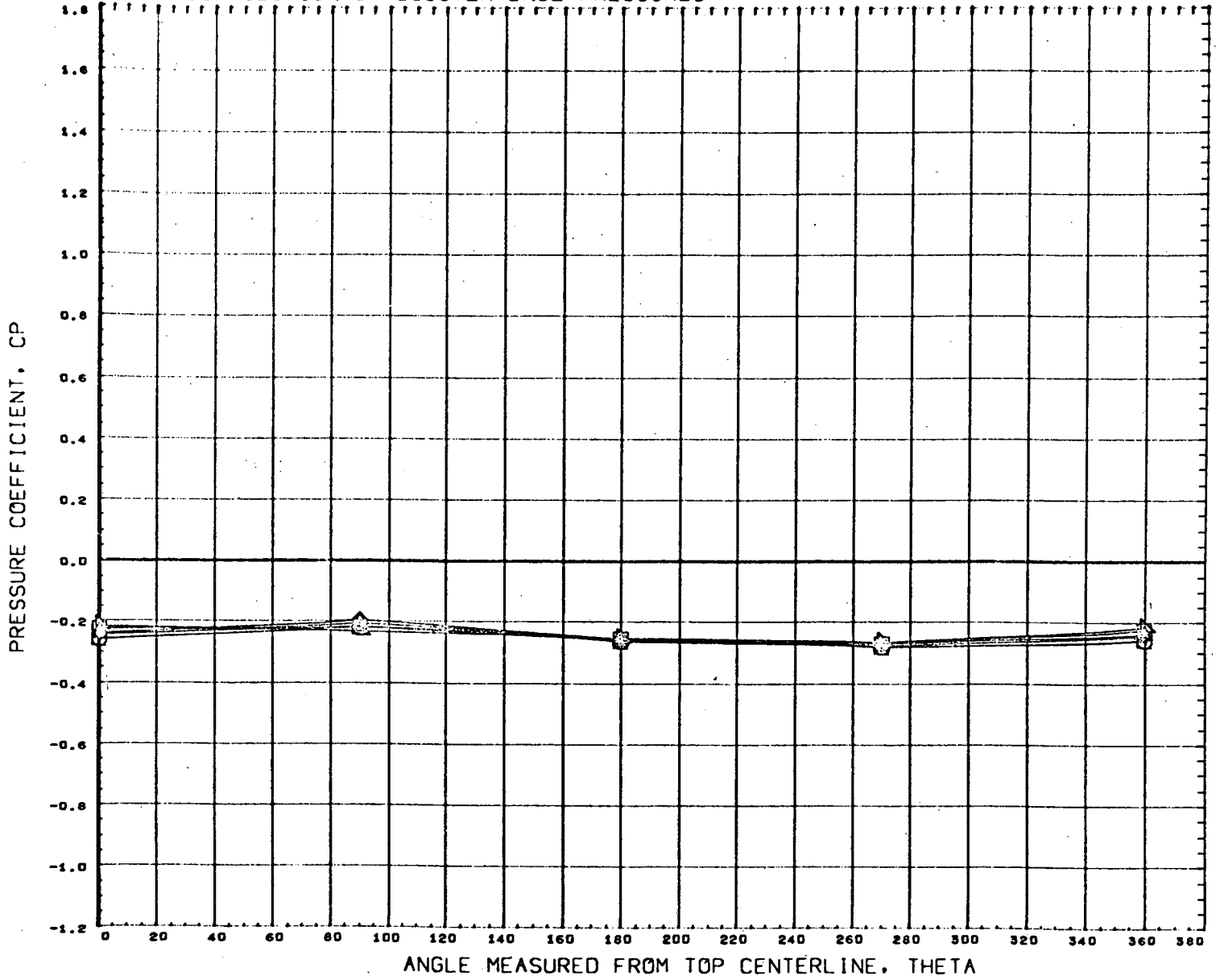

| SYMBOL | ALFB | X/L | M1 |
|--------|---------|-------|-------|
| ◻ | - 7.938 | 1.000 | 0.999 |
| ◊ | - 5.832 | | |
| ◊ | - 3.830 | | |
| ◊ | - 1.825 | | |
| ◊ | 0.148 | | |

BETA PARAMETRIC VALUES
0.000

REFERENCE FILE

RADIAL DISTRIBUTION OF BOOSTER BASE PRESSURES

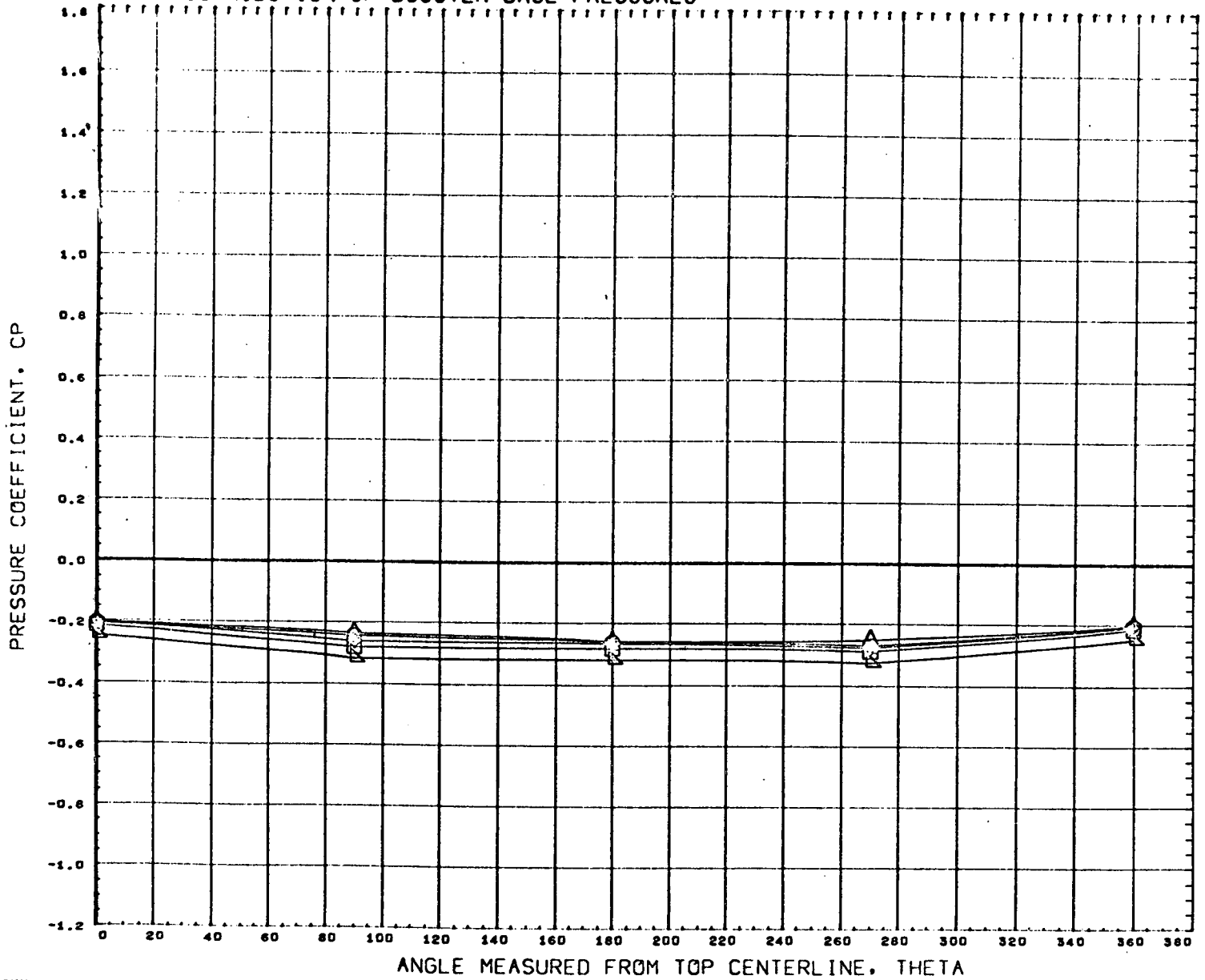

| SYMBOL | ALFD | X/L | M1 | BETA | PARAMETRIC VALUES |
|--------|--------|-------|-------|------|-------------------|
| ○ | 2.161 | 1.000 | 0.999 | | 0.000 |
| ◇ | 4.143 | | | | |
| ◇ | 6.134 | | | | |
| ◇ | 8.108 | | | | |
| ◇ | 10.097 | | | | |

REFERENCE FILE

RADIAL DISTRIBUTION OF BOOSTER BASE PRESSURES

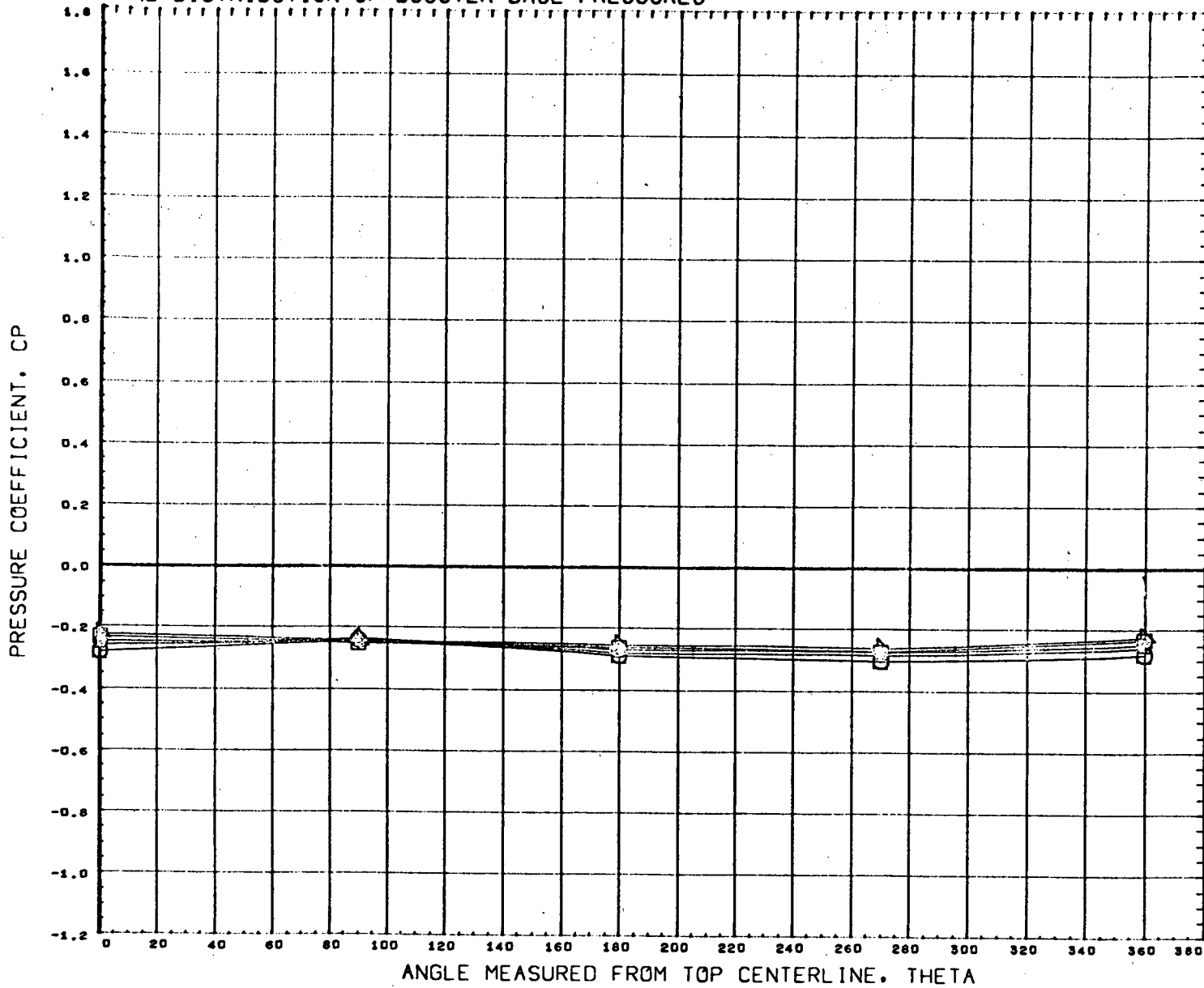

| SYMBOL | ALFB | X/L | M1 |
|--------|---------|-------|-------|
| ○ | - 7.924 | 1.000 | 1.100 |
| ◇ | - 5.825 | | |
| △ | - 3.839 | | |
| □ | - 1.836 | | |
| ◇ | 0.132 | | |

BETA PARAMETRIC VALUES
0.000

REFERENCE FILE

RADIAL DISTRIBUTION OF BOOSTER BASE PRESSURES

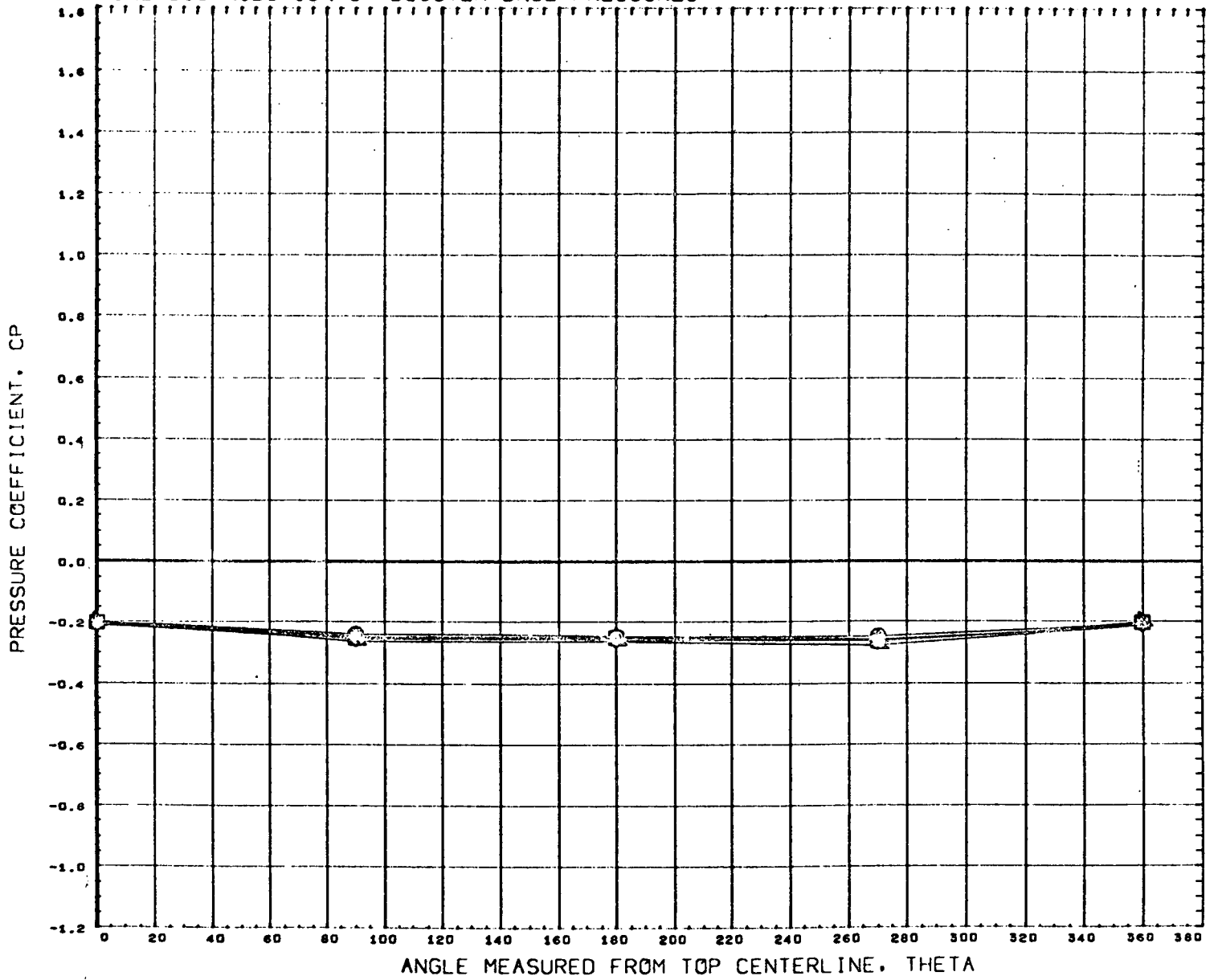

| SYMBOL | ALFB | X/L | M1 | BETA | PARAMETRIC VALUES |
|--------|--------|-------|-------|------|-------------------|
| ○ | 1.941 | 1.000 | 1.100 | | 0.000 |
| ◇ | 4.070 | | | | |
| ◇ | 6.179 | | | | |
| ◇ | 8.163 | | | | |
| ◇ | 10.138 | | | | |

REFERENCE FILE

RADIAL DISTRIBUTION OF BOOSTER BASE PRESSURES

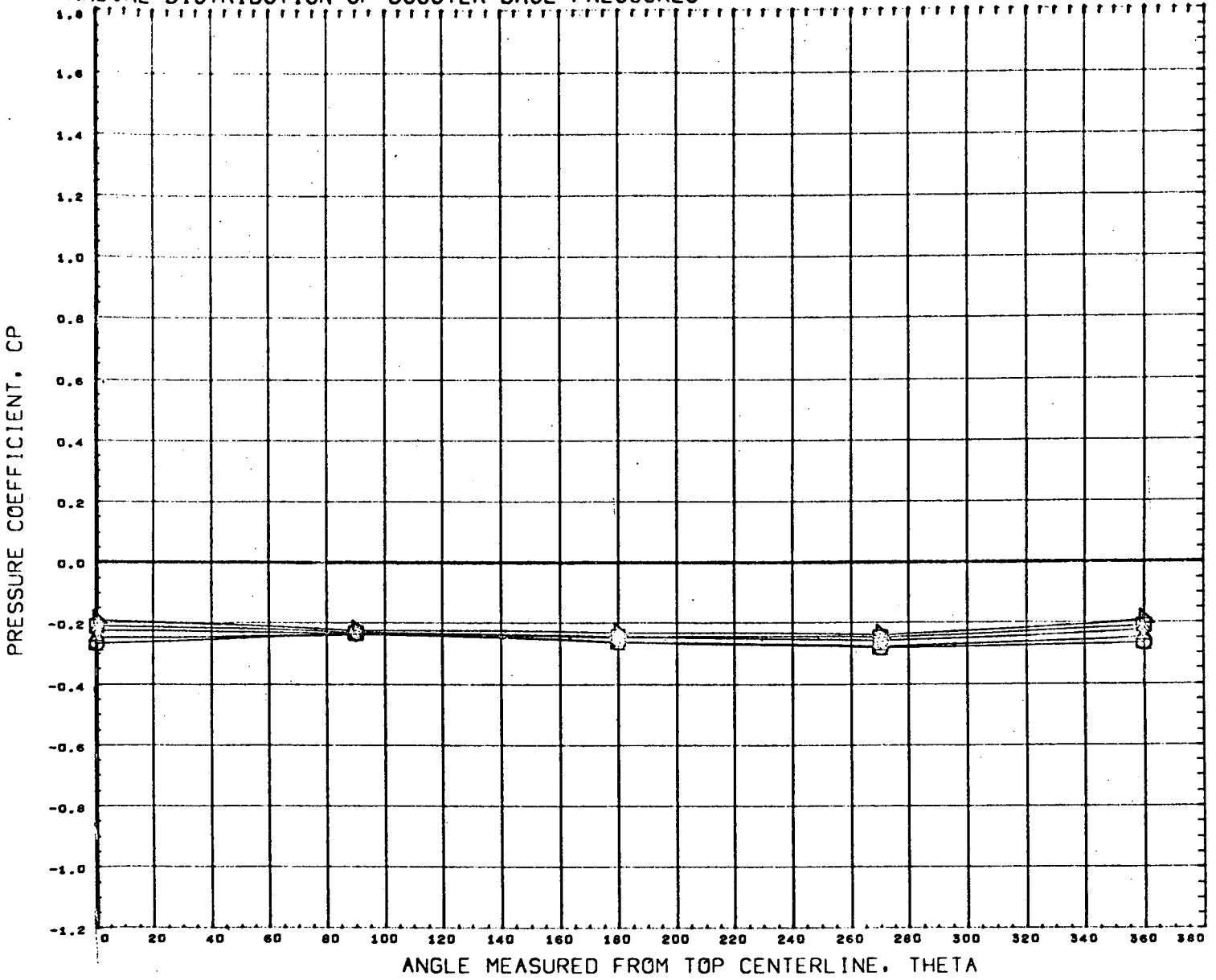

| SYMBOL | ALFD | X/L | M1 |
|--------|---------|-------|-------|
| ◇ | - 8.231 | 1.000 | 1.200 |
| ◇ | - 6.153 | | |
| ◇ | - 4.135 | | |
| ◇ | - 2.059 | | |
| ◇ | 0.120 | | |

BETA PARAMETRIC VALUES
0.000

REFERENCE FILE

RADIAL DISTRIBUTION OF BOOSTER BASE PRESSURES

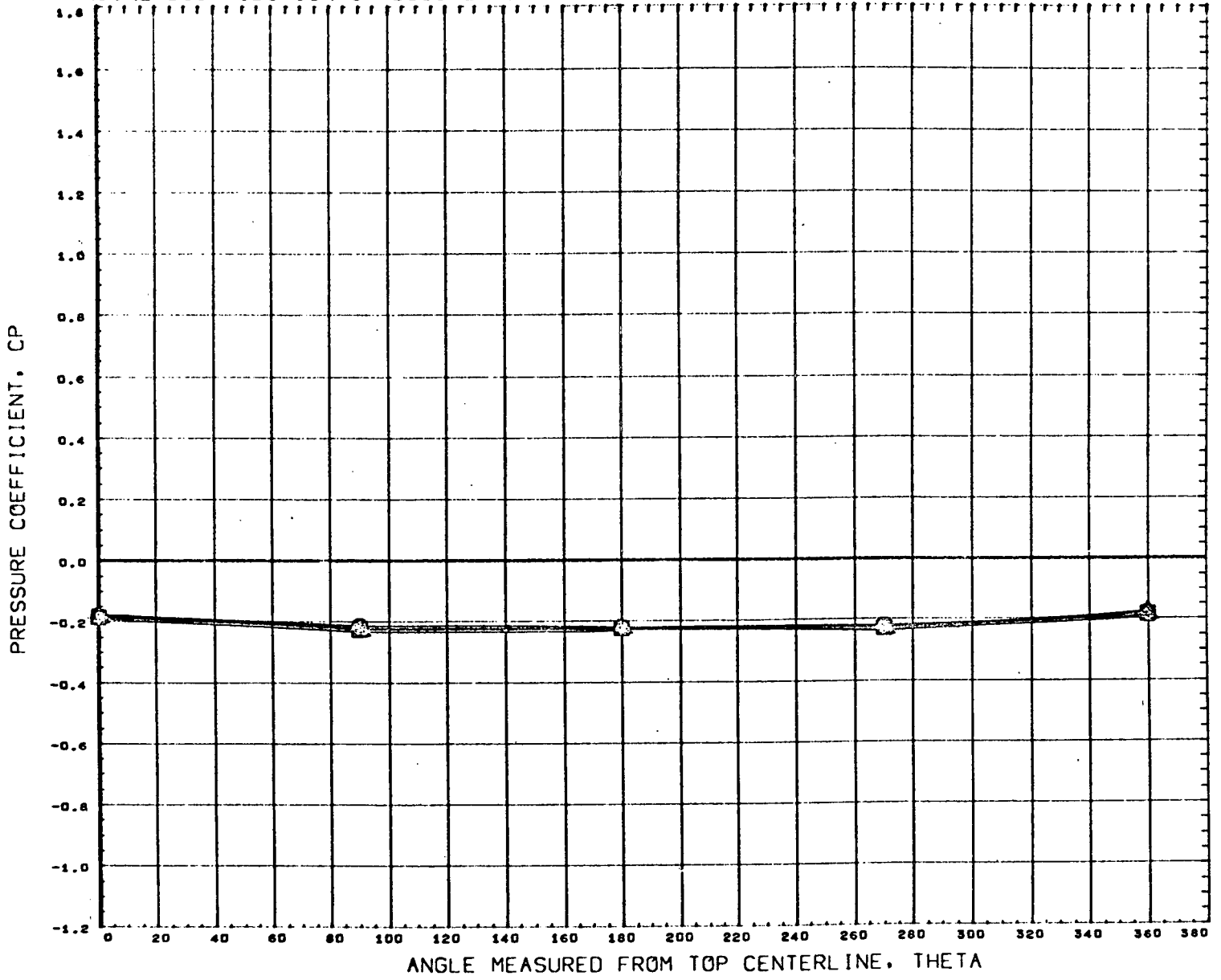

ANGLE MEASURED FROM TOP CENTERLINE, THETA

| SYMBOL | ALFB | X/L | M1 | BETA | PARAMETRIC VALUES |
|--------|--------|-------|-------|------|-------------------|
| ◇ | 1.926 | 1.000 | 1.200 | | 0.000 |
| ◇ | 4.054 | | | | |
| ◇ | 6.166 | | | | |
| ◇ | 8.159 | | | | |
| ◇ | 10.141 | | | | |

REFERENCE FILE

RADIAL DISTRIBUTION OF BOOSTER BASE PRESSURES

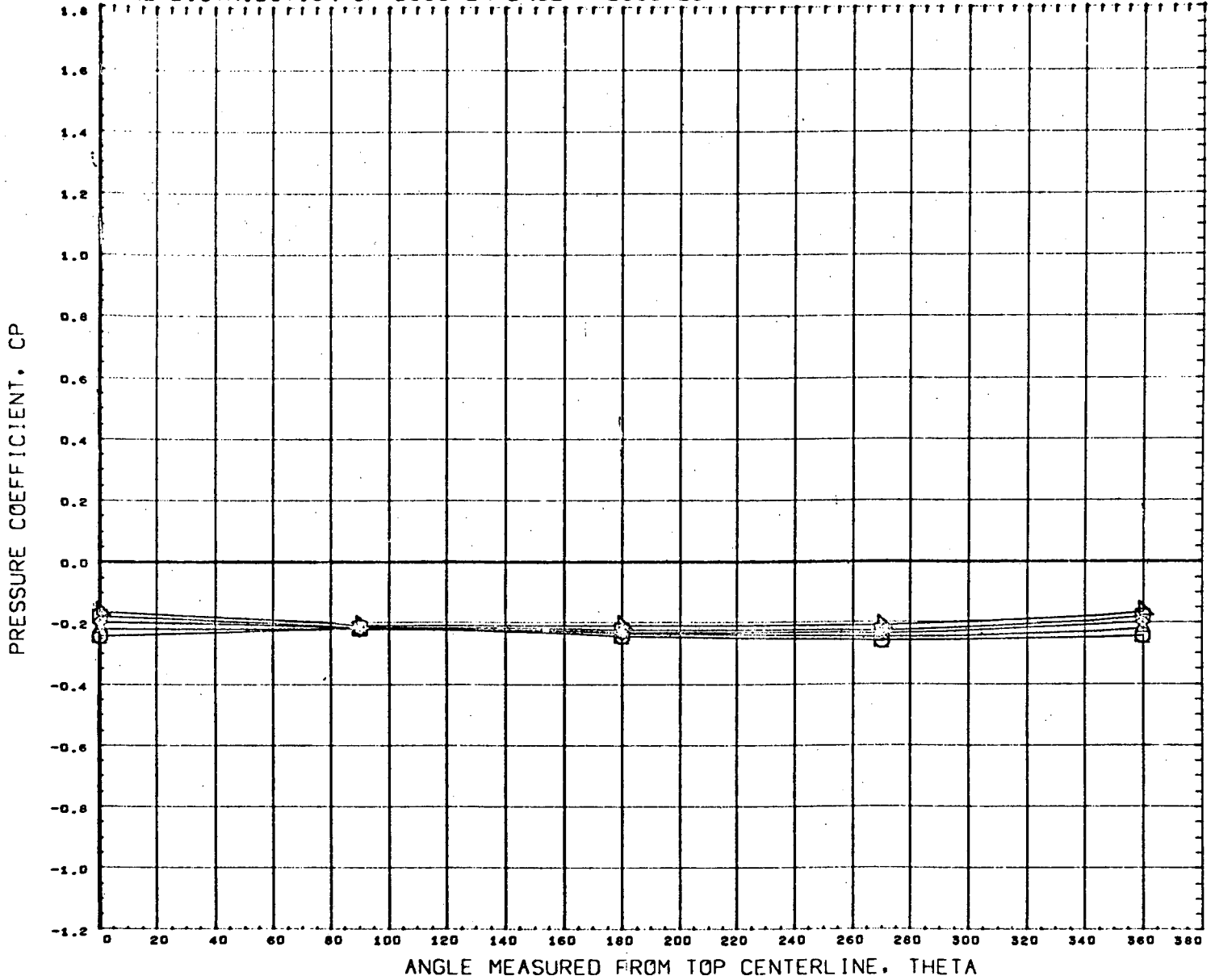

| SYMBOL | ALFB | X/L | M1 | BETA | PARAMETRIC VALUES |
|--------|-------|-------|-------|-------|-------------------|
| ◇ | 8.210 | 1.000 | 1.299 | 0.000 | |
| □ | 6.139 | | | | |
| ○ | 4.129 | | | | |
| △ | 2.017 | | | | |
| + | 0.107 | | | | |

REFERENCE FILE

RADIAL DISTRIBUTION OF BOOSTER BASE PRESSURES

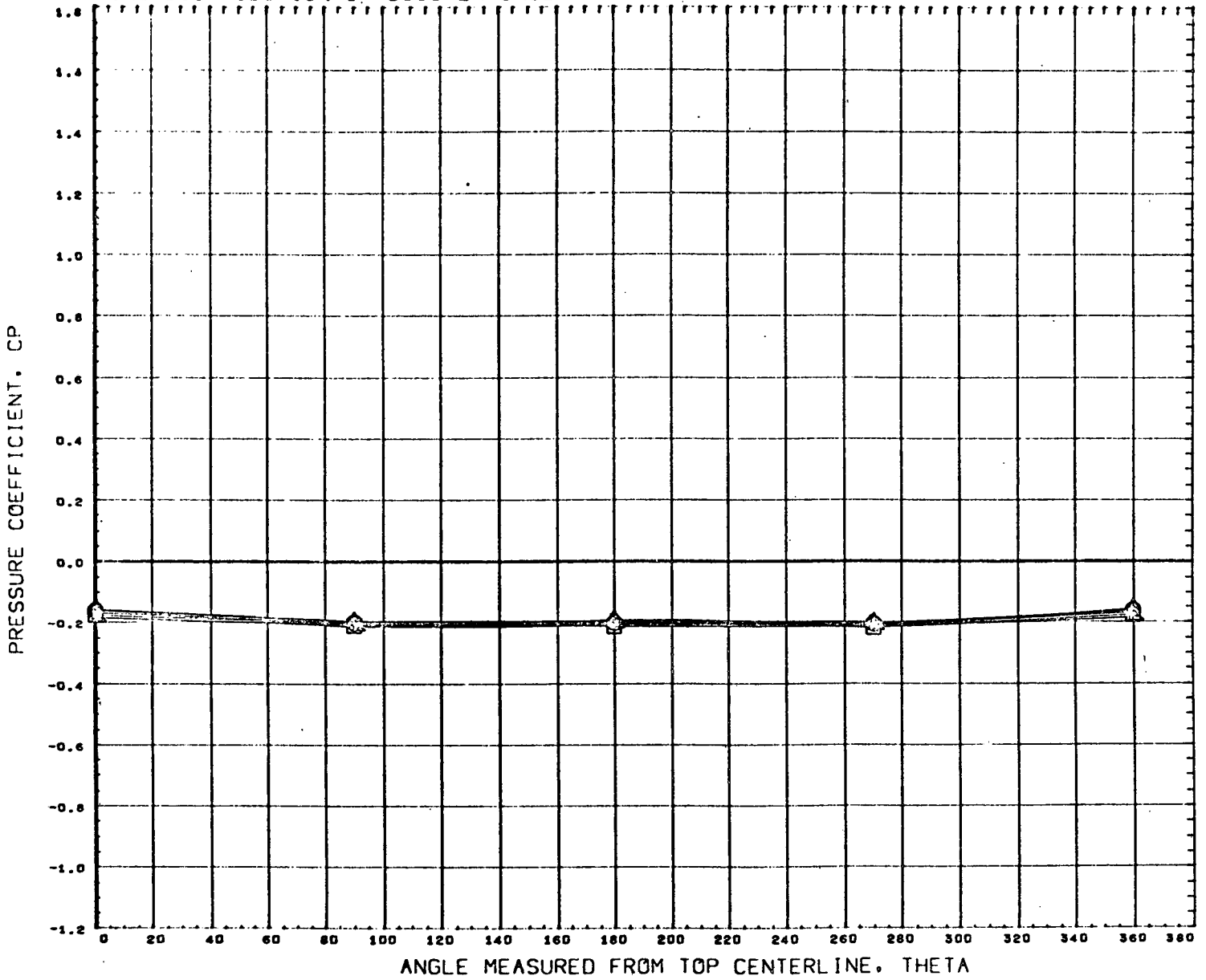

| SYMBOL | ALFB | X/L | M1 | BETA | PARAMETRIC VALUES |
|--------|--------|-------|-------|------|-------------------|
| ○ | 1.914 | 1.000 | 1.299 | | |
| ◇ | 4.038 | | | | |
| ◇ | 6.150 | | | | |
| ◇ | 8.153 | | | | |
| ◇ | 10.147 | | | | |

REFERENCE FILE

RADIAL DISTRIBUTION OF BOOSTER BASE PRESSURES

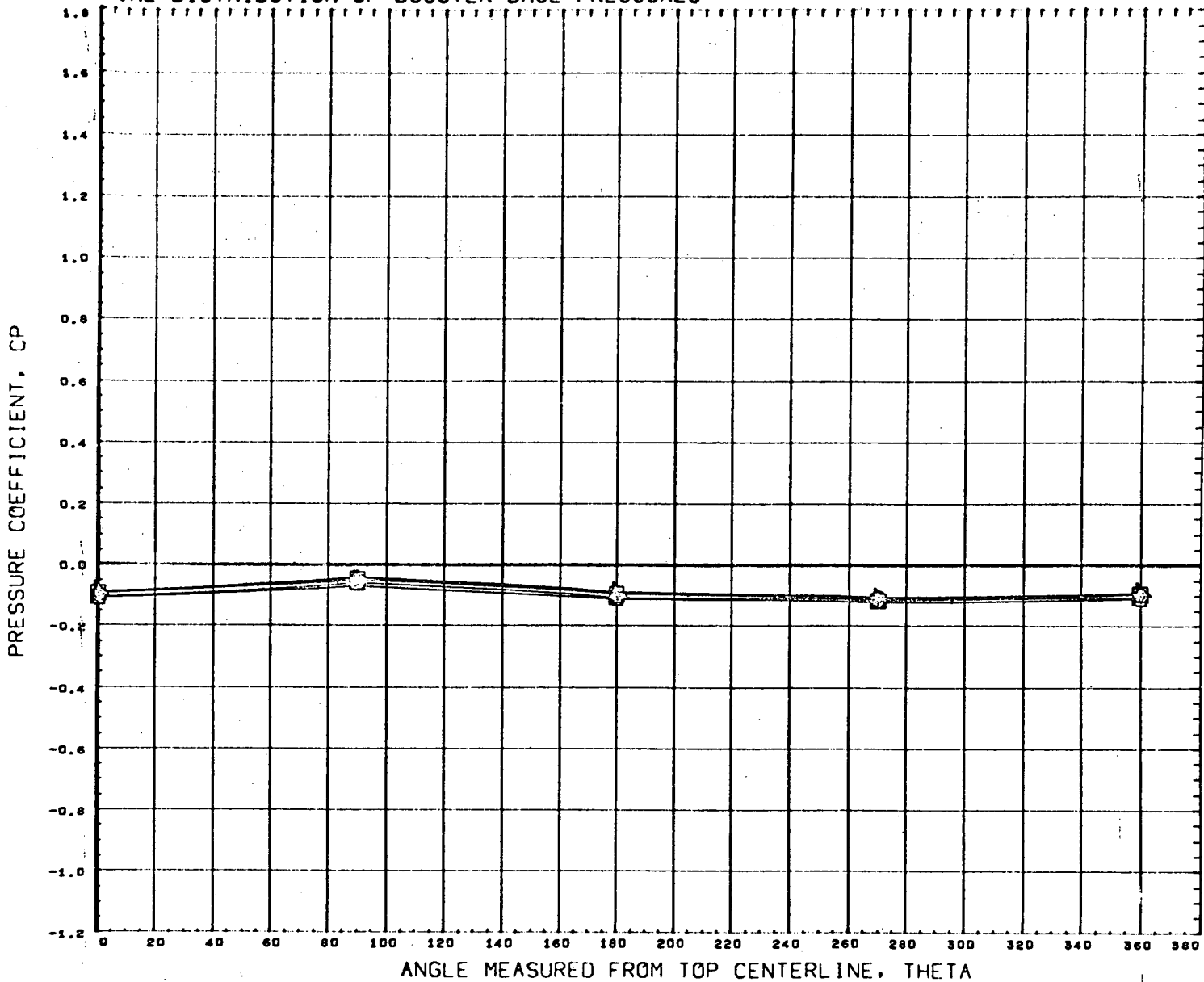

| SYMBOL | BETA | X/L | M1 | ALFB | PARAMETRIC VALUES |
|--------|-------|-------|-------|------|-------------------|
| ◇ | 5.936 | 1.000 | 0.597 | | 0.000 |
| ◇ | 3.933 | | | | |
| ◇ | 1.925 | | | | |
| ◇ | 0.211 | | | | |
| ◇ | 1.796 | | | | |

REFERENCE FILE

RADIAL DISTRIBUTION OF BOOSTER BASE PRESSURES

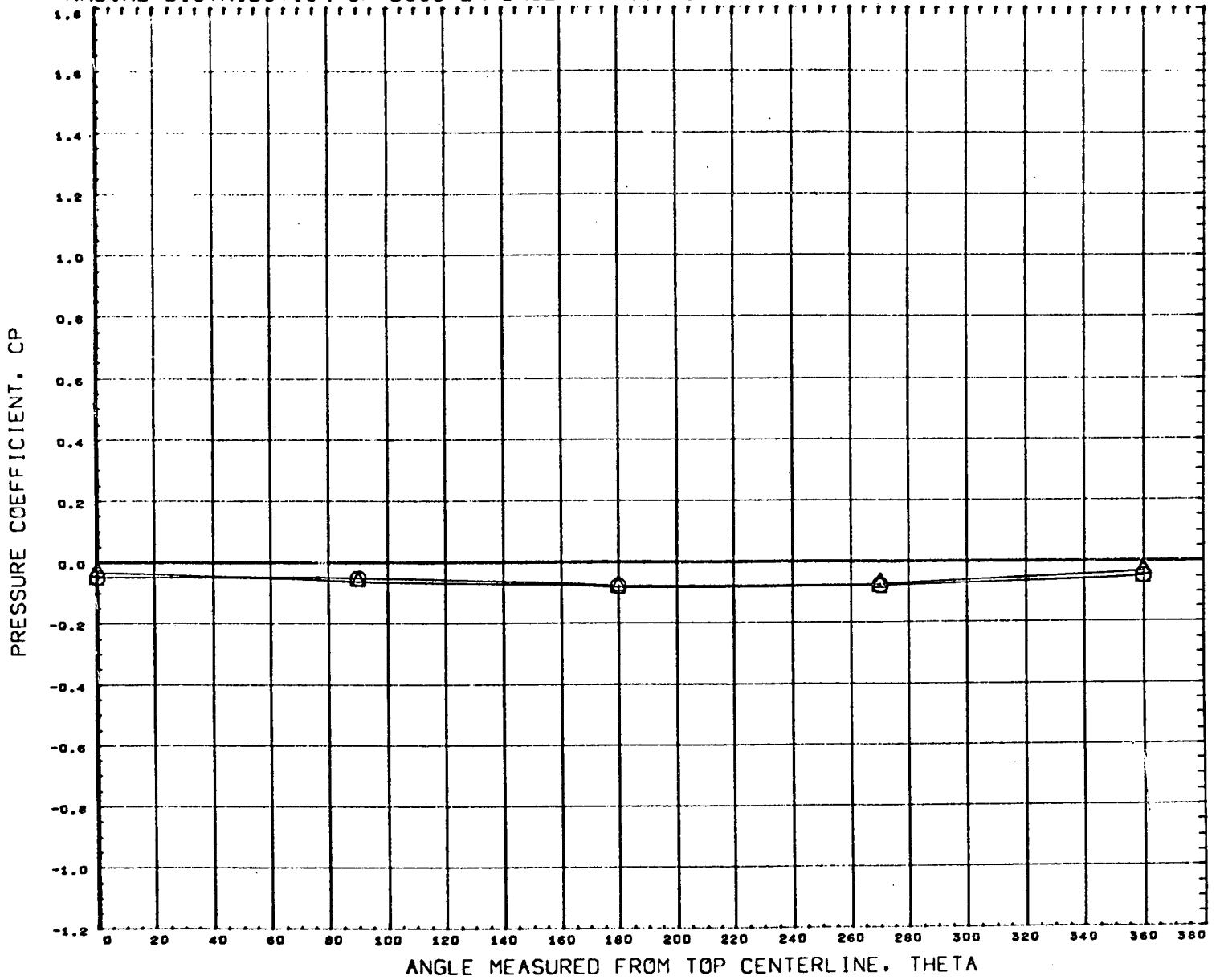

| SYMBOL | BETA | X/L | M1 | ALFB | PARAMETRIC VALUES |
|--------|-------|-------|-------|------|-------------------|
| ○ | 3.795 | 1.000 | 0.597 | | 0.000 |
| △ | 5.842 | | | | |

REFERENCE FILE

RADIAL DISTRIBUTION OF BOOSTER BASE PRESSURES

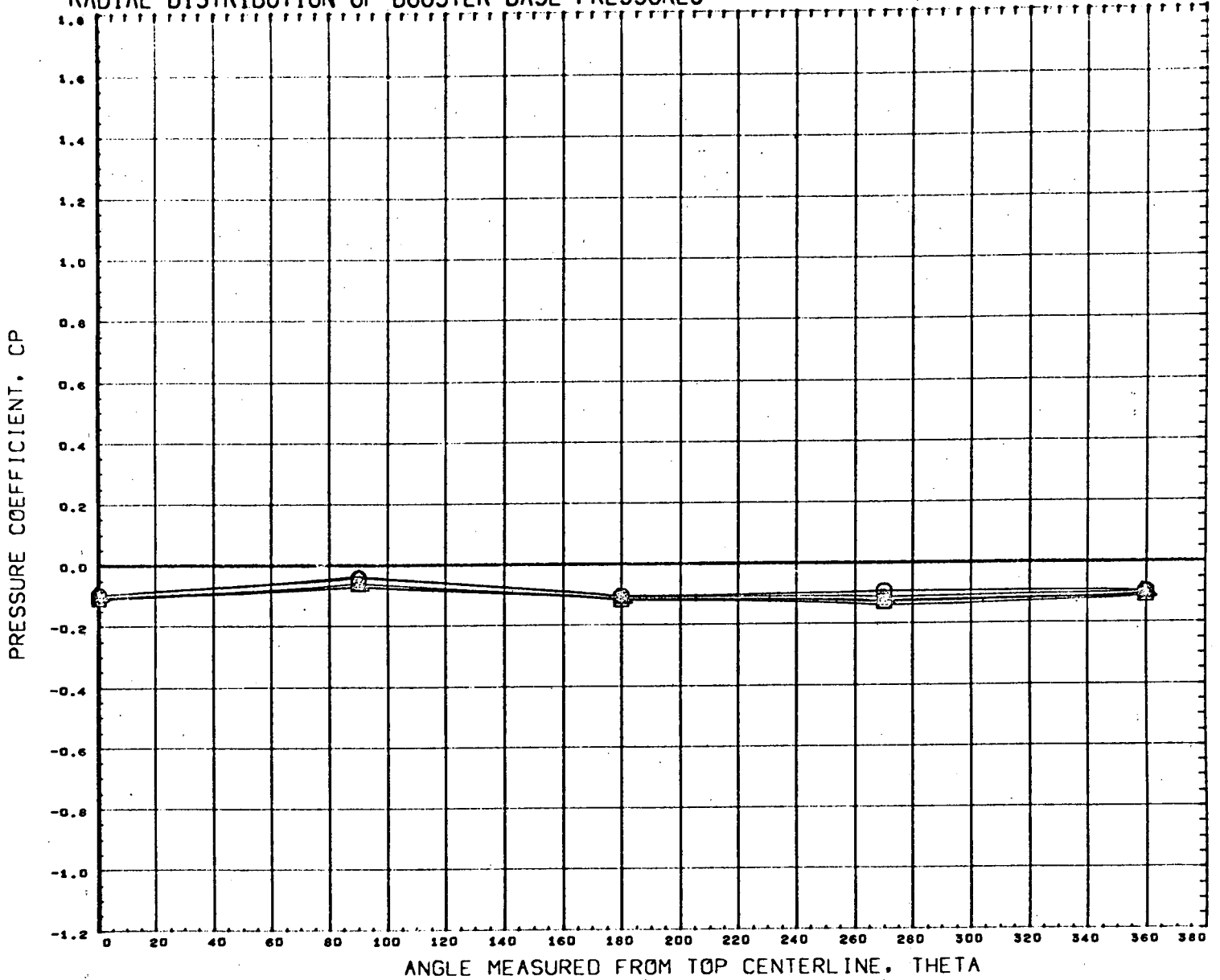

| SYMBOL | BETA | X/L | M1 | ALFB | PARAMETRIC VALUES |
|--------|---------|-------|-------|------|-------------------|
| □ | - 5.965 | 1.000 | 0.900 | | 0.000 |
| ◇ | - 3.882 | | | | |
| ◇ | - 1.921 | | | | |
| □ | - 0.218 | | | | |
| ◇ | 1.795 | | | | |

REFERENCE FILE

RADIAL DISTRIBUTION OF BOOSTER BASE PRESSURES

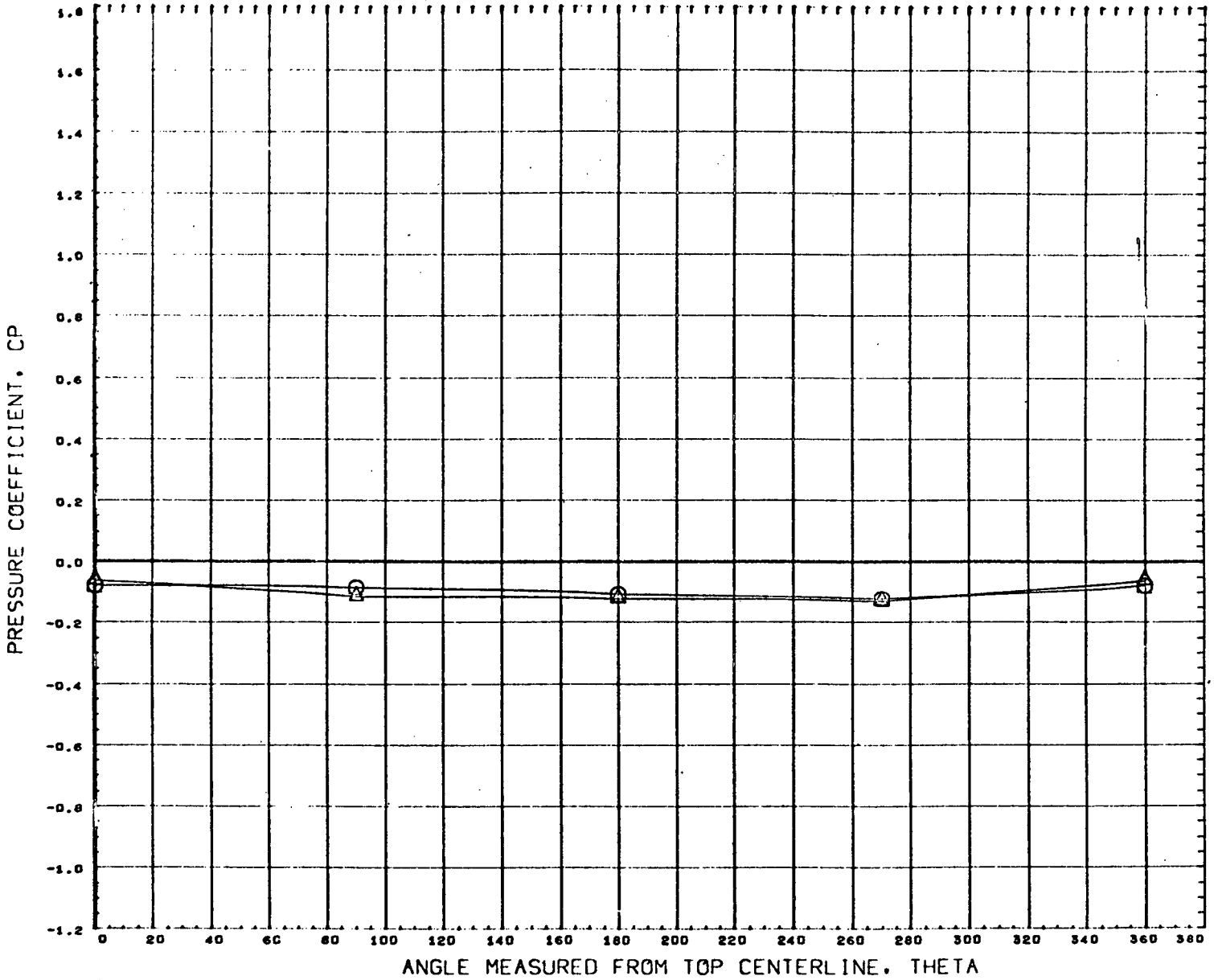

| SYMBOL | BETA | X/L | M1 | ALFB | PARAMETRIC VALUES |
|--------|-------|-------|-------|------|-------------------|
| ○ | 3.785 | 1.000 | 0.900 | | 0.000 |
| △ | 5.851 | | | | |

REFERENCE FILE

RADIAL DISTRIBUTION OF BOOSTER BASE PRESSURES

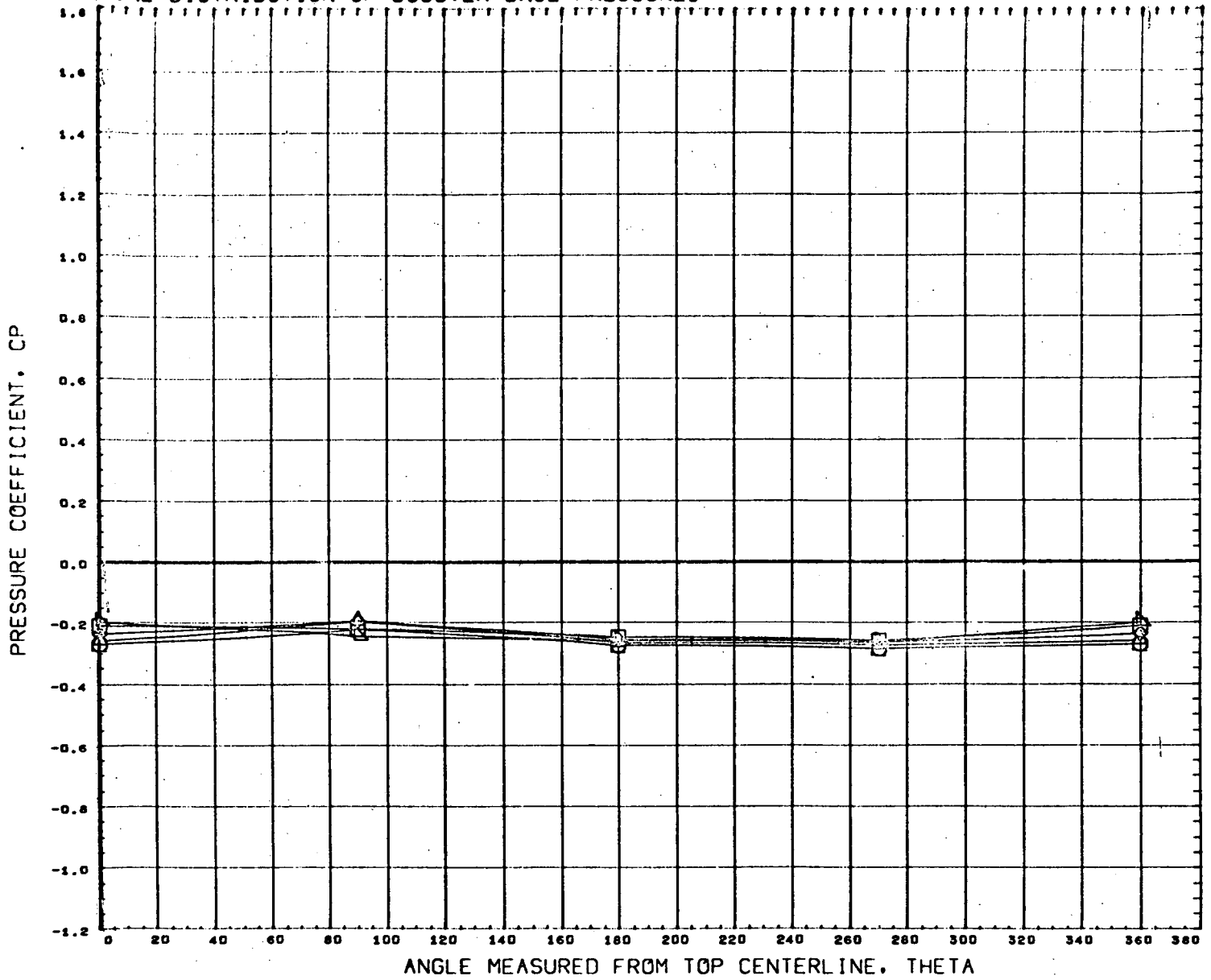

| SYMBOL | BETA | X/L | M1 | ALFB | PARAMETRIC VALUES |
|--------|---------|-------|-------|------|-------------------|
| □ | - 6.013 | 1.000 | 1.000 | | |
| ◇ | - 3.911 | | | | |
| △ | - 1.927 | | | | |
| ○ | - 0.219 | | | | |
| + | 1.802 | | | | |

REFERENCE FILE

RADIAL DISTRIBUTION OF BOOSTER BASE PRESSURES

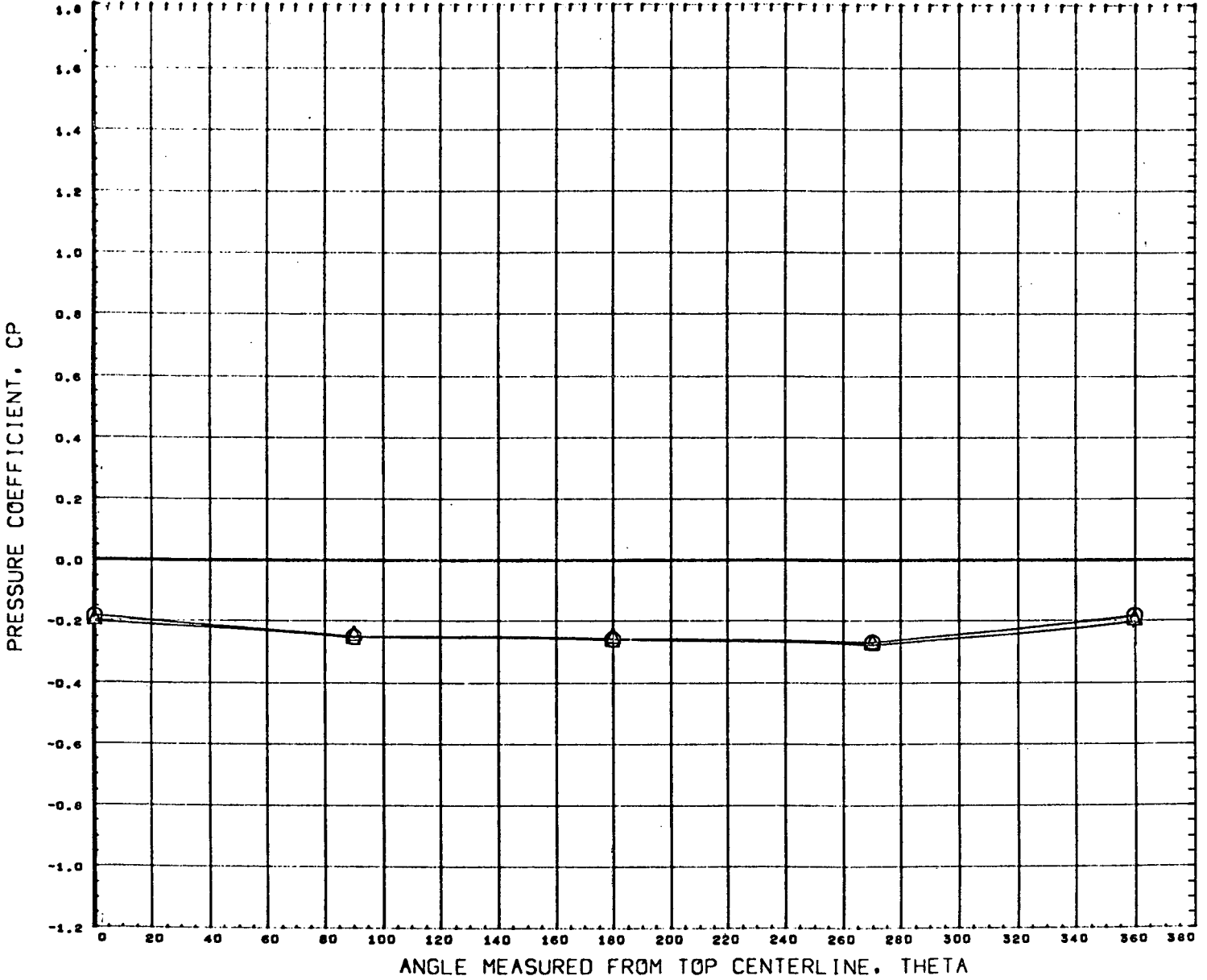

| SYMBOL | BETA | X/L | M1 | ALFB | PARAMETRIC VALUES |
|--------|-------|-------|-------|-------|-------------------|
| ○ | 3.808 | 1.000 | 1.000 | | |
| △ | 5.892 | | | 0.000 | |

REFERENCE FILE

RADIAL DISTRIBUTION OF BOOSTER BASE PRESSURES

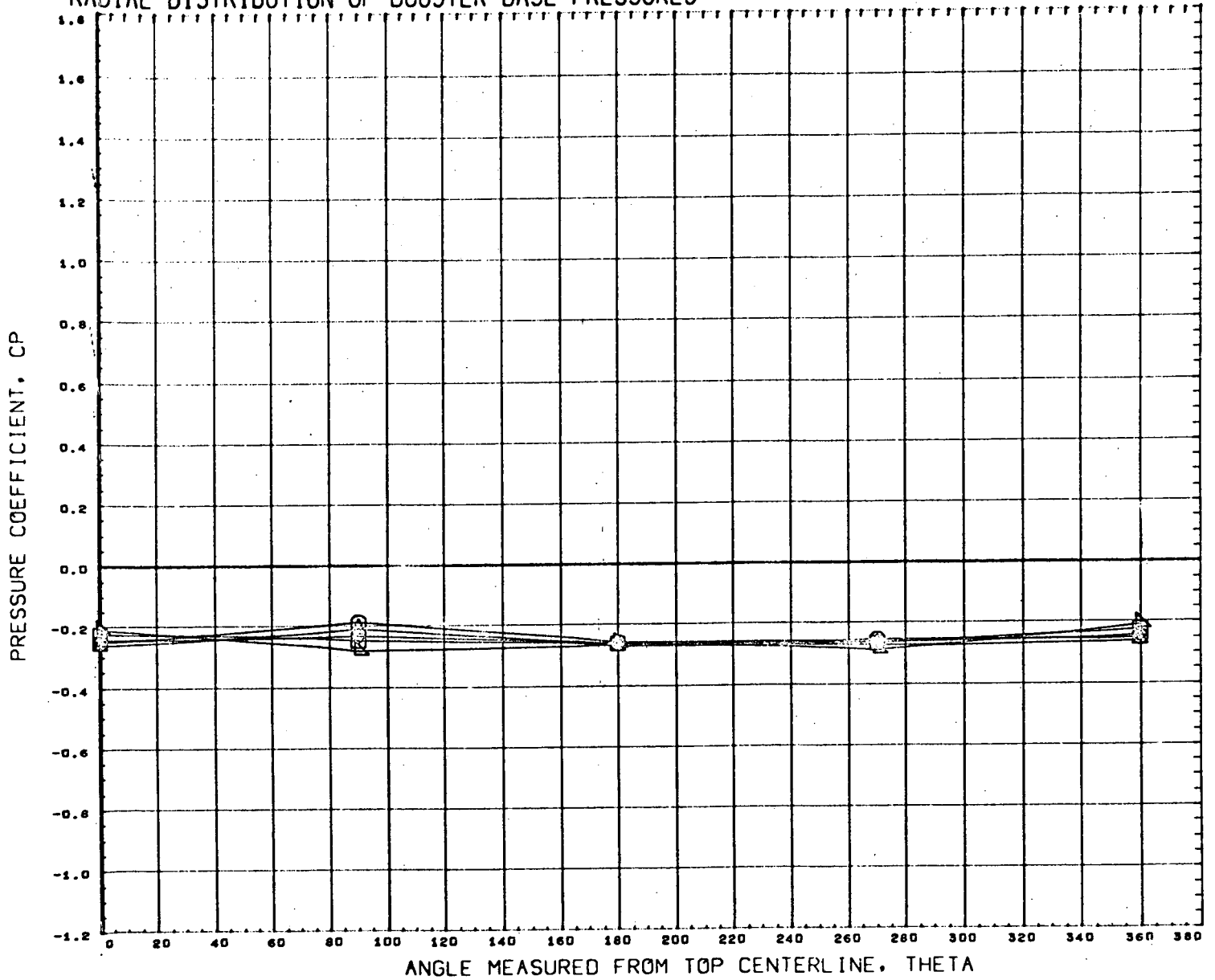

| SYMBOL | BETA | X/L | M1 |
|--------|-------|-------|-------|
| ◇ | 6.034 | 1.000 | 1.100 |
| ◇ | 3.925 | | |
| ◇ | 1.934 | | |
| ◇ | 0.220 | | |
| ◇ | 1.808 | | |

ALFB PARAMETRIC VALUES
0.000

REFERENCE FILE

RADIAL DISTRIBUTION OF BOOSTER BASE PRESSURES

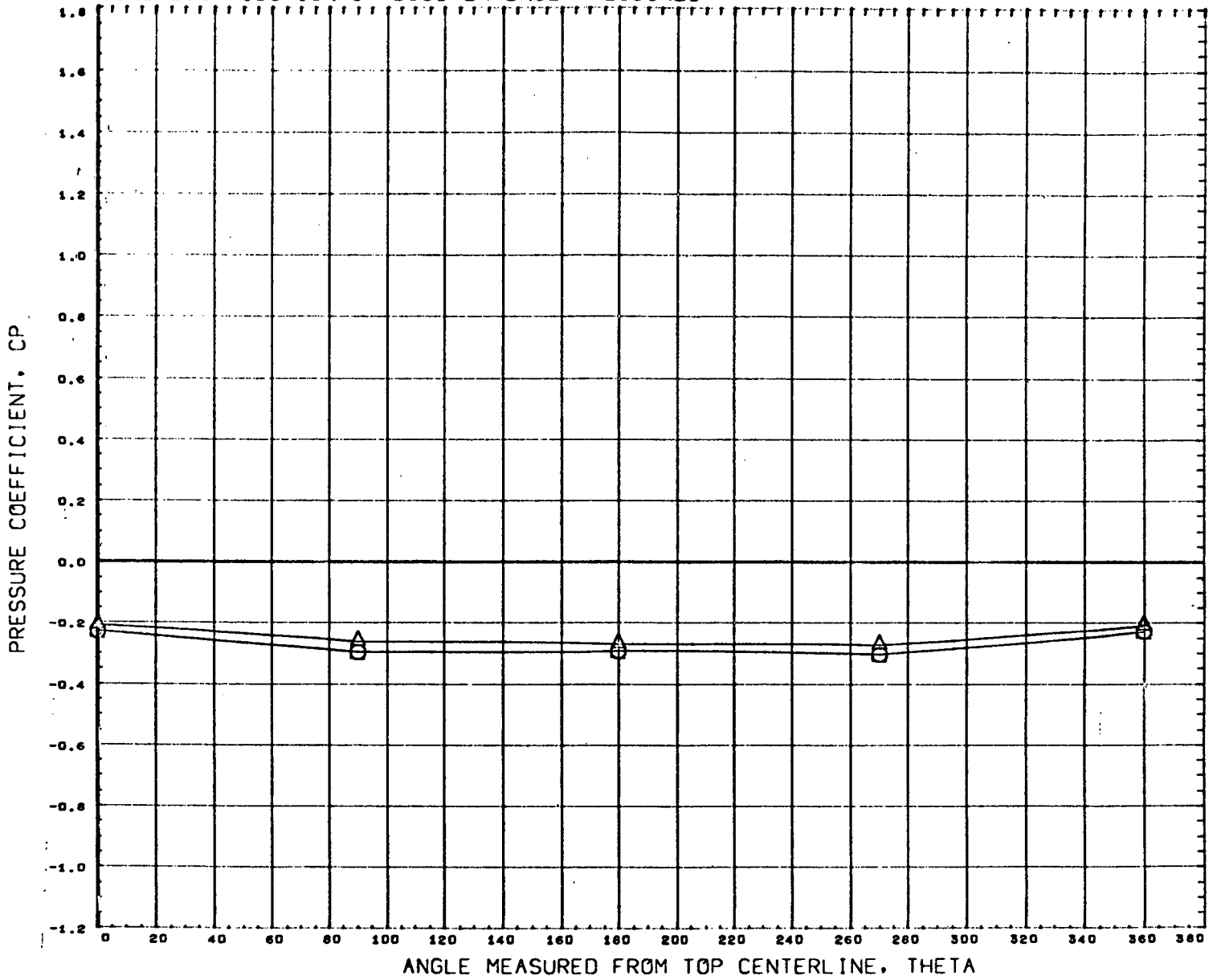

| SYMBOL | BETA | X/L | M1 | ALFB | PARAMETRIC VALUES |
|--------|-------|-------|-------|------|-------------------|
| ○ | 3.812 | 1.000 | 1.100 | | |
| △ | 5.968 | | | | 0.000 |

REFERENCE FILE

AEDC TC174 MDAC BOOSTER (BASE)

(ETC013)

PAGE 548

C-8

RADIAL DISTRIBUTION OF BOOSTER BASE PRESSURES

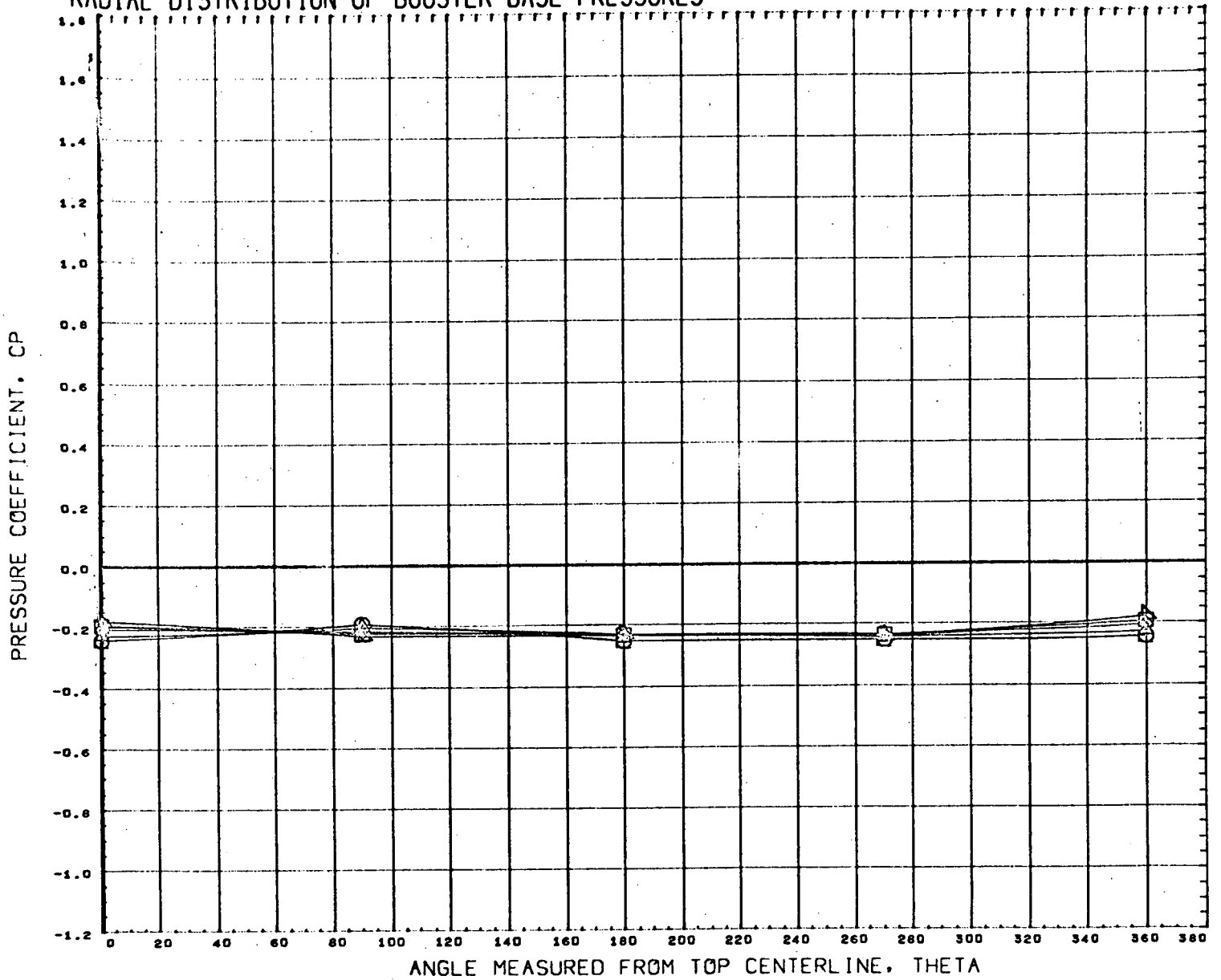

| SYMBOL | BETA | X/L | M1 | ALFB | PARAMETRIC VALUES |
|--------|---------|-------|-------|------|-------------------|
| ○ | - 6.044 | 1.000 | 1.201 | | 0.000 |
| ◇ | - 4.009 | | | | |
| ◻ | - 1.940 | | | | |
| △ | - 0.223 | | | | |
| + | 1.805 | | | | |

REFERENCE FILE

RADIAL DISTRIBUTION OF BOOSTER BASE PRESSURES

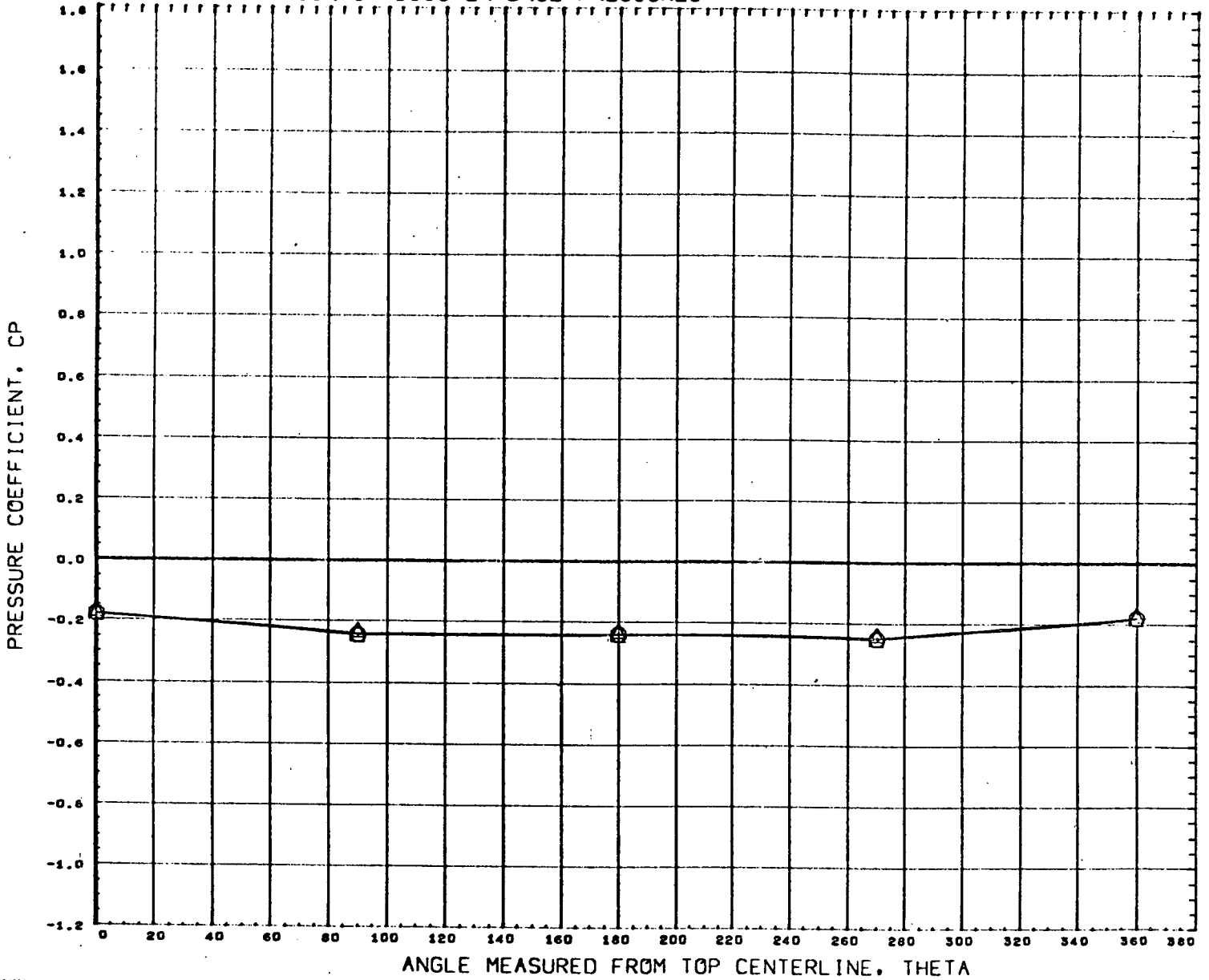

| | | | | |
|--------|-------|-------|-------|-------------------|
| SYMBOL | BETA | X/L | M1 | PARAMETRIC VALUES |
| ○ | 3.819 | 1.000 | 1.201 | ALFB |
| △ | 5.910 | | | 0.000 |

REFERENCE FILE

AEDC TC174 MDAC BOOSTER (BASE)

(ETC013)

PAGE 550

RADIAL DISTRIBUTION OF BOOSTER BASE PRESSURES

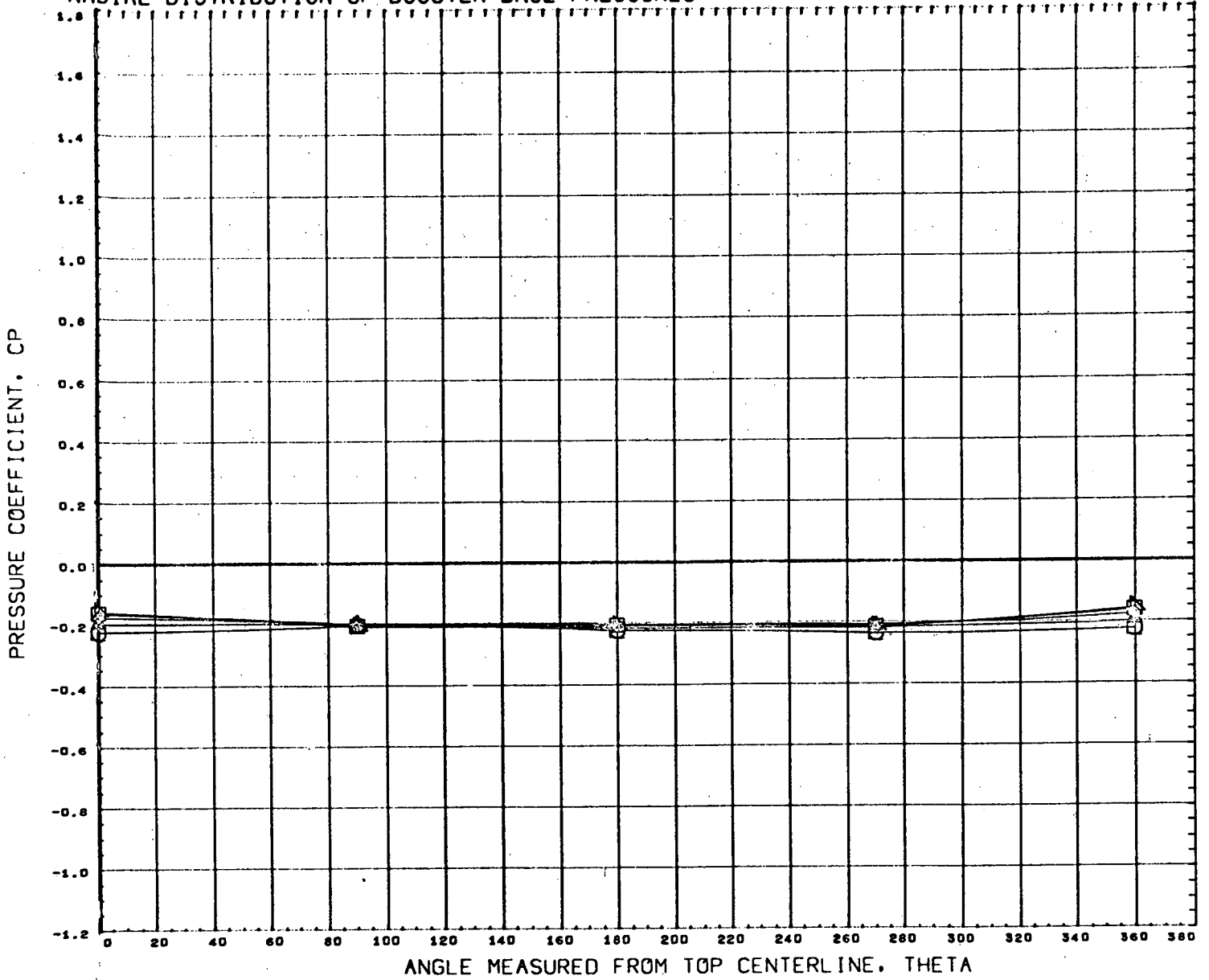

| SYMBOL | BETA | X/L | M1 | PARAMETRIC VALUES |
|--------|-------|-------|-------|-------------------|
| ○ | 6.041 | 1.000 | 1.299 | ALFB 0.000 |
| ◇ | 5.928 | | | |
| △ | 4.929 | | | |
| □ | 0.215 | | | |
| ▽ | 1.804 | | | |

REFERENCE FILE

RADIAL DISTRIBUTION OF BOOSTER BASE PRESSURES

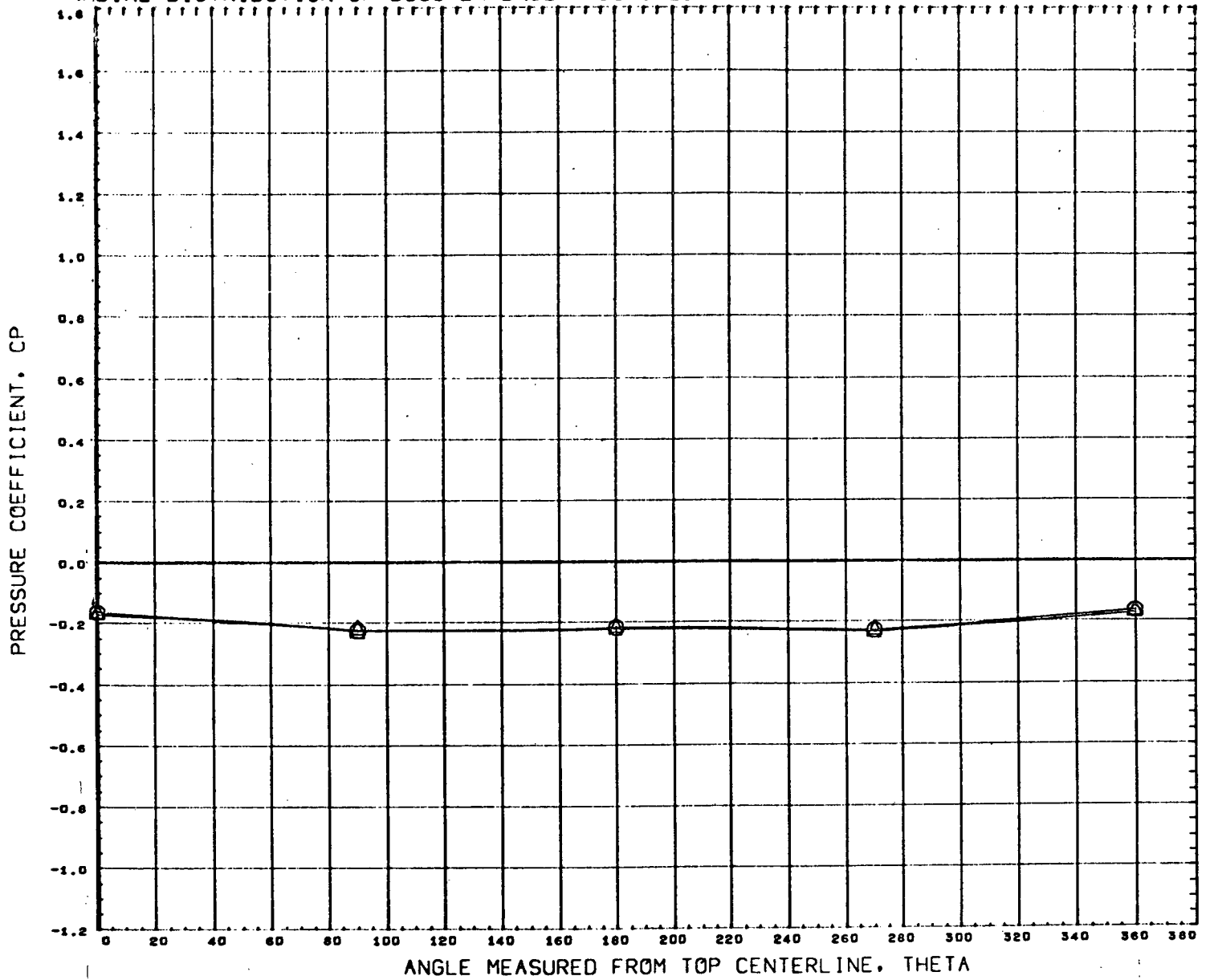

| SYMBOL | BETA | X/L | M1 | ALFB | PARAMETRIC VALUES |
|--------|-------|-------|-------|------|-------------------|
| ○ | 3.812 | 1.000 | 1.299 | | 0.000 |
| △ | 5.896 | | | | |

REFERENCE FILE

RADIAL DISTRIBUTION OF BOOSTER BASE PRESSURES

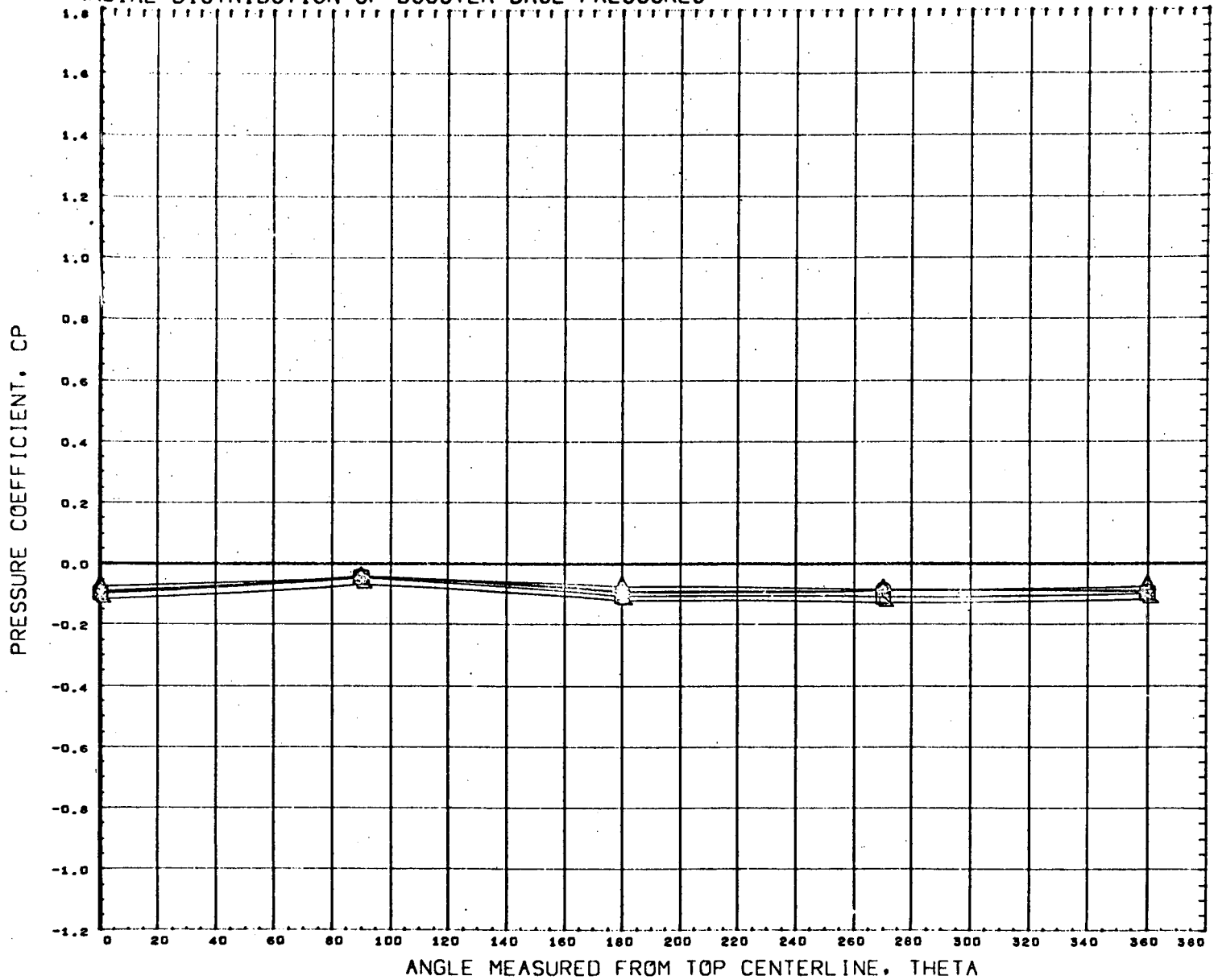

| SYMBOL | ALFB | X/L | M1 | BETA | PARAMETRIC VALUES |
|--------|-------|-------|-------|------|-------------------|
| ◇ | 8.102 | 1.000 | 0.902 | | 0.000 |
| ◇ | 6.057 | | | | |
| ◇ | 4.060 | | | | |
| ◇ | 1.956 | | | | |
| ◇ | 0.154 | | | | |

REFERENCE FILE

RADIAL DISTRIBUTION OF BOOSTER BASE PRESSURES

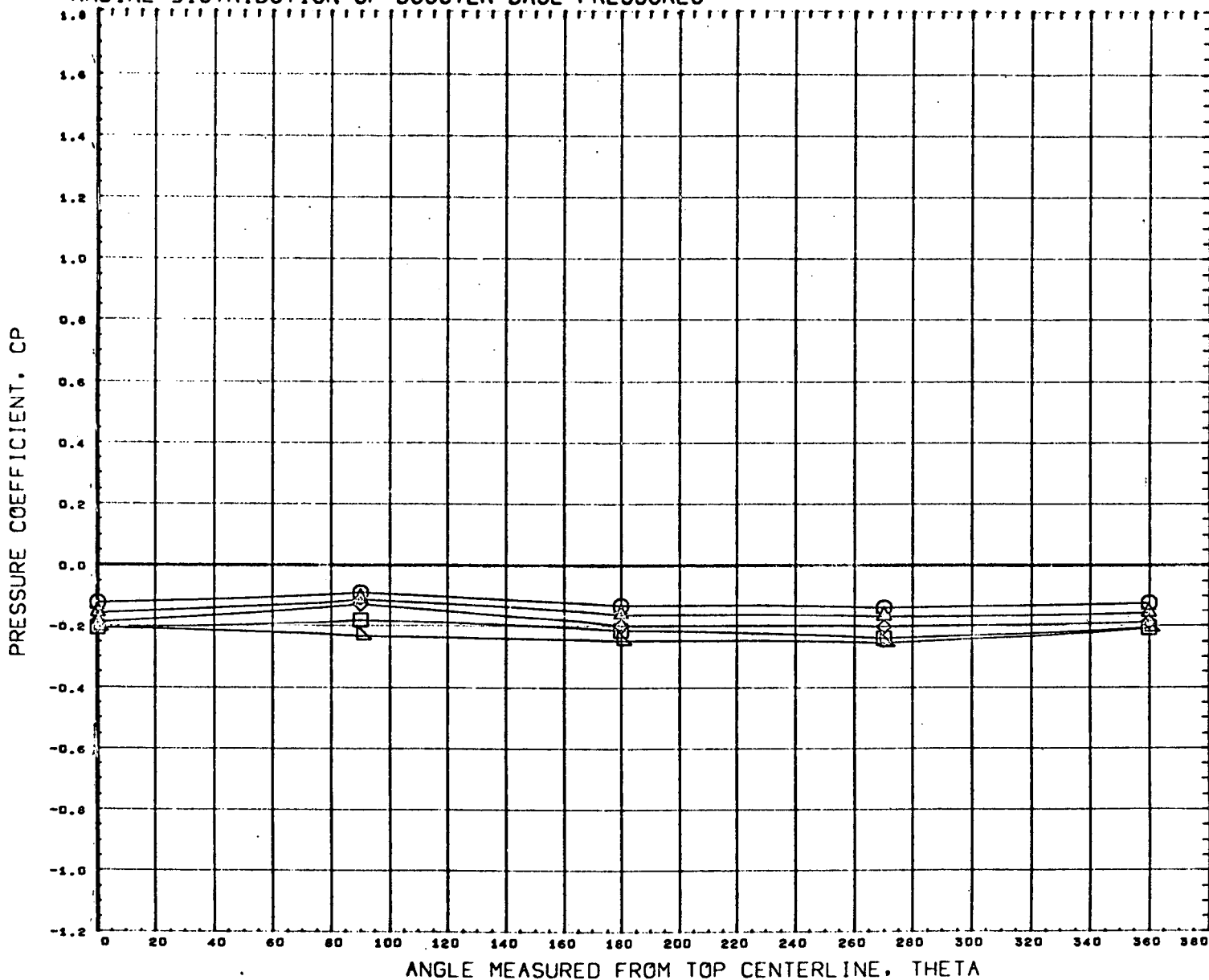

| SYMBOL | ALFB | X/L | M1 | BETA | PARAMETRIC VALUES |
|--------|-------|-------|-------|------|-------------------|
| ○ | 1.940 | 1.000 | 0.992 | | |
| ◇ | 3.993 | | | | |
| ◇ | 6.033 | | | | |
| ◇ | 7.982 | | | | |
| ◇ | 9.932 | | | | |

REFERENCE FILE

RADIAL DISTRIBUTION OF BOOSTER BASE PRESSURES

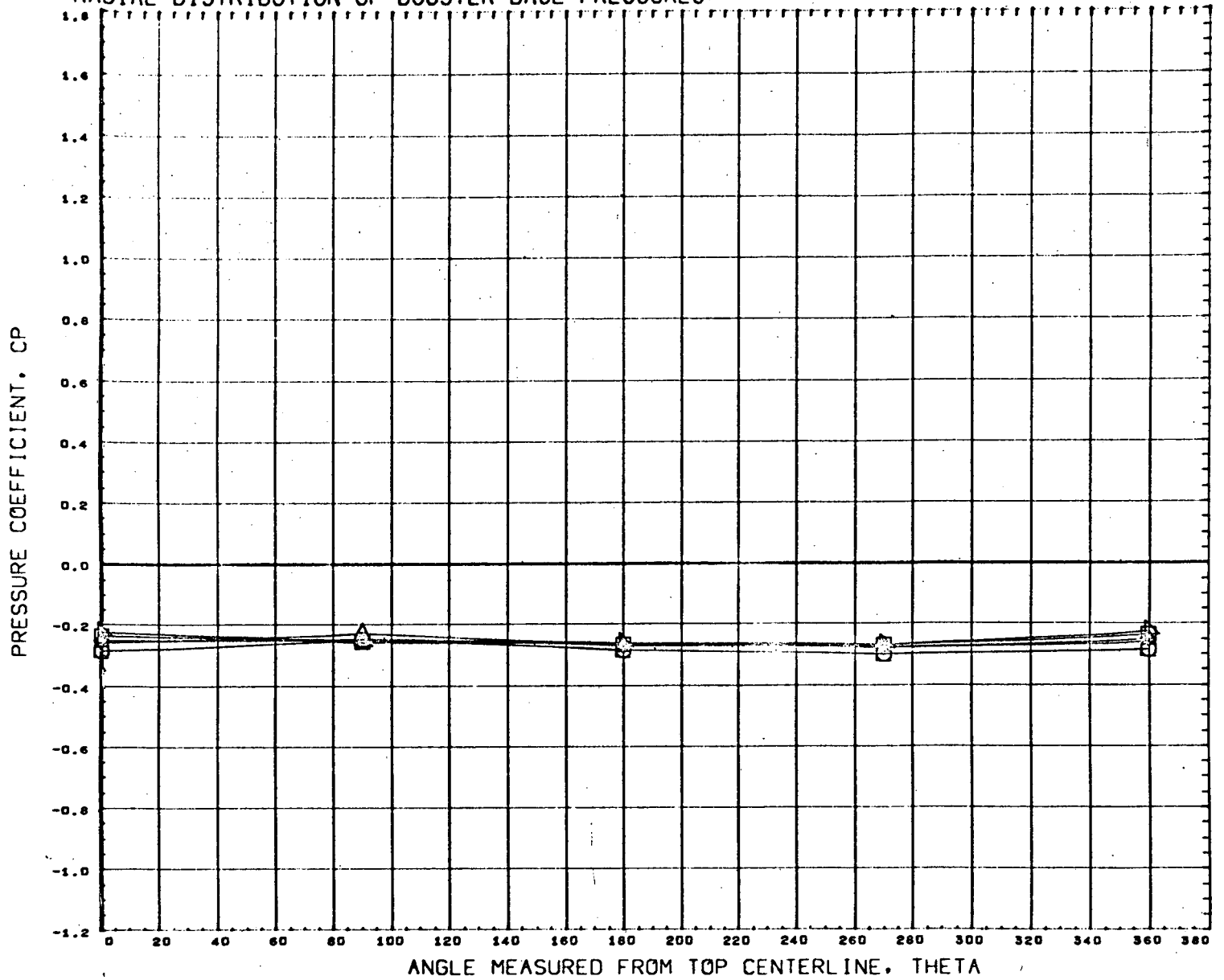

| SYMBOL | ALFB | X/L | M1 |
|--------|-------|-------|-------|
| ◇ | 8.189 | 1.000 | 1.101 |
| ◇ | 6.122 | | |
| ◇ | 4.119 | | |
| ◇ | 1.997 | | |
| ◇ | 0.125 | | |

PARAMETRIC VALUES
BETA 0.000

REFERENCE FILE

RADIAL DISTRIBUTION OF BOOSTER BASE PRESSURES

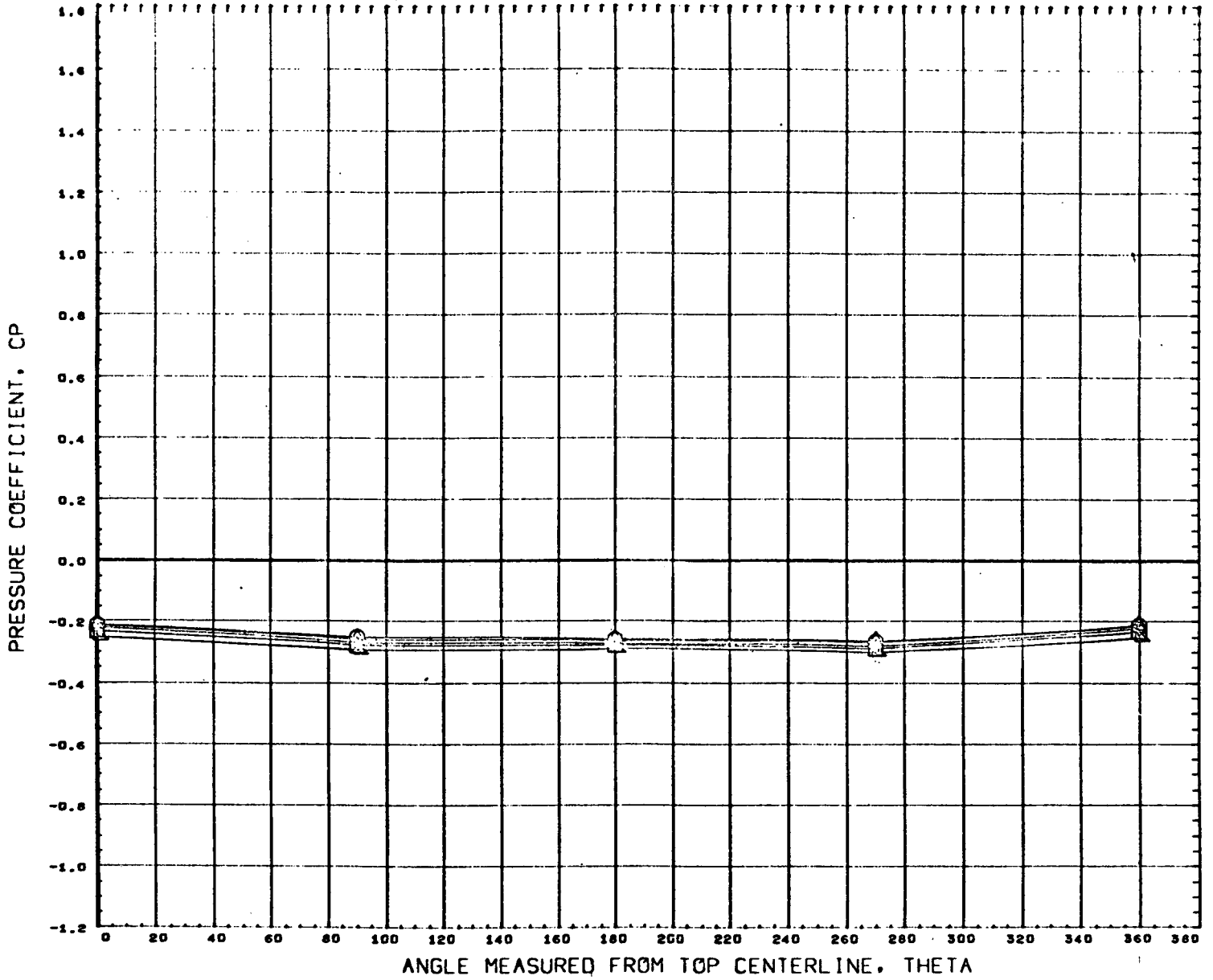

| SYMBOL | ALFB | X/L | M1 | BETA | PARAMETRIC VALUES |
|--------|--------|-------|-------|------|-------------------|
| ○ | 1.927 | 1.000 | 1.101 | | |
| ◇ | 4.042 | | | | |
| ◇ | 6.146 | | | | |
| ◇ | 8.139 | | | | |
| ◇ | 10.123 | | | | |

REFERENCE FILE