

Progress Report

NASA Research Grant
NGR 27-002-006

TELEMETRY EXPERIMENTS WITH
A HIBERNATING BLACK BEAR

J. J. Craighead

J. R. Varney

J. S. Sumner

F. C. Craighead Jr.

UNOFFICIAL
COPY FILE

June 30, 1972

Montana Cooperative Wildlife
Research Unit
University of Montana
Missoula, MT. 59801

SUMMARY

The objectives of this research were to develop and test telemetry equipment suitable for monitoring physiological parameters and activity of a hibernating bear in its den, to monitor this data and other environmental information with the Nimbus 3 IRLS data collection system, and to refine immobilizing, handling, and other techniques that will be required in future work with wild bears under natural conditions.

A temperature-telemetering transmitter was implanted in the abdominal cavity of a captive black bear and body temperature data was recorded continuously during a 3 month hibernation period. Body temperatures ranging between 37.5 and 31.8^oC were observed. Body temperature and overall activity were influenced by disturbances and ambient den temperature. Nychthemeral temperature changes were not noticeable. A load cell weight recording device was tested for determining weight loss during hibernation. Monitoring of data by satellite was not attempted. The implanted transmitter was removed and the bear was released with a radio-location collar at the conclusion of the experiment.

CONTENTS

Introduction	1
Den location attempts	2
Preparations for work with captive bears	3
Instrumentation	3
Temperature transmitter	7
Body temperature recording equipment	10
Surgical procedures	10
Body temperature data	13
Day-night rhythms	13
Response to disturbance	13
Response to cold	18
Influence of barometric pressure and relative humidity	20
Comparison of rectal and abdominal temperatures	20
Weight loss during hibernation	22
Activity monitoring	24
Release of bear	26
Summary	27
Acknowledgements	31
References	32

Introduction

This report describes work conducted with a hibernating black bear during the winter of 1971-72. Our overall objective is to develop the equipment and techniques that will permit us to conduct studies of the physiology and behavior of hibernating bears under natural conditions in the field. As a necessary step in this direction, we concentrated our work on a captive black bear and simulated natural denning conditions as closely as practical. In this way it was possible to test and refine equipment and techniques with much less effort and expense than would be necessary in similar work on animals in the field.

Our first specific objective was to develop and test telemetry equipment suitable for monitoring physiological parameters and activity from a hibernating bear in its den. The second objective was to locate a natural den in order to monitor the environment of a hibernating bear by satellite, using the IRLS system on Nimbus 3. Other objectives included refinement of immobilizing and handling techniques that will be necessary in future work with wild bears, determination of required drug dosages for lethargic animals, assessment of their effect on temperature regulation under severe winter conditions, and investigation of surgical techniques for implanting telemetry transmitters in the body of the animal.

In spite of considerable effort, we were not successful in locating a suitable natural den for environmental monitoring, so this part of the proposed work was not carried out. The work with the captive bear went as planned and most of our objectives were achieved. A detailed description of the work undertaken and the results obtained is given in the following pages.

Den Location Attempts

To locate a bear hibernating in a natural den we attempted to capture one prior to hibernation, fit it with a radiolocation collar, and follow its movements until it selected a den to spend the winter. We have used this technique successfully in previous years. (F. Craighead et al, 1966).

During most of October and early November, we concentrated our efforts in the vicinity of West Yellowstone, Montana. Baits were put out in areas where black bears had been reported and preparations were made to capture them. A black bear captured in late October was fitted with a radio collar, but he succeeded in removing it the following day. The same bear was recaptured a few days later and examination showed that his head-size to neck-size ratio was much smaller than typical, but the collar was replaced and the bear released. He again removed the collar the following day, so we made no further attempts to recapture him. Several early storms sent the bears to their hibernating dens and continuing snowstorms prevented further work in West Yellowstone.

Trapping efforts were continued into mid-November in the vicinity of Missoula, Montana, without further success. We also checked several reported or previously known den sites to see if any were occupied and satisfactory for the proposed environmental monitoring. One of these dens is shown in figure 1. We did not find any suitable dens occupied, so we concentrated our efforts on experiments with a captive bear.



Figure 1: Black bear den at the base of a large cedar tree near St. Regis, Montana

Preparations for Work with Captive Bears

We obtained a male black bear cub (approximate age 8 months) from the Montana State Fish and Game Department in October. On November 11, the animal was placed in a concrete block building containing 6 x 8 foot cells with no windows and steel mesh doors. An interconnecting doorway was constructed between two cells. A sliding gate permitted us to move the bear from one cell to the other. Ambient light was reduced to a low level to simulate the interior of a den covered with snow. Enough light entered around the door edges so that the animal could probably distinguish between night and day, as would be the case in a natural den.

A 3 x 3 x 4 foot wooden box was placed in one cell to provide an enclosure. Loose straw was put in the cell for bed material. The bear constructed a bed by dragging straw into the box the following day.

Food and water were placed in the den until December 15 when the bear had become noticeably lethargic and fed irregularly.

Instrumentation

We kept detailed records of the bear's activity, the den temperature, the bear's body temperature, local barometric pressure, disturbances, and other factors which might influence hibernation behavior.

Temperature in the den room was recorded by a Ryan Thermograph, a clockwork-driven chart recorder which provides a record for 30-day periods. Temperature and relative humidity were also recorded with a Casella hydrothermograph placed 30 feet from the den room. We found no significant differences between the temperature records at the two sites, so after the first month of operation the Ryan recorder was removed from the den.

This eliminated the disturbance caused when charts were changed.

The bear's body temperature was measured with a temperature-sensitive telemetry transmitter implanted in the abdominal cavity. Data from the transmitter was recorded by equipment near the den room. The transmitter and recording equipment are described in the following section.

Barometric pressure was obtained from daily Weather Bureau records since variations are insignificant over the short distance separating the den and the Missoula recording station.

The bear was observed visually with the aid of an infrared weapon-sight loaned to us by the Department of the Army. The scope was placed on a tripod and sighted on the den box. A black cloth draped over the scope and hole prevented light from entering the den during daytime observations. The equipment setup is shown in figure 2. Observations were made daily to determine the animal's degree of lethargy, changes of position, and other behavioral data.

An electrocardiogram implant transmitter and a proximity-type activity measuring system were designed but not completed before the bear had entered hibernation, so final design work and testing were deferred until next season. Tests were also conducted on an electronic weighing system that is discussed in a following section.

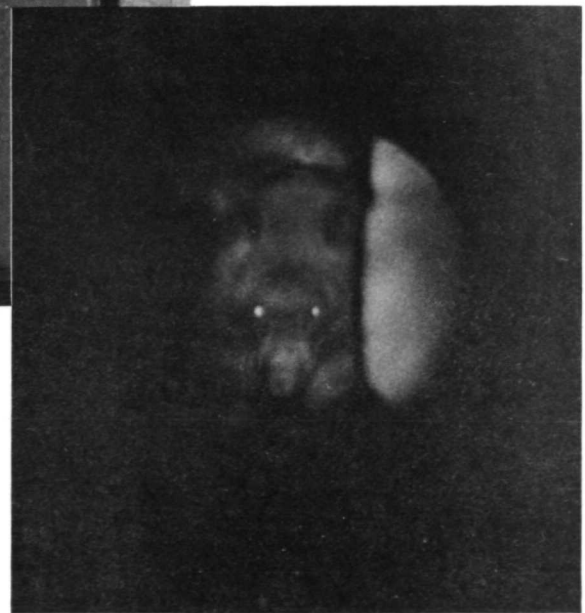

Figure 2: An infrared scope (shown here without the light-blocking drape) was used to observe the hibernating bear without disturbing him.

Temperature Transmitter

The circuit of the temperature sensitive transmitter used in the experiment is shown in figure 3. It is a simple 1 MHz blocking oscillator with its pulse rate determined by two thermistors in the collector-base path. It is similar in design to those used by Mackay (1970) and Goodman (1971). We have used this transmitter in past work and found it to be reliable and accurate (J. Craighead et al, 1971). A pulse rate vs. temperature curve for the transmitter is shown in figure 4. A Hg-625R mercury cell provides an estimated lifetime of several years at 37°C.

Transmitter components were imbedded in epoxy for mechanical support and protection. The transmitter assembly was then waterproofed with a mixture of beeswax and paraffin. An outer covering of Dow-Corning Type A Medical Silastic was used to prevent tissue reaction when implanted in the bear's body. A photograph of the unit is shown in figure 5. The completed unit was 4.5 x 2 x 1 cm. in size and weighed 12.8 grams.

The transmitter was calibrated in a constant temperature water bath and its thermal time constant was measured by subjecting it to an abrupt temperature change of 10°C. The thermal time constant was found to be 1.3 minutes in well-stirred water. The temperature indicated by the transmitter will reach 98.2% of the final value (equivalent to an error of less than 0.2°C) in 4 time constants, or 5.2 minutes.

The transmitter was recalibrated in the water bath after removal from the bear. We found no measureable shift in the temperature calibration.

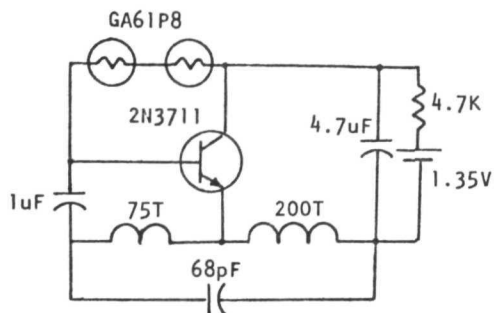

Figure 3: Body temperature telemetry transmitter circuit

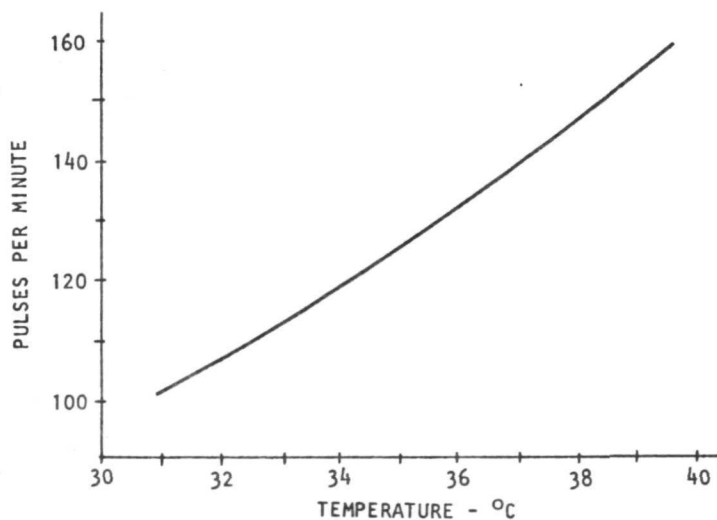

Figure 4: Temperature calibration curve for transmitter



Figure 5: Body temperature telemetry transmitter after removal from the bear in April. It was attached to the peritoneum with sutures to keep it in a known location.

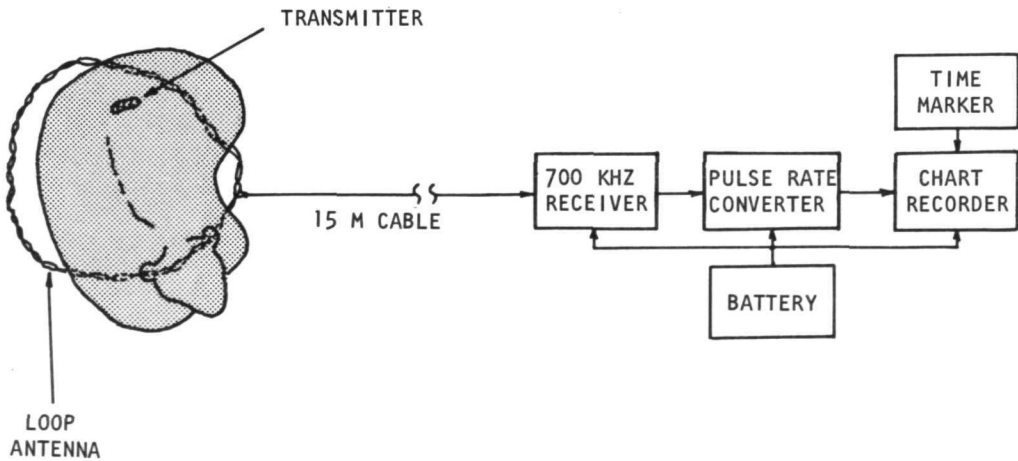

Figure 6: Body temperature recording equipment

Body Temperature Recording Equipment

The signal from the temperature transmitter in the bear's abdominal cavity was picked up by a circular loop antenna (14 turns of #24 wire, 20" in diameter) placed on the floor of the den directly under the bear's bed. The antenna was connected to a standard broadcast band receiver in an adjoining room by a 30' cable. Pulses from the transmitter detected by the receiver were converted to a DC current by a pulse rate converter (Varney, 1970) and recorded on a Rustrak model 288 chart recorder at 1 inch per hour chart speed. A block diagram of the recording setup is shown in figure 6.

Surgical Procedures

We immobilized the bear for the temperature transmitter implant operation by firing a syringe dart containing 45 mg of Sernalyn (phencyclidine hydrochloride, 100 mg/cc) into the shoulder muscles. An additional 15 mg was administered after the initial dose took effect and the bear was taken to a local veterinary clinic for the operation.

The bear was placed in a slightly head-down position on the operating table to keep excess saliva from blocking air passages and a 1/8 grain dose of atropine was given to reduce salivation. A patch of hair on the belly was shaved off with an electric clipper, and the area was washed and disinfected. A 10 cm incision was then made through the skin and fat layers along the midline from just below the umbilicus to 3 cm anterior to the penis. This location was selected because it is relatively free of large blood vessels and should present fewer problems than other areas if field surgery were attempted.

A small incision was made through the peritoneum into the abdominal

cavity, then lengthened with a pair of scissors. The transmitter, which had been sterilized overnight in Zephiran chloride (1:1000), was placed in the abdominal cavity and attached to the peritoneum in four places with nylon sutures. The abdominal cavity was closed with chromic cat gut sutures, Furacin powder was sprinkled into the incision, and the skin was sewed together with heavy nylon sutures. A 2 cc injection of penicillin-streptomycin was given at the conclusion of the operation. The entire procedure took about 45 minutes (photographs of the operation are shown in figures 7 and 8).

The bear was immobilized 12 days later (December 27) for examination of the incision and removal of the external stitches. Healing was proceeding normally. A slight inflammation was present in the caudal area of the incision so a 2 cc injection of Combiotic was given and the area washed with 1 cc of Combiotic. Hair regrowth on the belly was slower than we expected. The incision was checked again on January 18 and had completely healed.

We removed the transmitter from the animal on April 5 following the same procedure. Examination of the area around the transmitter showed that it had been encapsulated in a thin layer of scar tissue. We found no adverse tissue reaction or inflammation, and it appeared that the implant had been accepted well.

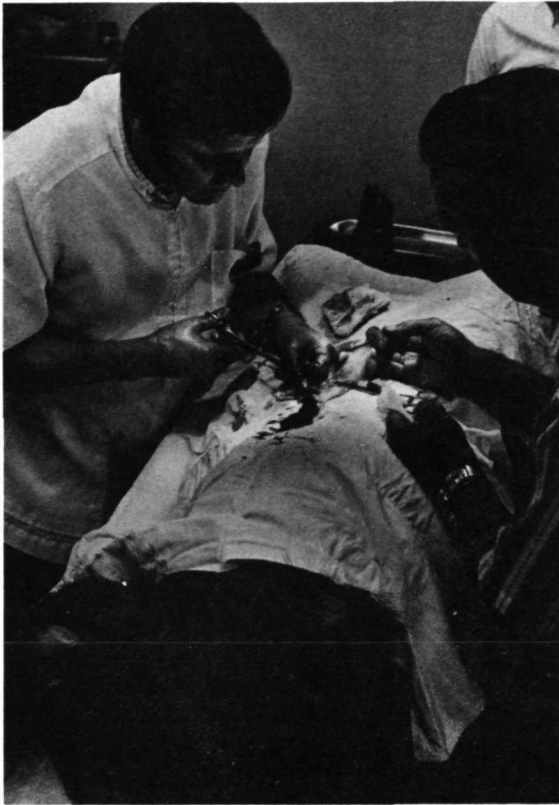

Figure 7:
Transmitter implant
operation

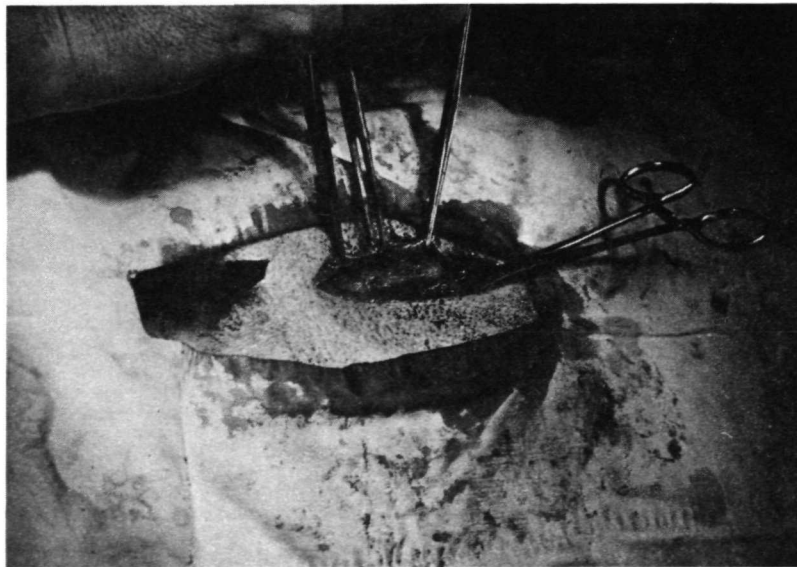

Figure 8: Placing the temperature transmitter
in the abdominal cavity

Body Temperature Data

Temperature data from the implanted transmitter were recorded continuously for a little over 3 months. As a check on the automatic recording system, manual counts of the transmitter pulse rate were made with a stopwatch during the daily equipment checks. Some gaps occur in the data during times when the bear was out of his bed or oriented unfavorably to the receiving antenna; they occurred more frequently at the beginning and end of the hibernation period and provide an index of the animal's activity.

The temperature data are summarized in figure 9. Manual temperature counts are shown on the graph, as are entrances into the den and other occurrences which probably disturbed the animal. Gaps due to equipment problems rather than animal movements are noted.

The same data in more compressed form are plotted with den temperature in figure 10, and with barometric pressure during the period between January 19 and March 20 in figure 11.

Day-Night Rhythms

Cyclic day-night temperature changes are not pronounced most of the time, although they did occur for a few short periods (for example, Dec. 30-Jan. 2 and Jan. 20-22, figure 9). Such changes were on the order of 0.5 to 1°C. At other times they did not occur at all or, if present, were obscured by larger trends or changes due to other factors.

Response to Disturbances

The largest and most significant changes in body temperature occurred in response to disturbances, and were related to the duration and intensity

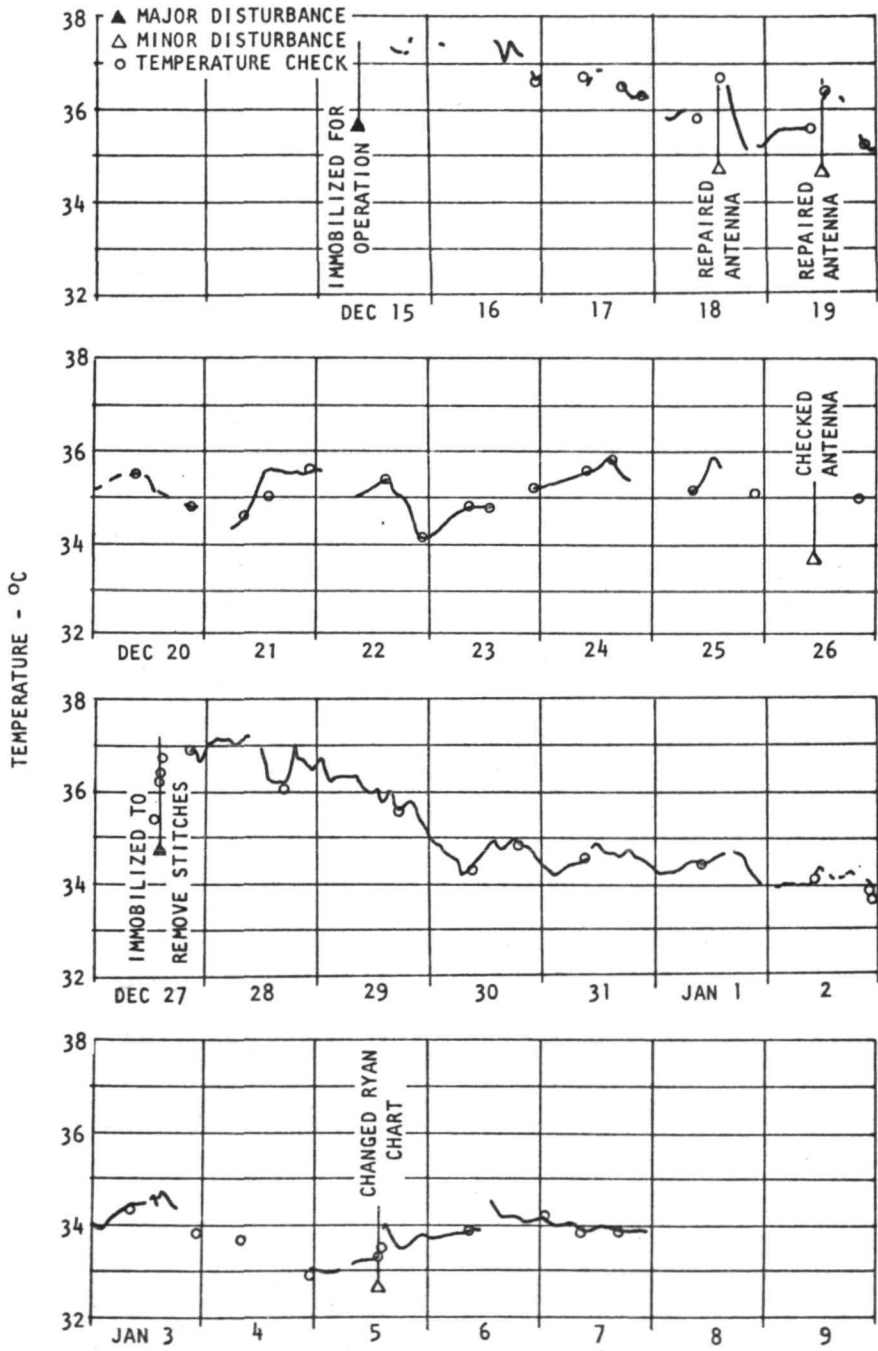

Figure 9A: Daily body temperature data

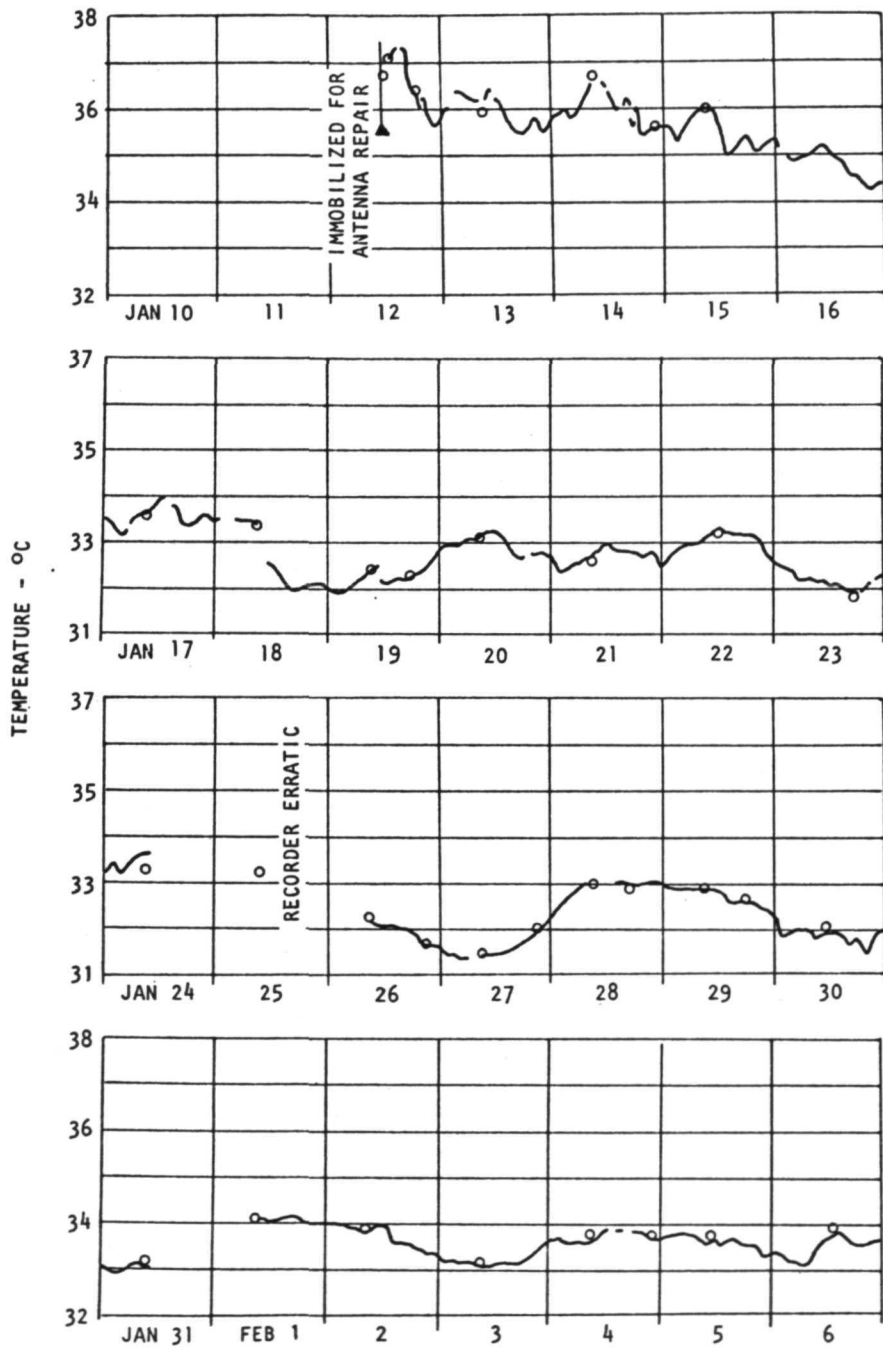

Figure 9B: Daily body temperature data (cont'd)

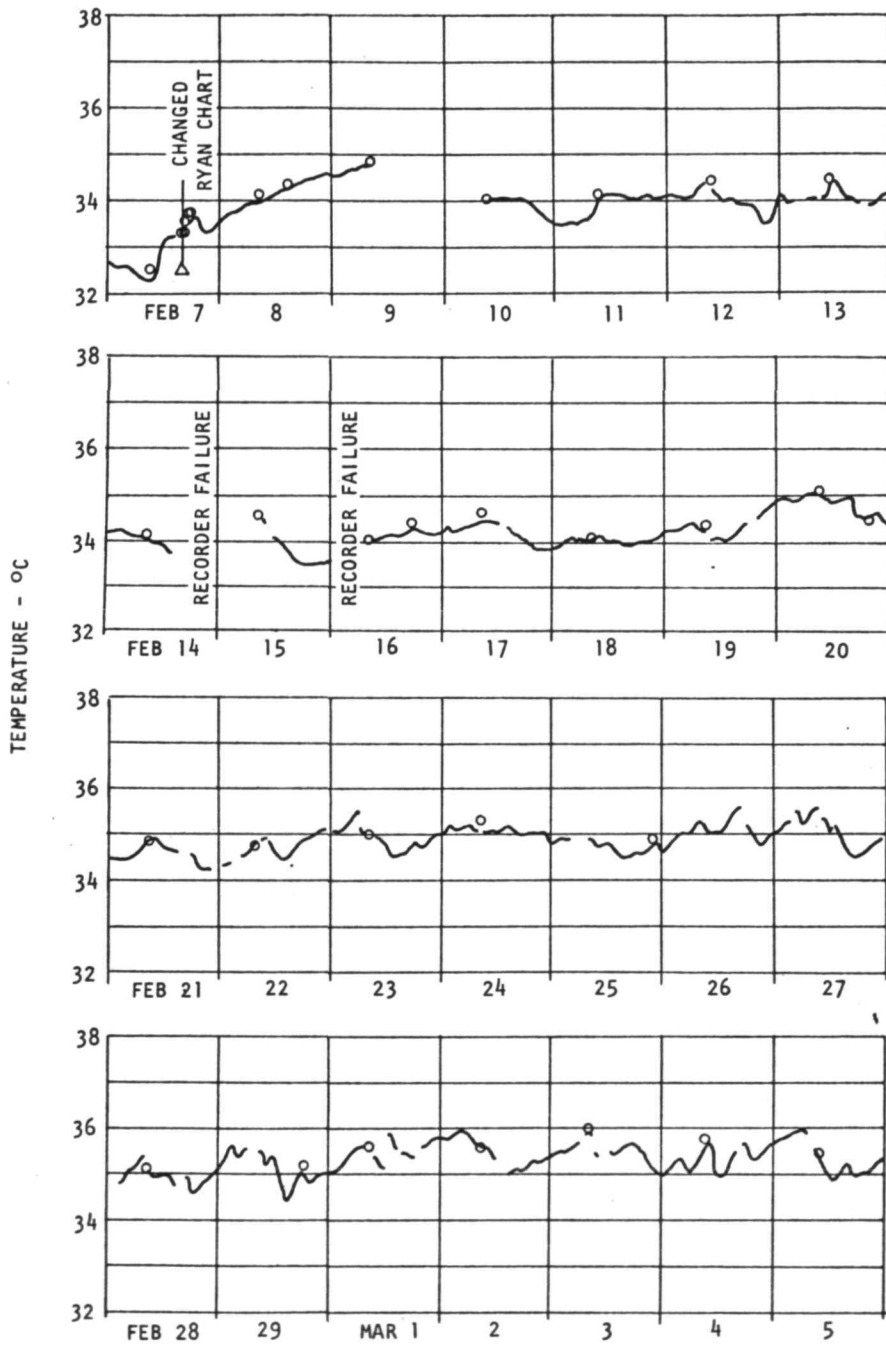

Figure 9C: Daily body temperature data (cont'd)

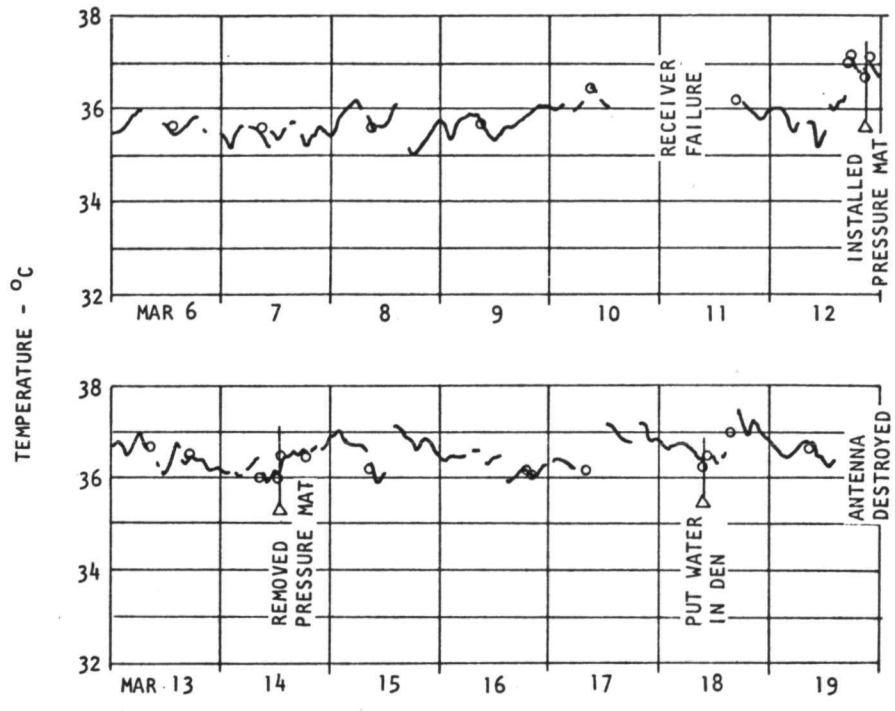

Figure 9D: Daily body temperature data (cont'd)

of the disturbance. On three occasions that the bear was immobilized his body temperature reached 37°C , declining about 2°C afterward over a period of 3 or 4 days before stabilizing again. During the immobilization on Dec. 27, temperature rose 2°C in a period of 2 hours.

When the disturbance was less severe (for example, when we entered the den for a minute or two to change charts in the temperature recorder or to repair a disconnected lead) the temperature rise was typically 0.5°C ; it did not behave in a predictable way afterward, sometimes rising and sometimes falling in a period of a few days.

Response to Cold

Data during the period between Jan. 24 and Feb. 10 is particularly interesting (see figure 10). A severe storm moved into the Missoula area, with subzero temperatures and high winds. As a result, the temperature in the den began dropping on Jan. 25. The bear's body temperature followed this downward trend until Jan. 27, reaching a low of 31.8°C . This is near the lowest temperatures which we are aware of in the literature (Hock, 1957). Then, although den temperature continued to drop, body temperature rose abruptly to 33°C . This cycle was repeated between Jan. 30 and Feb. 1. We suspect that a spontaneous arousal mechanism was operating, with 32°C being the lower limit that the bear could safely tolerate; a metabolism increase occurred when this danger point was reached.

In general, long term body temperature trends followed ambient temperature variations. This is particularly evident in figure 10 during the period between Feb. 5 and March 20. A gradual increase in den temperature took place during this time and was accompanied by a 3°C increase in body temperature. Variations in body temperature of unknown origin on the order of 1°C are superimposed on the long term trend.

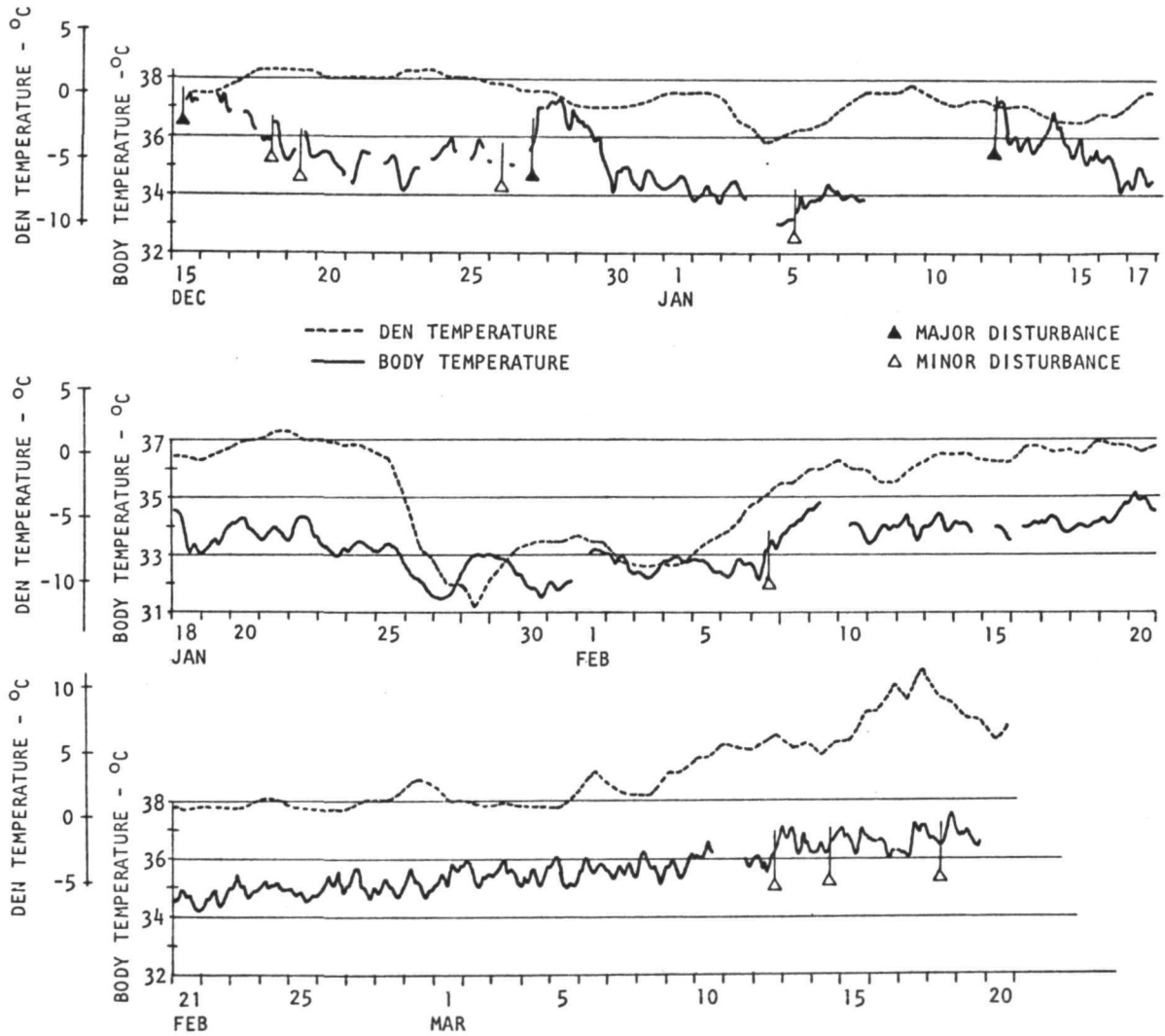

Figure 10: Body temperature and ambient den temperature

Influence of Barometric Pressure and Relative Humidity

The data obtained were not conclusive, but we are inclined to think that variations in barometric pressure had little effect on the body temperature or activity of the bear. No correlation between body temperature and pressure is evident in a visual examination of Figure 11 between Jan. 20 and Feb. 20. There was a gradual increase in pressure between Feb. 21 and March 20 which was paralleled by a rise in body temperature, but this was probably due to the den temperature increase during the same period rather than pressure changes.

Relative humidity data were taken for the hibernation period but did not appear to be significant. This was as expected, since it should have little effect on thermal balance or other factors which might affect the animal's hibernation behavior.

Comparison of Rectal and Abdominal Temperatures

On three occasions we took a series of rectal temperature measurements while the bear was immobilized for comparison with the telemetered abdominal temperature data. These times were when the stitches were removed on Dec. 27, when it was necessary to immobilize the bear to repair the den antenna on Jan. 12, and when the transmitter was removed on April 5. The intent was to evaluate the accuracy of rectal temperature measurements and obtain data for correlation with rectal temperature data obtained in previous years on other studies.

Rectal temperatures were taken with a glass-mercury thermometer inserted approximately 9 cm into the rectum. The thermometer was allowed to stabilize for 2 minutes after insertion before beginning to take readings. Abdominal readings were obtained by placing a portable radio

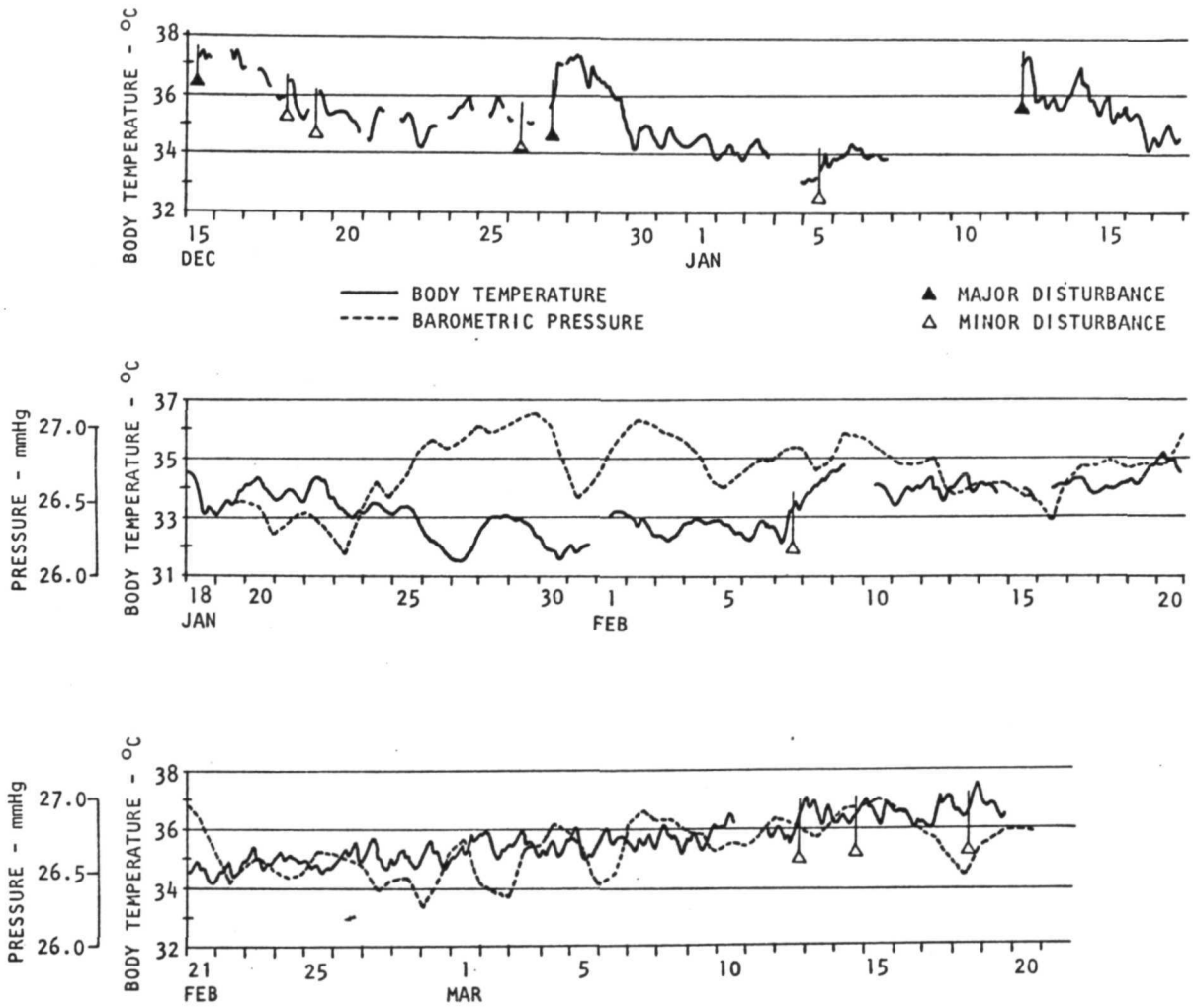

Figure 11: Body temperature and barometric pressure

next to the bear and counting the transmitter pulse rate with a stopwatch.

The data obtained is summarized in figure 12. Rectal temperature readings ranged from 1.3°C below to 0.3°C above the abdominal readings, with the rectal readings being generally lower. There is not sufficient data to make generalizations, but it gives a rough idea of the spread to be expected between the two readings. We plan to collect further data in future experiments.

Weight Loss During Hibernation

The bear was weighed whenever possible during the experiment to determine the rate of weight loss during hibernation. These data are summarized in figure 13. The bear weighed 75 lbs when placed in the den in November to acclimatize while feeding was continued. His weight increased to 93.5 lbs at the time of the implant operation on December 15. Food and water were not offered after this time. The bear became dormant, and his weight gradually declined during the winter to 68 lbs when the temperature transmitter was removed on April 5—a weight loss of 25.5 lbs. During the 112-day period from Dec. 15 to April 6, the average weight loss was .228 lbs per day. Feeding was resumed on April 7, and the bear's weight had returned to 90.5 lbs by April 19. In 12 days the bear regained weight at an average rate of 1.88 lbs per day.

A load-cell weighing system was evaluated for future use in more detailed studies of weight loss and metabolism. It consists of a reinforced plywood platform supported on three load cells which produce an output voltage proportional to the weight on them. They are connected to readout equipment that can be located at any desired distance. The system provides both a meter readout and a continuous chart record of the total

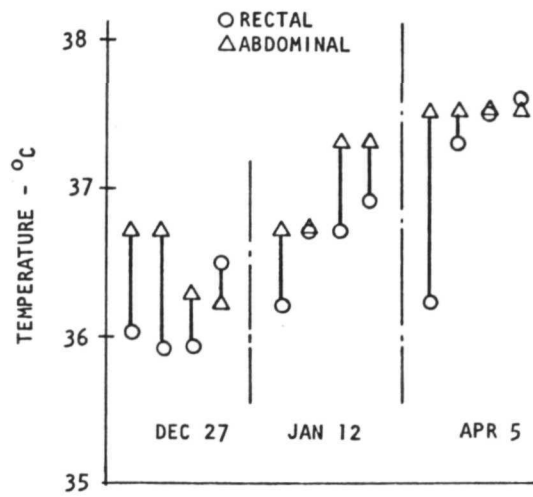

Figure 12: Comparison of rectal and abdominal temperatures

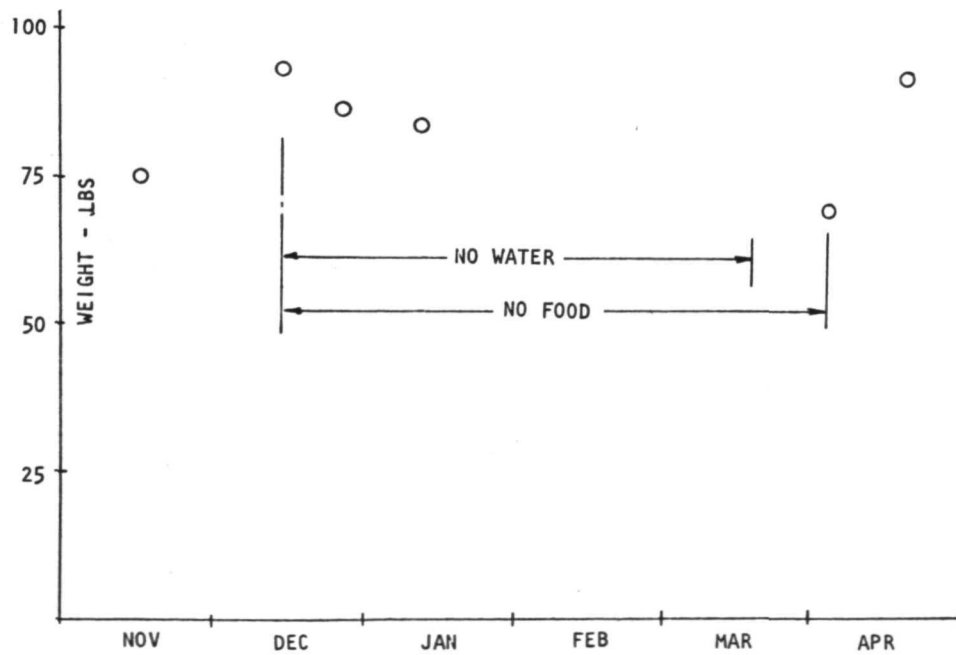

Figure 13: Changes in weight of bear between November 1971 and April 1972

weight on the platform. The platform is very solid mechanically compared to a conventional spring or balance system, with downward deflection for a 100 lb load being only .003 inches. The system is accurate to within $\frac{1}{2}\%$ of the full scale load of 100 lbs, or 0.5 lb. Larger loads can be accommodated by using less sensitive load cells. Photographs of the system in use are shown in figures 14 and 15.

The tests of the weighing system were satisfactory and indicate that this technique has considerable promise in future studies. In further experiments with hibernating captive bears, a weighing platform could be placed beneath the bed to give an accurate, continuous record of weight loss during the winter. This will enable us to correlate weight loss with temperature changes and metabolic increases during spontaneous arousal. Measurements could be made on a year-around basis by placing the platform where the bear would walk across it periodically. It could also be used to quantify activity at the beginning and end of the hibernation period by recording the amount of time spent in the bed. It may be possible to use the system in the den of a wild hibernating bear, although the construction of an unobtrusive platform and its installation in a natural den will pose a few problems.

Activity Monitoring

In future experiments with wild bears in natural dens, a means of measuring shifts of position and movements of the animal within the den will be of value.

A certain amount of information about such movements can be obtained with the temperature monitoring system used in this experiment. The range of the transmitter is limited to about 1 meter, so no data were obtained when the bear was not lying directly over the loop antenna in his bed.



Figure 14: Weighing platform with top removed to show the three load cells which support it



Figure 15: Weighing immobilized bear with platform

An examination of the temperature record for signal dropouts gave a general indication of the activity or inactivity of the bear. This was not foolproof, however, since signal loss can also occur when the transmitter is aligned orthogonally to the receiving antenna. Some gaps in data occurred as the animal shifted to an unfavorable position while remaining in the bed.

A second activity monitoring method we evaluated during this experiment was the use of a pressure sensitive mat which caused a switch closure when stepped on by the bear. The mat was placed by the water pan which was put in the den on March 18 in an attempt to determine when and how often the bear would drink. The results were unsatisfactory, as the bear chewed up the mat and destroyed it almost immediately.

Work was started on a coupled loop inductive proximity measuring system, but this was not tested because we decided it would be better to minimize disturbance to the bear. Development will continue on this approach for future den monitoring experiments.

Release of Bear

The bear gradually became less lethargic during March and began leaving the bed for short periods during the latter part of the month to explore the den. On March 19 he located the antenna cable and pulled it loose. Examination showed that it would be necessary to immobilize the bear to repair the damage. Since he was nearly out of hibernation, we decided to terminate the experiment instead. The temperature transmitter was removed from the bear on April 5.

The bear was immobilized again on April 19 to remove the stitches from the abdominal incision. The temperature telemetry transmitter that

had been removed earlier was inserted rectally and a continuous temperature recording was made for 2 hours to observe the effect of the immobilizing drug on temperature regulation. The indicated temperature remained nearly constant at 38.5°C.

The bear was held until June 15, when he was fitted with a radio-location collar and released (figure 16). We hope to follow his movements and those of a second instrumented black bear throughout the summer to obtain data on food habits and behavior. We also hope to track one to his den in the fall for further studies of hibernation behavior.

Summary

Our primary purpose in the work described in the preceding pages was to continue our development of equipment and methods for field monitoring of hibernating bears. The data obtained during the course of the experiment are of interest, but while we attempted to simulate natural hibernation conditions as nearly as possible, there are many factors which differ from a completely natural situation and could influence the information obtained. The experience gained in the temperature monitoring experiment has changed some of our initial ideas about den monitoring methods and suggested new lines of development and investigation.

It became apparent during the process of implanting the temperature transmitter in the abdominal cavity that such an operation would be a very ambitious undertaking under adverse field conditions in midwinter. We concluded that it would be preferable to conduct any necessary implant surgery early in the fall when it would be possible to capture and hold the animal for a few days for observation and recovery. This would reduce the risk to the animal and increase our confidence in the data obtained by



Figure 16: The bear was fitted with a radiolocation collar and released at the conclusion of the experiment.

allowing a longer period between the operation and the beginning of hibernation. Before release, the bear would be fitted with a radio collar and radiotracked until it entered a den for winter. With the temperature transmitter already implanted there would be no need to do surgery in the field.

If field surgery is necessary, it would be more practical to implant telemetering devices subcutaneously without attempting to enter the body cavity. Such surgery would be relatively minor and should have little effect on the animal even if done in midwinter. Temperatures obtained from a subcutaneous implant would differ somewhat from true deep body temperature, but differences could be minimized by selection of the proper location (near good blood supply and under a thick coat of fur or layer of fat). It should also be possible to obtain good EKG potentials from a subcutaneous implant by running leads under the skin for short distances from the transmitter.

The rapid rise in body temperature in response to disturbances, along with observations of the animal's behavior after entering the den when he was in a very lethargic condition, indicate that frequent visits to a natural den would be very disturbing to the animal and would influence results of behavioral or physiological monitoring. This is confirmed by earlier field experience; on all occasions when bear dens have been visited and examined, the bear has been alerted or partially aroused from lethargy by our presence. Instrumentation must be designed, therefore, for unattended operation over long periods of time. Satellite monitoring has a distinct advantage in this respect.

We experienced considerable difficulty with the bear finding well-concealed equipment and cabling, then chewing on it or pulling it, usually causing failure. Sensors placed in a natural den will have to be designed to be undetectable or indestructable. We did not have nearly as many problems of this kind in the earlier satellite monitoring experiment (J. Craighead et al, 1971), but perhaps this was simply luck and can't be expected to be the general rule.

It is likely that bears emerge from their dens for short times during the winter or early spring. We are considering developing a time lapse camera which could be set up outside the den and triggered by the bear moving away from a proximity detector inside the den; in this way photographs could be taken at intervals during the time that the bear was outside for later analysis.

In future work, development will be continued on equipment to monitor heart rate, respiration rate, and movements within the den. Heart rate will perhaps provide a better measure of the degree of lethargy and response to disturbance than body temperature. Further measurement of body temperature under natural conditions and its relationship to ambient den temperatures and heat conservation mechanisms will also be of interest.

Acknowledgments

This research was supported by the National Geographic Society and by National Aeronautics and Space Administration Research Grant NGR-27-002-006. We are grateful for the help of many people during the course of the study. Barometric pressure data was provided by Eric Nelson. Jeff Hart helped with the field survey of den sites and bear trapping activities in West Yellowstone. John Hechtel assisted throughout the project in handling and maintaining the bears, and in radio-tracking them after release. Dr. B.W. O'Gara provided us with advice and assistance in caring for the bears, and the implant surgery was done by Conrad Orr, DVM.

We wish to express our appreciation to the W.C. Dillon Company for the loan of the load cell weighing system, and to the Montana State Fish and Game Department for their cooperation and for providing us with the bear used in the project.

References

Craighead, F.C. Jr., and J.J. Craighead, 1966. Radiotelemetry of Large Western Mammals: Progress Report, 1965-1966. 67 pp. mimeo.

Craighead, J.J., F.C. Craighead Jr., J.R. Varney, C.E. Cote, 1971. Satellite Monitoring of Black Bear. BioScience 21 (24): 1206-1212.

Goodman, R.M., 1971. A Reliable and Accurate Implantable Temperature Telemeter. BioScience 21 (8): 370-374.

Hock, R.J., 1957. The Metabolic Rates and Rectal Temperatures of Active and 'Hibernating' Black Bears. Fed. Proc. 16 :440.

Mackay, R.S. 1970. Bio-Medical Telemetry. John Wiley & Sons, New York.

Varney, J.R., 1970. Radiotracking and Telemetering Equipment Design. In: Craighead, J.J. et al, Radiotracking and Telemetering System for Large Western Mammals: Final Report. AEC-RL0-1929-15.