

NASA TECHNICAL NOTE



NASA TN D-7469

NASA TN D-7469

# LUNAR ROVING VEHICLE NAVIGATION SYSTEM PERFORMANCE REVIEW

*by Earnest C. Smith and William C. Mastin*

*George C. Marshall Space Flight Center*

*Marshall Space Flight Center, Ala. 35812*

## TABLE OF CONTENTS

	Page
SUMMARY . . . . .	1
INTRODUCTION . . . . .	1
SYSTEM DESCRIPTION . . . . .	1
Requirements and Specifications . . . . .	1
Component Description . . . . .	2
System Operation . . . . .	6
Field Test . . . . .	13
PREFLIGHT SYSTEM ERROR ANALYSIS . . . . .	16
REAL-TIME OPERATIONS SUPPORT . . . . .	16
POSTFLIGHT EVALUATIONS . . . . .	19
APOLLO 15 LRV NAVIGATION SYSTEM EVALUATION . . . . .	19
APOLLO 16 LRV NAVIGATION SYSTEM EVALUATION . . . . .	28
Traverse I . . . . .	28
Traverse II . . . . .	28
Traverse III . . . . .	29
Evaluation . . . . .	29
APOLLO 17 LRV NAVIGATION SYSTEM EVALUATION . . . . .	41
Traverse I . . . . .	41
Traverse II . . . . .	41
Traverse III . . . . .	41
Evaluation . . . . .	41
CONCLUSION . . . . .	<b>53</b>
REFERENCES . . . . .	55

## LIST OF ILLUSTRATIONS

Figure	Title	Page
1.	Navigation system block diagram . . . . .	4
2.	Outline drawing for directional gyro . . . . .	5
3.	Display electronics . . . . .	6
4.	Outline drawing for signal processing unit . . . . .	7
5.	Analog functions _SPU . . . . .	9
6.	Digital functions _SPU . . . . .	11
7.	Range error versus distance . . . . .	14
8.	Bearing error versus distance . . . . .	15
9.	Position error versus map distance . . . . .	18
10.	TV display for real-time LRV heading alignment . . . . .	19
11.	TV display for real-time traverse analysis . . . . .	19
12.	Apollo 15, Traverse I plot . . . . .	25
13.	Apollo 15, Traverse II plot . . . . .	26
14.	Apollo 15, Traverse III plot . . . . .	27
15.	Apollo 16, Traverse I plot . . . . .	38
16.	Apollo 16, Traverse II plot . . . . .	39
17.	Apollo 16, Traverse III plot . . . . .	40
18.	Apollo 17, Traverse I plot . . . . .	50
19.	Apollo 17, Traverse II plot . . . . .	<b>51</b>
20.	Apollo 17, Traverse III plot . . . . .	52

APOLLO 15, 16, 17, 18, 19, 20, 21, 22, 23, 24, 25, 26, 27, 28, 29, 30, 31, 32, 33, 34, 35, 36, 37, 38, 39, 40, 41, 42, 43, 44, 45, 46, 47, 48, 49, 50, 51, 52, 53, 54, 55, 56, 57, 58, 59, 60, 61, 62, 63, 64, 65, 66, 67, 68, 69, 70, 71, 72, 73, 74, 75, 76, 77, 78, 79, 80, 81, 82, 83, 84, 85, 86, 87, 88, 89, 90, 91, 92, 93, 94, 95, 96, 97, 98, 99, 100

## LIST OF TABLES

Table	Title	Page
1.	LRV Navigation System Requirements . . . . .	3
2.	Traverse Position Errors . . . . .	17
3.	Apollo 15 LRV Navigation System Performance . . . . .	20
4.	Apollo 15 LRV Navigation System Initializations, Checks, and Updates .	21
5.	Apollo 15. Traverse I Bearing and Range Readouts . . . . .	22
6.	Apollo 15. Traverse II Bearing and Range Readouts . . . . .	23
7.	Apollo 15. Traverse III Bearing and Range Readouts . . . . .	24
8.	Apollo 16 LRV Navigation System Performance . . . . .	30
9.	Apollo 16 LRV Navigation System Initializations, Checks and Updates .	31
10.	Apollo 16. Traverse I Bearing and Range Readouts . . . . .	32
11.	Apollo 16. Traverse II Bearing and Range Readouts . . . . .	34
12.	Apollo 16. Traverse III Bearing and Range Readouts . . . . .	36
13.	Apollo 17 LRV Navigation System Performance . . . . .	42
14.	Apollo 17 LRV Navigation System Initializations, Checks, and Updates .	43
15.	Apollo 17. Traverse I Bearing and Range Readouts . . . . .	44
16.	Apollo 17. Traverse II Bearing and Range Readouts . . . . .	45
17.	Apollo 17. Traverse III Bearing and Range Readouts . . . . .	48
18.	Apollo 15, 16, and 17 LRV Navigation System Performance Summary . . . . .	54

# LUNAR ROVING VEHICLE NAVIGATION SYSTEM PERFORMANCE REVIEW

## SUMMARY

The Lunar Roving Vehicle (LRV) navigation system consists of a directional gyro, a set of incremental odometers, and a hybrid analog-digital signal processor plus appropriate controls and readouts. The system was tested in the laboratory and in the field and found to be adequate. It performed successfully on the lunar surface during Apollo Missions 15, 16, and 17, operating well within specifications.

## INTRODUCTION

The reliable performance of the LRV navigation system justified the dissemination of a description and review of operational characteristics for possible application to other projects. The selection of the type system used was a result of several years of study and investigation. Approaches studied covered the range from simple direction finders to sophisticated systems using satellite navigation aids. The system selected had to meet the requirements of accuracy, simplicity, reliability, ruggedness, light weight, and low power consumption. Added requirements were minimum crew time needed for operation, retention of navigation readouts with power loss, and capability of fabrication using existing technology.

The system chosen by MSFC to best fit these requirements was one consisting of a directional gyro, four odometers, a hybrid signal processor, and vehicle attitude, position, and speed indicating devices. Gyro heading initialization was accomplished by means of an extremely simple sun shadow device and vehicle attitude indicators. A prototype system [1] containing the essentials for evaluating operation was designed and fabricated in the Astrionics Laboratory at Marshall Space Flight Center (MSFC). Tests at MSFC and at Flagstaff, Arizona, [2] proved that a system of this type would meet the requirements of the Apollo missions. Error analyses and computer simulations carried on simultaneously with the hardware work led to the same conclusions.

## SYSTEM DESCRIPTION

### Requirements and Specifications [3]

The functions of the navigation system were to provide to the LRV crew the information necessary to return by the shortest route to the Lunar Module (LM), determine total distance traveled, determine vehicle speed, and navigate to a predetermined site. To

perform these functions, it was required that the system provide the capability for the crew to align the directional gyro unit (DGU) to lunar north to a display resolution of  $\pm 1$  deg using externally supplied ephemeris data, to display vehicle heading relative to lunar north, to utilize odometer pulses from four wheels to determine and display total distance traveled and vehicle speed, and to operate upon the DGU output and odometer pulses to determine and display range to the LM and bearing to the LM with respect to lunar north. It was required that the system be capable of operating from 0 to  $\pm 45$  deg in combined pitch and roll, at all yaw attitudes, and with steering rate inputs not in excess of 50 deg per second.

The system requirements are listed in Table 1. The thermal ranges for system components are:

	Operating	Nonoperating
Directional Gyro Unit	-54°C to +71°C (-65°F to +160°F)	-62°C to +93°C (-80°F to +200°F)
Signal Processing Unit	+10°C to +54°C (+50°F to +130°F)	-54°C to +185°C (-65°F to +185°F)
Display Electronics	-32°C to +54°C (-25°F to +130°F)	-54°C to +85°C (-65°F to +185°F)

Vibration and acceleration ranges will not be listed here because of their length but may be found in the referenced document.

### Component Description

A block diagram of the navigation system may be seen in Figure 1. The batteries and wheel pulse generators are not considered as part of the system proper, but provide indispensable inputs to it. The DGU is a Lear Seigler, Model 9010, two-degree-of-freedom gyro. It weighs 2.4 kg (5.5 lb) and has the dimensions shown in Figure 2. Power required is 115 V rms, single phase, 400 Hz, with consumption approximately 30 watts when starting and 15 watts when running. Direction information is provided by a synchro transmitter with a three-wire output. Drift was required to be less than 5 deg per hour under laboratory conditions, and less than **10** deg per hour during lunar operation.

The integrated position indicator (IPI) is manufactured by Abrams Instrument Corporation and is shown on the left portion of the display electronics, Figure 3. The heading indicator portion of the IPI consists of a compass rose with 2-deg divisions driven by an analog synchro follower excited from the synchro transmitter in the DGU. The bearing, distance, and range indicators are pulse driven up-down counters controlled by the

TABLE 1. LRV NAVIGATION SYSTEM REQUIREMENTS

Data Displayed	System 3 $\sigma$ Accuracy	Display Range	Display Resolution	Vehicle Accuracy
Heading <sup>a</sup>	$\pm 4.5$ deg	0 - 360 deg	1 deg	
Bearing to LM	$\pm 4.6$ deg	0 - 360 deg	1 deg	$\pm 6$ deg
Range to LM	$\pm 420$ m at 5 km	0 - 30 km	0.1 km	$\pm 600$ m at 5 km
Total Distance Traveled	+1%	0-99km	0.1 km	+2%
Velocity	$\pm 1.5$ km/hr	0 - 19 km/hr	1 km/hr	
Roll Attitude	$\pm 2$ degrss	+25 deg	$\pm 1$ deg	
Pitch Attitude <sup>b</sup>	$\pm 3$ deg rss	+25 deg	$\pm 3$ deg	
Sun Shadow Device	$\pm 2$ deg rss	$\pm 15$ deg	$\pm 1$ deg	

- a. Marked in 2-deg increments.
- b. Marked in 5-deg increments.

signal processing unit (SPU). The IPI weight is nominally 1.25 kg (2.7 lb), has front dimensions 9.65 cm (3.8 in.) by 9.65 cm (3.8 in.), and is 13.34 cm (5.25 in.) deep. Power required by the IPI consists of 115 V rms, single phase, 400 Hz (10.0 V-A when slewing, 2.0 V-A static) for the heading indicator, and 28 Vdc for the counters.

The SPU has the dimension shown in Figure 4 and weighs 5.33 kg (11.75 lb). The flight units were designed and produced by The Boeing Company. The SPU selects the distance increment detected by the third fastest wheel and resolves this increment into northings and eastings (in meters) using the heading input from the DGU synchro transmitter. These resolved increments are accumulated to yield Cartesian coordinates of the vehicle position with respect to the starting point. A Cartesian to polar coordinate transformation is then effected which produces the range and bearing of the vehicle with respect to its starting point. The voltage input to the SPU is  $36 \pm 4$  Vdc and power used is approximately 90 watts for the first 3 min after starting and approximately 40 watts thereafter. This includes the power required by the DGU and the IPI, as the voltages required for their operation are derived from the 36 Vdc in the SPU.

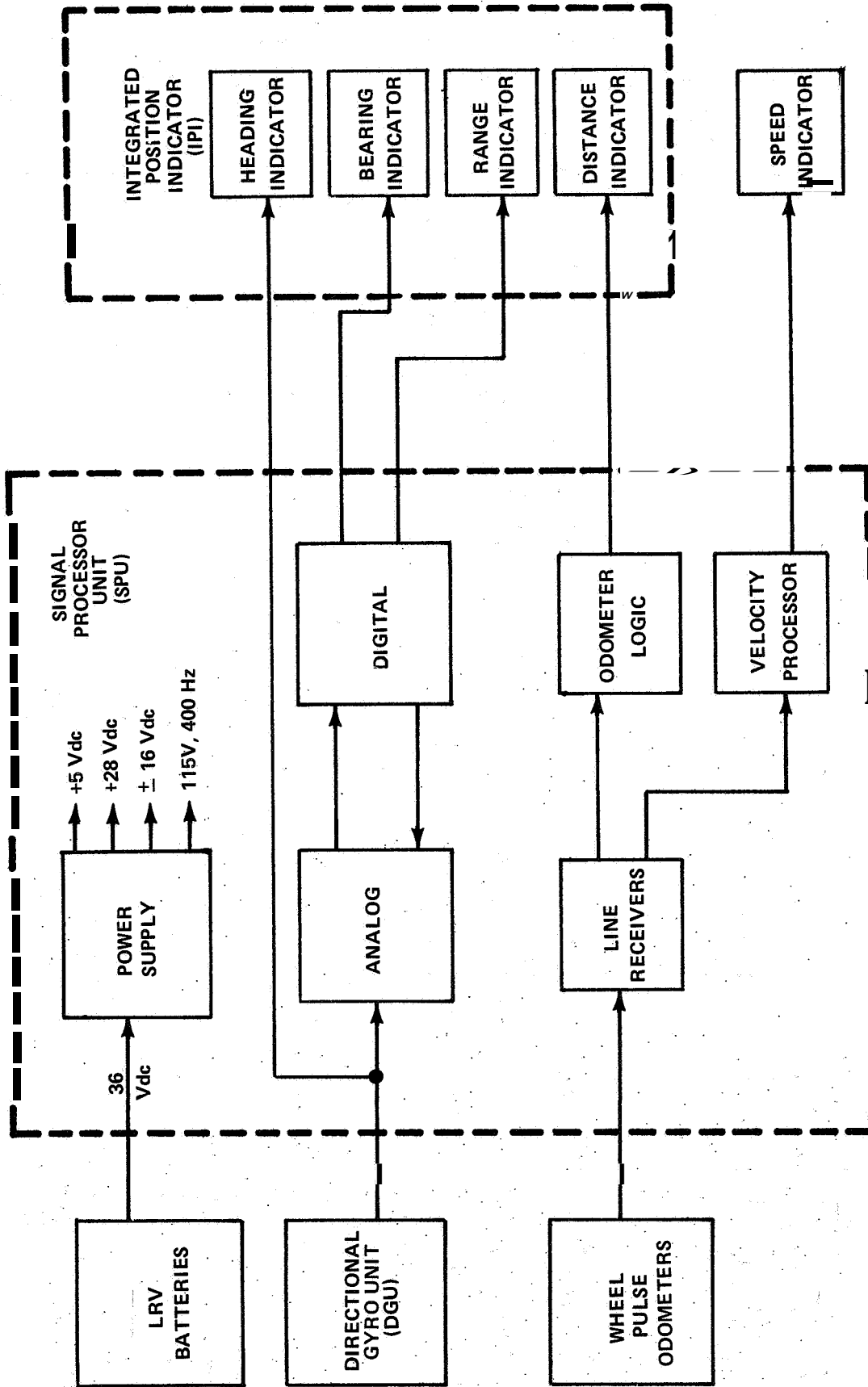

Figure 1. Navigation system block diagram.



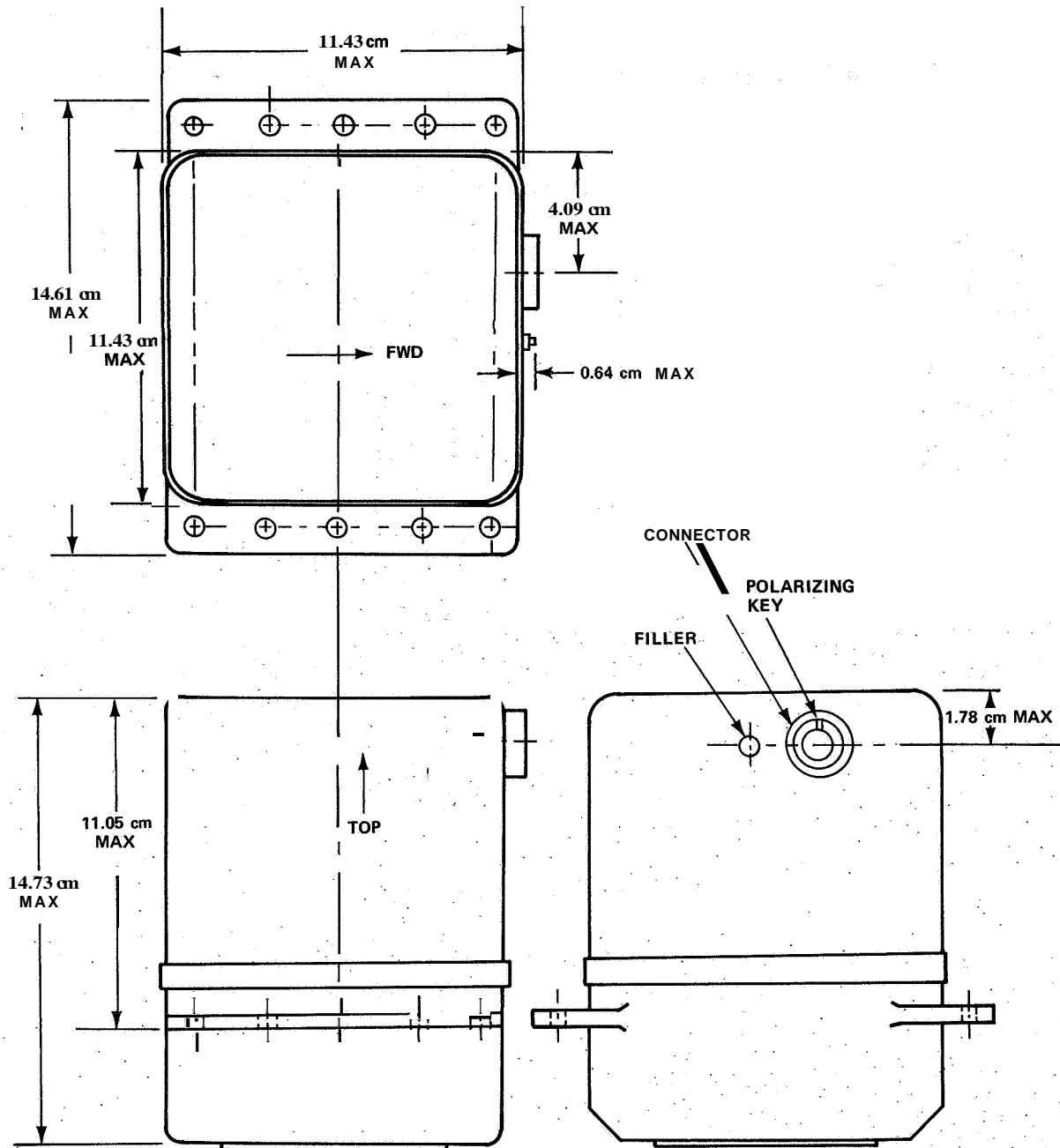

Figure 2. Outline drawing for directional gyro.

The attitude indicator is hinged to left side of the display electronics (Fig. 3). It is a one-axis, pendulous device which indicates vehicle roll when in the position shown and pitch when folded back against the side of the panel.

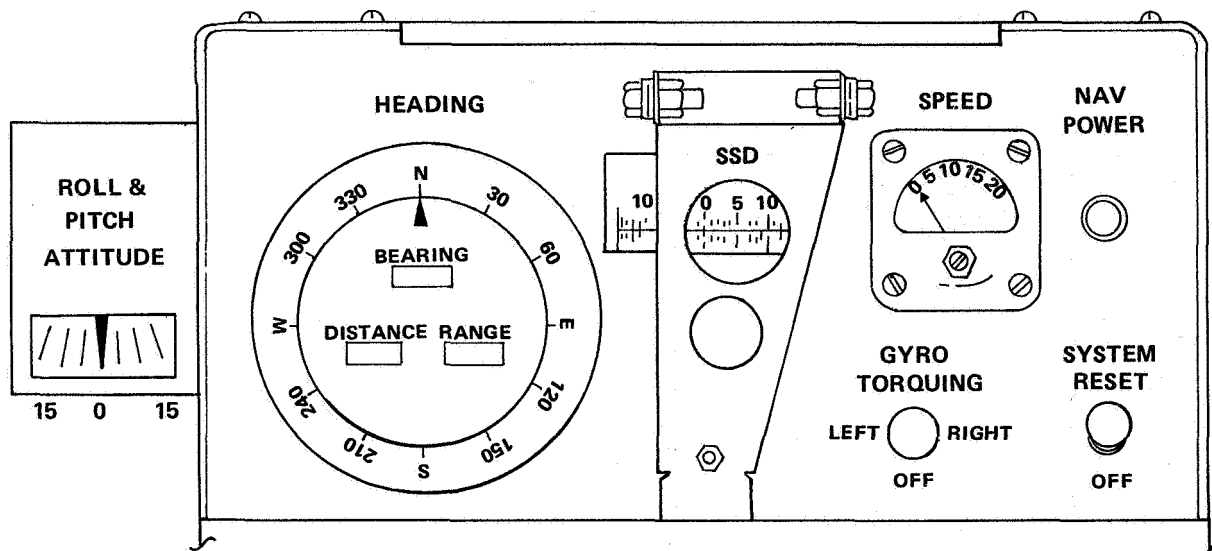

Figure 3. Display electronics.

The sun shadow device (SSD) is located in the center of the display electronics panel (Fig. 3). It is hinged at the top and has a needle at the free end which fits into the front panel when in the stowed position. In operation, the vehicle is parked down-sun and the SSD is rotated about the hinge line until the shadow of the needle falls across the scale. The deviation of the vehicle heading from the sun's azimuth plus 180 deg is then read directly from the scale at that point.

The speed indicator is a 200- $\mu$ amp meter scaled to read in kilometers per hour.

#### System Operation [4]

To begin operation, the vehicle is parked down-sun and the SSD and roll and pitch angles are read. The vehicle heading with respect to lunar north is then determined by the following equation :

$$\text{vehicle heading, } \alpha = (\text{sun azimuth } \pm 180 \text{ deg}) - (\pm \text{SSD}) + (\text{roll correction}) \\ + (\text{pitch correction})$$

The roll and pitch corrections are required because of the geometry of the SSD. They are determined by the following equations:

$$\text{roll correction (deg)} = \frac{\gamma \sin \beta}{0.065}$$

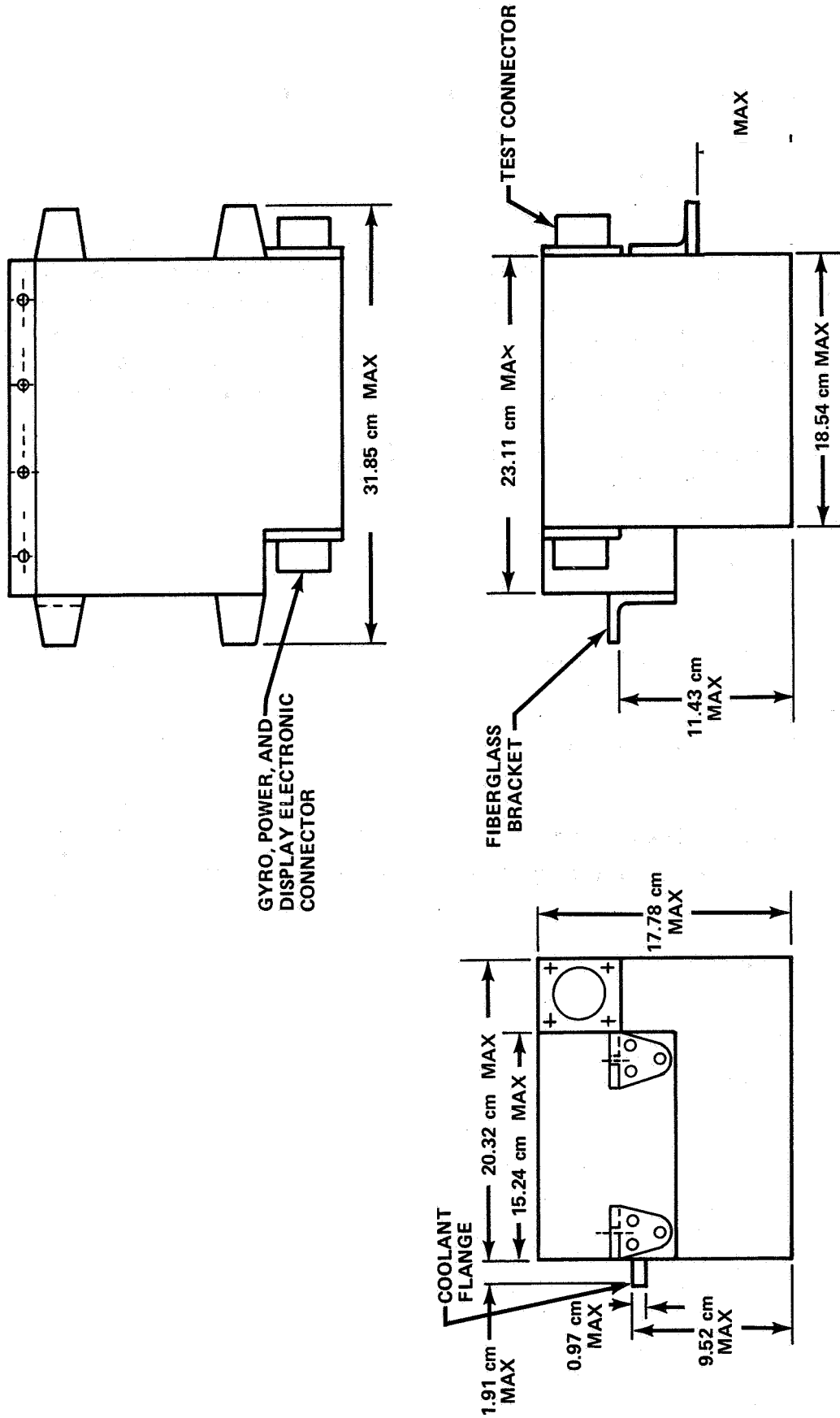

Figure 4. Outline Drawing for signal processing unit.

where  $\beta$  is the roll angle (+ for right side up),  $\gamma = 3.36 \sin \eta$ , and  $\eta$  is the sun elevation;

$$\text{pitch correction (deg)} = \text{SSD deg} [1 - 0.88 (\eta - 26 \text{ deg}) + 0.46 \sin \eta]$$

where  $\rho$  is the pitch angle (+ for nose down) and  $\eta$  is the sun elevation.

The sun's azimuth and elevation are obtained from the ephemeris. During lunar operation the astronauts read the SSD and attitude angles and reported them to the ground where the true heading was then obtained in a very short time from a computer. The DGU can be torqued to the true heading 3 min after power is applied to the navigation system. The reset switch is then activated momentarily to reset all internal registers and the range, distance, and bearing indicators to zero. The system is then ready for operation.

The analog functions of the SPU are shown in Figure 5. The heading information from the DGU synchro output is available on three wires as

$$S_1 = AE_T \sin a$$

$$S_2 = AE_T \sin (a + 120 \text{ deg})$$

$$S_3 = AE_T \sin (a + 240 \text{ deg}) \quad ,$$

where  $E_T$  is the single phase, 400 Hz synchro excitation voltage and  $a$  is the heading angle. The Scott "T" function is accomplished by applying the  $AE_T \sin a$  signal to an operational amplifier with a gain of one. To a second operational amplifier input is applied  $\frac{1}{2} (S_1 + S_2)$ , and the feedback resistor is selected such that the output is

$$\begin{aligned} 1.164 AE_T \left[ \frac{1}{2} \sin \alpha + \sin (\alpha + 120 \text{ deg}) \right] &= 1.164 AE_T \left( \frac{1}{2} \sin \alpha + \sin \alpha \cos 120 \text{ deg} \right. \\ &\quad \left. + \cos \alpha \sin 120 \text{ deg} \right) \\ &= 1.164 AE_T \left( \frac{1}{2} \sin \alpha - \frac{1}{2} \sin \alpha + 0.866 \cos \alpha \right) \\ &= AE_T \cos \alpha \end{aligned}$$

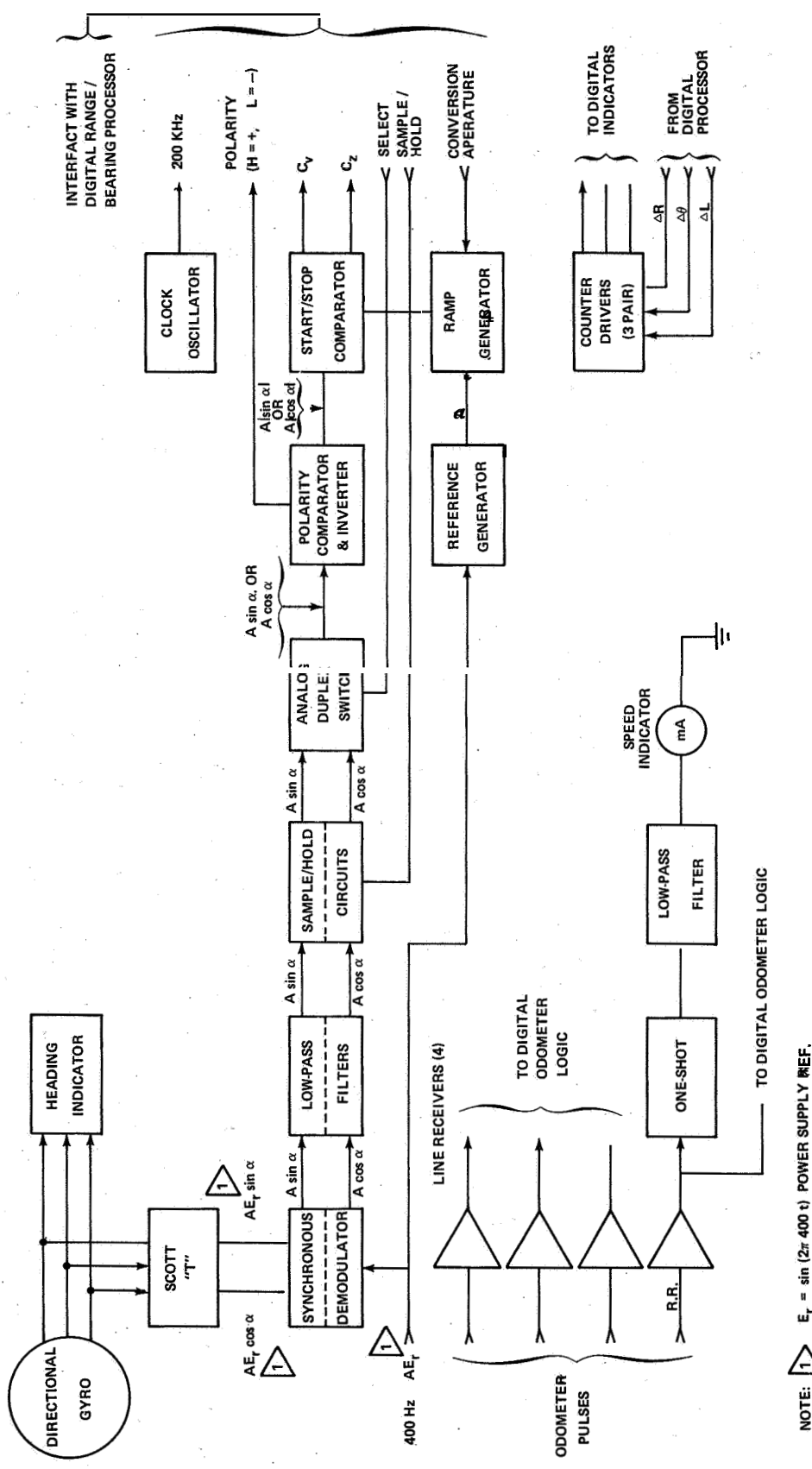

NOTE:  $\triangle = \sin(2\pi \cdot 400 t)$  POWER SUPPLY REF.

Figure 5. Analog function — SPU [4].

$S_3$  is grounded through a resistor for balanced synchro loading. Thus, the three-wire synchro information is converted to the sine and cosine of the heading angle. These signals are then demodulated and filtered so that dc levels result. They are converted to digital quantities on command from the digital programmer using sample-hold circuits, an analog duplex switch, and a ramp and counter analog-to-digital converter. The pulses from the right rear wheel are filtered and the resulting dc current drives a meter to indicate speed. There is nine-pulse-per-wheel resolution, each pulse representing a distance traveled of 0.245 m. The pulse repetition rate is thus directly proportional to vehicle speed.

The digital functions of the **SPU** (Fig. 6) are to process the digitized sine and cosine of heading and the wheel pulses to indicate range and bearing to the **LM** and total distance traveled. The wheel selection logic contains four channels of divide-by-3 counters to yield a **AS** (distance increment) of 0.735 m. This increment is signaled when the third fastest wheel has produced three pulses, the logic is reset, and the counting starts again. The slowest wheel must then produce an extra pulse before its count continues. This is done so that a disabled or dragging wheel will not stop operation and so that a spinning wheel will not cause erroneous distance calculations.

The **AS** pulses are counted by a divide-by-136 counter to convert them to a resolution of approximately 0.1 km. The output of this counter then drives the distance indicator. The counter output pulse weight is actually 99.96 m, giving a -0.04 percent error in the conversion.

The **AS** pulse from the wheel selection logic also initiates the process of converting the cosine  $a$  and sine  $a$  voltages to digital form, accumulating them and performing the vectoring operation. The process of accumulating the values of the sine and cosine of the heading angle at distance-traveled increments is equivalent to the multiplication

$$\text{north increment} = AS \cos a$$

$$\text{east increment} = AS \sin a$$

and the addition

$$\text{north coordinate} = \sum AS \cos a$$

$$\text{east coordinate} = \sum AS \sin a$$

These Cartesian coordinates are stored in the north and east registers shown in Figure 6.

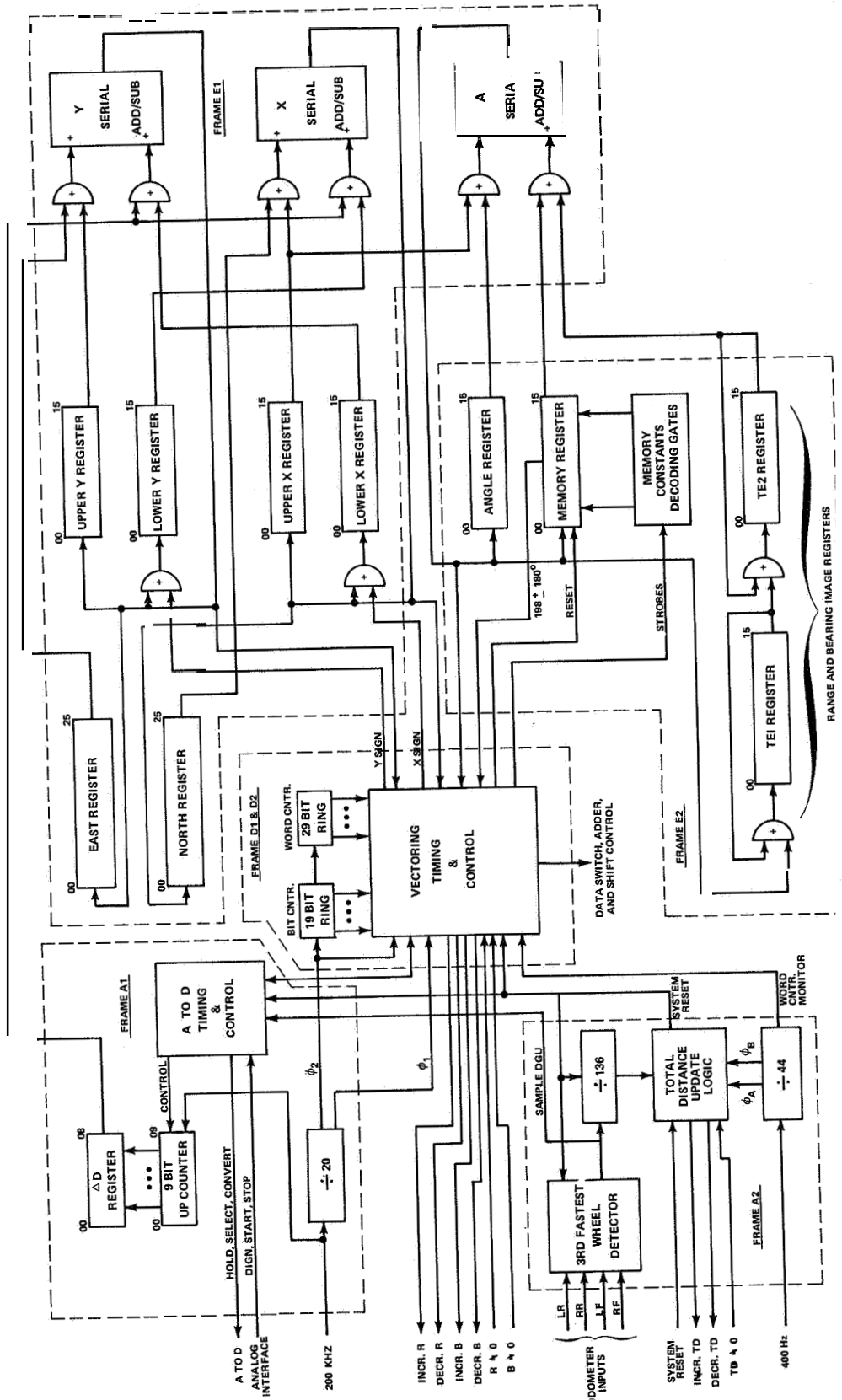

Figure 6. Digital functions - SPU [4].

The CORDIC (Coordinate Rotation Digital Computer) algorithm [5] is used to convert the north and east coordinates to the polar coordinates range,  $R$ , and bearing,  $\theta$ , to the LM by solving the following equations:

$$R' = K \sqrt{\text{north}^2 + \text{east}^2} = KR$$

and

$$e = \tan^{-1} (\text{east}/\text{north})$$

The constant  $K$  results from use of the algorithm and is compensated for in the SPU by controlling the slope of the ramp in the A/D converter.

The solution of the equations consists of rotating a given vector such that the final  $Y$  component is nulled. The equations for rotating a vector are

$$Y' = K(Y \cos \lambda + X \sin \lambda)$$

and

$$X' = K(X \cos \lambda - Y \sin \lambda)$$

Substituting  $X = R \cos \theta$  and  $Y = R \sin \theta$  into the above equations yields

$$\begin{aligned} Y' &= K(R \sin \theta \cos \lambda + R \cos \theta \sin \lambda) \\ &= KR \sin(\theta + \lambda) \end{aligned}$$

and

$$\begin{aligned} X' &= K(X \cos \lambda - Y \sin \lambda) \\ &= KR \cos(\theta + \lambda) \end{aligned}$$



Letting  $\lambda = -\theta$  ,

$$Y' = 0$$

and

$$X' = KR$$

The SPU performs a series of successively smaller rotations through fixed angles, chosen so as to be easily implemented digitally, until the Y register is nulled. The X register then contains the range. The sum of the angular rotations, properly scaled, is the bearing angle. At the end of each update period, the new computed quantities are compared to the quantities in image registers. Where required, the range and bearing indicators are updated and the image registers are filled with the new numbers.

### **Field Test [6]**

The navigation system underwent extensive tests and evaluations during design and manufacturing acceptance and environmental testing. It was felt that additional testing under field conditions with vehicle motion and variable wheel slip would add to confidence in its proper operation.

The system was mounted in a Travelall which had magnets fixed to the wheels to activate switches. The signals from these switches satisfactorily simulated the wheel pulses from the LRV wheels.

The test site was the Merrium Crater area near Flagstaff, Arizona. Maps and surveying and communications support were provided by the United States Geological Survey Facility there. The range and bearing of checkpoints with respect to a starting point ("LM Site") were thus accurately determined so that a meaningful evaluation of the navigation system could be made.

Gyro heading initializations and updates were accomplished using a sun shadow device and an ephemeris printout. The earth's rotation compensation was provided by applying a constant voltage to the gyro torquer.

Five sorties of 17.6 km, one of 19.7 km, and one of 20.0 km were made. The range and bearing errors as a function of distance traveled are shown in Figures 7 and 8. It can be seen that these errors are well within specifications.

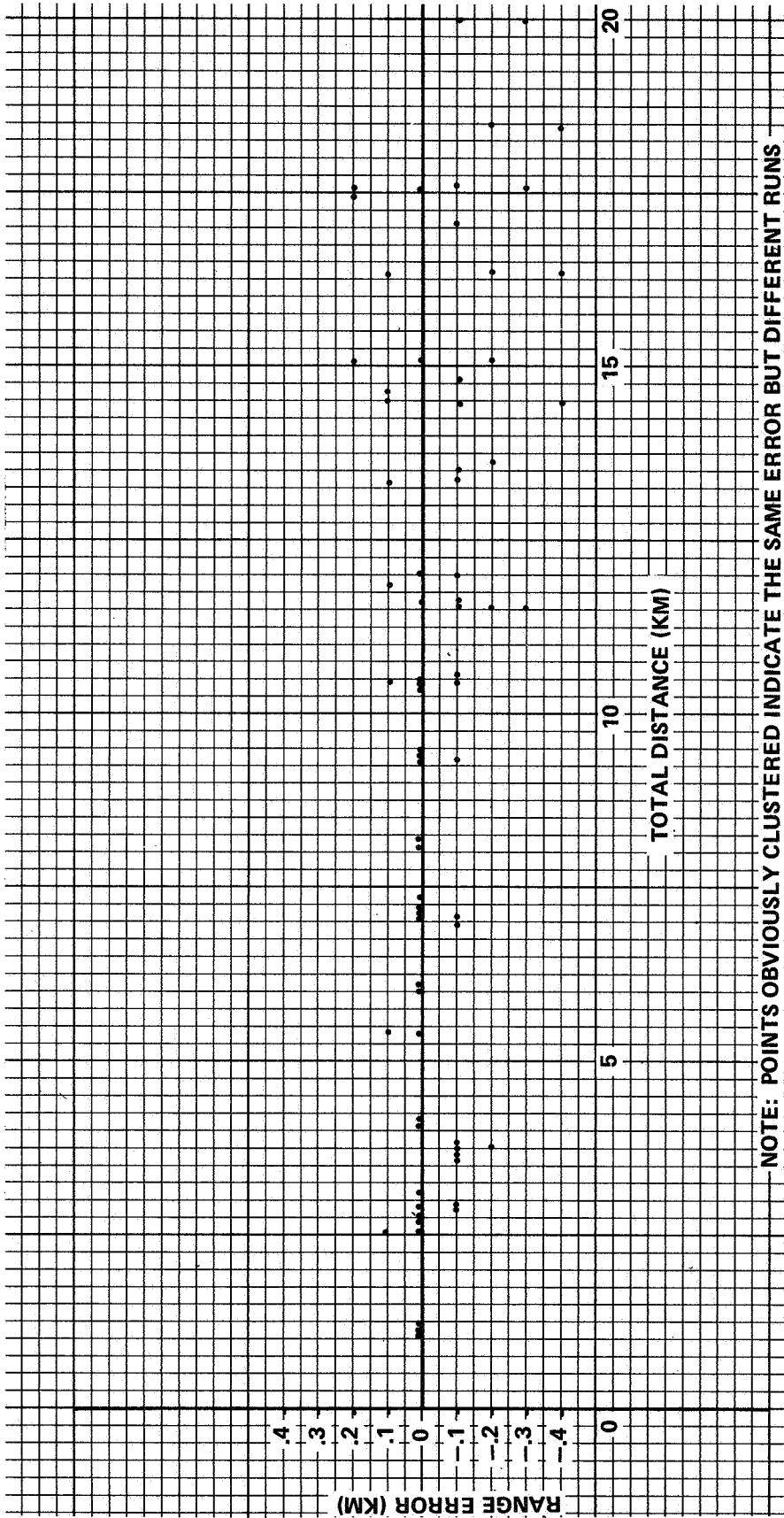
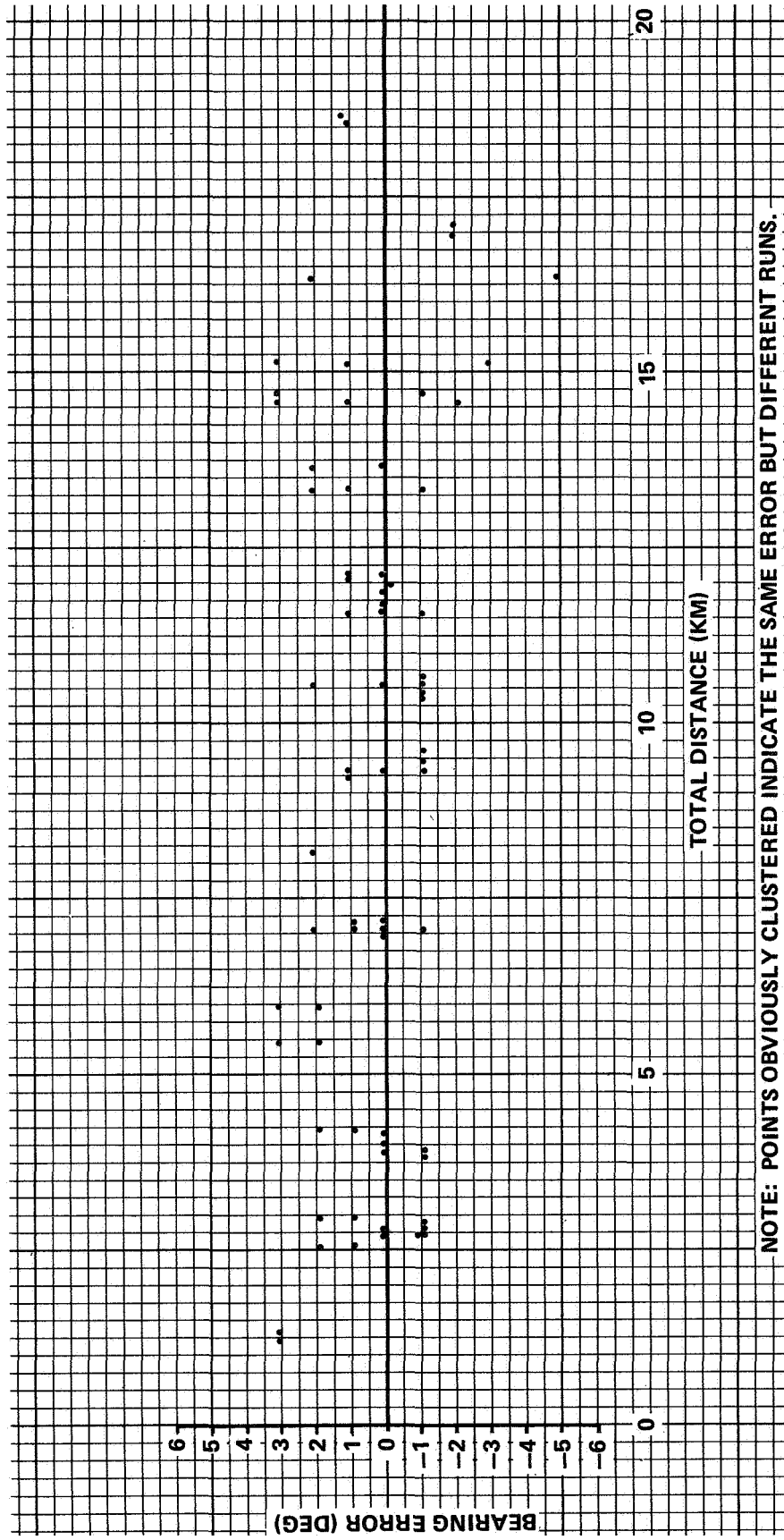

Figure 7. Range error versus distance.



**NOTE: POINTS OBVIOUSLY CLUSTERED INDICATE THE SAME ERROR BUT DIFFERENT RUNS.**

Figure 8. Bearing error versus distance.

## PREFLIGHT SYSTEM ERROR ANALYSIS

Prior to each mission, a system error analysis was performed with simulated inputs. These simulations provided data on the amount of position error to be expected from the system as a function of gyro drift and gyro misalignment correction frequency. The analyses were based on mission Traverse Data Packages supplied by NASA-Johnson Space Center (JSC). The data packages contained the following information:

Elevation Profile

Segment Azimuth

Slope (Cross Azimuth)

Lurain Type

Timeline

Operational parameters used in the analysis are listed below:

Constant Velocity : 8.0 km/hr

Wheel Slip: 1.85 percent

Yaw Misalignment:  $\pm 3.0$  deg

Yaw Drift Rate:  $\pm 1.0$  deg/hr and  $\pm 5.0$  deg/hr

Wander Factor: 1.1

Examples of position error results from some of the Traverse Data Packages are given in Table 2 and illustrated in Figure 9.

## REAL-TIME OPERATIONS SUPPORT

Operational support in real-time consisted of computing the LRV heading for azimuth initialization and update of performing traverse analyses with the information relayed to earth by the astronauts. Alignment of the LRV navigation system was accomplished by first having the crew measure the vehicle pitch and roll using the attitude indicator, and the orientation with respect to the sun using the sun shadow device. This information was relayed to the ground where, using it and the sun's azimuth and elevation obtained from the ephemeris table as input data, the vehicle's heading with respect to lunar north was calculated.

TABLE 2. TRAVERSE POSITION ERRORS

Run No.	Update at Stations	1.0 deg/hr Drift Rate (Yaw)			5.0 deg/hr Drift Rate (Yaw)		
		Σ x inum (m)	Closure (m)	Average (m)	Maximum (m)	Closure (m)	Average (m)
1	No Updates	327.	327.	158.	1609.	1609.	399.
2	11	288.	198.	154.	984.	984.	277.
3	12	293.	113.	158.	563.	563.	249.
4	13	292.	107.	150.	539.	539.	216.
5	14	292	89.	150.	444.	444.	244.
6	11 and 14	288.	58.	152.	394.	284.	202.
7	11 and 15	288	80.	144.	393.	392.	195.
8	12 and 14	293.	37.	161.	415.	185.	230.
9	12 and 15	293.	40.	156.	415.	195.	209.
10	11, 14, and 17	288.	15.	154.	394.	72.	193.
11	12, 14, and 17	293.	14.	164.	415.	71.	238.

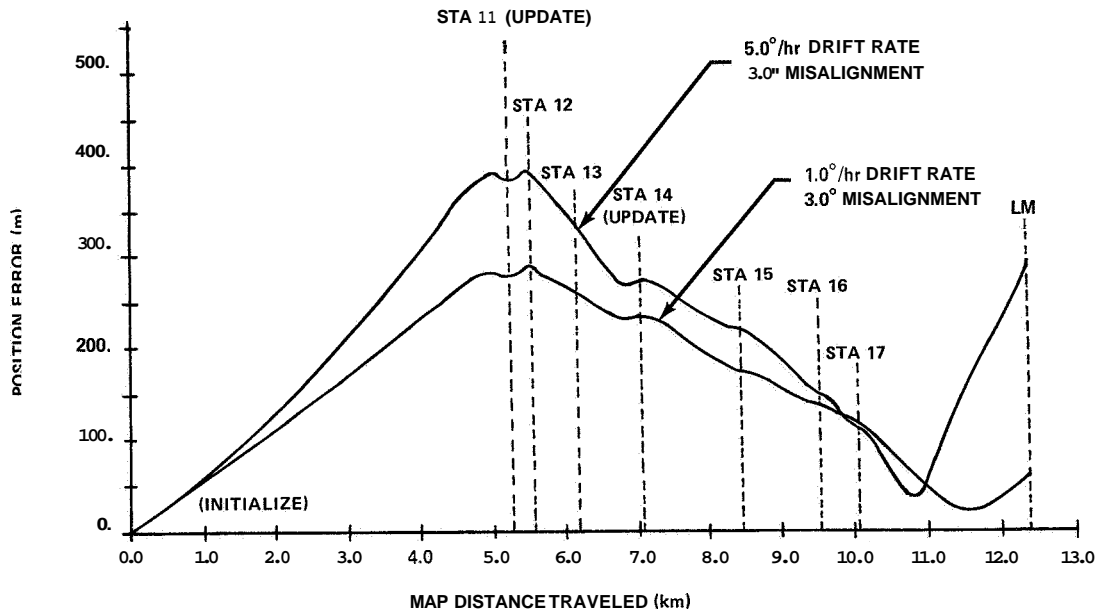

Figure 9. Position error versus map distance.

To illustrate this operation, assume the data available were those shown below:

Crew Readout

SSD: 3 deg left (-3 deg)

Pitch: 6 deg down (-6 deg)

Roll: 6 deg right (+6 deg)

Time

Year, Month, Day, Hour, Minute, Second

Ephemeris Table (Landing Site, Time)

Sun Azimuth: 87 deg (A deg = 87 deg)

Sun Elevation: 30 deg (E deg = 30 deg)

These data would be input to the computer and the vehicle heading displayed on a CRT as shown in Figure 10.

The computer was used during the lunar operations because of the importance of speed and accuracy. For other applications, the azimuth initialization could be accomplished using tables prepared for a time and site of operation.

Real-time traverse analysis was done using the computer program. The CRT display for this program is shown in Figure 11.

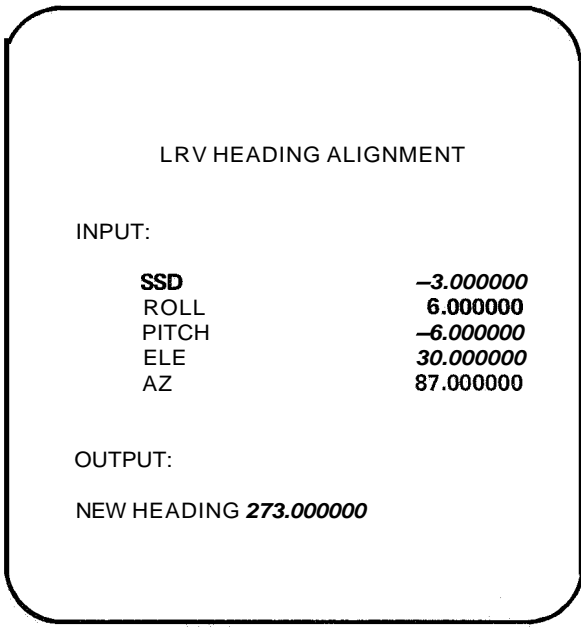

Figure 10. TV display for real-time LRV heading alignment.

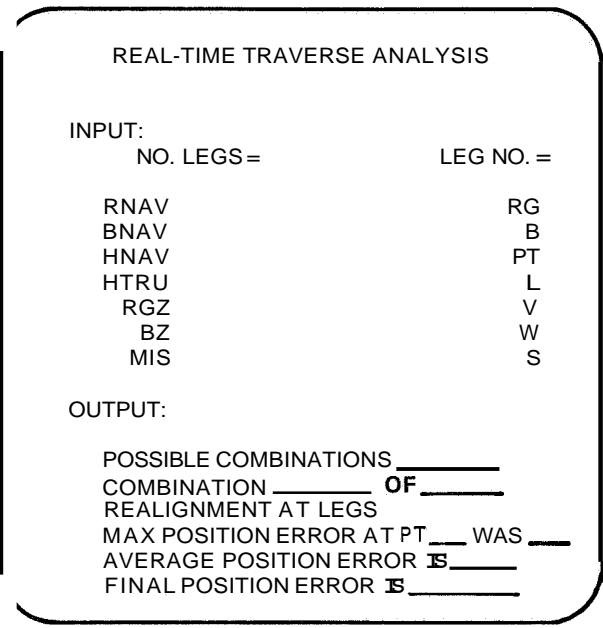

Figure 11. TV Display for real-time traverse analysis.

## POSTFLIGHT EVALUATIONS

The operation of the LRV navigation system was evaluated after each flight. The system readouts and performance parameters were tabulated and the sortie routes as determined from readouts were plotted and compared to positions determined by the lunar geology investigation team.

### APOLLO 15 LRV NAVIGATION SYSTEM EVALUATION

The LRV navigation system stayed well within the 600 meter position error specification on all three traverses. Gyro drift, gyro misalignment, case torquing, and wheel slippage were all contributors to position error; however, it is impossible to determine each quantitatively because of insufficient data. It is evident though that all errors were small and that the LRV navigation system performed very well. Data resulting from the evaluation are given in Tables 3 through 7 and Figures 12 through 14.

TABLE 3. APOLLO 15 LRV NAVIGATION SYSTEM PERFORMANCE

	Traverse I	Traverse II	Traverse III
Odometer Distance	10.3 km	12.5 km	5.1 km <sup>g</sup>
Map Distance <sup>a</sup>	9.0 km	11.7 km	4.5 km
Ride Time <sup>b</sup>	- 62 min	- 83 min	- 35 min
Park Time	- 74 min	~ 154 min	- 82 min
Total Time of Traverse	- 136 min	- 237 min	- 117 min
Average Velocity <sup>c</sup>	10.0 km/hr	9.0 km/hr	8.7 km/hr
Mobility Rate <sup>d</sup>	8.7 km/hr	8.46 km/hr	7.54 km/hr
Number of Navigation Checks	1	1	0
Number of Navigation Updates	0	1	0
Navigation Closure Error <sup>e</sup>	<200 m	<200 m	<200 m
Maximum Position Error	<300 m	<350 m	<250 m
Gyro Drift Rate	Little or None	Little or None	Little or None
Gyro Misalignment	Small	Small	Small
Percent Wander <sup>f</sup>	14%	7%	16%

- a. Map distance traveled, neglecting deviations around small craters
- b. The time spent riding, including minor stops, from departure to arrival at the LM.
- c. The odometer reading at the end of the traverse divided by the ride time.
- d. The map distance divided by the ride time.
- e. The position error in the navigation system at the end of the traverse
- f.  $\% \text{ wander} = \frac{\text{speed} - \text{mobility rate}}{\text{mobility rate}} \times 100\%$
- g. Had the navigation system been initialized at the LM instead of the ALSEP site, the odometer reading would be 5.2 km.



TABLE 4. APOLLO 15 LRV NAVIGATION SYSTEM INITIALIZATIONS, CHECKS, AND UPDATES

Ground Elapsed Time (day, hr, min, sec)	Pitch (deg)	Roll (deg)	Sun Shadow (deg)	MSFC Heading (deg)	Navigation Heading (deg)	Alignment Heading (deg)	Event
05 01 33 57	00	-1.0	0.0	279.4	240.0	279.0	Traverse I Navigation Initialization
05 03 23 03	00	8.0	1.0	281.9	280.0	No Alignment	Traverse I Navigation Check
05 23 11 05	-1.0	-1.0	0.5 to 1.0	283.9 to 284.4	305.0	283.0 <sup>a</sup>	Traverse II Navigation Initialization
06 02 15 28	0.0	5.0	-4.0	293.2	290.0	293.0	Traverse II Navigation Update
06 20 41 49	-2.0	-2.0	-0.5	291.6	Not Given	292.0	Traverse III Navigation Initialization

a. Alignment heading includes almost one degree misalignment.

TABLE 5. APOLLO 15, TRAVERSE I BEARING AND RANGE READOUTS

Ground Elapsed Time (day, hr, min, sec)	Navigation Bearing (deg)	Navigation Range (m)	Event
05 01 33 57	0	0	Navigation System Initialization
05 01 44 55	0	0	Departure from the LM
05 01 52 54	39	1100	
05 01 57 14	36	1700	
05 02 03 51	18	2300	
05 02 10 33	11	3200	Arrive at Station 1 (Elbow)
05 02 29 05	11	3200	Leave Station 1
05 02 34 55	17	3900	Arrive at Station 2
05 03 26 02	17	3900	Leave Station 2
05 03 33 04	11	3300	
05 03 42 50			Stop Near Rhysling Crater
05 03 47 08			Start
05 03 49 35	13	1600	
05 03 55 20	18	700	
05 03 58 15	34	200	
05 04 00 46	59	100	Arrive at the LM

TABLE 6. APOLLO 15, TRAVERSE II BEARING AND RANGE READOUTS

Ground Elapsed Time (day, hr, min, sec)	Navigation Bearing (deg)	Navigation Range (m)	Event
05 23 11 05	0	0	Navigation System Initialization
05 23 11 13	0	0	Departure from the LM
05 23 21 55	339	1300	
05 23 28 21	338	2200	
05 23 35 17	348	3000	
05 23 37 30	348	3300	
05 23 43 01	347	3900	
05 23 43 34	347	4000	
05 23 45 45	348	4300	
05 23 47 40	347	4400	
05 23 49 53	346	4700	Spur Crater at 3 O'clock
05 23 53 02	343	5000	Stop on the Front
06 00 58 29	343	5000	Start
06 01 01 11	347	5000	Stop on the Front
06 01 22 40	347	5000	Start
06 01 25 46	349	4700	Stop at Spur Crater
06 02 16 09	349	4700	Update and Leave Spur Crater
06 02 20 33	350	4300	On Tracks
06 02 28 59	347	3400	Arrive at Station 4 (Dune Crater)
06 02 45 44	347	3400	Leave Station 4
06 02 47 16	350	3300	On Tracks
06 02 56 09	347	2000	
06 02 59 07	340	1500	
06 03 04 27	352	700	
06 03 08 32	18	200	Arrive at the LM

TABLE 7. APOLLO 15, TRAVERSE III BEARING AND RANGE READOUTS

Ground Elapsed Time (day, hr, min, sec)	Navigation Bearing (deg)	Navigation Range (deg)	Event
06 20 41 49	0	0	Navigation Initialization at ALSEP <sup>a</sup> Site
06 20 48 28	0	0	Departure from the ALSEP Site
06 20 49 59	110	200	
06 20 52 42	113	600	
06 20 56 15	101	1000	
06 20 59 17	89	1400	
06 21 00 10	87	1500	
06 21 00 44	88	1600	Arrive at Scarp Crater
06 21 01 59	88	1600	Stop at Scarp Crater
06 21 16 50	88	1600	Leave Scarp Crater
06 21 19 26	88	1800	Arrive at Station 9
06 22 14 25	88	1800	Leave Station 9
06 22 16 45	93	2000	Arrive at Station 10
06 22 28 49	93	2000	Leave Station 10
06 22 45 45	32	0	Arrive at the LM

a. Apollo Lunar Surface Experiment Package

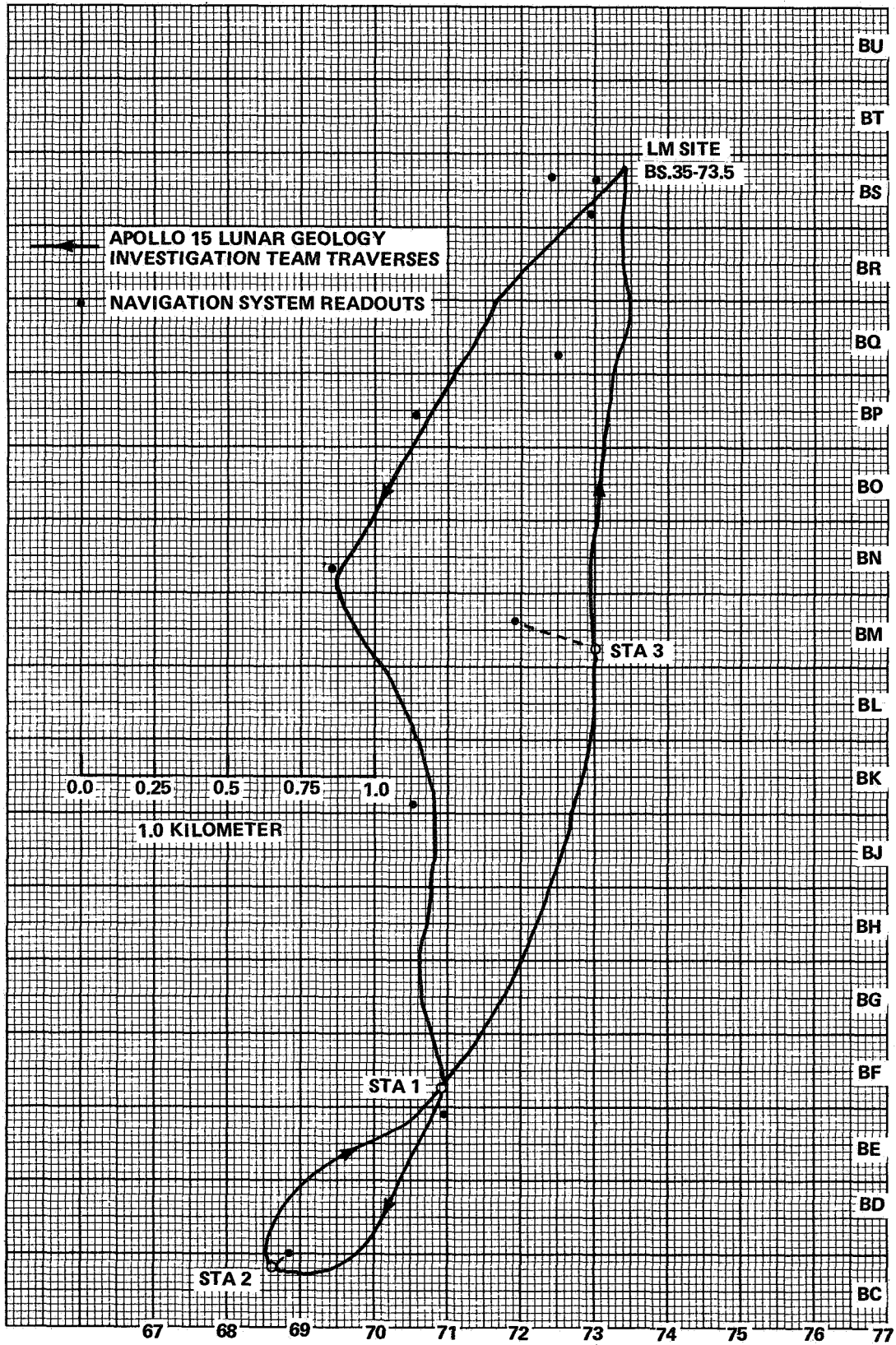

Figure 12. Apollo 15, Traverse I plot.

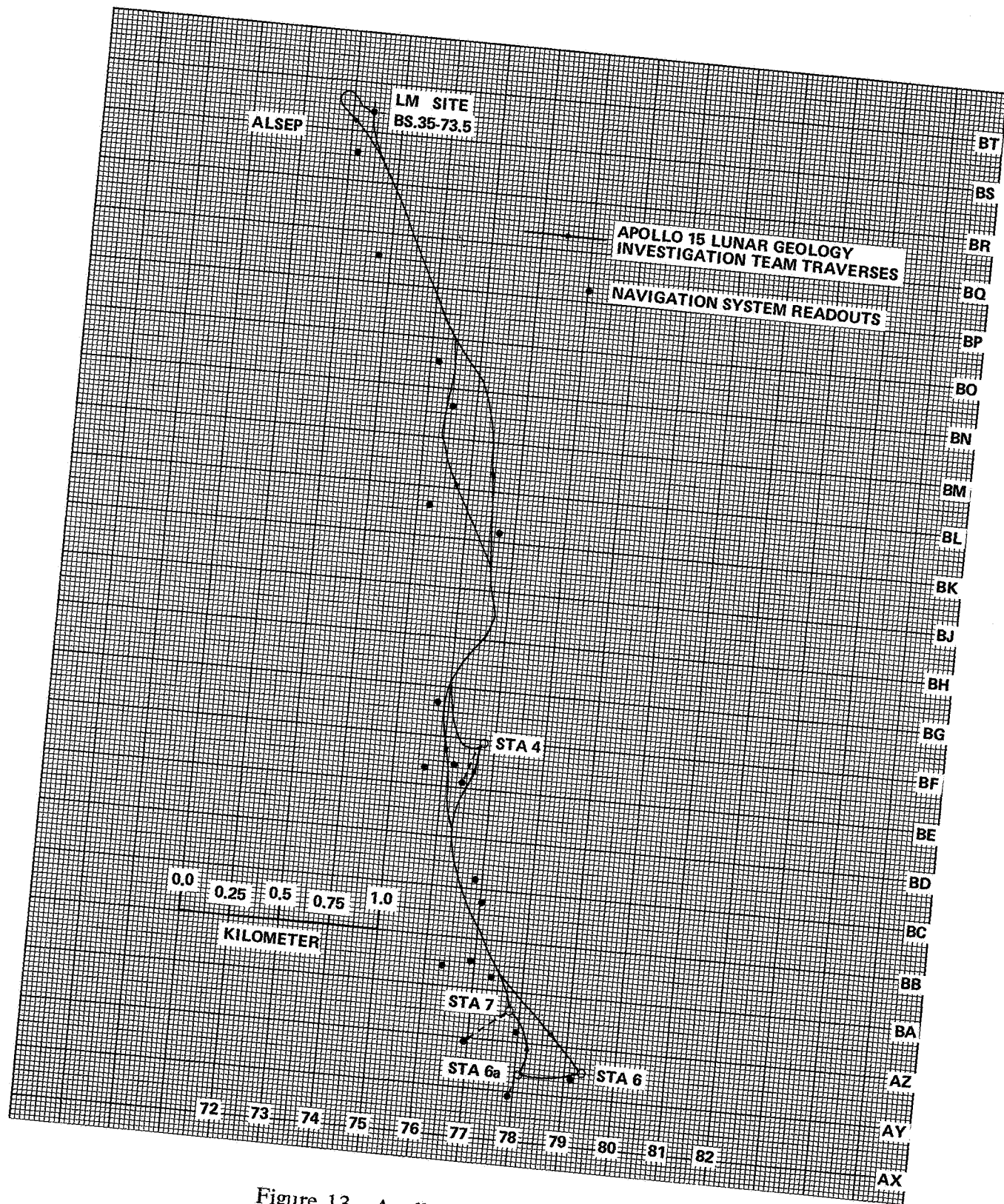

Figure 13. Apollo 15, Traverse II plot.

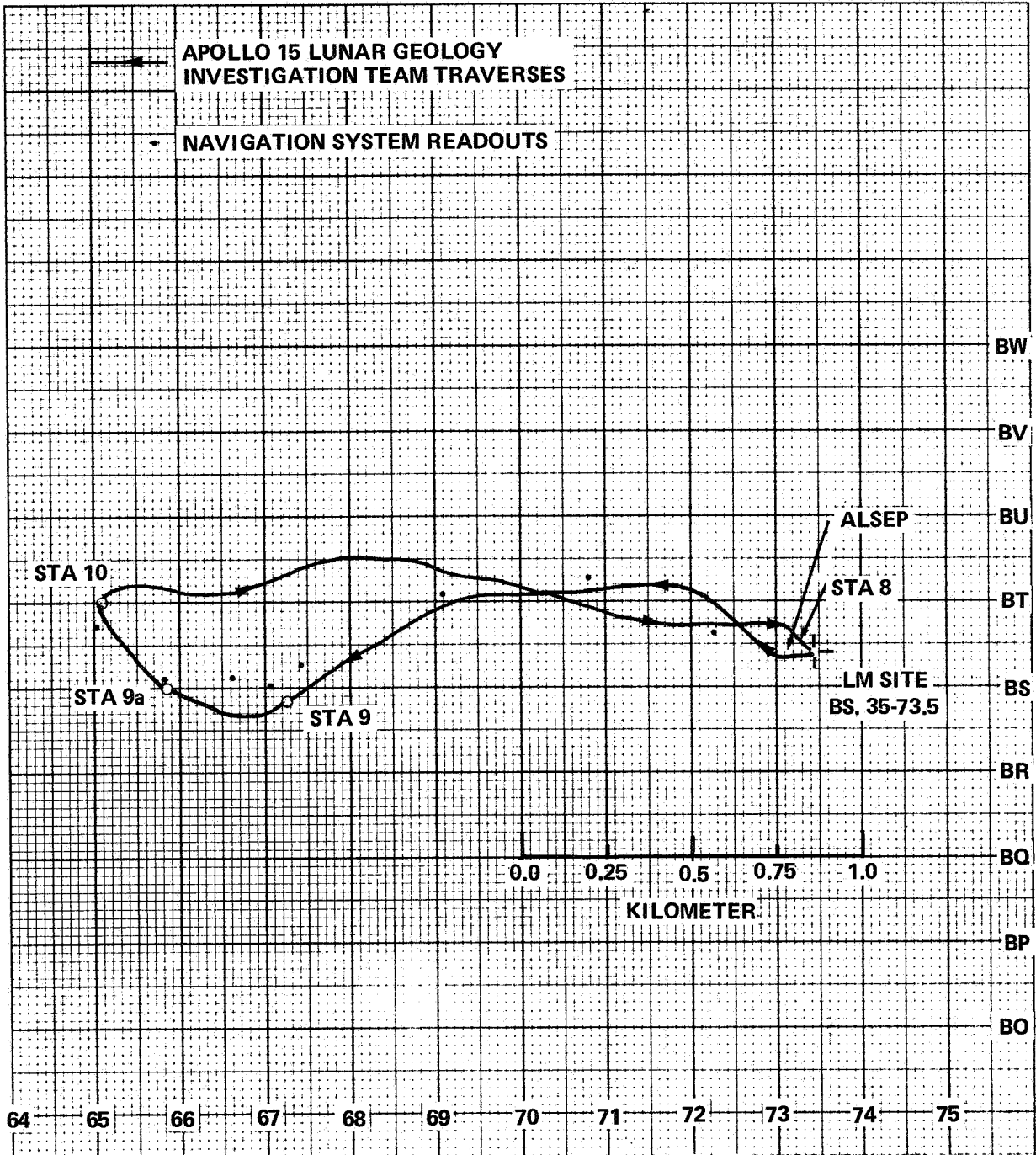

Figure 14. Apollo 15, Traverse III plot.

## APOLLO 16 LRV NAVIGATION SYSTEM EVALUATION

### Traverse I

During Traverse I, the navigation system stayed well within the 100m position error specification. A navigation system update was not required, and the navigation system closure was 0.0 m.

### Traverse II

During Traverse II, the navigation system operated normally up to Station 9 where the crew changed the power switches configuration. From Station 9 to the end of the traverse there was no change in range, bearing, and distance indications.

There was no telemetry on the LRV so evaluation of the reasons for this lack of navigation system updates had to be done using the crew voice recordings, postflight crew briefings, and a knowledge of the system. The rationale used in explaining this condition follows:

1. There was a switch configuration change at Station 9 to place all loads on Battery 1. From this point to the ALSEP site (Station 10) there was no change in range, bearing, and distance indications.
2. At the ALSEP site the navigation reset was activated and all indicators reset to zero, indicating that power was available at the counters and that they were not mechanically bound.
3. Heading and speed indicators operated normally during the drive from Station 9 to the ALSEP, indicating that power was on in the navigation subsystem, pulses were being received from the RR wheel, the 400 Hz inverter was operating, and the  $\pm 16$  Vdc power supply was operative.
4. The only failures within the navigation subsystem which would result in the conditions experienced, causing lack of update of both distance, bearing, and range, would be a malfunction in the third-fastest-wheel selection logic or the 5 volt power supply.
5. These symptoms would be caused by the lack of wheel pulses from two wheels.
6. At the beginning of EVA 111, the power switches were returned to the nominal configuration and the navigation system operated normally throughout the entire EVA.
7. This indicates that there was no failure in the navigation subsystem or that it had "fixed" itself, which appears highly unlikely.



8. The temperature was higher on EVA III than on EVA II, precluding the possibility that the problem was due to temperature.

9. A temporary power loss to the navigation subsystem results in indicator reset to zero or to "random" numbers, after which further operation adds to or subtracts from these numbers in a normal manner, indicating that power was not removed from the system.

10. Noise into the system might result in incorrect readings, but due to the circuitry and operation of the system would not cause the system to "lock up."

11. It must be concluded that the failure of the range, distance, and bearing indicators to update was due to lack of wheel pulses from two wheels (excluding the RR wheel, as the speed indicator was working, and its input is pulses from the RR wheel).

12. Wheel pulses would not be received from the two front wheels if drive power was removed from them. It should be noted that, upon arrival at the ALSEP site, the front wheel temperatures were off scale low and the rear wheel temperatures were 99°C (210°F).

13. The above statements were corroborated by extensive tests both on the qualification vehicle and on a subsystem breadboard in the laboratory.

14. It was concluded that during the drive power configuration change at Station 9 the front wheels were powered down, thus removing two wheel pulse inputs from the navigation system.

### **Traverse III**

At the beginning of Traverse III, the power switches were returned to the nominal configuration and the navigation system operated normally throughout the entire traverse. The navigation system stayed well within the 100 m position error specification. A navigation system update was not required, and the navigation system closure error was 0.0 m.

### **Evaluation**

The navigation system stayed well within the 100 m position error specification on all three traverses. The navigation system did not require an update during the lunar operation. Gyro drift, gyro misalignment, case torquing, and wheel slippage were all contributors to position error; however, it is impossible to determine each quantitatively because of insufficient data. It is evident, though, that all errors were small and that the LRV navigation system performed very well.

Data resulting from the evaluation are given in Tables 8 through 12 and Figures 15 through 17.

TAB E 8. APOLLO 16 LRV NAVIGATION SYSTEM PERFORMANCE

	Traverse I	Traverse II	Traverse III
Odometer Distance	4.2 km	11.3 km	11.1 km
Map Distance <sup>a</sup>	3.0 km	9.0 km	10.0 km
Total Ride Time <sup>b</sup>	-49 min		
Ride Time <sup>c</sup>	-43 min	- 83 min	- 73 min
Park Time	-219 min	-236 min	~ 146 min
Total Time of Traverse	-268 min	-319 min	-219 min
Average Velocity <sup>d</sup>	5.87 km/hr	8.19 km/hr	9.1 km/hr
Mobility Rate <sup>e</sup>	4.17 km/hr	6.52 km/hr	8.3 km/hr
Number of Navigation Checks	0	1	0
Number of Navigation Updates	0	0	0
Navigation Closure Error <sup>f</sup>	0 m		0 m
Maximum Position Error	100 m	100 m	100 m
Gyro Drift Rate	None	None	None
Gyro Misalignment	Small	Small	Small
Percent Wanderg	40%	26%	12%

- a. Map distance traveled, neglecting deviations around small craters.
- b. The time spent riding, including minor stops, Grand Prix Runs, from departure to arrival at the LM.
- c. Total ride time minus Grand Prix and minor stops.
- d. The odometer reading at the end of the traverse divided by the ride time.
- e. The map distance divided by the ride time.
- f. The position error in the navigation system at the end of the traverse.
- g.  $\% \text{wander} = \frac{\text{speed} - \text{mobility rate}}{\text{mobility rate}} \times 100\%$ .

TABLE 9. APOLLO 16 LRV NAVIGATION SYSTEM INITIALIZATIONS, CHECKS, AND UPDATES

Ground Elapsed Time (day, hr, min, sec)	Pitch (deg)	Roll (deg)	Sun Shadow (deg)	MSFC Heading (deg)	Navigation Heading (deg)	Alignment Heading (deg)	Event
05 00 43 46	0.0	0.5	-1.0	265.7		266.0	Traverse I Navigation Initialization
05 23 28 48	-4.0	1.0	-1.0	263.6	268	264.0	Traverse II Navigation Initialization
06 00 00 26	-3.0	3	-9.0	268.7	200	No Alignment	Traverse II Check
06 22 08 52	2.0	3.0	3.0	258.2	264	258	Traverse III Navigation Initialization

TABLE 10. APOLLO 16, TRAVERSE I BEARING AND RANGE READOUTS

Ground Elapsed Time (day, hr, min, sec)	Navigation Bearing (deg)	Navigation Range (deg)	Event
05 00 43 46	0	0.0	Navigation System Initialization
05 00 46 29	0	0.0	Departure from LM
05 00 55 18	33	0.1	Arrive at ALSEP
05 02 58 32	33	0.1	Leave ALSEP (No Drift)
05 03 00 44	65	0.2	
05 03 01 43	72	0.3	
05 03 04 00	89	0.4	
05 03 05 03	91	0.5	
05 03 07 28	89	0.7	Thought was Spook
05 03 10 33	89	1.0	
05 03 11 09	88	1.0	
05 03 12 24	87	1.1	Near Halfway
05 03 14 08			Arrive at Halfway
05 03 18 46			Leave Halfway
05 03 20 27	86	1.2	
05 03 23 15	87	1.4	

TABLE 10. (Concluded)

Ground Elapsed Time (day, hr, min, sec)	Navigation Bearing (deg)	Navigation Range (km)	Event
05 03 24 08	88	1.4	Arrive at Station 1 (Plum)
05 04 14 32	88	1.4	Leave Station 1
05 04 19 41	89	0.8	
05 04 21 10	87	0.8	Arrive at Station 2 (Buster and <b>Spook</b> )
05 04 48 07	87	0.8	Leave Station 2
05 04 54 14			Arrive at Grand Prix Site
05 04 56 59			Mark On } 1st Grand Prix
05 04 58 03			Mark Off }
05 04 58 09			Mark On } 2nd Grand Prix
05 04 59 24			Mark Off }
05 04 59 57			Leave Grand Prix Site
05 05 02 36	22	0.1	Arrive at Station 10
05 05 08 00			Leave Station 10
05 05 09 43			Arrive at LM

TABLE 11. APOLLO 16, TRAVERSE II BEARING AND RANGE READOUTS

Ground Elapsed Time (day, hr, min, sec)	Navigation Bearing (deg)	Navigation Range (km)	Event
05 23 28 48	0	0.0	Navigation System Initialization
05 23 31 40	0	0.0	Departure from LM
05 23 32 32	10	0.1	
05 23 33 32	356	0.3	
05 23 34 18	350	0.3	
05 23 37 25	348	0.8	
05 23 37 52	346	0.9	
05 23 39 02	348	1.0	
05 23 39 43	346	1.1	
05 23 40 49	344	1.2	
05 23 43 04	347	1.5	
05 23 44 39	348	1.6	
05 23 46 07	352	1.7	
05 23 47 52	355	2.0	
05 23 49 48	354	2.2	
05 23 52 09	354	2.5	
05 23 54 25	355	2.8	
05 23 55 36	355	3.0	
05 23 57 54	355	3.3	
05 23 58 59	354	3.4	
06 00 00 04	354	3.6	
06 00 01 19	355	3.7	

TABLE 11. (Concluded)

Ground Elapsed Time (day, hr, min, sec)	Navigation Bearing (deg)	Navigation Range (km)	Event
06 00 03 32	355	4.0	
06 00 04 09	354	4.0	
06 00 07 26	354	4.1	Arrive at Station 4 (Crown)
06 01 05 16	354	4.1	Leave Station 4
06 01 06 58	354	3.8	
06 01 10 11	353	3.5	Arrive at Station 5
06 01 58 40	353	3.5	Leave Station 5
06 02 04 21	355	3.0	
06 02 07 21	357	3.1	Arrive at Station 6
06 02 30 02	357	3.1	Leave Station 6
06 02 34 04	005	3.0	
06 02 35 02	006	3.0	
06 02 37 14	007	3.1	
06 02 39 12	010	3.0	
06 02 40 19	011	2.9	Arrive at Station 8
06 03 42 39	011	2.9	Right Rear Fender Extension Off
06 03 48 15	011	2.9	Leave Station 8
06 03 50 21	015	2.7	
06 03 53 48	007	2.6	Arrive at Station 9
06 04 31 20	007	2.6	Leave Station 9 (Lost LRV Navigation System)
06 04 54 51			Arrive at LM

TABLE 12. APOLLO 16, TRAVERSE III BEARING AND RANGE READOUTS

Ground Elapsed Time (day, hr, min, sec)	Navigation Bearing (deg)	Navigation Range (km)	Event
06 22 08 52	0	0.0	Navigation System Initialization
06 22 09 13		0.1	Departure from LM
06 22 10 06	162	0.1	
06 22 11 51	180	0.3	
06 22 14 15	195	0.6	
06 22 17 01	195	0.9	
06 22 18 57	189	1.2	Rim of Palmetto
06 22 20 27	195	1.4	
06 22 22 15	193	1.7	Navigation System Working Super
06 22 23 35	195	1.9	
06 22 26 14	195	2.2	
06 22 28 01	192	2.6	
06 22 29 04	192	2.7	
06 22 32 13	191	3.1	
06 22 33 <b>32</b>	190	3.4	
06 22 36 26	186	<b>3.7</b>	
06 22 39 19	181	4.0	
06 22 40 27	180	4.1	
06 22 42 56	179	4.4	
06 22 45 15	179	4.5	Arrive at Station 11/12 (North Ray)



TABLE 12. (Concluded)

Ground Elapsed Time (day, hr, min, sec)	Navigation Bearing (deg)	Navigation Range (km)	Event
07 00 09 46	179	4.5	Leave Station 11/12
07 00 11 17	170	4.4	
07 00 11 43			17 km/hr on the Moon
07 00 16 23	183	3.8	
07 00 17 39	184	3.8	Arrive at Station 13
07 00 46 33	184	3.8	Leave Station 13
07 00 47 31	186	3.7	
07 00 48 56	188	3.6	
07 00 51 45	191	3.1	
07 01 00 07	192	1.9	
07 01 04 04	194	1.4	
07 01 08 04	198	0.9	
07 01 09 54	198	0.7	
07 01 11 22	196	0.5	
07 01 15 38	188	0.1	Arrive at Station 10Prime
07 01 48 42	188	0.1	Leave Station 10Prime
07 01 49 11			Arrive at LM
07 02 24 57			Leave LM
07 02 27 09	243	0.2	Arrive at Station Rest in in Peace (RIP)

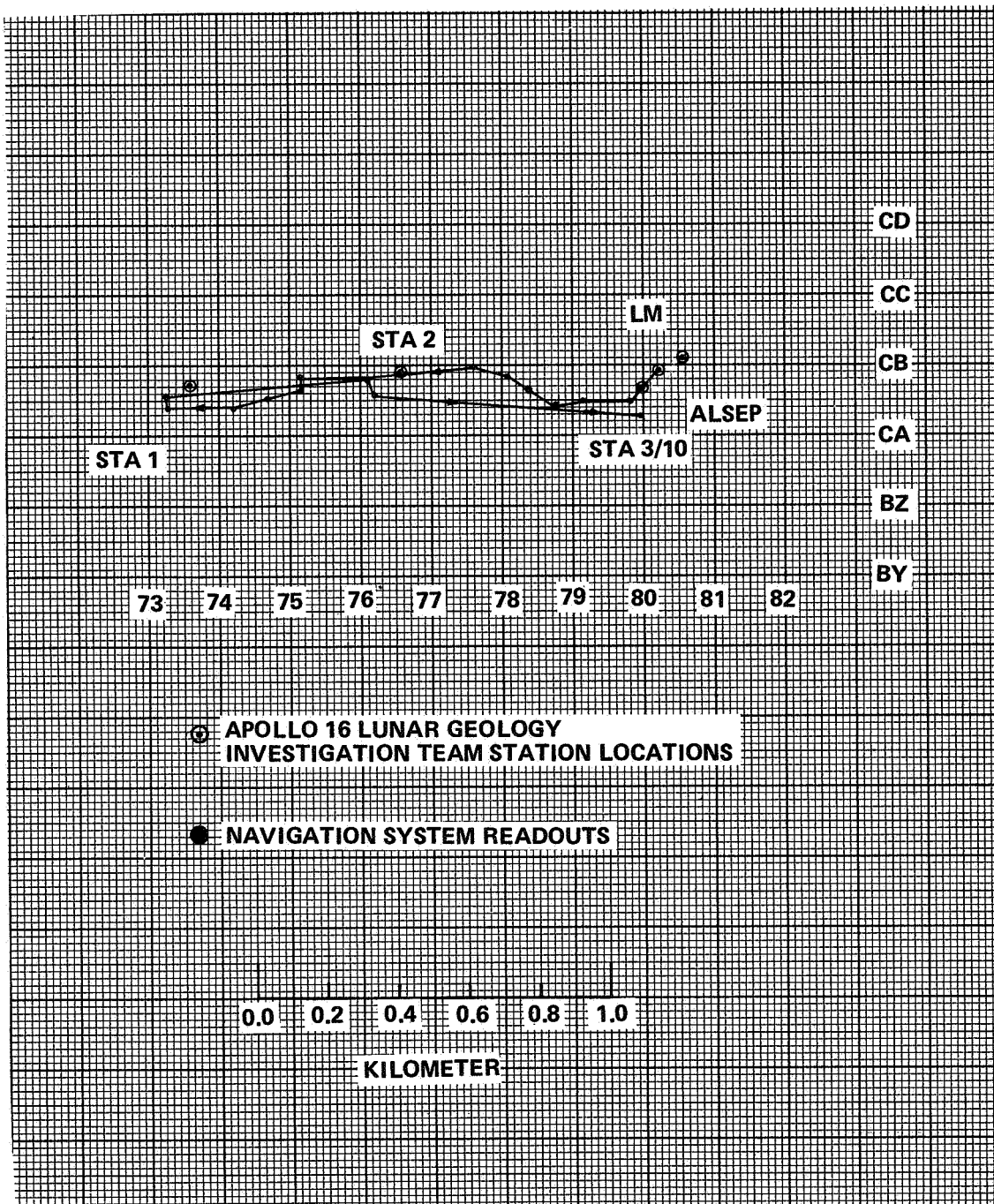

Figure 15. Apollo 16, Traverse I plot.

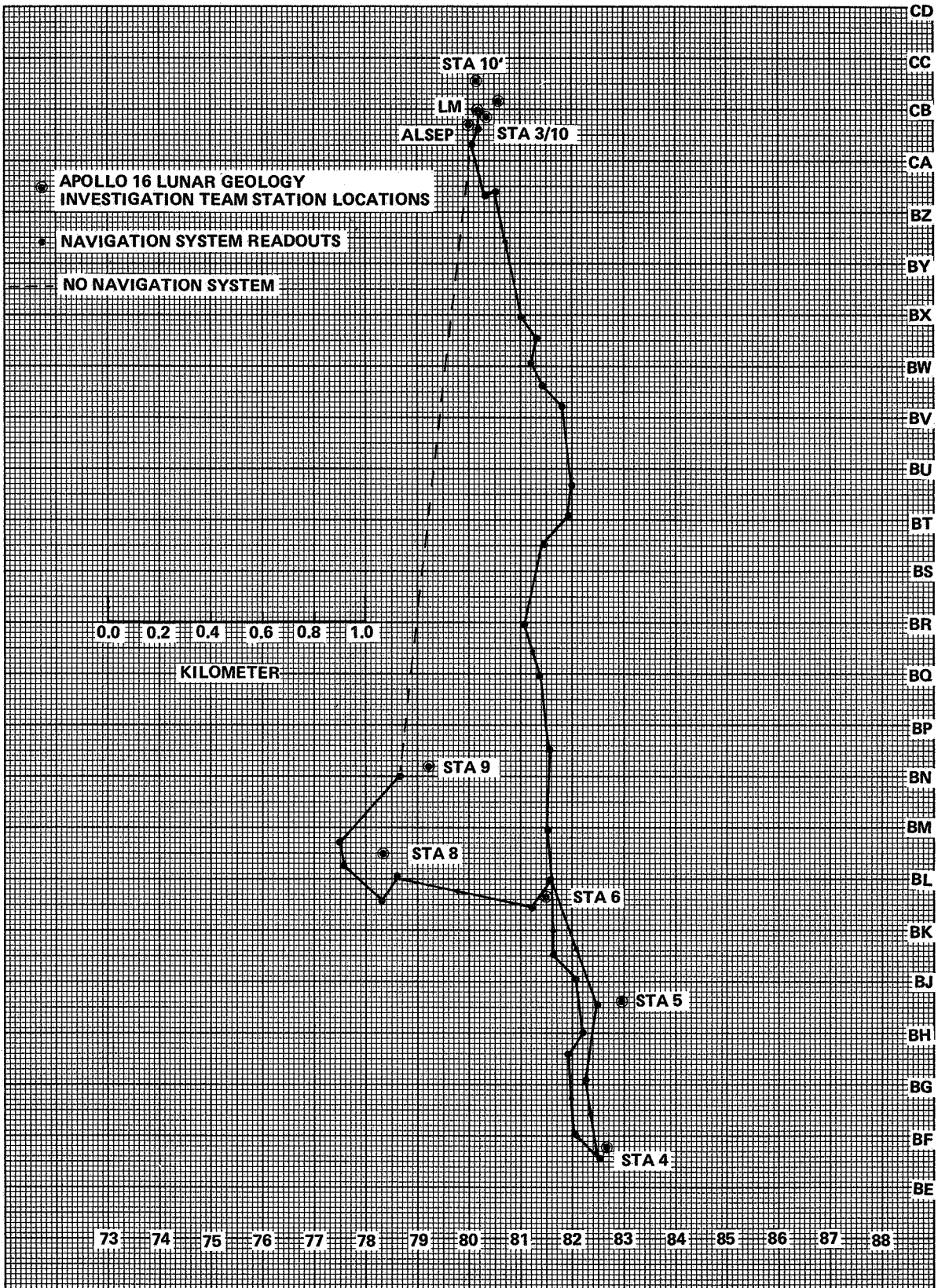

Figure 16. Apollo 16, Traverse II plot.

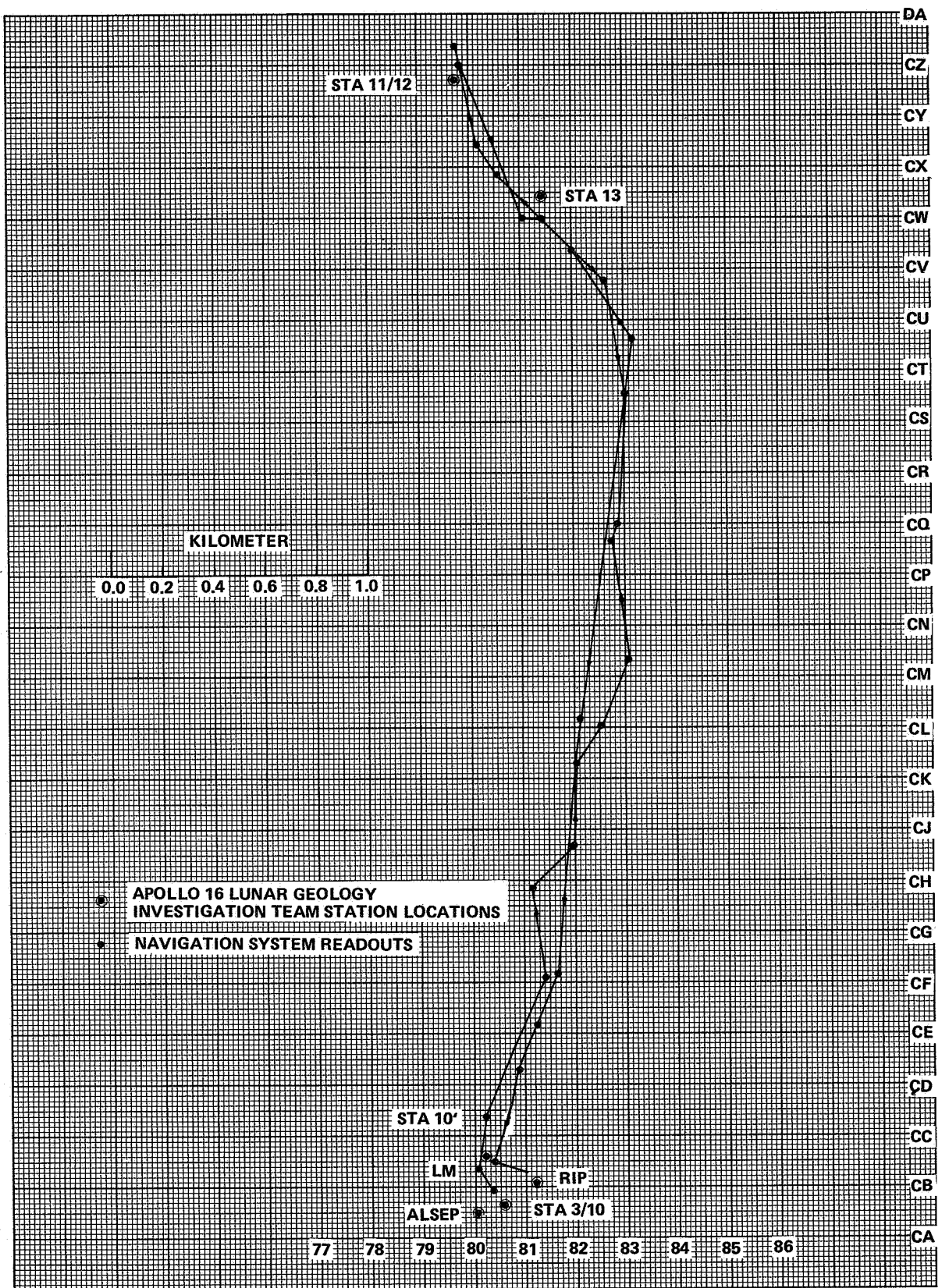

Figure 17. Apollo 16, Traverse III plot.

# APOLLO 17 LRV NAVIGATION SYSTEM EVALUATION

## Traverse I

During Traverse I, the navigation (NAV) system was initialized at the Surface Electrical Properties Experiment (SEP). A navigation system update was not required, and the navigation system closure error at the SEP was 0.0 m. The distance readout was 2.5 km at the end of Traverse I.

## Traverse II

During Traverse II, the navigation system was initialized at the SEP. A navigation system check was performed at Station 3. A navigation system update was not required, and the closure at the LM was 200 m. The navigation system was initialized at the SEP, which is approximately 150 m from the LM. Therefore, the closure error was approximately 50 m. The distance readout at the end of Traverse II was 20.1 km.

## Traverse III

During Traverse III, the navigation system was initialized at the SEP. A navigation system update was not required, and the closure at the LM was 100 m. The navigation system was initialized at the SEP, which is approximately 150 m from the LM. Therefore, the closure error was approximately 50 m. The distance readout at the end of Traverse III was 12.0 km.

## Evaluation

The navigation system position error was 100 m or less during all three traverses. The navigation system did not require an update during the lunar operation. Gyro drift, gyro misalignment, case torquing, and wheel slippage were all contributors to position error; however, it is impossible to determine each quantitatively because of insufficient data. It is evident, though, that all errors were small and that the LRV navigation system performed very well.

Data resulting from the evaluation are given in Tables 13 through 17 and Figures 18 through 20.

TABLE 13. APOLLO 17 LRV NAVIGATION SYSTEM PERFORMANCE

	Traverse I	Traverse II	Traverse III
Odometer Distance	2.5 km	20.2 km	12.1 km
Map Distance <sup>a</sup>	2.3 km	19.0 km	11.0 km
Ride Time <sup>b</sup>	- 33 min	- 145 min	- 91 min
Park Time	-33 min	- 176 min	- 195 min
Navigation System Operation Time <sup>c</sup>	-66 min	- 321 min	- 286 min
Average Velocity <sup>d</sup>	4.55 km/hr	8.35 km/hr	7.95 km/hr
Mobility Rate <sup>e</sup>	4.18 km/hr	7.85 km/hr	7.24 km/hr
Number of Navigation Checks	0	1	0
Number of Navigation Updates	0	0	0
Navigation Closure Error <sup>f</sup>	0 m		
Maximum Position Error	100m	100 m	100 m
Gyro Drift Rate	Small	Small	Small
Gyro Misalignment	Small	Small	Small
Percent Wanderg	9%	6%	10%

- a. Map distance traveled, neglecting deviations around small craters.
- b. The time spent riding, including minor stops, from departure to arrival at the SEP.
- c. The ride time plus the park time.
- d. The odometer reading at the end of the traverse divided by the ride time.
- e. The map distance divided by the ride time.
- f. The position error in the navigation system at the end of the traverse.
- g.  $\% \text{wander} = \frac{\text{speed} - \text{mobility rate}}{\text{mobility rate}} \times 100\%$ .

TABLE 14. APOLLO 17 LRV NAVIGATION SYSTEM INITIALIZATIONS, CHECKS, AND UPDATES

Ground Elapsed Time (day, hr, min, sec)	Pitch (deg)	Roll (deg)	Sun Shadow (deg)	MSFC Heading (deg)	Navigation Heading (deg)	Alignment Heading (deg)	Event
04 23 07 54	00	40	00	278.727	270	2790	Traverse I Navigation Initialization
05 18 48 56	00	10	00	281.98	281	No Alignment <sup>a</sup>	Traverse II Navigation Initialization
05 21 46 27	00	-10	00	281.618	282	No Alignment	Traverse II Check
06 17 39 07	00	0.0	0.0	287.16	291	287	Traverse III Navigation Initialization

a. Navigation system heading has almost one degree misalignment.

**TABLE 15. APOLLO 17, TRAVERSE I BEARING AND RANGE READOUTS**

Ground Elapsed Time (day, hr, min, sec)	Navigation Bearing (deg)	Navigation Range (km)	Event
04 23 03 31			Navigation System Alignment
04 23 05 45	292	0.2	In front of MESA (LM)
04 23 06 00	292	0.2	Departure from MESA (LM)
04 23 07 12	278	0.3	Arrive at SEP
04 23 07 54	0	0.0	Navigation System Initialization
04 23 11 02	0	0.0	Leave SEP
04 23 13 05	330	0.3	
	346	0.5	
	342	0.9	
	346	1.0	
04 23 24 02	346	1.1	Arrive at Station 1
04 23 56 47	346	1.1	Leave Station 1
	341	0.8	
	341	0.7	
	339	0.6	
	336	0.4	
05 00 10 30	252	0.0	Arrive at SEP



TABLE 16. APOLLO 17, TRAVERSE II BEARING AND RANGE READOUTS

Ground Elapsed Time (day, hr, min, sec)	Navigation Bearing (deg)	Navigation Range (km)	Event
05 18 45 00			Departure from LM
05 18 47 00	265	0.1	Arrive at SEP
05 18 48 56			Navigation System Initialization and Alignment
05 18 51 04	0	0.0	
	83	0.5	
05 19 02 50	83	1.0	
05 19 05 30	81	1.4	South of the Center of Camelot
05 19 09 41	78	2.0	Southern Rim of Horatio
05 19 11 13	80	2.6	
05 19 14 34	82	2.6	
05 19 19 03	80	2.9	North Side of Bronte
05 19 24 48	83	3.8	
	82	4.3	
05 19 37 58		4.9	
05 19 43 08	81	5.6	
05 19 44 47	81	5.7	
05 19 49 53	78	6.2	
05 19 52 18	78	6.5	
05 19 53 29	77	6.6	
05 20 01 08	71	7.4	

TABLE 16. (Continued)

Ground Elapsed Time (day, hr, min, sec)	Navigation Bearing (deg)	Navigation Range (km)	Event
05 20 03 00	71	7.6	Arrive at Station 2
05 21 07 47	71	7.6	Leave Station 2
05 21 12 32	71	7.0	
	73	6.6	
05 21 29 45	73	6.3	
	79	5.7	
	81	5.7	
	83	5.7	
	87	5.9	
05 21 46 27	87	6.0	Arrive at Station 3 (Lara)
05 21 46 27	87	6.0	Navigation System Alignment Check
05 22 25 54	87	6.0	Leave Station 3 (Lara)
	87	5.9	
05 22 31 58	90	5.3	
05 22 33 54	93	5.2	
05 22 34 08	94	5.1	
05 22 34 58	94	5.1	
05 22 35 29	94	5.0	
05 22 39 02	98	4.8	
05 22 40 07	99	4.7	

TABLE 16. (Concluded)

Ground Elapsed Time (day, hr, min, sec)	Navigation Bearing (deg)	Navigation Range (km)	Event
05 22 41 42	101	4.5	
05 22 42 57	102	4.4	Arrive at Station 4 (Shorty)
05 23 16 15	102	4.4	Leave Station 4 (Shorty)
	102	3.8	
05 23 23 03	103	3.4	
05 23 25 54	106	3.2	Arrive at Victory
05 23 29 57	106	3.2	Leave Victory
05 23 31 28	106	3.1	
05 23 35 55	103	2.5	
05 23 40 40	99	2.0	
05 23 42 43	94	1.7	
05 23 45 15	86	1.4	Arrive at Station 5 (Camelot)
06 00 15 20	86	1.4	Leave Station 5 (Camelot)
06 00 18 08	83	1.1	
	83	0.7	
	82	0.5	
06 00 23 12	81	0.4	Arrive at Location for Change 8
06 00 27 42	81	0.4	Leave Location for Change 8
06 00 32 24	89	0.2	Arrive at IM

TABLE 17. APOLLO 17, TRAVERSE III BEARING AND RANGE READOUTS

Ground Elapsed Time (day, hr, min, sec)	Navigation Bearing (deg)	Navigation Range (km)	Event
06 17 33 00			Departure from LM
06 17 35 07		0.1	Navigation System Alignment
06 17 41 22	0	0.0	Navigation System Initialization
06 17 46 12	207	0.4	
06 17 49 52	188	0.9	
06 17 51 24	187	1.1	
	185	1.5	
	184	2.3	
06 18 11 20	192	3.1	Arrive at Station 6
06 19 22 10	192	3.1	Leave Station 6
	193	3.1	
06 19 29 05	200	3.3	Arrive at Station 7
06 19 51 09	200	3.3	Leave Station 7
	210	3.4	
06 19 56 57	214	3.4	
06 20 02 35	226	3.6	
06 20 05 59	227	<b>3.9</b>	
06 20 07 40	226	4.0	Arrive at Station 8
06 20 55 33	226	4.0	Leave Station 8
	228	3.4	

TABLE 17. (Concluded)

Ground Elapsed Time (day, hr, min, sec)	Navigation Bearing (deg)	Navigation Range (km)	Event
	227	3.3	
	228	3.0	
06 21 05 39	230	2.9	East Rim of Cochise
06 21 09 37	230	2.5	
06 21 13 10	230	2.2	Arrive at Station 9
06 22 09 05	230	2.2	Leave Station 9
06 22 11 41	236	2.1	
06 22 15 00	244	1.7	
06 22 17 08	250	1.4	
06 22 20 04	253	1.1	
06 22 23 02	252	0.9	At Mariner
06 22 23 36	250	0.9	
06 22 26 13	252	0.6	
06 22 27 30	244	0.4	At San Luis Ray
06 22 28 51	252	0.2	
06 22 30 11	221	<b>0.2</b>	
06 22 37 47	151	0.1	Arrive at LM

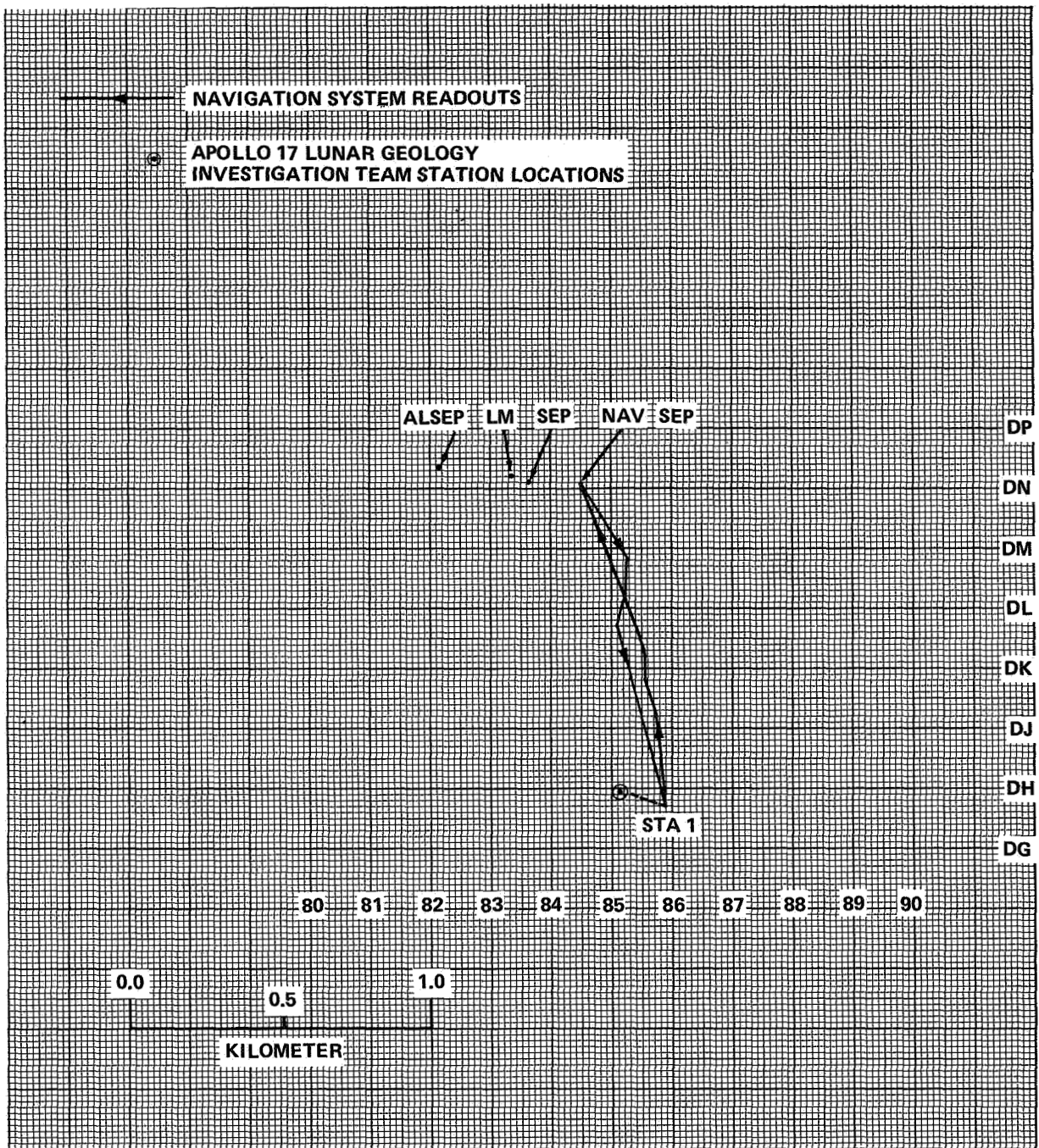

Figure 18. Apollo 17, Traverse I plot.

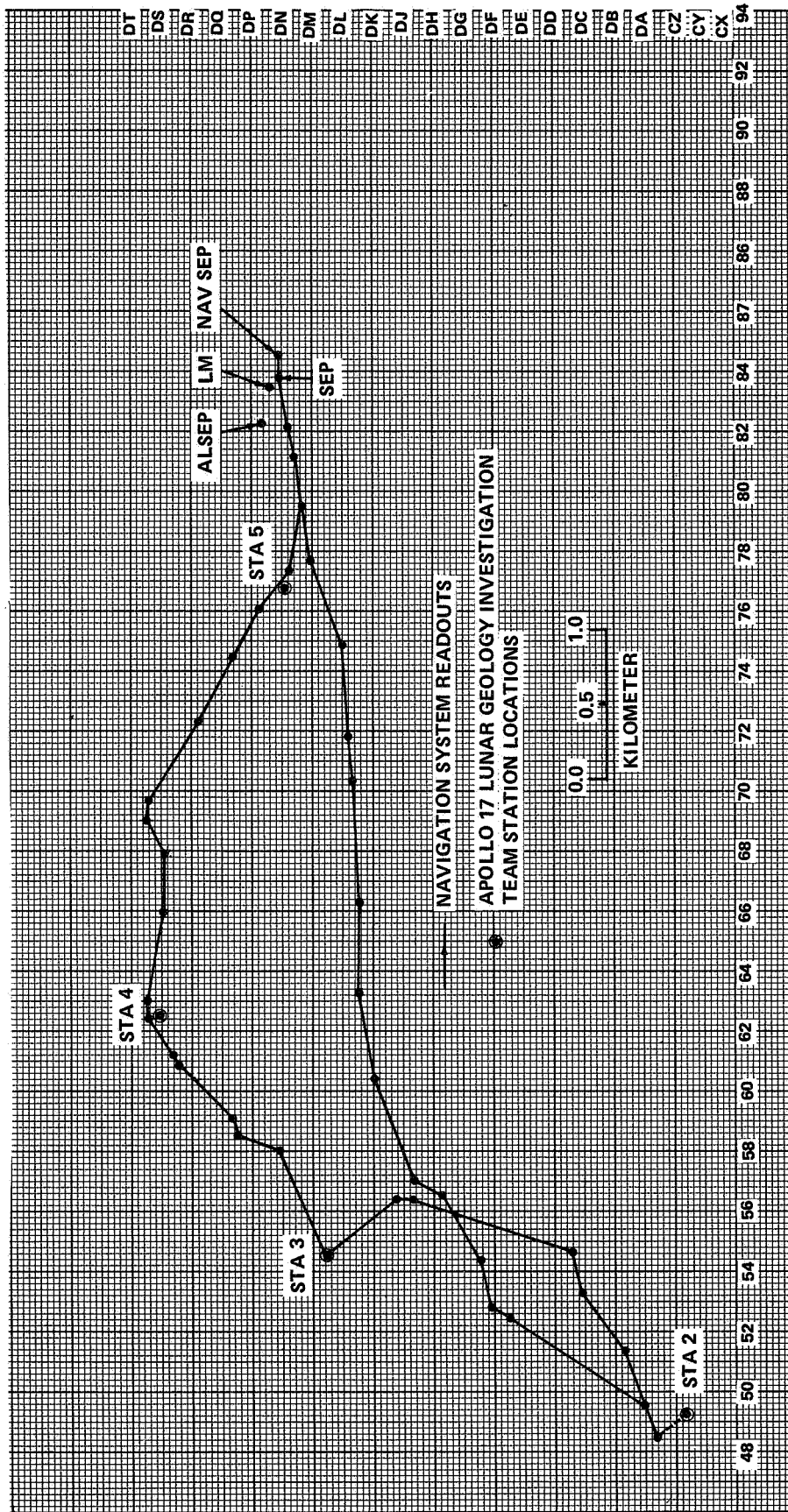

Figure 19. Apollo 17, Traverse II plot

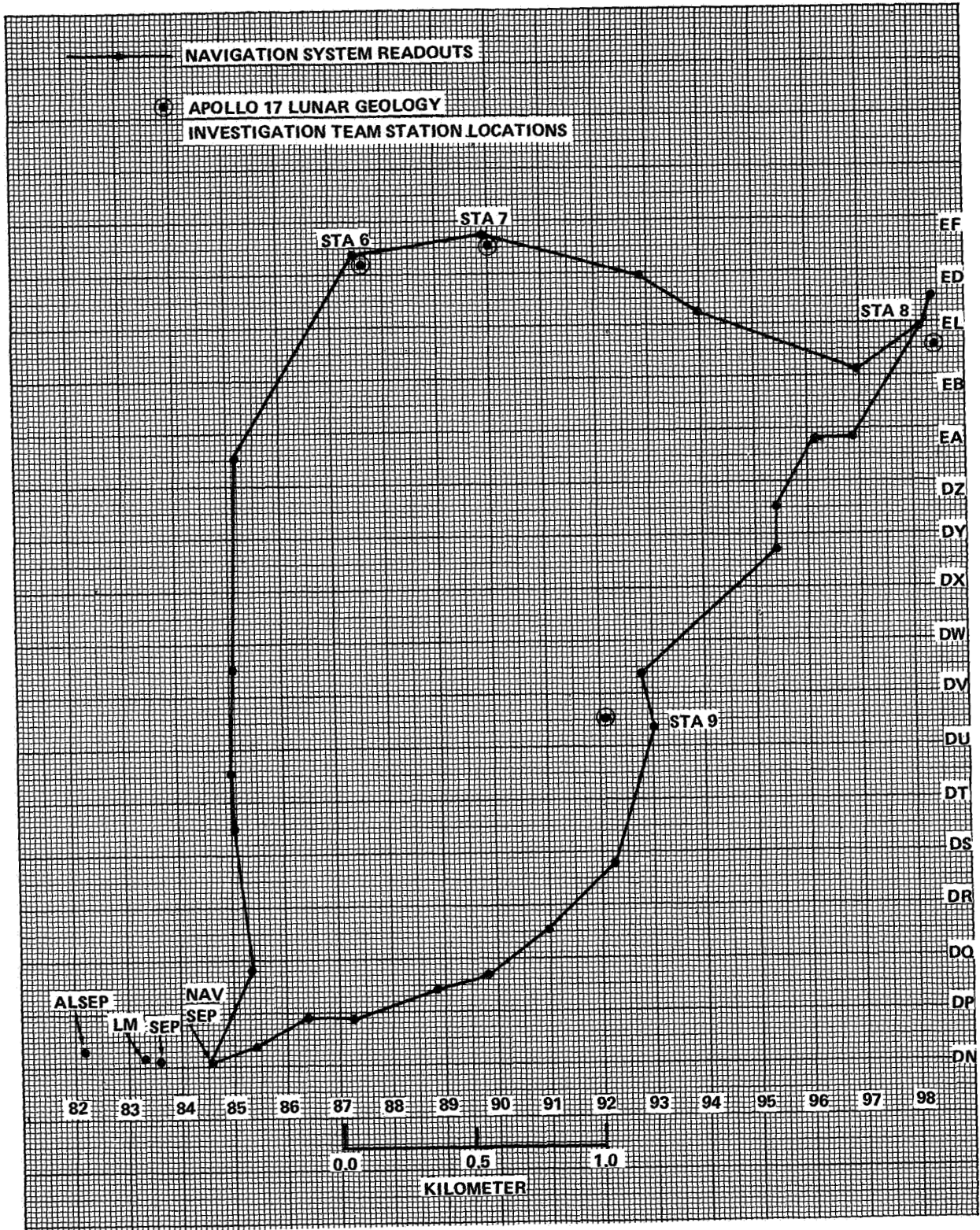

Figure 20. Apollo 17, Traverse III plot.



## CONCLUSION

The comparatively simple and economical directional gyro-odometer-processor navigation system successfully met the requirements of enabling the astronauts to find desired science sites, return to the lunar module, and return to previously visited sites. It withstood the vibrational environment of launch and the extreme thermal conditions of the lunar surface. A minimum of crew time and effort was required for its operation. The accuracy of the system proved to be much better than specified. Table 18 summarizes the performance during the three Apollo missions.

George C. Marshall Space Flight Center  
National Aeronautics and Space Administration  
Marshall Space Flight Center, Alabama, July 1973

TABLE 18. APOLLO 15, 16, AND 17 LRV NAVIGATION SYSTEM PERFORMANCE SUMMARY

	Apollo 15	Apollo 16	Apollo 17
Odometer Distance	27.9 km	26.6 km	34.8 km
Map Distance <sup>a</sup>	25.2 km	22.8 km	32.3 km
Ride Time <sup>b</sup>	~ 180 min	~ 199 min	~ 269 min
Park Time	- 310 min	- 601 min	- 304 min
Navigation System Operation Time <sup>c</sup>	- 490 min	- 800 min	- 573 min
Average Velocity <sup>d</sup>	9.30 km/hr	8.02 km/hr	7.76 km/hr
Mobility Rate <sup>e</sup>	8.40 km/hr	6.63 km/hr	7.20 km/hr
Number of Navigation Checks	2	1	1
Number of Navigation Updates	1 <sup>h</sup>	0	0
Navigation Closure Error <sup>f</sup>	<200 m	0	0
Maximum Position Error	<300 m	<100 m	<100 m
Gyro Drift Rate	<1 deg	<1 deg	<1 deg
Gyro Misalignment	<1 deg	<1 deg	<1 deg
Percent Wanderg	10.71%	20.96%	7.77%

- a. Map distance traveled, neglecting deviations around small craters.
- b. The time spent riding, including minor stops, from departure to arrival at the end point.
- c. The ride time plus the park time.
- d. The odometer reading at the end of the traverse divided by the ride time.
- e. The map distance divided by the ride time.
- f. The position error in the navigation system at the end of the traverse.
- g.  $\% \text{ wander} = \frac{\text{speed} - \text{mobility rate}}{\text{mobility rate}} \times 100\%$ .
- h. Alignment heading includes almost one degree misalignment.

## REFERENCES

1. Walls, B.F.; Mastin, W.C.; and Broussard, P.H., Jr.: Experimental Development Program for Lunar Surface Navigation Equipment. NASA TM X-64509, Apr. 30, 1970.
2. Walls, B.F.; Mastin, W.C.; and Broussard, P.H., Jr.: Laboratory and Field Tests of a Lunar Surface Navigation System. NASA TM X-64551, Aug. 28, 1970.
3. The Boeing Company: Engineering Critical Component Detail Specification for Navigation Subsystem. Report No. EC-20910003, Prepared Under NASA Contract No. NAS8-25145, Huntsville, Ala., Apr. 6, 1971.
4. Spearow, R.G.; Wahl, D.J.; and Tonkin, M.R.: Design and Test Data for Signal Processing Unit – Lunar Roving Vehicle Navigation Subsystem. Report No. D209-50025, Prepared Under Contract No. NAS8-25145, The Boeing Company, Huntsville, Ala.
5. Volder, J.E. : The Cordic Trigonometric Computing Technique. IRE Transactions on Electronic Computer, Sept. 1959, pp. 330-334.
6. Duchasneau, B.E.: Field Tests of the Navigation System Equipment Used on the Lunar Roving Vehicle. Report No. T209-10065-1, Prepared Under Contract No. NAS8-25145, The Boeing Company, Huntsville, Ala., Jan. 4, 1971.

1. REPORT NO. NASA TN D-7469		2. GOVERNMENT ACCESSION NO.		3. RECIPIENT'S CATALOG NO.	
4. TITLE AND SUBTITLE  Lunar Roving Vehicle Navigation System Performance Review				5. REPORT DATE November 1973	
				6. PERFORMING ORGANIZATION CODE	
7. AUTHOR(S) Earnest C. Smith and William C. Mastin				8. PERFORMING ORGANIZATION REPORT # M219	
9. PERFORMING ORGANIZATION NAME AND ADDRESS  George C. Marshall Space Flight Center Marshall Space Flight Center, Alabama 35812				10. WORK UNIT NO.	
				11. CONTRACT OR GRANT NO.	
12. SPONSORING AGENCY NAME AND ADDRESS  National Aeronautics and Space Administration Washington, D.C. 20546				13. TYPE OF REPORT & PERIOD COVERED  Technical Note	
				14. SPONSORING AGENCY CODE	
15. SUPPLEMENTARY NOTES  Prepared by Astrionics Laboratory, Science and Engineering					
16. ABSTRACT  The design and operation of the Lunar Roving Vehicle (LRV) navigation system are briefly described. The basis for the premission LRV navigation error analysis is explained and an example included. The real-time mission support operations philosophy is presented. The LRV navigation system operation and accuracy during the lunar missions are evaluated.					
17. KEY WORDS Navigation Lunar Dead Reckoning Sortie Performance			18. DISTRIBUTION STATEMENT		
19. SECURITY CLASSIF. (of this report) Unclassified		20. SECURITY CLASSIF. (of this page) Unclassified		21. NO. OF PAGES 61	22. PRICE Domestic, \$3.50 Foreign, \$6.00