

Q-FANSTM FOR GENERAL AVIATION AIRCRAFT

BY

ROSE WROBEL, HAMILTON STANDARD
MILLARD G. MAYO, HAMILTON STANDARD

DECEMBER 1973

Prepared under Contract No. NAS2-6834

HAMILTON STANDARD
Division of United Aircraft Corporation
Windsor Locks, Connecticut

for

SYSTEM STUDY DIVISION
OFFICE OF ADVANCED RESEARCH AND TECHNOLOGY

AMES RESEARCH CENTER
NATIONAL AERONAUTICS AND SPACE ADMINISTRATION

(NASA CR-114665) Q-FANSTM FOR GENERAL
AVIATION AIRCRAFT (Hamilton Standard)
267 p HC \$15.5

CSCL 10

N74-11726

Unclas.

33/ 2 2651

ABSTRACT

Continued growth of general aviation over the next 10 to 15 years is dependent on continuing improvement in aircraft safety, utility, performance and cost. Moreover, these advanced aircraft will need to conform to expected government regulations controlling propulsion system emissions and noise levels. An attractive compact low noise propulsor concept, the Q-FAN™ when matched to piston, rotary combustion, or gas turbine engines opens up the exciting prospect of new, cleaner airframe designs for the next generation of general aviation aircraft which will provide these improvements and meet the expected noise and pollution restriction of the 1980 time period. New Q-FAN methodology which was derived to predict Q-FAN noise, weight and cost is presented in this report. Moreover, based on this methodology Q-FAN propulsion system performance, weight, noise, and cost trends are discussed. Then the impact of this propulsion system type on the complete aircraft is investigated for several representative aircraft size categories. Finally, example conceptual designs for Q-FAN engine integration and aircraft installations are presented.

PRECEDING PAGE BLANK NOT FILMED

CONTENTS

	Page
SUMMARY	1
INTRODUCTION	2
SYMBOLS	4
AIRCRAFT CLASSIFICATIONS	7
Q-FAN GENERALIZATIONS	7
Q-FAN Characteristics	8
Performance	10
Noise	13
Weight	17
Cost	20
GEARBOX GENERALIZATION	21
Noise	21
Weight	22
Cost	22
ENGINE GENERALIZATIONS	22
Weight	23
Dimensions	23
Performance	23
Cost	23
Noise	23
COMPUTER PROGRAMS	26
Q-FAN Program	27
Aircraft Synthesis Program	28
PARAMETRIC STUDIES	30
Q-FAN Propulsion System	30
Preliminary Aircraft Design	34
Conceptual Aircraft Derived from the Synthesis Programs	39
CONCEPTUAL PROPULSION SYSTEM INTEGRATION	40
Q-FAN and Engine Integration	40
Aircraft and Propulsion System Integration	45
Propulsion Integration Summary	46
IDENTIFICATION OF FUTURE RESEARCH ITEMS	47
CONCLUDING REMARKS	49
REFERENCES	51

TABLES

No.		Page
I	Advanced General Aviation Q-FAN TM Study - Aircraft Classification	53
II	Rotor Variables	54
III	Duct and Vane Variables	55
IV	Variable Pitch Q-FAN TM Rotor Weight Equation Constants	56
V	Fixed Pitch Q-FAN TM Rotor Weight Equation Constants	57
VI	General Aviation Q-FAN TM O. E. M. Cost Equations for 1970 and 1980 - Fan Rotor Assembly - Variable Pitch	58
VII	Cost Equation Z Factors	59
VIII	General Aviation Q-FAN TM O. E. M. Cost Equations for 1970 and 1980 - Fan Rotor Assembly - Fixed Pitch	60
IX	General Aviation Q-FAN TM O. E. M. Cost Equations for 1970-1980 - Duct and Mount Assemblies	61
X	General Aviation Q-FAN TM O. E. M. Cost Equations for 1970-1980 - Gearbox Assembly	62
XI	Piston Engine Specific Weights	63
XII	Rotary Combustion Engine Specific Weights	64
XIII	Comparison of Current Propeller Propulsion System to Q-FAN	65
XIV	Aircraft Design Requirements and Parameters	66
XV	Light Twin Engine Aircraft Q-FAN Design Parameters	67
XVI	Single Engine Aircraft - Q-FAN Design Parameters	68

FIGURES

No.		Page
1	Q-FAN Wind Tunnel Model, Diameter = 18 in. (0.46 m)	69
2	Q-FAN Full Scale Demonstrator, Diameter = 4.6 ft. (1.40 m) ..	70
3	Q-FAN Components	71
4	Method Verification	72
5	Base Q-FAN Performance Curve - 1.0 Area Ratio	73
6	Total Activity Factor Adjustment to Power Coefficient	75
7	Total Activity Factor Adjustment to Thrust Coefficient	76
8	Tip Speed/Mach Number Adjustment to Power Coefficient	77
9	Tip Speed/Mach Number Adjustment to Thrust Coefficient	78
10	Duct Length Adjustment to Thrust Coefficient	79
11	Effect of Acoustical Treatment on Performance - 4.5 PNdB Noise Reduction	80
12	Base Q-FAN Blade Angle Curve - 1.0 Area Ratio	81
13	Q-FAN Noise Sources	83
14	One-Third Octave Band Comparison of Experiment and Theory	84
15	Correlation of Experimental Data with Theory	85
16	Noise Level of a Single 5 Ft. (1.52 m) Diameter Q-FAN at 66 Knots (34 m/s) Forward Speed - 2000 Total Activity Factor	86
17	Noise Prediction Method - Diameter Correction	87
18	Cross Sections of Typical General Aviation Q-FAN Including Duct Treatment	88
19	Q-FAN TM Assembly	89
20	Fan Rotor Assembly	90
21	Duct Assembly	91
22	Mount Assembly	92
23	Learning Curve for General Aviation Propellers	93
24	Gearbox Assembly	94
25	Gearbox Noise	95
26	Engine Noise Source	96
27	Noise of Unmuffled Water Cooled Rotary Combustion Engines ...	97
28	Noise of Unmuffled Piston Engines	98
29	Noise of Unmuffled Turbohaft Engines	99
30	Schematic View of Piston or Rotary Combustion Exhaust Mufflers	100
31	Performance of Piston and Rotary Combustion Engine Exhaust Mufflers	101
32	Muffler Weights for Piston Engines	102

FIGURES (Cont)

No.		Page
33	Muffler Weights for Rotary Combustion Engines	103
34	Turboshaft Engine Exhaust Noise Treatment	104
35	Turboshaft Engine Muffler Dimensions	105
36	Sample Case I of Computer Print Out	106
37	3.5 Ft. (1.07 m) Diameter Q-FAN/Rotary Combustion Engine System Characteristics	107
38	Rotor and Drag Characteristics for Minimum Q-FAN Noise	108
39	Characteristics of Q-FAN/Rotary Combustion Engine Propulsion Systems in the 1980's for a 4 - 6 Seat Light Twin Aircraft	109
40	Characteristics of Q-FAN/Piston Engine Propulsion Systems in the 1980's for a 4 - 6 Seat Light Twin Aircraft ...	110
41	Performance of Q-FAN/Rotary Combustion Engine Propulsion System in the 1980's on a Heavy Twin Engine Aircraft	111
42	Influence of Noise Limits on Propulsion System Characteristics for a Light Single Engine Aircraft	112
43	Effect of Cruise Speed on Choice of Wing Loading. Left, Single-Engine Four-Place Aircraft. Right, Twin- Engine Six-Place Aircraft	113
44	Mission Performance for Twin-Engine Six-Place Aircraft; Payload = 600 lb. (272 kg); Range = 1000 N. Miles (1852 KM); Altitude = 20,000 Ft. (6096 M)	114
45	Mission Performance for Single-Engine Four-Place Aircraft; Payload = 400 lb (161 kg); Range = 850 N. Miles (1574 KM); Altitude = 10,000 Ft. (3048 M)	115
46	Effect of Fan Design on Mission Performance, Fan Size, and Noise for Reduced Fan RPM	116
47	Effect of Fan Design on Mission Performance, Fan Size, and Noise for Constant Fan RPM	117
48	Effect of Level of Technology on Aircraft Size. Left, Rotary Combustion Engines. Right, Horizontally Opposed Piston Engines	118
49	Comparison of Cessna Model 340 Lay-out with Modified Aircraft Having Rotary Combustion Engines and Q-FAN as Pusher: Cruise Speed = 210 Knots True Airspeed, Altitude = 20,000 Ft	119
50	Conceptual High-Wing, Four-Place, Single-Engine Aircraft - Rotary Combustion Engine with Q-FAN as Pusher: Cruise Speed = 180 Knots, Altitude = 10,000 Ft	120

FIGURES (Cont)

No.		Page
51	Left Side View of Pylon - Mounted Rotary Combustion Engine Q-FAN Propulsion Pod	121
52	Top View of Pylon-Mounted Rotary Combustion Engine- Q-FAN Propulsion Pod	122
53	Forward-End View of Pylon-Mounted Rotary Combustion Engine - Q-FAN Propulsion	123
54	Rotary Combustion Engine Propulsion Pod	124
55	Pylon-Mounted Piston Engine - Q-FAN Propulsion Pod	125
56	Top View of Pylon-Mounted Piston Engine - Q-FAN Propulsion Pod	126
57	Forward End View of Pylon Mounted Piston Engine - Q-FAN Propulsion Pod	127
58	Piston Engine Propulsion Pod	128
59	Rotary Combustion Engine - Q-FAN Installation as a Pusher for a Single-Engine Aircraft	129
60	Piston Engine - Q-FAN Installation as a Pusher for a Single Engine Aircraft	130
61	Twin-Engine Installation - Rotary Combustion Engines with a Q-FAN as a Pusher	131
62	Twin-Engine Installation - Rotary Combustion Engines with Q-FAN as a Tractor	132
63	Twin-Engine Installation - Piston Figures with Q-FAN as a Pusher	133
64	Twin-Engine Installation - Piston Engines with Q-FAN as a Tractor	134
65	Single Engine Installation - Piston and Rotary Combustion Engines	135

APPENDIXES

	Page
A GENERALIZED METHOD OF Q-FAN PERFORMANCE ESTIMATION FOR GENERAL AVIATION AIRCRAFT	137
B GENERALIZED METHOD OF Q-FAN FAR-FIELD NOISE ESTIMATION FOR GENERAL AVIATION AIRCRAFT	169
C ENGINE GENERALIZATIONS	181
D Q-FAN COMPUTER PROGRAM	223

Q-FANSTM FOR GENERAL AVIATION AIRCRAFT

SUMMARY

The objective of this study sponsored by the Systems Study Division of the NASA Ames Research Center under Contract No. NAS2-6834 dated 8 March 1972 is to assess the potential of the prop-fan as a low noise propulsor for advanced general aviation aircraft. Because of its low noise signature, Hamilton Standard has adopted the name "Q-FANTM" for this promising new propulsor concept.

Analytical criteria for predicting the performance, noise, weight and cost of Q-Fans projected to the 1980 time period were established. Furthermore, noise, weight and cost criteria were established for piston, rotary combustion, and gas turbine engines and gearboxes. These criteria were programmed in FORTRAN IV and included in a NASA aircraft synthesis program for computing the aerodynamics, structural weights and costs of general aviation aircraft. Furthermore, the Q-Fan generalizations were combined in a smaller computer program to permit the assessment of Q-Fan characteristics separately. With these computer programs established, parametric studies were conducted on Q-Fan propulsion packages for several representative aircraft size categories. It is generally shown that for the 1980 time period, the propulsion package consisting of a Q-Fan combined with a rotary combustion engine results in a quiet, compact airplane system, with essentially the same performance weight and cost of present day propulsion systems.

Detailed conceptual propulsion system integration studies were made to deal with the problems of integrating the Q-Fan and engine and of installing the Q-Fan/engine propulsion package onto both single- and twin-engine aircraft. The compact rotary combustion engine and the gas turbine engine appear to be more compatible with Q-Fans in terms of interference problems and engine weight than the piston engine. Furthermore, the Q-FAN offers the aircraft designer a new degree of flexibility in configuring light aircraft.

Finally, a major contribution of this study is the new Q-Fan methodology which was derived to predict Q-Fan performance, noise, weight and cost. This methodology was utilized in the parametric studies, and it is intended that the reader of this report will have sufficient data to permit similar Q-Fan studies for any general aviation aircraft. A complete listing of the Q-Fan computer program with detailed instructions on its use are included. All the curves and equations for the analytical methods included in the computer program are presented with instruction of usage in lieu of the computer.

INTRODUCTION

Aviation forecasts for the next 10- to 15-year time period indicate continued steady growth of general aviation. The attainment of this forecasted growth is dependent upon the continued improvement in the safety, utility, performance and economy of general aviation aircraft. Furthermore, these aircraft will need to conform to government regulations, now in the formulative stage, controlling atmospheric pollution caused by engine emissions and acoustic pollution due primarily to the propulsion system.

Proposed engine emission restrictions are currently being studied by the manufacturers of engines for general aviation aircraft to determine the impact on engine performance, weight, and cost. Noise restrictions have already been established by the Federal Aviation Administration (FAA) for large turbine powered commercial transport CTOL aircraft and more stringent limits are being considered for the coming V/STOL aircraft. Even now the government is working on similar regulations for general aviation aircraft which are expected to be in force within a year. While the initial noise limitations may be quite moderate, it is reasonable to expect that these will become more restrictive as time goes on.

Thus, it is evident that the next generation of general aviation aircraft may need to incorporate major changes to both airframe and propulsion systems to attain the aforementioned improvements and to meet the anticipated noise restrictions. Accordingly, in the past few years, the government has sponsored propulsor, engine and airframe studies to assess the impact of noise restriction and advanced technology on general aviation aircraft of the 1980 time period (refs. 1, 2, and 3).

These studies indicated that moderate noise restrictions can be met with existing propeller technology. However, as the restrictions become more stringent it will be necessary to increase propeller diameter and number of blades significantly and to operate at very low tip speeds. This will result in not only dimensionally less compatible geometries than those of present aircraft but also in heavier and more costly propellers.

An attractive alternative to the larger quiet propeller was indicated in the study of other concepts (ref. 3). This is the prop-fan concept which is a small diameter multi-blade, ducted fan. The application of this device for STOL Aircraft has been discussed in considerable detail in previous publications (ref. 4, 5, 6).

In view of these attractive characteristics, the Systems Study Division of the NASA Ames Research Center, SSD, has awarded its developer, the Hamilton Standard Division, of United Aircraft Corporation, a two phase study contract (NAS2-6834) to assess the potential of the Q-Fan as an advanced, quiet propulsor for general aviation aircraft of the future.

Specifically, Phase I consisted of generalizing the performance, noise, weight and cost of Q-Fans; the performance, weight, cost and dimensions of piston, rotary combustion and gas turbine engines; and the weight and cost of gearboxes. Curtiss Wright Corporation provided the pertinent data for the rotary combustion engines. Similar data for the piston and gas turbine engines were developed by the NASA utilizing published data from the engine manufacturers.

Phase II consisted of computerizing these generalizations and incorporating them into a NASA synthesis program for computing the aerodynamics, structural weights, and costs of general aviation aircraft. Using this aircraft synthesis program, SSD conducted parametric studies for several representative aircraft size categories to determine the effect on aircraft geometric and operational characteristics of sizing Q-Fans to various noise levels. Furthermore, detailed conceptual propulsion system integration studies were made to deal with the problems of integrating the Q-Fan and engine and of installing the Q-Fan/engine propulsion package onto both a single and twin engine aircraft.

SYMBOLS AND ABBREVIATIONS

AF	blade activity factor	$\frac{100,000}{16} \int_{sco}^{1.0} \left(\frac{b}{D}\right) x^3 dx$
AR	ratio of rotor frontal area to duct exit area	
b	blade section width, ft (cm)	
B	number of blades	
BMEP	piston engine brake mean effective pressure, psi (N/cm ²)	
BVCAP	blade-stator spacing	
C	average O. E. M. Q-Fan cost for a no. of units/year, \$/lb	
C ₁	single unit O. E. M. Q-Fan cost, \$/lb.	
C _{LD}	blade section design lift coefficient	
C _{Li}	blade integrated design lift coefficient, 4	$\int_{sco}^{1.0} C_{LD} x^2 dx$
C _P	power coefficient,	$\frac{(K2) \text{ Power } (\rho_o/\rho)}{N^3 D^5}$
C _{PE}	effective power coefficient, C _P x P _{TAF} x P _{MN}	
C _{Tnet}	thrust coefficient,	$\frac{(K3) \text{ Thrust } (\rho_o/\rho)}{N^2 D^4}$
C _{Tnet(L/D)}	thrust coefficient adjustment for L/D	
C _{Tnet (acc)}	thrust adjustment for acoustical treatment	
C _{TE}	effective thrust coefficient,	$C_{Tnet} \times P_{TAF} \times P_{MN} - \Delta C_{Tnet (L/D)} + C_{Tnet (acc)}$
D	rotor diameter, ft (m)	

dB	decibel, $0.0002 \text{ dynes/cm}^2$ (reference value)
dB(A)	weighted decibel
E	empirical cost factor
F	cost factor based on quantity and configuration
F	degrees Fahrenheit
J_0	advance ratio
K1	English system, 101.4 (metric system, 60.)
K2	English system, 0.5×10^{11} (metric system, 1.264×10^8)
K3	English system, 1.514×10^6 (metric system, 2.938×10^3)
K4	English system, π (metric system, 10.31)
L/D	duct length to rotor diameter ratio
LF	learning curve factor for no. of units/year
LF_1	learning curve factor for a single unit
M	free stream Mach number
N	propeller speed, rpm (rev. /min)
N	newtons
O. E. M.	original equipment manufacturer
Power	shaft power, SHP (kw)
P_{TAF}	power coefficient adjustment for TAF
P_{MN}	M/TS adjustment to power coefficient
PNdB	units of perceived noise, dB
P. R.	pressure ratio _____
R	blade radius at propeller tip, ft (cm)

r	blade radius at blade element, ft (cm)
sc0	spinner cut-off point
SHP	shaft horsepower
SSD	Systems Study Division, the NASA Ames Research Center
T	Q-FAN thrust, lb (N)
T	absolute temperature
T _{TAF}	thrust coefficient adjustment for TAF
TAF	total activity factor, AF x B
T _{MN}	M/TS adjustment to power coefficient
TS	rotor tip speed, $\frac{(K4) ND}{60}$
Thrust	Q-FAN thrust, lb (N)
v	number of vanes
V	free stream velocity, knots (m/s)
x	fraction of rotor tip radius, r/R
z	learning curve factor ratio, $\frac{LF}{LF_1}$
$\beta_{3/4}$	rotor blade angle at 3/4 radius
Δ	increment
ρ_0/ρ	ratio of density at sea level standard day to density for a specific operating condition.
σ	solidity, 0.00027 x TAF

AIRCRAFT CLASSIFICATION

For this study, the Contractor used the same general aviation aircraft classifications that were developed for the Advanced General Aviation Propeller Study (ref. 3). General aviation aircraft were categorized into five basic groups on the basis of number of seats as the prime characteristics with present day propeller complexity, installed power, gross weight, cruise airspeed and number of engines as secondary characteristics. These classifications are presented in Table I. Q-Fans were not considered practical for classification I, the single engine fixed gear. Consequently, the study was made for classifications II through V.

Q-FAN GENERALIZATIONS

The Q-Fan, as its generic name, prop-fan, implies, lies intermediate in the propulsion spectrum between propellers and turbo-fans. As such, its low speed operating characteristics tend toward that of the propeller and its high speed cruise performance tends toward that of the turbo-fan. Thus it offers the potential of a low noise compact propulsor for application to moderate speed aircraft. Moreover, with the addition of sound suppression material on the duct walls, the noise levels of the Q-Fan can be further reduced without the weight or size penalties which would be required to reduce propeller noise by the same increment (ref. 3). Because of its low noise signature, Hamilton Standard has adopted the name "Q-FanTM" for this promising new propulsor concept.

The technology for an advanced subsonic propulsion Q-Fan system is being developed for application to large commercial STOL aircraft expected to be operational in the 1980's. Since the aerodynamic, acoustic, mechanical design and geometric characteristics of this new propulsor concept, as applied to STOL aircraft, have been discussed in considerable detail in previous publications (refs. 4, 5, 6), these subjects will not be covered further herein. Let it suffice to point out that the concept can be extended to include its application to advanced general aviation aircraft. For this application, the Q-Fan will need to be designed to operate at lower pressure ratios and tip speeds than would be optimum for the large STOL aircraft which may cruise at $M = 0.75 - 0.80$. These design characteristics will provide a geometrically compatible, quiet, efficient propulsion package for the relatively small advanced general aviation aircraft which will meet the increasingly more stringent low noise restrictions expected over the next 10 - 15 years (ref. 7).

The aforementioned Q-Fan technology program has included both wind tunnel model testing and full-scale hardware engine stand testing. The purpose of the latter effort is to demonstrate through an actual engine installation the predicted noise levels and to confirm the aerodynamic compatibility of the Q-Fan/core engine package and the

aerodynamic performance in both forward and reverse thrust operation indicated previously from the wind tunnel testing. Figure 1 shows a photograph of an 18-inch (45.6 cm) diameter, 12-bladed model Q-Fan tested in the United Aircraft Research Laboratories wind tunnel. This is a model of the full scale, 4.6 foot (1.40 m) diameter Q-Fan/Lycoming T-55-11A engine demonstrator mentioned above which is pictured in figure 2 (ref. 8).

The aerodynamic performance and acoustic data obtained on two model Q-Fans and on the full-scale demonstrator generally confirm the validity of the aerodynamic and acoustic design and prediction methodology being used for Q-Fans and which are being used as the basis for the current NASA sponsored study.

Design and performance criteria covering performance, noise, weight and cost of potential general aviation Q-Fans, in the 1970s and 1980s time period have been derived and incorporated into a computer program utilized for the parametric studies. Each technology area associated with these criteria has been identified and are discussed in the following text.

Q-Fan Characteristics

The Q-Fan components include the rotor, stator and duct which can be arranged in a tractor or pusher configuration as shown in figure 3. The Q-Fan is a compact, multi-bladed propulsor with the options of variable or fixed pitch blades, variable or fixed geometry and feathering and reversing capabilities. For the general aviation application, variable geometry is not required.

It has been chosen to define the rotor shape characteristics in the familiar propeller blade nomenclature of number of blades, B, activity factor, AF, and integrated design lift coefficient, C_{L_i} . AF and C_{L_i} are defined as follows.

$$AF = \frac{100,000}{16} \int_{sco}^{1.0} \frac{b}{D} x^3 dx$$

$$C_{L_i} = 4 \int_{sco}^{1.0} C_{L_D} x^3 dx$$

where

b/D = blade section width to rotor diameter ratio

x = blade section fraction of rotor tip radius

$C_{L,D}$ = blade section design lift coefficient

sco spinner cut-off point

The term solidity, σ , frequently used in fan work can be approximated by the propeller term total activity (TAF = B x AF) by the simple equation

$$\text{Solidity} = 0.00027 \times \text{TAF}$$

It is the ratio of the total blade area to the annulus area. The blades can be variable pitch or fixed pitch and the tip clearance between the blades and the duct should be less than 0.25% of the rotor diameter. These rotor characteristics are summarized on Table II.

The duct shape characteristics are duct length/rotor diameter ratio, L/D, rotor to duct exit area ratio, AR, and blade-stator spacing, BVGAP. For the tractor configuration BVGAP is defined in terms of fan blade chords and for the pusher configuration in terms of inlet stator vane chords. Two chord lengths have been selected for BVGAP for favorable noise characteristics. The ducts can be of fixed or variable geometry and will have approximately a 10% chord maximum thickness. The fan pressure ratio, P.R., can be related to the ratio of Q-Fan thrust, lb (N) to rotor diameter, ft (m) squared, T/D², by the following equation.

$$\text{P.R.} = 1.0 + (K) T/D^2$$

where

$$K = 0.0005 \text{ English units}$$

$$K = 0.00001 \text{ SI units}$$

These duct characteristics are summarized in Table III.

The stator shape characteristics are number of vanes (v) and vane activity factor, AF. For the tractor configuration the rotor is followed by fixed pitch swirl recovery or support vanes whereas for the pusher configuration fixed pitch inlet swirl vanes are followed by the rotor. These stator characteristics are summarized in Table III.

While the Q-Fan performance, noise, weight and cost generalizations presented herein have been made on the basis of the tractor configuration, it is felt that with proper design of the duct inlet in relation to the forebody, the performance and noise of the pusher configuration will be essentially the same as that of the tractor configuration. This will be discussed in more detail in the following text.

Performance Generalization

Over the last fifteen years Hamilton Standard has engaged extensively in the development of ducted fan aerodynamic performance and acoustic prediction methods. Some of the effort is documented in references 8 and 9. These analytical studies have been supported by experimental programs and a few are summarized in reference 10. Thus Hamilton Standard has developed the aerodynamic and acoustic technology required to design quiet efficient ducted fans.

The performance prediction method, called P-Fan I, has evolved from this extensive development effort and is capable of accurately evaluating the effects of rotor blade twist, camber and planform in addition to such rotor/duct variable as duct length, exit area ratio and stator drag. It is a ten radial element strip analysis of an actuator disk representation of the ducted propeller. Radial and axial induced velocities are computed at each radial station. From the mean vector triangle determined at each "strip", the section lift and drag are then determined and resolved into elemental thrust and power. The "strip data" is then integrated to obtain the rotor thrust and power. The vector triangles leaving the rotor are input to the stator vanes for those applications where stators are required, either for performance or structure and a similar strip analysis is performed. The total program is iterative on mass flow and is balanced when the duct exit static pressure satisfies the input pressure conditions. The appropriate quantity of airflow is determined by means of a compressible flow relation of momentum and energy transfer with the flow exhausting to the atmosphere at a prescribed static pressure level. A method of computing installed effects has been incorporated as part of the P-Fan I computer program which accounts for shroud external and internal drag losses and inlet ram recovery losses. The losses due to the engine cowling and other installation losses are not included. However, it is felt that these can be minimized by the careful design of the Q-Fan propulsion package.

This performance analysis method for Q-Fans is geared to the rotor-stator configuration, which is the tractor application for this study. For this configuration the stators are designed to remove the rotor swirl at optimum incidence at a designated operating condition. At off-design conditions the stator incidence is generally non-optimum but the swirl is still recovered. The pusher configuration has the guide vanes upstream of the rotor. The incidence on the inlet guide vanes is essentially constant for all operating conditions, but the rotor preswirl is proportional to the quantity of duct airflow. For this configuration the preswirl will not in general be cancelled by the fan rotor. The basic differences between the two configurations then are associated with the incidence and swirl recovery trade-offs. For the range of aerodynamic loadings associated with this study it is reasonable to expect that the predicted performance generalizations will apply to either the pusher or tractor configurations.

The P-Fan I program outputs a wide range of performance parameters. Those that will be used in this study are the nondimensional terms of power coefficient, C_p , net thrust coefficient (sum of rotor, stator and duct), $C_{T_{net}}$, for given advance ratios, J_0 and blade angles.

Method Verification. - Experimental programs conducted by Hamilton Standard have included testing of 3, 4, 5, 6, 7 and 12 bladed fans encompassing total activity factors from approximately 500 to 2200. For the extremes of this total activity range, excellent correlation has been found between experimental measurements and analytical performance data. The net thrust correlation is shown on figure 4 for a 500 total activity factor, 30-inch (76 cm) diameter model tested in a 0.667 length/diameter ratio duct at low forward speed. Also shown is the blade performance correlation for a 2200 total activity factor, 21-inch (53 cm)-diameter model tested in a long duct with a bellmouth inlet.

Generalized Performance Method - As was previously stated, Q-Fan performance is presented in the non-dimensional form of power coefficient, C_P , net thrust coefficient, C_{Tnet} , and advance ratio, J_0 . The horsepower, thrust, Q-Fan rotational speed, and diameter are included in C_P and C_{Tnet} as follows:

$$J_0 = \frac{(K1) V}{N D}$$

$$C_P = \frac{(K2) \text{ Power } (\rho_0/\rho)}{N^3 D^5}$$

$$C_{Tnet} = \frac{(K3) \text{ Thrust } (\rho_0/\rho)}{N^2 D^4}$$

where

K1 - English units, 101.4 (SI units 60.0)

V - forward speed velocity knots (m/s)

N - Q-Fan speed, rpm

D - Q-Fan rotor diameter, ft (m)

K2 - English units 0.5×10^{11} (SI units 1.764×10^8)

Power - shaft horsepower (kw)

ρ_0/ρ - ratio of density at sea level standard day to density for a specific operating condition

K3 - English units, 1.514×10^6 (SI units 2.938×10^3)

Thrust - pounds (N)

In order to minimize the number of curves and consequently the size and complexity of the computer program, adjustment factors are used to account for the effects of variation in total activity factor (TAF = AF x number of blades), duct length/rotor diameter ratio, tip speed/Mach number, and effect of acoustical treatment on performance. The effective power coefficient and thrust coefficient are defined as follows:

$$C_{PE} = C_P \times P_{TAF} \times P_{MN}$$

$$C_{TE} = C_{Tnet} \times T_{TAF} \times T_{MN} - C_{Tnet(L/D)} + C_{Tnet (acc.)}$$

- C_T - power coefficient
 P_{TAF} - total activity factor adjustment factor to power coefficient
 P_{MN} - Mach no./tip speed adjustment factor to power coefficient
 C_{Tnet} - net thrust coefficient (sum of rotor, stator and duct axial forces)
 $C_{Tnet(L/D)}$ - adjustment factor for duct length/rotor diameter variation to thrust coefficient
 T_{TAF} - total activity factor adjustment factor to thrust coefficient
 T_{MN} - Mach no./tip speed adjustment factor to thrust coefficient
 $C_{Tnet(acc.)}$ - acoustical treatment adjustment factor to thrust coefficient

The base Q-Fan has been selected on the basis of blade shapes which prior study had shown to be most favorable for minimum weight, low noise characteristics and good performance for general aviation aircraft. It incorporates blading with 2000 total activity factor, and 0.7 integrated design lift coefficient, a 0.45 rotor blade hub/tip ratio and a 1.08 duct length/rotor fan diameter ratio. Series 65 airfoil sections were selected from existing families of airfoil sections because of their favorable drag characteristics. Computations were made using P-Fan I for this base Q-Fan for a range of rotor-to-duct exit area ratios (0.8 to 1.1) to generate the base plots. This performance generalization format is shown for AR = 1.0 in figure 5.

Calculations were made for a total activity factor range from 750 to 3000. These calculations were utilized in deriving the adjustment factors P_{TAF} (fig. 6) and T_{TAF} (fig. 7) for the power and the thrust coefficients respectively. P_{TAF} is a function of TAF only, whereas T_{TAF} is a function of TAF and J_0 .

Similarly, calculations were made for a 450 (137) - 900 ft/s (274 m/s) tip speed range and 0.0 to 0.5 Mach number range. The adjustment factor, P_{MN} (fig. 8) to power coefficient is dependent on tip speed only, whereas the adjustment factor to thrust coefficient, T_{MN} (fig. 9) is dependent on tip speed and advance ratio J_0 . Thus T_{MN} is a function of both tip speed and Mach number (M) since Mach number can be defined in terms of tip speed, TS, and J_0 as follows:

$$M = \frac{C (TS) (J_0)}{\sqrt{T^{\circ}}}, \text{ where } C = 0.006478 \text{ in English units and } 0.02125 \text{ in. SI units.}$$

From calculations spanning a duct length/rotor diameter ratio, L/D , of 0.65 to 1.2 it was found that the power coefficient, C_P was not affected by L/D changes. The changes to thrust coefficient were generalized as a delta change in C_T as a function of L/D and advance ratio, J_0 as shown in figure 10.

Simple wall treatment for a noise suppression of 4.5 PNdB can be incorporated at no weight or cost penalty because it can be made a structural part of the propulsor. The effect of this acoustical treatment on performance was established. It is presented as $C_{T_{net}}(acc.)$ (fig. 11) and is a function of area ratio, AR , advance ratio, J_0 , and net thrust coefficient, $C_{T_{net}}$. The wall treatment will be discussed in more detail in the section on noise generalization.

The accuracy of each adjustment factor is generally within 2% with further deviations at the extremes.

The blade angle variation with power coefficient and advance ratio for the base Q-Fan with area ratio equal to 1.08 is presented on figure 12. This curve can be used in assessing the blade angle range required for the forward flight operating range. Moreover, this method can be used for predicting the performance of fixed pitch and two-position rotors as well as the constant speed rotors. For each of the base performance plots there is a plot of blade angle versus effective power coefficient for constant advance ratio.

A complete set of the performance curves, together with sample calculations and step-by-step explanations are included as Appendix A.

Noise Generalization

In reference 7, existing and anticipated future noise regulations are discussed. These noise limits show that aircraft now in operation that produce less than 99 PNdB at 500 ft. (152 m) would probably be considered acceptable by any of the existing rules. In the future where STOL aircraft noise limits now under discussion are considered a good guideline for tightened general aviation aircraft restrictions, limits of 95 to 85 PNdB at 500 ft. (152 m) appear to be a good criteria for general aviation for immediate to future restrictions.

Hamilton Standard has for many years been active in noise control research on unshrouded propellers. This experience was employed beginning in 1969 in the development of the methodology required for control of noise generated by the Q-Fan. This work resulted in 1971 in a methodology which explained all of the noise phenomena observed in model tests completed in 1970. In 1972 a program funded by NASA Langley (ref. 1) was completed where the influence of operating and configuration parameters on Q-Fan noise was studied.

There are four major noise components of the Q-Fan as shown in figure 13: rotor tone, rotor broadband, stator tone, and stator broadband. The level of rotor tones at harmonics of blade passage frequency are caused by inflow distortion or unsteadiness in the inflow to the fan which exists even under ideal test conditions. Rotor broadband noise is assumed to be the result of vortices shed from the blade tip or blade trailing edge. Stator tone and broadband noise is the result of fluctuating lift generated as the wake defects from the rotor blades intercept the stator vanes. The periodic characteristics of the wake define the stator tone levels while the unsteadiness of the wakes results in the stator broadband noise. An acoustical theory was developed which calculates all of these components. This method has been combined with the performance computer program, P-Fan I, and permits the investigation of the influence of many design parameters on noise.

In considering the relative merits of a tractor Q-Fan with fan duct exit stator vanes versus a pusher Q-Fan with fan duct inlet stator vanes, several noise trade-offs must be considered. Important sources in the tractor configuration are the interaction between the rotor wakes and the fan duct outlet stator vanes and interaction of the rotor with atmospheric disturbances and other inlet distortion. In converting from a tractor to a pusher installation the interaction between inlet guide vane wakes and the rotor blades is a noise source. Also, some distortion or turbulence from the upstream nacelle or fuselage will be present. Calculations of the noise increase due to upstream disturbances indicate that the noise can be reduced to negligible quantities by minimizing the disturbances. In the case of upstream inlet guide vanes, the disturbances caused by their wakes can be minimized by the use of airfoil sections and a proper spacing between the guide vanes and the rotor. Thus, an inlet stator vane assembly can be designed which not only produces minimal wakes because of the small amount of turning required but will produce the positive effect of reducing, or screening out, disturbances in the flow entering the rotor. Thus, within the tolerance of this study, the noise levels quoted for tractor Q-Fans should be equal to that of pusher Q-Fans.

The Perceived Noise Level (PNL) has been selected in this study as the noise rating scale because: 1) It is a good measure of the relative annoyance of the various aircraft designs considered in this study, 2) It can be estimated by use of a relatively simple calculation procedure, and 3) It is a reasonable indication of the subjective reaction to aircraft noise. It should be noted that calculations at some forward speed are most useful in assessing aircraft noise as acoustic measurements for certification are made with the aircraft in motion. Thus, the criteria has been established that noise will be evaluated at 500 feet (152 m) for a 66 knot (34 m/s) take-off condition.

Method Verification. - In order to show the capability of this method, comparisons with model tests are shown in figures 14 and 15. The 21 inch (53 cm) model used for these comparisons had 12 blades and 22 stator vanes and operated at a low pressure ratio subsonically. Complete details of the test of this fan can be found in reference 10. Figure 14 shows comparisons between measured and calculated 1/3 octave band spectrum. It can be seen that agreement is excellent at all but the low frequencies where duct effects and scrubbing noise dominate. The influence of these factors at low

frequencies does not affect annoyance so is not considered important. In addition, perceived noise level calculations for sideline noise were made for all available data from the model test program. These, along with the test data, are shown in figure 15. It can be seen that correlation over the horsepower range from 40 (29.8) to 225 HP (168 kw) and 500 (152) to 800 ft/s (244 m/s) speed is excellent. Differences between theory and experiment over the full range of horsepower and tip speed are less than ± 1.5 dB.

Generalized Noise Method. - The P-Fan I method in combination with an advanced noise prediction method is used in predicting maximum sideline PNdB at 500 ft (152 m) for a forward speed of 66 knots (34 m/s). The parameters which affect the noise computational procedure in P-Fan I are the following:

Fan diameter

Number of blades

Activity factor

Tip speed

Number of stators

Rotor to duct exit area ratio

Distance between rotor blades and stator vanes

Thrust

The effects of these parameters on noise were investigated in reference 11. It was shown that as the number of stator vanes varies from 3 to 7, the effect on noise is negligible. For the low pressure ratios applicable to general aviation aircraft, worthwhile noise reductions are achieved with distances between rotor blades and stator vanes (BVGAP) of as much as 4 blade chords. However as the BVGAP is increased, the duct becomes longer with a corresponding increase in weight. Therefore, a BVGAP of 2.0 was selected as a reasonable compromise for noise and weight. Furthermore, the duct exit area for minimum noise corresponds to a duct exit area ratio, AR equal to 1.0. While the influence of AR on noise does not appear to be large, noise levels could be increased by 2 dB for 0.8 AR. Therefore, because of their small affect on noise, number of vanes, BVGAP and AR were not included as variables.

Noise calculations were made using the P-Fan I computer program described previously for variations in rotor diameter, number of blades, activity factor, tip speed and thrust for an 1.0 area ratio and 2.0 BVGAP for 5 stator vanes. The generalized noise method was then developed from these calculations. Figure 16 shows a sample of the basic noise generalization curve for general aviation Q-Fans. Here the noise for a family of 5-foot (1.52 m) diameter Q-Fans at a total activity factor of 2000 is plotted as a function of thrust per diameter squared, T/D^2 , for a range of tip speeds. It should be noted that for a given tip speed line the fans have a specific geometry (number of

blades and shroud length-to-rotor diameter ratio, L/D), which was selected for minimum noise. Similar curves spanning a range of total activity factors of 750 to 3000 are available. Since the generalization presented in figure 16 is for 5-foot (1.52 m) diameter fans, a curve for the influence of diameter on noise is presented in figure 17. An examination of figures 16 and 17 show that at the lower values of T/D^2 , minimum noise is attainable at the higher tip speeds. Curves similar to figure 16 for a TAF range show that the cross-over points, where reductions in tip speed also reduce noise, are functions of the total activity factor. Furthermore, it can be seen from an inspection of figure 17, that the noise, as read from curves similar to figure 16, are reduced for diameters less than five feet and increased for diameters greater than five feet.

Since the weighted decibel, dB(A), is frequently used, an approximate correction factor to PNdB to obtain dB(A) was generated. From calculations for various fans over a range of configurations and operating conditions, it was determined that the corresponding dB(A) values can be approximated by subtracting 12 from the PNdB value.

A complete set of the noise curves, together with a sample calculation and step-by-step explanation are included as Appendix B.

Q-Fan Noise Suppression Methodology. - To establish the impact of duct treatment on weight, cost and noise of Q-Fans for general aviation applications, detailed methodology which was developed to design treatment for larger higher pressure ratio fans for both short take-off and landing and conventional take-off and landing aircraft has been used. This method requires as an input the noise spectrum and directivity of the fan. Then, by iterative calculations, the optimum location, length and depth treatment is established. Simple wall treatment was investigated for the general aviation application. The treatments considered consisted of (1) installation only along the aft wall (behind the stator), (2) aft wall plus mid-wall treatment (behind the rotor and stator) and (3) full wall treatment along the whole length of the duct (fig. 18). The results of the study show that the noise can be reduced 4.5 PNdB with aft wall treatment alone. A further reduction of 1.5 PNdB can be obtained by aft wall plus mid wall treatment. Mid wall treatment reduces both inlet and exhaust noise since it attenuates the rotor noise propagating aft and the stator noise propagating forward. As a consequence, inlet wall treatment does not significantly contribute to noise reduction over that attainable with aft wall plus mid wall treatment, because the mid wall treatment is sufficient to reduce the noise propagating from the inlet to a level well below that from the exhaust. The treatment consists of perforated material bonded to a honeycomb backing. Approximately 0.54 inches (1.37 cm) of treatment is required for aft wall treatment and approximately 3.5 inches (8.89 cm) for mid wall treatment. Further reductions in noise level could be obtained by incorporating more extensive aft treatment such as a longer duct or treated rings, which would then require inlet treatment.

There is no weight and cost penalty for inclusion of aft duct wall treatment as the treatment can be made a structural part of the propulsor. The cost of adding mid treatment is not considered practical for the 1.5 PNdB additional reduction due to the expense of the deep treatment required. Therefore, it is recommended that the treatment be

limited to aft wall only. The performance penalty due to the increased pressure loss from greater roughness of the perforated treatment relative to the smooth surface of an untreated fan has been discussed under the section on performance generalization.

A pusher configuration with inlet guide vanes has not been tested and consequently the fan noise spectrum and directivity pattern required to properly size duct treatment have not been defined. It is possible that the configuration of the inlet guide vanes will be such that they will act as a shield to forward propagation of noise generated as the inlet guide vane wakes impinge on the rotor blades. Then the aft noise will again be dominant in maximum sideline perceived noise levels. Until further data is available, it is recommended, therefore, that the same aft treatment as used in the tractor installation also be used in the pusher installation.

Weight Generalization

An accurate weight generalization of Q-Fans is difficult to achieve for many reasons. While a Q-Fan may be described generally by several parameters discussed previously, the actual design requirements can introduce a wide range of weights for several Q-Fans all having the same values of these parameters. For example, the type of control system required, the Q-Fan environment, aircraft operating airspeeds and attitudes all influence the Q-Fan design and consequently weight. Thus, only the gross geometric characteristics can be accounted for in any particular generalization.

In preliminary Q-Fan selection studies, there is a need for some means of estimating weight trends and it must be recognized that the final weights may vary significantly after all factors have been considered. Such weight estimating procedures have been prepared for various classes of Q-Fans.

The Q-Fan geometric parameters (diameter, number of blades, activity factor, duct length/rotor diameter ratio) and operational parameters (Power, RPM) incorporated in these formulae are those which experience has shown to have the most predominant effect on Q-Fan weight and the exponents have been established empirically to best fit the weight trends.

The Q-Fan assembly shown in figure 19, was divided into three modular subassemblies for weight and cost generalization and flexibility of installation on the aircraft. These modules are as follows:

1. Fan rotor assembly
2. Duct assembly
3. Gearbox or mount assembly

The modular concept provides the greatest flexibility for predicting propulsion unit weights since there are several ways to integrate the Q-Fan and engine and to install the Q-Fan/engine propulsor system in the aircraft. These differences are discussed later on in the text.

There is no existing Q-Fan hardware in the size range being considered for general aviation applications from which actual weights can be obtained to assist in deriving a generalized weight equation. Therefore, the weight equation was derived from detailed weight equations generated for each component in the three subassemblies.

Fan Rotor Assembly. - The fan rotor assembly can be either variable pitch or fixed pitch depending upon desired performance for a particular installation. The variable pitch fan rotor assembly includes the blades, barrel, blade retention, pitch change actuator (including counterweights in categories III and IV), spinner and fluid. Modifications are made to the barrel and blade for the fixed pitch rotor assembly and the blade retention bearings, pitch change actuator, counterweights and fluid are eliminated. The same basic component design concepts and materials that were selected as a result of a detailed weight and cost trade-off in reference 3 were used in this study. As was stated previously, Q-Fans were not considered practical for category I.

A weight equation was derived for each component based on the parameters of number of blades, blade tip diameter, activity factor/blade, horsepower and tip speed. The equations were then combined into the final rotor assembly equation shown in figure 20.

For lowest weight, the fan rotor barrel was assumed to be mounted on an integral tailshaft supported by either the mount assembly or a gearbox. The weight of this shaft is not included in the fan rotor assembly. If the fan rotor assembly is to be mounted directly on an engine shaft, the additional weight of a conventional flange mounting can be determined from the next to the last term of the equation (figure 20). However, integration of the rotor tailshaft directly with the engine is a desirable weight-saving feature that can be accomplished by coordination of the engine and fan designs. Table IV provides all constants and exponents to be used in the weight equation for a variable pitch fan rotor assembly with options for either solid forged aluminum blades or solid aluminum spar and fiberglass shell blades in aircraft categories IV and V. Constants for categories II and III are based on aluminum blades only since the additional cost for the lighter fiberglass blades did not seem warranted for these categories.

Table V provides weight equation constants for the fixed pitch rotor assembly that differ from the variable pitch rotor constants. The fixed pitch weight constants are not provided for category V aircraft since variable pitch is required to satisfy the performance requirements of this category of aircraft.

Duct Assembly. - The Q-Fan duct assembly shown in figure 21, includes the duct, vanes and inner mounting ring. Both aluminum and fiberglass construction was considered but fabricated aluminum was selected based on the most desirable cost per pound relationship.

Airfoil-shaped vanes are fastened to fittings in inner and outer box-type support rings. The duct leading section is bolted to the outer ring with access to the fasteners provided by removable panels on the outer duct skin. A bolt circle is provided on both the leading and trailing ends of the inner support ring for mounting the fan mount assembly or gearbox on the leading end and attaching the entire assembly to the airframe or engine on the trailing end. The outside diameter of the inner support ring is the centerbody diameter.

The duct assembly weight equation was derived from design sketches which were found to scale as a function of rotor diameter squared. Provision is also made to compute duct weights for any length/diameter ratio between 0.50 to 1.5. This weight equation applies to all aircraft categories.

Mount Assembly. - The Q-Fan mount assembly shown in figure 22, includes a cast magnesium alloy support housing, barrel tailshaft mounted on thrust and radial bearings, fan accessory drive gears (i. e. governor, tach generator, etc.) and an aluminum sheet metal afterbody located between the fan spinner and the duct inner mounting ring at the centerbody diameter. A bolt circle pattern is provided on the housing to mount the assembly on the leading end of the duct inner mounting ring. Bearing lubrication can either be self-contained or engine-supplied. The fan tailshaft can be driven by a floating splined quill shaft or by a flexible coupling. These drive shaft weights are not included in the equation since they are dependent upon engine location.

Mount assembly weight was found to vary with fan drive torque in the same relationship as gearboxes, with a constant modifier which reflects the absence of reduction gearing. Torque is represented in terms of shaft horsepower, rotor fan diameter, and tip speed parameters. Afterbody weight varies as rotor fan diameter squared. This weight equation applies to all aircraft categories.

When gearing is required, then the mount and gearbox weights are combined as discussed in the section on gearbox generalizations.

The same modular subassemblies are used for pusher as well as tractor configurations. Therefore, the weight equations are applicable for both configurations.

The following table shows approximate weight reductions of representative fixed pitch over variable pitch Q-Fan assemblies in categories II through IV for activity factors/blade in the 200 range.

<u>Category</u>	<u>Diameter Range (ft.)</u>	<u>Weight Reduction Range (%)</u>
II	2.5 - 3.0	17 - 11
III	2.5 - 3.0	24 - 18
IV	2.5 - 3.5	24 - 16

Cost Generalization

Selling price is the least adaptable to generalization of all items in this study because prices are negotiable and manufacturer's cost structures differ. Because of this, the generalized cost equation for the parametric studies was derived using the cost to the aircraft original equipment manufacturer, O.E.M. as a base.

Costs are based on analyses of the same modular subassemblies and components used in the weight study. Purchased part and material costs and labor cost based on an assumed labor rate of \$13.50/hour, both reflecting mark-up to 1970 O.E.M. cost, were determined from cost analysis of design sketches of the subassembly components.

Cost equations are presented in terms of first unit O.E.M. cost with an adjustment for producing a quantity of units. The first unit O.E.M. cost is based on the same labor rate and purchased parts and material cost for the 1970 and 1980 time periods. The adjustment factor for an increased quantity of units is based on an 89% slope learning curve (fig. 23).

Fan Rotor Assembly. - The variable pitch fan rotor assembly generalized cost equation shown in Table VI was derived from cost analyses of design sketches reflecting the same design concepts and materials used in the previous advanced propeller study (ref. 3). Number of rotor blades is the basic parameter as modified by empirical factor E, and first unit cost and configuration factor, F. The 1970 F and E factors can be used in 1980 for all categories if solid aluminum blades are desired. Modification of 1980 E factors is shown for categories IV and V to reflect the cost increase for fiberglass shell blades. Fiberglass shell blades were not considered for 1970 fans since present costs were considered prohibitive for the general aviation market.

Z is the adjustment for producing a quantity of units and is presented in Table VII. As was stated previously, it is based on an 89% slope learning curve. The quantity of Q-Fans to be manufactured corresponds to the estimate of the number of propellers to be produced in reference 3.

The fixed pitch fan rotor assembly generalized cost equation is shown in Table VIII for categories II, III and IV and is identical to the variable pitch cost equation of Table VI except for higher F factors. Fixed pitch fan costs per pound are somewhat higher than variable pitch since the cost per pound of the eliminated pitch change components are less than the remaining blade and barrel costs. However, the total fixed pitch fan rotor assembly cost is less due to the significant reduction in total weight.

Duct and Mount Assemblies. - Duct and mount assembly costs were also analyzed on a component basis resulting in a first unit cost/pound. Since the materials and design concept of these assemblies is the same for all categories, the first unit cost/pound is the same for all categories (Table IX). Average cost for a number of units

per year will vary with the Z factor which is dependent upon quantities manufactured. Again the Z factors are based on the 89% slope learning curve of figure 23.

When a gearbox is to be used, the cost of the mount is computed along with the gearbox cost as defined in the section on gearbox generalizations.

Since the costing was defined on the basis of the modular assemblies, the cost equation will be applicable for pusher as well as tractor configurations.

The cost equations have been computerized with learning factors associated with the 89% slope learning curve of figure 23. The user may substitute any other desired learning curve relationship.

Approximate cost reductions of representative fixed pitch over variable pitch Q-Fan assemblies in categories II through IV are shown below for activity factor/blade in the 200 range:

<u>Category</u>	<u>Diameter Range (ft.)</u>	<u>Cost Reduction Range (%)</u>
II	2.5 - 3.0	25 - 20
III	2.5 - 3.0	32 - 27
IV (aluminum - 1970)	2.5 - 3.5	32 - 24
IV (fiberglass - 1980)	2.5 - 3.5	24 - 17

GEARBOX GENERALIZATIONS

This section includes the noise, weight and cost generalizations made for gearbox assemblies.

Gearbox Noise

Gear noise is the result of periodic impacts of gear teeth during normal operation of a set of mating gears. The gear vibrations which are caused by these impacts may radiate sound directly or may create vibration energy which is transmitted through the gear shafts to the gearbox enclosure where it is radiated as sound. Design and fabrication details can influence the level of noise produced. For example, imperfectly matched gear teeth will produce more noise than perfectly machined teeth which result in lower impact levels on contact due to a rolling rather than impacting motion. For purposes of the study reported here a mean level for gearbox noise was used which assumes a single stage of reduction, and average quality gears. If gear noise at high engine powers were found to be a problem in any particular installation, more attention to design details and manufacturing tolerances might produce a gearbox with a lower noise level. For instance, it has been shown that bevel or herringbone pattern gear teeth, which include more rolling or sliding motion in the power transmission, are quieter than spur gears which create considerable gear tooth impact noise.

Figure 24 shows the gearbox noise generalization based on available test data. In general, it will be found that gearbox noise is not significant unless substantial suppression of engine and fan noise is included in the propulsion system. The corresponding dB(A) values may be approximated by subtracting 11 from the estimating PNdB values.

Weight

The gearbox assembly includes housing, bearings, tail shaft, afterbody, listed for the mount assembly on figure 25 and a single or two-stage concentric drive gear train with lubrication and scavenge pumps. Input drive shafting weight is dependent upon engine proximity and is not included in the generalized weight equation.

The assumption was made in this study that any drive gearing required for piston engine applications with a gear ratio of less than 2 would be supplied by the engine manufacturer as in present geared engines. The weights associated with geared piston engines would then be used, as required, and the mount assembly weight associated with the Q-Fan would also be used (fig. 22). The concentric gearboxes for which the weight equation was derived applies to applications requiring a gear ratio greater than 2. The gearbox can either be engine or fan-mounted depending upon the best location for optimum system weight. If the gearbox is engine-mounted with the engine mounted remote from the fan, the fan mount assembly weight must also be included.

Derivation of the weight equations shown in figure 25 is based on actual weights of gearboxes manufactured by Hamilton Standard and other manufacturers of engine gearboxes. Weight varies as a function of output torque and is represented in terms of power, fan diameter and tip speed. The equation for single-stage gearing is applicable to gear ratios between 2 and 5 and the two-stage gearing equation applies to gear ratios between 5 and 20. Afterbody weight is a function of fan diameter squared.

Cost

Gearbox costs were based on actual O. E. M. prices listed by manufacturers of engine gearboxes. The cost equation shown in Table X is presented in terms of first unit cost/pound for both the single and two-stage concentric gearboxes reflecting the added complexity of the latter. Z factors are shown in Table VIII and are based on an 80% slope curve (fig. 23).

ENGINE GENERALIZATIONS

The pertinent engine parameters required for the parametric and conceptual design studies are 1) performance (part throttle power, power at altitude, specific fuel consumption), 2) weight, 3) cost, 4) noise and 5) dimensions (maximum width, height, and length).

The Systems Study Division of NASA Ames has developed a generalized model for piston engine data using published data from the engine manufacturers for the performance, weight and dimensions. Details of the generalization are presented as Appendix C.

Weight and dimension data for rotary combustion engines were developed by Curtiss Wright for use in this study. These data were for two levels of technology-near term which represented the engines now being developed at Curtiss Wright and post 1980 advanced technology engines. The non-proprietary portions of the Curtiss Wright data are given in Appendix C. Engine performance characteristics for rotary combustion engines are assumed identical to that for piston engines.

A third set of data, also developed at NASA Ames, is given in Appendix C for gas turbine (turboprop/turboshaft) engines. Engine performance is not given since it is very dependent on the choice of engine cycle. The weight and dimension data are generalized using both U. S. and foreign engines.

Engine costs for each engine type has been documented in reference 2 and the data is included in Appendix C.

The assumption used in estimating the specific weight of piston engines for both 1975-1980 and the post 1980 time periods are listed in Table XI along with the resulting specific weights estimates. These estimates can be compared with the specific weight of typical current production engines also listed in Table XI. The estimates of rotary combustion engine specific weight used in the study are given in Table XII.

Engine Noise Generalization

As shown in figure 26 four noise sources are prominent in engine noise: exhaust noise, intake noise, case radiated noise, and gearbox noise.

The primary sources of exhaust noise for piston and rotary combustion engine are similar in that they are due to the release of puffs of gas into the atmosphere at considerable pressure as the exhaust valves open. Secondary sources in exhaust noise are due to air flowing through exhaust components such as manifolds, pipes and bypass valves. The source of gas turbine exhaust noise is more complex than that of internal combustion engines. Available evidence indicates that the primary source of this noise is turbulence generated by compressor and turbine blade interacting with gases flowing through the engine and by interaction of the high velocity gases passing through the engine and the surrounding walls. Noise due to combustion and jet noise at the outlet are also contributors but are probably of a lower level than turbulence sources generated by the compressors or turbines.

The source of intake noise of piston and rotary combustion engines is similar to that of exhaust noise but because of the lower pressures involved with intake flows, the level of intake noise is less. In gas turbine engines the primary noise is usually interaction between the gas flows through compressor blades and inlet guide vanes or stators which produces tones primarily at frequencies related to rotational speed times number of compressor blades, and to a lesser extent at frequencies related to rotational speed and its harmonics.

Case radiated noise is the portion of the total noise signature left after intake and exhaust are completely muffled. In piston or rotary combustion engines a significant source of case radiated noise is the ignition of the fuel within the engine which is a source of sound as these pulses are transmitted through the walls of the engine. Piston, rotor, valve and accessory component motions also contribute to case radiated noise of internal combustion engines. Case radiated noise of gas turbine engines has the characteristics of intake and exhaust noise, however, case radiated noise tends to have a more broadband character and to be dominant at lower frequencies due to the normally greater high frequency attenuation by the walls of the engine.

Engine Noise Methodology. - Piston engine noise generalizations have been based on work reported in reference 12. In this reference the little available test data were generalized to produce a spectrum shape and a sound power level as a function of important operating parameters. The data on spark ignition piston engines were found in reference 12 to be so limited that the generalization presented was based on diesel engine data. However, the similarity of the two types of engines indicates that the generalization should be valid. In the case of the rotary combustion engines the information from references 12 and 13 was used in the generalizations. From the trend curves and spectrum shapes of references 12 and 13 the noise level of each of the engine sources was generalized to produce the curves of figures 27 and 28. It should be noted in these curves that the intake noise levels are not muffled but do include the effect of a standard air cleaner which does provide some muffling. It is believed that these air cleaners reduces intake noise by about 10 PNdB.

Figure 27 shows the source noise levels of water cooled rotary combustion engines. It can be seen that exhaust noise substantially dominates inlet or case radiated noise. Therefore, suppression of exhaust noise can greatly benefit the total noise of this type of engine. Figure 28 shows the noise of piston engines. Two points should be noted in this figure as compared with the levels of figure 27. First, the exhaust noise of piston engines is slightly lower than that of rotary combustion engines. Second, the case radiated noise of a piston engine is substantially higher than that of the water cooled rotary combustion engine. The higher level of the piston engine case radiated noise is due to the fact that the piston engines used in general aviation aircraft are air cooled and therefore the engine walls are thinner, hence they transmit noise more easily than the engine walls of rotary combustion engines, which include a water jacket for cooling. From these observations it can be concluded that the noise of rotary combustion engines can be suppressed to a lower level than that of the piston engine before additional treatment of case radiated and intake noise is required.

The complexity of the mechanisms of noise generation of the gas turbine engine and the lack of detailed information on the influence of various design parameters prevented separation of intake, exhaust and case radiated noise in the current study. However, information was available from various engine manufacturers on the maximum sideline noise of various engines as a function of shaft power (fig. 29). In most cases, inlet noise is dominant in these turboshaft engines. An examination of figure 29 indicates that the level of unsuppressed turboshaft engines is generally lower than that of piston or rotary combustion engines.

The dB(A) value can be approximated by subtracting the following number of dB from the PNdB values

- 12 for piston engines
- 11 for water cooled rotary combustion engines
- 12.5 for gas turbine engines

Engine Noise Suppression Methodology. - To reach a noise goal of 95 or 85 PNdB inspection of the engine noise curves of the previous section will show that exhaust noise suppression is required for the piston and rotary combustion engines. For the gas turbine engines suppression is required to obtain a noise goal of less than 90 PNdB. The two forms of muffling from reference 13 which are shown schematically in figure 30 can be used in various combinations. The first of these is the manifold muffler. This consists simply of a tube of some finite length and diameter where tubes from the exhaust of each cylinder terminate. The second of these is the resonator muffler. This is simply an enlarged section of tubing which is attached downstream of the manifold muffler. Figure 31 summarizes the design curves for these two mufflers.

For the manifold muffler the information in figure 31 shows that a maximum of 16.5 PNdB reduction can be achieved with a value of 8 for the ratio of muffler volume to the volume of one cylinder of a reciprocating engine or to one chamber of a rotary combustion engine. This assumes that the ratio of length to diameter of the manifold muffler is 3.

For the resonator muffler the information in figure 31 shows that higher levels of attenuation can be achieved than that provided by the manifold muffler. The noise reduction of the resonator muffler is a function of expansion ratio of the muffler (ratio of the cross-section area of the muffler to the cross-section area of the pipe entering the muffler). And thus, the graph in figure 31 is plotted as a function of resonator volume to the square of engine exhaust pipe diameter. It is assumed that the ratio of muffler length to diameter is 4. It can be seen that the increase in noise reduction is quite rapid up to expansion ratios of about 200 inches (508 cm). At higher expansion ratios the increase is much less dramatic and it does not appear worthwhile to use expansion ratios above 600 inches (1524 cm). Also, the effect of these large expansion ratios on weight and volume must be considered.

Based on the above configurations, muffler weights can be found for various engine horsepowers as shown in figure 32 for piston engines and figure 33 for rotary combustion engines. The manifold muffler was selected for the engine noise reduction up to 16.5 PNdB because of its weight advantage. For further noise reduction, a combination of manifold and resonator mufflers was selected. The regions where one and two mufflers are required are presented in figures 32 and 33. It can be seen in both figures that as the noise level for the propulsion system is lowered the muffler weight increases in a geometrically proportional manner to the point where meeting a lower noise target would require the introduction of additional suppression for the case radiation and inlet noise. This additional weight and complexity has not been included in the present study.

Estimates of gas turbine engine noise reduction due to an exhaust muffler have been made and the results are presented on figures 34 and 35. The engine exhaust PNL attenuation is shown plotted against the non-dimensional muffler length to passage height ratio (fig. 34). The estimated dimensions for two muffler configurations with and without a centerbody are shown on figure 35. These dimensions are based on an exit area requirement of 0.1 square inches (0.645 cm^2), thus the centerbody is 4 inches (25.8 cm^2) in diameter. Also, the passage height to be used in figure 35 is D_1 for configuration 1 (without centerbody) and H_2 for configuration 2 (with centerbody). Suppression of gas turbine engine exhaust noise which is broadband in nature requires installation of large diameter exhaust pipes lined with acoustic materials which will withstand the high velocities and high temperatures of the turbine exhaust. Although no weight estimate of the mufflers for the turboshaft has been made for this study, it is believed that there may be a larger weight and cost penalty than that which results from installation of mufflers on piston or rotary combustion engines.

Indications are that the muffler effect on engine performance will be small. This effect is not included in the study. Furthermore, establishing the cost of engine muffling is also considered beyond the scope of this study.

COMPUTER PROGRAMS

The Q-Fan, engine and gearbox generalizations described in the previous text have been computerized and included in two computer programs. The Q-Fan generalizations have been presented in a Q-Fan computer program which can be used in preliminary sizing of Q-Fans for specific applications. The Q-Fan, engine, and gearbox generalizations have been included in the NASA airplane synthesis program which can be used in the rapid evaluation of the trade-offs between configuration parameters, propulsion systems, vehicle performance, and technology advances in an efficient manner. Both computer programs are described in the following text.

Q-Fan Computer Program

The performance generalizations for Q-Fans and the corresponding noise, weight and cost generalizations have been combined in a Q-Fan computer program. With this computer program, the aforementioned Q-Fan characteristics can be readily calculated for a range of Q-Fan geometries and operating conditions.

The required inputs are the following:

Q-Fan

1. Diameter range
2. Total activity factor range (activity factor x number of blades)
3. Variable pitch or fixed pitch rotor
4. Area ratio range
5. Gearbox option

Operating condition (maximum of 10)

1. Power or thrust or blade angle
2. Altitude
3. Velocity
4. Temperature, °F
5. Pressure
6. Tip speed range

Other

1. Airplane classification
2. Performance computation options
3. Cost computation options

As was described in the section on noise generalization, for a given total activity factor, the corresponding activity factor, number of blades and shroud length to rotor

diameter ratio are selected to give minimum noise for a given tip speed. The computer program automatically selects these Q-Fan characteristics for a given total activity factor and tip speed.

There are three performance computation options available: 1) if an engine is known, then the operating condition is defined with the power and the corresponding thrust and blade angle are computed, 2) if a Q-Fan thrust requirement is known, then the operating condition is defined with thrust and the power and blade angle are computed, 3) for fixed pitch application the operating condition is defined with the blade angle and the corresponding power and thrust are computed. Cost can be computed based on the 89% slope learning curve and the unit costs and quantities selected by Hamilton Standard from available surveys as discussed in the cost generalization section. There are the options of varying learning curve, unit costs, and quantities.

A sample print-out is included as figure 36. The initial input prints out as well as the Q-Fan parameters number of blades, activity factor and duct length/rotor diameter ratio corresponding to the input values of total activity factor and tip speed. Performance prints out for all the conditions and there is the additional print-out of noise, weight and cost for the 66 knot (34 m/s) operating conditions.

The program is coded in FORTRAN IV and has been run on an IBM System/370. Approximately 500 performance points can be computed per minute. A list of the program and pertinent input-output instructions are included as Appendix D.

Aircraft Synthesis Program

The NASA has developed a synthesis program used for aircraft design and mission performance prediction, (ref. 14). The Q-Fan, engine and gearbox generalizations described previously have been included in this program.

The program works on a given aircraft gross weight as a fixed input; a major sizing loop lays out the fuselage for a given number of seats, the wing for a given wing loading, and the tail sizes for required tail volume coefficients. Engines are sized to match thrust and drag at cruise with some rate of climb margin to provide a service ceiling, but the engines are resized if FAR climb performance is not met or a required takeoff distance is not achieved. Completion of the sizing loop determines the weight of fuel available to fly the mission.

The mission performance loop includes taxi, takeoff, climb and cruise segments and the range attainable with the available fuel is determined. If specified, the program will iterate on gross weight through the complete synthesis to match a desired value of range. Finally, an estimation is made of aircraft first cost and operating costs based on the aircraft weight statement, rates for overhaul and maintenance costs, and annual utilization.

The required inputs are the following:

1. Gross weight and payload
2. Number of passengers and seating arrangement
3. Aspect and taper ratios, sweeps, thicknesses and incidence
4. Tail volume coefficients (optional)
5. Flight conditions and requirements
6. Field length
7. Type of high lift devices
8. Configuration indication

The program is coded in FORTRAN IV and has been run on an IBM System/370. The normal computational time is about 4 minutes for a Q-Fan configuration with iterations on gross weight to meet a specified range.

PARAMETRIC STUDIES

Prior to discussing the complete aircraft system study, it is appropriate to preview the general characteristics of the Q-FAN propulsion system. The Q-FAN computer program in conjunction with the engine generalizations was used to study Q-FAN propulsion systems and the NASA synthesis program was used to evaluate the configuration, performance, and cost trends of the complete aircraft system. For the Q-FAN propulsion system studies, the design criterion was selected to be either a given thrust requirement at 66 knots 34 m/s typical of lift off or a given engine size. For the aircraft system study, the design criterion was gross weight, thrust and drag at cruise, FAR climb performance, and take-off distance.

Both the Q-FAN propulsion system study and the complete aircraft system study were based on variable pitch Q-FANS in order that the best performance would be obtained. It is realized that reductions in Q-FAN weight and cost may be attained at some sacrifice in performance by using fixed pitch Q-FANS. Although not included within the scope of this study, all the pertinent data is available to permit the investigation of fixed pitch Q-FANS.

Q-FAN Propulsion System

The propulsion system parametric studies have been conducted for the 1980 time period. Performance, noise, weight and cost were evaluated for the isolated Q-FAN/engine package. As previously stated, the drag of the engine cowling is not included. A comprehensive study was conducted for a 4-6 seat light twin engine aircraft incorporating Q-FAN/piston engine and Q-FAN/rotary combustion engine propulsion systems. While the weight and size of the gas turbine engine make it an attractive power plant, it is not expected to be cost competitive with the other two engine types even into the 1980's for this aircraft class. Accordingly the Q-FAN/gas turbine engine has not been covered in the detailed evaluation of this section. However it has been included later in the study of the complete aircraft system to provide a comparison of the Q-FAN/turboshaft engine with the piston and rotary combustion engine types as applied to the light twin aircraft. Since time permitted less extensive studies of a heavy twin engine aircraft and a single engine aircraft, only the Q-FAN rotary combustion engine propulsion system was studied. The gas turbine engine would be applicable for the heavy twin classification. Although gas turbine engine weight, cost and dimension generalization are presented in Appendix C, a satisfactory engine performance generalization has not yet been worked out due to the complex characteristics of the turbine engine cycle. Therefore, further data than presented in this report is required to study the Q-FAN/gas turbine propulsion package.

Light Twin Engine Aircraft. - For the study presented herein, propulsion systems applicable to a 4-6 seat light twin-engine aircraft typical of a category III aircraft (Table I) in the 1980's time period were considered. The sizing criteria were a representative lift off condition of 880 pounds (3914N) of thrust/nacelle at 66 knots (34 m/s) sea level, standard day and a cruise condition of 0.33 Mach number at 15,000 feet (4580 m) altitude with 75% power and 90% speed. The engines were assumed to be supercharged. All Q-FANS had duct acoustic treatment which reduces Q-FAN noise by 4.5 PNdB. Engine mufflers were included wherever necessary to reduce engine noise to the Q-FAN noise level. When combining two (approximately equal noise source) the combination results in a 3 PNdB higher noise level. The shaft power required to produce 880 pounds (3914N) of thrust was computed for a number of Q-FANS varying in diameter from 2.5 (0.76) to 4.5 feet (1.37 m) over a range of total activity factors and tip speeds. The corresponding noise levels and propulsion system weight and costs were also calculated. A sample plot is presented in figure 37 for the 3.5 foot (1.07 m) rotor diameter Q-FANS combined with rotary combustion engines of the 1980's time period. The Q-FAN total activity factor is also included on these plots. The breakdown of TAF to activity factor per blade and number of blades can be obtained from figure 38. It should be noted that the data is presented for a Q-FAN single nacelle. Obviously, for two nacelles the power, weight and cost must be doubled while the noise level is increased by 3 PNdB ignoring any shielding effects from the aircraft itself. Furthermore, it is shown in figure 33 that additional engine muffling for case radiated and inlet noise is required to attain noise levels below 76 PNdB/nacelle. An inspection of the curve at 92 PNdB (95 PNdB for 2 nacelles) shows that 344 SHP (257 kw) at a tip speed of 750 ft/s (228 m/s) is required. A 10 PNdB reduction (85 PNdB level) is attainable with essentially the same power plant by reducing the tip speed to 650 ft/s (198 m/s). For the 3.5' diameter Q-FAN this is accomplished at a 14% increase in weight and a 17% increase in cost. This weight and cost increases are essentially due to the higher total activity factor (increased blade width and/or number of blades) required to meet the performance at the reduced tip speed. Moreover, noise reductions of up to 17.4 PNdB are attainable, albeit at further increases in weight and cost.

Similar plots were made for Q-FAN rotor diameters of 2.5 (0.76), 3.0 (0.91) and 4.5 feet (1.37 m) with rotary combustion and piston engines. For each of these diameters, the optimum Q-FANS was selected for a range of PNdB levels. The corresponding horsepowers, weights, costs and tip speeds are shown on figure 39 for the Q-FAN/rotary combustion engine. This plot shows the very strong effect of diameter on the propulsion system characteristics. It is apparent that as propulsion package diameter is reduced the power plant size and system weight grow nonlinearly whereas the weight is reduced. Cruise thrust on the other hand increases significantly as Q-FAN diameter is reduced due primarily to the increase in the engine size required for T.O. Moreover, reducing perceived noise level for a given diameter results in similar trends with noise levels of as low as 75 PNdB (2 nacelles) being attainable albeit with increased cost in nacelle weight and cruise performance. Of course, increased cruise thrust could be obtained with increased power.

A comparison of figures 39 and 40 shows similar engine size, cost and cruise performance trends for both the Q-FAN/rotary combustion engine and Q-FAN/piston engine propulsion packages. The weight variation differs since the weights of the Q-FAN/piston engine propulsion system increases with increased diameter. The weight and cost of the piston engine propulsion systems are greater than those of the rotary combustion engine propulsion systems.

Using a typical present day propeller as a reference, a detailed propulsion system comparison is shown in Table XIII for a 3.0 foot (0.91 m) diameter Q-FAN combined with a piston engine and a rotary combustion engine. Using a typical present day propeller/piston engine propulsion system as a reference, a detailed propulsion system comparison was made with 3.0 foot (0.91 m) diameter Q-FAN/piston and Q-FAN/rotary combustion propulsion systems (Table XIII). Performance, noise, weight and cost are presented for the propulsor, engine and propulsion system. An inspection of the propulsion system summary of Table XIII shows that the Q-FAN propulsion systems are 18 PNdB quieter and that the Q-FAN/rotary combustion engine propulsion system has essentially the same performance, weight and cost of present day propulsion system, albeit with a larger sized engine. Examining the detailed characteristics it can be seen that the weight and cost of the Q-FAN propulsor in the 1980's are significantly higher than the present day propeller. However, the Q-FAN is 20.5 PNdB lower in noise. Taking advantage of the faster turning piston engines expected in the 1980's, the corresponding geared and muffled piston engine is only 10% heavier than the current engines even though the engine power is increased 35%. However, the larger engine required is costlier. On the other hand, the rotary combustion engine is 37% lighter and less expensive than the present day propeller piston engine configuration. It can also be seen that the engine noise of the piston engine has been reduced 12 PNdB by muffling while the equivalent muffler on the rotary combustion engine reduces the level by 19 PndB. For either engine, the cruise performance is slightly better because of the higher installed power.

It should be noted that interference losses between the propulsion system and aircraft have been neglected. Historically, this interference effect has been difficult to quantify. However, it is obvious that the compactness of the Q-FAN offers the potential of positioning this propulsion system more favorably than the propeller engine propulsion system. Thus it is expected that the interference losses will be significantly lower for the Q-FAN propulsion system than for the propeller propulsion system. Therefore, the installed propulsive efficiency of the Q-FAN may in fact be much closer to that of the propeller than the isolated performance comparison would indicate. Since it may have an important influence on propulsive efficiency, the interference losses need to be evaluated for both propulsion systems by wind tunnel and/or flight tests on appropriate general aviation aircraft.

Heavy Twin Engine Aircraft. - Although this case has not been studied as extensively as the light twin aircraft a propulsion package parametric study similar to the one previously described for the light twin engine aircraft was made for a representative heavy twin engine aircraft of airplane classification V (Table I). The design criteria was a 1500 pound (6672 N) thrust requirement per nacelle at 66 knots (34 m/s) and a cruise speed of 0.4 Mach number operating at 75% power and 90% of speed at 20,000 ft (6100 m).

A diameter, tip speed and total activity study was made for supercharged rotary combustion engines of the 1980 period. From this study, the optimum propulsion packages were selected for noise levels per nacelle of 82 and 92 PNdB (85 and 95 PNdB / aircraft) respectively. A 600 (447) to 800 SHP (596 kw) range was selected as reasonable engine sizes for this airplane. Power, weight, cost, cruise performance, tip speed and total activity factor were plotted versus diameter (fig. 41) for range of 3.0 (0.91) to 4.5 feet (1.37 m).

An inspection of figure 41 shows that as diameter is reduced from 4.5 ft. (1.37 m), the power, weight, cost and cruise performance increase for both noise levels. For each 0.5 feet (0.15 m) reduction in diameter, engine size (power) is increased about 12% with a corresponding 14% increase in cruise thrust due to the power increase. For a fan diameter range of 3.5 (1.07) to 4.5 feet (1.37 m), the weight would remain the same and the cost would increase 4% for each 0.5 feet (0.15 m) reduction in diameter. For diameters less than 3.5 feet (1.07 m), the weight increases 8% and the cost 16% per 0.5 foot (0.15 m) reduction in diameter.

The reduction in noise level per nacelle from 92 to 82 PNdB is obtainable at each diameter by increasing engine size (power) 3%, propulsion package weight 15% and cost 4% and increasing cruise performance approximately 3%.

Single Engine Aircraft. - For the study of Q-FANS for a hypothetical single engine aircraft for airplane classification II (Table I), the constraints of a specified 400 SHP (298 kw) rotary combustion engine size and a Q-FAN diameter of 2.5 ft. (0.76 m) were imposed. With these constraints, a tip speed and total activity factor study was made. Thrust at 66 knots (34 m/s) take off and at 0.28 Mach number cruise, Q-FAN propulsion package weight and cost, and rotor total activity factor were plotted versus noise level (PNdB) at constant tip speeds (Fig. 42).

An inspection of figure 42 shows that the optimum Q-FAN configuration from the standpoint of performance, weight and cost for 95 PNdB is a low total activity factor Q-FAN operating at 800 ft/s (244 m/s). An 85 PNdB level is attainable by reducing tip speed to 575 ft/s (175 m/s) and increasing total activity factor 80%. The 10 PNdB reduction is attainable by using the same engine and Q-FAN diameter at the expense of reducing performance 1%, and increasing weight 7% and cost 5%. Further noise reductions are attainable at additional losses in performance and increases in weight and cost.

Preliminary Aircraft Designs

Having presented this general picture of the Q-FAN, its current development status, performance and geometric characteristics and its interesting potential as a quiet propulsor for advanced general aviation aircraft, the next step is to look at the configuration, performance, and cost trends of the complete aircraft systems with variations in Q-FAN and engine geometric parameters for several levels of perceived noise to provide at least a preliminary picture of the aircraft propulsion concepts required for improved quiet general aviation aircraft for the 1980 time period.

S. S. D. at NASA Ames has conducted such a study of two aircraft to demonstrate the potential of Q-FAN propelled light aircraft--a six-passenger pressurized twin-engine aircraft of airplane category III and a four-passenger unpressurized single-engine aircraft of airplane category II. Pertinent design parameters are listed in Table XIV. The twin-engine aircraft is essentially a modified version of the Cessna Model 340. However, the single-engine aircraft is purely conceptual and has the following distinguishing design features: high wing, engine located directly behind the cabin with the Q-FAN as a pusher in line with the engine, and the tail supported by a boom tied directly to the wing and cabin structure above the engine and fan.

The major changes from the Model 340 design for the twin-engine aircraft are the wing loading, the wing location, the engine location, and the tail size. The engines are supported off the aft fuselage, and with this shift in weight, the wing is moved aft to provide for longitudinal stability. Removing the engines from the wings affects the estimation of wing weight in that the engine weight no longer provides a relieving load to the lift on the wing. Tail volume coefficients are predicted from empirical correlations involving the length, width, and height of the fuselage and the area, mean chord, and span of the wing.

Wing location and tail sizing was done in the same manner for the single-engine aircraft. Aircraft length is a fixed input and thus the length of the tail boom is determined in the iteration to locate the wing.

For both aircraft, a plain flap system was chosen as a baseline. However, it is recognized that a flap system providing a higher maximum lift coefficient is desirable for aircraft with higher wing loading (ref. 16). The advantage is using a single Fowler flap is demonstrated for the twin-engine aircraft.

In sizing the engines at cruise, the engines were assumed to be at 80% maximum power and 90% maximum RPM. The engines were resized if necessary to meet FAR Part 23 climb requirements.

Key Q-FAN design parameters are the fan tip speed and the total activity factor (activity factor per blade x number of blades). A criteria has been developed for selecting the number-of-blades/blade-activity-factor combination which, for a specified

total activity factor and tip speed, will minimize noise while not affecting efficiency (fig 38). The corresponding fan duct length/diameter ratio has also been established by these criteria (fig. 38). The nominal value for the number of blades was selected as 8; 6 and 10 blades were also investigated. It should be reemphasized that for a specified tip speed, each blade number corresponds to a specified total activity factor, i. e., blade number cannot be varied independent of the activity factor per blade. The fan area ratio was held constant at 1.0 which is assumed to be acceptable for the flight speeds used in this study (less than 250 knots (128 m/s)). All the results presented are for variable pitch fans. Q-FAN performance includes internal duct losses and external losses due to shroud drag. Skin friction drag on the engine nacelles is accounted for in the synthesis program, but engine cooling air drag is not.

Wing Loading. - As pointed out in reference 16, almost all current light aircraft are designed with a wing loading much too low for optimum cruise performance. Introduction of higher wing loadings will require high lift flap systems to maintain touchdown speeds and required field lengths at acceptable levels. The necessary high lift technology is modest compared to current transport designs and is now available for adoption into general aviation. The current progress made in this area is described in reference 16. Thus it was felt reasonable to optimize wing loading for good cruise performance, and a brief study was made for the two chosen aircraft to establish the proper wing loading at each cruise speed.

The results are given in figure 43 for both the single-engine aircraft and the twin-engine aircraft. The data for constant wing loading at increasing cruise speed is cross-plotted to give schedule of near optimum wing loading with cruise speed. The single-engine aircraft varies in wing loading from 38 (1815) to 48 psf (2295 N/m²) as cruise speed increases from 150 (77) to 200 knots (103 m/s) true air speed at 10,000 feet (3048 m) altitude, and the twin-engine aircraft varies in wing loading from 40 (195) to 48 psf (2295 N/m²) as cruise speed increases from 180 (92) to 240 knots (123 m/s) true air speed at 20,000 feet (6076 m) altitude.

To take full advantage of aerodynamic performance with increasing speed, the cruise altitude should be increased to fly closer to maximum lift-drag ratio. Practical considerations usually make this not feasible. For the single-engine aircraft, higher altitude would require cabin pressurization; and for the twin-engine aircraft, it is doubtful if full power could be economically achieved with supercharged engines at altitudes above 20,000 feet (6076 m).

Twin Engine Aircraft Mission. - The results shown in figure 44 for the six-place pressurized twin-engine aircraft are for a payload of 600 lbs. (272 g) and a range of 1000 n. mi. (1853 km). This payload corresponds to three passengers plus their baggage. The pilot and his baggage are accounted for as useful load rather than payload. These results are for cruise speeds from 180 (92) to 240 knots (123 m/s) true air speed and a direct comparison is made between piston engine powered aircraft, rotary combustion powered aircraft and turbine powered aircraft. It is assumed that the supercharged engines (piston and rotary combustion engines) maintain full sea level power

up to the 20,000 feet (6096 m) cruise altitude. As previously discussed the gas turbine engine performance was not generalized due to its complexity. Thus, the gas turbine engine performance was attained by adapting the Garrett AiResearch TPE331-1 engine performance into the synthesis program in a form that would permit engine scaling. The engine was assumed to be a turboshaft engine with the gearbox as a part of the Q-FAN. It should be noted that the gas turbine engines do not maintain the sea level power at altitude as do the supercharged piston or rotary combustion engines. Moreover, the TPE331 engine cycle is not necessarily the optimum choice for this aircraft mission. The level of technology is the 1975-80 time period.

The effect of cruise speed on the size of the aircraft is not surprising. This effect is more pronounced for the piston engine aircraft due to an increase in engine specific weight for piston engines above a rated power of 300 SHP (224 kw). Although the larger nacelles required for the piston engine create additional skin friction drag, the primary difference in the aircraft gross weights is due to the difference in engine specific weight between rotary combustion and piston engines. The gas turbine engine powered aircraft is the lightest of the three engine sized aircraft (fig 44) even though the gas turbine engine rated sea level power is considerably higher than the supercharged rotary combustion and piston engine powered aircraft. The aircraft are sized by cruise requirements and for the gas turbine powered aircraft, it results in sea level powers which are considerably more than those required by the piston and rotary combustion engine powered aircraft. The inherent low specific weight of the gas turbine engine accounts for this trend. As a reference point, the current Cessna Model 340 is listed at 5975 lbs. (2710 kg) gross weight and cruise at 210 knots (108 m/s). At this speed, the aircraft-with Q-FAN's and rotary combustion engines is at 6100 lbs. (2760 kg) gross weight, the aircraft with Q-FAN's and piston engines is at 7200 lbs. (3260 kg) gross weight and the aircraft with Q-FAN's and gas turbine engines is at 5650 lbs (2560 kg).

The Q-FAN/rotary combustion engine powered aircraft is the least costly as can be seen on figure 44. Although the gas turbine engine aircraft is more costly than the piston engine aircraft, at the higher speed range, the trend is reversed.

Also shown on figure 44 are the takeoff and landing performance assuming a plain flap over 60% of the wing span. In each case the takeoff distance to clear 50 feet (15 m) is less than 3600 feet (1100 m). As cruise speed increases the aircraft power loading increases, which would tend to reduce takeoff distance. However, the increase in wing loading has the opposite effect thus creating a bucket in the curves. The greater lapse rate of the gas turbine engine results in shorter take-off distances. Landing distance and touchdown speed both increase with the higher wing loading. The landing distance from 50 feet (15 m) altitude is less than 2500 feet (762 m), well below the takeoff distance. However, the touchdown speed varies from 100 (51) to 110 knots (57 m/s)-- considered to be too high for this class of aircraft.

As discussed in the section on wing loading, high lift flap systems will be needed for high wing loading aircraft. The full span single Fowler flap described in reference 16 was simulated in the synthesis program and the results are shown in figure 44 for the aircraft designed to cruise at 210 knots (108 m/s). Takeoff distance is reduced from 3260 feet (990 m) to 2600 feet (790 m), landing distance is reduced from 2160 feet (440 m) to 1940 feet (590 m), and most important, touchdown speed is reduced from 101.5 (52) to 91 knots (47 m/s).

Single Engine Aircraft Mission. - The results shown in figure 45 for the four-place unpressurized single-engine aircraft are for a payload of 400 lbs. (181 kg) and a range of 850 n. mi. (1580 km). Results are for cruise speeds of 150 (77) to 200 knots (103 m/s) true air speed at 10,000 feet (3048 m) altitude. Both non-supercharged and supercharged engines are used with an assumed level of engine technology in the 1975-1980 time period.

The comparison between rotary combustion powered aircraft and piston powered aircraft exhibits the same trend as for the twin-engine aircraft-- the higher engine specific weight penalizes the piston engines. Also shown are comparisons for supercharged and non-supercharged engines. For the rotary combustion engines, the constant power of the supercharged engine up to cruise altitude, which results in a lower sea level horsepower rating, is almost exactly offset by the additional weight of the turbo-supercharger. The result is virtually the same aircraft gross weight at a given design cruise speed for either rotary combustion engine type. However, for the piston engines there is a definite advantage for a supercharged engine due to the lower sea level horsepower rating.

Takeoff and landing performance are also shown on figure 45 and landing performance is quite similar to that shown for the twin-engine aircraft using plain flaps. Takeoff performance varies considerably between supercharged and non-supercharged engines due to the differences in the aircraft power loading. Although not shown, takeoff and landing distances and touchdown speed would all be reduced by approximately the increment shown in figure 44 if the Fowler flap were employed rather than the plain flap.

Effect of Q-FAN Design on Fan Noise. - As stated in the introduction, the major impetus for considering Q-FAN propulsors for general aviation is the potential for low noise. All aspects of the Q-FAN are involved in the design for low noise--tip speed, rotational speed, blade activity factor, number of blades, and shroud length to diameter ratio. Criteria have been developed to select the blade activity factor and the shroud length-diameter ratio based on the fan tip speed and the number of blades. Thus the design variables used in this study to affect noise were the maximum allowable fan tip speed, the fan RPM, and the number of blades.

The rotary combustion twin-engine aircraft was chosen to demonstrate the design tradeoffs used in Q-FAN design for low noise. An eight-bladed fan having a maximum RPM of 4500 and a maximum allowable tip speed of 800 fps (244 m/s) was chosen as the reference point, and the measure of system performance is the effect on cruise

range. Note that the maximum tip speed for this fan, chosen for maximum cruise efficiency, was actually 775 fps (236 m/s), slightly less than the maximum allowable. The reference aircraft cruises at 210 knots (108 m/s) over a range of 1000 n. mi (1552 km). The point of noise measurement was selected at 500 feet (153 m) sideline at sea level takeoff. The aircraft is assumed to be at 0.1 Mach number and out of ground effect.

The data in figure 46 are for reduced fan rotational speed, down to 3000 RPM, and for 6-, 8-, and 10-bladed fans. Noise is reduced for both an increased number of blades and decreased rotational speed. At each point the fan diameter and thus the fan tip speed is found which maximizes propulsive efficiency with the constraint of not exceeding 800 fps (244 m/s). This limit was reached only for the 6-bladed fan at 4500 RPM. Reducing fan RPM or increasing the number of blades each lead to heavier and more costly fan designs, which has a marked effect on the range performance. For all the data shown, range performance is degraded from that for the reference fan. It would appear that rotational speeds greater than 4500 RPM for the 8-bladed fan would lead to slightly greater range but at the expense of increased noise.

The noise level of the reference fan (for two propulsors) is 83.7 PNdB (approximately 72 dB(A)) which is considerably less than current propeller driven light aircraft. This noise is also less than that from the exhaust of either rotary combustion or piston engines. However, for these engines muffling can be achieved down to approximately 80 PNdB with very little weight penalty (fig. 33). Noise as low as 75 PNdB can be achieved with a 10-bladed fan at 3000 RPM but the range is reduced by approximately 40% due to the added weight. This would translate into a larger aircraft necessary to cruise the required 1000 n. mi. (1852 km).

An alternate way of obtaining low fan tip speed is to reduce the fan diameter at a constant RPM rather than reduce the RPM. This was done in the synthesis program and the results are shown in figure 47. Specifying both RPM and tip speed fixes the fan diameter, and the cruise propulsive efficiency cannot be optimized and thus suffers at the lower tip speed, as shown in figure 47. However, the reduced fan diameter leads to reduced fan weight and cost, and the result is a relatively small effect on the cruise range of the aircraft. The purpose of reducing tip speed is to reduce the noise, but in this case just the opposite resulted. The reduced diameter of the fan leads to higher fan disk loading (thrust/fan frontal area, T/D^2) at takeoff, which has an adverse effect on noise. As was discussed in the section on Q-FAN noise generalization, noise is a function of total activity factor ($AF \times B$). An inspection of figures 3B through 6B of APPENDIX B shows that noise increases with increases in T/D^2 and that at the higher T/D^2 values, the noise can be reduced by increasing total activity factor. Thus, increasing number of blades and consequently total activity factor would alter the noise shown in figure 47.

Noise can be reduced to a certain extent at a fixed diameter by reducing tip speed and increasing number of blades (total activity factor). However, for the very minimum noise an increase in diameter together with a tip speed reduction are required. These combined effects are more clearly shown in figure 39 and 40.

Effect of Advanced Propulsion Technology. - In a previous section, two levels of technology were described for the engines, Q-FANS and gearboxes; i. e. for the 1975-1980 time period and for the 1980-1985 time period. All previous aircraft design data presented in this study were generated assuming the near-term 1975-1980 technology. Figure 48 compares the aircraft sizes which result for the reference twin-engine aircraft (210 knots cruise speed and supercharged engines) assuming the two different technologies for engine and fan weight.

Figure 48A is a comparison for supercharged rotary combustion engines. Advanced technology results in a saving of 400 (180) to 500 lbs (226 kg) in aircraft gross weight for the 4-rotor engine. Increasing the number of rotors leads to lighter engine weight due to a smaller rotor scale size for a given power requirement, and comparisons are also shown for 2- and 6-rotor engines. To keep the displacement per unit time constant with smaller diameter rotors, the engine RPM must increase with an increasing number of rotors for constant power. For the far-term technology, Curtiss Wright predicts reduction in engine weight due to greater engine displacement per unit time which is achieved with increased engine RPM.

Figure 48B is a comparison for horizontally-opposed piston engines driving the Q-FAN directly with no gearbox. Again, these comparisons are for the twin-engine aircraft and the engines are supercharged. The comparison between near- and far-term technology at an engine RPM of 4500 reflects the reduction in engine specific weight and the reduction in Q-FAN weight. A reduction in aircraft gross weight of approximately 700 lbs (318 kg) is predicted. The increase in engine RPM to 5000 RPM will not result in a reduced engine weight with the method used to predict engine weight (see Appendix C) and the slight reduction in aircraft gross weight is due to a smaller fan designed for 5000 RPM.

Conceptual Aircraft Derived from the Synthesis Program

Simple layouts of a single and twin-engine aircraft developed from the synthesis program are presented in figures 49 and 50. The 6-place pressurized twin-engine aircraft in figure 49 is shown along with the current Cessna Model 340. The Cessna Model 340 has a gross weight of 5975 lbs. (2710 kg) with a wing loading of 32.4 psf (1552 N/m²), and the conceptual aircraft has a gross weight of 6100 lbs. (2880 kg) with a wing loading of 41 psf (1964 N/m²). Both cruise at 210 knots (108 m/s) (TAS) and 20,000 feet (6076 m) altitude. The design point for the conceptual aircraft is to carry 600 lbs (272 kg) of payload (3 passengers plus baggage) for a range of 1000 n. miles (1852 km).

The engines on the conceptual aircraft are the 1975-1980 near-term, 4-rotor, rotary combustion, turbo-supercharged engines rated at 300 SHP (226 kw). The Q-FAN has 8 blades and the tip diameter is 3.3 feet (1.0 m) and is mounted as a pusher. It was assumed that 44% of the wing volume is available for fuel storage and all the fuel is stored in the wing. Wing location is moved aft to provide proper longitudinal stability with the aft mounted engines and this results in a slightly smaller tail size.

A conceptual single-engine, Q-FAN powered unpressurized 4-place aircraft is shown in figure 50. This aircraft has a gross weight of 2700 lbs. (1222 kg) with a wing loading of 43 psf (2060 N/m²). The cruise speed is 180 knots (TAS) (92 m/s) at 10,000 feet (3048 m) altitude. It is powered by a 4-rotor, rotary combustion, unsupercharged engine rated at 397 SHP (296 kw) which is located aft of the cabin, directly in line with the fan. It is felt that a high wing is necessary to provide undistorted flow into the fan. At this cruise speed the flow will be accelerating into the fan thus creating a favorable pressure gradient minimizing the chances for separation off the engine nacelle ahead of the fan. The design point for this aircraft is to carry 400 lbs (181 kg) of payload (2 passengers plus baggage) for a range of 850 n. miles (1578 km).

More details of the propulsion system integration are given in the following section.

CONCEPTUAL PROPULSION SYSTEM INTEGRATION

Detailed conceptual propulsion system integration studies were made to investigate the problems of integrating the Q-FAN and engine and of installing the Q-FAN/engine propulsion package onto an aircraft. The study was made for both a single-engine and a twin-engine general aviation aircraft.

Since time permitted the study of only two engine types, the rotary combustion and piston engines were selected over the gas turbine. However, the circular packaging of the gas turbine installation will be similar to that of the rotary combustion engine.

Blade containment provisions were not incorporated in the Q-FAN duct since the design and construction of the fan blades and retention are identical with propellers which are designed as prime structures with sufficient safety margins to preclude failure.

Q-FAN and Engine Integration

Twin-Engine Aircraft - The off fuselage pylon-mounted Q-FAN propulsor and engine pod installation was selected for the conceptual design study for the twin-engine aircraft of category III because it essentially eliminates visibility problems and results in better overall appearance. Both the rotary combustion and horizontally-opposed piston engines were considered. Based on the propulsion system parametric study previously discussed, a 42 inch (107 cm) diameter Q-FAN engine power package designed to produce 880 lbs. (3900 N) thrust per nacelle at 66 knots (34 m/s) TAS for a sea level, standard condition was selected. Design parameters for the Q-FAN are listed in Table XV.

A pusher version of the pylon-mounted Q-FAN, with the engine mounted forward, was selected for this study; but a tractor version is configured in the same manner with the engine behind the fan. Acoustical wall treatment only is incorporated in the Q-FAN in the form of two concentric cylinders of honeycomb with perforated sheets; one the inside surface of the duct and the other on the outer surface of the centerbody behind the fan rotor blades. The maximum fan noise level is 80.5 PNdB maximum at 500 feet (152 m) sideline including this treatment. The engines have exhaust manifold mufflers which reduce engine noise to a maximum level of 80.5 PNdB at 500 feet (152 m) sideline. Therefore, ignoring possible shielding by the aircraft, the total installation noise level for the two Q-FAN/engine propulsion packages is 83.5 PNdB maximum, sideline at 500 feet (152 m).

Rotary Combustion Engine Installation - A liquid-cooled, 4-rotor, rotary combustion engine with 27.5 inch³ (451 cm³) rotor displacement was selected to provide 350 SHP (261 kw) at 9900 RPM within a 14.75-inch (37.47 cm) diameter envelope. This selection was based on the results of a parametric study furnished by Curtiss-Wright Corporation for aircraft rotary combustion engines. The engine is close-coupled to an integral concentric gearbox and fan rotor assembly. The engine with a gear reduction of 3.0:1 drives the fan at 3300 RPM. The fan operates at constant speed as controlled by a gearbox-mounted governor and has blade feathering.

Figures 51, 52, and 53 show the left side, top and forward end views of the pylon-mounted rotary combustion engine/Q-FAN propulsion pod, respectively and figure 54 shows a three dimensional view. The engine fits well within the fan centerbody diameter resulting in clean aerodynamic flow (no blockage) through the fan. This compact diametral fit leaves no space for accessories or drives around the engine sides so they must be located forward of the engine. The exhaust and intake manifolds run along the engine side and the fuel injector, oil pump, magnetos, tach generator, coolant pump, vacuum pump, starter, alternator, turbocharger, compressor, muffler, and intake air box are all forward of the engine and accessory gearbox. Some accessories are mounted on the gearbox and others are mounted on brackets in the cowling structure. The oil tank, oil cooler, and engine coolant radiator are mounted in the airframe to preserve the compact shape of the pod and to reduce the pylon-mounted weight. A small air inlet scoop feeding air to the turbocharger is the only opening on the front of

the pod. An additional scoop would be provided beneath the pylon at the fuselage junction to provide air to the oil cooler and engine radiator which are fuselage mounted.

The engine is mounted on two forward and two rear flexible side mounts which are supported on frames bolted to the pylon box beam structure. Duct support is obtained through the five inlet vanes to an engine-mounted ring. Since both the fan and the duct are engine mounted, a small duct-to-blade tip clearance is more easily maintained. The pylon has an airfoil cross section and is coincident with one of the five inlet vanes to reduce blockage effects on the fan. Detailed representation of cowling and pylon structure, wiring, fluid lines, and engine controls is outside the scope of this study and are not shown.

The rotary combustion engine used in this study represents the smallest diametral engine package projected to 1975-1980 technology. However, a smaller diameter Q-FAN with a greater power requirement can be used with this basic engine size by adding engine rotors to increase power and by moving the engine further away from the fan as the fan centerbody diameter becomes smaller. A more compact fan configuration is therefore obtained by adding slightly more pod length.

For the 1980-1985 time period, it is predicted that the engine diameter will be further reduced for the same power. Thus a more compact installation package will be possible.

Piston Engine Installation - Installation studies of the same Q-FAN with a horizontally-opposed piston engine were conducted. The Avco Lycoming IGS-540-A1D was selected as a typical engine in the required power range for the purpose of sizing the propulsion pod. This is a geared, supercharged engine with fuel injection rated at 380 SHP (283 kw) at 3400 RPM. The engine would be run direct drive at 3300 RPM for this application. Accessories are mounted essentially within the engine envelope and are not a major consideration in determining pod size. A serious disadvantage of the piston engine Q-FAN pod configuration is the relatively large engine frontal area which, if close-coupled, constitutes a blockage of air flow into the fan. The engine must be mounted far enough from the duct to provide sufficient air flow into the fan to maintain performance.

Figures 55, 56, 57 and 58 show the left side, top and forward end views of the piston engine/Q-FAN pod installation and three dimensional view respectively. Since it is unlikely that any shaft coupling can withstand the torsional excitations associated with the piston engine, it was decided to mount the fan on the end of an extended engine shaft with a standard shaft spline and cone configuration. A spherical support bearing was located on the shaft forward of the fan to constitute the rear engine mount. The bearing is mounted in a laminated elastomeric-metal sleeve that provides radial stiffness, but deflects axially to permit the forward engine mounts to react the fan thrust. The two forward engine mounts are standard bed-type mounts of the vibration isolator type that react lateral, torsional, and axial engine loads. This shaft engine mount concept was contributed by the Beech Aircraft Company Engineering Department.

The natural frequencies of the shaft with its associated masses must be maintained remote from the engine excitation frequencies by proper design of the components.

Pylon-mounting a horizontally-opposed piston engine on the side is difficult because of the side location of the cylinders. A modified bed mounting was used which incorporates a fabricated sheet metal "saddle" which supports the two forward mounts and transitions into a fabricated cylinder which supports the rear bearing mount and the fan shroud. This mount structure is built into the pylon box beam structure to carry the loads to the airframe.

The exhaust manifold muffler, intake air box, and oil cooler are mounted forward of the engine but the oil tank is mounted in the airframe. A large air scoop on the forward end of the pod supplies cooling air for the engine and oil cooler and a small scoop provides inlet air to the supercharger. Cooling air is exhausted through an annular opening ahead of the inlet guide vanes to the fan. Engine exhaust gases are discharged from the side near the forward end of the pod and flows rearward through the fan. Based on previous experiences it is not expected that the engine exhaust gas or the cooling air exhaust will significantly affect fan performance or structure integrity. Since the engine exhaust gas could contribute significantly to the noise signature if not discharged correctly, it is a detail which should be considered in any final design.

The piston engine pod is longer than the rotary combustion engine pod due to the required remote location from the fan duct and is much larger in cross section. A more complex mount structure and greater installation weight make the reciprocating horizontally-opposed piston engine less attractive for pylon mounting than the rotary combustion engine.

Single-Engine Aircraft. - A Q-FAN propulsion system for a single-engine, 4-passenger aircraft of category II was conceptually studied with both a rotary combustion engine and a horizontally-opposed piston engine. A pusher configuration on a single empennage aircraft was selected to provide maximum pilot and passenger visibility. From the propulsion system parametric studies discussed previously, a 30 inch (76 cm) diameter Q-FAN/engine propulsion package was selected for this Q-FAN and engine integration study. Design parameters for the Q-FAN are listed in Table XVI. This relatively small diameter fan was selected for this installation because the large fuselage frontal area constitutes a significant blockage of fan inlet air requiring the fan to be remotely mounted from the fuselage. Because of this remote fan mounting, it was decided to move it far enough from the fuselage to permit a smaller, lighter Q-FAN to be used within a reasonable power requirement range. The fan duct inlet has a more significant "bell-mouth" shape than a pod-type installation to prevent separation of the air entering the duct at a greater angle from around the fuselage.

Acoustic treatment similar to the previous pod-mounted Q-FAN is incorporated on the inner duct surface and the other engine cowling surface behind the fan rotor blades. Including this treatment, the maximum fan noise level is 82 PNdB at 500 feet (152 m) sideline. The engines have exhaust manifold mufflers which reduce the maximum engine noise level to 82 PNdB at 500 feet (152 m) sideline. Total installation maximum noise level is 85 PNdB at 500 feet (152 m) sideline.

Rotary Combustion Engine Installation. - A liquid-cooled, two-rotor combustion engine with 76.2 in.³/rotor (1249 cm³/rotor) displacement was selected to provide 100 SHP (298 kw) at 7300 RPM. The engine is a direct-drive, naturally aspirated type, bed-mounted on isolation mounts in the rear fuselage structure with accessories as shown in figure 59. An Oldham coupling couples the engine output shaft to a simple 1.65:1 spur gear mesh oil-cooled gearbox from which the fan is driven at 1400 RPM by a shaft with a universal joint at each end. The low torsional excitations of the rotary combustion engine permit the use of driveshaft couplings. An engine coolant radiator and oil cooler are mounted ahead of the engine and are supplied cooling air from an external air scoop. Engine exhaust is discharged ahead of the engine at the bottom of the fuselage remote from the fan inlet. An oil tank is located to the rear of the engine and is supported on brackets under the tail boom.

The fan rotor operates at constant speed as controlled by a governor bolted to a ring supported on the five inlet vane spars in the duct. Duct assembly attachment to the airframe is accomplished through bolted lug mounts under the tail boom and two struts connecting the bottom duct leading edge with the engine mount structure in the fuselage. The fuselage intersects the duct in a "wedge" shape on the upper half of the duct inlet and fairs with the fan centerbody in a semi-circular shape below the fan axis of rotation. This Q-FAN/powerplant configuration results in a compact aircraft installation with minimum blockage to fan air inlet flow.

Piston Engine Installation. - The same single-engine pusher Q-FAN installation was studied using a horizontally-opposed piston engine. A 6-cylinder Teledyne Continental "Tiara" Model T6-320 engine was selected to drive the fan directly at 4400 engine RPM. Although the maximum power rating of 320 SHP (239 kw) is less than the 400 SHP (298 kw) required, the outside shape and dimensions of this engine were used for the installation study and are shown in figure 69. (The next size engine provides more than the required power. The 8-cylinder T8-450 engine rated at 450 SHP (336 kw) at 4400 RPM is longer by one row of cylinders which would not effect the fuselage-to-fan interface). Although the Model T6-320 engine has the advantages of low height, compact accessory mounting, and no requirement for liquid coolant components, it has major disadvantages of a wide frontal area and inability to use drive-shaft couplings for the remote Q-FAN installation.

The wide frontal area requires a wider fuselage causing more blockage of air entering the fan inlet. A flange-mounted drive-shaft extension with the fan cone-mounted on the end is used with a spherical support bearing forward of the fan. This bearing is supported in the boom-mounted fan duct and is the rear engine mount, as in

the pod installation previously discussed. The shaft spring-mass system must be properly designed to avoid natural frequencies in the range of engine excitation frequencies. A standard bed-type mounting with vibration dampers is used to support the forward end of the engine on the fuselage structure. This forward mount reacts lateral, torsional, and axial engine loads. There is the potential of reducing piston engine size in the 1980's which will then permit a more compact propulsor package.

Aircraft and Propulsion System Integration

Preliminary conceptual sketches of Q-FAN's mounted in several locations on low-wing, light twin-engine aircraft were made. Both pusher and tractor configurations were studied above the wing and on the fuselage. The purpose of the sketches is to investigate the effect on aircraft balance and stability in a preliminary sense and the effect on pilot and passenger visibility and overall aircraft appearance. The study shows that the wing-mounting requires less change to aircraft balance but restricts pilot visibility in the tractor version and passenger visibility to a lesser degree in the pusher version. Pylon-mounting either version on the rear fuselage requires more balance revision to the aircraft but essentially eliminates visibility problems and results in better overall appearance.

Sufficient study was made on single-engine Q-FAN installations to conclude that the pusher configuration is the best choice for either a twin-boom or single-empennage aircraft to prevent restriction of pilot visibility by the fan duct. Pylon-mounting on top of the fuselage has the disadvantage of raising the thrust line high on the aircraft and presents a less pleasing appearance.

Based on these preliminary studies, it is concluded that achievement of the full benefits of the Q-FAN on the aircraft may require changes in aircraft balance and possibly wing, stabilizer, and cabin door location. The exception would be existing pusher-type aircraft where requirements to revise the configuration are much less.

The following discussion demonstrates (1) the difference in the propulsion package for pusher and tractor Q-FAN installations and for rotary combustion and piston engine installations each installed in a twin-engine aircraft and (2) the difference in pusher Q-FAN propulsion package installations on a single-engine aircraft for both the rotary combustion and piston engine powerplants.

Typical Twin-Engine Installation. - The pylon-mounted Q-FAN propulsion package presented in the previous section was studied on a modified Cessna 340 light twin-engine aircraft in two pods mounted on the side of the rear fuselage. Pusher and tractor versions of the aircraft installation are shown with the rotary combustion engine in figures 61 and 62 and with the horizontally-opposed piston engine in figures 63 and 64. For a more compact propulsion package, the Q-FAN diameter was reduced from the 42 inch (107 cm) diameter used in the Q-FAN and engine integration study to a 36 inch (91 cm) diameter. This reduction in diameter has minor effects on engine package

size. Spacing between the engine and fan is increased 6 inches (15 cm) to be compatible with the corresponding smaller 16.2-inch (41.1 cm) centerbody diameter, and the rotary combustion engine diameter increased less than an inch to provide the required power increase from 241 (257) to 400 SHP (298 kw) at 9100 RPM with a 2.35 gear reduction to drive the fan at 3820 RPM ((600 ft/s) (183 m/s) tip speed). Fan total activity factor increases to 2500 and duct L/D becomes 1.05.

Percent blockage of the fan duct area by the engine pod and pylon is approximately the same for either the pusher or the tractor installation. However, fan inlet blockage (pusher) may be more detrimental to fan performance than exit blockage because of the possibility of distortion at the fan albeit with reduced skin friction drag because of lower velocities in the inlet. Performance can be maintained, however, by careful attention to the fan inlet configuration in the design. The pusher configuration has the advantages of improving passenger visibility, providing lift near the tail to reduce required stabilizer area, and in the case of the heavier piston engine, locates the propulsion package center of gravity further forward.

The primary modifications to the existing aircraft configuration are: (a) relocation of the wing rearward to accommodate the shift in aircraft center of gravity, (b) relocation of the horizontal stabilizer upward to avoid the fan discharge, and (c) moving the cabin door forward of the wing. Comparison of the two engine types reveals the rotary combustion engine installation to be significantly more compact, creating less drag on the aircraft and less blockage on the fan than the piston engine. Even smaller diameter Q-FAN's can be used in a pod mounting if the engine-to-fan spacing is increased more. An alternative with the rotary combustion engine is to mount the engines in the fuselage and drive a compact Q-FAN pod through right-angle gearboxes and drive-shaft couplings.

Typical Single-Engine Installation. - A four-place, high wing, single-boom aircraft was selected to demonstrate the single-engine pusher installation concept. The rotary combustion and piston engine fuselage-mounted Q-FAN installations defined previously are shown installed on the aircraft in figure 65. Externally, the basic difference between the two installations is the wider fuselage required to accommodate the piston engine envelope. The wider fuselage offers more air inlet blockage to the Q-FAN possibly requiring a more remote mounting location.

Propulsion Integration Summary

From the propulsion system integration sketches (figures 51 to 60) and the airplane/propulsion system sketches (figures 61 to 65) which include the rotary combustion and piston engines, it is determined that:

1. The rotary combustion engine installation is more compact for both the twin-engine and single-engine aircrafts.

2. Accessories are more easily mounted around the irregular shape of the piston engine than the circular rotary combustion engine pod configuration.
3. Side pylon-mounting of the piston engine is difficult due to cylinder location.
4. Drive shaft couplings can be used with the rotary combustion engine where aircraft configuration requires a mounting remote from the fan. High torsional excitations preclude the use of drive-shaft couplings with the piston engine making it necessary to use a rigidly mounted shaft extension.
5. The compact rotary combustion engine installation presents less drag on the aircraft and less blockage of the Q-FAN air duct.
6. Q-FAN installations for low wing, light, twin-engine aircraft can be mounted on the wing or on the fuselage. The better location appears to be on the rear fuselage from the standpoint of good visibility and appearance. Either a pusher or tractor configuration can be used in this location but a pusher configuration is preferred for the forward locations.
7. Q-FAN installations on single-engine aircraft should be pusher configurations to preserve pilot visibility.

IDENTIFICATION OF FUTURE RESEARCH ITEMS

During the course of this study, the contractor has identified certain areas where the technology utilized in preparing the design criteria and the state-of-the-art advancements required for developing improved, quiet Q-FAN propulsion packages for general aviation will require further study and research. These areas are presented below with recommendations for further study and research.

1. Q-FAN/Rotary Combustion Engine Experimental Program

While the basic technology of the components of the Q-FAN/rotary combustion engine propulsion system have been established, an experimental investigation of the complete propulsion systems is an essential next step in the development of this new propulsion concept. Accordingly, it is proposed that the program outlined below be undertaken.

- a. Hardware - A Q-FAN should be built for an existing rotary combustion engine for an appropriate general aviation aircraft and run on a test stand to investigate the hardware compatibility and operating characteristics.

b. Performance Testing - Static, wind tunnel and flight tests over a range of typical operating conditions should be conducted to establish

- performance
- cooling drag
- aircraft/engine interference effects
- general handling characteristics
- ride quality

c. Acoustical Testing - Static and flyover tests should be conducted on an acoustic test facility and on an aircraft to define

- external near and far field noise
- cabin noise and vibration

2. Configuration Refinements

a. Duct Treatment - Tests should be conducted to confirm the level of reduction that can be achieved with simple acoustic treatment as described in this report. Performance losses should be measured in this program to establish whether additional treatment could be incorporated without penalties.

b. Advanced Airfoil Sections - In recent years analytical methods have been developed which permit the design of supercritical airfoil sections and low speed high lift, wide drag bucket airfoil sections. A limited amount of experiment data does substantiate the analytical procedures. It is proposed that the potential of using these new airfoil sections on Q-FANS both analytically and experimentally be investigated.

3. Refinements and Extensions to the Generalized Methods and Computer Programs

a. Integrated Design Lift Coefficient - Since this is the only rotor blade shape parameter not included as a variable in the performance generalization, it is recommended that the generalization be extended to include a variation in integrated design lift coefficient.

b. Engine Cowling - As was stated previously, the losses due to the engine cowling are not included in the prediction of installed performance. It is recommended that a procedure for evaluating the engine cowling drag be derived and included in the prediction of installed performance.

c. Reverse Thrust - The landing runway distances are a vital aspect of aspect of aircraft design and operation of aircrafts in category V (Table I). Therefore, it is recommended that a procedure for computing reverse thrust for a range of velocities corresponding to the landing run associated with any aircraft configuration with reversing Q-FANS be included with the general Q-FAN computational procedure. The

analytical method would be based on existing test data and empirical correction for the pertinent Q-FAN characteristics.

4. Engine Noise - During the course of the study it was found that very little noise data on any of the engines was available. This was particularly true in the case of piston and turboshaft engines. It is recommended that definitive test data on unmuffled engines be obtained over a range of operating conditions and a range of design parameters. From this an improved method for predicting engine noise should be developed.

In the muffler area limited information was also found. Both test and acoustic theory should be used to improve design, weight and performance methodology. In view of the foregoing a cost generalization has not been included in the present study. Furthermore, the effect of muffling on the performance needs to be established.

CONCLUDING REMARKS

1. The Q-FAN/rotary combustion engine offers the aircraft designer a new degree of flexibility in configuring light aircraft.
2. The Q-FAN selected for best aerodynamic performance will be approximately 18 dB quieter than current propeller/piston engine driven light aircraft.
3. An additional noise reduction of 5 dB may be achieved with fan design modification without significant increases in fan weight.
4. In the 1980's, the compact Q-FAN/rotary combustion propulsion systems show cost and weight levels competitive with current propeller/piston engine propulsion systems.
5. Advanced technology piston engines may be generally compatible with the Q-FAN if the predictions for reduced weight are attained and the cross-section profile can be reduced by adding cylinders or reducing the piston stroke.
6. Although the gas turbine engines are compatible with the Q-FAN in terms of interference problems and engine weight, the cost must be reduced to make it attractive for general aviation.
7. Aircraft systems incorporating high lift wing technology and Q-FAN/rotary combustion engine packages will be lighter, more economical, more compact and much quieter than current light aircraft.
8. Generalized methods for estimating performance, noise, weight and cost for Q-FAN propulsion packages including piston, rotary combustion and gas turbine engines have been developed.

9. The NASA synthesis program incorporating the Q-FAN propulsion package and the propeller propulsion package generalizations is a useful tool for preliminary evaluation of general aviation aircraft.

10. A separate Q-FAN computer program has been developed for examining only the Q-FAN parameters.

REFERENCES

1. Anon: Civil Aviation Research and Development Policy Study. Joint DOT-NASA Report, March 1971.
2. Lockheed Georgia Company: Technical Assessment of Advanced General Aviation Aircraft. NASA CR 114339, June 1971.
3. Worobel, R. and Mayo, M. G.: Advanced General Aviation Propeller Study NASA CR 114289, April 1971.
4. Rosen, G.: Prop-Fan - A High Thrust Low Noise Propulsor, SAE Paper No. 710470, May 1971.
5. Rosen, G.: Trends in Aircraft Propulsion. Canadian Aeronautics and Space Institute Paper Presented at the 12th Anglo-American Aeronautical Conference, July 1971.
6. Rosen, G.: New Fan for STOL Turbojets Reduces Noise, Doubles Thrust, Article Published in ICAO Bulletin, December 1972.
7. Metzger, B. and Worobel, R.: New Low Pressure Ratio Fans for Quiet Business Aircraft Propulsion. SAE Paper No. 730288, April 4, 1972.
8. Metzger, F.B. and Hanson, D.B.: Low Pressure Ratio Fan Noise Experiment and Theory. ASME Journal of Engineering for Power, Vol. 95, January 1973.
9. Barry, F.W. and Magliozzi, B.: Noise Detectability Prediction Method for Low Tip Speed Propellers. Air Force Flight Dynamics Laboratory, Technical Report AFDL TR 71-37, June 1971.
10. Metzger, F.B. and Ganger, T.G.: Prop-Fan - Results of Initial Prop-Fan Model Acoustic Testing. NASA CR 11842, December 4, 1970.
11. Metzger, F.B. Hanson, D.B., Menthe, R.W. and Towle, G.B.: Analytical Parametric Investigation of Low Pressure Ratio Fan Noise. NASA CR 2188 January 27, 1972.
12. Ungar, E. E., et al: A Guide for Predicting the Aural Detectability of Aircraft. Air Force Flight Dynamics Laboratory, Technical Report AFFDL-TR-71-22, March 1972.
13. Rudd, M. J. and Ungar, E. E.: Parametric Noise Comparison of Muffled Piston and Rotating Combustion Engines for General Aviation Aircraft. Bolt, Beranek, and Newman Inc., Report No. 2463, October 5, 1972.

14. Galloway, T.L. and Waters, M.H.: Computer Aided Parametric Analysis for General Aviation Aircraft. SAE Paper No. 730332, April 1973.
15. Waters, M.H., Galloway, T.L., Rohrbach, C. and Mayo, M.G.: Shrouded Fan Propulsors for Light Aircraft. SAE Paper No. 730323, April 1973.
16. Raisbeck, J.D.: Consideration of Application of Currently Available Transport Category Aerodynamic Technology in the Optimization of General Aviation Propeller-Driven Twin Design. SAE Paper No. 720337, March 1972.

TABLE I
ADVANCED GENERAL AVIATION Q-FAN™ STUDY
AIRCRAFT CLASSIFICATION

<u>Aircraft Class</u>	<u>Seats</u>	<u>Cruise Vel., MPH (k/s)</u>	<u>Engine Power SHP (kw)</u>	<u>Propeller Type</u>	<u>Application</u>	<u>Gross Weight, lb. (kg)</u>	<u>Price Range</u>	<u>Example Aircraft</u>
I. Single Eng. Trainer Fixed Gear	2-4	100-160 (45-72)	100-200 (75-149) Recip DD	Fixed Pitch 2 Blades	Trainer, Private; Rental, Aerobatic	1000-2500 (454-1132)	\$8-25K	CESNA 150, 172, Skyhawk BEECH Musketeer A23-1, PIPER Super Cub, Pittcock
II. Single Eng. Adv. Trainer Retract Gear IFR Equip.	4-6	120-150 (50-70)	150-300 (112-224) Recip DD & Geared Some Small Turboprops	Constant Speed 2 Blades, Cont. 3 Blade	Adv. Trainer Private (Family) Survey, Business	2000-4000 (909-1814)	\$20-50K	CESNA Skywagon 180, 240, 267, 210 BEECH Bonanza, Musketeer Super 300 PIPER Comanche C, Cherokee Arrow MOONEY M20F
III. Light Twins Retract Gear IFR Equip.	4-6	150-300 (67-134)	150-300 (118-224) Recip DD & Geared Some Small Turboprops	Constant Speed 2 Blades Some 3 Blades Deicing	Private (Family) Survey, Business	3500-6000 (1590-2720)	\$10-150K	CESNA Super Skymaster, Cessna BEECH Turbobaron, Barron 55 Pittcock Twin Comanche C, Aztec D MOONEY Aerostar
IV. Medium Twins Retract Gear IFR Equip.	6-11	150-300 (67-134)	300-450 (224-336) Turboprops, Recip DD & Geared	Constant Speed Full Feather Deicing 3 Blades	Executive Charter Air Taxi	6000-8000 (2720-3620)	\$100-250K	BAE BA 40, 40B, 40C, 421 BEECH Queen Air Duke PIPER Navajo 300, Turbo Navajo NORTH AMERICAN ROCKWELL- Shrike Commander PITTCOCK-BONANZA ISLANDER, Helio Twin Helicopter
V. Heavy Twins Retract Gear IFR Equip.	11 & Up	175-400 (78-178)	600-1500 (447-1119) Turbines	Constant Speed Full Feather Deicing, over 6 Blades & Blade	Large Executive Charter, Third Tier Air Liners	8000-15000 (3620-6800)	\$150-400K	EMBRAER Twin Otter DOUGLAS DC-3 NORTH AMERICAN ROCKWELL Shrike Commander PITTCOCK-BONANZA ISLANDER, Helio Twin Helicopter

TABLE II

ROTOR VARIABLES

● AF	-	ACTIVITY FACTOR / BLADE	120-270
● B	-	NUMBER OF BLADES	5-13
● TAF	-	TOTAL ACTIVITY FACTOR (BXAF) SOLIDITY (0.00027 X TAF)	750-3000 0.2-0.8
● CL; λ	-	INTEGRATED DESIGN LIFT COEFFICIENT	0.7
●	-	TIP CLEARANCE - PERCENT OF DIAMETER	0.25%
●	-	VARIABLE PITCH OR FIXED PITCH	
● TS	-	TIP SPEED	450-800 FT/S (137-244 M/S)

TABLE III
DUCT AND VANE VARIABLES

DUCT

- L/D - DUCT LENGTH / FAN DIAMETER RATIO 0.65-1.2
- A.R. - FAN TO DUCT EXIT AREA RATIO 0.8-1.1
- P.R. - FAN PRESSURE RATIO 1.01-1.15
 [1.0 + (0.0005) T/D²] ENGLISH UNITS
 [1.0 + (0.00001) T/D²] SI UNITS
- BVGAP - BLADE VANE SPACING 2.0
- - FIXED OR VARIABLE GEOMETRY

VANES

- V - NUMBER OF VANES 3-7

TABLE IV

VARIABLE PITCH Q - FAN™ ROTOR WEIGHT EQUATION CONSTANTS

CATEGORY CONSTANT	II	III	IV	IV Fiberglass Blade	V	V Fiberglass Blade
K _M	1.74	1.74	1.74	1.3	1.74	1.3
K ₁				26.5		
K ₂	0.06	0.07	0.07	0.07	0.06	0.06
K ₃	6.25	8.34	8.34	9.5 $\left(\frac{D}{5}\right)^{0.25}$	6.7	7.71 $\left(\frac{D}{5}\right)^{0.25}$
K ₄	1.13	1.6	1.6	1.6	1.6	1.6
K ₅	1.45	5.14	5.14	1.35 $\left(\frac{D}{5}\right)^{0.25}$	4.45	3.78 $\left(\frac{D}{5}\right)^{0.25}$
K ₆	0	2.33	2.33	2.33	0	0
K ₇				A		
Y		$\left[1 - \frac{0.08 \left(\frac{TS}{500}\right)}{\left(\frac{B}{10}\right) \left(\frac{AF}{170}\right)^{0.5}} \right]$				
P				0.8		
R	2.6	2.6	2.6	2.1	2.6	2.1
S				0.2		
T				0.2		
AF 170 - 250	U			1.9		
	V			0		
AF 110 - 170	U	$\left[5.4 \left(\frac{AF}{190} - 1.03\right) \right]^{0.5}$				
	V	0.2				
	Z	$\left[1 - \frac{0.031 \left(\frac{TS}{500}\right)}{\left(\frac{B}{10}\right) \left(\frac{AF}{170}\right)^{0.5}} \right]^{1.5}$				

A = 4.3 IF A MOUNTING FLANGE IS REQUIRED.
A = 0 IF A MOUNTING FLANGE IS NOT REQUIRED.

TABLE V

FIXED PITCH Q-FAN™ ROTOR WEIGHT EQUATION CONSTANTS

CATEGORY CONSTANT	II	III	IV	IV Fiberglass Blade
K ₁	25.2	25.2	25.2	25.2
K ₂	0	0	0	0
K ₃	0	0	0	0
K ₄	0	0	0	0
K ₅	4.20	4.80	4.80	$\frac{4.10}{(D/5)^{.25}}$
K ₆	0	0	0	0

NOTE: ALL OTHER CONSTANTS ARE THE SAME AS THE VARIABLE
PITCH ROTOR CONSTANTS.

THE FIXED PITCH FAN ROTOR ASSEMBLY INCLUDES:

- BLADES
- BARREL
- RETENTION
- SPINNER

TABLE VI
GENERAL AVIATION Q-FAN TM O.E.M. COST
EQUATIONS FOR 1970 AND 1980

FAN ROTOR ASSEMBLY (VARIABLE
PITCH)

$$C = ZF (7B^{0.5} + E)$$

$$C_1 = F (7B^{0.5} + E)$$

SPINNER

$$C = ZC_1$$

$$C_1 = 13.50$$

WHERE.

C = AVERAGE FAN COST FOR A NO. OF UNITS
YEAR. (\$/LB)

C₁ = FIRST UNIT FAN COST. (\$/LB)

$$Z = \frac{LF}{LF_1}$$

LF = LEARNING CURVE FACTOR FOR NO. UNITS/YEAR

LF₁ = LEARNING CURVE FACTOR FOR FIRST UNIT

B = NUMBER OF BLADES

F = FIRST UNIT COST & CONFIGURATION FACTOR

E = EMPIRICAL FACTOR

<u>CATEGORY</u>	<u>1970</u>		<u>1980</u>	
	<u>F</u>	<u>E</u>	<u>F</u>	<u>E</u>
II	2.1	1.5	2.1	1.5
III	2.1	3.5	2.1	3.5
IV	2.1	3.5	3.2	3.5
V	2.4	3.5	3.6	3.5

TABLE VII
COST EQUATION Z FACTORS

	<u>1970</u>		<u>1980</u>	
<u>CATEGORY</u>	<u>NUMBER OF FANS/YEAR</u>	<u>Z</u>	<u>NUMBER OF FANS/YEAR</u>	<u>Z</u>
<u>II</u>	2810	0.27	5470	0.24
<u>III</u>	1030	0.32	1990	0.28
<u>IV</u>	295	0.39	680	0.34
<u>V</u>	65	0.50	368	0.37

NOTE: NUMBER OF FANS PER YEAR IS THE NUMBER EXPECTED TO BE MANUFACTURED BY A TYPICAL MAJOR PROPELLER MANUFACTURER DURING THE YEAR INDICATED.

TABLE VIII

GENERAL AVIATION Q-FAN TM O.E.M. COST EQUATIONS FOR 1970 AND 1980

<p><u>FAN ROTOR ASSEMBLY</u> $\left(\frac{\text{FIXED}}{\text{PITCH}} \right)$</p> <p>$C = ZF (7B^{0.5} + E)$</p> <p>$C_1 = F (7B^{0.5} + E)$</p>	<p style="text-align: center;"><u>SPINNER</u></p> <p>$C = ZC_1$</p> <p>$C_1 = 13.50$</p>
---	--

WHERE.

C = AVERAGE FAN COST FOR A NO. OF UNITS YEAR. (\$/LB)

C₁ = FIRST UNIT FAN COST. (\$/LB)

Z = $\frac{LF}{LF_1}$

LF = LEARNING CURVE FACTOR FOR NO. UNITS/YEAR

LF₁ = LEARNING CURVE FACTOR FOR FIRST UNIT

B = NUMBER OF BLADES

F = FIRST UNIT COST & CONFIGURATION FACTOR

E = EMPIRICAL FACTOR

CATEGORY	1970	1980
II	2.4	1.5
III	2.6	3.5
IV	2.6	3.5

TABLE IX
GENERAL AVIATION Q-FANTM O.E.M. COST
EQUATIONS FOR 1970 AND 1980

DUCT AND MOUNT ASSEMBLIES:

$$C = ZC_1$$

WHERE:

C = AVG COST FOR A NUMBER OF UNITS/YEAR (\$/LB)

C₁ = FIRST UNIT COST (\$/LB)

$$Z = \frac{LF}{LF_1}$$

LF = LEARNING CURVE FACTOR FOR NO. UNITS/YEAR

LF = LEARNING CURVE FACTOR FOR FIRST UNIT

<u>SUB-ASSEMBLY</u>	<u>C₁</u>
DUCT	13.50
MOUNT	33.50
AFTERBODY	13.50

TABLE X
GENERAL AVIATION Q-FAN™ O.E.M. COST
EQUATIONS FOR 1970 AND 1980

GEAR BOX ASSEMBLY:

$$C = ZC_1$$

WHERE

C = AVG COST FOR A NUMBER OF UNITS/YEAR (\$/LB)

C₁ = FIRST UNIT COST (\$/LB)

$$Z = \frac{LF}{LF_1}$$

LF = LEARNING CURVE FACTOR FOR NO. UNITS/YEAR

LF₁ = LEARNING CURVE FACTOR FOR FIRST UNIT

C₁ = 150 FOR SINGLE-STAGE PLANETARY

C₁ = 180 FOR TWO-STAGE PLANETARY

C₁ = 13.50 FOR AFTERBODY

TABLE XI

PISTON ENGINE SPECIFIC WEIGHTS

TECHNOLOGY ENGINE TYPE	1975 - 1980		POST 1980	
	NON-SUPER- CHARGED	SUPER- CHARGED	NON-SUPER- CHARGED	SUPER- CHARGED
POWER/BORE AREA hp/in ² (kw/cm ²)	2.58 (.30)	2.83 (.33)	3.10 (.36)	3.64 (.42)
TYPICAL VALUES				
BMEP, psi (N/cm ²)	155 (102)	170 (117)	170 (117)	200 (138)
PISTON SPEED, fpm	2200	2200	2400	2400
MAXIMUM RPM	4500	4500	5000	5000
STUDY RANGE OF SPECIFIC WTC.				
SEA LEVEL POWER, hp (kw)	225-500 (168-373)	225-500 (168-373)	225-500 (168-373)	225-500 (168-373)
SPECIFIC WT., lb/hp (kg/kw)	1.30-1.59 (.79-.97)	1.45-1.70 (.88-1.03)	1.02-1.31 (.62-.80)	1.20-1.38 (.73-.84)
CURRENT PRODUCTION ENGINES				
SEA LEVEL POWER, hp (kw)	300 (224)	300 (224)		
SPECIFIC WEIGHT, lb/hp (kg/kw)	1.55 (.94)	1.70 (1.03)		

TABLE XII

ROTARY COMBUSTION ENGINE SPECIFIC WEIGHTS

TECHNOLOGY	ENGINE TYPE	RANGE OF SPECIFIC WEIGHTS, lb/hp (kg/kw)
1975 - 1980	SUPERCHARGED	.93 - 1.10 (.57 - .67)
	NON-SUPERCHARGED	.68 - .76 (.41 - .46)
POST 1980	SUPERCHARGED	.70 - .84 (.43 - .51)
	NON-SUPERCHARGED	.44 - .56 (.27 - .34)

TABLE XIII

COMPARISON OF CURRENT PROPELLER PROPULSION SYSTEM
TO Q-FAN PROPULSION SYSTEMS IN THE 1980'S

4 - 6 SEAT LIGHT TWIN AIRCRAFT

PROPULSOR CHARACTERISTICS	CURRENT PROPELLER	1980's Q-FAN		
Diameter, ft. (cm)	6.5(1.98)	3.0(.91)		
Number of blades	3	9		
Tip speed, ft./s (m/s)	915(279)	640(195)		
Speed, rpm	2700	4060		
Activity factor per blade	84	233		
Thrust, lbs. (N) at 66 kts (34 m/s)				
S.L., STD	880(3914)	880(3914)		
Cruise thrust, lbs. (N) at 0.33 Mach No.	316(1406)	329(1463)		
Weight, lbs. (kg)	77(35)	175(79)		
O.E.M. cost, dollars	803	1650		
Noise level/propulsor at 500 ft. (152 m)				
in PNdB (unsuppressed noise)	99.5	83.5		
Attenuation	0	-4.5		
Total	99.5	79.0		
ENGINE CHARACTERISTICS	PISTON	PISTON	ROTARY COMBUSTION	
Maximum power, SHP (kw)	285(213)	387(289)	387(289)	
RPM	2700	5000	15600	
Weight, lbs. (kg)				
Engine	460(209)	476(216)	263(119)	
Muffler	0(0)	10(5)	9(4)	
Gearbox	0(0)	19(9)	19(9)	
Total	460(209)	505(230)	291(132)	
O.E.M. cost, dollars				
Engine	6076	8050	4890	
Gearbox	0	590	590	
Total	6076	8640	5480	
Noise level/engine at 500 ft. (153 m)				
in PNdB				
Engine	89	91	98	
Muffler	0	-12	-19	
Gearbox	0	57	57	
Total	89	79	79	
PROPULSION SYSTEM SUMMARY				
Weight/nacelle, lbs. (kw)	537(244)	680(309)	466(211)	
O.E.M. cost/nacelle	6879	10290	7130	
Noise/nacelle at 500 ft. (153 m) in PNdB	100	82	82	

TABLE XIV

AIRCRAFT DESIGN REQUIREMENTS AND PARAMETERS

<u>Aircraft</u>	<u>Twin</u>	<u>Single</u>
Number of Seats	6	4
Design Point Payload*, lbs. (kg)	600 (272)	400 (182)
Field Length, ft. (m)	3600 (1100)	3600 (1100)
Cruise Altitude, ft. (m)	20,000 (7096)	10,000 (3048)
Climb Req.	FAR Part 23	FAR Part 23
Flap type	Plain	Plain
Wing Description		
Aspect Ratio	7.86	7.28
Sweep	0	0
Taper	.61	.46
Root Thickness	.18	.15
Tip Thickness	.09	.15

*Design point payload includes three passengers plus baggage for the twin-engine aircraft, and two-passengers plus baggage for the single-engine aircraft. Pilot plus his baggage is accounted as useful load not payload.

TABLE XV
 LIGHT TWIN ENGINE AIRCRAFT
 Q-FAN DESIGN PARAMETERS

FAN DIAMETER, IN. (CM)	42 (107)
NUMBER OF BLADES	8
TOTAL ACTIVITY FACTOR	1808
LIFT COEFFICIENT (C_{L_i})	0.7
BLADE TIP SPEED, FT./S. (M/S)	600 (183)
RPM	3300
MAX. POWER, SHP (KW)	350 (261)
DUCT L/D	0.98
CENTERBODY DIAMETER, IN. (CM)	19 (48)
NUMBER OF INLET GUIDE VANES	5
SINGLE-ENGINE CLIMB THRUST, LBS. (N)	
AT SEA LEVEL AND 66 KNOT (34 M/S)	880 (3914)
NOISE LEVEL (PNdB) at 500 FT (152M) SIDELINE/NACELLE	80.5

TABLE XVI
 SINGLE ENGINE AIRCRAFT
 Q-FAN DESIGN PARAMETERS

FAN DIAMETER, IN. (CM)	30 (76)
NUMBER OF BLADES	9
TOTAL ACTIVITY FACTOR	2052
LIFT COEFFICIENT (C_{L_1})	0.7
BLADE TIP SPEED, FT./S (M/S)	575 (175)
RPM	4400
MAX. POWER, SHP (KW)	400 (298)
DUCT L/D	1.08
CENTERBODY DIAMETER, IN. (CM)	13.50 (34)
NUMBER OF INLET GUIDE VANES	5
CLIMB THRUST, LBS. (N) AT SEA LEVEL AND 66 KNOTS (34 M/S)	810 (3603)
NOISE LEVEL (PNdB) at 400 FT (152M) SIDELINE/NACELLE	82

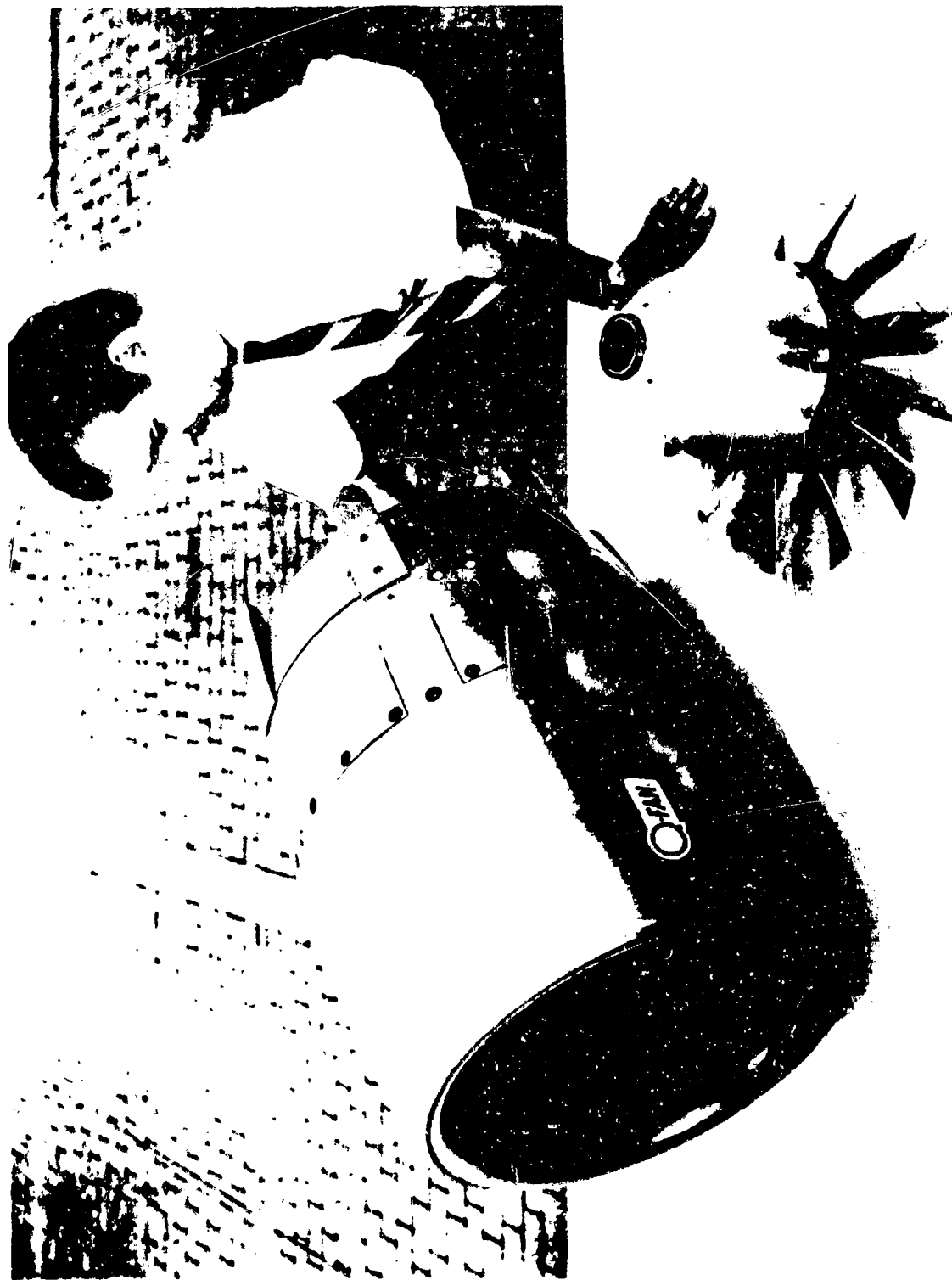

G40716

FIGURE 1 Q-FAN WIND TUNNEL TEST MODEL, DIAMETER = 18 IN. (0.46M)

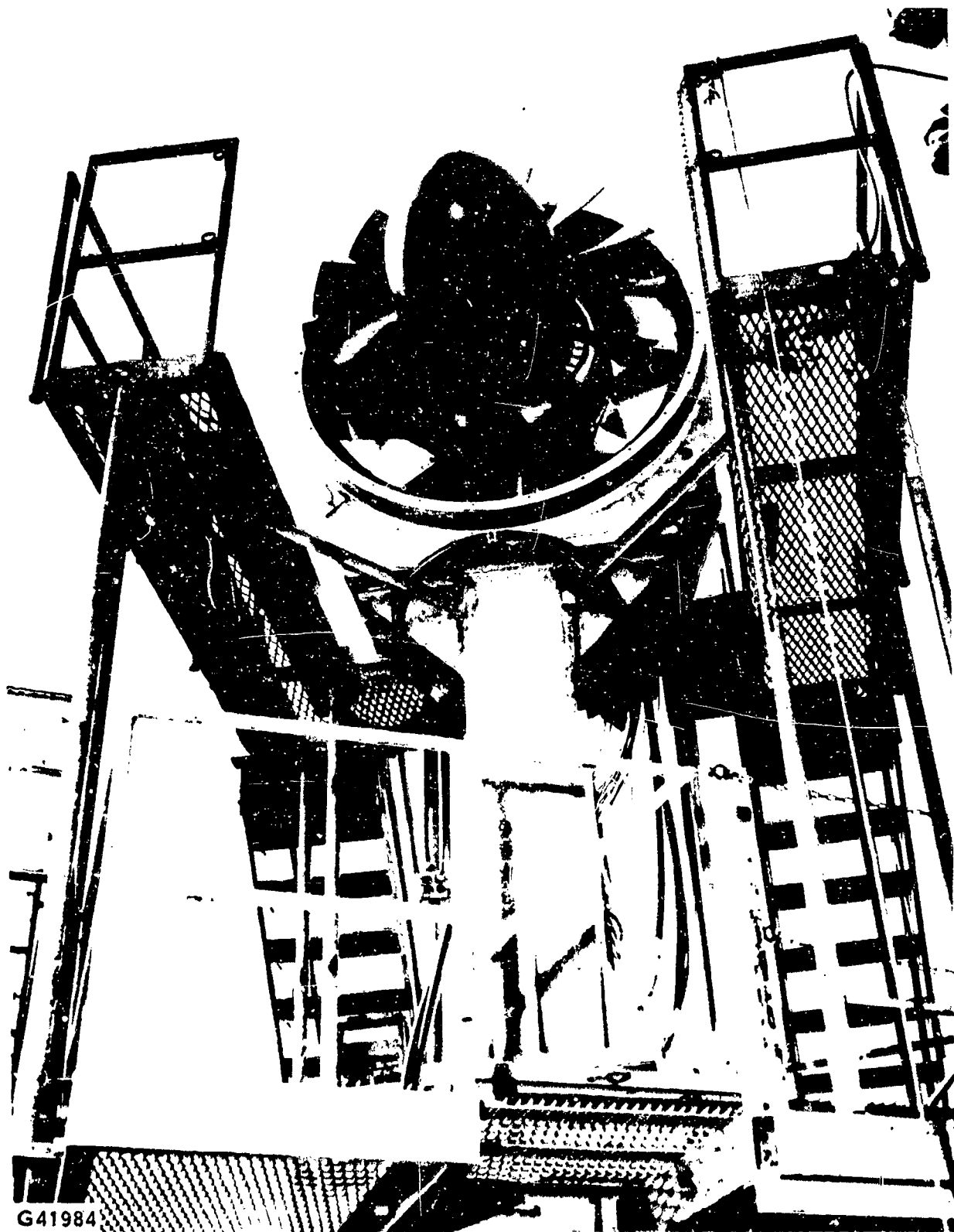

FIGURE 2 Q-FAN FULL SCALE DEMONSTRATOR, DIAMETER = 4.6 FT (1.40M)

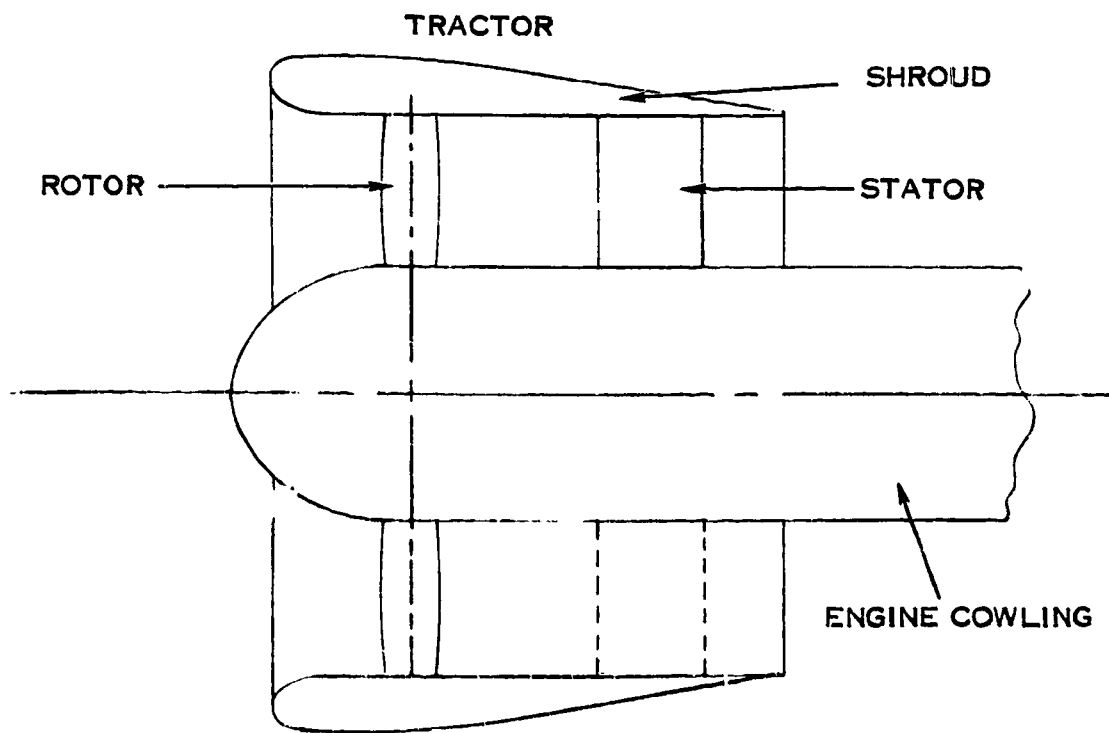
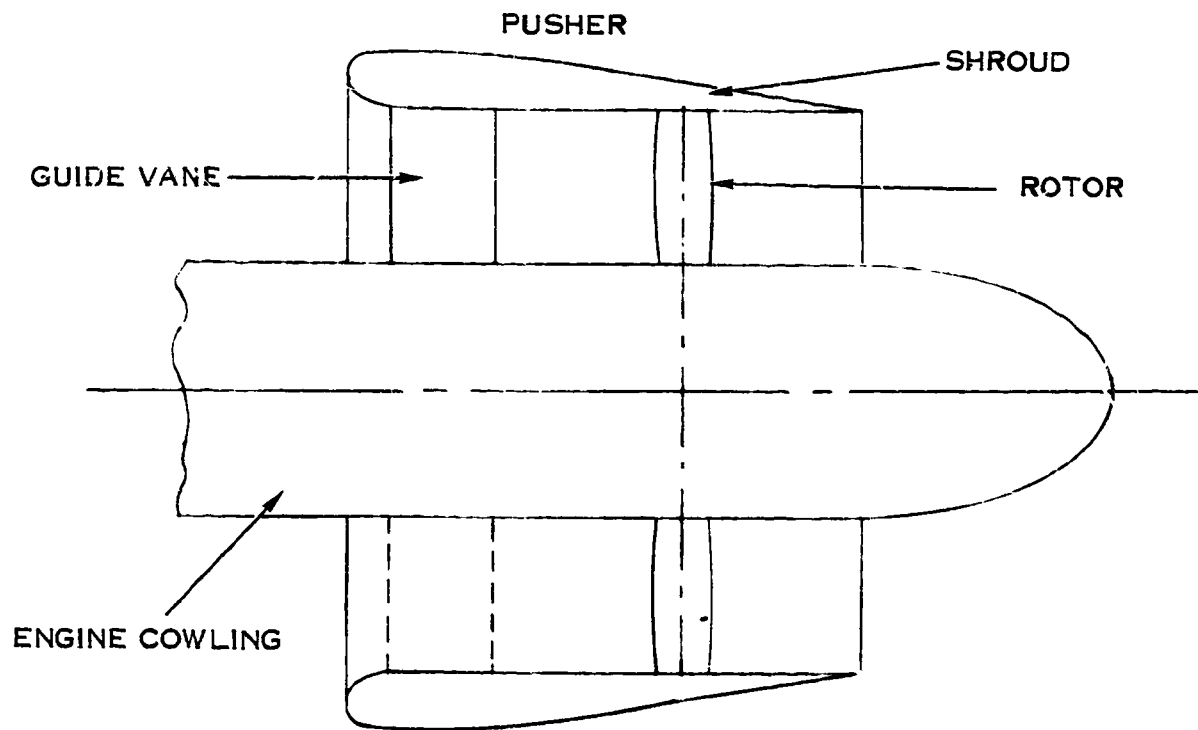
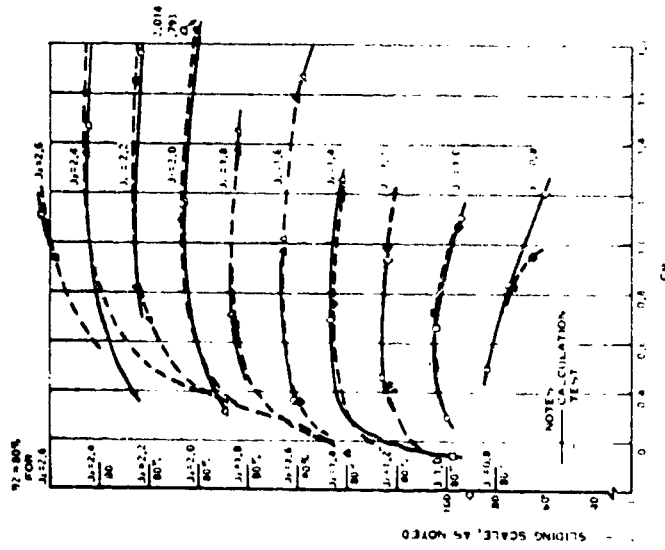
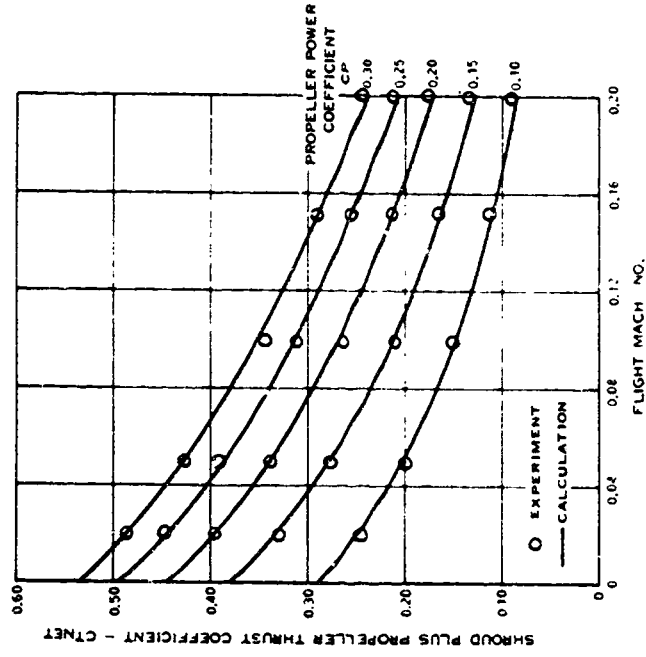

FIGURE 3. Q-FAN COMPONENTS



HAMILTON STANDARD AXIAL FLOW FAN TEST - CALCULATION & TEST COMPARISONS
TIP RELATING MACH NO. = 0.70



COMPARISON OF CALCULATED AND EXPERIMENTAL
SHROUDED PROPELLER NET THRUST COEFFICIENT
FOR A THREE BLADED PROPELLER

FIGURE 4. METHOD VERIFICATION

HOLDOUT FRAME |

$$J_0 = \frac{(K1) V}{ND}$$

$$C_{PE} = C_P \times P_{TAF} \times P_{MN}$$

$$C_P = \frac{(K2) \text{ POWER } (\rho_0/\rho)}{N^3 D^5}$$

$$C_{TE} = C_{T_{net}} \times T_{TAF} \times T_{MN} - \Delta C_{T_{NET}} (L/D) + \Delta C_{T_{NET}} (ACC.)$$

$$C_{T_{net}} = \frac{(K3) \text{ THRUST } (\rho_0/\rho)}{N^2 D^4}$$

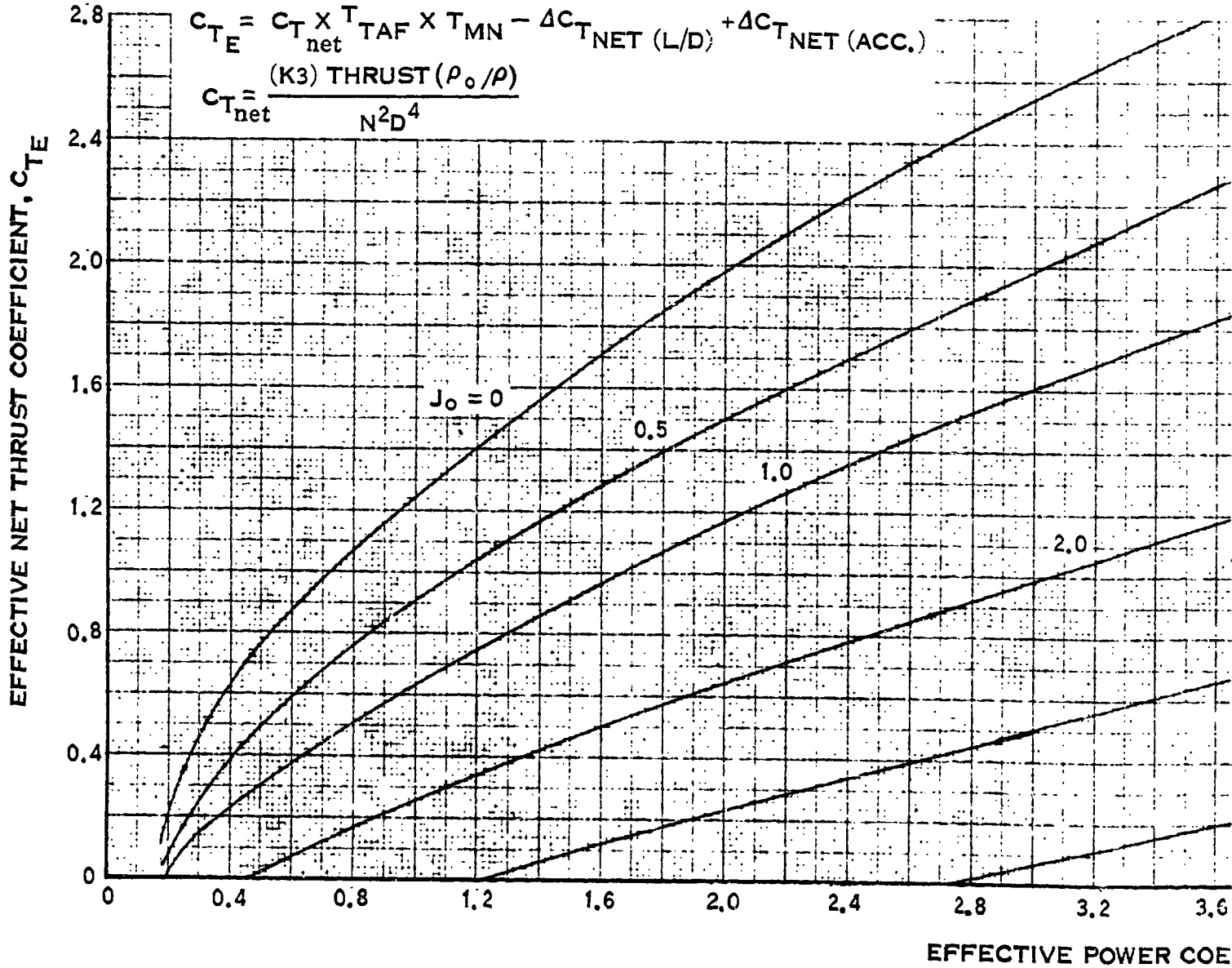

BLUET FRAME 2

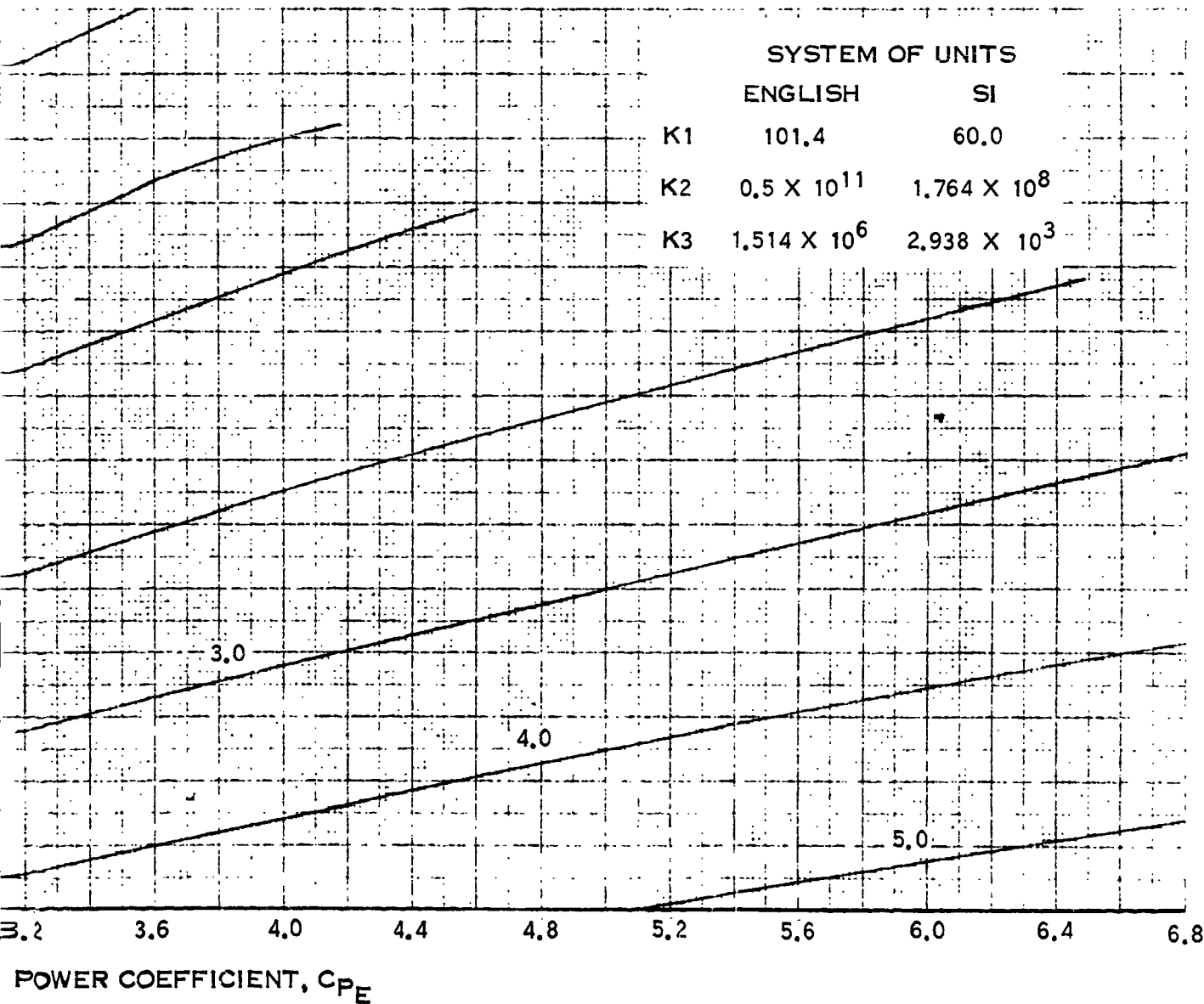

FIGURE 5. BASE Q-FAN PERFORMANCE CURVE - 1.0 AREA RATIO

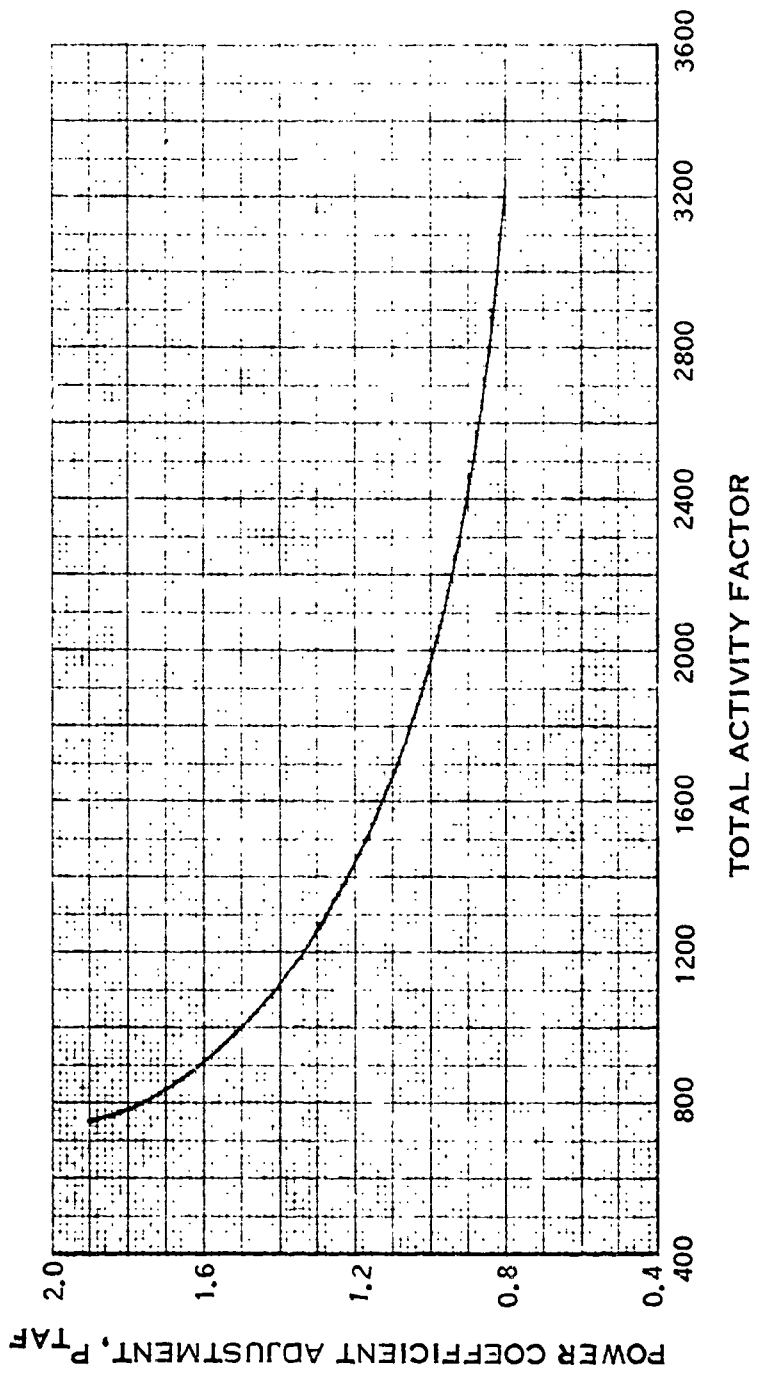

FIGURE 6. TOTAL ACTIVITY FACTOR ADJUSTMENT TO POWER COEFFICIENT

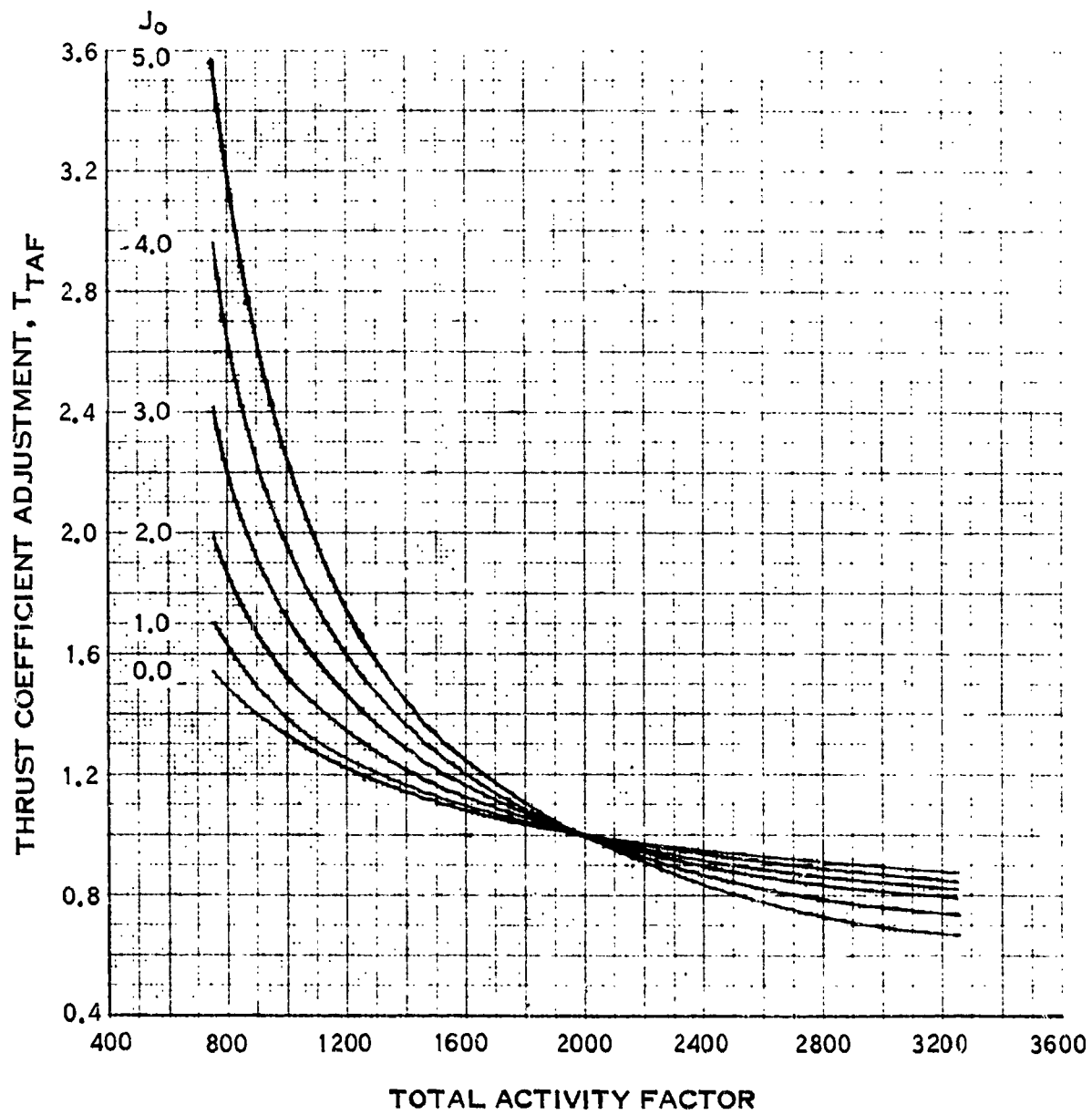

FIGURE 7. TOTAL ACTIVITY FACTOR ADJUSTMENT TO THRUST COEFFICIENT

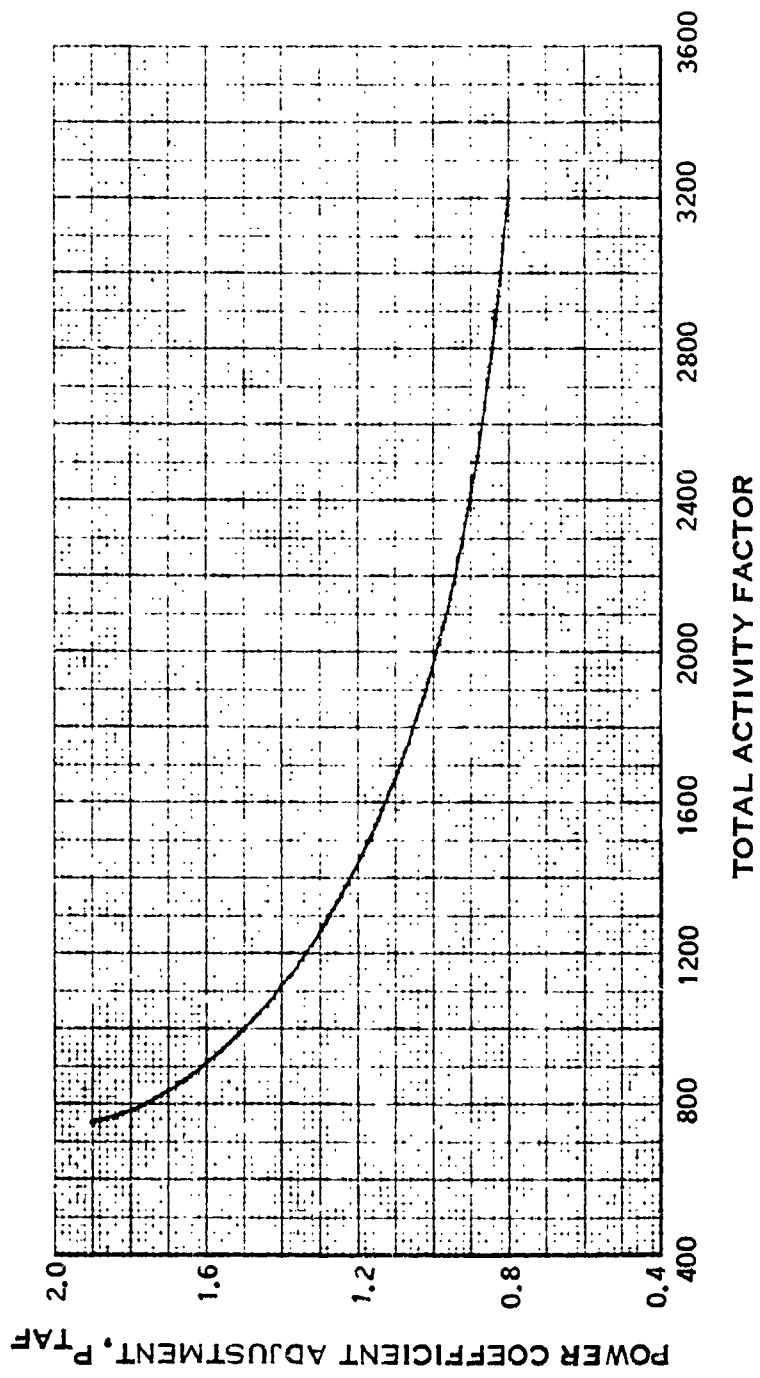

FIGURE 6. TOTAL ACTIVITY FACTOR ADJUSTMENT TO POWER COEFFICIENT

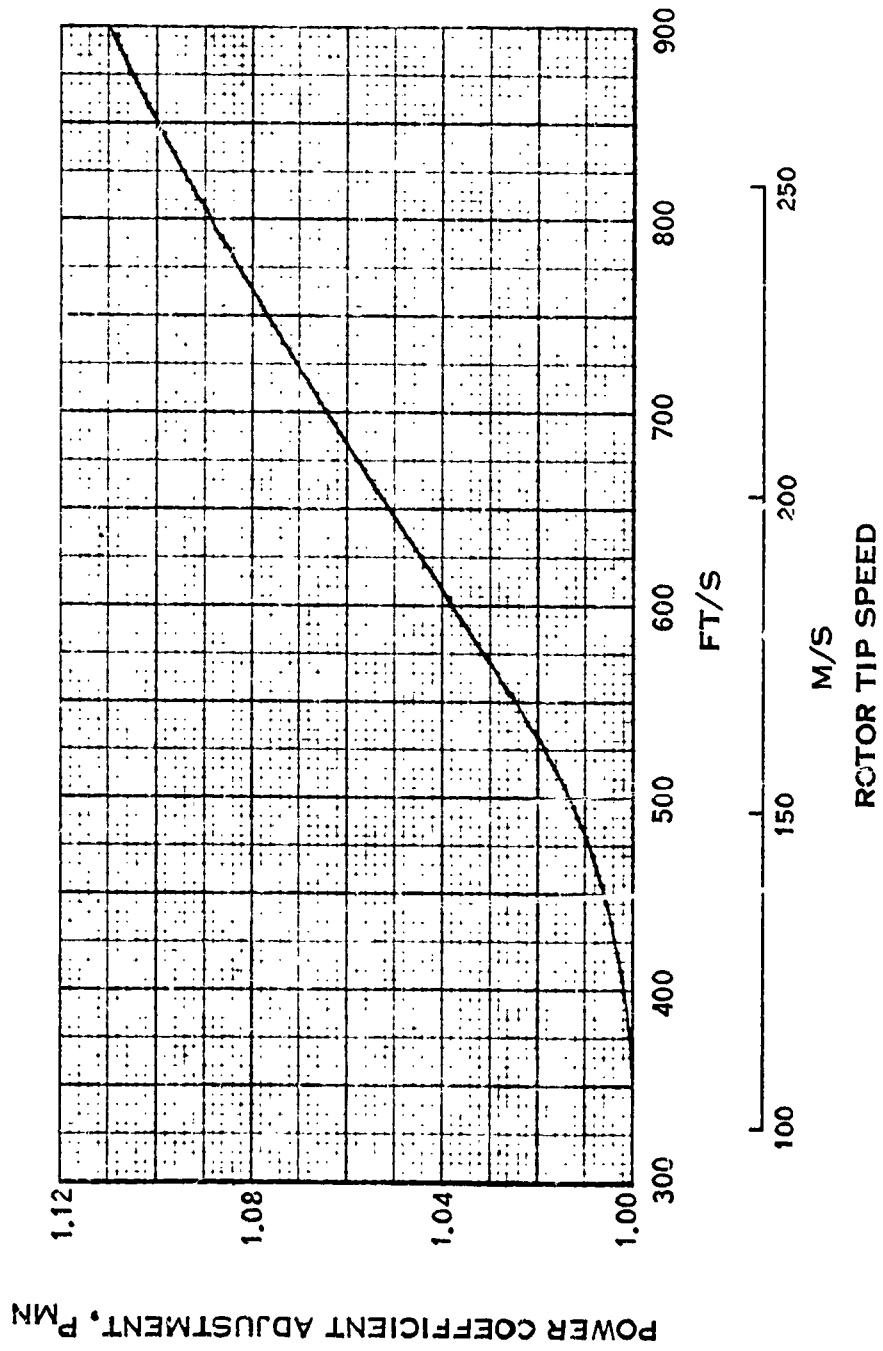

FIGURE 8. TIP SPEED/MACH NUMBER ADJUSTMENT TO POWER COEFFICIENT

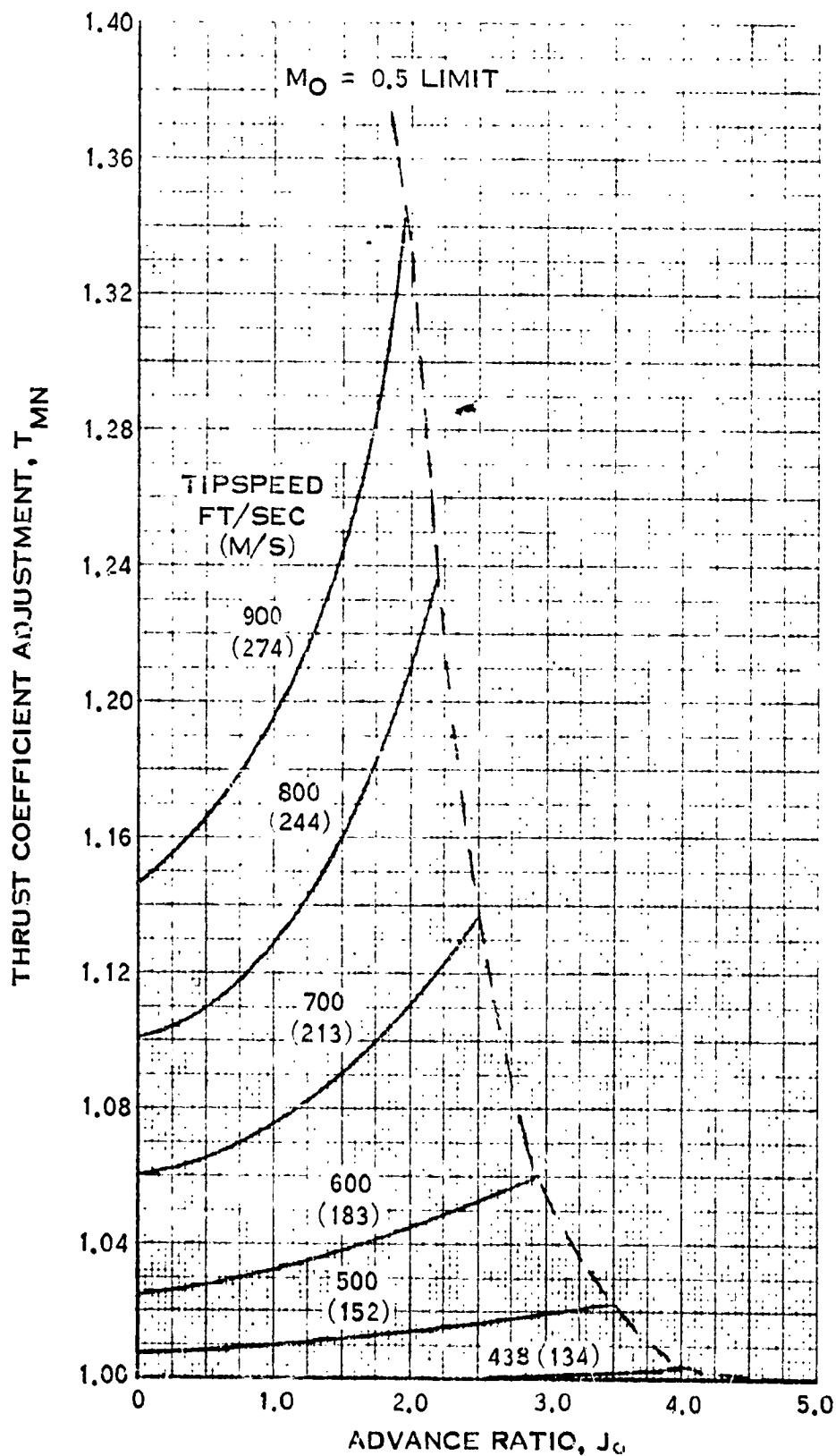

FIGURE 9. TIP SPEED/MACH NUMBER ADJUSTMENT TO THRUST COEFFICIENT

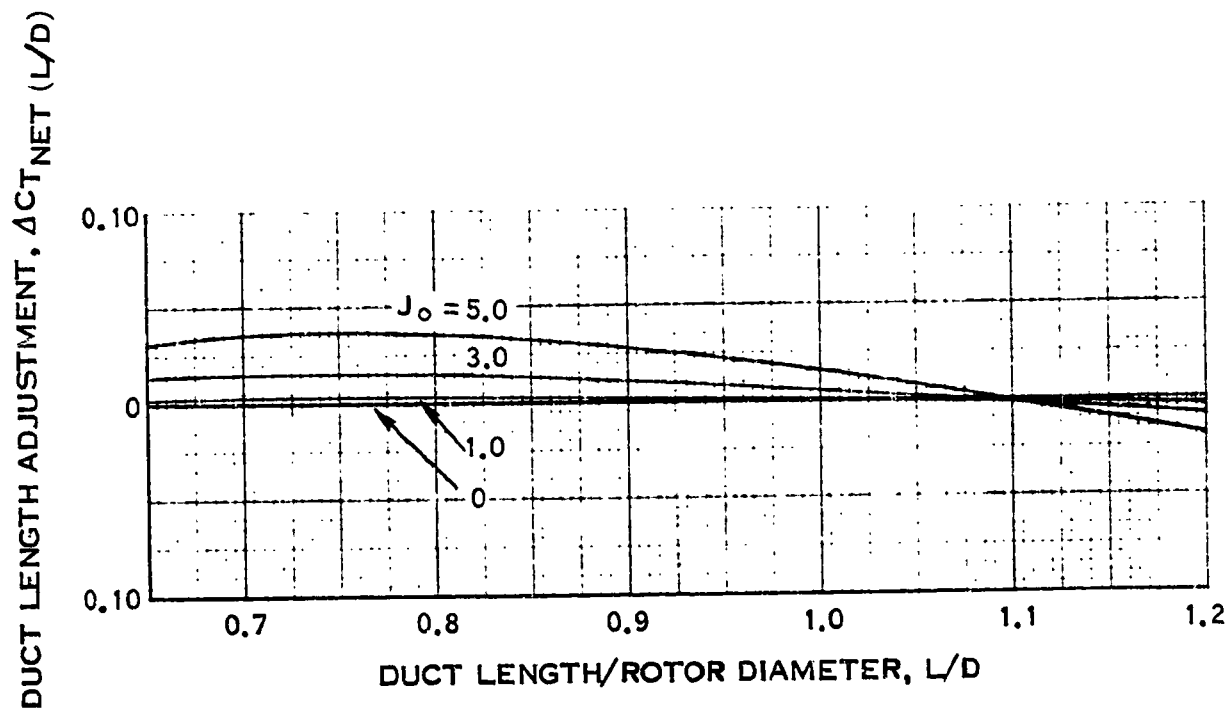

FIGURE 10. DUCT LENGTH ADJUSTMENT TO THRUST COEFFICIENT

$$C_{TEI} = (C_T \times T_{TAF} \times T_{MN}) - \Delta C_T(L/D)$$

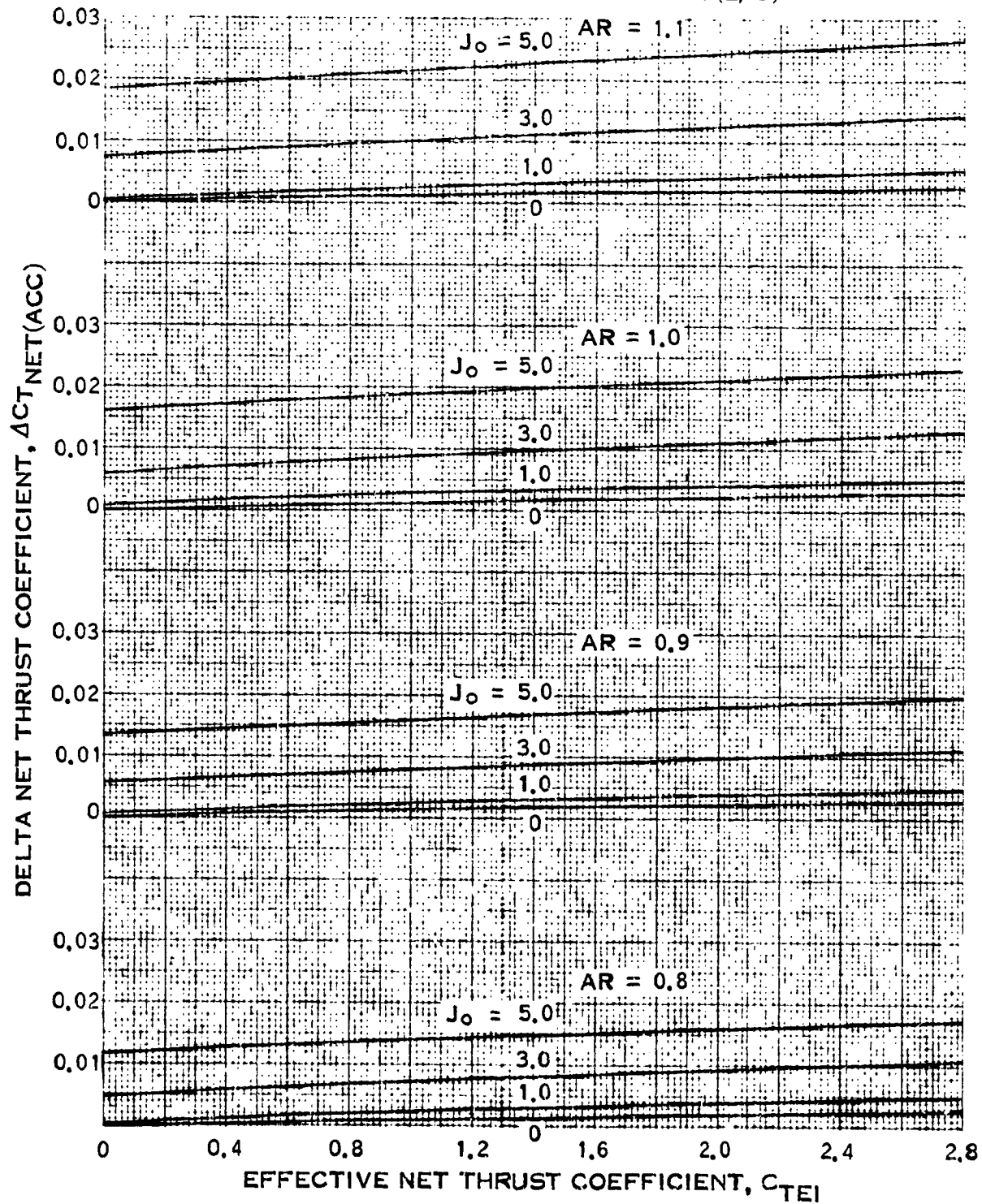
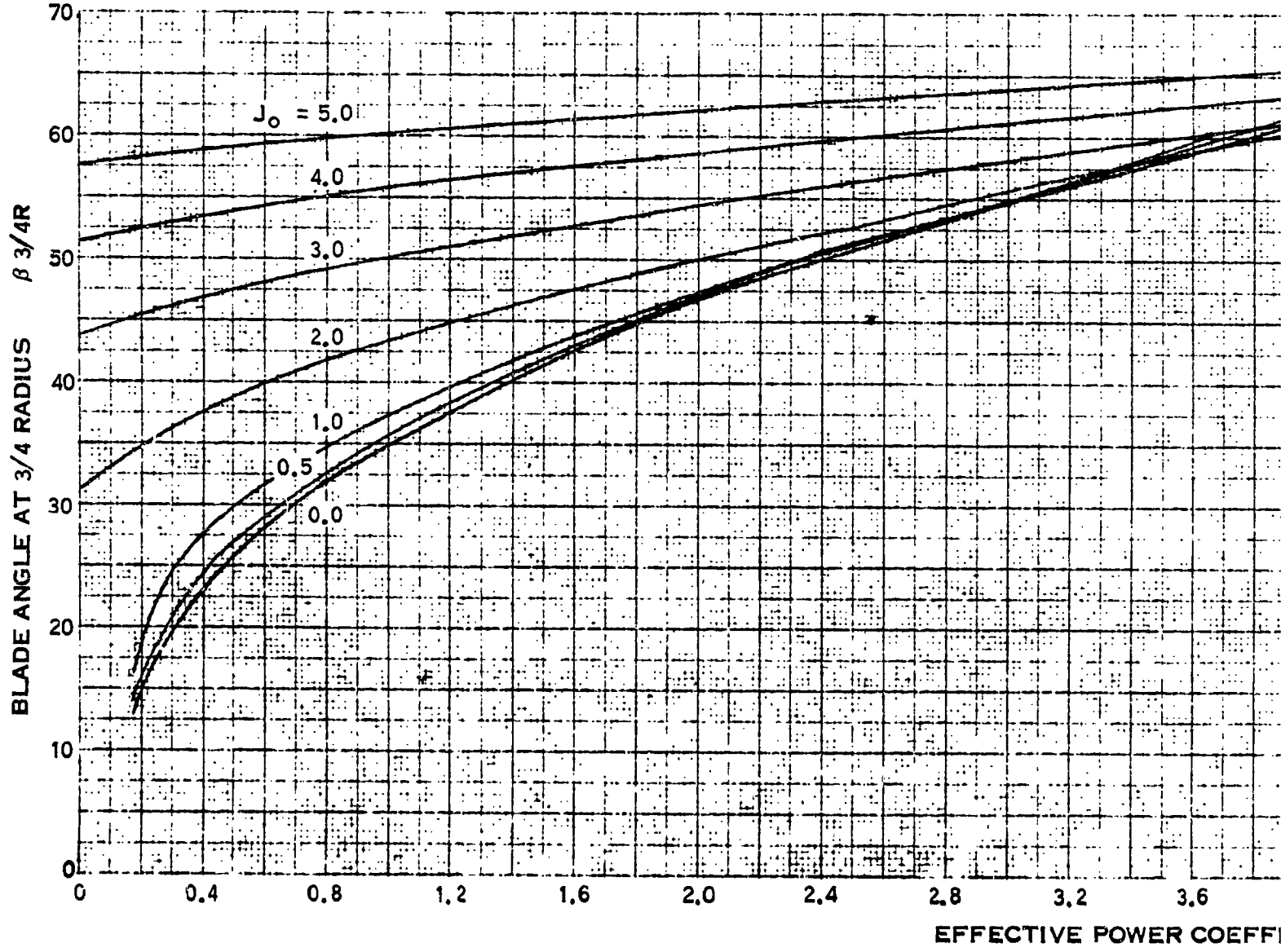

FIGURE 11. EFFECT OF ACOUSTICAL TREATMENT ON PERFORMANCE
4.5 PNdB NOISE REDUCTION

HOLDOUT FRAME

SYSTEM OF UNITS

	ENGLISH	SI
K1	101.4	60.0
K2	0.5×10^{11}	1.764×10^8



EFFECTIVE POWER COEFF

$$J_s = \frac{(K1)V}{ND}$$

$$C_{PE} = C_P \times P_{TAF} \times P_{MN}$$

$$C_P = \frac{(K2) \text{ POWER } (\rho_o/\rho)}{N^3 D^5}$$

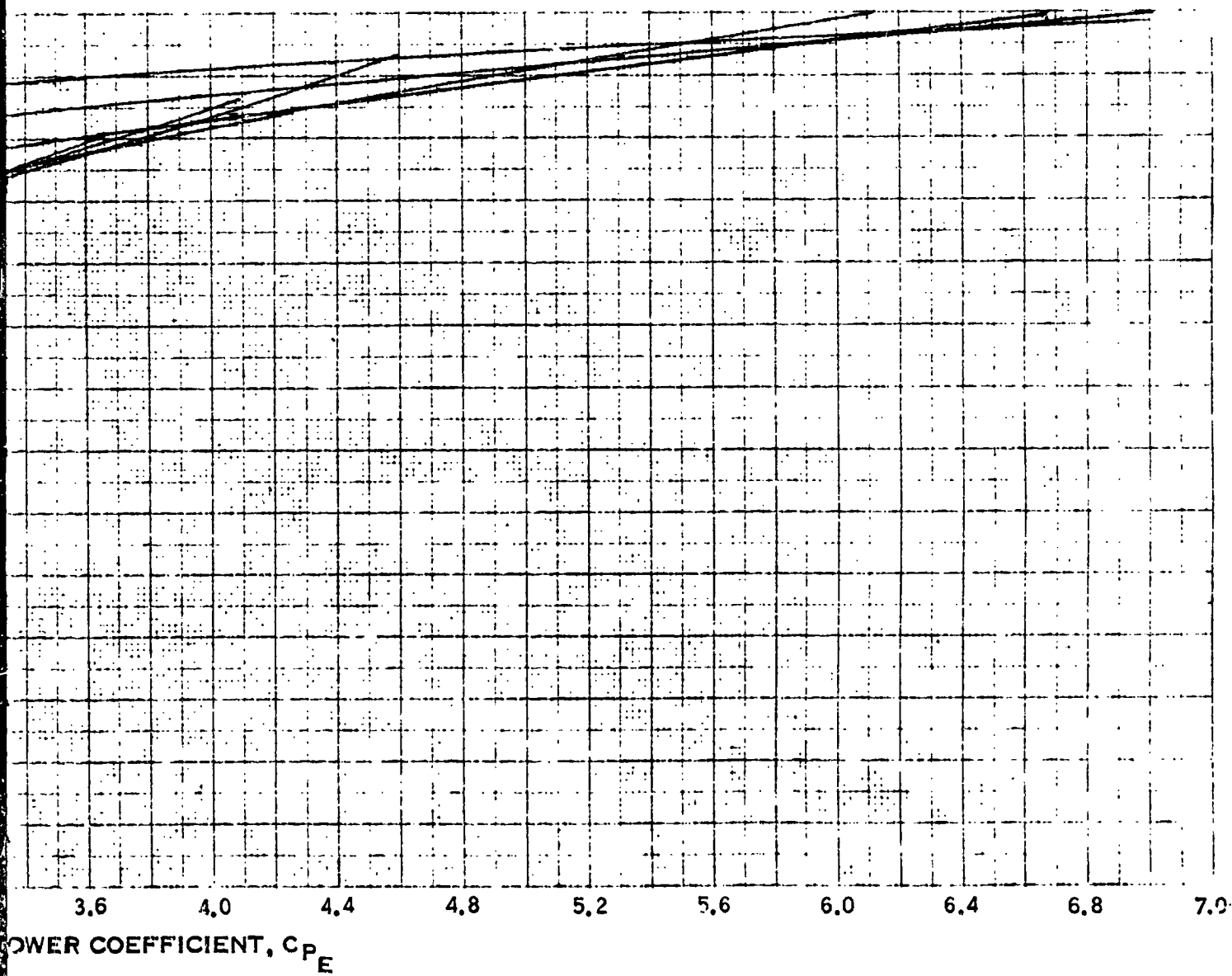
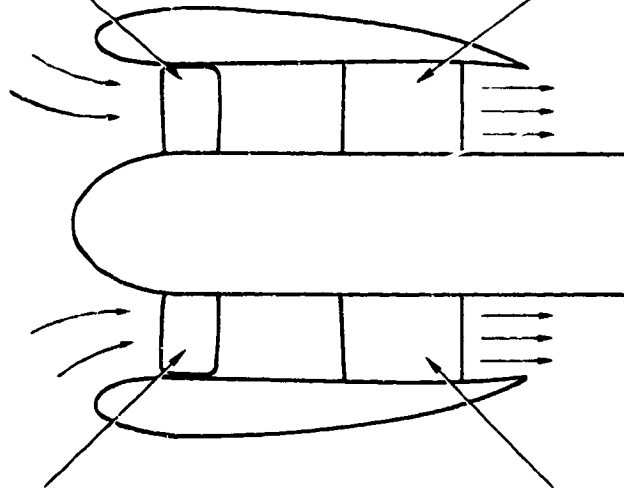

FIGURE 12. BASE Q-FAN BLADE ANGLE CURVE - 1.0 AREA RATIO

ROTOR TONE NOISE
DUE TO UNSTEADY BLADE LOADING

STATOR TONE NOISE DUE TO
PERIODIC FLUCTUATING LIFT



ROTOR BROADBAND NOISE
DUE TO VORTEX SHEDDING

STATOR BROADBAND NOISE
DUE TO RANDOM FLUCTUATING LIFT

FIGURE 13. Q-FAN NOISE SOURCES

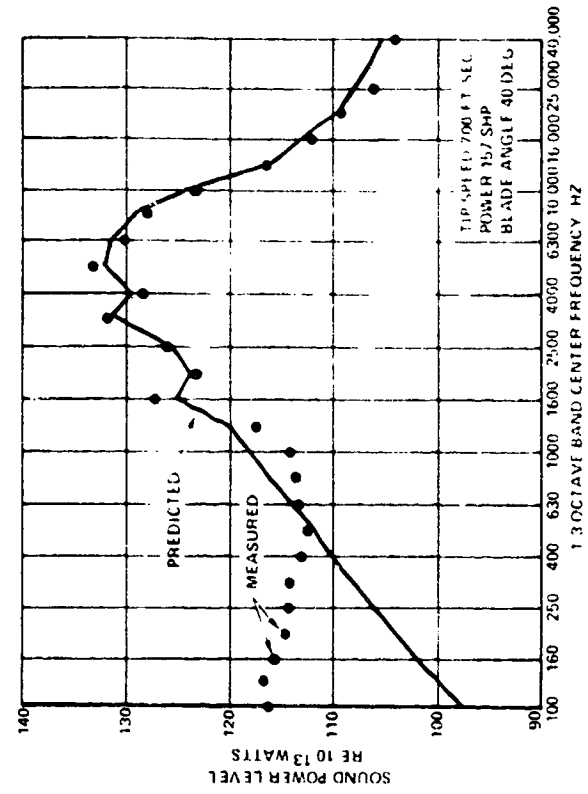
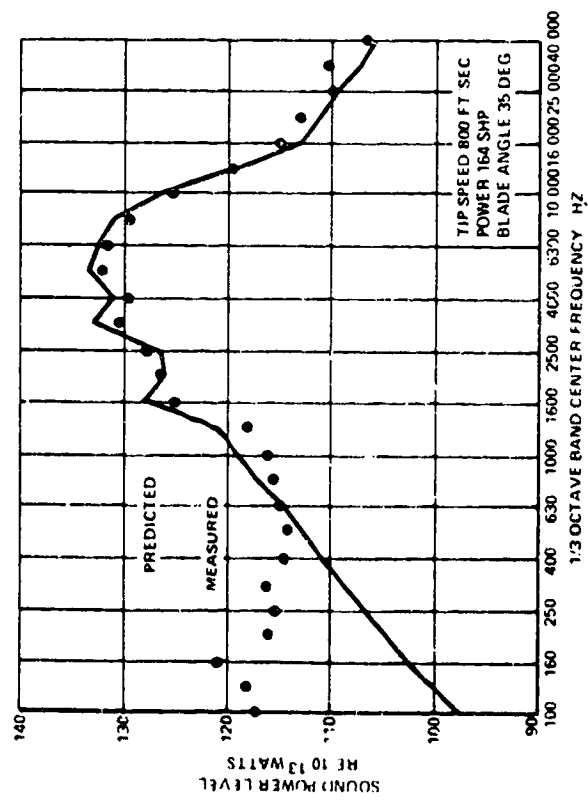
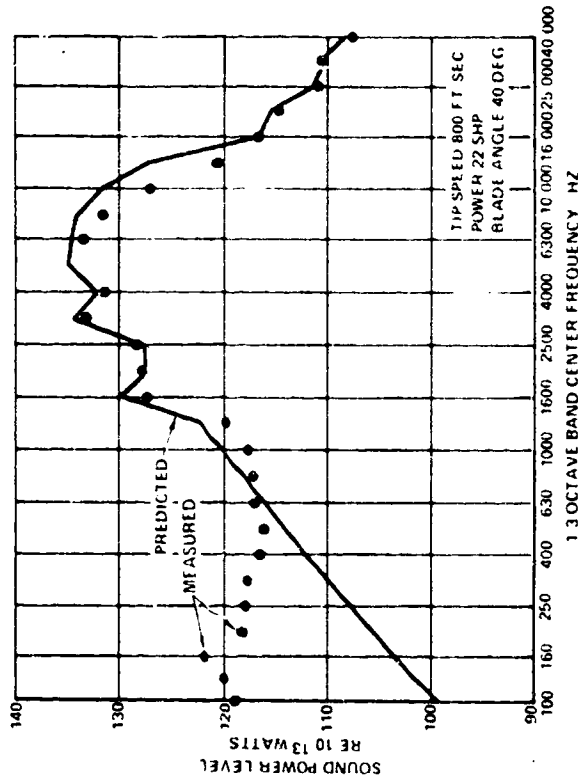
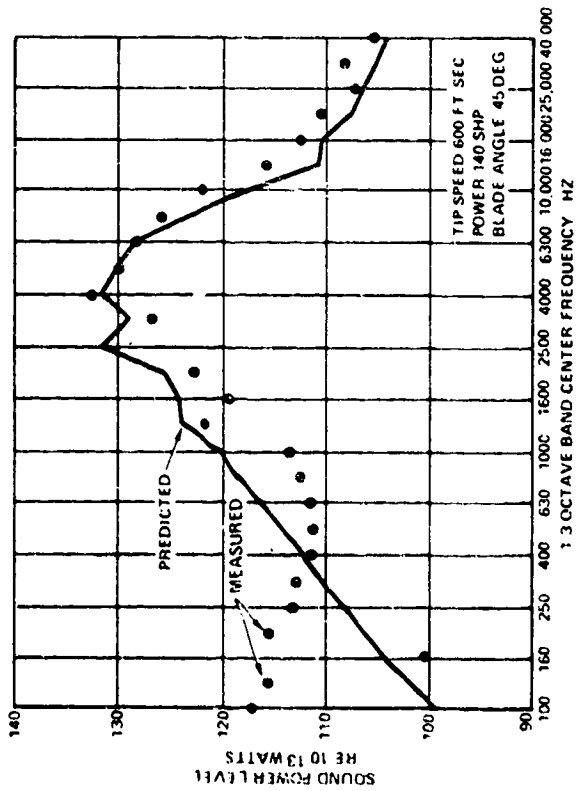

FIGURE 14. ONE-THIRD OCTAVE BAND COMPARISON OF EXPERIMENTAL AND THEORY

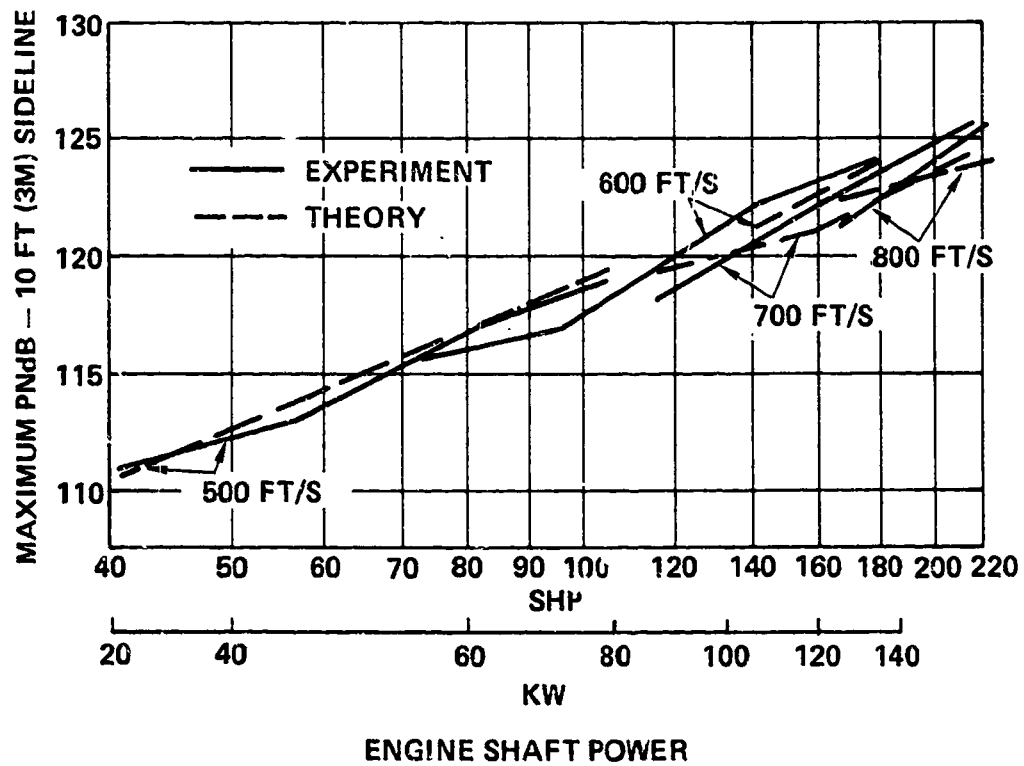

FIGURE 15. CORRELATION OF EXPERIMENTAL DATA WITH THEORY

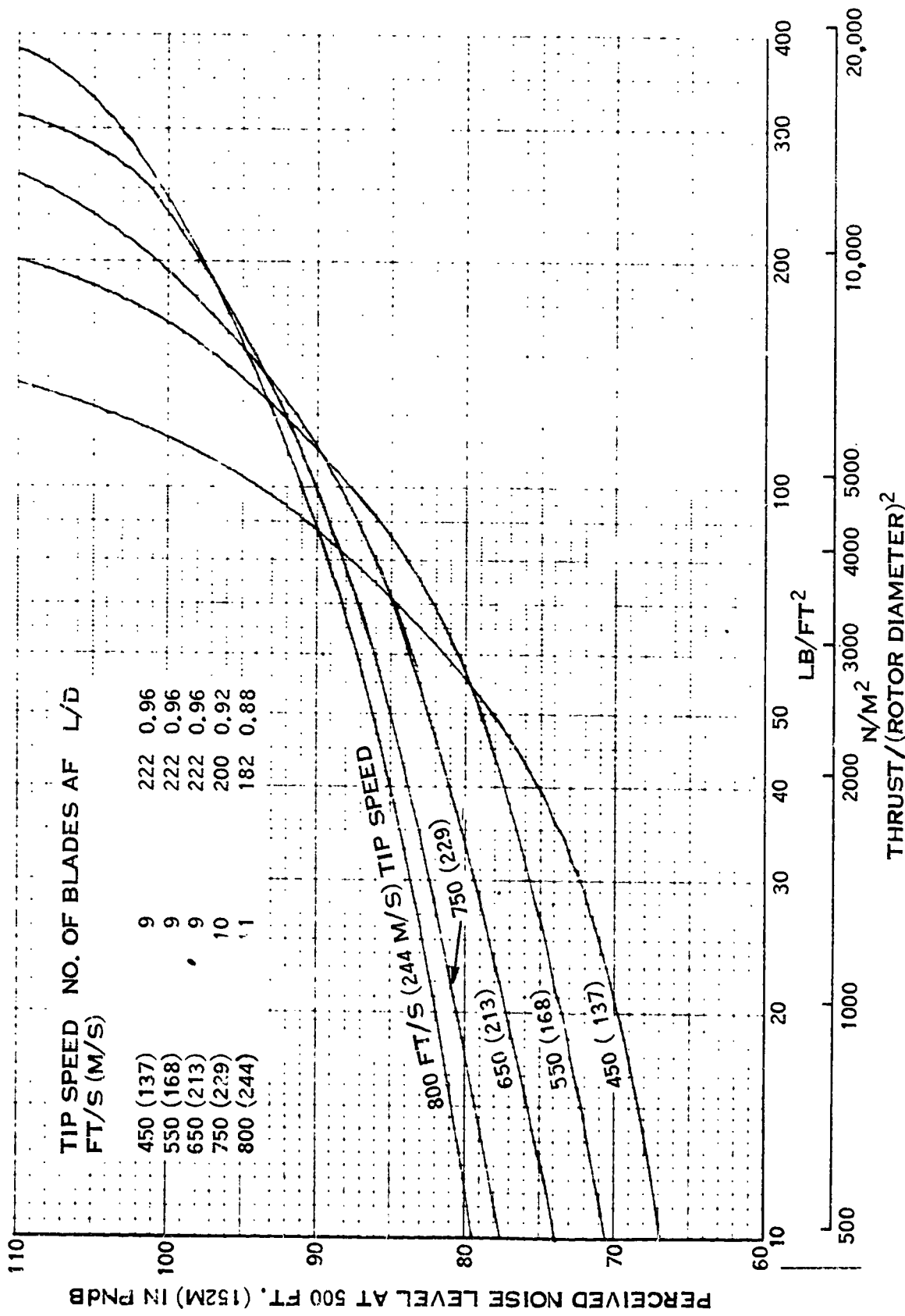

FIGURE 16. NOISE LEVEL OF A SINGLE 5-FOOT (1.52M) DIAMETER Q-FAN AT 66 KNOTS (34 M/S) FORWARD SPEED - 2000 TOTAL ACTIVITY FACTOR

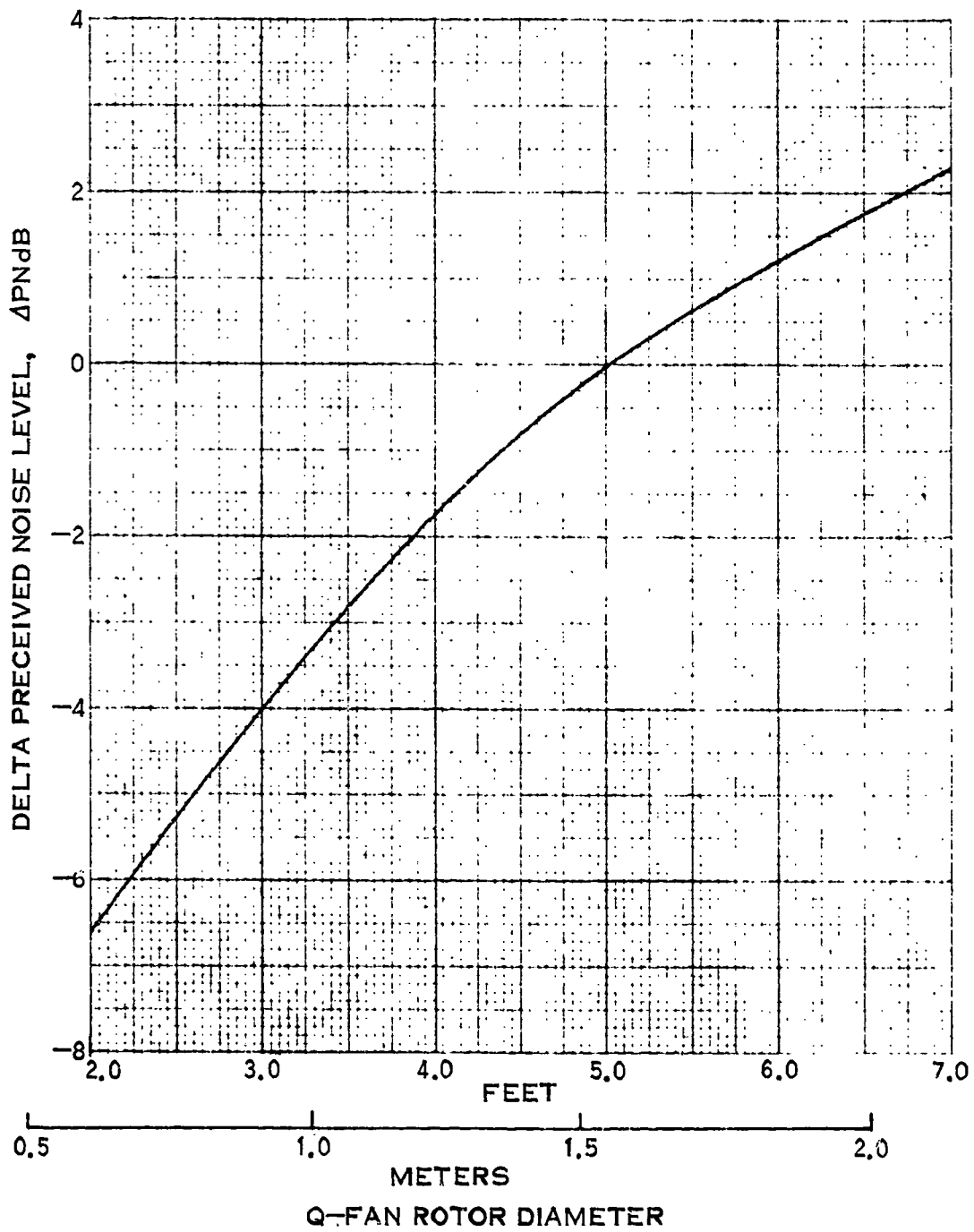
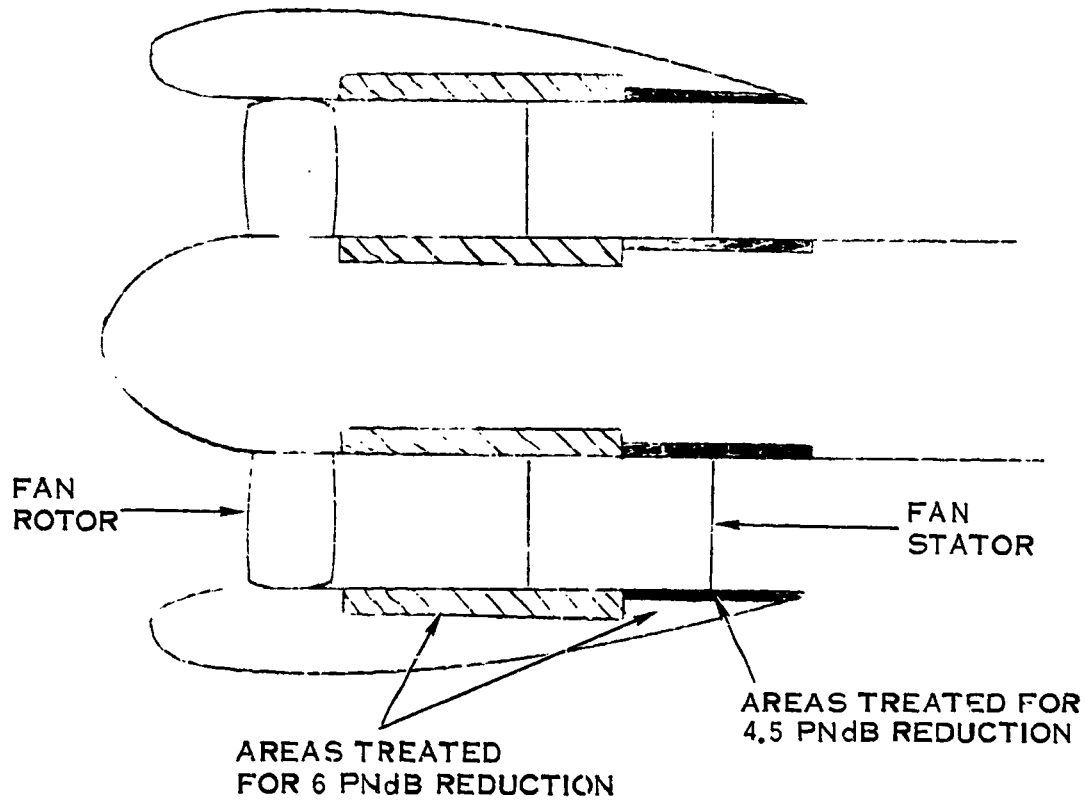

FIGURE 17. NOISE PREDICTION METHOD - DIAMETER CORRECTION



CROSS SECTION OF TYPICAL GENERAL AVIATION
Q-FAN INCLUDING DUCT TREATMENT

FIGURE 18. CROSS SECTION OF TYPICAL GENERAL AVIATION
Q-FAN INCLUDING DUCT TREATMENT

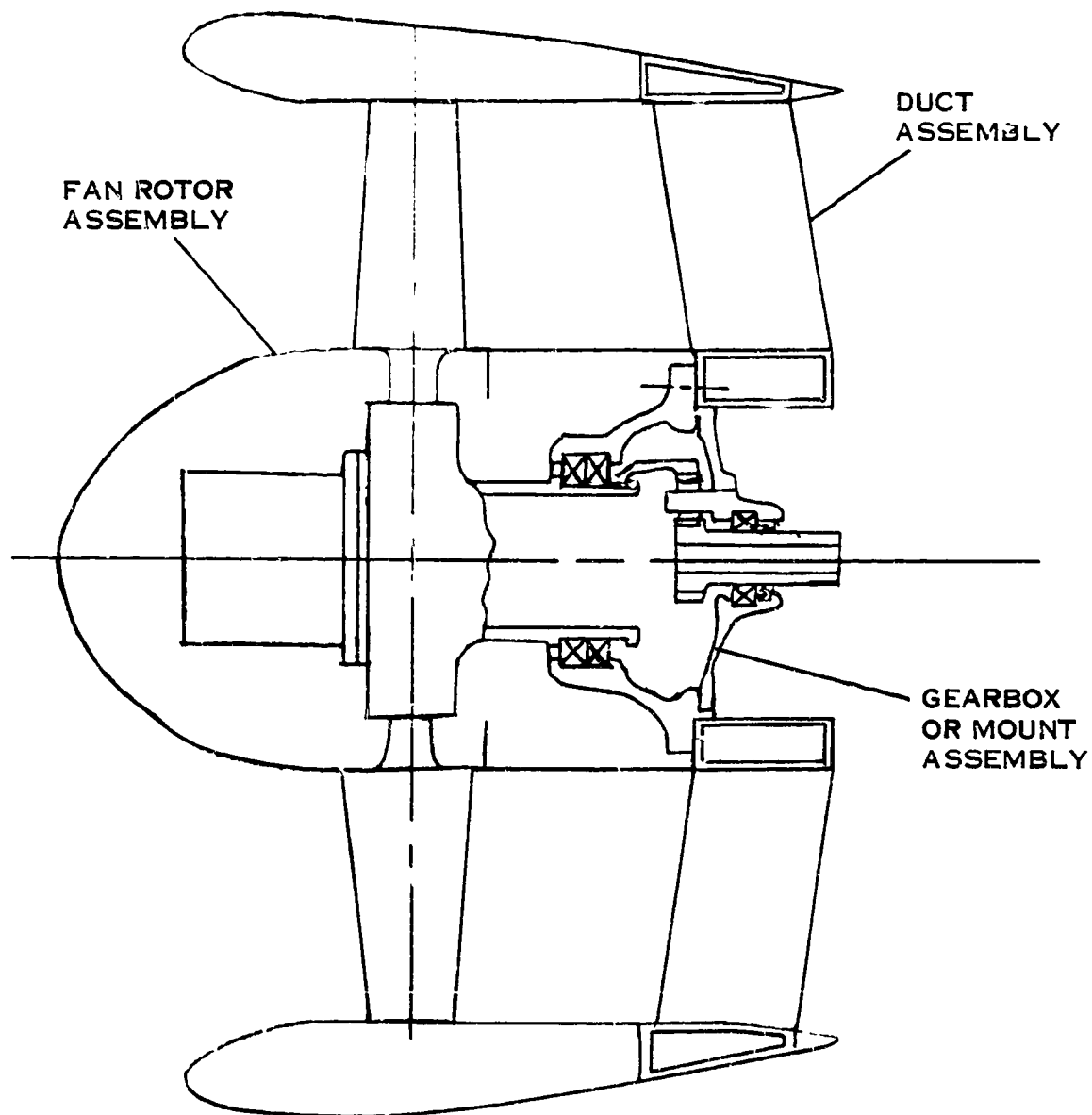
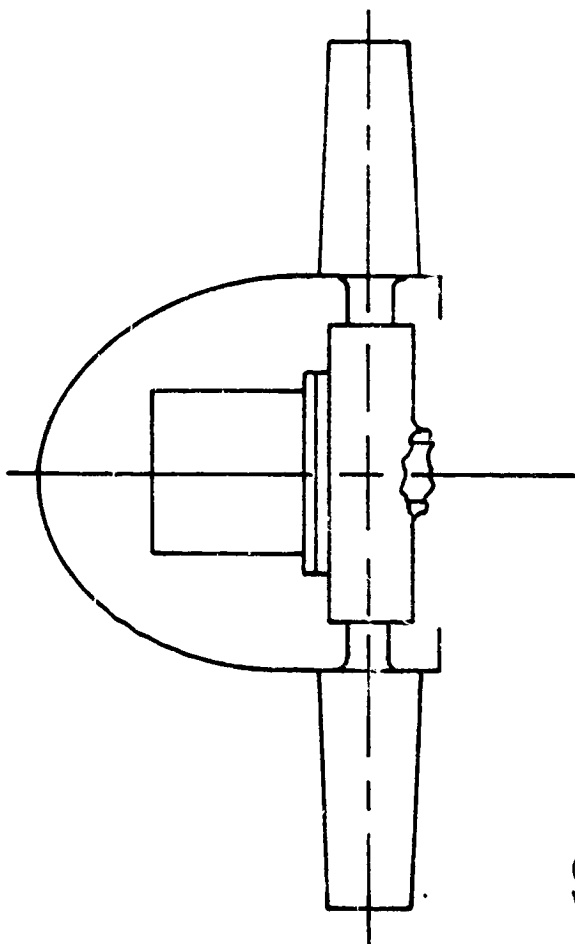

FIGURE 19. Q-FAN™ ASSEMBLY



INCLUDES:

BLADES
 BARREL
 RETENTION
 ACTUATOR
 SPINNER
 FLUIDS

WHERE:

B = NO. BLADES
 D = BLADE TIP DIA.(FT)
 AF = ACTIVITY FACTOR/BLADE
 SHP = HORSE POWER
 TS = TIP SPEED, (FT/S)

(SEE TABLE IV FOR CONSTANT VALUES)

$$W_T = K_M \left(\frac{B}{10} \right)^P \left(\frac{D}{5} \right)^R \left(\frac{AF}{170} \right)^{1.5} (U-V) \left(\frac{SHP}{100} \right)^S \left\{ \frac{K_1 Y [1 + K_2 \left(\frac{TS}{500} \right)^2 \left(\frac{5}{D} \right)]}{\left(\frac{AF}{170} \right)^{\frac{U-3V}{2}}} \right.$$

$$+ \frac{K_3 \left(\frac{AF}{170} \right)^V \left(\frac{TS}{500} \right)}{\left(\frac{D}{5} \right)^{0.82} \left[\frac{B(SHP)}{1000} \right]^{S/2}} + K_4 \left(\frac{AF}{170} \right)^{\frac{U+3V}{2}} \left(\frac{TS}{500} \right)^2 + K_5 Z \left(\frac{B}{10} \right)^T \left(\frac{SHP}{20D} \right)^{S/2} \left(\frac{TS}{500} \right)^3 \left. \right\}$$

COUNTERWEIGHTS	FLANGE	SPINNER
----------------	--------	---------

$$+ \frac{K_6 \left(\frac{D}{5} \right)^3 \left(\frac{AF}{170} \right)^{U-V}}{\left(\frac{TS}{500} \right)^2} + K_7 \left(\frac{SHP}{500} \right)^{0.2} + 0.93 D^2$$

FIGURE 20. FAN RECTOR ASSEMBLY

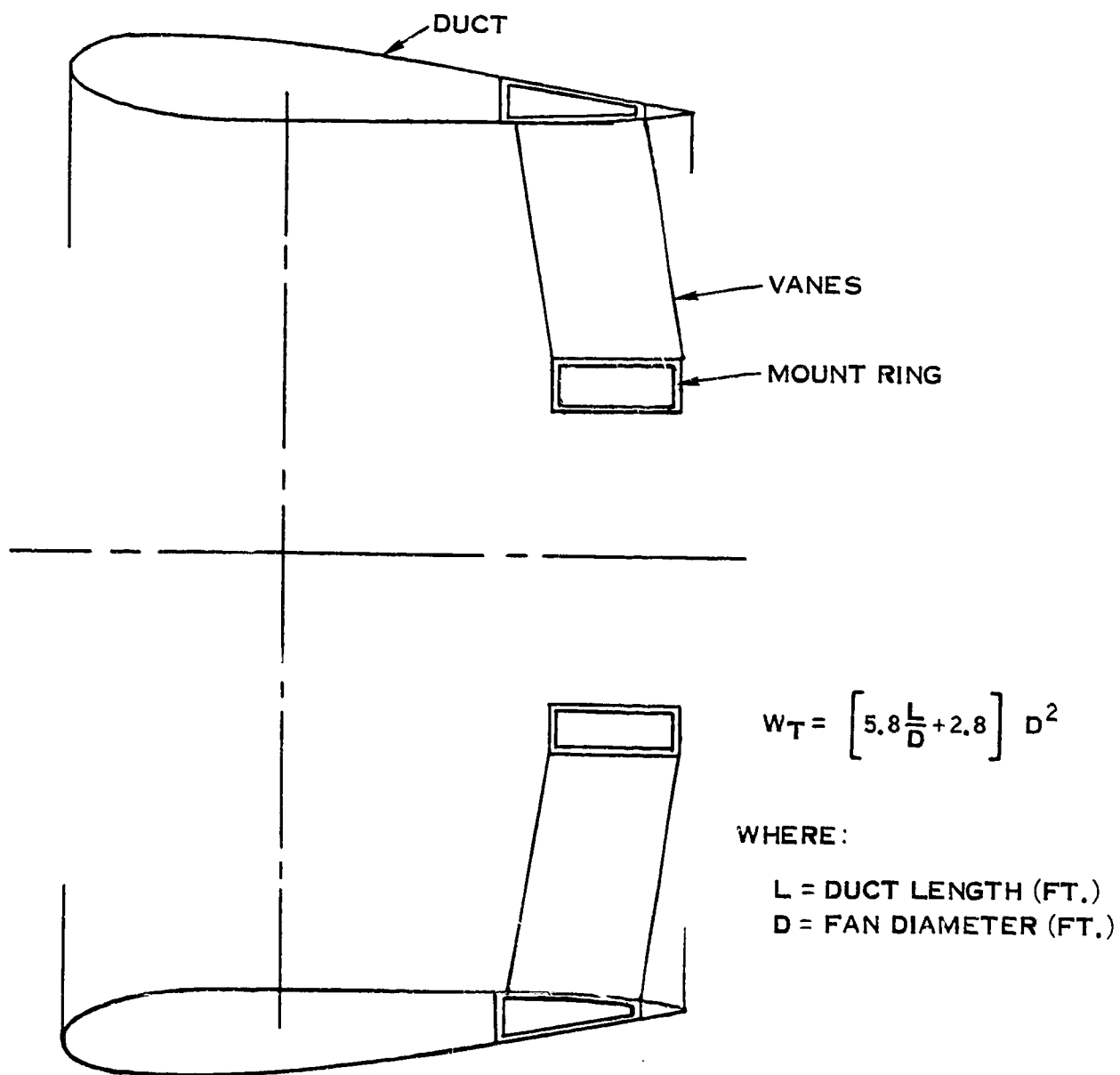

FIGURE 21. DUCT ASSEMBLY

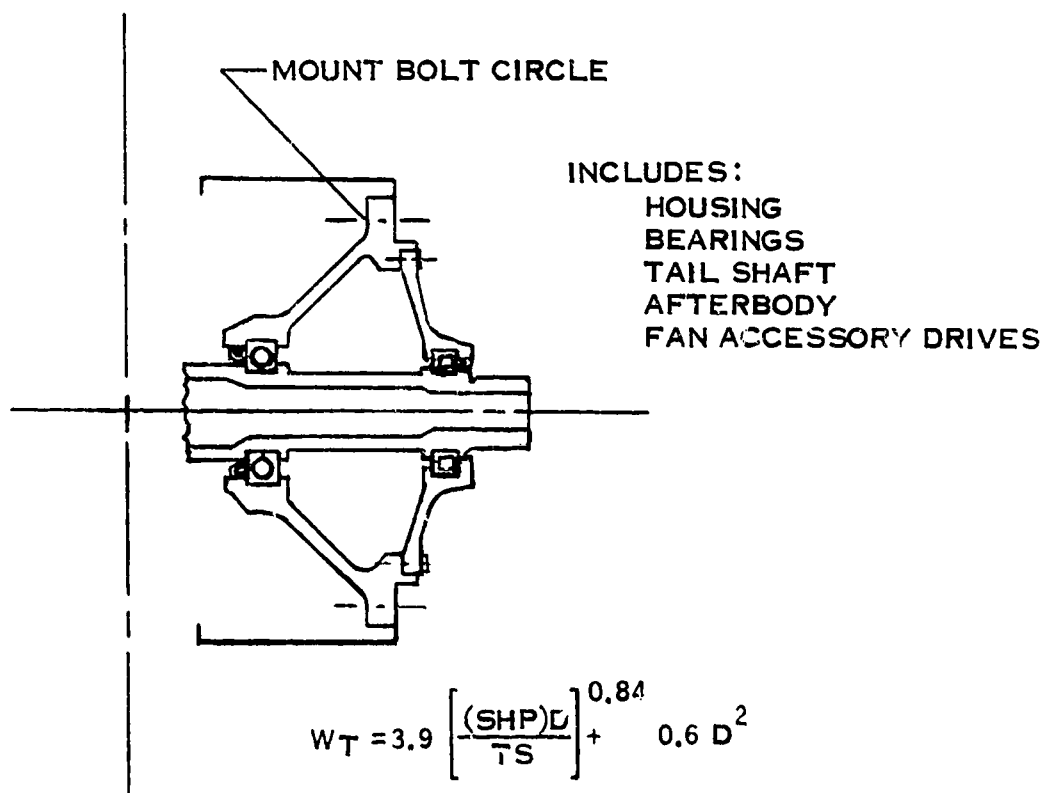

FIGURE 22. MOUNT ASSEMBLY

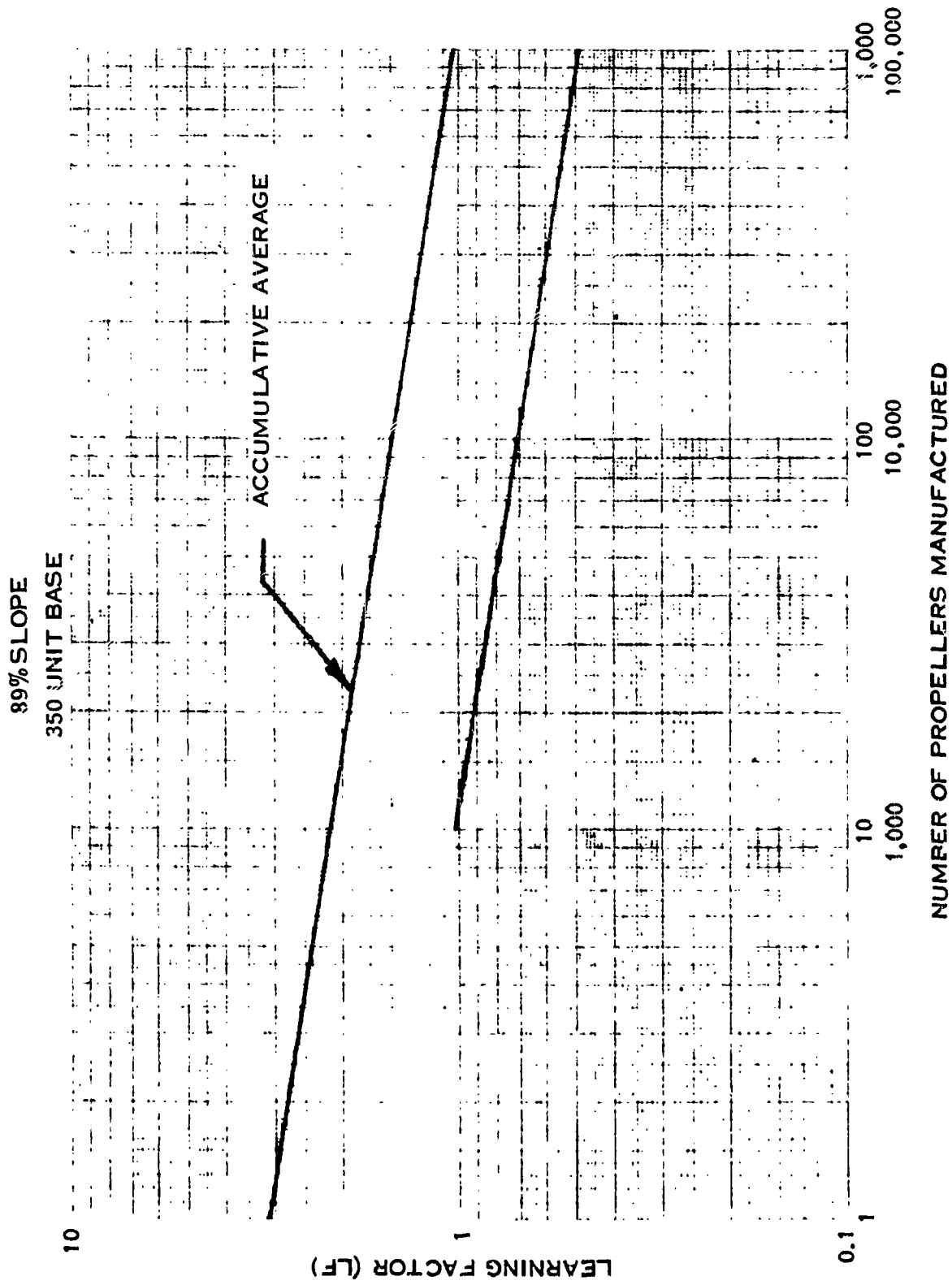

FIGURE 23. LEARNING CURVE FOR GENERAL AVIATION PROPELLERS

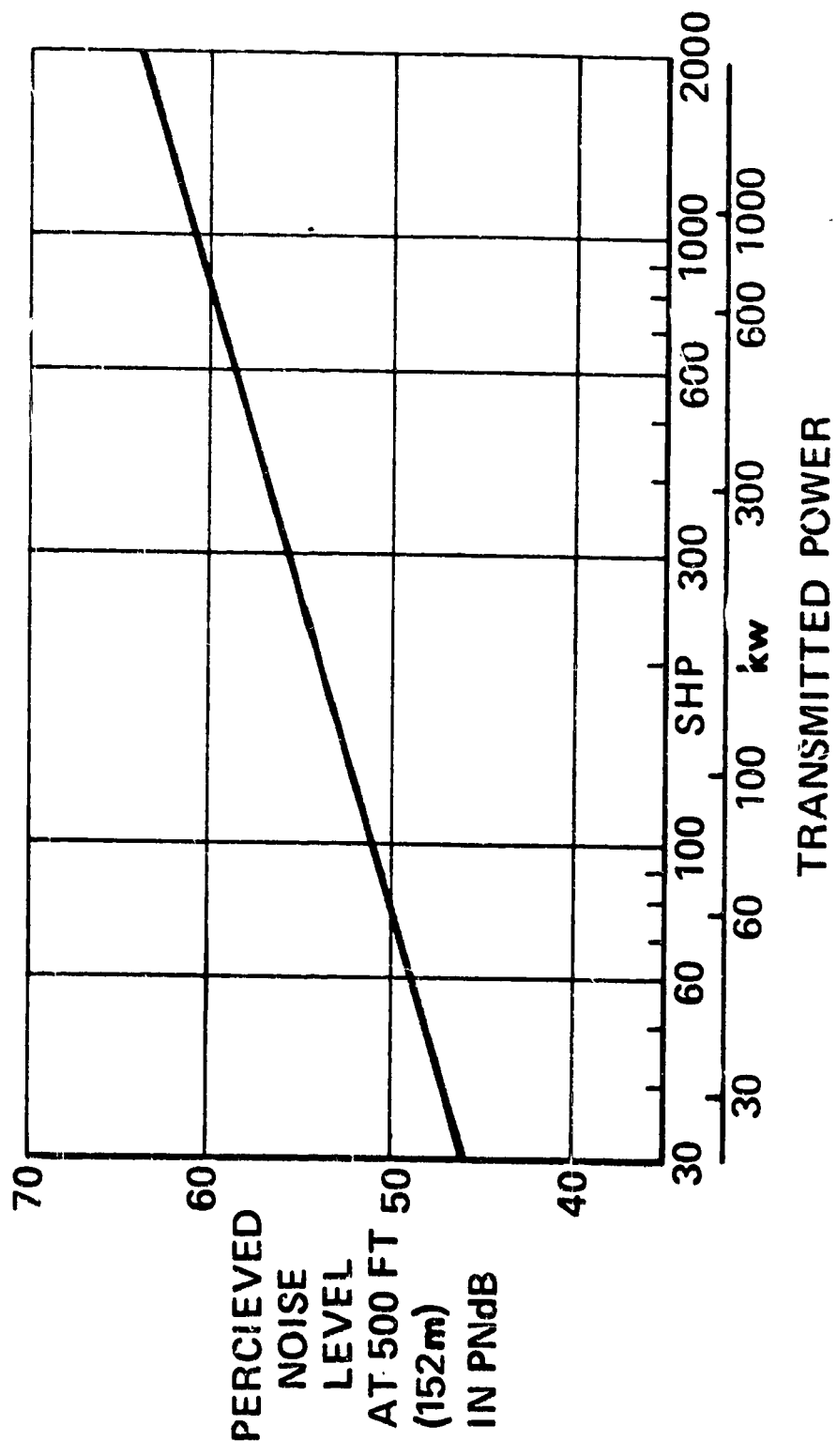
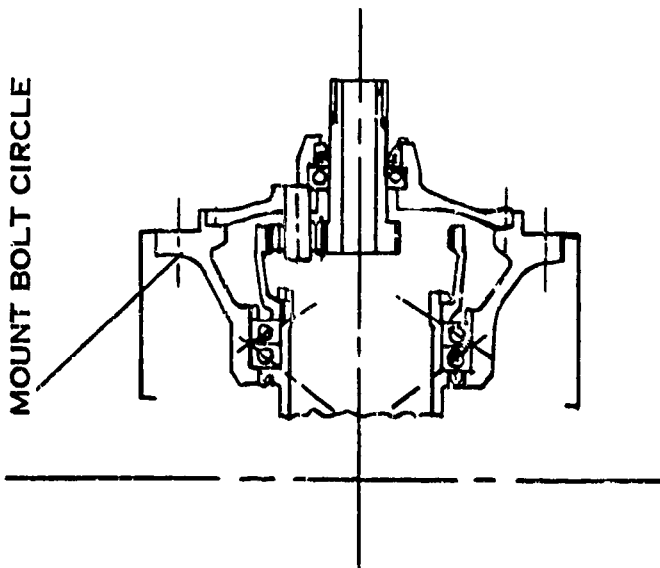

FIGURE 24. GEAR BOX NOISE

GEAR BOX ASSEMBLY
INCLUDES

- HOUSING
- BEARINGS
- PLANETARY GEARING
- TAILSHAFT
- AFTERBODY
- LUBE & SCAVENGE PUMP
(SINGLE OR 2-STAGE GEARING AS REQUIRED)
- FAN ACCESSORY DRIVES



SINGLE-STAGE. $W_T = 8 \left[\frac{(\text{SHP}) D}{TS} \right]^{0.84} + 0.6 D^2$
AFTERBODY

TWO - STAGE: $W_T = 10.6 \left[\frac{(\text{SHP}) D}{TS} \right]^{0.84} + 0.6 D^2$
AFTERBODY

FIGURE 25. BEAR BOX ASSEMBLY

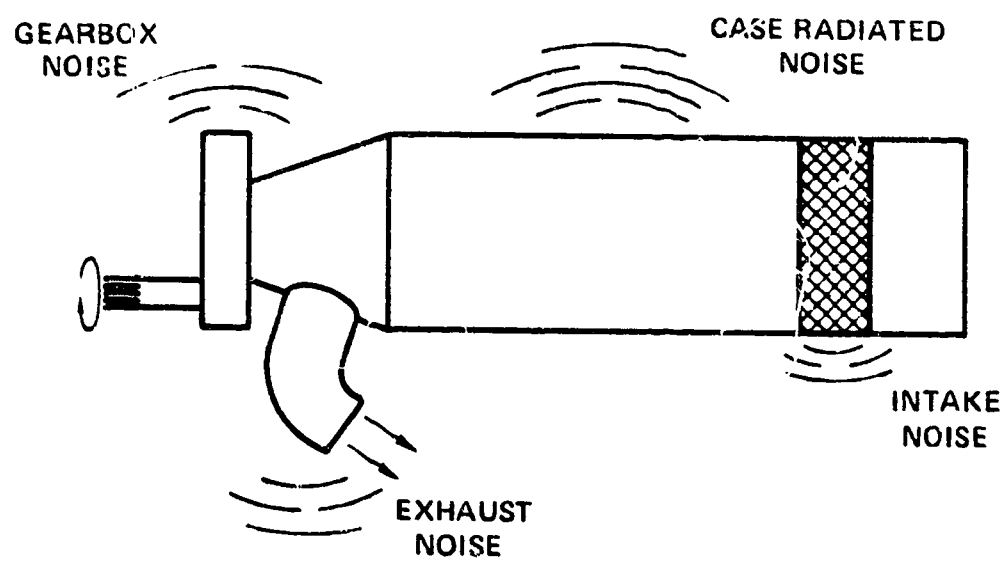

FIGURE 26. ENGINE NOISE SOURCE

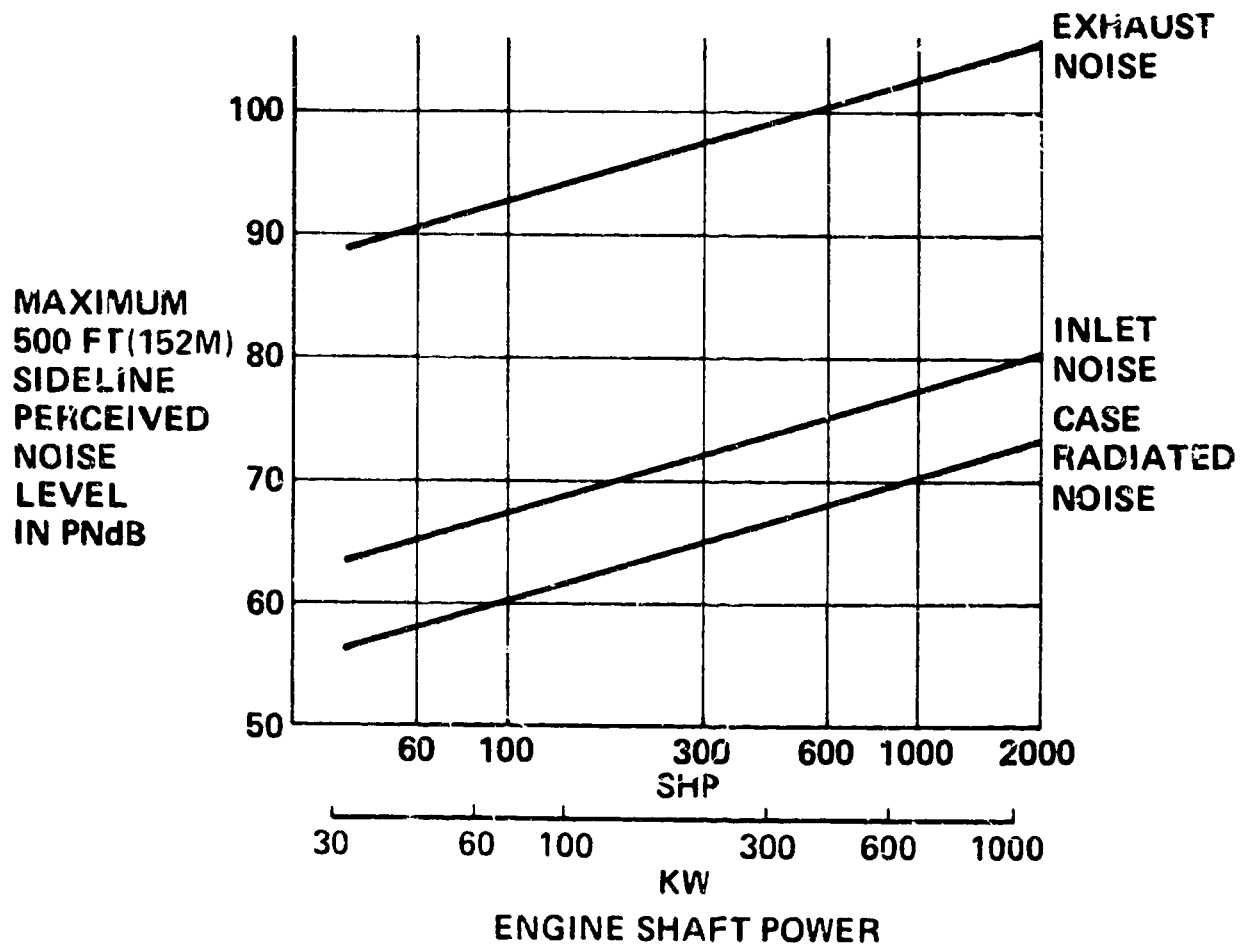

FIGURE 27. NOISE OF UNMUFFLED WATER COOLED ROTARY COMBUSTION ENGINES

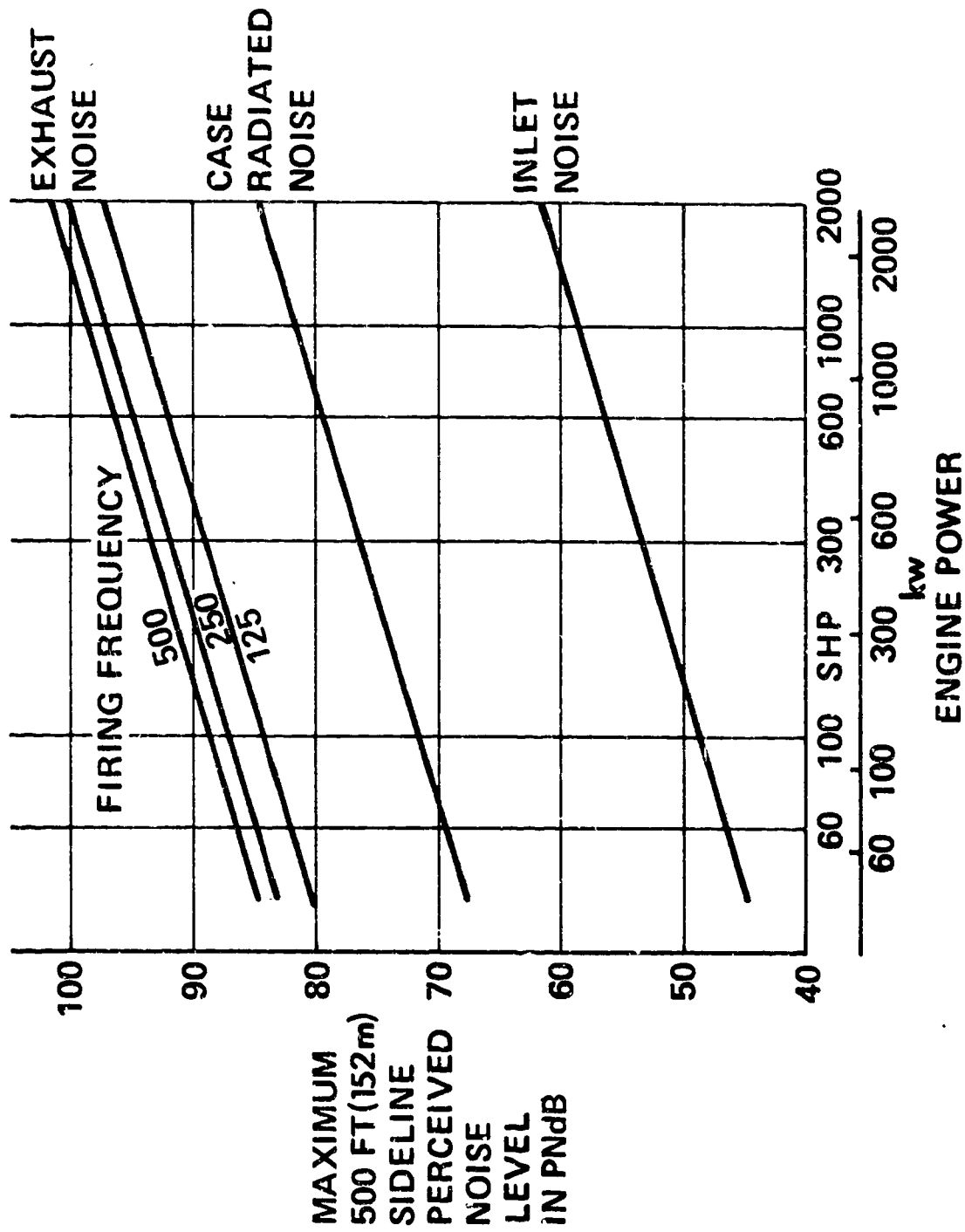

FIGURE 28. NOISE OF UNMUFFLED PISTON ENGINES

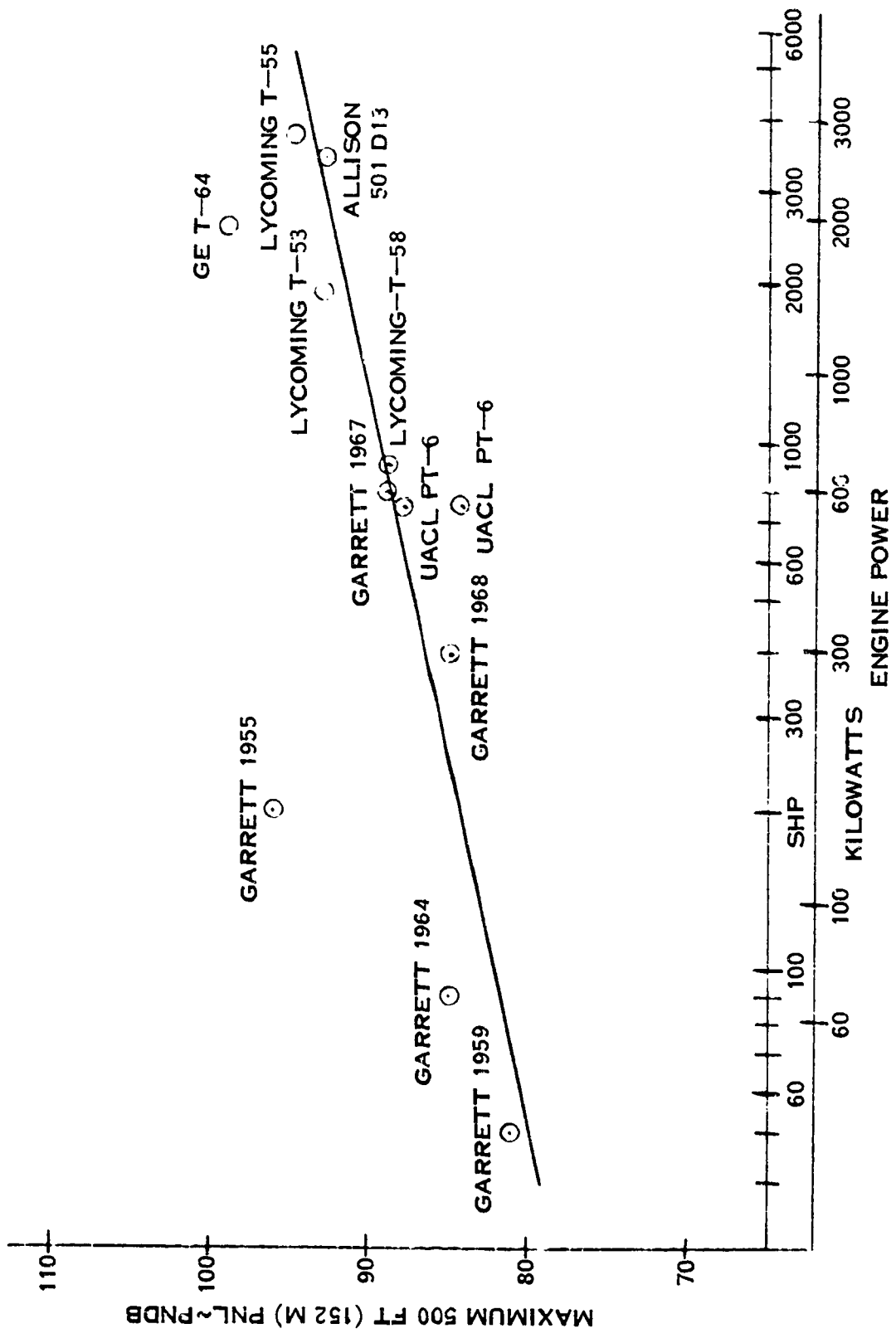

FIGURE 29. NOISE OF UNMUFFLED GAS TURBINE ENGINE

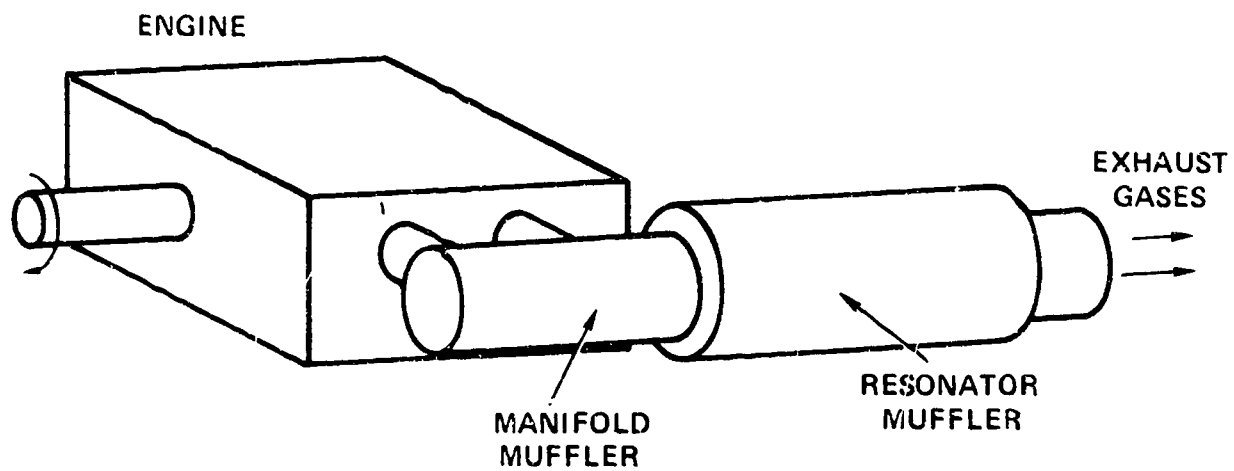

FIGURE 30. SCHEMATIC VIEW OF PISTON OR ROTARY COMBUSTION EXHAUST MUFFLERS

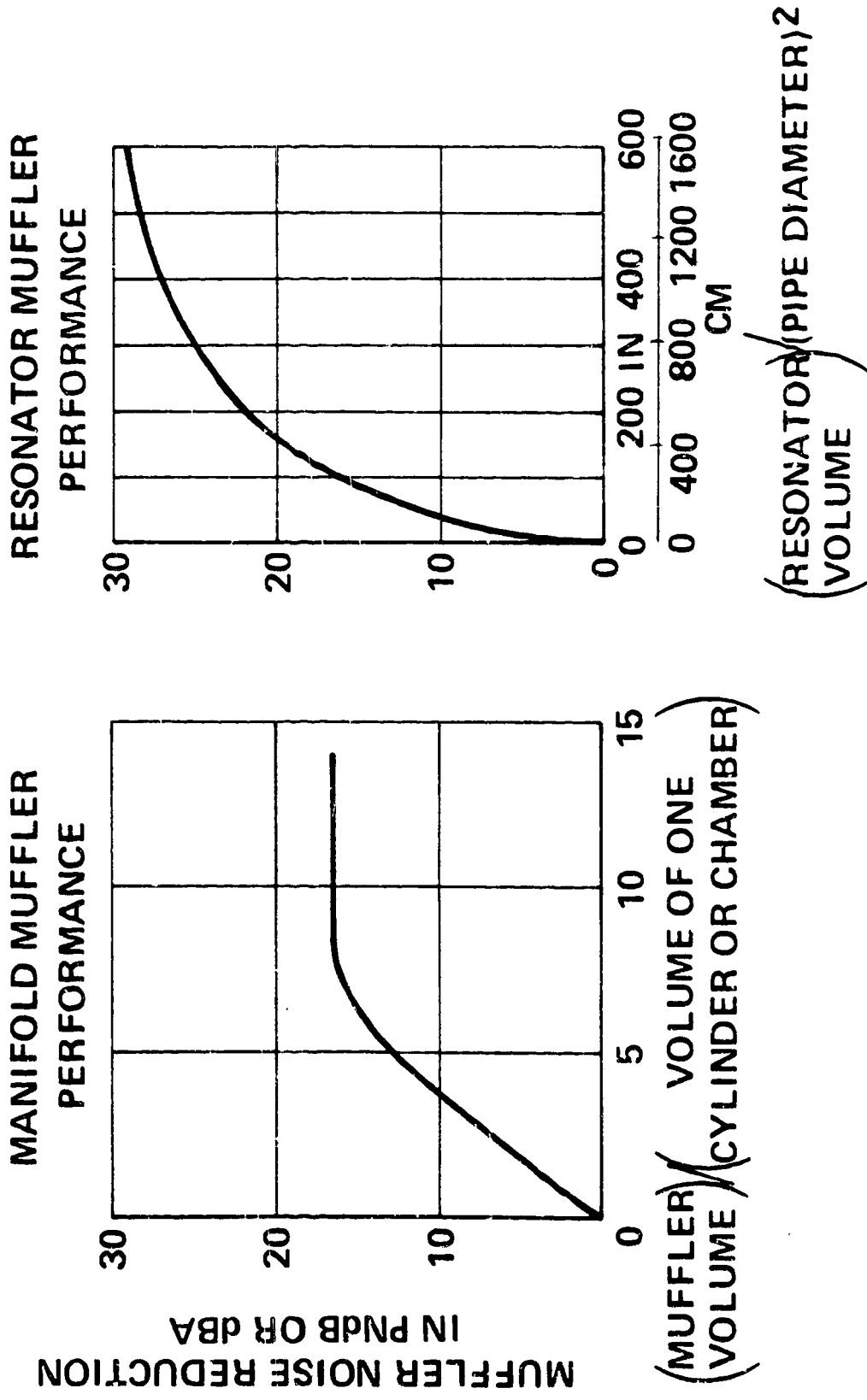

FIGURE 31. PERFORMANCE OF PISTON AND ROTARY COMBUSTION ENGINE EXHAUST MUFFLERS

ENGINE FIRING FREQUENCY	500 HZ	250 HZ	125 HZ
CORRECTION FACTOR TO BE ADDED TO ENGINE NOISE BELOW	0	+ 1.5 PNdB	+ 4.5 PNdB

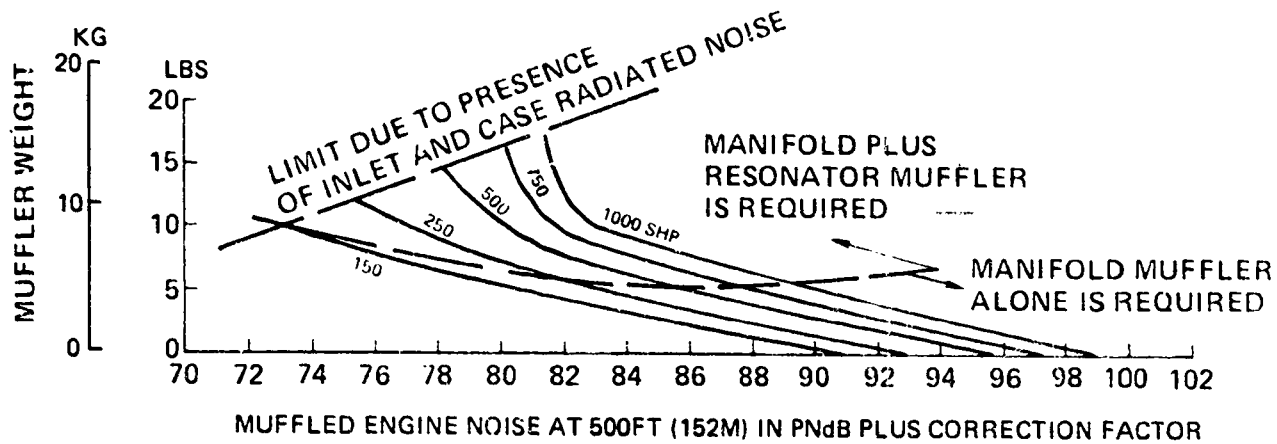

FIGURE 32. MUFFLER WEIGHTS FOR PISTON ENGINES

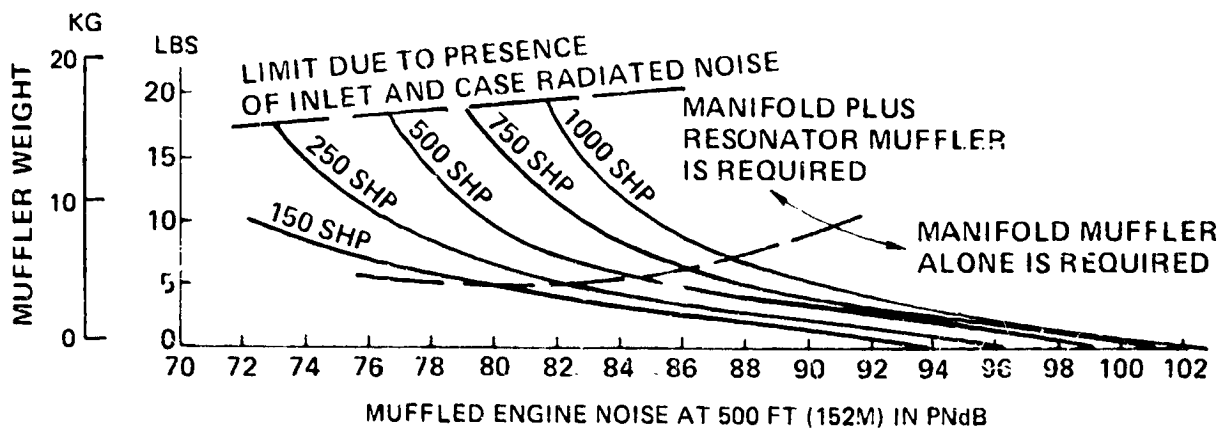

FIGURE 33. MUFFLER WEIGHTS FOR ROTARY COMBUSTION ENGINES

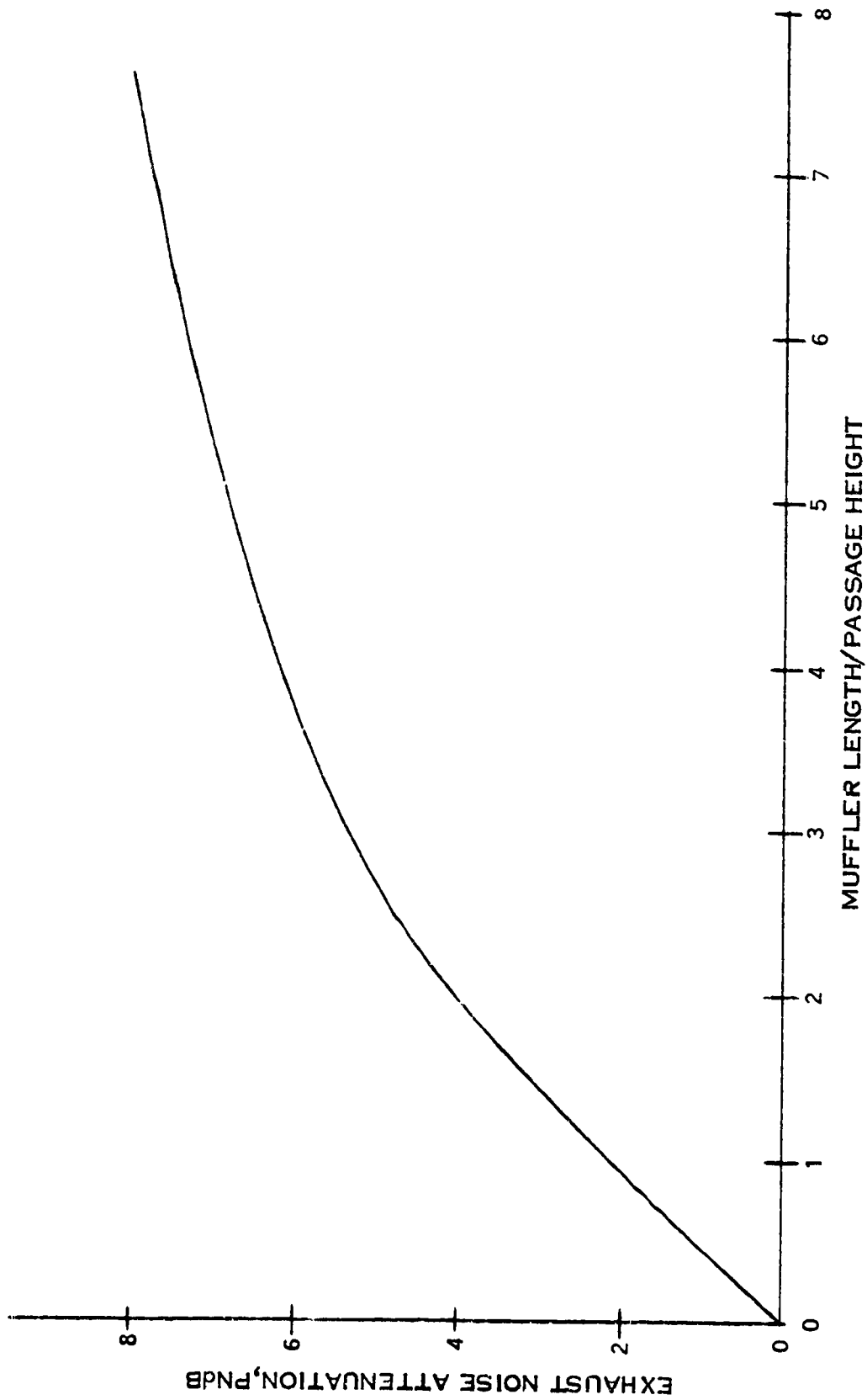

FIGURE 34. GAS TURBINE ENGINE EXHAUST NOISE TREATMENT NOISE TREATMENT

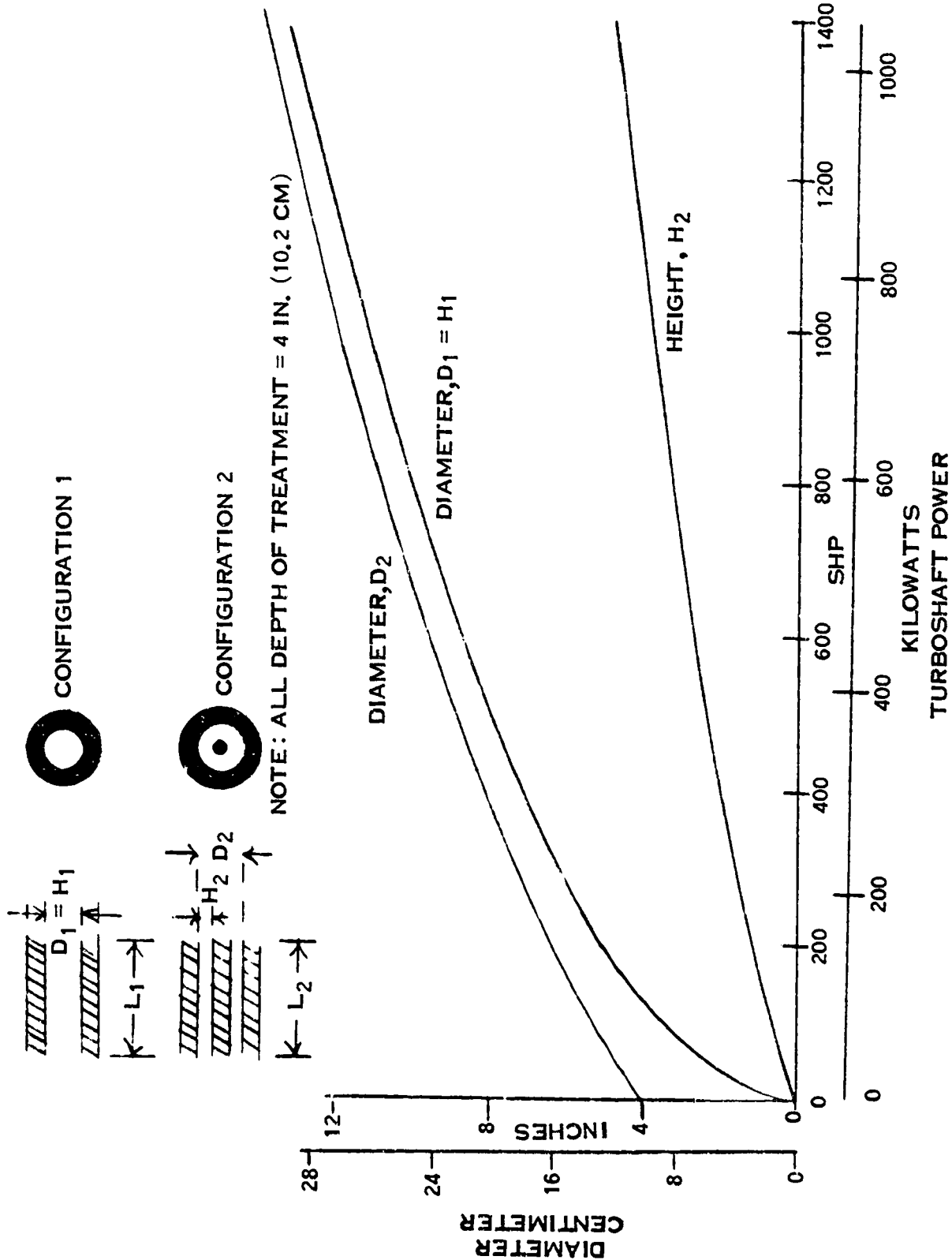

FIGURE 35. GAS TURBINE ENGINE MUFFLER DIMENSIONS

PAWELTON STANDARD COMPUTER DECK NO. H004
 COMPUTES PERFORMANCE, WEIGHT, AND COST FOR
 GENERAL AVIATION C-TRANS

THRUST INPUT -- TIP SPEED, AN, AND DIA. VARIATIONS

OPERATING CONDITION

THRUST = 1500. CLASSIFICATION = 5. CLIF = 0.0
 ALT-FT = 0. SHAFT ROT = 1. CLF = 0.0
 V-KTAS = 66.0 DATE = 1980. SCING = 0.0
 TEMP F = 0.0 PLANT = 0.
 PRESS. = 0. PITCH TYPE 0

TOTAL ACTIVITY FACTOR = 1.000.		AREA RATIO = 1.000		ANGLE		PNDB		DBA		WT-LBS		COST	
DIA. FT.	T.S.FPS	NO. PL	AF/BL	L/D	SHP	THRUST	ANGLE	PNDB	DBA	WT-LBS	COST		
3.50	550.	8.	137.5	0.860	711.	1500.	55.0	102.8	90.8	158.	2162.		
3.50	650.	8.	187.5	0.960	707.	1500.	45.3	95.0	87.0	169.	2487.		
3.50	750.	9.	165.7	0.920	736.	1500.	38.7	89.1	77.1	165.	2541.		
4.00	550.	8.	187.5	0.860	644.	1500.	47.7	92.6	80.6	205.	2761.		
4.00	650.	8.	187.5	0.960	636.	1500.	39.4	88.0	76.0	217.	3155.		
4.00	750.	9.	166.7	0.870	648.	1500.	34.1	85.5	73.5	213.	3223.		

TOTAL ACTIVITY FACTOR = 2.000.		AREA RATIO = 1.000		ANGLE		PNDB		DBA		WT-LBS		COST	
DIA. FT.	T.S.FPS	NO. PL	AF/BL	L/D	SHP	THRUST	ANGLE	PNDB	DBA	WT-LBS	COST		
3.50	550.	10.	250.0	1.046	727.	1500.	50.1	76.5	64.5	245.	4927.		
3.50	650.	10.	330.0	1.046	717.	1500.	41.1	70.1	67.1	274.	5919.		
3.50	750.	11.	227.3	1.021	728.	1500.	35.6	82.4	70.4	277.	6319.		
4.00	550.	10.	250.0	1.046	658.	1500.	42.3	75.3	63.3	315.	6249.		
4.00	650.	10.	250.0	1.046	656.	1500.	36.2	78.7	66.7	351.	7496.		
4.00	750.	11.	227.3	1.021	692.	1500.	31.5	82.3	70.3	355.	8014.		

TOTAL ACTIVITY FACTOR = 1.000.		AREA RATIO = 0.900		ANGLE		PNDB		DBA		WT-LBS		COST	
DIA. FT.	T.S.FPS	NO. PL	AF/BL	L/D	SHP	THRUST	ANGLE	PNDB	DBA	WT-LBS	COST		
3.50	550.	8.	187.5	0.960	757.	1500.	56.2	102.8	90.3	159.	2181.		
3.50	650.	8.	137.5	0.860	736.	1500.	45.8	95.0	83.0	165.	2503.		
3.50	750.	9.	166.7	0.920	730.	1500.	38.5	89.1	77.1	165.	2550.		
4.00	550.	8.	187.5	0.860	677.	1500.	48.3	92.6	80.6	205.	2778.		
4.00	650.	8.	187.5	0.860	655.	1500.	39.1	88.0	76.0	218.	3170.		
4.00	750.	9.	166.7	0.870	675.	1500.	33.2	85.5	73.5	213.	3240.		

TOTAL ACTIVITY FACTOR = 2.000.		AREA RATIO = 0.900		ANGLE		PNDB		DBA		WT-LBS		COST	
DIA. FT.	T.S.FPS	NO. PL	AF/BL	L/D	SHP	THRUST	ANGLE	PNDB	DBA	WT-LBS	COST		
3.50	550.	10.	250.0	1.046	765.	1500.	51.0	76.5	64.5	246.	4970.		
3.50	650.	10.	250.0	1.046	739.	1500.	41.1	70.1	67.1	275.	5952.		
3.50	750.	11.	227.3	1.021	752.	1500.	35.0	82.4	70.4	279.	6359.		
4.00	550.	10.	250.0	1.046	671.	1500.	43.3	75.3	63.3	316.	6270.		
4.00	650.	10.	250.0	1.046	671.	1500.	35.6	78.7	66.7	352.	7536.		
4.00	750.	11.	227.3	1.021	706.	1500.	30.7	82.3	70.3	357.	8051.		

FIGURE 36. SAMPLE CASE I OF COMPUTER PRINT OUT

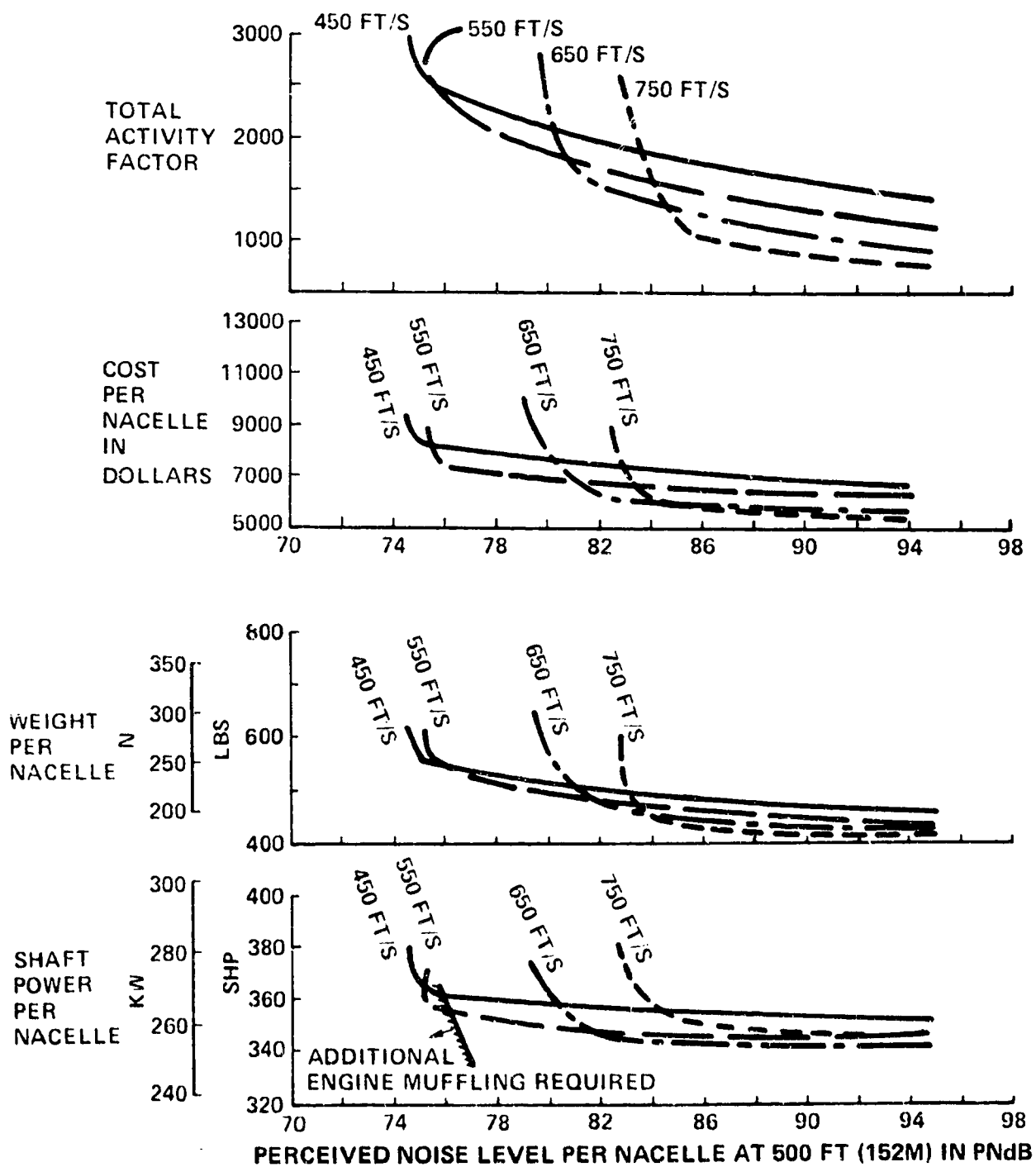

FIGURE 37. FT (1.07M) DIAMETER Q-FAN/ROTARY COMBUSTION ENGINE SYSTEM CHARACTERISTICS

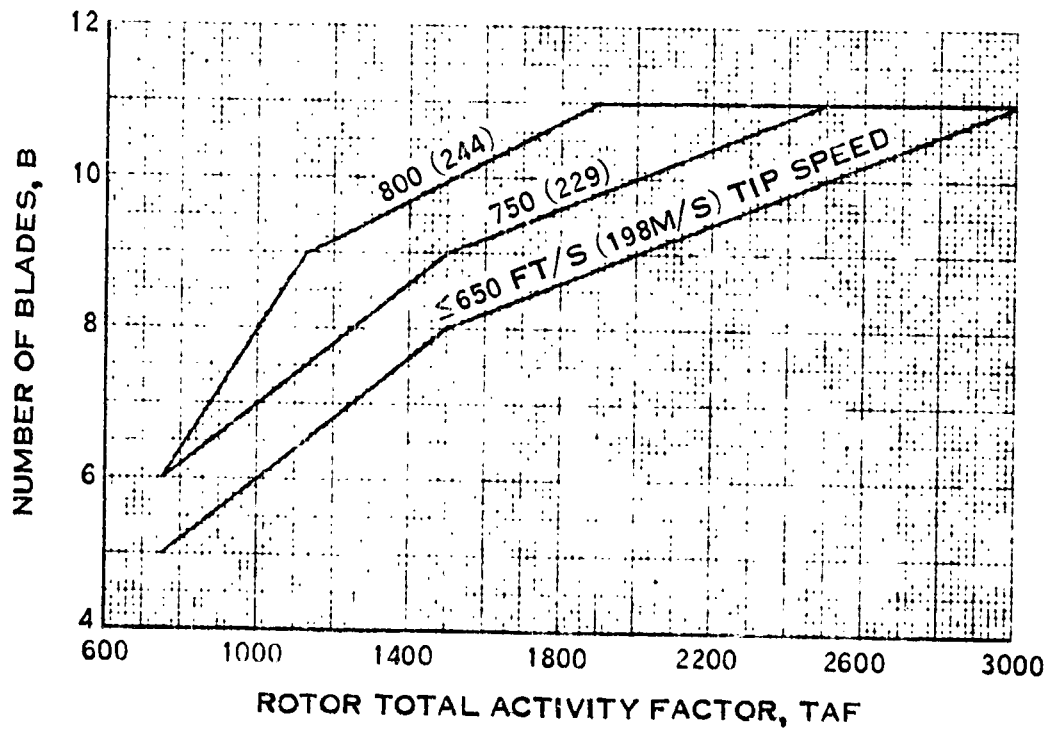
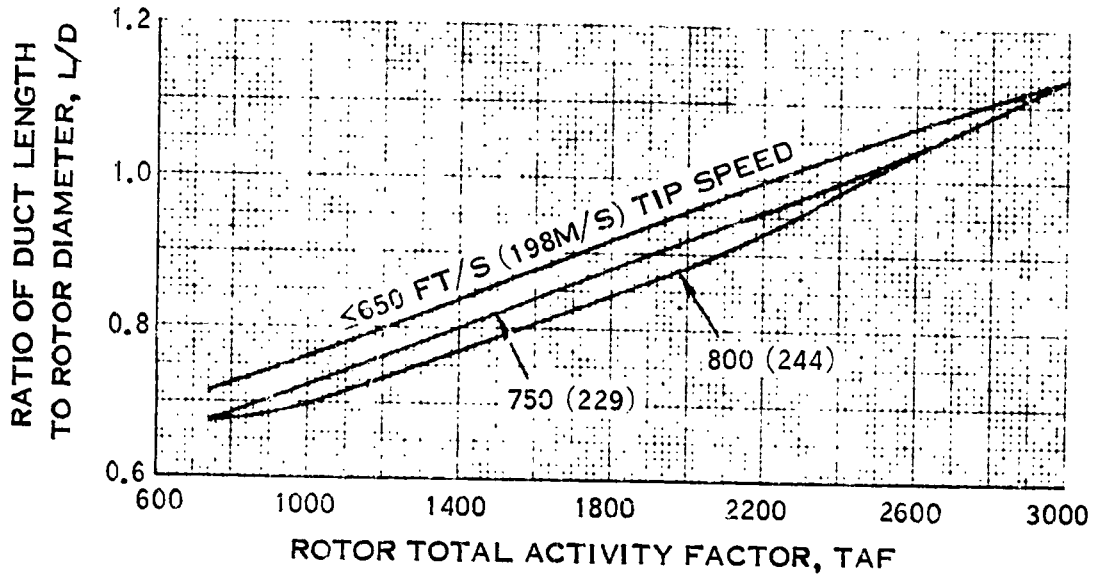

FIGURE 38. ROTOR AND DUCT CHARACTERISTICS FOR MINIMUM Q-FAN NOISE

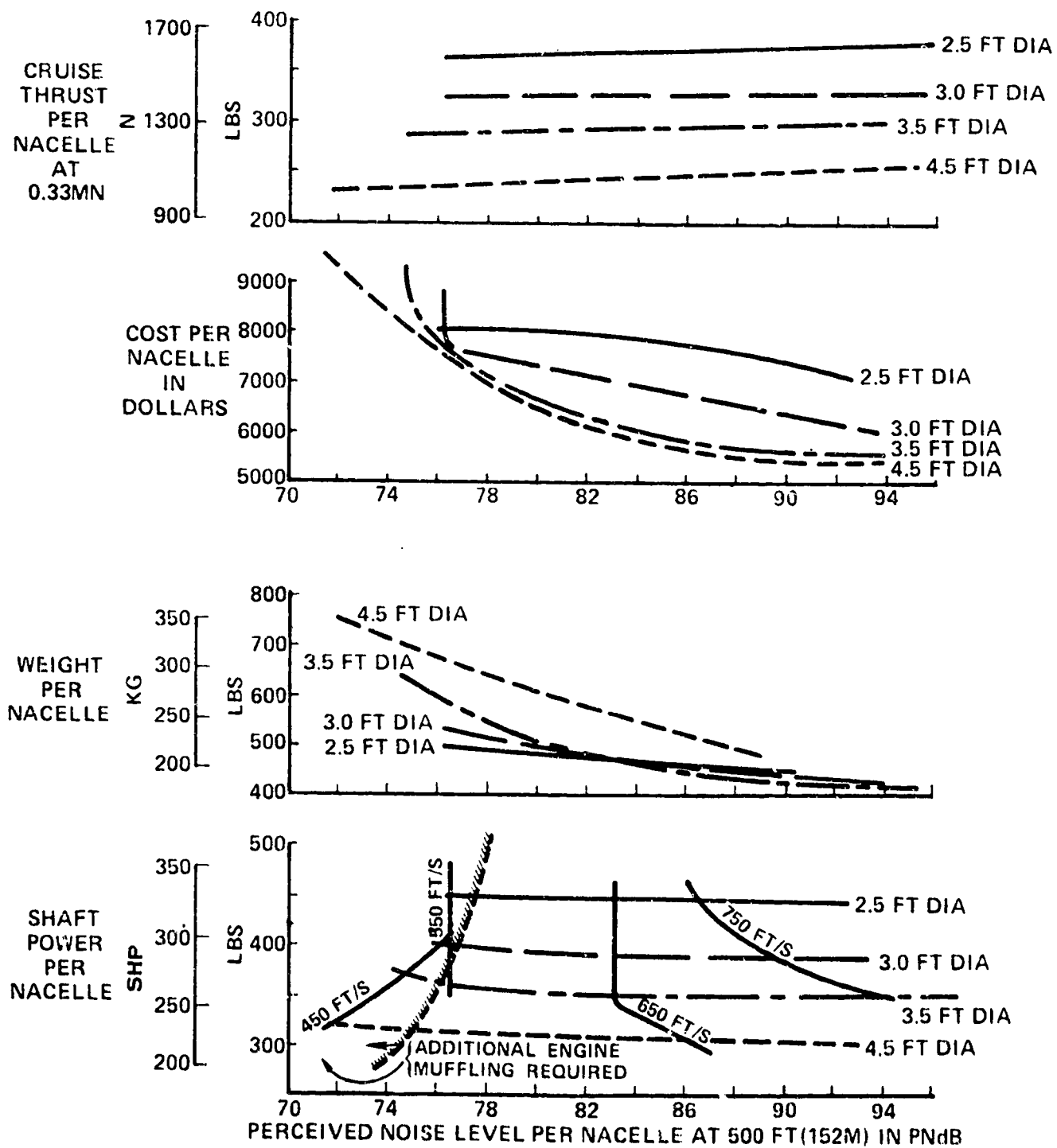

FIGURE 39. CHARACTERISTICS OF Q-FAN/ROTARY COMBUSTION ENGINE PROPULSION SYSTEMS IN THE 1980'S FOR 4-6 SEAT LIGHT TWIN AIRCRAFT

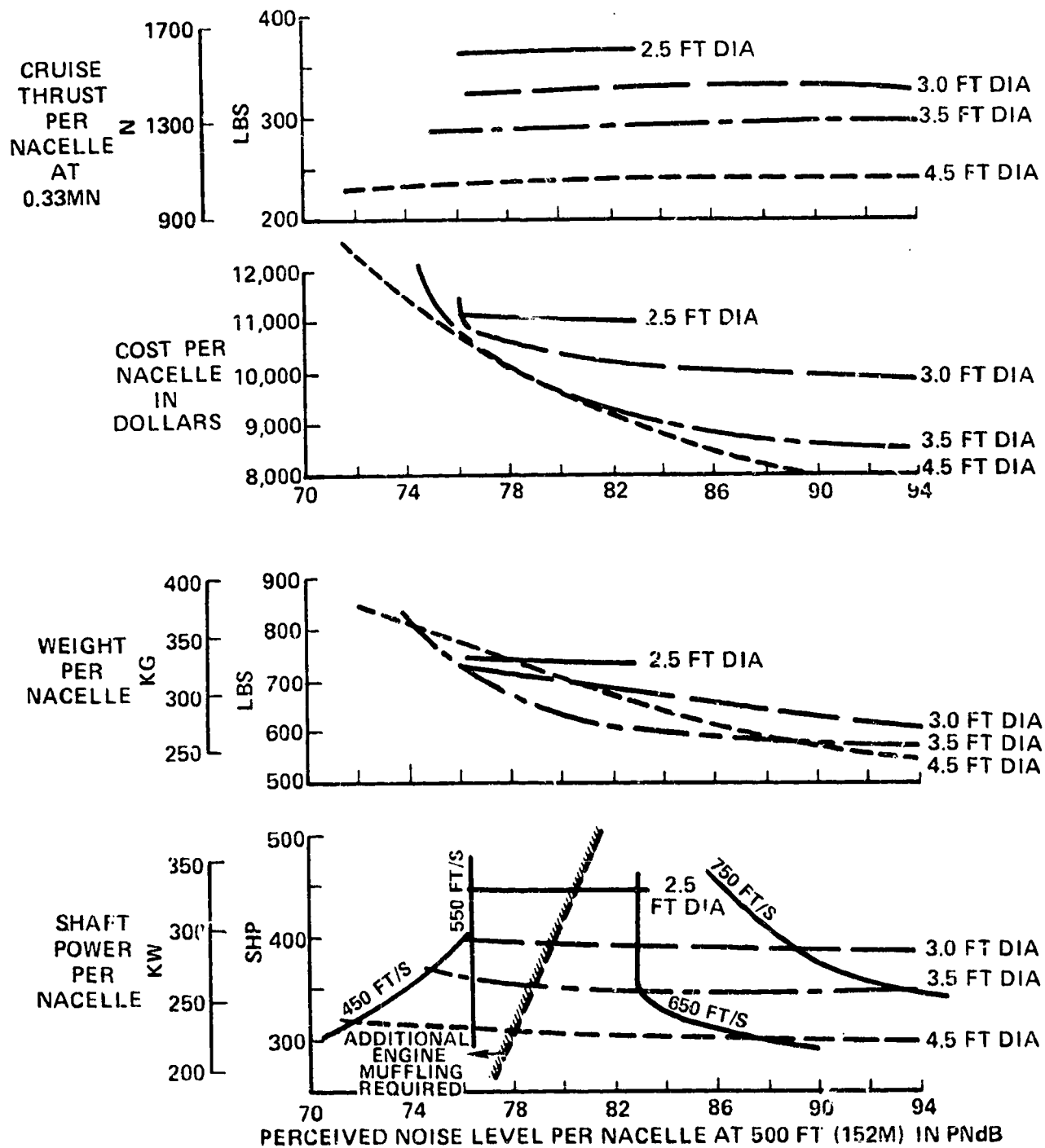

FIGURE 40. CHARACTERISTICS OF Q-FAN/PISTON ENGINE PROPULSION SYSTEMS IN THE 1980'S FOR 4-6 SEAT LIGHT TWIN AIRCRAFT

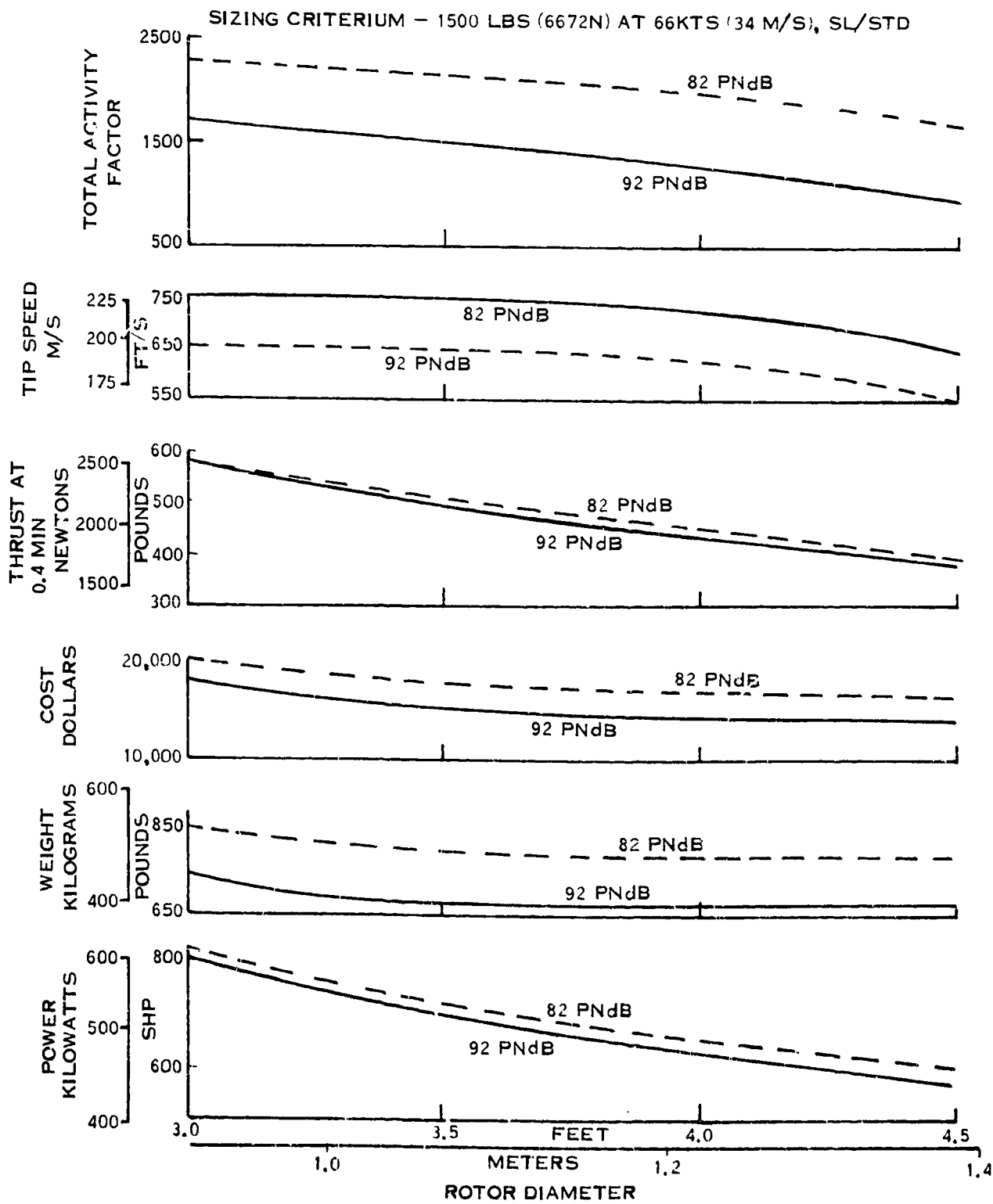

FIGURE 41. PERFORMANCE OF Q-FAN/ROTARY COMBUSTION ENGINE PROPULSION SYSTEM IN THE 1980'S ON A HEAVY TWIN-ENGINE AIRCRAFT (DATA PRESENTED FOR 1 Q-FAN/ENGINE)

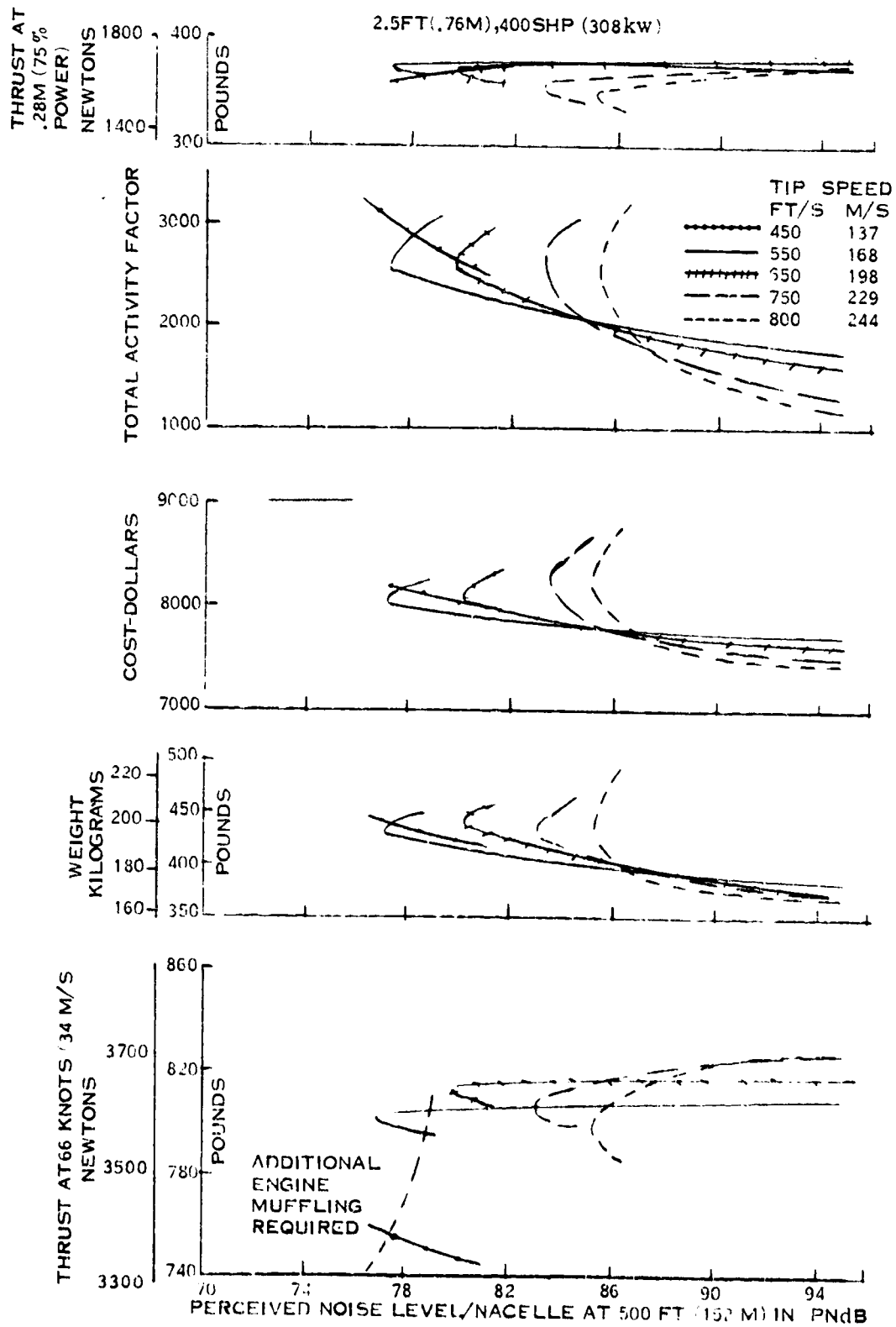

FIGURE 42. INFLUENCE OF NOISE LIMITS ON PROPULSION SYSTEM CHARACTERISTICS FOR A LIGHT SINGLE ENGINE AIRCRAFT

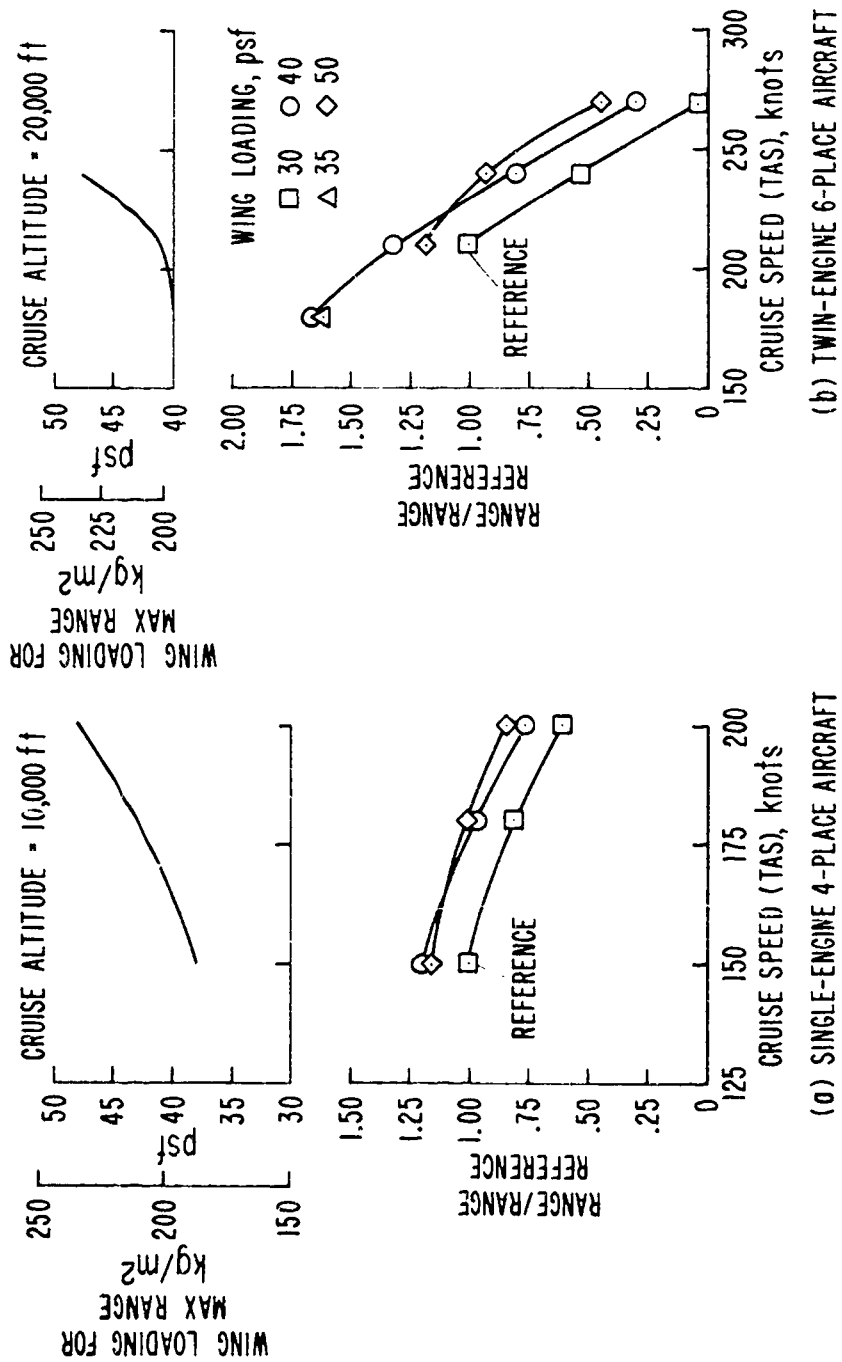

FIGURE 43. EFFECT OF CRUISE SPEED ON CHOICE OF WING LOADING. LEFT, SINGLE-ENGINE FOUR-PLACE AIRCRAFT. RIGHT, TWIN-ENGINE SIX-PLACE AIRCRAFT

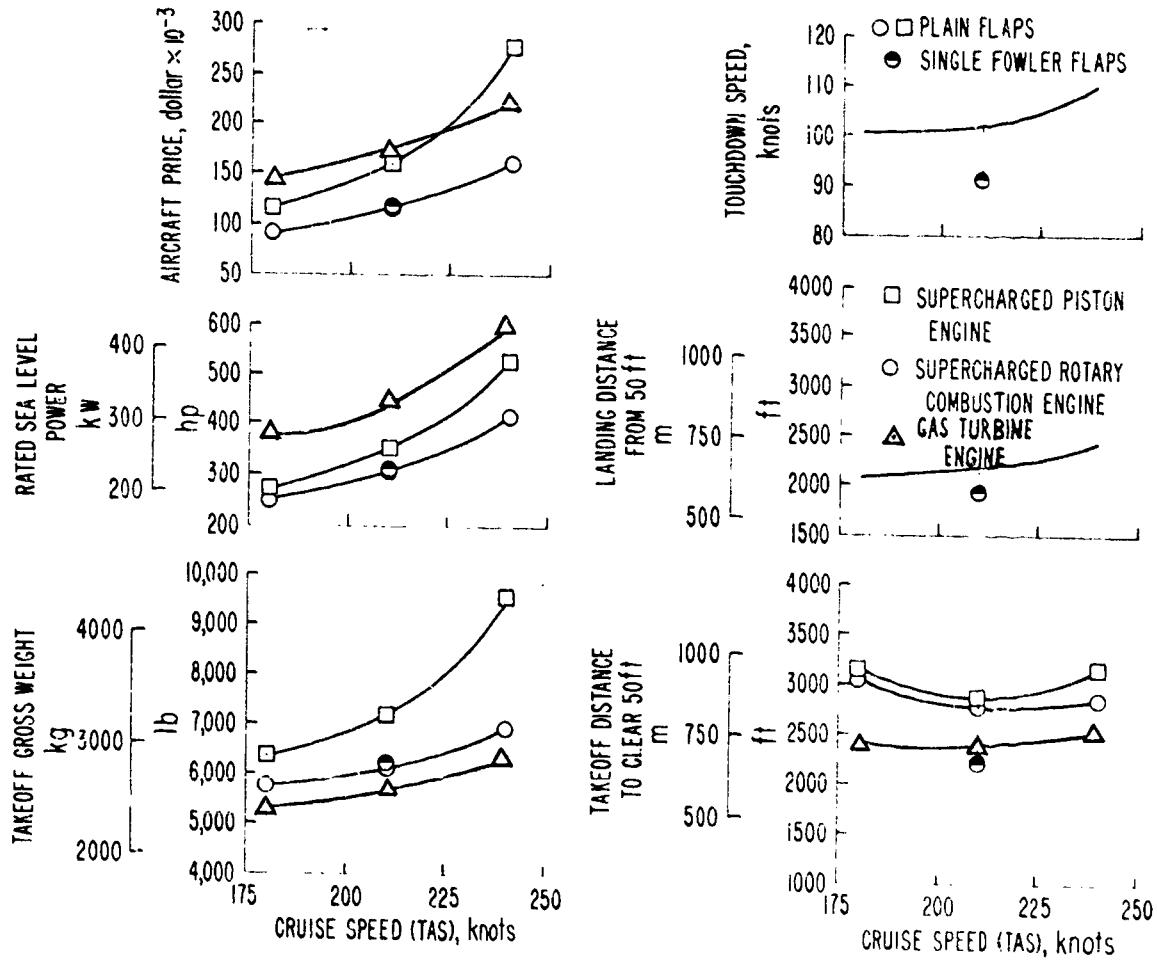

FIGURE 44. MISSION PERFORMANCE FOR TWIN-ENGINE SIX-PLACE AIRCRAFT, PAYLOAD 600 LB (272 KG), RANGE 1000 N. MILES (1852 KM), ALTITUDE 20,000 FT (6096 M)

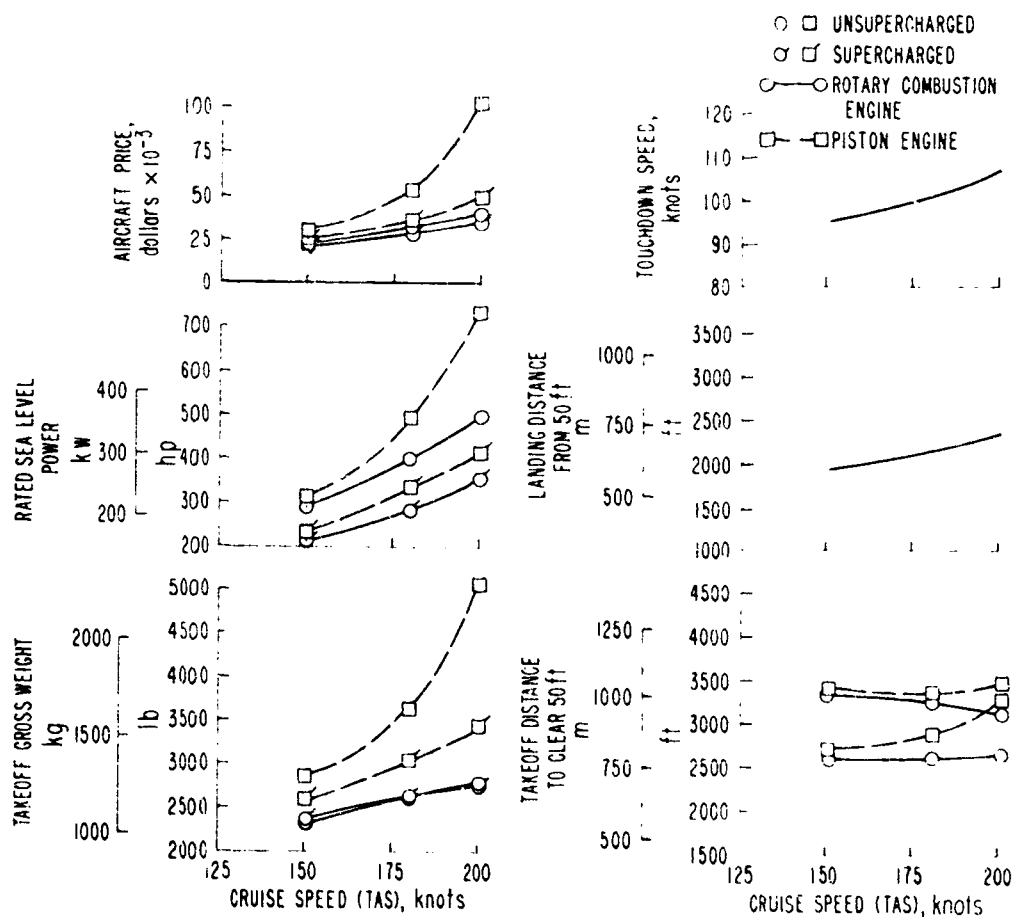

FIGURE 45. MISSION PERFORMANCE FOR SINGLE-ENGINE FOUR-PLACE AIRCRAFT, PAYLOAD 400 LB (161 KG), RANGE 850 N. MILES (1574 KM), ALTITUDE 10,000 FT (3048 M)

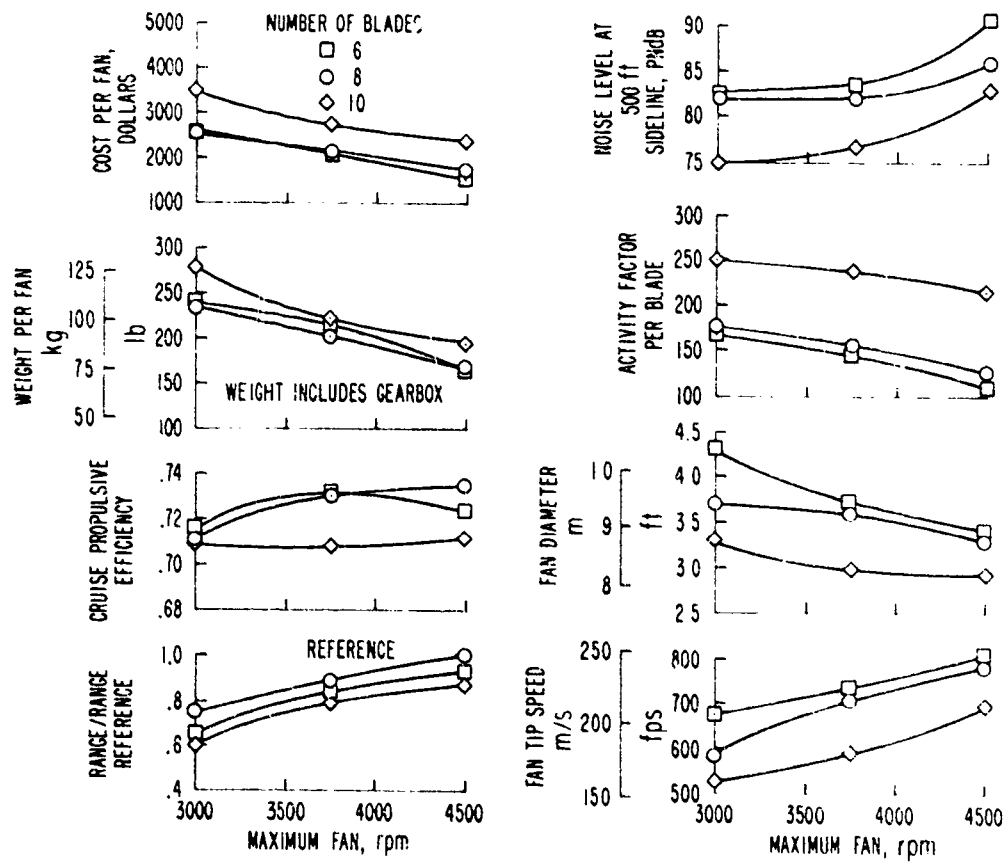

FIGURE 46. EFFECT OF FAN DESIGN ON MISSION PERFORMANCE, FAN SIZE, AND NOISE FOR REDUCED FAN RPM

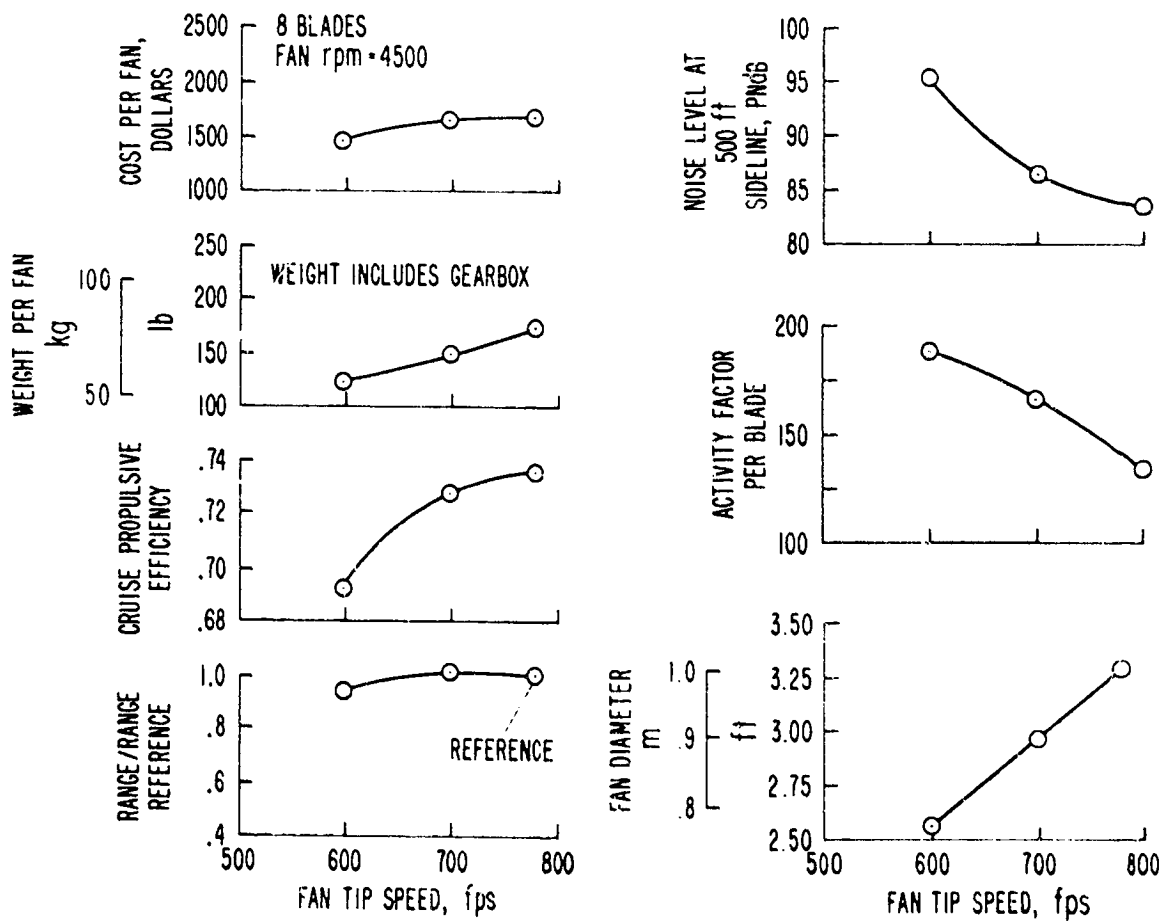

FIGURE 47. EFFECT OF FAN DESIGN ON MISSION PERFORMANCE FAN SIZE, AND NOISE FOR CONSTANT FAN RPM

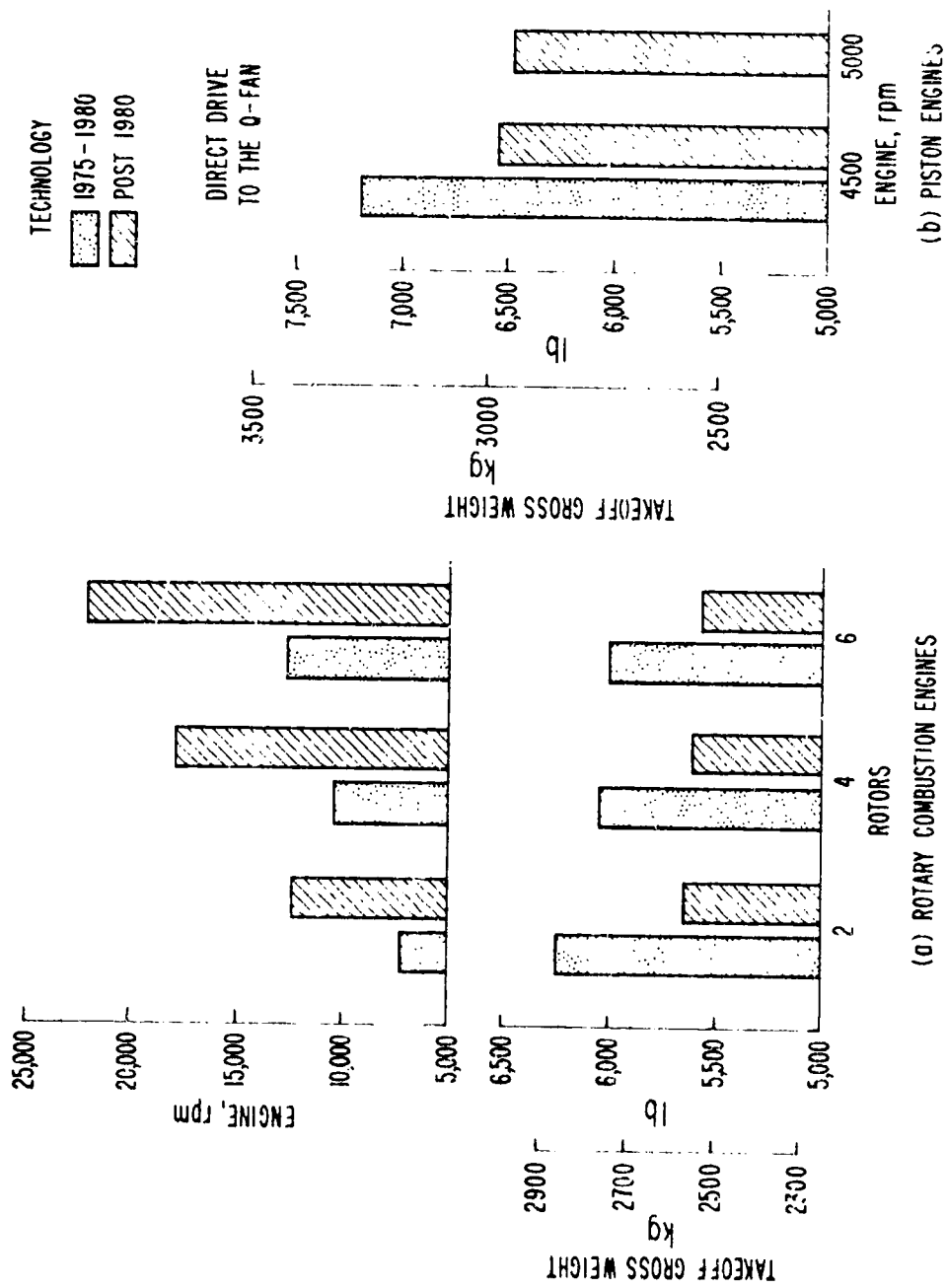

FIGURE 48. EFFECT OF LEVEL OF TECHNOLOGY ON AIRCRAFT SIZE. LEFT, ROTARY COMBUSTION ENGINES. RIGHT, HORIZONTALLY OPPOSED PISTON ENGINES

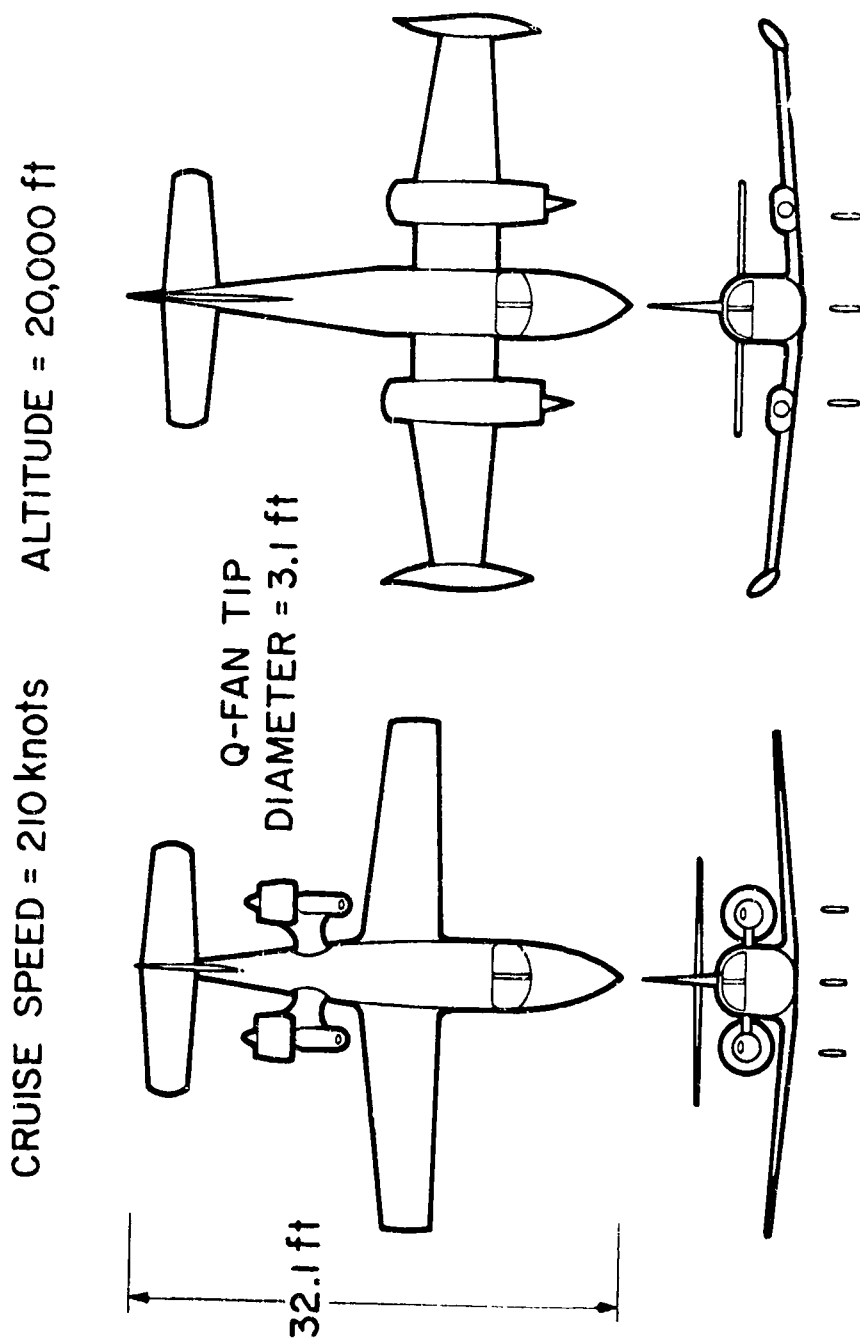

FIGURE 49. COMPARISON OF CESSNA MODEL 340 LAY-OUT WITH MODIFIED AIRCRAFT
HAVING ROTARY COMBUSTION ENGINES AND Q-FAN AS PUSHER
CRUISE SPEED 210 KNOTS TRUE AIRSPEED, ALTITUDE = 20,000 FT

CRUISE SPEED = 180 knots ALTITUDE = 10,000 ft

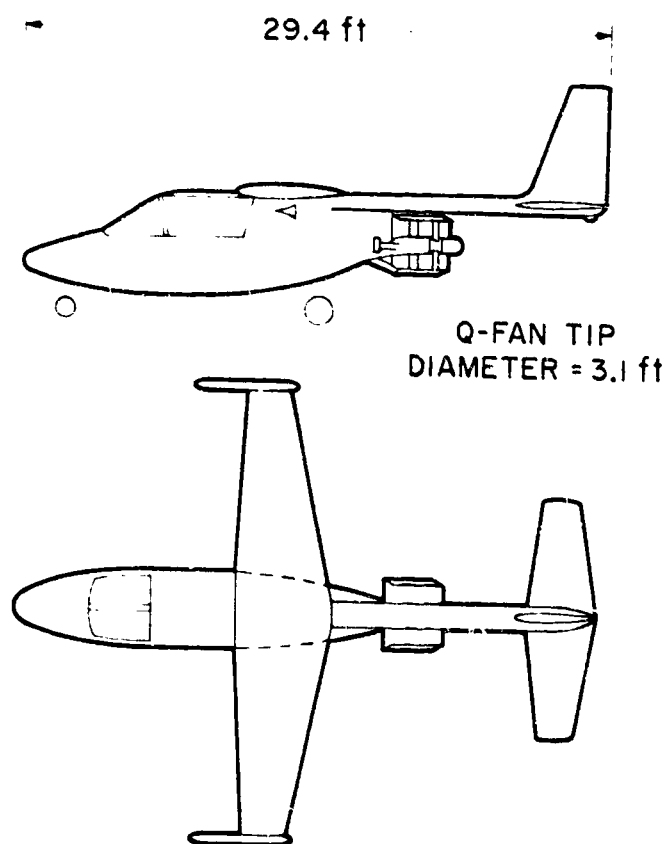

FIGURE 50. CONCEPTUAL HIGH-WING, FOUR-PLACE, SINGLE-ENGINE AIRCRAFT - ROTARY COMBUSTION ENGINE WITH Q-FAN AS PUSHER: CRUISE SPEED 180 KNOTS, ALTITUDE = 10,000 FT

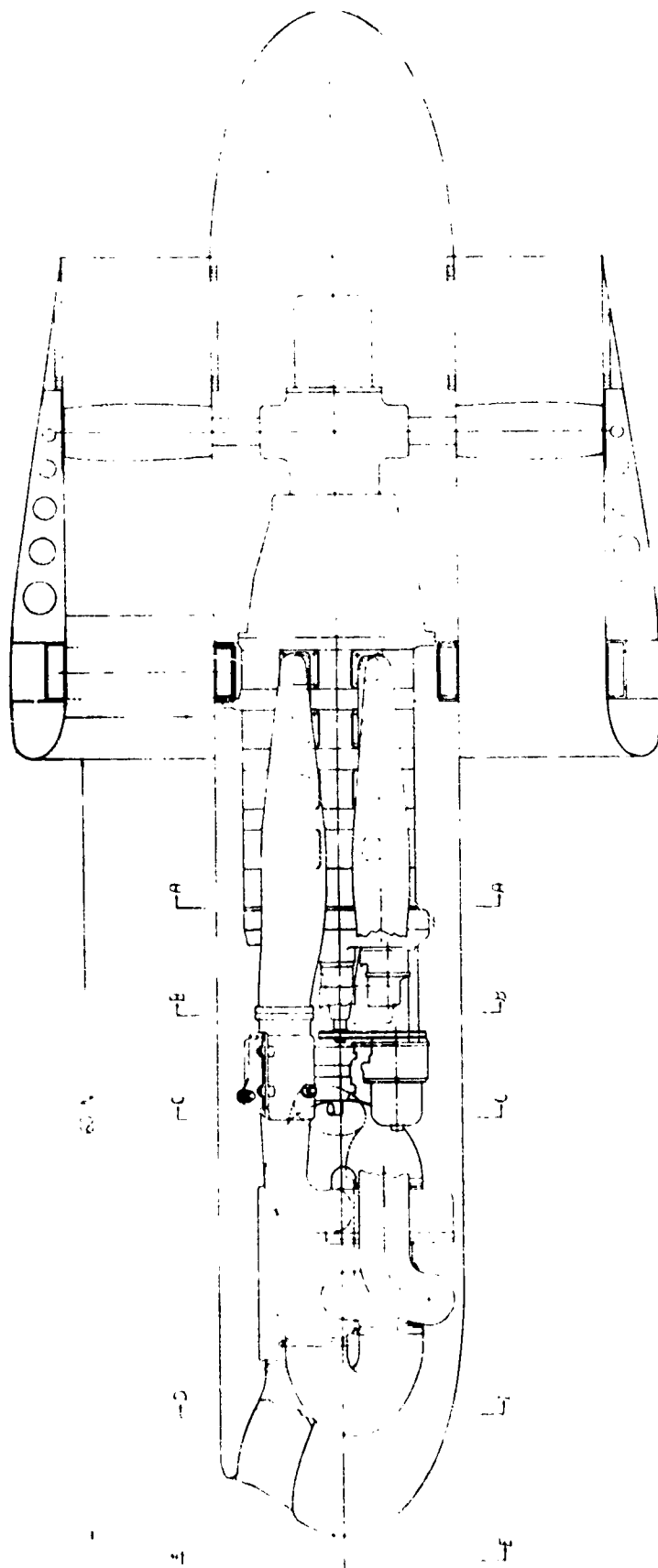

FIGURE 51. LEFT-SIDE VIEW OF PYLON - MOUNTED ROTARY COMBUSTION ENGINE--
Q-FAN PROPULSION POD

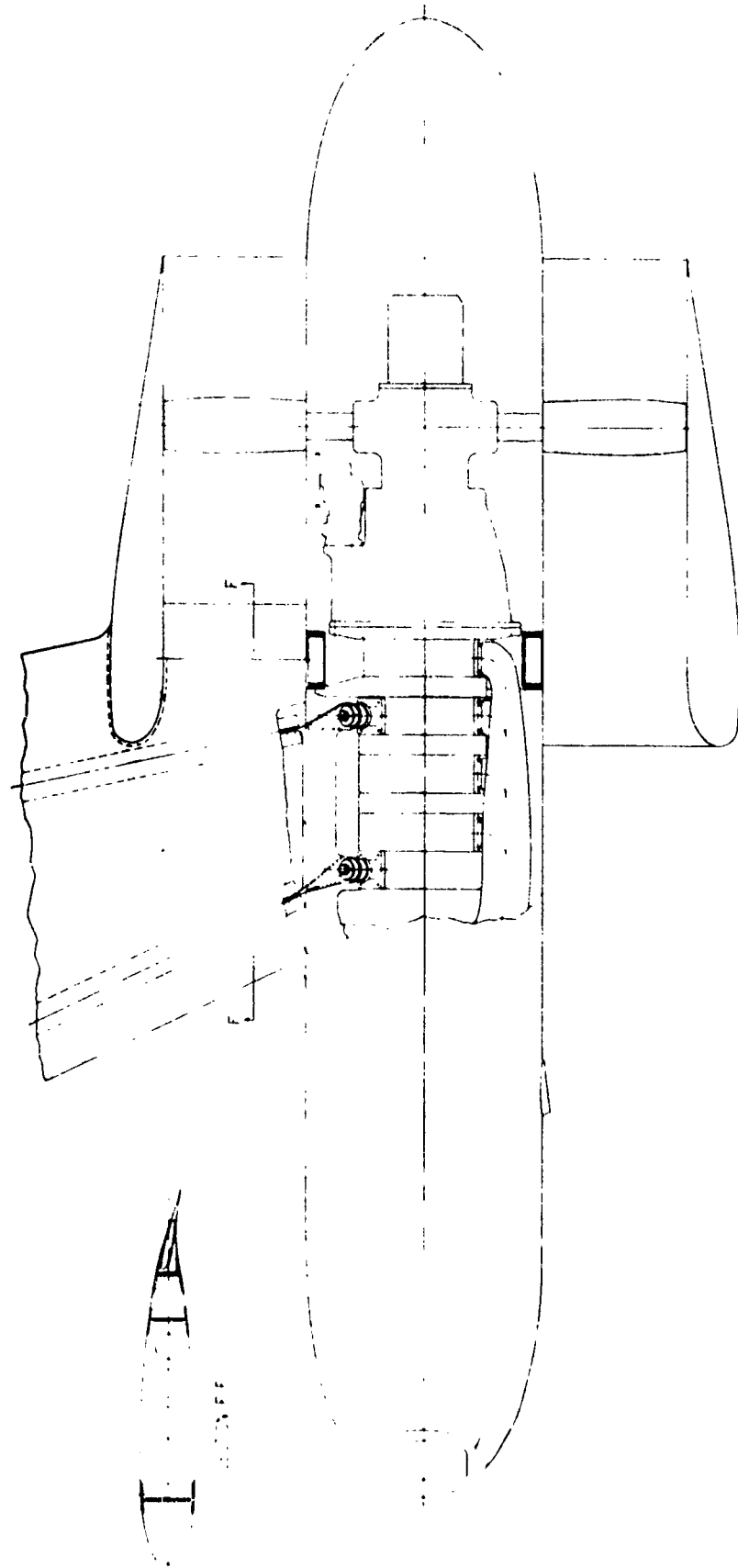

FIGURE 52. TOP VIEW OF PYLON-MOUNTED ROTARY COMBUSTION ENGINE-Q-FAN
PROPULSION POD

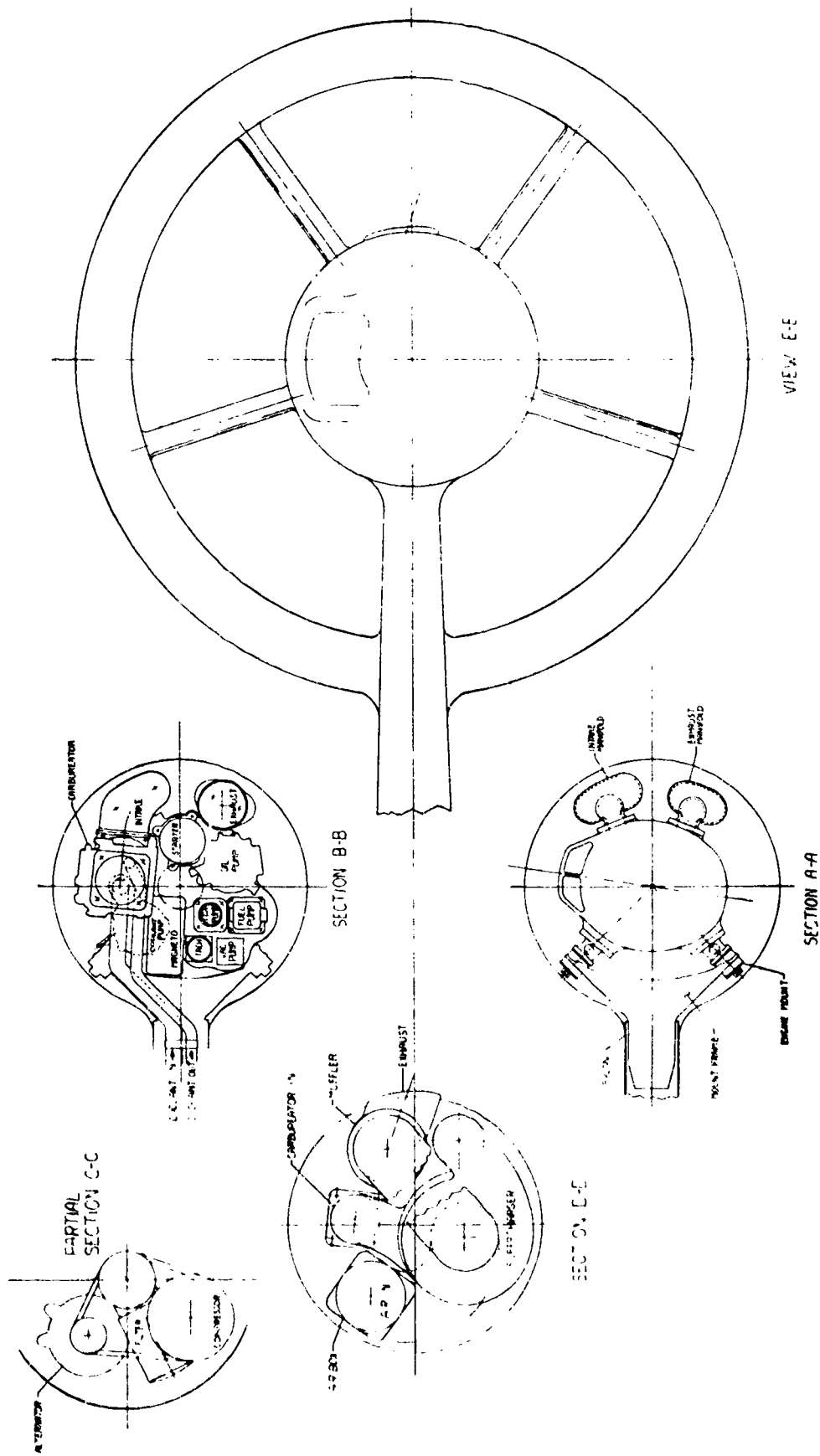

FIGURE 53. FORWARD-END VIEW OF PYLON-MOUNTED ROTARY COMBUSTION ENGINE—Q-FAN PROPULSION POD

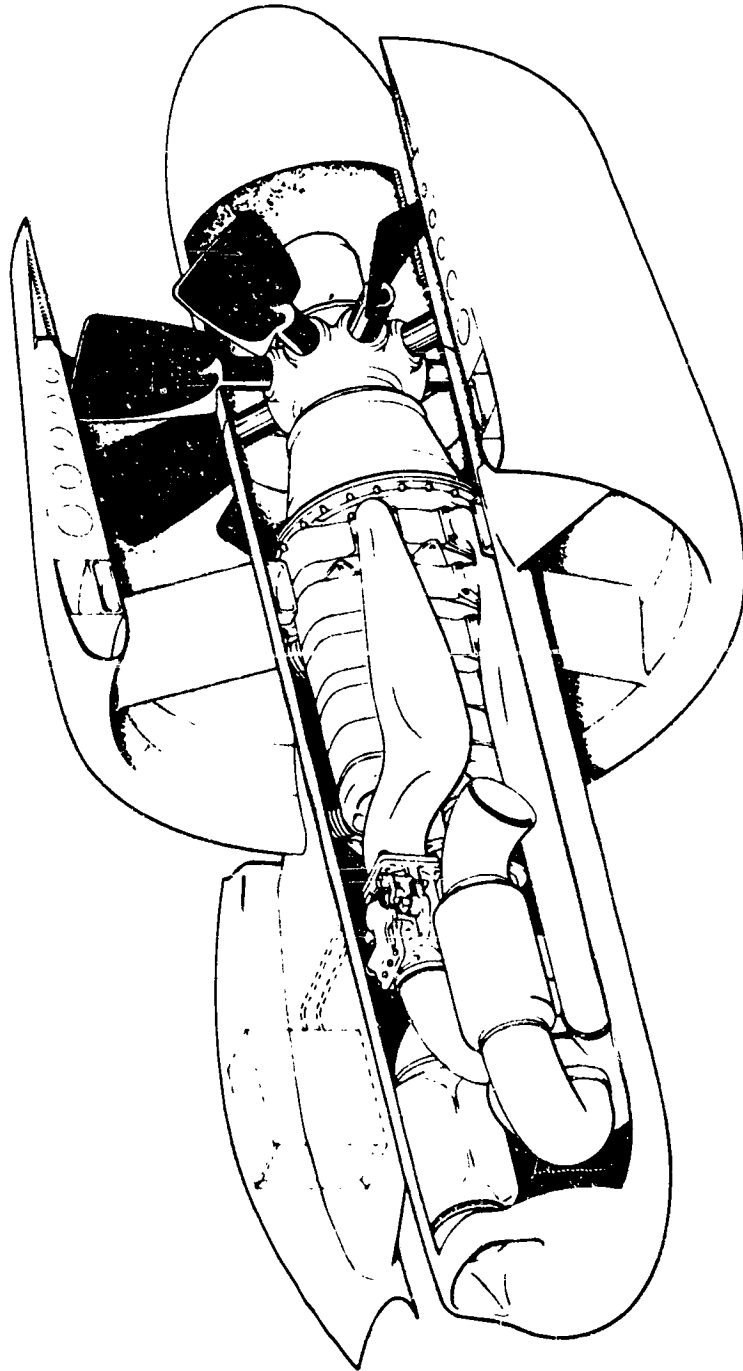

FIGURE 54. Q-FAN ROTARY COMBUSTION ENGINE PROPULSION POD

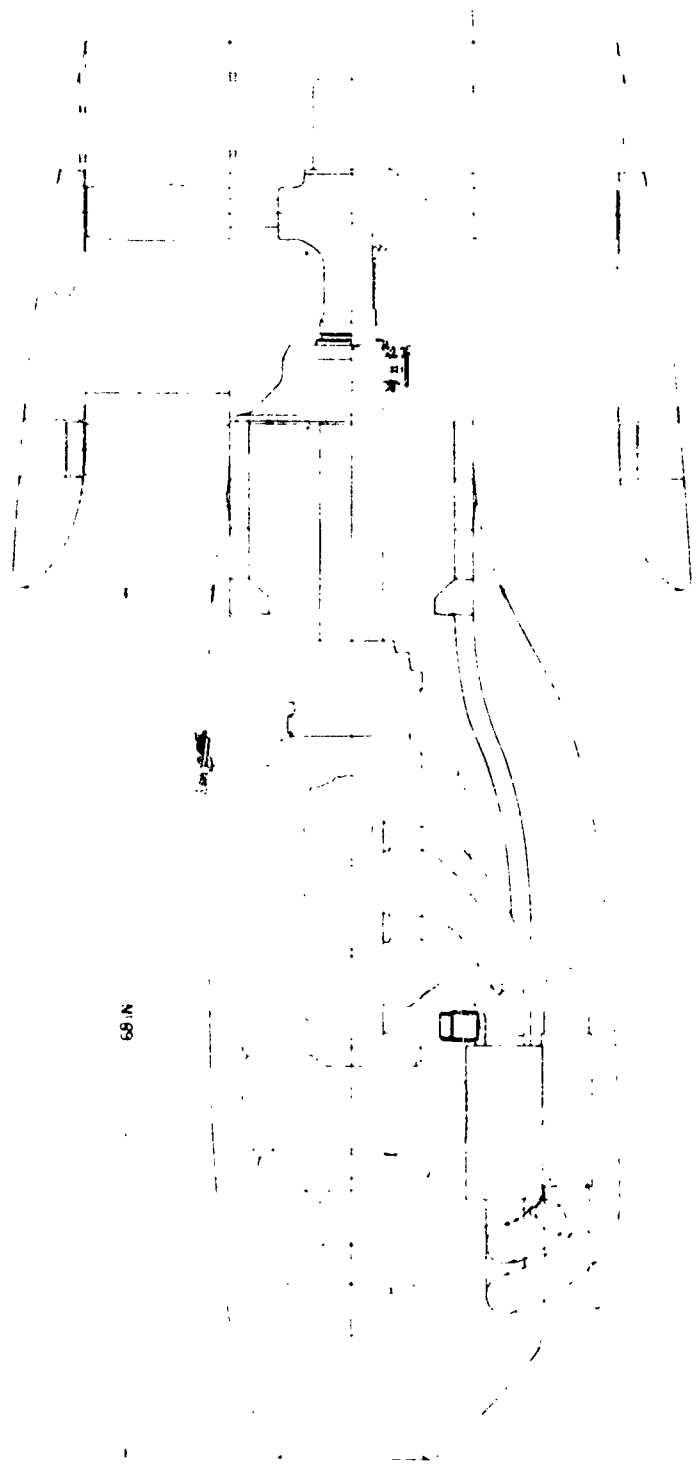

FIGURE 55. LEFT-SIDE VIEW OF PYLON-MOUNTED PISTON ENGINE--Q--FAN PROPULSION POD

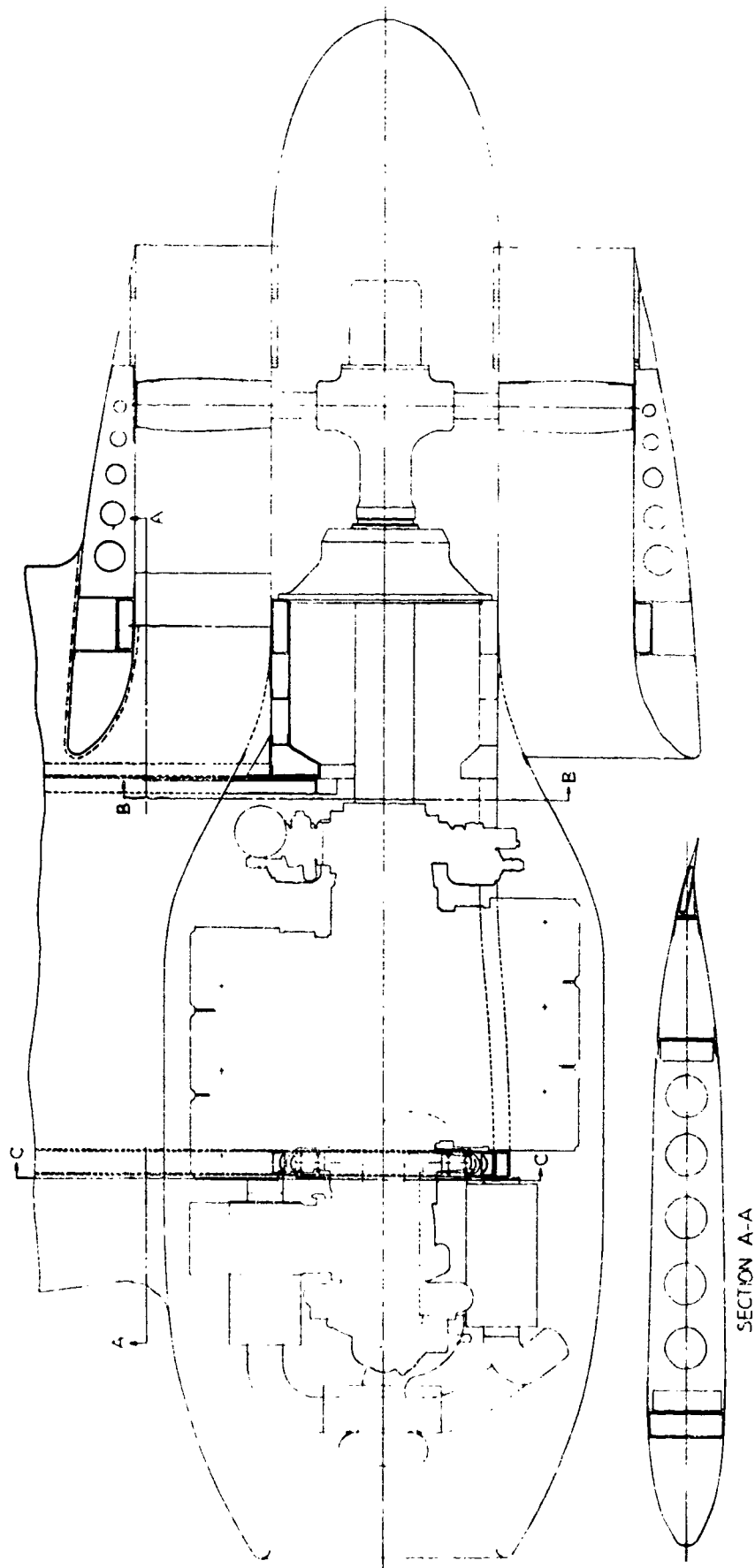

FIGURE 56. TOP VIEW OF PYLON-MOUNTED PISTON ENGINE-Q-FAN PROPULSION POD

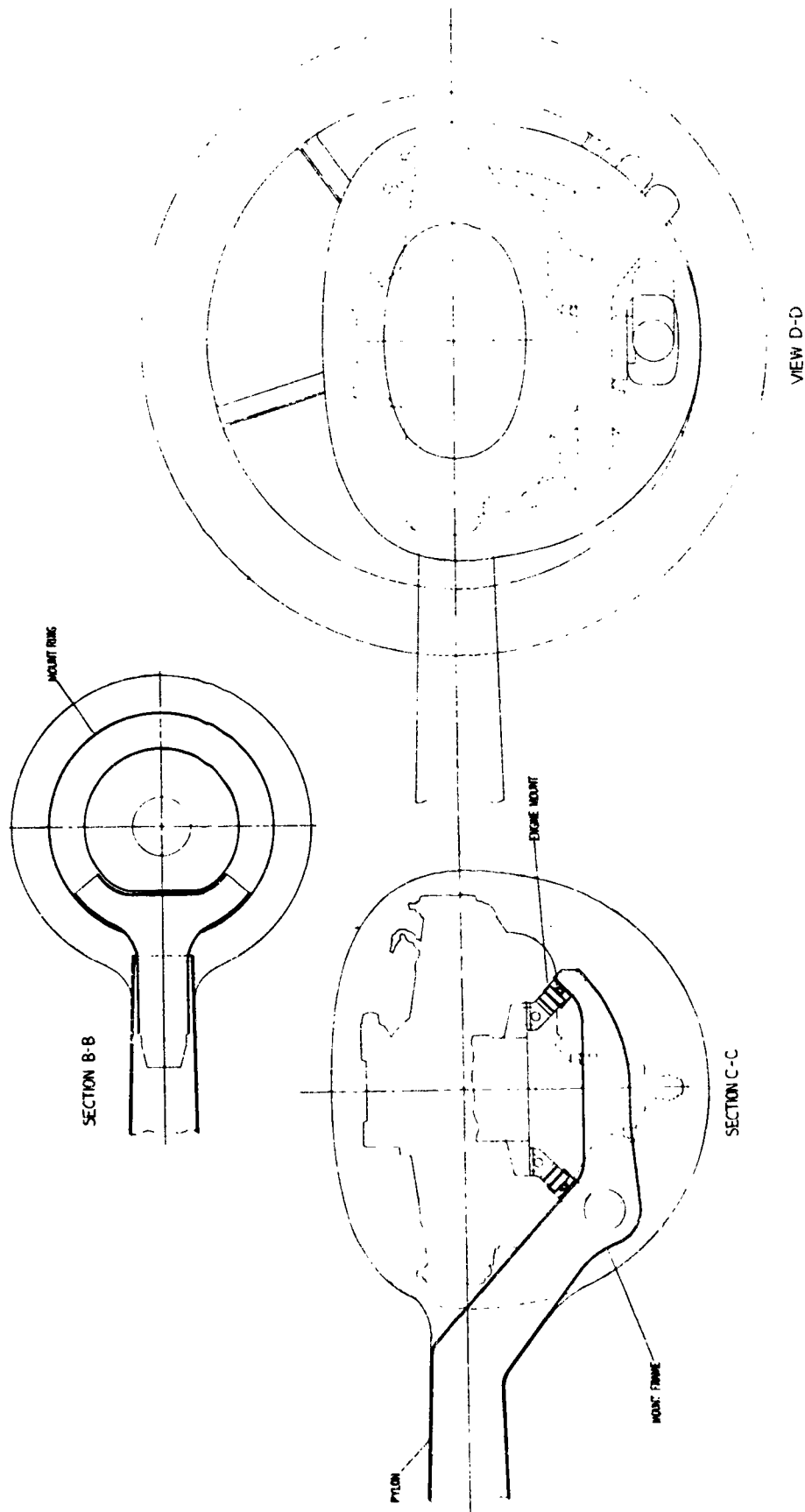

FIGURE 57. FORWARD-END VIEW OF PYLON-MOUNTED PISTON ENGINE-Q-FAN PROPULSION POD

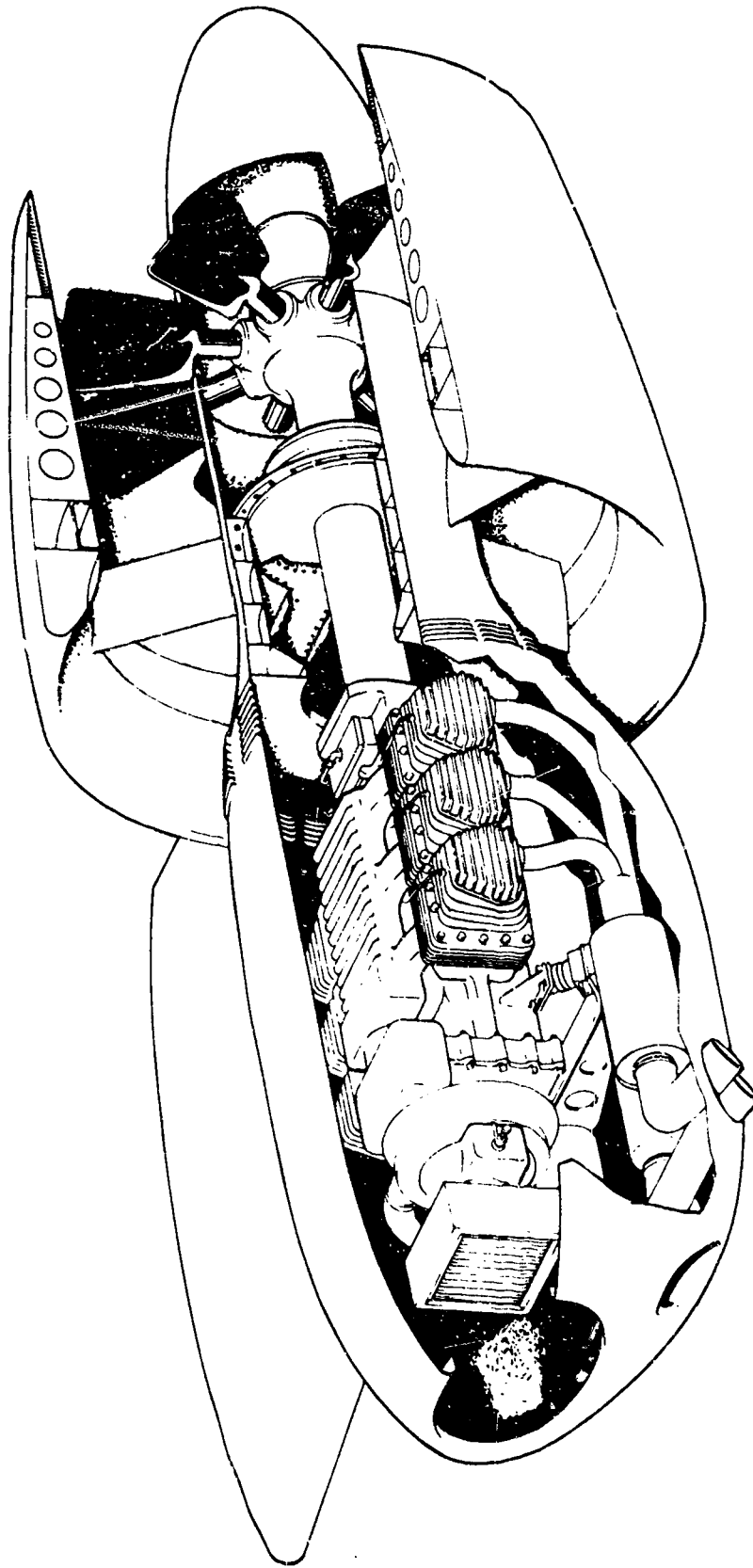

FIGURE 58. Q-FAN RECIPROCATING ENGINE PROPULSION POD

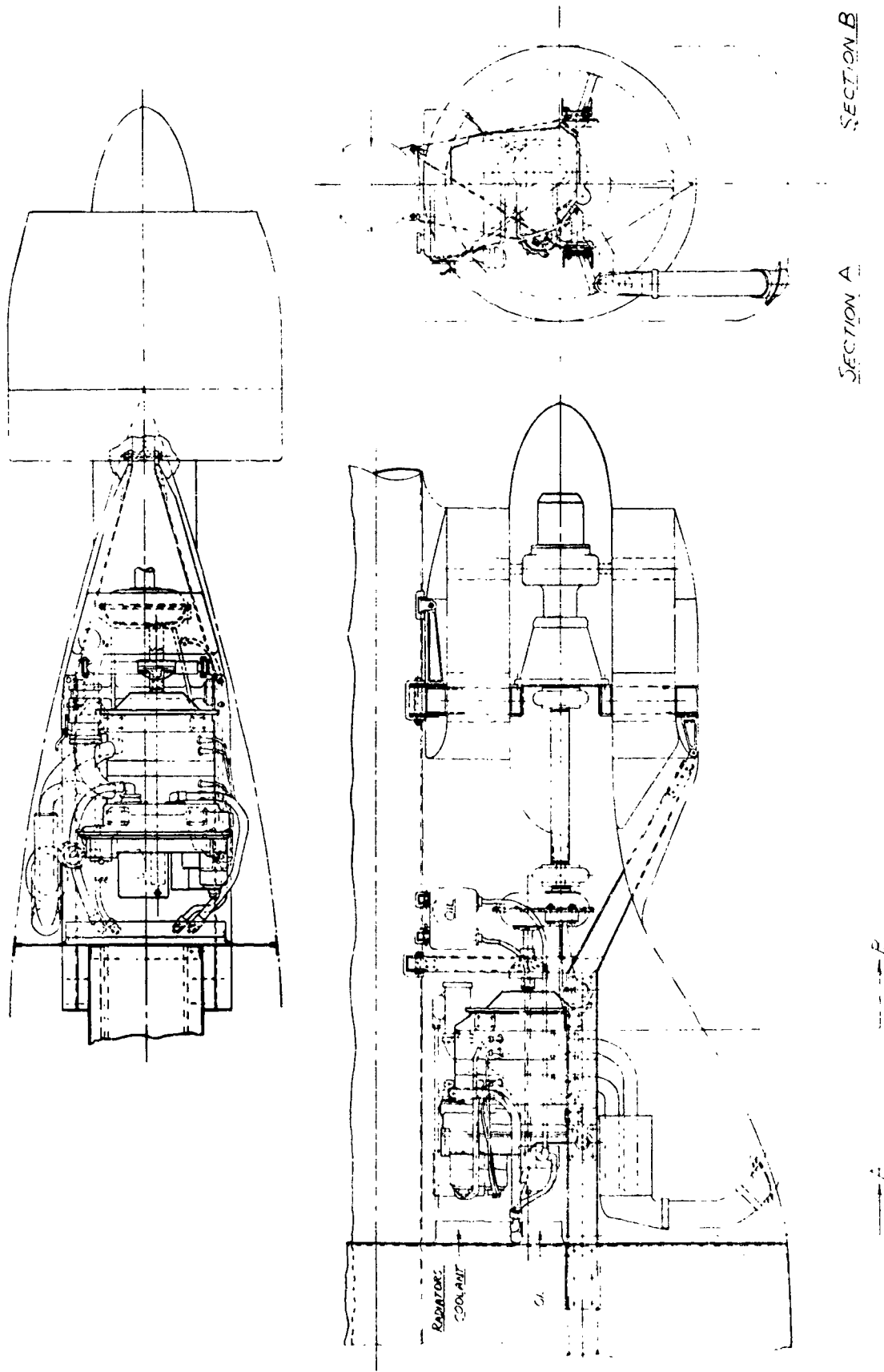
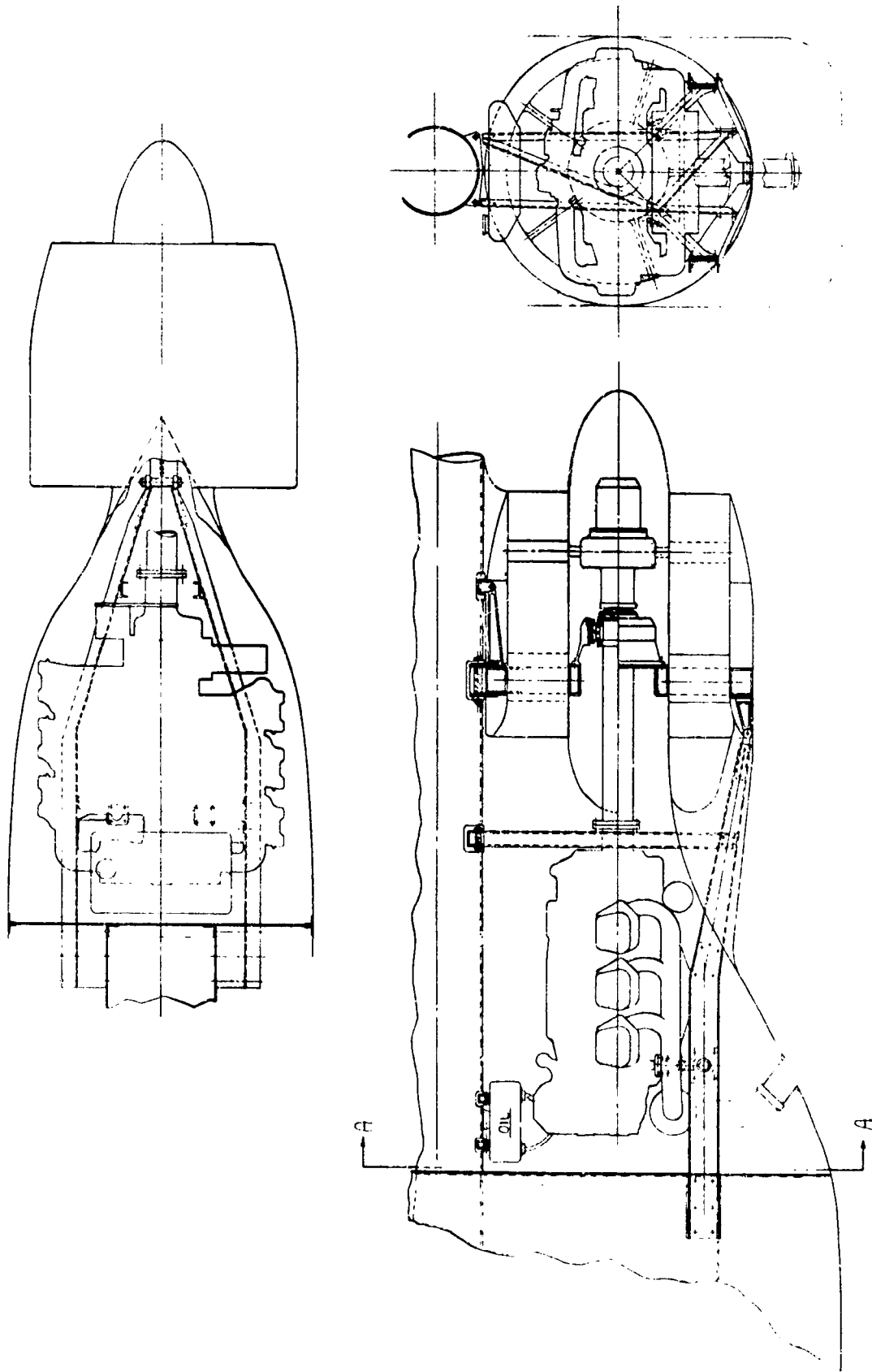

FIGURE 59. ROTARY COMBUSTION ENGINE — Q—FAN INSTALLATION AS A PUSHER FOR A SINGLE—ENGINE



SECTION A-A

FIGURE 60. PISTON ENGINE - Q-FAN INSTALLATION AS A PUSHER FOR A SINGLE ENGINE AIRCRAFT

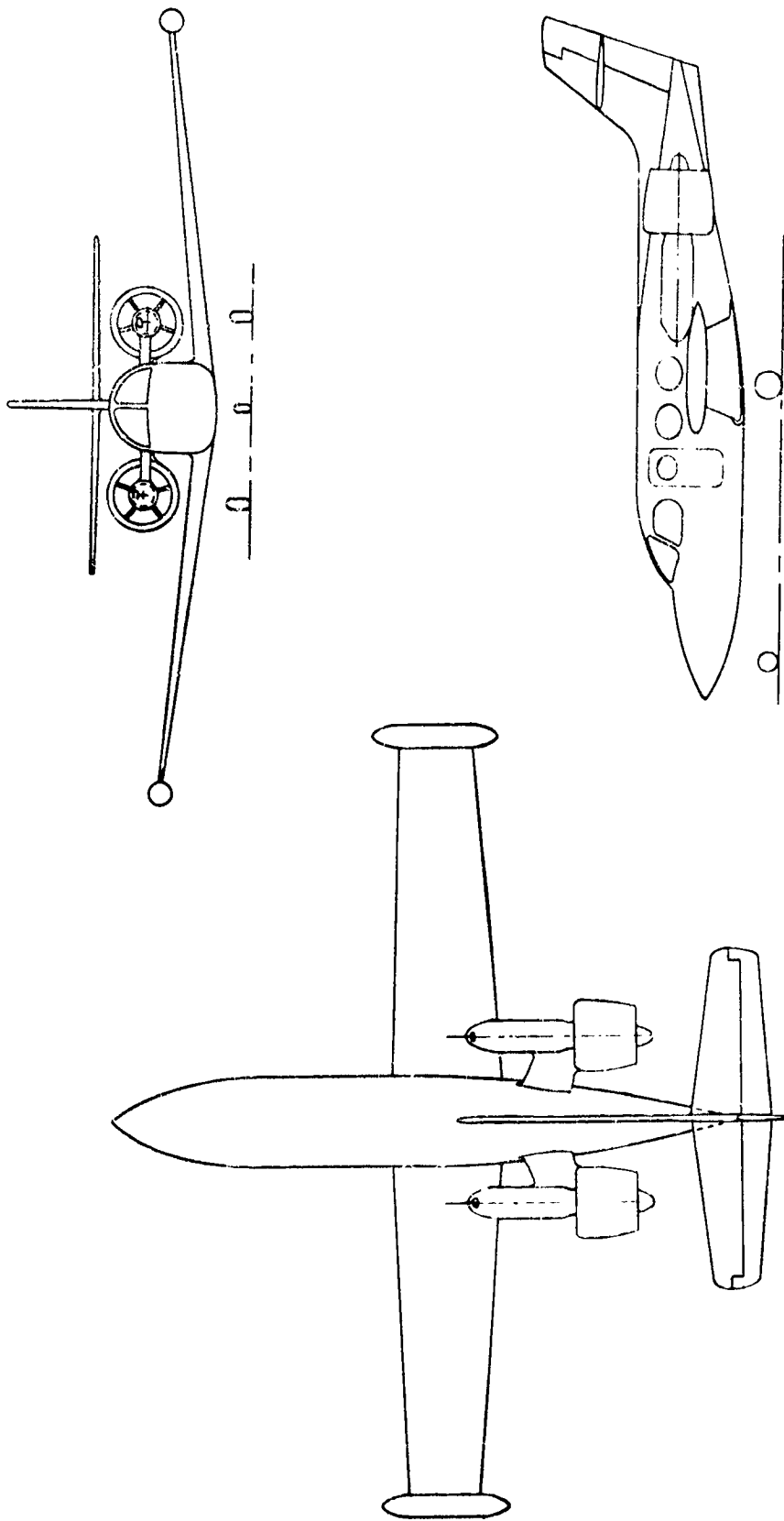

FIGURE 61. TWIN-ENGINE INSTALLATION - ROTARY COMBUSTION ENGINES WITH A Q-FAN
AS A PUSHER

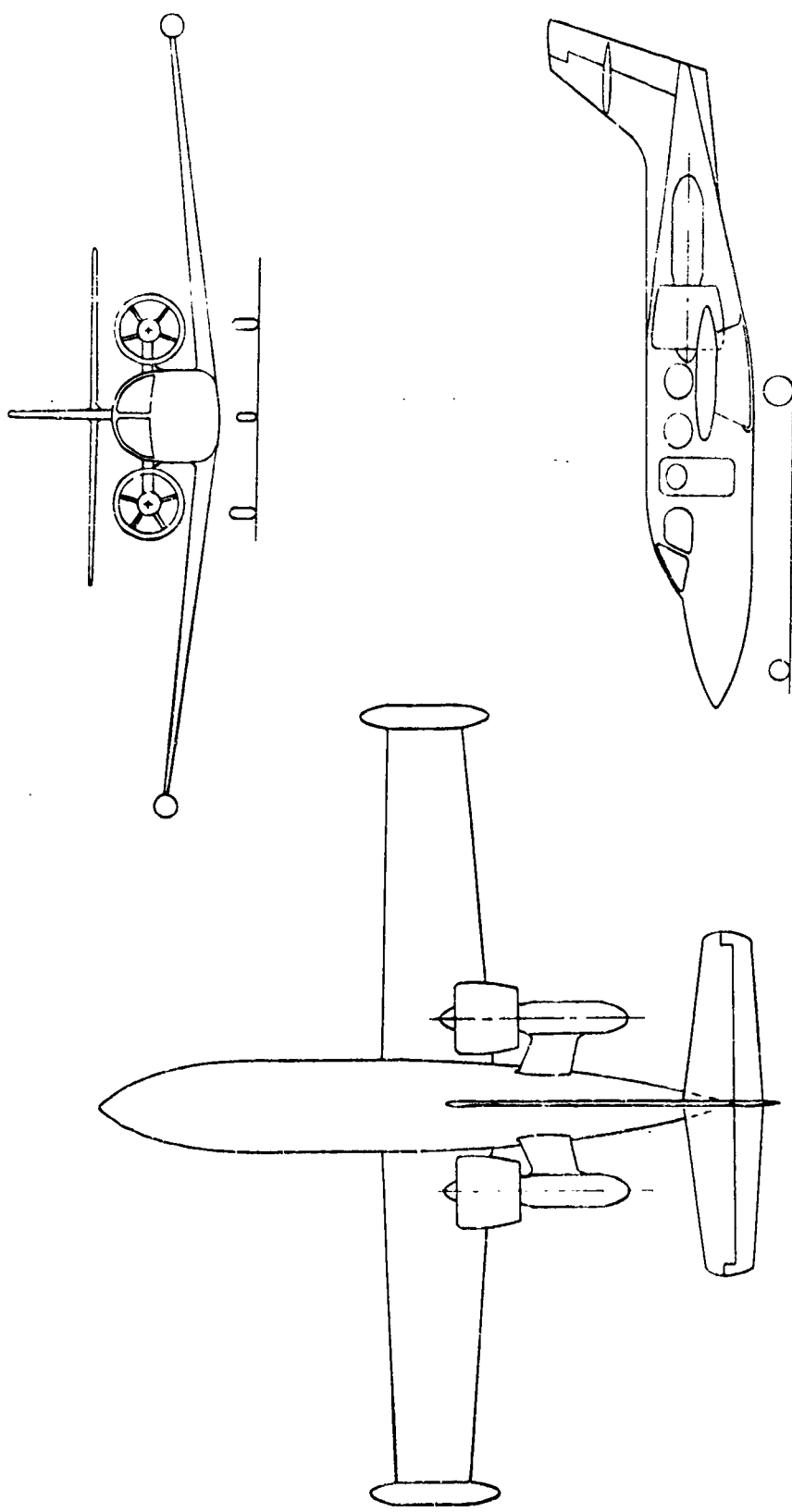

FIGURE 62. TWIN-ENGINE INSTALLATION — ROTARY COMBUSTION ENGINES WITH Q-FAN
AS A TRACTOR

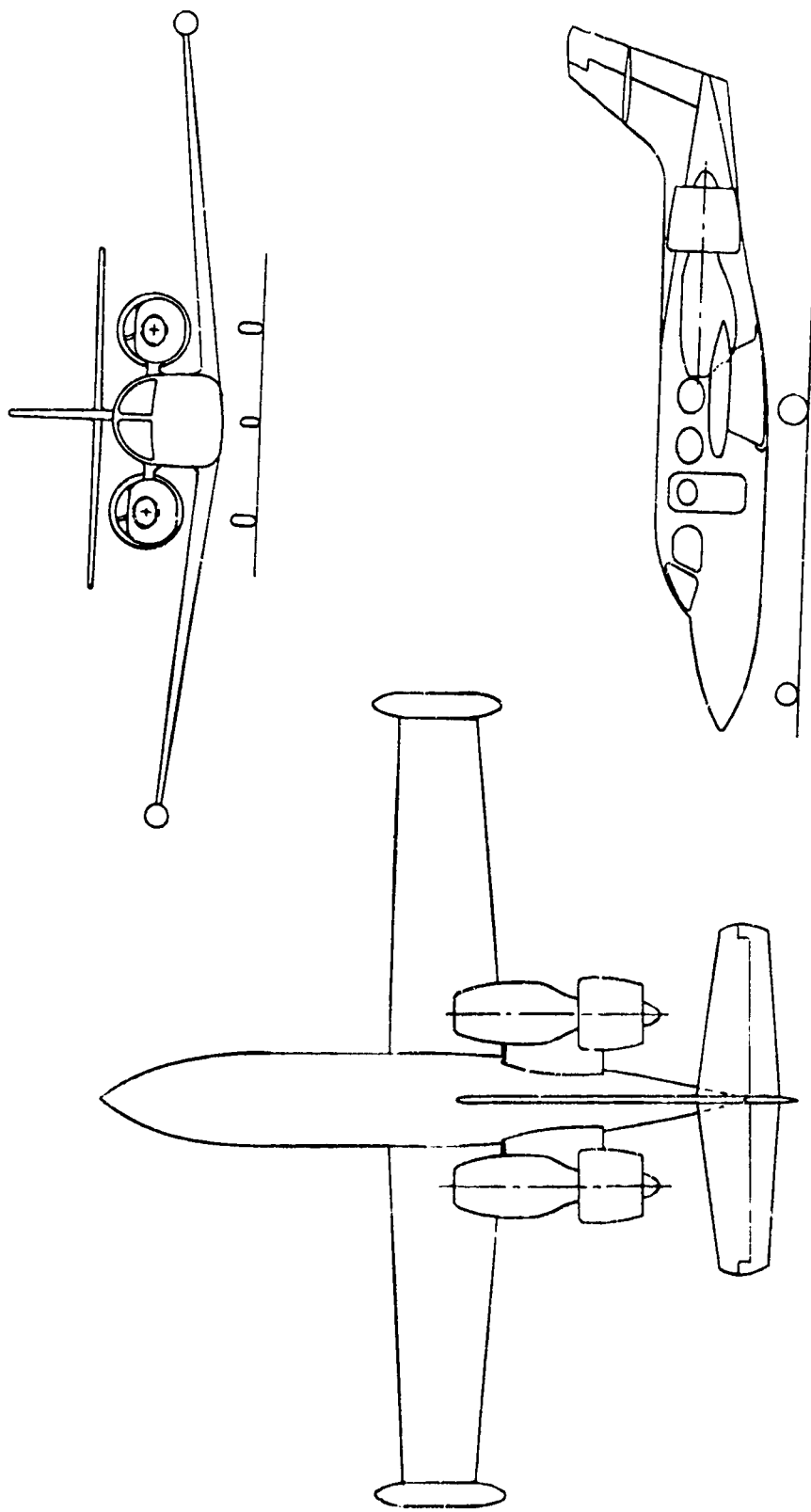

FIGURE 63. TWIN-ENGINE INSTALLATION - PISTON ENGINES WITH Q-FAN AS A PUSHER

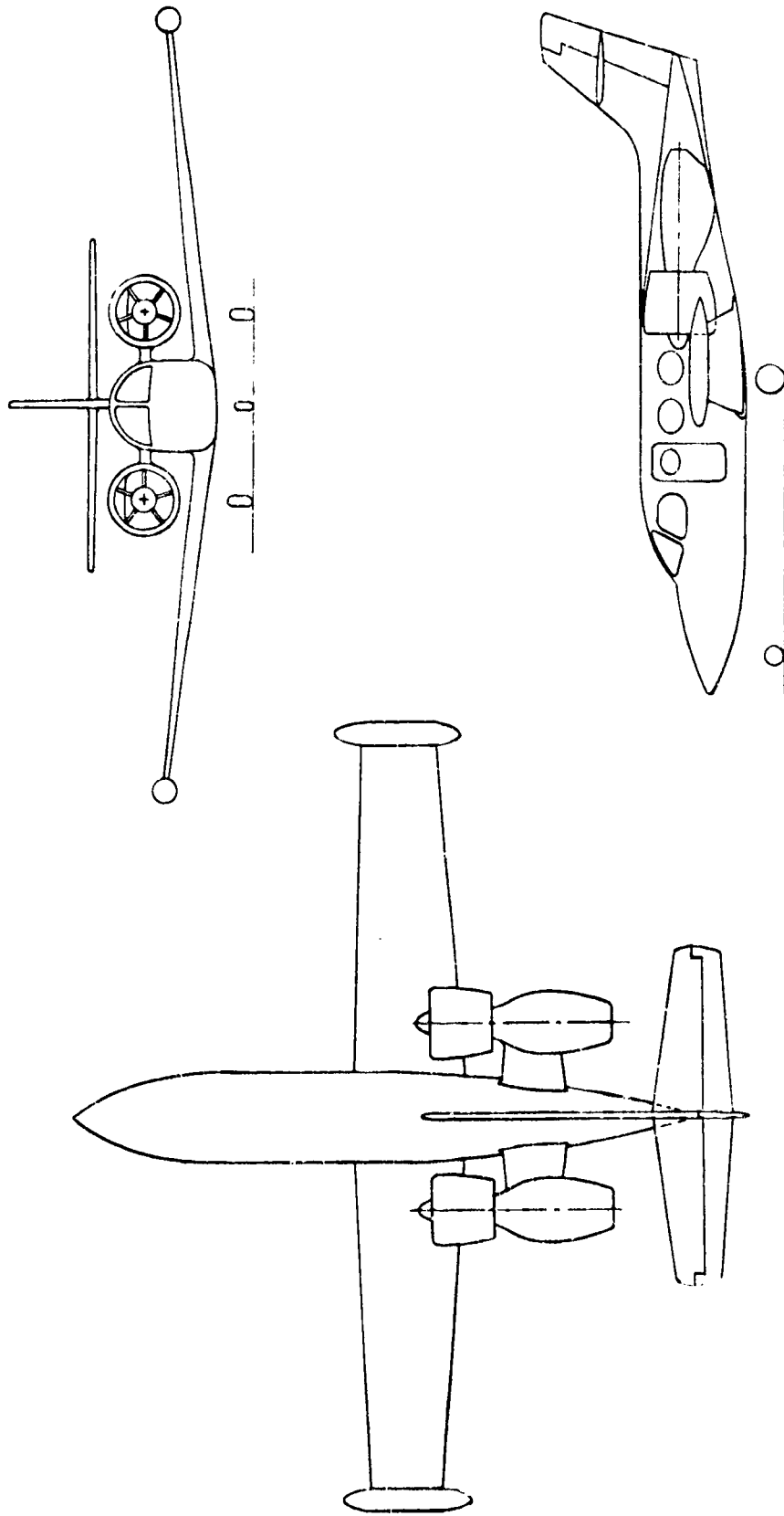

FIGURE 64. TWIN-ENGINE INSTALLATION - PISTON ENGINES WITH Q FAN AS A TRACTOR

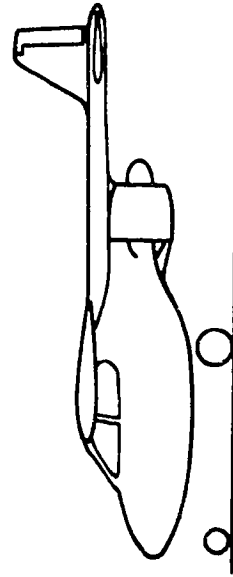
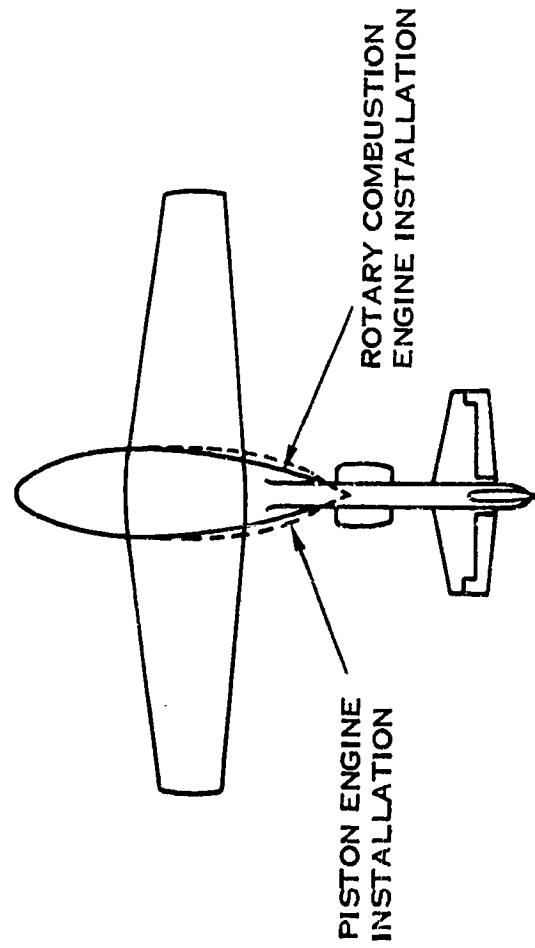
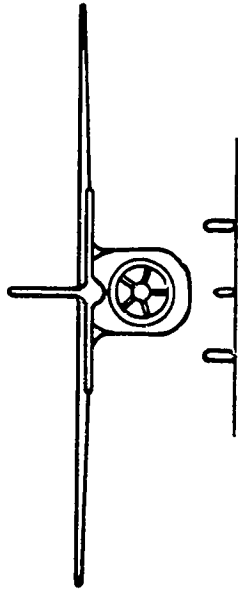

FIGURE 65. SINGLE ENGINE INSTALLATION—PISTON AND ROTARY COMBUSTION ENGINES

APPENDIX A

GENERALIZED METHOD OF Q-FAN PERFORMANCE ESTIMATION FOR GENERAL AVIATION AIRCRAFT

This appendix provides a generalized calculation method for Q-FansTM applicable for general aviation aircraft operating at static and in-flight conditions. The method can be used in preliminary design work to predict performance for constant speed, fixed pitch and two position Q-Fans. The form of method selected was governed primarily by the consideration of ease of usage and computerization. Accordingly, the method incorporates a series of performance maps for 0.8, 0.9, 1.0 and 1.1 rotor to duct exit area ratio, AR, all with a total activity factor, TAF, of 2000, an integrated design lift coefficient, C_{1i} , of 0.7 and a duct length to rotor diameter ratio, L/D of 1.08. Adjustments for total activity factor (activity factor per blade x number of blades), duct length to rotor diameter ratio, and compressibility losses are incorporated.

Performance Calculation Procedure

The method of calculating the static and flight performance, as described in the main text section on performance generalization, is presented below. A sample problem is included as figure A-1 for constant speed propellers and figure A-2 for fixed pitch propellers.

With the airplane flight and engine conditions given, and the Q-Fan characteristics known, the procedures as outlined on the sample computation sheet (fig. A-1 and fig. A-2) is as follows. English units will be used and the corresponding metric units will be included in parenthesis.

A. From known data, complete the top of the computation sheet. Identify airplane, engine and gear ratio (GR) and items 1 through 5 which are propeller diameter (D), number of blades, activity factor (AF), duct length to rotor diameter ratio (L/D), and area ratio (AR).

It should be noted that there is a criterion (fig. A-3) for selecting the number of blades/activity factor combination which, for a specified total activity and tip speed, will give minimum noise while not affecting performance. Therefore, it is recommended that figure A-3 be used in selecting the AF and number of blades combinations.

For fixed pitch Q-Fans go to instruction E.

B. Determine items numbered 6 through 10 from the airplane flight and engine conditions which have been selected for analysis as explained below. The English units are used with the SI units included in parenthesis:

Item No.

6. Attitude Identify flight condition
7. Thrust or Power Option 1. - The engine power, SHP (kw)/Q-Fan is given and the corresponding thrust, lb (N) is computed.
- Option 2. - The thrust, lb (N)/Q-Fan is defined and the power, SHP (kw) is computed.
8. Engine rpm N_e - engine speed, rpm
9. Pressure altitude ft (m)
10. Velocity V - airplane forward speed, knots true air speed (m/s)

C. Calculate items 11 through 15.

11. ρ_o/ρ Density ratio
12. f_c Ratio of speed of sound at standard day sea level to speed of sound at operating condition.
13. N Rotor speed = $N_e \times G.F.$
14. C_p or C_{Tnet} Option 1: $C_p = \frac{(K2) \text{ Power } (\rho_o/\rho)}{N^3 D^5}$
where $K2 = 0.5 \times 10^{11}$ (1.764×10^8)
- Option 2: $C_{Tnet} = \frac{(K3) \text{ Thrust}(\rho_o/\rho)}{N^2 D^4}$
where $K3 = 1.514 \times 10^6$ (2.938×10^3)
15. J_o Rotor advance ratio = $(K1) V/(ND)$
where $K1 = 101.4$ (60.)

D. The following items are read from curves or calculated

16. TAF Total activity factor (item 2 x item 3)
17. P_{TAF} or T_{TAF} TAF Adjustment Option 1 - P_{TAF} (fig. A-4)
Option 2 - T_{TAF} (fig. A-5)

Item No.

18. T. S./ f_c Rotor tip speed - $\frac{(K4) ND}{60 f_c}$

where $K4 = \pi$ (10.31)

19. P_{MN} or T_{MN} Tip speed/Mach no. adjustment

Option 1 - P_{MN} (fig. A-6)

Option 2 - T_{MN} (fig. A-7)

Items 20, 21 and 22 are for Option 2 only.

20. ΔC_{Tnet} (L/D) Duct length/rotor diameter adjustments (fig. A-8)

21. C_{TE1} $C_{TE1} = (C_{Tnet} \times T_{TAF} \times T_{MN}) - \Delta C_T$ (L/D)

22. ΔC_{Tnet} (acc.) Performance penalty for acoustical treatment to reduce noise 4.5 PNdB (fig. A-9)

23. C_{PE} or C_{TE} Option 1 - $C_{PE} = C_P \times P_{TAF} \times P_{MN}$

Option 2 - $C_{TE} = C_{TE1} + \Delta C_T$ (acc.)

24. C_{TE} or C_{PE} Option 1 - read for proper AR, C_{PE} and J_O from fig. A-10, A-11, A-12, or A-13. Interpolate if necessary.

Option 2 - Read for proper AR, C_{TE} and J_O from fig. A-10, A-11, A-12, or A-13. Interpolate, if necessary.

25. T_{TAF} or P_{TAF} Option 1 - T_{TAF} (fig. A-5)

Option 2 - P_{TAF} (fig. A-4)

26. T_{MN} or P_{MN} Option 1 - T_{MN} (fig. A-7)

Option 2 - P_{MN} (fig. A-6)

Items 27 and 28 are for Option 1 only.

27. ΔC_{Tnet} (L/D) Fig. A-8.

28. ΔC_{Tnet} (acc) Fig. A-9 with $C_{TE1} = C_{TE}$

Item No.

29. $C_{T_{net}}$ or C_P

Option 1:

$$C_{T_{net}} = \frac{C_{T_E} + \Delta C_{T(L/D)} - \Delta C_{T(acc.)}}{T_{TAF} \times T_{MN}}$$

Option 2:

$$C_P = \frac{C_{P_E}}{P_{TAF} \times P_{MN}}$$

30. Thrust or Power

Option 1 - Thrust = $\frac{(K5) C_{TN}^2 D^4}{\rho_0/\rho}$

where $K5 = 0.661 \times 10^{-6}$ (2.94×10^{-6})

Option 2 - Power = $\frac{(K6) N^3 D^5 C_P}{\rho_0/\rho}$

where $K6 = 2 \times 10^{-11}$ (1.112×10^{-11})

31. $\beta_{3/4}$

Blade angle at 3/4 radius. Read from fig. A-14, A15, A16, A17 for J_0 and C_{P_E} . Interpolate necessary.

E. Fixed Pitch Propellers: A blade angle, $\beta_{3/4}$ can be selected from computed $\beta_{3/4}$ for a specific operating condition (or conditions) for a constant speed Q-Fan. Then, for the selected $\beta_{3/4}$ and a range of engine rpm's, the corresponding power and thrust are computed for a given velocity and altitude by the following procedure. Then, the rpm most suitable for the aircraft operation can be selected.

Item No.

- | | |
|-------------------|--|
| 6. Attitude | Identify flight condition |
| 7. Engine rpm | N_e - select a range of rpm's |
| 8. Altitude _____ | ft (m) |
| 9. Velocity | V - airplane forward speed knots true airspeed (m/s) |
| 10. $\beta_{3/4}$ | Select |

F. Calculate items 11 through 14.

<u>Item No.</u>	
11.	ρ_o/ρ Density ratio
12.	f_c Ratio of speed of sound at standard day sea level to speed of sound at operating conditions.
13.	N Rotor speed = $N_e \times G.R.$
14.	J_o Rotor advance ratio - $K1/(ND)$

where $K1 = 101.4 (60.)$

G. The following items are read from curves or calculated

<u>Item No.</u>	
15.	C_{PE} Read from fig. A-14, A-15, A-16, A-17 for J_o and $\beta_{3/4}$. Interpolate, if necessary.
16.	TAF AF x B
17.	P_{TAF} TAF adjustment to power (fig. A-4)
18.	T.S./ f_c Rotor tip speed - $\frac{(Kr) ND}{60 f_c}$
where $K4 = \pi (10.31)$	
19.	P_{MN} Tip speed/Mach no. adjustment to power (fig. A-6)
20.	C_p $C_p = \frac{C_{PE}}{P_{TAF} \times P_{MN}}$
21.	Power $Power = \frac{(K6) N^3 D^5 C_p}{\rho_o/\rho}$
where $K6 = 2 \times 10^{-11} (1.112 \times 10^{-11})$	
22.	C_{TE} Read for proper AR, C_{PE} and J_o from fig. A-10, A-11, A-12, A-13. Interpolate, if necessary.
23.	T_{TAF} TAF adjustment to C_T (fig. A-5)

Item No.

24. T_{MN} Tip speed/Mach no. adjustment to C_T (fig. A-7)
25. $\Delta C_{T_{net}} (L/D)$ Duct length/rotor diameter adjustment (fig. A-8)
26. $\Delta C_{T_{net}} (acc.)$ Performance penalty for acoustical treatment to reduce noise 4.5 PNdB (fig. A-9)
27. C_T
$$C_T = \frac{C_{TE} + \Delta C_T (L/D) - \Delta C_T (acc.)}{T_{TAF} \times T_{MN}}$$
28. Thrust
$$\text{Thrust} = \frac{(K5) C_T N^2 D^4}{\rho_o/\rho}$$

where $K5 = 0.661 \times 10^{-6}$ (2.94×10^{-6})

FIGURE A-1

AIRPLANE: Hypothetical DATE: 3/13/73 CALC. NO. 100
 ENGINE: Hypothetical G. R. 0.25 SHEET NO. 1
 REFERENCE: Constant Speed CALC. BY: R.W. CHECKED BY: A.B.

1.	Diameter	3.5	3.5
2.	No. of Blades	10.0	10.0
3.	AF	250.0	250.0
4.	L/D	1.046	1.046
5.	AR	1.0	1.0
6.	Attitude	T.O.	Cruise
7.	Power or Thrust	1500 (Thrust)	550(SHP)
8.	Engine RPM	14192.0	13096.0
9.	Altitude	S.L.	20,000 '
10.	Velocity	66 KTS	245 KTS
11.	ρ_0/ρ	1.0	1.878
12.	f_c	1.0	1.078
13.	N	3548.0	3274.0
14.	C_p or C_T	1.202 (C_T)	2.80 (C_p)
15.	J_0	0.539	2.17
16.	TAF	2500.0	2500.0
17.	P_{TAF} or T_{TAF}	0.929 (T_{TAF})	0.90 (P_{TAF})
18.	TS/f_c	650.0	557.0
19.	P_{MN} or T_{MN}	1.052 (T_{MN})	1.027 (P_{MN})
20.	$\Delta C_{T_{net}}$ (L/D)	0.0012	-
21.	C_{TE1}	1.175	-
22.	$\Delta C_{T_{net}}$ (acc.)	0.0021	-
23.	C_{PE} or C_{TE}	1.177 (C_{TE})	2.59 (C_{PE})
24.	C_{TE} or C_{PE}	1.450 (C_{PE})	0.855 (C_{TE})

FIGURE A-1 (Continued)

AIRPLANE: Hypothetical DATE: 3/13/73 CALC. NO. 100
 ENGINE: Hypothetical G. R. 0.25 SHEET NO. 2
 REFERENCE: Constant Speed CALC. BY: R. W. CHECKED BY: A. B.

25.	T_{TAF} or P_{TAF}	0.90 (P_{TAF})	0.896 (T_{TAF})
26.	T_{MN} or P_{MN}	1.052 (P_{MN})	1.047 (T_{MN})
27.	$\Delta C_{T_{net}}$ (L/D)	-	0.0059
28.	$\Delta C_{T_{net}}$ (acc.)	-	0.0039
29.	C_T or C_P	1.531 (C_P)	0.914 (C_T)
30.	Thrust or SHP	717.0 (SHP)	518.0 (Thrust)
31.	$\beta_{3/4}$	41.1	54.1

FIGURE A-2

AIRPLANE:--- Hypothetical
 ENGINE: Hypothetical
 REFERENCE: Fixed Pitch

DATE: 3/13/73
 GR: D. D.
 CALC. BY R. W.

CALC. NO. 100
 SHEET NO. 3
 CHECKED BY: AB

1.	Diameter	2.5
2.	No. of Blades, B	9
3.	AF	228
4.	L/D	0.964
5.	AR	1.0
6.	Attitude	T.O.
7.	Engine rpm	4087.0
8.	Altitude	S.L.
9.	Velocity	66 KTS
10.	$\beta_{3/4}$	55.0
11.	ρ_0/ρ	1.0
12.	f_c	1.0
13.	N	4087.0
14.	J_0	0.655
15.	C_{PE}	3.04
16.	TAF	2052.0
17.	P_{TAF}	0.987
18.	TS/f_c	535.0
19.	PMN	1.021
20.	C_P	3.01
21.	Power	401
22.	C_{TE}	1.882
23.	TTAF	0.992
24.	T_{MN}	1.014
25.	$\Delta C_{Tnet} (L/D)$	0.0022
26.	$\Delta C_{Tnet} (acc.)$	0.0033
27.	C_T	1.870
28.	Thrust	80.6

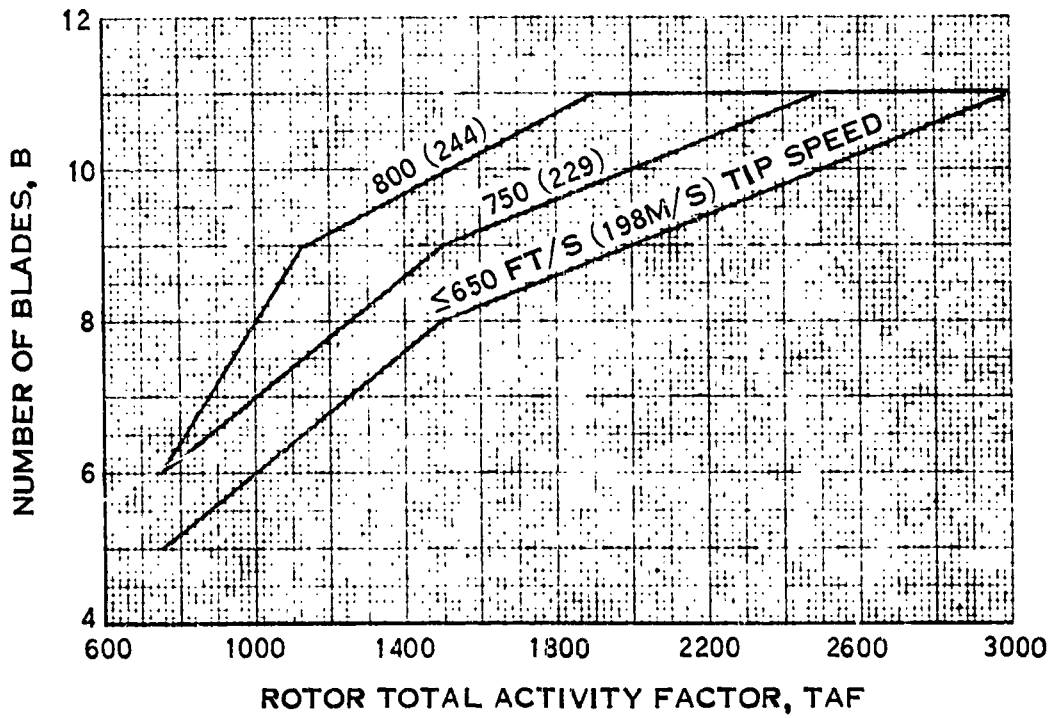
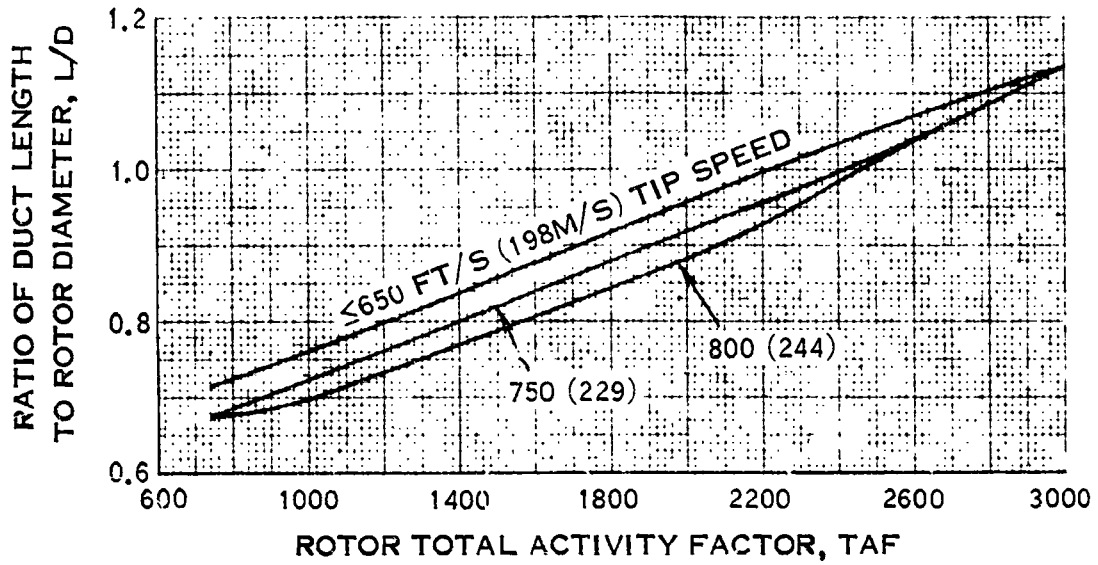

FIGURE A-3. ROTOR AND DUCT CHARACTERISTICS FOR MINIMUM Q-FAN NOISE

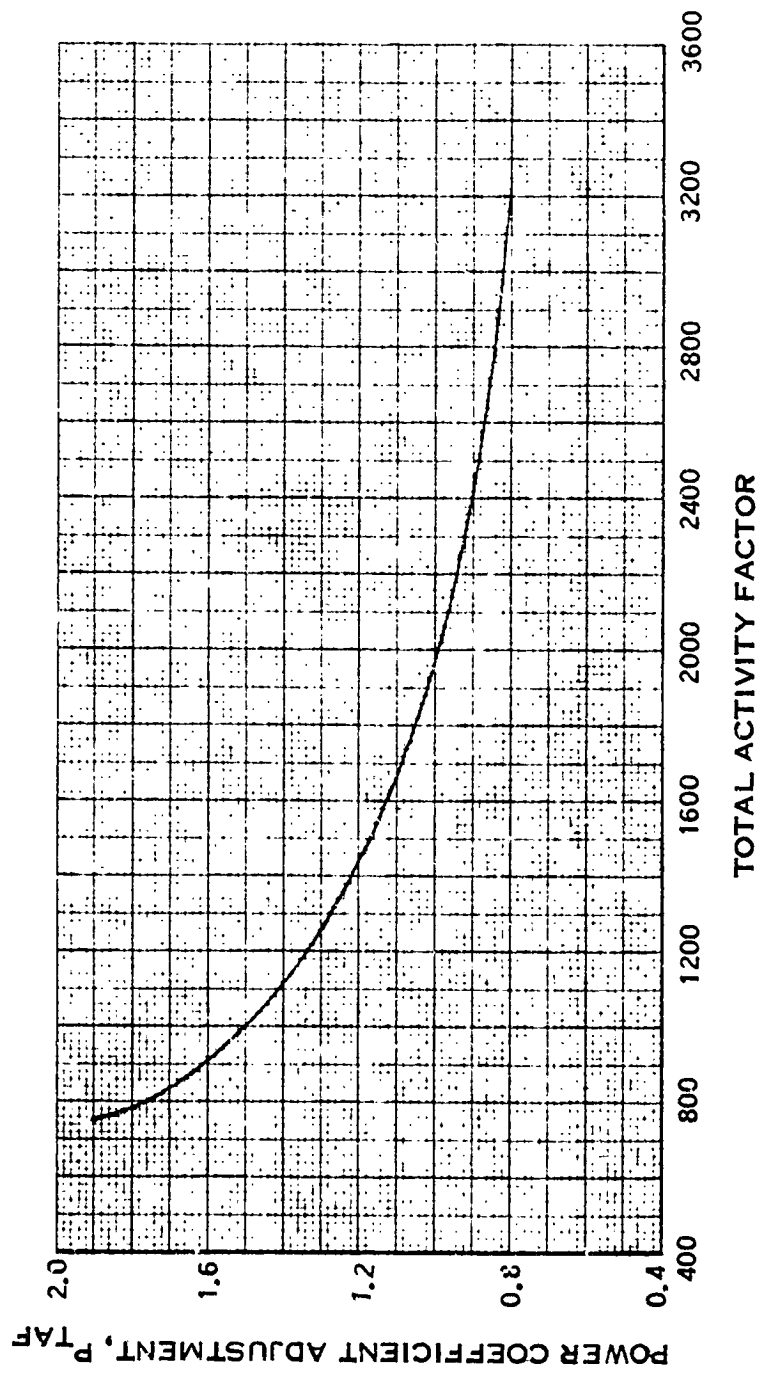

FIGURE A-4. TOTAL ACTIVITY FACTOR ADJUSTMENT TO POWER COEFFICIENT

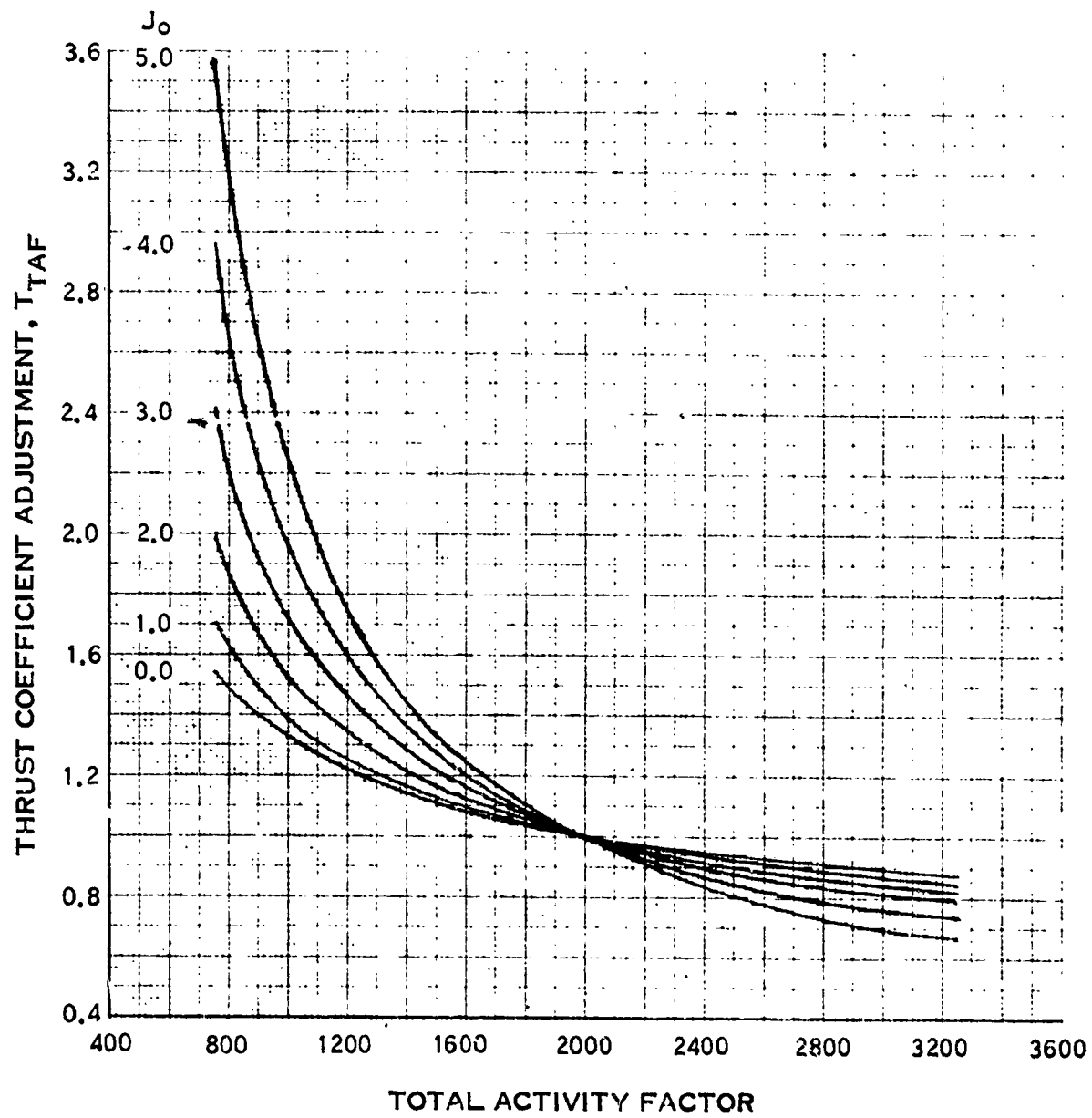

FIGURE A-5. TOTAL ACTIVITY FACTOR ADJUSTMENT TO THRUST COEFFICIENT

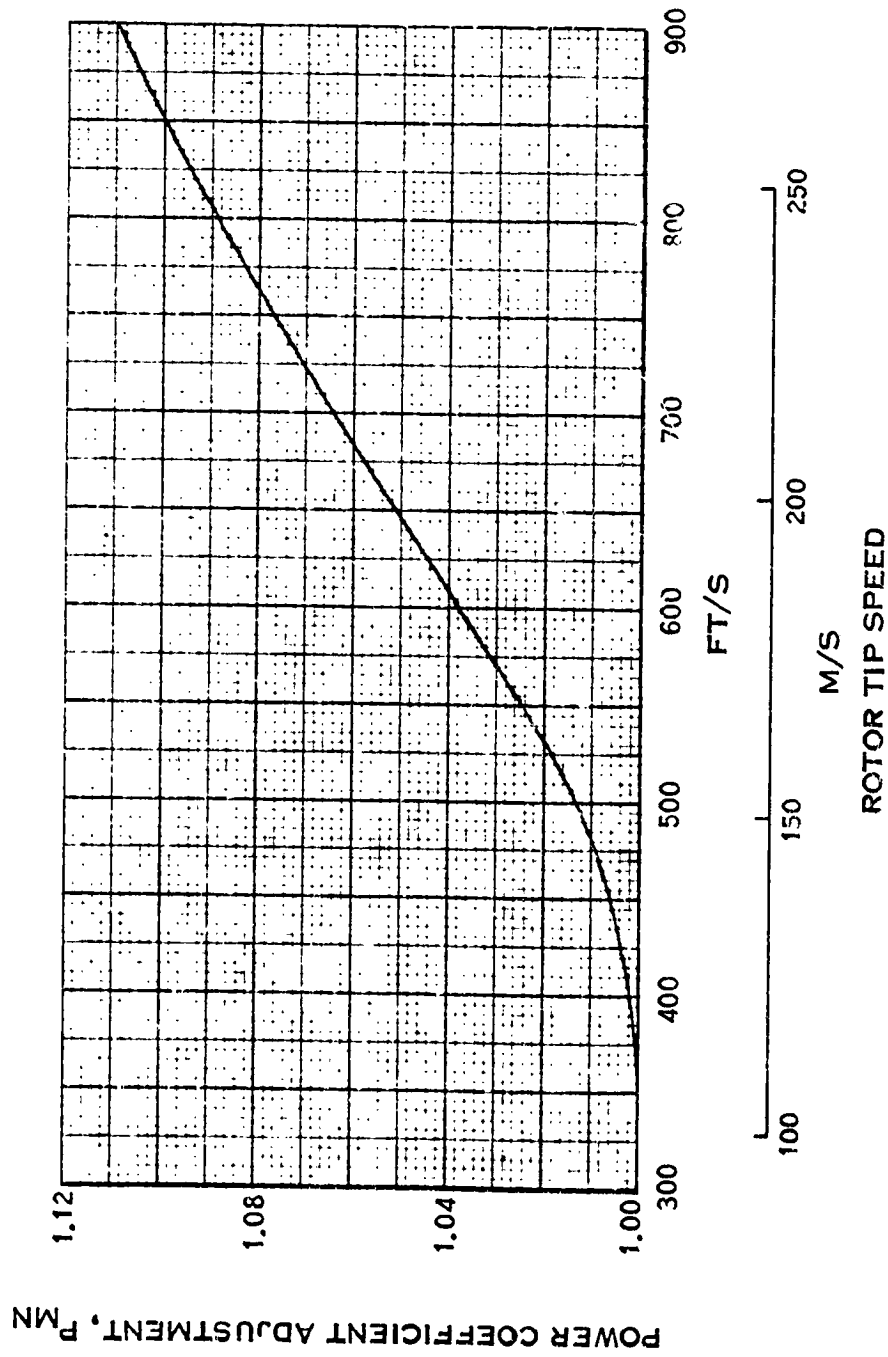

FIGURE A-6. TIP SPEED/MACH NUMBER ADJUSTMENT TO POWER COEFFICIENT

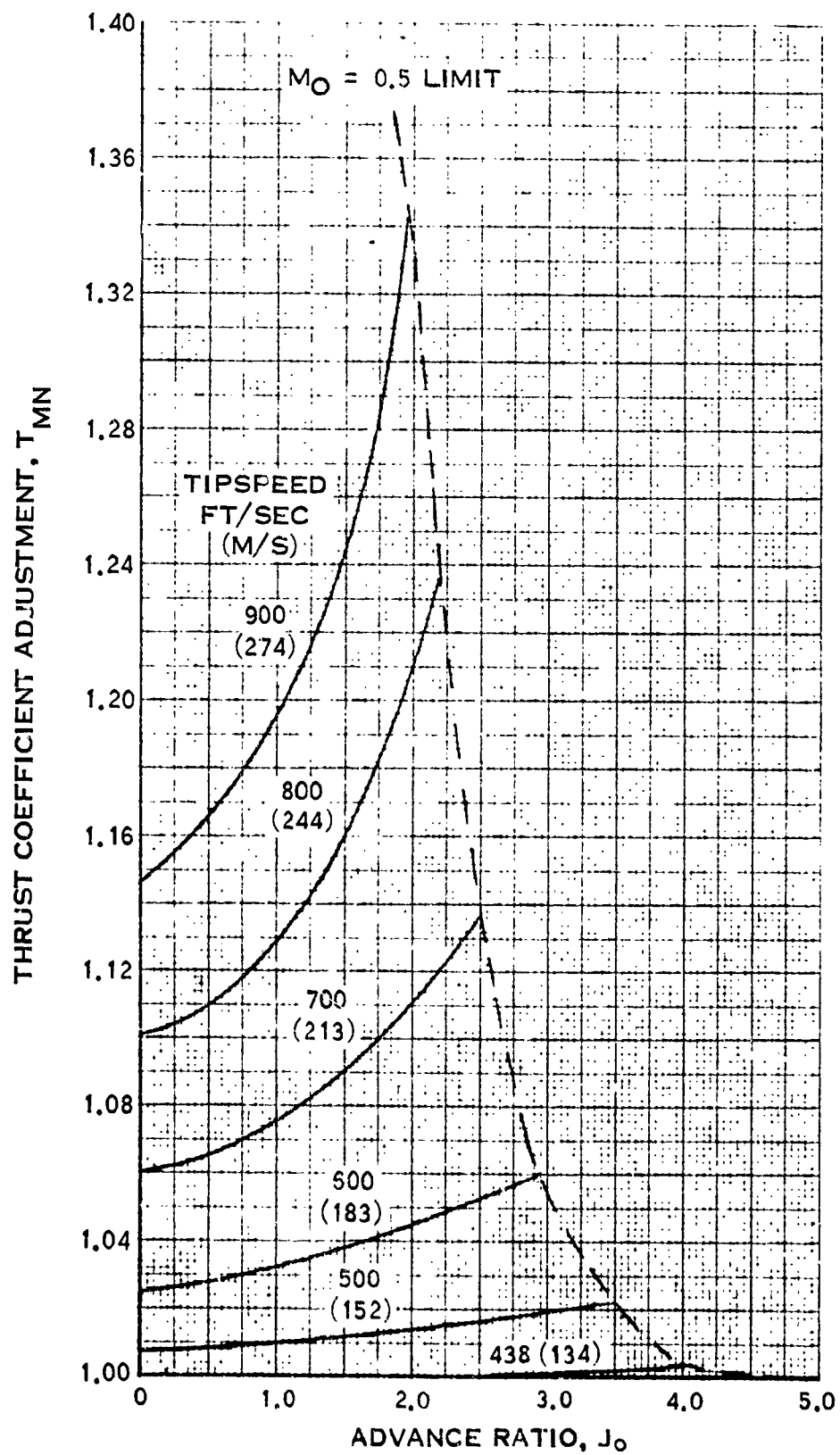

FIGURE A-7. TIP SPEED/MACH NUMBER ADJUSTMENT TO THRUST COEFFICIENT

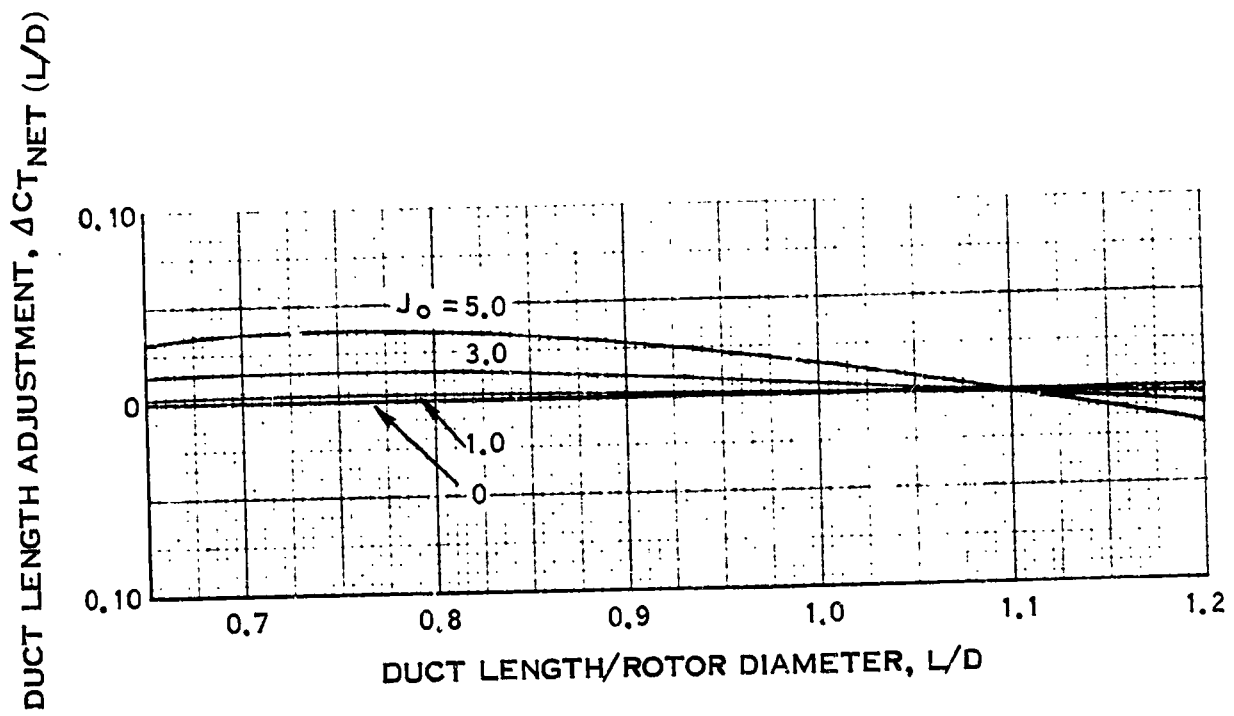

FIGURE A-8. DUCT LENGTH ADJUSTMENT TO THRUST COEFFICIENT

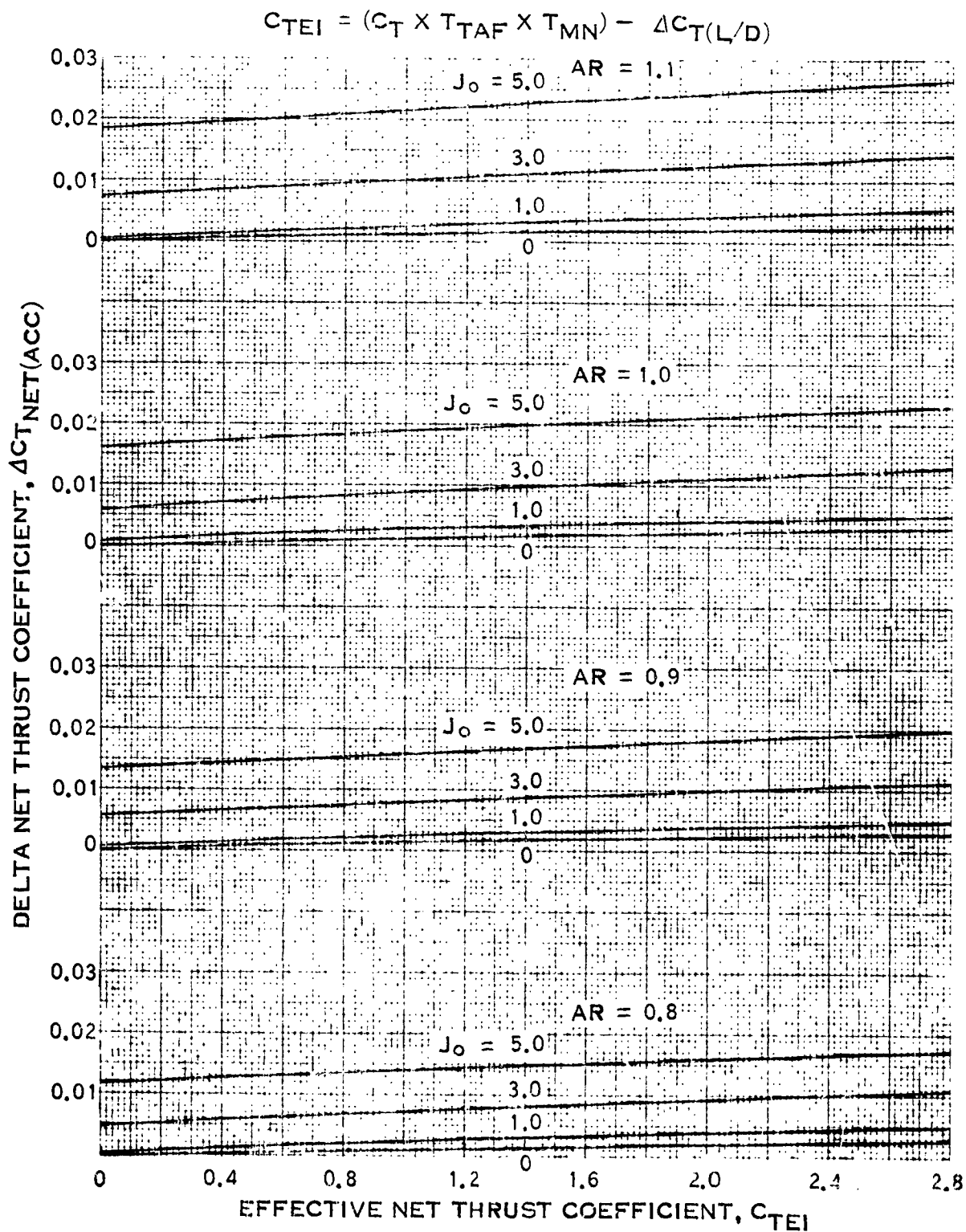
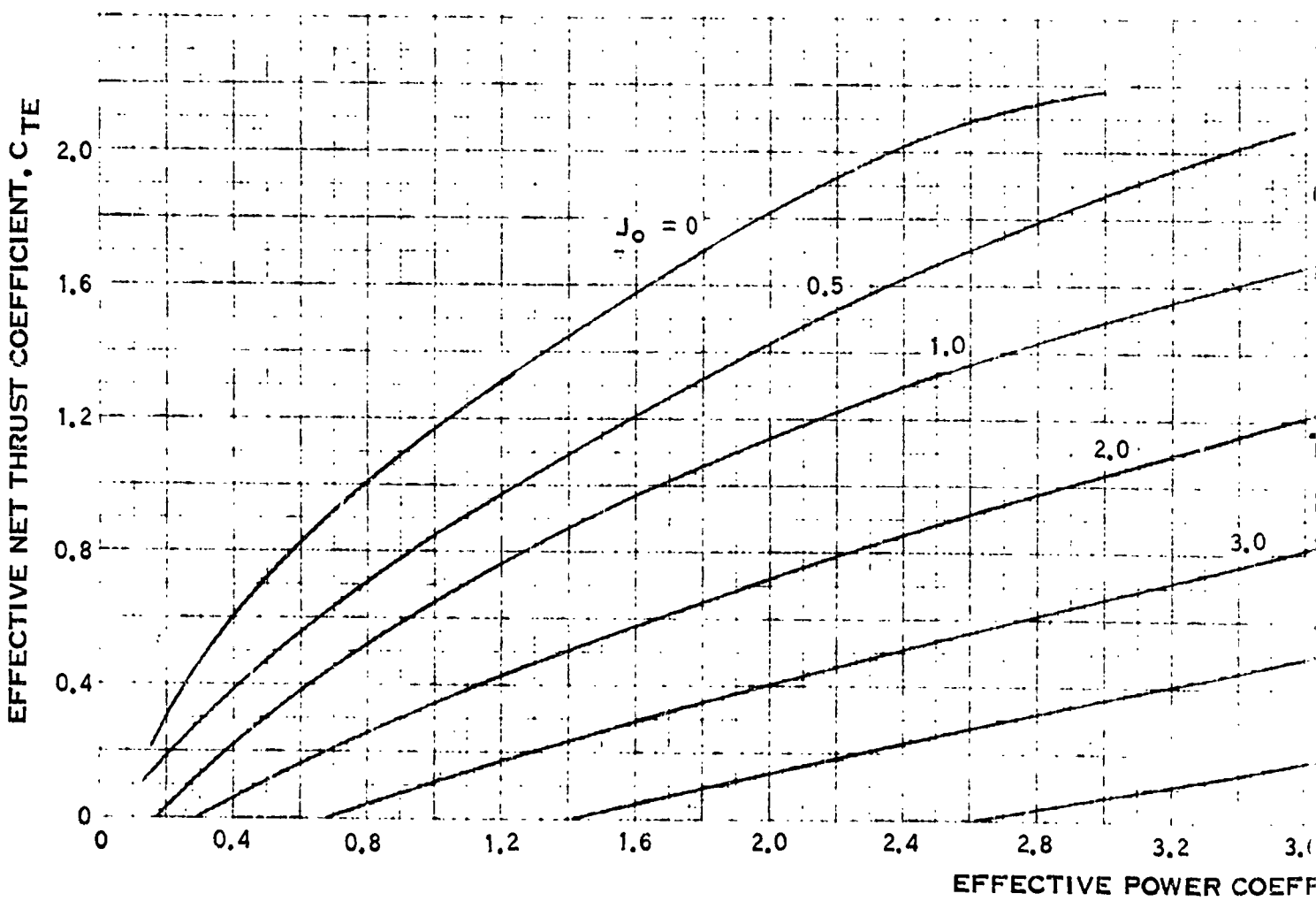

FIGURE A-9. EFFECT OF ACOUSTICAL TREATMENT ON PERFORMANCE
4.5 PNdB NOISE REDUCTION

FOLDOUT FRAME

SYSTEM OF UNITS
 ENGLISH SI

K1	101.4	60.0
K2	0.5×10^{11}	1.764×10^8
K3	1.514×10^6	2.938×10^3



HOLDOUT FRAME

$$J_0 = \frac{(K1) V}{ND}$$

$$C_{PE} = C_P \times P_{TAF} \times P_{MN}$$

$$C_P = \frac{(K2) \text{ POWER } (\rho_0/\rho)}{N^3 D^5}$$

$$C_{TE} = C_{T_{net}} \times T_{TAF} \times T_{MN} - \Delta C_{T_{NET}}(L/D) + \Delta C_{T_{NET}}(ACC.)$$

$$C_{T_{net}} = \frac{(K3) \text{ THRUST } (\rho_0/f)}{N^2 D^4}$$

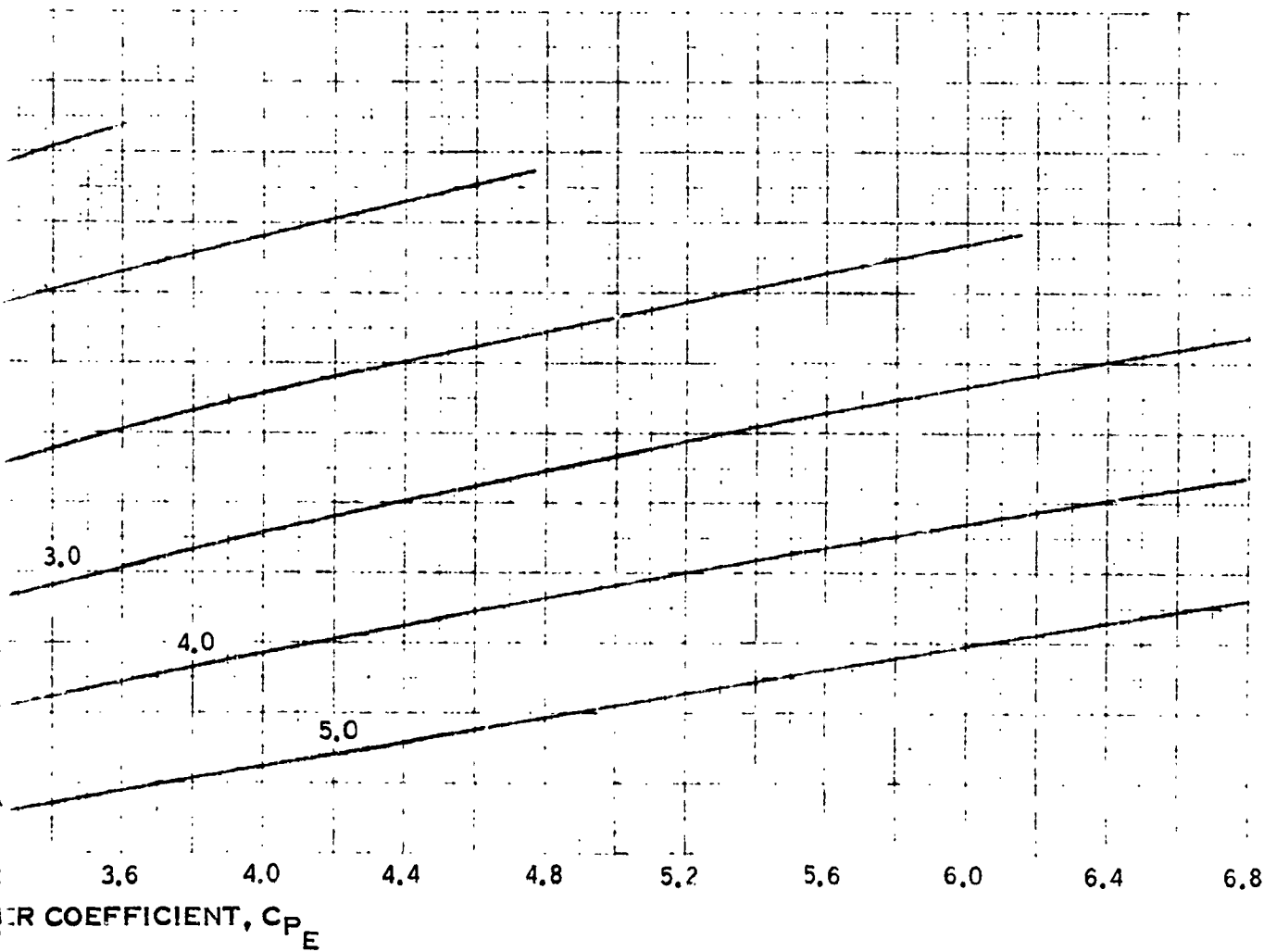

FIGURE A-10. BASE Q-FAN PERFORMANCE CURVE 0.8 AREA RATIO

FOUR OUT FRAME

$$J_o = \frac{(K1)V}{ND}$$

$$C_{PE} = C_P \times P_{TAF} \times P_{Mn}$$

$$C_P = \frac{(K2) \text{ POWER } (\rho_o/\rho)}{N^3 D^5}$$

$$C_{TE} = C_{T_{net}} \times T_{TAF} \times T_{MN} - \Delta C_{T_{NET}}(4D) + \Delta C_{T_{NET}}(ACC.)$$

$$C_{T_{net}} = \frac{(K3) \text{ THRUST } (\rho_o/\rho)}{N^2 D^4}$$

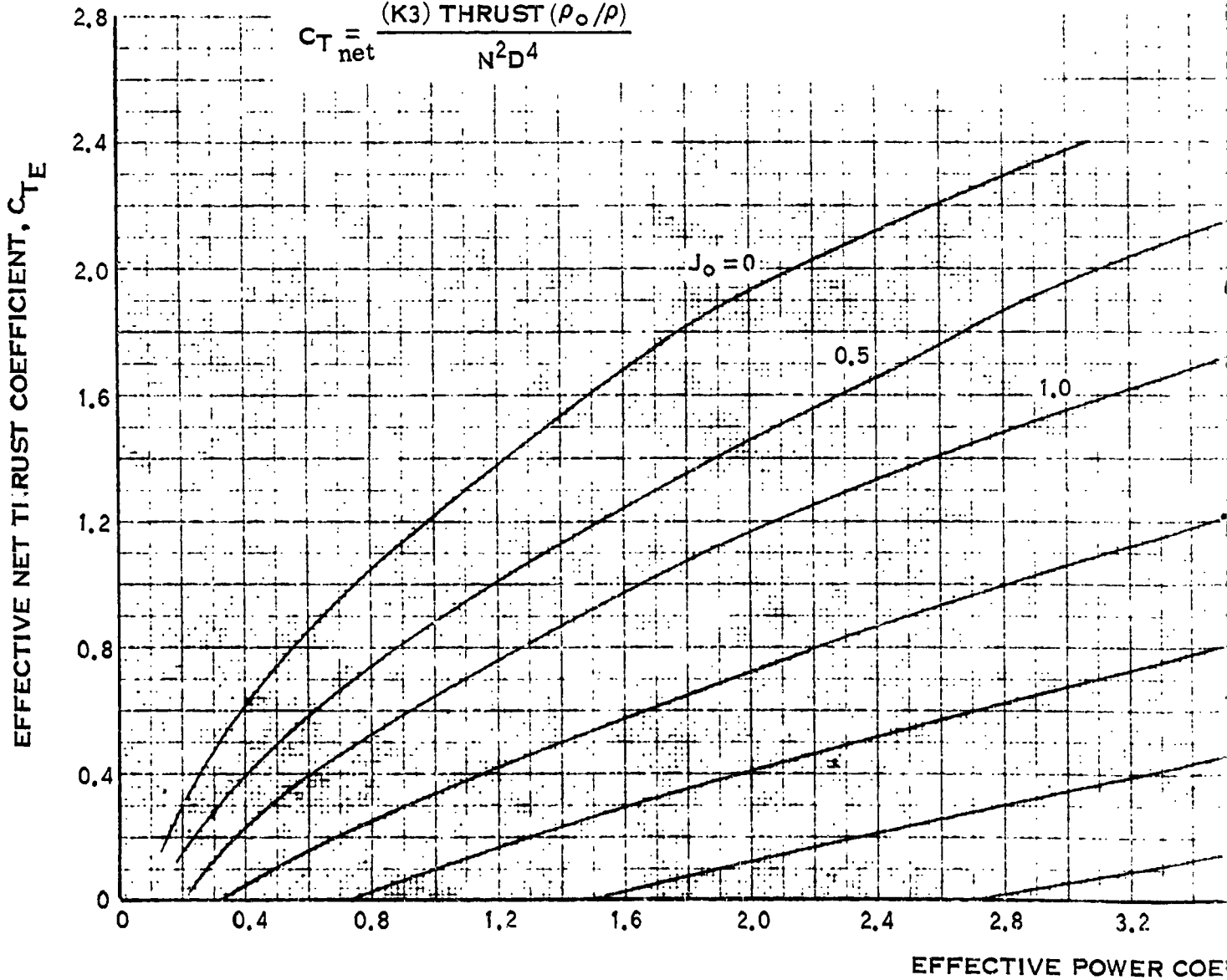

SYSTEM OF UNITS		
	ENGLISH	SI
K1	101.4	60.0
K2	0.5×10^{11}	1.764×10^8
K3	1.514×10^6	2.938×10^3

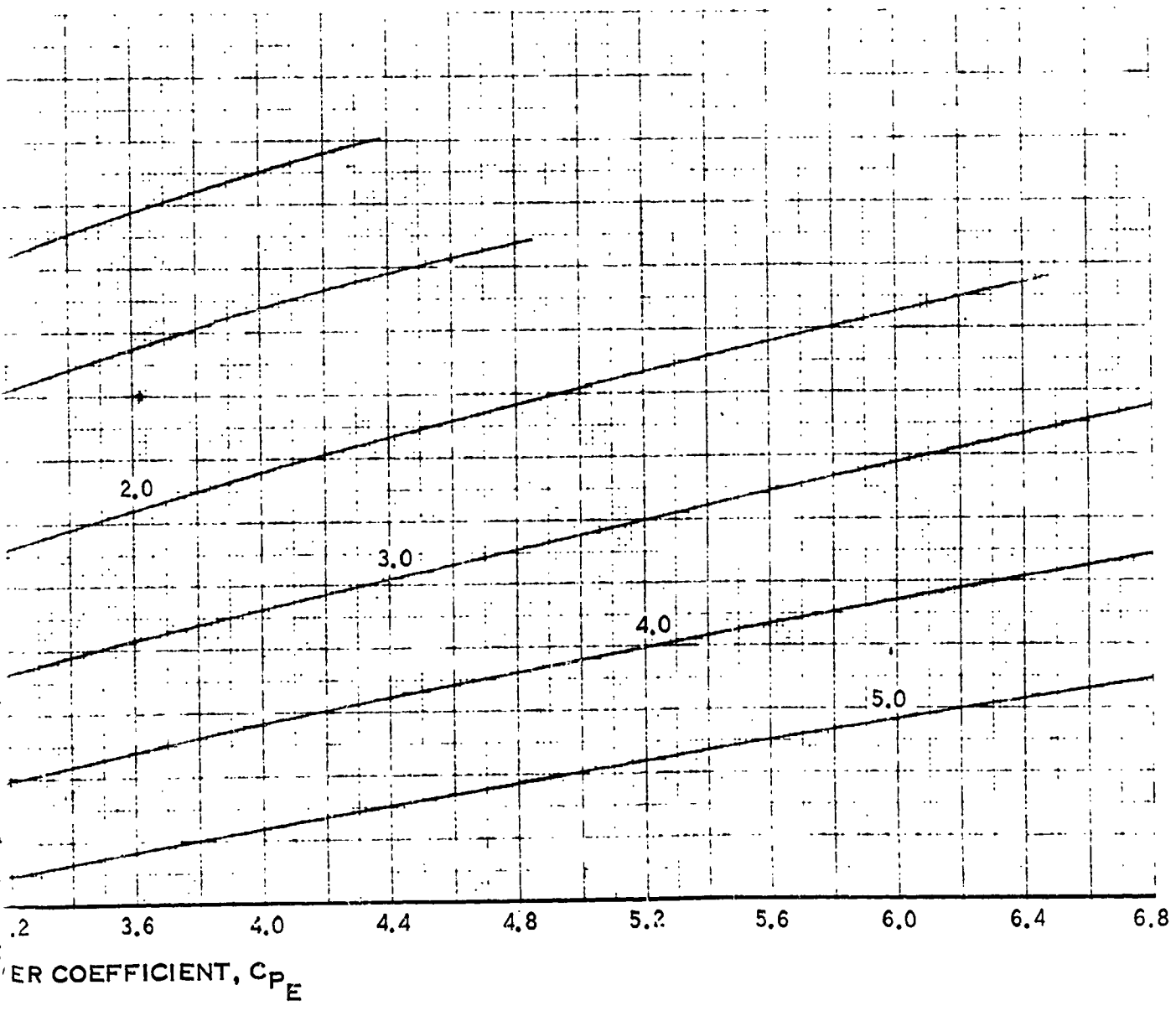

FIGURE A-11. BASE Q-FAN PERFORMANCE CURVE - 0.9 AREA RATIO

OUTBOARD FRAME

$$J_o = \frac{(K1) V}{ND}$$

$$C_{PE} = C_P \times P_{TAF} \times P_{MN}$$

$$C_P = \frac{(K2) \text{ POWER } (\rho_o/\rho)}{N^3 D^5}$$

$$C_{TE} = \frac{C_{T_{net}} \times T_{TAF} \times T_{MN} - \Delta C_{T_{NET}} (L/D) + \Delta C_{T_{NET}} (ACC.)}{(K3) \text{ THRUST } (\rho_o/\rho)}$$

$$C_{T_{net}} = \frac{N^2 D^4}{N^2 D^4}$$

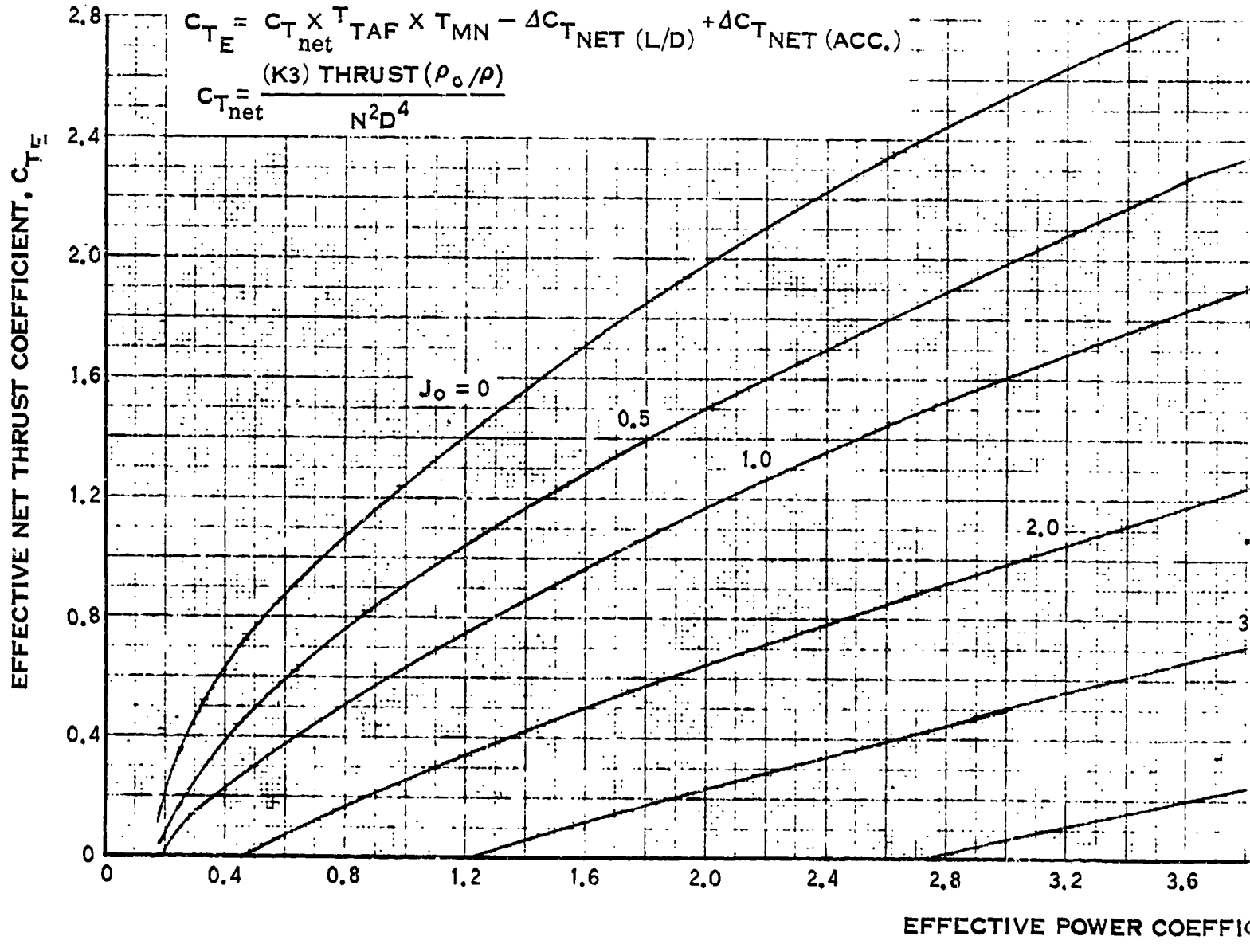

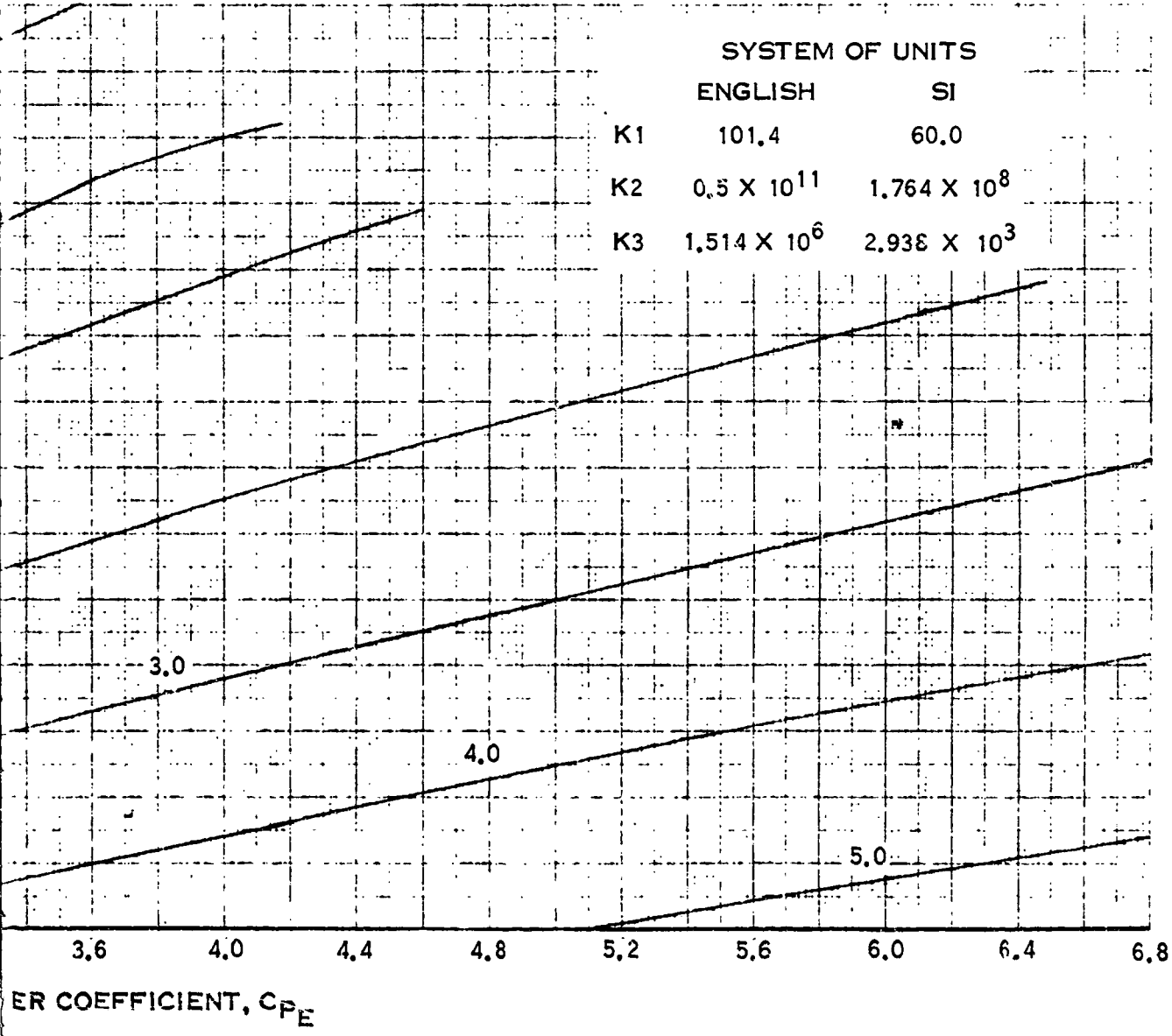
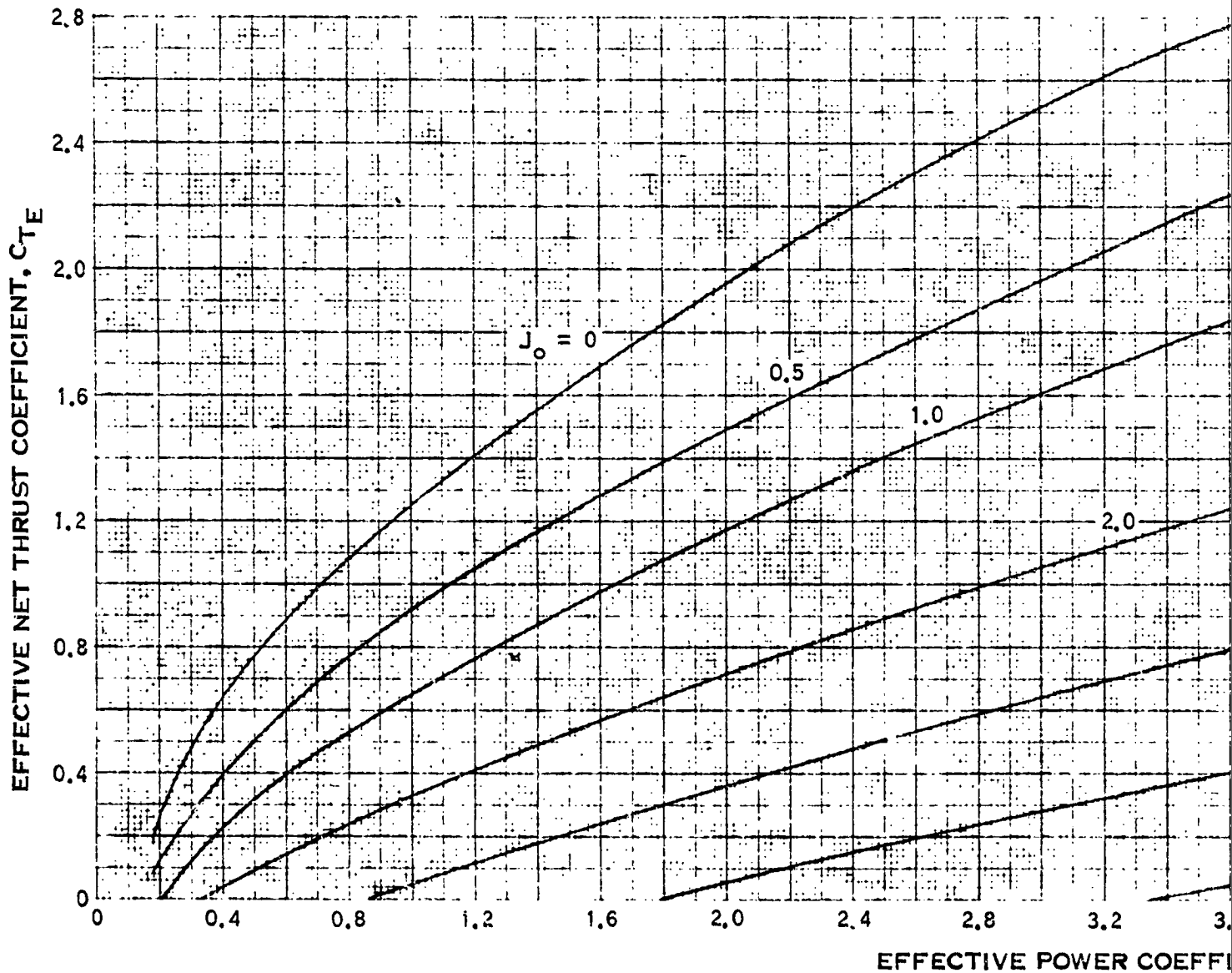

FIGURE A-12. BASE Q-FAN PERFORMANCE CURVE - 1.0 AREA RATIO

COLLUT FRANK 1

SYSTEM OF UNITS

	ENGLISH	SI
K1	101.4	60.0
K2	0.5×10^{11}	1.764×10^8
K3	1.514×10^6	2.938×10^{-3}



FOLDOUT FRAME 2

$$J_o = \frac{(K1)V}{ND}$$

$$C_{PE} = C_P \times P_{TAF} \times P_{MN}$$

$$C_P = \frac{(K2) \text{ POWER } \times (\rho_o/\rho)}{2N^3D^5}$$

$$C_{TE} = \frac{C_T \times T_{TAF} \times T_{MN} - \Delta C_{TNET}(L/D) + \Delta C_{TNET}(ACC.)}{net}$$

$$C_{Tnet} = \frac{(K3) \text{ THRUST } (\rho_o/\rho)}{N^2D^4}$$

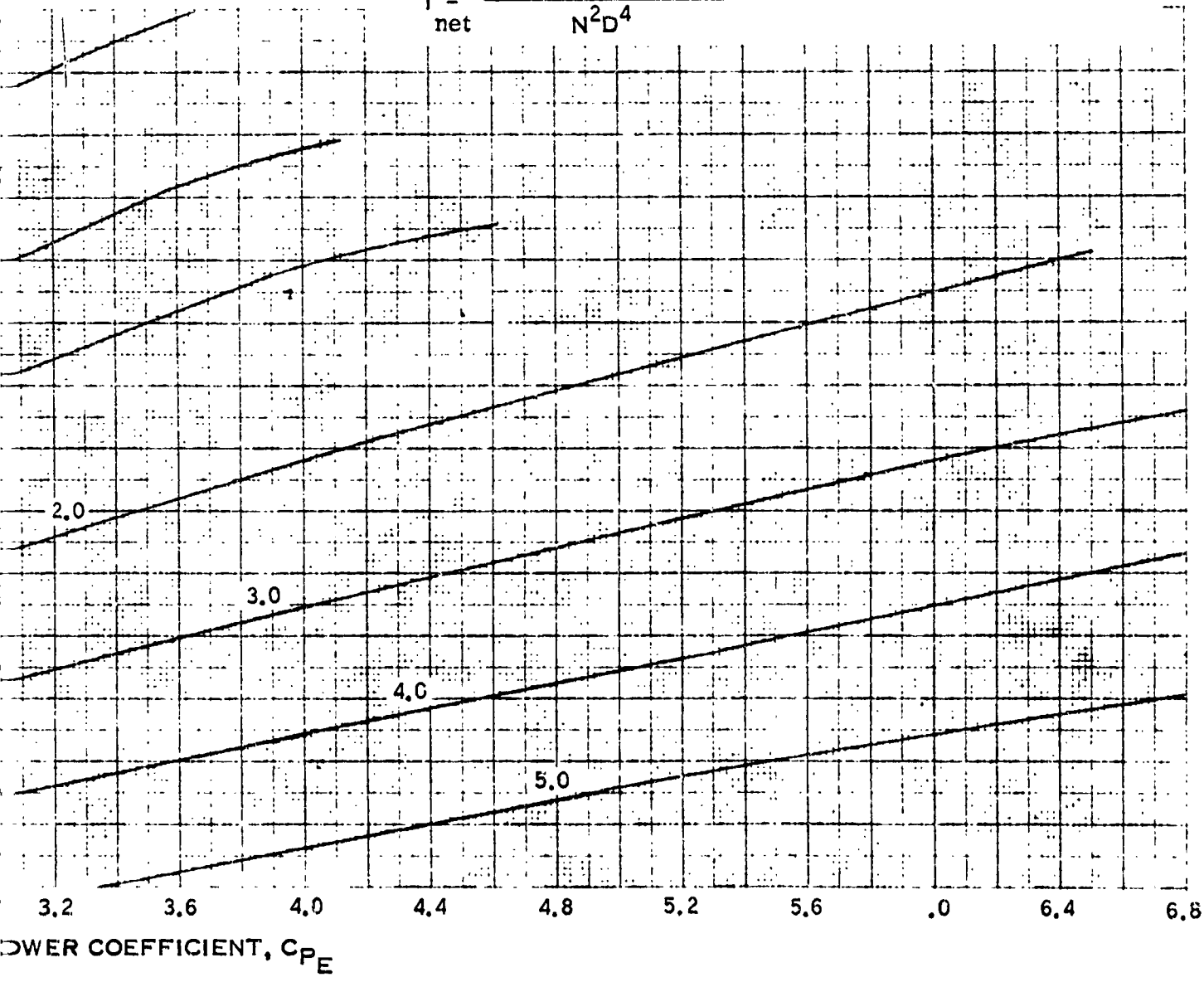

FIGURE A-13. BASE Q-FAN PERFORMANCE
CURVE - 1.1 AREA RATIO

FOLDOUT FRAME

$$J_0 = \frac{(K1)V}{ND}$$

$$C_{PE} = C_P \times P_{TAF} \times P_{MN}$$

$$C_P = \frac{(K2) \text{ POWER}(\rho_0/\rho)}{N^3 D^5}$$

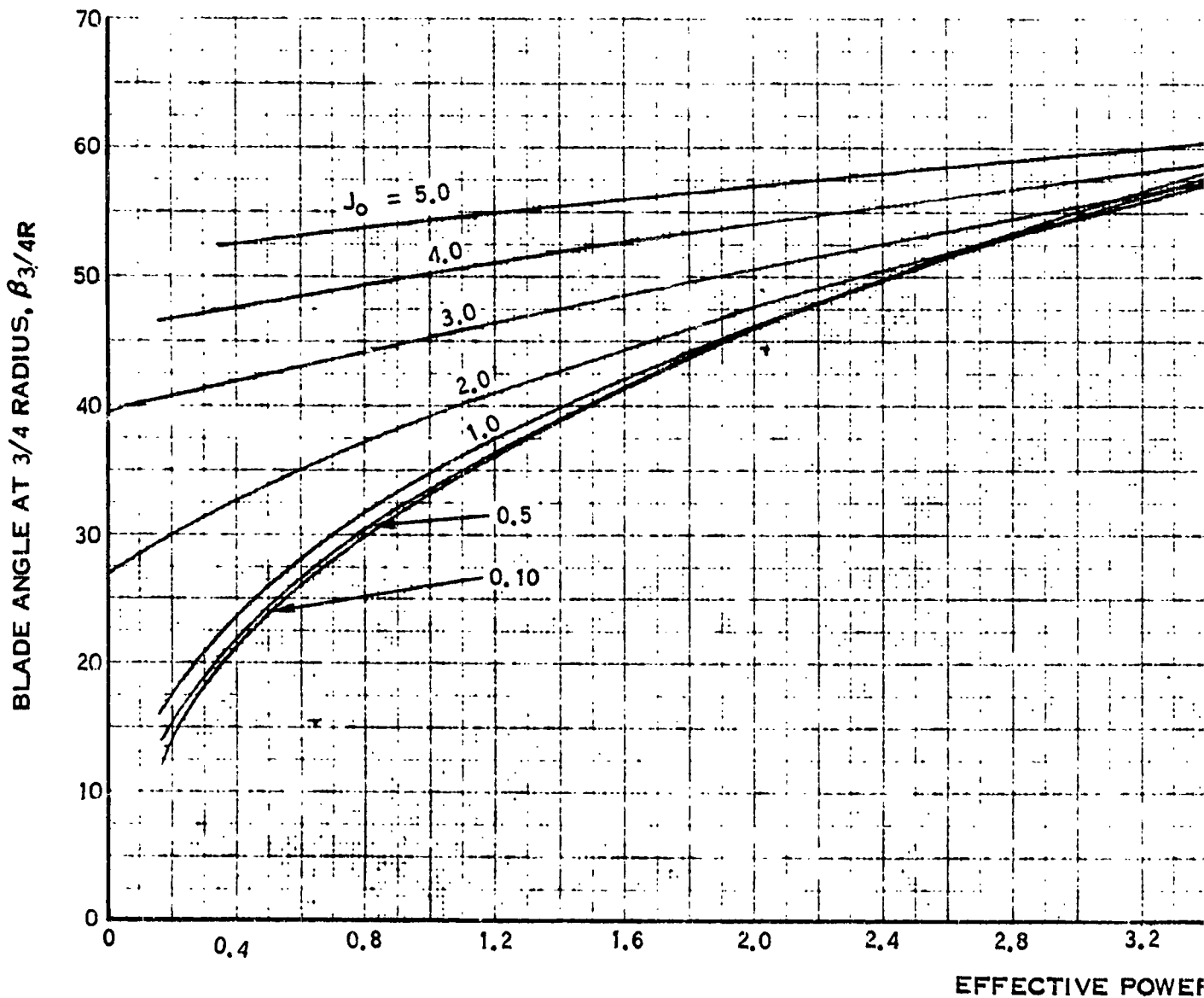

SYSTEMS OF UNITS		
	ENGLISH	SI
K1	101.4	60.0
K2	0.5×10^{11}	1.764×10^8

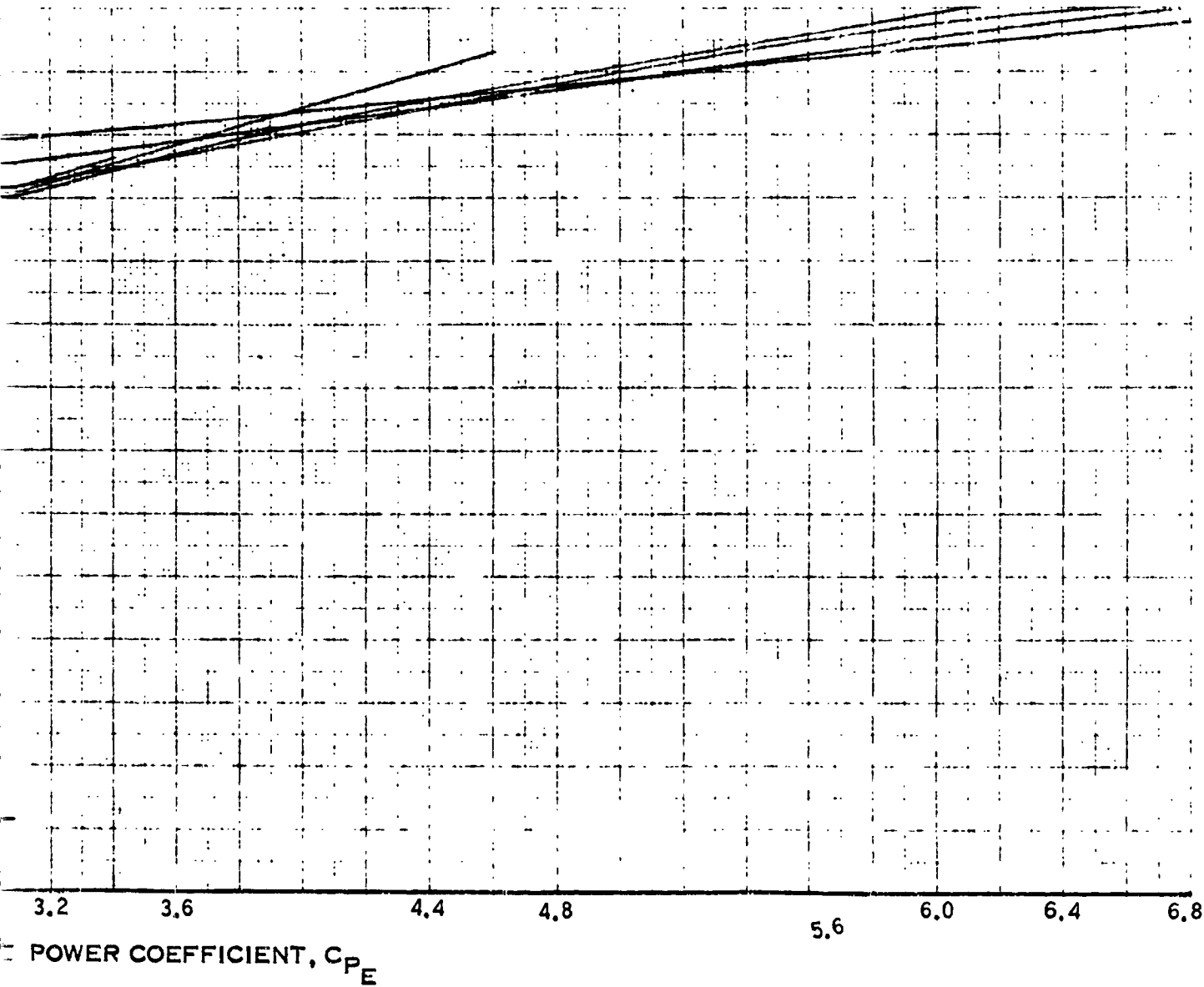
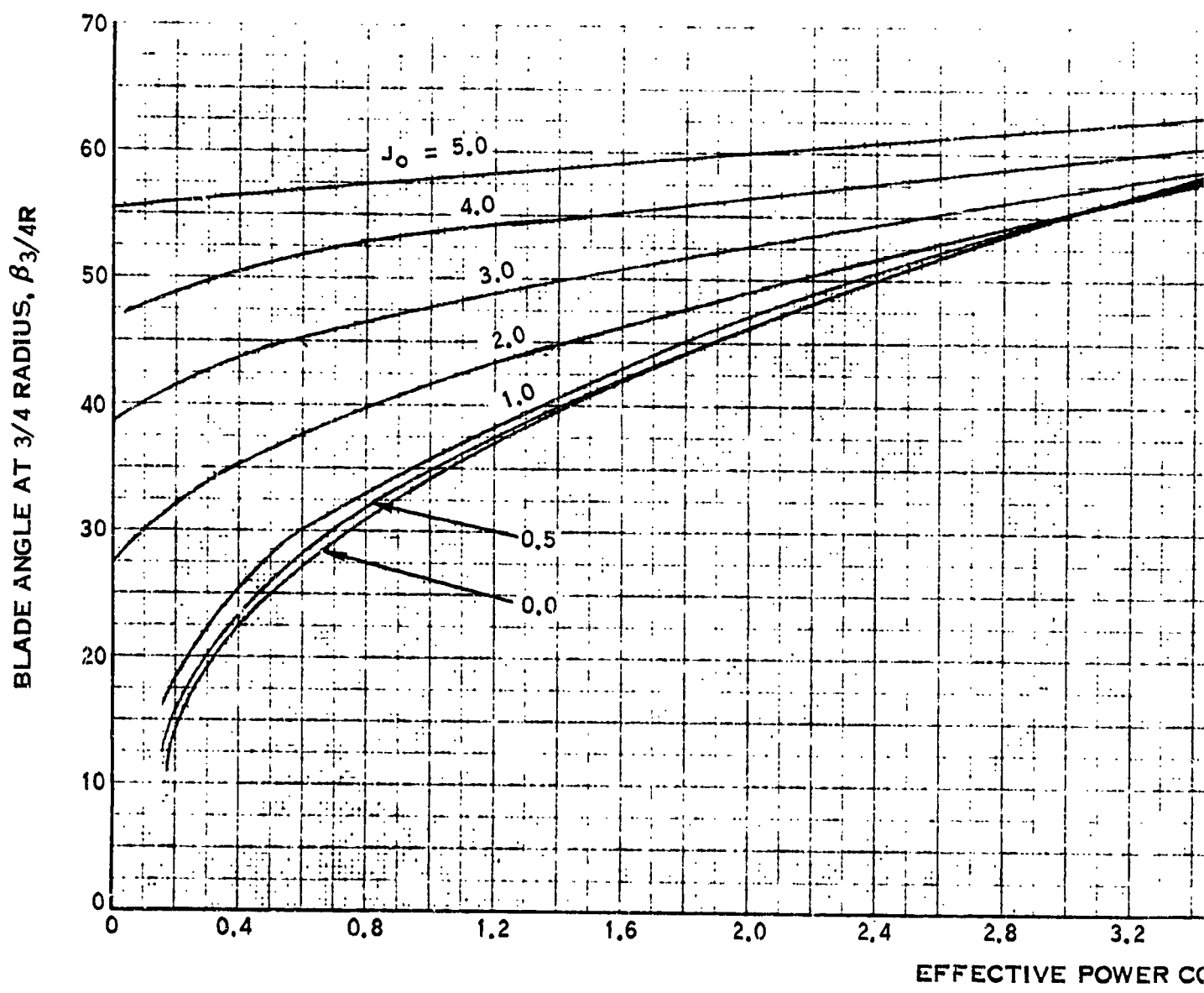

FIGURE A-14. BASE Q-FAN BLADE ANGLE CURVE - 0.8 AREA RATIO

FOLDOUT FRAME

$$J_0 = \frac{(K1)V}{ND}$$
$$C_{PE} = C_P \times P_{TAF} \times P_{MN}$$
$$C_P = \frac{(K2) \text{ POWER } (\rho_0 / \rho)}{2N^3 D^5}$$



EOLDOUT FRAME 2

SYSTEM OF UNITS		
	ENGLISH	SI
K1	101.4	60.0
K2	0.5×10^{11}	1.764×10^8

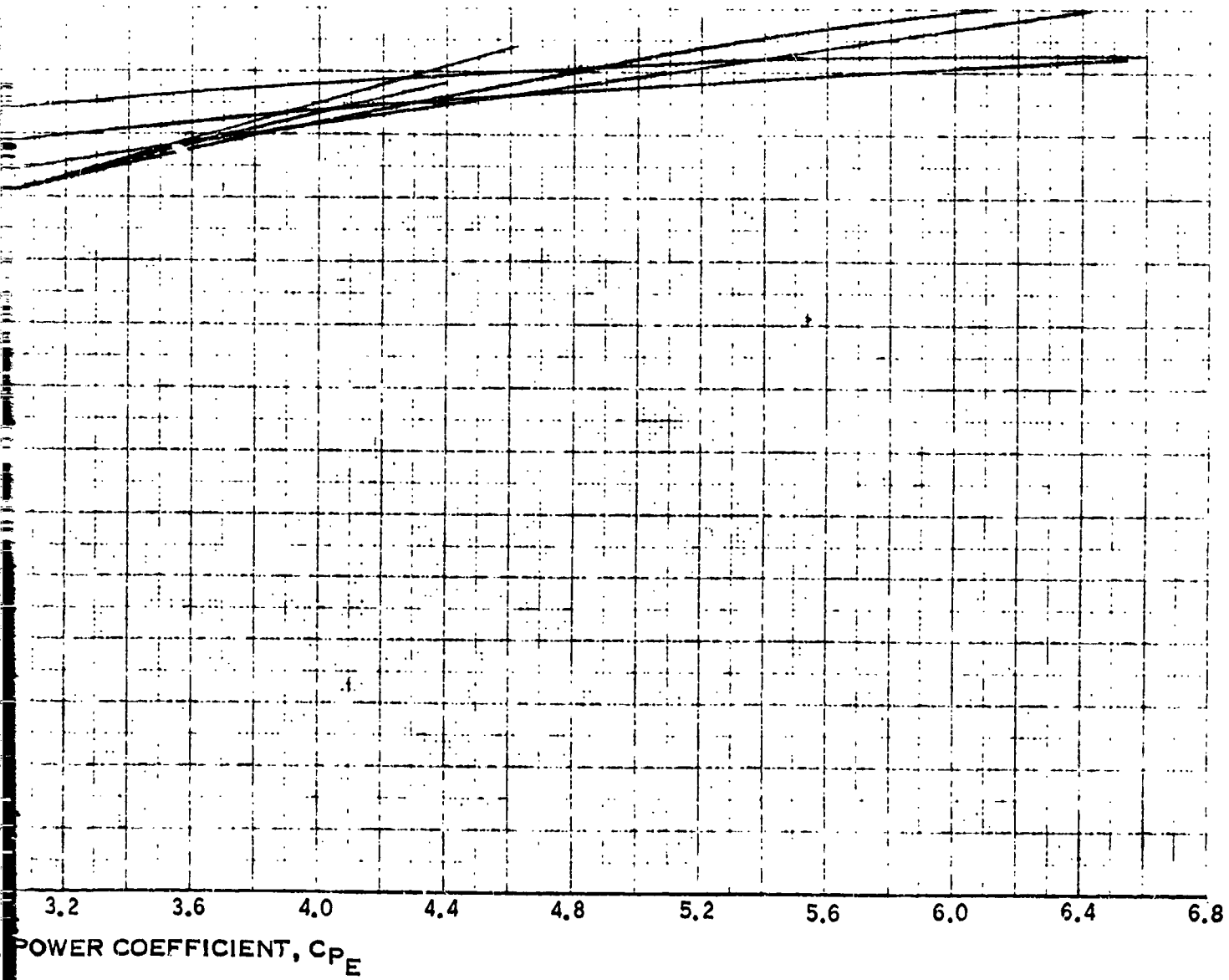

FIGURE A-15. BASE Q-FAN BLADE ANGLE
CURVE - 0.9 AREA RATIO

163/164

FOLDOUT FRAM. |

SYSTEM OF UNITS

	ENGLISH	SI
K1	101.4	60.0
K2	0.5×10^{11}	1.764×10^8

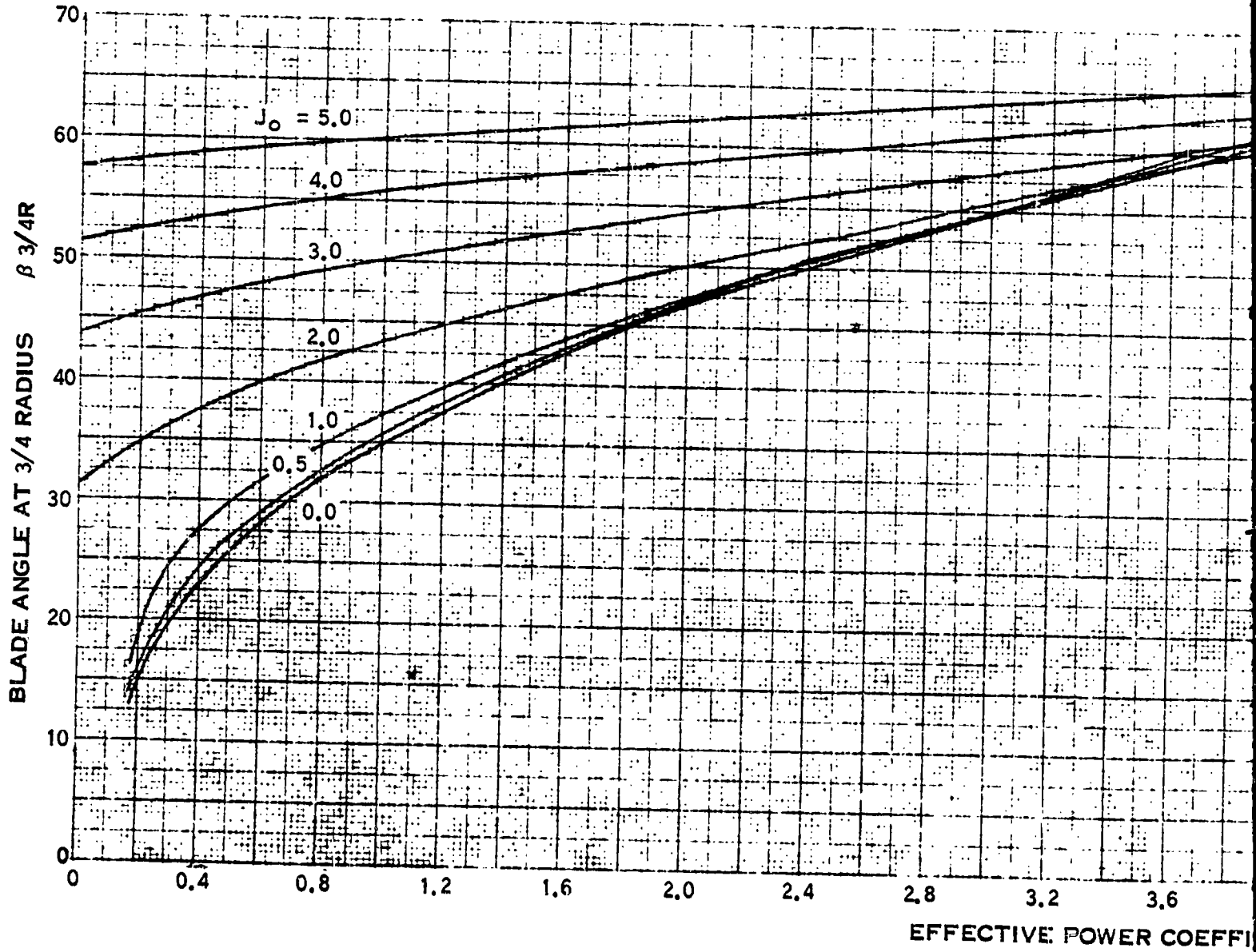

FOLDOUT FRAME

2

$$J_o = \frac{(K1)V}{ND}$$
$$C_{PE} = C_P \times P_{TAF} \times P_{MN}$$
$$C_P = \frac{(K2) \text{ POWER } (\rho_o/\rho)}{N^3 D^5}$$

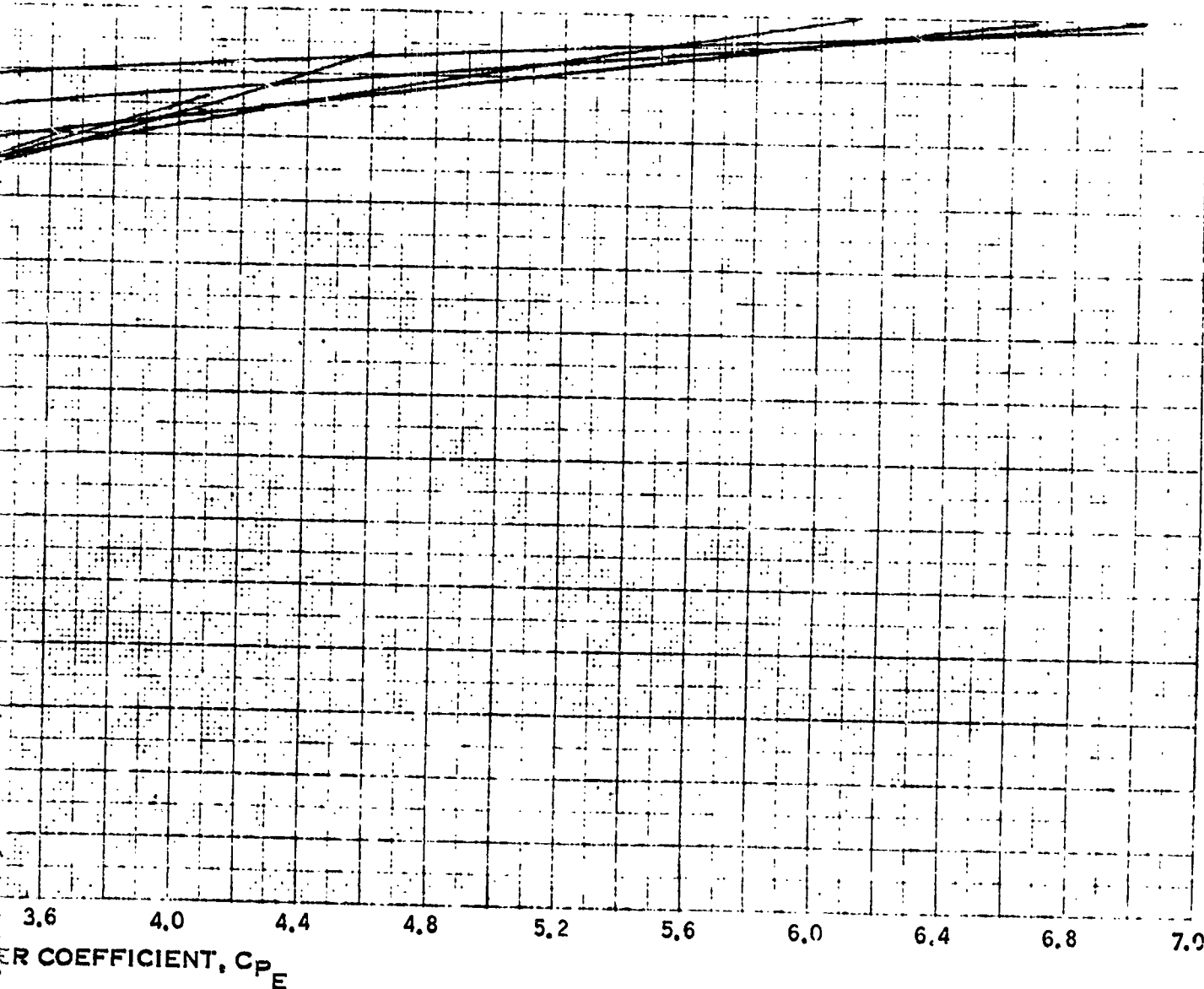

FIGURE A-16. BASE Q-FAN BLADE ANGLE CURVE - 1.0 AREA RATIO

FOLDOUT FRAME

$$J_0 = \frac{(K1)V}{ND}$$

$$C_{PE} = C_P \times P_{TAF} \times P_{MN}$$

$$C_P = \frac{(K2) \text{ POWER } (\rho_0 / \rho)}{N^3 D^5}$$

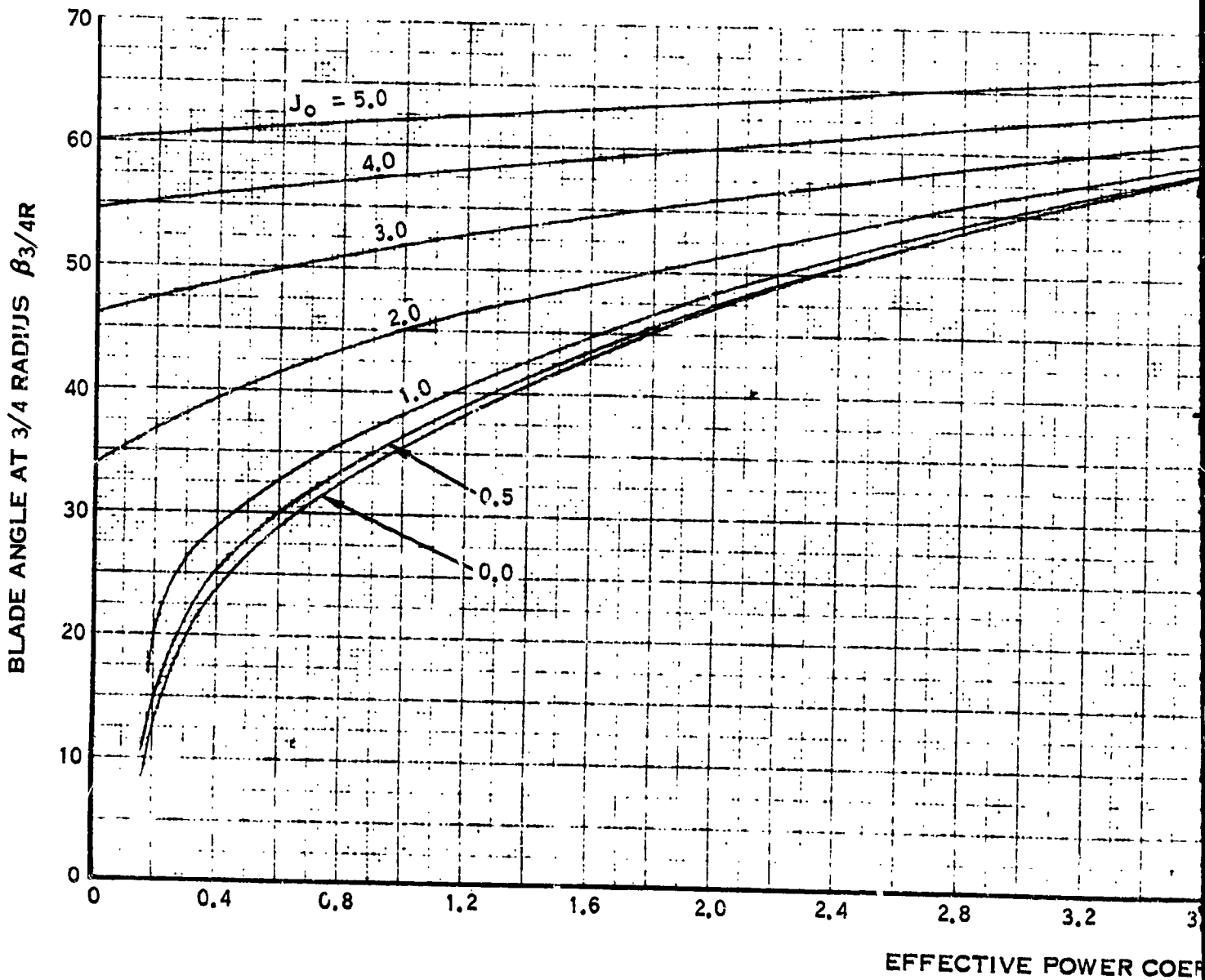

FOLDOUT FRAME 2

SYSTEM OF UNITS		
	ENGLISH	SI
K1	101.4	60.0
K2	0.5×10^{11}	1.764×10^8

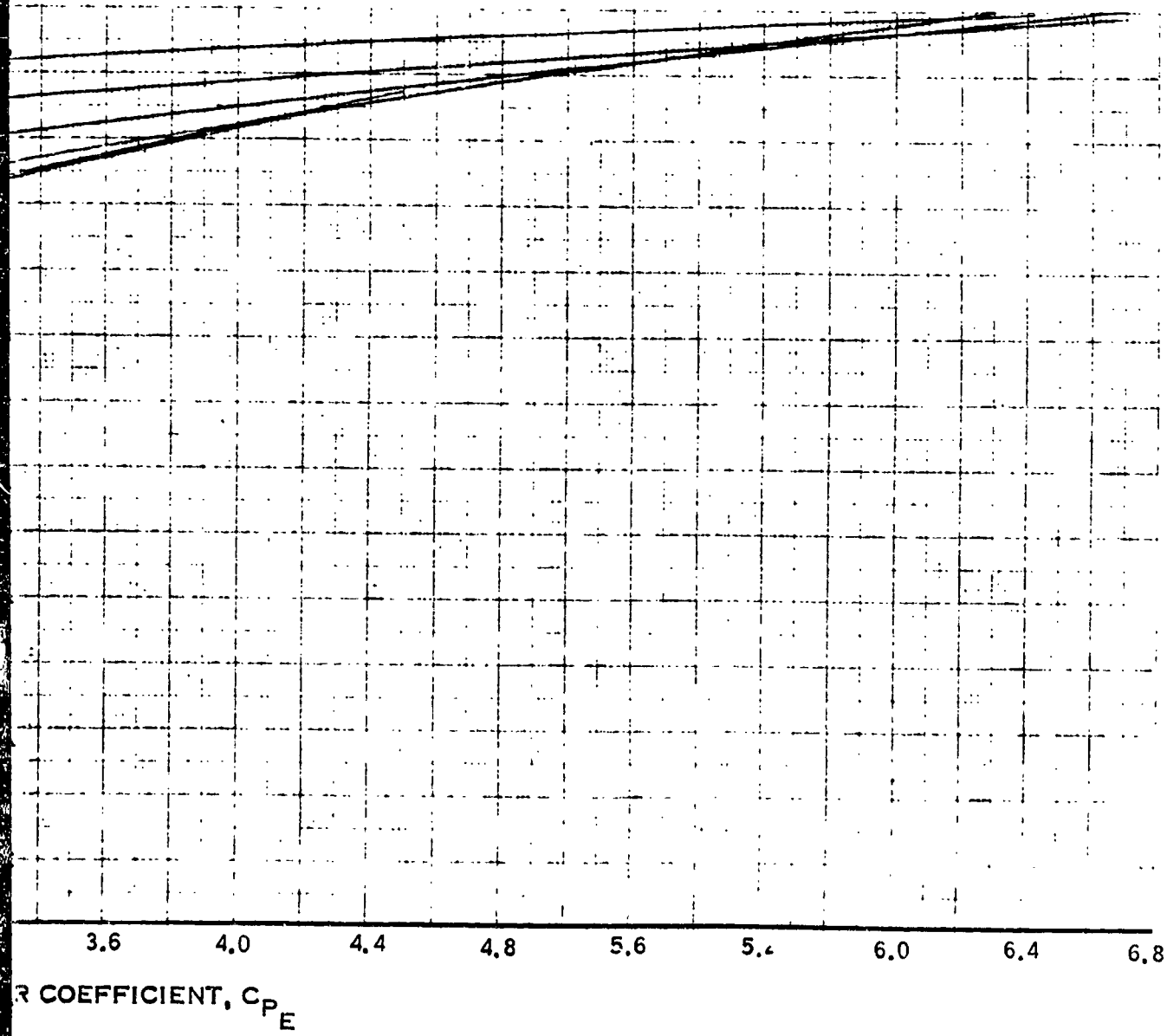

FIGURE A-17. BASE Q-FAN BLADE ANGLE CURVE - 1.1 AREA RATIO

APPENDIX B

GENERALIZED METHOD OF Q-FAN FAR-FIELD NOISE ESTIMATION FOR GENERAL AVIATION AIRCRAFT

Q-Fan noise at 66 knots (34 m/s) can be estimated using this generalized procedure from the following design and operating parameters.

1. Diameter
2. RPM or tip speed
3. Thrust at 66 knots (34 m/s)
4. Total activity factor (activity factor per blade x number of blades)

It should be noted that the method is predicated on using for a specific total activity factor the number of blades, activity factor per blade combination to minimize noise.

PERFORMANCE CALCULATION PROCEDURE

With the diameter, rpm, thrust, and total activity factor defined, the procedures as outlined on the sample computation sheet (fig. B-1) is as follows: The English units will be used and the SI units will be included in parenthesis.

A. From the known data, complete the top of the computation sheet. Identify the airplane, engine, gear ratio (G.R.), number of Q-Fans and distance (observer field point).

B. Determine items 1 through 7 from the Q-Fan, airplane and engine conditions which have been selected for analysis as explained below.

1. Diameter

D-rotor diameter, ft (m)

2. Activity factor/Blade

$$AF = \frac{100,000}{16} \int_{SCO}^{1.0} \left(\frac{b}{D}\right) x^3 dx$$

Where b/D - ratio blade width/blade diameter

x - fraction of blade tip radius

- | | | |
|-----|---------------|--|
| 3. | No. of blades | B - total number of blades in Q-Fan |
| 4. | Engine rpm | N_e - rpm |
| 5. | Velocity | 66 knots (34 m/s) |
| 6. | Thrust | T - Q-Fan thrust, lb (N) at 66 knots (34 m/s) |
| 7. | Distance | Observer field point, ft (m) |
| 8. | N | Rotor speed - $N_e \times G.R.$ |
| 9. | T.S. | Rotor tip speed - $\frac{(K4) ND}{60 f_c}$
Where $K4 = \pi$ (10.31) |
| 10. | TAF | AF x B |
| 11. | Check | Read no. of blades for proper TAF and tip speed from figure B-2. Be assured that proper selection is made before the calculation is continued. |
| 12. | T/D^2 | Compute |
| 13. | L1 | Noise level for 5.0 ft (1.52 m) diameter Q-Fan. Read from figures B-3, B-4, E-5, B-6. Interpolate, if necessary. |
| 14. | L2 | Diameter adjustment (fig. B-7). |
| 15. | L3 | 4.5 PNdB due to acoustical treatment |
| 16. | L4 | Spherical spreading of the sound to the location of interest (fig. B-8) |
| 17. | L5 | Adjustment for number of Q-Fans as follows: |

FIGURE 1B

AIRPLANE: Hypothetical NO. OF Q-FANS 1 CALC. NO. 100
 ENGINE: Hypothetical DATE: 3/13/73
 G. R. 0.812 CALC. BY R. W. CHECKED BY: AB

1.	Diameter, ft	3.0
2.	Activity factor	233.0
3.	No. of blades	9.0
4.	Engine rpm	5000.0
5.	Velocity, kts	66.0
6.	Thrust, lbs.	880.0
7.	Distance, ft	500.0
8.	N	4060.0
9.	T. S.	640.0
10.	TAF	2097.0
11.	Check	O. K.
12.	T/D^2	97.8
13.	L1	87.5
14.	L2	-4.0
15.	L3	-4.5
16.	L4	0
17.	L5	0
18.	PNL	79.0
19.	dB(A)	67.0

B. (Continued)

No. of Q-Fans

Adjustment

1 0

2 ±3.0

3 +4.8

4 +6.0

5 +7.0

6 +7.8

17. PNL

$PNdB = L1 + L2 + L3 + L4 + L5$

18. dB(A)

$dB(A) = PNdB - 12$

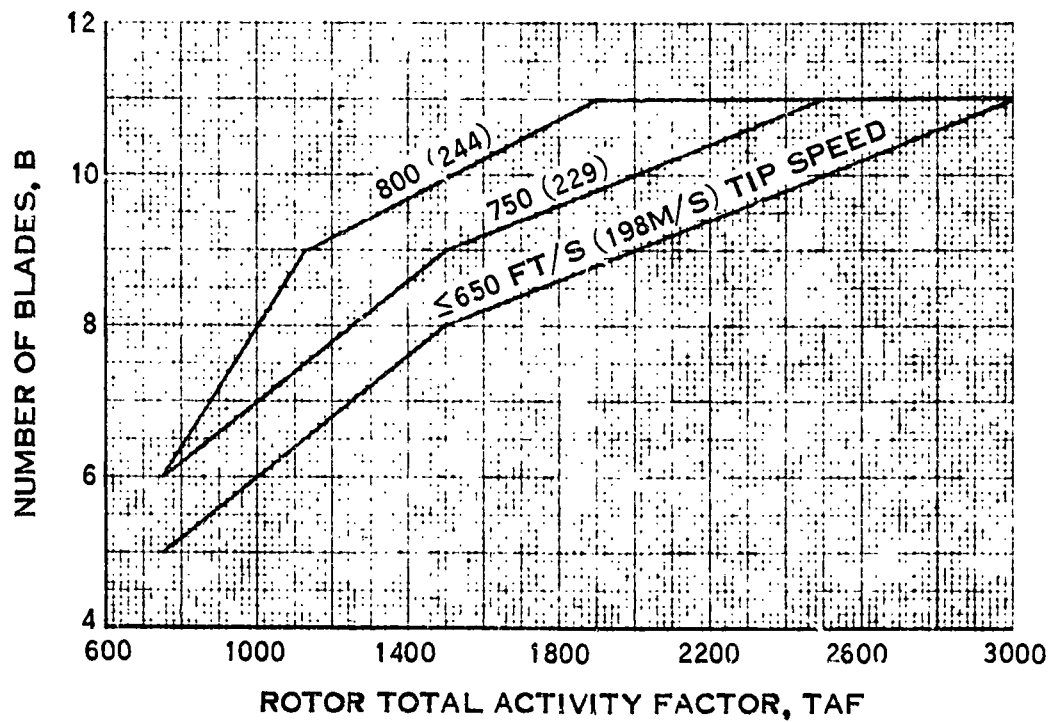
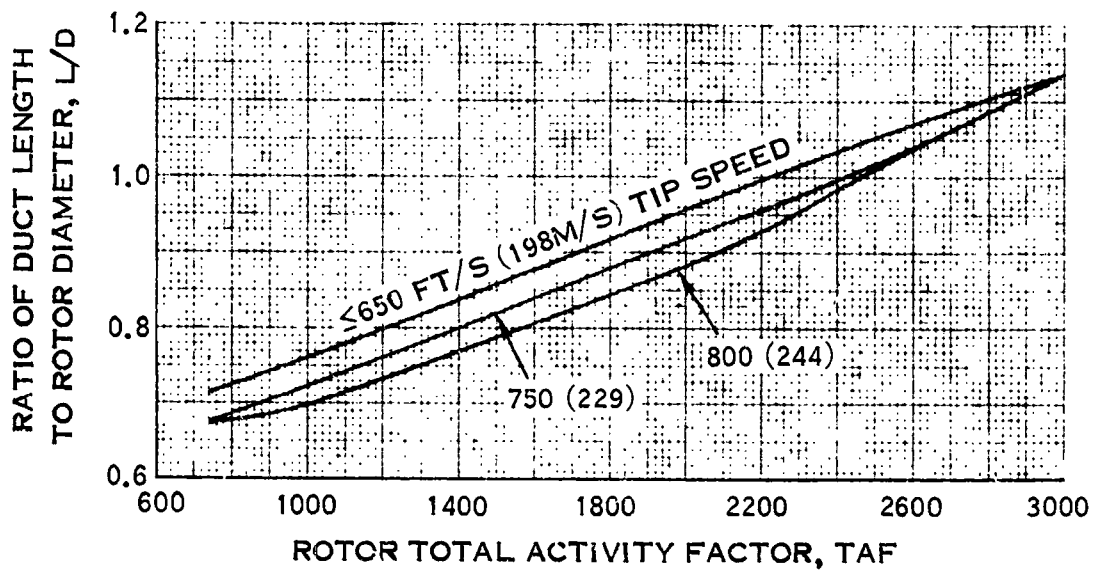

FIGURE B-2. ROTOR AND DUCT CHARACTERISTICS FOR MINIMUM Q-FAN NOISE

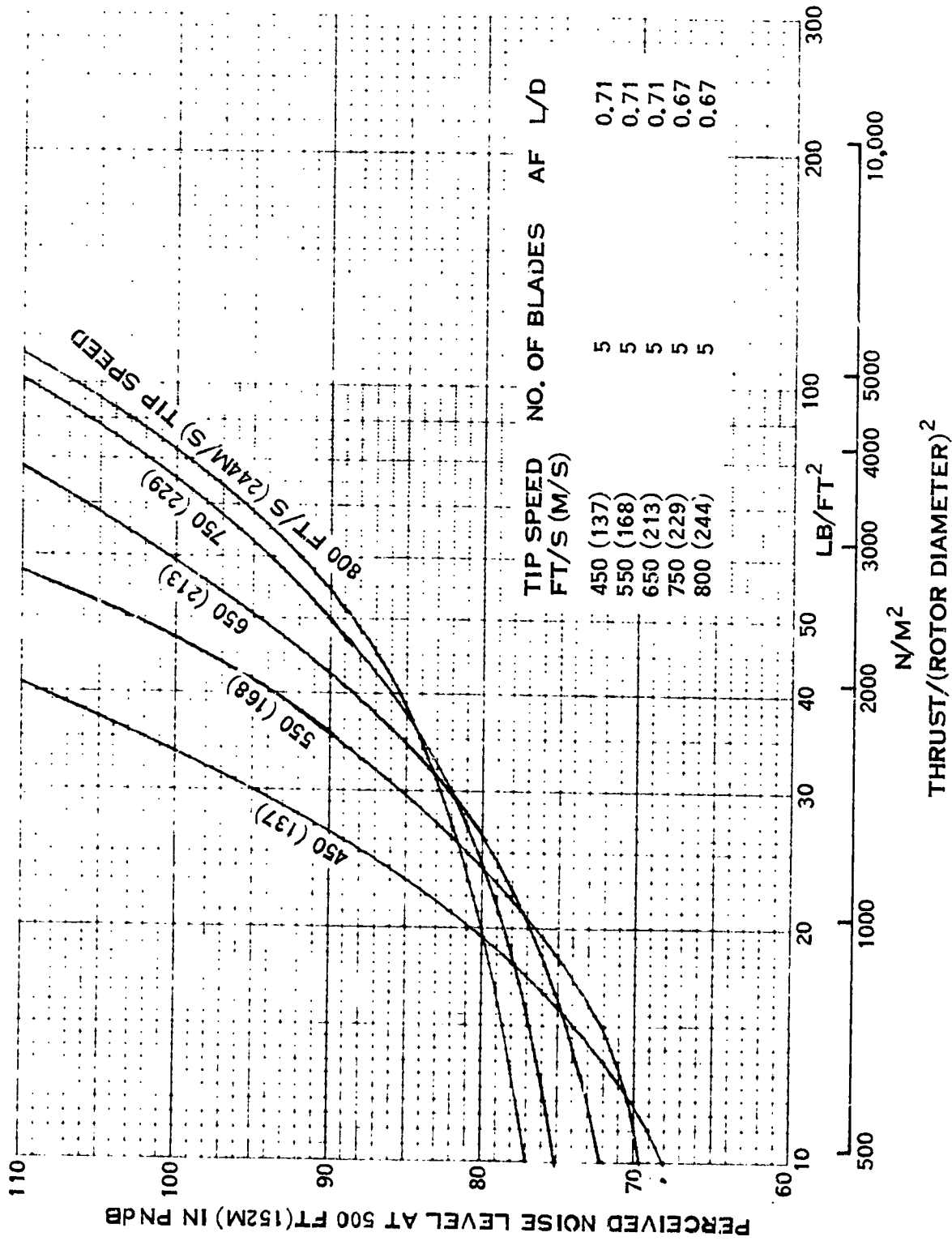

FIGURE B-3. NOISE LEVEL OF A SINGLE 5-FOOT (1.52M) DIAMETER Q-FAN AT 66 KNOTS (34M/S) FORWARD SPEED - 750 TOTAL ACTIVITY FACTOR

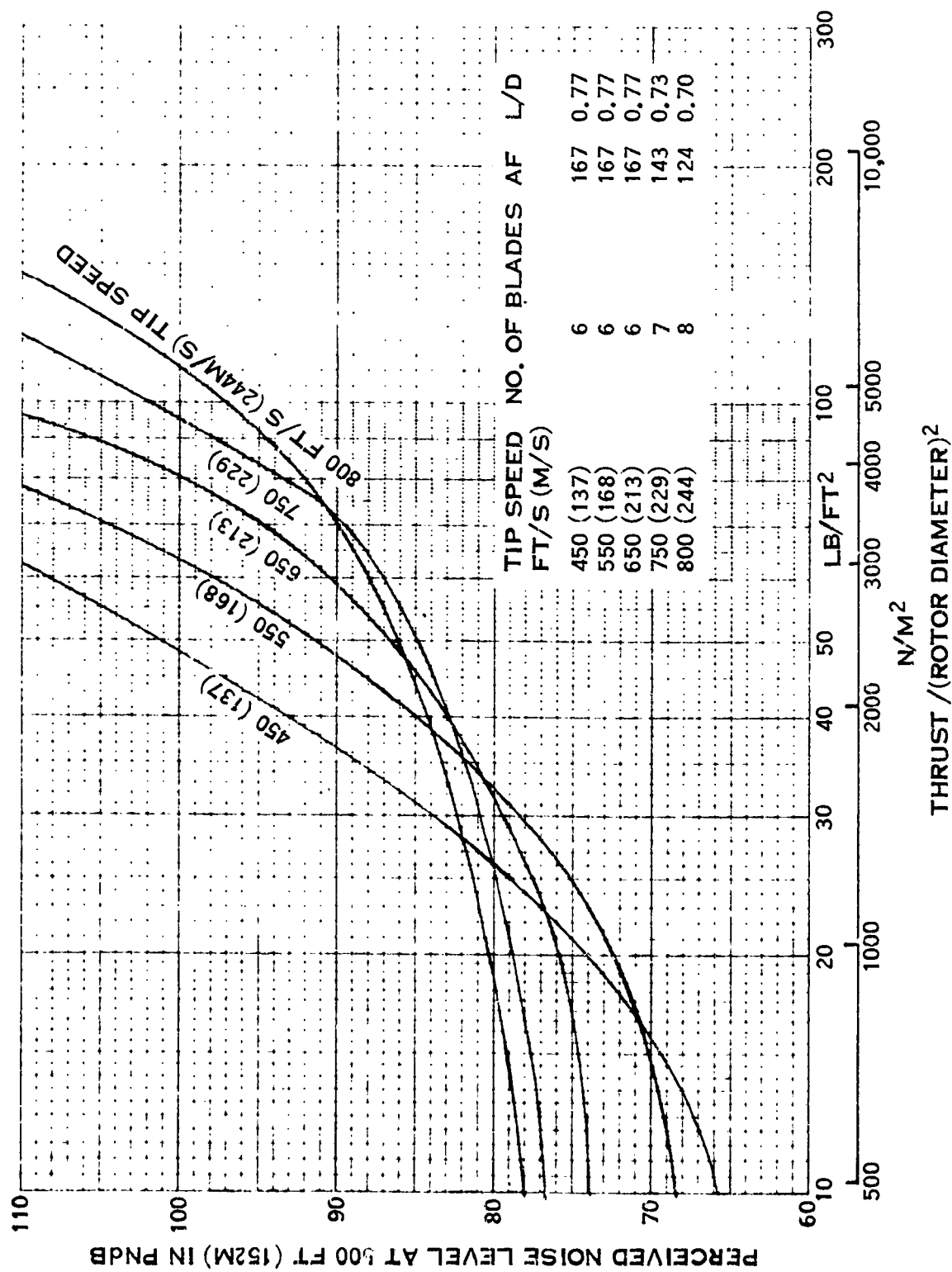

FIGURE B-4. NOISE LEVEL OF A SINGLE 5-FOOT (1.52M) DIAMETER Q-FAN AT 66 KNOTS (34 M/S)
FORWARD SPEED - 1000 TOTAL ACTIVITY

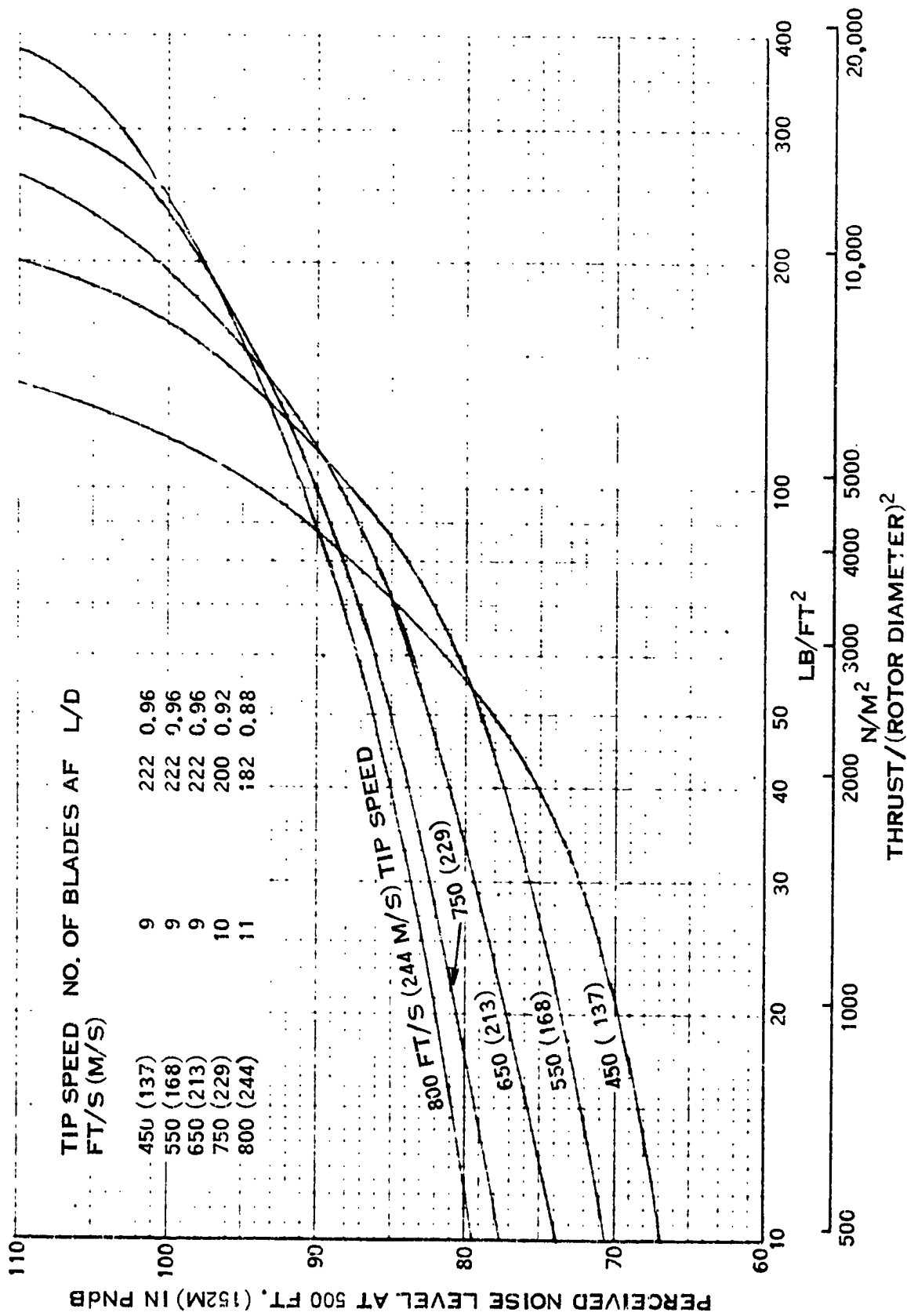

FIGURE B-5. NOISE LEVEL OF A SINGLE 5-FOOT (1.52M) DIAMETER Q-FAN AT 66 KNOTS (34 M/S) FORWARD SPEED - 2000 TOTAL ACTIVITY FACTOR

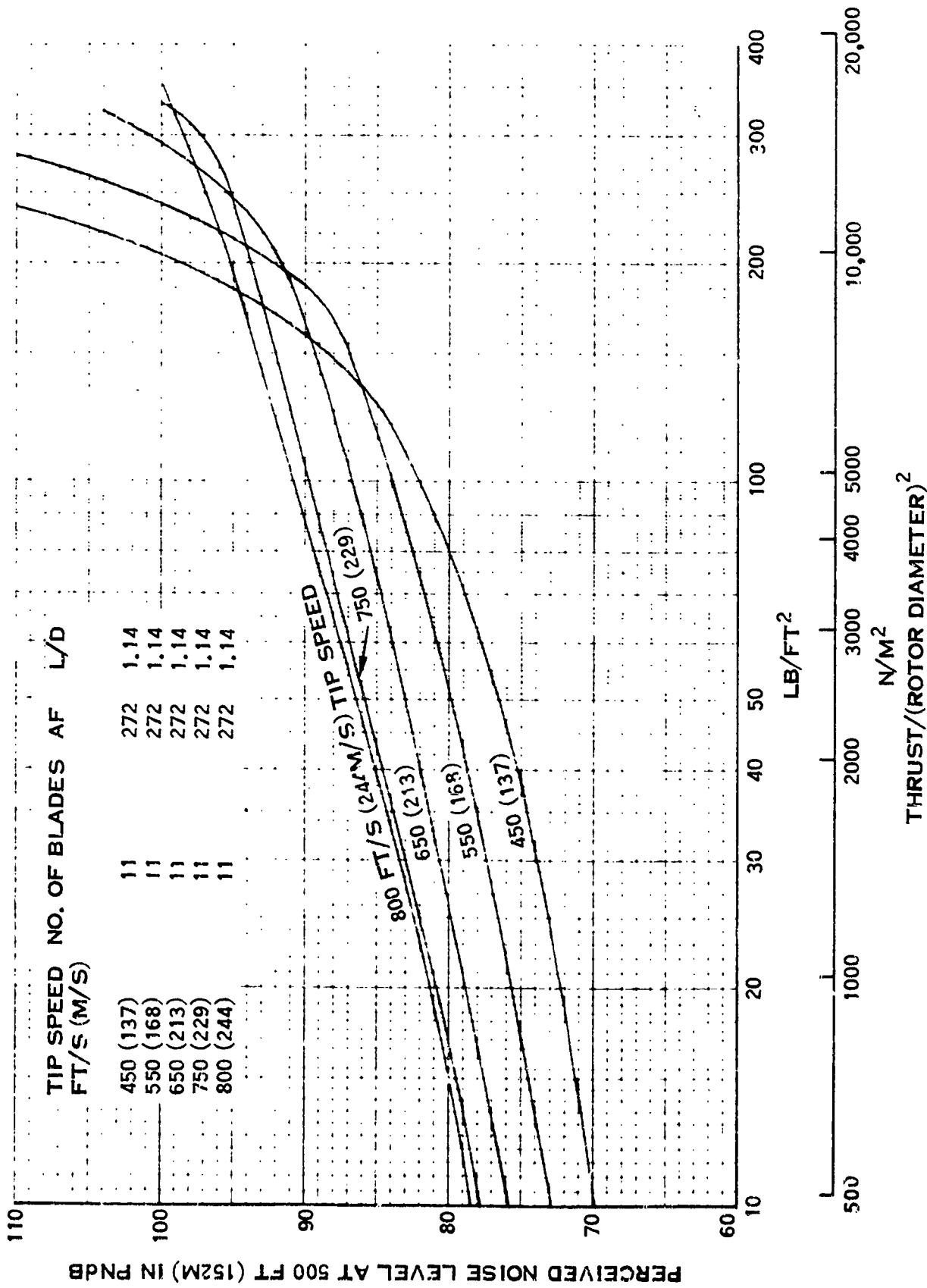

FIGURE B-6. NOISE LEVEL OF A SINGLE 5-FOOT (1.52M) DIAMETER Q-FAN AT 66 KNOTS (34M/S) FORWARD SPEED - 3000 TOTAL ACTIVITY FACTOR

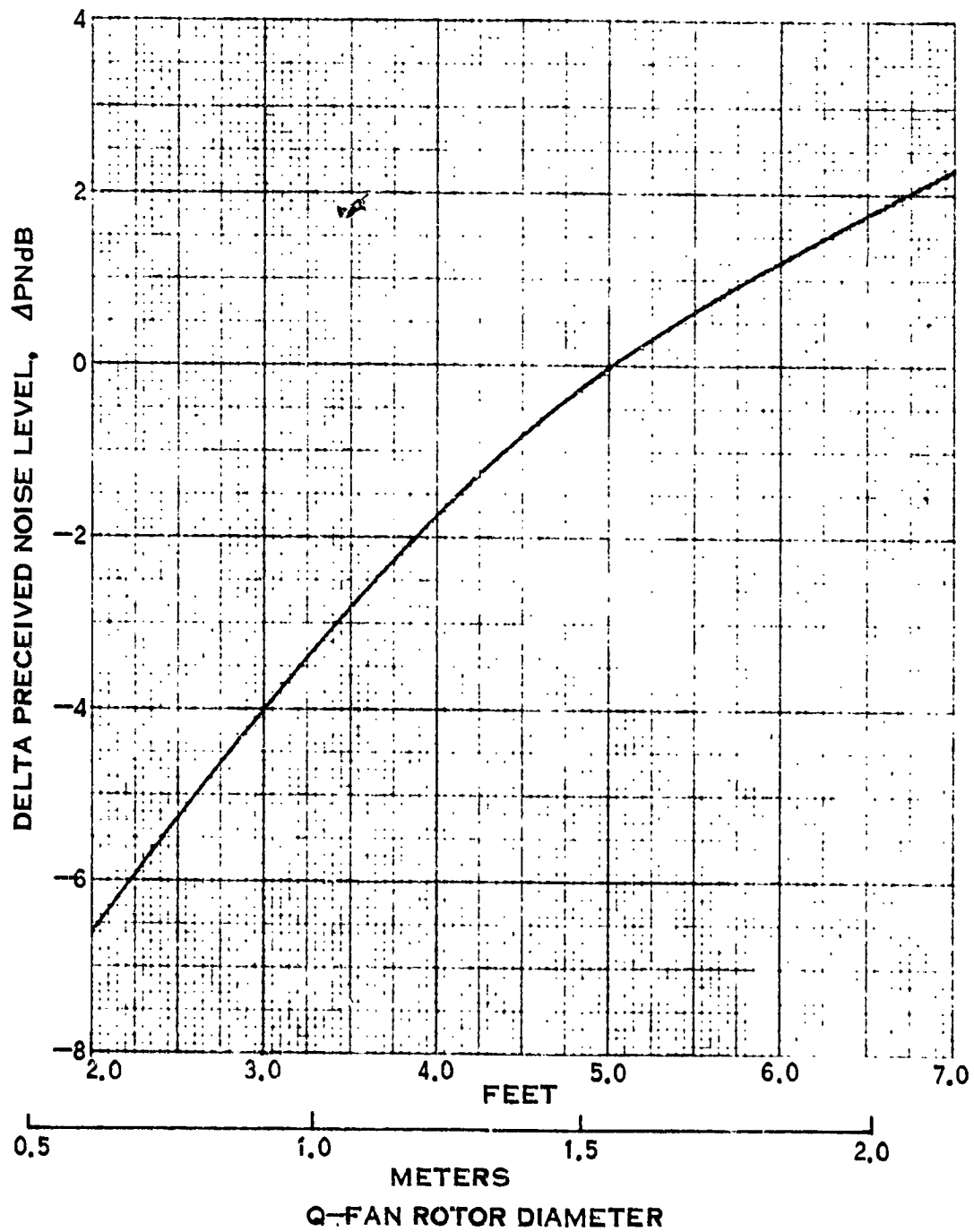

FIGURE B-7. NOISE PREDICTION METHOD — DIAMETER CORRECTION

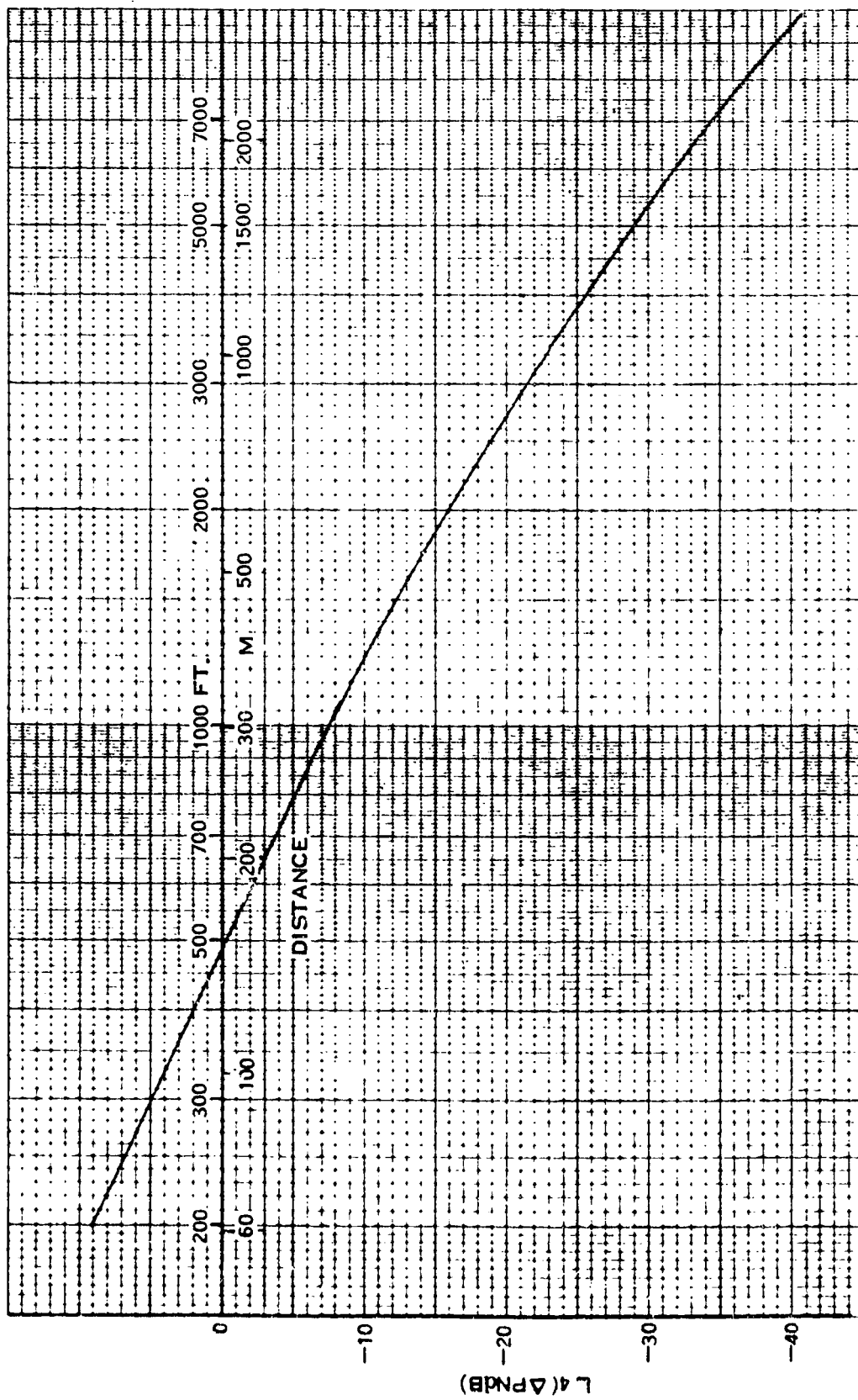

FIGURE B-8. NOISE PREDICTION METHOD - DISTANCE CORRECTION

APPENDIX C

ENGINE MODELS

This appendix includes the weight, dimension and cost data used in this study to predict the weight and size characteristics and engine prices for horizontally-opposed piston engines, rotary combustion engines, and turboprop/turboshaft engines. The method used to estimate piston engine part power and altitude performance is also included. All costs are given as 1970 original equipment manufacturer (OEM) costs.

Horizontally-Opposed Piston Engines

This model is to be used to predict the weight, dimensions, performance, and cost of horizontally-opposed piston, internal combustion engines currently being used in general aviation. The data used for this study are tabulated in Tables I-V. They represent a cross-section of engines being produced by Avco-Lycoming and Teledyne-Continental with several Franklin engines also included. All data were taken from "Janes All the World's Aircraft," 1970-71, and engines are grouped into the following classifications:

- (1) Non-supercharged, direct drive.
- (2) Non-supercharged, geared drive.
- (3) Turbosupercharged, direct drive.
- (4) Turbosupercharged, geared drive.

Nomenclature and performance equations used for 4-stroke piston engines are given in Table VI.

Engine Weight - Engine specific weight is defined as the ratio of engine dry weight to maximum rated power at sea level. This ratio is plotted against maximum sea level power in figure C-1 for non-supercharged, direct drive engines. The data correlate reasonably well showing a decrease in specific weight for increasing power up to 200 horsepower (149 kw) and then a constant specific weight of about 1.5 lb/hp (0.9 kg/kw) at higher levels of rated power. It is felt that the key technology parameter that affects engine specific weight is the horsepower per unit bore area. This parameter is the product of the piston speed (rpm x stroke) and the brake mean effective pressure (BMEP). Use of the power per unit bore area leads to the conclusion that increasing the engine open will not necessarily result in reduced engine specific weight unless it results in a higher

piston speed and thus higher displacement per cycle. The data from figure C-1 are re-plotted in figure C-2 with the engine specific weight normalized to a BMEP of 140 psi (100 N/cm²) and a piston speed of 1800 fpm (549 m/m). This combination results in a horsepower per unit bore area of 1.98 hp/in² (0.23 kw/m²).

The specific weight of the remaining three classes of engines is plotted in figure C-3. There is considerable scatter in the data, particularly when the new Continental Tiara engine models, which are designed for much higher engine speeds, are included. (Note that the Tiara engines are classed as geared engines because of the 2:1 reduction in speed from the engine to the output shaft.) The correlations are much improved when the specific weight is normalized to fixed values of BMEP and piston speed as shown in figure C-4.

Increases in piston speed are the result of either increased piston stroke or higher RPM. However, the output speed of the engine must be matched to an efficient propeller RPM and engines with high piston speeds are usually geared. Likewise, engines with high BMEP are usually supercharged to boost the pressure entering the cylinder. The piston speeds and BMEP levels of the different engine classes are approximated by the regions separated by the dotted lines in figure C-5.

Strict application of the normalized specific weight parameter would lead to continued reductions in engine specific weight at higher ratios of horsepower per unit bore area. However, structural and material limitations are bound to affect this trend. Figure C-6 plots engine specific weight against the horsepower-bore area ratio for two classes of engines. Only engines rated between 150 (112) and 300 (224) sea level horsepower (kw) are used in this figure to eliminate scale effects on the specific weight. For both classes shown, the data indicate that the specific weight approaches a minimum value at higher values of horsepower/bore area. The obvious conclusion is that careful judgement should be applied in using the normalized specific weight correlations given in figures C-2 and C-4.

Engine Dimensions - The dimensions of the engine are defined as maximum width, and length. The most consistent dimension is the engine width which is determined primarily by the size of an opposed pair of cylinders. Figure C-7 shows that engine width varies very little over a wide range of rated horsepower, and that the width decreases slightly at a given horsepower as the number of cylinders is increased.

The other two dimensions depend on whether the engine is geared or has a supercharger, and they are influenced by the location of engine accessories. Height can be traded for length and vice versa. This is shown in figures C-8 and C-9 which are correlations of the engine width-length ratio with the engine width-height ratio for the four different classes of engines. To determine the values of engine height and length, the engine width-height ratio must be specified.

Engine Cost - The selling price of horizontally-opposed piston engines was investigated in a study conducted by the Lockheed Georgia Company (ref. 2). Figure C-11 is taken from that study and it distinguishes between the different classes of engines defined earlier. Note that the price to an original equipment manufacturer (OEM price) shown on figure C-11 is approximately 60-65% of the selling price usually quoted.

Engine Performance - A simplified general model for engine performance includes part throttle horsepower, full throttle horsepower at altitude and the specific fuel consumption. Figure C-10a is a generalized curve of the fraction of maximum rated horsepower with the fraction of maximum throttle setting. The throttle setting represents reduced speed for non-supercharged engines or reduced manifold pressure for supercharged engines. The curve is not linear because most engines have better volumetric efficiency at part throttle settings for better cruise fuel economy. Specific engines may deviate by as much as ± 0.03 in fraction of rated horsepower at throttle settings of 0.9 and below.

Power at altitude is shown in figure C-10b for non-supercharged engines at 100% throttle setting. The parameters δ and θ are the non-dimensionalized values of ambient pressure and temperature as defined in the figure. For supercharged engines the rated sea level power is assumed constant up to a specified altitude--generally 15,000 (4580) to 20,000 ft (6100m).

There were not sufficient data available to correlate specific fuel consumption (SFC), but at maximum rated power the SFC is generally 0.5 (0.3) to 0.55 lb/hr/hp (0.33 kg/hr/kw). This value can be assumed constant for a 100% throttle setting at altitude, but at part power the SFC is reduced. Typical cruise values of SFC at cruise (65-75% power) are 0.42 (0.26) - 0.48 lb/hr/hp (0.29 kg/hr/kw).

Rotary Combustion Engines

To date there are no rotary combustion aircraft engines in production. However, the Curtiss Wright Corporation, sole North American licensee for aircraft rotary engines (Wankel design), is developing water cooled rotary engines for light aircraft; and they supplied engine weight and dimension data for use in this study. No engine performance is included in this section because it is assumed that engine power at altitude and fuel consumption are identical to piston engine performance.

For the study, Curtiss Wright supplied data for two levels of engine technology: near term, 1975-1980; and far term, post-1980. Only near term data is presented in this appendix. An indication of the post-1980 improvements in engine specific weight is given in Table X of the main text.

Engine Weight - As with piston engines, rotary engine specific weight is reduced at increasing rated power, as shown on figure C-12. It is apparent that specific weight approaches a minimum value at some rated power above that shown on the figure. Increasing the number of rotors for a given rated power reduces engine specific weight significantly.

Engine Dimensions - The increases in engine diameter and length with increasing rated power are shown in figure C-13. At a given power level, these dimensions can be varied considerably as the number of rotors is changed from 2 to 6.

Engine Cost - Curtiss Wright estimates of rotary engines costs, given in reference 2, are shown in figure C-14. Distinction is made between near term engine costs and the reduced costs that can be expected for future engines.

Supercharger Effects - All previous data are for non-supercharged engines. Superchargers can easily be adapted to rotary engines and they will affect engine specific weight, length and cost. An estimate of the specific weight of a supercharger (supercharger weight/rated horsepower) is given in the following table:

Rated Horsepower (kw)	100(75)	200(150)	300(225)	400(300)	500(375)
Supercharger Specific Weight lb/hp (kg/kw)	0.4(0.25)	0.35(0.21)	0.28(0.17)	0.25(0.15)	0.25(0.15)

The engine length is affected significantly by the addition of a supercharger, particularly if the installation is constrained not to increase the envelope diameter. In this event, the engine length is estimated to increase by twice the engine diameter. To account for the cost of the supercharger, engine specific cost (OEM cost/rated horsepower) is estimated to increase by 30% for turbosupercharged rotary engines.

Turboprop and Turboshaft Engines

The distinction between turboprop and turboshaft engines is the addition of a gear-box supplied with a turboprop engine which affects engine length and specific weight. Distinction must also be made between engines designed with axial compressor stages and/or centrifugal compressor stages since this will affect the engine length.

Data for existing production engines and a very few prototype engines are listed in Table VII. These data were taken primarily from "Janes All the World's Aircraft," but in several instances manufacturers' published data were used.

Engine Weight - The most common measure of engine size is the sea level rated horsepower. Figure C-15 shows engine weight plotted against sea level power. The trend of increasing weight with power is clearly established, but there is considerable scatter in the data.

A somewhat better correlation is obtained by plotting engine weight against airflow at sea level power as shown in figure C-16. This is to be expected since the airflow is the major factor in sizing the engine components. Also, the effect of the engine cycle parameters (compressor pressure ratio, turbine inlet temperature, etc.) on the engine specific weight can be estimated with this correlation:

$$\text{Power/Airflow} = f(\text{Cycle Parameters})$$

$$\text{Weight} = f(\text{Airflow})$$

$$\text{Specific Weight} = \text{Weight/Power}$$

$$= \text{Weight/Airflow}/(\text{Power/Airflow})$$

Using the lines drawn in figures C-15 and C-16, the specific weight and the weight/airflow ratio are plotted in figure C-17. Specific weight is diminished as rated power (or airflow) is increased. However, it is apparent that a minimum value is being approached at the higher power levels.

Engine Dimensions - Depending upon the engine design, the maximum frontal dimension can be an envelope diameter, a width, or a height. The data given in figure C-18 makes no distinction between these dimensions referring only to a maximum frontal dimension and plotting it against sea level power. Since no engines with offset gearboxes are included in the data, both turboprop and turboshaft engines are included. Also, the correlation is unaffected by the type of compressor. Intuitively, one would expect a smaller frontal dimension with an all-axial compressor, but this trend is not evident from the few engines plotted at 3000(2240) - 5000 horsepower (3740 kw) which have axial compressors.

The engine length, on the other hand, is affected by the type of compressor. As would be expected, engines with all-axial compressors are longer than engines having one or more centrifugal stages as shown in figures C-19 and C-20. Also, the addition of a gearbox adds length to the turboprop. Below 1000 rated horsepower, engine length appears independent of rated power. These engines all have centrifugal compressor stages.

Engine Cost - Estimated OEM costs have been made in reference 2 for both turboprop and turboshaft engines. These estimates are duplicated in figure C-21 with the data extrapolated out to 5000 horsepower to be consistent with the data shown previously.

TABLE I
NON-SUPERCHARGED/DIRECT-DRIVE/CARBURETOR

ENGINE	Sym- bol	No. Cyl.	hp	Wt. lbs	Length in.	Ht. in.	Width in.	Rated RPM	BMFP psi	Bore in.	Stroke in.	Dis- place. in ³	Comp. Ratio	FS fpm	HP/Ap hp/in ²
LYCOMING:															
0235-C1B	○	4	115	240	29.81	22.40	32.00	2800	139.6	4.38	3.88	233	6.75	1810	1.90
0-290-D2C	↓	4	140	263	29.81	22.68	32.24	2800	137.0	4.88	3.88	289	7.00	1810	1.88
0-320-A2B	↓	4	150	272	29.56	22.99	32.24	2700	137.6	5.12	3.88	319.8	7.00	1750	1.82
0-320-E2D	↓	4	150	268	29.05	22.99	32.24	2700	137.6	5.12	3.88	319.8	7.00	1750	1.82
0-360-A1D		4	180	294	29.81	24.59	33.37	2700	146.3	5.12	4.38	361.0	8.50	1970	2.18
ATH				294	31.82	19.22									
0-360-A1F6		4	180	294	30.70	24.59	33.37	2700	146.3	5.12	4.38	361.0	8.50	1970	2.18
A3A				285	29.56										
B2B5			235	395	37.22	24.56	33.37		133.5				7.20		
0-540-A1D5	○	6	250	367	37.22	24.56	33.37	2575	142.0	5.12	3.87	541.5	8.50	1660	1.79
-E4B5	↓		260	369				2700	140.8						
0-540-9	↓	6	305	452	34.73	25.57	34.70	3000	139.4	5.12	3.87	541.5	8.70	2065	2.18
CONTINENTAL:															
A65-8F	□	4	65	168.2	31.00	24.50	31.50	2300	130.9	3.88	3.63	171	6.3	1391	1.38
C90-16F	↓	4	95	198.7	31.24	28.78	31.50	2625	142.6	4.06	3.88	201	7.0	1700	1.84
O200 B	↓	4	100	220	28.53	23.18	31.56	2750	143.3	4.06	3.88	201	7.0	1780	1.93
O300 A	◇	6	145	268	37.97	27.41	31.50	2700	141.3	4.06	3.88	301	7.0	1745	1.87
M			240	410											
O470 R	◇	6	230	438	43.31	19.75	33.56	2600	148.8	5.0	4.0	471	8.0	1731	1.95
FRANKLIN:															
2A-120	△	2	60	130	23.70	22.70	30.70	3000	134.2	4.50	3.50	118	10.5	1750	1.78
4A-235B	△	4	130	220	30.50	25.1	31.30	2800	156.5	4.50	3.50	235	8.5	1632	1.94
6A-335B	▽	6	180	319	37.50	25.25	31.30	2800	152.0	4.50	3.50	335	7.0	1632	1.88
6A-350-C1	↓	6	240	329	37.50	25.25	31.30	2800	177.8	4.00	3.50	550	10.5	1632	2.20
6A-350-C2	↓	6	215	320	43.20	25.25	34.20	2800	173.7	4.50	3.50	350	10.5	1632	2.14

TABLE II
NON-SUPERCHARGED/DIRECT-DRIVE/FUEL INJECTION

ENGINE	Sym- bol	No. Cyl.	hp	Wt. lbs	Length in.	Ht. in.	Width in.	Rated RPM	BMEP psi	Bore in.	Stroke in.	Dis- place. in ³	Comp. Ratio	PS fpm	Hp/Ap hp/in ²
LYCOMING:															
IO-320-B1A	○	4	160	285	33.59	19.22	32.24	2700	146.8	5.12	3.88	319.8	8.5	1745	1.94
IO-360 B1B	↓	4	180	295	29.81	24.91	33.37		146.2				8.5		
IO-360-A1A		4	200	320	29.81	21.61	34.25	2700	162.5	5.12	4.38	361	8.7	1971	2.42
IO-540 DAA5	○	6	260	402	38.42	24.46	33.37	2700	140.8				8.5	1971	2.10
IO-540-C4B5	↓	6	250	402	38.42	24.46	33.37	2575	142.0	5.12	4.38	541.5	8.5	1880	2.02
IO-540-G1A5	↓	6	220	443	38.62	19.60	34.25	2575	164.7	5.12	4.38	541.5	8.7	1880	2.34
IO-720-A1A	○	8	400	597	46.08	22.10	34.25	2650	165.6	5.12	4.38	722	8.7	1938	2.43
CONTINENTAL:															
IO 346-A	□	4	165	296.5	30.00	22.48	33.38	2700	139.9	5.25	4.00	346	7.5	1800	1.91
IO-360-D	◇	6	210	327.0	34.03	23.74	31.46	2800	165.0	4.44	3.66	360	8.5	1810	2.26
IO-470-D	↓	6	260	426	43.64	19.75	33.56	2625	166.6	5.00	4.00	471	8.6	1750	2.21
IO-520-E	↓	6	285	457	37.97	27.32	33.56	2700	160.8	5.25	4.00	520	8.5	1800	2.19
IO-520-D	↓	6	300	454	36.86	23.79	34.90	2850	160.3	5.25	4.00	520	8.5	1900	2.31

TABLE III

NON-SUPERCHARGED/GEARED

ENGINE	Sym- bol	No. Cyl.	hp	Wt. lbs	Length in.	Ht. in.	Width in.	Rated RPM	BMEP psi	Bore in.	Stroke in.	Dis- place. in ³	Comp. PS Ratio	PS fpm	Hp/HP hp/in ²
LYCOMING:															
60-480-B1D	⊂	6	270	432	38.64	28.02	33.12	3400	131.0	5.13	3.88	479.7	7.3	2195	2.18
60-480-61D6	⊃	6	295	437	38.64	28.02	33.12	3400	143.2	5.13	3.88	479.7	8.7	2195	2.38
160-480-A1A6	⊂	6	295	455	40.76	28.02	33.12	3400	143.2	5.13	3.88	479.7	8.7	2195	2.38
CONTINENTAL:															
60-300	⊂	6	175	309	39.12	25.45	31.5	3200	144.0	4.06	3.88	301	7.3	2066	2.16
610-470A	⊃	6	310	456	44.72	21.8	33.56	3200	153.0	5.00	4.00	471	8.6	2130	2.47
4-160	⊂	4	180	264	33.86	20.85	32.82	4000	131.5	4.88	3.63	271	9.0	2420	2.41
6-285A	⊃	6	285	354	40.11	24.22	32.91	4000	139.0	4.88	3.63	406	9.0	2420	2.54
6-320	⊃	6	320	354	41.17	20.85	32.82	4400	141.9	4.88	3.63	406	9.6	2660	2.86

TABLE IV
TURBOSUPERCHARGED/DIRECT DRIVE

ENGINE	Sym- bol	No. Cyl.	hp	Wt. lbs	Length in.	Ht. in.	Width in.	Rated RPM	BMEP psi	Bore in.	Stroke in.	Dis- place. in ³	Comp. Ratio	PS fpm	Hp/Ap hp/in ²
LYCOMING:															
T10540A1A	○	6	(to 15K) 310	535	51.34	22.71	34.25	2575	176.1	5.12	3.87	541.5	7.3	1662	2.22
T10540C1A	↓	6	(to 15K) 250	483	40.38	30.33	33.37	2575	142.0	5.12	3.87	541.5	7.2	1662	1.79
T10-541-E1A4	↓	6	(to 15K) 380	632	52.07	25.17	35.66	3000	184.7	5.12	3.87	541.5	7.3	1938	2.71
CONTINENTAL:															
TS10360-A	◇	6	210	334	35.34	22.43	33.11	2800	164.7	4.44	3.88	360	7.5	1810	2.98
TS10-470-D	↓	6	260	511	57.57	20.25	33.56	2600	167.8	5.00	4.00	471	7.5	1732	2.20
TS10-520 B	↓	6	285	483	58.67	20.32	33.56	2700	160.5	5.25	4.00	520	7.5	1800	2.19
C	↓	6	285	460	40.91*	20.04	33.56	2700	160.5	5.25	4.00	520	7.5	1800	2.19
E	↓	6	300	483	39.75*	20.32	33.56	2700	169.0	5.25	4.00	520	7.5	1800	2.30
J	↓	6	310	487.8	39.25*	22.32	33.56	2700	174.4	5.25	4.00	520	7.5	1800	2.38
					+21.86										
					61.11 with turbo										

*Not including supercharger.

TABLE V

TURBOSUPERCHARGED/GLEARED

ENGINE	Sym- bol	No. Cyl.	hp	Wt. lbs	Length in.	Ht. in.	Width in.	Rated RPM	BMEP psi	Bore in.	Stroke in.	Dis- place. in ³	Comp. Ratio	PS fpm	Hp/AP hp/in ²
LYCOMING:															
T160 541-C1A	□	6	(to 15K) 400	703	57.57	22.65	34.86	3200	183.0	5.12	3.87	541.5	7.3	2060	2.86
-E1A	□	6	(to 15K) 425	701	57.57	22.65	34.86	3200	194.5	5.12	3.87	541.5	7.3	2060	3.04
CONTINENTAL:															
GTS10-520-C	◇	6	340	557	63.5	23.1	34.04	3200	161.3	5.25	4.00	520	7.5	2135	2.60
520-D	◇	6	375	550	64.13	26.63	34.04	3400	167.9	5.25	4.00	520	7.5	2265	2.88
T6-285	◇	6	285	402	41.17	20.85	32.82	4000	138.9	4.88	3.63	406	8.0	2420	2.54
T6-320	◇	6	320	412	45.85	20.85	32.82	4400	141.5	4.88	3.63	406	8.0	2660	2.85
T8-450	△	8	450	513	53.16	23.45	32.82	4500	149.1	4.88	3.63	542	8.0	2720	3.07

TABLE VI
 NOMENCLATURE AND PERFORMANCE EQUATIONS FOR 4-STROKE
 PISTON ENGINES

BMEP	- BRAKE MEAN EFFECTIVE PRESSURE, psi
PS	- MEAN PISTON SPEED, fpm
HP/A _p	- RATED POWER/PISTON BORE AREA, hp/in ²
BMEP	= 792000 (HP)/Displacement/Rated RPM
PS	= 2 (Rated RPM) (Stroke)/12
HP/A _p	= (BMEP) (PS)/132000

TABLE VII - TURBOSHAFT/TURBOPROP ENGINES

ENGINE	TYPE	SYMBOL	SHP hp	SFC lb/hr/hp	Comp. Press. Ratio	Comp. No. Stages	Diam. in.	Width in.	Height in.	Length in.	Weight lb	Airflow lb/sec
Allison 501-D13	TP	◇	3460	.588		14A	30		42	145.2	1756	
	TP	↓	4370	.546			27		39	146	1820	
	TP		3780	.575	9.25		27		39	146	1833	32.4
			3780	.576					39	146	1887	
			3500	.588					40	145	1679	
			4591	.546				44	146	1885		
			4591	.546				39	146	1825		
T63-A-5A	TS	△	317	.697	6.2		19.0	22.5	22.5	44.6	139	3.0
250-B17	TP	△	317	.697	6.2		19.0	22.5	22.5	44.6	182	3.0
Garrett TPE331-25/61	TP	∪	575	.632	7.9	2C	19.47	24.71	24.71	46.01	335	
		↓	665	.635	8.0						336	6.2
			715	.603	8.5						336	
	TP		840	.614	10.32		21.62	27.15	27.15	43.64	355	7.8
T76-G-10/12			715		8.5						320	
TSE-231-1	TS	0	474	.605	8.6	2C	19.1	22.5	22.5	41.0	171	4.3
TSE-36-1	TS	◊	240	.83	4.26	1C	27.89	21.79	21.79	30.0	178	3.0

ENGINE	TYPE	SYMBOL	SHP hp	SFC lb/hr/hp	COMP. PRESS. RATIO	NO. COMP. STAGES	DIAM. IN.	WIDTH IN.	HEIGHT IN.	LENGTH IN.	WEIGHT lb	AIRFLOW lb/sec
<u>Lycoming</u> T53-L-7	TP	✓	1100	.67	6.1	5A+ IC	23			58	555	
-L-11	TS	▽	1100	.68	6.1	5A+ IC	23			47.6	496	
-L-13	TS	▽	1400	.58	6.1	5A+ IC	23			47.6	530	
T55-L-7	TS	⊥	2650	.61	6.1	7A+ IC	24.3			44	580	
-L-9	TP	⊥	2850	.63	6.1	7A+ IC	24.3			62.2	795	
-L-11	TS	▷	3750	.52	6.1	7A+ IC	24.3			44	680	
PLT-27	TS	△	2060	.44		5A+ 4A+1C	17			37	320	
LTC4V-1	TS	▷	5000	.406	16.2	4A+8A					570	25
-4	TS	▷	10000	.406							1480	
LTS 101	TS	◻	592	.57	8.4	2A+1C		16	25.9	31.0		4.8
<u>General Electric</u> T58-3	TS	○	1272	.61	8.4	10A	18.8			59.0	309	12.4
-5		↓	1400	.61							335	13.7
-8B			1250	.61							305	12.4
-10			1400	.61							350	13.7
-16			1870	.53						63.3	440	13.7
CT58-110	TS		1250	.61	8.15		16.0			59.0	315	12.5
-140			1400	.61	8.4		16.0			59.0	340	13.7
T64-GE-7	TS	◻	3925	.476	13.0	14A		24.0	30.0	83.0	712	25.6
-412	TS	◻	3925	.476	13.0			24.0	30.0	83.0	710	25.6

ENGINE	TYPE	SYMBOL	SHP hp	SFC lb/hr/hp	COMP. NO.		DIAM. IN.	WIDTH IN.	HEIGHT IN.	LENGTH IN.	WEIGHT lb	AIRFLOW lb/sec
					PRESS. RATIO	COMP. STAGES						
-1/3	TS	□	3080	.485	12.6		24.0	30.0	83.0	723	24.5	
-6	TS	□	2850	.495	12.6		24.0	30.0	83.0	723	24.5	
-10	TP	□	2660	.505	12.6		29.0	46.0	113.0	1167	24.5	
-16	TS	□	3370	.476	13.0		24.0	30.0	68.0		25.6	
C164-GE-820	TP	□	2860	.503	13.0	15.8	29.0		113.0	1130	24.5	
GE-12	TS	□	1500					21	42.0			
<u>PWA/UACL</u> JFTD12A-1	TS	▽	4050	.69	6.85	9A	30		108	882		
S-9	TS	▽	1500	.434	15	2C	21.7		37.2	340		
PT6A-6	TP	□	500	.65		3A+1C	19		62	270		
20		↓	550	.649					62	275		
27			680	.632	6.7				62	289	6.8	
40			850	.620					66	363		
50			960	.592					70	454		
PT6B-9	TS	□	550	.665			19		60	245		
16		□	690	.618			19		60	269		
<u>Continental</u> T65-T-1 (TS325-1)	TS	□	310	.66	6.0	1A+1C	18.25	19.06	34.2	136	3.3	

ENGINE	TYPE	SYMBOL	SHP hp	SFC lb/hr/hp	COMP. PRESS. RATIO	NO. COMP. STAGES	DIAM. IN.	WIDTH IN.	HEIGHT IN.	LENGTH IN.	WEIGHT lb	AIRFLOW lb/sec
<u>Rolls Royce</u>												
<u>DAKT MK506/</u>												
	TP	⊙	1345	.713		2C	37.9			95	1026	
		↓										
MK510/R.Da6			1535	.69	5.5		37.9			97.6	1106	20.5
MK520/R.Da7			1700	.630	5.62					97.6	1207	23.5
MK102/RDa8			2470	.630						97.6	1237	
MK542/R.Da10			2750	.612	6.35					99.5	1366	27.0
MK201/R.Da12			2970	.607	6.35					99.5	1387	27.0
<u>TYNE MK506/</u>												
	TP	⊙	4200	.463	13.5	6A+9A	55			108.7	2275	46.5
		↓										
MK512/RTY.11			4660	.440							2275	
MK515/RTY.12			4820								2177	
MK21/RTY.20			4500	.485							2391	
GAZELLE NGA.2	TS	⊙	1430	.71	6.25	11A	42.5			75	928	16.4
		↓										
MK162 NGA13			1410	.71	5.9						940	15.8
MK165 NGA22			1600	.68	5.9						884	17.0
RS 360-07	TS	⊙	830	.495	12.15	4A+1C/ 2 spool		21.7	22.9	43	300	
NIMBUS	TS	∇	685	.85	6.5	2A+1C		38.6	34.2	73		11

ENGINE	TYPE	SYMBOL	SHP hp	SFC lb/hr/hp	COMP. PRESS. RATIO	NO. COMP. STAGES	DIAM. IN.	WIDTH IN.	HEIGHT IN.	LENGTH IN.	WEIGHT lb	AIRFLOW lb/sec
<u>Turbomeca</u>												
ARTOUSTE IIC	TS	△	523	.836	3.88	1C		15.35	21.5	56.7	315	7.05
IIIB	TS	△	543	.723	5.2	1A+1C		19.96	24.68	71.46	400	9.5
ASTAZOU AZ14	TP	⊠	800	.543		2A+1C	21.5			80.6	454	
AZ16		↓	940	.543							454	
AZ18			1155	.525							452	
IIA	TS	△	523	.623		1A+1C		18.8	18	50	249	5.5
IIIN	TS	△	592	.643				18.1	18.1	56.3	253	
BASTAN VIC	TP	⊠	986	.632	5.83	1A+C		26.97	30.53	80.1	687	10
VII		⊠	1045		6.68	2A+C	21.7			75.2	816	13.1
OREDON IV	TS	⊙	420				14.4			50.3	134	
<u>Rolls Royce-KHD</u>												
III2	TS	⊙	142	.93	4.96	1A+1C		13.5	17.4	30.7	75	1.91
<u>Turbomeca (C4)</u>												
Turmo IIIC	TS	⊙	1480	.603	5.9	1A+1C		27.3	28.2	78.0	655*	13.0
IIID	TP	⊙	1480	.616		1A+1C		36.8	36.5	73.6	805**	
6	TS	⊙	1677	.592		1A+1C						
10	TS	↓	1578			2A+1C			26.8	77.5	677*	
16	TS	↓	1973	.536		2A+1C						

*Fully equipped.
**Basic engine.

ENGINE	TYPE	SYMBOL	SHP hp	SFC lb/hr/hp	COMP. PRESS. RATIO	NO. COMP. STAGES	DIAM. IN.	WIDTH IN.	HEIGHT IN.	LENGTH IN.	WEIGHT lb	AIRFLOW lb/sec
Turbomeca/Agusta TM-251(TAA-230)	TS	∅	354	.86	4.0	1C	14.57	24.80	46.85	290	4.2	
MTU 6022-A1	TS	∅	217				21.25		45.20	165		
		↓	350							187		
			375								198	
720(PLT6)	TS	∅	1245	.646	5.5	4A+1C	20.3		78.5	485	13.5	
721 (PTL.10)	TS	∅			6.0	8A	19.1		91.3	550	22.0	
	TP	∅	2000	.673					105.3	660		
Motorlet (Czech) M601	TP	∅	505	.86	6.0	2A+1C	12.4		60.2	331	6.1	
		∅	633	.685			16.9		60.2	298		

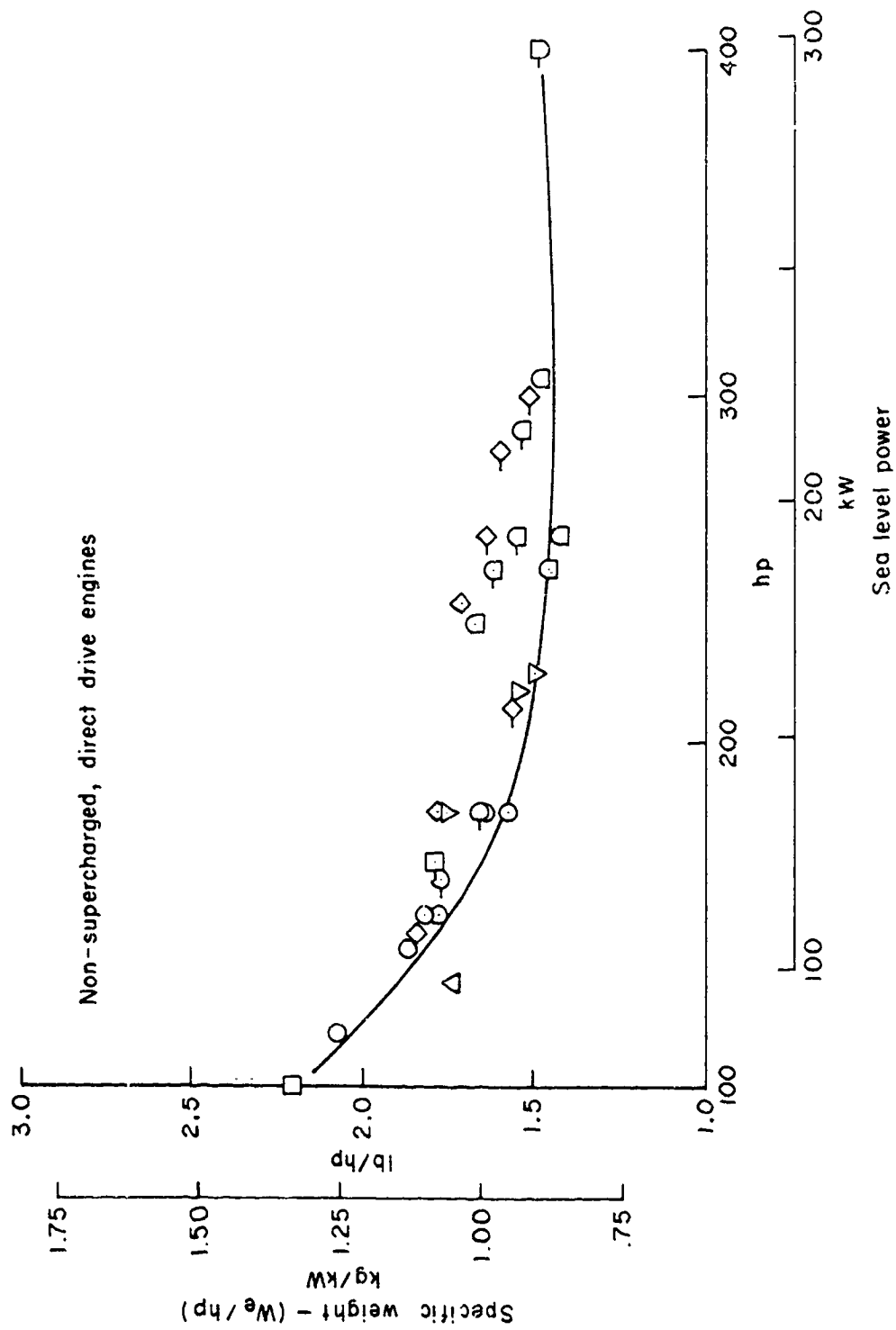

FIGURE C-1. SPECIFIC WEIGHT OF NON-SUPERCHARGED DIRECT DRIVE PISTON ENGINES

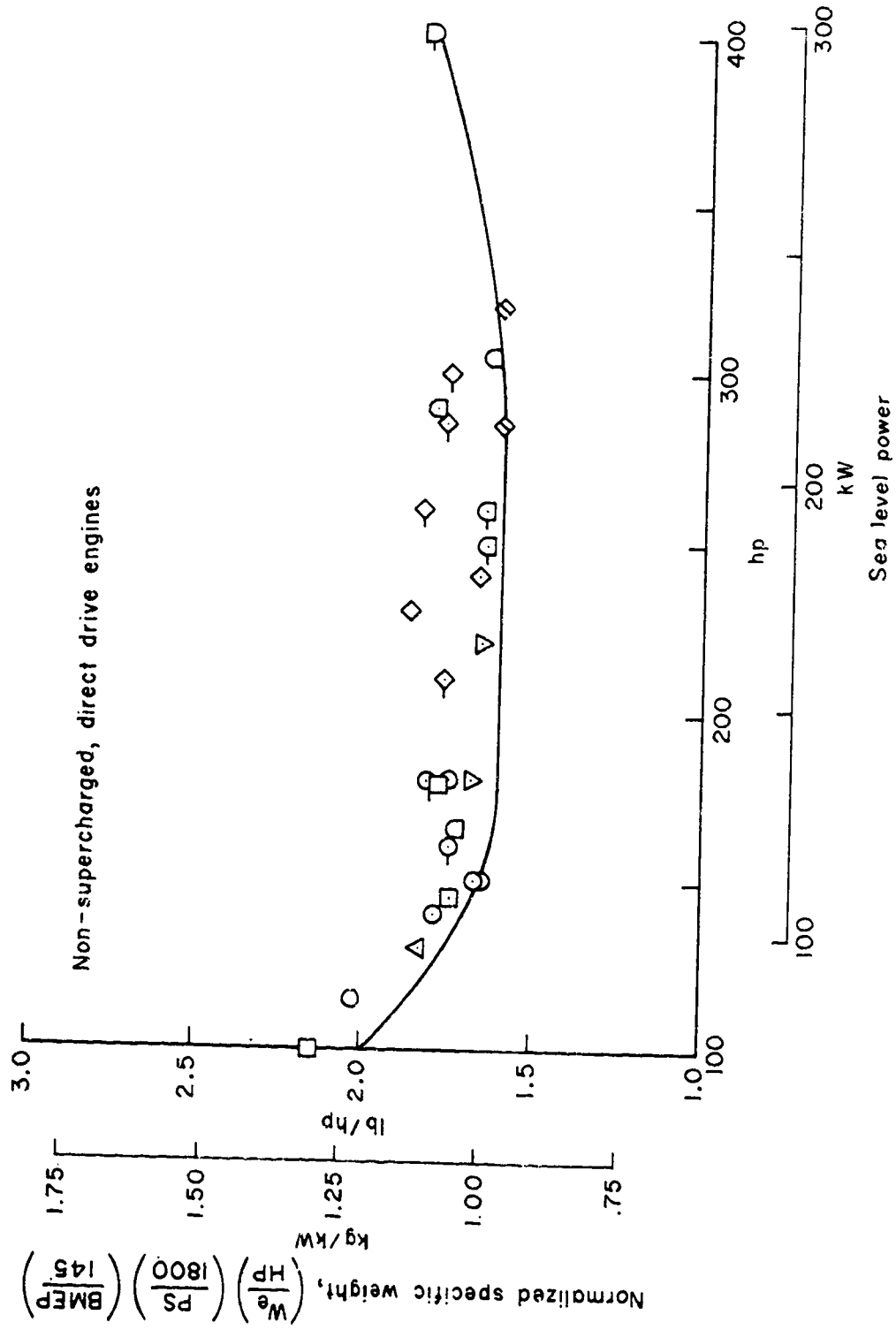

FIGURE C-2. NORMALIZED SPECIFIC WEIGHT OF NON-SUPERCHARGED DIRECT DRIVE PISTON ENGINES

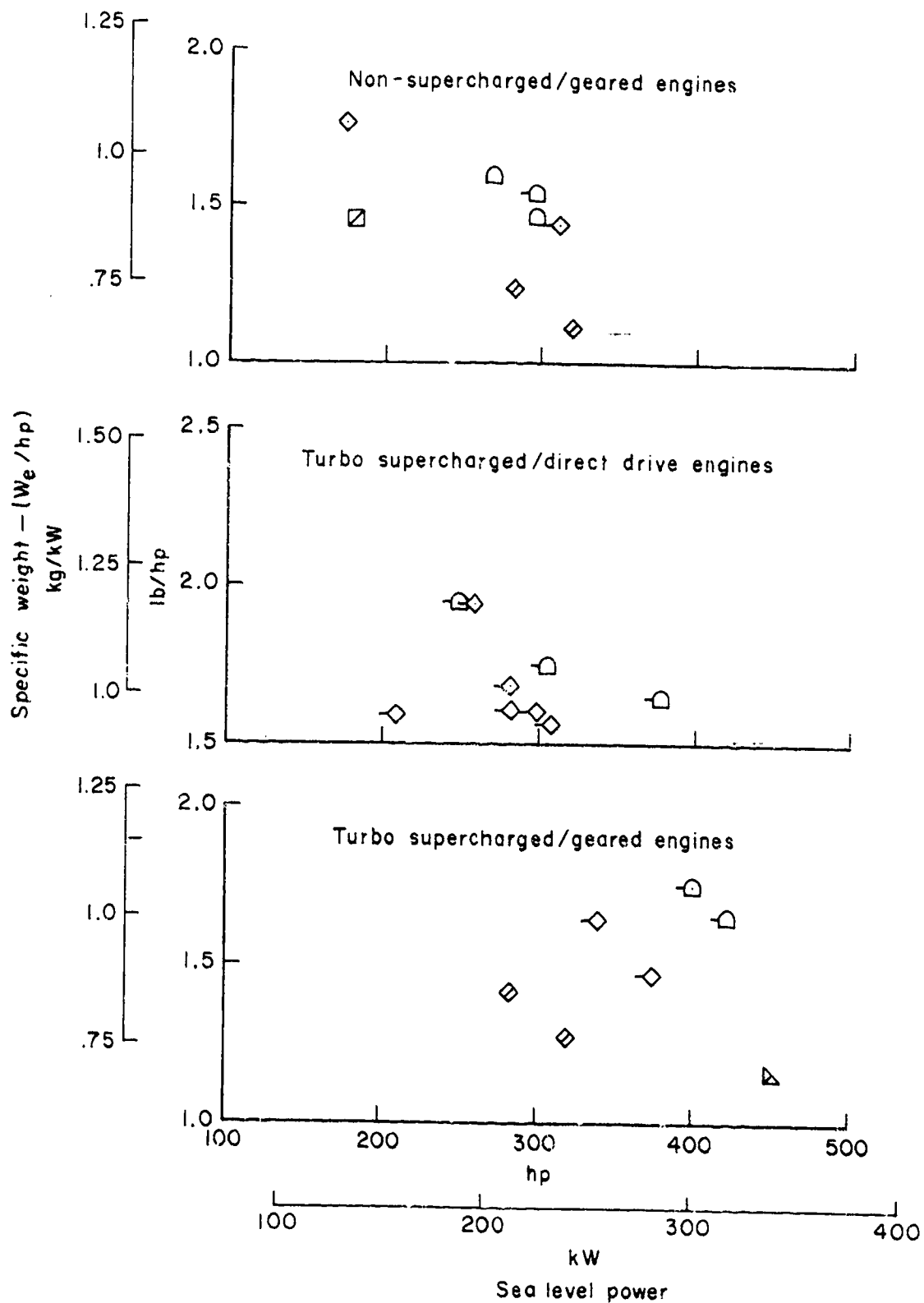

FIGURE C-3. SPECIFIC WEIGHT OF SUPERCHARGED AND/OR GEARED PISTON ENGINES

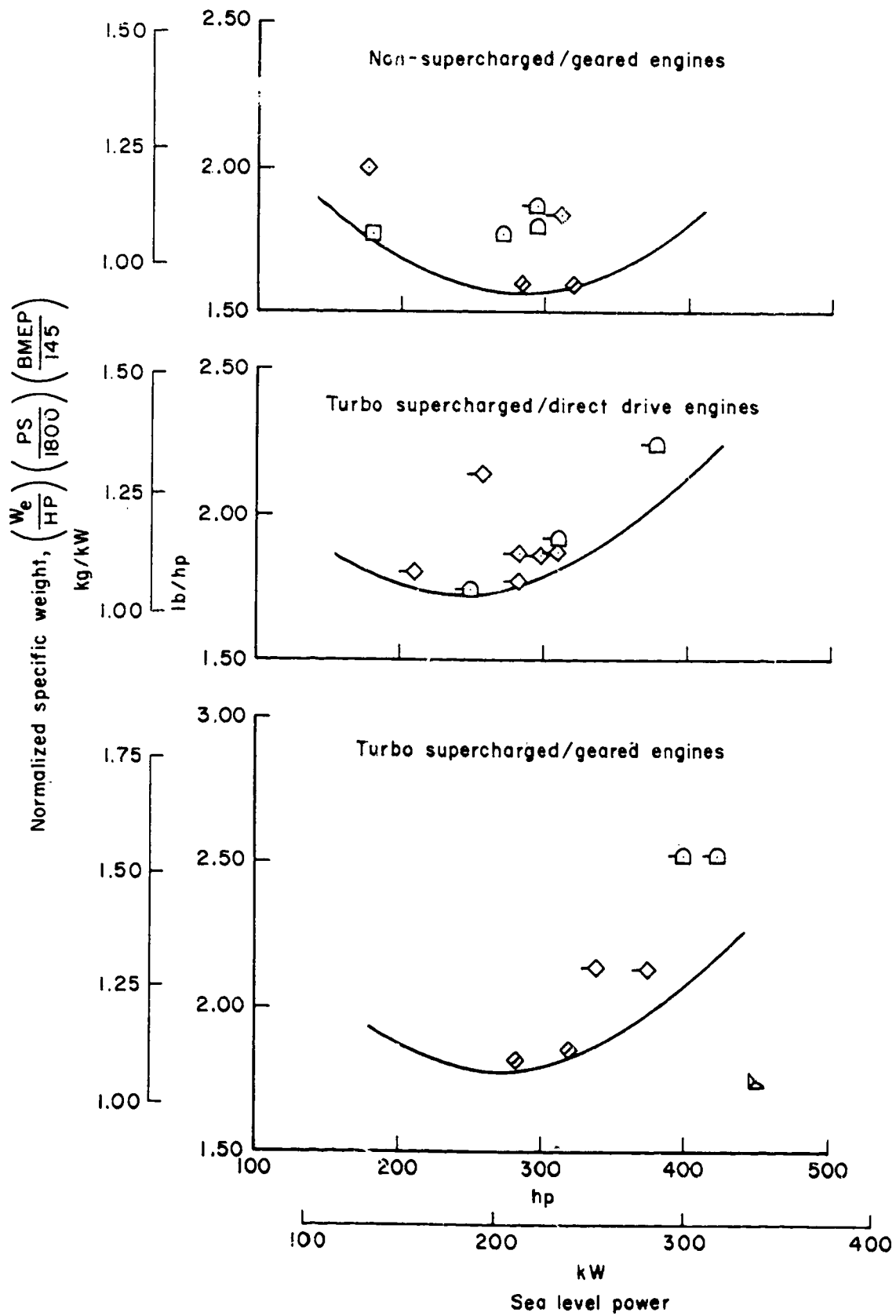

FIGURE C-4. NORMALIZED SPECIFIC WEIGHT OF SUPERCHARGED AND/OR GEARED PISTON ENGINES

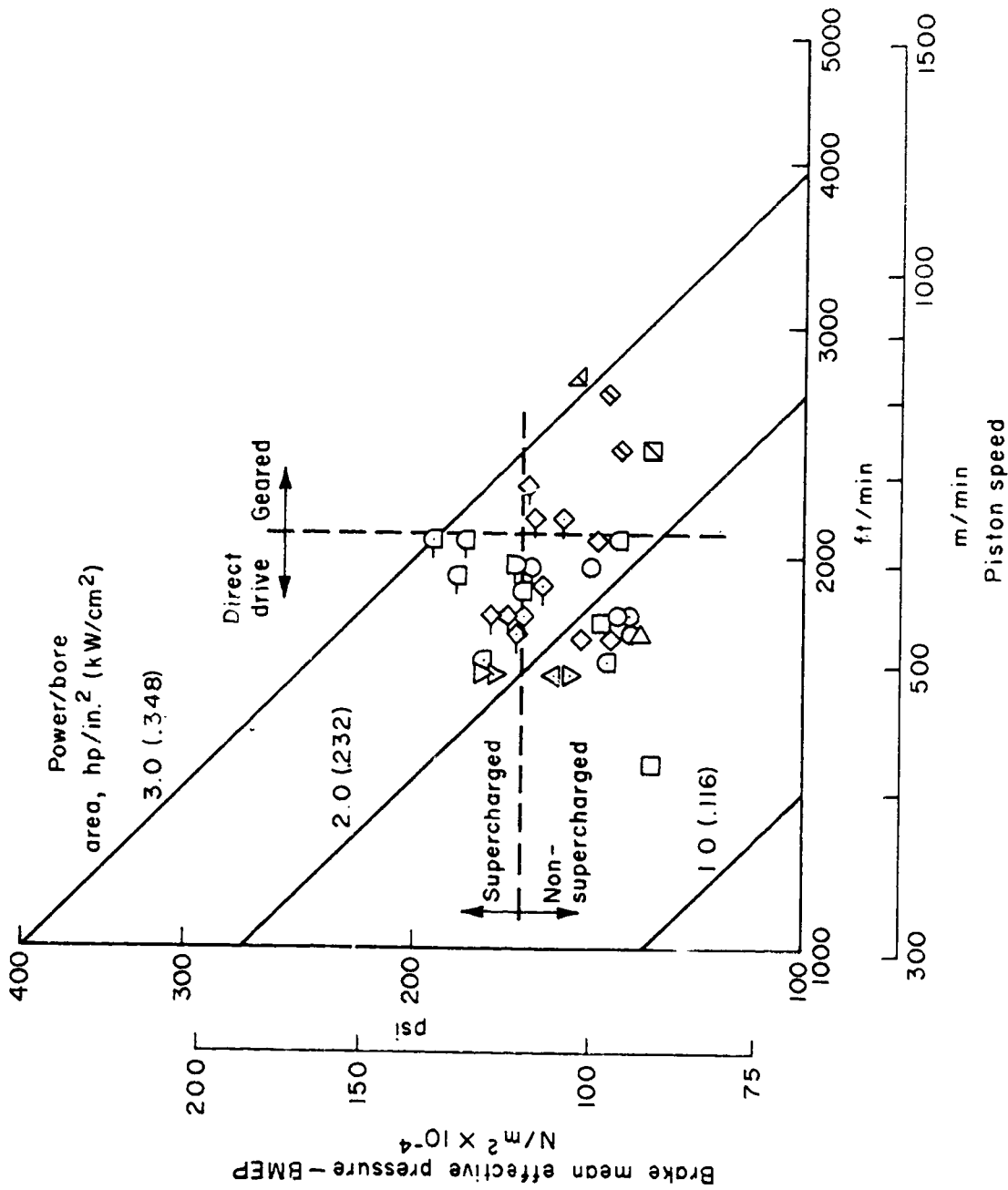

FIGURE C-5. PISTON SPEED AND BMEP OF CURRENT AIRCRAFT PISTON ENGINES

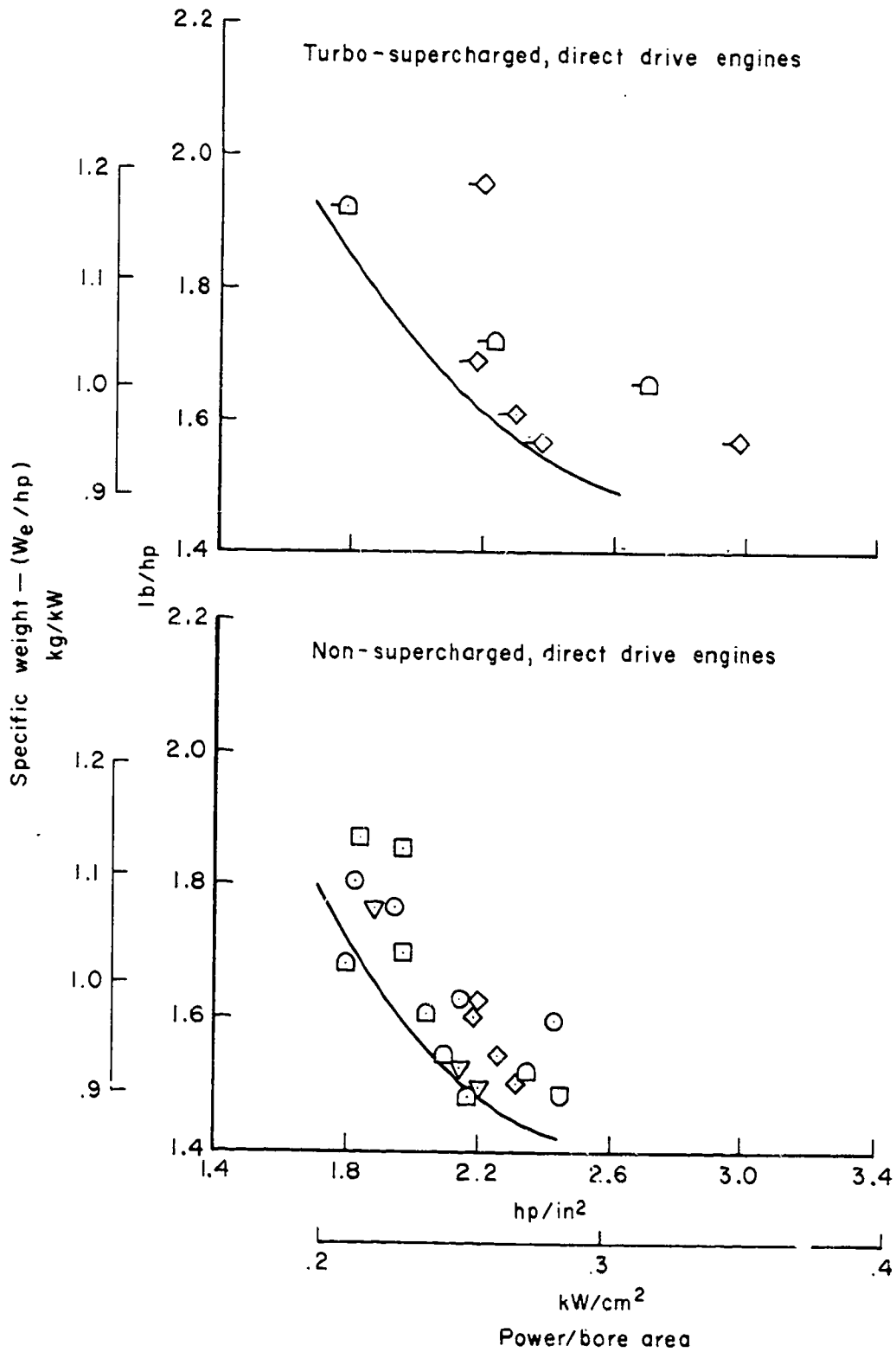

FIGURE C-6. EFFECT OF POWER/BORE AREA ON PISTON ENGINE SPECIFIC WEIGHT

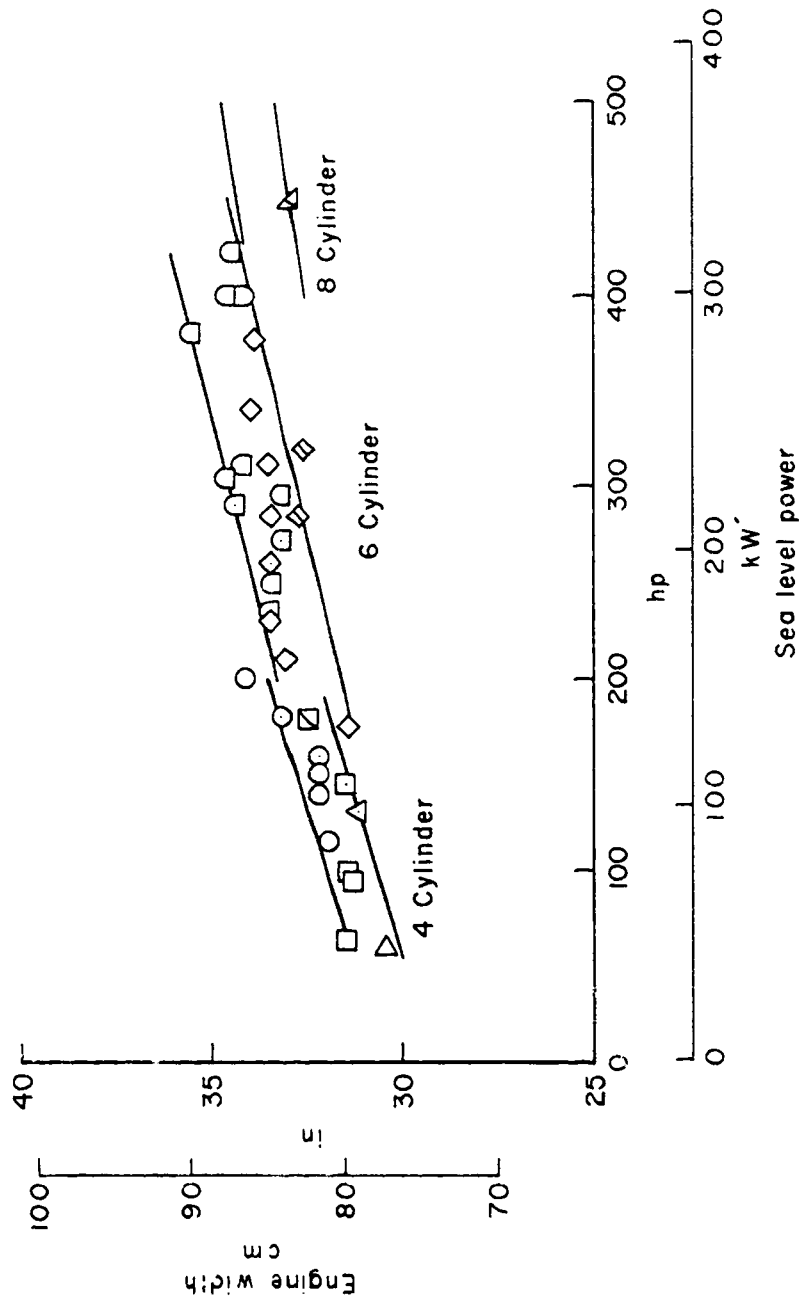

FIGURE C-7. PISTON ENGINE WIDTH

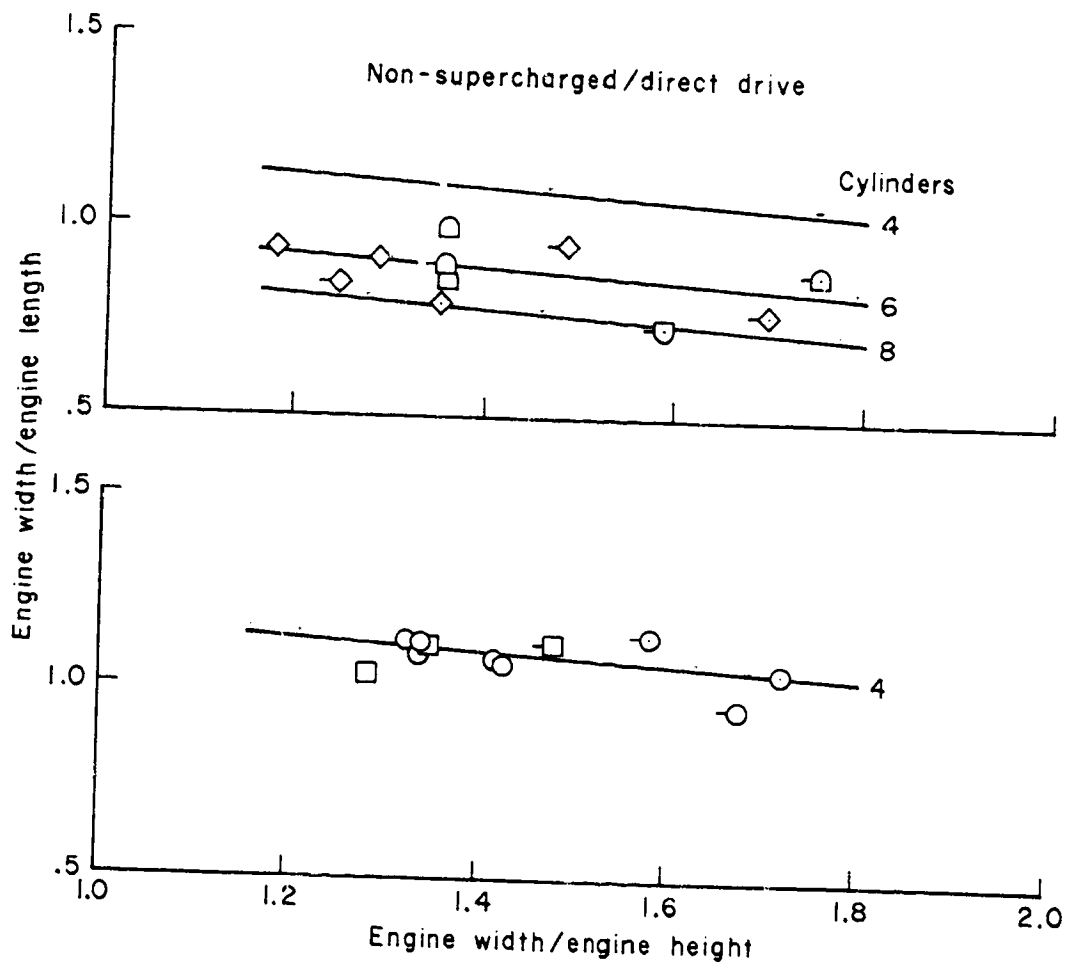

FIGURE C-8. DIMENSIONAL RELATIONS FOR NON-SUPERCHARGED, PISTON ENGINES DIRECT DRIVE

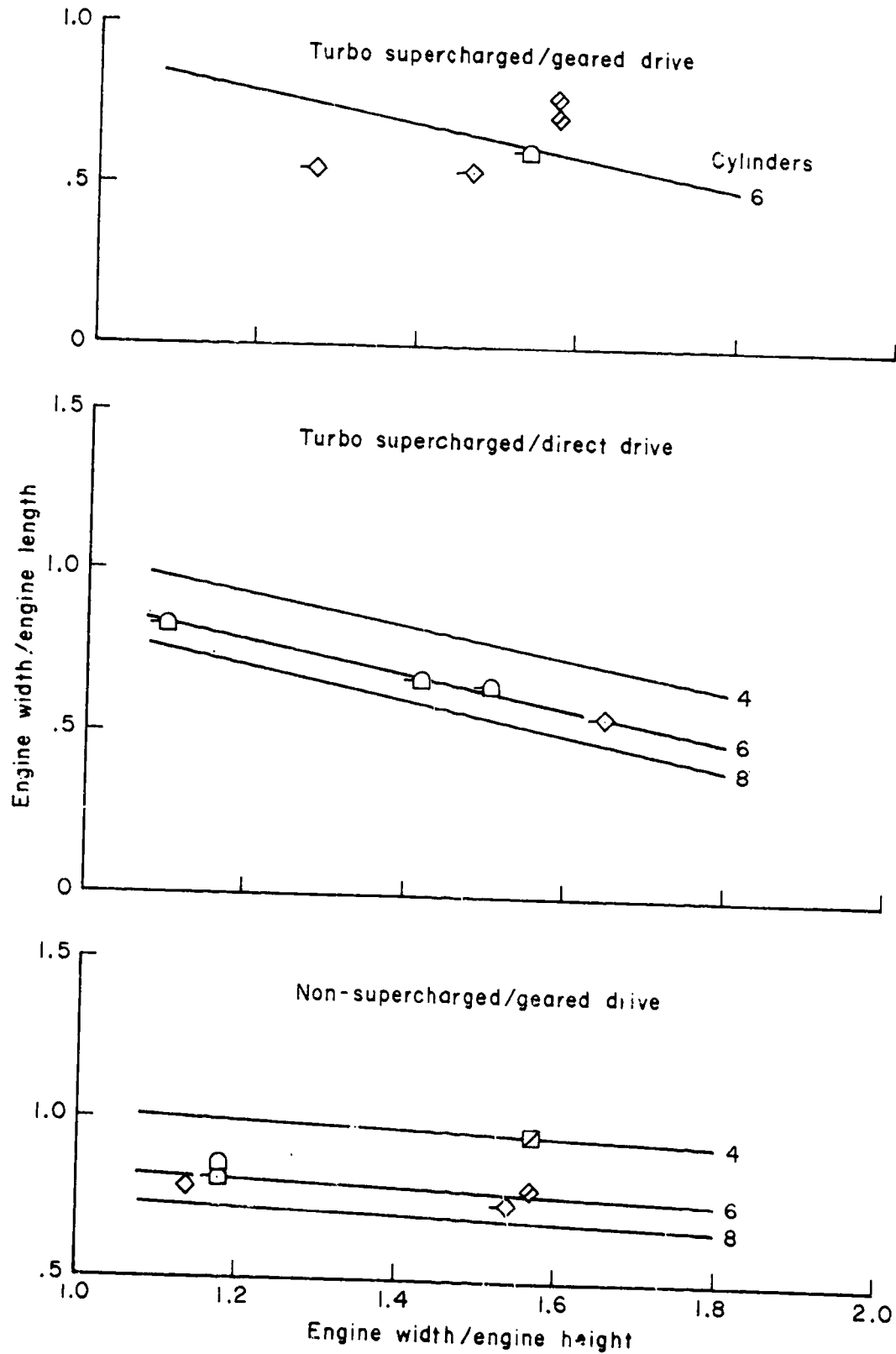

FIGURE C-9. DIMENSIONAL RELATIONS FOR SUPERCHARGED AND/OR GEARED PISTON ENGINES

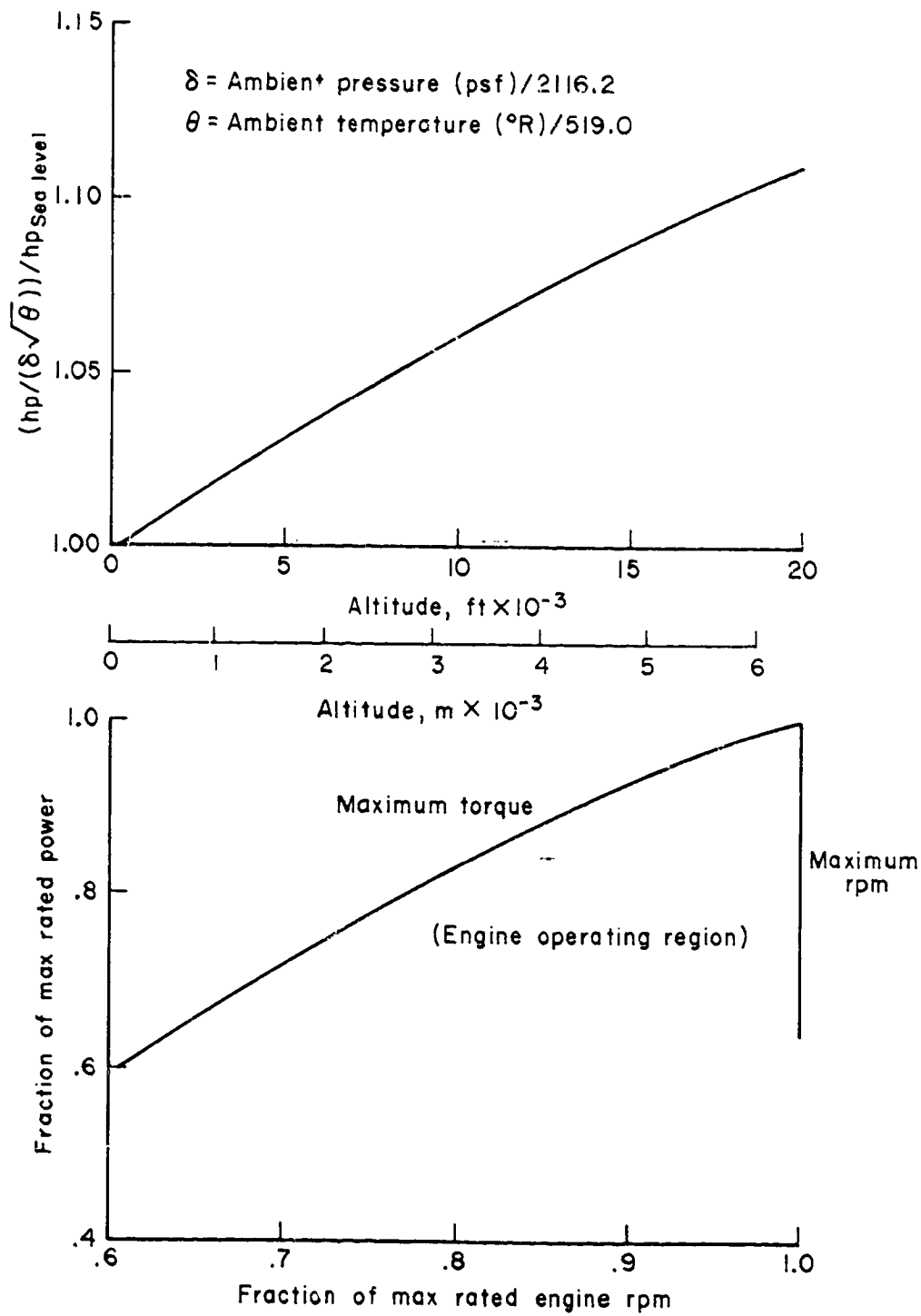

FIGURE C-10. PART POWER AND ALTITUDE PERFORMANCE OF AIRCRAFT PISTON ENGINES

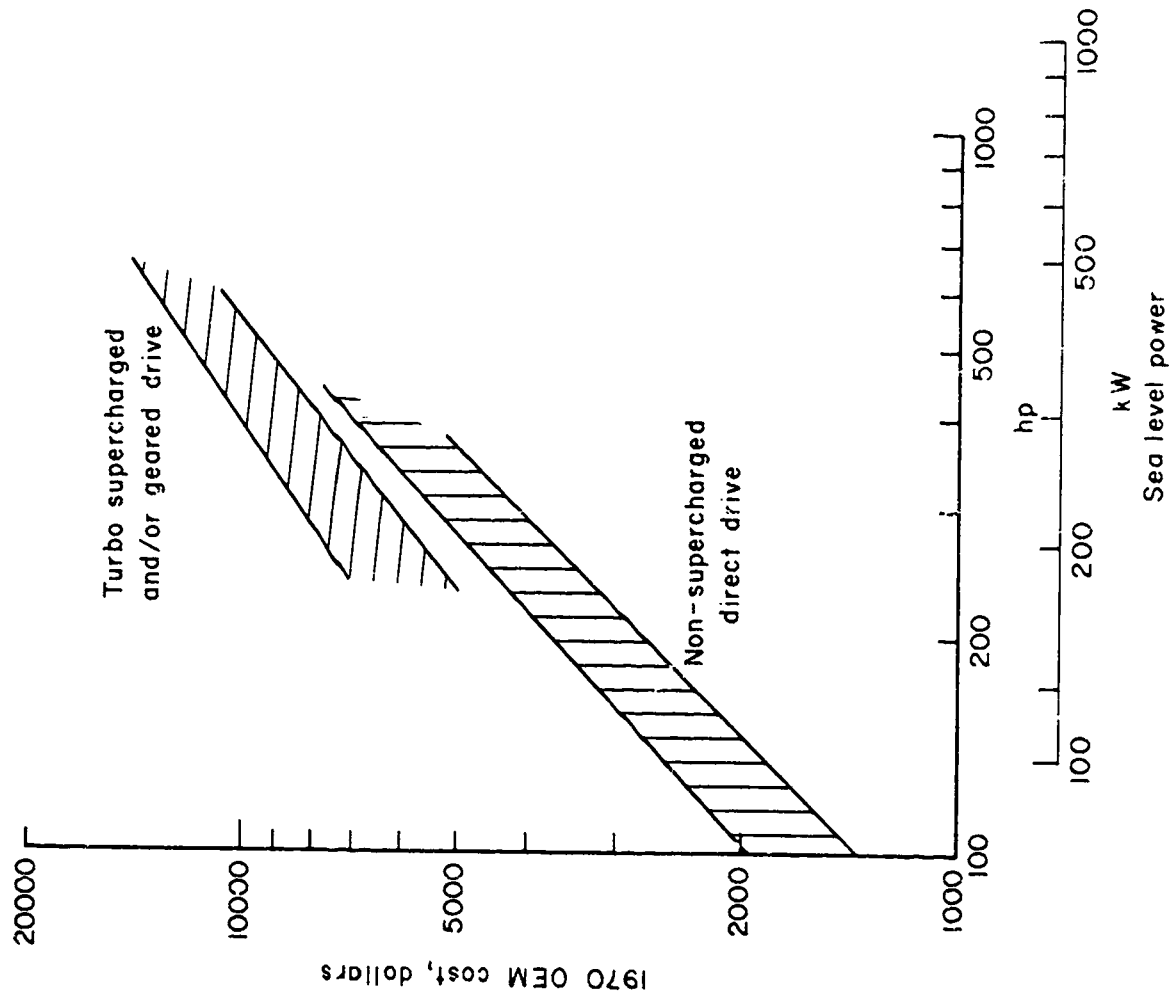

FIGURE C-11. 1970 C. E. M. COST OF AIRCRAFT PISTON ENGINES

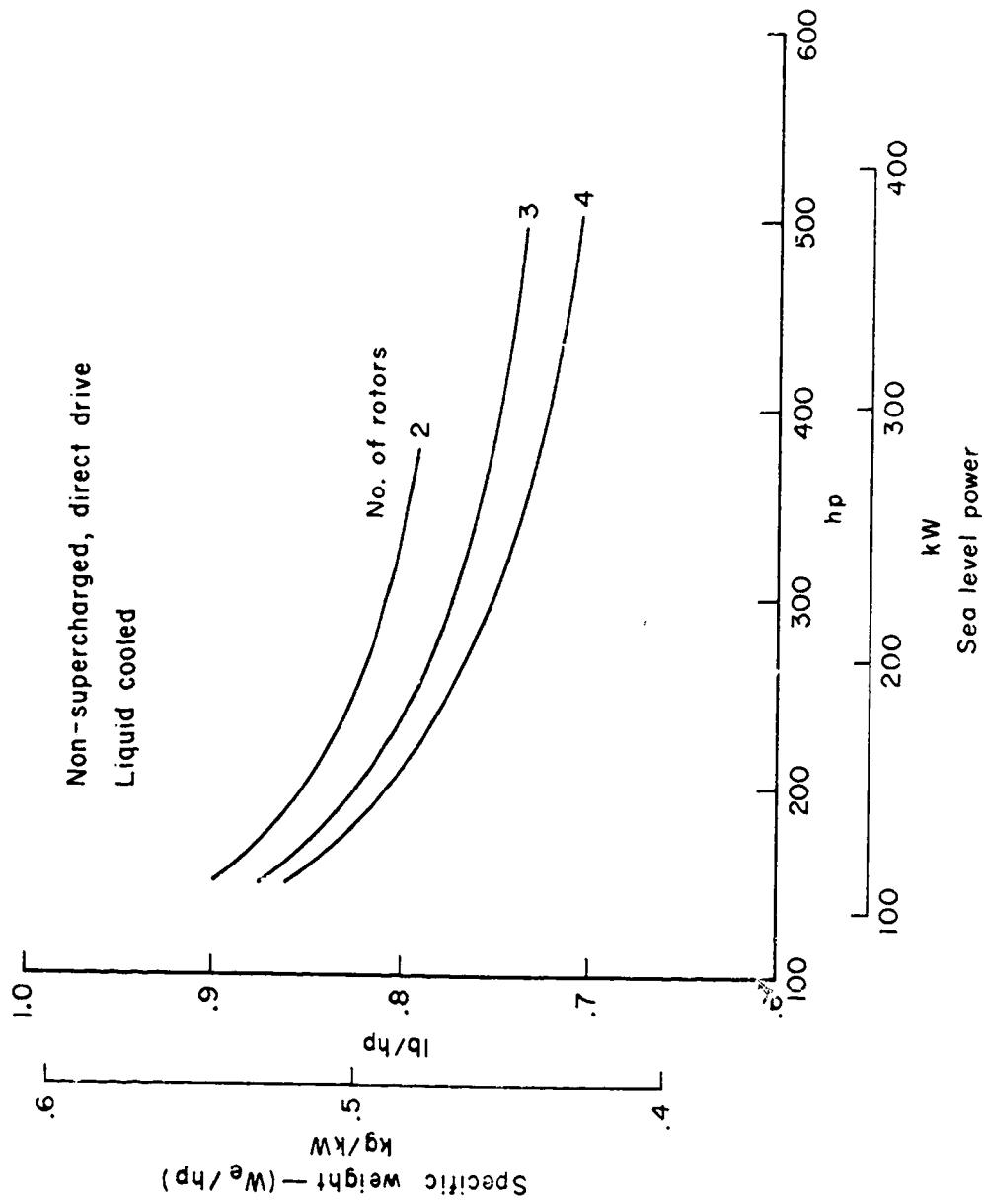

FIGURE C-12. SPECIFIC WEIGHT OF NEAR TERM ROTARY COMBUSTION AIRCRAFT ENGINES

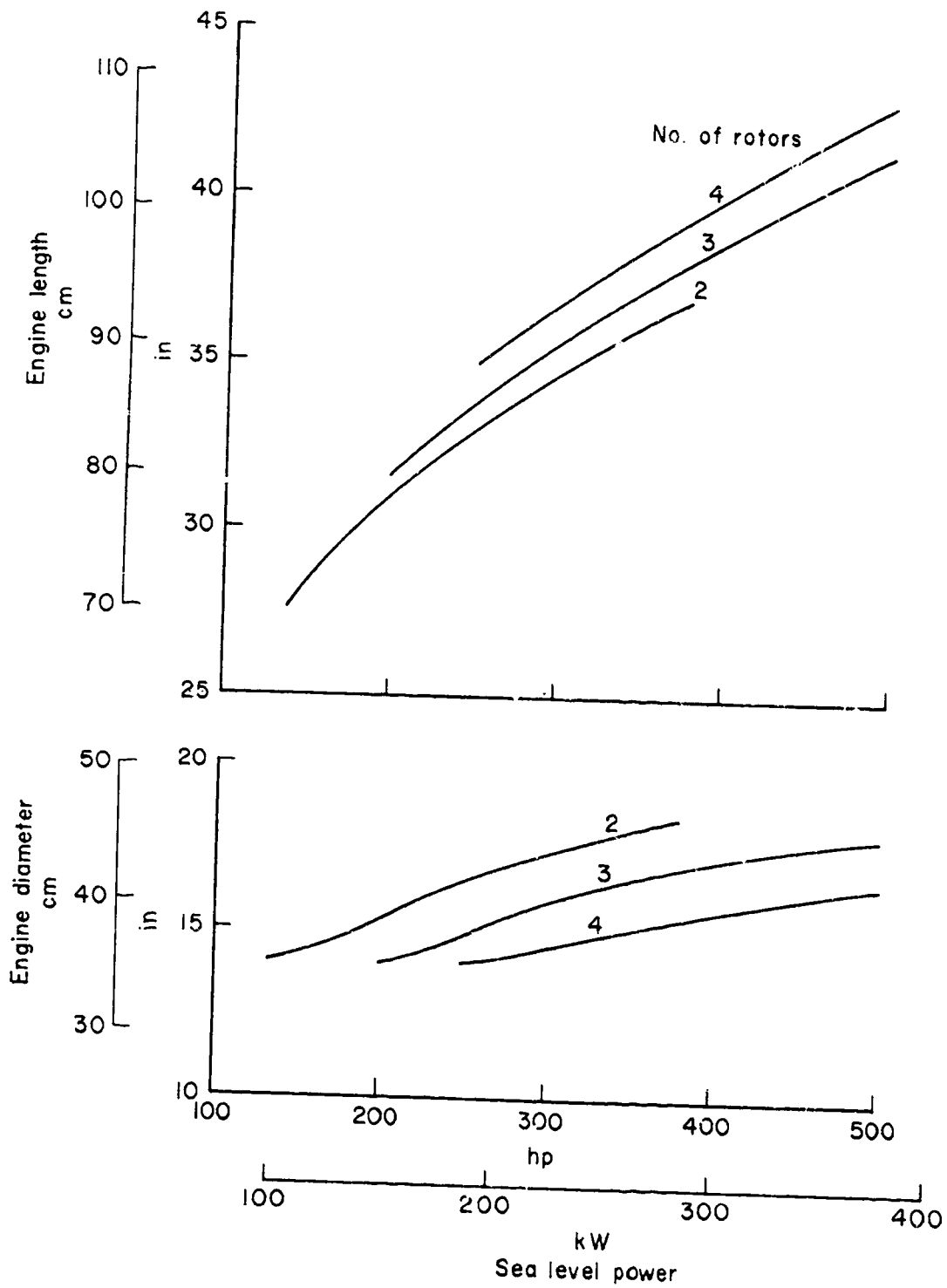

FIGURE C-13. ROTARY COMBUSTION ENGINE DIMENSIONS

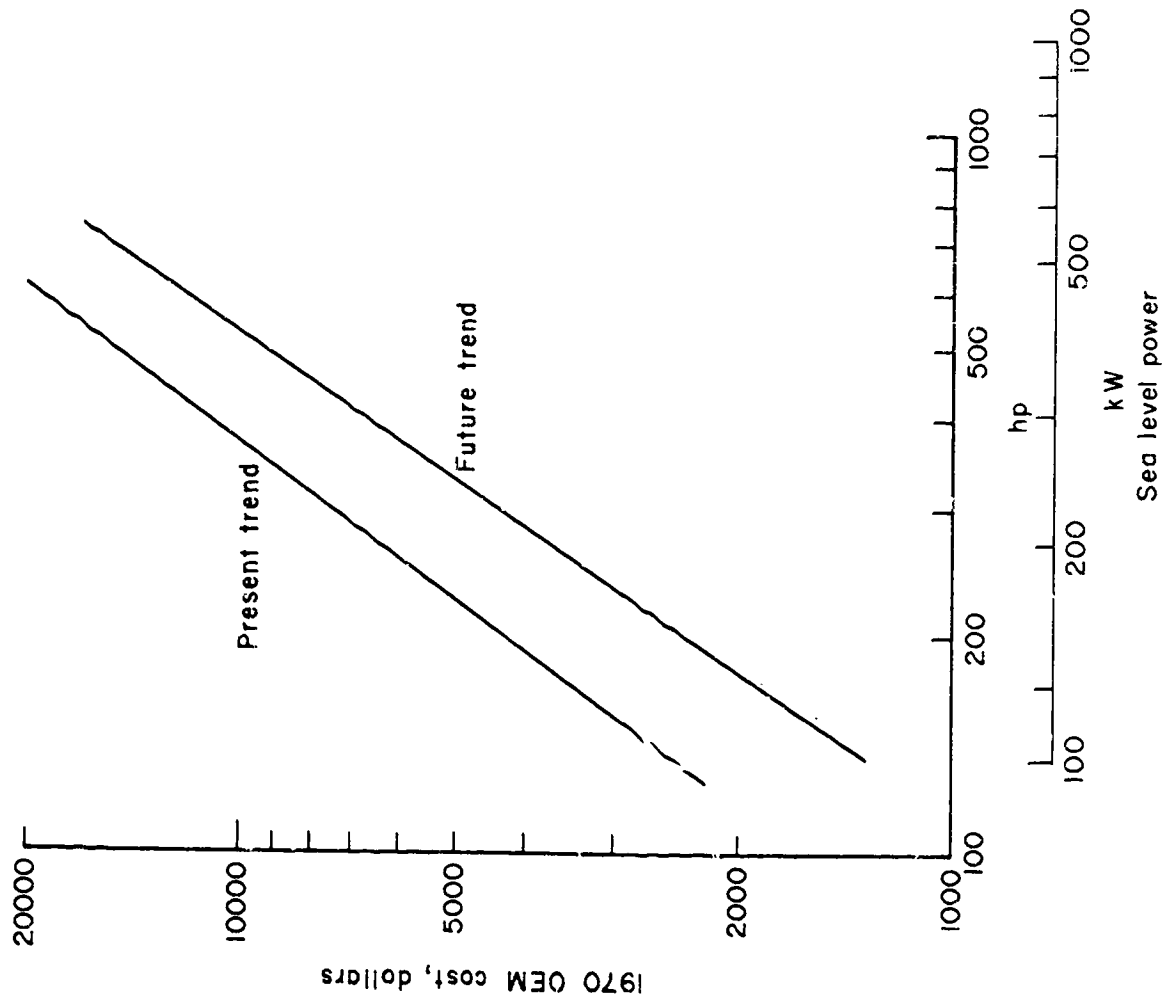

FIGURE C-14. ESTIMATED 1970 O.E.M. COSTS FOR ROTARY COMBUSTION AIRCRAFT ENGINES

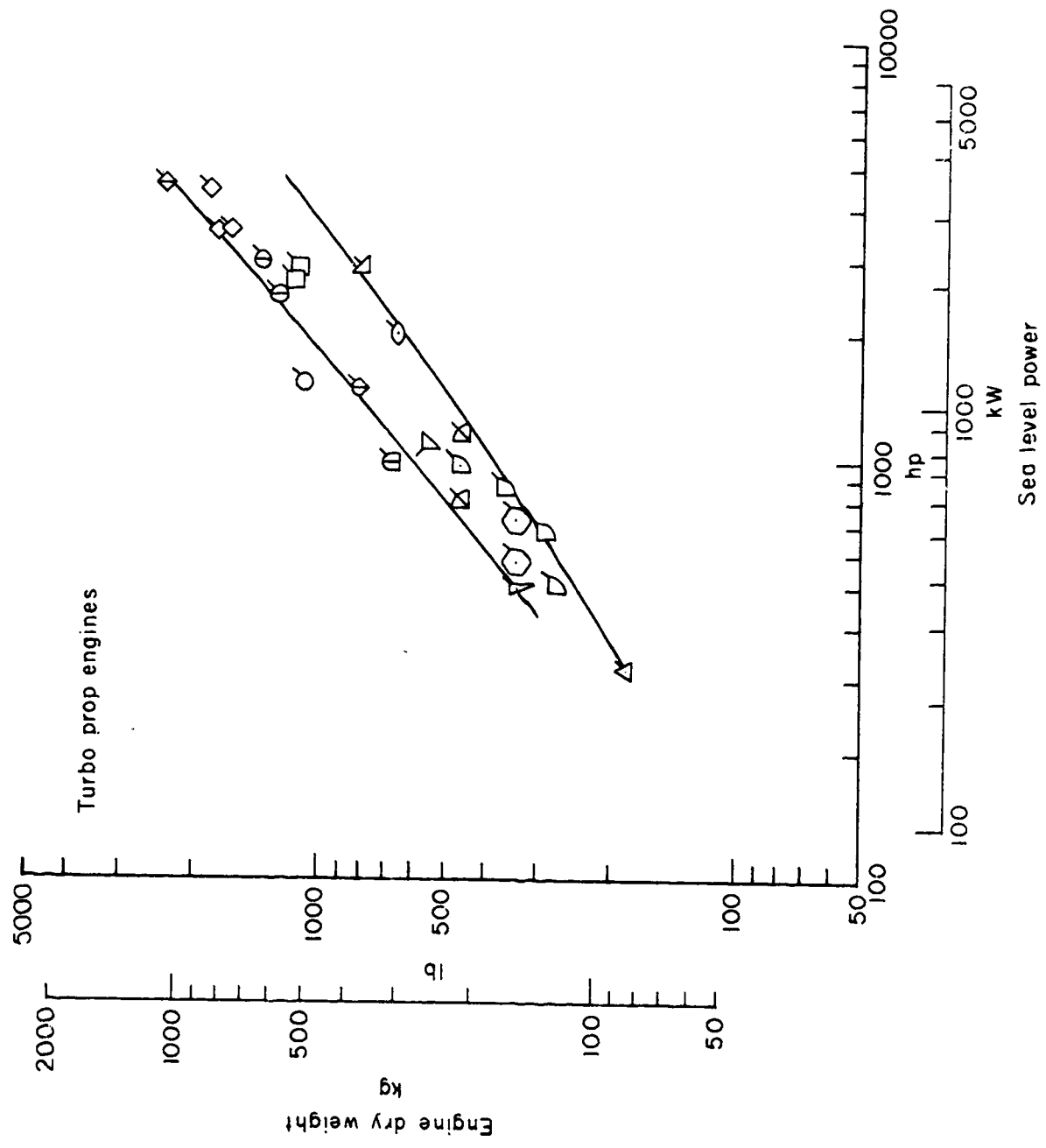

FIGURE C-15A. TURBOPROP ENGINE WEIGHT VARIATION WITH POWER AT SEA LEVEL

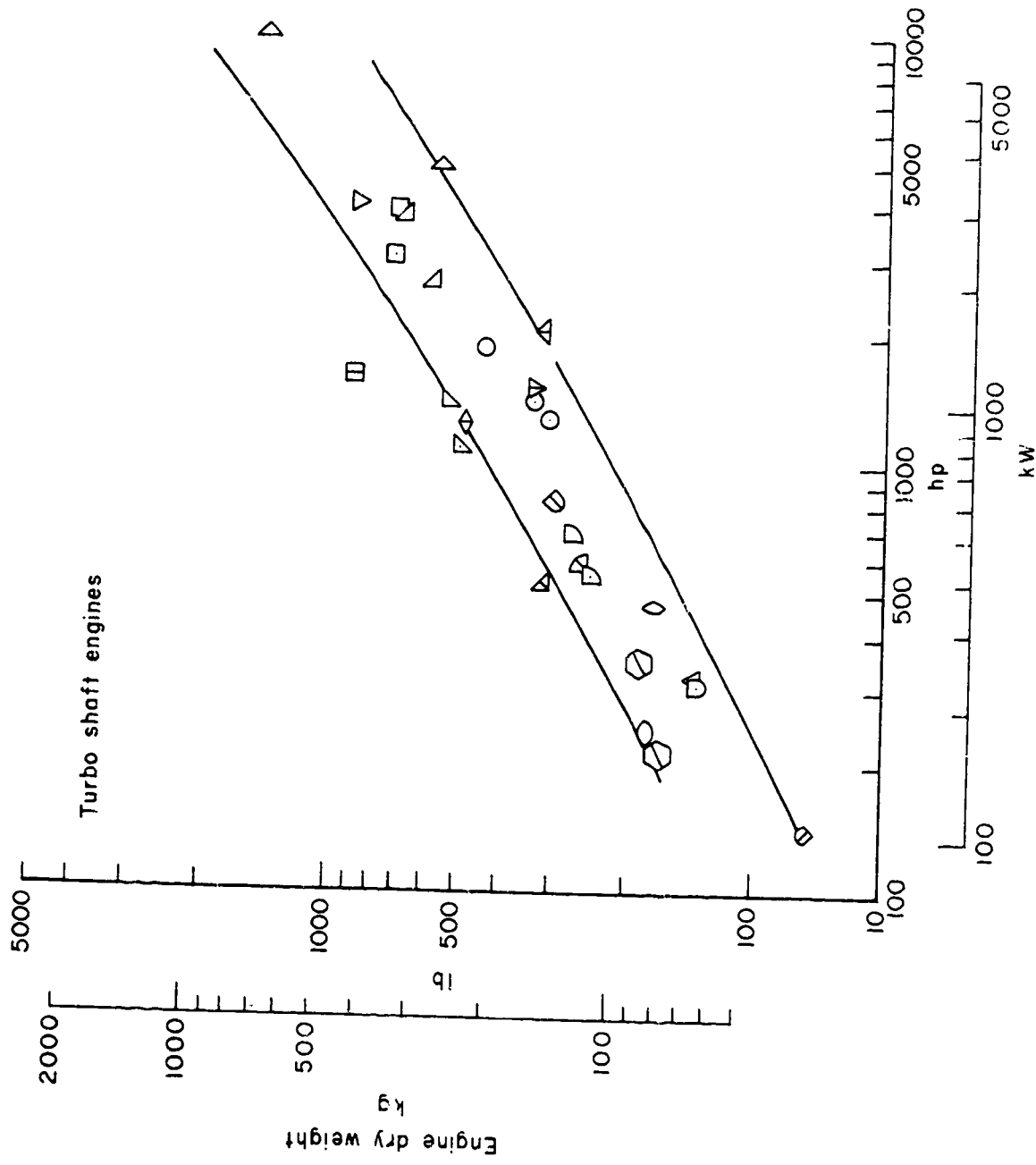

FIGURE C-15B. TURBOSHAFT ENGINE WEIGHT VARIATION WITH POWER AT SEA LEVEL

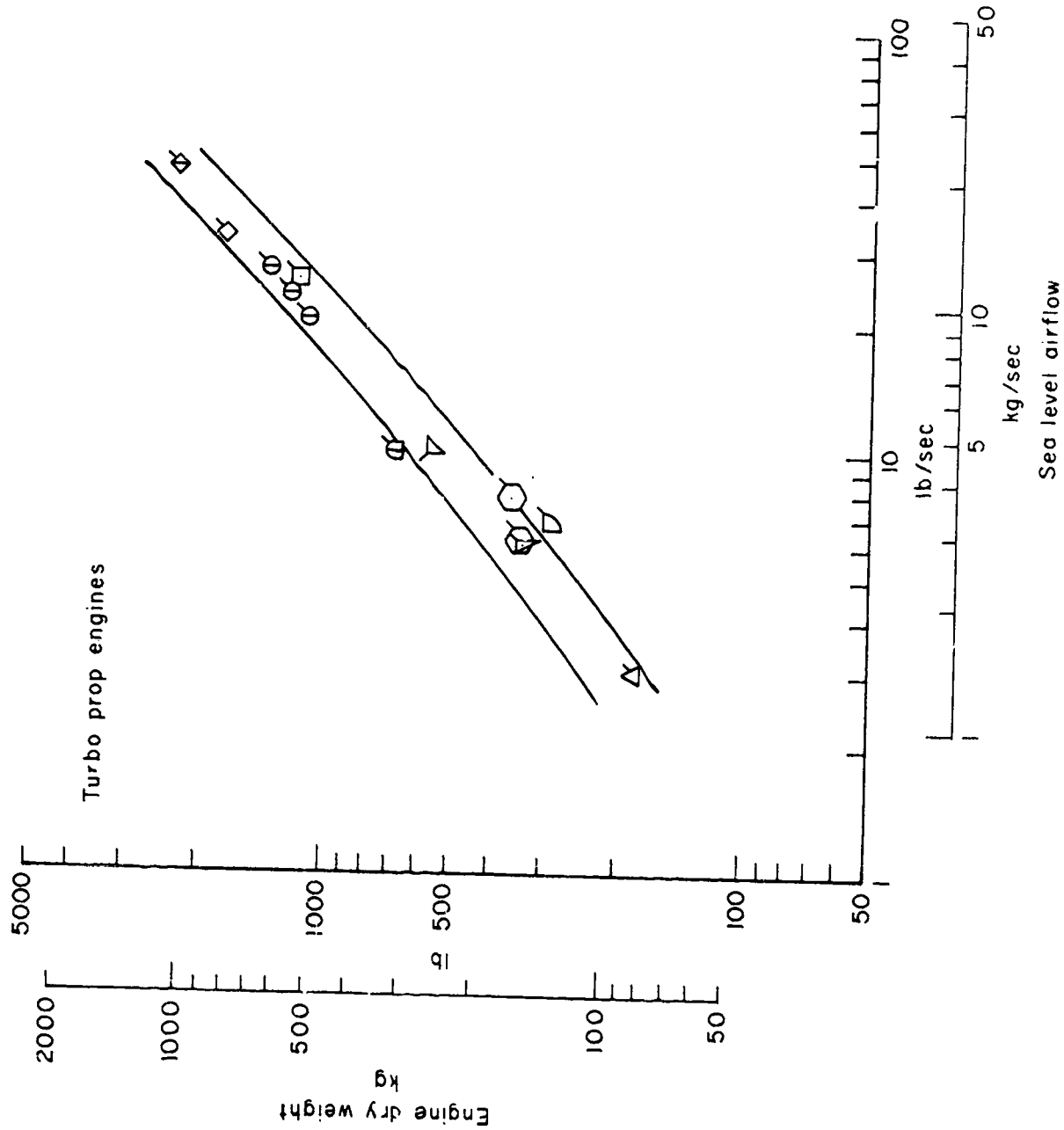

FIGURE C-16A. TURBOPROP ENGINE WEIGHT VARIATION WITH RATED SEA LEVEL AIRFLOW

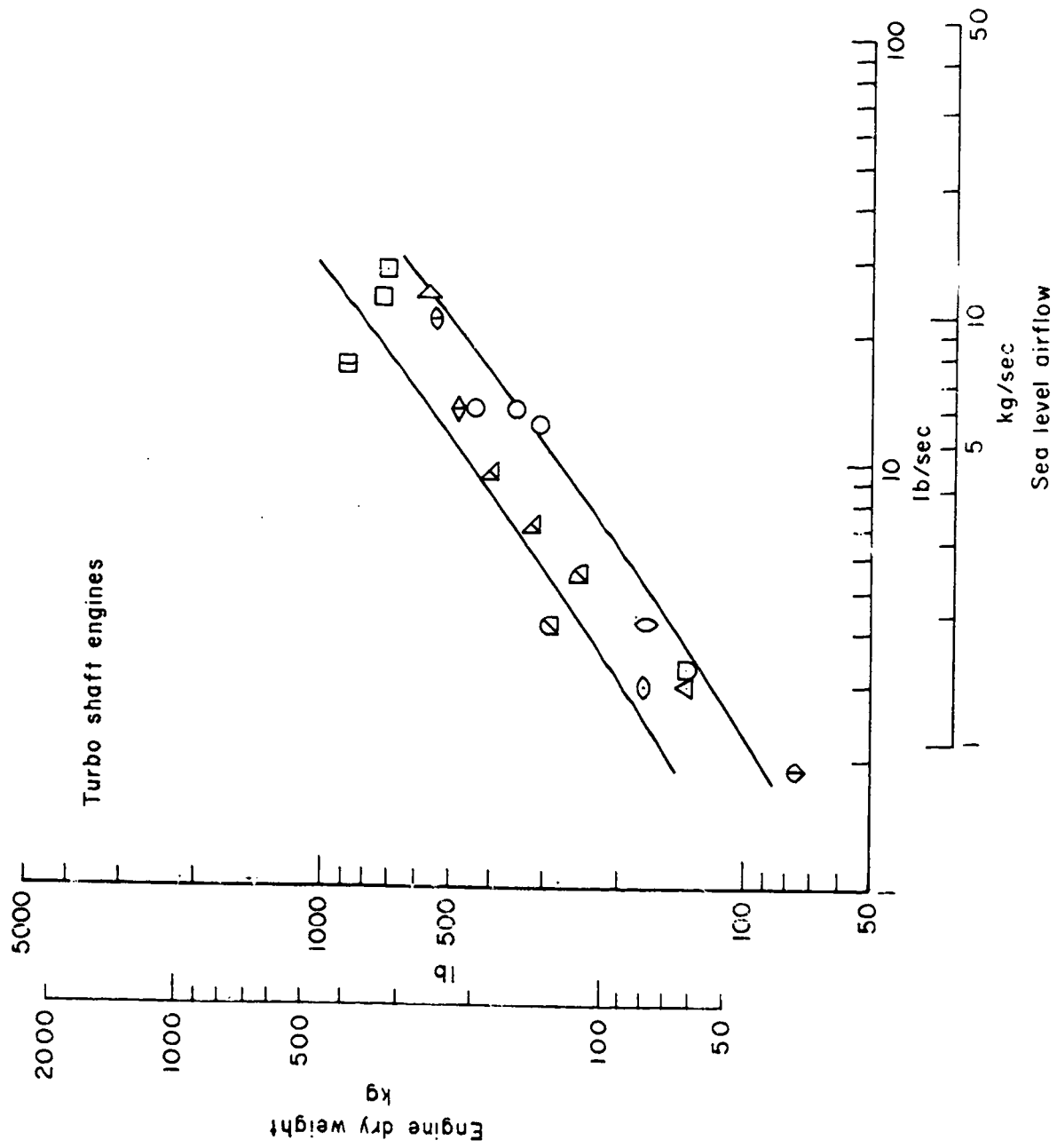

FIGURE C-16B. TURBOSHAFT ENGINE WEIGHT VARIATION WITH RATED SEA LEVEL AIRFLOW

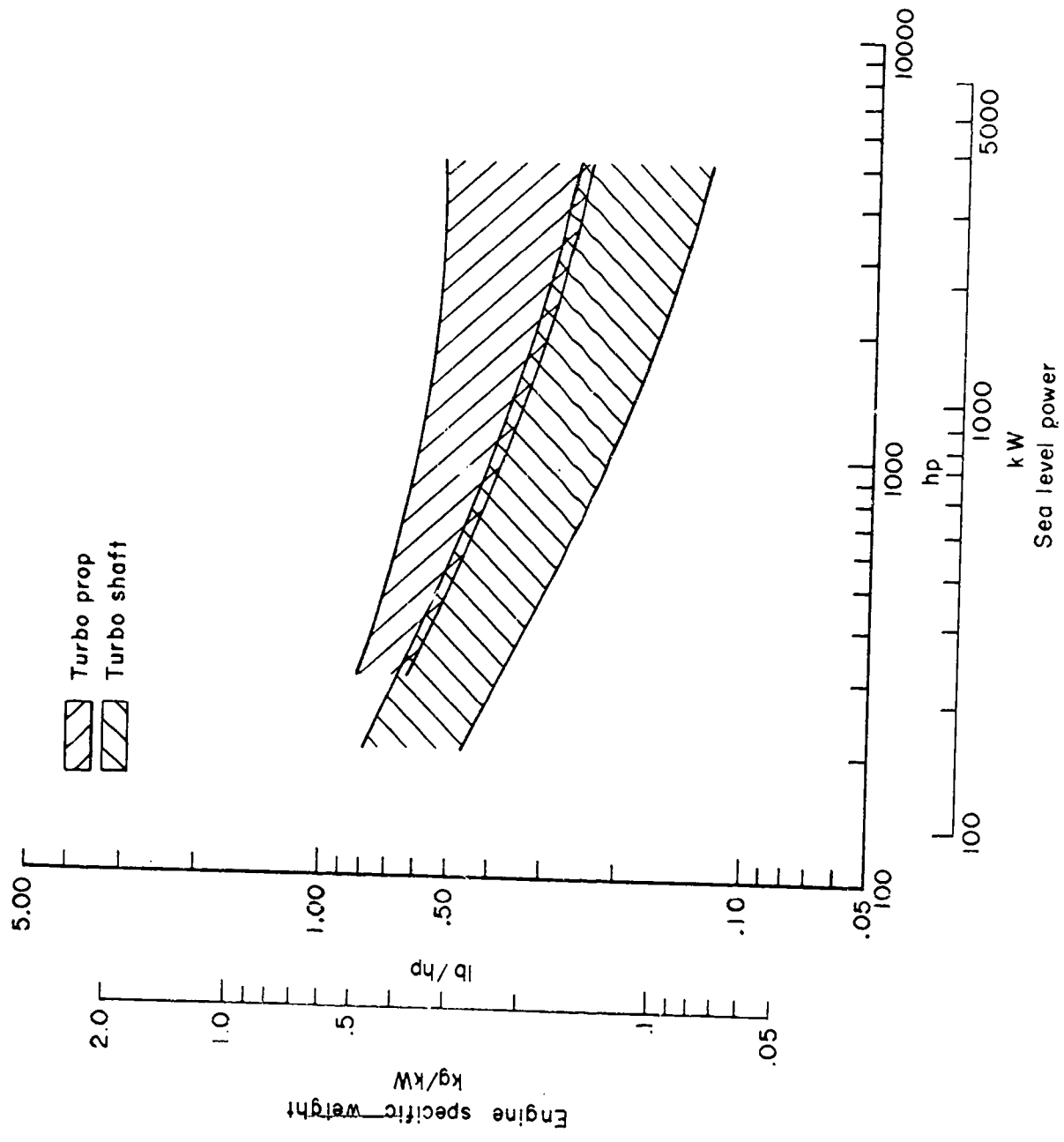

FIGURE C-17A. TURBOPROP AND TURBOSHAFT ENGINE SPECIFIC WEIGHT

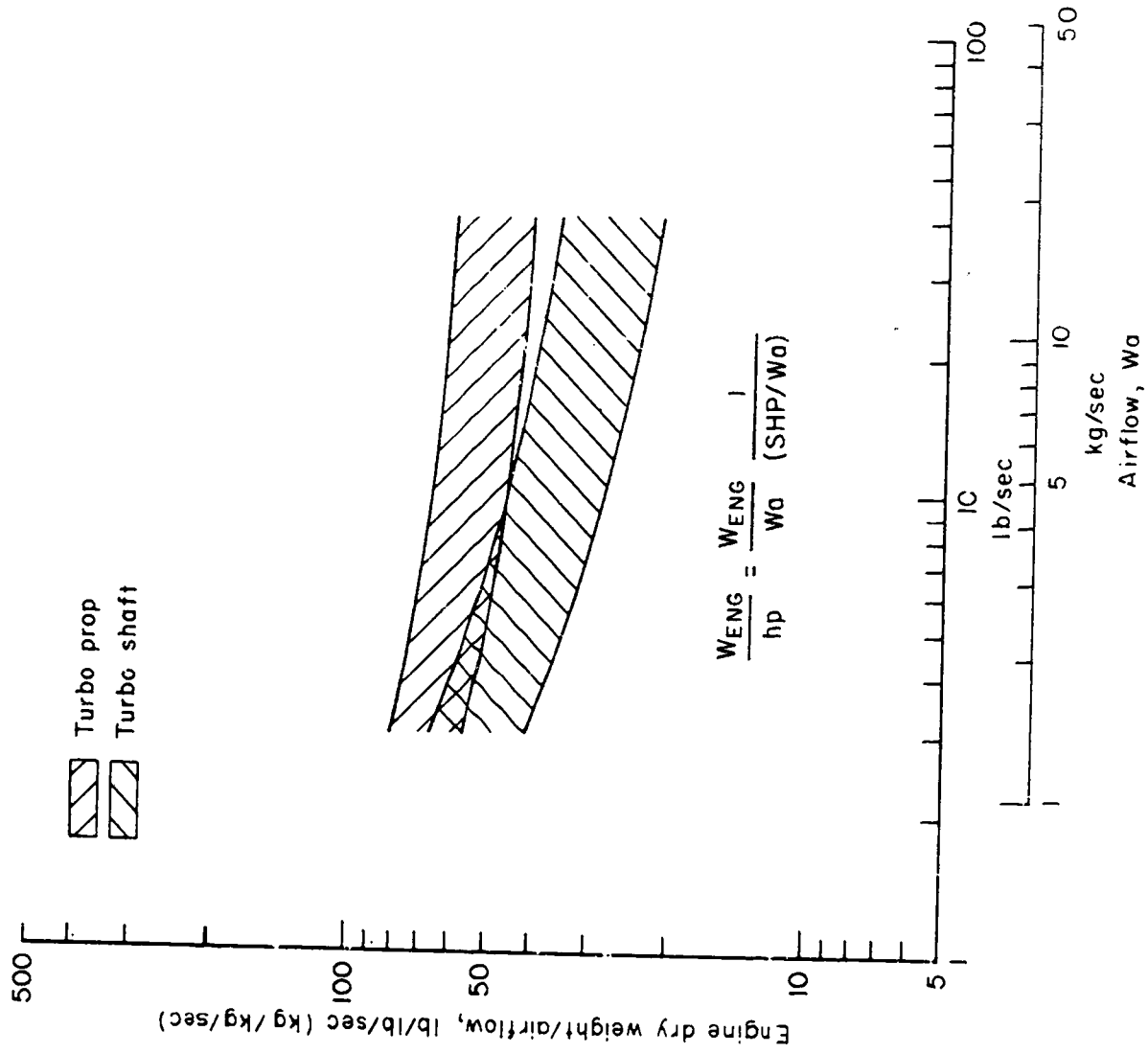

FIGURE C 17B. TURBOPROP AND TURBOSHAFT ENGINE DRY WEIGHT

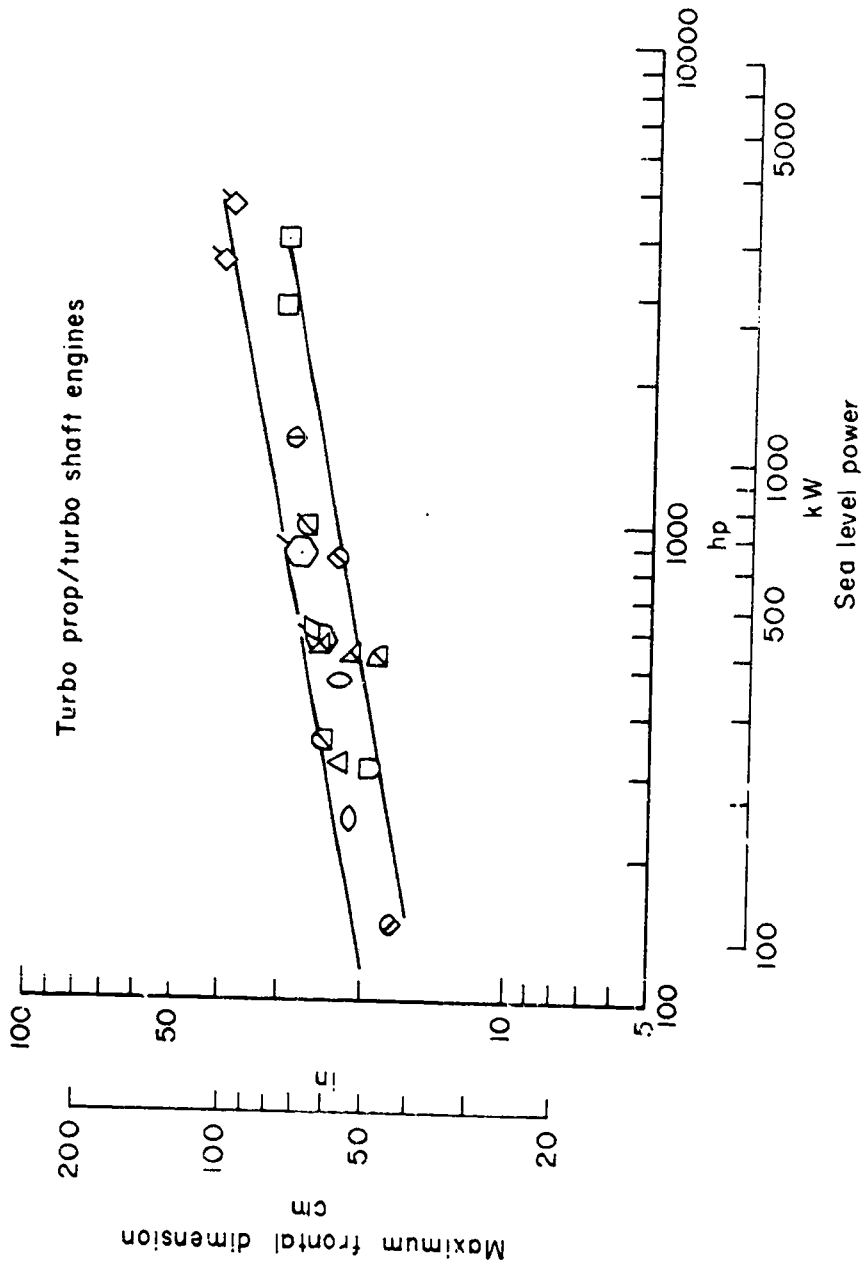

FIGURE C-18. TURBOPROP AND TURBOSHAFT FRONTAL DIMENSION

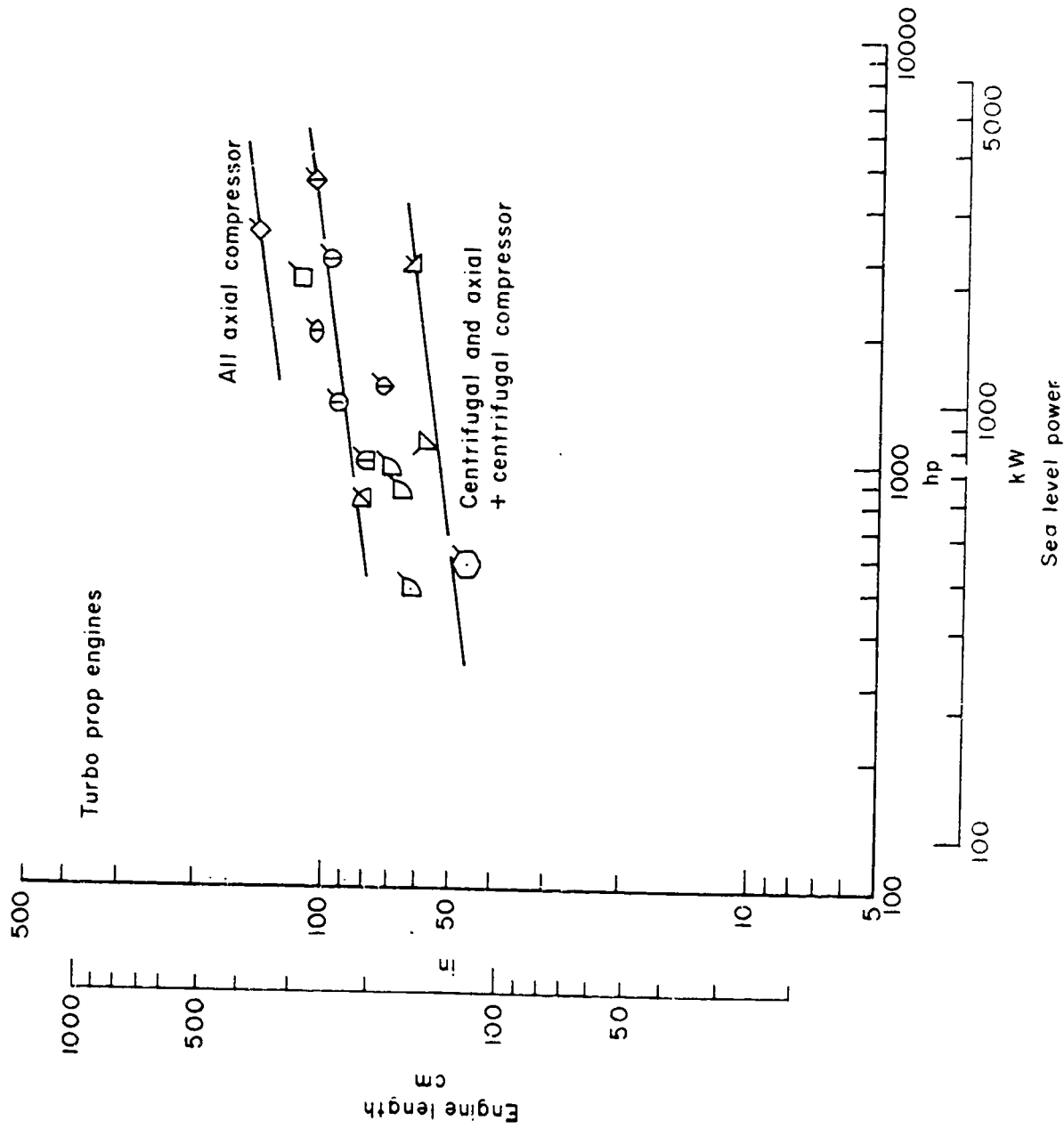

FIGURE C-19. TURBOPROP ENGINE LENGTH

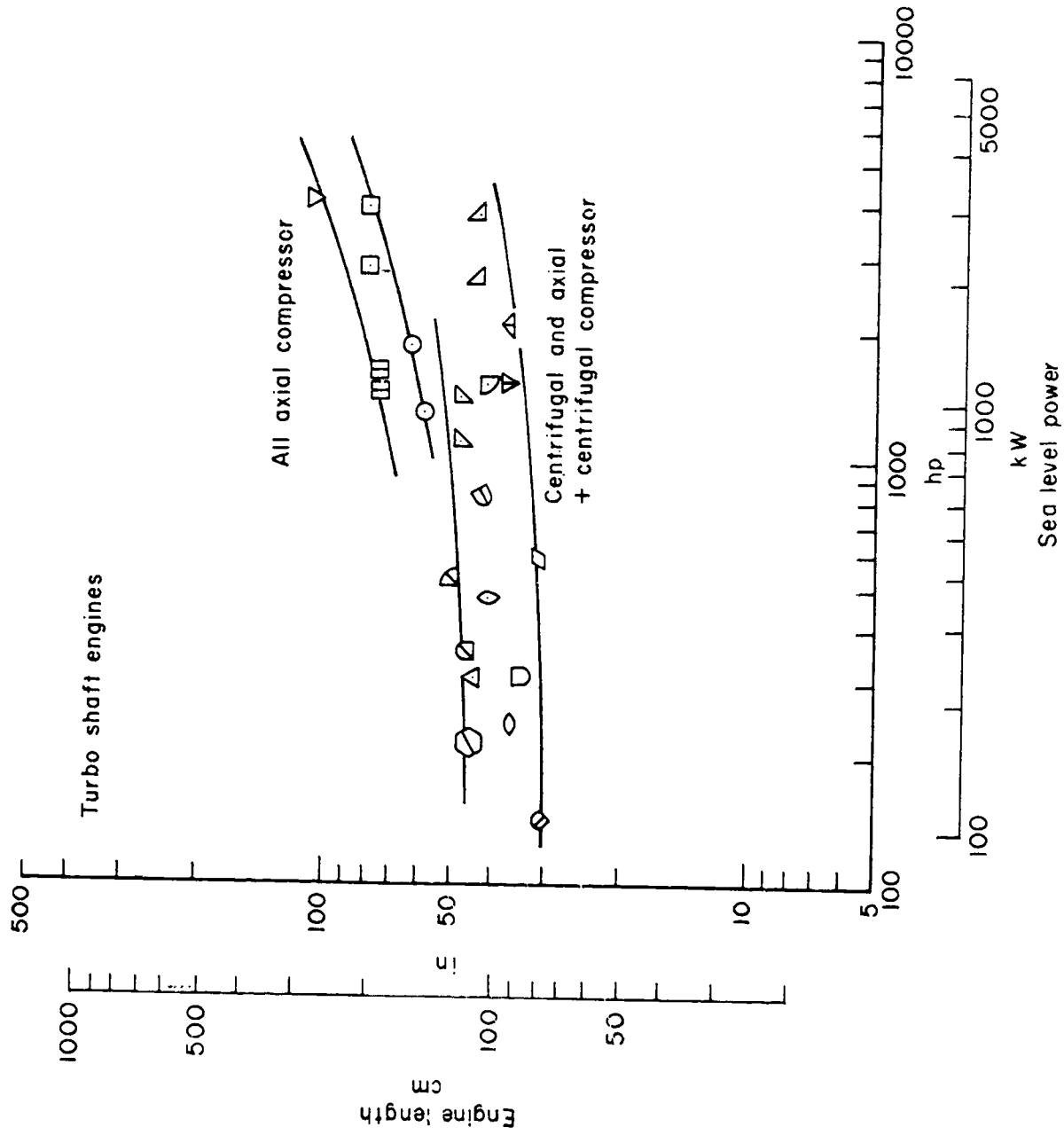

FIGURE C-20. TURBOSHAFT ENGINE LENGTH

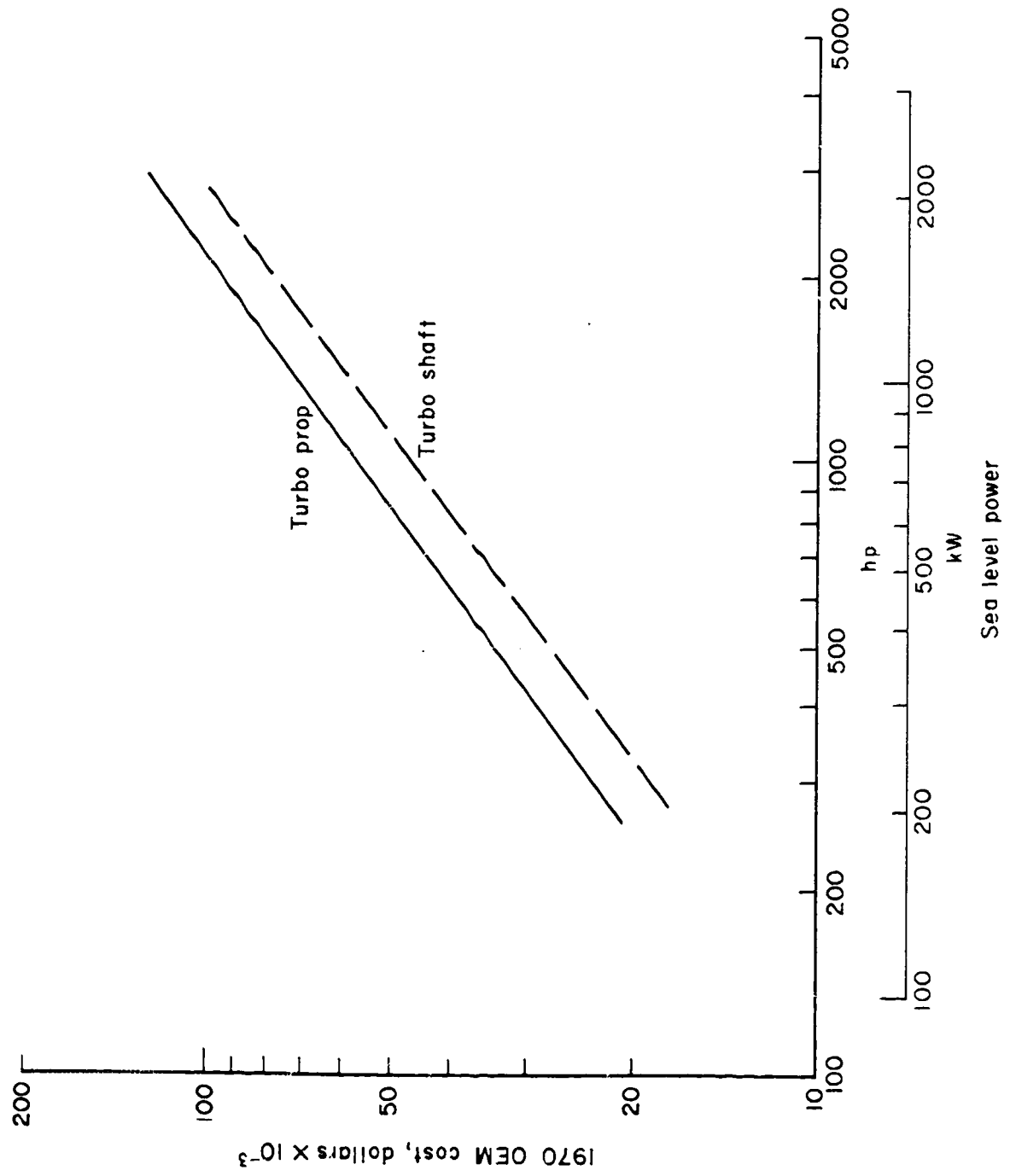

FIGURE C-21. 1970 O. E. M. COSTS FOR TURBOPROP AND TURBOSHAFT ENGINES

APPENDIX D

Q-FAN COMPUTER PROGRAM FOR GENERAL AVIATION AIRCRAFT

Performance, noise, weight and cost generalizations based on the methodology discussed in the main text were computerized. With this computer program, parametric studies can be made which permit the evaluation of trade-offs among these factors for various configurations. Variations in Q-Fan diameter, 2 - 7 feet, total activity factor (750 - 3000), activity factor (120 - 270), 0.7 integrated design lift coefficient, number of blades (5 - 11), duct length/rotor diameter ratio (0.65 - 1.20), rotor to duct exit area ratio (0.8 to 1.1) for a tip speed range of 450(137) to 800 ft/s (244 m/s).

Specific cost criteria based on a unit cost factor, a learning curve and manufacture quantity are included as well as the option of inputting these quantities.

The computer deck is designated Hamilton deck H604 and is programmed in FORTRAN V. The following are the pertinent input/output instructions.

Program Input

The first card includes the card number in column 3 and any legal Hollerith punched in columns 4 through 72. The second card contains the following input data in an (I3, 3X, 10F6.0) format:

1. Card number
2. Initial diameter, ft.
3. Increment in diameter if a range of diameters are to be computed
4. Number of diameters
5. Initial total activity (TAF) (the computer will select activity factor/blade, number of blades and duct length/rotor diameter ratio corresponding to minimum noise.
6. Increment of TAF if a range is to be computed.
7. Number of TAFs
8. Initial rotor to duct exit area ratio, A.R.
9. Increment of A.R. if a range is to be computed
10. Number of A.R. s.

11. Variable pitch = 0., fixed pitch = 1.

The third card contains the following input data in a (2I3, 7F6.0) format:

- 1 Card number
2. Number of operating conditions with a maximum of 10
3. Time period. Code 1970 or 1980 whichever time period is being studied.
4. Airplane classification (Table ID). It is to be noted that the Q-Fans weight and cost generalizations are not applicable for category I.
5. Mount - If gear box weight presented in section on gearbox generalizations is to be used, code mount = 1., since mount and gear box weights are combined. Otherwise code 0.

Items 6 through 9 include the various cost options. Code all of these items as zero if the cost criteria built into the computer program is to be used. It is defined as follows:

$$C = ZF (7.0^{0.5} + E)$$

$$C_1 = F (7.0^{0.5} + E)$$

where:

C - Average O.E.M. Q-Fan cost for a number of units/year, \$/lb.

C₁ - Single unit O.E.M. Q-Fan rotor cost, \$/lbs.

Z - $\frac{LF}{LF_1}$

LF - Learning curve factor for a number of units/year

LF₁ - Learning curve factor of a single unit

B - Number of blades

F - Single unit cost factor

E - Empirical factor

The 89% slope learning curve is used and F, E and quantities are defined as follows:

Category	1970			1980		
	F	E	Quantity	F	E	Quantity
II	2.1	1.5	2810	2.1	1.5	5470
III	2.1	3.5	1030	2.1	3.5	1990
IV	2.1	3.5	295	3.2	3.5	680
V	2.4	3.5	65	3.6	3.5	368

If any deviations are required, the following additional information must be coded.

Learning Curve Variation: It is based on assuming that a learning curve is a straight line when plotted on log paper. The learning curve is replaced as follows:

6. Learning curve factor for a single unit
7. Learning curve factor for 1000 units

Unit Cost Factor: If a revision in unit cost is required, code as follows:

8. Unit cost, \$/lb.

Quantity Variation: To investigate the effects of quantity changes on cost, code as follows:

9. Quantity to be used.

Subsequent cards are coded as follows with an (I6, 8F6.0) format:

1. Performance variations; KODE:
 - KODE = 1 for defining condition with thrust, (lbs.)
 - KODE = 2 for defining condition with power, SHP
 - KODE = 3 for defining condition with blade angle for fixed pitch application
2. SHP or thrust/Q-Fan or blade angle corresponding to option specified in (1) above.
3. Altitude in ft.
4. Velocity in knots, true airspeed. Code a condition corresponding to 66 knots for calculating of noise, weight, and cost.

5. Temperature in °F. If standard day, Code = 0.
6. Pressure in lbs/ft². If standard day, Code = 0.
7. Initial tip speed, $\frac{\pi ND}{60}$, fps
8. Increments of tip speed if a range is to be computed.
9. Number of tip speeds.

For subsequent cases, repeat all the input data previously specified. For termination code a card with 25 in an (I3) format.

Program Output

The input data prints out initially and then the pertinent data under the following headings:

1. DIA. FT - rotor diameter, ft.
2. T.S. FPS - tip speed, fps
3. NO.BL - number of blades
4. AF/BL - activity factor/blade
5. L/D - duct length to rotor diameter ratio
6. SHP - power
7. Thrust - net thrust/Q-Fan. Includes shroud external and internal drag losses and inlet ram recovery losses.
8. ANGLE - blade angle at 3/4 radius

The following items print out if velocity = 66 knots.

9. PND_B - perceived noise level at 500 ft. side line in PNdB
10. DBA - Weighted decibel, dBA
11. WT-LBS - Q-Fan weight in pounds
12. COST - Q-Fan cost in dollars

For the option where tip speed is varied, the calculations are made for the input ranges in the following order

1. Tip speed
2. Diameter
3. Total activity factor
4. Area ratio
5. Operating condition

The following warnings or messages print out

1. 'TOTAL ACTIVITY FACTOR OF 'F6.3', EXCEEDS LIMITS' - the input TAF exceeds the permissible 750-3000 TAF range. Check to see whether Δ TAF or number of TAF's result in exceeding the limit.
2. 'KODE IS AN ILLEGAL NUMBER, KODE = ', IC' - the input item specifying whether the horsepower, thrust or blade angle option is required has been included as other than 1, 2 or 3, the only options available.
3. 'ADVANCE RATIO TOO HIGH = F8.4' - check to see whether the input diameter, rpm, and velocity are correct. The advance ratio limits are 0 to 5.
4. 'AREA RATIO EXCEEDS LIMITS/AR = F3.0' - the input AR exceeds the permissible 0.8 to 1.1 AR range. Check to see whether, Δ AR or no. of AR's result in exceeding the limits.
5. 'BLADE ANGLE = F4.2, EXCEEDS LIMITS OF 21-60 DEGREES' - check to see that for option KODE = 3, the input blade angle is within the limits.
6. 'MACH NO. OF TIP SPEED LIMITS ARE EXCEEDED/MACH NO. = F4.3, TIP SPEED = F5.0' - the input exceeds the Mach No. limits of 0.0 to 0.5 or the tip speed exceeds the limits of 450 - 900 ft/s. Check to see whether Δ tip speed or no. of tip speeds results in exceeding the limits.
7. 'CPE = F5.3, EXCEEDS THE CPE LIMIT = F5.3' - the power or thrust requirement exceeds the limits of the generalization. Reduce power or thrust and try again.
8. 'ILLEGAL AIRPLANE CATEGORY' - the input value for airplane category no. is other than the permissible 2. - 5.

9. 'THE DIAMETER RANGE OF 2-7 FT. IS EXCEEDED; DIAMETER = ' - the diameter exceeds the 2-7 ft limit restriction for noise computation.
10. 'TIP SPEED = F6.0, EXCEEDS LIMITS FOR NOISE CALCULATION' - the permissible tip speed range for noise calculations of 450 - 800 ft/s has been exceeded.
11. 'THRUST/DIAMETER SQUARED = F5.0, EXCEEDS LIMIT FOR NOISE CALCULATION' - The thrust/diameter squared is too high. Reduce the thrust or power requirements and try again.

Sample Cases

Coding for three sample cases of the input are shown in figure D-1 and the corresponding output are presented as figures D-2 through D-4 respectively. The sample cases are presented in the following order:

1. The condition is defined by thrust, tip speed, AR and diameter variations and request for performance and cost calculations based on the information included in the computer program.
2. The condition is defined by power and tip speed and diameter variations and request for performance.
3. The condition is defined by blade angle and tip speed variation.

Computer Deck

The flow chart for the computer program is shown on figure D-5 and a listing is presented as figure D-6. The computer program has been run on an IBM - System/370. Approximately 500 operating conditions are computed per minute.

TABLE D-1

ADVANCED GENERAL AVIATION Q-FAN™ STUDY

AIRCRAFT CLASSIFICATION

Aircraft Class	Seats	Cruise Vel., MPH (m/s)	Engine Power SHP (kw)	Propeller Type	Application	Gross Weight, lbs. (kg)	Price Range	Example Aircraft
I. Single Eng. Trainer Fixed Gear	2-4	100-160 (45-72)	100-200 (75-149) Recip DD	Fixed Pitch 2 Blades	Trainer, Private Rental, Aerobatic	1000-2500 (454-1132)	\$8-35K	CESSNA 170, 172, Skyhawk BEECH Musketeer A2 M-19 PIPER Super Cub, Cherokee
II. Single Eng. Adv. Trainer Retract Gear IFR Equip.	4-6	120-150 (51-67)	150-300 (112-221) Recip DD & Geared Some Small Turboprops	Constant Speed 2 Blades, Some 3 Blades	Adv. Trainer Private (Family) Survey, Business	2000-4000 (909-1814)	\$20-50K	CESSNA Skywagon 180, 206, 207, 210 BEECH Bonanza, Musketeer Super 300 PIPER Comanche C, Cherokee Arrow MOONEY M20F
III. Light Twins Retract Gear IFR Equip.	4-6	150-300 (67-134)	150-300 (112-221) Recip DD & Geared Some Small Turboprops	Constant Speed 2 Blades Some 3 Blades Deicing	Private (Family) Survey, Business	3500-6000 (1590-2720)	\$40-120K	CESSNA Super Skymaster, 310C BEECH Turbobaron, Barron 55 PIPER Twin Comanche C, Aztec D MOONEY Aerostar
IV. Medium Twins Retract Gear IFR Equip.	6-11	150-300 (67-134)	250-450 (186-336) Turboprops, Recip DD & Geared	Constant Speed Full Feather Deicing 3 Blades	Executive Charter Air Taxi	6000-8000 (2720-3620)	\$100-200K	CESSNA 441B, 441Q, 441R, 421 BEECH Queen Air Duke PIPER Navajo 300, Turbo Navajo NORTH AMERICAN HOCEWELL- Shrike Commander PIPER-ARROW 15-A, 15-A, 15-A, Helio Twin, Callion
V. Heavy Twins Retract Gear IFR Equip.	11 & Up	175-400 (78-179)	600-1500 (447-1119) Turbines	Constant Speed Full Feather Deicing, Reverse 3 and 4 Blades	Large Executive Charter, Third Tier Air Liners	9000-12,500 (3920-5660)	\$300-600K	EMBRAER Twin Otter BOEING M-26 NORTH AMERICAN HOCEWELL Hawk Commander BEECH King Air BAE 140-140-140 Jetstream

ENGINEER ROSE WARBEL UAC CODING FORM #3 EXTENSION 306
 TITLE GENERAL AVIATION Q-FAN STUDY ANALYST R. WARBEL SHEET 1 OF 1
 JOB NO H601 ACCT NO 04600 W J N G 167-100-100A

1	2	3	4	5	6	7	8	9	10	11	12	13	14	15	16	17	18	19	20	21	22	23	24	25	
SAMPLE CASE #1																									
TIP SPEED, AR, AND DIA. VARIATIONS																									
1	THRUST INPUT	2	1500.	1000.	2	1.	-1	2																	
2	3.5	5.	0.	0.	0.	0.	100.	3.																	
3	11980.	5.	66.																						
4	11500.	0.																							
SAMPLE CASE #2																									
TIP SPEED, AR, AND DIA. VARIATIONS																									
1	THR INPUT	2	1500.	1000.	2	1.	-1	2																	
2	3.5	5.	0.	0.	0.	0.	50.	4.																	
3	11980.	5.	0.																						
4	2550	2000.	245.																						
SAMPLE CASE #3																									
TIP SPEED VARIATION -- FIXED PITCH																									
1	BLADE ANGLE INPUT	2	2000.	0.	1.	0.	1.																		
2	2.5	0.	0.	0.	0.	0.	-100.	4.																	
3	21980.	2.	66.																						
4	355.	0.	1000.	180.																					
5	355.																								

FIGURE D-1. SAMPLE INPUT CODING

HAMILTON STANDARD COMPUTER DECK NO. HCC-
 COMPUTES PERFORMANCE, WEIGHT, AND COST FOR
 GENERAL AVIATION Q-FANS

1 THRUST INPUT -- TIP SPEED, AR, AND DIA. VARIATIONS

OPERATING CONDITION

THRUST = 1500. CLASSIFICATION = 5. CLF1 = 0.0
 ALT-FT = 0. GEAR BOX = 1. CLF = 0.0
 V-KTAS = 66.0 DATE = 1980. SCING = 0.0
 TEMP F = 0.0 PITCH TYPE = 0. QLANT = 0.
 PRESS. = 0.

TOTAL ACTIVITY FACTOR = 1500. AREA RATIO = 1.000

DIA. FT.	T.S.FPS	NO. BL	AF/BL	L/D	SHP	THRUST	ANGLE	PNDB	DBA	WT-LBS	COST
3.50	550.	8.	187.5	0.860	711.	1500.	55.0	102.8	90.8	158.	2162.
3.50	650.	9.	187.5	0.860	707.	1500.	45.3	95.0	83.0	169.	2487.
3.50	750.	9.	166.7	0.820	706.	1500.	38.7	89.1	77.1	165.	2541.
4.00	550.	8.	187.5	0.860	649.	1500.	47.7	92.6	80.6	205.	2761.
4.00	550.	8.	187.5	0.860	636.	1500.	39.4	88.0	76.0	217.	3155.
4.00	750.	9.	166.7	0.820	648.	1500.	34.1	85.5	73.5	213.	3223.

TOTAL ACTIVITY FACTOR = 2500. AREA RATIO = 1.000

DIA. FT.	T.S.FPS	NO. BL	AF/BL	L/D	SHP	THRUST	ANGLE	PNDB	DBA	WT-LBS	COST
3.50	550.	10.	250.0	1.046	727.	1500.	50.1	76.5	64.5	245.	4927.
3.50	550.	10.	250.0	1.046	717.	1500.	41.1	79.1	67.1	274.	5919.
3.50	750.	11.	227.3	1.021	728.	1500.	35.6	82.4	70.4	277.	6319.
4.00	550.	10.	250.0	1.046	658.	1500.	43.3	75.3	63.3	315.	6249.
4.00	650.	10.	250.0	1.046	656.	1500.	36.2	78.7	66.7	351.	7496.
4.00	750.	11.	227.3	1.021	682.	1500.	31.5	82.3	70.3	355.	8014.

TOTAL ACTIVITY FACTOR = 1500. AREA RATIO = 0.900

DIA. FT.	T.S.FPS	NO. BL	AF/BL	L/D	SHP	THRUST	ANGLE	PNDB	DBA	WT-LBS	COST
3.50	550.	8.	187.5	0.860	753.	1500.	56.6	102.8	90.8	159.	2181.
3.50	650.	8.	187.5	0.860	736.	1500.	45.8	95.0	83.0	169.	2503.
3.50	750.	9.	166.7	0.820	730.	1500.	38.5	89.1	77.1	165.	2555.
4.00	550.	8.	187.5	0.860	677.	1500.	48.3	92.6	80.6	205.	2778.
4.00	650.	8.	187.5	0.860	655.	1500.	39.1	88.0	76.0	218.	3170.
4.00	750.	9.	166.7	0.820	670.	1500.	33.2	85.5	73.5	213.	3240.

TOTAL ACTIVITY FACTOR = 2500. AREA RATIO = 0.900

DIA. FT.	T.S.FPS	NO. BL	AF/BL	L/D	SHP	THRUST	ANGLE	PNDB	DBA	WT-LBS	COST
3.50	550.	10.	250.0	1.046	765.	1500.	51.0	76.5	64.5	246.	4970.
3.50	650.	10.	250.0	1.046	739.	1500.	41.1	79.1	67.1	275.	5952.
3.50	750.	11.	227.3	1.021	752.	1500.	35.0	82.4	70.4	279.	6359.
4.00	550.	10.	250.0	1.046	676.	1500.	43.3	75.3	63.3	316.	6279.
4.00	650.	10.	250.0	1.046	676.	1500.	35.6	78.7	66.7	352.	7536.
4.00	750.	11.	227.3	1.021	706.	1500.	30.3	82.3	70.3	357.	8065.

FIGURE D-2. SAMPLE CASE I OF COMPUTER PRINT OUT

HAMILTON STANDARD COMPUTER DECK NO. H6C4
 COMPUTES PERFORMANCE, NOISE, WEIGHT, AND COST FOR
 GENERAL AVIATION Q-FANS

1 SHP INPUT -- TIP SPEED, AR, AND DIA. VARIATIONS

OPERATING CONDITION

SHP = 550. CLASSIFICATION = 5. CLFi = 0.0
 ALT-FT = 20000. GEAR BOX = 1. CLF = 0.0
 V-KTAS = 245.0 DATE = 1980. SCING = 0.0
 TEMP F = 0.0 QUANT = 0.
 PRESS. = 0. PITCH TYPE = 0

TOTAL ACTIVITY FACTOR = 1500. AREA RATIO = 1.000
 DIA FT T.S.FPS SHP THRUST ANGLE
 3.50 600. 550. 514. 58.1
 3.50 650. 550. 522. 54.2
 3.50 700. 550. 524. 50.8
 3.50 750. 550. 519. 47.9
 4.00 600. 550. 520. 54.0
 4.00 650. 550. 526. 50.6
 4.00 700. 550. 525. 47.5
 4.00 750. 550. 517. 44.7

TOTAL ACTIVITY FACTOR = 2500. AREA RATIO = 1.000
 DIA FT T.S.FPS SHP THRUST ANGLE
 3.50 600. 550. 518. 54.1
 3.50 650. 550. 518. 50.6
 3.50 700. 550. 512. 47.6
 3.50 750. 550. 501. 44.8
 4.00 600. 550. 513. 50.8
 4.00 650. 550. 510. 47.6
 4.00 700. 550. 504. 44.7
 4.00 750. 550. 494. 42.2

TOTAL ACTIVITY FACTOR = 1500. AREA RATIO = 0.900
 DIA FT T.S.FPS SHP THRUST ANGLE
 3.50 600. 550. 520. 57.4
 3.50 650. 550. 528. 53.4
 3.50 700. 550. 529. 49.8
 3.50 750. 550. 526. 46.6
 4.00 600. 550. 530. 53.0
 4.00 650. 550. 534. 49.3
 4.00 700. 550. 534. 46.0
 4.00 750. 550. 528. 43.2

TOTAL ACTIVITY FACTOR = 2500. AREA RATIO = 0.900
 DIA FT T.S.FPS SHP THRUST ANGLE
 3.50 600. 550. 528. 53.0
 3.50 650. 550. 526. 49.4
 3.50 700. 550. 521. 46.1
 3.50 750. 550. 512. 43.2
 4.00 600. 550. 526. 49.3
 4.00 650. 550. 524. 45.9
 4.00 700. 550. 517. 43.0
 4.00 750. 550. 511. 40.6

FIGURE D-3. SAMPLE CASE II OF COMPUTER PRINT OUT

HAMILTON STANDARD COMPUTER DECK NO. H604
 COMPUTES PERFORMANCE, NOISE, WEIGHT, AND COST FOR
 GENERAL AVIATION Q-FANS
 1 BLADE ANGLE INPUT -- TIP SPEED VARIATION -- FIXED PITCH

OPERATING CONDITION

ANGLE = 55. CLASSIFICATION = 2. CLF1 = 0.0
 ALT-FI = 0. GEAR RCX = 1. CLF = 0.0
 V-KTAS = 66.0 DATE = 1980. SCING = 0.0
 TEMP F = 0.0 QUANT = 0.
 PRESS. = 0. PITCH TYPE 1

TOTAL ACTIVITY FACTOR= 2050. AREA RATIO = 1.000
 DIA. FT. T.S.FPS NU.BL WF/RL L/F SHP THRUST ANGLE PNDP DBA WT-LBS COST
 2.50 600. 11. 186.4 0.900 1256. 1809. 55.0 90.0 78.0 91.
 2.50 700. 10. 205.0 0.946 800. 1400. 55.0 88.5 76.5 87.
 2.50 600. 9. 227.8 0.964 556. 1029. 55.0 86.5 74.3 84.
 2.50 500. 9. 227.8 0.964 331. 696. 55.0 81.0 69.0 76. 444.

OPERATING CONDITION

ANGLE = 55. CLASSIFICATION = 2. CLF1 = 0.0
 ALT-FI = 1000. GEAR BCX = 1. CLF = 0.0
 V-KTAS = 180.0 DATE = 1980. SCING = 0.0
 TEMP F = 0.0 QUANT = 0.
 PRESS. = 0. PITCH TYPE 1

TOTAL ACTIVITY FACTOR= 2050. AREA RATIO = 1.000
 DIA FT T.S.FPS SHP THRUST ANGLE
 2.50 750. 771. 839. 55.0
 2.50 650. 500. 601. 55.0
 2.50 550. 309. 386. 55.0
 2.50 450. 167. 228. 55.0

FIGURE D-4. SAMPLE CASE III OF COMPUTER PRINT OUT

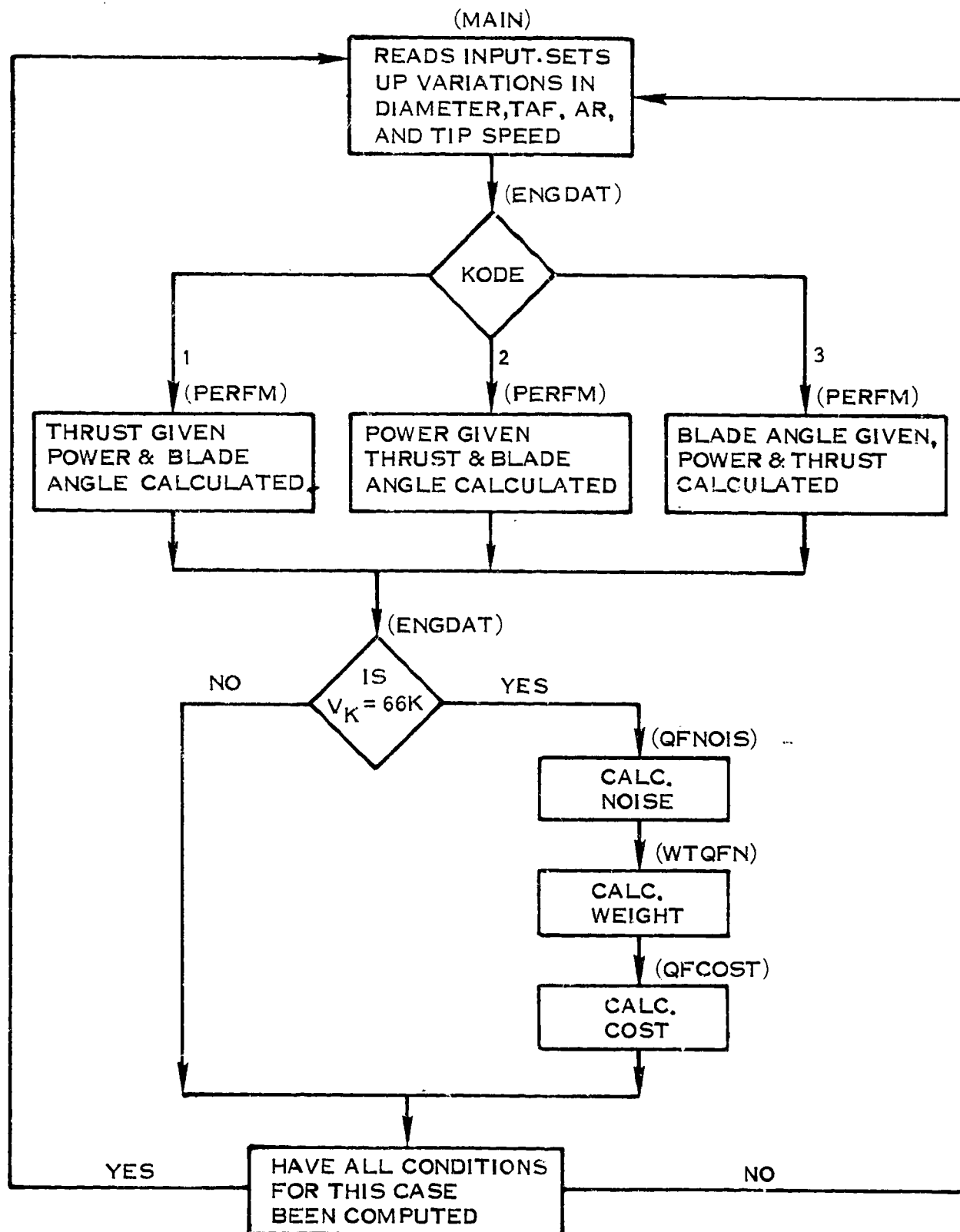

FIGURE D-5. FLOW CHART FOR H.S. DECK H604

```

HAMILTON STANDARD COMPUTER DECK H604 -Q-FANS FOR GENERAL AVIATION
DIMENSION CNBL(31),CLOD(27),JKODE(10),ALT(10),VKTS(10),TC(10),
LPO(10),TPSP(10),DTPSP(10),XTPSP(10),THRUST(10),SHP(10),ANGLE(10)
DATA CNBL /1.,1.,6.,3.,750.,1120.,1500.,1900.,2480.,3000.,650.,
1750.,800.,5.0,6.0,6.0,6.4,7.4,9.0,8.0,9.0,9.92,8.8,9.8,11.0,9.92,
211.0,11.0,11.0,11.0,11.0/
DATA CLOD /2.,1.,5.,3.,750.,960.,2000.,2420.,3000.,650.,750.,800.,
1.716.,.680.,.675.,.757.,.714.,.693.,.955.,.918.,.897,1.032,1.003,.994,
21.136,1.136,1.136/
PCPPM=1.0
ZFLAG=1.
CR=1.
NOF=1
5 WRITE (6,1)
1 FORMAT ('1',18X,'HAMILTON STANDARD COMPUTER DECK NO. H604'/14X,'COM
PUTES PERFORMANCE,NOISE,WEIGHT, AND COST FOR'/25X,'GENERAL AVIATIO
N Q-FANS')
READ (5,10) ICARD
10 FORMAT(I3,69H
1
)
IF(ICARD.EQ.25) GO TO 6000
WRITE(6,10) ICARD
READ (5,20) DIA,DDIA,XDIA,TAFI,DTAFI,XTAFI,ARI,DARI,XARI,
LXFP,KWRITE
IFP=XFP+.01
20) FORMAT(6X,10F6.0,16)
DDIA=XDIA+.01
DTAFI=XTAFI+.01
DARI=XARI+.01
READ (5,30) NOF,XDATE,CATN,GBOXM,CLF1,CLF,SCING,QUANT
30) FORMAT(3X,I3,10F6.0)
DO 50 IC=1,NOF
READ (5,40) JKODE(IC),TEMP,ALT(IC),VKTS(IC),TO(IC),PO(IC),TPSP(IC)
1,DTPSP(IC),XTPSP(IC)
40) FORMAT(3X,I3,10F6.0)
IF(JKODE(IC).GT.1) GO TO 42
THRUST(IC)=TEMP
GO TO 50
42 IF(JKODE(IC).GT.2) GO TO 44
SHP(IC)=TEMP
GO TO 50
44 ANGLE(IC)=TEMP
50 CONTINUE
XDATE=XDATE+.01
DO 5000 IC=1,NOF
PORO=0.
NTPSP=XTPSP(IC)
H=ALT(IC)
TJ=TO(IC)
PJ=PO(IC)
WRITE (6,55)
55) FORMAT (/23X,'OPERATING CONDITION'/)
KKDE=JKODE(IC)
GO TO (60,70,80),KKDE
60) WRITE (6,65) THRUST(IC),CATN,CLF1
65) FORMAT(I10,2X,'THRUST =',F7.0,5X,'CLASSIFICATION =',F5.0,4X,'CLF1

```

FIGURE D-6. LISTING OF ADVANCED GENERAL AVIATION Q-FAN PROGRAM
(PAGE 1 OF 26)

```

1  =',F6.2)
  GO TO 90
70 KKDE=7
  WRITE (6,75) SHP( IC),CATN,CLF1
75 FORMAT(1H0,2X,'SHP      =',F7.0,5X,'CLASSIFICATION  =',F5.0,4X,'CLF1
1  =',F6.2)
  GO TO 90
80 KKDE=8
  WRITE (6,85) ANGLE( IC),CATN,CLF1
85 FORMAT(1H0,2X,'ANGLE   =',F7.0,5X,'CLASSIFICATION  =',F5.0,4X,'CLF1
1  =',F6.2)
90 WRITE (6,95) H,GBOXM,CLF,VKTS( IC),XDATE,SCING,TO,QUANT,PO,IFP
95 FORMAT(3X,'ALT-FT =',F7.0,5X,'GEAR BCX',8X,'=',F5.0,4X,'CLF   =',
1F6.2/3X,'V-KTAS =',F7.1,5X,'DATE',12X,'=',F5.0,4X,'SCING =',F5.1/
23X,'TEMP F =',F7.1,31X,'QUANT =',F5.0/3X,'PRESS. =',F7.0,
35X,'PITCH TYPE',6X,I5)
  ARA=ARI-DARI
  DO 4000 I=1,NARI
  ARA=ARA+DARI
  TAF=TAFI-DTAFI
  DO 3000 J=1,NTAFI
  TAF=TAF+DTAFI
  IF(VKTS( IC).NE.66.) GO TO 285
  WRITE (6,280) TAF,ARA
280 FORMAT(1H0,'  TOTAL ACTIVITY FACTOR=',F7.0,'  AREA RATIO =',F6.3
1/'  DIA.FT. T.S.FPS NO.BL AF/BL L/D  SHP  THRUST  ANGLE  PNDB
2  DBA  WT-LBS  COST')
  GO TO 289
285 WRITE(6,288) TAF,ARA
288 FORMAT(1H0,'  TOTAL ACTIVITY FACTOR=',F7.0,'  AREA RATIO =',F6.3
1/'  DIA FT  T.S.FPS  SHP  THRUST  ANGLE')
289 DROT=DIA-DDIA
  DO 2000 K=1,NDIA
  DROT=DROT+DDIA
  TS=TPSP( IC)-DTPSP( IC)
  DO 1000 L=1,NTPSP
  II=0
  KODE=KKDE
  TS=TS+DTPSP( IC)
  XNMAX=60.*TS/(3.141617*DROT)
  DEFINITION OF NO. OF BLADES AND AF AS F(TAF,TS)
  IF(TAF.GE.750..AND.TAF.LE.3000.) GO TO 310
  WRITE(6,290) TAF
290 FORMAT(1H0,'  TOTAL ACTIVITY FACTOR OF',F6.3,'  EXCEEDS LIMITS')
  GO TO 6000
310 CALL P'LINE (CNBL,1,TAF,TS,BL,LIMIT)
  IRL=BL+.5
  BL=IRL
  AF=TAF/BL
  CALL BILINE (CLOD,1,TAF,TS,COD,LIMIT)
315 CALL ENGDAT (XNMAX,PCRPM,GR,DROT,THRUST( IC),SHP( IC),EFFP,VKTS( IC),
1ROPO,KODE,IERROR,WQFT,CQFT,BMEP,ZNQFT1,ZNQFT2,ANGLE( IC),NOE,CATN,
2PO,TO,BL,AF,COD,ARA,ZFLAG,GBOXM,IDATE,QUANT,CLF1,CLF,SCING,
3KWRITE,H,IFP)
  II=II+1
  IF(VKTS( IC).NE.66.) GO TO 400

```

FIGURE D-6. LISTING OF ADVANCED GENERAL AVIATION Q-FAN PROGRAM
(PAGE 2 OF 26)

```

GO TO (320,340,360,380),II
320 KODE=21
GO TO 315
340 IF (QUANT.EQ.0..AND.CLF1.EQ.0..AND.CLF.FQ.0..AND.SCING.EQ.0.) KODE 2
    l=11. 1
    IF (QUANT.EQ.0..AND.CLF1.NE.0..AND.CLF.NE.0..AND.SCING.EQ.0.) KODE 1
    l=12. 1
    IF (QUANT.NE.0..AND.CLF1.EQ.0..AND.CLF.EQ.0..AND.SCING.EQ.0.) KODE
    l=13
    IF (QUANT.NE.0..AND.CLF1.NE.0..AND.CLF.NE.0.) KODE=14
    IF (QUANT.EQ.0..AND.CLF1.EQ.0..AND.CLF.FQ.0..AND.SCING.NE.0.) KODE
    l=15
    IF (QUANT.EQ.0..AND.CLF1.NE.0..AND.CLF.NE.0..AND.SCING.NE.0.) KODE
    l=16
GO TO 315
360 KODE=31
GO TO 315
380 CONTINUE
WRITE (6,390) DRCT,TS,BL,AF,CCD,SHP(IC),THRUST(IC),ANGLE(IC),
    lZNOFT1,ZNQFT2,WQFT,CQFT
390 FORMAT (F7.2,F8.0,F7.0,F7.1,F6.3,F7.0,F8.0,F6.1,F8.1,F7.1,F8.0,F8.0)
    l)
GO TO 1000
400 WRITE(6,410) DROT,TS,SHP(IC),THRUST(IC),ANGLE(IC)
410 FORMAT(F8.2,2F11.0,F10.0,F10.1)
1000 CONTINUE
2000 CONTINUE
3000 CONTINUE
4000 CONTINUE
5000 CONTINUE
GO TO 5
6000 CONTINUE
END

```

FIGURE D-6. LISTING OF ADVANCED GENERAL AVIATION Q-FAN PROGRAM
(PAGE 3 OF 26)

```

SUBROUTINE ENGDAT (XNMAX,PCRPM,GR,DRGT,THRUST,SHF,EFFP,VKTS,RORO,
1KODE,IERROR,WQFT,CQFT,BMEP,ZNQFT1,ZNQFT2,BLANG,NOE,CATN,
2 PU,TO,BL,AF,COO,ARA,ZFLAG,GBOXM,IDATE,QUANT,CLF1,CLF,SCING,
3KWRITE,X,IFP)
COMMON /UNIV/ NPC ,NSC ,IDC ,H ,ST ,R ,W ,
1WF ,EM ,VMU ,EMMO ,ALPHLO,CLALPH,SW ,AR ,B ,
2EYEW ,ENP ,TA ,WC ,WGS ,KWRITE,DLMC4
3,KSIZE
COMMON/PRPDAT/ZJI,CP,CT
KWRITE=KRRITE
H=X
300 RPM=XNMAX*PCRPM*GR
AFT=AF*BL
IF (KODE.GT.10) GO TO 50
IF (KODE.LE.6) KPERFM=2
IF (KODE.EQ.7) KPERFM=1
IF (KODE.GT.7.AND.KODE.LT.11) KPERFM=3
50 IF (KODE.LT.42) GO TO 350
WRITE (6,55)KODE
55 FORMAT (1H0,3X,'KODE IS AN ILLEGAL NUMBER,KODE=',I3)
IERROR=1
GO TO 5000
350 TIPSPD=.05236*RPM*DRGT
6000 IF (KODE.LT.11) GO TO 400
IF (KODE.LT.21) GO TO 500
IF (KODE.LT.31) GO TO 600
CALL QFNQIS (AF,BL,TIPSPD,THRUST,DRGT, ZNQFT1,ZNQFT2,NOE,
1IERROR,KWRITE)
GO TO 5000
400 CALL PERFM (TO,PU,RORO,H,TIPSPD,SHF,THRUST,VKTS,DRGT,AFT,ARA,COO,
1KPERFM,BMEP,BLANG,RPM,IERROR,EFFP,GR,KWRITE)
GO TO 5000
500 CALL QFCOST (CATN,IDATE,CQFT,IERROR,KODE,CLF1,CLF,CQUANT,BL,SCING,
1IFP,KWRITE)
GO TO 5000
600 CALL WTQFN(BL,DRGT,AF,SHF,TIPSPD,CATN,ZFLAG,GBOXM,WQFT,IDATE,COO,
1IFP,KWRITE)
5000 RETURN
END

```

FIGURE D-6. LISTING OF ADVANCED GENERAL AVIATION Q-FAN PROGRAM
(PAGE 4 OF 26)

```

SUBROUTINE PERFM (TC,PC,RORO,H,TIPSPL,SHP,THRUST,VKTS,DRGT,AFT,ARA
1,CAU,KPERFM,BMEP,BLANG,RPM,IEPROR,EFFP,GR,KWRITE)
DIMENSION AAFT(11),APAFT(11),ATAFT(86),          ACOD(37),CTT(7),
1CPP(7),BLL(7),ATS(9),APMN(9),AJ(5),AMN(5),ZJJ(7),BLLL(4),CTIT(7),
2CPPP(4),SHPN(7),RPMP(4),SHPP(4),XAR(4),TS(7),TIPS(4),ATHRST(4),
3ASHP(4),ALTFR(11),PRESSR(11)          ,CIANG(16,7,4),BLLCH(53),
4IAR(4)          ,ATMN(72),BLDANG(12,7,4),CPAG(12,7,4),
5CPML(5),CPMJ(5),CPANG(16,7,4),INN(7,4),INA(7,4)
DIMENSION D1(112),D2(112),D3(112),D4(112),E1(112),E2(112),E3(112),
1E4(112),G1(84),G2(84),G3(84),G4(84),H1(84),H2(84),H3(84),H4(84)
2,A1(42),A2(42),A3(42),A4(42),CDCT(42,4)
EQUIVALENCE(U1,CTANG(1,1,1)),(U2,CTANG(1,1,2)),(U3,CTANG(1,1,3)),
1(U4,CTANG(1,1,4)),(E1,CPANG(1,1,1)),(E2,CPANG(1,1,2)),(E3,CPANG(1,
21,3)),(E4,CPANG(1,1,4)),(G1,CPAG(1,1,1)),(G2,CPAG(1,1,2)),(G3,CPAG
3(1,1,3)),(G4,CPAG(1,1,4)),(H1,BLDANG(1,1,1)),(H2,BLDANG(1,1,2)),
4(H3,BLDANG(1,1,3)),(H4,BLDANG(1,1,4))
5,(A1,CDCT(1,1)),(A2,CDCT(1,2)),(A3,CDCT(1,3)),(A4,CDCT(1,4))
DATA AAFT /750.,1000.,1250.,1500.,1750.,2000.,2250.,2500.,2750.,
13000.,3250./
DATA APAFT /1.9,1.5,1.31,1.17,1.078,1.,.94,.9,.86,.825,.805/
DATA ATAFT /1.,6.,11.,0.,1.,2.,3.,4.,5.,750.,1000.,
11250.,1500.,1750.,2000.,2250.,2500.,2750.,3000.,3250.,1.54,1.32,
21.195,1.10,1.04,1.0,.965,.94,.912,.89,.875,1.695,1.375,1.228,1.12,
31.052,1.0,.96,.92,.895,.87,.845,1.99,1.51,1.31,1.16,1.07,1.0,.95,
4.90,.865,.84,.82,2.415,1.708,1.408,1.21,1.087,1.0,.93,.875,.835,
5.81,.782,2.95,1.95,1.525,1.27,1.118,1.0,.915,.848,.795,.765,.738,
63.56,2.22,1.665,1.33,1.14,1.0,.89,.805,.740,.690,.665/
DATA ACOD /2.,4.,6.,0,1.,3.,5.,7.,9.,1.,1.1,1.2,
1.0005,.0003,.0001,.0,-.0005,-.001,.004,.0035,.0018,.0,-.0038,
2-.0065,.020,.0142,.0078,.0,-.0085,-.0187,.050,.037,.020,.0,-.0252,
3-.054/
DATA XAR /.8,.9,1.0,1.1/
DATA IAR /8,9,10,11/
DATA ATS /350.,400.,450.,500.,550.,600.,700.,800.,900./
DATA APMN /1.0,1.002,1.006,1.012,1.025,1.0385,1.065,1.0885,1.10/
DATA ZJJ /0.,.5,1.,2.,3.,4.,5./
DATA ALTFR /0.,10000.,20000.,30000.,40000.,50000.,
160000.,70000.,80000.,90000.,100000./
DATA PRESSR /1.0,.6877,.4595,.2970,.1851,.1145,.07078,
1.04419,.02741,.01699,.01054/
DATA TS /350.,450.,550.,650.,750.,850.,900./
DATA D1/
1.275,.522,.714,1.002,1.316,1.692,2.039,2.12,2.18,2.22,3.04,3.215,
23.52,3.835,4.02,0.,
3.17,.336,.690,1.391,1.586,1.868,2.13,2.28,2.518,2.725,2.970,3.37,
43.60,3*0.,
50.,.104,.494,1.042,1.313,1.551,1.718,1.900,2.335,2.615,3.035,3.285
6,4*0.,
7-.075,.139,.382,.590,.691,.936,1.176,1.294,1.349,1.528,1.762,2.125
8,2.515,2.7455,2*0.,
9-.423,-.159,.114,.432,.940,1.036,1.132,1.227,1.44,1.695,2.07,2.278
1,4*0.,
2-.34,.047,.226,.396,.530,.654,.800,1.069,1.3,1.625,1.84,5*0.,
3-.62,-.127,.148,.451,.736,.918,1.262,1.462,8*0./
DATA D2/
1.22,.634,.890,1.170,1.504,1.777,2.054,2.406,2.505,2.94,3.167,3.61,

```

FIGURE D-6. LISTING OF ADVANCED GENERAL AVIATION Q-FAN PROGRAM

(PAGE 5 OF 26)

24.03,4.16,2*0.,
 3.125,.279,.444,.577,.783,1.188,1.646,1.901,2.18,2.325,2.505,
 42.24,3.68,7.88,2*0.,
 5-.015,.028,.351,.539,.814,1.081,1.377,1.836,2.025,2.385,2.90,3.365
 6.3.56,3*0.,
 7-.186,.008,.237,.483,.740,1.047,1.325,1.619,1.869,2.31,2.74,2.90,
 84*0.,
 9-.403,-.097,.189,.522,.816,1.161,1.638,2.13,2.315,7*0.,
 1-.35,-.198,-.005,.487,.995,1.463,1.644,1.80,8*0.,
 2-.645,-.136,.093,.352,.910,1.198,1.350,9*0./
 LATA D3/
 1.18,.388,.571,.801,1.053,1.354,2.014,2.642,2.788,2.98,3.11,3.205,
 23.30,3.54,3.790,3.81,
 3.08,.215,.309,.483,1.021,1.199,1.611,2.227,2.369,2.46,2.61,2.72,
 42.82,3.085,3.36,3.46,
 5-.034,.235,.429,.631,.876,1.118,1.363,1.951,2.108,2.22,2.34,2.44,
 62.77,3.04,3.18,0.,
 7-.118,-.012,.250,.532,.871,1.138,1.431,1.675,1.923,2.11,2.24,
 82.523,2.685,3*0.,
 9-.26,-.067,.144,.497,.904,1.308,1.480,1.518,1.762,2.08,2.22,5*0.,
 1-.50,-.287,.016,.217,.475,.740,1.032,1.060,1.288,1.658,1.77,5*0.,
 2-.67,-.505,-.335,-.146,.037,.17,.297,.610,.84,1.22,1.32,5*0./
 DATA D4/
 1.12,.353,.519,.729,.957,1.23,1.831,2.337,2.467,2.84,3.212,3.54,
 23.90,4.158,4.39,0.,
 3.04,.177,.426,.624,.841,1.089,1.395,1.659,1.900,2.27,2.41,2.745,
 42.038,3.458,3.77,4.03,
 5-.040,-.006,.140,.481,.906,1.441,1.771,2.024,2.18,2.60,3.058,3.42,
 63.62,3*0.,
 7-.252,-.154,.033,.303,.600,.875,1.242,1.871,2.315,2.76,3.02,5*0.,
 8-.535,-.259,.107,.470,.994,1.410,1.7,2.11,2.40,7*0.,
 9-1.133,-.692,-.263,.035,.294,.572,.789,1.075,1.478,1.70,6*0.,
 1-1.171,-.935,-.514,-.074,.140,.478,.815,1.00,8*0./
 DATA E1/
 1.18,.34,.485,.788,1.212,1.769,2.418,2.692,3.0,3.65,5.6.8.10.,
 211.2,0.,
 3.18,.348,.771,1.932,2.309,3.0,3.6,4.09,5.,6.,8.,10.,11.2,3*0.,
 4.18,.267,.746,1.772,2.439,3.2,3.8,4.60,6.,8.,10.,11.2,4*0.,
 5.18,.549,1.101,1.64,1.925,2.651,3.487,3.903,4.237,5.00,6.11,8.,10.,
 6,11.2,2*0.,
 7-.229,.294,1.010,2.103,4.111,4.547,5.008,5.477,6.64,8.,10.,11.2,
 84*0.,
 9.18,1.624,2.407,3.208,3.857,4.479,5.224,6.786,8.,10.,11.2,5*0.,
 1.18,1.991,3.482,5.284,6.939,8.,10.,11.2,8*0./
 DATA E2/
 1.18,.41,.635,.943,1.374,1.720,2.267,3.067,3.65,5.,6.,8.,10.,11.2,
 22*0.,
 3.18,.304,.446,.601,.857,1.485,2.392,2.872,3.60,4.09,5.,8.,10.,11.2
 4,2*0.,
 5.18,.224,.529,.8,1.294,1.816,2.502,3.857,4.60,6.,8.,10.,11.2,3*0.,
 6.084,.337,.769,1.363,2.05,2.951,3.898,5.003,6.11,8.,10.,11.2,4*0.,
 7-.178,.481,1.288,2.457,3.588,5.063,7.458,10.,11.2,7*0.,
 8.18,.795,1.502,3.705,6.314,8.916,10.,11.2,8*0.,
 9.18,2.091,3.299,4.813,8.079,10.,11.2,9*0./
 LATA E3/
 1.18,.267,.355,.534,.781,1.121,2.083,3.256,3.648,4.4,5.2,6.0,6.84,

FIGURE D-6. LISTING OF ADVANCED GENERAL AVIATION Q-FAN PROGRAM
 (PAGE 6 OF 26)

28.,10.,11.2.
 3.18.,.264.,.327.,.486,1.168,1.457,2.231,3.576,4.09,4.4,5.2,6.0,6.848,
 48.,10.,11.2.
 5.197.,.398.,.646.,.571,1.416,1.879,2.397,3.888,4.603,5.2,6.0,6.848,8.
 6.10.,11.2.0.
 7.187.,.342.,.839,1.525,2.453,3.261,4.218,5.119,6.111,6.848,8.,10.,
 811.2,3*0.
 9.18.,.678,1.283,2.5,4.074,5.791,6.642,6.848,8.,10.,11.2,5*0.,
 1.18.,.766,1.869,2.749,3.964,5.314,6.679,6.848,8.,10.,11.2,5*0.,
 2.18.,.800,1.600,2.635,3.606,4.375,4.957,6.848,8.,10.,11.2,5*0./

DATA E4/

1.18.,.255.,.328.,.470.,.674.,.980,1.758,2.593,2.84,3.65,5.,6.,8.,10.,
 211.2,0.,
 3.18.,.257.,.438.,.643.,.901,1.262,1.792,2.308,2.824,3.6,4.09,5.,6.,8.,
 410.,1.2,
 5.18.,.212.,.299.,.771,1.5,2.618,3.442,4.134,4.60,6.,8.,10.,11.2,3*0.,
 6.076.,.211.,.521,1.107,1.871,2.675,3.794,6.113,8.,10.,11.2,5*0.,
 7-.147.,.503,1.56,2.887,5.019,6.743,8.,10.,11.2,7*0.,
 8-1.277.,1.08,1.617,2.886,4.177,5.437,6.578,8.,10.,11.2,6*0.,
 9-.360.,.509,2.442,4.738,5.994,8.,10.,11.2,8*0./

DATA INN/

114,14,13,12,9,8,7,
 114,14,12,12,9,8,6,
 115,11,10,14,12,11,8,
 115,16,13,11,9,10,8/

DATA INA/

112,10,9,12,11,11,8,
 112,12,10,11,10,9,9,
 112,12,12,12,12,12,12,
 111,12,10,12,9,10,12/

DATA G1 /

1.18.,.34.,.485.,.788,1.212,1.769,2.418,2.692,3.65,4.65,5.65,6.60,
 2.18.,.348.,.771,1.932,2.309,3.0,4.09,5.0,6.0,6.6,2*0.,
 3.18.,.267.,.746,1.773,2.439,3.8,4.6,5.6,6.6,3*0.,
 4-.345.,.0.,.549,1.101,1.640,1.925,2.651,3.487,3.903,5.00,6.11,6.6,
 5-.860.,-.580.,-.229.,.294,1.010,2.103,4.111,4.547,5.008,5.477,6.64,0.,
 6,-.164,-1.295,-.815,-.140,1.624,2.407,3.208,3.857,4.479,5.224,
 76.786,0.,
 8-2.25,-1.69,-1.32,-.4,1.991,3.482,5.284,6.939,4*0./

DATA G2 /

1.18.,.41.,.635.,.943,1.374,1.720,2.267,3.061,3.65,4.65,5.65,6.6,
 2.18.,.304.,.446.,.601.,.857,1.485,2.392,2.872,3.6,4.09,5.65,6.6,
 3.18.,.224.,.529,1.294,1.816,2.502,3.857,4.60,5.6,6.6,2*0.,
 4-.218.,.084.,.337.,.769,1.363,2.05,2.951,3.898,5.003,6.11,6.6,0.,
 5-1.13,-.885,-.555,-.178,-.481,1.288,2.457,3.588,5.063,7.458,2*0.,
 6-1.86,-1.57,-1.19,-.61,-.795,1.502,3.705,6.314,8.916,3*0.,
 7-2.84,-2.55,-2.14,-1.47,-.17,2.091,3.299,4.813,8.079/

DATA G3 /

1.18.,.267.,.355.,.534.,.781,1.121,2.083,3.256,3.648,5.2,6.0,6.84,
 2.18.,.264.,.327.,.487,1.168,1.457,2.231,3.576,4.09,5.2,6.0,6.848,
 3.18.,.197.,.398.,.646.,.971,1.416,1.879,2.397,3.888,4.603,6.0,6.848,
 4-.28,-.17.,.187.,.342.,.839,1.525,2.453,3.261,4.218,5.119,6.111,6.848
 5,-1.06,-.89,-.655,-.33.,.18.,.678,1.283,2.5,4.074,5.791,6.642,6.848,
 6-1.81,-1.61,-1.32,-.9.,.18.,.766,1.869,2.749,3.964,5.314,6.679,6.848
 7,-2.49,-2.135,-1.51,.18.,.80,1.6,2.635,3.606,4.375,4.957,6.848,7.2/
 DATA G4 /

FIGURE D-6. LISTING OF ADVANCED GENERAL AVIATION Q-FAN PROGRAM

```

1.18.,.255.,.328.,.470.,.674.,.980.,1.758.,2.593.,4.134.,5.370.,6.6.,0.,
2.18.,.257.,.438.,.643.,.901.,1.262.,1.792.,2.308.,2.824.,4.134.,5.37.,6.6.,
3.18.,.212.,.299.,.771.,1.50.,2.618.,2.442.,4.134.,5.370.,6.6.,0.,0.,
4-.475, -.165, .076, .211, .521, 1.107, 1.871, 2.675, 3.794, 6.113, 6.28, 6.6,
5-1.695, -1.200, -.658, -.147, .503, 1.56, 2.887, 5.019, 6.743, 0., 0., 0.,
6-2.44, -1.678, -1.277, .108, 1.617, 2.886, 4.177, 5.437, 6.578, 6.7, 2*0.,
7-3.76, -3.34, -1.918, -1.363, -.826, -.360, .509, 2.442, 4.738, 5.994, 6.2,
86.6/
DATA H1 /
113.,19.5,23.8,29.9,36.5,43.4,50.,52.1,60.1,67.5,74.9,81.5,
214.8,20.7,30.0,45.3,49.0,55.7,63.2,69.8,75.4,81.4,2*0.,
316.8,20.1,31.1,44.0,50.3,60.5,66.6,73.1,80.0,3*0.,
420.0,27.,34.7,40.3,44.8,47.2,52.5,57.9,60.5,65.5,70.0,71.7,
525.0,30.,35.,40.2,45.3,51.2,61.0,63.0,65.0,67.0,70.,0.,
630.,35.,40.,45.,52.9,55.6,58.3,60.5,62.6,65.0,70.5,0.,
735.,40.,45.,50.,57.3,60.9,65.2,69.1,4*0./
DATA H2 /
112.,22.7,28.,33.4,39.4,43.4,48.8,56.,60.1,66.1,72.,77.4,
214.2,20.0,24.6,28.0,32.6,41.0,50.0,54.0,59.5,62.5,71.5,76.5,
317.1,19.1,28.9,39.7,45.1,51.1,62.2,66.6,71.0,72.4,2*0.,
420.,29.6,34.4,39.5,44.3,49.3,55.0,60.4,66.0,70.0,72.4,0.,
525.,30.,35.,39.5,44.7,49.3,54.6,59.3,65.0,73.4,2*0.,
630.,35.,40.,45.,52.5,61.3,68.3,74.8,3*0.,
735.,40.,45.,50.,55.,60.,62.5,65.4,71.6,3*0./
DATA H3 /
113.7,17.4,21.8,26.8,31.6,36.9,47.5,56.9,60.1,71.6,77.5,83.6,
214.7,19.0,22.0,26.7,38.0,41.1,49.0,59.0,63.1,71.0,77.0,83.1,
316.5,18.3,27.6,32.4,37.0,42.0,46.5,50.7,60.7,66.6,75.0,80.5,
420.0,27.0,34.4,36.9,42.1,47.2,52.9,57.3,62.0,66.0,70.0,72.9,
525.0,30.0,35.0,40.0,45.5,48.6,51.5,56.4,61.9,67.4,70.0,70.7,
630.0,35.0,40.0,45.0,52.4,55.0,58.3,60.6,63.4,66.4,69.4,70.4,
735.0,42.5,50.0,52.5,59.8,61.4,63.3,64.9,66.1,67.1,69.4,70.0/
DATA H4 /
110.,17.,21.4,26.,30.5,35.1,44.9,52.2,61.6,70.0,75.8,0.,
213.,19.,26.,4.,21.,35.,40.,45.6,50.,54.,61.6,70.,75.8,
318.,21.6,26.4,35.4,43.8,52.8,58.1,61.6,70.0,75.8,2*0.,
420.,27.,34.8,37.0,40.9,45.8,50.6,55.0,60.3,69.4,70.,71.1,
525.,35.,41.0,45.7,49.6,54.4,59.0,65.4,70.0,3*0.,
630.,42.7,50.,55.,59.4,62.3,65.0,67.4,69.6,70.,2*0.,
735.,45.,56.1,59.4,58.6,59.5,61.3,64.6,68.0,69.7,70.,70.7/
DATA BLLCH /2.,9.,4.,21.,25.,30.,35.,40.,45.,50.,55.,60.,.8, .9, 1, 0
1,1.1,.97,.647,.34,.0,1.37,1.125,.86,.55,1.86,1.642,1.38,1.10,2.30,
22.10,1.84,1.56,2.77,2.52,2.26,2.00,3.25,2.955,2.66,2.38,3.77,3.445
3,3.12,2.78,4.38,4.05,3.62,3.17,5.00,4.634,4.25,3.71/
DATA CPML /3.65,4.09,4.60,6.11,6.64/
DATA CPMJ /0.,.5,1.,2.,2.3/
DATA ATMN /10.,9.,6.,2,5,1.0,1.5,2.0,2.5,3.0,3.5,4.0
1,438.,500.,600.,700.,800.,900.,1.000,1.007,1.024,1.060,1.100,1.146
2,1.000,1.008,1.028,1.066,1.110,1.166,1.000,1.010,1.032,1.076,1.130
3,1.196,1.000,1.012,1.037,1.090,1.159,1.244,1.000,1.014,1.044,1.110
4,1.209,1.355,1.000,1.016,1.052,1.136,1.292,1.475,1.000,1.019,1.060
5,1.168,1.379,1.553,1.000,1.022,1.070,1.208,1.450,1.601,1.000,1.025
6,1.080,1.253,1.524,1.634/
DATA A1/1.,7.,4.,0.,.5,1.,2.,3.,4.,5.,0,1.2,2.4,3.6,
1.000,.0014,.0028,.0042,
2.0002,.0019,.0037,.0054,

```

FIGURE D-6. LISTING OF ADVANCED GENERAL AVIATION Q-FAN PROGRAM
(PAGE 8 OF 26)
242

```

3.0006,.0027,.0048,.0060,
4.0024,.0048,.0072,.0096,
5.0049,.0075,.0101,.0127,
6.0082,.0108,.0135,.0162,
7.0118,.0143,.0168,.0193/
DATA A2/2.,7.,4.,0.,.5,1.,2.,3.,4.,5.,.0,1.2,2.4,3.6,
1.0000,.0014,.0028,.0044,
2.0003,.0020,.0037,.0054,
3.0007,.0027,.0048,.0068,
4.0026,.0050,.0075,.0099,
5.0057,.0084,.0110,.0137,
6.0092,.0123,.0153,.0183,
7.0138,.0166,.0194,.0222/
DATA A3/3.,7.,4.,0.,.5,1.,2.,3.,4.,5.,.0,1.2,2.4,3.6,
1.0000,.0015,.0030,.0046,
2.0004,.0020,.0037,.0054,
3.0009,.0030,.0050,.0071,
4.0030,.0056,.0081,.0106,
5.0062,.0093,.0124,.0155,
6.0118,.0140,.0172,.0204,
7.0163,.0196,.0228,.0261/
DATA A4/4.,7.,4.,0.,.5,1.,2.,3.,4.,5.,.0,1.2,2.4,3.6,
1.0000,.0015,.0030,.0045,
2.0004,.0022,.0041,.0060,
3.0008,.0031,.0055,.0079,
4.0034,.0060,.0088,.0114,
5.0074,.0106,.0138,.0170,
6.0128,.0163,.0198,.0233,
7.0187,.0222,.0258,.0294/
COD=CAC/1.2
IERROR=0
IF (ROFD.EQ.0.) GO TO 2010
FC=SQRT(518.69/TO)
GO TO 2090
2010 IF (TO.NE.0.) GO TO 2060
2000 IF (H-36000.)2020,2020,2040
2020 TO=518.688-.00356*H
GO TO 2060
2040 TO=389.988
2060 THETA2=518.69/TO
IF (PU.NE.0.) GO TO 2080
CALL UNINT(11,ALTPR(1),PRESSP(1),H,DELTA2,LIMIT)
2080 FC=SQRT(11*THETA2)
ROFD=1.0/(DELTA2*THETA2)
2090 IF (VKTS) 2100,2120,2100
2100 SMN=.001512*VKTS*FC
GO TO 2140
2120 SMN=TIPSPD*FC/1116.
2140 CALL UNINT (11,AAFT(1),APAFT(1),AFT,PAFT,LIMIT)
IF (LIMIT.NE.0) GO TO 5
ZJI=5.309*VKTS/TIPSPD
IF (ZJI.LE.5..AND.ZJI.GE.0.) GO TO 2155
WRITE (6,2150)ZJI
2150 FORMAT(1H0,3X,' ADVANCE RATIO TOO HIGH =',F8.4)
IERROR=1
GO TO 5000

```

FIGURE D-6. LISTING OF ADVANCED GENERAL AVIATION Q-FAN PROGRAM
(PAGE 9 OF 26)

```

2155 IF (KPERFM.GE.3) GO TO 8
2160 IF (KPERFM.EQ.2) GO TO 2180
      CP=.718*10.E6 *SHP*RDRD/(DRCT**2*TIPSPD**3)
      GO TO 2199
2180 CT=4148.*THRUST*RDRD/(DRCT**2*TIPSPD**2)
C  TCTAL ACTIVITY FACTOR ADJUSTMENT
2199 CALL BIQUAD (ATAFT,1,ZJI,AFT,TAFT,LIMIT)
      IF (LIMIT.EQ.0) GO TO 8
      5 WRITE (6,6) AFT
      6 FORMAT (1H0,3X,' TOTAL ACTIVITY FACTOR EXCEEDS THE LIMITS '/4X,
      1' TAF=',F6.0)
      IERROR=1
      GO TO 5000
C  SHROUD LENGTH/DIAMETER ADJUSTMENT
      8 CALL BIQUAD (ACDD,1,ZJI,CGD,CTCGD,LIMIT)
      10 CONTINUE
      IF (ARA.GL..799.AND.ARA.LE.1.101) GO TO 11
      WRITE (6,12) ARA
      12 FORMAT (1H0,3X,' AREA RATIO EXCEEDS LIMITS '/3X,' AR=',F3.0)
      IERROR=1
      GO TO 5000
      11 IAR=10.*ARA+.001
      DO 20 I=1,4
      IF (IAR.NE.IAP(I)) GO TO 20
      II=I
      III=I
      GO TO 30
      20 CONTINUE
      II=1
      III=4
      30 DO 1000 I=II,III
      GO TO (125,125,150,150,150),KPERFM
      125 IF (ZJI.NE.0.) GO TO 130
      IJ=1
      IIJ=1
      GO TO 175
      130 IJ=1
      IF (ZJI.GE.1.) IJ=2
      IF (ZJI.GE.2.) IJ=3
      IF (ZJI.GE.3.) IJ=4
      IIJ=IJ+3
      GO TO 175
      150 CALL BIQUAD (BLCH,1,BLANG,ARA,ZJLIM,LIMIT)
      IF (LIMIT.EQ.0.) GO TO 160
      WRITE (6,155) BLANG
      155 FORMAT (1H0,'BLADE ANGLE=',F4.2,' EXCEEDS LIMITS OF 21-60 DEGREES')
      IERROR=1
      GO TO 5000
      160 IJ=1
      IIJ=4
      IF (ZJLIM.GT.2..AND.ZJLIM.LE.3.) IIJ=5
      IF (ZJLIM.GT.3..AND.ZJLIM.LE.4.) IIJ=6
      IF (ZJLIM.GT.4..AND.ZJLIM.LE.5.) IIJ=7
      175 IX=0.
      DO 500 J=IJ,IIJ
C  MACH NO./ TIP SPEED ADJUSTMENT

```

FIGURE D-6. LISTING OF ADVANCED GENERAL AVIATION Q-FAN PROGRAM
(PAGE 10 OF 26)

```

3.0006,.0027,.0048,.0060,
4.0024,.0048,.0072,.0096,
5.0049,.0075,.0101,.0127,
6.0082,.0108,.0135,.0162,
7.0118,.0143,.0168,.0193/
DATA A2/2.,7.,4.,0.,5,1.,2.,3.,4.,5.,0,1.2,2.4,3.6,
1.0000,.0014,.0028,.0044,
2.0003,.0020,.0037,.0054,
3.0007,.0027,.0048,.0068,
4.0026,.0050,.0075,.0099,
5.0057,.0084,.0110,.0137,
6.0092,.0123,.0153,.0183,
7.0138,.0166,.0194,.0222/
DATA A3/3.,7.,4.,0.,5,1.,2.,3.,4.,5.,0,1.2,2.4,3.6,
1.0000,.0015,.0030,.0046,
2.0004,.0020,.0037,.0054,
3.0009,.0030,.0050,.0071,
4.0030,.0056,.0081,.0106,
5.0062,.0093,.0124,.0155,
6.0118,.0140,.0172,.0204,
7.0163,.0196,.0228,.0261/
DATA A4/4.,7.,4.,0.,5,1.,2.,3.,4.,5.,0,1.2,2.4,3.6,
1.0000,.0015,.0030,.0045,
2.0004,.0022,.0041,.0060,
3.0008,.0031,.0055,.0079,
4.0034,.0060,.0088,.0114,
5.0074,.0106,.0138,.0170,
6.0128,.0163,.0198,.0233,
7.0187,.0222,.0258,.0294/
COD=CAC/1.2
IEPRUR=0
IF (RORU.EQ.0.) GO TO 2010
FC=SQRT(518.69/T0)
GO TO 2090
2010 IF (T0.NE.0.) GO TO 2060
2000 IF(H-36000.)2020,2020,2040
2020 T0=518.688-.00356*H
GO TO 2060
2040 T0=389.988
2060 THETA2=518.69/T0
IF (PU.NE.0.) GO TO 2080
CALL UNINT(11,ALTPR(1),PRESSP(1),H,DELTA2,LIMIT)
2080 FC=SQRT(THETA2)
KOF0=1.0/(DELTA2*THETA2)
2090 IF (VKTS) 2100,2120,2100
2100 SMN=.001512*VKTS*FC
GO TO 2140
2120 SMN=TIPSPD*FC/1116.
2140 CALL UNINT (11,AAFT(1),APAF(1),AFT,PAFT,LIMIT)
IF (LIMIT.NE.0) GO TO 5
ZJI=5.309*VKTS/TIPSPD
IF(ZJI.LE.5..AND.ZJI.GE.0.) GO TO 2155
WRITE (6,2150)ZJI
2150 F0RMA(1H0,3X,' ADVANCE PATIC TOO HIGH =' ,F8.4)
IEPRUR=1
GO TO 5000

```

FIGURE D-6. LISTING OF ADVANCED GENERAL AVIATION Q-FAN PROGRAM
(PAGE 9 OF 26)
243

```

IX=IX+1
TPTSPD=TIPSPD/FC
CALL UNINT (9,ATS(1),APMN(1),TPTSPD,PMN,LIMIT)
IF(LIMIT.NE.0) GO TO 40
CALL BIQUAD (ATMN,1,ZJJ(J),TPTSPD,TMN,LIMIT)
GO TO 50
40 WRITE (6,45) SMN,TIPSPD
45 FORMAT (1H0,3X,'MACH NO. OR TIPSEED LIMITS ARE EXCEEDED'/4X,
1'MACH NO.=' ,F4.3,' TIPSEED=' ,F5.0)
IERROR=1
GO TO 5000
50 GO TO(100,200,300,300,300),KPERFM
100 CPE=CP*PAFT*PMN
CALL UNINT (INN(J,I),CPANG(1,J,I),CTANG(1,J,I),CPE,CTT(IX),LIMIT)
CALL BIQUAD (CCT(1,I) ,1,ZJI,CTT(IX),ACDCT,LIMIT)
CTT(IX)=(CTT(IX)+CTCOD-ACDCT)/(TAFT*TMN)
CT=CTT(IX)
CALL UNINT (INA(J,I),CPAG(1,J,I),BLDANG(1,J,I),CPE,BLL(IX),LIMIT)
GO TO 500
200 CTE=CT*TAFT*TMN-CTCOD
CALL BIQUAD (CCT(1,I) ,1,ZJI,CTE,ACDCT,LIMIT)
CTE=CTE+ACDCT
CALL UNINT (INN(J,I),CTANG(1,J,I),CPANG(1,J,I),CTE,CPP(IX),LIMIT)
CALL UNINT (INA(J,I),CPAG(1,J,I),BLDANG(1,J,I),CPP(IX),BLL(IX),
LIMIT)
CPP(IX)=CPP(IX)/(PAFT*PMN)
CP=CPP(IX)
GO TO 500
300 CALL UNINT (INA(J,I),BLDANG(1,J,I),CPAG(1,J,I),BLANG,CPP(IX),LIMIT
1)
IF (LIMIT.NE.0) GO TO 400
CALL UNINT (INN(J,I),CPANG(1,J,I),CTANG(1,J,I),CPP(IX),CTT(IX),
LIMIT)
GO TO 500
400 WRITE (6,450)
450 FORMAT (1H0,3X,' CP, CT, OR J ARE OFF CURVES')
IERROR=1
GO TO 5000
500 CONTINUE
IF(KPERFM.GE.3) GO TO 700
IF(IJ.NE.IIJ) GO TO 550
BLANG=BLL (I)
CTTT(I)=CT
CPPP(I)=CP
BLLL(I)=BLANG
GO TO 1000
550 CALL UNINT (4,ZJJ(IJ),BLL(I),ZJI,BLLL(I),LIMIT)
BLANG=BLLL(I)
IF(KPERFM.EQ.2) GO TO 600
CALL UNINT (4,ZJJ(IJ),CTT(1),ZJI,CTTT(I),LIMIT)
CT=CTTT(I)
GO TO 1000
600 CALL UNINT (4,ZJJ(IJ),CPP(1),ZJI,CP(1),LIMIT)
CP=CP(1)
GO TO 1000
700 IF(IJ.EQ.IIJ) GO TO 750

```

FIGURE D-6. LISTING OF ADVANCED GENERAL AVIATION Q-FAN PROGRAM
(PAGE 11 OF 26)

```

CALL UNINT(4,ZJJ(IJ),CTI(1),ZJI,CT,LIMIT)
CALL UNINT(4,ZJJ(IJ),CPP(1),ZJI,CP,LIMIT)
750 CALL BIQUAD(ATAFT,1,ZJI,AFT,TAFT,LIMIT)
CALL BIQUAD(ATMN,1,ZJI,TPTSPD,TMN,LIMIT)
CP=CP/(PAFT*PMN)
CALL BIQUAD(CDCT(1,I),1,ZJI,CT,ACDCT,LIMIT)
CT=(CT+CTCOD-ACDCT)/(TAFT*TMN)
ASHP(I)=CP*DROT**2*TIPSPD**3/(RORO*.718*10.E6)
ATHRST(I)=CT*DROT**2*TIPSPD**2/(4148.*RORO)
SHP=ASHP(I)
THRUST=ATHRST(I)
1000 CONTINUE
GO TO (1100,1200,1300,1300,1300),KPERFM
1100 IF(III.EQ.11)GO TO 1150
CALL UNINT(4,XAR(1),BLLL(1),ARA,BLANG,LIMIT)
CALL UNINT(4,XAR(1),CTTT(1),ARA,CT,LIMIT)
1150 THRUST=CT*DROT**2*TIPSPD**2/(4148.*RORO)
GO TO 1275
1200 IF(III.EQ.11)GO TO 1250
CALL UNINT(4,XAR(1),BLLL(1),ARA,BLANG,LIMIT)
CALL UNINT(4,XAR(1),CPPP(1),ARA,CP,LIMIT)
1250 SHP=CP*DROT**2*TIPSPD**3/(.718*10.E5*RORO)
1275 CPE=CP*PAFT*PMN
CALL UNINT(5,CPMJ(1),CPML(1),ARA,CPELM,LIMIT)
IF(CPELM.GE.CPE)GO TO 4500
WRITE(6,115) CPE,CPELM
115. FORMAT(1H0,'CPE=',F5.3,3X,'EXCEEDS THE CPE LIMIT=',F5.3)
IERROR=1
GO TO 5000
1300 IF(III.EQ.11)GO TO 4500
CALL UNINT(4,XAR(1),ASHP(1),ARA,SHP,LIMIT)
CALL UNINT(4,XAR(1),ATHRST(1),ARA,THRUST,LIMIT)
4500 IF(ZJI.EQ.0.)GO TO 4700
EFFP=CT/CP*ZJI
GO TO 5000
4700 EFFP=0.
5000 IF(KWRITE.NE.0) WRITE(6,9000)DROT,TIPSPD,SHP,THRUST,BLANG,ZJI,CP,
1CT,SMN,EFFP
9000 FORMAT(1H0,3X,'DIA.=',F3.1,3X,'TIPSPEED=',F4.0,3X,'SHP=',F7.0,3X,
1'THRUST=',F5.0/3X,'BLADE ANGLE=',F4.1,3X,'J=',F4.2,3X,'CP=',F5.3,
23X,'CT=',F5.3,3X,'MN=',F4.3,3X,'EFFP=',F4.3)
RETURN
END

```

FIGURE D-6. LISTING OF ADVANCED GENERAL AVIATION Q-FAN PROGRAM
(PAGE 12 OF 26)

```

SUBROUTINE QENOIS (AF, BL, TIPSPD, THRUST, DROT,          ZNQF1, ZNQF2,
1 NOE, IERROR, KWRITE)
  DIMENSION ZN1(155), ZN2(155), ZN3(155), ZN4(155), ZN5(155), ZN(155,5),
1  TAFL(5), ZNT(5), RDL(7), DPNL(7)
  EQUIVALENCE (ZN(1,1), ZN1), (ZN(1,2), ZN2), (ZN(1,3), ZN3), (ZN(1,4),
1 ZN4), (ZN(1,5), ZN5)
  DATA TAFL / 750., 1000., 1500., 2000., 3000./
  DATA RDL / 2., 3., 4., 5., 6., 7./
  DATA DPNL / -6.6, -4.0, -1.7, 0., 1.2, 2.3/
  DATA ZN1 / 1., 16., 8., 10., 15., 20., 30., 40., 50., 60., 70., 80., 90., 100.,
1 125., 150., 200., 250., 300., 450., 500., 550., 600., 650., 700., 750., 800.,
2 68.0, 68.7, 69.6, 70.7, 72.0, 73.5, 75.1, 77.0,
3 74.0, 72.1, 72.0, 73.0, 74.3, 75.5, 76.9, 78.5,
4 81.0, 77.5, 76.5, 76.4, 77.0, 77.7, 78.7, 80.0,
5 94.7, 89.0, 85.0, 83.0, 82.0, 82.0, 82.2, 83.0,
6 108.5, 99.0, 93.5, 90.3, 88.1, 86.9, 86.0, 85.5,
7 123.0, 110.0, 102.5, 98.0, 94.4, 91.6, 89.5, 88.5,
8 138.0, 124.0, 112.3, 105.3, 100.0, 96.4, 93.7, 92.0,
9 153.5, 140.3, 122.7, 112.5, 105.4, 100.8, 97.5, 95.5,
1 171.0, 154.5, 132.5, 120.0, 111.0, 105.3, 101.5, 99.4,
2 189.5, 170.0, 143.5, 128.5, 117.0, 110.5, 105.8, 103.0,
3 205.0, 187.0, 154.0, 136.0, 123.5, 115.3, 109.8, 106.5,
4 258.0, 228.0, 192.0, 166.0, 145.0, 129.8, 122.0, 115.5,
5 317.0, 275.0, 233.0, 198.0, 172.0, 150.0, 138.0, 128.0,
6 446.0, 382.0, 324.0, 271.0, 235.0, 202.0, 174.0, 158.0,
7 600.0, 505.0, 422.0, 351.0, 306.0, 259.0, 226.0, 196.0,
8 800.0, 660.0, 546.0, 460.0, 384.0, 326.0, 280.0, 240.0/
  DATA ZN2 / 2., 16., 8., 10., 15., 20., 30., 40., 50., 60., 70., 80., 90., 100.,
1 125., 150., 200., 250., 300., 450., 500., 550., 600., 650., 700., 750., 800.,
2 65.8, 66.5, 68.3, 71.4, 73.8, 75.2, 76.7, 78.0,
3 69.3, 69.2, 70.3, 72.5, 74.7, 76.1, 77.6, 79.0,
4 74.1, 72.8, 72.3, 74.3, 75.8, 77.5, 78.8, 80.0,
5 84.4, 79.8, 78.1, 78.6, 79.3, 80.0, 81.0, 82.0,
6 92.9, 88.0, 84.9, 83.7, 83.0, 82.5, 82.9, 84.0,
7 100.1, 95.0, 91.1, 98.1, 86.3, 85.0, 84.7, 86.0,
8 108.1, 102.6, 97.5, 93.4, 90.1, 88.0, 87.0, 87.8,
9 116.0, 110.0, 104.4, 99.0, 94.3, 90.9, 89.4, 89.9,
1 124.0, 117.8, 111.8, 105.5, 100.0, 95.8, 93.0, 92.1,
2 133.3, 126.0, 119.0, 111.9, 106.3, 101.1, 97.2, 94.6,
3 140.0, 132.8, 126.2, 119.4, 113.0, 107.2, 101.9, 97.0,
4 169.0, 158.0, 148.0, 138.5, 129.0, 119.8, 111.0, 103.3,
5 200.0, 184.0, 169.5, 156.0, 142.5, 132.0, 121.5, 111.0,
6 295.0, 260.0, 228.0, 206.0, 186.0, 167.0, 149.0, 133.8,
7 440.0, 380.0, 325.0, 275.0, 238.0, 210.5, 187.0, 165.0,
8 640.0, 525.0, 430.0, 355.0, 298.0, 263.0, 232.0, 206.0/
  DATA ZN3 / 3., 16., 8., 10., 15., 20., 30., 40., 50., 60., 70., 80., 90., 100.,
1 125., 150., 200., 250., 300., 450., 500., 550., 600., 650., 700., 750., 800.,
2 65.0, 67.3, 69.3, 71.3, 73.5, 75.4, 77.3, 79.0,
3 68.0, 69.3, 71.1, 73.0, 75.0, 76.8, 78.5, 80.3,
4 70.7, 71.5, 72.7, 74.4, 76.2, 78.1, 79.8, 81.5,
5 76.0, 75.0, 75.6, 76.8, 78.5, 80.0, 81.7, 83.1,
6 80.5, 78.9, 78.6, 79.3, 80.5, 81.7, 83.2, 84.9,
7 85.0, 82.5, 81.4, 81.9, 82.5, 83.5, 84.5, 86.0,
8 89.5, 86.6, 85.0, 84.3, 84.4, 85.0, 86.0, 87.4,
9 94.5, 91.1, 89.1, 87.3, 86.8, 86.8, 87.4, 88.5,
1 99.5, 95.7, 92.8, 90.8, 89.5, 89.0, 89.0, 89.5,

```

FIGURE D-6. LISTING OF ADVANCED GENERAL AVIATION Q-FAN PROGRAM
(PAGE 13 OF 26)

```

2105.0,100.6,97.0,94.9,93.0,91.8,91.0,91.0,
3110.0,105.7,102.0,98.5,96.2,94.2,92.9,92.2,
4130.0,121.0,111.4,108.8,103.0,99.4,96.8,95.5,
5156.,140.5,130.0,118.9,110.5,104.8,101.0,99.0,
6220.,188.5,166.0,141.0,129.5,119.5,114.0,109.5,
7296.0,245.0,207.0,178.0,156.0,140.0,131.5,128.0,
8380.0,306.0,251.0,214.0,186.0,166.0,154.0,150.0/
DATA ZN4 /4.,16.,8.,10.,15.,20.,30.,40.,50.,60.,70.,80.,90.,100.,
1125.,150.,200.,250.,300.,450.,500.,550.,600.,650.,700.,750.,800.,
266.9,68.6,70.4,71.9,73.8,75.8,77.6,79.5,
368.3,70.3,72.2,73.8,75.7,77.5,79.2,80.8,
469.8,71.6,73.4,75.1,77.0,78.7,80.5,82.0,
572.3,73.9,75.5,77.2,79.2,80.7,82.2,83.5,
674.8,75.8,77.3,79.0,81.0,82.5,83.8,85.0,
778.0,77.9,78.8,80.3,82.2,83.5,84.8,86.2,
881.3,80.0,80.3,81.5,83.3,84.6,86.0,87.2,
984.6,82.5,82.0,83.3,84.6,85.9,87.0,88.1,
187.8,84.6,83.9,84.7,85.8,86.8,88.0,89.0,
290.8,86.9,85.9,86.2,87.0,87.7,88.8,90.0,
393.6,89.1,87.8,88.1,88.4,89.3,90.1,90.9,
4104.0,96.2,92.5,91.8,91.5,91.3,91.7,92.9,
5116.5,102.7,96.8,95.5,94.4,93.7,93.9,94.8,
6151.3,124.0,109.8,104.5,100.5,97.9,97.9,98.0,
7196.0,153.5,129.5,116.4,108.0,103.4,100.9,100.6,
8246.0,191.5,158.5,136.5,123.5,113.8,107.4,103.0/
DATA ZN5 /5.,16.,8.,10.,15.,20.,30.,40.,50.,60.,70.,80.,90.,100.,
1125.,150.,200.,250.,300.,450.,500.,550.,600.,650.,700.,750.,800.,
269.9,71.5,73.0,74.4,75.8,77.0,77.8,78.5,
371.1,72.9,74.5,76.2,77.7,78.6,79.6,80.0,
472.0,73.8,75.5,77.1,78.6,79.9,80.9,81.5,
573.7,75.7,77.5,79.2,80.7,82.0,83.0,83.5,
675.1,77.0,78.9,80.6,82.0,83.4,84.5,85.0,
776.4,78.1,79.9,81.5,83.0,84.3,85.5,86.5,
877.8,79.2,80.9,82.3,84.0,85.5,86.6,87.5,
978.8,80.2,81.6,83.2,84.9,86.3,87.5,88.5,
179.8,81.0,82.4,83.8,85.5,86.8,88.3,89.6,
281.0,81.9,83.1,84.5,86.0,87.5,89.0,90.6,
382.0,82.8,84.0,85.2,86.9,88.3,90.0,91.6,
484.7,84.8,85.5,86.7,88.0,89.5,91.0,92.6,
588.3,86.8,86.8,88.0,89.3,90.6,92.1,93.6,
698.5,93.9,92.1,91.5,91.5,92.2,93.5,95.0,
7115.0,107.8,102.0,97.9,95.3,94.7,95.3,96.8,
8139.5,127.4,116.5,107.1,101.0,98.0,97.3,98.3/
IF (TIPSPD.GE.400..OR.TIPSPD.LE.800.) GO TO 100
WRITE (6,50) TIPSPD
50 FORMAT (1H0,' TIPSPD=' ,F6.0,' EXCEEDS LIMITS FOR NOISE CALCUL
1ATION' )
IERPOR=1
GO TO 1000
100 TAF=AF*BL
TOD2=THRUST/(DROCT**2)
IF(TOD2.GE.10..CR.TOD2.LE.300.) GO TO 200
WRITE (6,150) TOD2
150 FORMAT (1H0,' THRUST/DIAMETER SQUARED=' ,F5.0,' EXCEEDS LIMIT FOR
1 NOISE CALCULATION' )
IFRUR=1

```

FIGURE D-6. LISTING OF ADVANCED GENERAL AVIATION Q-FAN PROGRAM
(PAGE 14 OF 26)

```

GO TO 1000
200 DO 300 I=1,5
    CALL BIQUAD (ZN(I,I),1 ,TOD2,TIPSPD,ZNT(I),LIMIT)
300 CONTINUE
    CALL UNINT (5,TAFL(1),ZNT(1),TAF,ZNQF1 ,LIMIT)
    CALL UNINT (6,RDL(1),DPNL(1),DROT,DZNFQF,LIMIT)
    IF (LIMIT.EQ.0) GO TO 400
    WRITE (6,350) DRCT
350 FORMAT(1H0, 'THE DIAMETER RANGE OF 2-7 FT. IS EXCEEDED,DIAMETER=',
1 F3.0)
    IERROR=1
    GO TO 1000
400 XNOE=NOE
    ZNQF1=ZNQF1-4.5
    ZNQF1=ZNQF1+DZNFQF+10.*ALOG10(XNOE)
    ZNQF2=ZNQF1-12.
    IF (KWRITE.NE.0) WRITE(6,450) ZNQF1,ZNQF2
450 FORMAT(1H0, ' QFAN NOISE AT .1M.N AT 500 FEET = ',F6.1,' PNOB AND =
1 ',F6.1,' DB(A)')
1000 RETURN
END

```

FIGURE D-6. LISTING OF ADVANCED GENERAL AVIATION Q-FAN PROGRAM
(PAGE 15 OF 26)

```

SUBROUTINE WTCFN (BL,D,AF,SHF,T,CATN,ZFLAG,GBUXM,WQFT,IDATE,COD,
1 IIF,KWRITE)
DIMENSION ZKM(6),ZK1(6),ZK2(6),ZZ3(6),ZK4(6),ZZ5(6),ZK6(6),ZP(6),
1 ZK(6),ZS(6),ZT(6),ZK3(6),ZK5(6)
DIMENSION ZL5(4)
DATA ZL5/4.2,4.8,4.6,4.1/
DATA ZKM/1.74,1.74,1.74,1.3,1.74,1.3/
DATA ZK1/26.5,26.5,26.5,26.5,26.5,26.5/
DATA ZK2/.06,.07,.07,.07,.06,.06/
DATA ZZ3/6.25,8.34,8.34,9.5,6.7,7.74/
DATA ZK4/1.13,4.6,4.6,4.6,4.6,4.6/
DATA ZZ5/4.45,5.14,5.14,4.35,4.45,3.76/
DATA ZK6/.0,2.33,2.33,2.33,.0,.0/
DATA ZP/.8,.8,.8,.8,.8,.8/
DATA ZR/2.6,2.6,2.6,2.1,2.6,2.1/
DATA ZS/.2,.2,.2,.2,.2,.2/
DATA ZT/.2,.2,.2,.2,.2,.2/
COMMON / QCFW / WRDT,WSPIN,WDUCT,WIMT,WTFLG,WAFTB
IERROR=0
N=CATN+.01
IF (N.EQ.1)GO TO 15
IF (N.GT.3)GO TO 5
N=N-1
GO TO 7
5 IF (N.EQ.4.AND.IDATE.EQ.1970)N=3.
IF (N.EQ.5.AND.IDATE.EQ.1980)N=6
IF(N.GT.4.AND.IIF.EQ.1) GO TO 15
IF (N.GT.6) GO TO 15
7 IF(IIF.FQ.1) GO TO 14
GO TO (20,20,20,10,20,10),N
10 ZK3(N)=ZZ3(N)*(D/5.)**.25
ZK5(N)=ZZ5(N)/((.2*D)**.25)
GO TO 30
14 ZK3(N)=0.
ZK5(N)=ZL5(N)
IF(N.EQ.4) ZK5(N)=ZL5(N)/((.2*D)**.25)
GO TO 30
15 WRITE(6,17) CATN
17 FORMAT (1H0,3X,'ILLEGAL AIRPLANE CATEGORY, CATN=',F3.0)
IERROR=1
GO TO 300
20 ZK3(N)=ZZ3(N)
ZK5(N)=ZZ5(N)
30 FLAG=ZFLAG+.01
60 IF(FLAG.FQ.1) GO TO 62
ZK7=4.3
GO TO 65
62 ZK7=0.
65 ZY=1.+.08/(BL/10.*(AF/170.)**.5)*T/500.
IF (AF.LT.170.) GO TO 70
IF(N.GE.7)XY=1.0
ZV=0.
IF (N.LT.7)GO TO 67
ZU=1.7
GO TO 80
67 ZU=1.9

```

FIGURE D-6. LISTING OF ADVANCED GENERAL AVIATION Q-FAN PROGRAM
(PAGE 16 OF 26)

```

60 T= 80
70 IF (M.LT.7) GO TO 75
  ZV=0.
  ZU=.055*AF-4.25
  GO TO 80
75 ZV=.7
  ZU=(.4*(AF/100.-1.03))**.5
80 ZC1=1.5*(ZU-ZV)
  ZC2=(ZU-3.*ZV)/2.
  ZC3=ZS(N)/2.
  ZC4=(ZU+3.*ZV)/2.
  ZC5=ZU-ZV
  A=bL/10.
  U=D/5.
  C=AF/170.
  I=SHP/100.
  E=1/500.
  ZZ=(1.+0.031/(A*C**.5)*E)**.5
  .F(%.GE.7) ZZ=1.0
  X1=ZK1(N)*A**ZP(N)*G**ZR(N)*C**ZC1*H**ZS(N)
  X5=ZK5(N)*ZZ*A**ZT(N)*(SHP/(20.*D))**ZC3*E**3
  IF (IFP.EQ.1) GO TO 90
  X2=ZK1(N)*ZY*(1.+ZK2(N)*E**2/G)/C**ZC2
  X3=ZK3(N)*C**ZV*E/(G**.82*(A*H)**ZC3)
  X4=ZK4(N)*C**ZC4*E**2
  X6=ZK6(N)*C**3*C**ZC5*bL/E**2
90 X3=0.
  X4=0.
  X6=0.
  X2=25.2*ZY/C**ZC2
100 X7=ZK7*(SHP/500. )**2
  X8=.03*D**2
  WROT=X1*(X2+X3+X4+X5)+X6
  WSPIN=X8
  WDUCT=(5.8*CD+2.8)*U*D
  WTMT=0.
  WAFTB=C.
  WTFLG=0.
  IF (GRDXM.NE.0.) GO TO 150
  WTMT=3.*C*(SHP*D/T)**.84
  WAFTB=.6*D**2
150 IF (ZFLAG.EQ.1.) GO TO 200
  WTFLG=X7
200 WQFT=WROT+WSPIN+WDUCT+WTMT+WTFLG+WAFTB
  IF (KWRITE.NE.C) WRITE (6,250)CAIN,IDATE,SHP,T,WROT,WSPIN,WTFLG,
  WDUCT,WTMT,WAFTB,WQFT
250 FORMAT(1H0,3X,'QFAN WEIGHT'//3X,'AIRPLANE CATEGORY=',F3.0,3X,' DAT
  E=',15,3X,'SHP=',F5.0,3X,'TIPSPEED=',F+.0/3X,'ROTOR ASSEMBLY',
  2F8.1,'POUNDS'/3X,'SPINNER',7X,F8.1,'POUNDS'/3X,'FLNGE',8X,F8.1,
  3'POUNDS'/3X,'DUCT',10X,F8.1,'POUNDS'/3X,'MOUNT=',8X,F8.1,'POUNDS'/
  43X,'AFTERBODY',5X,F8.1,'POUNDS'/3X,'QFAN WEIGHT',3X,F8.1,'POUNDS')
300 RETURN
  END

```

FIGURE D-6. LISTING OF ADVANCED GENERAL AVIATION Q-FAN PROGRAM
(PAGE 17 OF 26)

```

SUBROUTINE QFCOST(CATN, IDATE, CQFT, IERROR, KODE, CCLF1, CCLF, CQUANT, BL
1, SCING, IFF, KWRITE)
DIMENSION XFX(2,5), XEX(2,5), XQUAN(2,5)
DIMENSION XFL(2,4)
COMMON / QFCW / WRCT, WSPIN, WDUCT, WTMT, WFLG, WAFTB
DATA XFL / 0., 0., 2.4, 2.4, 2.6, 2.6, 2.6, 4.9 /
DATA XFX / 0., 0., 1.5, 1.5, 3.5, 3.5, 3.5, 3.5, 3.5, 3.5 /
DATA XEX / 0., 0., 2.1, 2.1, 2.1, 2.1, 2.1, 3.2, 2.4, 3.6 /
DATA XQUAN / 0., 0., 2810., 5470., 1030., 1990., 295., 680., 65., 368. /
DATA UCCST1, UCCST2 / 13.50, 33.50 /
N=CATN+.01
IKOD=KODE-10
IERROR=0.
IF(N.GT.1.AND.N.LT.6) GO TO 10
IERROR=1
WRITE(6,5)CATN
5 FORMAT(1H0,3X,'ILLEGAL AIRPLANE CATEGORY, CATN=',F3.0)
GO TO 1000
10 IF(IDATE.EQ.1970) I=1
IF(IDATE.EQ.1980) I=2
GO TO (20,40,50,60,20,40), IKOD
20 CCLF1=3.2178
CCLF=1.02
30 CQUAN=XQUAN(I,N)
35 IF(IFF.EQ.1) GO TO 37
UCCST=XFX(I,N)*(7.*PL**+.5+XFX(I,N))
GO TO 70
37 UCCST=XFL(I,N)*(7.*PL**+.5+XFX(I,N))
GO TO 70
40 CCLF1=CCLF1
CCLF=CCLF
GO TO 30
50 CQUAN=CQUANT
CCLF1=3.2178
CCLF=1.02
GO TO 35
60 CQUAN=CQUANT
CCLF1=CCLF1
CCLF=CCLF
70 IF(KODE.GT.14) UCCST=SCING
XLN=(ALOG(CCLF)-ALOG(CCLF1))/6.90775527
XZN=EXP(ALOG(CQUAN)*XLN+ALOG(CCLF1))/CCLF1
80 CRCT=XZN*UCCST*WPCT
CONST=XZN*UCCST1
CSPIN=CONST*WSPIN
CDUCT=CONST*WDUCT
CTMT=XZN*WTMT*UCCST2
CAFTB=CONST*WAFTB
CFLG=XZN*XFX(I,N)*UCCST*WFLG
CQFT=CRCT+CSPIN+CDUCT+CTMT+CAFTB+CFLG
IF(KWRITE.NE.0) WRITE(6,100)CCLF1,CCLF,UCCST,CQUAN,CRCT,CSPIN,
1 CFLG,CDUCT,CTMT,CAFTB,CQFT
100 FORMAT(1H0,3X,'QFAN COST ',//3X,'CCLF1=',F6.4,3X,'CCLF=',F6.4,3X,
1 'UCCST=',F5.2,3X,'CQUAN=',F5.0
2 /3X,'ROTOR ASSEMBLY',3X,F5.0,' DOLLARS'/3X,'SPINNER',7X,F8.0,' DOL
2 LARS'/3X,'FLANGE',12X,F4.0,' DOLLARS'/3X,'DUCT',10X,F8.0,' DOLLARS
4 '/3X,'MOUNT',9X,F8.0,' DOLLARS'/3X,'AFTERBODY',4X,F8.0,' DOLLARS'//
5 /3X,'QFAN COST ',3X,F8.0,' DOLLARS')
1000 RETURN
END

```

FIGURE D-6. LISTING OF ADVANCED GENERAL AVIATION Q-FAN PROGRAM
(PAGE 18 OF 26)

```

          SUBROUTINE BILINE (T, I, XI, YI, Z, K)
ENTRY      BILIN (T, I, XI, YI, Z, K)
CBILINE
C
      DIMENSION T(1),XC(4), D(4), P(5), Y(4),C(4)
C      DIMENSION T(1),XC(4), D(4), P(5), Y(4),C(4)
C
      EQUIVALENCE (XC(1), D(1)),
1 (C(1), C1), (C(2), C2), (C(3), C3), (C(4), C4),
2 (D(1), D1), (D(2), D2), (D(3), D3), (D(4), D4),
3 (P(1), P1), (P(2), P2), (P(3), P3), (P(4), P4), (P(5), P5)
C
      TABLE SET UP
C      T(I) = TABLE NUMBER
C      T(I+1) = DEGREE CHOICE (0,1,3)
C      DEGREE CHOICE OPTIONS -0- USE FIRST VALUE OF TABLE FOR ANSWER
C                          -1- LINEAR INTERPOLATION
C                          -2- THIRD ORDER INTERPOLATION
C      T(I+2) = NUMBER OF (X) VALUES
C      T(I+3) = NUMBER OF (Y) VALUES (0. FOR UNIVARIATE TABLE)
C      T(I+4) = VALUES OF (X) IN ASCENDING ORDER
      TN = T(I+1)-2.0
      IF(T(I+1)) 20,20,30
20     K=0
      Z=T(I+2)
      GO TO 9990
30     NX = T(I+2)
      NY = T(I+3)
      J1 = I+4
      J2 = J1 + NX - 1
      IDX = I + 1
      X = XI
C      SEARCH IN X SENSE
      L = 0
      GO TO 1000
C      RETURN HERE FROM SEARCH OF X
100    K = KX
      IF (TN) 1103,104,104
104    JX= JX1

```

FIGURE D-6. LISTING OF ADVANCED GENERAL AVIATION Q-FAN PROGRAM

(PAGE 19 OF 26)

```

C THE FOLLOWING CODE PUTS X AND/OR Y VALUES IN XC BLOCK
105 DO 110 J=1,4
    XC(J) = T(JX1)
110 JX1 = JX1+1
C GET COEFF. IN X SENSE
    GO TO 2000
C RETURN HERE WITH COEFF. TEST FOR UNIVARE OR BIVARIATE
200 IF (NY) 300,210,300
210 JY = JX +NX
    IF (TN) 212,211,211
212 Z = C1 *(T(JY+1)-T(JY)) +T(JY)
    GO TO 9999
211 Z = 0.0
    DO 220 J=1,4
    Z = Z + C(J)*T(JY)
220 JY = JY+1
    GO TO 9999
C
C BIVARIATE TABLE
300 L=1
    X = Y1
    J1 = J2+1
    J2 = J1+NY-1
C SEARCH IN Y SENSE JX1 = SUBSCRIPT OF 1ST Y
    GO TO 1000
500 K = K+3*KX
C INTERPOLATE IN X SENSE
C SUBSCRIPT - BASE NO. OF COL. NO. OF YS
    IF (TN) 501,519,519
501 JY = JX1 +NY *(JX -IDX -2)
    JX = JY + NY
    Z = T(JY) +C1 *(T(JX)-T(JY))
    Z = (X- T(JX1))/ (T(JX1+1)-T(JX1))* (T(JY+1)+C1*(T(JX+1)-T(JY+1)))
1 -Z) +Z
    GO TO 9999
519 JY = J2+1 +(JX -IDX -3)*NY +JX1 -J1
    DO 550 M=1,4
    JX = JY
    Y(M) = 0.0
    DO 520 J=1,4
    Y(M) = Y(M) + C(J)*T(JX)
520 JX = JX+NY
550 JY = JY+1
C
C GET COEFF. IN Y SENSE
    GO TO 105
600 Z = 0.0
    DO 700 J=1,4
700 Z = Z + C(J)*Y(J)
9999 RETURN
C
C SEARCH ROUTINE - INPUT J1,J2,X
C -OUTPUT RA,RB,KX,JX1

```

FIGURE D-6. LISTING OF ADVANCED GENERAL AVIATION Q-FAN PROGRAM

(PAGE 20 OF 26)

```

1000 KX = 0
      DO 1010 J=J1,J2
      IF (T(J)- X) 1010,1050,1050
1010 CONTINUE
C    OFF HIGH END
      J = J2
      X = T(J2)
      KX = 2
      IF (TN) 1101,1020,1020
C    USE LAST 4 PCINTS AND CURVE B
1020 JX1 = J2-3
      RA = 0.0
      GO TO 1600
C    TEST FOR - - OFF LOW END, FIRST INTERVAL, OTHER
1050 IF(J-J1-1) 1080 , 1090 , 1100
1100 IF (TN) 1101,1102,1102
1101 JX1 = J-1
      GO TO 1601
1080 IF(T(J)-X) 1082,1090,1082
1082 KX = 1
      X = T(J1)
1090 JX1 = J1
      IF (TN) 1601,1091,1091
1091 RA = 1.0
      GO TO 1600
C    TEST FOR LAST INTERVAL NO, YES, NO
1102 IF (J -J2) 1500,1020,1500
1500 JX1 = J-2
      RA = (T(J) - X )/(T(J) - T(J-1) )
1600 RB = 1.0- RA
C
C    RETURN BACK TO MAIN BODY
1601 IF (L) 500, 100, 500
C
C    COEFFICIENT ROUTINE - INPUT X, X1, X2, X3, X4, RA, RB
1103 JX = JX1
2000 IF (TN) 2001,2002,2002
2001 C1 = (X -T(JX1)) / (T(JX1+1)-T(JX1))
      GO TO 2021
2002 DO 2010 J= 1,3
2010 P(J) = XC(J+1)-XC(J)
      P4 = P1+P2
      P5 = P2+P3
      DO 2020 J=1,4
2020 D(J) = X-XC(J)
      C1 = RA/P1*D1/P4*D3
      C2 = -RA/P1*D1/P2*D3 + RB/P2*D3/P5*D4
      C3 = RA/P2*D1/P4*D2 - RB/P2*D2/P3*D4
      C4 = RB/P5*D2/P3*D3
C    RETURN TO MAIN BODY
2021 IF (L) 600,200,600
      END

```

FIGURE D-6. LISTING OF ADVANCED GENERAL AVIATION Q-FAN PROGRAM
(PAGE 21 OF 26)

```

SUBROUTINE BIQUAD (T, I, XI, YI, Z, K)
ENTPY      BIQUO (T, I, XI, YI, Z, K)
C
C   THIS ROUTINE INTERPOLATES OVER A 4 POINT INTERVAL USING A
C   VARIATION OF 2ND DEGREE INTERPOLATION TO PRODUCE A CONTINUITY
C   OF SLOPE BETWEEN ADJACENT INTERVALS.
C   DIMENSION T(1),XC(4), D(4), P(5), Y(4),C(4)
C
C   EQUIVALENCE (XC(1), D(1))
C
C   TABLE SET UP
C   T(I)      = TABLE NUMBER
C   T(I+1)    = NUMBER OF (X) VALUES
C   T(I+2)    = NUMBER OF (Y) VALUES (0. FOR UNIVARIATE TABLE)
C   T(I+3)    = VALUES OF (X) IN ASCENDING ORDER
C   NX = T(I+1)
C   NY = T(I+2)
C   J1 = I+2
C   J2 = J1 + NX - 1
C   X = XI
C   SEARCH IN X SENSE
C   L = 0
C   GO TO 1000
C   RETURN HERE FROM SEARCH OF X
100  K = KX
C   JX = JX1
C   THE FOLLOWING CODE PUTS X AND/OR Y VALUES IN XC BLOCK
105  DO 110 J=1,4
C   XC(J) = T(JX1)
110  JX1 = JX1+1
C   GET COEFF. IN X SENSE
C   GO TO 2000
C   RETURN HERE WITH COEFF. TEST FOR UNIVARE OR BIVARIATE
200  IF (NY) 300,210,300
210  Z=0.
C   JY = JX+NX
C   DO 220 J=1,4
C   Z = Z + C(J)*T(JY)
220  JY = JY+1

```

FIGURE D-6. LISTING OF ADVANCED GENERAL AVIATION Q-FAN PROGRAM
(PAGE 22 OF 26)

```

        GO TO 9999
C
C   BIVARIATE TABLE
300   L=1
        X = YI
        J1 = J2+1
        J2 = J1+NY-1
C   SEARCH IN Y SENSE  JX1 = SUBSCRIPT OF 1ST Y
        GO TO 1000
500   K = K+3*KX
C   INTERPOLATE IN X SENSE
C   SUBSCRIPT - BASE  NO. OF COL.  NO. OF YS
        JY = J2+1 + (JX-1-3)*NY + JX1-J1
        DO 550 M=1,4
        JX = JY
        Y(M) = 0.
        DO 520 J=1,4
        Y(M) = Y(M) + C(J)*T(JX)
520   JX = JX+NY
550   JY = JY+1
C
C   GET COEFF. IN Y SENSE
        GO TO 105
600   Z = 0.
        DO 700 J=1,4
700   Z = Z + C(J)*Y(J)
9999  RETURN
C
C   SEARCH ROUTINE - INPUT J1,J2,X
C                   -OUTPUT RA,RB,KX,JX1
1000  KX = 0
        DO 1010 J=J1,J2
        IF (T(J)- X) 1010,1050,1050
1010  CONTINUE
C   OFF HIGH END
        X = T(J2)
        KX = 2
C   USE LAST 4 POINTS AND CURVE B
1020  JX1 = J2-3
        RA = 0.
        GO TO 1600
C   TEST FOR - - OFF LOW END, FIRST INTERVAL, OTHER
1050  IF(J-J1-1) 1080, 1090, 1100
1080  IF(T(J)-X) 1082,1090,1082
1082  KX = 1
        X = T(J1)
1090  JX1 = J1
        RA = 1.
        GO TO 1600
C   TEST FOR LAST INTERVAL  NO, YES, NO
1100  IF (J - J2) 1500,1020,1500
1500  JX1 = J-2
        RA = (T(J) - X )/(T(J) - T(J-1) )

```

FIGURE D-6. LISTING OF ADVANCED GENERAL AVIATION Q-FAN PROGRAM

(PAGE 23 OF 26)

```

1600 RB = 1. - RA
C
C RETURN BACK TO MAIN BODY
IF (L) 500, 100, 500
C
C COEFFICIENT ROUTINE - INPUT X, X1, X2, X3, X4, RA, RB
2000 DO 2010 J=1,3
2010 P(J) = XC(J+1)-XC(J)
P(4)=P(1)+P(2)
P(5)=P(2)+P(3)
DO 2020 J=1,4
2020 D(J) = X-XC(J)
C(1)=(RA/P(1))*(D(2)/P(4))*D(3)
C(2)=(-RA/P(1))*(D(1)/P(2))*D(3)+(RB/P(2))*(D(3)/P(5))*D(4)
C(3)=(RA/P(2))*(D(1)/P(4))*D(2)-(RB/P(2))*(D(2)/P(3))*D(4)
C(4)=(RB/P(5))*(D(2)/P(3))*D(2)
C RETURN TO MAIN BODY
IF (L) 600,200,600
END

```

FIGURE D-6. LISTING OF ADVANCED GENERAL AVIATION Q-FAN PROGRAM

(PAGE 24 OF 26)

```

SUBROUTINE UNINT ( N, XA, YA, X , Y, L)
C   REWRITTEN   SEPTEMBER 18, 1967
C   UNIVARIATE TABLE ROUTINE WITH SEPERATE ARRAYS FOR X AND Y - S 66
C
C   THIS ROUTINE INTERPCLATES OVER A 4 POINT INTERVAL USING A
C   VARIATION OF 2ND DEGREE INTERPOLATION TO PRODUCE A CONTINUITY
C   OF SLOPE BETWEEN ADJACENT INTERVALS.
C
DIMENSION XA(1), YA(1), D(4), P(5)
      L=0
      I=1
C   TEST FOR OFF LOW END  NO  = YES
      IF ( XA(1)-X ) 100, 150, 10
10    L=1
      GO TO 150
100   DO 120 I=2,N
      IF ( XA(I)-X ) 120, 150, 200
120   CONTINUE
C   OFF HIGH END
      I = N
      L= 2
150   Y= YA(I)
      GO TO 999
C   TEST FOR FIRST INTERVAL
200   IF(I-2) 240,220,240
C   FIRST INTERVAL
220   JX1 = 1
      RA = 1.
      GO TO 400
C   TEST FOR LAST INTERVAL
240   IF(I-N) 300, 250, 300
C   LAST INTERVAL
250   JX1 = N-3
      RA = 0.
      GO TO 400
300   JX1 = I-2
      RA = (XA(I)-X) / (XA(I)-XA(I-1) )
400   RB = 1. - RA

```

FIGURE D-6. LISTING OF ADVANCED GENERAL AVIATION Q-FAN PROGRAM
(PAGE 25 OF 26)

```

C
C   GET COEFFICIENTS AND RESULTS
      J = JX1
      DO 500 I=1,3
      P(I) = XA(J+1) - XA(J)
      D(I) = X - XA(J)
500  J = J+1
      D(4) = X - XA(J)
      P(4) = P(1) + P(2)
      P(5) = P(2) + P(3)
C   RFSULT
      Y = YA(JX1) * RA/P(1) * D(2)/P(4) * D(3) +
1     YA(JX1+1) * (-RA/P(1) * D(1)/P(2) * D(3) + RB/P(2) * D(3)/P(5)
2     * D(4)) + YA(JX1+2) * (RA/P(2) * D(1)/P(4) * D(2) - RB/P(2)
3     * D(2)/P(3) * D(4)) + YA(JX1+3) * RB/P(5) * D(2)/P(3) * D(3)
999  RETURN
      END

```

FIGURE D-6. LISTING OF ADVANCED GENERAL AVIATION Q-FAN PROGRAM

(PAGE 26 OF 26)