

16919
A FINAL REPORT

to

N74-20714
The National Aeronautics and Space Administration

on

THE PHYSICS OF CELLULAR SYNTHESIS, GROWTH AND DIVISION

NGR 39-009-008

by

Ernest C. Pollard
Principal Investigator

mi

Biophysics Department
The Pennsylvania State University
University Park, Pennsylvania
16802

At the time of the inception of this program basic research related to the missions of NASA was considered acceptable to the universities, and this was one such program. The missions to which it addressed itself were:

- (1) To arrive at an understanding of the character of the simplest and most primitive living cells found terrestrially so that there could be some guide as to the kind of cells to look for in extraterrestrial life, and also some guide as to the possibilities of finding life developed in this way anywhere else in the solar system;
- (2) to give some advice with regard to experimentation in zero gravity conditions, particularly those experiments which concerned small organisms; and
- (3) since NASA's space flights encounter considerable hazard from ionizing radiation, to try to understand the fundamentals of the effects of ionizing radiation on cells so as to make some prediction as to how much hazard could be taken by human beings with no permanent damage to them.

The change in policy which took out fundamental research supported in the universities as part of the NASA program came too soon for the impact of the program here on these three missions to be clearly seen. Nevertheless, it is possible to trace some effect and to see that some suggestions have been possible as a result of the program. The program generated a considerable scientific output, which is measured in terms of some 65 publications by a wide variety of authors. In addition, the program was highly instrumental in bringing into being the Biophysics Department at Penn State; this department is now a first-rate, on-going scientific organization which has won international recognition. The department currently carries a program of some 25 graduate

students (down from its peak of 40) and also approximately 30 undergraduate majors. It would not be right to give this final report without mentioning this most important fact as a very large part of the scientific value that has resulted from this program.

The Contributions to the Understanding of the Nature of the Living Cell.

The report generated by this program has resulted in a rather small number of significant publications, which have been followed by a course on the structure of the bacterial cell; the course has been given now a total of four times - three times at Penn State and once at the University of Florida - and is now summarized in what may become a book. In it is given a careful account with many references and closely figured reasoning on the structure of the membrane of the DNA and of the internal components of the cell. That such a structure can be postulated is interesting in its own right, and that there is a certain amount of external evidence for it is also interesting. The study of the detailed structure of bacteria has not really begun, but some progress is being made, and the work being done in this department is in the forefront of the effort. One of the things that are of considerable importance from the point of view of looking for extra-terrestrial life is the requirement that, for efficient functioning, a bacterial cell does have a defined structure. The nucleic acid is not randomly distributed throughout the cell, but instead is distributed in a series of pancake coils, which are themselves fastened in place. This suggestion came out of the work here and has been confirmed in general by Worcel and Burgi¹. Because this structure is apparently necessary for the functioning of microorganisms, and because it is really a rather developed thing and not anywhere approximating a random

structure, which might be expected, it suggests that the finding in extra-terrestrial places of forms of life similar to those found here is most unlikely. It is a much more productive thing to try to imagine what could be a precursor of this kind of life, and there is no doubt that the studies made here suggest that precursor would be extremely difficult to imagine, and very hard to look for. The difficulty might very well be eased if one postulate, suggested out of this project, were agreed upon; that is "A living system tends to take that structure which will optimize its function". To some this may seem to be a statement of the obvious, but to those who believe that life is constructed in physico-chemical terms, it is by no means obvious, because there is no driving force that will examine the function of a living cell and cause it to take an optimum form. It can do so as a process of evolution, but this involves the tedious and time-consuming process of trial-and-error. It is suggested that possibly this new postulate might provide a driving principle behind the principle of evolution.

The problem of zero gravity as concerned with small organisms has been approached mostly theoretically although some unpublished experiments suggest that the theory is probably right. A series of three papers on the problem of zero gravity has appeared²⁻⁴. The conclusion reached in all three of these studies was that for really small cells, the randomizing effect of thermal agitation was so great that it would really be effectively impossible to observe difference between cells in weightlessness and non-weightlessness. This is supported by some unpublished experiments, reported on in the same articles, in which considerable centrifugation produced no change in the behavior of the cell; this suggested that if the cell could function quite well at 50,000 g there would be no sense in looking at zero g. These studies have had

considerable effect in diminishing research done under very costly conditions on organisms where very little effect could be found. By contrast, larger cells seem to be quite productive, particularly cells in which the nucleus can be found in a different place under zero gravity conditions, and rare membranes will be altered by zero gravity. This work has resulted in a good deal of consultation, and the department has been represented at several quite influential conferences where these experiments were discussed at some length. It is the impression here that the work was useful.

Effect of Ionizing Radiation on Cells

In this area, which is experimentally relatively straightforward to study, our group has made a very considerable contribution, ranging all the way from studies of effects of radiation on molecules using the electron spin resonance technique as a method of study through the effect of mutation induced by various forms of ionizing radiation to various single molecular processes that occur in cells. While no firm doctrine of what radiation will do to cells has developed out of this, such a doctrine is very close to being possible. The reason why it is now possible is that figures on the separate actions of ionizing radiations are now available for the first time. Thus we know as a result of the work of this group what the effect of ionizing radiation is on genetic transcription, for example, or on the introduction of DNA degradation, post-irradiation, and all of it is probably summarized in an article that formed the basis of a series of Sigma Xi National Lectures in 1969⁵; this article is in the process of being updated this year and will be tested against the experiment in the University of Florida this winter. The net result is that in the area of ^{cell} survival, wisdom with regard to ionizing radiation and its possible effect has developed in this group. They are quite competent

to advise on basic problems that might be encountered in space flight, and should their wisdom ever be needed, the group is available and can be employed to contribute inputs in the event of space flight problems being hazardous.

Outside of this work are many publications which are involved with a laboratory where free inquiry is encouraged and in which the areas have not been exactly defined so as to make the work of a contract character. These can be seen in the list of references and publications following this report, and can be looked at in the series of reprints which have been forwarded over the years (some are included with this report).

It was a considerable blow to this Biophysics department when the change of policy took this very useful grant from us. Nevertheless, the time allowed to us for modification was just about adequate, and it is important to say that the program started something that has continued and is continuing. The department remains one of the best in biophysics in the world; it has an excellent record in the placement of its students after the completion of their degrees, and a fine record of on-going productivity in research. All of this is often characterized as a "spin-off" of a program clearly related to space in the early stages, and it should be stressed that such a "spin-off" is by no means a trivial thing because the characteristics of a space program automatically mean that the individual missions are only a part of the entire program, but that the existence of well-trained and competent people, who would not have been there but for the research program, is something that is on-going and that continues. We can point with considerable pride to exactly that.

Literature cited:

1. A. Worcel & E. Burgi. On the structure of the folded chromosome of Escherichia coli. J. Mol. Biol. 71:127-147 (1972).

2. E. C. Pollard. Theoretical studies on living systems in the absence of mechanical stress. *J. Theoret. Biol.* 8:113-123 (1965).
3. E. C. Pollard. Cellular effects of weightlessness. In Hypodynamics and Hypogravics: the Physiology of Inactivity and Weightlessness(ed. M. McCally) Academic Press, N.Y., 1968. pp. 109-116.
4. E. C. Pollard. Physical determinants of receptor mechanisms. In Gravity and the Organism (eds. S. Gordon & M. J. Cohen) U. Chicago, 1971. pp.25-31.
5. E. C. Pollard. Biological action of ionizing radiation. *Amer. Sci.* 57: (2)206-236 (1969).

Publications resulting from this project:

- H. E. Frey and E. C. Pollard, Ionizing radiation and bacteria: Nature of the effect of irradiated medium. *Radiat. Res.* 28:668-676 (1966).
- E. C. Pollard & T. F. Barone. The effect of ionizing radiation on genetic transcription: aspects of the mechanism. *Radiat. Res.* 5:194-200 (1966). (Suppl. 6)
- E. C. Pollard, J. Swez & L. J. Grady. Physical characteristics of residual DNA. *Radiat. Res.* 28:585-596 (1966).
- W. Snipes and P. K. Horan. Electron spin resonance studies of free radical turnover in gamma-irradiated single crystals of alanine. *Radiat. Res.* 30:307-315 (1967).
- J. Swez & E. C. Pollard. DNA-agar annealing of residual DNA after degradation by ionizing radiation. *Radiat. Res.* 29:475-482 (1966).
- E. C. Pollard & L. J. Grady. CsCl density gradient studies of intact bacterial cells. *Biophys. J.* 7:205-213 (1967).
- W. Bernhard & W. Snipes. ESR of free radical conversion in gamma-irradiated dihydrothymine. *J. Chem. Phys.* 46:2848-2849 (1967).
- W. Snipes & J. Schmidt. Free radical formation in amino acids exposed to thermal hydrogen atoms. *Radiat. Res.* 29:194-202 (1966).
- S. Person & M. Sclair. DNA degradation in E. coli produced by tritium decay. *Radiat. Res.* 33:66-73 (1968).
- W. Snipes & W. Bernhard. Irradiation of dihydropyrimidines. *Radiat. Res.* 33:162-173 (1968).
- M. Osborn, S. Person, S. L. Phillips & F. Funk. A determination of mutagen specificity in bacteria using nonsense mutants of bacteriophage T4. *J. Mol. Biol.* 26:437-447 (1967).
- M. Osborn & S. Person. Characterization of revertants of E. coli WU36-10 and WP2 using amber mutants and an ochre mutant of bacteriophage T4. *Mut. Res.* 4:504-507 (1967).
- L. J. Grady & E. C. Pollard. DNA degradation by ionizing radiation in Bacillus subtilis. Synergistic effect of actinomycin D. *BBA* 145:837-839 (1967).
- W. Taylor & W. Ginoza. Correlation of gamma-ray inactivation and strand scission in the replicative form of ϕ X174 bacteriophage DNA. *PNAS* 58: 1753-1757 (1967).
- R. S. Morgan & F. Kellogg. Bonding radii of 80S ribosomes. *Nature* 216:1302-1304 (1967).
- H. Dalen & T. Nevalainen. An in situ embedding and vertical orienting technique for cell cultures for electron microscopy. *Stain Technol.* 43:217-226 (1968).
- L. J. Grady & E. C. Pollard. Ionizing radiation-induced degradation of DNA in bacteria: A possible role for defective prophage. *Radiat. Res.* 36:68-86 (1968).

- P. K. Horan, W. D. Taylor, G. K. Strother & W. Snipes. Stability of radiation-induced organic free radicals: Decay by heat. *Biophys. J.* 8:164-174 (1968).
- S. Person. Lethal and mutagenic effects of tritium decay produced by tritiated compounds incorporated into bacteria and bacteriophages. IAEA, Vienna, 1968.
- S. Person & M. Osborn. The conversion of amber suppressors to ochre suppressors. *PNAS* 60:1030-1037 (1968).
- J. Schmidt & W. Snipes. Free-radical formation in a gamma-irradiated pyrimidine-purine co-crystal complex. *Int. J. Radiat. Biol.* 13:101-109 (1967).
- E. C. Pollard. The fine structure of the bacterial cell and the possibility of its artificial synthesis. In *Sci. in Progress*, Yale U., 1967. pp.133-170.
- F. Funk, S. Person & R. C. Bockrath. The mechanism of inactivation of T4 bacteriophage by tritium decay. *Biophys. J.* 8:1037-1050 (1968).
- H. Dalen & P. Scheie. Two types of long microextensions from cultivated liver cells. *Exp. Cell Res.* 53:670-673 (1968).
- E. C. Pollard. The degree of organization of the bacterial cell. In *Formation and Fate of Cell Organelles* (ed. K. B. Warren) Academic Press, 1967. *Symp. Int. Soc. Cell Biol.* 6:291-303.
- J. D. Chapman, J. Swez & E. C. Pollard. The inhibition of gamma-ray-induced degradation of *E. coli* B DNA by infection with T1, T2 and T4 bacteriophage. *Nature* 218:690-693 (1968)^{S-1}
- W. Bernhard & W. Snipes. Electron spin resonance of a gamma-irradiated single crystal of 3'cytidylic acid. *PNAS* 59:1038-1044 (1968).
- W. Snipes & B. Benson. Electron spin resonance of a gamma-irradiated single crystal of 5-nitro-6-methyl uracil. *J. Chem. Phys.* 48:4666-4670 (1968).
- B. Benson & W. Snipes. Free radicals formed in cytosine-5-³H by decay of a constituent tritium atom. *J. Chem. Phys.* 49:1435-1436 (1968).
- R. C. Bockrath, S. Person & F. Funk. Calculated energy deposits from the decay of tritium and other radioisotopes incorporated into bacteria. *Biophys. J.* 8:1027-1036 (1968).
- R. C. Bockrath, M. Osborn & S. Person. Nonsense suppression in a multiauxotrophic derivative of *Escherichia coli* 15 T: Identification of an amber triplet in the deoxyribomutase gene and its effect on thymine utilization. *J. Bacteriol.* 96:146-153 (1968).
- R. S. Morgan. The structure of the ribosomes of chromatoid bodies: A three-dimensional Fourier synthesis at low resolution. *Science* 162:670-671 (1968).
- P. Scheie & H. Dalen. Spatial anisotropy in *Escherichia coli*. *J. Bacteriol.* 96:1413-1414 (1968).
- P. Scheie & T. Smyth, Jr. The electrical resistance of intact integument of *Periplaneta americana* (L.). *Comp. Biochem. Physiol.* 26:399-414 (1968).
- P. Scheie, T. Smyth & M. Greer. Perforations in cockroach cuticle as viewed by a scanning electron microscope. *Ann. Entomol. Soc. Am.* 61:1346-1348 (1968).
- W. Snipes & J. Schmidt. Conformation of the hydrogen addition radical in 1-methyl thymine. *J. Chem. Phys.* 49:1443-1445 (1968).
- W. Taylor & W. Snipes. Enhancement of radiation effects by phosphate buffer at 77°K. *Int. J. Radiat. Biol.* 14:277-280 (1968).
- P. Todd, T. Coohill & J. Mahoney. Responses of cultured Chinese hamster cells to ultraviolet light of different wavelengths. *Radiat. Res.* 35:390-400 (1968).
- H. L. Atwood, T. Smyth & H. S. Johnston. Neuromuscular synapses in the cockroach extensor tibiae muscle. *J. Insect Physiol.* 15:529-535 (1969).
- P. K. Horan & W. Snipes. Free radical destruction by gamma-irradiation at 77°K. *Int. J. Radiat. Biol.* 15:157-161 (1969).
- T. Nevalainen. Electron microscopic observations on the shell gland mucosa of calcium-deficient hens (*Gallus domesticus*). *Anat. Res.* 164:127-140 (1969).

- T. Nevalainen. Fine structure of the parathyroid gland of the laying hen (Gallus domesticus). Gen. Comp. Endocrinol. 12:561-567 (1969).
- P. Scheie. Electrical resistance of intact integument throughout the molt cycle of a cockroach. Comp. Biochem. Physiol. 29:479-482 (1969).
- P. Scheie. Plasmolysis of E. coli B/r with sucrose. J. Bacteriol. 98:335-340 (1969).
- P. Scheie & H. Dalen. Surface features of cultured mammalian cells. In Scanning Electron Microscopy/1969, pp. 127-134.
- J. Schmidt & W. Snipes. Electron spin resonance of gamma-irradiated single crystals of 9-methyladenosine. Radiat. Res. 38:274-284 (1969).
- P. Todd, T. Coohill, A. B. Hellewell & J. Mahoney. Postirradiation properties of cultured Chinese hamster cells exposed to ultraviolet light. Radiat. Res. 38:321-339 (1969).
- B. Benson & W. Snipes. Free radicals in pyrimidines: E.S.R. of gamma-irradiated single crystals of alloxantin. Int. J. Radiat. Biol. 15:583-585 (1969).
- J. D. Chapman & E. C. Pollard. Characteristics of the enzymatic breakdown of DNA in E. coli in response to ionizing radiation. Int. J. Radiat. Biol. 15:323-333 (1969).
- H. Dalen & P. Scheie. Microextensions on Chang's liver cells as observed throughout their division cycle. Exp. Cell Res. 57:351-358 (1969).
- F. Funk & S. Person. Cytosine to thymine transitions from decay of cytosine-5-³H in bacteriophage S13. Science 166:1629-1631 (1969).
- C. E. Hildebrand & E. C. Pollard. The study of ionizing effects on E. coli by density gradient sedimentation. Biophys. J. 9:1312-1322 (1969).
- G. J. Kantor, S. Person & F. A. Anderson. Evidence for a function for the UAA codon in vivo. Nature 223:535-537 (1969).
- A. Yayanos & E. C. Pollard. A study of the effects of hydrostatic pressure on macromolecular synthesis in E. coli. Biophys. J. 9:1464-1482 (1969).
- W. Yeisley & E. C. Pollard. Division patterns from single E. coli cells. Biophys. J. 9:925-949 (1969).
- J. Cowlshaw & W. Ginoza. Induction of lambda prophage by nalidixic acid. Virology 41:244-255 (1970).
- F. Hallett, B. Hallett & W. Snipes. Reactions between singlet oxygen and the constituents of nucleic acid: Their importance in photodynamic processes. Biophys. J. 10:305-315 (1970).
- E. C. Pollard. The effect of ionizing radiation on the molecular biology of E. coli. In Current Topics in Radiation Research 6:51-127. (eds. M. Ebert & A. Howard) North-Holland, Amsterdam, 1970.
- See also Literature Cited, refs. #2-5.
- *E. C. Pollard & W. Solosko. The thermal inactivation of T4 and lambda bacteriophage. Biophys. J. 11:66-74 (1971).
- *B. Benson & W. Snipes. Free radicals in pyrimidines: E.S.R. of a gamma-irradiated single crystal of 5-nitouracil. Mol. Phys. 20:357-363 (1971)
- *H. Dalen & P. Todd. Surface morphology of trypsinized human cells in vitro. Exp. Cell Res. 66:353-361 (1971).
- *D.F. Myer & R. S. Morgan. Evidence for a link between division and differentiation in Entamoeba invadens. J. Protozool. 18:282-284 (1971).
- *C.E. Hildebrand & E. C. Pollard. Hydrostatic effects on protein synthesis. Biophys. J. 12:1235-1250 (1972). pressure
- *P. Scheie & R. Rehberg. Response of Escherichia coli B/r to high concentrations of sucrose in a nutrient medium. J. Bacteriol. 109:229-235 (1972).
- P. Scheie. Environmental limits of cellular existence. J. Theor. Biol. 28:315-326 (1970).
- * Reprint enclosed

JOURNAL OF BACTERIOLOGY, Jan. 1972, p. 229-235
Copyright © 1972 American Society for Microbiology

Vol. 109, No. 1
Printed in U.S.A.

Response of *Escherichia coli* B/r to High Concentrations of Sucrose in a Nutrient Medium

PAUL O. SCHEIE AND RITA REHBERG

Biophysics Department, The Pennsylvania State University, University Park, Pennsylvania 16802

Received for publication 23 August 1971

N 74-20714

Response of *Escherichia coli* B/r to High Concentrations of Sucrose in a Nutrient Medium

PAUL O. SCHEIE AND RITA REHBERG

Biophysics Department, The Pennsylvania State University, University Park, Pennsylvania 16802

Received for publication 23 August 1971

Escherichia coli B/r was subjected to sucrose concentrations up to 1 M in the presence of Nutrient Broth. Plasmolysis seldom was evident 2 min after this treatment. The subsequent response was characterized by transient decreases in optical density as well as changes in appearance as seen under phase optics. No transient effects were detected in the synthetic rates or in the division of the survivors.

Escherichia coli cells are expected to plasmolyze when subjected to high concentrations of sucrose (4, 6, 7, 24). Deplasmolysis generally follows after some minutes, but can be delayed if nutrients are removed from the medium before the sucrose is added (6). Cellular activities subsequent to deplasmolysis have received little attention. Reports that do exist are based on conditions under which either nutrients were removed for plasmolysis and then resupplied (17, 22) or the high concentrations of sucrose were diluted before measurements were made (3).

Almost no information is available on the response of these cells to high concentrations of sucrose under conditions that otherwise would permit optimal synthesis and growth. Some aspects of such a response are described in this report. Visible evidence of plasmolysis was found to be absent 1 to 2 min after the cells were placed in contact with the sucrose. However, subsequent transient changes in appearance as well as transient changes in optical density (OD) were observed. At the same time, no corresponding effects were detected in the synthetic rates or in the division rates of the surviving cells.

MATERIALS AND METHODS

E. coli B/r obtained from Stanley Person of this laboratory were grown in 10-ml volumes of air-bubbled Nutrient Broth (Difco) at 37 C. During log phase, at concentrations near 2×10^8 cells/ml, 3 ml of such cultures were pipetted into 7 ml of warmed, air-bubbled Nutrient Broth containing appropriate amounts of dissolved, reagent-grade sucrose. Various means were then used to monitor the response of the cell. The uniqueness of the response was checked by use of other strains of *E. coli*, B₈₋₁ and 15T⁻ (supplemented with thymidine at 0.4 μg/ml), also obtained

from Dr. Person, as well as a different species, *E. intermedia* (ATCC 21073).

Microscopic observation. Observations were carried out at room temperature with medium dark-contrast phase microscopes at magnifications of 1,000 to 2,000. Samples were removed and placed on microscope slides at various times after the cells were subjected to sucrose solutions. Vaseline or paraffin was placed around the cover slip to prevent evaporation. Photomicrographs were obtained with a $\times 90$ normal-contrast objective on a Leitz microscope with Kodak Contrast Copy film.

OD measurement. The OD of cell suspensions was measured at 425 nm with a Bausch & Lomb Spectronic-20 spectrophotometer. This information was used to determine growth rates and to follow changes subsequent to subjecting cells to sucrose. The test tube containing the entire culture of interest was transferred to the spectrophotometer for each measurement, a procedure that required less than 20 sec per reading.

Survival. Colony-forming ability was determined by diluting the cells through warm (37 C) blanks containing the same medium as the culture being examined, and then plating them in triplicate on nutrient agar plates containing the same sucrose concentration as the culture and blanks. The plates were incubated at 37 C, and colonies were counted when they became easily visible. This required incubation for 3 or 4 days at the higher sucrose concentrations.

Incorporation of radioactive macromolecule precursors. Log-phase cells were grown for approximately four division times in a Nutrient Broth medium containing the labeled compound to be investigated. For thymine, this included 0.093 μg of ¹⁴C-thymine/ml (New England Nuclear Corp.) at a specific activity of 0.04 μCi/ml, 0.4 μg of ¹²C-thymine/ml, and 250 μg of deoxyadenosine/ml. When such a culture reached about 10⁸ cells/ml, 6 ml was added to 14 ml of a similar solution containing, in addition, the appropriate concentration of sucrose. For the control, 3 ml of the culture was

added to 7 ml of the medium lacking sucrose. At specified times, 1-ml samples were removed and placed in 9 ml of cold 5% trichloroacetic acid for at least 2 hr. These suspensions were then filtered (0.45- μ m membrane filters; Millipore Corp.) and washed with 15 ml of 5% trichloroacetic acid. The filters were glued to plachets, dried, and counted with a Nuclear-Chicago gas-flow Geiger counter (model 1105). Incorporation was assumed concomitant with deoxyribonucleic acid (DNA) synthesis.

A similar procedure was followed for investigating the incorporation of uracil and proline into ribonucleic acid (RNA) and protein. For uracil incorporation, the medium contained 0.074 μ g of 14 C-uracil/ml at 0.02 μ Ci/ml; for proline incorporation, it contained 9 μ g of 14 C-proline/ml at 0.005 μ Ci/ml.

RESULTS

Appearance of cells. Cells were observed under phase contrast 1 to 2 min after being placed in a medium containing Nutrient Broth and sucrose. Very few signs of plasmolysis were evident, even in sucrose concentrations of

1 M, whereas in the absence of nutrients plasmolysis was evident for several minutes at 0.2 M sucrose (24). Figures 1b and e show typical phase micrographs of *E. coli* B/r cells shortly after they were immersed in 0.5 and 1.0 M sucrose, respectively. Deplasmolysis apparently had already occurred.

It is important to note that both a 1 M sucrose solution and normal *E. coli* cells have a refractive index near 1.38 (28). Hence, the fact that the cells, when placed in 1 M (and higher) sucrose, still appeared quite dark in positive phase contrast indicates that the refractive index of the cells had increased (2). This is consistent with the belief that deplasmolysis occurred as sucrose got into the cell.

The cells began to change their appearance as a function of time in the sucrose. Internal regions, often near the center of the cell, began to exhibit a decrease in contrast, indicating that the refractive index of this central portion of the cell was approaching that of the me-

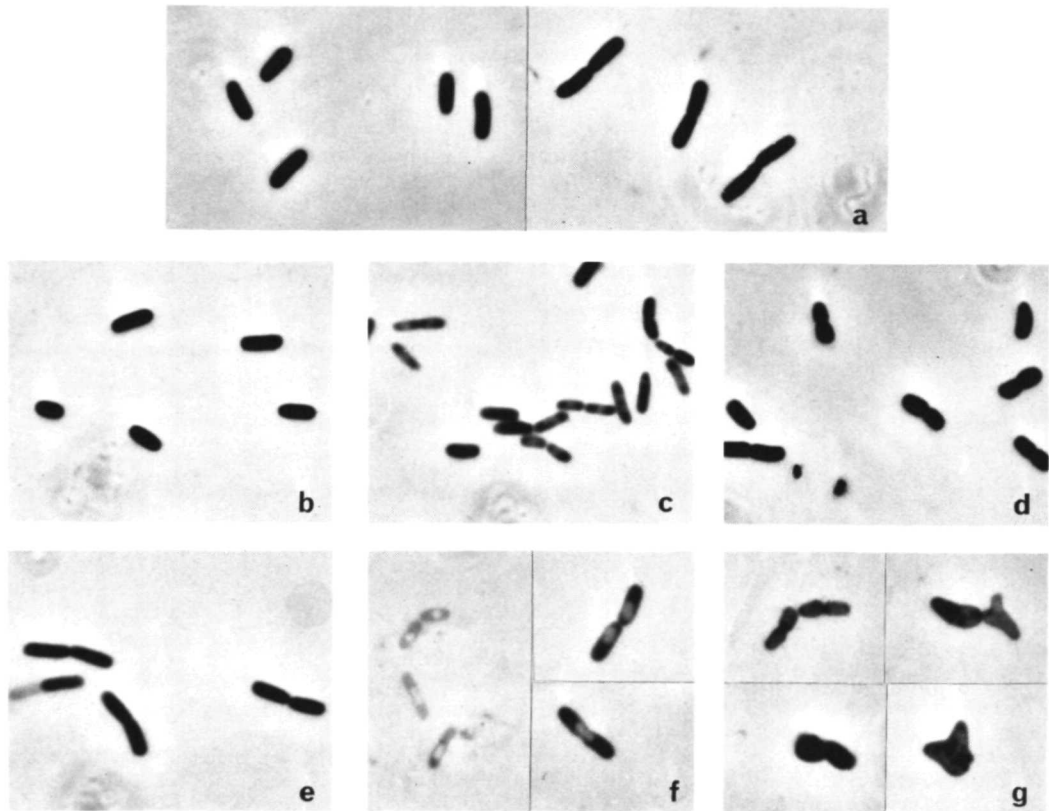

FIG. 1. Phase micrographs of *E. coli* B/r cells (1 mm = 0.49 μ m). (a) Normal log-phase cells. (b) Log-phase cells shortly after being placed in a broth medium containing 0.5 M sucrose. (c) Log-phase cells placed in broth with 0.5 M sucrose for approximately 15 min. (d) Cells in log phase grown in broth with 0.5 M sucrose. (e) Log-phase cells shortly after being placed in broth with 1 M sucrose. (f) Log-phase cells after being in broth with 1 M sucrose for 30 min. (g) Cells grown in broth with 1 M sucrose.

dium. Examples of this are shown in Fig. 1c and f. The regions of low contrast will be referred to as light centers. Light centers required a longer time to develop and became more pronounced with increased sucrose concentrations. A difference in contrast between cells can be noted in both Fig. 1e and f. This is believed to have been the result of a differential accessibility to the sucrose.

Certain orientations of plasmolyzed cells could present somewhat similar appearances; however, the appearance referred to here took several minutes to develop and did not change in tumbling cells as different views were presented, nor was more than an occasional cell observed that had the more familiar features of plasmolyzed cells, in particular, the sharp difference in contrast between cytoplasm and periplasmic space.

Eventually, much of the original contrast returned to cells placed in concentrations up to about 0.5 M sucrose, and although they may have become shorter they still maintained their rodlike shapes (Fig. 1d). On the other hand, many cells in 1 M sucrose, after several days of incubation, were found to have lost their normal shape; these cells usually showed less overall contrast than normal cells (Fig. 1g). The decrease in contrast of normal cells suggests that their internal environments had been at least partially restored to that for normally grown cells, whereas the swollen and distorted appearance of other cells suggests that sucrose may have interfered with normal construction of the rigid layer in the cell envelopes. It is not known whether cells with distorted shapes were capable of reverting to normal or of forming colonies.

The light centers resembled those shown in other phase micrographs of *E. coli* placed in media of raised refractive index (13, 23, 27). In those instances, the high refractive index was achieved with material such as serum albumin, gelatin, or polyvinylpyrrolidone whose osmotic activities, on a weight basis, are much less than that of sucrose. The light regions were purported to represent the positions of the nuclear material. Similar results could not be obtained by placing the cells used here in a medium containing 20 to 30% bovine serum albumin. Perhaps in these *E. coli* B/r cells the DNA normally was spread throughout the cell and the response to sucrose included a temporary rearrangement of the DNA to a more compact configuration. This is consistent with electron micrographs of normal B/r cells (25) as well as with other reports that nuclear material can exhibit altered appearance when

cells are subjected to various treatments either before or during the fixation process (11, 14, 15).

Several other factors were investigated for possible influence on this response. Light centers were observed when sucrose was replaced with similar concentrations of glucose or lactose (but not with NaCl), when Nutrient Broth was replaced with Roberts' C-minimal salts (20), when the culture in sucrose was bubbled with nitrogen, or when the culture was not bubbled at all. Pretreatment of the cells with chloramphenicol (0.1 mg/ml) to halt protein synthesis did not prevent the formation of light centers, but did prevent their subsequent disappearance. Both KCN (0.85 mg/ml) and low temperature (0 C) inhibited the formation of light centers. When cold cells in sucrose and broth were rewarmed, the light centers began to appear. When cells having light centers were centrifuged and resuspended in broth without sucrose, no light centers remained.

These results indicated that some metabolic activity was required for the appearance of light centers, that protein synthesis was required for the return to normal contrast in sucrose-containing media, and that formation of light centers was reversed rapidly when the sucrose was removed.

Changes in OD. OD at 425 nm showed an initial value near or slightly higher than that which would be expected by the dilution factor. The OD then underwent a transient decrease, the duration and amplitude of which increased with increasing concentrations of sucrose (Fig. 2). Light centers were most prevalent at times corresponding to the minimum of OD. These times for reaching the minimum OD are shown as a function of sucrose concentration in Fig. 3. The factors previously mentioned that affected the development of the observable light centers affected the decrease in OD in a similar manner.

Myers et al. (16) showed that cells placed in 0.6 osmolal sucrose should produce a 40% decrease in OD as a result of the increased refractive index of the medium. The shrinkage associated with plasmolysis was believed to increase the OD so that the OD which they measured was not much different from that of the control cells. The almost unchanged initial OD in even higher sucrose concentrations as reported here may indicate a similar cancellation of effects. The increased refractive index of plasmolyzed cells would be partially maintained as sucrose entered the cells during deplasmolysis. Rubenstein et al. (22) also reported a temporary decrease in OD in cells

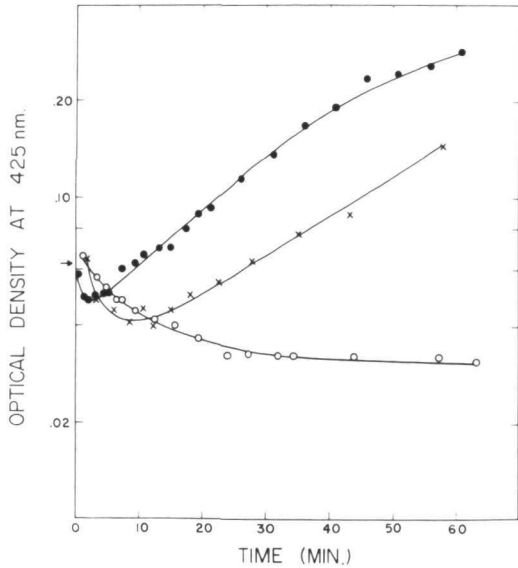

FIG. 2. Changes in optical density after *E. coli B/r* cells were subjected to sucrose-containing broth: ●, 0.2 M sucrose; ×, 0.5 M sucrose; ○, 1 M sucrose. The arrow indicates the expected initial value on the basis of dilution.

that had been washed before being subjected to sucrose. Other investigators have reported time-dependent optical effects at sugar concentrations of 0.2 M or less. These effects included increases in OD found in nongrowth media and attributed to cell shrinkage (1, 12), as well as decreases in OD attributed to swelling accompanying sugar uptake (18, 26) or to the sugar becoming associated with, and raising the refractive index of, the cell membrane (21). All of these effects could have been present when higher concentrations were used.

Dips in OD and the development of light centers also were observed at 0.5 M sucrose with *E. coli* B_{s-1}, *E. coli* 15T⁻, and *E. intermedia*. Plasmolysis vacuoles were evident in *E. intermedia* for several minutes.

Survival of colony-forming ability. It was desirable to determine whether the changes in appearance and in OD were accompanied by changes in colony-forming ability. Figure 4 shows the survival of colony-forming ability for cells subjected to, diluted through, and plated on sucrose-containing media. Decreased survival became appreciable above 0.6 M sucrose as reported for conditions conducive to more long-lasting plasmolysis (24). Since light centers were observed in cells at all concentrations above 0.2 M, the qualitative change observed in appearance was not correlated in any obvious fashion with cell death. Most cells

in 0.5 M sucrose developed light centers and also formed colonies with no evidence of a detrimental effect. In 1 M sucrose, light centers were as plentiful, but colony formation was depressed by 90%. It is possible that only cells

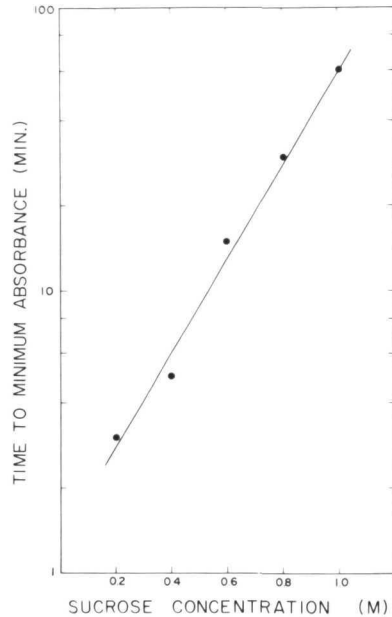

FIG. 3. Time required for the optical density to reach a minimum for *E. coli B/r* placed in broth containing various concentrations of sucrose.

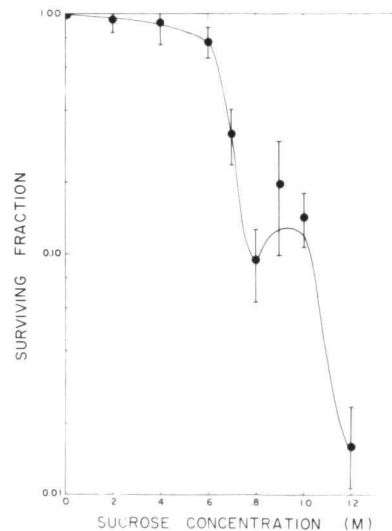

FIG. 4. Survival of *E. coli B/r* colony-forming ability in broth containing various concentrations of sucrose. Error bars represent standard deviations for three or more experiments.

not having light centers survived at the higher concentrations. The survival curve does hint that there may have been different lethal factors operating above and below a concentration of 1 M, although another interpretation is offered in the next section. Other evidence has shown survival of *E. coli* B to be near 90% when subjected to > 1 M sucrose if the sucrose is then diluted slowly (3).

Growth and rates of synthesis. Growth rates finally attained by survivors in various concentrations are shown in Fig. 5. Small amounts of sucrose actually enhanced growth in broth, but an upper limit seems likely to have existed near 1.6 M if a linear extrapolation is valid.

The transient changes observed in OD and in the appearance of cells were expected to be reflected in transient changes in the major metabolic processes, the synthesis of DNA, RNA, and protein. This was not the case. Figure 6 presents representative results of plating cells, on sucrose-containing plates, as a function of time after contact with sucrose. Extrapolations to zero time gave values corresponding to the survival shown in Fig. 4. The final slopes for 0.2 and 0.4 M sucrose were consistent with the growth rates at these concentrations (Fig. 5) and, clearly, these new division rates were achieved rapidly.

The behavior in 0.8 M sucrose (Fig. 6c) illustrates an effect that was not present at concentrations of 0.6 M and lower. An impressive decrease in survival was evident for cells diluted and plated within 20 min of being placed in the sucrose. Temperature shock was ruled out as a cause, because similar results were obtained when the experiment was performed in a room maintained at 37 C. Although the basis for this behavior has not been determined, we suggest that it might be the cause of the

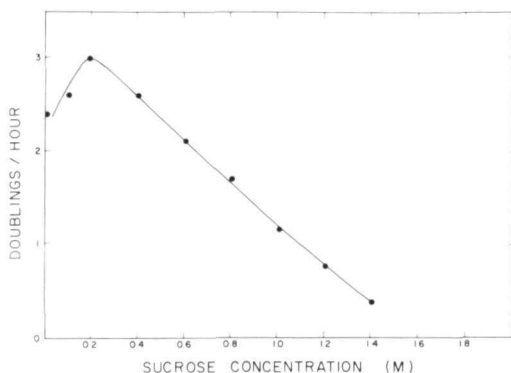

FIG. 5. Growth rates for *E. coli* B/r grown in broth with various concentrations of sucrose.

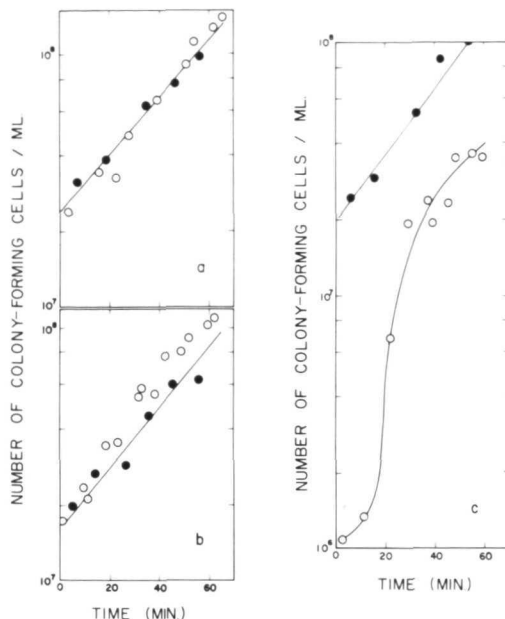

FIG. 6. Representative results showing colony-forming ability of *E. coli* B/r as a function of time after subjection to a sucrose-broth medium: (a) 0.4 M sucrose; (b) 0.6 M sucrose; (c) 0.8 M sucrose. Controls are represented by filled circles.

strange survival data in Fig. 4. It is possible that a physical factor, such as shear during pipetting, added to the lethality, or that a chemical factor, carried from the growth culture to the sucrose but absent in the dilution blanks and plates, was necessary for the initial stages of successful adaptation. A somewhat similar anomaly was noted by Rubenstein et al. (22), who suggested that it was the result of decreased ability of plasmolyzed cells to generate colonies on solid medium.

No transient effects were detected in the uptake of thymine, uracil, or proline for sucrose concentrations up to 0.8 M. Uptake curves at 0.6 M are presented in Fig. 7. Most of what appeared to be delays could be accounted for by assuming that only the surviving fraction shown in Fig. 4 participated in the uptake. This would imply a rapid cessation of the uptake machinery in nonsurvivors and may also account for a similar delay mentioned by Roberts et al. (20) and Rubenstein et al. (22). At the same time, it should be pointed out that Henneman and Umbreit found little depression in the respiration of glucose by *E. coli* B at 0.8 M sucrose (9).

DISCUSSION

Inferences based on these results may be

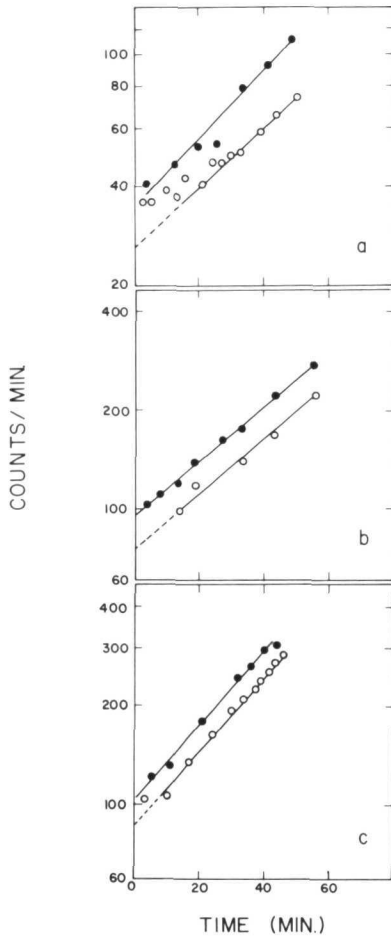

FIG. 7. Representative results showing incorporation of radioactive precursors into *E. coli* B/r cells exposed to broth with 0.6 M sucrose. Controls are represented by filled circles. (a) ^{14}C -thymine. (b) ^{14}C -uracil. (c) ^{14}C -proline.

made regarding several characteristics of *E. coli* cells. The apparently rapid deplasmolysis implies that the cells were not very impermeable to high concentrations of sucrose when nutrients were present. What is not clear is whether this is a normal state of affairs or whether plasmolysis caused a temporary alteration in the semipermeable barrier. It has been reported difficult to obtain plasmolysis in 100% of a population of cells (6, 24). This suggests that some cells are freely permeable to sucrose and the plasmolytic step may be omitted. It supports other evidence showing a high permeability of *E. coli* to sucrose (5, 10). On the other hand, it also has been reported that plasmolysis resulted in leaky cells with

increased permeability to other molecules such as uridine nucleotides (8).

A second point concerns the operation of the cell with the sucrose inside. Myers et al. (16) reported that maximal plasmolysis reduced the cell volume by 20%. Presumably, this represents the portion of a deplasmolyzed cell which is filled with the external concentration of sucrose. If 30% of the cell volume is external to the plasma membrane, as Myers et al. also reported, then the 20% figure represents about 30% of the internal volume. Sucrose in this volume might be expected, in addition to lowering the water activity, to increase the viscosity (0.5 M sucrose has a viscosity 50% higher than water) and decrease the dielectric constant of the cell sap. These changes in turn would decrease the expected rate of diffusion and increase the effects of ions and exposed charge groups on their surroundings. Processes for which these are rate-limiting should have been altered. One can note that diffusion rates in water have been shown to be only marginally compatible with the synthetic rates observed in bacteria when the cell is assumed to consist of enzymes in solution (19). Perhaps some internal organization exists and the synthetic processes measured in this study took place in environments other than those containing the sucrose.

The transient decrease in OD as well as transient changes in appearance may have been a combination of the cells changing volume as sucrose leaked in, together with some internal rearrangements as osmoadaptation took place. Electron microscopy could, perhaps, provide some necessary evidence for this.

The cause of the loss in viability at the higher concentrations of sucrose is unknown. It is interesting that the decrease in colony-forming ability began near 0.6 M sucrose, whether or not nutrients were present when sucrose was added (24). This concentration also represents the point at which Myers et al. (16) claimed that the plasmolytic volume decrease reached a maximum. Perhaps at higher osmolarities normally bound water is removed and leads to irreversible changes in macromolecular structure.

ACKNOWLEDGMENTS

Assistance in the early stages of this investigation was provided by Fred Henry, Kathy Hird, and Robert Goldstein.

This work was supported by grants to the department by the National Aeronautics and Space Administration (NGR 39-009-008 to E. C. Pollard) and by Public Health Service training grant GM-01015 from the National Institute of General Medical Sciences.

LITERATURE CITED

1. Avi-Dor, Y., M. Kuczynski, G. Schatzberg, and J. Mager. 1956. Turbidity changes in bacterial suspensions: kinetics and relation to metabolic state. *J. Gen. Microbiol.* **14**:76-83.
2. Barer, R., and S. Joseph. 1954. Refractometry of living cells. I. Basic principles. *Quart. J. Microsc. Sci.* **95**:399-423.
3. Bayer, M. E. 1967. Response of cell walls of *Escherichia coli* to a sudden reduction of the environmental osmotic pressure. *J. Bacteriol.* **93**:1104-1112.
4. Bayer, M. E. 1968. Areas of adhesion between wall and membrane of *Escherichia coli*. *J. Gen. Microbiol.* **53**:395-404.
5. Bernheim, F. 1963. Factors which offset the size of the organisms and the optical density of suspensions of *Pseudomonas aeruginosa* and *Escherichia coli*. *J. Gen. Microbiol.* **30**:53-58.
6. Birdsell, D. C., and E. H. Cota-Robles. 1967. Production and ultrastructure of lysozyme and ethylenediaminetetraacetate-lysozyme spheroplasts of *Escherichia coli*. *J. Bacteriol.* **93**:427-437.
7. Cota-Robles, E. H. 1963. Electron microscopy of plasmolysis in *Escherichia coli*. *J. Bacteriol.* **85**:499-503.
8. Gros, F. J., R. Gallant, and M. Cashel. 1967. Decryptification of RNA polymerase in whole cells in *Escherichia coli*. *J. Mol. Biol.* **25**:555-557.
9. Henneman, D. H., and W. W. Umbriet. 1964. Influence of the physical state of the bacterial cell membrane upon the rate of respiration. *J. Bacteriol.* **87**:1274-1280.
10. Hurwitz, C., C. B. Braun, and R. A. Peabody. 1965. Washing bacteria by centrifugation through a water-immiscible layer of silicones. *J. Bacteriol.* **90**:1692-1695.
11. Kellenberger, E. 1960. The physical state of the bacterial nucleus. *Symp. Soc. Gen. Microbiol.* **10**:39-66.
12. Mager, J., M. Kuczynski, G. Schatzberg, and Y. Avi-Dor. 1956. Turbidity changes in bacterial suspensions in relation to osmotic pressure. *J. Gen. Microbiol.* **14**:69-75.
13. Mason, D. J., and D. M. Powelson. 1956. Nuclear division as observed in live bacteria by a new technique. *J. Bacteriol.* **71**:474-479.
14. Mitchell, P., and J. Moyle. 1956. Osmotic function and structure in bacteria. *Symp. Soc. Gen. Microbiol.* **6**:150-180.
15. Murray, R. G. E. 1960. The internal structure of the cell, p. 35-96. *In* I. C. Gunsalus and R. Y. Stanier (ed.), *The bacteria*, vol. 1. Academic Press Inc., New York.
16. Myers, W. F., P. J. Provost, and C. L. Wisseman, Jr. 1967. Permeability properties of *Rickettsia mooseri*. *J. Bacteriol.* **93**:950-960.
17. Okrend, A. G., and R. N. Doetsch. 1969. Plasmolysis and bacterial motility: A method for the study of membrane function. *Arch. Mikrobiol.* **69**:69-78.
18. Packer, L., and M. Perry. 1961. Energy-linked light-scattering changes in *Escherichia coli*. *Arch. Biochem. Biophys.* **95**:379-388.
19. Pollard, E. C. 1968. The degree of organization in the bacterial cell. *Symp. Soc. Cell Biol.* **6**:291-303.
20. Roberts, R. B., P. H. Abelson, D. B. Cowie, E. T. Bolton, and R. J. Britten. 1957. Studies of biosynthesis in *Escherichia coli*. *Carnegie Inst. Wash. Publ.* 607.
21. Rogers, D., and S.-H. Yu. 1963. Turbidity changes during glucose permeation in *Escherichia coli*. *J. Bacteriol.* **85**:1141-1149.
22. Rubenstein, K. E., M. M. K. Nass, and S. S. Cohen. 1970. Synthetic capabilities of plasmolyzed cells and spheroplasts of *Escherichia coli*. *J. Bacteriol.* **104**:443-452.
23. Schaechter, M., J. P. Williamson, J. R. Hood, Jr., and A. L. Koch. 1962. Growth, cell and nuclear divisions in some bacteria. *J. Gen. Microbiol.* **29**:421-434.
24. Scheie, P. O. 1969. Plasmolysis of *Escherichia coli* B/r with sucrose. *J. Bacteriol.* **98**:335-340.
25. Scheie, P. O., and H. Dalen. 1968. Spatial anisotropy in *Escherichia coli*. *J. Bacteriol.* **96**:1413-1414.
26. Siström, W. R. 1958. On the physical state of the intracellularly accumulated substrates of β -galactosidase-permease in *Escherichia coli*. *Biochim. Biophys. Acta* **29**:579-587.
27. Stempen, H. 1950. Demonstration of the chromatinic bodies of *Escherichia coli* and *Proteus vulgaris* with the aid of the phase contrast microscope. *J. Bacteriol.* **60**:81-87.
28. Webb, S. J. 1965. Bound water in biological integrity. Charles C. Thomas, Publisher, Springfield, Ill.

Evidence for a Link Between Division and
Differentiation in *Entamoeba invadens*

N74-20714

DONNA F. MYER and RICHARD S. MORGAN

Copyright 1971 by the Society of Protozoologists
Reprinted from THE JOURNAL OF PROTOZOLOGY,
J. PROTOZOL., 18(2), 282-284 (1971).
Made in United States of America

Evidence for a Link Between Division and Differentiation in *Entamoeba invadens*

DONNA F. MYER and RICHARD S. MORGAN

Biophysics Dept., Pennsylvania State Univ., University Park, Penn. 16802 U.S.A.

SYNOPSIS. Growth curves in a monophasic, polyxenic medium are presented for a strain of *Entamoeba invadens*. Three characteristics of these curves are: 1) the increase in numbers of trophozoites is *linear* with time; 2) the increase in numbers of cysts is *linear* with time; and 3) the durations of these 2 periods are equal to each other. Additional experiments are described in

which variations of the culture conditions do not alter these 3 characteristics. Because of these data, we propose that, under the cultural conditions we have used, division of the trophozoites of *Entamoeba invadens* is coupled to the differentiation of these cells into cysts.

ALTHO Dobell (6), Balamuth (1), Balamuth & Howard (2), Barker (3) and Barker and Svihla (4), among others, have studied the structure and life cycle of various species of *Entamoeba*, a recent review by McConnachie (8) pointed out that little is known quantitatively about the course of growth and encystation of these organisms. For instance, the generation time of no species has been determined except in axenic culture (Diamond, 5), nor is there a clear understanding of the manner in which trophozoites differentiate into cysts. We present here the results of experiments on the growth of *Entamoeba invadens*. These studies recorded the numbers of trophozoites and cysts at regular, short intervals and under various experimental conditions *in vitro*, in order to determine the relation between growth and differentiation of this species. We propose, from the results here reported, that these 2 processes are coupled to each other in this organism.

MATERIALS AND METHODS

"TRM," the strain of *Entamoeba invadens* used, was a gift of D. C. Barker, who isolated it from a tortoise in Madagascar in 1963. It has been cultured continuously in this laboratory since 1964. Presently we use the following monophasic medium:

Part I. Buffered salt concentrate 20 ml
(40 g NaCl, 50 g K₂HPO₄, 6 g KH₂PO₄ in 1 liter distilled H₂O)

Yeast extract (Difco) 0.7 g
Distilled water 180 ml.

This solution is autoclaved and cooled.

Part II. Equine or bovine serum 90 ml
Cells from 100 ml of a 24-hour-old culture of *Clostridium perfringens*, grown on fluid thioglycollate medium (Difco), and collected by centrifugation at 8,000 rpm for 10 min in a Servall SS-1 rotor. The supernatant fluids of these cultures are discarded, as they are toxic to the amoebae.

Rice starch (Stein-Hall Co.), heated dry 0.5 g
at 180 C for 1 hr.

Part II is added to Part I and the resultant mixture (approximately 300 ml) poured into sterile glass (or plastic) screw-capped tubes, 13 × 100 mm, filling each to within about 0.5 ml of its brim. The tubes are placed upright in an incubator at 30 C, where, after a few hours, the *Clostridia* and rice starch settle to the bottom quarter of each tube, leaving a clear, pale, yellow-green supernatant fluid. After this time there is no evolution of gas, and the tubes will remain unaltered in this state for a week or so at 30 C. We take these facts to mean that the *Clostridia* (which are strict anaerobes) do not multiply to any significant extent under these conditions. Thus the chief source of nitrogen (the

Clostridia) and of carbohydrate (the rice starch) remain in a particulate form, which only the amoebae can ingest.

To inoculate a fresh experimental tube, we removed half the supernatant fluid from a tube which had itself been inoculated 2-3 days previously and added 0.5 ml of the mixed remainder to the new tube. Such an inoculum contains about 10⁵ amoebae. Once inoculated with our strain of *Entamoeba invadens*, the supernatant fluids of our culture tubes become somewhat turbid, due to the presence of a bacterial flora (whose exact nature is unknown) which accompanies the inoculum, while the sediments steadily diminish in volume as they become converted into amoebae. Stock cultures were transferred into fresh medium weekly.

Data for the resultant growth curves were obtained by counting in an American Optical "Bright-Line" hemocytometer the numbers of cells in well suspended portions of the entire contents of a culture tube. They are presented as "cells/0.9 mm³" (the volume of the counting chamber). The total number of cells in any tube may be approximated by multiplying these numbers by 10⁴. Counts were usually taken at intervals of every 6, frequently every 3, hr. The following data include the results of counts on 120 separate tubes, in a total of 30 separate experiments, each of which contained duplicate experimental tubes plus a control tube.

The medium we use was derived from that of Jones (7). We recognize that amoebic growth under these conditions is a highly complex phenomenon. Nevertheless, if our procedure is followed exactly, the resultant growth is found to be highly reproducible. Our cultures are polyxenic because, at the present time, axenic cultures of *Entamoeba histolytica* do not encyst (5) at all, and axenic *Entamoeba invadens* encysts only slightly (8).

RESULTS

The basic pattern of growth. In Fig. 1 are plotted the counts of the numbers of trophozoites and cysts as a function of time in a particular, but typical, experiment. Three characteristics of these curves, exemplified in this figure, have been observed in each of the 30 separate experiments we have made. They are:

- 1) the increase in number of trophozoites is *linear* with time;
- 2) the increase in number of cysts is *linear* with time;
- 3) the length of the interval of time during which the trophozoites increase in numbers is equal to the length of the interval of time during which the cysts increase in numbers. In addition we find that 2-3 cysts appear for every trophozoite that disappears, i.e. each trophozoite apparently forms more than one cyst.

We have searched (as have others, see 1) for external or environmental factors that would stimulate encystation, without finding any. For example, we found that

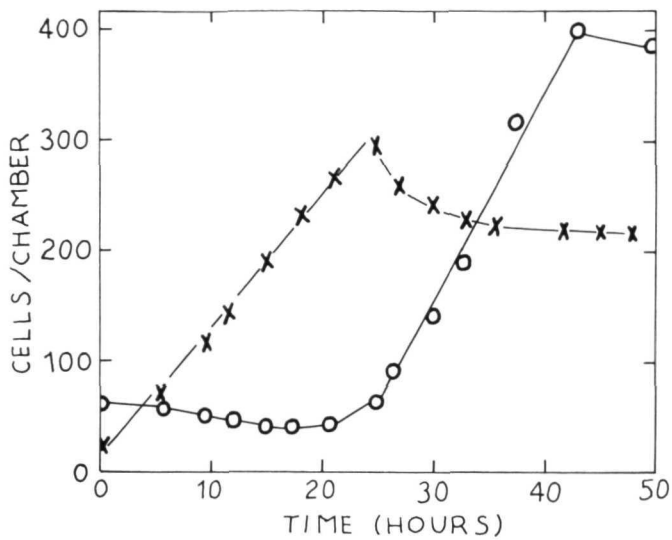

Fig. 1. Typical growth curve. Here the onset of encystation is coincident with the end of trophozoite proliferation. Cells from a 2-day-old culture of amoebae were inoculated into each of 3 tubes of fresh medium. Cells in the tubes were counted in the manner described in the text, for 50 hr. Each data point is the average of counts on 3 tubes with 2 counts in each tube. Note the linear increase in trophozoites (—X—) lasting 23 hr, and the linear increase of cysts (—O—) lasting 22 hr.

the onset of encystation was not advanced by early removal of the supernatant medium from a culture tube and its replacement by isotonic buffered salt solution (Fig. 2); it was not postponed by renewal of this supernatant with fresh medium (Fig. 3); nor was it affected at all by replacing the supernatant of a growing culture with one from a culture that was actively encysting (Fig. 4). Neither the size of the culture tube, the size of the inoculum, nor whether the tubes were periodically mixed or allowed to stand undisturbed affected the basic pattern outlined above.

It might be supposed that the density of the population of trophozoites is a factor related to encystation. Yet from Figs. 1-4 it can be seen that encystation may start with trophozoite concentrations anywhere from 125-400 cells/0.9 mm³. We have not found any correlation between the density of trophozoites and encystation, nor did Balamuth (1). We have not, however, tried to find a possible lower limit to the density of trophozoites which would still allow them to encyst.

From these experiments, we are led to view encystation as an intrinsic part of the growth of a trophozoite, and one that bears a temporal relation to its division. In addition, the data shown in Figs. 2-4 strongly imply that the bacterial flora in our cultures have no casual role in the encystation we observe.

Variations. Tho there appears from Fig. 1 to be a coincidence in time between the start of encystation and the end of proliferation of trophozoites, the data presented in Figs. 2 and 3 show that this is not a casual relation. In these figures we show the types of growth that may be seen when conditions are arranged so that nutrients

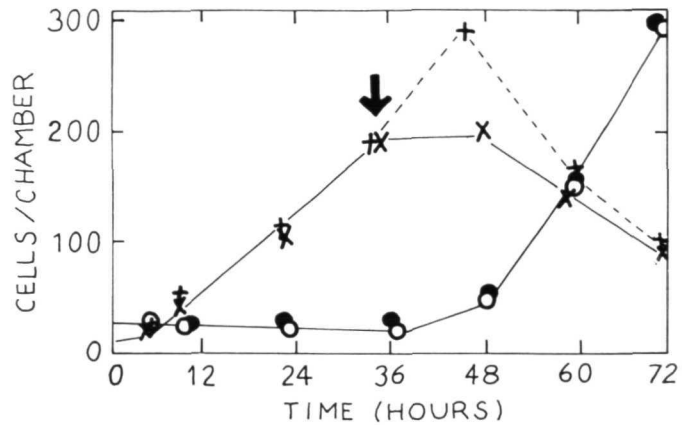

Fig. 2. Removal of nutrients. In the experimental tube, the onset of encystation occurs after the end of trophozoite proliferation. Duplicate cultures were grown from a 2-day-old inoculum; after 36 hr of growth (arrow) one tube was centrifuged for 5 min at 3,100 rpm in a clinical centrifuge. The nutrient supernatant, which included the bacteria, was removed and replaced with a non-nutrient buffered salt solution. Cells in both experimental and control tubes were counted in the normal manner thruout the experiment. (Control culture: trophozoites, —+—; cysts —●—. Culture from which the nutrients were removed: trophozoites —X—; cysts —O—. ↓ indicates substitution of salt buffer for nutrient supernatant.) It can be seen that the removal of nutrients did not cause an onset of encystation prior to that seen in the control.

are exhausted either before (Fig. 2) or after (Fig. 3) the onset of encystation. In both these cases, the onset of encystation is *not* coincident with the end of the increase in numbers of trophozoites, and hence cannot be directly due to a depletion of nutrients.

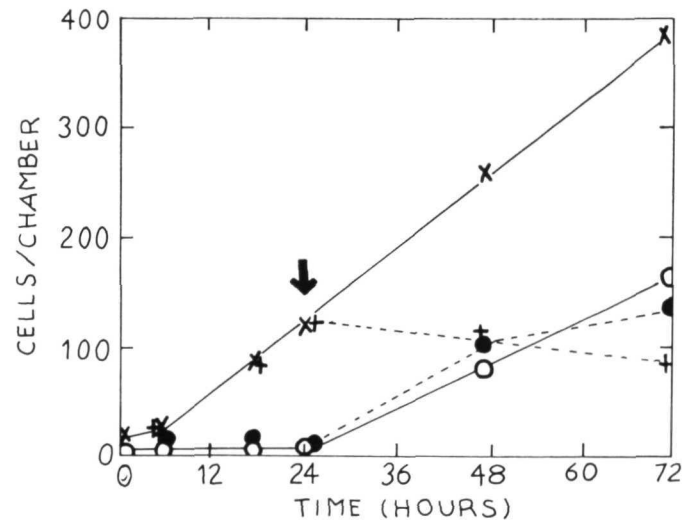

Fig. 3. Renewal of nutrients. In the experimental tubes, the onset of encystation occurs prior to the end of trophozoite proliferation. Three cultures were grown from a 5-day-old inoculum. At 24 hr (arrow) the cultures were centrifuged and the supernatants were replaced with fresh medium. This growth pattern is compared with cultures that were not given fresh medium during growth. (Control cultures: trophozoites —+—; cysts —●—. Cultures given fresh medium: trophozoites —X—; cysts —O—. ↓ indicates renewal of nutrients.) It can be seen that encystation was not postponed when nutrients were continually available.

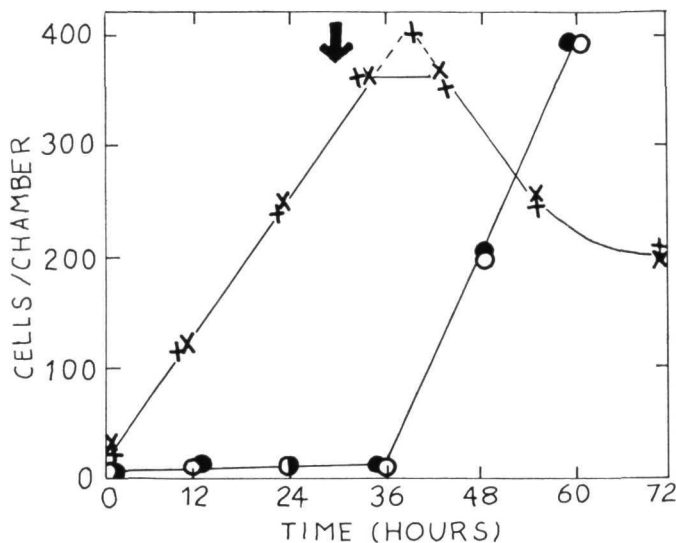

Fig. 4. Replacement of nutrients with "encysting" medium. To check for accumulation of some stimulator substance in the medium after a certain length of trophozoite proliferation, the medium supernatant from an actively encysting culture was removed. This "encysting" medium was substituted for the normal medium of a culture of trophozoites at 30 hr (arrow) prior to the expected onset of encystation. (Control culture: trophozoites —+—; cysts —●—. Culture with "encysting" medium substituted: trophozoites —X—; cysts —○—. ↓ indicates replacement of nutrients with "encysting" medium.) No indication was seen of stimulation of encystation, and the pattern was similar to that seen for replacement of medium with a non-nutrient salt solution (Fig. 2).

Note, however, that these variations in the onset of encystation do not violate the 3 characteristics listed above for the "basic pattern," which continues to hold for all cases.

DISCUSSION

We have observed that when *Entamoeba invadens* is grown in the manner described here, the increases in the numbers of both trophozoites and cysts are linear with time, and the durations of these increases are equal to each other. These findings reproducibly characterize all our experiments. Our data were collected by counting the numbers of cells at finer intervals of time than has been done previously; they confirm the suggestions of linearity that earlier work (1, 3) affords.

Currently, it is considered that the trophozoites of this organism multiply by binary fission until some, as yet unidentified, stimulus causes them to differentiate into cysts. This view predicts an increase in the number of trophozoites that is exponential with time. Furthermore, it offers no explanation of the fact that the process of encystation lasts as long as the period of trophozoite increase. Our results are not compatible with this view. Rather they point toward the existence of a more specialized type of multiplication in which division and differentiation are coupled to each other. Barker & Svihla (4),

on the basis of studies of the distribution of the ultraviolet absorption within these amoebae, suggested the occurrence of a "differential division" of late trophozoites. One of us (11) developed this concept to account quantitatively for the results presented here. We note that in axenic cultures of *Entamoeba histolytica*, in which this specialized division leading to encystation does not occur, the increase in the numbers of trophozoites is exponential with time (5), with a generation time of close to 20 hr.

Because the increase we see in trophozoites is not exponential with time, we cannot from the slope of the growth curve compute a generation time. If, however, we assume that the linearity of the increase in trophozoites is due to loss from the dividing population of half of the cells formed at each division, then we can compute a "division time." This is the time needed for the number of trophozoites in a growing population to double. In our experiments, this time is 1-3 hr.

We are attempting to learn more about the nature of the coupling between division and differentiation in *Entamoeba invadens*. At present we wish to emphasize that this organism has, in addition to its other intriguing and specialized properties (such as the ability to crystallize its ribosomes into chromatoid bodies, see 9, 10), the further peculiar and interesting ability to increase its numbers and to differentiate linearly with time.

This work was supported in part by Grant NGR 39-009-008 from the National Aeronautics and Space Administration. D.F.M. was a National Science Foundation trainee. We thank Dr L. S. Diamond for helpful suggestions.

REFERENCES

- Balamuth, W. 1962. Effects of some environmental factors upon the growth and encystation of *Entamoeba invadens*. *J. Parasit.* **48**, 101-9.
- Balamuth, W. & Howard, B. 1946. Biological studies on *Entamoeba histolytica*: The growth cycle. *Am. J. Trop. Med.* **26**, 771-82.
- Barker, D. C. 1963. A ribonucleoprotein inclusion body in *Entamoeba invadens*. *Z. Zellforsch.* **58**, 641-59.
- Barker, D. C. & Svihla, G. 1964. Localization of cytoplasmic nucleic acid during the growth and encystment of *Entamoeba invadens*. *J. Cell Biol.* **20**, 389-98.
- Diamond, L. S. 1968. Techniques of axenic cultivation of *Entamoeba histolytica*. *J. Parasit.* **54**, 1047-56.
- Dobell, C. 1928. Researches on the intestinal protozoa of monkeys and man: Description of the whole life cycle of *Entamoeba histolytica* in cultures. *Parasitology.* **20**, 357-412.
- Jones, W. R. 1946. Experimental infection of rats with *Entamoeba histolytica*. *Ann. Trop. Med. Parasit.* **40**, 130-40.
- McConnachie, E. W. 1969. The morphology, formation and development of cysts of *Entamoebae*. *Parasitology.* **59**, 41-53.
- Morgan, R. S. & Uzman, B. G. 1966. Nature of the packing of ribosomes within chromatoid bodies. *Science* **152**, 214-6.
- Morgan, R. S., Slayter, H. & Weller, D. L. 1968. Isolation of ribosomes from cysts of *Entamoeba invadens*. *J. Cell Biol.* **36**, 45-51.
- Myer, D. F. 1969. A quantitative study of the growth patterns of *Entamoeba invadens*. M. S. Thesis. Pennsylvania State University.

Free radicals in pyrimidines: E.S.R. of a γ -irradiated single crystal of 5-nitrouracil

by BRENT BENSON

N74-20714

Department of Physics, Southern Illinois University, Carbondale, Illinois 62901

and WALLACE SNIPES

Department of Biophysics, The Pennsylvania State University, University Park,
Pennsylvania 16802

(Received 2 July 1970)

Free radicals are observed in γ -irradiated single crystals of 5-nitrouracil with the unpaired electron showing hyperfine interaction with one nitrogen atom. The principal values of hyperfine coupling are $A_x = 22.5$ G, $A_y = 25.2$ G, and $A_z = 40.0$ G, and the principal values of the spectroscopic splitting factor are $g_u = 2.0117$, $g_v = 2.0064$ and $g_w = 2.0027$. The relationship of the directions of the corresponding principal axes to the molecular orientations show that the unpaired electron must be located in an sp^2 orbital on either $N_{(1)}$ or $N_{(5)}$. Considerations of the mechanism of radical formation and comparison to radiation damage in other molecules make the $N_{(1)}$ location seem more probable. The π interaction of the nitro group on $C_{(5)}$ evidently prevents the formulation of free radicals with the unpaired electron on $C_{(5)}$. That carbon atom is the most common location of unpaired electron density in other pyrimidine free radicals.

1. INTRODUCTION

This work is part of a research programme directed toward understanding the nature of free radical formation in gamma-irradiated substituted pyrimidines. Previous studies have shown that the 5-6 double bond of the pyrimidine ring is particularly susceptible to alteration by ionizing radiation [1-7]. When these alternations occur, a $2p\pi$ orbital on $C_{(5)}$ is usually the major site of the unpaired spin density. $C_{(5)}$ is the only ring carbon atom not bonded to a nitrogen atom. It was the apparent preference for radical formation at the 5-position that prompted a previous study of 5-nitro-6-methyluracil [8], where even $C_{(5)}$ is bonded to a nitrogen atom. In that case the unpaired spin was found to be on $C_{(4)}$ and $C_{(6)}$, apparently due to the influence of the π interaction of the nitro group on $C_{(5)}$ [8]. This interpretation was complicated, however, by the presence of the methyl group on $C_{(6)}$ because the carbon adjacent to a methyl has been observed to be a favoured site for unpaired spin density [7]. The present study of 5-nitrouracil avoids the complication of the 6-position methyl substituent, and the effect of the nitro group on $C_{(5)}$ may be determined more directly.

2. CRYSTAL STRUCTURE

Single crystals of 5-nitrouracil [9] were grown by slow evaporation of saturated aqueous solutions. The crystals, which decompose slowly in dry air, were covered with grease after harvesting.

Craven [10] determined the crystal structure of 5-nitrouracil to be monoclinic of space group $P2_1/c$ with four molecules per unit cell. Fortunately only two magnetically distinct molecules to the unit cell were found by E.S.R. measurements, and these are related by symmetry in such a way that even these two molecules were equivalent in two out of three planes of the experimental axis system. The structure of the parent molecule in the crystal is [10]:

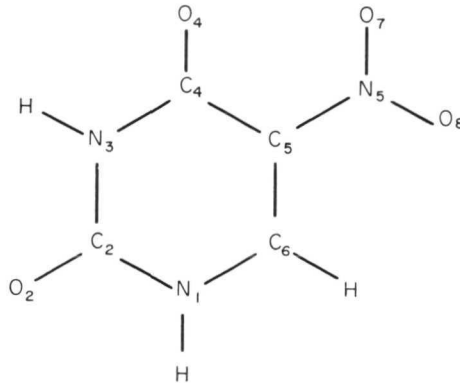

The 5-nitrouracil crystals have a rather distinct morphology as shown in figure 1. The cleavage plane has been reported [10] as $[100]$, the prominent crystal forms as $\{010\}$, $\{011\}$, $\{021\}$ and $\{11\bar{1}\}$. Cleavage and measurements of the angles between faces of several crystals similar to the one used in the E.S.R. study allowed determination of the crystallographic axes in relation to the observed morphology. The flat parallel faces belong to the $\{010\}$ form, parallel to the ac plane. The other faces belong to either $\{011\}$ or $\{021\}$ for one pair and $\{11\bar{1}\}$ for the other pair. The angle between the cleavage plane and the (011) or (021) faces measured in the ac plane should be 36.5° ; it was measured on a crystal in this experiment to be 37° . The angle between the cleavage plane and the $(11\bar{1})$ face also measured in the ac plane should be 29.3° ; it was observed here to be 29° . The axes chosen for the E.S.R. study are the a^*bc axes shown in figure 1. These directions were actually determined to be axes of symmetry by E.S.R. measurements before their relation to the known crystal structure was discovered. The crystal structure information was used to relate the directions of the E.S.R. parameters directly to the molecular structure.

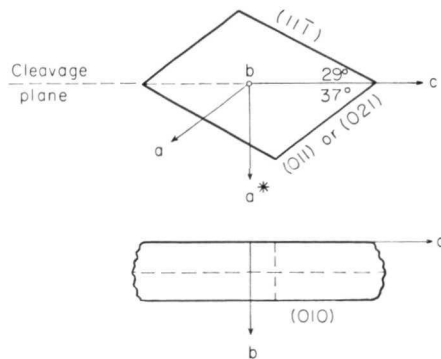

Figure 1. Crystal morphology of 5-nitrouracil.

3. EXPERIMENTAL TECHNIQUES AND DETERMINATION OF E.S.R. PARAMETERS

Single crystals were irradiated in air at room temperature with a dose rate of 0.8 MR/hour from a ^{60}Co gamma source. Doses of about 10 MR were required to produce a sufficient radical concentration for E.S.R. study. In addition to the major radical studied here, another radical was apparent at low doses at insufficient concentration for study.

E.S.R. spectra were obtained using a Varian 4502 spectrometer operating at 9.3 GHz. The spectra were recorded as the second derivative of the absorption. Data were taken at 10° intervals in the a^*b and ca^* planes, and at 5° intervals in the bc plane, using a Varian rotating cavity accessory. The g values were measured by comparison with the known g value of a DPPH marker.

A typical spectrum, shown in figure 2, is a 1 : 1 : 1 triplet characteristic of an unpaired electron coupled to a nucleus of spin 1. The only such nucleus in this molecule is nitrogen. The magnitude of the hyperfine splitting is also typical for nitrogen coupling. The hyperfine splittings and g values in each of the three planes of the experimental axis system are shown as a function of angle in figures 3, 4 and 5.

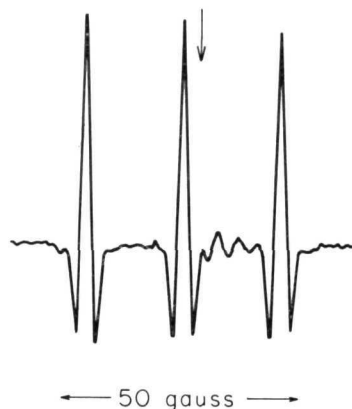

Figure 2. E.S.R. spectrum of γ -irradiated 5-nitrouracil taken at 9.3 GHz. The arrow shows the position of a DPPH marker.

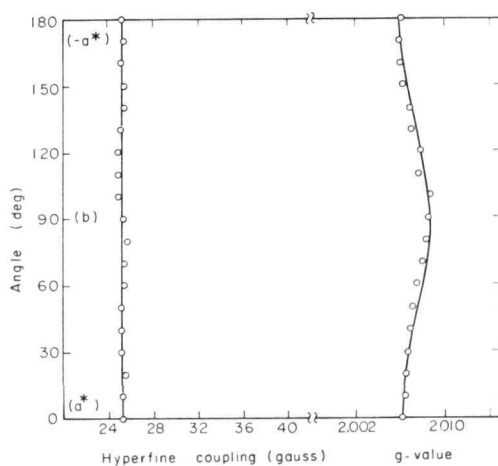

Figure 3. Hyperfine splitting and g value as a function of angle in the a^*b plane.

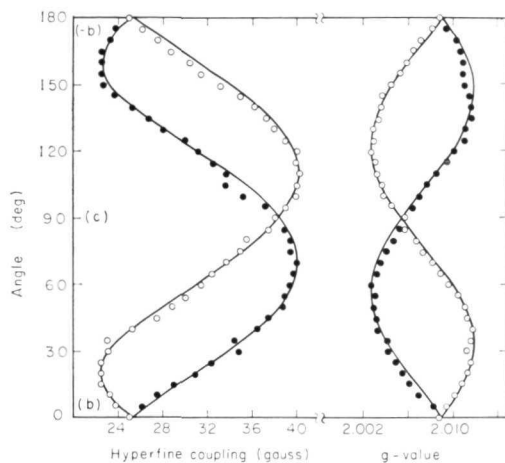

Figure 4. Hyperfine splitting and g value as a function of angle in the bc plane.

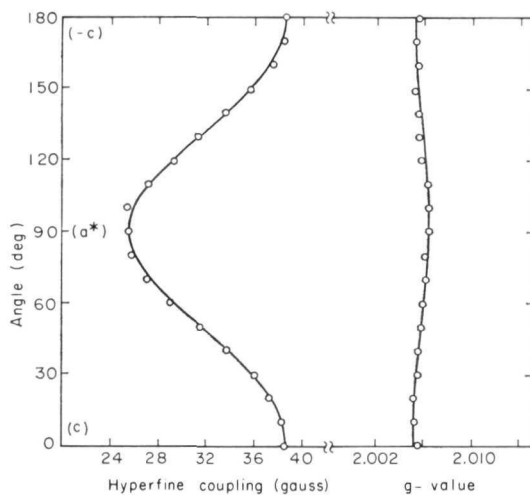

Figure 5. Hyperfine splitting and g value as a function of angle in the ca^* plane.

It is seen that there is considerable variation in the bc plane, with somewhat less variation in the other two planes.

The information from figures 3, 4 and 5 was used to determine the hyperfine coupling tensor and the g value tensor, following the method of Schonland [11]. These tensors were diagonalized to give the principal values shown in the table. Also shown are the direction cosines relating the principal axes to the experimental axis system.

4. STRUCTURE OF THE RADICAL

The table and figures 3, 4 and 5 show that the maximum and minimum hyperfine coupling principal values, as well as the minimum g value occur in the bc plane. This is almost exactly the plane that includes the pyrimidine rings and NO_2 groups of all of the molecules [10]. Because the maximum coupling and the minimum g values are in this plane, the unpaired electron must be in an sp^2 orbital on one of the

	Principal values	Direction cosines		
		a^*	b	c
g_u	2.0117	0	0.839	0.545
g_v	2.0064	1	0	0
g_w	2.0027	0	-0.545	0.839
A_x	22.5	0	0.940	0.342
A_y	25.2	1	0	0
A_z	40.0	0	-0.342	0.940

Principal values of the spectroscopic splitting factor (g) and the ^{14}N hyperfine coupling constant (A), and the direction cosines (l, m, n) relating the corresponding principal axes to the a^*bc axis system. Direction cosines for other molecules in the unit cell are given by $(l, -m, n)$, $(-l, -m, -n)$ and $(-l, m, -n)$.

nitrogen atoms. Furthermore, the large anisotropy of the g value and the large isotropic hyperfine coupling also indicate that the unpaired electron is in an sp^2 orbital. A radical with this electronic configuration, showing only nitrogen coupling, can be formed by hydrogen abstraction from $\text{N}_{(1)}$, hydrogen abstraction from $\text{N}_{(3)}$, or oxygen abstraction from the nitro group.

Figure 6 shows the orientation of the two magnetically distinct molecules in the bc plane. Also shown are the directions of the maximum hyperfine coupling for the two molecules. These should be the directions of the sp^2 orbitals containing the unpaired electrons. For either molecule it is evident that the unpaired electron could not be on $\text{N}_{(3)}$ because the maximum coupling direction does not correspond to the direction of the sp^2 orbital on $\text{N}_{(3)}$ that would remain after hydrogen abstraction. This direction does correspond to that expected for a radical formed

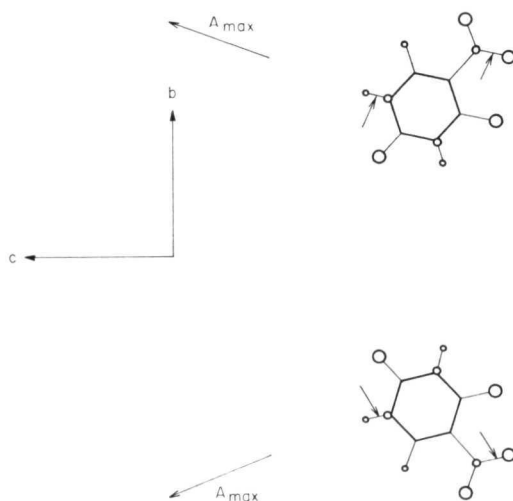

Figure 6. Orientations of the two magnetically distinct molecules per unit cell in the bc plane [10]. The directions of maximum hyperfine coupling are near to the directions of the sp^2 orbitals which would contain unpaired electrons if either $\text{H}_{(1)}$ or $\text{O}_{(7)}$ were removed by γ -radiation. The $\text{N}_{(1)}\text{-H}_{(1)}$ and $\text{N}_{(5)}\text{-O}_{(7)}$ bonds are indicated by small arrows.

by hydrogen abstraction from $N_{(1)}$ or by abstracting $O_{(7)}$ from the nitro group. The direction of maximum coupling is approximately 5° from that expected for the hydrogen abstraction radical and approximately 9° from that expected for the oxygen abstraction radical†. The E.S.R. data clearly do not distinguish between the two possibilities. Recourse may be made instead by looking for an analogy in the formation and structure of radicals in other compounds.

A radical with hyperfine coupling similar to that observed here was reported by Miyagawa in irradiated dimethylglyoxime [12]. That radical had the unpaired electron in an sp^2 orbital on a nitrogen that was covalently bonded to a carbon atom and an oxygen atom, as would be the case here for the $N_{(5)}$ radical. In dimethylglyoximine, radical formation did not require cleavage of an N–O bond as would be necessary to form the $N_{(5)}$ radical in 5-nitrouracil. Furthermore, of the two oxygens on $N_{(5)}$ of 5-nitrouracil, $O_{(7)}$ would have to be preferentially cleaved to give the observed directions of maximum nitrogen coupling. To our knowledge there has been no report of N–O bond cleavage in the formation of free radicals in similar structures by ionizing radiation. In addition, we did not observe this type of radical in irradiated 5-nitro-6-methyluracil [8]. Therefore, this structure for the radical of 5-nitrouracil does not seem probable.

In contrast to oxygen abstraction, the abstraction of hydrogen atoms is a common mechanism for radical formation in organic solids. In particular, hydrogen abstraction from $N_{(1)}$ of the pyrimidine rings of cytosine [13] and orotic acid [14] has been observed. Radicals could be similarly formed in 5-nitrouracil if the stable electronic configuration leaves the unpaired electron in a different orbital than that observed for cytosine and orotic acid. Here the unpaired electron must be in an sp^2 orbital in the plane of the ring, while in cytosine and orotic acid it is in the π system perpendicular to the plane of the ring.

The cytosine radical shows a resonance structure that puts part of the unpaired spin on $N_{(3)}$. Similar resonance structures are not possible in 5-nitrouracil because the two keto oxygens effectively block ring π interaction with $N_{(3)}$. In both cytosine and orotic acid, resonance structures leave unpaired spin density on $C_{(5)}$. This same type resonance could occur in 5-nitrouracil if the unpaired electron on N_1 were in a $2p\pi$ orbital rather than the sp^2 orbital as observed. It is interesting that in 5-nitrouracil the substituent at $C_{(5)}$ is one that interacts with the π electrons of the ring through resonance structures such as:

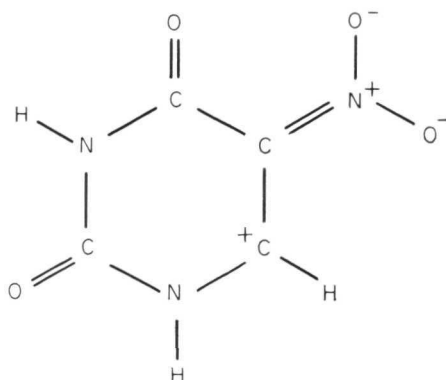

† These angles were calculated assuming the sp^2 orbitals to be along the external bisections of $C_{(2)}-N-C_{(6)}$ and $C_{(5)}-N_{(5)}-O_{(5)}$ respectively, using atomic coordinates reported by Craven [10].

The 5-substituent in cytosine and orotic acid, namely hydrogen, does not interact with the π electrons, so that delocalization between C₍₅₎ and N₍₁₎ may be more favourable for the N₍₁₎ radicals in these compounds.

5. CONCLUSIONS

On the basis of the discussion of the previous section, we suggest that the stable free radical in 5-nitrouracil irradiated at room temperature is formed by hydrogen abstraction from N₍₁₎, although abstraction of O₍₇₎ from N₍₅₎ remains as a possibility. In this compound, as in 5-nitro-6-methyluracil, no radical with unpaired spin density on C₍₅₎ is formed in significant quantity. This is in contrast to radical formation in most other pyrimidines. The nitro substituent at C₍₅₎ apparently has an influence on formation of C₍₅₎ radicals in each case.

It is not clear how the methyl group of 5-nitro-6-methyluracil would cause the radical to be formed by hydrogen addition to O₍₄₎ rather than forming the hydrogen abstraction radical as in 5-nitrouracil. It may be that both structural and environmental factors are important in determining what stable radicals are formed. In particular, if hydrogen addition to a keto-oxygen occurs by electron capture and subsequent proton transfer across a hydrogen bridge, the probability of proton transfer would be extremely dependent on the intermolecular distances [15]. Unfortunately, the crystal structure of 5-nitro-6-methyluracil has not been determined, and the appropriate comparisons cannot be made.

Previously, our programme of study has been directed toward understanding radical formation in pyrimidines in terms of their molecular structures. It is becoming apparent that the influence of environmental factors on radical formation should also be investigated.

This work was supported by AEC and NASA. *NO R-39-009-008*
We thank William Bernhard for the use of his computer programme.

REFERENCES

- [1] PRUDEN, B., SNIPES, W., and GORDY, W., 1965, *Proc. natn. Acad. Sci. U.S.A.*, **53**, 917.
- [2] BERNHARD, W., and SNIPES, W., 1966, *J. chem. Phys.*, **44**, 2817.
- [3] KASHIWAGI, M., 1966, *J. chem. Soc. Japan (Pure Chem.)*, **87**, 1294.
- [4] BENSON, B., and SNIPES, W., 1967, *Radiat. Res.*, **31**, 542.
- [5] BENSON, B., and SNIPES, W., 1969, *Int. J. Radiat. Biol.*, **15**, 583.
- [6] SCHMIDT, J., and SNIPES, W., 1967, *Int. J. Radiat. Biol.*, **13**, 101.
- [7] SNIPES, W., and BERNHARD, W., 1968, *Radiat. Res.*, **33**, 162.
- [8] SNIPES, W., and BENSON, B., 1968, *J. chem. Phys.*, **48**, 4666.
- [9] Obtained from Sigma Chemical Co., 3500 DeKalb St., St. Louis, Mo. 63118.
- [10] CRAVEN, B., 1967, *Acta crystallogr.*, **23**, 376.
- [11] SCHONLAND, D., 1959, *Proc. Phys. Soc. A*, **73**, 788.
- [12] MIYAGAWA, I., and GORDY, W., 1959, *J. chem. Phys.*, **30**, 1590.
- [13] COOK, J., ELLIOTT, J., and WYARD, S., 1967, *Molec. Phys.*, **13**, 49.
- [14] HORAN, P., and SNIPES, W., 1960, *Radiat. Res.*, **41**, 24.
- [15] MIYAGAWA, I., TAMURA, N., and COOK, J. W., Jr., 1969, *J. chem. Phys.*, **51**, 3520.

SURFACE MORPHOLOGY OF TRYPSINIZED HUMAN CELLS IN VITRO

N74-20714

H. DALEN¹ and P. W. TODD²

¹*Donner Laboratory, University of California, Berkeley, Calif. 94720, USA,*

Department of Pathology, Karolinska Sjukhuset, 10401 Stockholm 60, Sweden, and

²*Department of Biophysics, The Pennsylvania State University, University Park, Pa 16802, USA*

SUMMARY

Chang human liver cells were observed by phase contrast and scanning electron microscopy during trypsin treatment of monolayer cultures. The flattened interphase cell was caused to round up into a spherical structure leaving behind long slender cytoplasmic processes, named trypsinization retraction fibrils, which resemble the mitotic retraction fibrils but differ from these by being formed more rapidly (1-2 min). Another type of long microextensions revealed by the enzymatic treatment are the attachment fibrils, which are intercellular cytoplasmic strings under tension. The short microextensions projecting from the surface of the normal interphase cells disappear during the first 5 min of exposure to 0.03 % trypsin solution.

In the literature there exists much controversy concerning the mechanism of cell adhesion. The different hypotheses have been reviewed and discussed in great detail by Curtis [5], and there seem to be strong reasons to believe that the same mechanism is involved in cell-to-cell as in cell-to-substrate adhesion. The disaggregation of tissue and cell monolayers can be accomplished by applying mechanical forces, chelating agents or enzymatic treatment.

The use of trypsin has been common in cell and tissue culture since its adaptation for the dispersion of monolayers in 1953 [24]. The drastic effect of trypsin on cell monolayers is a familiar observation in the phase contrast microscope [13], but there are only a few reports describing the altered fine structure [7, 8, 10]. Functional changes have also been noted [2, 15, 17, 28].

The purpose for this investigation was to

compare observations on trypsin-treated cells using phase contrast microscopy with observations on surface morphology as revealed by the scanning electron microscope.

MATERIAL AND METHODS

Chang human liver cells (purchased from Grand Island Biological Co., Grand Island, N. Y.) grown in Eagle basal medium modified according to Chang [3] were used in these experiments. Single cell suspensions were obtained by treating overnight cultures with 0.03 % trypsin solution (Trypsin "1-300" obtained from General Biochemical Inc., Chagrin Falls, Ohio) made up in Puck's saline A [22]. After 10 min at 37°C the enzymatic activity was stopped by dilution with the growth medium, and clumps were broken up by pipetting. The cells were inoculated at different densities (100 to 5000 per dish) in plastic Petri dishes (Falcon Plastics, Los Angeles, Calif.), and incubated in a moist 5 % CO₂ atmosphere at 37°C. Morphological studies were performed on 20 h (single and double cells) and 7-day-old cultures. The in situ observations of the living cultures were carried out with an inverted phase contrast microscope, and areas of interest were encircled with a diamond scribe attached to the microscope. This marking procedure

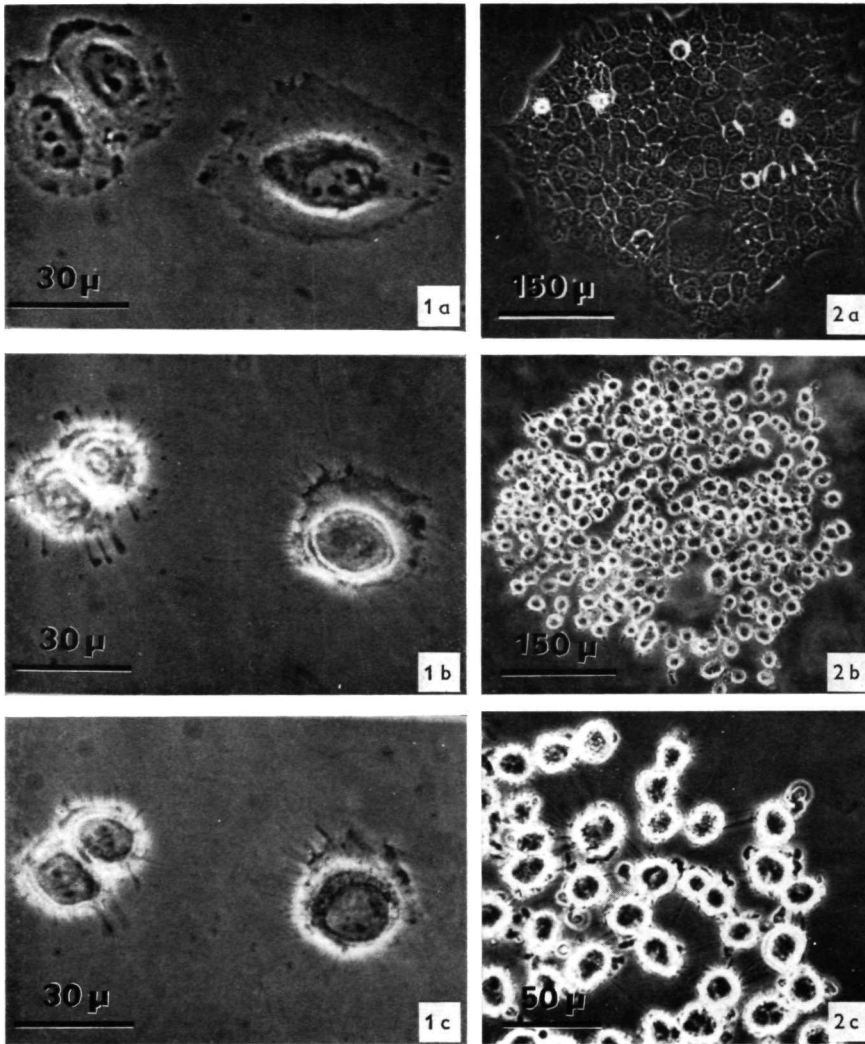

Fig. 1. Phase contrast micrographs of Chang human liver cells from a 20 h old culture; (a) before trypsin treatment; (b) same cells after 130 sec treatment with 0.03 % trypsin, (c) after 150 sec treatment. In the two latter micrographs the main bulk of the cytoplasm has retracted in the direction of the nucleus, leaving behind thin cytoplasmic processes (trypsinization retraction fibrils), which are faintly seen in the phase contrast microscope.

Fig. 2. Chang human liver cells from a 7-day-old culture; (a) before trypsin treatment; (b) same cells after 5 min treatment with 0.03 % trypsin; (c) higher magnification of the trypsinized cells showing intercellular attachment fibrils.

made it possible to localize the same cells in the scanning electron microscope.

Before adding the freshly made 0.03 % trypsin solution, the cultures were gently washed twice with Puck saline A. The selected cells were photographed immediately before adding the enzyme and at different intervals thereafter. All steps were carried out at 37°C. Finally the enzymatic activity was stopped by

quickly removing the trypsin solution, and the cells were first fixed for 10 min in ice-cold 1 % OsO₄. The postfixation was carried out for 3 h in 2 % glutaraldehyde at 4°C. Both fixatives were made up in 0.1 M phosphate buffer at pH 7.2 [18, 23]. After dehydration through increasing concentrations of ethanol the cells were allowed to air-dry.

The areas with the encircled cells were cut out,

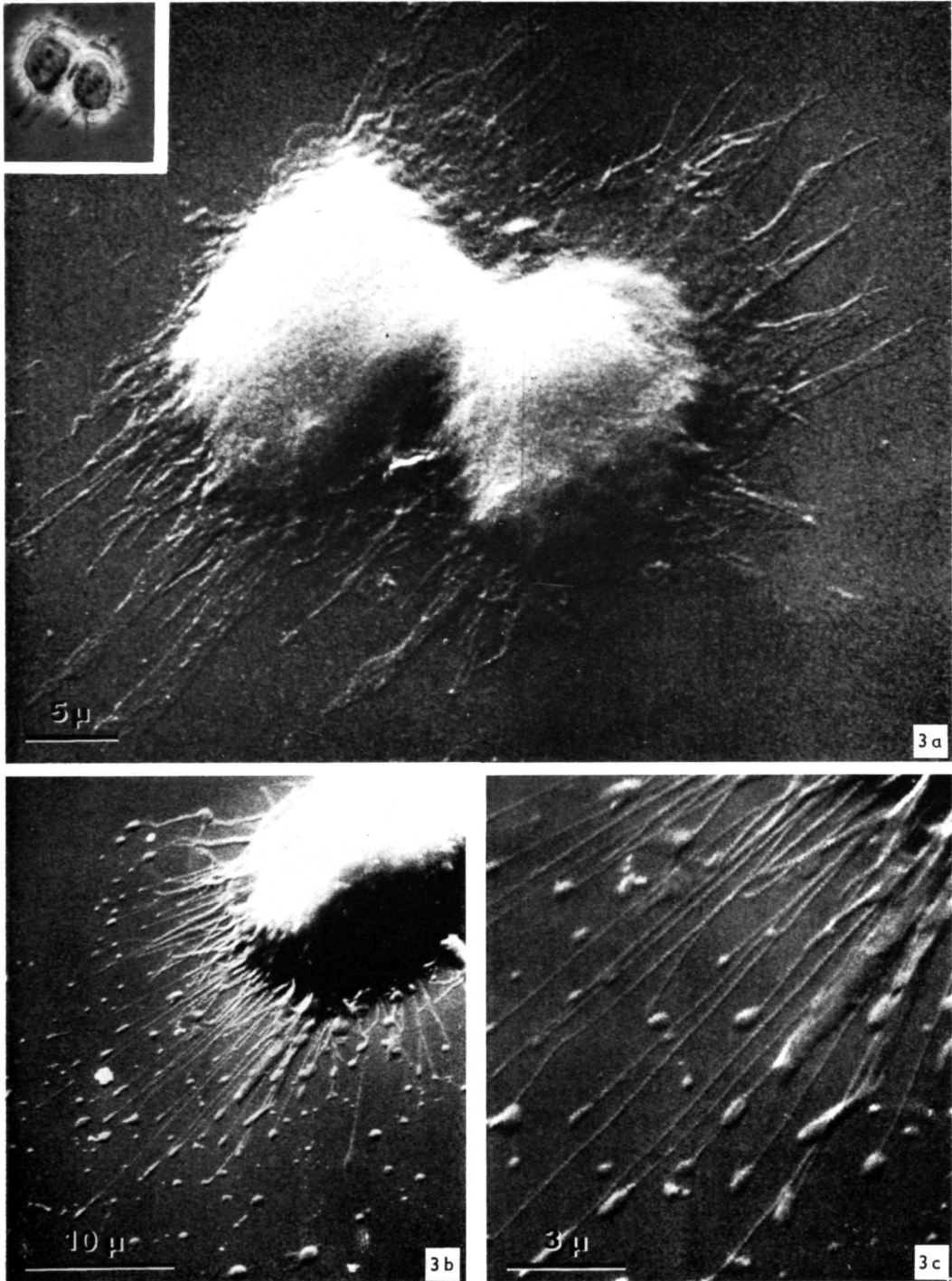

Fig. 3. Scanning electron micrographs of Chang human liver cells; (a) after 150 sec trypsin treatment, same cells as shown in fig. 1c, (inset) (b) part of a spherical mitotic cell demonstrating the long mitotic retraction fibrils, and (c) higher magnification of same cytoplasmic processes. Note the uniform diameter throughout their lengths and the terminal enlargements.

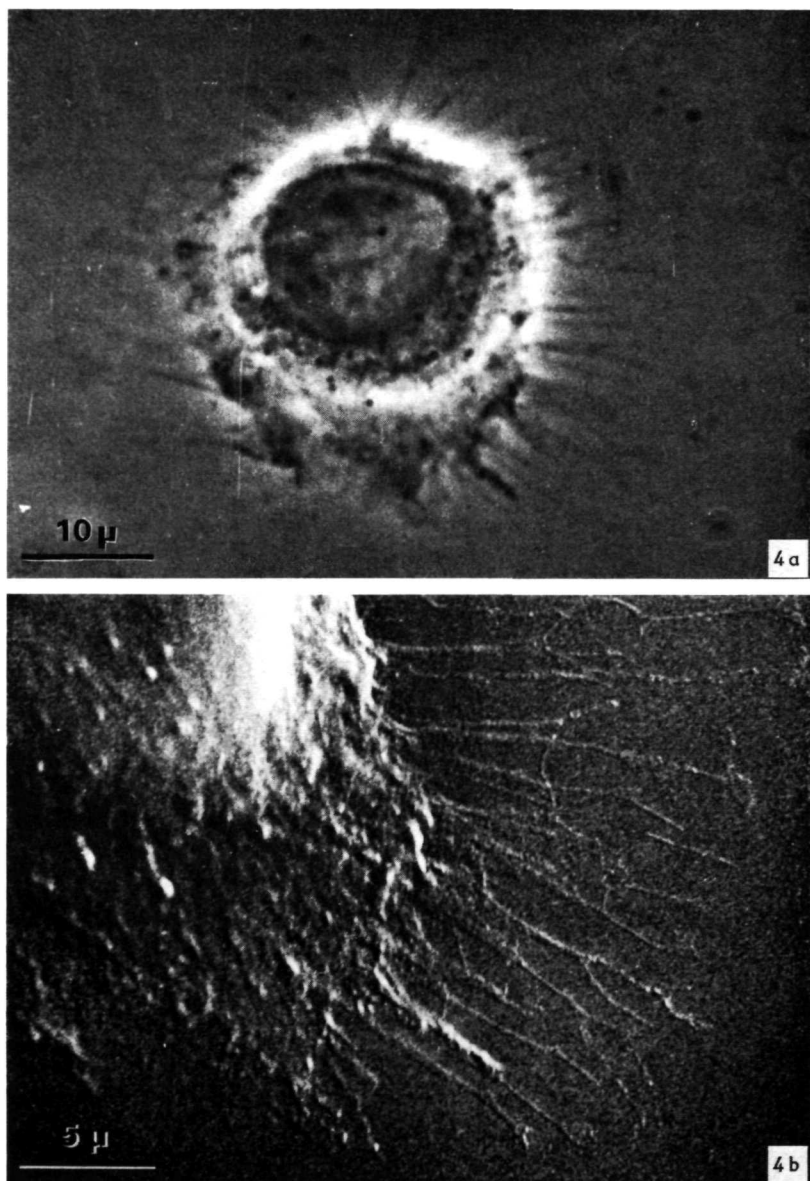

Fig. 4. Trypsinization retraction fibrils on a Chang human liver cell after 150 sec trypsin treatment; (a) as seen in phase contrast microscope; (b) part of the same cell as seen in the scanning electron microscope.

mounted on the rotating stage in a vacuum evaporator, and a thin conductive film of gold was evaporated on the specimen at 45° angle. The surface morphology was studied in JEOL (Model JSM-1) scanning electron microscope. The instrument had a 45° inclined sample holder and was operated at 25 kV with a specimen current near 3×10^{-11} A. The microscopic images were recorded on Polaroid film (Type 42).

RESULTS

The characteristic morphological pattern of Chang cells in vitro is the flattened, firmly attached interphase stage (figs 1a; 2a; 5a; 6a) compared to the spherical mitotic cell,

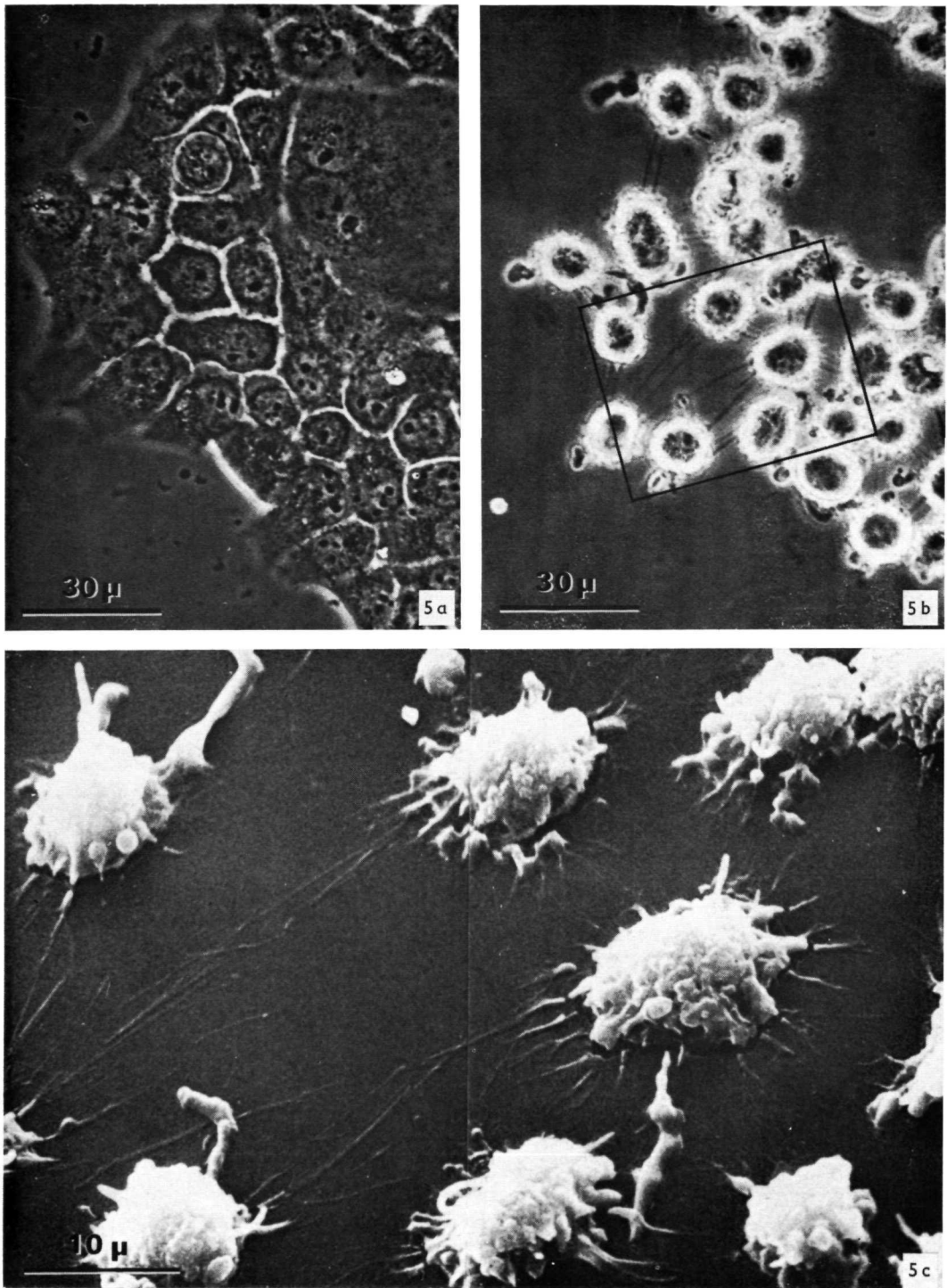

Fig. 5. Chang human liver cells in a 7-day-old culture; (a) seen in phase contrast microscope before trypsin treatment; (b) after 5 min treatment with 0.03 % trypsin, showing intercellular attachment fibrils; (c) the same cells outlined in (b) seen in the scanning electron microscope.

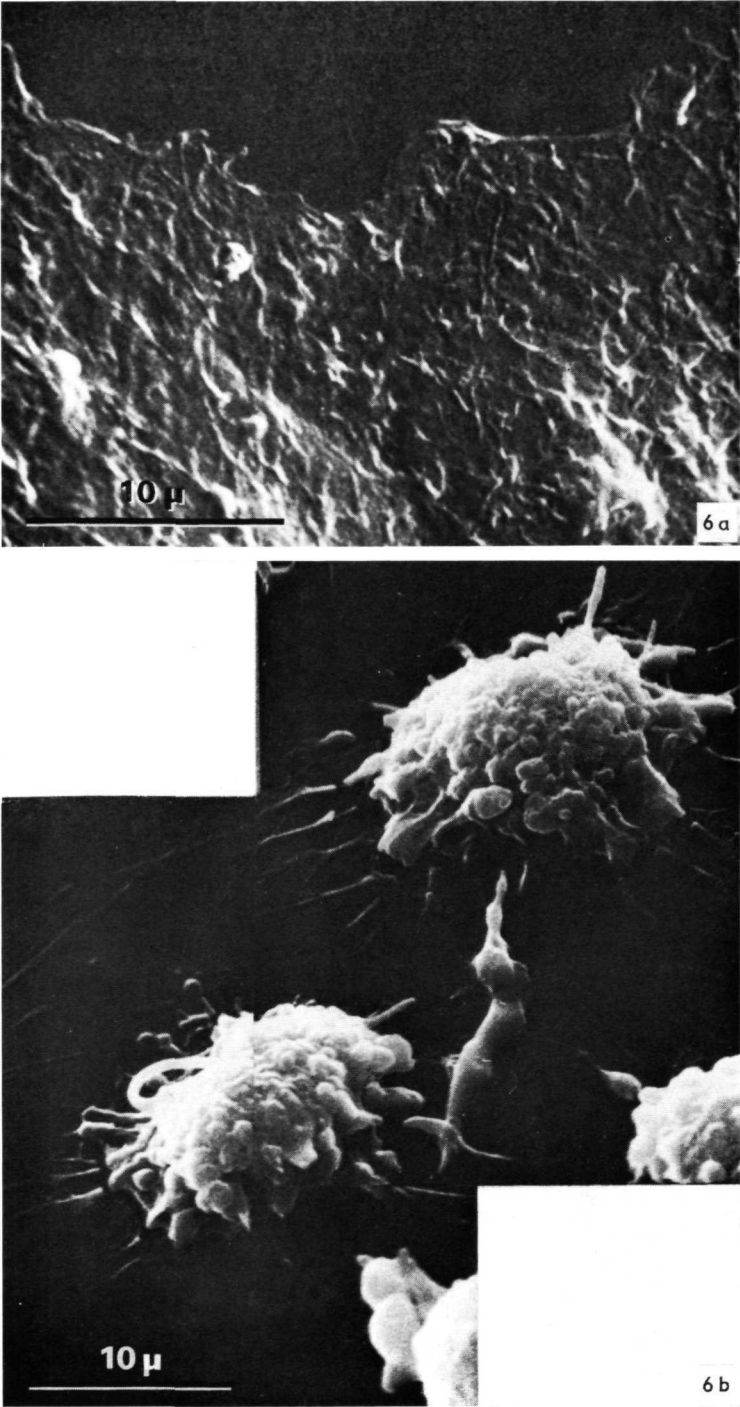

Fig. 6. Comparison of cell surfaces in 7-day-old cultures by scanning electron microscopy; (a) before trypsinization; (b) after 5 min trypsin treatment. Note the presence of numerous short microextensions on the normal interphase cells and their absence on the cauliflower-like surface of the trypsinized cells.

which mainly is attached to the plastic growth substratum by means of long mitotic retraction fibrils (fig. 3*b, c*).

In a short period of about 1 min after addition of the enzyme solution, no visible morphological changes of the interphase cells could be observed in the phase contrast microscope. This stage was followed by a rapid retraction of the main bulk of the cytoplasm into a sphere, leaving behind thin cytoplasmic processes (figs 2*c; 5c*). These structures which can be seen faintly in the phase contrast microscope (figs 4*a; 5b*) are prominent in the scanning electron micrographs (figs 3*a; 4b; 5c*). The retraction of the cytoplasm was in the direction of the nucleus. In the single cell the slender processes trail behind the retracting cytoplasm in all directions (fig. 4*a*), as also is the case with cells in colonies (figs 2*c; 5b, c; 6b*). Daughter cells (the two-cell stages), however, seem to attach to each other as well as to the plastic surface, so that the cells first detach and retract from the areas where they are not in contact with each other (figs 1*b, c; 3a*).

The surface of the normal Chang liver interphase cell contains numerous short microextensions (fig. 6*a*) [7], which disappear after trypsin treatment (fig. 6*b*). The surface of the spherical trypsinized cell appears as a cluster of smaller spheres (resembling cauliflower), and the long retraction fibrils persist through at least the first 5 min of trypsin treatment.

DISCUSSION

It is well established that the attachment between the cell surface and the substratum is broken by trypsin treatment. The destruction of binding forces causes the flattened interphase cell to round up into a spherical structure leaving behind long slender cyto-

plasmic processes. These morphological changes triggered off by the enzyme treatment closely resemble the structural changes seen during mitosis as previously described [7]. In both cases the main bulk of the cytoplasm retracts into a sphere leaving behind slender processes as far out as the cell was spread in the preceding interphase stage. The main difference may be that the natural mitotic process proceeds at a much slower speed, but they both may represent the same phenomenon.

Minor cytoplasmic surface projections have been observed on a number of cultivated cells and have most commonly been named microvilli [1, 4, 9, 10, 20], but terms like microfibrils [11], microspikes [26, 27, 30], microextensions [6, 7, 26, 27] and retraction fibrils [27] have been applied. They have been attributed different functional roles in processes such as cell aggregation [14], cell fusion [12], cell attachment and cytoplasmic spreading [7, 9, 27], anchoring devices [7] and storage organelles for excess cell membrane [10].

According to Taylor & Robbins [27] the microextensions projecting from the surface of cultivated cells can be divided into two groups: (*a*) microspikes and (*b*) retraction fibrils. The first type was characterized by active waving motion, rigidity and transient nature, while the representatives of the second group were of an immobile nature spun out from the borders of retracting cytoplasm. Unlike the free microspikes the retraction fibrils were attached to the supporting surface, often anchored by terminal enlargements.

Three types of long microextensions of the latter category have been observed on Chang human liver cells in culture: (1) Mitotic retraction fibrils have been seen to appear as the cells round up during mitosis (fig. 3*b, c*) [7]. So far similar processes are observed

on secondary chicken fibroblasts [19] and baby hamster kidney fibroblasts [10]. (2) Trypsinization retraction fibrils are seen in figs 3*a*; 4*a*, *b*. Extension of the enzymatic treatment for a few minutes resulted in slender cytoplasmic processes of uniform diameter throughout their length. As the mitotic retraction fibrils (fig. 3*c*) they often revealed terminal enlargements. Trypsinization of older cultures leads to the appearance of intercellular (3) attachment fibrils, which seem to be under tension (fig. 5*b*). That these fibrils are truly intercellular and not attached to the plastic is evident from the fact that some are above, some are below, and some are in the plane of focus when cells are viewed as shown in fig. 5*b*. Whether these arise from intercellular cytoplasmic bridges or from points of strong intercellular cohesion is not known. According to the findings of Sedar & Forte [25] tight junctions (zonula occludens) are not affected by the removal of the surface-bond-calcium by a chelating agent (EDTA). Fig. 5*c* indicates that the weakest, narrowest point in the attachment fibril occurs near its midpoint, suggesting that the two cells shared in its genesis. They may even be fused retraction fibrils attached to one another rather than the substratum—a possible reason why these colonies tend to float off as flakes when the culture vessel is shaken. The tendency of these fibrils to break during fixation and dehydration renders interpretation of the scanning electron micrographs (fig. 5) rather difficult, so most information about intercellular fibrils will come from phase micrographs.

The long attached microextensions may express the fact that the cell surface is heterogeneous with respect to its ability to attach to the substratum (in this case plastic). This could be due to the specific distribution of attachment proteins, transmembrane potenti-

al or ions [1, 16, 29] on the cell surface. It is also possible that these processes together with the cauliflower-like foldings of the trypsinized cell surface represent the excess surface material left over when the cells are transformed from the flattened to the spherical shape [10].

According to our findings in the scanning electron microscope and to the observations by Edwards & Fogh [8] the short microextensions (microvilli) disappear after trypsinization. However, their presence on the surface of resuspended HeLa cells a few minutes after the trypsin treatment [9] reflect their rapid transitional nature. Their disappearance could be more apparent than actual, as the highly convoluted surfaces of the cells of fig. 6*b* may mask their presence. Their reappearance as a function of time is a subject for further investigation.

It has been pointed out [5, 29] that the physical nature of cell contacts depends upon the radius of curvature of "probes" the cell is able to produce. The existence of long and short [7] microextensions provides considerable variety in the radii of curvature presented by cell surface projections down to a few hundred Å. Small radii of curvature are particularly favorable for electrostatic interactions so that the tips of micro-extensions should be reasonable places to seek divalent cationic bridges or salt linkages [21] in cell-to-cell or cell to substratum adhesions.

The authors wish to express their thanks to Professor C. A. Tobias and Professor Bo Thorell for their financial support and interest in the present investigation. We are also indebted to Dr T. L. Hayes for his valuable advice using the scanning electron microscope and to Miss Maj Andersson for her skillful technical assistance in preparing the micrographs.

This work was supported by the Southwest Center for Advanced Studies, Dallas, Texas, by The Swedish Medical Research Council (grant B71-12V-630-07) and by NASA grant ~~NS G-324~~. *NS G-324, NCR-39-009-008*

REFERENCES

1. Ambrose, E J, *Exptl cell res, suppl.* 8 (1961) 54.
2. Borle, A B, *J cell biol* 36 (1968) 567.
3. Chang, R S, *J exptl med* 113 (1961) 405.
4. Cornell, R, *Exptl cell res* 57 (1969) 86.
5. Curtis, A S G, *The cell surface: Its molecular role in morphogenesis.* Logos Press, London (1967).
6. Dalen, H & Scheie, P O, *Exptl cell res* 53 (1969) 670.
7. — *Ibid* 57 (1969) 351.
8. Edwards, G A & Fogh, J, *Cancer res* 19 (1959) 608.
9. Fisher, H W & Cooper, T W, *J cell biol* 34 (1967) 569.
10. Follett, E A C & Goldman, R D, *Exptl cell res* 59 (1970) 124.
11. Gey, G O, *Harvey lectures* 50 (1955) 154.
12. Harris, H, Watkins, J F, Ford, C E & Schoeffl, I, *J cell sci* 1 (1966) 1.
13. Hebb, C R & Chu, M W, *Exptl cell res* 20 (1960) 453.
14. Leesepts, R J, *J exptl zool* 153 (1963) 171.
15. Levine, S, *Exptl cell res* 19 (1960) 220.
16. Loewenstein, W R, *Ann NY acad sci* 137 (1966) 441.
17. Magee, W E, Sheek, M R & Sagik, B P, *Proc soc exptl biol med* 99 (1958) 390.
18. Millonig, G, *J appl physiol* 32 (1961) 1637.
19. O'Laigue, P, Dalen, H, Rubin, H & Tobias, C, *Science* 170 (1970) 464.
20. Overman, J R & Eiring, A G, *Proc soc exptl biol med* 107 (1961) 812.
21. Pethica, B A, *Exptl cell res, suppl.* 8 (1961) 123.
22. Puck, T T, Cieciora, S J & Fisher, H W, *J exptl med* 106 (1957) 145.
23. Sabatini, D D, Bensch, K & Barnett, R J, *J cell biol* 17 (1963) 19.
24. Scherer, W F, Syverton, J T & Gey, G O, *J exptl med* 97 (1953) 695.
25. Sedar, A W & Forte, J G, *J cell biol* 22 (1964) 173.
26. Taylor, A C, *J cell biol* 28 (1966) 155.
27. Taylor, A C & Robbins, E, *Develop biol* 7 (1963) 660.
28. Weiss, L, *Exptl cell res* 14 (1958) 80.
29. — *The cell periphery, metastasis, and other contact phenomena.* North-Holland, Amsterdam (1967).
30. Weiss, P, *The molecular control of cellular activity* (ed J M Allen) p. 1. McGraw-Hill, New York (1961).

Received December 3, 1970

Revised version received February 8, 1971

HYDROSTATIC PRESSURE EFFECTS ON PROTEIN SYNTHESIS

C. E. HILDEBRAND and E. C. POLLARD

From the Biophysics Department, Pennsylvania State University, University Park, Pennsylvania 16802. Dr. Hildebrand's present address is the Biomedical Research Group (H-4), Los Alamos Scientific Laboratory, University of California, Los Alamos, New Mexico 87544.

N74-20714

ABSTRACT The effects of high hydrostatic pressure on several phases of cell-free protein synthesis have been examined. The initial rate of polyuridylic acid (poly U)-directed synthesis of polyphenylalanine showed an apparent increase at 100 atm, above which the synthetic rate was reduced sharply with increased pressure up to 640 atm where 95% inhibition was observed. The magnitude of the inhibition of polyphenylalanine synthesis with increased pressure depended strongly on the magnesium salt concentration in the reaction system. Misreading of the poly U message, as measured by insertion of leucine in place of phenylalanine, dropped rapidly with increased pressure from 1 to 350 atm, above which the amount of misreading increased. Enzymatic activation of transfer RNAs (tRNAs) was reduced by increased pressure in the range 100-640 atm, where the rate of tRNA aminoacylation was 80% inhibited. Both nonenzymatic attachment of phenylalanyl-tRNA (phe-tRNA) to the poly U-ribosome complex and stability of the phe-tRNA-poly U-ribosome complex were decreased at high pressures (100-900 atm). The results of the action of pressure on the various phases of cell-free protein synthesis suggest that the major pressure-sensitive element in the protein synthetic machinery is the ribosome.

INTRODUCTION

Pressure as a distortion agent has been known for a long time to affect cell growth and viability. The effects of high hydrostatic pressures on macromolecular synthetic processes (i.e., protein, DNA, and RNA synthesis) have been studied recently in our laboratory and elsewhere (1-8) with the general conclusion that rates of synthesis are reduced by pressure in both bacterial and mammalian cells. In all cases, protein synthesis was found to be the most pressure sensitive, followed by DNA, and least sensitive RNA synthesis (3, 6, 7). In view of these findings, we thought it worthwhile to study the effect of pressure on synthesis in cell-free systems.

Because of its large sensitivity to high pressures, we have focused on the protein synthetic process. While the work was in progress a report of a study of translation stages by Arnold and Albright appeared (8). Our work confirms and adds to their

findings; an account of our work has been given previously (9). This study has examined the effects of pressure on the processes and components which together produce a polypeptide in response to the information provided in the nucleotide sequence of a messenger RNA (mRNA). In order to perform this investigation, a bacterial cell-free protein-synthesizing system was used so that certain steps in the process could be examined independently. The effects of high pressures on the following processes or states have been established: (a) total cell-free polypeptide synthesis; (b) fidelity of translation of a synthetic mRNA (poly U); (c) enzymatic activation of tRNAs; (d) nonenzymatic attachment of activated tRNAs to ribosomes and mRNA to form an aminoacyl-tRNA-(aa-tRNA)-mRNA-ribosome complex; and (e) stability of this complex at high pressures. The last two were stressed in the study by Arnold and Albright (8).

EXPERIMENTAL

Materials

The adenosine triphosphate (ATP, sodium salt), guanosine triphosphate (GTP, potassium salt), dithiothreitol, phosphoenolpyruvate, pyruvate kinase, L-amino acids, and the *Escherichia coli* K-12 tRNA (Grade B) were obtained from Calbiochem, Los Angeles, Calif. The poly U was purchased from Schwarz Bio Research, Orangeburg, N.Y. L-Phenylalanine-¹⁴C (4 mCi/mmole), L-leucine-¹⁴C (10 mCi/mmole), and L-amino acid-¹⁴C mix were bought from New England Nuclear Corp., Boston, Mass., and the L-phenylalanine-ring-4-³H (21 Ci/mmole) was obtained from Amersham/Searle Corp., Arlington Heights, Ill.

Apparatus

The high pressure apparatus used in this investigation has been described by Yyanos and Pollard (3). The hydraulic fluid consisted of two parts distilled water with one part Xerex antifreeze in order to minimize temperature rise due to compression and to aid in the prevention of rust. A reaction vessel similar to that used in these studies has been described by Koskikallio and Whalley (10) and permits rapid sampling of small-volume pressurized reactions. The temperature of the system was controlled by immersing the entire pressure vessel and, hence, the reaction assembly in a constant temperature water bath.

Preparation of Bacterial Extracts

All extracts used in this study were prepared from *E. coli* W3110 obtained from Dr. Stanley Person of this laboratory. A 10 ml culture of this bacterium was grown from a frozen stock in A-1 minimal medium (2 g NH₄Cl, 6 g Na₂HPO₄, 3 g KH₂PO₄, 5 g NaCl, 0.34 g MgCl₂·6H₂O, 0.155 g Na₂SO₄, 4 g glucose, and 1 liter distilled water) with aeration at 37°C. When the 10 ml culture reached the midlog phase of growth, it was used as an inoculum for a 500 ml vol of nutrient medium (8 g nutrient broth, 5 g glucose, and 1 liter distilled water). This culture was grown with aeration at 37°C to midlog phase, at which time it was used as an inoculum for an 18 liter nutrient culture. It was grown with vigorous aeration at 32 ± 1°C to a titer of 2-4 × 10⁸ cells/ml. The 18 liter culture was poured over a surplus of crushed ice, bringing the temperature to 0-3°C within 5 min. The bacteria were harvested in a continuous flow Sharples centrifuge (Sharples-Stokes Div., Pennwalt Corp., Warminster, Pa.). All of

the following operations were carried out at 3–5°C unless otherwise specified. The bacterial pellet was resuspended in a buffered salt solution (TMK buffer) containing 0.01 M Tris-Cl (pH 7.8), 0.06 M KCl, 0.014 M magnesium acetate, and 0.0001 M dithiothreitol (Cleland's reagent). After a low speed centrifugation, the washed bacterial pellet was weighed and frozen rapidly in dry ice-acetone and stored at –65°C until used.

The procedures for disruption of the bacteria and preparation of the extracts have been described by Nirenberg (11). In all cases, dithiothreitol was substituted for mercaptoethanol. Disruption of the bacterial cells was performed by two passages of the concentrated cell suspension through a French press at 16,000–24,000 psi. Additional dithiothreitol (0.1 μ mole/ml) was added to the lysate, and the cellular debris was removed by a low speed centrifugation. After DNase treatment and a 37°C incubation with GTP, ATP, pyruvate, pyruvate kinase, and 20 amino acids (at the same concentrations as used in cell-free synthesis) to remove ribosomes from endogenous mRNA, the bacterial extract was fractionated by centrifugation at 30,000 *g* for 30 min. The top four-fifths of the supernatant of each tube was removed and designated the S-30 fraction, containing enzymes, tRNAs, ribosomes, and small molecules. A portion of the S-30 was further fractionated by a 2 hr 100,000 *g* centrifugation, and the top four-fifths of the supernatant containing enzymes, tRNAs, and small molecules was decanted. The ribosomal pellet was resuspended by stirring at slow speed for 2 hr over a magnetic stirrer, washed 3 times by centrifugation, resuspended in TMK buffer, and designated W-Rib. The S-30 and S-100 preparations were dialyzed against 100 vol of TMK buffer for 15–18 hr with one change of the buffer at 8 hr. The S-30, S-100, and W-Rib preparations were rapidly frozen in dry ice-acetone and stored at –65°C until used. The protein content of the S-30, S-100, and W-Rib preparations was determined by a modification (12) of the method of Lowry et al. (13).

Cell-Free Synthesis of Polyphenylalanine

The synthesis of polyphenylalanine was initiated by adding poly U to the rest of the reaction mixture described in the legend of Fig. 1. The reaction mixture was divided into two portions, one of which was used to fill the high pressure reaction syringe and placed under pressure, and the other of which was held at 1 atm and 24°C as a control. The pressure reaction apparatus was assembled as rapidly as possible (2–3 min) at room temperature (22–24°C), and pressure was applied over a 1 min period.

Assay for Misreading of Poly U

The most frequently occurring misreading event in the cell-free protein-synthesizing system described above is the insertion of leucine in place of phenylalanine in the poly U-directed polypeptide (14). The misreading of the poly U as a function of both Mg^{++} concentration and pressure was examined by two methods. In one method, two parallel poly U-directed cell-free reactions were run as described in the legend of Fig. 1, one containing phenylalanine-¹⁴C at the specific activity and concentration noted above and the other containing unlabeled phenylalanine at 0.2 μ mole/ml in place of phenylalanine-¹⁴C and leucine-¹⁴C at 0.2 μ mole/ml and 10 mCi/mM in place of the unlabeled leucine. These reactions were sampled and assayed for the amounts of phenylalanine-¹⁴C and leucine-¹⁴C incorporated into the polypeptide products. In the other method, the incorporation of phenylalanine-³H and leucine-¹⁴C was followed in a single reaction. The phenylalanine-³H (40 mCi/mM) and leucine-¹⁴C (10 mCi/mM) were both supplied at 0.2 μ mole/ml in place of the phenylalanine-¹⁴C and unlabeled leucine in the reaction mixture described above. Samples of 200 μ l were taken as described in Fig. 1. All samples were filtered on Whatman GF/A glass fiber filters which had been soaked

in 95% ethanol. Each filter sample was washed with two 3 ml portions of ice-cold 5% TCA and then with 3 ml of 95% ethanol. The filters were placed in 3-ml glass vials and allowed to dry overnight. Toluene-PPO-POPOP¹ scintillation fluid (2.5 ml) was added to each vial, and the samples were counted in a Nuclear-Chicago liquid scintillation spectrometer (Nuclear-Chicago Corp., Des Plaines, Ill.). Corrections were made for ³H/¹⁴C crossover, and the ¹⁴C/³H ratio was determined for each sample.

Reaction System for Studying the Aminoacylation of E. coli tRNA

The components were mixed in the order listed. The system used for studying the effects of high pressure on the aminoacylation of *E. coli* tRNA contained the following ingredients in micromoles per milliliter unless otherwise specified: 100 Tris-Cl buffer (pH 7.8); 50 KCl; 1.0 ATP; 0.03 GTP; 10 magnesium acetate; 0.4 dithiothreitol; 75 phosphoenolpyruvate; 1.6 μ g/ml pyruvate kinase; 0.51 (1 μ Ci) amino acid-¹⁴C mix containing L-amino acids-¹⁴C alanine, arginine, aspartic acid, glutamic acid, glycine, histidine, isoleucine, leucine, lysine, phenylalanine, proline, serine, threonine, tyrosine, and valine; 0.12 mg/ml bovine serum albumin; 4 μ g/ml S-100 protein; and 2 mg/ml *E. coli* tRNA. All components except the tRNA were mixed at 0°C and then warmed to 24°C. The reaction was initiated by adding the tRNA, also at 24°C, to the reaction mixture. Samples (50–200 μ l) were taken into 3.0 ml of ice-cold 10% TCA, allowed to stand at 0°C for at least 30 min but not more than 2 hr, and filtered and washed with 2 vol of ice-cold 5% TCA on Millipore membrane filters (Millipore Corporation, Bedford, Mass.). The filters were glued to planchets, allowed to dry, and counted as described above.

Preparation of Phenylalanyl-¹⁴C-tRNA for Use in Binding Studies

The method used for preparing phenylalanyl-¹⁴C-tRNA (phe-¹⁴C-tRNA) has been adapted from the procedures of von Ehrenstein and Lipmann (15) and Moldave (16). The composition of the reaction system was as follows (in micromoles per milliliter unless otherwise specified): 100 Tris-maleate buffer (pH 7.0); 10 magnesium acetate; 0.8 dithiothreitol; 3 ATP; 20 phosphoenol pyruvate; 40 mg/ml pyruvate kinase; amino acid mix (minus phenylalanine); 0.1 each amino acid (see composition of cell-free reaction system for list of these amino acids); 0.013 phenylalanine-¹⁴C (SA 384 mCi/mM, New England Nuclear Corp.); 0.88 mg/ml S-100 protein; and 9.5 mg/ml *E. coli* K-12 tRNA. The above components were mixed at 0°C in the order listed and incubated at 24°C for 1 hr. The following procedures were carried out at 4°C. The 10 ml reaction was treated with 10 ml of water-saturated redistilled phenol, and the mixture was shaken vigorously for 1 hr. The phenol and aqueous phases were separated by centrifugation at 15,000 *g* for 20 min. The top aqueous layer containing the phe-¹⁴C-tRNA and other unlabeled aa-tRNA was removed and saved. The phenol layer was washed with 1 vol of distilled water by shaking for 1 hr. The water-phenol phases were separated and the aqueous phases combined. 0.1 vol of a 20% (w/w) solution of potassium acetate was added to the aqueous phase. The aa-tRNAs were precipitated by addition of 2 vol of 95% ethanol at -20°C; precipitation was allowed to proceed at 0°C for 30 min. The precipitate was collected by centrifugation at 15,000 *g* for 10 min. The precipitate was then dissolved in 10 ml of distilled water and dialyzed at 4°C for 8 hr against 10 vol of distilled water with three changes. Phe-¹⁴C-tRNA was recovered at approximately 5 mg/ml and 8.1×10^{-5} mCi/ml. The phe-¹⁴C-tRNA preparation was divided into 0.5 ml portions, quickly frozen in dry ice-acetone, and stored at -65°C.

¹ PPO, 2,5-diphenyloxazole; POPOP, 1,4-bis[2-(5-phenyloxazolyl)]-benzene.

Binding of Phe-¹⁴C-tRNA to Form the Phe-¹⁴C-tRNA-Poly U-Ribosome Complex

The system used to study the effects of pressure on the formation and stability of the aa-tRNA-mRNA-ribosome complex and the phe-¹⁴C-tRNA-poly U-ribosome complex specifically has been described by Nirenberg and Leder (17). The samples were filtered immediately on Millipore membrane filters (0.45 μ pore size, 25 mm diameter) and washed with two 3 ml portions of the same solution. The filters were glued to aluminum planchets, allowed to dry, and counted as described above. The amount of radioactivity retained by the filter was a measure of the extent of phe-¹⁴C-tRNA binding in the complex.

RESULTS

Characteristics of the Cell-Free Protein-Synthesizing System

The kinetics of polyphenylalanine synthesis in a cell-free reaction was shown in Fig. 1. Synthesis is dependent on the presence of poly U. Factors to consider are, first,

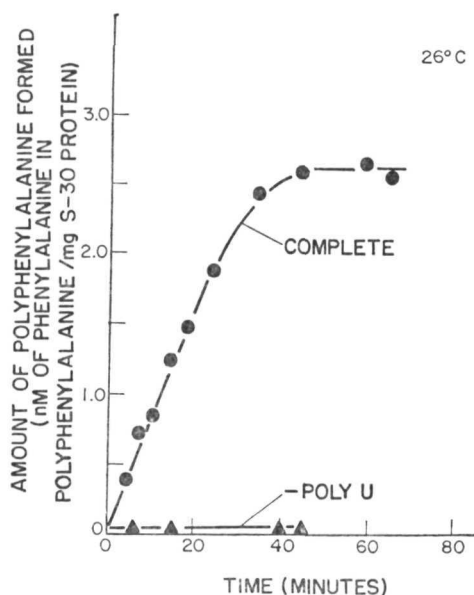

FIGURE 1 Time-course of a typical poly U-directed synthesis of polyphenylalanine. The cell-free protein-synthesizing system contained the following components in micromoles per milliliter unless specified: 100 Tris-Cl buffer (pH 7.8); 50 KCl; 16.8 magnesium acetate; 0.1 dithiothreitol; 1 ATP; 0.03 GTP; 7.5 phosphoenolpyruvate (sodium salt); 1.6 mg phosphoenolpyruvate kinase; 0.2 each of 19 L-amino acids (glycine, alanine, serine, aspartic acid, asparagine, glutamic acid, glutamine, isoleucine, leucine, cysteine, histidine, tyrosine, tryptophan, proline, threonine, methionine, arginine, lysine, and valine); 0.2 phenylalanine-¹⁴C (4 mCi/mmol, 8×10^{-4} mCi); 4 mg S-30 protein; and 160 mg poly U. Samples (200 μ l) were taken immediately into ice-cold 10% trichloroacetic acid (TCA) and held for at least 2 hr. The precipitates were then placed in suspension by rapid mixing on a Vortex mixer (Scientific Industries, Inc., Lake Worth, Fla.) and placed in an 85°C water bath for 30 min in order to solubilize the phenylalanine-¹⁴C residues attached to cold acid-precipitable tRNAs. The samples were placed at 0°C for 1-2 hr. The remaining precipitable material was collected and washed with ice-cold 5% TCA on Millipore membrane filters (0.45 μ pore size, 25 mm diameter). The filters were glued to aluminum planchets and counted under a gas-flow counter operated in the Geiger-Müller region (Nuclear-Chicago Corp., model D-47 with Q-gas) with an efficiency of approximately 25%.

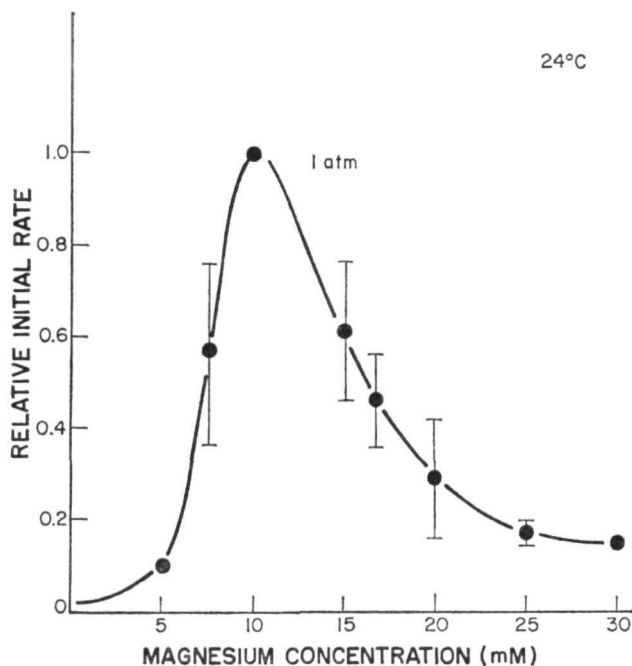

FIGURE 2 Dependence of initial rate of polyphenylalanine synthesis on magnesium concentration in the reaction system. The relative initial rate is the ratio of the initial rate measured at the given magnesium concentration to the initial rate measured at 10 mM magnesium concentration. The composition of the reaction system employed was described in the legend to Fig. 1.

the amount of phenylalanine which is available for enzymatic attachment to tRNA decreases as the reaction proceeds. Second, there is no mechanism for chain termination. This may prevent ribosome release and reutilization. Third, the bacterial RNases produce shorter and shorter pieces of poly U with time. All of these factors affect the final amount of polyphenylalanine synthesized but not the initial rate of synthesis. For this reason, the initial rate of synthesis between 3 and 20 min was used to measure the effect of pressure on the cell-free synthesis of polyphenylalanine. The effects of temperature, magnesium ion concentration, potassium ion concentration, and pH on polyphenylalanine synthesis were studied. The temperature dependence showed two components on an Arrhenius plot. The activation energy calculated was 35 kcal/mole from 11 to 26°C compared with 13 kcal/mole from 26 to 37°C.

The magnesium ion concentration dependence proved to be important in the interpretation of our work and is shown in Fig. 2. The initial rate at the various magnesium ion concentrations reached a maximum at approximately 10 mM Mg^{++} and varied sharply on both sides of the maximum. Potassium ion concentration had less effect. There was a shallow maximum between 60 and 80 mM K^+ . The optimum pH was 7.8, and less than 10% change occurred for 0.4 pH unit on each side.

Effect of Pressure on Initial Rate of Polyphenylalanine Synthesis

The pressure dependence of the initial rate of polyphenylalanine synthesis was examined by comparing the initial rate of synthesis in a pressurized reaction with that in a 1 atm control reaction run simultaneously, as shown in Fig. 3. To check that the process of sample removal did not vitiate the data, a test was made of a reaction at 1 atm which was pressurized just before sampling. Thus, sample removal under pressure was tested. No effect was observed. The temperature increase due to compression was less than 2°C , and tests of temperature dependence showed that this is negligibly important. The pressure-induced pH change was also too small to produce an effect.

The possibility of secondary effects produced by a pressure-induced pH change can be excluded on the basis that (a) the buffering system, Tris-Cl (pH 7.8), is an organic buffer with a small volume change upon ionization and, therefore, is only slightly affected by pressure (18), and (b) the pH dependence of the initial reaction is negligible over a broad pH range. The sharpness of the magnesium ion concentration dependence prompted an investigation of the effects of pressure at two magnesium ion concentrations: one at the optimum of Fig. 2 and the other well above

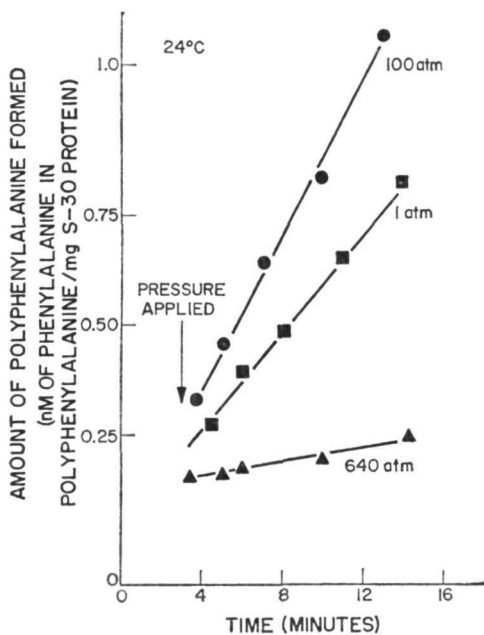

FIGURE 3

FIGURE 3 Initial kinetics of polyphenylalanine synthesis at two high pressures. The composition of the reaction systems was described in Fig. 1.

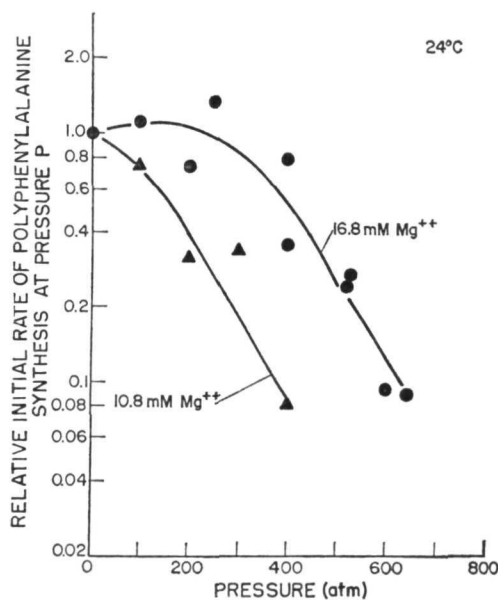

FIGURE 4

FIGURE 4 Pressure dependence of the initial rate of polyphenylalanine synthesis at two magnesium concentrations. The relative initial rate is defined as the ratio of the initial rate at pressure to the initial rate at 1 atm.

the optimum. The results of many kinetic studies of the pressure effect at the two magnesium ion concentrations are shown in Fig. 4. These results indicate a significantly greater pressure sensitivity at the lower magnesium ion concentration.

The capacity of the protein synthetic machinery to recover from an inhibitory pressure was studied. Fig. 5 shows the synthetic ability of the polyphenylalanine synthetic system after application of 920 atm, a totally inhibitory pressure, for 12 min after the reaction has been initiated. While the pressure-treated reaction does not synthesize as much polyphenylalanine before exhausting itself, the rate of synthesis immediately after pressure treatment approximately parallels the initial rate of the 1 atm control 11 min earlier.

Effect of Pressure on the Fidelity of Translation of Poly U

The fidelity of translation of synthetic mRNAs has been shown to depend upon ionic concentrations (namely, magnesium ions), pH, and temperature (14, 19). We examined the effect of pressure on the precision of translation of the poly U message by observing the frequency of incorporation of leucine into the poly U-directed polypeptide. First, we examined the effect of Mg^{++} concentration. Our find-

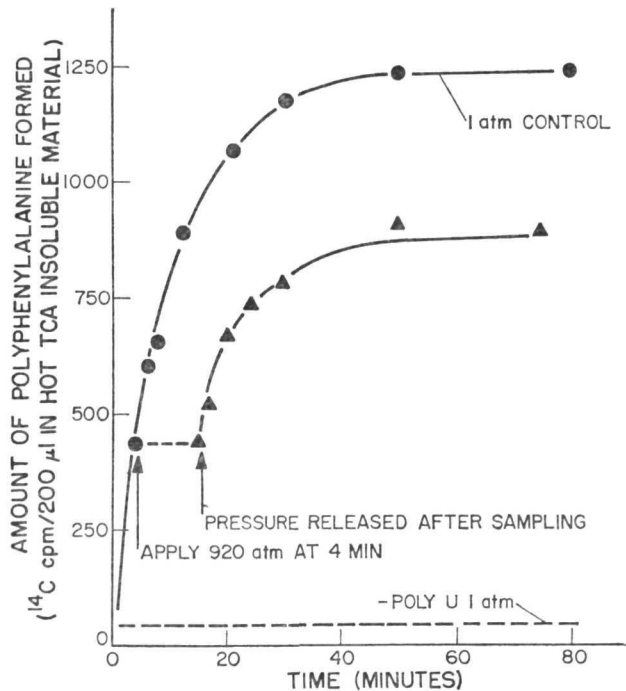

FIGURE 5 Reversibility of the pressure inhibition of the cell-free reaction. Concentrations of components in the reaction system were given in Fig. 1 (1000 cpm/200 μ l hot TCA-insoluble material = 625 pmoles phenylalanine- ^{14}C in polyphenylalanine/mg S-30 protein).

ings indicated a steady increase in misreading from 5 to 20 mM Mg^{++} . These agreed with work by Szer and Ochoa (14) which showed that misreading increases with increasing magnesium concentration from approximately 10 to 20 mM. Studies of the effect of pressure on fidelity of translation of poly U shown in Fig. 6 indicate that the amount of misreading in the pressurized system decreases with increasing pressure from 1 atm to approximately 350 atm, where an apparent minimum in this effect occurs. Above 350 atm the misreading again increases up to 470 atm, where the levels of synthesis are too low for accurate estimates of ratios.

Effect of Pressure on Aminoacylation of tRNAs

Because supply of aa-tRNAs must be available for selection by the translation complex, a decrease in this supply would result in a decrease in rate of polypeptide chain

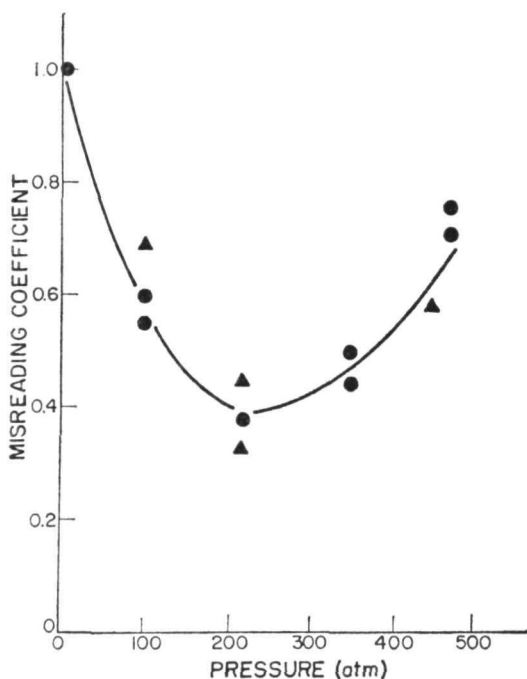

FIGURE 6

FIGURE 6 Pressure dependence of misreading of the poly U message. The misreading coefficient is defined as the ratio of the leucine/phenylalanine (leu/phe) content in the poly U-directed polypeptide product at pressure to the leu/phe content in the 1-atm product. The concentrations of components in the reaction system were listed in the legend of Fig. 1. Each point represents the average ratio obtained from triplicate samples in a single experiment: (—●—) double label experiment; (—▲—) single label experiments. Detail is given in the text. A misreading coefficient of 1.0 corresponds to an incorporation of one leucine residue to every seven phenylalanine residues, on the average.

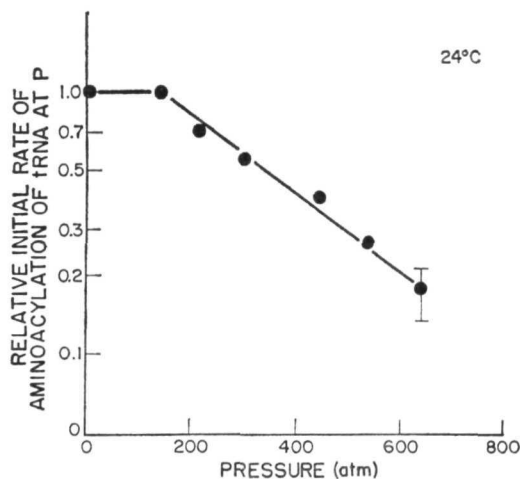

FIGURE 7

FIGURE 7 Pressure dependence of the initial rate of aminoacylation of *E. coli* tRNA. Details of the reaction system and sampling techniques are given in the text.

elongation. Accordingly, the effect of pressure on the rate of aa-tRNA formation was studied. The initial rate of formation (first 10 min) of aa-tRNAs in a pressurized reaction was compared with that in a 1 atm control reaction with results as shown in Fig. 7. In these experiments, the preparation (S-100) containing aminoacyl-activating enzymes had to be diluted a factor of 3000 in order to make the reaction kinetics slow enough to be followed by available methods. Even then the reaction kinetics were linear only for 15 min with a rapid leveling taking place between 15 and 20 min. These reaction mixtures contained 10 mM magnesium acetate, a concentration at which the synthesis of polyphenylalanine was approximately 50% inhibited at 150 atm, while at the same pressure the aminoacylation reaction was not affected. It should be noted that the aminoacylation reaction system measured the attachment of 15 different amino acids to their specific tRNAs. Hence, only the average pressure effect on the 15 different aminoacylating reactions is indicated in Fig. 7.

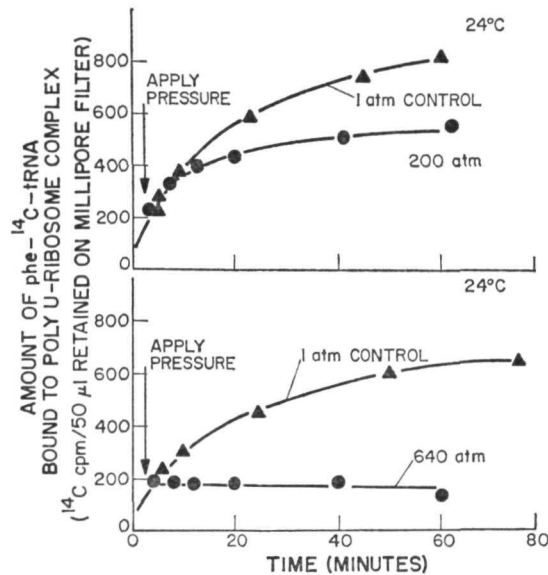

FIGURE 8 Effect of pressure on formation of the phe-tRNA-poly U-ribosome complex. The reaction system contained the following ingredients (in micromoles per milliliter unless specified): 100 Tris-acetate buffer (pH 7.0); 50 KCl; 5-50 magnesium acetate (specified for a given experiment); 0.2 mg/ml poly U; 0.52 mg ribosomal protein/ml W-Rib; and 1 mg/ml phe-¹⁴C-tRNA (1.6×10^{-5} mCi/ml). All components except the phe-¹⁴C-tRNA were mixed at 0°C and warmed to 24°C. The phe-¹⁴C-tRNA also at 24°C was added to initiate the binding reaction at zero time. To assay for the amount of phe-¹⁴C-tRNA bound in the complex, each 50 µl sample was taken into 3 ml of an ice-cold solution of 0.1 M Tris-acetate (pH 7.0), 0.05 M KCl, and 0.02 M magnesium acetate. The samples were filtered immediately on Millipore membrane filters (0.45 µ pore size, 25 mm diameter) and washed with two 3 ml portions of the same solution. The filters were glued to aluminum planchets, allowed to dry, and counted as described above. The amount of radioactivity retained by the filter was a measure of the extent of phe-¹⁴C-tRNA binding in the complex.

Attachment of Phe-tRNA to the Poly U-Ribosome Complex

The recognition of the correct amino acid in the sequence is achieved by specific attachment of the aa-tRNA to the messenger-ribosome complex. A technique used to study this interaction was developed by Nirenberg and Leder (17). Pressure effects on this stage were studied by Arnold and Albright (8); our data, described below, agree with theirs. Kinetic studies of the formation of the phe-¹⁴C-tRNA-poly U-ribosome complex indicated that the rate of complex formation was proportional to the difference between the maximum amount of complex formed at large times (e.g., 120 min) and the amount of complex formed at any previous time. An analysis of kinetic data showed that the proportionality constant for this relationship was a measure of the dissociation rate constant for the complex. Hence, there was no simple measure of the effect of pressure on rate of formation of the complex. The kinetics of formation of the phe-¹⁴C-tRNA-poly U-ribosome complex are shown for two pressures in Fig. 8. In both cases, pressure reduces the ability of the phe-tRNA to attach and remain attached to the complex. The effect is also greater at the higher pressure.

It is suggested that kinetic measurements shown in Fig. 8 can be described by two processes: one process for the attachment of phe-tRNA to the complex and the other process for the detachment of the phe-tRNA. In order to test this idea, the phe-¹⁴C-

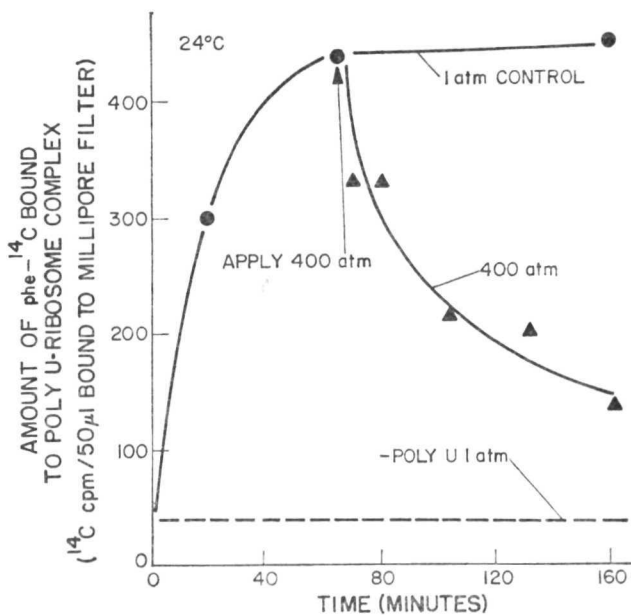

FIGURE 9 Effect of pressure on the stability of the phe-tRNA-poly U-ribosome complex formed at 1 atm and 24°C. The reaction was allowed to proceed to the maximum level of phe-tRNA binding. Pressure was applied to one portion while the other portion was held at 1 atm and 24°C. The reaction system composition and assay procedures were described in Fig. 8.

tRNA-poly U-ribosome complex was formed at 1 atm. When the amount of the complex reached a maximum, the reaction mixture was divided into two portions. One part was held at 1 atm at 24°C, while the other portion was subjected to 400 atm at 24°C. The results of this experiment are given in Fig. 9. Clearly, the increased pressure destabilizes the complex and phe-tRNA is either released or hydrolyzed so that the phenylalanyl-¹⁴C group is released from the complex. In order to determine whether the decrease in amount of phenylalanine-¹⁴C (i.e., phe-¹⁴C-tRNA) indicated by Fig. 9 was due to an increase in rate of hydrolysis of phe-tRNA at high pressure or to an actual release of phe-¹⁴C-tRNA from the complex, the amount of phe-¹⁴C-tRNA remaining in the reaction was measured as a function of time (Fig. 10). It was found that the total amount of phe-¹⁴C-tRNA in both the control and pressurized reactions decreased as a function of time. This decrease, however, was apparently due to the deacylation or hydrolysis of unbound phe-¹⁴C-tRNA, since in the control the amount of bound phe-¹⁴C-tRNA remained constant from 70 to 160

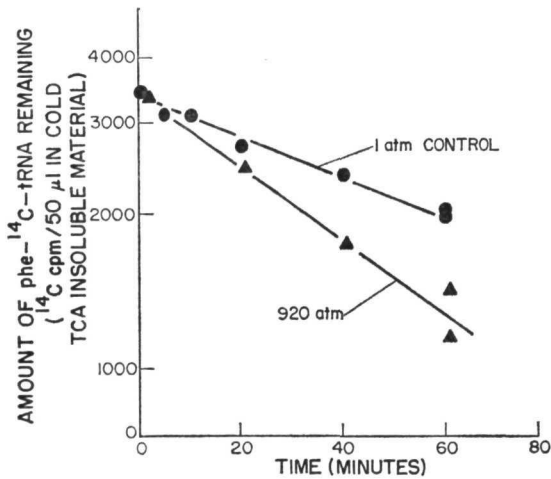

FIGURE 10

FIGURE 10 Effect of pressure on the stability of phe-¹⁴C-tRNA. Phe-¹⁴C-tRNA was incubated in Tris-maleate buffer (pH 7.0) with 0.05 M KCl and 0.02 M magnesium acetate at 1 atm and at 920 atm at 24°C. Sampling and assay procedures were detailed in Fig. 7.

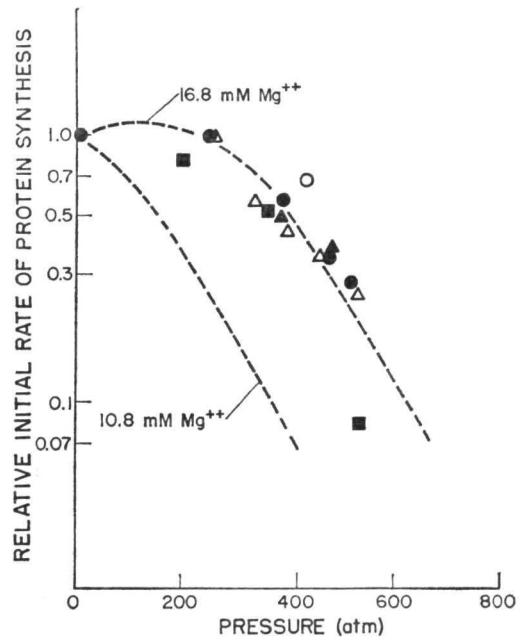

FIGURE 11

FIGURE 11 Effect of high pressure on the rates of protein synthesis in various organisms. The relative initial rate is the ratio of the initial rate at pressure to the initial rate at 1 atm. These data were obtained from the following sources: *E. coli* —, (—○—) Pollard and Weller (1); (—●—) Landau (4, 5); (—■—) Yayanos and Pollard (3); HeLa cells —, (—△—) Landau (6); *Vibrio marinus* —, (—▲—) Albright and Morita (7). All studies except those of Albright and Morita were done at 37°C, and the investigation of Albright and Morita was performed at 15°C. The dotted lines indicate the results of the cell-free study shown in Fig. 4.

min, while the free phe-¹⁴C-tRNA was deacylated. In addition, the decrease in amount of phe-¹⁴C-tRNA in the pressurized reaction was only slightly greater (about 30%) than that found for the control. It should be noted that, while these measurements do not preclude the possibility that cleavage of the phenylalanyl residue of the bound phe-tRNA is facilitated by pressure resulting in an observed apparent decrease in bound phe-tRNA, the measurements shown in Fig. 9 were made at 900 atm where there is a 30% decrease in amount of phe-¹⁴C-tRNA relative to the 1 atm control, but an 85% decrease in amount of bound phe-¹⁴C-tRNA. In addition to the above results, analysis of the kinetic data indicated that both the rate constant for complex formation and rate constant for complex dissociation increased with increasing pressure. The predominance of the dissociation process masks the effect of pressure on association.

DISCUSSION

The relevance of results obtained with a cell-free system to the functioning of an intact living cell has been approached by comparing the effects of pressure on protein synthesis in various kinds of cells (1, 3, 5-7) with the results of this study. The comparison is shown in Fig. 11. The effects of pressure on rate of protein synthesis in living organisms are remarkably similar to the pressure effect on initial rate of polyphenylalanine synthesis in the cell-free system at the higher magnesium salt concentration. This comparison suggests that the magnitude of pressure required to produce a change in the rate of protein (or polypeptide) synthesis is approximately the same in both the cell-free and the *in vivo* studies. The similarity of the pressure effect on cell-free protein synthesis to the effect on protein synthesis in such a broad spectrum of organisms with greatly differing degrees of complexity suggests that the pressure-sensitive elements are very likely the same in all of these systems.

In each of the processes studied (i.e., polyphenylalanine synthesis, misreading of the poly U, tRNA aminoacylation, and attachment of phe-tRNA to the ribosome-poly U complex), the action of high pressure is such that an increase in pressure above 1 atm at a given magnesium concentration produces an effect which correlates with the effect observed at a lower magnesium concentration at 1 atm. For example, the effect of pressure on total polyphenylalanine synthesis (cf., Fig. 4) at 16.8 mM magnesium acetate concentration shows a slight increase in synthetic rate for pressures from 1 to approximately 300 atm, above which there is a rapid decrease in rate with increasing pressure. Comparing the pressure dependence of the rate with the magnesium concentration dependence (Fig. 2), it is found that 16.8 mM magnesium concentration lies on the high magnesium side of the optimum concentration. As the magnesium ion concentration is decreased from 16.8 mM, the rate of synthesis increases approximately a factor of 1.7 at the 10 mM optimum concentration and decreases rapidly as the concentration falls below 11 mM. This result suggests a correlation between the effect of increased pressure at a given magnesium concentration and decreased magnesium concentration at a given pressure (namely, 1 atm).

One prediction based on this correlation is that, if pressure is applied to a reaction at the optimum 10 mM magnesium concentration, then a sharp decrease in rate of synthesis with increasing pressure should be observed. This prediction is verified by the results shown in Fig. 4. It should be noted that the apparent increase in polyphenylalanine synthetic rate between 1 and 300 atm at 16.8 mM magnesium concentration can be attributed partly to the decreased misreading in this pressure range (Fig. 6), where the greater fidelity of phenylalanine insertion at close to the 1 atm rate would produce an apparent increase in rate of polyphenylalanine synthesis. A similar explanation can partly account for the increase in synthetic rate as the magnesium concentration is reduced from 16.8 to 10 mM. Results of the studies of magnesium concentration dependence of misreading of poly U show that a significant decrease in misreading occurs as the magnesium acetate concentration is decreased from 20 to 10 mM. In this case, the predicted effect of increased pressure at 16.8 mM magnesium would be a rapid decrease in misreading over the pressure range extending from 1 to approximately 300 atm. This prediction is confirmed by the results shown in Fig. 6. The action of pressure on the recognition mechanisms in the translation complex is clearly not simple. There appear to be two separate effects of pressure on the fidelity of the reading process. First, there is the initial decrease in misreading (greater fidelity) as pressure is increased from 1 to approximately 300 atm. Second, above 300 atm the misreading appears to increase with increasing pressure. The first process can be implicated in the correlation between pressure effect and magnesium concentration described above. The second process might be attributed to pressure-induced distortions in the translation complex such that the precise interactions between the poly U codons and the anticodons of the aa-tRNAs and among the aa-tRNAs, the peptidyl-tRNAs, and the ribosome cannot occur and insertion of miscoded amino acids (in this case, leucine) takes place.

In the studies of the effect of pressure on initial rate of tRNA aminoacylation, it was found that the rate at 5 mM magnesium acetate concentration and 1 atm was approximately 30% less than the rate at 10 mM. The effect of high pressure on the rate of aminoacylation (Fig. 7) indicated that, as pressure is increased above 1 atm at 10 mM magnesium concentration, there is no effect up to approximately 100 atm. Above 100 atm, there is an exponential decrease of aminoacylation rate with increasing pressure. These findings substantiate the correlation between the effect of increased pressure at a given magnesium concentration and decreased magnesium concentration at 1 atm.

The attachment of phe-tRNA to the poly U-ribosome complex showed a sharp dependence on magnesium concentration. The amount of phe-tRNA which could be bound in an excess of poly U and ribosomes increased from very little (less than 5%) at 5 mM magnesium concentration to maximum (100%) at 22 mM and was constant up to 42 mM magnesium concentration. The effect of pressure applied to this reaction at 20 mM magnesium concentration would be predicted to decrease the

amount of binding. The results of pressure studies (Fig. 8) confirm this prediction. It should be noted that the binding of phe-tRNA to the poly U-ribosome complex in this system is mediated by noncovalent interactions. The amount of phe-tRNA bound to the complex at a given pressure reached the same level relative to the 1 atm control whether pressure was applied just after initiation of the complexing reaction or after the maximum level of complex formation had been at 1 atm. These results suggest that the phe-tRNA-poly U-ribosome complex dissociated until the equilibrium level had been reached.

The above considerations indicate that one very significant element involved in the action of pressure is the interaction of magnesium ions with anionic groups in the macromolecular components of the protein-synthesizing apparatus. This suggestion is supported by the fact that both magnesium ions and phosphate groups show large volume decreases on passage from the associated state to the dissociated state (20-22). Hence, the interaction between magnesium ions and phosphate groups is strongly affected by pressure.

The studies of magnesium concentration dependence of the processes described above suggest that the ionic equilibria involving magnesium ions may be critical. By application of pressure, the magnesium ion-phosphate interaction might be dissolved. While the magnesium ion is mobile and can leave the immediate environment, the phosphate groups are immobile since they form the backbone of the nucleic acid molecules (namely, rRNA or tRNA). The electric fields of the neighboring unshielded negatively charged phosphate groups would produce large forces which would stress the RNA molecule and which could produce a conformation change not only in the RNA molecule but, more significantly, in the ribosome. The sharp dependence of translational processes on magnesium concentration and the large effect of pressure on these processes, together with the correlations noted above in comparing pressure effects with magnesium-dependence, make the proposed action of pressure on protein synthesis an attractive mechanism which can be tested further.

These studies and those of Arnold and Albright (8) exclude the possibility that high pressure acts on only one of the processes involved in the translation of mRNA. The data from the cell-free studies, however, can be examined to determine the relative sensitivities of the various processes which are required for translation of mRNA. Our experiments indicate that the supply of phe-tRNAs to the translation complexes is not the primary element, and we suggest that the most sensitive element to pressure action on polyphenylalanine synthesis must then be among the macromolecular components which are involved in (a) the formation of the translation complex; (b) the events which occur during the elongation cycle (i.e., peptidyl transfer and/or translocation); and/or (c) the checking and selection of aa-tRNAs by the translation complex. The ribosome is very likely that element, and its pressure sensitivity would be reflected in the pressure effect on each of the three functions described above.

Recent studies have demonstrated the cooperative nature of ribosomal function (23-25). Hence, any perturbation introduced on one part of the ribosome could have many manifestations, including changes in fidelity of translation of mRNA, changes in rates of synthesis, and changes in structural integrity. The findings of this study have demonstrated that high pressure has large effects on rate of synthesis, fidelity of translation, and stability of the translation complex. These results strongly implicate the ribosome or an interaction requiring participation of the ribosome as the major sensitive element for the action of high pressure on protein synthesis.

This work was performed while Dr. Hildebrand was a National Institutes of Health predoctoral fellow and was partially supported by National Aeronautics and Space Administration grant NGR-39-009-008.

Received for publication 14 February 1972.

REFERENCES

1. POLLARD, E. C., and P. K. WELLER. 1966. *Biochim. Biophys. Acta.* **112**:573.
2. YAYANOS, A. A. 1967. A study of the effects of hydrostatic pressure on macromolecular synthesis and thymineless death in *Escherichia coli*; and of the compressions of some solutions of biological molecules. Ph.D. Thesis. Pennsylvania State University, University Park.
3. YAYANOS, A. A., and E. C. POLLARD. 1969. *Biophys. J.* **9**:1464.
4. LANDAU, J. V. 1966. *Science (Wash. D. C.)*. **153**:1273.
5. LANDAU, J. V. 1967. *Biochim. Biophys. Acta.* **149**:506.
6. LANDAU, J. V. 1970. High Pressure Effects on Cellular Processes. A. M. Zimmerman, editor, Academic Press, Inc., New York.
7. ALBRIGHT, L. J., and R. Y. MORITA. 1968. *Limnol. Oceanogr.* **13**:637.
8. ARNOLD, R. M., and L. J. ALBRIGHT. 1971. *Biochim. Biophys. Acta.* **238**:347.
9. HILDEBRAND, C. E., and E. C. POLLARD. 1971. *Biophys. Soc. Annu. Meet. Abstr.* **11**:264a.
10. KOSKIKALLIO, J., and E. WHALEY. 1959. *Faraday Soc. Trans.* **55**:809.
11. NIRENBERG, M. W. 1963. *Methods Enzymol.* **6**:17.
12. KANTOR, G. J., S. PERSON, and F. A. ANDERSEN. 1969. *Nature (Lond.)*. **223**:535.
13. LOWRY, O. H., N. J. ROSEBROUGH, A. L. FARR, and R. J. RANDALL. 1951. *J. Biol. Chem.* **193**:265.
14. SZER, W., and S. OCHOA. 1964. *J. Mol. Biol.* **8**:823.
15. VON EHRENSTEIN, G., and F. LIPMANN. 1961. *Proc. Natl. Acad. Sci. U.S.A.* **47**:941.
16. MOLDAVE, K. 1963. *Methods Enzymol.* **6**:757.
17. NIRENBERG, M. W., and P. LEDER. 1964. *Science (Wash. D. C.)*. **145**:1399.
18. MORITA, R. Y., and R. D. HAIGHT. 1962. *J. Bacteriol.* **83**:1341.
19. GRUNBERG-MANAGO, M., and J. DONDON. 1965. *Biochem. Biophys. Res. Commun.* **18**:517.
20. HAMANN, S. D., and W. STRAUSS. 1955. *Faraday Soc. Trans.* **51**:1684.
21. OWEN, B. B., and S. R. BRINKLEY. 1941. *Chem. Rev.* **29**:461.
22. ELLIS, A. J., and D. W. ANDERSON. 1961. *J. Chem. Soc.* 1765.
23. MIZUSHIMA, S., and M. NOMURA. 1970. *Nature (Lond.)*. **226**:1214.
24. APIRION, D., and D. SCHLESSINGER. 1969. *Proc. Natl. Acad. Sci. U.S.A.* **63**:795.
25. KURLAND, C. G. 1970. *Science (Wash. D. C.)*. **169**:1171.

THE THERMAL INACTIVATION
OF T₄ AND λ BACTERIOPHAGE

N74-20714

E. C. POLLARD *and* WINIFRED SOLOSKO

Reprinted from the BIOPHYSICAL JOURNAL, 1971, Vol. 11, No. 1, pp. 66-74 Printed in U.S.A.

THE THERMAL INACTIVATION OF T₄ AND λ BACTERIOPHAGE

E. C. POLLARD *and* WINIFRED SOLOSKO

*From the Department of Biophysics, The Pennsylvania State University,
University Park, Pennsylvania 16802*

ABSTRACT Thermal inactivation of T₄ and λ bacteriophage shows two components of differing sensitivity are present. These cannot be interpreted as owing to nucleic acid and protein. One protein function—the inhibition of radiation-induced DNA degradation—is lost with quite different thermal kinetics. λ heated in the presence of DNase is more rapidly inactivated; λ is also protected by slow cooling after heat. These results suggest that the packing of the DNA in the head occurs so as to permit different degrees of thermal expansion in the outer coils. These can rupture the coat and this is one form of inactivation. Killed vaccines could be more safely made by heating in the presence of a nuclease followed by rapid cooling.

INTRODUCTION

Thermal inactivation studies of viruses have been of interest to us for many years. The process is often characterized by relatively simple kinetics, fitting the relation $\ln N/N_0 = -k_1t$ where N and N_0 are the active and original virus activities, t is the elapsed time, and k_1 is a rate constant, and can be analyzed in terms of the theory of absolute reaction rates (1). It is also often true, however, that the kinetics are more complex; thus Woese (2) finds that the thermal inactivation of animal viruses is generally a two-component inactivation, meaning that there are two rate constants, each component following first-order kinetics. Experiments by Pollard and Wood-yatt (3) indicated that the inactivation of T₁ phage has two components in proportions varying with temperature. Attempts to select populations of resistant and sensitive phage were never successful. Accordingly, we decided to study the kinetics of inactivation of phages T₄ and λ to see if the same phenomenon is found: it is. In addition we considered the possibility that the coiling of the DNA in the phage head could occur so that different base ratio segments were on the outside and that different relative expansions between protein and DNA could cause different ruptures of the protein coat, which would inactivate the virus. To test this we examined the loss of infectivity of λ in the presence of DNase and found a marked effect; we tested the inactivation of a component of the virus due only to protein (the inhibition of radiation-induced DNA degradation) and found quite different kinetics for it; and we observed that heating and slow cooling gave less inactivation. We therefore advance the hypothesis that one method of thermal inactivation of viruses is by differential expansion and cracking open of the protein coat.

TABLE I
A COMPARISON OF RELEVANT FEATURES OF T₄ AND λ BACTERIOPHAGES

Bacterio- phage	DNA content	Gene arrangement	Nucleotide composition	Head size		Tail size		
				Width	Length	Width	Length	
	<i>g/particle</i>			<i>mμ</i>		<i>mμ</i>		
T ₄	2.5 × 10 ⁻¹⁷	Permuted	A*	32.3	65	95	20	95
			T	33.3				
			G	18.1				
			HMC	16.5				
			C	0.0				
λ	1.2 × 10 ⁻¹⁷	Not permuted	A	21.3	54	54	7	140
			T	28.6				
			G	22.9				
			HMC	0.0				
			C	27.1				

* A = adenine; T = thymine; G = guanine; HMC = 5-hydroxymethylcytosine; C = cytosine. The nucleotide composition is from Sinsheimer (5) and the head and tail sizes are from Stent (6).

In Table I we show the general properties of T₄ and λ phages. T₄ is bigger, contains more DNA, and also has hydroxymethylcytosine in place of cytosine. The adenine-thymine content of λ is less, meaning that its DNA should be harder to melt. The genome of T₄ is permuted; that of λ is not (4).

EXPERIMENTAL PROCEDURES

Table II shows the stock cultures and their origins. Phage preparations were obtained from lysates by spinning at 8000 *g* for 10 min in the presence of chloroform. This was repeated three times and then the phage supernatant was siphoned off the chloroform and stored in nutrient broth at 4°C.

Thermal Inactivation of Virus

For the experiments used to study thermal inactivation of the entire phage, 0.1 ml virus stock solution was added to 10 ml of 0.8% nutrient broth warmed to the desired experimental temperature. At different times 0.1 ml samples of the mixture were diluted into 10 ml of nutrient broth at room temperature. These were further diluted and plated.

For temperatures above 70°C where the reaction rate is rapid a "rapid transfer" method was used. 0.1 ml was added to 10 ml of nutrient broth at the high temperature and after the desired time interval the entire contents were rapidly transferred into beakers containing 90 ml nutrient broth at room temperature.

Protein Moiety Inactivation: Inhibition of DNA Degradation

In *Escherichia coli* B_{s-1} ionizing radiation induces rapid and nearly complete degradation of the DNA. This degradation is inhibited by phage ghosts (7) which have been treated by DNase and hence is because of the protein coat. In order to observe the effect of heat on this inhibi-

TABLE II
THE ORIGINS OF THE STOCK CULTURES USED

Virus	Source	Host cell	Source
T ₄	S. Person*	<i>E. coli</i> B	ATCC 11303
	W. Ginoza*	<i>E. coli</i> B _{s-1}	S. Person
		<i>E. coli</i> W602	W. Ginoza
T ₄ amb22	S. Person	<i>E. coli</i> K12CR63	S. Person

* S. Person and W. Ginoza. Department of Biophysics, The Pennsylvania State University, University Park, Pennsylvania 16802.

tion process the DNA of the cells were labeled with thymine-¹⁴C by the method of growth in the presence of deoxyadenosine (8). Cells were grown in Roberts' C minimal salts (NH₄Cl, 2 g; Na₂HPO₄, 6 g; KH₂PO₄, 3 g; NaCl, 3 g; MgCl₂, 10 mg; Na₂SO₄, 26 mg) with 0.5% glucose and 0.5 μg/ml of deoxyadenosine at 37°C. Thymine-¹⁴C (specific activity 100 μCi/mM) was diluted to a specific activity of 0.05 μCi/ml. When the cells had grown to a concentration of 10⁸/ml nonradioactive thymine was added at 20 μg/ml of culture. The cells were allowed to grow for another 30 min to "chase" the label. They were then centrifuged at 6000 *g* for 3 min, washed with medium containing cold thymine, centrifuged again, and resuspended in phage attachment medium (0.8% nutrient broth plus 0.5% NaCl) warmed to 37°C. Samples were then bubbled with oxygen, given 21 krad gamma radiation using a Gammacell 200 (Atomic Energy of Canada Ltd., Ottawa, Ont.), and transferred back to 37°C and aerated. 1.0 ml samples were taken at intervals and added to 1 ml cold 10% trichloroacetic acid (TCA). After 30 min the mixture was filtered, and the filter was dried and counted in a Geiger-Mueller counter. For the action of phage, the same procedure was followed, with the addition of phage at 10 min after infection. The same procedure was followed with heated phage. The multiplicity of infection was approximately 3.

Deoxyribonuclease on λ Phage

Pancreatic DNase I (Worthington Biochemical Corp., Freehold, N.J.) was used at a concentration of 200 μg/ml. Small test tubes containing 1.4 ml nutrient broth were warmed to the desired temperature; then 0.4 ml DNase and 0.2 ml phage were added. After the desired time at the temperature chosen, the mixture was transferred to a small beaker with 18 ml nutrient broth with 0.02 M Mg at room temperature. Incubation at 37°C followed for 1 hr, and then the samples were diluted and plated.

Where longer exposures to heat were called for, in which case the DNase itself becomes inactivated, additions of DNase were made at 1½ min intervals. In each case an equivalent volume of water was substituted for the DNase in the control case.

Thermal Inactivation with Slow Cooling

The same procedure was adopted for the time of heating at the desired temperature. However, this was followed by transferring the whole tube to a water bath 10°C lower in temperature for 1-5 min, and subsequently allowing the tube to cool to room temperature before diluting and plating.

Thermal Constants

From these data, using the theory of absolute reaction rates, some values for the enthalpy and entropy of activation can be derived. These are sometimes useful for comparison. Table III gives such values.

TABLE III
SOME VALUES FOR ENTHALPY AND ENTROPY OF ACTIVATION

Process	Enthalpy	Entropy
	<i>kcal/mole</i>	<i>cal/mole per K°</i>
T ₄ plaque-forming ability		
(Fast component)	79	161
(Slow component)	86	183
λ plaque-forming ability		
(Fast component)	76	155
(Slow component)	83	173
T ₄ ability to inhibit degradation	135	

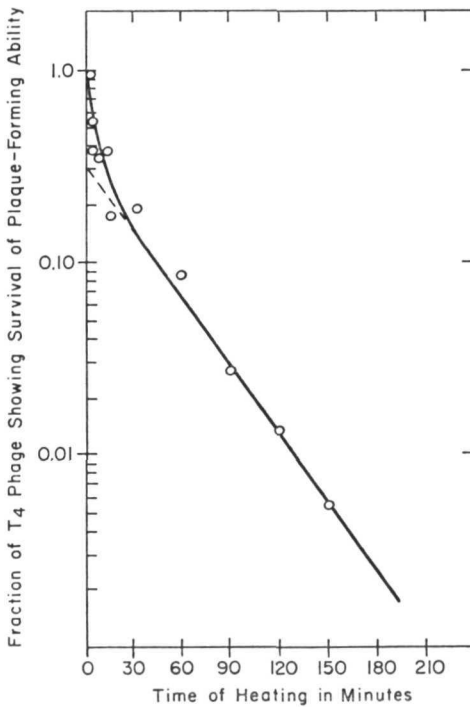

FIGURE 1

FIGURE 1 Thermal inactivation of T₄ phage at 65°C. Survival of plaque-forming ability as a function of time was determined by plating experiments using *E. coli* B as the host bacteria.

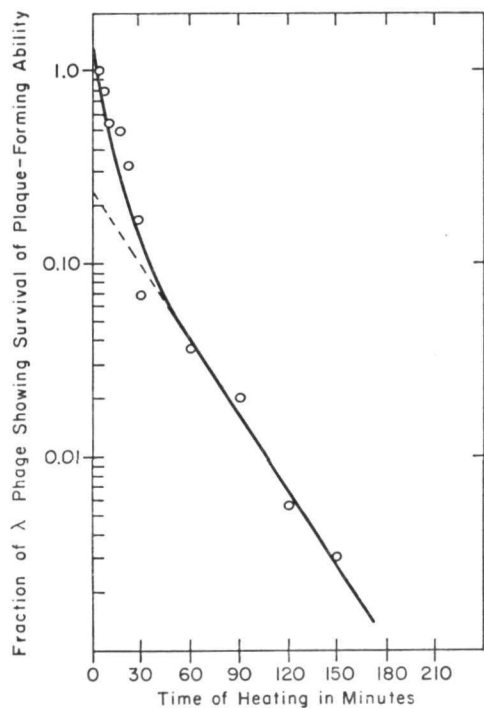

FIGURE 2

FIGURE 2 Thermal inactivation of λ phage at 65°C. *E. coli* W602 was the host cell.

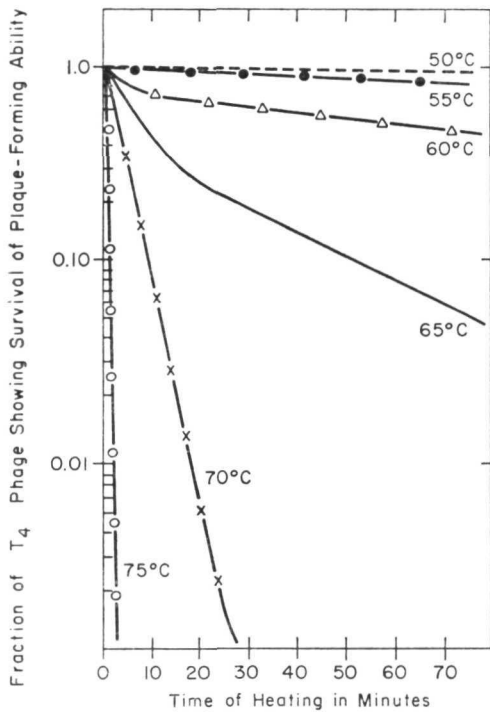

FIGURE 3

FIGURE 3 Thermal inactivation of T_4 phage at various temperatures. Survival of plaque-forming ability was determined by plating experiments using *E. coli* B as the host bacteria. Experimental points are not shown; the data are approximately as seen in Fig. 1.

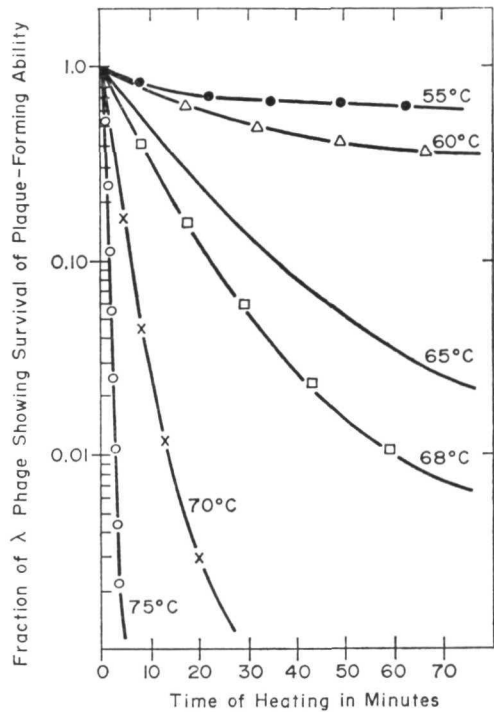

FIGURE 4

FIGURE 4 Thermal inactivation of λ phage at various temperatures. Experimental points are not shown; the data are approximately as seen in Fig. 2.

EXPERIMENTAL RESULTS

Two sample curves showing the thermal inactivation of T_4 and λ are shown in Figs. 1 and 2. Both were observed at 65°C ; both show the two-component appearance. In Figs. 3 and 4 are shown the curves found at various temperatures. In order to avoid confusion on the page the experimental points are not always given. The two-component aspect is less apparent at high temperatures. In Fig. 5 can be seen the data for one single experimental series in which the inhibition of DNA degradation is studied. It is apparent that within 10 min after the addition of unheated phage the loss of ^{14}C label in the TCA-precipitable fraction (undegraded DNA) is checked, and that this ability to inhibit is lost as the phage are heated. By taking the difference in per cent degradation between the situation without any phage and that for unheated phage as 100% the fraction of degradation-inhibiting ability can be estimated. This can be compared with the loss of plaque-forming ability and the result is seen in Fig. 6. Quite clearly the effect of heat is not as drastic, nor does it show

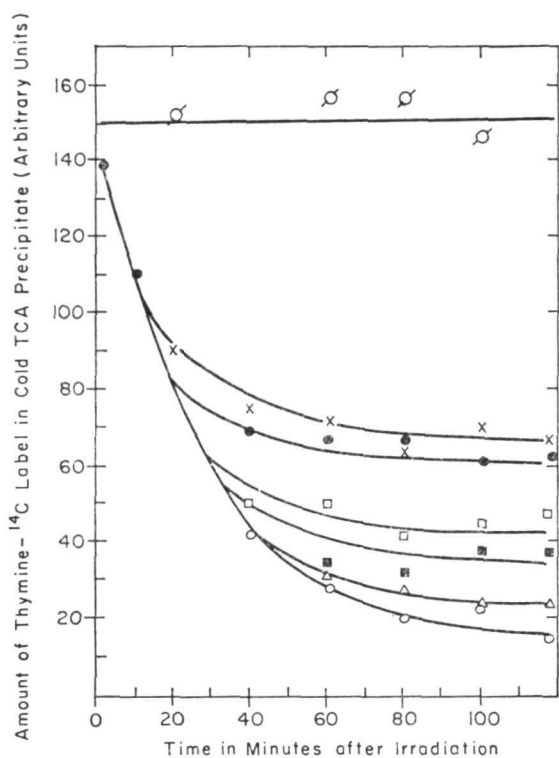

FIGURE 5

FIGURE 5 Inhibition of DNA degradation in irradiated *E. coli* B_{r-1} cells at 37°C by T₄ phage previously heated at 65°C for various lengths of time. Control unirradiated ∅; irradiated plus unheated phase ×; 13 min heat ●; 30 min heat □; 60 min heat ■; 90 min heat △; no phage ○.

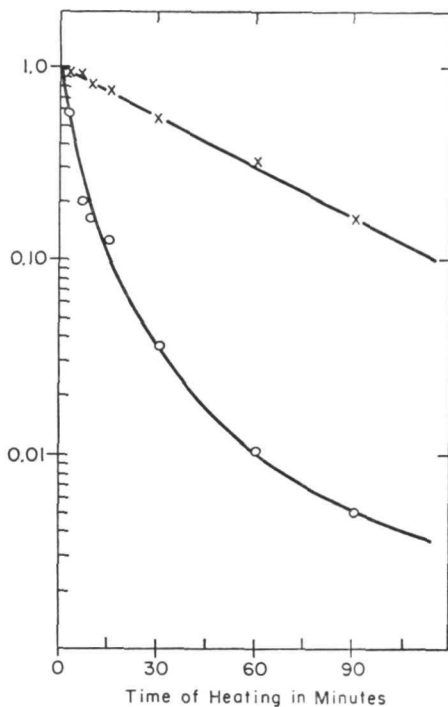

FIGURE 6

FIGURE 6 Comparison of survival of T₄ phage plaque-forming ability (○) at 65°C with survival of ability to inhibit DNA degradation in the irradiated host cell (×). Survival of plaque-forming ability as a function of time was determined by plating experiments. Survival of ability to inhibit DNA degradation was calculated from Fig. 5. These two curves are quite different.

the two-component feature. Similar conclusions are reached for heating at 69.5°C. The data for four temperatures are shown in Fig. 7. It can be seen that the range of temperature in which the inhibiting ability is lost is less than that for the loss of infectivity.

The Effect of DNase

Heating T₄ in the presence of DNase showed very little effect. One reason for this may be found in the relative inactivation rates of the virus and the enzyme. DNase is itself sensitive to heat in this temperature range. On the other hand, λ which inactivates faster at lower temperatures, showed a marked effect. The difference may reflect the nature of the protein coat in the two cases. In Fig. 8 we show the effect of

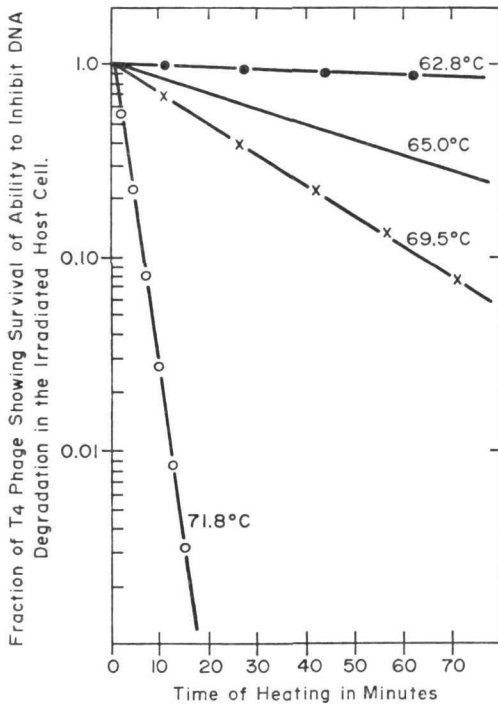

FIGURE 7

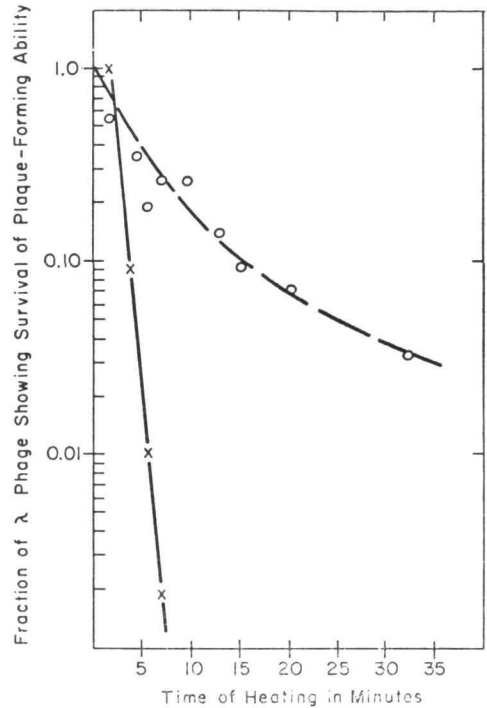

FIGURE 8

FIGURE 7 Temperature dependence for the survival of T_4 phage ability to inhibit DNA degradation in the irradiated host cell. Comparison with Fig. 3 shows the amount of inhibited DNA degradation. The number of plaque-forming phages is also quite different both in span of temperature and in single vs. bimodal curves. Experimental points are not shown; the data are approximately as seen in Fig. 6.

FIGURE 8 Comparison of survival of λ phage plaque-forming ability at 70°C when DNase is added (X) in concentrations of about $200\ \mu\text{g}/\text{ml}$ and when no DNase (control O) is added. Equal amounts of water were added to keep the dilutions equal.

heating λ at 70°C in the presence of DNase. The presence of the enzyme markedly increases the amount of inactivation. Similar, but not quite so dramatic, effects were observed at 75°C .

The Effect of Slow Cooling

Fig. 9 shows the two inactivation curves obtained when the virus was rapidly cooled and when it was permitted to reach room temperature relatively slowly. It can be seen that the slow component of the two-component inactivation curve is markedly accentuated. Similar results were obtained at 65°C .

DISCUSSION

The experimental results indicate that the kinetics of the loss of plaque-forming ability for T_4 do not correspond to the loss of one protein function at all. They also

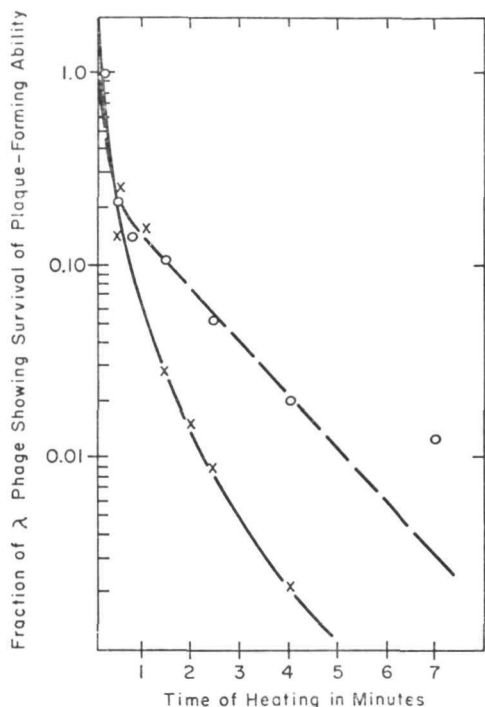

FIGURE 9 Thermal inactivation of λ phage at 75°C utilizing the technique of slow cooling (O) compared to the technique of rapid cooling (X).

indicate that any one preparation of virus must have two populations, one of which is sensitive and one less so. The populations are not stable in the sense that selection of the resistant fraction leads to a resistant population, but rather that there is always a fraction that is sensitive in any one virus preparation. It was suggested that the packing of the DNA could be such that the outer layers could readily expand in some cases and not in others, the difference being due to the local excess of adenine-thymine pairs. The question arises as to why this expansion should inactivate the virus. In the case of T_4 this present work does not suggest an answer. On the other hand, in the case of λ , the two facts that exposure of the heated phage to DNase causes sharply increased loss of infectivity and that annealing diminishes the loss suggest that the expansion of the DNA can cause a rupture of the protein coat and that this can render the phage vulnerable to attack from agents outside, notably nucleases. The process of annealing permits the coat to return to a normal shape.

We therefore advance, as one reason for the presence of more than one component of inactivation, the concept that the DNA is packed inside the head randomly, or at least not wholly uniformly, and that this packing gives a population of resistant or sensitive cells dependent on the base ratio in the part of the DNA that is packed on the outside and hence able to expand. This suggestion was previously advanced (9) in a slightly different form.

One of the problems of preparing killed vaccines is the presence of a component that is resistant so that the vaccine is dangerously alive. Our work would suggest

that one useful addition to the technique would be to heat the virus in the presence of the appropriate nuclease and to cool very rapidly after heating.

This work was supported by NASA contract NGR 39-009-008 and AEC contract AT(30-1)2804.

Received for publication 18 June 1970 and in revised form 4 August 1970.

REFERENCES

1. POLLARD, E. C. 1953. *The Physics of Viruses*. Academic Press, Inc., New York.
2. WOESE, C., 1960. *Ann. N. Y. Acad. Sci.* **83**:741.
3. POLLARD, E. C., and S. WOODYATT. 1964. *Biophys. J.* **4**:376.
4. THOMAS, C. A. 1966. *Progr. Nucl. Acid. Res. Mol. Biol.* **5**:329.
5. SINSHEIMER, R. L. 1960. *Nucl. Acids Protein Syn.* **3**:194.
6. STENT, G. S. 1963. *Molecular Biology of Bacterial Viruses*. W. H. Freeman and Co. Publishers, San Francisco.
7. CHAPMAN, J. D., J. SWEZ, and E. C. POLLARD. 1968. *Nature (London)*. **218**:690.
8. BOYCE, R. P., and R. B. SETLOW. 1962. *Biochim. Biophys. Acta.* **61**:618.
9. POLLARD, E. C. 1964. *Advan. Chem. Phys.* **7**:234.