

ADDITIONAL DEVELOPMENT OF LARGE DIAMETER CARBON MONOFILAMENT

by B.A. Jacob and R.D. Veltri

(NASA-CR-134607) ADDITIONAL DEVELOPMENT
OF LARGE DIAMETER CARBON MONOFILAMENT
Contractor Report, Jun. 1973 - Feb. 1974
(United Aircraft Corp.)

N74-21765

CSCL 11D G3/18

Unclas
36838

UNITED AIRCRAFT RESEARCH LABORATORY

Prepared for

NATIONAL AERONAUTICS AND SPACE ADMINISTRATION

NASA Lewis Research Center

Contract NAS3-16803

Reproduced by
NATIONAL TECHNICAL
INFORMATION SERVICE
U.S. Department of Commerce
Springfield, VA. 22151

1. Report No. CR-134607	2. Government Accession No.	3. Recipient's Catalog No.
4. Title and Subtitle DEVELOPMENT OF LARGE DIAMETER CARBON MONOFILAMENT (U)	5. Report Date February 1974	6. Performing Organization Code
	8. Performing Organization Report No.	10. Work Unit No.
7. Author(s) B. Jacob R. D. Veltri	11. Contract or Grant No. NAS 3-16803	13. Type of Report and Period Covered Contractor Report June 1973 to February 1974
9. Performing Organization Name and Address United Aircraft Research Laboratories East Hartford Connecticut 06108	14. Sponsoring Agency Code	
	12. Sponsoring Agency Name and Address NATIONAL AERONAUTICS AND SPACE ADMINISTRATION Washington, D. C. 20546	
15. Supplementary Notes Project Manager, David L. McDanel, Materials & Structures Division, NASA Lewis Research Center, Cleveland, Ohio		
16. Abstract The chemical vapor process for preparing a large diameter carbon-base monofilament from a BCl_3 , CH_4 and H_2 gas mixture with a carbon substrate fiber was further studied. The effects of reactor geometry, total gas flows and deposition temperature on the tensile strength of the monofilament were investigated. It was noted that consistent results could only be obtained when the carbon substrate fiber was cleaned. The strength of the monofilament was found to depend on the highest temperature and the temperature profile of the monofilament in the reactor. The strength of monofilament produced in the DC and RF reactors were found to be similar and similar alloy compositions in the monofilament were attained when the same gas ratios were used. The tensile strength of the monofilament at $500^\circ C$ was found to be 60 to 70% of the room temperature tensile strength. No degradation was noted after exposure to molten aluminum.		
17. Key Words (Suggested by Author(s)) Carbon, Boron, Monofilament, Chemical Vapor Deposition, Modulus, Reinforcement, Filament	18. Distribution Statement Unclassified - unlimited	
19. Security Classif. (of this report) Unclassified	20. Security Classif. (of this page) Unclassified	

* For sale by the National Technical Information Service, Springfield, Virginia 22151

TABLE OF CONTENTS

SECTION	PAGE
Summary	1
Introduction	2
Results	4
Initial Experimentation	4
DC Reactor Geometry Configuration	7
Radial Change in Alloy Composition	9
RF Reactor Experiments	10
Elevated Temperature Tensile Strength of the Boron-Carbon Monofilament	14
Tensile Properties of Monofilament After Exposure to Molten Aluminum	14
Discussion	15
Conclusions	18

PRECEDING PAGE BLANK NOT FILMED

SUMMARY

The object of this work was to optimize the tensile strength of a carbon-base monofilament produced from a chemical vapor deposition process. Gas ratios of BCl_3/CH_4 and H_2/CH_4 of 2.34 were used in the gas system and carbon was used as a substrate.

The relationship between total gas flow, gas flow patterns, reactor geometry, and deposition temperature and the tensile strength of the monofilament was studied. The most important parameter in the process was the deposition temperature. Controlling the maximum temperature and the temperature profile of the monofilament was required to produce high strength monofilament.

The chemical composition of the carbon-boron alloy was controlled by varying the $\text{CH}_4:\text{H}_2$ ratio in the gas composition. Attempts to produce a high tensile strength monofilament by depositing a layer of high-strength, high boron content alloy on the outer surface of the monofilament were unsuccessful.

High strength monofilament was also produced in the RF reactor. The chemical composition of the carbon-boron alloy deposited in an RF reactor was the same as that deposited in a DC reactor when identical gas compositions were used in each reactor.

The tensile strength of the monofilament at 500°C was 60% of the room temperature strength for monofilament containing 77 w/o B in the alloy and 74% of the room temperature strength for monofilament containing 66 w/o B. The tensile strength of monofilament was not changed after exposure to molten aluminum.

INTRODUCTION

There has been a great deal of interest recently in the development of carbon reinforcement for metal matrix applications. Most of this effort has been directed toward the use of carbon multifiber yarns and tows. Carbon yarns are becoming more readily available with various strengths and moduli and the cost of these yarns is being reduced continuously. Initially attempts were made to produce these yarns with high moduli, but recently attention has been given specifically to developing a low cost carbon yarn with little scatter in strength and modulus. As the price of these yarns has been lowered, the incentive for using carbon yarn in all types of composites has increased. Adding to the impetus to use this yarn was the fact that carbon researchers have even reported an increase in strength of carbon at elevated temperatures. The low cost of carbon yarn made it attractive for use in aluminum and its high temperature properties has induced researchers to consider it for use in high temperature matrices such as nickel.

For the past several years there has been a great deal of effort directed toward producing carbon-aluminum and carbon-nickel composites. With any metal matrix one of the most difficult problems has been to impregnate the yarn with metal matrices so that the individual fibers in the yarn would be evenly dispersed. There is also an additional problem that the properties of the fibers are easily deteriorated by reactions with the matrix material. If attempts are made to coat the fibers with barrier layers care has to be taken that the small carbon fibers are not affected by diffusion of the coating into the body of the fiber.

Although some success has been obtained in forming carbon yarn-aluminum composites (Ref. 1), these composites still do not have properties competitive with those of boron-aluminum composites containing relatively large boron filaments.

The relative advantages and disadvantages of using carbon multifiber yarns and tows versus using carbon monofilaments have been discussed in Ref. 2. Fabrication problems would be greatly reduced when large diameter carbon monofilaments are used. Composite fabrication techniques currently used with boron filaments could be transferable and the broad background of boron-aluminum composite experience could be utilized, instead of being forced to develop a whole new technology based upon small diameter carbon multifiber yarns and tows. In addition, protective coatings could be applied much more easily on large diameter monofilaments. Also, the relative fraction of coating material to filament area would be much less for the monofilaments, thus increasing the effective volume fraction of usable reinforcement and lessening the effect of the coating on the properties of the composite.

In an effort to obtain large diameter carbon monofilament for use as reinforcement for metal matrix composites, NASA-Lewis awarded several contracts to develop large diameter carbon monofilament using different fabrication methods. The first method involved the impregnation with resin of commercially available small-diameter carbon yarns and tows. The resin impregnated bundles was then pyrolyzed to form a

carbon yarn-carbon matrix composite monofilament (Refs. 3 and 4). Although reasonable strengths were obtained, difficulty was encountered in making these composite filaments because of nonuniform impregnation and cracking due to thermal expansion mismatches during pyrolysis.

The second approach consisted of using the chemical vapor deposition (CVD) method. Contracts were awarded to Hough Laboratory (Refs. 5 and 6). Initial work was done using a tungsten wire substrate, but it was found that better results were obtained using a carbon fiber substrate. Initially, pure pyrolytic graphite was deposited upon the substrate, but it was found that failure would occur by telescoping of the carbon layers over each other. This problem was eliminated by the addition of borane gas to the reactant hydrogen-hydrocarbon gases, which caused boron to be deposited to pin the carbon slip planes. This material contained approximately 30-40 percent boron.

UARL also has done research in the area of large-diameter carbon-base monofilaments. Attempts have been made using resin pyrolysis, direct conversion of large organic precursor fibers and the CVD process. Each technique had drawbacks, but the CVD process was selected for further study because it was felt to have the most potential for making the desired monofilament, even though the monofilaments produced were initially weak. It was decided to employ a combination of methane and boron trichloride as the reactant gases. The reactor used was similar to that used for boron filament development, Fig. 1, where the substrate is heated resistively and is drawn through mercury seals into a chamber where the reactant gases are introduced. Carbon fiber produced by Great Lakes Carbon Company was chosen as the substrate because of its low density and because of previous experience.

In the initial NASA-Lewis Contract awarded to UARL, NASA CR-121229, Ref. 7, it was shown that a high modulus carbon-boron alloy monofilament could be chemically vapor deposited onto a carbon substrate from a H_2 , BCl_3 and CH_4 gas mixture. The modulus was linearly dependent on the w/o boron in the monofilament. Monofilaments with 39 w/o through 75 w/o boron were amorphous and the w/o boron of the monofilament was controlled by the gas mixture. The condition of the carbon substrate fiber was important in determining the strength of the monofilament. Inherent with the carbon substrate fiber are outgrowths and surface impurities. In some cases, the impurities were localized in the outgrowths. The carbon-boron deposition reacted with these impurities and either terminated an experimental run by breaking the monofilament, within the reactor, or produced monofilament with excessive scatter in the tensile strength. It was assumed that boron was reacting with the impurities, because as the w/o boron in the carbon-boron alloy increased, the frequency of the reactions increased and the scatter in tensile strength also increased. Instead of covering the impurities with a precoat the investigators chose to devise a method of cleaning the substrate.

It was determined that by passing the substrate fiber through an RF reactor in an atmosphere of chlorine the impurities, and in some cases the outgrowths, could be removed from the surface of the fiber. Unfortunately, the process could not be standardized because the substrate velocity and fiber temperature required to clean the fiber appeared to vary with each shipment of fiber.

The investigations conducted in this contract are a continuation of the research described in NASA CR-121229 (Ref. 7). The object of this program was to optimize the UARL chemical vapor deposition process to produce a large-diameter, high-strength, high-modulus carbon monofilament. Parameters such as deposition temperature, substrate velocity, reactor geometry, gas ratios and total reactant gas flows were studied. The effect of variations of these parameters were noted from both property measurements such as diameter, tensile strength, Young's Modulus and density, and from the optical and electron microprobe analyses.

The program was divided into the three tasks listed:

- Task I - Process Development and Optimization
- Task II - Property Evaluation
- Task III - Reports

To attain this objective, the program was divided into three phases:

1. Investigate the effects of reactor geometry, gas flows and reactor temperature profiles of a single stage DC reactor.
2. Investigate the possibility of increasing the strength of the monofilament with an outermost layer of high strength, high boron content carbon-boron alloy.
3. Compare the properties of monofilament produced in a single stage RF reactor with monofilament produced in a DC reactor.

RESULTS

Initial Experimentation

It was determined, in NASA CR-121229 (Ref. 7), that the carbon-boron composition of the monofilament was sensitive to the composition of the reactant gases - specifically, the CH_4 to H_2 ratio. Consequently, a fixed gas composition was used for experimentation in the DC reactor. The ratio of gases in this composition were H_2 to $\text{BCl}_3 = 1:1$, and CH_4 to BCl_3 or $\text{H}_2 = 2.34:1$. This ratio yields a monofilament with an average of 66 w/o boron, and gives the most reproducible results.

The initial experimentation consisted of two 4 x 4 Latin Squares. In both squares the temperature levels were 1150, 1170, 1190 and 1210°C. The substrate velocities were 0.169 cm/sec (20 ft/hr), 0.254 cm/sec (30 ft/hr), 0.338 cm/sec (40 ft/hr), and 0.423 cm/sec (50 ft/hr). Total gas flows were 600, 700, 800 and 900 cc/min.

The substrate fiber for the first Latin Square was Great Lakes carbon monofilament Lot #1142, package #2 which had been cleaned in an RF reactor in chlorine at 1800°C at a fiber velocity of 0.677 cm/sec (80 ft/hr).

Upon completion of these experimental runs, Nos. NC-1-16, 600 feet of the same substrate was cleaned in chlorine at a draw speed of 0.594 cm/sec (70 ft/hr). The object was to repeat the series of experiments with the same substrate cleaned with different parameters. Unfortunately, the substrate cleaned at a substrate velocity of 0.594 cm/sec would not produce long runs.

Random sections of the fiber produced violent reactions within the reactor. Figure 2 is a scanning electron microscope photograph of the fracture surface associated with one of these reactions and Fig. 3 shows the electron microprobe analysis of this fracture. Only silicon and chlorine were detected as impurities.

Figure 4 is a section of the substrate fiber within two feet of the section that caused the fracture shown in Fig. 2. Silicon and a trace of potassium and calcium were detected as impurities in this surface.

Attempts were made to improve the substrate by cleaning in chlorine at 1800°C at a substrate velocity of 0.51 cm/sec (60 ft/hr). At this velocity, the surface of the substrate fiber became pitted and it was decided not to use this substrate for further monofilament studies. Because of the problems associated with substrate fiber Lot #1142, Lot #1117 was chosen as a substrate for the monofilament produced for the second Latin Square analysis. Lot #1117 was cleaned in chlorine at 1800°C at a substrate velocity of 0.594 cm/sec.

Electron microprobe chemical analyses of the surface of both substrates cleaned at various parameters is given in Table I. With the exception of sulfur and silicon, the impurities listed are associated with outgrowths on the surface of the fiber. Figure 5, a scanning electron microscope photograph of Great Lakes Carbon Co. Lot #1117, package #3, in the as received condition, shows a typical outgrowth. Sulfur is inherent in the carbon substrate fiber, and it is uniformly distributed throughout the fiber.

To date, Lot #1142 is the only substrate fiber to show random sites with a relatively large amount of silicon.

The tensile data of the monofilament produced for first Latin Square analysis - run Nos. NC-1 through NC-16 - are shown in Tables II-A,B,C,D.

The data for the second Latin Square analysis - run Nos. NC-21 through NC-24 and NC-27 through NC-38 are shown in Tables III-A,B,C,D. The substrate velocities for this Square were randomized in a different pattern than that used in the first analysis.

The effects of the parameters on the average UFS and the average diameter of the carbon based monofilaments are shown in Figs. 6 through 11. Normally, the temperature of the monofilament is monitored at a point 1/3 of the total reactor length down from the top electrode. However, during experimental run number NC-28, it was observed that the effect of changing temperature draw speed and total gas flow over a reasonably wide range of values considerably changed the temperature profile of the monofilament in the reactor. Therefore, on experimental runs subsequent to NC-28, the temperature of the carbon based monofilament was measured at the top electrode, the same standard measuring point described above, and at the bottom electrode. The temperature profile data for runs NC-29 through NC-38 are given in Table IV. Photomicrographs of cross sections of the monofilament produced in experimental runs NC-21 through NC-24 and NC-27 through NC-38 are shown in Figs. 12, 13, 14 and 15.

A Latin Square analysis indicates the effect of individual parameters on the average value of a property being investigated which would lead to the optimization of the property being studied. For the experiments described herein, the properties investigated were monofilament tensile strength and diameter. The graphs of Figs. 6 through 11 show essentially identical trends of tensile strength and diameters, regardless of substrate, as functions of the parameters studied. The variation in the average diameter vs. substrate velocity or total gas flow for the two Squares, Figs. 7 and 8 may be due to the fact that temperature was controlled at a point rather than along the entire monofilament. It has been shown that differences in profiles exist for the same measured temperature. This can be seen in studies of ring formation in the monofilament. Note that although the temperature is the same for runs NC-24, NC-30, NC-34 and NC-38 only the former two show the presence of rings (Figs. 12 through 15). From data attained and presented in NASA CR-121229 (Ref. 7) it was concluded that the interior rings represented a higher carbon content alloy.

The average strength does not vary as much as the diameter as a function of the parameters studied, Figs. 9, 10 and 11. But, it is interesting to note that the average strength of monofilament produced at 1150°C and at 1210°C, shown in Fig. 9, is lower than that produced at temperatures in between.

The lower strength of the fiber produced at 1150°C would seem to be a real property of the monofilament since cross sections show no tendency for compositional changes (ring formation) within the fiber. This would imply that the outermost deposition layer - that portion of the monofilament that is deposited at the bottom of the reactor at a temperature of approximately 1100°C - would be weaker than the inner portions of the monofilament deposited at higher temperatures. The assumption was, to a certain extent, proven in the fracture surface study of the monofilament produced in runs NC-1 through NC-16. The fracture surface of all monofilaments in these runs with tensile strength less than 173 KN/cm² (250 ksi) observed with a Scanning Electron Microscope showed that many of the fractures were surface initiated.

The reason for the lower strength of monofilament produced at 1210°C is not known, but it may be related to the tendency for ring formation (Figs. 12 and 13) at the higher temperature.

Monofilaments from run NC-24, NC-29 and NC-30 (those which contained rings) were studied by X-ray diffraction techniques. No evidence of crystallinity was observed in any of the X-ray patterns.

Because the combined effect of changes in total gas flow, substrate velocity and deposition temperature were not successful in optimizing the monofilament tensile strength, the remaining experimentation to optimize the strength properties of the fiber were directed toward obtaining a uniform temperature profile within the reactor.

DC Reactor Geometry Configuration

The standard DC reactor used for the experimentation, Fig. 1, consisted of a 1.5 cm glass tube with ends expanded to 2.22 cm to accept top and bottom stainless steel electrodes. The overall length of the reactor was 66 cm.

Reactant gases were introduced into and exhausted from the reactor through stainless tubing that extended through the electrodes and were silver soldered to them.

The substrate fiber passed through the reactor through 0.254 mm sapphire jewels centered in the electrodes. The reactor was sealed by means of O-rings at the electrode - reactor glassware interface and by a mercury pool at the substrate fiber-jewel orifice interface. The mercury also provided the electrical path to supply power to the substrate fibers.

In a DC reactor, the temperature profile of the monofilament depends upon the length of the reactor, the substrate velocity, the gas composition and the maximum temperature obtained. Because of resistance changes in the monofilament as the diameter of the monofilament increases, a constant current power supply is necessary to prevent thermal runaway. The overall effect in a DC reactor is a lower temperature of the monofilament at the exit electrode than anywhere else in the reactor. Convection current losses are greater at the exit end of the monofilament, the larger diameter increases surface radiation loss and, with constant electric current, less power is dissipated in the larger diameter monofilament.

The hottest portion of the monofilament is just inside the entry electrode. This hot spot can be controlled to a certain extent by varying gas velocity or gas composition. For example, a gas composition with a high hydrogen content would cool the monofilament just below the entry electrode and smooth out the hot spot.

Another technique of controlling the temperature profile of a DC reactor is to use a multi-stage reactor system. With a proper balance between substrate velocity and individual stage lengths, the diameter difference of the monofilament within a

stage is controlled such that the differences in surface radiation losses and monofilament power dissipation in the area of the exit electrode are not excessively different from those at the entrance electrode. The desired final diameter of a monofilament or a specified production rate determines, within practical limits, the number of stages that comprise a system.

Although multi-stage systems diminish the temperature profile effects encountered in a single-stage DC reactor, they do not eliminate them. At the same time, multi-stage systems necessitate a more complex plumbing system for the reactant gases and introduce sites of possible contamination - the interconnecting electrodes between stages. Because of the simplicity of a single stage reactor system, it was decided to continue experimentation with a single stage reactor and to investigate reactor geometric and gas flow patterns that might produce a uniform temperature within the reactor. The reactor geometries were based on experience acquired at UARL on the use of the chemical vapor deposition process.

In the experimentation conducted, the temperature of the monofilament was measured at locations:

1. Within 2.54 cm of the entry electrode, designated T
2. At the standard control point approximately 1/3 of the reactor length below the entry electrode, designated C
3. In cases where a side entry port was used, at the point where the side entry gas would strike the monofilament, designated S
4. Within a 2.54 cm of the exit electrode designated B

The temperatures recorded are averages with a variation of approximately 15°C.

Many low tensile strengths were obtained in the experimentation and were tentatively attributed to the geometry or gas pattern changes. The data of experimental runs with poor tensile properties are tabulated listing only high, low and average values along with the coefficient of variation. Individual tensile data are tabulated for experimental runs in which there would appear to be an enhancement of the CVD process. With the exception of Run No. NC-57, each sample was given 10 individual tensile tests.

The substrate used was Great Lakes Carbon Lot No. 1117, Pkg. 3 cleaned in chlorine at 1800°C with a substrate velocity of 0.594 cm/sec.

The first attempt at controlling the temperature profile involved the use of a tapered reactor. When the smaller diameter of the taper was adjacent to the gas inlet the reactor was designated as in the normal position. A 180° rotation of the reactor was designated as the inverted position. See Fig. 16. Runs No. NC 41, 42, 43, 48A, 48B

and 48C were made with this reactor in the normal mode, and the temperature profiles and tensile data are shown in Table V. The individual tensile data for Runs No. NC-43 and NC-48A are given in Table VI. The tapered reactor was then used in the inverted mode and runs were made at total gas flows of 700, 800 and 900 cc/min. These data are shown in Table VII.

Next, a side entry port reactor was fabricated so that gas additions could be made to the reactor. The side port was located approximately 1/3 of the total reactor length up from the exit electrode with an entry angle of 30°. The angle was arbitrarily chosen to prevent gas addition from directly impinging upon the monofilament. The reactor in this configuration was designated as a normal side port reactor and a 180° rotation of the reactor was designated as an inverted side port reactor. See Fig. 17.

With the reactor in the normal mode and 800 cc/min of BCl₃, H₂, CH₄ gas composition introduced at the entry electrode, 100 cc/min N₂ was introduced at the side port. Unfortunately, a break occurred within the reactor after a 2 min. run. The data for this run NC-57 are shown in Table VIII.

The reactor was then used in the inverted mode and with 800 cc/min of composition gas introduced at the entry electrode, 100 cc/min of N₂ was introduced at the side port for runs with two different filament temperatures. The experiments were repeated except that Ar was used instead of N₂ - Runs NC-60 and NC-61. The data for these runs are shown in Tables IX and X.

N₂ and Ar were chosen for these experiments because they have low thermal conductivities, and are not known to effect the deposition process. The experiments were designed to investigate the effect of lowering the thermal conductivity of the gases within the reactor on the temperature profile of the fiber.

These experiments were repeated and expanded somewhat. The experiments were run with 100 cc/min of Ar introduced into the side port, Run No. NC-113, and with 100 and 200 cc/min of N₂ introduced into the side port, Run Nos. NC-114 and NC-115. The tensile data and the monofilament temperature profiles are shown in Tables XI-A and XI-B. Run Nos. NC-116, 117, 118 and 119 are 1/2 hour divisions of a continuous two hour run made under conditions similar to those used for Run No. NC-115. The overall average of these 40 measurements is 190 KN/cm² (276 ksi) ± 50 KN/cm² (60 ksi).

Radial Change in Alloy Composition

The experimentation to change the boron content in the surface of the fiber consisted of using the side entry port reactor in the normal position, Fig. 17, and introducing H₂ into the side port. Runs were made with 700, 800, 900 and 1000 cc/min total gas flow of the CH₄, BCl₃ and H₂ composition into the top of the reactor and either 100 or 200 cc/min of H₂ injected into the side port. The data for these experiments are shown in Table XII and the individual tensile test data of Run No. 53 is shown in Table XIII.

A third reactor was fabricated and is shown in Fig. 18. With this reactor, gas was introduced at the top and bottom of the main reactor body and exhausted through the side port. The gas ratio injected into the bottom of the reactor was a ratio known to yield a higher boron content in the deposit than that injected at the top electrode.

Two experiments were conducted using this reactor. In both experiments a gas composition with ratios $H_2:BCl_3 = 1:1$, $CH_4:H_2 = 2.34:1$ and $CH_4:BCl_3 = 2.34:1$ was fed into the reactor through the top electrode and a composition with ratios $H_2:BCl_3 = 1.22:1$, $CH_4:H_2 = 1:.44$ and $CH_4:BCl_3 = .44:1$ was fed into the bottom of the reactor through the bottom electrode and the reactant gases were exhausted through the side port.

In Run No. 72, the total gas flow into both top and bottom electrodes was 755 cc/min while in Run No. 71, 755 cc/min was introduced into the top electrode and 355 cc/min was introduced into the bottom electrode. The tensile data for monofilament produced in these experiments are shown in Table XIV.

In both experiments the effect of exhausting gas through the side port was to greatly lower the temperature of the monofilament in the portion of the reactor below the side port. The decrease in temperature was less severe with the smaller total gas flow introduced into the bottom of the reactor - Run No. 71.

One final experiment was conducted using this reactor. The gas flow pattern was changed by introducing 755 cc/min of gas ratio $CH_4:H_2 = 2.34:1.0$ into the top electrode and 377 cc/min of gas ratio $CH_4:H_2 = 1.0:1.2$ into the side exit port. Gas was exhausted through the bottom electrode. The temperature profile of the monofilament within the reactor under these conditions was far from ideal. Monofilament temperature was $1172^\circ C$ at the top electrode, $1095^\circ C$ just above the side port, $1115^\circ C$ just below the side port and $1095^\circ C$ at the bottom electrode. The resultant monofilament was friable and only five tensile specimens could be tested. The data for this run, NC-110, are shown in Table XV-A, B. The substrate for this experiment was Great Lakes Carbon, Lot #1117, package #4, cleaned in chlorine at $1700^\circ C$.

RF Reactor Experiments

The RF reactor, Fig. 19, utilizes a power coupling system which requires no physical contact to the substrate fiber while supplying the energy required to heat the substrate. The system is comprised of three units, the RF power supply and controls, the power splitting and phasing network and a pair of resonant coupling cavities.

The power supply operates at 40.68 MHz and is capable of delivering approximately 1 kw of RF power into a 50 ohm load. The power controls regulate the RF output power to maintain the substrate fiber temperature at a predetermined value. Temperature control is accomplished by monitoring the brightness of the substrate fiber with

a photocell and maintaining that brightness at a desired level. The level is determined by an optical pyrometer temperature measurement of the substrate fiber.

The 50 ohm output of the power supply is split and phased to drive two resonate coupling cavities in push-pull. The splitting network has the capability of delivering power to either cavity over a range of 0 to 100%. Phasing of the output is accomplished by using different lengths of the coaxial cable connecting the splitting network to the cavities.

The cavities are identical coaxial resonators approximately 50.8 cm (20 in.) long and 9.16 cm (4 in.) in diameter. The center conductor is a 1.90 cm (0.75 in.) copper pipe electrically connected to one end of the 9.16 cm outer line and capacitively loaded at the other end. The resonate frequency of the cavity is the operating frequency of the power supply, 40.68 MHz.

A 1.3 cm pyrex tube passes through the 1.9 cm center copper tubes and the cavities are secured approximately 91.6 cm apart with the capacitively loaded ends facing each other. The ends of the pyrex tube are fitted with gas seals, schematically shown in Fig. 20. With the substrate fiber strung through the glassware, the coupling cavities are adjusted to produce the field configuration required to couple power into the fiber. By adjusting the power division between the two cavities, the system provides a uniform substrate fiber temperature in the area between the two resonators.

The exact mode of coupling that exists is not fully understood however, the impedance or loading which is impressed across the resonator can be represented by a high resistance load across an auto transformer. The resonator must be driven at a tap point which is equivalent to the coaxial cable impedance, 50 ohms, if optimum power is to be coupled to the fiber.

Substrate fiber conductivity and diameter are the two major parameters which determine the resonate loading. Changing either of these parameters will change the loading and subsequently change the impedance at the tap point on the resonator. Some variation of the tap point impedance can be tolerated without changing the position of the tap, but gross changes in the fiber characteristics, such as changing the substrate fiber from tungsten to carbon, does require a change in the position of the tap to return the resonator to a 50 ohm input impedance.

Before using the RF reactor for the production of carbon based monofilament, the tap point of the resonating cavities had to be changed to match the impedance of the carbon substrate fiber. As was the case in studies using a DC reactor, the gas composition with ratios $H_2:BCl_3 = 1:1$, and CH_4 to BCl_3 or $H_2 = 2.34:1$ was considered to be a standard for the experimentation with the RF reactors. However, other gas compositions were used to compare the chemical composition of carbon-boron alloy monofilament produced in an RF reactor with that produced in a DC reactor.

The substrate fiber used in the first experiments was Great Lakes Carbon Co., Lot #1190, Package #3 in the as received condition. The total gas flow was 1200 cc/min and the substrate velocity was 0.59 cm/sec (70 ft/hr). Experimental Run Nos. NC-62 and NC-63 were made with the standard gas composition (CH_4 to H_2 ratio of 2.34:1). Monofilament temperatures were 1180°C for NC-62 and 1210°C for Run No. NC-63. The tensile strength data for these runs are shown in Table XVI.

The gas composition was then modified slightly and monofilament was produced from the new ratios. These experiments were designed to provide a cursory investigation to examine the effect of changing gas composition on tensile strength.

Run NC-64 was produced from a gas composition with ratios $\text{H}_2:\text{BCl}_3 = 1.0:2.0$, $\text{CH}_4:\text{H}_2 = 4.0:1.0$ and $\text{CH}_4:\text{BCl}_3 = 4.0:1.0$.

Run NC-66 was produced from a gas composition with ratios $\text{H}_2:\text{BCl}_3 = 1.0:1.0$, $\text{CH}_4:\text{H}_2 = 1.0:2.0$ and $\text{CH}_4:\text{BCl}_3 = 1.0:2.0$.

Deposition temperature for Run NC-64 was 1225°C and for Run NC-66 was 1150°C. The total gas flow and 0.59 cm/sec respectively.

The tensile data for Runs NC-64 and NC-66 are shown in Table XVII.

Generally, lower tensile strengths were expected whenever the carbon substrate fiber was used in the as received condition. But it was not felt that the substrate fiber itself could account for the poor tensile strength results of Run NC-63. Consequently, the RF reactor system was re-evaluated. More critical substrate impedance measurements were made and the location of the tap points of the resonating cavities were changed. The temperature control system was serviced and the experiments were repeated.

Monofilament was produced with Great Lakes Carbon Lot #1190, Package #1 in the as received condition as the substrate fiber. The tensile strength data from these experiments - Runs Nos. NC-73 through NC-78 - are shown in Table XVIII, A and B. The substrate fiber was then precleaned in chlorine at 1700°C with a substrate velocity of 0.59 cm/sec (70 ft/hr) and monofilament was produced from this precleaned fiber. These tensile strength data - Runs NC-79 through NC-84 are shown in Table XIX, A and B.

The gas composition for the above experiments had the following ratios, $\text{H}_2:\text{BCl}_3 = 1.0:2.8$, $\text{CH}_4:\text{H}_2 = 1.0:1.2$ and $\text{CH}_4:\text{BCl} = 2.34:1.0$, or a $\text{CH}_4:\text{H}_2$ ratio of 1.0:1.2. The total gas flow was 1700 cc/min.

Monofilament was also produced using the precleaned carbon fiber as a substrate and a gas composition with the standard $\text{CH}_4:\text{H}_2$ ratio of 2.34:1. The total gas flow for these experiments was 1200 cc/min and the tensile strength data are shown in Table XX, A and B.

Some excellent monofilament was produced - note Runs NC-73, 77, 80, 82 and 83 - but the variation of the diameter in almost all runs was excessive. It was believed that the inconsistency in the tensile strength data - compare Run Nos. 82 and 84 was directly related to diameter fluctuations which in turn were caused by temperature excursions. The temperature of the monofilament in the reactor varied in an erratic manner. During some experiments, the temperature fluctuations were visually discernable and in others, the only indication of a temperature fluctuation was the variations of the diameter of the monofilament produced.

A second servicing of the temperature control system revealed an exposed wire, a potential RF path to ground, in the cable connecting the temperature sensing transducer to the control electronics. After the cable had been replaced a correlation between monofilament temperature fluctuations or, equivalently, diameter fluctuations and voltage fluctuations in the power line feeding the RF amplifier was observed. A power line regulator was obtained but the only instrument available was a mechanical type - regulation accomplished with a motor driven variable transformer. This type of regulator works well for small line fluctuations, but the response time of the unit is too long when it has to accommodate large changes in voltage. Consequently, experimental runs in the RF reactor were conducted only during periods of relatively stable line voltage - midmorning and midafternoon. Line voltage was monitored for all remaining experiments and the range of the diameter of the monofilament in any experiment is an indication of the instability of the line voltage. It is interesting to note in the data presented that strong monofilament can be produced even though the diameter varies up to approximately 15 microns (0.0006 in.). When the line voltage (temperature) fluctuations are large enough to produce monofilament with diameter variations of 15 microns or greater, there is a tendency for sections of the monofilament to develop rings of different composition, resulting in weak monofilament.

The substrate for monofilament produced in the final experiments conducted on the RF reactor was Great Lakes Carbon, Lot #1190, Package #2. Run NC-97, gas ratio 1.0:1.2 was made with the substrate fiber in the as received condition and subsequent runs were made with fiber that had been cleaned in chlorine at 1700°C. The tensile strength data for Run No. NC-97 are shown in Tables XXI, A and B.

Run Nos. NC-98 through NC-103 were made to investigate the effect of temperature on the tensile strength of the monofilament. The gas ratio for Run Nos. 98, 99 and 100 was 1.0:1.2 while the ratio for Run Nos. 101, 102 and 103 was 2.34:1.0. The tensile strength data are shown in Tables XXII, A and B, and XXIII, A and B, respectively. Included in Table XXII, A and B, are Run Nos. NC-104, 105 and 112, repeats of Run No. NC-100.

Run No. NC-111 essentially a repeat of Run NC-102 is included in Table XXIII. Run Nos. NC-111 and NC-112 were made on the same day, and during these runs power line fluctuations were extreme. In addition, Runs NC-111 and NC-112 are specimens made from a different lot of substrate. Ring formation is apparent in the monofilament produced in Runs NC-111 and 112.

The initial calculation to determine the flow rates for the $\text{CH}_4:\text{H}_2$ ratio of 1.0:1.2 yielded a total flow of 1700 cc/min. Run Nos. NC-98, 99, 100, 104, 105 and 112 were made with this total flow. The flow was reduced to 1275 cc/min to compare the tensile strength of monofilament produced from ratios 1.0:1.2 and 2.34:1 with comparable total gas flows. Runs were made at 1180°C and 1200°C - NC-107. The tensile strength data for these runs are shown in Tables XXIV, A and B. The poor tensile properties of the monofilament produced in Run. No. NC-107 should be attributed to the RF power supply instability.

Elevated Temperature Tensile Strength of the Carbon-Boron Alloy Monofilament

The elevated temperature strength of Run Nos. NC-97, 99 and 103 was measured at 500°C using a system described elsewhere (Ref. 8).

Briefly, the system is a 10 cm long by 8 mm diameter silica tube centered in a core heater. The ends of this tube are reduced to approximately 1 mm. For inert atmosphere testing, a 55 cc/min argon flush was maintained throughout the test with argon flowing into the tube through a side port and exiting through the reduced ends. For measurements made in air, the side port and the ends were exposed to the atmosphere. The hot zone in the center of the tube was relatively flat over 2.54 cm, varying by $\pm 10^\circ\text{C}$ at a nominal 500°C.

To tensile test a sample, the furnace was placed between crossheads, and a 23 cm length of monofilament was threaded through the tube and secured to the crossheads with wax. Each sample was held at temperature for nine minutes - sufficient time for the wax to solidify enough to prevent pull out - and then tested. Any fractures that occurred outside the furnace were disregarded and fractures within the furnace were assumed to have occurred within the hot zone.

The tensile data of these measurements are shown in Table XXV, A and B, XXVI, A and B, and XXVII, A and B. The room temperature (RT) tensile strength is shown in previous tables and is repeated for comparison purposes.

Tensile Properties of Monofilament After Exposure to Molten Aluminum

Carbon-boron alloy monofilament-aluminum composites were fabricated and the tensile strength of monofilament extracted from the composite after fabrication was measured.

The composites were fabricated by plasma spraying a layer of 713 Al onto a sheet of 6061 Al foil. Monofilament was then placed between sheets such that the 713 Al surface was in contact with the monofilament. The lay up was then hot pressed at 600°C for 15 minutes at 206.7 N/sq.cm. (300 psi). This hot press temperature, approximately 10°C above the liquidus of 713 Al assured a large percentage of molten aluminum. After fabrication, the monofilament was leached from the composite with HCl and the tensile strength was measured.

The monofilament used in these experiments was from Run No. NC-102. Adjacent lengths of the fiber were divided into two groups. One group was used to fabricate the composite and the second group was used as a control. The data from this experiment are shown in Table XXVIII.

DISCUSSION

The experimentation completed in NASA CR-121229 (Ref. 7) showed that the cleaning of the substrate fiber in Cl_2 was worthwhile. But it was determined that the cleaning parameters (fiber velocity and substrate fiber temperature) could not be standardized because each lot of substrate fiber and even different spools of fiber from the same lot contained different kinds of impurities and flaws. Some lots of substrate fiber required a temperature of 1800°C to clean it while other lots were pitted after cleaning at this temperature.

The technique that evolved from the experimentation was to clean the substrate fiber at some temperature and fiber velocity, observe the surface of the cleaned fiber with a light microscope, and empirically adjust the parameters until observation with a light microscope showed long sections of the end of the spool to be clean and smooth. The process was standardized to the extent that the fiber velocity was generally set at 0.55 cm/sec (65 ft/hr) while the fiber temperature was changed. The temperatures required to produce clean substrate were generally between 1700 and 1800°C . If, after cleaning a spool of fiber at a temperature determined as described above, the carbon-boron deposition process indicated that the entire length of the spool had not been thoroughly cleaned, the spool was discarded and a new spool was cleaned.

The experimentation also showed that, with a BCl_3 , CH_4 and H_2 gas systems, the carbon-boron composition in the deposited alloy was dependent upon the CH_4 to BCl_3 ratio; as this ratio decreased, the boron coating of the alloy increased. However, it was found that H_2 could prevent methane decomposition and might be more important in controlling the monofilament composition. That is, if the CH_4 to H_2 ratio was decreased the boron content of the alloy increased.

Intuitively, one would expect that the highest tensile strength monofilament would be achieved with a carbon-boron alloy with the highest w/o of B. This concept was verified when monofilament was produced containing 75 w/o B. The average tensile strength of this monofilament was 304 KN/cm^2 (440 ksi), its modulus was $33 \times 10^6 \text{ N/cm}^2$ (49×10^6 psi), and its density was 2.226 g/cc. However, considerable difficulty was encountered in depositing this alloy because of reactions with impurities inherent in the substrate fiber.

As a consequence, a gas composition was selected ($\text{CH}_4:\text{BCl}_3$ and $\text{CH}_4:\text{H}_2 = 2.34:1$) from the previous study (Ref. 7) which gave a filament with 66 w/o B and had an average modulus of $27 \times 10^6 \text{ N/cm}^2$ (39×10^6 ksi) and a density of 2.079 g/cc.

It was found with this gas composition, that there was a tendency for increased tensile strength for the monofilament with increased deposition temperature over a limited range of temperatures. The composition of the carbon-boron alloy did not change within this range of temperatures studied but if the deposition temperature exceeded the upper limit, the deposit had a tendency to form rings of varying carbon-boron composition.

The initial experimentation conducted under this contract - the Latin Square Studies, with a DC reactor - showed the same tendency for increased tensile strength for the monofilament with increased deposition temperature, Fig. 9, but the tensile strength could not be optimized because various combinations of parameters produced ring formation within the monofilament.

Emperically, with this gas composition, whenever the monofilament deposition temperature exceeds approximately 1200°C, ring formation becomes apparent. It is reasonable to assume that the rings of different composition are associated with the decomposition of CH_4 . At the higher temperatures, the decomposition is at its maximum and a high carbon content alloy is deposited. As the carbon content of the gas is depleted by deposition and the H_2 content is increased by decomposition of the CH_4 , an alloy containing less carbon is deposited on the substrate. When the deposition temperature is excessively high, this process can repeat itself forming multiple rings of varying composition. These multiple ranges were noted in monofilament deposited at approximately 1250°C and are shown in Fig. 21. Included in Fig. 21 are the chemical compositions of the various rings. The monofilament shown in Fig. 21 was produced in the early experimentation under Contract CR-121229 (Ref. 7) and was reported therein.

Because the deposition temperature is the parameter that has the strongest effect on the diameter of the monofilament, see Figs. 6, 7 and 8, high temperatures are required to obtain high deposition rates. A uniform, high deposition temperature would allow the production of monofilament with reasonable diameters at faster substrate velocities, and would eliminate the tendency for ring formation.

The attempts to produce a uniform monofilament temperature within the reactor were, for the most part, successful. Note Tables V and VI, the results of the experimentation with a normal tapered reactor. The monofilament produced in this reactor in runs NC 43 and NC 48A have a much higher average tensile strength than would normally be expected at their deposition temperatures, and the diameters are also larger than would be expected. This same general trend of higher strengths and larger diameters was exhibited in the monofilament produced in the side port and inverted side port reactors, Tables VIII, IX, X and XI. Although the results were extremely encouraging, there was not enough time to pursue these experiments further.

The experiments designed to produce a strong outer coating on the surface of the monofilament were not as successful as those designed to produce a uniform temperature profile. As stated, the attempts to control the carbon-boron alloy by injecting gases with different compositions disrupted the temperature profile so much that the monofilament produced had poor tensile properties.

The results of the experiments in which H₂ was injected into the lower one-third of the reactor were very interesting, Tables XII and XIII. The chemical composition of monofilament produced in Run Nos. NC-51A, 52, 52B, 53, 53A and 54B was measured at a site adjacent to the substrate fiber and at a site adjacent to the outer surface. The w/o of B within a monofilament was essentially identical at both locations and varied in the series of experiments from 75 to 79 w/o of B while a composition of 66 w/o of B would be expected from the initial gas composition. It would appear that the introduction of H₂ into the lower one-third of the reactor changed the deposition process throughout the length of the reactor - the injected H₂ produced the same results as a gas composition with a high H₂ content.

In spite of the equipment difficulties experienced with the RF reactor, some excellent monofilament was produced. Note Tables XXII and XXIII. Two gas compositions were used to compare the composition of the alloy produced in the RF reactor with that produced in a DC reactor. The chemical composition of monofilament produced in Run Nos. NC-82 and 84 - CH₄:H₂ = 1.0:1.2 - and Run No. NC-86 - CH₄:H₂ = 2.34:1.0 were determined by electron microprobe analysis and are shown in Table XXIX. These analyses agree with the analysis of monofilaments produced in a DC reactor using the same gas ratios.

Monofilament produced in Run Nos. NC-82 and 84 have radically different average tensile strengths, 276 KN/cm² for NC-82 and 153 KN/cm² for NC-84. The difference in strength can be attributed to the ring formation that developed in the monofilament produced in NC-84. See Fig. 22. The ring was not thick enough to be accurately analyzed with an electron microprobe and the analysis stated was conducted on the remainder of the monofilament.

The tensile data for monofilament produced in Run No. NC-97 (Table XXI) and Run No. NC-102 (Table XXIII) are typical strength values of monofilament produced from an uncleaned substrate versus a cleaned substrate. Although the total gas flow was different for the two runs, all previous experimentation had shown no tendency for a change in tensile strength with a change in total gas flow.

The experiments conducted to investigate the effects of deposition temperature on the tensile strength of the monofilament - Tables XXII and XXIII - are revealing. With the exception of Run Nos. 111 and 112, the experiments were run under stable operating conditions. No strong tendency for an increase in tensile strength with increase in deposition temperature over the range of 1150°C to 1200°C was apparent. It is not known whether independence of deposition temperature would be found for monofilament produced in a DC reactor having a uniform temperature profile.

Monofilament produced in the RF reactor was used to determine the high temperature tensile properties and the tensile strength of the monofilament after exposure to molten aluminum.

The decrease in the strength of the monofilament at 500°C in argon and air from the room temperature strength was 40% for Run No. NC-97 and NC-99. As stated, the gas composition used to produce monofilament for both of these runs - CH₄:H₂ = 1.0:1.2 - yields approximately 77 w/o B in the carbon-boron alloy.

The decrease in the strength of the monofilament at 500°C in argon and air from the room temperature strength was 26% for the monofilament produced in Run No. NC-103. The gas composition used in Run No. NC-103 ($\text{CH}_4:\text{H}_2 = 2.34:1.0$) yields 66 w/o B. It would appear that the monofilament with the lower B content retains its strength better at 500°C.

The final experimentation completed in the contract period, the tensile strength of the monofilament after extraction from an aluminum composite, showed that the strength of the monofilament is not degraded by molten aluminum.

CONCLUSIONS

Based upon the results obtained during this contract, the following conclusions were drawn:

1. High tensile strength and high modulus carbon-based monofilament can be chemically vapor deposited onto a carbon substrate fiber from a BCl_3 , CH_4 and H_2 gas system. With no precoat on the substrate fiber, the tensile strength of the monofilament depends upon the condition of the substrate fiber. Tensile strengths with the least amount of scatter were attained when the substrate fiber had been precleaned in chlorine.
2. Deposition rate is dependent upon deposition temperature, the faster rates occurring at higher temperatures. However, for a fixed gas composition, there is an upper temperature limit for deposition that if exceeded the composition of the monofilament separates into zones of varying composition.
3. Monofilament produced in either a DC or an RF reactor, from a fixed gas composition, has the same chemical composition, and that composition can be controlled by changing the $\text{CH}_4:\text{H}_2$ ratio.
4. The decrease in tensile strength of monofilament at 500°C is greater for the monofilament with the higher w/o of B.
5. The tensile strength of monofilament containing 66 w/o of B in the carbon-boron alloy is unchanged after exposure to molten aluminum.

REFERENCES

1. Rossi, R. C. et al.: "Development of Aluminum-Graphite Composites", Ceramic Bulletin. Vol. 50, No. 5, (1971).
2. McDanel, D. L.: "A Review of Carbon Fiber Reinforced Metal Matrix Composites - The Potential of Large-Diameter Carbon-Base Monofilaments", NASA TM X-52922 (1970).
3. Quackenbush, N. E.: "Large-Diameter Graphite/Carbon Composite Filament Development", NASA CR-72769 (1970).
4. Bradshaw, W. G., P. C. Pinoli, and A. E. Vidoz: "Development of Manufacturing Process for Large-Diameter Composite Monofilaments by Pyrolysis of Resin-Impregnated Carbon-Fiber Bundles", NASA CR-120973 (1972).
5. Hough, R. L.: "Development of Manufacturing Process for Large-Diameter Carbon-Base Monofilaments by Chemical Vapor Deposition:", NASA CR-72770 (1970).
6. Hough, R. L. and R. D. Richmond: "Improvement of Chemical Vapor Deposition Process for Production of Large Diameter Carbon Base Monofilament", NASA CR-120902 (1971).
7. Jacob, B. A. and R. D. Veltri: "Development of Large Diameter Carbon Monofilament", NASA CR-121229, (1973).
8. Veltri, R. D., and S. F. Galasso: "Apparatus for Measuring the High Temperature Strength of Filaments," the Rev. of Sci. Ins., Vol. 42, No. 3, pp. 369-370, March 1971.

TABLE I

Electron Microprobe Chemical Analysis of Great Lakes Carbon Co.

Substrate Fiber.

Lot No.	Package No.	Cleaning Temp.	Draw Speed		Elements Detected by Spectral Beam Analysis		
			cm/sec	ft/hr	Major	Minor	Trace
1142	1	As Received	(No Cleaning)		S	-	-
1142	1	1800°C	0.68	80	S	-	-
1142	1	1800°C	0.594	70	S	Si	K,Ca
1142	1	1800°C	0.51	60	S	-	-
1117	3	As Received	(No Cleaning)		K	S*,Cl	-
1117	3	1800°C	.594		Si	K,Ca	S*

* Less than major classification because electron beam does not fully penetrate outgrowth.

TABLE II-A

Individual Tensile Tests for Total Gas Flow of 600 cc/min
Gage Length = 2.54 cm

Substrate. Great Lakes Carbon Lot #1142. Package #3 cleaned in an
R.F. reactor in chlorine at 1800°C with a Draw Speed of 0.68 cm/sec (80 ft/hr)

Run No.	NC-1		NC-5		NC-9		NC-13	
Temp.	1150°C		1170°C		1190°C		1210°C	
Substrate Velocity (cm/sec) (ft/hr)	.169	20	.423	50	.254	30	.338	40
Dia (μ) (mils)	66	2.6	68.6	2.7	89	3.5	104	4.1
UTS K N/cm ² Ksi	120	174	108	157	94	137	143	208
	130	188	118	172	117	170	146	211
	149	217	132	192	127	185	151	219
	152	220	150	217	150	218	157	227
	152	220	156	227	163	236	160	233
	227	156	186	264	163	236	165	239
	163	236	195	284	171	248	182	264
	165	240	210	305	176	256	185	268
	170	247	213	310	198	287	187	271
	198	287	247	358	209	304	192	278
Avg UTS (K N/cm ²) (Ksi)	156	226	171	248	157	228	167	242
Std. Dev. (K N/cm ²) (Ksi)	26	31	55	66	43	52	22	26
Coeff. Var. (%)	13.8		26.6		22.8		10.9	

TABLE II-B

Individual Tensile Tests for Total Gas Flow of 700 cc/min
Gage Length = 2.54 cm

Substrate. Great Lakes Carbon Lot #1142. Package #3 cleaned in an
R.F. reactor in chlorine at 1800°C with a Draw Speed of .68 cm/sec (80 ft/hr)

Run No.	NC-2		NC-6		NC-10		NC-14	
Temp	1150°C		1170°C		1190°C		1210°C	
Substrate Velocity (cm/sec) (ft/hr)	.338	40	.254	30	.423	50	.169	20
Dia. (μ) (mils)	66	2.6	81.5	3.2	81.5	3.2	107	4.2
UFS	143	207	110	159	85	123	139	202
(K N/cm ²) (K si)	149	217	167	243	132	192	144	209
	160	231	189	275	133	193	152	221
	161	234	219	318	138	200	165	239
	162	235	220	319	144	210	176	255
	182	264	230	334	194	282	188	273
	197	285	235	341	197	286	189	274
	197	285	237	344	214	311	209	304
	211	306	239	347	216	314	219	318
	212	308	254	368	217	315	249	361
Avg. UTS (K N/cm ²) (Ksi)	177	257	210	305	167	242	183	266
Std. Dev. K N/cm Ksi	31	37	52	63	56	67	42	51
Coeff. Var. (%)	14.5		20.7		27.7		19.2	

TABLE II-C

Individual Tensile Tests for Total Gas Flow of 800 cc/min
Gage Length = 2.54 cm

Substrate. Great Lakes Carbon Lot #1142. Package #3 cleaned in an
R.F. reactor in chlorine at 1800°C with a Draw Speed of .68 cm/sec (80 ft/hr)

Run No.	NC-3		NC-7		NC-11		NC-15	
Temp.	1150°C		1170°C		1190°C		1210°C	
Substrate Velocity (cm/sec) (ft/hr)	0.423	50	0.169	20	0.338	40	0.254	30
Dia. (μ) (mils)	66	2.6	89	3.5	91.5	3.6	104	4.1
UTS (K N/cm ²) (Ksi)	147	214	107	155	99	144	54	78
	158	230	145	210	140	204	74	108
	163	237	164	238	179	260	104	152
	186	269	173	251	180	261	118	171
	187	271	186	270	183	265	152	220
	195	282	187	271	190	275	183	265
	201	292	192	279	204	296	183	265
	214	310	195	283	204	296	189	275
	214	310	224	325	216	313	195	283
	216	314	248	360	224	326	208	302
Avg UTS (K N/cm ²) (Ksi)	188	273	182	264	182	264	146	211
Std. Dev. (K N/cm ²) (Ksi)	30	36	47	57	45	54	66	80
Coeff. Var. (%)	13.2		21.5		20.6		37.6	

TABLE II-D

Individual Tensile Tests for Total Gas Flow
of 900 cc/min. Gage Length = 2.54 cm.

Substrate. Great Lakes Carbon Lot # 1142 Package #3 Cleaned in an
R.F. Reactor in Chlorine at 1800°C With a Draw Speed of .68 cm/sec (80 ft/hr)

Run No.	NC-4		NC-8		NC-12		NC-16	
Temp.	1150°		1170°C		1190°C		1210°C	
Substrate Velocity (cm/sec) (ft/hr)	0.254	30	0.338	40	0.169	20	0.423	50
Dia (μ) (mils)	76.2	3.0	76.2	3.0	101.5	4.0	92.7	3.65
UTS (KN/cm ²) (Ksi)	84	122	93	134	82	119	54	79
	89	129	110	159	154	224	188	272
	100	145	179	260	155	225	197	286
	128	185	181	263	176	255	204	296
	133	192	181	263	193	280	204	296
	134	194	190	276	197	286	209	304
	137	199	190	276	221	321	215	313
	137	199	201	292	225	327	217	314
	168	244	206	299	227	329	218	317
	184	267	208	301	235	341	218	317
Avg. UTS (KN/cm ²) (Ksi)	129	188	174	252	187	270	192	279
Std. Dev. (KN/cm ²) (Ksi)	39	46	48	58	57	68	60	72
Coeff. Vor. (%)	24.7		23.0		25.2		25.8	

TABLE III-A

Individual Tensile Tests for Total Gas Flow
of 600 cc/min. Gage Length = 2.54 cm

Substrate. Great Lakes Carbon Lot #1117 Package #3 Cleaned in an
R.F. Reactor in Chlorine at 1800°C With a Draw Speed of .594 cm/sec (70 ft/hr)

Run No.	NC-21		NC-22		NC-23		NC-24	
Temp.	1150°C		1170°C		1190°C		1210°C	
Substrate Velocity (cm/sec) (ft/hr)	.169	20	.254	30	.338	40	.423	50
Dia (μ) (mils)	71	2.8	75	2.95	83.8	3.3	89	3.5
UTS (KN/cm ²) (Ksi)	67	97	184	266	60	88	62	90
	74	107	207	300	168	243	64	94
	81	117	210	305	168	243	72	104
	81	117	218	316	174	253	147	213
	82	119	228	331	210	304	155	225
	106	154	234	340	228	331	172	249
	112	162	237	344	232	337	172	249
	123	179	245	356	239	347	180	262
	129	187	270	392	243	353	198	288
	168	244	272	395	250	363	202	293
Avg. (KN/cm ²) (Ksi)	102	148	231	334	197	286	142	207
Std. Dev. (KN/cm ²) (Ksi)	38	46	34	40	70	84	67	80
Coeff. Vor. (%)	30.9		12.1		29.3		38.8	

TABLE III-B

Individual Tensile Tests for Total Gas Flow
of 700 cc/min. Gage Length = 2.54 cm

Substrate. Great Lakes Carbon Lot # 1117 Package #3 Cleaned in an
R.F. Reactor in Chlorine at 1800°C With a Draw Speed of .594 cm/sec (70 ft/hr)

Run No.	NC-27 1150°C		NC-28 1170°C		NC-29 1190°C		NC-30 1210°C	
Temp.								
Substrate Velocity (cm/sec) (ft/hr)	.254	30	.169	20	.423	50	.338	40
Dia (μ) (mils)	76.2	3.0	114.3	4.5	91.5	3.6	96.5	3.8
UTS (KN/cm ²) (Ksi)	110	159	72	104	54	79	118	172
	115	167	91	132	68	98	187	272
	122	177	93	135	102	147	194	282
	127	184	124	179	149	216	204	295
	136	198	137	198	152	221	207	300
	144	209	158	230	169	246	207	300
	173	251	163	236	173	251	210	304
	195	283	165	239	176	255	211	307
	227	329	180	261	179	260	216	313
	235	341	199	289	190	275	222	322
Avg. UTS (KN/cm ²) (Ksi)	158	230	138	200	141	205	198	287
Std. Dev. (KN/cm ²) (Ksi)	56	67	51	61	59	71	36	43
Coeff. Var. (%)	29.3		30.6		34.6		14.9	

TABLE III-C

Individual Tensile Tests for Total Gas Flow of 800 cc/min
Gage Length = 2.54 cm

Substrate. Great Lakes Carbon Lot # 1117 Package # 3 Cleaned in an R.F.
Reactor in Chlorine at 1800°C With a Draw Speed of .594 cm/sec (70 ft/hr)

Run No.	NC-31		NC-32		NC-33		NC-34	
Temp.	1150°C		1170°C		1190°C		1210°C	
Substrate Velocity (cm/sec) (ft/hr)	0.338	40	0.423	50	0.169	20	0.254	30
Dia (μ) (mils)	61	2.4	66	2.6	101.5	4.0	99	3.9
UTS (KN/cm ²) (Ksi)	122	177	111	160	175	255	118	172
	133	194	137	198	186	270	124	180
	141	205	143	208	187	272	157	228
	141	205	163	236	191	277	168	244
	164	238	163	321	192	278	186	269
	171	248	221	321	192	278	186	269
	175	254	228	330	200	290	209	303
	191	277	234	340	203	294	213	310
	206	299	239	347	211	306	216	314
	210	304	239	347	214	310	226	328
Avg UTS (KN/cm ²) (Ksi)	165	240	188	272	195	283	180	261
Std. Dev. (KN/cm ²) (Ksi)	37	44	60	72	14	17	46	55
Coeff. Var. (%)	18.5		26.4		6.0		21.1	

TABLE III-D

Individual Tensile Tests for Total Gas Flow of 900 cc/min
Gage Length = 2.54 cm

Substrate. Great Lakes Carbon Lot # 1117 Package # 3 Cleaned in an R.F.
Reactor in Chlorine at 1800°C With a Draw Speed of .594 cm/sec (70 ft/hr)

Run No.	NC-35		NC-36		NC-37		NC-38	
Temp.	1150°C		1170°C		1190°C		1210°C	
Substrate Velocity (cm/sec) (ft/hr)	0.423	50	0.338	40	0.254	30	0.169	20
Dia (μ) (mils)	80	3.25	89	3.5	78.7	3.2	113	4.45
UTS	90	130	125	182	105	153	95	138
(KN/cm ²) (Ksi)	120	175	147	213	116	168	132	191
	123	178	150	218	137	199	146	212
	145	211	161	234	141	205	160	232
	149	217	172	249	161	234	171	248
	152	220	179	260	170	246	186	270
	162	235	186	270	211	306	197	286
	164	239	186	270	223	323	235	341
	174	253	218	317	238	346	235	341
	187	271	229	333	266	386	241	350
Avg UTS (KN/cm ²) (Ksi)	147	213	175	255	177	257	180	261
Std. Dev. (KN/cm ²) (Ksi)	35	42	38	46	66	79	59	71
Coeff. Var. (%)	19.6		18.2		30.9		27.1	

TABLE IV

Monofilament D.C. Reactor Temperature Profiles

Run Nos.	29	30	31	32	33	34	35	36	37	38
Total Gas Flow cc/min	700		800				900			
Temperature (°C)										
Top electrode	1380	1315	990	1045	1130	1210	1190	1170	1190	1190
Std. Measuring pt.	1185	1195	1150	1170	1190	1210	1150	1170	1190	1210
Bottom Electrode	1060	1065	1015	1035	1080	1080	1060	1100	1055	1075

TABLE V

Temperature Profiles and Tensile Strength Data of Monofilament
Produced in a Normal Tapered Reactor

Substrate Velocity 0.254 cm/sec (30 ft/hr)

Run No.	Total Gas Flow (cc/min)	Temperature (°C)			Dia.		UTS (KN/cm ²) (Ksi)				Coefficient of Variation (%)		
		T	C	B	(μ)	(mils)	High	Low	Avg.				
NC 41	600	1120	1155	1100	74	2.9	188	272	58	85	118	171	29.3
NC 42*	600	1190	1140	1125	84	3.3	216	313	79	115	160	233	27.9
NC 43	700	1100	1115	1100	76	3.0	203	294	127	180	169	245	12.1
NC 48A	800	1135	1120	1090	102	4.3	237	344	157	227	199	289	12.7
NC 48B	900	1135	1142	1085	91	3.6	193	280	63	91	124	180	34.9
NC 48C	1000	1120	1135	1100	90	3.55	207	301	90	131	143	208	27.1

* Substrate velocity was 0.338 cm/sec (40 ft/hr)

TABLE VI

Individual Tensile Tests for Runs NC 43 and NC 48A

Run No.	NC 43		NC 48 A	
UTS KN/cm ² (Ksi)	127	180	157	227
	151	219	167	242
	158	229	184	267
	166	240	197	286
	175	255	201	291
	175	255	202	293
	177	257	206	300
	177	257	206	300
	180	262	233	337
	203	294	237	344

TABLE VII

Temperature Profiles and Tensile Strength Data of Monofilament
Produced in an Inverted Tapered Reactor

Substrate Velocity 0.254 cm/sec (30 ft/hr)

Run No.	Total Gas Flow (cc/min)	Temperature °C			Dia.		UTS (KN/cm ²) (Ksi)					Coefficient of Variation (%)	
		T	C	B	(μ)	(mils)	High	Low	Avg.				
NC 44	700	1120	1155	1130	105	4.15	226	327	64	92	126	183	38.1
NC 45	800	1185	1155	1115	109	4.3	260	377	72	105	139	202	53.9
NC 46	900	1160	1155	1100	74	2.9	239	347	58	84	145	211	45.7

TABLE VIII

Temperature Profiles and Individual Tensile Strength Data of Monofilament Produced in a
Normal Side Port Reactor

Substrate Velocity 0.254 cm/sec (30 ft/hr)

Run No.	Total Gas Flow cc/min	Side Port Gas	Temperature (°C)				Dia		UTS		Coefficient of Variation (%)
			T	C	S	B	μ mils	KN/cm ²	Ksi		
NC57	800	100 cc/min N ₂	1130	1165	1170	1085	84	33	221	320	12.7
									272	395	
									274	398	
									302	438	
Avg. UTS									267	388	
KN/cm ² Ksi											

TABLE IX

Temperature Profiles and Tensile Strength Data of Monofilament
Produced in an Inverted Side Port Reaction

Substrate Velocity 0.254 cm/sec (30 ft/hr)

Run No.	Total Gas Flow (cc/min)	Side Port Gas	Temperature °C				Dia		High	UTS		Avg.	Coefficient of Variation (%)		
			T	C	S	B	μ	mils		KN/cm ²	Ksi				
NC 58	800	100 cc/min N ₂	1130	1155	1155	1140	84	3.3	229	332	114	165	187	271	17.6
NC 59	800	100 cc/min N ₂	1170	1160	1160	1145	91	3.6	280	407	130	188	227	330	18.9
NC 60	800	100 cc/min Ar	1060	1115	1135	1130	69	2.7	250	362	117	170	187	271	19.6
NC 61	800	100 cc/min Ar	1145	1165	1155	1150	91	3.6	279	405	120	174	203	294	32.0

TABLE X

Individual Tensile Tests for Runs NC 58, 59, 60 and 61

RUN NO.	NC 58		NC 59		NC 60		NC 61	
UTS KN/cm ² Ksi								
	114	165	130	188	117	170	120	174
	154	223	205	297	150	218	152	221
	179	260	218	317	171	249	173	251
	181	263	220	319	184	266	208	302
	193	279	220	319	187	271	208	302
	197	286	229	333	190	275	213	309
	199	289	235	341	190	275	218	317
	209	304	254	368	211	306	222	322
	213	309	279	405	220	319	234	339
	229	332	280	407	250	362	279	405

Table XI-A

Individual Tensile Tests of Monofilament
 Produced in an Inverted Side Port Reactor
 Substrate - Great Lakes Carbon Co. Lot #1117, Package #4
 Cleaned in Chlorine at 1700°C
 Gas Ratio - CH₄:H₂ = 2.34:1
 Total Flow Reactant Gas = 800 cc/min
 Gage Length = 2.54 cm

Run No.	NCl13	NCl14	NCl15	NCl16	NCl17	NCl18	NCl19
Avg. Deposition Temp (°C)							
At Top Electrode	1165	1152	1187	1190	1195	1180	1190
At Side Entry Port	1145	1172	1180	1170	1177	1195	1190
At Bottom Electrode	1085	1152	1155	1155	1162	1172	1155
Side Port Gas	Ar	N ₂	N ₂	N ₂	N ₂	N ₂	N ₂
Flow Rate (cc/min)	100	100	200	200	200	200	200
Substrate Velocity (cm/sec)	0.296	0.296	0.296	0.296	0.296	0.296	0.296
Diameter (μ)	76.3	80	85	73.6	73.6	73.6	73.6
UTS (KN/cm ²)	99 132 201 207 224 236 253 271 277 280	150 150 175 217 234 239 239 245 255 267	170 212 223 224 235 242 244 246 250 252	99 99 175 193 203 214 224 240 243 255	94 179 188 200 202 208 211 211 211 235	104 159 171 173 182 190 212 227 248 255	151 154 156 159 170 172 177 214 219 219
Avg UTS (KN/cm ²)	218	217	230	195	194	192	179
Std. Dev. (KN/cm ²)	74	52	30	67	46	55	33
Coeff. of Var. (%)	28	20	11	29	24	24	15

Table XI -B

Individual Tensile Tests of Monofilament
 Produced in an Inverted Side Port Reactor
 Substrate - Great Lakes Carbon Co. Lot #1117, Package #4
 Cleaned in Chlorine at 1700°C
 Gas Ratio - CH:H₂ = 2.34:1
 Total Flow Reactant Gas = 800 cc/min
 Gage Length = 1 inch

Run No.	NC113	NC114	NC115	NC116	NC117	NC118	NC119
Avg. Deposition Temp (°C)							
At Top Electrode	1165	1152	1187	1190	1195	1180	1190
At Side Entry Port	1145	1172	1180	1170	1177	1195	1190
At Bottom Electrode	1085	1152	1155	1155	1162	1172	1155
Side Port Gas	Ar	N ₂	N ₂	N ₂	N ₂	N ₂	N ₂
Flow Rate (cc/min)	100	100	200	200	200	200	200
Substrate Velocity (ft/hr.)	35	35	35	35	35	35	35
Diameter (mils)	3.0	3.15	3.35	2.9	2.9	2.9	2.9
UTS (ksi)	144 191 291 300 325 342 368 393 402 406	218 218 254 315 340 347 347 356 370 388	246 308 323 326 341 352 355 357 363 366	144 144 254 280 295 310 325 348 352 371	136 260 272 290 293 303 306 306 306 340	151 231 248 251 265 275 307 330 360 371	219 224 227 231 247 250 257 310 318 318
Avg. UTS (ksi)	316	315	334	282	281	279	260
Std. Dev. (ksi)	89	62	36	81	55	66	40
Coeff. of Var. (%)	28	20	11	29	20	24	15

TABLE XII

Temperature Profiles and Tensile Strength Data of Monofilament
Produced in a Normal Side Port Reactor

Gas injected into side port was H₂. Substrate velocity 0.254 cm/sec (30ft/hr)

Run No.	Total Gas Flow cc/min	Side Port Gas cc/min	T	Temperature				Dia. μ	mils	UTS			Avg.	Coefficient of Variation (%)	
				C	S	B	High			KN/cm ²	Ksi	Low			
NC 51	700	0	1150	1170	1130	1085	76	3.0	261	379	103	150	192	278	26.4
NC 51A	700	100	1150	1170	1100	1065	70	2.75	206	300	52	76	139	201	36.4
NC 52A	800	0	1140	1170	1130	1105	83	3.25	235	341	93	135	181	263	26.8
NC 52	800	100	1148	1170	1105	1100	71	2.8	206	300	45	65	124	180	50.7
NC 52B	800	200	1175	1170	1035	1035	67	2.65	215	312	19	27	79	114	83.6
NC 53B	900	0	1180	1180	1155	1120	88	3.45	241	349	82	119	158	229	27.3
NC 53A	900	100	1170	1180	1095	1080	76	3.0	232	337	15	21	114	165	72.2
NC 53	900	200	1170	1170	1020	1030	69	2.7	301	436	24	35	207	300	43.8
NC 54	1000	0	1155	1180	1140	1100	85	3.35	205	297	53	77	141	204	41.6
NC 54A	1000	100	1175	1170	1100	1080	80	3.15	153	222	9	13	72	104	54.1
NC 54B	1000	200	1175	1180	1040	1030	72	2.85	246	357	92	133	179	260	25.2

TABLE XIII

Individual Tensile Tests for Run NC 53

UTS KN/cm ²	Ksi		
		24	35
		63	91
		198	288
		220	319
		245	356
		249	361
		253	366
		259	375
		259	375
		300	436

Table XIV

Individual Tensile Tests of Monofilament Produced in a Side Port DC Reactor

Run No.	71		72	
Dia (μ) (mils)	77.5	3.1	75	3.0
UTS (kN/cm ²)(ksi)	28	41	47	69
	64	93	64	94
	101	146	64	94
	105	152	69	100
	109	158	77	112
	121	175	86	125
	141	204	112	162
	153	222	168	243
	169	245	180	262
	217	315	241	349
Avg. UTS (kN/cm ²)(ksi)	121	175	111	161
Std. Dev. (kN/cm ²)(ksi)	64	77	77	93
Coeff. of Var. (%)	44		58	

Table XV-A

Individual Tensile Tests of Monofilament
 Produced in a Side Exit Port DC Reactor
 Substrate - Great Lakes Carbon Co. Lot #1190, Package #2
 Cleaned in Chlorine at 1700°C

Gage Length = 2.54 cm

Run No.	NC 110			
	Top Electrode	Above Side Port	Below Side Port	Bottom Electrode
Deposition Temp. (°C)	1172	1095	1115	1095
Substrate Vel. (cm/sec)	0.296			
Diameter (μ)	70.0			
UTS (KN/cm ²)	46			
	58			
	70			
	157			
	201			
Avg. UTS (KN/cm ²)	106			
Std. Dev. (KN/cm ²)	82			
Coeff. of Var. (%)	64			

Table XV-B

Individual Tensile Tests of Monofilament
 Produced in a Side Exit Port DC Reactor
 Substrate - Great Lakes Carbon Co. Lot #1190, Package #2
 Cleaned in Chlorine at 1700°C

Gage Length = 1 inch

Run No.	NC 110			
	Top Electrode	Above Side Port	Below Side Port	Bottom Electrode
Deposition Temp. (°C)	1172	1095	1115	1095
Substrate Vel. (ft/min)	35			
Diameter (mils)	2.75			
UTS (ksi)	67 84 101 227 291			
Avg. UTS (ksi)	154			
Std. Dev. (ksi)	99			
Coeff. of Var. (%)	64			

Table XVI

Individual Tensile Tests of Monofilament Produced in an RF Reactor

Run No.	62		63	
Dia (μ) (mils)	80	3.2	107.5	4.3
UTS (kN/cm ²)(ksi)	90	131	31	45
	91	132	39	56
	93	135	39	57
	99	144	57	83
	112	162	60	88
	119	172	61	88
	144	209	63	91
	175	255	81	117
	178	259	96	140
	185	269	115	167
Avg. UTS (kN/cm ²)(ksi)	129	187	64	93
Std. Dev. (kN/cm ²)(ksi)	47	56	32	39
Coeff. of Var. (%)	30			41

Table XVII

Individual Tensile Tests of Monofilament Produced in an RF Reactor

Run No.	64		66	
Dia (μ) (mils)	82.5	3.3	57.5	2.3
UTS (kN/cm ²)(ksi)	47	69	159	231
	61	89	185	268
	79	114	196	289
	79	114	205	297
	88	128	241	350
	93	135	241	350
	101	147	247	358
	102	148	259	375
	110	159	281	408
	122	177	326	474
Avg. UTS (kN/cm ²)(ksi)	88	128	234	339
Std. Dev. (kN/cm ²)(ksi)	27	33	59	72
Coeff. of Var. (%)	25		21	

Table VXIII-A

Individual Tensile Tests of Monofilament Produced in an R.F. Reactor
Substrate - Great Lakes Carbon Co. Lot #1190, Package #1 in As Received Condition

Gage Length = 2.54 cm

Run No.	78	75	74	77	73	76
Deposition Temp. (°C)	1160	1170	1170	1180	1180	1200
Substrate Velocity (cm/sec)	0.296	0.424	0.508	0.424	0.508	0.508
Diameter (μ)	84.0-89.0	71.0	54.5-63.5	63.5-70.0	70.0	75.0
UTS (kN/cm ²)	135 165 171 173 197 205 216 226 228 240	157 179 215 224 229 237 237 302 311 353	142 167 172 185 208 209 214 221 232 232	168 192 203 210 220 232 247 263 267 289	139 180 209 209 255 255 261 273 278 354	89 91 94 121 126 133 146 149 151 156
Avg. UTS (kN/cm ²)	196	244	198	229	241	125
Std. Dev. (kN/cm ²)	40	73	36	45	72	32
Coeff. of Var. (%)	17	25	15	16	25	21

Table XVIII-B

Individual Tensile Tests of Monofilament Produced in an R.F. Reactor
 Substrate - Great Lakes Carbon Co. Lot #1190, Package #1 in As Received Condition

Gage Length = 1 inch

Run No.	78	75	74	77	73	76
Deposition Temp. (°C)	1160	1170	1170	1180	1180	1200
Substrate Velocity (ft/hr)	35	50	60	50	60	60
Diameter (mils)	3.3-3.5	2.8	2.15-2.5	2.5-2.75	2.75	2.95
UTS (ksi)	196 240 248 251 286 298 314 327 331 348	227 260 312 325 333 344 344 438 451 513	207 242 250 268 302 303 311 321 336 337	244 279 295 305 320 337 359 382 388 420	202 261 303 303 370 370 379 396 404 513	129 132 136 176 183 193 212 217 220 227
Avg. UTS (ksi)	284	355	288	333	350	182
Std. Dev. (ksi)	47	88	44	55	87	38
Coeff. of Var. (%)	17	25	15	16	25	21

Table XIX-A

Individual Tensile Tests of Monofilament Produced in an R.F. Reactor
 Substrate - Great Lakes Carbon Co. Lot #1190, Package #1 Cleaned in Chlorine at 1700°C

Gage Length = 2.54 cm

Run No.	81	83	80	79	82	84
Deposition Temp. (°C)	1150	1150	1180	1180	1200	1200
Substrate Velocity (cm/sec)	0.296	0.424	0.296	0.424	0.296	0.424
Diameter (μ)	78.7-105.5	70.0-75.0	91.5-101.5	71.0-101.5	81.5-90.2	72.4-81.5
UTS (kN/cm ²)	78 91 173 189 199 206 230 239 243 278	185 200 204 218 227 233 238 238 248 267	173 176 201 232 233 247 257 257 304 325	80 90 159 160 175 219 219 219 233 244	235 248 262 270 275 277 282 284 285 345	102 130 136 146 158 158 162 171 183 187
Avg. UTS (kN/cm ²)	192	226	240	180	276	153
Std. Dev. (kN/cm ²)	78	30	60	70	35	31
Coeff. of Var. (%)	34	11	21	32	11	17

Table XIX-B

Individual Tensile Tests of Monofilament Produced in an R.F. Reactor
 Substrate - Great Lakes Carbon Co. Lot #1190, Package #1 Cleaned in Chlorine at 1700°C

Cage Length = 1 inch

Run No.	81	83	80	79	82	84
Deposition Temp. (°C)	1150	1150	1180	1180	1200	1200
Substrate Velocity (ft/hr)	35	50	35	50	35	50
Diameter (mils)	3.1-4.55	2.85-2.95	3.6-4.0	2.8-4.0	3.4-3.55	2.85-3.4
UTS (ksi)	113 132 252 267 289 300 334 347 353 404	268 290 296 317 329 339 345 345 361 388	251 255 291 336 338 359 373 373 442 476	116 130 230 232 253 318 318 318 338 354	341 360 380 392 399 402 410 413 413 501	149 188 198 212 209 229 235 248 266 272
Avg. UTS (ksi)	279	328	349	261	401	222
Std. Dev. (ksi)	94	36	72	83	42	37
Coeff. of Var. (%)	34	11	21	32	11	17

Table XX-A

Individual Tensile Tests of Monofilament Produced in an R.F. Reactor
 Substrate - Great Lakes Carbon Co. Lot #1190, Package #1 Cleaned in Chlorine @ 1700°C

Gage Length = 2.54 cm

Run No.	85	86
Deposition Temp. (°C)	1150	1180
Substrate Velocity (cm/sec)	0.424	0.424
Diameter (μ)	73.6-77.5	89
UTS (kN/cm ²)	109 144 168 172 180 181 182 183 187 197	136 138 148 150 154 158 161 170 172 175
Avg. UTS (kN/cm ²)	170	156
Std. Dev. (kN/cm ²)	31	17
Coeff. of Var. (%)	15	9

Table XX-B

Individual Tensile Tests of Monofilament Produced in an R.F. Reactor
 Substrate - Great Lakes Carbon Co. Lot #1190, Package #1 Cleaned in Chlorine @ 1700°C

Gage Length = 1 inch

Run No.	85	86
Deposition Temp. (°C)	1150	1180
Substrate Velocity (ft/hr)	50	50
Diameter (mils)	2.9-3.05	3.5
UTS (ksi)	158	198
	209	200
	243	214
	250	218
	262	223
	263	229
	265	234
	266	247
	271	249
	286	255
Avg. UTS (ksi)	247	227
Std. Dev. (ksi)	37	20
Coeff. of Var. (%)	15	9

Table XXI-A

Individual Tensile Tests of Monofilament
 Produced in an R.F. Reactor
 Substrate - Great Lakes Carbon Co. Lot #1190, Package #2
 As Received Condition
 Gas Ratio $\text{CH}_4:\text{H}_2 = 1.0:1.2$
 Total Gas Flow = 1700 cc/min
 Gage Length = 2.54 cm

Run Nos.	NC 97
Deposition Temp. ($^{\circ}\text{C}$)	1200
Substrate Vel. (cm/sec)	0.296
Diameter (μ)	68.5-71.0
UTS (KN/cm^2)	123 142 145 156 185 192 201 219 235 237
Avg. UTS (KN/cm^2)	184
Std. Dev. (KN/cm^2)	49
Coeff. of Var. (%)	22.1

Table XXI-B

Individual Tensile Tests of Monofilament
 Produced in an R.F. Reactor
 Substrate - Great Lakes Carbon Co. Lot #1190, Package #2
 As Received Condition
 Gas Ratio $\text{CH}_4:\text{H}_2 = 1.0:1.2$
 Total Gas Flow = 1700 cc/min
 Gage Length = 1 inch

Run Nos.	NC 97
Deposition Temp. ($^{\circ}\text{C}$)	1200
Substrate Vel. (ft/min)	35
Diameter (mils)	2.7-2.8
UTS (ksi)	178 206 211 227 268 279 292 318 341 344
Avg. UTS (ksi)	267
Std. Dev. (ksi)	59
Coeff. of Var. (%)	22

Table XXII-A

Individual Tensile Tests of Monofilament
 Produced in an R.F. Reactor
 Substrate - Great Lakes Carbon Co. Lot #1190, Package #2
 Cleaned in Chlorine at 1700°C
 Gas Ratio CH₄:H₂ = 1.0:1.2
 Total Gas Flow = 1700 cc/min
 Gage Length = 2.54 cm.

Run Nos.	NC 98	NC 99	NC 100	NC 104	NC 105	NC 112*
Deposition Temp. (°C)	1150	1180	1200	1200	1200	1190
Substrate Vel. (cm/sec)	0.296	0.296	0.296	0.296	0.296	0.296
Diameter (μ)	62.5	71.0	76.3-81.5	71.0-81.5	71.0-83.8	81.3-95.5
UTS (KN/cm ²)	183	166	172	187	138	121
	186	183	244	209	183	127
	227	224	244	216	187	164
	241	226	246	225	201	180
	249	249	250	229	203	189
	260	249	256	231	233	205
	293	259	286	237	254	220
	304	280	292	311	254	231
	315	304	314	338	257	234
	326	311	321	405	259	236
	Avg. UTS (KN/cm ²)	258	245	262	259	217
Std. Dev. (KN/cm ²)	61	57	52	84	49	51
Coeff. of Var. (%)	20	19	17	27	19	22

*Substrate - Great Lakes Carbon Lot #1117, Package #4 Cleaned in Chlorine at 1700°C

Table XXII-B

Individual Tensile Tests of Monofilament
 Produced in an R.F. Reactor
 Substrate - Great Lakes Carbon Co. Lot #1190, Package #2
 Cleaned in Chlorine at 1700°C
 Gas Ratio CH₄:H₂ = 1.0:1.2
 Total Gas Flow = 1700 cc/min
 Gage Length = 1 inch

Run Nos.	NC 98	NC 99	NC 100	NC 104	NC 105	NC 112*
Deposition Temp. (°C)	1150	1180	1200	1200	1200	1200
Substrate Vel. (ft/min)	35	35	35	35	35	35
Diameter (mils)	2.45	2.8	3.0-3.2	2.8-3.4	2.8-3.3	3.2-3.8
UTS (ksi)	265	240	249	271	201	175
	270	266	354	303	265	185
	329	325	354	313	271	238
	350	328	357	327	292	261
	361	362	362	333	295	275
	378	362	371	336	338	297
	425	377	415	344	368	319
	442	406	424	452	368	335
	457	442	456	490	374	340
	473	451	466	589	376	342
Avg. UTS (ksi)	375	356	381	376	315	277
Std. Dev. (ksi)	74	69	63	100	59	62
Coeff. of Var. (%)	20	19	17	29	19	22

*Substrate - Great Lakes Carbon Lot #1117, Package #4 Cleaned in Chlorine at 1700°C

Table XXIII-A

Individual Tensile Tests of Monofilament
 Produced in an R.F. Reactor
 Substrate - Great Lakes Carbon Co. Lot #1190, Package #2
 Cleaned in Chlorine at 1700°C
 Gas Ratio $\text{CH}_4:\text{H}_2 = 2.34:1.0$
 Total Gas Flow = 1200 cc/min
 Gage Length = 2.54 cm.

Run Nos.	NC 101	NC 103	NC 102	NC 111 *
Deposition Temp. (°C)	1150	1180	1200	1190
Substrate Vel. (cm/sec)	0.296	0.296	0.296	0.296
Diameter (μ)	62.5-76.3	81.3-83.8	87.6-91.5	77.4-112
UTS (KN/cm ²)	171	153	199	102
	179	226	245	145
	200	239	247	154
	207	262	254	155
	226	264	256	156
	227	270	263	159
	229	276	270	170
	234	286	272	178
	243	292	274	191
	252	311	281	192
Avg. UTS (KN/cm ²)	217	258	256	160
Std. Dev. (KN/cm ²)	32	53	28	31
Coeff. of Var. (%)	12	17	9	16

*Substrate - Great Lakes Carbon Lot #1117, Package 4 Cleaned in chlorine at 1700°C

Table XXIII-B

Individual Tensile Tests of Monofilament
 Produced in an R.F. Reactor
 Substrate - Great Lakes Carbon Co. Lot #1190, Package #2
 Cleaned in Chlorine at 1700°C
 Gas Ratio CH₄:H₂ = 2.34:1.0
 Total Gas Flow = 1200 cc/min
 Gage Length = 1 inch

Run Nos.	NC 101	NC 103	NC 102	NC 111 *
Deposition Temp. (°C)	1150	1180	1200	1190
Substrate Vel. (ft/min)	35	35	35	35
Diameter (mils)	2.65-3.0	3.2-3.3	3.45-3.6	3.05-4.4
UTS (ksi)	249 260 290 300 328 330 332 339 353 366	222 327 347 381 384 397 400 415 423 451	289 355 359 369 372 382 392 395 397 407	148 211 224 225 226 231 246 258 278 279
Avg. UTS (ksi)	315	374	372	233
Std. Dev. (ksi)	40	64	34	38
Coeff. of Var. (%)	12	17	9	16

*Substrate - Great Laeks Carbon Lot #1117, Package 4 Cleaned in chlorine at 1700°C

Table XXIV-A

Individual Tensile Tests of Monofilament
 Produced in an R.F. Reactor
 Substrate - Great Lakes Carbon Co. Lot #1190, Package #2
 Cleaned in Chlorine at 1700°C
 Gas Ratio CH₄:H₂ = 1.0:1.2
 Total Gas Flow = 1275 cc/min
 Gage Length = 2.54 cm

Run Nos.	NC 106	NC 107
Deposition Temp. (°C)	1180	1200
Substrate Vel. (cm/sec)	0.296	0.296
Diameter (μ)	77.4-80.0	82.8-117.0
UTS (KN/cm ²)	141 151 219 229 239 240 241 247 247 280	9 29 43 80 88 110 129 143 149 145
Avg. UTS (KN/cm ²)	223	93
Std. Dev. (KN/cm ²)	53	63
Coeff. of Var. (%)	20	56

Table XXIV-B

Individual Tensile Tests of Monofilament
 Produced in an R.F. Reactor
 Substrate - Great Lakes Carbon Co. Lot #1190, Package #2
 Cleaned in Chlorine at 1700°C
 Gas Ratio $\text{CH}_4:\text{H}_2 = 1.0:1.2$
 Total Gas Flow = 1275 cc/min
 Gage Length = 1 inch

Run Nos.	NC 106	NC 107
Deposition Temp. (°C)	1180	1200
Substrate Vel. (ft/min)	35	35
Diameter (mils)	3.05-3.15	3.25-4.6
UTS (ksi)	205 219 318 333 346 348 350 359 359 407	13 42 63 116 128 159 187 207 216 219
Avg. UTS (ksi)	324	135
Std. Dev. (ksi)	63	76
Coeff. of Var. (%)	20	56

Table XXV-A

Individual Tensile Tests of Monofilament
 Measured in Air at Room Temperature, in Air at 500°C
 and in Argon at 500°C

Atmosphere	Run No. 97		
	Air	Air	Argon
Test Temperature	RT	500°C	500°C
UTS (KN/cm ²)	123 142 145 156 184 192 201 219 235 237	74 84 101 109 125 126 127 129 137	103 113 113 114 116 116 119 121 126 139
Avg. UTS (KN/cm ²)	184	112	118
Std. Dev. (KN/cm ²)	49	27	12
Coeff. of Var. (%)	22	20	8

Table XXV-B

Individual Tensile Tests of Monofilament
 Measured in Air at Room Temperature, in Air at 500°C
 and in Argon at 500°C

Run No. 97

Atmosphere	Air	Air	Argon
Test Temperature	RT	500°C	500°C
UTS (ksi)	178	107	149
	206	122	163
	211	146	163
	227	158	166
	268	182	168
	279	183	168
	292	185	173
	318	187	176
	341	198	184
	344		202
Avg. UTS (ksi)	267	163	171
Std. Dev. (ksi)	59	32	14
Coeff. of Var. (%)	22	20	8

Table XXVI-A

Individual Tensile Tests of Monofilament
 Measured in Air at Room Temperature, in Air at 500°C
 and in Argon at 500°C

Run No. 99			
Atmosphere	Air	Air	Argon
Test Temperature	RT	500°C	500°C
UTS (KN/cm ²)	166	110	103
	183	110	115
	224	132	140
	226	132	145
	249	136	146
	249	143	150
	259	148	156
	280	148	164
	304	210	185
	311	213	246
Avg. UTS (KN/cm ²)	245	148	155
Std. Dev. (KN/cm ²)	57	44	47
Coeff. of Var. (%)	19	24	25

Table XXVI-B

Individual Tensile Tests of Monofilament
 Measured in Air at Room Temperature, in Air at 500°C
 and in Argon at 500°C

Run No. 99

Atmosphere	Air	Air	Argon
Test Temperature	RT	500°C	500°C
UTS (ksi)	240	159	149
	266	159	167
	325	192	204
	328	192	210
	362	198	212
	362	207	218
	377	214	226
	406	214	238
	442	305	268
	451	310	357
Avg. UTS (ksi)	356	215	225
Std. Dev. (ksi)	69	53	57
Coeff. of Var. (ksi)	19	24	25

Table XXVII-A

Individual Tensile Tests of Monofilament
 Measured in Air at Room Temperature, in Air at 500°C
 and in Argon at 500°C

Run No. 103

Atmosphere	Air	Air	Argon
Test Temperature	RT	500°C	500°C
UTS (KN/cm ²)	153	156	118
	226	162	169
	239	181	193
	262	195	195
	264	199	196
	270	200	198
	276	223	199
	286	226	206
	292	227	213
	311	255	218
Avg. UTS (KN/cm ²)	258	202	191
Std. Dev. (KN/cm ²)	53	37	35
Coeff. of Var. (%)	17	15	15

Table XXVII-B

Individual Tensile Tests of Monofilament
 Measured in Air at Room Temperature, in Air at 500°C
 and in Argon at 500°C

Run No. 103

Atmosphere	Air	Air	Argon
Test Temperature	RT	500°C	500°C
UTS (ksi)	222	226	172
	327	235	245
	347	263	280
	381	283	284
	383	388	284
	392	289	287
	400	323	289
	415	327	298
	423	330	310
	451	371	317
Avg. UTS (ksi)	374	294	277
Std. Dev. (ksi)	64	45	42
Coeff. of Var. (%)	17	15	15

Table XXVIII

Individual Tensile Tests of Monofilament in the As Produced
Condition and Other Leaching from a Monofilament - Al Composite

Monofilament Run No. NC-102

	As Produced		Leached from Composite	
(KN/cm ²) (Ksi)	130	187	222	322
	165	239	222	322
	211	306	226	327
	215	312	238	345
	215	312	238	345
	216	314	240	348
	218	317	241	350
	226	327	261	379
	226	327	271	393
	236	343	271	393
	267	388	272	395
	276	400	274	397
	285	414	278	403
	290	421		
	301	437		
Avg. UTS (KN/cm ²)(Ksi)	232	336	250	363
Std. Dev. (KN/cm ²)(Ksi)	57	68	26	31
Coeff. of Var. (%)		20		9

Table XXIX

Chemical Composition of Monofilament
Produced in an RF Reactor

Run No.	Element	Weight Percent
NC 82	B	78
	C	22
NC 84	B	76
	C	24
NC 86	B	64
	C	36

CHEMICAL VAPOR DEPOSITION DC REACTOR

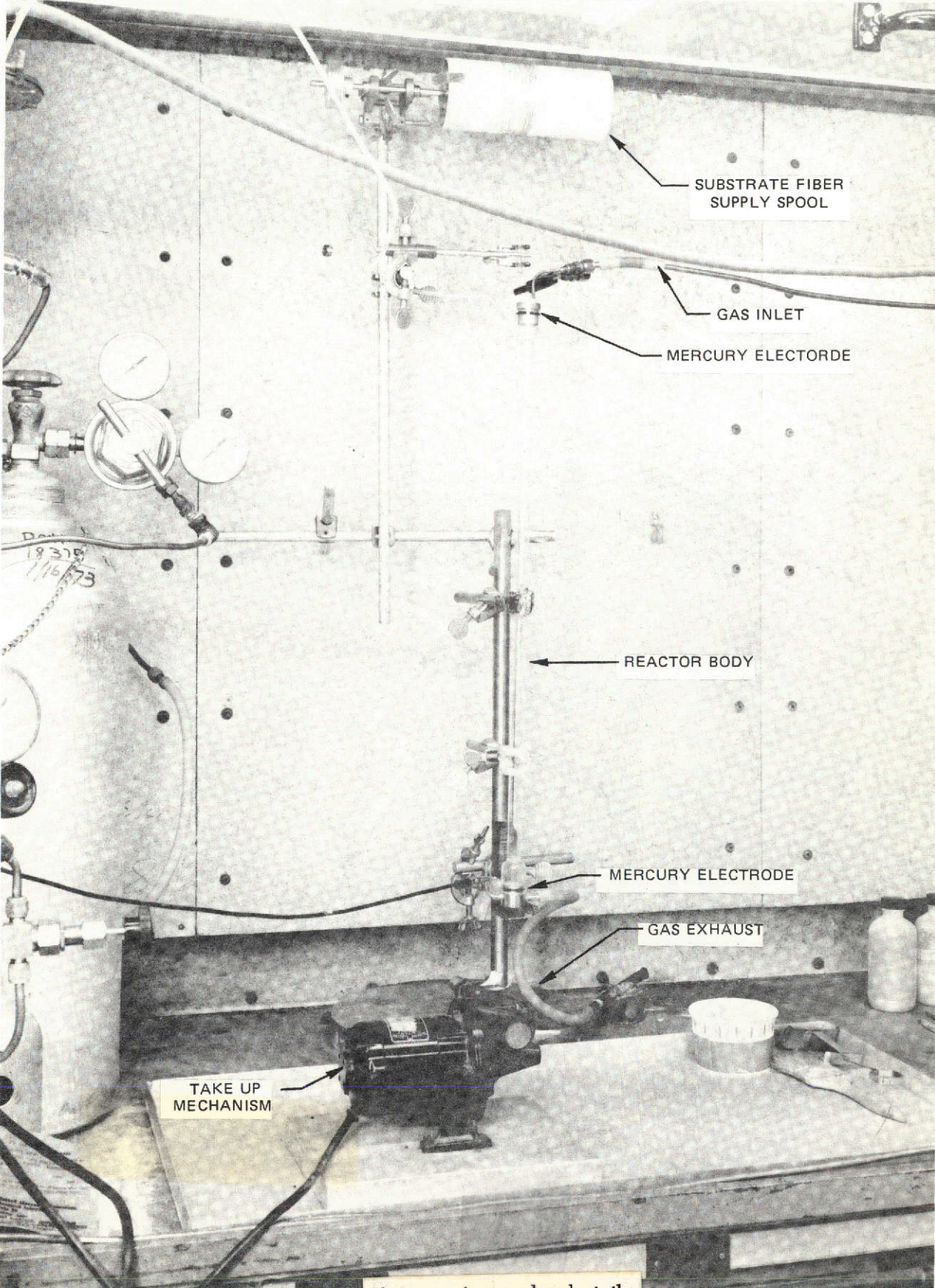

SUBSTRATE FIBER SUPPLY SPOOL

GAS INLET

MERCURY ELECTORDE

REACTOR BODY

MERCURY ELECTRODE

GAS EXHAUST

TAKE UP MECHANISM

This page is reproduced at the back of the report by a different reproduction method to provide better detail.

SCANNING ELECTRON MICROSCOPE PHOTOGRAPH
OF FRACTURE SURFACE OCCURRING WITHIN
A DC REATOR

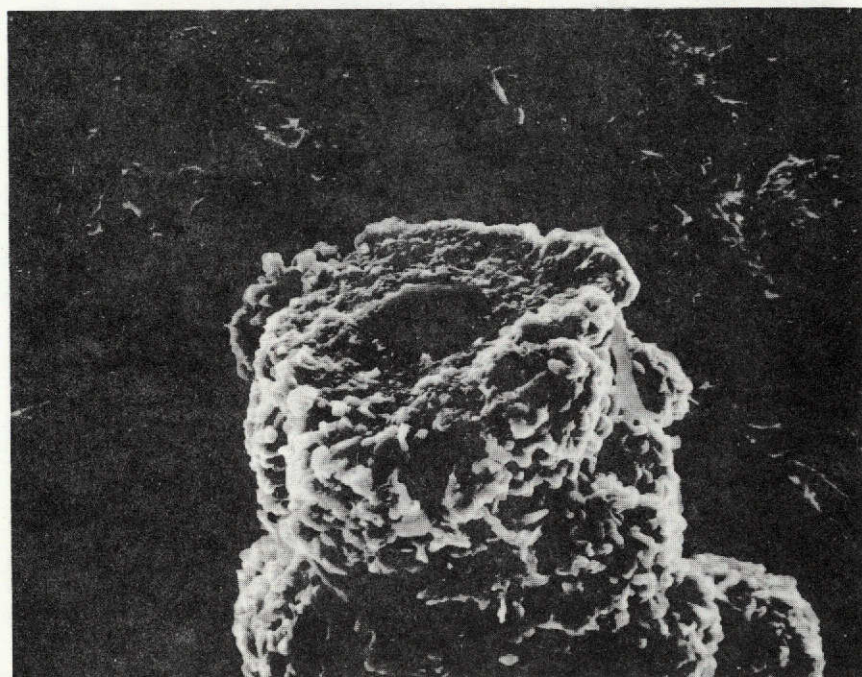

20 μ

This page is reproduced at the
back of the report by a different
reproduction method to provide
better detail.

ELECTRON MICROPROBE ANALYSIS OF A SECTION OF
THE FRACTURE SHOWN IN FIGURE 1

FIG. 3

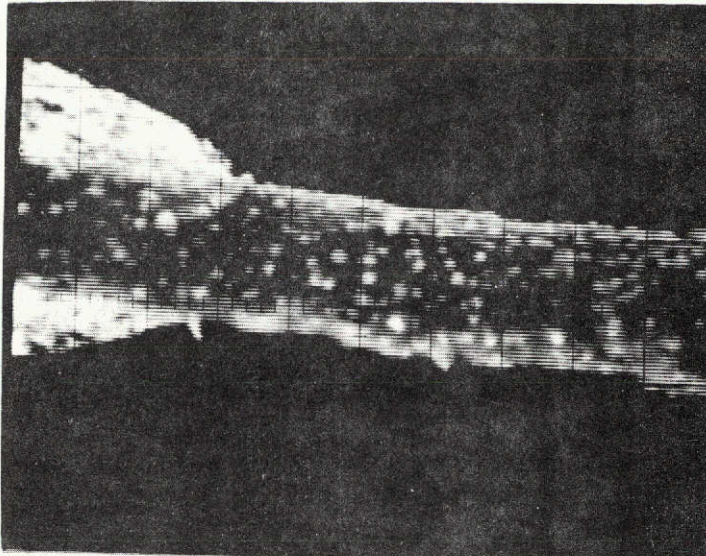

ELECTRON IMAGE

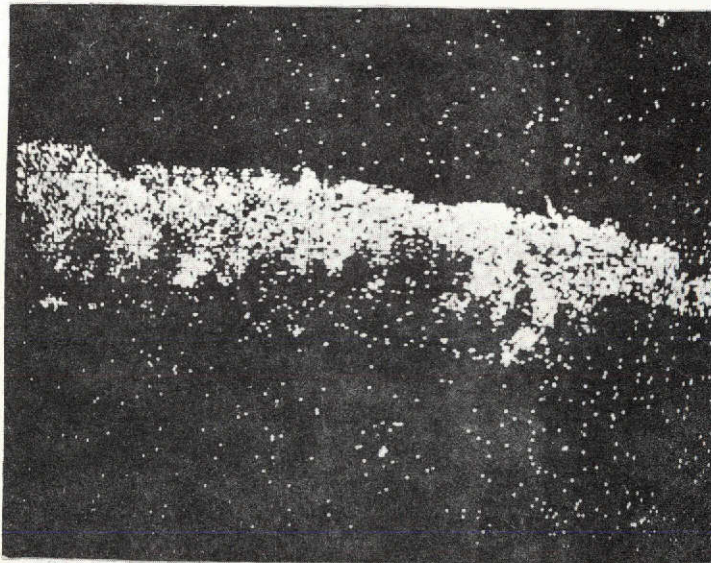

SILICON X-RAYS

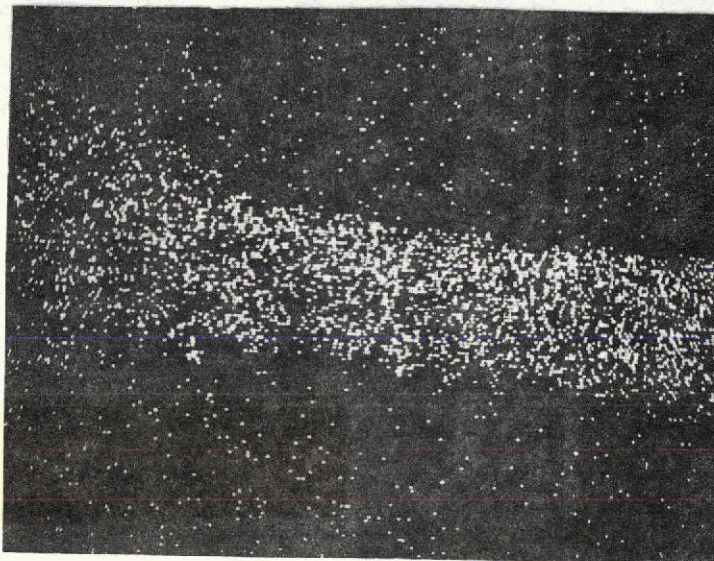

CHLORINE X-RAYS

30 μ

This page is reproduced at the back of the report by a different reproduction method to provide better detail.

SCANNING ELECTRON MICROSCOPE PHOTOGRAPH OF
A SECTION OF GREAT LAKES CARBON LOT NO. 1142
CLEARED IN CHLORINE AT 1800°C AT A
SUBSTRATE VELOCITY OF 0.594 CM/SEC

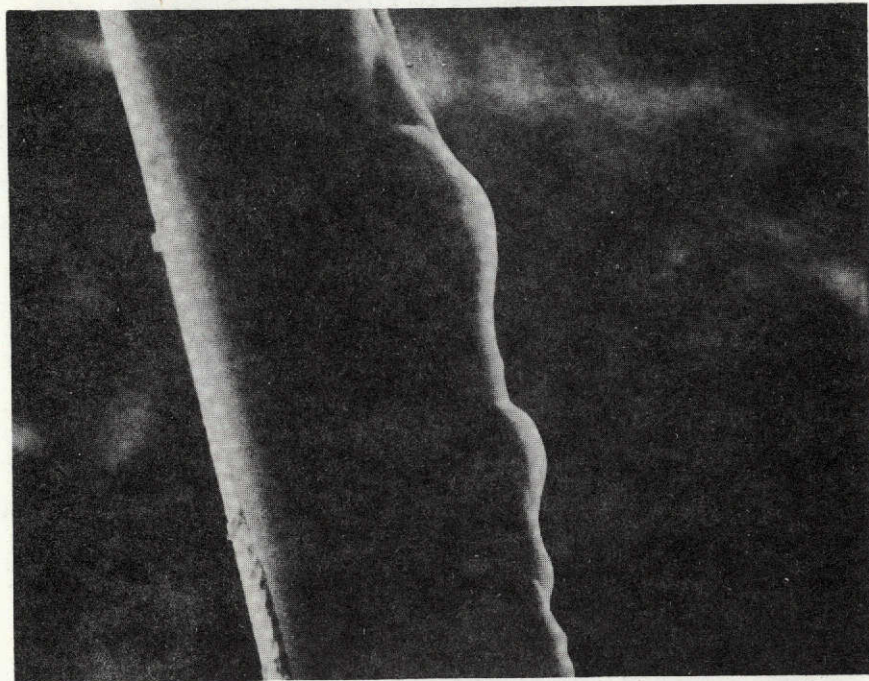

10 μ

This page is reproduced at the
back of the report by a different
reproduction method to provide
better detail.

SCANNING ELECTRON MICROSCOPE PHOTOGRAPH OF
GREAT LAKES CARBON COMPANY CARBON
SUBSTRATE FIBER LOT NO. 1117 PACKAGE
NO. 3 IN THE AS RECEIVED CONDITION

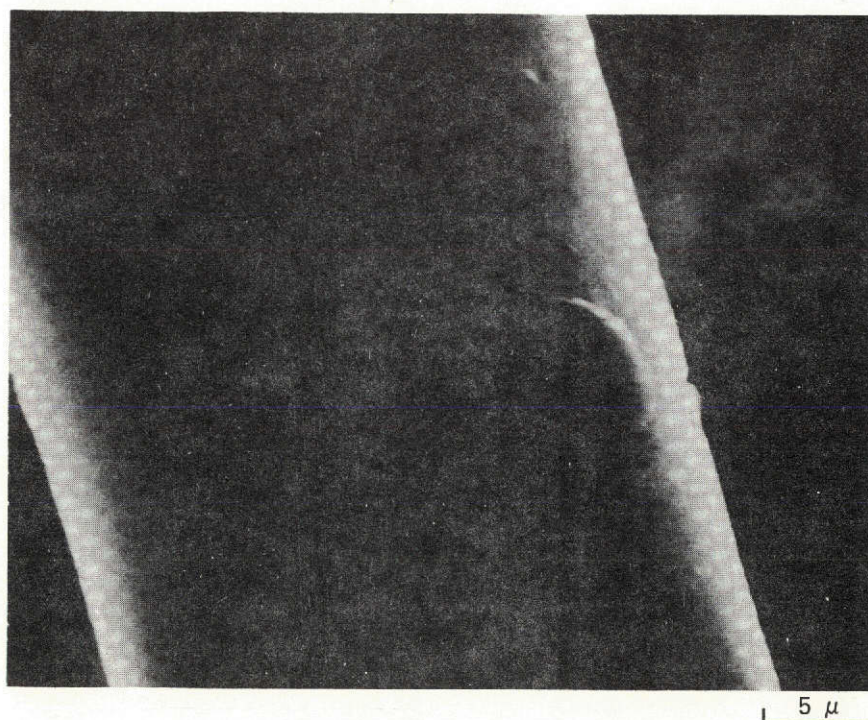

This page is reproduced at the back of the report by a different reproduction method to provide better detail.

AVERAGE DIAMETER VS DEPOSITION TEMPERATURE

- SUBSTRATE - GREAT LAKES CARBON CO. LOT NO. 1142 PACKAGE NO. 1
- SUBSTRATE - GREAT LAKES CARBON CO LOT NO. 1117 PACKAGE NO. 3

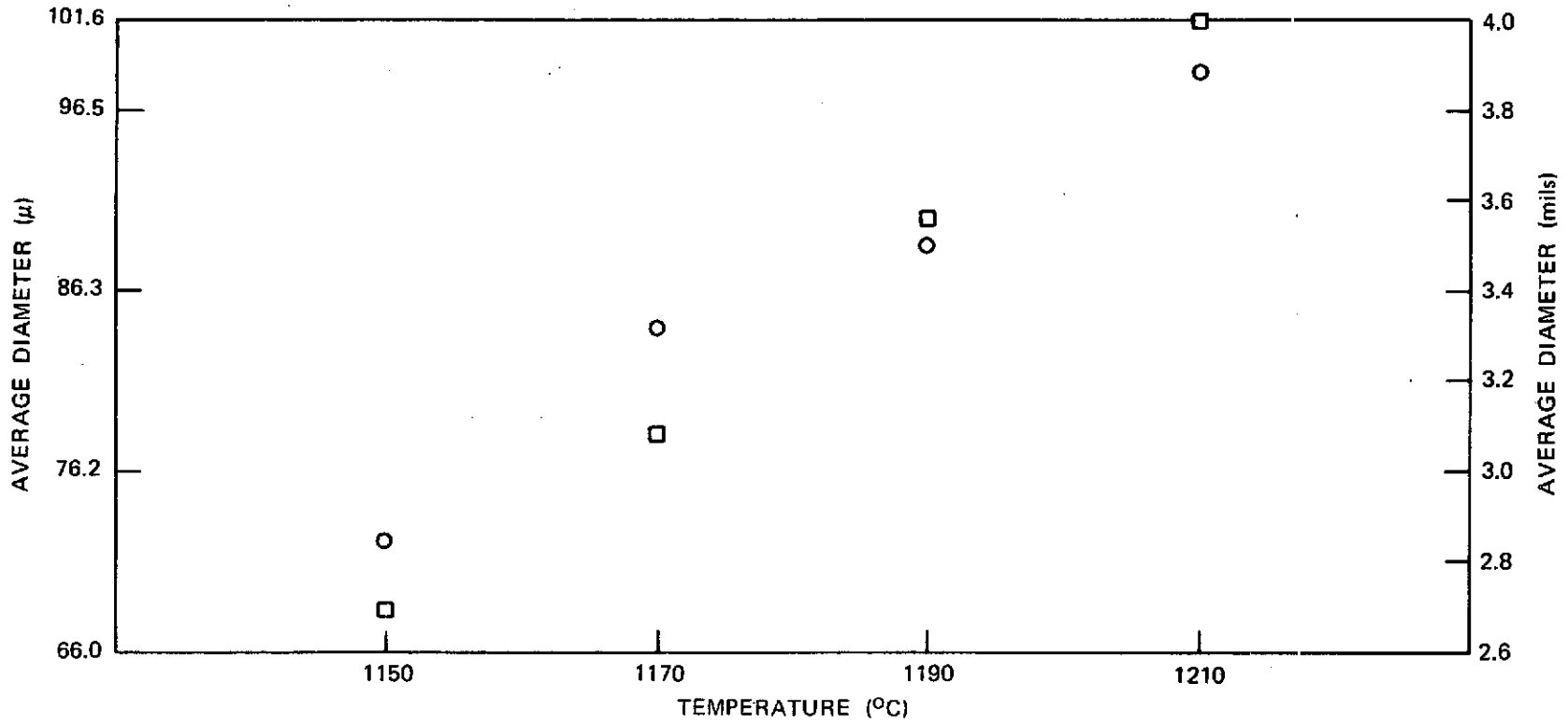
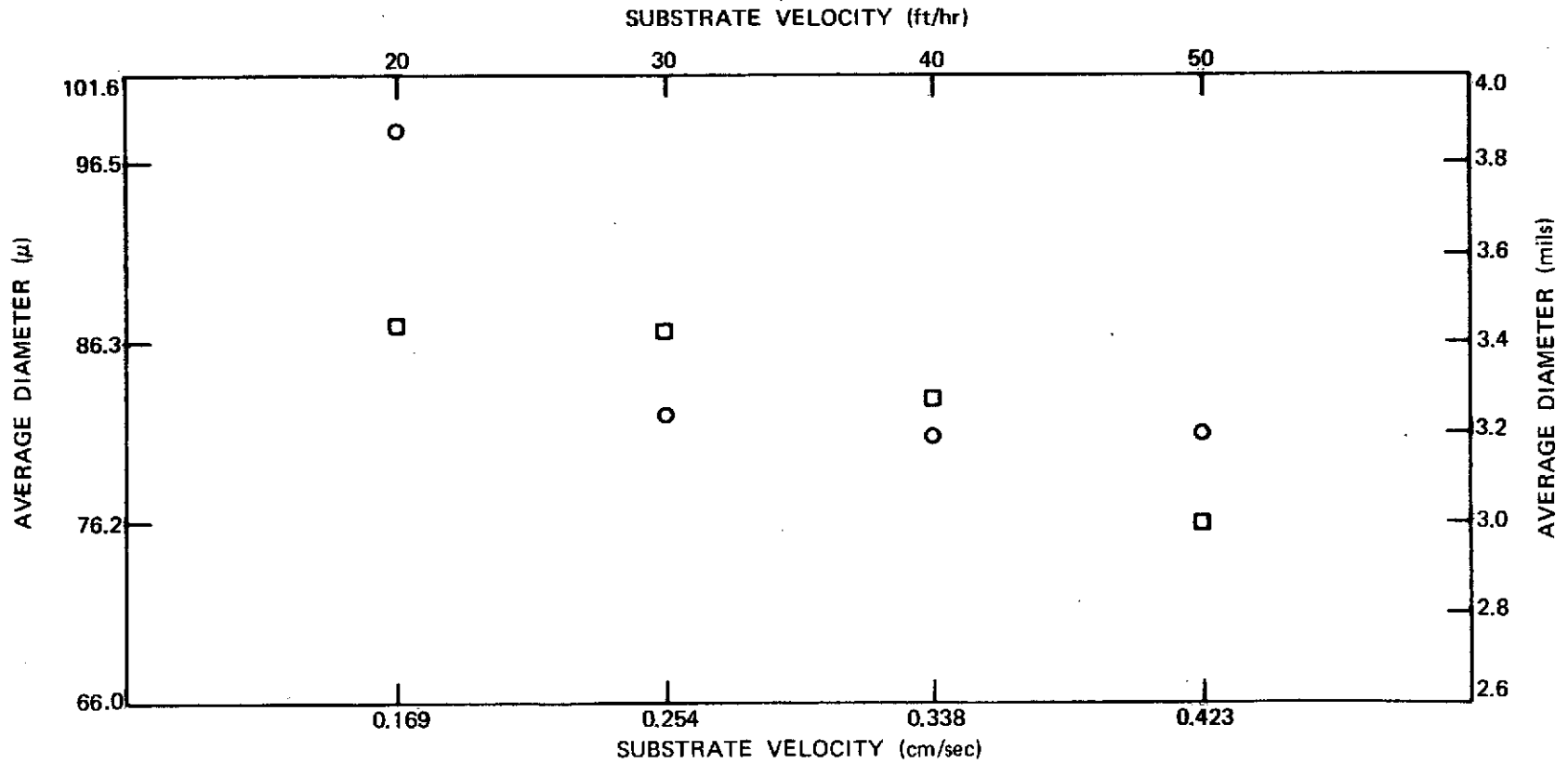

FIG. 6

AVERAGE DIAMETER VS SUBSTRATE VELOCITY

- SUBSTRATE - GREAT LAKES CARBON CO LOT NO 1142 PACKAGE NO. 1
- SUBSTRATE - GREAT LAKES CARBON CO LOT NO. 1117 PACAKGE NO. 3



AVERAGE DIAMETER VS TOTAL GAS FLOW

- SUBSTRATE - GREAT LAKES CARBON CO LOT NO. 1142 PACKAGE NO. 1
- SUBSTRATE - GREAT LAKES CARBON CO LOT NO. 1117 PACKAGE NO. 3

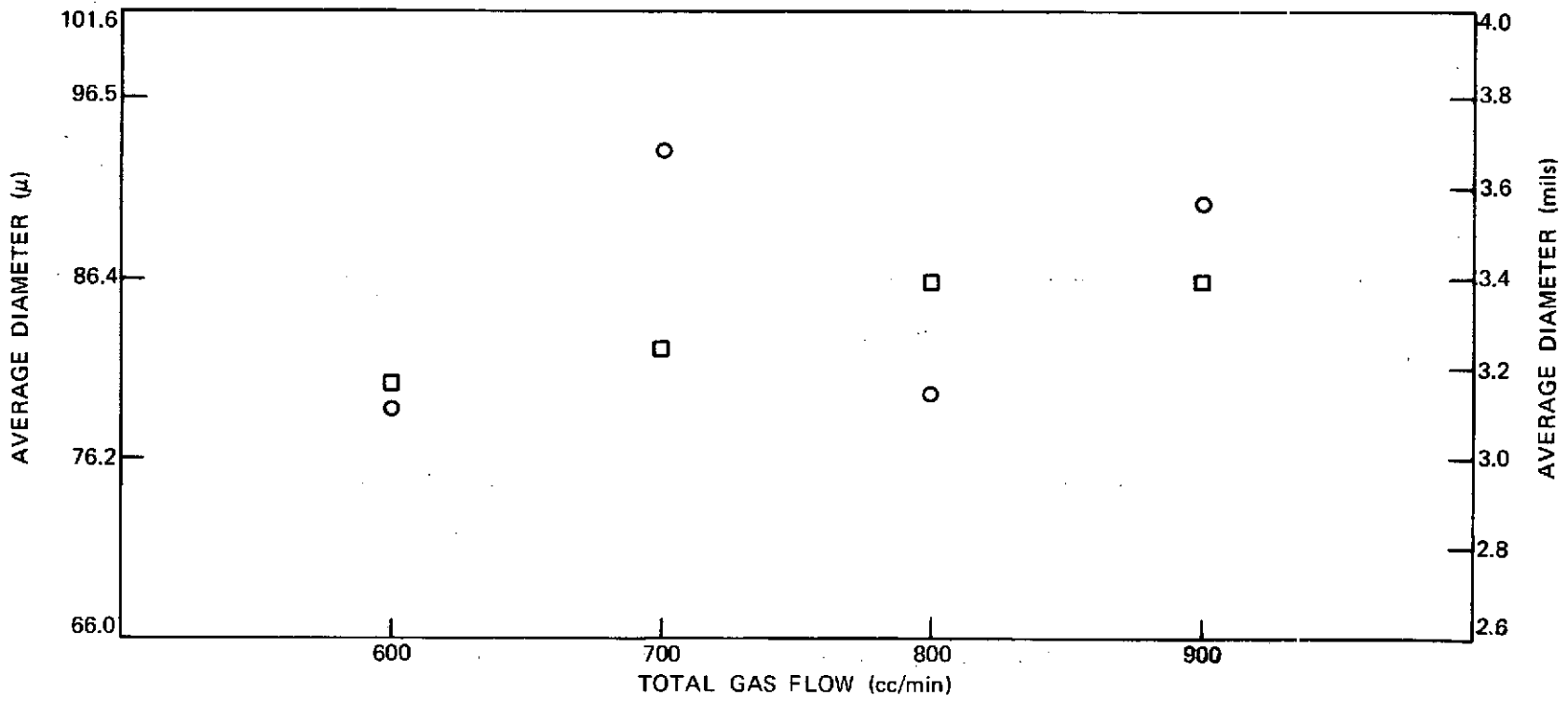
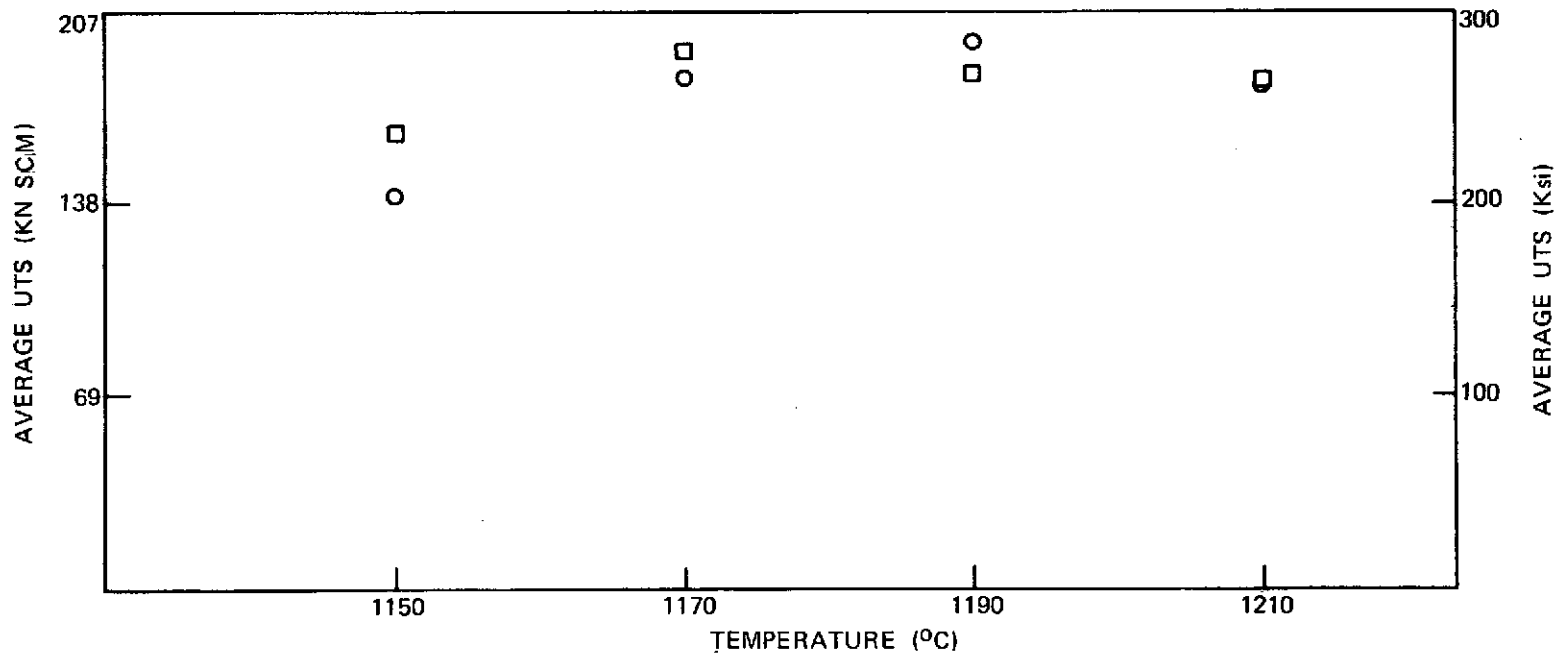

FIG. 8

AVERAGE TENSILE STRENGTH VS DEPOSITION TEMPERATURE

- SUBSTRATE - GREAT LAKES CARBON CO LOT NO. 1142 PACKAGE NO. 1
- SUBSTRATE - GREAT LAKES CARBON CO LOT NO. 1117 PACKAGE NO. 3



AVERAGE TENSILE STRENGTH VS TOTAL GAS FLOW

- SUBSTRATE – GREAT LAKES CARBON CO LOT NO. 1142 PACKAGE NO. 1
- SUBSTRATE – GREAT LAKES CARBON CO. LOT NO. 1117 PACKAGE NO. 3

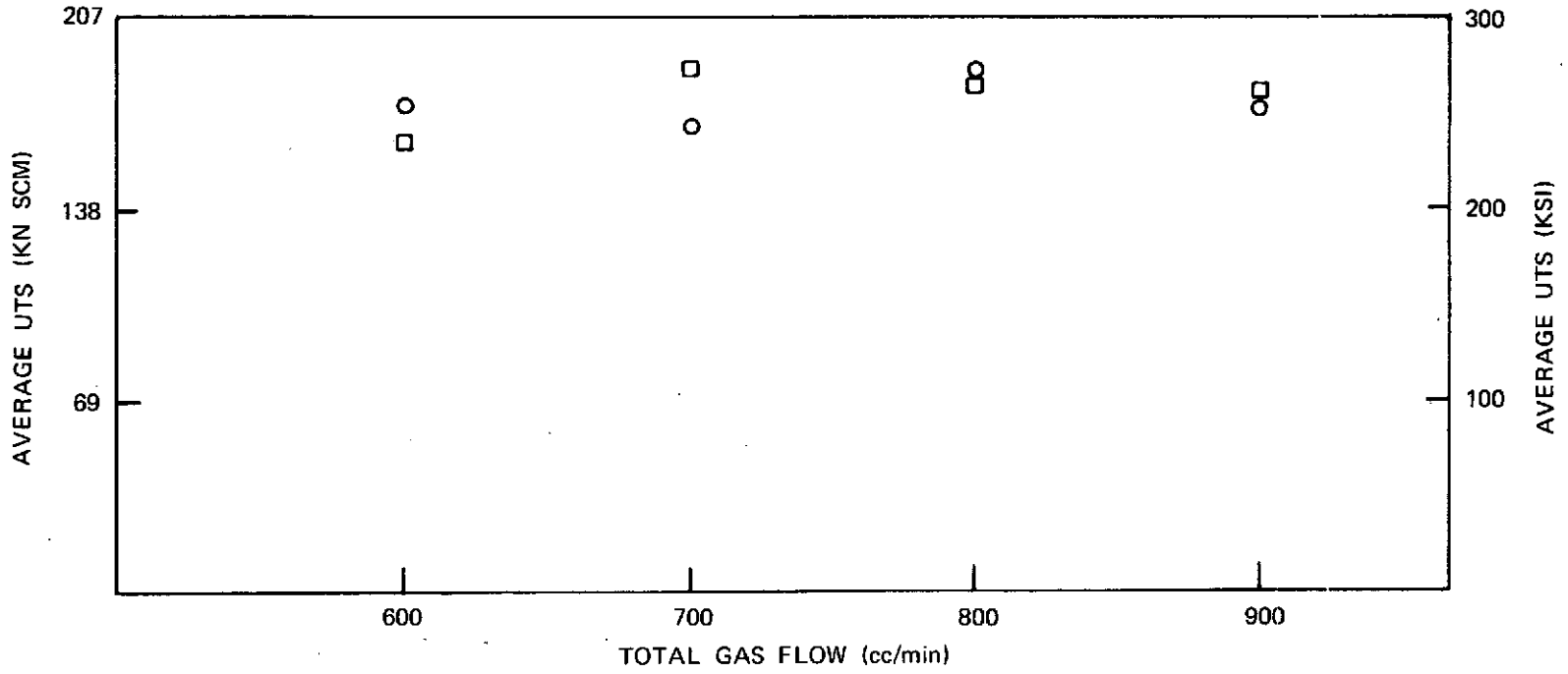

FIG. 10

AVERAGE TENSILE STRENGTH VS SUBSTRATE VELOCITY

- SUBSTRATE – GREAT LAKES CARBON CO LOT NO. 1142 PACKAGE NO. 1
- SUBSTRATE – GREAT LAKES CARBON CO. LOT NO. 1117 PACKAGE NO. 3

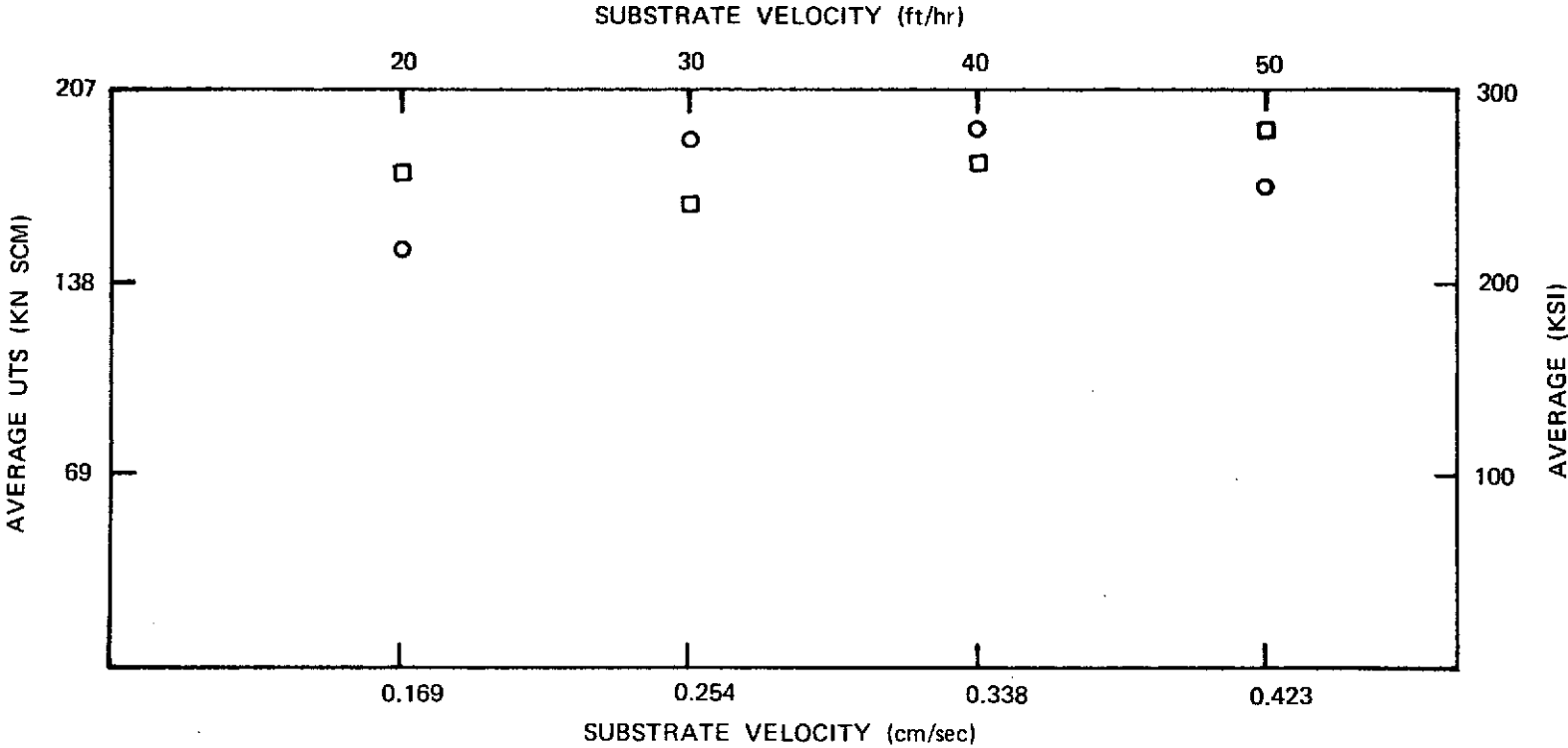
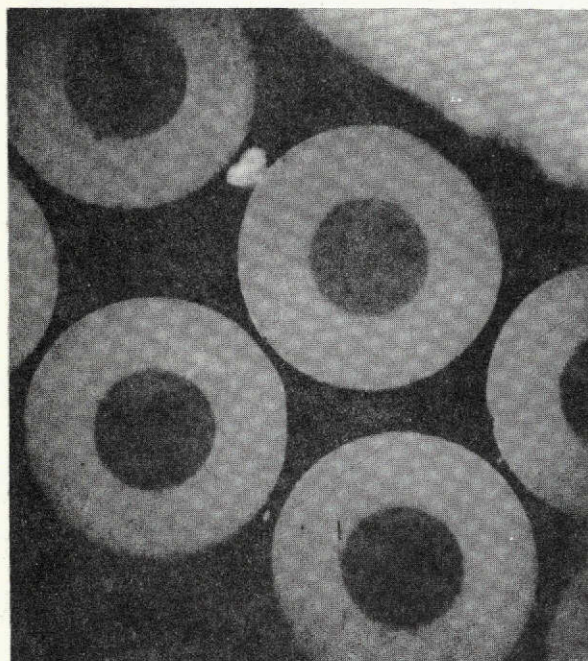

FIG. 11

CROSS SECTION PHOTOMICROGRAPHS OF MONOFILAMENT PRODUCED WITH A TOTAL GAS FLOW OF 600 cc/min



NC-21

1150°C

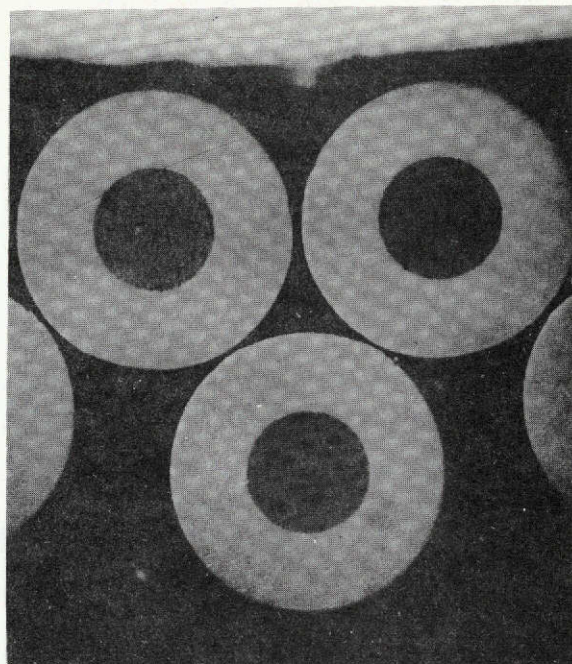

NC-22

1170°C

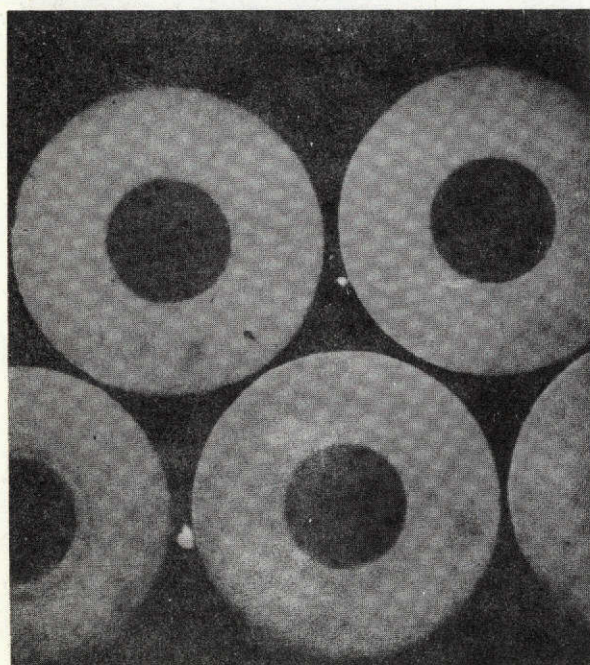

NC-23

1190°C

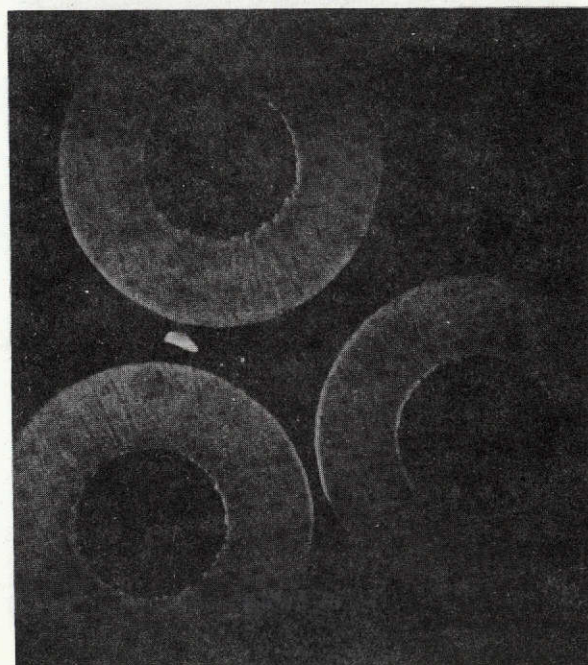

NC-24

1210°C

20 μ

This page is reproduced at the back of the report by a different reproduction method to provide better detail.

CROSS SECTION PHOTOMICROGRAPHS OF MONOFILAMENT PRODUCED WITH A TOTAL GAS FLOW OF 700 cc/min

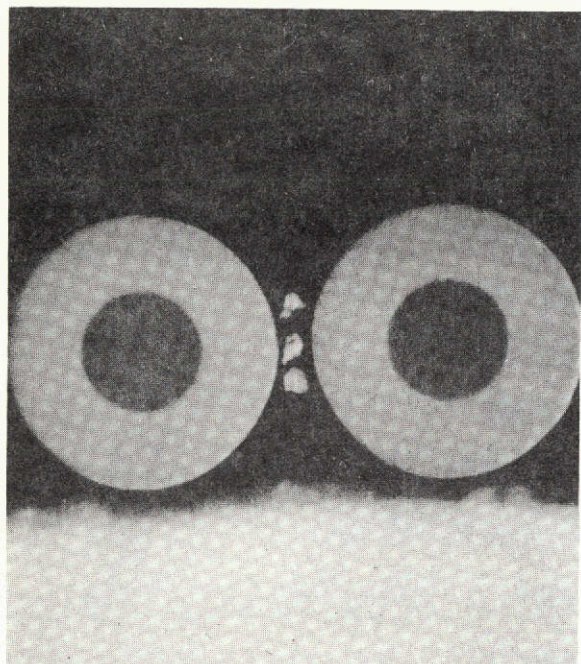

NC-27

1150°C

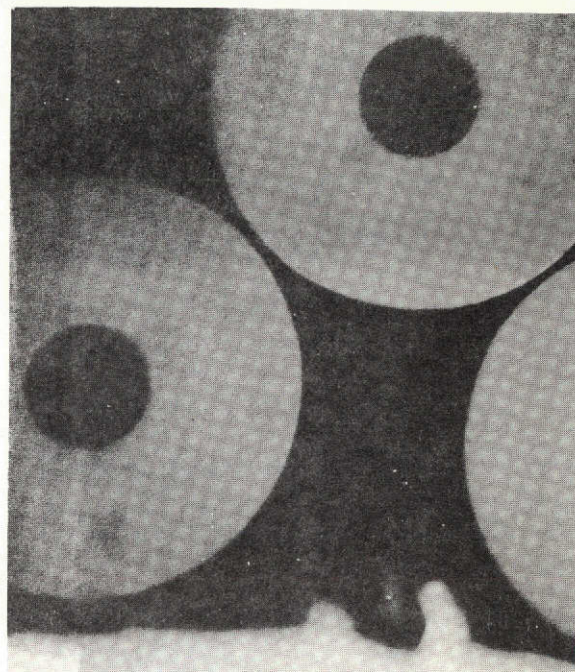

NC-28

1170°C

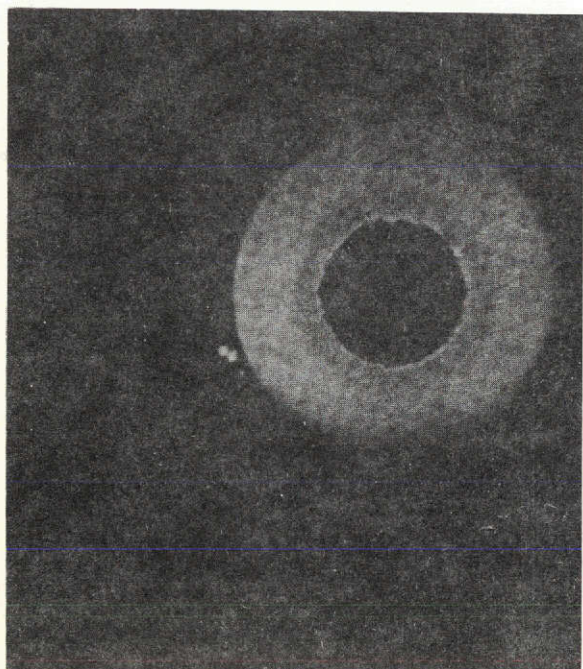

NC-29

1190°C

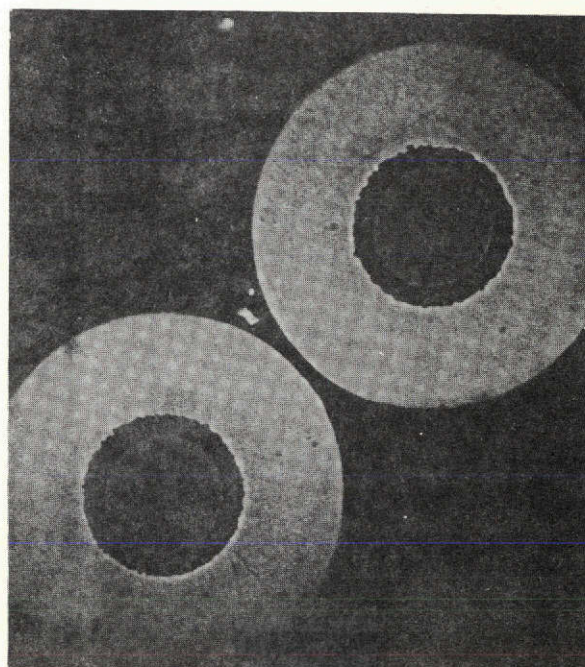

NC-30

1210°C

20 μ

This page is reproduced at the back of the report by a different reproduction method to provide better detail.

CROSS SECTION PHOTOMICROGRAPHS OF MONOFILAMENT PRODUCED WITH A TOTAL GAS FLOW OF 800 cc/min

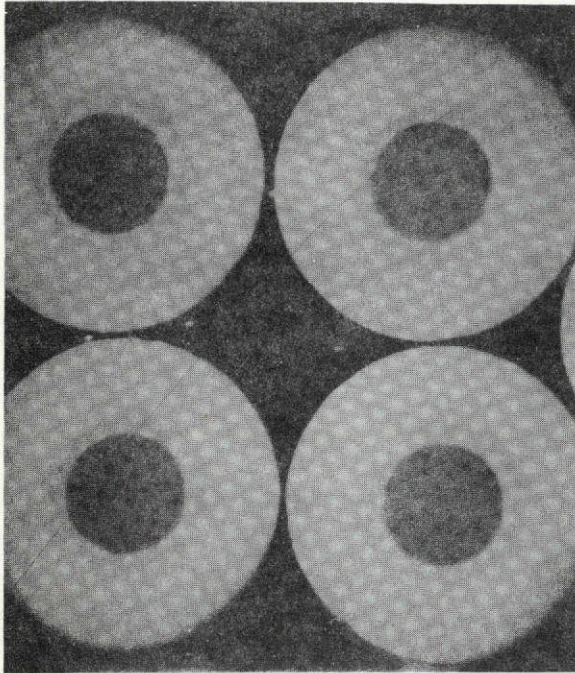

NC-31

1150°C

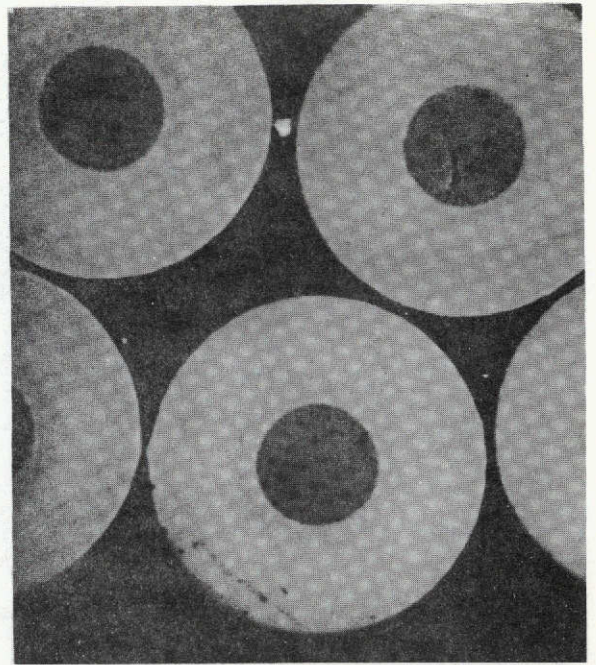

NC-32

1170°C

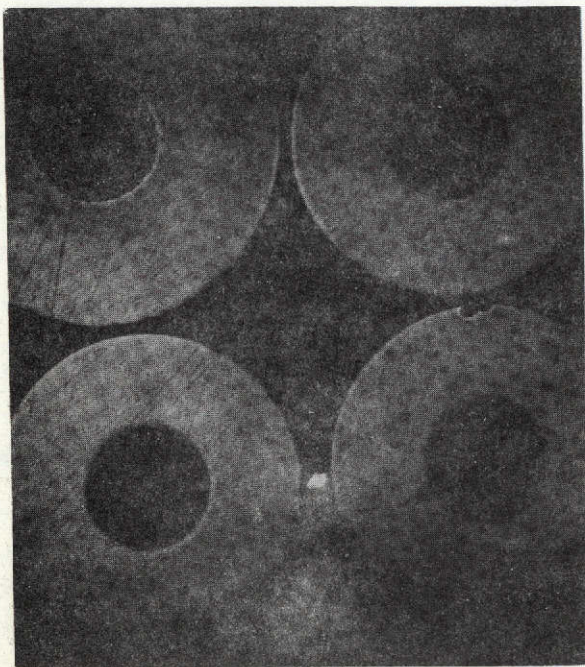

NC-33

1190°C

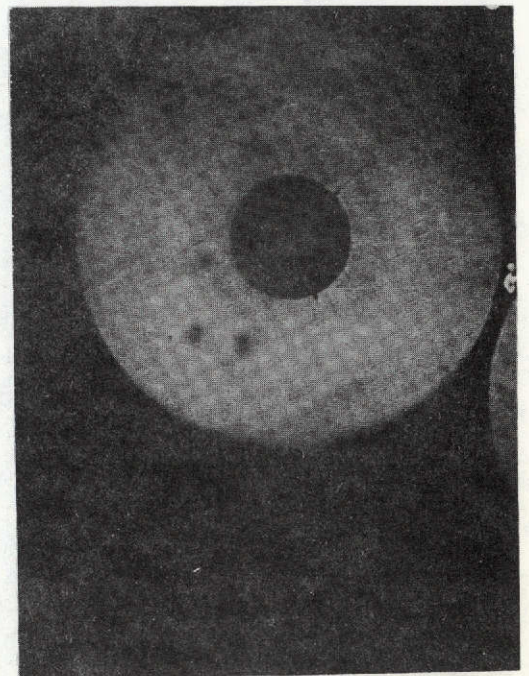

NC-34

1210°C



20 μ

This page is reproduced at the back of the report by a different reproduction method to provide better detail.

CROSS SECTION PHOTOMICROGRAPHS OF MONOFILAMENT PRODUCED WITH A TOTAL GAS FLOW OF 900 cc/min

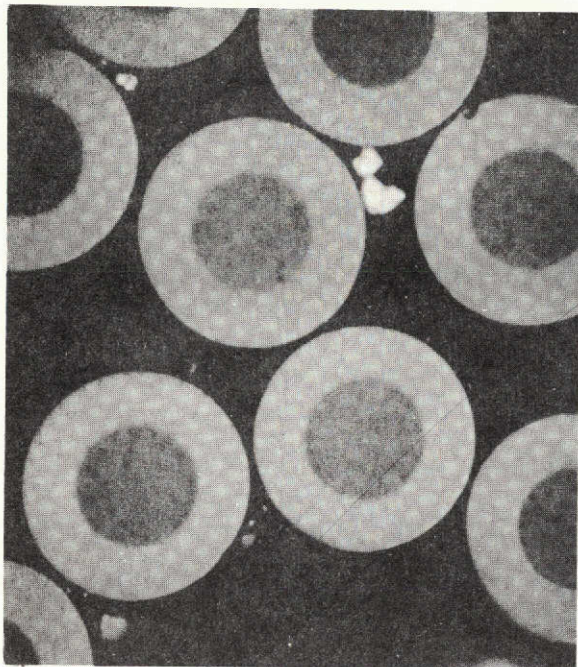

NC-35

1150°C

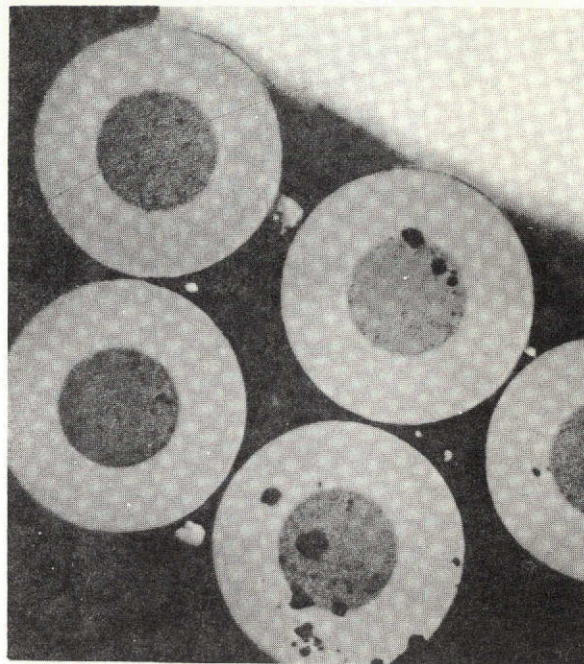

NC-36

1170°C

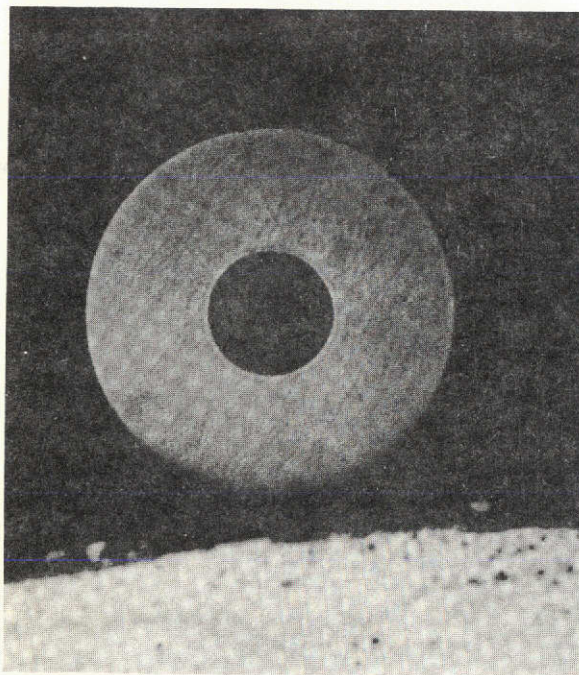

NC-37

1190°C

20 μ

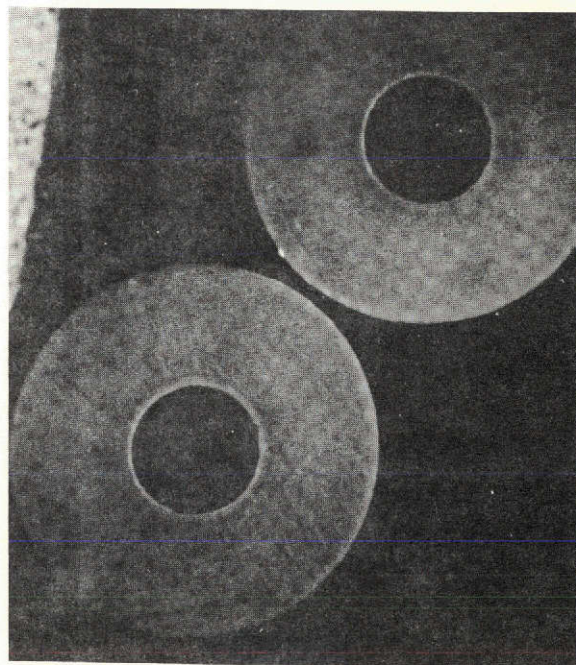

NC-38

1210°C

This page is reproduced at the back of the report by a different reproduction method to provide better detail.

TAPERED REACTOR

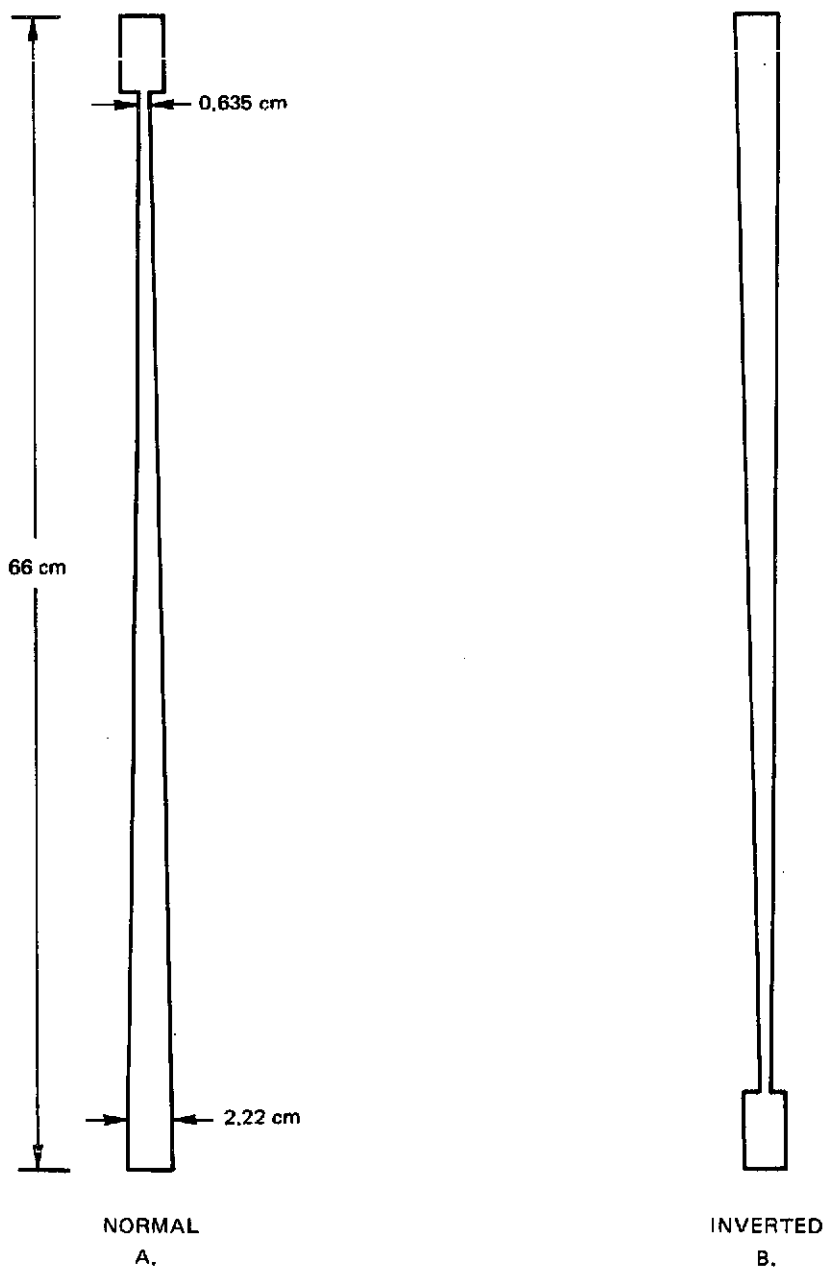

SIDE ENTRY PORT REACTOR

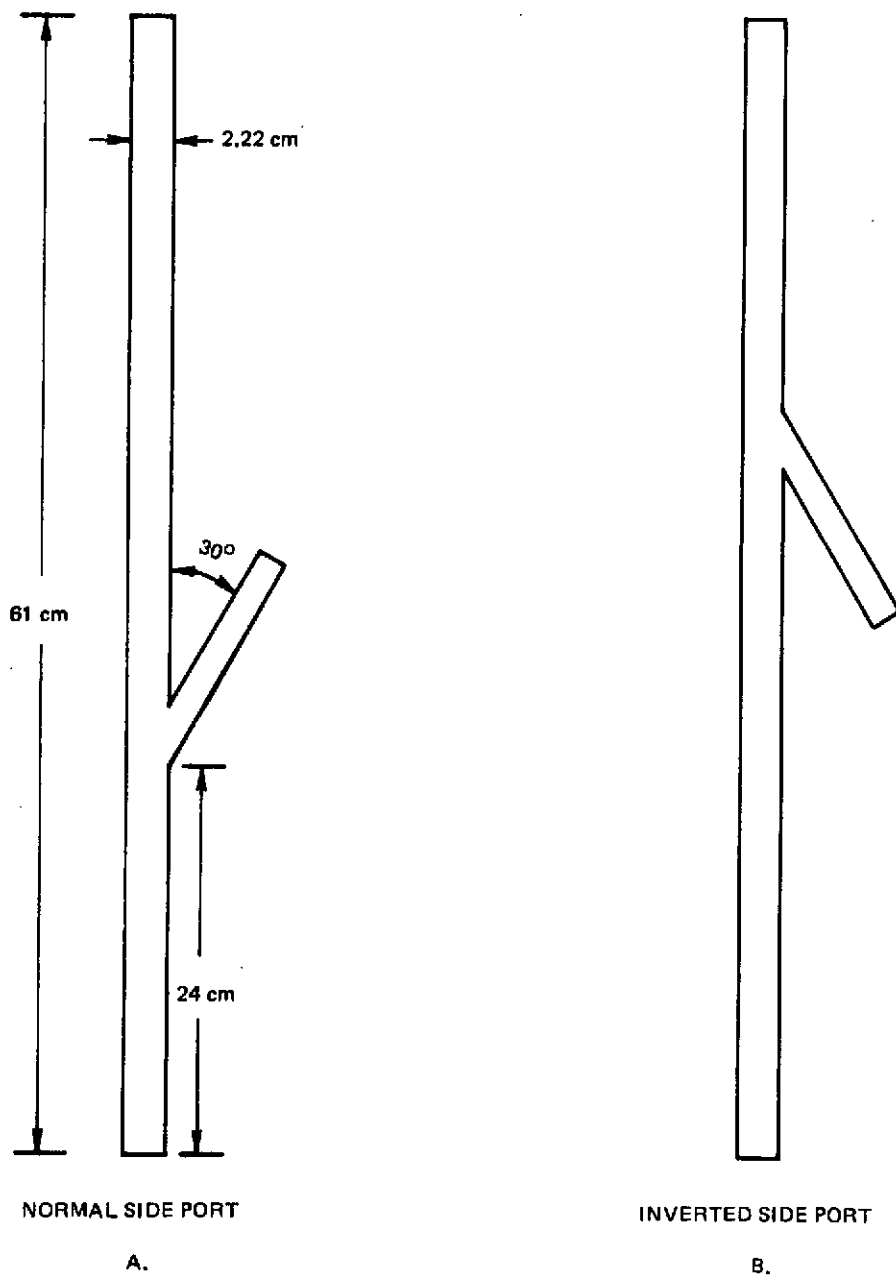

SIDE EXIT PORT REACTOR

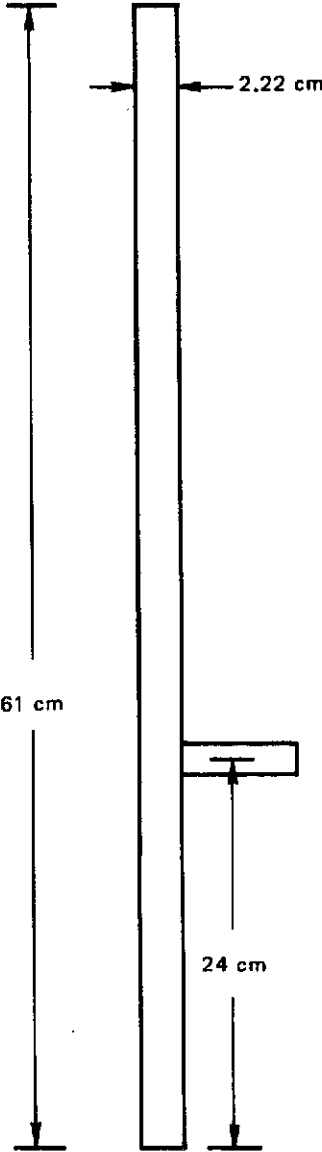

CONTINUOUS RF REACTOR

FIG. 19

OPERATING FREQUENCY - 40.68 MEGAHERTZ

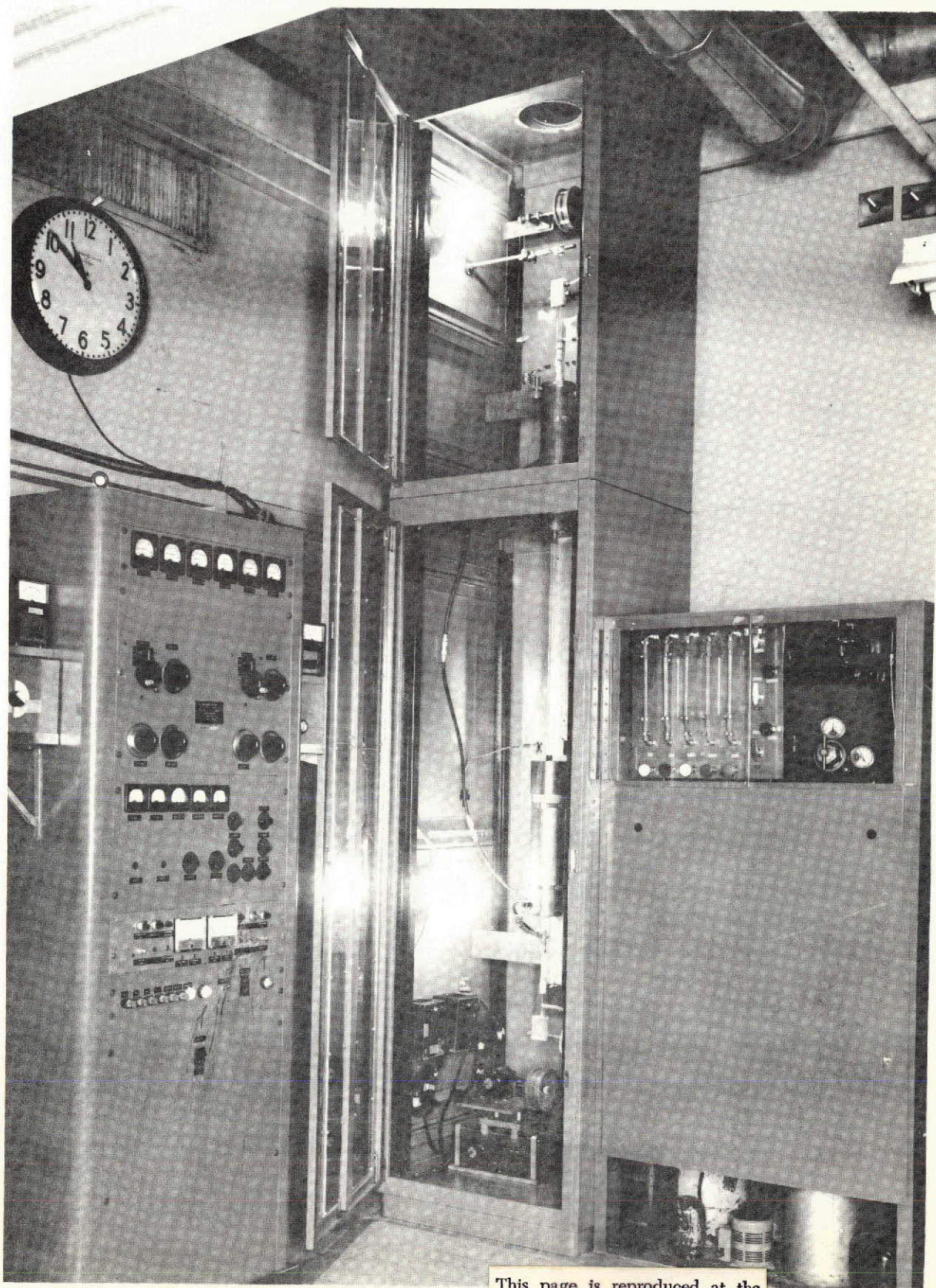

RL-73-234-B

This page is reproduced at the back of the report by a different reproduction method to provide better detail.

RF REACTOR GAS SEAL

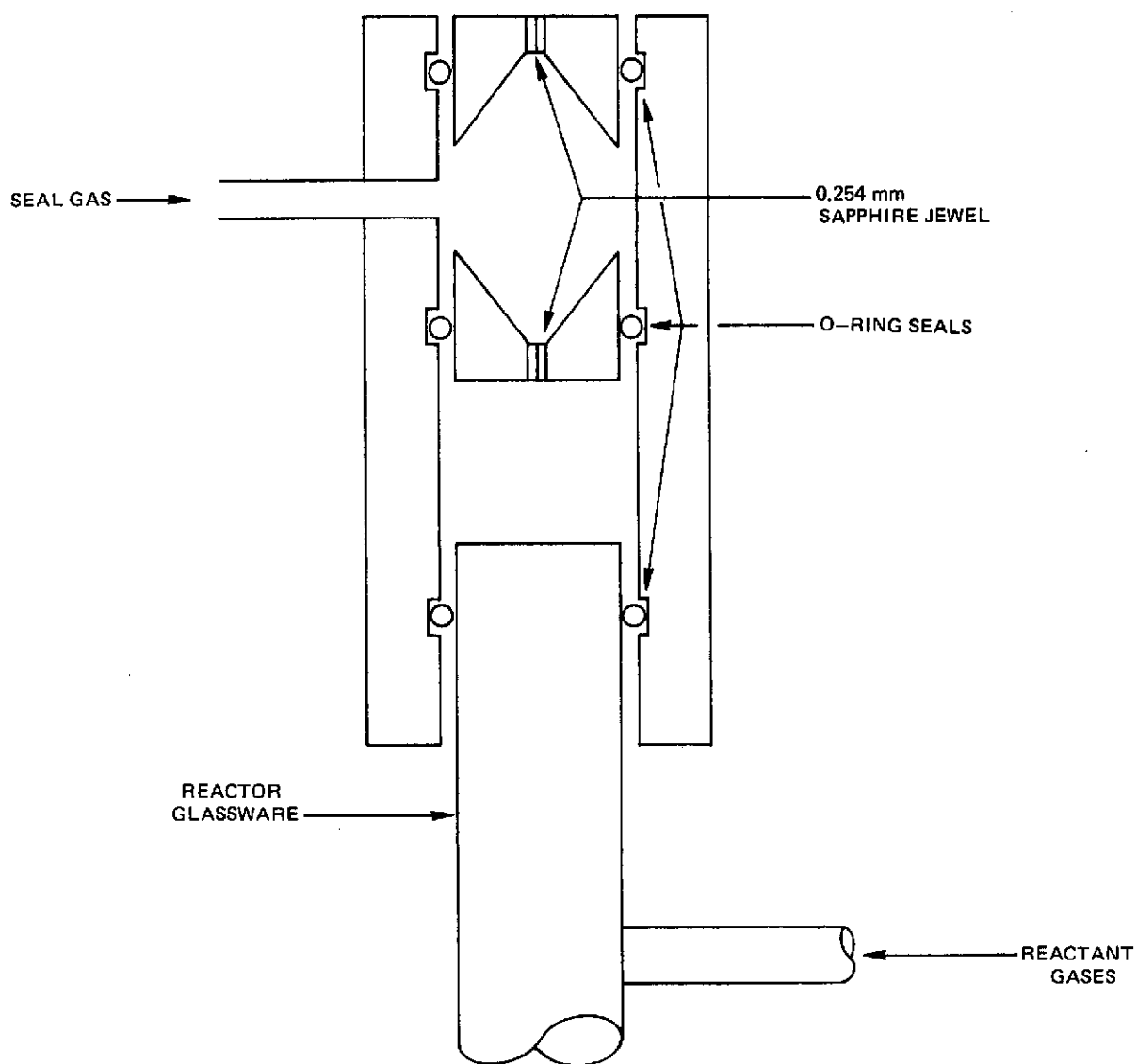

RESULTS OF POINT COUNT ANALYSES OF THREE FIBERS,
A REPRESENTATIVE FIBER BEING SHOWN IN THIS FIGURE

CH_4/BCl_3 RATIO = 5
POWER APPLIED 264 WATTS

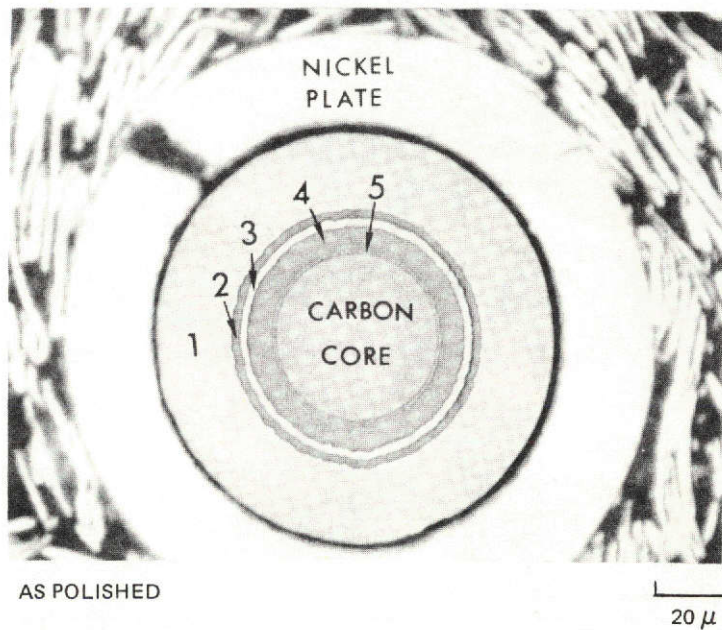

ZONE	CONCENTRATION w/o (a/o)	
	BORON	CARBON
NO. 1 THICK OUTER ZONE	40.0 (42.6)	60.0 (57.4)
NO. 2 DARK THIN ZONE	21.9 (23.7)	78.2 (76.3)
NO. 3 LIGHT THIN ZONE	50.2 (52.8)	49.8 (47.2)
NO. 4 DARK INNER ZONE	29.4 (31.6)	70.7 (68.4)
NO. 5 VERY THIN INNER ZONE	17.4 (19.0)	82.6 (81.0)

This page is reproduced at the back of the report by a different reproduction method to provide better detail.

CROSS SECTION PHOTOMICROGRAPHS OF MONOFILAMENT PRODUCED
IN AN R.F. REACTOR

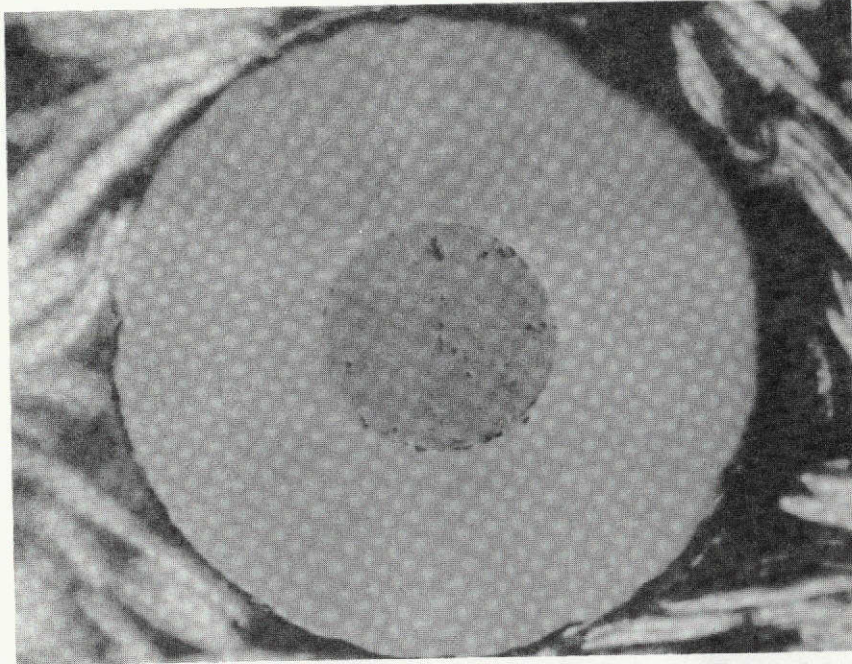

NC 82

10 μ

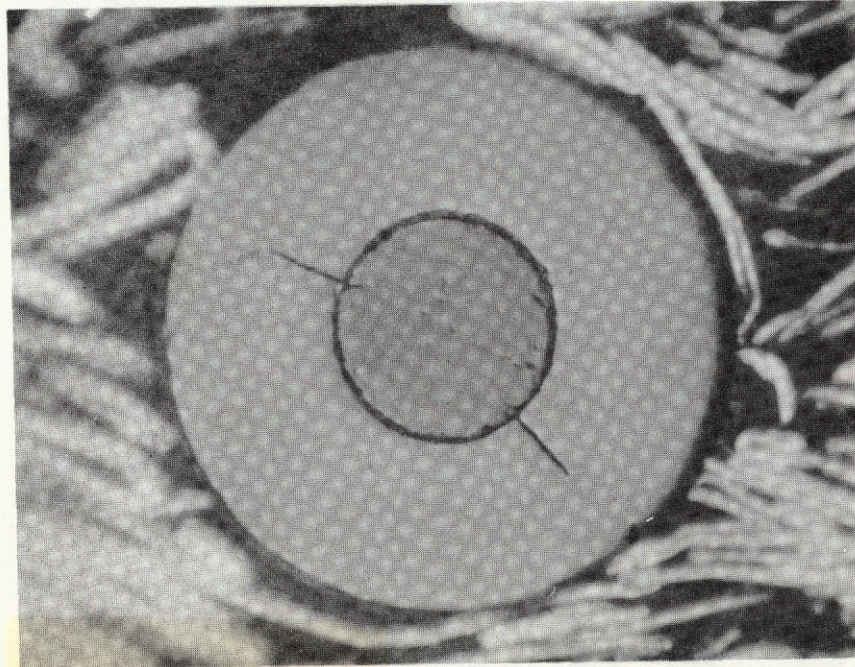

NC 84

10 μ

This page is reproduced at the back of the report by a different reproduction method to provide better detail.