

CR 134293

(NASA-CR-134293) CYCLES IN METABOLISM
AND HEAT LOSS (Webb Associates) -63 p HC
\$6.25
64CSCL 06P
N74-25627

CYCLES IN METABOLISM AND HEAT LOSS

James F. Annis, Samuel J. Troutman, and Paul Webb

Distribution of this report is provided in the interest of information exchange. Responsibility for the contents resides in the author or organization that prepared it.

Prepared under Contract No. NAS9-12683 by
Webb Associates, Inc.
Yellow Springs, Ohio 45387

63/04
Unclas
40533

for
NATIONAL AERONAUTICS AND SPACE ADMINISTRATION

TABLE OF CONTENTS

	page
Introduction	1
Description of the Experiments	3
Suited quiet day routine	3
Nude quiet day routine	4
Stay awake day routine	5
Fixed metabolism day routine	6
Description and Application of the Suit Calorimeter	7
Application of the Heat Balance Equation	10
Subjects	12
Methods	14
Experimental protocol	14
Measurements	16
Instrumentation and Equipment	18
Indirect Calorimetry	18
Direct Calorimetry	22
Water Cooling Garment	22
Insulative Clothing Assembly	23
H _w Computer	25
Water Loop Controller	26
Data Recording System	26
Bicycle Ergometer	27
Cardiotachometer System	28
Weights and Measures	28
Environmental Chamber	28
Special Equipment for Nude Man Calorimetry	29
System Performance Analysis	29
Results	30
24-Hour Totals	30
Effects of the Suit Calorimeter	42
Effects of Sleep	45
Effects of Fixed Metabolism	48
Summary of Results	54
Discussion	55
References	59

PRECEDING PAGES BLANK NOT FILMED

LIST OF TABLES

Table #		page
1	Physical Description of the Subjects	13
2	List of Measurements	17
3	Descriptive Data for the WCG's used in this Study	24
4	Summary of the 24-hour Heat Balance Measurements	34
5	Summary of the Respiratory Gas Exchange, Fluid Balance, & Food (Fuel) Balance Data over 24 Hours	35
6	Change in Body Temperatures (T_{re} , T_{ac} , \bar{T}_s) and Estimation of Heat Storage from \bar{T}_b Calculations over 24 Hours	41

LIST OF FIGURES

Fig. #		page
1	Block diagram of the suit calorimeter system	20
2	Block diagram of system components for the nude experiments	21
3	Bar chart comparing heat production and losses over 24 hours	32
4	Histographic presentation of heat loss pathway totals over 24 hours expressed as percentages of heat production	33
5	Bar chart of the 24-hour fluid balance for each experiment	38
6	Graphic comparison of fuel deficits and average RER's over 24 hrs.	40
7	Line graph comparing M, ΣH , and T_{re} for subject SJT in the quiet day (suited) and nude quiet day experiments (hourly values)	43
8	Line graph comparing M, ΣH , and T_{re} for subject SAL in the quiet day (suited) and nude quiet day experiments (hourly values)	44
9	Line graph comparing hourly values of M, ΣH , and T_{re} for subject SJT in the quiet and stay awake day experiments	46
10	Line graph comparing hourly values of M, ΣH , and T_{re} for subject SAL in the quiet and stay awake day experiments	47
11	Line graph comparing hourly values of M, ΣH , and T_{re} for subject SJT in the quiet and fixed metabolism experiments	49
12	Line graph comparing hourly values of M, ΣH , and T_{re} for subject SAL in the quiet and fixed metabolism experiments	50
13	Line graph showing interrelationships of S and T_{re} for all experiments on subject SJT	52
14	Line graph showing interrelationships of S and T_{re} for all experiments on subject SAL	53

CYCLES IN METABOLISM AND HEAT LOSS

James F. Annis, Samuel J. Troutman, and Paul Webb

SUMMARY

Using calorimetric techniques, subjects' metabolism, thermoregulation, and body temperatures were monitored continuously for 24-hour days, using three types of experimental routines. A water cooling garment (WCG) was used for direct calorimetry, while partitional calorimetry was used to establish a non-suited comparison for one of the routines. In this replicated routine, called the "quiet day," the subjects were sedentary throughout the daytime hours and slept normally at night. Results indicate that the WCG may act to reduce 24-hour total oxygen consumption ($\dot{V}O_2$) or heat production, possibly due to the lowered energy cost of thermoregulation.

Data were examined for effects of the different test routines on circadian patterns in metabolism, thermoregulation, and body temperature. Staying awake damped the magnitude of nocturnal change in metabolism, heat loss, and body temperature without obliterating circadian rhythms. Fixed metabolism further damped these responses. When metabolism was elevated either by staying awake or by work, an energy imbalance resulted at the end of the 24-hour measurement period. The imbalance indicated a net surplus of heat produced. The amount was significant and appeared to be directly related to activity level as well as to fuel intake deficits. Body temperatures did not reflect these imbalances.

✓

INTRODUCTION

The water cooled garment (WCG)--or liquid cooled garment (LCG), as it is often called--is primarily a product of space technology. As long ago as 1959 the possibility of using a water cooling garment for lunar exploration was suggested by Billingham (1), but the first suits actually developed were intended for use by RAF pilots. Space usage, when it came, was strictly applied to the problem of removing excess metabolic heat from thermally isolated (pressure suited) active astronauts. Because the energy cost of work in full pressure suits is high, air cooling, such as was used in early Gemini EVA, was not considered efficient enough for use by Apollo astronauts during lunar exploration. The need to specify and build a space qualifiable garment naturally resulted in investigations dealing with the physiological aspects of water cooling, and physiological research was initiated in a number of laboratories in the early 1960's. A useful review of the work performed through 1970 was published by Nunneley (2). In addition to its continuing use in space flight, the WCG is now being applied as a thermoprotective device for industrial workers and divers, and it is the central component of our suit calorimeter.

Regardless of application, certain aspects of the interrelationship of human thermoregulatory mechanisms versus WCG function and operation are still not well understood. In our laboratory, studies dealing with metabolic time constants (3, 4, 5) and automatic control of water cooling

using physiological feedback (6) ultimately led to the application of the WCG-thermally isolated man complex to whole body calorimetry.

Historically, human (whole body) calorimeters were complex, expensive, and difficult to operate. Often it was weeks before the results of a given experiment were known. In our laboratory we have combined continuous indirect calorimetry ($\dot{V}O_2$ measurement) and continuous direct calorimetry using the WCG, and produced a more dynamic form of whole body calorimetry. In 1972 we published the results of the first WCG calorimeter experiments (7). In three experiments reported, accurate ($\pm < 1\%$) 24-hour heat balances were obtained on both inactive and active men. Because of the continuous nature of the data, it was possible to analyze transients in heat production and loss and to hypothesize about circadian patterns in thermophysiological variables (8). For example, is the diurnal-nocturnal pattern observed in rectal temperature merely the result of phase shifts between heat production and heat loss rather than day-night thermal or other more complex set-point changes, as has been suggested by other investigators? How many of the patterns observed in our recent study resulted from physiological forcing by the thermally powerful WCG?

The purpose of the study reported here was to investigate the interactions of cycles in metabolism, thermoregulation, and body temperature, and to determine the nature of the cycles when they are isolated--that is, while one of the three is held constant. The principal objectives of the study were to determine the circadian effects of metabolism of a greater magnitude than previously studied, the effects of sleep, and the effects of wearing a WCG.

DESCRIPTION OF THE EXPERIMENTS

In order to fulfill the objectives of the study, four types of experiment were completed, using two subjects; hence eight experiments comprise the series analyzed. All experiments included a full 24-hour day of continuous measurement plus an equilibration period, consisting of a 6 to 8-hour night of sleep, during which the subject wore full instrumentation and slept in the environmentally controlled chamber where the experiment took place. The average elapsed time for each complete experiment was nearly 33 hours, and in six of the eight experiments the WCG calorimeter was worn throughout. All experiments included indirect calorimetric estimates of heat production based upon continuous measurement of oxygen consumption ($\dot{V}O_2$) and carbon dioxide production ($\dot{V}CO_2$). The following paragraphs describe the protocol used in each of the four types of experiment.

Suited Quiet Day Routine

In the procedure we called the "quiet day" routine, the subject wore the WCG calorimeter assembly for the entire test period. Following normal awakening from the equilibration night of sleep, the subject spent the daytime hours engaged in minimal activity--usually reading or watching television--while remaining seated in the chamber. Since he was not required to remain alert, dozing was allowed. When he felt ready for bedtime, he began a second night of supine sleep. When he awoke the following morning (or at the completion of 24 hours since arising the preceding day), the experiment was terminated. All nourishment, which was freely available except when it might interfere with the experiment routine, consisted of liquids--

black coffee, cocoa, or a specially prepared dextrose solution containing 0.5 kcal/cc of the sugar and fresh lemon juice for flavoring. The weight, temperature, calorie content, and time of each liquid food intake (I_{lf}) were logged for future use in heat balance calculations. Body waste functions were permitted as required by the subjects. Fortunately this consisted only of urinary output (O_u), since the need for defecation did not occur. Subjects had been advised to limit their diet to low bulk foods for two days preceding an experiment, but no strict control was exercised. Subjects' weights were obtained hourly except during sleep. Chamber temperature was maintained at a constant 30°C level.

A semi-automatic mode of control of WCG inlet water temperature (T_{wi}) was selected for use in all suited experiments. The set point T_{wi} was based upon subject preference, and usually only two temperatures were used--one for daytime and one for nighttime. This approach to control, we thought, would minimize the number of fluctuations in T_{wi} observed when complete automatic control schemes are employed. We believe that this control procedure approximately matched basal metabolic rates (BMR) for the subjects, and it served as the basis of comparison for the other experiments.

Nude Quiet Day Routine

The protocol for the nude quiet day routine ("nude quiet") was similar to the suited quiet day routine except that the WCG was not used. Body coverage consisted of an athletic supporter and the required instrumentation only. Since the WCG was not used, the heat loss quantities were determined using partitioned calorimetry techniques. Most of the environmental descriptors required for partitioned calorimetry were either measured

during the experiments or had been determined previously for our chamber. Chamber dry bulb temperatures (T_{db}) were selected by the subject for his comfort; frequent changes were discouraged. Normally the daytime temperatures remained constant at the selected level and a single, but slightly warmer, environment was used while the subjects slept at night. Water vapor pressures averaged 11-14 mm Hg and produced relative humidities ranging from 40 to 50%.

Direct calculations of the radiant (R) and convective (C) heat exchange using standard equations were not made in the analysis of these experiments, since the exact influence of postural effects (seated in a chair or lying down to sleep) on C and R was not known. Therefore heat exchange via these pathways was obtained using the Gagge method (9) of deriving the combined R & C values. Storage (S) was assumed to be zero over the 24 hour test period. Additional information about the method of calculation used is presented in "Application of the Heat Balance Equation."

Because of the similarity in procedures, a comparison of the nude quiet and the quiet day results permits conclusions to be drawn with regard to possible effects of the WCG calorimeter upon metabolic rate, thermoregulation, and body temperature over a 24-hour period.

Stay Awake Day Routine

In this type of experiment the procedures and instrumentation were exactly the same as those used in the suited quiet day routine, except that the subjects were not permitted to sleep during the 24-hour calorimetric balance period. (Sleep was permitted during the equilibration night.) This routine, entitled the "stay awake" day, when compared to the quiet day experiments, demonstrates the effect of sleep on the three principal thermoregulatory responses of interest--metabolism, heat loss, and rectal temperature.

Fixed Metabolism Day Routine

In these experiments the subjects were required to maintain a fixed activity level continuously for 24 hours; they are therefore entitled the "fixed metabolism" days. The individual work rates were selected to produce an oxygen consumption rate just in excess of the maximum level observed during the quiet day routine. The objective was to keep the $\dot{V}O_2$ constant within $\pm 10\%$ of the selected target value. The activity level was largely self-paced by visual monitoring of a continuous $\dot{V}O_2$ analog signal produced by the MRM (see "Instrumentation and Equipment"). In addition, observers reported actual average minute $\dot{V}O_2$ levels to the subject each 10 minutes of the 24 hours. This form of control worked quite well, as subjects usually were able to meet the $\pm 10\%$ accuracy level. The principal form of activity was bicycle pedalling (leg work) while seated in a comfortable chair positioned to the rear of the ergometer. Mechanical or external work (W) was measured electromechanically during one of these experiments. Subjects were permitted to engage in other forms of activity, such as arm work or moving about the chamber, but they were used sparingly since accuracy of control was more difficult. The only schedule break in activity occurred during the hourly weight determinations; unscheduled breaks for urination and for drinking were brief. None of the breaks lasted more than 2 or 3 minutes, and the subject was usually able to keep up his 10-minute oxygen consumption total despite them.

By maintaining MR fixed, the goal of the fixed metabolism experiments was to isolate heat production in order to determine the influence of this component upon thermoregulation and body temperature.

DESCRIPTION AND APPLICATION OF THE SUIT CALORIMETER

In all but the nude quiet day experiments, body heat balance was determined by the use of our suit calorimeter, which was very similar to the one described in a previous publication (7). Briefly, the suit calorimeter consists of the following basic items: 1) apparatus for measuring \dot{V}_{O_2} and \dot{V}_{CO_2} simultaneously and continuously; 2) the WCG and its associated water control and measurement devices; 3) an insulative clothing assembly; 4) other measurements to complete the description of heat dissipation. Detailed descriptions of the metabolism components of the calorimeter are given in later sections of this report: see "Methods" and "Instrumentation and Equipment." At this time we will describe only how the suit calorimeter works.

The estimation of heat production, or indirect calorimetry, from \dot{V}_{O_2} measurements is well known and need not be redescribed here. Since our earlier study we have added the measurement of \dot{V}_{CO_2} ; this data permits the use of correct caloric equivalents of O_2 , since the time averaged respiratory exchange ratio (RER) is known over a selected period of time. Determination of urine urea nitrogen and other indices of protein metabolism were not made; however, non-protein caloric equivalents of O_2 were used in calculation of heat production. If over a period of time the measured RER exceeded the usually quoted limits of 0.7 to 1.0, the caloric equivalent of O_2 for the closest RER was used. The effects of these potential errors will be discussed later (see "System Performance Analysis").

The heart of the direct calorimetric measurement was the heat removal (H_w) by the water in the WCG. The tubing network of the WCG was worn directly on the skin in order to pick up and carry away metabolic heat as soon as it was available at the surface of the body. Except for the face, the soles of the feet, and the palms of the hands, the tubing covered the entire body surface. The H_w was quantified from:

$$H_w = \dot{m}_w c (T_{wo} - T_{wi}) \quad (1)$$

where \dot{m}_w is the mass flow rate of water through the suit; c is the specific heat of water; T_{wo} is the outlet water temperature; and T_{wi} is the inlet water temperature.

The insulative garment assembly was worn over the WCG in order to limit heat exchange between the man-garment system and the chamber environment. To further minimize heat leakage, the chamber dry bulb temperature (T_{db}) was maintained at a constant $30 \pm 0.2^\circ\text{C}$. This temperature had been determined empirically to be the point at which the least heat exchange occurred (7). Because of the rather small maximum difference in temperature at interfaces throughout the complete system, the heat leak in or out must necessarily have been small. In this particular group of experiments the largest gradient observed was approximately 5°C between the skin and the water and 2.5°C between the water and the chamber air.

Because it is subjectively pleasing and physiologically sound, evaporative heat loss (H_E) was allowed to continue fairly normally. The insulative garment did not include a water impermeable layer; therefore insensible perspiration which managed to diffuse or be wicked to the surface was evaporated to the environment. The garments were not completely sealed; however, air

passageways were blocked so that air motion under or within the clothing layers was slight. Convective heat exchange (C) via this pathway is thought to have been extremely small. Frank sweating never occurred even though the subjects were active during the fixed metabolism day routine; they had no need to sweat since sufficient cooling was furnished to satisfy this thermoregulatory response (7, 10). Evaporative weight loss, which was detected by weight change, was corrected by a weight equivalent to the difference between O₂ uptake and CO₂ production.

A small amount of heat exchange was associated with the ventilatory flow of the metabolism measurement device (MRM). This flow furnished breathing air and washed the facial area under a special mask. Any respiratory or facial evaporative loss was detected with the change in weight. Some convective warming of the air, which was drawn from the 30°C chamber atmosphere, did occur. By measuring the increase in air temperature across the man and from knowledge of the fixed flow rate, the convective loss (C) was calculated using the following relationship:

$$C_{rf} = \dot{m}\rho c (T_{ex} - T_a) \quad (2)$$

where C_{rf} is the convective heat exchange from respiration and the face; \dot{m} is the mass flow rate of air; c is the specific heat of air; ρ is the density of air; T_{ex} is the temperature of the MRM exhaust air; and T_a is the temperature of the ambient air in the chamber.

Chamber wall temperature (T_w) and the outer surface of the insulative clothing assembly always ran very nearly the same, within about $\pm 0.1^\circ\text{C}$. Radiant heat exchange was probably small even though the radiant properties of the two surfaces were different.

Since both hot and cold liquids were consumed by the subjects, heat given to or taken from the subjects to bring the liquid to body temperature was taken into account in calculating heat balances. The heat exchange of the man with the liquid food ($\pm H_{lf}$) was calculated as follows:

$$\pm H_{lf} = m_{lf}c (T_{re} - T_{lf}) \quad (3)$$

where m_{lf} is the mass of the liquid (water-food); c is the specific heat of water; T_{re} is the rectal temperature; and T_{lf} is the temperature of the liquid food.

Application of the above mathematical relationships and the use of symbols in calculating heat balances via the heat balance equation are discussed in the following section.

APPLICATION OF THE HEAT BALANCE EQUATION

The body heat balance equation is the biologist's statement of the First Law of Thermodynamics that describes the rate at which a body generates and exchanges heat energy with its environment. Any net excess or decrement in heat over a period of time is theoretically reflected in measurable changes in body heat content, or storage (S). In its currently approved form the equation is written as follows:

$$S = M \pm E - (\pm W) \pm R \pm C \pm K \quad (4)$$

where S is the rate of storage of body heat (+ for net gain by body); M is metabolic free energy production (always +); E is evaporative heat transfer; W is work (+ for positive work against external forces); R is radiant heat exchange (+ for net gain); C is convective heat transfer (+ for net gain); and K is conductive heat transfer (+ for net gain). (11)

In calorimetry, all terms of the equation but one are measured. The unmeasured term is storage, which cannot be measured because mean body temperature (\bar{T}_b) cannot be reliably measured in living bodies. Proportionality equations based upon discrete temperatures produce values for \bar{T}_b which are of questionable accuracy. It can be calculated as follows:

$$\bar{T}_b = 0.67 T_c + 0.33 \bar{T}_{sk} \quad (5)$$

where T_c is core temperature and \bar{T}_{sk} is mean skin temperature. Only with accurate and complete whole body calorimetry can S be estimated, and, as we shall discuss later, even this value may be in error.

In partitional calorimetry S is assumed to be zero, so that the more difficult to measure (or calculate) components of the balance equation may be lumped and obtained by subtraction. Hence the equation is satisfied by a value for a combined R and C heat exchange. Because of measurement complexity, convective and radiative heat transfer are combined and assigned an amount of heat gain or loss (usually loss) required to produce an S of zero for the time period studied. Since with nude resting men external work (W) and conductive transfer (K) are assumed to be zero, the required measurements are M and E . As stated earlier, we have chosen the Gagge (9) technique of analyzing the partitional calorimetry experiments performed in this study, although some of the variables required on calculation of R and C were measured and were known for our chamber, e. g. air velocity. As a result the form of heat balance equation adapted for the partitional calorimetry data presented is as follows:

$$M = E + C_{rf} \pm H_{lf} + h_r + c (\bar{T}_{sk} - \frac{\bar{T}_a + \bar{T}_w}{2}) + S \quad (6)$$

Since $S = 0$, the equation may be rewritten:

$$h_r + c (\bar{T}_{sk} - \frac{\bar{T}_a + \bar{T}_w}{2}) = M - (E + C_{rf} \pm H_{lf}) \quad (7)$$

where $h_r + c$ is the coefficient of radiative and convective exchange.

An average coefficient for each partitional calorimetry run was derived using 24-hour average temperatures and 24-hour total heat exchange values (right side of equation 3). In order to find the actual R + C value for a given hour, the average coefficient obtained was multiplied by the actual ΔT between skin and the mean air/wall temperature for that period. The coefficient values obtained for our subjects compare favorably with published values at equivalent air speeds (12). When hourly balances were calculated, the hourly S values were not zero--only the 24-hour net cumulative S is forced to equal zero. This technique permitted estimation of the cyclic patterns of S over the experimental day.

The derivation of values and symbols especially adapted to the calculation of heat balances in the suit calorimeter experiments has already been discussed. There the standard heat balance equation (equation 4) can be rewritten specifically to our case, as follows:

$$S = M - (H_E + H_W \pm H_{lf} + C_{rf} + W) \quad (8)$$

In general, metric units have been used in presentation of the data obtained in this study. All heat units are expressed in kilocalories (kcal). Also, data is presented as 24-hour or as 1-hour totals or averages.

SUBJECTS

The two men used in these experiments are experienced test subjects selected from our laboratory staff. Both are engineers, healthy, and moderately fit, with a $\dot{V}O_2$ -max ranging from 40 to 50 cc/kg. The principal physical descriptors for the subjects are given in Table 1, below.

Table 1. Physical Description of the Subjects

<u>Subject</u> initials	<u>Age</u> yrs.	<u>Height</u> cm	<u>Weight</u> kg	<u>A_b</u> m ²	<u>body fat, est.</u> %
SAL	24	174	65	1.75	12
SJT	37	188	93	2.15	20

The two subjects represent the extremes in physical type in our staff, and normally lead quite different lives. From previous studies it was known that subject SJT prefers cooler environments (below "normal comfort" levels) and that he possesses unusual sleep habits--often awakening and getting up for variable lengths of time during the night. SJT shows a tendency toward weight gain (he had dieted prior to these experiments), although he consumes only one meal each day (dinner). During the work day his intake is largely limited to black coffee. This subject smokes approximately 15 cigarettes per day, and he was allowed to smoke sparingly during the experiments.

The other subject, SAL, is a non-smoker, drinks little coffee, is extremely thermosensitive, and prefers to sleep late in the morning. SAL has no weight problem, has never dieted, and frequently consumes "natural" foods. It was not unusual for this subject to enter an experiment in a nutritionally depleted state or, at least, with a minimum of carbohydrate reserves. The fixed metabolism experiment reflected this subject's dependence upon body fat stores as his fuel source, since his RER was 0.70 averaged over the 24 hours.

METHODS

Experimental Protocol

Although many aspects of the experimental protocol have already been described, an overall view of how the experiments were conducted has not been presented. The general protocol and procedures were the same for all experiments.

The subjects reported to the laboratory approximately one hour prior to their normal bedtime. During this period personal preparation was done, e. g. application of ECG electrodes and insertion of the T_{re} probe. At the same time the experiment monitor would precondition the chamber and the WCG system and conduct pre-experiment instrumentation check-out and calibration. When the subject entered the chamber, his nude weight was immediately taken and logged, and, unless the experiment was a nude quiet day routine, the dressing procedure followed. For the nude quiet days, dressing consisted principally of applying a skin temperature harness.

The only differences in protocol between the nude quiet day experiments and the suited runs were those aspects concerned with the operation of the suit calorimeter system. In the suit calorimeter runs, after the nude weight was taken, the pre-weighed WCG and insulative clothing assembly were donned. After instrumentation hook-ups were completed, the subjects were again weighed, fully instrumented and clothed. The elapsed time up to this point averaged about an hour; the clock time was usually between 2300 and 2400 hours of the first night. Next, the subjects reclined (supine position) upon a canvas stretcher cot within the chamber. The experiment clock was started and all data except change in clothed body weight were monitored by an

observer throughout the night. Since the night of sleep was merely an equilibration period, the data will not be reported here.

Upon awakening in the morning, the subject was weighed. Following urination and a liquid breakfast, at the succeeding even hour (0800 to 1000 local time) the 24-hour measurement day was started. Every hour on the hour the subject was weighed. Change in weight each hour was corrected for intake-output and $\text{CO}_2\text{-O}_2$ weight differences and used in calculating evaporative heat losses for the period. Except during sleep, this procedure was applied throughout all experiments. Liquid intake and urination were permitted as desired. Upon awakening after the second night of sleep, or at the completion of the 24-hour measurement day, following a final clothed and nude weight measurement, the experiment was terminated.

In the stay awake routine the procedures were very similar, except that the subjects were not permitted to doze during the day or sleep during the second night. Since the subjects were awake, their weights were taken hourly throughout the second night.

During the fixed metabolism day, work was initiated at the beginning of the 24-hour measurement period. Work, as judged from $\dot{V}\text{O}_2$, was continued at a constant rate throughout the day and second night until 24 hours of activity were completed. As previously stated, the work rate for each subject was selected to exceed his highest $\dot{V}\text{O}_2$ level during his preceding quiet day experiment.

Measurements

The determination of body heat balances required quantification of both heat production and heat exchange pathways. In the eight experiments performed, eight general types of measurement were made, and these were composed of 20 different measurements. All of these variables and their symbols and derived values are listed in Table 2. Measurement types numbered 1, 3, 4, 5, 7, and 8 and their specific measurements applied to all experiments. Obviously type #2 and type #6 pertain only to experiments in which the WCG was used, and experiments in which measurable external work was performed, respectively. Sixteen specific measurements were required for the nude quiet day experiments, in which the heat exchange was obtained using partitional calorimetry techniques.

The first 11 specific variables listed in the table were automatically logged at pre-selected time intervals by a specially designed data printing system. These data points were usually printed every 10 minutes throughout the experiment. The 16 individual skin temperatures (T_{sk}) sampled and the mean skin temperature (\bar{T}_{sk}) were printed separately. The hourly presentation of most of the data used in this report represents either totals or averages of the six individual print cycles per hour. All measurements that were not automatically printed were recorded manually by observers in an experiment log book. In one of the fixed metabolism runs, the external work analog signal was recorded on a strip-chart recorder and this record analyzed by planimetry in order to obtain hourly totals. Heart rate was manually logged, either from a cardiometer reading or by counting the audio output of an FM radio receiver. A description of the complete measurement system and the individual instruments used is given in the next section of this report.

Table 2. List of Measurements

<u>Measurement type</u>	<u>Measurements, specific</u>	<u>Symbol</u>	<u>Derived values</u>	<u>Symbol</u>
1. Respiratory exchange	oxygen consumption rate	$\dot{V}O_2$	heat production; mass of O ₂ intake	M mO ₂
	carbon dioxide production rate	$\dot{V}CO_2$	mass of CO ₂ produced; respiratory exchange ratio	mCO ₂ RER
2. W. C. G.	inlet water temp. outlet water temp. mass flow rate of water	T_{wi} T_{wo} \dot{m}_w	} } WCG heat removal	H_w
3. Body temperatures	skin temp.	T_{sk}		
	rectal temp.	T_{re}	} mean body temp.	\bar{T}_b
	auditory canal temp.	T_{ac}		
4. Environmental conditions (chamber)	dry bulb temp. wet bulb temp. wall temp. air velocity	T_{db} T_{wb} T_w V_a	} } water vapor pressure; relative humidity; radiant & convective heat exchange coefficient	P_{H_2O} % RH $h_c + r$
5. Body weight change	nude weight	W_n		
	clothed weight	W_c	} } food calories (kcal)	
	intake weight-liquid	I_{lf}		
	intake temp. - liquid	T_{lf}	body heat loss (gain) to food	$\pm H_{lf}$
	output weight-urine	O_{ur}		
6. Work	external work	W	M corrected for W	
7. Other physiological data	heart rate	HR		
8. Other temperatures	ventilating air temp.	T_{va}	respiratory and facial convective exchange	C_{rf}

INSTRUMENTATION AND EQUIPMENT

The first requisite in performing human calorimetry is the development of a measuring system capable of continuously monitoring those parameters needed to obtain the calorimetric picture with a reasonable degree of accuracy and reliability. We have over a period of several years designed and refined such a measuring system, which is specific to the generation of physiologically derived analog signals proportioned to produce the pertinent data in manageable form. This system is presented in Figure 1 as a block diagram showing the major components of our suit calorimeter and their interrelationships. Figure 2 is a second block diagram showing an abbreviated system which was used only in the nude man partitioned calorimetry. These components--that is, the water cooled suit and associated insulating garments, major control instruments, monitoring equipment, and the environmental chamber--are described in this section, and an estimation of the total system performance is given.

Indirect Calorimetry

The respiratory gas exchange was monitored continuously for oxygen consumption and carbon dioxide production. This was accomplished by using our Metabolic Rate Monitor, or MRM (13) for measuring oxygen consumption, and a Beckman LB-1, Model 15-A infrared carbon dioxide analyzer for carbon dioxide production.

Due to the requirement for CO₂ analysis, the MRM was modified to operate with a fixed ventilation rate of 85 liters/min. A fixed volume flow was necessary to eliminate the possibility of servo tracking errors in the mixed gas sample used for CO₂ analysis. The full-scale range of the MRM in this mode of operation was limited to a maximum of 1 liter/min, or approximately

twice our expected level of operation. The subject's respiratory exchange was from the volume of gas that passed over his face, similar to the operation of a standard MRM. The oxygen sensor, located downstream from the man, detected the depression in PO_2 from that of room air caused by the subject and produced an electrical signal that was scaled to be proportional to oxygen consumption (1 VDC = 1 liter/min) in standard liters per minute. This analog signal was then used as an input to a totalizer-integrator (to be described later in this section) for the purpose of obtaining a total of the oxygen consumed for a predetermined period.

The analog of carbon dioxide production was obtained by continuously sampling the MRM ventilation volume for the percentage of carbon dioxide. The gas was sampled by pumping approximately 200 ml/min through the Beckman LB-1 analyzer; thereby the increases in carbon dioxide content could be detected, thus generating an electrical signal proportional to the percentage of CO_2 . This signal was scaled (1 VDC = 1 liter/min) and used as the input to a second totalizer-integrator for the purpose of totalizing carbon dioxide production for a predetermined time period. As a validation, the analyzer was calibrated using standard calibrating gases ($\pm 0.2\%$) prior to a total system calibration.

The system calibrations of the MRM and LB-1 employed our standard dilution technique, where a second gas, usually nitrogen, is metered into a fixed ventilation volume, and in the case of oxygen, depresses the PO_2 and simulates a man consuming oxygen. Using this technique, nitrogen was introduced to calibrate the MRM and CO_2 was introduced for the calibration of the LB-1. The CO_2 calibration also provided a calibration check on the oxygen consumption response. This technique has a combined accuracy and repeatability of ± 10 ml, based on the measurement of the dilution volumes. When

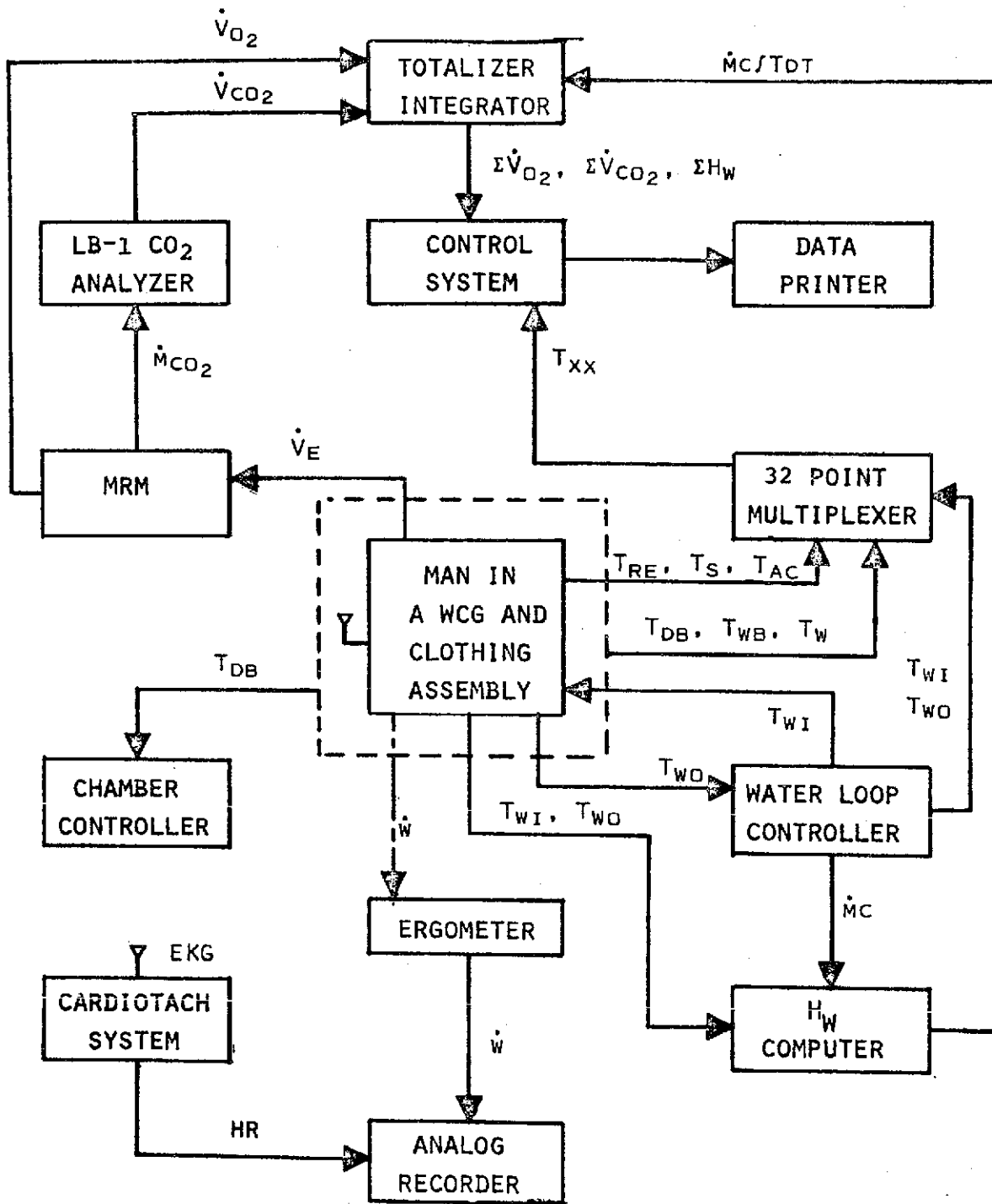

Figure 1. The block diagram shows the interrelationships of the components of the suit calorimeter system used in the experiments. Symbols are explained in the text.

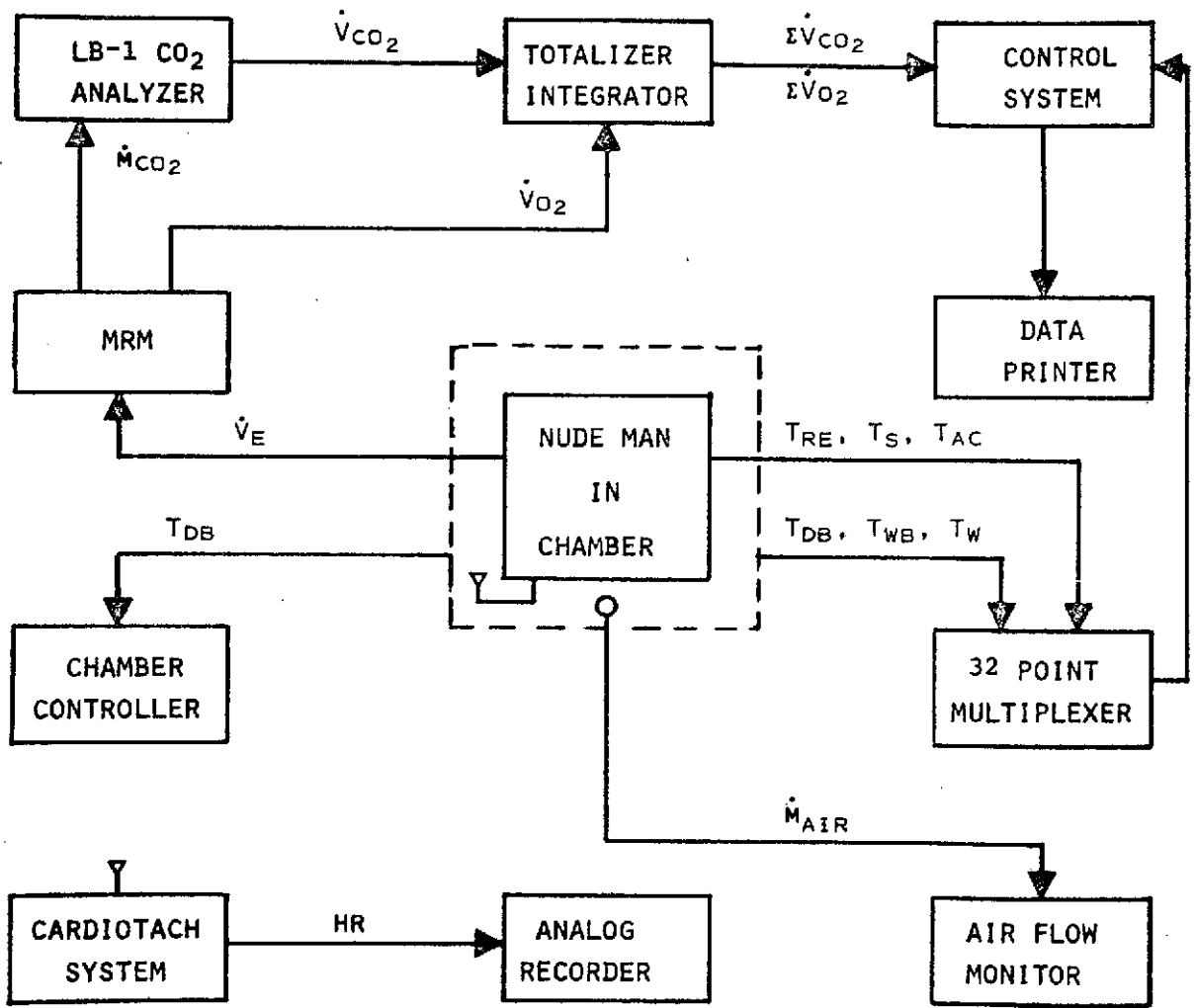

Figure 2. During the nude quiet day experiments, the system components were modified as depicted in this block diagram.

operated in the fixed flow mode, the MRM has a predicted random error in the indicated oxygen consumption of $\pm 3\%$, whereas the combined inherent random error of the LB-1 is $\pm 1.5\%$. Based on repeated calibrations of our analysis system, the estimated accuracy and repeatability of the indicated oxygen consumption and carbon dioxide production levels was $\pm 3\%$.

Direct Calorimetry

Water Cooling Garment. -- Probably the most important component of the suit calorimeter is the water cooling garment. Since good fit is important and the subjects were very different in size, two individually tailored but otherwise similar garments were constructed especially for this project. After starting with commercially purchased dance leotards fabricated of lightweight stretch nylon, we completed the full coverage garments by adding gauntlets, stockings, and a head-shaped cap of similar material. To the inner surface of the full garments a selected number of small silicone rubber tubes (0.13 cm ID x 0.29 cm OD, JaBar Silicone Corp.) of known length were sewn. Except for retention threads, the tubes were bare; they were manifolded in groups of six to form five thermal compartments. The same total number and length of tubes was used in both suits despite the difference in sizes. This was accomplished by varying the space between tubes and by making the course of a given tube more or less tortuous. The five individual compartments were: head, upper torso, arms, hips, and legs. Flow direction over the limbs was from distal to proximal. Tube density was proportioned to approximate the underlying muscle mass. The larger distribution tubes (0.47 cm ID x 0.79 cm OD) were made of polyvinyl chloride (Tygon, Norton Co.) and were grouped for attachment to their respective inlet or outlet main manifolds, which were located over the wearer's lower abdominal area. All of the flow in and out of the WCG's passed through these manifolds.

Within each were positioned three matched thermistor beads (Yellow Springs Instrument Co.) which sensed the inlet and outlet water temperatures (T_{wi} and T_{wo} respectively).

Each WCG was equipped with a full length torso front zipper and limb zippers for ease of donning. Sixteen small disk thermistors (Y. S. I. #425) which sensed skin temperature were attached to the inner surface of each WCG. The individual thermistors were located so that \bar{T}_{sk} was area weighted. Also they were spaced midway between the small tubes to prevent undue direct cooling. The distribution tubes were positioned to limit countercurrent heat exchange, hence improving the effectiveness of the WCG. The completed garments contained approximately 140 cc of water and weighed an average of 3.4 kg with complete instrumentation. The subjects found these WCG's extremely comfortable to wear. The average flow rate used throughout all experiments was 1.5 liters/min. Some specifications for the garments are given in Table 3.

Insulative clothing assembly. --To limit thermal exchange between the man-WCG complex and the environmental chamber in the suit calorimeter experiments, an insulative clothing assembly was worn. The clothing layers from the WCG outward were: 1) two-piece flocked cotton athletic warm-up suit; 2) heavy woolen socks; 3) two-piece down-filled survival (Arctic) suit; 4) down-filled booties; 5) down-filled hood; 6) sheepskin shearling gloves. All of the body garments were closed with drawstrings, elastic, knitted cuffs, or Velcro closures to prevent air movement in and out of the clothing during subject activity. Since the assembly did not include a water impermeable layer, evaporative losses were allowed to continue normally. The entire assembly weighed 3.3 kg and any moisture trapped in the layers during the course of an experiment was not detected as a weight change. The complete

Table 3.
Descriptive Data for the WCG's Used in This Study

<u>Com-</u> <u>partment</u>	<u>Cooling tubes*</u>			<u>Distribution tubes</u>				<u>Total WCG</u> <u>flow propor-</u> <u>tion*</u> <u>% of total</u>	
	<u>No.</u>	<u>leng.</u> <u>tube</u> <u>(m)</u>	<u>total</u> <u>leng.</u> <u>(m)</u>	<u>vol.</u> <u>(cc)</u>	<u>small WCG</u>		<u>large WCG</u>		
					<u>leng.</u> <u>(m)</u>	<u>vol.</u> <u>(cc)</u>	<u>leng.</u> <u>(m)</u>	<u>vol.</u> <u>(cc)</u>	
head**	12	0.5	6.0	12.7	3.2	60.7	3.2	60.7	23.3
arms	12	1.0	12.0	25.5	3.2	57.1	3.5	61.6	17.5
upper torso	12	1.0	12.0	25.5	1.7	29.3	1.6	27.8	14.4
hips	12	1.0	12.0	25.5	1.1	17.7	1.4	24.3	19.2
legs	24	1.0	24.0	50.1	3.5	61.9	3.4	59.2	25.7

*The values were the same for both WCG's.

**The same head cooler was used with both WCG's.

suit calorimeter system, including the MRM mask and motor-blower, added approximately 7.5 kg to the subject's nude weight.

H_w computer.--Specific to generating an electrical analog of the heat being removed by the water cooled suit was the measurement of the mass flow of water through the suit and the temperature difference between the inlet and the outlet water temperatures. This was performed by a special H_w computer.

The mass flow rate was continuously measured with a turbine flowmeter (Milliflow model FTM-10-LB, Flow Technology, Inc.), which produced a linear pulse output over a flow range of 0.5-3.5 liters/min. The accuracy and repeatability was established at $\pm 0.7\%$, based on timed collections and volumetric measurements. Temperatures were measured at the main suit manifolds, which were specifically designed to provide good mixing, using a selected pair of thermistors (Y. S. I. type #44003) matched to within $\pm 0.02^\circ\text{C}$. These thermistors were used as the two active elements of a bridge circuit, the output of which was an electrical analog of the difference between T_{wO} and T_{wi} , and scaled to produce 1 VDC for each $^\circ\text{C}$ differential. The responses of the two thermistor probes were electrically phased to reduce the effects of the suit water circulation time. The electrical output from the bridge circuit and the flowmeter were then multiplied by an analog circuit (Equation 1), the output being H_w , where 1 VDC was equal to 1 kcal/min. This was then used to drive a third totalizer-integrator for totalizing the H_w for discrete time periods. The H_w computer was calibrated by substituting precision decade resistors for the matched thermistors and simulating temperature differences over the 0 to 10°C delta while the flowmeter was in operation, normally at 1.5 liters/min. The output was then calibrated to yield the correct electrical analog. Tests of the H_w computer with the suit assembly resulted in a random error of $\pm 1.5\%$ (7).

Water loop controller. --Control of the inlet water temperature was achieved using a proportional setpoint controller (7). The water temperature was maintained with a pair of servo controlled bypass valves which allowed a variable fraction of the water from the suit to be cooled in a 5°C water-to-water heat exchanger, then re-mixed with the uncooled part and returned to the suit. The water-to-water heat exchanger has a continuous cooling capacity of 12 kcals/min and a peak cooling rate of approximately 16 kcals/min. The 5°C heat exchanger (PCC-34C, Blue M Corporation) was automatically controlled to maintain its setpoint temperature.

Water was circulated through the suit and the temperature control elements by a pump (Gelber, Model 12-41-303) driven by a universal electric motor and coupled magnetically to the pumphead. The power to the motor was regulated by a constant current source. Absolute constancy of the flow rate was not required, since it was continuously measured by the flowmeter described earlier.

Data Recording System

The physiological parameters that were continuously monitored were reduced to digital form and printed automatically on a standard electric typewriter modified to interface with our data conversion system. The data conversion system is comprised of four basic sub-systems; the data printer, the 32-point multiplexer, the data control system, and the totallizer-integrators.

The data printer (typewriter) has solenoid actuated keys that are made to function by the data control system, which controls the sequencing of all data inputs, timing, and clock functions. Interfaced to this system is the 32-point multiplexer which selects all data inputs and controls the fields

on the printout format. The multiplexer is designed to connect thermistors (series 400, Y. S. I.) to an automatic bridge circuit with an accuracy of $\pm 0.1^{\circ}\text{C}$, which generates an analog of the temperature being monitored. This analog is converted to digital form and displayed on a digital voltmeter (Weston #1292) held and printed in sequence. A secondary data capability is the input of the totalizer-integrator to the data control system in digital form.

The totalizer-integrator (Acromag #1320, Acromag, Inc.) accepts an analog DC input signal and produces output pulses at a rate proportional to the input signal. These pulses are counted on an event counter (Newport model 6200) to produce the integral of the input signal versus time. We have calibrated our system to produce one pulse for each 10 ml of oxygen consumption, and one pulse for each 10 small calories of heat removal (h_w). They are provided with zero suppression to prevent noise from being totalized. The resulting accuracy of these units was determined to be $\pm 0.5\%$.

Bicycle Ergometer

When there was an external work component, a modified Monark bicycle ergometer was used to produce a continuous analog of the work component. The modification consisted of the removal of the mechanical brake (belt) and weighted pendulum from the large wheel. The brake was then replaced with a generator (Bosch LJ/REG. 180/6/2500L3) with a belt drive system attached to the rim of the large wheel. A constant current source was applied to the generator stator and the generator output loaded with a 1 ohm 50 watt reostat, which was adjusted to provide an analog of a 50 watt load. The bicycle ergometer was then calibrated, using a subject as the prime mover, and the wattage output of the generator calibrated to

the metabolic activity, using Åstrand's calibration procedure (14). The analog of the wattage was scaled so that 1 VDC was equal to 1 kcal/min (69.767 watts). This analog was recorded on a Houston model 3000 analog recorder. The estimated repeatability of this calibration technique was $\pm 1.5\%$ of the indicated wattage.

Cardiotachometer System

The subject's heart rate was monitored continuously using a Biolink telemetry system (#368, Biocom, Inc.) and displayed on a Biotachometer (#4710, Biocom, Inc.).

Weights and Measures

The subject's liquid intake (food) and output (urine) were weighed on a small 50-lb platform beam scale (model 51TX, Homs) located outside the chamber. A Fairbanks model 5962 platform balance was located in the chamber and used to measure the subject's weight. The combined accuracy of the weighing system was evaluated to be ± 5 gms.

Environmental Chamber

Our environmental chamber is a semi-closed system with inside dimensions of 2.4 m x 2.6 m x 2.5 m; it has two large windows. The air circuit is designed to allow new air from the outside environment to be introduced at a rate of 500 liters/min to reduce the effects of CO₂ buildup; the mean velocity of the recirculating air is maintained at approximately 35 fpm. Inside temperatures are controlled to within $\pm 0.1^\circ\text{C}$ of the setpoint, using proportional control techniques. We routinely measured wet bulb (T_{wb}) and dry bulb (T_{db}) temperatures of the chamber air, and three wall temperatures (T_w)--low, mid, and high.

Special Equipment for Nude Man Calorimetry

Figure 2 shows the abbreviated system used for nude man calorimetry. The obvious components of the total system not included in this diagram are those related directly to the suit calorimeter, with the exception of the air velocity monitor (Hastings Precision Air Meter, model B-72), which was used to determine the velocity profile around the nude man and for estimating the combined heat losses to the chamber environment during calorimetry.

System Performance Analysis

The performance of the total system was considered with respect to probable sources of error in the major components. Each component of the system was analyzed separately, as stated in their descriptions, to determine whether the probable system error was consistent with the objectives of the experiments. This consisted of a tabulation of all known sources of error represented by adjustment and calibration errors, approximations, and input-output data errors.

In general, random errors are not additive; therefore, using the square root of the sum of the squares of the individual errors plus the refinement of cross-correlation functions, the probable error of the system performance was estimated, using Equation 9:

$$\Delta e_{\text{probable}} = \frac{\sqrt{(\Delta e_1)^2 + (\Delta e_2)^2 + (\Delta e_3)^2 + \dots + (\Delta e_n)^2 + \Delta_{12}\Delta e_1\Delta e_2 + \dots + \Delta_{1n}\Delta e_1\Delta e_n}}{4} \quad (9)$$

Allowing for the peak magnitude of the individual random errors for each subsystem, the probable error in the total system performance was found to be $\pm 2.4\%$.

RESULTS

The presentation of the data obtained in the eight experiments that comprised this study is divided into two major sections. First we shall examine the results of the full 24-hour day in terms of the components of the heat balance equation and associated metabolic aspects. Second, an analysis of the effects of the four different test routines and the resultant effects upon circadian rhythms in heat production, thermoregulation, and body temperature will be presented. The primary time block examined will be one hour. Because of the limited number of experiments and lack of repetitions, combined average response data are not given. The effect of subject variability upon the patterns observed will be discussed. The great number of data points obtained and the variety of measurements made make statistical analysis very tempting; however, we have attempted to avoid this by presenting data in its simplest forms. Rigorous mathematical analysis of the periodic or cyclic phenomena observed is not warranted.

24-Hour Totals

In the analysis of the full 24-hour measurement day totals, the first question asked was: did we obtain heat balances in our experiments; were there matches or mismatches in calculated heat production and heat dissipation? Was there a storage (S) change in any of the runs? Historically, except for one questionable experiment, we had always seen balances over 24-hour periods when a very similar suit calorimeter was used (7). The answer to these queries is that we did not have balances in all of the experiments in this series.

Since there was no balance, we jumped to the conclusion that there must be some error in our measurement systems. Either the direct or the indirect calorimetry must be high or low. However, our post-experiment analysis could uncover no errors that were out of line with the quoted system error. Some hidden equipment malfunction that went undetected during an experiment was ruled out, since an experiment that did not balance as expected often was followed by one that did. Because of the automation in data handling, we usually had an idea whether a heat balance was going to be achieved before an experiment was completed. Using this foreknowledge, a particularly thorough effort was made to check measurement systems immediately after each run. Sometimes minor problems were uncovered, but if they meant changes in caloric values, the corrections have been included in the final data presented here. Mistakes in arithmetic were also found and corrected, but still the mis-matches remained. Was there some logic to the pattern in mis-matches? Answer: yes, there did seem to be. The possible explanations and ramifications of this apparent paradox are reserved for the discussion section of the report. Let us proceed to look at the data.

The 24-hour totals for the individual components of the heat balance equation for the eight experiments are presented in Table 4. The data are arranged according to experiment type and listed for each subject. The data are again presented in histographic form in Figure 3. As is apparent from both the table and the graph, reasonable heat balances were achieved in both subjects in the quiet day runs. The 3.3% difference in direct versus indirect calorimetry in subject SAL may largely be accounted for by the predicted system error. The storage for the nude quiet day tests, as has been mentioned, was assumed to be zero. Except for the insignificant difference in the quiet day run on subject SJT, the storage changes in the suited experiments were always positive (increase in body heat content). The magnitude of the storage

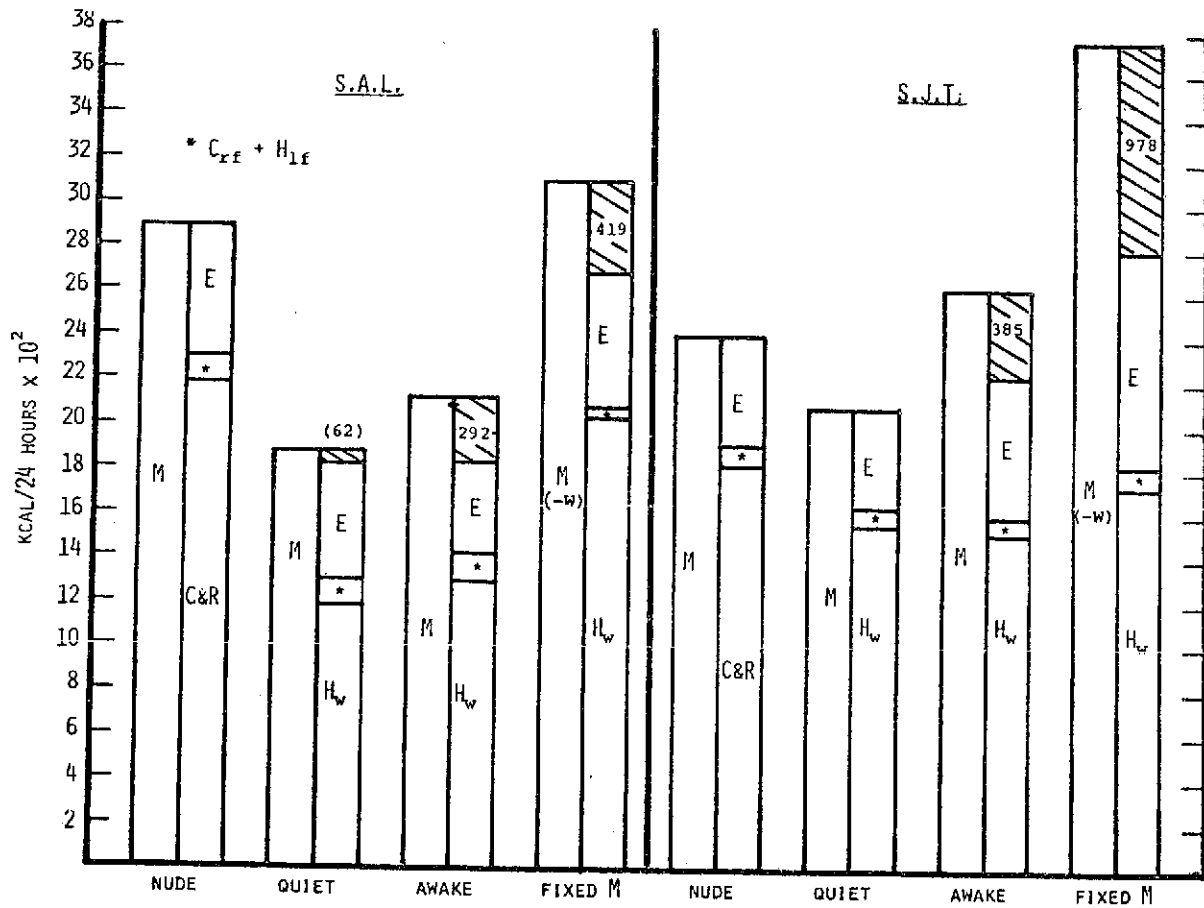

Figure 3. Heat production for 24 hours (M) is compared by this bar graph with all the heat losses (H_w or R + C, C_{rf} + H_{lf}, and E) for each of four experiments for the two subjects. If the heat loss bar does not reach as high as the heat production bar, a shaded area is shown with a numerical value for the size of the mismatch, in kcal.

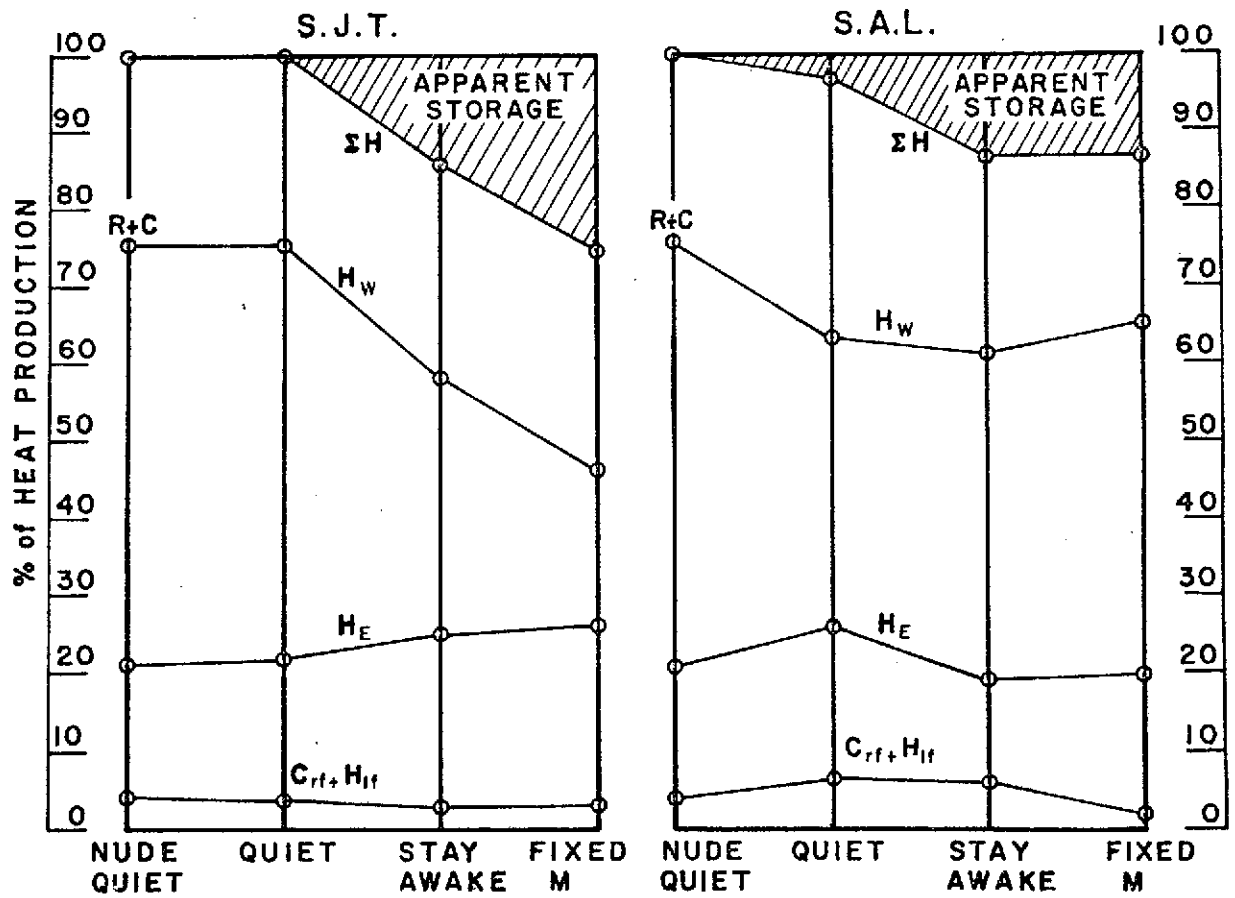

Figure 4. The individual heat loss pathways and their totals are plotted as percentages of M to demonstrate how the subjects lost body heat in the various experiments. Heat not accounted for is shown as apparent storage.

Table 4.

Summary of Calorimetric Measurements--24-hour Totals

Expt. type	Subj. initials	start- end hr.	H_E ¹	$\pm H_{lf}$ ²	C_{rf} ³	H_w	C+R	ΣH	M	W	M-W	S	% diff.
			kcal	kcal	kcal	kcal	kcal	kcal	kcal	kcal	kcal	kcal	kcal
nude quiet	SAL	08-08	601	-28	76 ⁴	---	2185	2890	2889	---	2889	+1	---
	SJT	08-08	499	- 7	86	---	1817	2409	2411	---	2411		---
quiet day	SAL	10-10	521	-29	86	1179	---	1815	1877	---	1877	+62	3.3
	SJT	08-08	448	+13	86	1561	---	2082	2081	---	2081	-1	0.05
stay awake	SAL	10-10	410	-36	86	1298	---	1830	2122	---	2122	+292	13.8
	SJT	08-08	645	+16	86	1521	---	2236	2621	---	2621	+385	14.7
Fixed metab- olism	SAL	08-08	694	+43	86	2030	---	2763	3433	325 ⁵	3108	+345	11.1
	SJT	09-09	975	-17	86	1729	---	2807	4169	384	3785	+978	25.8

1. Includes correction for CO₂-O₂ differences.

2. (-) = heat loss; (+) = heat gain from liquid-food intake.

3. Convective respiratory and facial heat loss to MRM air flow.

4. MRM fixed flow = 75 lpm, flow = 85 lpm for other experiments.

5. Estimation based upon measured value for other subject.

Table 5.

Summary of Respiratory Gas Exchange, Fluid Balance, and Food Balance Data

24-Hour Totals

Expt. type	Subj. initials	$\dot{V}O_2$ liters	$\dot{V}CO_2$ liters	mO_2 gms	mCO_2 gms	RER avg.	mCO_2 $-mO_2^1$ gms	liquid intake gms	$H_2O_M^2$ gms	urine output gms	H_2O^3 balance \pm gms	food intake kcal	fuel deficit ⁴ kcal
nude	SAL	590	499	843	977	.84	144	1638	359	1311	-350	1124	1765
quiet	SJT	488	470	638	921	.96	223	2730	308	3242	-1065	923	1488
quiet	SAL	382	349	546	683	.91	137	1116	233	1669	-1218	543	1334
day	SJT	431	356	616	697	.83	81	2227	249	2531	-827	443	1638
stay	SAL	443	346	634	677	.79	43	1143	251	1537	-850	459	1663
awake	SJT	546	442	780	866	.81	86	3338	313	3175	-636	716	1905
fixed	SAL	729	508	1042	996	.70	-46	2953	366	3106	-984	988	2445
metab- olism	SJT	862	714	1233	1400	.83	167	3610	503	3755	-1322	1147	3022

1. Value used to adjust evaporative loss (H_E).

2. CHO/fat mixture from RER, protein metabolism based on estimated daily urine urea nitrogen.

3. Includes corrected H_E losses.

4. Deficit = $M - I_f$.

had a direct relationship with the magnitude of M --that is, the large ΔS occurred when the subjects had no sleep and/or worked continuously for the day. More about this later.

Except for the presence or absence of the suit calorimeter, the protocol for the nude and suited quiet day experiments was very similar. Therefore the depression in M during the suited experiments (shown in the Figure) probably is significant, since the differences are larger than would be expected from day to day variation. We feel that the sedating effect must be associated with the suit calorimeter. The actual reductions amounted to 14% and 35% for subjects SJT and SAL respectively; for subject SAL, M during the stay awake day in the calorimeter is even lower than during the nude quiet day.

The external work (W) in the fixed metabolism experiments amounted to approximately 10% of the total M . The values for subject SJT were measured, while for SAL they were estimated from $\dot{V}O_2$ level, body weight, and the value measured for the other subject.

When the heat loss pathway quantities are presented as a percentage of total M , as depicted in Figure 4, the relationship of "apparent" storage with heat production is obvious. The pathway percentages are plotted individually (except for C_{rf} and H_{lf}), not cumulatively. The values for C_{rf} and H_{lf} and H_E are very similar for both subjects in all of the experiments and represent approximately 4% and 22% of the total heat loss (ΣH) respectively. For subject SJT, the $R + C$ loss of the nude quiet day is exactly the same percentage as the H_W in the quiet day. Since evaporative loss was permitted in the calorimeter, perhaps this is not surprising. Comparing the same two experiments for subject SAL, it appears as if the reduction in H_W in the quiet run is accounted for by the H_E and the S .

The 24-hour totals for the respiratory gas exchange and for fluid-fuel balance data are presented in Table 5. The average RER values ranged from .70 to .96, with the lower individual run values tending to occur during the more active days. The type of response may be predicted under the circumstances of the tests. In all cases except one (fixed metabolism, SAL), the $m\text{CO}_2$ expired exceeded the $m\text{O}_2$ consumed. Using standard calculating methods, it is easily seen that when RER is less than .73, the weight of O_2 consumed will exceed the weight of CO_2 produced. The CO_2 - O_2 weight differences are reflected in the H_E values given in Table 4.

Subject fluid balances were always negative for the 24-hour period. The values ranged from (-)350 gms to (-)1322 gms. Urine output was perhaps somewhat elevated even during the nude quiet day experiments, particularly for subject SJT. Some of the increase may have been due to the diuretic effect of the coffee and/or cocoa consumed by the subjects. Metabolic water (H_2O_M) production was in part estimated since the actual protein breakdown was unknown. However, using subject mass and activity level adjustments for 24-hour normals in urine urea nitrogen excretion, a small amount of H_2O_M was included in the total as having come from protein sources. The fluid balance data is presented graphically in Figure 5. As can be seen in the figure, the liquid intake on the average nearly equalled the urine output alone. The deficit is shown as the shaded area in the figure.

In none of the experiments did the food calorie intake keep pace with the metabolic demand. The fuel deficits are also given in Table 5. On the average, approximately 30% of the energy demand was supplied from body fuel stores. In two runs more than 2400 kcal deficits were incurred. At the rate of 9.3 kcals/gm of fat, nearly 120 gms of fat breakdown may have occurred.

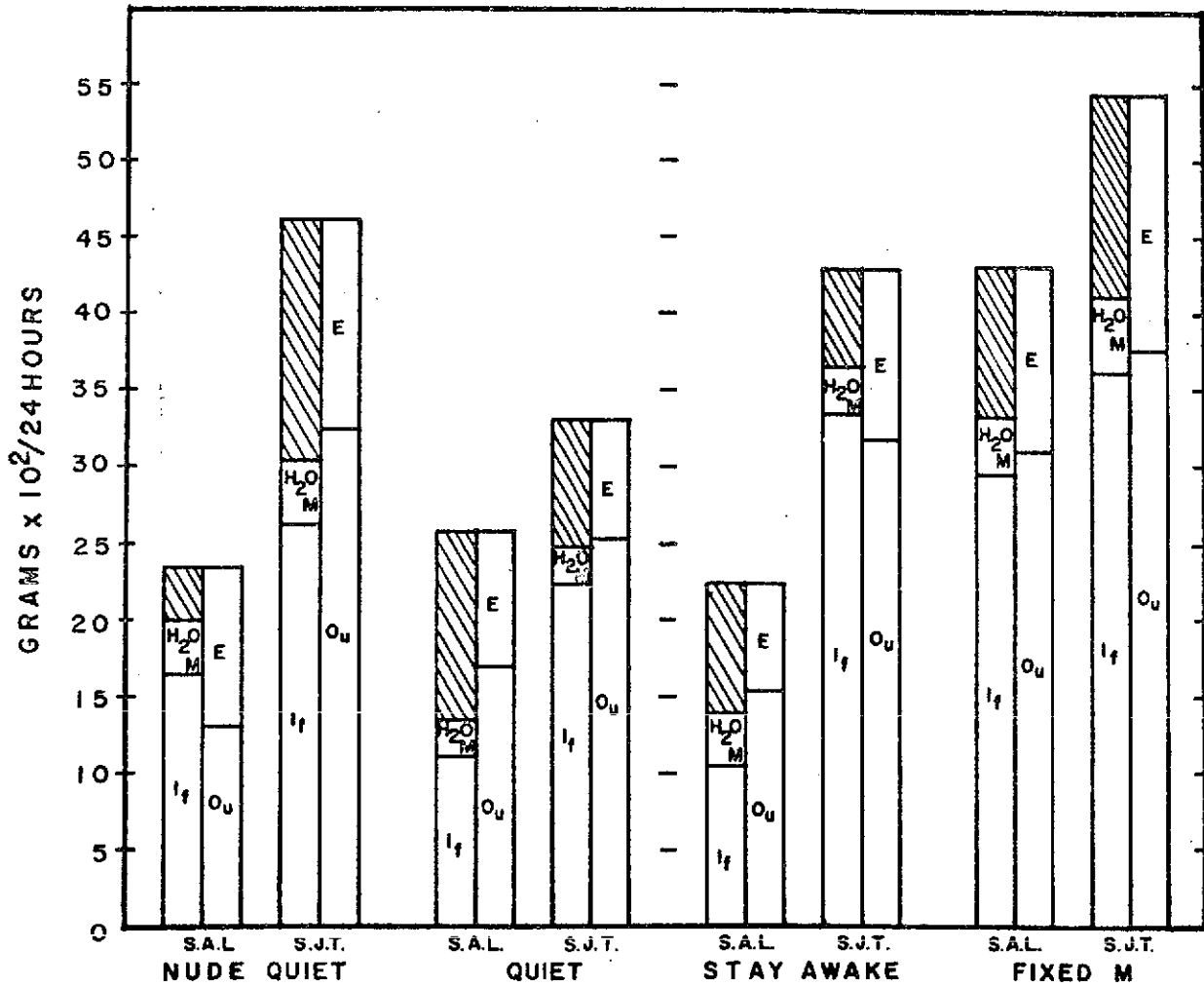

Figure 5. The fluid intake never did equal the fluid output over 24 hours. The deficit for each experiment is shown as the shaded area. H₂O_M is metabolic water, I_f is liquid intake, O_u is urine output, and E is evaporative water loss.

Most of the deficit supply apparently did come from fat, since a good correlation between RER lowering and fuel deficit was shown in the data. This effect can be seen in Figure 6. The one exception (fixed metabolism, SJT) may have resulted from a better carbohydrate reserve status at the beginning of the experiment.

The three principal body temperatures measured-- T_{re} , T_{ac} , and \bar{T}_{sk} --never were very different at the beginning and at the end of an experiment. The values obtained are given in Table 6. The variation in T_{re} throughout the day will be presented in later graphs, but hourly values for T_{ac} and \bar{T}_{sk} will not be presented. Generally the T_{ac} 's followed nicely the T_{re} in magnitude of change and pattern across the day. As would be expected, the response time of T_{ac} is shorter than that for T_{re} , and T_{ac} usually ran approximately 0.1-0.2°C below T_{re} . Mean skin temperatures always ranged between 32 and 35°C in both suited and nude runs. Because skin temperatures are extremely sensitive to environmental factors, it is doubtful if meaningful circadian patterns are discernable in these experiments. The use of proportionality equations in calculating \bar{T}_b and the prediction of changes in S therefrom has already been discussed. The changes in S based upon \bar{T}_b changes across the 24-hour period are also given in Table 6. The calculated values range from +0.6 to +56.5 kcals for all eight runs. The range results from the use of the minimum and maximum weighting coefficients normally quoted in the literature (see Table 6). The S obtained in this fashion has not been used to "correct" the S values presented in this report, which are obtained calorimetrically and are very much larger in several cases. Although the relatively long test period may justify the use of $\Delta\bar{T}_b$, our general distrust of the quantitative accuracy of this technique will not permit its use as a "corrector."

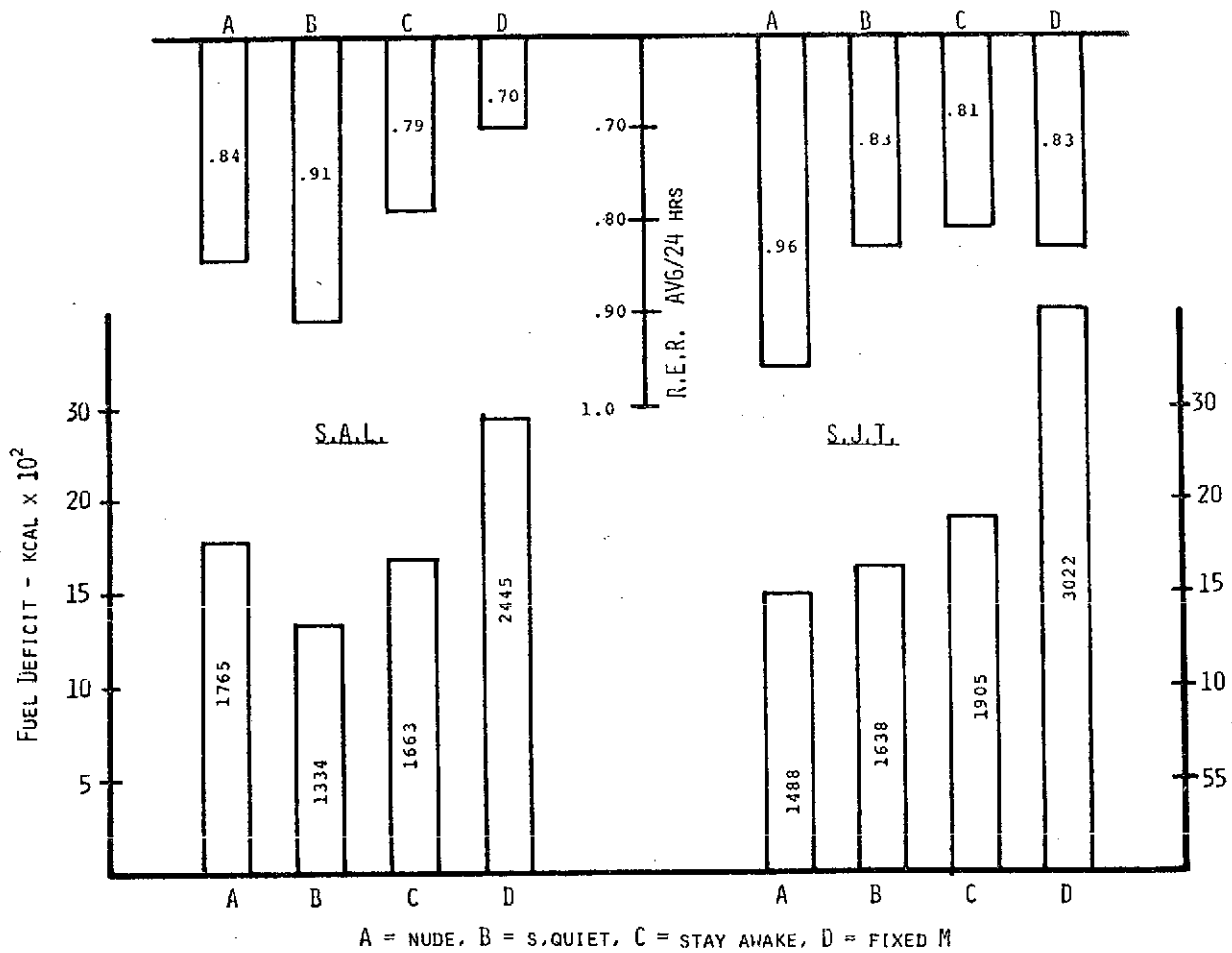

Figure 6. The caloric value of the food ingested over 24 hours did not equal the energy expenditure. The fuel deficit (bottom) generally shows an indirect relationship with the average RER (top) obtained in each experiment.

Table 6.
Experiment Start-End Body Temperatures
and Estimation of S from \bar{T}_b

<u>Expt.</u> <u>type</u>	<u>Subj.</u> <u>initials</u>	T_{re}		T_{ac}		\bar{T}_s		<u>S*</u> <u>estimated range</u> kcal
		<u>start</u> °C	<u>end</u> °C	<u>start</u> °C	<u>end</u> °C	<u>start</u> °C	<u>end</u> °C	
nude	SAL	36.6	36.6	36.2	36.2	33.4	34.0	+3.2 - +10.7
quiet	SJT	36.2	36.6	36.2	36.4	33.2	33.4	+0.6 - +14.7
quiet day	SAL	36.8	36.8	36.1	36.4	33.2	33.6	+7.1 - +9.4
	SJT	36.7	37.3	36.8	37.3	32.5	33.5	+45.9 - +56.5
stay awake	SAL	37.1	37.3	37.0	37.1	33.8	34.1	+8.9 - +12.5
	SJT	37.3	37.3	37.2	37.2	34.0	33.7	-2.3 - -7.6
fixed metab- olism	SAL	37.0	37.5	36.9	36.5	33.5	33.5	+4.9 - +18.0
	SJT	27.1	37.7	37.0	37.6	33.4	33.0	+20.8 - +38.6

* Estimation of storage (S) range based upon following relationships:

$$\bar{T}_b = 0.67 T_{re} + 0.33 \bar{T}_s$$

$$\bar{T}_b = (0.90 \frac{T_{re} + T_{ac}}{2}) + 0.10 \bar{T}_s$$

$$S = \Delta \bar{T}_b \times m \times c$$

Effects of the Suit Calorimeter

One of the objectives of this study was to determine what effect, if any, the WCG (or the control of the WCG) has on metabolic cycles. In order to determine the answer to that question one must examine the interrelationships of metabolism, thermoregulation, and body temperature obtained for the nude quiet and the quiet day runs. The comparative plots for the hourly values of ΣH , M , and T_{re} for the two subjects are presented in Figures 7 and 8. The most clear effect noticed by examining the figures is that M was lower for both subjects when the WCG was worn. As previously stated, the percentage reduction amounts to 35% and 14% for subjects SAL and SJT respectively. The reduction is most evident during the non-sleeping hours of the day. In sleep the M differences are not large; however, the heat loss (ΣH) remains high in the nude quiet runs. Body temperature as represented by T_{re} appears to reflect the increased M when one is nude even though the heat loss is increased in proportion to M . As already noted, the 24-hour total M for the stay awake run for subject SAL was lower than his nude run, even though he had no sleep. Perhaps the chamber was somewhat cool for this man, hence an increased activity level was stimulated by the desire for warmth. The subject reported no shivering; however, some O_2 demand may have resulted from increased muscle tension. This subject has rather a low amount of subcutaneous fat insulation.

In addition to the general effect of the WCG on lowering M , the suit calorimeter tended to reduce diurnal random fluctuations in both M and ΣH . In other words, the WCG smooths the hunting aspects in both metabolism and thermoregulation. The slowly responding T_{re} is not affected; the WCG has no effect on its circadian pattern. The midday and midnight peaks in M exhibited by subject SAL (Figure 8) during the suit run may be buried in the elevated M during the nude experiment. The midnight peak in M is also present in subject SJT on both nude and suited days.

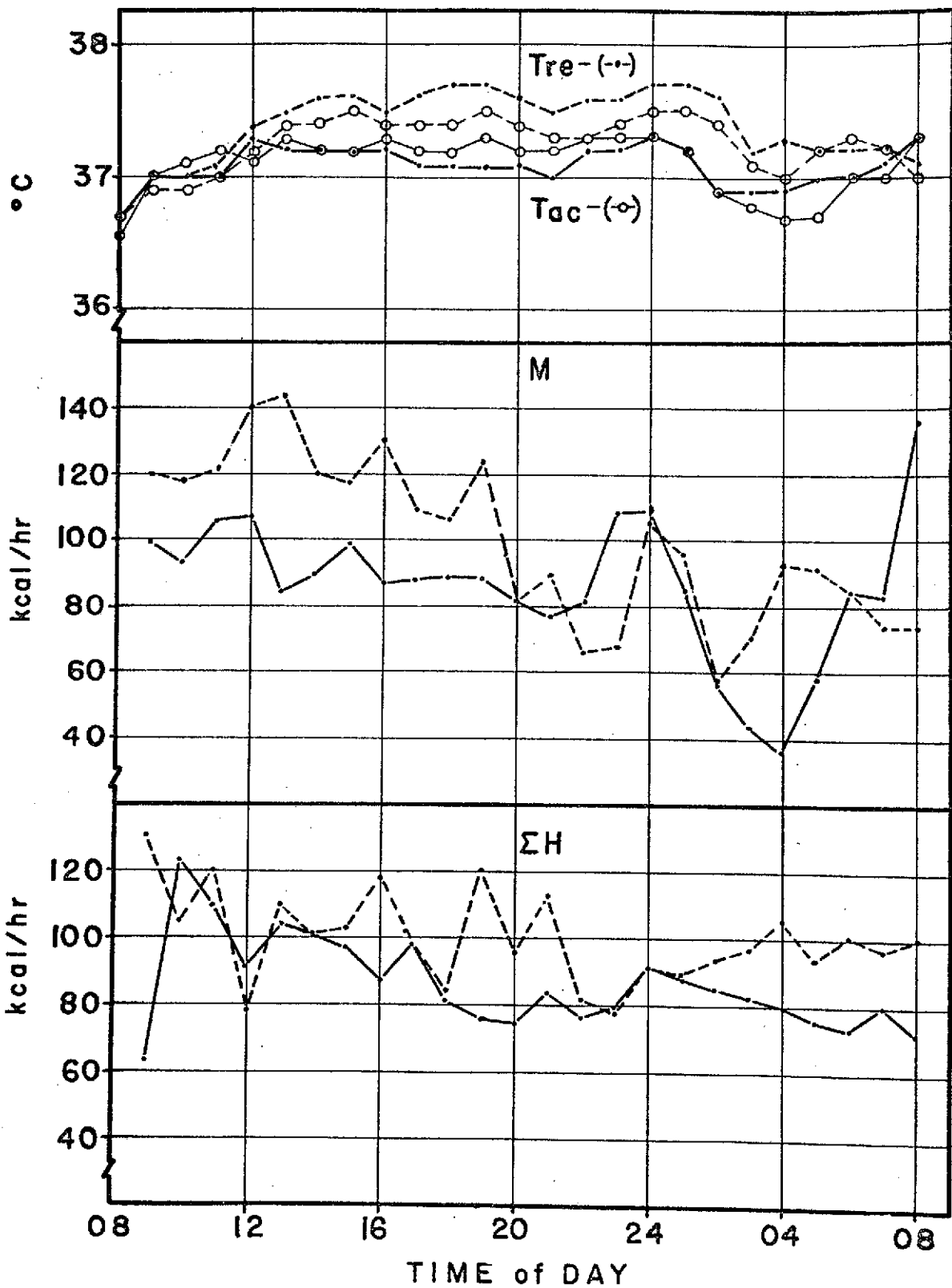

Figure 7. The circadian variations in heat production (M), thermoregulation (ΣH), and body temperature from rectal (T_{re}) or ear canal (T_{ac}) temperature, compared for the nude quiet (dashed line) and the suited quiet (solid line) days for subject SJT. The individual points represent the total M and ΣH , or the average temperature for the preceding hour.

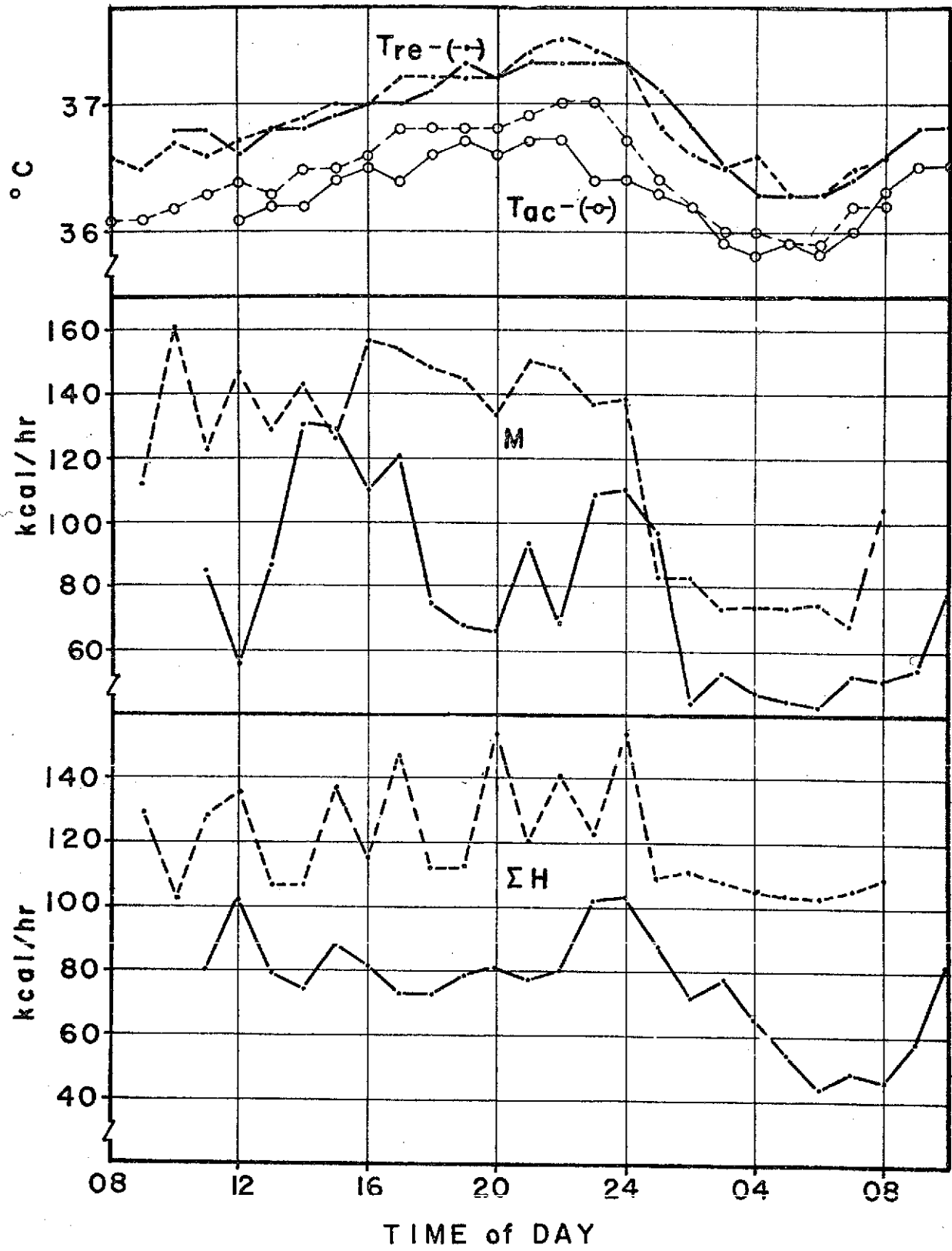

Figure 8. The same as Figure 7, p. 43, but for subject SAL.

One hypothesis that occurs to us is that the properly controlled WCG represents an ideal means for the body to lose heat produced without an energy cost to the process. That is, the amount of energy which would typically be required by the nude man to operate his thermoregulatory mechanisms is not needed when he is wearing the WCG.

Effects of Sleep

In order to determine the effect of sleep on the three metabolic indicators of choice (M , ΣH , and T_{re}), we can compare the results obtained in the quiet day and the stay awake tests. The hourly value plots for the 24-hour measurement periods are given in Figures 9 and 10 for subject SJT and subject SAL respectively. The first and most obvious influence on metabolic patterns induced by sleeplessness is the elevated M and ΣH during the night of the stay awake experiments. It is interesting, however, that although the stay awake nighttime M is elevated compared to quiet day sleeping, it is nevertheless somewhat lower than the daytime average for subject SJT and higher than the daytime average for subject SAL. The higher daytime M for subject SJT probably resulted from forced alertness and activity maintained by this subject with the knowledge that he must not sleep. His natural tendency for nighttime alertness may have permitted a degree of relaxation not permitted earlier in the day.

The normal depression of T_{re} from 2400 to 0400 hours is obviously lessened by lack of sleep in the stay awake experiments. T_{re} drops during the sleeping portion of the quiet day (2400-0400 hours) were 0.4°C and 1.0°C for subject SJT and SAL respectively. With no sleep, the T_{re} drops for the same period were only 0.1°C and 0.3°C . It appears as if the circadian pattern described by T_{re} is, at least in part, a product of the interplay of M and ΣH . Also, T_{re} tends to follow reversals in magnitudes of M and ΣH rather

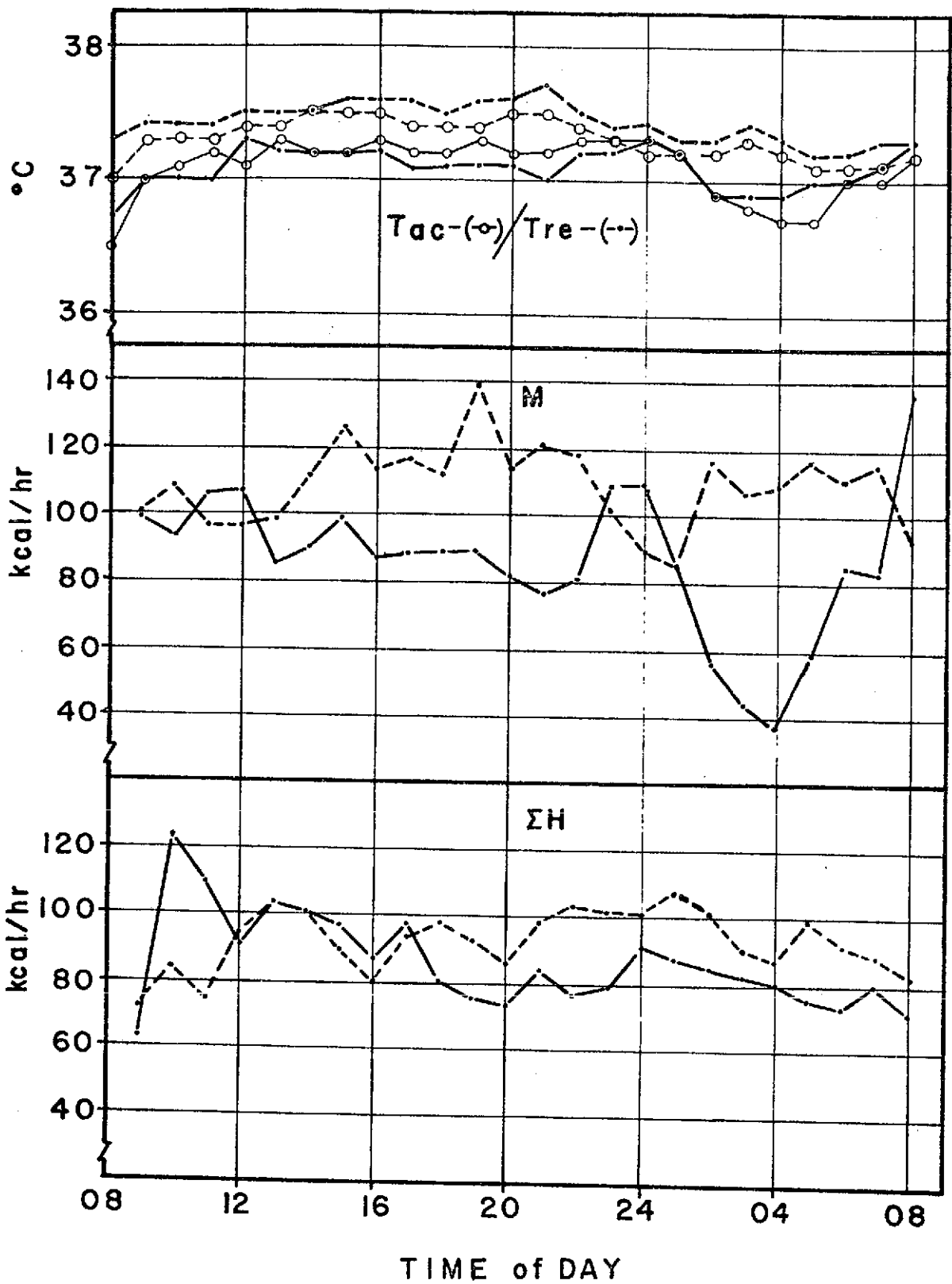

Figure 9. The effects of staying awake (dashed line) upon heat production, thermoregulation, and body temperature when compared to the quiet day (solid line) in the suit calorimeter, for subject SJT. Symbols are as in Figures 7 and 8.

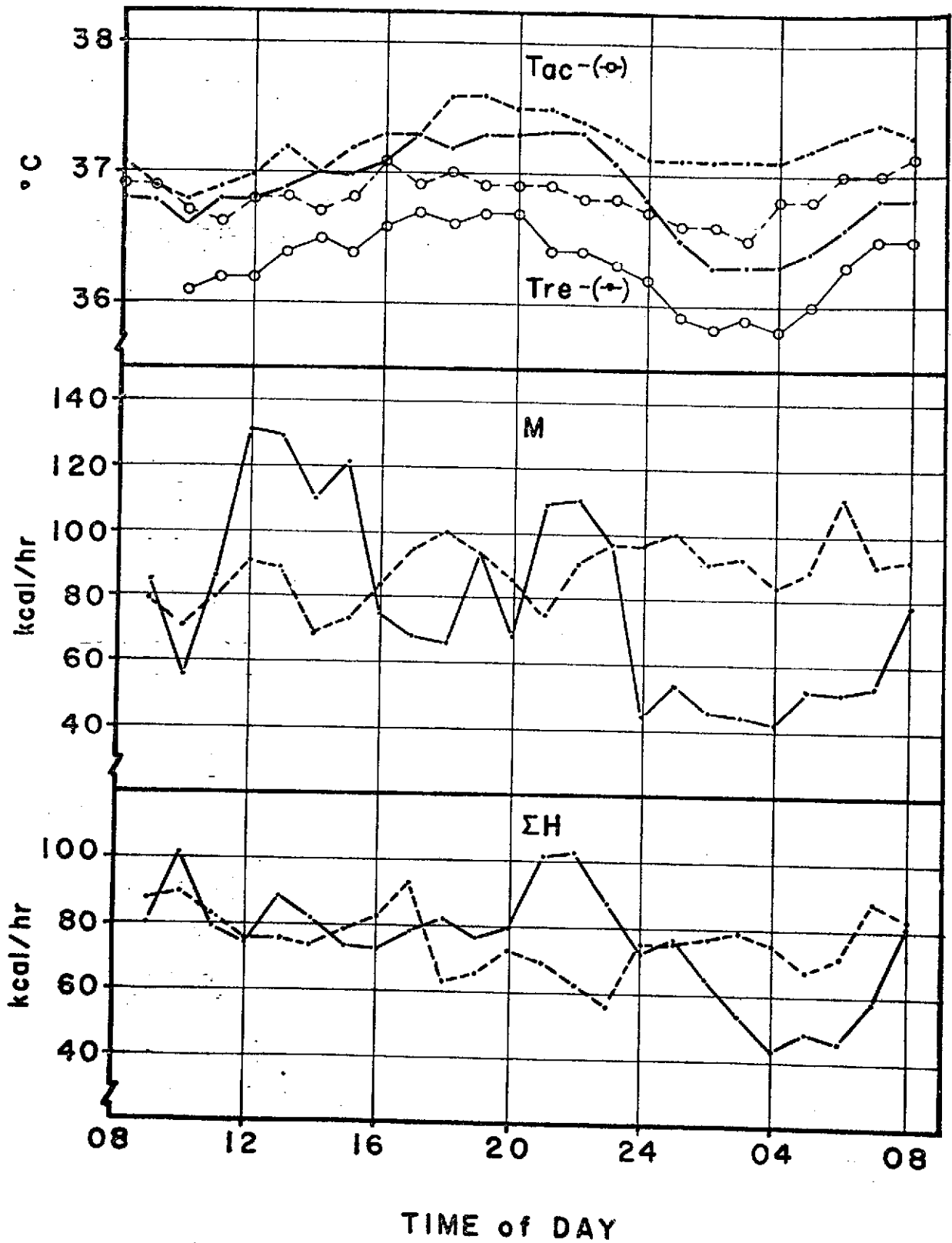

Figure 10. The same as Figure 9, p. 46, but for subject SAL.

faithfully, but its magnitude of change does not relate reliably to the magnitudes of changes in M and ΣH . T_{re} , therefore, is not a particularly accurate indicator of body heat content. In this set of experiments, rates of change in either M or ΣH seem to dictate T_{re} change, with slower rates of change showing little or no effect on T_{re} . Again referring to figures 9 and 10, it will be seen that over the same time period (2400-0400), when the subjects had no sleep, the hourly total heat production exceeds heat loss in all but one hour, even though T_{re} does decrease slightly. The pre-bedtime jump in M and ΣH observed for both subjects during the quiet day was missing when no sleep was allowed.

Hypotheses based upon two experiments are indeed tenuous. However, doing just that, we hypothesize that circadian patterns in both thermoregulation and body temperature appear to be largely manifestations of activity level. Interestingly, T_{re} defies this conclusion because T_{re} actually dips during the sleepless nights even though hourly storage values were almost always positive.

Effects of Fixed M

By holding M fixed for 24 hours continuously and comparing the impact of this maneuver with a normal quiet day, one may draw conclusions about the effect of heat production on cycles in heat loss and body temperature. Such a comparison is given in Figures 11 and 12 for subject SJT and SAL respectively.

The first impression obtained by looking at the data is that, despite the fixed M , the ΣH and T_{re} continue to show a normal diurnal pattern, being elevated only enough to account for the increased heat production. Although

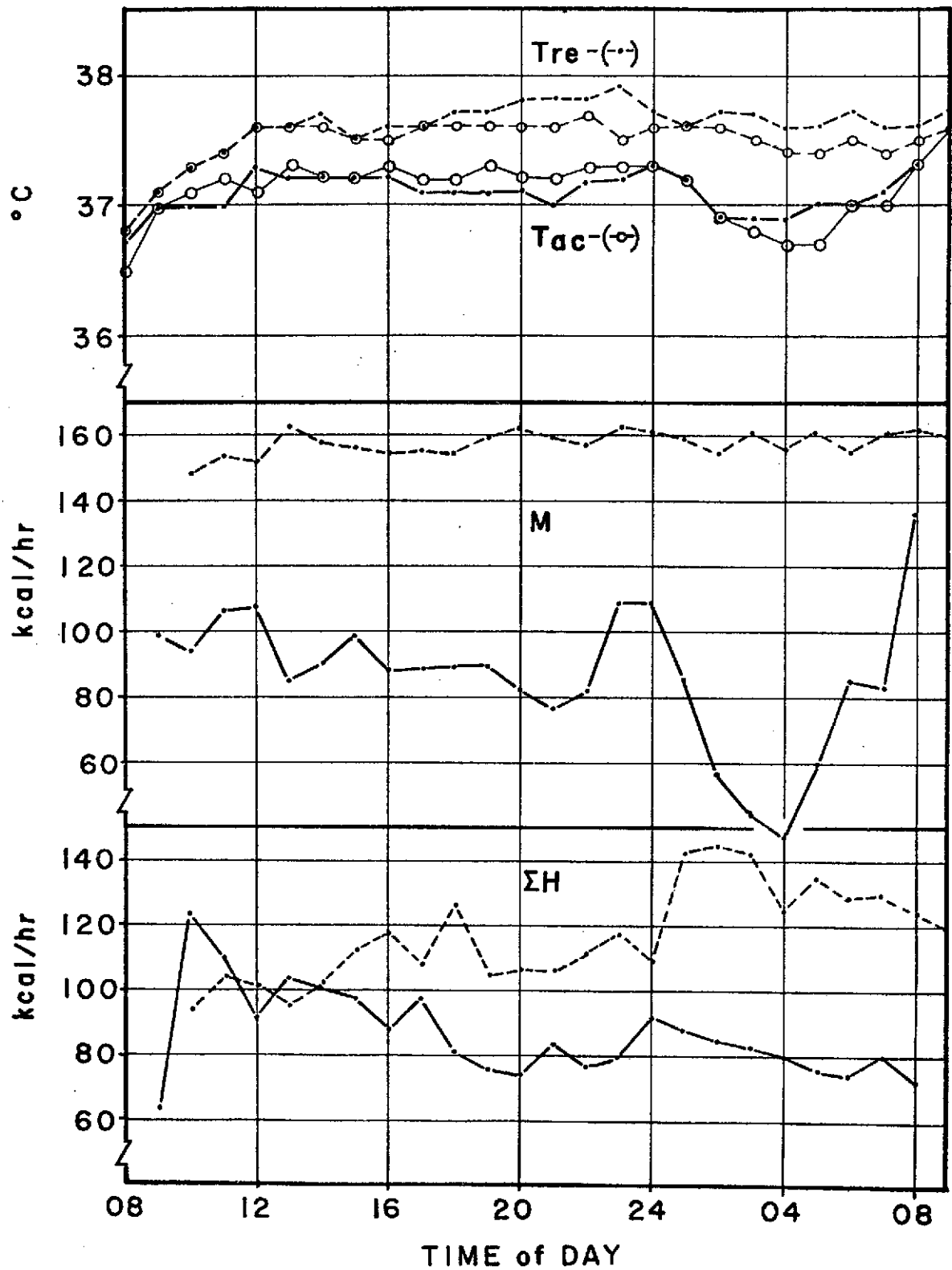

Figure 11. The effects of fixed M (dashed lines) upon thermoregulation and body temperature, compared to the quiet (solid line) day for subject SJT. Symbols are as in preceding four figures.

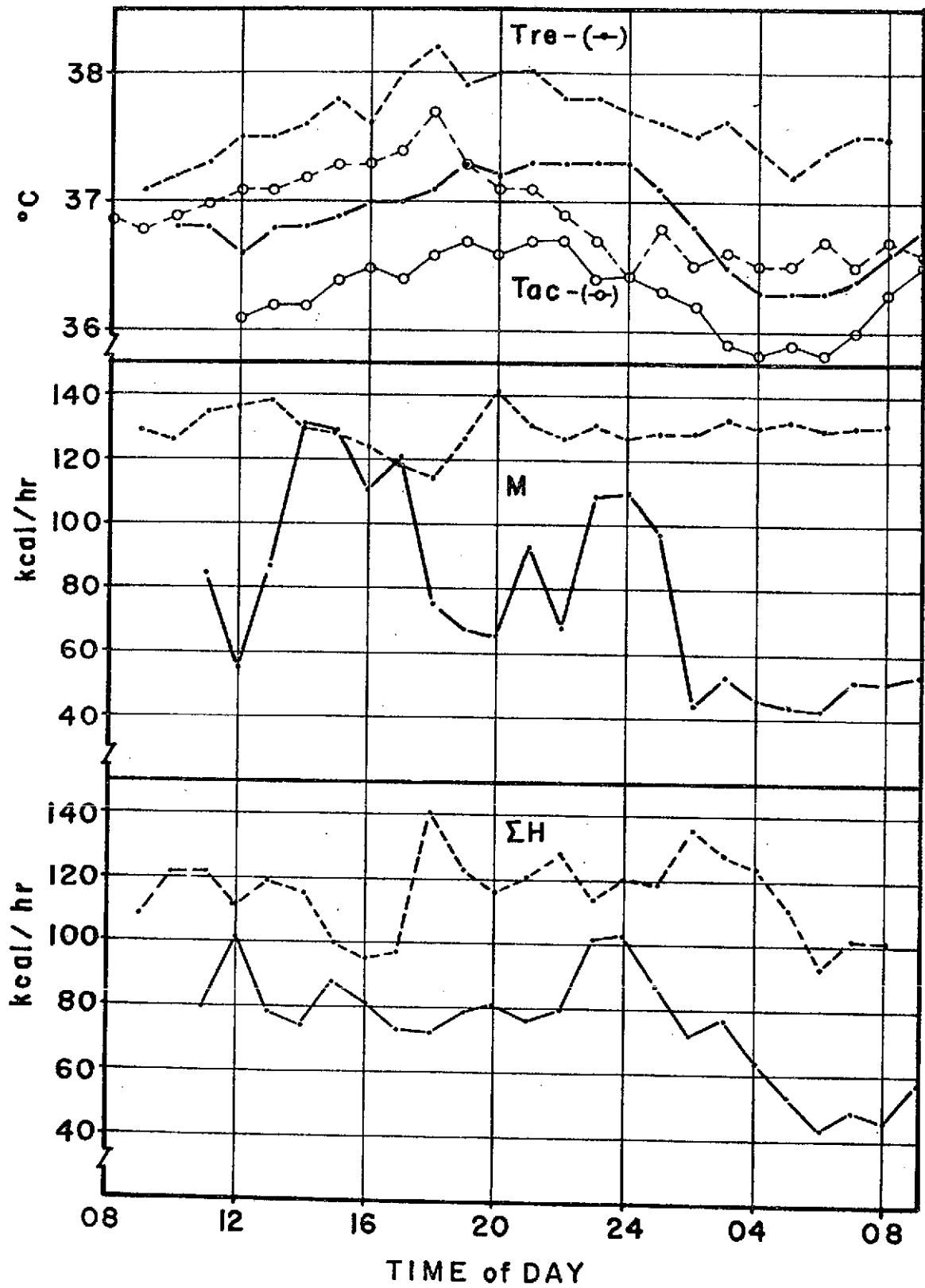

Figure 12. The same as Figure 11, p. 49, but for subject SAL.

ΣH tends to increase gradually throughout most of the day, it does not keep pace with heat production. In fact, in one subject (SAL), the ΣH follows an elevated but typical nighttime pattern. This picture is also true for this subject's T_{re} . All of this in the face of an apparently increasing heat storage. The other subject, SJT, shows a rather large atypical jump in nighttime ΣH , although it starts to decline prior to the 0900 end of the experiment. Unfortunately, this subject (SJT) shows a very flat T_{re} circadian pattern in all of his runs. Certainly in both men there is no indication in either ΣH or T_{re} of the ever increasing heat storage that is apparent from the data. Obviously, cooling potential was available to the men via the WCG. With an average ΔT between \bar{T}_{sk} and \bar{T}_w of 4°C , the WCG, in our experience, was capable of removing at least 1.5 times the highest measured heat production rate. The overnight heat production during the fixed metabolism day averaged 2.6 times that for the sleeping portion of the quiet day for both subjects. The ΣH over the same period does not keep pace, and averages only 1.7 times the sleep heat loss rates. Meanwhile the T_{re} differences at night are not significantly increased over the daytime differences between the fixed metabolism and the quiet days.

The somewhat random diurnal fluctuations in thermoregulation continued even though heat production was very constant. Since the WCG parameters were also stable (T_{wi} and \dot{m}), the fluctuations in ΣH during the fixed metabolism experiments were not forced. The body's thermoregulatory mechanisms appear to retain heat or dump heat independently from S changes. Similarly, T_{re} may reflect S changes, particularly if the rate of change is relatively high, but continues to follow an offset circadian rhythm even though body heat content (S) is ever increasing. This response is not strikingly obvious; however, the reader may judge for himself by studying Figures 13 and 14 in which T_{re} versus S values are plotted hourly for subject SJT and SAL respectively.

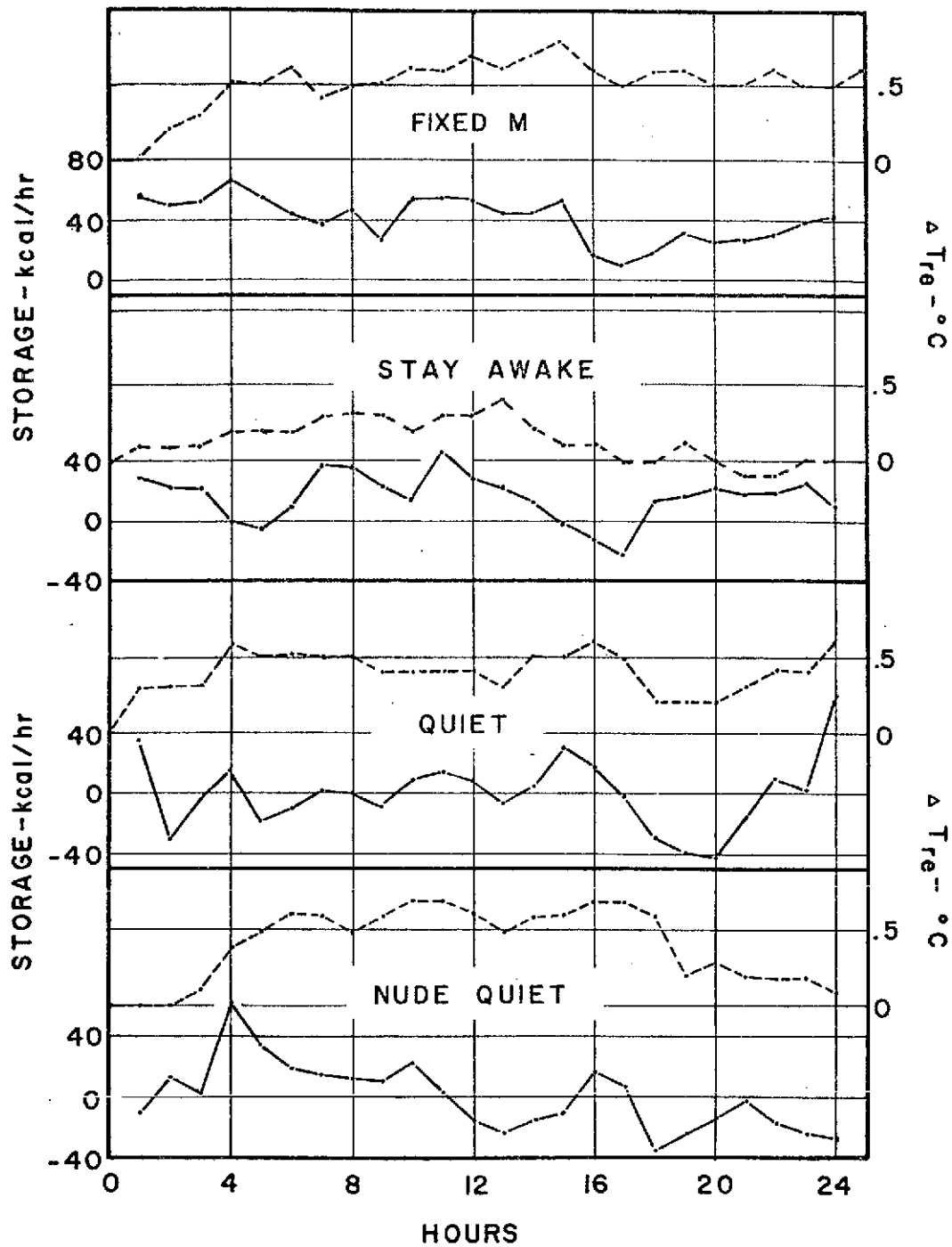

Figure 13. This graph compares the hourly changes in T_{re} (dashed line) and storage (S), (solid line), for subject SJT in the four different experiment routines. Note that the S values are not cumulative. T_{re} may follow the direction of S, hour by hour, but it does not rise steadily in those long periods when S is continually positive and thus accumulates to a high storage level.

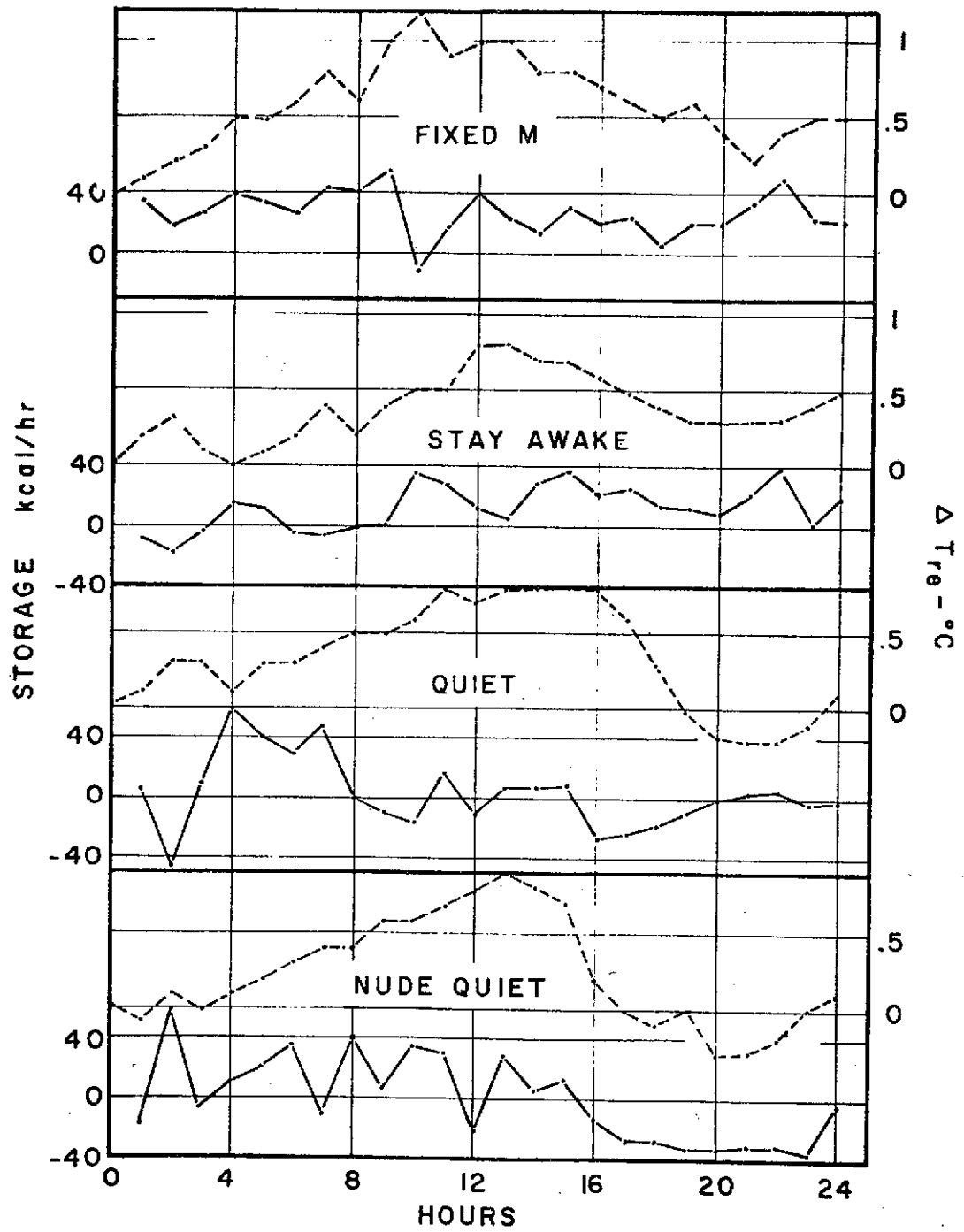

Figure 14. The same as Figure 13, p. 52, but for subject SAL.

Summary of Results

In summary, the following basic findings were made in this study:

1. An energy imbalance results when subjects remain awake or work continuously for 24 hours.
2. The amount of the imbalance appears to be directly related to activity level as well as to fuel intake deficits.
3. Body temperature, as indicated by T_{re} and T_{ac} , does not reflect these imbalances.
4. The WCG tends to lower metabolism and smooth thermoregulatory fluctuations without destroying circadian patterns. It is possible that the WCG may lower metabolism by reducing the energy cost of thermoregulation.
5. Staying awake tends to damp the magnitudes of nocturnal change in metabolism, thermoregulation, and body temperature without obliterating circadian rhythms.
6. When metabolism is elevated and fixed for a complete day, circadian variations in thermoregulatory responses and body temperature continue to be faintly visible.

DISCUSSION

One purpose of the study was to see whether wearing the water cooled garment as a calorimeter alters the normal responses of a subject in some way. The answer seems to be yes. Both subjects in this study were quieter, metabolically, wearing the suit than without it. This was shown in Figures 7 and 8, in which both metabolic level and heat loss level were lower and less variable in the quiet day (in the suit) than during the nude quiet day. Along the same lines, in an earlier study (7) the same quiet day (in the suit) procedure on two different men had shown that their heat production and heat loss levels were phenomenally low--a daily metabolic turnover of only 1440 kcals.

Another purpose was to verify that the circadian cycles in M , ΣH , and T_{re} that had been seen in the earlier study (8) would be found in the two new subjects of the present study. They were, even though certain individualities are evident, like the low variability of SJT's T_{re} curve.

The part of this study that was meant to modify circadian cycles of M , ΣH , and T_{re} seemed to show that changing activity patterns--sleepless nights, or continual work--not only produced the obligatory changes in M , but modified ΣH and T_{re} patterns as well. When the subjects stayed awake for 24 hours, the usual nocturnal fall in M was lessened, and the corresponding falls in ΣH and T_{re} were much reduced, although not eliminated. Thus it seems fair to say that activity is the important driver of these circadian rhythms, or, conversely, that circadian cycles in ΣH and T_{re} are largely determined by man's usual pattern of high M during the day and low M at night.

So much for what we set out to show experimentally. As always, however, something unexpected occurred, which is at least as interesting as the results we expected. This was the observation that although heat balances were again nearly perfect for the quiet day procedure, they seemed to be enormously in error in both the stay awake and the fixed metabolism procedures.

The imbalance was always in the direction of much more energy being released from fuel (as evidenced by oxygen consumption and CO₂ production) than could be accounted for as heat loss in the calorimeter. The first reaction to this was that there must be something wrong with our methods. We are always critical of our own techniques, and compulsive about calibrating and recalibrating. A series of searching critiques and re-checks of equipment failed to provide evidence of measurement error of any real significance.

Considering that the most likely error in indirect calorimetry might have been the \dot{V}_{O_2} measurement, we back-calculated that the instrument error would have had to be approximately 140 cc/min or 23.5%. No such error was found in the post-experiment calibration check. This held true for all the experiments of the series in which positive energy balances were obtained. It must also be remembered that both the subjects and the experimentors were experienced in the measurement of \dot{V}_{O_2} and the assessment of exercise levels. Subject SJT normally averages approximately 350 cc/min \dot{V}_{O_2} when seated quietly. Judging from the external work measured in his fixed metabolism experiment, he was well above this level of \dot{V}_{O_2} ; certainly he was very close to the 600 cc/min target value. Why then the large imbalance in some of the experiments? Perhaps instead of error in measurement there was something wrong with our expectations.

Another explanation was eliminated by the following argument. If the imbalance were actually heat storage, but our many temperature sensors somehow were in the wrong places to discover it, then how hot should the subjects have become? To take the most dramatic case, subject SJT in his fixed metabolism run apparently stored 978kcal. His body weight is 93 kg, so his mean body temperature should have risen by $978/(93 \times 0.83) = 12.67^{\circ}\text{C}$. It is hard to believe either that the skin probes, rectal probe, and ear canal probe missed detecting such a change, or that SJT would have been comfortable with a mean body temperature of, let's say, 47°C . The other possibility is that the "heat" was stored in some out-of-the-way corner, some distance from the temperature probes. This idea fails to convince when numbers are used. Suppose this remote body mass has a high specific heat--say 1.0, equal to water. And suppose it is as large a mass as skeletal bone, about 15% of the total mass. In our example of 93 kg SJT and the 978kcal, his skeletal mass is about 14 kg, and its final temperature rise would have been $978/(14 \times 1) = 69.86^{\circ}\text{C}$. Assuming an average initial temperature of 36°C , his final average skeletal temperature would have had to be 105.86°C . The final temperature would have had to be even higher in any single organ, like the liver or the spleen.

So if the "storage" is not heat, then what sort of energy imbalance can we be dealing with? We can only speculate. In general, there are exothermic and endothermic processes, both in chemical reactions and in thermodynamic events. Oxidation of fuels releases "free energy," but that energy does not always have to appear as heat, even after allowing for external mechanical work. Can the body store significant quantities of potential energy, such as ATP or other energy-rich material? Our reading suggests such storage is not large enough to account for what we observed. Is the classical heat balance equation (Eq. 4, p. 10) good only under certain circumstances?

After we had erected as many hypotheses as the number of man-hours we spent arguing (and that was more than a few), our present guess is that the deficits in caloric intake in our experiments, which roughly correlate with the imbalances, might be the cause of those imbalances. The idea led us to look back over our own earlier studies in the days before we called the water cooled garment a calorimeter. In many previous experiments (4), we had regularly seen heat production exceed heat loss during 1-hour and 2-hour exercise periods. Since no food was taken during those experiments, a fuel intake deficit was present, meaning that fuel from body stores had to be mobilized.

In addition to reviewing our old experiments, we examined early calorimetry data searching for similar imbalances when subjects were active during a 24-hour measurement period. Fortunately we were able to obtain a copy of Atwater and Benedict's respiration calorimeter study, published in 1903 (15). The 55 experiments reported represent a monumental effort involving a high degree of complexity. When groups of similar experiments were averaged, good energy balances were obtained. However, in one series of experiments involving work (bicycle ergometer) and lasting at least 24 hours, where the diet (largely fat) was also deficient, as was ours, imbalances occurred. The energy estimated indirectly exceeded that measured directly; hence energy storage in some form must have occurred. It could not be accounted for by changes in body temperature. In one case the mis-match amounted to nearly 670 kcals over 24 hours. Considering the similarities with our stay awake and fixed metabolism experiments, their results are very interesting.

This hypothesis is easy enough to test. Experiments similar to those reported here could be carried out, but with food intake carefully matched to energy expenditure. Also, experiments could be done where food intake

exceeded energy expenditure. In the first case, there should be little or no imbalance, and in the second, if an imbalance appeared, it should be one showing greater heat loss than heat production. Such experiments would do much to enlarge our knowledge of metabolic processes and nutrition.

REFERENCES

1. Billingham, John. Heat exchange between man and his environment on the surface of the moon. *J. Brit. Interplanetary Soc.* 17:297-300, 1959.
2. Nunneley, Sarah A. Water cooled garments: a review. *Space Life Sciences* 2: 335-360, 1970.
3. Webb, Paul; and Annis, James F. Bio-thermal responses to varied work programs in men kept thermally neutral by water cooled clothing. NASA CR-739. National Aeronautics and Space Administration, Washington, D. C. , 1967.
4. Webb, Paul; Annis, James F. ; and Troutman, Samuel J. , Jr. Automatic control of water cooling in space suits. NASA CR-1085. National Aeronautics and Space Administration, Washington, D. C. , 1968.
5. Webb, Paul; Troutman, Samuel J. , Jr. ; and Annis, James F. Automatic cooling in water-cooled space suits. *Aerospace Med.* 41:269-277, 1970.
6. Troutman, Samuel J. , Jr. ; and Webb, Paul. Automatic control of water cooled suits from differential temperature measurements. NASA CR-86244. National Aeronautics and Space Administration, Washington, D. C. , 1969.
7. Webb, Paul; Annis, James F. ; and Troutman, Samuel J. , Jr. Human calorimetry with a water-cooled garment. *J. Appl. Physiol.* 32: 412-418, 1972.
8. Webb, Paul. Metabolic heat balance data for 24-hour periods. *Inter. J. Biometeor.* 15: 151-155, 1971.
9. Gagge, A. P. ; and Hardy, J. D. Thermal radiation exchange of the human by partitional calorimetry. *J. Appl. Physiol.* 23: 248-258, 1967.

10. Webb, Paul; and Annis, James F.; Cooling required to suppress sweating during work. *J. Appl. Physiol.* 25: 489-493, 1968.
11. Bligh, John; and Johnson, K. G. Glossary of terms for thermal physiology. *J. Appl. Physiol.* 35: 941-961, 1973.
12. Kerslake, D. McK. The Stress of Hot Environments. Cambridge University Press, 1972.
13. Webb, Paul; and Troutman, Samuel J., Jr. An instrument for continuous measurement of oxygen consumption. *J. Appl. Physiol.* 28: 867-871, 1970.
14. Åstrand, Per-Olof. Work tests with the bicycle ergometer. (pamphlet) Monark-Crescent AB, Varberg, Sweden.
15. Atwater, W. O.; and Benedict, F. G. Experiments on the metabolism of matter and energy in the human body. U. S. Dept. of Agriculture, Office of Experiment Stations, Bulletin No. 136, 1903.