

P
2 mif

May 1974

NASA TECHNICAL MEMORANDUM

NASA TM X-64846



MSFC SKYLAB ATM CALIBRATION
ROCKET PROJECT

Skylab Program Office



NASA

*George C. Marshall Space Flight Center
Marshall Space Flight Center, Alabama*

(NASA-TM-X-64846) MSFC SKYLAB ATM
CALIBRATION ROCKET PROJECT Final
Technical Memorandum (NASA) 467 p HC
\$5.00

165 CSCL 22B

N74-26319

G3/31 Unclass
39951

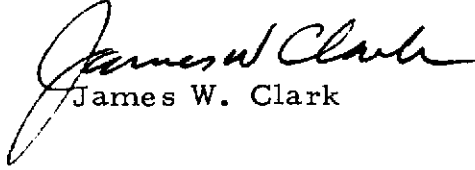
1. REPORT NO. NASA TM X-64846		2. GOVERNMENT ACCESSION NO.		3. RECIPIENT'S CATALOG NO.	
4. TITLE AND SUBTITLE MSFC SKYLAB ATM CALIBRATION ROCKET PROJECT				5. REPORT DATE May 1974	
				6. PERFORMING ORGANIZATION CODE	
7. AUTHOR(S)				8. PERFORMING ORGANIZATION REPORT #	
9. PERFORMING ORGANIZATION NAME AND ADDRESS George C. Marshall Space Flight Center Marshall Space Flight Center, Alabama 35812				10. WORK UNIT NO.	
				11. CONTRACT OR GRANT NO.	
12. SPONSORING AGENCY NAME AND ADDRESS National Aeronautics and Space Administration Washington, D. C. 20546				13. TYPE OF REPORT & PERIOD COVERED Technical Memorandum Final	
				14. SPONSORING AGENCY CODE	
15. SUPPLEMENTARY NOTES					
16. ABSTRACT <p>This report provides the National Aeronautics and Space Administration (NASA) Headquarters, Office of Space Science (OSS), Marshall Space Flight Center (MSFC), and other interested agencies, with results of the Apollo Telescope Mount (ATM) Calibration Rocket (CALROC) performances and anomalies encountered. The performance period included six CALROC flights during the Skylab 2, 3 and 4 missions as well as those rocket flights prior to the Skylab mission which carried CALROC hardware for test purposes. Background material such as project purpose, management, launch facilities, booster and payload configuration is included for better understanding of the CALROC payload and its mission objectives.</p> <p>Three successful calibration flights with the NRL CALROC Scientific Instrument and two successful calibration flights with the HCO CALROC Scientific Instrument were obtained. Both the NRL and HCO data are being processed and the curves and/or data will be available at NRL, HCO or MSFC in late 1974 or early 1975.</p> <p>Initial calibration data analyses indicate that the data are adequate to excellent and that calibration of the Skylab ATM solar astronomy data will be successfully achieved.</p>					
17. KEY WORDS			18. DISTRIBUTION STATEMENT Unclassified-unlimited  James W. Clark		
19. SECURITY CLASSIF. (of this report) Unclassified		20. SECURITY CLASSIF. (of this page) Unclassified		21. NO. OF PAGES 165	22. PRICE NTIS

ACKNOWLEDGEMENT

This report was written by J. R. Brothers, Martin Marietta Corporation, and is based upon information supplied by the following government and industry organizations:

George C. Marshall Space Flight Center
Ames Research Center
White Sands Missile Range
Naval Research Laboratory
Harvard College Observatory
Ball Brothers Research Corporation
Lockheed Missile and Space Company
Bristol Aerospace Limited
Fairchild Space and Electronics
AVCO Systems
Computer Sciences Corporation

TABLE OF CONTENTS

Abstract	11
Table of Contents	iii
List of Illustrations	v
List of Tables	vii
Abbreviations	viii
SECTION 1. INTRODUCTION	1
1.1 Project Purpose	2
1.2 Project Management	3
1.3 Launch Facilities	4
1.4 Data Analysis	4
1.5 Summary Results	4
SECTION 2. CONFIGURATION	7
2.1 Rocket Motor	8
2.2 Payload	13
2.2.1 NRL Scientific Instrument	14
2.2.2 HCO Scientific Instrument	16
2.2.3 NRL Pointing Control System	24
2.2.4 HCO Pointing Control System	31
2.2.5 NRL Telemetry	31
2.2.6 HCO Telemetry	37
2.2.7 Nosecone and Recovery System	43
2.2.8 Separation Systems	43
2.2.9 Igniter Housing	43
2.2.10 Interface Control Drawings	50
SECTION 3. TEST FLIGHT SUMMARY	54
SECTION 4. PERFORMANCE - CALROC TEST FLIGHTS	58
4.1 Flight 21.001	60
4.2 Flight 21.007	61
4.3 Flight 21.008	61
4.4 Flight 21.009	66
4.5 Flight 21.011	69
4.6 Flight 21.016	76
4.7 Flight 21.019	76
4.8 Flight 21.020	83
SECTION 5. SKYLAB CALROC FLIGHT SUMMARY	95
SECTION 6. PERFORMANCE - SKYLAB 1/2 CALROC FLIGHTS	99
6.1 Flight 21.021	100
6.2 Flight 21.012	110

TABLE OF CONTENTS (CONTINUED)

	Page
SECTION 7. PERFORMANCE - SKYLAB 3 CALROC FLIGHTS	118
7.1 Flight 21.022	119
7.2 Flight 21.013	133
SECTION 8. PERFORMANCE - SKYLAB 4 CALROC FLIGHTS	144
8.1 Flight 21.023	145
8.2 Flight 21.014	150

LIST OF ILLUSTRATIONS

<u>Figure</u>	<u>Title</u>	<u>Page</u>
1-1	Typical CALROC Launch at WSMR	5
1-2	Typical CALROC Payload Post-Flight Recovery at WSMR . . .	6
2-1	Skylab CALROC Payload Booster Motor Configuration . . .	10
2-2	Typical Skylab CALROC Flight Profile	11
2-3	BBVC Rocket Motor	12
2-4	NRL CALROC Scientific Instrument	15
2-5	HCO CALROC Scientific Instrument	17
2-6	Optical Schematic of the HCO CALROC Spectroheliometer .	18
2-7	Areas of the Solar Disc Monitored by the ATM and HCO CALROC Spectroheliometer	19
2-8	HCO CALROC Payload on CALROC Vacuum Pump	21
2-9	HCO CALROC Channel Electron Multiplier Detector Unit . .	22
2-10	NRL CALROC SPARCS, Forward View	25
2-11	NRL CALROC SPARCS, Aft View	26
2-12	NRL CALROC SPARCS, Side View	27
2-13	NRL CALROC SPARCS, Side View	28
2-14	CALROC Top Hat and Magnetometer	29
2-15	SPARCS Sensor and Valve Locations	30
2-16	HCO CALROC Intermediate and Fine Sun Sensors	33
2-17	Typical CALROC Nosecone and Recovery System	44
2-18	CALROC Nosecone and Recovery System	45
2-19	Typical CALROC Preflight Recovery System	46
2-20	Typical CALROC Post-Flight Recovery System	47
2-21	Typical CALROC Manacle Ring	48
2-22	Typical CALROC Igniter Housing	49
4-1	Payload 21.007 Altitude History	63
4-2	Payload 21.007 Velocity History	64
4-3	Vehicle 21.007 Roll Rate History	65
4-4	Payload 21.009 Altitude History	67
4-5	Payload 21.009 Velocity History	68
4-6	Payload 21.011 Altitude History	70
4-7	Payload 21.011 Velocity History	71
4-8	Payload 21.011 Roll Rate History	72
4-9	Post-Flight NRL CALROC 21.011 Payload	74
4-10	BBVC Flight 21.019 Altitude History	78
4-11	BBVC Flight 21.019 Velocity History	79
4-12	Flight 21.019 Roll Rate	80
4-13	Flight 21.019 Yaw Coarse Solar Sensor Output	82
4-14	Post-Flight CALROC 21.019 Payload	87
4-15	Roll Rate Versus Time-Flight 21.020	89
4-16	Flight 21.020 Altitude History	90
4-17	Flight 21.020 Velocity History	91
6-1	Post-Flight HCO CALROC 21.021 Payload, Aft End	101
6-2	Post-Flight HCO CALROC 21.021 Payload, Vacuum Dome Rupture	102

LIST OF ILLUSTRATIONS (CONTINUED)

<u>Figure</u>	<u>Title</u>	<u>Page</u>
6-3	Post-Flight HCO CALROC 21.021 Payload, Carbon Deposit Seen Through Vacuum Door	103
6-4	Payload 21.021 Altitude History	105
6-5	Post-Flight HCO CALROC 21.021 Payload	107
6-6	Velocity History - Flight 21.021	108
6-7	Roll Rate Versus Time from Lateral Magnetometer - Flight 21.021	109
6-8	Roll Rate Versus Time from Lateral Magnetometer - Flight 21.012	111
6-9	Velocity History - Flight 21.012	112
6-10	Altitude History - Flight 21.012	113
7-1	Roll Rate Versus Time from Lateral Magnetometer - Flight 21.022	120
7-2	Flight 21.022 Longitudinal Accelerometer	121
7-3	Velocity History - Flight 21.022	122
7-4	Altitude History - Flight 21.022	123
7-5	CALROC 21.022 Scientific Instrument Flight Temperatures	127
7-6	CALROC 21.022 Scientific Instrument Flight Temperatures	128
7-7	CALROC 21.022 Scientific Instrument Flight Pressure . .	130
7-8	Post-Flight HCO CALROC 21.022 Payload	132
7-9	Flight 21.013 Roll Rate Profile	134
7-10	Flight 21.013 Velocity Profile	135
7-11	Flight 21.013 Altitude Profile	136
7-12	Post-Flight NRL CALROC 21.013 Payload	143
8-1	Post-Flight HCO CALROC 21.023 Payload	149
8-2	Post-Flight NRL CALROC 21.014 Payload	154

LIST OF TABLES

<u>Table</u>	<u>Title</u>	<u>Page</u>
2-1	CALROC Hardware Manufacturers	9
2-2	SPARCS Control Parameters	32
2-3	PCM #1 (2259.5 Mhz)	38
2-4	PCM #1 Channel 15 Sub-Multiplexer	39
2-5	PCM #2 (2251.5 Mhz)	40
2-6	FM/FM (2279.5 Mhz)	41
2-7	FM/FM Channel 93 Commutator Assignment	42
2-8	CALROC Electrical Interface Control Drawings	51
2-9	CALROC Mechanical Interface Control Drawings	53
3-1	CALROC Hardware Test Flight Summary	56
4-1	Payload 21.007 Flight Profile	62
4-2	Payload 21.019 Flight Profile	77
4-3	SPARCS Commutator Number 2 Peak Temperatures	84
4-4	Thermocouple Commutator Peak Temperatures and Comparisons	85
4-5	Payload 21.020 Flight Profile	88
4-6	Maximum Temperature Data, Flight 21.020	93
5-1	CALROC Flight Summary	97
6-1	Flight 21.021 Sequence of Events	106
6-2	21.012 Flight Profile	114
7-1	21.022 Flight Performance	124
7-2	21.013 Flight Profile	137
8-1	Payload 21.023 Flight Parameters	146

ABBREVIATIONS

<u>Symbol</u>	<u>Definition</u>
Å	Angstrom
AGC	Automatic Gain Control
ARC	Ames Research Center
ATM	Apollo Telescope Mount
BBVC	Black Brant VC
CALROC	Calibration Rocket
CCIG	Cold Cathode Ionization Gauge
CSS	Coarse Sun Sensor
DC	Direct Current
EUV	Extreme Ultraviolet
FM	Frequency Modulated
FPS	Fine Pointing System
FSS	Fine Sun Sensor
GMT	Greenwich Mean Time
GSFC	Goddard Space Flight Center
G-Timer	Acceleration Timer
HCO	Harvard College Observatory
HV	High Voltage
ICD	Interface Control Drawing
IDT	Image Disector Tube
IRIG	Inter-Range Instrumentation Group
LMSC	Lockheed Missile Space Company
M12	Yaw Magnetometer
M13	Pitch Magnetometer
MgF ₂	Magnesium Flouride
MSFC	Marshall Space Flight Center
NASA	National Aeronautics and Space Administration
NBS	National Bureau of Standards
NRL	Naval Research Laboratory
OMSF	Office of Manned Space Flight

ABBREVIATIONS (CONTINUED)

<u>Symbol</u>	<u>Definition</u>
ORSA	Ogive/Recovery/Separation Assembly
OSS	Office of Space Science
Pc	Motor Chamber Pressure
PCM	Pulse Code Modulation
PDU	Photomultiplier Detector Unit
PI	Principal Investigator
PIC	Project Initiation Conference
RF	Radio Frequency
S12	Yaw Sun Sensor
S13	Pitch Sun Sensor
SIT	Silicon Intensified Target
SPARCS	Solar Pointing Aerobee Rocket Control System
ST	SPARCS Thermister
STRAP	Stellar Tracking Rocket Attitude Positioning
TC	Thermocouple
TM	Telemetry
V1, 2, etc.	SPARCS Valves 1, 2, etc.
WSMR	White Sands Missile Range

Section 1
INTRODUCTION

SECTION 1

INTRODUCTION

This report provides the National Aeronautics and Space Administration (NASA) Headquarters, Office of Space Science (OSS), Marshall Space Flight Center (MSFC), and other interested agencies, with results of the Apollo Telescope Mount (ATM) Calibration Rocket (CALROC) performances and anomalies encountered. The performance period included six CALROC flights during the Skylab 2, 3 and 4 missions as well as those rocket flights prior to the Skylab mission which carried CALROC hardware for test purposes. Background material such as project purpose, management, launch facilities, booster and payload configuration is included for better understanding of the CALROC payload and its mission objectives.

1.1 Project Purpose. In 1970 the Naval Research Laboratory (NRL), Harvard College Observatory (HCO), American Science and Engineering (AS&E) and others proposed to the NASA inflight calibration of the Skylab ATM experiments. After review by MSFC, the NRL and HCO calibration projects were approved by NASA Headquarters. The Project Initiation Conference (PIC) was held at Goddard Space Flight Center (GSFC) on June 8 and 9, 1971.¹ The purpose of the calibration rockets was to obtain solar scientific data for use in calibrating the Skylab ATM S082 (NRL) and S055 (HCO) solar data taken by the respective experiments onboard Skylab during the Skylab mission.² The Skylab ATM experiments were calibrated approximately two and one-half years prior to launching Skylab. In addition, sensitivity checks were made periodically up to as late as possible before launch. The last opportunity to conduct such a check occurred immediately following thermal vacuum test of the ATM in September 1972. However, due to unpredictable changes, such as reflectance characteristics of optical equipment, limit operational life of photomultipliers, and ultraviolet (UV) film characteristics, calibration during Skylab operations was a

-
1. John Humphreys Memorandum, "NRL and HCO Pre-Initiation Conferences (PIC) for the Calibration Rocket Program," to W. C. Keathley, NASA Marshall Space Flight Center, Huntsville, Alabama, June 14, 1971.
 2. Project Requirements Document for ATM Calibration Rocket Project, Marshall Space Flight Center, Huntsville, Alabama, dated February 8, 1973.

necessity. These changes could not be predicted because of the unknown effects of space environment on equipment and film. Even with carefully controlled manufacturing, test and environmental storage conditions degradation and efficiency losses occur in an unpredictable manner.

To assure an accurate representation of the solar data accumulated by both the S082 and S055 experiments, whose optical systems were fabricated in excess of two years prior to launch, it was necessary to measure the solar phenomenon present by a separate nondegraded system coincident with the Skylab ATM operations. The most practical system available, which satisfied all requirements, was the sounding rocket/payload system. The system utilized for CALROC was a Black Brant VC rocket motor and payload whose solar scientific data will be used in post-Skylab Mission data analysis to adjust the Skylab ATM data for degradation effects.

The sounding rocket instruments were calibrated immediately before and immediately after the flight and the calibration transferred when the rocket instruments and ATM experiments simultaneously (or within four Skylab orbits) measured the average intensity (HCO) emitted by a quiet area of the solar disc that was several arc minutes in extent. This area of the disc must be relatively free of centers of activity, filamentary structure, and coronal holes.

1.2 Project Management. The ATM Experiments Branch at MSFC was assigned overall project responsibility as requested by the Office of Manned Space Flight (OMSF) at NASA Headquarters. Responsibility for the rocket motor, all payload supporting subsystems and launch operations was assigned to Goddard Space Flight Center (GSFC) with the scientific instruments (both the Naval Research Laboratory [NRL] S082 and the Harvard College Observatory [HCO] S055) remaining under the management responsibility of MSFC. Management responsibility of the pointing control subsystem (SPARCS) was further delegated to NASA Ames Research Center (ARC).

Goddard Space Flight Center has been launching sounding rockets, similar to the Black Brant used for CALROC, for many years at numerous launch sites throughout the world. At each launch site GSFC utilized a launch crew composed of GSFC, military and civilian employees. Generally, the rocket motors were shipped directly from the manufacturer to the launch site for mating with the payload. The payload, prior to mating with the rocket motor, usually undergoes a series of horizontal tests under the management responsibility of GSFC. After the payload and rocket motors had been assembled as a vehicle, at White Sands Missile Range (WSMR), it was placed in the launch tower by U.S. Navy and WSMR civil service personnel. GSFC was responsible for launch tower checkout (vertical) with the assistance of WSMR, contractor and project personnel. Actual countdown and launch of all CALROC's was done by U.S. Naval Ordnance Missile Test Facility personnel stationed at WSMR.

1.3 Launch Facilities. White Sands Missile Range (WSMR), White Sands, New Mexico, was chosen as the launch site for all CALROC launches because it provided land recovery, was available throughout the CALROC Project and provided acceptable travel costs associated with each launch.

Since tower launches are considered to be more accurate with better impact prediction than rail launches, it was decided to use only tower launches for CALROC. Figure 1-1 shows a typical CALROC launching at White Sands Missile Range. Since simultaneous (or at least within four Skylab orbits) viewing of the same area on the sun was required to calibrate the Skylab data, rapid payload and film recovery was also required such that CALROC pointing coordinates could be relayed to the Skylab astronauts for updating Skylab pointing. Figure 1-2 illustrates helicopter recovery of CALROC payload 21.013.

Obtaining the necessary calibration with CALROC to calibrate the Skylab S082 and S055 ATM experiment data required very close coordination between the CALROC launch team and the Skylab mission planners and operations personnel. CALROC launch dates and times were based on the proposed Skylab flight plan. The exact sun area for calibration data gathering was selected jointly by the CALROC and Skylab principal investigators within the last 24 hours prior to a CALROC launch. On the day of a CALROC launch, Skylab mission operations at Johnson Space Center (JSC) was contacted by telephone periodically by the MSFC CALROC representative at WSMR and appraised of the CALROC countdown progress. During the last 15 minutes of countdown the telephone line to Skylab Mission Operations was kept open so that the JSC flight controllers could hear the actual countdown and firing of the CALROC. Continuous telephone contact was maintained with Skylab Mission Operations throughout the CALROC powered flight, calibration data taking period and verification that the payload was on the main parachute during recovery. If the actual flight CALROC pointing coordinates were different from the targeted coordinates previously relayed to the Skylab astronauts, new coordinates were relayed by telephone to Skylab Mission Operations for transmittal to the orbiting astronauts.

1.4 Data Analysis. Scientific data analysis will be done by the organization (MRL and HCO) responsible for design, manufacture and test of the scientific instruments. Data reduction and analysis will continue for some time and in those instances where final results are not available, appropriate references will be provided.

1.5 Summary Results. Five of the six CALROC launches were successful resulting in three NRL (S082) experiment calibration points and two HCO (S055) experiment calibrations spanning the three manned flight segments of Skylab. Initial calibration data analysis indicates that calibration of the Skylab ATM solar astronomy data will be successfully achieved.

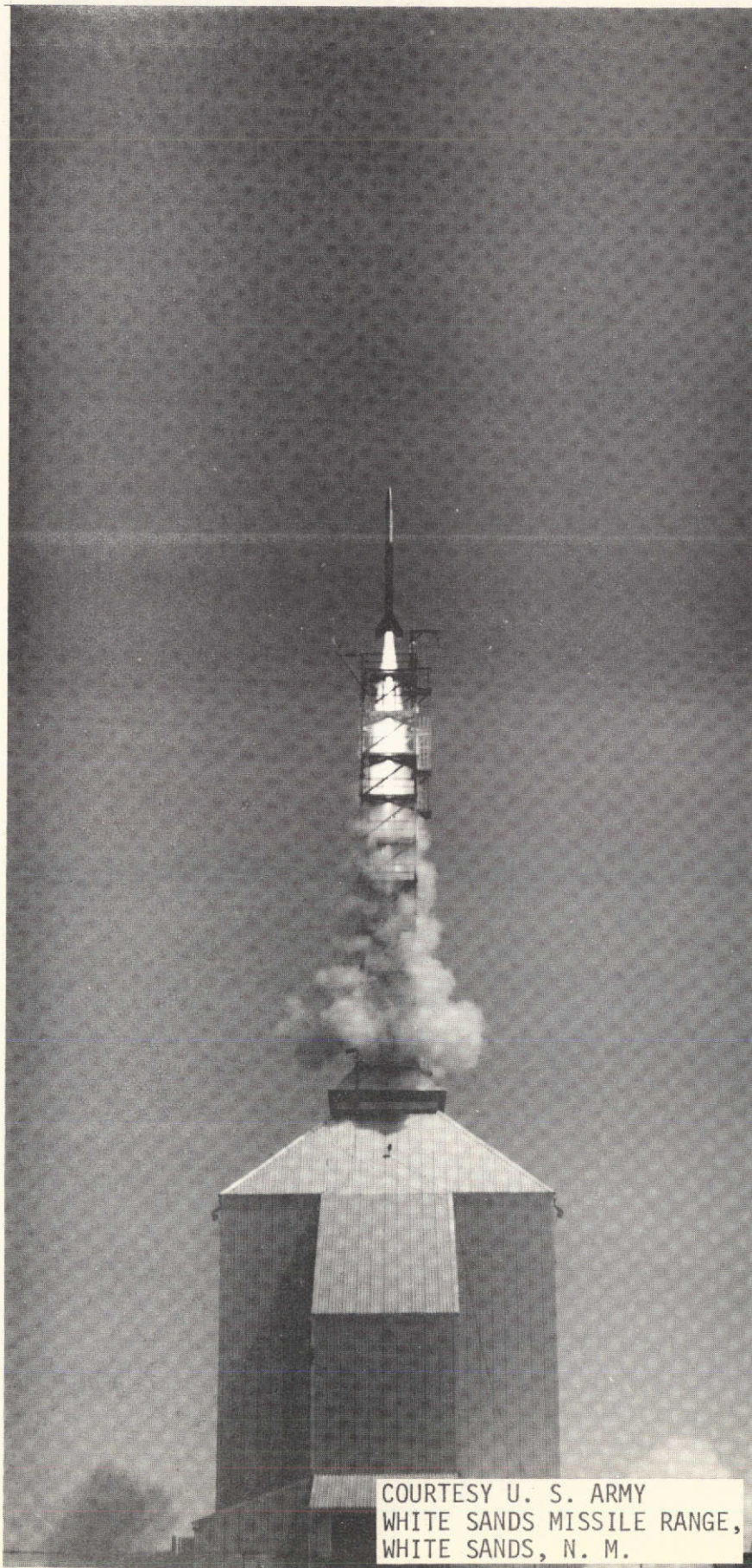

Figure 1-1. Typical CALROC Launch at WSMR.

Figure 1-2. Typical CALROC Payload Post-Flight Recovery at WSMR.



COURTESY U. S. ARMY
WHITE SANDS MISSILE RANGE,
WHITE SANDS, N. M.

Section 2
CONFIGURATION

SECTION 2

CONFIGURATION

The ATM Calibration Rockets (CALROC) were designed and manufactured in two principal parts; a payload and a payload booster or rocket motor. The payload was composed of several subsystems (Nosecone, Recovery, SPARCS, Telemetry, Scientific Instrument and Igniter Housing) each designed and fabricated by the indicated manufacturers in Table 2-1. However, to ensure proper mating, the subsystem section of the payload which mates with the motor (Igniter Housing) was manufactured by the motor manufacturer (Bristol Aerospace Limited, Winnipeg, Canada.

The CALROC configuration, shown in Figure 2-1, was the result of configuration studies by GSFC, ARC, NRL, HCO, and others. This configuration provided for payload/motor separation at the Igniter Housing/Scientific Instrument joint and a controlled payload consisting of the Scientific Instrument, Telemetry, Pointing Control subsystem and Recovery system. Note that the ogive or nosecone was not part of the controlled payload since it was separated at the Ogive/Recovery subsystem joint. A typical flight profile of the CALROC payloads is shown in Figure 2-2.

Since Goddard Space Flight Center (GSFC) was responsible for designing, testing, and launching numerous sounding rocket payloads (sometimes simultaneous), they instituted a payload numbering system to minimize confusion. In that system the number 21 occurring in the first two digits of the payload number was set aside for use only with payloads launched on Black Brant sounding rockets. Generally, payloads were numbered as they were approved by NASA Headquarters, MSFC and GSFC and were not necessarily flown in the numbered sequence. One exception to the above numbering sequence occurred with the NRL and HCO CALROC flights numbered as blocks (21.011 through 21.014 and 21.020 through 21.023).

2.1 Rocket Motors. The rocket motors used for launching the CALROC payloads were four fin Black Brant VC (BBVC) solid propellant rocket motors 17.2 inches in diameter, 210 inches long, weighing approximately 2,700 pounds, burning 32.4 seconds and developing a sea level total impulse of 506,100 pound-seconds.³ The propellant was solid grain polyurethane/ammonium perchlorate with variable cross section. A typical Black Brant VC Motor is shown in Figure 2-3. This

3. "Part II, Technical Details, 26KS20000 , Black Brant Rocket Motor for Black Brant VC Rocket System," Engineering Report 71533, Rocket and Space Division, Bristol Aerospace Limited, Winnipeg, Canada, October 1971.

Table 2-1. CALROC Hardware Manufacturers

<u>SUBSYSTEM</u>	<u>MANUFACTURER</u>	<u>LOCATION</u>
Nosecone	Bristol Aerospace Limited	Winnipeg, Canada
Nosecone Separation	Bristol Aerospace Limited	Winnipeg, Canada
Recovery	Bristol Aerospace Limited	Winnipeg, Canada
Parachutes	Pioneer Parachute Company	Manchester, Connecticut
SPARCS	Lockheed Missile & Space Company	Sunnyvale, California
NRL Telemetry	Naval Research Laboratory & Goddard Space Flight Center	Washington, D.C.
HCO Telemetry	International Technology and Engineering	Washington, D.C.
NRL Instrument	Ball Brothers Research Corp.	Boulder, Colorado
HCO Instrument	Harvard College Observatory & Ball Brothers Research Corp.	Boston, Massachusetts Boulder, Colorado
Payload Separation	Bristol Aerospace Limited	Winnipeg, Canada
Igniter Housing	Bristol Aerospace Limited	Winnipeg, Canada
Black Brant Motor	Bristol Aerospace Limited	Winnipeg, Canada

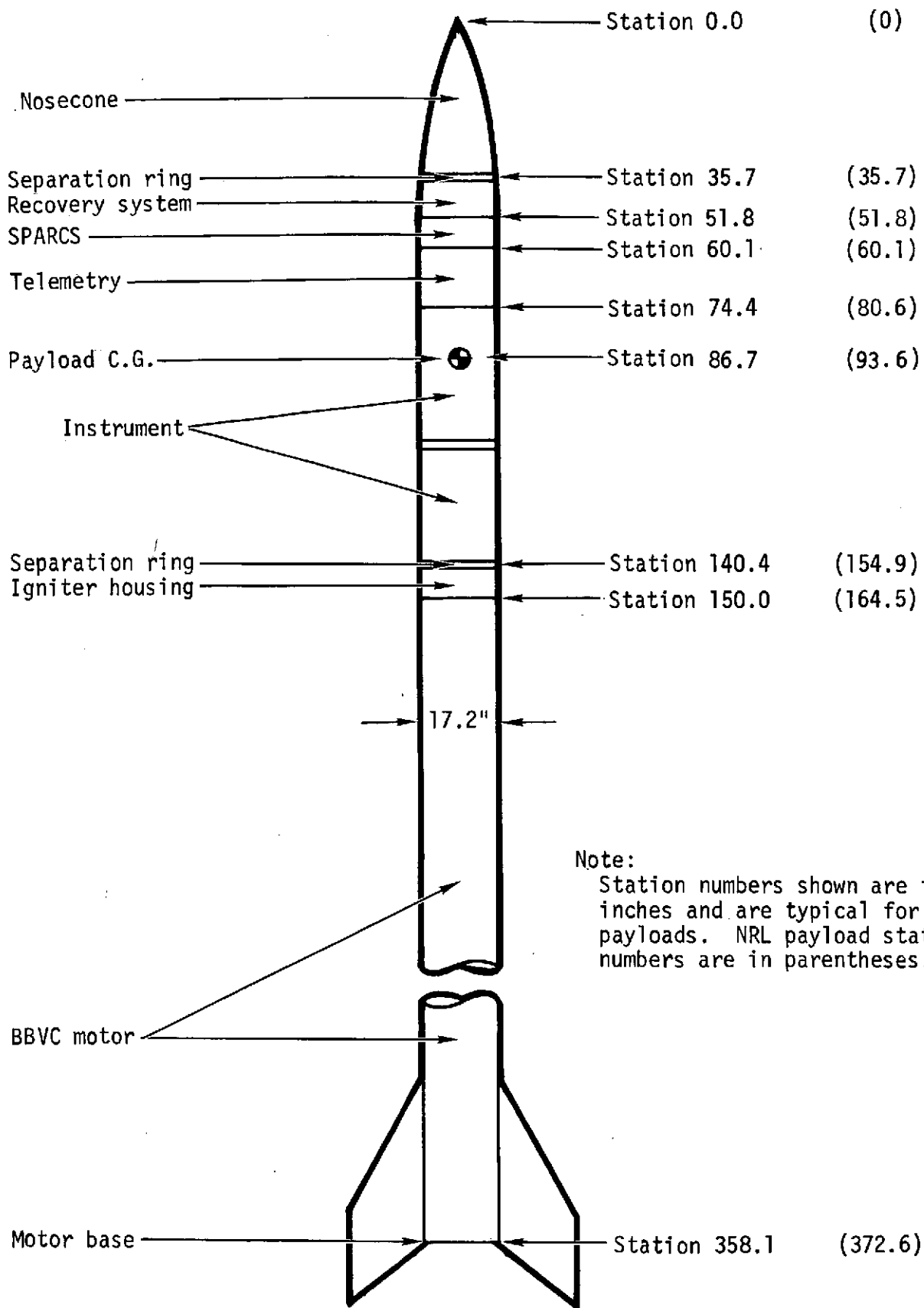

Figure 2-1. Skylab CALROC Payload/Booster Motor Configuration

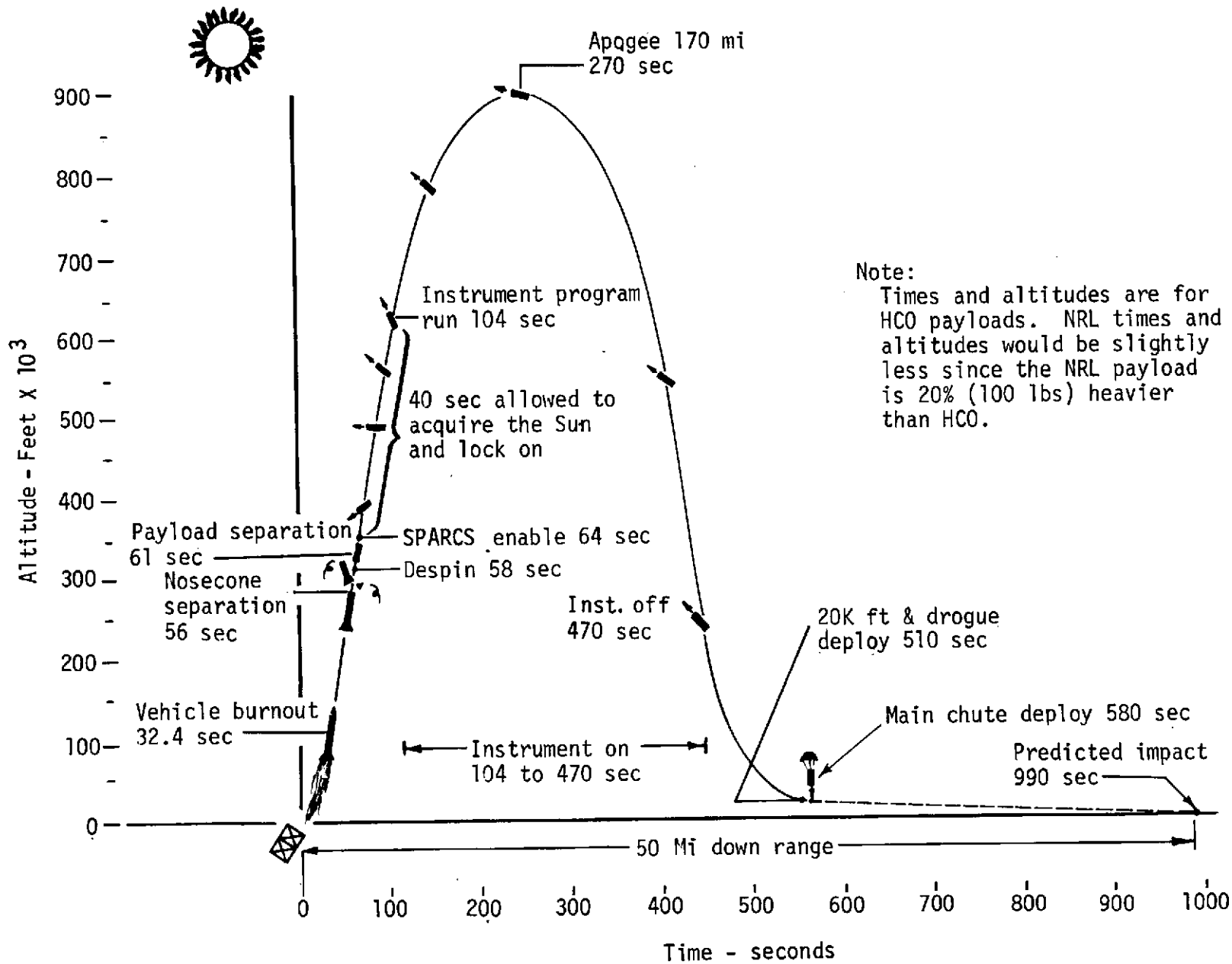
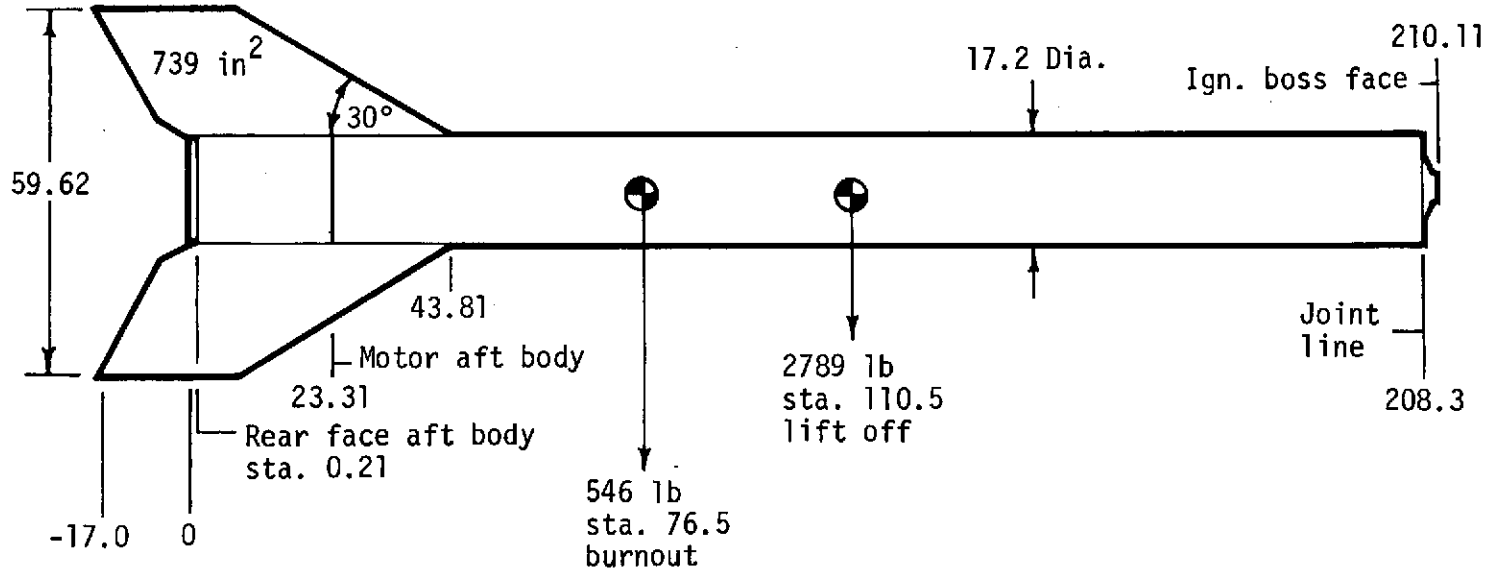

Figure 2-2. Typical Skylab CALROC Flight Profile



Physical Properties

	<u>Liftoff</u>	<u>Burnout</u>
MI Pitch/yaw (SL-ft ²)	2034	492
MI roll (SL-ft ²)	32.66	13.05

Weight Summary

Case	259.0	1b
Inerts	125.0	
Propellant	2198.0	
Igniter	5.23	
Nozzle exit cone	51.0	
Aft tower pads	6.47	
Fwd tower pads	2.25	
Aft body w/fins	<u>142.00</u>	
@ Lift off	2789.0	1b
Consumed	<u>-2243.0</u>	
Propellant	2198	546.0 1b
Inerts	43	@ burnout
Igniter	<u>2</u>	
Total	2243	

Figure 2-3. BBVC Rocket Motor

motor has the capability to launch a 500-pound payload to an apogee of approximately 175 statute miles or a 600-pound payload to 150 statute miles. More important on the CALROC Project was the payload time above a given altitude. The BBVC Rocket Motor provides approximately 235 seconds experiment time above 100 statute miles for a 600-pound payload and 285 seconds for a 500-pound payload. Fins on the BBVC rocket motor were set prior to flight such that a spin or roll rate of 4.0 ± 0.6 revolutions/second would be obtained during flight.

2.2 Payloads. All CALROC payloads were stacked as shown in Figure 2-1, except payloads 21.001, 21.007, 21.008 and 21.016 which used an aft end recovery subsystem located between the Instrument and Igniter Housing. Each subsystem (SPARCS, Telemetry, Instrument and etc.) was attached to its adjacent subsystem with radial screws, tension screws or manacle ring. Radial screws had been used on most BBVC payload joints prior to CALROC and were in fact used on the Igniter Housing/Motor joint on CALROC test flights 21.001, 21.007 and 21.008. The decision to use tension screw and manacle ring joints on CALROC payloads was the direct result of a radial screw joint failure on a BBVC payload (21.004) launched at Wallops Island July 1971. The 21.004 payload broke at one of the radial screw joints during powered flight.

Payloads for each CALROC test flight included some CALROC type hardware. Each test flight, except 21.011 carried scientific instruments which were not associated with Skylab S082 or S055 experiments or their related NRL and HCO CALROC Instruments. Thus, various scientific experimenters were able to obtain data by incorporating their experiments on CALROC test flights. Performance results on non-CALROC hardware flown on all test flights can be obtained by contacting the appropriate personnel of the Sounding Rocket Division, Goddard Space Flight Center, Maryland. Three flights (21.001, 21.008 and 21.016) provided test flight data on CALROC type Igniter Housings and BBVC Motors. Three additional test flights (21.009, 21.019 and 21.020) provided data on CALROC type Igniter Housings, BBVC Motor, Payload Separation systems, Nosecone Separation systems, Recovery systems, Nosecones, and Pointing Control systems. Each test flight is discussed individually in Section 4 of this report. The first launching of an all CALROC type payload was NRL 21.011 on April 3, 1973, at WSMR. This flight was a test flight to test the complete CALROC system operation and determine film exposure times.

Skylab CALROC payloads were divided into two separate type payloads: three NRL payloads (21.012, 21.013, 21.014) and three HCO payloads (21.021, 21.022, 21.023) each launched on separate BBVC rockets at WSMR. All payloads were the same diameter as the BBVC rocket motor (approximately 17.2 inches). All NRL payloads were

the same length, approximately 164.5 inches, while the HCO payloads were 150.0 inches.

2.2.1 NRL Scientific Instrument. The NRL Scientific Instrument, shown in Figure 2-4, was composed of four photographic camera subsystems and two supporting subsystems. The camera subsystems were:

a. "A" Spectroheliograph - Photographs the full sun and provides spectroheliograms from 760 to 1700 Å to aid in calibrating the Skylab ATM S082A spectroheliograph data.

b. "B" Spectrograph - Provides spectrograms throughout the range 2135 to 1200 Å for calibrating the Skylab ATM S082B spectrograph data.

c. "C" Spectrograph - Provides spectrograms throughout the range 2000 to 1200 Å for calibrating the CALROC flight film.

d. "H" Heliograph - Photographs the full sun in the integrated wavelengths 650 to 150 Å for corollary information.⁴

The "A" and "B" camera subsystems were 1/2 scale duplicate optical systems of the orbiting Skylab systems. Each NRL Scientific Instrument (of which three were fabricated and flown) was 74.2 inches long, weighed approximately 275 pounds and was flown in an evacuated container. Since the calibration equipment was photographic all scientific data was on film, thus requiring successful and timely recovery.

The Scientific Instrument supporting subsystems were:

a. H-alpha video and photographic subsystems for determining the actual pointing position of the CALROC Scientific Instrument during flight.

b. Fine pointing subsystem with command link capability for in-flight adjustment of the Scientific Instrument pointing coordinates. Such adjustments were provided to correct unexpected pointing errors in flight and to select new targets of opportunity.

References 4, 5, and 6 are suggested for more detailed information on the NRL Scientific Instrument.

-
4. "CALROC, Calibration Eye for the NRL Skylab Solar Experiment" Ball Brothers Research Corporation, Boulder, Colorado.
 5. "NRL/ATM CALROC Instrument, Phase II Design Review," Ball Brothers Research Corporation, Boulder, Colorado, May 3, 1972.
 6. "Design and Performance Specification for NRL Calibration Rocket Instrument," Ball Brothers Research Corporation, Boulder, Colorado, April 15, 1972.

Figure 2-4. NRL CALROC Scientific Instrument

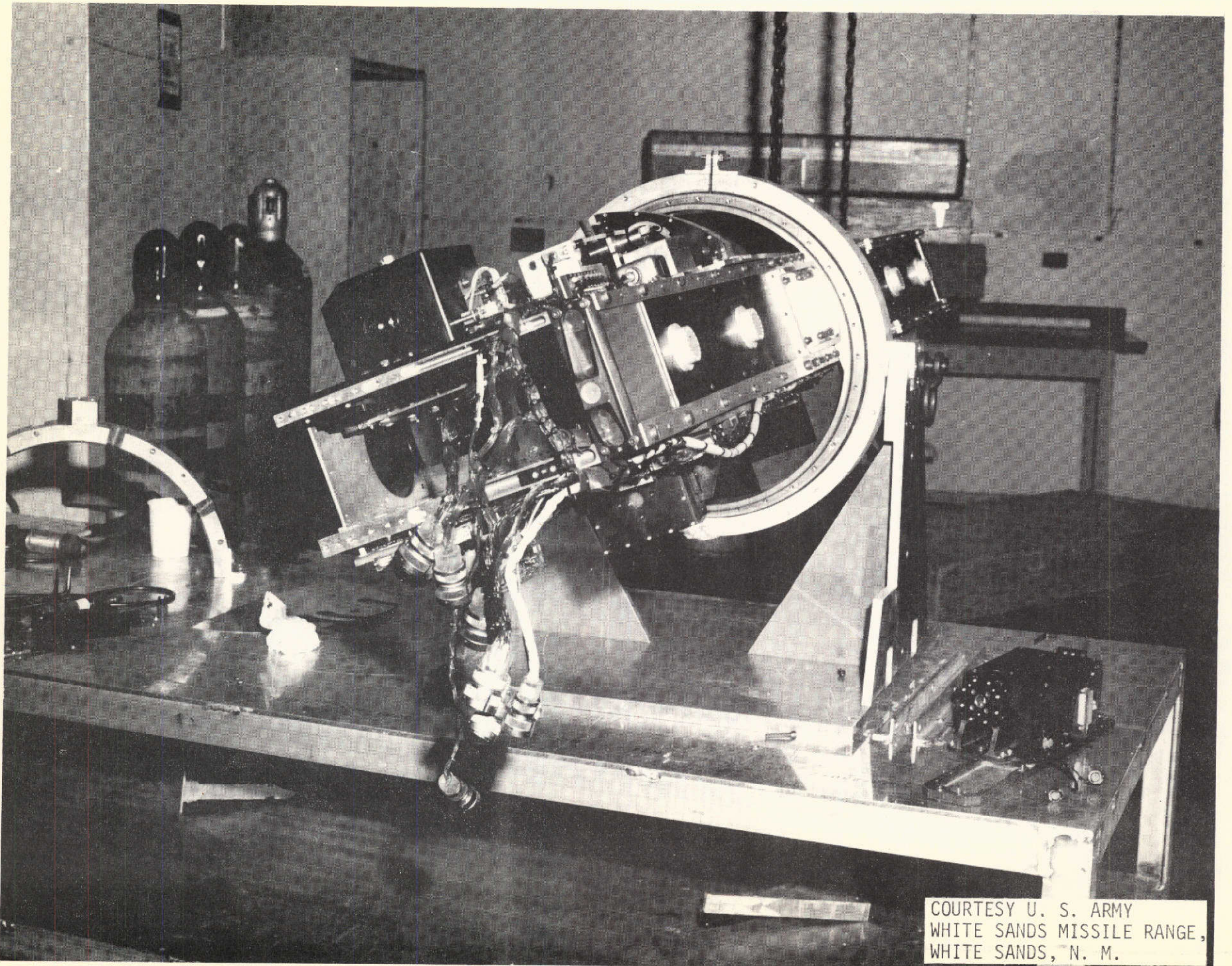

COURTESY U. S. ARMY
WHITE SANDS MISSILE RANGE,
WHITE SANDS, N. M.

2.2.2 HCO Scientific Instrument. The HCO Scientific Instrument, shown in Figure 2-5, was an extreme ultraviolet (EUV) spectroheliometer designed to monitor solar radiation in the wavelength range 1350 Å to 300 Å with a 1.6 Å spectral resolution.⁷ The spectroheliometer consisted of three main subsystems; a telescope, spectrometer and pointing reference camera.

An optical schematic of the spectroheliometer is shown in Figure 2-6. The iridium-coated Cer-vit telescope mirror formed an image of the sun on the entrance slit plate, a small portion of this image being admitted through the entrance slit into the spectrometer. The slit plate was highly polished and reflected the visible light image of the solar disc through a relay lens and neutral density filter to the film plane of a pointing reference camera system.

The telescope mirror was an off-axis paraboloid having a focal length of 90 cm and a collection area of 51.8 cm², and was mounted in a cell which was driven about its vertical axis to provide a one dimensional scan of the solar image. The entrance slit of the spectrometer accepted radiation from a 4 arc min x 20 arc sec area of the solar disc, a 4 x 4 (arc min)² area being mapped with twelve steps of the mirror scan. Figure 2-7 provides a comparison of the CALROC raster scan area to the Skylab ATM raster scan area. The mirror cell is driven by a stepper motor and cam with the step motion initiated by a signal from a micro-switch on the spectrometer grating drive cam. Spectral and spatial scans were synchronized with the mirror stepping during the retrace of the spectral scan. A monitor mirror mounted in front of the primary mirror accompanied the instrument throughout testing prior to launch and enabled any contamination of the optical system to be readily detected. The structure of the telescope section also provided the location and mount for light baffling of the instrument and SPARCS fine sun sensor (FSS). The FSS and a separate alignment mirror were aligned to the optical axis of the instrument. Subsequent co-alignment checks were readily made using the alignment mirror and a reference mirror on the front face of the FSS.

Solar radiation entering the spectrometer was diffracted by a gold concave reflection grating and the Extreme Ultraviolet (EUV) spectrum was focused onto two exit slits, each equipped with an open-structure channel electron multiplier as the detector. In addition, a nitric oxide ionization chamber was used to monitor the intensity of the strong Hydrogen Lyman alpha line at 1215.7 Å. A module containing a light emitting diode and a phototransistor provided an optical reference of the grating position at one position of the spectral scan.

7. "Handbook for the Harvard College Observatory Calibration Rocket Spectroheliometer," Volume I, Harvard College Observatory, Cambridge, Massachusetts, March 1973.

Figure 2-5. HCO CALROC Scientific Instrument

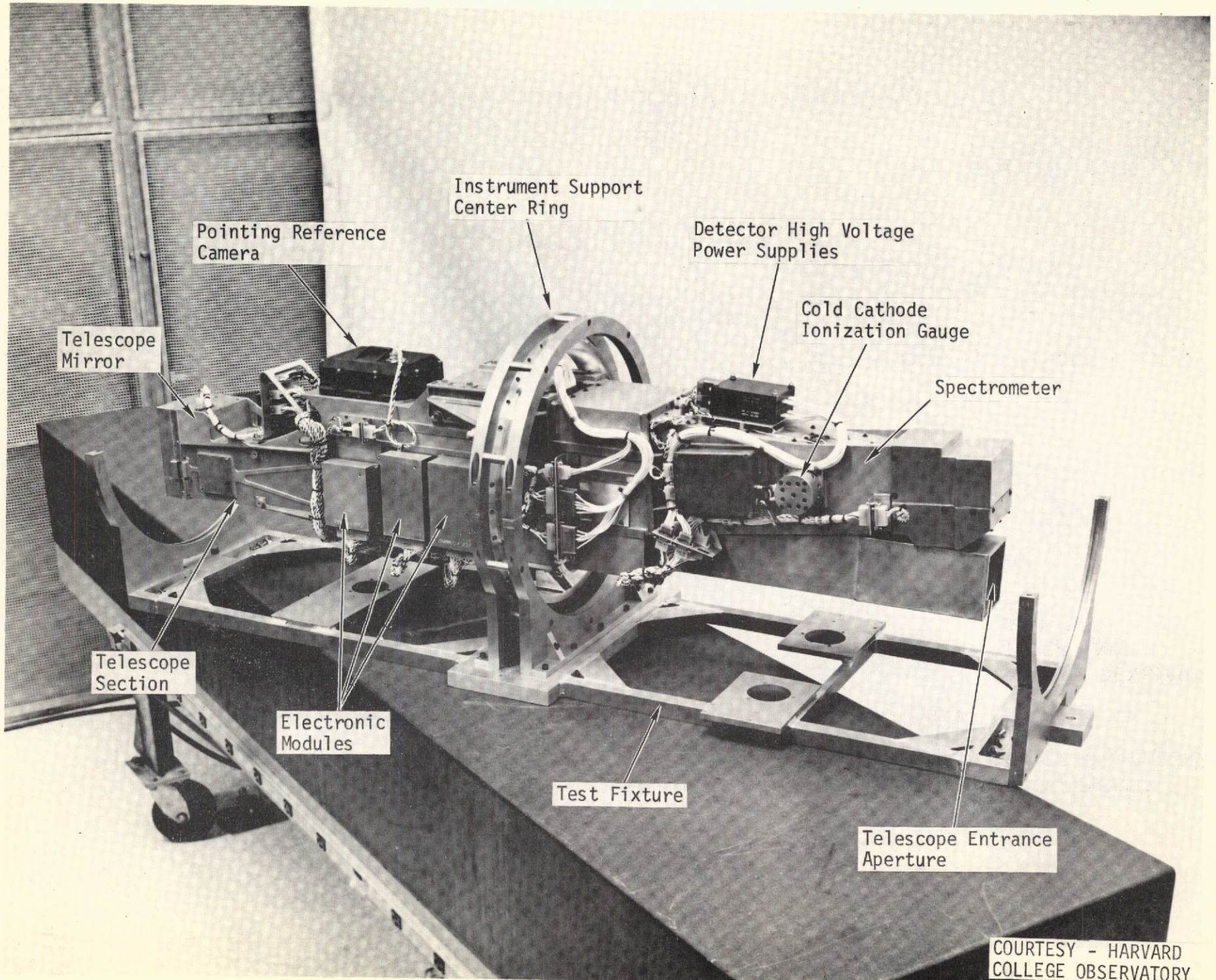

COURTESY - HARVARD COLLEGE OBSERVATORY

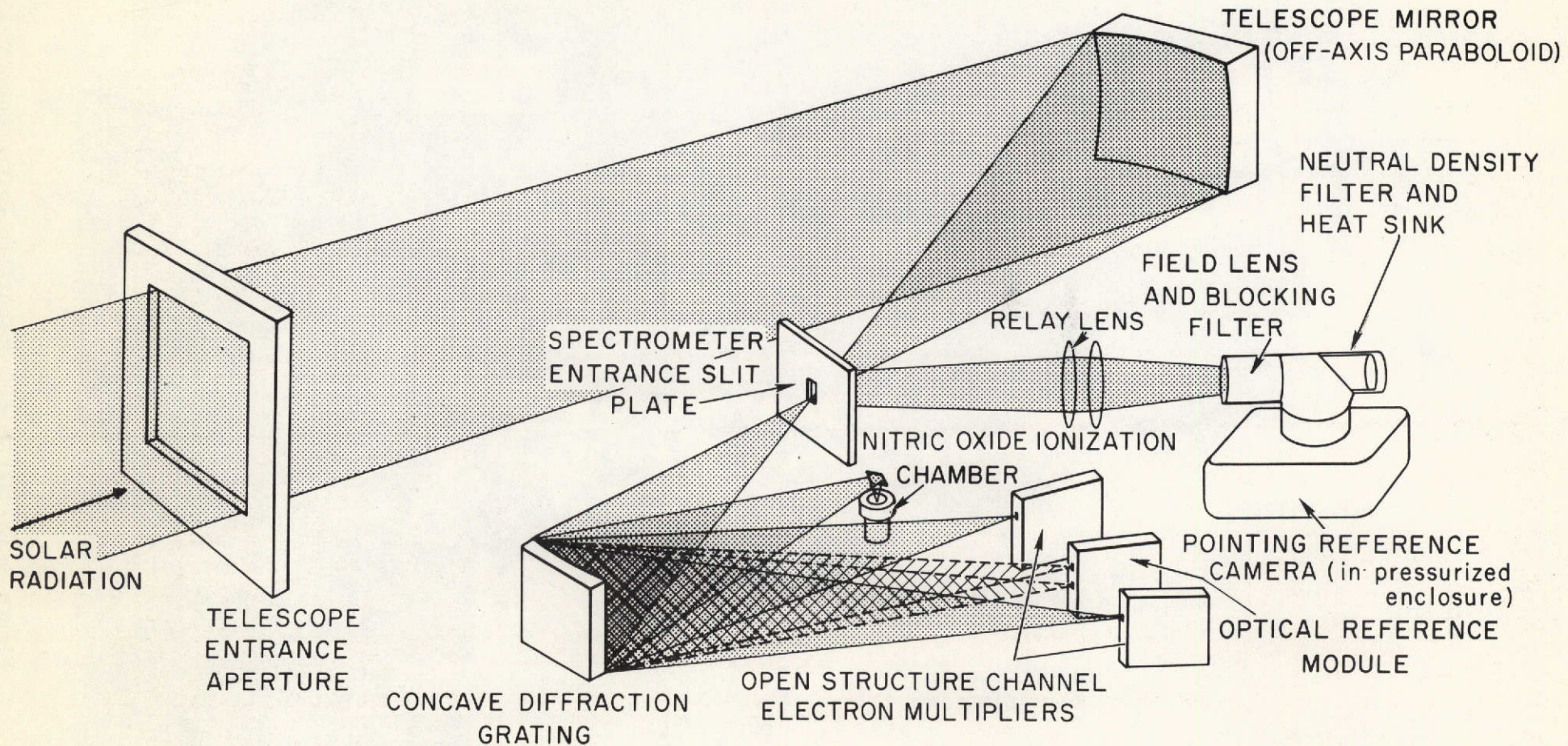

COURTESY HARVARD
COLLEGE OBSERVATORY

Figure 2-6. Optical Schematic of the HCO CALROC Spectroheliometer

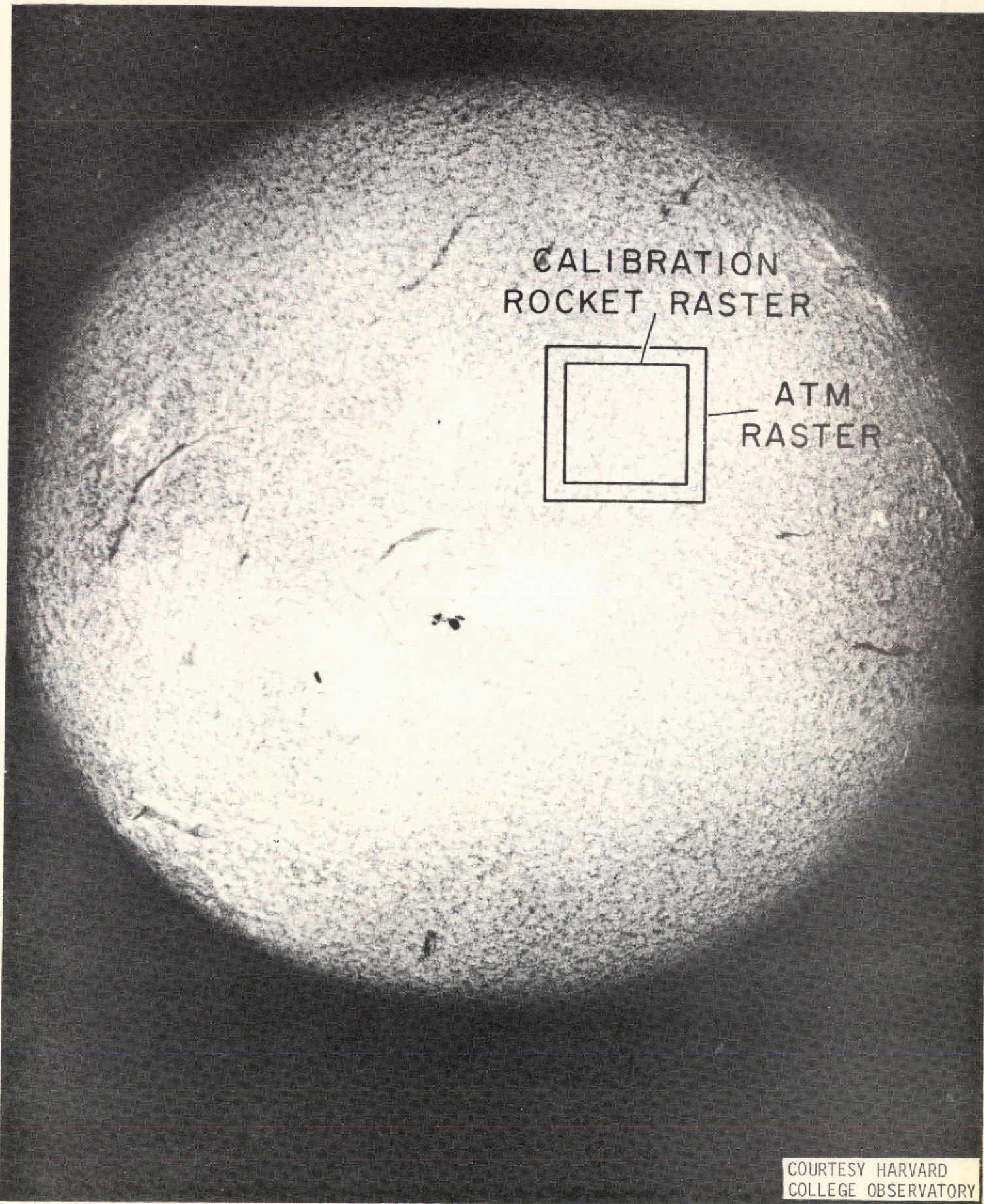

COURTESY HARVARD
COLLEGE OBSERVATORY

Figure 2-7. Areas of the Solar Disc Monitored by the ATM and HCO CALROC Spectroheliometers.

The spectrometer was mounted in a modified Johnson-Onaka arrangement where the grating was rotated about an axis lying outside its surface, in a way such that each of the two exit slits were in exact focus for a grating angle, and hence wavelength, that were approximately at the center of the scan range. The gold-coated concave diffraction grating had a radius of curvature of 50 cm and a ruling frequency of 1800 lines per mm. The two exit slits were set to monitor radiation in the wavelength ranges 1340 Å to 786 Å and 850 Å to 296 Å, respectively. All the exit slits were wider than the entrance slit and also significantly wider than the spectral lines generated by laboratory light sources or the solar plasma. The exit slits were also wider than the blurred spectral image of the entrance slit produced at wavelengths where the Johnson-Onaka mounting results in some defocus. The instrument line profiles, therefore, had a trapezoidal shape with a flat top, so that a detector received the full intensity of a given spectral line for several steps of the grating scan. The wavelength bandpass for both detectors was set a 1.6 Å, equivalent to that of the narrow exit slit in the ATM spectroheliometer. Wavelength scans were always taken from long to short wavelengths with the grating retracing rapidly to the long wavelength end and simultaneously actuating a microswitch providing a mechanical reference of grating position. This microswitch was used to initiate the mirror scan and pointing reference camera drive systems. The grating was driven by a variable-reluctance stepper motor, moving through an angle equivalent to 0.2 Å per step. Two scan speeds were used; an 80 Å band at the short wavelength end of the spectrum being scanned at a rate of 84 steps per second, while the remainder of the spectrum was scanned at a rate of 333 steps per second. The slower speed provided an increased integration time for the weak solar emission lines at wavelengths below 380 Å. A complete scan consisted of 3000 steps, including retrace, and required a time of 12.6 seconds. The grating was commanded to move directly to a stow position at the high point of the drive cam for protection during launch and also prior to parachute deployment.

The entrance slit had dimensions of 80 microns by 1040 microns, corresponding to an angular field of view of 20 arc sec by 4 arc min. The exit slits were 143 microns wide by 3 mm in length. All the slits were produced by electron-discharge machining, the slit plates being manufactured from thin stainless steel. Photoelectric detectors employed in the spectrometer were two-stage channel electron multipliers requiring an operating vacuum of 1×10^{-5} torr. A special vacuum pumping system (shown in Figure 2-8 attached to one of the HCO CALROC payloads) was designed and built for ground test and launch preparation of the HCO Scientific Instruments.

The channel electron multiplier (see Figure 2-9) together with its associated charge-sensitive amplifier were potted in a module designated the photomultiplier detector unit (PDU), the front of which carried an exit slit of the spectrometer. These multipliers differ in

Figure 2-8. HCO CALROC Payload on CALROC Vacuum Pump.

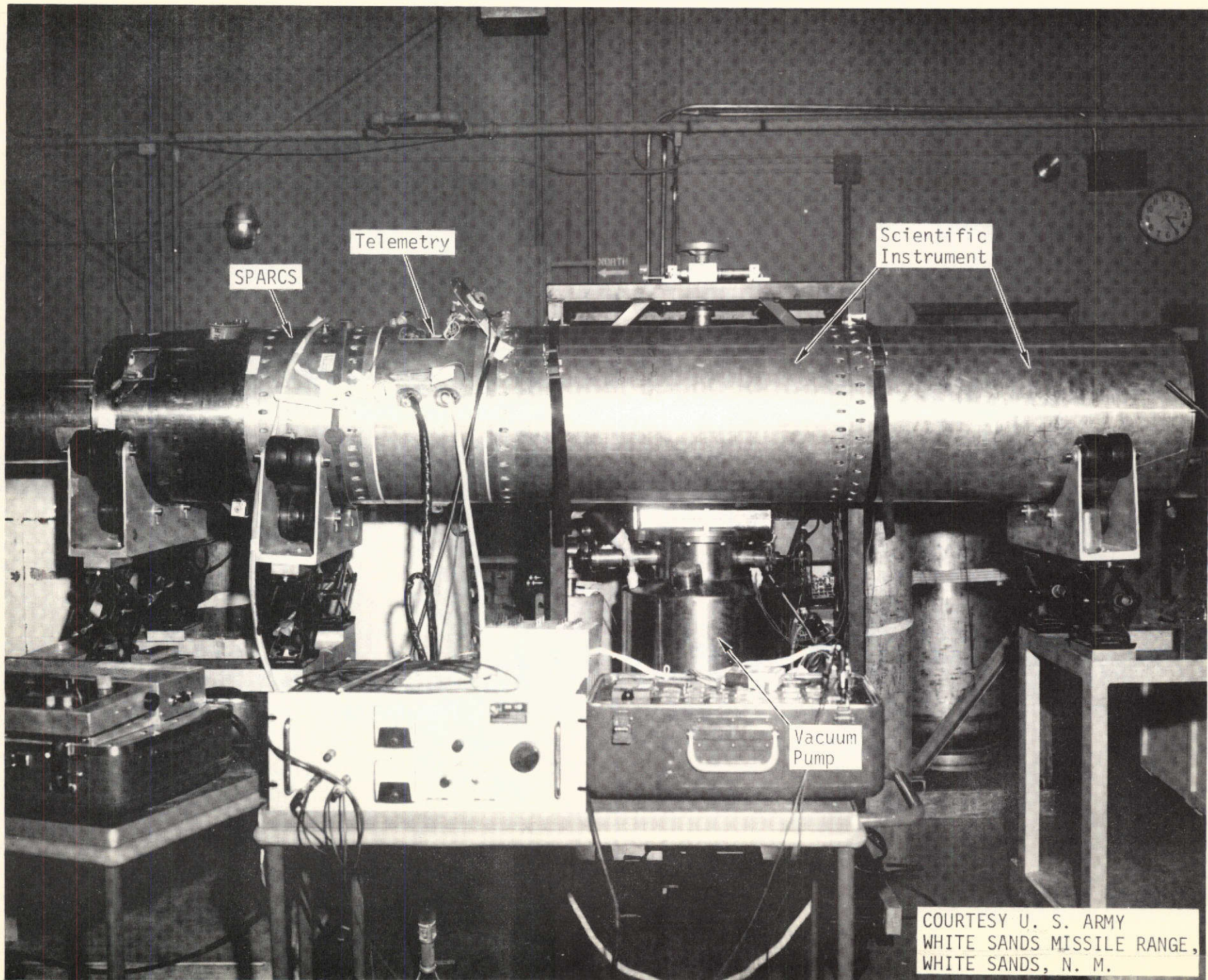

COURTESY U. S. ARMY
WHITE SANDS MISSILE RANGE,
WHITE SANDS, N. M.

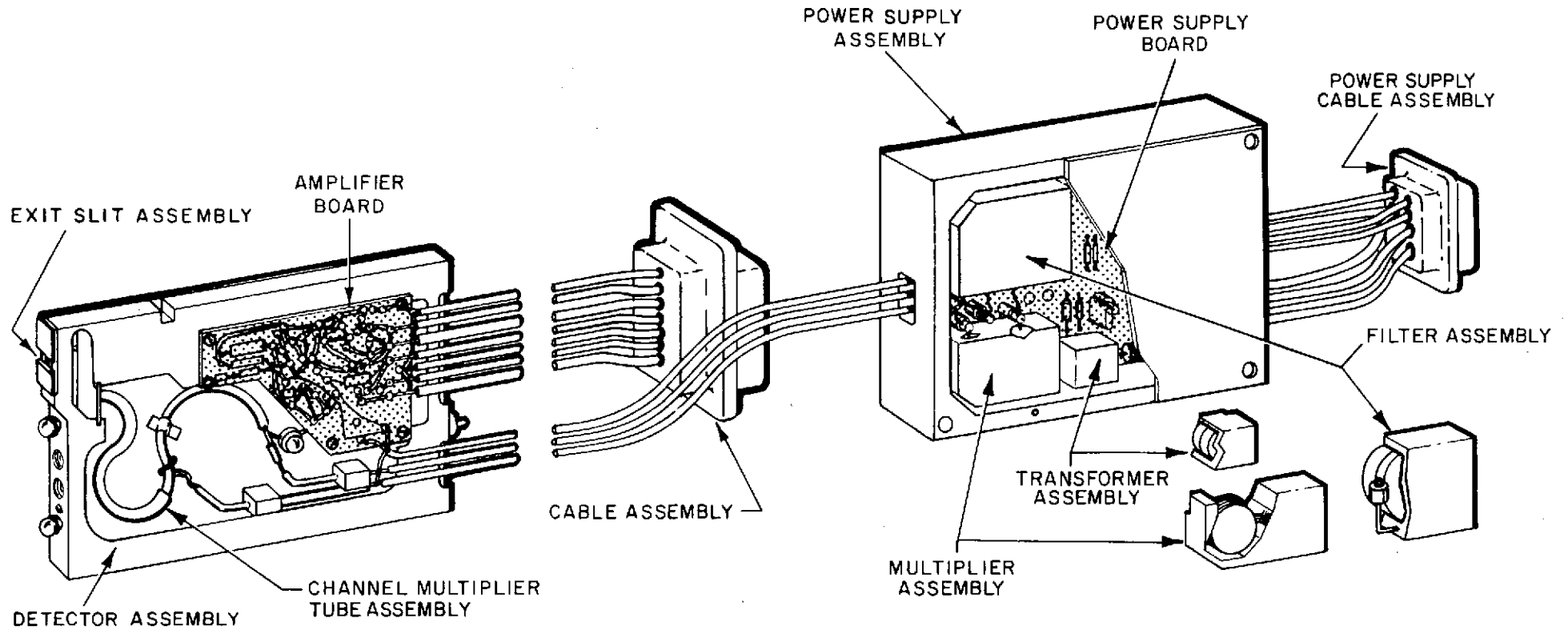

COURTESY HARVARD
COLLEGE OBSERVATORY

Figure 2-9. HCO CALROC Channel Electron Multiplier Detector Unit

an important respect from conventional units in that a low-resistance ($\approx 10^8$ ohm) channel section has been added in series with the standard channel, which has a nominal resistance of the order of 10^9 ohms. This has the effect of increasing the wall current at the output end of the multiplier thereby increasing the overall gain and providing a linear response to signal levels in excess of 5×10^5 counts/second. To accommodate the astigmatic exit image of the spectrometer, a slot 8 mm long and 1 mm wide was cut in the channel wall at the input end of the multiplier. Radiation entering this slot struck the opposite wall of the channel at normal incidence with the semiconducting inner channel surface acting as a photocathode for the long wavelength detector. The cathode for the short wavelength channel was coated with a 2000 Å thick layer of Magnesium Fluoride (MgF_2) to increase the quantum yield at wavelengths below 900 Å (Lapson and Timothy 1973). This detector thus had a sensitivity about 2.6 times that of the uncoated detector for wavelengths below 600 Å. The multipliers were operated in a pulse counting mode and had life expectancies of greater than 10^{11} accumulated counts.

Although the channel electron multipliers display a linear response to high count rates, the intensity of the Hydrogen Lyman alpha line at 1215.7 Å was such that it saturated these detectors. A nitric oxide ionization chamber, equipped with a MgF_2 window, was therefore included in the spectrometer to measure the intensity of this spectral line. A MgF_2 overcoated aluminum mirror was used to direct the diffracted beam onto the window of the ionization chamber (see Figure 2-6). The output current was measured by a two-decade logarithmic electrometer amplifier.

An optical reference of the grating position was obtained by means of a combination of light emitting diode transmitter and a photo-transistor receiver. The diode and phototransistor were mounted in a module that was located in the spectrometer in a manner identical to that for the channel electron multipliers. Radiation emitted by the diode was detected by the transistor when the grating was normal to the optical axis of the module. In this way a precise determination of the grating angle was obtained once per scan without the requirement of an external light source. This accurate reference was used both in the analysis of the spectral data and to control the exact position in the spectrum at which the scan speed was changed.

The open structure channel electron multipliers could not be operated safely unless the pressure inside the spectrometer was less than 1×10^{-5} torr. Accordingly, a cold cathode ionization gauge (CCIG) was mounted in the spectrometer to measure the pressure during ground testing and throughout flight. The gauge covers a pressure range 10^{-3} to 10^{-7} torr, and was identical to that mounted inside the spectrometer of the ATM S055 Experiment.

The Scientific Instrument was mounted to a center ring, which attached to the payload skin through three mounting pads, inside an evacuated section of the payload with the sun end facing downward during launch. This type mounting minimizes interactions between the Instrument and rocket skin or structure. Each HCO Scientific Instrument (of which two were fabricated and flown with one refurbished and reflowed) was approximately 66 inches long and weighed approximately 200 pounds.

Since the channel electron multipliers were operated in a pulse counting mode, the scientific data did not require storing on film, but rather was transmitted real time over Pulse Code Modulation (PCM) telemetry to range ground stations. Thus, parachute recovery of the payload was not absolutely essential, but highly desirable for post-flight calibration comparison and refurbishment for future flights.

2.2.3 NRL Pointing Control System. The NRL Pointing Control System (shown in Figures 2-10, 2-11, 2-12, 2-13), commonly called Solar Pointing Aerobee Rocket Control System (SPARCS) was a cold gas (Freon-14) on-off, Sun-oriented attitude and pointing control system. Figures 2-10 and 2-11 are forward and aft views, respectively, of an NRL SPARCS unit that flew on payload 21.009, then was refurbished and later flown on payload 21.013. Figures 2-12 and 2-13 are side views of the SPARCS unit in Figure 2-10 showing the location of the coarse or acquisition sun sensor and roll jets, respectively. SPARCS utilized three different sets of sun sensors and a magnetometer (roll) to provide acquisition, intermediate and fine pointing position information and rate gyros for rate sensing.

Acquiring the sun and maneuvering the payload to within $\pm 10^\circ$ of the sun center, after SPARCS enable, was accomplished with quartz covered coarse sun sensors having a 360° field-of-view and mounted in the payload skin. After experiencing some difficulties with sun acquisition on early test flights, a set of intermediate sun sensor eyes, having a $\pm 30^\circ$ field-of-view in the pitch and yaw axes, were incorporated into the SPARCS. Final fine pointing was accomplished with the Fine Sun Sensor which had a $\pm 10^\circ$ field-of-view in pitch and yaw and generally pointed the payload to within less than one arc second error of selected targets on the solar disc. The immediate and fine sun sensors were located in the instrument sun end near station 150. Figure 2-14 shows the location of the two axis magnetometer in the top hat. Figure 2-15 shows the top hat, valves and sensor locations within the payload SPARCS, Recovery and Nosecone sections. No inertial platforms or closed loop guidance was used. The rocket and payload were launched from a variable launch angle-launch azimuth tower using spin stabilization during rocket motor burn and no active control system. After motor burnout, the motor and payload were sequentially despun, separated, and SPARCS activated for sun acquisition and fine

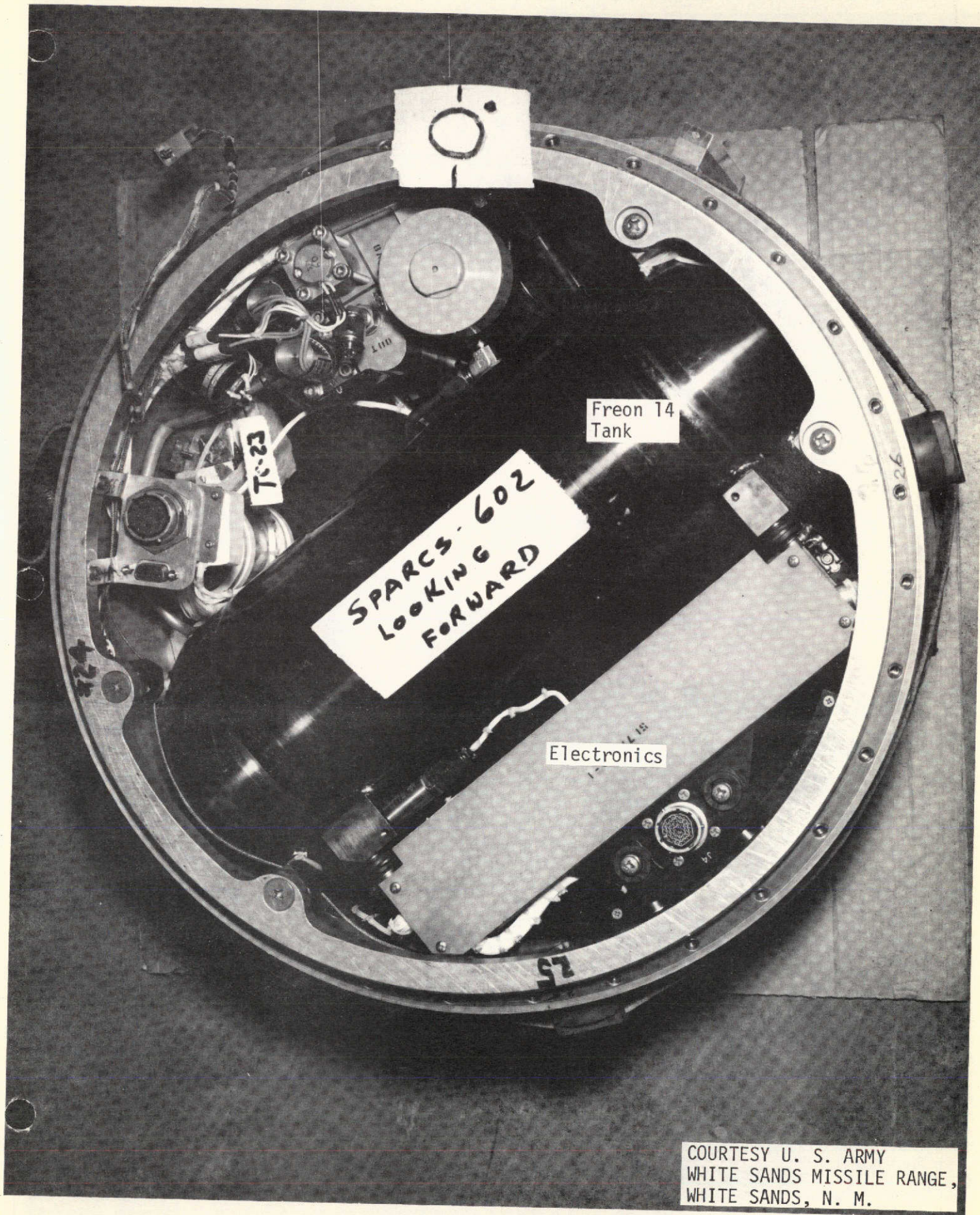

COURTESY U. S. ARMY
WHITE SANDS MISSILE RANGE,
WHITE SANDS, N. M.

Figure 2-10. NRL CALROC SPARCS, Forward View.

Figure 2-11. NRL CALROC SPARCS, Aft View.

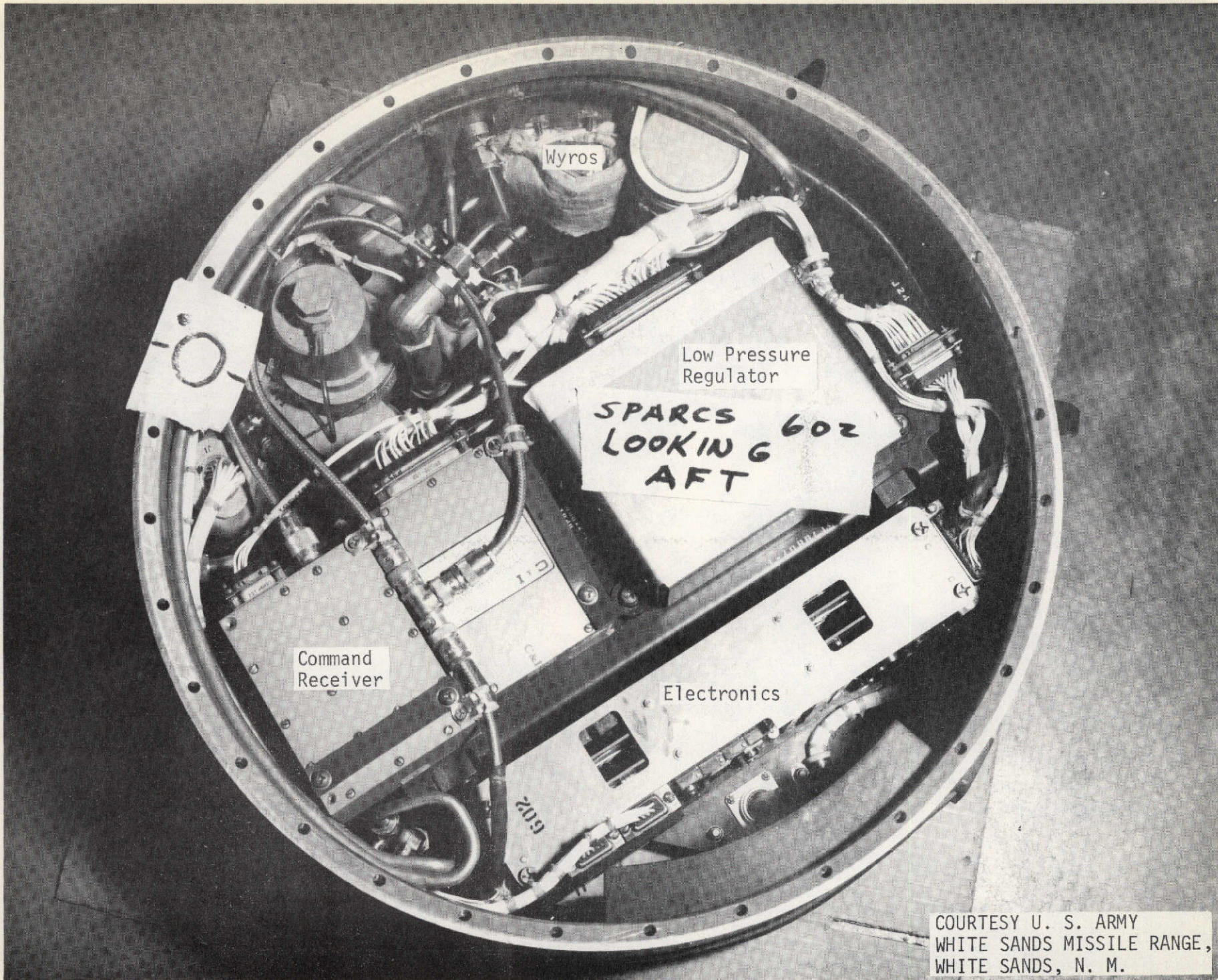

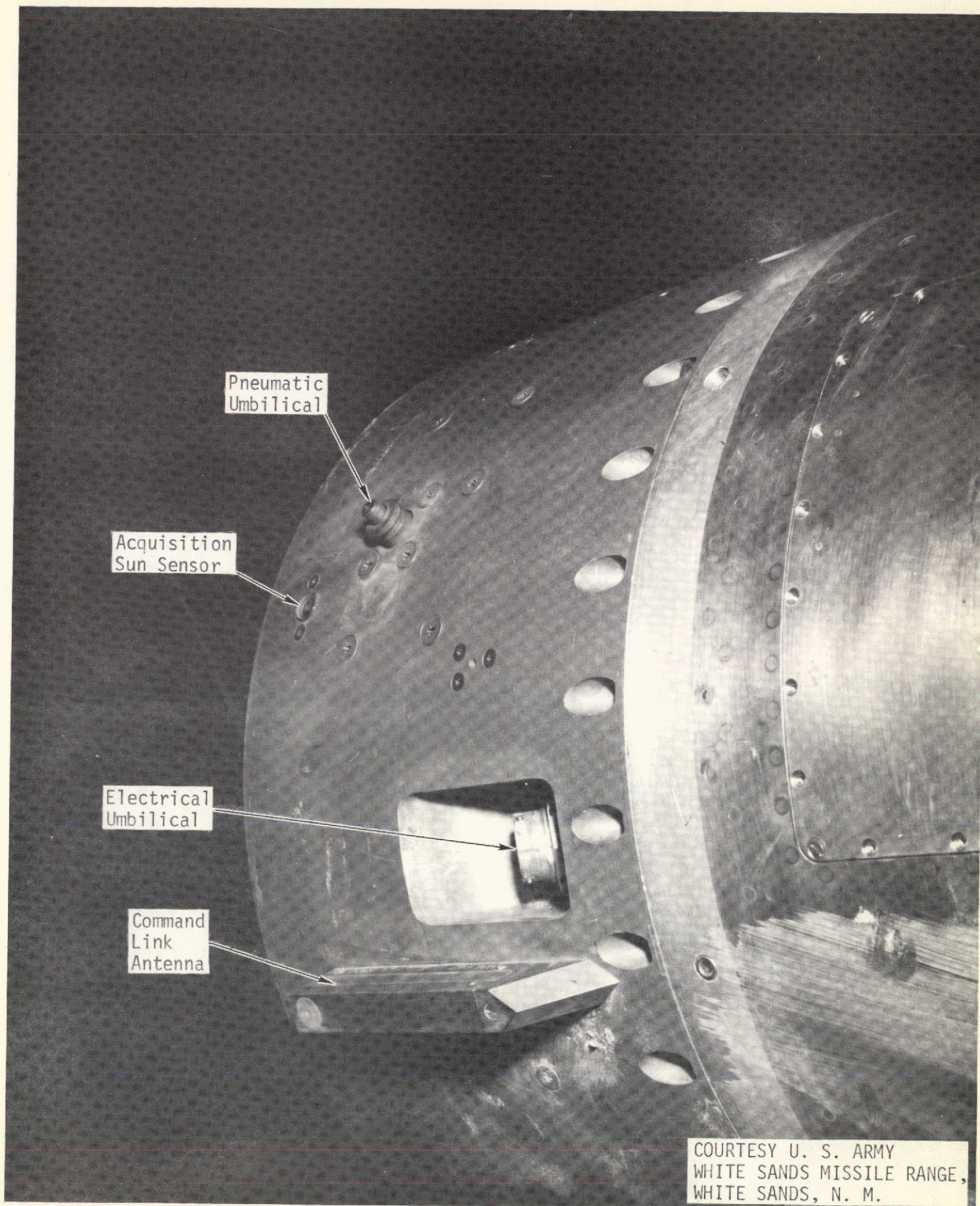

COURTESY U. S. ARMY
WHITE SANDS MISSILE RANGE,
WHITE SANDS, N. M.

Figure 2-12. NRL CALROC SPARCS, Side View.

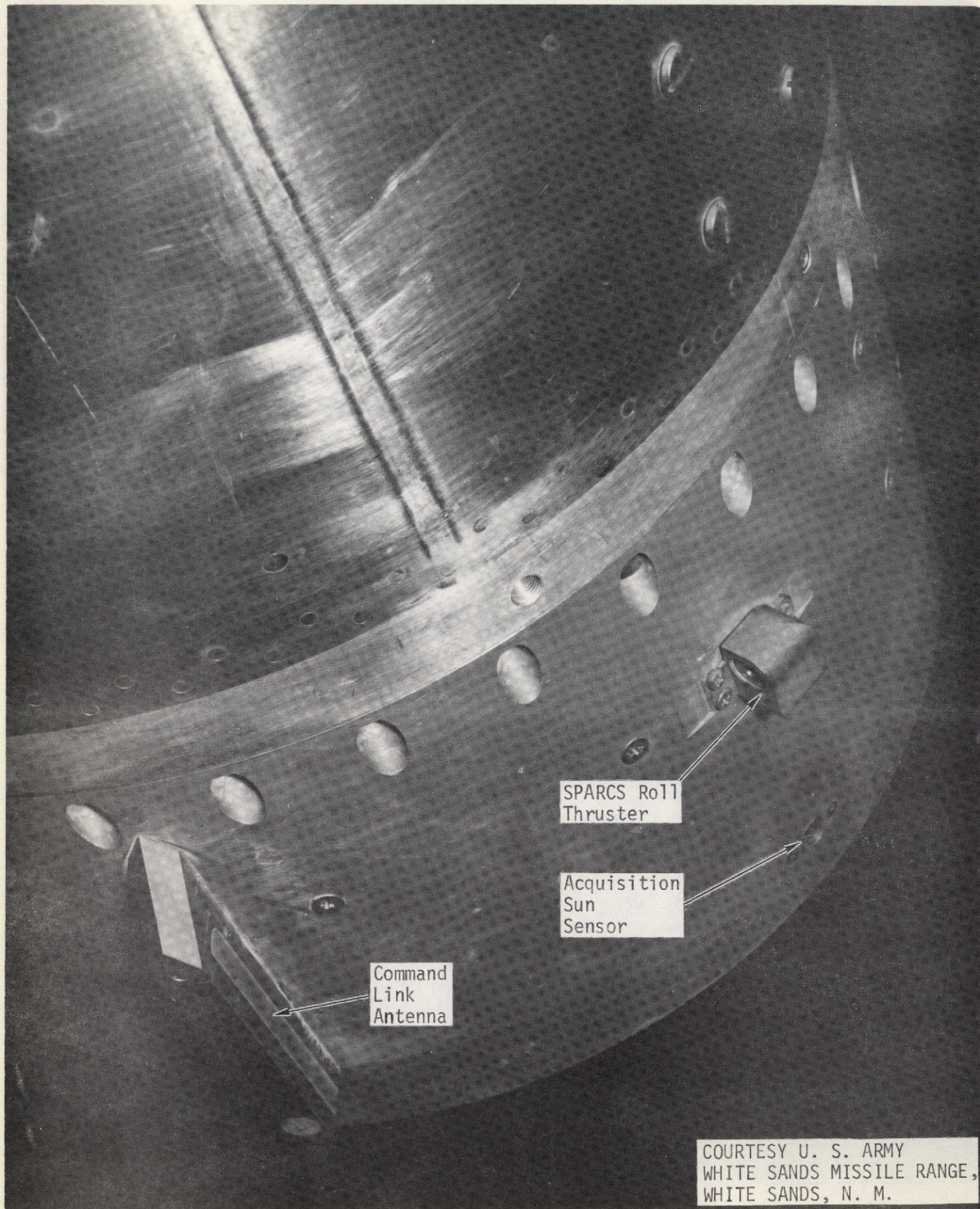

Figure 2-13. NRL CALROC SPARCS, Side View.

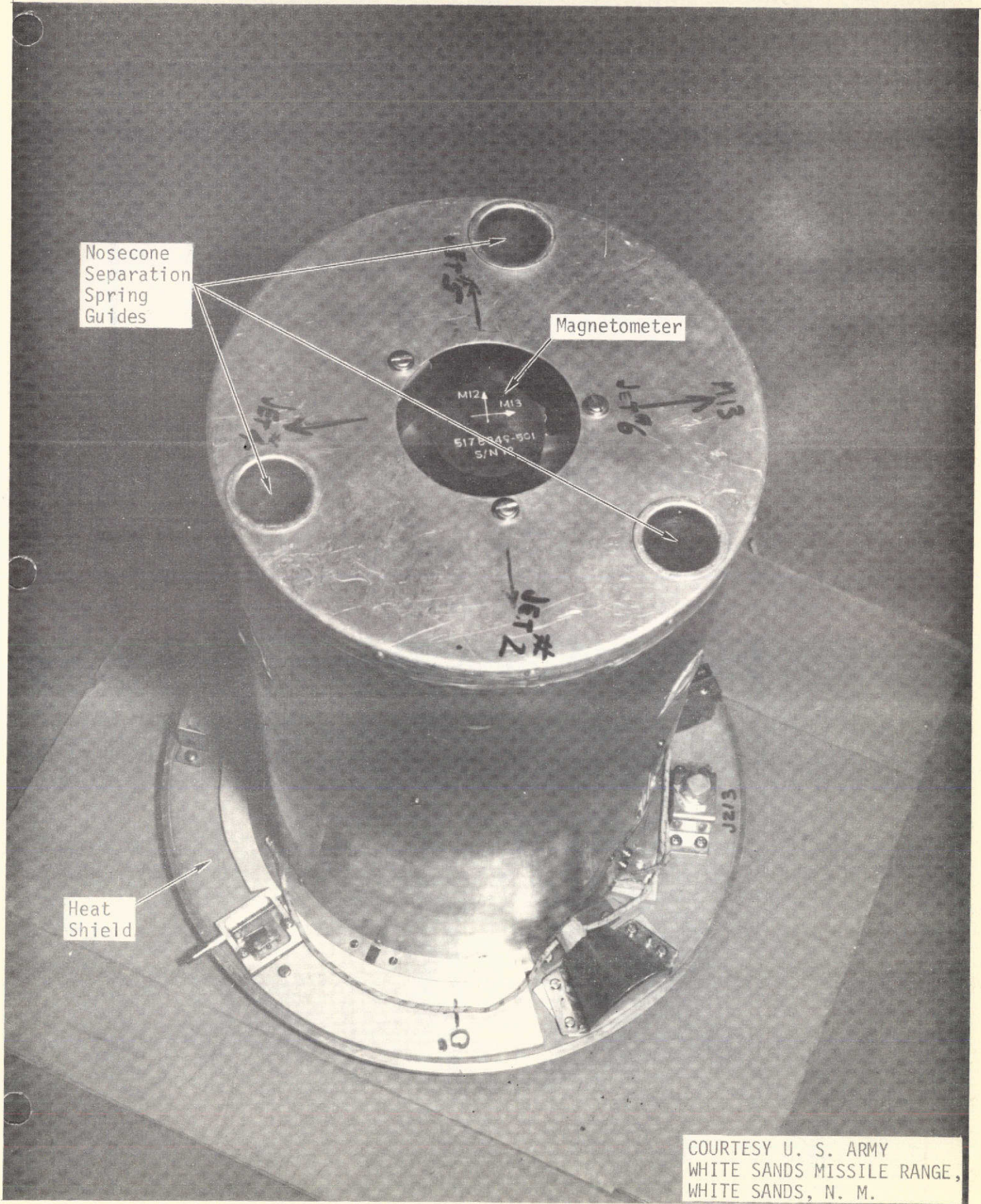
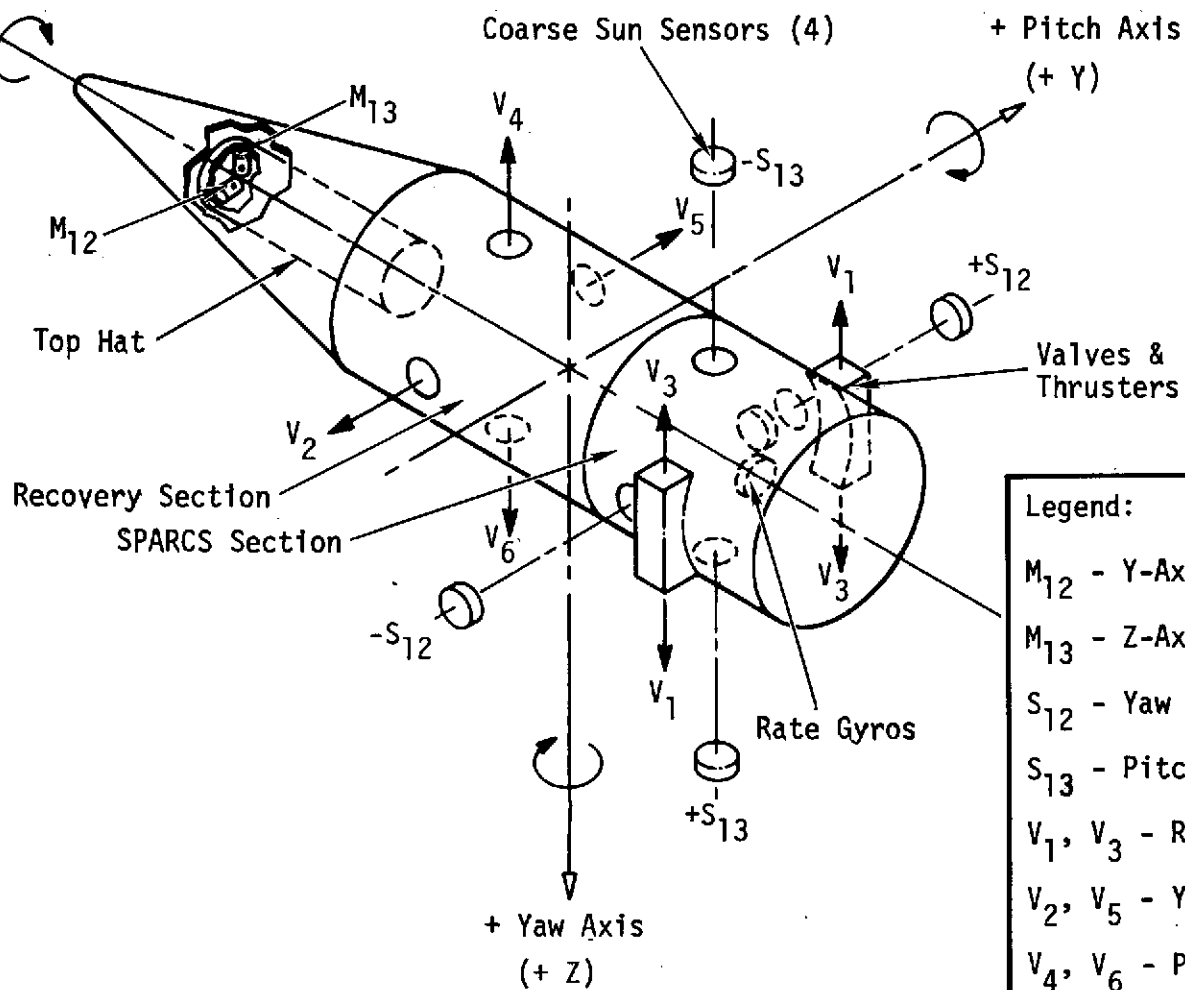

Figure 2-14. CALROC Top Hat and Magnetometer.

+ Roll Axis
(+ X)



Legend:

M₁₂ - Y-Axis Magnetometer

M₁₃ - Z-Axis Magnetometer

S₁₂ - Yaw Coarse Sun Sensor

S₁₃ - Pitch Coarse Sun Sensor

V₁, V₃ - Roll Valves & Thrusters

V₂, V₅ - Yaw Valves & Thrusters

V₄, V₆ - Pitch Valves & Thrusters

Figure 2-15. SPARCS Sensor and Valve Locations

pointing throughout the mission. The NRL SPARCS unit shown in Figure 2-10 was identical to the other two NRL SPARCS units flown, which were approximately 8.3 inches long and weighed approximately 55 pounds, including the Freon gas. The SPARCS control valves were single stage, spool type operating with Freon-14 gas. The tank supply pressure was 4500 psi, which was stepped down by regulators to an operating pressure of 625 psi during sun acquisition and approximately 25 psi during fine pointing. Table 2-2 illustrates the SPARCS force and acceleration parameters generated using single stage valves with the aforementioned gas pressures. A discussion of the SPARCS control logic and considerable additional information on the CALROC SPARCS can be found in Reference 8. The NRL SPARCS included a command link which was unique to the NRL payloads. This command link provided a ground controller, usually the principal investigator or scientist, the capability to select in real time flight any new pointing position that lay within 1200 arc seconds of the radiometric center of the sun.⁹ The minimum maneuver in any direction with the command link was 2.4 arc seconds.

2.2.4 HOC Pointing Control System. The HOC pointing control system was a SPARCS identical to the NRL SPARCS without command link capability. Real time command capability to maneuver the inflight HOC payload was not an HOC requirement. The HOC SPARCS weighed about five pounds less than the NRL SPARCS or approximately 50 pounds. Location of the intermediate and fine sun sensors, shown in Figure 2-16, were in the same vicinity as in the NRL payloads.

2.2.5 NRL Telemetry. The NRL Telemetry was an S-band system 20.5 inches long, weighing approximately 76 pounds and included one Frequency Modulated (FM) video link, one FM/FM housekeeping data link, a C-band radar beacon, a tone ranging receiver, three battery packs, four G-timers, four antennas, accelerometers, calibrators, and other supporting hardware.

The FM video link data was obtained with a special television camera and filter system located within the Scientific Instrument section. The camera output signal was applied directly to a specially selected wide-band RF transmitter located in the telemetry (TM) system, with the resultant modulated carrier power applied to a "lower" ring

8. "Solar Pointing Aerobee Rocket Control System (SPARCS) Manual," NASA, Ames Research Center, Moffett Field, California, October 1971.

9. "Specification for the SPARCS Command Link," NASA, Ames Research Center, Moffett Field, California, March 1, 1972.

Table 2-2. SPARCS Control Parameters

PAYLOAD	OPERATIONAL MODE	AXIS	FORCE	ACCELERATION
HCO	Sun Acquisition (625 psi)	Pitch/Yaw	2.4 lbs	$5.7-6^{\circ}/\text{sec}^2$
		Roll	4.22 lbs	$100^{\circ}/\text{sec}^2$
	Fine Pointing (≈ 25 psi)	Pitch/Yaw	.08 lbs	$.2^{\circ}/\text{sec}^2$
		Roll	.145 lbs	$3.5^{\circ}/\text{sec}^2$
NRL	Sun Acquisition (625 psi)	Pitch/Yaw	5.7 lbs	$5.7-6^{\circ}/\text{sec}^2$
		Roll	5.0 lbs	$100^{\circ}/\text{sec}^2$
	Fine Pointing (≈ 25 psi)	Pitch/Yaw	.11 lbs	$.2^{\circ}/\text{sec}^2$
		Roll	.185 lbs	$3.5^{\circ}/\text{sec}^2$

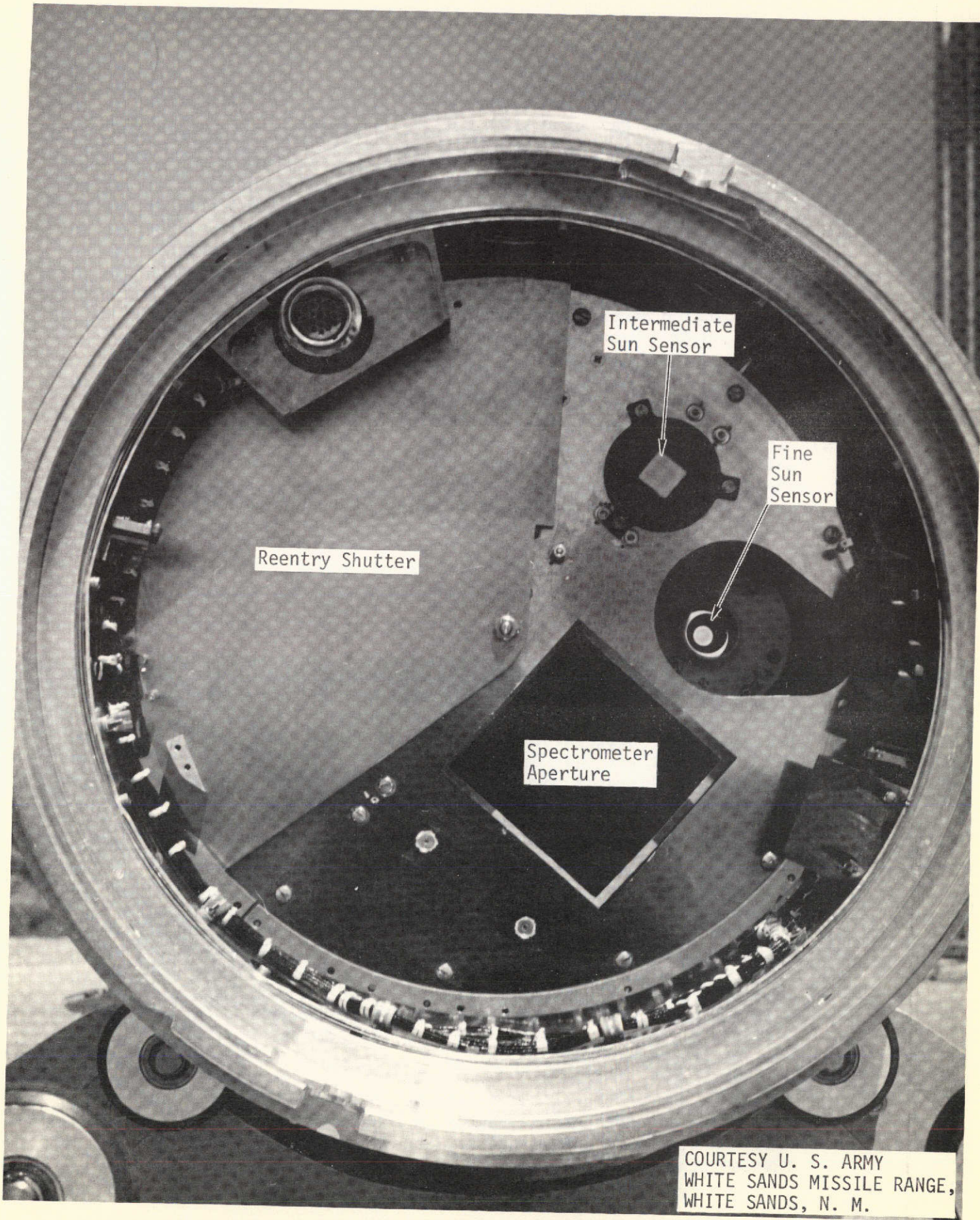

COURTESY U. S. ARMY
WHITE SANDS MISSILE RANGE,
WHITE SANDS, N. M.

Figure 2-16. HCO CALROC Intermediate and Fine Sun Sensors

antenna, located adjacent to the Instrument section, for radiation.¹⁰ The transmitter unit was located on the TM rack close to the Scientific Instrument camera interface to minimize signal losses. Transmitter selection required a series of acceptance tests to be conducted on one or more models, with test emphasis placed on selecting a model that was small, efficient, and light-weight, yet operated with proper linearity, modulation sensitivity, and Radio Frequency (RF) power output over environmental extremes. Additional tests, to include the airborne antenna, the camera, transmitter, and receiving stations was conducted prior to acceptance test completion, since the received television picture resolution depended on both airborne and receiving station operational characteristics.

The FM/FM link carried data generally referred to as "housekeeping". Seventeen standard Inter-Range Instrumentation Group (IRIG) subcarrier oscillators, band Numbers 5 through 21, formed an FM/FM multiplex with sufficient data handling capacity to encode and transmit performance information related to the Scientific Instrument, SPARCS, TM, Motor, Nosecone eject, Despin/separation, and Recovery. Each subcarrier data assignment was made in accordance with required data frequency response, since response is directly proportional to subcarrier frequency deviation. Subcarrier data response utilization was further enhanced by channel switching, via timer programmed relay commands, such that performance data, particular only to specific portions of the flight profile, was obtained on a minimum amount of subcarriers. In addition to channel switching, time division multiplexing, or commutation, was used for data signals of a quasi-static nature. Examples of such data are temperature, battery voltage levels, plenum pressure, etc. An inflight calibrator was utilized to sequentially apply a precision "staircase" voltage input to selected subcarriers. Each calibration was applied, for a short interval, during a specified portion of the flight. The calibrator was designed to operate on a "fail-safe" basis, i.e., a loss in calibrator power would return all subcarrier input lines to the data mode. Tone ranging reference oscillator frequencies were applied to the FM subcarrier multiplex and selected to cause no intermodulation effects. The FM multiplex was applied, via a mixer/amplifier, to the input of an FM S-band transmitter. The modulated RF carrier power was applied to the upper S-band antenna, i.e., the end ring antenna adjacent to the SPARCS section, for radiation on an assigned center frequency of 2279.5 Mhz. Components comprising the FM/FM system, including calibrators, commutators, and channel switching relays were selected, whenever possible, from GSFC flight proven stores to ensure component availability, reliable performance of each component and established calibration/alignment procedures.

-
10. "Design and Performance Specification Skylab CALROC Instrumentation/Telemetry for the NRL Payload," Document Number 0012-S/L, NASA Goddard Space Flight Center, Sounding Rocket Division, Instrumentation Branch, July 19, 1972.

A C-band radar beacon, with a dual element antenna array, was included in the TM system. The beacon assisted ground radar systems to acquire and track the target rocket from launch through recovery. Due to the prime nature of payload recovery, a tone ranging subsystem was also included in the TM system design. This system utilized a payload receiver and antenna tuned for reception of a ground transmitted 550 Mhz carrier frequency. This carrier frequency was modulated with a 210 KHz reference oscillator which was received, demodulated, and reapplied to the FM subcarrier multiplex. Tone ranging ground antennas received the radiated telemetry signal, determining azimuth of the rocket from interferometer phase, and range by phase comparison of the received reference frequency to the ground referenced frequency. A dual element antenna array, tuned for 550 Mhz reception, was located on the TM can.

A centralized battery system was incorporated into the TM systems to provide operating power to the following:

- a. Scientific Instrument electronics
- b. Scientific Instrument pyrotechnic actuators
- c. SPARCS command receiver
- d. Nosecone eject/despin/separation actuators
- e. TM electronics/performance transducers

The battery system contained three battery packs, each pack consisting of 20 cells with all packs located within a pressurized battery container. The container was located in the TM system in such a manner as to permit either complete removal of the container for battery servicing or removal of only the container's pressure plug, via the TM door. Plug removal was necessary for venting internal pressure buildup during charging, the plug being reinstalled to seal the box prior to launch. Separate power control relays and "stepping" switches were incorporated, where required, to permit independent system operation on both "external" (blockhouse) and "internal" (battery) power modes. Distribution of all power included individual power returns routed to one main TM ground reference. Distribution, in support of the Scientific Instrument electronics also provided separate and redundant switching to disconnect "external" power returns from "internal" power returns. Pyrotechnic actuator power distribution included redundant barometric "safe/arm" switch provisions, incorporated into each actuator system, permitting ground power checks to be conducted without premature or accidental pyrotechnic actuation.

To minimize weight and volume required, the TM system design utilized a centralized battery container of sufficient size to contain the three sets of batteries, provide pressurization, and contain connector access to each battery pack. One of the three battery packs, designated B-3, supplied power only to a selected portion of the Scientific Instrument electronics and was referred to as "quiet" power. Quiet power and distribution was required by the scientific programmer, high and low level commutators, and the Image Disector Tube - Fine Pointing System (IDT-FPS), since these devices were likely to be susceptible to actuator power transients and noise anticipated to be present on remaining power buses. Separate and redundant "Ledex" stepping switches, for both the input and return power lines were incorporated, permitting disconnection of all external lines during ground tests and flight.

Power for operation of the television camera, filter oven, transmitter, and beacon was supplied from the B-1 pack on a continuous duty basis. Individual relay distribution for these continuous duty devices was incorporated, including external line disconnect provisions for the television camera and filter oven. Power distribution to a time "armed" actuator bus was included, actuator bus power being required to advance the "A", "C", and "H" camera subsystems in the Scientific Instrument system. Camera actuation times were derived from the scientific exposure timer only, with TM timers serving only to apply "arming" power to the actuator bus soon after payload separation. Squib actuation power, although required only on a momentary basis, was distributed through current limiting resistors and short duration timer closures. Design loads on the B-1 battery permitted full "internal" load operation for at least 25 minutes with nominal battery voltage within the range of 28 ± 4 volts DC. Charging provisions were incorporated to maintain battery capacity.

Power for operation of the subcarrier oscillators, inflight calibrator, commutator, transmitter, tone ranging, and SPARCS command receiver was supplied from the B-2 pack. Power distribution, similar to that provided for the B-1 actuator bus, was included via a timer "armed" actuator. The B-2 actuator bus supplied power to advance the "B" and "H-alpha" camera subsystems of the Scientific Instrument. Design loads on this battery permitted full internal operation for at least 25 minutes with a nominal battery voltage of 28 ± 4 volts DC.

Four "G"-actuated 6-pole timers were selected to provide a sufficient number of timer poles to incorporate redundant timing. Two timers were designated as "prime", the remaining two as "backup". Each timer pole was individually set for actuation, and each pole mechanically configured to permit short duration actuation. Each timer incorporated a geared clock mechanism, powered by a stored force, with a clock "run" escapement mechanism released by "tripping"

a pre-set timer weight. A sustainer longitudinal acceleration of +3G's of .5 seconds duration imparts sufficient force to trip the weight for initiation of clock "run". All timers were positioned in the TM system to permit access for manual re-setting and/or initiating timer run during acceptance and pre-launch tests.

The TM system included a single axis servo accelerometer for measurement of longitudinal thrust and parachute loads, a single axis magnetometer for longitudinal aspect sensing, and detection circuits and/or switches for monitoring timer status, battery voltages, and vehicle sequencing release mechanisms, i.e., separation, despin, nosecone eject, etc. In addition, a pitch-yaw angle of attack gauge, located on the nose tip, and a chamber pressure gauge, located in the Igniter Housing, were energized and signal conditioned by the TM system.

2.2.6 HCO Telemetry. The HCO Telemetry was an S-band system 14.3 inches long, weighing approximately 75 pounds and included two Pulse Code Modulation (PCM) links, one FM/FM link, two sets of G-timers, three battery packs, a tone ranging receiver, a radar beacon, three sets of antennas, accelerometers, calibrators, commutators, and other supporting hardware. PCM link #1, operating at 2259.5 Mhz, carried the Scientific Instrument, SPARCS and housekeeping functions shown in Tables 2-3 and 2-4. Note that Table 2-4 is a listing of the submultiplexed functions on channel 15 in Table 2-3. PCM link #2, operating at 2251.5 Mhz, carried additional Scientific Instrument functions and redundant critical Scientific Instrument functions that were on link #1 as illustrated in Table 2-5. The FM/FM link, operating at 2279.5 Mhz, carried housekeeping data only as shown in Tables 2-6 and 2-7.

The G-timers were 6 pole, 90 second mechanical timers used to activate payload functions such as nosecone eject, despin, payload separation, SPARCS enable, power up the Scientific Instrument, etc.

Three battery packs were located in the HCO Telemetry (B-1, B-2 and B-3). B-1 and B-2 were 20 cell HR-3 type batteries providing power for housekeeping functions with B-1 also providing redundant power to the camera drivers and relay driver. B-3 was a 20 cell HR-1 type battery providing power to the Scientific Instrument only.

A radar beacon and a tone range receiver identical to those used in the NRL TM were part of the HCO Telemetry system used for tracking and determining range of the payload throughout flight. The beacon utilized a folded valentine antenna whereas spike type antennas were used for tone ranging and thrust termination. Flush-mounted S-band antennas were used to transmit the FM/FM and PCM data.

Table 2-3. PCM #1 (2259.5 Mhz)

<u>CHANNEL</u>	<u>FUNCTION</u>
0	Not Used
1	Not Used
2	Detector #2 LSW
3	Detector #2 MSW
4	Frame Counter
5	Optical Reference
6	Lyman - α
7	CCIG
8	Mirror Position
9	Grating Clock
10	SPARCS FSS Pitch
11	SPARCS FSS Yaw
12	SPARCS Jets 1 & 3
13	SPARCS Jets 4 & 6
14	SPARCS Jets 2 & 5
15	Sub Multiplexed (32 sub channels)

Table 2-4. PCM #1 Channel 15 Sub-Multiplexer

<u>SUB-CHANNEL</u>	<u>FUNCTION</u>
0	Not Used
1	Battery #1 Monitor
2	Battery #2 Monitor
3	Battery #3 Monitor
4	Parachute Data #1
5	Parachute Data #2
6	Despin Weights Monitor
7	Recovery System Lid Monitor
8	Manacle Ring and Nosecone Eject Monitor
9	Instrument +40V Monitor
10	Instrument +28V Monitor
11	Instrument +24V Monitor
12	Instrument +15V Monitor
13	Instrument +5V Monitor
14	Instrument -5V Monitor
15	Instrument -15V Monitor
16	Instrument HV #1 Monitor
17	Instrument HV #2 Monitor
18	Instrument Temp #1 Monitor
19	Instrument Temp #2 Monitor
20	Instrument Temp #3 Monitor
21	Instrument Temp #4 Monitor
22	Instrument Temp #5 Monitor
23	Instrument Temp #6 Monitor
24	Dome Monitor
25	Rocket Separation Loop Monitor
26	Nosecone Eject Current Monitor G-Timer #1
27	Nosecone Eject Current Monitor G-Timer #2
28	Despin/Separation Current Monitor, Payload Timer
29	Despin/Separation Current Monitor, Igniter Housing Timer
30	Shutter Monitor
31	Not Used

Table 2-5. PCM #2 (2251.5 Mhz)

<u>CHANNEL</u>	<u>FUNCTION</u>
0	Not used
1	Not Used
2	Detector #1 LSW
3	Detector #1 MSW
4	Frame Counter
5	Optical Reference
6	Lyman - α
7	CCIG
8	Mirror Position
9	Grating Clock
10	Instrument Events
11	OV Calibrate
12	+25V Calibrate
13	+5V Calibrate
14	Grating Stow
15	Mirror Stow

Table 2-6. FM/FM (2279.5 Mhz)

<u>VCO FREQUENCY</u>	<u>FUNCTION</u>
165 Khz	SPARCS Commutator
121	Pitch Accelerometer
93	Instrumentation Commutator
70	SPARCS Jets 2 and 5
52.5	SPARCS Jets 4 and 6
40	SPARCS Jets 1 and 3
30	Longitudinal Accelerometer
22	FSS Yaw
14.5	FSS Pitch
10.5	Yaw Accelerometer
7.35	Motor Pressure (Pc)
5.4	Ogive Pitch
3.9	Ogive Yaw
3.0	Longitudinal Magnetometer
2.3	Lateral Magnetometer

Table 2-7. FM/FM Channel 93 Commutator Assignment

<u>POSITION</u>	<u>FUNCTION</u>
1	Ground
2	+5V
3	Separation/Despin #1
4	Separation/Despin #2
5	Despin Weights
6	Separation Loop (Rocket)
7	G-Timer Monitor (Igniter Housing)
8	Spare
9	Nosecone Loop
10	Recovery System Lid Monitor
11	Current Monitor #1 (Nosecone Eject #1)
12	Current Monitor #2 (Nosecone Eject #2)
13	Parachute Data #1
14	Parachute Data #2
15	P-M (Recovery System Pressure)
16	Manacle Switch Monitor and Nosecone Eject
17	Parachute Timer Monitor #1
18	Parachute Timer Monitor #2
19	G-Timer #1
20	G-Timer #2
21	Battery Monitor #1
22	Battery Monitor #2
23	Battery Monitor #3
24	Vacuum Dome Monitor
25	Instrument On
26	Instrument On
27	Spare
28	Spare
29	+5V
30	+5V
31	Not Used
32	FM/FM Data Output on Channel 93

2.2.7 Nosecone and Recovery Systems (ORSA). The Nosecone and Recovery system, commonly called ORSA (Ogive, Recovery, Separation Assembly), illustrated in Figure 2-17 was flown on all NRL and HCO CALROC payloads. Its principal components were a 3:1 ogive, nosecone separation springs, SPARCS magnetometers and pitch/yaw jets, heat shield, manacle ring and parachutes. The total system was 51.8 inches long and weighed approximately 97 pounds. The 3:1 Ogive or Nosecone was separated from the payload by electrical signals from the instrumentation and telemetry system approximately 56 seconds after launch. The heat shield, located at station 35.7 in Figure 2-18, was normally deployed at approximately 20,000 feet on re-entry which, in turn, deployed the drogue chute, then followed by the main parachute some 13-14 seconds later (see Figure 2-2). The parachutes were reefed and designed to withstand shock loads of 50 g's and safely land a 600-pound payload at velocities no greater than 35 feet/second. Figures 2-19 and 2-20 illustrate preflight and post-flight recovery systems, respectively.

2.2.8 Separation Systems. Two separation systems were used on all CALROC payloads: one to separate the payload from the Rocket Motor and Igniter Housing after Motor burnout and a second one to remove the Nosecone during flight. Both separation systems employ manacle rings of the type shown in Figure 2-21. The Nosecone Separation system used three springs in sufficient compression to impart an adequate delta velocity to the Nosecone during separation to prevent any inflight collision. At Nosecone separation the vehicle was separated into four distinct parts; Nosecone, manacle rings and payload/motor combination. The payload separation system used four springs, shown in Figure 2-22, mounted on the Igniter Housing and compressed to provide a separation velocity between payload and rocket motor of 2 feet/second. At payload separation the existing vehicle was separated into four distinct parts; controlled payload, manacle rings and Igniter Housing Motor combination. Activation and timing of both separations were controlled by redundant mechanical timers in the Instrumentation and Telemetry system.

The payload separation logic consisted of two isolated initiation circuits, each of which contained pressure switches, a G-timer, a safety/arm connector and five HRL batteries. These circuits were located in the Igniter Housing with the batteries mounted such that they were easily removed through an access door.

2.2.9 Igniter Housing. The Igniter Housing illustrated in Figure 2-22 was identical to all Igniter Housings used in the CALROC project. Each Igniter Housing was approximately 9.6 inches long, weighed approximately 73.8 pounds, and included both a yo-yo despin system and a thrust termination system. The yo-yo despin system consisted of two weights attached to 3 1/4 wraps of cable and released such that the weights absorb rotational energy thereby despinning the rocket and payload from 4 revolutions/second to zero in

Figure 2-17. Typical CAIROC Nosecone and Recovery Systems.

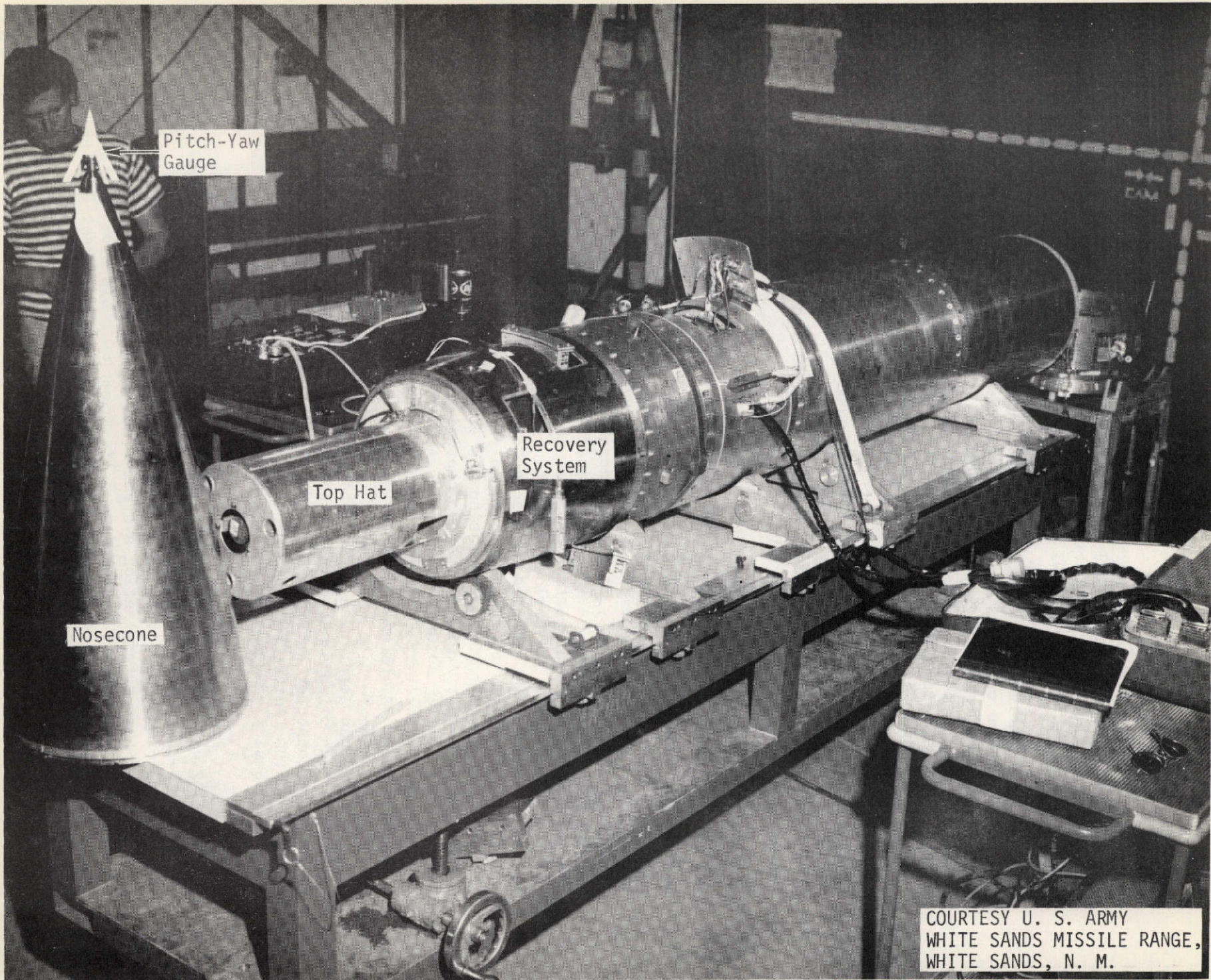

COURTESY U. S. ARMY
WHITE SANDS MISSILE RANGE,
WHITE SANDS, N. M.

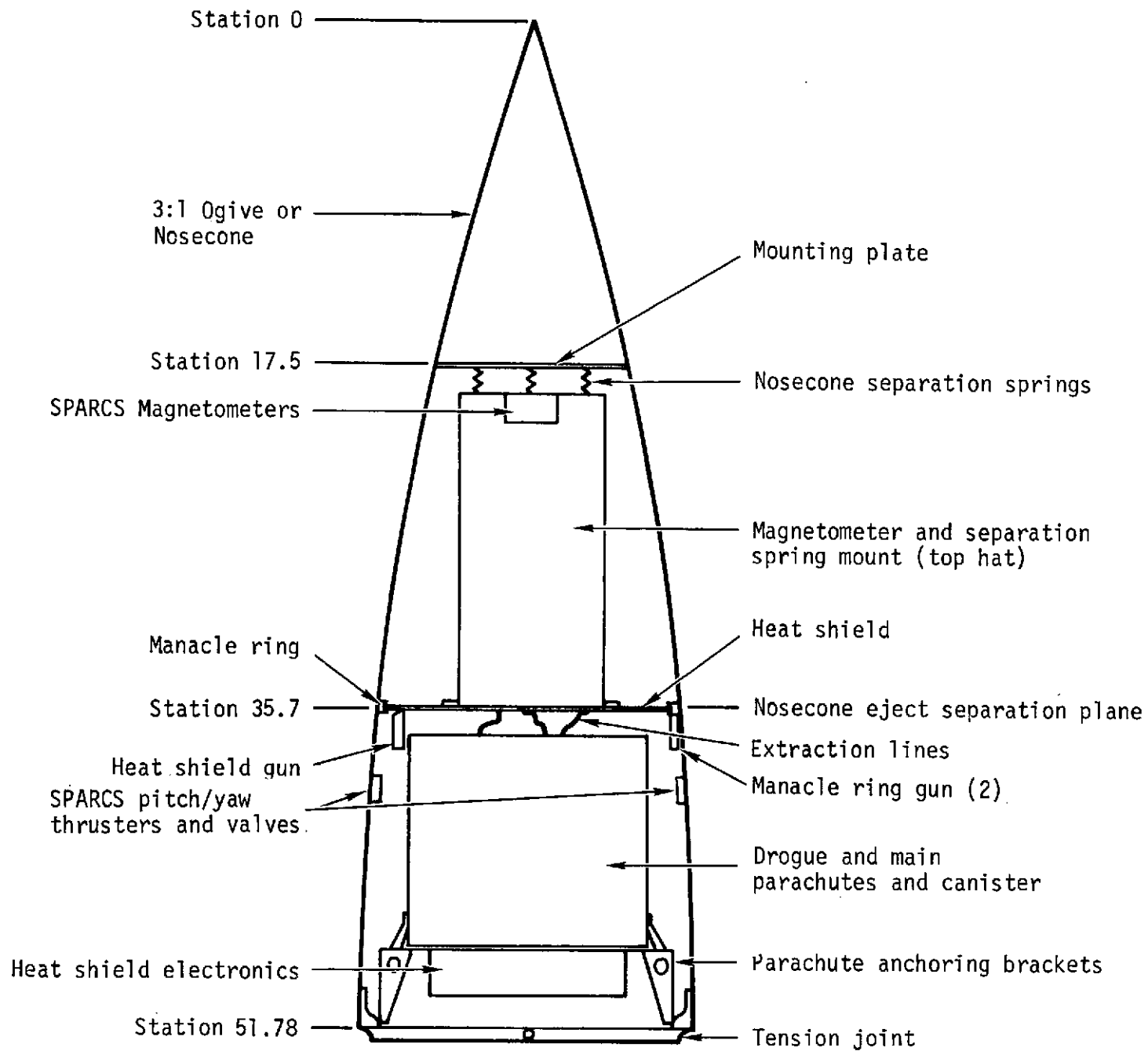
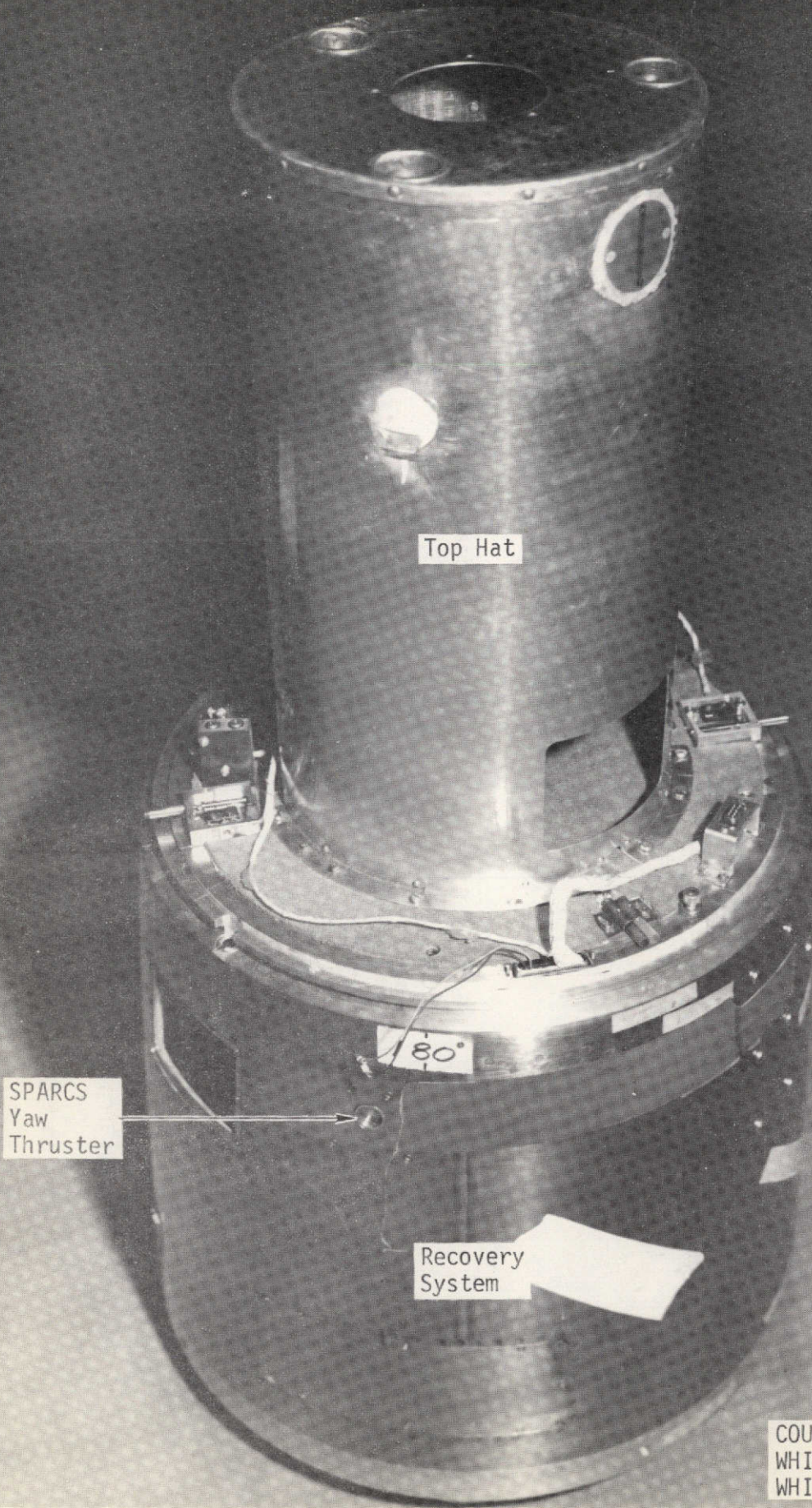

Figure 2-18. CALROC Nosecone and Recovery System



COURTESY U. S. ARMY
WHITE SANDS MISSILE RANGE,
WHITE SANDS, N. M.

Figure 2-19. Typical CALROC Preflight Recovery System.



COURTESY U. S. ARMY
WHITE SANDS MISSILE RANGE,
WHITE SANDS, N. M.

Figure 2-20. Typical CALROC Post-Flight Recovery System.

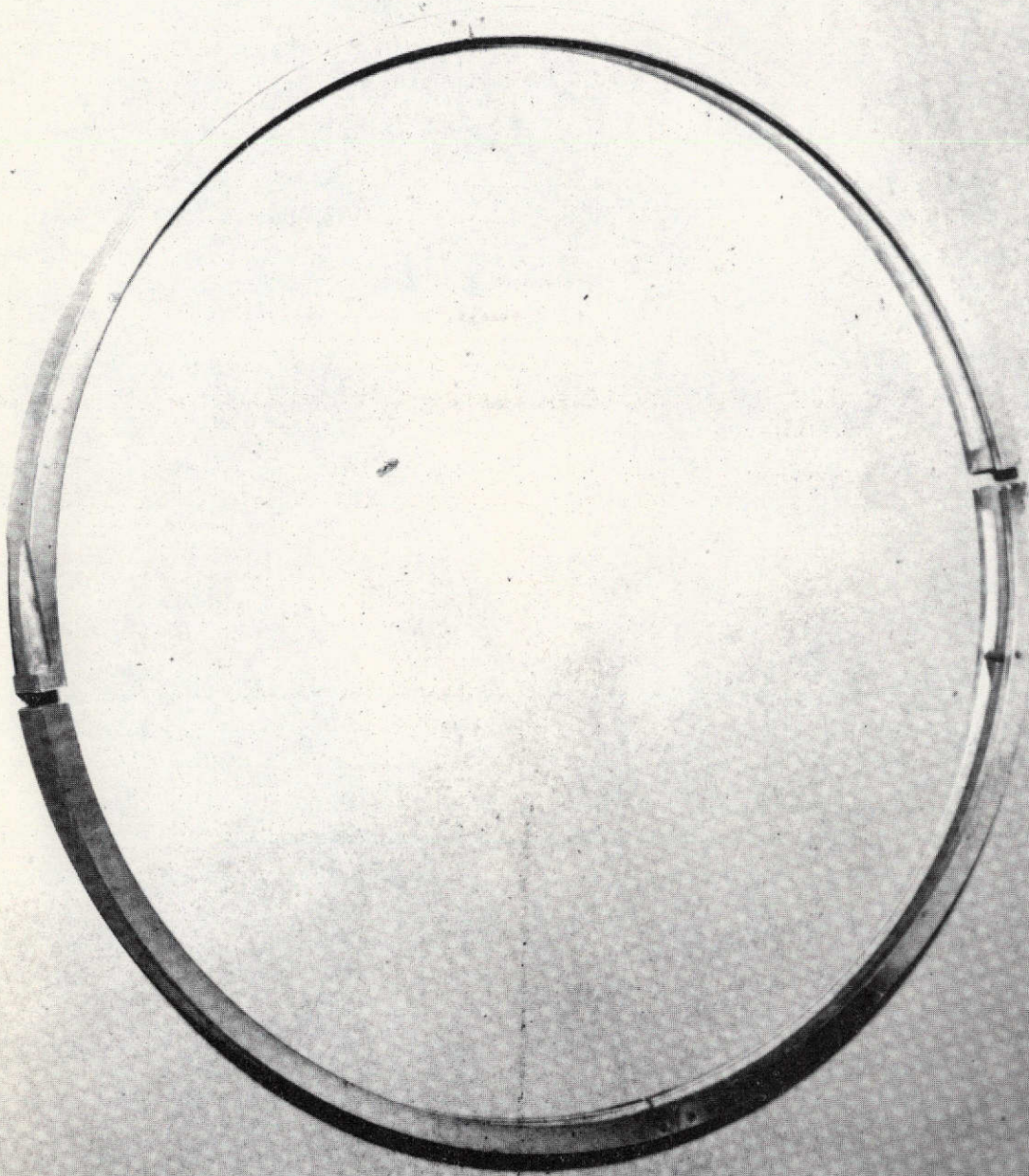

COURTESY U. S. ARMY
WHITE SANDS MISSILE RANGE,
WHITE SANDS, N. M.

Figure 2-21. Typical CALROC Manacle Ring.

Figure 2-22. Typical CAIROC Igniter Housing.

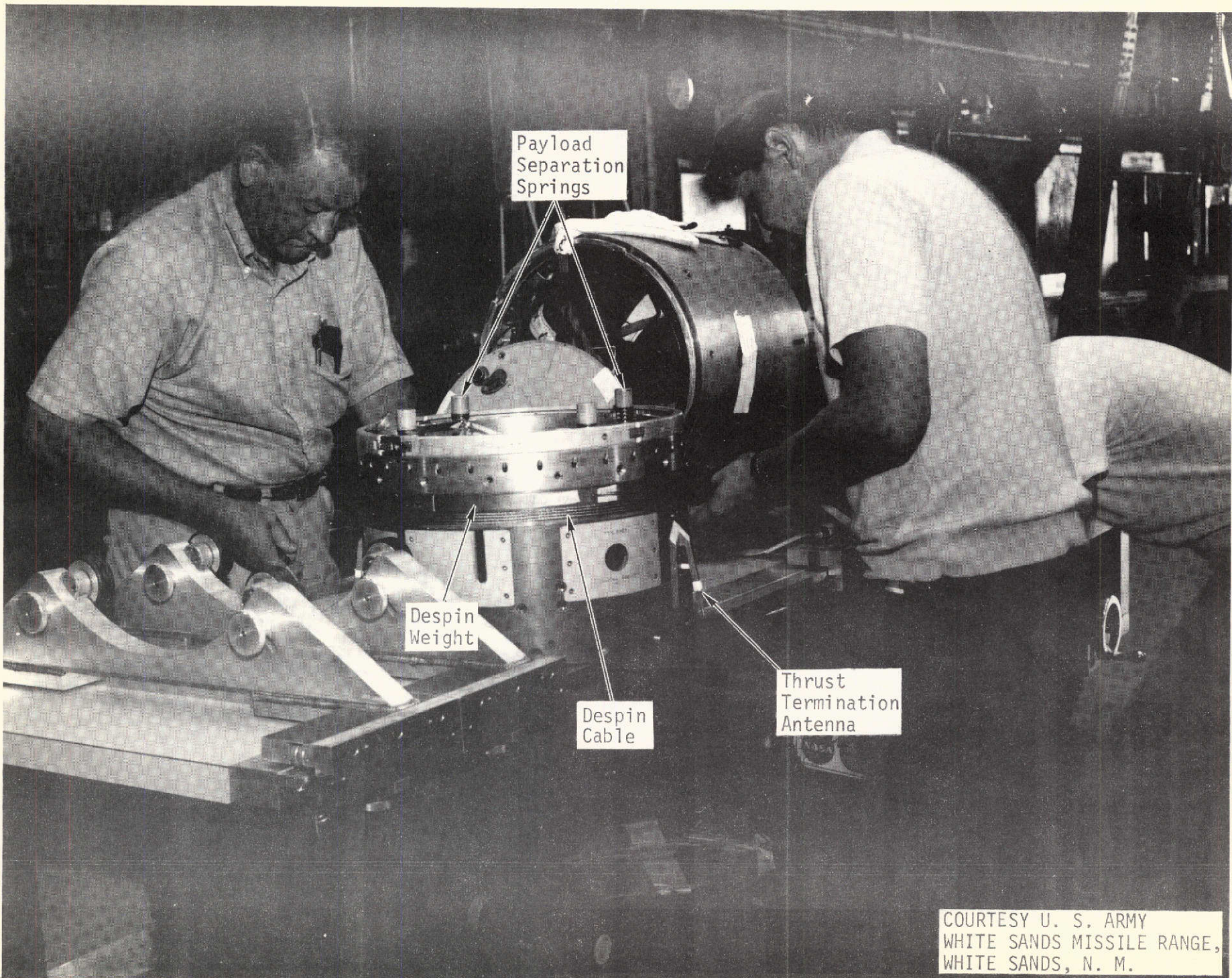

COURTESY U. S. ARMY
WHITE SANDS MISSILE RANGE,
WHITE SANDS, N. M.

approximately 1 second. The weights fit into cutouts in the Igniter Housing and the cables were wrapped around the housing in a circular groove. Prior to deployment the two weights were secured by a single cable which passed through the center of the housing. Release of the weights was achieved by severing the cable with a pyrotechnic cutter. Two cutters were supplied for redundancy. After the rocket and payload were despun, then mechanical timer signal initiated payload separation.

The thrust termination unit consisted of two flexible linear shaped charges which were bonded into a moulded polyurethane foam ring. One charge was positioned to sever the Igniter Housing wall and the other placed in a slightly offset position over the motor head end. This charge was designed to cut a hole in the head end thus neutralizing thrust as well as inducing a tumbling motion to the Motor. Since the shaped charges were located in the Igniter Housing, extensive damage to the Igniter Housing and the payload end attached to the Igniter Housing was expected if thrust termination was ever commanded. Such a situation occurred on CALROC flight 21.021 and will be discussed in the performance section of this report.

The Safe/Arm assembly was an electromechanical device which prevented thrust termination until 8 seconds after launch as well as isolating the detonators from the power supply during checkout. At launch the timer was started by a pull-away lanyard secured to the launcher at a point adjacent to the Igniter Housing. There was an auxiliary switch in the Safe/Arm assembly which in the event of thrust termination, could initiate payload separation if so desired.

The initiation system was comprised of a command receiver, receiver battery, antenna system and wiring harness. The receiver and thrust termination unit squib were powered by the 28 VDC nicad battery. When the "Destruct" command is transmitted by the ground station, the signal is fed from the quadraloop antenna system to the command receiver. To fulfill the destruct command the receiver signal must be modulated by two tones simultaneously. These two tones cause closure of power relays within the receiver, thus applying voltage to the detonators.

2.2.10 Interface Control Drawings. Electrical and Mechanical Interface Control Drawings (ICDs) were developed and maintained separately for the NRL and HCO CALROC payloads. The Electrical ICDs were developed and revised by the Martin Marietta Corporation (Huntsville) for Marshall Space Flight Center (MSFC) and distributed, with Goddard Space Flight Center concurrence, to the appropriate CALROC personnel. An ICD was developed for each payload subsystem interface resulting in a total of ten electrical ICDs. In addition, two electrical ground schematics of the NRL payload were developed and distributed. The Electrical ICDs and ground schematics are listed in Table 2-8 showing the MSFC drawing numbers and last revision dates.

Table 2-8. CALROC Electrical Interface Control Drawings

<u>DRAWING TITLE</u>	MSFC <u>DRAWING NUMBER</u>	<u>REVISION</u>	<u>DATE</u>
NRL ORSA	68M00017	D	7/19/73
NRL SPARCS	68M00018	E	11/12/73
NRL Telemetry	68M00019	E	8/21/73
NRL Instrument	68M00020	E	7/18/73
NRL Igniter Housing	68M00021	B	7/19/73
NRL Ground Schematic	SKNRLGS	A	11/20/73
NRL Instrument Quiet Ground Schematic	SKNRLIQG	None	7/24/72
HCO ORSA	68M00022	E	5/11/73
HCO SPARCS	68M00023	G	11/12/73
HCO Telemetry	68M00024	D	9/24/73
HCO Instrument	68M00025	E	11/2/73
HCO Igniter Housing	68M00026	D	5/11/73

Originals of the CALROC Electrical ICDs were given to the MSFC Documentation Repository in February 1974 for microfilming and storage. Copies of the ICDs may be obtained upon request to the MSFC Documentation Repository.

The Mechanical ICDs were developed by Goddard Space Flight Center (GSFC) and distributed, with MSFC concurrence, to the appropriate CALROC personnel. An ICD was developed for each payload subsystem interface resulting in a total of ten mechanical ICDs. The Mechanical ICDs were listed in Table 2-9 showing the GSFC drawing numbers and last revision dates.

Table 2-9. CALROC Mechanical Interface Control Drawings

<u>DRAWING TITLE</u>	<u>GSFC DRAWING NUMBER</u>	<u>REVISION</u>	<u>DATE</u>
NRL Telemetry	GR-34-195	A5	7/31/72
NRL SPARCS	GR-34-196	A5	7/31/72
NRL Igniter Housing	GR-34-197	A7	7/31/72
HCO Igniter Housing	GR-34-198	B1	10/20/72
NRL Instrument	GR-34-199	A5	7/31/72
HCO SPARCS	GR-34-200	B1	10/20/72
HCO Instrument	GR-34-201	B1	10/20/72
NRL Recovery System	GR-34-202	A5	7/31/72
HCO Recovery System	GR-34-203	B1	10/19/72
NRL Nosecone	GR-34-204	A5	7/31/72
HCO Nosecone	GR-34-205	B1	10/19/72
NRL ICD List	GR-34-206	None	3/23/72
HCO ICD List	GR-34-207	B1	10/20/72
HCO Telemetry	GR-34-208	B1	10/20/72

Section 3

TEST FLIGHT SUMMARY

SECTION 3

TEST FLIGHT SUMMARY

The sounding rocket philosophy that it is more economical to build, test and launch several sounding rockets using minimum documentation and change control than to require tight change controls and complete documentation on a few sounding rockets was used on the CALROC test project. This philosophy permitted some failures and in the case of the CALROC test flights resulted in four subsystem failures on three flights. Five of eight test flights were successful with forty-one (41) of forty-five (45) subsystems performing successfully.

Flight testing of CALROC type hardware began at WSMR on May 31, 1972, with the launching of the first Black Brant VC rocket payload at WSMR (21.001) and terminated on August 30, 1973, with the launching of payload 21.007. During this period, eight payloads were launched at WSMR (seven prior to the first Skylab CALROC flight on June 4, 1973), with varying amounts of CALROC type hardware. The amount of CALROC hardware varied, as shown in Table 3-1, from only a Black Brant VC Motor and CALROC type Igniter Housing on 21.001, to a totally CALROC payload on 21.011. Most test flights carried Scientific Instruments other than CALROC, thus providing a dual purpose test flight.

Although some anomalies were encountered in non-CALROC hardware, all CALROC subsystems flown on each test flight were considered successful, except for the SPARCS and Recovery subsystems on flight 21.011, April 3, 1973. Flight 21.011 was the first flight of a totally NRL CALROC payload. During this flight, SPARCS failed to acquire the sun because of an undetected wiring error within the SPARCS subsystem. In effect one cell of the SPARCS coarse eyes (acquisition sun sensor) was wired into an open pin of an electrical connector thus providing no output error in that direction when the payload was pointing off the sun. Test equipment, in particular the air bearing test facility at Ames Research Center, was wired with a compensating error such that the error remained undetected during ground testing. The Recovery subsystem failed when the main parachute failed to open as a result of a design and/or test deficiency in the parachute main risers and mouth locks.

Following the launch of rocket/payload 21.001 on May 31, 1972, was rocket/payload 21.008 launched June 9, 1972, with a CALROC type Igniter Housing, using radial screw joints, and CALROC type Separation subsystems, using a single release manacle ring. CALROC type hardware on flight 21.008 was a complete success.

The third test flight, 21.020 launched October 24, 1972, carried the first HCO CALROC configured payload and was sometimes called the

Table 3-1. CALROC Hardware Test Flight Summary

Flight number	Launch date	Igniter Housing	Scientific Instrument	Telemetry	Control system	Recovery system	Separation systems	Remarks
21.001	5-31-72	*	University of Colorado	FM/FM	SPARCS V **	Aft	P/L separation system was manacle ring with single release. N/C separation system was clamshell with cable release.	*Igniter Housing was CALROC type with radial screw joints and modified despin system. **This SPARCS failed because it used glass covered coarse sun sensor eyes which were damaged by aerodynamic heat.
Successful		Yes	N/A	N/A	No	N/A	N/A	
21.007 (refly of 21.001)	8-30-73	*	University of Colorado	FM/FM	SPARCS V **	Aft	Same as 21.001	*Igniter Housing was CALROC type with radial screw joints and modified despin system. **Same SPARCS as on 21.001, but with quartz covered coarse sun sensor eyes.
Successful		Yes	N/A	N/A	N/A	N/A	N/A	
21.008	6-9-72	*	University of California	PCM	STRAP	Aft	Separation systems were manacle ring with single release.	* Igniter Housing was CALROC type with radial screw joints.
Successful		Yes	N/A	N/A	N/A	N/A	N/A	
21.009*	1-22-73	CALROC	University of Colorado	PAM/FM/FM	CALROC NRL SPARCS VI ** (Used WYROS)	CALROC ***	CALROC	* Second HCO configured payload. **First CALROC NRL SPARCS using quartz covered coarse sun sensor eyes. ***First front end CALROC Recovery system.
Successful		Yes	N/A	N/A	Yes	Yes	Yes	
21.011*	4-3-73	CALROC	NRL CALROC	NRL CALROC	CALROC NRL SPARCS VI (Used WYROS)	CALROC	CALROC	* First NRL CALROC configured payload. **Failed because of undetected wiring error within SPARCS. ***Failed because main parachute never deployed. See text for details.
Successful		Yes	No contest	Yes	No **	No ***	Yes	
21.016 (refly of 21.008)	2-10-73	CALROC	University of California	PCM	STRAP	Aft	Same as 21.008	
Successful		Yes	N/A	N/A	N/A	No	Yes	
21.019* (refly of 21.009)	5-18-73	CALROC	University of Colorado	PAM/FM/FM	CALROC NRL SPARCS VI **	CALROC	CALROC	* Third HCO configured payload. **First gyros and intermediate sun sensors used with SPARCS.
Successful		Yes	N/A	N/A	Yes	Yes	Yes	
21.020*	10-24-72	CALROC **	None	FM/FM	CALROC configuration with CALROC quartz covered sun sensors but no actual control.	None	CALROC ***	* First HCO configured payload. **First CALROC Igniter Housing with tension screw joints. ***First CALROC dual release manacle ring Separation systems.
Successful		Yes	N/A	N/A	N/A	N/A	Yes	

"HCO Lead Shot." This flight was highly instrumented for temperature data and was the first flight of the CALROC Igniter Housing with tension screw joints and the CALROC dual release manacle ring Separation subsystems. This payload did not include a Recovery subsystem, Scientific Instrument or SPARCS. All CALROC hardware operated successfully and all temperature measurements, except one, were successfully obtained.

The fourth test flight, 21.009, launched January 22, 1973, was the second HCO CALROC configured payload. This flight was highly instrumented for temperature data and was the first test flight of a CALROC (front end) Recovery subsystem and NRL SPARCS using wyros and quartz covered coarse sun sensor eyes. Excellent temperature data were obtained and after a longer than expected sun acquisition time, SPARCS maintained good pointing stability and accuracy. All CALROC hardware operated successfully and all temperature measurements, except one, were successfully obtained.

The fifth test flight, 21.016, launched on February 10, 1973, was essentially a reflly of rocket/payload 21.008, using a CALROC tension screw joint Igniter Housing. All CALROC hardware operated successfully. (The payload was lost due to a malfunctioning Recovery system which was not CALROC design or hardware.)

The sixth test flight was rocket/payload 21.011 discussed earlier in this section.

The seventh test flight 21.019 launched May 18, 1973, was essentially a reflly of rocket/payload 21.009 with gyros instead of wyros in SPARCS and intermediate sun sensors flown for the first time. SPARCS pointing was excellent and twenty-eight (28) of twenty-nine (29) temperature measurements were obtained. All CALROC hardware operated successfully. This flight was added to flight test the modifications made following the 21.011 failures and was the last test flight prior to launching the first Skylab CALROC on June 4, 1973.

Flight 21.007, launched August 30, 1973, was considered a CALROC test flight only because it was an additional flight of the Black Brant VC Motor, CALROC type Igniter Housing using radial screw joints and the CALROC quartz covered coarse sun sensor eyes. This flight was essentially a reflly of rocket/payload 21.001 with the quartz covered eyes. All CALROC hardware operated successfully.

Section 4

PERFORMANCE - CALROC TEST FLIGHTS

SECTION 4

PERFORMANCE - CALROC TEST FLIGHTS

The purpose of the CALROC test flight project was to launch as many Black Brant VC rocket/payloads as possible, prior to the Skylab mission and within the funding constraints, to obtain maximum confidence in the flight worthiness of the BBVC motor and CALROC hardware. Several of the test flights listed in Table 3-1 were funded with non-Skylab funds and carried non-CALROC scientific experiments and hardware.

The CALROC test flight project included eight Black Brant VC launches with some carrying complete CALROC payloads and others only partial CALROC hardware. Four of the test flight payloads (21.001, 21.007, 21.008, 21.016) were testing CALROC Nosecones, Separation systems, Parachutes, Igniter Housings and Booster Motors and were not configured necessarily to either an NRL or HCO CALROC configuration. Three of the other four test flights (21.009, 21.019, 21.020) were HCO configurations chosen because they were some 100 pounds lighter than NRL payloads and would therefore provide higher atmospheric exit velocities resulting in maximum expected CALROC payload temperatures. The eighth test flight (21.011) was a complete NRL CALROC payload including the Scientific Instrument.

In addition to the CALROC test flights numerous subsystem tests, air bearing tests, bend tests, vibration tests and payload integration tests were conducted prior to each test flight with many of these tests repeated prior to the Skylab CALROC flights. Typical subsystem tests were:

- a. Manacle ring deployment
- b. Nosecone/payload separation
- c. Payload/Booster Motor separation
- d. Payload/parachute drops
- e. SPARCS air bearing
- f. Electrical functional
- g. Vibration
- h. Telemetry/ground station functional
- i. Telemetry/Instrument functional

- j. Instrument vacuum functional
- k. Instrument baseline

Having successfully passed subsystem level testing, the subsystems were assembled into payloads for further testing. Typical payload tests and the locations performed prior to shipping the payload to the launch site were:

- a. Air bearing - NASA, Ames Research Center
- b. Static Bend - NASA, Ames Research Center and Ball Brothers Research Corporation
- c. Vibration - NASA, Ames Research Center and Ball Brothers Research Corporation
- d. Sun Alignment - NASA, Ames Research Center and Ball Brothers Research Corporation
- e. Spin Balance - NASA, Ames Research Center and Ball Brothers Research Corporation
- f. Integration - NASA, Ames Research Center and Ball Brothers Research Corporation

4.1 Flight 21.001. The first WSMR launching of a Black Brant VC vehicle (21.001) occurred on May 31, 1972, at approximately 22:25:0 GMT. The Booster Motor was the identical type used on the CALROC project and was, therefore, considered as a CALROC test flight. The Igniter Housing flown on the 21.001 payload was similar to the CALROC Igniter Housings, differing only in the radial joint used rather than the tension joint planned for use on all CALROC Igniter Housings. The joint under consideration was between the Igniter Housing and the Rocket Motor. The yo-yo despin system used a 2.25 wrap design and achieved a final spin rate of 0.93 revolutions/second. Apparently, the prime timer failed because the despin and other events were approximately one second later than expected. Calm-shell ejection and payload separation were smooth resulting in a pitch rate of 4.5 degrees/second and a yaw rate of 3 degrees/second which were within the SPARCS V limit of 10 degrees/second. Both the Rocket Motor and Igniter Housing performed as expected or designed.

SPARCS Telemetry records indicate that SPARCS despin the payload to zero, however, the coarse sun sensors never put the payload into an attitude such that the intermediate sun sensors (SEAS) could take over. SPARCS gas pressures indicated that the pneumatic subsystem performed satisfactorily with sufficient gas after despin to perform the mission.

The most significant damage on the payload was the SPARCS coarse sun sensors glass covers. Three of the covers (each about the size and shape of a regular flashlight bulb) had a hole in the leading portion which protruded out from the SPARCS skin approximately 0.25 inches. The shape of the hole and deformation were such as could be formed by overheating during ascent. Deformation of the covers would affect the performance of the sun sensors causing them to give erroneous signals. This is thought to be the reasons that SPARCS did not successfully point the experiment at the sun. The sensor output showed changes of characteristics during maximum ascent heating. The fourth sun sensor cover was melted more severely in the opposite direction being located between two antennas which were charred on the same side. It is speculated that this melting and charring on one side was caused by re-entry heating.

A University of Colorado solar experiment was flown on this flight.

4.2 Flight 21.007. CALROC test flight 21.007, a re-fly of the 21.001 payload scientific instrument, was launched at WSMR August 30, 1973, at approximately 18:01:0 GMT. The payload weighed 463 pounds. Vehicle performance, as indicated in Table 4-1 and Figures 4-1, 4-2, and 4-3, was very near predicted. Booster Motor burnout time was some 1.7 seconds earlier than predicted which resulted in slightly lower than predicted burnout velocity and burnout altitude.¹¹ Early Motor burnout had an insignificant effect on vehicle roll rate, time of apogee and apogee altitude. As on flight 21.001, a University of Colorado solar experiment was flown with only the Booster Motor of CALROC type hardware and the Igniter Housing using a radial rather than a tension joint. Booster Motor and Igniter Housing performance, as previously stated, was normal.

4.3 Flight 21.008. The second WSMR launching the a Black Brant VC vehicle (21.008) occurred on June 9, 1972, at approximately 06:25:0 GMT. This vehicle was carrying a stellar science payload for the University of California.

This test vehicle was flown for the purpose of:

- a. Obtaining additional data on the BBVC payload trajectory and dispersion.
- b. Severely test the CALROC recovery parachute.
- c. Test the CALROC 3:1 ogive or nosecone.
- d. Test the new PCM telemetry ground station at WSMR for use with HCO CALROC payloads.

11. Richard Ott, Memorandum, "NASA Black Brant VC (BBVC) 21.007 Preliminary Flight Performance Data Report," NASA, Goddard Space Flight Center, Greenbelt, Maryland, September 7, 1973.

Table 4-1. Payload 21.007 Flight Profile

<u>EVENT/CONDITION</u>	<u>ACTUAL</u>	<u>PREDICTED</u>
Liftoff time, T (GMT)	17:25:19.8	---
Peak acceleration (g's)	12.8	13.0
Burnout @ (sec)	T + 30.7	T + 32.4
Burnout velocity (fps)	7375	7406
Burnout altitude (ft)	98400	104252
Burnout roll rate (rps)	4.15	4.0
Despin @ (sec)	T + 53.46	T + 53
Despin roll rate (rps)	1.05	1.0
Payload separation @ (sec)	T + 57.29	T + 57
Apogee @ (sec)	T + 278	T + 276.55
Apogee altitude (stat mi)	186.1	187.9

NOTE: Igniter Housings built by Bristol Aerospace and flown prior to NASA purchases of Black Brant VC vehicles used a despin design of 2.25 wraps which reduced the spin rate from four revolutions/second to one revolution/second with the control system then reducing the spin rate to zero. Payloads 21.001 and 21.007 used the 2.25 wrap despin system design whereas CALROC used a 3.25 wrap design.

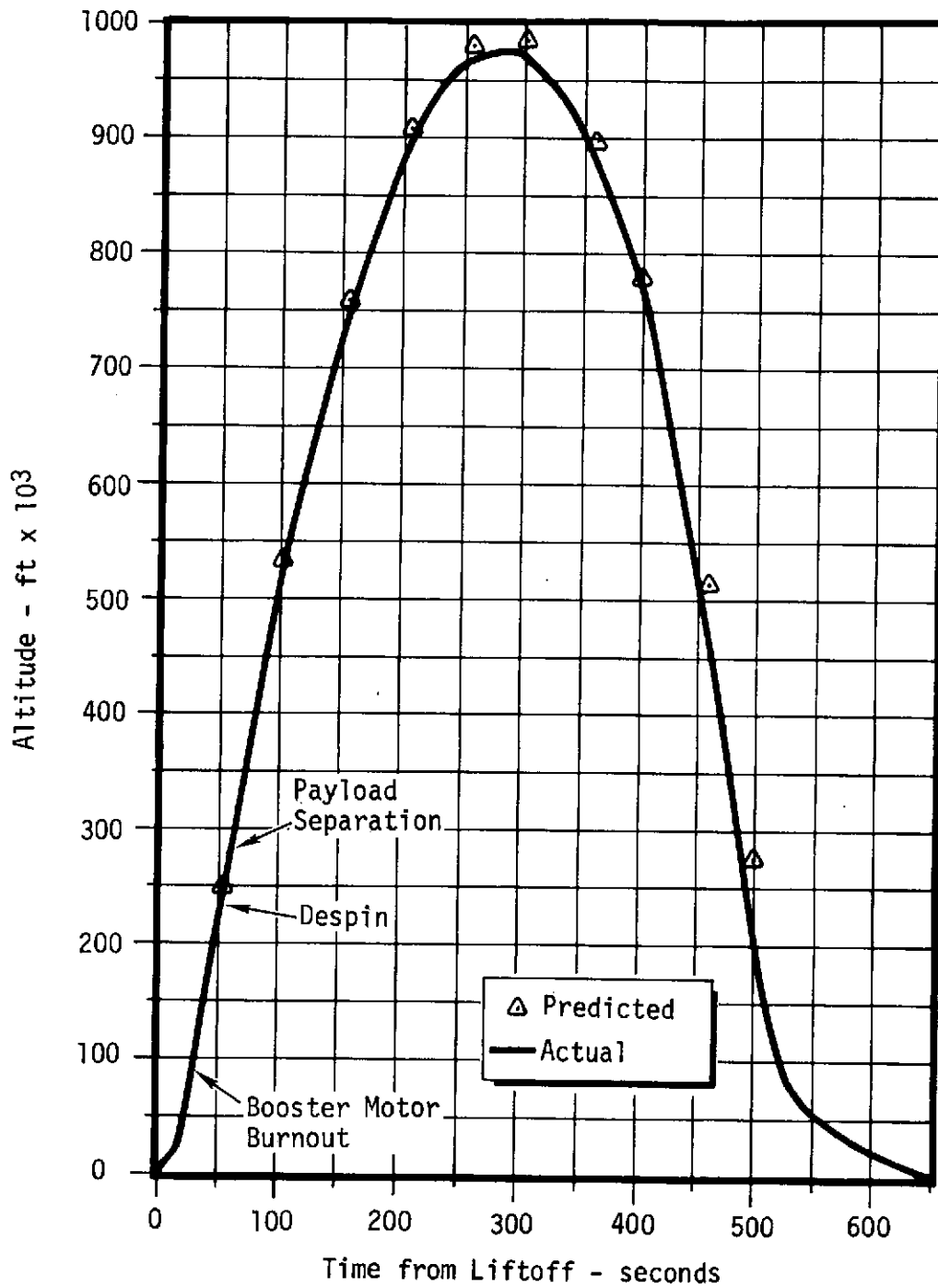

Figure 4-1. Payload 21.007 Altitude History

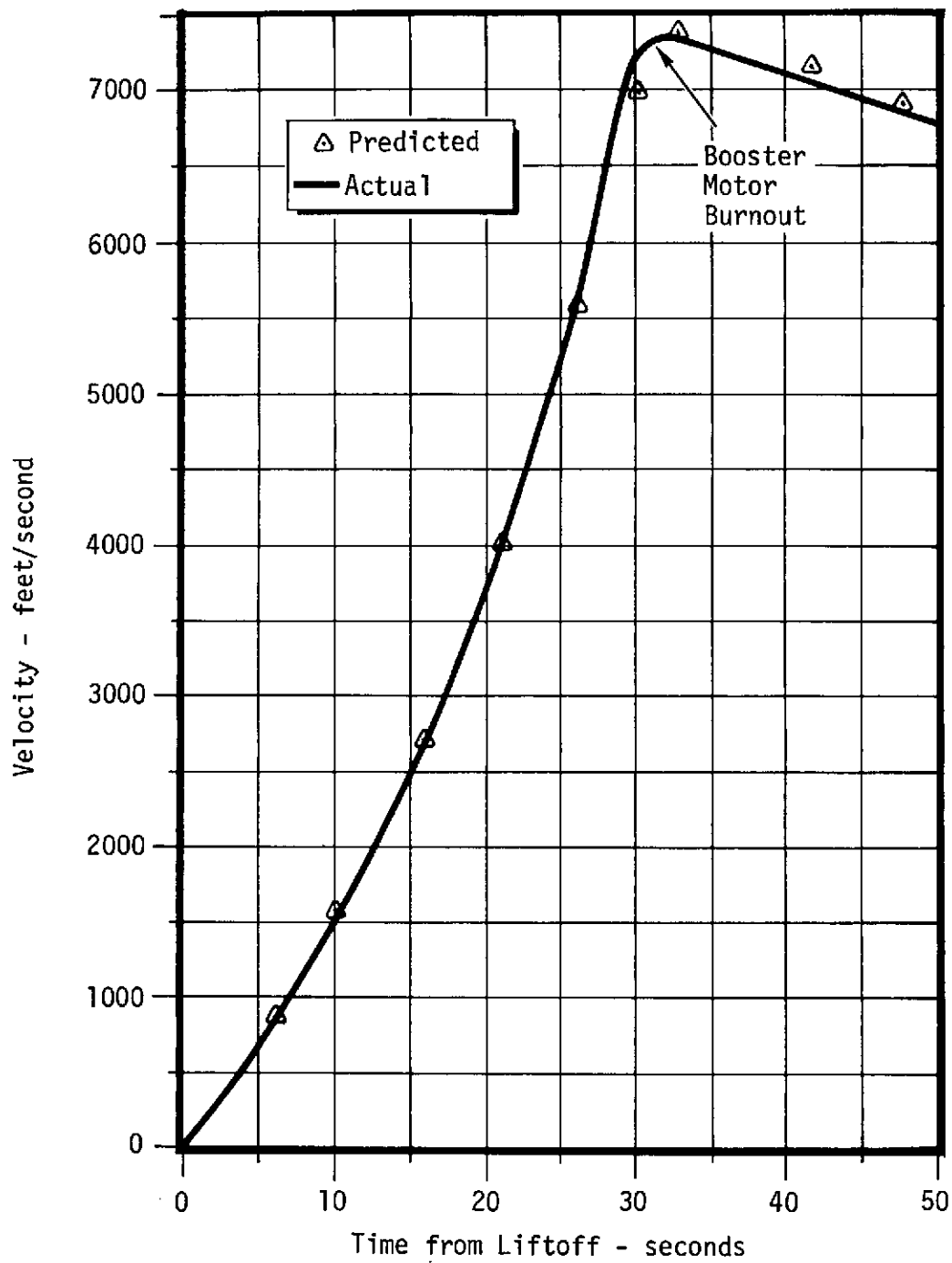

Figure 4-2. Payload 21.007 Velocity History

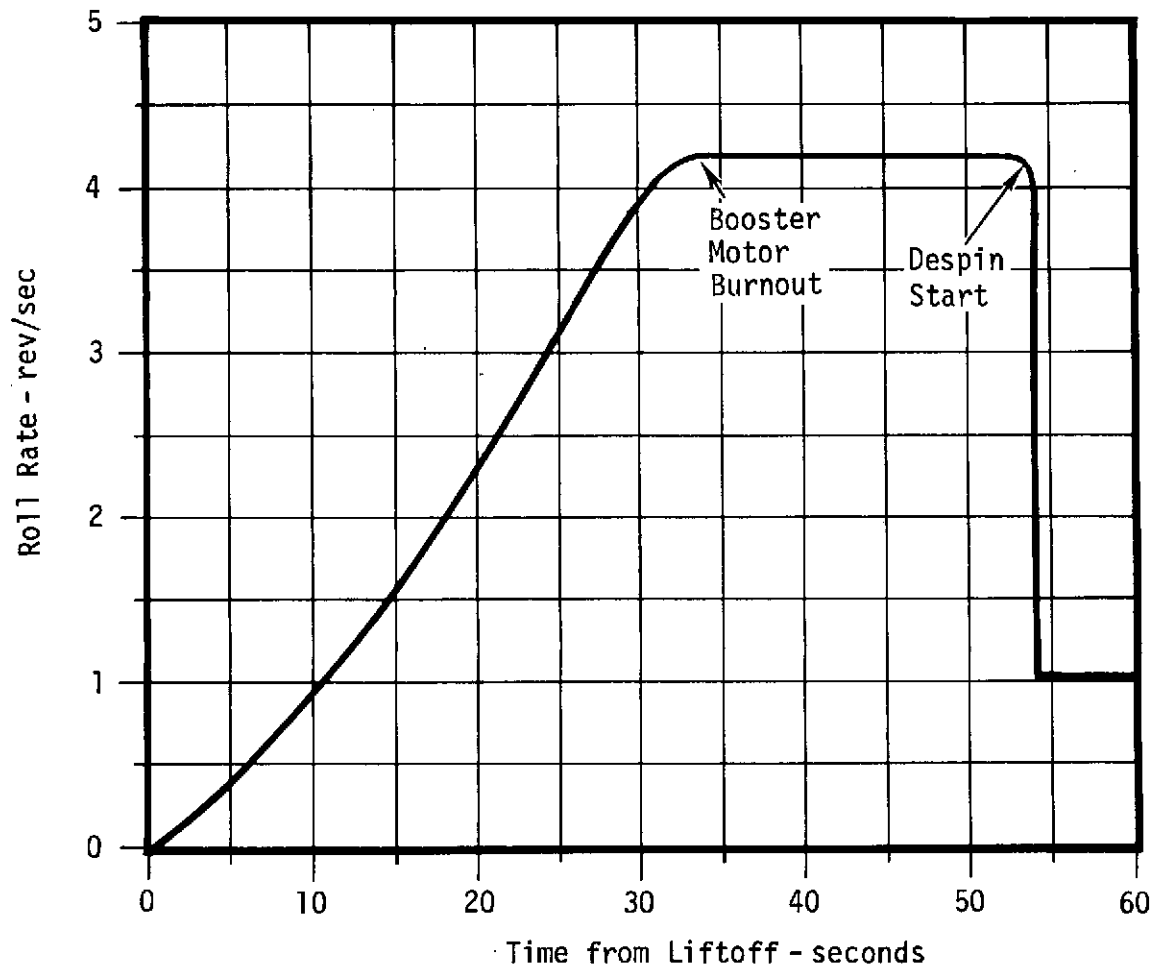

Figure 4-3. Vehicle 21.007 Roll Rate History

Some of the more important 21.008 vehicle flight parameters were:¹²

Apogee (predicted)	130 statute miles
Apogee (actual)	128.5 statute miles
Apogee time (predicted)	230 seconds
Apogee time (actual)	225.7 seconds
Burnout altitude (above MSL)	92,933 feet
Burnout time	32.4 seconds
Burnout velocity	6,096 feet/second
Spin rate	4.2 revolutions/second
Spin rate (after yo-yo deploy)	.56 revolutions/second

The above data indicates a normal trajectory. The payload, weighing 683 pounds, was successfully recovered on a parachute designed for only 600 pounds. No problems were reported with the PCM telemetry ground station.

4.4 Flight 21.009. CALROC test flight 21.009 was the second HCO payload configuration launched at WSMR. The payload weighed approximately 500 pounds and was launched January 22, 1973, at 23:10:6.414 GMT with 26 thermocouples, an NRL SPARCS and a University of Colorado solar experiment.¹³ The purpose of this rocket flight was to obtain additional temperature data on a CALROC type payload flying on a BBVC Motor and to further test several CALROC subsystems. Those CALROC subsystems flown were: a Nosecone (third flight), Recovery system (first flight), Nosecone Separation (second flight), Payload Separation (second flight), Igniter Housing (second flight), and an NRL SPARCS (first flight). The payload was fabricated to the HCO CALROC payload length and weight. The BBVC Motor performed in a normal manner as shown in the payload altitude and velocity time histories in Figures 4-4 and 4-5. Apogee and peak exit velocity for this payload were slightly less than on flight 21.007 due to a 40 pound heavier payload on 21.009. All CALROC subsystems performed nominally resulting in a

12. C. Spencer, Memorandum S&E-CSE-A-72-249, "Black Brant VC Flight 21.008," to W.C. Keathley, NASA, Marshall Space Flight Center, Huntsville, Alabama, June 14, 1972.

13. "Black Brant VC, Flight 21.009 Temperature Data," Interoffice memo, WDH/505/473, Fairchild Space and Electronics Division, March 14, 1973.

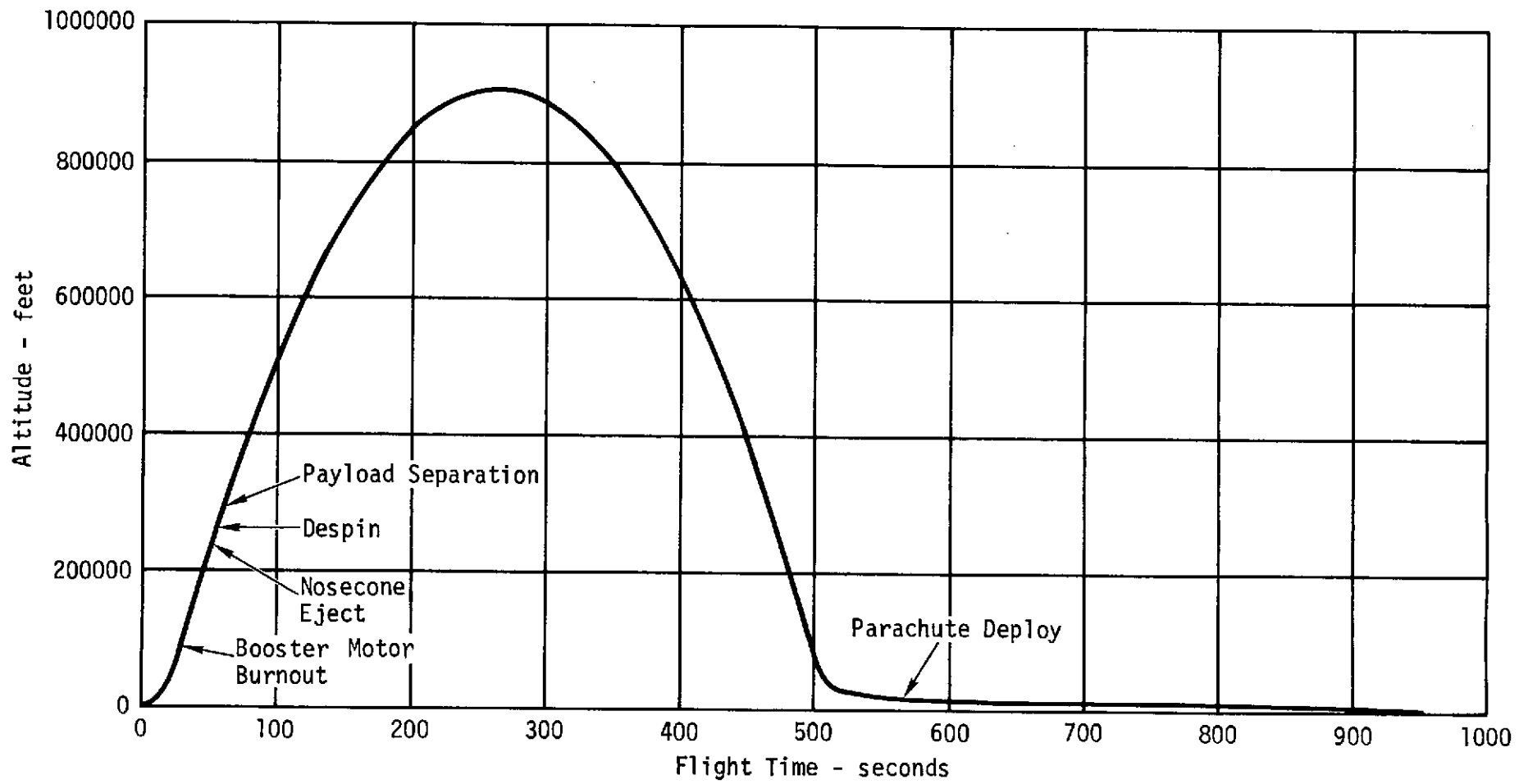

Figure 4-4. Payload 21.009 Altitude History

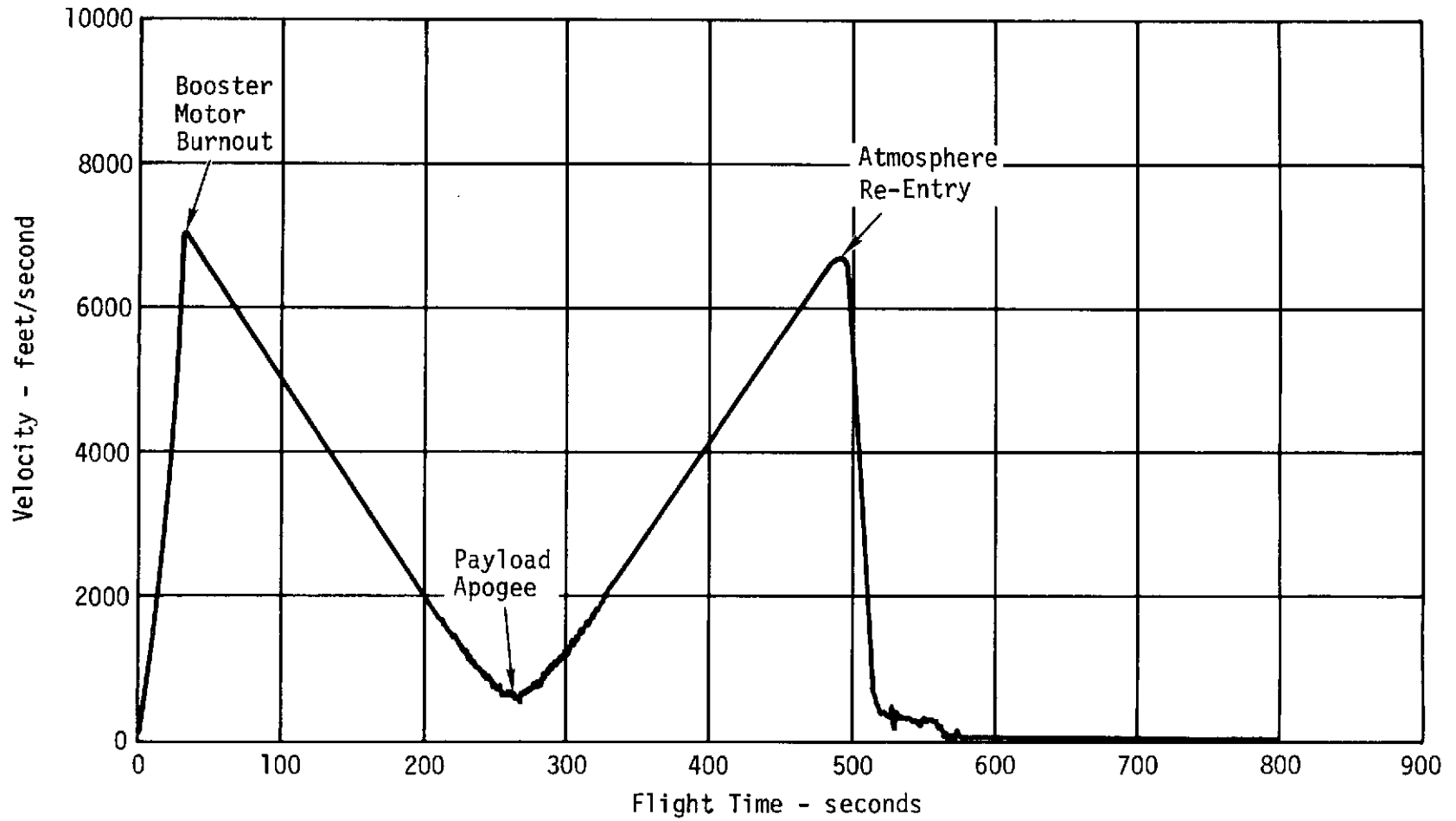

Figure 4-5. Payload 21.009 Velocity History

successful mission.^{14,15} Only one of the 26 thermocouples appeared to have failed during flight. Five SPARCS anomalies, 1) long sun acquisition time, 2) roll/yaw oscillation, 3) offset pitch fine sun sensor telemetry signal, 4) command link low signal level, and 5) temporary loss of SPARCS telemetry data on re-entry did not prevent a successful SPARCS flight. SPARCS fine pointing of the payload was achieved at 108.8 seconds after liftoff or 46.8 seconds after SPARCS enable.¹⁶ Long term (peak-to-peak with a 20-second period) pointing stabilities of 2 arc seconds in pitch, 25.5 arc seconds in yaw and .78 degrees in roll were obtained within 111 seconds after liftoff. The payload was successfully recovered, refurbished and later flown as test flight 21.019 on May 18, 1973.

4.5 Flight 21.011. CALROC test flight 21.011 was the first fully NRL CALROC payload to be launched at WSMR. The payload, weighing 589.8 pounds, was launched successfully on April 3, 1973, at 17:20:1.595 GMT.¹⁷ The BBVC Motor performed in a normal manner providing the payload altitude and velocity time histories in Figures 4-6 and 4-7.¹⁸ Since this payload was approximately 90 pounds heavier than flight 21.009, its apogee and peak exit velocity were slightly less than on 21.009. Vehicle roll rate shown in Figure 4-8 was within design limits of 4 ± 0.6 revolutions/second. Despin was initiated at 62.4 seconds and completed by 63.2 seconds which was within the design requirements of despinning from 4 revolutions/second to 0 within one second. All CALROC subsystems, except the NRL Telemetry and NRL Scientific Instrument, had been flown successfully on previous CALROC test flights. The NRL Telemetry subsystem flown on 21.011 operated successfully. Booster and payload functions, such as booster burnout, separations, despin, Instrument enable, and drogue parachute deployment, occurred on time or within acceptable tolerances. Three other important functions (sun acquisition, SPARCS fine pointing, and main parachute deployment) did not occur at all or with sufficient accuracy to permit mission success.

-
14. Memorandum, "Preliminary Flight Data Report - NASA 21.009." NASA Goddard Space Flight Center, Sounding Rocket Division, February 6, 1974.
 15. K. Madigan Interoffice Memorandum WDH/505/476, "BBVC Flight 21.009 Housekeeping Commutator Data," to C. Thomas, Fairchild Space and Electronics Division, March 16, 1973.
 16. "Final SPARCS Flight Summary for 21.009," LMSC/D343977, Lockheed Missile and Space Company, Sunnyvale, California, May 2, 1973.
 17. E. Kadar, "Vehicle Data Package for Black Brant VC 21.011," NASA Goddard Space Flight Center, Sounding Rocket Division, Greenbelt, Maryland, January 30, 1973.
 18. "Black Brant VC Flight 21.011 Postflight Data Reduction and Analysis," AVCO Systems Division, Seabrook, Maryland, July 1973.

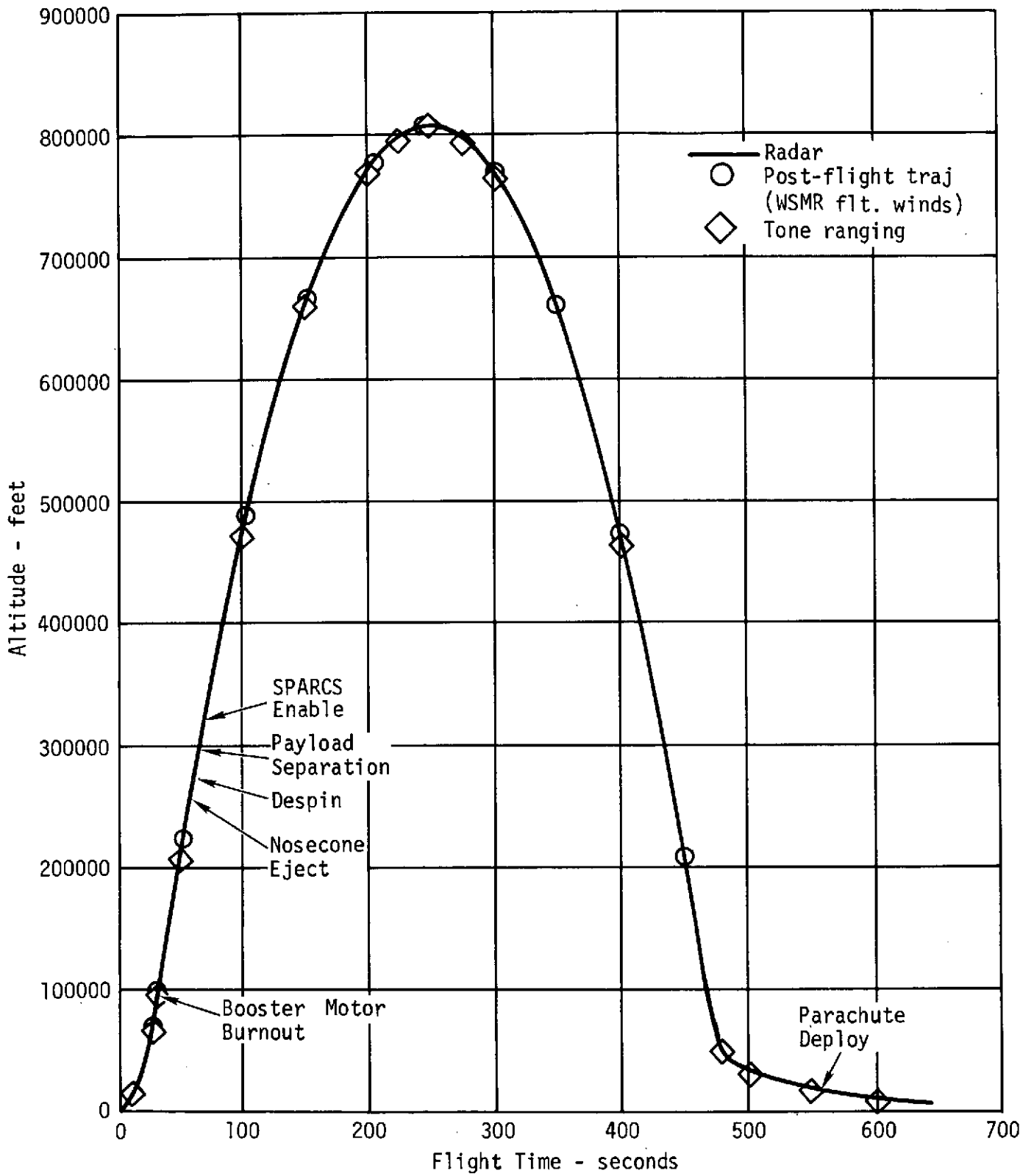

Figure 4-6. Payload 21.011 Altitude History

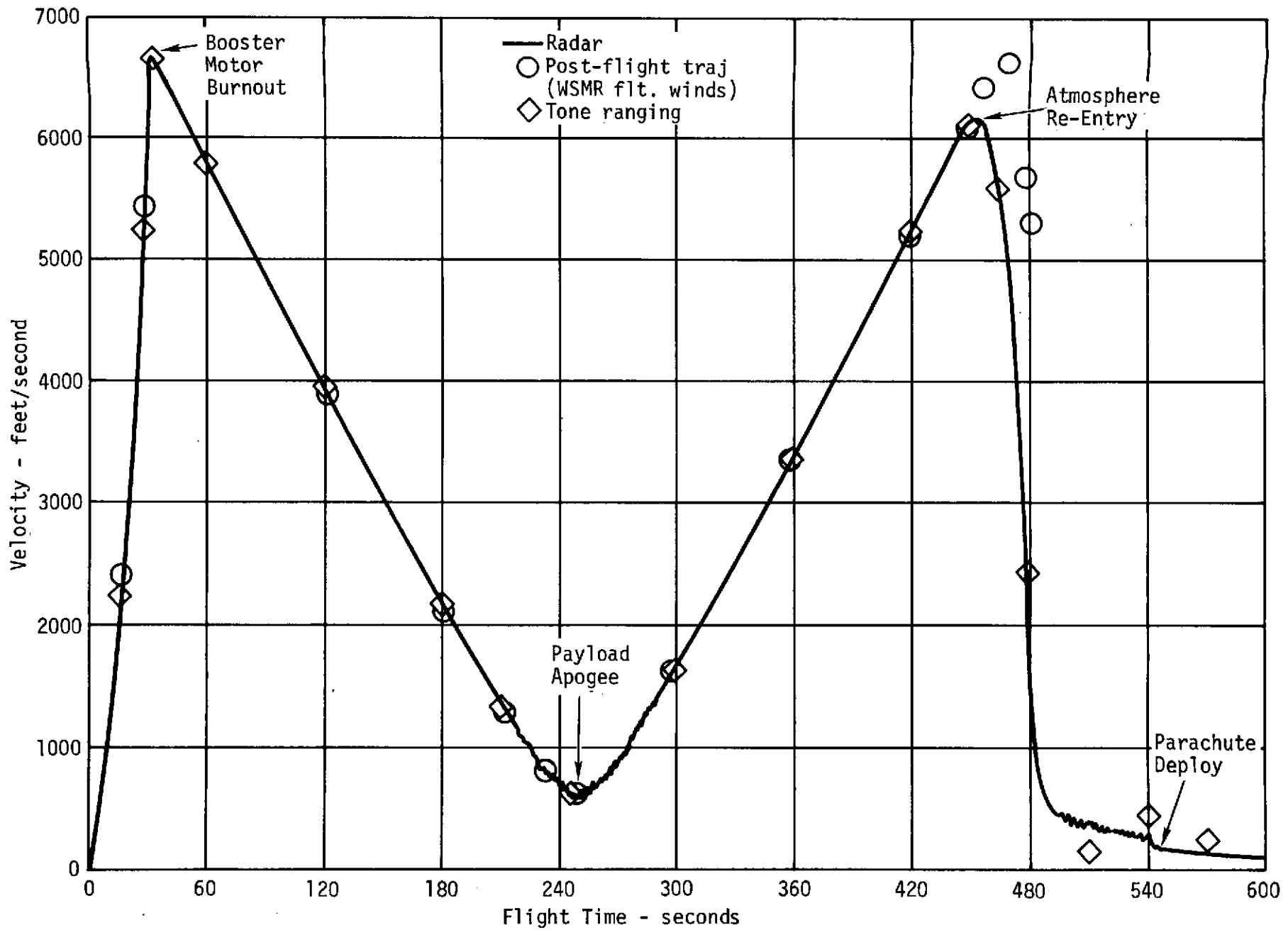

Figure 4-7 Payload 21.011 Velocity History

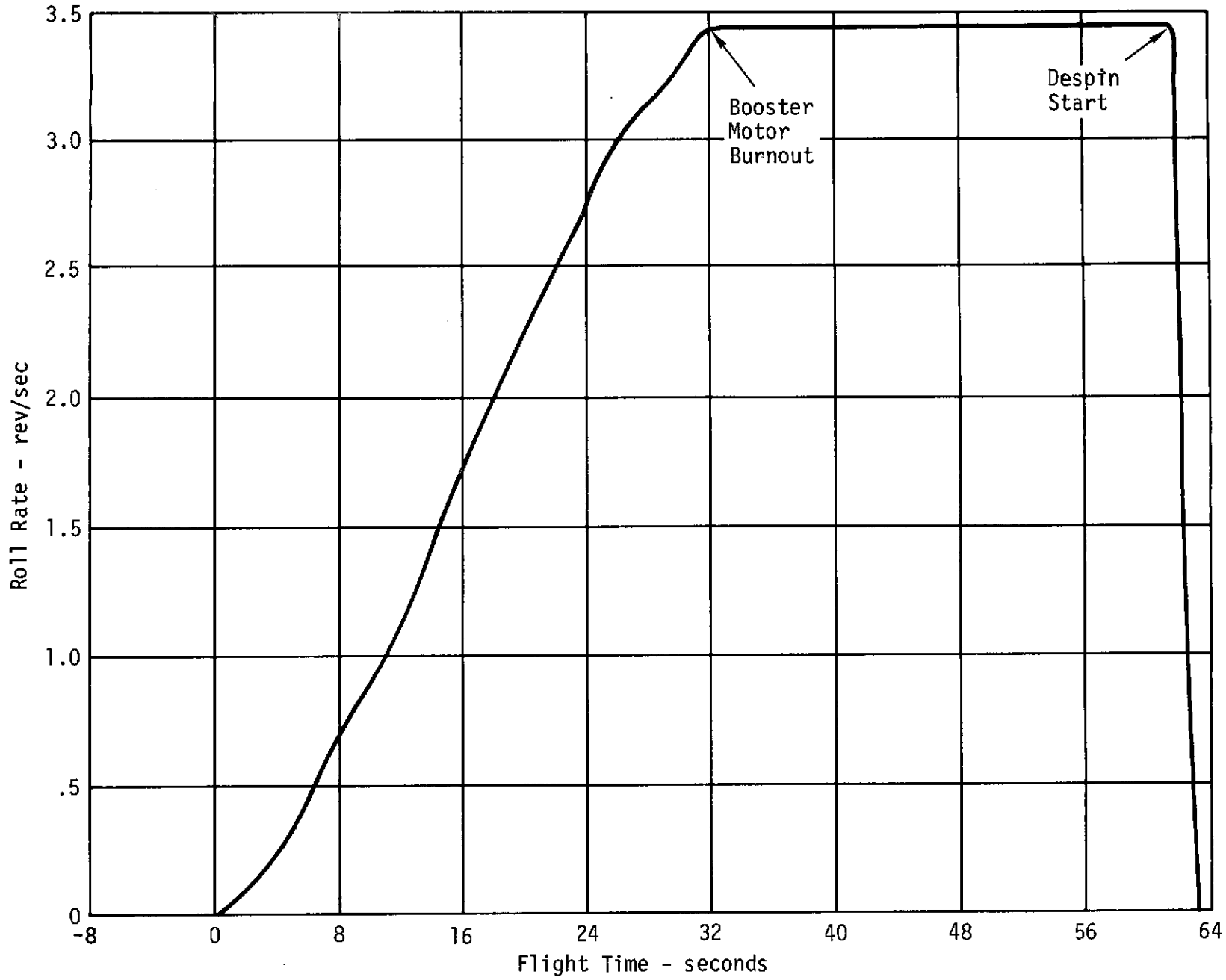

Figure 4-8. Payload 21.011 Roll Rate History

SPARCS failed to properly acquire the sun during the 21.011 payload flight. Immediately following SPARCS enable, the residual payload roll rate changed appreciably, indicating that SPARCS was assuming control of payload attitude. One second after enable, intermittent valve operation began, at a rate of 14 operations/second which continued throughout the flight. Two sets of SPARCS Fine Sun Sensors (FSS) were flown on this payload, each of which showed some activity during this period, and then momentarily went through saturation at T+77.4 seconds. At the same time, the Scientific Instrument Image Dissector Tube (IDT) saturated. By T+85 seconds both sets of eyes were quiescent. This has been interpreted by CALROC personnel as SPARCS sweeping through the solar disc and overshooting. At various periods throughout the remainder of the flight both FSS's showed short periods of activity as if they were being illuminated. The periods were roughly T+140 to 146 seconds, 162 to 170 seconds, and 185 to 198 seconds, etc., randomly for a total of 10 times until reentry. The IDT showed minor coincidental response in some instances, and none in others. These indications could be interpreted as SPARCS maneuvering near the edge of the sun without ever locking onto it. Throughout this entire period the telemetry magnetometer showed continuous changes in attitude with respect to the earth's magnetic field.

Postflight inspection and analyses indicate that the SPARCS failure was caused by an undetected wiring error in SPARCS. One of the sun cells in the SPARCS coarse sun sensor was wired into an open pin resulting in no output signal error when off the sun. Thus SPARCS stabilized near the sun but not within the normal Fine Sun Sensor (FSS) acquisition field of view ($\pm 10^\circ$). At this point in the CALROC project, SPARCS did not include the intermediate sun sensor located in the Scientific Instrument near the fine sun sensor. As a result of this failure, an intermediate sun sensor was incorporated into all CALROC SPARCS.

Failure of SPARCS to achieve sun acquisition precluded obtaining test calibration data with the NRL Scientific Instrument. The Scientific Instrument was virtually destroyed when the main parachute failed to open and the payload impacted on the WSMR with only drogue chute recovery.

The cause of the Recovery system failure was immediately apparent upon examination of the parachute assembly as it lay on the desert (Figure 4-9). The main parachute was contained in a canvas bag which was closed by four flaps and secured by a bight (loop) of one of the main risers. Excessive friction between the main riser bight and the mouth lock retaining loop pulled the innermost mouth flap through holes in the other three flaps, relocking the mouth lock after the riser line bight had finally pulled free. As a consequence, the main parachute was never deployed, and the only decelerating force, which was too small to be effective, came from the captive drogue chute.



COURTESY U. S. ARMY
WHITE SANDS MISSILE RANGE,
WHITE SANDS, N. M.

Figure 4-9. Post-Flight NRL CALROC 21.011 Payload.

Because of damage to the four main risers on previous Black Brant flights due to sharp edges of a rapidly rotating canister assembly, protective leather chaffing strips had been sewed to the main risers. This modification had been successfully demonstrated in a drop test, and during the flight of CALROC test flight 21.009. This NRL CALROC flight was the third application of this modification, and proved it to be unreliable. The additional bulk of the leather on the bight, coupled with increased friction, and holes too large in the other three mouth flaps, distorted the mouth lock assembly and caused the bottom flap to be pulled through the other three flaps and relock the main parachute bag. Impact damage throughout the payload was so extensive that refurbishment was not possible. The payload was disassembled and parts used for test purposes.

Several significant changes to the CALROC Recovery subsystem were implemented as a result of the 21.011 failure. They were:

- a. Change the main parachute mouth locks from four to eight.
- b. Add a mouth lock cord fed through a loop on each flap and tied.
- c. Add two knife cutters stitched to two risers for cutting the tie cord.
- d. Replace leather scuff guards with less bulky aluminized asbestos on both main risers and drogue bridle.
- e. Accordion fold the drogue tow line.

These changes were proven through five drop tests prior to any flight testing and further tested on CALROC test flight 21.019 and a Canadian rocket flight at Churchill, Canada on May 7, 1973. The drop tests consisted of dropping a light payload (325 pounds) using only a drogue, a heavy payload (850 pounds) with both drogue and main parachute deployment and three drops of cylindrical body configurations simulating the NRL and HCO CALROC payload weights. These tests were all successful.

Except for two minor discrepancies which were known before launch, the payload Instrumentation/Telemetry system performed nominally in flight, without any failures. Two discrepancies involved instrumentation magnetometers, which had inadvertently been wired 180 degrees out of phase, and a vacuum door monitor which was found inoperative in the vertical checks.

RF signal strengths for both the S-band FM/FM telemetry system and the wide band S-band television system were well above threshold levels at all receiving stations, producing high quality data with no

drop-outs. Although no solar image was produced by the television system due to lack of pointing, the sync signals received through the microwave relay system at the PI van indicated that the picture quality would have been of acceptable quality.

4.6 Flight 21.016. Black Brant VC test flight 21.016, a refly of the payload 21.008 Scientific Instrument weighing 656 pounds, was launched at WSMR on February 10, 1973, at 04:08:1.7 GMT. Performance of the Rocket Motor and payload subsystems appeared to be normal until time for parachute deployment. The main parachute deployed improperly causing a canopy inversion.¹⁹ As a result of this failure, it was decided to increase the canopy attachment strength with additional stitching of the mouth lock flaps and to reef the main parachute. It should be noted that, although this payload was 56 pounds over the parachute design limit (600 pounds), a 683 pound payload was successfully recovered on flight 21.008 on June 9, 1972.

4.7 Flight 21.019. CALROC test flight 21.019, a refly of the payload 21.009 Scientific Instrument, weighing 519 pounds, was the third HCO payload configuration launched at WSMR. It was launched May 18, 1973, at 16:00:0.055 GMT with 26 thermocouples and a CALROC Nosecone, Recovery system, Nosecone Separation system, Payload Separation system, Igniter Housing, NRL SPARCS and a University of Colorado experiment. The primary objectives of this rocket flight were to flight test the modified recovery and SPARCS subsystems. Secondary objectives were:

- a. Flight test the CALROC Nosecone (fourth flight).
- b. Flight test the CALROC Separation systems (third flight).
- c. Flight test the CALROC Igniter Housing (third flight).
- d. Flight test the Black Brant Rocket (eleventh NASA flight).
- e. Obtain additional temperature data on CALROC type payloads.
- f. Further test CALROC ground stations, communications, and TV link.

Data in Table 4-2 and Figures 4-10, 4-11 and 4-12 indicate that booster and payload performances were near the preflight predicted values.²⁰ Booster burnout occurred 1.4 seconds early, resulting in a

19. F. Collins, Memorandum, "Pioneer Parachute Company, Inc., Analysis of Parachute on NASA 21.016," NASA, Goddard Space Flight Center, Sounding Rocket Division, March 9, 1973.

20. "BBVC Flight 21.019 Postflight Analysis and Instrumentation and Calibration Report," AVCO Systems Division, 10210 Greenbelt Road, Seabrook, Maryland, July 25, 1973.

Table 4-2. BBVC Flight 21.019 Flight Profile

<u>EVENT/CONDITION</u>	<u>ACTUAL</u>	<u>PREDICTED</u>
Liftoff time, T (GMT)	16:00:0.055	----
Tower exit velocity (fps)	198.5	207.8
Tower exit time (sec)	T+1.51	T+1.508
Peak thrust-axis acceleration (g's)	12.80	11.22
Burnout @ (sec)	T+31.0	T+32.4
Burnout velocity (fps)	6955	7015.9
Burnout altitude (ft)	96,000	107,000
Burnout roll rate (rps)	3.93	4.0
Nosecone eject @ (sec)	T+54.33	T+54.1
Despin @ (sec)	T+56.73	T+57.0
Post-despin roll rate (rps)	0.0393	0
Payload separation @ (sec)	T+60.18	T+60.4
SPARCS enable @ (sec)	T+63.1	T+63
SPARCS acquisition @ (sec)	T+95	T+103
Apogee @ (sec)	T+259.0	T+261.9
Apogee altitude (stat mi)	165.83	168.80
Heat shield deployment @ (sec)	T+556.34	T+533.9
Altitude at heat shield deployment (ft)	18,310	20,000
Payload impact @ (sec)	T+957.5	T+1,010

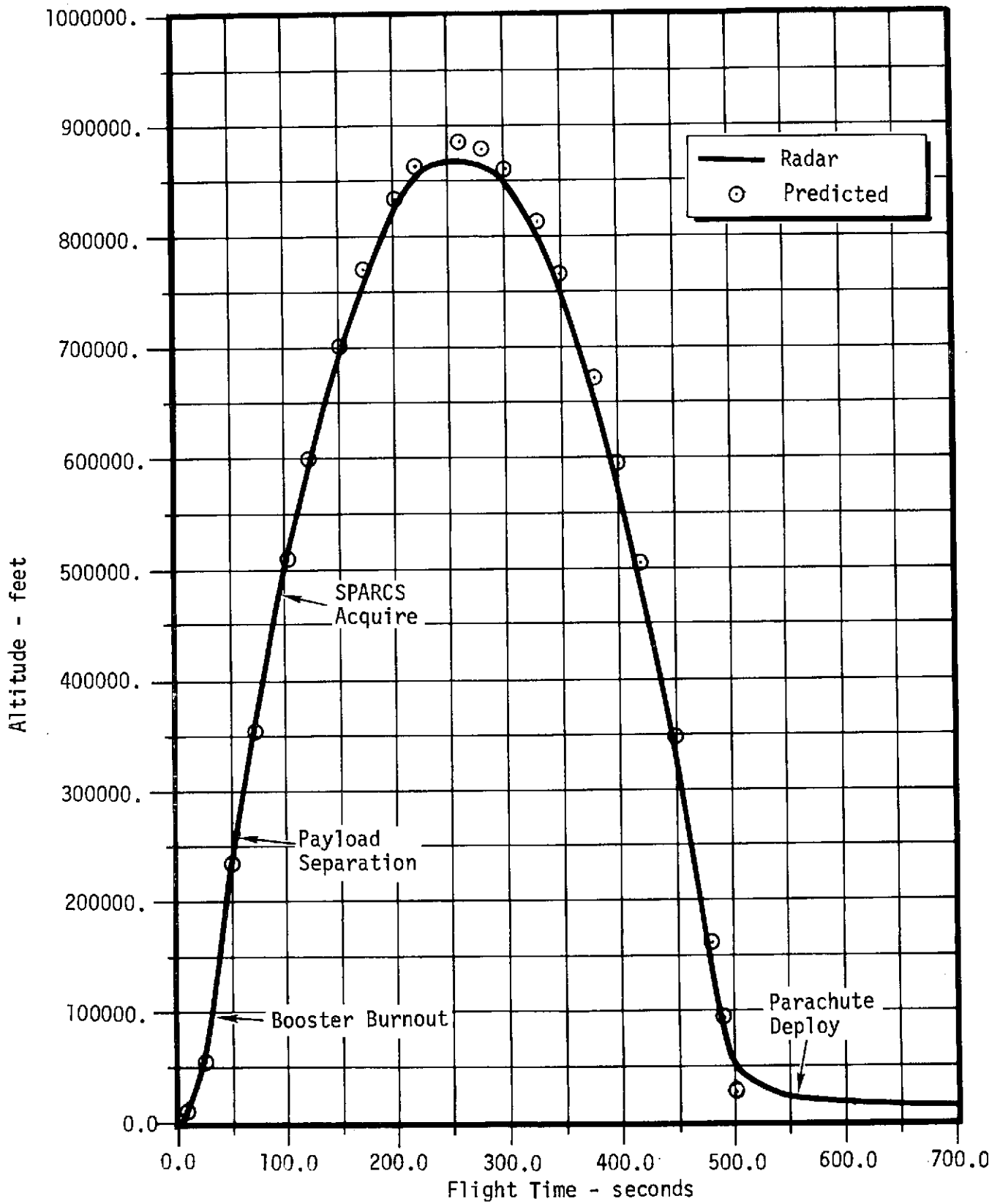

Figure 4-10. BBVC Flight 21.019 Altitude History

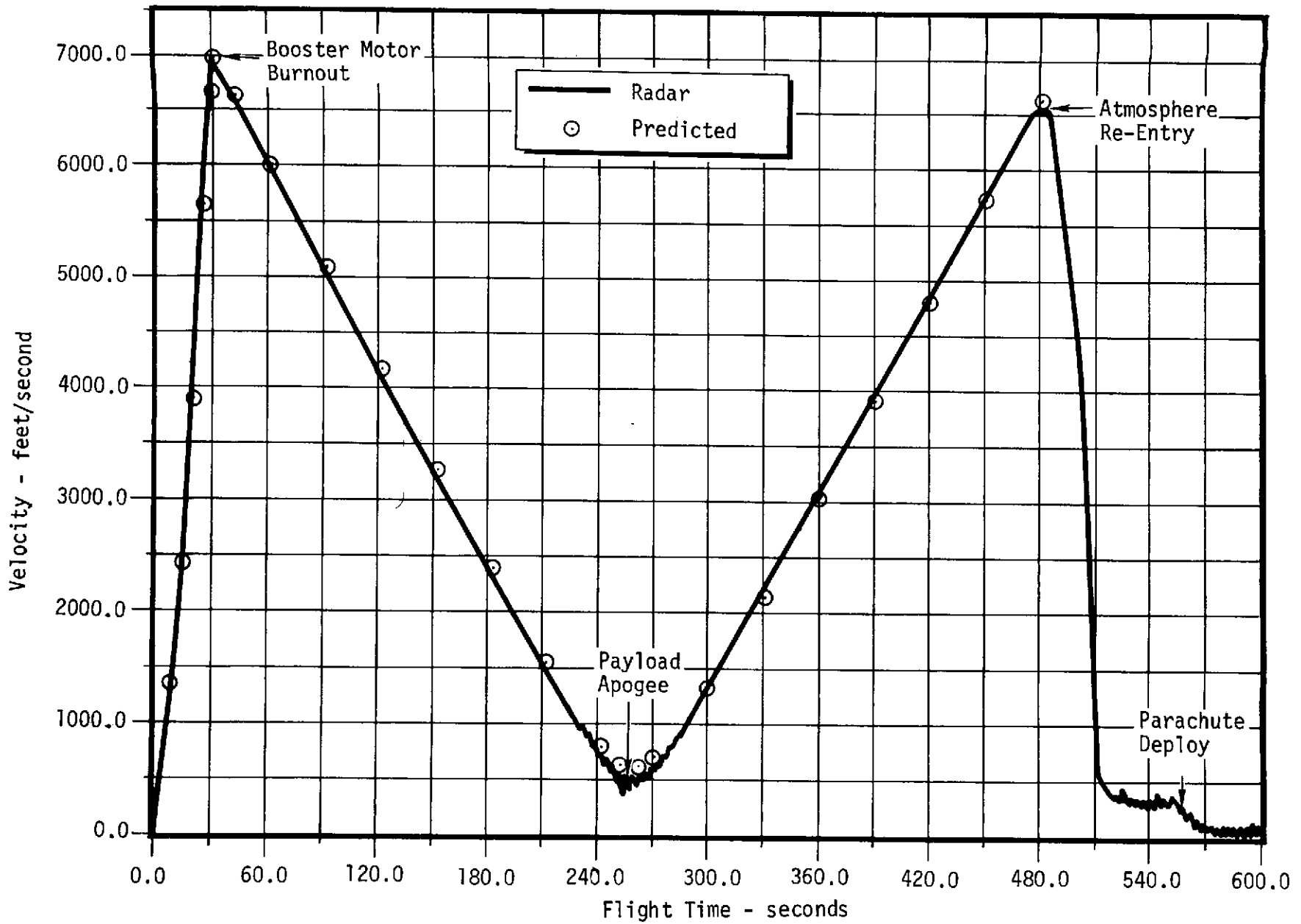

Figure 4-11. BBVC Flight 21.019 Velocity History

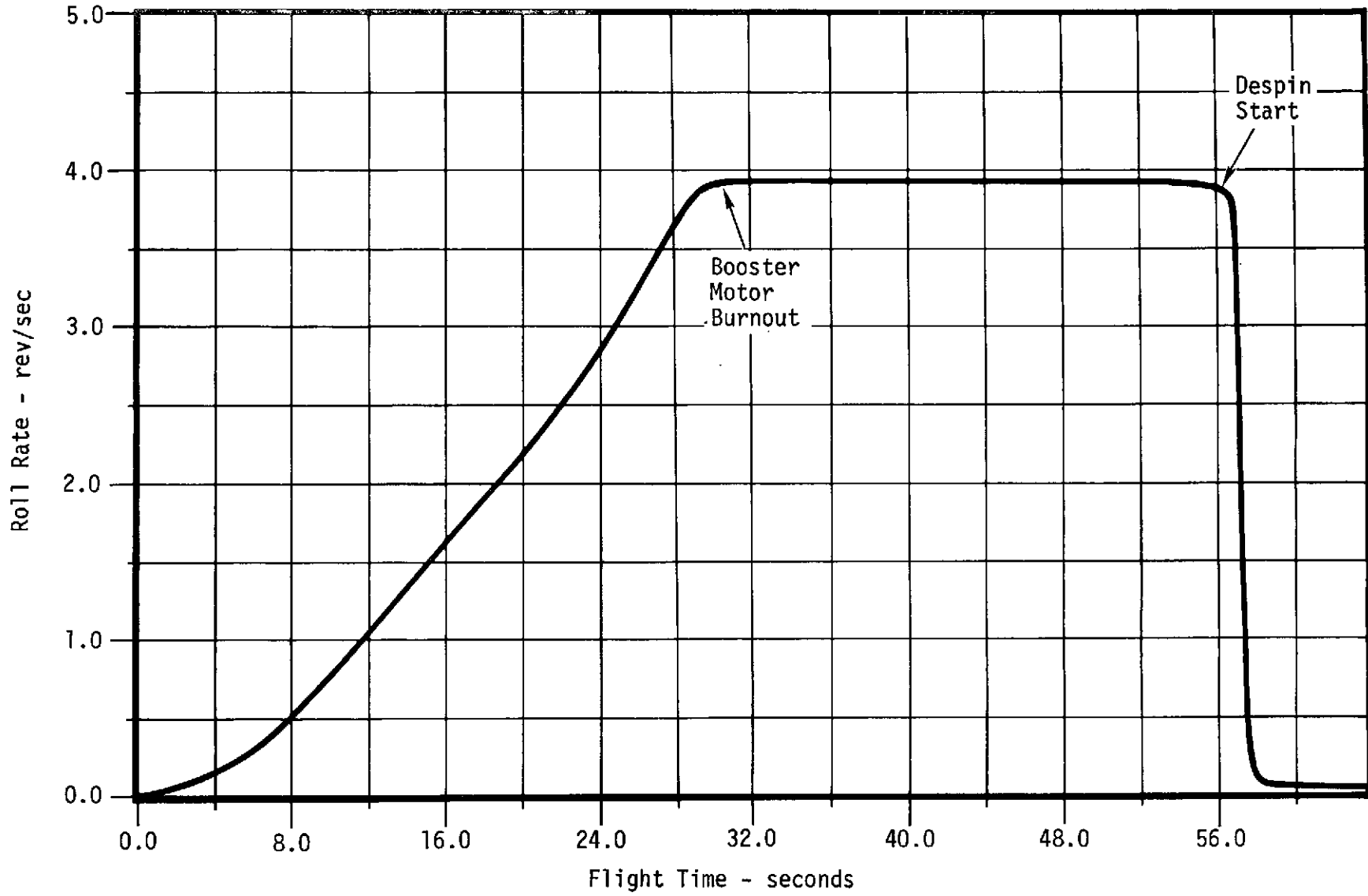

Figure 4-12. Flight 21.019 Roll Rate

lower than expected burnout velocity, burnout altitude, apogee time and apogee altitude. The apogee altitude was within 1.79 percent of predicted, which was well within the three-sigma apogee dispersion (± 6 percent).²¹ Table 4-2 and Figure 4-13 indicate timely separations and a better than expected time for sun acquisition (95 seconds versus 103 seconds predicted).

This was the first successful flight of SPARCS since the failure on 21.011 April 3, 1973. During the 21.019 flight, several SPARCS commands failed to execute. Review of telemetry data and bench testing of the recovered receiver/decoder indicated several commands, transmitted at T+177 seconds and T+214 through T+400 seconds failed to execute because of intermittently faulty receiver operation.

This anomaly was found, through bench testing, to be caused by intermittent received "squegging" (a variation in input receiver sensitivity) which, in turn, was the result of a component failure in the receiver voltage regulator. Functional testing of the 21.019 receiver indicated that when "squegging" the receiver operated abnormally in two respects. One, the receiver produced a faulty signal strength indication which was independent of input signal level and second, the receiver required an input signal of -60 dbm (decibels in millivolts) to operate. When not "squegging" the receiver operated within specification (i.e., a threshold of -102 dbm) and also the signal strength measurement was found to be an accurate indication of input signal level.

Records of flight telemetry indicated that during periods of command failure the signal strength measurement was equivalent to -86 dbm input, and consequently, the failures were not due to inadequate signal but could be attributed to "squegging." This conclusion was functionally verified through bench testing.

The receiver was returned to GSFC for removal and failure analysis of the failed component. The input transistor was found to be shorted and probable cause of failure was a large voltage transient on the rocket +28 volt supply.

Although SPARCS had the above anomaly, it successfully acquired the sun, in less than predicted time, and maintained a pitch/yaw pointing accuracy of better than 1 arc second (design goal 20 arc seconds).²² This payload was using SPARCS intermediate sun sensors

-
21. Memorandum 17865, "NASA Black Brant VC (BBVC) 21.019 Preliminary Flight Report," Goddard Space Flight Center, Space Applications and Technology Directorate, Sounding Rocket Division, Greenbelt, Maryland, June 13, 1973.
 22. "Preliminary SPARCS Flight Summary for 21.019," LMSC/D346773, Lockheed Missile and Space Company, Sunnyvale, Calif., July 27, 1973.

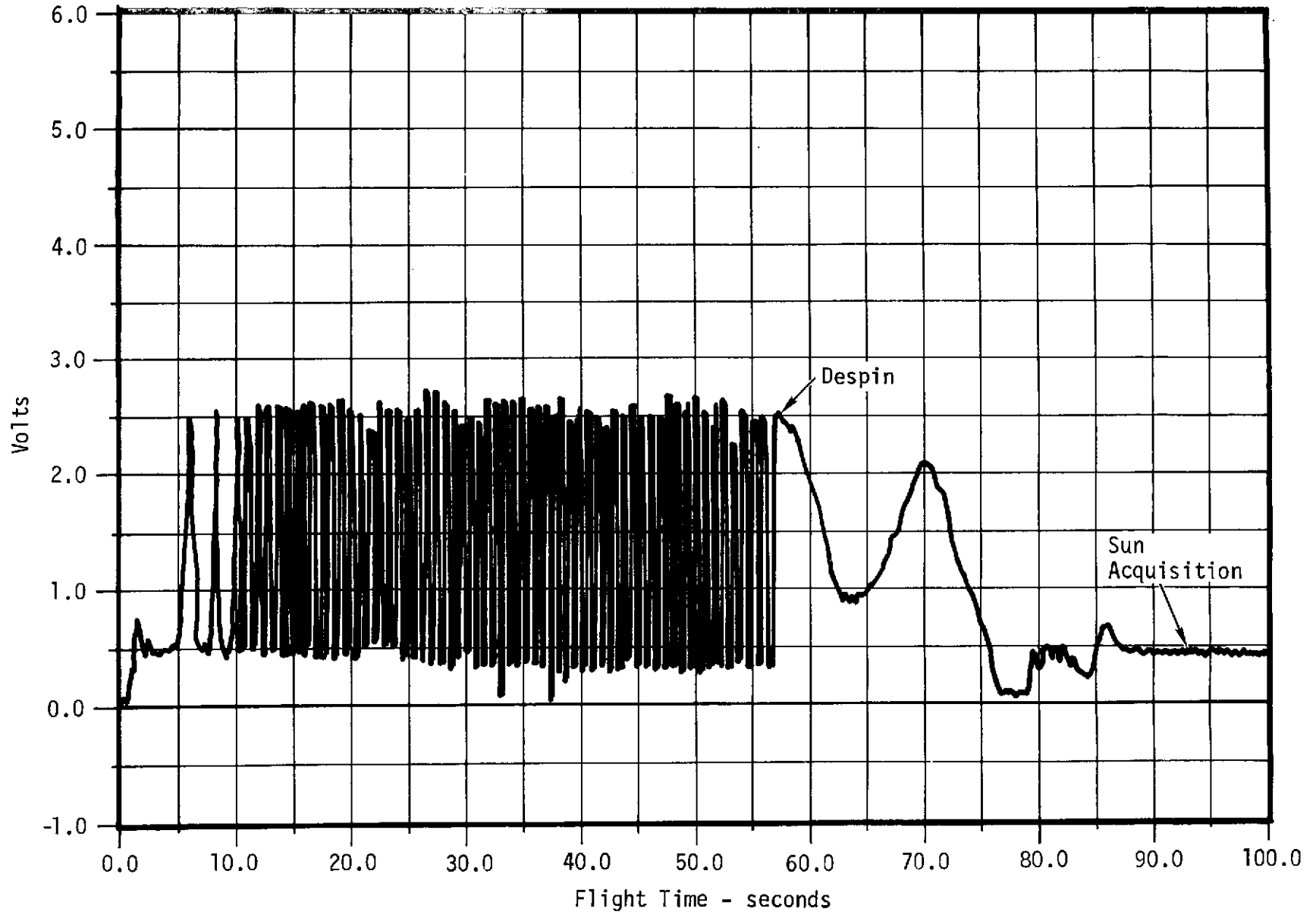

Figure 4-13. Flight 21.019 Yaw Coarse Solar Sensor Output

(located near the fine sun sensor) and rate gyros for the first time. Previous flights used wyros rather than gyros for rate sensing.

Tables 4-3 and 4-4 summarize and compare 21.009 and 21.019 thermocouple temperature data. Since flight 21.019 was essentially a reflly of the 21.009 payload, it should be noted that the higher temperatures on 21.019 were due to a slightly higher burnout velocity for flight 21.019. The CALROC parachute recovery system recovered payload 21.019 in excellent condition, as shown in Figure 4-14. The SPARCS unit was refurbished and later flown successfully as part of the 21.013 payload on September 4, 1973.

4.8 Flight 21.020. CALROC test flight 21.020, weighing 468 pounds, was the first HCO payload configuration launched at WSMR. It was launched October 24, 1972, at 16:20:2.609 GMT for the purpose of:

- a. Obtaining additional data on the Black Brant VC motor.
- b. Flight test the CALROC Nosecone (second flight).
- c. Flight test the CALROC Nosecone Separation system (first flight).
- d. Flight test the CALROC Payload Separation system (first flight).
- e. Flight test the CALROC Igniter Housing using tension joints (first flight).
- f. Obtain temperature data on an HCO type payload.

Since this was a test flight weighted to an HCO configuration and not requiring sun pointing or recovery no Control system, Recovery system or Scientific Instrument was included in the payload. An HCO payload configuration was chosen over an NRL payload because the HCO payload was some 100 pounds lighter and would therefore have a higher atmospheric exit velocity resulting in maximum temperatures throughout the payload. Table 4-5 illustrates some of the more important events during the 21.020 flight. Figures 4-15, 4-16, and 4-17 indicate that vehicle roll rate, payload altitude and payload velocity were very near design or expected values.

Vehicle roll rate increased steadily during the first 30 seconds of flight then remained constant at or near the design rate of 4 revolutions per second. At 56.6 seconds, payload despin (yo-yo) was initiated reducing the spin rate to approximately .9 rps within 1 second (see Figure 4-15). Figure 4-17 shows the velocity history of payload 21.020 and is typical of Black Brant VC type payloads. The payload velocity increased to a maximum at booster burnout decreased to some

Table 4-3. SPARCS Commutator Number 2 Peak Temperatures

<u>DESIGNATION</u>	<u>STATION (in.)</u>	<u>Ø* degrees</u>	<u>LOCATION DESCRIPTION</u>	<u>SPARCS ENABLE TEMPERATURE (°F)</u>	<u>SPARCS ACQUIRE TEMPERATURE (°F)</u>	<u>MAXIMUM TEMPERATURES (°F)</u>	
						<u>EXIT</u>	<u>REENTRY</u>
Thermocouple No. 1	59	67.5	On CSS chip (copper housing)	68	68	90	140
Thermocouple No. 2	59	349	On CSS chip (Aluminum housing)	260	245	335	310
Skin Thermistor	102	105	Near aft CSS	390	353	402	380
Block Thermistor	102	105	CSS block	95	115	95	210
Connector Thermistor	94	0		80	81	80	94

*Ø measured clockwise looking aft from 0° (North)

Table 4-4. Thermocouple Commutator Peak Temperatures and Comparisons

DESIG- NATION	STATION (in.)	ϕ^*	LOCATION DESCRIPTION	GAGE T _{MAX} (°F)	EXIT T _{MAX} (°F)		REENTRY T _{MAX} (°F)	
					21.009	21.019	21.009	21.019
TC-3	49	124°	Skin - lower ORSA	1100	660	685	769	796
TC-4	54.6	281°	Skin - telemetry extension	1100	420	450	360	390
TC-5	84	101°	Skin - upper ex- periment bay	1100	435	475	505	577
TC-6	100	124°	Skin - upper ex- periment bay	1100	420	450	490	568
TC-7	120	124°	Skin - lower ex- periment bay	1100	425	460	545	620
TC-8	39.5	105°	SPARCS valve- insulation	800	145	155	371	402
TC-9	39.5	75°	SPARCS valve body	600	63	67	---	105
TC-10	40.5	105°	SPARCS valve block	600	60	80	---	112
TC-11	37.5	75°	Drogue gun skin (No. 1)	800	250	295	750 (400)	645 (345)
TC-12	37.5	75°	Drogue gun body (No. 1)	600	---	100	275	280
TC-13	37.5	255°	Drogue gun skin (No. 2)	800	220	275	545 (350)	619 (330)
TC-14	37.5	255°	Drogue gun body (No. 2)	600	---	85	230	263

* Measured clockwise looking aft from 0° (North)
() At heat shield release

Table 4-4. Thermocouple Commutator Peak Temperatures and Comparisons (Continued)

DESIG- NATION	STATION (in.)	ϕ^*	LOCATION DESCRIPTION	GAGE T _{MAX} (°F)	EXIT T _{MAX} (°F)		REENTRY T _{MAX} (°F)	
					21.009	21.019	21.009	21.019
TC-15	35.7	---	Heat shield skin	600	65	80	196	236
TC-16	35.7	---	Heat shield cork	600	62	80	145	188
TC-17	37.5	75°	Drogue gun squib housing (No. 1)	800	---	84	---	166
TC-18	37.5	225°	Drogue gun squib housing (No. 2)	800	---	82	---	156
TC-19	36.7	135°	Forward manacle ring flange	800	260	280	685 (400)	680 (400)
TC-20	138.8	118°	Aft manacle front flange	600	---	206	305	310
TC-21	140.4	118°	Aft manacle ring	600	175	212	---	---
TC-22	141	118°	Aft manacle adapter flange	600	165	186	---	---
TC-23	58.5	67.5°	Skin - SPARCS exten- sion	600	---	---	---	---
TC-24	60	67.5°	SPARCS section rear flange	600	---	214	---	288
TC-25	59	67.5°	SPARCS - copper eye block	600	---	105	---	169
TC-26	59	349°	SPARCS aluminum eye block	600	---	200	---	261
House- keeping thermistor			Reference temperature	160	70	78	75	83

* Measured clockwise looking aft from 0° (North)

() At heat shield release

Figure 4-14. Post Flight CALROC 21.019 Payload.



COURTESY U. S. ARMY
WHITE SANDS MISSILE RANGE,
WHITE SANDS, N. M.

Table 4-5. Payload 21.020 Flight Profile

<u>EVENT</u>	<u>TIME (sec)</u>		<u>VELOCITY (ft/sec)</u>		<u>ALTITUDE (ft)</u>		<u>RANGE (ft)</u>	
	<u>ACTUAL</u>	<u>PREDICTED</u>	<u>ACTUAL</u>	<u>PREDICTED</u>	<u>ACTUAL</u>	<u>PREDICTED</u>	<u>ACTUAL</u>	<u>PREDICTED</u>
Launch	0*	-2.609	0	0	4050	4050	---	---
Tower exit	1.52	1.55	198	200	4200	4200	---	---
Burnout	33.1	32.4	7170	7234	109400	105298	10000	7435
Nose tip eject	53.5	54	6480	6541	247100	253916	25000	19763
Despin	56.6	57	6380	6447	266300	273324	27000	21449
Payload separation	60.1	60	6250	6354	288900	292435	30000	23132
Apogee	267.2	270	700	561	926600 (175.5 st mi)	946219 (179.2 st mi)	179000	143280
Impact (Motor)	--	522	---	5877	---	4000	333400 (63.1 st mi)	286388 (54.2 st mi)
(Payload)	603	610	---	330	---	4000	---	---

*Launch Time 16 hours, 20 minutes, 2.609 seconds (GMT)

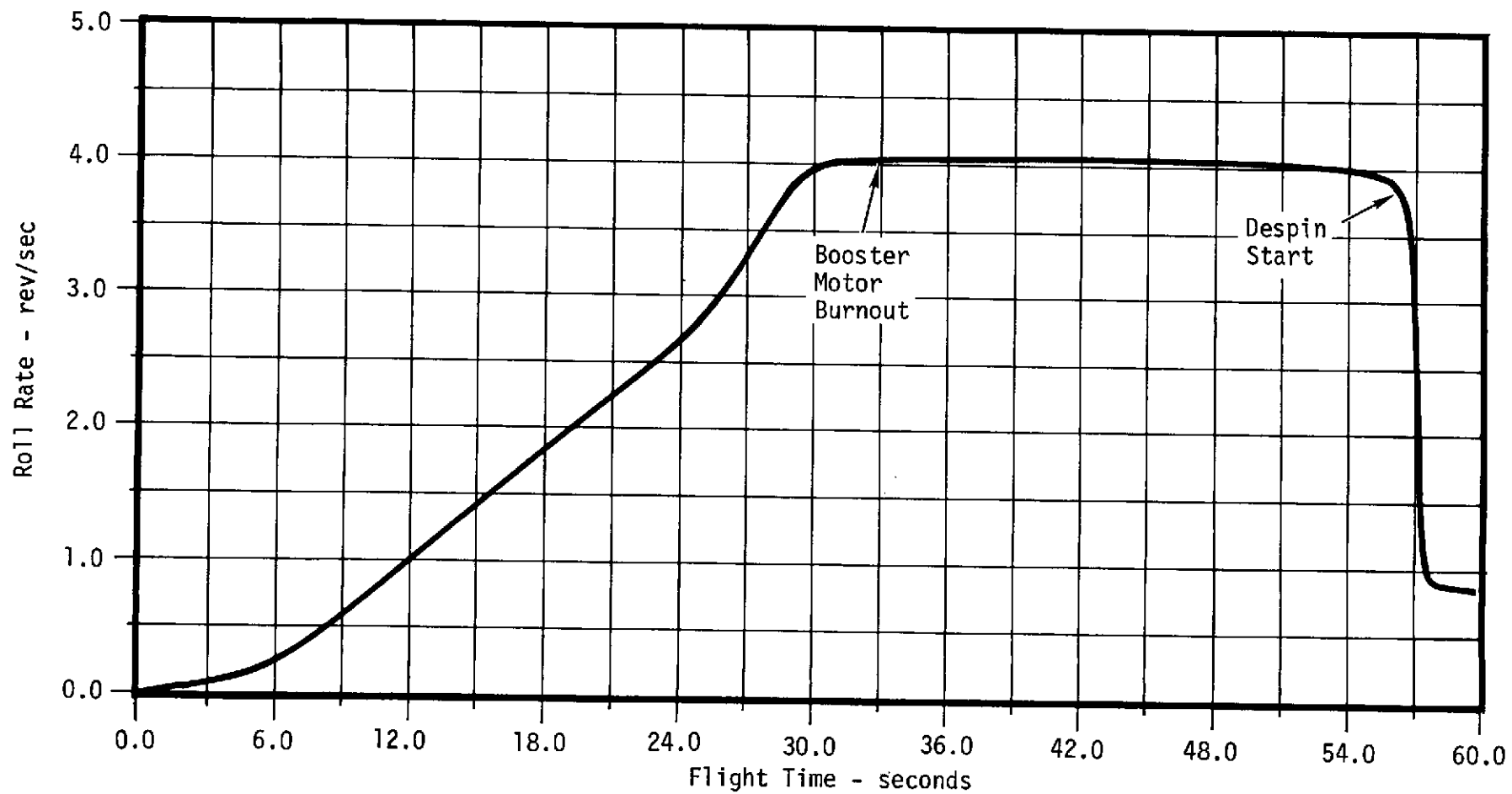

Figure 4-15. Roll Rate Versus Time - Flight 21.020

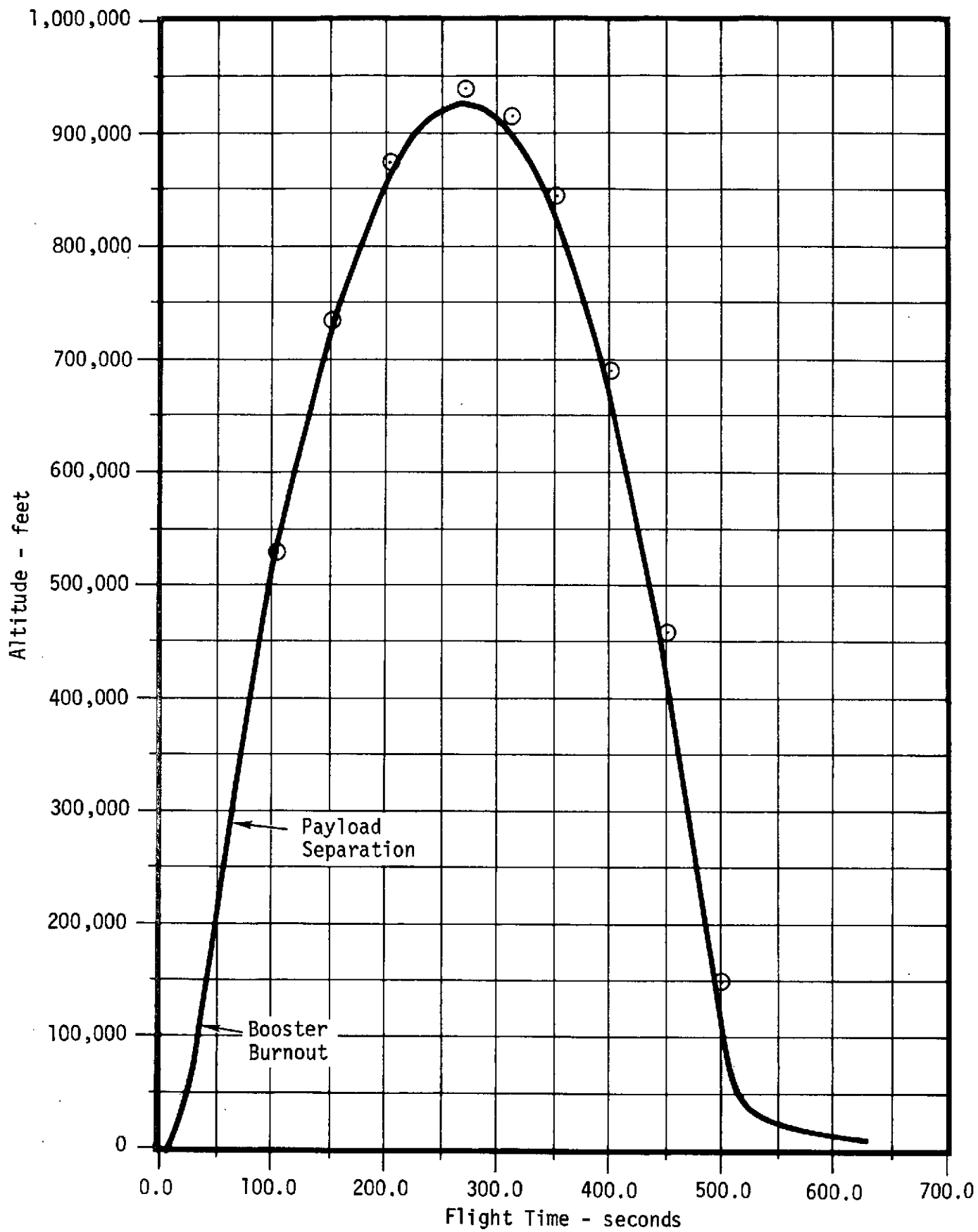

Figure 4-16. Flight 21.020 Altitude History

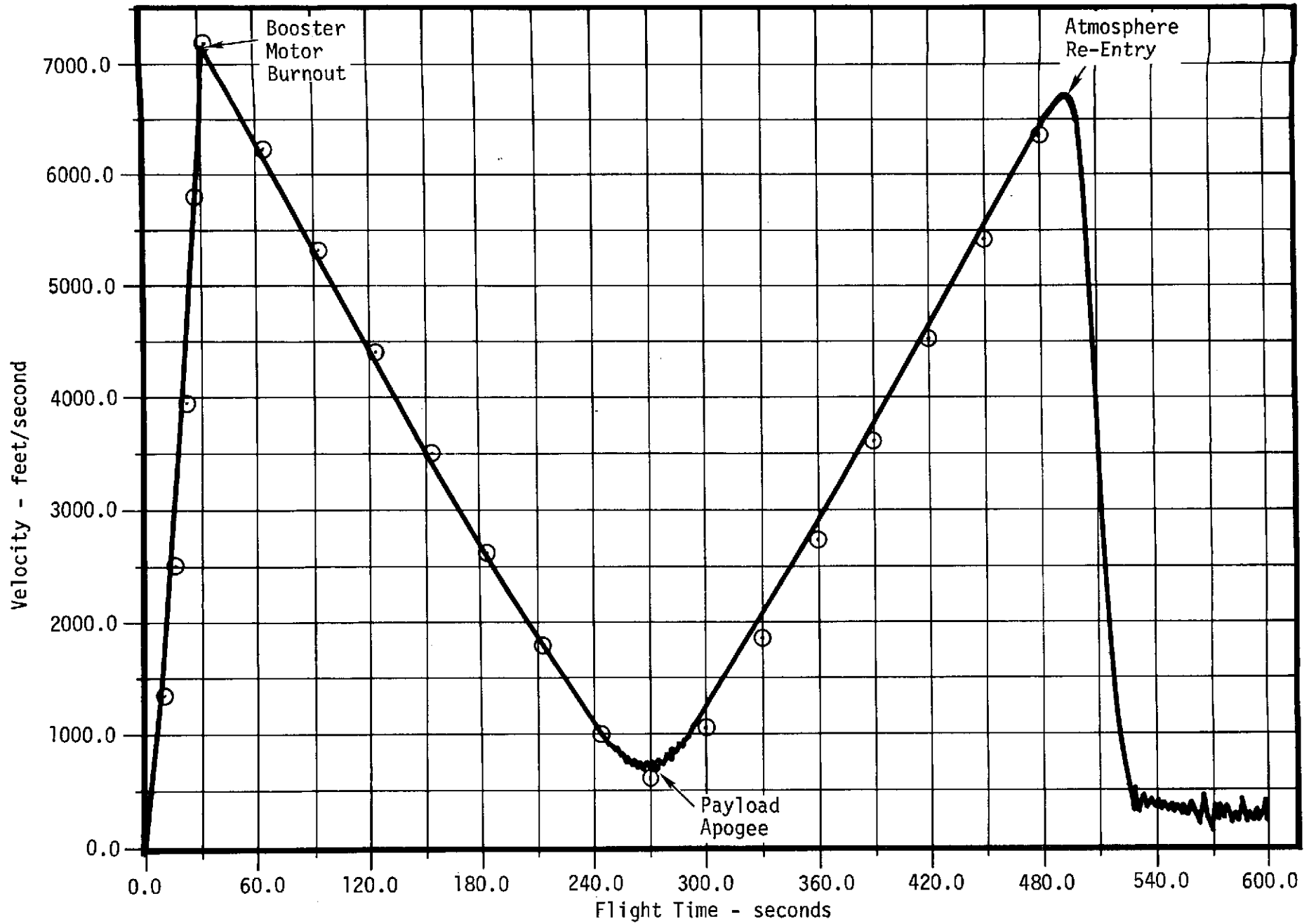

Figure 4-17. Flight 21.020 Velocity History

minimum value at apogee, then increased to a maximum again just prior to entering the earth's atmosphere. As the payload entered the earth's atmosphere, its velocity greatly decreased. All mission objectives were met, including the acquisition of temperature data in Table 4-6, thus qualifying 21.020 as a successful mission.²³

23. Memorandum 14966, "Black Brant VC 21.020 Flight Report," Goddard Space Flight Center, Space Applications and Technology Directorate, Sounding Rocket Division, Greenbelt, Maryland, April 16, 1973.

Table 4-6. Maximum Temperature Data, Flight 21.020

<u>MEASUREMENT</u>	<u>EXIT (°F)</u>	<u>RE-ENTRY (°F)</u>	<u>STATION NO. (inches)</u>	<u>LOCATION</u>
T/C-1	980	---	28.7	Nose tip-skin
T/C-2	820	---	33.5	Nose tip-skin
T/C-3	294	---	35.0	Nose tip-flange
T/C-4	Failed	Failed	36.7	Lower ORSA-flange
T/C-5	243	---	35.7	Forward manacle ring
T/C-6	798	844	38.3	Lower ORSA-skin
T/C-7	650	660	49.3	Lower ORSA-skin
T/C-8	263	402	51.0	Lower ORSA-flange
T/C-9	241	338	62.0	Telemetry bay-flange
T/C-10	368	415	63.6	Telemetry bay-skin
T/C-11	503	474	68.6	Telemetry bay-skin
T/C-12	122	539	39.0	Lower ORSA-valve block
T/C-13	62	562	40.5	Lower ORSA-valve block
T/C-14	186	274	77.3	Forward exp. bay-flange
T/C-15	125	688	39.0	Lower ORSA-valve block
T/C-16	445	457	90.5	Forward exp. bay-skin
T/C-17	355	388	104.8	Forward exp. bay-skin
T/C-18	234	319	106.2	Forward exp. bay-flange
T/C-19	225	294	107.6	Center ring
T/C-20	234	334	109.1	Aft exp. bay-flange
T/C-21	343	393	110.8	Aft exp. bay-skin
T/C-22	72	631	40.5	Lower ORSA-valve block
T/C-23	335	404	137.1	Aft exp. bay-skin
T/C-24	209	306	138.8	Aft exp. bay-flange
T/C-25	214	---	140.4	Manacle ring
T/C-26	189	---	141.0	Adapter ring-flange

Table 4-6. Maximum Temperature Data, Flight 21.020 (Continued)

<u>MEASUREMENT</u>	<u>EXIT</u> <u>(°F)</u>	<u>RE-ENTRY</u> <u>(°F)</u>	<u>STATION NO.</u> <u>(inches)</u>	<u>LOCATION</u>
SPARCS Therm. 1 (ST-1)	251	375	59.0	SPARCS-quartz sun sensor
ST-2	229	330	59.0	SPARCS-standard sun sensor
ST-3	257	345	59.0	SPARCS-quartz sun sensor (180° from ST-1)
ST-4	-	-	59.0	SPARCS (180° from ST-2)
ST-5	336	420	59.0	SPARCS-skin near ST-1
ST-6	327	404	59.0	SPARCS-skin near ST-3
ST-7	288	364	59.0	SPARCS-skin near ST-2
ST-8	312	357	59.0	SPARCS-skin near ST-4
ST-9 (Not used)	-	-	59.0	
ST-10 (Not used)	-	-	59.0	
ST-11 (Reference temp.)	60	80	59.0	
ST-12	80	237	59.0	SPARCS TM plate

Section 5
SKYLAB CALROC FLIGHT SUMMARY

SECTION 5

SKYLAB CALROC FLIGHT SUMMARY

The Skylab ATM Calibration Rocket Project had a minimum success criteria of one successful HCO flight and one successful NRL flight during the overall Skylab mission. The CALROC project was approved by NASA headquarters based on the concept that it was more economical to build, test and launch six calibration rockets using minimum documentation, standard sound rocket design, quality and reliability control and minimum change board control while permitting up to four failures than to require Skylab type detailed analysis, design, documentation, quality, reliability and change board control on only two rockets which would require 100% success. Based on this concept it was expected that some failures would be encountered. Five successes out of six launches far exceed the minimum success criteria established by NASA headquarters.

Six calibration Rockets were flown during the overall Skylab mission; two each during Skylab 1/2, Skylab 3 and Skylab 4. Five of the six flights were successful, as shown in Table 5-1, in obtaining good calibration data for use in calibrating the Skylab ATM S055 Ultraviolet Scanning Polychromator Spectroheliometer and S082 Extreme Ultraviolet Spectroheliograph and Spectrograph Experiment data. All payloads were recovered in refurbishable condition and some hardware was in fact refurbished and reflown.

The one and only failure was HCO flight 21.021, launched June 4, 1973, which was terminated early (2.2 seconds prior to Motor burnout) by the WSMR safety officer. Thrust termination was commanded as a result of radar indications that the payload would land off the WSMR if the Motor was allowed to continue thrusting. Post-flight analyses indicated a normal Rocket Motor performance and that the WSMR boundary overshoot was due to some confusion among the WSMR aerodynamic launch personnel who provided an incorrect launch tower setting to the U. S. Navy launch crew. Early thrust termination resulted in no calibration data, however, many of the subsystems performed as designed. The payload was recovered, refurbished and reflown on HCO flight 21.023 December 10, 1973.

The first launching of an NRL CALROC payload (21.012) during the Skylab mission occurred June 13, 1973. All subsystems, except the SPARCS and Scientific Instrument performed as designed. The SPARCS design goal was to provide pointing accuracies of less than 20 arc seconds error in pitch and yaw and 1.2 degrees in roll. Except for a 100 second period where unexplained motions of approximately 60 arc seconds occurred, SPARCS maintained pointing accuracies of less than 0.25 arc seconds error in pitch, 0.5 arc seconds in yaw and 72 arc seconds in roll. The total solar observing or calibration data time was approximately 318 seconds (108 to 426 seconds flight time), providing approximately 218 seconds of good calibration data. The

Table 5-1. CALROC Flight Summary

Flight number	Launch date	All systems successful	Remarks
HCO 21.021	6-4-73	No	Flight was terminated early by WSMR safety officer because it appeared to be going off range. The payload Telemetry, Nosecone Separation and payload Recovery systems worked properly. The Igniter Housing, Payload Separation, Scientific Instrument and SPARCS could not perform properly due to excessive tumbling, contamination and electrical malfunctions as a result of termination. No calibration data were obtained. See section 6 of text for more details.
NRL 21.012	6-13-73	Yes	All subsystems, except the SPARCS and Scientific Instrument, performed as expected. SPARCS had some large excursions causing some loss of calibration data. Calibration data was somewhat degraded by film fogging, overexposure and stray light within the Scientific Instrument. Adequate data was obtained to calibrate the Skylab 2 Mission S082 data.
HCO 21.022	8-9-73	Yes	All subsystems performed as expected. SPARCS provided excellent pointing and the payload was recovered in very good condition. Excellent calibration data were obtained even with the Scientific Instrument power supply #2 inoperative. This caused a loss of first order data in the wavelength range below 800 Å. Second order data was obtained down to 419 Å. Calibration data via telemetry was excellent.
NRL 21.013	9-4-73	Yes	All subsystems performed adequately to obtain sufficient data for a good calibration. Except for a few minor "jumps" of 5-10 arc seconds, SPARCS provided excellent pointing. These "jumps" had a minimal effect on calibration data. One-half of the "A" camera subsystem filter shutter failed in flight causing a minor effect on calibration data. Except for some minor dents during impact, the payload was recovered in excellent condition.
HCO 21.023	12-10-73	Yes	The flight was a complete success. Excellent calibration data were obtained with all subsystems performing in excellent fashion. The payload was recovered in very good condition.
NRL 21.014	1-15-74	Yes	Except for a small SPARCS roll drift during early flight all systems performed as designed. The roll drift caused a slight smearing of the first exposure on the "A" camera subsystem. All remaining "A", "B", "C", "H" and H-α camera exposures were very good, thus providing very good calibration data during the Skylab-4 Mission.

Scientific Instrument operated successfully obtaining adequate calibration data even with some minor problems such as background film fogging, overexposure and stray light.

The second HCO CALROC launch (21.022) occurred during Skylab 3. This launch was successful in every way, except for one high voltage power supply which tripped out and caused a loss of first order calibration data through the 770Å to 296Å range and second order calibration data through the 419Å to 296Å range. First order calibration data was obtained through the 1340Å to 770Å range and second order spectral lines of 499Å, 537Å, 584Å, 625Å and 629Å. The SPARCS maintained pointing accuracies of less than 0.3 arc seconds peak-to-peak error in pitch and yaw and less than 0.1 degree peak-to-peak error in roll throughout the calibration data taking period (109 seconds to 472 seconds). Except for the non-operation of power supply #2 this was a completely successful calibration flight.

The second NRL CALROC payload (21.013) launched during the Skylab mission was launched September 4, 1973. All payload subsystems performed satisfactorily. Good calibration data was obtained with each camera subsystem, however, the data was somewhat different from the data obtained on the first NRL calibration flight (21.012). This difference was resolved with the third NRL CALROC flight (21.014) January 15, 1974.

The third HCO CALROC launch (21.023) occurred December 10, 1973. All payload subsystems performed in excellent fashion. The flight was a complete success. Excellent calibration data were obtained from all three detectors with the CALROC and Skylab ATM Scientific Instruments observing the same region of the solar disc.

The third NRL CALROC payload (21.014) launched during the Skylab mission was launched January 15, 1974. All payload subsystems performed as designed. Except for a slight smearing of the first film exposure, caused by an unexplained SPARCS roll drift, calibration data (photographs) were excellent. The SPARCS roll drift caused some calibration data to be taken over a sun filament, which was planned as an area of avoidance, however, through close coordination with the Skylab flight controllers and astronauts the Skylab ATM Experiments were pointed to the same filament.

In summary, adequate to excellent calibration data were obtained on three NRL CALROC flights and two HCO CALROC flights. The calibration data are still being reduced, analyzed and compiled into a form such that calibration curves can be developed for the Skylab ATM Experiments data. NRL and HCO scientific personnel have stated that the calibration curves will be transmitted to Marshall Space Flight Center in late 1974 or early 1975.

Section 6

PERFORMANCE - SKYLAB 1/2 CALROC FLIGHTS

SECTION 6

PERFORMANCE - SKYLAB 1/2 CALROC FLIGHTS

The Skylab mission began on May 14, 1973, with the launching of Skylab at Kennedy Space Center, Florida. Skylab was designated as Skylab 1 and the first crew of astronauts, launched on May 25, 1973, was designated as Skylab 2. Thus, the Skylab 1/2 mission began on May 14, 1973, and terminated with the splashdown of the Skylab 2 crew on June 22, 1973. During this period, two Skylab ATM Calibration Rockets were launched at WSMR. The first was HCO flight number 21.021 which obtained no calibration data and was, thereby, classified as a failure. The second was NRL flight number 21.012 which did obtain calibration data and was thereby classified as a success.

6.1 Flight 21.021. HCO flight 21.021 was launched at WSMR on June 4, 1973, at approximately 17:10 GMT. The payload weighed 497.3 pounds and was launched for the purpose of obtaining data to calibrate the HCO S055 ATM Experiment data taken onboard Skylab 2. The flight was terminated by the WSMR safety officer 30.2 seconds after liftoff and approximately 2.2 seconds prior to Motor burnout because the vehicle was on a trajectory which, if continued, would violate the northern boundary of WSMR.²⁴ Post-flight analyses indicate that the Rocket Motor was performing in a normal manner just prior to thrust termination. The analysis has revealed that due to some confusion among the WSMR aerodynamic (wind-weighting) launch personnel, an incorrect launch tower setting (approximately one degree in launch elevation) was provided to the U. S. Navy launch crew which resulted in the vehicle overshooting the northern range boundary. New launch procedures and thrust termination criteria were adopted immediately which solved this type problem on future launches.

Some of the payload damage resulting from thrust termination can be seen in Figures 6-1, 6-2, and 6-3. The degree of subnominal

24. J. Lane, Memorandum, "Preliminary Post-Flight Evaluation of Black Brant VC NASA 21.021," NASA, Goddard Space Flight Center, Sounding Rocket Division, Greenbelt, Maryland, June 26, 1973.

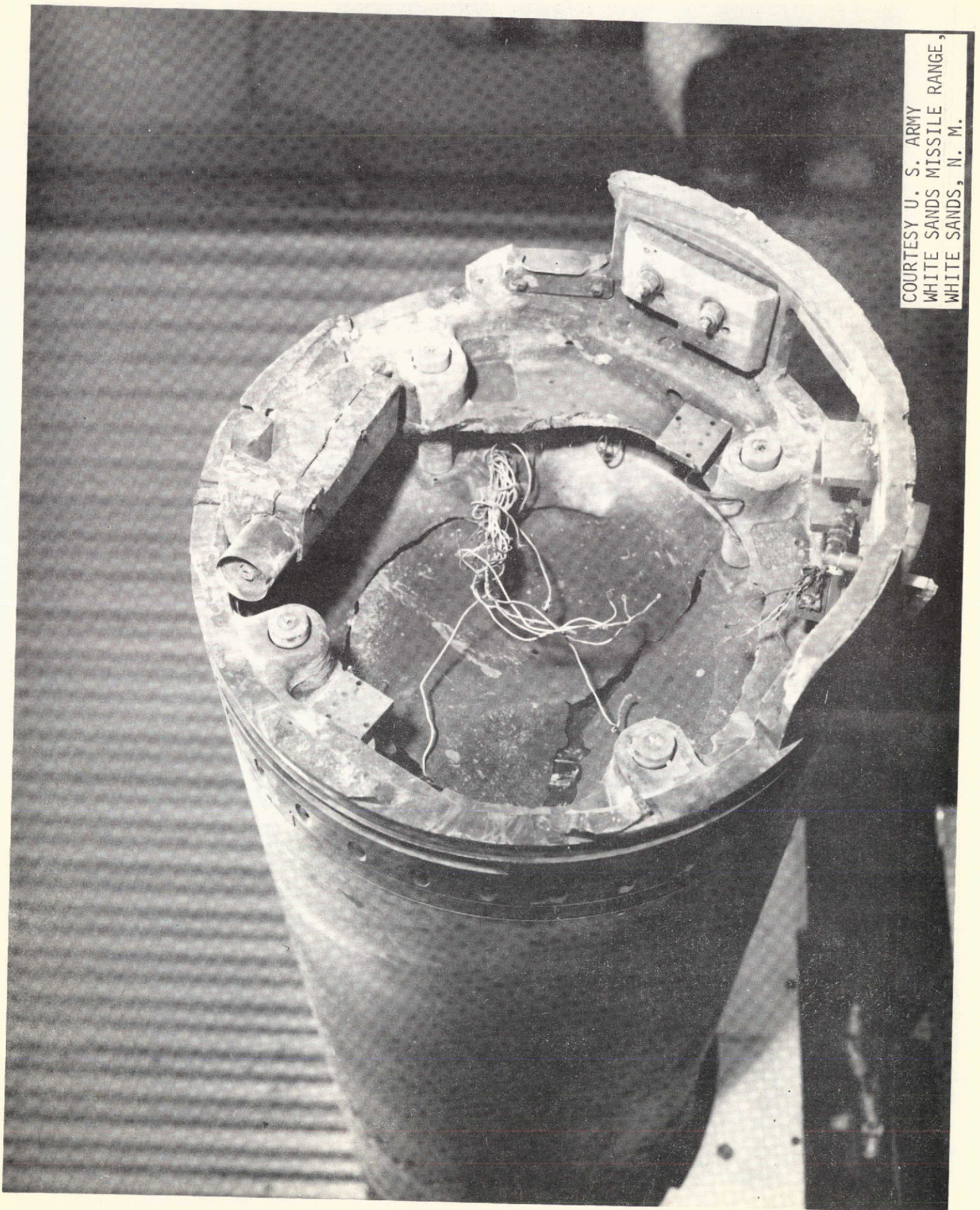

COURTESY U. S. ARMY
WHITE SANDS MISSILE RANGE,
WHITE SANDS, N. M.

Figure 6-1. Post-Flight HCO CALROC 21.021 Payload, Aft End.



COURTESY U. S. ARMY
WHITE SANDS MISSILE RANGE,
WHITE SANDS, N. M.

Figure 6-2. Post-Flight HCO CALROC 21.021 Payload, Vacuum Dome Rupture.

Figure 6-3. Post-Flight HCO CALROC 21.021 Payload, Carbon Deposit Seen thru Vacuum Door.

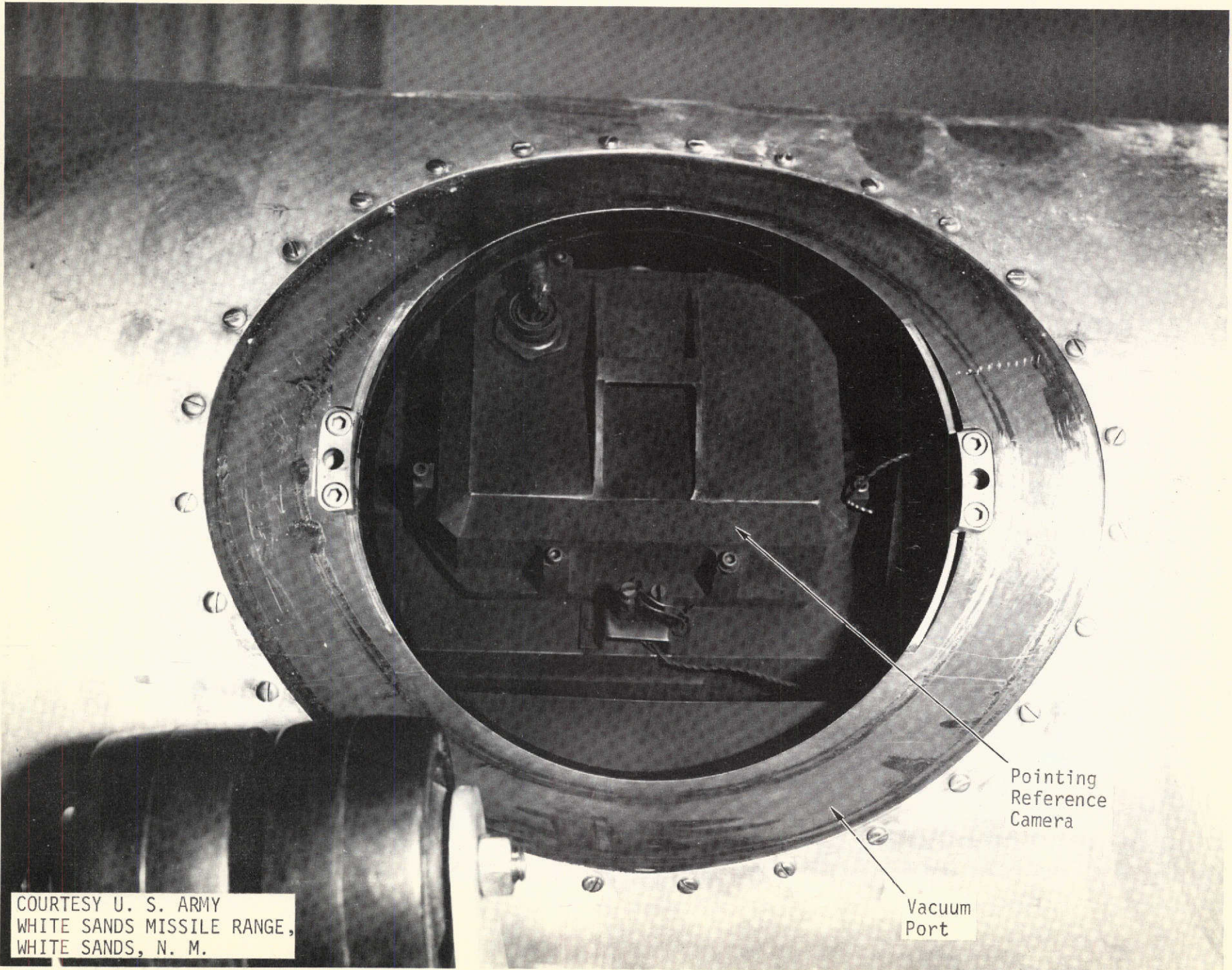

COURTESY U. S. ARMY
WHITE SANDS MISSILE RANGE,
WHITE SANDS, N. M.

performance is illustrated in Figure 6-4 which presents the planned (theoretically predicted) and actual (from smoothed 113 radar) altitude time profiles.²⁵ The planned trajectory had an apogee altitude of 899,000 feet whereas the actual apogee was only 432,000 feet (see Table 6-1). No calibration data was obtained, however, the flight was not a total failure. Many of the subsystems performed in flight as designed and the payload was recovered in refurbishable condition as shown in Figure 6-5. The Black Brant VC Rocket Motor was shown in Figures 6-6 and 6-7 to be performing as designed until thrust termination. Vehicle velocity and roll rate (spin) were almost identical to the design or theoretical values. The damaged Igniter Housing shown attached to the recovered payload in Figure 6-5, did not get a chance to prove all its subsystems on flight 21.021. Obviously, one system in the Igniter Housing worked perfectly; the thrust termination system. When thrust was terminated the shaped charge exploded the Igniter Housing and imploded the Scientific Instrument vacuum dome (Figure 6-2). Shortly after thrust termination the despinn mechanism was activated; however, due to excessive tumbling, as a result of thrust termination, payload despinn could not be verified.

The SPARCS was enabled at approximately 63 seconds and immediately tried to acquire the sun. Sun acquisition was not possible due to large lateral rates ($100^\circ/\text{second}$ compared to a design limit of $10^\circ/\text{second}$) as a result of thrust termination.²⁶ Attempts at sun acquisition were continued by SPARCS until its gas pressure reached zero at 260 seconds. Even if sun acquisition had been successful, fine pointing was impossible due to smoke and fire damage of the intermediate and fine sun sensors at thrust termination.

With SPARCS unable to fine point the payload at the sun, acquisition of solar calibration data was impossible. Even if SPARCS had been able to fine point the payload, obtaining calibration data was still impossible due to carbon deposits throughout the Scientific Instrument which resulted from thrust termination and imploding the instrument vacuum bulkhead (See Figure 6-3). The Scientific Instrument was turned on and successfully run through its program. Many functional aspects of the hardware were verified in flight.

25. "Final Report for NASA Flight 21.021, "Computer Science Corporation, Silver Springs, Maryland, August 1973.

26. E. Bissell, Memorandum, "NASA Black Brant VC (BBVC) 21.021 Preliminary Flight Report," NASA, Goddard Space Flight Center, Sounding Rocket Division, Greenbelt, Maryland, July 5, 1973.

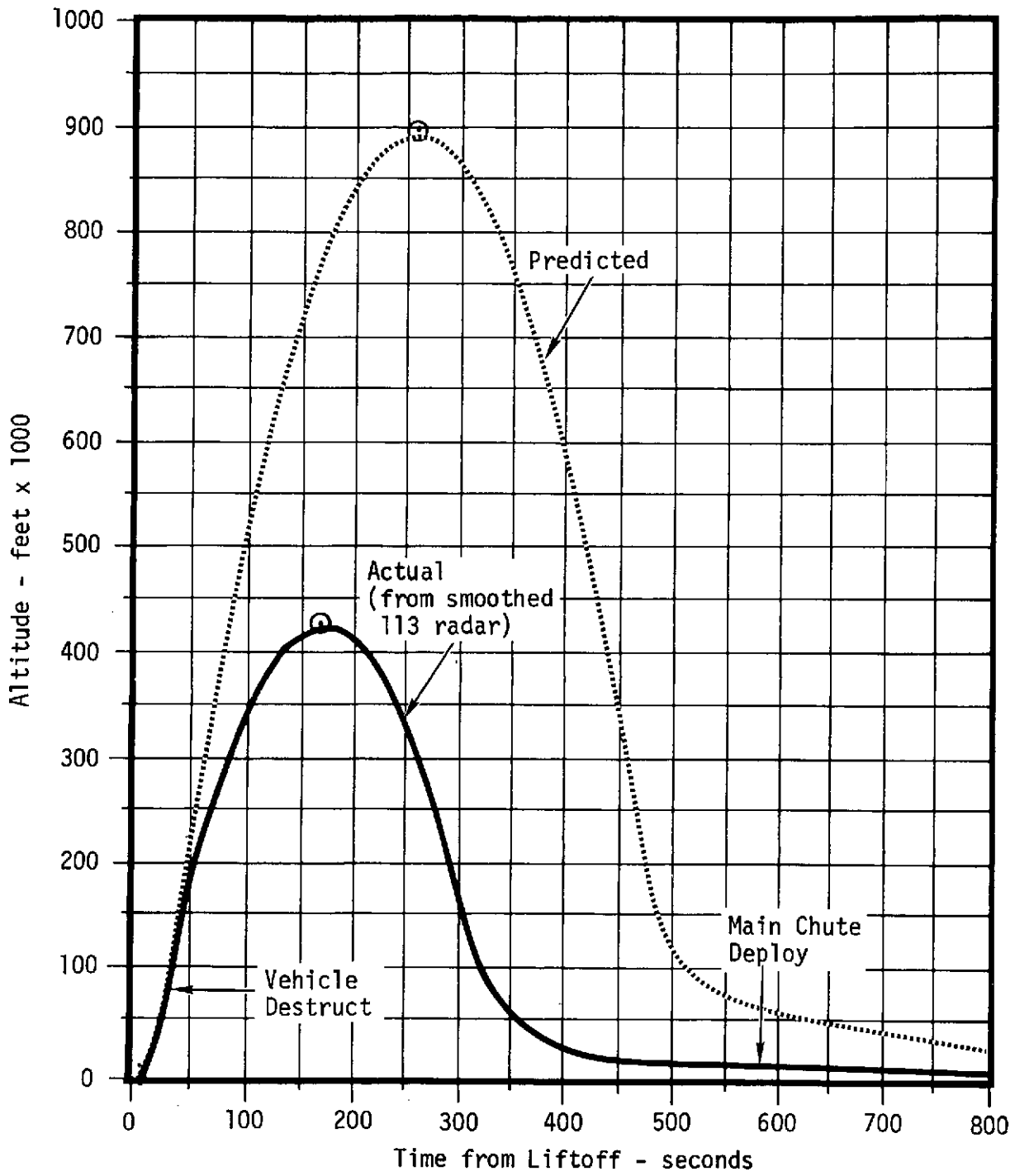

Figure 6-4. Payload 21.021 Altitude History

Table 6-1. Flight 21.021 Sequence of Events

<u>EVENT</u>	<u>PREDICTED TIME</u> (seconds)	<u>ACTUAL TIME</u> (seconds)	<u>HEIGHT</u> (feet)	<u>VELOCITY</u> (feet/second)
Ignition	-	0 (17:10:1.50 GMT)	4079	0
Liftoff	-	0 (17:10:1.64 GMT)	4079	0
Tower exit	1.51	1.51	4208	213
Max. dynamic pressure	-	20	35,983	3620
Vehicle destruct	-	30.23	88,400	6730
Booster burnout	32.4	-	-	-
Nosecone separation	56	55	203,500	3870
Despin	58	30.3	88,400	6730
Payload separation	61	30.3	88,400	6730
Vacuum dome separation	(DID NOT SEPARATE DUE TO DAMAGE AT THRUST TERMINATION)			
Instrument "ON"	109.5	30.3	-	-
Apogee	270	177	432,000	763
Instrument "OFF"	460	394	-	-
Heat shield & drogue deploy	508	438	20,250	305
Main chute deploy	580	455	17,497	72
Payload impact	990	867	-	-

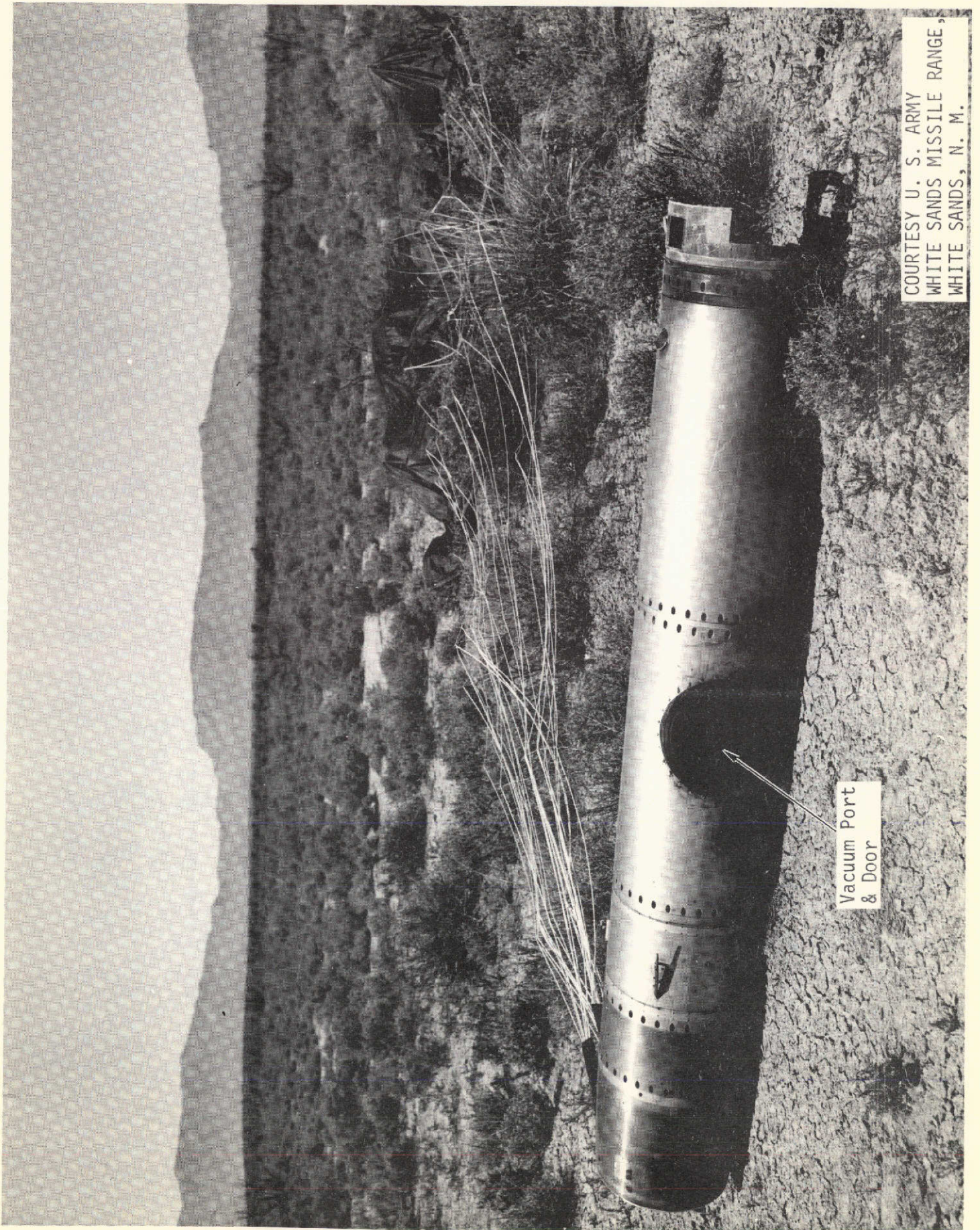

Figure 6-5. Post-Flight HCO CALROC 21.021 Payload.

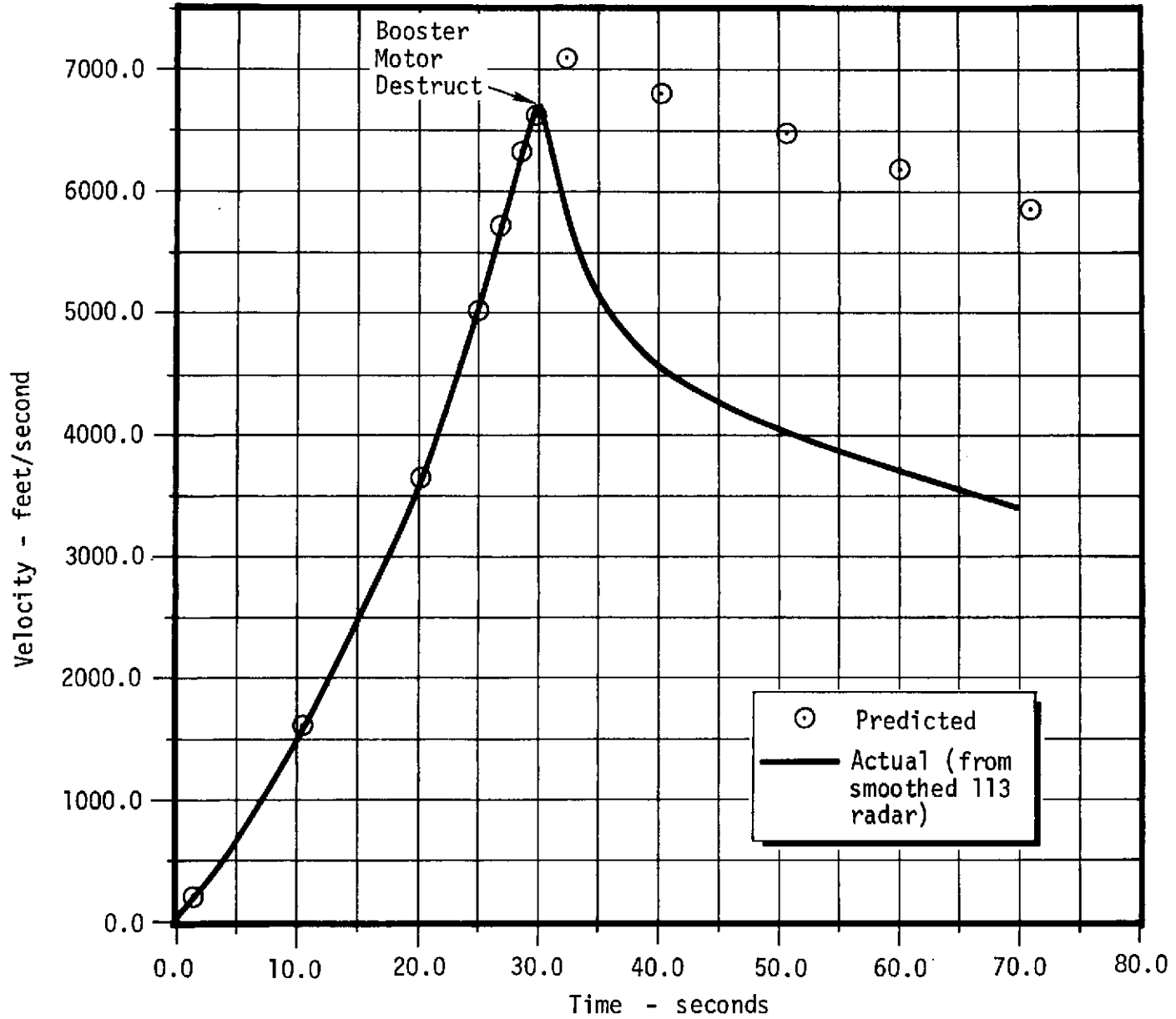

Figure 6-6. Velocity History -- Flight 21.021

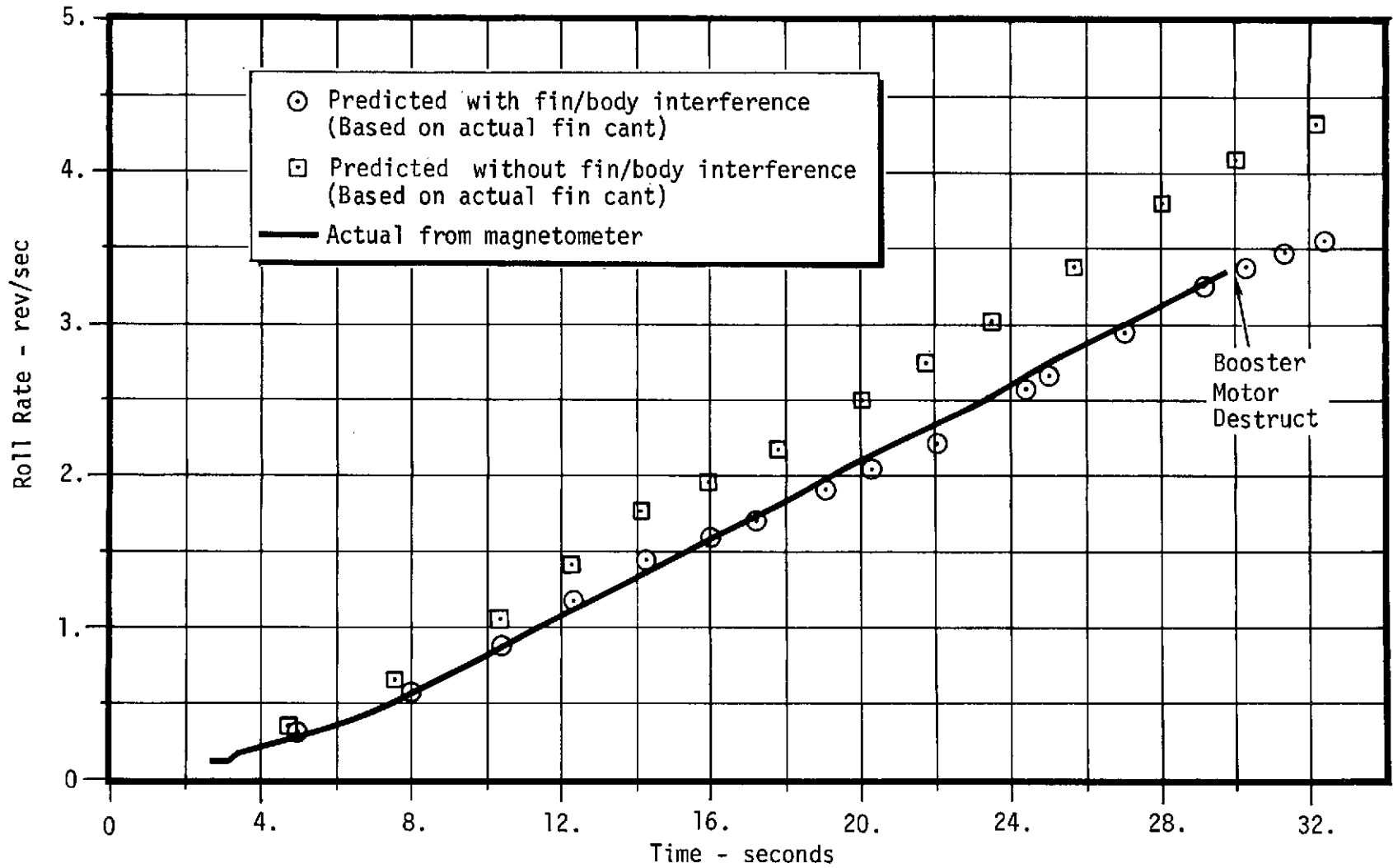

Figure 6-7. Roll Rate versus Time from Lateral Magnetometer -- Flight 21.021

Following Instrument turn-off, the drogue and main parachutes were deployed and successfully recovered the payload as shown in Figure 6-5. This payload was refurbished and later flown on flight 21.023.

The Telemetry system used on flight 21.021 was composed of three links (link #1 - PCM #1, link #2 - PCM #2, link #3 - FM/FM) which performed flawlessly. Link #1 carried SPARCS, Scientific Instrument and housekeeping data, whereas link #2 carried only redundant or backup Scientific Instrument data. Link #3 carried only SPARCS and housekeeping data. Proper operation of some channels of links #1 and #2 could not be verified due to an inoperative Scientific Instrument.

6.2 Flight 21.012. Payload 21.012, weighing approximately 590 pounds, was launched at WSMR June 13, 1973 at approximately 17:38 GMT for the purpose of obtaining data to calibrate the NRL S082 Experiment data taken onboard Skylab 2. Vehicle performance parameters such as spin rate, velocity and altitude were near predicted values as shown in Figures 6-8, 6-9, and 6-10. Vehicle spin rate increased linearly from zero at tower exit to 3.5 revolutions/second (design goal 4 ± 0.6) at 30 seconds, remained approximately constant to despin activation at 60.5 seconds, then dropped to zero within 1 second as the despin weights were released. In Figure 6-10 the payload altitude at apogee was approximately 20,000 feet lower than predicted due to a flight path angle some 1.24 degrees lower than predicted.²⁷

A listing of the major events during the flight of 21.012 is shown in Table 6-2. All critical events such as nosecone separation, despin, payload separation, vacuum dome separation and SPARCS fine pointing occurred successfully on or near predicted times.

SPARCS was enabled at 67.0 seconds and 27.4 seconds later had acquired the sun and was in the fine pointing mode. During the period 100 - 200 seconds SPARCS experienced some random, discrete and unexplained motions of approximately 60 arc seconds magnitude which had detrimental effects on the calibration data. This will be discussed in more detail in the following paragraphs of this report. From 200 seconds to the Scientific Instrument shutter closing over the fine sun sensor at 413.7 seconds, SPARCS maintained pointing accuracies of less than 0.25 arc seconds error in pitch, 0.5 arc

27. Final Report for NASA Flight 21.012, Computer Sciences Corporation, Silver Springs, Maryland, September 1973.

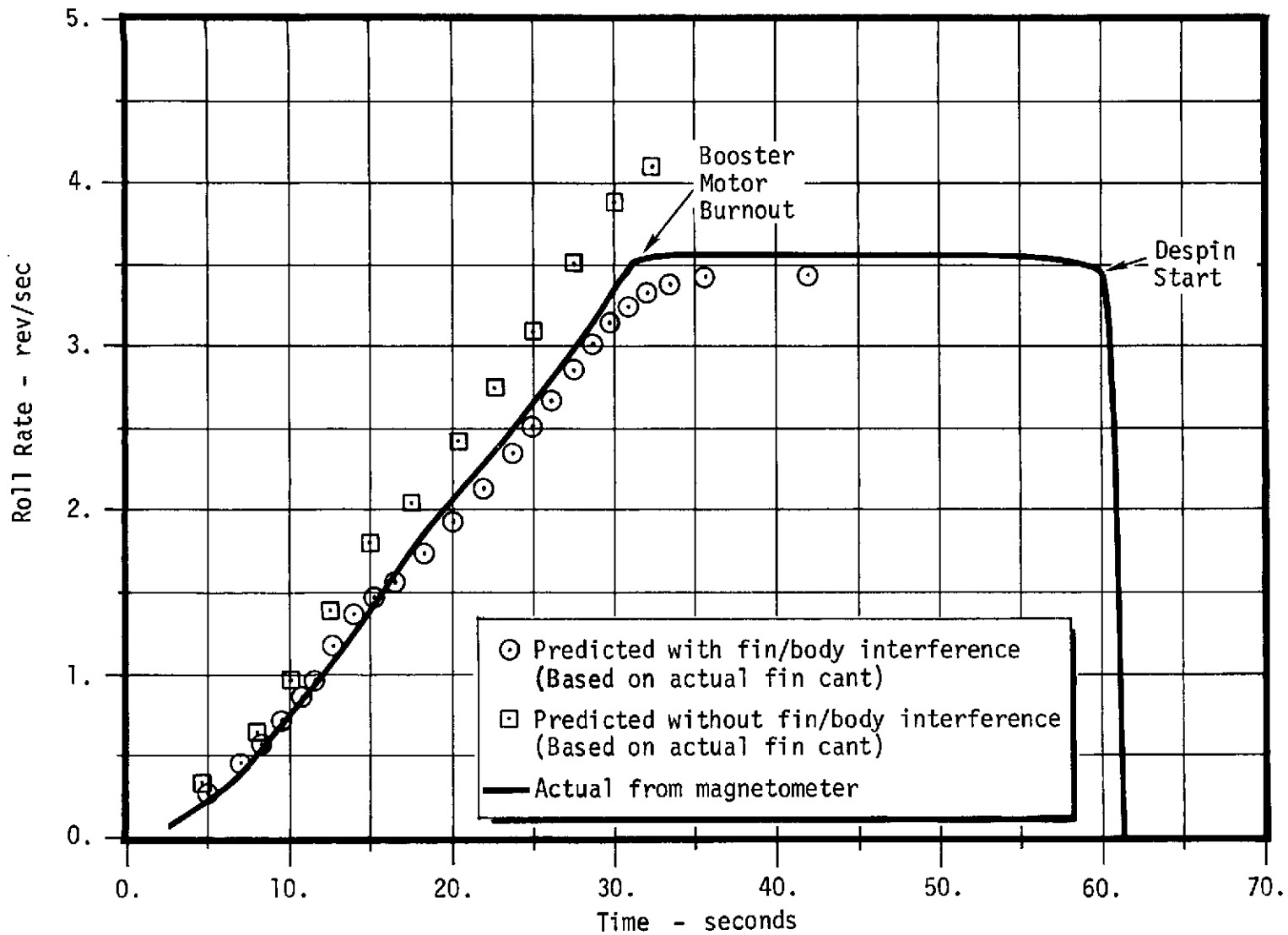

Figure 6-8. Roll Rate versus Time from Lateral Magnetometer - Flight 21.012

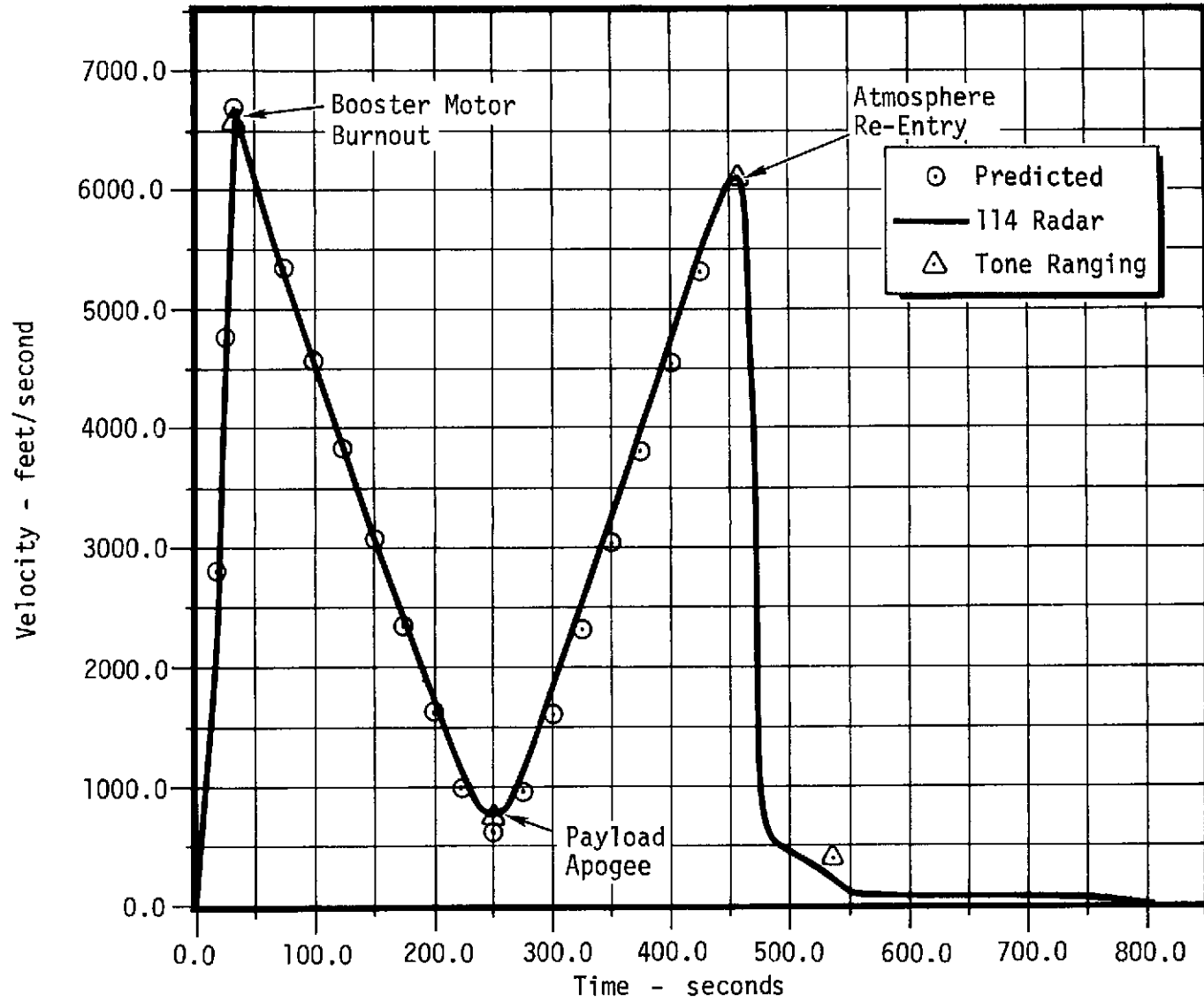

Figure 6-9. Velocity History Flight 21.012

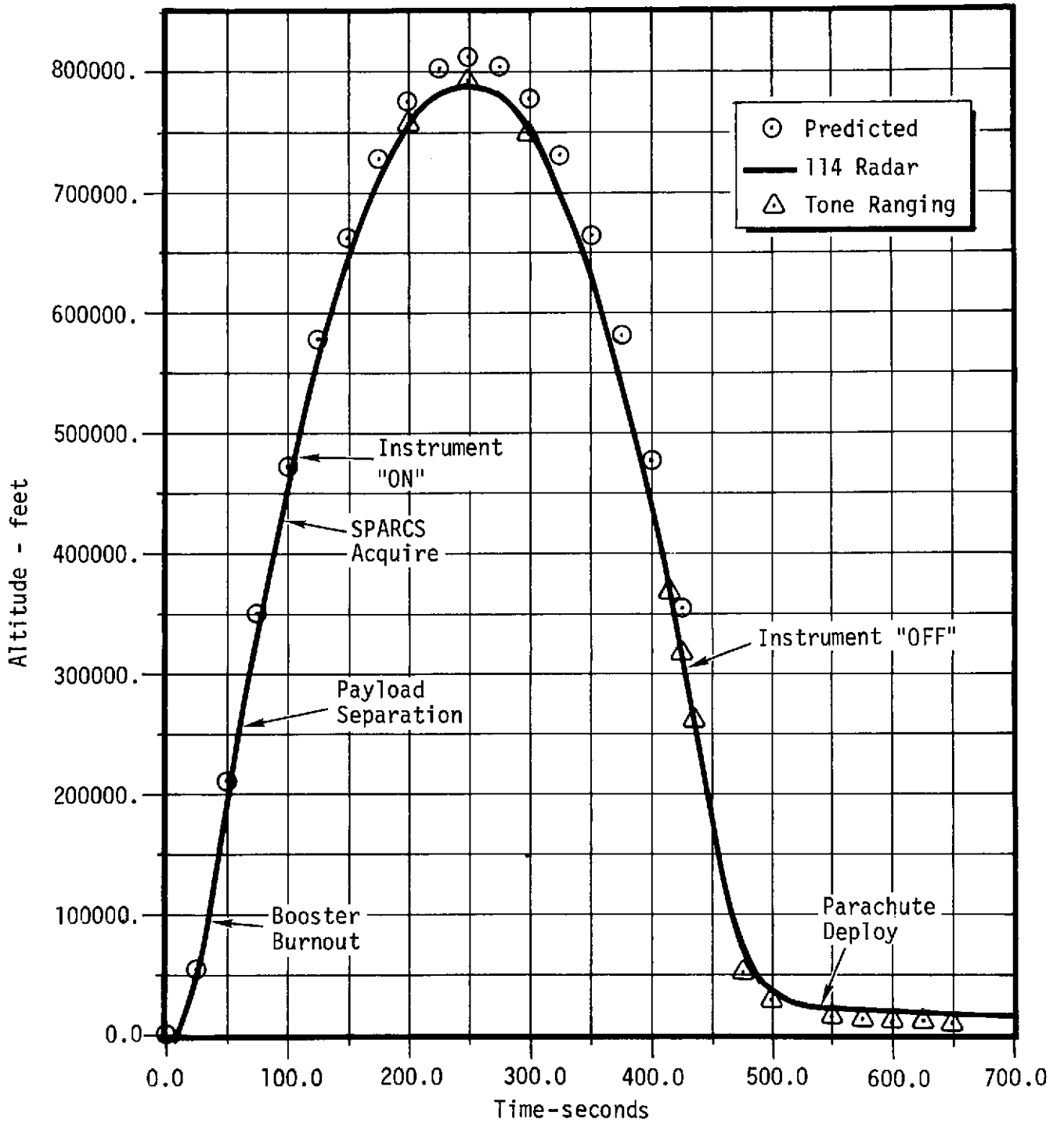

Figure 6-10. Altitude History Flight 21.012

Table 6-2. 21.012 Flight Profile

<u>EVENT/CONDITION</u>	<u>ACTUAL</u>	<u>PREDICTED</u>
Liftoff Time T+0 (GMT)	17:38:29.2	
Tower exit velocity (fps)	193	192.5
Tower exit time (sec)	1.54	1.54
Peak acceleration (g's)	13	13
Burnout time (sec)	31.8	32.4
Burnout velocity (fps)	6,800	6,700
Burnout altitude (ft)	99,000	99,570
Burnout roll rate (rps)	3.6	4.0±.6
Nosecone eject time (sec)	57.5	58.5
Despin time (sec)	61.5	61.0
Post despin roll rate (rps)	0	0
Payload separation time (sec)	63.2	64.5
SPARCS enable (sec)	67.0	68
Sun acquisition (sec)	94.4	107
Instrument "ON" time (sec)	108	107
Apogee time (sec)	246	250.3
Apogee altitude (stat mi)	149.7	154.2
Instrument "OFF" time (sec)	426	427
Heat shield deployment (sec @ ft)	530.3 @ 20,000	20,000
Velocity at heat shield deployment (fps)	300	-
Parachute deployment (sec)	542	494
Payload impact (sec)	840	900

seconds in yaw and 72 arc seconds in roll.²⁸ The design goal was less than 20 arc seconds error in pitch and yaw and 1.2 degrees in roll. This SPARCS was recovered, refurbished and later flown as part of payload 21.014 on January 15, 1974.

The Scientific Instrument was enabled at approximately 100 seconds and obtained adequate data to calibrate the Skylab S082 data during the Skylab 2 mission. However, due to the aforementioned random motion with SPARCS, background film fogging, overexposure and stray light some degradation of data was present. Data acquisition by the "A", "B", "C" and "H" camera subsystems are discussed in the following paragraphs.

One set (4 frames) of excellent spatial resolution spectroheliograms in both the short and the long wavelength positions were obtained with the "A" calibration spectrograph during moments of stable pointing. The remaining 12 on limb frames were seriously degraded because of the aforementioned SPARCS instabilities.

Three major problems occurred with the "A" calibration spectrograph.

a. The speed of the "A" calibration spectrograph was much faster than expected, therefore, many of the frames were overexposed. This was attributed to payload evacuation prior to launch and less atmospheric absorption because of high rocket altitude. This problem was corrected by using 104 instead of 101 film on future CALROC flights.

b. An excess of film fogging caused damage to the solar images. This resulted in a reduction of calibration accuracy since the laboratory spectra were not placed onto the flight film. This problem was minimized on flight 21.013 by using 104 instead of 101 film and placing laboratory spectra on the flight film.

c. The quality of the spectroheliograms suffered from stray light, caused by the grating used in this instrument. The grating used was an old ruling with some imperfections. A new grating is being produced and may be implemented into the refurbished payload to be flown on 21.014 during Skylab 4.

The "B" calibration spectrograph (1175 to 2120⁰Å) obtained 23 exposures. The spectrograph and telescope were in good focus.

28. "Preliminary SPARCS Flight Summary for 21.012," IMSC/D346729, Lockheed Missile and Space Company, Sunnyvale, California, July 18, 1973.

Solar intensities, derived from one film strip indicate, that the calibration was proper.²⁹ Two major problems occurred, which reduced the accuracy of the calibration.

a. Because of large unexplained discrete jumps (approximately 60 arc seconds) of the SPARCS pointing system, approximately one-half of the exposures did not have the pre-programmed position on the solar disk. The SPARCS jumps were too large to be compensated for by the pointing reference system, built into the telescope. Therefore, these exposures were of only limited value when used for comparison with the ATM exposures.

b. The 101 UV film, used for the short wavelength portion of the spectrograph showed an unexpected large amount of background fogging (density 0.6). Because the calibration spectra were placed onto these flight films, corrections were derived, but the accuracy of the calibration was less than expected. Film fogging is believed to be caused by ionization which was reduced by keeping the ion gauge off as much as possible and using 104 rather than 101 UV film.

All sets of "C" calibration spectrograph exposures were usable since this instrument did not require fine pointing. Film fogging was present on all 101 films, but the 104 film exposures came out good.

Because of SPARCS pointing instabilities, four of the twelve "H" heliograph exposures were ruined. Film fogging was present on all eight of the 101 film exposures. Three of the 104 film exposures which were free from fogging showed excellent resolution.

Five instrument anomalies which were detected and require corrective action were:

a. An excess amount of dirt was present on the slit of "B" spectrograph after launch, which was not seen during the last testing. It was assumed that this dirt was shaken loose during liftoff and fell onto the slit plate. Two catastrophic failures were possible under those conditions; a piece of dirt could block the slit or a piece of dirt could make the pointing reference system inoperative. Corrective action has been taken. A cover has been built which will protect the slit plate during the powered portion of the flight and will be released together with all other launch locks. More attention will be given to payload cleaning prior to launch.

29. Dr. G. Brueckner, Letter 7419-189, Naval Research Laboratory, Washington, D. C., June 29, 1973.

b. Small dust particles apparently punched numerous small holes (less than 1μ) into all three filters. This could have happened during liftoff or impact. One large hole was present in the second filter of the "H" camera subsystem, which probably was caused by the impact of a particle. Fortunately, this hole did not develop in the image area of the sun which would have been catastrophic. Protective covers have been designed for all three thin film filters to prevent any damage during liftoff.

c. The Silicon Intensified Target (SIT) television camera showed signs of saturation during the portion of the flight, when pointed at the sun center. The SIT television camera Automatic Gain Control (AGC) was set incorrectly prior to flight.

d. The H-alpha photographic pictures of the slit plate were smeared because of "B" camera subsystem main mirror vibration induced during shutter motion of the H-alpha camera. This was caused by a mechanical resonance in the "zero-G" environment. The resonance was not removed on flights 21.013 and 21.014, but its effects were eliminated by including a neutral density filter and increasing the H-alpha film exposure time.

e. Upon impact, the Scientific Instrument front doors did not remain closed and as a consequence, dust entered into the payload. The door mechanism relied on a differential pressure between ambient and the inside of the payload. This differential pressure was most likely not maintained because of the impact shock. Future CALROC flights used latches which kept the doors closed during impact.

Following Scientific Instrument turnoff, the drogue and main parachutes were deployed and successfully recovered the payload. This payload was refurbished and reflown on flight 21.014.

The NRL Telemetry records indicate that the system flown on 21.012 performed within the design acceptance criteria and no changes were considered necessary on components, circuitry, hardware, antennas, etc.³⁰ Review of telemetry records indicate the systems performance was as expected. The Telemetry system was recovered and refurbished for use on payload 21.014.

Summarizing the results of this flight, it can be stated that enough information was gathered to calibrate the Skylab S082 data taken during the Skylab 2 mission.

30. John Cameron, Memorandum to E. E. Bissell, "Preliminary Post-flight Report on CALROC 21.012 (NRL)," NASA, Goddard Space Flight Center, Sounding Rocket Division, Greenbelt, Maryland, June 21, 1973.

Section 7

PERFORMANCE - SKYLAB 3 CALROC FLIGHTS

SECTION 7

PERFORMANCE - SKYLAB 3 CALROC FLIGHTS

The Skylab 3 Mission began on June 22, 1973 following the undocking and splashdown of the Skylab 2 crew. An unmanned period June 22, 1973 to July 28, 1973, preceded the launching of the Skylab 3 crew on July 28, 1973. Thus, the Skylab 3 Manned Mission began on July 28, 1973 and terminated with the splashdown of the Skylab 3 crew on September 25, 1973. During this period, two Skylab ATM Calibration Rockets were launched at WSMR. The first was HCO flight number 21.022 and the second NRL flight number 21.013. Both flights obtained sufficient data to properly calibrate the Skylab data, thus qualifying as successful missions.

7.1 Flight 21.022. HCO payload 21.022, weighing 495 pounds, was launched at WSMR August 9, 1973 at 17:30:58.42 GMT for the purpose of obtaining data to calibrate the HCO SO55 experiment data taken onboard Skylab 3. Vehicle performance parameters such as vehicle roll rate, acceleration, velocity and altitude are shown in Figures 7-1, 7-2, 7-3 and 7-4. Additional flight performance data are shown in Table 7-1. The vehicle burnout velocity was slightly less than predicted, resulting in a lower than predicted payload apogee. The BBVC Rocket Motor performance was slightly under prediction, however, each of the above parameters were within design specifications indicating that the rocket motor performed as designed. Vehicle despin and payload separation occurred successfully and on time.

Following successful despin and payload separation, SPARCS was enabled at 64.0 seconds. Thirty seconds later SPARCS had acquired the sun and was in the fine pointing mode. SPARCS maintained fine pointing accuracies of less than 0.3 arc seconds peak-to-peak error in pitch and yaw and less than 0.1 degree peak-to-peak error in roll throughout the calibration data taking period (109 to 472.4 seconds).³¹ The design goal was less than 20 arc seconds error in pitch and yaw and less than 1.2 degrees error in roll. This SPARCS was recovered in excellent condition, with no apparent damage.

All Scientific Instrument subsystems functioned correctly with the exception of high voltage power supply #2 (HVPS) which tripped

31. "Preliminary SPARCS Flight Summary for 21.022" LMSC/D338306, Lockheed Missile and Space Company, Sunnyvale, California, August 27, 1973.

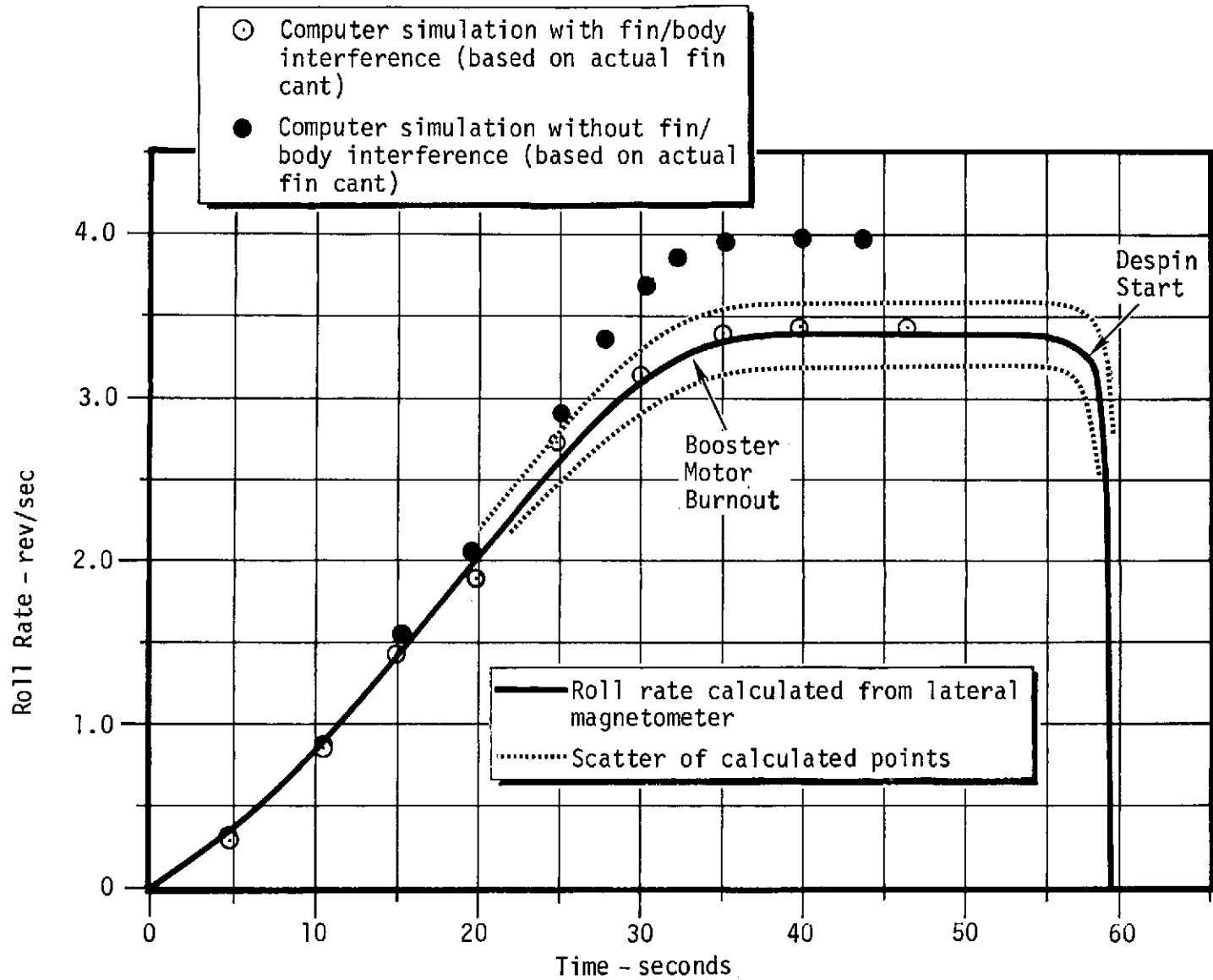

Figure 7-1. Roll Rate Versus Time from Lateral Magnetometer
Flight 21.022

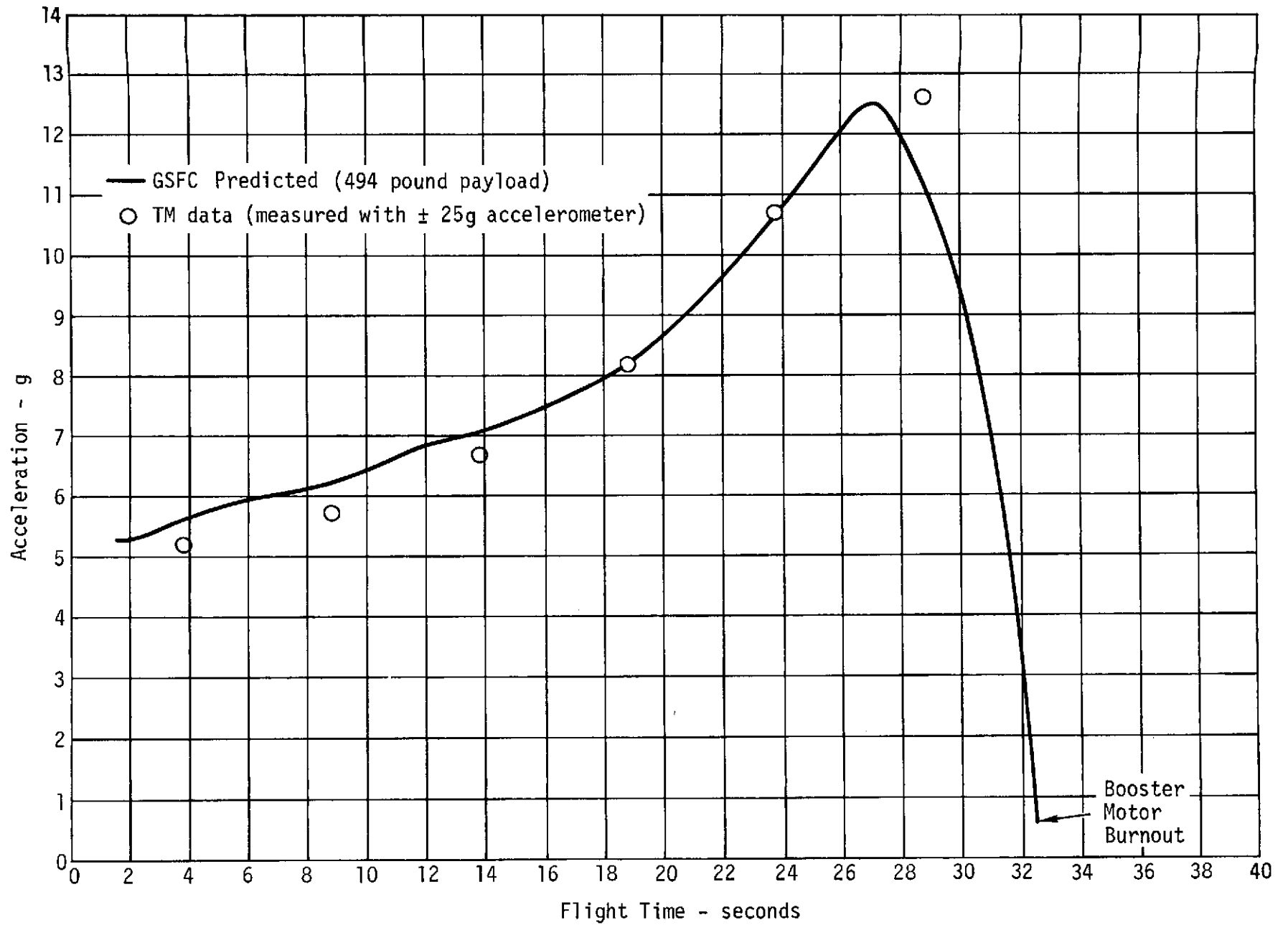

Figure 7-2. Flight 21.022 Longitudinal Accelerometer

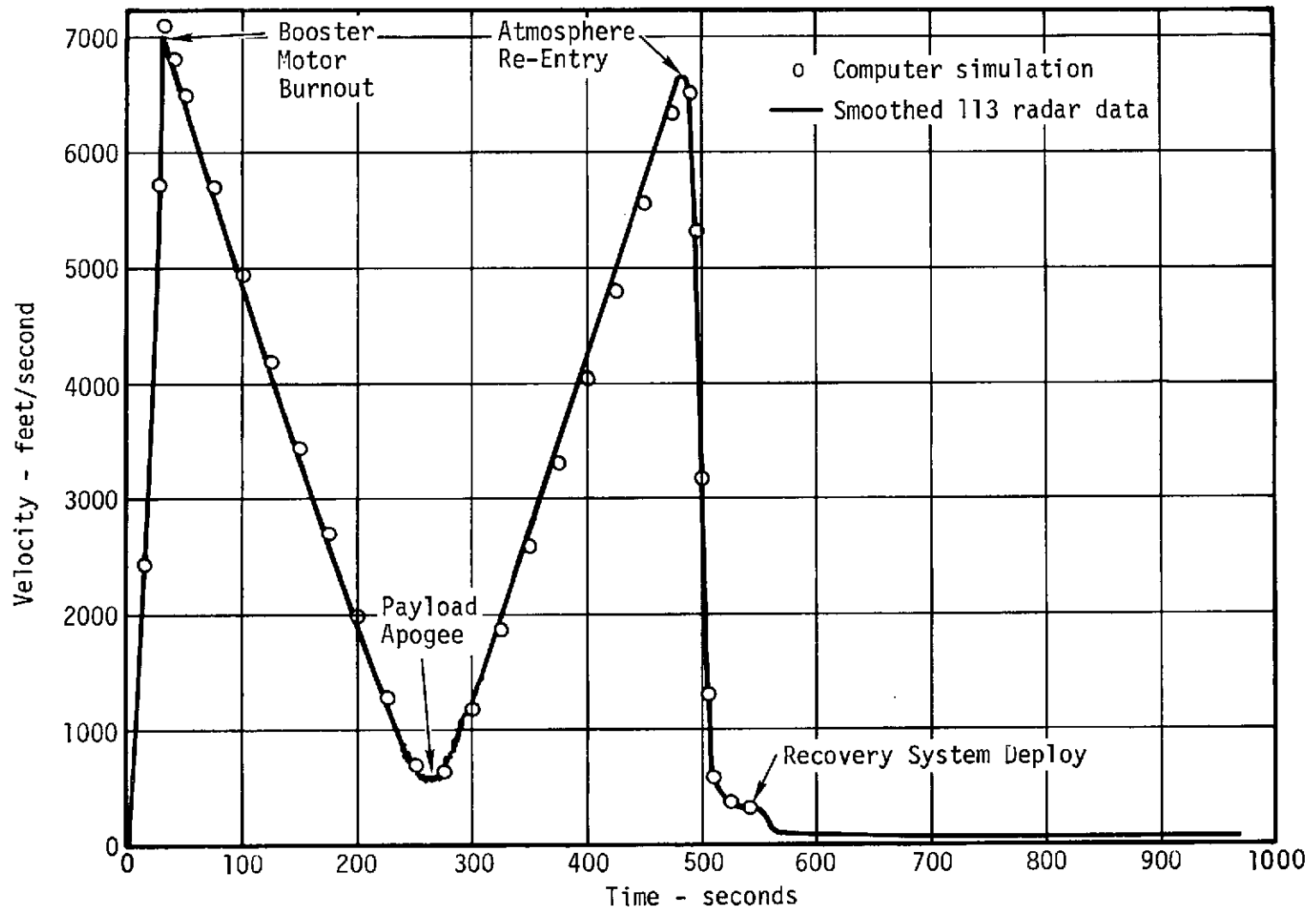

Figure 7-3. Velocity History - Flight 21.022

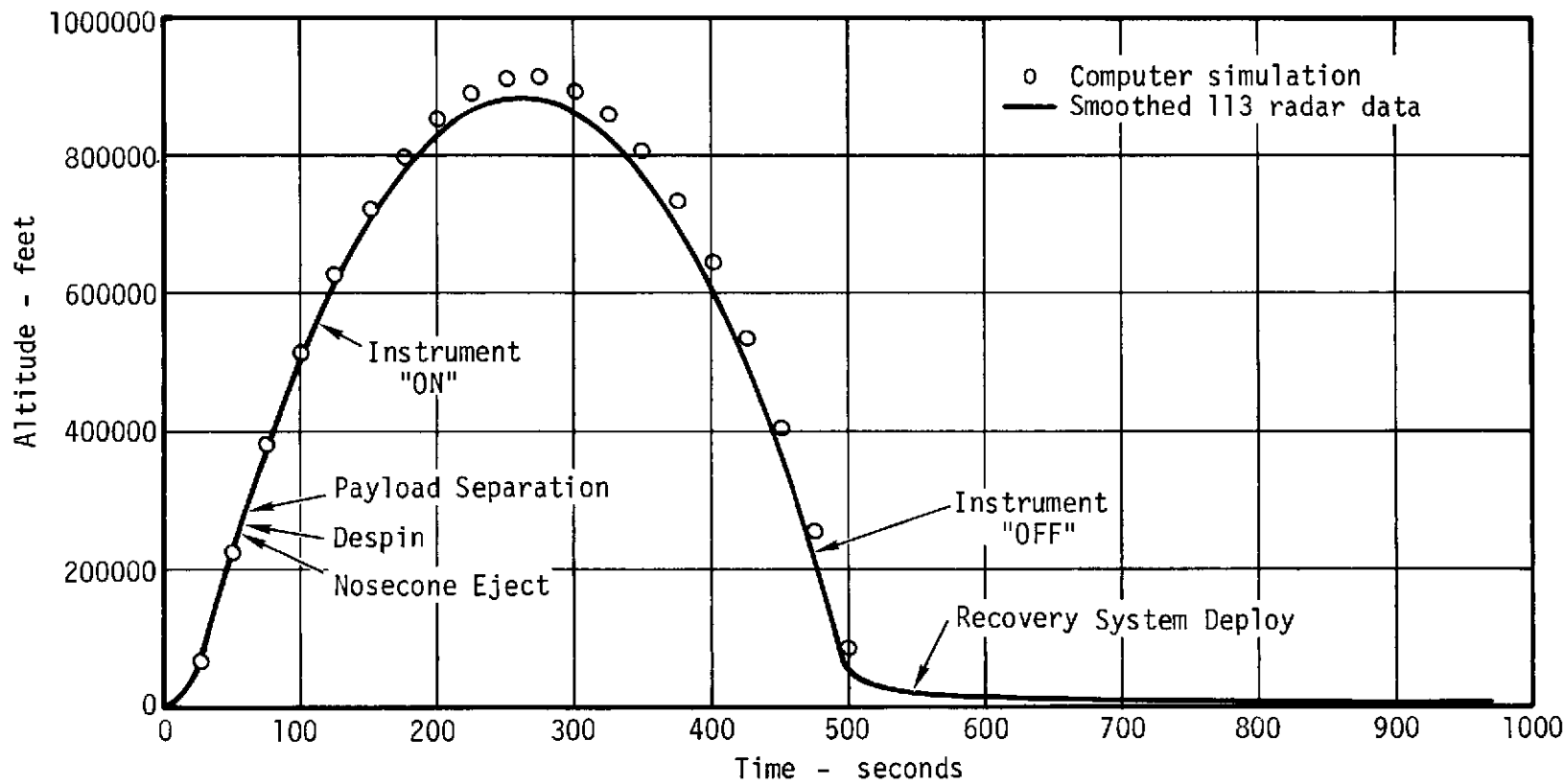

Figure 7-4. Altitude History - Flight 21.022

Table 7-1. 21.022 Flight Performance

	<u>PREDICTED</u>	<u>ACTUAL</u>	<u>COMMENTS</u>
Tower exit			
Time (sec)	1.53	1.49	Approx time based on magnetometers and lateral accelerometers
Velocity (ft/sec)	196.5	-	
Vehicle burnout			
Time (sec)	32.42	32.6	Time of max velocity from radar. Chamber pressure shows 32.9 seconds. Tone ranging shows 6978 ft/sec.
Altitude (ft)	103,848	102,919	
Velocity (ft/sec)	7104	6979	
Nosecone eject			
Time (sec)	56	56.0	Time from Telemetry. Approximate altitude from radar
Altitude (ft)	---	255,000	
Vehicle despin (Yo-Yo)			
Time (sec)	58	58.8	Time from Telemetry. Approximate altitude from radar
Altitude (ft)	---	774,000	
Payload separation			
Time (sec)	61	61.0	Time from Telemetry. Approximate altitude from radar
Altitude (ft)	294,000	287,000	
SPARCS enable			
Time (sec)	64	64	---
Altitude (ft)	---	315,000	
Sun acquisition			
Time (sec)	100	94.2	---
Altitude (ft)	---	470,000	
Instrument "ON"			
Time (sec)	109.5	109	---
Altitude (ft)	---	551,000	
Apogee (Payload)			
Time (sec)	265.1	261.6	Time from radar. Apogee was 3.1% low
Altitude (stat mi)	172.8	167.4	

Table 7-1. 21.022 Flight Performance
(Continued)

	<u>PREDICTED</u>	<u>ACTUAL</u>	<u>COMMENTS</u>
Instrument "OFF"			
Time (sec)	460	472.4	
Altitude (ft)	---	225,000	
Top hat off			
Time (sec)	---	487.2	
Altitude (ft)	---	120,000	
Heat shield deployment			
Time (sec)	565	546.87	Time from Telemetry. Approximate altitude from radar. Approximate velocity from radar
Altitude (ft)	20,000	20,000	
Velocity (ft/sec)	---	310	
Drogue deploy shock			
Time (sec)	---	547.9	Time from Telemetry
Drogue disreef shock			
Time (sec)	569	551	Time from Telemetry
Main chute deploy shock			
Time (sec)	577	558.8	Time from Telemetry
Main chute disreef shock			
Time (sec)	581	563.5	Time from Telemetry
Vehicle impact			
Time (sec)	652	---	
Payload impact			
Time (sec)	990	980	Approximate loss of Telemetry signals

FOOTNOTE:

1. Measured altitude and velocity are from "Quick-Look" #112 radar data.

out due to the lack of an override circuit.³² This unit was a development unit which did not have an override for the corona protection trip circuit and was mistakenly used as a flight unit following refurbishment from the Skylab ATM Program. The HVPS apparently tripped out either after the last high voltage functional prior to flight or at the instant of liftoff. The HVPS operated correctly during post-flight UV baseline tests and has since been removed from the instrument. Only Murphy's law can explain why this supply never tripped out during the five high voltage functional tests prior to flight. The loss of HVPS #2 resulted in a loss of detector #2 with a resultant loss of first order calibration data through the range 770Å to 296Å and second order calibration data through the 419Å to 296Å range. Detector #1 recorded 28 spectral scans providing first order calibration data through the 1340Å to 770Å range and second order spectral lines of 499Å, 537Å, 584Å, 625Å and 629Å. Detector #3 (ionization chamber) recorded the peak intensity of the strong Hydrogen Lyman Alpha line at 1216Å (saturated on the photomultiplier detector #1). These spectral data were apparently completely satisfactory in all respects. The aperture on detector #3 was, however moved back to the focal plane to sharpen the output pulse for the 21.023 flight.

The temperature sensor on the spectrometer exit slit failed during final integration of the payload, and a decision was taken to fly without this non-critical monitor. The temperature data obtained with the remaining five sensors during the flight are shown in Figures 7-5 and 7-6. It can be seen that although the Scientific Instrument mounting ring reached a temperature of about 100°C at apogee, the thermal isolation of the optical system was completely satisfactory, maintaining a temperature of about 16°C during the data taking part of the flight. Furthermore, the shutter and heat shield protected the optical system from thermal damage during re-entry. Significant heating of the Scientific Instrument did, however, occur while the payload was suspended from the parachute and was lying in the desert prior to recovery. During this period the Scientific Instrument was no longer under vacuum and hence no longer thermally isolated from the rocket skin. The temperature of the pointing reference camera rose to a level at which the emulsion of the H- α film became soft, posing a threat to the image quality. Although processing the overheated film was difficult the photographs taken during the CALROC 21.022 flight were satisfactory.

32. Dr. J. G. Timothy, Memorandum, "Temperature and Pressure Data from the CALROC II Flight," Harvard College Observatory, Boston, Massachusetts, October 31, 1973.

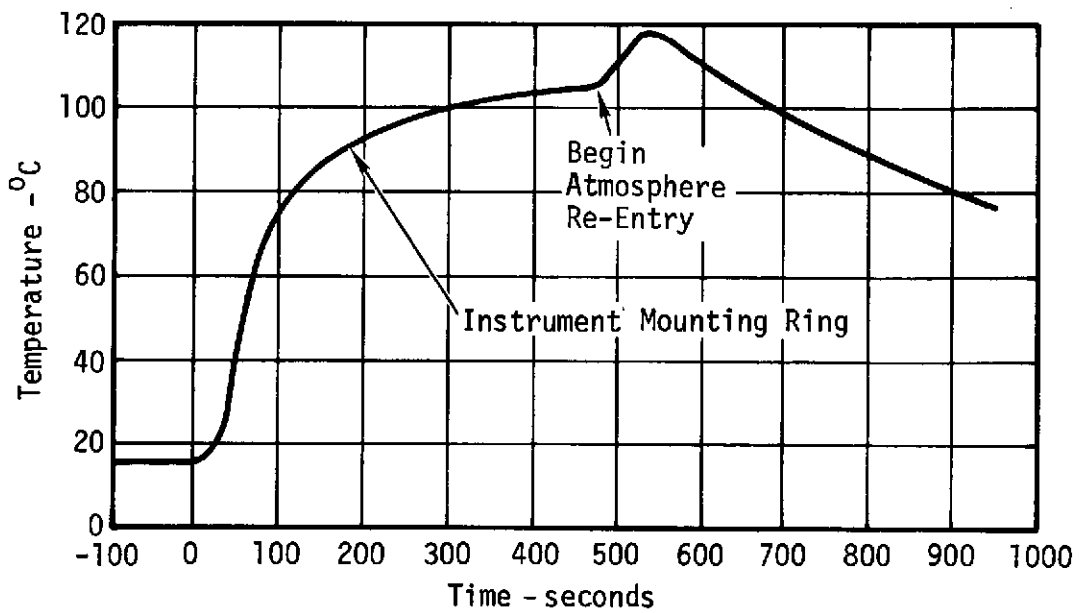
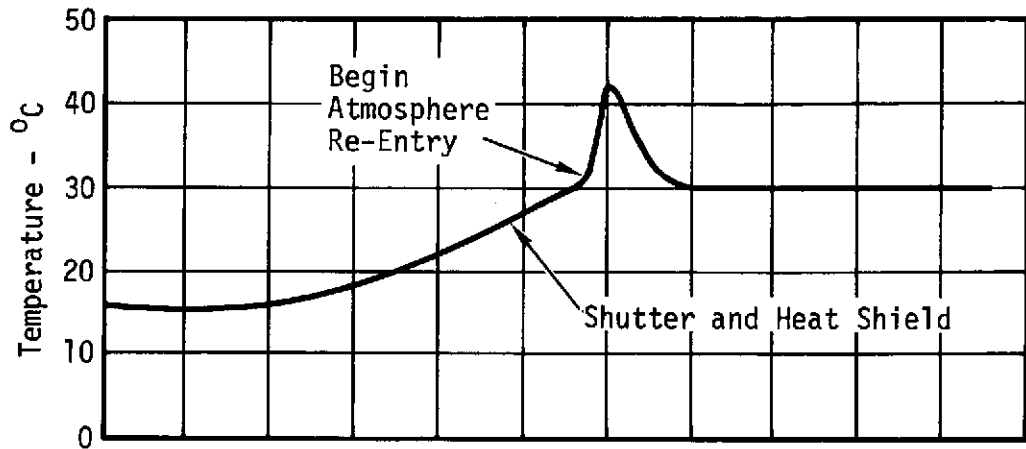

Figure 7-5. CALROC 21.022 Scientific Instrument Flight Temperatures

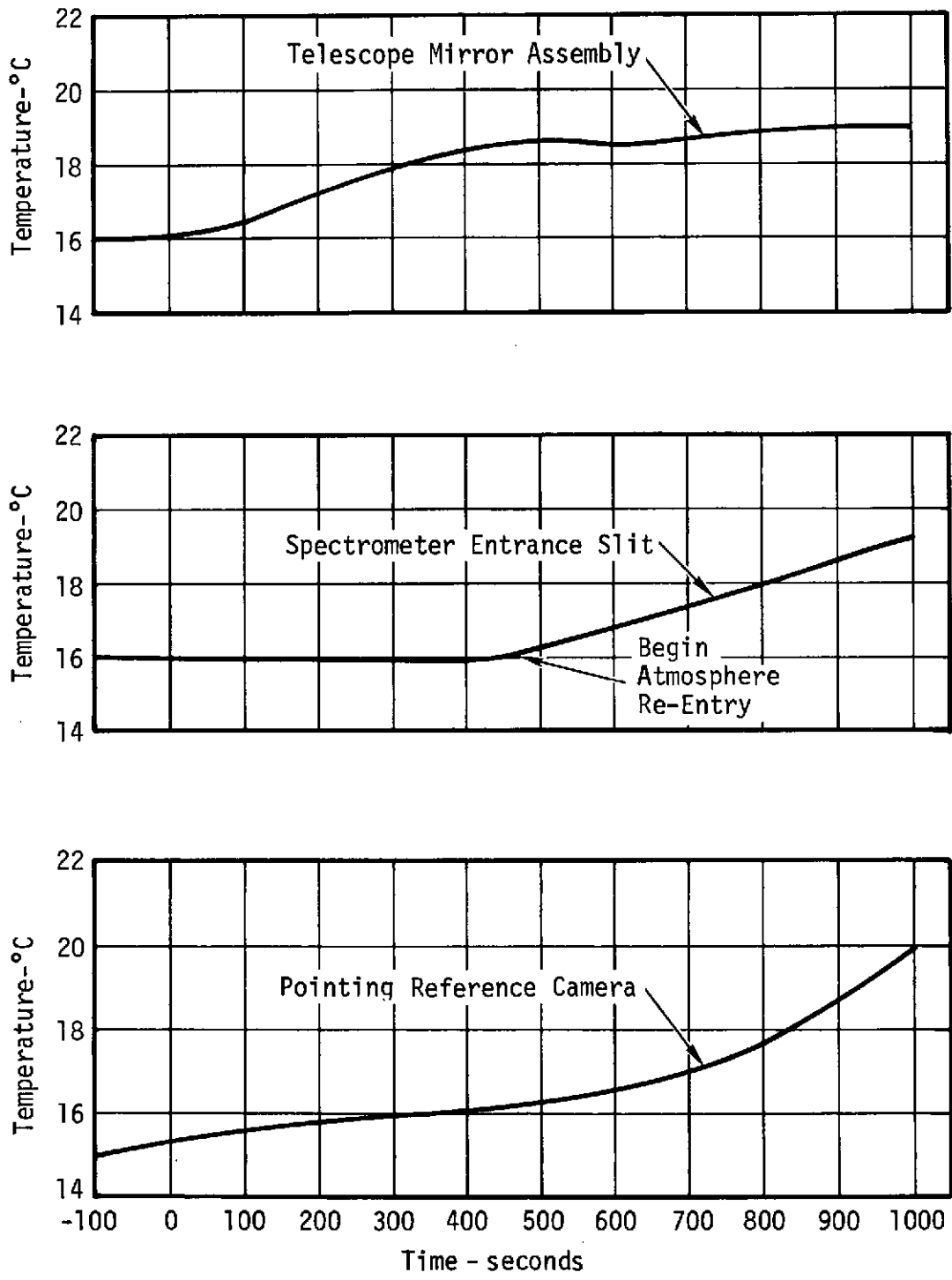

Figure 7-6. CALROC 21.022 Scientific Instrument Flight Temperatures

The Scientific Instrument section of the payload was evacuated for a period of approximately 40 hours prior to launch. The pumping port in the rocket skin was closed and the cryogenic pumping system retracted at T minus 120 seconds with the spectrometer pressure stabilized at 7×10^{-6} torr as measured on the internal cold cathode ionization gauge. Following the isolation of the Scientific Instrument the pressure rose asymptotically to a value of 1.4×10^{-4} torr at launch. The spectrometer pressure profile up to the time of gauge turnoff (T plus 110 seconds) is shown in Figure 7-7. A small perturbation in pressure can be seen immediately following liftoff with a sharp rise to about 9×10^{-4} torr during the period of maximum vibration and thrust acceleration. As an identical pressure rise was observed on the first CALROC flight (21.021) it can be attributed to the combined effects of outgassing from the heated skin and release of trapped gas by vibrational forces. Unfortunately, no data were obtained from the pressure gauge for the time period T plus 30 seconds to T plus 65 seconds due to overloading of the electrometer amplifier used to detect the ion current. This overloading was a direct result of vibration induced microphony at the amplifier input. However, payload separation occurred at T plus 60 seconds and the spectrometer would be expected to backfill to some fraction of the ambient atmospheric pressure (approximately 10^{-2} torr) at that time. It can be seen from Figure 7-7 that when the gauge started operating correctly at T plus 65 seconds the spectrometer pressure and the theoretical average atmospheric pressure were in agreement to within a factor of two. Following payload separation the spectrometer pressure fell rapidly to about 5×10^{-4} torr. It then rose to 6×10^{-4} torr before falling again to a value of 1.9×10^{-4} torr at the time of detector high voltage turn-on. The rise in pressure was coincident with the period of coarse acquisition, and hence maximum gas emission, by the SPARCS pointing control subsystem. It is therefore clear that the SPARCS subsystem had a major effect on the pressure environment of the payload at the time of coarse acquisition. However, after SPARCS entered the fine pointing mode and SPARCS gas pressure was reduced no further pressure effects were observed, and the system had no adverse effect on the quality of the solar EUV measurements. Extrapolating the pressure profile beyond T plus 110 seconds indicated that the spectrometer pressure was less than 1.0×10^{-4} torr for most of the data taking part of the flight. No effects of residual gas inside the spectrometer were observed in the EUV data and it was thus concluded that the operation of the payload pumping system was completely satisfactory in all respects.

Recalibration of the telescope mirror indicated a maximum shift in the reflectance of about 10% from the preflight values. For most wavelengths the shift was of the order of 9% or less.³³ Operation of the

33. Dr. G. Timothy, Memorandum, "Quick-Look Report on HCO Instrument Subsystem Performance 21.022", Harvard College Observatory Boston, Massachusetts, August 9, 1973.

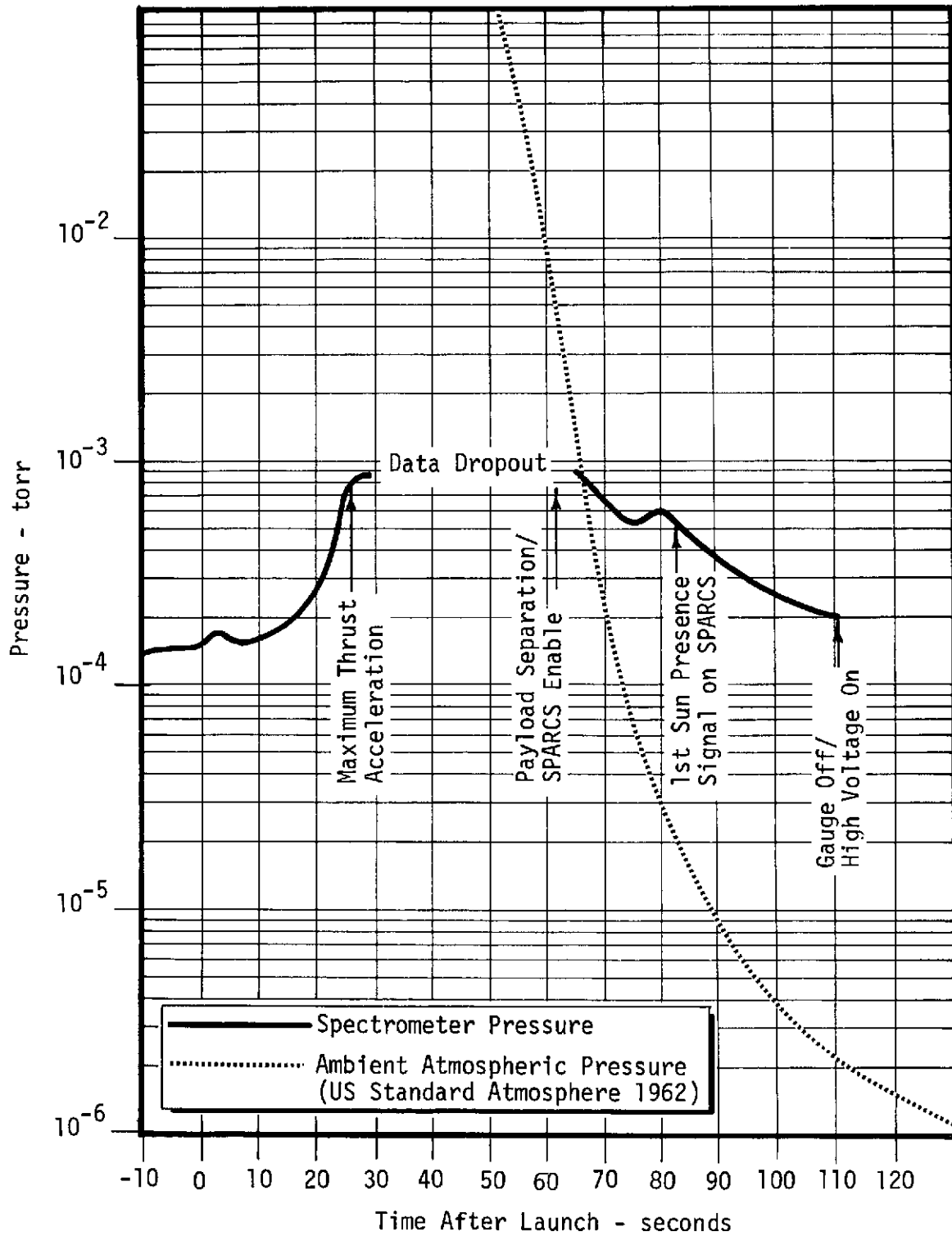

Figure 7-7. CALROC 21.022 Scientific Instrument Flight Pressure

spectrometer during the postflight UV baseline tests was completely satisfactory.

Measurement of the pointing reference camera photographs have been completed. The desired coordinates of the center of the raster pattern were 100 arc seconds North of central meridian and 445 arc seconds West of central longitude. The average coordinates of the center of the CALROC raster were 116.5 arc seconds North and 405 arc seconds West for the scan centered at apogee. Although a 10 arc second strip was thus East and outside of the ATM raster pattern, the pointing was essentially satisfactory. Payload pointing can be improved by:

a. Rotating the payload during the Carson tests using the BBRC coelostat. The SPARCS coelostat at WSMR was completely unsatisfactory for those tests.

b. Setting to electrical null from the SPARCS FSS and compensating for FSS dark current using the offset potentiometers.

Except for the non-operation of detector #2 this was a completely successful calibration flight.

The Telemetry system provided adequate signal strength throughout flight with all events occurring and monitors functioning as predicted.³⁴ During the Booster Motor burn portion of the flight there was intermittent housekeeping commutator data due to aerodynamic heating of the wiring/connectors in the Nosecone and Recovery area which may have caused shorting of the Telemetry 5-volt regulator. The system was modified to provide better thermal insulation and another 5-volt regulator added prior to the 21.023 flight. The Telemetry system was recovered in satisfactory condition.

The Recovery system functioned properly and successfully recovered the payload as shown in Figure 7-8. Heat shield deployment occurred at 20,000 feet (as designed) with the drogue and main parachutes deploying in the proper and normal manner.³⁵ The drogue and main parachutes were found to be in very good condition during postflight inspection. There was some evidence of re-entry aerodynamic heating

34. J. Wolff Memorandum, "NASA Black Brant 21.022 HCO CALROC Flight Report," to E. Bissell, NASA Goddard Space Flight Center, Sounding Rocket Division, Greenbelt, Maryland, September 20, 1973.

35. J. Lane, Memorandum, "Preliminary Post-Flight Evaluation of Black Brant VC (BBVC) NASA 21.022," NASA, Goddard Space Flight Center, Sounding Rocket Division, Greenbelt, Maryland, August 15, 1973.

Figure 7-8. Post-Flight HCO CALROC 21,022 Payload.



COURTESY U. S. ARMY
WHITE SANDS MISSILE RANGE,
WHITE SANDS, N. M.

on the stainless steel recovery end of the payload, however, little or no aerodynamic flow went past the heat shield prior to its deployment.

7.2 Flight 21.013. NRL flight 21.013, weighing 599.2 pounds, was launched at WSMR September 4, 1973 at 16:45:0.84 GMT for the purpose of obtaining a second set of data to calibrate the NRL S082 experiment data during Skylab 3. Vehicle performance parameters such as vehicle roll rate, velocity and altitude were near predicted values as shown in Figures 7-9, 7-10, and 7-11. Additional flight performance data are included in Table 7-2. Vehicle roll rate (4.25 rps) was slightly higher than on previous flights, yet within design limits (4.0 ± 0.6 rps). Vehicle velocity and payload altitude were slightly less than observed on previous NRL CALROC flights. (Compare Tables 6-2 and 7-2). This was due in part, to a lower acceleration and shorter burn time.

SPARCS was enabled at 66.7 seconds and 29.3 seconds later had acquired the sun and was in the fine pointing mode. SPARCS maintained fine pointing accuracies of less than 0.5 arc seconds peak-to-peak error in pitch and yaw and less than 0.01 degrees error in roll throughout the calibration data taking period.³⁶ The design goal was less than 20 arc seconds error in pitch and yaw and less than 1.2 degrees error in roll. The 21.013 SPARCS had the best performance to date on NRL CALROC payloads. The decision to rely on the FSS electrical null rather than the optical null for primary mirror co-alignment was apparently correct as the initial pitch/yaw position was where it was expected to be. There were some 15 unexplained "jumps" in SPARCS. (5-10 arc seconds of 1 second duration.) It is believed the "jumps" were probably due to dirt particles falling in front of the FSS eyes. This type of motion has been simulated at NASA Ames Research Center by dropping sand in front of the FSS. The jumps correspond to times when the most particles were observed on the H-alpha TV; that is, at the beginning of the flight and at each camera actuation. After the jumps, the SPARCS returned to the normal pointing. This SPARCS was recovered in excellent condition.

Numerous changes were incorporated into the 21.013 Scientific Instrument as a result of the 21.012 flight. The changes were:

a. Baffles to enclose the "A", "H", and "C" camera subsystems eliminating stray light.

36. "Preliminary SPARCS Flight Summary for 21.013." LMSC/D338362, Lockheed Missile and Space Company, Sunnyvale, California, September 13, 1973.

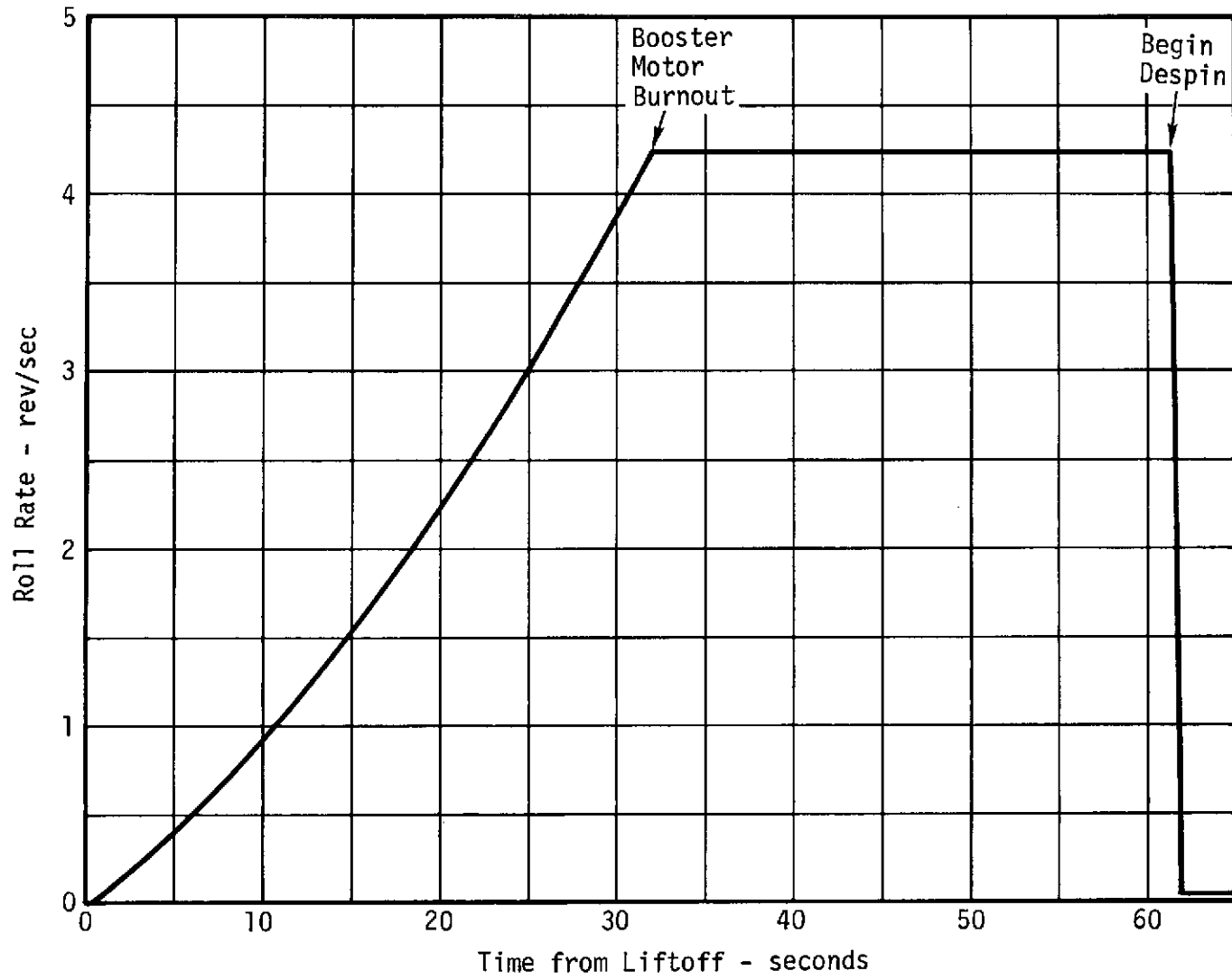

Figure 7-9. Flight 21.013 Roll Rate Profile

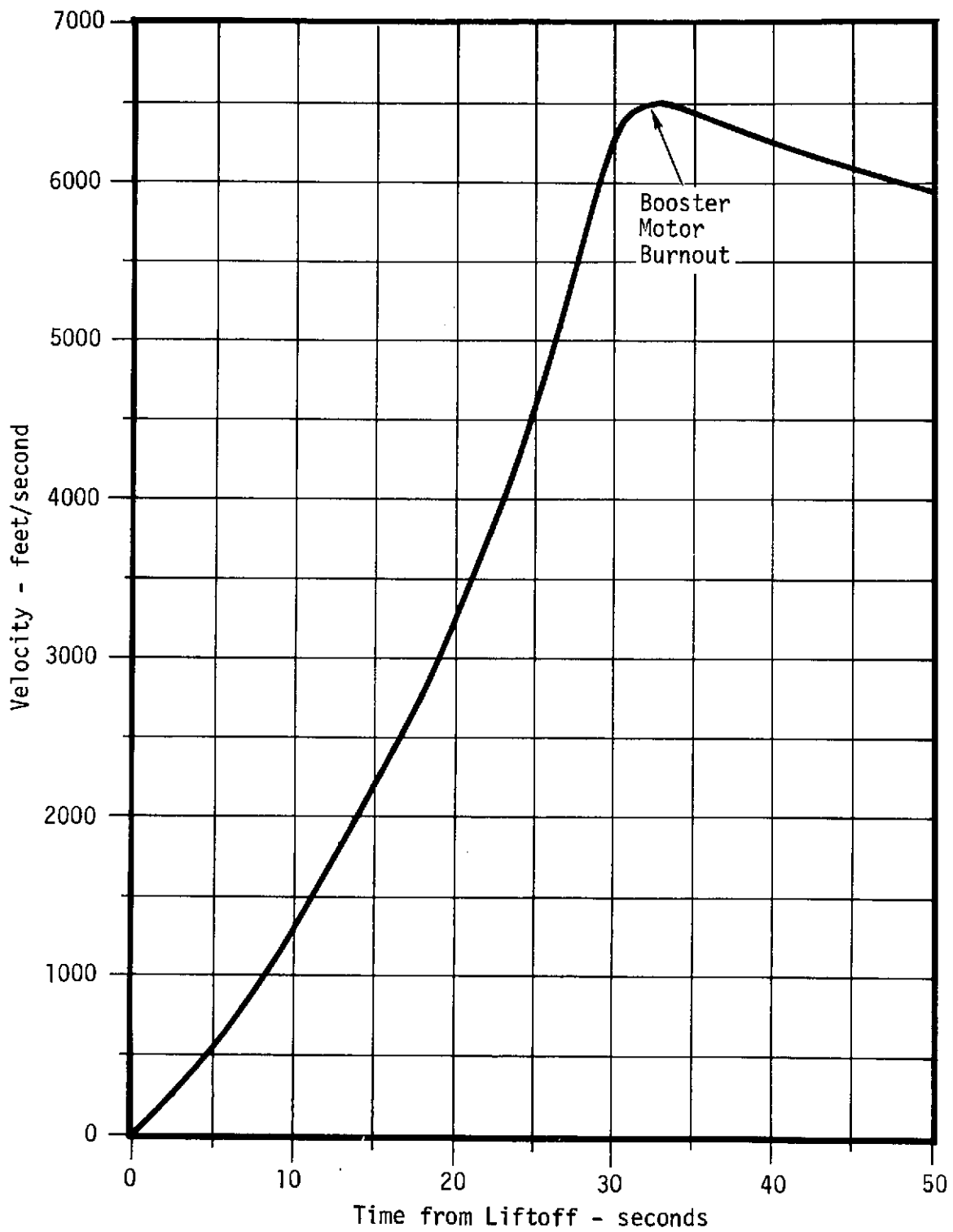

Figure 7-10. Flight 21.013 Velocity Profile

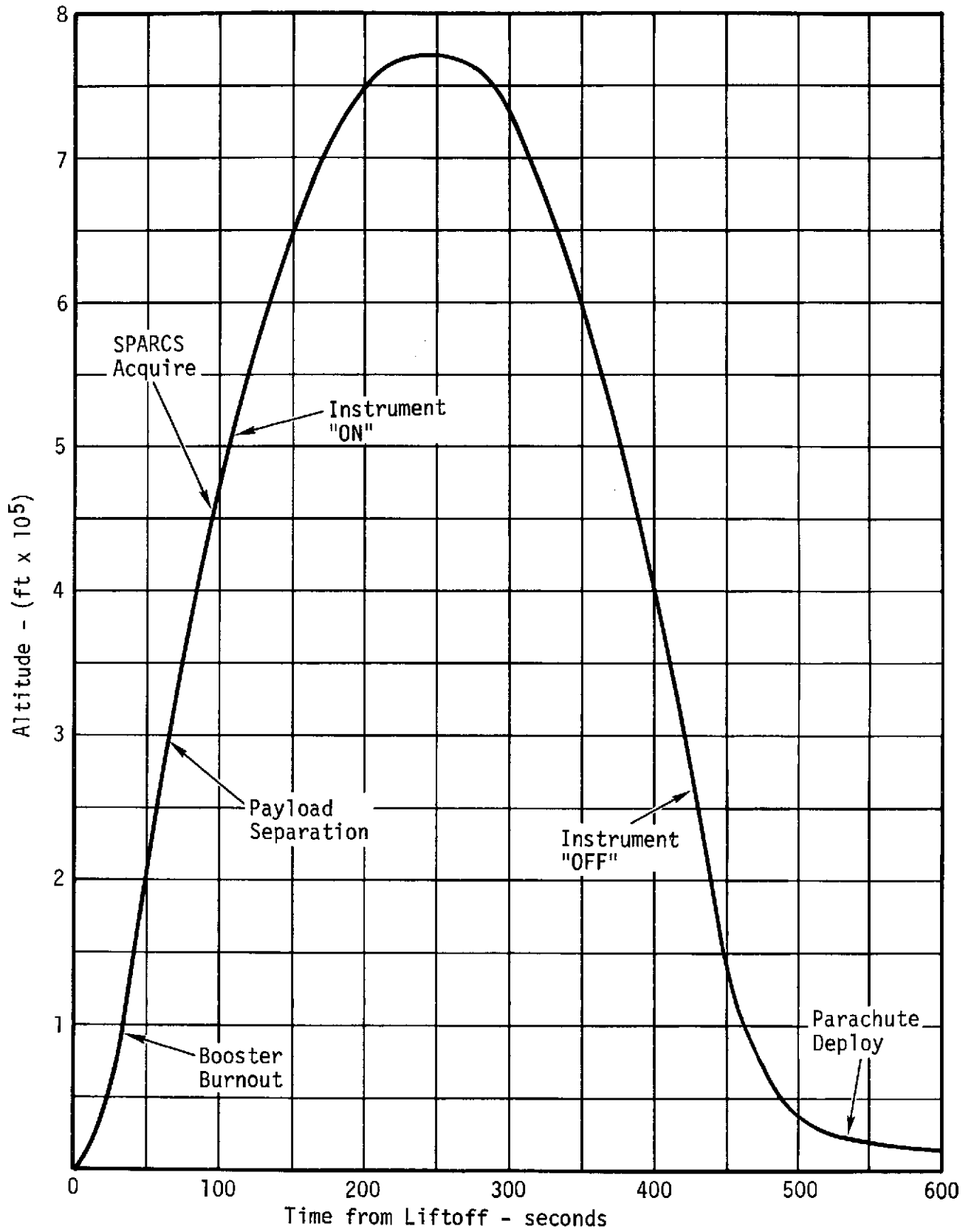

Figure 7-11. Flight 21.013 Altitude Profile

Table 7-2. 21.013 Flight Profile

<u>EVENT CONDITION</u>	<u>ACTUAL</u>	<u>PREDICTED</u>
Liftoff time T+0 (GMT)	16:45:0.84	
Peak acceleration (g's)	11.75	13
Burnout time (sec)	31.6	32.4
Burnout velocity (fps)	6,520	6,650
Burnout altitude (ft)	96,664	98,732
Burnout roll rate (rps)	4.25	4.0±.6
Nosecone eject time (sec)	57.95	57.5
Despin time (sec)	61.5	61.0
Post despin roll rate (rps)	0.054	0.0
Payload separation time (sec)	64.0	64.5
SPARCS enable (sec)	66.7	68
Sun acquisition (sec)	96.0	
Instrument "ON" (sec)	128	127.0
Apogee time (sec)	244.0	248.4
Apogee altitude (stat mi)	146.0	151.8
Heat shield deployment (sec @ ft)	525.43/20,000	20,000
Instrument "OFF" (sec)	426	427
Top hat off (sec)	451	N/A
Chute deployment (sec)	538.34	541
Payload impact (sec)	840	890

- b. Front aperture stops. Sheet metal cutouts mounted on the aperture plate to further reduce stray light.
- c. "B" slit plate protector in the form of a blade in front of the slit plate to prevent contamination falling on the slit plate during launch. The blade was retracted by a launch lock squib mechanism.
- d. "H" primary filter protector in the form of a door on the instrument side of the aperture plate. The door was spring loaded and opened when the vacuum dome came off.
- e. "H" secondary aluminum filter protector. The "H" camera door was moved from just behind to just in front of the filter so that the door would protect the filter during launch.
- f. "A" aluminum filter protector. A door was added in front of the aluminum filter and actuated by the existing "A" camera film slides launch lock.
- g. The aperture plate bleedup valves were replaced because those on 21.012 were damaged on impact and allowed dust to be sucked into the Instrument. The new valves bleed up to ambient and include fine mesh filters.
- h. Heavier bracket on the "A" camera-to-grating Invar rod. The 21.012 bracket broke on impact.
- i. "A" zero order shield modified to eliminate stray light in the short wavelength position.
- j. Blackened magnesium "C" camera housing and "B" film cassette to reduce film fogging, (also teflon free black magnesium film drums for the same reason). Vacuum tests show blackened magnesium to have much fewer film fogging effects than either black aluminum or teflon coated black magnesium.
- k. Modification of vacuum dome switch bracket. On previous flights the microswitch bracket became distorted during final assembly and falsely indicated "dome off" in the tower.
- l. The balance weight was mounted to the aperture plate front surface instead of radially toward the skin.
- m. The Fine Pointing System (FPS) range was increased from approximately 55 seconds to over 200 seconds enabling the FPS to follow the SPARCS anomalies of 21.012.

n. A monitor point was added to the H-alpha TV camera to determine the light level during flight. (21.012 appeared to saturate).

o. A new SIT tube was installed in the H-alpha TV camera improving the image quality.

The 21.013 payload was launched with three known anomalies. They were:

a. Aperture skin thermister (channel 84) was not always reading properly.

b. One electronics launch-lock back-up squib was reading open. This was believed to be an erroneous reading as it had happened a few days before launch. At that time, the squib connector was cleaned up and it read satisfactorily. Even if it was "open" the primary squib would actuate the launch lock.

c. The FPS would saturate prematurely in one direction -200 arc seconds instead of the -300 arc seconds design. Extensive testing before flight indicated proper FPS operation other than premature saturation which was not critical to mission success.

The following conclusions can be drawn relative to the Scientific Instrument operation during the 21.013 flight.³⁷

a. H-Alpha TV Camera. The H-alpha TV video was saturated or near saturation on all the limb positions. It appears the TV camera was set up at Westinghouse with more "average AGC" than "Peak detection AGC". This averages the black to the right of the limb with the solar disc video, driving up the solar disc video which saturated the video amplifier.

b. H-Alpha Film Camera. The 150 millisecond exposures were slightly overexposed, but were usable for identifying on-the-disc features. The 200 millisecond exposures were overexposed but usable for identifying limb features.

c. Heliograph ("H") Camera Subsystem. All telemetry received from the "H" camera subsystem indicated proper electro-mechanical operation throughout the flight. The pictures from the "H" camera look excellent. Some frames may have lost some resolution due to SPARCS jumps. The "H" camera subsystem appears to have survived recovery with little damage except for the aperture filter.

37. R. Schumacher, Memorandum 7149-78, "Final Report NI-3 CALROC 21.013, Naval Research Laboratory, Washington, D. C. March 11, 1974. .

d. "C" Camera Subsystem. Telemetry indicated the "C" camera subsystem worked properly electro-mechanically, with the exceptions of apparently a 1/2 drum movement at camera pulse 10 (T+256 seconds) and skipping drum position number 12 at T+280 seconds. The flight film shows good sectorized spectra of the right density. Two of the spectra indicated the camera drum did not position properly. The other 21 spectra show good camera drum alignment. Due to repetitious exposures, it is believed no data was lost.

e. "B" Camera Subsystem. Telemetry indicated the "B" camera subsystem performed properly with the exception of a 10 arc second peak to peak movement of the primary mirror when the H-alpha film camera actuated. The spectrographs indicated good data on all camera positions except one. The 24 second exposure of the 300 arc second position was lost when the Principal Investigator (PI) inadvertently commanded the payload in the wrong direction. The spectral density was less than desired due to the use of 104 rather than 101 film. The preflight, flight and postflight calibrations correlation seems to be excellent. There appears to be some type of a problem with the predicted values of densities when compared with 21.012 data. It is hoped that flight 21.014 will resolve these differences.

f. "A" Camera Subsystem. One-half of the new aluminum filter shutter failed to open when the "A" camera launch lock was fired (because of a loose screw). Consequently, only one-half of each spectroheliograph was obtained. The effect of this failure on the calibration data is minimal. The short wavelength frames are of sufficient density to provide a satisfactory calibration. The synchrotron calibration spectrum was present with no obvious latent image degradation. The camera double exposed one frame in the short wavelength sequence. The long wavelength frames were weak and will make calibration difficult. The best long wavelength exposure ended up on a short wavelength slide due to a camera double exposure. Thus, the focus was not optimum and no long wavelength synchrotron calibration was present. The synchrotron calibration on the rest of the long wavelength frames was satisfactory, but the solar densities were very low. There were some stray light streaks which could be due to filter pinholes, filter shutter door reflection and/or, baffle reflection. At the present baffle reflections appear to be the most likely cause, as the streaks move with grating position movement.

g. Fine Pointing System. The Fine Pointing System removed all motions of the limb perpendicular to the slit as expected. However, there were two anomalies not expected: the 10 arc second peak to peak movement of the primary mirror caused by the Nikon H-alpha film camera and the apparent 4-6 arc second absolute pointing error (-z direction, toward solar center).

The camera subsystems were calibrated before flight in a similar manner with the exception of the "A" camera. The "A" camera flight film was calibrated at National Bureau of Standards (NBS) before flight. Thus, the two primary camera subsystems, the "A" Spectro-heliograph and the "B" Spectrograph, flew with calibrated flight film.

The "A", "C", and "H" camera subsystem hardware flown on this flight (21.013) was refurbished from flight 21.012. This hardware returned from 21.012 in refurbishable condition and reflying it made it easier to correlate 21.013 data with 21.012 data.

The 21.013 flight was the most successful NRL CALROC flight to date. All subsystems performed satisfactorily and good calibration data was obtained with each camera subsystem. The payload received a severe shock on ground impact but the damage was not extensive enough to prevent good post flight calibration of the A and B camera subsystems. However, the data obtained from the 21.013 flight was sufficiently different from the data obtained from the 21.013 flight to require a 21.014 launch for calibration of the S082A and S082B Experiments during Skylab 4.

A postflight review of the telemetry data and recovered Telemetry/instrumentation system was conducted and the results indicate the overall performance of the system to be completely satisfactory.³⁸

Excellent quality telemetry data were obtained throughout the flight interval. All timer-initiated events occurred on time, with battery supply voltages remaining nominal. All signal conditioners, tone ranging, beacon, and transducer performances were satisfactory except for a momentary abnormal indication on the motor chamber pressure (P_c) gauge. The P_c gauge data indicated a shorted data output was present for approximately 300 milliseconds during tower exit and again from T+12 seconds until T+19 seconds during flight. During all other portions of the flight the P_c data was normal and good data were obtained. Reasons for the abnormal periods of P_c data were believed to be associated with either the internal gauge wiring or the external wiring between the gauge and the Telemetry input interface. The abnormal indication was believed to be a random situation, therefore, no P_c gauge corrective action on future CALROC flights was deemed necessary. The only telemetry subsystem change on flight 21.013 was the replacement of one-fourth amp fuses in the SPARCS

38. J. Cameron, Memorandum, "Post-Flight Report on Telemetry/ Instrumentation System Performance on NRL CALROC Launch 21.013," NASA, Goddard Space Flight Center, Sounding Rocket Division, Greenbelt, Maryland, September 28, 1973.

command receiver power distribution circuit with one-eighth amp fuses. One-eighth amp fuses were used because one-fourth amp fuses were not available. Performance of the television signal transmission system was very satisfactory. A continuous and good quality signal was received throughout the period of sun acquisition. A review of the recovered system indicates no structural or mechanical attachment damage was encountered due to flight and/or recovery loads.

The Recovery system operated properly and the payload was recovered in reasonably good condition as shown in Figure 7-12. The payload landed in the hills and on descent one edge of the Instrument hit a rock resulting in a major distortion and crumpling of the outer skin. The damage as such did not distort the Scientific Instrument optical bench beyond repair. Actually, the Scientific Instrument was easily removed from the outer can (skin). The impact was on hard ground and localized on one corner of the can which dislodged one of the cameras, without camera damage. GSFC feels that the recovery system design was adequate to properly recover a 600-pound payload.³⁹

39. J. Guidotti, Memorandum, "NASA Black Brant VC (BBVC) 21.013 Preliminary Flight Report", NASA, Goddard Space Flight Center, Sounding Rocket Division, Greenbelt, Maryland, October 3, 1973

Figure 7-12. Post-Flight NRL CALROC 21.013 Payload.



Vacuum Port

COURTESY U. S. ARMY
WHITE SANDS MISSILE RANGE,
WHITE SANDS, N. M.

Section 8

PERFORMANCE - SKYLAB 4 CALROC FLIGHTS

SECTION 8

PERFORMANCE - SKYLAB 4 CALROC FLIGHTS

The Skylab 4 mission began on September 25, 1973 with the undocking and splashdown of the Skylab 3 crew. An unmanned period preceding the launching of the Skylab 4 crew on November 16, 1973. Thus, the Skylab 4 manned mission began on November 16, 1973 and terminated with the splashdown of the Skylab 4 crew on February 8, 1974. During this period, two Skylab ATM Calibration Rockets were launched at WSMR. The first was HCO flight number 21.023 and the second NRL flight number 21.014. Both flights obtained excellent data for calibrating the Skylab 4 data and thus were classified as successful.

8.1 Flight 21.023. HCO flight 21.023, weighing 496 pounds, was launched at WSMR on December 10, 1973 at 19:10:0.23 GMT for the purpose of obtaining a second set of data to calibrate the HCO S055 Experiment data taken onboard Skylab 4. Rocket Motor performance and payload trajectory were nominal.⁴⁰ Peak altitude (apogee) was 168.5 statute miles as compared to a predicted apogee of 172 statute miles. Vehicle maximum roll rate was 3.85 revolutions/second as compared to a design roll rate of 4 ± 0.6 revolutions/second. The motor chamber pressure (P_c) gauge failed at approximately T+27 seconds with the cause unknown. The pitch-yaw gauge became erratic at T+25 seconds and failed at T+35 seconds as expected. This gauge has experienced similar conditions on previous Black Brant VC rocket flights. All mechanical functions such as yo-yo despin, nosecone eject, payload separation, heat shield deployment, drogue and main parachute deployments occurred in a normal manner and approximately on time. A tabulation of CALROC 21.023 flight parameters can be found in Table 8-1.

Following successful despin and payload separation, SPARCS was enabled at T+63.4 seconds. Less than 20 seconds (19.3) later, SPARCS had acquired the sun and was in the fine pointing mode. Except for two short intervals of time, SPARCS maintained fine pointing accuracies of less than 0.3 arc seconds peak-to-peak error in pitch and yaw and less than 0.1 degree peak-to-peak error in roll throughout the calibration data taking period (T+109.0 to T+447 seconds).⁴¹

-
40. J. Wolff, Memorandum, NASA Black Brant 21.023 HCO CALROC Flight Report, "NASA, Goddard Space Flight Center, Sounding Rocket Division, Greenbelt, Maryland, February 5, 1974
41. "Preliminary SPARCS Flight Summary for 21.023," IMSC/D384859, Lockheed Missile and Space Company, Sunnyvale, California, January 16, 1974.

Table 8-1. Payload 21.023 Flight Parameters⁴²

<u>EVENT</u>	<u>ACTUAL</u>	<u>PREDICATED</u>	<u>REMARKS</u>
Launch @ (GMT)	19:10:0.23		
Burnout velocity (fps)	7020	7086	
Burnout @ (sec)	31.8	32.4	
Burnout roll rate (rps)	3.85	4.0	
Nosecone eject @ (sec)	55-56	56	
Despin @ (sec)	57-58	58	
Payload separation @ (sec)	60-61	60	
Instrument Programmer "ON" (sec)	63-64	63	
SPARCS modes @ (sec)			
Coarse mode	63.65-77.52		
Intermediate mode	77.52-82.80		
Fine mode	82.80-462.05		
Intermediate mode	462.05-463.60		Re-entry
Coarse mode	463.60-LOS		
Instrument "ON" @ (sec)	109	109.5	
Apogee altitude (stat mi)	168.5	172	2% Low
Instrument "OFF" @ (sec)	470	460	
Recovery initiation			
Altitude (ft)	22,000	20,000	
Time (sec)	558	570 + 15	
Impact (stat mi)	70.5 North	56 North	Within 2-sigma
	23.8 West	15 West	

42. M. Nolan, Memorandum "Preliminary Post-Flight Report for NASA 21.023", NASA, Goddard Space Flight Center, Sounding Rocket Division, Greenbelt, Maryland, January 15, 1974.

The design goal was less than 20 arc seconds error in pitch and yaw and less than 1.2 degrees error in roll. Although SPARCS acquired the sun in 19.3 seconds following "enable," the total time required to stabilize the payload for Instrument "turn-on" was 36 seconds. This stabilizing time was somewhat longer than the anticipated 25 seconds because of a final roll maneuver of 158 degrees. The roll position was 158 degrees from the roll null angle programmed into the SPARCS' roll registers when the "G" switch, or fine pointing switch occurred 22 seconds after SPARCS enable. The remaining time was required to correct this roll error. Pitch/yaw stability was affected during this time due to coupling of the roll into the pitch and yaw axis. The effects were less than 5 arc seconds error peak to peak.

The two short intervals of time mentioned earlier when SPARCS exceeded the 0.3 arc second peak-to-peak error in pitch and yaw occurred at T+130-131 seconds and T+248.5 seconds. The disturbance at T+130 caused a 6 arc second pointing error in pitch and 12 arc seconds in yaw. The T+248.5 disturbance caused errors of 8.5 arc seconds in pitch and 9 arc seconds in yaw. In addition a 0.2 arc second disturbance in pitch for approximately 0.25 seconds was observed each time the Scientific Instrument camera shutter operated. The Nikon camera shutter was triggered every 13.17 seconds during the flight starting at T+109.5 seconds. These disturbances did not affect the calibration data and the source of the first two disturbances has not, as yet, been determined.

SPARCS was recovered in excellent condition and could be refurbished for a future flight.

From a preliminary analysis of the Scientific Instrument data the following conclusions can be drawn:⁴³

a. The flight was a complete success. Excellent data were obtained from all three detectors with the CALROC and ATM Scientific Instruments observing the same region of the solar disc. The Scientific Instrument was recovered in an undamaged condition and is currently being recalibrated in the laboratory. Details of these results will be available in due course.

b. There was an unexplained northerly motion of approximately 10 arc seconds observed in photograph #8. The motion was real and

43. Dr. J. G. Timothy, Memorandum, "Quick-Look Report on Third Harvard CALROC (21.023)," Harvard College Observatory, Boston, Massachusetts, January 9, 1974.

outside the measurement error. The location of the raster center was 133 arc seconds South and 35 arc seconds West of sun center. The desired location was 150 arc seconds South and 30 arc seconds West, however, the field of view of the CALROC lay completely within the field of view of the ATM. The pointing was thus completely satisfactory.

c. The pressure inside the Scientific Instrument was 7.4×10^{-5} Torr at launch and 5.7×10^{-5} Torr at the time of high voltage turn-on. This was the best vacuum of the three HCO CALROC flights.

d. Temperatures were cooler than those observed on the second CALROC flight (21.022) with a maximum temperature at the Scientific Instrument mounting ring of 106°C . No signs of thermal damage were observed on the emulsion in the pointing reference camera. Full details of the temperature and pressure profiles are available at Harvard College Observatory.

The data from the last two HCO CALROC flights will be of immeasurable value in interpreting the scientific data from ATM and we have thus satisfied the primary requirements of the HCO CALROC project.⁴³

Instrumentation and Telemetry performance was satisfactory.⁴⁰ Two abnormalities were noticed. The P_c gauge failed at approximately T+27 seconds and the pitch-yaw gauge failed at T+35 seconds. Similar difficulties have been noticed with these gauges on previous Black Brant VC flights. The pitch-yaw gauge failure was believed to be caused by exit heating. This gauge provides valuable diagnostic data and will be used until a less heat sensitive gauge is developed. No explanation is available for the P_c gauge failure.

The recovered payload, shown in Figure 8-1, was in very good condition, with one dent in the Ogive/Recovery Separation Assembly (ORSA) skin. The ORSA skin did exhibit effects of a hot re-entry. The stainless steel skin exhibited considerable areas of "bluing". One connector at the front end of the ORSA had been very hot sometime during flight. The two areas of excessive heating were apparently caused by incomplete seating of the heat shield against the ORSA Aft Assembly. All ORSA Aft Assemblies had been modified to eliminate one heat shield connector and move the other connector radially inboard. Aluminum "plugs" were used to "fill in" the spaces left open by the modification. The "plugs" did not exactly match the mating surface of the heat shield. Two openings (approximately 0.015 inches by 3 inches) apparently allowed ram air to flow into the aft assembly during re-entry.⁴⁴

44. R. Plihal, Memorandum to J. Wolff, "HCO Skylab 21.023 Vehicle Subsystem Action Item Report," Goddard Space Flight Center, Sounding Rocket Division, Greenbelt, Maryland, January 18, 1974.



Figure 8-1. Post-Flight HCO CALROC 21.023 Payload.

8.2 Flight 21.014. NRL flight 21.014, weighing approximately 590 pounds, was launched at WSMR on January 15, 1974 at 19:00 GMT for the purpose of obtaining a third set of data to calibrate the NRL S082 Experiment data taken onboard Skylab 4. The Rocket Motor performance was satisfactory, providing burnout 31.9 seconds after liftoff, a vehicle roll rate of 4.25 revolutions/second and a payload apogee of 146 statute miles.⁴⁵ Predicted performance parameters were 32.4 seconds for burnout, 4.0 ± 0.6 revolutions/second roll rate and payload apogee of 151 statute miles. Payload apogee time was 244.4 seconds as compared with 250 seconds predicted. The lower than predicted apogee and apogee time resulted from the earlier than predicted burnout which has been characteristic of Black Brant VC Motors used on the CALROC project. Telemetered data from the SPARCS commutator indicated that the vehicle roll rate was reduced from 1530 degrees/second (4.25 rps) to 23.3 degrees/second with the yo-yo despin system and to zero by SPARCS 0.45 seconds after SPARCS enable.

SPARCS was enabled at T+68.1 seconds and had achieved fine pointing of the payload 28.6 seconds later (T+96.7 seconds). In another 26.3 seconds (T+123 seconds) payload pointing was completely stabilized in all three axes and ready for Scientific Instrument "turn-on." The H- α TV tapes reveal that SPARCS initially acquired at approximately the correct roll angle of $\phi_{\sigma} = 321^{\circ}$ at T+117 seconds. By T=130 seconds SPARCS had rolled to $\phi_{\sigma} = 320^{\circ}$. SPARCS continued to drift in roll slowly so that at T+240, $\phi_{\sigma} = 316^{\circ}$ and at T+340, $\phi_{\sigma} = 314^{\circ}$. One consequence of the roll drift was to put the -50 arc second pointing position of the "B" camera slit over a filament. Filament pointing had been planned as an area of avoidance. However, this position was relayed to Skylab so that the Skylab S082B Experiment was pointed to the same filament. The major consequence of the roll drift was a slight smearing of the first "A" exposure (T+128 to T+184).

The SPARCS pitch, yaw pointing stability was excellent. It was the best of all the NRL CALROC flights. SPARCS maintained payload pointing accuracies of less than 0.5 arc seconds error in pitch and yaw and except for the aforementioned roll drift maintained less than 0.1 degrees error in roll from T+123 seconds to T+432.3 seconds when the Scientific Instrument shutter closed over the Fine Sun Sensor.⁴⁶ The design goal was the same as in all previous CALROC flights. The SPARCS command link performed all three inflight commands flawlessly.

45. E. Bissell, Memorandum to L. Belew, "Quick Look Flight Report on NASA 21.014," NASA, Goddard Space Flight Center, Sounding Rocket Division, Greenbelt, Maryland.

46. "Preliminary SPARCS Flight Summary for 21.014," LMSC/D384948, Lockheed Missile and Space Company, Sunnyvale, California, February 8, 1974.

The 21.014 Scientific Instrument was basically a refurbished 21.013 flight instrument. No major changes were incorporated into 21.014. The minor changes that were incorporated for repair, and improvement were:⁴⁷

- a. A New H- α filter was installed for improved efficiency.
- b. New skins (aperture end and electronic end) were fabricated to replace the damaged skins from previous flights.
- c. A new vacuum dome was fabricated; this item was lost with each flight.
- d. A new front aperture plate was fabricated, aligned and installed.
- e. The 21.012 flight Fine Sun Sensor (FSS) was used.
- f. Damage to the structure mount of the "B" camera and substructure of the "A" Camera Subsystem was repaired; this damage occurred at 21.013 recovery impact.
- g. A neutral density filter was added to the H- α film camera optics and the H- α exposure times were increased. This produced clearer H- α pictures by increasing the ratio of exposure time to shutter vibration time.
- h. The "soft" zener that caused the premature FPS servo saturation on 21.013 was replaced.
- i. FPS video gain was reduced to prevent saturation in flight.
- j. The FPS relay lens was replaced and system realigned. The lens was broken from 21.013 recovery impact.
- k. The "A" camera aluminum filter protection door was reworked to prevent malfunctioning. This door jammed halfway open on flight 21.013.
- l. Refurbished all cameras. This was regular maintenance practice.
- m. The damaged 21.013 flight programmer electronics cable connector was replaced.

47. "Final Report NI-4 CALROC 21.014," Naval Research Laboratory, Washington, D. C., March 15, 1974

n. A new program plug was designed and fabricated, which was necessary with each flight.

o. The baffling that was interfering between the structure and the slit slot assembly was removed.

p. The "A" film slide holders were modified to improve the focus positioning.

q. The center ring that was deformed by the 21.013 recovery impact, was repaired.

r. A new SIT tube was installed in the H- α TV camera. This was needed for improved H- α TV reception.

s. "A" camera launch lock mechanism was reworked to prevent hanging up on "A" base plate.

Telemetry information indicated the "A" camera subsystem worked properly electromechanically. At first it was thought the "Start" slide did not cycle, but further investigation indicated it did cycle and went past the magnetic switch position. The eight prime "A" exposures (1 through 4 and 6 through 9) look very good. The 2.5 second and 4.0 second exposures were too weak to be usable (as expected). The baffle reflection problem of 21.013 did not appear on 21.014 and the grating stray light was reduced. The resolution was about 5 arc seconds over the entire wavelength range, as predicted. The synchrotron calibration exposures were present on each strip, and appeared to be of the correct density. The aluminum filter was still in good condition and was used for post-flight calibration. A ruptured launch lock squib apparently did not degrade the Instrument efficiently.

The "B" Camera Subsystem telemetry data indicated the "B" Camera Subsystem operated properly electro-mechanically with one exception. The "B" camera door microswitch did not indicate closed. It did indicate the door had left the "Open" position. After recovery examination showed the door was closed. All 24 exposures looked very good and were usable for calibration. The deuterium and nitrogen calibration spectra were present, at the correct density. The 112 second exposure at -50 arc seconds shows the solar continuum down to less than 1300Å, which was one of the prime objectives. The "B" camera cassette was designed with enough film slots to accommodate the fast 101 film, but when loaded for a full program with the slower 104 film, there remained some film slots that were not usable for calibration. Those late exposures were on the re-entry portion of the trajectory and too far into the atmosphere for "B" Spectrograph calibration. To take full advantage of the Instrument and the rocket flight, the last

few slots were loaded with 101 film. The combination of SPARCS and FPS kept the Instrument slit pointed to the sun until program end. The 101 film fog level was less than 0.10 which was typical for this emulsion when exposed to vacuum. These factors plus the fast exposures produced a bonus of good atmospheric extinction data.

The flight telemetry data indicated the "C" Camera Subsystem operated properly electro-mechanically. All 24 exposures looked very good. The pre and post-flight calibrations agree. The choice of slit size was correct, giving the proper range of densities over the sectorized segments.

The flight telemetry data indicated the "H" Camera Subsystem operated properly electro-mechanically. The eight (8) prime exposures (1 through 4 and 5 through 9) looked very good, showing a good range of densities and a resolution of 5 arc seconds or less.

The H- α television camera performed properly. The combination of a newly aligned H- α TV oven and the camera adjusted for 100 percent peak detection, produced the best TV image of all NRL CALROC flights. The TV AGC came out as predicted for the first time. Details on the H- α photographs were the best yet achieved, due to the improved oven alignment and the longer exposure times which mask the primary mirror motions caused by the Nikon camera transport. These photographs will be of great value in accurately correlating the pointing positions with the Skylab ATM observations.

In section 7-2 of this report it was stated that there were some differences between the 21.012 and 21.013 calibration data that would be resolved on flight 21.014. Flight 21.014 data agrees with the 21.013 data, thus requiring some adjustment in the 21.012 data before it can be used as calibration data.

All events controlled by timers occurred as programmed except for the heat shield eject microswitch monitor which did not operate. Other payload monitors indicated heat shield ejection occurred at the proper time. Following heat shield ejection, drogue and main parachute deployment was late (approximately 3,000 feet), however, the payload was recovered in excellent condition with no signs of any external impact damage. The recovered payload is shown in Figure 8-2. Internally the Scientific Instrument "H" camera broke loose from its mounting base at payload impact. Some distortion of the instrument honeycomb structure was caused by payload impact. These impact failures were not serious enough to prevent post-flight calibration of the Scientific Instrument or affect the calibration data for use with the Skylab S082 experiment data.

All instrumentation performed satisfactorily and telemetry data was received to loss of signal (LOS) at 710 seconds.



COURTESY U. S. ARMY
WHITE SANDS MISSILE RANGE,
WHITE SANDS, N. M.

Figure 8-2. Post-Flight NRL CALROC 21.014 Payload.

APPROVAL

MSFC SKYLAB ATM CALIBRATION ROCKET PROJECT

FINAL REPORT

ATM Experiments Branch

The information in this report has been reviewed for security classification. Review of any information concerning Department of Defense or Atomic Energy Commission programs has been made by the MSFC Security Classification Officer. This report, in its entirety, has been determined to be unclassified.

This document has also been reviewed and approved for technical accuracy.

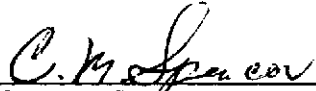

C. M. Spencer
CALROC Project Engineer
ATM Experiments Branch



W. C. Keathley
Chief
Experiments Branch
ATM Project



Rein Ise
Manager
Skylab Program Office