



(NASA-TM-X-72199) ANALYTICAL DESCRIPTION  
OF THE MODERN STEAM AUTOMOBILE (NASA)  
CSSL 13F

N75-14134

Unclas  
G3/37 06516

## ANALYTICAL DESCRIPTION OF THE MODERN STEAM AUTOMOBILE

By Jerry A. Peoples  
Program Development

Reproduced by  
NATIONAL TECHNICAL  
INFORMATION SERVICE  
US Department of Commerce  
Springfield, VA. 22151

NATIONAL AERONAUTICS AND SPACE ADMINISTRATION

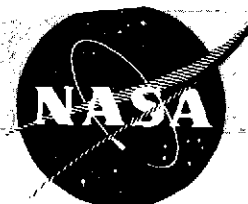

1. REPORT NO. M-TU-74-7	2. GOVERNMENT ACCESSION NO.	3. RECIPIENT'S CATALOG NO.
4. TITLE AND SUBTITLE Analytical Description of the Modern Steam Automobile		5. REPORT DATE November 1974
7. AUTHOR(S) Jerry A. Peoples		6. PERFORMING ORGANIZATION CODE
9. PERFORMING ORGANIZATION NAME AND ADDRESS George C. Marshall Space Flight Center Marshall Space Flight Center, Alabama 35812		8. PERFORMING ORGANIZATION REPORT #
12. SPONSORING AGENCY NAME AND ADDRESS National Aeronautics and Space Administration Washington, D. C. 20546		10. WORK UNIT NO.
15. SUPPLEMENTARY NOTES  Prepared by Program Development		11. CONTRACT OR GRANT NO.
16. ABSTRACT  This report represents the sensitivity of operating conditions upon performance of the modern steam automobile. The word "modern" has been used in the title to indicate that emphasis is upon miles per gallon rather than theoretical thermal efficiency. This has been accomplished by combining classical power analysis with the ideal Pressure-Volume diagram. Several parameters are derived which characterize performance capability of the modern steam car.  The report illustrates that performance is dictated by the characteristics of the working medium, and the supply temperature. Performance is nearly independent of pressures above 800 psia.  Analysis techniques presented herein were developed specifically for reciprocating steam engines suitable for automotive application. Specific performance charts have been constructed on the basis of water as a working medium. The conclusions and data interpretation are therefore limited within this scope.  This discussion is addressed to scientists and engineers well-versed in the mathematics of steam engineering.		13. TYPE OF REPORT & PERIOD COVERED  Miscellaneous
17. KEY WORDS  <b>PRICES SUBJECT TO CHANGE</b>	18. DISTRIBUTION STATEMENT  Unclassified and Unlimited Distribution  <i>Jerry A. Peoples</i>	
19. SECURITY CLASSIF. (of this report)  Unclassified	20. SECURITY CLASSIF. (of this page)  Unclassified	21.

## PREFACE

The creation of water and the means by which it may be transformed into a compressible gas are nature's great contribution to the technological advance of man. Steam power is a natural. The availability of water, and the simple construction of the piston steam engine represent a combination heretofore never matched. This may well be called "the great combination." Historically, this combination first put America on powered wheels. But, since those days, other combinations have been recognized as having merit. The most recent is the internal combustion engine. Others take the form of vehicles powered by batteries and gas turbines. All of these combinations have their own peculiar problems and advantages. Nevertheless, these later combinations represent design supremacy. Every detail of every part has mathematical reason. They are functional designs. Such systems operate at their optimum state limited only by the physical laws which at that same time make them possible.

Successful operation of these combinations depend upon a design excellence never conceived by steam car designers. Such excellence puts the Doble in a posteriority state. It's no wonder steam is considered to be the anachronism of power. The contrast between the great combination and contemporary combinations is truly revealed in the engineering concept of "Engineering Design" versus "steam engine engineering." Design of modern steam equipment must therefore be approached indiscriminately. The steam automobile designer must wake up and come out of his beautiful idea of big clumsy machinery with chrome plated levels and many gages with brass cases. Design, fabrication, and sale of a modern steam automobile system must be considered with an ostensible attitude. The designer must take off his duster, throw down his wrench, and pick up his pencil. He must formulate reason through analytical analysis and create design purpose rather than fabrication from discarded parts. The designer, manufacturer, and salesman must strive to achieve "perfect purpose."

# TABLE OF CONTENTS

	Page
SUMMARY . . . . .	1
I. INTRODUCTION . . . . .	1
II. SELLING THE STEAM CAR . . . . .	2
Phase I (1900-1905) . . . . .	6
Phase II (1920-1925) . . . . .	6
III. GENERALIZED CONSIDERATIONS . . . . .	8
First-Order Analysis . . . . .	8
Second-Order Analysis . . . . .	8
Third-Order Analysis . . . . .	9
Fourth-Order Analysis . . . . .	9
IV. CARDINAL CONSIDERATIONS . . . . .	26
A. Effects of the Booty Number . . . . .	26
B. Fuel Economy in Perspective . . . . .	30
C. Miles Per Gallon Summary . . . . .	46
V. BOILER AND POWER CONSIDERATIONS . . . . .	51
A. Steam Generator Efficiency . . . . .	57
B. Power . . . . .	61
C. Interesting Steam Vehicle Data . . . . .	69
D. Characteristics of Pressure Degradation During the Admission Phase . . . . .	75
E. Starting Torque . . . . .	83
VI. HARDWARE DESCRIPTION . . . . .	86
A. Variable Pressure Boiler (VPB) . . . . .	86
B. VPB Performance Characteristics . . . . .	91
C. Edification of Miles Per Gallon . . . . .	94
D. The Steam Engine . . . . .	100
E. Turbines . . . . .	103
F. The Steam Piston Engine . . . . .	108
V. CONCLUSIONS . . . . .	109

## TABLE OF CONTENTS (Concluded)

	Page
APPENDIX A — RELATIONSHIP FOR MILES PER GALLON . . . . .	111
APPENDIX B — DEFINITION OF TOTAL GEAR RATIO . . . . .	114
APPENDIX C — LIMITING SPEED AS A FUNCTION OF ABATE- MENT NUMBER . . . . .	115
APPENDIX D — DEVELOPMENT OF AN EXPRESSION FOR THE PRESSURE CHANGES TAKING PLACE WITHIN A CYLINDER . . . . .	117
APPENDIX E — DERIVATION OF THE COUNT NUMBER . . . . .	121

## LIST OF ILLUSTRATIONS

Figure	Title	Page
1.	Ideal P-V diagram . . . . .	9
2.	Influence of cutoff on Dour Number . . . . .	10
3.	Influence of cutoff on Supple Number . . . . .	13
4.	Effect of cutoff and temperature upon steam rate. Steam rate is a very weak function of pressure . . . . .	14
5.	Sensitivity of fuel rate with cutoff. . . . .	15
6.	Booty Number versus pressure . . . . .	18
7.	Relationship between Abatement Number and fuel consumption . . . . .	19
8.	Relationship between Abatement Number and vehicle speed . . .	21
9.	Relationship between fuel consumption and vehicle speed . . . .	23
10.	Effect of cutoff upon the Count Number. For any engine design, a cutoof of about 46 percent minimizes the Count Number . . . . .	32
11.	The effect of pressure and temperature upon miles per gallon (MPG) by the working medium only. The term $144v/\Delta H$ is directly proportional to MPG for any steam car system design. The proportionally constant will depend upon engine displacement, gear ratio and cutoff . . . . .	35
12.	Maximum theoretical performance available from the Rankine Cycle using water. Conditions are specified in text . . . . .	39
13.	Performance available from the Rankine Cycle under maximum conditions where the cutoff is allowed to be increased above the theoretical minimum. This chart is applicable for water at 90° F . . . . .	42

## LIST OF ILLUSTRATIONS (Continued)

Figure	Title	Page
14.	Sensitivity of miles per gallon to pressure for a fixed cutoff of 15 percent and an Abatement Number changing such to maintain sixty miles per hour . . . . .	43
15.	Engine performance for a fixed cutoff of 5 percent at 60 miles per hour. Performance is almost insensitive to pressure. High pressure cannot be justified on the basis of miles per gallon. . . . .	45
16.	Engine performance for a fixed cutoff of 1 percent at 60 miles per hour. The condenser suction pressure is 1.0 psia. High supply pressures cannot be justified on the basis of miles per gallon. . . . .	47
17.	Summarized performance for a throttled pressure greater than 800 psia and supply temperature of 900° F. For 15, 10, and 5 percent cutoff the exhaust pressure is 8 psia. At 1 percent cutoff the exhaust pressure is 1.0 psia . . . . .	48
18.	Sensitivity of fuel consumption to cutoff and temperature. This curve is representative for supply pressures 800 psia and above, and for condenser suction pressures between 1.0 and 15 psia. . . . .	49
19.	Relationship between engine speed and engine displacement necessary to satisfy the fixed speed requirement, 60 mph, of Figure 18 . . . . .	52
20.	Steam generating capability . . . . .	54
21.	White generator temperature distribution. . . . .	55
22.	Modern boiler temperature distribution. . . . .	56
23.	Combustion temperatures . . . . .	58

## LIST OF ILLUSTRATIONS (Continued)

Figure	Title	Page
24.	Steam generator efficiency . . . . .	60
25.	Variation of horsepower with Abatement Number . . . . .	65
26.	Steam vehicle acceleration performance to sixty miles per hour . . . . .	66
27.	Fuel flow required for given vehicle speed. Based on a typical vehicle . . . . .	73
28.	Steady state pressure for given fuel flow. . . . .	75
29.	Heat rejection characteristics of thermal engines . . . . .	76
30.	Time which the admission valve is open for specified cutoffs. . .	77
31.	Cylinder pressure degradation with time . . . . .	79
32.	Cylinder pressure degradation with cutoff. . . . .	80
33.	Cylinder pressure degradation with cutoff. . . . .	81
34.	Generalized pressure degradation . . . . .	82
35.	Torque characteristics . . . . .	84
36.	Starting torque characteristics of a twelve cylinder engine. . . .	85
37.	Control approach for the variable pressure boiler. . . . .	89
38.	Operation of the VPB system. . . . .	90
39.	Pressure transients occurring with a variable pressure boiler . . . . .	92
40.	Fuel consumption characteristics of the VPB concept. . . . .	93



## LIST OF ILLUSTRATIONS (Concluded)

Figure	Title	Page
41.	Transient engine speed characteristics of the VPB concept with a total gear ratio of .77 feet and .5 lb/min input of fuel. . . . .	95
42.	Law between vehicle speed and engine speed for given total gear ratio . . . . .	96
43.	Transient power characteristics for a variable pressure generator. . . . .	97
44.	Miles per gallon for a 300 in. <sup>3</sup> engine having 1.0 percent cut-off, 1200 psia operating pressure. . . . .	99
45.	Effect of expansion ratio on Rankine cycle efficiency for various steam chest temperatures and pressures . . . . .	105
46.	Occultation valving. . . . .	107
47.	Principle of valving by piston occultation. . . . .	108
48.	Occultation valving concept applied to a three cylinder engine . . . . .	110

## LIST OF TABLES

Table	Title	Page
1.	Dour Number . . . . .	11
2.	Supple Number . . . . .	13
3.	Steam Vehicle at Sixty Miles Per Hour, 100 Percent Throttle . . . . .	67
4.	Steam Vehicle Performance at Sixty Miles Per Hour for Different Cutoffs, 100 Percent Throttle . . . . .	69

## LIST OF SYMBOLS

<u>Symbol</u>	<u>Definition</u>
$A_o$	Initial orifice flow area — in. <sup>2</sup>
$\eta_B$	Boiler efficiency — (decimal)
$\eta_S$	System efficiency based on equivalent heat power
$D_N$	Dour number
$\Delta H$	Enthalpy change as water passes through boiler BTU/lb
$E$	Heat of combustion — BTU/lb
$F$	Fuel flow — lb/min
$F_R$	Fuel rate — gal/hr
$G$	$R_W r / R_G$ (Total Gear Ratio) — ft
$M_G$	Steam generated — lb/min
$M_R$	Steam required — lb/min
$N$	Engine speed — rev/min [Engine is connected directly to drive shaft in a one to one ratio; if not, let $r/R_G$ represent the reduction between engine and drive axle (steady state, final drive ratio)].
$P$	Throttled pressure — psia
$P_A$	Exhaust pressure — psia
$P_M$	Mean effective pressure — psia
$R$	Steam gas constant — ft-lb/lb <sub>m</sub> — °R
°R	Steam temperature — degrees Rankin

## LIST OF SYMBOLS (Concluded)

<u>Symbol</u>	<u>Definition</u>
$r$	Differential drive pinion radius — in.
$RF$	Total retarding force acting on vehicle (rolling road resistance plus aerodynamic force)
$R_G$	Differential drive gear radius — in.
$R_W$	Wheel (tire) radius — ft
$\rho$	Fuel density — lb/gal
$S_N$	Supple number
$T$	Steam temperature — degrees Rankin
$T_E$	Average engine torque per Rev, ft-lb
$T_W$	Average wheel torque per Rev, ft-lb
$V$	Engine displacement per revolution — in. <sup>3</sup> /rev (unless specified otherwise)
$V_C$	Vehicle speed — miles/hr
$V_M$	Limiting vehicle speed — miles/hr
$\omega$	Drive axle rotational speed — rad/min
$X$	Engine cutoff — dimensionless (decimal)
$\gamma$	Isentropic Exponent
$k$	Polytropic Exponent
$v$	Specific volume, lb/ft <sup>3</sup>
$O/F$	Oxidizer flow/fuel flow ratio

# ANALYTICAL DESCRIPTION OF THE MODERN STEAM AUTOMOBILE

## SUMMARY

The limits of miles per gallon of the steam engine in the power size suitable for automobiles are developed analytically. Although steam is selected as the working medium upon which analytical data are produced and reported, the analytical description is general and can be applied to any working medium.

The modern steam car is defined from an analytical point of view rather than concentration upon hardware design. Equations are developed which illustrate the effects of engine displacement, gear ratio, supply temperature and pressure, working medium, and Fuel/Air ratio upon performance. Emphasis is placed upon those factors which have the greatest effect upon miles per gallon.

It is indicated that water offers the best possible performance. Although performance is most sensitive to temperature, acceptable performance can be obtained at 800-900° F. Performance is a weak function of pressure above 800 psia.

## I. INTRODUCTION

The analytical data presented in this report is a spin-off of the authors involvement in research and development programs at Marshall Space Flight Center. This experience includes hydraulic control systems for the Saturn vehicle, energy conversion schemes for the early conception stages of the Lunar Roving Vehicles, and currently the thermal analysis of the space shuttle experiments.

No attempt is made in this report to define the most suitable steam engine configuration. This is an analytical study of steam car capability based upon the skills and knowledge which the author has accumulated in his normal day to day routine.

Basically, this report provides a means by which a steam car designer can intelligently select operating parameters on a mathematical basis rather than some other convenient basis. Overall, this basis will provide results in the best trade-off between all system parameters, which can ultimately lead to an optimized configuration.

The analytical description given is based upon ideal conditions. The results are therefore optimistic and represents the best which can be achieved by the modern steam car.

## II. SELLING THE STEAM CAR

The entrance into the modern age of the steam car could be depicted by an imaginary lecture presented by a steam automotive sales engineer. Such a possible lecture is outlined below for the purpose of placing steam automotive components and systems in proper perspective to present energy conversion systems. The theme presented by this imaginary lecture is more important than the ideas. The wisdom portrayed through the theme of this lecture should temper the reader's judgements of modern steam concepts.

Mumble, jumble-jumble, mumble characterizes all automobile advertisements; however, Detroit does obtain results. A critical evaluation will show that the typical advertisement says very little about the product. Advertisements include cars sitting on mountain tops or cruising through rough lonely deserts. Therefore, sales principles can be generalized into two statements:

1. The public does not know what it really wants.  
Detroit dictates and the public demands.
2. The value of advertising is to appease those who already have purchased the particular make advertised.

Based on these two concepts alone, the modern steam automobile has many possibilities. However, this alone will not guarantee the success of steam automotive systems. There still must be a philosophy with deep roots, which is based on concrete evidence as to why the public purchases a particular make. In the opinion

of many, this underlying philosophy can be stated as: "Performance And Reliability Are Taken For Granted, Cost and Style Are Not." This concept has to be accepted within the definitions and limitations to be stated. Actually the reasons for buying are subconscious. Even though the buyer may not be fully aware of the reasons for his purchases, the underlying philosophy guides his judgment even in a subconscious sense. If any automobile owner is asked why he purchased the make he did, he would probably mention nothing about cost or style. As a matter of fact, he may be more likely to mention those things relating to performance and reliability, such as comfort, roadability, and driveability. This is not a contradiction to the basic philosophy. It is a matter of understanding human nature. Man tends to defend his decision in the light of those arguments which compliment him. To say openly that a car has been purchased on the basis of cost is not very complimentary to himself. Style could be mentioned but it is more controversial than descriptions like roadability. Words like roadability are more of a feeling rather than a well defined definition. An individual attempting to justify or defend his decision will more likely avoid a controversial issue.

Interpreting the basic philosophy involves many facets resulting from a variety of conditions. When a prospective buyer is looking for an automobile, the basic philosophy says that performance and reliability take secondary place. Now this applies during the initial purchases of a given make. Without even driving the car, the buyer has preconceived ideas as to what it should do on the road. If the automobile does not meet his expectation, from a reliability and performance viewpoint, then these factors will become a major criterion if he ever considers purchases of that same make in future years. This may well be called: "The principle of predetermination of recall." That is to say, whenever one recalls a bad experience, his next decision is predetermined or at least partially determined. It must also be remembered that what one person considers satisfactory, another may consider completely unsatisfactory. These concepts of performance can decrease these characteristics of his car and still expect to sell automobiles on the basis of price or style. The peoples faith in the Studebaker proved this. These concepts are meant to imply that the performance and reliability of this year's models must be at least as good as last year's. It is not meant to imply

that a buyer will sacrifice reliability and performance for cost or style. The public has been reconciled to the fact that automobiles have great potential for getting you there and back. This idea is justified since no one hesitates to drive a thousand miles to visit a friend. People also do this and expect no more trouble than a flat tire. But the 1905 era was never blessed with this confidence. Thus, performance and reliability must always prove out, but this is not a criterion in selecting an automobile. This means that the designers cannot relax and must always search for that extra something to maintain performance, with less cost.

Now, you must also realize that the basic philosophy is relative. This is essential or everyone would be riding bicycles. Some consider the highest priced Cadillac as being low cost; others consider the lower priced Ford as being expensive. As a result, both Fords and Cadillacs are sold. The same applies to style; however, to sell the most cars, the manufacturers must select a cost and style which meet the approval of the majority. Some people have argued the philosophy of pay a little more and get the best. If they do this, it is only because they wanted the more expensive automobile in the first place. Price was important for prestige reasons or the price was well within their financial means anyway. It may well be said that the performance and capability of a Cadillac are greater than those of a Ford; however, this is an acceptable difference. People do not expect as much out of the lower priced cars as they do the higher priced ones. This illustrates the relative nature of performance and reliability. The expectation of people are in proportion to their preconceived ideas. Now, this does not mean that an individual will select an automobile known to have lasting defects even if the price is low. In this case the buyer has been affected by the principles of pre-determination. His recall may be based on his own experience or the experience of his neighbors.

If there is any reason why people consciously or subconsciously purchase a given make, it is to reflect their income level. Again, this is human nature. Performance and reliability are very controversial subjects whenever a particular make is involved. Cost and style are more exact and easier to evaluate and to get people to agree on. Sometimes a manufacturer will wonder why a particular make and model will outsell another make and model in the same price range. The reason for this is style. If costs



are the same, the choice will be based on the buyer's opinion of style. Again this may well be subconscious. It works like this: your car seems to perform better just after you washed and cleaned it up (of course, this is a false inner feeling). From the viewpoint of style, a long low sweptback configuration will make the car seem better even though it has nothing to do with performance or reliability.

Now, let's put this philosophy to work by answering the question, "Why did steam fail"? In the first place, it must be remembered that the automobile situation was much different than it is now. Initially (1900) all cars, both steam and gas, were expensive. In the second place, reliability could not have been much of a basis for a decision since there was no basis for comparison. People did not have any idea whether the car would last one year or twenty years. Consequently, some people purchased two each. In the third place, the steam car was a mess. All systems were non-condensing which meant frequent water fillings. If anyone has read the procedure for filling a 1900-1905 steam car with water and gas they know of the laborious task it must have been. Steam car enthusiasts point out the ease of operating and maintaining a steam car.

In these cases, they are always talking about the 1920-1925 era. Originally, around 1900 or so, normal care of a steam car was nothing to brag about. These factors set the stage for nonimplementation of the "principle of predetermination of recall." The downfall occurred in two phases: the first phase about 1905; the second phase began in the 1920's and ended within a few years.

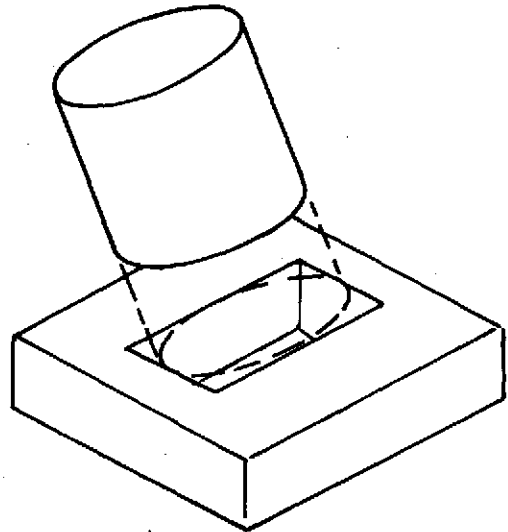

This picture reveals the modern state of Steam Automotive Systems. Removal of this image is the goal of steam enthusiasts.

## PHASE I (1900-1905)

The gas engine has instant start with no complicated procedures for gas filling. The steam car required 5 to 6 minutes for starting and frequent water fillings, since they employed non-condensing systems. It may be argued that the broken arms from cranking gas cars and the inferior power output were not worth the extra time to keep the steam car running. Nevertheless, this major difference initially resulted in most people preferring gas cars. After a newly purchased gas car became a year or so old, the points began to wear, hard starts were common, and reliability and performance proved inadequate. At this point, "the principle of predetermination of recall" put the buyer against gas cars. But in the mean time, practically all steam car companies had failed as a result of gas car purchases. It wasn't possible to purchase a new steam car. Of course, the Stanley was still around but its market was limited. Since the public was fundamentally dissatisfied with gas, steam had its chance; but they had already been forced out. Thus the principle of predetermination of recall could not be inacted. Non-implementation of the principle of recall describes the situation of the steam car. This constituted the mass technology development of the gas engine. A review of the records will show that 90% of the steam car companies were bankrupted by 1905. Many were bankrupted by 1903. This means that the majority of those who purchased gas cars around 1900 were not ready to purchase another for at least 3 to 5 years. Considering that in 1900 cars were driven very little and not at all in the winter, this time interval is reasonable for the gas car to prove its imperfections. Also, the high initial cost helped prevent procurement of a second car within a year or so. By the time the public realized that the problem of maintaining a steam car was worthwhile, as compared to the gas car, they (the public) had already put the steamer out of business.

## Phase II (1920-1925)

By the time steam automobiles got wound up again after its first defeat, the 1920's were at hand. However, in the meantime the development of the gas car had proceeded to the point that cost,

performance, and reliability had reached an acceptable level. During this period, gas cars could be purchased for \$400.00. When steam appeared, the cost per unit was typically \$1000 to \$1500. Some were as high as \$4000 to \$6000. Now in this day when the typical man worked 10 hours for \$3 to \$5, cost became the ax that slew the steam car for the second time around. There wasn't enough individual wealth to support these expensive automobiles. It is of small consequence that other giants fell as the result of cost also. Machines such as Pierce-Arrow, Dusenburg, Auburn, etc., were the ultimate in performance and reliability. Cost was the only difference between life and death. They failed because there were not enough people to support these expensive automobiles. The steam car had two chances, and failed each time for different reasons. The first situation was a matter of circumstances; the second was cost. Thus, the events of 60 years past reinforces the basic philosophy. This philosophy teaches a great deal about how the return of the steam car should be managed. First and most important is to prevent the "principle of predetermination of recall" from being acted out. This requires a good basic design, but this is not what will sell the car. The cost factor must be considered very carefully. Scales must be based on cost and style, with less emphasis on the performance capability. As already stated, people will not buy a car based on power, speed acceleration, and reliability. But these must be proved out in test trials. Of course, several models and combinations must be offered to span a wide cost and style range in order to facilitate the variance of the pocketbook and concepts of beauty.

The symbol for this talk has been a round peg in a square hole. The round peg represents the steam car, the public as the square hole. As the drawing shows there is room for the peg to fit, but it's very uncomfortable. The fit can be made snug by filling around the peg. This filling is represented by you, the steam car showroom salesman.

Some years ago, the Packard automobile company advertised through a simple statement: "Ask the man who owns one." This type advertising is indicative of many satisfied buyers. Promoters of modern steam systems must strive for the same image.

### III. GENERALIZED CONSIDERATIONS

The first considerations for analysis is to develop the tools and criteria upon which the analysis will be based. Initially it may appear that very little could be said about analytical methods. The Mollier Chart and classical thermodynamics have been used for years. Yet, the Mollier Chart and classical thermodynamics are concerned with work rather than power. Also, the Mollier chart cannot depict the effect of cutoff, clearance volume, compression pressures and compression temperatures, or determine the miles per gallon available from a selected design.

The Mollier Chart is primarily a tool to determine theoretical thermal efficiency. In today's environment of the energy crisis, thermal efficiency is only of secondary importance, as miles per gallon stands as the only valid measure of economy. The relationship between thermal efficiency and miles per gallon has never been demonstrated. However, as will be illustrated later, a good measure of miles per gallon can be obtained with pressures and temperatures which yield only mediocre thermal efficiency.

Probably the greatest disadvantage of the Mollier Chart is its inability to predict power. The Mollier chart provides only the available work per pound of steam. To obtain power, the available mass flow rate must either be assumed or calculated by other means.

With this background we can rank any analytical approach by one of the following categories:

#### First-Order Analysis

This analysis is characterized by the Mollier Chart. It represents analysis of a given vapor cycle designed to operate at fixed conditions. Results are usually very optimistic. Major outputs are cycle thermal efficiency and work. Usually power is obtained by assuming a flow rate.

#### Second-Order Analysis

The second-order analysis combines the Mollier chart and the ideal P-V diagram. This order of analysis allows for evaluation of cutoff, engine displacement, engine speed capability, required evaporation rate, power, and the inter-relationships.

## Third-Order Analysis

The third-order analysis is concerned with the Mollier chart and the P-V diagram, with consideration for clearance volume, boiler efficiency variation with evaporation rate, friction, exhaust conditions, compression pressures, and temperatures.

## Fourth-Order Analysis

The fourth-order analysis is the point design and hardware test.

This report will be concerned primarily with a second-order analysis. A third-order analysis can be found in *Steam Automotive Analysis* [1].

Since the aim in this chapter is to develop tools for evaluation purposes, it is foreseen that the need for new terms will arise. New terms are created for the purpose of encapsulating a concept. This allows a single word or term to depict what otherwise may take several paragraphs to explain.

To begin with, consider that the ideal P-V diagram is illustrated in Figure 1. The work available per revolution (single acting) is the enclosed shaded area. Solving this area gives

$$W = \frac{P V}{12} \left[ \frac{Xk - X^k}{k - 1} - \frac{P_A}{P} \right] \quad (1)$$

Where the cutoff X is the ratio  $V_o/V_T$ , equation (1) illustrates the effect of all the parameters required to define the P-V diagram. The effect of cutoff can be found by plotting  $(Xk - X^k) / (k - 1)$ . This plot is given in Figure 2.

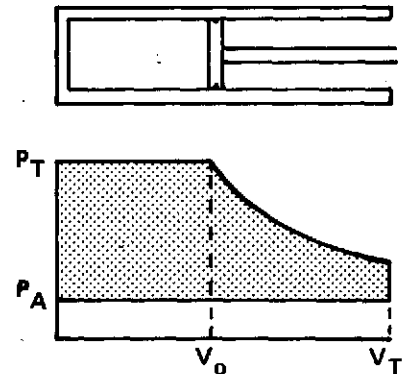

Figure 1. Ideal P-V diagram.

The complexity of equation (1) makes it difficult to work with. The expression can be simplified by noting that the throttle pressure,  $P_T$ , is measured in several hundred psia, whereas,  $P_A$  is just a few psia. The ratio  $P_A/P_T$  therefore is very small and can be omitted.<sup>1</sup> Now, notice that values of the term  $(Xk - X^k) / (k - 1)$  can be tabulated as shown in Table 1 for different values of cutoff, with  $k$  as an argument in the table. Referring to the values in Table 1 as the Dour Numbers,  $D_N$ , equation (1) becomes

$$W = \frac{PV}{12} D_N ,$$

where

$$D_N = \frac{Xk - X^k}{k - 1} . \tag{2}$$

The expression for work is now very simple to use. For any cutoff, the value of the Dour Number can be read from a table like Table 1. It can be shown that the Dour Number is equal to the ratio of the mean effective pressure to the throttle pressure

$$D_N = \frac{P_M}{P} = \frac{Xk - X^k}{k - 1} . \tag{3}$$

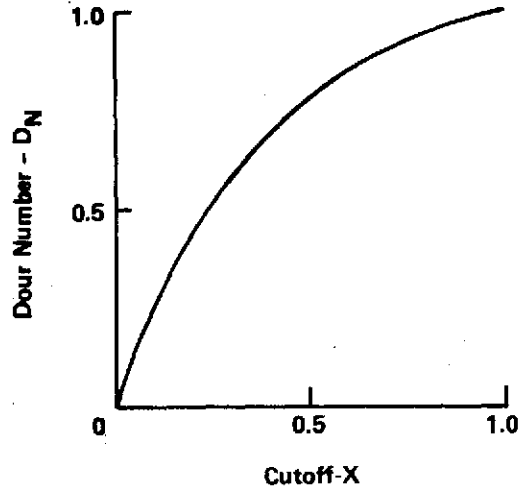

Figure 2. Influence of cutoff on Dour Number.

1. Caution: For very low cutoff, the Dour Number approaches the ratio of  $P_A/P_T$  and thus  $P_A/P_T$  cannot be omitted.

TABLE 1. DOUR NUMBER

Cutoff Percent	Ratio of Specific Heat		
	1.3	1.2	1.1
6	0.1740	0.1891	0.2071
12	0.3083	0.3274	0.3493
18	0.4213	0.4413	0.4636
24	0.5186	0.5380	0.5592
30	0.6032	0.6210	0.6403
36	0.6768	0.6927	0.7096
42	0.7408	0.7545	0.7690
48	0.7962	0.8077	0.8197
54	0.8438	0.8531	0.8627
60	0.8842	0.8914	0.8988
66	0.9178	0.9232	0.9286
72	0.9452	0.9489	0.9527
78	0.9668	0.9691	0.9714
84	0.9827	0.9839	0.9852
90	0.9933	0.9938	0.9943
96	0.9990	0.9990	0.9991

The Dour Number actually describes that percent (decimal) of maximum work for which the cycle is capable. The Dour Number varies between zero and one for cutoff between zero and 100 percent. Also, notice that although equation (1) was derived on the basis of a single cylinder, if an engine has multiple cylinders  $V$  becomes the total displacement.

The Dour Number represents the first of several new terms which will be introduced. As will be shown, the Dour Number relates directly to basic steam engine performance. For an example, the average torque produced by an engine is the work per cycle divided by  $2\pi$ , thus

$$T_A = \frac{P V}{24\pi} D_N \quad (4)$$

Thus, the Dour Number plays an important part in establishing engine average torque. Also, equation (4) is simple enough for quick calculations.

The development of equation (2) represents one of the two basic relationships necessary to establish the power capability of a selected design. The second is an expression for the steam mass flow rate required to sustain a given generator pressure and engine speed. This expression is

$$M_R = \frac{P V X N}{12 R T} \quad (5)$$

Equation (5) is derived by considering the volume of steam required to fill Volume  $V_0$ , noted in Figure 1. If the steam generator cannot supply the rate required by equation (5), the generator pressure and engine speed will deteriorate until a power level is reached which is indicative of the rate being generated. The importance of mass flow rate to power can be determined by substituting equation (5) into (2),

$$\text{hp} = \frac{MRT}{33000} \frac{D_N}{X} \quad (6)$$

In this equation, the mass flow rate has been generalized as  $M$ . Notice that the value of the Dour Number divided by cutoff can also be tabulated, as was suggested earlier. Such has been done in Table 2, giving the value  $D_N/X$  the name Supple Number,  $S_N$ , thus

$$\text{hp} = \frac{MRT}{33000} S_N \quad (7)$$

Power, therefore, like work, becomes very simple to evaluate. A graph of the Supple Number is given in Figure 3. As will be shown, the Supple Number is also an important parameter in establishing steam engine performance. For an example, steam rate can be obtained from equation (7) by solving for the ratio  $M/\text{hp}$ , thus

$$S_R = \frac{1979820}{RT S_N} \quad (8)$$



TABLE 2. SUPPLE NUMBER

Cutoff Percent	Ratio of Specific Heat		
	1.3	1.2	1.1
5	2.976	3.253	3.588
10	2.662	2.845	3.056
15	2.446	2.578	2.723
25	2.134	2.210	2.294
30	2.010	2.069	2.134
40	1.801	1.837	1.875
45	1.710	1.738	1.767
55	1.547	1.563	1.580
60	1.473	1.485	1.497
70	1.338	1.344	1.350
75	1.275	1.279	1.283
85	1.158	1.159	1.161
90	1.103	1.104	1.104
100	1.000	1.000	1.000

Equation (8) is plotted in Figure 4. This plot indicates that from a steam rate viewpoint a low cutoff is desirable. Notice that steam rate is not a function of pressure, but can be very sensitive to temperature.

The required mass flow rate was introduced through Equation (5). The required mass flow rate is indicative of the demands which a specific design imposes on a steam generator. The generator ability to supply that rate can be thought of as available evaporation rate,

$$M_A = \eta_B \frac{EF}{\Delta H} \quad (9)$$

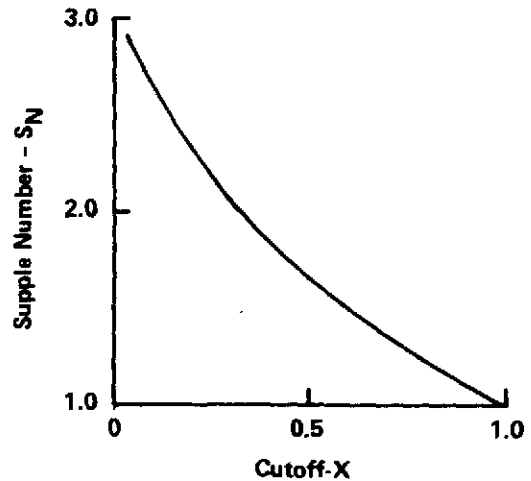

Figure 3. Influence of cutoff on Supply Number.

The  $\Delta H$  term comes from the Mollier Chart. Under steady state conditions, the required evaporation rate will equal the available evaporation rate. In order for this to happen, the generator pressure and, thus, the engine speed may have to decrease until this is so. This fact is important in determining the transient response of a given design. This will be discussed in more detail later.

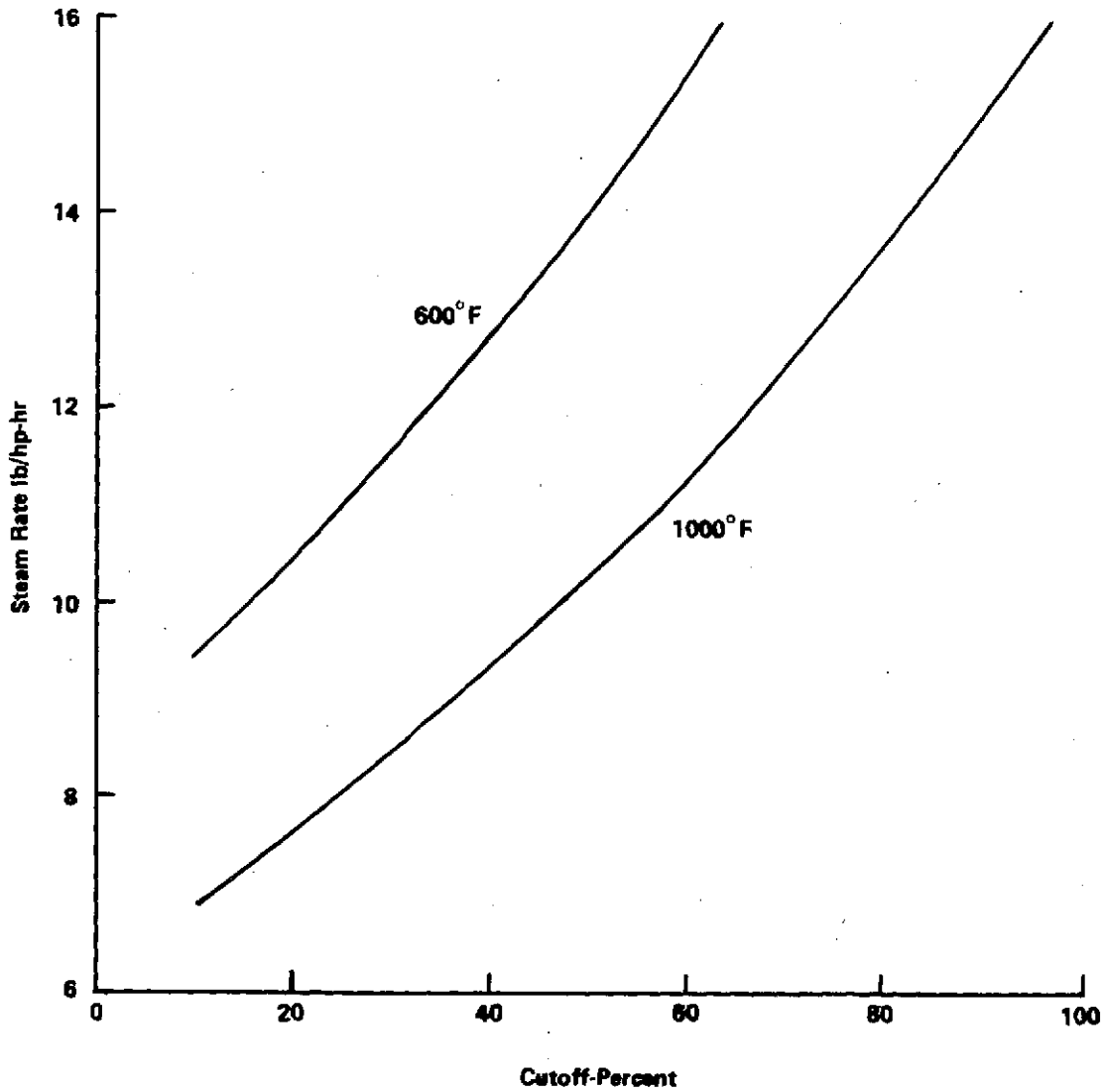

Figure 4. Effect of cutoff and temperature upon steam rate.  
Steam rate is a very weak function of pressure.

Substituting equation (9) into equation (6) and solving for F/hp gives the fuel rate of the system,

$$\text{Fuel Rate} = \frac{1,980,000}{\eta_B \frac{RT}{\Delta H} E S_N} \text{ lb/hp-hr} \quad (10)$$

Again the importance of the Supple Number is reinforced. A plot of equation (10) is given in Figure 5.

The theoretical limit of a typical steam Rankine system is about 0.3 lb/hr-hr. Yet, in 1968, Mr. Lear [2] claimed that his Delta engine would be capable of 0.4 lb/hr-hr. This claim indicates that Mr. Lear was depending on erroneous data. This erroneous data source is one of the reasons why his dream has never materialized as he conceived of it in 1968.

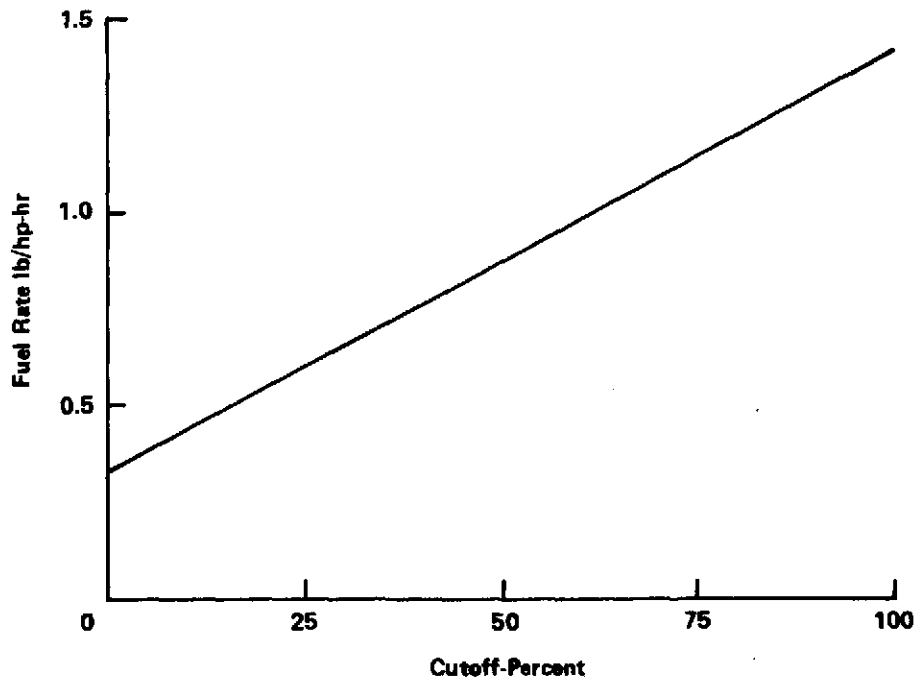

Figure 5. Sensitivity of fuel rate with cutoff.

The most important fact about equation (10) is the appearance of the group of terms  $(RT/\Delta H)$ . The parameter of this group relates entirely to the working medium. It is obvious that a working medium which can exhibit a high  $(RT/\Delta H)$  certainly will reduce the fuel rate. It will be illustrated later that this group can be used as a criterion for evaluating the influence of a different working media upon performance. For now we will give this group the name Booty Number ( $B_N$ ) so its discussion can be facilitated later.

$$B_N = \frac{RT}{\Delta H} \text{ ft-lb/BTU} \quad . \quad (11)$$

It is the opinion of the author that some of Mr. Lear's optimistic speculations on performance were based upon the hope of a new working medium which exhibited a very high Booty Number. To the knowledge of the author, there is no fluid which exhibits a higher Booty Number than water. Mr. Lear's staff probably had no knowledge of the Booty Number, per se. They only speculated on the importance of the capability of the working medium.

The most important performance parameters of the steam automobile is miles per gallon. Traditionally, thermal efficiency has been the measure of performance which the engineer has attempted to improve. Performance on the basis of miles per gallon has been omitted. The engineer selected an operating pressure and temperature which gave a reasonable thermal efficiency and then empirically measured and accepted the miles per gallon which the system gave.

Now consider the arrangement of variables which dictate the ultimate performance parameter, miles per gallon. It is assumed that the vehicle is being driven in a straight path on a level road. The relationship between miles per gallon and the system parameters is

$$\text{MPG} = 0.0142 \eta_B \frac{\rho E}{X} \frac{RT}{\Delta H} \frac{1}{\left[ \frac{PV}{G} \right]} \quad . \quad (12)$$

The derivation for equation (12) is given in Appendix A. The parameters have been grouped to facilitate evaluation.

Now consider the Booty Number ( $RT/\Delta H$ ). At first it may appear that the Booty Number may vary over a wide range of pressures and temperatures. However, the change in the gas constant,  $R$ , and enthalpy,  $\Delta H$ , with regard to pressure and temperature are compensating. As a result, the change is only slight. This effect is illustrated in Figure 6. The Booty number changes only about 13 percent for pressure variations between 400 and 1000 psia and temperatures between 800 and 1000° F. The Booty Number can therefore be considered a constant over small variations in pressure and temperature. Since the other variables  $P$ ,  $\eta_B$ , and  $E$  are constants<sup>2</sup>, miles per gallon can be expressed in terms of the groups ( $PV/G$ ) and cutoff.

It is interesting to note that the effect of temperature upon fuel consumption can only be instituted through the Booty Number. The Booty Number changes a maximum of 4.7 percent for a temperature change of 11 percent (900 to 1000° F). The affect of pressure upon the Booty Number is even less sensitive. For a 150 percent change in pressure (400 to 1000 psia), the Booty Number changes only 2.4 percent for a temperature of 900° F. At 1000° F the Booty Number changes only 1.6 percent.

Since the effect of temperature can only occur through the Booty Number and since the Booty Number varies only slightly over a wide range of temperatures, it is concluded that the effect of temperature upon performance has been overemphasized. The Booty Number is important because it is a measure of the influence of the working medium upon miles per gallon. For water, the Booty Number is typically about 82 ft-lb/BTU. The Booty Number is larger for inorganic fluids than for organic fluids. Typically, water has a Booty Number 23 percent greater than freon. In the experience of the author, water represents the best medium from a performance point of view.

For a given cutoff, miles per gallon becomes a function of only ( $PV/G$ ). The effect of pressure displacement and gear ratio is so great upon miles per gallon that this group has been given the special name, Abatement Number ( $PV/G$ ). By looking at equation (12), it is evident that miles per gallon increases as the Abatement Number decreases. It is noted that the gear ratio has a special definition, as given in Appendix B. Normally, it would be expected that miles per gallon would increase with pressure, or at least the thermal efficiency would increase. But low pressure decreases the Abatement Number, thus increasing the miles per gallon. It is concluded that thermal efficiency, as affected by pressure, is a poor measurement of performance (MPG).

---

2. Boiler efficiency varies slightly with evaporation rate.

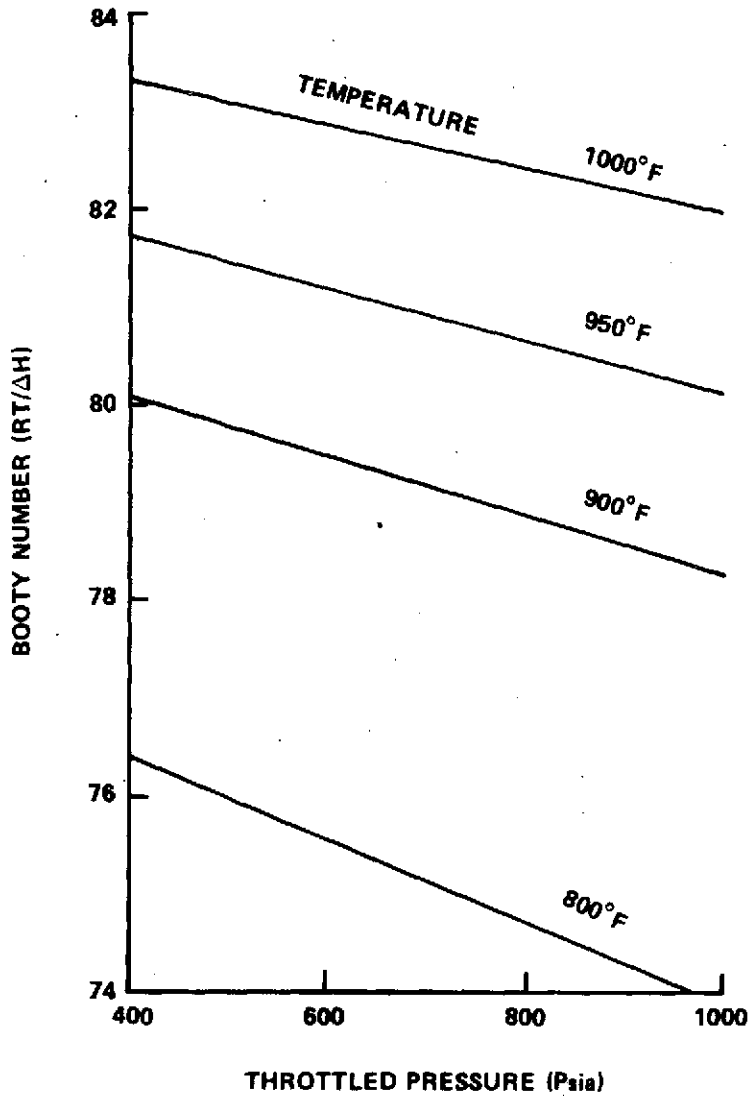

Figure 6. Booty Number versus pressure.

Miles per gallon as a function of Abatement Number is given in Figure 7. Low fuel consumption is obtained with low Abatement Numbers. However, low fuel consumption is not obtained without a sacrifice. As the Abatement Number becomes smaller, the limiting speed of the vehicle becomes curtailed. Thus, there is a trade-off between miles per gallon and the limiting speed of the vehicle. This trade is what performance is all about. An Abatement Number should be selected which will give a low fuel consumption and, at the same time, result in a reasonable speed to cope with freeway speeds. The Abatement Number is a measure of the power which can be delivered to the rear axle. As this capability is decreased, the speed capability also decreases. It is noted that

pressure and displacement have the same affect. An increased engine displacement can be thought of as an increase in pressure. The reverse is also true.

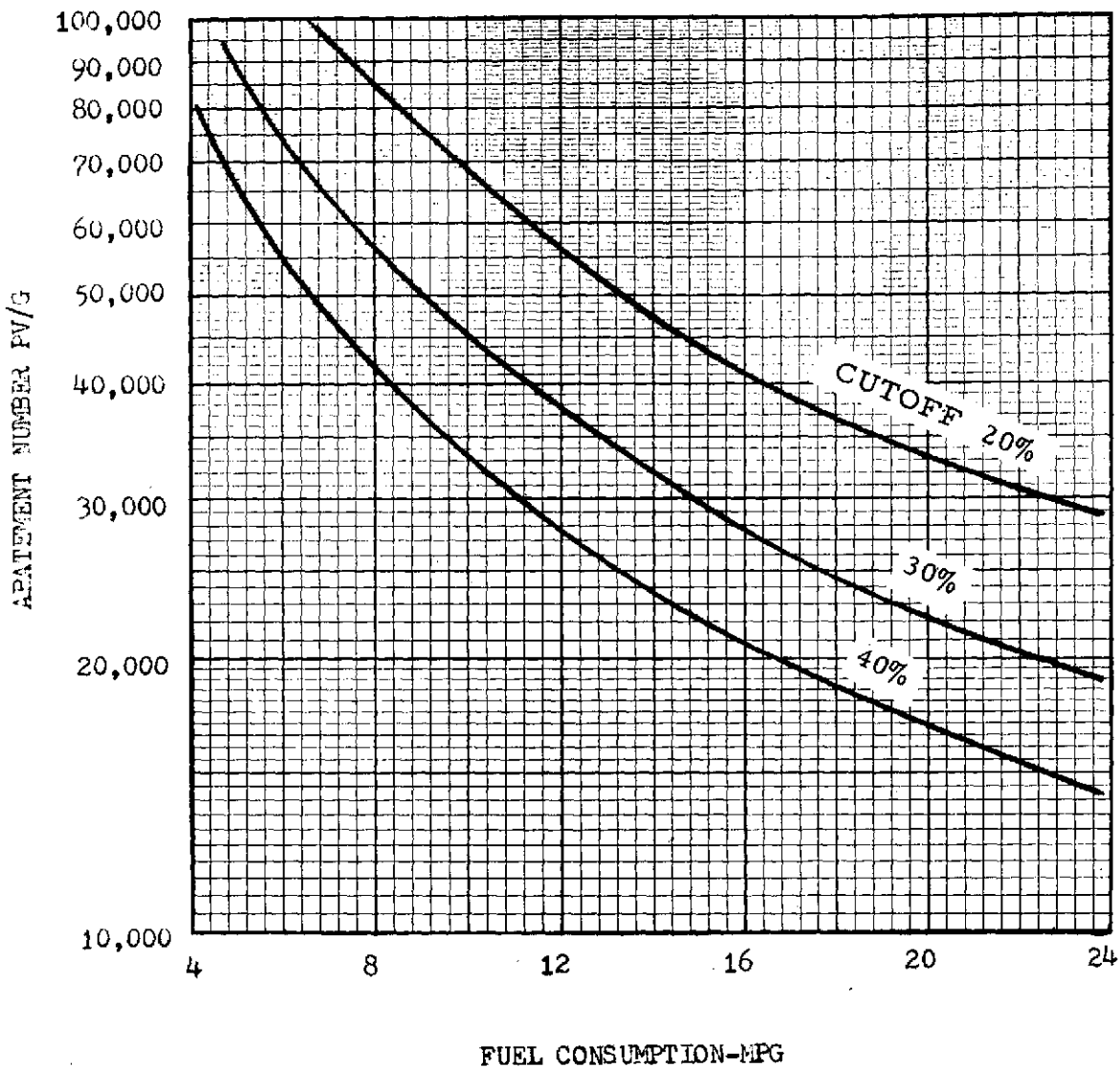

Figure 7. Relationship between Abatement Number and fuel consumption.

The relationship between the maximum speed of the vehicle and Abatement Number is

$$V_M = \sqrt{\frac{D}{24\pi} \frac{PV}{G} \frac{1}{K_2 A} - \frac{K_1}{K_2 A}} \quad (13)$$

Where  $K_1$  is 20 pounds per 1000 pounds of vehicle weight,  $K_2$  is between 0.001 and 0.002. For a four door sedan ( $K_2$ ),  $A$  is the frontal area of the vehicle. The derivation for this relationship is given in Appendix C.

At this point it becomes advantageous to define a typical automobile so equation (13) can be generalized upon. Taking a typical vehicle, such as a four door sedan weighing 3200 pounds and having a frontal area of 30 square feet, equation (13) reduces to

$$V_M = \sqrt{0.354 \frac{PV}{G} D_N - 1706} \quad . \quad (14)$$

Equation (14) is plotted in Figure 8. By using equations (12) and (14), the tradeoff between miles per gallon and limiting speed may be made. For example, it may be seen from Figure 7 that 12 miles per gallon may be obtained at 30 percent cutoff with an Abatement Number of 35600. Entering this Abatement Number value to Figure 8 results in a limiting speed value of about 80 miles per hour. Once the Abatement Number is known, the values for pressure, displacement, and gear ratio can be logically selected. The Abatement Number limits the system size to be within the performance range desired. In the past, pressure and engine size have been selected on the basis of either convenience or thermal efficiency. Now, through the criteria of the Abatement Number, "design reason" can be established.

It may be noted that large Abatement Numbers are not compatible with good design. For an example, consider a 120 in.<sup>3</sup> engine operating at 1000 psia and a gear ratio of 0.3 ft, the Abatement Number is

$$\frac{PV}{G} = \frac{(1000)(120)}{0.3} = 400,000 \text{ lb-in.}^2/\text{ft} \quad . \quad (15)$$

Using Figure 7, we may see that this value is completely off the chart. Miles per gallon will be less than four. For good performance, the Abatement Number should be limited between values of 30,000 and 40,000. These values result in good speed capability and, at the same time, give low fuel consumption.



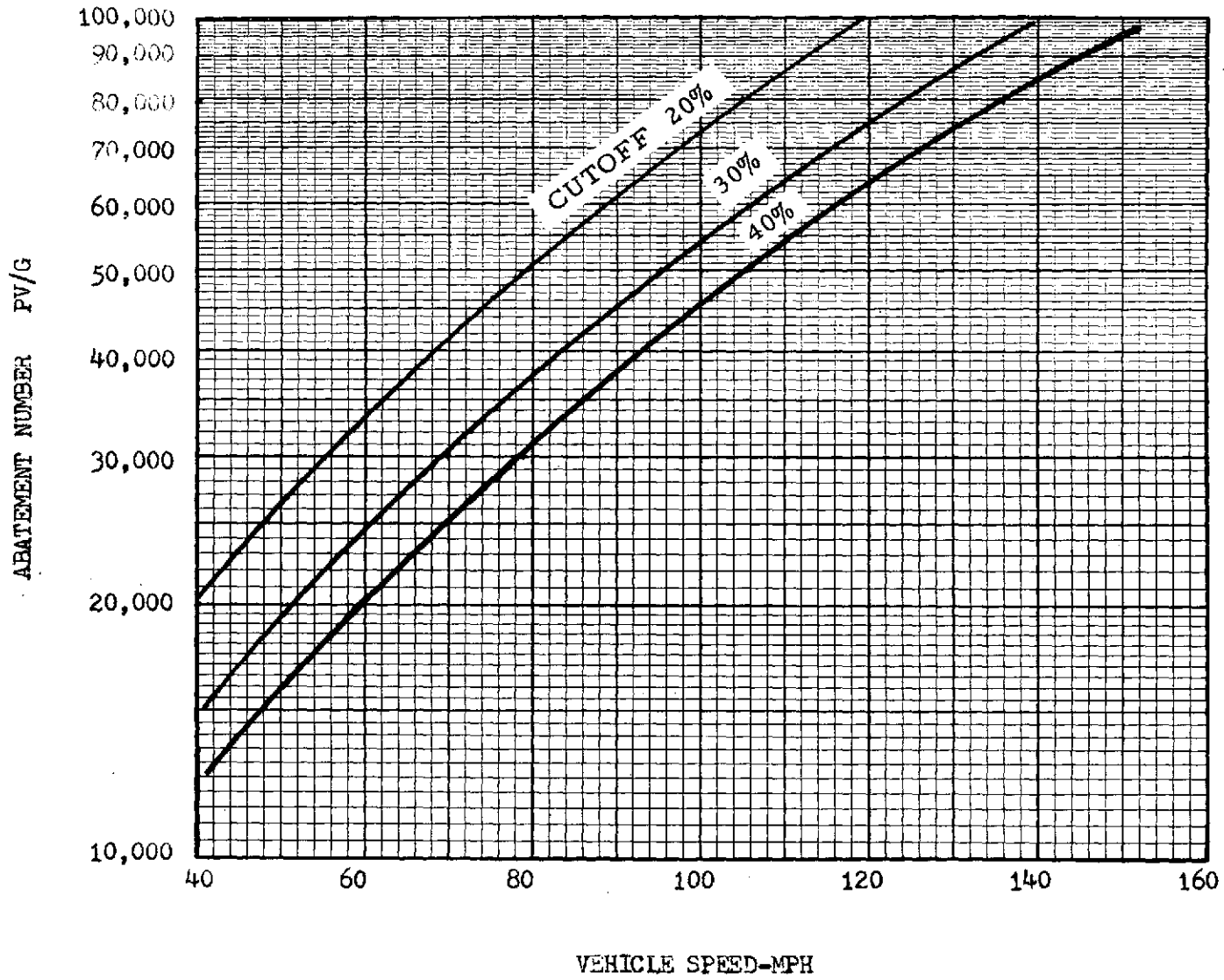

Figure 8. Relationship between Abatement Number and vehicle speed.

It should be noted that high power, high speed vehicles will require a high Abatement Number in accordance with equation (14). In a practical design, the Abatement Number will not be selected on the basis of miles per gallon only. A performance sacrifice will be made to achieve freeway speeds.

By now it is obvious that the Abatement Number of equations (12) and (14) can be eliminated, resulting in a relationship between miles per gallon and limiting speed. Making this substitution gives

$$\text{MPG} = 0.00502 \eta_B \rho E \frac{RT}{\Delta H} \left[ \frac{S_N}{1706 + V_M^2} \right], \quad (16)$$

or by substituting typical values,

$$\text{MPG} = \frac{51,160 S_N}{1706 + V_M^2} \quad (17)$$

A plot of equation (17) is presented in Figure 9, which relates the expected miles per gallon for selected limiting speeds. Figure 9 represents the fuel consumption at the limiting speed. After seeing the effect of pressure upon miles per gallon, the thought of a variable pressure boiler comes to mind. This concept would allow the driver an option of varying the pressure, depending upon the urgency of high speeds. A variable pressure boiler could be achieved by varying the fuel rate. As the fuel rate increases, the boiler pressure would increase to a power level indicative of the power represented by the fuel rate input. By varying the fuel rate, the driver would have the option of sacrificing miles per gallon for greater limiting speeds. A variable pressure boiler is one technique which could be used to optimize a system to satisfy both low and high speed driving conditions.

A variable pressure boiler is almost self explanatory. Traditionally, steam systems have been designed to operate at preselected, fixed boiler pressure. A variable pressure boiler simply implies that the boiler pressure varies as the driver demands different vehicle speeds. The concept of a variable pressure boiler was not conceived lightly, but rather to solve specific problems relating to the modern steam automobile.

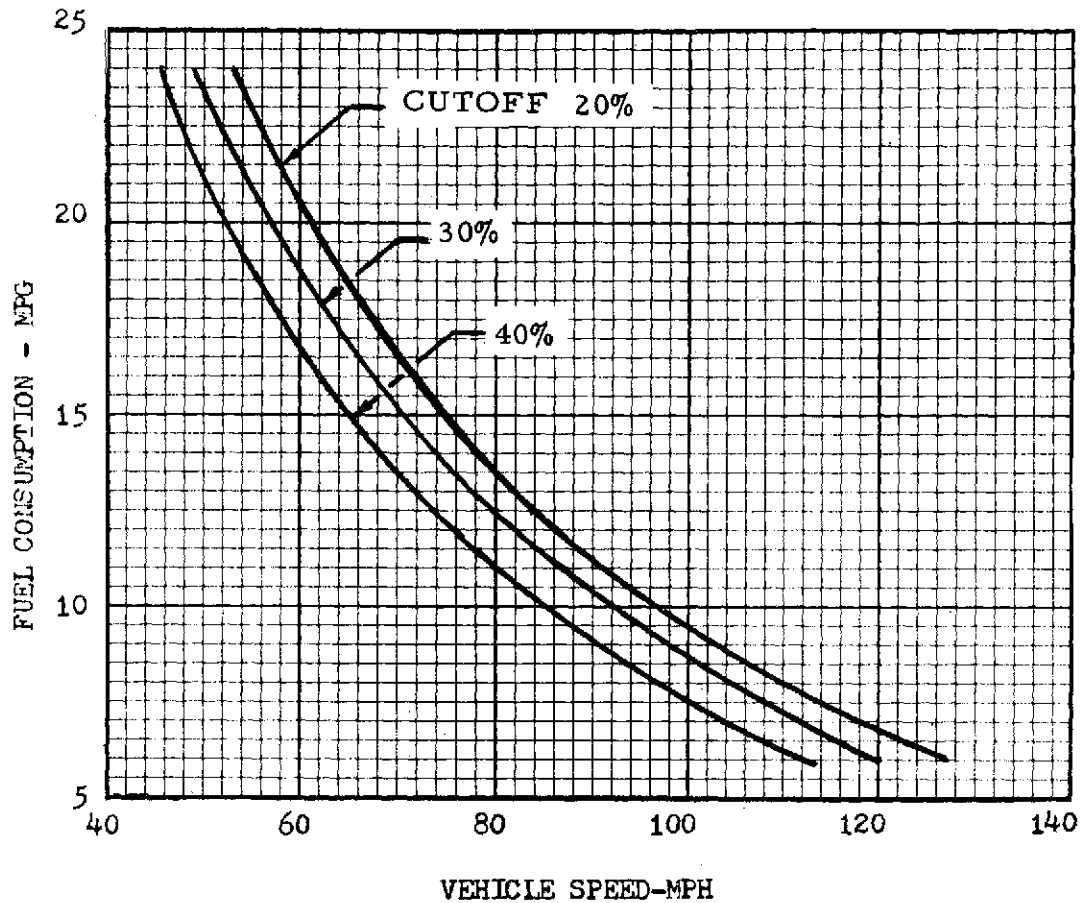

Figure 9. Relationship between fuel consumption and vehicle speed.

Steam enthusiasts are quick to point out that the steam system employed in an automobile requires neither clutch nor transmission. Also, that the engine does not consume fuel while stopped. The engine is geared with a fixed gear ratio to the rear wheels and when the vehicle stops, the engine stops. The point of this argument is that the steam system is simpler and thus less costly than its rival, the internal combustion engine.

These arguments would have been true for the 1940's. But by the performance standards and capabilities demanded by today's modern automobile, these arguments are no longer valid. This disposition is developed as follows:

- First — The auxiliary power equipment will require an auxiliary engine which does run continuously, or the main engine must run continuously. The expense associated with an auxiliary engine off-sets the previous cost arguments. Besides, an auxiliary engine (which runs continuously) is difficult to justify when the possibility exists to idle the main engine.
- Second — A fixed gear ratio cannot satisfy the demand for smooth riding at low speeds and also meet the speeds demanded for freeway performance.
- Third — A fixed gear ratio is not consistent with the low speed torque requirements and low fuel consumption demanded at higher speeds.

The above arguments represent the challenge for the new era of steam. The challenge can be met with a variable pressure boiler, along with the integration factors required for system operation. A System Description will require that the engine has a relatively small displacement in accordance with the criteria of the Abatement Number for low fuel consumption. The engine will be attached to an automatic transmission of the type in common use today. Upon starting, the boiler pressure will be allowed to rise to about 60 psia<sup>3</sup>. At this point, a solenoid valve will open the throttle (in this case, just a valve) wide open. The 60 psia will be just enough to allow the engine to idle at 300 to 400 RPM. During this part of the start cycle, the fuel rate will be mechanically set just sufficiently to maintain idle speeds. Initially, the fuel rate will be automatically set at a much higher value until the 60 psia is reached. When the solenoid valve opens, the fuel rate automatically reverts to its idle setting. The system has no throttle, per se. The engine speed will be increased by varying the fuel rate to the atomizer. Control of the fuel rate would be at the option of the driver by depressing the accelerator. As the accelerator is depressed, the boiler pressure will rise, increasing the engine speed and thus propelling the car. From start, combustion will be continuous until the system is shut down.

At first, it may be imagined that the boiler pressure would reach unsafe and uncontrollable levels. Not so! As the pressure increases, the vehicle also accelerates, thus tending to bleed down the boiler. The pressure will rise until a power level is reached which is indicative of the fuel rate input commanded by the driver. Simulations of this type system indicate that the pressure history within the boiler vary as illustrated on the next page.

---

3. Actual value determined by tests.

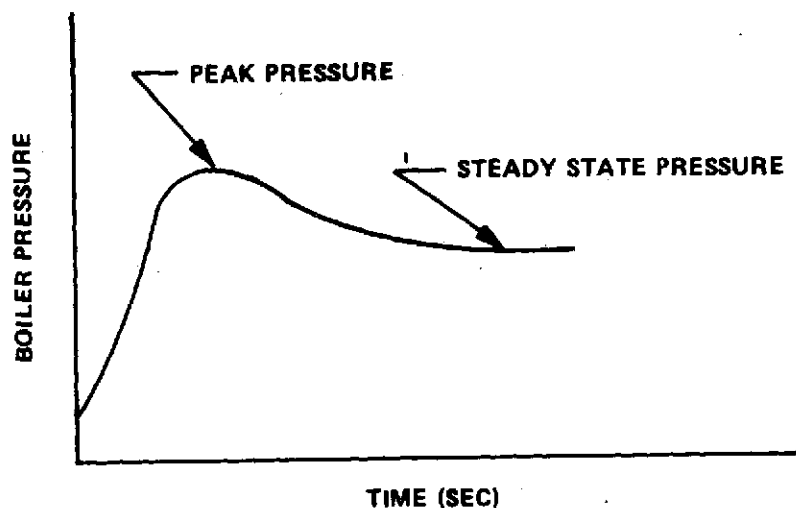

As the accelerator is further depressed, the steady state pressure becomes higher, increasing the power and thus driving the vehicle to greater speeds. When the accelerator is released, the fuel rate input reverts to its idle value. Detailed performance of this type control will be given later.

The reader should be aware that the tools developed in this chapter were based upon the ideal P-V program. The results which may be obtained from the use of any of the equations will be optimistic. However, it indicated the results that may be expected and what lies within the realm of possibilities. Very specific data has been prepared to obtain desired performance. A reason has been established for determining operating pressure and engine displacement. Also, the effects of cutoff, pressure, displacement, gear ratio, and temperature upon specific performance parameters have been indicated.

An important idea is the emphasis of miles per gallon parameters in lieu of theoretical thermal efficiency parameters. It has been indicated that good fuel efficiency (miles per gallon) can be obtained at very low pressures and mediocre temperatures (contrary to the implied requirements for theoretically high thermal efficiency). The sensitivity of miles per gallon to temperature is slight. Temperature is not an independent variable in the equation controlling miles per gallon. Other variables associated with temperature ( $R$  and  $\Delta H$ ) vary with temperature in such manner that the resulting parameter, Booty Number, is nearly constant over a wide range of

temperatures. There is a mistaken idea that miles per gallon efficiency increases proportionally to the increase in thermal efficiency, but such is not true. From the viewpoint of performance, no other working medium gives better results than water. Finally an alternate approach to the basic technique of operating a Steam Rankine System has been suggested. This approach is consistent with good miles per gallon, high starting torque, and freeway speeds.

## IV. CARDINAL CONSIDERATIONS

### A. Effects of the Booty Number

The contest between miles per gallon and thermal efficiency is important enough to consider the issue further. System efficiency is the ratio of the equivalent heat power output to the equivalent heat power input.

$$\eta_S = \frac{\eta_B \text{ MRT } S_N}{778 \text{ M}\Delta H} = \frac{\eta_B}{778} \left[ \frac{RT}{\Delta H} \right] S_N \quad (18)$$

Thermal efficiency is therefore the Booty Number times the Supple Number. But the Booty Number changes only slightly for a wide range of temperatures. Thermal efficiency is much more sensitive to the Supple Number. Regardless of how thermal efficiency is affected by the temperature, miles per gallon efficiency is determined primarily by the Abatement Number. The point is, for those temperatures of interest, there seems to be little relationship between temperature and miles per gallon.

The trend toward elevation of the supply temperature has resulted from extrapolation of the effect of the source temperature upon the Carnot cycle. However, as has been indicated, real engine performance differs greatly from Carnot, especially as to the effect of cycle parameters. The extrapolation from Carnot to a practical Rankine cycle has proven to be insignificant --- from a practical point of view, reversible heat cycles such as the Carnot cycle may not necessarily serve as good models for useful heat engines --- [3].

System efficiency, as spoken of here, has been derived on the basis of power considerations. We can also conceive of efficiency based upon miles per gallon. Such an efficiency would be the ratio of actual miles per gallon ( $MPG_A$ ) divided by the theoretical maximum miles per gallon ( $MPG_T$ ),

$$\eta_{MPG} = \frac{MPG_A}{MPG_T} \quad (19)$$

The actual miles per gallon have already been developed through the influence of the Abatement Number. From Appendix C, the Abatement Number is

$$\frac{PV}{G} = \frac{24 \pi [K_1 + K_2 AV_M^2]}{D_N} \quad (20)$$

Making this substitution into the  $MPG_A$  equation,

$$MPG_A = 0.001883 \eta_B \rho E \frac{RT}{\Delta H} \frac{S_N}{[K_1 + K_2 AV_M^2]} \quad (21)$$

The constants  $K_1$  and  $K_2$  are left in generalized form since the entire expression containing them will cancel when divided by  $MPG_T$ .

To obtain the expression for the theoretical miles per gallon, we assume that the entire energy rate supplied,  $FE$ , is consumed by the work rate required to sustain the retarding forces at the limiting velocity,

$$\frac{(778) (60)}{5280} FE = [\text{Retarding Force}] V_M \quad (22)$$

The Retarding Force is  $K_1 + K_2 AV_M^2$  and  $MPG_T = V_M \rho / 60F$

Making these substitutions, the theoretical miles per gallon are,

$$MPG_T = \frac{778}{5280} \frac{PE}{[K_1 + K_2 AV_M^2]} \quad (23)$$

The theoretical miles per gallon are the maximum possible fuel MPG capability. Note that this expression is also valid for all heat energy conversion devices. The engine could be a diesel, turbine, and, of course, internal combustion. It also would apply to motor cycles, etc. Note that the maximum theoretical miles per gallon have nothing to do with source temperature. On the contrary, the maximum possible theoretical thermal efficiency depends entirely upon temperature (Carnot Cycle)<sup>4</sup>. By reducing our analysis to a more practical parameter for performance ( $MPG_T$ ), temperature is eliminated as a sensitive parameter. This is an indication that too much emphasis has been placed upon the importance of temperature for practical engines. This disposition is based upon the fact that miles per gallon are a far better standard of performance than theoretical thermal efficiency.

The maximum miles per gallon occur at low speeds where  $K_1 \gg K_2 AV_M^2$ .

Letting the velocity approach zero we can find the maximum possible miles per gallon capability of a heat type energy conversion system. For a typical automobile,  $K_1 = 64$ , the maximum possible miles per gallon for an automobile under constant powered conditions are typically:

$$MPG_T = \frac{(778)(6.7)(19500)}{(5280)(64)} = 300 \frac{\text{miles}}{\text{gal}} \quad (24)$$

The efficiency of a Rankine Cycle energy conversion system based upon MPG is

$$\eta_{MPG} = \frac{MPG_A}{MPG_T} = \frac{\eta_B RT}{778 \Delta H} S_N \quad (25)$$

---

4. Carnot engines do not exist.



This is exactly the same expression obtained for system efficiency based upon power. Thus,

$$\frac{\text{Power out}}{\text{Power in}} = \frac{\text{MPG}_A}{\text{MPG}_T} \quad (26)$$

This simply states that high power output is accomplished at the sacrifice of  $\text{MPG}_A$ . This idea is not new, but the preceding equations give the exact relationships.

The efficiency of the Rankine Cycle, based on miles per gallon, approaches maximum as cutoff approaches zero. Taking typical values, the typical maximum practical efficiency of the Rankine Cycle can be found,

$$\eta_{\text{MPG}} = \frac{0.85}{778} (81.2) (2.25) = 0.20 \quad (27)$$

where:

$$\text{Temperature} = 950^\circ \text{F} \quad ,$$

$$\text{Pressure} = 600 \text{ psia} \quad ,$$

$$\therefore \frac{RT}{\Delta H} = 81.2 \text{ ft-lb/BTU} \quad ,$$

$$\gamma = 1.3 \quad ,$$

$$X = 0.20 \quad ,$$

$$S_N = 2.25 \quad , \text{ and}$$

$$\eta_B = 0.85 \quad .$$

A Carnot Cycle with the same source temperature and a sink temperature of 300° F will have an efficiency of 0.46. Just for fun, it is interesting to compare the Rankine Cycle efficiencies at extreme temperature and pressures. Taking a supply temperature of 1600° F and a pressure of 2000 psia, the Booty Number will be about 95. The efficiency based on miles per gallon will be only 23.6 percent. This is a small increase for the problems introduced at those high pressures and temperatures. On a practical scale, there is no justification for the modern steam automobile to employ high temperatures and pressures. The higher operating conditions will give high thermal efficiency, but thermal efficiency does not translate into miles per gallon efficiency in a one-to-one fashion.

## B. Fuel Economy in Perspective

It may appear that the concept of the Abatement Number and its influence upon miles per gallon would represent an apotheosis of steam engine performance. In the midst of the energy crisis, what could be more important than a criteria for designing steam systems which give very acceptable miles per gallon? However, the utilization of fuel within our economy is much more involved and complex than to attempt to characterize its use primarily in terms of good miles per gallon. The best use of fuel requires a more sophisticated usage criteria than simply miles per gallon. One factor which must be considered is the time involved in sustaining an acceptable miles per gallon.

To illustrate this point, consider a driver who wishes to go from point (A) to point (B). The operator is very interested in consuming the minimum amount of fuel in driving between these two points. However, the operator is also interested in driving the distance in a reasonable time. If the operator drives relatively slow, he obtains good miles per gallon. But, the time involved may be excessive or even unacceptable. On the other hand, if the operator drives faster, he may sacrifice fuel for less driving time. This is an important consideration, especially to the trucking industry where drivers are paid by the mile. In this case, the criteria for fuel utilization should be based upon minimizing fuel consumption for the maximum miles which can be traveled in the shortest time.

The same idea applies to passenger car use, where it is desirable to accelerate and pass a slower driver but at the same time use as little fuel as possible. In this situation, it is also a safety consideration. The operator wants to sacrifice fuel to get around the slower driver, as soon as possible. Also, just

in normal use of a vehicle, time is valuable and deadlines seem to be with us continuously. Therefore, in every driving situation, the operator is consciously or unconsciously trading off miles per gallon to arrive at the predetermined destination in the time allowed.

For now, we should generalize upon this idea of "time" and how it relates to miles per gallon. Ultimately, we want a criterion to judge how a steam engine may be designed to get the best trade-off between fuel consumption and sustaining power necessary to reduce the driving time between points A and B. This criterion will be referred to as the Count Criterion. The word "count" implies counting for all the factors involving the best fuel/time usage.

The Count Criterion is made up of two factors. The first factor is pounds of fuel consumed per mile ( $lb_f/mile$ ). Of course, this factor should be made as small as possible. The time involved in going between two points is a measure of the horsepower that must be sustained to maintain high speeds. The second factor is the horsepower that must be sustained over the time period required to travel between points (A) and (B). The parameter, power per hour (hp/hr), should be as great as possible to ensure speed capability, but at the same time reduce the time which the power must be sustained.

The ratio of the first factor to the second factor is the Count Number ( $C_N$ ), and it is desirable to make the number as small as possible. The Count Criterion involves varying the engine parameters to reduce  $C_N$  to its smallest value,

$$C_N = \frac{lb_f/mile}{hp/hr} \quad (28)$$

An expression for  $C_N$  can be developed by dividing fuel rate by the unit vehicle acceleration capability. This derivation is given in Appendix E, but is summarized here for discussion purposes,

$$C_N = \frac{1890 W}{\eta_B \left(\frac{RT}{\Delta H}\right) \left(\frac{PV}{G}\right) E} \left[ \frac{1}{D_N S_N} \right] \quad (29)$$

In interpreting the  $C_N$ , it is important to recognize that an optimum value does not exist which will fit all situations. Situations certainly exist where large sacrifices in fuel consumption can be justified to reduce the driving time between two points. However, for a given engine design represented by an Abatement Number, Booty Number and vehicle weight,  $W$ , there exists a cutoff value which will reduce the  $C_N$  for that design to a minimum value. The minimum value of  $C_N$  implies that the minimum fuel was required per mile in order to sustain a given horsepower for one hour. It can be shown that a cutoff of 46 percent will minimize the  $C_N$ . This fact can be visualized in Figure 10, which is a plot of  $(1/D_N S_N)$  as a function of cutoff. The minimum value occurs at 46 percent cutoff for  $\gamma = 1.2$ . Simply stated, a cutoff of 46 percent will allow for a vehicle to accelerate and pass a second vehicle in the shortest time with the minimum fuel.

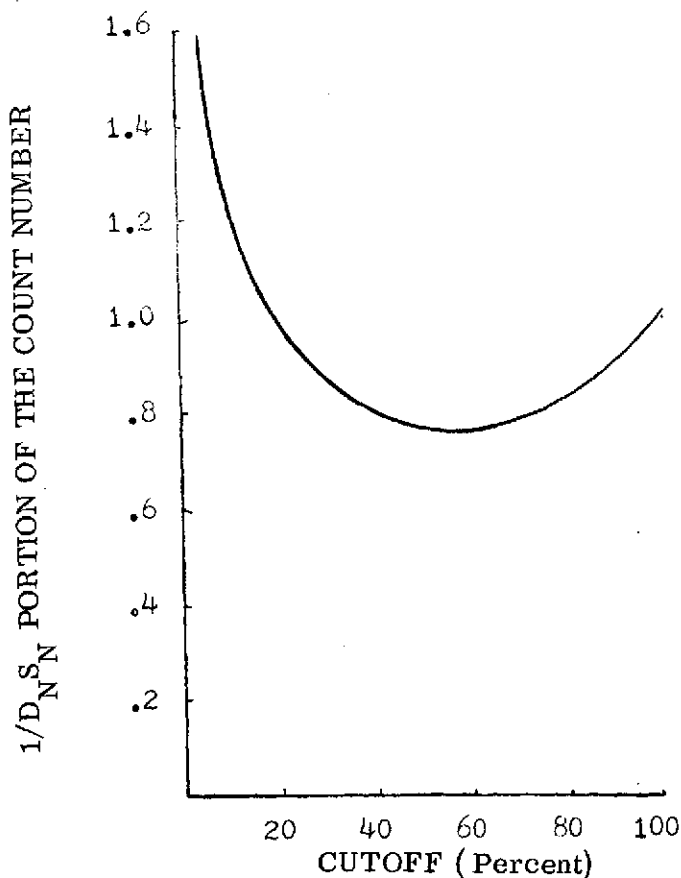

Figure 10. Effect of cutoff upon the Count Number. For any engine design, a cutoff of about 46 percent minimizes the Count Number.

It will be noticed that the curve in Figure 10 is rather flat on the bottom. Minimum  $C_N$  could be maintained for cutoff varying between 40 and 60 percent.

These results are stipulated upon a constant Abatement Number. If the Abatement Number decreased as a result of greater steam demand by going to 60 percent cutoff, the overall effect would have to be evaluated to determine which cutoff resulted in the minimum Count Number. So in reality, there is a relationship between the Abatement Number and cutoff. The Count Number should not be thought of as a minimum fuel criterion. The criterion for minimum fuel consumption is governed by low cutoff and low Abatement Numbers. The Count Number simply relates the best capability of an engine design to trade-off sacrifices in fuel consumption for sustaining a given power level over a given time period.

In a sense, the Count Criteria of 46 percent cutoff implies that a cutoff greater than 46 percent is not required for the modern steam car. At 46 percent cutoff, the ratio between admission work and expansion work is 1.37. Thus, the admission work is 37 percent greater than the expansion work at the minimum Count Number. In practice, it would probably be more beneficial to the total design if a cutoff of 40 percent was selected for the Count Criterion rather than 46 percent. At 40 percent, the Count Number is still very near its minimum. At this lower cutoff, a small steam rate is imposed upon the condenser.

There is also a geometric interpretation which can be applied to the Count Number. This interpretation has to do with the cutoff which results in the maximum expansion work available. For an example, the expansion work can be related as

$$\text{Expansion Work} = PV \left[ \frac{X - X^\gamma}{\gamma - 1} - \frac{P_A}{P} (1 - X) \right] . \quad (30)$$

Realizing that the maximum value of  $P_A/P$  is  $X^\gamma$ , in order to avoid "looping" the expansion work is zero at zero cutoff and 100 percent cutoff. All other values of cutoff produce finite values for expansion work. It can be shown that the maximum expansion work occurs at a cutoff of about 42 percent. These results are interpreted as being strongly related to the Count Number. The basis for this interpretation is that the cutoff which gives the minimum Count Number is also close to the cutoff which gives maximum expansion work. The implications of

the Count Number is not intended to imply that a steam system should be continuously operated at 46 percent cutoff. It is inferred that the capability to change the cutoff to 46 percent should be incorporated in the design. When passing or extremely high speeds are necessary, the driver would have the option to engage the 46 percent cutoff level.

Equation (12) is in a general form and can be applied quickly and directly for any working medium. The gas constant (R) is usually readily available. The reader is cautioned that equation (12) resulted from application of the ideal gas laws. In performing refined calculations, the constant (R) has to be thought of as (ZR), where (Z) is the compressible factor. Evaluation of the variation in miles per gallon, as a result of pressure and temperature for a given working medium, can be made by reducing the Booty Number to variables of pressure and specific volume (v),

$$\text{Booty Number} = \frac{ZRT}{\Delta H} = \frac{144 Pv}{\Delta H} \quad (31)$$

Equation (12) reduces to

$$\text{MPG} = 0.0142 \eta_B \frac{PE}{X} \frac{144v}{\Delta H} \frac{G}{V} \quad (32)$$

This equation suggests that for any given design, MPG is at the mercy of

$$\frac{144v}{\Delta H} \quad (33)$$

which is totally descriptive of the working medium. The variation in MPG can be evaluated by determining how  $144v/\Delta H$  varies. MPG is directly proportional to the value of  $144v/\Delta H$ .

Figure 11 illustrates the variation of  $144v/\Delta H$  for water, with pressure and temperature. This chart suggests that miles per gallon is strongly sensitive to pressure, in that increases of pressure decrease the miles per gallon.

This is opposite to the effect of pressure upon theoretical thermal efficiency. Notice that at relatively high pressure (600-1200 psia), the effect of temperature is very slight. A system operating at 800 psia and 700° F produces almost the same miles per gallon as it would if the temperature is increased to 1100° F. This is a very significant result. The problem introduced by operating at 1100° F is not worth the insignificant gain in MPG.

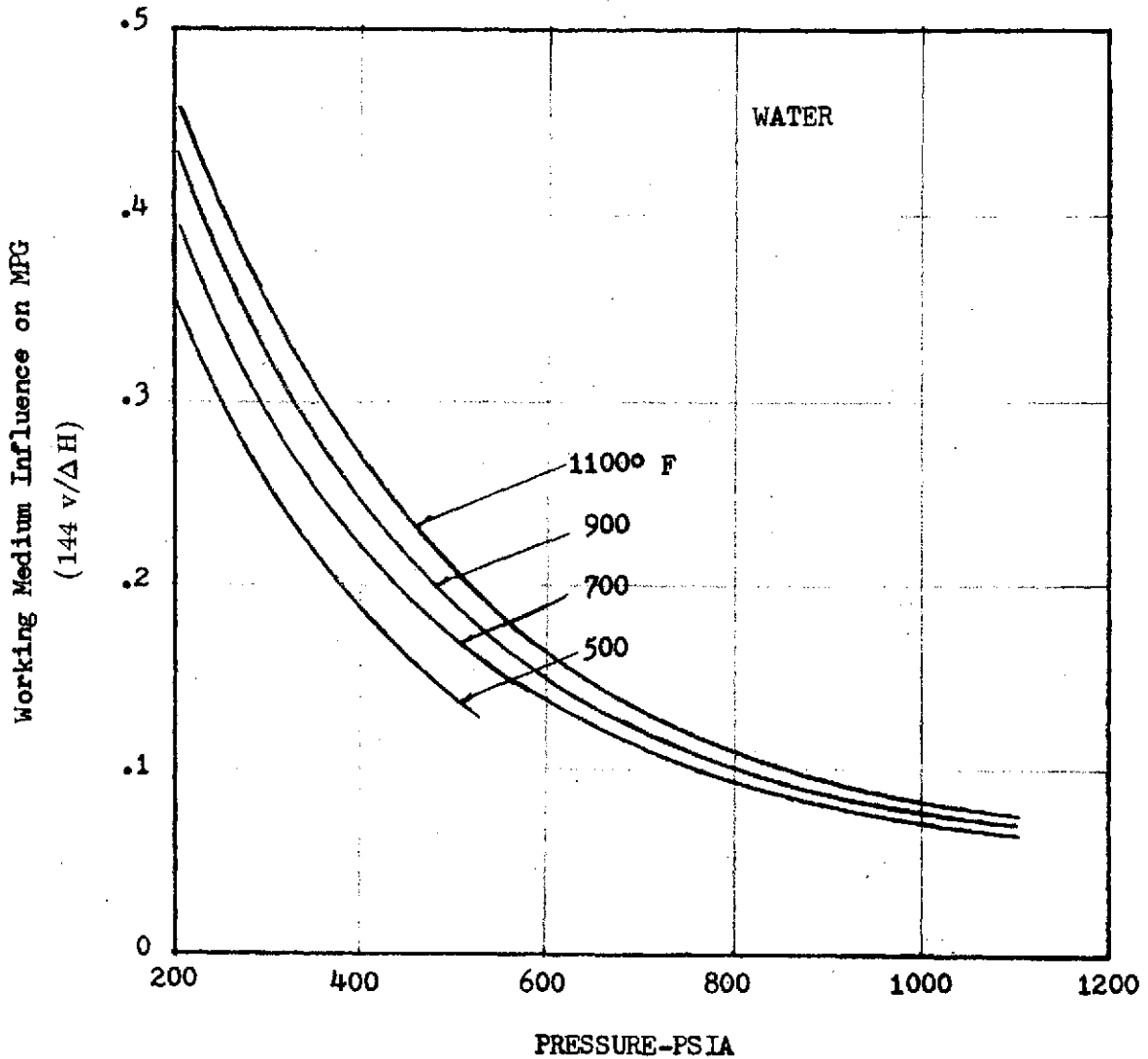

Figure 11. The effect of pressure and temperature upon miles per gallon (MPG) by the working medium only. The term  $144v/\Delta H$  is directly proportional to MPG for any steam car system design. The proportionally constant will depend upon engine displacement, gear ratio and cutoff.

Temperature has greater effects at the lower pressures. For an example, at 400 psia and 700° F, a 57 percent increase in temperature will produce 25 percent increase in MPG. As a final example of the upside-down nature of MPG, as related to thermal efficiency, more miles per gallon are available at 500 psia and 700° F than are available at 1000 psia and 1100° F. These statements are made under the conditions that the design is arbitrary. Miles per gallon are proportional to  $144v/\Delta H$ , but the proportional constant changes, depending upon the design. Ultimately, the relationship between the design and working medium will be illustrated and techniques will be discussed to select a design which reinforces the performance capability of the working medium.

The foregoing exercise was used to determine the ultimate effect of pressure and temperature of the working medium upon miles per gallon for a given design. This technique has been presented to illustrate how any working medium may be evaluated in its contribution to MPG. However, this is not the whole story. The other part is the role of the design. In the final analysis, the designer seeks a design which will enhance miles per gallon with the constraint of limiting speed capability.

Now, the foregoing has clearly defined the role of the working medium in its influence and capability upon miles per gallon. However, of much more importance is the influence of the working medium upon system design and how the working medium and system design are combined to give more miles per gallon. After all, the goal of the design is to select a working medium, adjust operating conditions, and pick design parameters which will give the maximum miles per gallon for a given speed or power capability. At first it may not be obvious as to how the working medium may affect system configuration and possibly material selection. With water, there are virtually no pressure and temperature limitations. However, organic fluids do have limitations. For the purposes discussed here, water will be used for illustration. However, the theory can certainly be employed for any working medium. To evaluate the combined effect of the working medium and system design, the influence of pressure and temperature upon miles per gallon for a fixed vehicle speed will be explored. At first, the solution to this problem may appear uninteresting, since equation (12) can be easily solved for any working medium and engine parameters. There are no obvious optimum operating conditions.

When a fixed speed is specified, the value of the Abatement Number times the Dour Number becomes predetermined.<sup>5</sup> This means that cutoff, displacement, pressure, and gear ratio can vary over wide limits, within those required

---

5. For a given vehicle weight etc.



to maintain a fixed given speed. An important consideration is whether a particular combination of these parameters exists which will result in maximizing miles per gallon, and the answer is yes.

In order to discover the best combination of parameters, it will be necessary to employ the Fundamental Law of Pressure and Displacement. For a given working medium, the maximum miles per gallon is obtained when the cutoff is reduced to the lowest possible value, as constrained by a pressure necessary to prevent looping, and with the displacement and gear ratio consistent in combination with the predetermined Dour Number to maintain the pre-selected speed. To comprehend this law, consider equation (12) rewritten as before but without cancelling out the pressure:

$$\text{MPG} = 0.0142 \eta_B \frac{\rho E}{X} \left( 144 \frac{Pv}{\Delta H} \right) \left( \frac{1}{\frac{PV}{G}} \right) \quad (34)$$

The identity of the Abatement Number is maintained for two reasons:

1. It is a necessary calculation for determining how displacement and gear ratio must change in maintaining a fixed speed, as pressure and cutoff change.

2. Knowledge of the Abatement Number provides design data for the engine displacement and gear ratio necessary at the pressure which will yield maximum miles per gallon.

Visualize a working medium at temperature, T, and at pressure, P. Selection of these operating conditions predetermines v, and  $\Delta H$ .<sup>6</sup> Let the temperature remain fixed and visualize what happens as the pressure increases. As we have already seen, the group of parameters sensitive to the working medium will begin to decrease. However, the cutoff can be allowed to decrease in accordance with

$$X = \left[ \frac{P_A}{P} \right]^{\frac{1}{\gamma}} \quad (35)$$

---

6. Exhaust conditions are determined by  $P_A$  at saturated liquid conditions.

This value of cutoff represents the smallest cutoff value without inducing looping. Thus, as the pressure increases, the cutoff may be changed to a smaller value, causing the miles per gallon to increase. As the pressure increases, resulting in a predetermined cutoff and Dour Number, the value of displacement and gear ratio must change in order to satisfy the fixed speed requirement.<sup>7</sup> Although it is not obvious, the overall effect is to increase the Abatement Number. Thus, for every discrete pressure, there is a calculable cutoff, Abatement Number, and the associated miles per gallon. If this process of allowing the pressure to increase is continued, it is of interest to know how the miles per gallon change will occur over a wide pressure range.

The reader should realize that parameters which affect miles per gallon are being manipulated in a fashion to improve miles per gallon under the constraint of maintaining a fixed speed. The truth of this statement lies in acceptance of the Fundamental Law of Pressure and Displacement. The author has no rigid proof of this law; however, in performing many calculations in the solution of equation (12), no other criterion has resulted in better performance than that resulting from application of this law. This law may be better thought of as an algorithm which is related to maximizing miles per gallon.

The results are given in Figure 12. Miles per gallon are plotted, with pressure as an independent variable. Three curves are shown for the fixed temperatures indicated. This entire chart is based upon a fixed speed capability of 60 mph. Associated with every pressure level is a value for cutoff, Dour Number, and Abatement Number. Figure 12, therefore, has built in and predetermined engine design characteristics, as indicated in the matrix below:

Pressure (PSIA)	Abatement Number (PV/G)	Cutoff (Percent)	Dour Number <sup>8</sup>
200	51,428	8.4	0.191
500	88,148	4.2	0.111
800	118,621	2.9	0.082
1100	145,899	2.3	0.067

7. See Appendix C for relationship between vehicle speed, pressure displacement, gear ratio, and Dour Number.

8. Since low cutoff values are involved, the contribution of  $P_A/P$  must be considered in computing the Dour Number.

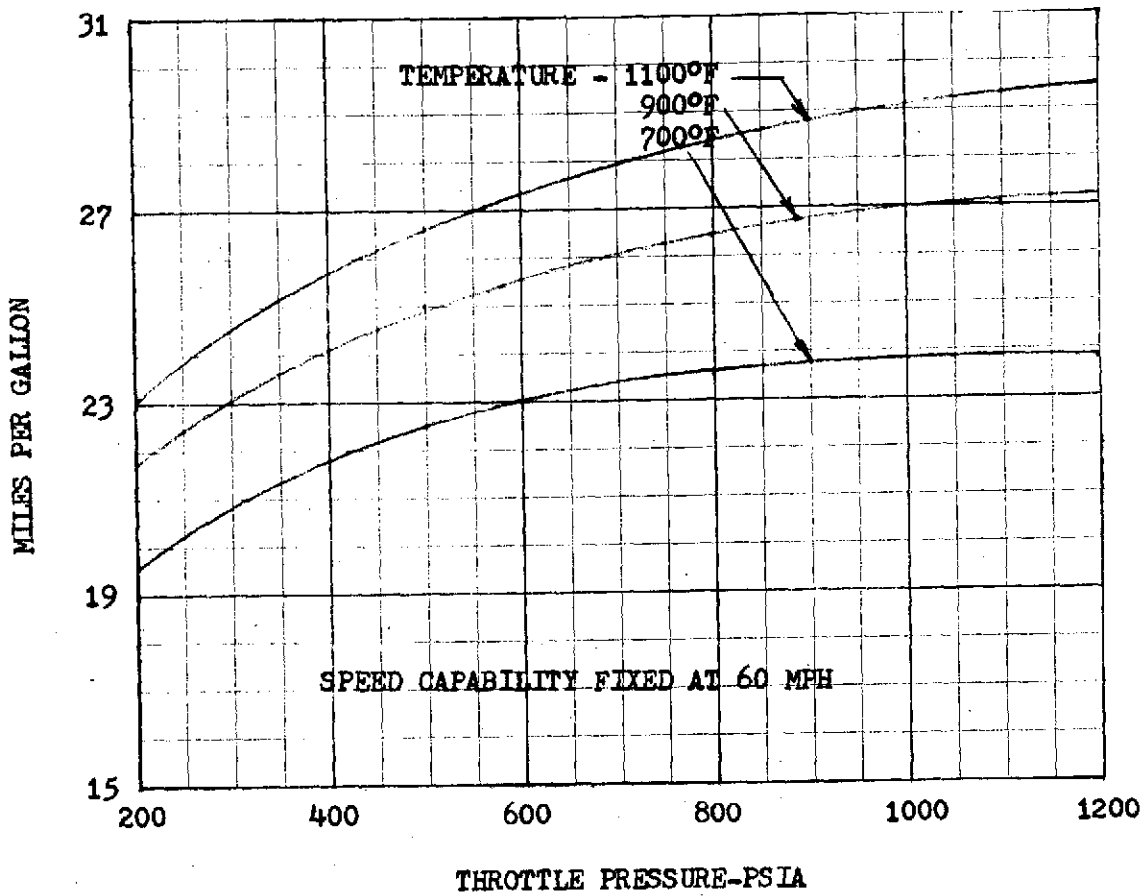

Figure 12. Maximum theoretical performance available from the Rankine Cycle using water. Conditions are specified in text.

In carrying out the calculation, the following assumptions were made concerning the other variables:

$$\rho = 6.7 \text{ lb/gal,}$$

$$E = 19500 \text{ BTU/lb,}$$

$$K_1 = 70 \text{ (3500 Pound Automobile),}$$

$$K_2 = 0.001225 \text{ (4 door sedan),}$$

$A = 27 \text{ ft}^2$  frontal area,

$\gamma = 1.3$ , and

$\eta_B = 0.85$  .

The following observations are noted concerning Figure 12:

1. For typical steam engines (water), these values represent the best possible performance available.
2. Performance is acceptable for all pressures between 200 and 1200 psia and temperature between 700° F and 1100° F.
3. After about 800 psia, the gain in MPG increases slowly with pressure. This is especially true at 700° F.
4. Based upon these trends, there seems to be absolutely no justification for pressures beyond 1000 psia.
5. An operation temperature between 700° F and 900° F offers the most satisfactory performance without the lubrication problems introduced at much higher temperatures.

As an example of how to utilize the above chart, the relationship between engine displacement and gear ratio is computed for a pressure of 800 psia (the Abatement Number is 118,621):

$$\frac{PV}{G} = 118,621 \quad \text{and} \tag{36}$$
$$\frac{V}{G} = \frac{118621}{800} = 148.2 \quad .$$

This means that the engine displacement ( $\text{in.}^3$ ) divided by the gear ratio (ft) must be 148.2 in order for the vehicle to be capable of 60 mph, with a cutoff of 4.2 percent at the throttled pressure of 800 psia.

Figure 12 is presented as the ultimate performance capability. However, in a real design, the ideal cutoff cannot be accomplished because of restrictions imposed by:

1. Cylinder condensation,
2. Wire drawing, and
3. Release volume losses.

It is therefore much more practical to talk about minimum cutoff in terms of "cutoffs having a fixed percent value greater than the theoretical minimum." In other words, let cutoff (x) vary as

$$X = \left[ \frac{P}{\frac{A}{P}} \right]^{\frac{1}{\gamma}} (1 + I) , \quad (37)$$

where (I) is the decimal increase in cutoff. For a 100 percent increase, (I) would be 1.00.

Figure 13 shows the effect of increasing the cutoff value above the theoretical minimum. This chart has been constructed for a temperature of 900° F.

It is emphasized that the characteristics given in Figures 12 and 13 are based on an optimum engine design capable of 60 mph. Similar data could be developed for any speed. From surveys made by the author, the effect of changing the limiting speed is to shift the curve in the vertical direction. Characteristics of the "curve" shape are preserved. Thus, the conclusions already made are valid for any speed. Greater speeds tend to move the curves downward and vice versa for decreasing speeds.

The design requirement for meeting optimizing conditions may be completely prohibitive. For example, a variable cutoff would be required which would be governed by the condenser, suction pressure, and throttle pressure. Also, under varying loads, the pressure would fluctuate, changing the Abatement Number. This may even create a need to have a variable gear ratio. At best, satisfying the conditions to obtain optimum performance could be a formidable design problem, which ultimately could not be warranted on a production cost basis.

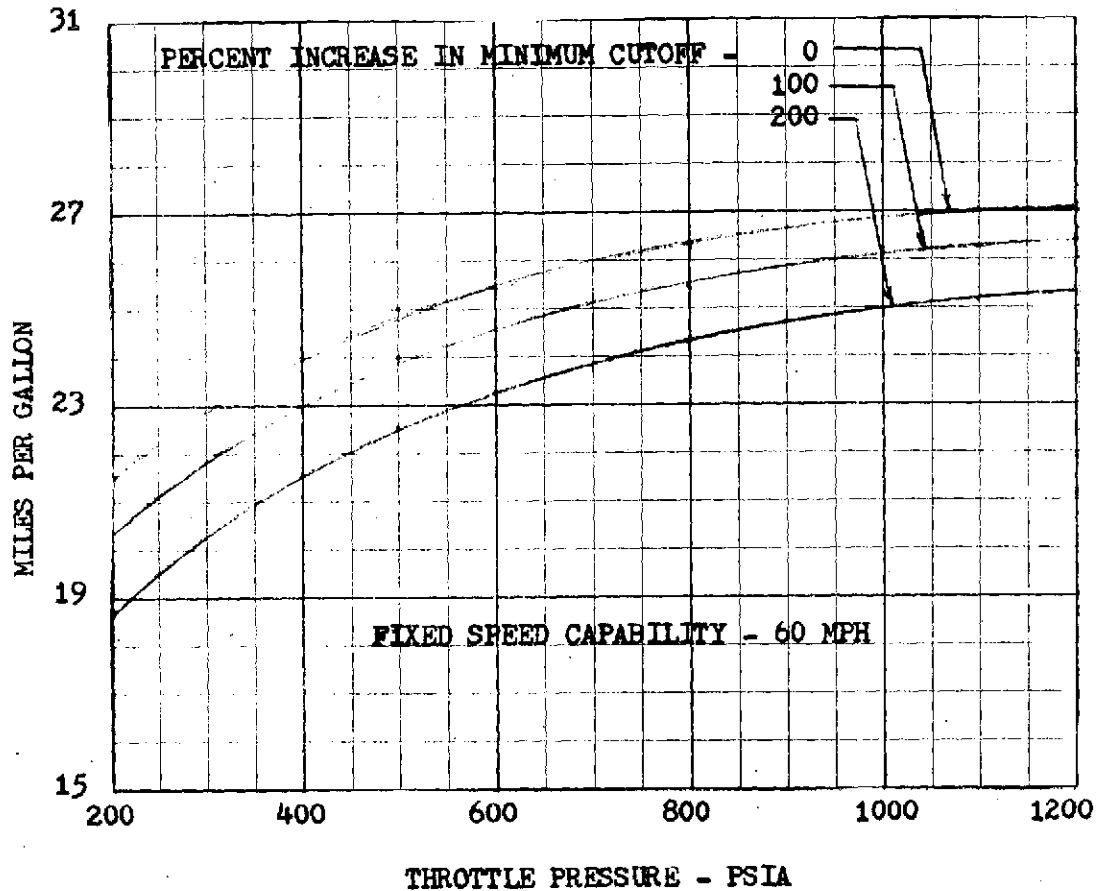

Figure 13. Performance available from the Rankine Cycle under maximum conditions where the cutoff is allowed to be increased above the theoretical minimum. This chart is applicable for water at 900° F.

At best, the performance of the optimum design may serve its purpose as a desirable limit, as the Carnot Cycle serves as a desirable limit in its own special way. It is noted however, that the performance of the Carnot Cycle is impossible to achieve, whereas, the criteria for maximizing MPG with the steam engine is achievable.

Since the ideal design would be difficult to achieve, it is a worthy task to study miles per gallon as a function of pressure for a fixed cutoff under the constraint of a fixed speed capability. This situation is a much more realistic than those applicable to Figure 13. The cutoff would not be a function of pressure, but would be selected on the basis of convenience or the limitation of the valving device employed.

For purposes of study, a cutoff of 15 percent will be selected. These results are shown in Figure 14. As before, the Abatement Number is allowed to change in order to maintain a capability of sixty miles per hour. These results indicate that for a fixed speed capability and a fixed cutoff, miles per gallon are essentially insensitive to pressure. The Abatement Numbers associated with Figure 14 are given below:

Pressure Psia	Abatement Number	Dour Number	Cutoff Percent
200	44,133	0.327	15
500	41,116	0.351	15
800	40,425	0.357	15
1100	40,118	0.360	15

For a single engine, there is certainly no justification for high pressure on the basis of miles per gallon. It will be noted that these results are inferior to those of Figure 12 for the same temperature. By comparing Figure 12 with Figure 14, the cost in miles per gallon can be assessed as to the relative complexity of the two engines which these figures represent.

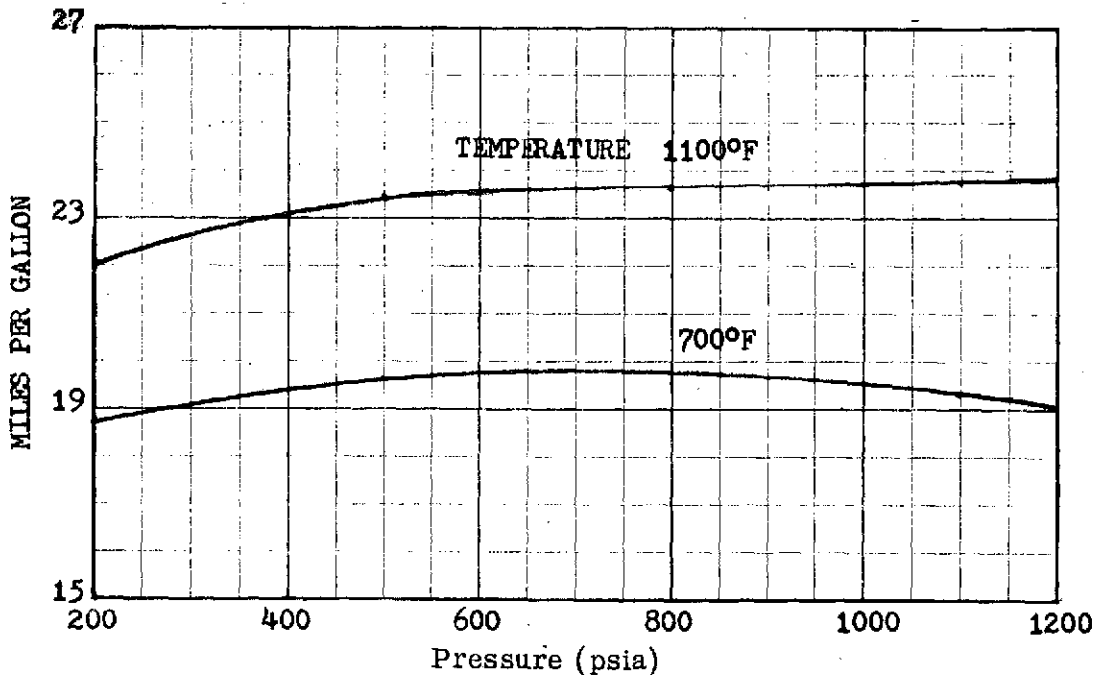

Figure 14. Sensitivity of miles per gallon to pressure for a fixed cutoff of 15 percent and an abatement number changing such to maintain sixty miles per hour.

The foregoing does not completely dictate design. However, several logical steps seem to be in order for the system to be compatibly designed:

1. All major considerations should be based on miles per gallon and limiting speed capability, which are compatible with the energy crisis which we are experiencing in times like these.

2. Most important, a decision must be made concerning the level of optimum performance desired. Ultimately, this may mean some analysis of equation (12) if cutoff varies in accordance with another algorithm, other than those already presented.

3. Depending upon the results of analysis for the selected algorithm, a decision can be made as to the combination of the operating pressure and temperature.

4. Selection of temperature is primarily a matter of the level of material selection cost and lubrication difficulties which the promoters are willing to tolerate. It is emphasized that high temperature (1000° F) is not a requirement to obtain acceptable miles per gallon. Above all, the teachings of the Carnot Cycle about the source temperature should be avoided. No consideration should be given to the theoretical thermal efficiency.<sup>9</sup>

5. Depending upon the influence of pressure and desired speed capability, an Abatement Number can be selected.

6. The Abatement Number will determine the required displacement and gear ratio to meet the speed requirement.

7. Arbitrary selection of system parameters will, in most cases, lead to a disappointment in speed capability, miles per gallon, and accompanying engine speed. Return to the front of this report and read the preface again.

An engine which employs a fixed cutoff is of particular interest, since it represents the simplest configuration. Also, the nature of such an engine is worthy of further analysis just to establish fundamental characteristics.

---

9. May the great T-S diagram in the sky forgive me.



Figure 14 gave results for an engine having a fixed 15 percent cutoff. A fundamental question is, What happens to performance as cutoff is fixed at lower values? Figure 15 is performance at 60 mph with a fixed cutoff of 5 percent. Note that the same conclusions can be made as noticed at 15 percent fixed cutoff. Above 600 to 800 psia, performance is not sensitive to pressure. Actually, at the lower temperature (700° F), performance dropped off a little at 1200 psia.

Up to this point, all of the performance data have been based upon a condenser suction pressure of 8 psia. Now as lower cutoff values are introduced, the pressure ratio of 8 psia to 1200 psia is not low enough for a real low cutoff without encountering looping. As a far out reach to evaluate large expansion ratios, the supply pressures were maintained as before but the condenser pressure was reduced to 1.0 psia. This condition allowed for a fixed cutoff of 1 percent.

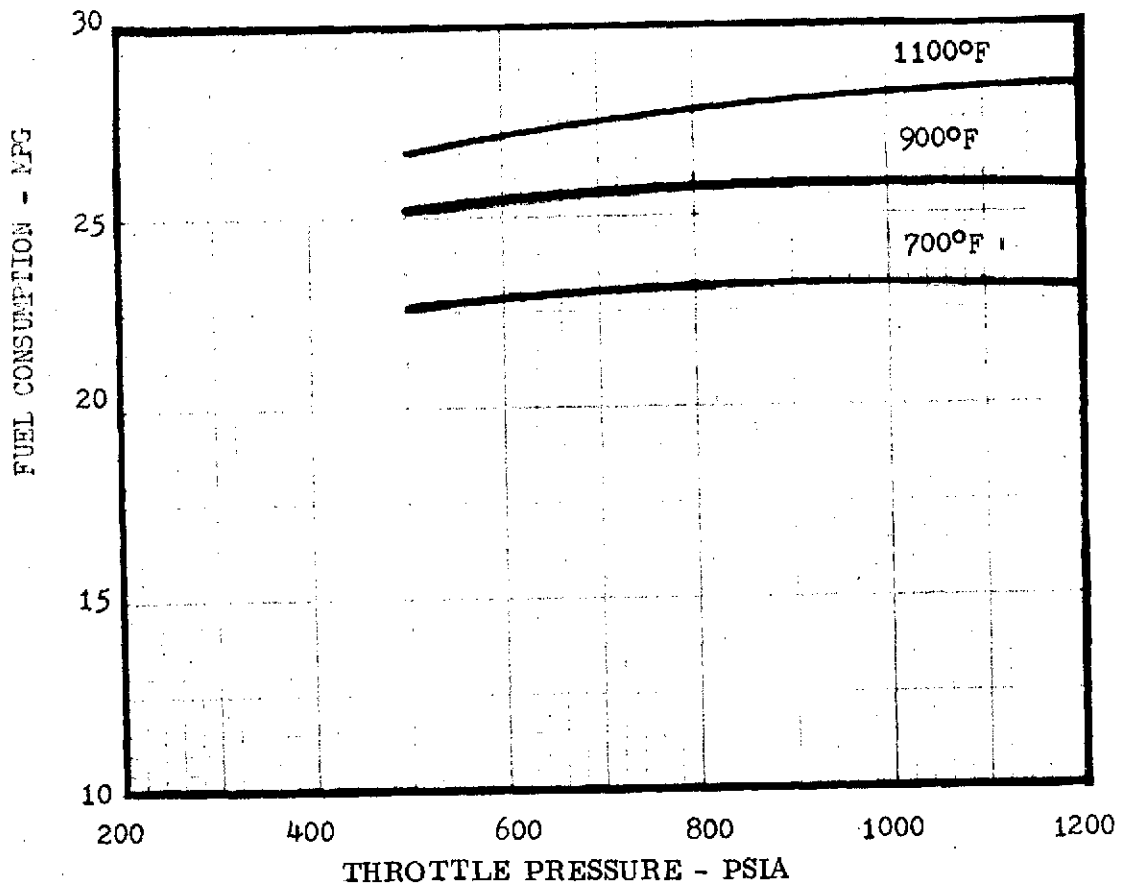

Figure 15. Engine performance for a fixed cutoff of 5 percent at 60 miles per hour. Performance is almost insensitive to pressure. High pressure cannot be justified on the basis of miles per gallon.

It is realized that comparison of 1 percent cutoff data under these conditions gives an advantage to the 1 percent cutoff engine. However, in an extremely low cutoff engine the reader must realize that either high initial pressure or low condenser pressure will be required. Under actual conditions, both may be required, depending upon the value of the cutoff. In any event, the 1 percent fixed cutoff data are shown in Figure 16. As before, performance is not a function of pressure as long as the supply pressure is sufficient to maintain a valid 1 percent cutoff.

By comparing all of the figures for the fixed cutoff case, it becomes apparent that pressures beyond 800 psia will not improve performance. However, temperature is important. In order to summarize all these data for the fixed cutoff case, Figure 17 is presented. These data are valid for all engines operating above 800 psia and at a supply steam temperature of 900° F. Of course, as stated before, the 1 percent cutoff case is applicable for a condenser suction pressure of 1.0 psia, whereas the others are for 8 psia. It seems clear, if the conditions required for very low cutoff can be maintained, high expansion ratio engines offer a distinct advantage.

It is noted that all of the foregoing data were based upon reversible and adiabatic processes with an ideal P-V diagram. The specific results are therefore optimum, but the importance of this analysis is the relative magnitudes. Also, the technique given herein can certainly be extended to account for real engine effects, to a depth for which an investigator has time and money to spend.

Assumptions relating to system characteristics in developing data in this section are:

Isentropic exponent	=	1.3
Boiler Efficiency	=	0.85
Frontal Area	=	27 ft <sup>2</sup>
Vehicle weight	=	3500 lb
K <sub>2</sub>	=	0.00125

### C. Mile Per Gallon Summary

From the preceding figures, it can be observed that performance is not much improved above 800 psia. And for more realistic conditions, as illustrated in Figure 13 and 14, almost no improvement is realized above 800 psia.

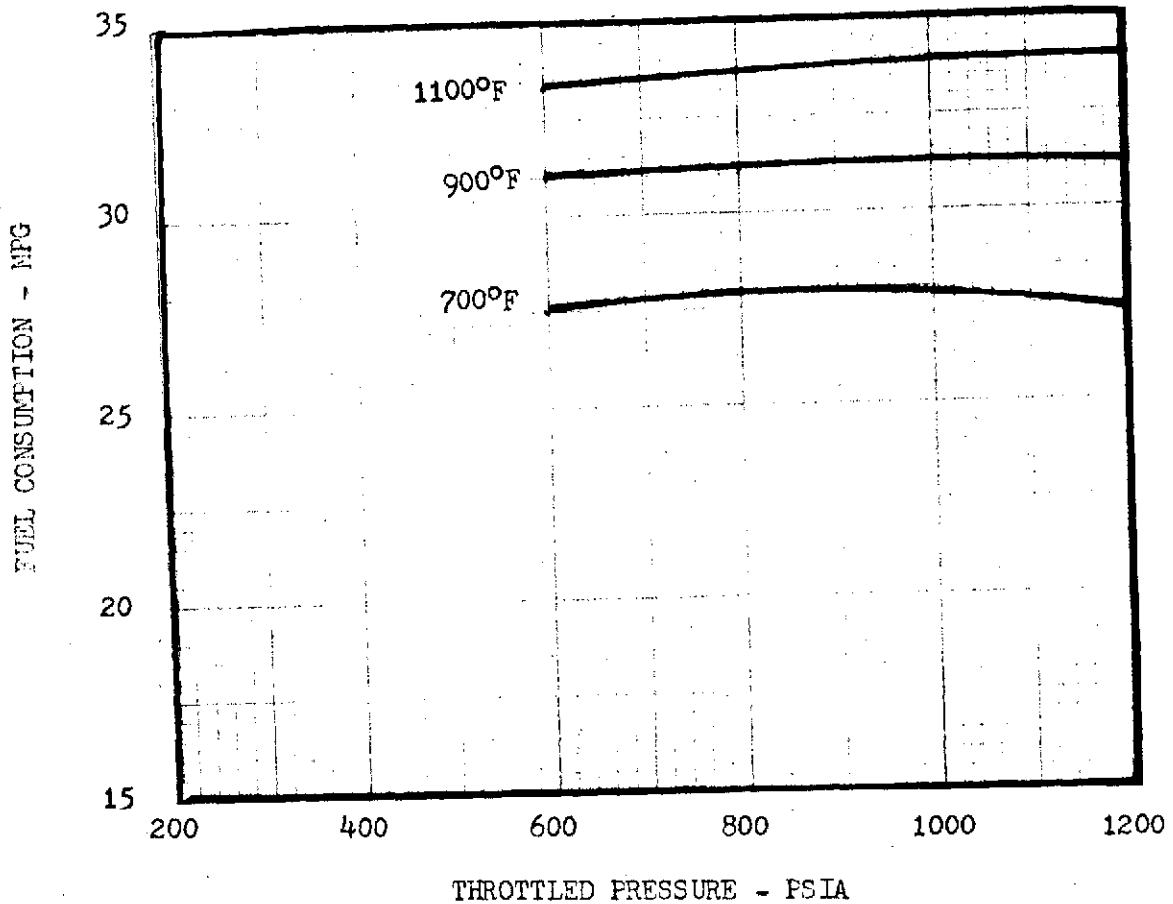

Figure 16. Engine performance for a fixed cutoff of 1 percent at 60 miles per hour. The condenser suction pressure is 1.0 psia. High supply pressures cannot be justified on the basis of miles per gallon.

Another characteristic of equation (12) is the independence of miles per gallon of the condenser section pressure for supply pressures above 600 psia. This fact has not been graphically illustrated, but has been observed by the author for a variety of cutoffs, pressures, and suction pressures.

The above two facts allow for a great generalization to be made concerning miles per gallon. Miles per gallon can be accurately represented as a function of temperature and cutoff only as long as the throttled pressure is above 800 psia and condenser pressure is between 1.0 and 15.0 psia.

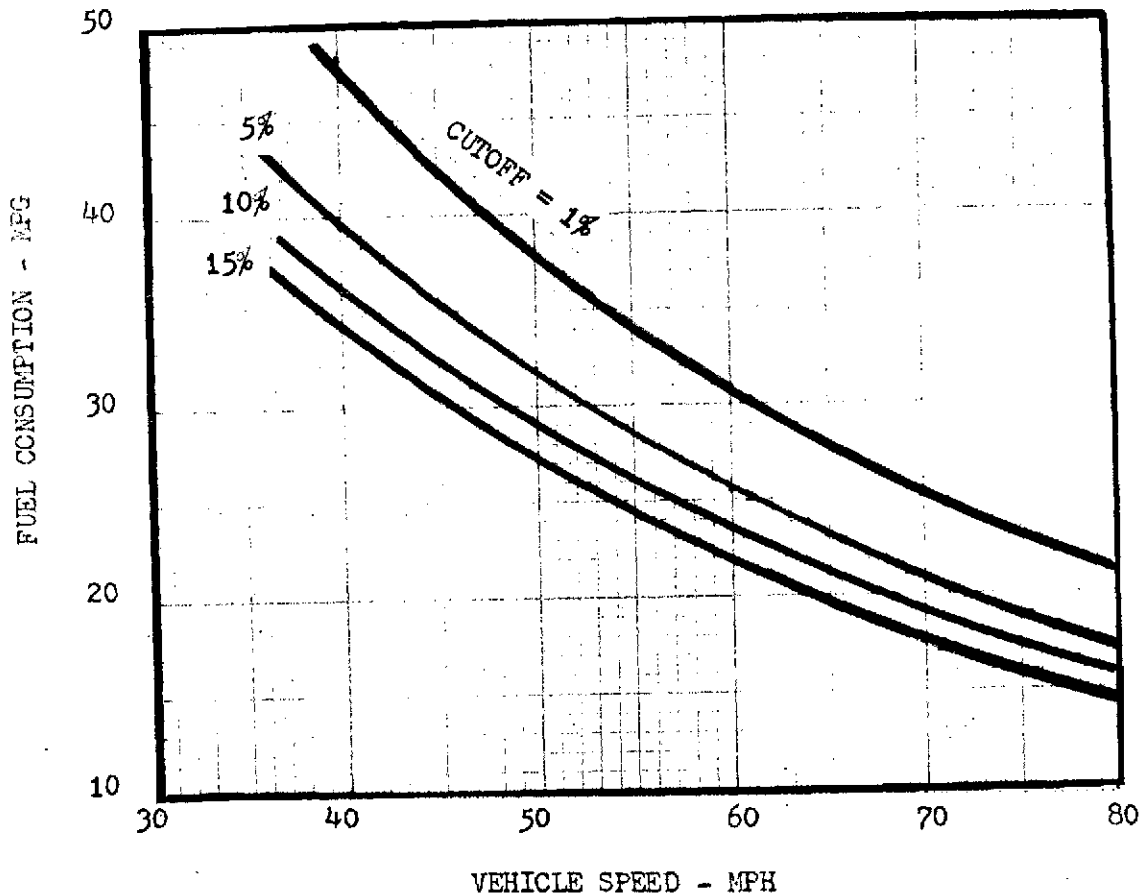

Figure 17. Summarized performance for a throttled pressure greater than 800 psia and a supply temperature of 900° F. For 15, 10, and 5 percent cutoff the exhaust pressure is 8 psia. At 1 percent cutoff the exhaust pressure is 1.0 psia.

This generalization is represented by Figure 18 for a fixed vehicle speed of 60 miles per hour. For every discrete cutoff, the Abatement Number is allowed to change to achieve 60 mph. The Abatement Number associated with each cutoff is noted on Figure 18. This figure applies only for 60 mph, but charts could be made for any selected speed. For each discrete cutoff and temperature, Figure 18 is portrayed as the best which can be expected from a modern steam car. Just as important is the indicated sensitivity of MPG to cutoff and temperature.

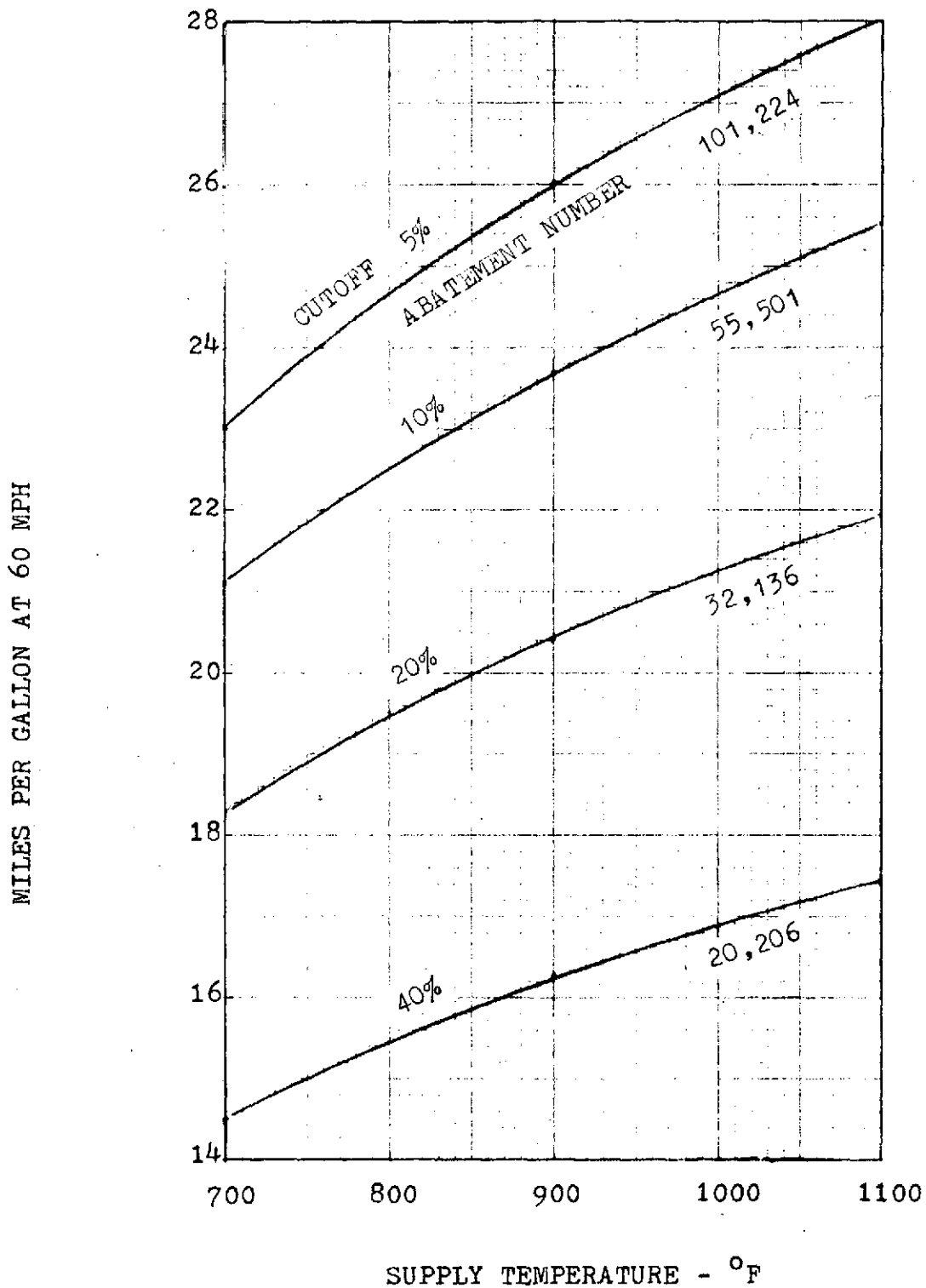

Figure 18. Sensitivity of fuel consumption to cutoff and temperature. This curve is representative for supply pressures 800 psia and above, and for condenser suction pressures between 1.0 and 15 psia.

In classical thermodynamic analysis, much ado is made over the effect of temperature upon efficiency. From a miles per gallon point of view, consider the following quantitative importance of temperature. At 10 percent cutoff and 700° F supply steam, the fuel consumption is about 21 MPG. Now let the temperature be increased by 57 percent to 1100° F. The resulting increase in miles per gallon is only about 21 percent. The point of this example is that a large percent change in temperature is required to constitute a moderate increase in miles per gallon. Also, for the relative magnitudes of the design and operating problem represented by 700° F versus 1100° F, the sober thinker will be thinking of lower temperatures than 1100° F.

The author has been completely puzzled about the philosophy of the California Steam Bus Project. Its leadership advocates pressures up to 2000 psia and temperatures to 1400° F. If these operating conditions result in superior performance worthy of the operating problem cost, it will have to be demonstrated through actual hardware. The mathematical analysis indicated that the relatively small increase in performance is not worthy of the mammoth operating problems to be solved. If any gain is to be realized, it results from the temperature and not the pressure. Operation at 2000 psia will yield absolutely no increase in MPG over that at 800 or 1000 psia.

In order to sustain 60 mph it is obvious that a certain relationship must exist between engine speed and engine displacement. This relationship is represented by the Abatement Number and the other equations relating vehicle speed, gear ratio, and engine speed. It can be shown that for a fixed vehicle speed of 60 mph, the relationship between engine speed, Abatement Number, and displacement is

$$N = \frac{A_N}{.951 V} \quad , \quad (38)$$

where:

$N$  = engine speed, rpm,

$A_N$  = Abatement Number, lb-in./ft, and

$V$  = engine displacement, in.<sup>3</sup>.

The above equation is plotted in Figure 19. This Figure represents the relationship between engine RPM and engine displacement in order to satisfy the requirements of Figure 18. It is noted that Figure 19 is consistent with the equation governing vehicle speed and gear ratio,

$$\text{mph} = 0.07136 \text{ N G} \quad . \quad (39)$$

From this equation, a discrete gear ratio will be particular for each engine speed of Figure 16. For example, at 2000 rpm, the required gear ratio is

$$G = \frac{\text{MPH}}{0.07136 \text{ N}} = \frac{60}{(0.07136) (2000)} = 0.42 \text{ ft} \quad . \quad (40)$$

It is on the basis of Figure 19 that the author advocates a transmission for the modern steam car. It indicates that smooth driving cannot be achieved at both ends of the speed spectrum without a transmission.

## V. BOILER AND POWER CONSIDERATIONS

"With enough steam it will put out about 600 horsepower" [4]. This statement was made by Mr. Lear concerning his Delta engine, in June 1969. In many respects this statement carries the wisdom needed for the modern steam car. It has a hidden "if", as the power of a steam system comes from the steam generator, not the engine. The engine serves as a power transfer mechanism between the generator and rear axle. If the generator can sustain high pressure with high steam flow rates, power is guaranteed regardless of the engine displacement. Enough steam is the key to high horsepower output.

One of the greatest steam project failures of this century was the result of underestimating the boiler size necessary to sustain a given horsepower. This was the Paxton Project of the early 50's. The car was designed for 150 horsepower, yet the generator had only 57 square feet of heating area. As a data point, the 1907 White generator had 45.8 square feet, with a resulting 40 horsepower output. By these measurements, the Paxton Car generator should have had over 170 square feet of heating surface. As a result, the Paxton Car was never tested.

ENGINE SPEED - RPM

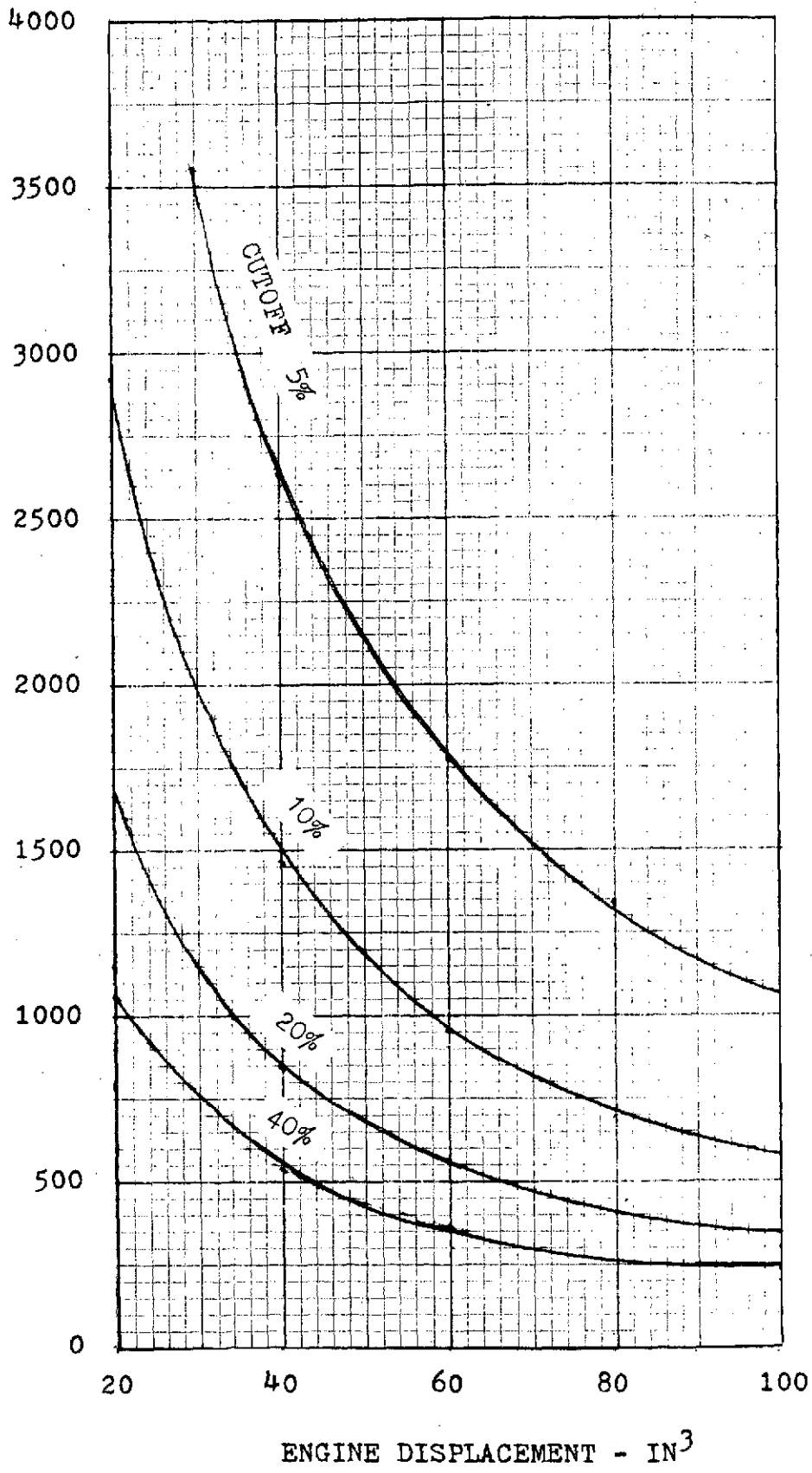

Figure 19. Relationship between engine speed and engine displacement necessary to satisfy the fixed speed requirement, 60 mph, of Figure 18.



At first one may argue that 1907 technology should not be compared with the technology that could be achieved in the 50's. This doesn't seem to be the case for steam generators. Twenty years later, the Doble E generator had 88 square feet and produced about 95 horsepower. This data point is consistent with the White car data.

A comparison between the type of generators, power and heating surface is given in Figure 20. Two types are shown, the monotube and firetube. The performance of the monotube type construction offers superior performance. No doubt, the modern steam car will have this type boiler. It appears that the 1907 White and Doble E represented superior performance.

As a rule of thumb, the steam generator provided about one horsepower per square foot of heating surface. This implies that a 600 horsepower system would require at least 600 square feet of heating surface.

The monotube steam generator volume required for a given surface area,  $A_s$ , can be computed by using the following suggested equation,

$$\text{Volume (ft}^3\text{)} = 0.038 d A_s + 2 \quad , \quad (41)$$

where

$$A_s = \text{tube surface area (ft}^2\text{)}$$

d - Tube diameter - in.

This expression allows for two cubic feet of combustion gas volume. For 600 square feet of heating surface, fabricated from 0.5 in. diameter tubing, the required generator volume is about 13.5 ft<sup>3</sup>. These dimensions result in a generator about 2.56 ft high and 2.5 ft in diameter. Adding a few inches for the insulation, exhaust flue, controls, etc., dimensions approach 3 by 3 ft.

This size generator is not compatible with the American automobile, especially if the engine and generator are to be located up front. Further insight on generator area can be obtained by a little more scientific approach.

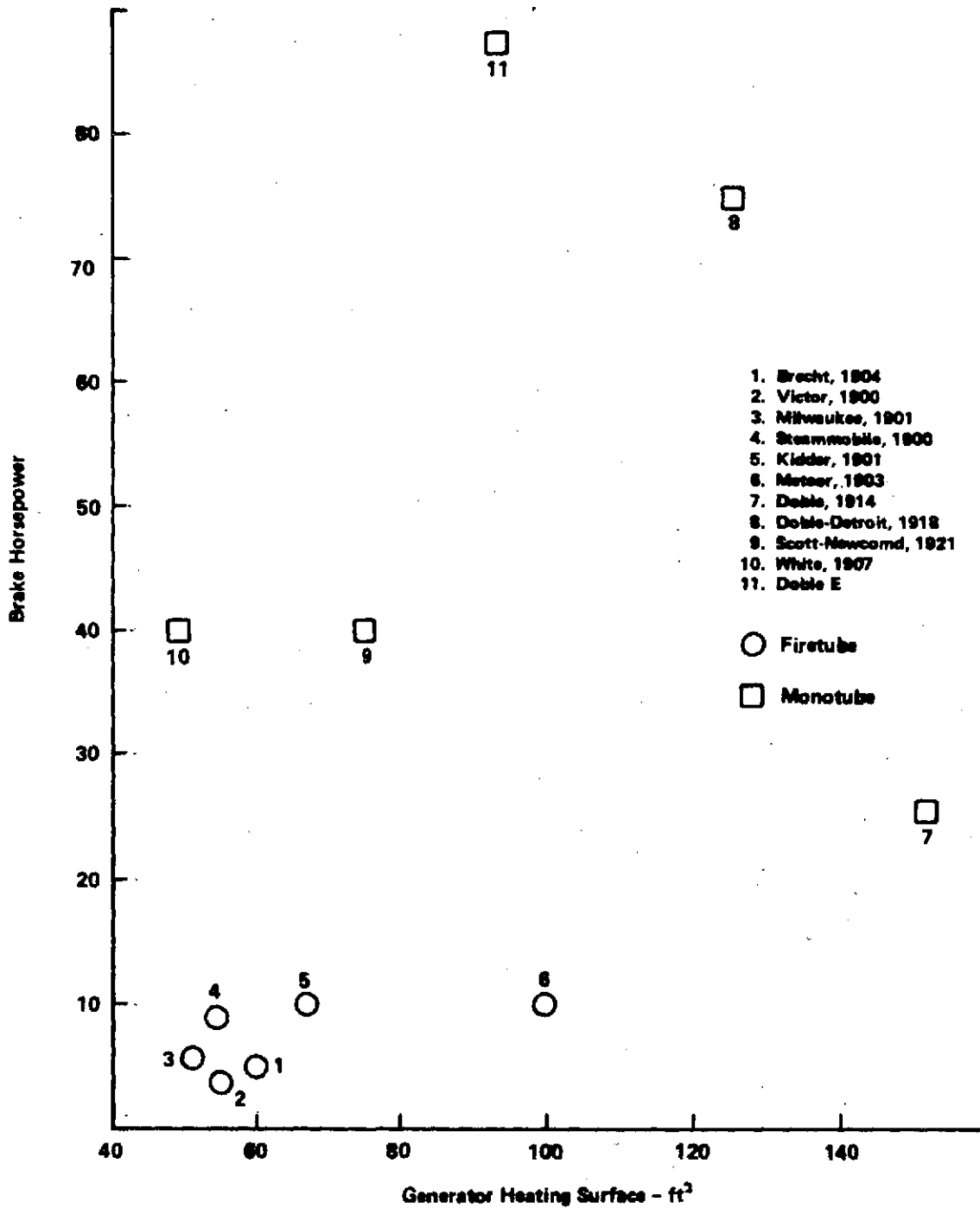

Figure 20. Steam generating capability.

From tests conducted by R. C. Carpenter [5] on the White generator, the following were obtained as average values:

Steam temperature = 783° F,

Flue Gas Temperature = 543° F, and

Feed Water Temperature = 205° F.

The temperature of the combustion gases was not reported, but based on a stoichiometric mixture, the gas temperature is estimated at 3600° F. Figure 21 represents these temperature relationships for a counter flow arrangement, such as the White generator.

The overall heat transfer coefficient can be computed from

$$U = \frac{Q}{A \left[ \frac{\theta_1 - \theta_2}{\ln \frac{\theta_1}{\theta_2}} \right]}, \quad (42)$$

where Q is the heat transferred from the hot combustion gases to steam. This Q is not known, except in terms of power output of the system, 40 horsepower. The Q necessary for brake power is

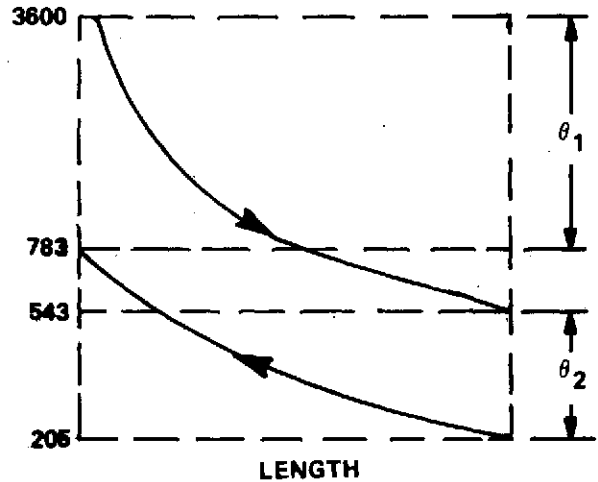

Figure 21. White generator temperature distribution.

$$Q = \frac{\text{hp}}{\eta_T} = \frac{40 \text{ hp}}{0.20} \frac{33000 \text{ ft-lb}}{\text{hp} \cdot \text{min}} \frac{\text{BTU}}{778 \text{ ft-lb}} \frac{60 \text{ min}}{\text{hr}},$$

or

$$Q = 508,997 \text{ BTU/hr} \quad (43)$$

Substituting into equation (42) gives,

$$U = \frac{508,997}{45.8 \left[ \frac{2817 - 338}{\text{Ln } \frac{2817}{338}} \right]}$$

$$= 9.5 \frac{\text{BTU}}{\text{hr-ft}^2 - ^\circ\text{F}} \quad (44)$$

Assuming that this value is typical of the heat transfer capability, an extrapolation can be made to systems operating at higher temperatures. Consider the modern boiler represented by Figure 22.

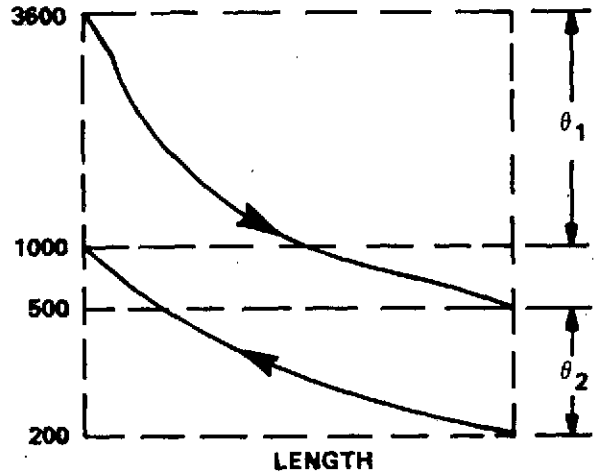

Figure 22. Modern boiler temperature distribution.

The horsepower obtained per square foot of heat surface is,

$$\frac{\text{hp}}{A} = \eta_T U \frac{(\theta_1 - \theta_2)}{\text{Ln } \frac{\theta_1}{\theta_2}}$$

$$= (0.20) 9.5 \frac{\text{BTU}}{\text{hr-ft}^2 \cdot ^\circ\text{F}} \left[ \frac{2600 - 300}{\text{Ln } \frac{2600}{300}} \right] \cdot ^\circ\text{F} 0.000392 \frac{\text{hp-hr}}{\text{BTU}}$$

$$= 0.796 \frac{\text{hp}}{\text{ft}^2} \quad (45)$$

The size of a 600 horsepower boiler may therefore be underestimated. Based on this number, about 760 square feet of heating surface would be required. A 600 horsepower boiler for an automobile becomes even less attractive and more impractical.

## A. Steam Generator Efficiency

Steam generator efficiency is determined by two factors, design and excess air. Quality of the design can be judged on the basis of the flue gas temperature, whereas excess air determines the temperature of the combustion gases. These two factors combine to produce the steam generating capability. The relative importance of these two factors will now be investigated.

For the most part, boiler efficiency is controlled by the temperature of the combustion gases. Typical combustion temperatures are illustrated in Figure 23. The temperature is a function of the oxidizer flow rate to the fuel flow rate (O/F ratio). The O/F ratio can also be expressed in terms of percent excess air. Excess air is that quantity of air above that necessary for a complete combustion. Complete combustion occurs at about an O/F ratio of 15 (stoichiometric mixture). At this ratio, the combustion gas temperature is at a maximum. If the percent excess air is negative, it means that insufficient air exists for complete combustion and, thus, the temperature is curtailed. If the percent of excess air is positive, the extra air is also having to be heated and this results in a lower mixing temperature. In Figure 23, both the percent of excess air and the O/F ratio are shown.

The rate at which energy is transferred to water (steam) is

$$M_A \Delta H = M_G C_P [T_1 - T_2] \quad , \quad (46)$$

where:

$M_G$  = Mass flow rate of combustion gases,

$C_P$  = Heat capacity of combustion gases,

$T_1$  = Combustion gas temperature, and

$T_2$  = Flue gas temperature.

Equation (46) relates the rate of energy loss from the combustion gases to the energy gained by the steam. Noting that the total mass flow of the combustion gases is

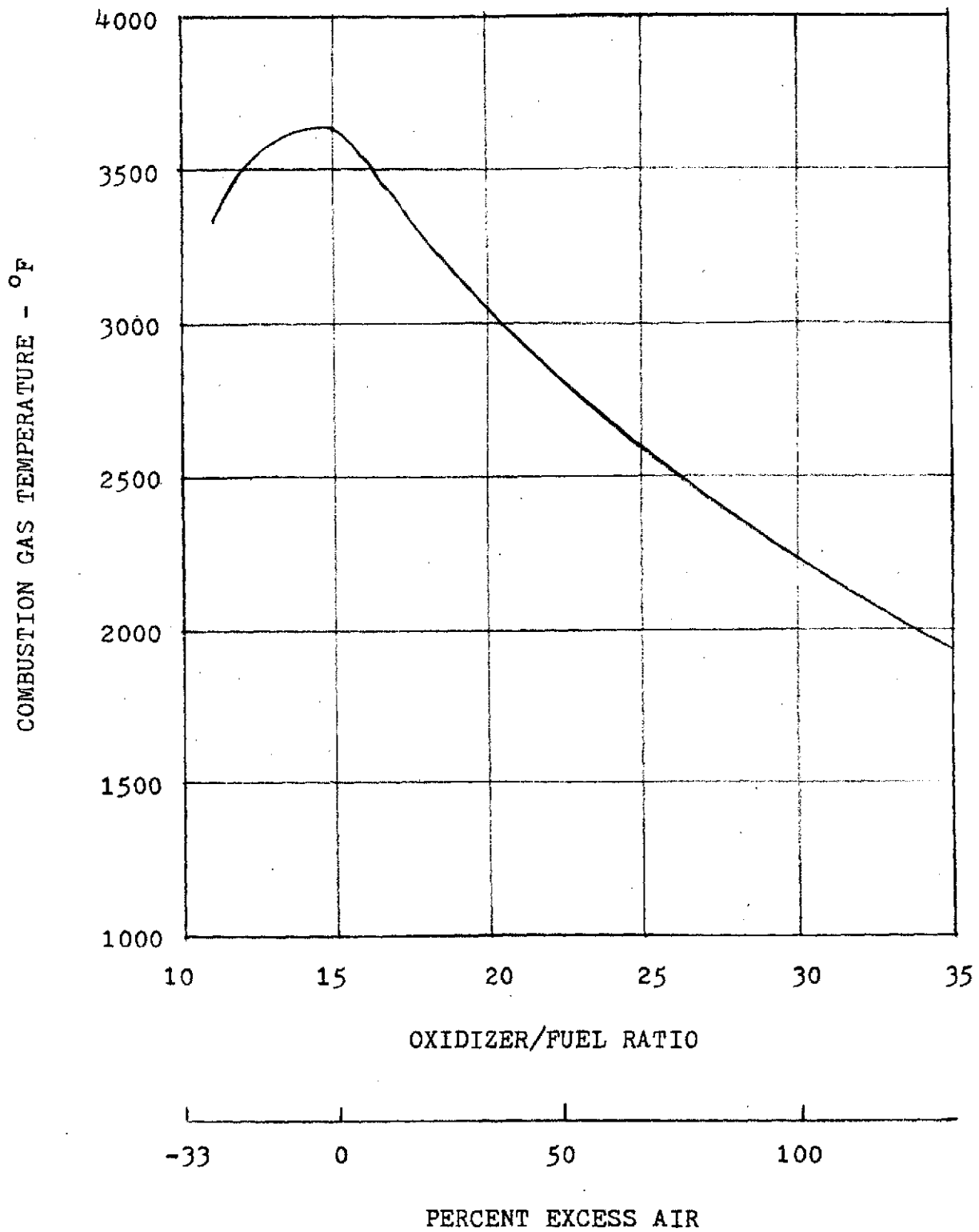

Figure 23. Combustion temperatures.

$$M_G = F (1 + 0/F) \quad , \quad (47)$$

and that boiler efficiency can be described as

$$\eta_B = \frac{M_A \Delta H}{EF} \quad , \quad (48)$$

then substitution into equation (46) yields an expression for boiler efficiency in terms of  $0/F$ , combustion temperature, and flue temperature,

$$\eta_B = \left[ \frac{1 + \frac{0}{F}}{E} \right] C_P (T_1 - T_2) \quad . \quad (49)$$

Arbitrary substitution cannot be made into equation (49).

As indicated in Figure 23, the combustion gas temperature,  $T_1$ , is a function of  $0/F$ . Temperature  $T_2$  depends upon design and is therefore unknown. Equation (49) can be solved parametrically as shown in Figure 24. This chart was obtained by picking respective values for  $0/F$  and  $T_1$  from Figure 23. Actual performance probably occurs somewhere between the two curves for assumed flue temperatures. It is interesting to note that the maximum efficiency approaches only about 85 percent. It seems that boiler efficiencies of 90 percent and 95 percent may be extremely exaggerated.

Computing efficiency for the Doble Model E steam generator, test data from Doble Steam Cars show that values between 81 and 82 percent were obtained. It is also noted that tests conducted by A. W. Gardiner [6] yields a maximum efficiency of about 82 percent. The theoretical characteristics of Figure 24 are therefore consistent.

Maximum efficiency is obtained between 50 and 100 percent excess air. Usually air blowers are not utilized which are able to supply this amount of air, especially for the higher fuel rates. Size and power requirements have limited flow capacity for blowers. Possibly, one of the best ways to increase performance has been overlooked.

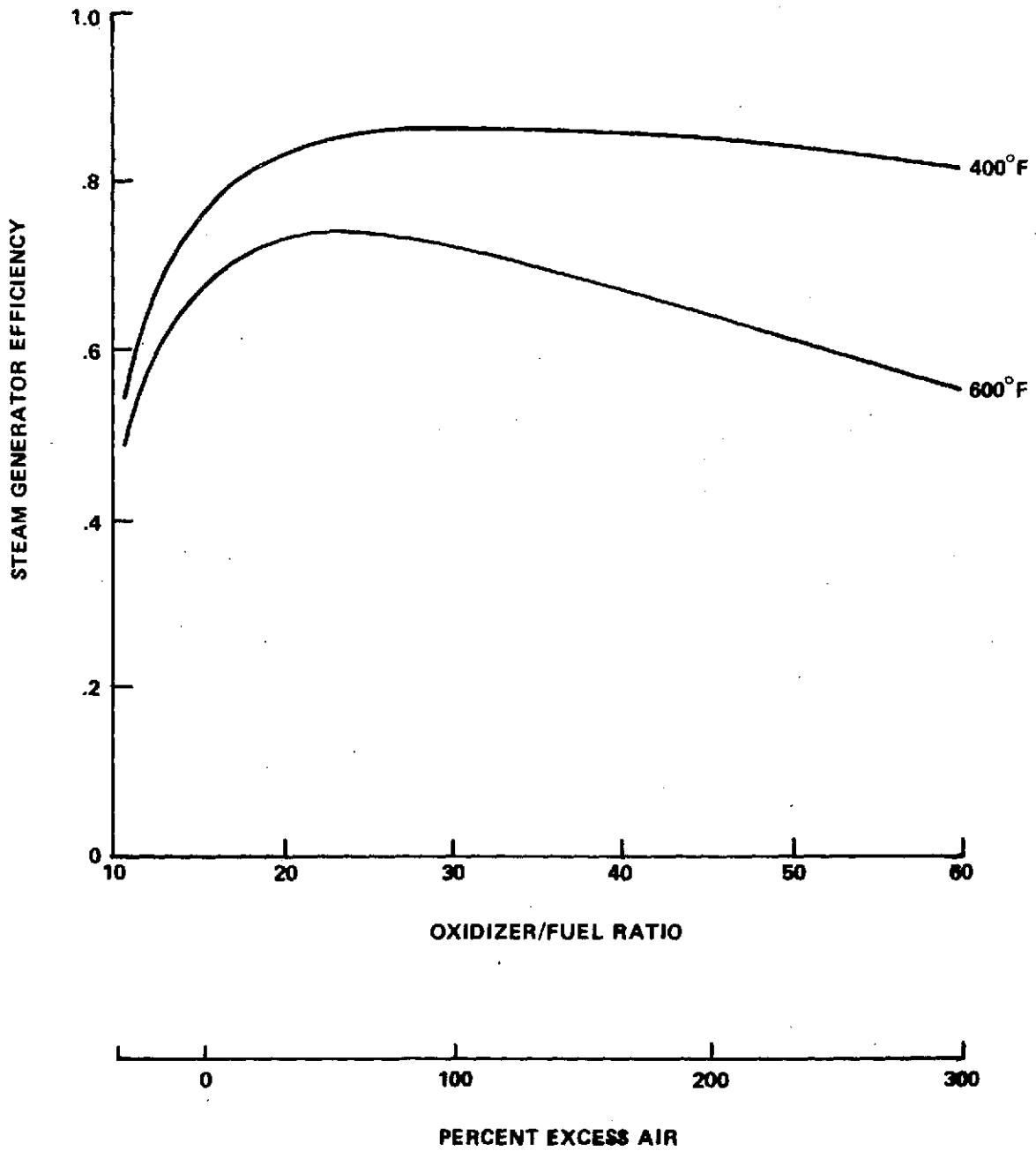

Figure 24. Steam generator efficiency.



It is suggested that any percent of excess air may be available without the use of large blowers, by utilizing ram air. A scoop could be designed and located near the fan to collect ram air moving through the condenser. The amount of air could be controlled by the duct area. It may be feasible and desirable to enclose the entire condenser in a shroud and vent the ram air through the boiler. This technique could also improve performance, since the energy added to the air by the condenser would not have to be supplied by combustion.

## B. Power

The most classical steam engine problem is the determination of the power required to equal performance of the internal combustion engine. It has been stated that power by any other name is still power. Also, it has been estimated that only half the power is required of steam for equal performance. The answer lies between these two extremes, and the answer is not immediately obvious. Since the torque-speed curves are different, it seems certain that performance would be different. This is an important issue. If the modern steam car is to have equivalent performance, what should its power capability be?

The designer is also very interested in knowing how to determine "rated power". At first he may be tempted to calculate power based on the "PLAN" equation but any results from this approach would be in error since it has no parameters representing the steam generator capability. Both pressure and engine speed are arbitrarily selected, based on the assumption that the generator has the capability to supply the steam required for the speed at the selected pressure.

There is a fixed relationship between pressure and speed; thus they cannot be selected arbitrarily. It is noted however, that if an existing system is subjected to a controlled testing procedure, the PLAN equation will yield the correct answer. But for design purposes, the PLAN equation is inadequate.

The steam power paradox resulted from lack of a criterion which could serve as a basis of comparison. The approach taken here is to define a criterion, and then make the comparison. Four criteria will be developed, then it will be clear as to the relative power merits of steam versus the internal combustion engine.

First criterion - What is being compared? This criterion establishes, in a very fundamental way, what is to be compared. Basically we are comparing a power system with a fixed gear ratio to a power system having a variable gear ratio and this fact really affects the results. Although the torque-speed curves of an internal combustion engine are inferior to those of a steam system, the transmission becomes a great equalizer. The transmission accomplishes two things:

1. The torque at the rear axle is greatly multiplied.
2. The automobile reflected inertia to the engine shaft is greatly reduced.

As a result, acceleration capability of the internal combustion system is a worthy opponent.

Second criterion - What is the fuel flow capability? The power of any energy conversion device can be determined by the fuel flow capacity of that device and the system efficiency. Fuel flow is indicative of heat equivalent power, and the efficiency will indicate the percent of heat power that is converted to brake horsepower. Therefore,

$$\begin{aligned} \text{Brake Horsepower} &= \frac{\text{hp} - \text{min}}{3300 \text{ ft-lb}} \cdot \frac{778 \text{ ft-lb}}{\text{BTU}} \cdot \frac{19500 \text{ BTU}}{\text{lbf}} \cdot \text{F} \cdot \frac{\text{lbf}}{\text{min}} \cdot \eta_{\text{System}} \\ &= 460 \eta_S \text{F} \quad . \quad . \quad . \end{aligned} \quad (50)$$

In a fine analysis, the system efficiency,  $\eta$ , is a function of fuel flow. This results from engine friction, compression pressures, volumetric efficiency, etc. Even so, if we know the bulk system efficiency and fuel flow rates of each system, then the brake horsepower can be very accurately calculated. It must be admitted that the efficiency of the internal combustion engine is greater than that for steam systems and, thus, for the same fuel flow, the internal combustion system will yield a greater horsepower. The percent increase of internal combustion power over steam power is

$$\text{Percent (decimal)} = \frac{\eta_{\text{i.c.}}}{\eta_{\text{Steam}}} - 1 \quad . \quad . \quad (51)$$

Using typical efficiencies, internal combustion systems produce 25 per- cent more power. However, this is determined on the basis of equal fuel flow rates. The steam system is much less constrained in fuel flow than the internal combustion system<sup>10</sup>. The fuel flow of an internal combustion system is limited by the number of cylinders, volumetric efficiency, and engine red line speed. No such constraints exist with the steam system, except for the limiting energy release per cubic foot within the steam generator.

Third criterion - What is the effect of a limited Abatement Number? This criterion also deals with a technique to calculate horsepower, but is a little more subtle. Consider equation (2),

$$\text{Power} = \frac{PVN}{(12)(33000)} D_N \quad .$$

Now by combining equation (C-5) of Appendix C with equation (A-3) of Appen- dix A, an expression for N can be obtained,

$$N = \frac{1}{0.07136} \sqrt{0.354 \frac{PV}{G^3} D_N - \frac{1706}{G^2}} \quad . \quad (52)$$

Combining the two above equations, an expression for power in terms of the Abatement Number may be obtained:

$$\text{Horse Power} = D_N \sqrt{4.41 \times 10^{-10} \left(\frac{PV}{G}\right)^3 D_N - 2.12 \times 10^{-6} \left(\frac{PV}{G}\right)^2} \quad (53)$$

Equation (53) is complicated, but a very useful tool in determining the effect of pressure, displacement, and gear ratio upon power. Equation (53) gives the maximum power possible for a given Abatement Number and Dour

---

10. Assume no use of super chargers.

Number. Also, the equation applies to a typical automobile defined earlier. In utilizing equation (53), the Abatement Number must be computed on the basis of the steady state pressure of the steam generator with 100 percent throttle. The importance of Abatement Number is again reinforced. Power, vehicle speed, and miles per gallon depend upon the Abatement Number. These situations should be referred to as a sustained Abatement Number, and this means steady state values.

The characteristics of equation (53) are given in Figure 25. In the high Abatement Numbers, the power approaches 300 to 400 horsepower. It should be pointed out that the Abatement Number, as presented herein, was derived on the basis of an ideal P-V diagram. The power levels in Figure 25 will be optimistic.

Fourth criterion - What is the time required to accelerate to 60 MPH? So far the comparison criteria have been concerned with the type of cars and techniques for computing the maximum power of a steam system. The fourth criterion deals with the capability of a power system to accelerate the vehicle. The basis for comparison is the time required to accelerate to sixty miles per hour. To make this comparison, test results for the internal combustion system will be accepted from the magazine Road & Track's "Road Test Annual" for 1971. From this magazine, a vehicle can be selected which has nearly the weight projected for our typical vehicle. For these purposes, the following vehicle was selected:

Make: Peugeot 504  
Power: 87 horsepower at 5500 RPM  
Weight: 3075 pounds  
Time to Sixty: 16 seconds

This Peugeot will be compared against a steam vehicle, in accordance with the First Criterion.

Weight: 3200 pounds  
Type Control: Fuel flow proportional to difference between set pressure and generator pressure, 0.030 pound of fuel per minute per psia.  
Cutoff: 30 percent.

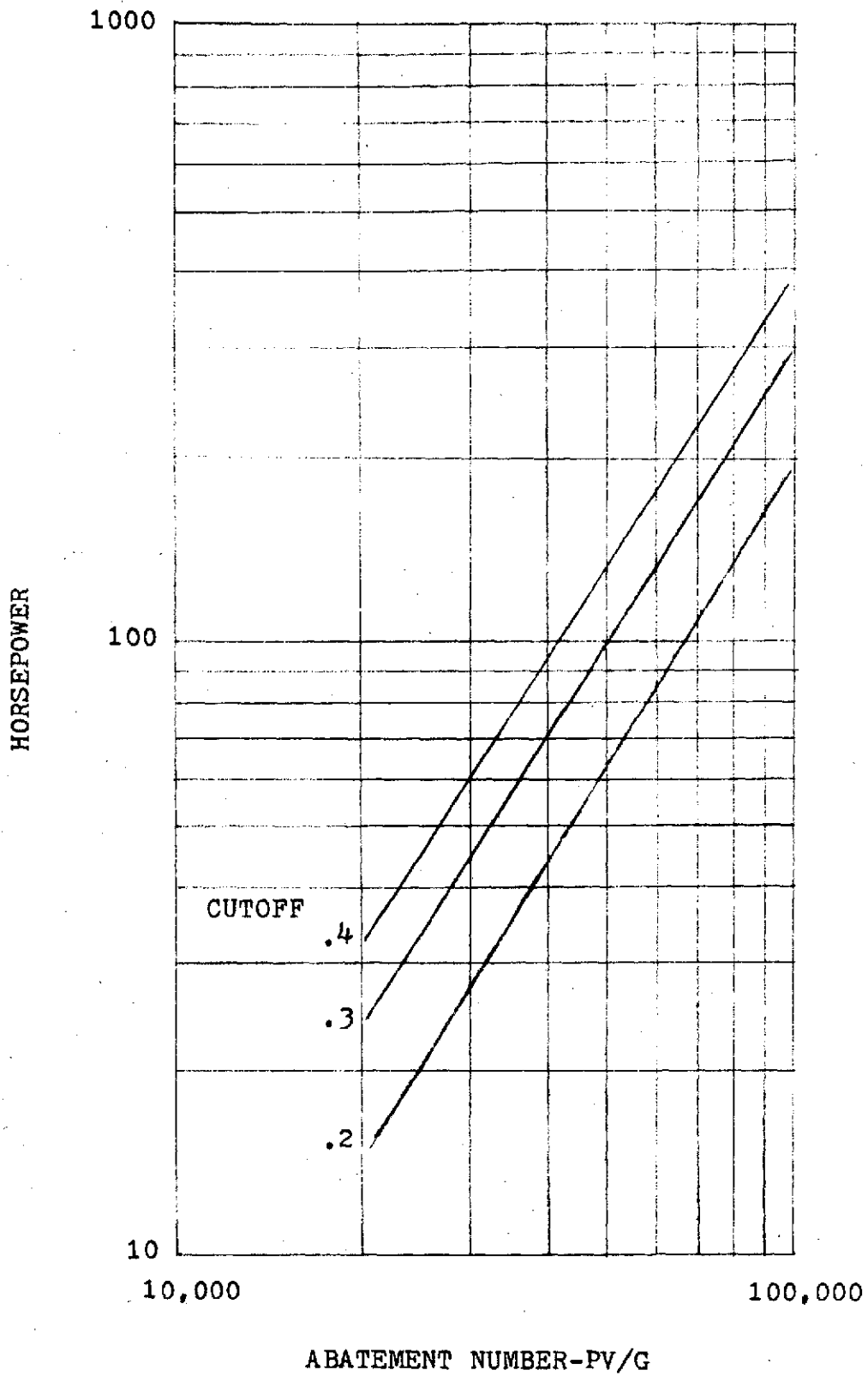

Figure 25. Variation of horsepower with Abatement Number.

Gear Ratio:  $G = 0.7$

Cutoff Fuel Flow: 2 lb/min (18 gal/hr)

The "time-to-sixty" performance is given in Figure 26. Engine displacement is plotted against "time to sixty" for different initial pressures. It is emphasized that the initial pressures degraded during the acceleration run. A line has been drawn at 16 seconds, the Peugeot's time to sixty. At the intersections marked A, B, and C, the steam vehicle performance is equal to the Peugeot's. Performance characteristics at the points of intersections are given in Table 3. It is important to recognize that the values in Table 3 are not steady state values, but represent performance at sixty miles per hour. The throttle is 100 percent. Table 3 summarizes computer results of a model which includes boiler and engine dynamics and mass flow feedback effects on boiler pressure.

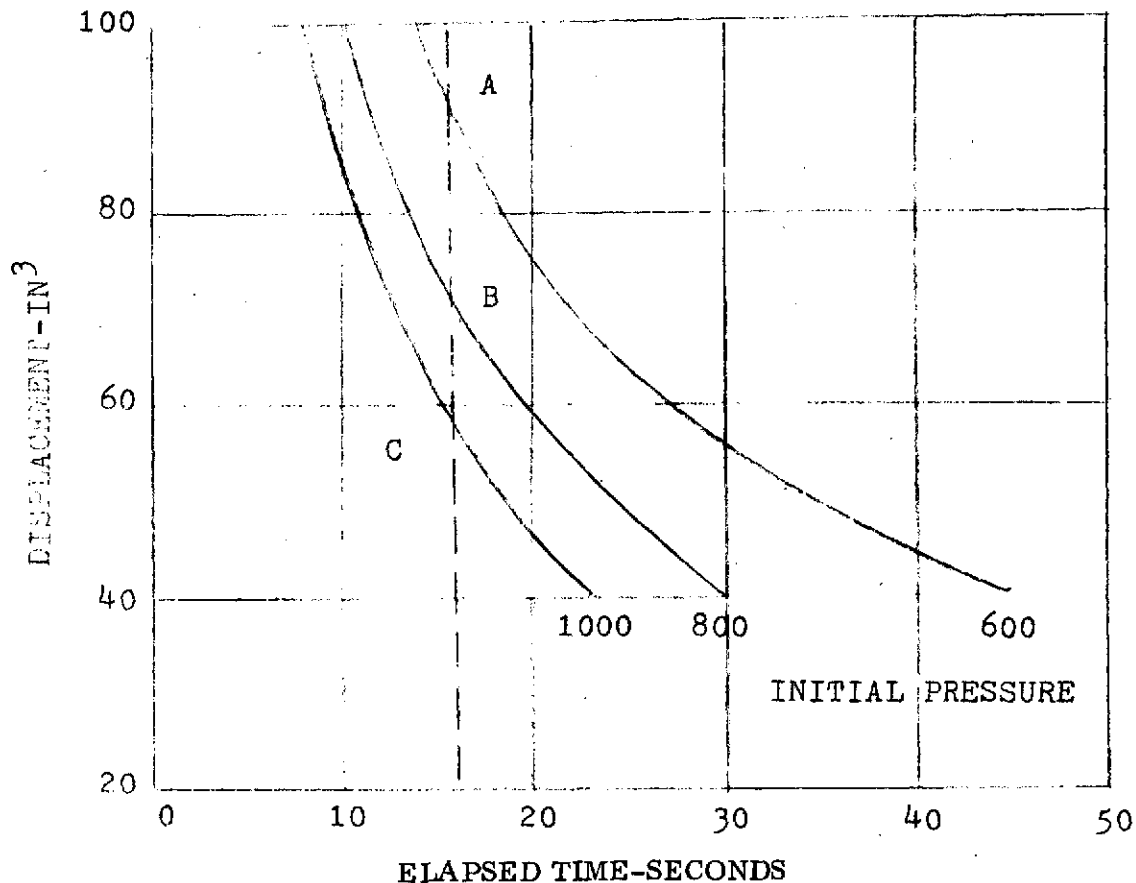

Figure 26. Steam vehicle acceleration performance to sixty miles per hour.

TABLE 3. STEAM VEHICLE AT SIXTY MILES PER HOUR,  
100 PERCENT THROTTLE

Abatement Number	73,400	75,500	76,500
Intersection	A	B	C
Initial Pressure (psia)	600	800	1000
Pressure @ 60 MPH (psia)	557	755	954
Horsepower @ 60 MPH	92	95	97
MPG @ 60 MPH	5.2	4.9	4.8
Fuel Consumed (lb)	.240	.245	.250
Steam Generated (lb/min)	12.6	13.1	13.5
Displacement (in. <sup>3</sup> )	92	70	56

Several factors are of special interest. Miles per gallon are greatest within the lower pressure, because the Abatement Number is lowest at 92 in.<sup>3</sup> displacement. Also, the power is smallest, in accordance with the Abatement Number. The fuel rate and steam generation are all constrained with these results. The miles per gallon are low, but this can be expected under maximum energy conversion demand. These results seem to indicate that it is better to have a relative large displacement than a mediocre displacement.

For all practical purposes, the power seems to be independent of pressure or displacement. The results are constant with the prediction of the Second Criterion. Power is a function of only system efficiency and fuel flow. The power tabulated is based on the ideal P-V diagram, and therefore greater than the brake horsepower of the Peugeot.

In all the cases, consider that the control system has allowed the fuel flow to reach its maximum cutoff value before a steady state pressure was reached. This occurred after 36 seconds. The maximum power of the system is therefore represented by that fuel rate, about 163 ideal indicated horsepower. Actually, under high power conditions, the fuel flow will always peg the limit if enough time is allowed. Therefore, by these standards, the maximum power of a system is always set by the fuel flow limit. However, rating systems by this method are not a clear definition of power conversion since, in a large measure, this level can be varied over a wide range for the same steam generator. It is therefore suggested that power capability be weighted on the basis of the system's ability to exchange its fuel consumption into power over a specific time period. For an

example, after 16 seconds about 0.25 pounds of fuel was consumed and the ideal indicated power was 97 horsepower. The Peugeot Power at 16 seconds is not known, but it is speculated that it will be near 87 horsepower, since the transmission allows the engine to operate near its maximum speed. If the steam engine system considered here is rated on the basis of power at maximum fuel rate, then it could be argued that it takes 163 ideal indicated horsepower to equal the performance of an 87 brake horsepower Peugeot.

If the steam system is rated on the basis of power developed at sixty miles per hour, then 97 ideal indicated horsepower is required to be equivalent to the performance of an 87 brake horsepower Peugeot. The Abatement Number cannot be used to compute maximum, since steady state conditions have not been achieved.

Regardless of how the power rating is established, there seems to be no advantage of steam engine horsepower over internal combustion engine horsepower. Actually, it appears that equal performance requires equal power. It is noted that a steam system having an on-off type control would not violate the basic conclusion given here. The time to sixty would be less since the total amount of fuel burned would be greater. The power at sixty would also be greater.

These results may be disappointing to steam enthusiasts. Nevertheless, it must be accepted because conversion of energy into power is power, by any other name.

A discussion on power would not be complete without an explanation of equation (7). In substituting values into this equation, some judgement needs to be exercised for the values picked for  $M$  and  $S_N$ . This equation indicates that power increases with a decrease in cutoff for a fixed mass flow rate,  $M$ . In fact, as the cutoff decreases in any practical system, the steam demand would decrease, thus the control system would decrease the heat source (or cut it off). As a result the power would decrease. In considering any practical control system, it is not acceptable to visualize a decreasing cutoff and an increasing (or constant) steam flow rate occurring simultaneously. To get an increase in power, the cutoff must increase, resulting in a greater steam demand,  $M$ . The increase in  $M$  greatly offsets the decrease in  $S_N$ . The total result is an increase in power with an increasing cutoff. If the control system had an override so that  $M$  and  $S_N$  could be controlled separately, equation (7) will yield the correct results. Otherwise, the supply number,  $S_N$ , and mass flow,  $M$ , are not independent variables.



To illustrate this point, the same engine used in the Peugeot comparison will be analyzed at different cutoffs. A forty-cubic-inch engine with an initial pressure of 1000 psia and 100 percent throttle was selected. Table 4 illustrates the system performance at 60 miles per hour. As discussed earlier, as the supple number increases (decrease in cutoff), the steam generation rate decreases. The reverse is also true. In going from 15 percent cutoff to 60 percent cutoff, the supple number decreases by about 40 percent but the mass flow rate increases by about 280 percent. The increase in mass flow rate offsets the decrease in supple number. The increase in power at the larger cutoff is also indicated by the small time needed to attain sixty.

TABLE 4. STEAM VEHICLE PERFORMANCE AT SIXTY MILES PER HOUR FOR DIFFERENT CUTOFFS, 100 PERCENT THROTTLE

Displacement (in. <sup>3</sup> )	40	40	40
Initial Pressure	1000	1000	1000
Cutoff	0.15	0.30	0.60
Supple Number ( $S_N$ )	2.44	2.0	1.47
Time to 60 MPH (sec)	43	23.5	15.5
Steam Generator (lb/min)	4.87	9.86	18.42
Pressure @ 60 MPH (psia)	986	970	932
Horsepower @ 60 MPH	43	70.8	100

### C. Interesting Steam Vehicle Data

It is interesting to make special note of some of the relationships already developed. They can be manipulated to give interesting characteristics of the vehicle. While these characteristics are not particularly important to design, they make good discussion items for the news media. The importance of the news media must not be overlooked in attempts to draw attention to the steam vehicle.

To begin, consider equation (A-3) of Appendix A. This equation describes,

$$V_c = 0.07136 NG \quad ,$$

which includes the relationship between engine speed, N and resulting vehicle speed,  $V_c$  (mph). The gear ratio, G, is defined in Appendix B. Solving for the ratio  $N/V_c$  and multiplying the right hand side by 60 min/hr, gives engine revolutions per mile,

$$\text{Engine Revolutions per mile} = \frac{840.33}{G} .$$

For a total gear ratio of 0.7 ft, the engine turns over about 1200 times per mile. The racing vehicle which ran 127.66 mph at Ormond, Florida, in January 1906 made 350 revolutions to the mile. This means that the vehicle had a total gear ratio of 2.4.

Another interesting fact is pounds of steam required per mile. To obtain this expression, we begin with equation (5). Dividing by N gives the pounds of steam per revolution,

$$\text{Pounds of steam per revolution} = \frac{PVX}{12RT} .$$

Multiplying these two expressions together will give the pounds of steam required per mile,

$$\text{Pounds of steam per mile} = 70.03 \frac{PVX}{GRT} . \tag{54}$$

As an example, assume a system that has a steady state pressure of 800 psia, where:

$$V = 60 \text{ in.}^3,$$

$$X = 0.40,$$

$$G = 0.7 \text{ ft.},$$

$$T = 1260^{\circ}\text{R}, \text{ and}$$

$$R = 83 \text{ ft-lb/lb}_m \text{ } ^{\circ}\text{R} .$$

The pounds of steam required per mile are

$$70.3 \frac{(800)(60)(0.4)}{(0.7)(83)(1260)} = 18.4 \frac{\text{lb}}{\text{mile}} \text{ or } 2.45 \frac{\text{gal}}{\text{mile}} . \quad (55)$$

It has been shown that horsepower can be represented by system efficiency,  $\eta_s$ , and fuel flow,  $F$ . Also, horsepower is equal to the total retarding force  $RF$ , acting on the vehicle times the vehicle speed,  $V_c$ . Equating these two expressions for power

$$F \eta_s = RF (V_c)$$

$$F \frac{\text{lb}}{\text{min}} \cdot E \frac{\text{BTU}}{\text{lb}} \frac{778 \text{ ft-lb}}{\text{BTU}} \eta_s = RF \text{ lb } V_c \frac{\text{miles}}{\text{hr}} \frac{5280}{60} \frac{\text{ft-hr}}{\text{mile-min}}$$

where:

$$F = 4.8 \times 10^{-5} (RF) (V_c)$$

and

$$\eta_s = 0.12 . \quad (56)$$

The total retarding force,  $RF$ , for a typical vehicle can be found in Appendix C.

$$RF = 64 + 0.0375 V_c^2 .$$

Substituting this force expression will give a relationship between fuel flow and miles per hour,

$$F = 4.8 \times 10^{-5} (64 + .0375 V_c^2) V_c \quad (57)$$

Equation (57) indicates that, in the final analysis, vehicle speed is a function of fuel flow only. Engine displacement and pressure are not factors. Equation (57) assumes that the engine can run at the speed demanded by the gear ratio and displacement. Regardless of the type of control system employed, maximum speed will be a function of fuel flow only. It can be noted that this also applies to the internal combustion engine systems. Equation (57) is plotted in Figure 27. At first, only rolling road friction has to be overcome. This force is small and, consequently, a small amount of fuel is required. However, when aerodynamic forces become the dominating force, the fuel rate becomes exceedingly great for small increases in vehicle speed. At 100 mph, a little over 2 lb/min of fuel is required (18 gal/hr).

For a given vehicle speed (fuel flow), engine displacement steady state pressure will be predetermined. Realization of the degradation of initial pressure to a steady state pressure is important in proper evaluation of engine-generator performance. In using the Abatement Number, the steady state pressure must be used. The steady state pressure can be found by equating engine power ( $T\omega$ ) to fuel flow and system efficiency,

$$\text{Power} = T\omega = \eta_s F$$

and

$$\frac{PV}{24 \pi} D_N \text{ ft-lb N } \frac{\text{Rev}}{\text{min}} 2 \pi = F \frac{\text{lb}}{\text{min}} E \frac{\text{BTU}}{\text{lb}} 778 \frac{\text{ft-lb}}{\text{BTU}} \eta_s \quad (58)$$

From Appendix A,

$$V_c = 0.07136 NG \quad .$$

Substituting and solving for the steady state pressure gives

$$P = 1.56 \times 10^6 \frac{F}{V_c} \frac{G}{D_N V} \quad (59)$$

But from equation (57), there is a fixed relationship between fuel flow,  $F$ , and vehicle speed,  $V_c$ . Making this substitution into equation (59) gives the steady state pressure,

$$P = 74.88 (64 + .0375 V_c^2) \frac{G}{D_N V} \quad (60)$$

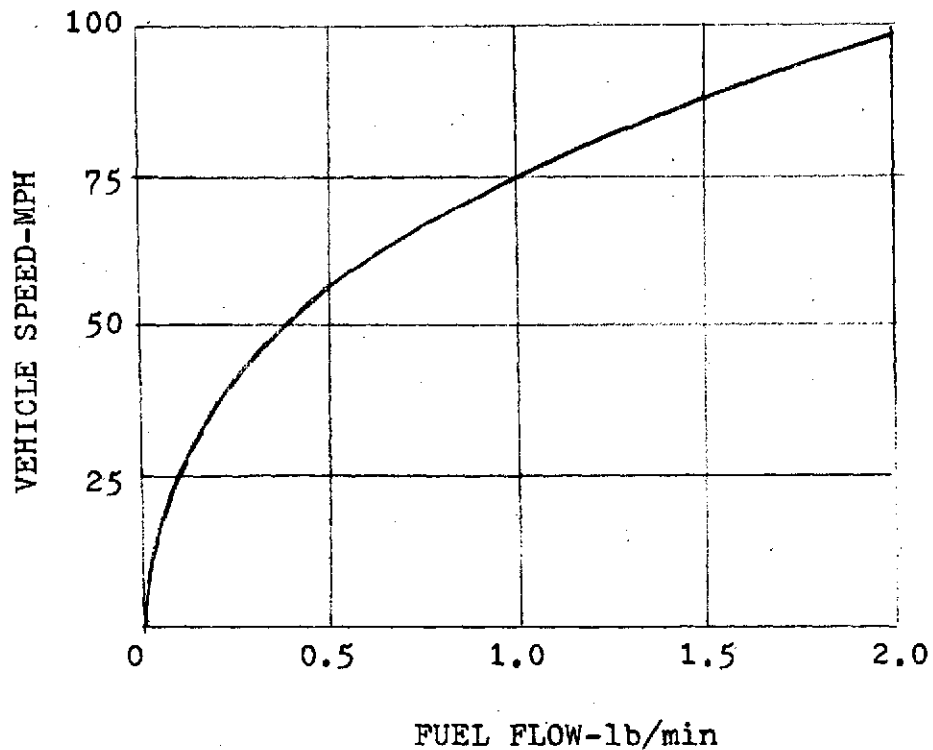

Figure 27. Fuel flow required for given vehicle speed, Based on a typical vehicle.

Equation (60) describes the steady state pressure under maximum power conditions, 100 percent throttle and the maximum fuel flow that results in the maximum velocity,  $V_c$ . Equation (60) is plotted in Figure 28. The steady pressure can be low, even at the high fuel rates, if the engine displacement is large.

The degradation of the initial pressure is the factor which invalidates the use of the PLAN equation as a design equation. Engine speed and steady state pressure are not independent variables.

The last interesting factor is one which is usually avoided in energy conversion discussions. System efficiency is the ratio of power output to the equivalent heat power input,

$$\frac{\text{hp (out)}}{\text{hp (in)}} = \eta_s \quad (61)$$

Very seldom is the power rejected, related to the useful power output,

$$\text{hp (Rej.)} = \text{hp (in)} - \text{hp (out)} \quad (62)$$

Combining these two expressions, the ratio between the power rejected (to the condenser) to the useful power can be established as

$$\frac{\text{hp (Rej)}}{\text{hp (out)}} = \frac{1 - \eta_s}{\eta_s} \quad (63)$$

Equation (63) is plotted in Figure 29. In this chapter, a typical system efficiency has been taken at 12 percent. At this system efficiency, 7.3 times more power is rejected in the condenser than that converted to useful work.

## D. Characteristics of Pressure Degradation During the Admission Phase

A very interesting but difficult problem to solve analytically is "wiredrawing". Wiredrawing is the term given for the pressure decay occurring within the cylinder during the admission phase of the stroke. Wiredrawing is the result of orifice flow. The flow orifice which restricts flow may be within the throttle valve or porting valves at the engine intake. The purpose here is to evaluate the nature of wiredrawing and to establish a criteria for sizing valve openings.

To begin with, the initial pressure or the initial conditions within the cylinder must be defined. It has been assumed that, at top dead center the valve has been opened for a sufficient time to allow the clearance volume to pressurize to supply pressure. Thus, at time equal zero,  $P = P_0$ .

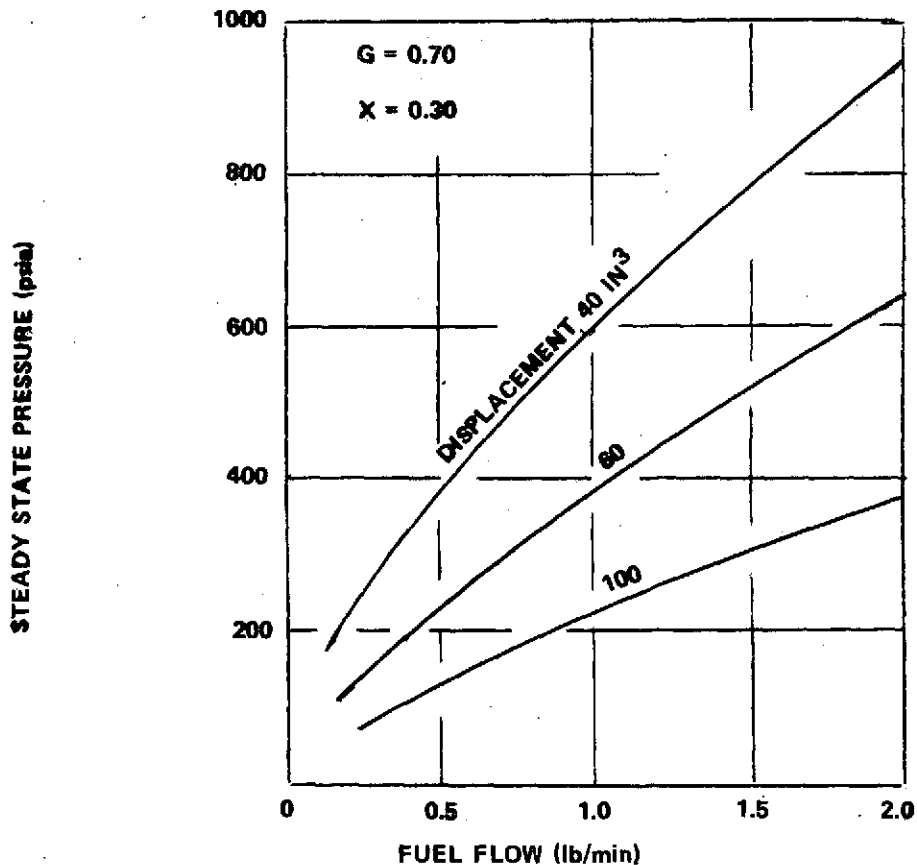

Figure 28. Steady state pressure for given fuel flow.

After top dead center the valve begins to close. It closes in a cosine function and closes completely at the predetermined cutoff. The problem treated is the determination of pressure within the cylinder while the orifice flow area and cylinder volume changes with time. The relationships which control this pressure are developed in Appendix D, equation (D-11).

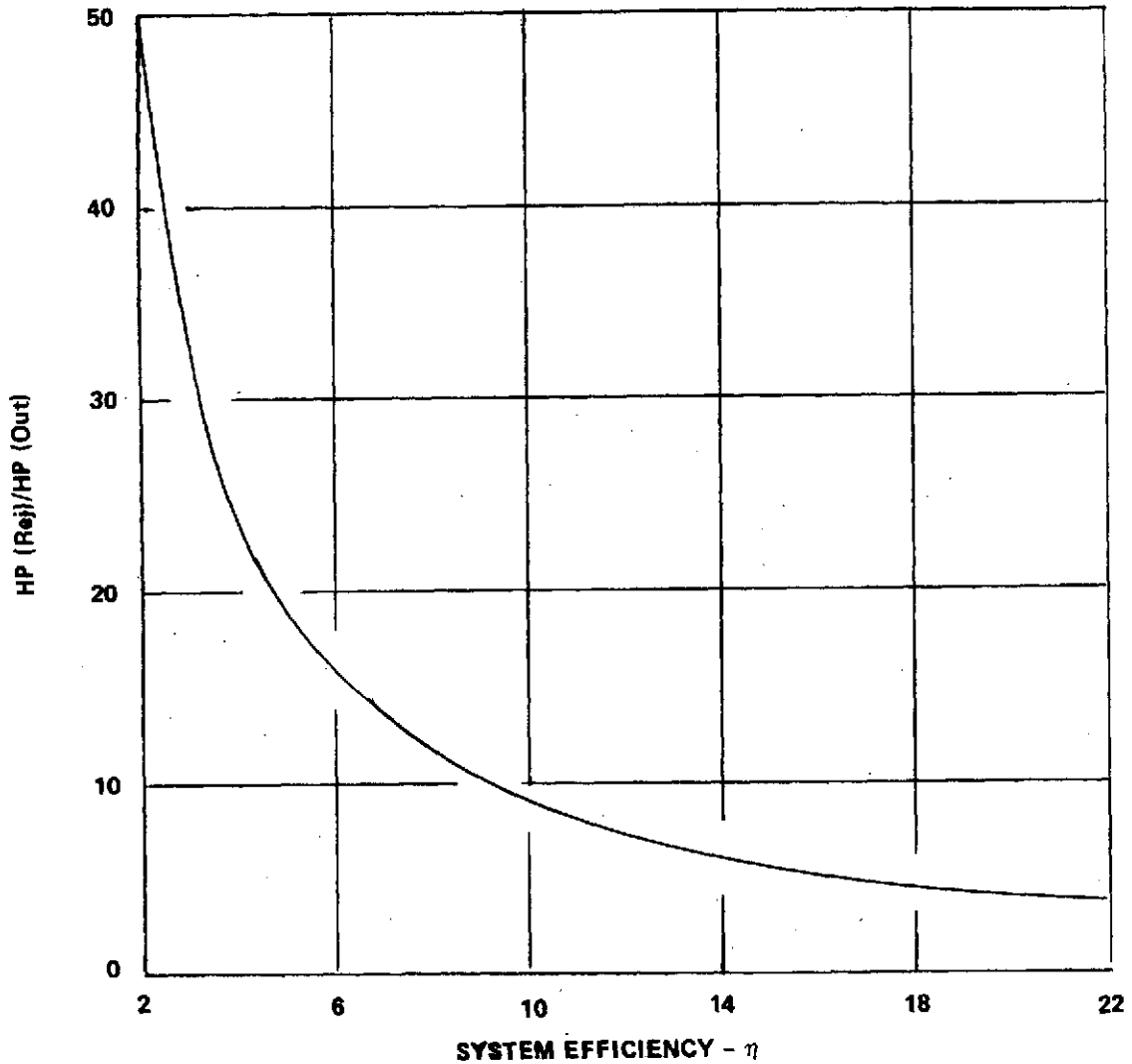

Figure 29. Heat rejection characteristics of thermal engines.



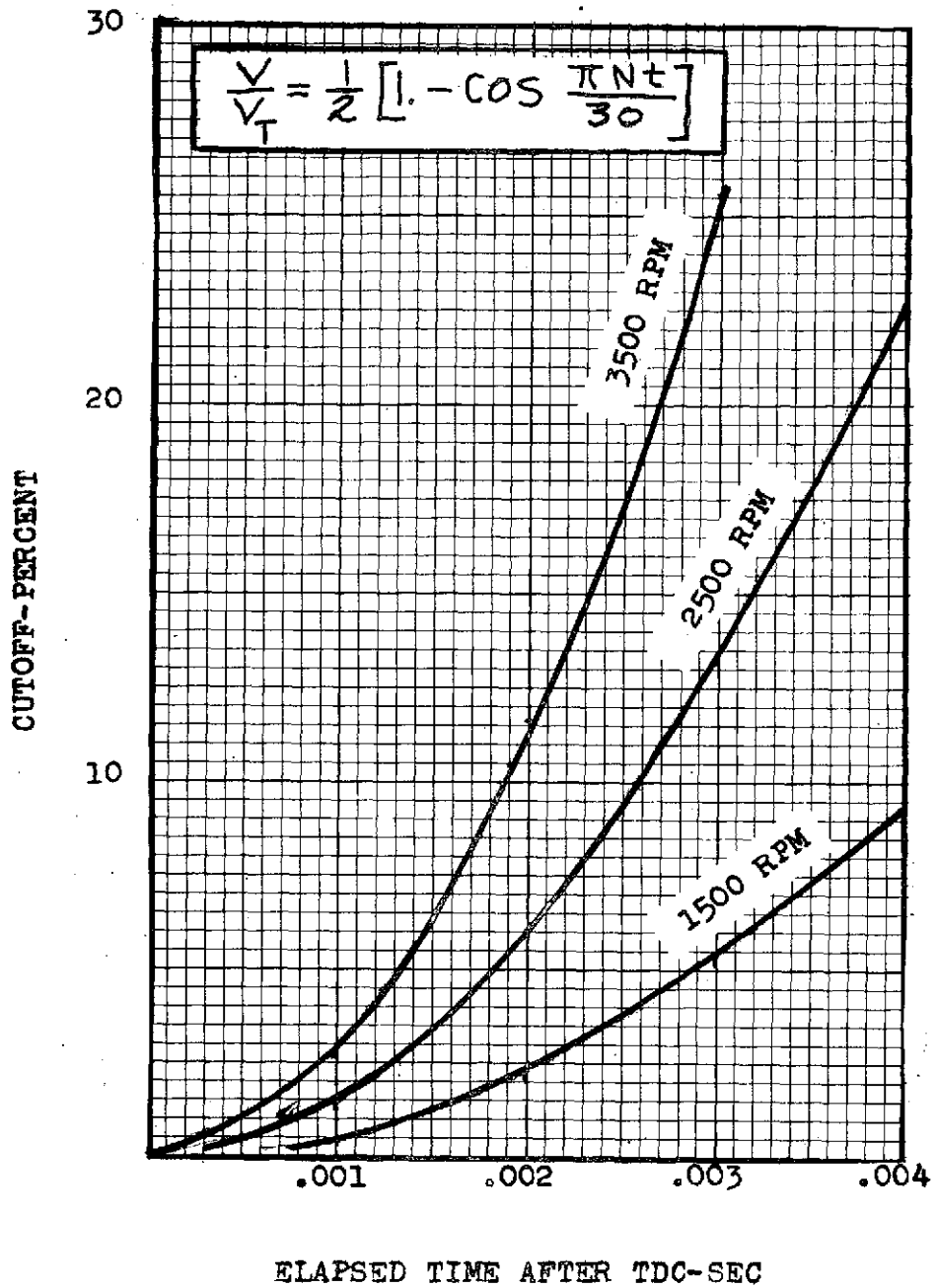

Figure 30. Time which the admission valve is open for specified cutoffs.

The time allowed for the steam to keep the cylinder volume pressurized is illustrated in Figure 30. At 20 percent cutoff, with an engine speed of 2500 RPM, only 0.0037 seconds are allowed for pressurization. Note how the greater speed restricts the time. This is why steam reciprocating engines have been basically low speed devices. At high speeds, it becomes difficult to get the steam into the cylinder. There has to be a pressure differential before steam will flow into the cylinder. As the steam flows, the pressure drop tends to be decreased. This pressure drop is referred to as pressure degradation. Typical degradation of pressure is illustrated in Figure 31. Pressure degradation is presented as the ratio of the cylinder pressure,  $P$ , to the supply pressure,  $P_o$ . The value of the pressure ratio is not a function of  $P_o$ . The pressure ratios of Figure 31 were computed for a boiler pressure of 1000 psia. This ratio would not change if the curve was recomputed for 500 psia. If the valve opening is not sufficiently large, very great pressure degradation will result. This is especially true as the cylinder volume and engine speed increases. For a large cutoff (50 percent), the cylinder pressure at cutoff will most likely be much less than supply pressure. For an example, at 3000 rpm a cylinder volume of 25 in.<sup>3</sup> will degrade the pressure to 42 percent of supply pressure within 0.003 seconds.

Raw data obtained from Appendix D, equation (D-11), are given in Figures 32 and 33. Again, the pressure drop can be significant even at a moderate cutoff, if the flow area is too small. It does appear that the rate at which the pressure drop occurs decreases as the cutoff increases. The drop between 10 percent and 30 percent is much less than what occurs between zero and 10 percent. The solid lines are for a temperature of 800° F. In Figure 33, the dashed line is for an initial orifice diameter of 0.5 inches, but for 1000° F in lieu of 800° F. The influence of temperature is not a major effect.

It is desirable to generalize upon these results and establish a relation so that the pressure degradation can be computed at ease for any design. An attempt at this is represented in Equation (64):

$$\frac{P}{P_o} = A + B\beta + C\beta^2 + D\beta^3 \quad , \quad (64)$$

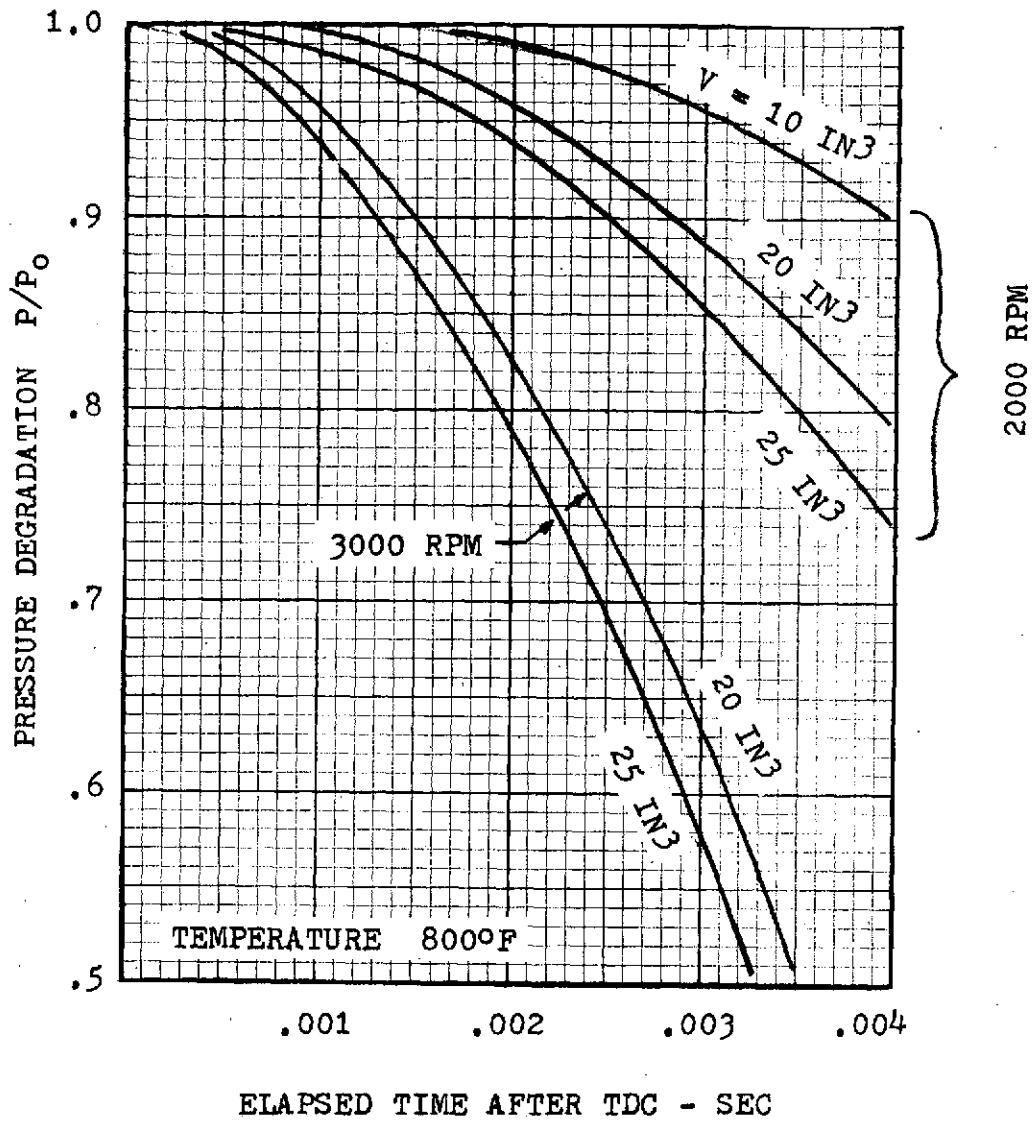

Figure 31. Cylinder pressure degradation with time.

where

$$A = 9.849 \times 10^{-1},$$

$$B = -2.632 \times 10^{-5},$$

$$C = 8.769 \times 10^{-10},$$

$$D = -1.130 \times 10^{-4},$$

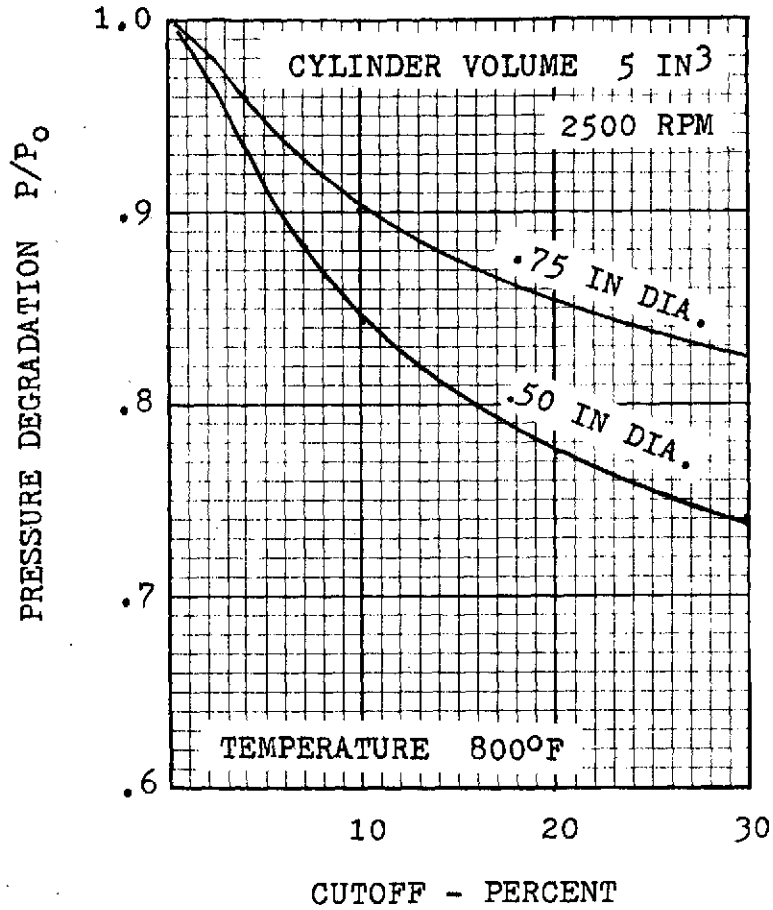

Figure 32. Cylinder pressure degradation with cutoff.

$$\beta = \frac{NVX}{A_o} ,$$

$$0 \leq \beta \leq 40,000 ,$$

$$T = 1260^\circ\text{R} ,$$

and

$$V = \text{volume of single cylinder (in.}^3\text{)} .$$

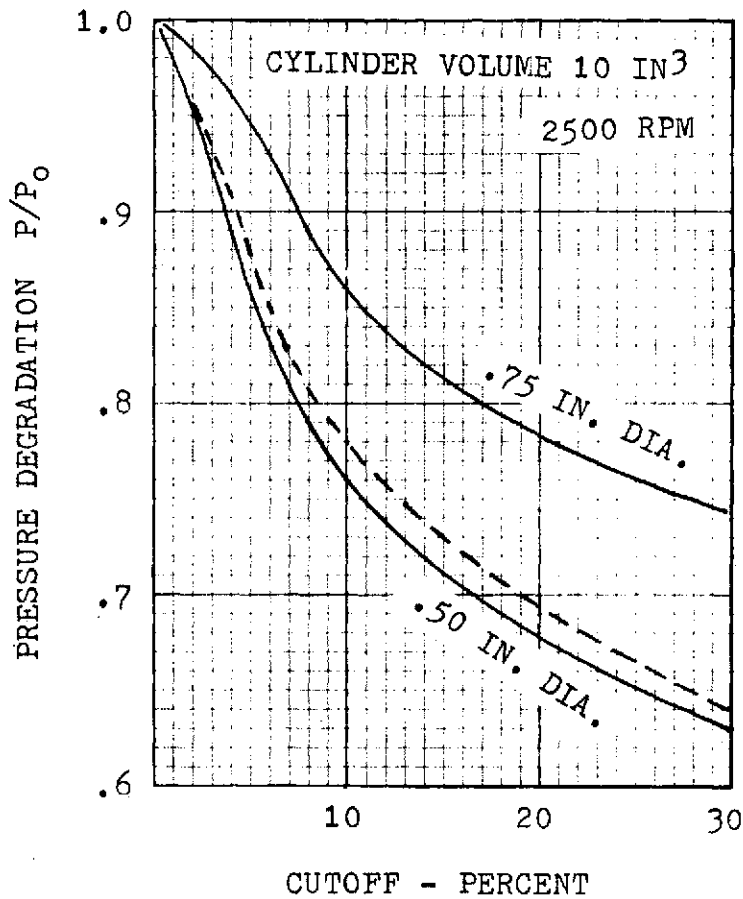

Figure 33. Cylinder pressure degradation with cutoff.

This equation is an approximate solution to equation (D-11) of Appendix D. Notice that as  $\beta$  becomes small; the pressure degradation approaches 0.9840 instead of 1.00. A plot of equation (64) is given in Figure 34. (Equation (64) is not recommended for design). It and Figure 33 are presented only to indicate behavior. For design purposes, it is suggested that equation (D-11) of Appendix D be solved for the design in question. Equation (64) can be used to establish configurations worthy of detailed analysis.

Equation (64) is really a little complicated to work with. Also, it covers a large range of  $P/P_0$  for which the designer has no interest. Another approximate solution, but limited to  $P/P_0$  greater than 0.800 is

$$\frac{P}{P_0} = 1 - \frac{\beta}{40,000}, \quad 0 \leq \beta \leq 8,000 \quad (65)$$

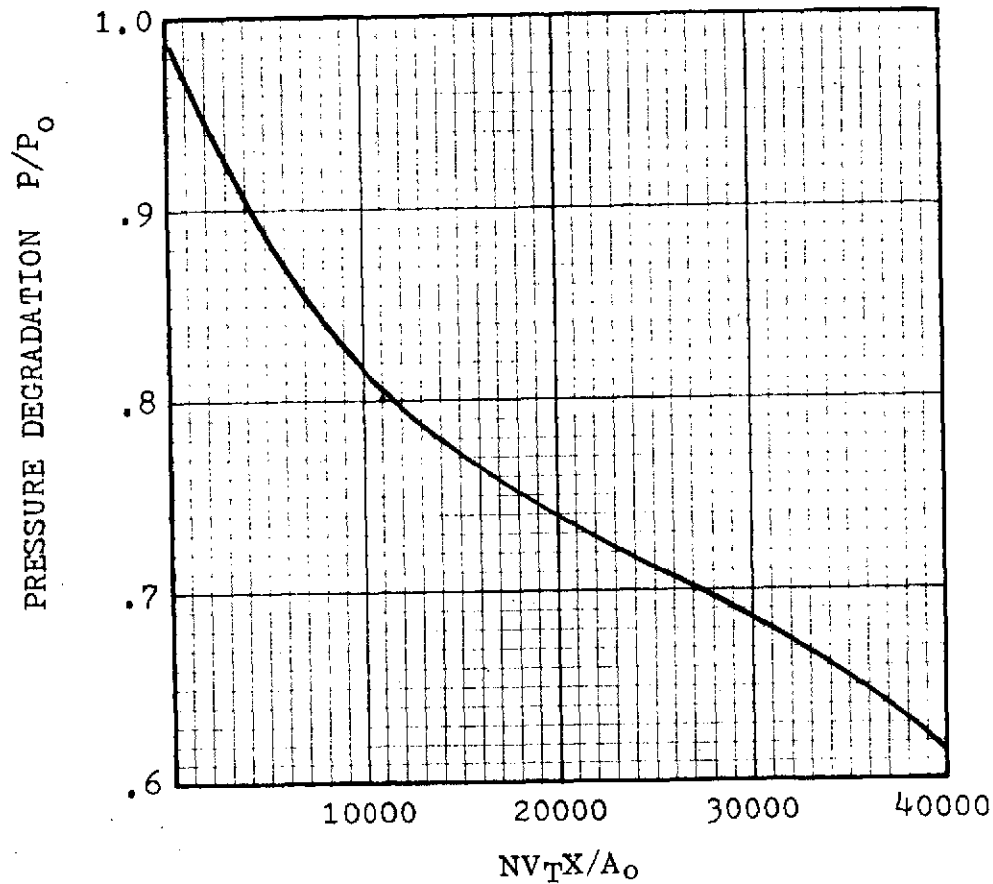

Figure 34. Generalized pressure degradation.

Equation (65) can also be used to develop possible valve/cylinder configurations. For an example, what is the maximum cylinder volume which will result in no more than 10 percent ( $P/P_0 = 0.9$ ) pressure loss for a 0.5-in. diameter flow orifice, 20 percent cutoff, and an engine speed of 1500 RPM? From equation (65),

$$\beta = 4000, \text{ and}$$

$$V = 4000 \frac{A_o}{NX} = 4000 \frac{0.196}{(1500)(0.20)} = 2.6 \text{ in.}^3$$

This result indicates that a very small cylinder volume is required to prevent a pressure degradation. In general, this is the message of equations (64) and (65). Normally, we want larger cylinder volumes. The pressure degradation associated with larger volumes is not bad, if we know the amount of pressure loss. By knowing the loss, a more accurate estimate can be made of power and torque characteristics.

## E. Starting Torque

The starting torque of an engine is something that requires more attention than may at first be realized. Usually it is taken for granted that the torque of a steam engine is unconditionally acceptable. The statement that "a steam engine has maximum torque at start" has become an axiom. However, careful scrutiny of how a steam engine starts will yield some surprising results. In general, the starting torque is not as great as may be expected. The average torque can be computed from

$$T = \frac{PV}{24 \pi} D_N \quad (66)$$

But the starting torque may be greater than or less than the average running torque, depending upon cutoff, number of cylinders, and the angular start position.

To illustrate this point, consider the torque wave shape produced by a single cylinder engine with about 40 percent cutoff, as illustrated in Figure 35. The average running torque is represented by the dashed line. If the angular start position is between zero and 72 deg, the starting torque could be typically represented at point (A), which is greater than the average torque. Or if the angular start position is at (C), the starting torque will be less than the average. If the angular position is past 72 deg, as indicated by point (B), the starting torque will be zero since the angular degrees of admission have been passed. The valve is closed. Maximum starting torque will occur at point (D) just prior to cutoff. Of course, after one revolution, the equation for the average running torque becomes valid.

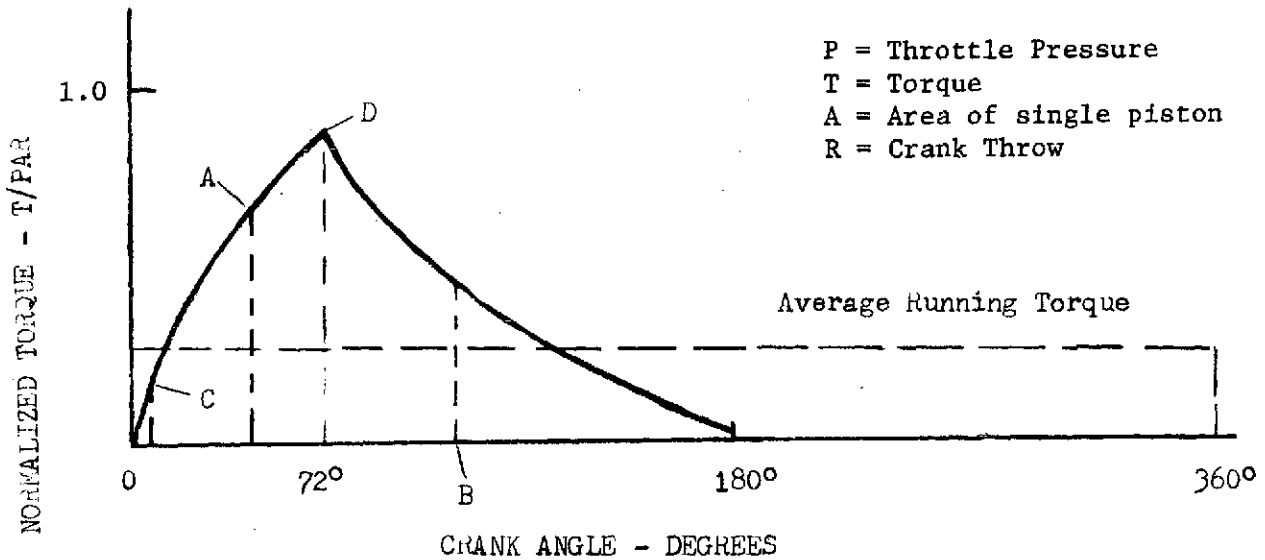

Figure 35. Torque characteristics.

Now, consider a more complex engine illustrated in Figure 36. This is a twelve cylinder engine, showing the first 120 degrees of rotation. Cylinders 6, 7, and 8 do not appear, since their wave occurs between 120 and 360 degrees. Cutoff is 30 percent. The running torque wave shape is shown as curve (A) and is the sum of all the individual waves within any given increment of rotation. However, at start, all cylinders are not pressurized since some are beyond the rotational point of cutoff. If the start position is at (B), cylinders 3, 4, 5, 9, 10, 11, and 12 are not pressurized. The only two cylinders taking part in the starting torque are 1 and 2. These two torque waves add to the starting torque at point (C). This angle presents the maximum starting torque. As rotation continues, other cylinders become pressurized and the torque curve builds up to the running torque, as indicated. The worst starting angle occurs at 30 deg (and increments at 30 deg), where only cylinder 2 is pressurized. At this angle, the starting torque begins at point (D). Even though the starting torque can be much less than expected, it does build up within only a few degrees of rotation. The maximum torque does not occur at start. However, after start and at low speed (small boiler load), the torque is maximal since the pressure is maximum and since all cylinders are pressurized. Also, during start the throttle setting may be small. If this coincides with a bad crank angle, the starting torque can be very small. However, if the engine doesn't start, the throttle will "flood". That is, boiler pressure will be realized within the cylinder (s) even at low throttle. The starting torque cannot therefore be necessarily related to the throttle setting.



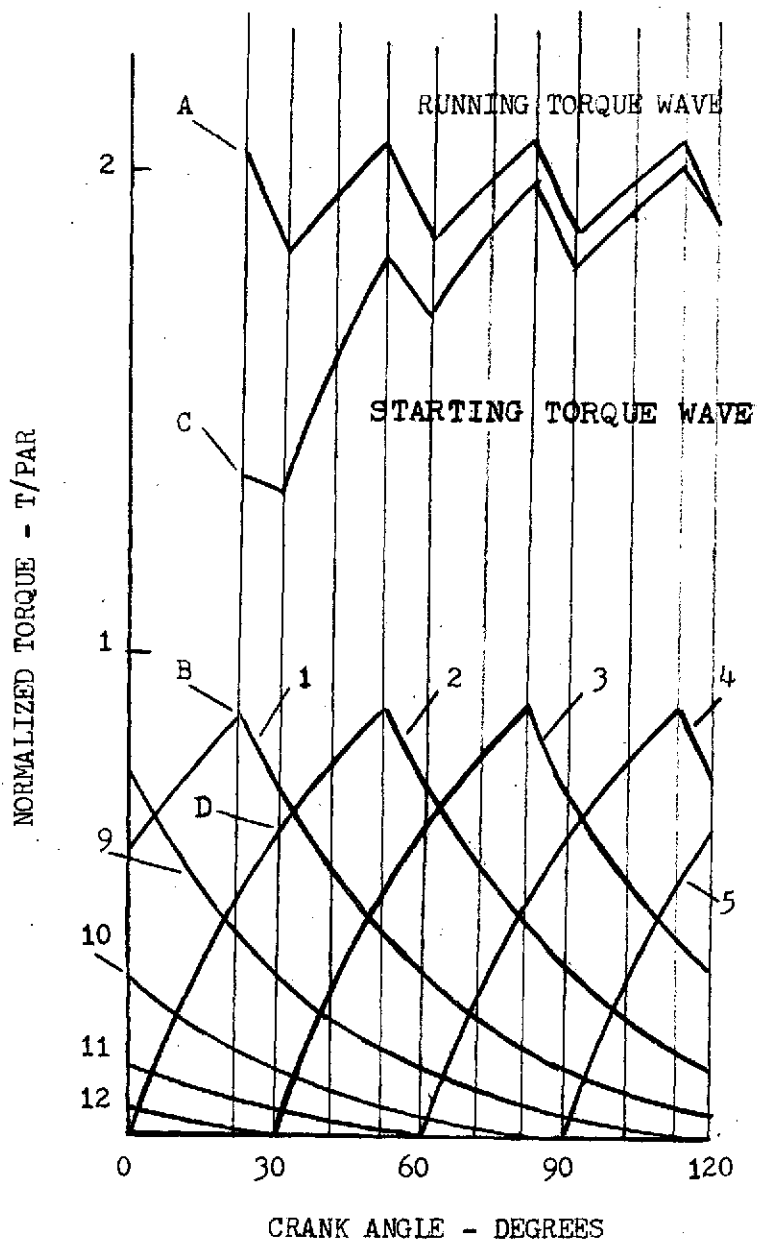

Figure 36. Starting torque characteristics of a twelve cylinder engine.

Starting characteristics cannot be determined by a dynamometer since, at zero speed, the dynamometer imposes no load. Special tests are required to determine starting characteristics. From an analytical viewpoint, start torque should be calculated at the worst crank angle, with system pressure applied.

## VI. HARDWARE DESCRIPTION

The hardware described in this chapter is new, untried, and thus unproven. Nevertheless, this hardware represents the epitome of simplicity and, at the same time, introduces a new philosophy toward design and operation of the modern steam automobile. It is emphasized that the approach is not just refinements of existing techniques, but an entirely new idea of what the modern steam automobile should incorporate.

Some of these ideas may prove to be invaluable to the success of modern steam cars, and others may probably be exposed to as just plain impractical. This is the probability incurred when techniques are presented purely on the basis of intellectual activity rather than test results. The author remembers the words of Bill Lear, "With one test, I can disprove a hundred equations." How true this is! However, without ideas there would be nothing to test for.

The first concept deals with the logic of operating a steam system at constant pressure with an on-off type control. This concept will be referred to as the variable pressure boiler (VPB).

### A. Variable Pressure Boiler (VPB)

Between 1876 and 1940, many innovations have been applied to the "steam engine." In spite of the wide variations in design, all steam systems had one common factor: an operation dominated by fixed boiler pressure. The systems were designed and provided with the necessary controls to maintain boiler pressure at a fixed predetermined value. This philosophy was carried into the 1950's with the Paxton project, and more recently by Bill Lear's vapor dyne system. The necessary sensors, prime movers, plumbing, and force-balance devices employed over the past 70 years are epitomized by the plumber's nightmare. The operation of a steam boiler-engine system at a fixed boiler pressure represents the greatest snag which has hindered modern steam car developments. The primary purpose of this discussion is to introduce an entirely new control concept, the VPB.

Even though Stanley, White, and Delling performed above their gas counterparts, the performance of a modern steam automobile system must be capable of exceeding previous records. It is doubtful if even the design approach used on previous steam systems has the capability of meeting modern demands. The

validity of these statements is based on total performance, which includes odor, as well as speed and power. Steam enthusiasts will accept steam in any form; however, the modern steam car must be designed for the man, the girl, and the lady who doesn't give a "hoot" about steam. Many thousands of people are interested only in getting there and back safely, reliably, and at reasonable cost.

The younger generation often asks, "Why did steam automobiles fail?" There have been many complicated answers. But the simple truth is that steam technology was in a mess. It literally took both an engineer and a maintenance man to keep a vehicle going.

The antique steam systems were designed for a fixed boiler supply pressure and temperature. The systems were provided with sensors and regulators to maintain boiler conditions as near constant as possible. Even the most modern developments reinforce this mode of operation. It is ironic that all of serious steam developments over the past 20 years have not introduced any new control innovations. Most efforts have been concerned with refinements of existing designs through materials or gimmicks.

A boiler provides steam at the desired pressure to the engine throttle, and the throttle is essentially a variable orifice which can throttle the supply steam mass flow. Therefore, the throttle was a means of speed and power control. It is believed that the throttle of the modern steam car must take a new form from that of its historical image. In concept, the throttle can be wide open continuously. The approach taken by current developments (and antiques) is (was) to preprogram a fuel rate, depending upon a pressure error between design and actual pressures. This fuel rate is geared to the maximum heat input for the boiler. It is the intent that the predetermined fuel rate can maintain boiler pressure under all conditions. Speed and power are controlled by the throttle which can be varied manually by the driver.

The VPB approach controls speed and power by manually varying the fuel rate. The throttle is maintained wide open after start. The primary objective of the recommended control system is to achieve the modern characteristics mentioned earlier. The methods to achieve these ends involve more than physical hardware. The scheme proposed here is a new concept, a new philosophy for making vapor power cycles practical.

What are the ideal performance characteristics of a power unit suitable for automotive application? The answer has been known for years. At low speeds, capability for a large traction effort and high acceleration are most desirable. As the engine (automotive) speeds up, torque should be traded off

for speed since less acceleration is needed. This tradeoff can be augmented by allowing the boiler pressure to decrease with speed. Realizing that ultimately flow rate is indicative of power, the maximum power level will not be compromised. This approach allows torque to be exchanged for speed. In conventional designs, torque was controlled primarily by the throttle cutoff.

The VPB concept is a technique to change gears without a transmission. At low speeds, the boiler exhibits a high pressure, giving high torque capability. As the engine speed increases, the boiler pressure would be allowed to decrease to some steady state value. This essentially trades off acceleration capability to some steady state value. This essentially trades off acceleration capability for speed.

The VPB concept also precludes the use of a normalizer. Boiler behavior actually enhances operation of the VPB principles. Under conditions of "high fire", the boiler pressure will be relatively low in accordance with the VPB concept. Also, the engine speed and power must necessarily be at a maximum. If the load were suddenly removed, the automatic fuel control would reduce the fuel rate to idle value; however, the residual heat in the boiler would continue to cause evaporation (thermal lag). Even though no fire is supplied to the boiler, the pressure will more than double. In the past, this pressure rise has been controlled by use of a normalizer.

In systems which would employ the VPB concept, the boiler pressure at "high fire" will be about 400 psia. Under sudden shutdown conditions, the pressure will rise to about 1000 psia. Normalizers are not required to limit the pressure since, under normal operation of the VPB concept, pressure is relatively low. Sudden shutdown represents extreme conditions. Under less extreme conditions, the pressure rise will be less pronounced, thus being proportional to the pressure rise required in the VPB concept.

The simplest representation of the VPB is illustrated in Figure 37. The accelerator controls the fuel flow output of the fuel pump. The connection between the accelerator and fuel pump may be mechanical or electrical. In any event, the rate at which fuel is burned depends upon the command of the operator by pressing the accelerator. Schematically, there is no throttle. Control of the engine speed is entirely activated by the accelerator. The engine is equipped with a simple two speed automatic transmission. After start, the engine idles at 300 to 400 RPM to run the necessary auxiliary equipment. The boiler pressure will increase upon pressing the accelerator, causing the engine to accelerate and thus propel the vehicle. When the accelerator is released, the fuel flow rate reverts to its idle flow. In order to fully describe the start and running characteristics of the VPB system, a more comprehensive representation of the system is given in Figure 38.

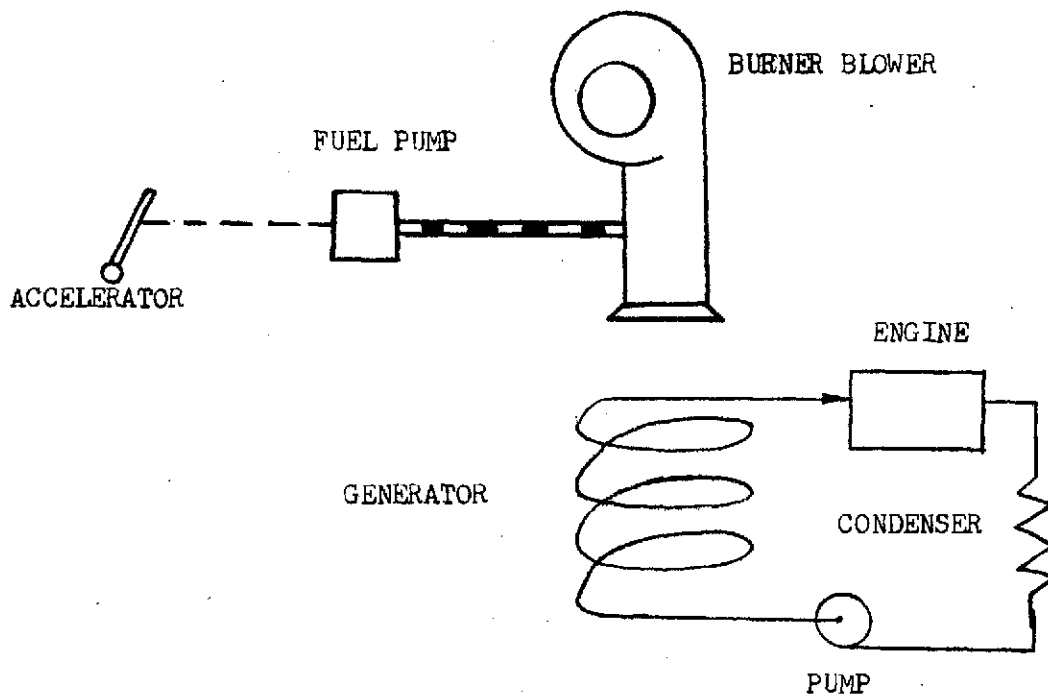

Figure 37. Control approach for the variable-pressure boiler.

Upon closing the start switch, maximum voltage will be imposed upon the fuel flow pump, thus pumping maximum fuel into the burner. This will probably last about ten seconds until the pressure transducer senses about 40 to 60 psia. At that pressure level, two events take place.

1. Output from the pressure transducer will result in activating the solenoid-operated throttle to the wide open position. The engine will start.
2. The relay is also activated, switching from the fire-up position to the run position. With the relay in the run position, voltage to the fuel pump is controlled by the potentiometer connected to the accelerator. With the accelerator in its relaxed position, the potentiometer allows just enough voltage to generate enough steam to idle the engine.

From start, the fire burns continuously until it is stopped by the start switch. Continuous burning will reduce pollutants.

It is realized that in an actual design, additional circuitry would be required to control the solenoid throttle to its dropout position after opening the start switch. Also, upon recycling the system, a few seconds time delay may be required to allow the fire to establish its temperature distribution prior to allowing the solenoid throttle to be activated. Also, the burner-blower motor current would have to be adjusted with accelerator position.

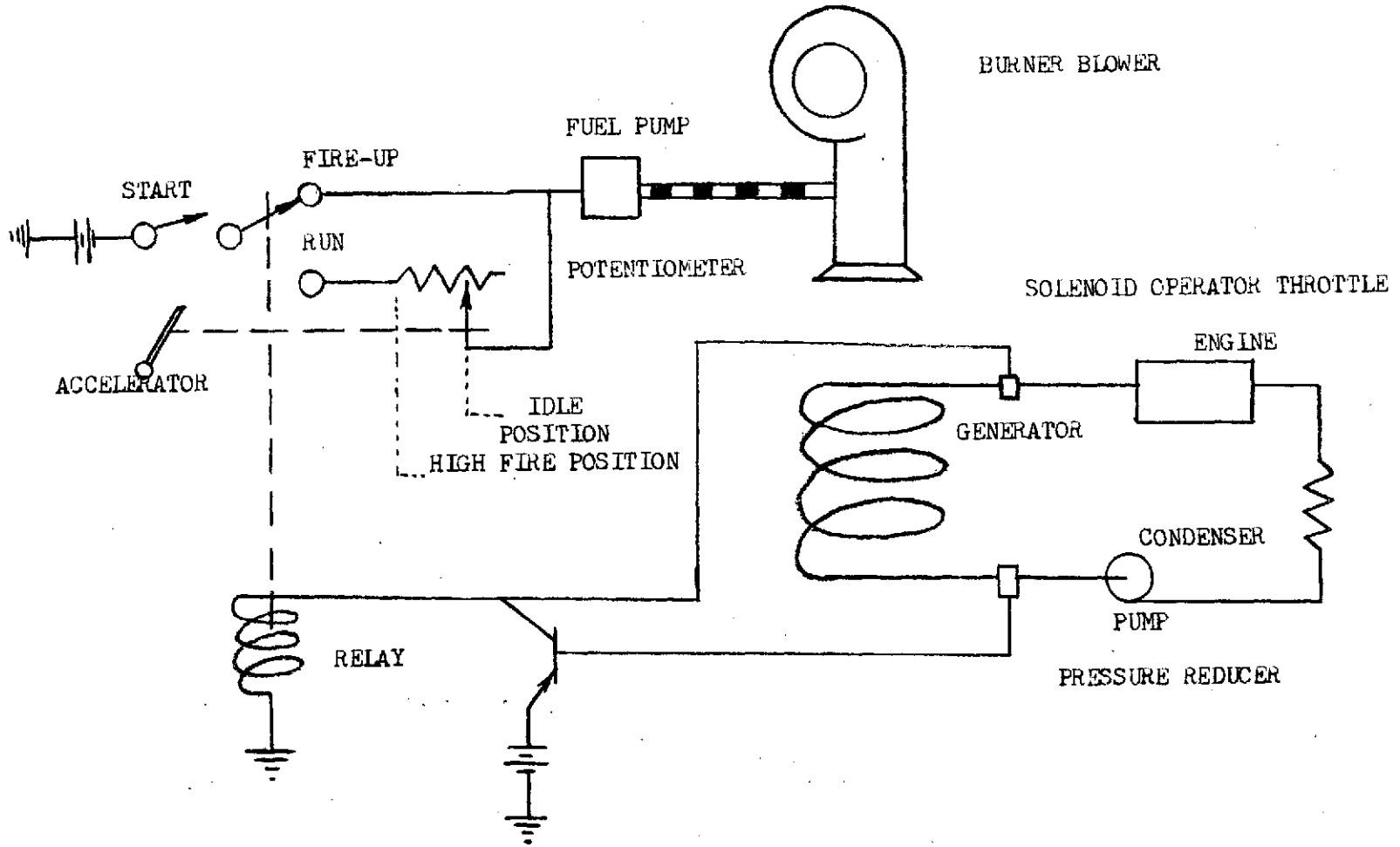

Figure 38. Operation of the VPB system.

## B. VPB Performance Characteristics

For the purpose of analytical demonstration, the following generator-engine-system parameters are selected. No significance should be attached to these specific values.

Total gear ratio . . . . .	0.77 ft
Ratio of specific heat . . . . .	1.3
Engine displacement . . . . .	40 in. <sup>3</sup>
Cutoff . . . . .	30 percent
Condenser suction pressure . . .	8 psia
Vehicle weight . . . . .	3000 lb
Supple steam temperature . . . .	1460° R
Generator time constant . . . . .	3 seconds

At start, the transmission will have a ratio of 0.3. At 10 MPH, the transmission shifts to 0.60 and, at 30 MPH, the transmission establishes a one-to-one drive between the engine and drive shaft. The total gear ratio, as defined in Appendix B, remains at 0.77 feet.

In this analysis, it is assumed that the start sequence has been executed and that the engine is idling at 300 RPM. At time zero, the accelerator will be depressed to impose a fixed fuel flow rate into the boiler.

Projected transient pressure characteristics are illustrated in Figure 39. Two curves are shown, one for a command fuel flow of 0.2 lb/min and another for 0.5 lb/min. Pressure is very stable, rises to a peak and decays to a steady state value. The steady state value is identical to that described by equation (59) in Chapter 5. Notice that the transmission shifting does not result in any pressure surges.

It appears that the boiler response is very rapid. The maximum pressure is achieved within a few seconds and, of course, the vehicle will begin to move immediately upon the command input. The fuel consumption concept associated with the command fuel input of 0.2 lb/min is illustrated in Figure 40. The apparent discontinuity will occur as a result of the transmission shifting to higher gear ratios. After about 20 seconds of acceleration, the vehicle will be able to

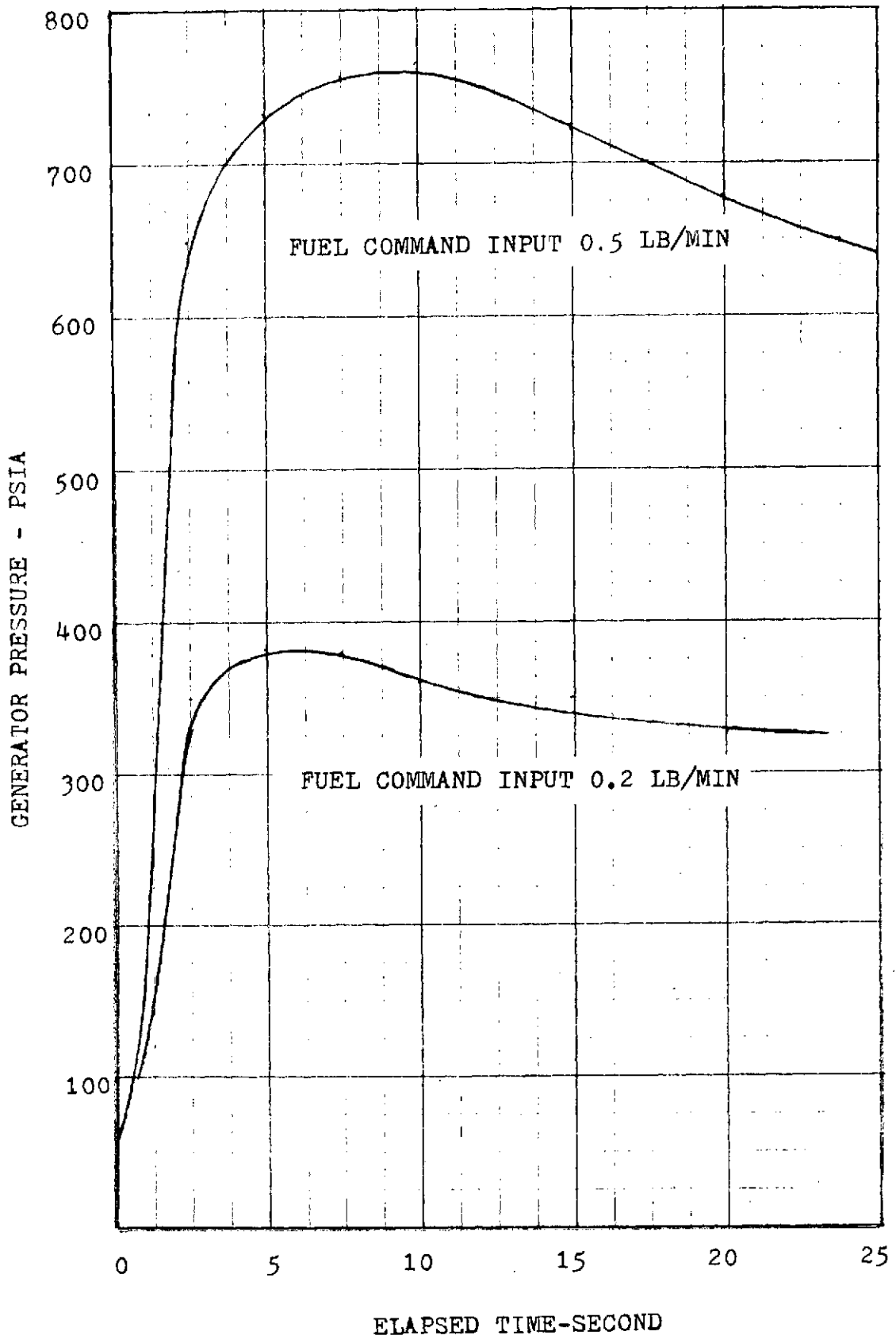

Figure 39. Pressure transients occurring with a variable pressure boiler.



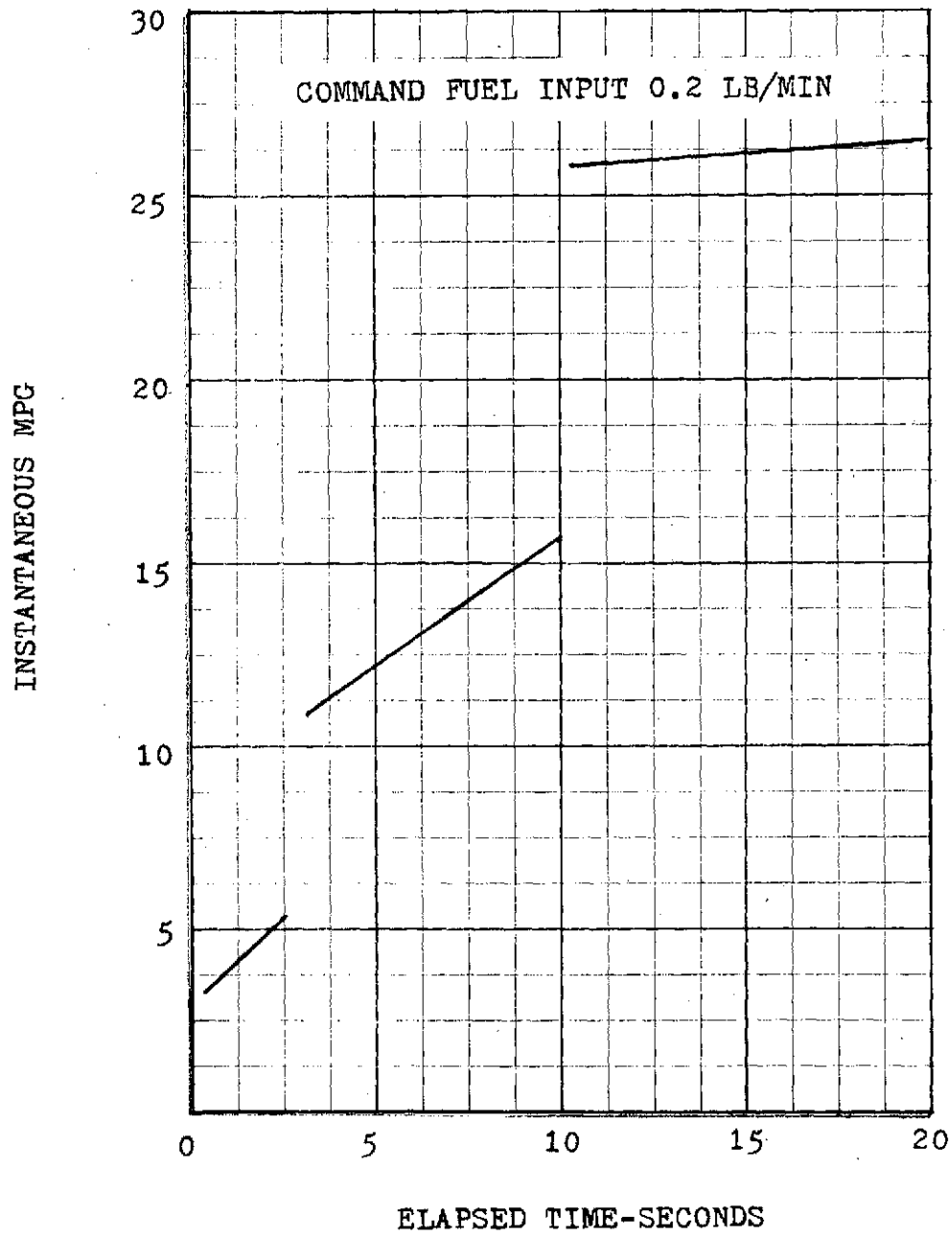

Figure 40. Fuel consumption characteristics of the VPB concept.

achieve 20 mph, with a fuel consumption of about 26 MPG. With 0.5 lb/min of fuel input, the vehicle will be able to achieve 70 mph after 25 seconds, with a fuel consumption of 15.4 MPG.

The engine speed concept for 0.5 lb/min input is shown in Figure 41. From the idle position, the speed increases with a decreasing rate until some steady state value is reached. In this particular case, a total gear ratio will result in speed slightly over 1000 RPM. Any engine speed may be specified for any vehicle speed, just by adjusting the gear ratio. The law between vehicle speed and engine speed is illustrated in Figure 42. However, the designer must realize that as the total gear ratio increases the acceleration capability decreases.

Power characteristics are shown in Figure 43. After about ten seconds, the power curve levels off to its steady state value. This particular curve is for a fuel input of 0.5 lb/min. In every respect, the variable pressure boiler approach shows performance that is satisfactory. However, there are two aspects which may hinder its acceptability to the public. First, the variable pressure boiler must be able to generate steam efficiently at low fire. The ability of a boiler to generate low steam flow rates under super heated conditions are not known. Tests will be required to establish the economy of the VPB concept at low fire. Secondly, boiler response must be prompt under immediate need for power. Assume that an operator is on a slight hill at a stop light and the vehicle is being held by the brake. The engine is idling at 400 RPM. When the light changes, the operator will probably release the brake and immediately depress the accelerator. Depending upon the response of the boiler, the vehicle may not accelerate immediately. Some time may be required for the boiler pressure to build sufficiently to overcome the retarding torque caused by the hill. Tests will be required to determine the vehicle characteristics under these conditions.

### C. Edification of Miles Per Gallon

Historically, steam engines adapted for automotive application have had displacements on the order of 100 in.<sup>3</sup>, or less, with cutoff between 20 and 40 percent. Operating temperatures have been 800 to 1000° F, with pressures between 500 and 1000 psia. In all (almost), superheated steam has been utilized.

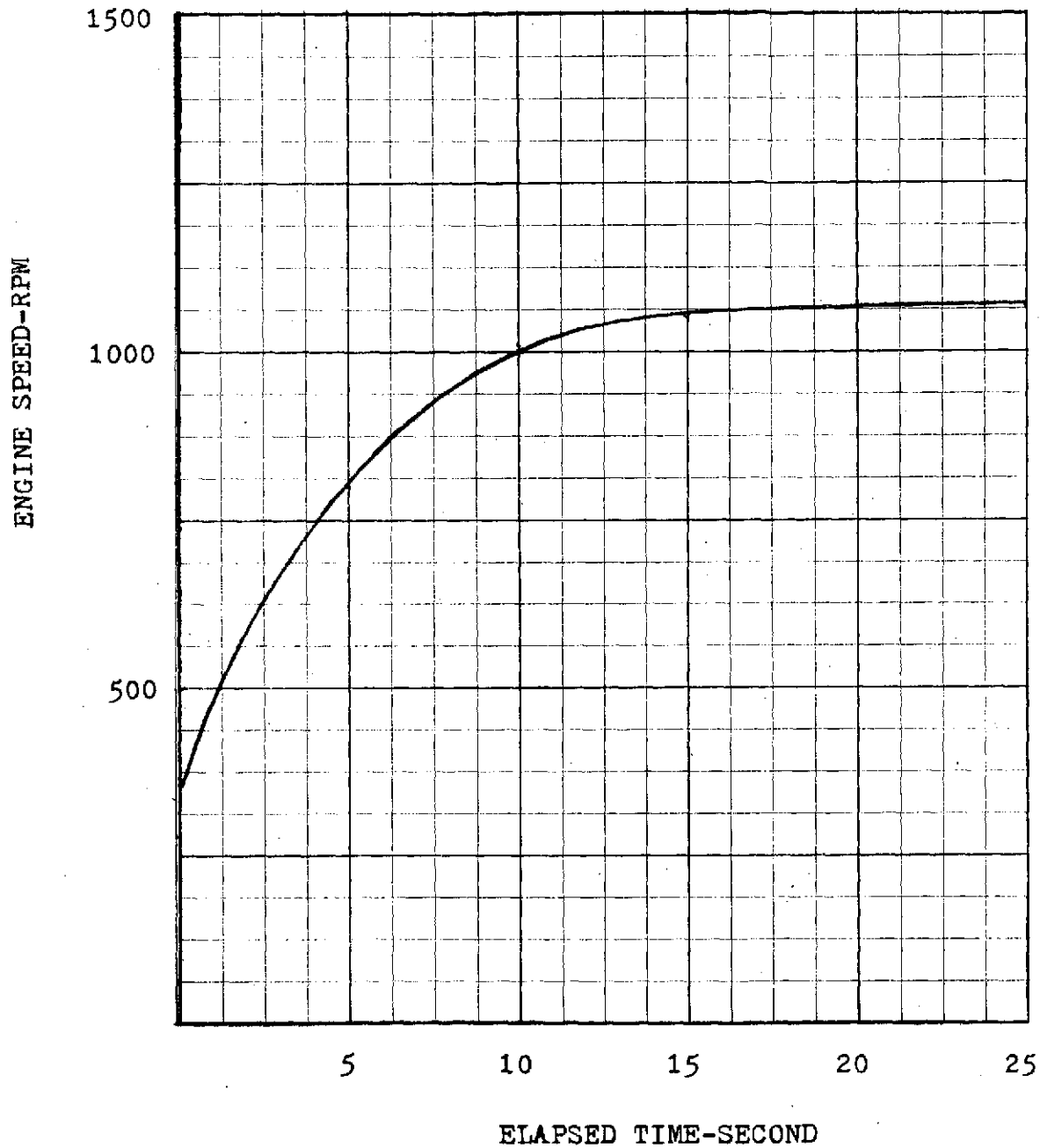

Figure 41. Transient engine speed characteristics of the VPB concept with a total gear ratio of .77 feet and .5 lb/min input of fuel.

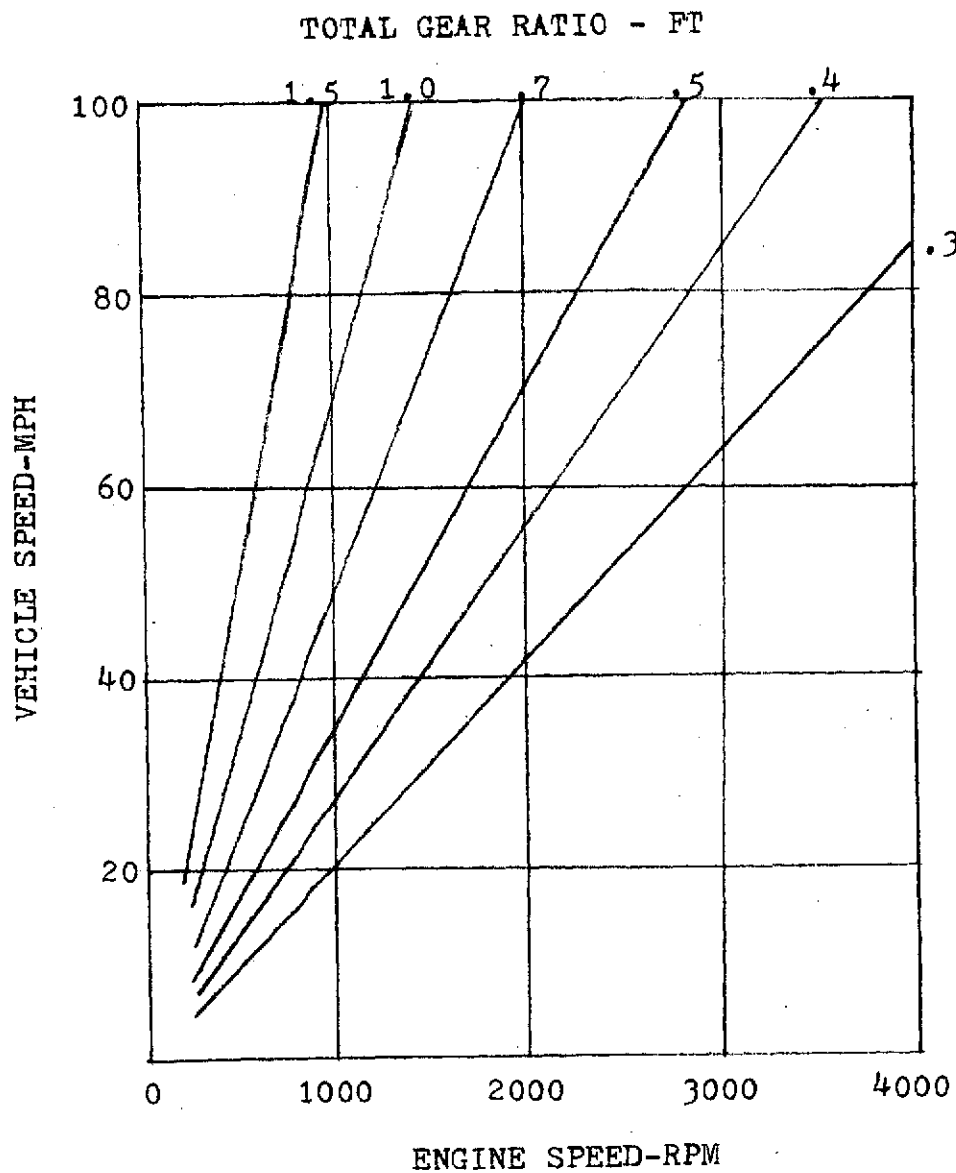

Figure 42. Law between vehicle speed and engine speed for given total gear ratio.

It has been argued previously that temperature is a poor yardstick for evaluating system performance in terms of miles per gallon. Temperature is a great parameter for depicting theoretical thermal efficiency, but a weak factor in determining miles per hour capability of a steam system. To illustrate this point, consider the equation presented early for system efficiency based on indicated horsepower.

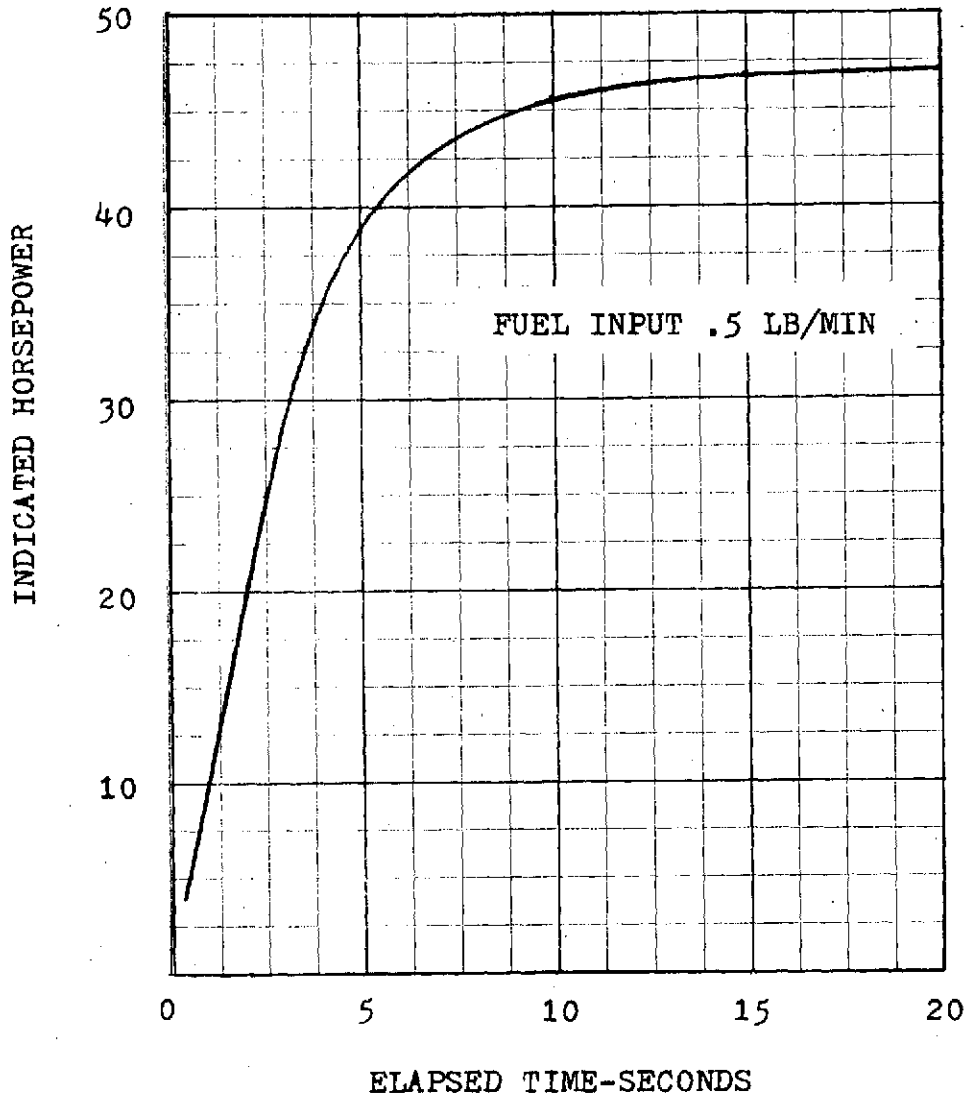

Figure 43. Transient power characteristics for a variable pressure generator.

$$\eta_S = \frac{\eta_B}{778} \frac{RT}{\Delta H} S_N$$

If we substitute into this equation, using historical operating values of  $T = 1000^\circ \text{F}$ ,  $P = 1000 \text{ psia}$ ,  $X = 30 \text{ percent}$ ,  $S_N = 2.0$ ,  $\gamma = 1.3$ , and  $\eta_B = 0.90$ ; we find that,

$$\eta_S = \frac{0.9}{778} (82) (2.0) = 19 \text{ percent} .$$

This is the typical efficiency that would be expected.

Realizing that temperature is more of a design hazard in a steam system than an asset, consider now a system operating at 1000 psia but at a much reduced temperature (saturated) and cutoff. The booty number will decrease but the supple number increases. Substituting,  $\eta_B = 0.9$ ,  $T = 544^\circ \text{ F}$ ,  $P = 1000 \text{ psia}$ ,  $RT/\Delta H = 60 \text{ ft-lb/BTU}$ ,  $X = 1 \text{ percent}$ ,  $\gamma = 1.08$ , and  $S_N = 4.87$ ; then,

$$\eta_S = \frac{0.9}{778} (60) (4.87) = 33 \text{ percent} .$$

This is a 74 percent increase over what is normally considered typical. This percent increase is sufficiently large enough to warrant further investigation.

At the outset, it was realized that a one-percent cutoff results in low engine torque. In order to achieve high speeds, the designer must resort to high Abatement Numbers. This requires a relatively large engine displacement and low total gear ratio. However, the gain will be fantastically high miles per gallon.

The Abatement Number concept to evaluation of miles per gallon has been applied to a system operating at lower temperature, low cutoff, large engine displacement, and relatively high pressures. The results are given in Figure 44. At 70 MPH, the miles per gallon is a factor of three greater than what would be expected with an IC engine running at the same speed. These results are achieved using saturated steam where the temperatures impose no lubrication problems.

This philosophy of operation is contrary to current trends. Actually, it appears to violate the fundamental law which governs good performance. It is the opinion of the author that temperature is an excellent tool for measuring theoretical thermal efficiency, but is a very weak factor in governing the miles per gallon capability of a Rankine steam system.

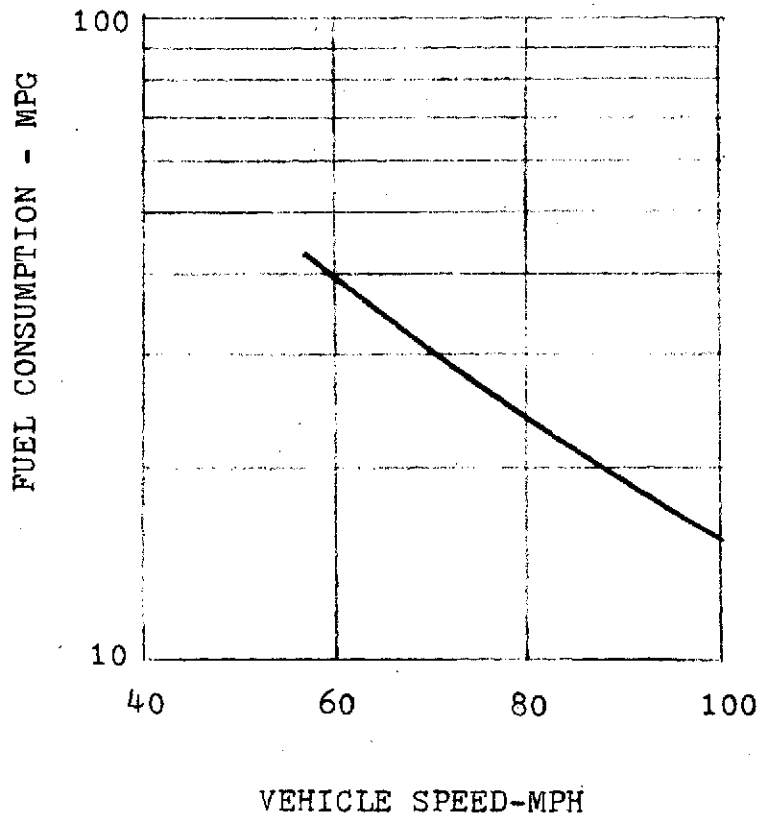

Figure 44. Miles per gallon for a 300 in.<sup>3</sup> engine having 1.0 percent cutoff, 1200 psia operating pressure.

The question has been posed to the author many times, "Why is this so?" The Carnot cycle has served as the standard for evaluating heat engine performance, but it has been stated many times that no engine can duplicate the cyclic process of the Carnot engine. Temperature has been the single parameter upon which to increase efficiency. The Carnot cycle and the resulting first and second law which relates to the power output of a cycle. The Carnot cycle depends upon quasi-static processes. This is a necessary requirement to eliminate all thermal gradients between the source and the working medium. The Carnot cycle, therefore, produces theoretical work but zero power. Therefore, the Carnot cycle and its temperature implication has little relevance to the miles per gallon performance of a power producing steam Rankine cycles. In many respects engineers, designers, and promoters of the modern steam vehicle have been handicapped by their technical education.

## D. The Steam Engine

No one man invented the steam engine. It began in 1750 when Thomas Newcomen invented his cylinder vacuum device for pumping water. This engine allowed the cylinder volume to be filled with steam, driving out the air. Water was then injected into the cylinder, causing the steam to condense. The condensing steam created a vacuum, thus allowing atmospheric pressure to push the piston down [7].

The single most important improvement to the steam engine was made by Oliver Evans in 1804. Evan's engine utilized the steam pressure generated in a boiler to drive the piston rather than atmospheric pressure. Thus, the steam engine became mature.

Evans' patent expired in 1825. By this time, high-pressure engines were in wide use. It is interesting to note that Evans was met with immediate opposition when he introduced his engine. The main thrust of the opposition seems to be a matter of safety. High pressure boilers were too dangerous. Actually, Evans was subject to the age-old idea that, "If I did think of it, it couldn't be any good."

After Evans moved the steam engine from its "toy" state to a viable device which would reshape America's technology, all kinds of engines appeared. As early as 1830, inventors began to investigate ways to build a rotary engine. The motivation for rotary engine seem to result from the idea that a great loss of power results from the reciprocating movement. This idea was the belief that a cardinal phenomenon was involved in changing reciprocating motion to rotary motion. This means that the supposed loss of power resulted from the bell-crank mechanism and not from friction which accompanies any device. This phenomenon of power loss in a reciprocating engine was never clearly defined or demonstrated. It was the general opinion of the inventors of that day that direct conversion of the "pressure energy" into rotary motion would represent a great improvement in performance. As early as 1822, Minus Ward [8] showed that there were no cardinal energy loss phenomena associated with the reciprocating engine. Nevertheless, 123 patents were issued in this country for rotary engines before 1860 [7].

To the extent of research by the author, a successful rotary steam engine has never been demonstrated. This excludes the turbine which has been successfully adapted to large power plant stations. Even today, the contest between rotary and reciprocating engines goes on. The primary problem of rotary engines reduces to sealing (low leakage) and maintaining tolerance. This is exactly the problem which plagues developers of rotary engines today.



Even so, over the past several years since the air pollution issue, there has been a rash of development of rotary engines. These developments have been applied to the internal combustion engines as well as steam engines. The author has had the privilege to talk personally to the inventors of rotary engines. In every case, the inventor points out the "loss-efficiency" of reciprocating engines. The variation of torque with angular position is always emphasized. This, says the inventor, represents "loss efficiency". The term "loss efficiency" is not original with the author but rather a quote by the inventors. Inventors today still believe that the bell-crank mechanism has cardinal deficiencies in changing reciprocating motion to rotary motion. Some inventors claim a 50 percent increase in MPG on the basis of the superiority of rotary machines over reciprocating machines. It is noted however, that a rigid development of this rationale has never been presented. Actually, as Minus Wood illustrated in 1822, no such valid rationale exists.

Consider this argument, efficiency cannot be based upon torque. Efficiency must be based upon work, power, or miles per gallon. The work depends entirely upon the volumetric changes which the steam is subject to. For identical volumetric changes, the work per revolution will be identical regardless of the mechanical mechanism through which the work is manifested. Even though the torque may be varying widely, there is no loss in the available work. In a reciprocating device, the torque variations are such that the resulting net work is identical to a rotary machine whose torque is varying another way. To illustrate further,

$$\text{Work} = \underbrace{\int_0^{\pi} T_1 d\theta}_{\text{Reciprocating}} = \underbrace{\int_0^{2\pi} T_2 d\theta}_{\text{Rotary}} \quad (67)$$

Therefore, reciprocating and rotary engines can be represented as

$$T_1 = P_1 A_1 R_1 \sin \theta = \frac{P_1 V_1}{2} \sin \theta \quad , \quad \text{and} \quad (68)$$

$$T_2 = P_2 A_2 R_2 = P_2 \frac{V_2}{2\pi} \quad , \quad (69)$$

where

$T_{(1,2)}$  = engine torque ,

$P_{(1,2)}$  = pressure ,

$A_{(1,2)}$  = area ,

$\theta$  = engine displacement ,

$R_1$  = crank throw, and

$R_2$  = engine radius .

Therefore,

$$\frac{P_1 V_1}{2} \int_0^{\pi} \sin \theta \, d\theta = \frac{P_2 V_2}{2\pi} \int_0^{2\pi} d\theta , \quad (70)$$

for equal pressure and displacement. As  $P_1 V_1 = P_2 V_2$ , then

$$\frac{1}{2} \int_0^{\pi} \sin \theta \, d\theta = \frac{1}{2\pi} \int_0^{2\pi} d\theta ,$$

$$\frac{1}{2} [-\cos \theta]_0^{\pi} = \frac{1}{2\pi} [\theta]_0^{2\pi} , \quad \text{and}$$

$$1 = 1 . \quad (71)$$

Thus for equal displacement and equal pressures, rotary engines have no advantage over reciprocating engines in delivering the work potential. The specific engine configuration is represented by equations (68) and (69) for  $T_1$  and  $T_2$ . The example above represents the simplest representation of each engine. In the case of the rotary engine, area  $A_2$  orbits a radius of  $R_2$  through  $2\pi$  radians, thus sweeping out a displacement,  $V_2$ . It is recognized that some rotary engines cannot be represented by this simple model. In these cases, if the engine torque can be written as a function of angular displacement, the basic equation,

$$\text{Work} = \int_0^{2\pi} T d\theta \quad ,$$

describes the available work. For equal pressure, displacement, and cutoff, the work delivered to the shaft per revolution will be identical for both the reciprocating and rotary engine.

The rotary engine is smaller and lighter than its equivalent reciprocating engine. To a large extent, this fact has been the motivation for recent rotary engine developments. The modern steam system has been strongly accused of being heavy and bulky, which results in design problems. However, when the Williams, Pritchard, Keen, and Carter steam cars (which have reciprocating systems) are considered, the argument for bigness and heaviness seem to be somewhat false or, at least, overstated. The rotary engine, therefore, seems to have little to offer over its highly developed rival reciprocating engine. This is especially true when one considers a 140-year development period of the rotary system without a single solid success.<sup>11</sup> Outside of the wheel and axle, no other mechanical development has enjoyed more success than the bell-crank mechanism.

## E. Turbines

It has been the opinion of the author that if the steam reciprocating engine cannot be made to work technically and economically, then there is no chance for the steam turbine. This statement is not intended to imply that the reciprocating

---

11. Even the Wankel is yet to be judged. Its low miles per gallon and premature maintenance record may spell its death.

engine will always remain supreme, but it is merely the summation of observations made over several years.

This point requires further qualification in view of the analysis, tests, and evaluation which Mr. Lear has supported for the reciprocating engine. Lear abandoned the reciprocating engine in favor of the turbine. To understand why the reciprocating engine didn't work out for Mr. Lear, his approach to steam power must be considered. Mr. Lear was not only interested in developing a successful system, he was aiming at a super performing system. He was interested in superpower, super miles per gallon, and super speeds.

Now any engineer, who is worth his salt and equipped with only the classical tools of analysis, will judge that the first step in developing such a super system must be to exhibit a super theoretical thermal efficiency. The variation of thermal efficiency with pressure and temperature is illustrated in Figure 45 [6]. From this figure, it may be realized that super thermal efficiency results from super operating conditions. Thus, the engineer may recommend a high pressure and high temperature approach. There would be two facts which neither the engineer nor Mr. Lear were aware of and which would ultimately result in failure for the piston engine:

1. The requirement for super performance imposes super problems. In summary, these would be lubrication, material, structural, and wire drawing problems.

2. Even if the lubrication, material, structural, and wire drawing problems were solved, performance would not be much better than a system operating at a much lower pressure and temperature.

Mr. Lear apparently reasoned that the problems associated with the piston engine at the high operating conditions could not be solved within a reasonable time at a reasonable cost. Thus, the steam piston engine was plugged by Mr. Lear as inadequate for the modern steam car.

This report has presented new data which indicate thermal efficiency is a poor measure of realizable performance and that high pressure and high temperature are not required for satisfactory performance in meeting the demands of the modern steam car. The steam piston engine and its capability have been misjudged and abused. It is technically incorrect to regard the piston engine as being inadequate to meet the requirements for the modern steam car.

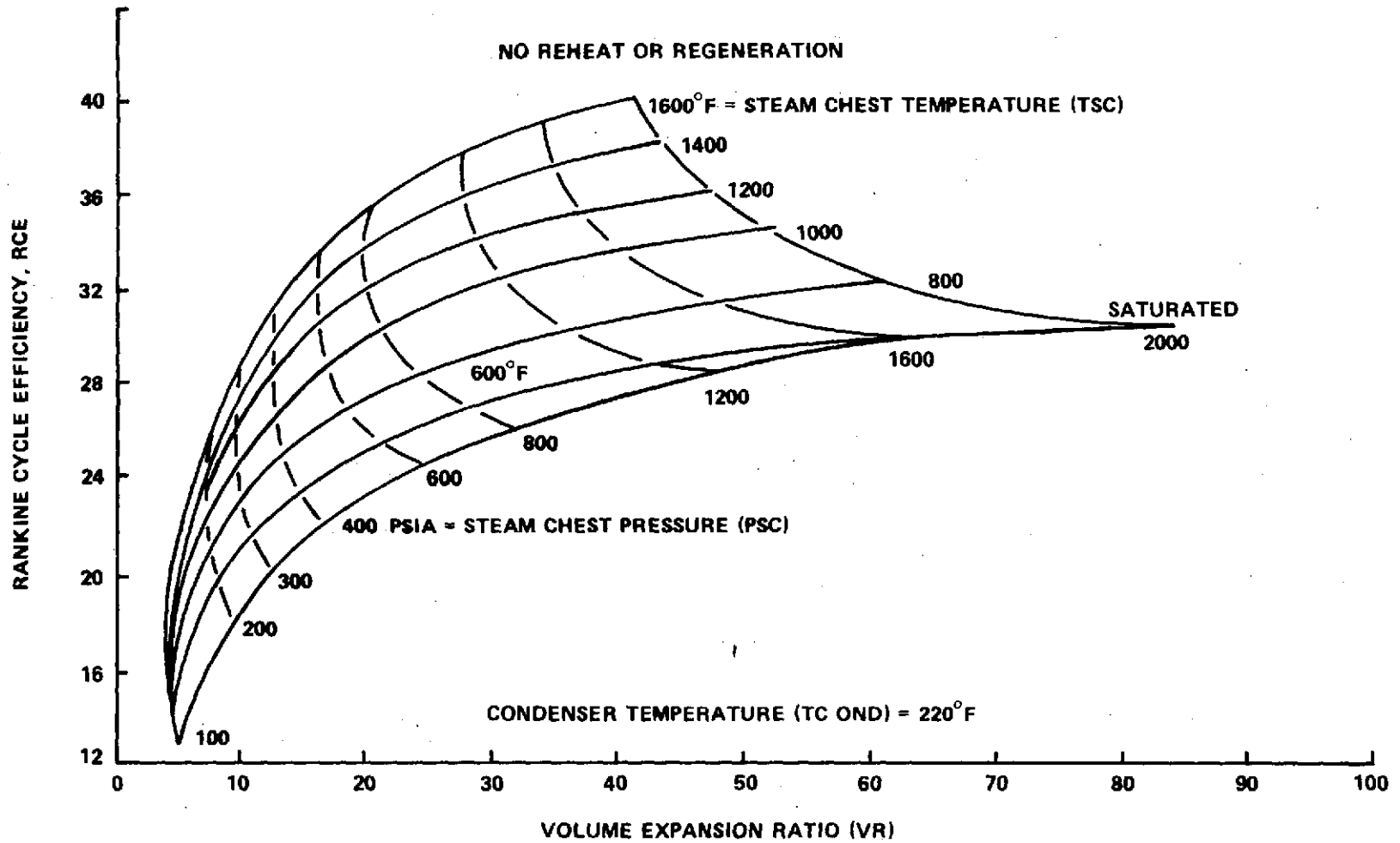

Figure 45. Effect of expansion ratio on Rankine cycle efficiency for various steam chest temperatures and pressures.

## F. The Steam Piston Engine

It has already been stated that the successful modern steam vehicle will be powered by a piston engine. The availability of piston engine configurations and the variation in valving mechanism are as varied as the people to originate them. In most cases, the trend has been to build bigger engines with greater speed capability and with continuous variable cutoff. In most cases, these engines have appeared in the literature over the past ten years. Just over the past year there has been a completely different attitude about what any future automobile should be. The idea of high power and gadgetry has been replaced with adequate power and simplicity.

One particular configuration exhibits such simplicity that it warrants discussion. This engine concept is illustrated in Figure 46 [9]. Valving is accomplished by utilizing the piston. When the pistons are in the correct geometric position, with respect to ports through the cylinder wall, a flow channel is completed from the supply line to the piston, ready for its power stroke. This is called occultation valving.

Valving by piston occultation is illustrated in Figure 47 [9]. This piston (or each cylinder) is similar to the conventional pistons in any reciprocating engine, except for (1) the length which is somewhat longer, and (2) each piston has grooves of a predetermined length, as illustrated. The steam supply source is located at  $P_s$ . Although two supply sources are shown, in practice they would be common. Steam commutation is allowed under the following conditions:

1. Channel 7 communicates with 16 whenever piston flow groove (A) subtends Ports 33 and 34.
2. Channel 16 communicates with Channel 9 whenever piston flow groove (C) subtends Ports 35 and 36.
3. Channel 11 communicates with Channel 15 whenever piston flow groove (D) subtends Ports 41 and 42.
4. Channel 15 communicated with Channel 5 whenever piston flow groove (B) subtends Ports 43 and 44.

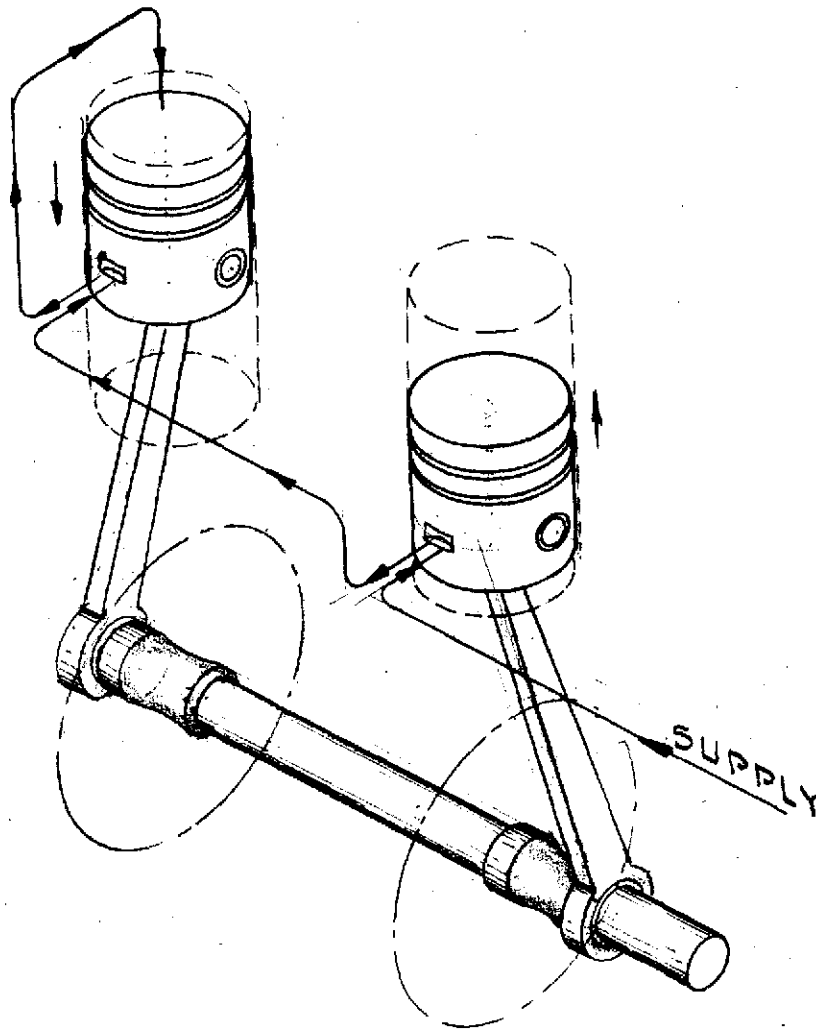

Figure 46. Occultation valving.

The crank throw has been drawn at 90 degrees; however, studies have shown that this occultation scheme is valid for 90 to 120 degrees between adjacent throws. Cutoff is established by the piston length of the flow grooves and the location of the supply parts.

A three cylinder engine with the crank throws at 120 degrees apart is illustrated in Figure 48 [9]. The three arrows located on each cylinder represent the supply steam lines. The top piston is in position for admission as controlled by the middle piston. The middle piston is just completing the admission part of its stroke, as controlled by the bottom piston. The bottom piston is returning to TDC and its supply steam is cut off, as controlled by the top piston.

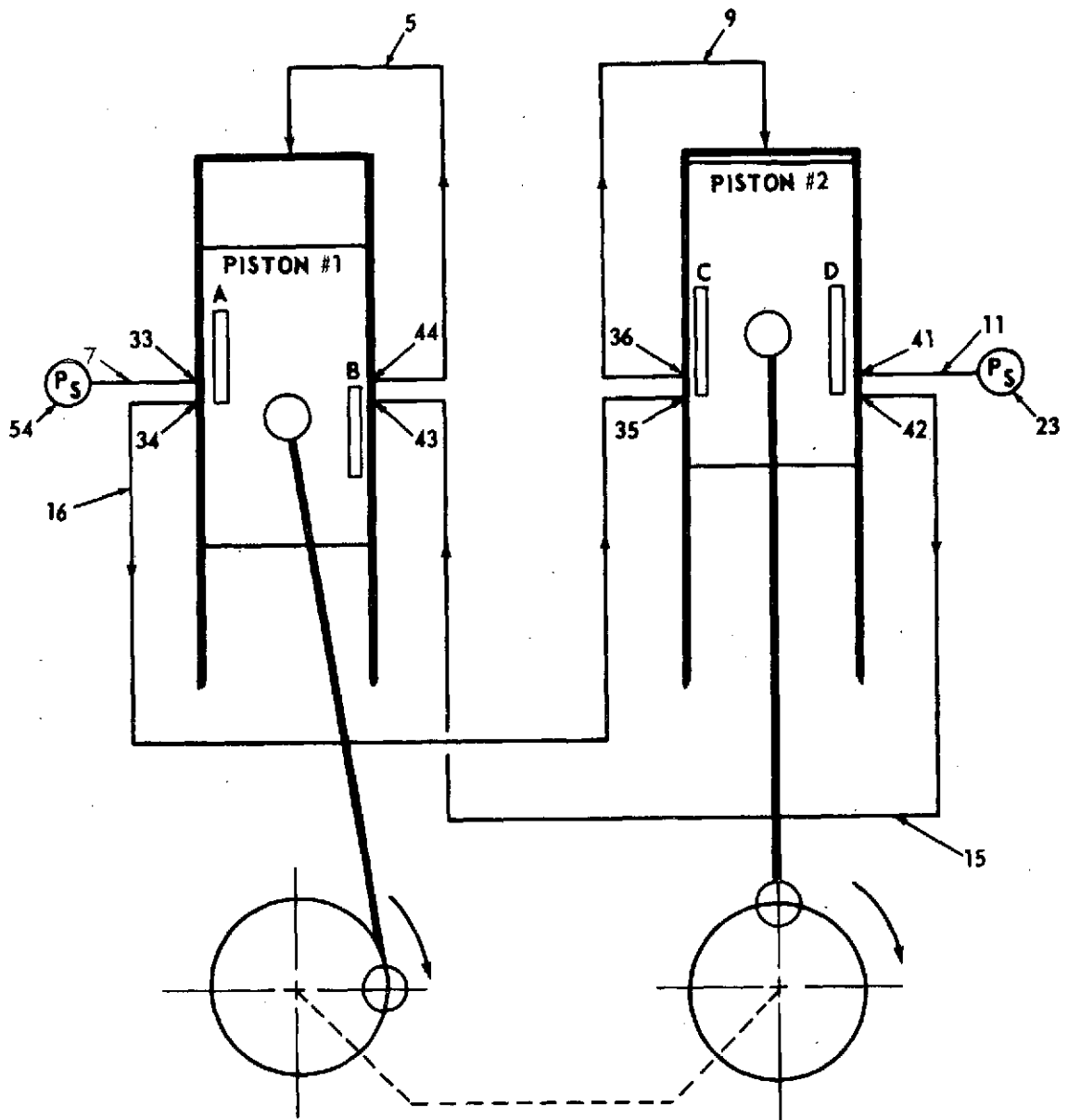

Figure 47. Principle of valving by piston occultation.

In the position shown, steam flows into Channel 7 through Port 33, flow groove A, and Port 34 into Channel 16. From this channel, steam is omitted to the right-hand cylinder through Port 35, flow groove C, Port 36, and Channel 9. Steam



also flows through Ports 41 and 42 into Channel 15; however, the steam flow is occulted by the piston at Port 44. Cutoff to the right cylinder occurs whenever Port 33 is occulted by the piston (top of flow groove A passes Port 33). This scheme will occult the steam to either cylinder. The steam is allowed to exhaust through a uniflow port.

## VII. CONCLUSIONS

Performance of the modern steam car in terms of miles per gallon can be very precisely represented in analytical form. Performance can be characterized by grouping discrete design parameters which result from the rigorous mathematical treatment. This analysis technique will allow the steam car designer to make the trade-off between maximum speed capability and miles per gallon necessary to meet prescribed requirements.

The primary benefit is the introduction of an analytical approach, which relates to miles per gallon rather than thermal efficiency which classical techniques have offered. Gasoline is bought by the gallon at the service station, not thermal efficiency.

More recent steam car projects have been directed toward super performance. Such designs have been based on classical analysis which dictate high pressures and temperatures. Most of these projects have resulted in failure as a consequence of problems incurred by the high temperatures and pressures. From a miles per gallon point of view, near super performance can be obtained at modicre temperature and pressures.

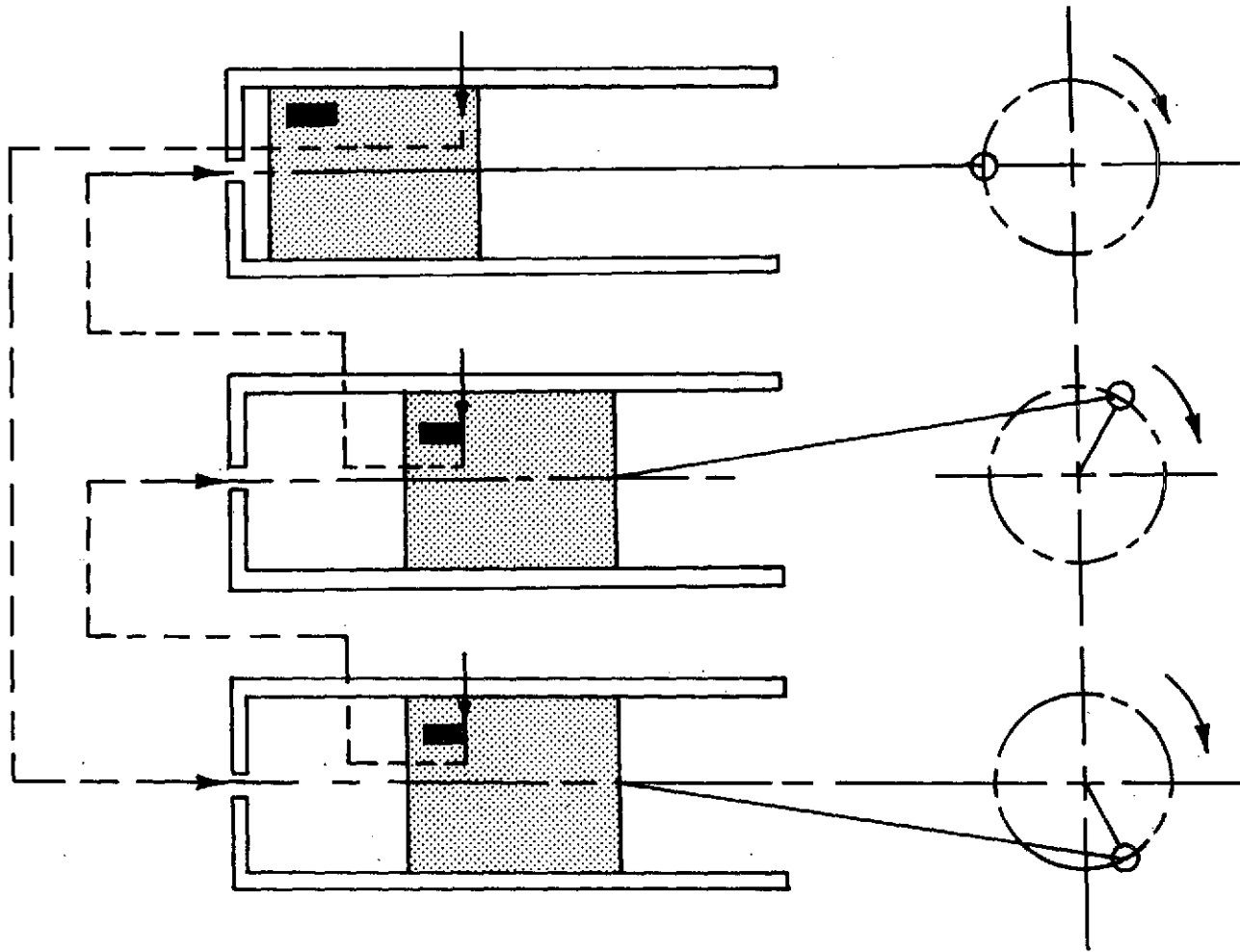

Figure 48. Occultation valving concept applied to a three cylinder engine.

## APPENDIX A. RELATIONSHIP FOR MILES PER GALLON

It is assumed that a passenger vehicle is being driven in a straight path on a level road. Since gear ratio is important, a separate definition is given in Appendix B. It is suggested that the reader understand this definition before proceeding with the following derivation.

The following mathematical expressions establish the relationship between "miles per gallon" (MPG) and other parameters which are characteristic of the steam system. The velocity of the vehicle,  $V_c$ , can be described by

$$V_c \frac{\text{miles}}{\text{hr}} = R_W \text{ ft } \omega_A \frac{\text{rad}}{\text{sec}} \frac{3600}{5280} \frac{\text{miles-sec}}{\text{ft-hr}} \quad . \quad (\text{A-1})$$

This equation is simply the wheel radius times the angular speed of the drive wheel, in radians per second.

The angular speed of the wheels  $\omega_A$ , can be described as:

$$\omega_A \frac{\text{rad}}{\text{sec}} = N \frac{\text{rev}}{\text{min}} 2\pi \frac{\text{rad}}{\text{rev}} \frac{\text{min}}{60 \text{ sec}} \frac{r}{R_G} \quad . \quad (\text{A-2})$$

Substitution of equation (A-2) into equation (A-1) gives

$$V_c \frac{\text{miles}}{\text{hr}} = \frac{3600}{5280} \frac{2\pi}{60} N R_W \frac{r}{R_G} \quad ,$$

or

$$V_c = 0.07136 N R_W \frac{r}{R_G} \quad . \quad (\text{A-3})$$

Note the form of the total gear ratio. This arrangement is identical to the definition of gear ratio given in Appendix B. Development of equation (A-3) completes the first part of this Appendix. It is our purpose now to develop an expression for N which can be substituted into equation (A-3).

It is important to recognize that there are two mass flow rates peculiar to steam systems. Both of these flow rates are discussed in Steam Automotive Analysis [1]. Expression for these rates will be taken from this book.

First is the mass flow rate,  $M_G$ , of steam being generated by the boiler. This rate can be described by

$$M_G \frac{\text{lbm}}{\text{min}} = \eta_B \frac{E \frac{\text{BTU}}{\text{lb}} F_R \frac{\text{gal}}{\text{hr}} \rho \frac{\text{lb}}{\text{gal}}}{\Delta H \frac{\text{BTU}}{\text{lb}_m} 60 \frac{\text{min}}{\text{hr}}}$$

or

$$M_G = \eta_B \frac{E F_R \rho}{60 \Delta H} \quad (A-4)$$

The second mass flow rate,  $M_R$ , is the required flow to sustain a set of operating conditions. This flow rate can be described by

$$M_R \frac{\text{lbm}}{\text{min}} = \frac{P \frac{\text{lb}}{\text{in}^2} V \frac{\text{in.}^3}{\text{Rev}} N \frac{\text{Rev}}{\text{min}} X}{R \frac{\text{ft-lb}}{\text{lb}_m} - ^\circ R T ^\circ R 12 \frac{\text{in.}}{\text{ft}}}$$

or

$$M_R = \frac{P V N X}{12 R T} \quad (A-5)$$

Under steady state driving conditions,  $M_G$  equals  $M_R$ . Setting equations (A-4) and (A-5) equal to each other and solving for N gives

$$N = \frac{\eta_B E F_R \rho}{5 \Delta H PV X} \quad (A-6)$$

At this point it is important to recognize that MPG can be represented by the ratio

$$\frac{V_c}{F_R} = \frac{\frac{\text{miles}}{\text{hr}}}{\frac{\text{gal}}{\text{hr}}} = \frac{\text{miles}}{\text{gal}} \quad (A-7)$$

This ratio can be obtained by substitution of N of equation (A-6) into equation (A-3) and dividing by  $F_R$ ,

$$\frac{V_c}{F_R} \text{ (MPG)} = .0142 \eta_B \frac{E\rho}{X} \frac{RT}{\Delta H} \frac{G}{PV} \quad (A-8)$$

## APPENDIX B. DEFINITION OF TOTAL GEAR RATIO

The gear ratio is illustrated below. As shown, the engine is attached directly to the drive shaft. The gear ratio is represented by ( $r$ ) and ( $R_G$ ).

Although  $N$  is referred to as the angular speed of the drive shaft,  $N$  also represents the shaft speed which is attached to the engine. The ratio  $r/R_G$  represents the reduction between the drive axle and the engine shaft.

In the derivation shown below, the drive wheel radius  $R_W$  appears with  $r$  and  $R_G$  in the form

$$G = R_W \frac{r}{R_G} \quad , \quad (B-1)$$

where  $G$  is referred to as the total gear ratio. The total gear ratio has units of  $R_W$  feet.

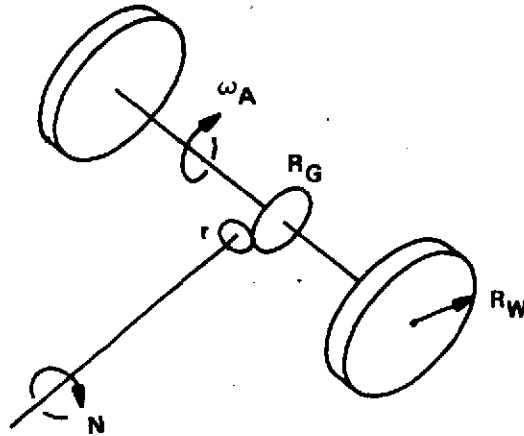

## APPENDIX C. LIMITING SPEED AS A FUNCTION OF ABATEMENT NUMBER

The vehicle is being driven in a straight path on a level road. No slipping is assumed.

From Steam Automotive Analysis [1], the average engine torque per revolution can be described as

$$T_E \text{ ft - lb} = \frac{P \frac{\text{lb}}{\text{in.}^2} V \frac{\text{in.}^3}{\text{Rev}} D_N}{2\pi \cdot 12 \frac{\text{in.}}{\text{ft}}} ; \quad (\text{C-1})$$

therefore, the wheel torque is

$$T_W \text{ ft - lb} = \frac{R_G}{r} \frac{PV}{24\pi} D_N . \quad (\text{C-2})$$

This wheel torque must be balanced by the total retarding forces. From Kent's Mechanical Engineer's Handbook [10], the retarding force F can be described as

$$F \text{ lb} = K_1 + K_2 A V_M^2 , \quad (\text{C-3})$$

where:

$V_M$  = maximum vehicle speed - MPH ,

$K_1$  = 20 pounds per 1000 pounds of vehicle weight (for a 4 door sedan,  
 $K_1 = 0.00125$ )

$K_2$  = varies between 0.001 and 0.002 and ,

$A$  = frontal area,  $\text{ft}^2$  .

Multiplying the retarding force by wheel radius,  $R_W$ , gives the resistance torque on the rear axle, thus

$$\left( K_1 + K_2 A V_M^2 \right) R_W = \frac{R_G}{r} \frac{PV}{24 \pi} D_N \quad (C-4)$$

Solving for  $V_M$  gives

$$V_M = \sqrt{\frac{D_N}{24 \pi} \frac{PV}{G} \frac{1}{K_2 A} - \frac{K_1}{K_2 A}} \quad (C-5)$$



## APPENDIX D. DEVELOPMENT OF AN EXPRESSION FOR THE PRESSURE CHANGES TAKING PLACE WITHIN A CYLINDER

At TDC, it is assumed the valve is fully open and the clearance volume has been pressured to be throttled pressure. The valve closes in a cosine function. Flow inductance is zero.

We begin by defining the steam mass confined with the cylinder,

$$\rho V = M \quad . \quad (D-1)$$

Differentiating with respect to time,

$$\rho \frac{dV}{dt} + V \frac{d\rho}{dt} = \dot{M} \quad . \quad (D-2)$$

Here,  $\dot{M}$  is the rate of change of mass taking place within the cylinder which satisfies the density and volume functions on the left hand side. Dividing this equation by  $\rho V$  and substituting  $P = 12 RT$  for  $\rho$  in the right hand side gives

$$\frac{d\rho}{\rho dt} = \frac{12 RT \dot{M}}{PV} - \frac{dV}{V dt} \quad . \quad (D-3)$$

Equation (D-3) describes the density changes taking place within the cylinder. However, it is more convenient to work with pressure than density. An expression for the left hand side of the equation can be found by differentiating

$$\rho = \frac{P}{12 RT} \quad , \quad (D-4)$$

thus

$$\frac{d\rho}{dt} = \frac{1}{12 RT} \left[ \frac{dP}{dt} - \frac{P}{T} \frac{dT}{dt} \right] \quad (D-5)$$

Multiplying this equation by  $1/\rho$  and noticing that  $P = 12 \rho RT$  we have

$$\frac{d\rho}{\rho dt} = \frac{1}{P} \left( \frac{dP}{dt} - \frac{P}{T} \frac{dT}{dt} \right) \quad (D-6)$$

Equation (D-6) gives the value for the density change; but, now it is desirable to have  $d T/dt$  in terms of pressure. In order to find this relationship between pressure and temperature, the type process needs to be specified. We will assume a polytropic process described by

$$PT^{\frac{-\gamma}{\gamma-1}} = \text{const} \quad (D-7)$$

Differentiation gives

$$\frac{dP}{dt} T^{\frac{-\gamma}{\gamma-1}} - \left( \frac{\gamma}{\gamma-1} \right) PT^{\frac{-2\gamma+1}{\gamma-1}} \frac{dT}{dt} = 0 \quad (D-8)$$

Dividing by  $T^{\frac{-2\gamma+1}{\gamma-1}}$  and solving for  $dT/dt$  gives

$$\frac{dT}{dt} = \left( \frac{\gamma-1}{\gamma} \right) \frac{T}{P} \frac{dP}{dt} \quad (D-9)$$

Substituting this equation in equation (D-6) yields

$$\frac{d\rho}{\rho dt} = \frac{1}{P} \left[ \frac{dP}{dt} - \frac{P}{T} \left( \frac{\gamma-1}{\gamma} \right) \frac{T}{P} \frac{dP}{dt} \right] \quad (D-10)$$

Simplifying this equation, the desired expression for density is

$$\frac{d\rho}{\rho dt} = \frac{1}{P\gamma} \frac{dP}{dt} \quad (D-11)$$

Equation (D-11) may now be substituted into equation (D-3), giving the desired rate of change of pressure taking place within the cylinders

$$\frac{1}{\rho\gamma} \frac{dP}{dt} = \frac{12 RT \dot{M}}{PV} - \frac{dV}{V dt}$$

or

$$\frac{dP}{dt} = \frac{12\gamma RT \dot{M}}{V} - \frac{P\gamma}{V} \frac{dV}{dt} \quad (D-12)$$

Equation (D-12) describes the pressure change taking place within the cylinder for an inflow mass rate,  $\dot{M}$ , and rate of change of cylinder volume,  $dV/dt$ . The rate of change of mass flowing into the cylinder depends upon the difference between the upstream pressure (boiler pressure)  $P_o$ , and the downstream pressure (cylinder pressure),  $P$ . When the ratio of these pressures ( $P/P_o$ ) is equal to or greater than about 0.5, the mass flow rate can be represented by an elliptical approximation,

$$\dot{M} = \frac{2 B C_d A}{\sqrt{RT}} \sqrt{P P_o^2 - P^2} \quad (D-13)$$

The elliptical approximation is very accurate and is used often where it is desirable to avoid the more complicated equations for orifice flow. The value for B used here was 3.78, derived from Table 7 of Kent's Mechanical Engineer's Handbook [11]. A is the orifice flow area, which is a function of time. At time zero, A is equal to  $A_o$ , the maximum orifice opening. A is described by

$$A = A_o \text{ Cos} \left( \frac{\pi}{2} \frac{t}{t_o} \right) , \quad (\text{D-14})$$

where  $t_o$  is the time required for the piston to move to the point of cutoff. In terms of cutoff,  $t_o$  is

$$t_o = \frac{30}{\pi N} \text{ Cos}^{-1} [ 1 - 2X ] . \quad (\text{D-15})$$

In the derivation given here, it is assumed that the flow area closes as a cosine function. Depending upon the cam design, any other appropriate function can be used.

The expression for volume is much easier to visualize. Assuming simple harmonic motion, the cylinder volume as a function of time is

$$V = \frac{V_T}{2} \left[ 1 - \text{Cos} \frac{\pi N}{30} t \right] . \quad (\text{D-16})$$

This expression may be differentiated to find  $dV/dt$ ,

$$\frac{dV}{dt} = \frac{V_T N \pi}{60} \text{ Sin} \frac{\pi N}{30} t . \quad (\text{D-17})$$

Equations (D-13), (D-16), and (D-17) may be substituted into equation (D-12) for a complete expression of the pressure change taking place within the cylinder. The resulting expression is very complicated and cannot be solved by hand. The results given herein are based on a Runge-Kutta method, using a digital computer.

## APPENDIX E. DERIVATION OF THE COUNT NUMBER

From equation (10) of Chapter III, the fuel rate is

$$\frac{F}{\text{hp}} \left( \frac{\text{lb}_f}{\text{hp} - \text{hr}} \right) = \frac{1,980,000}{\eta_B \frac{RT}{\Delta H} E S_N} \quad (\text{E-1})$$

To obtain the Count Number, both sides of this equation need to be divided by the acceleration capability of the vehicle. The engine acceleration capability is

$$\dot{N} = \frac{T}{J_e} \frac{\text{Rev}}{2\pi \text{ rad}} \frac{(3600)^2 \text{ sec}^2}{\text{min}^2} \quad (\text{E-2})$$

where

$$T = \frac{PV}{24\pi} D_N \text{ (ft-lb)} \quad ,$$

$$J_e = \frac{W}{g} G^2 \text{ (ft-lb-sec}^2) \quad ,$$

$$g = 32.2 \text{ ft/sec}^2 \quad ,$$

$$W = \text{Vehicle Weight (lb)} \quad , \quad \text{and}$$

$$\dot{N} = \text{Rev/min}^2 \quad .$$

But from equation (A-3) in Appendix A,

$$N = \frac{V_c}{0.07136 G} \quad ,$$

and differentiating gives

$$\dot{N} \frac{\text{Rev}}{\text{min}^2} = \frac{\dot{V}_c \left( \frac{\text{miles}}{\text{hr}^2} \right)}{(60) (.07136) G} \quad (\text{E-3})$$

Substituting, we obtain

$$\dot{V}_c = 3.771 \times 10^6 \frac{PV}{G} \frac{D_N}{W} \quad (\text{E-4})$$

Dividing both sides of the equation for fuel rate by  $\dot{V}_c$  gives

$$C_N = \frac{.525 W}{\eta_B \frac{RT}{\Delta H} \frac{PV}{G} E D_N S_N} \frac{\text{lb}_f/\text{mile}}{\text{hp/hr}} \quad (\text{E-5})$$

## REFERENCES

1. Peoples, Jerry: Steam Automotive Analysis. Carlton Press Inc.: New York, 1970.
2. Burnham, Frank: Airborne Steam Engine is Bill Lears' Next Project. American Aviation, October 28, 1968, p. 25.
3. Fay, James A.: Molecular Thermodynamics. Addison-Wesley Publishing Company, Inc., Reading, Mass. 1965, p. 345.
4. Wood, Nat, ed.: According to Bill Lear. Machine Design, June 12, 1969, p. 21.
5. Carpenter, R. C.: Steam Plants of the White Motor Car. ASME, vol. 28, No. 1127, 1907, p. 581.
6. Gardiner, A. W.: Transients In a Monotube Boiler. Ph. D. Thesis, Virginia Polytechnic Institute, March 1973.
7. Pursell, Carroll W. Jr.: Early Stationary Steam Engines In America. Smithsonian Institute Press, Washington, D. C., 1969.
8. Ward, Minus: American Journal of Science, vol. 4, No. 1, 1822, p. 90.
9. Peoples, Jerry: Patent No. 3653297. April 4, 1972.
10. Richardson, Ralph A.: Automotive Engineering. Kent's Mechanical Engineer's Handbook, Twelfth ed., John Wiley & Sons, Inc., 1954, p. 2.
11. Mackey, C. O.: Engineering Thermodynamics. Kent's Mechanical Engineers Handbook, Twelfth ed., John Wiley & Sons, Inc., 1954, p. 3-62.