

## 4. THE EFFECTS OF LIGHTNING ON DIGITAL FLIGHT CONTROL SYSTEMS

J. Anderson Plumer  
General Electric Co.  
Corporate Research and Development

Wilbert A. Malloy  
Delco Electronics Division  
General Motors Corp.

and

James B. Craft  
NASA Flight Research Center

### SUMMARY

Present practices in lightning protection of aircraft deal primarily with the DIRECT EFFECTS of lightning, such as structural damage and ignition of fuel vapors. There is increasing evidence of troublesome electromagnetic effects, however, in aircraft employing solid-state microelectronics in critical navigation, instrumentation and control functions. The potential impact of these INDIRECT EFFECTS on critical systems such as Digital Fly-by-Wire (DFBW) flight controls has been studied by several recent research programs, including an experimental study of lightning-induced voltages in the NASA F8 DFBW airplane. The results indicate a need for positive steps to be taken during the design of future fly-by-wire systems to minimize the possibility of hazardous effects from lightning.

### INTRODUCTION

Present practices in lightning protection of aircraft deal predominantly with what may be called the DIRECT EFFECTS of lightning, including burning, blasting and physical deformation of skins and structural elements. Existing lightning

protection specifications, such as MIL-B-5087B, (Bonding, Electrical, and Lightning Protection, for Aerospace Systems) concentrate on electrical bonding and its function in minimizing these effects. Other criteria such as FAA Advisory Circular No. AC 25-3A, provide guidance for protection against lightning ignition of flammable fuel-air mixtures. Concern with these effects has been necessary since safety of flight in a lightning environment has heretofore primarily depended upon protection against fuel ignition and structural damage that can be produced by lightning. There is increasing evidence of troublesome electromagnetic effects due to lightning, however, as a result of transient surge voltages induced in aircraft electrical wiring. These voltages have caused both permanent damage and temporary malfunction of equipment.

Earlier vacuum tube electronics were inherently less vulnerable to lightning-induced voltage surges; however, the newer generations of modern, solid state microcircuitry are increasingly more vulnerable to upset or damage from such effects. Because these are electromagnetically induced effects, they are often referred to as the INDIRECT EFFECTS of lightning. Recently, these effects have been receiving additional attention since the flight safety of modern aircraft is increasingly dependent on reliable operation of critical electronic systems. At present there are no standards or specifications applicable to the INDIRECT EFFECTS of lightning.

With the advent of fly-by-wire systems, particularly those with digital computer and control electronics, the indirect effects of lightning very clearly have the potential of presenting a hazard to safety of flight. This hazard may be particularly acute for digital systems. While most practical digital fly-by-wire systems would include multiple redundant control circuits it is possible to conceive of a situation in which the high level electromagnetic interference produced by lightning could interfere with all channels of a fly-by-wire system at once, raising the possibility that there may in fact be no real redundancy with respect to lightning effects.

The NASA Flight Research Center has developed and is presently demonstrating a digital fly-by-wire (DFBW) flight control system in an F8 aircraft. Recognizing the possibility of this hazard, a program was implemented with General Electric to evaluate the possible electromagnetic effects of lightning on this flight control system and obtain data for use in minimizing these effects in future generations of fly-by-wire aircraft. The F8 DFBW system was not designed to withstand lightning strike effects. Therefore, the opportunity existed to experimentally determine the severity of effects in this unprotected system, thus providing test data upon which to base design guidelines for protection of future systems.

## SYMBOLS

A/C	Aircraft
AGC	Apollo Guidance Computer (DFCS computer)
BCS	Backup Control System
DFCS	Digital Flight Control System
DFBW	Digital Fly by Wire
IR	Structural ohmic resistive voltages
$i_L$	Lightning current

## TEST AND MEASUREMENT TECHNIQUE

A recently developed simulated lightning test and measurement system known as the TRANSIENT ANALYSIS technique offers a means of investigating the electromagnetic effects of lightning without hazard to the aircraft being tested. This technique, the development of which was sponsored by the Aerospace Safety Research and Data Institute of NASA-Lewis Research Center (Ref. 1), consists of injecting current surges into an aircraft, of the same waveshape as those produced by lightning but of greatly reduced amplitude. The responses of the aircraft's electrical circuits to these current surges can be measured and then extrapolated to correspond with full lightning stroke amplitudes to determine if they present a hazard to the equipment under test. During the development of this technique, tests were made to show that the response of an aircraft electrical system was linear with lightning current amplitude and that this extrapolation was valid. The transient analysis technique was utilized in the study of the NASA F8 DFBW aircraft in this program. A photograph of the aircraft and test setup is shown in Figure 1.

The test circuit is shown on Figure 2(a). The airframe is connected to ground at the point nearest the terminals of the circuit being measured via a 36 inch wide, 3 mil aluminum foil. This was attached to the instrument table and the hangar ground about 20 feet away. Use of the aluminum foil provides a very low impedance between the airframe and instrument table. The instrument cable was placed along this foil so that no air gap existed between it and the foil. As shown on Figure 2(b), the lightning current circuit is grounded once and only via this airframe ground foil. Consequently, no simulated lightning

current could flow off of the airframe along this path or the instrument cable shield and get back to the transient analyzer.

Most of the tests were made with a unidirectional simulated lightning stroke current rising to its crest in 2.75 microseconds and decaying to half value after 60 microseconds. This waveform is representative of natural lightning stroke waveforms and is similar to the waveform specified for indirect effects testing of the Space Shuttle. Its crest amplitude was set at 300 amperes to minimize the possibility of interference or damage to any of the electronic systems or components aboard the aircraft. Natural lightning strokes exceed 200,000 amperes about 1% of the time and average about 30,000 amperes in amplitude. Therefore, voltages induced by this waveform must be extrapolated upward by a factor of 100 to correspond with an average lightning stroke or 670 to correspond with a severe 200 kA stroke. The test current waveform is shown on Figure 2a.

It will be noted that damped oscillations appear on the test current wavefront. These are believed to be the result of traveling wave reflections in the transmission line formed by the aircraft and return conductor beneath it. Measurements were made of the current entering as well as leaving the aircraft, verifying that the superimposed oscillations flowed through the aircraft along with the fundamental current waveform. The extent to which oscillations or "jagged edges" occur in natural lightning current wavefronts is not well known, although available oscillographic data (Ref. 2) does show evidence of such occurrences in some strokes.

Induced voltages were measured by a Tektronix Type 545 oscilloscope with a Tektronix Type G differential pre-amplifier. The differential measurement system previously developed for this technique and described in Ref. 1 was utilized. One channel of the measurement circuit was normally connected to the circuit conductor being measured, and the other channel was connected to the DFCS ground, airframe ground or circuit low side, as required for the measurement being made. The pre-amplifier subtracted the signal on the second channel from that on the first so that common-mode errors induced in the instrument cable would not appear in the measurement.

Measurements were made with the DFBW system powered with batteries and operating in the primary mode. Access to most circuits was made with break-out boxes at important interfaces in order to maintain circuit continuity, although some measurements were made at opened interfaces to obtain measurements of open-circuit voltages at cable ends.

## DESCRIPTION OF DFBW SYSTEM

The F8 digital fly-by-wire flight control system components are shown in Figure 3. A single digital primary channel and triple redundant electrical analog backup channels replaced the F8 mechanical control system. The primary and backup channels all provide three-axis control of the airplane. The digital channel consists of a lunar guidance computer, inertial measurement unit, coupling data unit, and astronaut display and keyboard, all taken from the Apollo guidance and navigation system. A mode and power panel permits the pilot to request the lunar guidance computer to make mode and gain changes. The three-channel backup control system consists only of surface position command electronics. Specially designed electro-hydraulic secondary actuators interface the primary and backup electronic commands with the conventional F8 control surface power actuators.

Figure 4 shows the general arrangement of the flight control system hardware in the F8 airplane. Five secondary actuators were required, one for the rudder and one each for the two horizontal stabilizers and the two ailerons. The Apollo lunar guidance computer is the heart of the primary control system and performs all flight control computations.

The DFBW system is described in more detail in Reference 3.

## TEST RESULTS

Measurements were made at a variety of primary and backup system interfaces. Of greatest interest were the induced voltages appearing at the wiring interfaces with the primary DFCS system, which includes the Apollo lunar guidance computer (AGC). Figures 5, 6 and 7 show some of the measurements. For all of these measurements the simulated lightning current entered the nose and exited from the tail of the aircraft. Figure 5 shows measurements made at the J25 interface on circuits coming from the mode and power control panel and stick, BCS and yaw trim transducers in the cockpit area. These appear as damped oscillations at a fundamental frequency of about 1 megahertz. Most of the voltage has subsided after about 6 microseconds has elapsed. Each voltage shown on Figure 5 is a damped oscillation at a fundamental frequency of about 1 megahertz since all conductors follow the same bundle to the cockpit. The waveforms have slight variations which are probably due to differences in load impedances at each end.

Figure 6 shows voltages induced in the pitch, roll and yaw control sensor circuits coming to the DFCS computer, but the measurements were made at plug P4 with this plug disconnected from the DFCS system. These, therefore, are open circuit voltages and are not necessarily the same as the voltages which might appear at the closed interface, since DFCS input impedances would affect the voltages impressed across them. The characteristic frequencies of the open-circuit voltages measured at pins D-E (osc. 528), G-H (osc. 525), W-X (osc. 523) and Y-Z (osc. 526) have a fundamental frequency of about 1.7 megahertz with lower amplitude oscillations of several higher frequencies superimposed. These are induced in circuits coming from the DFCS stick transducer in the cockpit. The fundamental frequency of voltages measured at pins A-B (osc. 524) and U-V (osc. 527) in circuits coming from the rudder pedal transducer in the tail area is also 1.7 megahertz but without as much of the superimposed higher frequency component. Neither fundamental frequency is the same as that measured at the closed J25 interface in circuits also coming from the cockpit area.

The closed circuit J2 interface measurements shown on Figure 7 are of the same 1 megahertz fundamental as those measured at the J25 interface of Figure 5, except that the polarity is reversed.

## DISCUSSION OF RESULTS

### Induced Voltages

Study of the induced voltages measured in this system indicates that they are primarily of aperture magnetic flux origin due to the absence of long-duration unidirectional components induced by diffusion magnetic flux appearing inside the airframe when lightning current has diffused to the inside of its skin. Indications of structural IR voltage components are also absent, as expected, since the system is single-point grounded and has no direct reference to the airframe at locations remote from the DFCS pallet where these measurements were made. The single-point ground to the airframe is at the DFCS pallet.

The most prevalent frequency of oscillation of induced voltages measured at the DFCS interface is about 1 megahertz. This is not the same frequency as the oscillations superimposed on the simulated lightning current wavefront, which is 2.6 megahertz. In fact, there is no similarity between this frequency and that of induced voltages measured anywhere in the DFCS system. Fourier transformations were made to determine the frequency spectral distribution of the actual lightning test waveform as compared with an idealized smooth-front waveform.

Spectral peaks above the smooth-front waveform distribution occur in the test waveform distribution at 2.5, 5 and 8 megahertz, but not at the 1 megahertz frequency of the induced voltages measured at the DFCS interfaces.

The induced voltages reach their maximum during the first several microseconds of lightning current flow, which is when the lightning current and corresponding aperture flux are changing most rapidly. Continued oscillations appearing for several more microseconds are most likely the result of subsequent traveling waves in the circuit being measured. If this is so, the frequency of these voltages is primarily a function of the distributed circuit inductance and capacitances.

The variation in fundamental frequencies and presence of more than one frequency component in a single voltage is probably due to variations in circuit routing and interconnections with other circuits in the system.

The ranges of voltage amplitudes measured at the DFCS interfaces, when scaled to a 200,000 ampere (fast) lightning waveform, are presented in Table I.

Table I - Range of Induced Voltage Amplitudes  
(Scaled to  $i_L = 200 \text{ kA}$ )

<u>INTERFACE</u>	<u>INDUCED VOLTAGE AMPLITUDE</u> (0 - Peak Volts)	
	<u>MIN.</u>	<u>MAX.</u>
Stick Trim and MPC Inputs to DFCS (J25)	233	900
Stick Transducer Inputs to DFCS (P4)	40	87
DFCS Control Outputs (J2)	233	400
BCS Control Inputs (J12)	222	422
Mode and Power Control (J15)	833	1132
Mode and Power Control (J14)	213	732
Power Dist. Bay (+28VDC BUS)	160	200
DFCS Ground to A/C Ground	-	666

Voltages measured at other locations in the DFBW system, such as at the secondary actuators and BCS electronics, were of generally similar magnitudes.

## Impact on DFCS System

The expected impact of the induced voltages measured in the DFCS system on system operation was analyzed by DELCO Electronics, manufacturer of the DFCS. Comparison of individual component vulnerability data, when available, with induced voltage levels at single circuit interfaces was utilized to determine vulnerability of system components and effect on circuit operation. In other cases, best engineering judgment was used. An example of such an assessment is the attitude (yaw, pitch or roll) gain logic power circuits (pins A-W) from the MPC panel to the DFCS pallet. The schematic diagram of one of these circuits is shown on Figure 8. Induced voltages at the J25 interface are shown on Figure 5 (i.e. osc. 505). The voltages at the J25 interface (DFCS) ranged from 566 to 865 volts, and at the J15 interface (MPC), 1065 to 1132 volts. At the MPC, the induced voltage exceeds the 1000 volt (at sea level) dielectric breakdown rating of the switch. Arc-over may therefore occur either to case and mounting or between contacts, with a possibility of switch failure.

This circuit (+28 VDC) provides a request to the computer to change attitude control loop gain. If the wiper arm of the switch burns open, the computer will notice no gain requests and under this condition is programmed to assume attitude gain position 1. The DFCS control will survive at this gain position. If the switch would short such that two gain-position requests exist, the computer is programmed to assume the lower gain of the two requests. The DFCS control will survive.

At the AGC, the induced voltage exceeds the 500 volt dielectric breakdown rating of the 20K resistor, R2. Arc-over of R2 may then expose capacitor C1 to damaging overvoltage, causing it to short circuit. If it remains shorted during the entire lightning flash, no further damage should occur. If C1 opens between successive strokes of a multiple stroke flash, arc-over(s) of the 1.5K resistor R4 on successive strokes may permanently destroy transistor Q1. If C1 is short circuited, the AGC gain change circuit will be inhibited. Selection of this gain position after the lightning flash will cause the computer to select attitude gain position 1. The DFCS control will survive at that gain position. The same applies if transistor Q1 fails.

As another example, the DFCS digital control output circuits are considered. The schematic diagram of these circuits is shown on Figure 9. Induced voltages measured at the J2 interface are shown on Figure 7 and range from 233 to 400 volts. Those measured at the P12 end ranged between 222 and 422 volts. At the DFCS, capacitor C2 has a 15V rating. Therefore it would



break down as a short circuit. The capacitor could then fail as an open circuit. In either case the remaining circuit components would probably survive the lightning stroke. These are dual circuits which provide attitude commands which are utilized as control surface inputs. The dual outputs are compared to each other for failure detection purposes. Since capacitor C2 can be failed as an open or short circuit, several combinations were considered. If C2 is shorted as a dual output, no failure detection would occur. The pilot would discover that a problem existed only by noting the lack of aircraft response to control stick position. If one of the dual command outputs contained C2 open circuited and the other short circuited, any off-neutral control stick position would trigger the failure detection circuit which would remove that attitude axis control from DFCS to the BCS. In the case of C2 open-circuited as a dual output, DFCS aircraft attitude control could be maintained.

Other individual circuits were assessed in the same manner. Failure in some circuits is likely to degrade DFCS performance, but in others, the consequences appear minimal. It is evident, from Figures 5, 6 and 7, that lightning-induced voltages appear simultaneously in all DFCS circuits.

They also appeared in the 3 BCS channels. Thus, the consequences of simultaneous failures in many circuits must be fully assessed before the total impact on system operation can be determined. This has not been accomplished for this system. In general, however, it was found that many DFCS components are vulnerable to the induced voltages expected from a 200,000-ampere lightning stroke. The most vulnerable components are capacitors, transistors, and relay arc-suppression diodes. The least vulnerable components that may be damaged are switches, relays, forward loop diodes, and inductors.

It should be remembered that the DFCS equipment is an adaptation of existing Apollo Lunar Module equipment that was not designed to survive lightning-induced voltages, and also, that a 200,000 ampere stroke is likely to occur only about 1% of the time. The average amplitude is about 30,000 amperes. Under this condition, component vulnerability is reduced.

## CONCLUSIONS

This program represents the first experimental investigation of lightning-induced effects on a fly-by-wire system, digital or analog. The results of this study are therefore significant, both for this particular aircraft and for future generations of aircraft and other aerospace vehicles such as the Space Shuttle, which will employ digital fly-by-wire flight control systems. Particular conclusions from this work are as follows:

1. Equipment bays in a typical metallic airframe are poorly shielded and permit substantial voltages to be induced in unshielded electrical cabling inside.
2. Lightning-induced voltages in a typical aircraft cabling system pose a serious hazard to modern electronics, and positive steps must be taken to minimize the impact of these voltages on system operation.
3. Induced voltages of similar magnitudes will appear simultaneously in all channels of a redundant system.
4. A single-point ground does not eliminate lightning-induced voltages. It reduces the amount of diffusion-flux induced and structural IR voltage but permits significant aperture-flux induced voltages.
5. Cable shielding, surge suppression, grounding and interface modifications offer means of protection, but successful design will require a coordinated sharing of responsibility among those who design the interconnecting cabling and those who design the electronics. A set of Transient Control Levels for system cabling and Transient Design Levels for electronics, separated by a margin of safety, should be established as design criteria. Data from this and other experimental programs should be utilized to help establish these criteria.

## REFERENCES

1. Walko, L.C., "A Test Technique for Measuring Lightning-Induced Voltages on Aircraft Electrical Circuits", NASA CR-2348, General Electric Corporate Research and Development Report No. SRD-72-065, January, 1973.

2. Berger, K., "Novel Observations on Lightning Discharges: Results of Research on Mount San Salvatore", Journal of the Franklin Institute, Vol. 283, pp. 478-525, June, 1967.
3. Deets, D.A. and Szalai, K.J., "Design and Flight Experience With a Digital Fly-By-Wire Control System in an F-8 Airplane", AGARD paper.

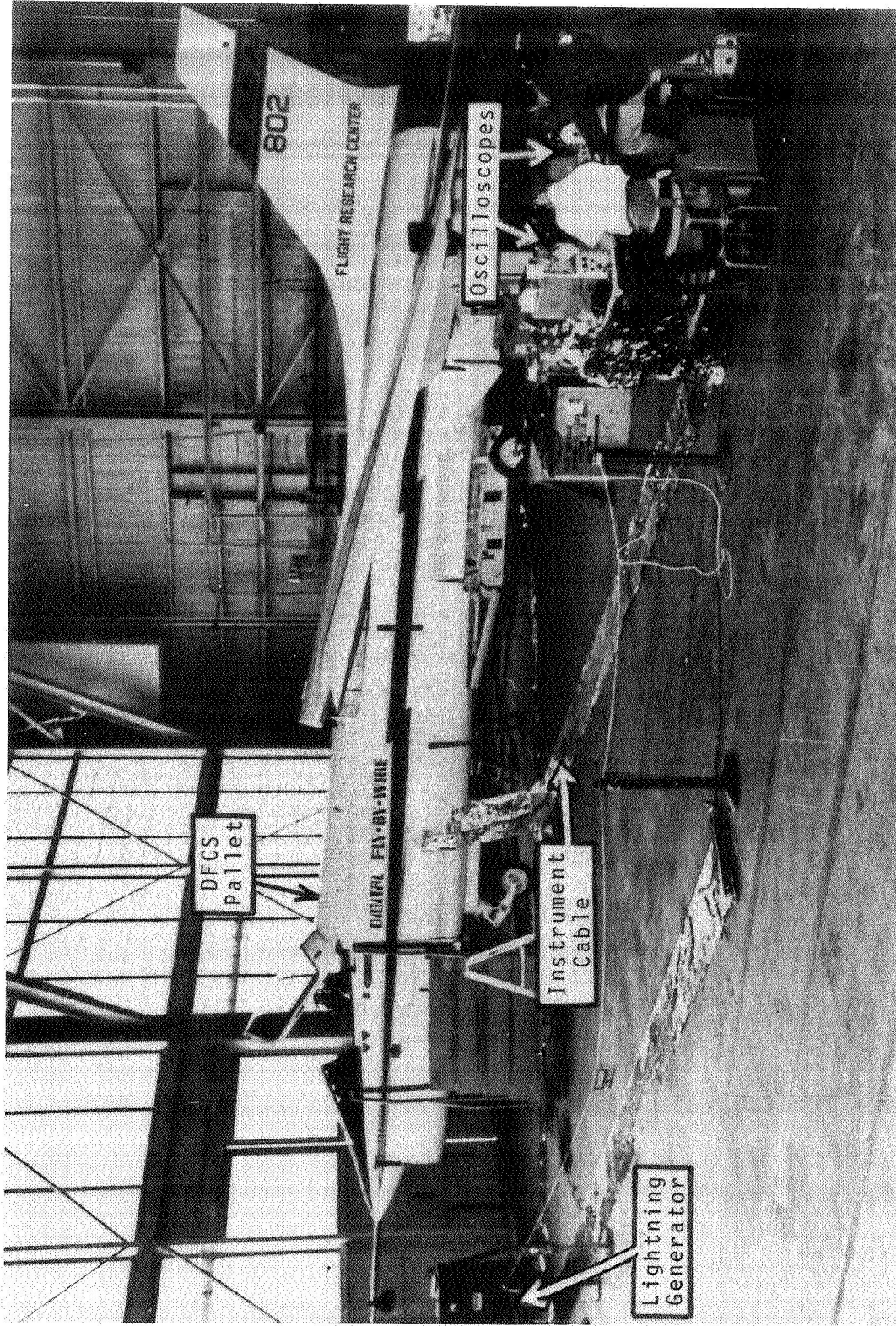
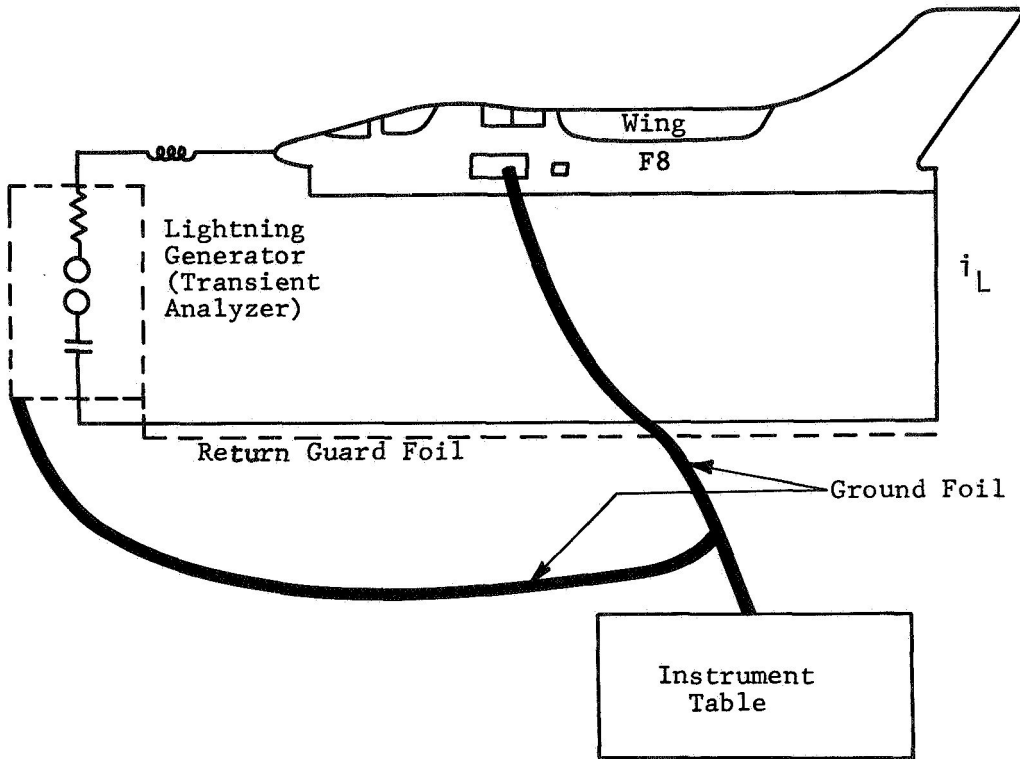
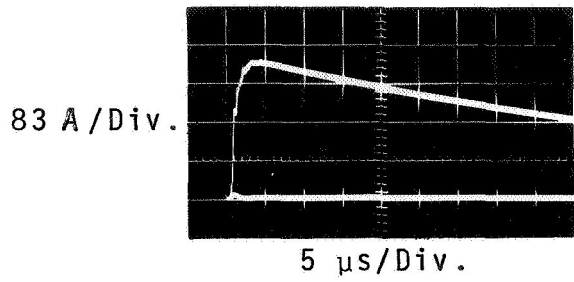
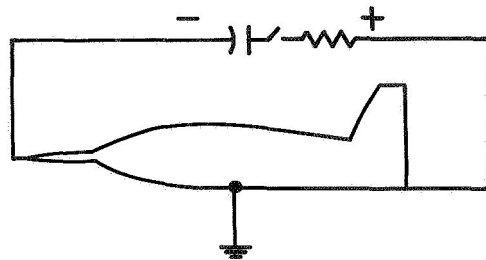

FIGURE 1 - TEST SETUP FOR MEASUREMENT OF LIGHTNING-INDUCED VOLTAGES IN NASA F8 DFBW AIRPLANE.

Simulated Lightning Current  
300 Amperes Peak



a) Actual Test Circuit



b) Equivalent Test Circuit

FIGURE 2 - SIMULATED LIGHTNING WAVEFORM AND TEST CIRCUIT

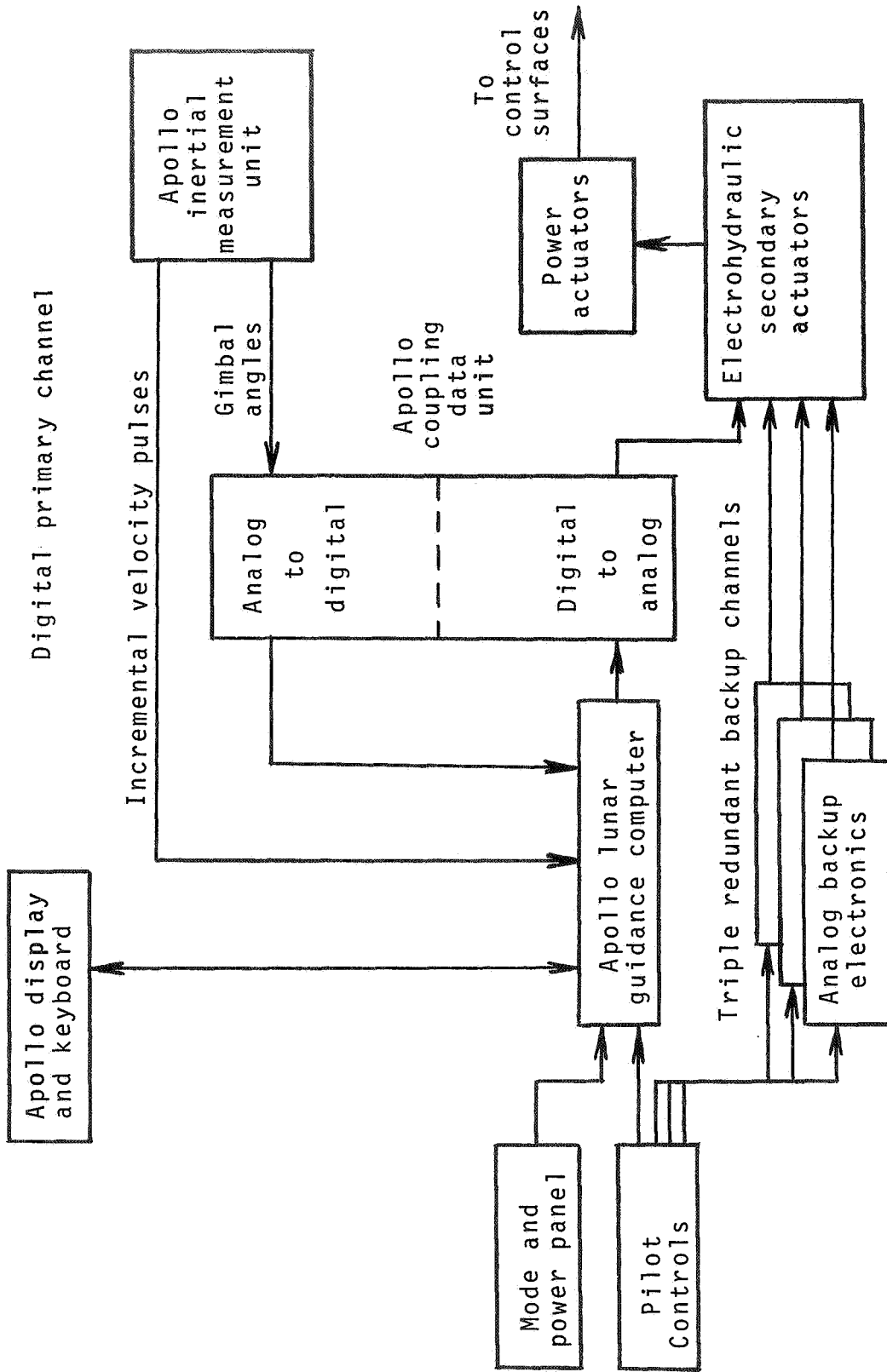

FIGURE 3 - F-8 DIGITAL FLY-BY-WIRE CONTROL SYSTEM HARDWARE ELEMENTS.

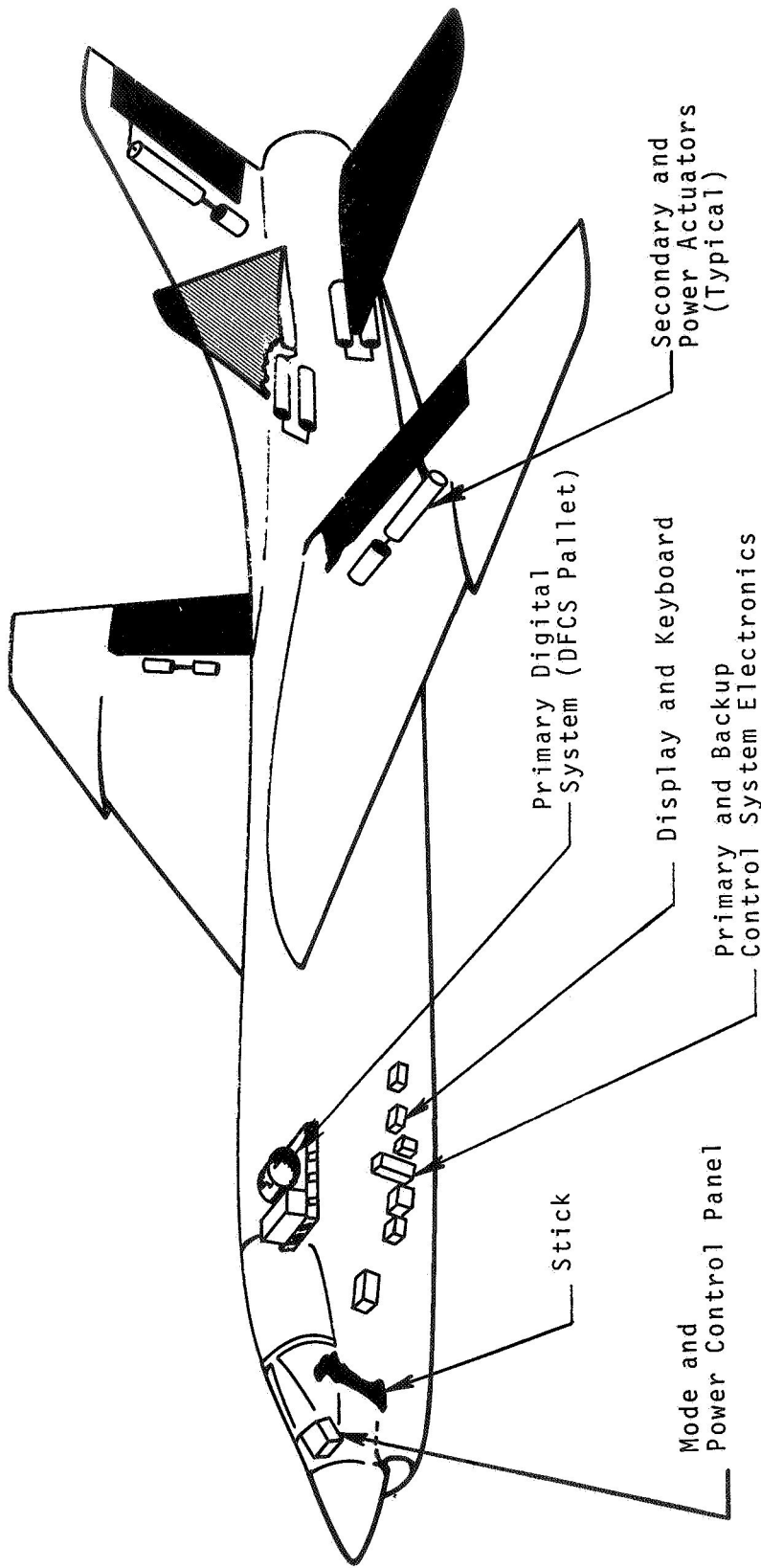
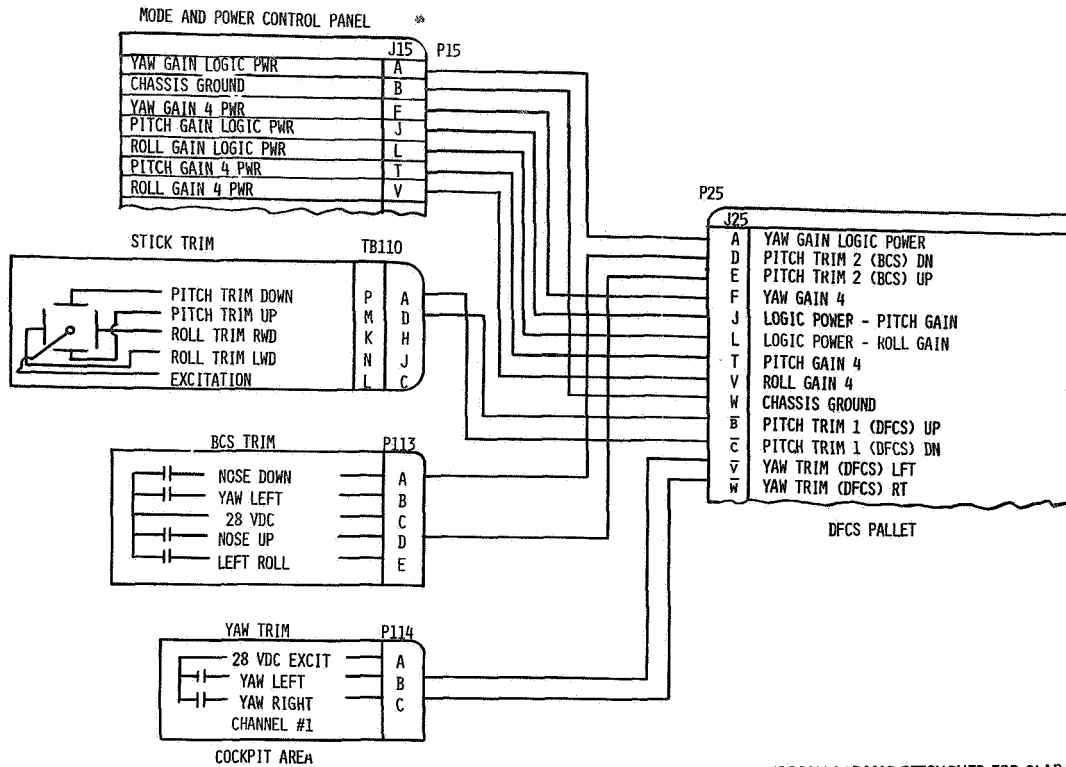

FIGURE 4 - LOCATION OF FLY-BY-WIRE CONTROL SYSTEM HARDWARE IN F8 AIRPLANE .



(OSCILLOGRAMS RETOUCED FOR CLARITY.)

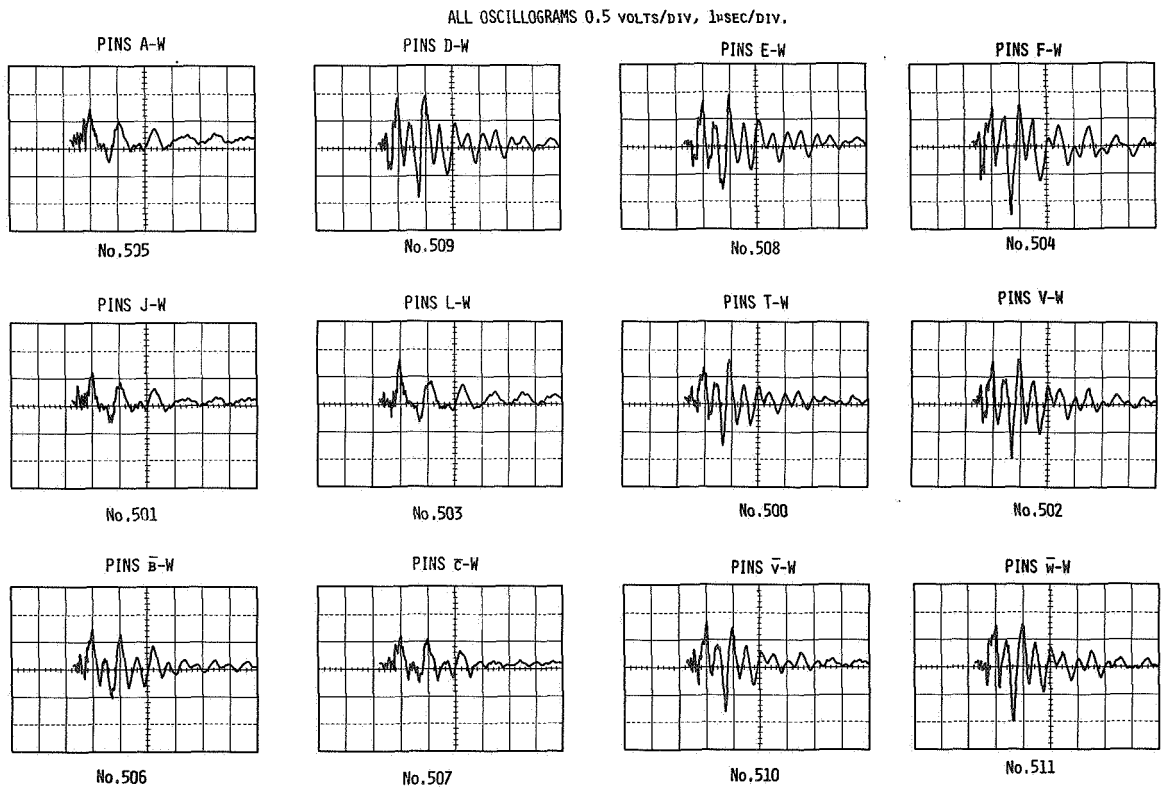
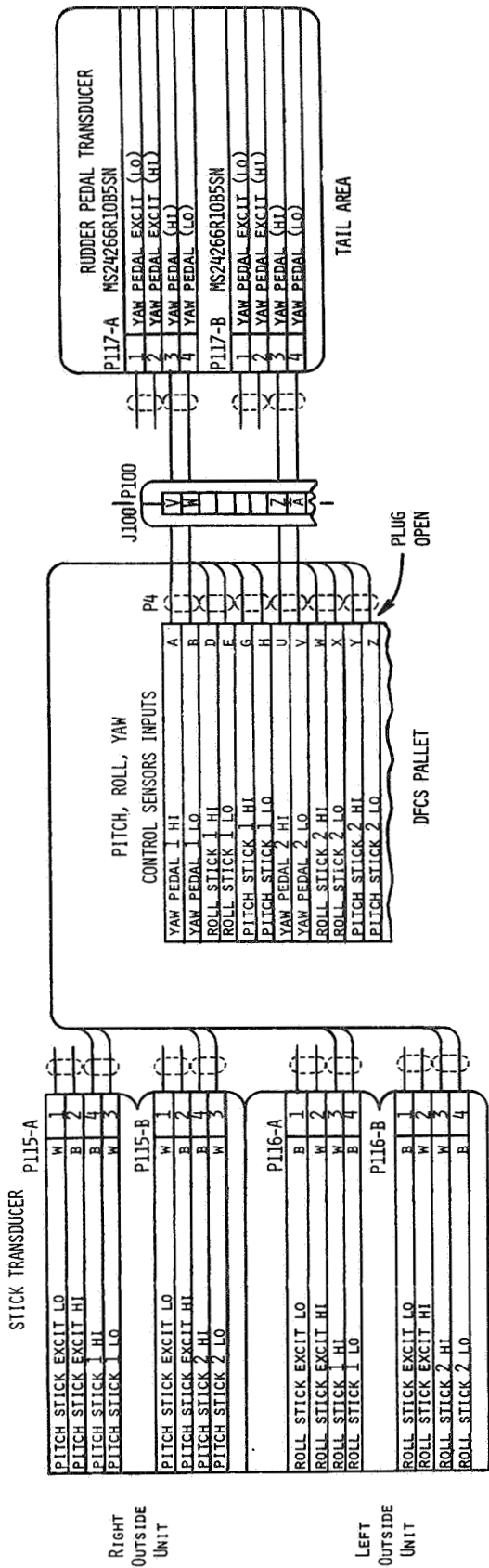

FIGURE 5 - INDUCED VOLTAGES ON MPC AND STICK TRIM INPUTS TO DFCS AT J25 INTERFACE.





(OSCILLOGRAMS RETOUCHE FOR CLARITY.)

ALL MEASUREMENTS ON CONNECTOR P4  
ALL OSCILLOGRAMS 0.1 VOLTS/DIV, 1μSEC/DIV.

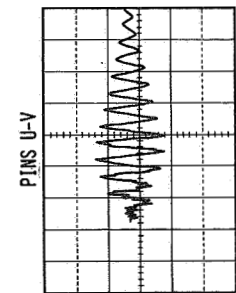
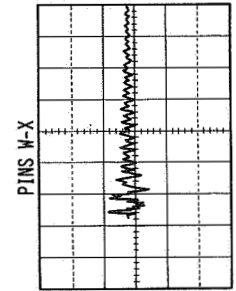
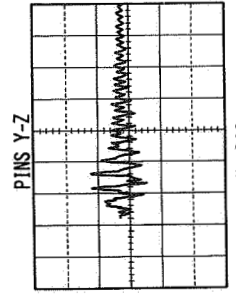
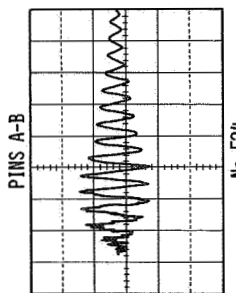
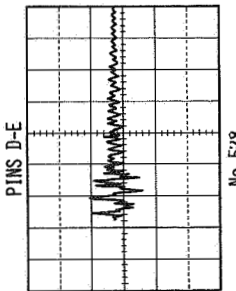
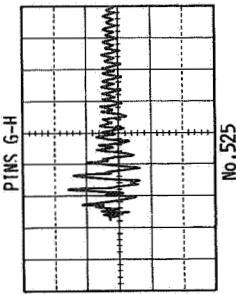
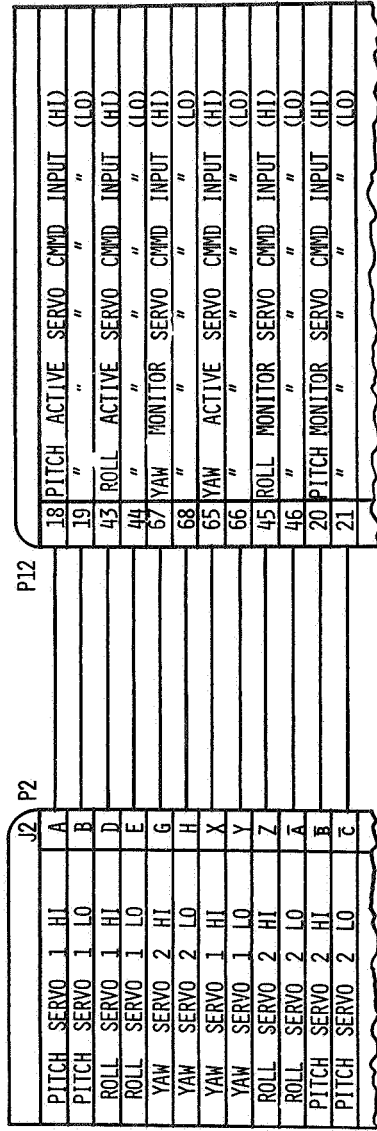

FIGURE 6 - INDUCED VOLTAGES ON CONTROL SENSOR INPUTS TO DFCS AT P4 (OPEN).

DFCS Digital Control  
Digital-to-Analog  
Converter

Primary Control Electronics #1



DFCS PALLET

LEFT GUN BAY

(OSCILLOGRAMS RETOUCHE FOR CLARITY.)

ALL MEASUREMENTS: 0.5 VOLTS/DIV, 1 μSEC/DIV.

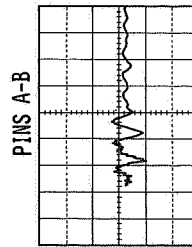

No. 514

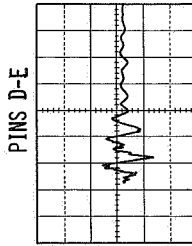

No. 516

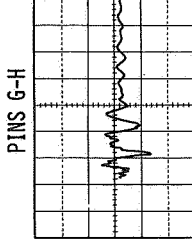

No. 518

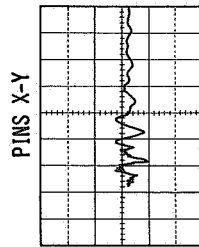

No. 515

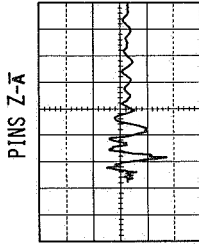

No. 517

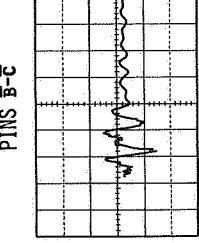

No. 519

FIGURE 7 - INDUCED VOLTAGES ON DFCS DIGITAL CONTROL CIRCUITS AT J2 INTERFACE.

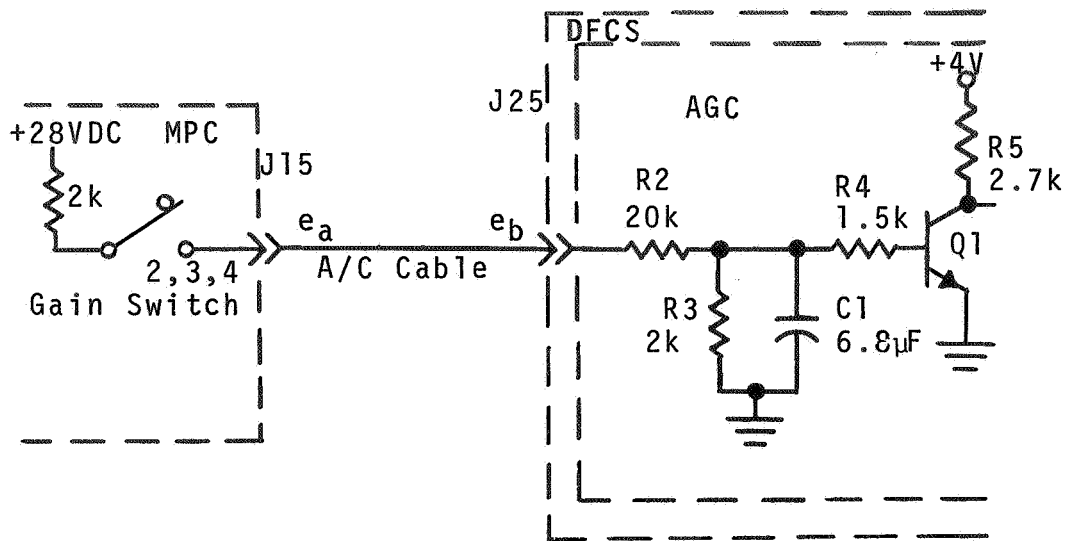

J15 Interface

$e_a$  average = 1119 V<sub>(o-p)</sub>

$e_a$  range = 1065 to 1132 V

f = 1.0 MHz

No. of measurements = 5  
 (J15: Yaw & Roll Gain 4;  
 Not Shown in Figures)

J25 Interface

$e_b$  average = 677 V<sub>(o-p)</sub>

$e_b$  range = 566 to 865 V

f = 1.0 MHz

No. of measurements = 3  
 (J25: Yaw, Pitch & Roll  
 Gain 4 - Fig.6, osc. 505,  
 500,502)

FIGURE 8 - ATTITUDE GAIN SWITCH POSITION 2, 3, and 4  
 SIGNAL CIRCUIT FOR DFCS AND MPC INTERFACE.

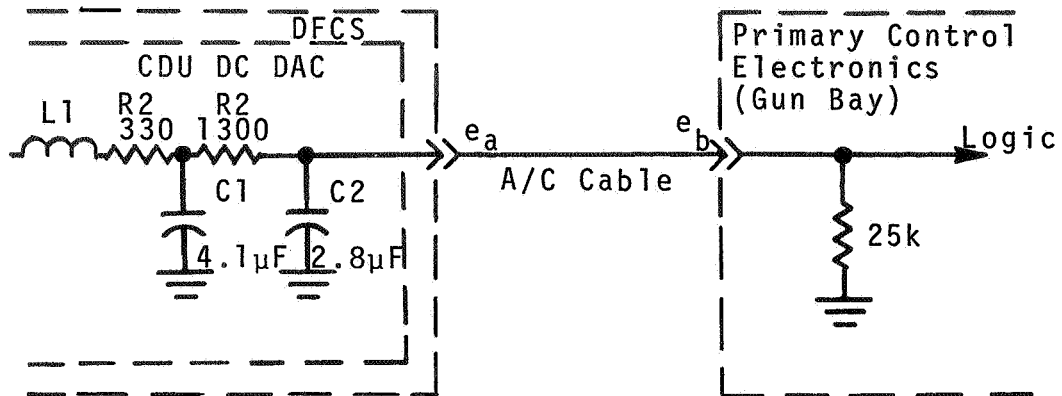

$e_a$  average = 316 V<sub>(o-p)</sub>

$e_b$  average = 355 V<sub>(o-p)</sub>

$e_a$  range = 233 to 400 V<sub>(o-p)</sub>     $e_b$  range = 222 to 422V<sub>(o-p)</sub>

$f = 1.0$  MHz

$l = 1.0$  MHz

No. of measurements = 6  
(J2: Yaw, Pitch and Roll  
DACs' 1 and 2, Figure 7)

No. of measurements = 3  
(Yaw, Pitch and Roll  
primary commands)

FIGURE 9 - DFCS DIGITAL CONTROL DIGITAL-TO ANALOG  
CONVERTER OUTPUT SIGNAL CIRCUIT TO  
PRIMARY CONTROL ELECTRONICS.