

N75 19148

THE EFFECTS OF DISPLAY VARIABLES & SECONDARY LOADING
ON THE DUAL AXIS CRITICAL TASK PERFORMANCE*

George M. Swisher
Wright State University
Dayton, Ohio

S. Nataraj
Sinclair Community College
Dayton, Ohio

ABSTRACT

Jex, Jewell and Allen (3) discussed the development of the dual-axis critical tasks and the effects of display format and control stick variation. This paper investigates the effects of scanning displays for separated instruments, separated versus combined displays and the effects of secondary loading. In addition an operator rating scale for handling qualities is established analogous to the Cooper Harper Scale.

* This research was made possible by the loan of analog computing equipment from the Air Force Directorate of Airframe Engineering, Flight Control Division, Wright-Patterson Air Force Base, Ohio. The authors acknowledge the help received from Bill Bohrer, M. J. Cook and John M. Howard. This paper was presented at the 9th Annual Manual Conference held at M.I.T., Boston During May 23, 24, and 25.

INTRODUCTION

Jex and McDonnell (4,5,6,7) developed a "critical" tracking task for man/machine research related to the operator's effective delay time. The auto paced single axis critical task mechanization yields consistent, reliable and very low variance measurements of the critical levels of instability. Swisher and Maher (10) investigated the degradation of human operator psychomotor performance and human information processing due to secondary loading and environmental stresses of heat and noise. Swisher, Bethke and Cook (11) studied the operator performance of critical tracking task due to intermittent display.

Jex, Allen & Jewell (3) have worked on dual axis critical task and have investigated different symbol formats and different control sticks (force stick and a softly-sprung finger control stick). The same autopacing principle and parameters as used for the single-axis critical instability tasks were used.

This paper investigates further the dual axis critical task for variations of number of controls and displays and also investigates the stress sensitivity of critical tracking tasks for secondary loading.

METHOD

Subjects

Six male college students were used as subjects. All the subjects reported 20/20 (un)corrected vision and freedom from auditory and psychomotor deficiencies. Subject age ranged from 20 to 23 years of age.

PRECEDING PAGE BLANK NOT FILMED

Apparatus

Figure 1 shows the block diagram and Figure 2 shows the analog mechanization of the no input dual axis critical task using two EAI-TR-20 10-volt analog computers in a slaved configuration. The displays used were two Hewlett Packard 122 A scopes set at 0.366 cm/volt sensitivity. The control sticks were identical U.S.A.F. type number C-1 Formation Sticks with ± 10.0 volt output. The stick was calibrated for a sensitivity of 4.16 volts/Newton. The C-1 formation stick was cascaded with a 0.58 potentiometer to make it compatible to the control stick used by Jex. The resulting stick system had a sensitivity of 2.413 volts/Newton.

Testing

A repeated Latin-Square design was used to assign the order of presentation for the different conditions (Table I).

The distance between the centers of the two displays was 10". The displays were at a height of 40" from the floor and 84" away from the subject. The distance between the controls was 20". The displays are listed in Table II.

Each subject was briefed concerning the experiment and his task prior to training. The subject was first given one set of telephone test (74 trials). The subject was then given 3 trials of the test task for training, followed by 3 trials of tracking alone, 6 trials of tracking and telephone and 3 trials of tracking alone for each of the eight conditions. The telephone test alone was given only once.

TABLE I

ORDER PRESENTATION OF EXPERIMENTAL CONDITIONS

Subject	Sequence							
	Line Display					Dot Display		
1	1	2	3	4	5	6	7	8
2	2	3	4	5	1	7	8	6
3	3	4	5	1	2	8	6	7
4	4	5	1	2	3	6	7	8
5	5	1	2	3	4	7	8	6
6	1	2	3	4	5	8	6	7

Instructions to the Subjects

You will be given either a line or a point display on one or two oscilloscopes. You are also given one or two joystick controls. For each trial, the display is brought to the center by the experimenter. You are told "Ready, go", and then the display will tend to get away from the center. Your primary task is to keep the display on the oscilloscope centered for as long as possible by manipulating the joystick motion forward and backward, or sideward, depending on the display motion. When you lose control of the display the trial is completed. The duration for which you hold the display within the range is the criterion.

For some trials you will be given a telephone test simultaneously with the tracking task. You are asked to listen to a series of messages which are logical statements. The letters used are P, Q, R and S and the words used are

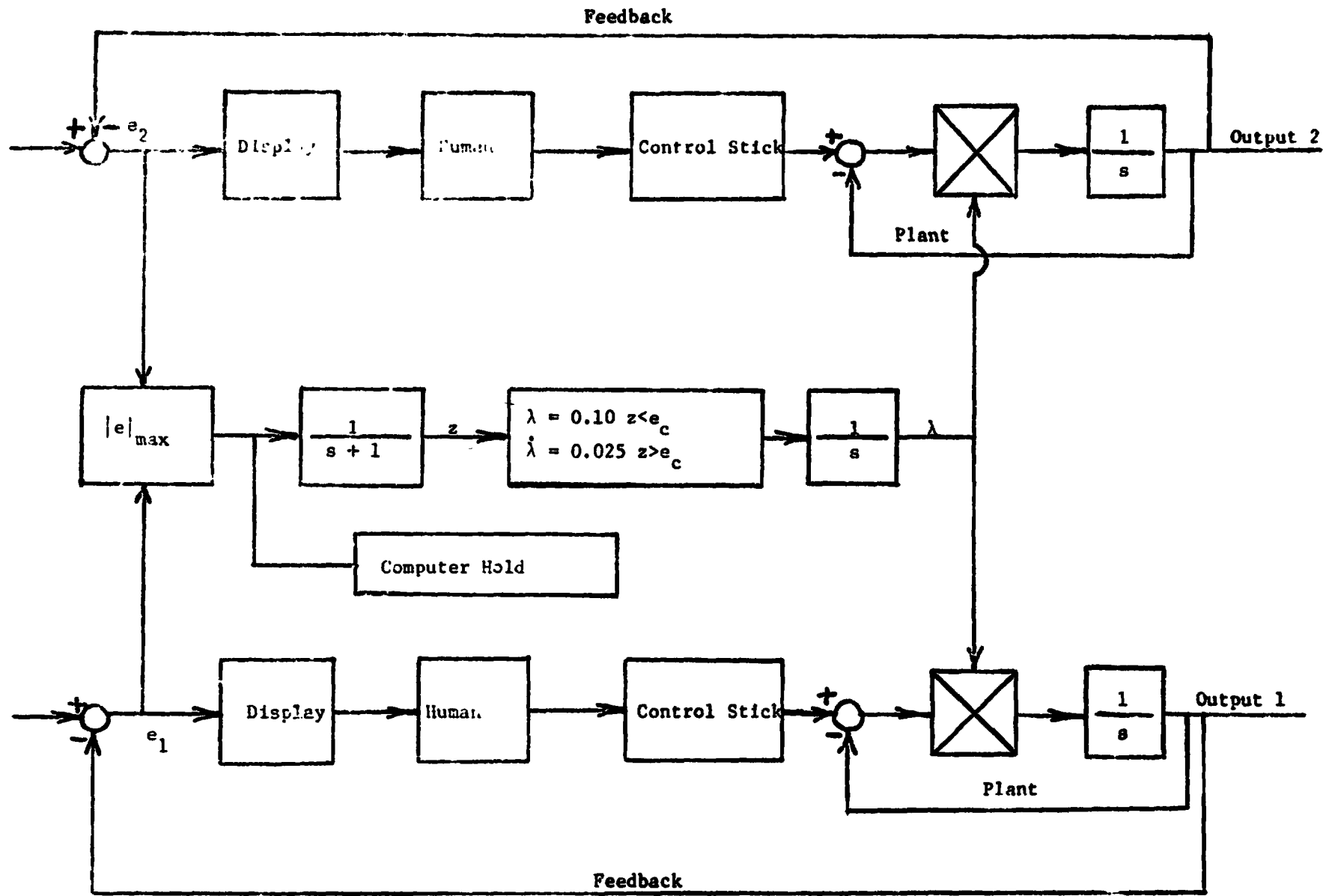

Figure 1. Block Diagram of Dual Axis Critical Task.

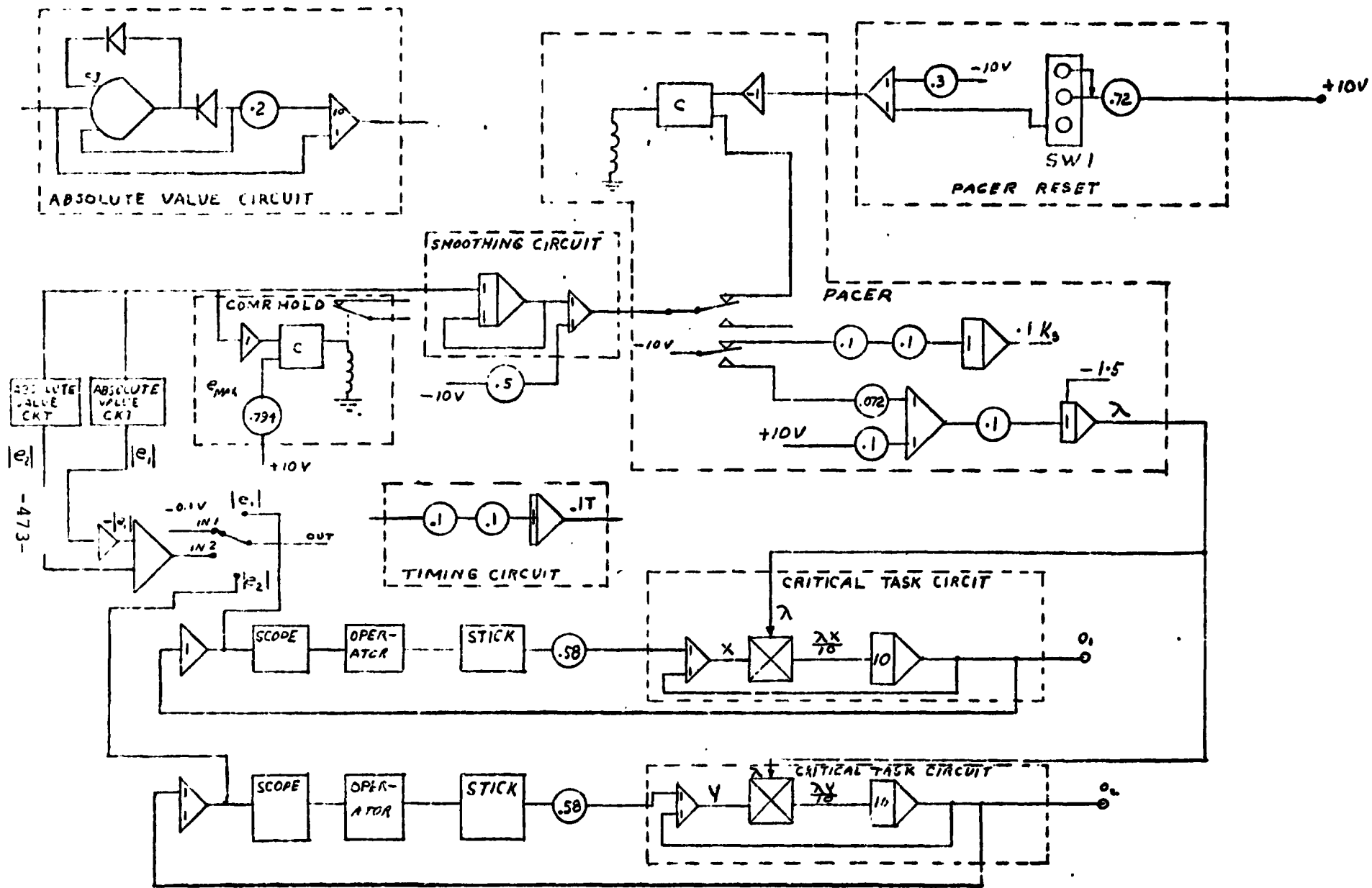
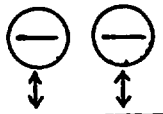

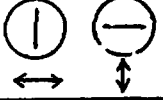
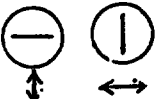
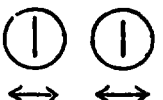



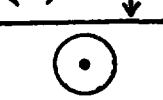

Figure 2. Analog Computer diagram of task.

TABLE II
TRACKING DISPLAY CONDITIONS

CONDITION 1		<p>DISPLAY </p> <p>STICK MOTION </p>
CONDITION 2		
CONDITION 3		
CONDITION 4		
CONDITION 5		
CONDITION 6		
CONDITION 7		
CONDITION 8		

"precedes" and "follows". Note that the order in which the letters come in the alphabet is of no importance in this test. We are concerned only with their order in the statement. Your task is to listen carefully to each statement and decide promptly whether it is right (yes) or wrong (no), then call out your decision. Provide an answer for each statement, even if you doubt it. Are there any questions?

Secondary Task

The secondary cognitive test used was a modification of the Baddeley Telephone Test reported by Guignard (12). The subject listens to a series of purportedly logical statements, some of which are in fact logically absurd. The task was paced at one statement every 5 seconds and the number of errors were scored. Omissions of answers were considered as errors.

The tracking performance measures recorded for each tracking run were T (total run time), λ (critical divergence frequency), and t_s (time of rate shift on autopaced task). These voltages were read on a Fluke 8000 A Digital Multimeter.

RESULTS

The descriptive statistics are presented in an integrated tabular and graphic form. The graphs show the mean and the standard deviation of scores. The tables, located below the graphs, present numerical values of mean and standard deviation.

Critical Divergence Frequency (λ)

The critical divergence frequency λ is defined as that divergence frequency when the subject loses control. The results shown in Figure 3 indicate that the mean λ did not vary much and the largest variability was observed in condition 6 (both tracking alone and combined). All but condition 1 showed a degradation in performance with the secondary test added.

Total Tracking Time (T)

The total tracking time (T) is defined as the time from the onset of tracking until one of the errors exceeds the display. The results are shown in Figure 4. The highest tracking times were recorded in condition 6 with no telephone test. This condition also had the highest variability. All conditions showed a degradation in performance with the secondary test added (except condition 1 and 2).

Rate Switching Time (t_s)

Switching time t_s , represented the time from the onset of a trial until the instantaneous absolute system error reached the level at which the instability rate switched from high to low rate. Group performance as defined by the switching time score is shown in Figure 5. Condition 3, 4 and 6 yielded high scores but condition 6 had the highest variability. Secondary loading caused a degradation in performance for all conditions except condition 1 and 2.

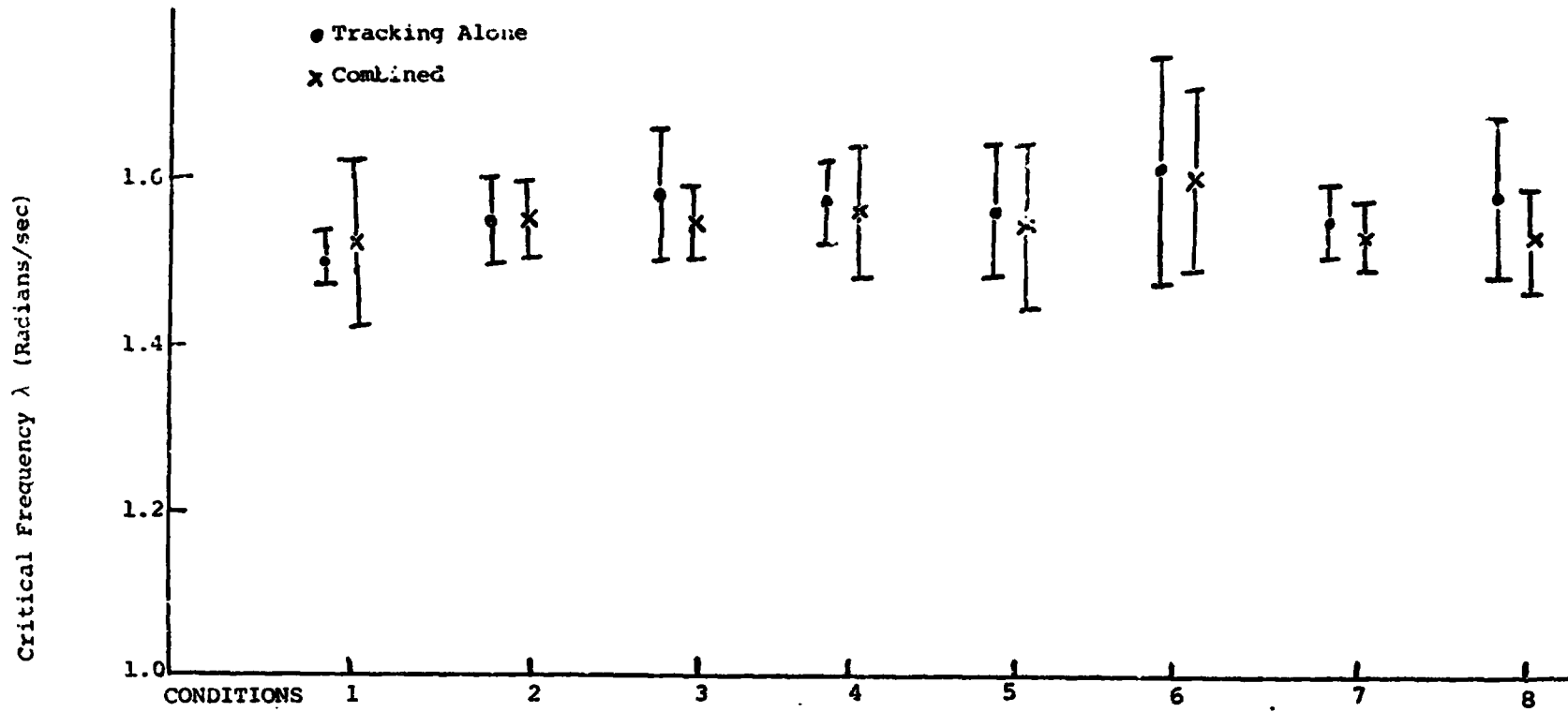

<u>Mean</u> Tracking Alone	1.500	1.550	1.579	1.577	1.562	1.616	1.552	1.578
Combined	1.544	1.552	1.545	1.560	1.540	1.601	1.535	1.534
<u>St. Dev.</u>								
Tracking Alone	.03217	0.04941	.07919	.04838	.07908	.13911	.04141	.09402
Combined	.1035	.04805	.04195	.08111	.10402	.11438	.03391	.05366
N	36	36	36	36	36	36	36	36

Figure 3. Critical frequency for tracking with and without secondary loading

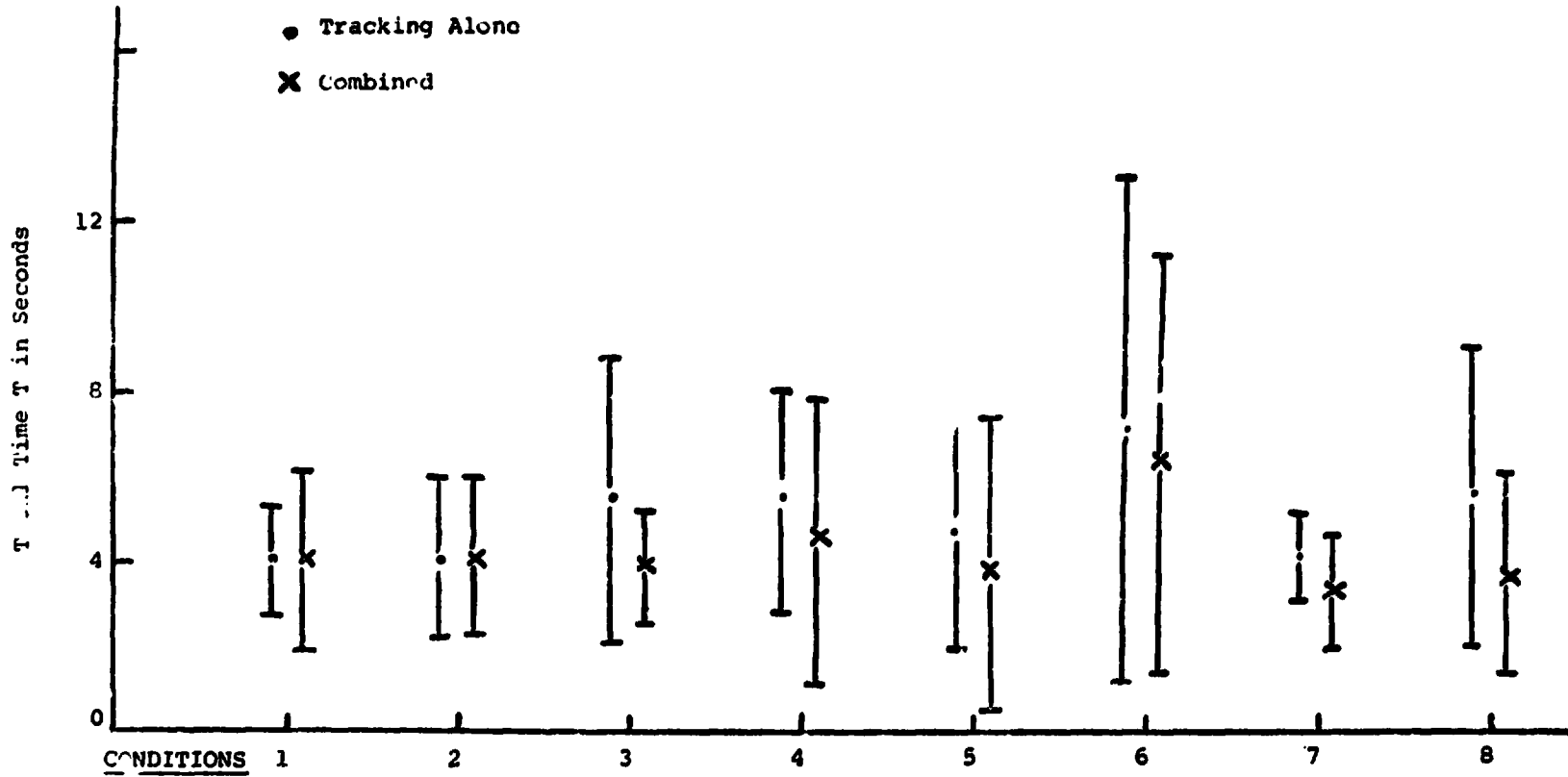

<u>Mean Tracking</u>		1	2	3	4	5	6	7	8
Alone		4.09	3.98	5.35	5.3	4.74	6.97	3.93	5.47
Combined		3.91	4.02	3.80	4.48	4.03	6.30	3.26	3.52
<u>Std. Dev. Tracking</u>		1	2	3	4	5	6	7	8
Alone		1.388	2.0316	3.433	2.9305	2.8361	5.944	0.8597	3.555
Combined		2.222	2.1363	1.8633	3.475	3.736	4.8861	1.3962	2.567
N		36	36	36	36	36	36	36	36

Figure 4. Total time for tracking with and without secondary loading

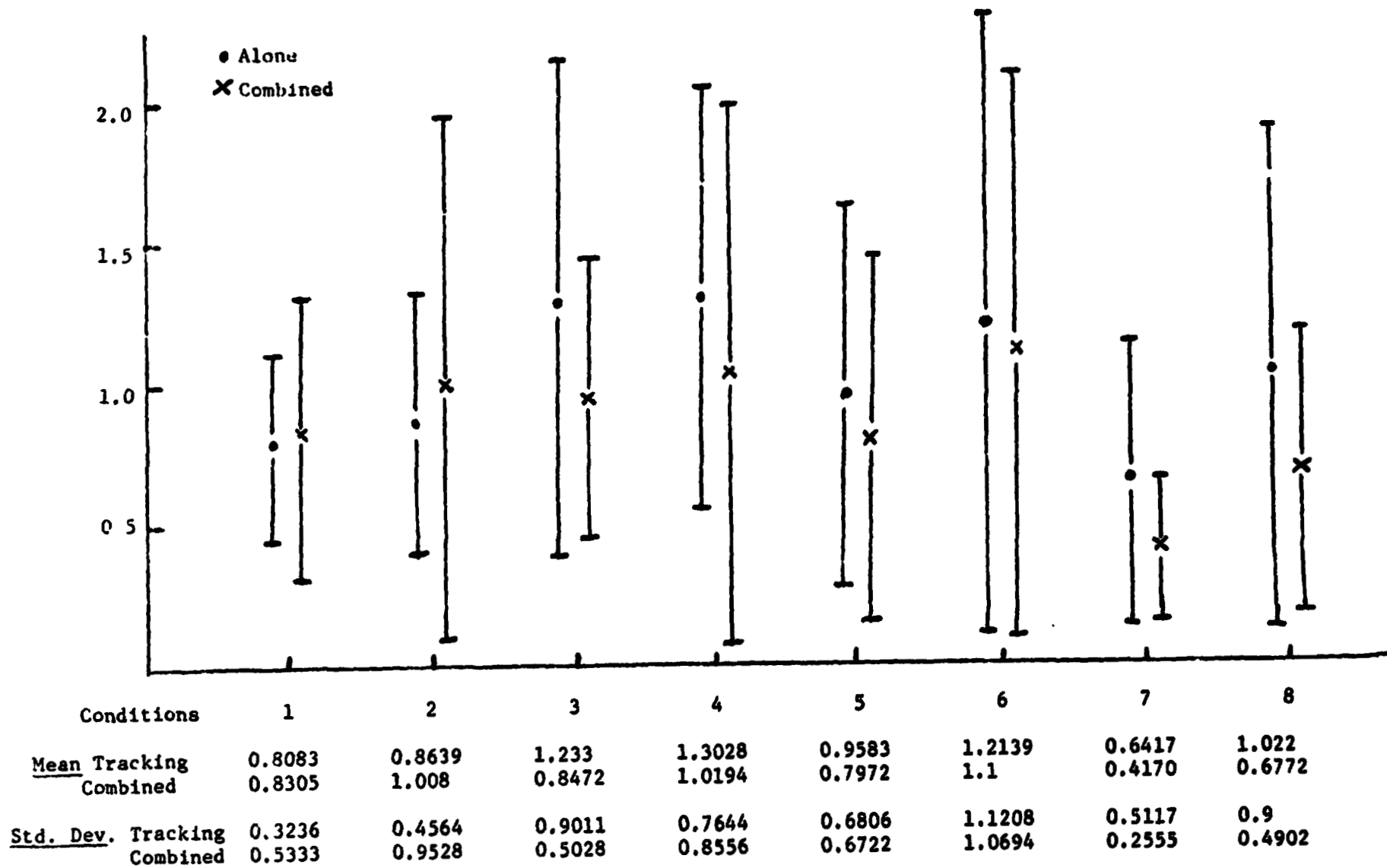

Figure 5. Rate Switching Time for Tracking With and Without Secondary Loading

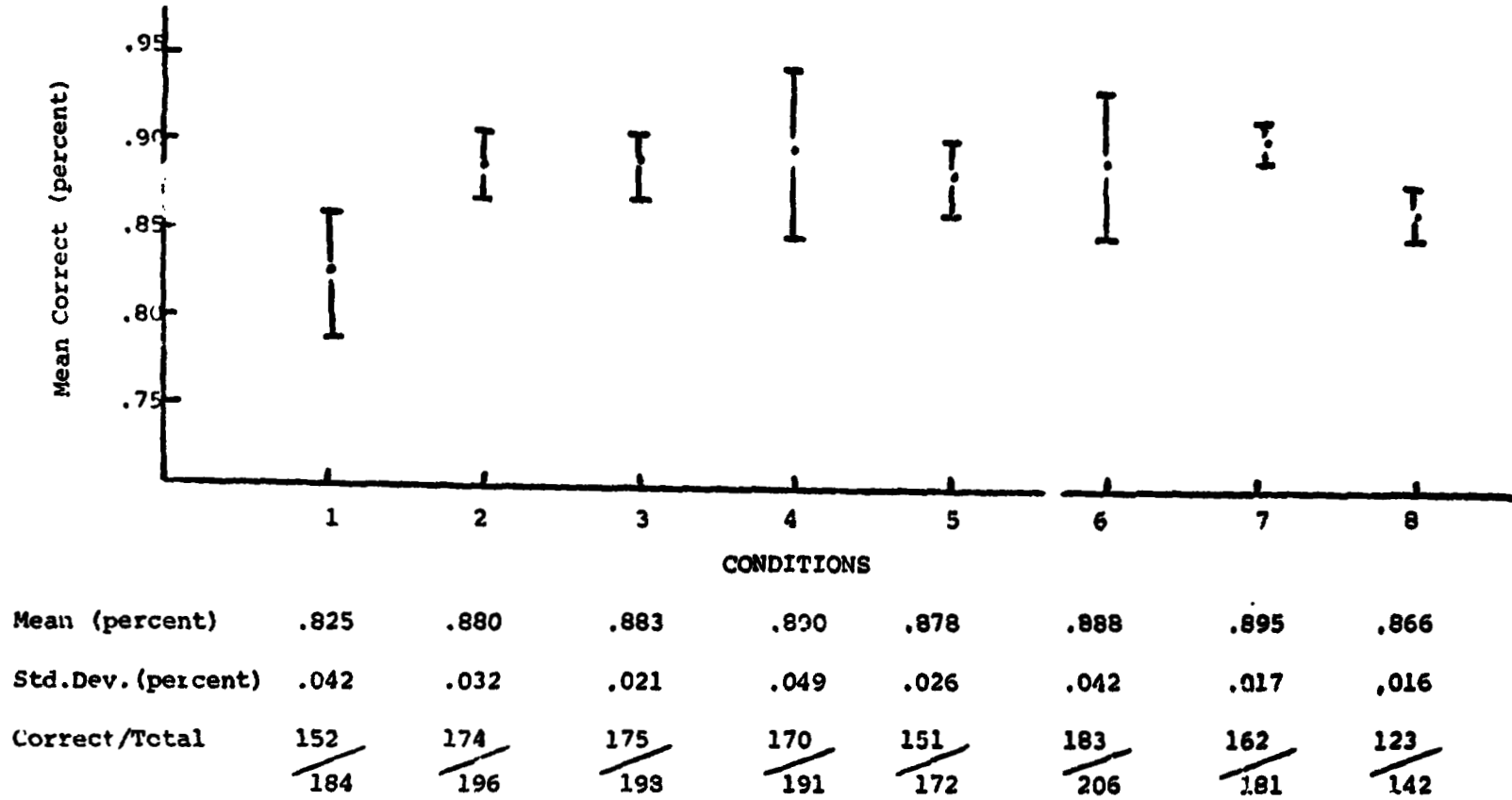

Figure 6. Correct Responses (percent) on Telephone Test

TABLE III

NUMBER OF TIMES AN OPERATOR LOST A PARTICULAR DISPLAY FIRST

	<u>C O N D I T I O N S</u>							
	<u>1</u>	<u>2</u>	<u>3</u>	<u>4</u>	<u>5</u>	<u>6</u>	<u>7</u>	<u>8</u>
<u>LEFT</u>								
Tracking Alone	24	25	26	25	24	22	24	21
Tracking Combined	24	22	24	25	23	23	25	22
<u>RIGHT</u>								
Tracking Alone	12	11	10	11	12	14	12	15
Tracking Combined	12	14	12	11	13	13	11	14
N	36	36	36	36	36	36	36	36

TABLE IV

PERFORMANCE RATING SHEET

Please indicate by circling your choice rating in the scale 1 through 7, as to the ease of operation. Number 1 indicates "least comfortable" and number 7 indicates "most comfortable".

1.	Two Controls, Two Displays (line) in vertical direction, Two Oscilloscopes	1	2	3	4	5	6	7
2.	" " " " (Dot) " " " " "	1	2	3	4	5	6	7
3.	" " " " (line) " horizontal " " "	1	2	3	4	5	6	7
4.	" " " " (line) at right angles to each other Two Oscilloscopes	1	2	3	4	5	6	7
5.	One " " " (line) at right angles to each other " "	1	2	3	4	5	6	7
6.	Two " " " (dot) One Oscilloscope	1	2	3	4	5	6	7
7.	One " " " (dot) One Oscilloscope	1	2	3	4	5	6	7

Name: _____

Date: _____

Performance Rating Scale:

A performance rating scale (Table IV) was given to the subjects to indicate their preference of each condition on a "one" to "seven" scale with "one" indicating the least comfortable and "seven" indicating the most comfortable. Table V shows the mean scores for each condition. Conditions 1 and 6 were rated best and the total tracking time for condition 6 agrees with this result. The total tracking time for condition 8 was the least and the subjects rated condition 8 as the most uncomfortable. Conditions 2 and 3 were rated low because the anthropometric motions involved in moving the sticks were perpendicular to each other.

Loss of Display

All the subjects used were right handed. It was noted (Table III) that the display controlled by the left hand was lost first in approximately an order of 2 to 1 compared to the display controlled by the right hand.

Telephone Test

Figure 6 shows the subject consistently paid attention to the secondary loading. The mean correct response to the telephone test in all conditions did not vary much in its range. The largest variability in mean correct response, occurred in conditions 1, 4, and 6, in which the direction of motion of the two displays was the same.

TABLE V

SUBJECTIVE RATING OF TRACKING CONDITIONS

Condition	Individual Ratings	Mean Rating
1	6, 7, 6, 5, 7, 6	6.1667
2	2, 4, 1, 4, 3, 4	2.8333
3	2, 4, 1, 2, 3, 3	2.5
4	4, 3, 3, 4, 3, 4	3.5
5	3, 3, 3, 7, 3, 1	3.3333
6	6, 7, 6, 7, 3, 6	6.1667
7	3, 2, 3, 4, 2, 3	2.8333
8	3, 3, 3, 1, 2, 1	2.1667

CONCLUSIONS

The critical divergence frequency (λ) was not affected by primary loading. The secondary loading produced a degraded performance in total tracking time and also in rate switching time (except in condition 2) for all conditions. A large variability was noticed in condition 6 which may be due to the fact that this condition was rated to be the most comfortable one. The subjects showed a preference to the dot display with the display moving in the vertical axis. The subjects showed a high correction percentage in the telephone test showing that they were well motivated for the task.

RECOMMENDATIONS

The results of this research support that Jex's critical task can be used in evaluation of operator's performance measures in dual-axis critical tracking task. In experiments of this type, it is recommended that a mixed hand dominant population be used because as exemplified in this research the left display was lost in a 2 to 1 ratio compared to the right display.

-278-

REFERENCES

1. Anderson, R. O., Westbrook, C. B. and Pietrasek, P. E. "Handling Qualities and Pilot Work Load," W-PAFB, F.D.L., TR/DC: TM 66-5. September 1966.
2. Harper, R. P., Cooper, G. E. "The Use of Pilot Rating in the Evaluation of Aircraft Handling Qualities", NASA TN D-5153.
3. Jex, H. R., Jewell, W. F. and Allen, R. W. "Development of the Dual Axis and Crosscoupled Critical Tasks," Proceedings of the 8th Annual Conference on Manual Control, 1972.
4. Jex, H. R., McDonnell, J. D. and Phetak, A. V. "A Critical Tracking Task for Man/Machine Research Related to the Operator's Effective Delay Time," Part I and II NASA CR-616 and CR-674. November 1966/ January 1967.
5. Jex, H. R., Allen, R. W. and Magdaleno "Display Format Effects on Precision Tracking Performance Describing Functions, Remnant," AMKL TR-71-63, W-PAFB, Ohio. 1971.
6. Jex, H. R., "Two Applications of a Critical Instability Task to Secondary Work Load Research," S.T.I., TR-155-1, February 1967.
7. Jex, H. R., Allen, R. W. "Research on a New Human Dynamic Response Text Battery," 6th Annual Conference on Manual Control, April 1970.
8. Kelley, C. W. "The Measurement of Tracking Proficiency," Human Factors, Vol. 11, No., February 1969.
9. McDonnell, J. D. "Pilot Rating Techniques for the Estimating and Evaluation of Handling Qualities," AFF DL-TR-68-76, December 1968.
10. Swisher, G. M. and Maher, P. "The Degradation of Tracking Performance as a Function of Environmental Stresses of Heat and Noise," Proceedings of the 8th Annual Conference on Manual Control, 1972.
11. Swisher, G. M., Bethke, R., and Cook, M. J. "The Effect of Intermittent Error Displays on the Operator Critical Tracking Performance." Proceedings of the 8th Annual Conference on Manual Control, 1972.
12. Guignard, J. C., "A Telephone Test for Use in Combined Stress Experiments," Wright State University Environmental Stress Research Unit Internal Memo 70-6, December, 1970.