

STRESS RELAXATION AND MECHANICAL PROPERTIES  
OF  
RL-1973 AND PD-200-16  
SILICONE RESIN SPONGE MATERIALS

Final Report  
Contract No. NAS1-13342  
Texas A&M Research Project - RF 3098

NASA-CR-132622) STRESS RELAXATION AND  
MECHANICAL PROPERTIES OF RL-1973 AND  
PD-200-16 SILICONE RESIN SPONGE MATERIALS  
Final Report, 6 Jun. 1974 - 28 Apr. 1975  
(Texas A&M Research Foundation) 181 p HC

N75-21372

Unclas  
18602

63/24

a  
report



from the Texas A&M  
RESEARCH FOUNDATION

College Station, Texas



Prepared for  
National Aeronautics and Space Administration  
Langley Research Center  
Hampton, Virginia 23665

by

Texas A&M Research Foundation  
College Station, Texas 77843

April 1975



STRESS RELAXATION AND MECHANICAL PROPERTIES

OF

RL-1973 AND PD-200-16

SILICONE RESIN SPONGE MATERIALS

by

D. Saylak  
J. S. Noel  
J. S. Ham  
R. McCoy

Mechanics and Materials Research Center  
Texas A&M University  
College Station, Texas 77843

Final Technical Report

on

Contract No. NAS1-13342

April 1975

National Aeronautics and Space Administration

Langley Research Center

Hampton, Virginia 23665

## FOREWORD

This final report was prepared by the Mechanics and Materials Research Center of Texas A&M University for the National Aeronautics and Space Administration, Langley Research Center under Contract NAS1-13342, "Stress Relaxation and Mechanical Properties of RL-1973 and PD-200-16 Silicone Resin Sponge Materials." Work reported herein was performed under the direction of Mr. A. Chapman who served as the Contracting Officer's technical monitor. Program duration was from 6 June 1974 to 28 April 1975.

The authors wish to acknowledge the contributions of the following individuals who were directly responsible for performing the program tasks and preparing this final report: Research Assistants; W. E. Conger and D. J. Fisher--Civil Engineering, N. Conrad--Aerospace Engineering. Laboratory assistance and data reduction was also provided by M. E. G. Fisher and K. Johnson.

## TABLE OF CONTENTS

	Page
FOREWORD . . . . .	i
LIST OF TABLES . . . . .	iii
LIST OF FIGURES . . . . .	iv
SYMBOLS . . . . .	vi
1.0 INTRODUCTION . . . . .	1
1.1 Purpose . . . . .	1
1.2 Scope and Objectives . . . . .	1
1.3 Background . . . . .	2
2.0 TECHNICAL PROGRAM . . . . .	4
2.1 General . . . . .	4
2.2 Materials . . . . .	4
2.3 Experimental Program . . . . .	5
2.3.1 Sample Preparation . . . . .	5
2.3.2 Apparatus . . . . .	7
2.3.3 Test Methods . . . . .	11
2.3.4 Data Reduction Procedures . . . . .	12
3.0 DISCUSSION OF RESULTS . . . . .	18
3.1 Tangent and Secant Moduli . . . . .	18
3.2 Relaxation Moduli . . . . .	23
3.3 Measurement of Glassy Transition Temperature . . . . .	32
3.4 Failure Data . . . . .	42
4.0 CONCLUSIONS AND RECOMMENDATIONS . . . . .	48
4.1 Conclusions . . . . .	48
4.2 Recommendations for Future Work . . . . .	49
REFERENCES . . . . .	51



## LIST OF TABLES

		Page
TABLE I	Tangent and Secant Shear Moduli for PD-200-16 Foam	21
TABLE II	Tangent and Secant Shear Moduli for RL-1973 Foam	22
TABLE III	Measured Thermal Properties of the Silicone Resin Sponge (SRS) Materials	41

## LIST OF FIGURES

Figure No.	Title	Page
1	Double lap shear specimen.	6
2	Cross-section of low temperature cryostat.	9
3	Typical stress relaxation trace.	13
4	Typical constant rate-to-failure trace.	14
5	Typical stress-strain curve identifying major parameters.	16
6	Initial tangent moduli observed for the PD-200-16 foam. The crosshead displacement rate was 0.05 in/min, (0.127 cm/min).	19
7	Initial tangent moduli observed for the RL-1973 foam. The crosshead displacement rate was 0.05 in/min, (0.127 cm/min).	20
8	Relaxation moduli measured for the PD-200-16 foam. The imposed strain was 1%.	24
9	Relaxation moduli measured for the PD-200-16 foam. The imposed strain was 3%.	25
10	Relaxation moduli measured for the PD-200-16 foam. The imposed strain was 5%.	26
11	Relaxation moduli measured for the PD-200-16 foam. The imposed strain was 10%.	27
12	Relaxation Moduli measured for the RL-1973 foam. The imposed strain was 1%.	28
13	Relaxation moduli measured for the RL-1973 foam. The imposed strain was 3%.	29
14	Relaxation moduli measured for the RL-1973 foam. The imposed strain was 5%.	30
15	Relaxation moduli measured for the RL-1973 foam. The imposed strain was 10%.	31
16	Schematic drawing of dilatometer.	33

LIST OF FIGURES  
(CONTINUED)

Figure No.	Title	Page
17	Curve showing the temperature measured in the dilatometer during a trial test cycle.	36
18	Curve showing the thermal strains as a function of temperature for the RL-1973, Sample 1.	37
19	Curve showing the thermal strains as a function of temperature for the RL-1973, Sample 2.	38
20	Curve showing the thermal strains as a function of temperature for the PD-200-16, Sample 1.	39
21	Curve showing the thermal strains as a function of temperature for the PD-200-16, Sample 2.	40
22	Failure shear stresses and corresponding strains observed for the PD-200-16 at the various test temperatures.	43
23	Failure shear stresses and corresponding strains observed for the RL-1973 at the various test temperatures.	44
24	The stresses at maximum load plotted against the corresponding strains for the PD-200-16.	46
25	The stresses at maximum load plotted against the corresponding strains for the RL-1973.	47

## SYMBOLS

A	shear area, mm <sup>2</sup>
G	modulus, N/m <sup>2</sup>
h	sample thickness, mm
L	sample length, mm
P	load, N
T	temperature, degrees Kelvin (K)
t	time, seconds
W	sample width, mm
$\alpha$	coefficient of thermal expansion, mm/mm/K
$\gamma$	shear strain, mm/mm or %
$\Delta$	sample deformation, mm
$\tau$	shear stress, N/m <sup>2</sup>

### Subscripts:

c	constant
g	glassy
i	initial
m	maximum or failure
o	reference
rel	relaxation
s	secant

## 1.0 INTRODUCTION AND SUMMARY

### 1.1 Purpose

The purpose of this study is to measure stress relaxation characteristics and other mechanical properties of two silicone resin sponge materials over a broad range of cold temperatures well below those anticipated during a space shuttle orbiter mission.

### 1.2 Scope and Objectives

The overall scope of the activity for this project was to furnish personnel, facilities, services, equipment and materials necessary to evaluate the stress relaxation and mechanical properties of two, government-furnished silicone resin sponge materials. Specific objectives included:

- Conduct shear stress relaxation tests at four (4) strain levels and nine (9) temperatures for each material.
- Determine failure properties at nine (9) temperatures and one (1) strain rate not to exceed  $0.005 \text{ s}^{-1}$ .
- Evaluate initial tangent modulus, ultimate secant modulus, ultimate strength and strain at failure.
- Determine glass transition temperature,  $T_g$  and coefficient of linear thermal expansion,  $\alpha$ , for each material.
- Publish a final report of test results.
- Return tested samples to NASA-Langley upon completion of the work.

### 1.3 Background

The materials evaluated in this program represent candidates proposed for use as a strain-isolating layer by which the reusable surface insulation (RSI) for the space shuttle orbiter is attached to the shuttle primary structure. The brittle RSI is the baseline thermal protection system for the spacecraft and was developed to withstand severe thermal gradient of the order of 1400 K including temperatures in the cryogenic range.

Two silicone resins which have been processed into low-density sponges are under consideration for use as the strain-isolating bond material. At cryogenic temperatures the materials undergo a transition and become relatively stiff. Since the bondline temperature may remain in the cryogenic range during reentry when the orbiter is being heated, the possibility exists that the strain isolation pad may not perform its required function. To overcome this problem it may become necessary to place a sheet of high modulus material between the silicone sponge layer and the RSI to further minimize excessive induced strain. The addition of this strain arresting plate would increase the weight of the thermal protection system and hence add an additional weight penalty to the entire orbiter and its mission.

Recent work (ref. 1) involving the characterization of the mechanical behavior of silicone elastomers has shown that strain at failure may increase at certain low temperatures. It was also suggested that stiffness values might decrease as the temperature became colder. These behavioral characteristics are contrary to those normally expected in which strain capabilities decrease and moduli increase to relatively constant glassy

values. However, if these behavior characteristics can be substantiated it may be possible to eliminate the strain arresting plate and its attendant weight. The tests and results discussed in this report were designed to provide a resolution of this question.

Supportive tests to establish the linear coefficient of thermal expansion,  $\alpha$ , and glass transition temperature,  $T_g$ , were also conducted on each material to assist in the analysis of experimental results.

## 2.0 TECHNICAL PROGRAM

### 2.1 General

Stress relaxation tests were conducted by loading specimens in double-lap shear to a preselected strain level and monitoring the decay of stress with time. Before performing the test, the specimen temperature was allowed to stabilize. Time to achieve thermal equilibrium was determined by monitoring the output of a thermocouple embedded within a control specimen in the environmental chamber. The selected strain level was applied at a strain rate of  $0.002 \text{ s}^{-1}$  and was maintained for at least one hour while the specimen stress level was recorded. The specimen was then loaded to failure at  $0.002 \text{ s}^{-1}$ . Initial tangent modulus, secant modulus at failure (i.e., at maximum stress), ultimate stress and corresponding strain were determined for each test.

A total of 72 tests on each material were performed as described above; generally, two replicate tests for each condition. Each material was subjected to at least 36 test conditions including the temperatures and strain levels listed below:

Strain levels (4): 1, 3, 5 and 10 percent

Temperatures (9): 100, 125, 150, 175, 200, 225, 250,  
275 and 300 K.

### 2.2 Materials

The two foams studied in this work were silicone based formulations which the manufacturers considered to be proprietary. The General Electric material, PD-200-16, is an open-cell RTV-560 with no other additives but



filler and blowing agent. The major constituent is poly(methylphenylsiloxane). The Raybestos Manhattan material, RL-1973, is a closed-cell foam and was also indicated to be a poly(methylphenylsiloxane) with vinyl groups crosslinked with an organic peroxide crosslinking agent. The GE material also contained crosslinking sites and a crosslinking agent which were not specified. Thus, it was impossible to distinguish between these two materials from the chemical descriptions made available (ref. 2). The above information was obtained by telephone conversations with representatives of both GE and Raybestos.

## 2.3 Experimental Program

### 2.3.1 Sample Preparation

The double-lap shear specimen consists of identical pieces of the silicone sponge material (12.7 x 25.4 x 127.0 mm) sandwiched between three aluminum platens (4.8 x 25.4 x 177.8 mm) as shown in Figure 1. The PD-200-16 and RL-1973 samples were bonded in blocks of seven or eight as needed in order to preclude the possibility of a bonding irregularity permeating the entire sample group. Before bonding, the aluminum bars were roughened by sandblasting and degreased with acetone. The bars were coated with SS-400 Primer and allowed to dry for one hour or longer. The RTV-560 adhesive was prepared in accordance with General Electric specifications (ref. 3) using dibutyl tin dilurate as a catalyst.

The aluminum bars were separated with glass slides on a clean paper sheet, and coated with a thin layer of the prepared RTV compound. Initially, dry sheets of the silicone resin foam were attached to this wet

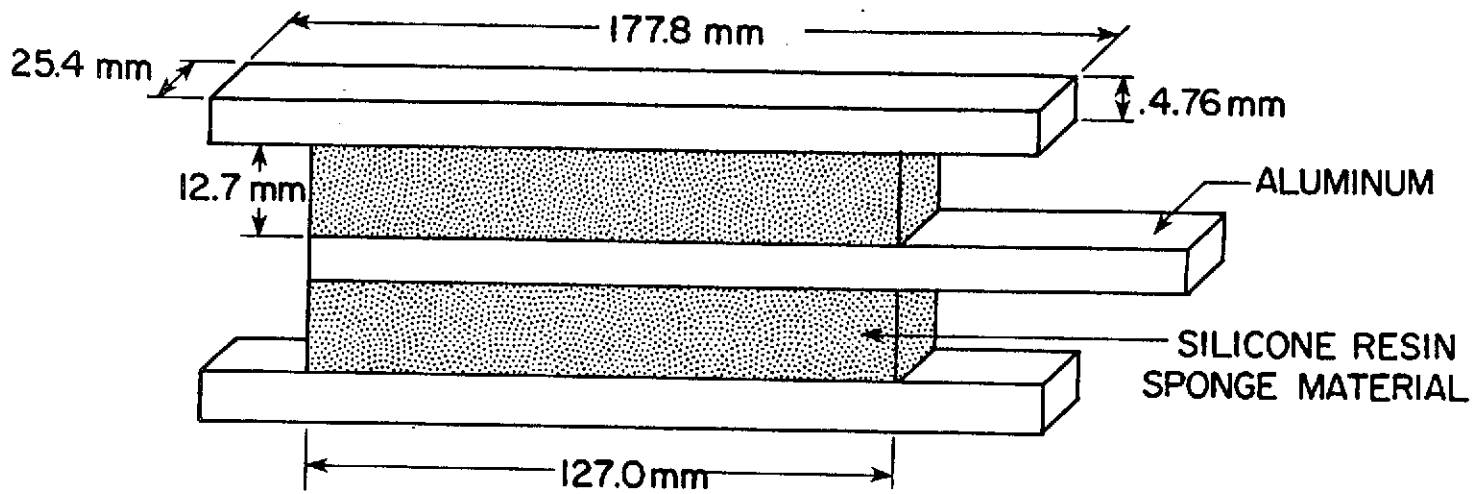

A. UNLOADED

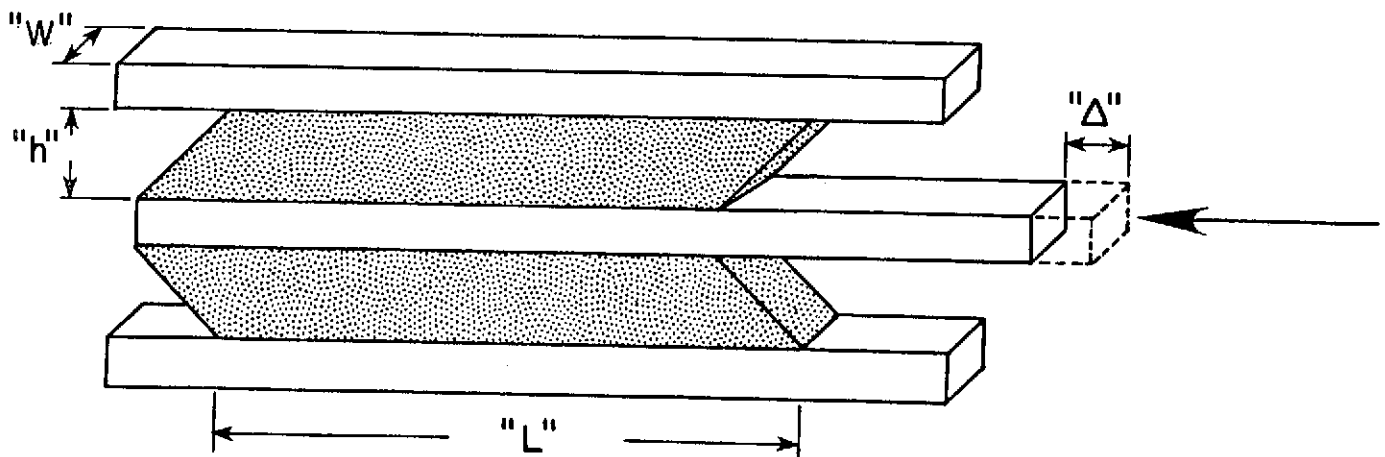

B. LOADED

Figure 1. Double lap shear specimen.

layer and set aside to dry. It was found that the PD-200-16 material bonded well in this manner because of its great porosity. In contrast, the RL-1973 material frequently failed to become thoroughly wetted and, consequently, formed poor bonds. It became necessary to add RTV 560 to both the RL-1973 sponge and the aluminum platen to achieve a secure bond.

After the bars and material were properly positioned and aligned, they were taped to the table to avoid slippage during curing of the adhesive. In accordance with General Electric specifications for the RTV bonding material, the samples were allowed to set for 48 hours at room temperature. They were then taken to an environmental chamber and kept at a constant temperature of 333 K and 25% R.H. for at least 72 hours to ensure complete curing of the bond. The blocks of sample were removed from the environmental chamber and the protruding RTV and silicone foam trimmed from the sides of each sample with razor blades. After the samples had cooled to room temperature, those that were to be tested at temperatures less than 275 K were individually wrapped in dessicated plastic bags to avoid moisture and placed in a freezer at 258 K. Samples used for the warmer temperatures were kept at 296 K and 55% R.H.

### 2.3.2 Apparatus

The primary piece of equipment used to perform the relaxation and failure tests was the Instron Universal Testing Machine. Forces encountered ranged from less than 4.0 N at the warmer test temperatures to more than  $20 \times 10^3$  N at the colder temperatures. At the warmer temperatures, two load cells with maximum ranges 0 to 900 N and 0 to

450 N respectively were used, while at the temperatures below the glassy transition, a 9 MN maximum load cell with a 0 to 225 N full scale maximum sensitivity was used. All loads were recorded on the 254 mm wide motor driven chart of the Instron console.

Linear variable differential transformers (LVDT's) were the primary instruments used to measure sample deformation. The LVDT's employed had a 5 mm total travel with a sensitivity of  $1.27 \times 10^{-3}$  mm per microvolt ( $\mu\text{v}$ ). The LVDT's were calibrated such that 0.127 mm of deformation (1% strain) produced 1000  $\mu\text{v}$  of output. The output of the LVDT's was fed into a signal conditioner and was converted to a digital readout and printed on paper tape. When low temperature conditions caused the LVDT's to malfunction, displacement dials (with total travel of 5 mm) were substituted in their place. The deformations readings were then taken manually.

Thermocouples. All temperatures were determined and monitored by the use of copper-constantan thermocouples. The range of measurable temperatures with this type of thermocouple far exceed the 100 K to 300 K range of this testing program. By coupling the thermocouples into the same signal conditioner mentioned above, it was possible to measure a change in temperature of 0.5 K. Inherent asymmetries in the thermocouple wire allowed an absolute calibration only as close as  $\pm 3$  K.

Cold Chamber. To provide a stable thermal environment necessary to test the properties of the silicone sponge material, a low temperature cryostat was constructed (see Figure 2). The side walls of the chamber were constructed of polystyrene foam and phenolic plates formed

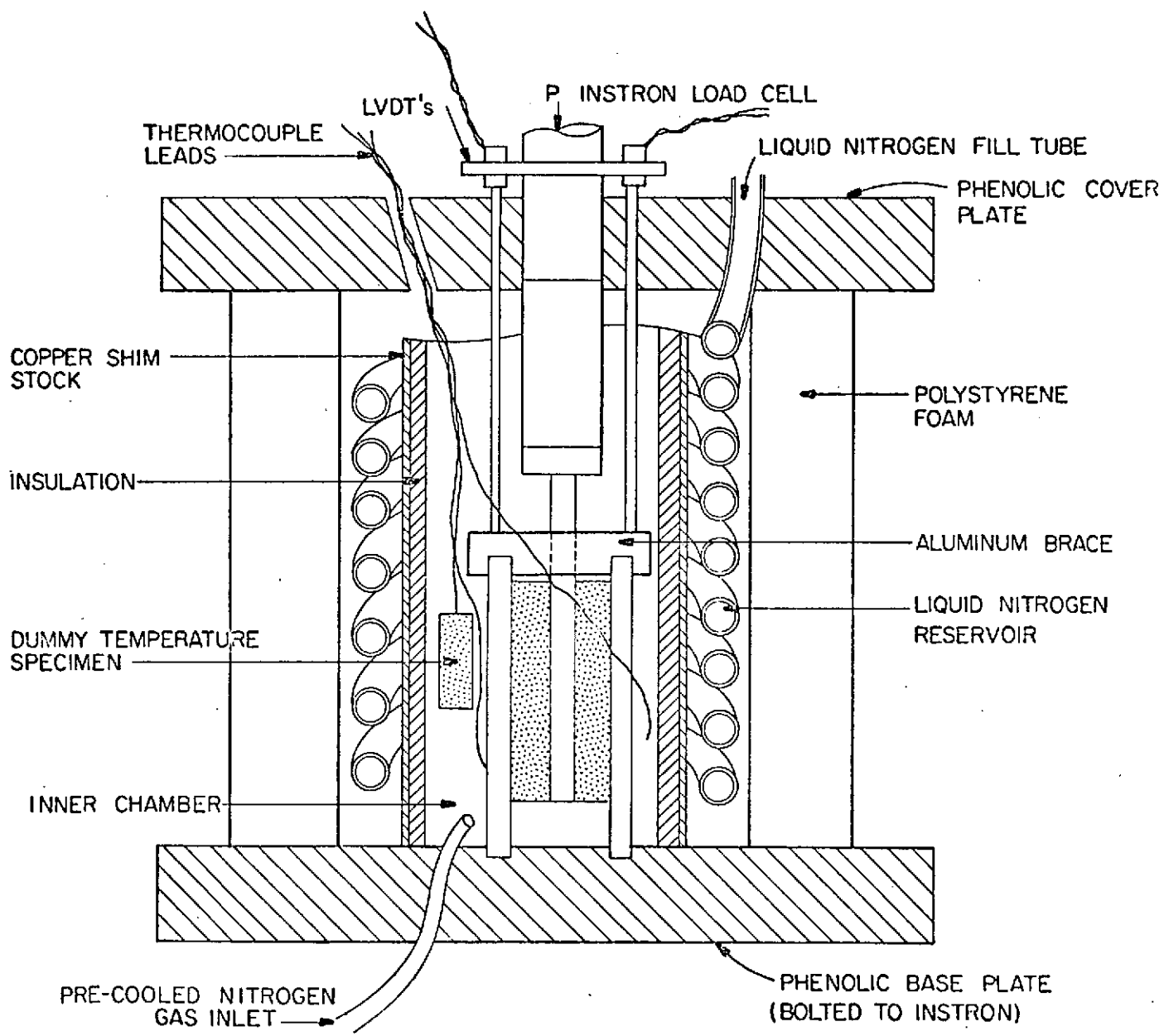

Figure 2. Cross-section of low temperature cryostat.

the base and cover. The inner chamber was constructed using thin sheets of copper shimstock which served three purposes: (1) to add high thermal conductivity in the vertical direction, (2) to avoid the formation of thermal layers within the chamber and (3) to form a reservoir surrounding the sample for the addition of liquid nitrogen into the chamber. In order to precondition the chamber, nitrogen gas, which had been pre-cooled in a liquid nitrogen bath, was introduced into the inner chamber surrounding the sample. The vapor pressure of this cool, dry gas prevented moisture from entering the apparatus and contaminating the specimen. The gas flow rate was kept low enough so as not to disturb the sample, but yet adequate to maintain a continuous circulation. To bring the chamber down to the desired test temperatures, liquid nitrogen was added as needed through a fill tube through the phenolic cover plate. To provide greater stability to the cooling process, a 4 m length of TYGON tubing, through which the liquid nitrogen was fed, was attached to the fill tube and fitted into a coil within the annular space between the chamber wall and the shimstock. Since both open ends of the tube extended outside the chamber, the liquid nitrogen did not come in contact with either the copper or the sample. The low thermal conductivity of the TYGON tubing provided a slow, stable temperature control within the cryostat.

Special walk-in environmental chambers located in the laboratory building were used to perform tests at temperatures of 250 K, 275 K and 300 K. These rooms were large enough to hold the entire test setup and their controlled temperature and humidity made the use of the cryostat described above unnecessary.

### 2.3.3 Test Methods

Before testing, all load cells, LVDT's and thermocouples were calibrated. Liquid nitrogen was poured into the thermal chamber to prepare it for the sample. An aluminum brace was affixed to the top of the sample while in the freezer in its plastic bag. After a wait of 20 to 30 minutes to allow the chamber to cool, the sample was removed from the freezer and transported to the testing apparatus. It was quickly removed from its plastic cover and set into the chamber. Three thermocouples were then inserted into the chamber, two in the space around the sample and one in a dummy sample of the material to be tested. The chamber lid was quickly set in place and the flow of nitrogen gas was initiated. The Instron crosshead was lowered until the load cell push-rod was just touching the center platen of the sample. The apparatus so assembled was allowed to sit for one to two hours to reach the testing temperature and stabilize. Liquid nitrogen was then added to the chamber reservoir as needed to lower the temperature. After approximately 40 minutes, the three thermocouples showed a stable test environment, but at least 20 minutes additional soak time was allowed for each sample. At the end of this waiting period, the LVDT's or displacement dials were attached and zeroed and the crosshead was brought down slightly to cause a slight preload on the sample (no more than one or two percent of the testing load).

To start the test, the crosshead was set in downward motion at a rate of 0.02 mm/s and halted when the desired strain level as indicated by the LVDT's was reached. Deformation, temperature and time were printed out at two minute intervals during the test while loads on the sample were recorded continuously. One of the two thermocouples hanging free in the

chamber was chosen as the reference. The use of the thermocouple in the dummy specimen was discontinued early in the program because it responded too slowly to temperature transients to permit adequate control to be maintained. Liquid nitrogen was added to the reservoir and/or the gas flow to the inner chamber adjusted as necessary to maintain a constant temperature within the chamber throughout the test.

At the end of 60 minutes of test time, the load scale on the Instron was changed and once again the crosshead was set in downward motion at a rate of 0.02 mm/s until the sample failed. Simulated Instron readouts showing typical traces of the relaxation and constant strain rate-to-failure tests are shown in Figures 3 and 4, respectively.

#### 2.3.4 Data Reduction Procedures

The calculations of shear stress,  $\tau$ , shear strain,  $\gamma$ , and shear relaxation modulus,  $G_{rel}(t)$ , for the test specimen shown in Figure 1 were based on the following relationships:

$$\tau = \frac{P}{A} \quad (1)$$

$$\gamma_c = \frac{\Delta}{h} \quad (2)$$

where:

- P = applied force, N
- A = shear area = W x L  
= 1/2 (25.4 mm x 127.0 mm)  
= 1.6 x 10<sup>3</sup> mm<sup>2</sup>
- Δ = sample deformation, mm
- h = thickness of silicone resin  
sponge material,  
= 12.7 mm

$$G_{rel}(t) = \frac{\tau(t)}{\gamma_c}$$

In addition to the shear relaxation modulus,  $G_{rel}(t)$ , mechanical behavior parameters evaluated for each test included (1) initial tangent



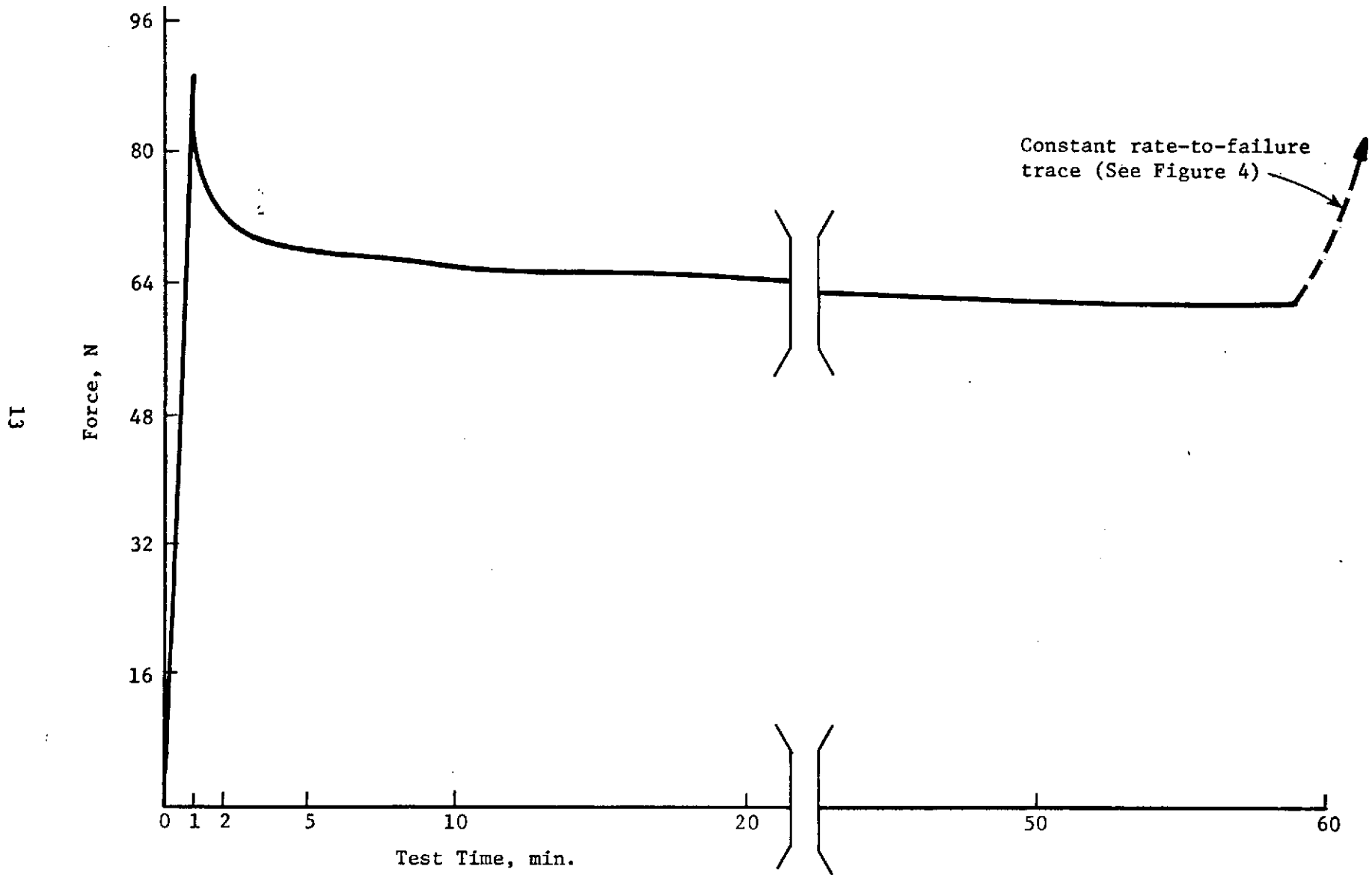

Figure 3. Typical stress relaxation trace.

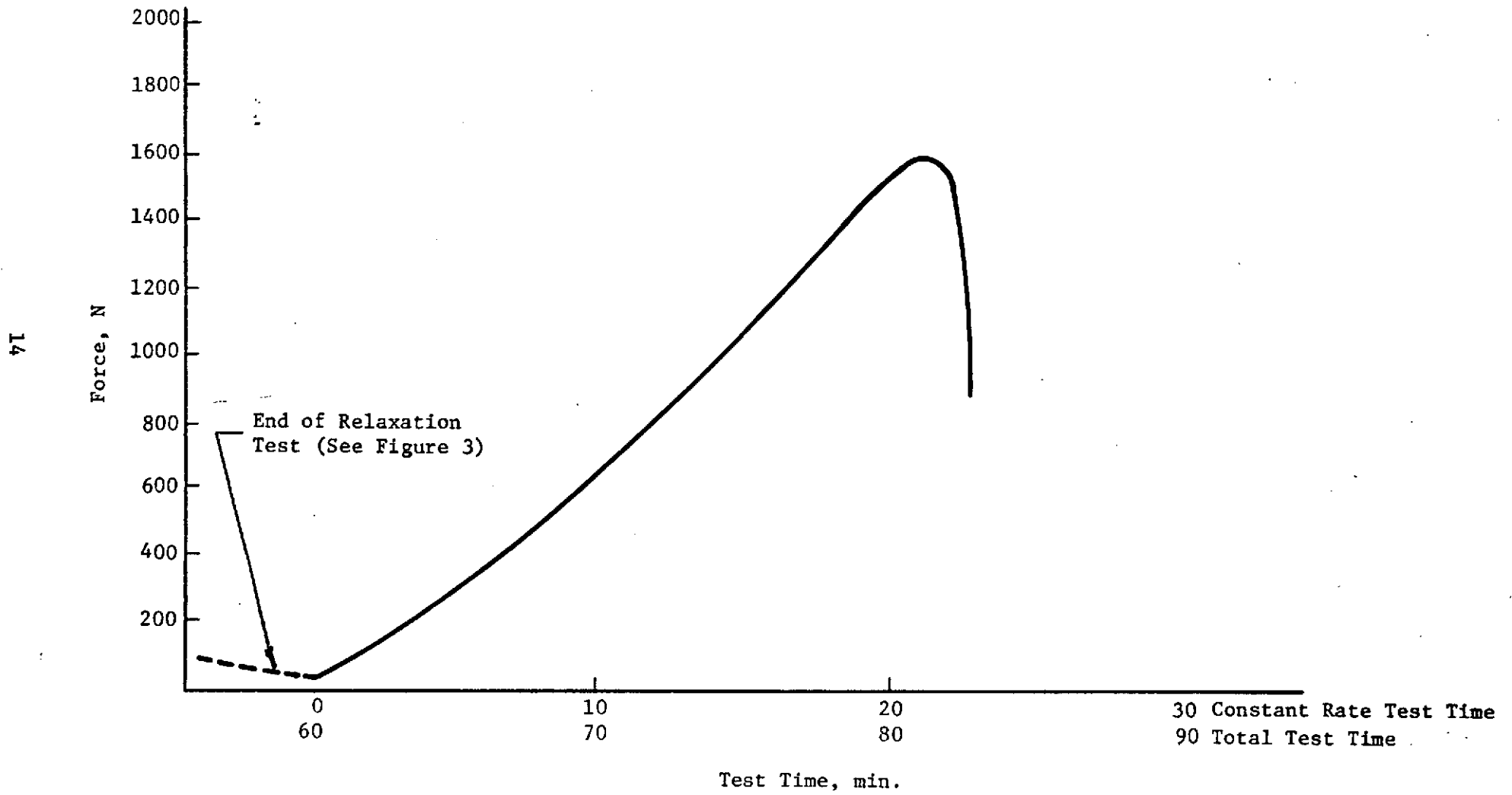

Figure 4. Typical constant rate-to-failure trace.

modulus,  $G_1$ ; (2) stress at failure,  $\tau_m$ ; (3) strain at failure,  $\gamma_m$  and (4) secant modulus at failure,  $G_s$ . The location of these parameters on a typical test curve is shown in Figure 5.

A computer program was generated to calculate these parameters. The format is given in Appendix A and tabulated values are shown in Appendix B. This program also used the Compudyne plotter which generated the stress-strain curves for each test also given in Appendix B. At least 15 points were used to generate each of these curves.

The initial tangent modulus reported herein is the average slope exhibited by the stress-strain curve prior to relaxation (as indicated by the vertical off-set in Figure 5). This was used to minimize any inconsistencies which would have been introduced by employing the slope of the stress-strain curve through the origin because of the frequent existence of a toe or positive curvature in the initial portion of the traces.

As shown in Figure 5, failure for the calculation of  $\tau_m$ ,  $\gamma_m$  and  $G_s$  was assumed to occur at the point of maximum load. The rupture point was not used because there was no way of determining how or exactly when the sample first began to tear while it was in the test chamber. To calculate the secant modulus,  $G_s$ , the final loading trace (i.e., after relaxation) was extrapolated to the strain axis with a curve drawn parallel to the original trace as shown in Figure 5. The maximum stresses and strains were then measured from that point. This procedure would not be expected to effect the failure properties since the strain levels at failure were usually large compared to those imposed during relaxation.

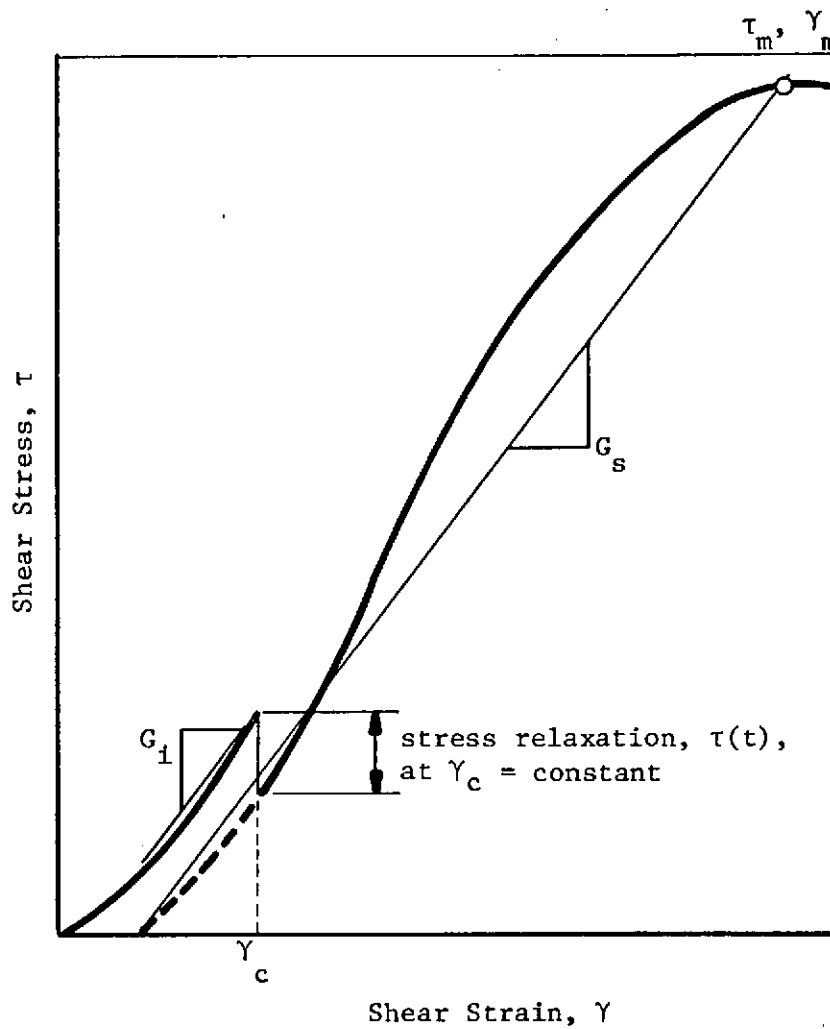

Figure 5. Typical stress-strain curve identifying major parameters.

In keeping with kinetic theory for rubbers (ref. 4) the stress and stiffness values are presented in their temperature reduced form, e.g.  $G_{rel}(T_0/T)$ , where  $T_0$  and  $T$  are the absolute values of the reference and test temperatures, respectively. This correction becomes more significant the greater the difference between  $T_0$  and  $T$ . The reference temperature,  $T_0$ , used for this correction was 300 K.

### 3.0 DISCUSSION OF RESULTS

For discussion purposes the test data for each of the two materials, PD-200-16 and RL-1973, were divided into four convenient categories: (1) tangent and secant moduli, (2) relaxation moduli, (3) thermal properties and (4) failure properties.

#### 3.1 Tangent and Secant Moduli

The values measured for the tangent modulus,  $G_t$ , and the secant modulus,  $G_s$ , are shown in Tables I and II for the PD-200-16 and RL-1973 materials, respectively. The values shown at each temperature represent the arithmetic average of the three to eight tests run at that temperature. As stated earlier, the initial tangent modulus represents the average slope exhibited by a given stress-strain curve prior to the relaxation test.

The data points plotted in the graphs of Figures 6 and 7 represent the individual test values of the tangent moduli. The tangent modulus values shown in Tables I and II, which as stated above, are averages of the measured values, served as guides for drawing the broken lines shown on the graphs. Both the tables and the figures illustrate a phenomenon that was demonstrated by nearly all the data for both materials. As the samples were cooled below room temperature they tended to remain quite more compliant (indeed PD-200-16 became more compliant). The modulus of the PD-200-16 material decreased somewhat below the room temperature values as the temperature decreased to about 175 K. With further decrease in temperature the modulus rapidly increased about two orders of magnitude.

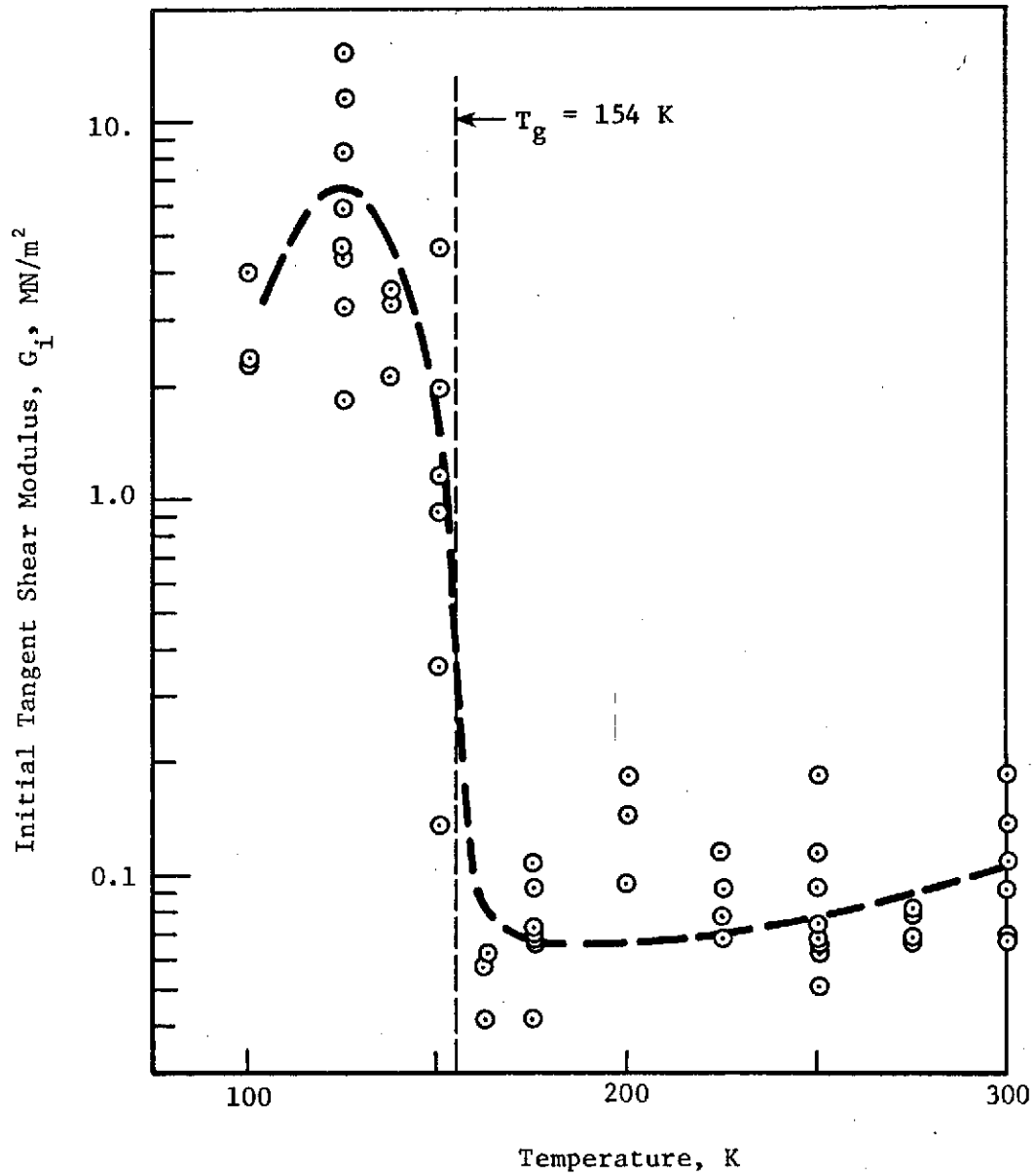

Figure 6. Initial tangent moduli observed for the PD-200-16 foam. The crosshead displacement rate was 0.05 in/min, (0.127 cm/min).

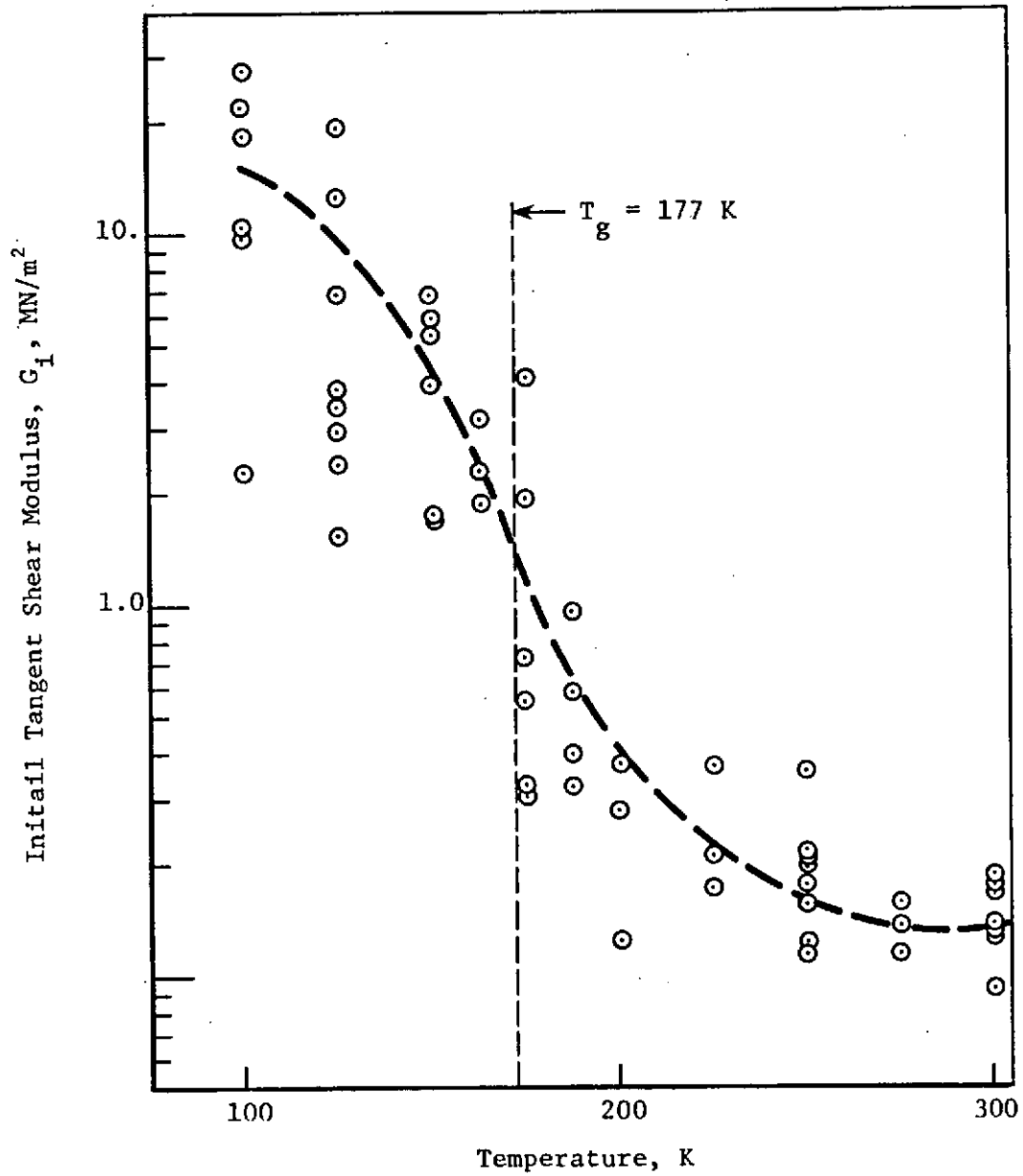

Figure 7. Initial tangent moduli observed for the RL-1973 foam. The crosshead displacement rate was 0.05 in/min, (0.127 cm/min).



TABLE I. Tangent and Secant Shear Moduli for PD-200-16 Foam. These Moduli Represent the Averages for All Tests Run at the Specified Temperature.

Test Temperature ( K)	Tangent Modulus $G_{i2}$ (N/m <sup>2</sup> )	Secant Modulus $G_{s2}$ (N/m <sup>2</sup> )
300	110,000	209,000
275	74,000	120,000
250	89,000	203,000
225	88,000	138,000
200*	141,000	175,000
175	74,000	242,000
163*	54,000	1,840,000
150	1,520,000	3,630,000
138*	3,000,000	10,600,000
125	7,350,000	12,900,000
100*	2,860,000	11,500,000

\*The average of three tests only.

TABLE II. Tangent and Secant Shear Moduli for RL-1973 Foam. These Moduli Represent the Averages for All Tests Run at the Specified Temperature.

Test Temperature ( K)	Tangent Modulus $G_{t2}$ (N/m <sup>2</sup> )	Secant Modulus $G_{s2}$ (N/m <sup>2</sup> )
300	141,000	209,000
275*	137,000	111,000
250	192,000	227,000
225	280,000	190,000
200*	256,000	418,000
188	570,000	918,000
175	1,300,000	1,910,000
163*	2,460,000	1,310,000
150	4,240,000	11,300,000
125	6,640,000	18,200,000
100	15,000,000	18,200,000

\*The average of three tests only.

At temperatures lower than 125, the stiffness of PD-200-16 decreased with further decrease in temperature as shown in Figure 6 by the curve representing the best fit of the data. The modulus of RL-1973, in contrast changed only slightly at temperatures as low as 250 K. But below 250 K the stiffness increased gradually with decreasing temperature until it reached values as high as PD-200-16.

### 3.2 Relaxation Moduli

Shear relaxation modulus is plotten versus time in Figures 8 through 11 for PD-200-16 and in Figures 12 through 15 for RL-1973. Each figure represents one imposed strain level so that four graphs are shown for each material, one for 1, 3, 5 and 10% strain. Data for at least nine temperatures ranging from 100 to 300 K are shown in each figure. In most instances two intermediate temperatures in the neighborhood of the transition temperature are also included.

As can be seen, both materials are very compliant in shear. Here as in all test the PD-200-16 could be characterized as having about half the stiffness of the RL-1973 at most temperatures. Both materials show only slight relaxation through the 60 min. test duration at both the cold and warm extremes. Only at the intermediate temperatures is there an indication of a greater slope to the log-log relaxation curve. These intermediate temperatures, interestingly enough, are near the transition temperatures identified by thermal expansion tests as described in Section 3.3 below.

No correlation between the strain level of the relaxation test and the measured relaxation modulus was observed.

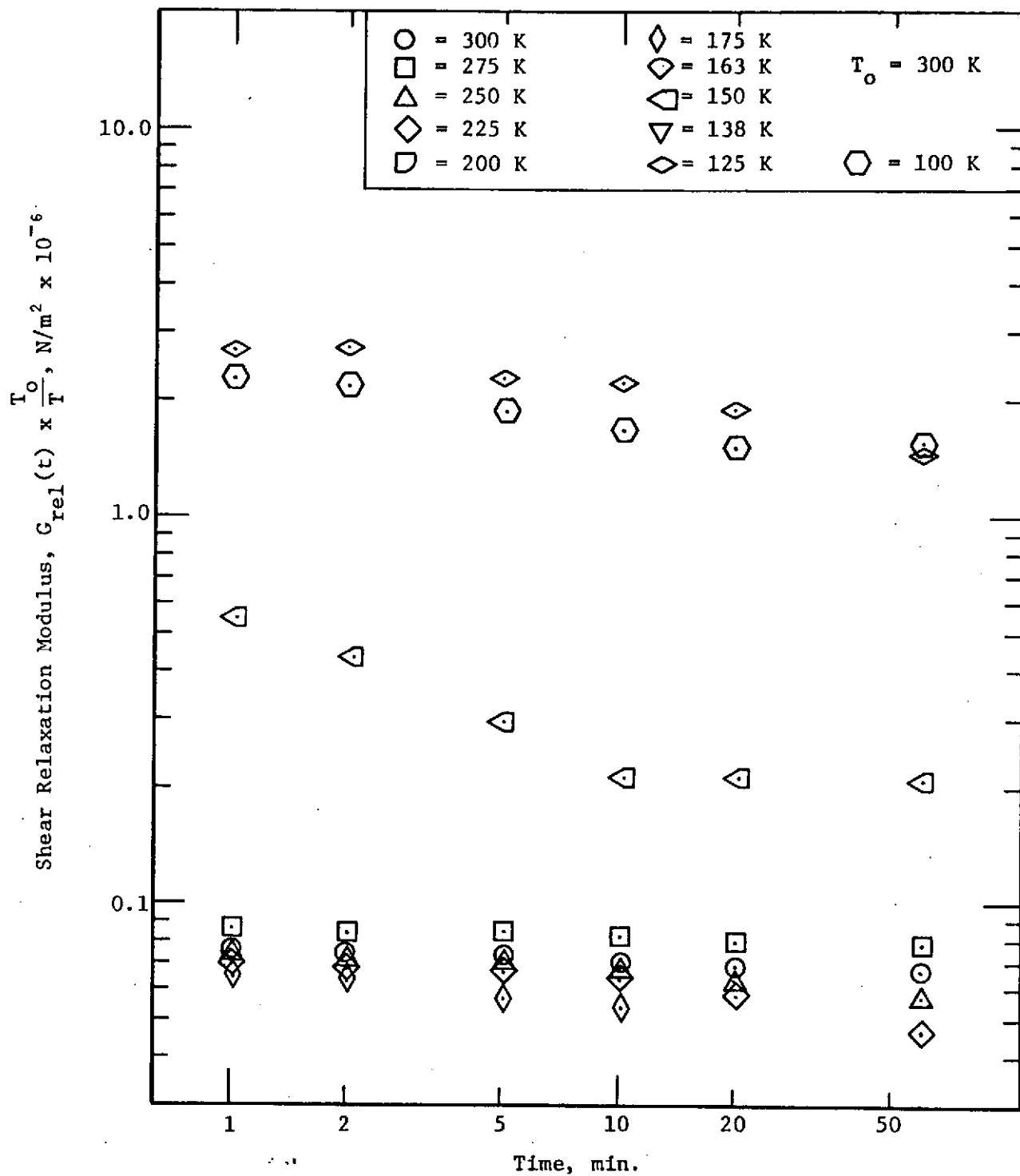

Figure 8. Relaxation moduli measured for the PD-200-16 foam. The imposed strain was 1%.

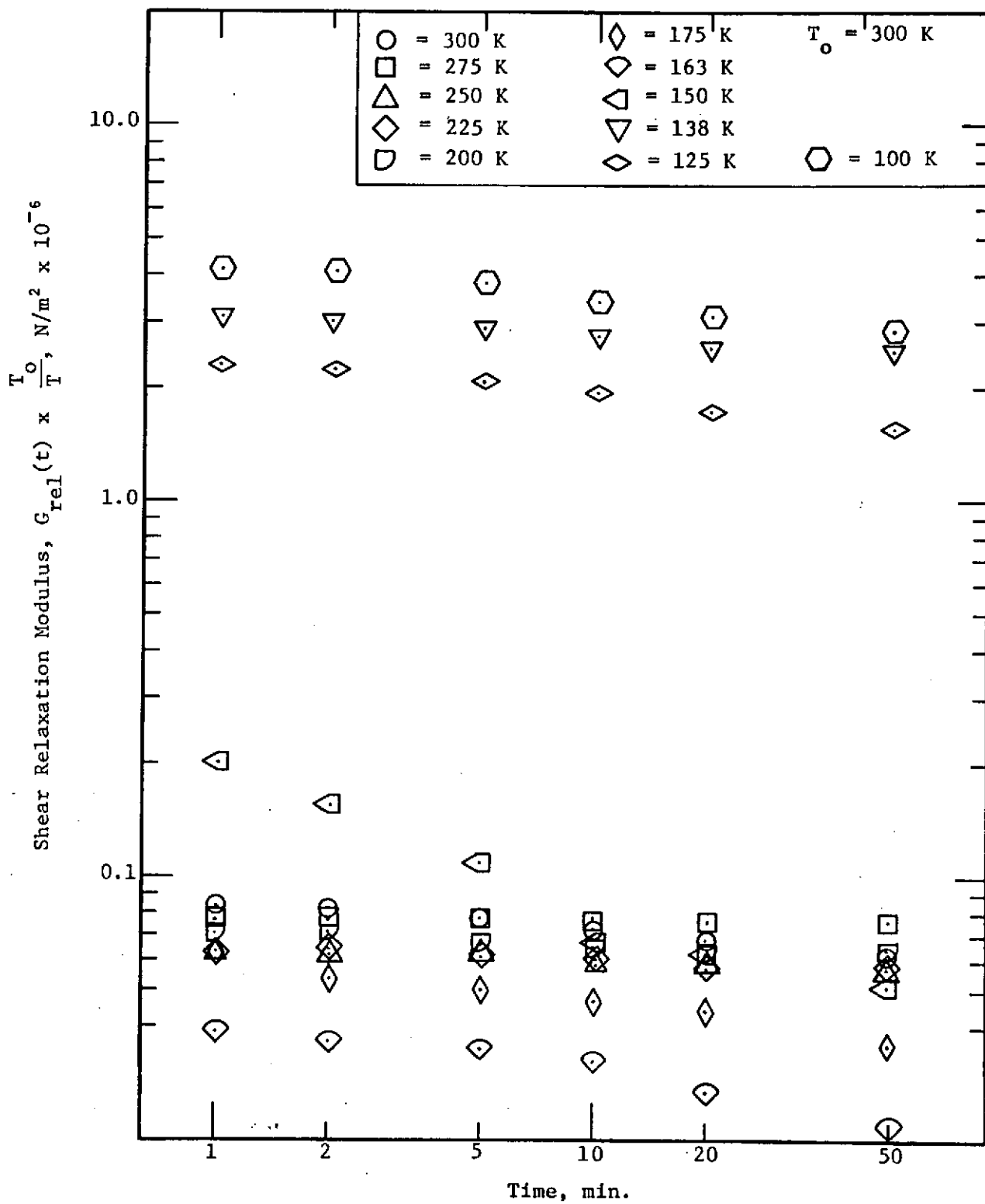

Figure 9. Relaxation moduli measured for the PD-200-16 foam. The imposed strain was 3%.

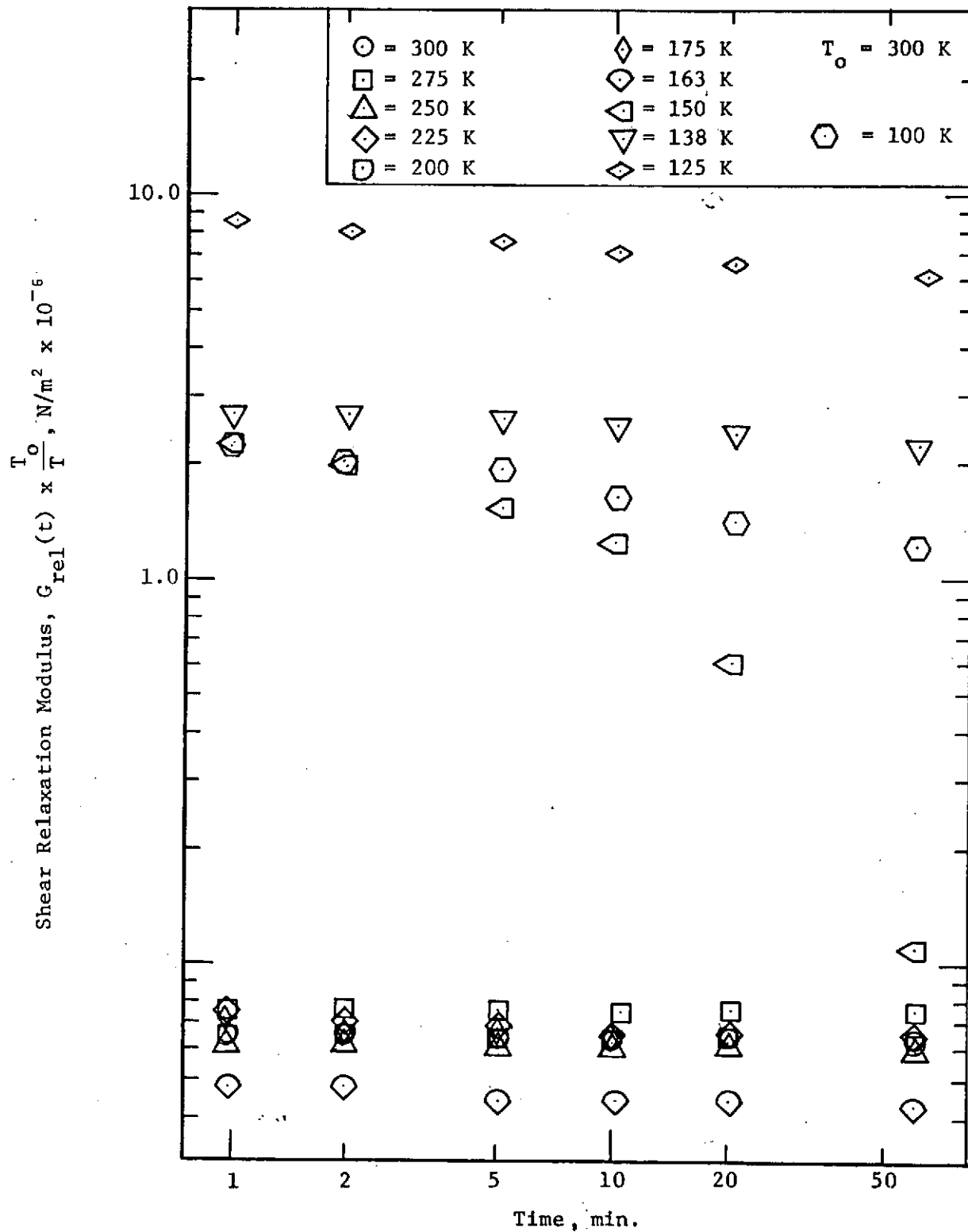

Figure 10. Relaxation moduli measured for the PD-200-16 foam. The imposed strain was 5%.

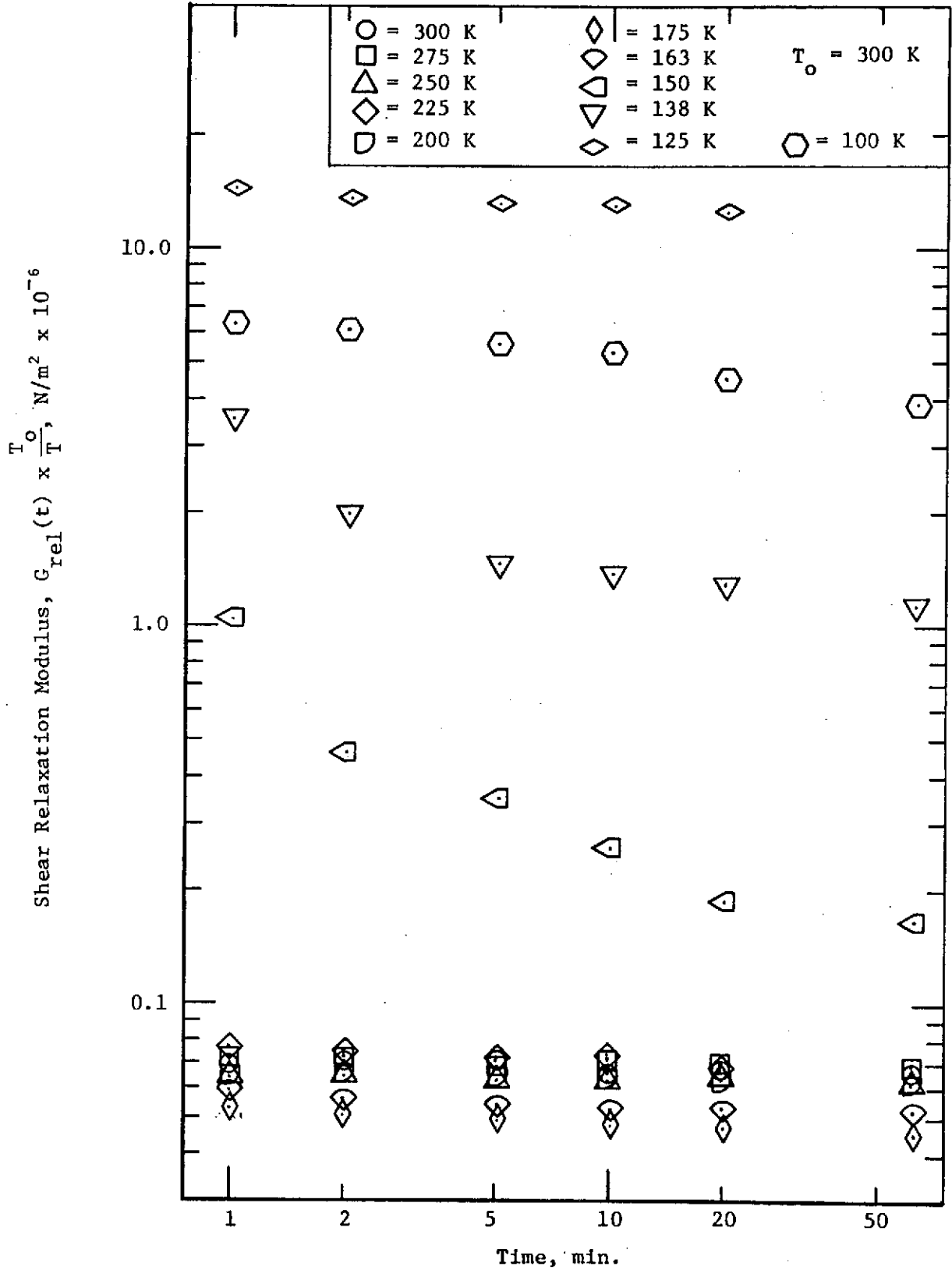

Figure 11. Relaxation moduli measured for the PD-200-16 foam. The imposed strain was 10%.

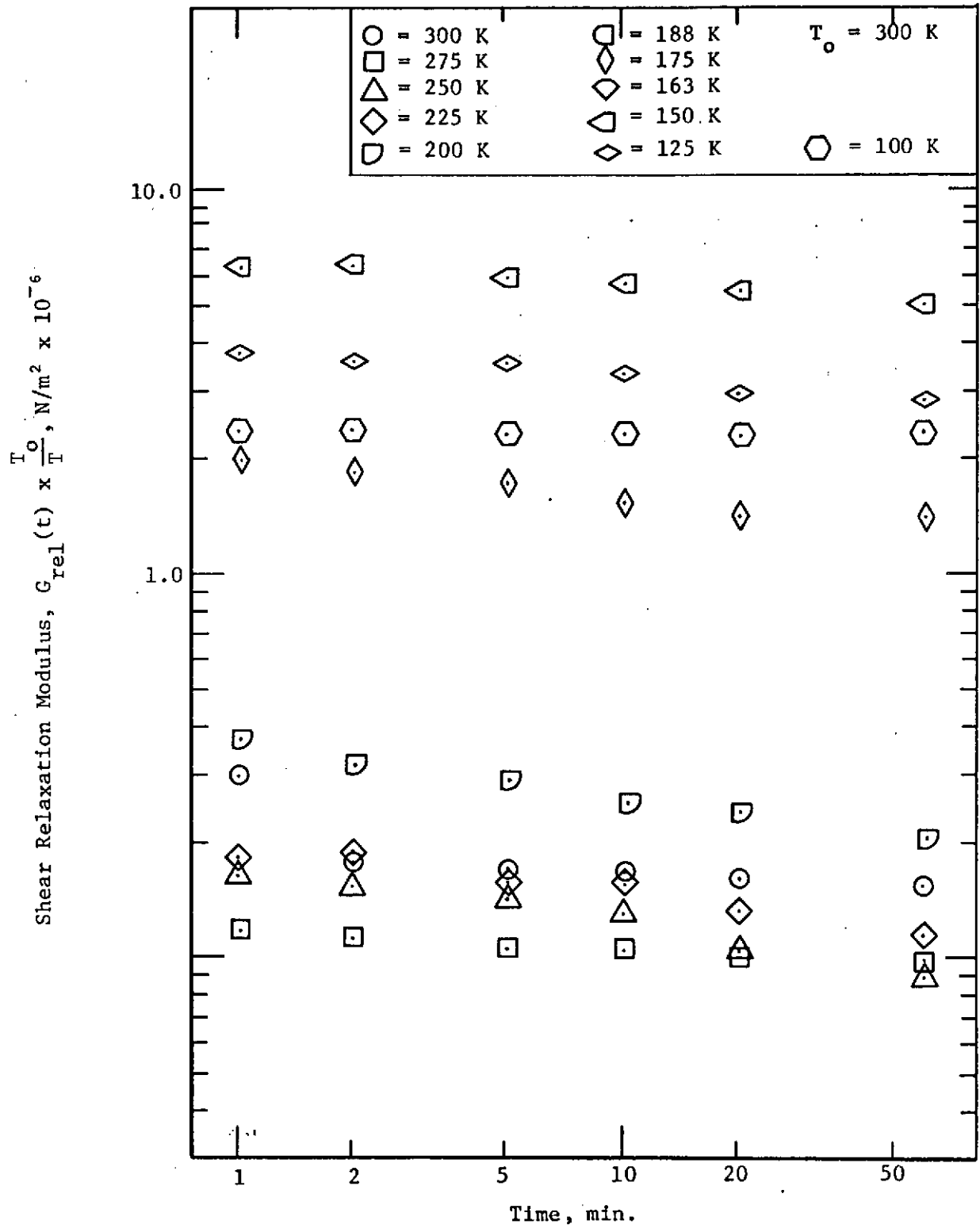

Figure 12. Relaxation Moduli measured for the RL-1973 foam. The imposed strain was 1%.



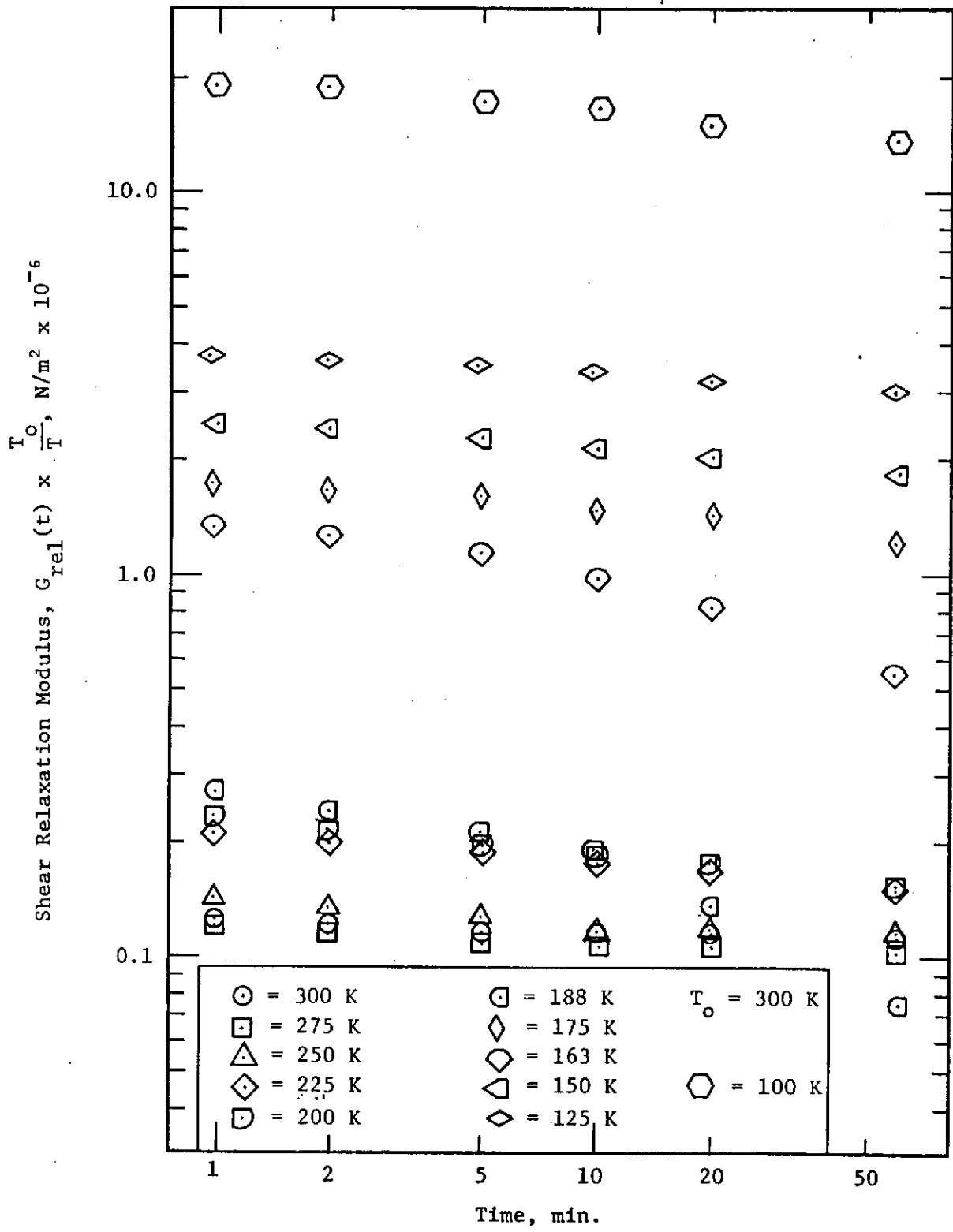

Figure 13. Relaxation moduli measured for the RL-1973 foam. The imposed strain was 3%.

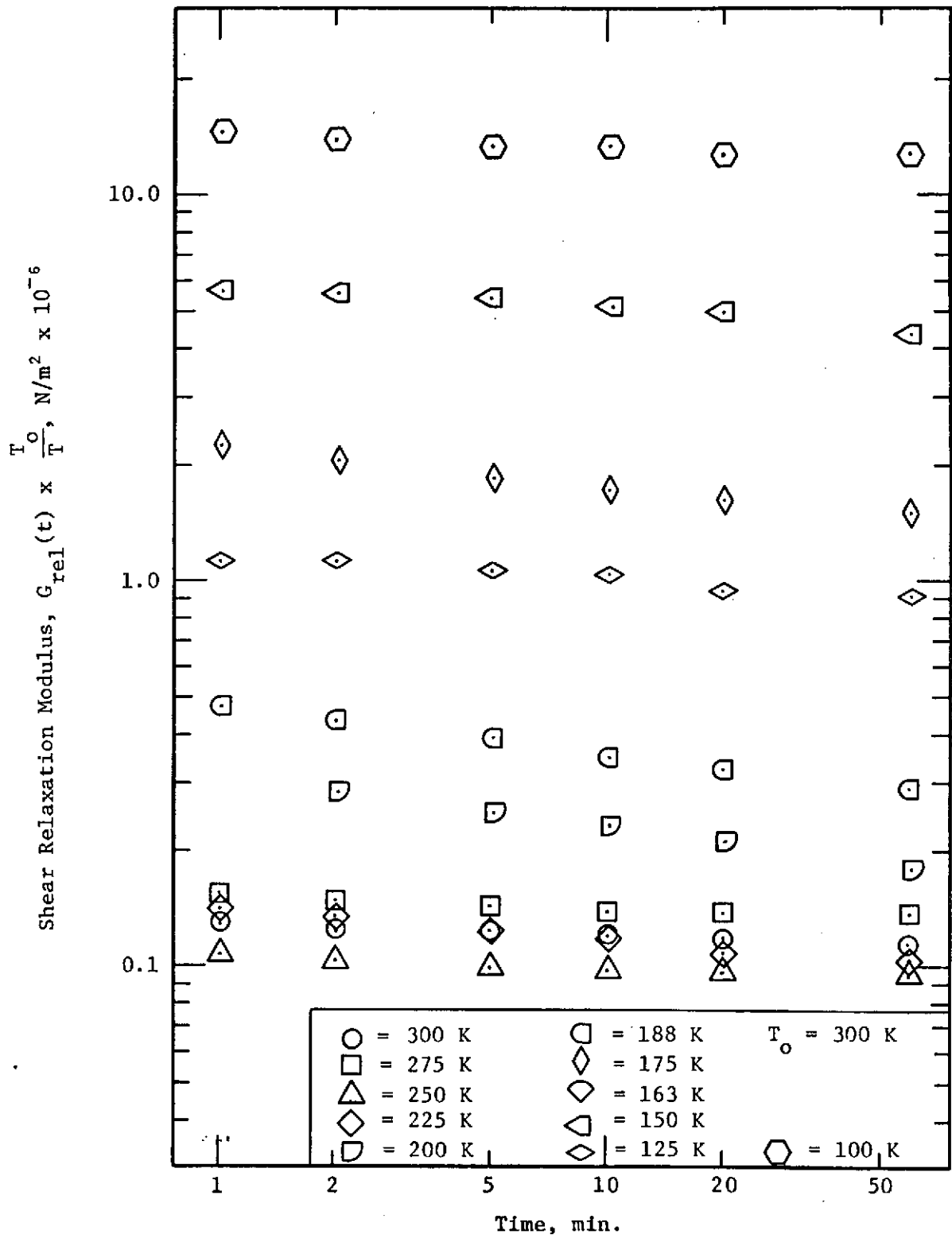

Figure 14. Relaxation moduli measured for the RL-1973 foam. The imposed strain was 5%.

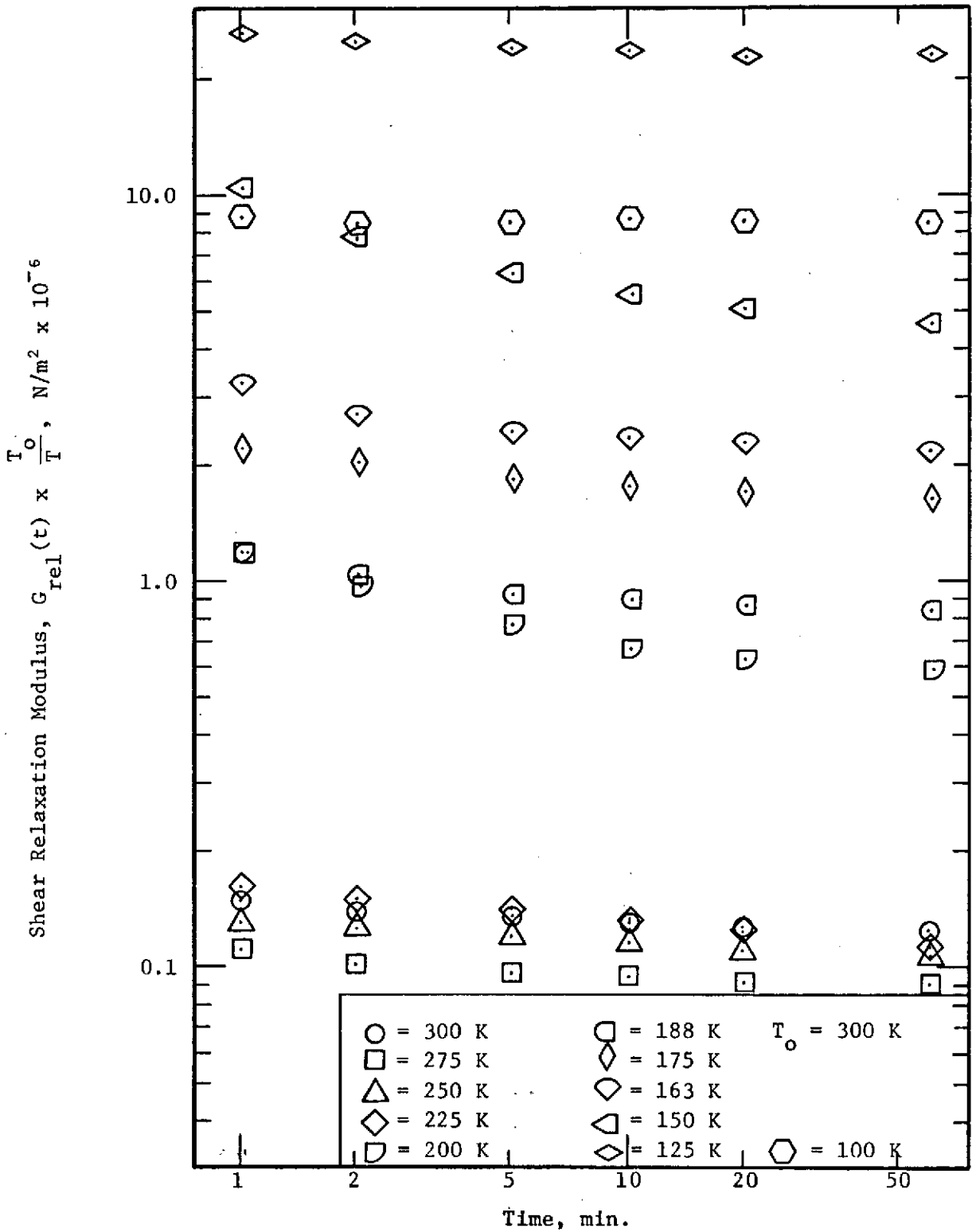

Figure 15. Relaxation moduli measured for the RL-1973 foam. The imposed strain was 10%.

The trends of the shear relaxation moduli with temperature appear to correlate exactly with those indicated by the initial tangent moduli as discussed in Section 3.1 above. Initial tangent and relaxation modulus data for the PD-200-16 exhibit the same decreasing stiffness with decreasing temperature to well below 200 K. Similarly the RL-1973 shows only a slight tendency to stiffen as temperature decreases to about 225 K.

Further, three out of four strain levels give an indication that the PD-200-16 stiffness might be decreasing at the lowest temperature (100 K). However, the great scatter inherent in the data continues to cloud this conclusion. It might be noted that two of the four figures indicate the same phenomena for the RL-1973.

### 3.3 Measurement of Glassy Transition Temperature

To measure the linear coefficients of thermal expansion,  $\alpha$ , and the glassy transition temperature,  $T_g$ , a dilatometer quite similar to that described in ASTM D 696-44 was constructed. (See Figure 16.) The apparatus is very nearly identical to that described in the JANNAF Solid Propellant Mechanical Behavior Manual (ref. 5).

The device consists of a large styrofoam solid with an oversized cavity into which a  $6 \times 10^{-3} \text{ m}^3$  stainless steel beaker is placed. The space surrounding the beaker serves as a liquid nitrogen bath which is used to cool the beaker and its contents. The beaker contains a massive

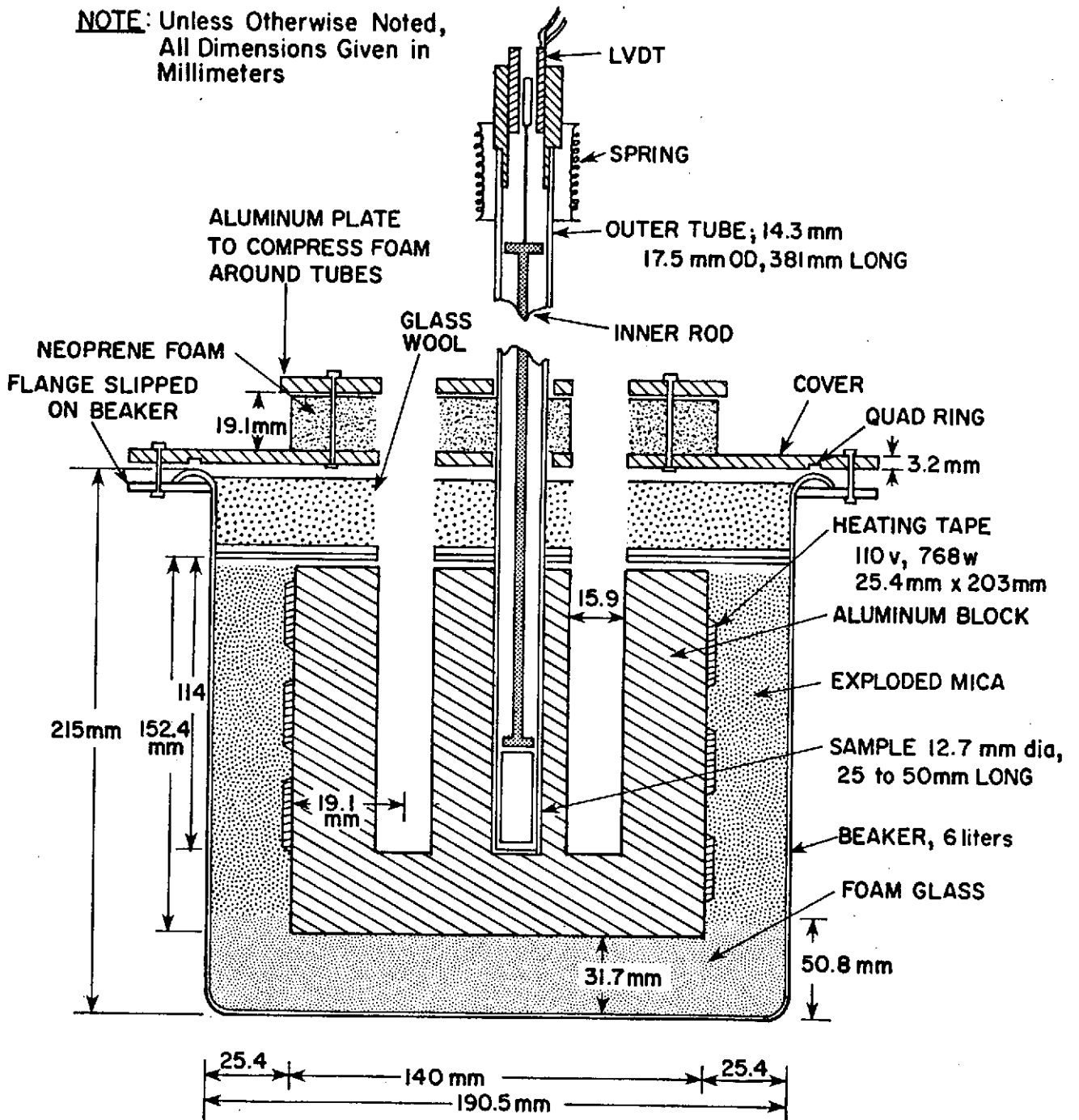

Figure 16. Schematic drawing of dilatometer.

aluminum block heavily insulated from the beaker, thus isolating the block from rapid or erratic temperature fluctuations caused by the nitrogen. To prevent nitrogen vapor from spilling over the top of the beaker and disturbing the even temperature distributions in the core, a cover plate, sealed with a Quad-ring, was used. Three holes were drilled through the lid, through the insulation and well into the aluminum core. Quartz tubes containing the test samples were inserted into these cavities. A Neoprene foam sheet was laid on top of the beaker cover with undersized holes for the quartz tubes to form a seal against the ambient air. A center hole provided the cavity for the thermocouples required to control and monitor the temperature.

Specimens of the material to be tested were machined to 13 mm x 13 mm x 51 mm long and placed in the bottom of the quartz tubes. Then small, light quartz rods with flat bakelite feet were inserted in the tubes over the specimen as indicated in Figure 16. The vertical movement of these rods, reflecting the expansion and contraction of the specimen, were measured with small linear variable differential transformers mounted at the top of the tube.

Once the apparatus was assembled and readied, a test cycle was performed to determine whether or not the cooling and heating rates would be satisfactory ( $<1$  K/min). Further, one of the quartz rods was positioned against the bottom of a quartz tube without a sample in place. The resulting output gave a system error characteristic of the device for which a correction could subsequently be made when reducing data.

A plot of temperatures versus time for this trial run is shown in Figure 17. The device inherently cools at a faster rate than it warms, but in both instances the rates were well below 1 K/min. The lowest temperature recorded during the trial run was 160 K while the test plans were to go as low as 123 K. Therefore, the cooling portion of the cycle was continued for a longer duration to extend the lower excursion.

The conduct of the actual tests were performed with two specimens, one of each material. Two such tests were conducted. The outputs of both the thermocouples and LVDT's were sensed and recorded on paper tape at 900 second intervals.

Figures 18 and 19 indicate the results of the tests for the RL-1973, and Figures 20 and 21 for the PD-200-16 silicone resin sponges. The thermal strains, defined as the change in length divided by the original length, are plotted versus temperature. The data were collected both during the cooling and warming portion of tests so hysteresis accounts for a significant portion of the apparent scatter.

Two straight lines were drawn through the data points for each material and their slopes were calculated to give the linear (as opposed to volumetric) coefficients of thermal expansions. It is evident that the straight lines fit the test data for the PD-200-16 sponge better than for the RL-1973. The intersection of the two lines on each graph indicates the value of the glassy transition temperature. These results are summarized in Table III.

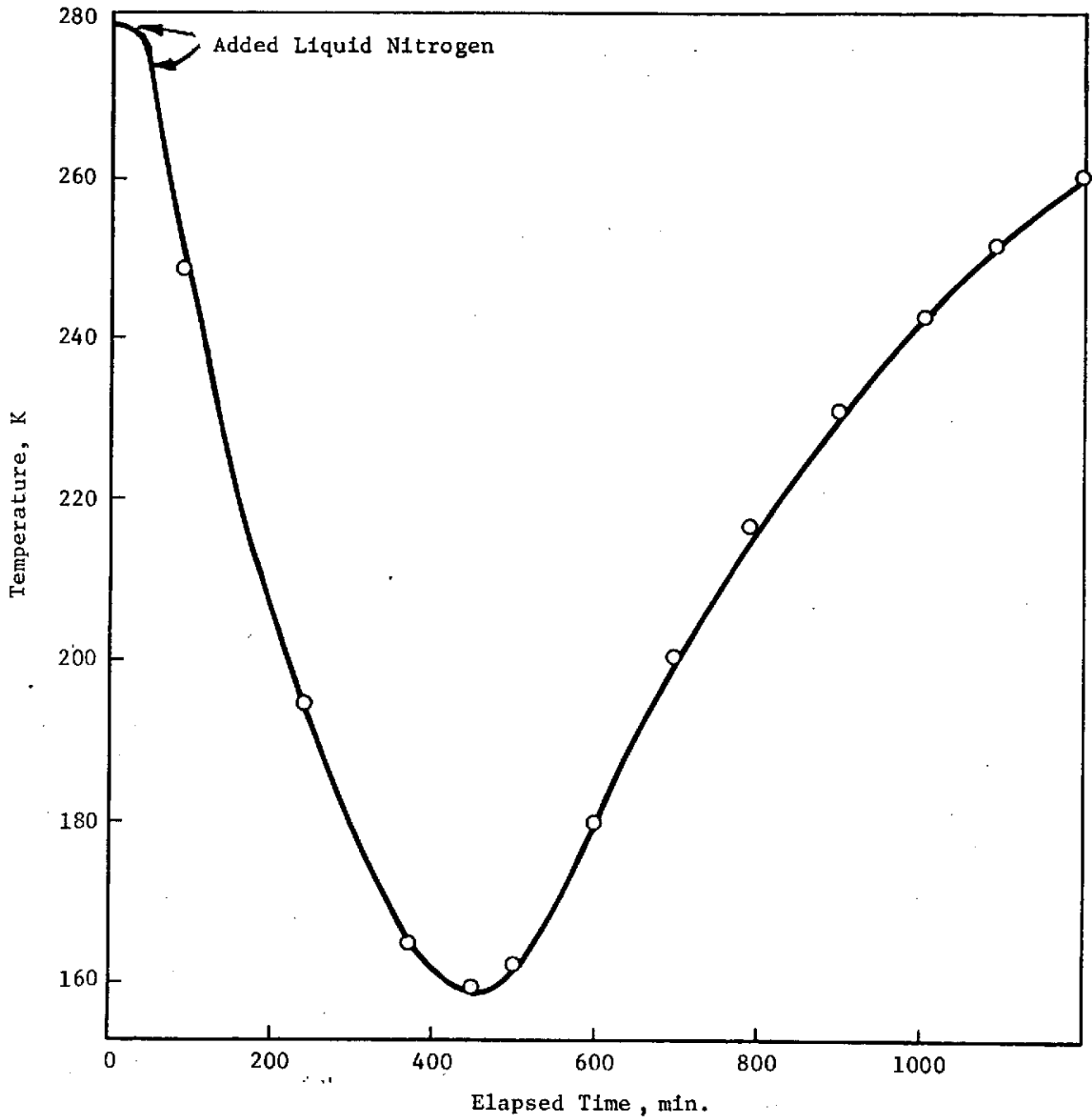

Figure 17. Curve showing the temperature measured in the dilatometer during a trial test cycle.



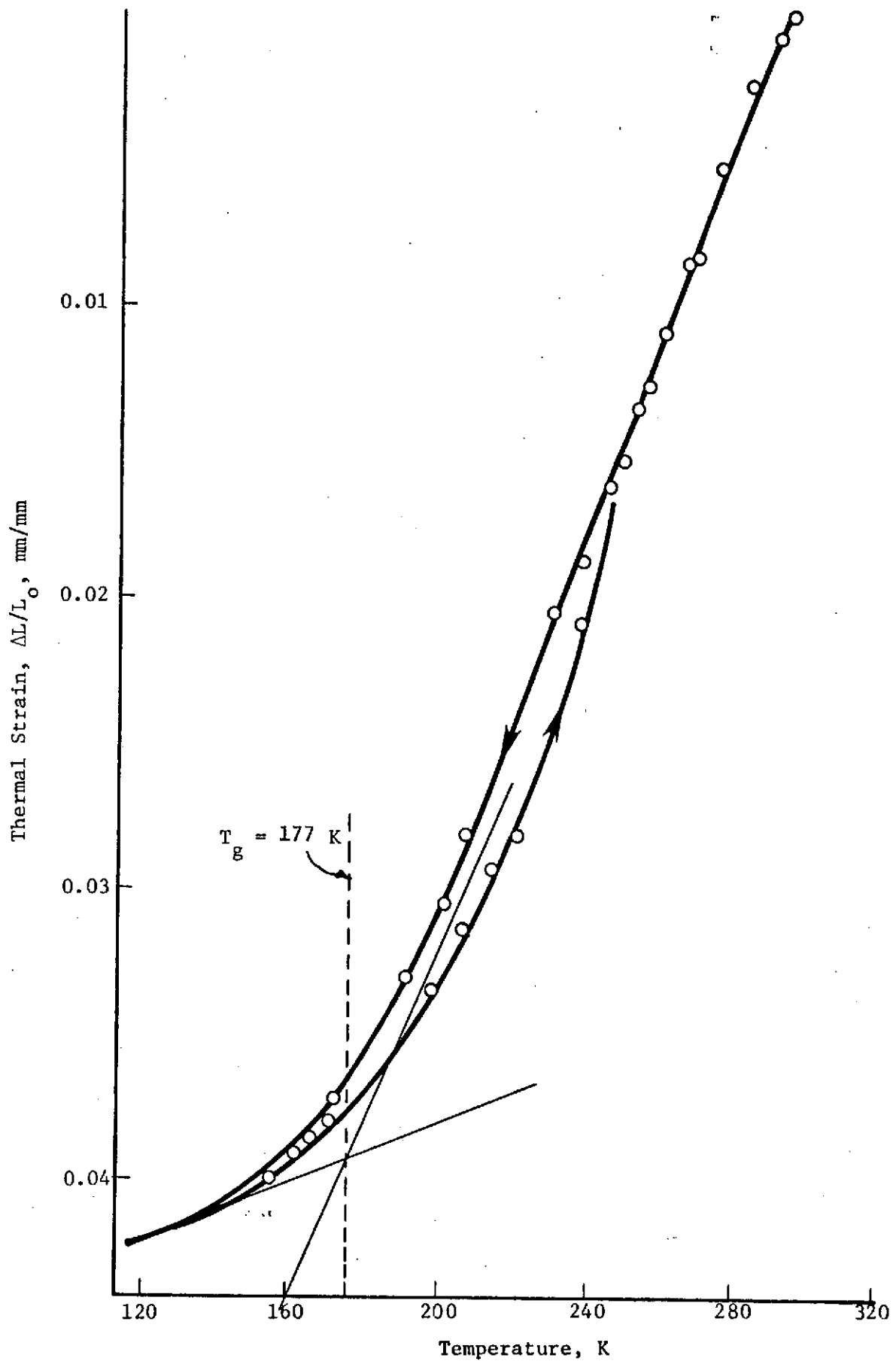

Figure 18. Curve showing the thermal strains as a function of temperature for the RL-1973, Sample 1.

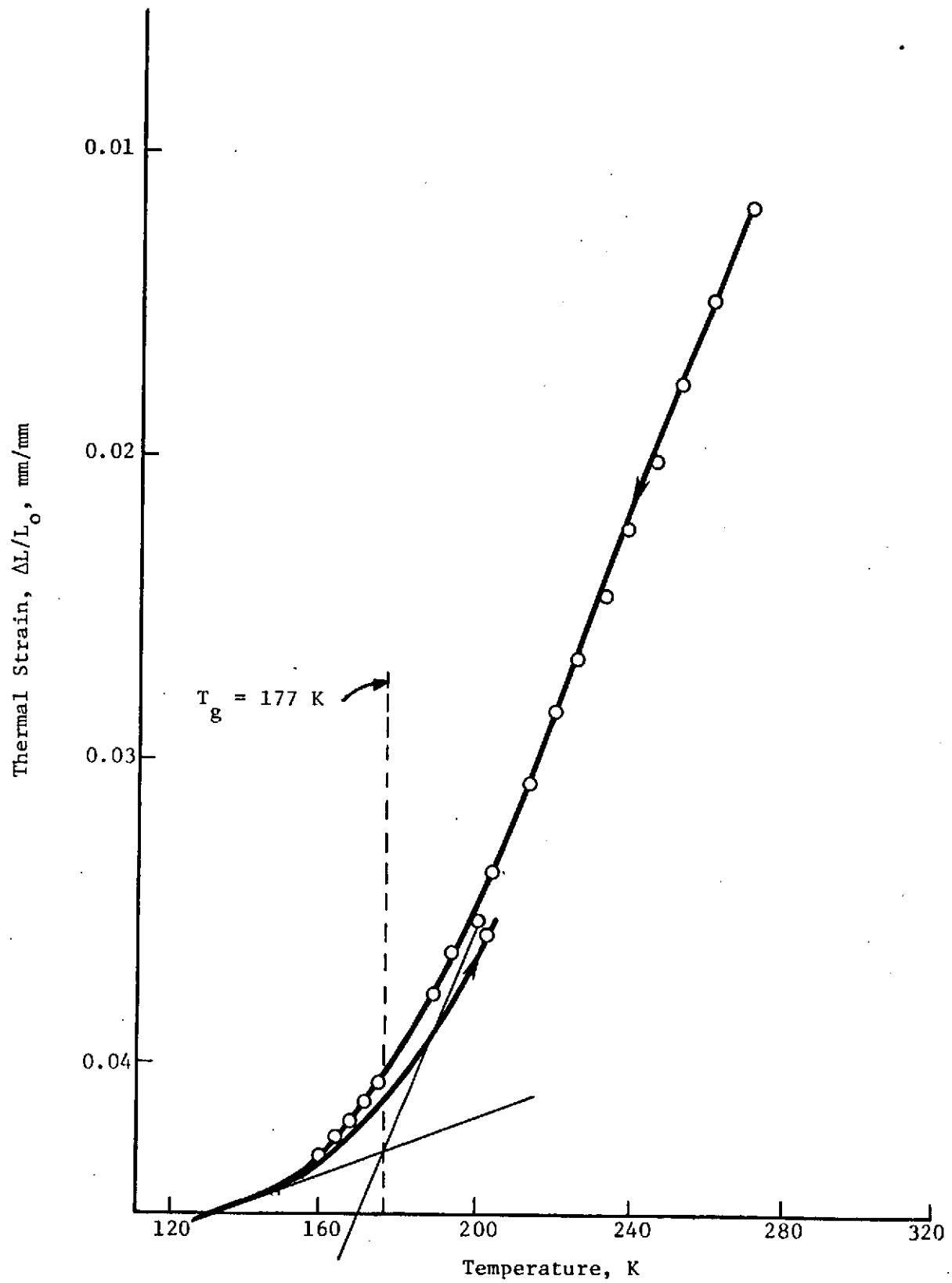

Figure 19. Curve showing the thermal strains as a function of temperature for the RL-1973, Sample 2.

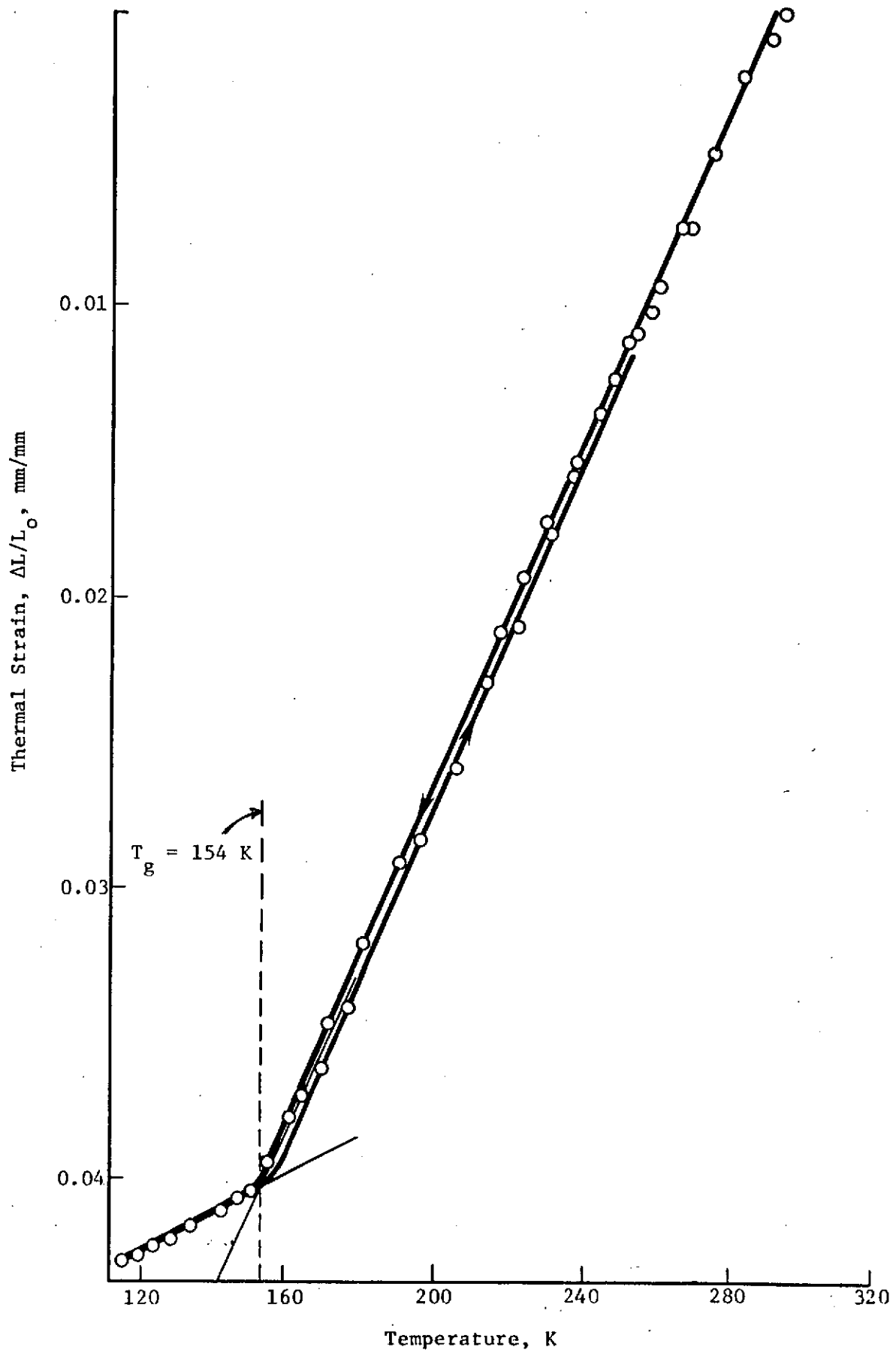

Figure 20. Curve showing the thermal strains as a function of temperature for the PD-200-16, Sample 1.

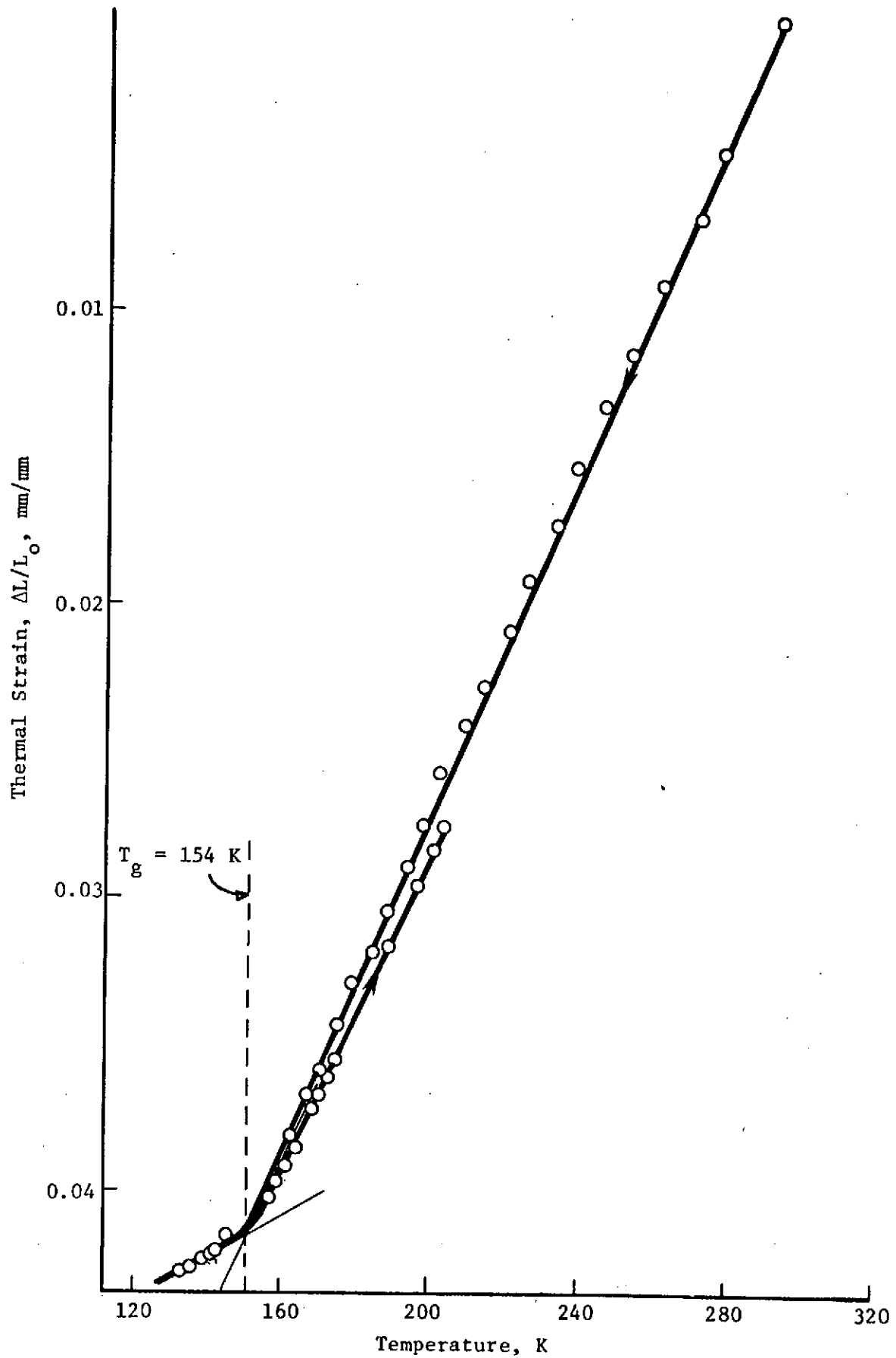

Figure 21. Curve showing the thermal strains as a function of temperature for the PD-200-16, Sample 2.

TABLE III. Measured Thermal Properties of the Silicone Resin Sponge (SRS) Materials

	<u>PD-200-16</u>	<u>RL-1973</u>
Glassy Transition Temperature, $T_g$ (K)	154	174
Average Linear Coefficient of Thermal Expansion above $T_g$ (mm/mm/K)	$28 \times 10^{-5}$	$33 \times 10^{-5}$
Average Linear Coefficient of Thermal Expansion below $T_g$ (mm/mm/K)	$6.1 \times 10^{-5}$	$4.8 \times 10^{-5}$

The experimentally determined glass transition temperatures given above are consistent with those for silicone rubbers as found in the literature (ref. 1). On the other hand, the results reflected in Figures 6 and 7 would indicate a significant amount of stiffening at temperatures well below these glassy temperatures. This characteristic, often observed for silicones, is not consistent with that experienced with other organic polymers which typically exhibit a maximum stiffness at the  $T_g$ . The reasons for this behavior have not yet been established.

One possible explanation for this behavior is that the temperature related property changes may lag, in time, the actual temperature change in the sample. Such delays have been observed by measuring volumetric changes in a material while undergoing temperature excursions. In carefully controlled tests significant volumetric shrinkage will continue well after a steady-state lower temperature has been reached. If such phenomena are also characteristic of stiffnesses and other properties (e.g. Poisson's ratio) then a ready explanation is available for the observations described above.

This hypothesis can be verified by conducting an additional series of selective stress relaxation tests utilizing a number of different

conditioning times at temperatures below  $T_g$ . The time at which the modulus ceases to change with storage time will be the recommended conditioning time.

### 3.4 Failure Data

Following the relaxation tests the specimens were strained to failure at a constant-rate strain of  $0.002 \text{ s}^{-1}$ .

Failure was defined simply as the point of maximum force (See Figure 5). It was noted during the 300 K (room temperature) tests that specimen tearing or other signs of failure were always present prior to reaching maximum load. However, since the majority of the tests were performed with the specimen concealed within a conditioning chamber it was not always possible to observe and record these earlier indications of failure. In order to be consistent the point of failure was taken to be where the load attained its largest value.

Figures 22 and 23 show the maximum stresses and the corresponding strains for the PD-200-16 and RL-1973, respectively. These stresses and strains are plotted in their unreduced form; i.e., without the  $T_0/T$  correction factor.

Note should be taken of the fact that the constant displacement rate tests were interrupted at various strain levels (1, 3, 5 or 10%) to perform the relaxation tests. These strain levels are low compared to subsequent strains at failure. Therefore, it seems reasonable to assume that the failure data was not significantly influenced by the intervening relaxation.

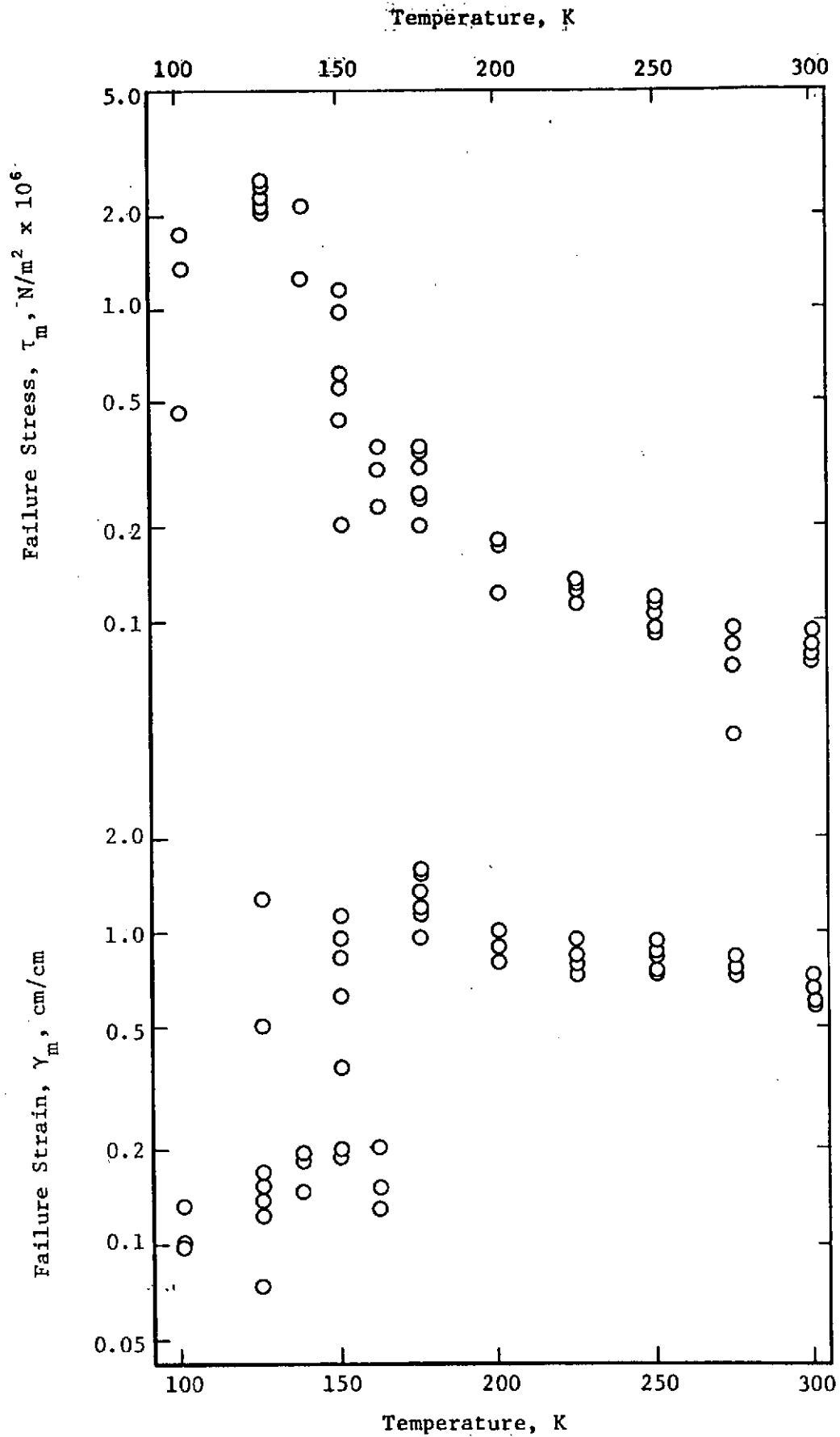

Figure 22. Failure shear stresses and corresponding strains observed for the PD-200-16 at the various test temperatures.

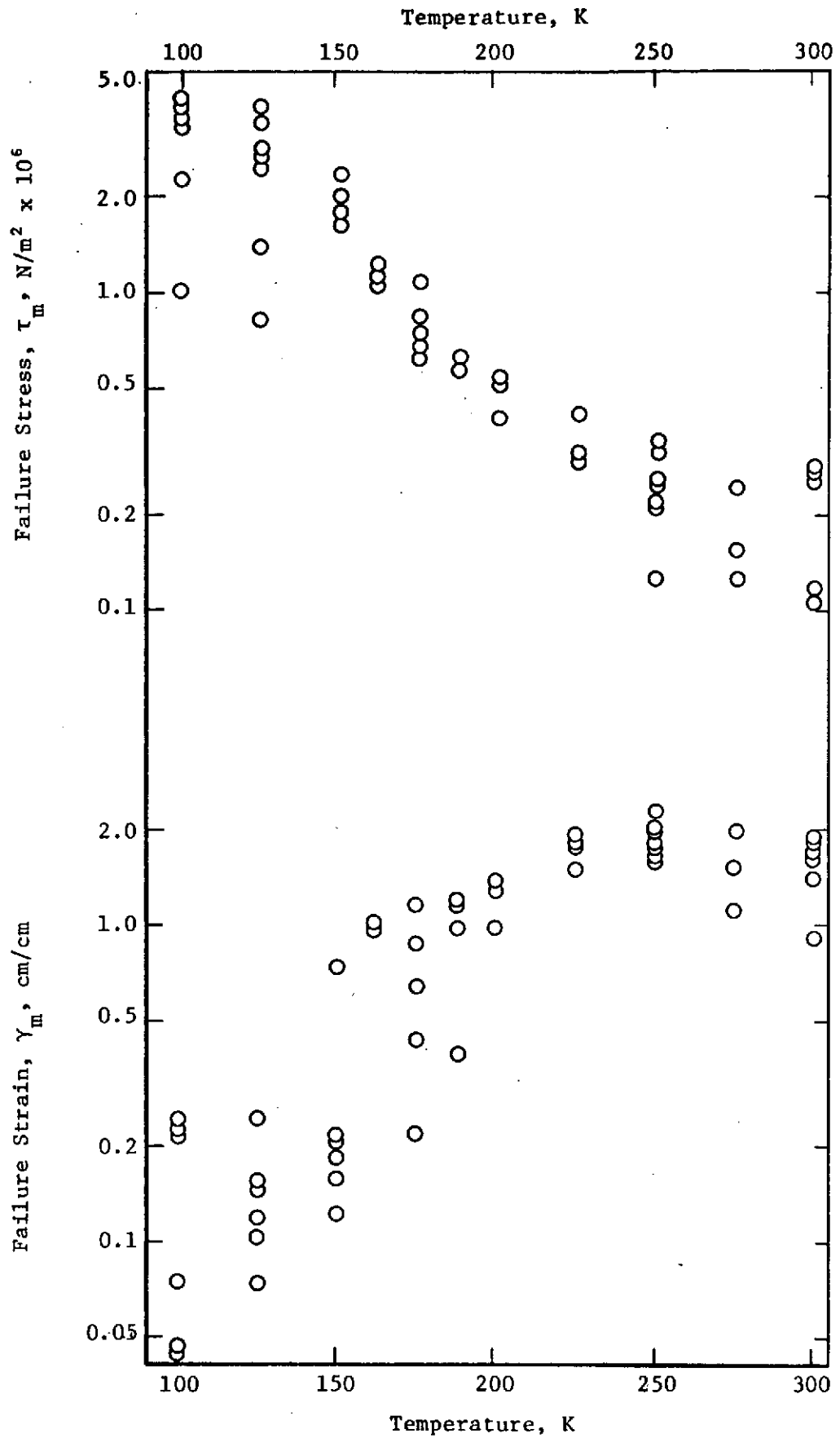

Figure 23. Failure shear stresses and corresponding strains observed for the RL-1973 at the various test temperatures.



Finally, Figures 24 and 25 show the maximum stresses plotted against the maximum strains. Such plots are often used to show failure data obtained from uniaxial tests and are referred to as failure envelopes (ref. 6). Such curves imply that failure is independent of the loading history, often a convenient but also often an invalid assumption.

The stresses used in these plots were adjusted by the factor  $T_0/T$  where  $T_0$  was arbitrarily selected to be 300 K. Therefore, the failure stresses at the lower temperatures were considerably magnified.

Several points are shown plotted with a diagonal arrow pointing upward and to the right. For one reason or another these failures were believed to be invalid and premature. For example, a specimen which failed by debonding the adhesive from the aluminum bar would be so labeled. As a result, such points were considered to give, at best, only a lower limit for the true failure stress and strain.

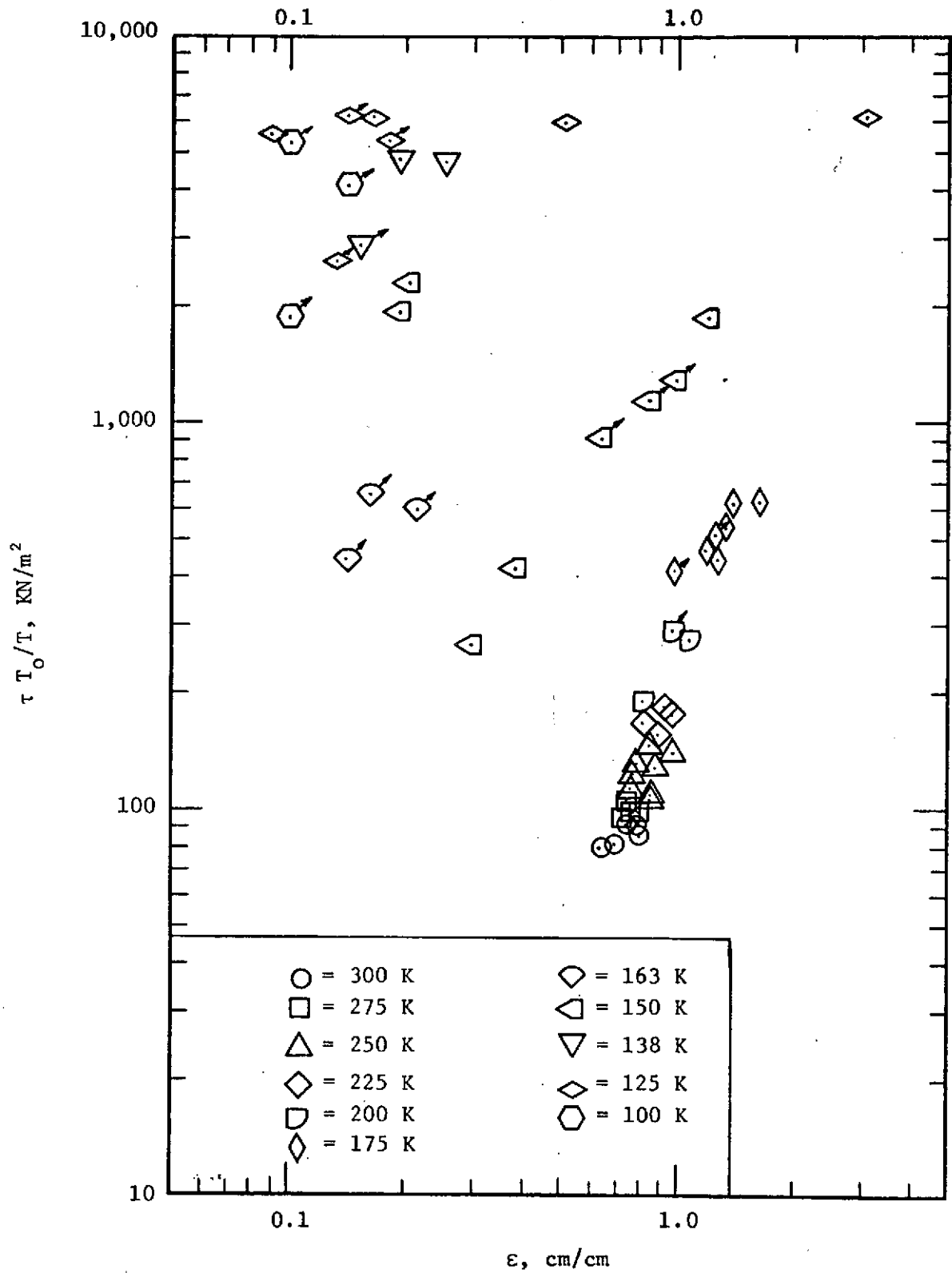

Figure 24. The stresses at maximum load plotted against the corresponding strains for the PD-200-16.

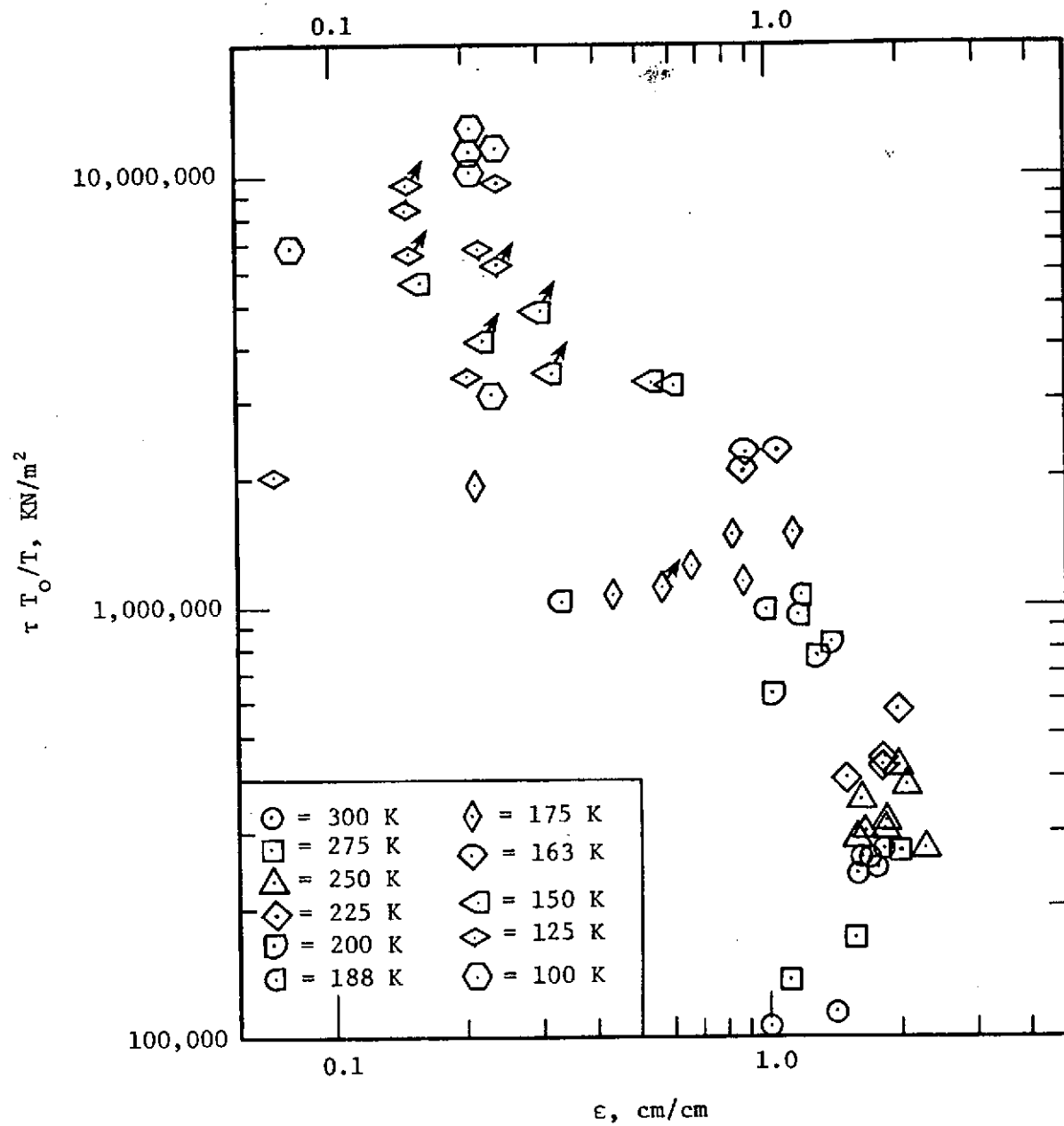

Figure 25. The stresses at maximum load plotted against the corresponding strains for the RL-1973.

## 4.0 CONCLUSIONS AND RECOMMENDATIONS

### 4.1 Conclusions

The stress relaxation response characteristics of PD-200-16 and RL-1973 silicone resin foams were measured over a temperature range of 100 to 300 K and four strain levels (1, 3, 5 and 10%). Initial tangent, secant moduli and failure properties were also determined for each material at these test conditions. The following represent the conclusions reached:

1. The two silicone foams studied, PD-200-16 and RL-1973, were both extremely compliant at room temperature (i.e., respectively less than 100 and 200 N/m<sup>2</sup>) over a range of temperatures from 300 K down to near their respective transition temperatures. Almost inevitably the PD stiffness was 100 N/m<sup>2</sup> or below and the RL was 200 N/m<sup>2</sup> or below over this range.

2. Only a slight amount of stress relaxation was observed in both materials during the 60 minute test periods except at intermediate temperatures. The slope of the log-log relaxation curve never exceeded 0.1 except in this locale.

3. The experimentally determined transition temperatures of 154 K for the PD and 177 K for the RL were consistent with those found in the literature (ref. 1) for similar chemically structured materials. It should be noted that these transitions while reflecting a change in the rate of thermal expansion did not fit the classical definition of glassy transition because the shear modulus at this temperature (and below) was in no sense "glassy" or elastic. However, the transition temperature

did indicate the onset, with cooling, of an extremely rapid increase in the stiffness.

4. The stiffness increased approximately two orders of magnitude over the range of temperatures of the tests.

5. The data were extremely scattered. This scatter can possible be explained by an apparent change of the properties as a function of the duration of the thermal conditioning time. The possibility of this phenomenon, suggested by I. K. Spiker of NASA's Johnson Space Center led to several exploratory side tests which seemed to indicate its validity.

6. No decisive evidence was found relating the measured stiffness values to the test strain levels.

7. Both stress and strain values measured at failure may be unconservative for design purposes because of the inability to observe specimen behavior in the cryostat.

#### 4.2 Recommendations for Future Work

Figures 6 and 7 indicate that both PD-200-16 and RL-1973 experience the greatest degree of viscoelasticity at temperatures below their respective glass transition temperatures. This is contrary to that normally expected in rate dependent materials. If this represents the true characteristic of silicone rubbers such behavior would be unique. If it is not, any modelling of this behavior and consequently any analysis which incorporates this model would be suspect.

One possible reason for this behavior can be attributed to insufficient sample conditioning. If a test were run prematurely the results

produced would tend to be shifted to the shorter times (i.e., to the left) as shown in Figures 6 and 7. As the test temperature assumes lower values the conditioning times required to reach thermal equilibrium increases. It is therefore recommended that a more in-depth study of the transition zones of the two materials be undertaken, with initial consideration being devoted toward establishing the necessary pre-test conditioning time to achieve thermal equilibrium in the samples.

This can be accomplished by extending the one hour conditioning time used throughout this program and rerunning selective relaxation tests. In addition to temperature, volumetric contraction during conditioning should also be monitored. The time required for the thermal contractions to cease will establish the desired conditioning time. Stress relaxation tests at this conditioning time should verify or refute the existence of the high degree of viscoelasticity in the two materials below their  $T_g$ . These results would also be extremely beneficial to future characterizations of polymers for use at cryogenic temperatures.

## REFERENCES

1. Owen, H. T.; and Carroll, M. T.: Development of Design Allowable Data for Adhesives for Attaching Reusable Surface Insulation, Final Technical Report for Contract No. NAS9-12392, General Dynamics, Convair Aerospace Division, October 1972.
2. Telephone conversation with Dr. A. Hiltz of General Electric, Valley Forge Space Center, Box 8555, Philadelphia, Pa. 19101 and Mr. J. Owens of Raybestos-Manhattan, Garco and Oher Ave., North Charleston, S. C. 29406.
3. General Electric RTV Silicone Rubber, Technical Data Book S-35 Silicone Products Department, Waterford, N. Y.
4. A. V. Tobolsky; and R. D. Andrews: J. Chem. Phys., Vol. 11, p. 123 (1943).
5. ICRPG Solid Propellant Mechanical Behavior Manual, The Johns Hopkins University Applied Physics Laboratory, Silver Spring, Maryland, Chemical Propulsion Information Agency Publication No. 21, September 1963.
6. Smith, T. L.: Proceedings of the Royal Society, A, Vol. 282, p. 102 (1964).

STRESS RELAXATION AND MECHANICAL PROPERTIES  
OF  
RL-1973 AND PD-200-16  
SILICONE RESIN SPONGE MATERIALS

by

D. Saylak  
J. S. Noel  
J. S. Ham  
R. McCoy

APPENDIX A

COMPUTER PROGRAM FORMAT

Mechanics and Materials Research Center  
Texas A&M University  
College Station, Texas 77843

Final Technical Report

on

Contract No. NAS1-13342

1 March 1975

National Aeronautics and Space Administration

Langley Research Center

Hampton, Virginia 23665

*Best available copy*

1 A



## APPENDIX A

This appendix contains a listing of the FORTRAN Code used to reduce the test data to the format shown in Appendix B.

LISTING OF PROGRAM USED TO REDUCE DATA

```

IMPLICIT REAL * 8 (A-H,  $\phi$ -Z)
DIMENSION STRESS(100), STRAIN(100), ET(100), ES(100)
100 CCONTINUE
C READ IN DATA
STRAN $\phi$  = 0.0
STRES $\phi$  = 0.0
READ(5,10) SAM1, SAM2, SAM3, SAM4, SAM5, SAM6, SAM7
10 F $\phi$ RMAT(7A8)
READ(5,20) P $\phi$ INTS,ST $\phi$ P
20 F $\phi$ RMAT(2F10.5)
N = P $\phi$ INTS
D $\phi$  30 I = 1,N
30 READ(5,40) STRESS(I), STRAIN(I)
40 F $\phi$ RMAT (2F10.5)
C CALIBRATE DATA
D $\phi$  50 I = 1,N
STRESS(I) = STRESS(I) * 6895.
STRAIN(I) = STRAIN(I) * 100.
IF(STRAIN(I).EQ.0.0) G $\phi$  T $\phi$  110
ADD = STRESS(5) - STRESS(6)
IF(I.GT.5) STRESS(I) = STRESS(I) + ADD
ES(I) = STRESS(I) / STRAIN(I) * 100.
ET(I) =(STRESS(I) - STRES $\phi$ ) / (STRAIN(I) - STRAN $\phi$ ) * 100.
110 CCONTINUE
STRES $\phi$  = STRESS(I)
STRAN $\phi$  = STRAIN(I)
IF(I.GT.5) STRESS(I) = STRESS(I) - ADD
50 CCONTINUE
C WRITE  $\phi$ UT DATA
WRITE(6,60) SAM1, SAM2, SAM3, SAM4, SAM5, SAM6, SAM7
60 F $\phi$ RMAT('1', ////, 10X, 7A8)
WRITE(6, 70)
70 F $\phi$ RMAT(///, 13X, ' STRESS ',12X ' STRAIN ',14X, ' GT M $\phi$ DULUS ',
*10X,'GS M $\phi$ DULUS')
D $\phi$  80 I = 1,N
80 WRITE(6,90) STRESS(I), STRAIN(I), ET(I), ES(I)
90 F $\phi$ RMAT( 10X, F10.1, 10X, F10.4, 10X, F12.0, 10X, F12.0)
C DRAW THE STRESS-STRAIN CURVE
CALL CURVE(STRESS, STRAIN, SAM1, SAM2, SAM3, SAM4, SAM5, SAM6, SAM
*7, N)
IF(ST $\phi$ P.EQ.0.) G $\phi$  T $\phi$  100
CALL LINE4
WRITE(6,120)
120 F $\phi$ RMAT('1')
ST $\phi$ P
END

```

(CONTINUED)

```

SUBROUTINE CURVE(STRESS, STRAIN, SAM1, SAM2, SAM3, SAM4, SAM5, SAM
*6, SAM7, N)
REAL*8 STRESS(100), STRAIN(100), SAM1, SAM2, SAM3, SAM4, SAM5,
C SAM6, SAM7
DIMENSION STRES(100), STRAN(100)
S1 = 500000.
S2 = 1000000.
S3 = 2000000.
S4 = 4000000.
E1 = 50.
E2 = 200.
S1DX=S1/10.
S2DX = S2/10.
S3DX=S3/10.
S4DX=S4/10.
E1DX=E1/10.
E2DX=E2/10.
DØ 10 I = 1,N
STRES(I) = STRESS(I)
10 STRAN(I) = STRAIN(I)
IF(STRESS(N).LE.S1) CALL AXIS1(0.0,0.0,' STRESS (N/MS)',
C 14, 10., 90., 0.0, S1DX, 20.)
IF(STRESS(N).LE.S1) GØ TØ 20
IF(STRESS(N).LE.S2) CALL AXIS1(0.0, 0.0, ' STRESS (N/MS)',
C14, 10., 90., 0.0, S2DX, 20.)
IF(STRESS(N).LE.S2) GØ TØ 20
IF(STRESS(N).LE.S3) CALL AXIS1(0.0, 0.0, ' STRESS (N/MS)',
C 14, 10., 90., 0.0, S3DX, 20.)
IF(STRESS(N).LE.S3) GØ TØ 20
CALL AXIS1(0.0, 0.0, ' STRESS (N/MS)',
20 C 14, 10., 90., 0.0, S4DX, 20.)
CONTINUE
IF(STRAIN(N).LE.E1) CALL AXIS1(0.0,0.0, 'STRAIN (PERCENT)',-16,
C10., 0.0, 0.0, E1DX, 20.)
IF (STRAIN(N).LE.E1) GØ TØ 40
CALL AXIS1( 0.0, 0.0, 'STRAIN (PERCENT)',-16, 10., 0.0, 0.0,E2DX,
40 C20.)
CONTINUE
IF(STRESS(N).GT.S1) GØ TØ 30
IF(STRAIN(N).GT.E1) GØ TØ 35
CALL LINE1(E1, 0.0, S1, 0.0,E1DX,S1DX)
GØ TØ 75
35 CALL LINE1(E2, 0.0, S1, 0.0,E2DX,S1DX)
GØ TØ 75
30 IF(STRESS(N).GT.S2) GØ TØ 50
IF(STRAIN(N).GT.E1) GØ TØ 55
CALL LINE1(E1, 0.0, S2, 0.0, E1DX,S2DX)
GØ TØ 75
55 CALL LINE1(E2, 0.0, S2, 0.0, E2DX,S2DX)
GØ TØ 75
50 IF (STRESS(N).GT.S3) GØ TØ 60
IF(STRAIN(N).GT.E1) GØ TØ 65
CALL LINE1(E1, 0.0, S3, 0.0, E1DX,S3DX)
GØ TØ 75

```

(CONTINUED)

```
65 CALL LINE1(E2, 0.0, S3, 0.0, E2DX,S3DX)
   GØ TØ 75
60 IF(STRAIN(N).GT.E1) GØ TØ 70
   CALL LINE1(E1, 0.0, S4, 0.0, E1DX,S4DX)
   GØ TØ 75
70 CALL LINE1(E2, 0.0, S4, 0.0, E2DX,S4DX)
75 CØNTINUE
   CALL SYMBØL(1., 10.,.2, SAM1, 0.0, 8)
   CALL SYMBØL(2.4,10.,.2, SAM2, 0.0, 8)
   CALL SYMBØL(3.7,10.,.2, SAM3, 0.0, 8)
   CALL SYMBØL(4.95, 10., .2, SAM4, 0.0, 8)
   CALL SYMBØL(6.35, 10., .2, SAM5, 0.0, 8)
   CALL SYMBØL(7.75,10.,.2,SAM6,0.0,8)
   CALL SYMBØL(9.15,10.,.2,SAM7,0.0,8)
   CALL LINE2(STRAN, STRES, N, 2,1,1)
   CALL LINE3(15.)
   RETURN
   END
```

(END)

STRESS RELAXATION AND MECHANICAL PROPERTIES  
OF  
RL-1973 AND PD-200-16  
SILICONE RESIN SPONGE MATERIALS

by

D. Saylak  
J. S. Noel  
J. S. Ham  
R. McCoy

APPENDIX B

COMPUTER PRINTOUT

Mechanics and Materials Research Center  
Texas A&M University  
College Station, Texas 77843

Final Technical Report

on

Contract No. NAS1-13342

1 March 1975

National Aeronautics and Space Administration  
Langley Research Center  
Hampton, Virginia 23665

PD-33 100K 1% OCT. 16

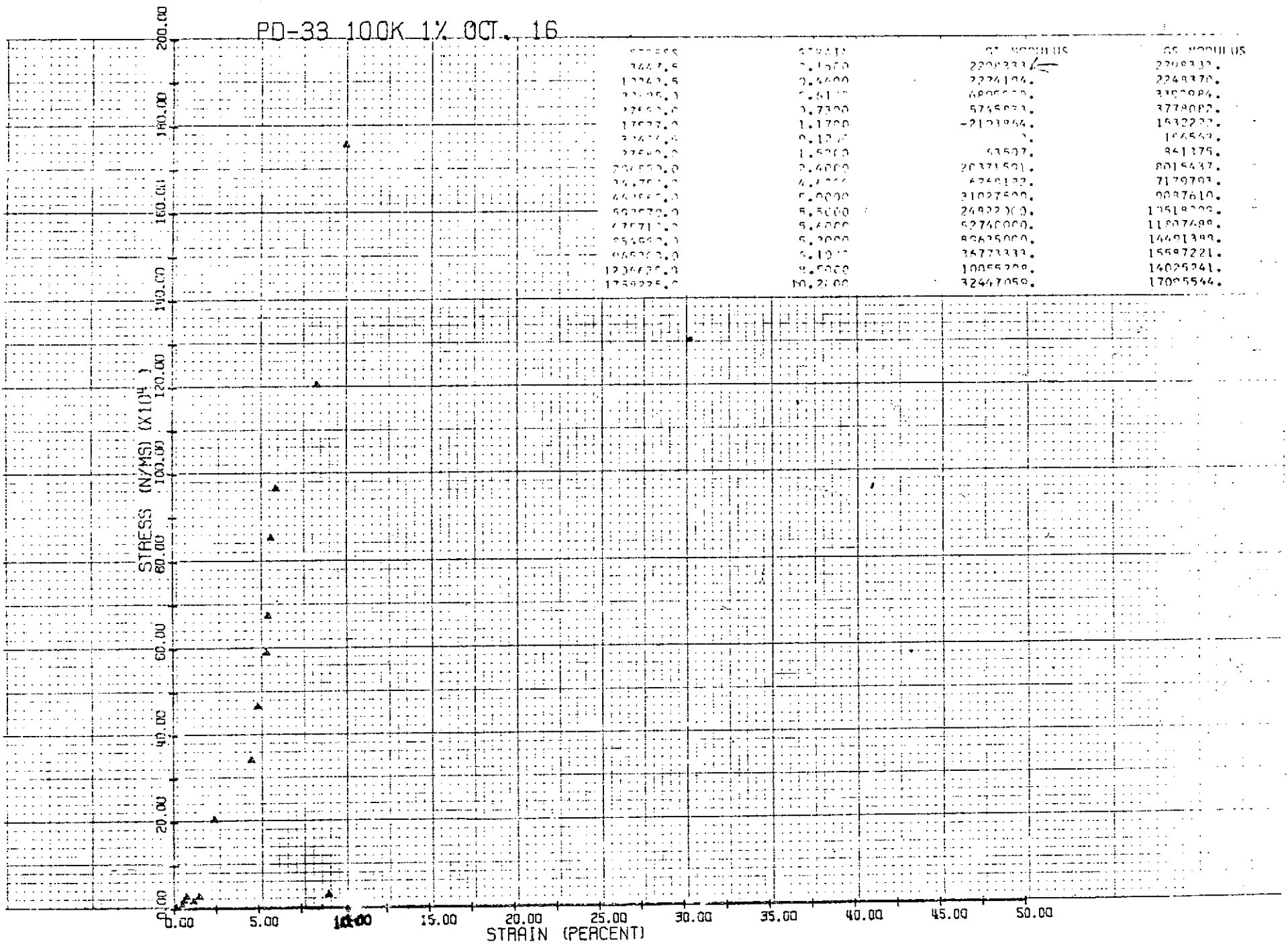

STRESS (N/MS)	STRAIN (PERCENT)	STRESS (N/MS)	STRAIN (PERCENT)
3247.5	1.1500	220733.6	22.0000
10761.5	2.4600	227419.6	22.4000
22105.0	5.6100	489500.0	30.0000
32650.0	7.7300	574500.0	37.8000
17000.0	1.1700	-210196.4	16.2200
3247.5	0.1200		1.6500
32650.0	1.5200	51500.0	3.1700
200000.0	2.4000	2037150.0	20.3700
3247.5	4.2000	4740100.0	47.4000
44000.0	5.0000	31027500.0	31.0275
59000.0	5.5000	24922000.0	24.9220
47571.0	5.4000	52740000.0	52.7400
85100.0	5.9000	89635000.0	89.6350
84500.0	5.1000	36773333.0	36.7733
123660.0	8.0000	10055200.0	10.0552
175925.0	10.2000	32447050.0	32.4471

7A

PD-35 100K 5% OCT. 15

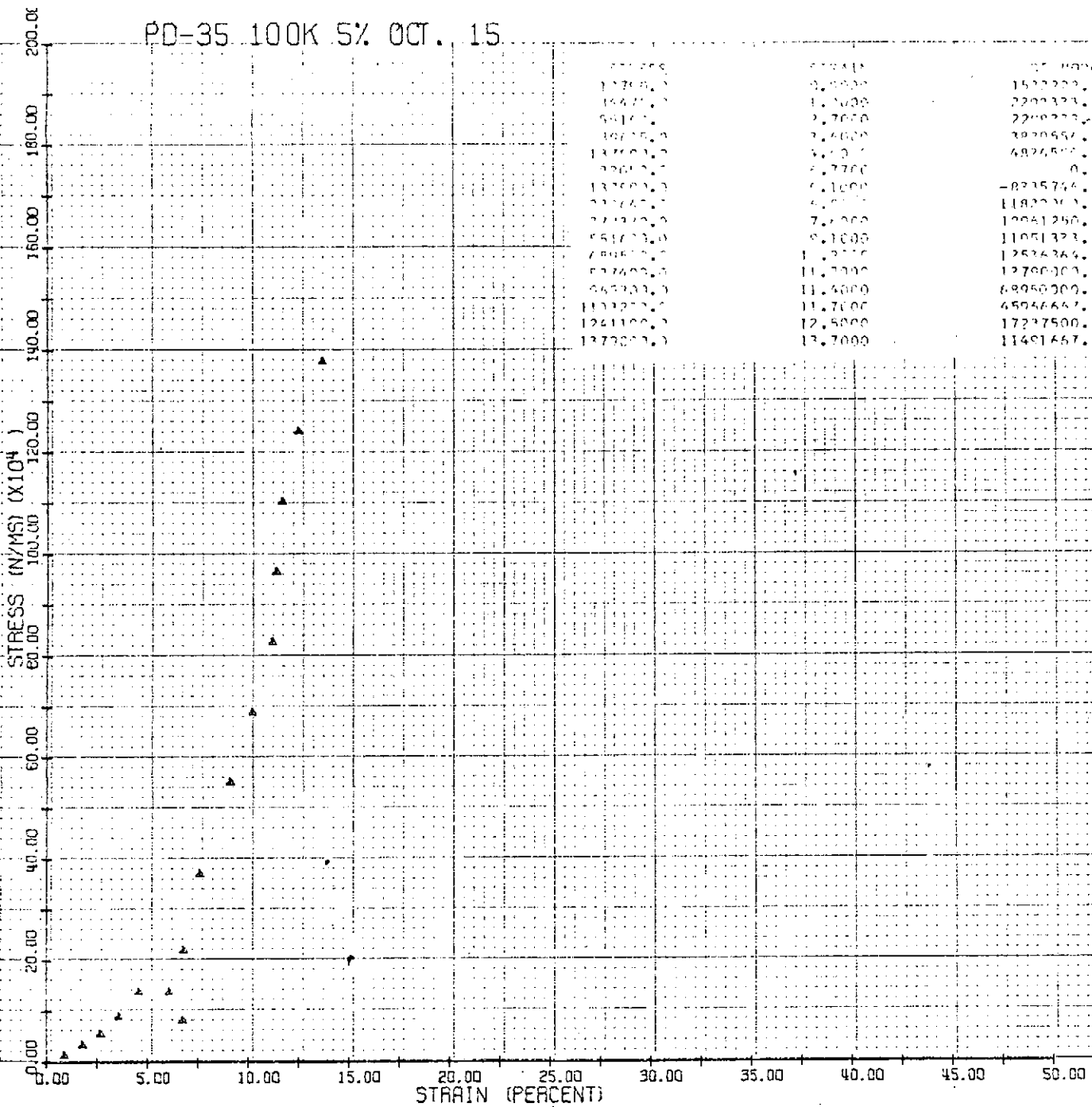

STRESS	STRAIN	STRESS	STRAIN
137000.0	13.7000	153222.0	15.3222
134700.0	13.4700	149527.0	14.9527
131600.0	13.1600	146000.0	14.6000
127700.0	12.7700	142645.0	14.2645
123000.0	12.3000	139455.0	13.9455
117500.0	11.7500	136425.0	13.6425
111200.0	11.1200	133550.0	13.3550
104100.0	10.4100	130825.0	13.0825
97200.0	9.7200	128250.0	12.8250
90500.0	9.0500	125825.0	12.5825
84000.0	8.4000	123450.0	12.3450
77700.0	7.7700	121125.0	12.1125
71600.0	7.1600	118850.0	11.8850
65700.0	6.5700	116625.0	11.6625
60000.0	6.0000	114450.0	11.4450
54500.0	5.4500	112325.0	11.2325
49200.0	4.9200	110250.0	11.0250
44100.0	4.4100	108225.0	10.8225
39200.0	3.9200	106250.0	10.6250
34500.0	3.4500	104325.0	10.4325
30000.0	3.0000	102450.0	10.2450
25700.0	2.5700	100625.0	10.0625
21600.0	2.1600	98850.0	9.8850
17700.0	1.7700	97125.0	9.7125
14000.0	1.4000	95450.0	9.5450
10500.0	1.0500	93825.0	9.3825
7200.0	0.7200	92250.0	9.2250
4100.0	0.4100	90725.0	9.0725
1200.0	0.1200	89250.0	8.9250

84

PD-66 100K 10% JAN. 2

H 6

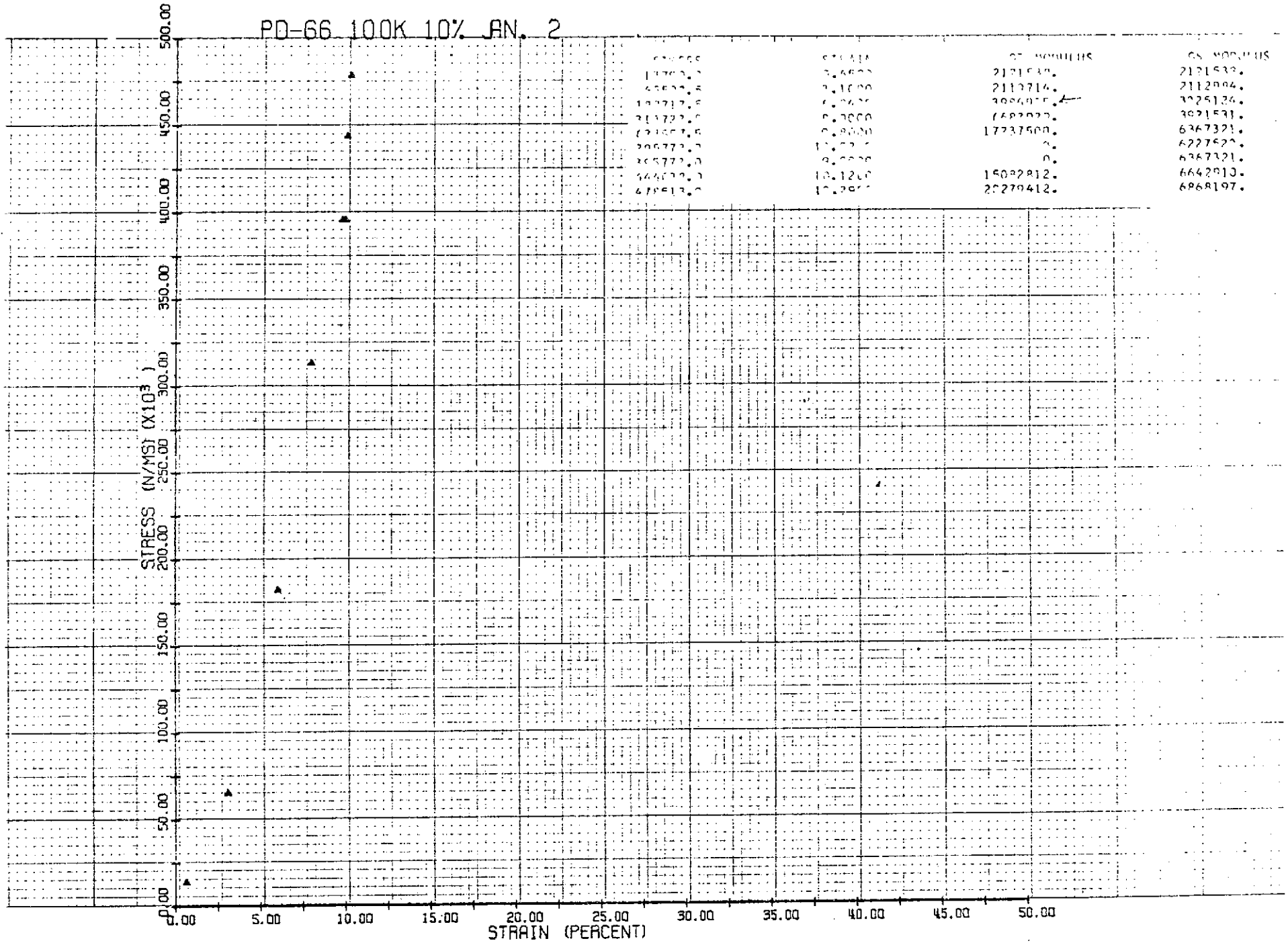



PO-34 125K 1% OCT 23

STRESS	STRAIN	GT. MODULUS	CS. MODULUS
57675.0	1.0100	1911485.	1911485.
113375.0	1.0500	1613723.	1767640.
170075.0	5.2500	8367676.	5010000.
226775.0	6.1500	34475000.	10000244.
283475.0	7.4500	20695000.	12167647.
340175.0	8.1500		10172951.
396875.0	10.0500	34475000.	12348256.
453575.0	12.4500	51712500.	14666901.
510275.0	12.1500	20695000.	15222222.
566975.0	13.6500	13700000.	15153866.
623675.0	14.4000	27590000.	15801042.

10

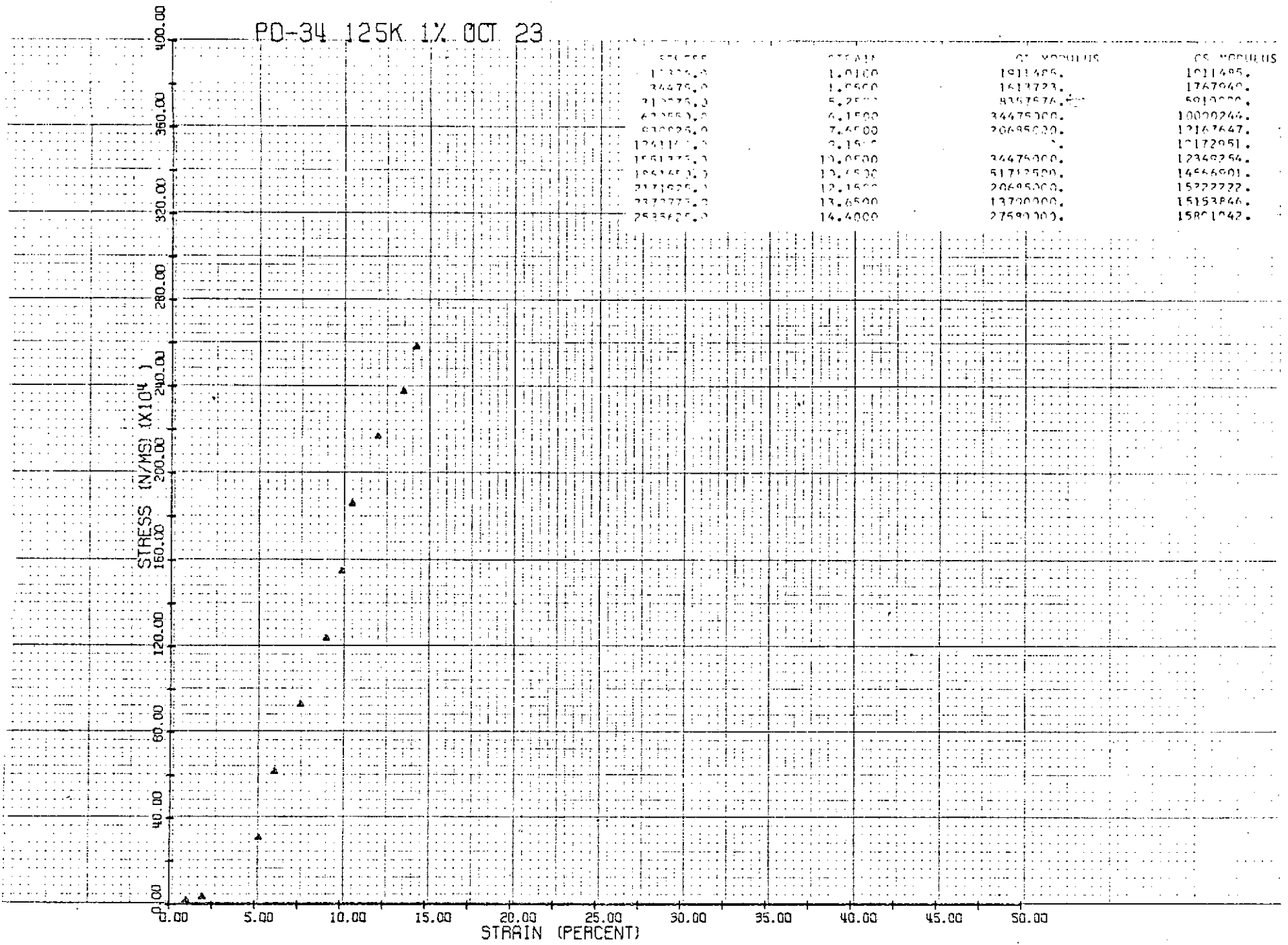

PC-51 125K 1% NOV. 22

111

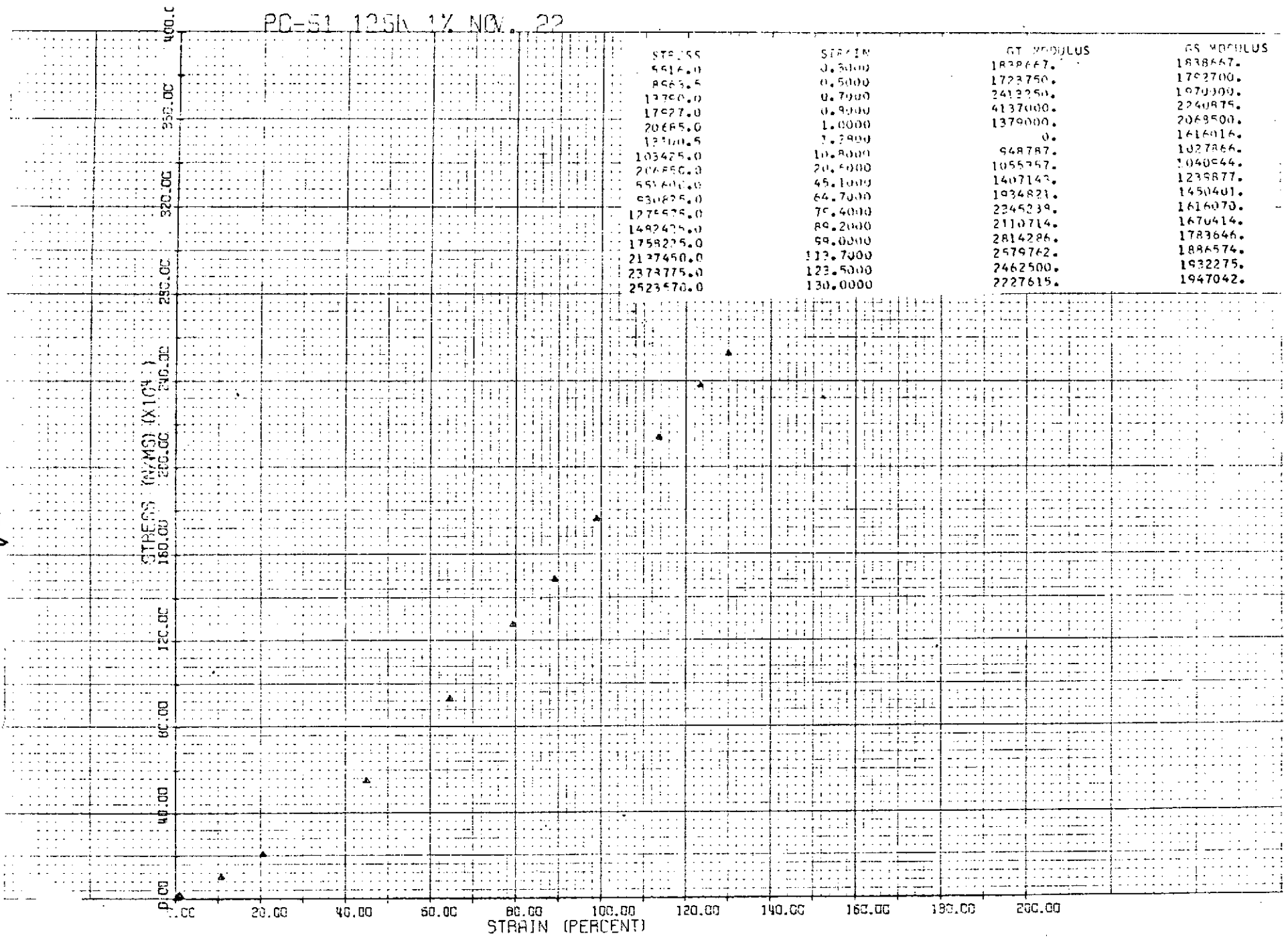

STRESS	STRAIN	GT MODULUS	SS MODULUS
5516.0	0.5000	1838667.	1838667.
8665.5	0.5000	1723750.	1792700.
13760.0	0.7900	2412250.	1970300.
17627.0	0.9000	4137000.	2240875.
20665.0	1.0000	1379000.	2069500.
13700.5	1.2900	0.	1616016.
103425.0	10.8000	948787.	1027866.
206650.0	20.6000	1055757.	1040544.
551600.0	45.1000	1407143.	1239877.
930825.0	64.7000	1934821.	1450401.
1275525.0	75.4000	2345239.	1616070.
1492425.0	89.2000	2110714.	1670414.
1758225.0	99.0000	2814286.	1783646.
2127450.0	113.7000	2579762.	1886574.
2373775.0	123.5000	2462500.	1932275.
2523570.0	130.0000	2227615.	1947042.

PD23 125K 3% OCT. 17

STRESS	STRAIN	GF. MODULUS	GF. MODULUS
3467.8	0.4500	766111.	766111.
30455.0	1.5000	1641667.	1370000.
41773.0	1.9000	6895000.	2290333.
55163.0	2.1000	4506667.	2626667.
43652.0	2.4000	4506667.	2872217.
32201.5	3.2000	0.	2156689.
40000.0	5.2000	1185040.	1720709.
173375.0	7.0500	4506667.	2541176.
275000.0	8.2000	1370000.	3510000.
370225.0	9.4500	1370000.	4324704.
480450.0	10.9500	4805000.	4678525.
596175.0	11.5500	17337500.	5330939.
670000.0	11.7000	4805000.	6146548.
700000.0	11.8500	6895000.	6941549.
630000.0	12.4500	2290333.	7714667.
1043725.0	13.2000	18336667.	8321011.

STRESS (N/MS) (X10<sup>11</sup>)

STRAIN (PERCENT)

12 A

PU-52 125K 3% NOV. 20

134

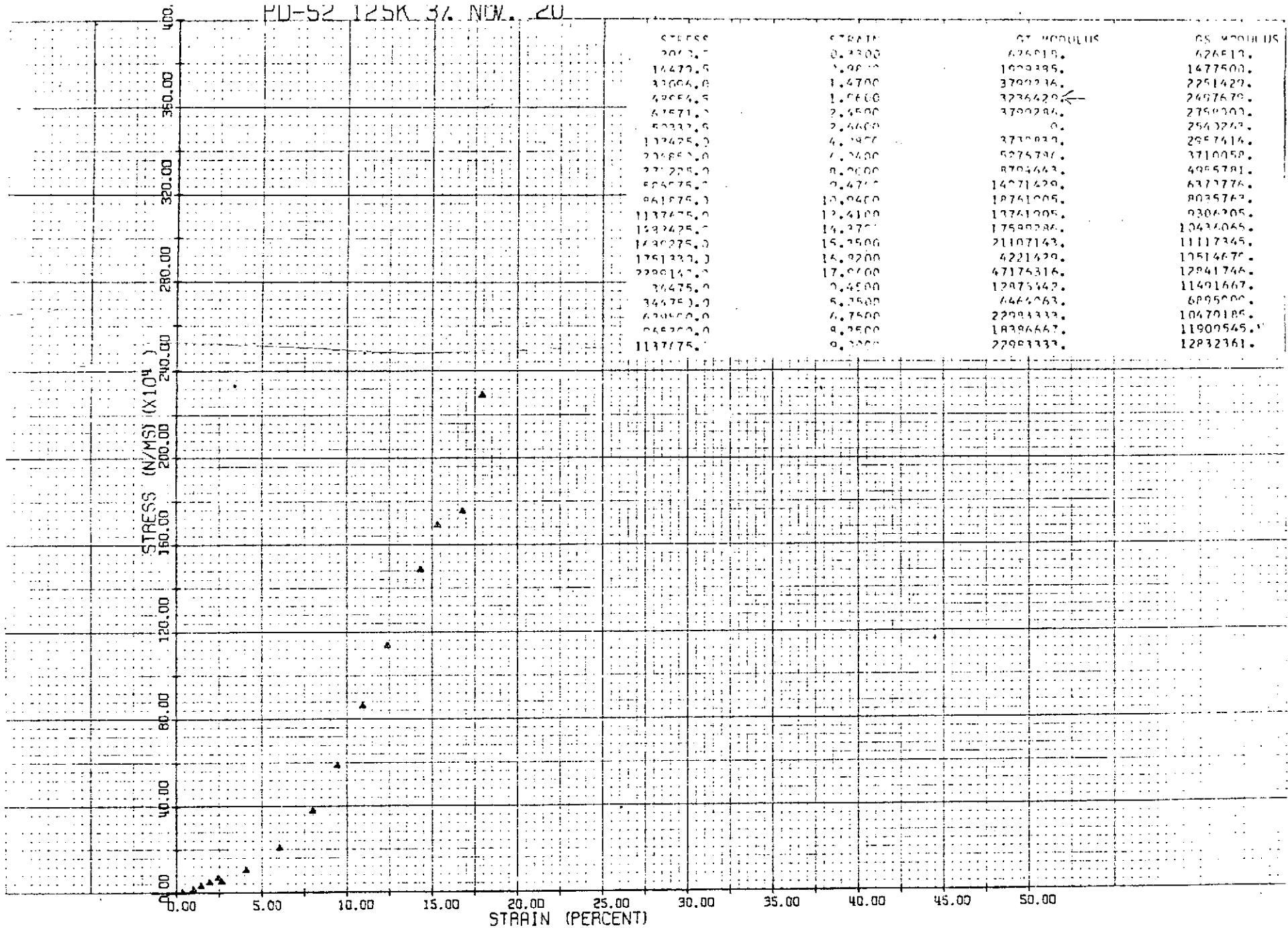

PO-27 125K 5% OCT. 22

14  
0 4T

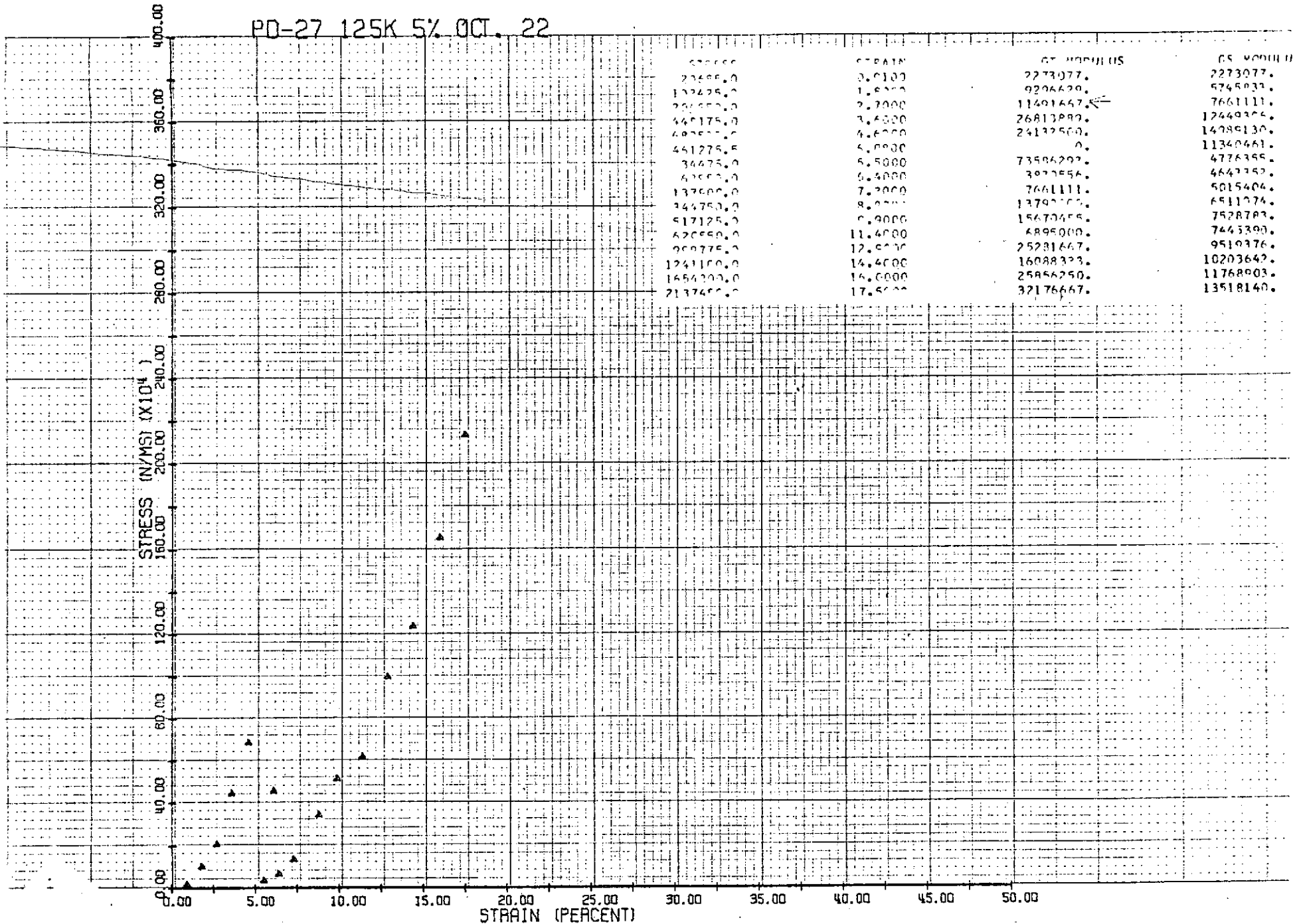

PD-50 125K 5% NOV. 20

STRESS  
 25854.0  
 101354.5  
 162722.0  
 198576.0  
 246151.5  
 293402.5  
 413700.0  
 613655.0  
 812610.0  
 1109720.0  
 1544420.0  
 1765120.0  
 1978665.0  
 2102610.0  
 2299460.0  
 2523570.0

STRAIN  
 0.0000  
 2.5000  
 3.4000  
 3.6000  
 4.0000  
 4.9400  
 6.5000  
 7.0000  
 8.0000  
 9.8000  
 11.4000  
 12.0000  
 13.1000  
 13.6000  
 14.7000  
 16.0000

G1 MODULUS  
 3658571.  
 4319375.  
 6218799.5  
 7170800.  
 9515100.  
 0.  
 13480609.  
 24904375.  
 27217222.  
 24132500.  
 21546875.  
 24515556.  
 26718125.  
 26718125.  
 25856250.  
 9546923.

G2 MODULUS  
 3658571.  
 4054260.  
 4785941.  
 5091692.  
 5594352.  
 4992824.  
 7022292.  
 8091836.  
 10443402.  
 12678357.  
 17923061.  
 14698122.  
 15432168.  
 16091719.  
 16613667.  
 16039494.

15 A

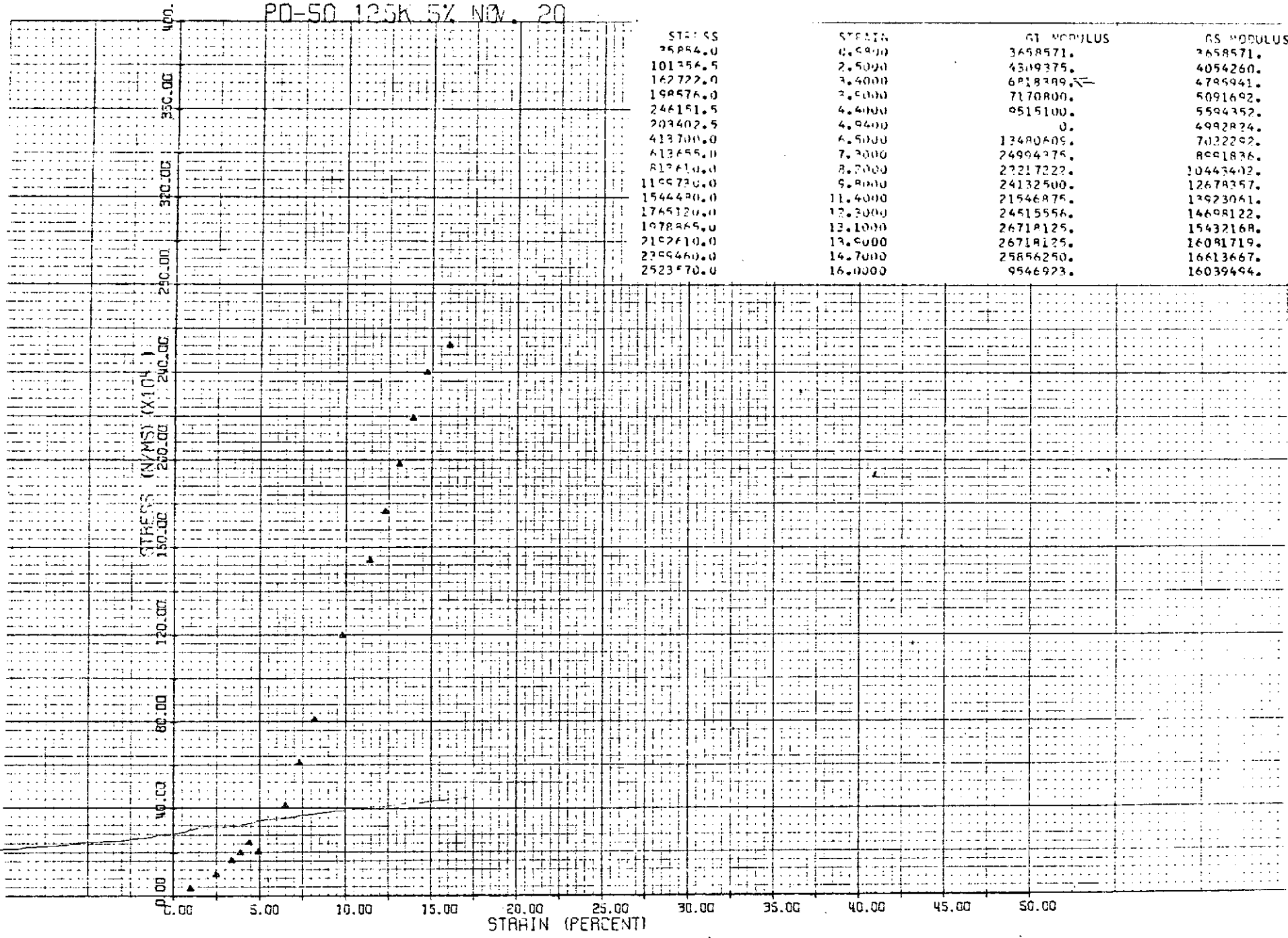

□

PD49 125K 10% DEC. 3

16 A

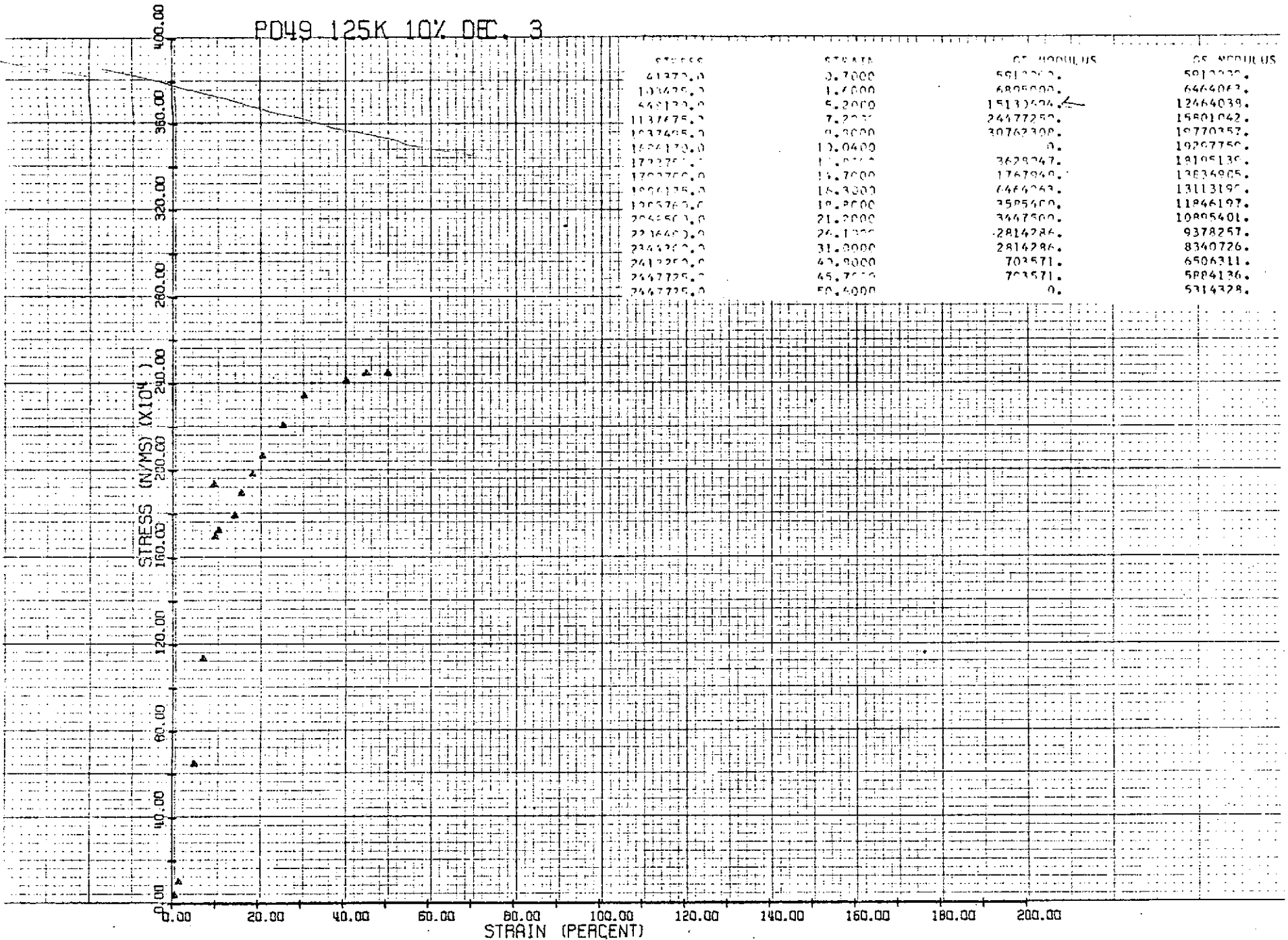

PU-64 138K 3% DEC. 17

STRESS	STRAIN	GT MODULUS	GS MODULUS
10170.0	0.6500	2333697.	2213697.
20660.0	1.1400	2814784.	2540273.
44164.5	1.4700	7517857. ←	2834141.
74801.5	2.1200	4231420.	3154788.
94077.6	2.8600	4036099.	3400885.
75065.0	3.9200	0.	3310513.
124113.0	4.5700	3113871.	3243813.
205453.0	6.2100	5045122.	3719525.
317173.0	7.8400	6765099.	4353340.
412733.7	9.4700	5922084.	4623363.
531430.0	10.4100	12084401.	5426320.
647150.0	11.6900	9363000.	5800367.
77284.0	12.4100	15135344.	6417184.
891875.0	13.2200	10921002.	6696958.
1034550.0	14.0400	21209864.	7538337.
1251400.0	15.2500	17805420.	8422231.

STRESS (N/MS) (X10<sup>4</sup>)

STRAIN (PERCENT)

17A



PD-54 138K 5% NOV. 25

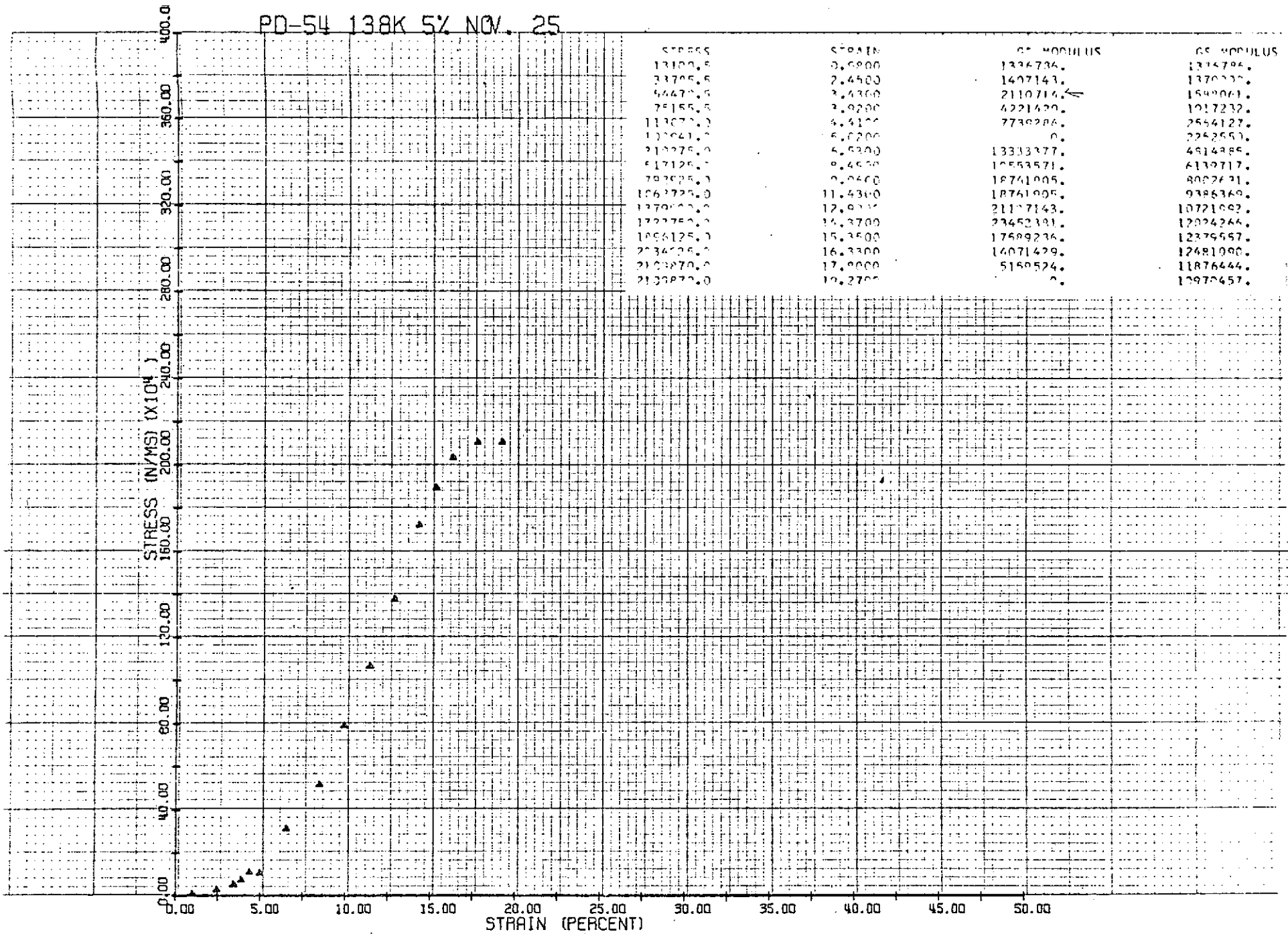

18

PD-53 138K 10% NOV. 25

194

STRESS (N/MS) (X10<sup>4</sup>)

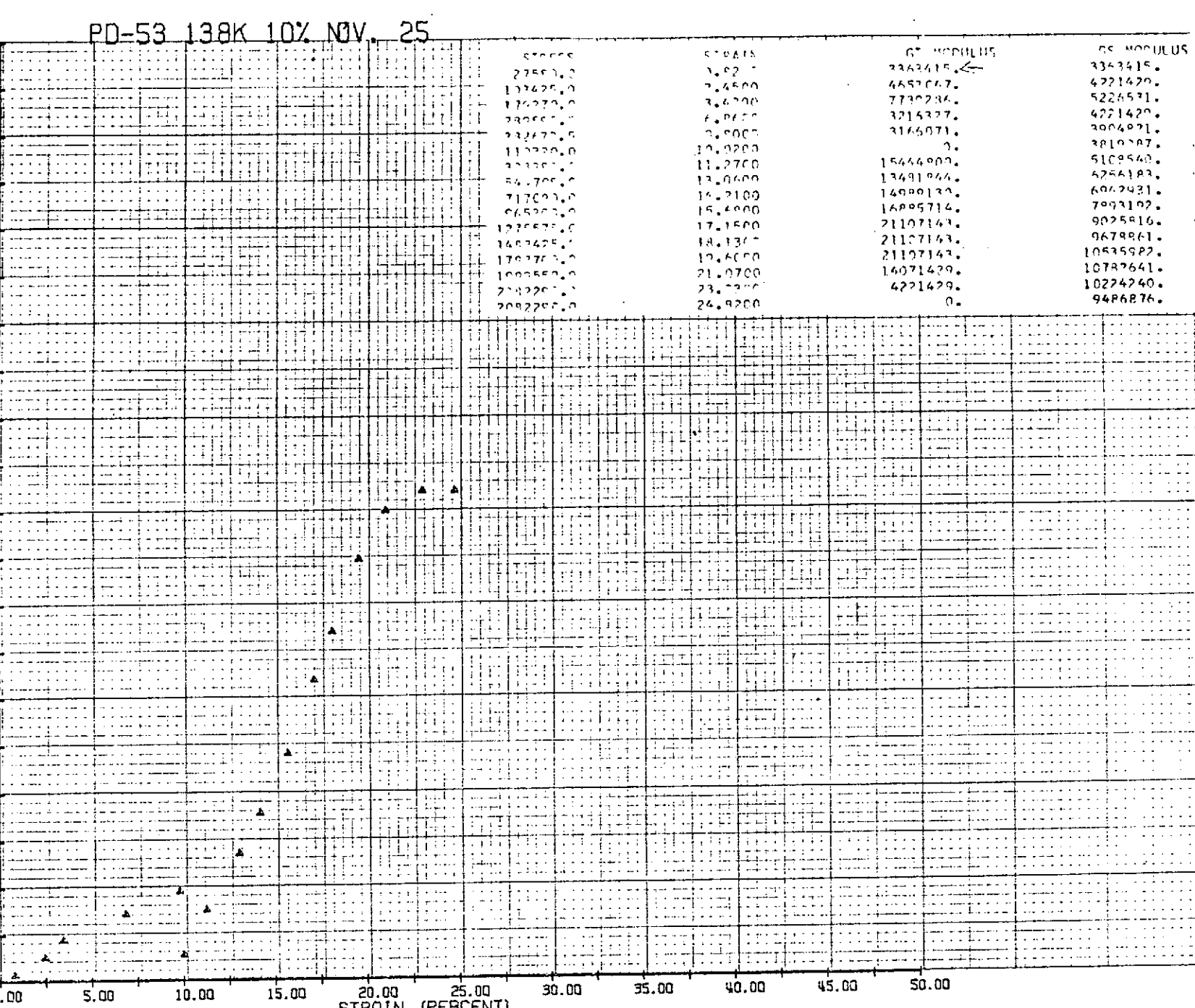

STRESS	STRAIN	GT MODULUS	GS MODULUS
2750.0	3.92	3363415.	3363415.
107625.0	7.4500	4657067.	4221420.
176270.0	8.6200	7730284.	5226531.
38000.0	6.8650	3215327.	4221420.
332470.0	9.9000	3165071.	3004021.
110330.0	10.0200	?	3810707.
32130.0	11.2700	15444000.	5109540.
54700.0	12.0600	13491944.	4256183.
317000.0	14.2100	14990130.	6062431.
66500.0	15.4900	16995714.	7993102.
1270570.0	17.1500	21107143.	9025816.
1463425.0	18.1300	21107143.	9678861.
179370.0	19.6000	21107143.	10535922.
1000550.0	21.0700	14071429.	10787641.
200220.0	23.0200	4221429.	10224240.
2092200.0	24.9200	0.	9486876.

PD-39 150K 1% OCT. 31

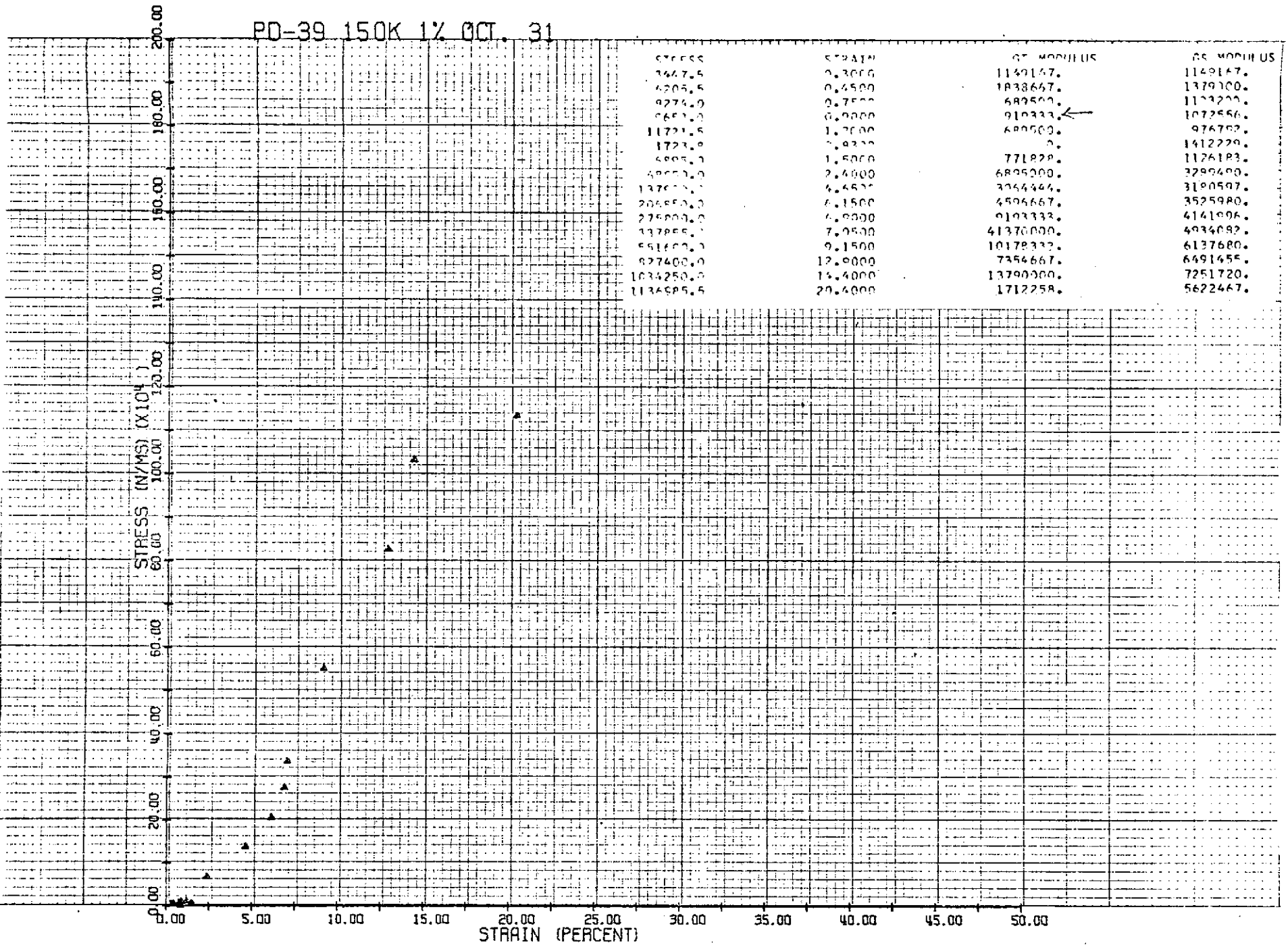

20 A

PD-63 150K 3% DEC. 12

STRESS (X10<sup>3</sup>) (S/N) (MS) SSES

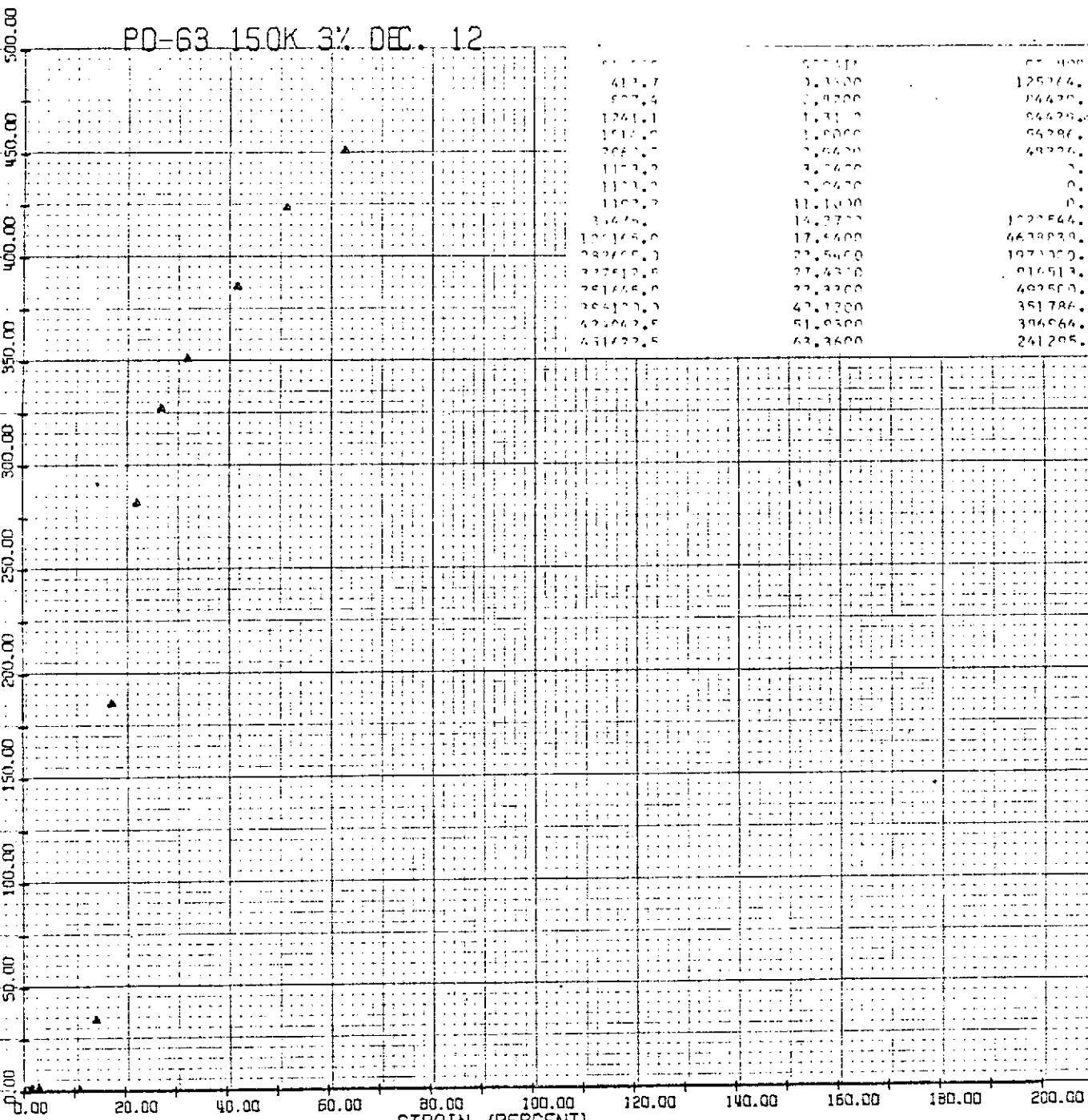

613.7	675.0	67.400 1115	68.400 1115
527.4	613.0	125774.	175314.
1241.1	527.0	14470.	100222.
1511.0	1241.1	84478.	64750.
2021.7	1511.0	54296.	64271.
1173.2	2021.7	49226.	70357.
1173.2	1173.2	0.	60567.
1102.2	1173.2	0.	70367.
3147.5	1102.2	11.1000	14416.
12116.0	3147.5	14.2700	20427.
28260.0	12116.0	17.4400	463839.
22752.5	28260.0	22.5400	197100.
25166.0	22752.5	27.4310	916513.
28412.0	25166.0	32.3200	492500.
42262.5	28412.0	47.1200	351784.
43122.5	42262.5	51.0300	306564.
	43122.5	63.3600	241295.

21 A

PD-31 150K 3%

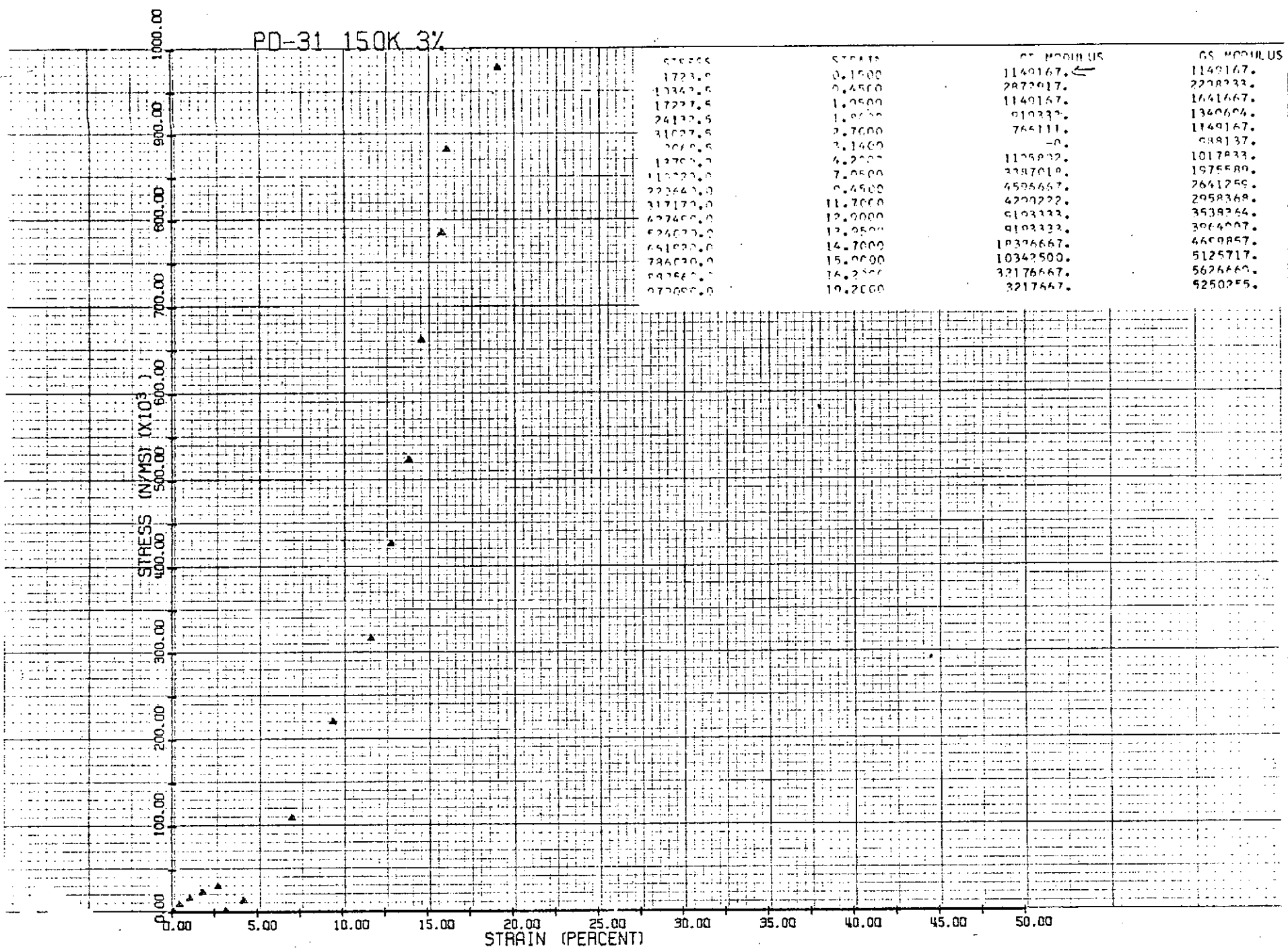

STRESS	STRAIN	GT MODULUS	GS MODULUS
1723.0	0.1500	1149167. ←	1149167.
17342.5	0.4500	2872017.	2278233.
17227.5	1.0500	1149167.	1641667.
24132.5	1.8000	910333.	1360604.
31027.5	2.7000	765111.	1149167.
3660.5	3.1400	-0.	688137.
12702.7	4.2000	1125832.	1017833.
110222.0	7.0500	3387010.	1975580.
222442.0	9.4500	4525657.	2641259.
317172.0	11.7000	4220222.	2958368.
422450.0	12.9000	5103333.	3538264.
524022.0	12.9500	9103333.	3964007.
651022.0	14.7000	10376667.	4609857.
736022.0	15.0000	10342500.	5125717.
892560.0	16.2000	32176667.	5626660.
972000.0	19.2000	3217667.	5250255.

22 A



PD-42 150K 5% DEC. 4

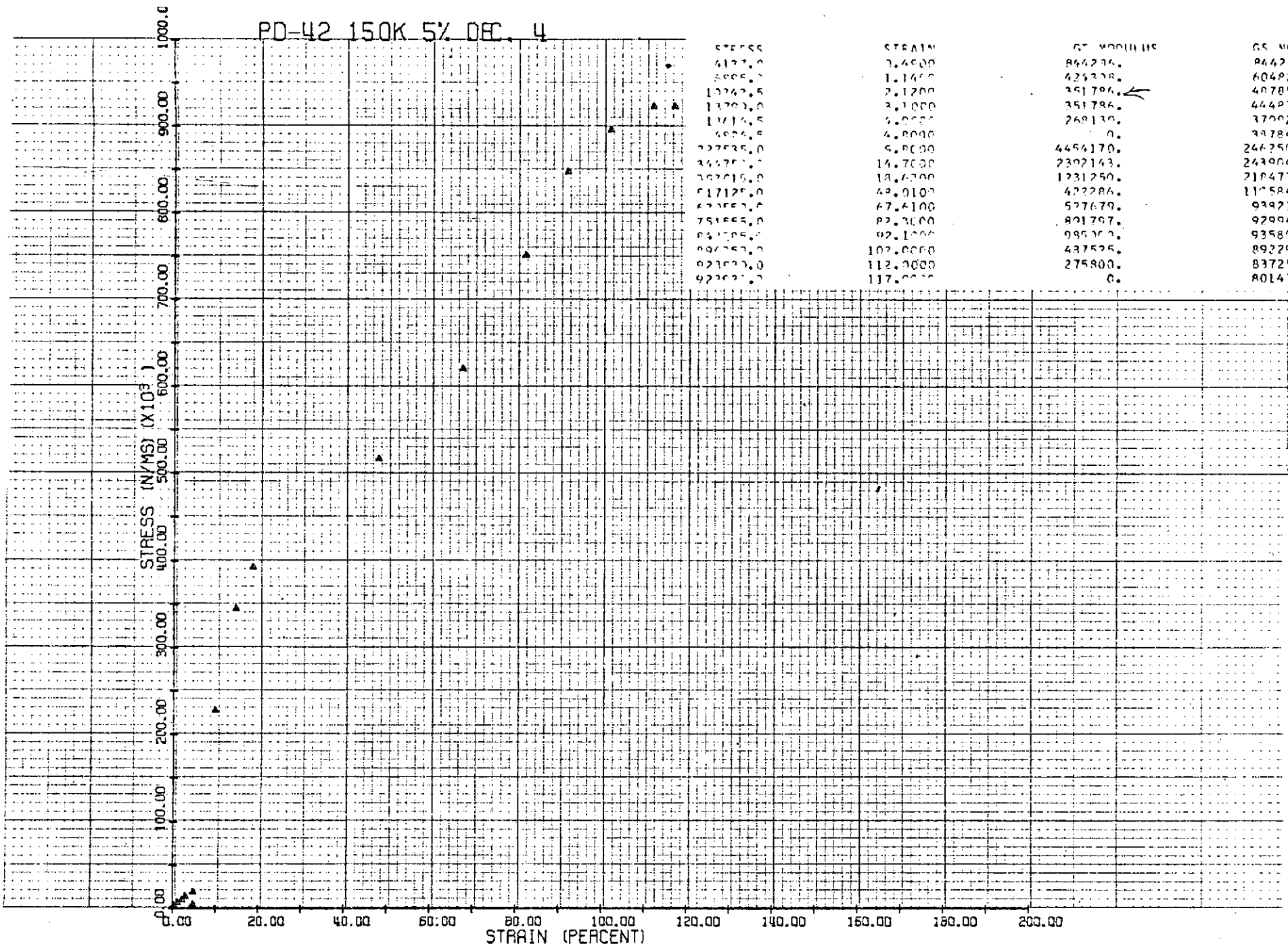

24

PD-69 150K 10% AN. 2

25 P

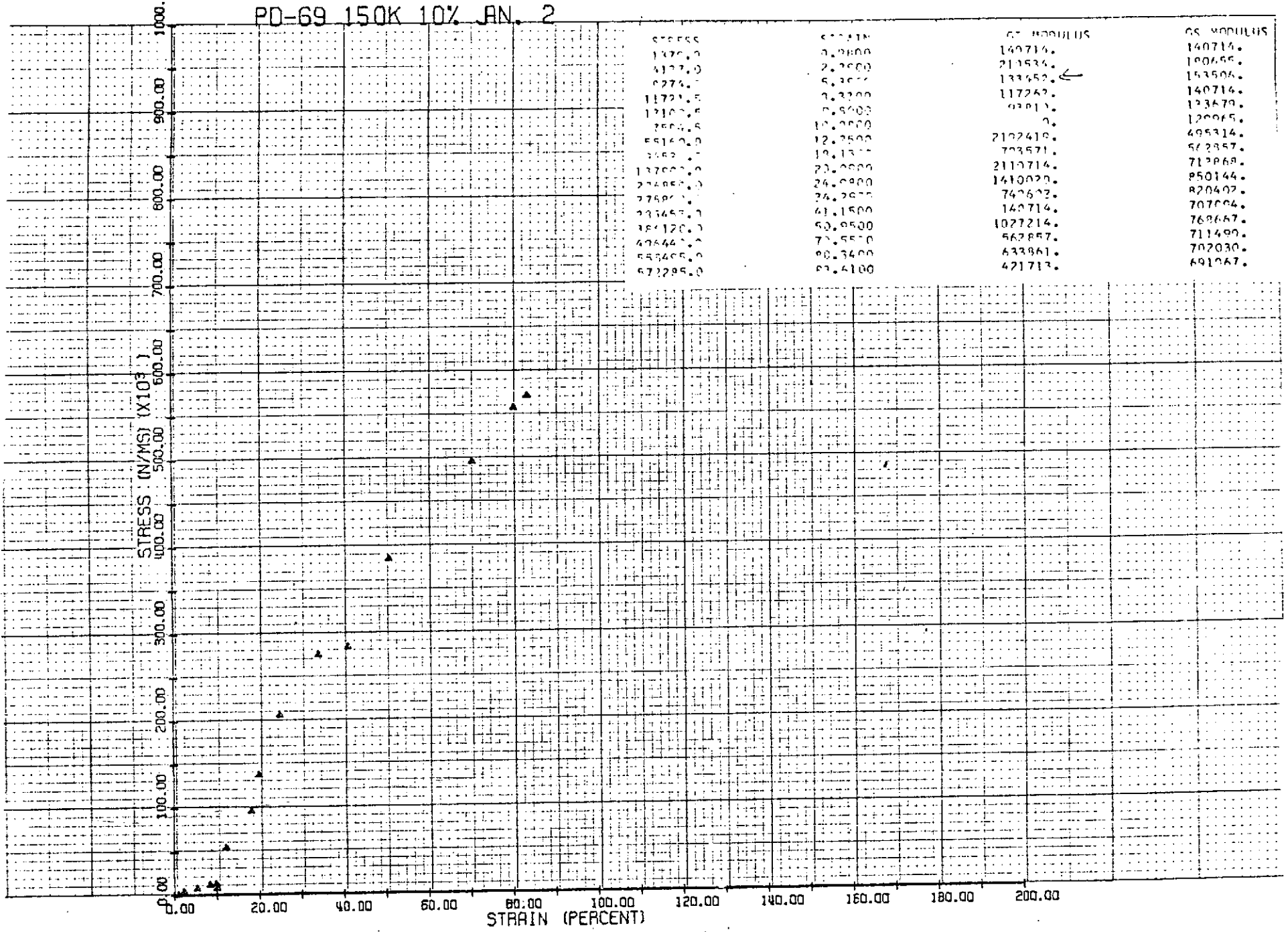

STRESS	STRAIN	GS MODULUS	GS MODULUS
1370.0	3.2800	140714.	140714.
4177.0	2.2600	211534.	190655.
6274.0	5.2600	133552.	153506.
11721.5	3.2200	117267.	140714.
12100.5	0.5600	93913.	123679.
3554.5	10.2000	0.	120965.
5514.0	12.2500	2122410.	495314.
3452.0	19.1500	703571.	572357.
13700.0	20.2000	2110714.	713969.
27400.0	26.0800	1410020.	850144.
27500.0	26.2800	742602.	820402.
33545.0	41.1500	140714.	707064.
38120.0	50.9500	1027214.	768667.
42644.0	72.5500	562857.	711499.
55340.0	90.3400	633861.	702030.
67229.0	93.4100	421713.	691067.



PO-46 150K 10% OCT. 31

STRESS	STRAIN	GT MODULUS	GS MODULUS
3647.5	0.3000	1149167.	1149167.
62550.0	2.5500	2604778.	2433529.
104873.5	4.8000	1991889.	2226510.
155137.5	7.2500	2145111.	2210532.
194507.5	9.1500	1970000.	2147623.
14543.0	9.1000	0.	2159423.
27500.0	9.7500	1697231.	2128610.
53055.0	11.2500	2293333.	2151240.
94530.0	12.0000	4596667.	2304079.
124110.0	12.7500	3677333.	2394859.
151650.0	13.6500	3064444.	2429667.
179270.0	15.7500	1313333.	2280822.
214850.0	18.4000	1225778.	2148942.
234420.0	21.7500	735467.	1905239.
262010.0	22.2500	367733.	1511007.
234420.0	33.7500	-612889.	1227821.
204850.0	38.2500	-612889.	1011267.

101X1 (SM/IN) STRESS

00.00  
00.05  
00.10  
00.15  
00.20  
00.25  
00.30  
00.35  
00.40  
00.45  
00.50  
00.55  
00.60  
00.65  
00.70  
00.75  
00.80  
00.85  
00.90  
00.95  
1.00

STRAIN (PERCENT)

26 A

PD-62 163K 3% DEC. 11

STRESS	STRAIN	GT. MODULUS	GS. MODULUS
177.5	0.3300	41788.	41788.
244.9	1.0200	42214.	42043.
351.7	1.3100	42214.	42107.
477.4	1.9000	56286.	45967.
617.3	2.6500	42431.	45029.
767.6	3.0100	0.	36651.
908.0	4.5700	30779.	15992.
1068.3	6.3700	76511.	33122.
1270.0	9.1700	114216.	51128.
1405.0	9.1400	213247.	68365.
1542.0	10.6100	281428.	97169.
1700.0	11.5000	351785.	119339.
1848.0	12.0800	422142.	131421.
1951.0	12.5700	562857.	148431.
2137.0	13.0600	562857.	163806.
2304.0	13.7200	306984.	175189.

STRESS (N/MS) (X10<sup>3</sup>)

STRAIN (PERCENT)

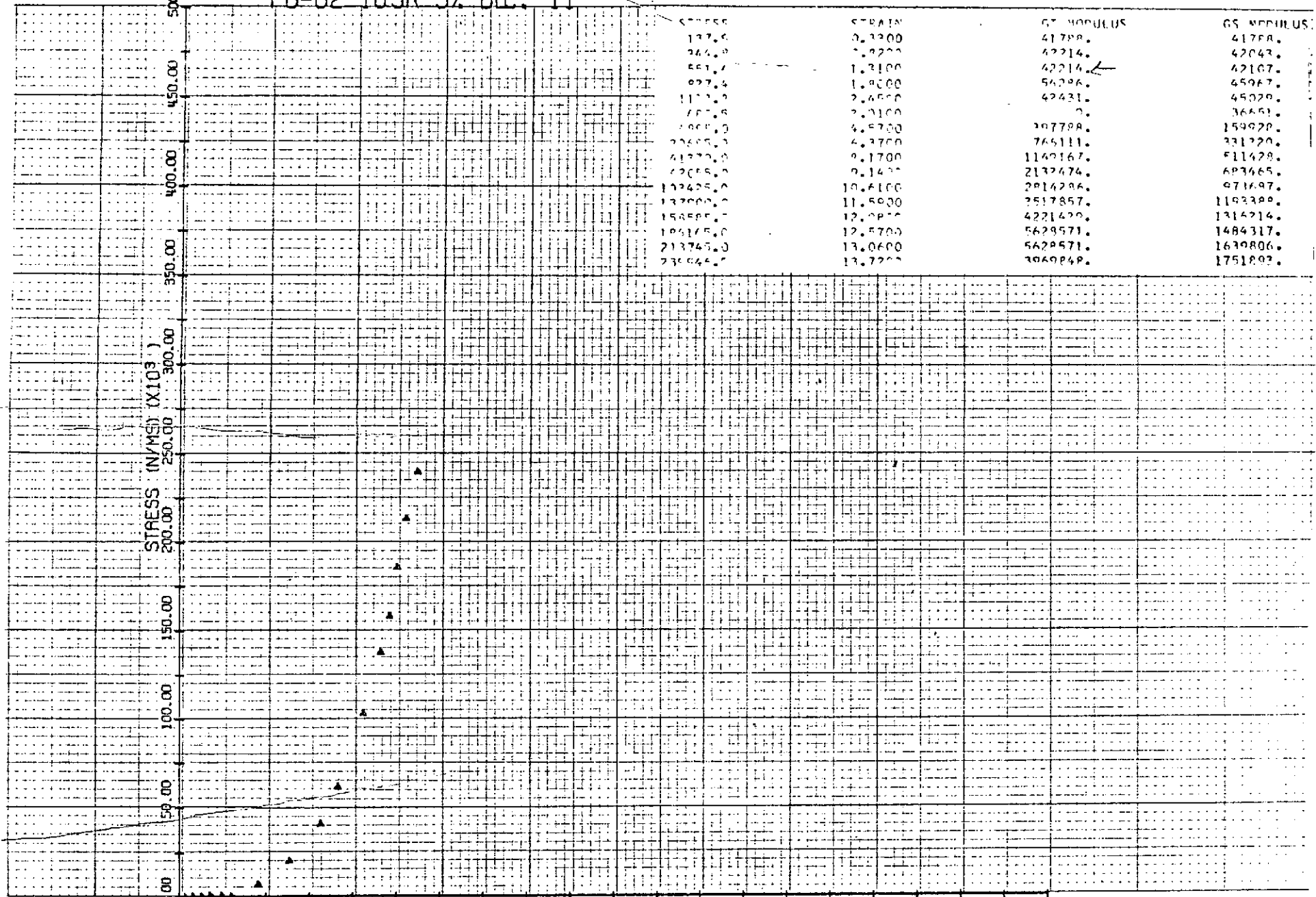

27R

PD-59 163K 5% DEC. 10

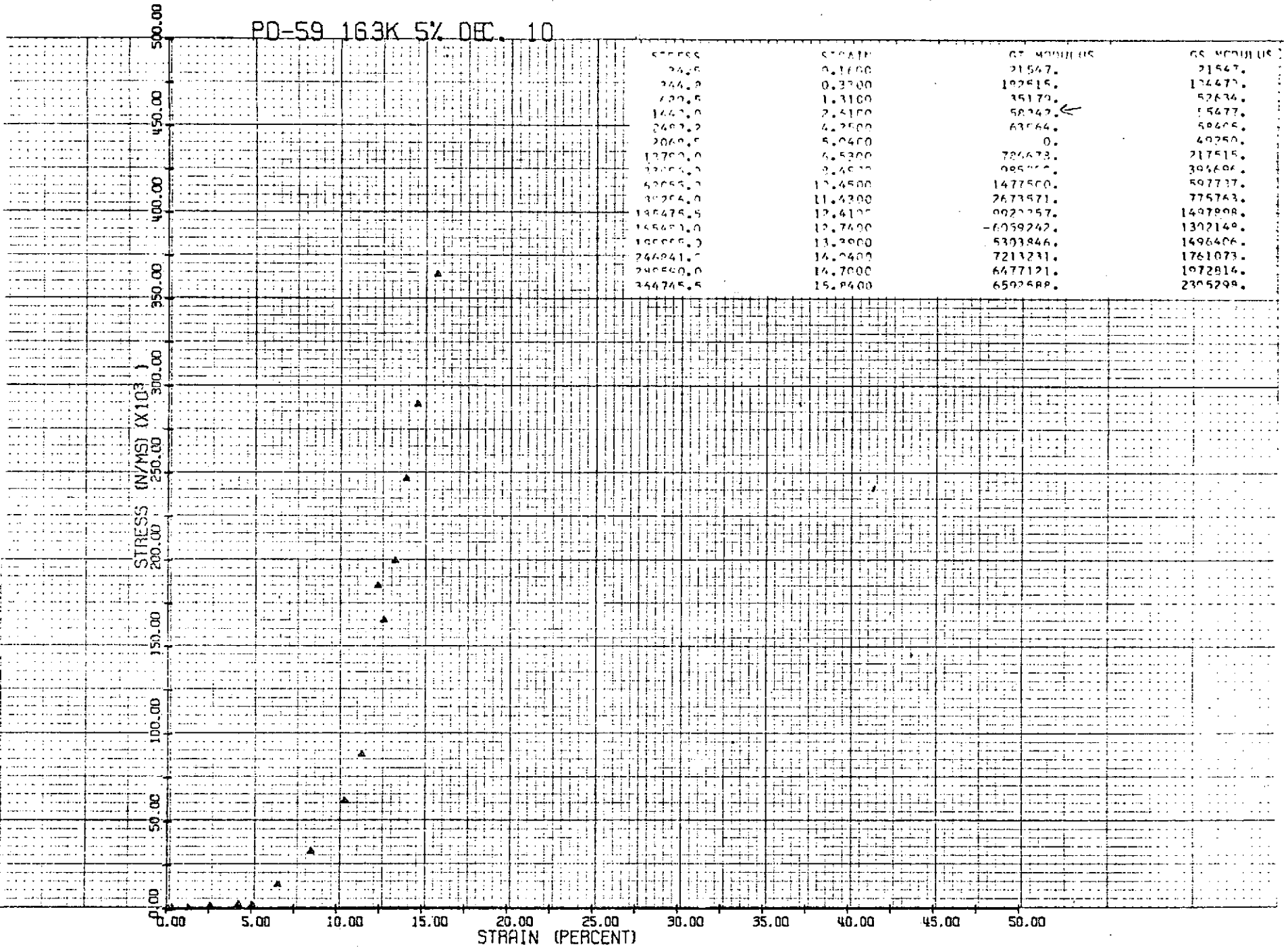

28 A

PD-60 163K 10% DEC. 11

STRESS	STRAIN	CS MODULUS	CS MODULUS
750.4	1.0000	77307.	77307.
2413.3	3.4300	67543.	70357.
2516.5	5.2300	61200. ←	67235.
4610.7	7.1800	56205.	64251.
5722.0	9.1400	56574.	62613.
5263.7	10.0200	0.	57114.
2785.0	11.9200	812894.	177581.
34475.0	13.0000	938005.	261073.
55167.0	14.7000	1579108.	378521.
80137.3	16.5000	1915278.	566168.
124110.0	17.4700	3554124.	713181.
163416.7	17.8900	5857303.	808419.
136175.3	18.7900	4762143.	903864.
237877.5	19.7600	5274785.	1206276.
268956.7	20.4100	4773467.	1319881.
312275.0	21.3500	4221429.	1452817.

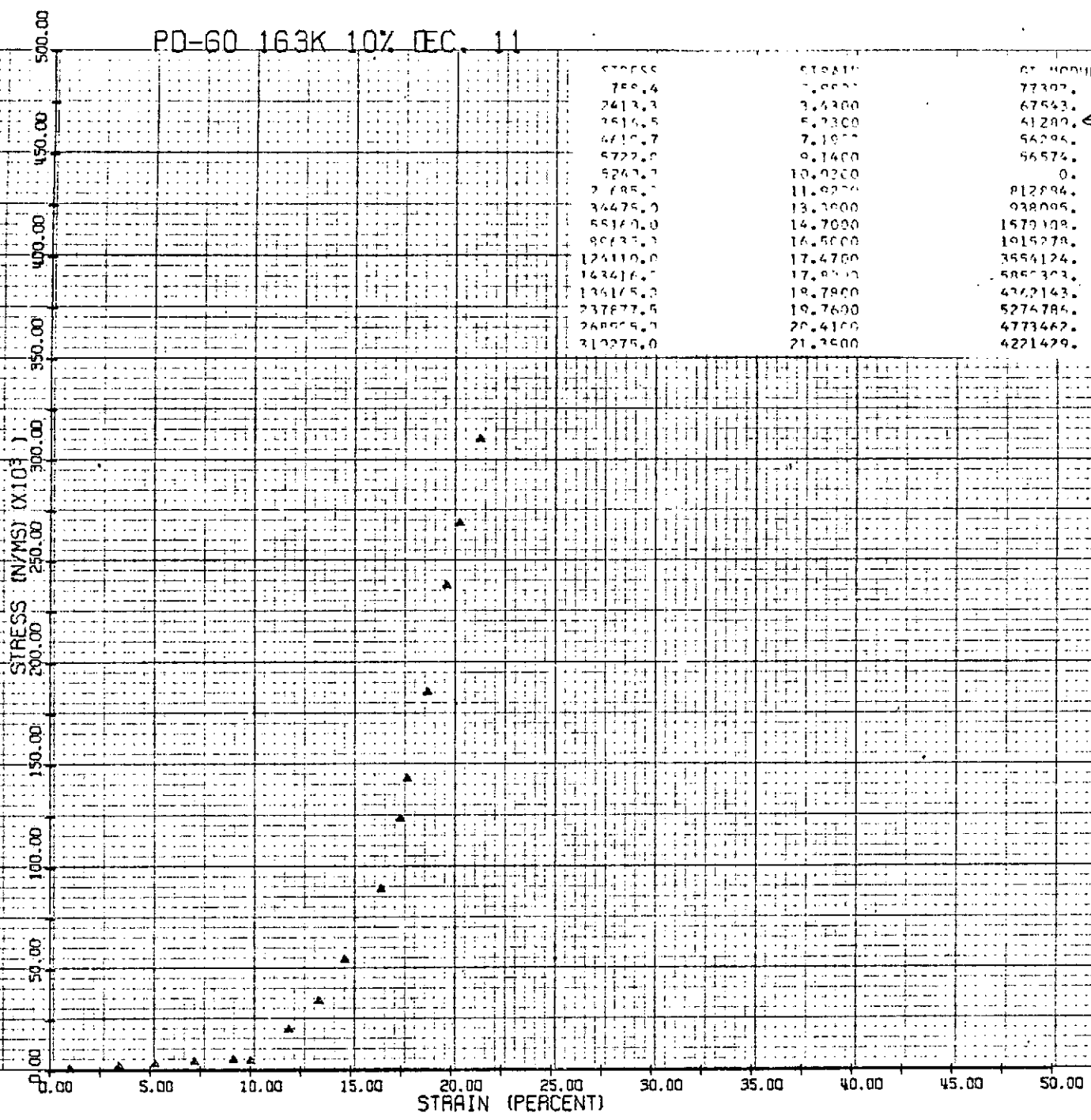

29A

PD-67 175K 1% JAN. 3

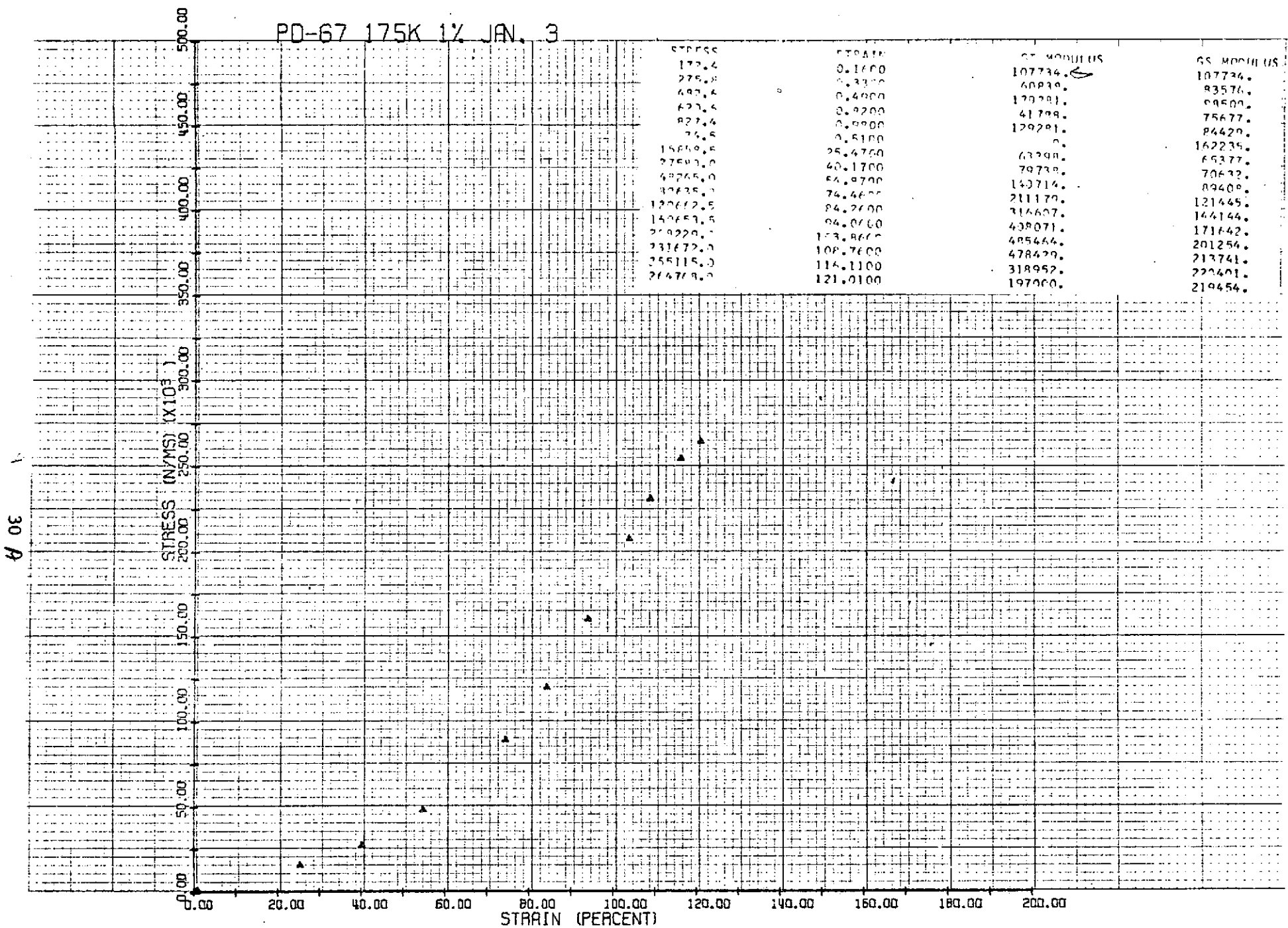

PD-14 175K 3% OCT. 1

31A

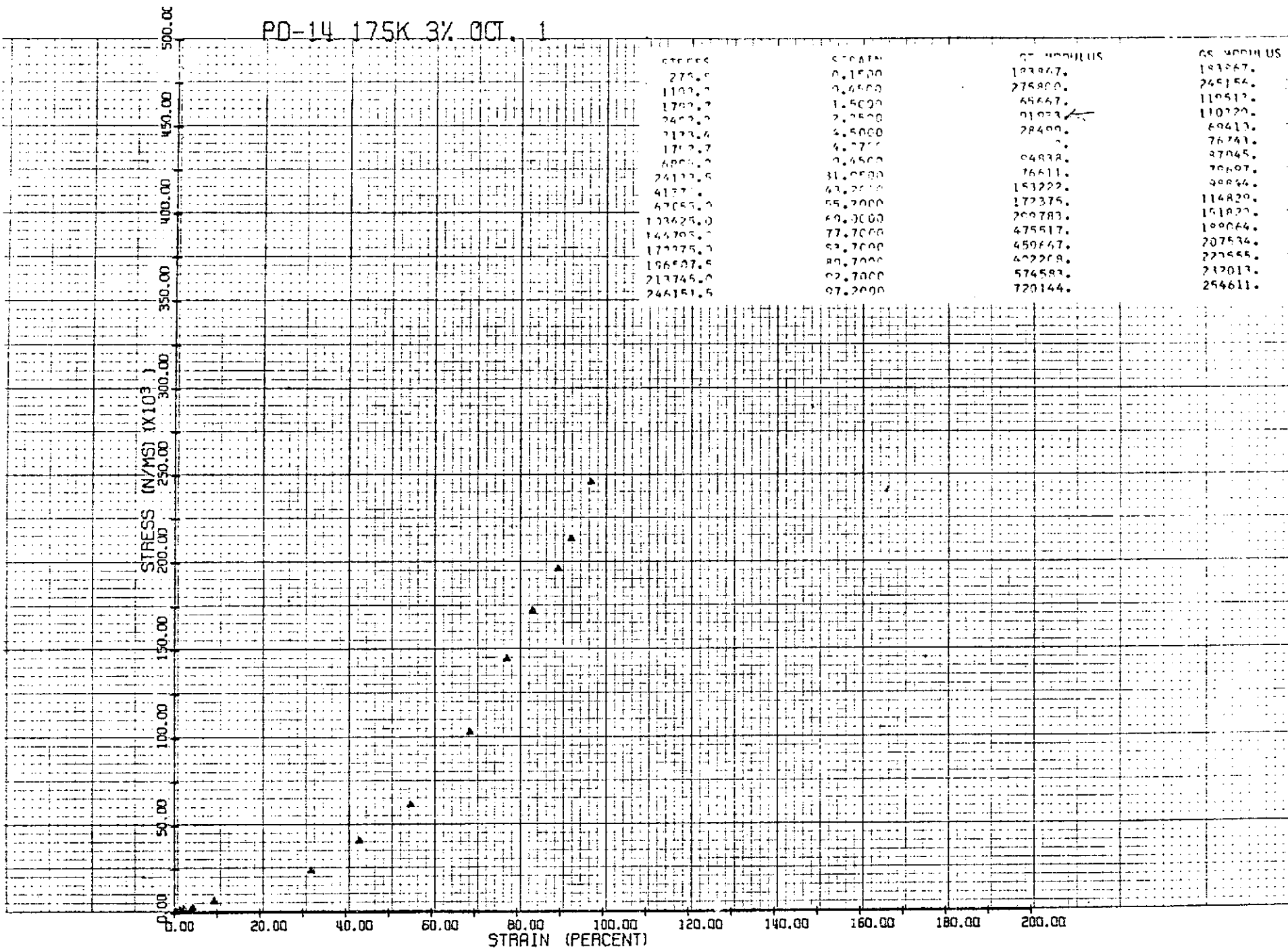

PD-55 175K 3% DEC. 9

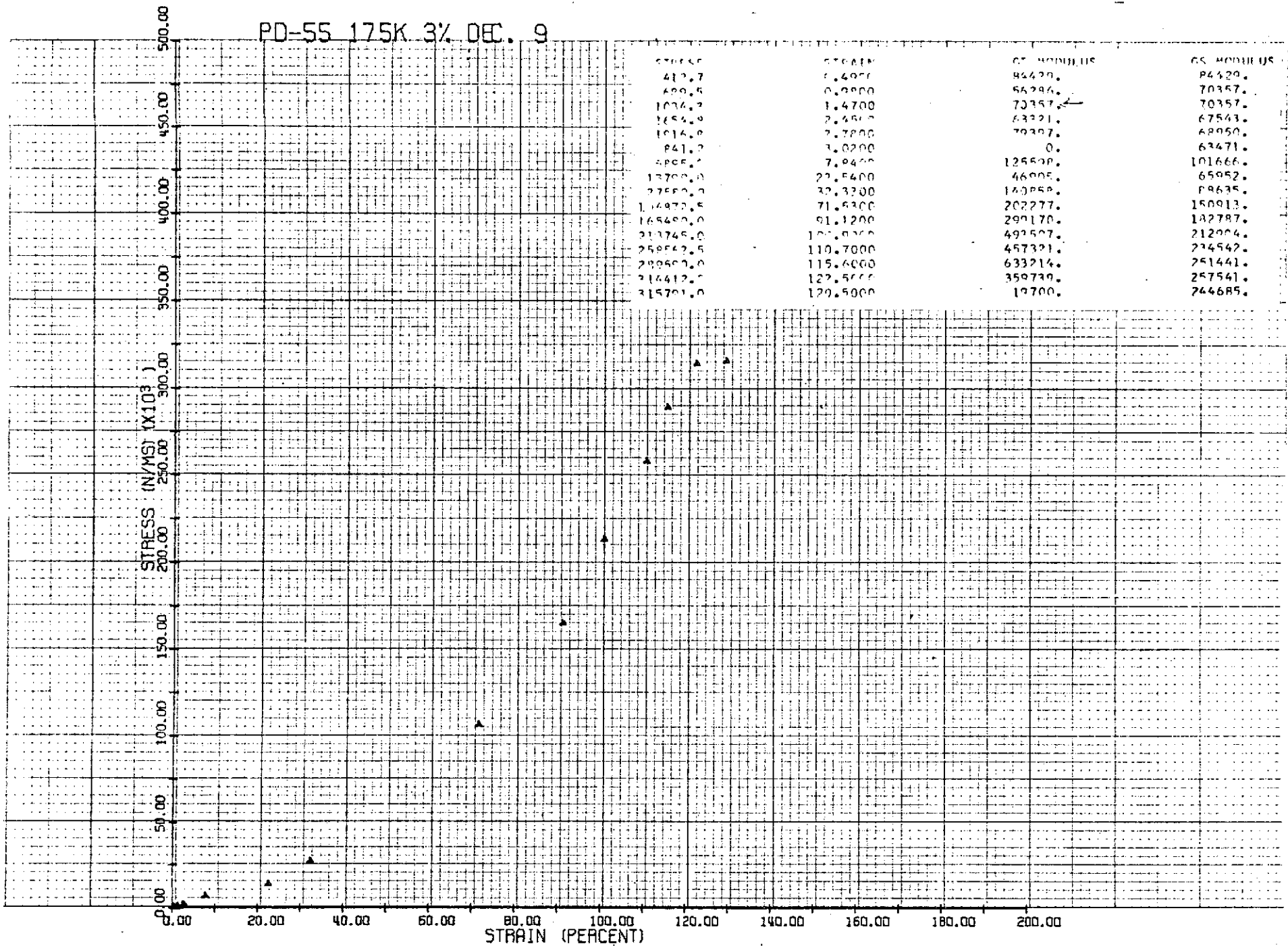

32 A



PD-41 175K 5% NOV. 8

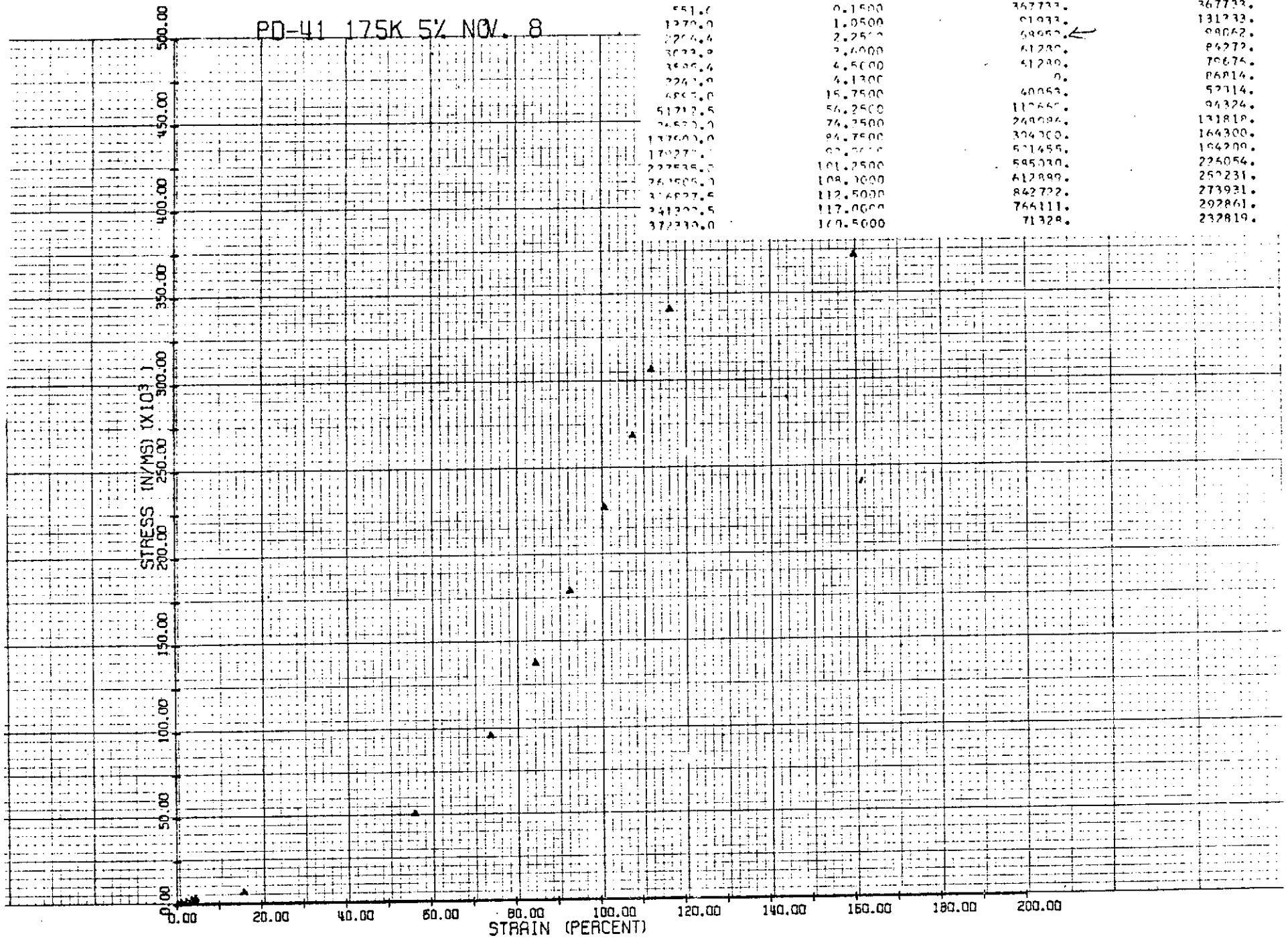

551.6	0.1500	367733.	367733.
1270.0	1.0500	61933.	131233.
2264.4	2.2500	58963.	99062.
3633.9	3.6000	61230.	84272.
3886.4	4.5000	51230.	78675.
2241.0	4.1300	0.	86814.
4855.0	15.7500	60053.	57114.
51712.5	56.2500	112660.	94324.
24520.0	76.2500	249084.	131818.
137600.0	94.7500	394300.	164300.
170270.0	97.5000	511455.	194200.
227835.0	101.2500	595030.	224054.
261005.0	108.1000	612899.	252231.
316827.5	112.5000	842722.	273931.
341300.5	117.0000	765111.	292861.
372310.0	119.5000	71328.	232819.

33 A



PD-57 175K 5% DEC. 9

65 MODULUS	65 MODULUS
570500	570488
1074.3	1.4700
1370.0	1.9600
2060.5	2.9400
2750.0	3.9200
3370.6	4.9000
3900.0	5.8800
5510.0	12.4500
15050.0	26.3100
27500.0	40.0000
51700.0	59.6000
74466.0	69.4000
172275.0	93.0000
251667.5	109.4000
336767.5	119.4000
336474.0	120.0000
345435.0	138.0000

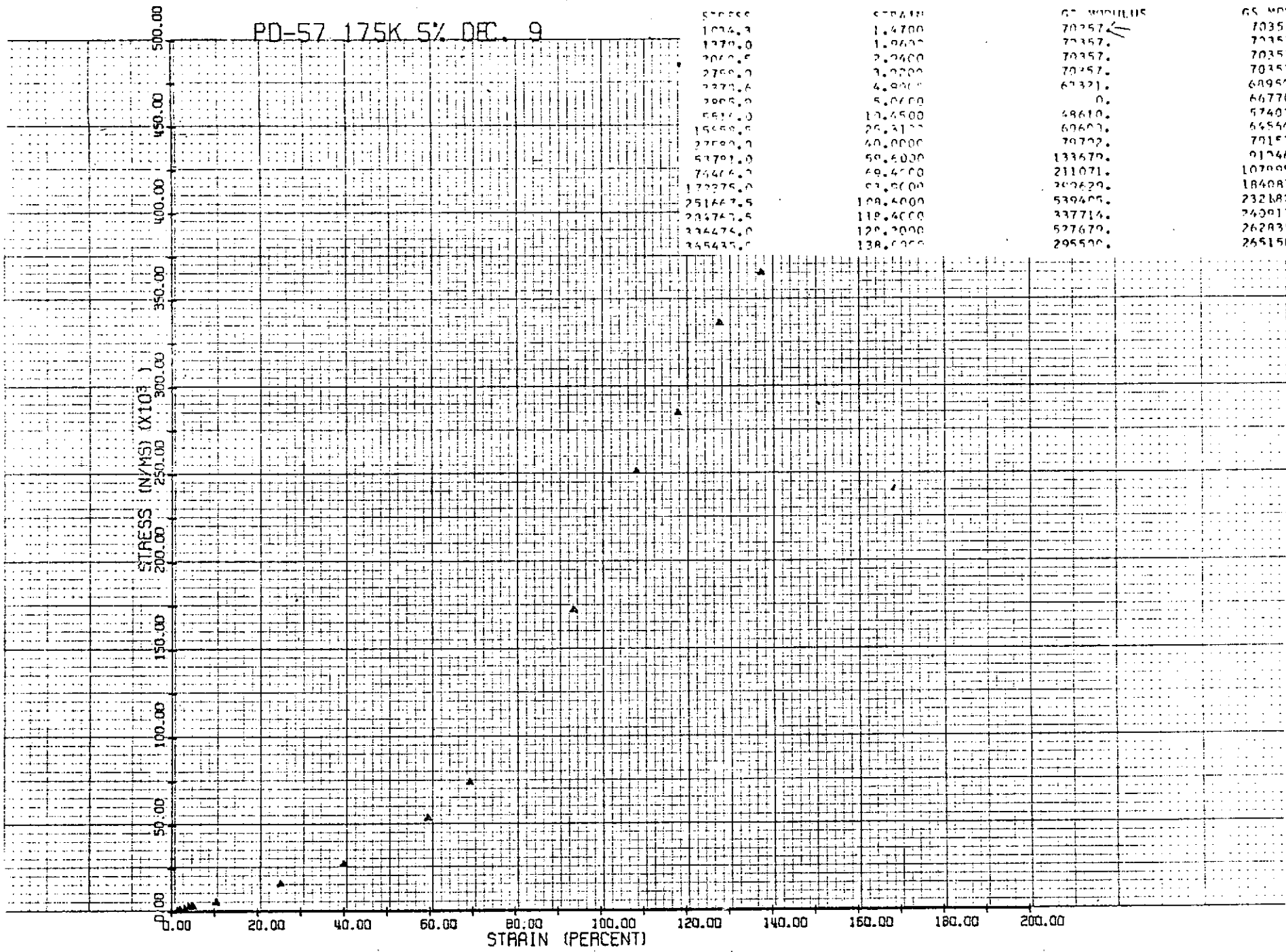

34

PD-58 175K 10% DEC. 10

35 A

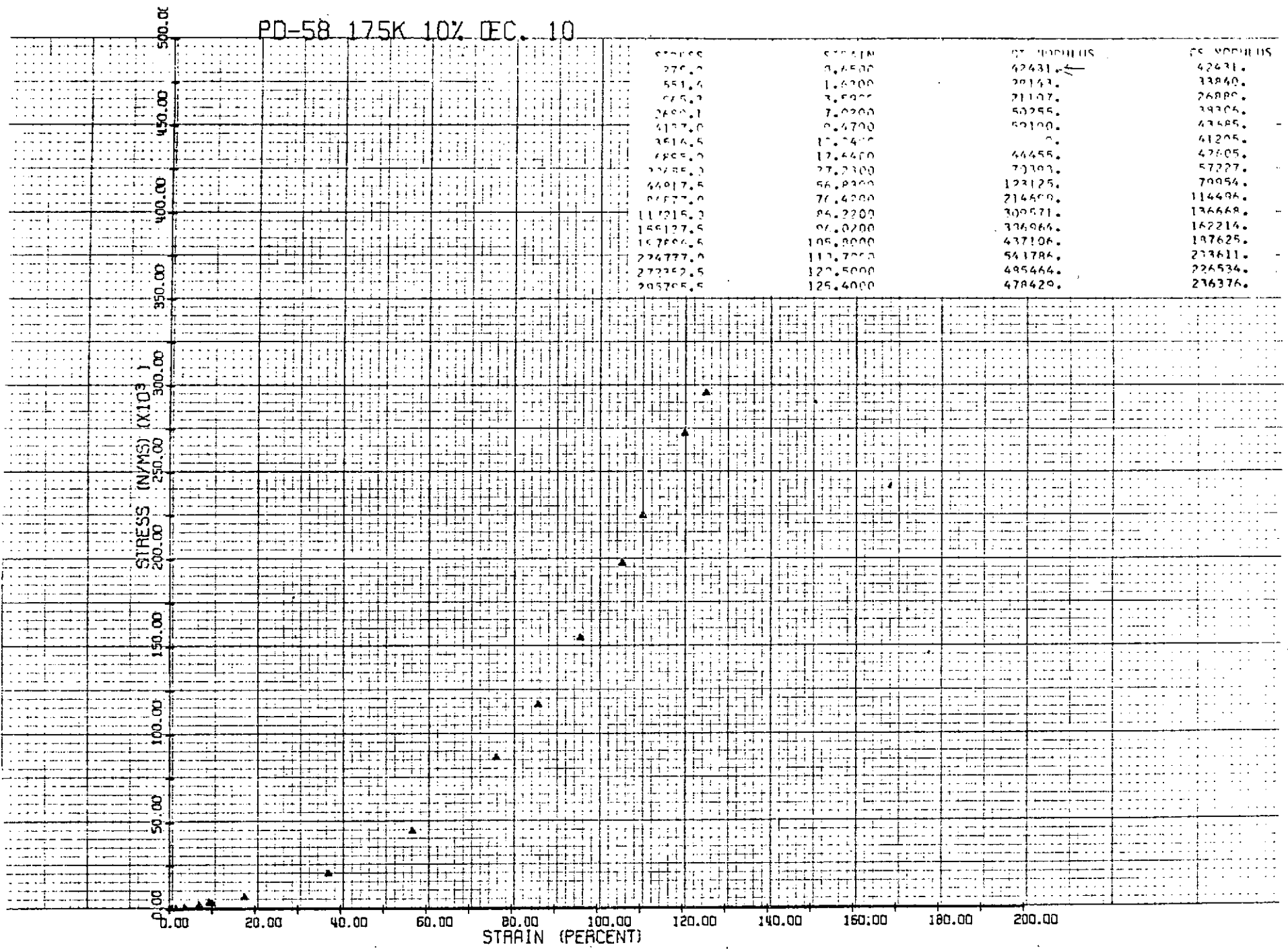

STRESS (N/MS) (X10 <sup>3</sup> )	STRAIN (PERCENT)	ST. MODULUS	TS MODULUS
270.0	3.6500	42431.	42431.
551.6	1.6200	29143.	33860.
875.2	3.5900	21107.	26880.
2690.1	7.0200	50255.	39306.
5137.0	9.4700	52100.	43485.
3516.5	17.7400	0.	41205.
4895.0	17.4400	44455.	47605.
2285.0	27.2300	70303.	57227.
64917.5	56.8200	123125.	70954.
81577.0	76.4200	214600.	114496.
111215.2	86.2200	309571.	136668.
155127.5	96.0200	376964.	162214.
167856.5	105.8000	437106.	187625.
224777.0	113.7000	541784.	233611.
272252.5	120.5000	495464.	226534.
295765.5	125.4000	478429.	236376.

PD-68 175K 10% AN. 3

36

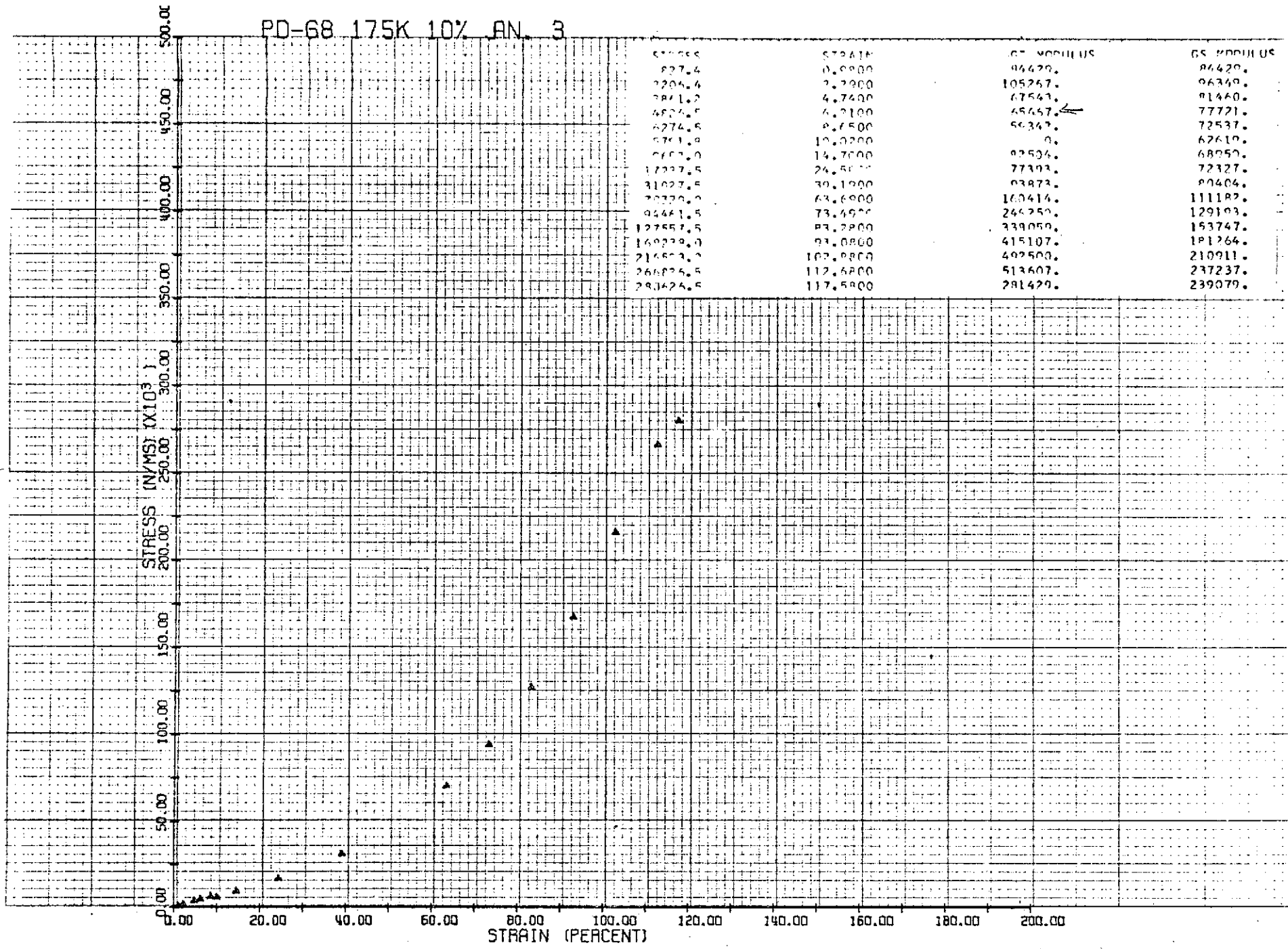

STRESS	STRAIN	E1 MODULUS	E2 MODULUS
827.4	0.0000	86429.	86429.
2204.4	2.2000	105257.	86349.
3841.2	4.7400	67543.	81440.
4824.5	6.2100	48457.	77721.
4274.5	8.7500	50347.	72537.
5781.9	10.0200	0.	67610.
6667.0	14.7000	82504.	68950.
17227.5	24.5000	77393.	72327.
31027.5	30.1900	83873.	80404.
70270.0	43.6900	160414.	111182.
94461.5	73.4900	246250.	129103.
127557.5	83.2800	339050.	153747.
169229.0	93.0800	415107.	181264.
216527.0	102.8800	492500.	210911.
266826.5	112.6800	513607.	237237.
290624.5	117.5800	281429.	239079.

PD-10 200K 3% SPT. 26

STRESS	STRAIN	G <sub>T</sub> MODULUS	G <sub>S</sub> MODULUS
0.0000	0.1500	183867.0	183867.0
275.0	0.7500	114017.0	129707.0
550.0	1.5000	73547.0	121127.0
825.0	2.2500	36777.0	125374.0
1100.0	3.0000	27500.0	137000.0
1375.0	3.7500	0.0	90591.0
1650.0	4.5000	59558.0	65371.0
1925.0	5.2500	85010.0	77365.0
2200.0	6.0000	153222.0	60416.0
2475.0	6.7500	124060.0	110417.0
2750.0	7.5000	245156.0	132725.0
3025.0	8.2500	318231.0	154003.0
3300.0	9.0000	457667.0	140984.0
3575.0	9.7500	393056.0	181130.0
3850.0	10.5000	383056.0	191185.0
4125.0	11.2500	383056.0	200278.0

37 A

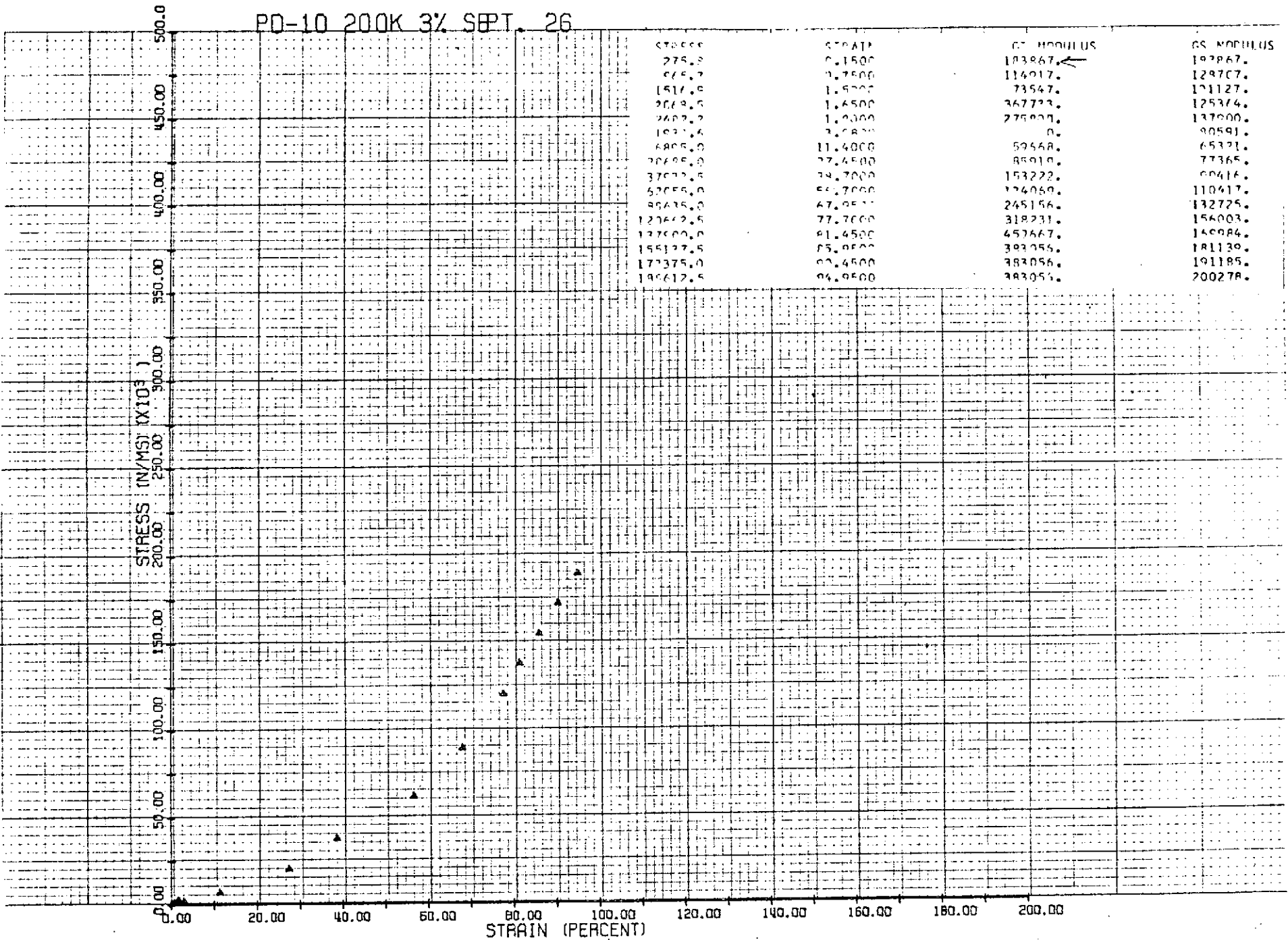

PD-2 200K 5% SEPT. 23

STRESS	STRAIN	ST. MODULUS	RS. MODULUS
345.0	0.7000	114917.	114917.
645.0	0.7400	134902.	127013.
1773.0	2.7000	30005.	63043.
2555.4	7.5000	85766. ←	71823.
3346.1	9.6000	75065.	72697.
3756.6	9.5000	60000.	73015.
3853.0	12.2000	51383.	54827.
4660.0	27.4000	74046.	62011.
3720.0	41.8000	95763.	74228.
4276.0	50.2000	147750.	86531.
5522.0	60.8000	155113.	98662.
7724.0	68.4000	235892.	113079.
9550.0	75.2000	287012.	129281.
11322.0	79.8000	200783.	139110.
12411.0	89.0000	626818.	152195.

STRESS (N/MS) (X10<sup>3</sup>)

STRAIN (PERCENT)

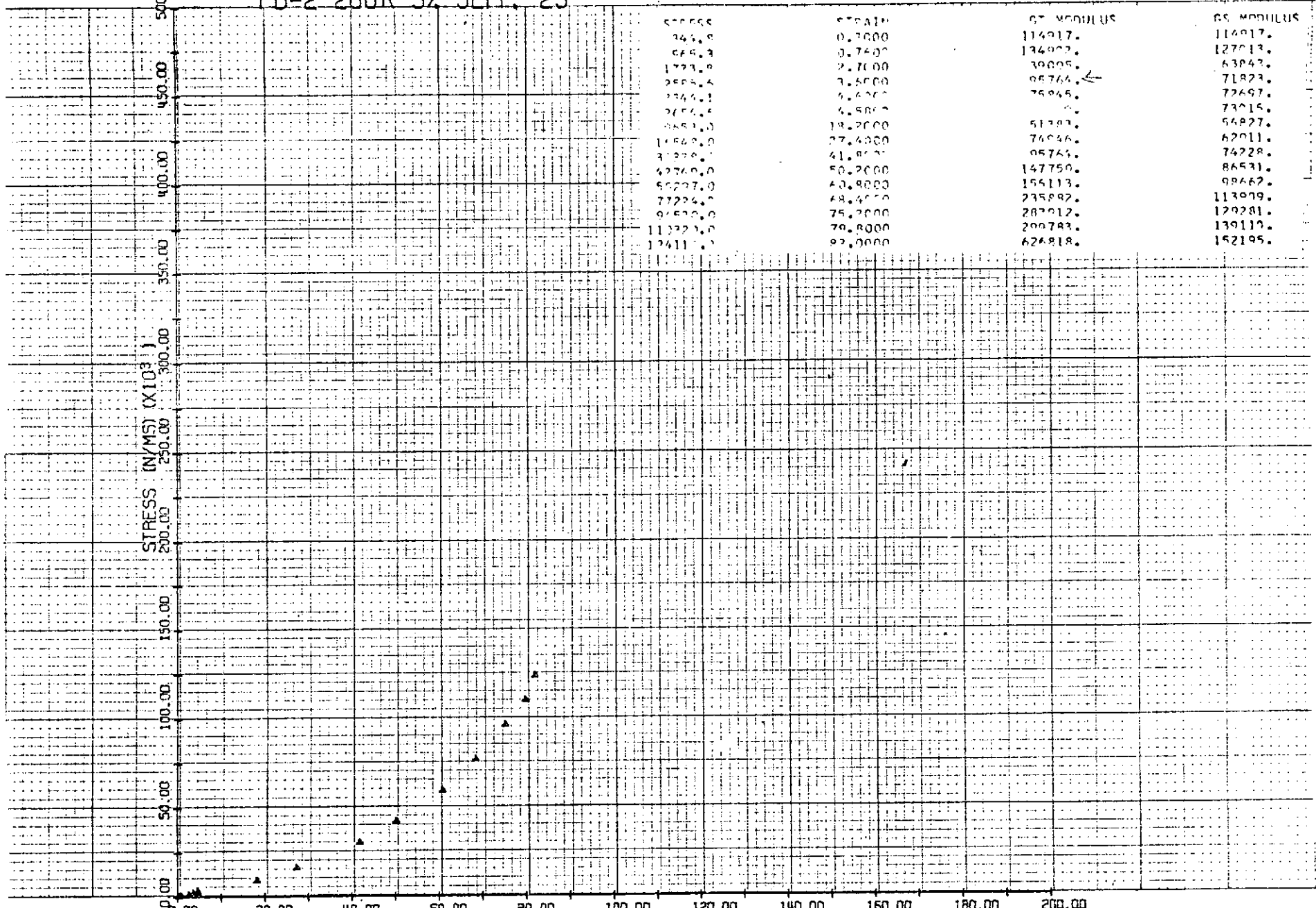

38

PD-14 200K 10% SEPT. 23

STRESS (N/MS) (X10<sup>3</sup>)

500.00  
450.00  
400.00  
350.00  
300.00  
250.00  
200.00  
150.00  
100.00  
50.00  
0.00

STRAIN (PERCENT)

0.00 20.00 40.00 60.00 80.00 100.00 120.00 140.00 160.00 180.00 200.00

57000	57000	65 400000	65 400000
275.9	0.1510	183867.	183867.
2206.4	3.7500	53628.	59837.
3723.7	4.9000	144467. ←	77560.
5652.0	8.7000	40507.	64087.
7032.0	9.7000	27933.	75623.
6412.0	10.2700	0.	68487.
1136.5	27.0000	23402.	40604.
24122.5	45.0000	76411.	55007.
41373.0	55.2100	153222.	74650.
62005.0	72.7500	125364.	96152.
90742.0	77.2500	450667.	107910.
133429.0	84.0000	376464.	123864.
122662.5	89.2500	328333.	135891.
140242.5	96.7500	367723.	153864.
165400.0	101.2500	383256.	164050.
182717.5	105.7500	383056.	173369.

39 A

C-2

PD-9 225K 1% SEPT. 20

40

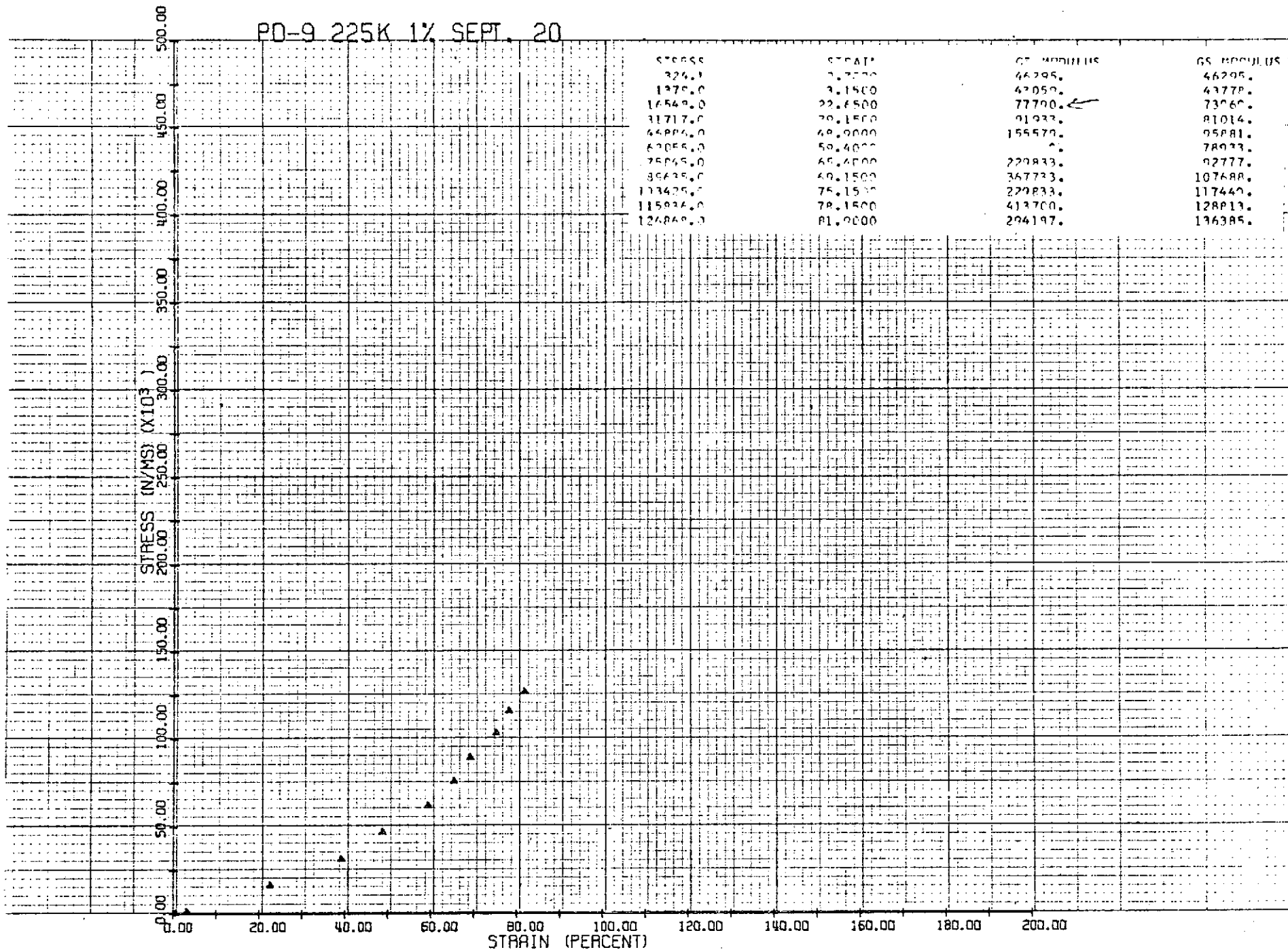

STRESS	STRAIN	CS MODULUS	GS MODULUS
326.1	3.7500	46295.	46295.
1370.0	3.1500	43050.	43778.
16549.0	22.4500	77790. ←	73060.
31717.0	20.1500	91933.	81014.
44884.0	49.0000	155579.	95881.
67055.0	59.4000	229833.	78933.
75045.0	60.4000	367733.	92777.
89635.0	69.1500	229833.	107688.
103425.0	75.1500	229833.	117440.
115836.0	78.1500	413700.	128813.
124869.0	81.0000	294197.	136385.



PD-16 225K 3% SPT. 9

41 A

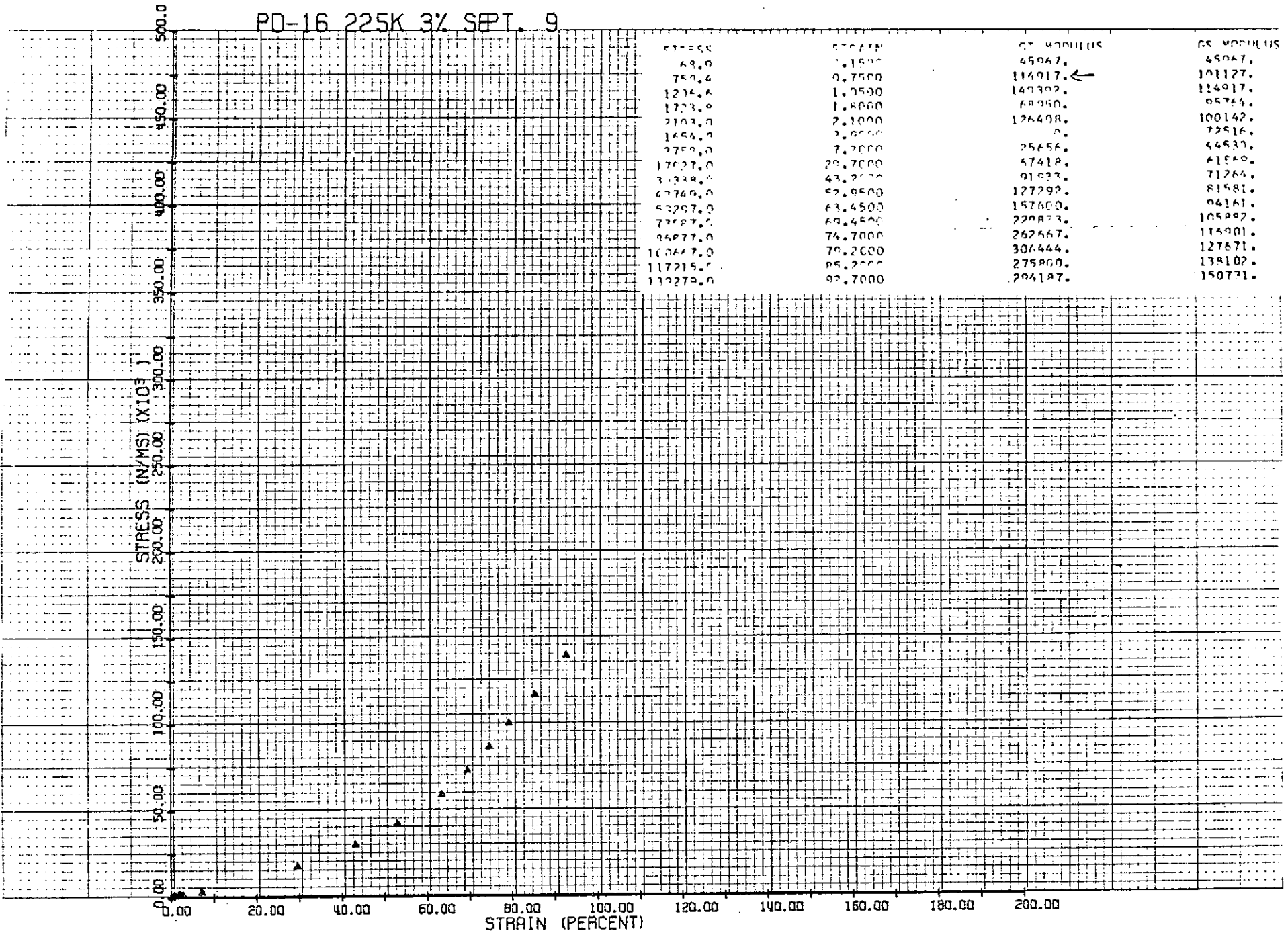



PD-17 225K 5% SPT. 9

STRESS	STRAIN	GS MODULUS	GS MODULUS
670.8	0.9100	68192. ←	68192.
1370.7	1.8200	65219.	76611.
1762.7	2.7300	49967.	66396.
2750.0	3.6400	17756.	76611.
3700.6	4.5500	55160.	71948.
2600.1	4.2000	0.	78830.
2750.0	4.6000	17237.	73447.
16540.0	25.0000	67508.	68674.
30770.0	41.0000	86189.	75509.
44121.0	52.4000	127265.	85398.
50207.0	62.3000	153222.	96176.
76464.0	69.9000	199592.	107420.
89256.0	75.2000	260189.	118187.
107475.0	82.1000	219841.	126730.
118504.0	85.2000	489323.	139923.
132394.0	96.5000	122035.	137820.

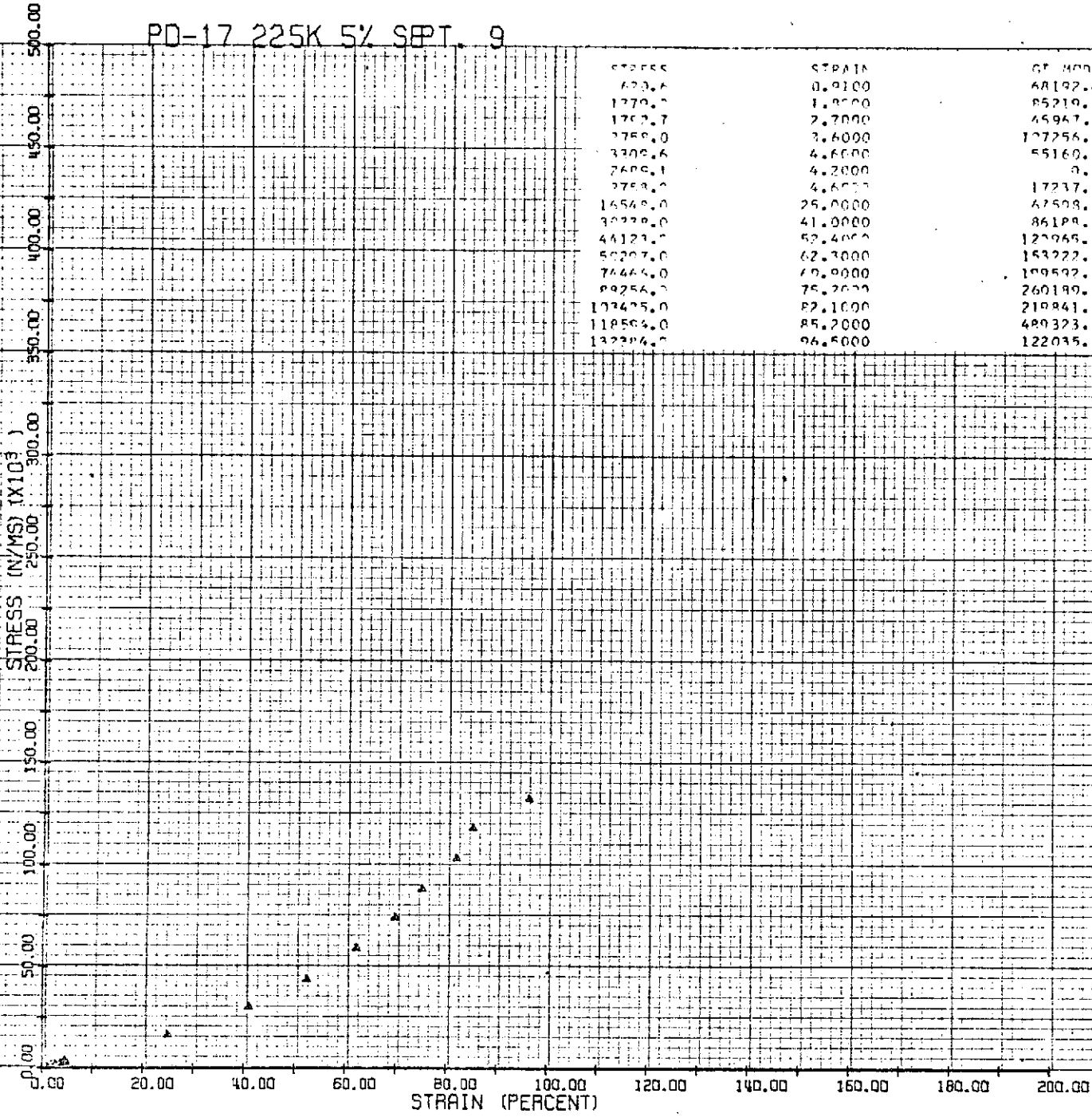

42

PD-15 225K 10% SEPT. 9

STRESS	STRAIN	GT MODULUS	CS MODULUS
4557.7	4.5000	101127.	101127.
5516.0	6.7500	64353.	91933.
6205.0	7.5000	45067.	92740.
4805.0	8.2500	61022.	83574.
7722.4	9.0000	110320.	85804.
4602.1	10.0000	0.	77224.
10252.5	24.7500	24775.	45067.
27605.7	39.7500	76611.	56782.
34475.0	51.0000	109157.	69626.
49265.0	60.7500	141436.	81151.
52627.5	66.7500	172375.	89351.
72307.5	72.7500	229833.	100937.
42763.0	74.5000	275823.	129509.
87002.5	91.0000	229833.	114104.
103425.0	85.2000	246250.	122605.
112747.5	89.2500	255370.	128629.

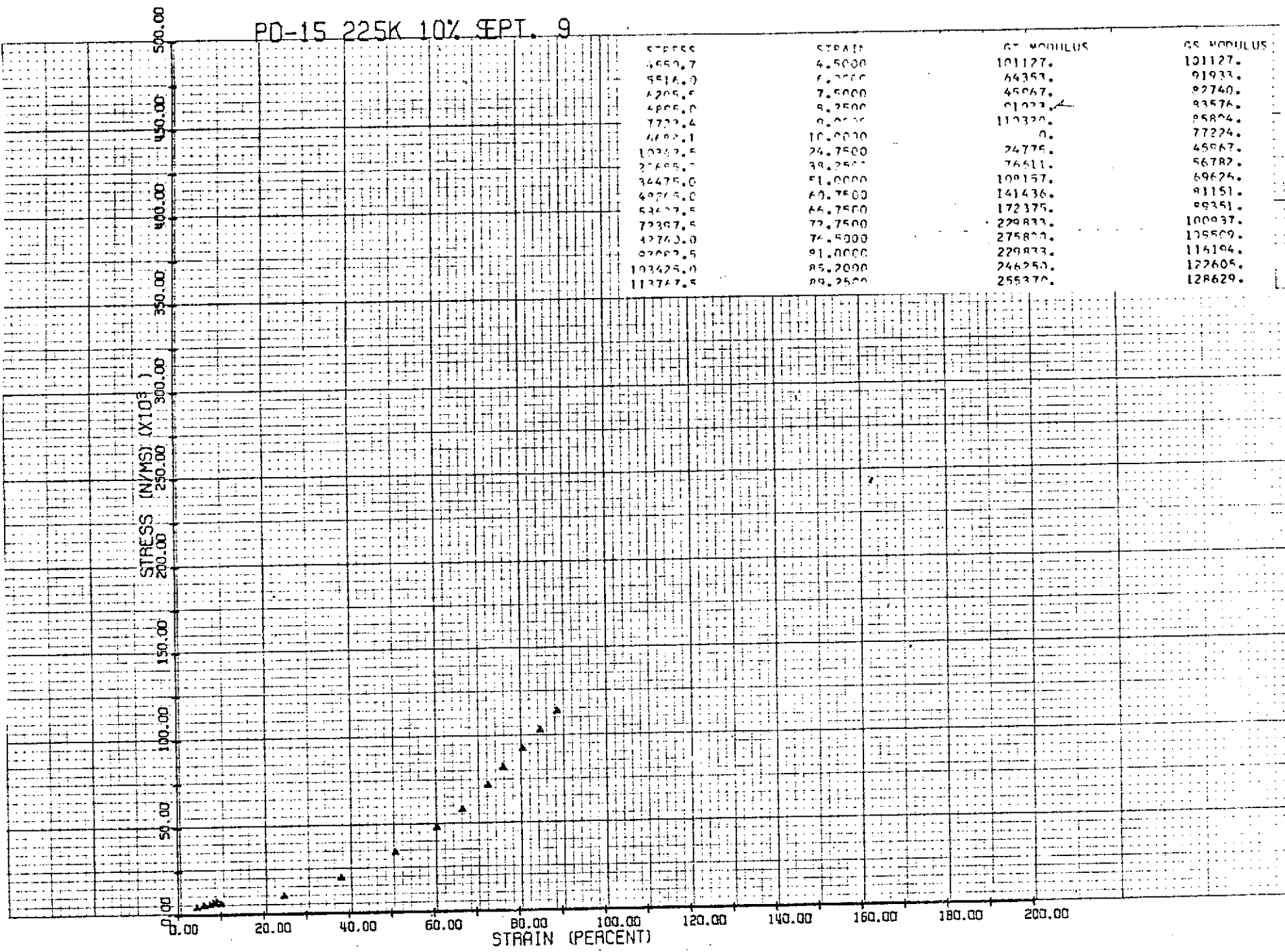

43 A

PD-48 250K 1 1/2 NOV. 8

STRESS	STRAIN	CS. MODULUS	GS. MODULUS
50.4	0.1500	59757.	59757.
227.6	0.3000	91933.	75845.
365.4	0.4500	91933.	81208.
551.4	0.7600	60052.	72579.
717.1	0.9100	119320.	78870.
551.4	0.9100	0.	78800.
2805.0	12.2000	56186.	57873.
12700.0	21.3000	75760.	65519.
22795.0	30.4000	75760.	68587.
27500.0	37.2000	131397.	74585.
36675.0	43.3000	113533.	97001.
41770.0	49.4000	113023.	84080.
55160.0	57.0000	191447.	97062.
62555.0	62.8000	191447.	102336.
75045.0	67.6000	202794.	112442.
88254.0	74.5000	175870.	118687.

STRESS (N/MS) (X10<sup>3</sup>)

STRAIN (PERCENT)

44 A

PD-3 250K 1% SEPT 4

45 #

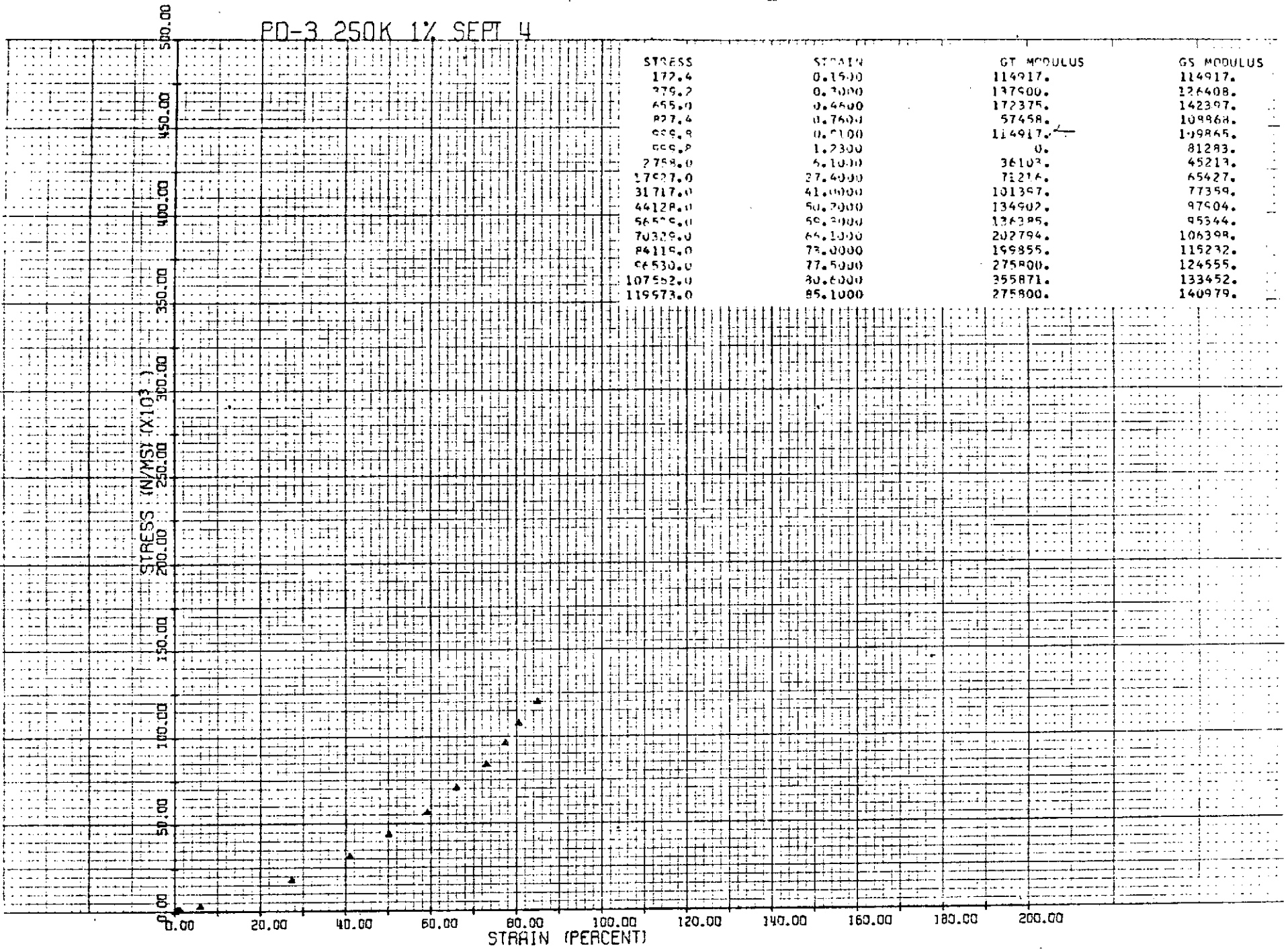

STRESS	STRAIN	GT MODULUS	GS MODULUS
172.4	0.1500	114917.	114917.
279.2	0.3000	137900.	124408.
455.0	0.4500	172375.	142397.
627.4	0.7600	57458.	109868.
666.8	0.9100	114917.	199865.
666.8	1.2300	0.	81283.
2758.0	5.1000	36103.	45213.
17627.0	27.4000	71216.	65427.
31717.0	41.0000	101397.	77359.
44128.0	50.7000	134902.	97504.
56576.0	59.3000	136385.	95344.
70329.0	64.1000	202794.	106398.
84115.0	73.0000	199855.	115232.
96530.0	77.5000	275800.	124555.
107562.0	80.6000	355871.	133452.
119573.0	85.1000	275800.	140979.

PO-43 250K 3% NOV. 8

46

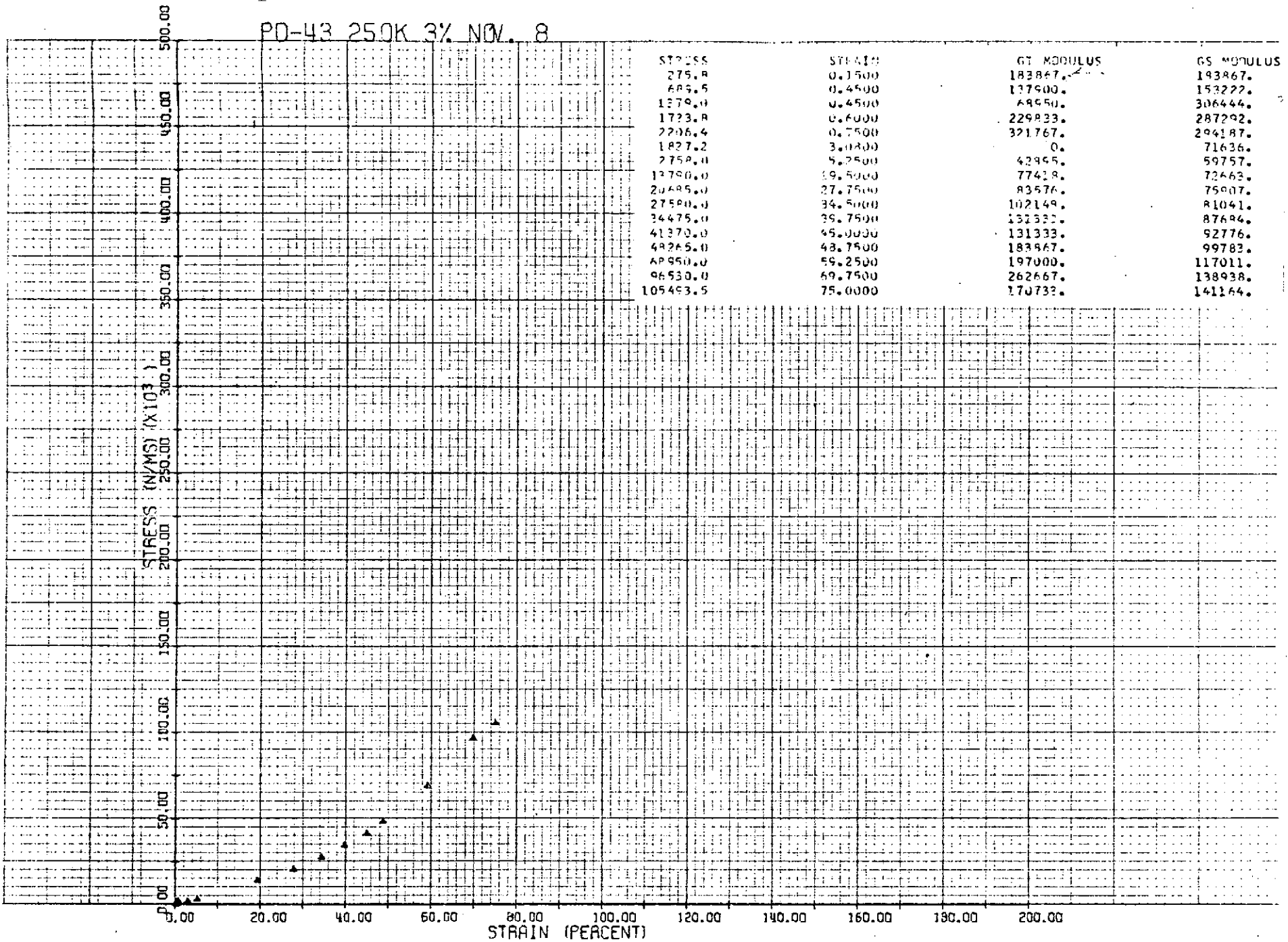

STRESS	STRAIN	GT MODULUS	GS MODULUS
275.8	0.1500	183867.	193867.
489.5	0.4500	137900.	152222.
1279.0	0.4500	89950.	306444.
1723.8	0.6000	229833.	287292.
2206.4	0.7500	321767.	294187.
1827.2	3.0000	0.	71636.
2758.0	5.2500	42965.	59757.
12790.0	19.5000	77418.	72663.
20485.0	27.7500	83576.	75907.
27590.0	34.5000	102149.	81041.
34475.0	39.7500	131322.	87694.
41270.0	45.0000	131333.	92776.
49265.0	48.7500	183867.	99783.
68950.0	59.2500	197000.	117011.
96530.0	69.7500	262667.	138938.
105493.5	75.0000	170732.	141164.

PD-6 250K 3% AUG 28

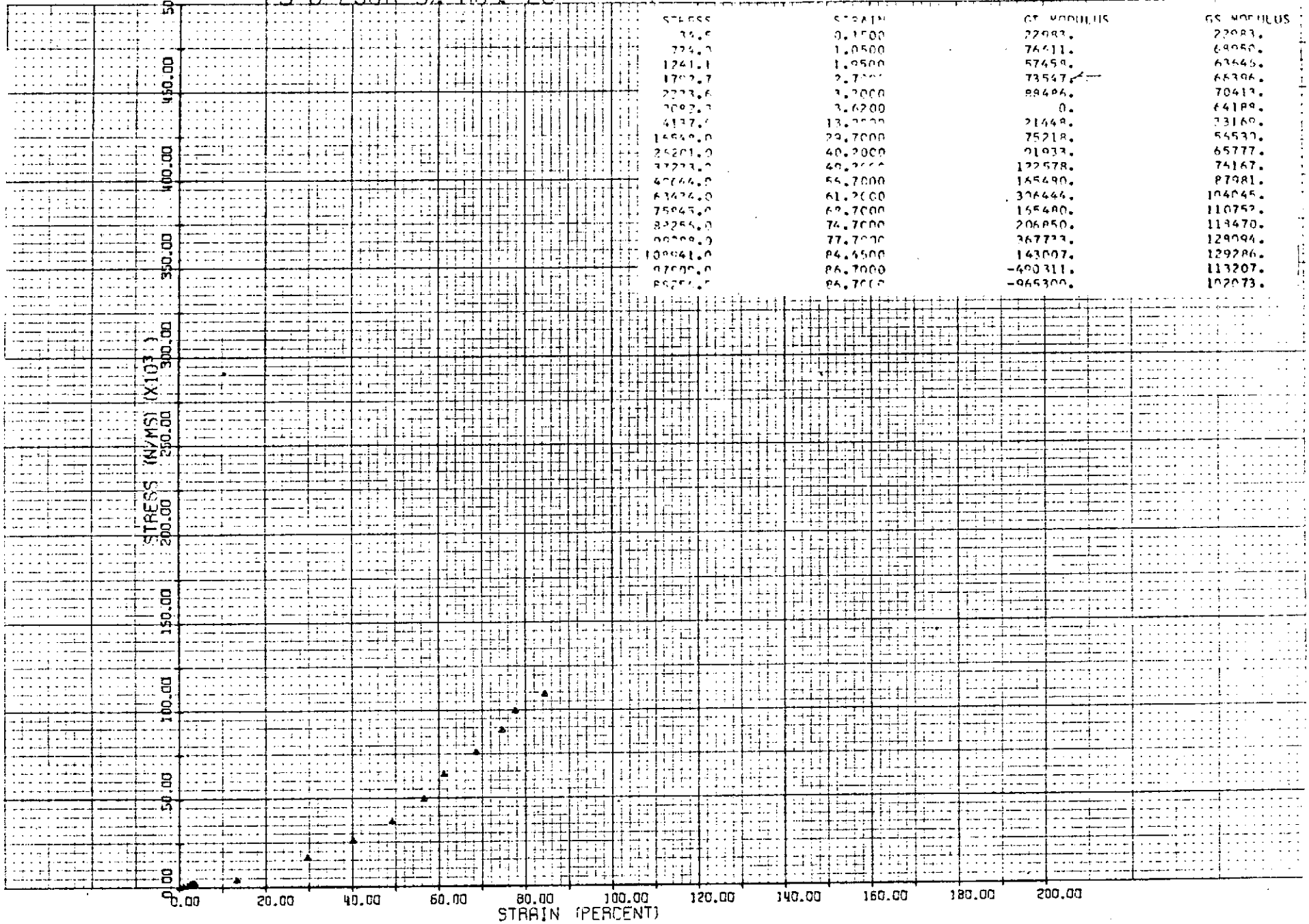

477

PD-47 250K 5% NOV. 7

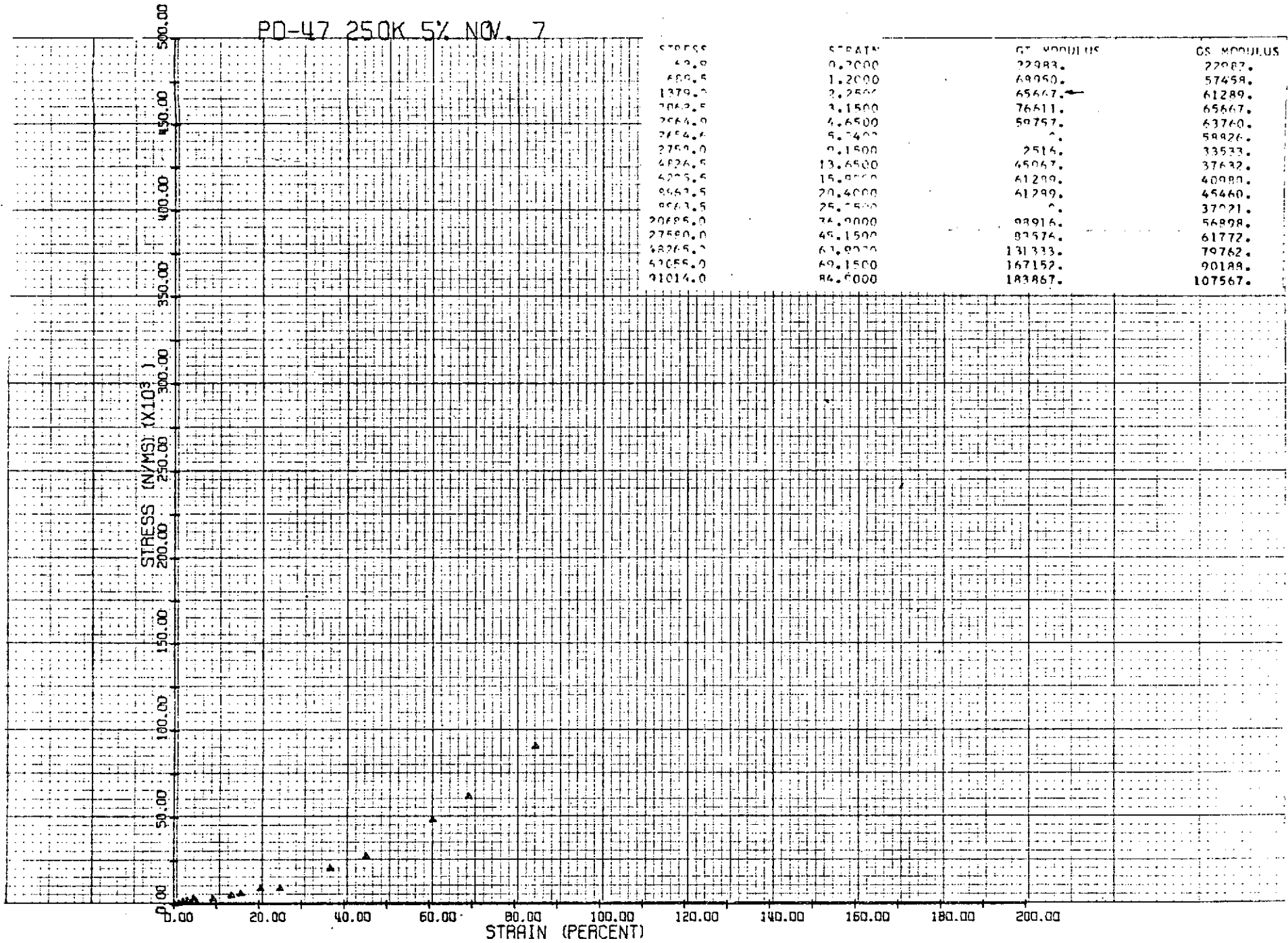

STRESS	STRAIN	GT MODULUS	GS MODULUS
42.0	0.2000	22983.	22987.
600.5	1.2000	69950.	57458.
1379.0	2.2500	65667.	61289.
2042.5	3.1500	76611.	65667.
2664.0	4.6500	59757.	63760.
2864.6	5.7400	.	59926.
2759.0	6.1500	2516.	33533.
4026.5	13.6500	45067.	37632.
4225.6	15.8500	61299.	40980.
8643.5	20.4000	61299.	45660.
8663.5	25.7500	.	37021.
20685.0	76.9000	93916.	56898.
27580.0	45.1500	87576.	61772.
62265.0	61.9000	131333.	79762.
62055.0	69.1500	167152.	90188.
91014.0	84.6000	183867.	107567.

48



PD-5 250K 5% AUG. 27

49 A

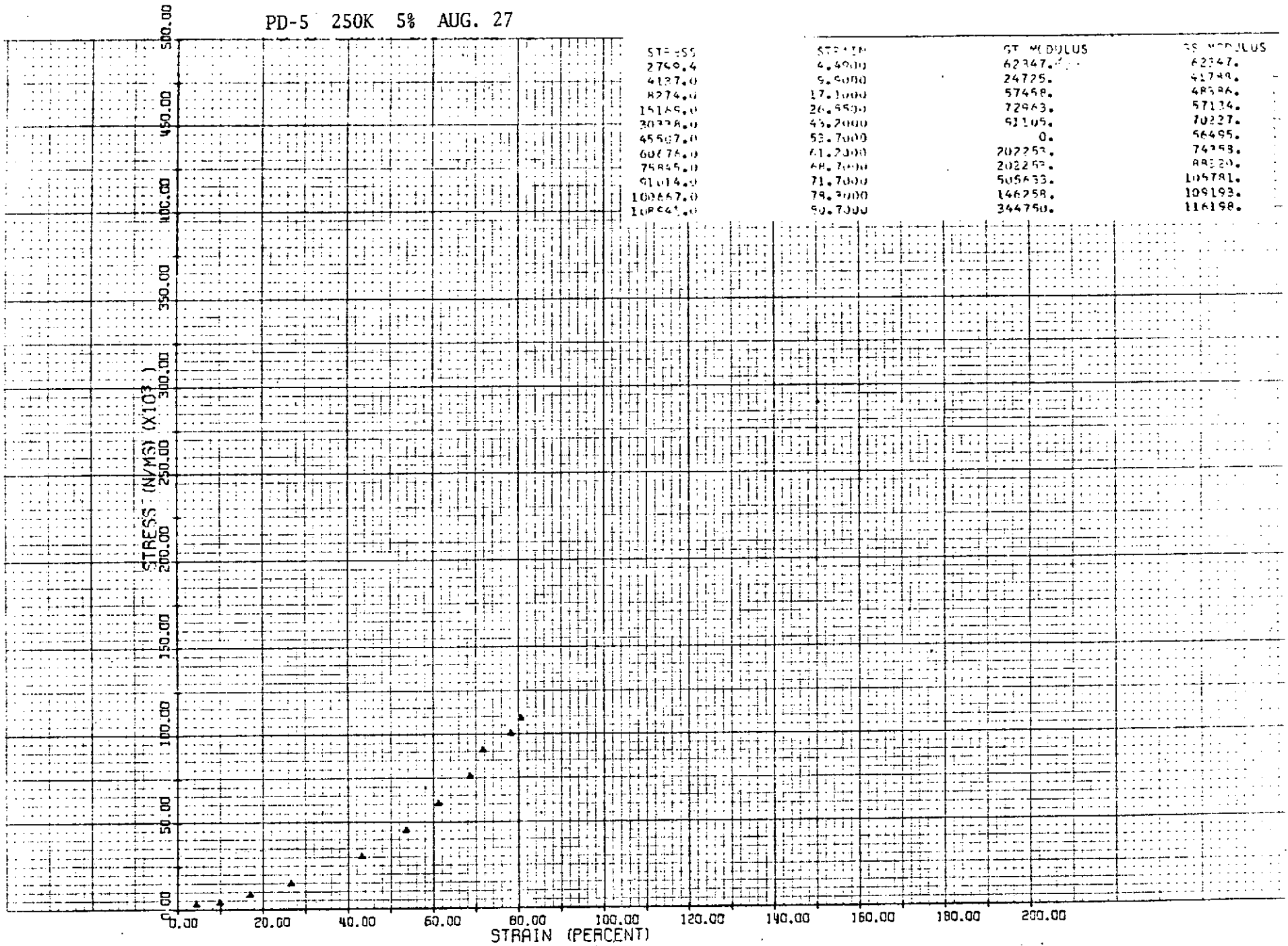

STRESS  
2740.4  
4137.0  
8274.0  
15169.0  
30338.0  
45507.0  
60676.0  
75845.0  
91014.0  
106183.0  
121352.0

STRAIN  
4.4000  
9.6000  
17.1000  
26.9500  
43.2000  
53.7000  
61.2000  
68.7000  
71.7000  
79.3000  
90.7000

GT MODULUS  
62347.  
24725.  
57458.  
72963.  
93105.  
0.  
202253.  
202253.  
505633.  
146258.  
344750.

SS MODULUS  
62347.  
41749.  
48386.  
57134.  
70227.  
56495.  
74253.  
88320.  
105781.  
109193.  
116198.



PD-4 250K 10% SEPT. 4

STRESS	STRAIN	GT MODULUS	GS MODULUS
137.9	0.5000	45967.	45967.
2344.3	4.0500	58997.	57884.
4107.0	8.7500	66396.	61789.
5761.9	9.0000	73547.	64353.
7032.9	10.5000	82740.	66980.
8688.7	9.7500	0.	72504.
8274.0	25.5000	10037.	73799.
17627.0	33.2500	75710.	47769.
26701.0	44.5000	100291.	57088.
35954.0	55.5000	107256.	65223.
45507.0	53.5000	321767.	78379.
53781.0	66.0000	110320.	82009.
64813.0	69.7500	294187.	93416.
75945.0	76.5000	165437.	99594.
85468.0	81.0000	214511.	105979.
86520.0	95.5000	245156.	113304.

STRESS (N/MS) (X10<sup>3</sup>)

500.00  
450.00  
400.00  
350.00  
300.00  
250.00  
200.00  
150.00  
100.00  
50.00  
0.00

STRAIN (PERCENT)

0.00 20.00 40.00 60.00 80.00 100.00 120.00 140.00 160.00 180.00 200.00

50 A

PD-44 250K 10% NOV. 6

SI A

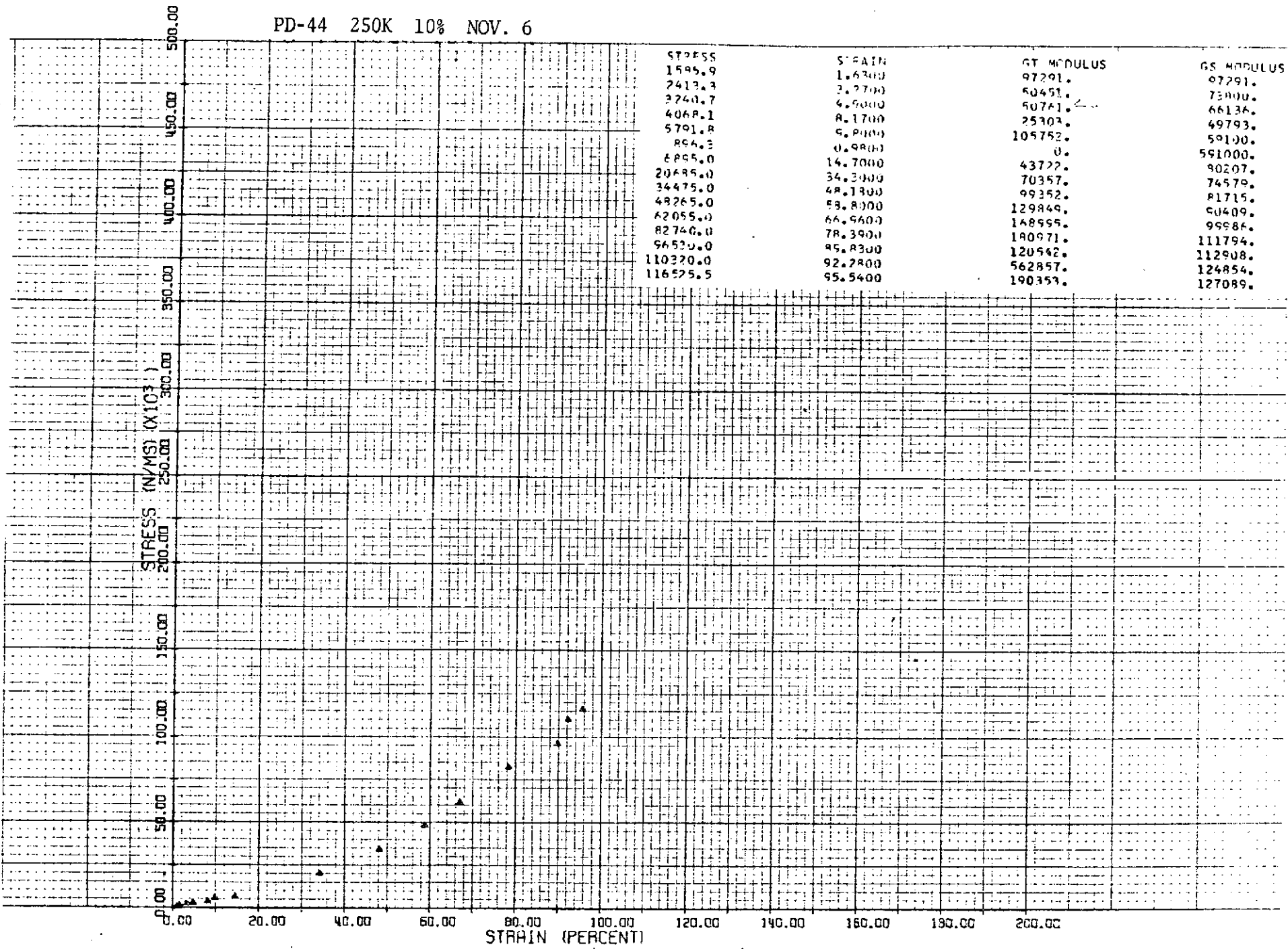

STRESS	STRAIN	GT MODULUS	GS MODULUS
1595.9	1.6300	97291.	97291.
2413.3	3.2700	50451.	73800.
3240.7	4.9000	50761.	66136.
4068.1	6.1700	25303.	49793.
5791.8	9.2600	105752.	59100.
864.3	0.9800	0.	591000.
8895.0	14.7000	43722.	90207.
20685.0	34.3000	70357.	74579.
34475.0	48.1800	99352.	81715.
48265.0	58.8000	129849.	50409.
62055.0	66.5600	168995.	99886.
82740.0	78.3900	180971.	111794.
96530.0	95.8300	120542.	112908.
110320.0	92.2800	562857.	124854.
116525.5	95.5400	190353.	127089.



PO-13 275K 3% ALG 22

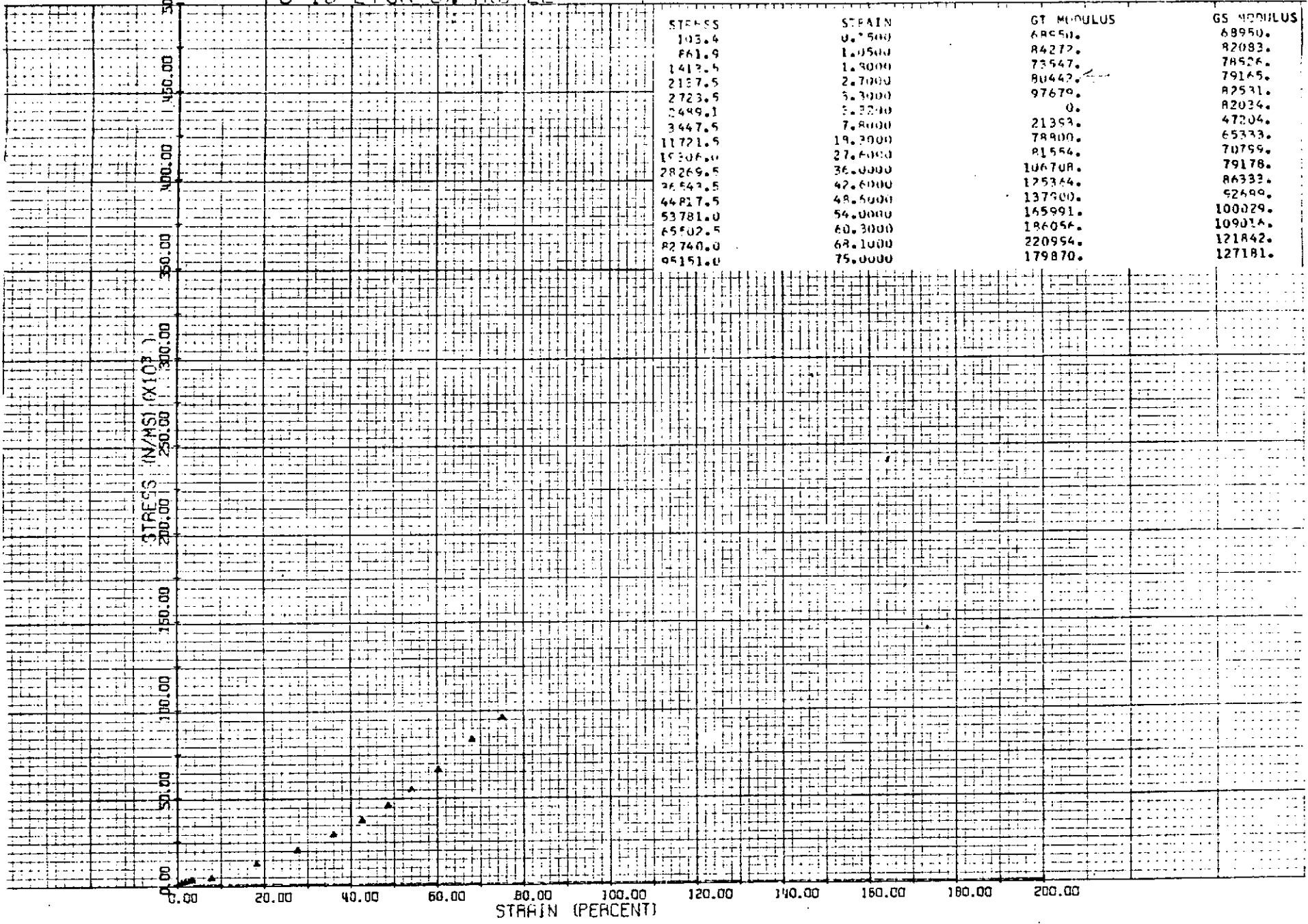

53 A

PD-19 275K 5% AUG 22

STRESS	STRAIN	GT MODULUS	GS MODULUS
34.5	0.1500	22983.	22983.
1034.3	1.5200	72976.	68043.
1861.7	2.1000	142655.	88650.
2654.6	3.6000	52862.	73738.
3916.5	4.9000	66298. ←	71764.
3792.3	4.6100	0.	76279.
4137.0	7.6000	24005.	56067.
9653.0	14.3000	82323.	68371.
14568.0	22.9000	82119.	72123.
24822.0	31.3000	97361.	79700.
34475.0	41.0000	99515.	84399.
46896.0	50.5000	134902.	93646.
55297.0	57.5000	170014.	103341.
68550.0	62.2000	205383.	111052.
78602.0	68.6000	219386.	118209.
86877.0	71.0000	188045.	122537.

STRESS (N/MS) (X10<sup>3</sup>)

STRAIN (PERCENT)

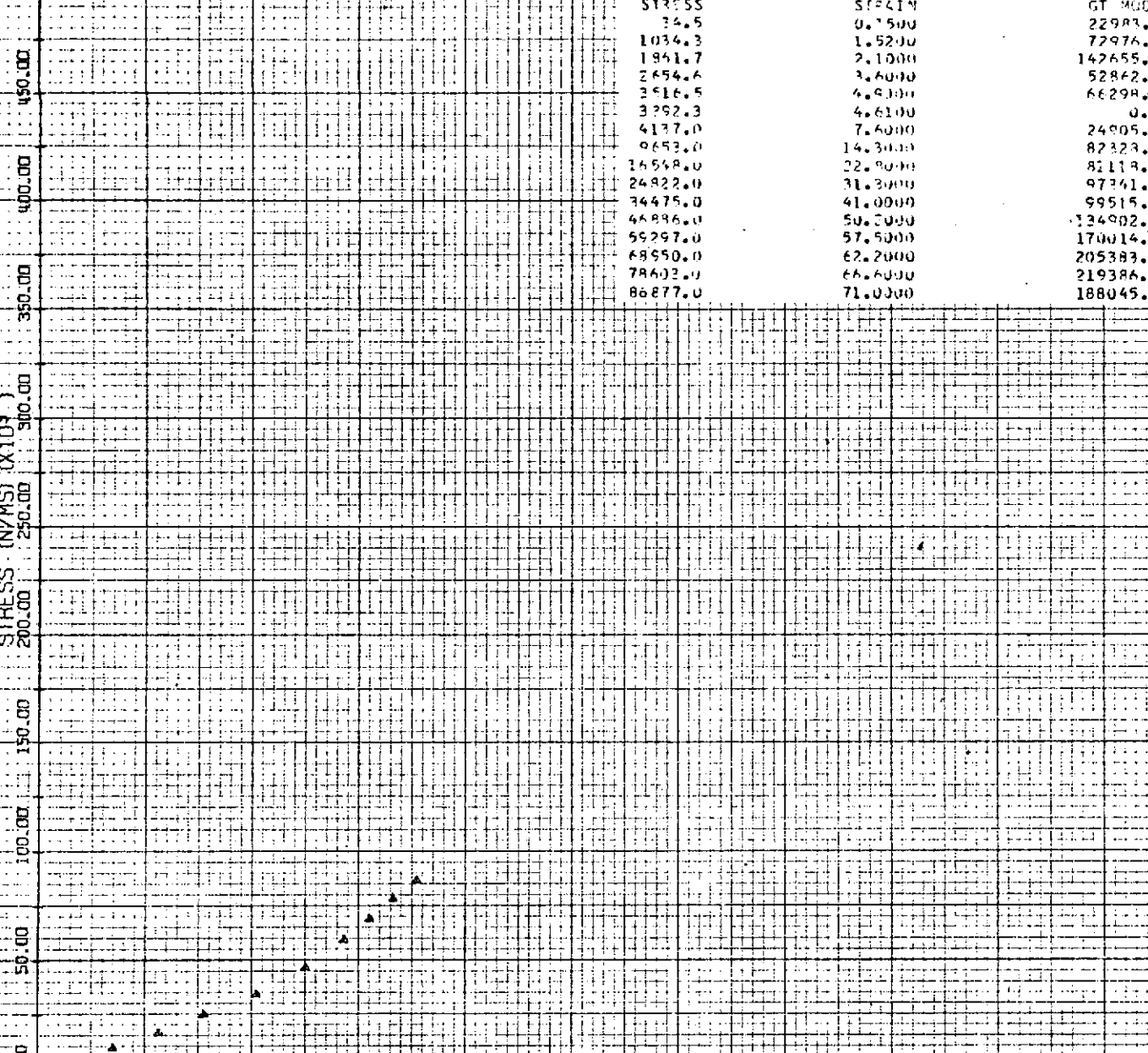

54 A

PD-20 275K 10% AUG 23

STRESS	STRAIN	GT MODULUS	GS MODULUS
75.8	0.7000	9163.	9163.
159.0	2.0500	67599.	70160.
2447.5	5.2500	68950. ←	69607.
4857.1	7.6500	74486.	71203.
8274.0	9.6000	-102541.	75911.
22154.0	9.6000	0.	35698.
34475.0	24.0000	11572.	21518.
42265.0	37.5000	102149.	50545.
62155.0	48.7500	170320.	64339.
75945.0	59.5000	141436.	77189.
81014.0	66.0000	197367.	89311.
82740.0	72.7500	294256.	99980.
82055.0	81.0000	193867.	108524.
44128.0	82.0500	-788000.	97051.
	83.2500	-1723750.	70805.
	85.2000	-919333.	48144.

55 A

STRESS (N/CM<sup>2</sup>) (X 10<sup>11</sup>)

0.00 50.00 100.00 150.00 200.00 250.00 300.00 350.00 400.00 450.00 500.00

STRAIN (PERCENT)

0.00 20.00 40.00 60.00 80.00 100.00 120.00 140.00 160.00 180.00 200.00

PD-21 300K 1% PLG. 19

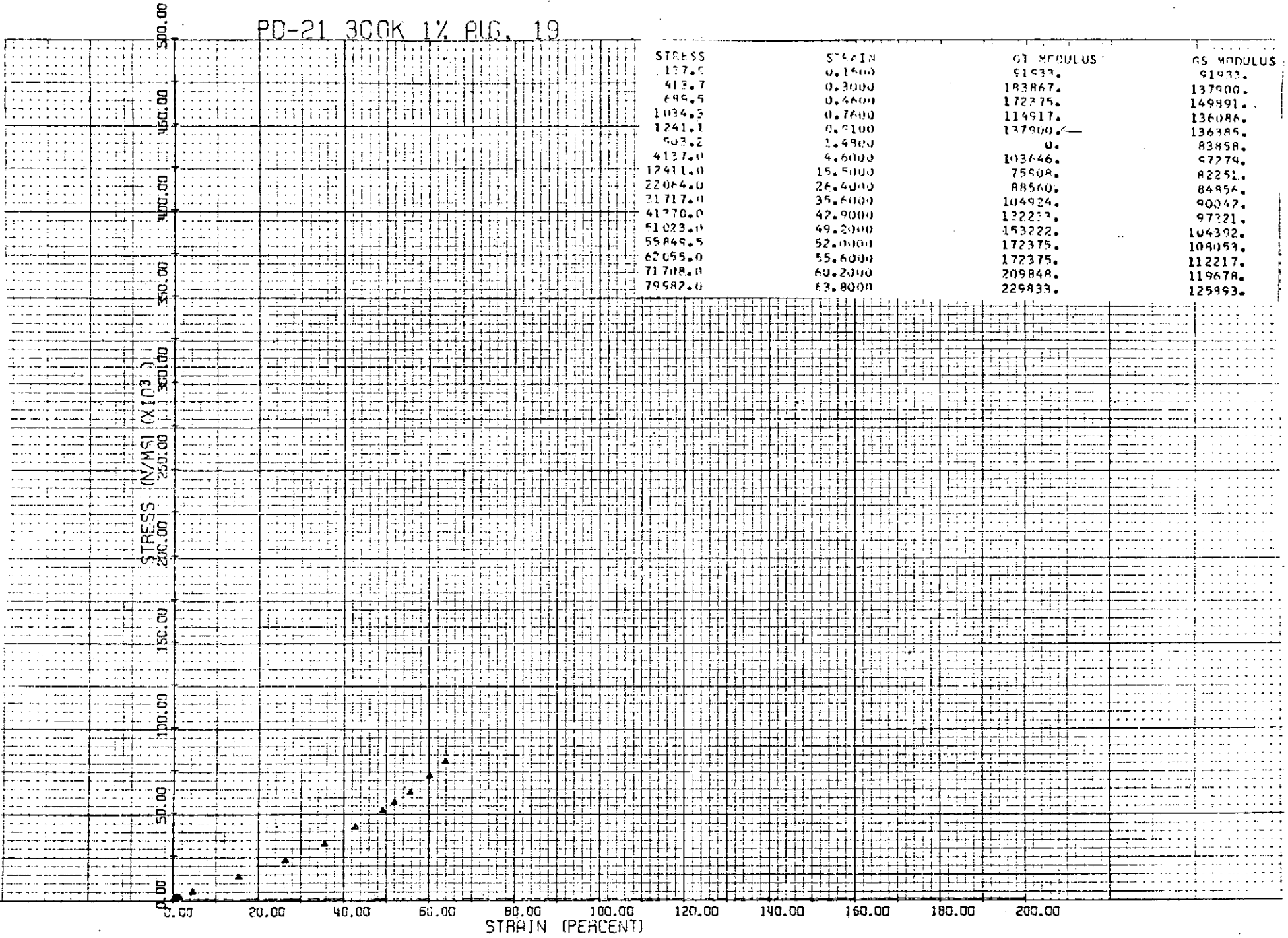

STRESS	STRAIN	GT MODULUS	GS MODULUS
137.5	0.1500	91939.	91939.
413.7	0.3000	183867.	137900.
699.5	0.4500	172375.	149991.
1034.5	0.7500	114917.	136086.
1241.1	0.9100	137900.	136385.
503.2	1.4800	0.	83858.
4137.0	4.6000	103646.	67274.
12411.0	15.5000	75908.	82251.
22064.0	26.4000	88560.	84956.
31717.0	35.6000	104924.	90047.
41370.0	42.9000	122233.	97321.
51023.0	49.2000	153222.	104392.
55849.5	52.0000	172375.	108053.
62055.0	55.6000	172375.	112217.
71708.0	60.2000	209848.	119678.
79582.0	63.8000	229833.	125993.

56



PD-11 300K 3% AUG 15

57A

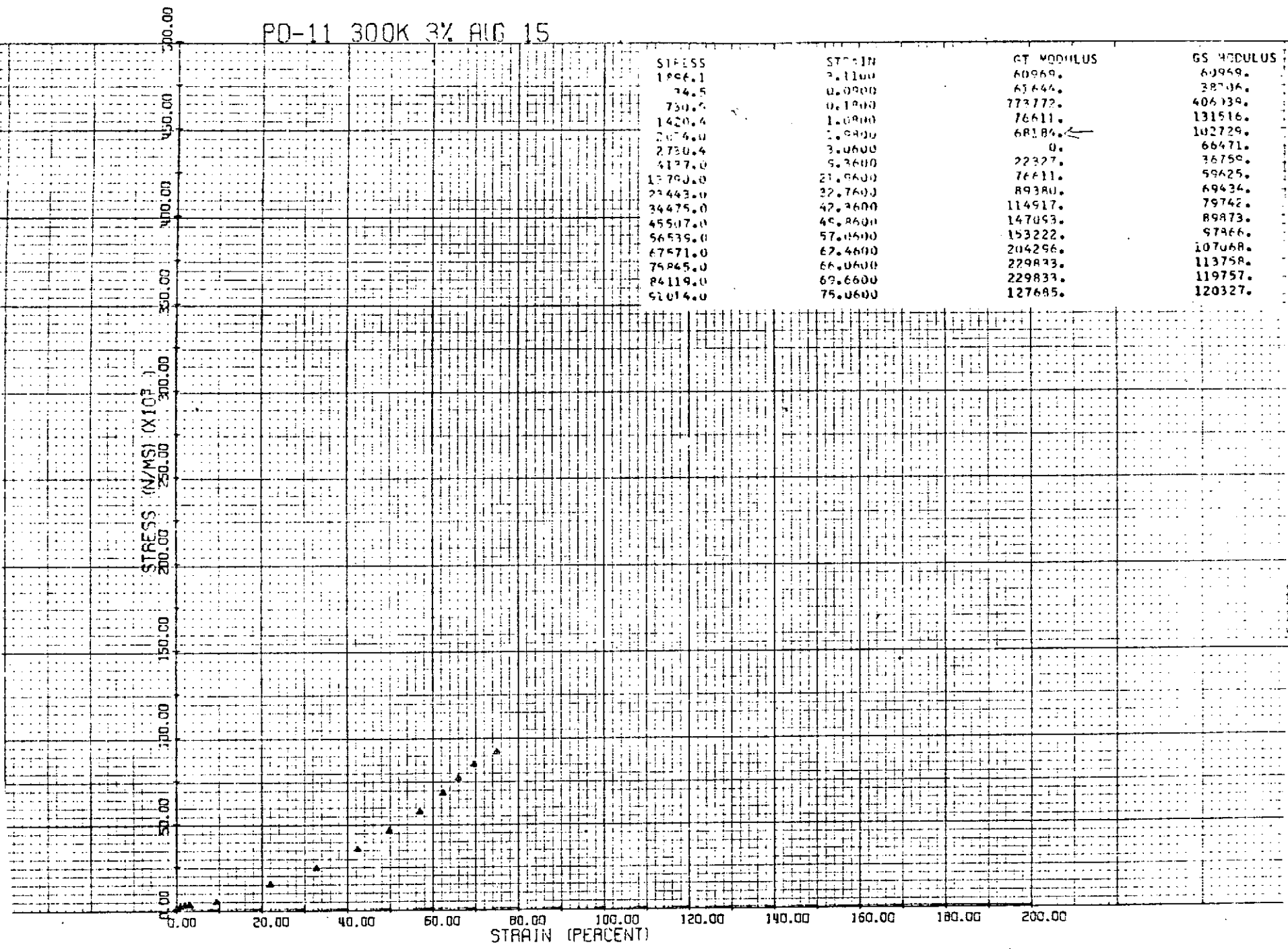

STRESS	STRAIN	GT MODULUS	GS MODULUS
186.1	2.1100	40969.	60949.
74.5	0.0000	63644.	38706.
730.4	0.1000	773772.	406139.
1420.4	1.0000	76611.	131516.
2076.0	1.0000	68184. ←	102729.
2730.4	3.0000	0.	66471.
4177.0	5.0000	22327.	36759.
13700.0	21.0000	76611.	59625.
23443.0	32.7600	89380.	69434.
34475.0	42.0000	114917.	79742.
45507.0	49.0000	147053.	89873.
56539.0	57.0000	153222.	97466.
67571.0	62.0000	204296.	107068.
75045.0	66.0000	229873.	113758.
84119.0	69.6600	229833.	119757.
52014.0	75.0000	127685.	120327.





PD-38 300K 5% OCT. 27

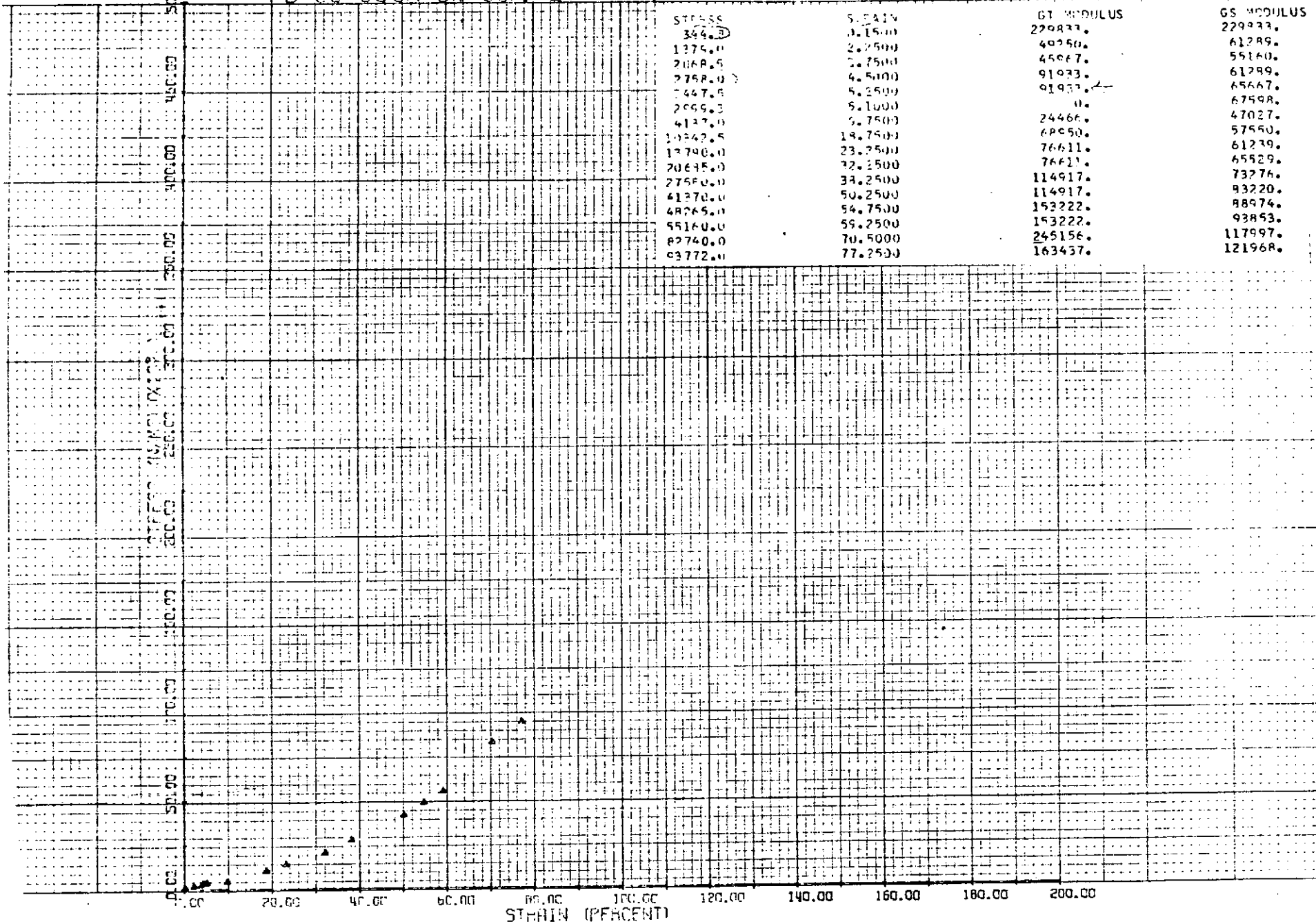

STRESS	STRAIN	GT. MODULUS	GS. MODULUS
344.0	1.1500	220833.	220833.
1375.0	2.2500	40750.	61289.
2068.0	3.7500	45067.	55160.
2768.0	5.0000	91033.	61289.
3467.0	6.2500	91933.	65667.
4167.0	7.5000	0.	67598.
4867.0	8.7500	24466.	47027.
5567.0	10.0000	60050.	57550.
6267.0	11.2500	76611.	61239.
6967.0	12.5000	76611.	65529.
7667.0	13.7500	114917.	73276.
8367.0	15.0000	114917.	93220.
9067.0	16.2500	153222.	88974.
9767.0	17.5000	153222.	93853.
10467.0	18.7500	245156.	117997.
11167.0	20.0000	163437.	121968.

59 A

PO-22 300K 10% AUG 16

STRESS	STRAIN	GT MODULUS	GS MODULUS
137.5	0.4500	30644.	30644.
1930.0	3.0000	70207.	64353.
3861.2	5.8500	67740.	66003.
5816.0	7.9500	78800.	69384.
7032.9	10.3500	63204.	67951.
6561.5	10.5800	0.	66474.
8618.8	22.0500	13155.	37735.
13740.0	30.1500	71823.	45875.
20685.0	37.0500	88357.	54615.
28559.0	46.0500	107149.	62976.
37237.0	52.2500	131333.	71202.
46886.0	58.0500	146258.	79605.
56535.0	64.3500	178759.	87926.
66192.0	69.7500	178759.	94958.
76534.5	74.2500	229833.	103132.
85478.0	79.0500	186740.	108209.

STRESS (N/MSI) (X10<sup>11</sup>)

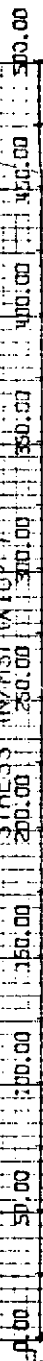

STRAIN (PERCENT)

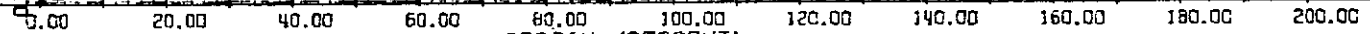

6079

RL-13 100K 1% OCT. 16

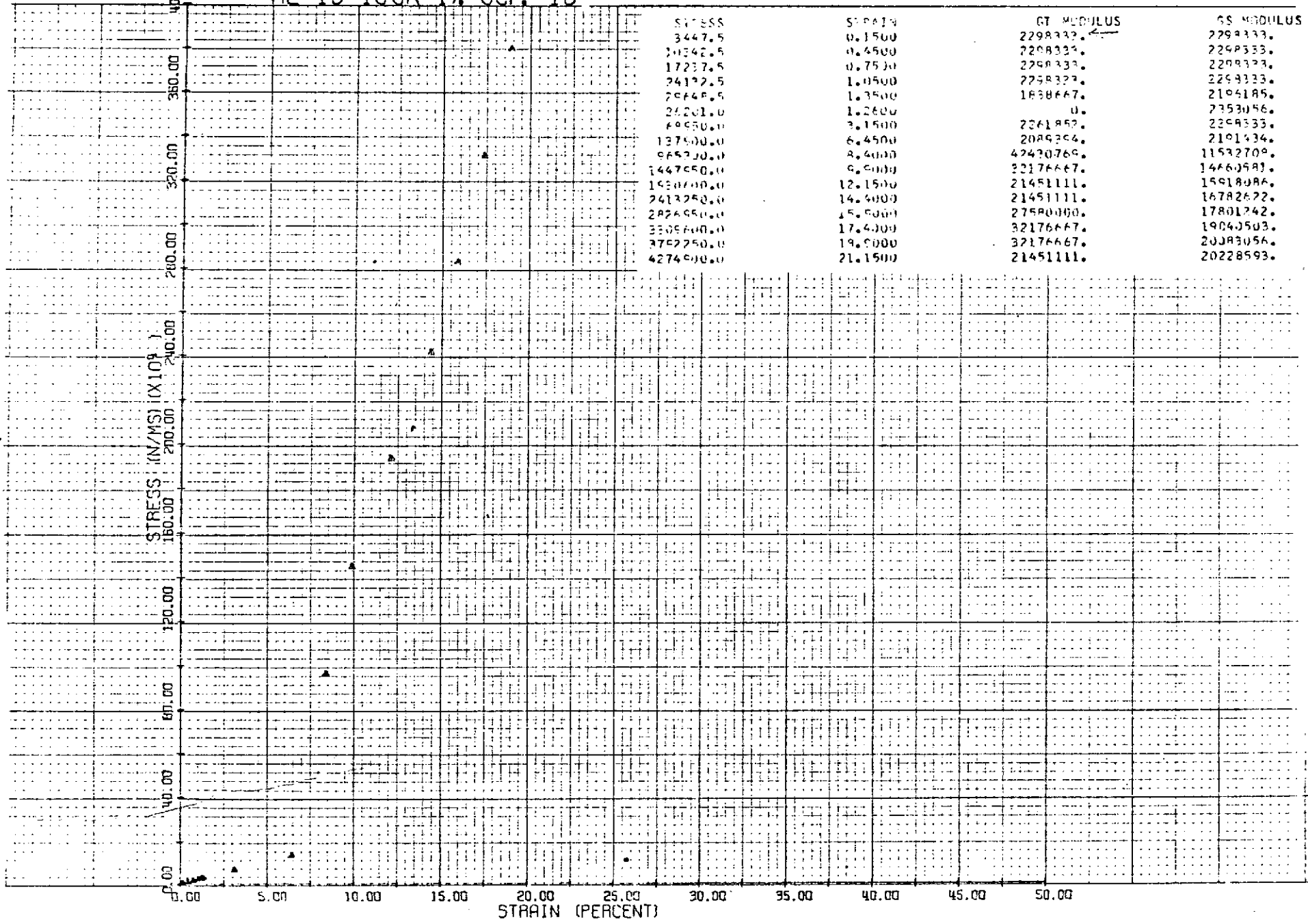

619

RI-42 100K 34 SEP 19

STRESS	STRAIN	GT MODULUS	GS MODULUS
75155.5	0.4500	11562286.	11562385.
161343.0	1.1400	17589286.	14152855.
250978.0	1.6300	18292857.2	15397423.
471619.0	2.4500	26507317.	19249714.
595728.0	3.1000	19093946.	19217032.
416498.0	3.0600	0.	19468235.
510220.0	3.9200	10903721.	17589286.
555265.0	8.9200	1829286.	8833730.
758450.0	13.7200	3236429.	6834694.
806350.0	18.6200	2814286.	5776692.
1013565.0	22.5400	2990179.	5292081.

STRESS (N/MS) (X10<sup>11</sup>)

STRAIN (PERCENT)

62

RL-8 100K 5% OCT. 8

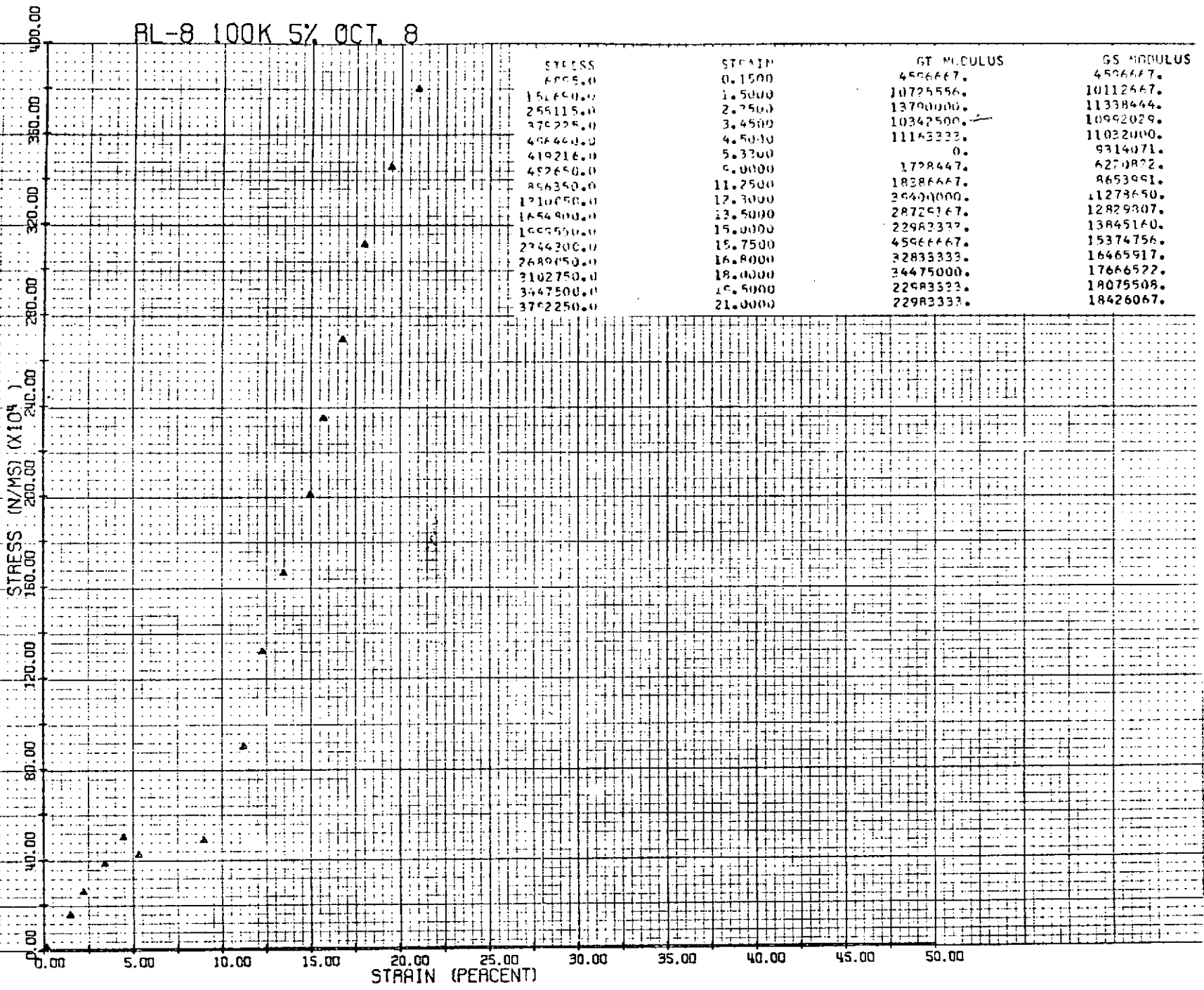

STRESS	STRAIN	GT MODULUS	GS MODULUS
400.00	0.1500	4506667.	4506667.
350.00	1.5000	10725556.	10112667.
300.00	2.7500	13700000.	11338644.
250.00	3.4500	10342500.	10992029.
200.00	4.5000	11163333.	11022000.
150.00	5.3300	0.	9314071.
100.00	6.0000	1728447.	6270822.
50.00	11.2500	18286667.	8653991.
0.00	17.3000	26400000.	11278650.
	13.5000	28725167.	12829307.
	15.0000	22983333.	13845160.
	15.7500	45966667.	15374756.
	16.8000	32833333.	16465917.
	18.0000	34475000.	17666522.
	18.5000	22983333.	18075508.
	21.0000	22983333.	18426067.

63 A

RL-67 100K 5% DEC. 4

STRESS	STRAIN	GI MODULUS	GS MODULUS
20338.0	0.4200	7223333.	7223333.
162722.0	1.7600	15760000.	12914444.
441966.5	2.5300	21697662.6	17469150.
672952.0	3.3700	27497917.	19968902.
911914.5	4.2200	30419119.	22073903.
861875.0	4.4500	0.	20932910.
1012565.0	4.6400	79836942.	23344925.
1172150.0	5.1000	34475000.	24343814.
1447950.0	5.9000	34475000.	25721856.
1670600.0	7.2000	37126623.	27781104.
2202930.0	7.6000	93082600.	31218020.

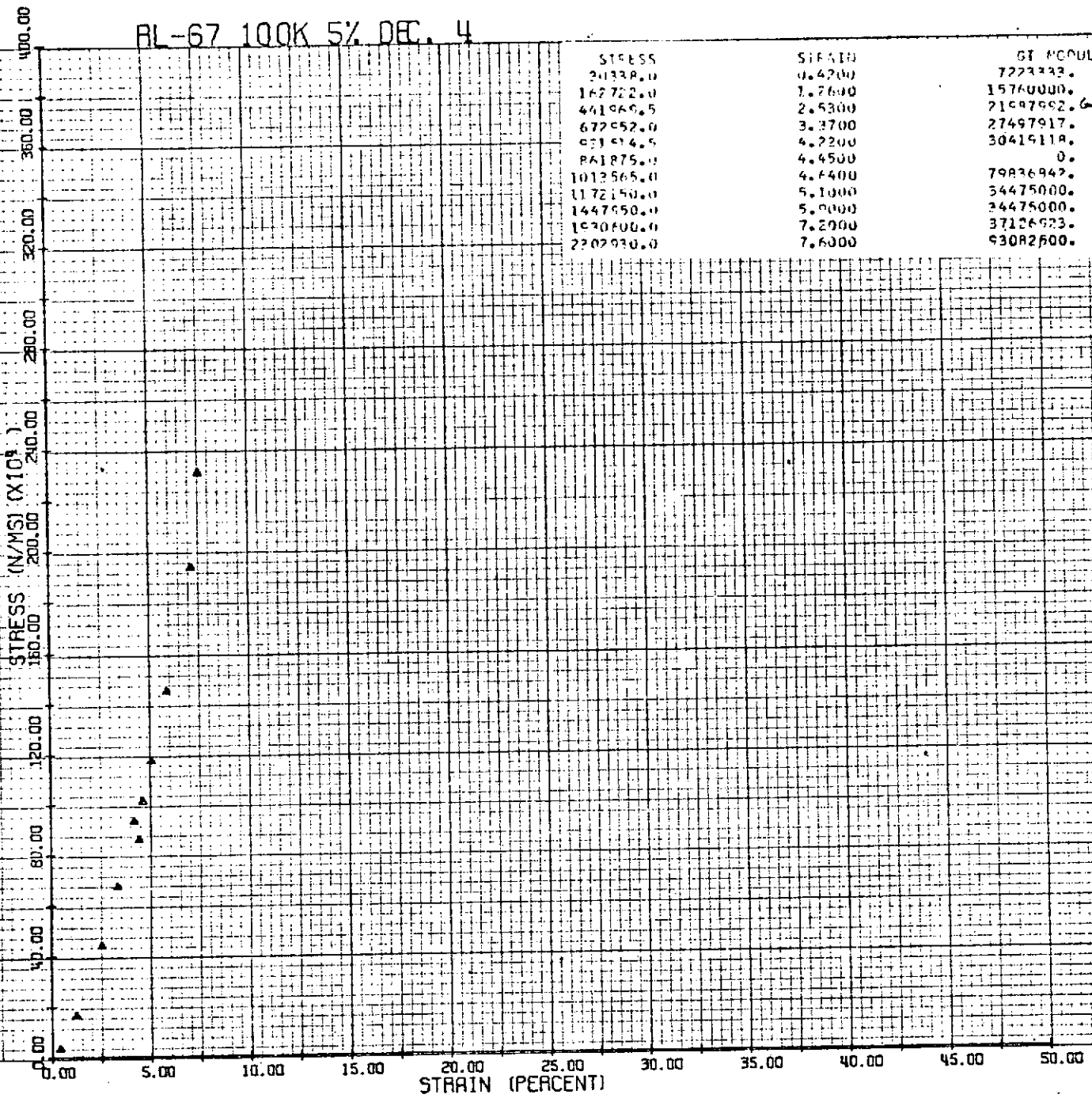

49

10



AL-8 100K 5% OCT. 8

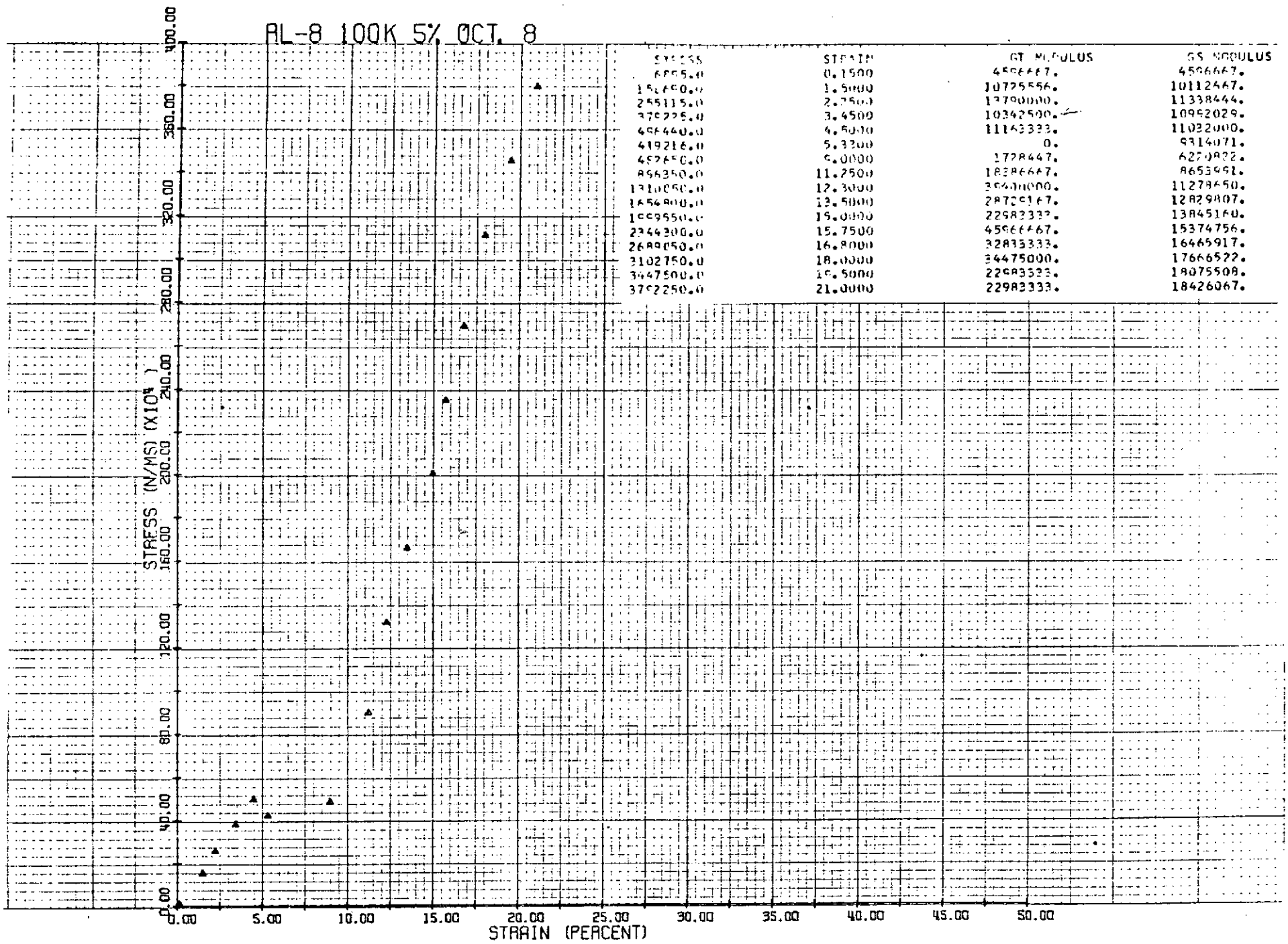

STRESS	STRAIN	GT MODULUS	GS MODULUS
6005.0	0.1500	456667.	456667.
156650.0	1.5000	1075556.	10112467.
255115.0	2.7500	1379000.	11338444.
370225.0	3.4500	10362500.	10992029.
496460.0	4.5000	11163333.	11022000.
419216.0	5.3200	0.	9314071.
492450.0	5.0000	1728447.	6270822.
896350.0	11.2500	1828667.	8653491.
1310050.0	12.3000	3660000.	11278450.
1656800.0	12.5000	28725167.	12829807.
1663550.0	15.0000	22583333.	13845160.
2344300.0	15.7500	45666667.	15374756.
2689050.0	16.8000	32833333.	16465917.
3102750.0	18.0000	34475000.	17666522.
3447500.0	19.5000	22983333.	18075508.
3702250.0	21.0000	22983333.	18426067.

65 A



RL-16 100K 5% OCT. 9

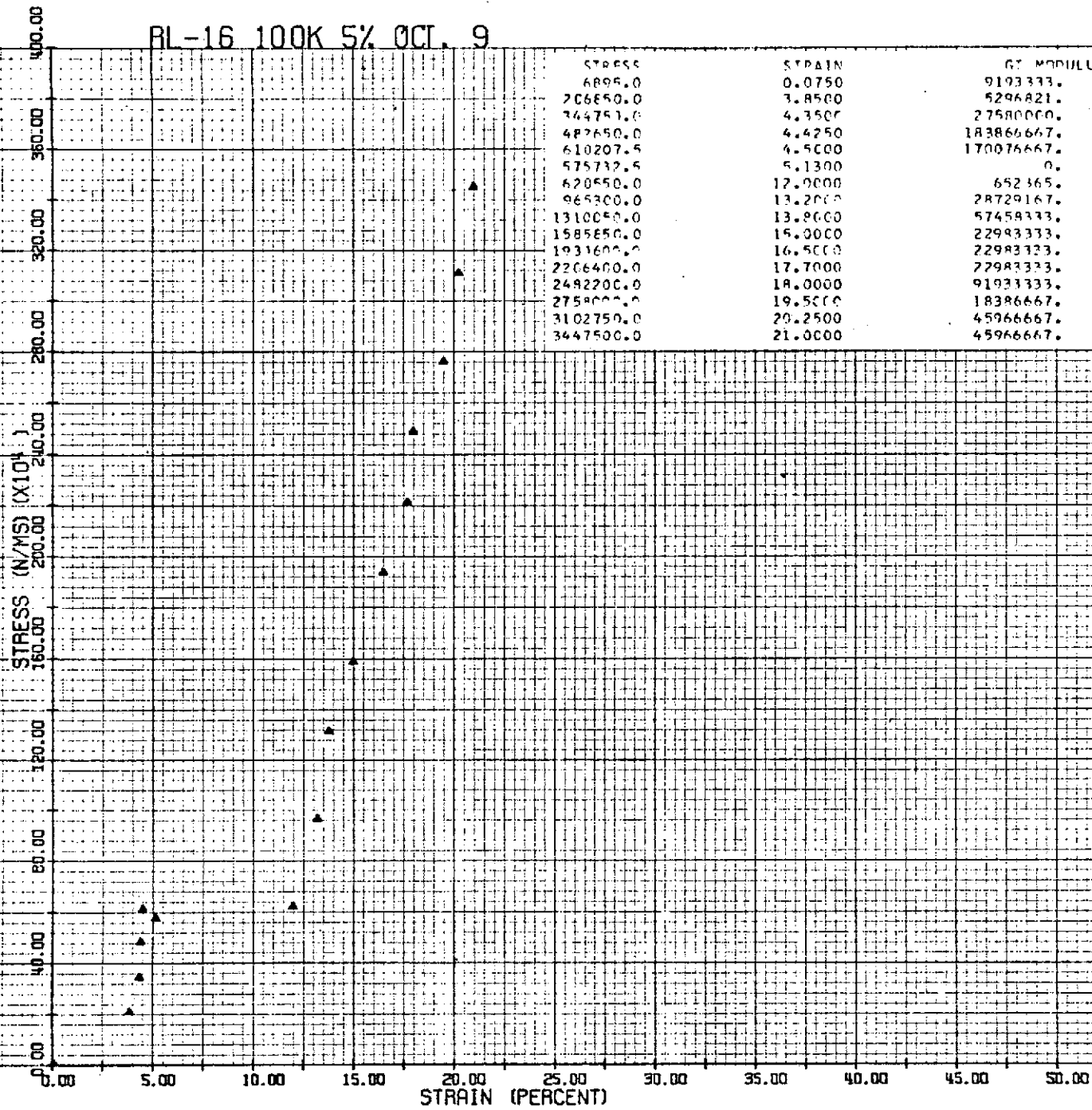

STRESS	STRAIN	GT MODULUS	GS MODULUS
6895.0	0.0750	9193333.	9193333.
206650.0	3.8500	5296821.	5372727.
344751.0	4.3500	27580000.	7925287.
487650.0	4.4250	183866667.	10907345.
610207.5	4.5000	170076667.	13567167.
575732.5	5.1300	0.	11804883.
620550.0	12.0000	652365.	5488542.
965300.0	13.2000	28729167.	7674053.
1310050.0	13.8000	57458333.	6742935.
1585850.0	15.0000	22983333.	10902167.
1931600.0	16.5000	22983333.	11909545.
2266600.0	17.7000	27983333.	12660311.
2482200.0	18.0000	91933333.	13981528.
2758000.0	19.5000	183866667.	14320385.
3102750.0	20.2500	459666667.	15492469.
3447500.0	21.0000	459666667.	16580833.

66 A

RL-11, 100 K, STRAIN = 10%, OCT. 8, 1974

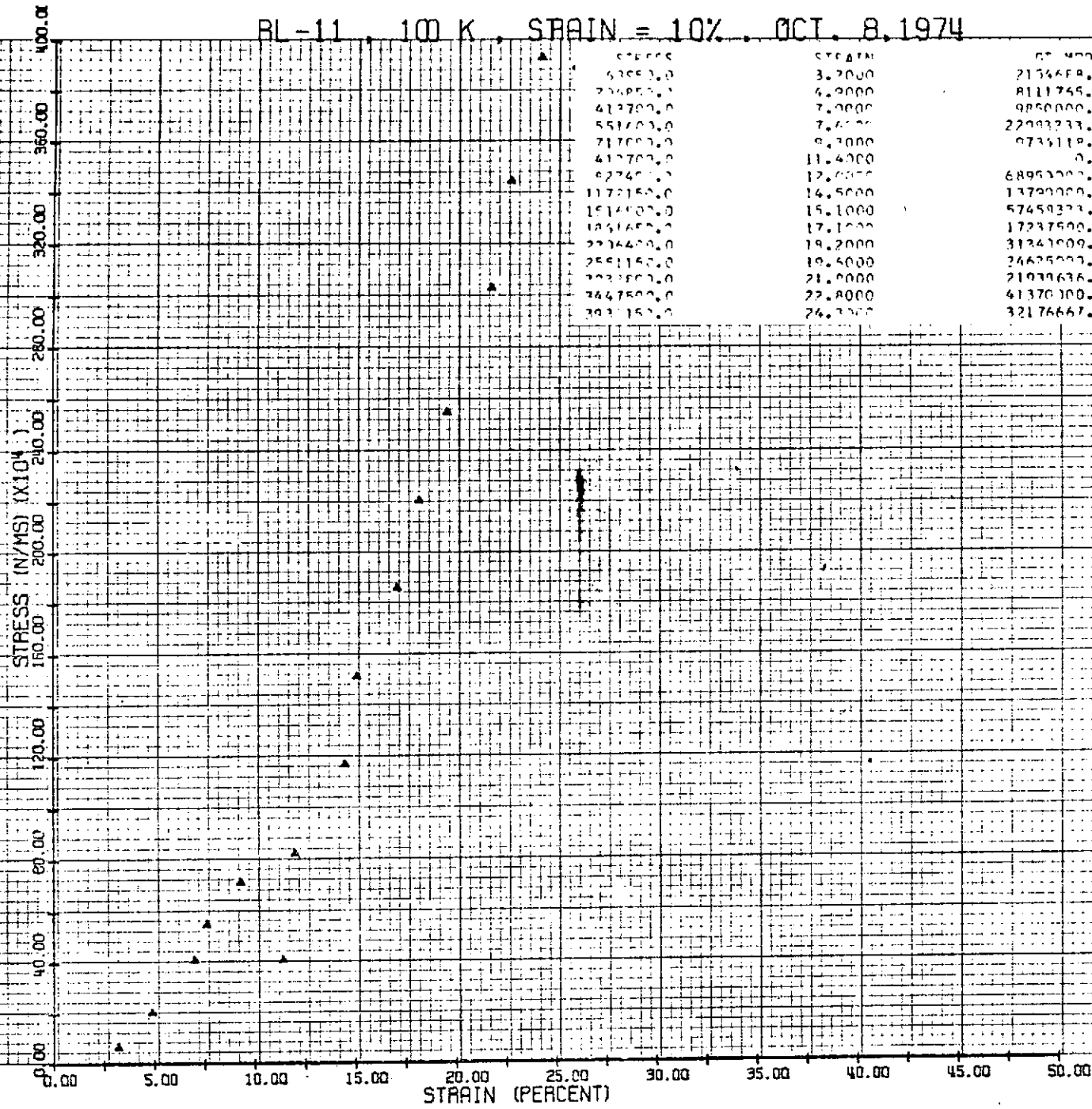

STRESS	STRAIN	GS MODULUS	GS MODULUS
53550.0	3.2000	2154689.	2154688.
70685.1	4.2000	8111745.	4271429.
412700.0	7.2000	9850000.	5910000.
551600.0	7.6000	22993233.	7257895.
717000.0	8.2000	9735118.	7710538.
412700.0	11.4000	0.	6290175.
627400.0	12.6000	68953000.	9423167.
1172150.0	14.5000	13799000.	10176069.
1514500.0	15.1000	57459323.	12054834.
1251650.0	17.1000	17237500.	12662054.
2234400.0	18.2000	31247900.	13790000.
2551150.0	19.5000	24625000.	14563929.
2231500.0	21.0000	21039636.	15308165.
2447500.0	22.8000	41370000.	16451228.
3931500.0	24.2000	32176667.	17421934.

RL-26 125K 1% OCT. 23

STRESS (N/MS) (X10<sup>8</sup>)

STRAIN (PERCENT)

STRESS	STRAIN	GT MODULUS	GS MODULUS
7447.5	0.1500	2248333.	2298223.
73750.0	0.4500	3447500.	3064444.
24132.5	0.9000	2298333.	2681389.
34475.0	1.2000	3447500.	2872917.
46896.0	1.7500	8774000.	3473037.
31717.0	1.1200	0.	4186250.
69550.0	2.4000	2908829.	3504958.
206850.0	4.6500	6128889.	4774602.
413700.0	5.2000	27580000.	7942019.
561600.0	6.9000	9193333.	8214943.
758450.0	7.6500	27580000.	10112667.
856350.0	7.9500	45956667.	11465648.
1034250.0	8.4000	50644444.	12493083.
1172150.0	9.9000	9193333.	11993121.
1256260.0	10.0500	82740000.	13045045.
1413475.0	10.2000	78143333.	14006314.

89

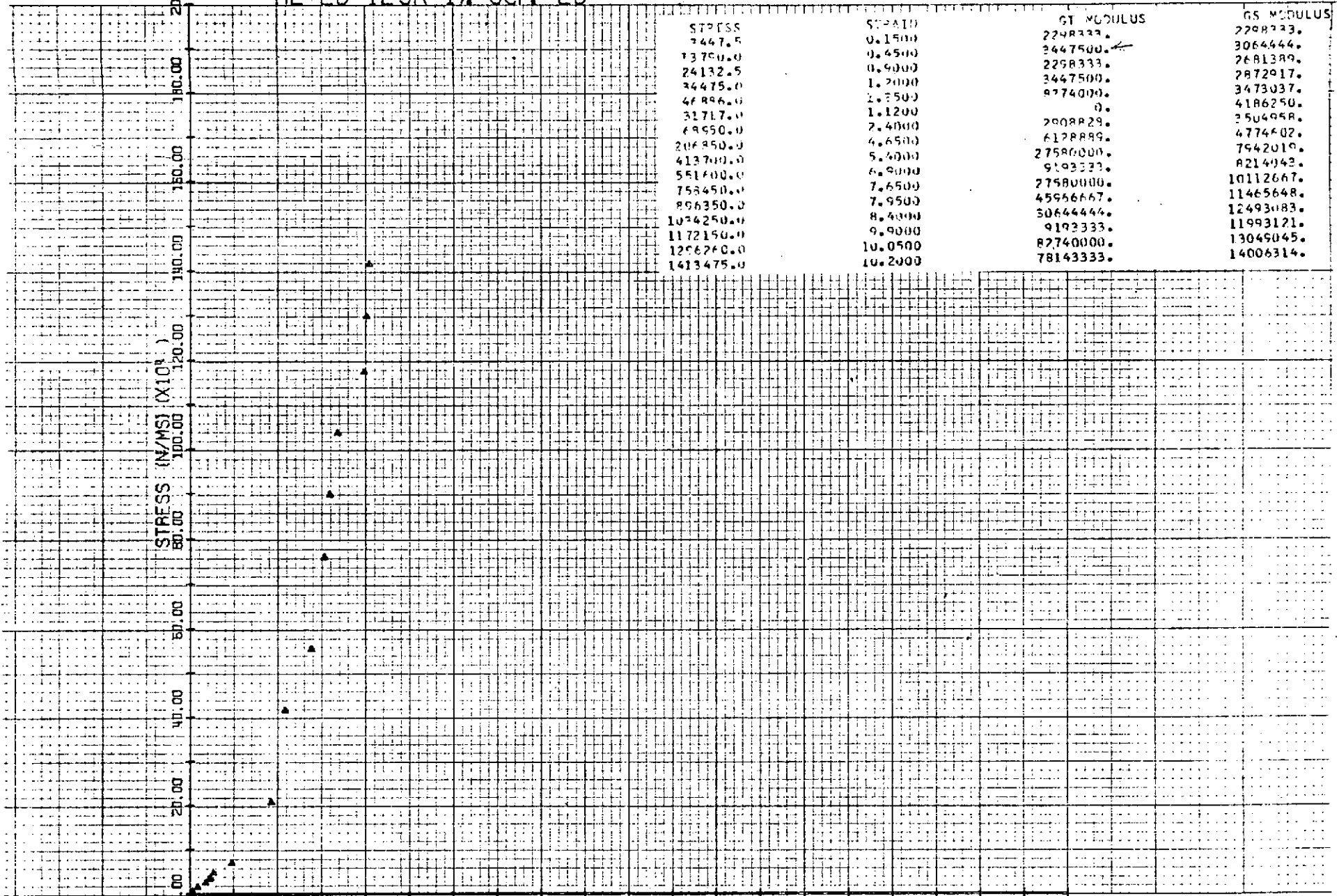

RL-79 125K 1% JAN. 5

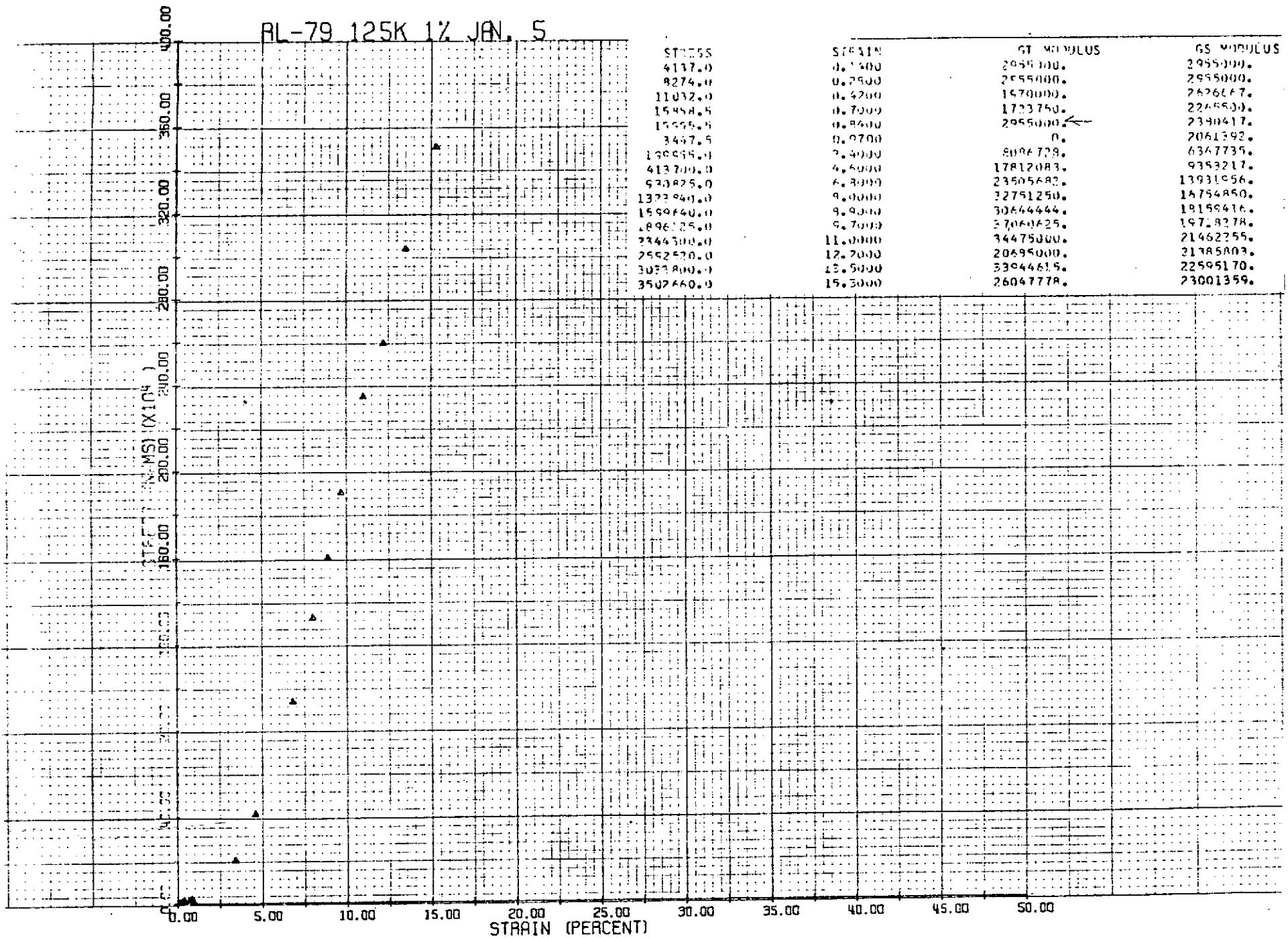

STRESS
4137.0
8274.0
11032.0
15458.5
19895.5
3447.5
19009.0
41370.0
93082.0
137294.0
159964.0
189612.0
234430.0
255252.0
303180.0
350260.0

STRAIN
0.1000
0.2500
0.4200
0.7000
0.8600
0.0700
2.4000
4.6000
6.8000
9.0000
9.9000
9.7000
11.0000
12.7000
13.5000
15.3000

GT MODULUS
2955000.
2955000.
1970000.
1723750.
2995000. ←
0.
8096729.
17812083.
23505682.
32791250.
30644444.
37060625.
34475000.
20695000.
33944615.
26047778.

GS MODULUS
2955000.
2955000.
2626667.
2265500.
2380417.
2061392.
6367735.
9353217.
13931956.
16754850.
18159416.
19718278.
21462255.
21785803.
22595170.
23001359.

AL-12 125K 3% OCT. 21

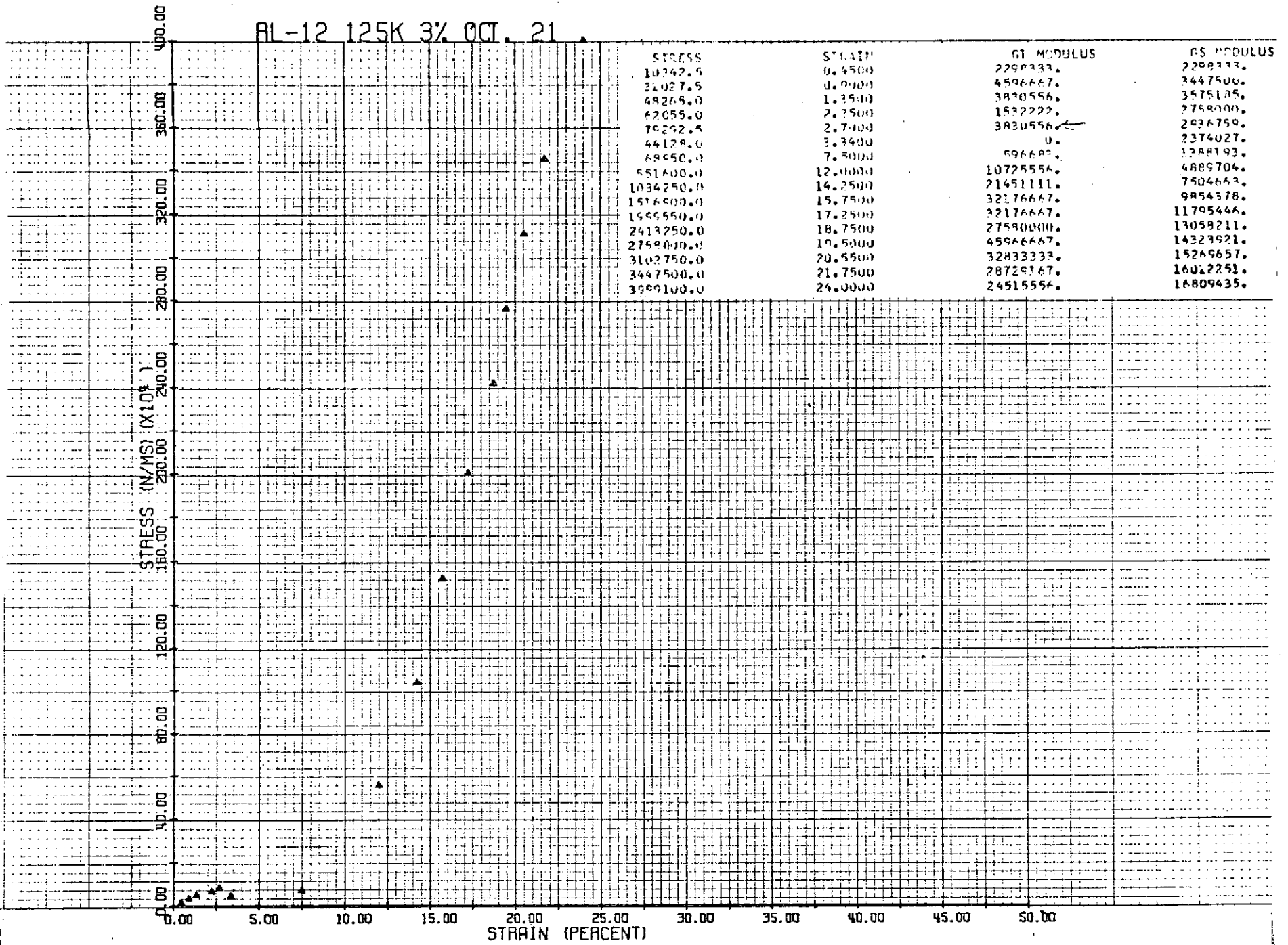

70

AL-4 125K 3% OCT. 18

71.4

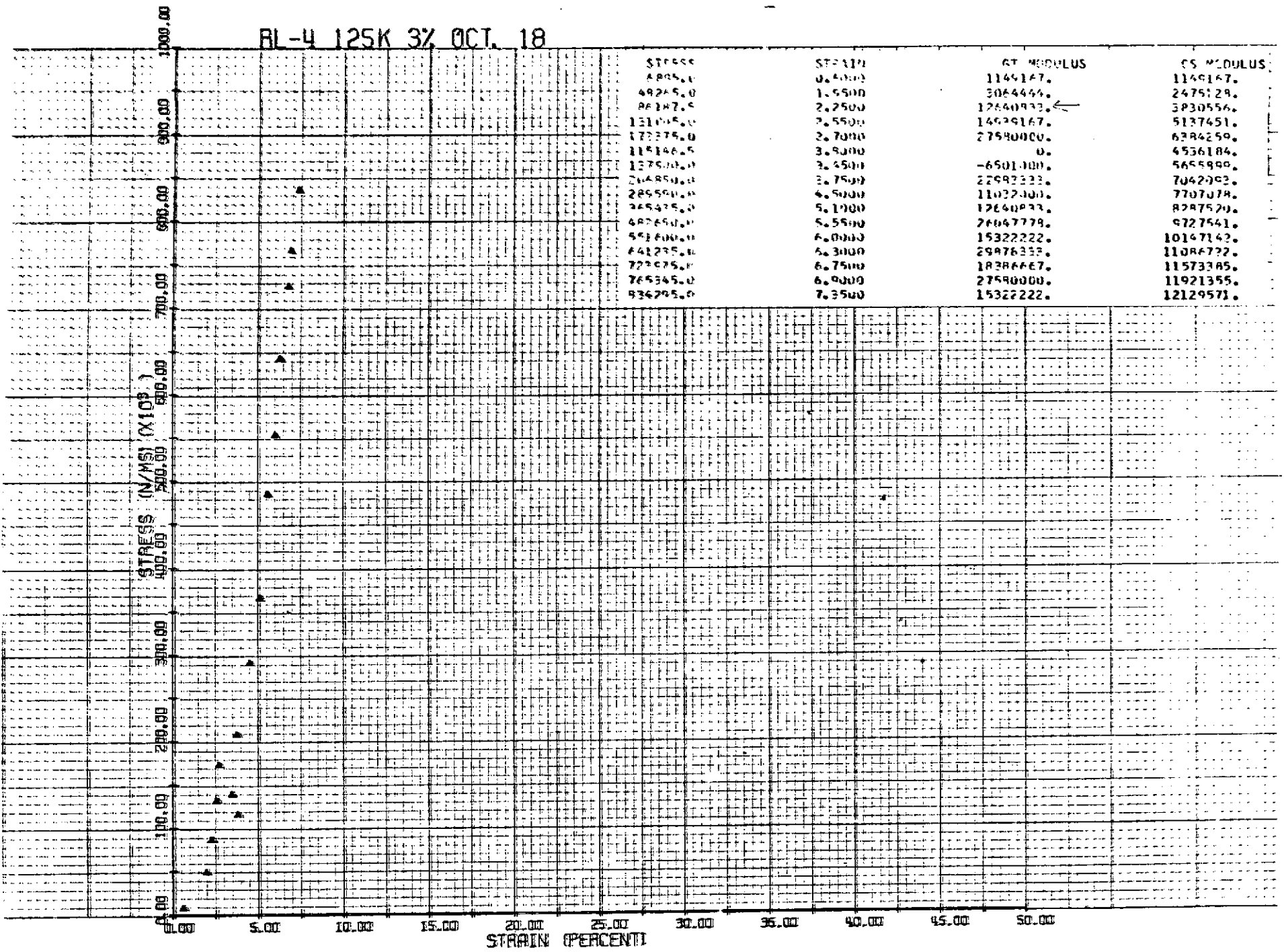

AL-58 125K 3% NOV. 15

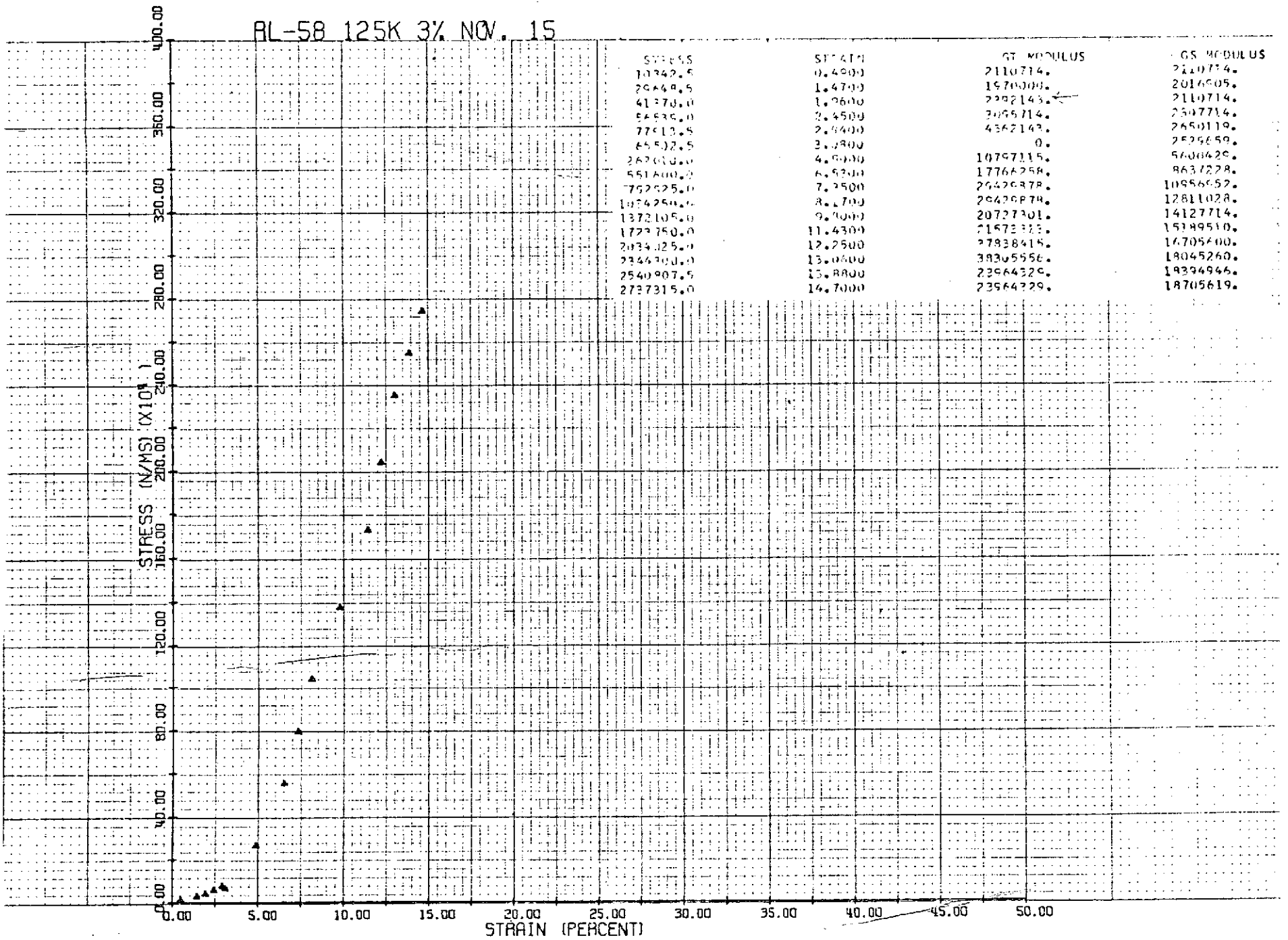

72



AL-38 125K 5% OCT. 12

73A

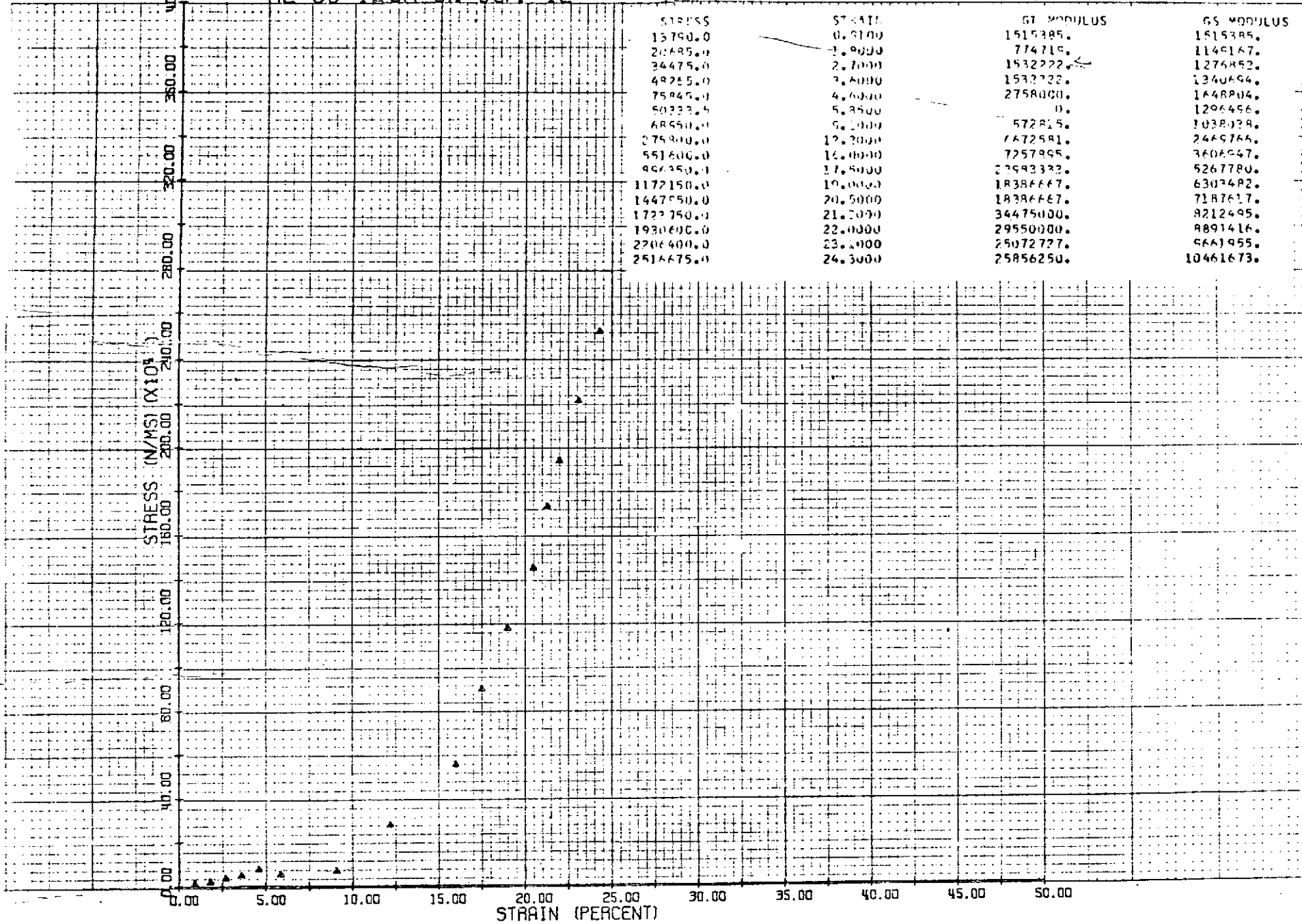



RL-59 125K 5% NOV. 14

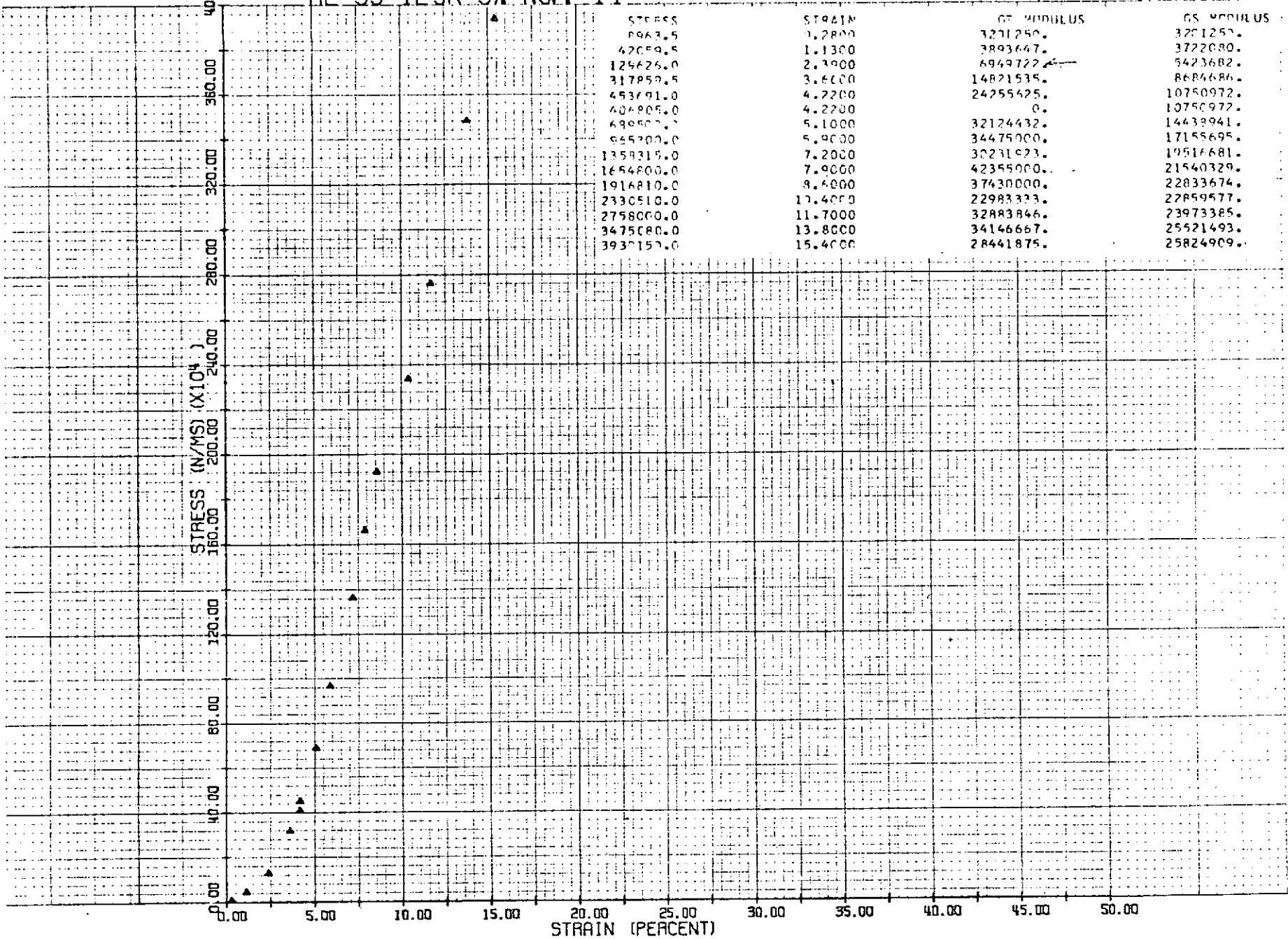

74 A

61-53 12-16 10% 21

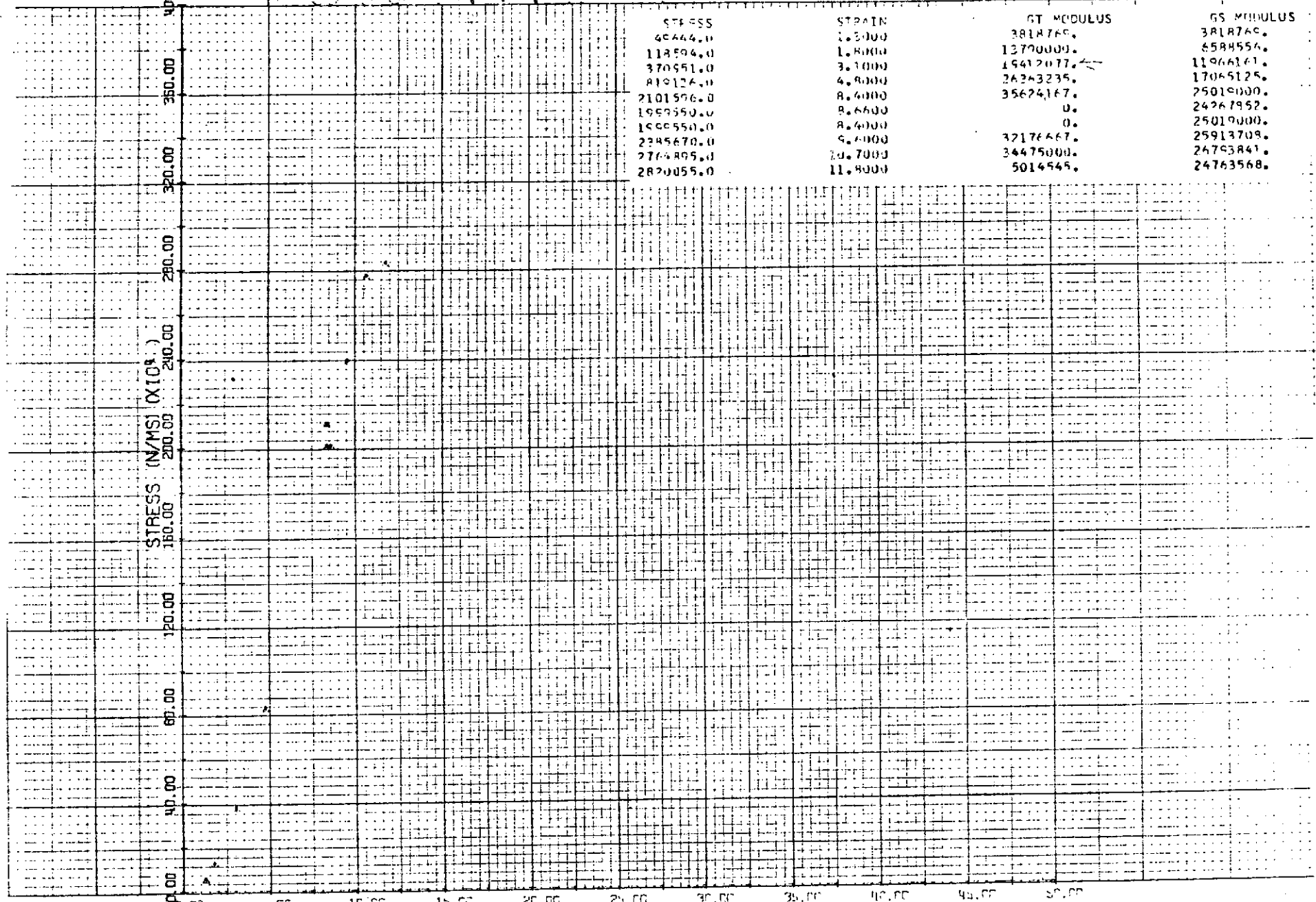

STRESS	STRAIN	GT MODULUS	GS MODULUS
46444.0	1.5000	3818769.	3818769.
118594.0	1.8000	13770000.	6588554.
370551.0	3.1000	19412077.	11966161.
819124.0	4.9000	26363235.	17065125.
2101596.0	8.6000	35624167.	25019000.
1969550.0	8.6600	0.	24267952.
1900550.0	8.6000	0.	25019000.
2285670.0	9.6000	32176667.	25913709.
2764895.0	10.7000	34475000.	26793841.
2820055.0	11.8000	5014545.	26763568.

75 A

AL-44 150K 1% OCT. 29

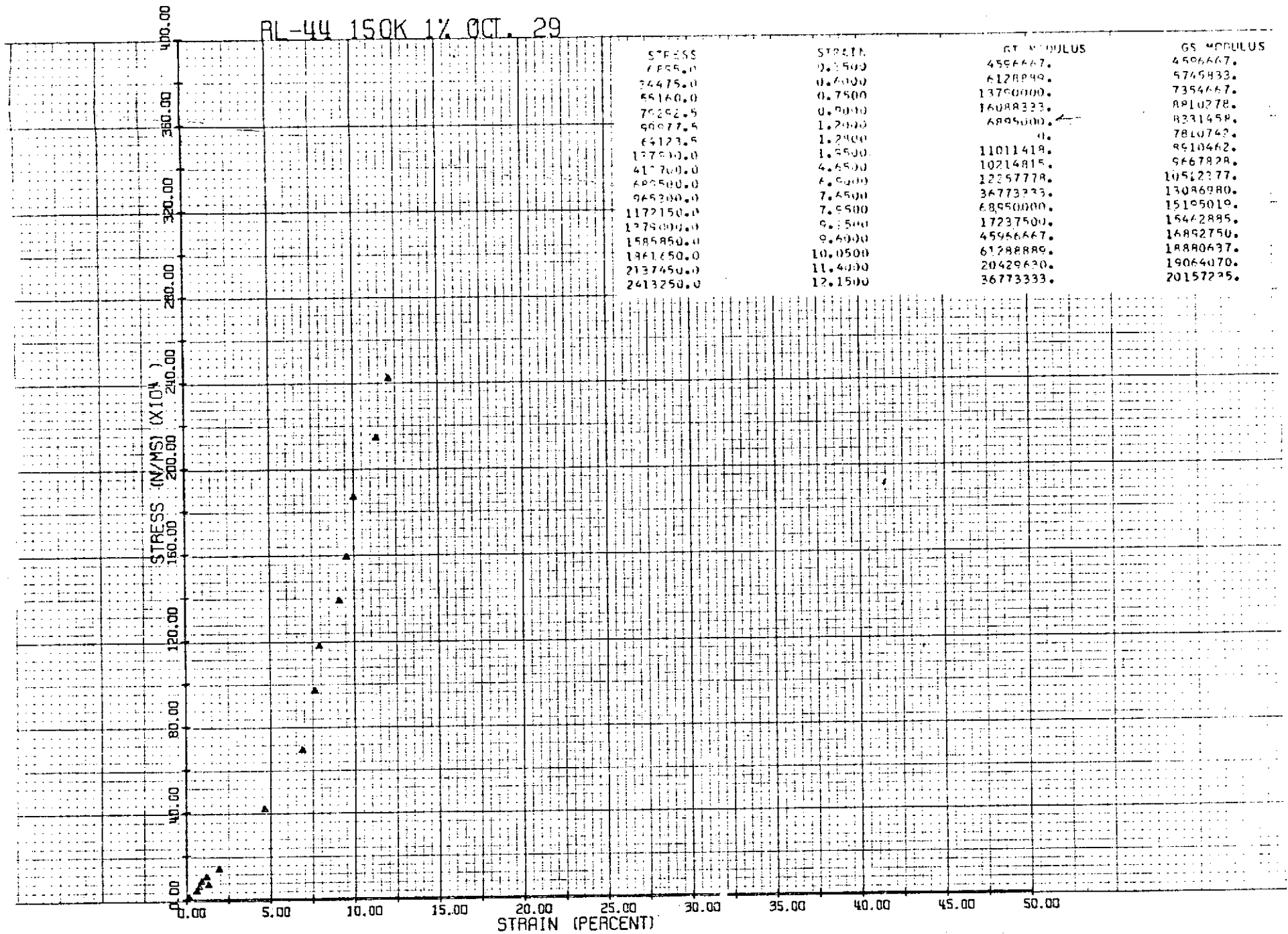

76

RL-31 150K 3% OCT. 29

STRESS	STRAIN	GT MODULUS	GS MODULUS
10740.5	0.9900	1055257.	1055257.
13790.0	1.4700	703571.	628095.
27490.0	1.9600	2814286.	1407143.
41270.0	2.4500	2814286.	1688571.
49444.0	2.9400	1688571.	1688571.
37522.5	3.0000		1654800.
68550.0	4.0900	2872017.	1977243.
206850.0	6.5300	5628571.	3347190.
413700.0	8.9900	8442857.	4727433.
620550.0	11.4300	9442857.	5531484.
877430.0	12.0700	12612805.	6420210.
1034250.0	14.7000	12690184.	7115452.
1172150.0	15.5200	16817073.	7628038.
1310050.0	16.3300	17024691.	8094130.
1516500.0	17.1500	25225610.	8913245.
1723750.0	20.4200	6325688.	8498881.

77A

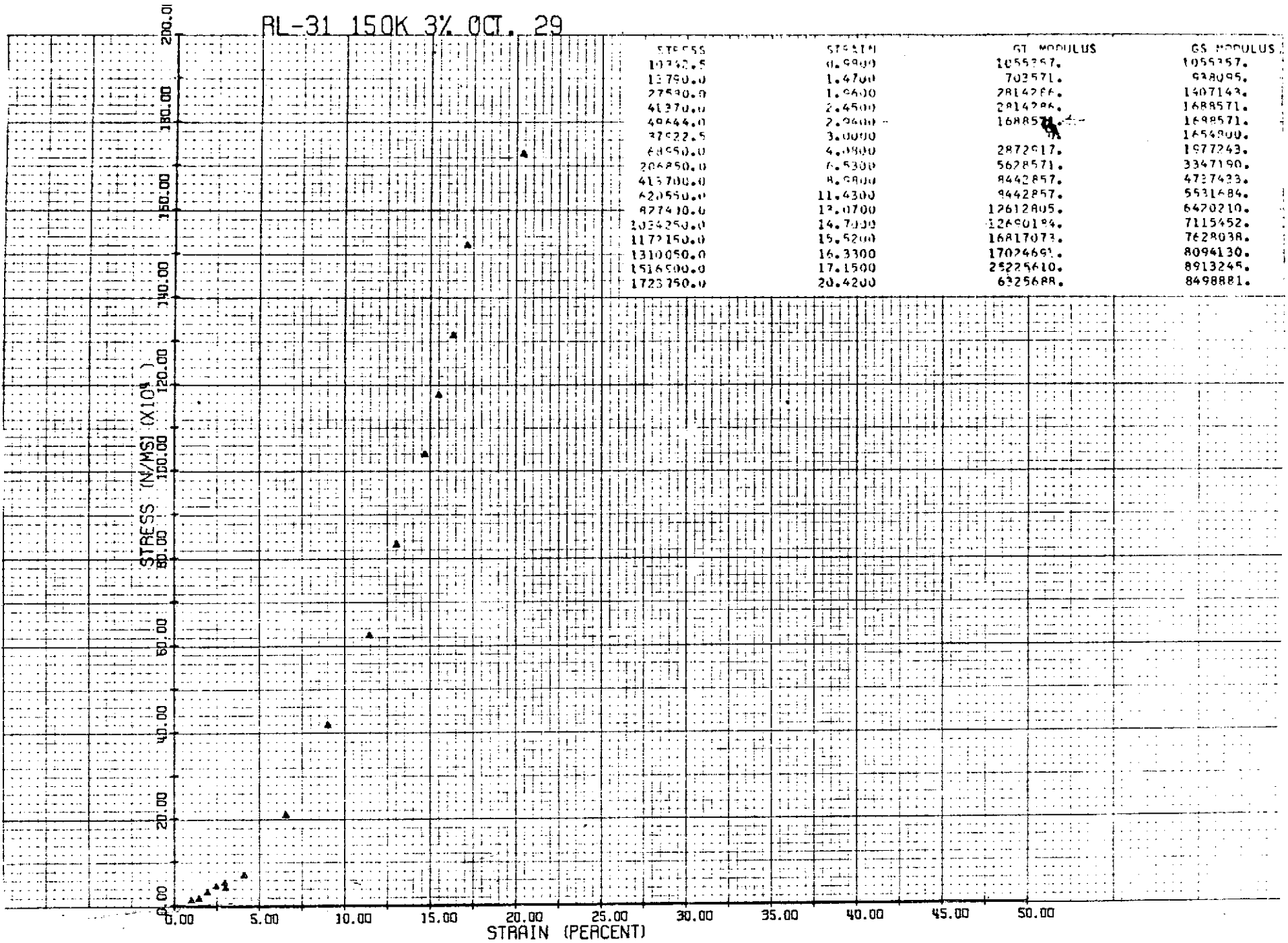

BL-60 150K 3% NOV. 26

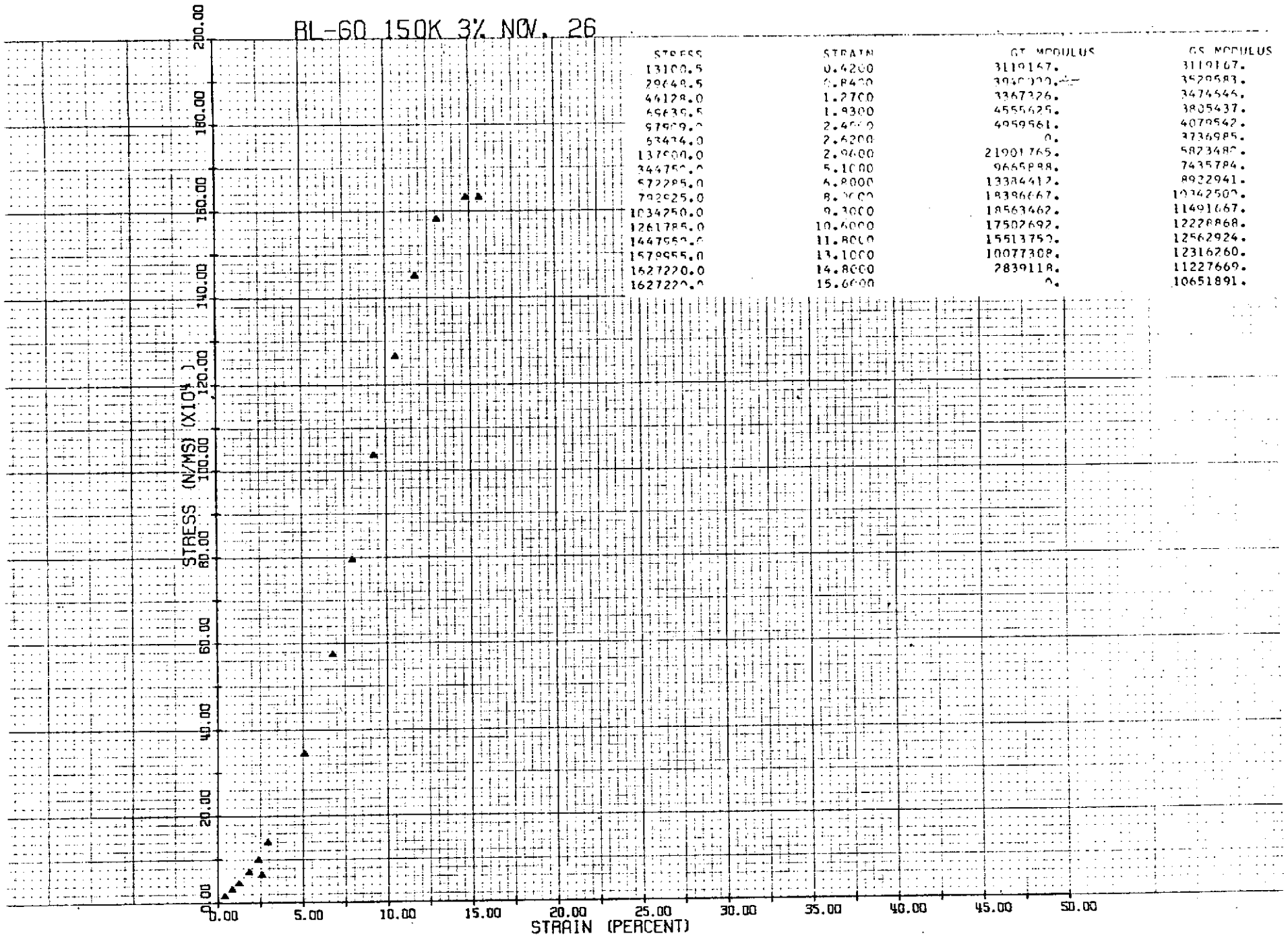

78 A

AL-57 150K 5% NOV. 26

STRESS
10347.5
58607.5
106972.5
144755.0
186165.0
167411.5
413700.0
758450.0
1034250.0
1379000.0
1723750.0
1959550.0
2275750.0
2620100.0
2876950.0
2826950.0

STRAIN
0.4200
2.1000
3.0000
3.4300
3.8000
4.2500
5.0000
7.0000
9.2000
10.4000
11.5000
12.5000
13.4000
14.6000
16.3000
18.0000

GT MODULUS
2462500.
2872917.
5362778.
6480625.
10342500.
0.
17750957.
16416667.
21215389.
28729167.
31346909.
27590000.
30644444.
28729167.
12167647.
0.

GS MODULUS
2462500.
2750833.
3562417.
4358676.
4890079.
4240661.
7525060.
9888652.
11489168.
13478299.
15186987.
16178428.
17150026.
18101736.
17482844.
15631686.

STRESS (N/MS) (X10<sup>7</sup>)

STRAIN (PERCENT)

79 A

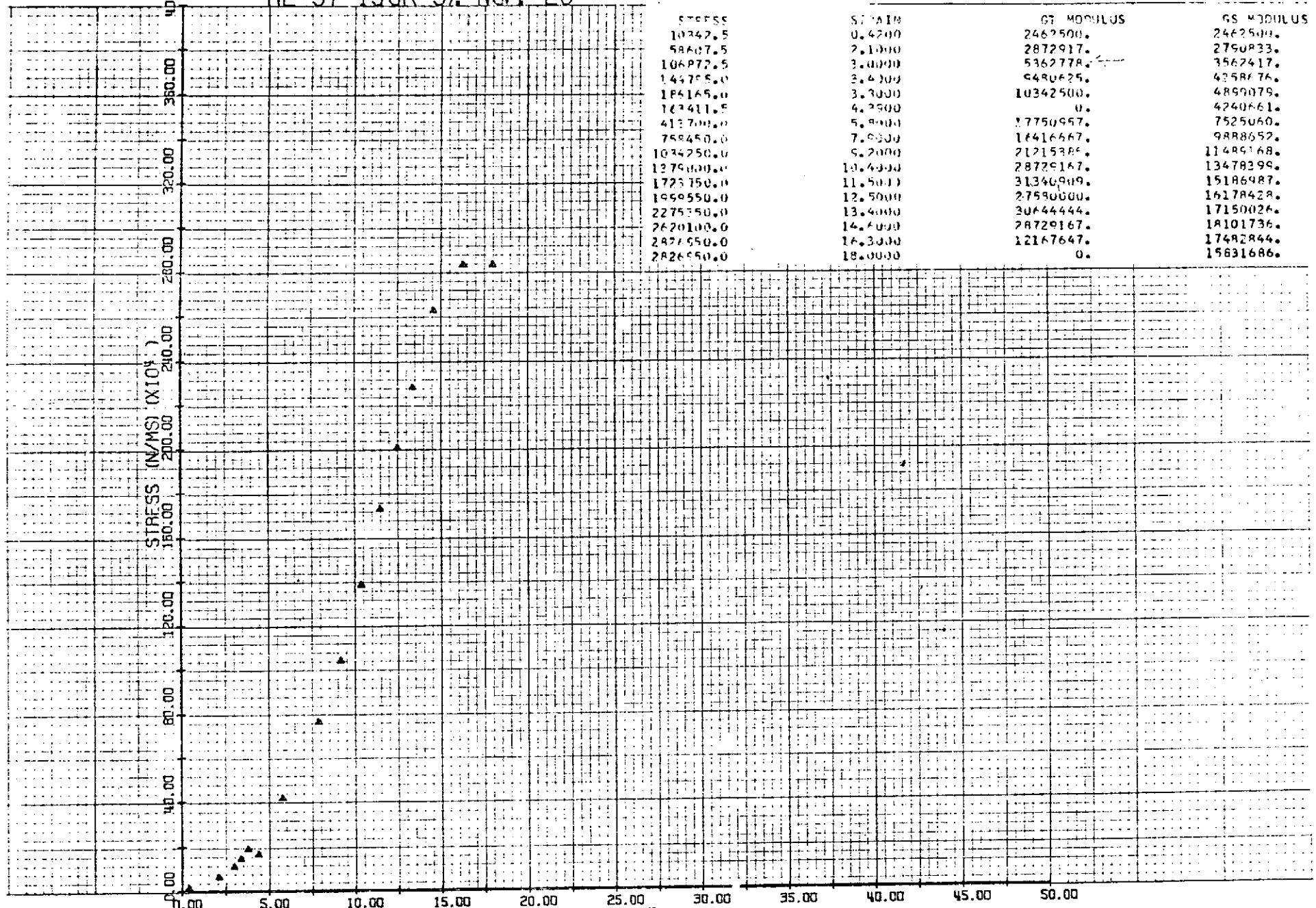

BL-45 150K 10% CT. 29

STRESS	STRAIN	GT. MODULUS	CS MODULUS
10342.5	0.4500	2298333.	2298333.
11721.5	1.6500	114917.	710394.
53781.0	4.9500	1274530.	1086485.
110320.0	7.4500	2094037.	1442797.
141347.5	9.4500	1723750.	1495741.
641225.0	9.9600	0.	1419157.
686507.0	12.0000	2359931.	1580104.
996350.0	13.5000	13790000.	2936759.
1034250.0	15.0000	0193333.	3562417.
1172157.0	15.7500	18386667.	4268333.
1310050.0	16.5000	18386667.	4910076.
1514900.0	17.2500	2758700.	5895725.
1654800.0	18.0000	18386667.	6416181.
1792700.0	18.7500	18386667.	6895000.
1930600.0	21.0000	6128889.	6812917.
2040920.0	21.7500	14709333.	7085207.

STRESS (N/MS) (X10<sup>4</sup>)

STRAIN (PERCENT)

80

AL-54 150K 10% DEC. 2

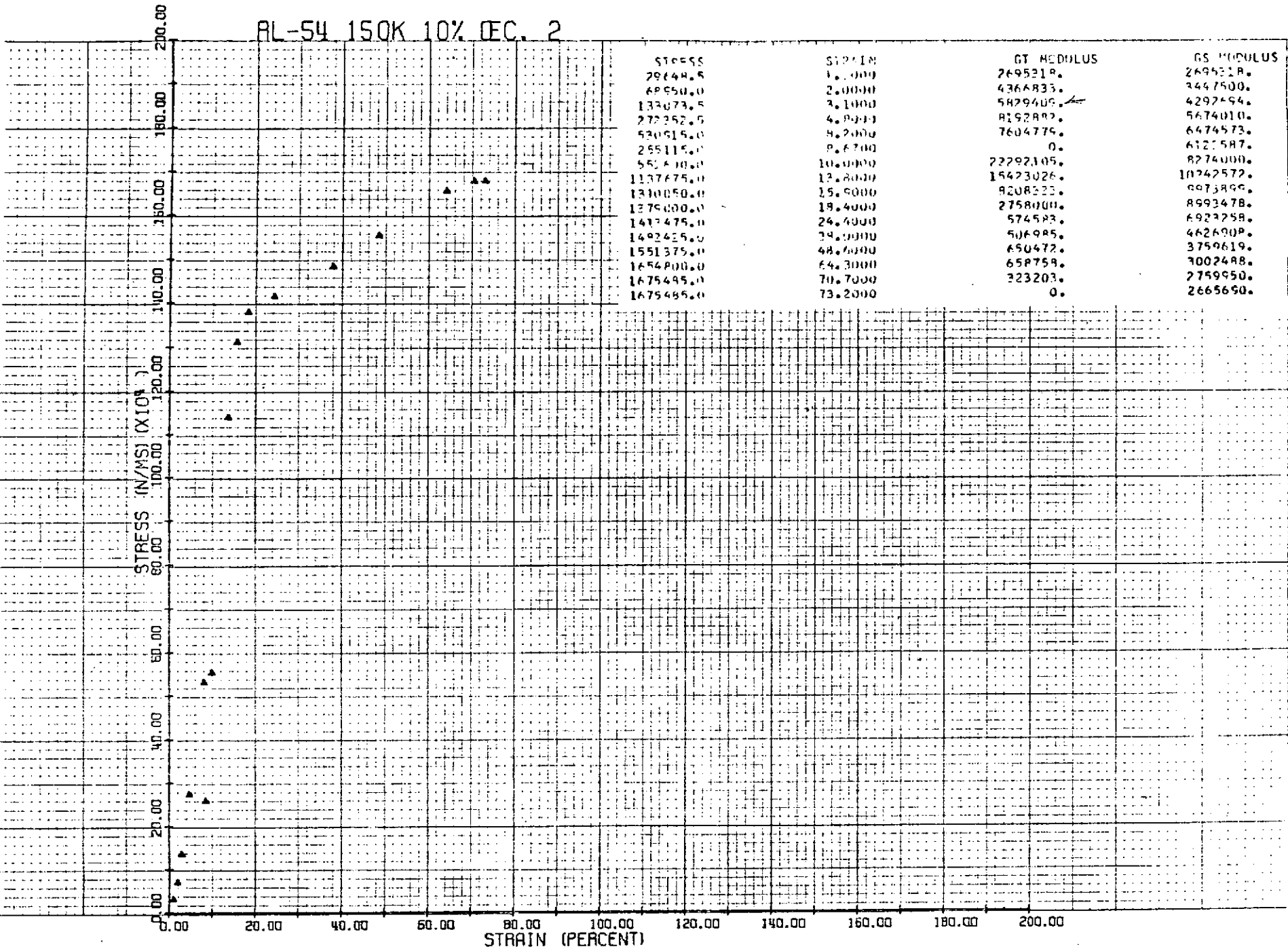

18



RL-62 163K 3% DEC. 3

STRESS (N/MS) (X10<sup>11</sup>)

200.0  
180.0  
160.0  
140.0  
120.0  
100.0  
80.0  
60.0  
40.0  
20.0  
0.0

572.55  
8205.5  
8274.0  
16549.0  
27530.0  
45438.5  
51169.0  
54530.0  
220640.0  
376225.0  
496500.0  
861875.0  
93720.0  
1074250.0  
1137675.0  
1247995.0  
1247995.0

STRAIN  
0.4000  
0.8400  
1.2700  
1.6900  
2.5300  
2.7400  
3.6000  
5.5000  
7.6000  
16.1000  
22.9000  
141.4000  
54.6000  
66.7000  
89.2000  
101.2000

GT MODULUS  
1477500.  
492500.  
1924186.  
2624667.  
1887917.  
0.  
12327424.  
5910000.  
7551667.  
3650294.  
1024042.  
66605.  
-111710.  
854752.  
490311.  
0.

OS MODULUS  
1477500.  
585000.  
1302997.  
1631993.  
1716937.  
1585347.  
3670574.  
4525627.  
5361770.  
4458156.  
2705636.  
683161.  
1946006.  
1748043.  
1430790.  
1261131.

82 H

STRAIN (PERCENT)

0.00 20.00 40.00 60.00 80.00 100.00 120.00 140.00 160.00 180.00 200.00

AL-55 163K 5% DEC. 2

STRESS	STRAIN	GT. MODULUS	GS MODULUS
13790.0	0.7500	1839667.	1839667.
44817.5	2.1000	2298333.	2134167.
68950.0	3.1500	2298333.	2188889.
99825.0	4.2000	1970000.	2134167.
113078.0	5.1000	2604778.	2217216.
103425.0	6.6000	0.	1713303.
310275.0	18.4500	1745570.	1724027.
482450.0	20.8500	7182292.	2361165.
655025.0	32.8500	1436458.	2023373.
722975.0	41.8500	766111.	1752994.
827400.0	55.3500	766111.	1512291.
930825.0	68.8500	766111.	1365981.
965300.0	80.3500	255370.	1183914.
999775.0	91.3500	383056.	1105011.
1069725.0	102.4500	621171.	1052590.

STRESS (N/IN<sup>2</sup>) (X10<sup>5</sup>)

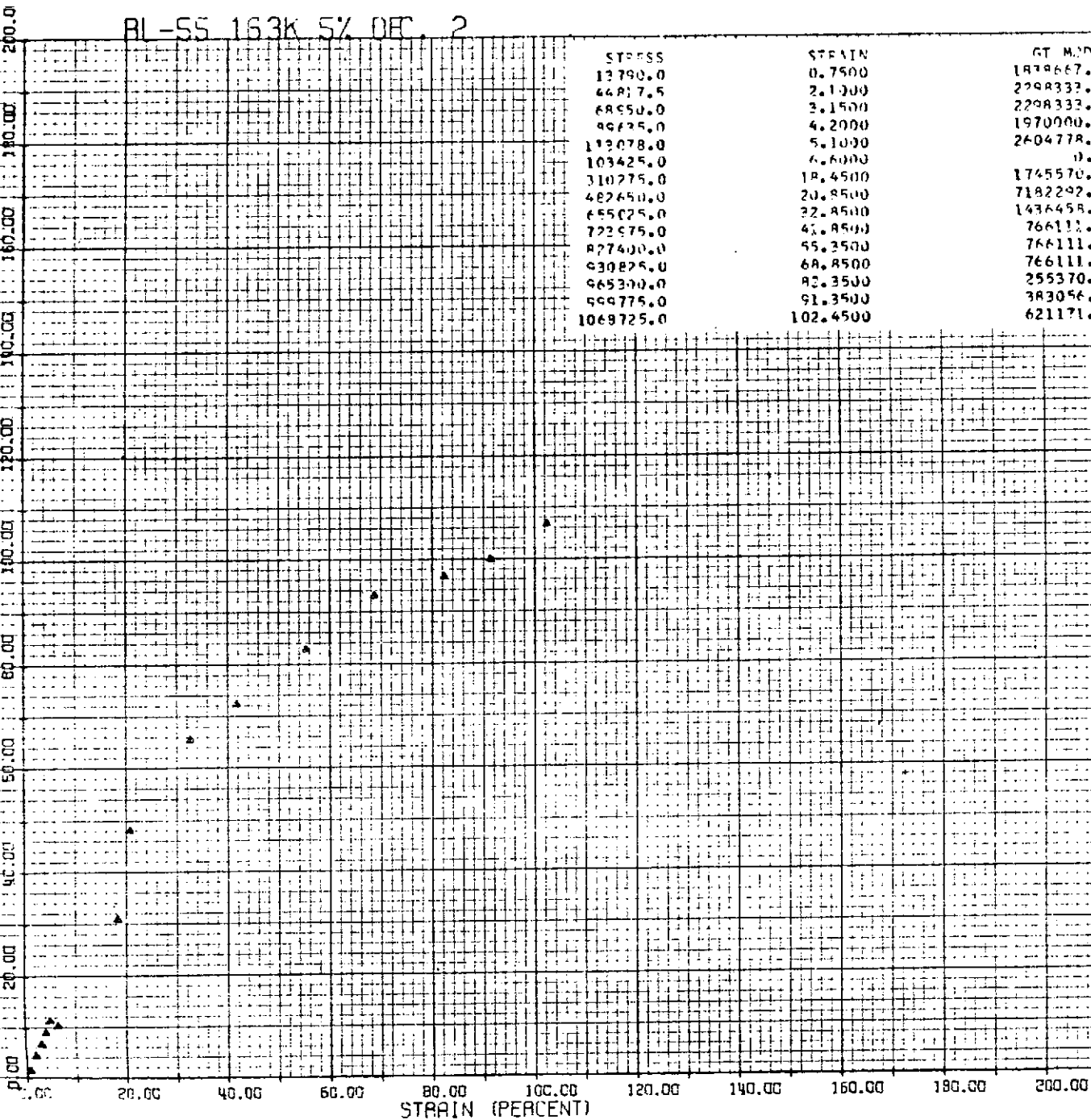

STRAIN (PERCENT)

10

83 A

RL-63 163K 10% REC. 3

STRESS	STRAIN	GT MODULUS	GS MODULUS
15695.5	0.7000	2856500.	2856500.
74466.0	2.4000	3204147.	3102750.
144795.0	4.7000	4137000.	3831535.
206032.5	6.1000	7756875.	4616926.
327512.5	7.5000	1532222.	4145728.
491338.5	8.2000	0.	3055465.
344750.0	9.9000	10097130.	4958828.
482650.0	12.7000	4925000.	4651370.
592970.0	19.7000	1970000.	4039039.
703290.0	25.7000	1576000.	3357565.
765920.0	34.0000	760075.	2499459.
920925.0	54.5000	775178.	1961747.
1034250.0	67.0000	814370.	1746189.
1110095.0	80.2000	597205.	1564469.
1137675.0	88.7000	328333.	1447406.
1137675.0	95.7000	0.	1341535.

STRESS (N/MS) (X10<sup>4</sup>)

STRAIN (PERCENT)

84

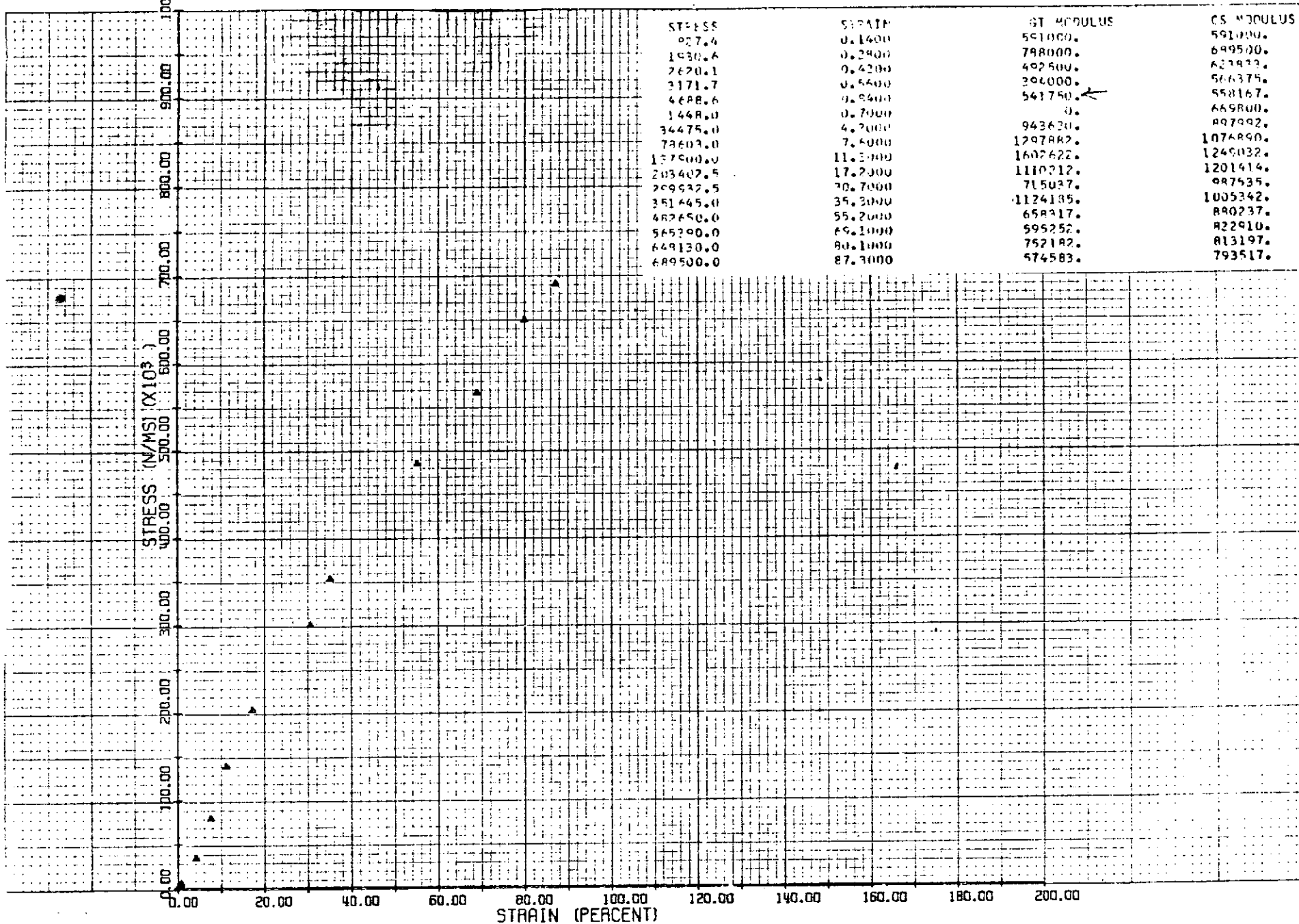

85 A

AL-43 175K 3% NOV. 1

STRESS (N/MSI) (X10<sup>3</sup>)

STRAIN (PERCENT)

STRESS	STRAIN	GT MODULUS	GS MODULUS
6875.0	0.0000	2298337.	2299232.
34475.0	1.2000	3064444.	2872517.
55140.0	1.8000	3447500.	3064444.
75292.5	2.5500	3217667.	3109910.
64530.0	3.0000	3930556.	3217667.
57518.0	2.7900	0.	3459857.
48550.0	3.7500	1145167.	2868720.
172375.0	6.7500	3447500.	3125733.
275800.0	10.5000	2758000.	2994400.
375275.0	15.9000	1951415.	2644539.
449175.0	25.5000	710925.	1908969.
517125.0	34.5000	766111.	1610932.
586075.0	47.3000	538672.	1320691.
655025.0	57.0000	710925.	1216907.
655025.0	74.0000	0.	933563.
655025.0	84.0000	0.	825758.

98

AL-36 175K 3% DEC. 6

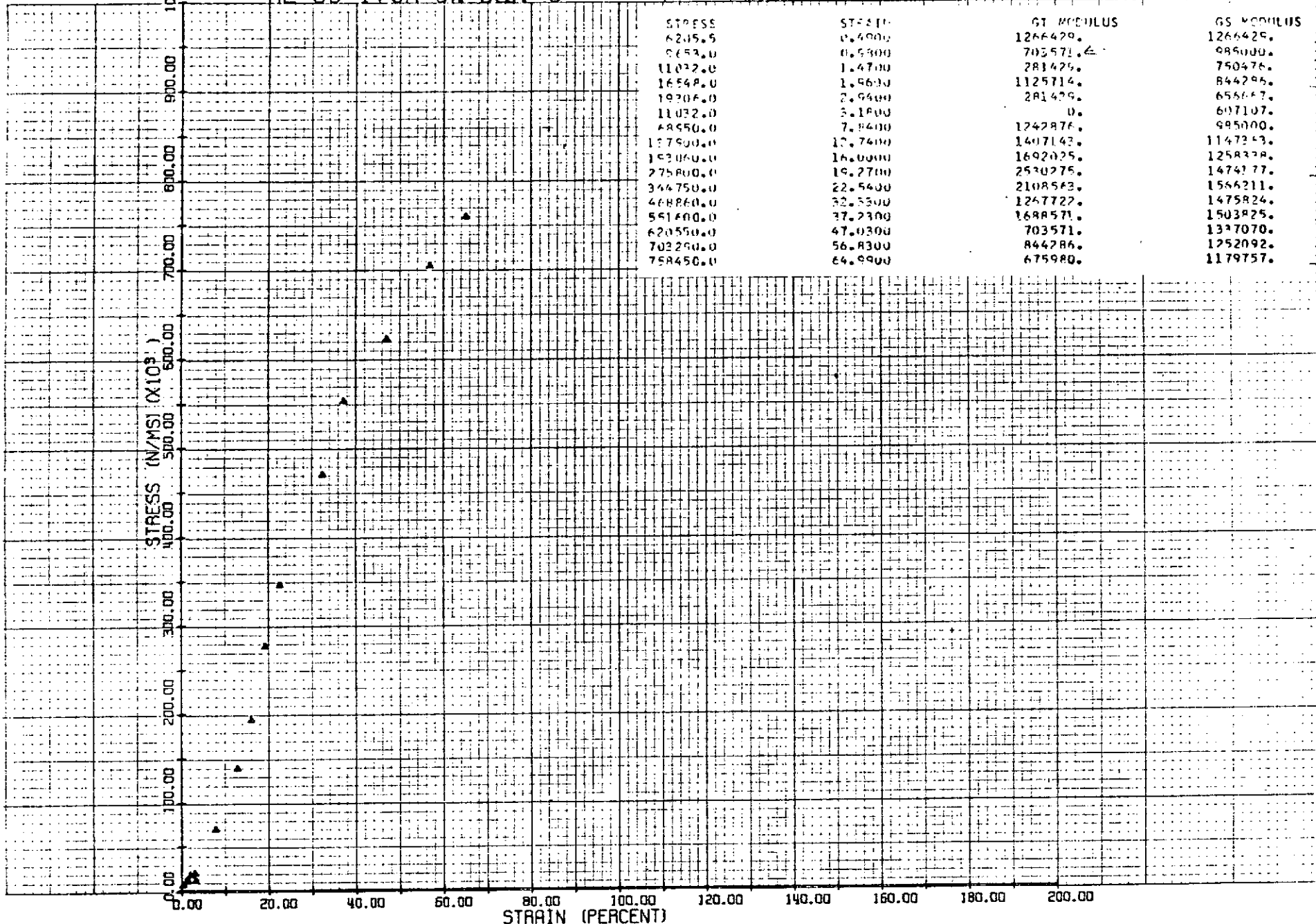

STRESS	STRAIN	G1 MODULUS	G5 MODULUS
6205.5	0.4000	1266429.	1266429.
9653.0	0.6000	703571.6	985000.
11032.0	1.4700	281429.	750476.
16548.0	1.9600	1125714.	844285.
19306.0	2.9400	281429.	656647.
11032.0	3.1800	0.	607107.
48950.0	7.8400	1242876.	985000.
157900.0	17.7400	1407143.	1147343.
153060.0	16.0000	1692025.	1258328.
275800.0	19.2700	2530275.	1474777.
344750.0	22.5400	2108563.	1566211.
468860.0	32.5300	1267722.	1475824.
561600.0	37.2300	1688571.	1503825.
620550.0	47.0300	703571.	1337070.
702290.0	56.8300	844286.	1252092.
758450.0	64.9900	675980.	1179757.

87 A

AL-7 175K 5% AUG. 30

STRESS	STRAIN	GT MODULUS	GS MODULUS
12790.0	0.1500	9193333.	6193333.
68950.0	1.5000	4085526.	4596667.
103425.0	2.2500	4596667.	4596667.
127500.0	2.7000	4596667.	4596667.
161742.0	4.5000	1562867.	3585400.
24461.6	4.3200	0.	3734792.
103425.0	4.9500	1422778.	3440539.
159585.0	6.7500	3064444.	3340244.
206850.0	7.5000	6435333.	3645753.
267010.0	8.2500	7254667.	3986564.
330560.0	9.1500	7661111.	4347995.
413710.0	12.5000	1902069.	3559863.
462650.0	22.5000	766111.	2442362.
591600.0	23.0000	656667.	1874186.
620550.0	42.5000	656667.	1580302.

STRESS (N/MS) (X 10<sup>3</sup>)

1000.0  
900.00  
800.00  
700.00  
600.00  
500.00  
400.00  
300.00  
200.00  
100.00  
0.00

STRAIN (PERCENT)

0.00 5.00 10.00 15.00 20.00 25.00 30.00 35.00 40.00 45.00 50.00

88 A



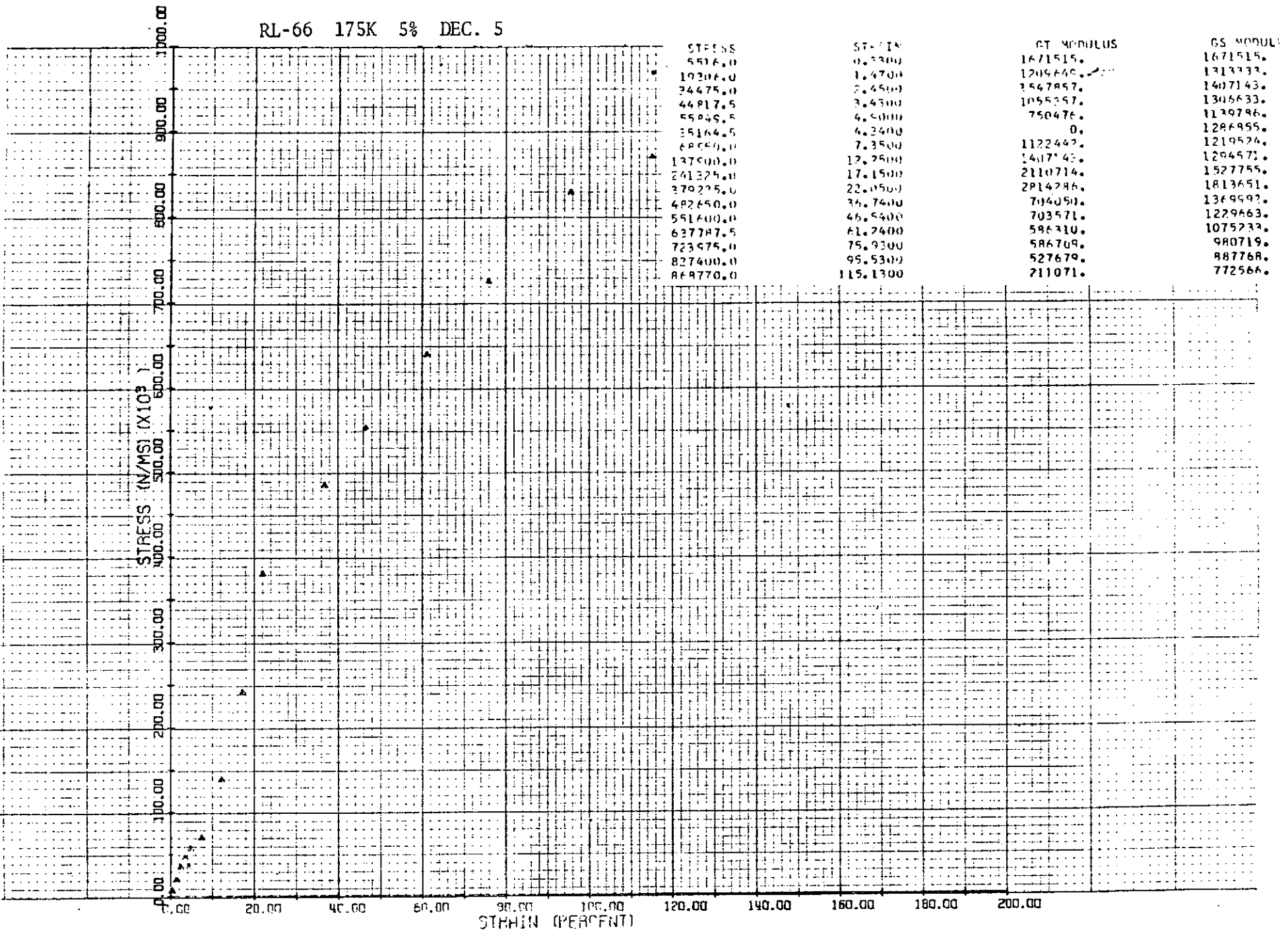

89 A



AL-70 175K 10% REC. 16

90 06

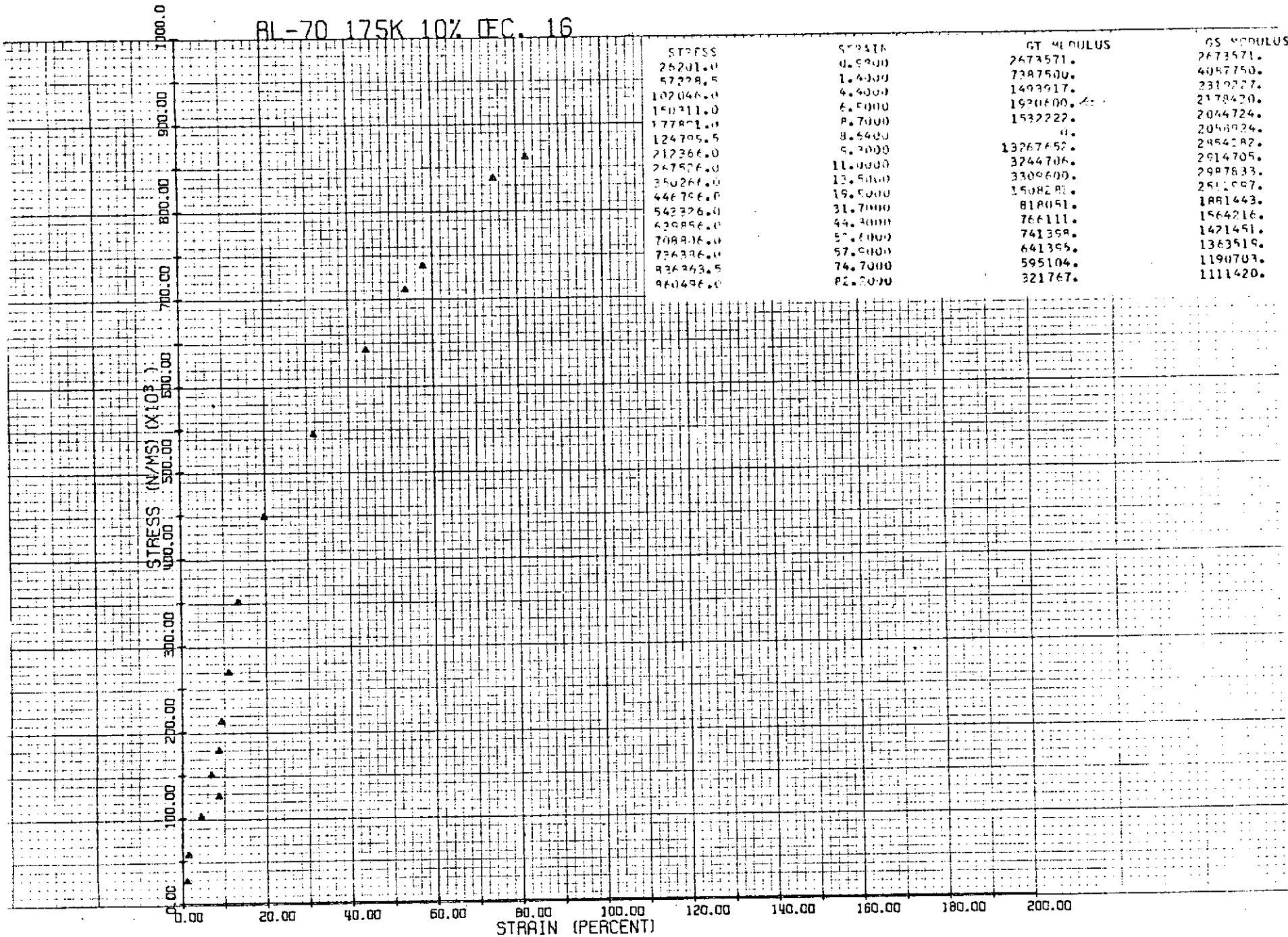

STRESS	STRAIN	GT MODULUS	GS MODULUS
25201.0	0.5000	2673571.	2673571.
57228.5	1.4000	7387500.	4087750.
102046.0	4.4000	1493917.	2319277.
150311.0	6.5000	1920800.	2178420.
177801.0	8.7000	1532222.	2044724.
124795.5	8.5400	0.	2048924.
212366.0	9.3000	13267652.	2854282.
267526.0	11.0000	3244706.	2914705.
350266.0	13.5000	3309600.	2997833.
446766.0	19.5000	1508281.	2511997.
542326.0	31.7000	818051.	1881443.
639856.0	44.3000	766111.	1564216.
708936.0	57.6000	741399.	1421451.
736336.0	57.9000	641399.	1363519.
836343.5	74.7000	595104.	1190703.
960496.0	82.2000	321767.	1111420.

RI-48 175K 10% NOV. 8

STRESS  
 37522.5  
 48530.0  
 162032.5  
 217102.5  
 275800.0  
 208644.5  
 275800.0  
 448175.0  
 637787.5  
 741212.5  
 844637.5  
 930925.0  
 909775.0  
 1068725.0  
 1107200.0  
 1107200.0

STRAIN  
 1.9600  
 4.9000  
 6.8600  
 8.7300  
 10.7900  
 10.9000  
 11.9200  
 12.0200  
 13.0600  
 14.5300  
 16.0000  
 17.3100  
 18.4500  
 19.9200  
 21.2300  
 21.8800

RT MODULUS  
 1934821.  
 1992457.  
 3341664.  
 2752381.  
 2000770.  
 0.  
 7368186.  
 10773475.  
 10748214.  
 7035714.  
 7035714.  
 6579198.  
 6048246.  
 4690476.  
 2631679.  
 0.

GS MODULUS  
 1934821.  
 1970000.  
 2361950.  
 2607353.  
 2690272.  
 2530275.  
 2944258.  
 4332206.  
 5458582.  
 5618500.  
 5748706.  
 5811557.  
 5826782.  
 5742372.  
 5550426.  
 5385537.

STRESS (N/MS) (X10<sup>4</sup>)

STRAIN (PERCENT)

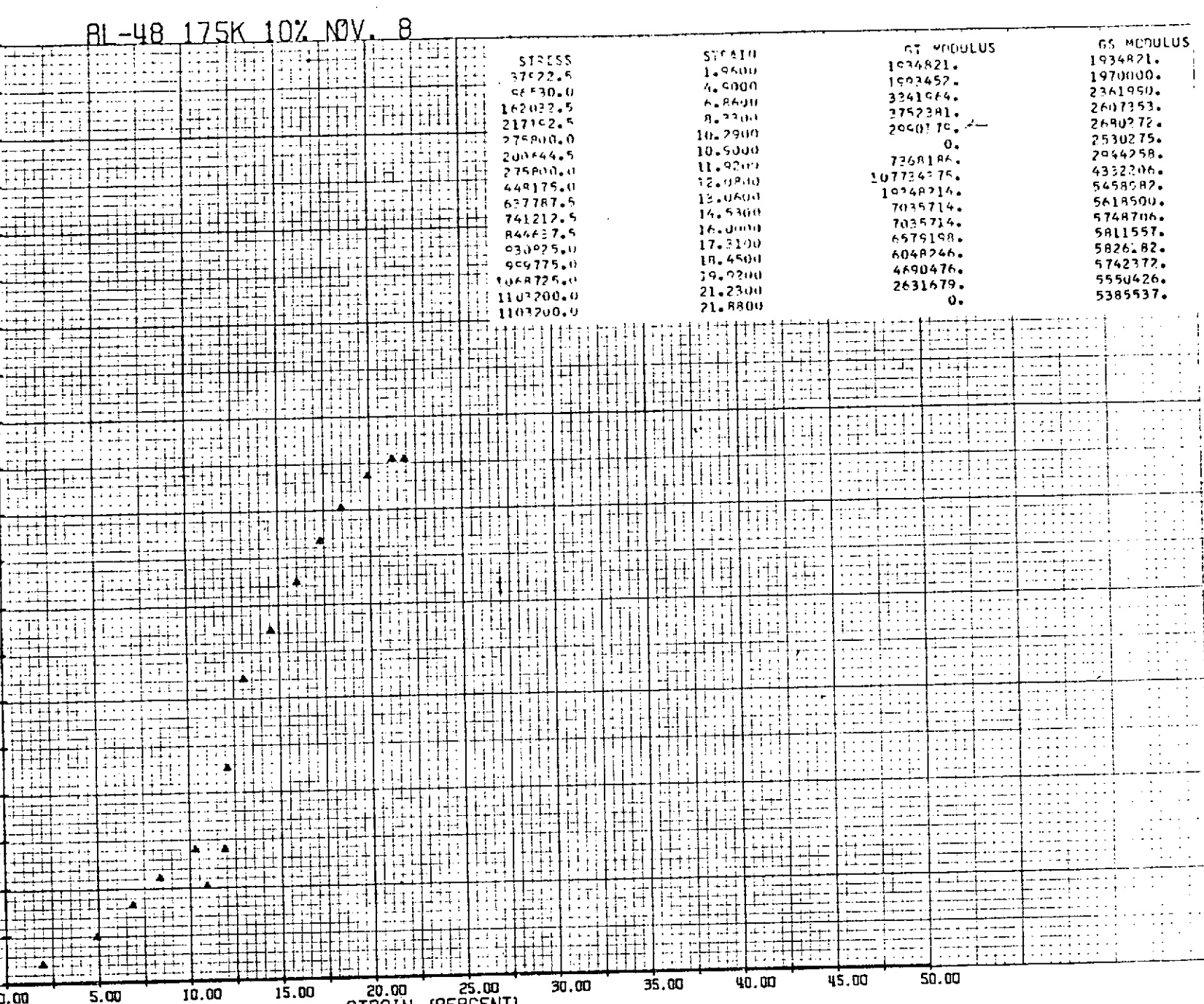
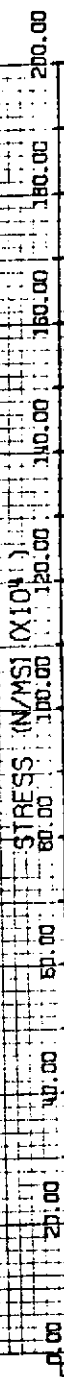

91 A

RL-68 188K 1% JAN. 3

STRESS	STRAIN	GS MODULUS	GS MODULUS
551.6	0.1400	394700.	394000.
2137.5	0.4700	546375.	508917.
3693.1	0.7600	394700.	480188.
3740.7	0.7000	394700.	462450.
4137.0	0.8400	660750.	492500.
34.5	0.6300	0.	962093.
39301.5	2.9700	1609304.	1512335.
50701.0	3.7000	2420096.	1713501.
64873.3	5.4100	1622352.	1684806.
148927.5	12.9000	974702.	1253841.
220640.0	22.3100	615625.	1012354.
344750.0	24.9000	4773462.	1406653.
427563.5	26.4000	4360594.	1616539.
517125.0	28.2000	5247961.	1848325.
620550.0	30.7000	6137000.	2034699.
662614.0	32.9000	1050467.	1971697.

STRESS (N/MS) (X 10<sup>3</sup>)

STRAIN (PERCENT)

92 H

AL-74 188K 5% DEC. 12

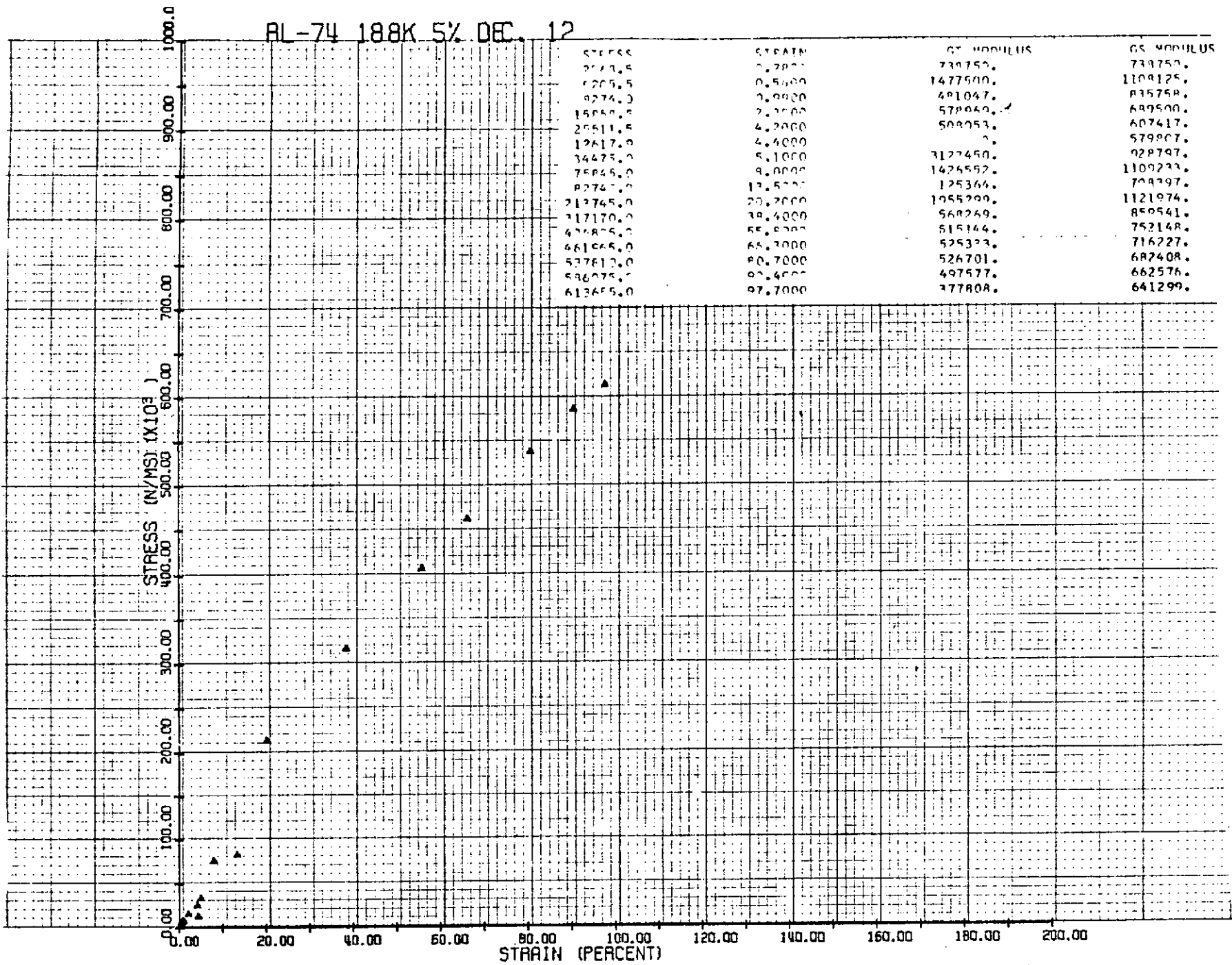

93 R

RL-75 188K 3% DEC. 13

76

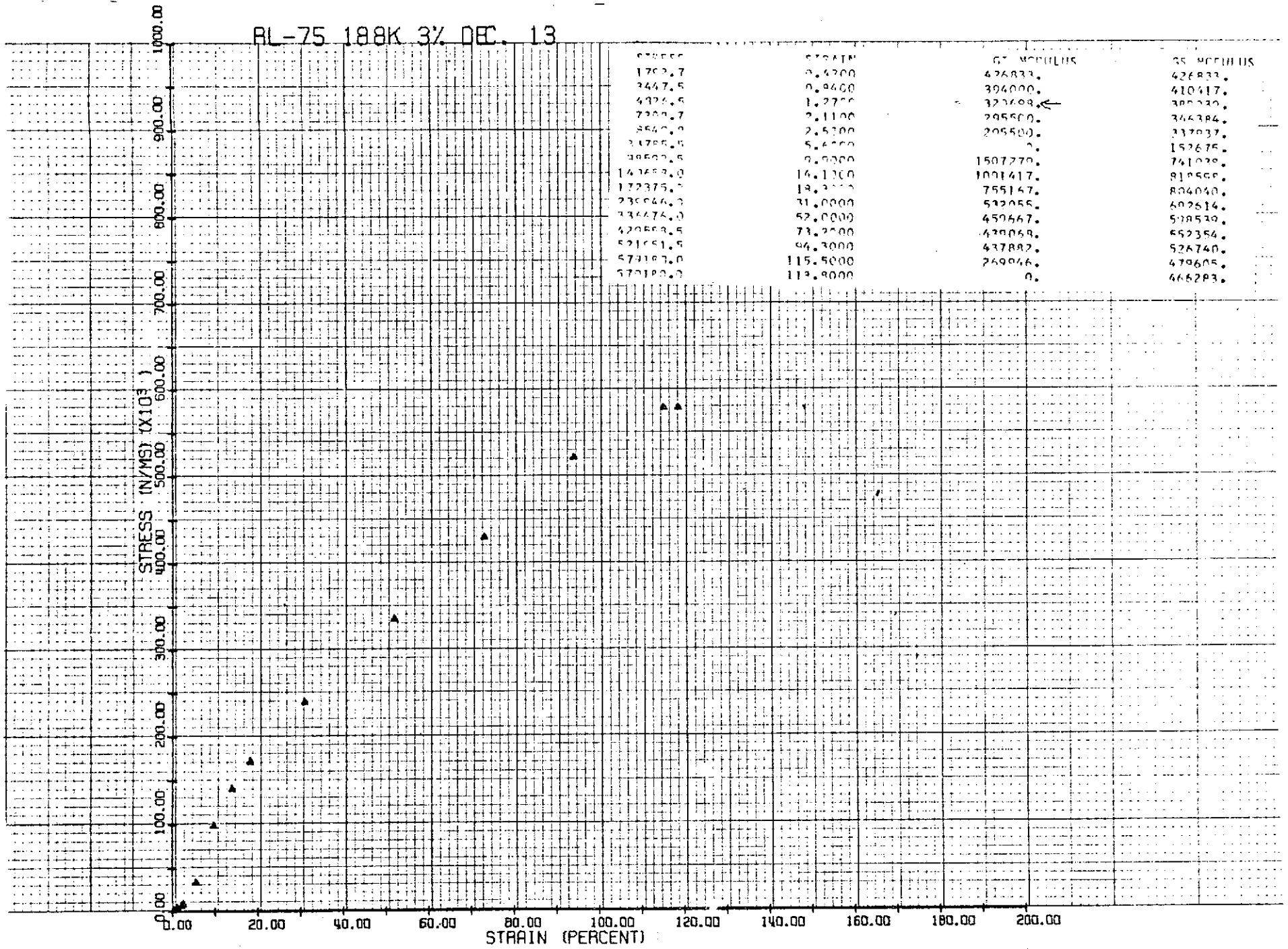

RL-73 188K 10% DEC. 13

95A

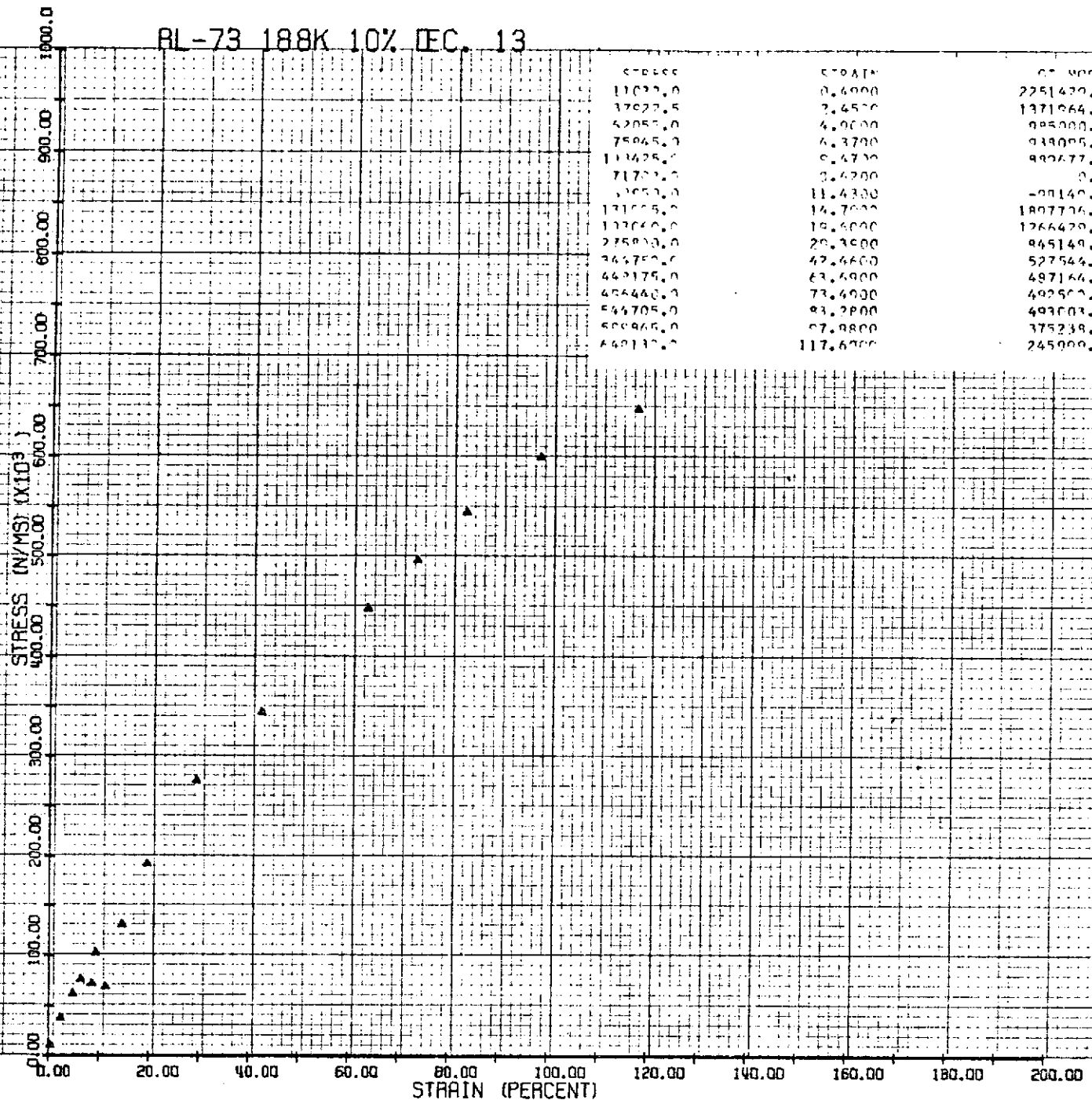

STRESS	STRAIN	CS MODULUS	CS MODULUS
11022.0	0.6900	2251420.	2251420.
37027.5	2.4500	1371064.	1547857.
62055.0	4.9000	985000.	1266429.
75045.0	6.3700	939005.	1190650.
111425.0	9.4700	982677.	1092131.
71700.0	9.6700	0.	1169826.
13050.0	11.4300	-20140.	600726.
131005.0	14.7000	1807776.	1106952.
137060.0	19.6000	1266420.	1166021.
235000.0	29.3500	945149.	1046332.
365750.0	42.6600	527544.	886639.
442175.0	63.6900	497166.	753481.
454460.0	73.6900	492500.	718679.
544705.0	93.2900	493003.	692149.
599860.0	97.9800	375239.	644603.
669130.0	117.6900	245000.	578101.

AL-34 200K 1% SEPT. 30

STRESS (N/MS) (X 10<sup>3</sup>)

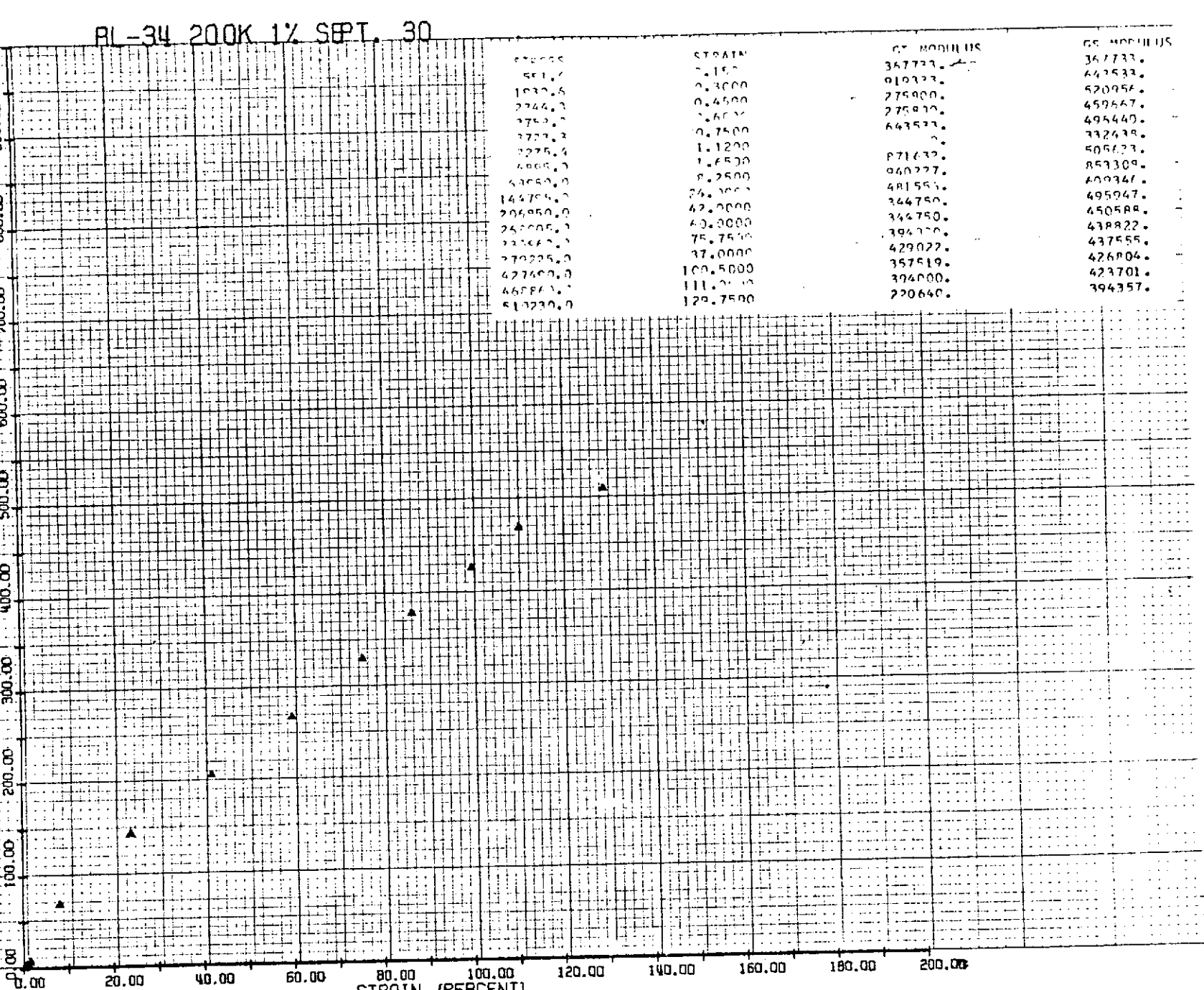

STRAIN	GT MODULUS	GS MODULUS
0.150	367723.	367733.
0.3000	919323.	643533.
0.4500	275900.	520956.
0.6000	275900.	459667.
0.7500	643533.	495440.
1.1200	0.	332439.
1.2500	871632.	505123.
1.2500	940227.	859309.
1.2500	481553.	609347.
24.0000	344750.	495047.
42.0000	344750.	450588.
60.0000	394700.	438822.
75.7500	429022.	437555.
37.0000	357519.	426904.
100.5000	394000.	423701.
111.0000	220640.	394357.
129.7500		

OK



AL-37 200K 3% SPT, 25

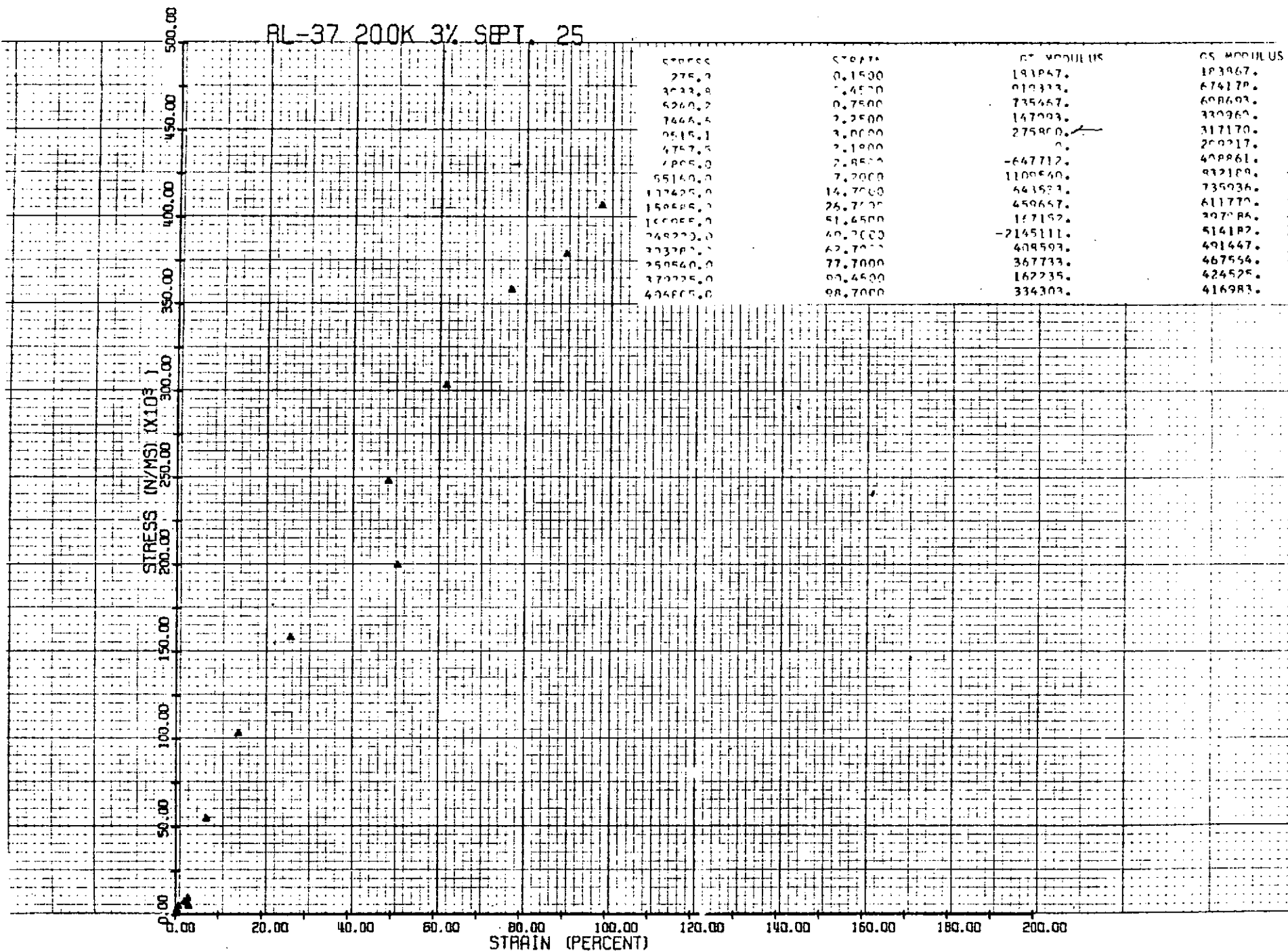

97 A



RL-33 200K 10% SEPT. 26

STRESS (N/MS) (X10<sup>3</sup>)

STRAIN (PERCENT)

STRESS	STRAIN	GT. MODULUS	GS. MODULUS
1241.1	2.3000	53061.	53061.
31203.3	4.6000	1307052.	680507.
64460.7	6.9000	1507498.	968061.
97530.0	9.2000	1273164.	1026915.
110070.0	11.4000	586076.	895321.
70707.0	11.7900	.	1109029.
26510.0	10.6000	7425784.	1487580.
117215.0	12.7000	667250.	1303507.
177275.0	25.1000	487860.	931237.
234430.0	47.2000	340067.	683130.
266425.0	50.3000	387844.	603458.
350540.0	76.3000	371587.	552507.
412700.0	89.7000	402628.	520616.
475755.0	107.0000	358599.	501987.
517125.0	121.0000	295500.	478091.
544705.0	137.0000	172375.	442387.

98 A

RL-29 225K 1% SEPT. 19

STRESS	STRAIN	GE MODULUS	GE MODULUS
275.9	0.1500	183867.	183867.
615.3	2.3000	459667.	321767.
1654.0	0.4000	220023.	275900.
2244.3	0.7500	459667.	312573.
2905.0	1.0000	367733.	321767.
1074.3	0.9000	0.	321767.
34475.0	4.6500	891753.	791433.
55160.1	30.1500	81118.	139127.
37260.0	40.4500	141476.	170376.
110320.0	66.1500	167152.	169587.
134452.5	78.9000	120275.	172768.
145400.0	83.1500	217737.	179640.
196577.5	106.4500	229833.	186003.
224007.5	117.9000	245156.	191645.
258577.5	131.4000	255370.	198197.
293037.5	149.6000	191528.	197389.

STRESS (N/MS) (X10<sup>3</sup>)

STRAIN (PERCENT)

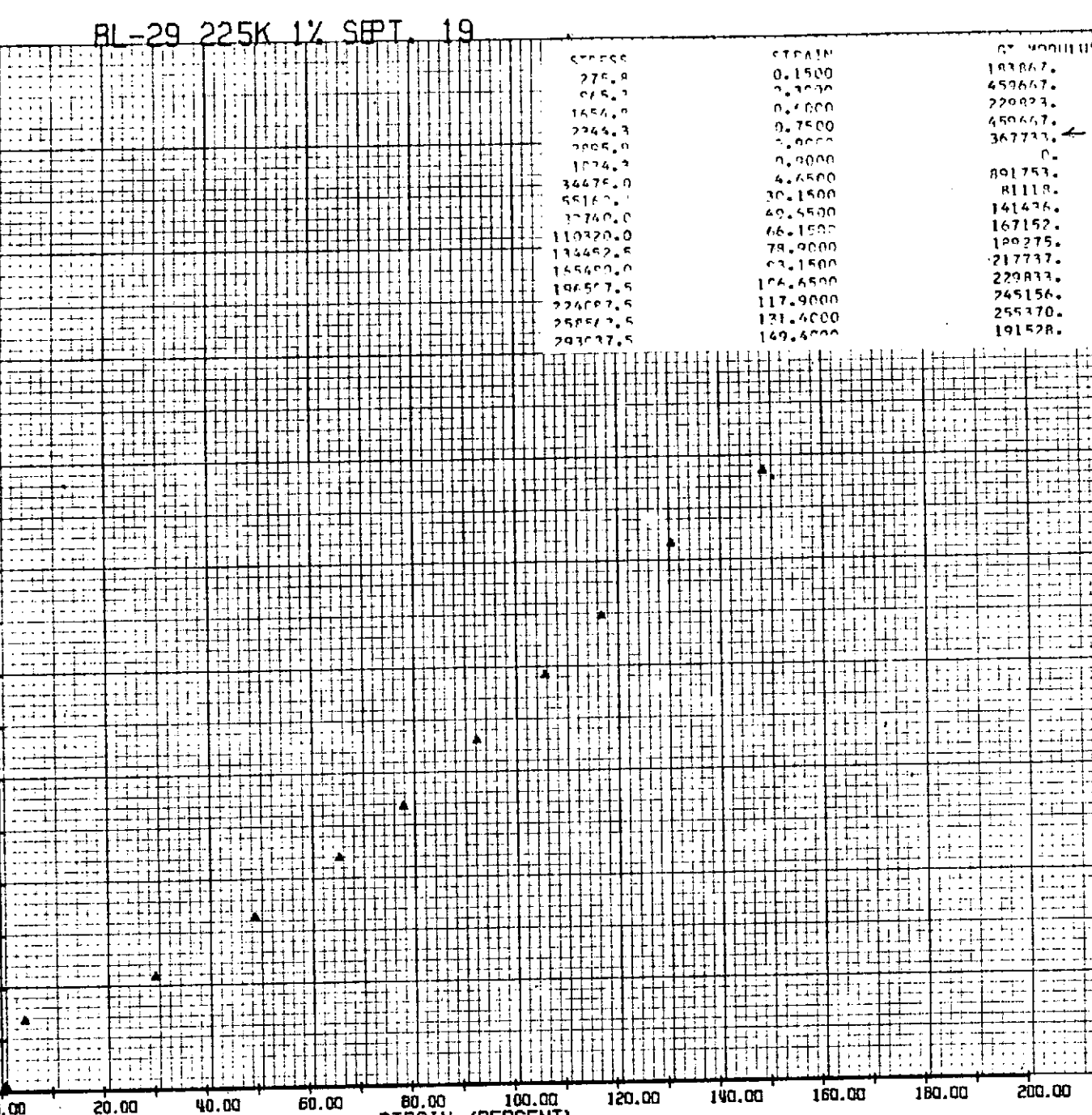
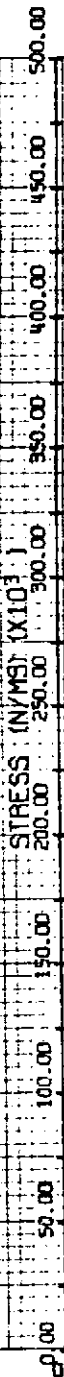

KEUFFEL & ESSER CO.

PRINTED IN U.S.A.

66

AL-27 225K 3% SEPT. 17

100 A

STRESS (N/MSI X 10<sup>3</sup>)

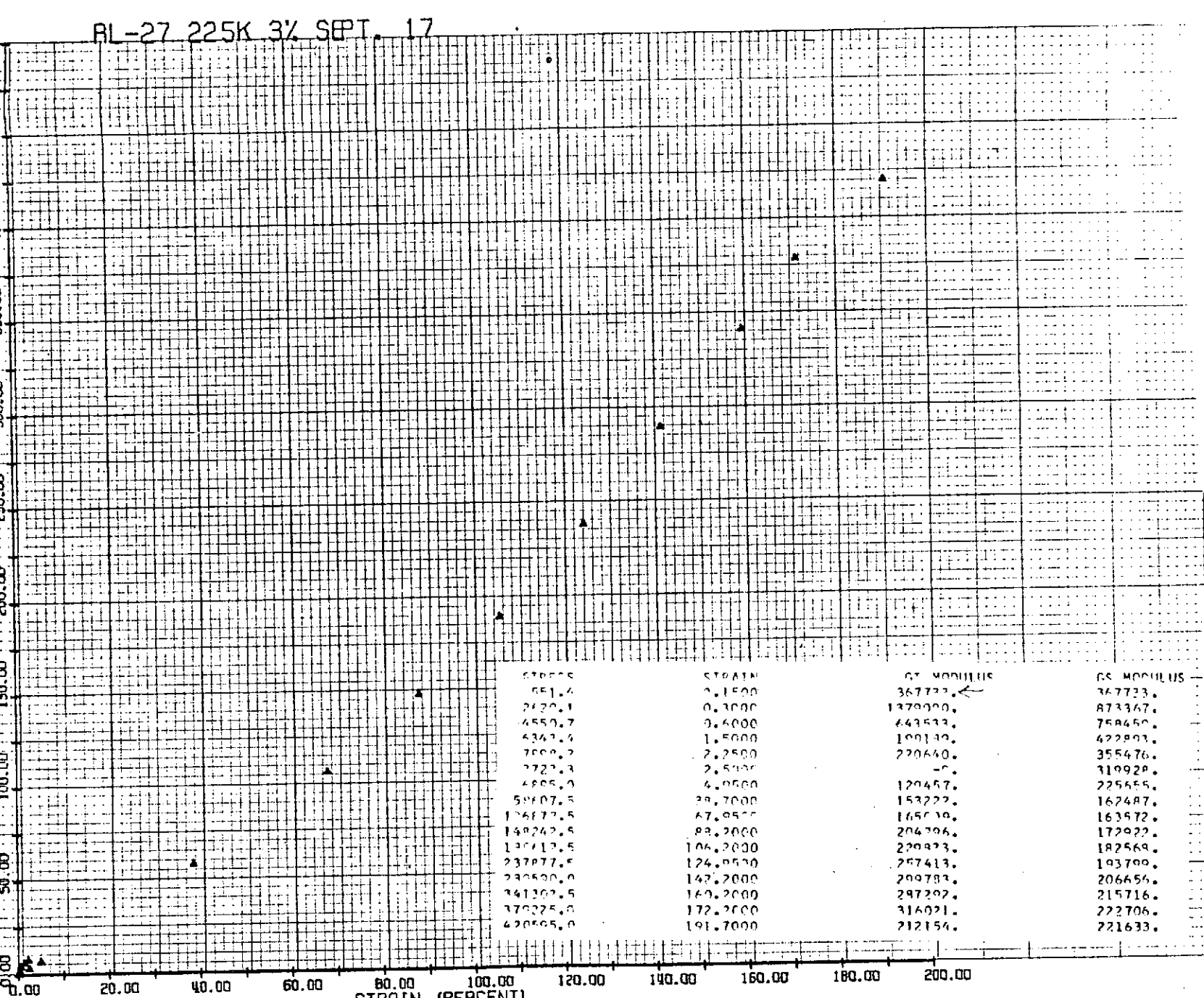

STRESS	STRAIN	GT MODULUS	GS MODULUS
670.00	0.1500	367733.0	367733.0
651.4	0.3000	1379000.0	873367.0
2620.1	0.6000	643533.0	758450.0
4550.7	1.5000	100130.0	422893.0
6343.4	2.2500	220640.0	355476.0
7000.2	2.5000	-	319920.0
7723.3	4.0500	120457.0	225655.0
4605.0	39.7000	153222.0	162487.0
59407.5	67.0500	165030.0	163572.0
126177.5	83.2000	204396.0	172922.0
148240.5	106.2000	220973.0	182569.0
130613.5	124.0500	257413.0	193700.0
237977.5	147.2000	209783.0	206656.0
230500.0	160.2000	297292.0	215716.0
341307.5	172.2000	316021.0	222706.0
379225.0	191.7000	212154.0	221633.0
420595.0			

PO-17 225K 5% SPT. 9

STRESS	STRAIN	GT MODULUS	GS MODULUS
620.6	0.9100	68192. ←	68192.
1379.7	1.9000	85219.	76611.
1797.7	2.7000	45967.	66396.
2759.0	3.6000	107256.	76611.
3309.6	4.6000	55160.	71948.
2689.1	4.2000	0.	79830.
2759.7	4.6000	17237.	73447.
16549.0	25.0000	47578.	68674.
30279.0	41.0000	86188.	75500.
44129.0	52.4000	127965.	85398.
50207.0	62.3000	153222.	96176.
74464.0	69.9000	109592.	107420.
89256.7	75.2000	260189.	118187.
103425.0	82.1000	219841.	126730.
118564.0	85.2000	489323.	139923.
132284.7	96.5000	122035.	137829.

STRESS (N/MS) (X10<sup>3</sup>)

500.00  
450.00  
400.00  
350.00  
300.00  
250.00  
200.00  
150.00  
100.00  
50.00  
0.00

STRAIN (PERCENT)

0.00 20.00 40.00 60.00 80.00 100.00 120.00 140.00 160.00 180.00 200.00

101

01

AL-35 225K 5% SEPT. 19

STRESS	STRAIN	CS MODULUS	CS MODULUS
551.4	0.1500	347733.	367733.
2806.9	1.5000	173652.	193967.
4826.6	3.0000	129737.	160093.
6767.1	4.5000	129707.	150159.
8825.6	6.0000	609500.	183867.
5171.3	5.1000	0.	173051.
1800.0	11.2500	39029.	93772.
17237.5	45.0000	32664.	46426.
94187.5	60.0000	28792.	130206.
122640.5	87.7500	133967.	141672.
165137.5	125.7500	101529.	150159.
192412.5	121.5000	218899.	159067.
224007.5	135.0000	255370.	168698.
258967.5	150.0000	220833.	176811.
213037.5	166.5000	209939.	178193.
313727.5	182.2500	131332.	174144.

STRESS (N/MS) (X10<sup>3</sup>)

STRAIN (PERCENT)

102 A

BL-22 225K 10% EPT. 18

STRESS	STRAIN	GT MODULUS	GS MODULUS
3750.0	2.9000	281420.	281420.
3814.0	2.6500	197610.	225147.
4665.0	2.6100	261875.	264176.
12411.0	5.5300	140714.	190061.
14136.0	7.2500	210213. ←	192310.
28295.0	7.7000	0.	103568.
20685.0	16.2300	137421.	159100.
41370.0	33.4800	120612.	139624.
62055.0	60.4300	102338.	122885.
82740.0	87.8400	135130.	125976.
124110.0	170.6400	140714.	178857.
143020.5	117.5000	221122.	162309.
164507.5	134.7400	201020.	149782.
237877.5	135.5400	5045122.	179394.
275907.0	171.4900	105546.	163922.
310275.0	187.0900	222276.	168762.

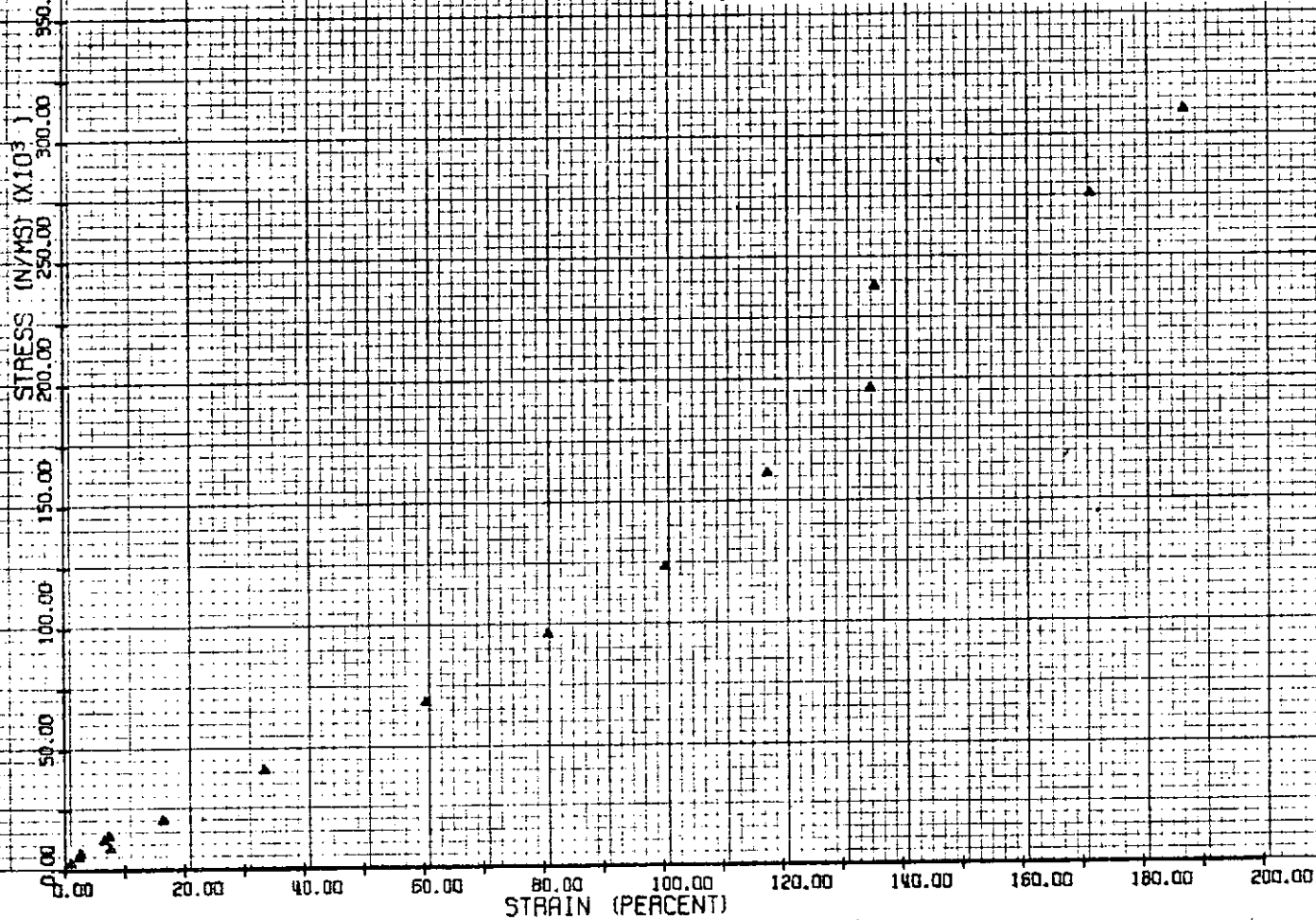

103

AL-52 250K 1% NOV. 8

STRESS	STRAIN	GT. MODULUS	CS. MODULUS
500.00	0.4500	122578.	122578.
450.00	0.0000	91933.	117256.
400.00	1.3500	61933.	102149.
350.00	1.8000	152222.	114917.
300.00	2.1000	229822.	131333.
250.00	1.0600	0.	260189.
200.00	1.0500	66676.	171845.
150.00	7.2000	210133.	109753.
100.00	11.7000	193867.	153640.
50.00	19.2700	137900.	171872.
0.00	27.4500	125364.	157094.
	43.2000	131333.	148211.
	58.0500	131333.	143701.
	82.9500	172375.	151998.
	122.7000	207369.	182229.
	189.4500	70044.	173325.

STRESS (N/MS) (X10<sup>3</sup>)

STRAIN (PERCENT)

104 B



RL-23 250K 1% SEPT. 7

105 A

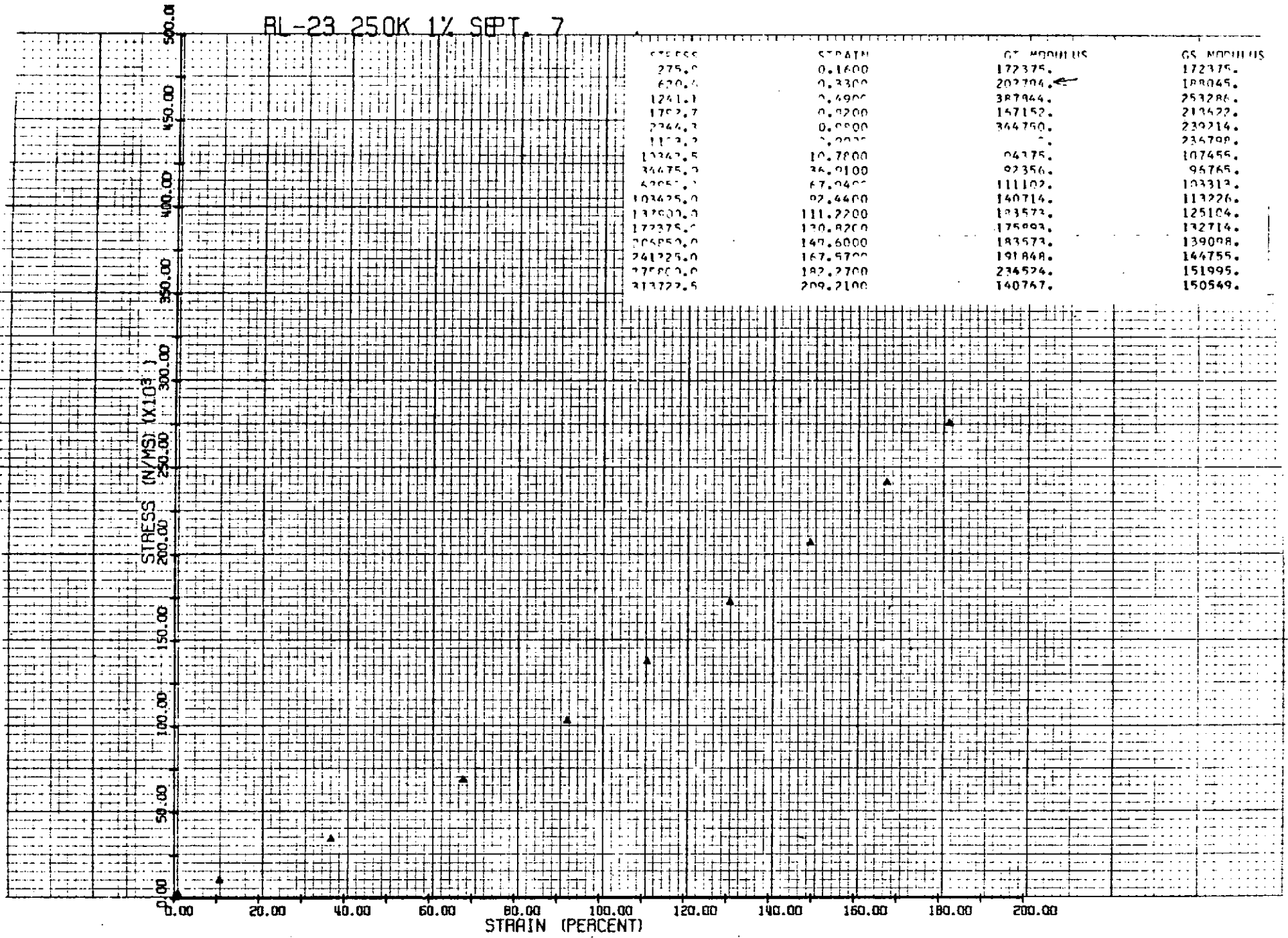



BL-24 250K 3% SEPI. 5

106A

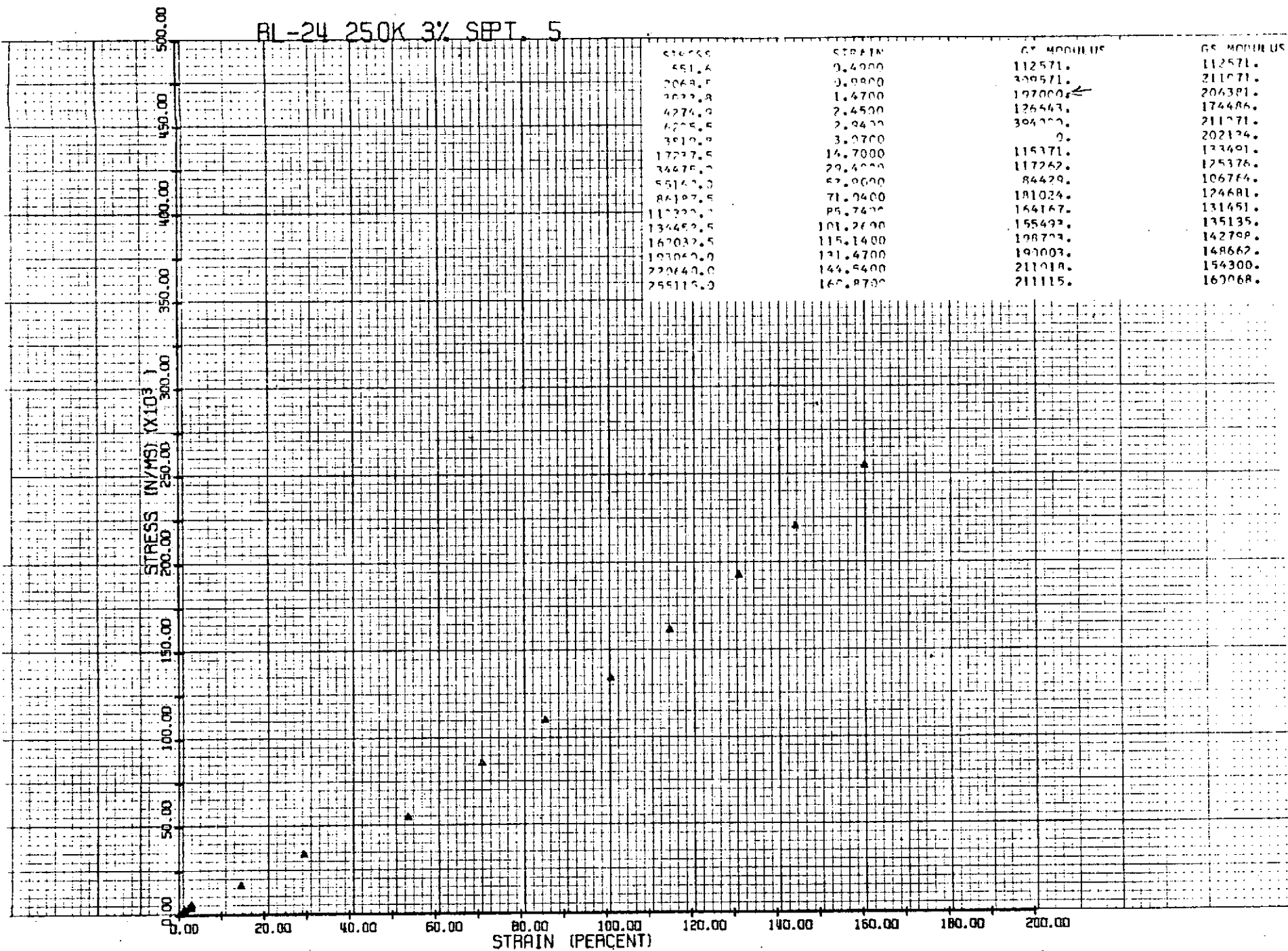

AL-51 250K 3% NOV. 13

STRESS	STRAIN	G' MODULUS	G'' MODULUS
57000	0.4500	919373.	919333.
4137.0	0.0000	-612989.	153222.
1770.0	1.3500	214511. ←	173652.
2744.3	1.9000	245156.	191528.
3667.5	2.2500	109189.	193060.
4363.0	3.0200	0.	163836.
3151.0	2.9500	1042362.	90240.
1270.3	21.2000	92420.	92221.
27590.0	55.9500	111434.	130720.
59160.0	67.2000	122578.	104370.
48050.0	79.2000	114917.	105976.
37763.0	86.7000	193867.	112714.
06530.0	97.2000	131333.	114725.
110220.0	131.7000	159884.	126555.
155480.0	163.2000	175111.	135927.
220640.0	179.7000	158794.	138027.

STRESS (N/MS) (X10<sup>6</sup>)

STRAIN (PERCENT)

107 K

AL-39 250K 5% SEPT. 6

STRESS (N/MS) (X10<sup>3</sup>)

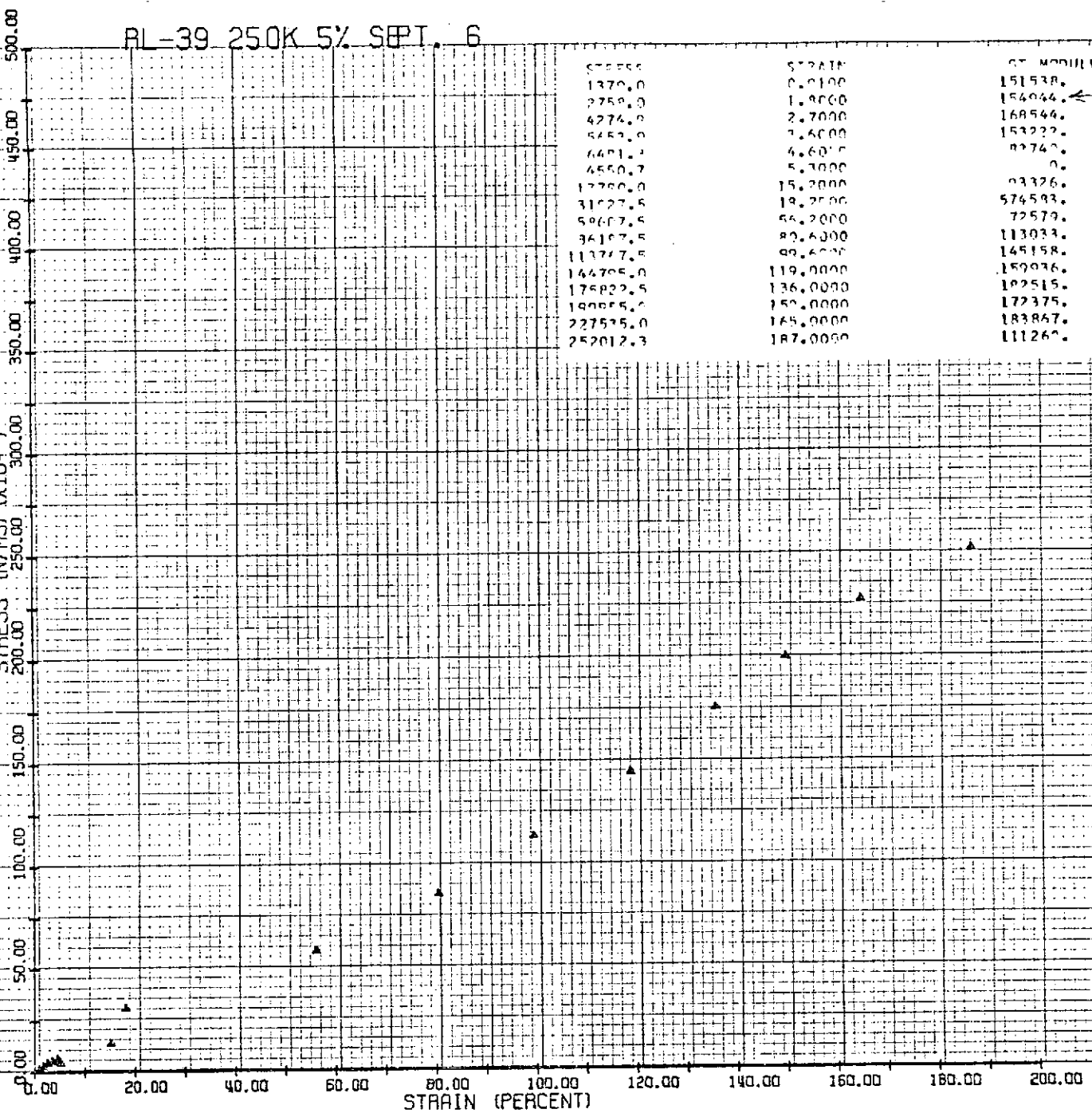

STRESS	STRAIN	GS MODULUS	GS MODULUS
1370.0	0.0100	151538.	151538.
2750.0	1.0000	154044. ←	153222.
4274.0	2.0000	168544.	158130.
5452.0	3.0000	153222.	157051.
6401.7	4.0000	82747.	143028.
6550.7	5.0000	0.	122280.
12760.0	15.0000	83326.	103425.
31027.5	18.0000	574583.	181088.
50607.5	56.0000	72579.	107719.
36107.5	80.0000	113033.	109328.
113747.5	90.0000	145158.	116163.
144705.0	119.0000	159036.	123200.
175822.5	136.0000	192515.	137701.
199025.0	150.0000	172375.	134590.
227515.0	165.0000	183867.	139070.
252012.3	187.0000	111260.	135798.

108 R

81-50 250K 5% NOV. 13

109 A

STRESS	STRAIN	G' MODULUS	G'' MODULUS
1585.0	0.0000	161221.	161221.
2750.0	1.9600	112607.	140714.
3841.2	2.9400	112571. ←	131333.
4835.5	1.0200	98500.	123125.
5722.0	4.0000	91444.	116793.
4725.0	4.0000	.	114917.
11072.0	14.7000	64765.	81755.
14540.0	24.5000	54236.	71567.
37064.0	39.2000	112571.	86044.
53050.0	80.8400	96105.	86512.
110320.0	117.5900	112571.	94656.
137000.0	128.8200	120911.	100048.
155480.0	157.6000	145858.	105626.
173060.0	178.2200	135264.	109702.
220640.0	225.3800	58235.	98334.
220640.0	222.0300	0.	99415.

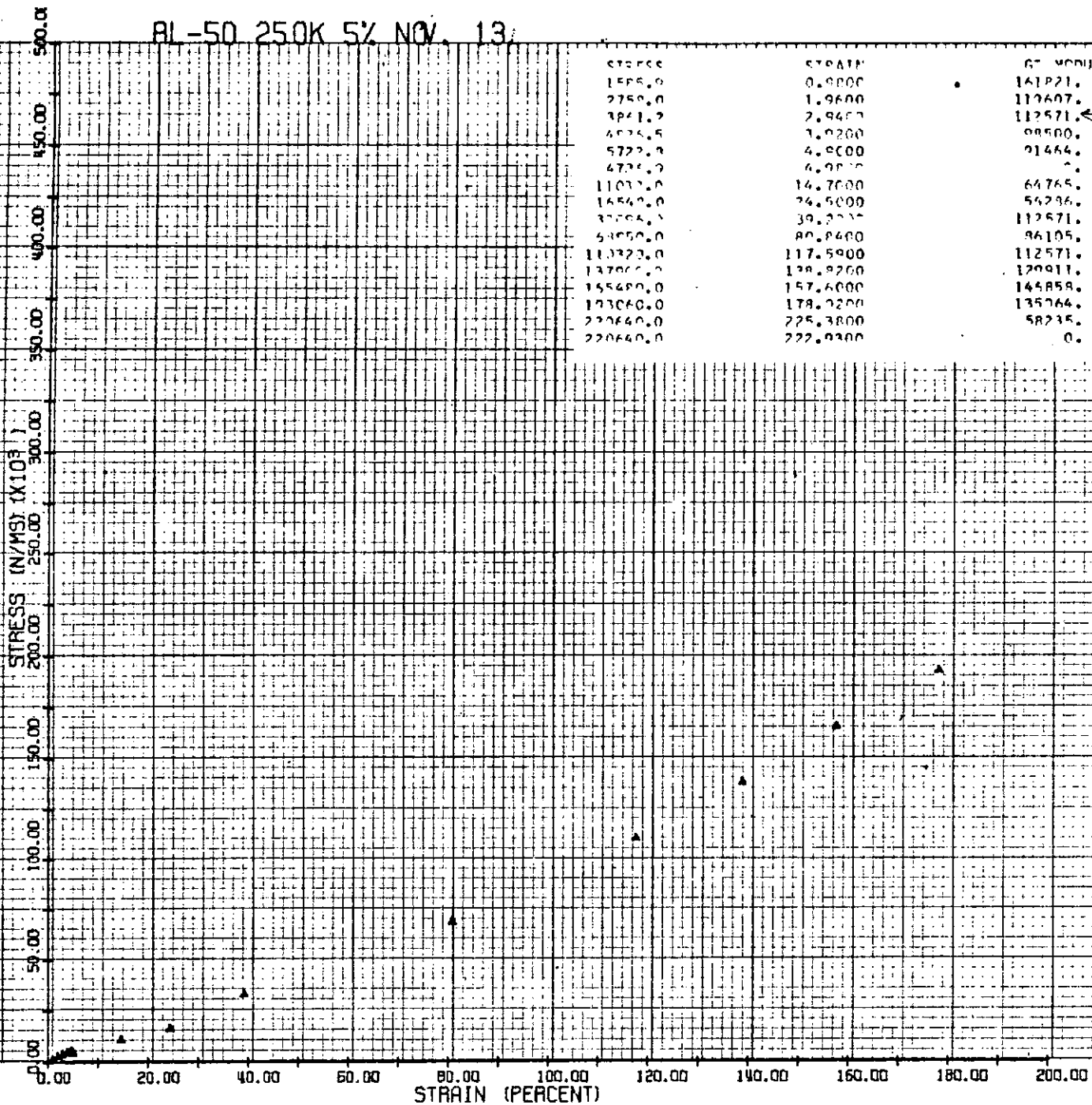

AL-28 250K 10% SEPT. 5

110

STRESS (N/MS) (X10<sup>3</sup>)

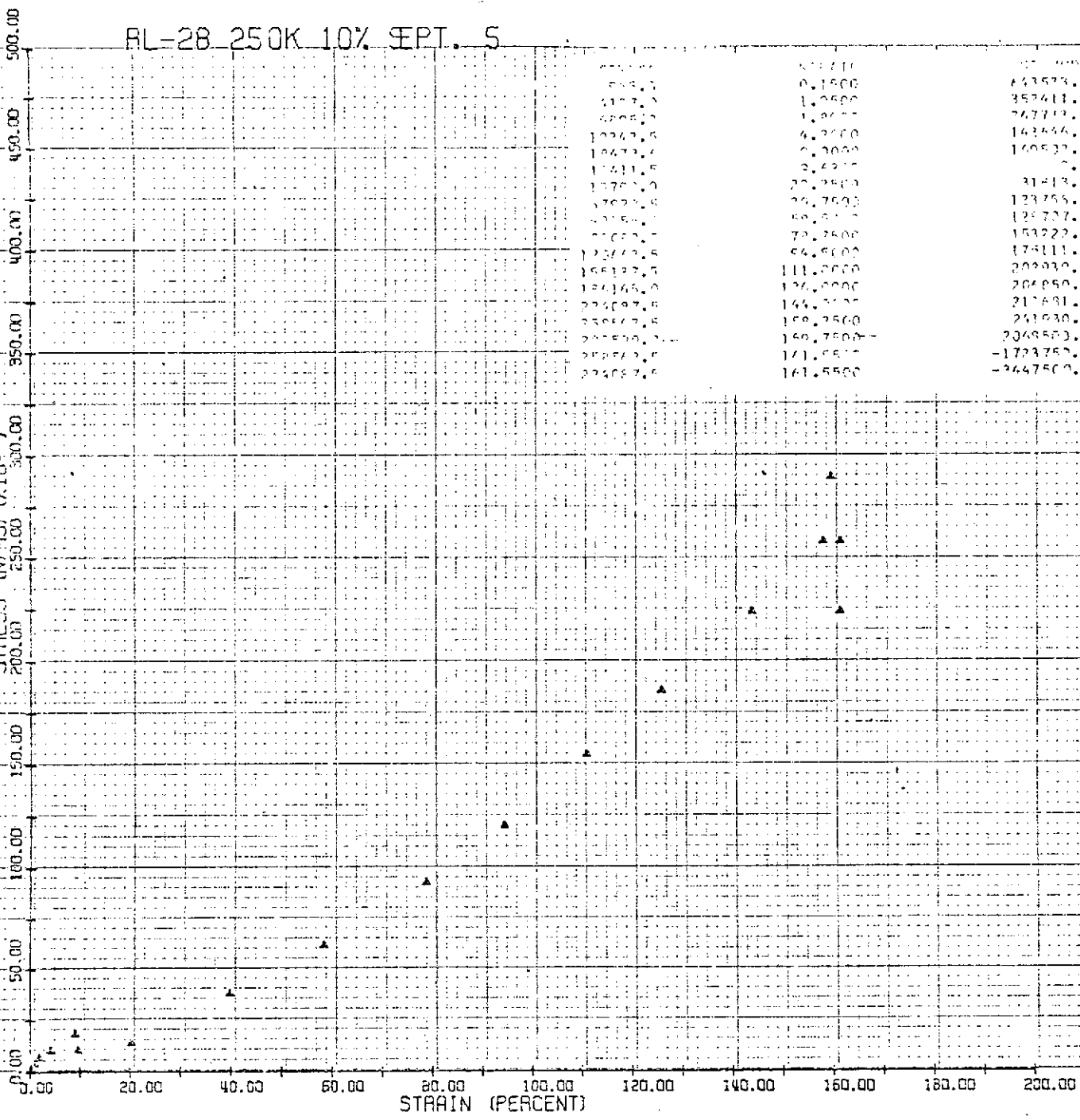

STRESS (N/MS)	STRAIN (PERCENT)	STRESS (N/MS)	STRAIN (PERCENT)
0.1500	0.1500	643573.	643573.
1.2600	1.2600	357411.	357411.
1.8600	1.8600	767713.	767713.
4.2600	4.2600	143556.	143556.
6.3000	6.3000	248280.	248280.
8.4200	8.4200	295319.	295319.
20.9500	20.9500	191086.	191086.
29.7500	29.7500	31413.	31413.
39.5000	39.5000	123755.	123755.
49.2500	49.2500	124737.	124737.
59.0000	59.0000	153222.	153222.
68.7500	68.7500	175111.	175111.
78.5000	78.5000	202930.	202930.
88.2500	88.2500	266950.	266950.
98.0000	98.0000	217691.	217691.
107.7500	107.7500	251930.	251930.
117.5000	117.5000	204950.	204950.
127.2500	127.2500	-172375.	-172375.
137.0000	137.0000	-244750.	-244750.
146.7500	146.7500		
156.5000	156.5000		
166.2500	166.2500		
176.0000	176.0000		
185.7500	185.7500		
195.5000	195.5000		
205.2500	205.2500		

AL-46 250K 10% NOV. 13

A III

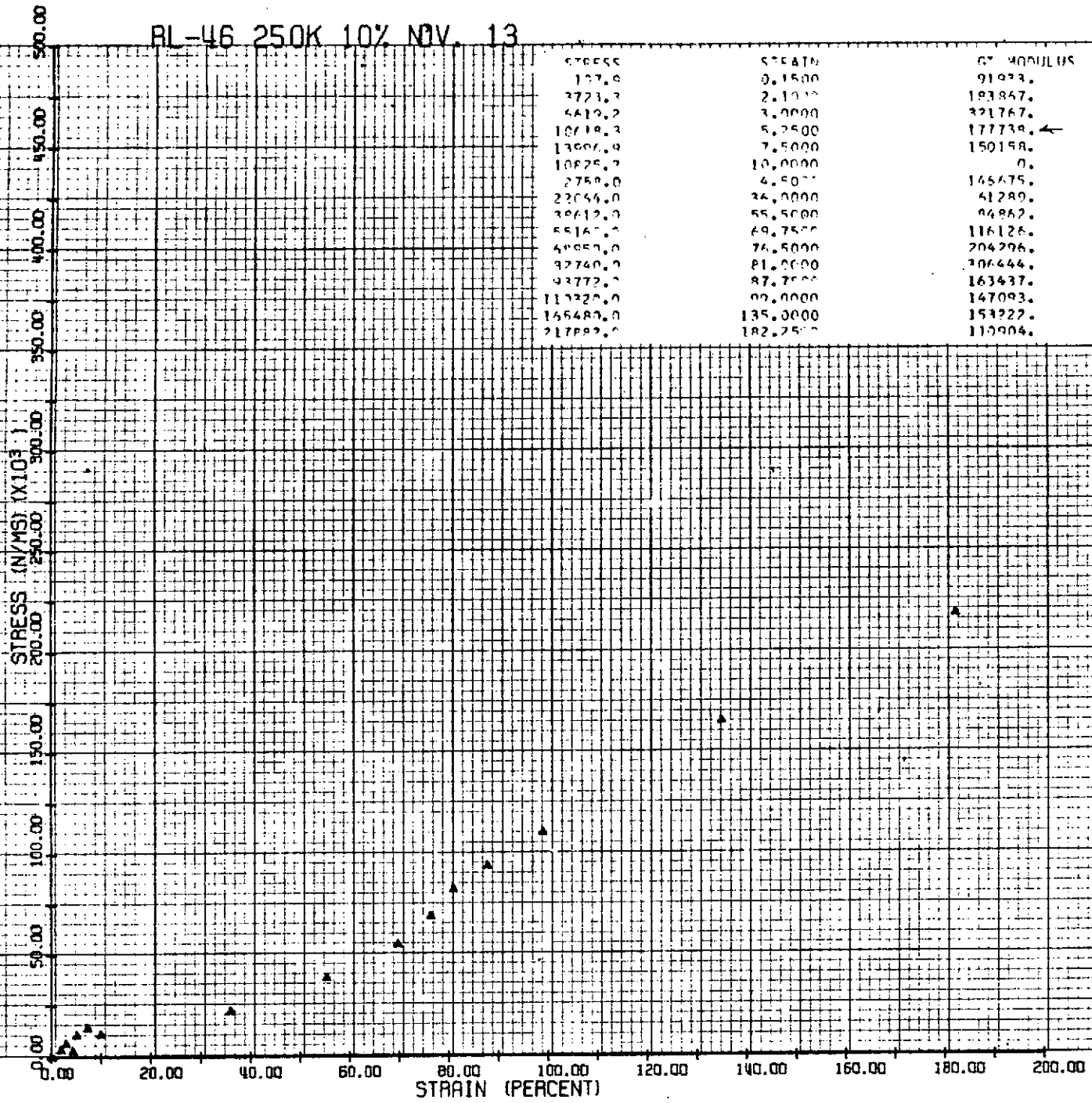

RL-19 275K 1% AUG. 21

STRESS	STRAIN	GT. MODULUS	GS. MODULUS
137.0	0.3000	43947.	45967.
227.4	0.6000	229833.	117900.
1516.0	1.2000	114917.	126408.
2256.4	1.7333	137970.	129789.
2769.0	2.1000	137900. ←	131333.
2827.1	2.3900	0.	131962.
13757.0	12.0000	118497.	121007.
27695.0	19.2000	95764.	111541.
27597.0	26.4000	95764.	107238.
44817.5	43.5700	100804.	104709.
62055.0	53.8000	112663.	106779.
75945.0	70.5000	117863.	108618.
93782.5	83.1000	136806.	112892.
107425.0	91.2000	127695.	114206.
117215.0	101.1000	139293.	116663.
122731.0	111.3000	54078.	110927.

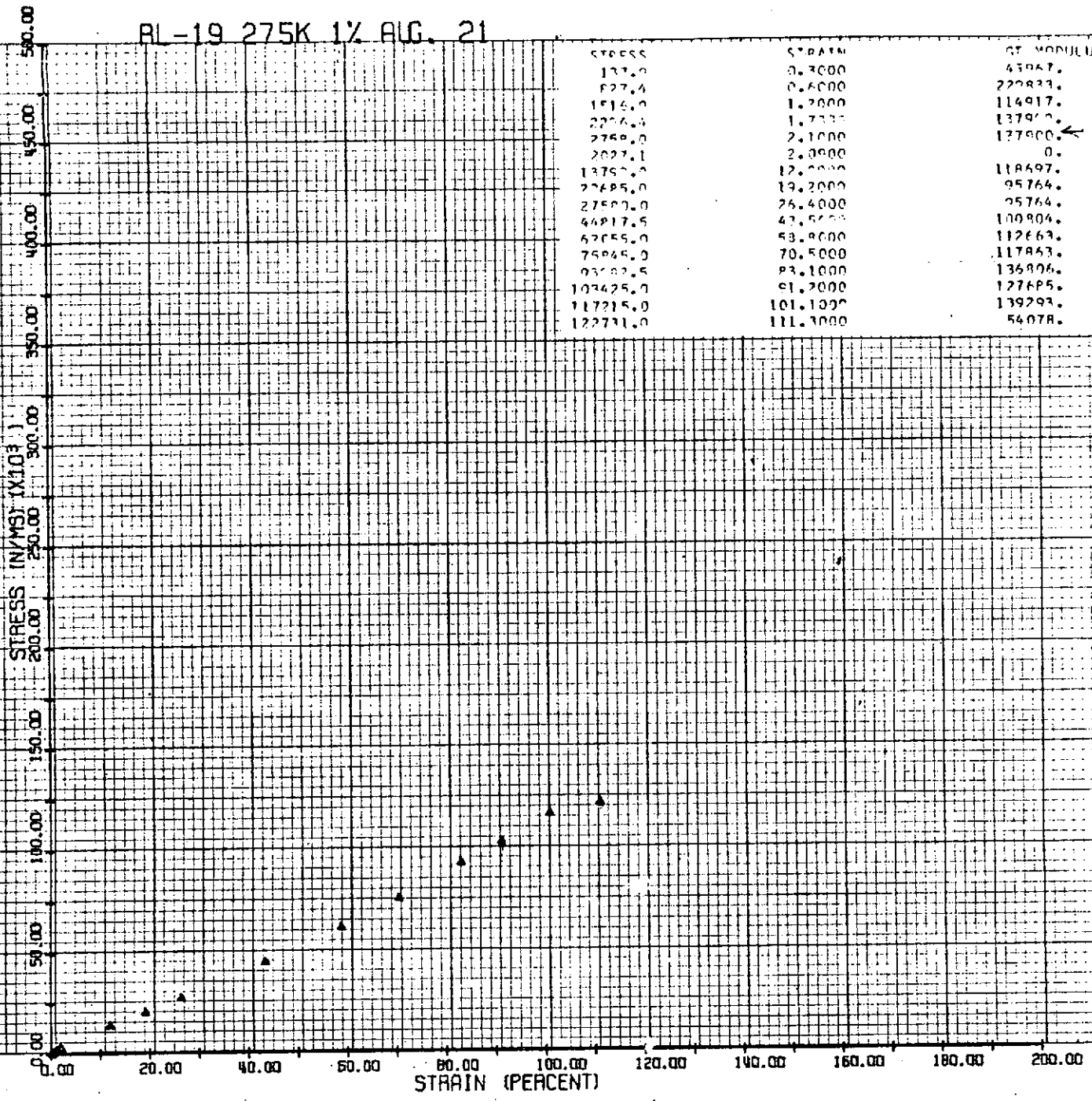

112 A





AL-20 275K 5% ALG. 21

STRESS	STRAIN	GT MODULUS	GS MODULUS
877.5	1.4900	168857.	168857.
2249.7	1.4700	154796.	159474.
4137.3	2.2900	218622.	180455.
6275.5	3.5900	150115.	172855.
7699.2	5.2300	100211.	152929.
1557.2	3.9500	?	164911.
17237.5	9.3300	307105.	224715.
21077.5	22.0500	100510.	147281.
51712.5	42.6300	170810.	126702.
75845.0	44.1800	111984.	120432.
98677.5	84.7600	117262.	119662.
127662.5	103.3800	111000.	118118.
124117.0	122.4000	18060.	102505.
137903.0	135.5600	105509.	102794.
148242.5	146.5000	94538.	102178.
155137.5	155.3200	78175.	100815.

113A

STRESS (N/MS) (X10<sup>3</sup>)

STRAIN (PERCENT)



RL-18, 25 K, STRAIN = 10%, AUG. 21, 1974

114 A

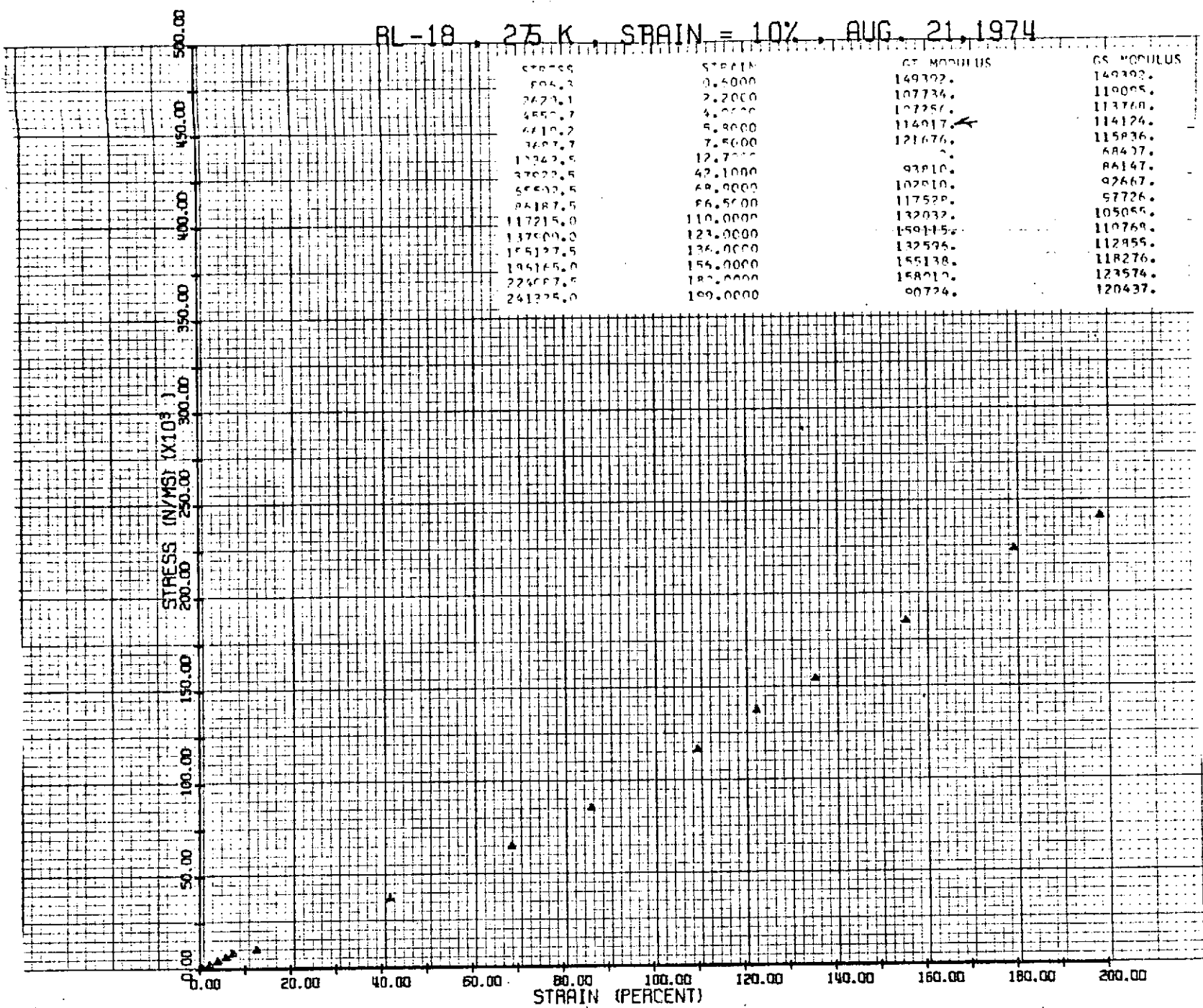

BL-65 300K 1/2 DEC. 3

11

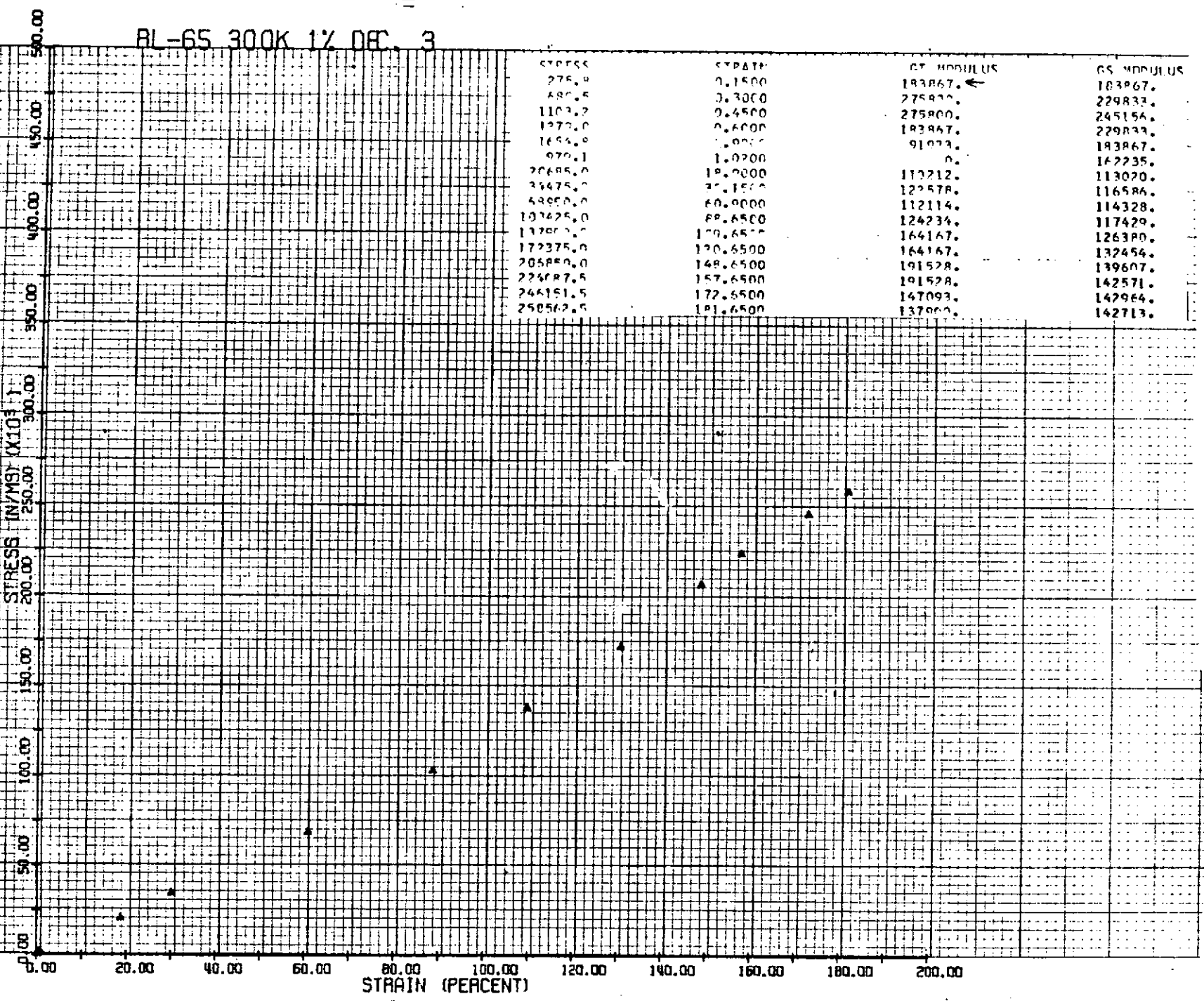

STRESS	STRAIN	GT. MODULUS	GS. MODULUS
275.4	0.1500	183867. ←	183867.
480.5	0.3000	275800.	229833.
1103.2	0.4500	275800.	245154.
1273.0	0.6000	183867.	229833.
1654.0	1.0000	91073.	183867.
270.1	1.0000	0.	162235.
20685.0	18.0000	110212.	113020.
26475.0	20.1500	122578.	116586.
43050.0	60.0000	112114.	114328.
107625.0	88.6500	124234.	117429.
137000.0	100.6500	164167.	126380.
172375.0	120.6500	164167.	132454.
205850.0	148.6500	191528.	139607.
224087.5	157.6500	191528.	142571.
246151.5	172.6500	147093.	142964.
250562.5	181.6500	137000.	142713.

115A

RI-15 300K 1 1/2 AUG. 19

116A

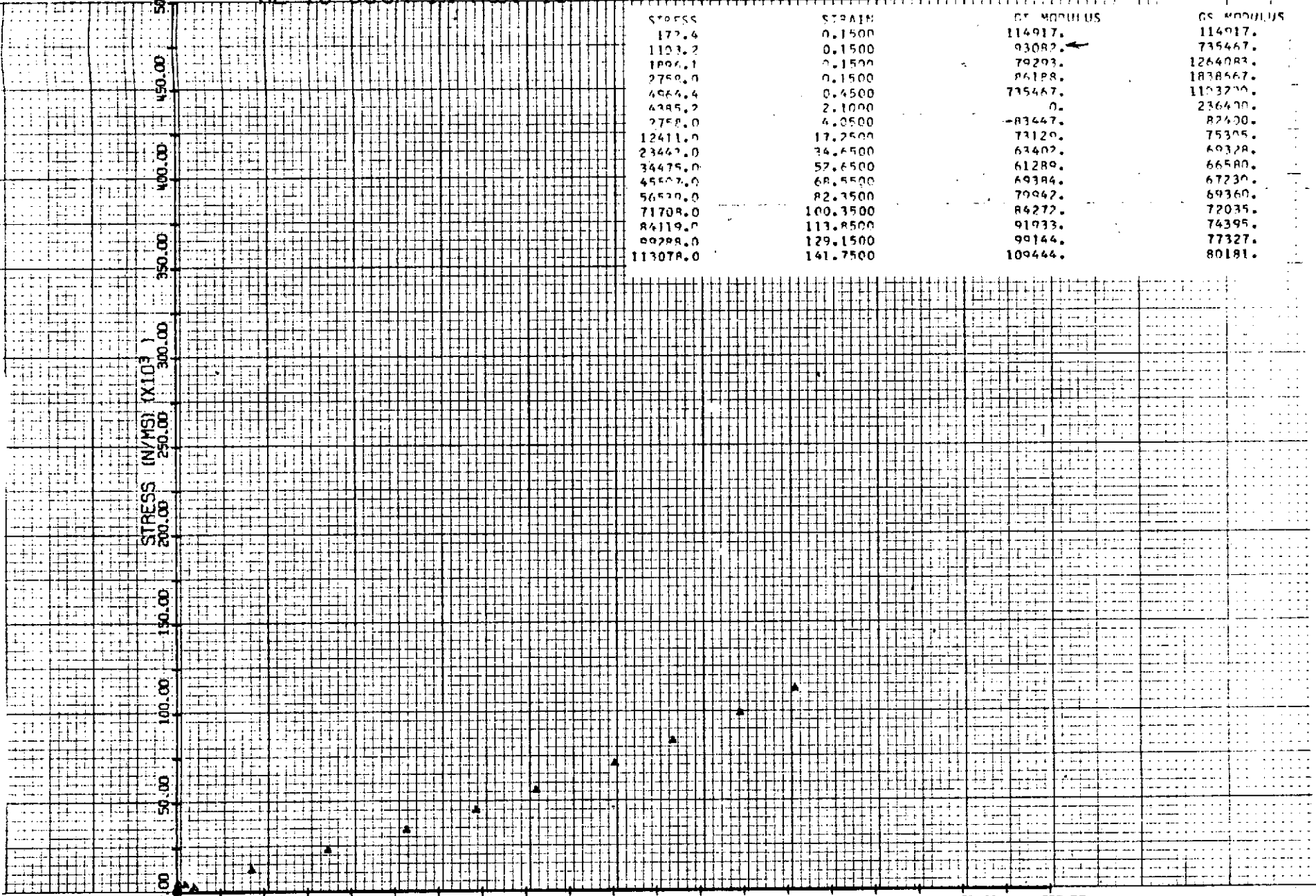

STRESS	STRAIN	DT MODULUS	DS MODULUS
177.4	0.1500	114917.	114917.
1103.2	0.1500	93082.	735467.
1896.1	0.1500	79293.	1264083.
2750.0	0.1500	86188.	1838567.
4964.4	0.4500	735467.	1103200.
4385.2	2.1000	0.	236400.
2758.0	4.0500	-83447.	82400.
12411.0	17.2500	73120.	75305.
23467.0	34.4500	63402.	69378.
34475.0	52.6500	61289.	66580.
45507.0	68.8500	49394.	67230.
56510.0	82.3500	79947.	69360.
71708.0	100.3500	86272.	72035.
84119.0	113.8500	91933.	74395.
99288.0	129.1500	99144.	77327.
113078.0	141.7500	109444.	80181.

AL-17 300K 3% ALG. 19

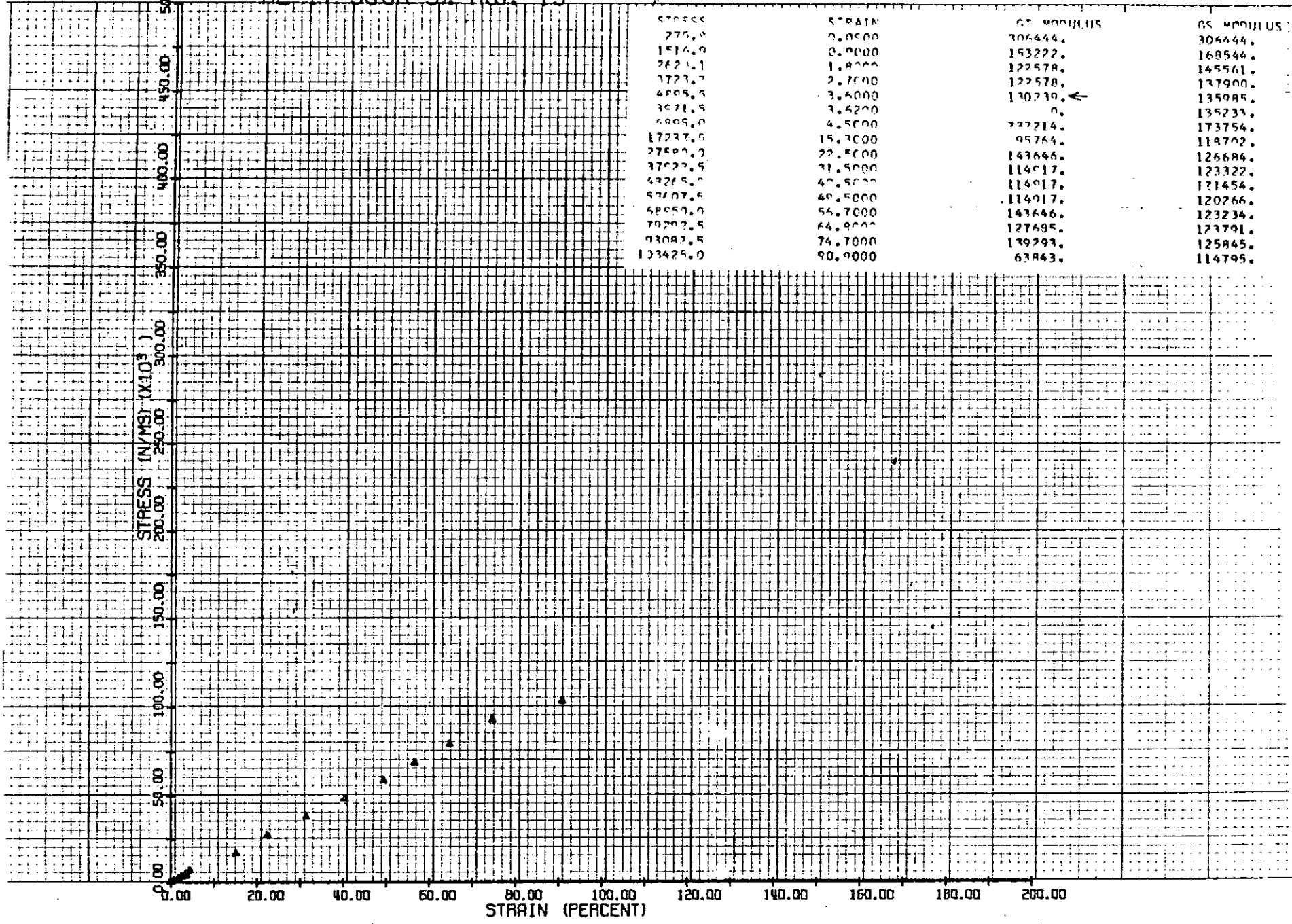

STRESS	STRAIN	GT. MODULUS	RS. MODULUS
275.0	0.0500	304444.	304444.
1514.0	0.0000	153222.	168544.
2625.1	1.8000	122578.	145561.
1723.7	2.7000	122578.	137900.
4895.5	3.6000	130730. ←	135985.
3071.5	3.6200	0.	135233.
4895.0	4.5000	222214.	173754.
17237.5	15.3000	95764.	119702.
27500.0	22.5000	143646.	126684.
37227.5	31.5000	114917.	123322.
43265.0	40.5000	114917.	121454.
53107.5	49.5000	114917.	120266.
48950.0	56.7000	143646.	123234.
70207.5	64.9000	127685.	123791.
93092.5	74.7000	139293.	125845.
133425.0	90.9000	63843.	114795.

117 A

RL-64, 300K, STRAN=3%, DEC. 4, 1974

118

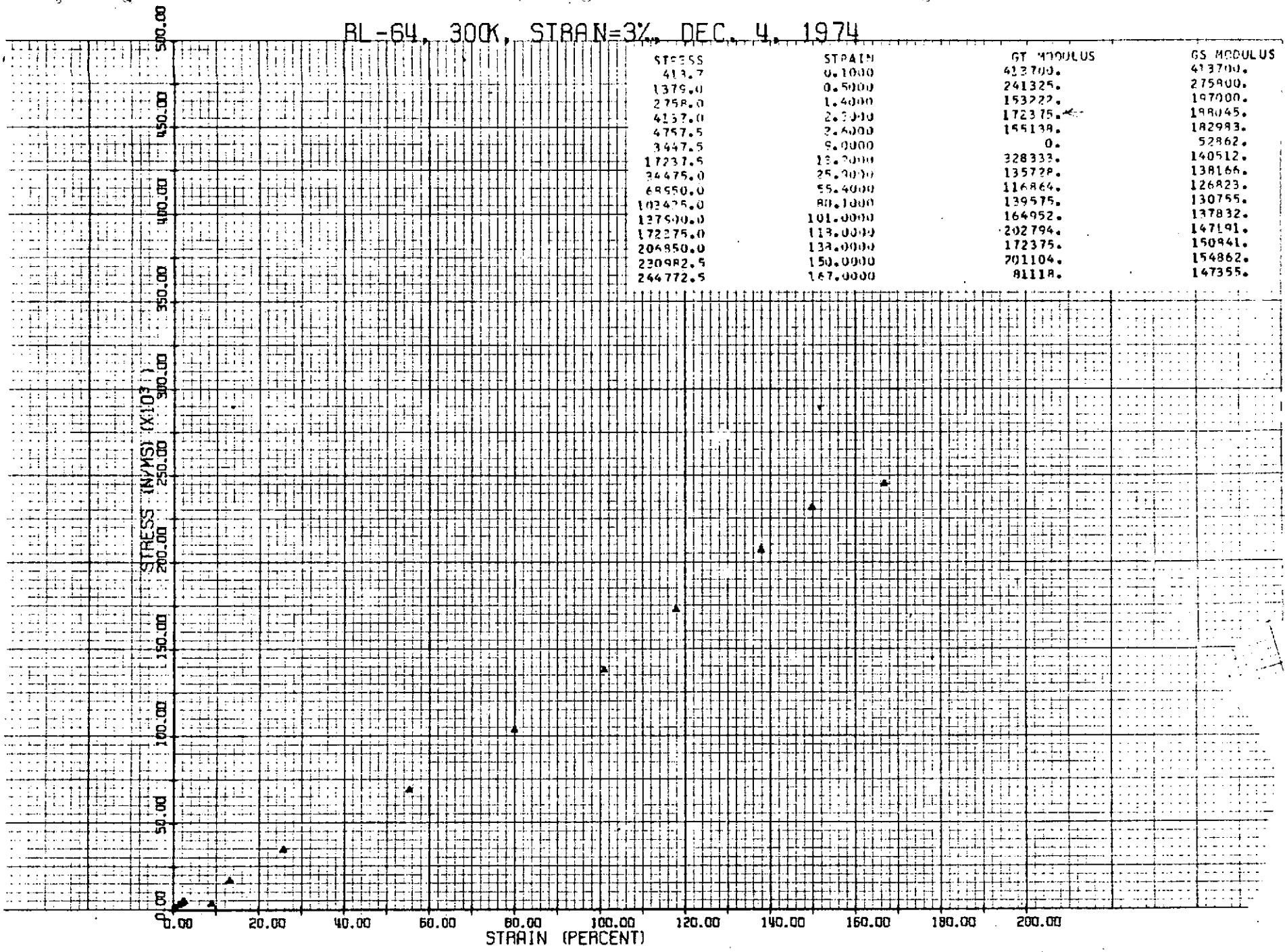

AL-5 300K 5% AUG 20

119

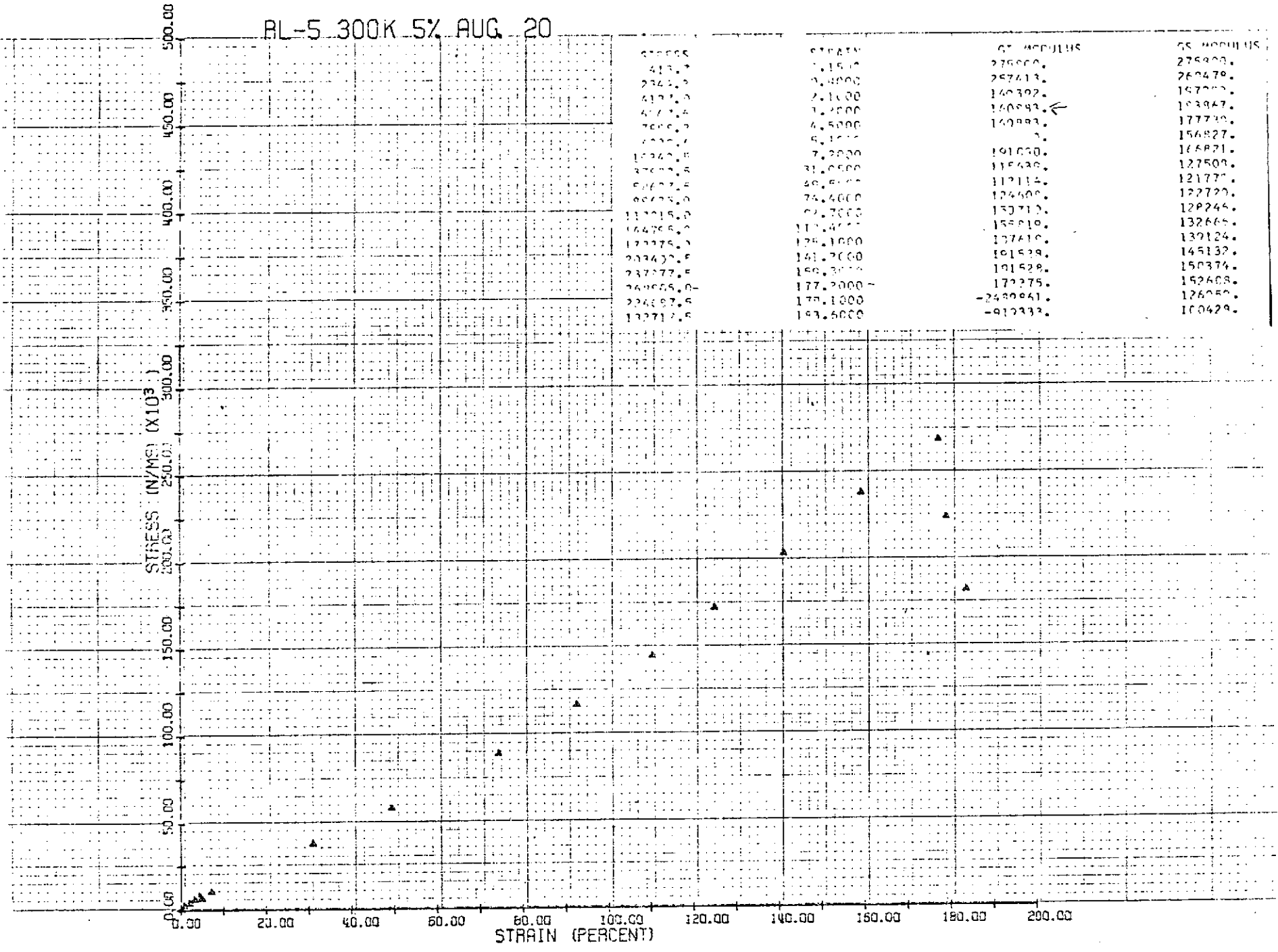

RL-72 300K 5% DEC. 13

STRESS	STRAIN	GS MODULUS	GS MODULUS
690.5	0.1500	459667.	459667.
2068.5	1.2000	131333.	172375.
3447.5	2.1000	162222.	164167.
4964.6	3.3000	126408.	150436.
6205.5	4.2000	117900.	147750.
8500.3	5.2000	98740.	124110.
11077.5	9.7000	64478.	98740.
15172.5	27.4500	123707.	110212.
18650.0	46.9500	106077.	113755.
103425.0	62.7000	109444.	112673.
137007.0	88.2000	135196.	119185.
172375.0	111.4500	148280.	125255.
189612.5	130.2000	183867.	133695.
206850.0	141.4500	153222.	135248.
232361.5	151.2000	176795.	137927.
	170.7000	130828.	137116.

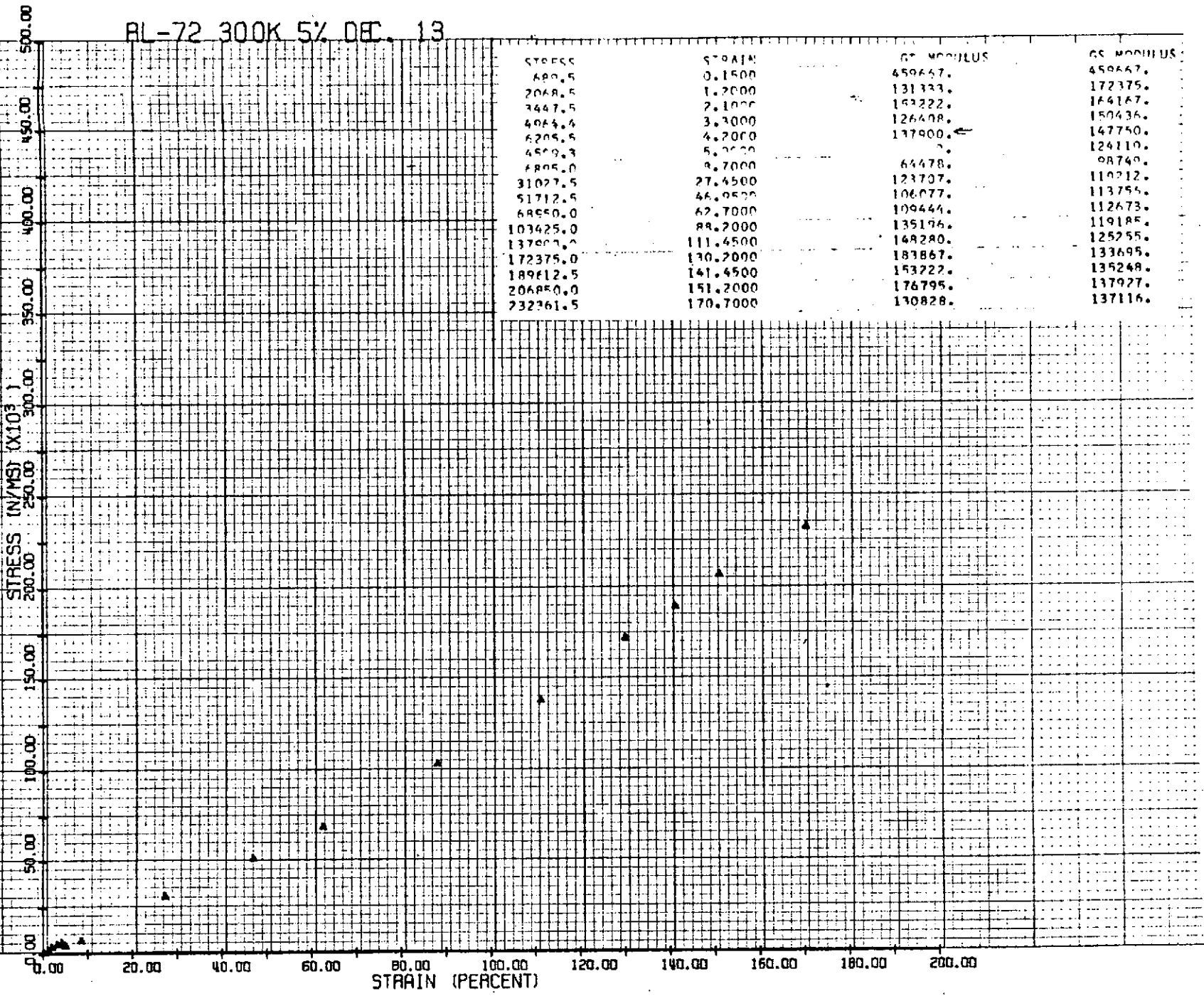

120 A



AL-9 300K 10% AUG. 20

STRESS (KSI) (MM/N) SS&H

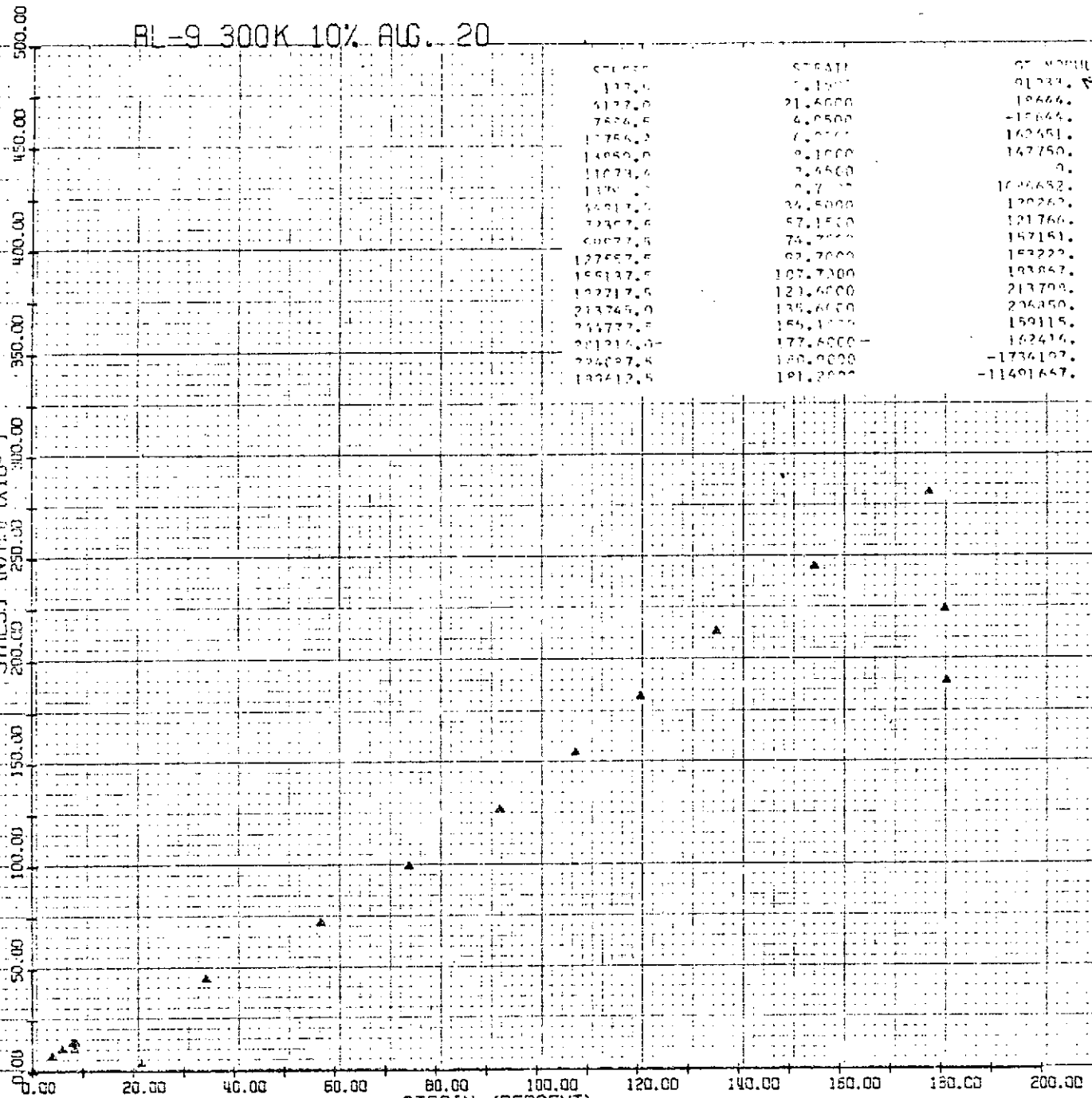

STRESS	STRAIN	GS. MODULUS	GS. MODULUS
576.00	2.1000	91234.0	91033.0
1172.0	4.2000	18666.0	19153.0
5172.0	21.4000	-15664.0	187272.0
7884.0	42.8000	162451.0	179270.0
17756.0	70.7000	162750.0	171098.0
14080.0	91.0000	0.0	164011.0
11674.0	124.5000	1626632.0	190574.0
1370.0	157.0000	120262.0	137980.0
5491.0	24.5000	121766.0	131554.0
22302.0	57.1500	152151.0	137564.0
60922.0	74.2000	152222.0	140807.0
127557.0	92.2000	183867.0	146632.0
155137.0	107.7000	213798.0	153817.0
192717.0	123.4000	236850.0	159683.0
213745.0	135.6000	159115.0	159612.0
234777.0	155.1000	162416.0	159967.0
251214.0	172.4000	-1736197.0	125414.0
224097.0	180.0000	-11491657.0	106180.0
182612.0	181.2000		

121H



AL-71, 300K, STRAIN 10%, DEC. 13, 1971

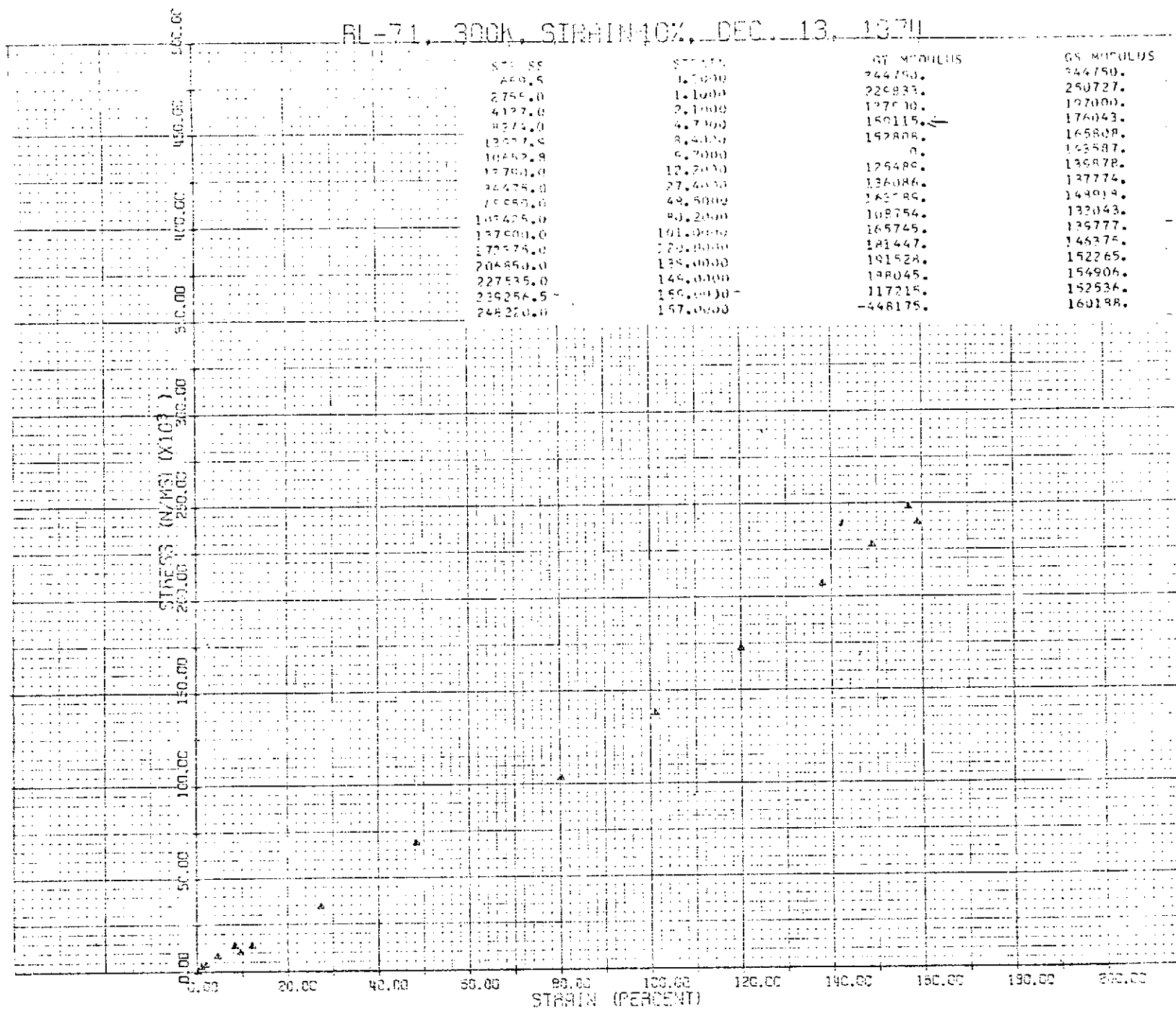

122 A



KEUFFEL & ESSER CO.

PRINTED IN U.S.A.