

NASA CR-134769

(NASA-CR-134769) ANALYSIS OF TURBOFAN  
ENGINE PERFORMANCE DETERIORATION AND  
PROPOSED FOLLOW-ON TESTS (American Airlines,  
Inc.) 130 p HC \$5.75 CSCL 21E

N75-27009

Unclas  
G3/07 28636

ANALYSIS OF TURBOFAN ENGINE PERFORMANCE DETERIORATION  
AND PROPOSED FOLLOW-ON TESTS

by

G. P. Sallee, H. D. Kruckenberg, and E. H. Toomey

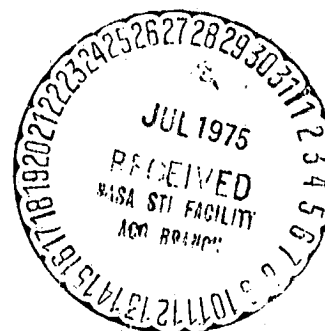
AMERICAN AIRLINES, INC.

prepared for

NATIONAL AERONAUTICS AND SPACE ADMINISTRATION

CONTRACT NAS 3-18537

NASA Lewis Research Center  
Cleveland, Ohio.



FOREWORD

The research described herein which was conducted by American Airlines, Inc., in conjunction with their subcontractor, Pratt & Whitney Aircraft, was performed under NASA Contract NAS3-18537. The NASA Program Manager was John E. McAulay, Airbreathing Engines Division, Lewis Research Center.

PRECEDING PAGE BLANK NOT FILMED

ABSTRACT

The investigation reported herein analyzed and documented available data and engine parts on in-service JT3D and JT8D engines relative to engine deterioration. The results of this investigation led to the conclusion that the fan-compressor system of these engines contributed a major portion of the long term engine deterioration. An engine test and instrumentation plan was then formulated for a proposed follow-on program. The goal of this program was to verify the above conclusion and to attempt to identify more precisely which components of the fan-compressor system are at fault.

PRECEDING PAGE BLANK NOT FILMED

## TABLE OF CONTENTS

	<u>Page</u>
SUMMARY	1
INTRODUCTION	2
RESULTS & DISCUSSION	3
ANALYSIS AND DOCUMENTATION OF CURRENT INFORMATION	3
. In-Service Performance Data	3
. Prior Performance Recovery Efforts	20
. Condition of In-Service Parts and Their Estimated Effect on Performance	22
. Fan-Compressors	22
. Combustors	32
. Turbines	42
. Seals & Clearances	47
. Material Consumption/Repair Rates	57
. Study of Performance Deterioration Utilizing Engine Simulation Decks	63
. Cost Versus Performance Improvement Trade-offs	65
. Impact of Study Results on Advanced Engines and Technology Research Planning	84
PROPOSED TEST PROGRAM	85
. General Considerations	85
. Test Configurations	88
. Sequence of Testing	89
. Proposed Instrumentation	91
. Data Validity	97
. Data Acquisition and Analysis Plan	98
. Test Procedures and Conditions	100
. Test Facilities	102
. Test Scheduling	105
. Program Cost	105
INDUSTRY DISCUSSION	105
CONCLUSIONS & RECOMMENDATIONS	106
APPENDIX I - Part Tolerance & Seal Clearance Summary for Both JT8D & JT3D Engine Builds	109

PRECEDING PAGE BLANK NOT FILMED

## LIST OF ILLUSTRATIONS

<u>Figure</u>	<u>Title</u>	<u>Page</u>
1	Typical High Bypass Engine Deterioration Rate	8
2	Fuel Flow Deviation Based Upon B707-323C CEML Data	9
3	Fuel Flow Deviation Based Upon B727 CEML Data & Test Cell Data	10
4	Test Cell Fuel Flow Trend Plot for JT3D-3B Cruise Power	11
5	Test Cell Fuel Flow Trend Plot for JT8D-9 Cruise Power	12
6	Test Cell EGT Trend Plot for JT3D-3B Cruise Power	13
7	Test Cell EGT Trend Plot for JT8D-9 Cruise Power	14
8	Fuel Flow Deviation Based Upon B727 CEML Data & Test Cell Data	15
9	Test Cell $\Delta$ LP Ratio Trend Plot for JT3D-3B Cruise Power	16
10	Test Cell $\Delta$ HP Ratio Trend Plot for JT3D-3B Cruise Power	17
11	Test Cell $\Delta$ LP Ratio Trend Plot for JT8D-9 Cruise Power	18
12	Test Cell $\Delta$ HP Ratio Trend Plot for JT8D-9 Cruise Power	19
13	Change in Thrust Specific Fuel Consumption of a JT3D-3B Engine Resulting from Engine Modification	23
14	Change in Thrust Specific Fuel Consumption of a Spey 511-14 Engine Resulting from Engine Modification	24
15	Change in Thrust Specific Fuel Consumption of a JT8D-9 Engine due to Water Wash and Engine Modification	25
16	The Effect of Complete Module Changes on the Performance of a JT8D Engine	26

<u>Figure</u>	<u>Title</u>	<u>Page</u>
17	Shadowgraph of JT3D 5th Stage Compressor Blade at 88.8 Percent Span	37
18	Shadowgraph of JT3D 9th Stage Compressor Blade at 96.1 Percent Span	38
19	Shadowgraph of JT3D 15th Stage Compressor Blade at 80.4 Percent Span	39
20	JT3D-3B Sample Turbine Blade Shadowgraph	48
21	Turbine Shadowgraph Analysis of JT3D	49
22	Turbine Shadowgraph Analysis of JT8D	50
23	Turbine Blade Surface Roughness of JT3D	51
24	Turbine Shroud Knife Edge Wear	52
25	Impact of Observed & Measured Turbine Deviations on Engine Fuel Consumption	53
26	Fuel Consumption Sensitivity to Component Deterioration for the JT3D-3B at Sea Level Static, Standard Day for Constant EPR	66
27	Fuel Consumption Sensitivity to Component Deterioration for the JT8D-9 for Sea Level Static, Standard Day at Constant EPR	67
28	Low Compressor Deterioration Study at Constant EPR	68
29	Low Compressor Deterioration Study at Constant EPR	69
30	Fan - LPC Operating Point Shifts due to LPC Deterioration - Separate Nozzle Engine (JT3D-3B) at Constant EPR	70
31	Fan - LPC Operating Point Shifts due to LPC Deterioration - Common Nozzle Engine (JT8D-9) at Constant EPR	71
32	Engine Test Data for the JT3D-3B at Standard Sea Level Static Conditions at Takeoff Power	72
33	Engine Test Data for the JT8D-9 at Standard Sea Level Static Conditions at Takeoff Power	73

<u>Figure</u>	<u>Title</u>	<u>Page</u>
34	Compressor Deterioration on JT3D-3B Engine	74
35	Compressor Deterioration on JT8D-9 Engine	75
36	Turbine Deterioration on the JT3D-3B and JT8D-9 Engines - Standard Sea Level Static Condition at Constant EPR	76
37	Hypothetical Trend of Achievable Cost Per Operating Hour	81
38	Proposed Instrumentation Locations	93
39	Station 2.4 Probe Configuration	96
40	Engine Gas Generator Performance	99
41	JT8D Fan, Low Compressor & High Compressor Areas of Measured Seal Tolerances	112
42	JT8D Turbine Areas of Measured Seal Tolerances	113
43	JT3D Fan & Low Compressor Areas of Measured Seal & Blade Tip Tolerances	114
44	JT3D High Compressor Areas of Measured Seal & Blade Tip Tolerances	115
45	JT3D High & Low Turbine Areas of Measured Seal & Blade Tip Tolerances	116

LIST OF TABLES

<u>Table</u>	<u>Title</u>	<u>Page</u>
I	Sea-Level Performance Changes at 1.65 EPR due to Shop Repair - JT3D-3B Engine (S/N 667783)	27
II	Major Parts Replacement History of JT3D-3B Engine (S/N 667783)	28
III	Sea-Level Performance Changes at 1.65 EPR due to Shop Repair - JT3D-3B Engine (S/N 645738)	29
IV	Major Parts Replacement History of JT3D-3B Engine (S/N 645738)	30
V	Surface Roughness of Compressor Blades Before Cleaning	32
VI	Surface Roughness of Compressor Blades After Cleaning	34
VII	A Summary of Visual Observation of JT3D and JT8D Parts	35
VIII	Dimensional Comparison of In-Service Compressor Blades with New Blades	36
IX	Estimated Effects of Deteriorated Fan-Compressor Parts on the Engine Fuel Consumption	40
X	JT8D Performance Deterioration Influenced by Fuel Nozzle Clogging	43
XI	Turbine Airfoil Shape Observations	44
XII	Turbine Flowpath Observations	44
XIII	Impact of Observed and Measured Deviations on Engine Fuel Consumption for Seals and Leakage	56
XIV	Scrap Rate and Estimated Wear-out Life in 1972 and 1973 for Fan Blades of the JT3D and JT8D Engines	58
XV	Scrap Rate and Estimated Wear-out Life in 1972 and 1973 for Compressor Blades of the JT3D and JT8D Engines	59



<u>Table</u>	<u>Title</u>	<u>Page</u>
XVI	Scrap Rate and Estimated Wear-out Life in 1972 and 1973 for Compressor Vanes of the JT8D Engines	60
XVII	Scrap Rate and Estimated Wear-out Life in 1970-1973 for Turbine Blades of the JT3D and JT8D Engines	61
XVIII	Scrap Rate and Estimated Wear-out Life in 1970-1973 for Turbine Vanes of the JT3D and JT8D Engines	62
XIX	Current Maintenance Cost Vs. Fixed Scrap Rate Cost for JT3D-3B	82
XX	Current Maintenance Cost Vs. Fixed Scrap Rate Costs for JT8D-9	83
XXI	Proposed JT8D-9 Performance Restoration Program Summary	92
XXII	Proposed Instrumentation	94
XXIII	Summary of Proposed Tests for Each Engine Configuration	101
XXIV	Instrumentation Sensitivity Factors for JT8D-9 at Sea Level Static, Std. Day Takeoff	103
XXV	Instrumentation Sensitivity Factors for JT8D-9 at 30,000 Ft., 0.8 Mach No., Std. Day Max. Cruise	104

## ABBREVIATIONS AND SYMBOLS

B.O.W. -	Bill of Work
B/C -	Burner Can
CEML -	Computerized Engine Monitor Log
Cruise Power -	Engine power setting required to maintain normal aircraft flight level and speed.
EGT -	Exhaust Gas Temperature
EMD -	Engineering Master Drawing
FOD -	Foreign Object Damage
$F_n$ -	Engine Thrust
HPC -	High Pressure Compressor
HPT -	High Pressure Turbine
HSI -	Hot Section Inspection
I.D. -	Inside Diameter
L.E. -	Leading Edge
LPC -	Low Pressure Compressor
LPT -	Low Pressure Turbine
N.G.V. -	Nozzle Guide Vanes
O.A.S. -	Outer Air Seal
O.D. -	Outside Diameter
PBP -	Pay Back Period
P.I.T. -	Performance Improvement Tradeoff
PPH -	Pounds Per Hour (Fuel Flow)
PR -	Pressure Ratio
QEC -	Quick Engine Change
S.L. -	Sea Level
T.E. -	Trailing Edge

ABBREVIATIONS AND SYMBOLS. (Contd.)

- TED - Trailing Edge Diameter
- "T" Duct - Transition Duct - convergent section downstream of burner cans
- TSFC - Thrust Specific Fuel Consumption (Fuel Flow/Thrust)
- WF/PB - Ratio Units ~ Fuel Flow (Lbs/Hr)/Burner Pressure (PSIA)
- $\Delta$  HP - Percent change from nominal, High Pressure Compressor ratio  
( $P_{s4}/P_{s3}$ )
- $\Delta$  LP - Percent change from nominal, Low Pressure Compressor ratio  
( $P_{s3}/P_{t2}$ )
- EPR - Delta change in Engine Pressure Ratio
- $N2/\sqrt{\theta T2}$  - High Compressor Speed Corrected to Standard Day Conditions
- $\frac{\Delta N2}{\sqrt{\theta T2}}$  - Delta change in High Compressor Rotor Speed
- $N1/\sqrt{\theta T2}$  - Low Compressor Speed Corrected to Standard Day Conditions
- $\frac{\Delta N1}{\sqrt{\theta T2}}$  - Delta change in Low Compressor Rotor Speed
- $\Delta E_n/S_{T2}$  - Delta change in Corrected Thrust
- $\frac{\Delta W_f}{S_{T2}\sqrt{\theta T2}}$  - Delta change in Corrected Fuel Flow
- $\Delta \frac{EGT}{\theta T2}$  - Delta change in Corrected Exhaust Gas Temperature
- $\Delta \frac{P_{s4}}{P_{s3}}$  - Delta change in High Compressor Static Pressure Ratio
- $\Delta \frac{P_{s3}}{P_{t2}}$  - Delta change in Low Compressor Static Discharge to total Inlet Pressure Ratio
- $\Delta \frac{W_{at}}{S_{T2}/\sqrt{\theta T2}}$  - Delta change in Corrected Total Engine Airflow
- $\Delta \frac{W_{ac}}{S_{T2}/\sqrt{\theta T2}}$  - Corrected Engine Core Airflow
- $\frac{F_n}{S_{t2}}$  - Corrected Net Thrust

## ANALYSIS OF TURBOFAN ENGINE PERFORMANCE DETERIORATION

### AND PROPOSED FOLLOW-ON TESTS

#### SUMMARY

The investigation reported herein covered two primary efforts. The first of these was (1) an analysis of currently available in-service JT3D and JT8D data as it relates to performance deterioration, (2) a documentation of in-service engine parts condition and an estimate of the effect on performance, and (3) a survey of engine parts replacement/repair rates. The second primary effort was the formulation of an overall test program for a proposed follow-on investigation. This program identifies the required test vehicles, instrumentation, procedures, conditions and facilities.

The results of this investigation indicated that 60 to 70 percent of the observed increase in JT3D and JT8D fuel consumption is due to deterioration of the fan-compressor system, 10 to 15 percent is due to the turbine deterioration, and the remainder to losses associated with engine seals and clearances. The primary reasons in arriving at these conclusions are (1) the performance simulation studies used in conjunction with the in-service data trends suggested that the fan-compressor system was substantially involved in the deterioration process and (2) the observed condition of typical deteriorated parts and the normal restoration of engine parts on in-service engines also led to the conclusion that the fan-compressor system was significantly involved in the performance losses.

These conclusions, which were more qualitative than quantitative, led to a recommended test program. The objectives of this program are to first verify that the fan-compressor system was a primary factor in engine deterioration and second to attempt to identify which components and/or sub-components of the fan-compressor system were the major contributors and to what degree.

## INTRODUCTION

The loss or deterioration of engine performance as engine time increases has been well known for many years. Although performance deterioration is variable from one engine type to another and even from engine to engine of the same model, the magnitude of overall engine performance loss is approximately known once a specific engine model develops sufficient historical experience. Furthermore, a list of probable causes of deterioration can be itemized with reasonable certainty (e.g., fan-compressor FOD, combustor fuel nozzle coking, turbine stator deformation, seal and clearance changes, etc.). However, what has not been known with any degree of precision is the magnitude of loss due to individual components as they are exposed to everyday usage. This lack of knowledge, coupled with the relatively low cost of fuel, has produced no economic incentive to be greatly concerned about performance deterioration.

However, in the past two years fuel costs have multiplied two to three times. Furthermore, the total fuel supply which previously appeared to be limitless has now become uncertain. In addition, there is evidence that newer high performance engines exhibit a higher performance deterioration rate than the older engines. Consequently, there are strong forces promoting a reexamination of the engine maintenance practices of the airline industry. Until now, these maintenance practices have been directed almost exclusively at producing mechanical integrity. Any restoration of performance in the past has largely come about as a by-product of maintaining engine reliability.

As a result of the above stated changes in the airline environment and also because of NASA's general interest in the conservation of energy, a program was initiated to expand the knowledge relating to the causes of engine performance deterioration. The initial program envisioned was to first conduct a study and planning effort which is reported herein which would logically lead into a hardware type evaluation. It was recognized that some type of test program was necessary to develop some "hard" data which could then provide the impetus to revise maintenance practices and provide a practical method of improving fuel usage. This overall approach was directed at two primary objectives: (1) an improvement in fuel consumption on current engines and (2) information which could provide design criteria or guidelines for future engines.

The information presented in this report covers an evaluation of available data from American Airlines on the performance trends of the JT3D and the JT8D turbofan engines, an examination of the engine parts condition of in-service engines, and a documentation of the engines' parts replacement/repair rates. The performance trend data is then combined with existing engine simulations to arrive at probable causes of engine deterioration. In addition, estimates of performance degradation are made based on the in-service parts condition. Based on these results and the engine parts consumption/repair rates, conclusions are drawn as to the cause of long-term engine performance deterioration.

The report also presents some ideas on replacement cost versus performance improvement. A proposed overall test program is then described. Its intent is to verify the accuracy of the study estimates and to identify which engine subcomponents are significant with regard to engine performance loss.

## RESULTS AND DISCUSSION

The approach to analyze the cause of engine performance changes and the probable causes of the observed deterioration of SFC leads down several paths. The source of engine deterioration can be analyzed on the basis of the measured performance of the average or typical engines as they leave the test stand and from cockpit engine instrument readings recorded during cruise. The results of this type of analysis presumes that adequate instrumentation of sufficient sensitivity, accuracy and repeatability exists to permit the analysis to proceed with a reasonable degree of confidence. The instrumentation accuracy problem is diminished as more samples are taken and averaged.

The second path of analysis concerns the evaluation of engine hardware that has seen extensive service. Engine performance is achieved by the fundamental shape of the various gas path parts, the control of the leakage beyond that which is required for essential cooling and losses associated with flow over and around the blades and vanes which cause losses due to inefficiency. Through the process of time, the shape of the various gas path parts is changed due to the effects of erosion and foreign object damage. In addition, changes in the temperature pattern in the hot section causes localized bowing of nozzle guide vanes. Cases, due to repeated loads and temperature differential, also warp out of shape. Current maintenance programs have been directed at minimizing the cost of repair. As a result of this overall philosophy, work on engine repairs has, in general, been concentrated on restoration of hot section parts. Less attention has been paid to the cold section, compressor and fan section of the engine.

A third path of analysis is the inferences that can be drawn from examining the data on engine parts replacement/repair rates. Although this approach by itself may well be misleading, if the conclusions drawn are in tune with other analysis approaches, it offers additional circumstantial evidence.

### Analysis and Documentation of Current Information

In-Service Performance Data - The purpose of this phase of the study was to review the trends of engine performance with accumulated time in-service as the basis for defining an engine test program to recover the major portion of observed increases in engine specific fuel consumption. New engine specific fuel consumption performance levels result from the adherence of each engine build to defined standards for the aerodynamic shape of gas path parts, and physical dimensions and clearances. When

engines are new, they exhibit performance characteristics which, while having some variability on an engine-to-engine basis, meet limits as to the minimum thrust and maximum specific fuel consumption. The objective of this part of the study was to focus on the causes for the observed increases in fuel consumption of in-service engines relative to the average of new production engines. The specific causal factors behind this average increase in fuel consumption are difficult to discern.

The maintenance practices of the many airlines result in the scrambling of the parts from different engines during the disassembly, repair and reassembly process. The continued introduction of new engines into a fleet of aircraft masks the cost of engine maintenance and the deterioration in performance when viewed on a fleet basis. The repair process often scrambles the newer parts from the new engines into older engines such that traceability of performance deficiencies to one particular module or component of the engine becomes more difficult with time. Once the introduction of new engines in a fleet stops, the trends of performance deterioration with operating time accelerate unless specific action is taken to prevent the occurrence.

From the performance records maintained on overhauled/repared engine acceptance tests and in-flight engine performance monitor logs, a continuing gradual deterioration in engine specific fuel consumption performance has been observed. This experience is related to time and to the mix of new and older engines in any specific airline's fleet of aircraft. The rate of deterioration or increase in fuel consumption at constant thrust has been noticeably more rapid with the newer higher performance engines. Modification programs undertaken to improve engine reliability and correct specific problems, i.e., cracking of a particular blade, have produced changes in the performance levels of the average engine; sometime for the better but more often for the worse. The performance trends from specific airlines will vary based on the average age of their particular fleet of engines. The average annual fleet trends for American's engines indicate that the fuel consumption per year (about 3,000 engine operating hours) has increased for the JT3D 0.4%, the JT8D 0.5%, the Spey about 1% and the CF6 and JT9 between 1 and 1.5%. During specific periods of time, reversals of the general trend have occurred due to modification programs. Incorporation of new turbine seals of improved design in the JT8D and general reliability program modifications to the JT3D which included replacements of high pressure turbine parts, are examples of modifications which improved fuel consumption.

The general inference drawn from these data is that the long term trends are probably the effect of long term erosion damage and/or increased seal clearances which have not been removed/restored during engine repair. Rapid deterioration, that which occurs in less than 1,000 hours, is generally the result of the loss of clearances in the high pressure areas of the engine with the most likely candidate being the high pressure turbine blade tip seals. Beyond these general inferences, no other specific conclusions as to the specific sections of the engine most responsible for the increased fuel consumption are possible.

using this form of data. For this program, engine performance and parts condition were limited to the JT3D and JT8D engines.

A brief summary is in order at this point concerning engine types and delivery dates. American Airlines has a current inventory, as of January 1, 1975, of various low bypass engine types as follows:

<u>Type</u>	<u>Engines</u>	<u>Initial Delivery</u>	<u>Avg. Time</u>
JT3D-1	125	10/23/58	(12 Yrs)
JT3D-3B	347	4/30/66	(8 Yrs)
Final Delivery of JT3D's <u>4/9/69</u>			
JT8D-1/7	206	2/26/64 Thru 8/16/68	(8 Yrs)
JT8D-9	152	2/2/68 Thru 4/30/69	(6 Yrs)

The newest low bypass engine in American's fleet is the JT8D-9.

Turbine engine deterioration occurs in two steps as defined below:

Short Term Deterioration - When delivered new, seals are at their minimum tolerance and the aerodynamic flow path performance is usually as designed. But, considerable performance loss is experienced during the first 1,000 hours of engine operation due mainly to seal wear in. From 1,000 to 3,000 hours of operation the aerodynamic flow path is interrupted by a gradual change in blade profile brought on by blade erosion. The high bypass ratio engines usually exhibit a more pronounced short term deterioration than is noted for the JT3D and JT8D engines. Figure 1 represents a typical high bypass engine deterioration profile.

Long Term Deterioration - Long term deterioration usually occurs after the engine has been in service for 2,000 to 3,000 hours (Figure 1). Long term engine deterioration is usually associated with hot section distress (1st stage nozzle guide vane condition, fuel spray pattern, etc.). When an engine goes through American Airlines' repair shop most of the long range performance deterioration associated with the hot section is eliminated during engine build. Current repair practices do not recapture much of the short term deterioration due to seal wear and longer term deterioration due to compressor blade erosion.

During stabilized cruise the Flight Engineer fills out an engine monitor log form which includes engine speeds (N1 and N2), EGT, fuel flow and engine pressure ratios. Also included is a record of altitude, static and total air temperature and Mach number. The form is removed from the aircraft at flight termination and the data contained on it are teletyped to American Airlines Maintenance Center in Tulsa where it



is sorted according to aircraft and date. The data are corrected to sea level conditions and subsequently compared to a baseline value. The data are compressed and averaged over a period of time and represents the fleet average.

In this particular case, Figure 2 illustrates the deviation of actual fuel flow in percent from the baseline value in cruise for the B707-323C fleet for a period of six years. The B707-323C aircraft has four (4) JT3D-3B engines installed. As indicated, an adverse trend is apparent up till 1973. Since 1973, the fuel flow deviation has run at a nearly constant value slightly over 3%. During this time period, the 1st stage nozzle guide vanes (large grain structure) were being replaced with vanes of a smaller grain structure to reduce vane bowing.

The JT8D cruise data for B727 aircraft are collected the same way as the JT3D data. Up till the middle of 1972, the fleet average was made up of JT8D-1, -7 and -9 engines as depicted in Figure 3. From mid 1972 and on, the computer program was revised to distinguish between -1 and -7 in one group and the -9 by itself. The basic curve offset (4%) represents the condition of the JT8D-1 and -7 engines in 1968. The dip in 1969 and 1970 is due to the introduction of new JT8D-9 engines and the decreasing trend since 1973 is due, in part, to the new 5 knife edge outer seal at the first turbine stage being installed per a service bulletin on all engines.

Along with the in-flight monitoring program, American has a test cell computer program which maintains a data bank on all engines run through the test cells. From these data a variety of comparisons can be made. Figure 4 is an example of one such comparison where the data from all engines of one type are averaged monthly and the average deviation from the current new engine baseline is represented on the trend plot by an "A". The low and high deviations for that month are also shown as an "L" and "H", respectively. This trend plot indicated that during a four year period the cruise power setting fuel flow trend for the JT3D-3B engine has increased until the deviation is 185 Lbs/Hr. above baseline. The curve in Figure 4 also indicates short periods of time where the trend drastically increases and decreases. The deterioration shown in Figure 4 is in addition to that occurring on the wing. The on-wing upward data trend illustrated in Figure 2 reflects the total deterioration trend.

The JT8D engine, in contrast to the JT3D-3B engine, does not show quite as steady an increase in the fuel flow trend plot as shown in Figure 5. During this period, from 7/72 through 6/74, the fuel flow trend has increased 70 Lbs/Hr.

The corresponding changes in EGT for the JT3D-3B and JT8D-9 are shown in Figures 6 and 7, respectively. The JT3D-3B engine has experienced an 8°F increase over the four year period shown. The JT8D-9 during the first half of the time period shown produced a substantial EGT increase but since the installation of the 5 knife edge seal in the first turbine stage, the EGT has significantly decreased.

Taking the test cell deterioration rate, as illustrated in Figures 5 and 7, and superimposing it upon the Computerized Engine Monitor Log (CEML) data for the JT8D-9 engines (Figure 8) depicts the portion of deterioration attributable to long term on-the-wing deterioration versus repeated build deterioration (1.2% from mid 1970 to mid 1974) associated with current build practices. This figure suggests that a portion of the performance change from baseline occurs during service operation while the remainder occurs through shop restoration practices which are aimed at maintaining minimum shop costs without sacrificing airworthiness.

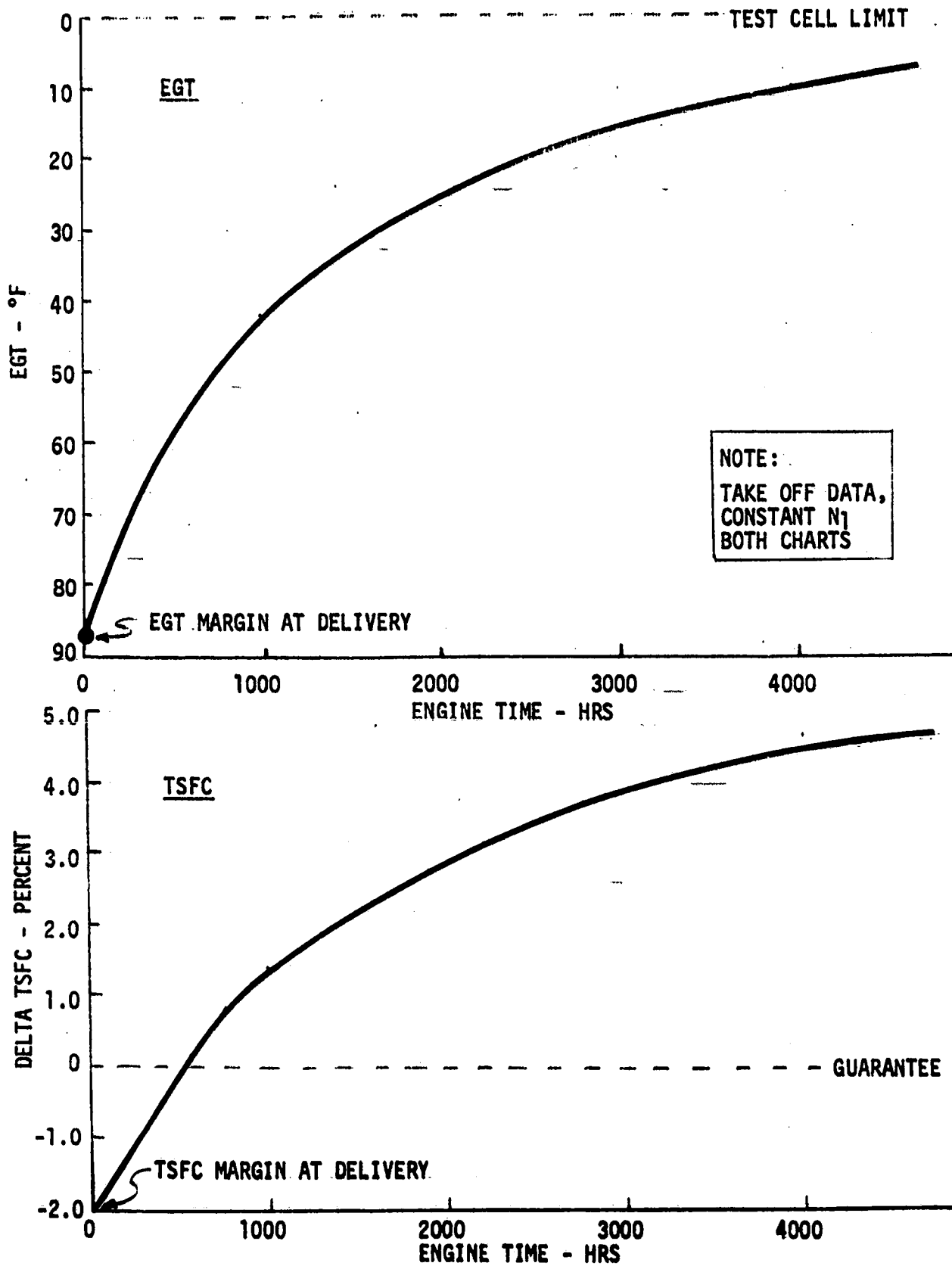
Assuming that 2% of the increase in fuel consumption shown in Figure 8 can be recovered, it will result in a savings of 29,190 gallons for every 3,500 hours of JT8D engine operation. This savings is significant not only from the cost standpoint, but also from the rate of depletion of our natural reserves.

Additional test cell data are shown in Figures 9 through 12 where the trends of LP and HP pressure ratios are presented for the JT3D-3B and the JT8D-9 engines. The delta low pressure compressor ratio trend plot for the JT3D-3B is presented in Figure 9 and shows that from 11/72 through 6/74 the LP ratio increased 0.4%. Also shown is a rather sharp short term decrease from 2/72 through 9/72. The delta high pressure compressor ratio for the JT3D-3B is shown in Figure 10 and indicates a pressure ratio decrease of 1.2% between 11/72 and 6/74. The relationship between the LPC pressure ratio and the HPC pressure ratio shift can be explained, in part, by the fact that since the end of 1972, more work (new parts, etc.) was done on the high compressor but no additional work was done on the LP compressor.

The test cell delta LP ratio trend plot for the JT8D-9 engine is illustrated in Figure 11. Since 7/72 through 6/74 a decrease of 0.5% in the LP compressor pressure ratio is evident. In April of 1973, the low pressure compressor assembly was shifted with respect to the stators and resulted in an improvement in the stall margin of the engine. This could explain, in part, some of the shifting noted. The major cause of the change in pressure ratio is most likely the installation of the new 5 knife edge outer seal at the first turbine stage which commenced in quantity around January 1972. The delta HP ratio trend plot presented in Figure 12 indicates that an increase of 0.8% can be observed in the HP compressor pressure ratio for the same period of time as discussed in the previous figure. Again, the new 5 knife edge outer seal installation is probably the basic cause for the pressure ratio increase.

In summary, a gradual deterioration in engine performance for both the JT3D-3B and JT8D-9 engines after overhaul indicates that parts of the engine are experiencing gradual deterioration and corrective action is not being taken because the available data do not identify specific parts of the fan-compressor system causing the deterioration. Total replacement of these components would not be economically feasible.

FIGURE 1 - TYPICAL HIGH BYPASS ENGINE DETERIORATION RATE



**Figure 2. Fuel Flow Deviation Based Upon  
B707-323C CEML Data**

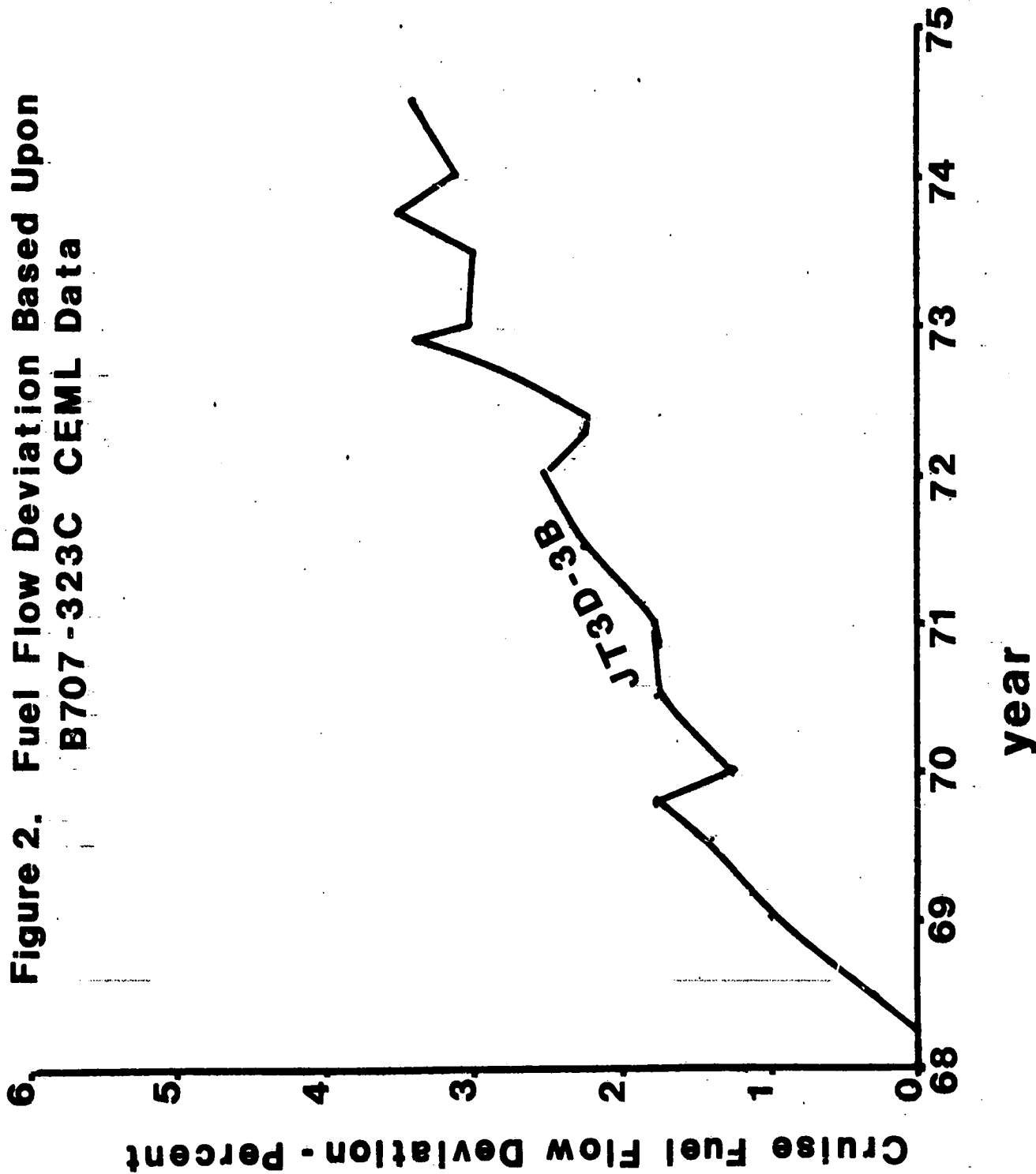
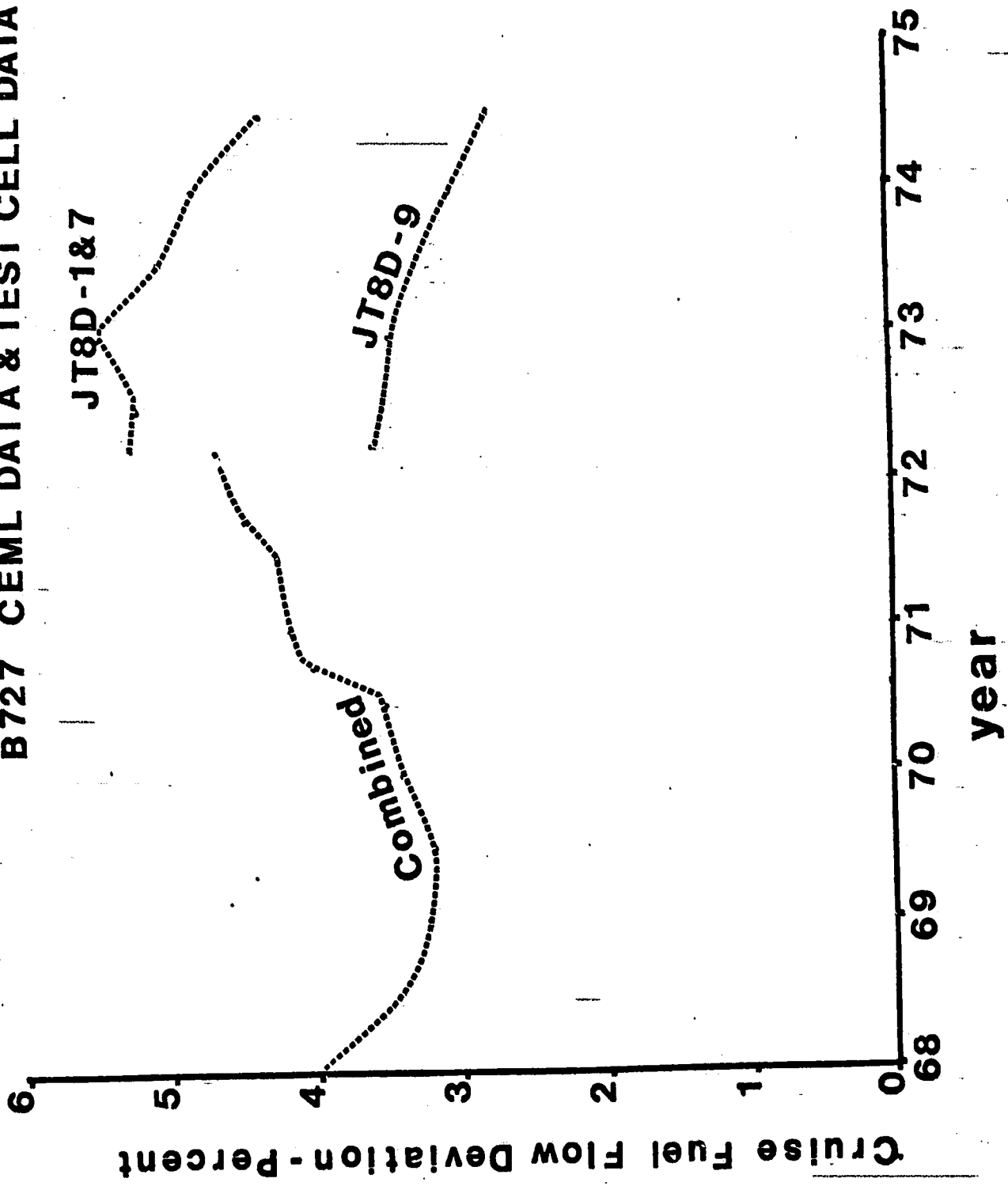
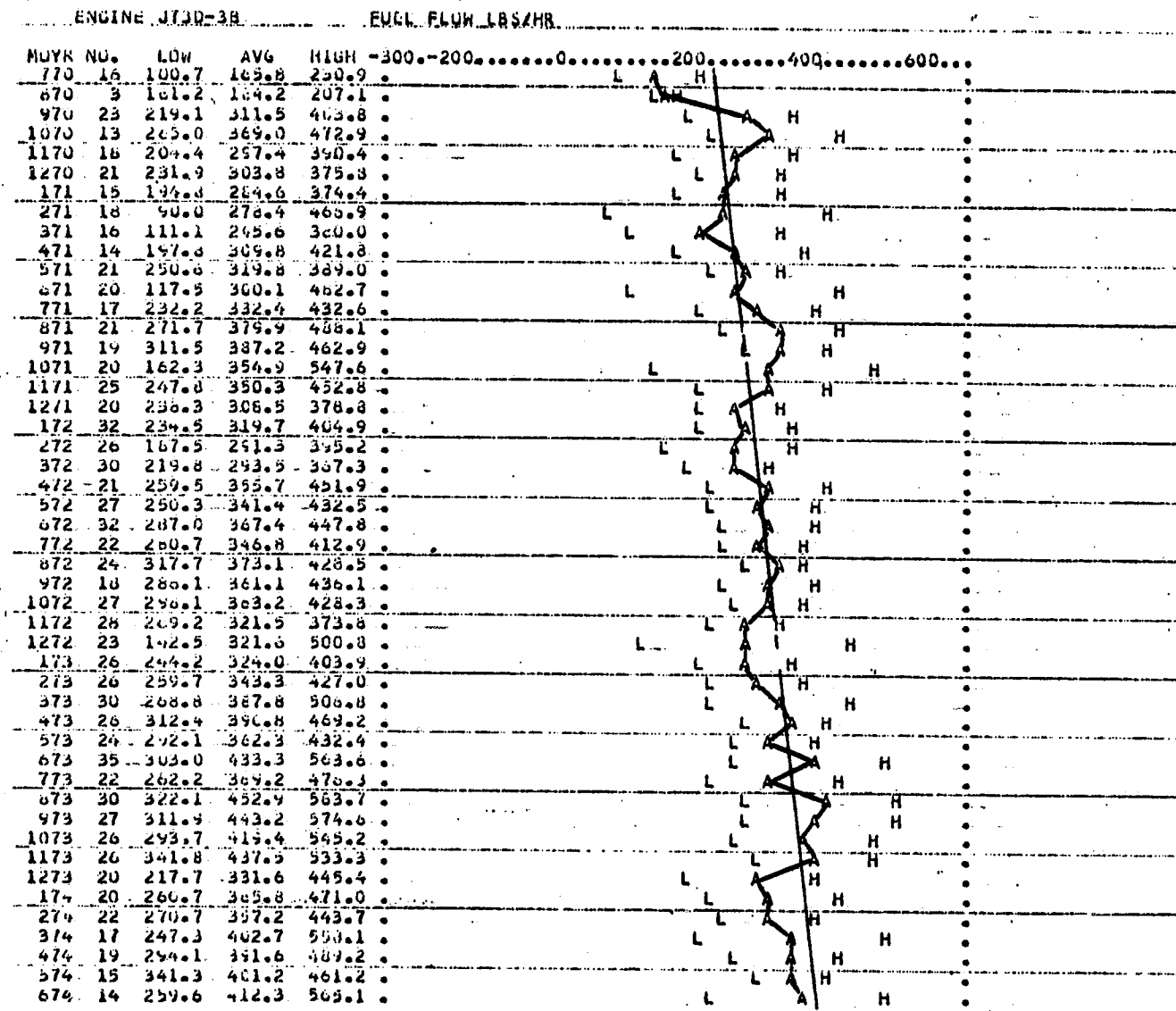


Figure 3. Fuel Flow Deviation Based Upon  
B727 CEML DATA & TEST CELL DATA



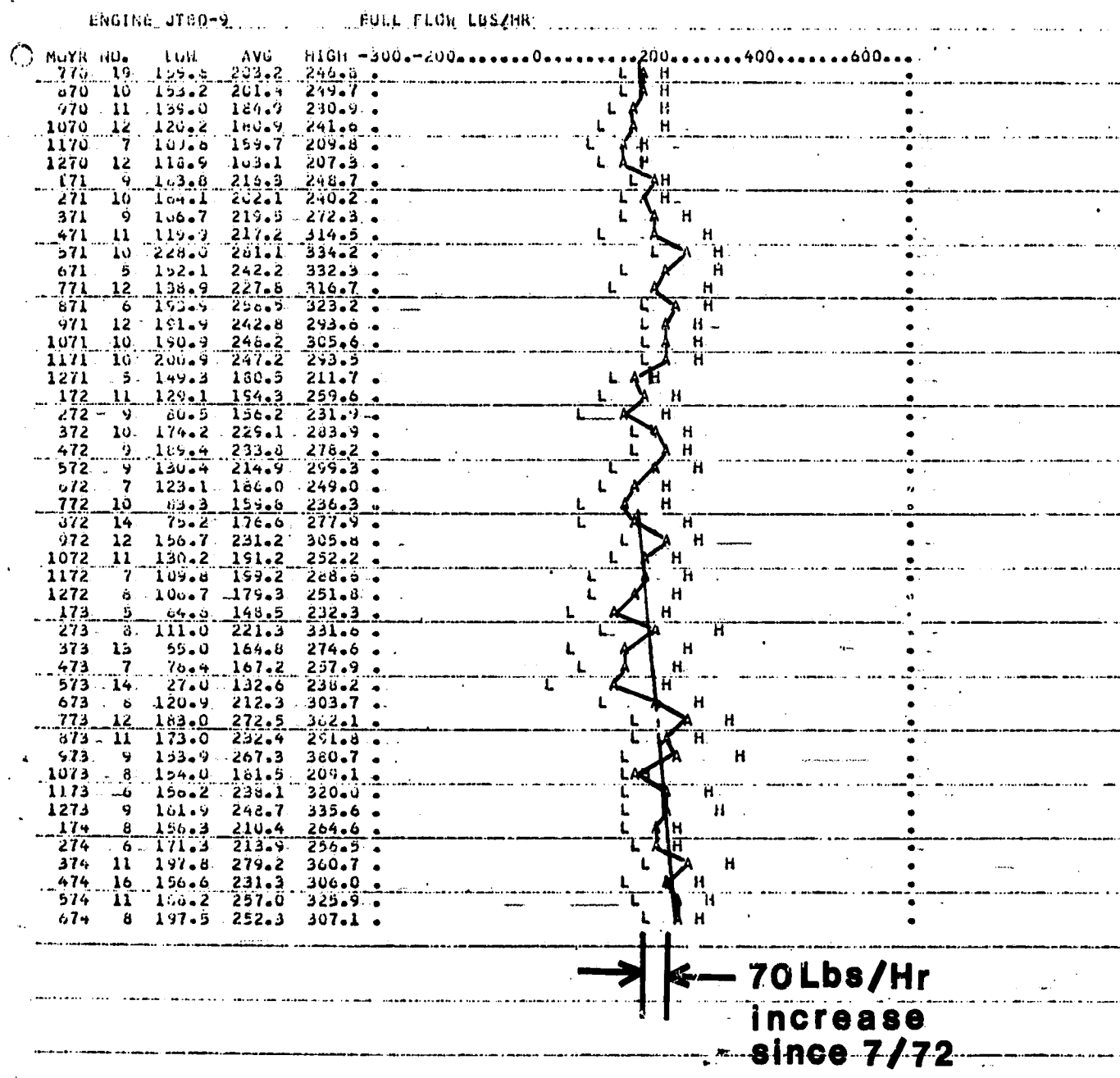
# Figure 4. Test Cell Fuel Flow Trend Plot for JT3D-3B Cruise Power For Period 7/70 Thru 6/74



→ | ← 185 Lbs/Hr  
increase

ORIGINAL PAGE IS  
OF POOR QUALITY

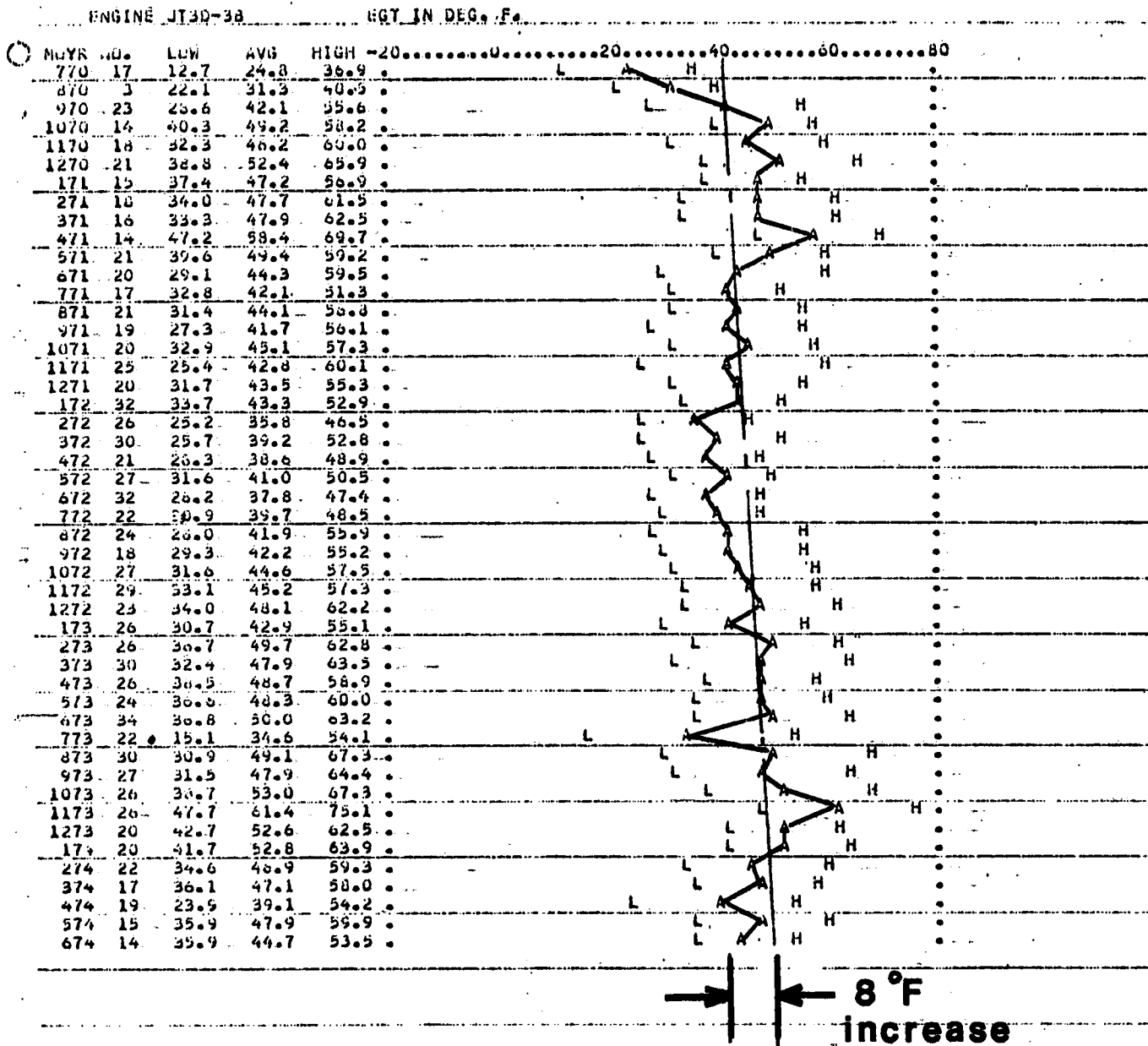
# Figure 5. Test Cell Fuel Flow Trend Plot for JT8D-9 Cruise Power For Period 7/70 Thru 6/74



# Figure 6. Test Cell EGT Trend Plot for JT3D-3B

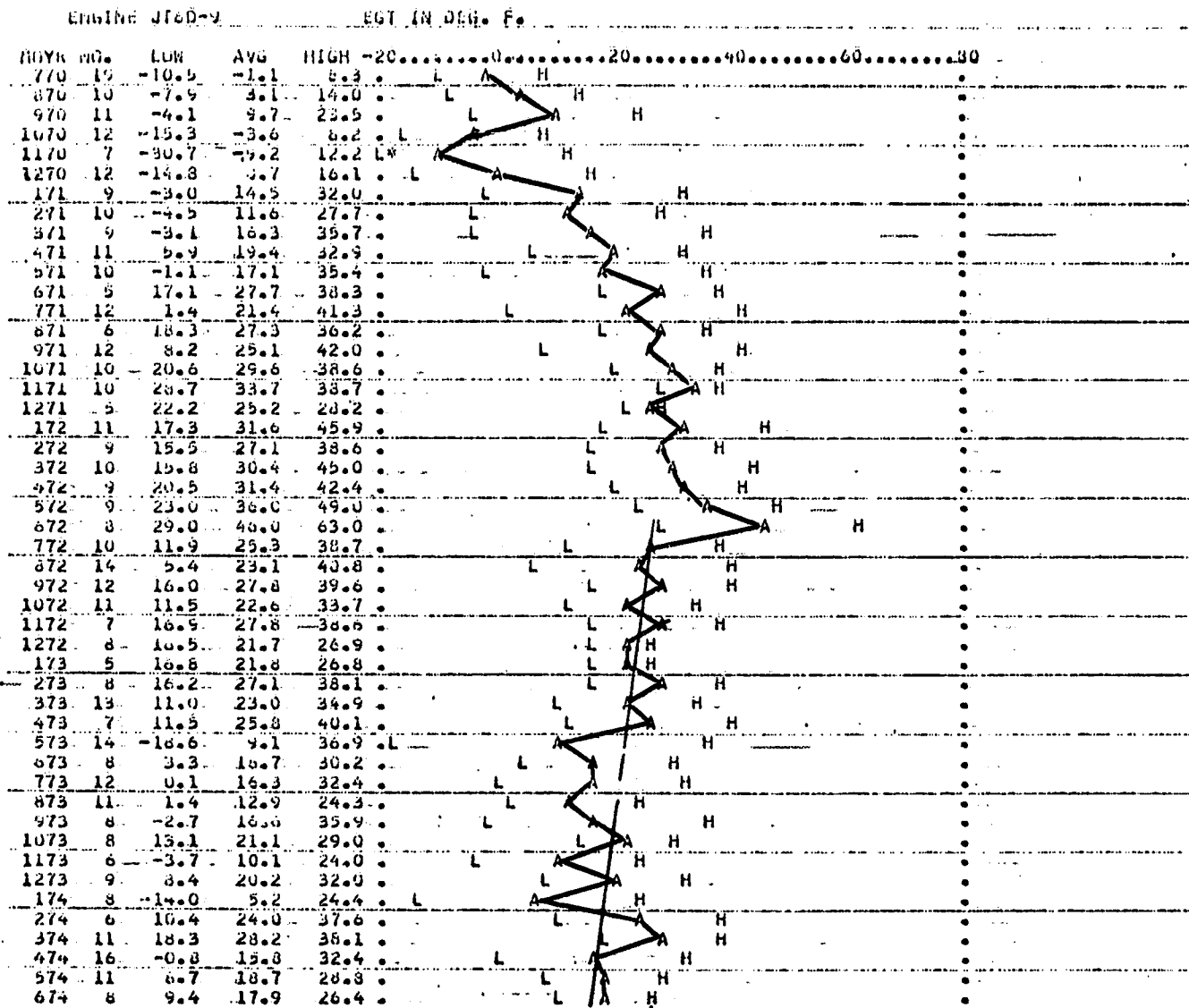
## Cruise Power

### For Period 7/70 Thru 6/74



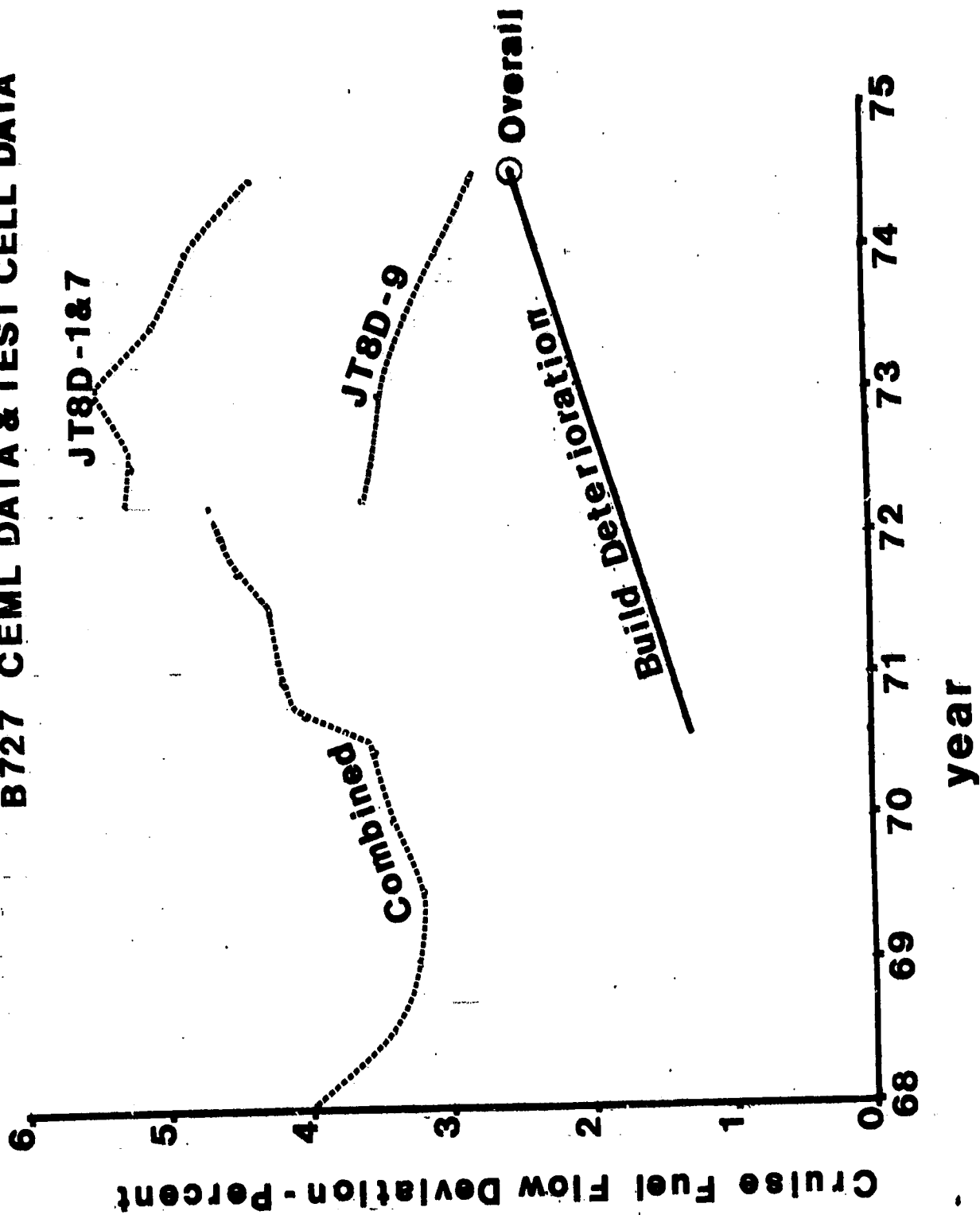


# Figure 7. Test Cell EGT Trend Plot for JT8D-9 Cruise Power For Period 7/70 Thru 6/74



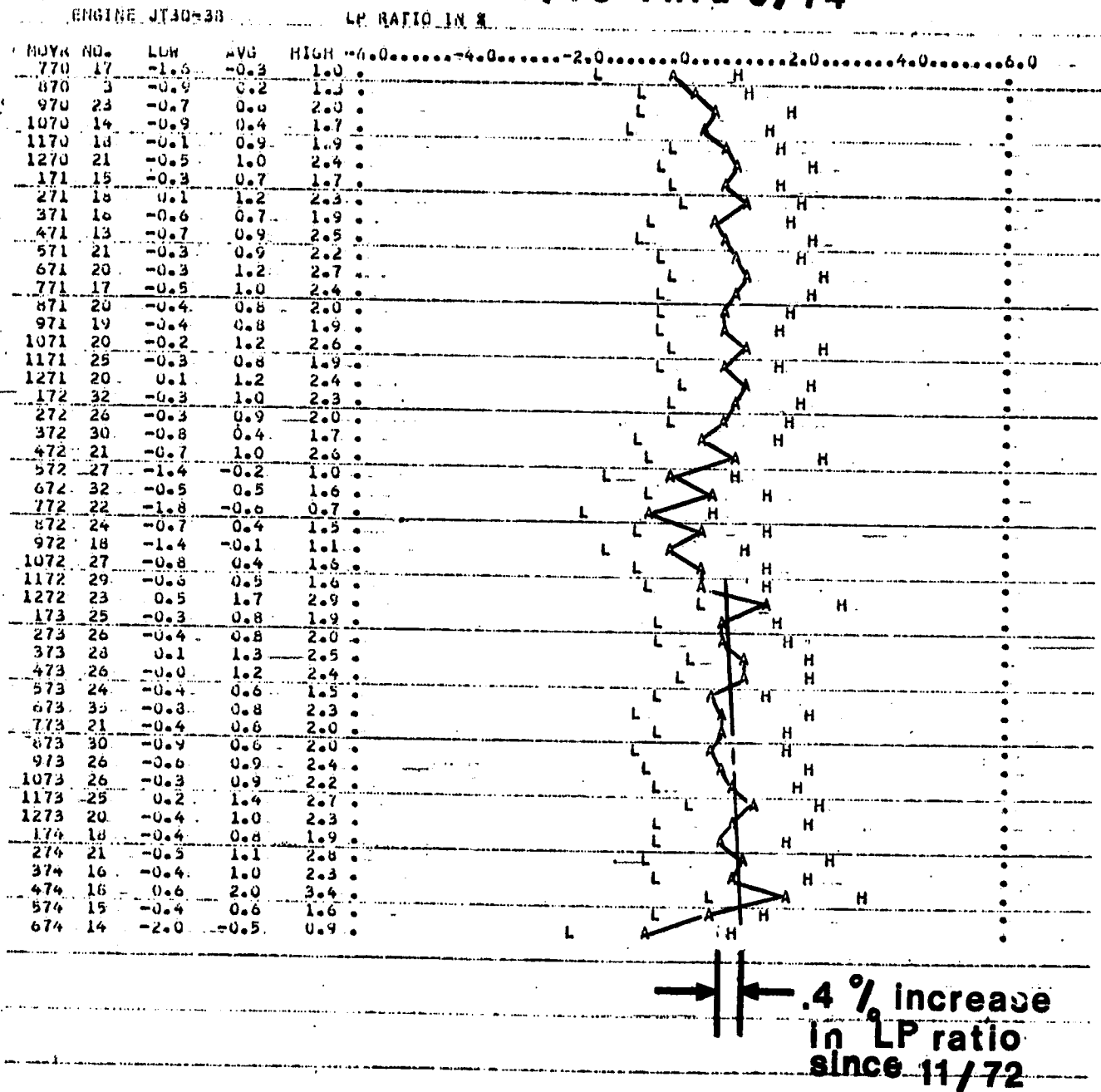
**10 °F decrease since 7/72**

**Figure 8. Fuel Flow Deviation Based Upon  
B727 CEML DATA & TEST CELL DATA**

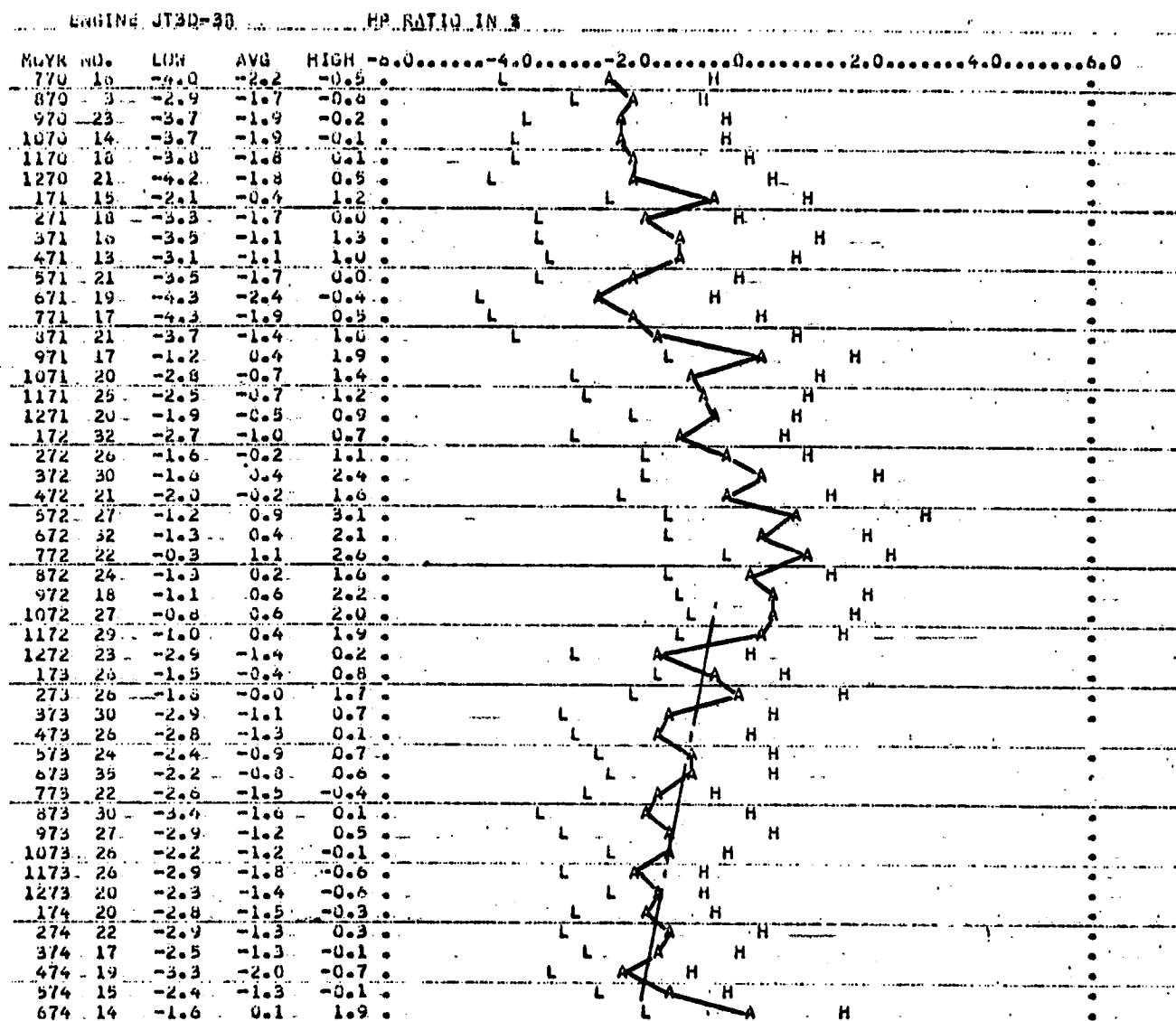


# Figure 9. Test Cell Δ LP Ratio Trend Plot for JT3D-3B Cruise Power

## For Period 7/70 Thru 6/74

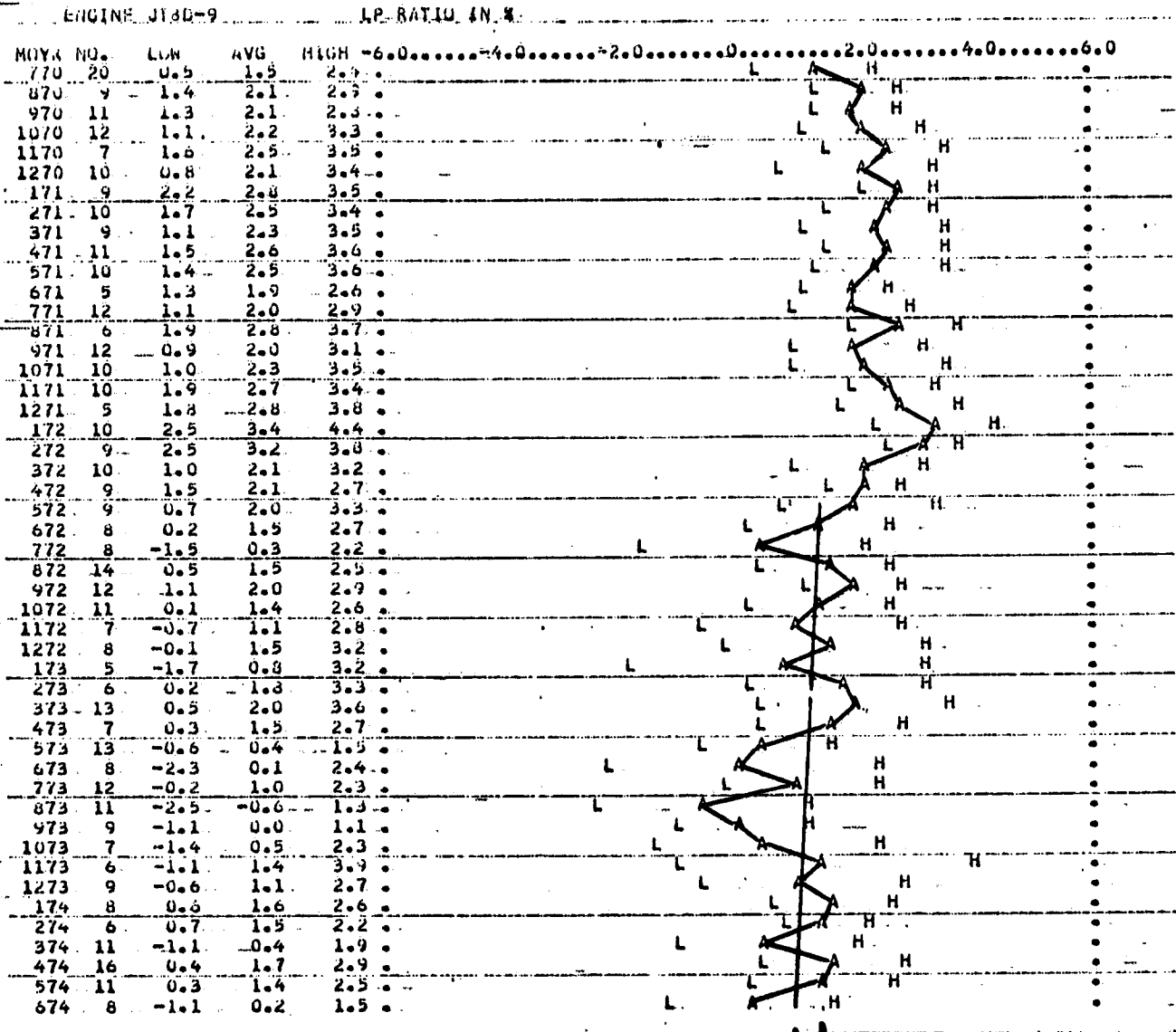


**Figure 10. Test Cell A HP Ratio Trend Plot for JT3D-3B  
Cruise Power  
For Period 7/70 Thru 6/74**



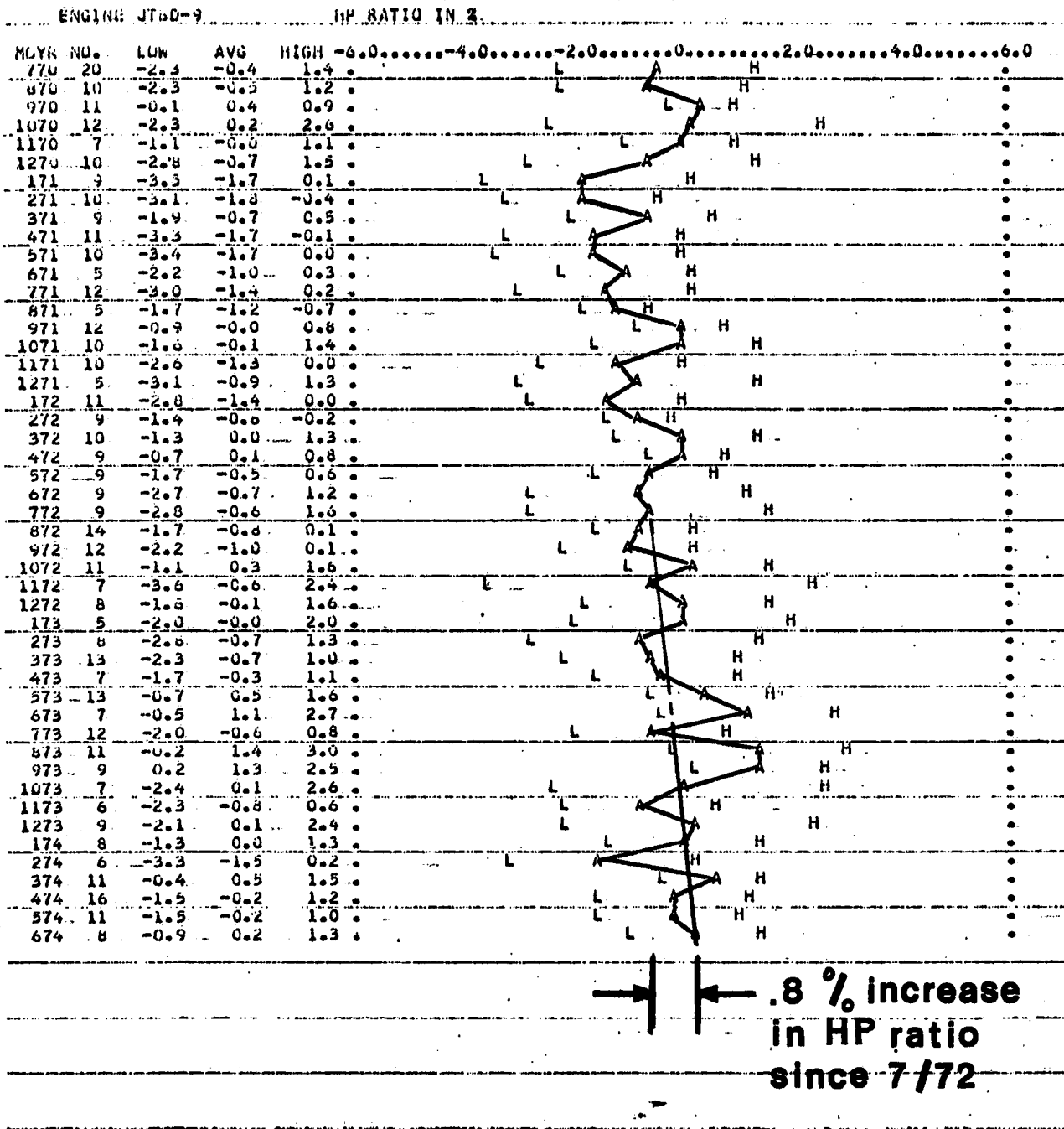
→ | ← 1.2 % decrease  
in HP ratio  
since 11/72

**Figure 11. Test Cell Δ LP Ratio Trend Plot for JT8D-9  
Cruise Power  
For Period 7/70 Thru 6/74**



5% decrease  
in LP ratio  
since 7/72

# Figure 12. Test Cell Δ HP Ratio Trend Plot for JT8D-9 Cruise Power For Period 7/70 Thru 6/74



ORIGINAL PAGE IS  
OF POOR QUALITY

Prior Performance Recovery Efforts - Initial performance recovery testing efforts were directed at recovery of EGT and stall margin and only lately has attention been placed on recovery of fuel consumption alone. In 1964 a new JT3D-3B engine was run on a test cell to establish a baseline. The engine was subsequently torn down and burner cans with 4000 hours on them, an 8000 hour "T" duct, severely eroded 1st turbine blades and repaired 1st turbine outer seal were installed in the engine. The engine was then rerun and TSFC increased 1.2% as shown in the bar chart of figure 13. The 1st stage turbine tip clearance was then increased .031" and the TSFC increased another 0.9%. A new 1st stage turbine outer seal was installed and the TSFC decreased 0.75%. The first nozzle guide vane area was reduced one percent and the TSFC decreased 0.8%. The final engine performance as modified above was an increase in TSFC of .55% above new engine performance.

A typical Rolls Royce Spey 511-14 engine was selected to evaluate various Bills-of-Work which might improve the aerodynamic performance of the engine. The first modification was recontouring of the low pressure blade leading edges. The engine was subsequently run in a test cell and an improvement in TSFC of 0.87% as shown in figure 14 was noted over the unmodified engine run. The second modification involved coating of the low compressor blades with Nubelon "S" paint which was sprayed on and required oven curing. This produced an additional TSFC improvement of 0.29%. Reworking of the HP compressor blades and the burner cans improved the TSFC 0.14% more.

The high pressure turbine 2nd stage tip clearance was then made to the minimum value which resulted in .14% improvement in TSFC and finally a decrease in 2nd stage turbine nozzle guide vane area of 3% resulted in a TSFC improvement of .43%. All of the above modifications resulted in a total improvement in TSFC of 1.87%. It should be pointed out that this improvement is not from a new engine baseline, but from its own operating baseline. Subsequent testing of a series of Spey engines in 1970 produced results of 1.5% average reduction in TSFC for this low compressor rework as discussed above. Further back-to-back testing of new blades versus reworked blades indicated additional fuel consumption reduction for new blades versus repaired blading of 0.8% on average. This additional savings was not justified based on the cost impact to operating economics. The manufacturer indicated that the effectiveness of the low compressor work was probably associated with recovery of total airflow due to improved leading edge shape and reduced roughness.

A JT8D-1 engine with 11,800 hours of service was rerun on the test cell after 2200 hours of operation in service since last repair. An increase in TSFC of 3.17% or 200 lbs/hr was measured at an EPR of 1.7 compared to its previous acceptance test after repair. The engine was subsequently water washed and rerun in the test cell. An improvement of 1.74% in TSFC (110 lb/hr) was measured. The engine was torn down and new 8th, 9th and 10th stage compressor blades were installed. The Bill-of-Work resulted in an improvement of 1.9% in TSFC (120 lb/hr) as shown in figure 15. New 7th stage blades did not produce further improvements in TSFC.

A new redesigned 1st stage turbine outer seal (5 knife edge) was then installed in the engine which resulted in 1.75% improvement in TSFC (110.5 lb/hr). This reduction in fuel consumption, however, is not really attributable to performance recovery being a design improvement.

In summary, the above modifications resulted in an overall TSFC improvement of 5.4%. Based upon this, the engine TSFC was reduced 2.2% or 130 lbs/hr below its original repaired performance level prior to the 2200 hours in service. Unfortunately, the condition of the compressor parts removed from the engine was not documented and the representativeness of those parts to average parts remains unknown. This increment in performance for blade replacement can not be directly related. Compressor performance had deteriorated during the 11,800 hours of service and the water wash and replacement of blades were effective in recovering a portion of that performance loss.

During this study a JT8D engine was run in the cell and rejected for excessive EGT. The engine was returned to the shop where a low turbine module from another engine was installed. A significant change in thrust was noted and EGT increased by 3°C but airflow remained constant. The engine was returned to the shop and the low compressor was interchanged with another engine. The airflow decreased by 16 lbs/sec and the EGT temp decreased 10°C. The final engine configuration indicated a decrease in airflow combined with a reduction in EGT and an associated increase in fuel consumption. The various configurations are shown in Figure 16.

The main point to be made is that the LP compressor removed from this engine was torn down and a complete dimensional check was conducted. The resultant data indicated that the low compressor was within repair manual limits yet there were significant changes in overall engine performance.

Two high time JT3D-3B engines were selected for use in evaluating clearance and mechanical part conditions during this specific program. The evaluation of parts condition and engine tolerances recorded during rebuilding are discussed later. The test cell data comparisons between as received and repaired conditions are discussed below.

Engine S/N 667783 was run with the quick engine change (QEC) installed both before and after shop repair. The changes in performance are set forth in Table I. The major component repairs accomplished during the shop visit are listed in Table II. A 3.2% improvement was noted in corrected fuel flow and EGT decreased 42°F after repair. The engine, however, remained 3.8% above average new engine fuel consumption as indicated even after extensive work.

Engine S/N 645738 was similarly tested. The corresponding change in performance noted is presented in Table III. In the repaired configuration, the fuel flow decrease was 2.9%, EGT decreased 39°F but a thrust loss of 300 lbs was exhibited. The performance recovery on this engine was less than expected. The fuel consumption was 4.4%



above average new engine performance when returned to service. The corresponding component repairs accomplished during this shop visit are listed in Table IV.

The conclusion reached from these two specific engine tests is that the repair process did recover a part of the deterioration exhibited when the engine was brought into the shop for time. The engines received extensive repairs as noted; however, less than half of the excess fuel burn was recovered. The source of the residual losses can only be estimated without detailed study, testing and improved instrumentation. However, the first engine did receive repaired first stage fan blades while the second engine did not. Secondly, the compressor blading was not replaced in either engine with new blading; therefore, compressor flow and efficiency losses can be assumed. The major objective of this activity was to determine seal clearances as there was feeling that they were a major source of performance loss. Typical repairs were accomplished with the exception that special attention was focused on seals and clearances. The engines as returned to service were somewhat better than average repaired engines with respect to fuel consumption, EGT and total airflow but far poorer than desired.

In overall terms, American Airlines has expended an estimated two million dollars over the years in repetitive performance test work in attempting to recover engine performance. In retrospect, this effort has been less than fully productive due to a variety of reasons. The major reasons, however, are the lack of adequate instrumentation, facilities and engineering expertise in relating engine part condition to overall performance. Perhaps most important, however, is that fuel cost reductions were not as important as they are in today's environment and fuel budgets are not the responsibility of airline maintenance groups.

#### Condition of In-Service Parts and Their Estimated Effect on Performance-

##### Fan-Compressors

Visual observations were made on numerous fan compressor parts prior to teardown and refurbishment by AA Maintenance Center. A typical engine has gas path surfaces that are coated with deposits of dirt, salt, oil, etc. which greatly increase surface roughness and thereby cause performance losses. Only at the leading edge on the suction surface, especially near the blade or vane tip is the airfoil relatively smooth. The smooth surface is caused by the abrasive action of dust particles polishing and eventually eroding the airfoil. Fan blades and LPC blades have smoother surfaces but are coated with an oily film. The surface roughnesses of some JT3D blades were measured prior to cleaning and were found to have finishes of up to 100 micro-inches (see Table V).

Once compressor airfoil have been cleaned of protective coating the surface roughness increases at a faster rate. When both new and cleaned used blades are combined in one disk the new blades will have

Figure 13. - Change in Thrust Specific Fuel Consumption of a JT3D-3B engine resulting from engine modification. Baseline was a new engine. Net thrust constant.

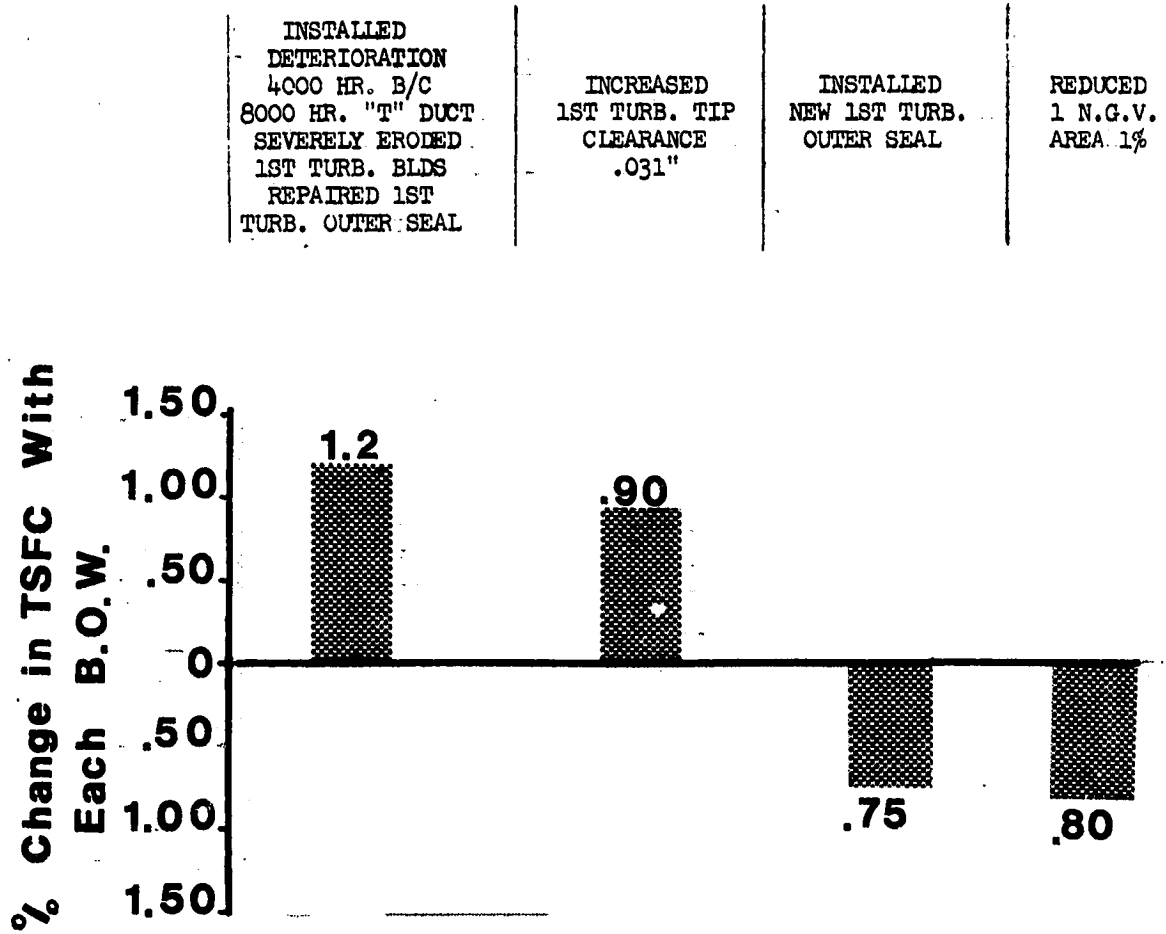


Figure 14. - Change in Thrust Specific Fuel Consumption of a Spey 511-14 engine resulting from engine modification. Baseline was an in-service engine. Net thrust constant.

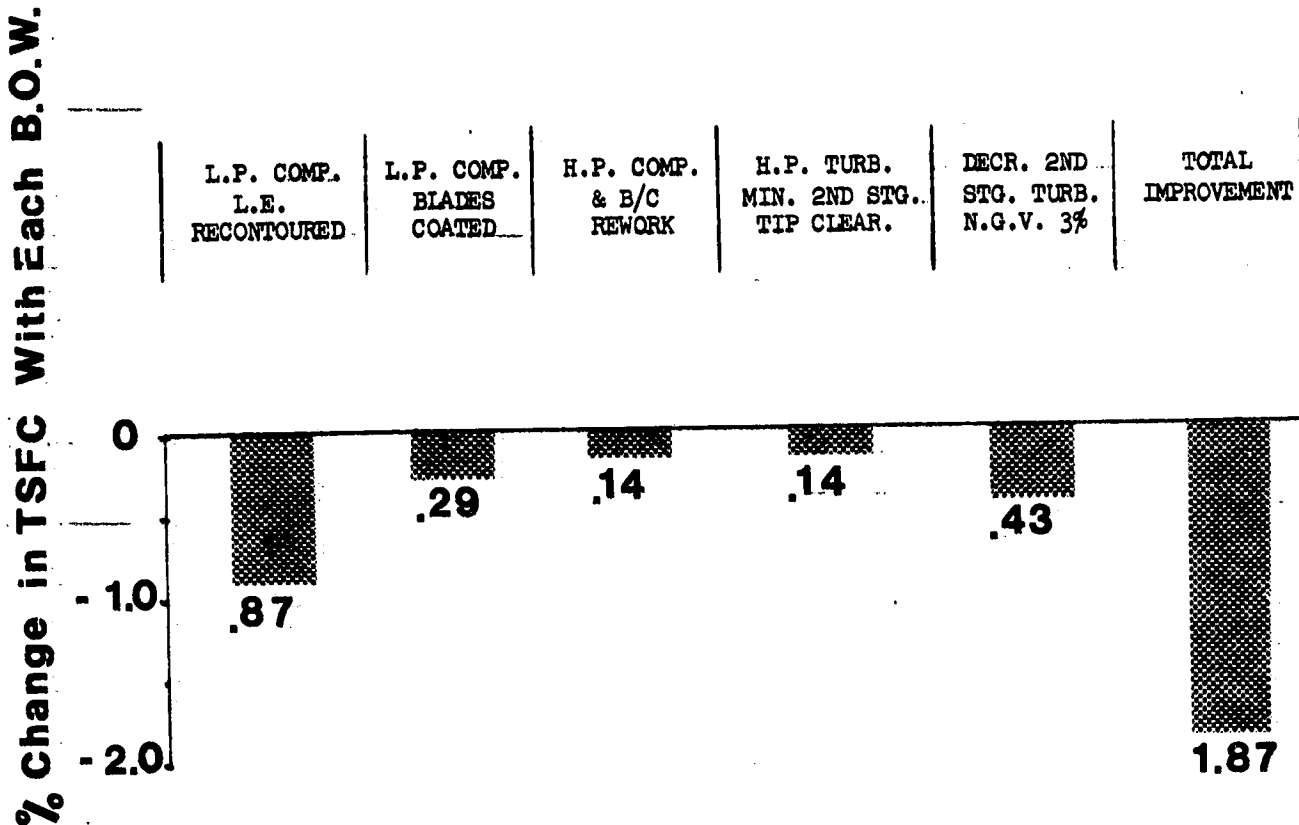
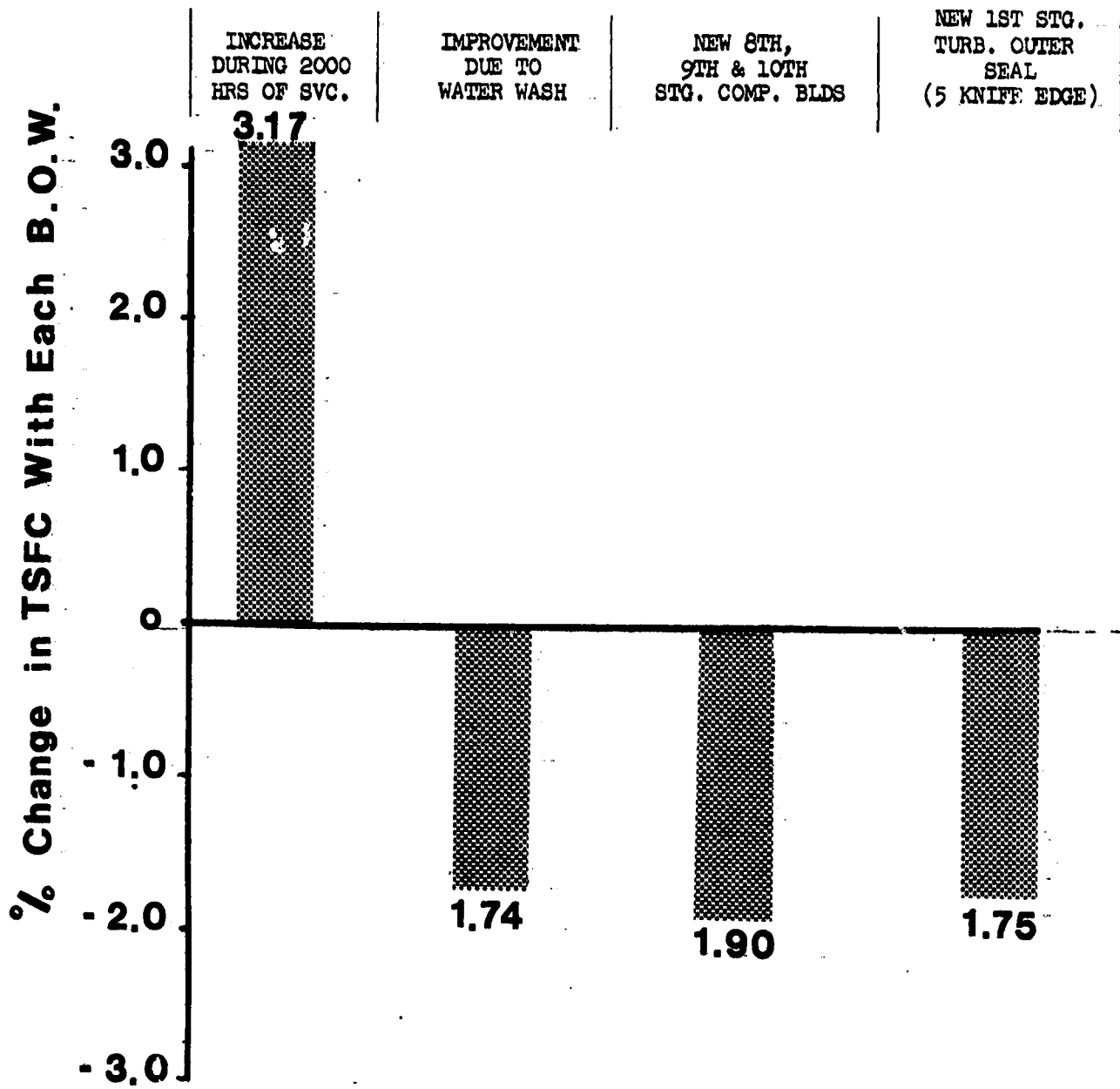
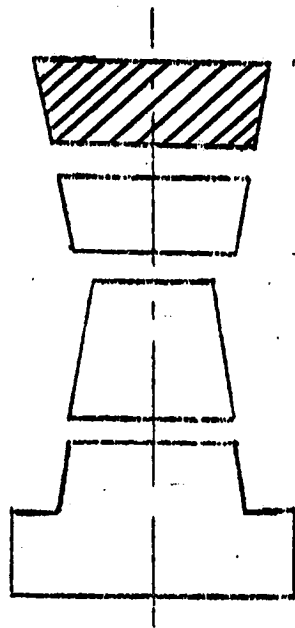


Figure 15. - Change in Thrust Specific Fuel Consumption of a JT8D-9 engine due to water wash and engine modification. Baseline was an in-service engine. Net thrust constant.



$\frac{\Delta F_n}{S_{T2}}$ Lbs	$\Delta EPR$	$\frac{\Delta N_2}{\sqrt{\theta T_2}}$ RPM	$\frac{\Delta M_F}{S_{T2} \sqrt{\theta T_2}}$ Lbs/Hr	$\frac{\Delta EGT}{\theta T_2}$ °C	$\frac{\Delta P_{S4}}{P_{S3}}$	$\frac{\Delta P_{S3}}{P_{T2}}$	$\frac{\Delta W_{at}}{\sqrt{\theta T_2} S_{T2}}$ Lbs/Sec
270 ↓	.26 ↓	30 ↑	80 ↑	3 ↑	.75 ↑	.03 ↓	0

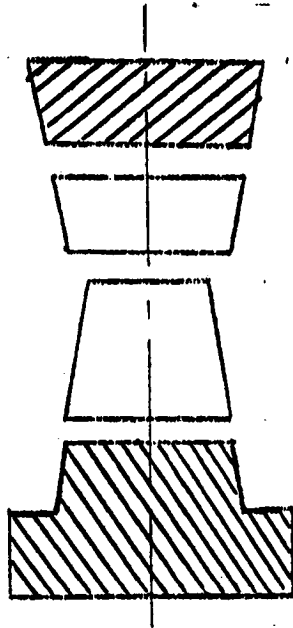
Performance change when interchanging low turbine modules.



CONFIGURATION #1

270 ↑	.20 ↑	30 ↓	40 ↓	10 ↓	.47 ↓	.085 ↑	16 ↓
-------	-------	------	------	------	-------	--------	------

Performance change when interchanging low compressor modules.



CONFIGURATION #2

0	.06 ↓	0	40 ↑	7 ↓	.28 ↑	.055 ↑	16 ↓
---	-------	---	------	-----	-------	--------	------

Performance change from initial engine baseline with low compressor and low turbine module swap.

Figure 16. - The effect of complete module changes on the performance of a JT8D engine. Corrected LP speed of about 8100 rpm.

Table I - Sea-Level Performance Changes at 1.65 EPR due to Shop Repair. JT3D-3B Engine (S/N 667783)

PARAMETER	(1) PRIOR TO REPAIR	(2) AFTER REPAIR	(3) BASELINE AVE. NEW	(2)-(1) DETERIORATION RECOVERED	(2)-(3) RESIDUAL DETERIORATION
$F_n/\theta t_2$ (Lb.)	15580	15700	15500	+120	+200
TSFC	.515	.496	.484	-4.0%	+2.5%
$\frac{W_f}{S t_2 \sqrt{\theta t_2}}$ (Lb/Hr)	8025	7780	7500	-245	+280
$\Delta W_f$ (Corr.) %	+7.0	+3.8	0	-3.2	+3.8
$T_{t7}/\theta t_2$ ( $^{\circ}$ F)	871	829	793	-42	+34
$\frac{N1}{\sqrt{\theta t_2}}$ (rpm)	6105	6055	6050	-50	+5
$\frac{N2}{\sqrt{\theta t_2}}$ (rpm)	9455	9510	9470	+55	+40
$P_{s3}/P_{t2}$	3.350	3.315	3.355	-.035	-.050
$P_{s4}/P_{t3}$	3.350	3.465	3.435	+115	+0.30
$P_{s4}/P_{t7}$	6.81	6.95	6.95	+14	0
** $\frac{WAT/\theta t_2}{S t_2}$ (Lbs/Sec.)	423	430	430	+7	0
** $\frac{WAC/\theta t_2}{S t_2}$ (Lbs/Sec.)	171	175.5	178	+4.5	-2.5

Engine Total Time = 11,748 Hours

\*\*Lbs/Sec. at 6050 NI/ $\sqrt{\theta t_2}$

Table II - Major Parts Replacement History of JT3D-3B Engine (S/N 667783)

<u>AREA OF ENGINE</u>	<u>REPAIRED</u>
<u>Fan</u>	
1st Blades	X
Fan Case	X
<u>Low Pressure Compressor</u>	
4th thru 9th Blade	X
4th thru 8th Vane and Shroud	X
7th thru 9th Spacers	X
Compressor Inlet Case	X
Compressor Intermediate Case	X
Duct Compressor Front and Rear	X
<u>High Pressure Compressor</u>	
10th, 12th thru 16th Blades	X
10th thru 15th Vane and Shroud	X
10th thru 15th Spacers	X
<u>Turbine</u>	
1st Turbine Blades	New
2nd thru 4th Blades	X
1st Nozzle Guide Vanes (Bolt on Type)	X
Case Turbine Nozzle	X
<u>Nozzle Areas (Class) During Buildup</u>	
1st Stage	1098.8
2nd Stage	864.8
3rd Stage	332.0
4th Stage	663.0

Table III - Sea-Level Performance Changes at 1.65 EPR due to Shop Repair.  
 JT3D-3B Engine (S/N 645738)

PARAMETER	(1) PRIOR TO REPAIR	(2) AFTER REPAIR	(3) BASELINE AVE. NEW	(2)-(1) DETERIORATION RECOVERED	(2)-(3) RESIDUAL DETERIORATION
$F_n/\sigma_{t2}$ (Lb.)	15800	15500	15500	-300	0
TSFC	.510	0.505	0.484	-12%	+4.3%
$\frac{W_F}{\sigma_{t2} \sqrt{\theta_{t2}}} \text{ (Lb/Hr)}$	8050	7825	7500	-225	+325
$\Delta W_f \text{ (Corr.) \%}$	7.3%	4.4%	0	-2.9%	4.4%
$T_{t7}/\theta_{t2}$ (°F)	867	828	793	-39	+35
$\frac{N1}{\sqrt{\theta_{t2}}} \text{ (rpm)}$	6065	6050	6050	-15	0
$\frac{N2}{\sqrt{\theta_{t2}}} \text{ (rpm)}$	9475	9470	9470	-5	0
$P_{s3}/P_{t2}$	3.295	3.345	3.365	+0.050	-0.020
$P_{s4}/P_{t3}$	3.355	3.420	3.435	+0.065	-0.015
$P_{s4}/P_{t7}$	6.73	6.92	6.95	+0.19	-0.03
** $\frac{WAT \sqrt{\theta_{t2}}}{\sigma_{t2}} \text{ (Lbs/Sec.)}$	424	426	430	+2	-4
** $\frac{WAG \sqrt{\theta_{t2}}}{\sigma_{t2}} \text{ (Lbs/Sec.)}$	173	175	178	+2	-3

Engine Total Time = 16,001 Hours

\*\*Lbs/Sec. at 6050 NI/ $\sqrt{\theta_{t2}}$



Table IV - Major Parts Replacement History of JT3D-3B Engine (S/N 645738)

<u>AREA OF ENGINE</u>	<u>REPAIRED</u>
<u>Fan</u>	
Fan Discharge Case	X
1st and 2nd Spacer	X
<u>Low Pressure Compressor</u>	
4th thru 9th Stage Blades	X
4th thru 8th Vane and Shroud	X
4th thru 6th and 8th Spacer	X
4th Stage Air Seal-Comp. Rotor	X
Compressor Inlet Case	X
<u>High Pressure Compressor</u>	
10th thru 16th Blade	X
10th, 12th thru 15th Vane and Shroud	X
10th thru 15th Spacer	X
<u>Turbines</u>	
1st Stage Blades (Weld on Pins)	X
3rd Stage Blades	X
1st and 3rd Turbine Outer Air Seal	X
Nozzle Inner and Outer Case	X
<u>Nozzle Guide Vane Class during Buildup</u>	
1st Stage	1082.2
2nd Stage	864.8
3rd Stage	425.0
4th Stage	667.0

a smoother surface finish after the same elapsed service time. Also, greater deposits are found in the area of a vane assembly where a vane has been replaced.

After parts have been cleaned and refurbished by the American Airlines Maintenance Center the surface finish is greatly improved. Some sections of airfoil surface are still rough, especially leading edge and pressure surface just aft of the leading edge, but these surfaces are smoother than dirty parts.

The surface finishes were measured for some compressor blades after being cleaned. The finishes would be typical of the condition of airfoil after engine repair if the compressor was torn down. Some of the airfoils have surface finishes of 70 to 80 microinches (see Table VI) which is probably causing a performance loss. In other engine programs changing the surface roughness of the stator vanes from 30 to 70 microinches has cost up to 1% in TSFC.

Foreign object damage (FOD) causes nicks and tears in airfoil which must be blended smoothly to eliminate stress concentrations. The blended surfaces cause a camber loss, both leading edge and trailing edge, which can increase pressure loss and reduce efficiency and pressure rise capability. The outer 50% of the fan blade span have much blending of FOD, especially on the leading edges. The LPC blades in the JT3D engines also have much blending of FOD especially in the trailing edge. One stage may have much damage, the next very little, as if an object stopped on the vane leading edge and nicked the upstream blade trailing edges before proceeding downstream. This damage was most evident on fan blades and JT3D LPC stages, probably because of longer service. Some JT3D engines, however, with service routes which require fewer take offs and landings had little FOD.

Leading edges of blades in the low and high pressure compressor become blunted from the abrasive effect of dust and dirt sucked into the engine. As this material is centrifuged to the outer diameter in the rear stages the wear pattern becomes localized at the tips of the blades. In addition to the leading edge blunting, the trailing edges of JT8D high pressure compressor blades become rounded at the tip. Reduced camber and its effect on compressor performance can be estimated. Changes in blade tip shape may increase effective blade tip clearance and shift radial velocity profiles but this response is not so predictable. Blade tips showed only very light rub marks on a few stages. This is an indication that most stages do not rub and blade tip clearance do not increase.

A summary of visual observations of JT3D and JT8D compressor parts made at American Airlines Maintenance Center is presented in Table VII. A JT3D engine with nearly 20,000 hours service time was torn down and laid out for dirty inspections. Other parts for both engine types were inspected during various stages of rebuild.

Dimensional checks were also made for some of the used blades which are typical of parts in service. A summary of the measurements compared to present blueprint requirements of new parts is presented in Table VIII. Blade length has not changed. The blades showed

little sign of tip rubbing and this is confirmed by measurement. The blade tips, however, had rounded corners.

The measure of blade chord shows the pattern of erosion. Only near the blade tip is the effect of erosion measurable as a loss in chord. Actually, the blade tip chord is reduced more than the table indicates because the measurements were made at the outermost inspection section which is located 20% from the blade end.

In addition, shadowgraphs were made of the compressor blades which were compared with the airfoil shape of new, nominal blade contours. Figures 17 through 19 show this comparison for stages 5, 9, and 15 of the JT3D compressor. The blades erode at the leading edge, blunting and distorting the leading edge shape and reducing the blade chord. In the JT8D HPC there is also trailing edge erosion at the blade tip. Vane leading edges at the extreme outer diameter show signs of wear and it has been reported that vane trailing edges are eroded. Measurements are needed to confirm this.

The effects on performance of the deviations from new fan compressor parts have been estimated and are summarized in Table IX. The variations from new parts condition that were evaluated were blunt leading edges on compressor blades and lack of trailing edge camber on compressor blades caused by erosion, foreign object damage, and the surface roughness of cleaned blades.

In addition, there are other observed variations from new compressor parts that may have a significant effect on performance. The performance decrements of the following items have been estimated.

- a) The influence of eroded stator vanes.
- b) The effect of rounded instead of squared blade tips with respect to tip sealing.
- c) Radial performance changes caused by blended FOD and blade tip erosion.

As summarized on Table IX the total estimated effect of deteriorated fan-compressor parts on engine fuel consumption was 250 and 210 lbs per hour for the JT3D and JT8D engines, respectively. These fuel flow rates amount to 70 and 60 percent of the total increase in fuel flow of the deteriorated engine over the new engine.

#### Combustors

The general condition of the JT3D combustor section parts inspected was very good. The combustion chambers in some instances require weld repair for cracks, but there was no evidence, in the parts inspected, of burnout or configuration distortion which would result in a degradation of the combustor efficiency level. On some fuel nozzle nut "faces", there was evidence of carbon deposits. However, there was no evidence of carbon deposition in the primary or secondary fuel orifices which would result in nozzle flow reduction or fuel spray pattern distortion.

Table V. Surface Roughness of Compressor Blades before cleaning.

<u>Engine</u>	<u>Stage</u>	<u>No. of Samples</u>	<u>Surface</u>	<u>Roughness A.A. Micro Inches</u>
JT3D	4	2	Suction Pressure	20-40 45-110
JT3D	5	2	Suction Pressure	10-20 35-80
JT3D	7	2	Suction Pressure	15-25 35-80
JT3D	11	2	Suction Pressure	35-65 35-110
JT3D	13	2	Suction Pressure	35-85 35-70
JT3D	14	3	Suction Pressure	25-60 30-50
JT3D	15	2	Suction Pressure	30-100 30-65

Table VI. Surface Roughness of Compressor  
Blades after cleaning.

<u>Engine</u>	<u>Stage</u>	<u>No. of Samples</u>	<u>Surface</u>	<u>Roughness A.A. Micro Inches</u>
JT3D	10	1	Suction Pressure	8-16 12-44
JT8D	1	1	Pressure	240-250
JT8D	2	1	Pressure	50-70
JT8D	3	1	Suction Pressure	30-40 35-45
JT8D	5	3	Suction Pressure	30-40 35-55
JT8D	7	1	Pressure	50-80
JT8D	9	3	Suction Pressure	45-60 40-55
JT8D	11	3	Suction Pressure	35-40 35-50
JT8D	13	3	Suction Pressure	10-15 15-25

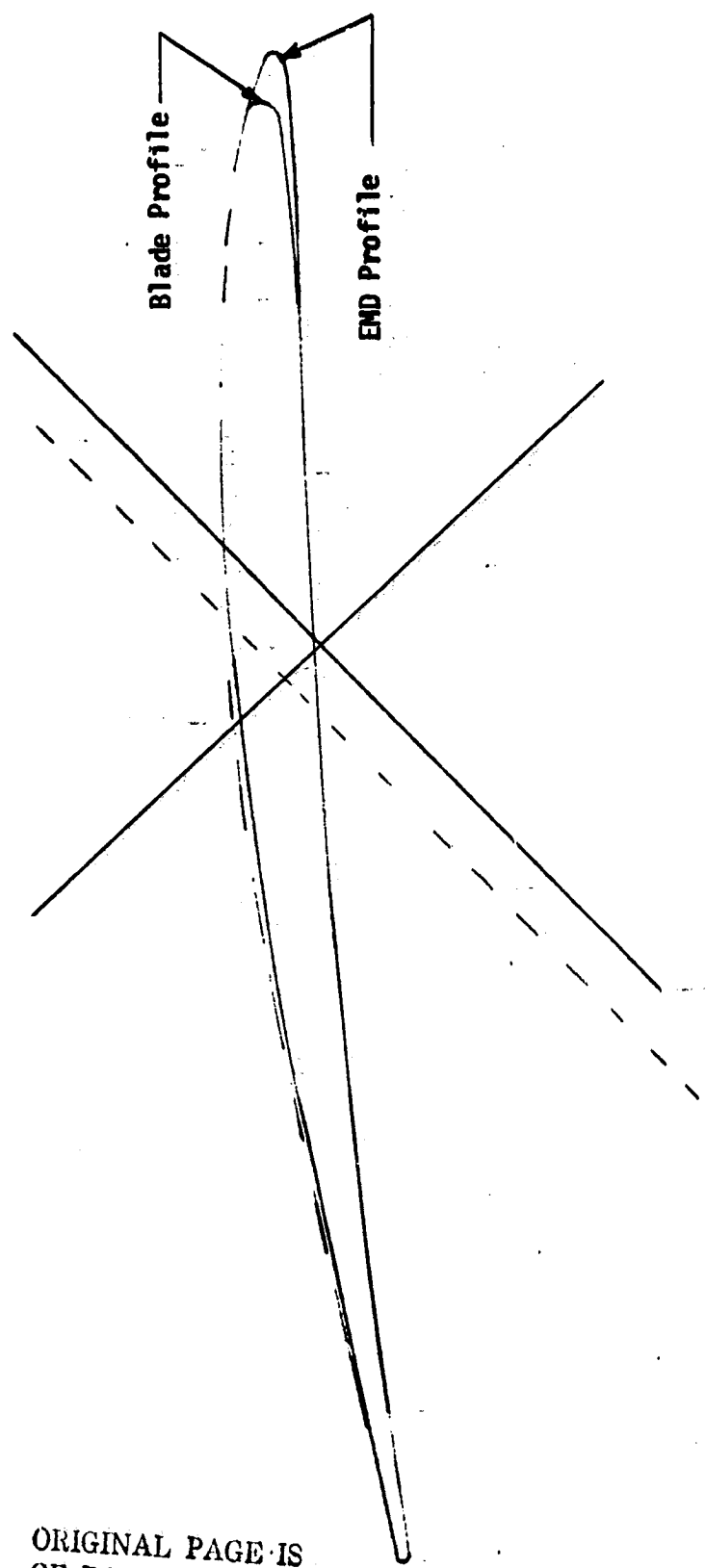
Table VII. A summary of visual observation of JT3D and JT8D Parts.

	<u>FAN</u>	<u>LPC</u>	<u>HPC</u>
<u>Erosion</u>	Blade tip leading edges are blunt.	Blade tip leading edges are blunt.	Blade tip leading edges are blunt. Trailing edge tips are rounded.
<u>Foreign Object Damage</u>	Blade tips are extensively blended on leading edges, especially 3D's.	Blade trailing edges have blended FOD, especially 3D's.	Some blended FOD was found on all stages.
<u>Surface Roughness</u>			
a) Before Cleaning		a) Blades have oily slick.	a) Blade and vane surfaces are rough.
b) After Cleaning	b) Pressure surfaces are pitted.	b) All vanes have pitted leading edges.	b) Surfaces are rougher than new airfoil.
<u>Airfoil Quality</u>			Vane trailing edges have been correctively bent.
<u>Blade Tips</u>	No rubbing.	Light rubs.	Light rubs.

Table VIII. Dimensional comparison of in-service compressor blades with new blades.

<u>ENGINE</u>	<u>STAGE</u>	<u>PART NUMBER</u>	<u>MEASUREMENT</u>	<u>DEVIATION FROM NEW PART</u>
JT3D	6	389906	Blade Length	None
JT3D	6	389906	Blade Chord, Tip	-1.6%
JT3D	7	389907	Blade Length	None
JT3D	7	389907	Blade Chord, Tip	-4.8%
JT3D	10	506510	Blade Length	None
JT3D	10	506510	Blade Chord, Root	None
JT3D	10	506510	Blade Chord, Mean	None
JT3D	10	506510	Blade Chord, Tip	-2.4%
JT3D	15	464215	Blade Length	None
JT3D	15	464215	Blade Chord, Tip	-2.3%
JT3D	16	464216	Blade Length	None
JT3D	16	464216	Blade Chord, Root	None
JT3D	16	464216	Blade Chord, Tip	-2.7%
JT8D	5	429505	Blade Length	None
JT8D	7	454407	Blade Length	None
JT8D	9	467509	Blade Length	None
JT8D	9	439411	Blade Length	None
JT8D	9	439413	Blade Length	None

Figure 17. Shadowgraph of JT3D 5th stage compressor blade at 88.8 percent span.



ORIGINAL PAGE IS  
OF POOR QUALITY



Figure 18. Shadowgraph of JT3D 9th stage compressor blade at 96.1 percent span.

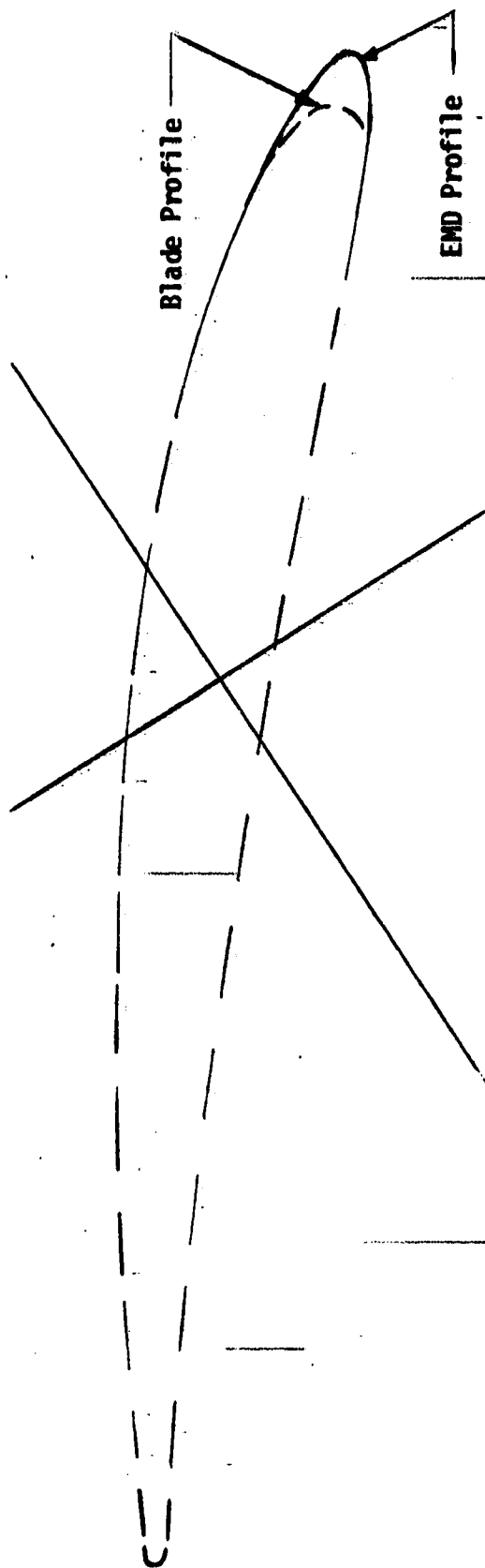


Figure 19. Shadowgraph of JT3D 15th stage compressor blade at 80.4 percent span.

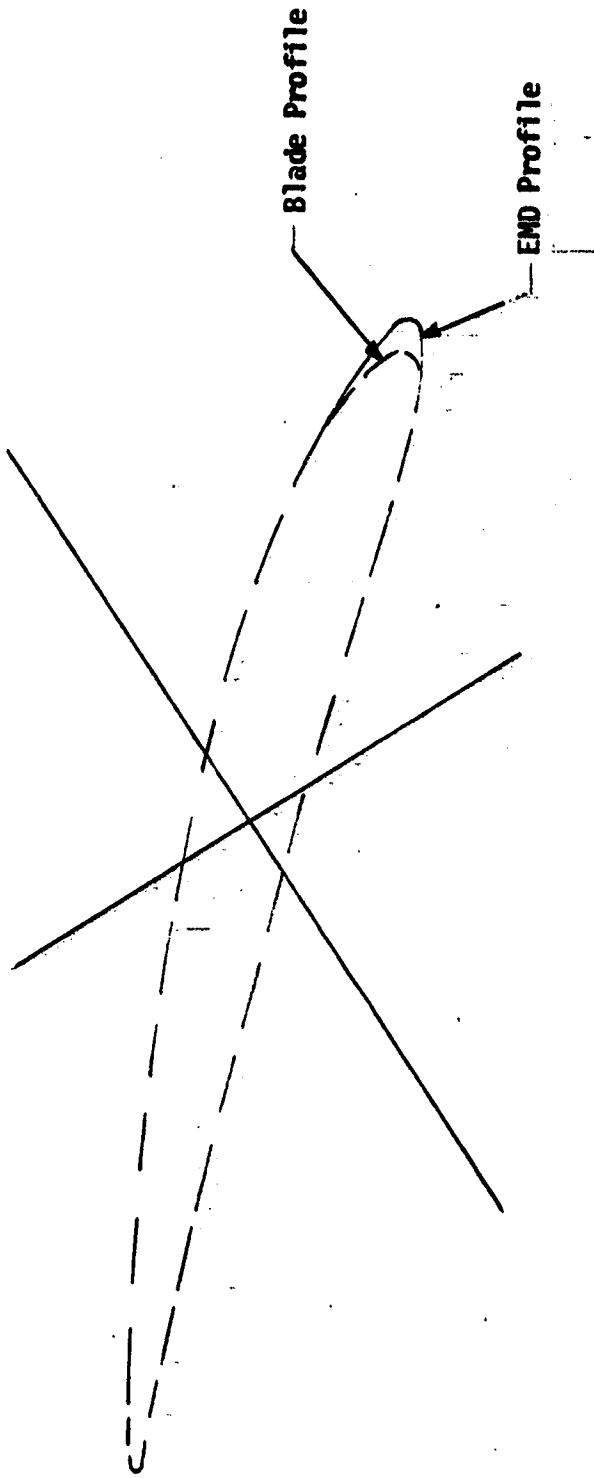


Table IX. Estimated effects of deteriorated fan-compressor parts on the engine fuel consumption.

ESTIMATED FROM PMA TEST RESULTS AND ANALYTICAL ESTIMATES		ANALYTICAL PROJECTION				% of Total Engine Deterioration		
Engine	Leading Edge Erosion Blades	Foreign Object Damage	Surface Roughness Cleaned Blades LPC & HPC	Fan Roughness	Vane Erosion		Rounded Blade Tips	Total
JT3D	+70 PPH	+50 PPH	+40 PPH	+20 PPH	+30 PPH	+40 PPH	+250 PPH	70%
JT8D	+30 PPH		+100 PPH	+20 PPH	+20 PPH	+40 PPH	+210 PPH	60%

On several early vintage JT3D burner clamps, the resistance seam weld attaching the "louver ring" to the burner clamp was cracked. However, the "louver ring" is trapped in place when the burner clamp is assembled, and hence no distortion to the aerodynamic flow path results.

Shrinkage of the transition duct outer seal, observed frequently at combustion section inspection, permits an excess of compressor discharge airflow to be induced at the outer diameter of the turbine inlet annulus. This excess in "cool air" produces a shift in the shape of the average turbine inlet radial temperature profile. The result may be a change in the measured EGT level of the engine. There is no evidence to indicate that this shift results in degradation of combustion efficiency level.

Inspection of a typical diffuser case assembly showed no evidence of sheet metal distortion or deterioration which would result in a change in the aerodynamic characteristics of the diffuser.

In summary, there was no evidence that the condition of the combustor parts of the JT3D, most of which had been repaired at previous hot section inspections (HSI), contributed to an increase in engine fuel consumption rate.

The inspection of JT8D fuel nozzle and supports, first turbine nozzle guide vanes and turbine outer air seals did, however, indicate deterioration which contributes to increased fuel consumption between HSI.

The American Airlines fuel nozzles inspected showed evidence of excessive carbon formation in the secondary fuel orifice. Bench flow tests of high time (~4000 hours) nozzles as received in the repair shop showed flow reductions of up to 45% in the secondary flow schedule. Fuel nozzle flow schedule reduction has been observed in fuel nozzle support assemblies as early as 2000 hours after HSI. There was no evidence of carbon formation in the nozzle primary orifice and flow bench tests of the fuel nozzles have not indicated a primary orifice flow reduction problem.

Inspection of first turbine nozzle guide vanes with 4000 hours since HSI showed considerable evidence of metal burnout and vane bowing. The vane assemblies exhibiting the most distress were located behind fuel nozzles having the least reduction in fuel nozzle flow schedule. These fuel nozzles received a "more than average" fuel flow rate, causing the related combustor cans to operate at a higher than average burner exit temperature level, thus producing local turbine vane distress.

Another area of distress related to the fuel nozzle carbon formation problem is the higher rate of deterioration of the turbine outer air seal. The distress of the outer air seal is greatest behind those combustors operating at higher than average exit temperature. The deterioration results in an increase in turbine blade tip clearance, as discussed in a later section of this report.

The combustors and transition ducts inspected showed no evidence of distress related to fuel nozzle flow reduction, spray cone distortion or operation at higher than average burner exit temperature level. There was no evidence of combustor configuration deterioration which would alter the combustor aerodynamics and degrade the combustion efficiency level.

A summary of the direct performance deterioration as a result of the fuel nozzle clogging due to carbon formation is presented on Table X. An analysis of the burner-to-burner operating differences due to higher than average and less than average (clogged) fuel nozzles indicates that a combustion efficiency loss results at cruise and lower power operation flight points only. It is estimated that this loss could increase TSFC up to 0.2 percent.

The first turbine nozzle vane bowing and burning, and the increased turbine outer air seal clearance result in TSFC performance deterioration due to rematch penalties in the turbine. The vane burning/bowing and seal clearance degradation is greatest behind those combustors whose fuel nozzles are not clogged, since these nozzles flow greater than the average fuel flow rate and produce greater than average turbine inlet temperatures.

#### Turbines

A visual inspection was made of typical American Airlines JT3D and JT8D deteriorated engine turbine parts. The observations pertaining to the turbine were primarily concerned with the condition of those parts whose surfaces are scrubbed by the primary gas stream. The visual comparison of incoming and outgoing blading, clearly indicated the turbine receives concentrated attention during shop repair.

Table XI summarizes the results of the visual inspection pertaining to airfoil shape. As noted, hot-spot damage was observed in both the JT3D and JT8D engines. The damage, bowing and/or burning was restricted to the first vanes. Burning was not observed in the JT3D. Foreign object damage was not evident in either engine. Leading edge distortion was minimal and in most cases limited to the blade tip section just inboard of the shroud. Trailing edge distortions, thinning or blunting was not visible to the naked eye. Surface erosion was noticeable and concentrated at the root and tip sections of both vanes and blades. These results suggest that on replacement of burned and or bowed vanes, the loss in turbine performance associated with airfoil shape would be, excluding the effect of surface roughness, returned to nearly that of a new turbine. Since subtle deviations in airfoil shape not visible to the naked eye can affect performance, samples of typical blading were subjected to surface contour and roughness measurements. The results will be discussed later.

**Table X JT8D PERFORMANCE DETERIORATION  
INFLUENCED BY FUEL NOZZLE CLOGGING**

<u>CAUSE</u>	<u>EFFECT</u>
● NON-UNIFORM BURNER-TO-BURNER FUEL DISTRIBUTION	LOSS OF COMBUSTOR EFFICIENCY AT CRUISE - RESULTS IN TSFC INCREASE
● 1ST TURBINE NOZZLE VANE BOWING / EROSION / BURNING	REMATCH DUE TO A <sub>5</sub> INCREASE - RESULTS IN TSFC INCREASE
● INCREASE 1ST TURBINE BLADE - OUTER AIR SEAL CLEARANCE	REMATCH DUE TO REDUCED TURBINE WORK - RESULTS IN TSFC INCREASE

Table XI - Turbine Airfoil Shape Observations

Component	Vane Burning	Vane Bow	F.O.D.	Distortion		Surface Condition
				Leading Edge	Trailing Edge	
High Press. Turb.	Yes JT8D only	Yes	None	Thinning noted near tip shrouds	None	Light erosion concentrated at blade tips
Low Press. Turbine	No	No	None	None to thinning noted near tip shroud	None	Light erosion concentrated at vane I.D. pressure side O.D. suction & pressure side

The observations of those surfaces forming the outer and inner contours of the turbine flowpath (platforms and shrouds), the rotor shroud knife edge seals, and the blade firtrrees are summarized in Table XII. Moderate to heavy platform shingling was noted in the first vane row, in particular the outer platforms of the JT8D. This type of distress opens leakage flowpaths which allow either primary flow to bypass the row or secondary flow to enter the primary stream. A performance penalty results in either case by reducing the potential and kinetic energy levels of the gas stream leaving the first vane row. The shrouds in all rows observed showed evidence of heavy shroud notch repair suggesting that between shop repairs some performance may be lost by leakage through the shrouds and the variations in rotor flow area (stage reaction) due to twisting under the application of gas loads. The knife edge seals observed showed signs of wear and damage which appeared to be the result of shroud notch repair. Leakage through the firtrrees was also visible especially in the area of the blade retaining rivet.

Table XII Turbine Flowpath Observations

Component	Rotor-Tip Knife Edge Seals	Shrouds Rotor	Vane & Blade Platforms	Firtrrees
High Press. Turb.	Evidence of stationary knife edges rubbing rotor shroud	Heavy wear & shroud notch repair noted	Heavy platform* shingling, evidence of leakage thru & around platforms	Evidence of flow thru
Low Press. Turbine	Elements of knife edges front & rear show signs of wear & squared-off edges	Heavy wear & shroud notch repair noted	Condition good	Evidence of flow thru

\*especially JT8D 1st vane O.D. platforms

The observations noted in Table XII suggest that leakage paths exist resulting in the loss of working fluid from the primary gas path, and these should be considered as sources of performance deterioration.

In summary the visual observations lead one to conclude that:

1. The performance deterioration associated with airfoil contour variations is non-existent or minimal.
2. On shop repair the performance loss attributable to shroud leakage and blade twist is recovered.
3. The leakage paths associated with platform shingling, knife edge seal and firtree wear may not be removed during shop repair and should be considered as sources of progressive turbine deterioration.

Samples of the JT3D and JT8D turbine blading described as being typical of deteriorated engines were subjected to dimensional inspections that would provide data to determine the extent of deviations in

- . airfoil contour
- . surface finish
- . blade shroud knife edge height

Since the inspections were limited to a small sample size (2 rotor blades of each stage of both JT8D and JT3D), the results can only be used to identify likely sources of performance loss that should be subjected to further investigation.

Airfoil contours were taken at three spanwise stations by the shadowgraph method. The working shadowgraphs were 20 times size. A typical example, reduced in size is shown in figure 20. The shadowgraph analysis concentrated on identifying variations in

- . leading & trailing edge shape
- . surface curvature
- . trailing edge diameter
- . gaging distance
- . stagger angle (twist)

The shadowgraph analyses have verified that the airfoil contours of all the sections inspected were within the allowed tolerance band, indicating that any change of the airfoil contours during operation and overhaul is minimal.



Figure 21 summarizes the results of the JT3D shadowgraph analysis. Shown are the variations in blockage resulting from variations in trailing edge diameter and the impact of the variation on turbine performance assuming the blade contour was nominal when new. Note also that the change in rotor flow areas (from nominal) due to the combined effects of variations in surface curvature, trailing edge diameter and stagger angle were found to be small, imposing a minimal effect on turbine performance.

The results of the JT8D shadowgraph analysis are summarized in figure 22. As shown the deviations noted were, as in the case of the JT3D, found to be small having little impact on turbine performance. One may conclude from the shadowgraph analysis that engine deterioration cannot be attributed to the loss of turbine airfoil shape through the effects of erosion and/or reworking of the airfoil surfaces during repeated repairs.

The amount of roughness considered admissible is that maximum height of a roughness element which causes no increase in drag over that of an aerodynamically smooth surface. The effect of roughness is different depending on whether the surface boundary layers are turbulent or laminar. In the case of a turbulent layer, roughness increases the drag when the roughness elements penetrate the laminar sublayer. In the case of a laminar boundary layer, roughness causes the drag to increase by shifting the transition zone toward the leading edge.

The critical roughness is the minimum height of a roughness element which causes transition to move forward from its smooth surface position. Also the drag of an airfoil experiencing laminar separation would decrease when the roughness element exceeds the critical value since transition to a turbulent boundary layer would result, increasing the capability to withstand a larger adverse pressure gradient. Since turbine airfoils have turbulent boundary layers on the major portion of their surface, the admissible roughness as defined by H. Schlichting may be used as an indicator of performance changes due to surface roughness.

The surface roughness of a set of JT3D airfoils were measured using a Micrometrical Manufacturing Co. Profilometer, and the results are shown in figure 23. On comparing the measured and admissible roughness one may conclude the turbine performance deterioration due to surface roughness is restored on shop repair and cannot be a contributor to the progressive increase in engine deterioration.

The change in knife edge height induced by rubbing and/or erosion was determined by measuring the radial distance between a known reference plane (z plane) and the tip of the knife edge and comparing the measurement with the nominal blueprint value. Again the sample size was small hence the results can only be used as an indicator of a problem.

Figure 24 contains a summary of the results of shroud knife edge wear. Note that in the case of the JT8D the measured variation in radial height

was comparable to the allowable tolerance band, suggesting little reduction in knife edge height. However, the comparison of JT3D radial heights indicates that the second and third stage knife edge seal heights are reduced considerably from nominal. These data suggest that tip leakage control may be marginal in the JT3D low pressure turbine and therefore a contributor to the noted progressive deterioration in engine performance.

The leakage of burner discharge flow around the first turbine vane or through case flange seals is handled on a cycle basis and represents a loss in turbine working fluid which impacts the turbine efficiency through Mach number and incidence losses induced by the increase in expansion ratio required to meet shaft work requirement.

Figure 25 summarizes the impact of the observed deviations on engine fuel consumption. Note that the sum of the individual penalties results in a fuel flow increase that is a small percentage of the total fuel flow increment of an average engine (i.e., about 15 percent for both the JT3D and JT8D engines).

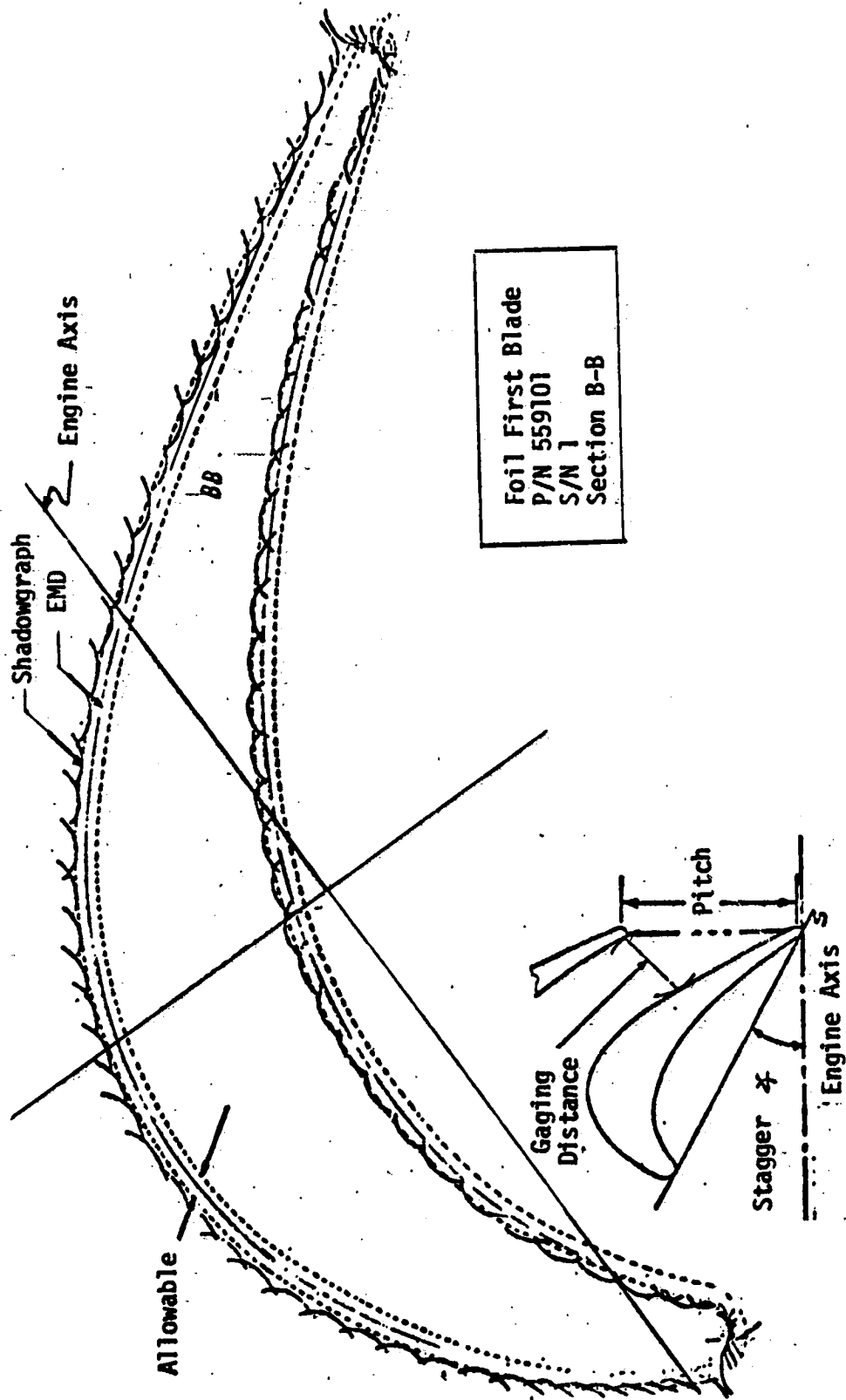
#### Seals & Clearances

Another area considered worthy of evaluations during the study was the various gas path potential leakage areas. Initial evaluation of AA test cell data had indicated that losses throughout the engine could have pronounced effect on TSFC. Particular attention was directed at areas between the output from the high compressor and the inlet to the high turbine. Detail measurements were taken on JT3D and JT8D engines' internal seals and clearances throughout the gas path. Appendix I summarizes the results of these activities. In addition, a review of repair practices was made to determine the extent of reconditioning of high pressure flanges.

In general, the information indicates that seal dimensions are maintained in accordance with P&WA Overhaul Manual. However, seal measurements obtained from JT8D disks in storage with only a few cycles left indicate that in several instances one or more knife edges of the 13th stage HPC inner airseal exceed the manual limits and hence should require reworking. Also, the first turbine inner front seal min/max limits exceed the blueprint limits by .010". In addition, information provided for turbine inner airseals shows that the seals are often burnt or curled, indicating that seal clearances have increased with engine operation.

In order to determine what impact seal tolerances could have on engine performance, the secondary flow system for the JT8D engine was analyzed. The secondary flow system was evaluated for a cruise flight condition with compressor and turbine labyrinth seals having minimum, nominal, maximum and replace limits. The analysis was made for a cruise flight condition with nominal gas stream pressures and temperatures, and estimated hot seal clearances.

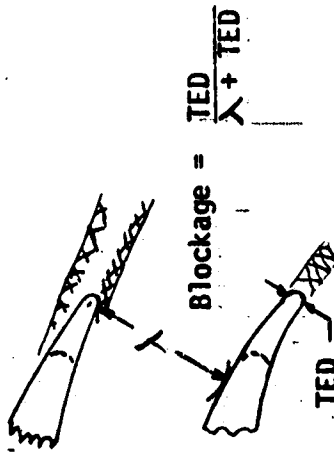
Figure 20. JT3D-3B Sample Turbine Blade Shadowgraph



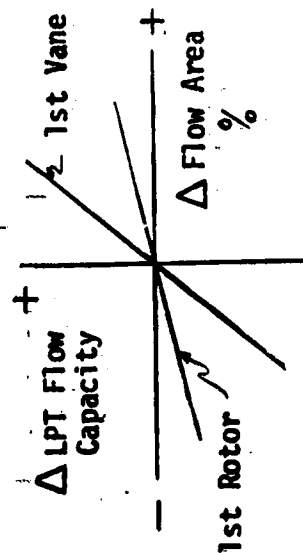
ORIGINAL PAGE IS  
OF POOR QUALITY

Figure 21. Turbine Shadowgraph Analysis of JT3D

- o ALL AIRFOIL CONTOURS WERE WITHIN THE ALLOWABLE TOLERANCE BAND.
- o TRAILING EDGE BLOCKAGE WAS GREATER THAN NOMINAL.



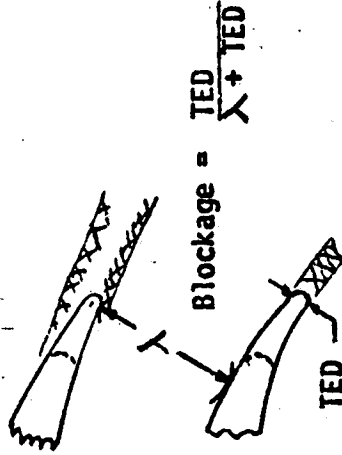
- o FLOW AREAS WERE CLOSED RELATIVE TO NOMINAL.



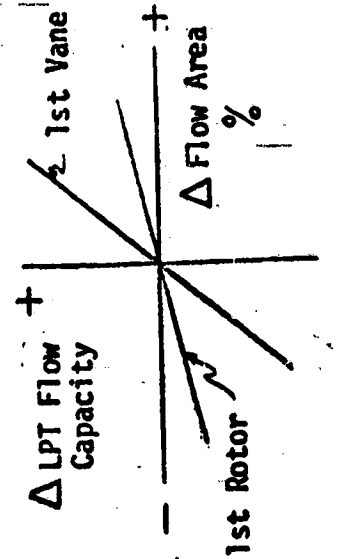
STAGE NUMBER	BLOCKAGE %	EFFICIENCY PENALTY %	FUEL FLOW PENALTY PPH	STAGE NUMBER	ROW FLOW AREA %	TURBINE FLOW CAPACITY %	FUEL FLOW PENALTY PPH
1	+ .82	-.11	+5	1	-.9	Ni1	0.0
2	-.28	Ni1	0.0	2	-.2	-.06	+1
3	+1.16	-.05	+5	3	-1.8	+1.17	+5
4	+.59	Ni1	0.0	4	-3.8	-.13	+4

Figure 22. Turbine Shadowgraph Analysis of JT8D

- o ALL AIRFOIL CONTOURS WERE WITHIN THE ALLOWABLE TOLERANCE BAND.
- o TRAILING EDGE BLOCKAGE WAS GREATER THAN NOMINAL.



- o FLOW AREAS WERE CLOSED RELATIVE TO NOMINAL.



STAGE NUMBER	BLOCKAGE %	EFFICIENCY PENALTY %	FUEL FLOW PENALTY PPH
1	+0.73	Ni1	+5
2	.06	Ni1	0
3	+0.30	-.05	+5
4	+0.03	Ni1	0

STAGE NUMBER	ROM FLOW AREA %	TURBINE FLOW CAPACITY %	FUEL FLOW PENALTY PPH
1	-.84	Ni1	0
2	-.85	-.26	+3
3	-.84	-.10	+1
4	-.52	-.06	+1

Figure 23. Turbine Blade Surface Roughness of JT3D

THE ADMISSIBLE ROUGHNESS FOR TURBULENT BOUNDARY LAYERS MAY BE ESTIMATED BY USE OF THE FOLLOWING EQUATION\*.

•  $R_{ADM} \leq 100 \frac{bx}{REY_{bx}}$

WHERE:  $bx$  = AXIAL CHORD

$REY_{bx}$  = REYNOLDS NUMBER

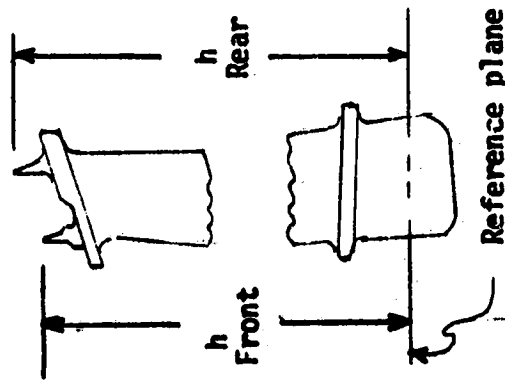
STAGE NUMBER	MEASURED SURFACE ROUGHNESS (MICRO INCHES)		ADMISSIBLE ROUGHNESS (MICRO INCHES)
	PRESSURE SIDE	SUCTION SIDE	
1	52-92	48-88	172
2	56-68	36-56	265
3	28-36	40-64	373
4	60-85	52-102	518

o SURFACE ROUGHNESS DOES NOT APPEAR TO BE A FACTOR INFLUENCING LONG TERM ENGINE DETERIORATION.

\* Schlichting Herman - Boundary Layer Theory, McGraw Hill Inc. Fourth Edition, pp. 557-563

Figure 24. Turbine Shroud Knife Edge Wear

STAGE NUMBER	JT3D		JT8D		FUEL FLOW PENALTY (PPH)
	▲ TIP CLEARANCE (INCHES) FRONT	▲ TIP CLEARANCE (INCHES) REAR	▲ TIP CLEARANCE (INCHES) FRONT	▲ TIP CLEARANCE (INCHES) REAR	
2	-0.002	+0.030	+0.006	+0.008	0.0
3	+0.018	+0.031	+0.003	+0.002	0.0
4	+0.006	+0.004	+0.009	+0.015	10
					10
					20
					5.0
					3.0



▲ Tip Clearance =  $h$  nominal -  $h$  measured

Figure 25. Impact of Observed & Measured Turbine Deviations on Engine Fuel Consumption

DEVIATION	AIRFOIL CONTOUR	SURFACE ROUGHNESS	TRAILING EDGE BLOCKAGE	BLADE FLOW AREA	TIP KNIFE EDGE SEAL WEAR	1ST VANE PLATFORM LEAK	TOTAL FUEL FLOW INCREASE (PPH)	% OF DETERIORATED ENGINE EXCESS* FUEL FLOW
JT3D	0.0	0.0	+10	+10	+20	+5	+45	13
JT8D	0.0	0.0	+10	+5	10	+30	+55	16

\*Approximately 350 PPH

o TASK I TURBINE STUDIES INDICATE THAT THE OBSERVED AND/OR MEASURED DEVIATIONS FROM NOMINAL ACCOUNT FOR A SMALL PERCENTAGE OF THE NOTED TYPICAL DETERIORATED ENGINE FUEL FLOW INCREMENT.



A comparison of the secondary cooling flow with nominal and replace seal limits shows that the secondary flow increases 15% with replace seal clearances, which results in a performance penalty of approximately 10 pph fuel flow at cruise. This comparison is presented only to estimate a maximum possible performance effect. The detail measurements of selected parts and general observations tend to show that seals are not at replace limits.

Inspection of a small sample of American Airlines JT3D and JT8D turbine blades was made to determine the change in blade knife edge height. In the case of the JT8D, measured variation in blade knife edge height were small. However, the data indicated that the second and third stage knife edge heights are reduced considerably from nominal in the JT3D engine. The results suggest that the tip clearance control may be a contributor to the long term engine deterioration. Again, the sample size was small, hence the results can only be used as an indicator of a problem.

Detailed measurements of rotor tip clearances are not available, therefore, the absolute value of performance reduction cannot be assessed. However, it should be noted that a 10 mil clearance increase in the outer air seals for the JT3D and JT8D engines will result in fuel flow increases of 25 to 60 pph respectively.

Photographs and/or detailed measurements are not available to document the high pressure flanges in the JT3D and JT8D engine leakage observations. They are the result of a visual inspection of a small sample of overhaul engines. The engines were examined at American Airline overhaul facility. Leakage patterns were observed on incoming JT3D engine high pressure flanges. Subsequent investigation of other JT3D engines showed variation in leakage indications from engine to engine. Generally, the flange areas showed varying amounts of discoloration in the flange area believed to be caused by leakage. However, some JT3D engines showed no indication of leakage at the flanges.

The JT8D engines that were examined resulted in a different set of observations. The high pressure flanges did not show the discoloration patterns that were observed in the JT3D. The outward appearance of the JT8D flanges does not indicate a flange leak but this lack of indication does not necessarily mean that flange leakage is not present.

Quantitative evaluation of these observed flange leakage indications is not possible without additional data. It is important to note, however, that these leaks are present and could have a significant effect on performance. It is difficult to assess the impact on long term deterioration but it is felt that the overhaul procedure tends to result in a consistent, regularly applied approach, which results in small variations from overhaul to overhaul.

A summary of the effect of seal leakages and tip clearance on the engine fuel flow is presented in Table XIII. The fuel flow increases are also presented in terms of the percent of total fuel flow increase of a deteriorated engine. Seals and clearance contribute 10 to 20 percent of the total engine deterioration.

Table XIII. IMPACT OF OBSERVED AND MEASURED DEVIATIONS

ON ENGINE FUEL CONSUMPTION  
FOR SEALS AND LEAKAGE

ENGINE	SECONDARY FLOW SEALS (PPH)	ROTOR TIP CLEARANCES (PPH)	FLANGE LEAKAGE (PPH)	TOTAL FUEL FLOW INCREASE (PPH)	PERCENTAGE OF TOTAL ENGINE DETERIORATION %
JT3D	10	25	UNKNOWN, BUT SENSITIVE	35	10
JT8D	10	60	UNKNOWN, BUT SENSITIVE	70	20

Material Consumption/Repair Rates - Support in analyzing general performance deterioration can be obtained from reviewing the consumption of material used in repairing engines. This data base should consist of the average scrap rates for material from the gas path, per engine repair, averaged over a sufficient period of time to cover several repairs per engine.

Detailed records were reviewed of the scrap rate, outside service repair volumes, and material consumption data for gas path parts. Reviewing the compressor and turbine airfoil scrap rate and estimated wear-out life, showed large variation in observed life. Observed life is the number of hours flown by all engines times the number of blades/vanes in the stage divided by the total number scrapped for that stage. Tables XIV & XV show the scrap rate and estimated wear-out life for fan and compressor blades of the JT3D and JT8D. The large variation is indicative of the following:

- a. The stages with low scrap rates have minimum structural problems, may be difficult to get to and/or are large enough to be repaired several times before they are scrapped.
- b. The stages that have a higher scrap rate are subject to failure or are not economically repairable.

The tendency is for larger parts to be structurally stronger and more repairable. The lack of inspection provisions in both JT8D and JT3D and considerable cost of disassembly of the compressor sections, produces reluctance to disassemble either unit unless stall problems, disk time or visible damage makes such a disassembly necessary. Further, to minimize the cost of repair, parts that meet the rather broad overhaul and repair manual limits are reused. These limits were developed without special consideration for the performance impact of the repairs.

Tables XVI, XVII & XVIII present the same type of data for stationary airfoils - vanes and turbine nozzles as well as turbine blades. It is noticeable that low pressure compressor vane assemblies are not repaired and very little scrappage is noted. Consequently, it is reasonable to assume that they are not in good shape from a performance standpoint. The type of repair undertaken on turbine nozzles and blades subject them to a restamping operation which aids in ensuring proper blade twist. Such is not the case in compressor blades as twist is not measured.

Repairs to stator vane assemblies in general consist of replacement of individual broken vanes and restoration of seal surfaces. Wholesale replacement of vanes is not undertaken except in specific cases.

The general conclusion to be drawn from this review is that, based on scrap rate and repair rate information, the probable major long term performance losses can be mainly associated with non restoration of fan and compressor aerodynamic blading.

**Table XIV. - Scrap rate and estimated wear-out life  
in 1972 and 1973 for fan blades of the  
JT3D and JT8D engines.**

JT8D

TOTAL ENGINE HOURS 1,599,767

<u>ITEM</u>	<u>NUMBER SCRAPPED</u>	<u>OBSERVED LIFE - HOURS</u>
1ST FAN BLADE	1,864	* 24,000
2ND FAN BLADE	658	* 100,000

JT3D

TOTAL ENGINE HOURS 2,362,376

<u>ITEM</u>	<u>NUMBER SCRAPPED</u>	<u>OBSERVED LIFE - HOURS</u>
1ST FAN BLADE	- 138	INDEF.
2ND FAN BLADE	187	<u>400,000</u>

\* APPROXIMATION DUE AVERAGING TWO DIFFERENT ENGINE MODELS

Table XV. - Scrap rate and estimated wear-out life in 1972 and 1973 for compressor blades of the JT3D and JT8D engines.

JT3D TOTAL ENGINE HOURS - 2,362,376

<u>ITEM</u>	<u># SCRAPPED</u>	<u>OBSERVED LIFE HOURS</u>
-------------	-------------------	----------------------------

Low Pressure Compressor

4TH STG.	4,828	25,000
5TH STG.	1,929	* 80,000
6TH STG.	898	* 190,000
7TH STG.	3,028	* 68,000
8TH STG.	7,234	* 32,600
9TH STG.	6,394	37,700

High Pressure Compressor

10TH STG.	7,205	23,900
11TH STG.	8,086	21,900
12TH STG.	7,509	23,600
13TH STG.	8,697	20,300
14TH STG.	10,194	19,700
15TH STG.	9,276	21,600
16TH STG.	7,236	25,100

JT8D TOTAL ENGINE HOURS - 1,599,767

<u>ITEM</u>	<u># SCRAPPED</u>	<u>OBSERVED LIFE HOURS</u>
-------------	-------------------	----------------------------

Low Pressure Compressor

3RD STG.	785	130,000
4TH STG.	1,171	85,000
5TH STG.	1,522	67,000
6TH STG.	5,489	18,000

High Pressure Compressor

7TH STG.	2,613	36,700
8TH STG.	2,040	45,400
9TH STG.	4,626	20,700
10TH STG.	4,405	23,200
11TH STG.	6,074	18,400
12TH STG.	8,953	14,300
13TH STG.	6,245	18,900

\*APPROXIMATIONS DUE AVERAGING TWO DIFFERENT ENGINE MODELS.

Table XVI. - Scrap rate and estimated wear-out life in 1972 and 1973 for compressor vanes of the JT8D engines.

JT8D

TOTAL ENGINE HOURS 1,599,767

<u>ITEM</u>	<u>NUMBER SCRAPPED</u>	<u>OBSERVED LIFE - HOURS</u>
<u>Low Pressure Compressor</u>		
1st Stage	450	181,307
2nd Stage	51	1,976,182
3rd Stage	177	60,477
4th Stage	303	395,982
5th Stage	13	123,059
<u>High Pressure Compressor</u>		
7th Stage	18	88,876
8th Stage	44	36,358
9th Stage	23	69,555
10th Stage	17	94,104
11th Stage	25	63,991
12th Stage	9	177,752
13th Stage	5	319,953

Note: Stages 1 thru 4 are individual vane assemblies whereas stages 5 thru 13 are segmented assemblies.

Table XVII. - Scrap rate and estimated wear-out life  
in 1970-1973 for turbine blades of the  
JT3D and JT8D engines.

JT8D

TOTAL ENGINE HOURS - 3,126,701

<u>ITEM</u>	<u>NUMBER SCRAPPED</u>	<u>OBSERVED LIFE - HOURS</u>
1ST HPT BLADE	17,712	14,100
2ND LPT BLADE	5,148	53,400
3RD LPT BLADE	3,990	73,000
4TH LPT BLADE	1,899	120,000

JT3D

TOTAL ENGINE HOURS - 4,940,396

1ST HPT BLADE	61,173	10,500
2ND LPT BLADE	10,952	52,300
3RD LPT BLADE	9,986	53,400
4TH LPT BLADE	3,364	100,000



Table XVIII. - Scrap rate and estimated wear-out life in 1970-1973 for turbine vanes of the JT3D and JT8D engines.

JT8D

TOTAL ENGINE HOURS - 3,126,701

<u>ITEM</u>	<u>NUMBER SCRAPPED</u>	<u>OBSERVED LIFE - HOURS</u>
1ST HPT VANE	18,536	7,835
2ND LPT VANE	4,543	65,000
3RD LPT VANE	2,158	101,500
4TH LPT VANE	1,240	195,000

JT3D

TOTAL ENGINE HOURS - 4,940,396

1ST HPT VANE	6,216	50,000
2ND LPT VANE	834	> 400,000
3RD LPT VANE	978	> 400,000
4TH LPT VANE	1,068	> 300,000

Study of Performance Deterioration Utilizing Engine Simulation Decks -  
The possible sources of increased fuel consumption due to engine deterioration were investigated for JT3D-3B and JT8D-9 engines using engine simulation computer programs. The programs were used to determine the sensitivity of engine fuel consumption to deterioration in each component. Specific deteriorated engines were also simulated and test cell trend curves were analyzed in an attempt to isolate the components contributing to the increased fuel consumption.

The effect of an arbitrary amount of deterioration in each component on the fuel consumption was estimated. The resulting sensitivity factors, in terms of fuel consumption increase due to component efficiency loss, flow capacity loss, leakage and seal clearance change are given in Figures 26 & 27 for the JT3D-3B and JT8D-9, respectively. These factors indicate which component(s) could have the most effect on fuel consumption if they experience deterioration. If any of the most influential components are in poor condition, they would be prime candidates for improved repairs or increased parts replacement to improve fuel consumption. Conversely, these factors can be used to screen out the components that have little influence on fuel consumption and therefore do not require further attention.

The following conclusions were drawn from the analysis of the sensitivity factors:

1. High compressor and high turbine flange leakage have a very significant effect on fuel consumption. The effect of flange leakage is greater in the JT3D than it is in the JT8D. This difference exists because the leakage flow in the JT3D goes overboard and the leakage flow in the JT8D goes into the fan duct and still contributes to the nozzle flow.
2. Fan hub and low compressor flow capacity loss (by themselves without an efficiency loss) have a significant effect on fuel consumption since the resulting reduction in core flow requires higher turbine temperature to maintain the same EPR, hence higher fuel consumption.
3. Loss in fan efficiency, compressor efficiency, turbine efficiency or increased leakage in the turbines requires the engine to run to a higher turbine temperature to maintain the same EPR, causing an increase in fuel consumption.
4. Fan tip flow capacity loss (by itself without an efficiency loss) results in increased fan speed which forces the low compressor to pass more flow. The increased core flow results in a reduction in turbine temperature and fuel flow.
5. Deterioration of the high compressor flow capacity increases rotor speed, but has little effect on fuel consumption because there is little change in the high compressor and high turbine efficiency associated with the increase in high rotor speed.

For reasons related to the parts inspection, the fuel consumption sensitivity to low compressor deterioration was analyzed in more detail. Figures 28 and 29 show the effect of primary flow and efficiency loss due to low compressor deterioration on the measured parameters of the JT3D and JT8D. While the low compressor deterioration, by itself, does not duplicate the shift in the measured test cell parameters, it does indicate that a significant increase in fuel consumption can result from degradation of this component. Differences between the JT3D and JT8D fuel flow increases, low rotor speed shifts, etc., were found to be due to the "matching" differences between a separate nozzle (JT3D) and a common nozzle (JT8D) engine. As shown in Figure 30, a reduction in low compressor flow capacity and efficiency in the JT3D-3B causes a reduction in low compressor flow and pressure ratio plus an increase in fan pressure ratio and total flow along the original fan operating line. In the JT8D, which has a single nozzle for both streams, the "rematch" is governed by the static pressure balance in the tailpipe. In this case, loss of low compressor flow capacity and efficiency causes some of the core flow to shift to the fan stream which increases the bypass ratio at about the same total flow. As shown in Figure 31, the fan pressure ratio increases. The fan pressure ratio increase is necessary to offset the effect of the increased fan flow. An increase in fan flow without a fan pressure ratio increase would produce a higher duct Mach number and too low a static pressure in the fan duct section of the tailpipe, but the increased fan pressure raises the static pressure in the tailpipe so that it is equal to the level of the static pressure in the engine stream in the tailpipe.

The test cell data shows about 350 pph fuel flow increase in both engines or about 4.0% fuel flow increase for the JT3D and JT8D. In order to determine the cause of increased fuel consumption, test cell data of specific engines with approximately average performance were analyzed with the aid of computer simulation programs. It became apparent that the test data, which is shown on Figures 32 and 33, could be simulated by many combinations of component deterioration. For example, an efficiency loss of one component could be "traded" for an efficiency loss of another component with no change in the measured parameters. This anomaly is due to the paucity of parameters measured in production engines. Since component temperatures (TT2.5, TT3 and TT4) and fan pressure (PT2.5) are not measured, the changes in the component characteristics could not be determined uniquely.

Component condition was then used to narrow down the possible sources of deterioration. Parts inspection and analysis indicated that the fan and compressors receive significantly less attention in the repair shop than the turbines do. (See compressor, turbine and seal sections of this report for a detailed discussion of parts condition.) Simulation analysis shows that the fuel consumption increase and most of the changes in the other measured parameters can be explained by reasonable losses in fan and compressor flow capacity and efficiency. Various combinations of fan and compressor deterioration will yield the same shift in measured parameters, for the same reason given previously, that is, too few parameters measured. Some of the possible combinations of fan

and compressor deterioration that will line-up average deteriorated 3D and 8D engines are given in Figures 34 and 35. Test cell trend curves did show about a 2% and a 3% decrease in turbine expansion ratio (PS4/Pt7) in the JT3D and JT8D, respectively. This decrease in turbine expansion ratio can only be attributed to a loss in turbine performance (efficiency or leakage) or an increase in 1st stage turbine nozzle area. Therefore, while the fan and compressors are considered to be the major causes of the fuel consumption increase (based on parts condition) the turbines must contribute some to the fuel consumption increase.

As a cross-check on the assumption that fan and compressor deterioration is the major cause of the observed performance losses, an attempt was made to simulate the performance loss assuming only turbine deterioration. The fuel consumption increase was assumed to be the result of equal amounts of deterioration in each turbine as indicated in Figure 36. The results of this analysis showed that the turbines by themselves cannot explain the deterioration. The turbine deterioration required to produce the observed fuel consumption increase would result in a loss of low rotor speed of about 99 rpm in the JT3D and a loss of about 209 rpm in the JT8D, as shown in the figure. Test cell data shows that there is little or no change in low rotor speed. Therefore, the increased fuel consumption must be the result of at least some fan and compressor deterioration. It could be argued in the case of the JT3D that all the deterioration could occur in the high pressure turbine without any significant change in low rotor speed. (Note the subtotals in Figure 36.) If this were the case, however, the result would be a large drop in high rotor speed (over 300 rpm) which the test data shows does not occur.

Cost Vs. Performance Improvement Trade-Offs - Maintenance policies in the airlines have permitted the long term gradual increase in engine fuel consumption as a direct result of efforts to reduce aircraft operating costs. Engine material represents such a high proportion of both engine and overall aircraft maintenance costs that substantial engineering efforts on both the part of the airlines and the engine manufacturers have been expended in reducing material consumption. Past airline economic studies concerning the cost to recover the increase in engine fuel consumption have invariably resulted in the conclusion that the cost for new material would exceed any estimable savings from reduced fuel consumption.

Several economic factors have changed in the last 18 months which suggest that these conclusions are no longer valid. The first factor is the rapidly increasing cost of fuel and reduced or threat of reduced supply. The second factor is the improved understanding of the economic relationship between engine repair standards and the resulting average time between engine shop visits.

The deterioration in engine specific fuel consumption performance has:

- increased the consumption of hot section parts due to increased operating temperatures

FIGURE 26 - FUEL CONSUMPTION SENSITIVITY TO COMPONENT DETERIORATION  
FOR THE JT3D-3B AT SEA LEVEL STATIC, STANDARD DAY FOR  
CONSTANT EPR

### FAN:

● 1% DECREASE IN:

OD FLOW CAPACITY = -20 PPH FUEL FLOW\*  
OD EFFICIENCY = +32  
ID FLOW CAPACITY = +52  
ID EFFICIENCY = +30

### COMPRESSORS:

● 1% DECREASE IN:

LPC FLOW CAPACITY = +32  
LPC EFFICIENCY = +36  
HPC FLOW CAPACITY = +5  
HPC EFFICIENCY = +36

● 1% HPC FLANGE LEAKAGE  
= +196

### TURBINES:

● 1% INCREASE IN:

EFFECTIVE HPT AREA = +18  
HPT EFFICIENCY LOSS = +39  
HPT FLANGE LEAKAGE = +284  
1ST VANE FRONT FLOW = +5  
1ST DISK FRONT FLOW = +52  
1ST DISK REAR FLOW = +32

EFFECTIVE LPT AREA = +31  
LPT EFFICIENCY LOSS = +83  
2ND DISK FRONT FLOW = +55  
4TH DISK REAR FLOW = +44

● 10 MILS CLEARANCE INCREASE

1ST O.A.S. = +13  
2ND O.A.S. = +6  
3RD O.A.S. = +4  
4TH O.A.S. = +3

**\*95 PPH = 1% FUEL FLOW INCREASE**

FIGURE 27. - FUEL CONSUMPTION SENSITIVITY TO COMPONENT DETERIORATION FOR THE JT8D-9 FOR SEA LEVEL STATIC, STANDARD DAY AT CONSTANT EPR

FAN:

- 1% DECREASE IN:
  - OD FLOW CAPACITY = -24 PPH FUEL FLOW\*
  - OD EFFICIENCY = +24
  - ID FLOW CAPACITY = +19
  - ID EFFICIENCY = +19

COMPRESSORS:

- 1% DECREASE IN:
  - LPC FLOW CAPACITY = +14
  - LPC EFFICIENCY = +19
  - HPC FLOW CAPACITY = -5
  - HPC EFFICIENCY = +42

- 1% HPC DISCHARGE BLEED LEAKAGE TO FAN DUCT = +111

TURBINES:

- 1% INCREASE IN:
  - EFFECTIVE HPT AREA = +17
  - HPT EFFICIENCY LOSS = +48
  - HPT FLANGE LEAKAGE = +101
  - 1ST VANE PLATFORM FLOW = +27
  - 1ST DISK FRONT FLOW = +65
  - 1ST DISK REAR FLOW = +48

- EFFECTIVE LPT AREA = +12
- LPT EFFICIENCY LOSS = +57
- 2ND DISK FRONT FLOW = +68
- 2ND DISK REAR FLOW = +56
- 3RD DISK FRONT FLOW = +80
- 4TH DISK REAR FLOW = +27

- 10 MILS CLEARANCE INCREASE

- 1ST O.A.S. = +30
- 2ND O.A.S. = +7
- 3RD O.A.S. = +11
- 4TH O.A.S. = +11

\* 83 PPH = 1% FUEL FLOW INCREASE

FIGURE 28. - LOW COMPRESSOR DETERIORATION  
STUDY AT CONSTANT EPR

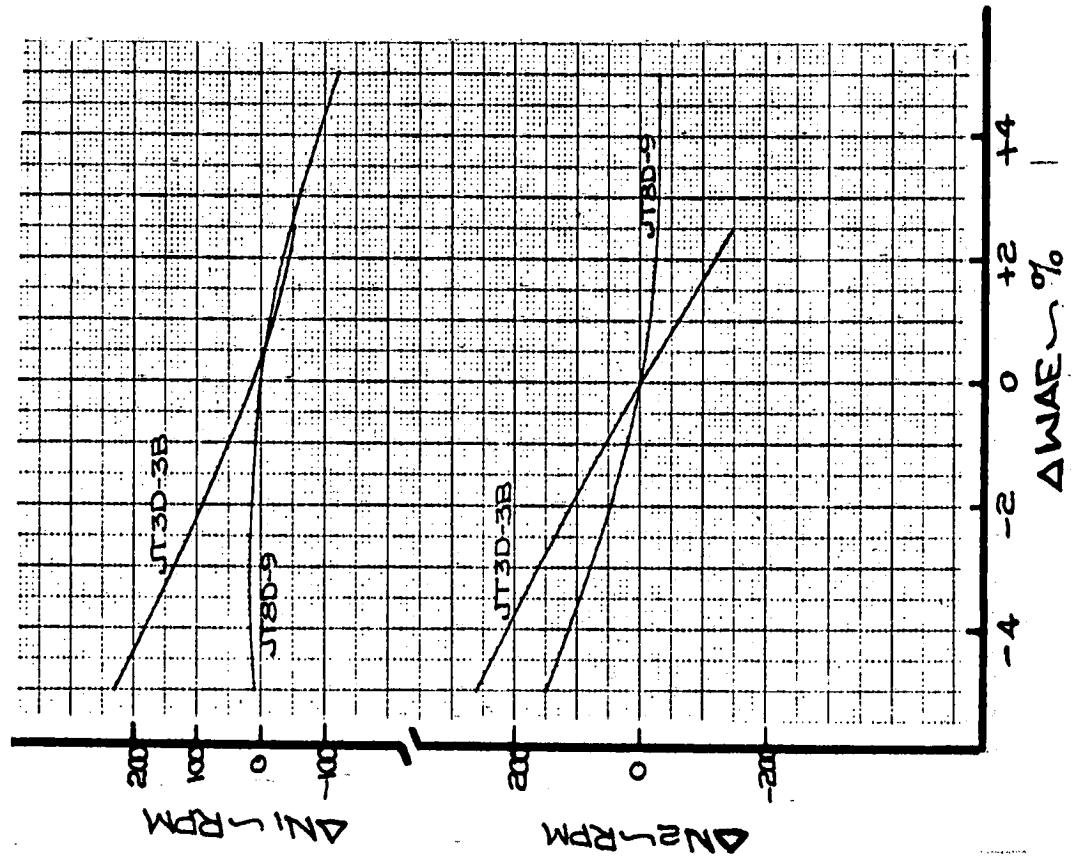
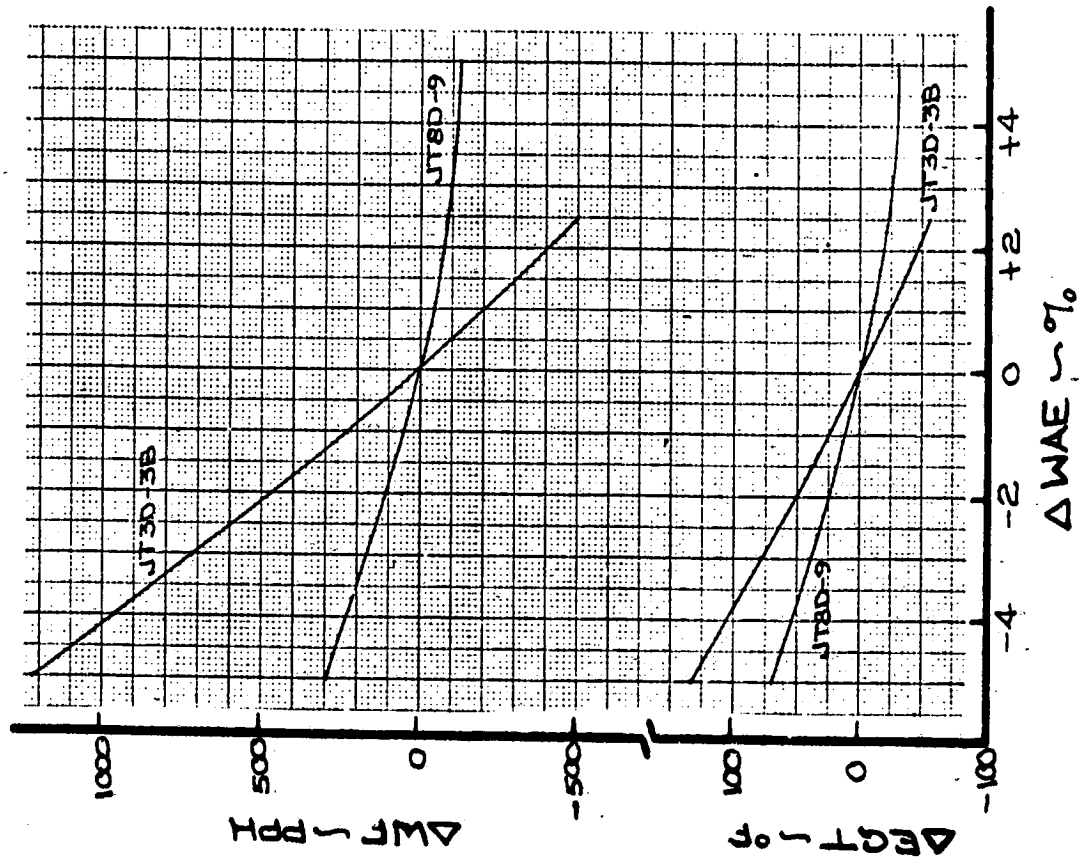


FIGURE 29. - LOW COMPRESSOR DETERIORATION  
STUDY AT CONSTANT EPR

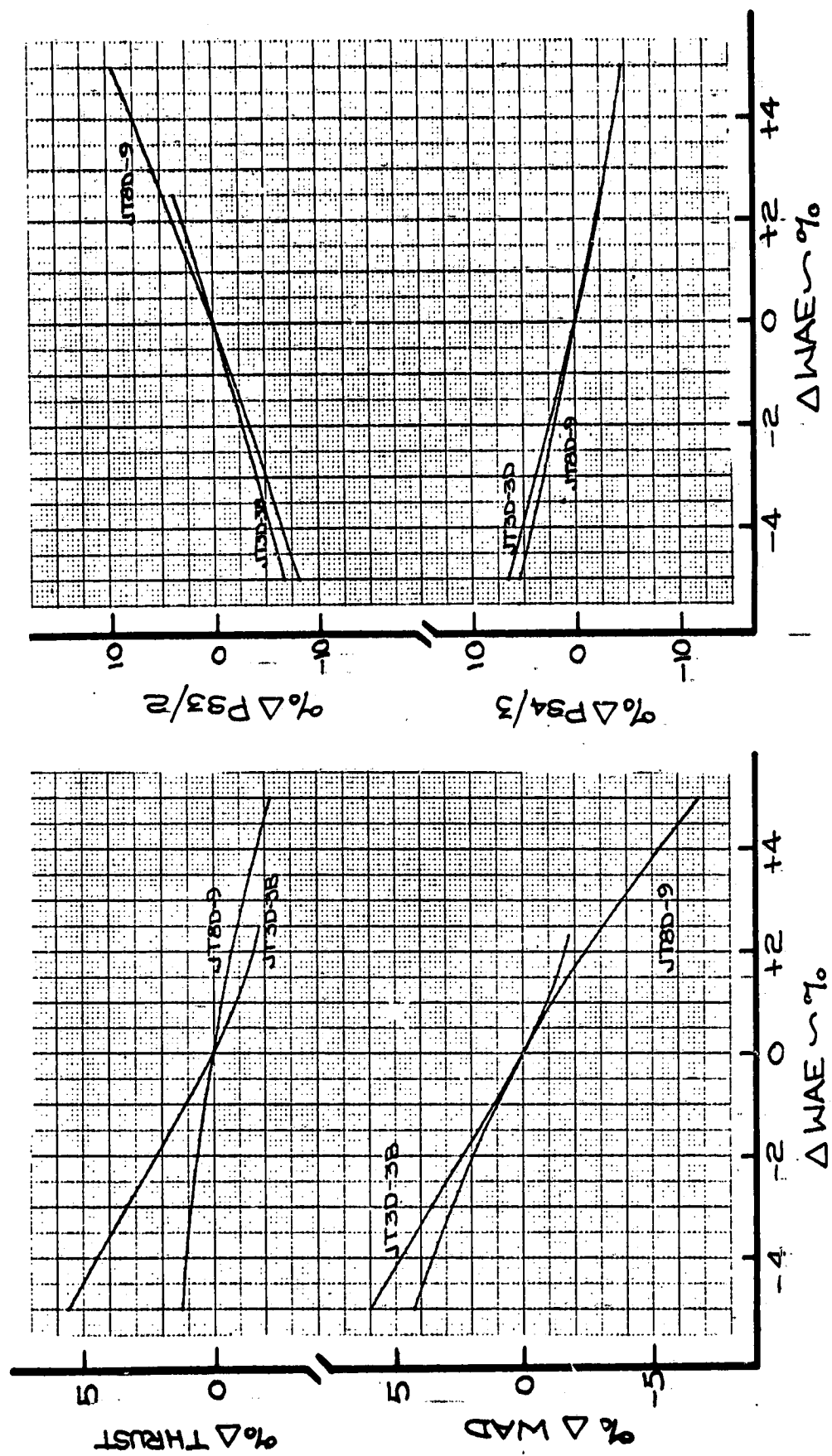
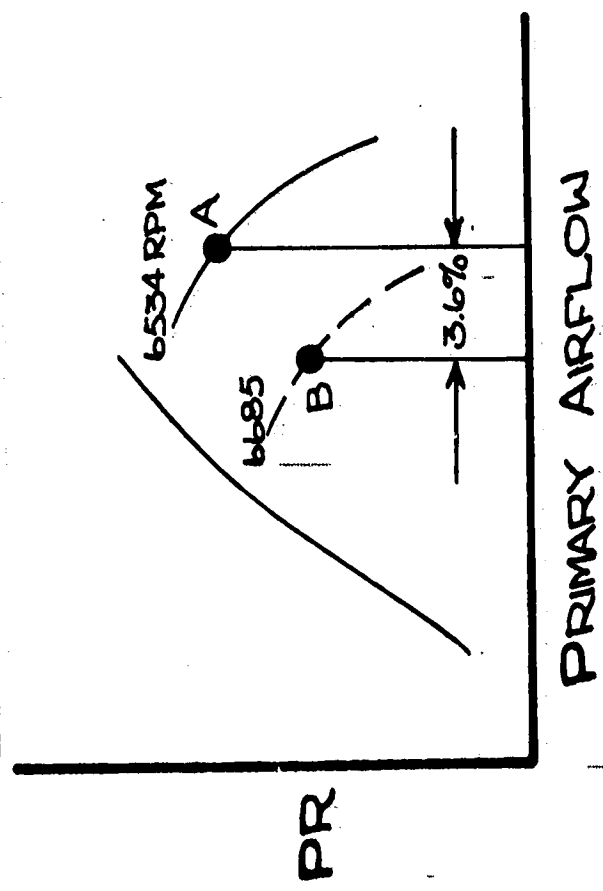




FIGURE 30. - FAN - LPC OPERATING POINT SHIFTS DUE TO LPC DETERIORATION. SEPARATE NOZZLE ENGINE (JT3D-3B) AT CONSTANT EPR

LOW COMPRESSOR



FAN

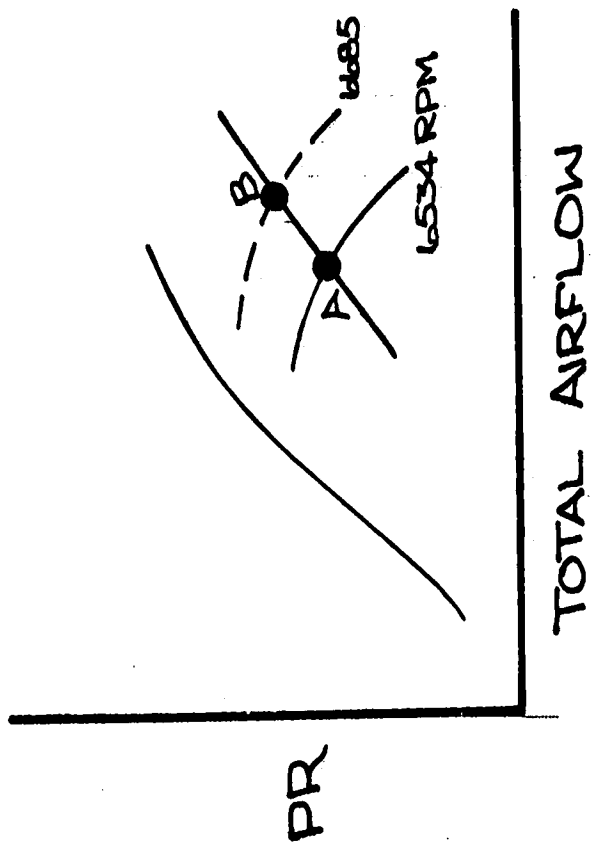
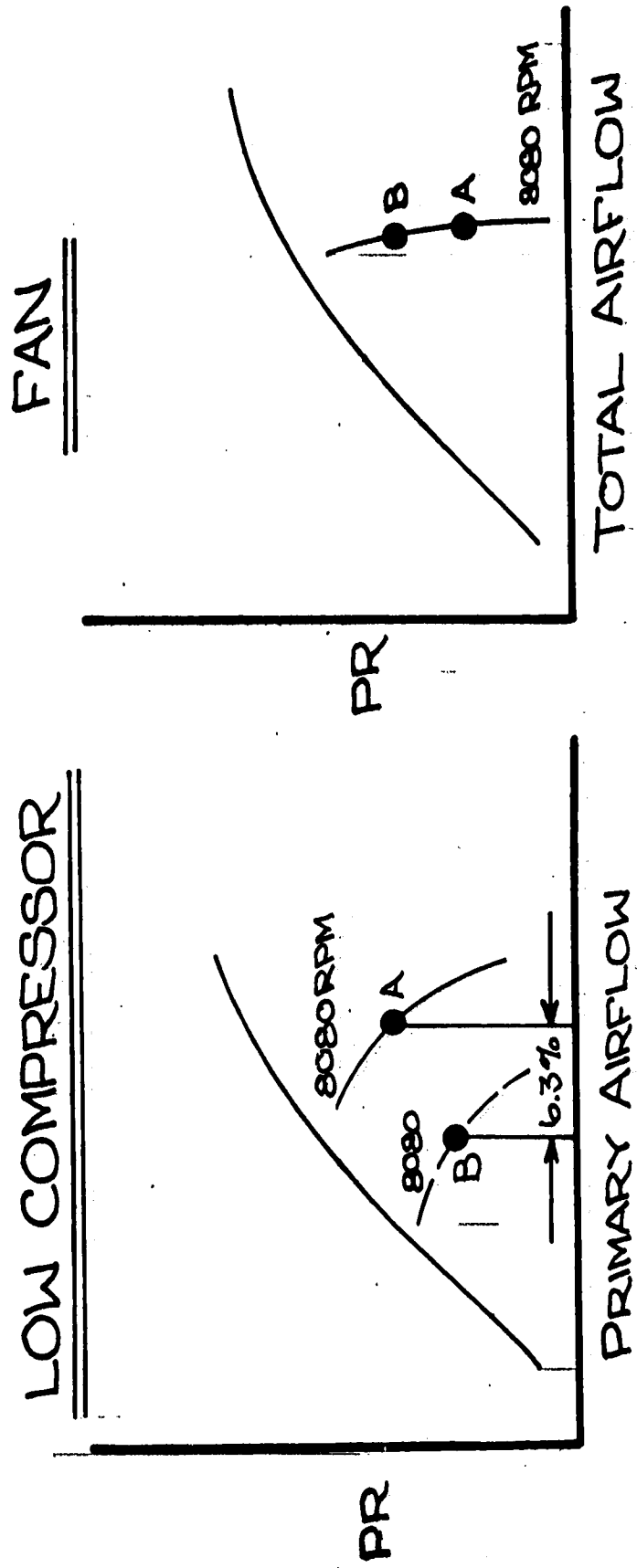


FIGURE 31. - FAN - LPC OPERATING POINT SHIFTS DUE TO LPC DETERIORATION. COMMON NOZZLE ENGINE (JT8D-9) AT CONSTANT EPR



ORIGINAL PAGE IS  
OF POOR QUALITY

FIGURE 32. - ENGINE TEST DATA FOR THE JT3D-3B AT STANDARD  
SEA LEVEL STATIC CONDITIONS AT TAKEOFF POWER

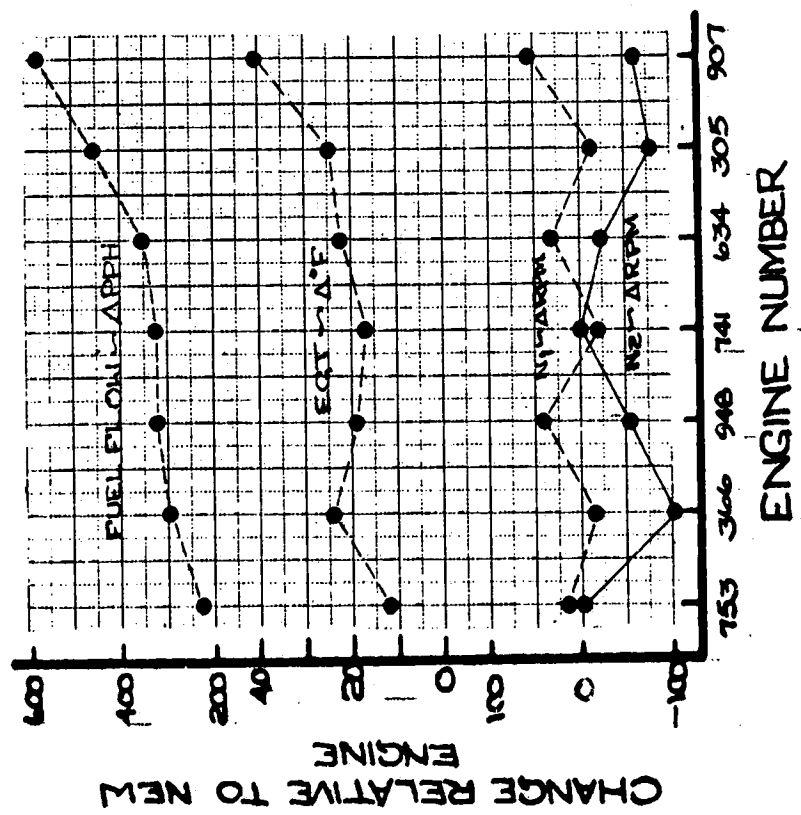
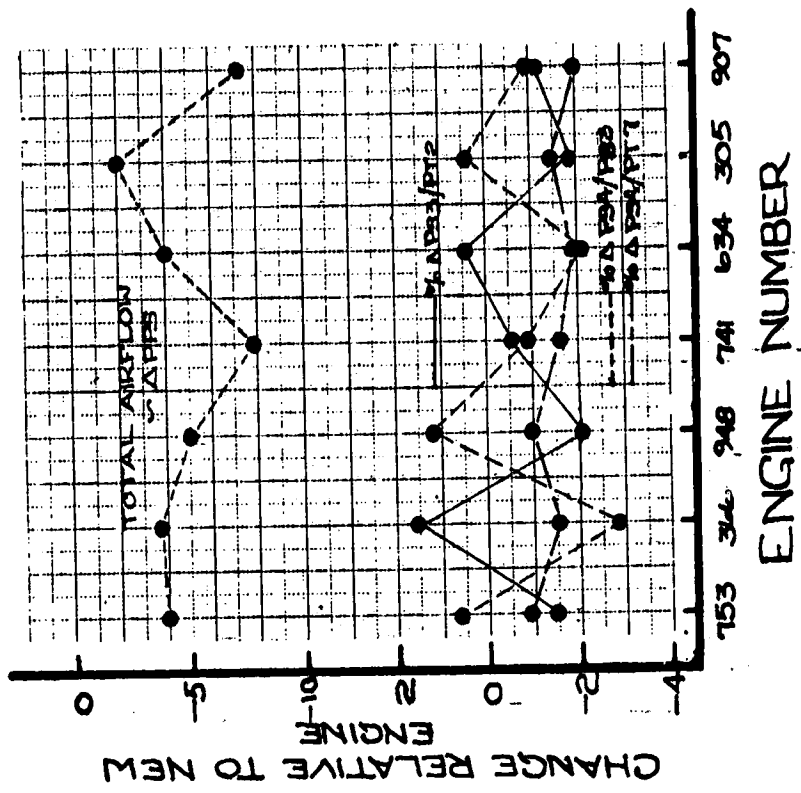


FIGURE 33. - ENGINE TEST DATA FOR THE JT8D-9 AT STANDARD SEA LEVEL STATIC CONDITIONS AT TAKEOFF POWER

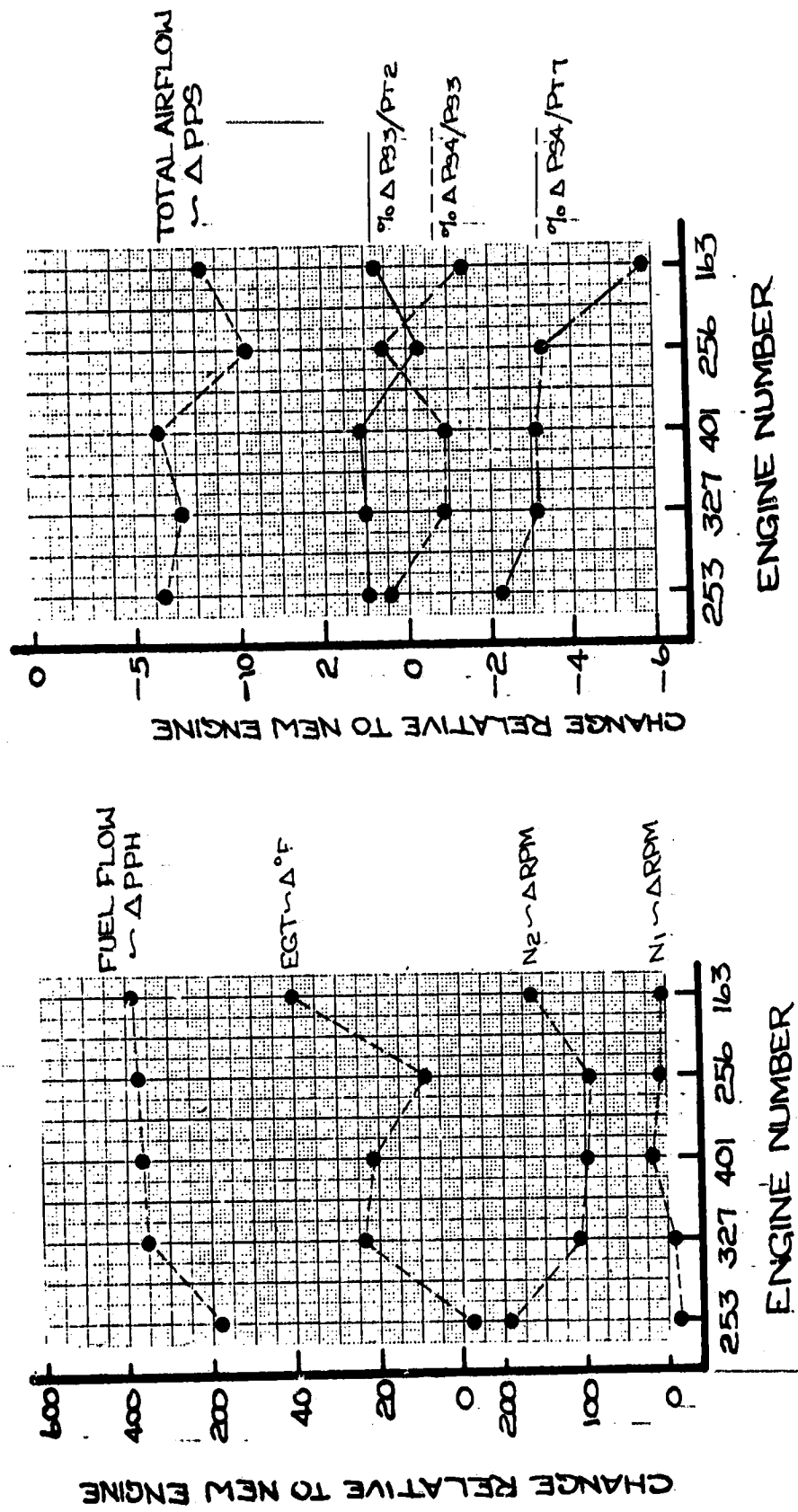


FIGURE 34. - COMPRESSOR DETERIORATION ON JT3D-3B ENGINE

MEASURED PARAMETERS\*

ENGINE PRESSURE RATIO	1.842
Δ THRUST ∼ LBS.	+ 78
Δ FUEL FLOW ∼ LBS/HR	+ 450
Δ % TSFC ∼ LBS/HR/LB	+ 4.4
Δ N <sub>1</sub> ∼ RPM	- 10
Δ N <sub>2</sub> ∼ RPM	- 75
Δ % Low Compressor Pressure Ratio	- 1.9
Δ % High Compressor Pressure Ratio	+ 0.4
Δ % Turbine Pressure Ratio	- 1.5
Δ TOTAL FLOW ∼ PPH	- 2
Δ CORE FLOW ∼ PPH	- 1

\* AT SEA LEVEL STATIC, STANDARD DAY

COMBINATIONS OF POSSIBLE CAUSES OF DETERIORATION

	①	②	③	④
FLOW CAPACITY LOSS				
FAN O.D.	0	0	0	0
FAN I.D.	1%	1%	0	7%
LPC	4%	4%	4%	1%
HPC	1/4%	1/2%	1/2%	1/2%
EFFICIENCY LOSS				
FAN O.D.	1%	1%	0	0
FAN I.D.	1%	1%	0	5%
LPC	3%	3%	5%	0
HPC	3 1/2%	2 1/2%	2 1/2%	2 1/2%

FIGURE 35. - COMPRESSOR DETERIORATION ON JT8D-9 ENGINE

MEASURED PARAMETERS\*

ENGINE PRESSURE RATIO	2.047
$\Delta$ THRUST $\sim$ LBS.	-124
$\Delta$ FUEL FLOW $\sim$ LBS/HR	+329
$\Delta$ % TSFC $\sim$ LBS/HR/LB	+4.9
$\Delta$ N <sub>1</sub> $\sim$ RPM	+83
$\Delta$ N <sub>2</sub> $\sim$ RPM	+129
$\Delta$ % LOW COMPRESSOR PRESSURE RATIO	+1.0
$\Delta$ % HIGH COMPRESSOR PRESSURE RATIO	-0.2
$\Delta$ % TURBINE PRESSURE RATIO	+0.8
$\Delta$ TOTAL FLOW $\sim$ PPH	+0.8

COMBINATIONS OF POSSIBLE CAUSES OF DETERIORATION

	①	②	③
FLOW CAPACITY LOSS			
FAN O.D.	3%	2%	2%
FAN I.D.	1%	0	0
LPC	2%	5%	5%
HPC	1%	14%	14%
EFFICIENCY LOSS			
FAN O.D.	4%	4%	2%
FAN I.D.	2%	0	0
LPC	5%	5%	7%
HPC	2%	2%	2%

\* AT SEA LEVEL STATIC, STANDARD DAY

FIGURE 36. - TURBINE DETERIORATION ON THE JT3D-3B AND JT8D-9 ENGINES. STANDARD SEA LEVEL STATIC CONDITION AT CONSTANT EPR.

	$\Delta W F \sim P P H$		$\Delta N I \sim R P M$	
	JT3D	JT8D	JT3D	JT8D
● 1% INCREASE IN:				
EFFECTIVE HPT AREA	+18	+17	0	-8
HPT EFFICIENCY LOSS	+39	+48	0	-17
1ST VANE FLOW	+5	+27	-2	-12
1ST DISK FRONT FLOW	+52	+65	-3	-21
1ST DISK REAR FLOW	+32	+48	-6	-18
		+146		-11
	SUB TOTAL			
EFFECTIVE LPT AREA	+31	+12	-12	-15
LPT EFFICIENCY LOSS	+83	+57	-28	-33
2ND DISK FRONT FLOW	+55	+68	-15	-29
4TH DISK REAR FLOW	+44	+27	-30	-36
● 10 MILS CLEARANCE INCREASE:				
1ST O.A.S.	+13	+30	+3	-9
2ND O.A.S.	+6	+7	-2	-5
3RD O.A.S.	+4	+11	-2	-3
4TH O.A.S.	+3	+11	-2	-3
TOTALS	+385	+428	-99	-209

- . increased the number of engine removals for high EGT and compressor stall.
- . increased the operating expense through increased trip fuel burn

Historical engine maintenance cost records strongly suggest that long term efforts to reduce the cost of engine repairs have resulted in decreased time between shop visit and long term increases in hourly operating costs. It seems reasonable to expect that careful investment in parts restoration or replacement over and above current levels can reverse not only fuel consumption performance trends but also removals associated with engine stall and excess EGT. These factors along with increased hot section parts lives should lead to improvement in engine premature removal rates and resulting reduction in shop volume. The economics associated with engine performance recovery should consider the investment in engine material replacement or restoration against the benefits of lower fuel consumption and increased time between engine shop visit for repair (yield). In this respect, there are few hard technical facts to use as proof. There is insufficient information available as to the impact of specific repairs or specific part replacements on overall engine performance. Secondly, the impact of increased depth of engine restoration on average engine time between repair (yield) can only be uncovered by analyzing years of engine repair cost data with knowledge of the trends in build standard, modification programs and maintenance program philosophies (i.e. overhaul to scheduled shop visit to condition monitored maintenance).—

The test program planned will provide answers to the effect of specific parts replacements and refurbishment on engine performance. It will obviously not provide the information needed to estimate incremental increase in time between overhaul/repair. These estimates will need to be based on analysis with "guesstimates" as to the relationship between engine performance and build standard improvement and TBO/yield. This proof of yield improvement will require several years to develop and until such proof is developed, the airlines will have to proceed on the basis of engineering judgement and faith that since new engines run longer, a better repaired engine will also run longer. It is American's experience that for both the JT8D and JT3D increased yield does result from modest increases in engine repair costs. Figure 37 shows this concept in graphic form. As the cost per repair is increased the time between repair increases. Obviously, there is a level where too little restoration is accomplished and also a level where too much material replacement is undertaken. The optimum, however, appears to be at a level that is higher than today's cost per repair which would result in lower engine maintenance cost per future operating hour.

In the American Airlines back-to-back testing of the JT8D, discussed earlier, a 1.9% reduction in TSFC was measured after replacement of the 8th, 9th and 10th stage compressor blades with new blades. The material cost, \$853, \$882 and \$787 per stage respectively, amounts to an investment of \$2522 dollars in new material. Average current new material



cost per average repair for these three stages is \$360. Additionally, current average blade repair maintenance cost is \$718. Both expenses were avoided thereby reducing the net additional cost to \$1444. Assuming an average cruise fuel burn of 500 gallons per engine hour and a 30 cent per gallon fuel price, then if the 1.9% TSFC improvement applied to the altitude cruise condition, it would produce the following result:

$$\text{Savings} = \text{Fuel Flow} \times \text{SFC} \times \$/\text{Gallon} = \$/\text{Hour}$$

$$\text{Savings} = 500 \times .019 \times \$.30 = \$2.85/\text{Hour}$$

The payback period for this investment is computed as follows:

$$\text{Payback Period} = \frac{\text{Investment } \$}{\text{Savings } \$/\text{Hour}}$$

$$\text{Payback Period} = \frac{\$1444}{2.85 \$/\text{Hour}} = 506 \text{ Hours}$$

The improvement in TSFC should last for some extended period of operating time. The knowledge of how rapidly compressor blades lose performance is sketchy and requires detailed analytical and experimental studies, however, their performance appears to deteriorate slowly for the first 5,000 flight cycles based on examination of high time compressor blading. A measurable improvement in overall operating costs is therefore obviously potentially available. Further, exhaust gas temperature was reduced by 8°F decreasing turbine inlet temperature by 12 to 13°F. This reduction would have an additional beneficial impact on hot section parts life.

The parts scrap rate information, discussed earlier, provides indication that there is non-uniformity in replacement rates in the various stages of the compressors. By readjusting blade and vane acceptance criteria, it should be possible to obtain a more uniform and somewhat more efficient compressor. Table XIX compares current maintenance costs to cost for an assumed 25,000 hour scrap life for blades and vanes in the low compressor and fan and 20,000 hour scrap life for high compressor parts of the JT3D-3B. If blade scrap rates of 100% scrap per 25,000 hours for LPC blades and vanes and 100% scrap per 20,000 hours for HP compressor blades and vanes can be substituted for current low scrap plus high repair procedures, the incremental material cost for gas generator compressor parts excluding fan would be increased by  $(1.322 - .598) + (1.169 - 1.159) = \$.734/\text{hour}$ . This amount of increased hourly cost would be supported by a reduction in JT3D-3B TSFC at cruise conditions, with 30 cent/gallon fuel, of 0.5% or less than 3 gallon per engine hour.

Table XX presents the same comparison for the JT8D. The incremental cost for the same policy would increase JT8D material costs by  $(0.514 - 0.337) + (1.575 - 1.747) = 0.005\$/\text{hour}$  or essentially zero increase in hourly operating cost. The replacement or repair of fan blades and stators under the same policy would raise operating costs from 0.72 to 1.005 dollars per operating hour. These changes in repair versus scrap

policy could lead to substantial recovery in performance. While these examples are only estimates of the change in material expense for putting more uniformity in compressor condition than currently in practice, the performance pay back in terms of reduced fuel consumption could be 1% or more. If fuel consumption performance improvement of only modest proportion is achieved, pay back would be quite rapid.

American Airlines consumes 1 billion gallons of fuel on an annual basis in its fleet of 707 and 727 aircraft. The average increase of fuel burn for all engines due to deterioration amounts to 4% over initial new engine average performance. The excess cost of this burn of 40 million gallons based on 11¢/gallon fuel is 4.4 million dollars; however, on 30¢/gallon fuel the excess cost is 12 million dollars annually. Some of the excess fuel consumption is due to factors associated with short term performance deterioration. The bulk is in losses occurring over the long term and believed to be erosion-dominated performance losses. The estimated performance losses accounted for in the compressor section is 60 to 70% of the total or 2.4 to 2.8%. The potential recoverable excess consumption is therefore between 24 and 28 million gallons per year. Performance recovery testing by AA on compressor repairs has demonstrated 1% on the Spey and 1.9% reduction in TSFC on the JT8D at modest cost. The unfortunate fact is that records were not maintained on the condition of the parts removed so the improvements may or may not be applicable to other engines of the same type. Nonetheless, there appears to have been sufficient, although limited, success in making SFC improvements to warrant further research into the TSFC effects of compressor blade and vane replacement and/or repairs to determine the most cost effective approach.

Current investment in JT8D maintenance costs amount to an average of fifty thousand dollars (\$50,000) per average shop visit of which \$25,000 is material. Doubling the average amount of gas path compressor material replacement would increase the per shop visit costs by roughly \$7,000. The increased repair activity in the compressor sections should lead to lower fuel consumption and to improved turbine inlet and exhaust gas temperature. These of themselves should reduce premature removal rates for both stall and high EGT.

During 1972 and 1973, 524 JT8Ds were repaired by AA. Of these, 130 were removed for high EGT and stall, with 28 removals coming at less than 1000 engine hours since last shop visit. Engine operating hours for this time period were 1,600,000. Average time between shop visits for the period was 3055 hours. If the 28 low time and half of the high time removals, 50, for high EGT or stall could have been avoided, then the average time between repairs could have increased to 3580 hours. If 524 engines were repaired at \$50,000 and ran 1,600,000 engine hours or 446 at \$57,000 ran the same hours the cost per engine hour is \$16.40 for the first case and \$15.90 for the second case. The net reduction of \$0.50 per hour is worth \$800,000 in savings exclusive of any savings in reduced fuel burn. If a 1% savings in cruise TSFC had been achieved

by the increased compressor activity, the savings of fuel would have amounted to 8.6 million gallons for the two year period. The inclusion of increased yield from work on engine performance recovery is an intimate part of performance recovery economics.

The assessment of cost effectiveness would be based on a Performance Improvement Tradeoff Factor which is defined as follows:

$$\text{P.I.T. Factor} = W_f \times \Delta \text{SFC} \times \$/\text{Gallon} \times K - \frac{\text{Incremental Cost}}{\text{P.L.} \times \text{Flt. Hr./Cycle}}$$

Where:  $W_f$  is current engine fuel flow at cruise conditions in gallons/hour

. $\Delta$ SFC is the improvement in cruise thrust specific fuel consumption

.\$/gallon is anticipated or actual fuel cost

.K is the impact of SFC improvement on fuel consumed to carry fuel

.Incremental cost is the additional expense arising from the introduction of new material or more completely repaired material over and above standard airline repair expense level for the items repaired or replaced

.P.L. - estimated average flight cyclic life at new part performance

.Flt/Hours/Cycle - is the average flight hours of the aircraft per flight

The P.I.T. factor for the JT8D compressor parts replacement example would be calculated as follows:

$$\text{P.I.T.} = 550 \times .019 \times .30 \times 1.10 - \frac{1444}{*5000 \times 1.2}$$

$$= 3.14 - .24 = 2.90$$

$$= 2.90 \text{ \$/Hr net decrease in operating cost}$$

\*5000 flight cycles is AA estimate of compressor blade cyclic life before pronounced effects of erosion are present.

Any positive number is an overall operating cost savings.

Any negative is a loss in dollars per engine operating hour.

Figure 37. Hypothetical Trend of Achievable Cost Per Operating Hour

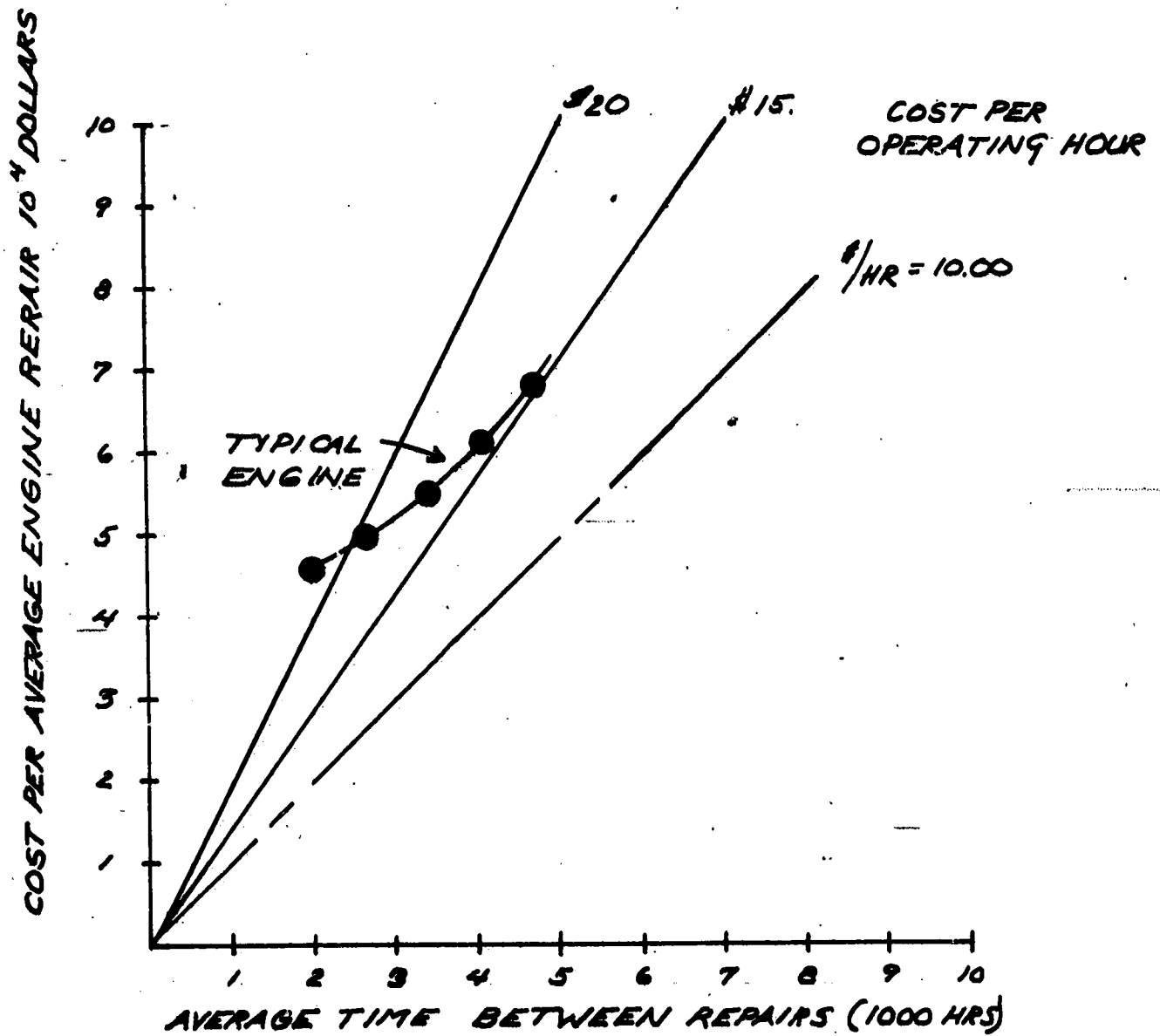


Table XIX - Current Maintenance Cost Vs.  
Fixed Scrap Rate Cost for  
JT3D-3B

	Current Expense 1974 \$/Hr		\$/Hr of 100% New Material @25,000 hours.
	<u>Mat'l</u>	<u>Mat'l + Repair*</u>	
Fan			
Blades	0.022	0.226	1.053**
Vanes	<u>0.010</u>	<u>0.010</u>	<u>0.365</u>
	0.032	0.236	1.418
LPC			
Blades	0.270	0.389	0.459
Vanes	<u>0.034</u>	<u>0.209</u>	<u>0.863</u>
	.304	.598	1.322
HPC			@20,000 hours
Blades	0.233	0.793	0.306
Vanes	<u>0.169</u>	<u>0.362</u>	<u>0.863</u>
	0.402	1.159	1.169

\*Repairs costs are adjusted to a 1974 fully allocated labor cost of \$23.94/hr.

\*\*Fan Blade Restoration by Electron Beam Weld replacement of Leading Edge 100% blades every 25000 hours = 0.295 \$/hr.

Table XX. - Current Maintenance Cost Vs.  
Fixed Scrap Rate Costs for  
JT8D-9

	Current Expense 1974 \$/Hr		\$/Hr of 100% New Material @25000 Hours
	<u>Mat'l</u>	<u>Mat'l + Repair*</u>	
Fan			
Blades	0.100	0.312	0.584
Vanes	<u>.063</u>	<u>.209</u>	<u>.421</u>
	0.163	.521	1.005
Low Pressure Compressor			
Blades	0.155	0.216	0.207
Vanes	<u>0.047</u>	<u>0.121</u>	<u>0.307</u>
	0.202	0.337	0.514
High Pressure Compressor			@20000 Hours
Blades	0.346	0.844	0.377
Vanes	<u>0.211</u>	<u>.903</u>	<u>1.198</u>
	0.557	1.747	1.575

\*Repair costs are adjusted to a 1974 fully allocated labor cost of \$23.94/hr.

\*\*Fan Blade Restoration by Electron Beam Weld replacement of Leading Edge per 25000 hours = 0.304 \$/hr.

## Impact of Study Results on Advanced Engines and Technology Research Planning

Pressures to conserve fuel almost automatically suggest that engines of improved cycle efficiency be developed and that they will be economically beneficial to the airlines. The results of this study and the trends in engine fuel consumption with time from the newer, more efficient high bypass engines suggest that the practical reality of achieving real improvements in engine specific fuel consumption are probably more restricted than anyone would desire to believe. The common result of studies concerning more energy efficient engines is that tighter clearance control, higher overall cycle pressure ratio and higher turbine inlet temperature will be needed to significantly reduce engine fuel consumption. These studies, however, tacitly assume that the performance thus achieved will last and such is not the case based on current airline experience.

Figure 1 from an earlier section of this report shows the trend in engine fuel consumption versus service time for a representative high bypass ratio engine. Theoretical studies providing increased component efficiencies for tighter clearance control must be considered unreal in the light of current inability to retain such clearances past the first few hours of operation. Visual comparison of new advanced compressor blading versus older styles, gives little confidence that the problems of changing performance with erosion are being addressed. The newer blading is characterized with thinner and sharper leading and trailing edges and more highly twisted shapes. Further, the gas turning tends to be introduced in the last few percent of the chord. The visible erosion damage sustained by current blading suggests that these are the areas that suffer from erosion attack. Higher temperature turbine blading will of necessity be coated to prevent sulfidation/oxidation. The life of these coatings today are completely unsatisfactory and are dictating the short life of current turbine blading. The increase in operating costs for even more advanced blades without longer life coatings would probably be prohibitive.

The engine economic studies completed previously and reported under NASA CR 134645 cover the maintenance cost of current and advanced propulsion systems where performance is allowed to deteriorate with time. The cost to maintain even higher performance engines will, of necessity, be higher than predicted by this report if an effort is made to hold the fuel consumption to a level reasonably close to the initial production standards. The magnitude of these costs cannot be estimated due to a lack of success in recovering the lost performance in current engines. Further, the complete lack of data on the cause, effect and time relationships that are inherent in current engine performance deterioration make projections suspect. Only engineering estimates as the probable causes for deterioration based on analytical study are available.

All of the above suggest the need for additional technology efforts into understanding the mechanisms of erosion and means of preventing, retarding or recovering blading performance from the results of erosive attack. The technology approaches recommended are:

- 1) Coatings for protection of compressor and turbine parts
- 2) Airfoil shapes and their sensitivity to erosion with the emphasis on developing new designs which are less sensitive to such attack or can be reshaped after attack to recover their full performance potential
- 3) Dimensional clearance control problem under rapid thermal transient conditions and aircraft imposed loading (what happens to the clearances during an aircraft hard landing and engine thrust reverser operation?)
- 4) Advanced blade tip sealing techniques which permit running at realistic and maintainable clearances while reducing the losses inherent with such sealing philosophies.

Advanced engines with improved thermal efficiency are obviously needed in the face of the energy availability and cost forecasts. Research on higher pressure ratio and temperature engines will be required to achieve these objectives. Such research activities must not focus on higher pressure ratio compressors and higher temperature turbine technologies, but must cover the broader scope recommended if they are to be fruitful. From an airline point of view, smart technology planning will address the whole apple and not just the obvious objective.

The JT8D test program recommended herein is a first and necessary type of test to establish the fundamental beginnings of our understanding into the cause and effect relationships needed for advanced studies. The results will be beneficial to the airlines in attempting to reduce the fuel consumption of current engines. This impact is, however, incidental to the long term projected technology research needs to permit the development of more realistic energy efficient engines for the future.

#### PROPOSED TEST PROGRAM

General Considerations - Based upon the data previously presented, the conclusion reached was that 60 to 70 percent of long term engine performance deterioration occurs in the fan-compressor systems of the JT3D and JT8D engines. The airfoil sections of fan and compressor blades and vanes in every engine experience the same basic problems of blade erosion and foreign object damage but to varying degrees.

In general, the high time engines experience the severest blade erosion and foreign object damage. Based upon this, an engine with an excess of 3000 hours (time removal) on the cold section should be selected for testing. In addition, engine fuel flow should have increased above the new engine baseline by approximately 3.5 percent after repair. It is anticipated that the above criteria will assure that a typical degraded engine will be selected. A thorough examination will be conducted on the engine to assure that the performance degradation is due to gradual part deterioration and not to an undetected fault or engine component problem.



Neither the JT3D nor JT8D engines have bosses in the cases which will permit the installation of gas path instrumentation in the compressor or fan areas. While such instrumentation has been installed in experimental and development engines, special cases were normally used and the bosses were removed for the production design to reduce cost, avoid cracking problems and simplify manufacture. In order to achieve the objectives of the proposed Test Program, additional instrumentation relative to the typical service engine instrumentation is essential. There are three reasons for proposing this instrumentation. First, component or module efficiency determinations are necessary to pinpoint the effect of planned changes in engine parts both new and repaired. Secondly, loss of core airflow is a prime suspect and additional instrumentation will be required to accurately determine the changes in core airflow. Thirdly, to achieve a high degree of confidence in TSFC improvements demonstrated they must be identified to the changes in module efficiencies and flow capacities. Higher confidence levels will result from the addition of engine instrumentation capable of breakdown into component performance.

While stage by stage instrumentation throughout the engine would extend our ability to ascertain precise causes of deterioration within the engine, such is not recommended. Stage pressure and temperature instrumentation would be likely to obscure performance changes by disturbing gas passages more than that caused by deteriorated hardware.

In addition, increased program costs and time would have to be expected with the more complex instrumentation setup. The additional program costs and time are believed to outweigh the potential improvement in understanding achievable by this course of action. This type of instrumentation is most applicable to a rig program which could conceivably be required to define more precisely the source of deterioration uncovered in the planned tests.

The probable sources of the major portion of the long term deterioration of engine specific fuel consumption have been isolated to the loss of airflow and efficiency in the fan and compressor elements of the engine. The factors that have led to this condition have been previously discussed and the test program listed below has as its objective the recovery of airflow both total and specifically core airflow as the first priority. Secondly, the recovery of fan and compressor efficiency which are intimately related in the loss of airflow capacity of the low and high compressor units is the next priority. With these conclusions, repair actions addressed at recovery of airflow will undoubtedly bring about an improvement in overall compressor and fan efficiency. Both fan and compressor foreign object damage are intimately related to the loss of efficiency and airflow as the recovery of the damaged blades by blending and the standards associated with those repairs have not taken into account the impact of overall efficiency on airflow. The repair of one blade in a rotor set would have insignificant impact. However, the passage of time sees larger and larger numbers of repaired blades in a rotor yielding the slow deterioration in specific fuel consumption. The construction of engines makes the strip and repair process of low

compressors quite costly. As a consequence, blade and vane restoration activity tends to be centered on disk life change out time periods. The more difficult a particular stage is to arrive at in the disassembly process, the more chance there is that less restoration will be undertaken unless serious damage is uncovered in the inspection process. The other fundamental cause of long term deterioration is the gradual effects of erosion on the leading and trailing edges of fan, compressor blades and vanes. Leading edge erosion which produces bluntness of the leading edges and particularly the outer or tip portions of the blades cause localized reduction in flow capacity due to reduction in the flow passage area and an associated loss in efficiency due to larger boundary layer losses.

The exact percentage of airflow loss with blade tip erosion is unknown and can only be estimated at this time. Insufficient records have been maintained to determine the rate at which the erosion and resulting losses have occurred and therefore, theory has been utilized as a first cut approximation in determining suggested blade and vane repair and/or replacement rates. From the previous discussion of blade and vane scrapage rates, repair cycles, and extent of repairs, it is obvious that such activity has not been uniform throughout the compressors. It is possible that other airlines deviate from this position somewhat, however, uniformity in repair and/or replacement of intervals for hardware is essential. Other airlines were contacted regarding their overhaul policies and only minor deviation from American Airlines procedure was noted. It is probable that vane assemblies will retain their performance for longer periods of time prior to replacement than blading and that the material of the blades and vanes has a large impact on the rate at which erosion reduces the leading and/or trailing edge shape to the critical point where significant flow loss and efficiency losses occur.

The relative importance of the various aerodynamic characteristics, i.e. tip clearance, blade chord width, leading edge shape, trailing edge angle, etc., varies between the fan, low and high compressors. Blunting of the leading edges of the outer, supersonic portion of the fan blades affect the airflow and efficiency by up to 3 percent -- there being a roughly uniform reduction in both efficiency and airflow. The front stages of the low compressor establishes the airflow for the core of the engine at high power, i.e., cruise, climb and takeoff. The center and rear stages of the low compressor are more important from a low power airflow and altitude deceleration stall point of view. Once the airflow has been essentially captured by the early stages of the low compressor, the first stages of the high compressor are equally important in extracting the flow from the low compressor and assuring that the low compressor operating line is in the proper position. These rear stages of the high compressor are important in assuring proper low power acceleration stall margins. Rear blade tip clearances in the high compressor are most important for compressor efficiency of the high compressor unit, combustor inlet profile and influences on turbine inlet temperature profile. Stator outlet vane angle is more important than leading edge condition as it establishes the angle of attack on

C-2

the blade rows and variations in the stator exit angle can reduce blade life due to induced cyclic loading of the following blade row. Localized trailing edge variation occurs as the result of damage, poor assembly technique during revane operation or trailing edge blending due to foreign object damage. Severe local distortion can lead to the development of severe rotating stall and loss of flow capacity. Adequate tooling for checking stator vane trailing edge angles unfortunately does not exist. To repeat, the condition of the first few stages in any rotor assembly are the most important from an airflow standpoint and the loss of core airflow has a large impact on overall fuel consumption and exhaust gas temperature.

Test Configurations - A series of engine tests will be conducted utilizing various engine hardware configurations. All configuration changes will be physically accomplished by American Airlines at their Tulsa Maintenance Center. The first group of tests would be focused on fan (total) airflow and efficiency. The mechanical condition of fan blades and vanes with respect to new blades and vanes show variations from root to tip and between stages. The first blade receives more repair than the second blade due to the more serious nature of foreign object damage and the tips more than the roots. Both stages of the fan will be treated uniformly even though such has not been the practice in service.

To understand the cause and effect relationships between mechanical condition and performance, a series of four tests will be undertaken. Run number one should be with average current condition fan blades and stator vanes. Run number two should be with all new hardware. Run number three should be with reworked fan blades and repaired/revaned stator vanes. Run number four will address repaired blades and old stator vanes. Additional testing of new first blade and vane and old second blade and vane could be contemplated to complete the matrix. The mechanical condition of each set of blades and vanes tested will be thoroughly documented.

Analytical core airflow analyses combined with part condition and part scrap rate studies suggest that the loss of core airflow is probable and therefore an effective target for performance recovery. The primary objective for the next group of test configurations will address recovery of core airflow and low compressor efficiency.

Four specific configurations will be tested. The first test will be run with current typical condition blades and vanes. The second in the series with all new blades and vanes. The third test of the series with repaired blades and original stator vanes. Additional testing of new blades and original stator vanes will complete the matrix. The mechanical condition of the parts tested will be extensively documented as will the clearance of all seals and blade rows.

Past performance recovery testing suggests that replacement of early high compressor blades is an effective means of performance recovery. The increased sensitivity of overall engine performance to high

compressor flow and efficiency suggest that the high compressor be divided into two halves. Again, uniform treatment of both stator vanes and blades will be done even though such is not common in airline service.

The first test in the series will be with baseline average hardware. The second with all new compressor hardware in both halves. The third test with all new blades and vanes in the front half and original hardware in the back half. A fourth and fifth test, repaired blades and vanes in all stages; and repaired blades in the front half original blades in rear half of the compressor, will be undertaken.

The test conditions and parts documentation requirements will be identical to those discussed previously. Of particular interest is the impact of Reynold Number effects on the performance of the various compressor configurations. It is anticipated that the sensitivity of compressor performance to overall blade and vane condition will be more pronounced at cruise flight conditions and that sea level testing alone would not show the full potential savings in fuel consumption. Off idle stall testing will also be undertaken during this series to determine the impact of the condition of rear compressor stages on off idle stall margin.

The compatibility of the various configurations of fan, low compressor and high compressor to each other is of real concern to the airlines. It is probable that certain of the configurations suggested are more cost effective than others. As a hypothetical example, the rework of the early stages of the low compressor may reduce fuel consumption but equally they may reduce the stall margin of the low compressor to an unacceptable level because of high compressor performance losses. The test program will also be directed at ensuring that compatibility can be maintained. The various configurations to be tested above will be tested independently and in different sequences. The most logical approach is to use two engines and start from the low compressor on one leaving the fan and high compressor in the as is condition. The second engine test program should start with the high compressor and leave the low compressor and fan in as is condition.

Somewhere in the course of the testing it would be desirable to include an upgraded low turbine to determine the effect of seal clearance on overall fuel consumption performance. The configuration to be tested would be minimum tip-seal and rotor seal clearances with existing blading, and to class all low turbine nozzle areas without changing the parts or their location in the assembly.

Sequence of Testing - Two engines will be utilized during the test program. The proposed sequence for the various test configurations is presented in Table XXI and discussed in the following paragraphs.

### Engine #1

A high time engine will be selected which has been removed or will be removed for life limited disk change out. Prior to the testing, an inspection will be made to ensure that no serious mechanical condition exists that would jeopardize the completion of the test series or be an obvious source of performance loss. The engine will be run on a sea level test cell at American Airlines to determine the performance of the engine relative to when it was last repaired in the shop. The engine will be water washed and retested to determine the increment in performance associated with the water wash and will be subjected to standard American Airlines stall testing. The engine will then enter the typical American Airlines repair cycle and selected nominal hardware will be installed to bring the engine to a representative condition. The additional instrumentation required will also be installed at this time. A steady state calibration run will follow. The engine will then be shipped to NASA-LeRC for baseline tests.

The engine will be returned to American Airlines after the baseline tests and all new low and high compressor hardware (blades and vanes) will be installed. A ten (10) point run will be conducted before shipment of the engine to NASA. A complete series of runs will be made at NASA. A series of stall tests will be run to determine if there has been any significant change in the sea level acceleration or altitude deceleration stall characteristics.

The next configuration change will consist of new stage 7th through 9th blades and vanes. The other new hardware (low compressor and stage #10 through #13) will be replaced with the initial build hardware. The following configuration will have new compressor blades and vanes installed in stage 10 through 13. The engine will then have a new high compressor with a standard build low compressor and fan. The engine will be run at American Airlines before shipment to NASA where a full test series will be conducted.

The fan/low compressor series will then be initiated with the installation of new blades and vanes in stage 3 through 6. The only baseline hardware left in the front end of the engine at this time will be the fan stages 1 and 2. For this phase of testing, the first and second stage fan blades will be changed on the engine while it is installed in the test cell at NASA. At this stage the engine will have a new fan, low and high compressor and results should match those previously obtained during tests of engine #1, configuration B (see Table XXI).

In conjunction with the fan testing a new upgrade low pressure turbine module could be installed and run to see what impact it had on fuel consumption and exhaust gas temperature level. The low turbine area was selected for testing because it does not receive the attention that the high turbine receives during repair. Low turbine efficiency lost shows up as a decrease in low turbine work which could also result in lower total airflow through the engine.

The compressor test series outlined above is an attempt to locate the most probable area of performance degradation. The test results can, and will, vary from engine to engine because of the interaction of one stage upon another. To be meaningful, repeatability of test results between two engines thus becomes important. Efficiency and airflow measurements are the most important feature of this series as they impact fuel consumption and exhaust gas temperature.

#### Engine #2

A similar test program will be conducted on a second engine. After the baseline run at NASA, the engine will be modified by American Airlines to an all new blade configuration (stages 1 through 13). The subsequent testing will involve configurations with repaired blades and original (baseline) vanes. The same areas of the compressors will be evaluated but the order will be different as shown in Table XXI. The order of testing was reversed purposely to test the high compressor on one engine while testing the low compressor on the other. This should allow an early evaluation of the most probable area of performance degradation and would permit some revision to the testing if required. In general, the test plan should adhere to the guidelines shown on Table XXI.

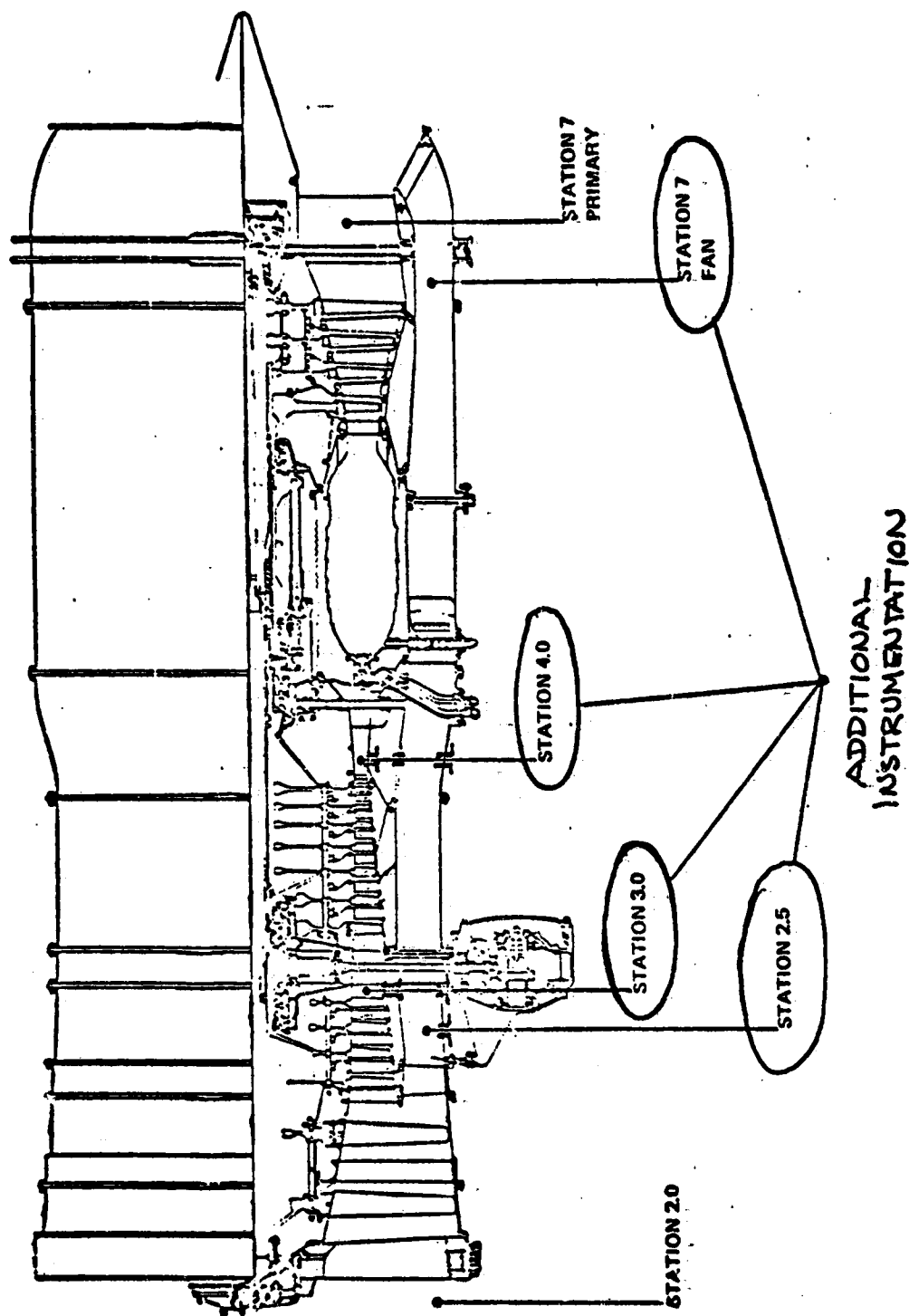
Proposed Instrumentation - The proposed instrumentation of pressure and temperature probes at engine stations 2, 2.5, 3, 4, and 7 is shown in Figure 38. Production engines have provisions for only static pressures at stations 3 and 4, and total temperature and pressures at station 7. The installation of the additional instrumentation is highly recommended. This instrumentation is similar to that used in JT8D experimental/development engines, thus, the basic design of the necessary probes and probe bosses is currently available. A list of the recommended pressure and temperature probe quantities by station is provided in Table XXII.

Some additional design and fabrication work is necessary to make the design suitable for flight weight cases. The low compressor fan case, diffuser fan case, intermediate case, diffuser case and fan exhaust case of two JT8D-9 flight engines will need to be modified to accept the recommended instrumentation probes. The low compressor fan case bosses will have to be redesigned since the experimental cases have integral bosses. A riveted on boss design is recommended to permit the American Airlines flight engine cases to be reoperated. The probe bosses for low compressor and diffuser fan cases will be riveted to the flight cases. All other bosses will be welded to their respective cases. The probe bosses should be designed and fabricated by P&WA for delivery to and installation by AA on flight cases. These reoperated cases may not be flight worthy. Investigations into means for recovery of the modified cases to permit continued use would be planned. The lead time necessary to redesign the low compressor fan case is six (6) weeks. The present lead time for procurement of bosses is twelve (12) weeks and for the probes is twenty (20) to twenty-four (24) weeks.

Table XXI. Proposed JT8D-9 Performance Restoration Program Summary

<u>Engine #1</u>	<u>Engine #2</u>
A. Base-line Run	A. Base-line Run
B. New Compressor Hardware (Blades & Vanes) (N1 & N2)	B. New Compressor Hardware (Blades Only) (N1 & N2)
C. New Stages 7 thru 9 (Blades & Vanes; Base-line Hardware for other stages)	C. Reworked Stages 3 thru 6 (Reworked Blades) (Base-line Hardware) (Other Stages)
D. New Stage 10 thru 13 (Blades & Vanes) (Base-line Hardware) (In Stage 1 thru 6)	D. Reworked Stage 1 thru 2 (Reworked Blades) (Base-line Hardware) (Stage 7 thru 13)
<u>Stop Point (Evaluation)</u>	<u>Stop Point (Evaluation)</u>
E. New Stage 3 thru 6 (Blades & Vanes) (Base-line Hardware) (In Stage 1 & 2)	E. Reworked Stage 7 thru 9 (Reworked Blades)
F. New Stage 1 thru 2 (Blades & Vanes) (All Engine Hardware)	<u>Stop Point (Evaluation)</u>
	Option
	:Reworked Stage 10 thru 13 (Reworked Blades)
	OR
	:Low Turbine, New Parts (New Hardware)

Figure 38. - Proposed Instrumentation Locations



ORIGINAL PAGE IS  
OF POOR QUALITY



Table XXII. Proposed Instrumentation

1. Station 2.0 - Six (6) pitot static probes located at various circumferential locations in the instrument ring which is secured to the engine inlet case. These probes will supply engine inlet total and differential pressures.
2. Station 2.5 - Fan Discharge Pressure and Temperature
  - a) Four (4) total pressure rakes consisting of five probes each.
  - b) Sixteen (16) temperature probes consisting of one T/C each, redesigned with long calibrated lead thermocouple wire.
3. Station 3.0 - Low Pressure Compressor Discharge Pressure and Temperature
  - a) Four (4) total pressure rakes consisting of five probes each.
  - b) Four (4) temperature rakes consisting of five T/C's each, with long calibrated lead thermocouple wire.
4. Station 4.0 - High Pressure Compressor Discharge Pressure and Temperature (May be feasible to use quiet engine instrumentation with mounting spacer.)
  - a) Two (2) total pressure probes consisting of 4 probes each.
  - b) Two (2) total temperature probes consisting of 4 T/C's each. Lead wire should be matched to probe T/C wire.
5. Station 7 - Turbine Discharge Pressure and Temperature
  - a) Six (6) total pressure probes, manifolded together to provide an average primary exhaust total pressure.
  - b) Eight (8) standard temperature probes measuring primary exhaust gas temperature which can be read individually or as an average of all eight.
6. Station 7F - Fan Discharge Pressure
  - a) Six (6) total pressure probes, manifolded together to provide an average fan total exhaust pressure.

There has been great interest expressed in obtaining station 2.4 (core inlet) instrumentation for the proposed program in that it would be helpful in defining the performance effect of fan blade changes. In the past, experimental engines have been instrumented with 2.4 leading edge sensors. However, these engines have utilized stainless steel vanes which allowed for sensor attachment and intricate sensor lead routing necessitated sensor lead cutting on each engine disassembly.

The best instrumentation for station 2.4 are still leading edge sensors. However, proposed test program schedules and cost considerations make this method a poor candidate for the intended program for the following reasons:—

- . Sensor attachment to aluminum vanes will result in poor sensor durability due to aluminum attachment problems with risk of engine damage.
- . Sensor routing problems will result in total sensor replacement during each engine disassembly.
- . The fixed sensors will not tolerate planned water washes for reasons of sensor accuracy and durability.

A replaceable probe appears to have the best potential for meeting the program desires. The probe concept presented in Figure 39 is similar to a leading edge installation. The probe is externally flange mounted at the outer diameter case with a crossover tube (housing the sensor leads) extending through the fan duct to a dummy splitter nose. At the dummy splitter, the station 2.4 probe is attached. The probe is shaped somewhat similar to a vane leading edge and is physically supported to the existing vane and/or modified vane in the effort to reduce aerodynamic blockage and probe diameter for structural considerations. The probe tip should extend through the inner diameter wall for added structural strength. Advantages of this design:

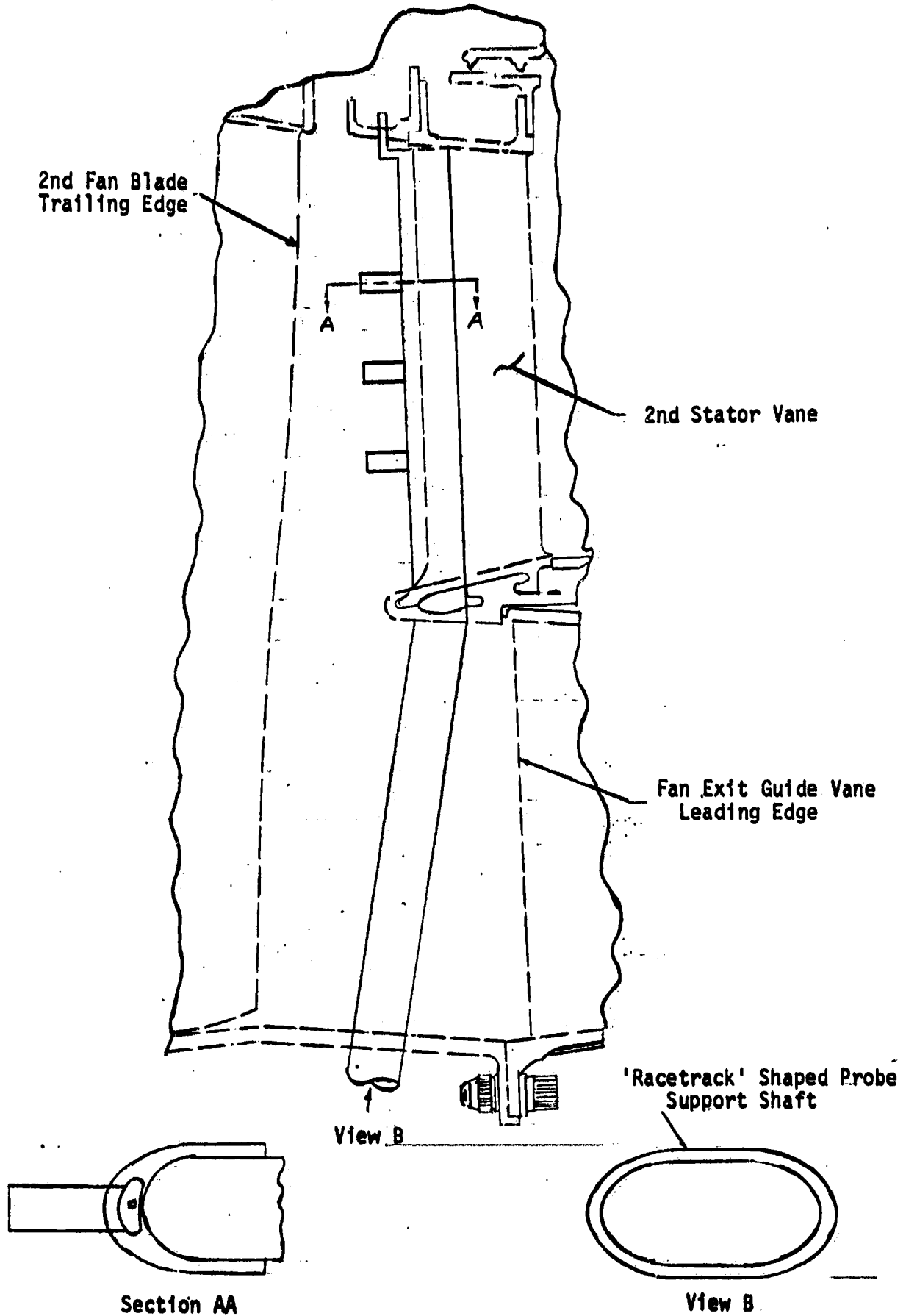
- . It is replaceable.
- . It produces minimal probe blockage.
- . Increased instrumentation precision (same probe for back-to-back tests).

Disadvantages of this design:

- . Engine hardware modifications will make the parts unusable for flight use and increase program costs.
- . The probe concept is expensive to develop.

The installation of this type of replaceable probe would require the following design considerations:

Figure 39. - Station 2.4 Probe Configuration



- . Particle flowpath map to define upstream wakes, distortions
- . Detailed vibration analysis studies

To complete the design would take three (3) months for both total pressure and temperature probes and approximately five (5) months to procure the probes. In addition, prior to releasing this probe design an engine test program would be needed to determine the effect of the probes on 3rd compressor blade stress. This engine testing would require a minimum of three (3) months to complete. Based on these considerations, installation of 2.4 instrumentation is not recommended for the proposed program. It is believed that planned measurements at stations 2, 3, and 4 will provide sufficient indications of fan root performance for the planned test program.

Data Validity - Positive recommendations to the airlines concerning performance improvements achieved by engine hardware changes are contemplated on the basis of the planned back-to-back testing. To fulfill the intended purpose, the precision of the measured parameters that go into performance calculations must be defined in order to avoid the risk of saying that a change is real when it has only happened by chance.

To meet this objective, there should be 95% confidence that TSFC changes on the order of +0.5% or less are due to a hardware change rather than chance. To be assured of this and have confidence in other calculated gas generator changes, a high level of precision should be maintained for the duration of the test period.

Discussions with NASA concerning the NASA data system hardware and operational techniques to be used, indicate that a high degree of precision is obtainable from the instrumentation system. However, there was little accuracy documentation available and the precision of the system was not known.

A recommended calibration test plan will be developed in concert with NASA to perform the desired analysis of the test data and determine the precision of the data system. Much of the work would be done prior to engine running but calibration data should be acquired during the first series of engine runs with no hardware changes to ensure that no problems peculiar to running exist.

The parameter precisions determined from the tests would be used in performance calculation and supplied to the performance analysis and compressor design specialists in order to assist them assessing hardware changes.

In order to ensure that the data acquisition system continues to perform satisfactorily during the entire program, monitoring of confidence channel data acquired during each test point is recommended and planned.

Data Acquisition and Analysis Plan - The current raw data format being utilized by NASA in the JT8D REFAN test program will be compatible with current P&WA data reduction computer programs for the current JT8D engines. Only minor adjustments, if any, are anticipated. The NASA quick look computer printout on JT8D REFAN test data, however, will require some modification to provide simplified editing capability in the areas of instrumentation profile checks, fuel flow meter comparisons and other sensitive performance parameters to facilitate data validity checks essential to maintaining the recommended test program schedule. Rapid transmission of data tapes containing the test data will be essential to maintaining the program schedule and to this end, special handling techniques are recommended. American Airlines would expect to help in this regard by providing special handling capabilities between Cleveland and Hartford. In addition to the data acquisition recommendations discussed above, an on-line data surveillance program is recommended. Such a program could be integrated into the data acquisition program and recorded on magnetic tape along with the primary test data.

Reduction of test data is broken into several phases. In general, the following procedure is recommended. A quick look of the raw engine data provides an opportunity to profile pressure and temperature rake data, to compare fuel flow meter agreement, and to check out sensitive areas in airflow and thrust measurement systems. After consistency of test data is adequately determined, the gas generator curves (Figure 40) plotted from the data reduction program output will be compared to preceding altitude tests and to the American Airlines test run at SLS. Once the baseline configuration is run at NASA and data validity is established, back-to-back comparisons at both altitude test conditions will be made. Confidence in measured TSFC and EGT changes will be established by comparing component or module efficiency changes, flow capacity changes, and other gas generator parameter shifts with their effect on TSFC and EGT utilizing influence coefficients. Once the performance improvement has been established, then the performance change will be correlated in the observed part condition.

The main thrust of the proposed program is the determination of the relationship between compressor blade and vane mechanical condition and both fan and compressor performance and overall engine performance. Compressor blade and vane performance are attacked by erosion and by mechanical repair of blades and vanes to remove foreign object damage. There is scant information on the influence of rounded leading edges and blade tips or trailing edge erosion on overall compressor performance or stall characteristics. Pressure surface pitting should also have an adverse influence on boundary layer thickness and therefore on compressor flow and efficiency. The performance effects of erosion and FOD damage repair may also be different for different blade shapes. The planned program will provide a first insight as to the performance effect of these factors and thereby on design criteria for future engines. During the course of the test program detailed visual inspections of gas path parts are planned. Physical measurements for chord, roughness, tip clearance, etc., in addition to shadowgraphs of typical blades and vanes are also contemplated. These measurements and

**Figure 40. - Engine Gas Generator Performance**

— Baseline Configuration  
- - - Hardware Change Configuration

Fuel Flow

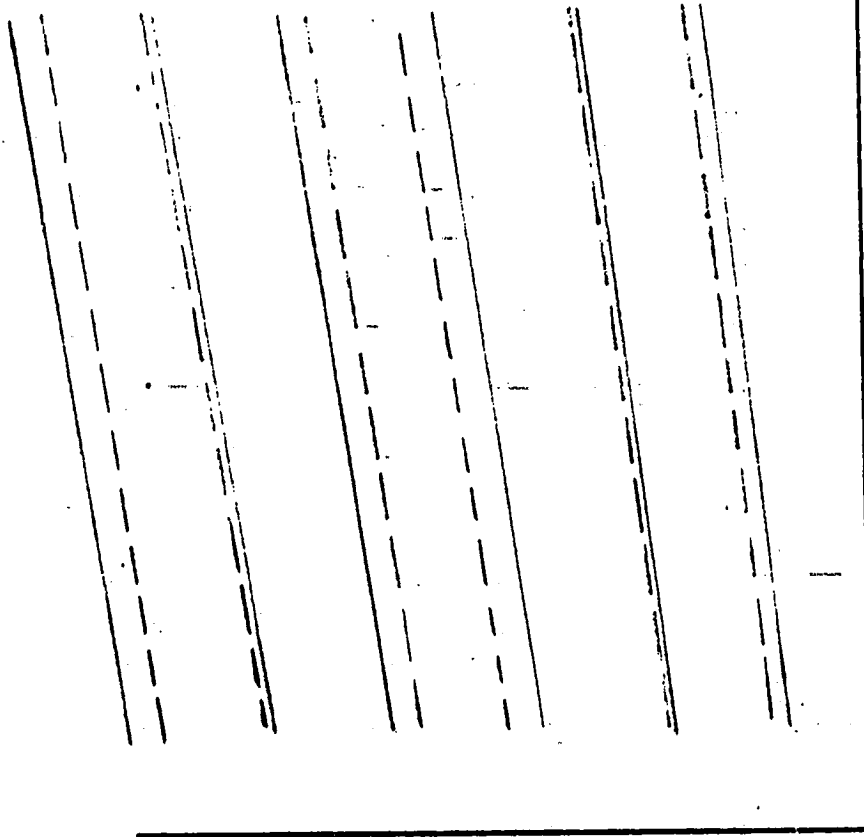
Speeds

Temperatures

Efficiencies

Pressure Ratios

Air Flows



Engine Power

observations in conjunction with compressor and engine performance data obtained from the planned test sequences will be analyzed and interpreted. From the early test results, the definition of "rework" for the compressor parts for the second engine will be developed. Recommendations will be developed for additional and more detailed compressor rig, multi-stage as well as single stage, and cascade testing covering both current and advanced compressor designs to isolate the discrete effects of the different deterioration items (i.e. blunt leading edge, loss of tip chord, surface roughness, etc.) based on the test results.

Computer simulations of each of the test engines are recommended. These simulations are necessary to evaluate the effect of the hardware changes at flight conditions not included in the test program and to provide a means for determining the total fuel conserved over a typical flight path for each hardware change. Since sea level static testing will not be done (due to test cell limitations) the simulations can be used to estimate the performance improvements at this flight condition which will provide the airlines with an estimate of what to expect in their sea level test stands from the recommended hardware changes as well as a correlation of the performance improvements observed at sea level with those to be expected at cruise.

The simulations can also be used to estimate the total performance improvement possible from a combination of changes. Interactive effects from two or more changes can be evaluated with the simulations. Based on the knowledge gained from the testing, additional test stand instrumentation to monitor deterioration levels should be recommended to the airlines. Trade-offs between cost and complexity on the one hand with the instrumentation required to understand deterioration (and other engine problems) on the other hand are necessary so that the new instrumentation recommended will provide the airlines with the most information with a minimum of additional equipment.

Finally, the knowledge gained from the JT8D engine model tested should be applied to other engine models now in service. By relating the component improvements found in the test engine to the components of the other engine models and incorporating these improvements into simulations of other engine models, the performance improvements to be expected in other engine models can be estimated.

Test Procedures and Conditions - The proposed testing will be conducted at American Airlines and NASA-LeRC. The tests will consist of steady-state performance and stall tests and in general will be conducted on each engine configuration. Table XXIII summarizes the type, conditions, etc. of the testing.

The steady-state tests will consist of a ten point test at the specific flight condition called for. The altitude acceleration-deceleration tests will simply document a throttle snap acceleration and then deceleration at altitude conditions.

Table XXIII. Summary of Proposed Tests for Each Engine Configuration

<u>Location</u>	<u>Remarks</u>
American Airlines Sea-Level Facility	<ul style="list-style-type: none"> <li>. 10 point sea-level performance</li> <li>. Standard stall tests (off idle and stall grade)</li> </ul>
NASA-LeRC Altitude Facility	<ul style="list-style-type: none"> <li>. Steady-state performance at altitude - Mach number of 30,000 feet, 0.8 and minimum altitude and Mach number (about 10,000 feet and 0.1)</li> <li>. Acceleration-deceleration tests at altitudes of 30,000 and 10,000 feet and 0.8 and 0.1 Mach number.</li> </ul>

The stall tests will be to check the LPC and HPC stall margin. The specific low pressure compressor stability check planned is a test in which air is bled from the high compressor exit to the low compressor inlet as a means of increasing the low compressor operating line a predetermined amount. The bleed flow is regulated by an orifice plate and a shut off valve. Three orifices (1.414, 1.30, 1.20 in. diameter) are used to determine the stall free operating range with three levels of operating line. If the engine is stall free below a rotor speed ( $N1/\sqrt{\theta T2}$ ) of 7350, 7650, 8000 rpm with 1.414, 1.30, 1.20 inch diameter orifices respectively, the engine is considered to have acceptable low compressor surge margin.

The high compressor stability test planned evaluates the off idle stall characteristics by evaluating a series of snap accelerations on a warm engine with the effective acceleration schedule enriched beyond that provided by the normal fuel control acceleration cam. This enrichment is obtained by bypassing additional fuel around the control metering valve to the fuel manifold through a fuel line, orifice, and shut off valve. The required test procedure investigates the high compressor stall characteristic of a warm engine with the acceleration schedule effectively increased 3 WF/PB ratio units (lb/hr-psi). A series of 3 snap accelerations should be performed from idle speed and 7100 rpm  $N2/\sqrt{\theta T2}$  with a #3 fuel orifice after the engine has been warmed up at takeoff power for 5 minutes. If the engine is stall free, the engine is considered acceptable. If the engine stalls on the snaps from idle speed but not from 7100 rpm, a series of 3 snaps is conducted with a #2 orifice from idle speed. If the engine is stall free on this second series of snap accelerations, the high compressor stability is considered acceptable. The engine is unacceptable if it stalls on the snaps from 7100 rpm with the #3 orifice from 7100 rpm or on the snap from idle with the #2 orifice. A detailed test procedure and a list



of required equipment will be provided as part of the Program for both the low and high compressor stability checks.

These tests are recommended to ensure that engine stability margin is maintained in the process of selective repairs of the JT8D high and low compressors.

Test Facilities - The selection of a test facility site involved several important factors such as facility availability/capability, the number of parameters to be selected, associated instrumentation accuracies, and data recording capability.

The large number of recommended parameters to be sampled, instrumentation accuracies, and data recording facilities are beyond the capability of American's test stand. Pratt & Whitney Aircraft has the capability to conduct the tests but would have difficulty in keeping a test cell available for the test period of 14 months. Additionally, both cost and the credibility of the results to the airlines are considerations which should not be overlooked.

The NASA Lewis Research Center has been conducting a JT8D REFAN test program. The instrumentation accuracy is sufficient to satisfy the requirements list in Tables XXIV and XXV. Table XXIV represents the instrumentation sensitivity factors required during sea level static, standard day conditions while Table XXV represents those required at 30,000 feet, 0.8 Mach number, standard day conditions.

An additional important consideration is that only minor adjustments will be required in the data recording and reduction program that were used in the JT8D REFAN program. Some modification will be required to provide simplified editing capability in the area of instrumentation profile checks and other sensitive performance parameters to facilitate data validity checks essential to maintaining the recommended test program schedule.

It is therefore recommended that the tests be conducted at the NASA Lewis Research Center utilizing as much of the JT8D REFAN test program as possible. This test plan also offers another advantage in that NASA would be an unbiased observer and the information gained could be used by them in furthering design of future engines.

In summary, it is recommended that the airline conduct pre and post modification testing at sea level to the extent of their capability. In addition, stall grade and off idle stall testing should be accomplished by the airline. NASA should conduct the sea level and altitude testing with full data recording. It is recognized that the NASA test cells cannot produce sea level static conditions due to plant capacity limits and that low altitude, low speed testing will need to be used in lieu of static conditions. Analytical techniques will be used to extrapolate these data to the sea level static condition.

Table XXIV. Instrumentation Sensitivity factors for  
JT8D-9 at Sea Level Static, Std. Day Takeoff

+1% Fan O.D. Efficiency	=	+1.4	°F	TT2
	=	-0.12	PSIA	PT2
	=	-1.8	°F	TT2.5 O.D.
	=	+0.22	PSIA	PT2.5 O.D.
+1% Fan I.D. Efficiency	=	-1.3	°F	TT2
	=	-0.11	PSIA	PT2
	=	-1.6	°F	TT2.5 I.D.
	=	+0.23	PSIA	PT2.5 I.D.
+1% LPC Efficiency	=	+1.4	°F	TT2.5 I.D.
	=	-0.21	PSIA	PT2.5 I.D.
	=	-1.8	°F	TT3
	=	+0.43	PSIA	PT3
+1% LPC Efficiency	=	+2.2	°F	TT2
	=	-0.20	PSIA	PT2
	=	-3.48	°F	TT3
	=	+0.82	PSIA	PT3
+1% HPC Efficiency	=	+3.3	°F	TT3
	=	-0.81	PSIA	PT3
	=	-5.1	°F	TT4
	=	+3.07	PSIA	PT4

Table XXV. Instrumentation Sensitivity Factors for  
 JT8D-9 at 30,000 Ft., 0.8 Mach No., Std.  
 Day Max. Cruise

+1% Fan O.D. Efficiency	=	-1.3	°F TT2
	=	-0.05	PSIA PT2
	=	-1.7	°F TT2.5 O.D.
	=	+0.11	PSIA PT2.5 O.D.
+1% Fan I.D. Efficiency	=	+1.2	°F TT2
	=	-0.052	PSIA PT2
	=	-1.6	°F TT2.5 I.D.
	=	+1.1	PSIA PT2.5 I.D.
+1% LPC Efficiency (Isolated LPC)	=	+1.3	°F TT2.5 I.D.
	=	-0.1	PSIA PT2.5 I.D.
	=	-1.7	°F TT3
	=	+0.20	PSIA PT3
+1% LPC Efficiency (Overall LPC)	=	+2.1	°F TT2
	=	-0.09	PSIA PT2
	=	-3.3	°F TT3
	=	+0.39	PSIA PT3
+1% HPC Efficiency	=	+3.1	°F TT3
	=	-0.38	PSIA PT3
	=	-4.8	°F TT4
	=	+1.4	PSIA PT4

Test Schedule - After completion of each test run at NASA, the engine will be shipped to Tulsa for the next Bill-of-Work. The engine turn time at Tulsa will be approximately thirty days. The engine will then spend approximately thirty days at NASA.

Two engines will be utilized during the tests. While one engine is at Tulsa, the other will be at NASA. Rotating the engines between the locations will permit efficient use of facilities and personnel at both locations and shorten the total test period.

The exception to this general schedule is the fan testing where the installation of the modified fans would be undertaken at Lewis by a special American Airlines crew with the engine installed in the test stand. Removal of the inlet duct by NASA personnel to permit access to the engine by AA personnel is assumed.

Therefore, the 14 engine test series, described previously, will require an elapsed time of 14 months to complete. An additional period of three months prior to testing will be required to design the bosses and modify the engine cases for the additional test instrumentation. The overall program will require 17 months.

Program Costs - The estimated cost for budgetary and planning purposes to conduct the test program as recommended is \$1,250,000. This cost estimate includes the costs for both the American Airlines and Pratt & Whitney efforts as discussed previously and as set forth in this section. This cost per test excluding actual NASA testing expenses is approximately \$90,000. Fixed costs for instrumentation and case scrappage reduce the actual cost per test to a lower value. Fourteen test configurations are included in recommended program. This cost estimate also covers all data analysis and report writing activities.

Industry Meeting - On 26 November 1974, an industry meeting was conducted by American Airlines and Pratt & Whitney Aircraft at NASA Lewis Research Center for the purpose of briefing the industry on the status of the effort reported herein. The major airlines have all undertaken test work in an attempt to improve the performance of their engines. The major factors limiting the success are the non-conclusiveness of the test results. This makes management unwilling to commit (and rightly so) to significant investment in hardware without more substantial proof of payback of the investment.

The representatives of United and Pan American were essentially in agreement with the conclusions that American Airlines and Pratt & Whitney developed during the course of this investigation, i.e., that considerable performance loss was attributable to the fan, low and high compressors due to erosion and foreign object damage. Four airlines submitted engine performance information concerning fuel consumption increases, probable problem areas, part scrap rates, and current efforts undertaken to reduce or control SFC with time.

In most cases, fuel consumption increases ranged from less than 1% to over 4.5% from JT8D new engine performance and from 2.5% to 7% increase over new JT3D engine baselines. In all cases, LPC and HPC contamination and blade erosion along with first stage turbine nozzle and outer air-seal deterioration was felt to be the most prevalent causes for performance changes.

Scrap and repair policy relative to fan, low compressor and high compressor in general coincides directly with Pratt & Whitney Overhaul and Repair Manuals. Compressor blade replacement statistics agree in general with those reported by American Airlines.

General conclusions from the industry can be stated as follows. It appears that parts condition (blade and vane) in the cold section of the engine is contributing a significant amount to performance degradation. A more definitive test program is required to substantiate the above. This test program must be structured to tie part configuration to performance in order to provide a meaningful economic measure of performance improvement. In order to accomplish this, adequate instrumentation and data recording equipment must be utilized.

#### CONCLUSIONS/RECOMMENDATIONS

Conclusions - It is concluded that between 60 and 70 percent of the observed increase in JT3D and JT8D fuel consumption is estimated to be associated with deterioration of compressor and fan performance. The principle cause of the deterioration has been the reduced effort expended on restoration of compressor performance due to previous operating economic conditions, lack of adequate instrumentation to determine the performance losses and the problems associated with measurement of engine airflow by the airlines. Between 10 and 15 percent of the long term increase in fuel consumption appears to be attributable to the turbine performance losses. The degree of restoration activity that commonly goes on in the hot section of the engine suggests that this level of loss may be improved slightly but the economics are not favorable.

The balance of the increase in fuel consumption is believed attributable to general deterioration of seal clearances. The major area of improvement holding potential is in the compressor and turbine tip seal areas. Performance simulation studies suggest that the performance changes observed cannot be accounted for by deterioration of the turbine performance alone. Losses in airflow and compressor efficiency with small turbine performance losses do explain the changes noted. Review of American Airlines part scrap rate histories clearly indicate a less than uniform approach to replacement of compressor blades and stator assemblies. Review of part condition suggests that compressor blades suffer from erosion of the leading edges in the outer 30% of the blade span and stators from trailing edge erosion. Current JT3D and JT8D production instrumentation does not provide adequate guidance as to the component or module responsible for higher fuel consumption.

Responses to the questions posed to other airlines concerning the extent of their performance problems indicate that all are confronted with similar problems, the degree of which is proportional to the average age of their fleet of engines.

The major airlines have all undertaken test work in an attempt to improve the performance of current engines. These efforts have had minimal success due to a number of factors. The major factors limiting the success is the non-conclusiveness of the test results. Major departures from existing material replacement policies require significant investment in maintenance which managements have been unwilling to undergo without substantial proof of payback of the investment. The limited instrumentation, lack of facilities and considerable expense associated with back-to-back engine testing have made the airlines unwilling to undertake the repetitive testing necessary to obtain the proof on an individual airline basis. The results of this study have improved the airlines' understanding of the probable causes for long term performance deterioration. What is necessary is the proof that improvements can be made and the performance can be recovered on a cost effective basis. NASA's unbiased position in this regard, in addition to their facilities and expertise, are needed to provide the confidence necessary to proceed.

The airlines note that the more advanced engines deteriorate more rapidly. It is probable that even more advanced engines directed at fuel conservation will deteriorate even more rapidly unless their designs reflect techniques to reduce the long term effects of erosion, etc. This area of technology needs to be pursued to ensure that efforts on advanced compressors and turbines for more energy efficient aircraft are not lost in the first hours of airline operation.

Recommendations - Based on the conclusions discussed, the following is recommended. The results of the studies have suggested that reduction of the excess fuel consumption currently exhibited by current JT3D and JT8D engines is achievable and potentially cost effective. The test program outlined herein should be pursued to identify the amount of fuel consumption reduction achievable and the cost effectiveness of doing so.

Based on the study findings, it is recommended that performance recovery activity be concentrated on the compressor and fan with the objective of understanding the relationship between mechanical part condition and compressor performance; and the relationships between compressor efficiency loss and airflow loss. The condition of compressor parts to be tested should cover the existing part condition, new parts, and repaired parts to determine the relative importance of gross changes in leading edge shape, blade tip shape and stator trailing edge condition. This effort should be considered an initial step as it is probable that more detailed analytical and experimental studies will be required to define the impact of specific conditions on overall performance (i.e. leading edge shape as distinct from trailing edge shape, etc.).

NASA should consider the impact of these types of long term performance deterioration problems on their overall long range research efforts. As an example, the rate of change of leading edge shape with time or flight cycles should be considered as part of advanced fan and compressor research activities. The higher performance engines are by far more sensitive to losses in core airflow and core compressor efficiency than the older engines studied during this program. There is every reason to believe that the more complex shape, thinner leading edges, etc. of advanced blading will be even more sensitive than current designs. Technology research directed at improving engine performance must consider the total environment in which engines operate to be considered smart technology. High cost blading must maintain its performance over long periods of operation or be restorable to original performance in order to be effective in energy conservation.

The contractors consider that the test program recommended herein warrants NASA support and is a necessary first step towards achieving short term energy conservation. It will provide the initial step in a far reaching technology program directed at improving the real fuel conservation capabilities of future technology engines and provide the economic and performance data to support activation of such energy saving programs by the airlines and military services.

## APPENDIX I

### PART TOLERANCE & SEAL CLEARANCE SUMMARY FOR BOTH JT8D & JT3D ENGINE BUILDS

A considerable increase in engine fuel consumption and exhaust gas temperature can occur if core airflow is lost through seal leakage. When excessive seal leakage occurs, the airflow available to provide thermal work when fuel is added is decreased markedly. To obtain the same engine thrust with reduced airflow requires the addition of more fuel and this results in higher exhaust gas temperature and an increase in thrust specific fuel consumption.

The seals in the JT8D engine are designed to prevent recirculation of air from an area of high pressure to an area of low pressure. For example, Figures 41 and 42 indicate the basic critical seal areas of the JT8D which could allow recirculation in the compressor or loss through the turbine seals of a certain amount of airflow above the design value which will result in considerable increase in fuel flow and EGT.

Measurements were recorded for the JT8D seal areas indicated by items number 1 thru 11 in Figures 41 and 42. These measurements were given to P&WA Engineers who used the information to make analytical performance loss estimates. The analytical performance estimates are discussed in the Seals and Clearances Section of the main report. The seal areas except those noted as follows were found to be within P&WA manual limits.

The 13th stage air sealing ring located on the rear side of 13th stage compressor rotor is a mandatory measurement. A total of four knife edge seals is involved. A review of seven 13th stage rotors indicated that only one knife edge seal had exceeded the P&WA manual limit. A survey was conducted on fifteen 13th stage rotors that had less than 3,000 cycles left. Approximately fifty percent of these rotors had one or more of the knife edge seals exceeding the P&WA manual limits. The seal lands (4 total per seal) were found to be within P&WA manual limits. The lands are built up with metal spray and remachined when the tolerances exceed the P&WA manual limits.

In summary, review of American Airlines' procedures used to establish seal clearances for the JT8D engine show a consistent approach that would tend to eliminate secondary flow seals as a major contributor to long term deterioration. No concernable deviations in part dimensions from the specified P&WA Overhaul Manual dimensions were revealed.



The same JT3D-3B engines selected for evaluation of part condition in the low and high compressor sections during teardown were followed through their repair cycle in the shop and seal tolerances and compressor blade tip clearances were recorded. Figure 43 thru Figure 45 indicate the areas of the engine where seal tolerances and compressor blade tip clearances were recorded during engine buildup. Many of the parts and components including compressor blades, vanes and shrouds, and cases were offloaded for repair during engine disassembly. Serviceable repaired parts removed previously from other engines were installed in these engines during buildup. The practice utilized at American Airlines for offloaded parts requires that they be restored to new part dimensions. This procedure is felt to be necessary to control part interchangeability because of the part interchanging that occurs from engine to engine which tends to minimize tolerance problems. This practice does not apply to compressor blades which are currently processed according to the repair limits outlined in the P&WA repair manual.

The seal tolerances and blade tip clearances were recorded for those engine areas indicated in Figure 43 thru Figure 45 during buildup of engine S/N 645738. The same number representing different engine locations on the figures is used to indicate that the minimum and maximum tolerances are the same value for each of those locations (Figures 1 thru 3). The seal areas and blade tip clearances except those noted as follows were found to be within P&WA manual limits.

Review of the dimensions recorded as illustrated in Figure 43 relates to both the fan and low compressor sections of the engine. The air seal measurements indicated by number 2 in Figure 43 was found to be a 50 percent split between those falling within the P&WA reference dimensions (manufactured limits) and replace limits. No dimension exceeds the replace limit for the seal land diameters.

Similar measurements were taken in the high compressor area as indicated by Figure 44. The forward seal land diameter in the intermediate case indicated by number 3 was within P&WA reference limits while the aft seal land diameter was found to be within the check and repair limit. However, the fwd air seal knife edge was beyond P&WA check and repair limits while the aft portion was within check and repair limits. The spacer knife edge seal to seal land diameter (number 4, Figure 44) was found to be within check and repair limits. In fact, 75% of the dimensions were within reference dimensions. The knife edge seal diameter (number 5) for both the fwd and aft knife edge was found to be outside the P&WA reference dimension. The mating seal ring land diameter was not recorded. Blade tip clearances (number 16, Figure 45) for the 1st through 4th stage turbines were found to exceed the manual limits for some individual blades. However, the average value for all the blades was found to be within the manual limits.

In summary, the seal tolerances for engine S/N 645738 were found to be within P&WA manual limits. The biggest discrepancy noted concerned the turbine blade tip clearances for individual turbine blades in all four

stages. The performance data for this engine is shown in the section titled "Prior Performance Recovery Efforts" of the main report.

The previous seal tolerances and blade tip clearances recorded for JT3D engine S/N 645738 were also recorded for engine S/N 667783. The exceptions are noted as follows.

The seals indicated as numbers 1 and 2 (Figure 43) were found to be within P&WA check and repair limits with the exception of the 7th to 8th stage fwd seal land diameter which exceeded the P&WA check and repair limit. The fan and low compressor blade tip tolerances (see number 12) were found to be within limits with the exception of the 1st and 2nd fan blade tip clearances. Some blades in the first stage fan had tip clearances which exceeded the maximum allowed in the P&WA repair manual. Second stage fan blades exceeded both the minimum and maximum limits given in the Maintenance Manual.

The seals indicated by numbers 3 and 4 in the high compressor (Figure 44) were within P&WA manual limits with the exception of the 15th and 16th aft seal land diameter which was outside the P&WA specified clearance limits. The rear 16th compressor knife edge seal (number 5, Figure 44) was found to exceed P&WA reference limits but did not exceed the 'replace if over' limits.

The seals in the turbine area as indicated by numbers 6 through 11, 17, 20, and 21 were found to be within the P&WA check and repair limits. Approximately 50% of the tolerances fell within the check and repair limits while the remainder were within P&WA reference dimensions (manufacturing limits). Both the first and second stage turbine tip blade clearances (number 16) were found to exceed both the minimum and maximum limits for some of the blades. However, the average tip clearance for the 1st and 2nd turbine blades was found to lie within the P&WA manual limits. The third stage rear turbine tip blade clearance was exceeded by some blades, but the average value for all the blades was within P&WA manual limits. The fourth stage turbine blade tip clearances were found to be okay.

In summary, engine S/N 667783 exceeded the P&WA manual limits concerning individual blade tip clearances for the 1st and 2nd fan blades and for the 1st through 3rd turbine blades. The various seal areas in Figures 43 through 45 were found to be within manual limits with exception of the 7th to 8th stage fwd seal land diameter and the 15th and 16th stage aft seal land diameter which exceeded manual limits. The performance data for this engine is given in the main report.

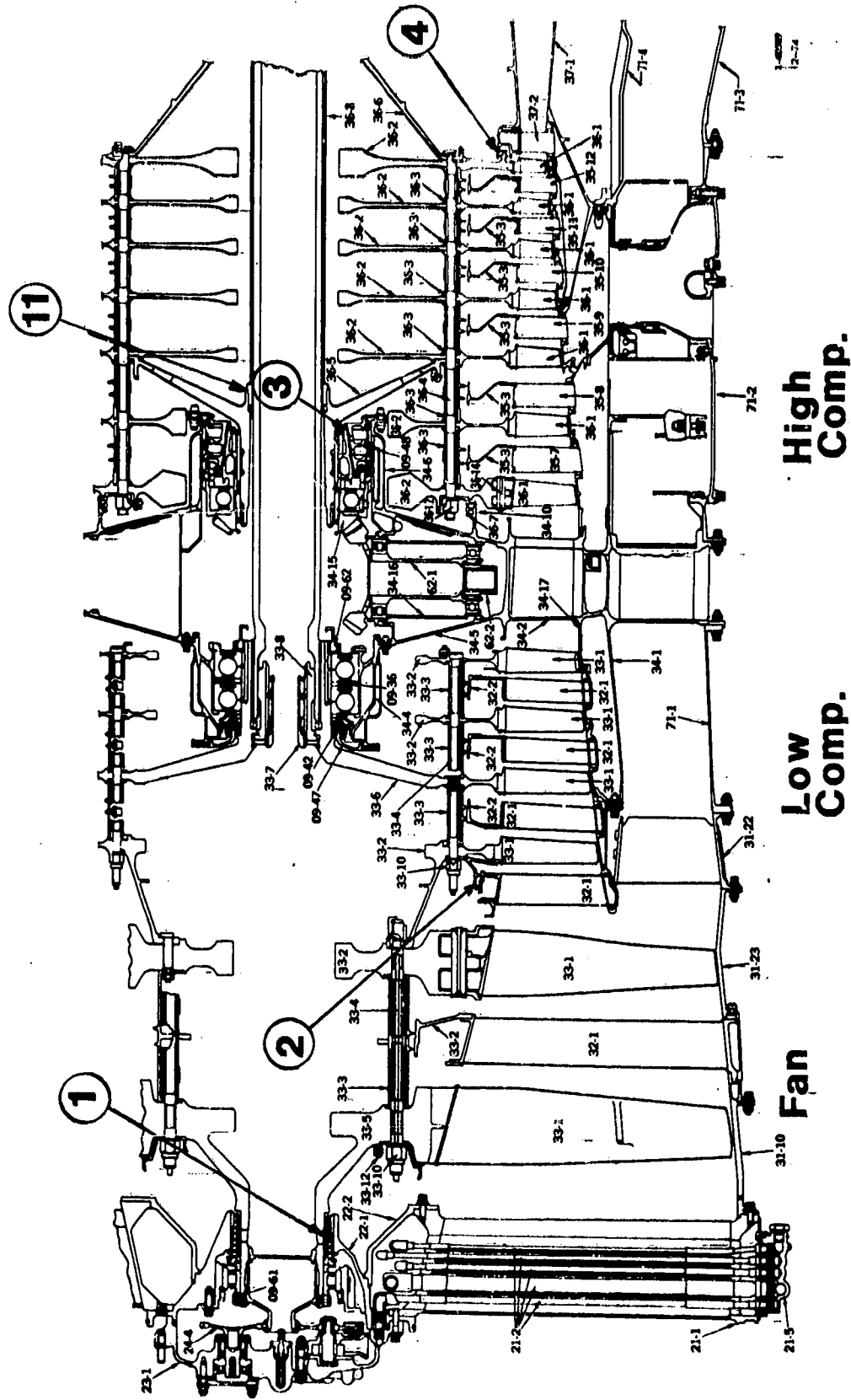


FIGURE 41 - JT8D FAN, LOW COMPRESSOR & HIGH COMPRESSOR  
AREAS OF MEASURED SEAL TOLERANCES



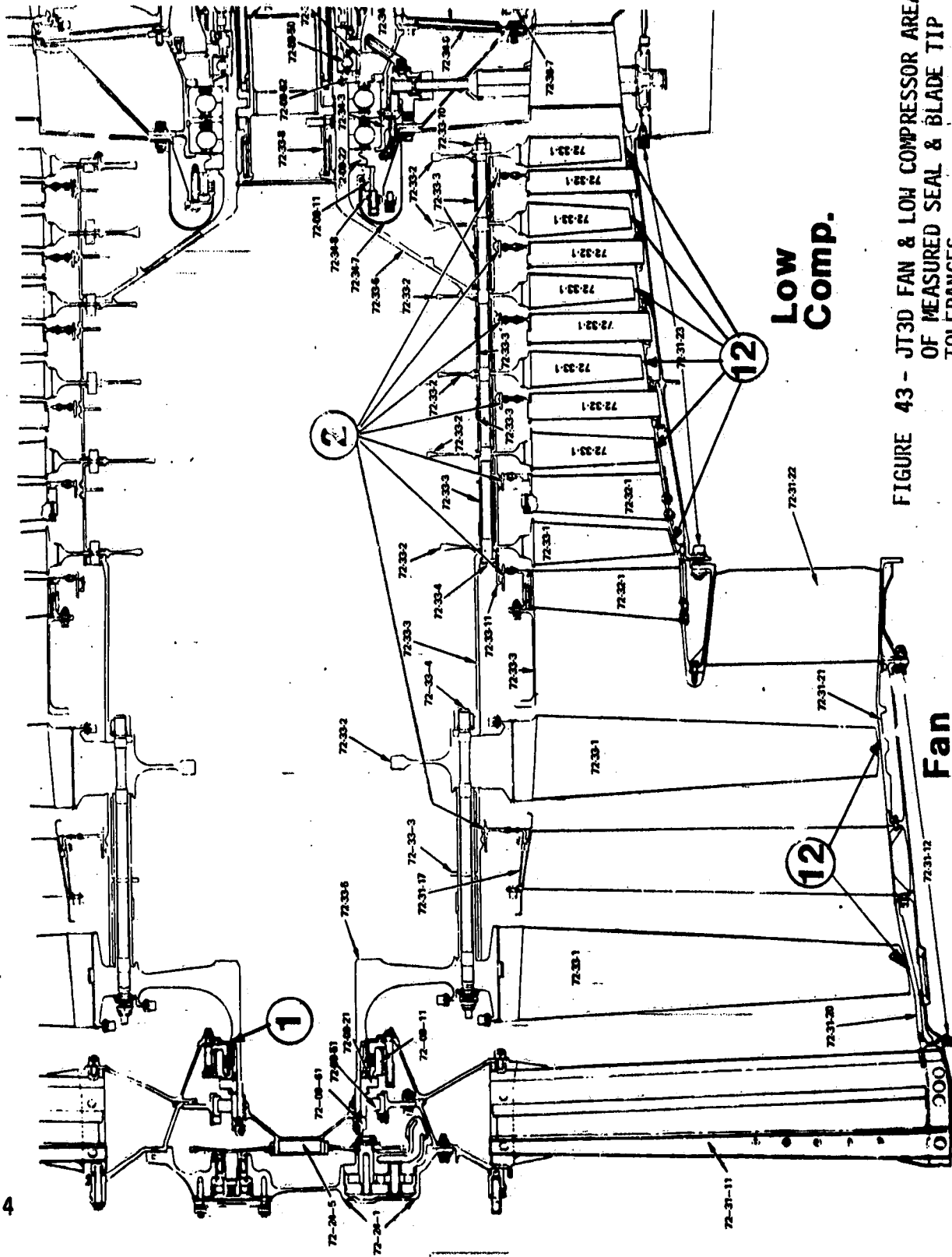


FIGURE 43 - JT3D FAN & LOW COMPRESSOR AREAS OF MEASURED SEAL & BLADE TIP TOLERANCES

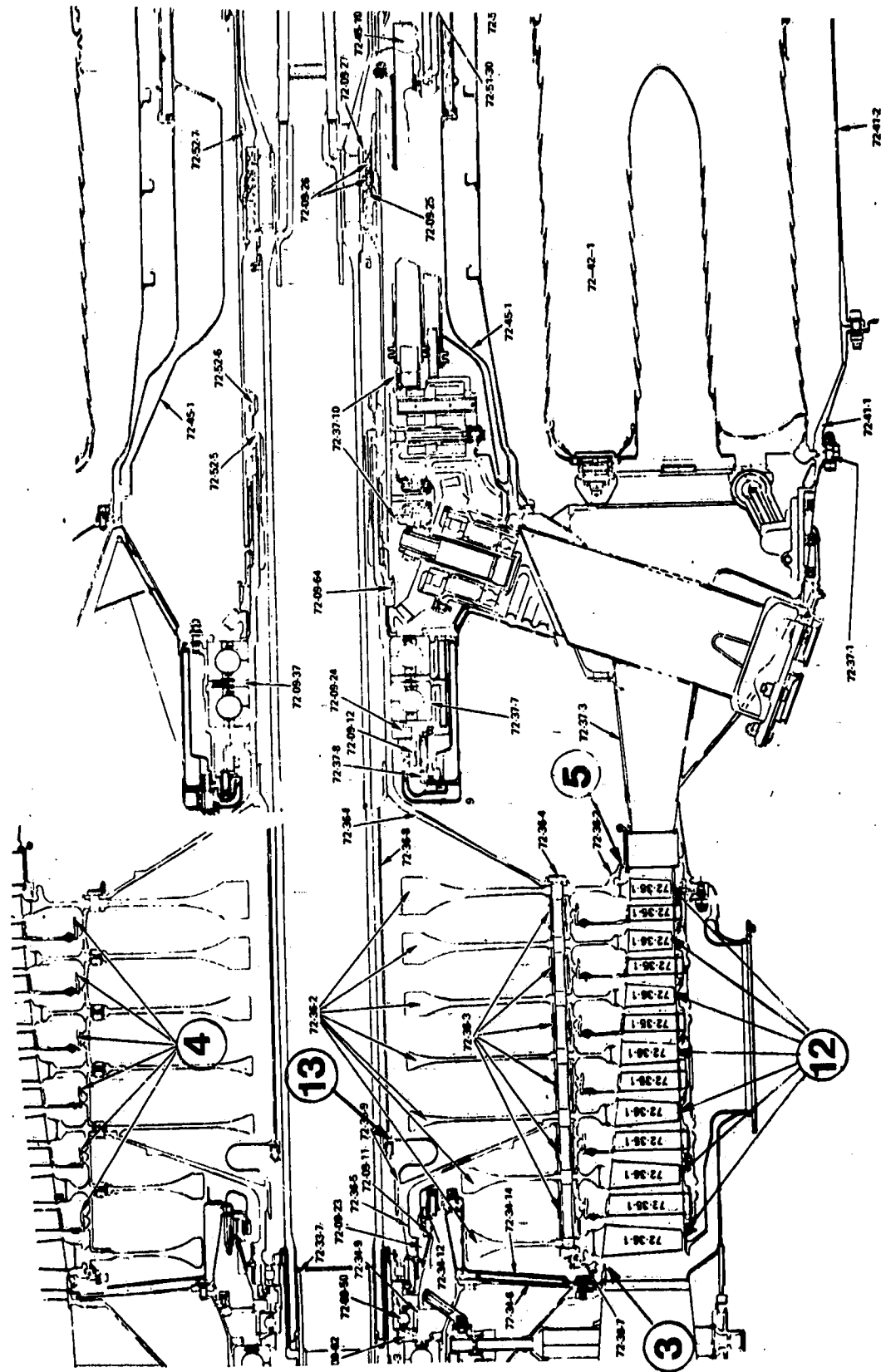


FIGURE 44 - JT3D HIGH COMPRESSOR AREAS OF MEASURED SEAL & BLADE TIP TOLERANCES

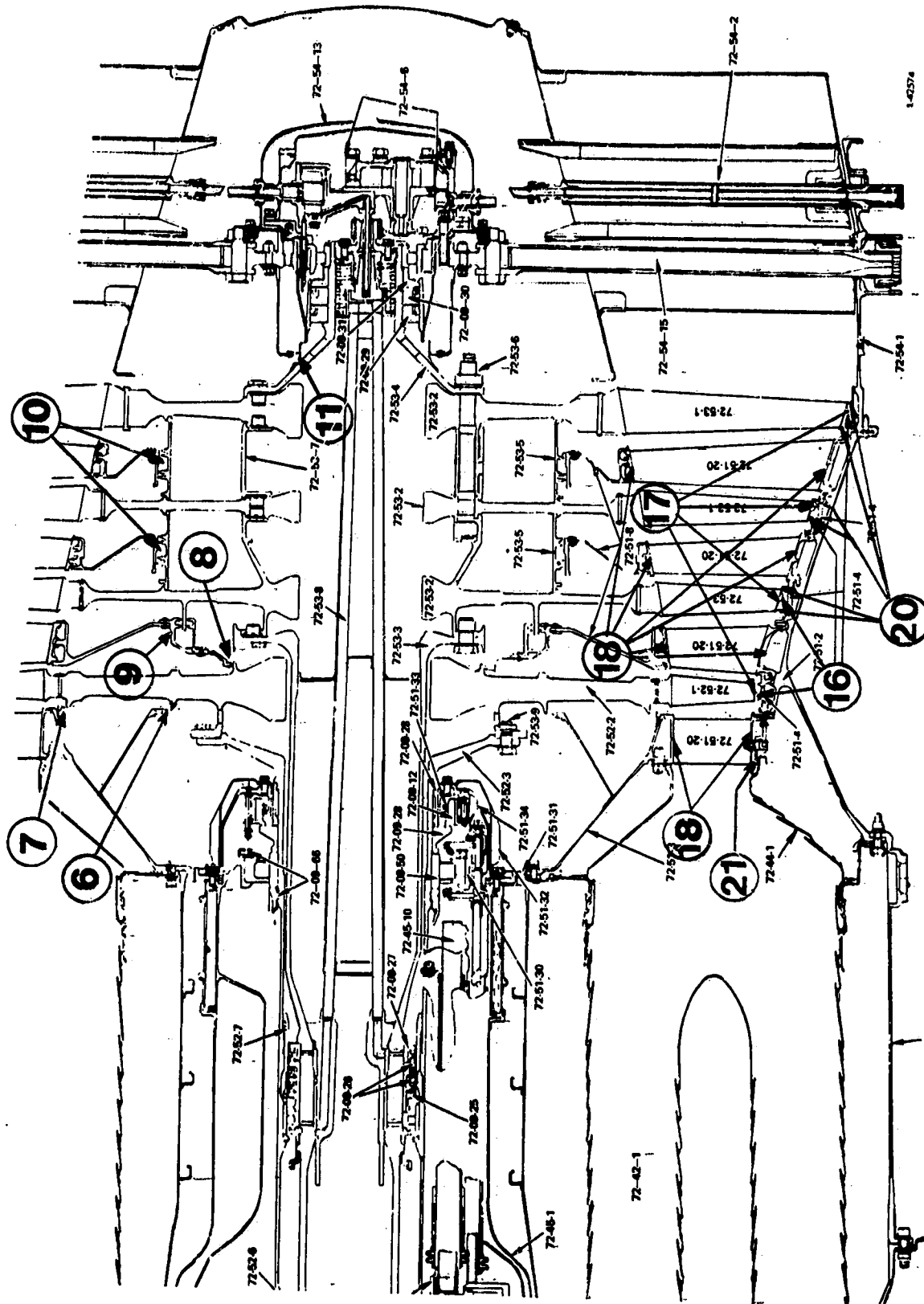


FIGURE 45 - JT3D HIGH & LOW TURBINE AREAS OF MEASURED SEAL & BLADE TIP TOLERANCES

ORIGINAL  
OF POOR

ORIGINAL PAGE IS  
OF POOR QUALITY