

LORAN-C EXPANSION: IMPACT ON PRECISE TIME/TIME INTERVAL

John F. Roeber, Jr., USCG Headquarters

ABSTRACT

On 16 May 1974, the Secretary of Transportation and Commandant of the Coast Guard announced that Loran-C had been chosen as the navigation system to serve the U. S. Coastal Confluence Zone. At the present time, reliable CONUS Loran-C ground-wave timing coverage extends westward only about as far as Boulder, CO. This paper illustrates the groundwave hyperbolic and timing coverage which will result from the planned CONUS expansion. Time frames are provided.

While not directly related to the subject of the paper, a status report on the planned reduction in Loran-C PTTI tolerances is presented.

INTRODUCTION

After several years of theoretical and practical evaluations of several navigation systems (Loran-A, Loran-C, Decca, and Differential Omega), the U. S. Coast Guard recommended to the Department of Transportation (DOT) that a single navigation system, Loran-C, could best serve the disparate navigation/positioning needs in the U. S. Coastal Confluence Zone (CCZ). The Secretary of Transportation subsequently approved the recommendation and, with the support of the Office of Telecommunication Policy and General Accounting Office, announced the choice on 16 May 1974. Follow-on announcements have described the expansion necessary to cover all of the CCZ.

LORAN-C EXPANSION

Figure 1 illustrates the existing Loran-C hyperbolic coverage in the CCZ. Notice that in Figure 1 the range limits are established for a receiver that requires a signal-to-noise ratio (SNR) of at least -10dB in order to acquire the Loran-C signals. While this is a limiting factor with the new, low-cost, civil-use receivers, it is not for a timing receiver. In timing receiver applications, of course, it is also not necessary to receive more than one station. Figure 2 is a projection of the groundwave timing coverage currently available in the U. S. In this case the range limits are based on my personal experience. I assume that signal acquisition is accomplished by identifying the Loran-C

Preceding page blank

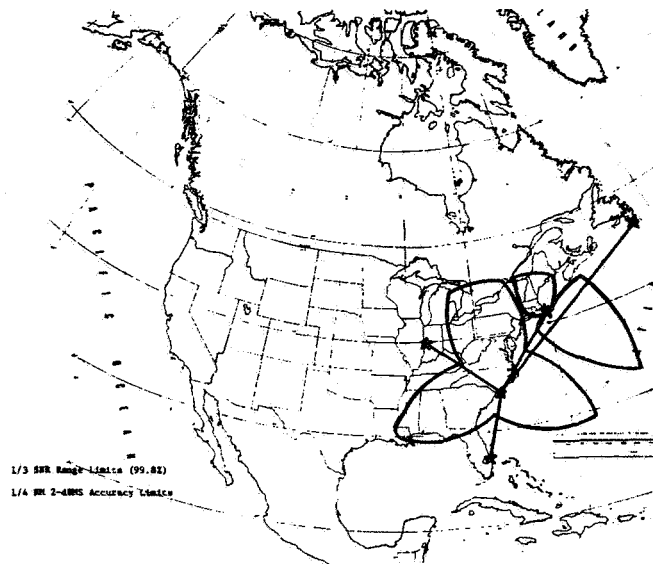

Figure 1. Existing U.S. CCZ Loran-C Hyperbolic Coverage

pulses visually on an oscilloscope. Third-cycle identification is assumed to be accomplished through the use of the Signal Strobe of an Austron 2000-C receiver to draw out the pulse. These assumptions, in short, give conservative range limits when compared with ranges available through the use of a synchronous filter, or knowledge of time and various delays to better than 5 microseconds so that signal acquisition and cycle identification can take place without "seeing" the signal. Figure 3 illustrates the approximate locations of the CONUS Loran-C stations after the expansion is completed. The stations are arranged in seven chains (including the existing North Pacific Chain). Again, the coverage shown is hyperbolic coverage for a civil-use receiver. Figure 4 is a schedule for the implementation. The first stage of the implementation, the U. S. West Coast Chain, was funded this fiscal year (FY). The next two chains to the North, the Northwest U. S. and Gulf of Alaska chains were originally scheduled for completion in late 1977, but due to the programmed completion of the Trans-Alaska Pipeline, the on-air date for all three of these chains was set as 1 January 1977 (assuming orderly approval of funds for the other two chains).

One of the new chains, the Cape Race/Caribou/Nantucket chain, shown on Figure 3, is not necessarily part of the expansion program. Since no additional funds are required to implement this chain other than the additional operating and maintenance expenses, and since it provides excellent coverage in a prime fishing area, such an operational chain may be established.

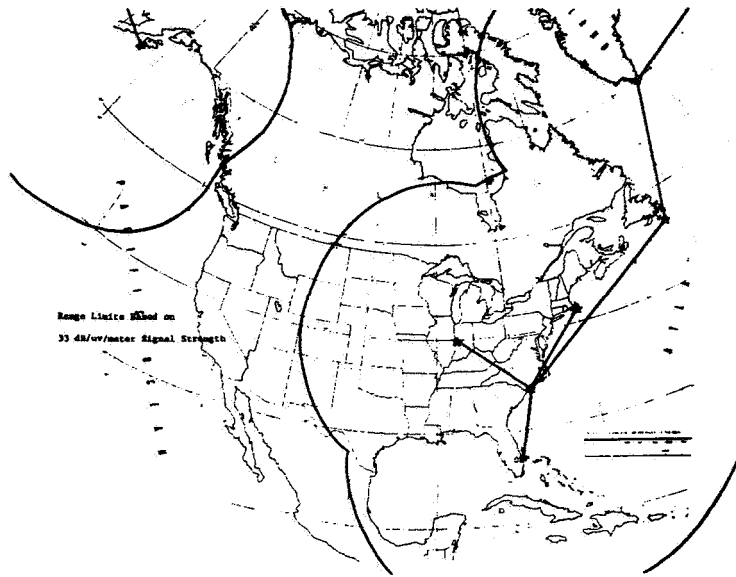

Figure 2. Existing U.S. Loran-C Groundwave Timing Coverage

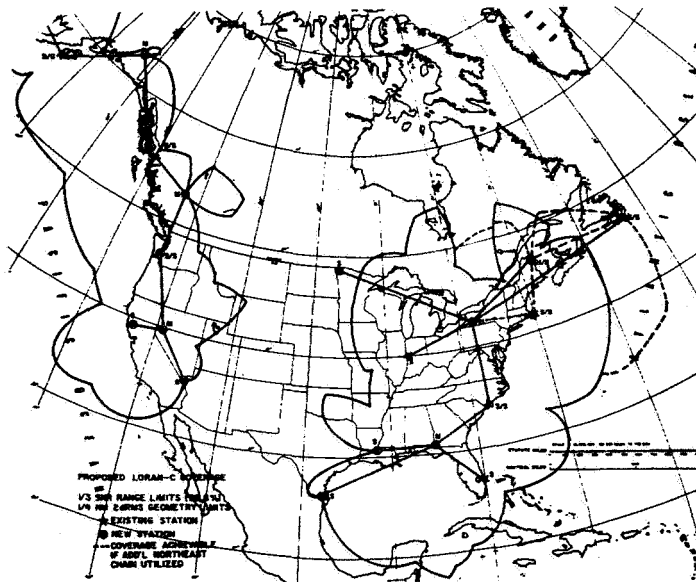

Figure 3. Proposed U.S. CCZ Loran-C Hyperbolic Coverage

CONUS TIMING COVERAGE EXPANDED

Figure 5 illustrates the timing coverage to be expected upon completion of the Loran-C CONUS expansion. There are at present no specific requirements to time any of the new chains. As a result, Figure 5, and the plans outlined in the following discussion are not final.

<u>AREA</u>	<u>DATE</u>
WEST COAST	1 JANUARY 1977
GULF OF ALASKA	1 JANUARY 1977
EAST COAST RECONFIGURATION	1 JULY 1978
GULF OF MEXICO	1 JULY 1978
GREAT LAKES	1 FEBRUARY 1980

Figure 4. Implementation Schedule For CONUS Loran-C Expansion

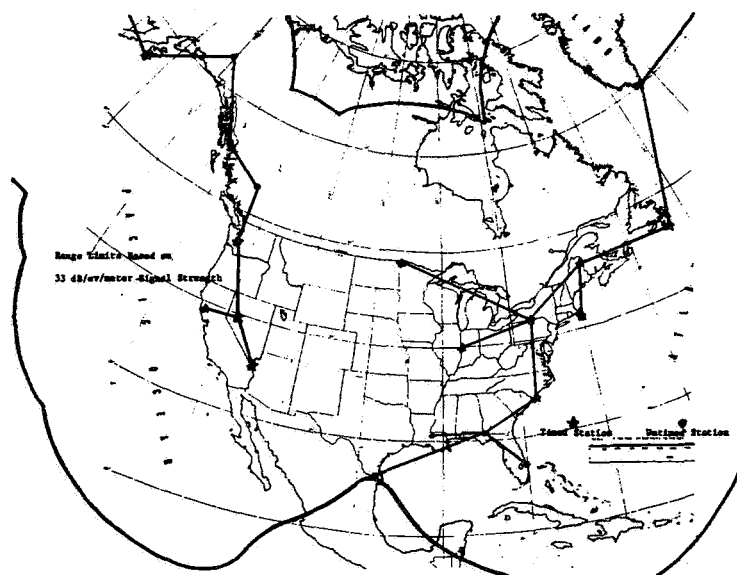

Figure 5. Proposed U.S. Loran-C Groundwave Timing Coverage

The basis for the timing coverage is that all points in CONUS must be within groundwave range of at least one station of a timed chain. The Coast Guard definition of a timed chain is a chain that has a specified time tolerance with respect to UTC(USNO). As can be seen from Figure 5, this basic timing criterion is met if only three of the CONUS chains are timed (East Coast, West Coast, and North Pacific). This would allow the use of a frequency offset in the other chains with attendant advantages in minimizing cross rate interference. These untimed chains could still

be used to transfer time between two points that are both within the coverage area of any one chain. In addition, they could be used in the absolute sense if a suitable Null Ephemeris Table were developed.

LORAN REPLACEMENT EQUIPMENT

While the expansion of Loran-C under the National Implementation Plan (NIP) is the Loran-C program receiving the most publicity, there is another program with less dramatic, but still real impact on PTTI. This program is the Loran Improvement Program (LIP).

The first major step in modernizing the Loran-C ground station equipment was the development of the AN/FPN-54 (COLAC) timer at the U. S. Coast Guard Electronics Engineering Center (EECEN) in 1969-1970. An improvement in the operational performance of COLAC-equipped stations was demonstrated in the period 1971-1972. This improvement was directly attributed to the COLAC's solid-state circuitry, modular maintenance philosophy, and operator oriented design. After noting the success of COLAC and realizing the extent and possible consequences of the remaining Loran-C problems, an ambitious ground station equipment improvement program was initiated at EECEN during early 1973. The general goal of this program was to improve the Loran-C chain operational performance while simultaneously reducing the personnel manning levels and equipment costs. Basically this program consisted of the development of a solid-state Loran Replacement Equipment (LRE) package which would replace the older generation timers and low signal-level pulse generating equipment and, in addition, modify the existing Loran-C transmitters.

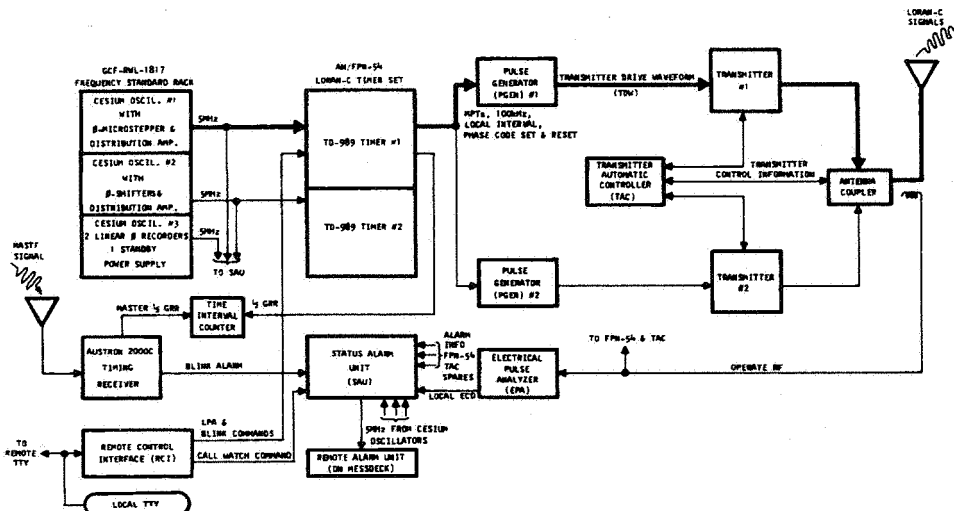

Figure 6. Loran Replacement Equipment

The LRE performs the basic Loran-C signal generation in a more precise, stable, reliable, and controllable manner than was possible with the older generation equipment. Figure 6 is a block diagram of a typical LRE configuration. A description of the major units which comprise the LRE package is presented herein.

Frequency Standard System. (Figure 7) This unit provides the 5 MHz and 1 MHz time base frequencies to the remaining LRE. The phase micro-stepper and phase shifters allow for precise correction of the cesium 5-MHz outputs. Two linear phase recorders provide continuous monitoring of the three cesium outputs.

AN/FPN-54 Loran-C Timer. The COLAC replaces the timing functions of the AN/FPN-38, 41, and 46 timers. The COLAC is a solid-state time generator whose basic function is to provide the signals necessary to drive the transmitters. More specifically, the COLAC provides the accurate and reliable timing waveforms which control the time of emission of the radiated Loran-C pulses.

Transmitter Control Set (TCS). The TCS replaces existing Transmitter Control Groups. The functions performed by the TCS are aiding in generation of a standard Loran-C pulse shape, monitoring the pulse amplitude, and automatically switching transmitters in the event of a transmitter failure. The TCS equipment units and their primary functions are:

(a) Pulse Generator (PGEN): Develops a transmitter driving waveform (TDW) from the timing signals received from the COLAC. The TDW is shaped within the PGEN to insure that the transmitter radiates a standard pulse shape with proper phase code and droop characteristics.

(b) Transmitter Automatic Controller (TAC): Automatically switches transmitters in the event of a failure of the operate transmitter. The TAC performs this function by monitoring the on-air Loran-C signal and the availability of the transmitter drive waveform. It also allows for manual switch of transmitters.

(c) Electrical Pulse Analyzer (EPA): Provides a capability for precise and unambiguous measurements of Loran-C pulse shape and amplitude. By appropriate programming, via front panel switches, the following measurements may be made: amplitude of pulse peak for any pulse, amplitude of half-cycle peaks (1 - 19) within the first pulse, and envelope-to-cycle difference (ECD) of the first pulse. All measurements are displayed on a front panel digital meter and provided at a rear panel connector in either analog or BCD form. In addition, the EPA generates a reference envelope waveform which is used in conjunction with an oscilloscope and the operate PGEN to permit pulse analysis to be accomplished.

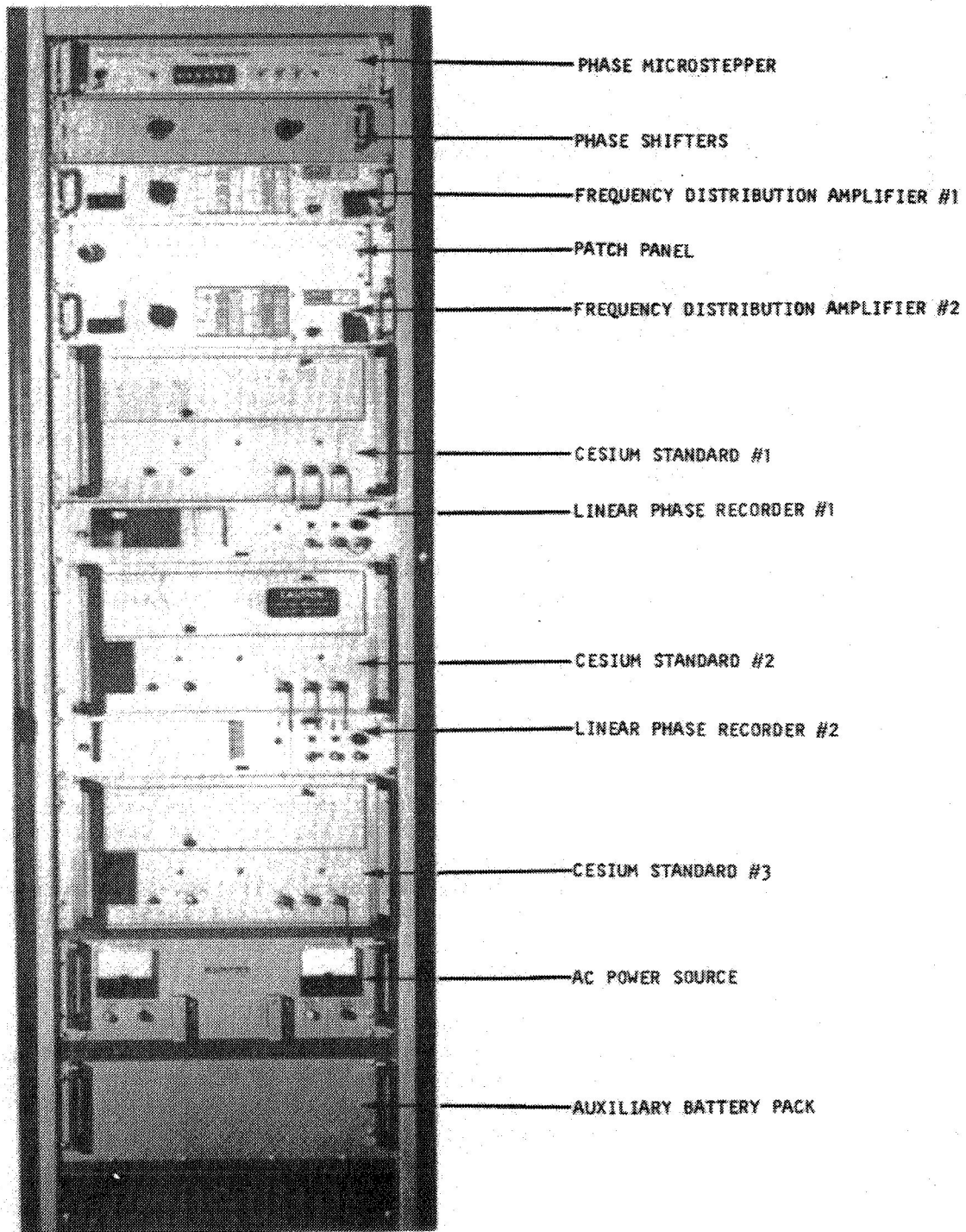

Figure 7. Frequency Standard System

Auxiliary Rack. The Auxiliary Rack contains units which perform the following functions:

(a) Status Alarm Unit (SAU): Provides a centralized alarm node and display position for all LRE alarm indications. In addition, the SAU monitors alarms for other important parameters (failure of 5 MHz, excessive ECD fluctuations, etc.) which affect the ability of the station to stay on-air in tolerance (Figure 8).

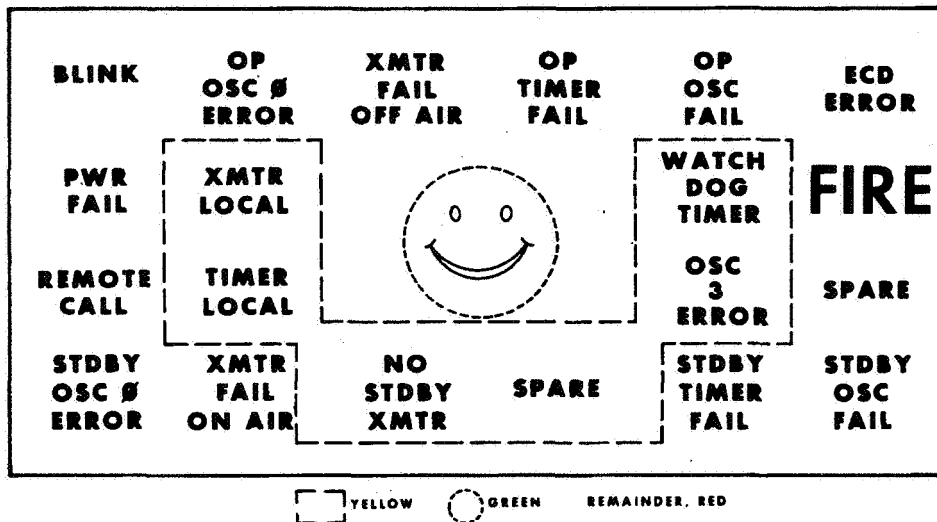

Figure 8. Status Alarm Unit

(b) Remote Control Interface (RCI): The RCI presently being installed with the LRE permits the following commands to be entered: local phase adjustments (LPA), start and stop blink, and call watch. The CALL WATCH command activates the audio alarms of the SAU to awaken the station watchstander in the event of an emergency. The RCI-2, presently under development, will expand the RCI capabilities, and permit a remote computer to control the LRE and perform all of the control and log-keeping functions for a Loran-C chain.

(c) Austron 2000-C Timing Receiver: Replaces the monitoring function of the older generation timers at secondary stations. A station "control number" is generated by comparing the receiver sampling strobe, tracking the master station, to the 1/2 Group Repetition Rate (1/2 GRR) generated in the COLAC at the secondary station.

RELIABILITY AND MAINTAINABILITY

One LRE design goal was to improve the reliability of the Loran-C

ground station equipment, and hence the system operational performance. Improved equipment reliability was achieved through careful design of the LRE units and overall system.

Reliability. The LRE was designed using high quality solid-state components. The printed circuit modules were conservatively designed, insuring that all components functioned at far below maximum ratings during normal operation. These efforts contribute to a very high Mean Time Between Failure (MTBF) for the LRE units, and thus to the high reliability of the Loran-C system. For example, under normal circumstances, there is no need to switch from the operate to the standby timers. This is in contrast to the operation of the older generation timers with weekly switches to perform preventative maintenance.

The complete LRE package is presently installed at LORSTA's Nantucket, Dana, Jupiter, and Estartit. Daily message reports on the performance of the U. S. East Coast Chain stations so equipped were evaluated at Coast Guard Headquarters. The overall performance of these stations for the period July 1973 through September 1974 is illustrated in Table I.

TABLE I UNUSABLE TIME BEFORE LRE VS AFTER LRE

	BEFORE LRE INSTALLATION			AFTER LRE INSTALLATION		PERCENT REDUCTION IN UNUSABLE TIME
	(minutes)			(minutes)		
LORSTA	1971	1972	1973	AVERAGE	1974	
JUPITER	889	506	623	673	317	52.9
NANTUCKET	530	479	991	667	231	65.4
DANA	858	367	716	647	336	48.1
TOTAL	2,277	1,352	2,330	1,986	884	55.5

Table I. Station Reliability Before and After LRE Installation

Maintainability. Use of the complete LRE package has significantly reduced the required maintenance. Table II illustrates the Loran-C equipment maintenance (excluding that for transmitters) required at LORSTA's Dana and Nantucket for periods before and after LRE installation.

	BEFORE LRE	AFTER LRE	PERCENT
	AVERAGE		REDUCTION IN
	1971,1972, AND 1973	1974	MAINTENANCE
	(hours) (Note 1)	(hours) (Note 1)	EFFORT
LORSTA			
NANTUCKET	717	81	89.8%
BANA	877	35	96.6%
TOTAL			93.7%

NOTE 1. INFORMATION TAKEN FROM LORSTA'S REPORT OF LORAN STATION OPERATION AND ELECTRONICS ENGINEERING (CG-2899), MARCH THRU OCTOBER FOR YEARS INDICATED.

NOTE 2. TRANSMITTER MAINTENANCE NOT INCLUDED IN THIS TABULATION.

Table II. Station Maintenance-man-hours Before and After LRE

ALL CHAIN LORAN-C TIME SYNCHRONIZATION

A report on this program was presented at the 1973 PTTI Planning Meeting by LCDR Sherman. No significant changes have occurred in the program since that time save for an unfortunate delay of almost a year. This delay was caused by personnel shortages (witness the absence of LCDR Sherman at this year's meeting) and procurement delays. All of the required equipment is now in the procurement process, and in fact, most of the equipment has been delivered to our laboratory. The project to assemble the equipment in a rack, print suitable technical manuals, and ship the equipment to the stations has been initiated. We expect the first equipment to be in the field in the Spring of 1975. In the meantime, the Coast Guard, with the cooperation of the U. S. Naval Observatory, is attempting to maintain the values for (UTC(USNO)-Loran-C) within 5 microseconds for the timed chains. This will of course be much easier to accomplish when the equipment is in the field to make the published values independent of clock trips.

ACKNOWLEDGEMENTS

My thanks to LCDR G. R. Goodman and LT R. P. Oswitt for the information on the LRE.