

General Disclaimer

One or more of the Following Statements may affect this Document

- This document has been reproduced from the best copy furnished by the organizational source. It is being released in the interest of making available as much information as possible.
- This document may contain data, which exceeds the sheet parameters. It was furnished in this condition by the organizational source and is the best copy available.
- This document may contain tone-on-tone or color graphs, charts and/or pictures, which have been reproduced in black and white.
- This document is paginated as submitted by the original source.
- Portions of this document are not fully legible due to the historical nature of some of the material. However, it is the best reproduction available from the original submission.

**NASA TECHNICAL
MEMORANDUM**

NASA TM X-72752

NASA TM X-72752

**DUAL FREQUENCY SCATTEROMETER MEASUREMENT
OF OCEAN WAVE HEIGHT**

J. W. Johnson
W. L. Jones
C. T. Swift
W. L. Grantham
D. E. Weissman

July 8, 1975



(NASA-TM-X-72752) DUAL FREQUENCY
SCATTEROMETER MEASUREMENT OF OCEAN WAVE
HEIGHT (NASA) 23 p HC \$3.25 CSCL 08C

N75-28/60

Unclas
G3/48 29869

This informal documentation medium is used to provide accelerated or special release of technical information to selected users. The contents may not meet NASA formal editing and publication standards, may be revised, or may be incorporated in another publication.

**NATIONAL AERONAUTICS AND SPACE ADMINISTRATION
LANGLEY RESEARCH CENTER, HAMPTON, VIRGINIA 23665**

1. Report No. NASA TM X- 72752	2. Government Accession No.	3. Recipient's Catalog No.	
4. Title and Subtitle Dual Frequency Scatterometer Measurement of Ocean Wave Height		5. Report Date	
		6. Performing Organization Code	
7. Author(s) J. W. Johnson, W. L. Jones, C. T. Swift, W. L. Grantham, D. E. Weissmar		8. Performing Organization Report No.	
		10. Work Unit No.	
9. Performing Organization Name and Address NASA Langley Research Center Hampton, Virginia 23665		11. Contract or Grant No.	
		13. Type of Report and Period Covered	
12. Sponsoring Agency Name and Address National Aeronautics and Space Administration Washington, D. C. 20546		NASA Technical Memorandum	
		14. Sponsoring Agency Code	
15. Supplementary Notes Paper presented at the 1974 USNC/URSI Meeting, Boulder, Colorado, October 14-17, 1974			
16. Abstract A technique for remotely measuring RMS wave height averaged over an area of the sea surface has been developed theoretically and verified with a series of aircraft flight experiments. The measurement concept involves the cross-correlation of the amplitude fluctuations of two monochromatic reflected signals with variable frequency separation. The signal reflected by the randomly distributed specular points on the surface is observed in the backscatter direction at nadir incidence angle. The measured correlation coefficient is equal to the square of the magnitude of the characteristic function of the specular point height from which RMS wave height can be determined. The flight scatterometer operates at 13.9 GHz and 13.9 - Δf GHz with a maximum Δf of 40 MHz. Measurements have been conducted for low and moderate sea states at altitudes of 2, 5, and 10 thousand feet. The experimental results agree with the predicted decorrelation with frequency separation and with off-nadir incidence angle.			
17. Key Words (Suggested by Author(s)) (STAR category underlined) <u>Communications</u> , Electromagnetic Rough Surface Scattering, Dual Frequency Scatterometer, Radio Oceanography		18. Distribution Statement Unclassified - Unlimited	
19. Security Classif. (of this report) Unclassified	20. Security Classif. (of this page) Unclassified	21. No. of Pages 23	22. Price* \$3.25

*Available from { The National Technical Information Service, Springfield, Virginia 22151
STIF/NASA Scientific and Technical Information Facility, P.O. Box 33, College Park, MD 20740

INTRODUCTION

A dual frequency electromagnetic scattering technique has been developed for measuring the rms height of a randomly rough surface and has been applied to the remote sensing of significant wave height on the ocean surface. This measurement involves a near-nadir looking radar that transmits and then receives two monochromatic signals simultaneously. At the receiver, the two radar returns are correlated as a function of their variable frequency separation. The resulting cross correlation depends primarily on the rms wave height. A theoretical analysis of this technique has been verified in a series of laboratory measurements by Weissman¹. Presently, NASA/LaRC is conducting an experimental program with an airborne dual frequency scatterometer (DFS) to verify this measurement concept under a variety of sea state conditions. A future goal of this research is to conduct daily measurements of sea state on a synoptic scale. This could be implemented by installing inexpensive, self-contained, compact radar units with low power requirements on the exterior of commercial and/or government aircraft that travel over ocean paths of interest. Figure 1 gives an idea of the commercial coverage of the Atlantic and Pacific oceans by one carrier.

This paper deals with the dual frequency technique, the aircraft program, and typical results for low and moderate sea states.

THEORY

In the dual frequency technique, two monochromatic signals are transmitted at normal incidence to the surface as shown in Figure 2. The backscattered signal amplitudes are cross correlated as a function of the frequency difference between the two carriers. Since the illuminated area consists of randomly situated scattering points, the returned signal amplitude at each frequency will fluctuate randomly and the degree of correlation between the two envelopes depends on the relative heights of the scatterers.

The time expressions for the backscattered fields, $e_1(t)$ and $e_2(t)$, are given in Figure 3, and the amplitude modulation terms, \underline{E}_1 and \underline{E}_2 , are written as phasors. The two frequency correlation function, $R(\Delta f)$, is defined as the cross correlation of \underline{E}_1 and \underline{E}_2 normalized to the product of their respective rms values. Furthermore, it can be shown that $|R(\Delta f)|^2$ involves the cross correlation of only the amplitude terms in \underline{E}_1 and \underline{E}_2 and no phase information is required.

To derive the correlation function in terms of rms wave height, the physical optics approximation is used in solving Helmholtz integrals for the backscattered fields at each frequency. This leads to a specular point summation at each frequency, and when these are cross correlated the result is as shown in Figure 4. Here, the first term in the first equation introduces a deterministic phase angle that can be ignored for studying roughness effects. The second term is the mean value of the phase difference evaluated at the difference frequency, Δf , due to the random elevation, h_n , of the specular points about the mean surface. This term is also the characteristic function

of the specular point heights, or the Fourier transform of their probability density function. Thus, the rms height can be determined by inversion of the transform. The right hand term in this equation includes the effects of antenna beam spreading and off nadir alignment on the measurement of $R(\Delta f)$. This effect can be made negligible by properly choosing system parameters.

Assuming that the specular point heights are Gaussian distributed, then the theoretical result for $R(\Delta k)$, where $\Delta k = 2\pi(\Delta f/c)$, is as shown in Figure 5. Significant wave height, $H_{1/3}$, the term used by oceanographers to represent sea state, is approximately equal to 4 times the rms wave height, σ , for a fully developed sea. The pattern function in this figure is a predictable term; thus, a measurement of $|R(\Delta f)|$ versus frequency separation with the DFS will infer the rms wave height on the surface.

Figure 6 shows the decorrelation effect due to beam curvature or off nadir alignment. Points on the surface at the same elevation may be separated in range and erroneous decorrelation may occur. This effect determines the maximum allowable beam width and alignment error tolerances for a dual frequency/sea state measurement.

Theoretical calculations of correlation coefficient versus Δf for nadir alignment and a 3.0° antenna beamwidth are shown in Figure 7. These curves show how the correlation function varies with roughness as σ ranges from 0.1 meter to 7.0 meters. At $\sigma = 0.1$ meter, the correlation function is mainly influenced by beam curvature decorrelation, but as σ exceeds 0.5 meter the roughness term dominates so that it can be accurately inferred from an observation. Figure 8 shows the off nadir alignment effect that has been accentuated in the calculations by setting the viewing angle equal to

5.67°. Under these conditions, only very rough seas could be measured accurately.

AIRCRAFT MEASUREMENT PROGRAM

The aircraft in Figure 9 is the Johnson Space Center NC-130 B (NASA 929) which has been used in the DFS flight program. Two missions have been conducted -- the first in early June 1974 and the second in August 1974. Figure 10 is a photograph of the scatterometer mounted to a rail structure on the lowered cargo ramp of the aircraft. In the measurement position, it views the ocean surface at incidence angles from 0-53 degrees.

The DFS hardware is a modification to an existing scatterometer (RADSCAT) that operates in a long pulse, beam limited mode and measures average scattered power. Figure 11 is a block diagram showing that part of the system that is pertinent to the DFS. Pulses are alternately transmitted at $f_a = 13.9$ GHz and $f_b = f_a + \Delta f$, where $\Delta f = 0 - 40$ MHz. Separate f_a and f_b local oscillators are synchronized with the transmitter to maintain a 300 MHz intermediate frequency. The envelopes of the received pulses are separated in the DFS correlator, and the f_a and f_b pulses are sampled and held to form continuous signals which are then cross correlated.

Typical results from the June 1974 flights are shown in Figures 12 and 13. When these measurements were made, the winds and sea were calm, approximately 5 knots and 1 foot rms, respectively. Measurements at nadir just barely detect the presence of roughness. The off nadir data in both Figures 12 and 13 show excellent agreement with the theory, and comparing the two

sets of curves for 5000 feet and 10,000 feet shows the stronger decorrelation at 10,000 feet due to a larger range spreading effect.

During the second mission extremely calm seas were again encountered, and Figure 14 shows some typical results at nadir. When the seas are so calm that the roughness decorrelation cannot be resolved (less than 1 foot rms), the pattern decorrelation effect is not great enough to lead to erroneous results. Fortunately, a tropical depression formed in the Caribbean during the last week in August and flights were conducted in the vicinity of this storm, which later grew into Hurricane Carmen. At one test site about 200 miles northeast of Puerto Rico the surface winds were in the 20-30 knot range. Two sets of data, upwind and downwind, were taken and the results have been fitted to a theoretical curve for an rms wave height of 0.7 meter ($H_{1/3} = 9$ feet) in Figure 15. There is appreciable scatter in these data, but this may be reduced in the future by using longer integration times and by accounting for aircraft pitch and roll. Results thus far are considered preliminary since laser wave profile data taken on each flight have not yet been reduced for comparison.

SUMMARY

The theoretical development of a dual frequency correlation technique for remotely sensing R.M.S. wave height on the ocean surface has been developed, and a flight program for proving the measurement concept is in progress.

Flight results have been obtained for low and moderate sea states and for incidence angles from nadir to 55 degrees. Preliminary results are in excellent agreement with the theory for both surface roughness effects and

antenna pattern decorrelation. The data analysis is now being refined to correct for aircraft motion. Wave heights inferred by the DFS will also be compared to laser wave profile data. Future flights are planned for high sea states; nevertheless, the results at this point indicate that this technique is valid and would be successful for measurements from aircraft.

REFERENCES

1. Weissman, D. E., "Two Frequency Radar Interferometry Applied to the Measurement of Ocean Wave Height," IEEE Trans. on Ant. and Prop., Vol. 21, No. 5, Sept. 1973.

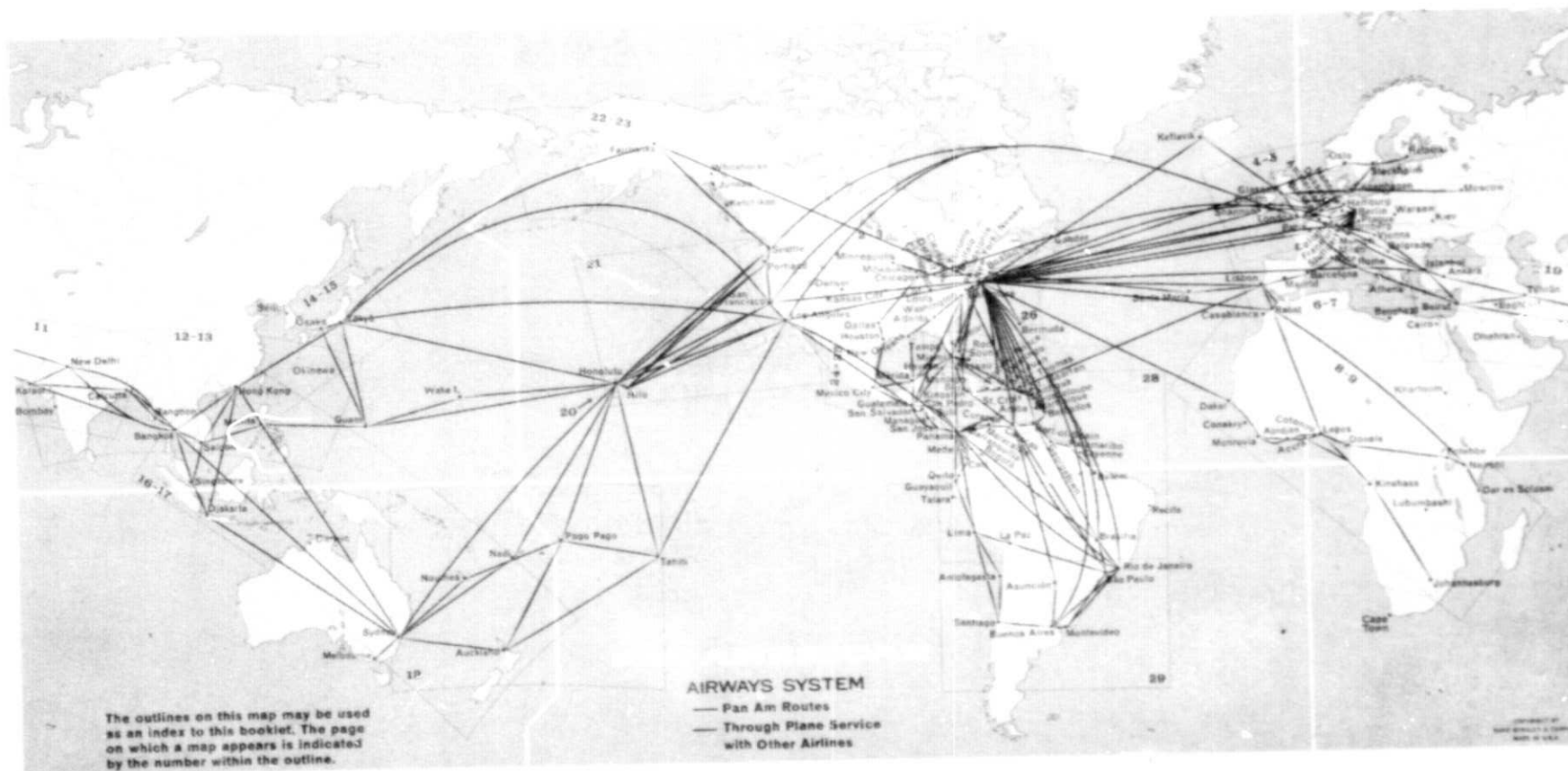
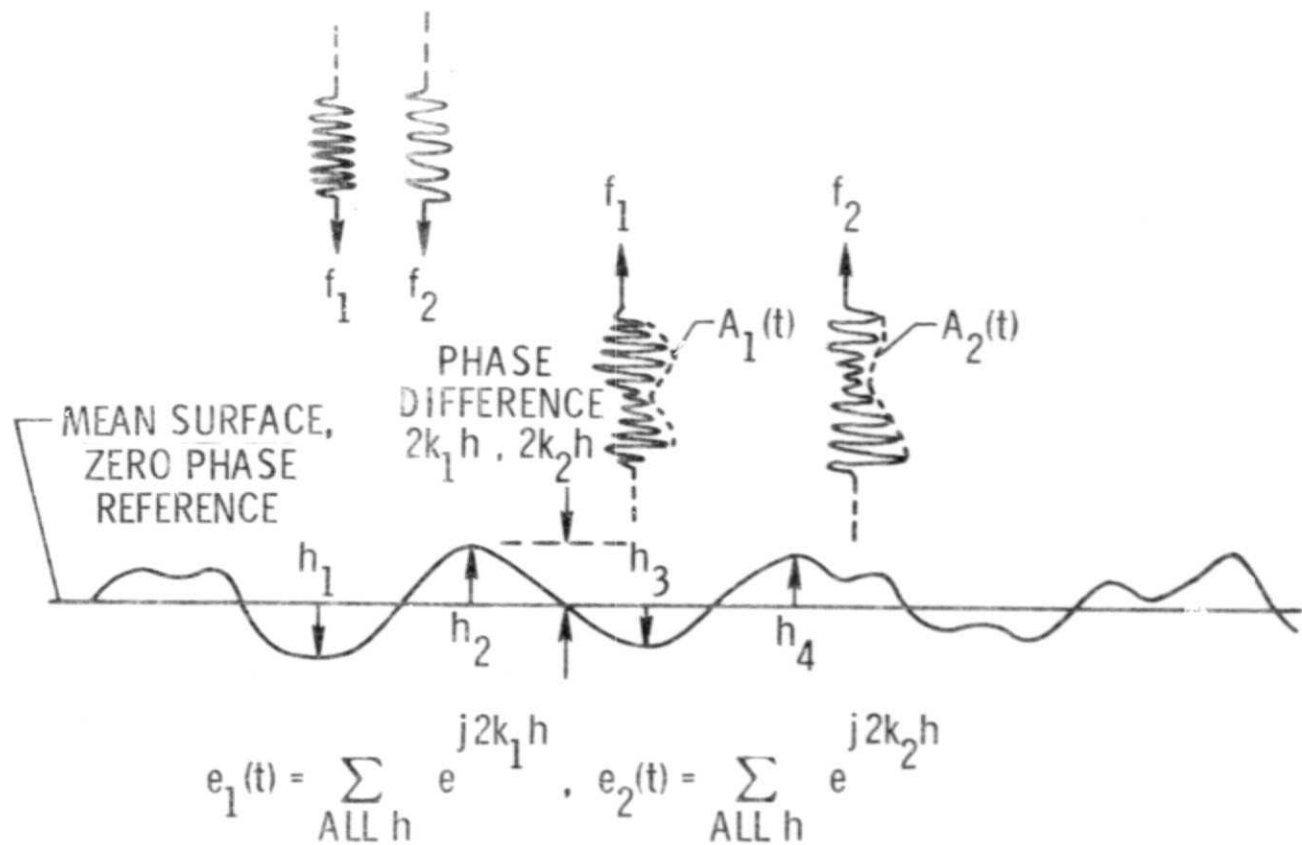

Figure 1. Pan Am Commercial Routes



THE SIZE OF THE RELATIVE PHASE SHIFTS AMONG SCATTERING POINTS AT f_1 NOT SAME AS AT f_2

Figure 2. Dual Frequency Principle

RECEIVED FIELDS :

$$\begin{aligned}
 e_1(t) &= A_1(t) \cos(\omega_1 t + \Phi_1 + \theta_1(t)) \\
 &= \operatorname{Re} \left\{ A_1(t) e^{j\theta_1(t)} \cdot e^{j(\omega_1 t + \Phi_1)} \right\} \\
 &= \operatorname{Re} \left\{ \underline{E}_1 e^{j(\omega_1 t + \Phi_1)} \right\}
 \end{aligned}$$

$$\underline{E}_1 = A_1(t) e^{-j\theta_1(t)}$$

$$e_2(t) = \operatorname{Re} \left\{ \underline{E}_2 e^{j(\omega_2 t + \Phi_2)} \right\}$$

$$\Delta f = f_2 - f_1$$

$$\underline{E}_2 = A_2(t) e^{j\theta_2(t)}$$

TWO FREQUENCY CORRELATION FUNCTION :

$$\underline{R}(\Delta f) \triangleq \frac{\langle \underline{E}_1 \cdot \underline{E}_2^* \rangle}{\left[\langle |\underline{E}_1|^2 \rangle \langle |\underline{E}_2|^2 \rangle \right]^{1/2}} = \frac{\langle A_1 A_2 e^{j(\theta_1 - \theta_2)} \rangle}{\left[\langle A_1^2 \rangle \langle A_2^2 \rangle \right]^{1/2}}$$

ALSO

$$\left| \underline{R}(\Delta f) \right|^2 = \frac{\langle (A_1^2(t) - \langle A_1^2 \rangle) (A_2^2(t) - \langle A_2^2 \rangle) \rangle}{\text{NORMALIZING TERMS}}$$

Figure 3. Definition of Correlation Function In Terms of Scattered Fields

$$R(\Delta k) = e^{+j2(\Delta k)R_0} \left\langle e^{+j2(\Delta k)h_n} \right\rangle \left\langle e^{+j\Delta k \left(\frac{x_n^2 + y_n^2}{R_0} \right)} \right\rangle$$

ASSUMING h_n IS INDEPENDENT OF CURVATURE

$$\Delta k = \frac{2\pi(\Delta f)}{c}$$

$$\left\langle e^{j2(\Delta k)h_n} \right\rangle = \int_{-\infty}^{\infty} p(h_n) e^{+j2(\Delta k)h_n} dh_n$$

= CHARACTERISTIC FUNCTION OF h_n

Figure 4. Correlation Function In Terms of Roughness and Beam Curvature

IF SPECULAR POINTS ARE GAUSSIAN DISTRIBUTED

$$p(h_n) = \frac{1}{\sigma\sqrt{2\pi}} e^{-\frac{h_n^2}{2\sigma^2}}$$

WHERE

σ = RMS HEIGHT

$$= 1/4 H_{1/3}$$

THEN

$$|R(\Delta k)| = e^{-2\sigma^2(\Delta k)^2} \cdot \text{(PATTERN FUNCTION OF } \Delta k)$$

Figure 5. Correlation Function for A Gaussian Surface

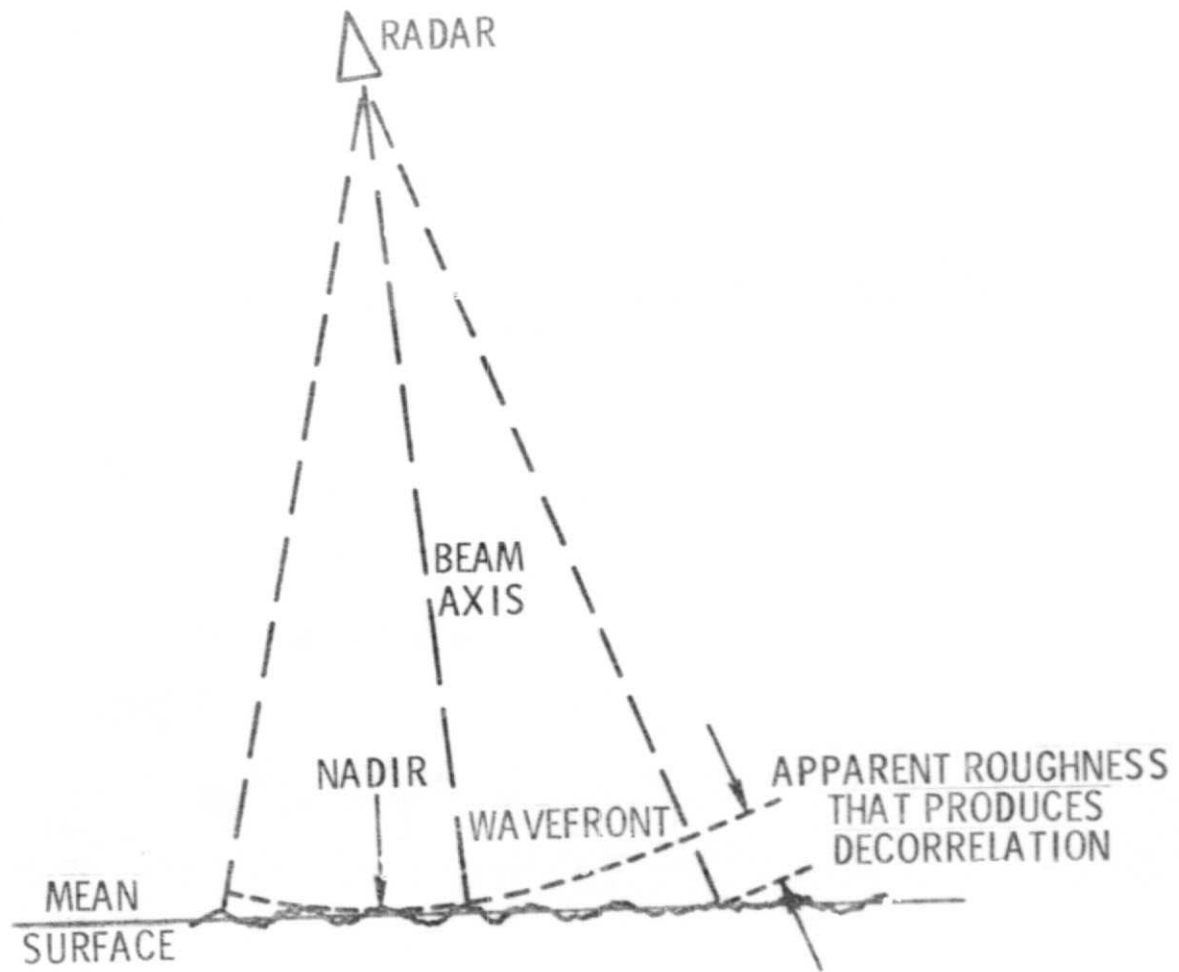

Figure 6. Beam Curvature Decorrelation Effect

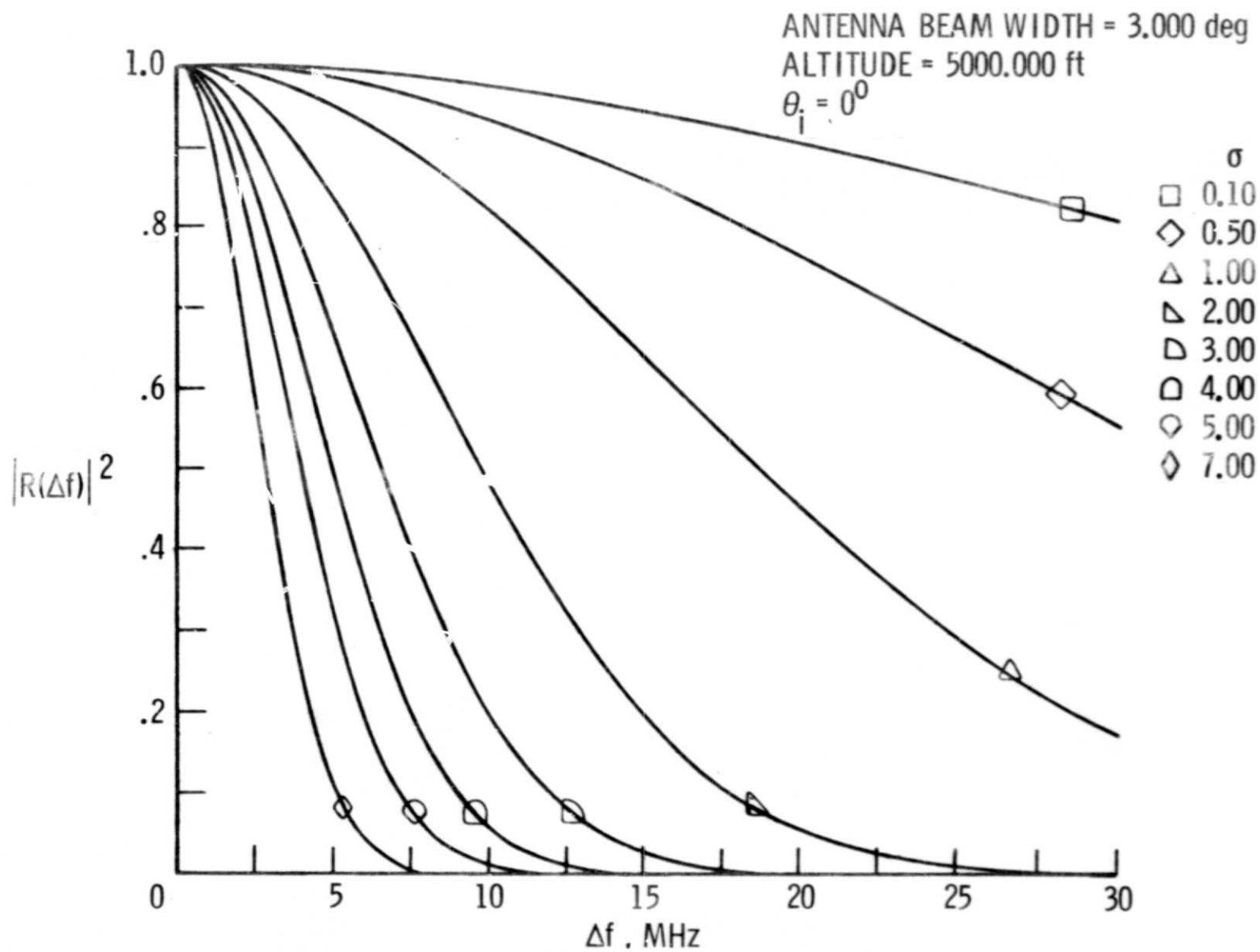

Figure 7. Roughness Decorrelation at Nadir Incidence

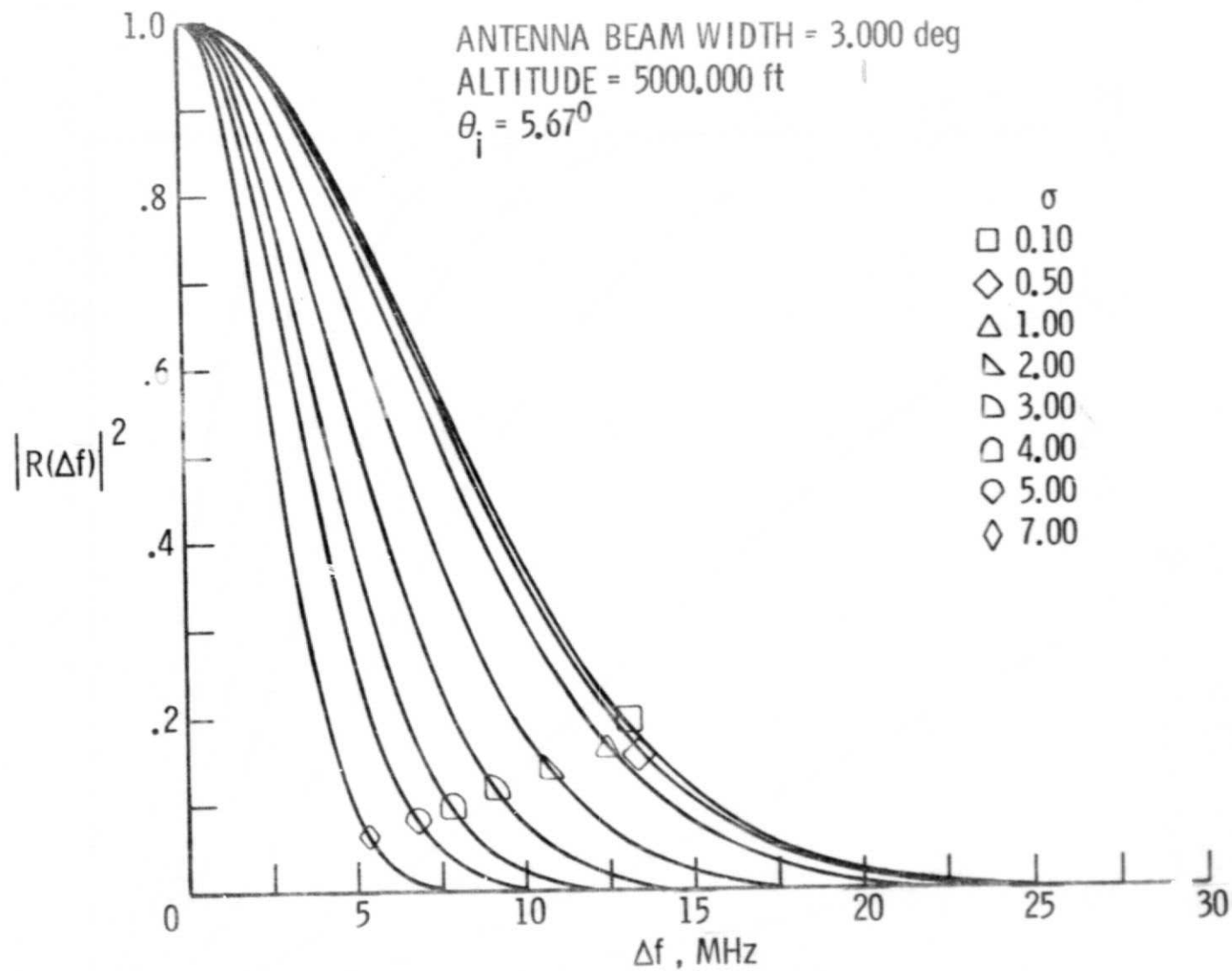

Figure 8. Off-Nadir Effect on Decorrelation



Figure 9. NC-130B Used In Aircraft Program



Figure 10. DFS In Measurement Configuration

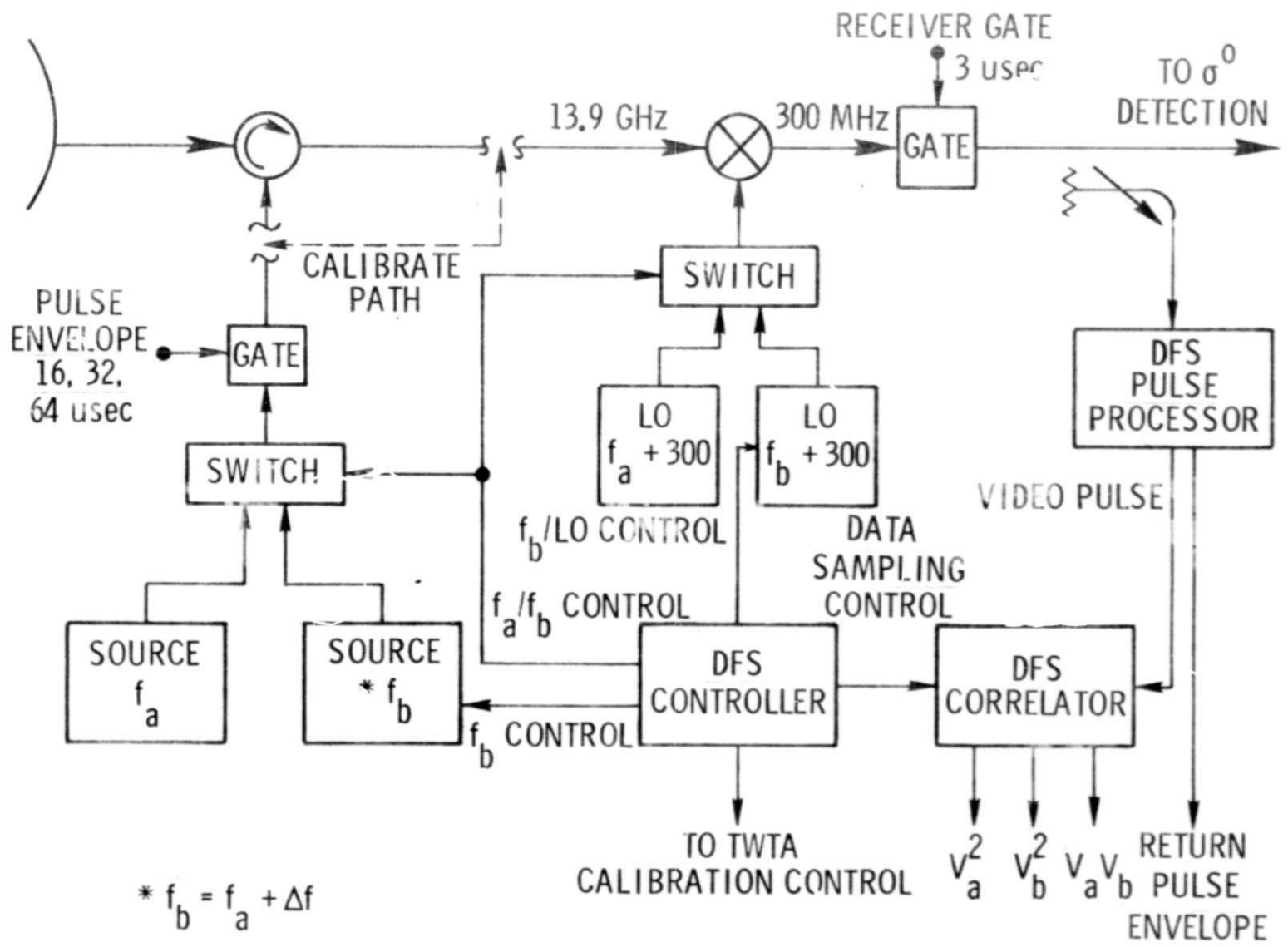

Figure 11. Dual Frequency Scatterometer (DFS)

ANTENNA BEAM WIDTH = 1.500 DEGREES

ALTITUDE = 5000.000 FEET

SIGMA = 0.326

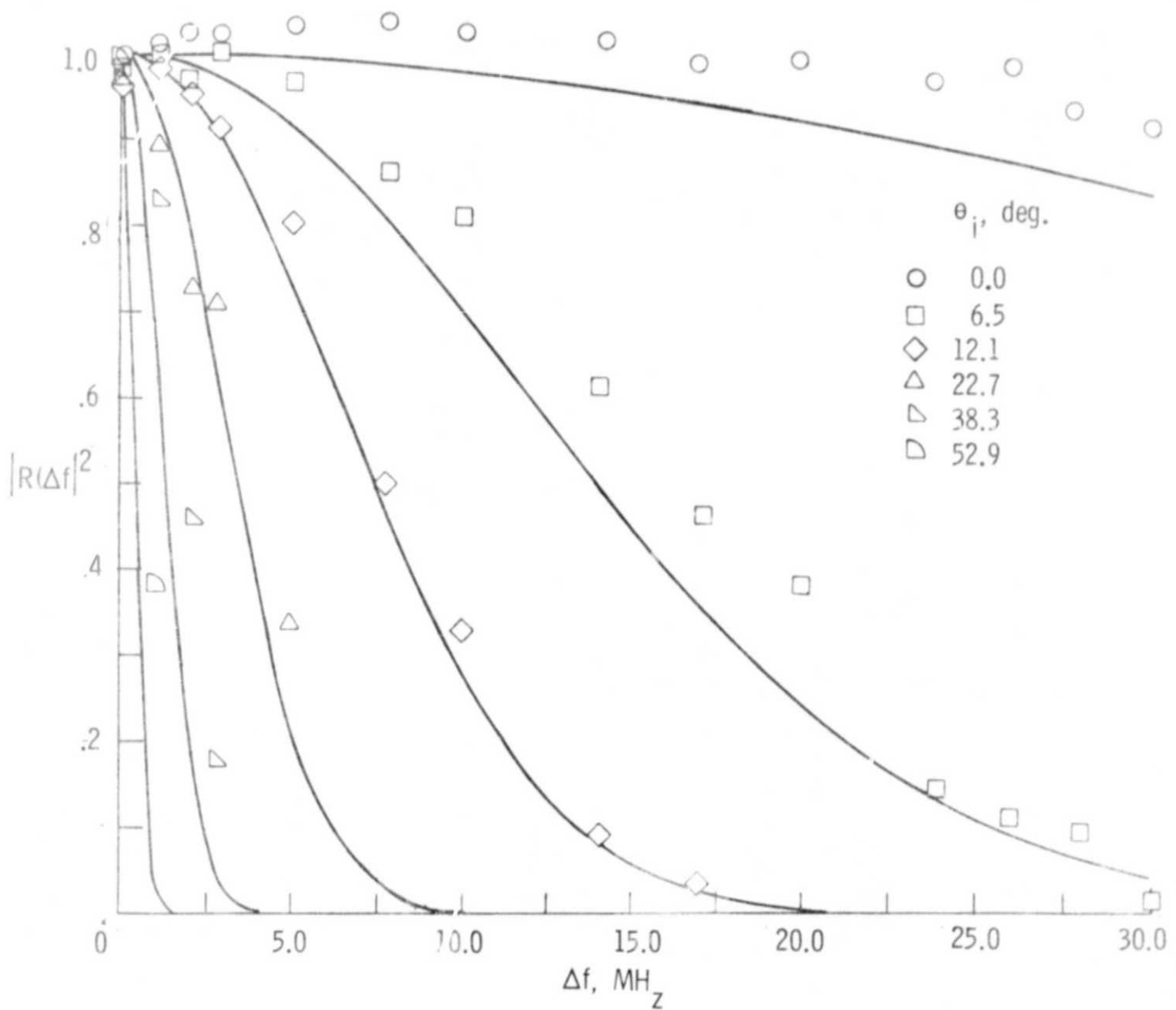

Figure 12. June, 1974, 5000 Ft., Flight Results

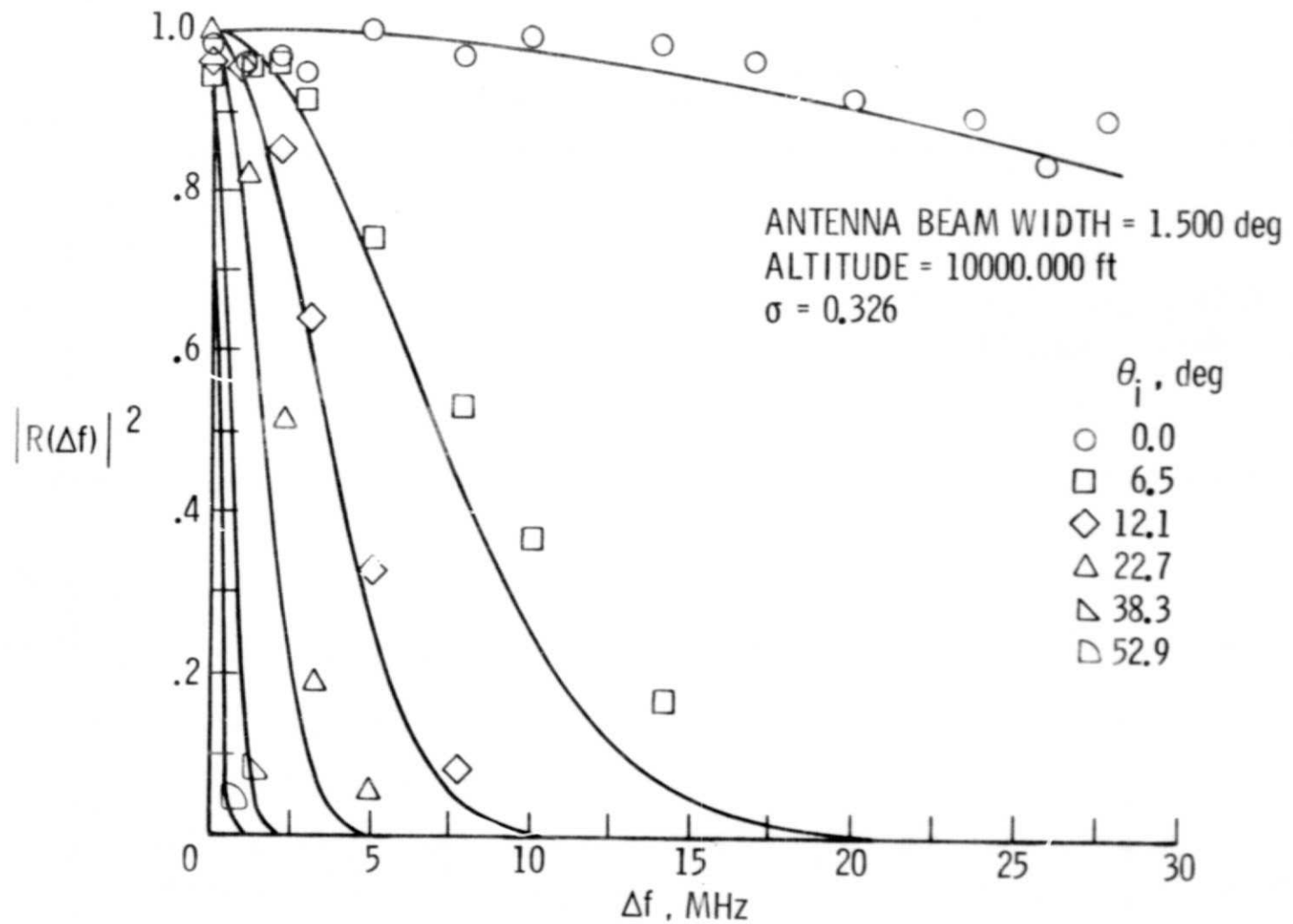

Figure 13. June, 1974, 10 000 Ft., Flight Results

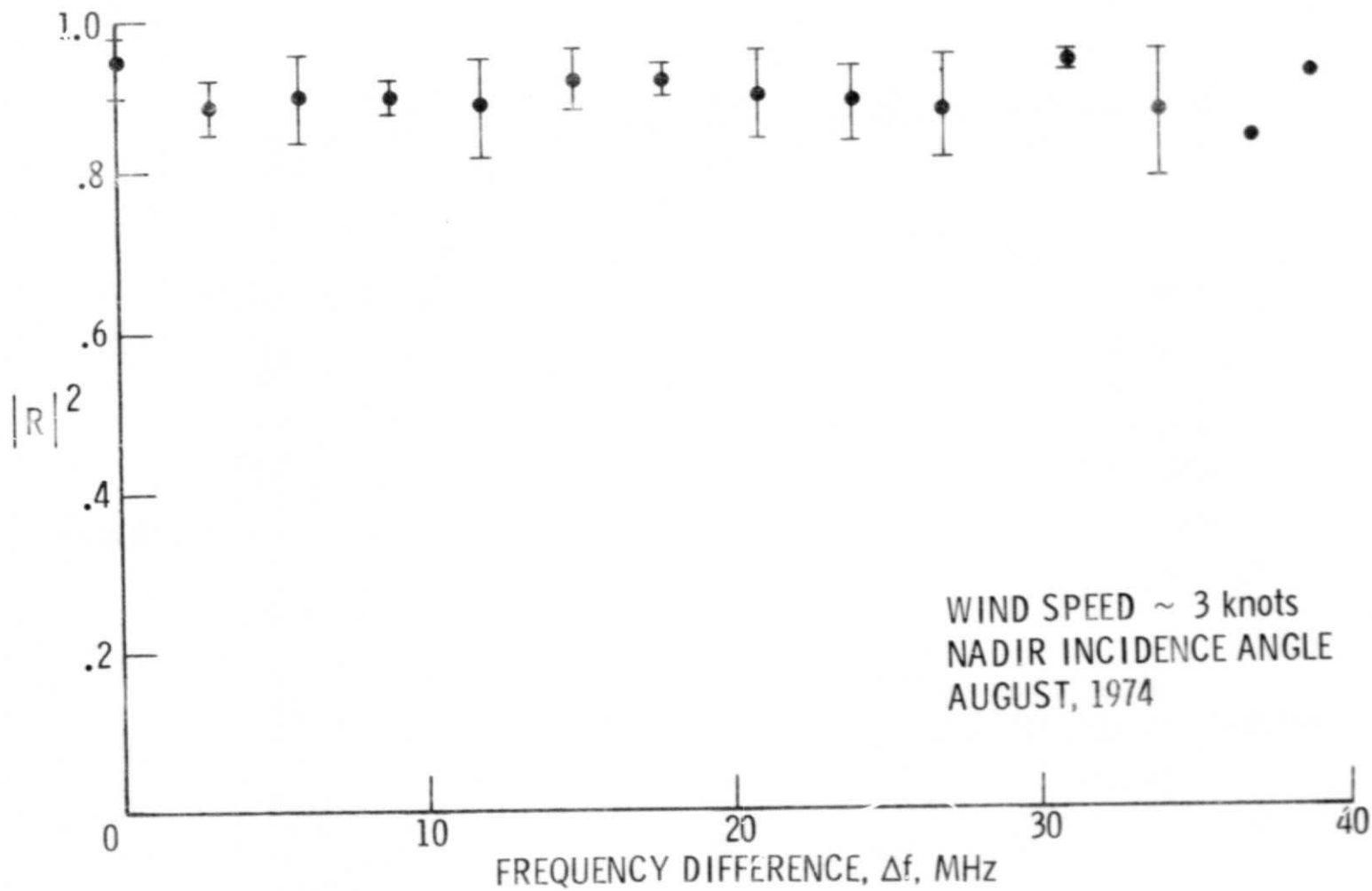

Figure 14. Low Sea State Flight Results

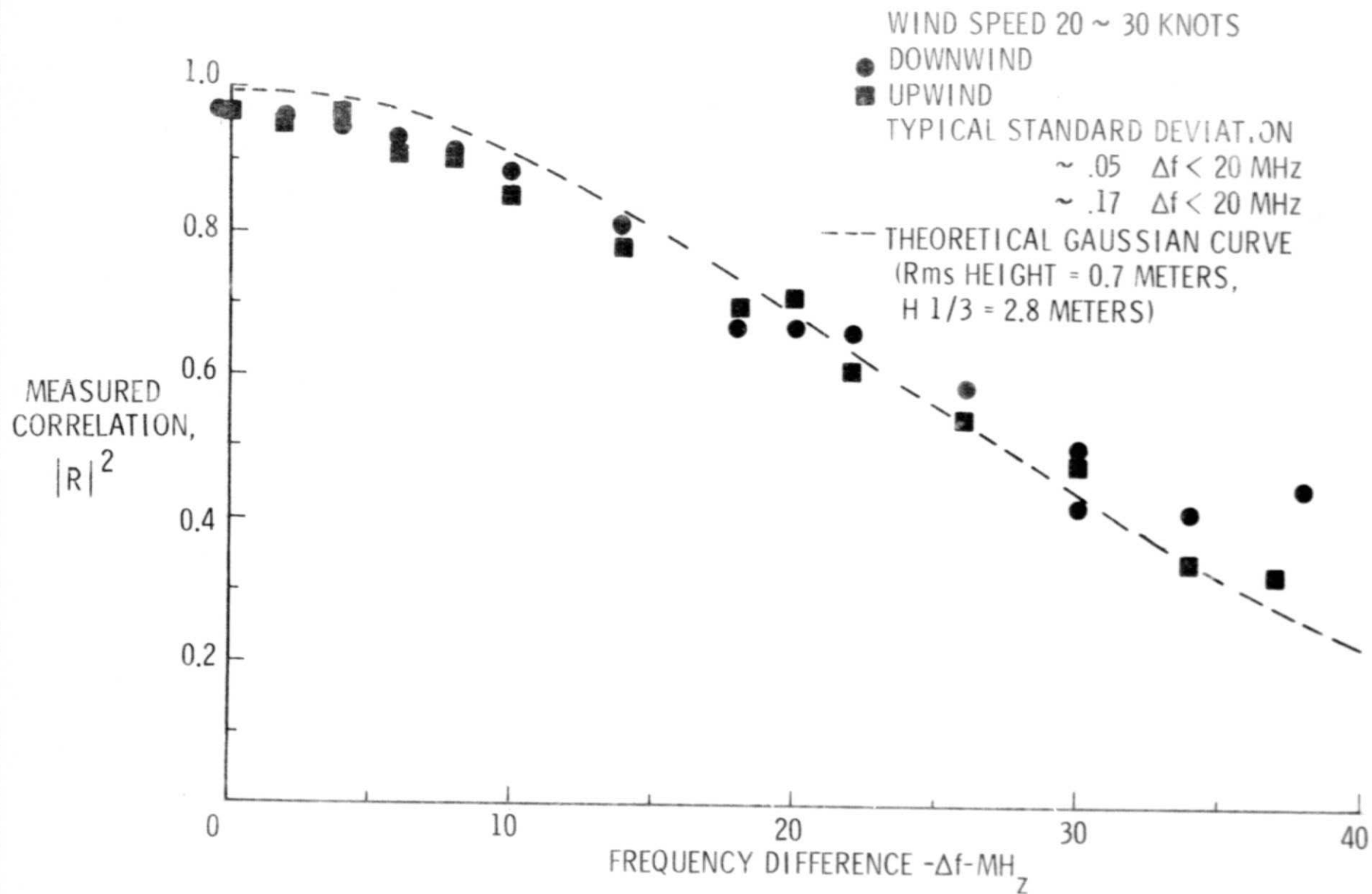

Figure 15. Moderate Sea State Flight Results