

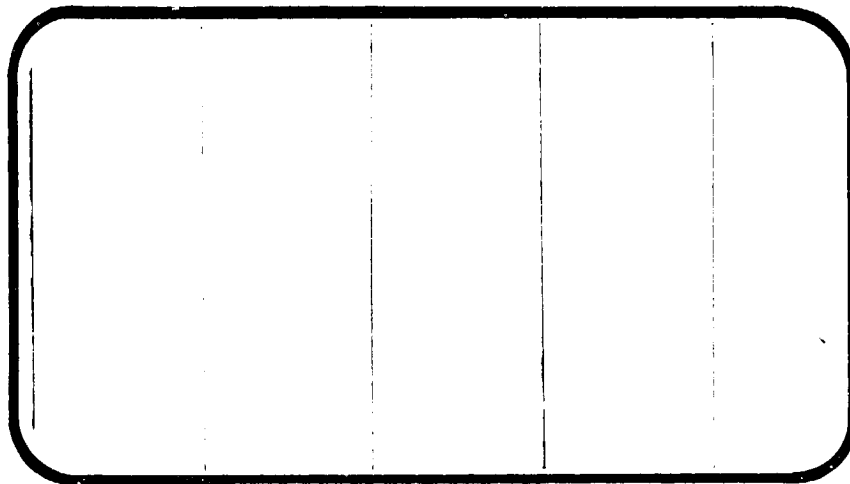

NATIONAL AERONAUTICS AND SPACE ADMINISTRATION

NASA CR-

134117



(NASA-CR-134117) AERODYNAMIC RESULTS OF A
SEPARATION EFFECTS TEST CONDUCTED IN THE
ALTO 40 BY 47 INCH TUNNEL A FACILITY ON THE
ROCKWELL INTERNATIONAL LAUNCH CONFIGURATION
3 (MODEL-OIS) INTEGRATED VEHICLE (IA13),

N75-31238

Unclas
G3/15 33793

SPACE SHUTTLE

AEROTHERMODYNAMIC DATA REPORT

JOHNSON SPACE CENTER

HOUSTON, TEXAS

DATA Management services

SPACE DIVISION



CHRYSLER
CORPORATION

July, 1975

DMS-DR-2062
NASA CR-134,117

AERODYNAMIC RESULTS OF A SEPARATION EFFECTS
TEST CONDUCTED IN THE AEDC 40 x 40 INCH TUNNEL A
FACILITY ON THE ROCKWELL INTERNATIONAL LAUNCH
CONFIGURATION 3 (MODEL 32-OTS) INTEGRATED VEHICLE
(IA13)

Vol. I of III

J. H. Campbell, II
Rockwell International Space Division

Prepared under NASA Contract Number NAS9-13247

by

Data Management Services
Chrysler Corporation Space Division
New Orleans, La. 70189

for

Engineering Analysis Division

Johnson Space Center
National Aeronautics and Space Administration
Houston, Texas

TUNNEL TEST SPECIFICS:

Test Number: AEDC VA-323
NASA Series Number: IA13
Test Dates: July 5-17, 1973

FACILITY COORDINATOR:

Larry L. Trimmer
ARO, Inc.
VKF-SH
Arnold Air Force Station
Tullahoma, Tenn. 37389
Phone: (615) 455-2611 ext 7377

PROJECT ENGINEER:

John H. Campbell, II
Rockwell International Space Division
12214 Lakewood Blvd.
Mail Code AC-07
Downey, California 90241
Phone: (213) 922-2440

DATA MANAGEMENT SERVICES:

Prepared by: Liaison - J. E. Vaughn
Operations - Maurice Moser, Jr.

Reviewed by: G. G. McDonald, J. L. Glynn *JL*

Approved by: *N. D. Kemp*
N. D. Kemp, Manager
Data Management Services

Concurrence:
J. G. Swider
J. G. Swider, Manager
Flight Technology Branch

Chrysler Corporation Space Division assumes no responsibility for the data presented other than display characteristics.

AERODYNAMIC RESULTS OF A SEPARATION EFFECTS
TEST CONDUCTED IN THE AEDC 40 x 40 INCH TUNNEL A
FACILITY ON THE ROCKWELL INTERNATIONAL LAUNCH
CONFIGURATION 3 (MODEL 32-OTS) INTEGRATED VEHICLE
(IA13)

by

J. H. Campbell, II
Rockwell International Space Division

ABSTRACT

Experimental aerodynamic investigations were conducted from July 5 through July 17, 1973, in the AEDC/VKF tunnel A facility, on a 0.01 scale model (Model 32-OTS) of the Rockwell International launch configuration 3 Integrated Vehicle (excluding the left-hand booster). The AEDC captive trajectory system was utilized in conjunction with the tunnel primary sector to obtain "grid-type" data for tank (ET) abort from the Orbiter (SSV), and for nominal separation of one Booster (SRB) from the Orbiter-Tank combination. Booster separation was investigated with and without separation motors plume simulation. The plumes were generated by eight $M_j = 2.15$ nozzles using a 1500 psia cold air supply.

Free stream data were obtained for all models (orbiter, tank, orbiter-tank, and right-hand booster) to provide baselines for evaluation of proximity effects.

The entire investigation was conducted at a nominal free stream Mach number of 4.5 and at Reynolds number per foot ranging from approximately 7.0×10^5 to 6.6×10^6 .

This report is published in three volumes. Volume I contains data figures through page 894. Volume II contains the remaining data figures and the appendix (tabulated source data) is found in Volume III.

TABLE OF CONTENTS

	PAGE
ABSTRACT	iii
INDEX OF MODEL FIGURES	2
INDEX OF DATA FIGURES	3
NOMENCLATURE	5
INTRODUCTION	9
CONFIGURATIONS INVESTIGATED	12
TEST FACILITY DESCRIPTION	14
DATA REDUCTION	15
TABLES	
I TEST CONDITIONS	17
II DATASET/RUN NUMBER COLLATION SUMMARY	18
III MODEL DIMENSIONAL DATA	39
FIGURES	
MODEL	49
DATA	60
VOLUME I - 1 through 894	
VOLUME II - 895 through 1498	
APPENDIX	60
VOLUME III - TABULATED SOURCE DATA	

INDEX OF MODEL FIGURES

<u>FIGURE</u>	<u>MODEL</u>	<u>PAGE</u>
1.	Axis Systems	49
2.	Model Sketches	
	a. Integrated Vehicle Configuration 3 (Mated)	50
	b. Model 32-OTS Integrated Vehicle Configuration 3	51
	c. Model 32-OTS Orbiter and Tank Configuration 3	52
	d. Tank Separation from Orbiter	53
	e. Booster Separation from Orbiter/Tank	54
	f. 32-OTS Booster Model Forward Thruster Nozzle Block	55
	g. 32-OTS Booster Model Aft Thruster Nozzle Block	56
	h. 32-OTS Orbiter/Tank Forward Attachment	57
	i. 32-OTS Orbiter/Tank Aft Attachment	58
3.	AEDC von Karman Gas Dynamic Facility Tunnel A	59

INDEX OF DATA FIGURES

TITLE	SCHEDULE OF PLOTTED COEFFICIENTS	PAGE
Volume I		
Isolated Orbiter Aerodynamic Characteristics	A	1-9
Isolated External Tank Aerodynamic Characteristics	A	10-12
Isolated Orbiter with External Tank Aerodynamic Characteristics	A	13-15
Isolated Solid Rocket Booster w/o Plumes Aerodynamic Characteristics	B	16-23
Isolated Solid Rocket Booster w/Plumes Aerodynamic Characteristics	B	24-27
Effect of External Tank Separation on Orbiter Aerodynamic Characteristics	C	28-324
External Tank Aerodynamic Characteristics During Separation from Orbiter	C	325-621
Effect of SRB w/o Plumes Separation on Orb/ET Aerodynamic Characteristics	C	622-894
Volume II		
SRB w/o Plumes Aerodynamic Characteristics During Separation from Orb/ET	D	895-1076
Effect of SRB w/Plumes Separation on Orb/ET Aerodynamic Characteristics	C	1077-1328
SRB w/Plumes Aerodynamic Characteristics During Separation from Orb/ET	D	1329-1498

Schedule of Coefficients Plotted:

A) CN, CA, CLM, CBL, CY, CYN vs ALPHA

B) CN, CLM, CY, CYN vs ALPHA

C) CN, CA, CLM, CBL, CY, CYN vs Z

D) CN, CLM, CY, CYN vs Z

NOMENCLATURE

<u>SYMBOL</u>	<u>PLOT SYMBOL</u>	<u>DEFINITION</u>
a		speed of sound; ft/sec
V		velocity; ft/sec
M	MACH	Mach number, V/a
q_∞	Q(PSF)	dynamic pressure, $\rho V^2/2$; psf
ρ	RHO	mass density; slugs/ft ³
A_b		base area; ft ²
C_{A_b}	CAB	base force coefficient, $-A_b(P_b - P_\infty)/q_\infty S_w$; <u>base force</u> $q_\infty S_w$
C_{A_f}	CAF	forebody axial force coefficient; $C_A - C_{A_b}$
C_A	CA	axial force coefficient excluding adjustments for base and sting/balance cavity pressure measurements; <u>axial force</u> $q_\infty S_w$
C_N	CN	normal force coefficient; <u>normal force</u> $q_\infty S_w$
C_l	CBL	rolling moment coefficient; <u>rolling moment</u> $q_\infty S_w l_{ref}$
C_m	CLM	pitching moment coefficient; <u>pitching moment</u> $q_\infty S_w l_{ref}$
C_Y	CY	side force coefficient; <u>side force</u> $q_\infty S_w$
C_n	CYN	yawing moment coefficient; <u>yawing moment</u> $q_\infty S_w l_{ref}$

NOMENCLATURE (Continued)

<u>SYMBOL</u>	<u>PLOT SYMBOL</u>	<u>DEFINITION</u>
S_w	SREF	reference wing area; ft ²
CPS		captive trajectory system
P_{b1}/P_∞	PB1/P	number one base pressure ratio
P_{b2}/P_∞	PB2/P	number two base pressure ratio
P_c/P_∞	PC/P	sting/balance cavity pressure ratio
P_{b1}	PB1	number one base pressure; psia
P_{b2}	PB2	number two base pressure; psia
P_c	PC	SRB separation nozzle chamber pressure; psia
P_∞	P	freestream static pressure, psia
$P_{t\infty}$	PTOTAL	freestream total pressure, psia
$C_{P_{b1}}$	CPB1	number one orbiter base pressure coefficient, ($P_{b1} - P_\infty$)/ q_∞
$C_{P_{b2}}$	CPB2	number two orbiter base pressure coefficient, ($P_{b2} - P_\infty$)/ q_∞
C_{P_c}	CPC	sting balance cavity pressure coefficient, ($P_c - P_\infty$)/ q_∞
R/l	RN/L	freestream unit Reynolds number x 10 ⁻⁶ ; per foot
l_{ref}	LREF BREF	reference dimension used to reduce the measured balance moment data to coefficient form, orbiter model body length, inches
δ_a	AILRON	aileron deflection; degrees
δ_e	ELEVTR	elevon deflection; degrees

NOMENCLATURE (Continued)

<u>SYMBOL</u>	<u>PLOT SYMBOL</u>	<u>DEFINITION</u>
δ_r	RUDDER	rudder deflection; degrees
$\Delta\alpha$	DALPHA	parameter name for nominal angle of attack difference, ($\Delta\alpha = \alpha_{SRB} - \alpha_{OT}$) or ($\Delta\alpha = \alpha_{ET} - \alpha_0$); degrees
$\Delta\beta$	DBETA	parameter name for nominal angle of sideslip difference, ($\Delta\beta = \beta_{SRB} - \beta_{O/T}$) or ($\Delta\beta = \beta_{ET} - \beta_0$); degrees
$\alpha_{O/T}$	ALPHA	orbiter tank angle of attack. All source data are presented as a function of $\alpha_{O/T}$, except for isolated tests and those where the tank is separating from the orbiter; degrees $\alpha_{SRB} = \alpha_{O/T} + \Delta\alpha$
α_0	ALPHA	orbiter angle of attack. Source data are presented as a function of α_0 for isolated tests and those where the tank is separating from the orbiter; degrees $\alpha_{ET} = \alpha_0 + \Delta\alpha$
α_{ET}	ALPHA	external tank angle of attack. Source data are presented as a function of α_{ET} , only, for tests of the isolated external tank, degrees
α_{SRB}	ALPHA	solid rocket booster angle of attack, source data are presented as a function of α_{SRB} , only, for tests of the isolated SRB, degrees
$\beta_{O/T}$	BETA	orbiter tank angle of sideslip. All source data are presented as a function of $\beta_{O/T}$ except for isolated tests and those where the tank is separating from the orbiter; degrees $\beta_{SRB} = \beta_{O/T} + \Delta\beta$
β_0	BETA	orbiter angle of sideslip. Source data are presented as a function of β_0 for isolated tests and those where the tank is separating from the orbiter; degrees $\beta_{ET} = \beta_0 + \Delta\beta$

NOMENCLATURE (Concluded)

<u>SYMBOL</u>	<u>PLOT SYMBOL</u>	<u>DEFINITION</u>
β_{ET}	BETA	external tank angle of sideslip. Source data are presented as a function of β_{ET} , only, for tests of the isolated external tank, degrees
β_{SRB}	BETA	solid rocket booster angle of sideslip. Source data are presented as a function of β_{SRB} , only, for tests of the isolated SRB, degrees
δ_{SB}	SPDBRK	speed brake flare angle, degrees
c.g.		center of gravity
$T_{t\infty}$	TTOTL	freestream total temperature; °R
T_{∞}	T	freestream static temperature; °R
ΔX	X	separation distance measured along the longitudinal, X axis; inches. See figures 2d and 2e
	XMRP	X station of the moment reference center; inches. See figures 2b and 2c
ΔY	Y	separation distance measured along the lateral, Y axis; inches. See figures 2d and 2e.
	YMRP	Y station of the moment reference center; inches. See figures 2b and 2c.
	ZMRP	Z station of the moment reference center; inches. See figures 2b and 2c.
ΔZ	Z	separation distance measured along the vertical Z axis; inches. See figures 2d and 2e.

INTRODUCTION

The NASA Space Shuttle Integrated Vehicle (SSV) is comprised of four components: an orbiter (O), an external fuel tank (ET) for the orbiter, and two solid rocket boosters (SRB's). During the ascent phase of the SSV the ET and SRB's are separated from the orbiter, and return to earth. In order to assure clean separation of the ET and the SRB's from the orbiter it is necessary to know the aerodynamic forces acting on these components, and the orbiter, during the separation procedure. This test was conducted to determine the interacting aerodynamic effects for two situations: 1) nominal abort of the SRB from the orbiter/external tank combination and 2) emergency abort of the external tank from the orbiter.

Data were obtained at a freestream Mach number of 4.5 with Reynolds number varying from 7.0×10^5 to 6.6×10^6 per foot. The SRB has small rocket motors which are utilized to assure positive separation. During these tests motor operation was simulated by using cold air jets and data were recorded with and without these motor plume simulations.

The isolated vehicle components were tested over an angle of attack and sideslip range as shown below:

<u>Vehicle Component</u>	<u>α Range</u>	<u>β Values</u>
Orbiter	-10° to 30°	0°, 5°, 10°
External Tank	-40° to 10°	0°, 5°
Orbiter/External Tank	-10° to 30°	0°, 5°
Solid Rocket Booster	-30° to 15°	-10°, 0°, 5°, 10°, 20°, 30°

INTRODUCTION (Continued)

In order to examine the interacting flow field effects during the two abort situations, the separating component was held at attitudes relative to the parent configuration and moved to various field positions to record aerodynamic data. The relative attitudes tested were:

<u>Vehicle Component</u>	<u>$\Delta\alpha$ Range</u>	<u>$\Delta\beta$ Values</u>
External Tank	-30° to 5°	0°, ±5°
Solid Rocket Booster	-20° to 5°	0°, ±5°, -10°, -20°

where for external tank $\Delta\alpha = (\alpha_{ET} - \alpha_0)$, $\Delta\beta = (\beta_{ET} - \beta_0)$ and for solid rocket booster $\Delta\alpha = (\alpha_{SRB} - \alpha_{O/ET})$, $\Delta\beta = (\beta_{SRB} - \beta_{O/ET})$.

The vertical (Z), longitudinal (X) and lateral (Y) separation distance ranges were:

<u>Vehicle Component</u>	<u>X-Inches(f.s.)</u>	<u>Y-Inches(f.s.)</u>	<u>Z-Inches(f.s.)</u>
External Tank	0 to 1200	-200 to 200	0 to 1300
Solid Rocket Booster	0 to 1600	0 to 800	0 to 100

where for the external tank, X, Y, and Z = 0 when the ET nose is in the mated position with respect to the orbiter. (See figure 2d.) For the SRB, X, Y, and Z = 0 when the SRB nose is in the mated position with respect to the Orbiter/External Tank. (See figure 2e.)

During SRB separation testing (see figure 2e.) the external tank was rigidly attached to the orbiter, which was supported inverted on the tunnel primary sector. The booster was supported on the CTS via a flow-through balance and sting.

During external tank separation testing (see figure 2d.), the

INTRODUCTION (Concluded)

orbiter was supported inverted on the primary sector and the ET was supported on the CTS.

No base or cavity pressure taps were built into the models. To obtain these pressures (two base, one cavity per model), hardline tubing was routed to the vicinity of the model bases and bent into areas where pressures were desired.

As an aid in clarifying the interdependence of the test configuration with the tabulated source data in the Appendix, the following array is a necessary adjunct to the Run Summary Schedule of Table II.

<u>DATASET</u>	<u>BALANCE</u>	<u>TEST CONFIGURATION</u>	<u>APPENDIX PAGE NUMBER</u>
RTJ001 } through RTJ099 }	Orbiter	} Tank Separating From Orbiter	1
RTJT01 } through RTJT99 }	Tank		89
RTJ100 } through RTJ283 }	Orbiter Tank	} SRB Separating From Orbiter Tank	90
RTJ300 } through RTJ483 }	SRB		178
RTJ500 } RTJ501 }	Tank	} Isolated	179
RTJ502 } through RTJ507 }	Orbiter		361
RTJ508 } RTJ509 }	Orbiter Tank		362
RTJ510 } through RTJ536 }	SRB		543
			543
			544
			545
			550
			551
			552
			553
			565

CONFIGURATIONS INVESTIGATED

The 0.01-scale 32-OTS models consists of an orbiter, tank, and one booster (with metric high-pressure separation thrusters, fore and aft). See figures 2b and 2c.

The configuration of each vehicle component tested is given below. Pertinent dimensional data for these model components may be found in Table III.

Orbiter 09 = (B₁₉C₇F₅M₄) (W₁₀₇E₂₃) (V₇R₅) where:

<u>Component</u>	<u>Definition</u>
B ₁₉	Fuselage per Rockwell line VL70-000139B. (Model drawing SS-A00062)
C ₇	Canopy per Rockwell Lines VL70-000139B. (Model drawing SS-A00062)
E ₂₃	Elevons per Rockwell lines VL70-000139B. (Model drawing SS-A00109)
F ₅	Body flap per Rockwell lines VL70-000139B. (Model drawing SS-A00062)
M ₄	Orbital Maneuvering System per Rockwell lines VL70-000139B. (Model drawing SS-A00062)
R ₅	Rudder per Rockwell lines VL70-000139B and VL70-000095. (Model drawing SS-A00062)
V ₇	Vertical tail per Rockwell lines VL70-000139B and VL70-000095. (Model drawing SS-A00062)
W ₁₀₇	Wing per Rockwell lines VL70-000130B. (Model drawing SS-A00109)

The external tank (T₁₀) is not broken down into subassemblies and was constructed to Rockwell lines VL72-000088 and VL78-000041 (Model Drawing SS-A-00108).

CONFIGURATIONS INVESTIGATED
(Concluded)

The solid rocket booster (S_g) is not broken down into subassemblies and was constructed to Rockwell lines VL72-000088 and VL77-000036 (Model Drawing SS-A-00113).

TEST FACILITY DESCRIPTION

The AEDC von Karman Facility (VKF) Tunnel A is a continuous, closed-circuit, variable density wind tunnel with an automatically driven flexible-plate-type nozzle and a 40- by 40-in. test section (see Figure 3). The tunnel can be operated at Mach numbers from 1.5 to 6 at maximum stagnation pressures from 29 to 200 psia, respectively, and stagnation temperatures up to 750^oR (M = 6). Minimum operating pressures range from about one-tenth to one-twentieth of the maximum at each Mach number. A description of the tunnel and airflow calibration information may be found in the Test Facilities Handbook*.

*Test Facilities Handbook (Ninth Edition). "von Karman Gas Dynamics Facility, Vol. 3", Arnold Engineering Development Center, July 1971.

DATA REDUCTION

Six-component aerodynamic force and moment data were recorded for the Orbiter, External Tank, and Orbiter/ET. Four-component force and moment data were recorded for the SRB. Thrust loads generated by the SRB separation motors were treated as tares and were subtracted from balance recorded loads before computing coefficients. For Orbiter freestream and LF abort testing, the Orbiter was mounted on the AEDC 0.85-inch 4.00-Y-36-037 balance. For ET freestream and ET abort, the ET was mounted on the AEDC 0.85-inch 4.00-H-36-049 balance. For SRB separation, the Orbiter/ET was mounted on the 4.00-Y-36-049 balance. For SRB freestream and separation, the SRB was mounted on the Rockwell 0.625-inch 4.00-H-34-065 flow-through balance.

All force and moment data were reduced to coefficient form in the body axis system. Base and balance cavity pressures were recorded. However, no pressure adjustments were made to the force and moment data. All coefficients are based on the following reference dimensions.

$$S_{REF} = \text{orbiter wing reference area} = 0.269 \text{ ft}^2$$

$$l_{REF} = b_{REF} = \text{orbiter body length} = 12.903 \text{ inches}$$

Moments are about the following reference c.g. locations:

Orbiter (Isolated and with ET separating):

$$XMRP = 8.516 \text{ inches aft of orbiter nose (see figure 2c)}$$

$$ZMRP = 4.0 \text{ (fuselage reference line 4.0)}$$

External Tank (Isolated and while separating from orbiter):

$$XMRP = 10.94 \text{ inches aft of ET nose (see figure 2c)}$$

$$ZMRP = 0.0 \text{ (tank centerline)}$$

Orbiter/ET (Isolated and with SRB separating)

XMRP = 7.43 inches aft of ET nose

(see figure 2b)

ZMRP = 0.47 inches above ET centerline

SRB (Isolated and while separating from Orbiter/ET)

XMRP = 9.67 inches aft of SRB nose (see figure 2b)

ZMRP = 0.0 (SRB centerline)

TEST : IA13 (VA 323)

DATE : POST-TEST

TEST CONDITIONS

MACH NUMBER	TOTAL PRESSURE (Pounds/Sq. Inch)	DYNAMIC PRESSURE (pounds/sq. inch)	STAGNATION TEMPERATURE (degrees Fahrenheit)
4.53	110	5.27	145
4.52	80	3.85	
↓	58	2.80	
4.51	28.9	1.41	
4.48	11.6	0.58	
↓	10.8	0.54	↓

BALANCE UTILIZED: 4.00-Y-36-037; 4.00-Y-36-049; 4.00-Y-34-065

	CAPACITY:	ACCURACY:	COEFFICIENT TOLERANCE: (ACCURACY)
NF	±150 ±200 ±135	±0.2 ±0.3 ±0.25	$\frac{\sim}{\infty}$
SF	±75 ±100 ±100	±0.15 ±0.3 ±0.2	
AF	±25 ±50 -	±0.15 ±0.3 -	
PM	±300 ±380 ±360	±0.5 ±1.0 ±1.0	
RM	±20 ±80 -	±0.2 ±0.4 -	
YM	±150 ±190 ±275	±0.5 ±1.0 ±0.75	↓

- COMMENTS:
- 1). THE -037 MOUNTED IN ORBITER FOR "ORBITER-ISOLATED" AND "TANK SEPARATION."
 - 2). THE -049 MOUNTED IN ORBITER FOR "ORBITER-TANK ISOLATED" AND "BOOSTER SEPARATION." ALSO MOUNTED IN TANK FOR "TANK ISOLATED" AND "TANK SEPARATION."
 - 3). THE -065 MOUNTED IN BOOSTER FOR "BOOSTER ISOLATED" AND "BOOSTER SEPARATION."

EXTERNAL TANK SEPARATION DATA

TABLE II.

DATE POST-TEST

DATA SET RUN NUMBER COLLATION SUMMARY

DATA SET IDENTIFIER	CONFIGURATION	SCHD.		PARAMETERS/VALUES						NO. OF RUNS	MACH NUMBERS				TEST RUN NUMBERS
		A	B	DB	Y	Z	MACH	PT	DEL		DER	RF	0	400	
RTJ051	09/T10	0	0	5	0	A	4.53	110	0	0	0	1	2	3	4
002				0		B						5	6	7	8
003						B						12	11	10	9
004						B						13	14	15	16
005						B						20	19	18	17
006						C						21	22	23	24
007						D						25	26	27	28
008						D						32	31	30	29
009						D						33	34	35	36
010						D						40	39	38	37
011						E						41	42	43	44
012						E						48	47	46	45
013						E						49	50	51	52
014						E						56	55	54	53
015						1300						57	58	59	60
016						A						61	62	63	64
017						F						65	66	67	-
018						F						68	69	70	71

CM IGLM KY KYN GBL ICA X
 A) = 0, 100, 200, 300, 400, 600 INCHES (FULL SCALE)
 B) = 0, 100, 200, 300, 400, 600, 800, 1000, 1300
 C) = 200, 300, 400, 600, 800, 1000, 1300
 D) = 0, 100, 200, 300, 400, 600, 800, 1000, 1300
 E) = 600, 800, 1000, 1300
 F) = 0, 100, 200, 300, 400, 600, 800

X, B, DB, DP - DEGREES ; X, Y - INCHES (FULL SCALE) ; DEL, DER - DEGREES ; PT - PSIA ; RF - DEGREES (RUDDER FLARE)
 * 0 DATA - ORBITER DATA, T DATA - EXTERNAL TANK DATA

EXTERNAL TANK SEPARATION DATA

TABLE II. (Continued)

TEST: IA13		DATA SET RUN NUMBER COLLATION SUMMARY												DATE: POSTTEST							
DATA SET IDENTIFIER	CONFIGURATION	SCHD.		PARAMETERS/VALUES								NO. OF RUNS	X - MAG# NUMBERS								
		α	β	MM	PT	DEL	DER	RF	Y	Z	DB		DA	DB	DC	DD	DE	DF	0	400	800
RTJ 019	09/T10	-5	0	4.53	110	0	0	0	0	0	0	0	0	0	0	0	0	75	74	73	72
020																		76	77	78	79
021																		83	82	81	80
022																		84	85	86	87
023																		88	89	90	91
024																		95	94	93	92
025																		96	97	98	99
026																		103	102	101	100
027																		104	105	106	107
028																		111	110	109	108
029																		112	113	114	115
030																		119	118	117	116
031																		120	121	122	123
032																		124	125	126	127
033																		128	129	130	131
034																		135	134	133	132
035																		136	137	138	139
036																		143	142	141	140

CN - CLM - CY - CYN - CAB - CA
 Z SCHEDULES: A) = 0, 100, 200, 300, 400, 600 INCHES (FULL SCALE); B) = 0, 100, 200, 300, 400, 600, 800, 1000
 C) = 200, 300, 400, 600, 800, 1000, 1300; D) = 300, 400, 600, 800, 1000, 1300
 E) = 600, 800, 1000, 1300; F) = 0, 100, 200, 300, 400, 600, 800

α, β, DA, DB - DEGREES; X, Y - INCHES (FULL SCALE); DEL, DER - DEGREES; PT - PSIA; RF - DEGREES (RUDDER RANGE)

TABLE II. (Continued)

EXTERNAL TANK SEPARATION DATA

DATA SET RUN NUMBER COLLATION SUMMARY

DATE: POST-TEST

TEST: ZA15

DATA SET IDENTIFIER	CONFIGURATION	SCHD.		PARAMETERS/VALUES										NO. OF RUNS	MACH NUMBERS				TEST RUN NUMBERS
		α	β	DK	DA	Y	Z	MMH	PT	DEL	DER	RF	0		400	800	1200		
RTJ037	09/T10	-10	0	-5	0	0	C	4.52	80	0	0	0	0	0	144	145	146	147	
038				-10			D							148	149	150	151		
039						200	D							155	154	153	152		
040						5	D							156	157	158	159		
041							D							163	162	161	160		
042				-20			G							164	165	166	167		
043						200	G							171	170	169	168		
044						5	G							172	173	174	175		
045							G							179	178	177	176		
046				-30			1300							180	-	-	-		
047				6			B							181	182	183	184		
048				1			B							188	187	186	185		
049				-4			HJ*							189	190	191	192*		
050				-9			I, J, K**							193	194	195*	196**		
051				-19			1000							197	-	-	-		

	13	19	25	31	37	43	49	55	61	67	73	76
CM												
Z												

- B) 0, 100, 200, 300, 400, 600, 800, 1000 INCHES (FULL SCALE)
- C) 200, 300, 400, 600, 800, 1000, 1300
- D) 300, 400, 600, 800, 1000, 1300
- E) 800, 1000, 1300
- F) 400, 600, 800, 1000
- G) 800, 1000
- H) 200, 300, 400, 600, 800, 1000
- I) 600, 800, 1000

α, β, DK, DA - DEGREES ; X, Y - INCHES (FULL SCALE) ; DEL, DER - DEGREES ; PT - PSI A, RF - DEGREES (RUDDER FLARE)

EXTERNAL TANK SEPARATION DATA

TABLE II. (Continued)

TEST: IA-13		DATA SET RUN NUMBER COLLATION SUMMARY												DATE: 6-22-77	
DATA SET IDENTIFIER	CONFIGURATION	SCMD.		PARAMETERS VALUES										X MACHINE NUMBER	
		a	B	Dx	dx	Y	Z	Mbr.	Fr	St	StH	StL	StR	200	1200
RTJ052	d ₉ /T ₁₀	0	0	0	0	-200	E	2.53	110	10	-10			199	
053							R							11	
054				0	0	200	E							200	
055						-5	-200	B						201	
056						5	0	B						202	
057						5	200	B						203	
058						-10	0	-200	D					204	
059							0	0	D					205	
060							0	200	D					206	
061							-5	-200	D					207	
062							5	0	D					208	
063							5	200	D					209	
064							-20	0	-200	E				210	
065							0	0	E					211	
066							0	200	E					212	
067							-5	-200	E					213	
068							5	0	E					214	
069							5	200	E					215	

CN 15LM 157 KYN 15BL 15A 13 12 11 10 9 8 7 6

a B B) 0.1M 200 300 400 500 600 700 800 900 1000 1100 1200 (FS)

E) 600 700 800 900 1000 1100 1200

EXTERNAL TANK SEPARATION DATA
 TEST: IA '3

TABLE II. (Continued)

DATE: POST-TEST

DATA SET RUN NUMBER COLLATION SUMMARY

DATA SET IDENTIFIER	CONFIGURATION	SCHD.		PARAMETERS/VALUES							NO. OF RUNS	MACH-NUMBERS					
		a	b	Dk	D/B	Y	Z	MACH	PT	DEL		DER	RF	0	400	800	1200
RTJ 070	09/110	-5	0	0	0	-200	F	4.52	80	+10	-10	0	216				
071						0	F						217				
072						200	F						218				
073						-200	F						219				
074						0	F						220				
075						200	F						221				
076						-200	D						222				
077						0	D						223				
078						200	D						224				
079						-200	D						225				
080						0	D						226				
081						200	D						227				
082						-200	E						228				
083						0	E						229				
084						200	E						230				
085						-200	E						231				
086						0	E						232				
087						200	E						233				

TEST RUN NUMBERS

31 32 33 34 35 36 37 38 39 40 41 42 43 44 45 46

300, 600, 800, 1000, 1200, 1500 INCHES (FULL SCALE)
 E) = 600, 800, 1000, 1500
 F) = 0, 100, 200, 300, 400, 600, 800

PT - PSIA ; RF - DEGREES (KUDGER FLARE)

EXTERNAL TANK SEPARATION DATA TABLE II. (Continued)

TEST: IA13		DATA SET RUN NUMBER COLLATION SUMMARY												DATE: POST-TEST											
DATA SET IDENTIFIER	CONFIGURATION	PARAMETERS/VALUES												NO. OF RUNS	MACH NUMBERS				TEST RUN NUMBERS						
		SCHD.	DX	DB	Y	Z	MACH	PT	DEL	DER	RF	X	400		800	1200									
RTJ 088	09/T10	0	0	0	0	B	4.53	110								0	234	235	236	237					
089			-10			D											238	239	240	241					
090			-20			E											242	243	244	245					
091			0			B	200										246	247	248	249					
092			-10			D											250	251	252	253					
093			-20			E											254	255	256	257					
094			0			B											258	259	260	261					
095			-10			D											262	263	264	265					
096			-20			E											266	267	268	269					
097			0			B											270	271	272	273					
098			-10			D											274	275	276	277					
099			-20			E											278	279	280	281					

CM ... CLM ... ICY ... KYN ... KBL ... CA ...
 COEFFICIENTS
 B = 0, 100, 200, 300, 400, 500, 800, 1000 INCHES (FULLSCALE)
 E = 600, 800, 1000, 1 ...
 D = 300, 400, 600, 800, 1000, 1300
 X, B, DX, DB - DEGREES; X, Y - INCHES (FULLSCALE); DEL, DER - DEGREES; PT - PSIA; RF - DEGREES
 (RUDDER FLAKE)

Booster (SRB) Separation TABLE II. (Continued)

TEST: ZA13 DATE: POST-TEST

DATA SET/RUN NUMBER COLLATION SUMMARY

DATA SET IDENTIFIER	CONFIGURATION	SCHD:		PARAMETERS/VALUES								NO. OF RUNS	TEST RUN NUMBERS						
		a	B	Dx	Dy	Y	Z	MACH	PT	PCH	RF		C	300	600	900			
RTJ 180	Op Tio/S8	0	0	0	0	0	A	4.48	11.6	1500	0		303	304	305	-			
101	(PLUMES ON)					500	A	4.51	29	750			-	-	306	-			
102				0	0	200	A						307	308	309	310			
103				200	A								314	313	312	311			
104				400	A								315	316	317	318			
105				800	800								319	320	321	322			
106				0	A					1500			323	324	325	326			
107				200	A								330	329	328	327			
108				400	A								331	332	333	334			
109				800	800								335	336	337	338			
110				0	A			4.52	58				339	340	341	342			
111				200	A								346	345	344	343			
112				400	A								347	348	349	350			
113				800	800								351	352	353	354			
114				0	A			4.53	110				355	356	357	-			
115				5	A								358	359	360	-			
116				10	A								361	362	363	364			
117				200	A								368	367	366	365			

7 13 19 25 31 37 43 49 55 61 67 75 76

SCHEDULES

COEFFICIENTS

A) = 0, 50, 100, 150, 200, 300, 400, 600, 800, 1000 INCHES (FULL SCALE)

RTJ100 THROUGH RTJ283 - ORBITER/TANK DATA
 RTJ300 THROUGH RTJ423 - SRB DATA

BOOSTER (SRB) SEPARATION

TABLE II. (Continued)

TEST: **IA 13** DATE: **POST-TEST**

DATA SET IDENTIFIER	CONFIGURATION	SCHD.		PARAMETERS/VALUES						NO. OF RUNS	MACH NUMBERS					TEST RUN NUMBERS
		α	β	Dx	D β	Y	Z	MACH	PT		PCH	RF	0	300	600	
RTJ 118	2g Tio/S8 (PLUMES ON)	0	0	0	0	400	A	4.53	110	1500	0	369	370	371	372	
119	↓					800	800					373	374	375	376	
120	(PLUMES OFF)					0	A					377	378	379	380	
121						200	A					384	383	382	381	
122						400	A					385	386	387	388	
123						800	800					389	390	391	392	
124						↓	↓					-	-	-	-	
125						400	A					-	-	-	-	
126				5		0	B					395	-	-	398	
127				↓		200	B*					396	-	-	399	
128				↓		400	B					397	-	-	400	
129				-5		0	A,C*					411*	409	401	402	
130				↓		200	A,C*					412*	403	404	405	
131				↓		400	A					410	408	407	406	
132				↓		800	800					413	414	415	416	
133				-10		↓	↓					417	418	419	420	
134				↓		400	A					421	422	423	424	
135	↓			↓		0	D,E,F**					425	427*	429*	432	

X=1600
393
394

1	7	13	19	25	31	37	43	49	55	61	67	75	76
CLM	CLM	CLM	CLM	CLM	CLM	CLM	CLM	CLM	CLM	CLM	CLM	CLM	CLM

COEFFICIENTS
 A) = 0.50, 100, 150, 200, 300, 400, 600, 800, 1000 INCHES (ALL SCALE)
 B) = 0.50, 100, 150, 200, 300, 400, 600
 C) 50, 100, 150, 200, 300, 400, 600, 800, 1000
 D) = 200, 300, 400, 600, 800, 1000
 E) = 150, 200, 300, 400, 600, 800, 1000

TABLE II. (Continued)

BOOSTER (SRB) SEPARATION

TEST: IA/3 DATE: POST-TEST

DATA SET/RUN NUMBER COLLATION SUMMARY

DATA SET IDENTIFIER	CONFIGURATION	SCHD.		PARAMETERS/VALUES										NO. OF RUNS	MACH NUMBERS				TEST RUN NUMBER
		α	β	Dx	DA	Y	Z	MACH	PT	PCH	RF	α	β		γ	δ			
RTJ 136	09T10/S8 (PUMES OFF)	0	0	-10	0	200	DE*	4.53	110	-	0	0	426	428*	300	600	900	431	
137				-20		0	G					433	434	435			436		
138						200	G					440	439	438			437		
139						400	G					441	442	443			444		
140				↑		800	800					445	446	447			448		
141				0	5	0	A					449	-	-			452		
142						200	A					450	-	-			453		
143				↑		400	A					451					454		
144				-5		200	A					455	456	457			458		
145						400	A					462	461	460			459		
146						0	H					463	464	465			466		
147				↑		800	800					467	468	469			470		
148				-10		0	H					471	472	473			474		
149						200	DA*					475	477*	478*			479		
150						400	A					476	482	481			480		
151				↑		800	800					483	484	485			486		
152				-20		0	↑					487	488	489			490		
153				↑		400	A, I*					494*	491	492			493		

1	7	13	19	25	31	37	43	49	55	61	67	73	79
1	7	13	19	25	31	37	43	49	55	61	67	73	79
1	7	13	19	25	31	37	43	49	55	61	67	73	79

Z SCHEDULES
 A) = 0, 50, 100, 150, 200, 300, 400, 600, 800, 1000 INCHES (PUMES OFF)
 B) = 200, 300, 400, 600, 800, 1000
 C) = 50, 100, 150, 200, 300, 400, 600, 800, 1000
 D) = 100, 150, 200, 300, 400, 600, 800, 1000
 E) = 400, 600, 800, 1000
 F) = 300, 400, 600, 800, 1000
 G) = 600, 800, 1000
 H) = 400, 600, 800, 1000

BOOSTER (SRB) SEPARATION

TABLE II. (Continued)

TEST: IA13 DATE: POST-TEST

DATA SET RUN NUMBER COLLATION SUMMARY

DATA SET IDENTIFIER	CONFIGURATION	SCHD.		PARAMETERS/VALUES										TEST RUN NUMBERS								
		α	β	DX	DB	Y	Z	MACH	PT	PCH	RF	NO. OF RUNS										
RTJ 154	0g Tio/Sg	0	0	0	-20	0	H	4.53	110	-	0	0	300	600	900							
155	(PLUMES OFF)	Y	Y	Y	Y	200	H, A*	Y	Y	Y	Y											
158	(PLUMES ON)			5	0	0	B	4.51	28.9	1500												
159				Y		200	B															
160				Y		400	B															
161				-5		0	C, A*															
162				Y		200	A, C*															
163				Y		400	A															
164				Y		800	800															
165				-10		Y	Y															
166				Y		400	A															
167				Y		0	D, E, F**															
168				Y		200	D, E, C, A***															
169				-20		0	G															
170				Y		200	G															
171				Y		400	G															
172				Y		800	800															

CN: ISSA, ISY, KYN, KBL, ISA
 A) = 0, 50, 100, 150, 200, 300, 400, 600, 800, 1000 INCHES (FULL SCALE)
 B) = 0, 50, 100, 150, 200, 300, 400, 600
 C) = 50, 100, 150, 200, 300, 400, 600, 800, 1000
 D) = 200, 300, 400, 600, 800, 1000
 E) = 100, 150, 200, 300, 400, 600, 800, 1000
 F) = 150, 200, 300, 400, 600, 800, 1000
 G) = 600, 800, 1000
 H) = 400, 600, 800, 1000
 I) = 150, 200, 300, 400, 600, 800, 1000
 J) = 400, 600, 800, 1000
 K) = 150, 200, 300, 400, 600, 800, 1000
 L) = 400, 600, 800, 1000
 M) = 150, 200, 300, 400, 600, 800, 1000
 N) = 400, 600, 800, 1000
 O) = 150, 200, 300, 400, 600, 800, 1000
 P) = 400, 600, 800, 1000
 Q) = 150, 200, 300, 400, 600, 800, 1000
 R) = 400, 600, 800, 1000
 S) = 150, 200, 300, 400, 600, 800, 1000
 T) = 400, 600, 800, 1000
 U) = 150, 200, 300, 400, 600, 800, 1000
 V) = 400, 600, 800, 1000
 W) = 150, 200, 300, 400, 600, 800, 1000
 X) = 400, 600, 800, 1000
 Y) = 150, 200, 300, 400, 600, 800, 1000
 Z) = 400, 600, 800, 1000

BOOSTER (SRP) SEPARATION TABLE II. (Continued) DATE: **POST-TEST**

TEST: **JA 13** DATA SET RUN NUMBER COLLATION SUMMARY

DATA SET IDENTIFIER	CONFIGURATION	PARAMETERS/VALUES													NO. OF RUNS	MACH NUMBERS				TEST RUN NUMBERS
		SCHD.		DX	DY	Z	MACH	PT	PCH	RF	X	300	600	900						
		α	β																	
RTJ 173	OpTrio/58	0	0	5	5	0	B		4-53	110	-	0		565	-	-	900			
174	(PLUMES OFF)					200	B							566	-	-	568			
175						400	B							567	-	-	570			
176						200	B							575	-	-	571			
177						400	B							576	-	-	572			
178						0	J							574	-	-	573			
179						400	B							577	-	-	582			
180						200	K, B*							578	-	-	581*			
181						0	J							579	-	-	580			
182						200	B, J*							587*	-	-	583			
183						400	B, L*							588*	-	-	584			
184						0	J							586	-	-	585			
185						5	C							589	-	-	-			
186						200	C							590	-	-	-			
187						0	C, A*							591	-	-	594*			
188						200	C, A*							592	-	-	595*			
189						400	A							593	-	-	596			
190						5	H							597	598	599	600			

7 13 19 25 31 37 43 49 55 61 67 73 76

SCHEDULES: A) = 0, 50, 100, 150, 200, 300, 400, 600, 800, 1000 INCHES (RULLSCAME) B) = 0, 50, 100, 150, 200, 300, 400, 600
 C) = 50, 100, 150, 200, 300, 400, 600, 800, 1000 H) = 400, 600, 800, 1000
 J) = 400, 600 K) = 200, 300, 400, 600
 L) = 300, 400, 600

BOOSTER (S&B) SEPARATION

TABLE II. (Continued)

DATA SET RUN NUMBER COLLATION SUMMARY

DATE: POST-TEST

DATA SET IDENTIFIER	CONFIGURATION	SCMD.		PARAMETERS/VALUES							NO. OF RUNS	TEST RUN NUMBERS			
		α	β	DX	DB	Y	Z	MACH	PT	PCH		RF	X	MACH-NUMBERS	NO.
RTJ 191	09 T10 / S8	0	0	-5	-5	200	C, A*	4.53	110	-	0	0	300	600	900
192	(PLUMES OFF)					400	A					601	602	603*	606*
193						800	800					603	604	608	607
194												609	610	611	612
195												613	614	615	616
196						400	A, C*					620*	617	618	619
197						200	I, C*, E**					621	622*	623*	624*
198						0	H					625	626	627	628
199							H					629	630	631	638*
200						200	H, I*, E**					632	631	636*	639*
201						400	H, C*, E**					633	634*	635*	640*
202						800	800					641	642	643	644
203						0	D, A*					645	-	-	648*
204						200	D, A*					646	-	-	649*
205						400	A					647	-	-	650
206						0	G, H*					651	652	653*	654
207						200	A, C*, D, E**					662*	659*	658*	655*
208						400	A, E*, F**					661*	660*	657	656
						800	800					663	664	665	666

SN 154A 154B 154C 154D 154E 154F 154G 154H 154I 154J 154K 154L 154M 154N 154O 154P 154Q 154R 154S 154T 154U 154V 154W 154X 154Y 154Z

A) = 0, 5, 10, 15, 20, 30, 40, 60, 80, 100, 150, 200, 300, 400, 600, 800, 1000 INCHES (RANSOME)
 B) = 20, 30, 40, 60, 80, 100
 C) = 50, 100, 150, 200, 300, 400, 600, 800, 1000
 D) = 100, 150, 200, 300, 400, 600, 800, 1000
 E) = 600, 800, 1000
 F) = 300, 400, 600, 800, 1000

BOOSTER (SRB) SEPARATION TABLE II. (Continued)
TEST: IA13 DATE: **PAST TEST**

DATA SET RUN NUMBER COLLATION SUMMARY

DATA SET IDENTIFIER	CONFIGURATION	SCHD.		PARAMETERS/VALUES										MACH NUMBERS				NO. OF RUNS	TEST RUN NUMBERS			
		α	β	DX	DB	Y	Z	MACH	PT	PCN	RF	X	300	600	900	667	668		669	900		
RTJ 209	Or Tro/S8	0	0	-10	-10	800	800	4.53	110	-	-	0	667	668	669	900	667	668	669	900		
210	(PLUMES OFF)					400	A, D, E, I						680	677	676	671	680	677	676	671		
211						200	D, H, I						679	678	672	673	679	678	672	673		
212						0	I, G, H						681	682	675	674	681	682	675	674		
213						-20	H, G						689	690	683	684	689	690	683	684		
214						200	D, G, H						692	691	688	685	692	691	688	685		
215						400	D, G, H						694	693	687	686	694	693	687	686		
216						800	800						695	696	697	698	695	696	697	698		
217						-20	G						699	-	-	702	699	-	-	702		
218						200	G						700	-	-	703	700	-	-	703		
219						400	G						701	-	-	704	701	-	-	704		
220						-5	G, M						714	713	705	706	714	713	705	706		
221						200	G, M						715	711	708	707	715	711	708	707		
222						400	G						716	712	709	710	716	712	709	710		
223						800	800						717	718	719	720	717	718	719	720		
224						-10							721	722	723	724	721	722	723	724		
225						0	G, M						734	733	725	726	734	733	725	726		
226						200	G						735	731	728	727	735	731	728	727		

7 13 19 25 31 37 43 49 55 61 67 73 76
 G, H, I, J, K, L, M, N, O, P, Q, R, S, T, U, V, W, X, Y, Z
 SCHEDULE: A) = 0, 10, 100, 150, 200, 300, 400, 500, 600, 800, 1000, 1500, 2000, 3000, 4000, 5000, 6000, 8000, 10000
 B) = 100, 150, 200, 300, 400, 600, 800, 1000
 C) = 400, 600, 800, 1000
 D) = 300, 400, 600, 800, 1000
 E) = 600, 800, 1000
 F) = 800, 1000

BOOSTER (SRB) SEPARATION
TEST: ZA13

TABLE II. (Continued)

DATA SET RUN NUMBER COLLATION SUMMARY

DATE: POST-TEST

DATA SET IDENTIFIER	CONFIGURATION	SCHD.		PARAMETERS/VALUES									NO. OF RUNS	MACH-NUMBERS																			
		α	β	Dx	Dy	Z	MACH	PT	PEH	RF	X	300		600	900																		
RTJ 227	09 T10/S8	0	0	-20	-10	400	4.53	110						0	736	737	738	739	740	741	742	743	744	745	746	747	748	749	750	751	752		
228	(PLUMES OFF)				-20	0																											
229						200																											
230						400																											
231						800																											

TEST RUN NUMBERS

13 19 25 31 37 43 49 55 61 67 75.76

CM I G L M I S Y . . . I S Y N . . . S O F . . . I S A . . .

α β

BOOSTER (SRB) SEPARATION

TABLE II. (Continued)

DATA SET IDENTIFIER	CONFIGURATION	SCHD.		PARAMETERS/VALUES							NO. OF RUNS	MACH-NUMBERS				TEST RUN NUMBER
		α	β	$D\alpha$	$D\beta$	γ	Z	MACH	PT	PTH		RF	0	200	400	
RTJ 232	09 Tio/S8	0	5	5	5	0	B		4.51	28.9	1500	0	853	854	855	
233	(RUNGS ON)			0	0		B						858	857	856	
234					-5		J, B*						899	902*	903*	
235					-10		J, B*						900	925*	924*	
236					-20		J						901	942	943	
237				0	5		A						859	860	861	
238					0		A, 800*						864	867	862	883*
239					-5		H, A*, 800						906	904*	905*	890*
240					-10		H, D*, A*, 800**						909	926*	927*	891*
241					-20		H, I*, 800**						910	941*	940*	898*
242				-5	5		C, A*						865	866	869*	
243					0		C, A*, 800**						868	867	872*	884*
244					-5		H, C*, A*, 800**						907	912*	913*	889*
245					-10		H, C*, 800*						908	929*	928*	892*
246					-20		H, 800*						911	938	939	897*
247				-10	5		D, A*						873	874	870*	
248					0		D, A*, 800**						876	875	871*	885*
249					-5		G, D*, F*, 800**						916	915*	914*	888*

CONF. ELEM. 15X. 15YN. 150. 15A. 15B. 15C. 15D. 15E. 15F. 15G. 15H. 15I. 15J. 15K. 15L. 15M. 15N. 15O. 15P. 15Q. 15R. 15S. 15T. 15U. 15V. 15W. 15X. 15Y. 15Z. 15AA. 15AB. 15AC. 15AD. 15AE. 15AF. 15AG. 15AH. 15AI. 15AJ. 15AK. 15AL. 15AM. 15AN. 15AO. 15AP. 15AQ. 15AR. 15AS. 15AT. 15AU. 15AV. 15AW. 15AX. 15AY. 15AZ. 15BA. 15BB. 15BC. 15BD. 15BE. 15BF. 15BG. 15BH. 15BI. 15BJ. 15BK. 15BL. 15BM. 15BN. 15BO. 15BP. 15BQ. 15BR. 15BS. 15BT. 15BU. 15BV. 15BW. 15BX. 15BY. 15BZ. 15CA. 15CB. 15CC. 15CD. 15CE. 15CF. 15CG. 15CH. 15CI. 15CJ. 15CK. 15CL. 15CM. 15CN. 15CO. 15CP. 15CQ. 15CR. 15CS. 15CT. 15CU. 15CV. 15CW. 15CX. 15CY. 15CZ. 15DA. 15DB. 15DC. 15DD. 15DE. 15DF. 15DG. 15DH. 15DI. 15DJ. 15DK. 15DL. 15DM. 15DN. 15DO. 15DP. 15DQ. 15DR. 15DS. 15DT. 15DU. 15DV. 15DW. 15DX. 15DY. 15DZ. 15EA. 15EB. 15EC. 15ED. 15EE. 15EF. 15EG. 15EH. 15EI. 15EJ. 15EK. 15EL. 15EM. 15EN. 15EO. 15EP. 15EQ. 15ER. 15ES. 15ET. 15EU. 15EV. 15EW. 15EX. 15EY. 15EZ. 15FA. 15FB. 15FC. 15FD. 15FE. 15FF. 15FG. 15FH. 15FI. 15FJ. 15FK. 15FL. 15FM. 15FN. 15FO. 15FP. 15FQ. 15FR. 15FS. 15FT. 15FU. 15FV. 15FW. 15FX. 15FY. 15FZ. 15GA. 15GB. 15GC. 15GD. 15GE. 15GF. 15GG. 15GH. 15GI. 15GJ. 15GK. 15GL. 15GM. 15GN. 15GO. 15GP. 15GQ. 15GR. 15GS. 15GT. 15GU. 15GV. 15GW. 15GX. 15GY. 15GZ. 15HA. 15HB. 15HC. 15HD. 15HE. 15HF. 15HG. 15HI. 15HJ. 15HK. 15HL. 15HM. 15HN. 15HO. 15HP. 15HQ. 15HR. 15HS. 15HT. 15HU. 15HV. 15HW. 15HX. 15HY. 15HZ. 15IA. 15IB. 15IC. 15ID. 15IE. 15IF. 15IG. 15IH. 15IJ. 15IK. 15IL. 15IM. 15IN. 15IO. 15IP. 15IQ. 15IR. 15IS. 15IT. 15IU. 15IV. 15IW. 15IX. 15IY. 15IZ. 15JA. 15JB. 15JC. 15JD. 15JE. 15JF. 15JG. 15JH. 15JI. 15JJ. 15JK. 15JL. 15JM. 15JN. 15JO. 15JP. 15JQ. 15JR. 15JS. 15JT. 15JU. 15JV. 15JW. 15JX. 15JY. 15JZ. 15KA. 15KB. 15KC. 15KD. 15KE. 15KF. 15KG. 15KH. 15KI. 15KJ. 15KK. 15KL. 15KM. 15KN. 15KO. 15KP. 15KQ. 15KR. 15KS. 15KT. 15KU. 15KV. 15KW. 15KX. 15KY. 15KZ. 15LA. 15LB. 15LC. 15LD. 15LE. 15LF. 15LG. 15LH. 15LI. 15LJ. 15LK. 15LL. 15LM. 15LN. 15LO. 15LP. 15LQ. 15LR. 15LS. 15LT. 15LU. 15LV. 15LW. 15LX. 15LY. 15LZ. 15MA. 15MB. 15MC. 15MD. 15ME. 15MF. 15MG. 15MH. 15MI. 15MJ. 15MK. 15ML. 15MN. 15MO. 15MP. 15MQ. 15MR. 15MS. 15MT. 15MU. 15MV. 15MW. 15MX. 15MY. 15MZ. 15NA. 15NB. 15NC. 15ND. 15NE. 15NF. 15NG. 15NH. 15NI. 15NJ. 15NK. 15NL. 15NM. 15NO. 15NP. 15NQ. 15NR. 15NS. 15NT. 15NU. 15NV. 15NW. 15NX. 15NY. 15NZ. 15OA. 15OB. 15OC. 15OD. 15OE. 15OF. 15OG. 15OH. 15OI. 15OJ. 15OK. 15OL. 15OM. 15ON. 15OO. 15OP. 15OQ. 15OR. 15OS. 15OT. 15OU. 15OV. 15OW. 15OX. 15OY. 15OZ. 15PA. 15PB. 15PC. 15PD. 15PE. 15PF. 15PG. 15PH. 15PI. 15PJ. 15PK. 15PL. 15PM. 15PN. 15PO. 15PP. 15PQ. 15PR. 15PS. 15PT. 15PU. 15PV. 15PW. 15PX. 15PY. 15PZ. 15QA. 15QB. 15QC. 15QD. 15QE. 15QF. 15QG. 15QH. 15QI. 15QJ. 15QK. 15QL. 15QM. 15QN. 15QO. 15QP. 15QQ. 15QR. 15QS. 15QT. 15QU. 15QV. 15QW. 15QX. 15QY. 15QZ. 15RA. 15RB. 15RC. 15RD. 15RE. 15RF. 15RG. 15RH. 15RI. 15RJ. 15RK. 15RL. 15RM. 15RN. 15RO. 15RP. 15RQ. 15RR. 15RS. 15RT. 15RU. 15RV. 15RW. 15RX. 15RY. 15RZ. 15SA. 15SB. 15SC. 15SD. 15SE. 15SF. 15SG. 15SH. 15SI. 15SJ. 15SK. 15SL. 15SM. 15SN. 15SO. 15SP. 15SQ. 15SR. 15SS. 15ST. 15SU. 15SV. 15SW. 15SX. 15SY. 15SZ. 15TA. 15TB. 15TC. 15TD. 15TE. 15TF. 15TG. 15TH. 15TI. 15TJ. 15TK. 15TL. 15TM. 15TN. 15TO. 15TP. 15TQ. 15TR. 15TS. 15TT. 15TU. 15TV. 15TW. 15TX. 15TY. 15TZ. 15UA. 15UB. 15UC. 15UD. 15UE. 15UF. 15UG. 15UH. 15UI. 15UJ. 15UK. 15UL. 15UM. 15UN. 15UO. 15UP. 15UQ. 15UR. 15US. 15UT. 15UU. 15UV. 15UW. 15UX. 15UY. 15UZ. 15VA. 15VB. 15VC. 15VD. 15VE. 15VF. 15VG. 15VH. 15VI. 15VJ. 15VK. 15VL. 15VM. 15VN. 15VO. 15VP. 15VQ. 15VR. 15VS. 15VT. 15VU. 15VV. 15VW. 15VX. 15VY. 15VZ. 15WA. 15WB. 15WC. 15WD. 15WE. 15WF. 15WG. 15WH. 15WI. 15WJ. 15WK. 15WL. 15WM. 15WN. 15WO. 15WP. 15WQ. 15WR. 15WS. 15WT. 15WU. 15WV. 15WW. 15WX. 15WY. 15WZ. 15XA. 15XB. 15XC. 15XD. 15XE. 15XF. 15XG. 15XH. 15XI. 15XJ. 15XK. 15XL. 15XM. 15XN. 15XO. 15XP. 15XQ. 15XR. 15XS. 15XT. 15XU. 15XV. 15XW. 15XX. 15XY. 15XZ. 15YA. 15YB. 15YC. 15YD. 15YE. 15YF. 15YG. 15YH. 15YI. 15YJ. 15YK. 15YL. 15YM. 15YN. 15YO. 15YP. 15YQ. 15YR. 15YS. 15YT. 15YU. 15YV. 15YW. 15YX. 15YY. 15YZ. 15ZA. 15ZB. 15ZC. 15ZD. 15ZE. 15ZF. 15ZG. 15ZH. 15ZI. 15ZJ. 15ZK. 15ZL. 15ZM. 15ZN. 15ZO. 15ZP. 15ZQ. 15ZR. 15ZS. 15ZT. 15ZU. 15ZV. 15ZW. 15ZX. 15ZY. 15ZZ.

Booster (SRB) Separation

TABLE II. (Continued)

TEST: IA/3

DATA SET RUN NUMBER COLLATION SUMMARY

LATE POST-TEST

DATA SET IDENTIFIER	CONFIGURATION	SCHD.		PARAMETERS/VALUES						NO. OF RUNS	Y - MAGN NUMBERS				TEST RUN NUMBERS
		a	B	DA	DB	X	Z	MAK	PT		PCH	RF	0	200	
RTJ 250	09 To / 58	0	5	-10	-10	0	G, H, I, 800**	4.51	28.9	1500	0	917	930*	931**	932**
251	(PLUMES ON)			↓	-20		G, 800*					918	936	937	896*
252				-20	5		G					877	878	879	
253					0		G, 800*					882	880	881	886*
254				-5	-10		M, G, 800**					919	922*	923**	887*
255				-10	-20		M, 800*					920	932	933	894*
256	↓			-20	0		M, 800*			↓		921	935	934	895*
257	(PLUMES OFF)			0	0		A			-		945	-	-	-
↓ 258	↓			↓	5		A			↓		944	-	-	-

19	25	31	37	43	49	55	61	67	75 76
CA	15	15	15	15	15	15	15	15	15
6									

TABLE II. (Continued)

BOOSTER (S.R.B.) SEPARATION

TEST: ZA13

DATE: POST-TEST

DATA SET RUN NUMBER COLLATION SUMMARY

DATA SET IDENTIFIER	CONFIGURATION	SCHD.		PARAMETERS/VALUES						NO. OF RUNS	MAGNET NUMBERS				TEST RUN NUMBER	
		a	B	Dx	Dy	X	Z	MKA	PT		PCH	RF	0	200		400
RTJ 259	09 T10 / 58	0	-5	5	5	0	B		4.51	28.9	1500	0	1041	1042	1043	-
260	(PLUMES ON)						B						1046	1045	1044	-
261				-5			J, B*						1091	1094*	1095*	-
262				-10			J, K*, B**						1092	1115*	1114*	-
263				-20			J, K*						1093	1132	1133*	-
264				0	5		A, 800*						1047	1048	1049	1071*
265					0		A, 800*						1052	1051	1050	1078*
266				-5			H, A*, 800**						1098	1096*	1097*	1077*
267				-10			H, D*, A*, 800**						1101	1116*	1117*	1086*
268				-20			H, 800*						1102	1131	1130	1087*
269				-5	5		C, A*, 800**						1053	1054	1057*	1072*
270					0		C, A*, 800**						1056	1055	1060*	1077*
271				-5			H, C*, A*, 800**						1099	1104*	1105*	1080*
272				-10			H, I, B*, 800**						1100	1119*	1118*	1085*
273				-20			H, 800*						1103	1128	1129	1088*
274				-10	5		D, A*, 800**						1061	1062	1058*	1073*
275					0		D, A*, 800**						1064	1063	1059*	1076*
276				-5			G, D, F*, 800**						1108	1107*	1106*	1081*

CA 114 M 15X 151 M 1566 KA 13 19 25 31 33 37 43 45 55 6

BOOSTER (SRD) SEPARATION TABLE II. (Continued)

TEST: ZA13 DATA SET RUN NUMBER COLLATION SUMMARY DATE: POST-TEST

DATA SET IDENTIFIER	CONFIGURATION	SCHED.		PARAMETERS/VALUES							NO. OF RUNS	MACH NUMBERS			
		A	B	Dx	Dy	Z	MACH	PT	PCH	RF		0	200	400	800
RTJ 277	Og Tio/Sg	0	-5	-10	0	G ₁ , I ₁ ^{***}	4.51	28.9	1500	0	1109	1120	1127	1084	
278	(RUNS ON)			-20		G ₁ , 800*					-	1126	1127	1089	
279				-20	5	G ₁ , 800*					1065	1066	1067	1074	
280					0	M ₁ , G ₁ ^{***}					1070	1068	1069	1075	
281					-5	M ₁ , G ₁ ^{***}					1110	1112	1113	1082	
282					-10	M ₁ , 800*					1111	1122	1123	1083	
↑ 283	↑	↑	↑	↑	-20	M ₁ , 800*					-	1125	1124	1090	

TEST RUN NUMBERS: 13 14 25 31 37 49 55 67 75 76

STATUS: ISM 15X 15YM 1505 15A 15Y 15Z

DATE: 1964 10 20 1505

ISOLATED ET, Φ , and Φ_{ET} TABLE II. (Continued)

TEST: IA 13		DATA SET RUN NUMBER COLLATION SUMMARY										DATE	MACH NUMBERS						
DATA SET IDENTIFIER	CONFIGURATION	SCHD.		PARAMETERS/VALUES										NO. OF RUNS	MACH NUMBERS				
		A	B	P	DEL	DER	1	2	3	4	5	6	7			8	9	10	
RTJ 500	T ₁₀	A	0	110	-	-	-	-	-	-	-	-	-	-	-	-	-	453	
T 50	↓	A	5	110	-	-	-	-	-	-	-	-	-	-	-	-	-	282	
RTJ 502	Φ_9	B	0	80	-40	-40	-	-	-	-	-	-	-	-	-	-	-	283	
T 503	↓				10	10	-	-	-	-	-	-	-	-	-	-	-	291	
T 504	↓				110	-10	-	-	-	-	-	-	-	-	-	-	-	293	
T 505	↓				0	0	-	-	-	-	-	-	-	-	-	-	-	295	
T 506	↓				5	0	0	-	-	-	-	-	-	-	-	-	-	297	
T 507	↓				10	0	0	-	-	-	-	-	-	-	-	-	-	299	
RTJ 508	Φ_9 T ₁₀	B	0	289	0	0	-	-	-	-	-	-	-	-	-	-	-	301	
T 509	↓	B	5	289	0	0	-	-	-	-	-	-	-	-	-	-	-	1136	
																		1134	

ISOLATED ET, Φ , and Φ_{ET} TABLE II. (Continued)

DATE: _____ MACH: ALPHA 6

TEST RUN NUMBERS: _____

CONFIDENTIAL

A) -40, -30, -20, -15, -10, -5, 0, 5, 10
 B) -11, -27, 10, 16

ISOLATED SRK
TAILS

TABLE II. (Continued)

DATA SET RUN NUMBER COLLATION SUMMARY

DATE: POST-TEST

DATA SET IDENTIFIER	CONFIGURATION	SCHD.		PARAMETERS/VALUES										NO. OF RUNS	MACH NUMBERS		TEST RUN NUMBERS	
		α	β	P	P/4													
RTJ 510	SR (PLUMES OFF)	A	-10	110	-												751	
511			0		-												753	
512			5		-												763	
513			10		-												773	
514			20		-												783	
515			-10	58	-												793	
516			0		-												803	
517			5		-												813	
518			10		-												823	
519			20		-												833	
520			-10	28.9	-												843	
521			0		-												946	
522			5		-												952	
523			10		-												958	
524			20		-												964	
Y 525	Y	B	20	Y	-												970	
																	977	

1	7	13	19	25	31	37	43	49	55	61	67	73	76
SCHEDULES													
A) -30°-25°-20°-15°-10°-5° 0° 5° 10° 15°													
B) -30°-25°-20°-15°-10°													
C) 10.15°													
MACH NUMBERS: 101, 102, 103, 104, 105, 106, 107, 108, 109, 110, 111, 112, 113, 114, 115, 116, 117, 118, 119, 120, 121, 122, 123, 124, 125, 126, 127, 128, 129, 130, 131, 132, 133, 134, 135, 136, 137, 138, 139, 140, 141, 142, 143, 144, 145, 146, 147, 148, 149, 150, 151, 152, 153, 154, 155, 156, 157, 158, 159, 160, 161, 162, 163, 164, 165, 166, 167, 168, 169, 170, 171, 172, 173, 174, 175, 176, 177, 178, 179, 180, 181, 182, 183, 184, 185, 186, 187, 188, 189, 190, 191, 192, 193, 194, 195, 196, 197, 198, 199, 200													

TABLE II. (Concluded)

ISOLATED SRB

TEST: IA-13			DATA SET / RUN NUMBER COLLATION SUMMARY												DATE: POST-TEST																							
DATA SET IDENTIFIER	CONFIGURATION	SCHD.		PARAMETERS/VALUES												NO. OF RUNS	MACH NUMBERS																					
		α	β	PT	PC	PC	PC	PC	PC	PC	PC	PC	PC	PC	PC			PC	PC	PC	PC																	
RTJ527	S8 (PLUMES ON)	A	-10	20.9	750																																	
528			0																																			
529			5																																			
530			10																																			
531			20																																			
532			-10		1500																																	
533			0																																			
534			5																																			
535			10																																			
536			20																																			

TEST RUN NUMBERS

1 7 13 19 25 31 37 43 49 55 61 67 73 76

CM... KEA... SY... A) -30° → 15°, Ax = 5°

MACH... ALPHA...

α ON β SCHEDULES

TABLE III. MODEL DIMENSIONAL DATA

MODEL COMPONENT: BODY (E₁₉)

GENERAL DESCRIPTION: Configuration 3 lightweight Orbiter fuselage

Model Scale = 0.010 Model Drawing No. SS-A00062

DRAWING NUMBER: VI.70-000139B

<u>DIMENSIONS:</u>	<u>FULL-SCALE</u>	<u>MODEL SCALE</u>
Length ~ in.	<u>1290.3</u>	<u>12.903</u>
Max. Width ~ in. (@ X ₀ = 1528.3 in.)	<u>267.6</u>	<u>2.676</u>
Max. Depth ~ in. (@ X ₀ = 1480.52 in.)	<u>244.5</u>	<u>2.445</u>
* Fineness Ratio	<u>4.846</u>	<u>4.846</u>
Area ~ ft. ²		
Max. Cross-Sectional (@ X ₀ = 1480.52 in.)	<u>386.67</u>	<u>0.03867</u>
Planform	<u> </u>	<u> </u>
Wetted	<u> </u>	<u> </u>
Base	<u> </u>	<u> </u>

* Fineness Ratio is the fuselage length divided by the equivalent diameter for the maximum cross-sectional area.

TABLE III. MODEL DIMENSIONAL DATA (CONTINUED)

MODEL COMPONENT: Canopy (C7)

GENERAL DESCRIPTION: Configuration 3 lightweight Orbiter Canopy

Model Scale = 0.010

Model Drawing No. SS-A00062

DRAWING NUMBER

VL70-000139B

DIMENSION:

FULL SCALE

MODEL SCALE

Length ($X_0 = 433$ IN. to $X_0 = 670$ IN.)

237

2.370

Max Width

Max Depth

Fineness Ratio

Area

Max Cross-Sectional

Planform

Wetted

Base

TABLE III. MODEL DIMENSIONAL DATA (CONTINUED)

MODEL COMPONENT: Elevon (E₂₃)

GENERAL DESCRIPTION: Configuration 3 lightweight orbiter elevons

Data for (1) of (2) sides

Model Scale = 0.010 Model Drawing No. SS-A00109

DRAWING NUMBER: VL70-000139B

<u>DIMENSIONS:</u>	<u>FULL-SCALE</u>	<u>MODEL SCALE</u>
Area ~ ft. ²	<u>205.52</u>	<u>0.02055</u>
Span (equivalent)~in.	<u>353.34</u>	<u>3.5334</u>
Inb'd equivalent chord ~ in.	<u>114.78</u>	<u>1.1478</u>
Outb'd equivalent chord ~ in.	<u>55.00</u>	<u>0.550</u>
Ratio movable surface chord/ total surface chord		
At Inb'd equiv. chord	<u>0.208</u>	<u>0.208</u>
At Outb'd equiv. chord	<u>0.400</u>	<u>0.400</u>
Sweep Back Angles, deg		
Leading Edge	<u>0.00</u>	<u>0.00</u>
Tailing Edge	<u>-10.24</u>	<u>-10.24</u>
Hingeline	<u>0.00</u>	<u>0.00</u>
Area Moment (Normal to hinge line)~ft ³	<u>1548.07</u>	<u>0.00155</u>

TABLE III. MODEL DIMENSIONAL DATA (CONTINUED)

MODEL COMPONENT: Body Flap (F₅)

GENERAL DESCRIPTION: Configuration 3 lightweight orbiter body flap

Model Scale = 0.010

Model Drawing No. SS-A00062

DRAWING NUMBER

VL70-000139B

DIMENSION:

FULL SCALE

MODEL SCALE

Length ~ in.

84.70

0.8470

Max Width ~ in.

267.6

2.6760

Max Depth

Fineness Ratio

Area ~ ft.²

Max Cross-Sectional

Planform

Wetted

Base

142.5195

0.01425195

38.0958

0.00380958

TABLE III. MODEL DIMENSIONAL DATA (CONTINUED)

MODEL COMPONENT: OMS Pod (M₁)

GENERAL DESCRIPTION: Configuration 3 lightweight Orbiter Orbital
Maneuvering System Pod.

Model Scale = 0.010 Model Drawing No. SS-A00062

DRAWING NUMBER VL70-000139B

<u>DIMENSION:</u>	<u>FULL SCALE</u>	<u>MODEL SCALE</u>
Length~in.	<u>346.0</u>	<u>3.460</u>
Max Width~in.	<u>108.0</u>	<u>1.080</u>
Max Depth~in.	<u>113.0</u>	<u>1.13</u>
Fineness Ratio	<u> </u>	<u> </u>
Area		
Max Cross-Sectional	<u> </u>	<u> </u>
Planform	<u> </u>	<u> </u>
Wetted	<u> </u>	<u> </u>
Base	<u> </u>	<u> </u>

TABLE III. MODEL DIMENSIONAL DATA (CONTINUED)

MODEL COMPONENT: Rudder (R₅)

GENERAL DESCRIPTION: Configuration 3 lightweight Orbiter rudder

Model Scale = 0.010 Model Drawing No. SS-A00062

DRAWING NUMBER: VL70-000139B
 VL70-000095

<u>DIMENSIONS:</u>	<u>FULL-SCALE</u>	<u>MODEL SCALE</u>
Area~ft. ²	<u>106.38</u>	<u>0.010638</u>
Span (equivalent)~in.	<u>201.0</u>	<u>2.010</u>
Inb'd equivalent chord~in.	<u>91.585</u>	<u>0.91585</u>
Outb'd equivalent chord~in.	<u>50.833</u>	<u>0.50833</u>
Ratio movable surface chord/ total surface chord		
At Inb'd equiv. chord	<u>0.400</u>	<u>0.400</u>
At Outb'd equiv. chord	<u>0.400</u>	<u>0.400</u>
Sweep Back Angles, deg.		
Leading Edge	<u>34.83</u>	<u>34.83</u>
Tailing Edge	<u>26.25</u>	<u>26.25</u>
Hingeline	<u>34.83</u>	<u>34.83</u>
Area Moment (Normal to hinge line)~ft ³	<u>526.13</u>	<u>0.00053</u>

TABLE III. MODEL DIMENSIONAL DATA (CONTINUED)

MODEL COMPONENT: VERTICAL TAIL (V7)

GENERAL DESCRIPTION: Configuration 3 lightweight orbiter vertical tail,
double wedge airfoil sections with rounded leading edge.

Model Scale = 0.010

Model Drawing No. SS-A00062

DRAWING NUMBER:

VL70-000139 B
VL70-000095,

DIMENSIONS:

FULL-SCALE

MODEL SCALE

TOTAL DATA

Area (Theo) ~ ft ² Planform	<u>413.25</u>	<u>0.04132</u>
Span (Theo) ~ in.	<u>315.72</u>	<u>3.1572</u>
Aspect Ratio	<u>1.675</u>	<u>1.675</u>
Rate of Taper	<u>0.507</u>	<u>0.507</u>
Taper Ratio	<u>.404</u>	<u>.404</u>
Sweep Back Angles ~ deg.		
Leading Edge	<u>45.000</u>	<u>45.000</u>
Trailing Edge	<u>26.249</u>	<u>26.249</u>
0.25 Element Line	<u>41.130</u>	<u>41.130</u>
Chords:		
Root (Theo) WP	<u>268.50</u>	<u>2.6850</u>
Tip (Theo) WP	<u>108.47</u>	<u>1.0847</u>
MAC	<u>199.81</u>	<u>1.9981</u>
Fus. Sta. of .25 MAC	<u>1463.50</u>	<u>14.6350</u>
W. P. of .25 MAC	<u>635.522</u>	<u>6.35522</u>
B. L. of .25 MAC	<u>0.00</u>	<u>0.00</u>
Airfoil Section		
Leading Wedge Angle ~ deg.	<u>10.000</u>	<u>10.000</u>
Trailing Wedge Angle ~ deg.	<u>14.920</u>	<u>14.920</u>
Leading Edge Radius ~ in.	<u>2.00</u>	<u>0.020</u>
Void Area ~ ft ²	<u>13.17</u>	<u>0.0013</u>
Blanketed Area ~ ft ²	<u>12.67</u>	<u>0.0012</u>

TABLE III. MODEL DIMENSIONAL DATA (CONTINUED)

MODEL COMPONENT: WING (W₁₀₇)

GENERAL DESCRIPTION: Configuration 3 lightweight Orbiter wing

Model Scale = 0.010

Model Drawing No. SS-A00109

DWG. NO. VL70-000139B

DIMENSIONS:

FULL-SCALE

MODEL SCALE

TOTAL DATA

Area (Theo.) ~ ft ²		
Planform	2690.00	0.2690
Span (Theo) ~ in.	936.68	9.3668
Aspect Ratio	2.265	2.265
Rate of Taper	1.277	1.277
Taper Ratio	0.200	0.200
Dihedral Angle, deg. (@ T.E. of Elevon)	3.500	3.500
Incidence Angle, deg.	0.500	0.500
Aerodynamic Twist, deg.	+3.000	+3.000
Sweep Back Angles, deg.		
Leading Edge	45.000	45.000
Trailing Edge	-10.21	-10.21
0.25 Element Line	35.009	35.009
Chords: ~ in.		
Root (Theo) B.P.O.O.	689.21	6.8921
Tip, (Theo) B.P.	137.85	1.3785
MAC	474.81	4.7481
Fus. Sta. of .25 MAC	1136.89	11.3689
W.P. of .25 MAC	299.20	2.9920
B.L. of .25 MAC	182.13	1.8213

EXPOSED DATA

Area (Theo) ~ ft ²	1752.29	0.17523
Span, (Theo) ~ in. (From B.P. 108 in.)	720.68	7.2068
Aspect Ratio	2.058	2.058
Taper Ratio	0.2451	0.2451
Chords: ~ in.		
Root (@ B.P. 108)	562.40	5.6240
Tip	137.85	1.3785
MAC	393.03	3.9303
Fus. Sta. of .25 MAC	1185.31	11.8531
W.P. of .25 MAC	300.20	3.0020
B.L. of .25 MAC	251.76	2.5176
Airfoil Section (Rockwell Mod NASA)		
XXXX-64		
Root $\frac{T}{c} = @ Y_0$ 199 to NAXA 0010	0.10	0.10
Tip $\frac{T}{c} =$	0.12	0.12

Data for (1) of (2) Sides

Leading Edge Cuff		
Planform Area ~ ft ²	18.200	0.00182
Leading Edge Intersects Fus M. L. @ Sta	500	5.00
Leading Edge Intersects Wing @ Sta	1083.1	10.831

ORIGINAL PAGE IS
OF POOR QUALITY

TABLE III. MODEL DIMENSIONAL DATA (CONTINUED)

MODEL COMPONENT: External Tank (T₁₀)

GENERAL DESCRIPTION: Configuration 3 External Oxygen Hydrogen Tank

Model Scale = 0.010 Model Drawing No. SS-A00108

DRAWING NUMBER VL72-000038
VL78-000041

<u>DIMENSION:</u>	<u>FULL SCALE</u>	<u>MODEL SCALE</u>
Length~in.	<u>1865</u>	<u>18.65</u>
Max Diameter~in.	<u>324</u>	<u>3.24</u>
Max Depth	<u> </u>	<u> </u>
Fineness Ratio (Length/Max. Dia.)	<u>5.75617</u>	<u>5.75617</u>
Area~ft ²		
Max Cross-Sectional	<u>572.555</u>	<u>0.05726</u>
Planform	<u> </u>	<u> </u>
Wetted	<u> </u>	<u> </u>
Base	<u> </u>	<u> </u>

TABLE III. MODEL DIMENSIONAL DATA (CONCLUDED)

MODEL COMPONENT: Booster (S_g)

GENERAL DESCRIPTION: Configuration 3 Booster Solid Rocket Motor
Data for 1 of 2 Boosters

Model Scale 0.010 Model Drawing No. SSA-00113

DRAWING NUMBER VL72-000088
VL77-000036

<u>DIMENSION:</u>	<u>FULL SCALE</u>	<u>MODEL SCALE</u>
Length (Includes Nozzle)~in.	<u>1741.0</u>	<u>17.410</u>
Max Width (Tank Dia.)~in.	<u>142.0</u>	<u>1.420</u>
Max Dia. (Max. Nozzle Shroud Dia.)~in.	<u>205.0</u>	<u>2.050</u>
* Fineness Ratio	<u>8.49268</u>	<u>8.49268</u>
Area~ft ²		
Max Cross-Sectional (Nozzle Shroud)	<u>229.21</u>	<u>0.02292</u>
Planform	<u> </u>	<u> </u>
Wetted	<u> </u>	<u> </u>
Base	<u> </u>	<u> </u>

* Length divided by nozzle shroud diameter.

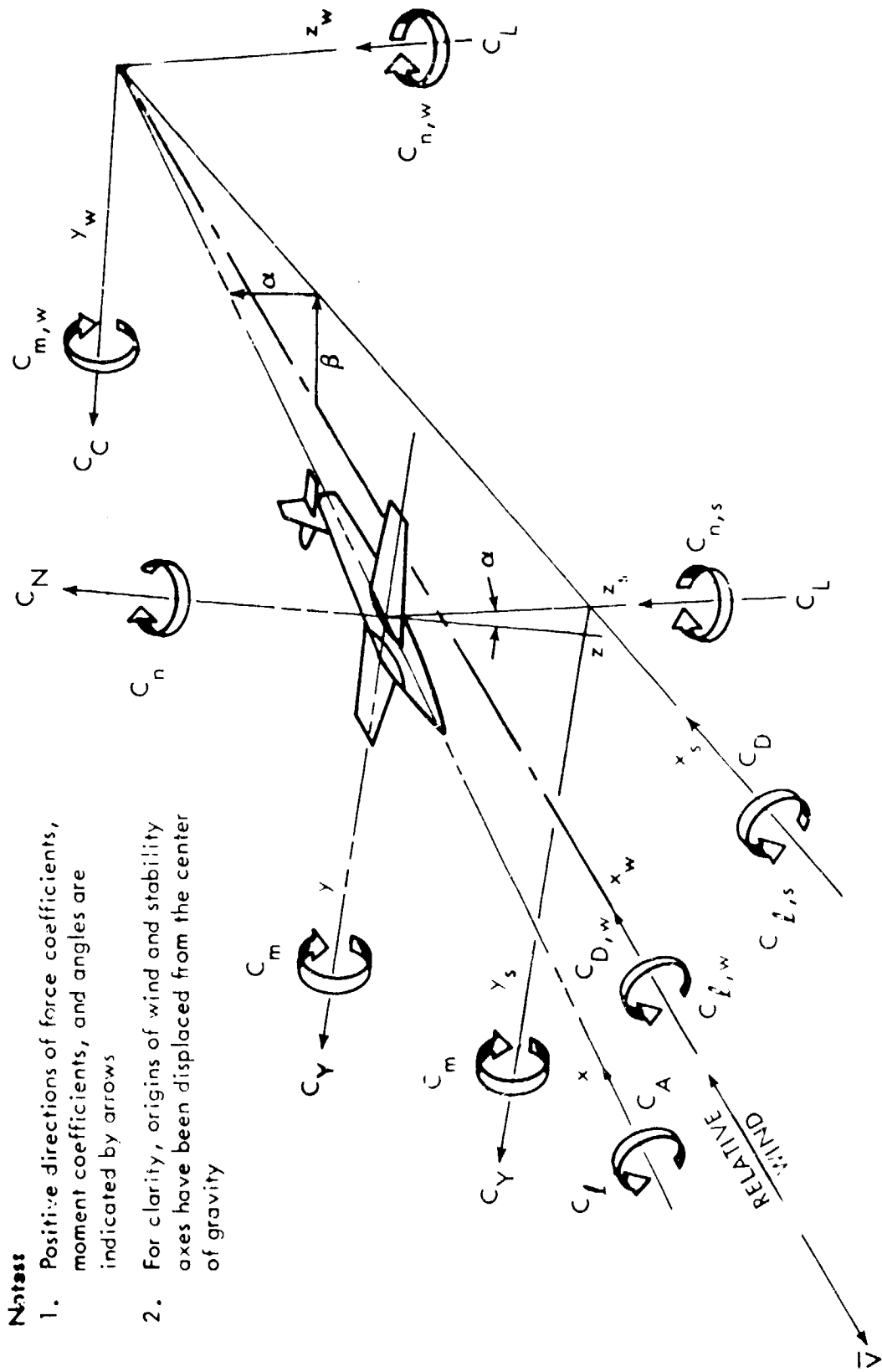

Notes

1. Positive directions of force coefficients, moment coefficients, and angles are indicated by arrows
2. For clarity, origins of wind and stability axes have been displaced from the center of gravity

Figure 1. Axis Systems

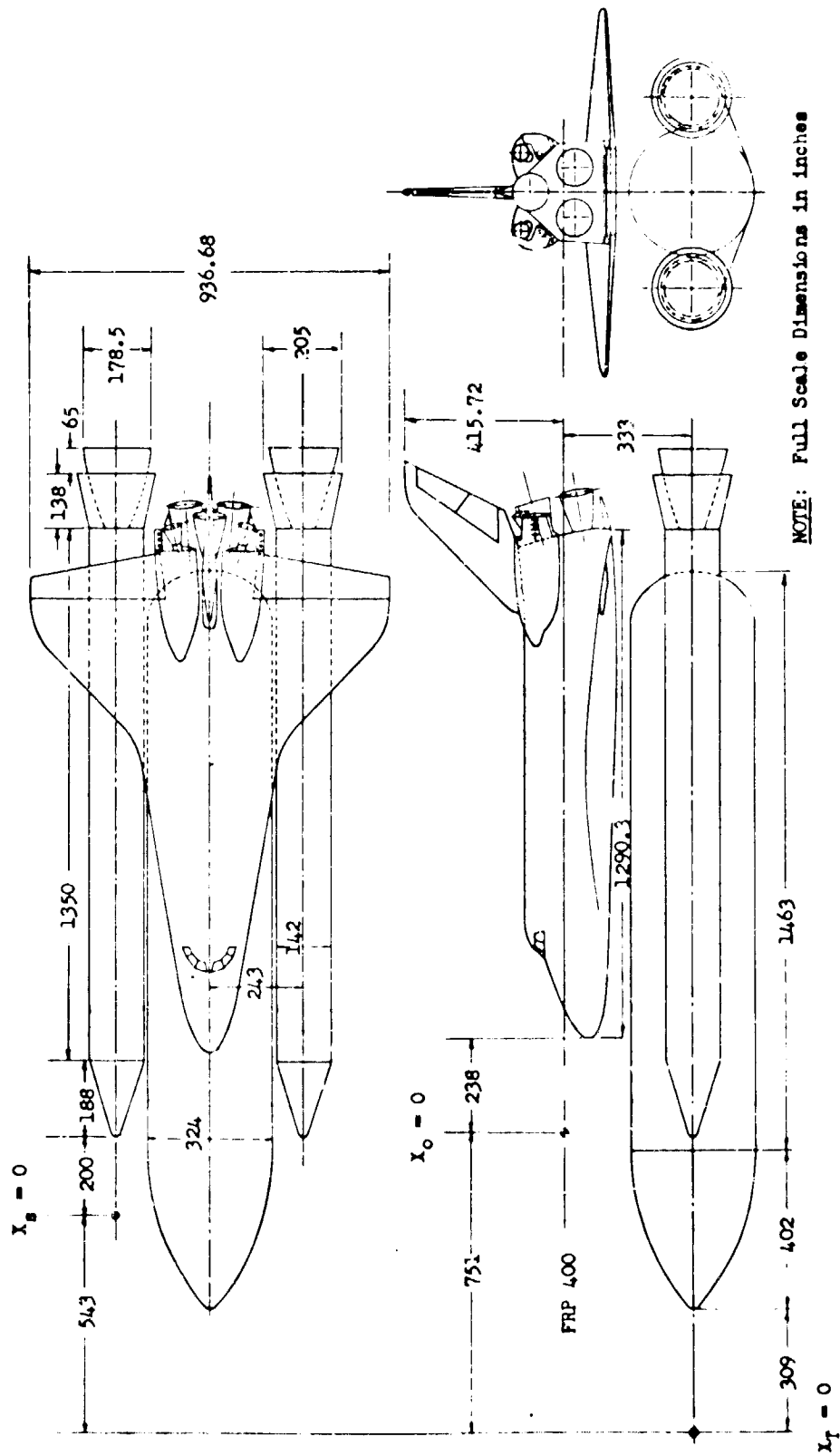

a. Integrated Vehicle Configuration 3 (Mated)

Figure 2. Model Sketches

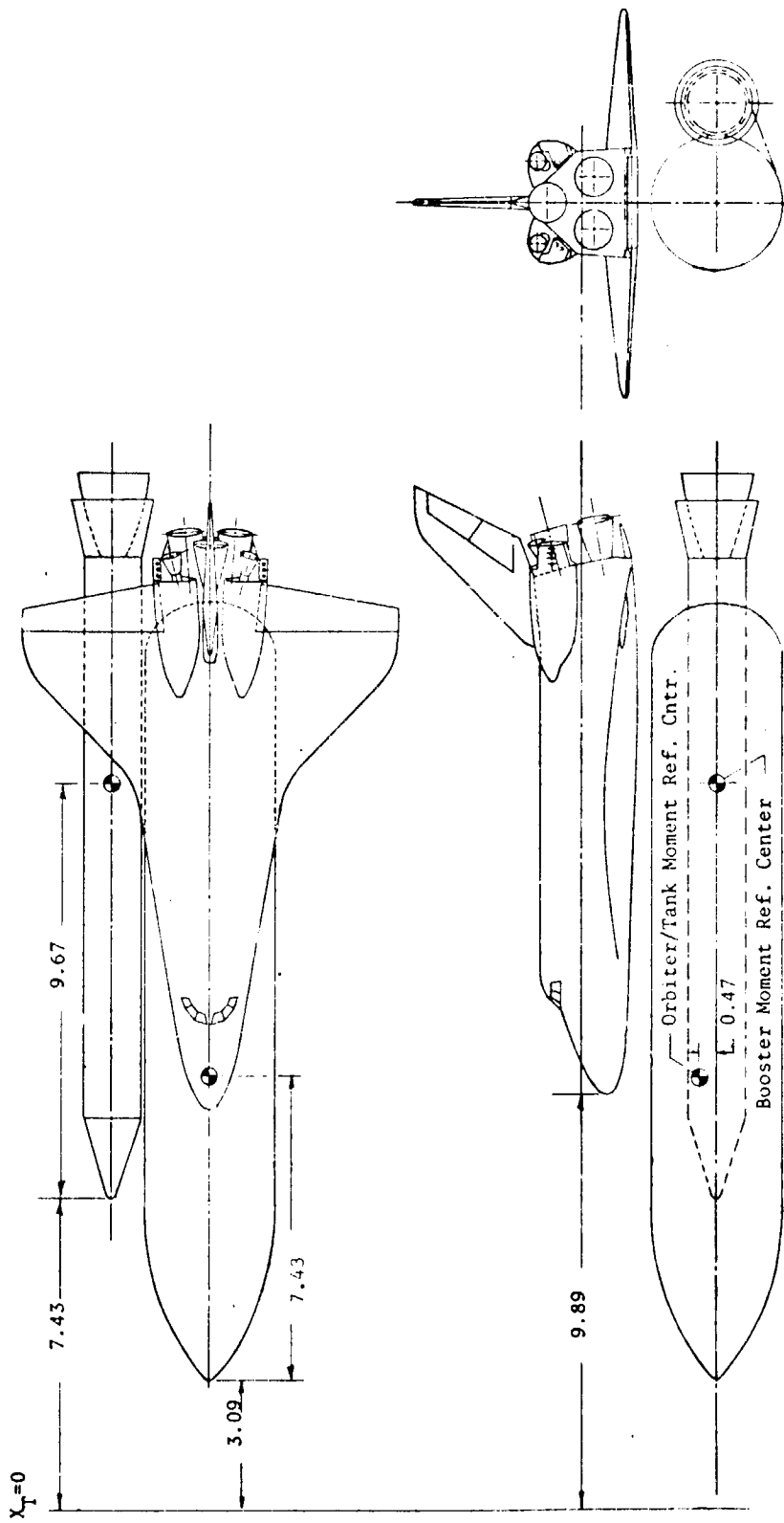

NOTES:

1. Only righthand booster used for Booster Separation testing.
2. Orbiter rigidly attached to tank.
3. Mated position shown.
4. All dimensions in inches.

b. Model 32-OTS Integrated Vehicle Configuration 3

Figure 2. - Continued

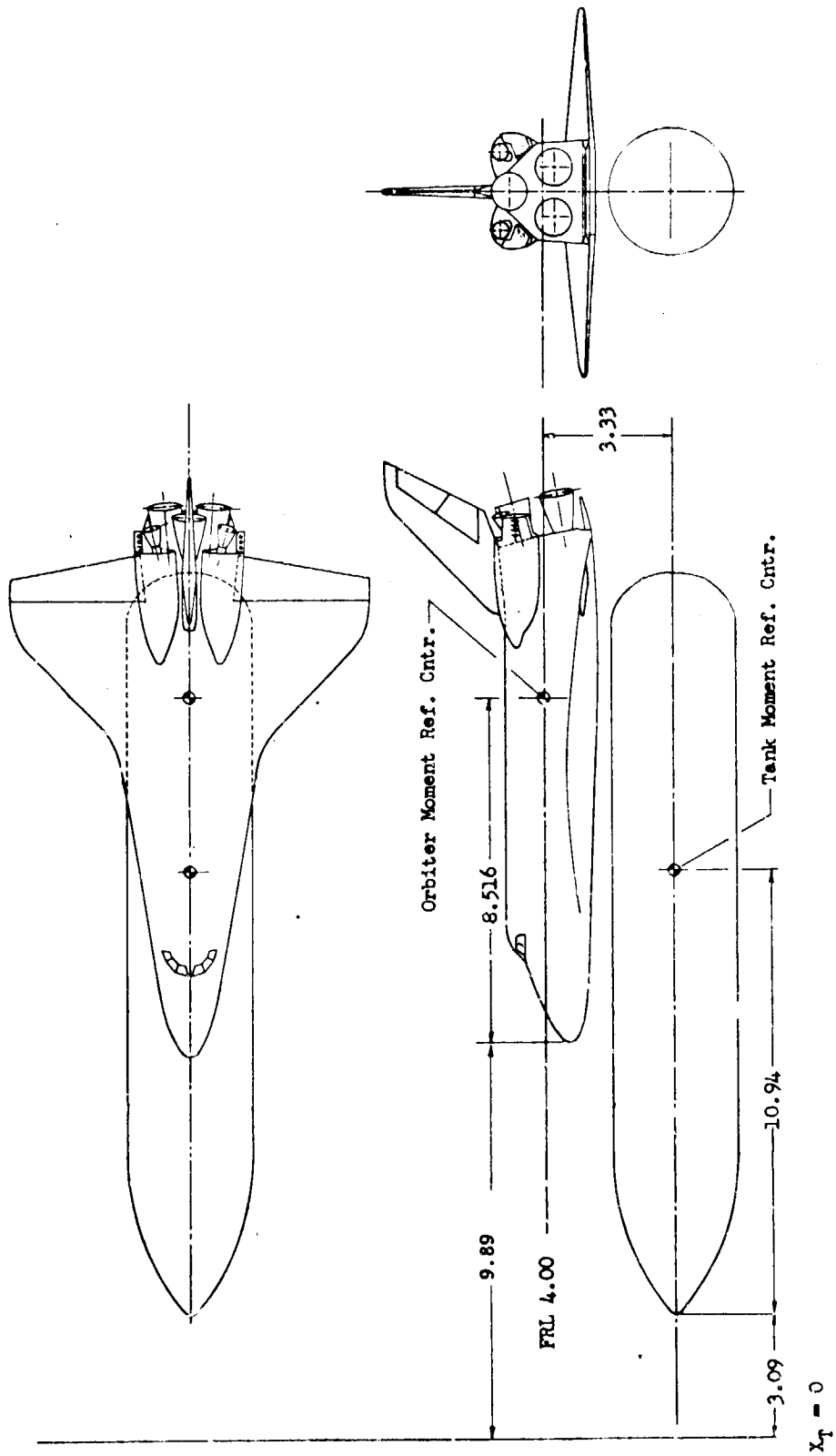

NOTES:

1. Models for Tank separation from Orbiter testing.
2. Mated position shown.
3. All dimensions in inches.

c. Model 32-OTS Orbiter and Tank Configuration 3

Figure 2. - Continued

NOTES

1. X, Y, and Z = 0 in. when tank nose is in its mated position.
2. α and β for tank are defined in similar manner to that indicated for Orbiter.

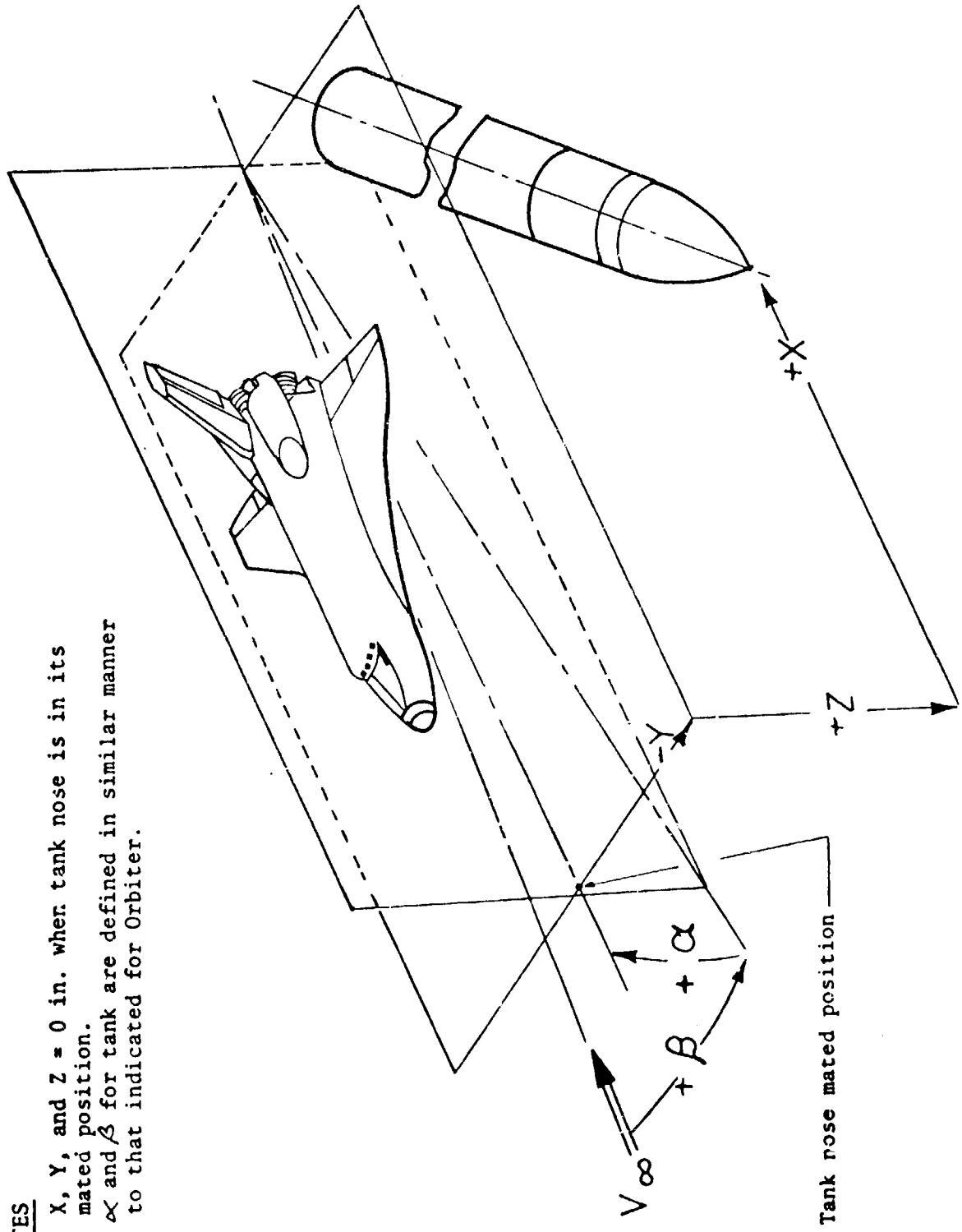

d. Tank Separation from Orbiter

Figure 2. - Continued

NOTES:

1. X, Y, and Z = 0 when Booster nose is in its mated position.
2. α and β for Booster are defined in similar manner to that indicated for the Tank.
3. For IAL3, it is the right-hand Booster that is tested (not the left-hand, as indicated here). For the right-hand Booster, positive Y is to the right.

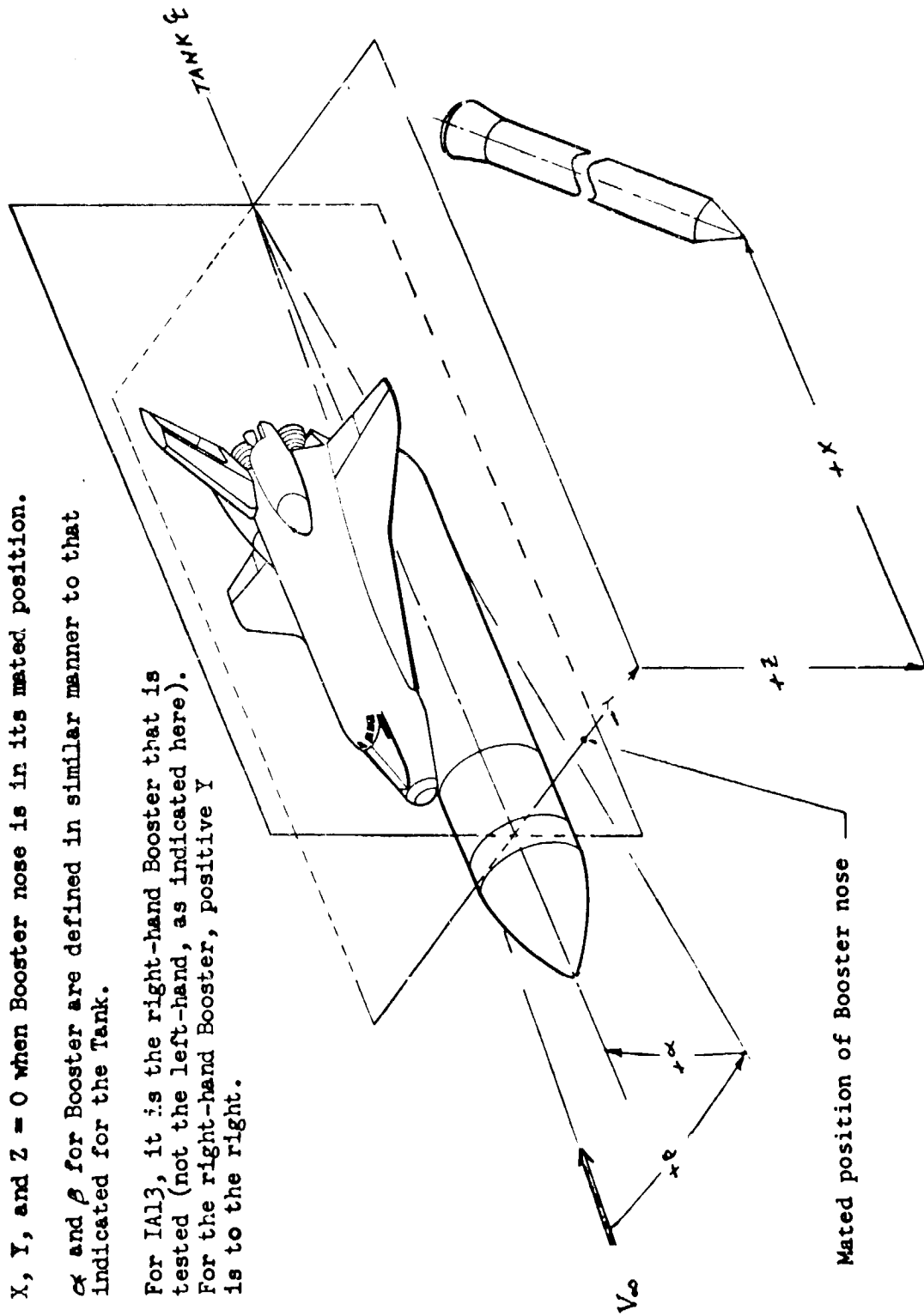

e. Booster Separation from Orbiter/Tank

Figure 2. - Continued

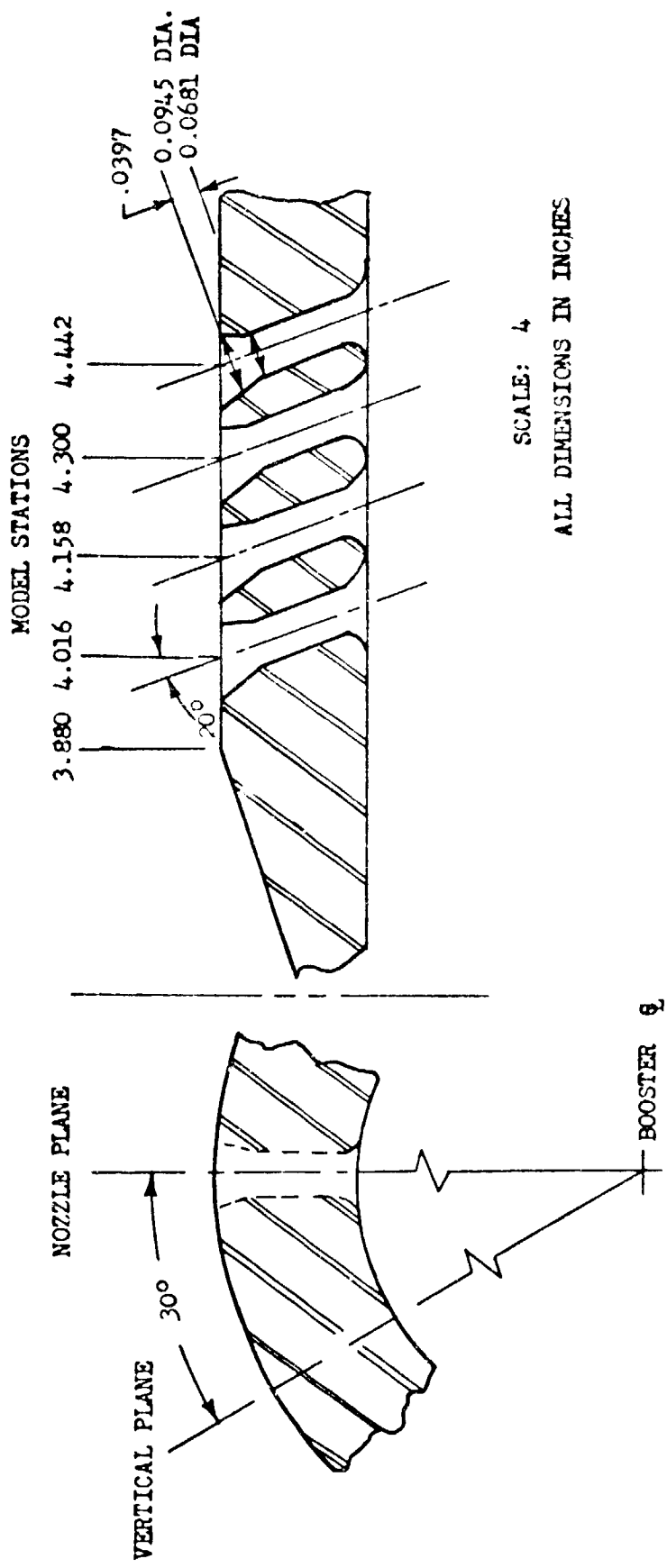

f. 32-OTS Booster Model Forward Thruster Nozzle Block
Figure 2. - Continued

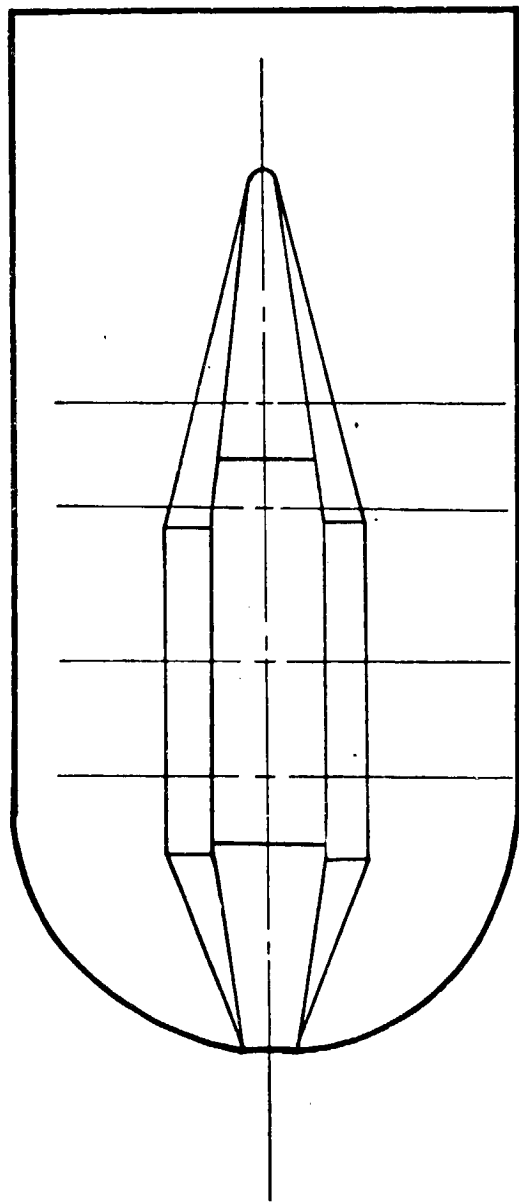

17.610 17.780 18.005 18.165 MODEL STATIONS

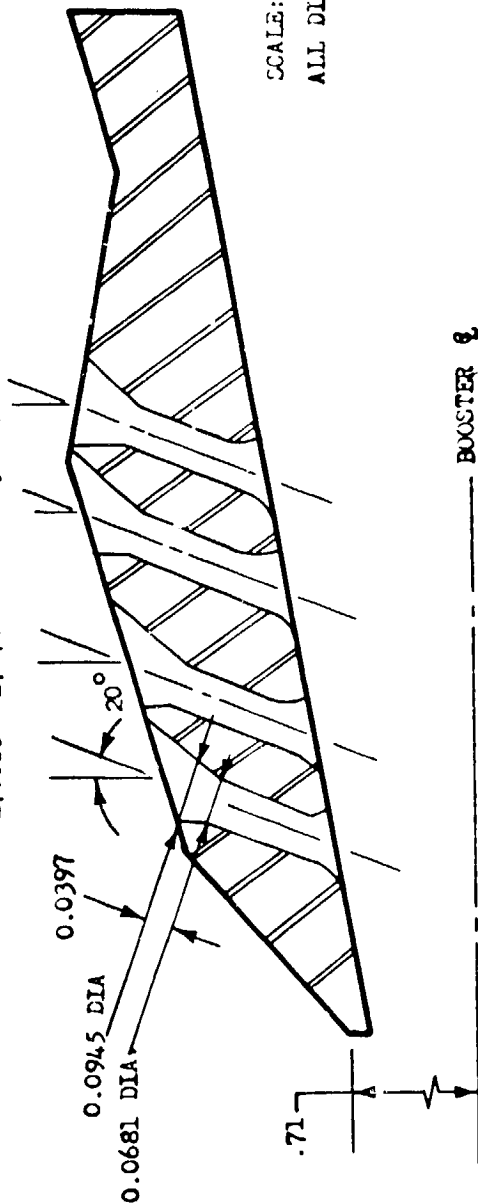

SCALE: 4
ALL DIMENSIONS IN INCHES

g. 32-OTS Booster Model Aft Thruster Nozzle Block
Figure 2. - Continued

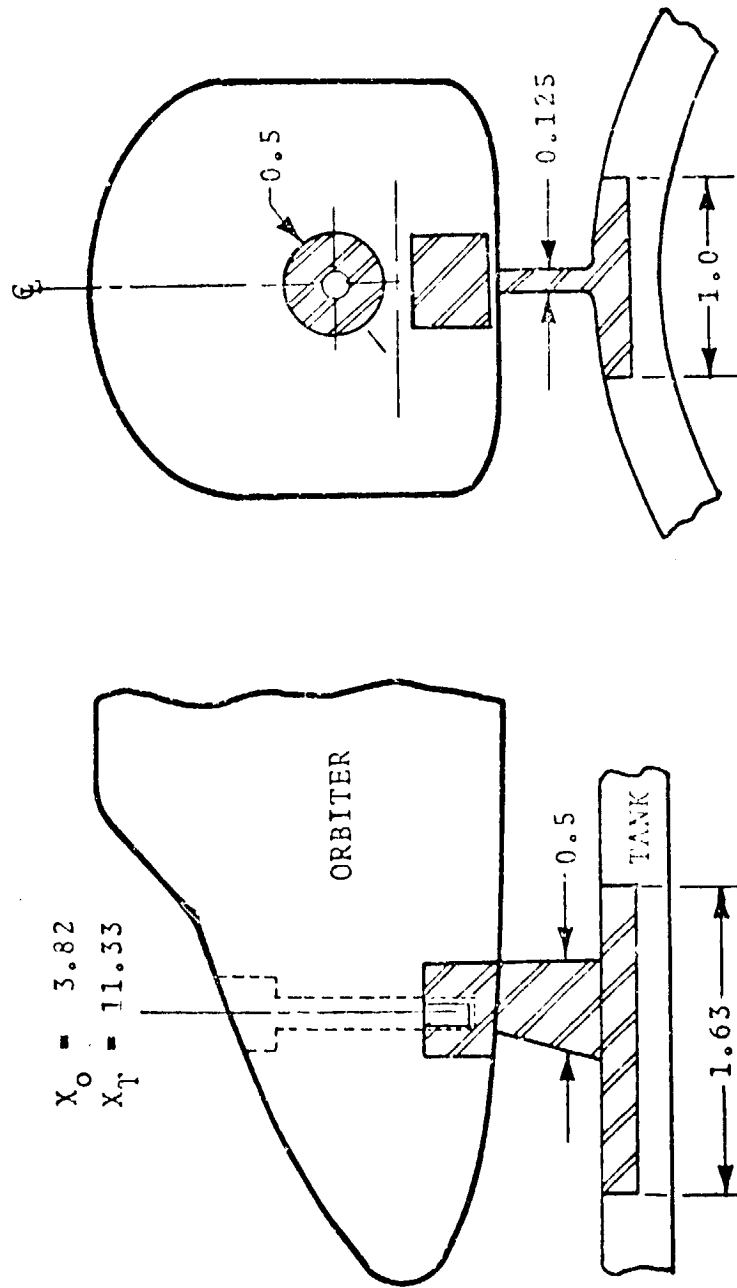

ALL DIMENSIONS IN INCHES

h. 32-OPS Orbiter/Tank Forward Attachment
 Figure 2. - Continued

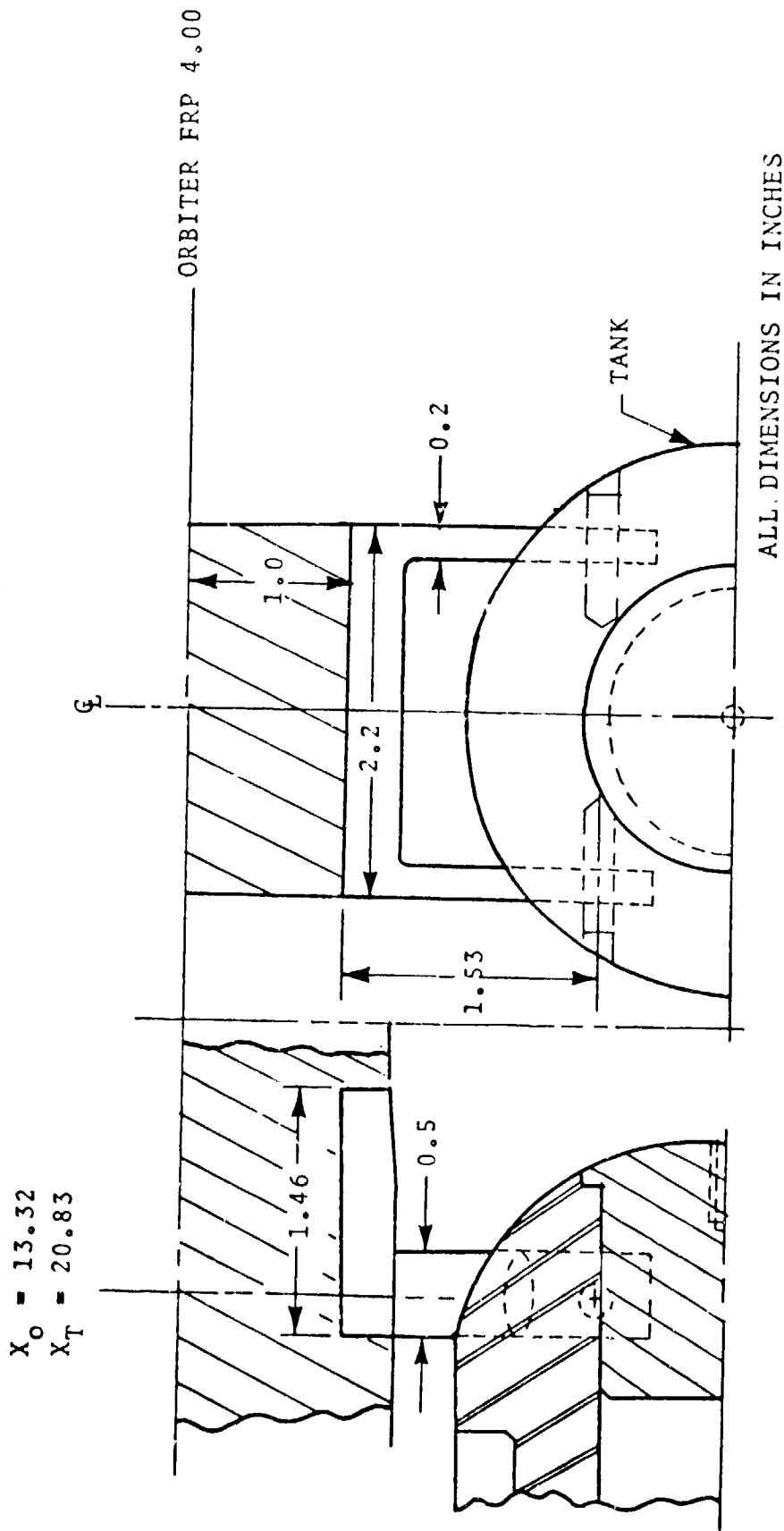

i. 32-OYS Orbiter/Tank Aft Attachment

Figure 2. - Continued

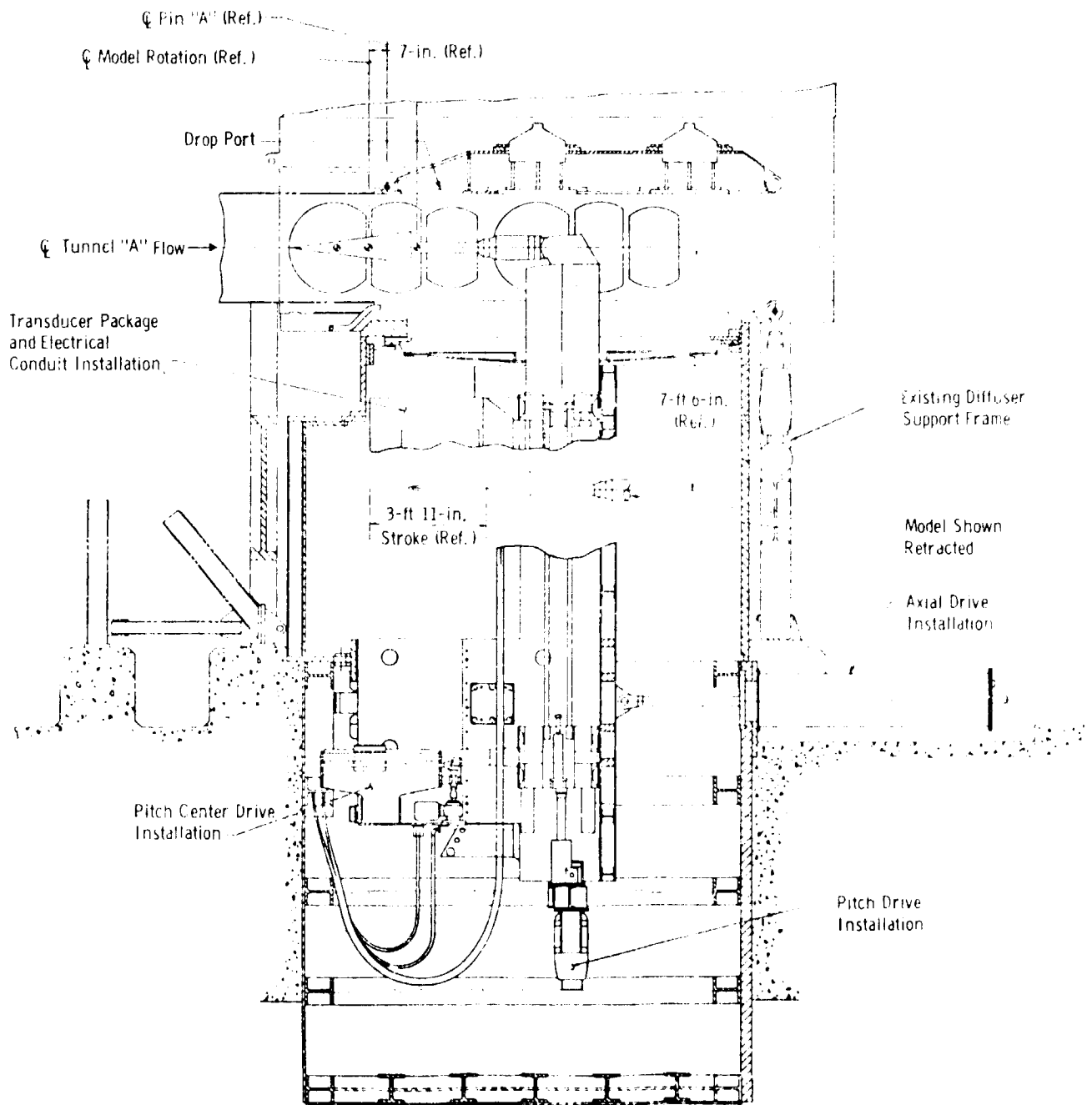

FIGURE 3. AEDC von Karman Gas Dynamic Facility Tunnel A

<u>Volume</u>	<u>Description</u>
I	Data Figures (pages 1 through 894)
II	Data Figures (pages 895 through 1498)
III	Tabulated Source Data

DATA FIGURES

VOLUME I

SEE THE ASSOCIATED DATA DOCUMENT FOR REFERENCE CHARACTERISTICS FOR INDIVIDUAL DATASETS

BETA	ELEVTR	AIRLON	PTOTAL
1.000	.000	.000	80.000
5.000	.000	.000	80.000
10.000	.000	.000	80.000

DATA SET SYMBOL	CONF	ORATION	DESCRIPTION
(R7505)	□	A13	ISOLATED ORBITTER (05)
(R7506)	◇	A13	ISOLATED ORBITTER (06)
(R7507)	◇	A13	ISOLATED ORBITTER (07)

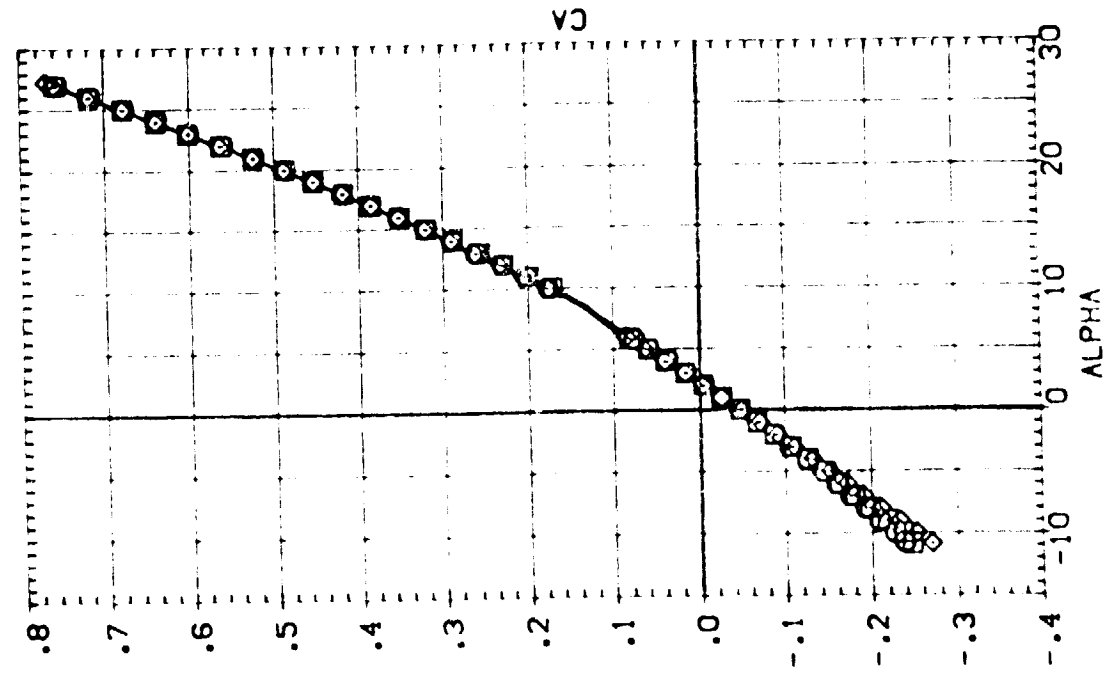
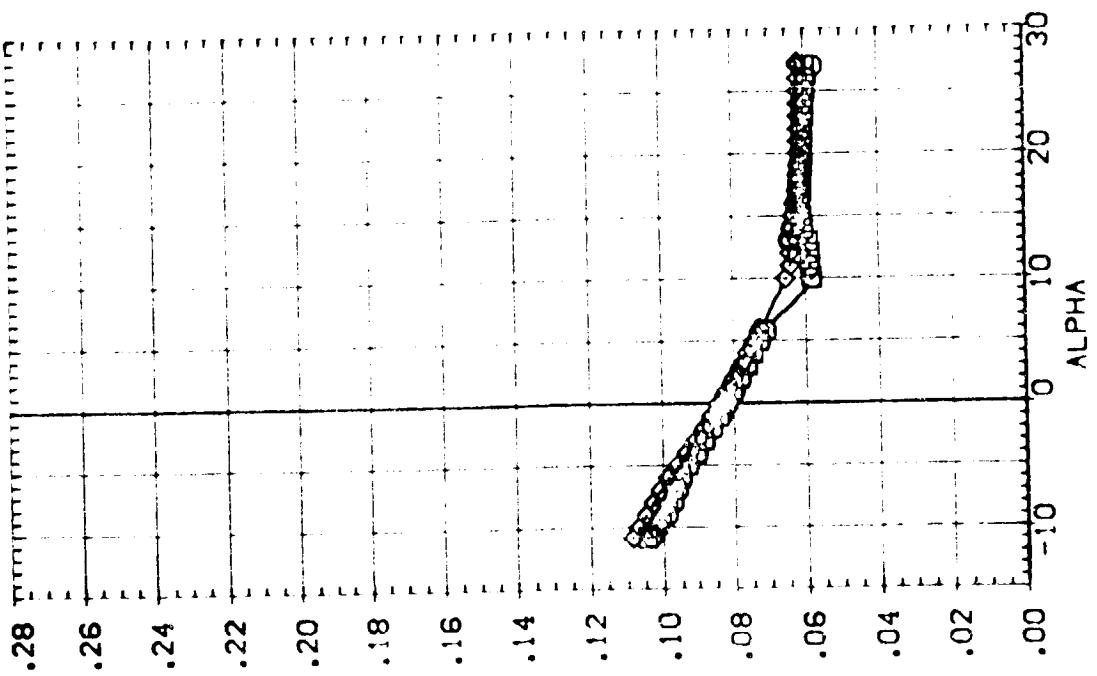

ISOLATED ORBITTER AERODYNAMIC CHARACTERISTICS

(M)MACH = 4.52

DATA SET \$=SOOL CONFIGURATION DESCRIPTION
 [R1505] □ SOLATED ORBITER (03)
 [R1506] ◇ SOLATED ORBITER (03)
 [R1507] SOLATED ORBITER (03)

BETA ELEVTR ALTRPWN RTOTAL CTRMTR CTRMTR CTRMTR
 .000 .000 .000 80.000 .000 .000 .000
 .000 .000 .000 80.000 .000 .000 .000
 5.000 .000 .000 80.000 .000 .000 .000
 10.000 .000 .000 80.000 .000 .000 .000

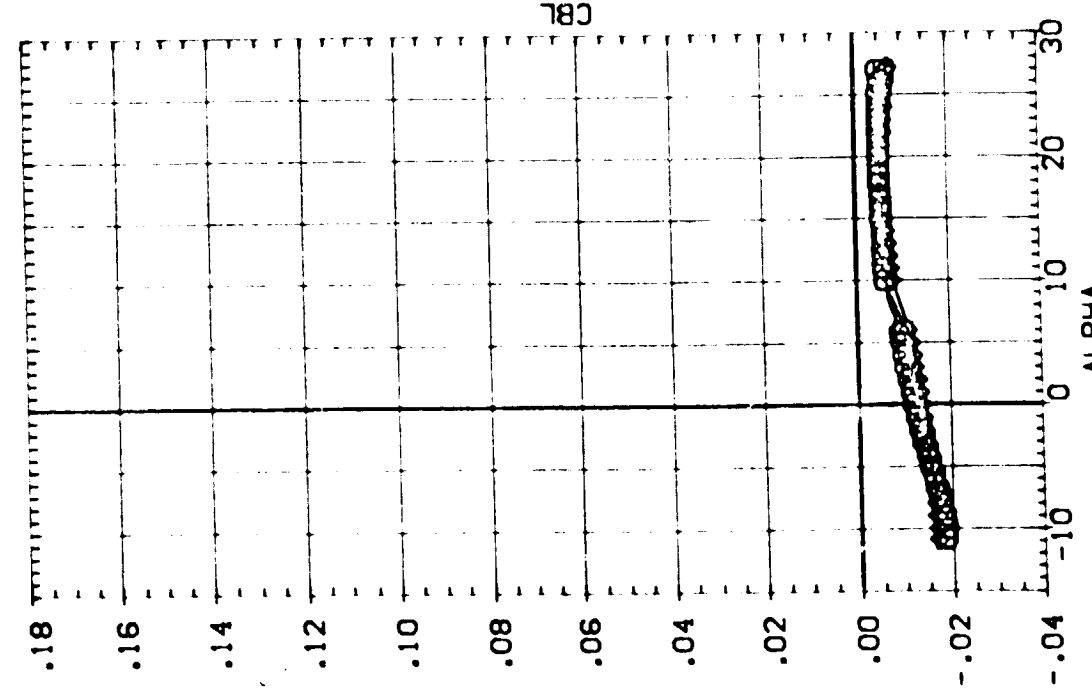
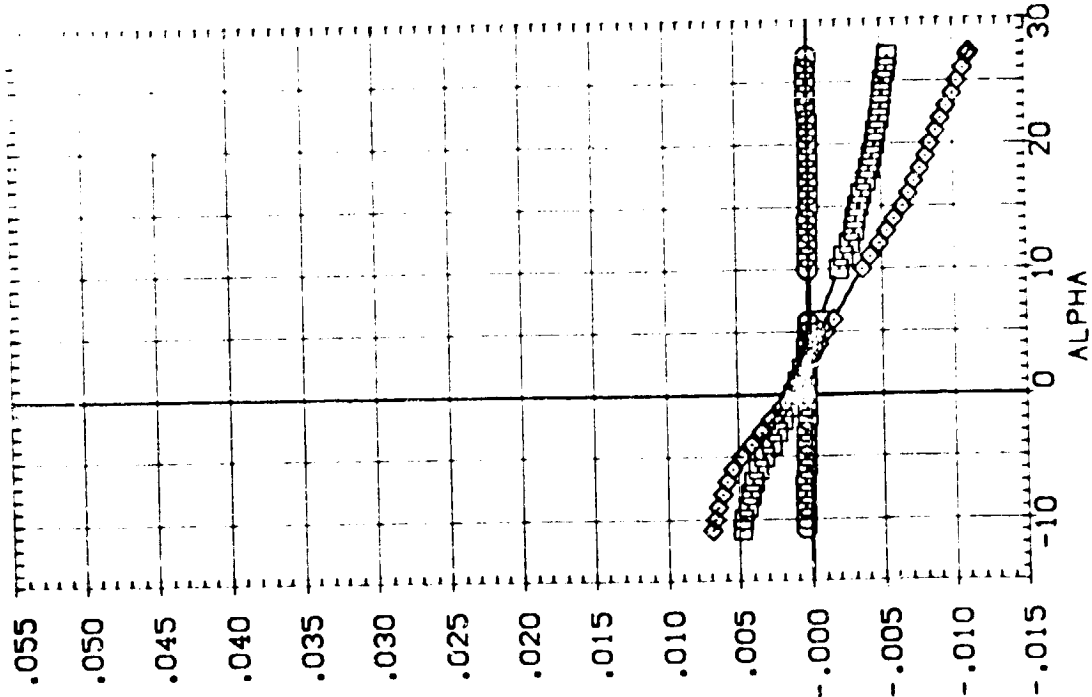

ISOLATED ORBITER AERODYNAMIC CHARACTERISTICS

(A)MACH = 4.52

SEE THE ASSOCIATED DATA DOCUMENT FOR REFERENCE CHARACTERISTICS FOR INDIVIDUAL DATA SETS

BETA	ELEVTR	AILETRN	PITOTAL
.000	.000	.000	80.000
.5.000	.000	.000	80.000
10.000	.000	.000	80.000

DATA SET SYMBOL	CONFIGURATION DESCRIPTION
[R:505]	[A13] ISOLATED 98BITER (09)
[R:506]	[A13] ISOLATED 98BITER (09)
[R:507]	[A13] ISOLATED 98BITER (09)

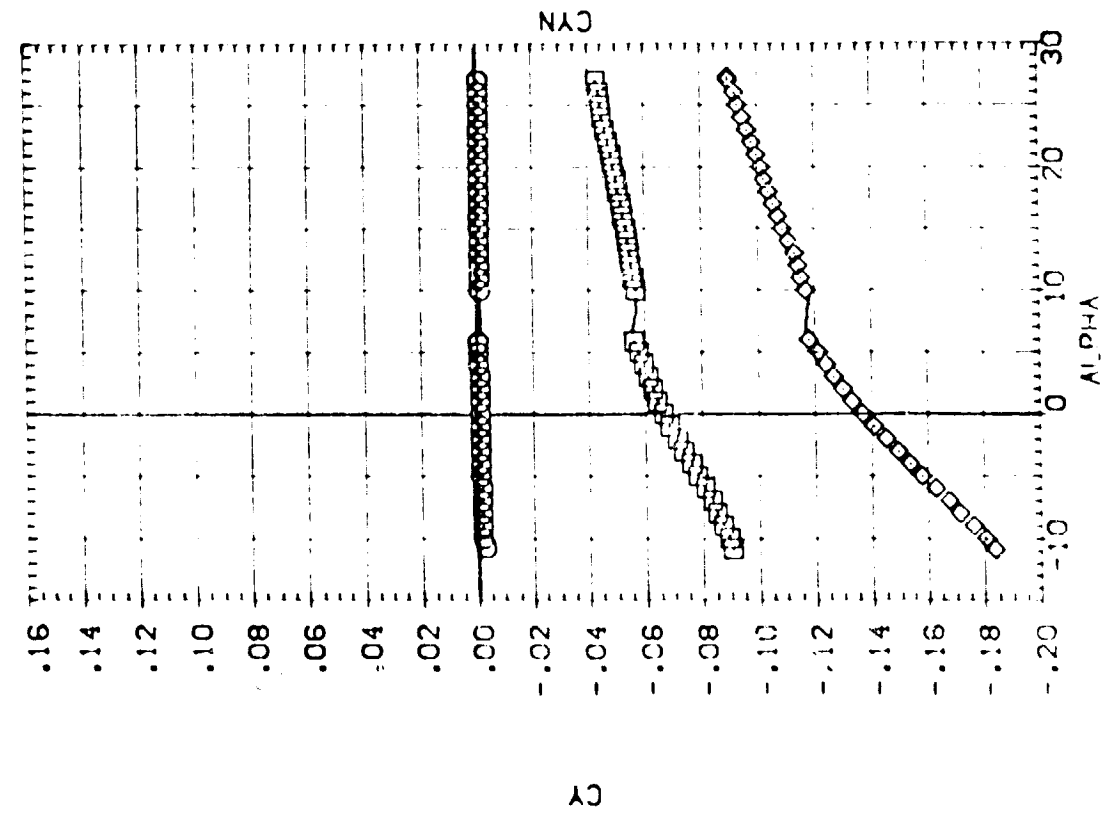
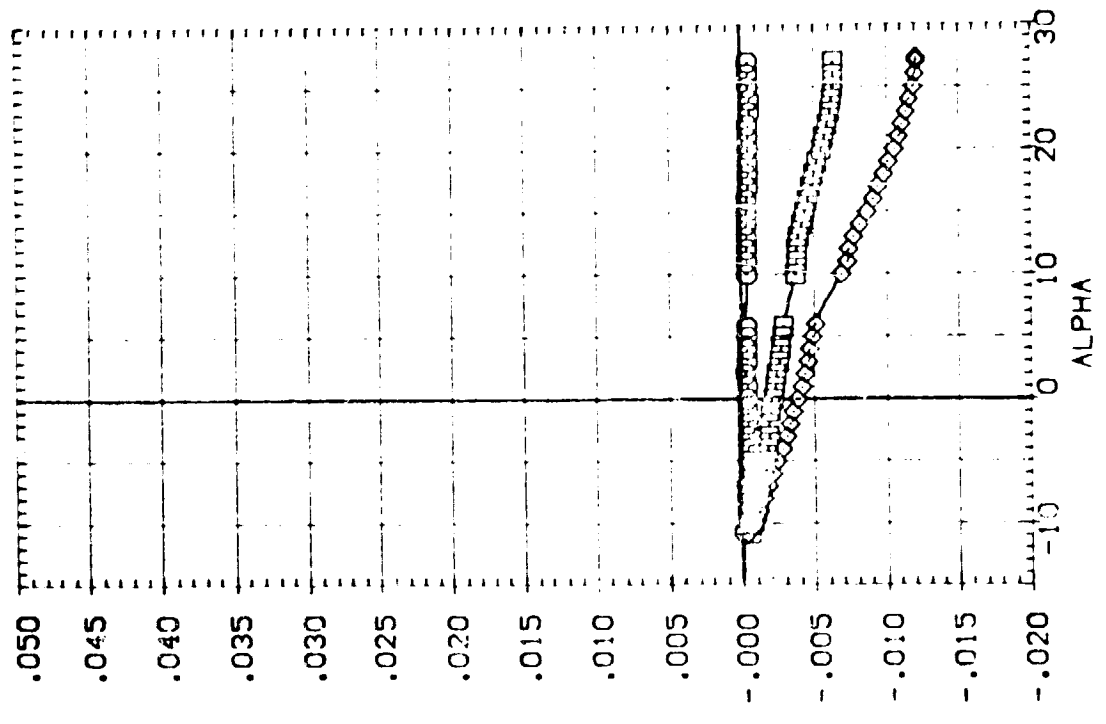

ISOLATED 98BITER MERCURY-INDIC CHARACTERISTICS

CANADIAN PATENT 4,52

DATA SET SYMBOL CONFIGURATION DESCRIPTION
 [R:502] □ SOLATED ORBITER (09)
 [R:505] ○ SOLATED ORBITER (09)
 [R:503] ◇ SOLATED ORBITER (09)

BETA CLEVTR ALL-RON PTOTAL USE UNIT
 .000 -10.000 .000 80.000 80.000 80.000
 .000 .000 .000 .000 .000 .000
 .000 10.000 .000 80.000 80.000 80.000

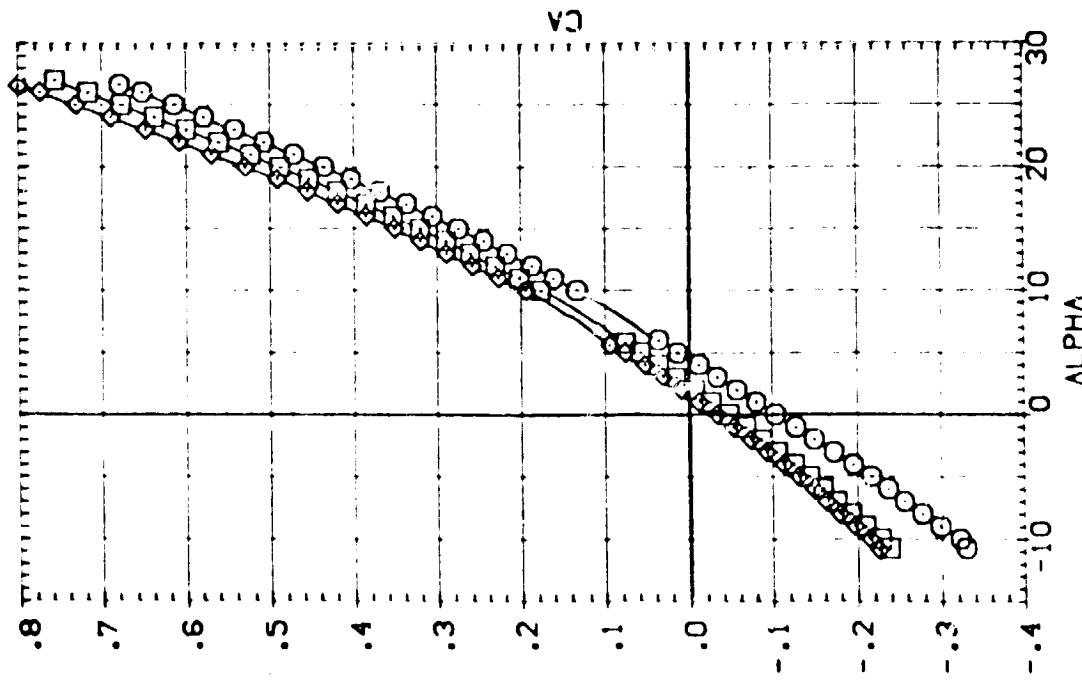
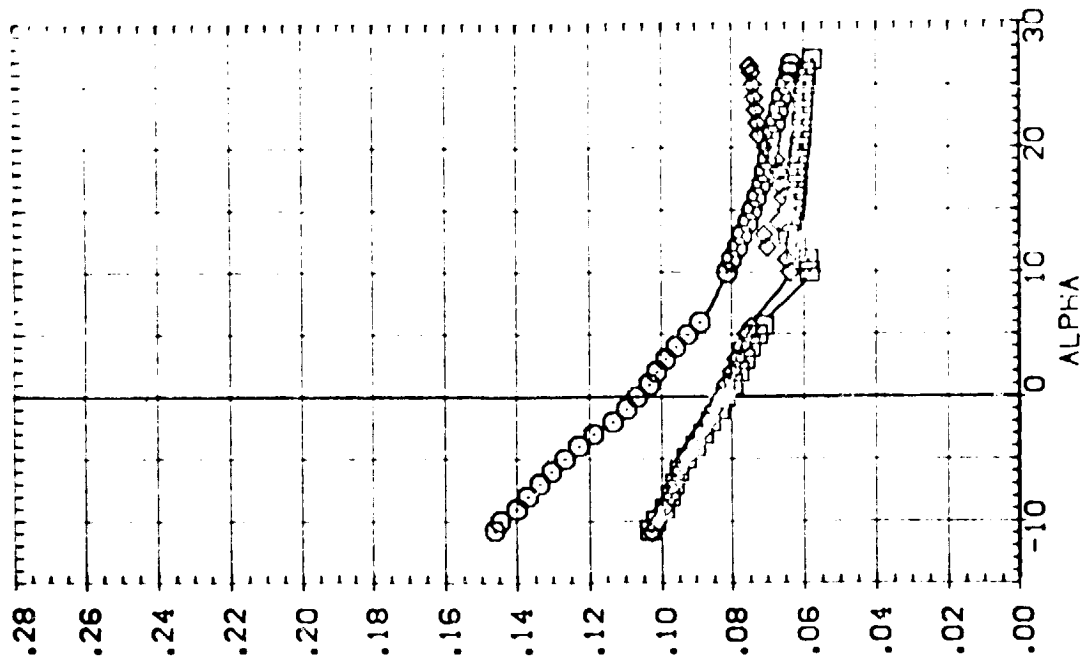

ISOLATED ORBITER AERODYNAMIC CHARACTERISTICS

(M)MACH = 4.52



DATA SET SYMBOL CONFIGURATION DESCRIPTION
 (RT:502) (A13) ISOLATED ORBITER (OS)
 (RT:503) (A13) ISOLATED ORBITER (OS)
 (RT:503) (A13) ISOLATED ORBITER (OS)

BETA ELEVTR AILRON PTOTAL
 .000 -40.000 .000 80.000
 .300 10.000 .000 80.000
 .000 10.000 .000 80.000

SEE THE ASSOCIATED DAT.
 DOCUMENT FOR REFERENCE
 CHARACTERISTICS FOR
 INDIVIDUAL DATASETS

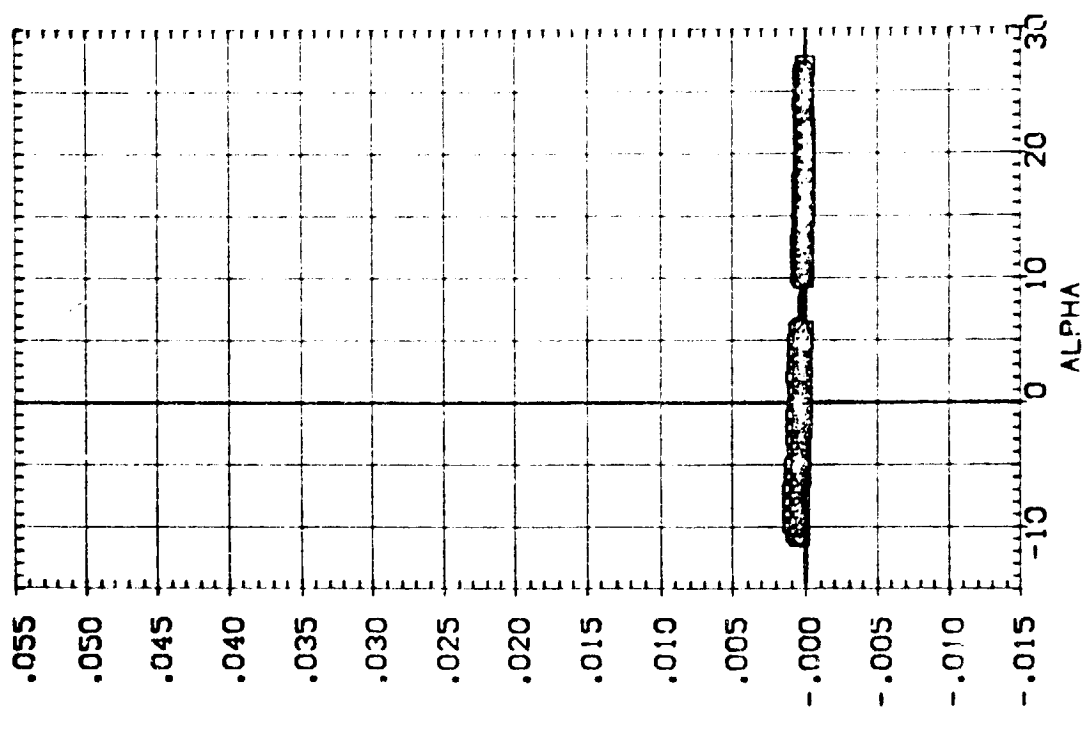
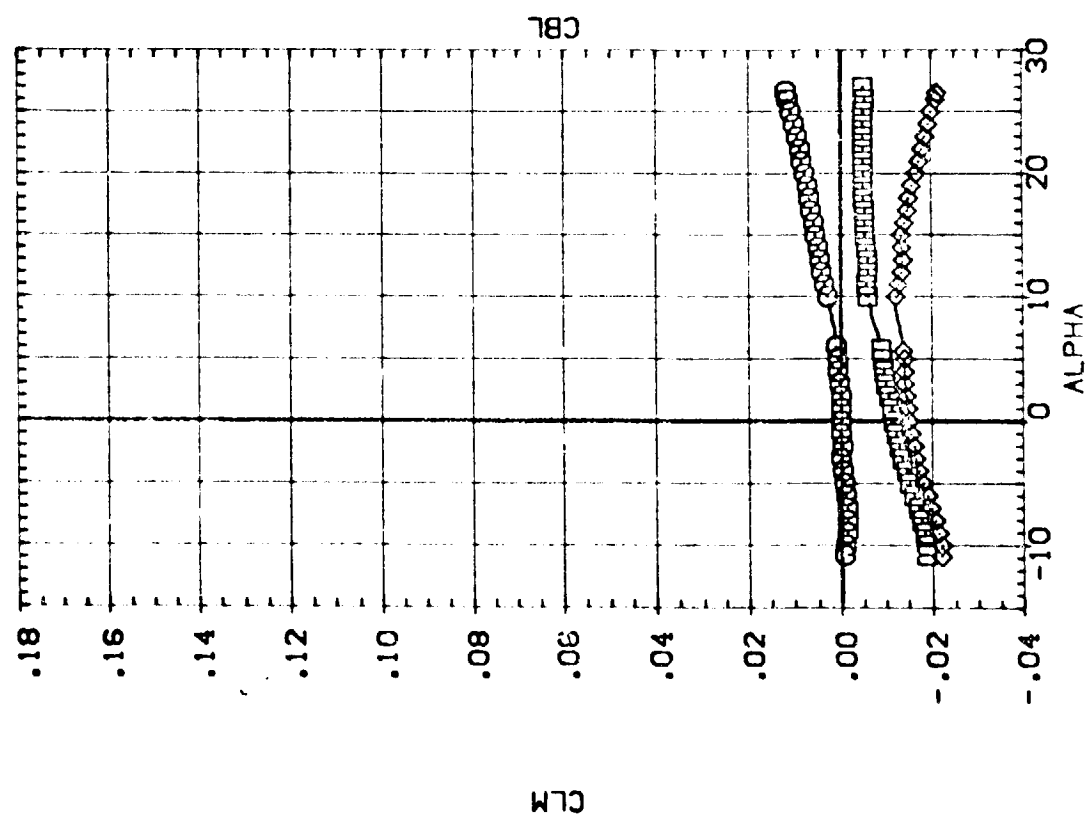

ISOLATED ORBITER AERODYNAMIC CHARACTERISTICS

(A)MACH = 4.52

BETA .000
 .000
 .000

ELEV'R ALLRON PTOTAL
 -40.000 .000 80.000
 .000 .000 80.000
 10.000 .000 80.000

D-1 SET SYMBO. CONFIGURATION DESCRIPTION
 [RT4502] [A13] ISOLATED ORBITER (09)
 [RT4505] [A13] ISOLATED ORBITER (09)
 [RT4503] [A13] ISOLATED ORBITER (09)

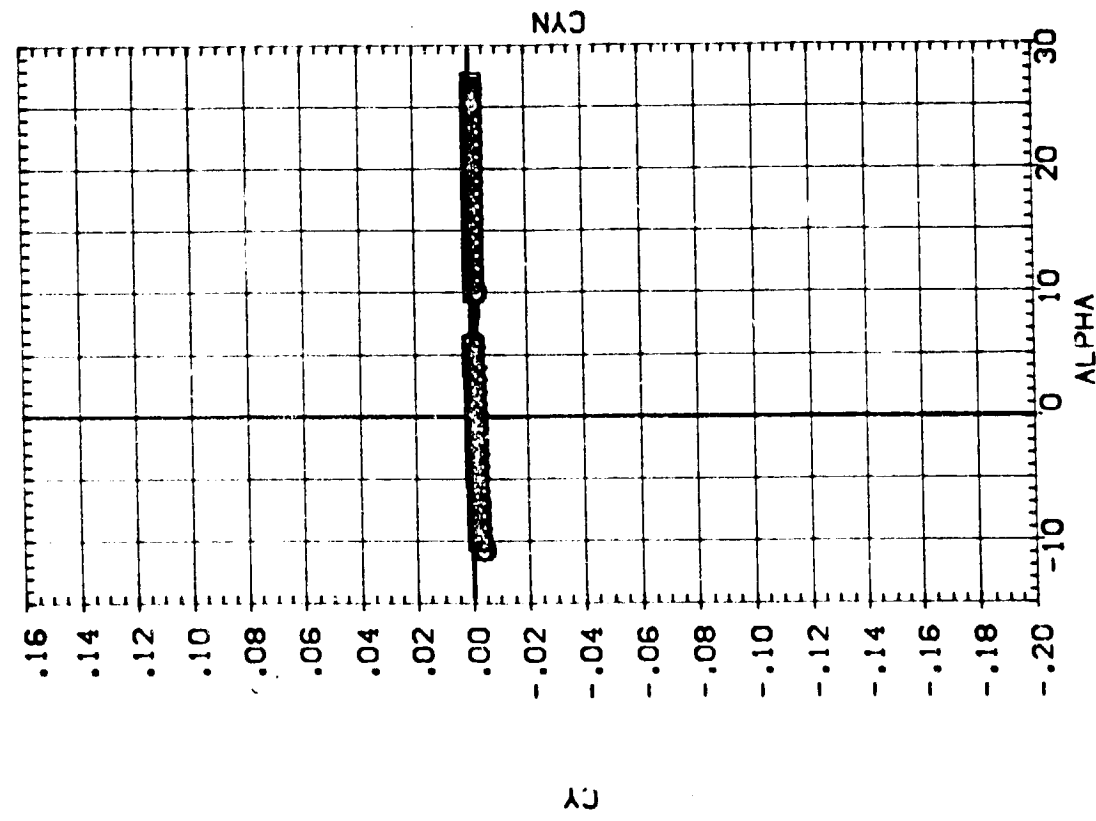
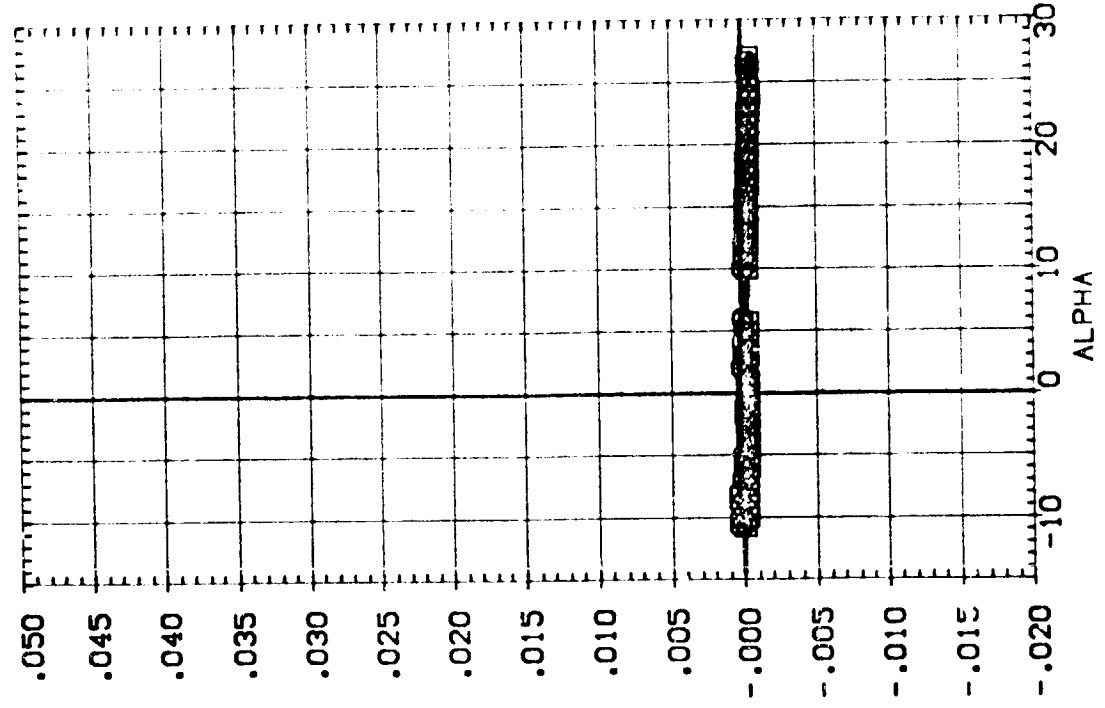

ISOLATED ORBITER AERODYNAMIC CHARACTERISTICS

(A)MACH = 4.52



DATA SET SYMBOL ○ CONFIGURATION DESCRIPTION
 (RTJ504) ○ (A13 ISOLATED ORBITER (OB))

BETA .000 ELEVTB .000 AILRON 10.000 PTOTAL 80.000
 SEE THE ASSOCIATED DATA DOCUMENT FOR REFERENCE CHARACTERISTICS FOR INDIVIDUAL DATASETS

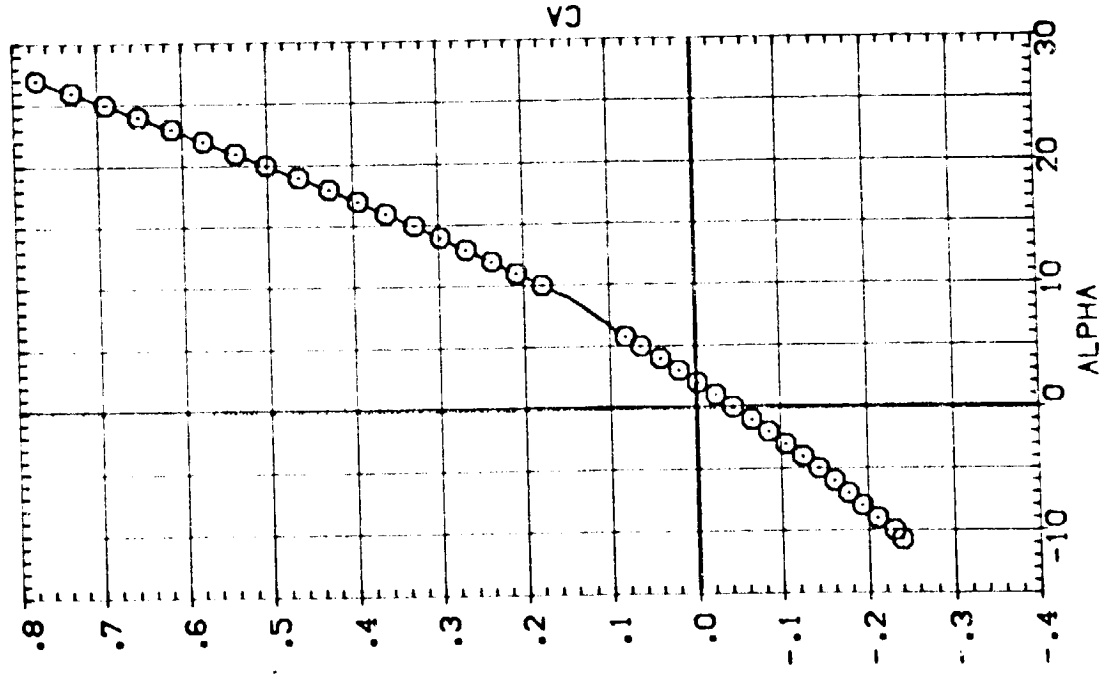
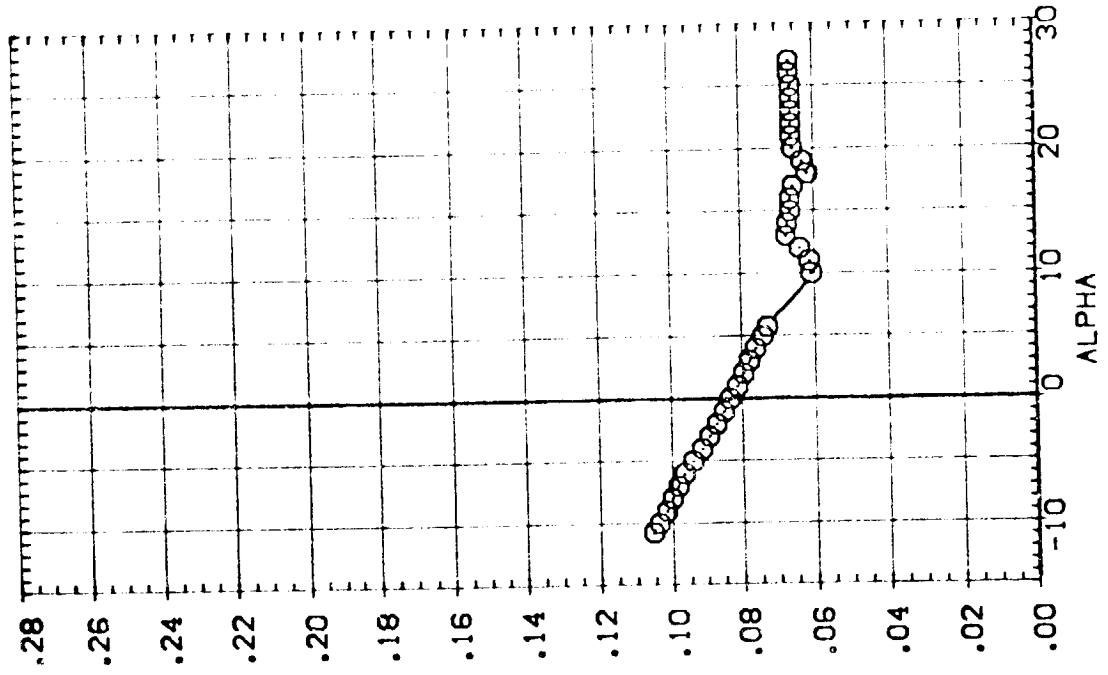

ISOLATED ORBITER AERODYNAMIC CHARACTERISTICS

(A)MACH = 4.52

DATA SET SYMBOL: 1A13 ISOLATED ORBITER (OS)

BETA: .000
ELEVTR: .00
ALLRON: 10.000
PTOTAL: 80.000

SEE TAB A FOR
DOCUMENT NUMBER
CHARACTERISTICS FOR
INDIVIDUAL DATA SETS

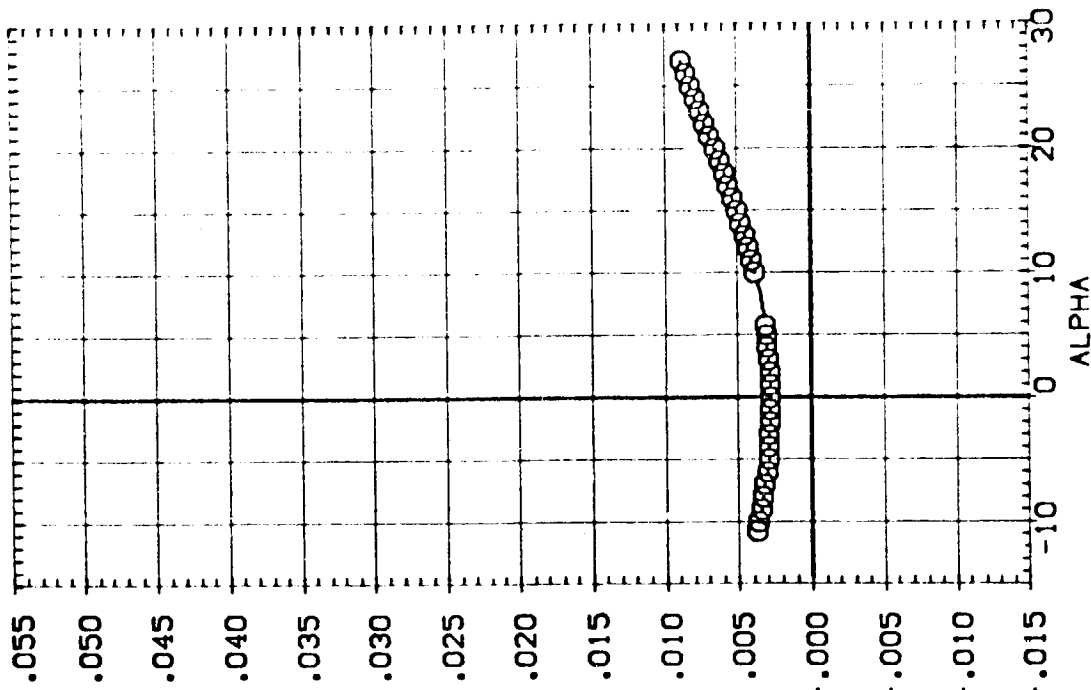
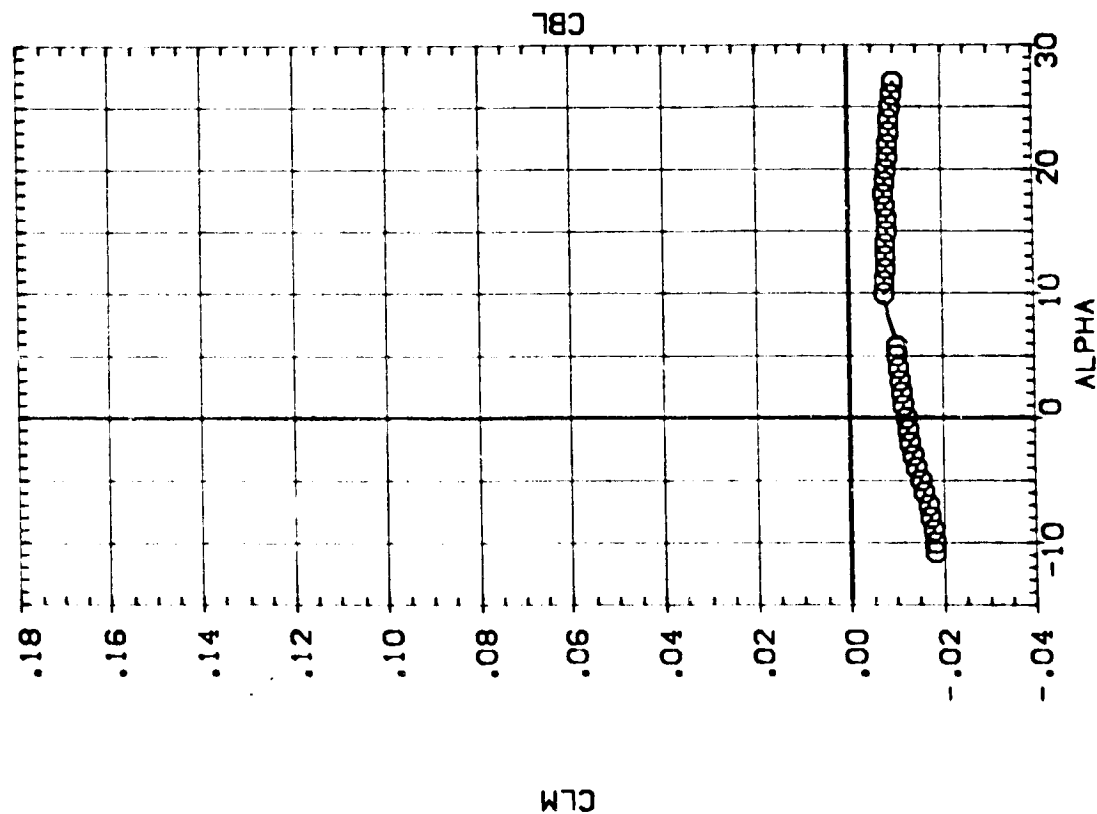

ISOLATED ORBITER AERODYNAMIC CHARACTERISTICS

(A)MACH = 4.52



DATA SET SYMBOL (R7J504) ○ CONFIGURATION DESCRIPTION (A13 ISOLATED ORBITER (09))

BETA .000 ELEVTR .000 AIRLRN 10.000 PTOTAL 60.000

SEE THE ASSOCIATED DATA DOCUMENT FOR REFERENCE CHARACTERISTICS FOR INDIVIDUAL DATASETS

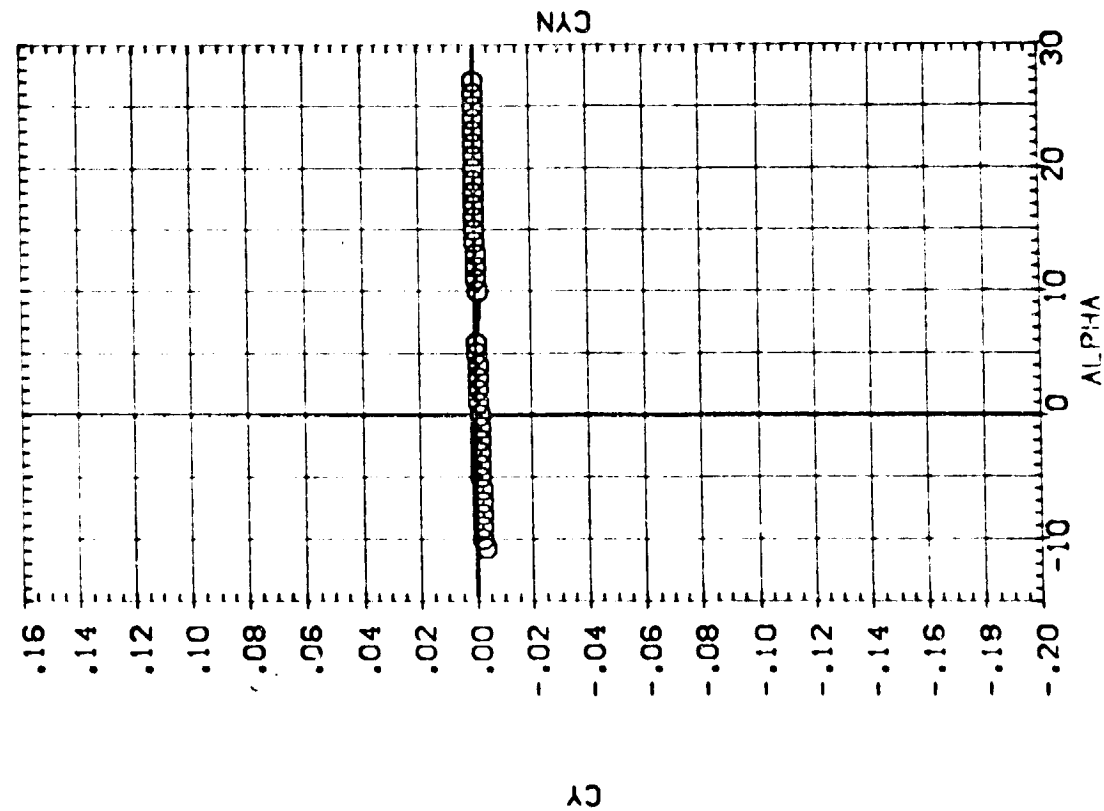
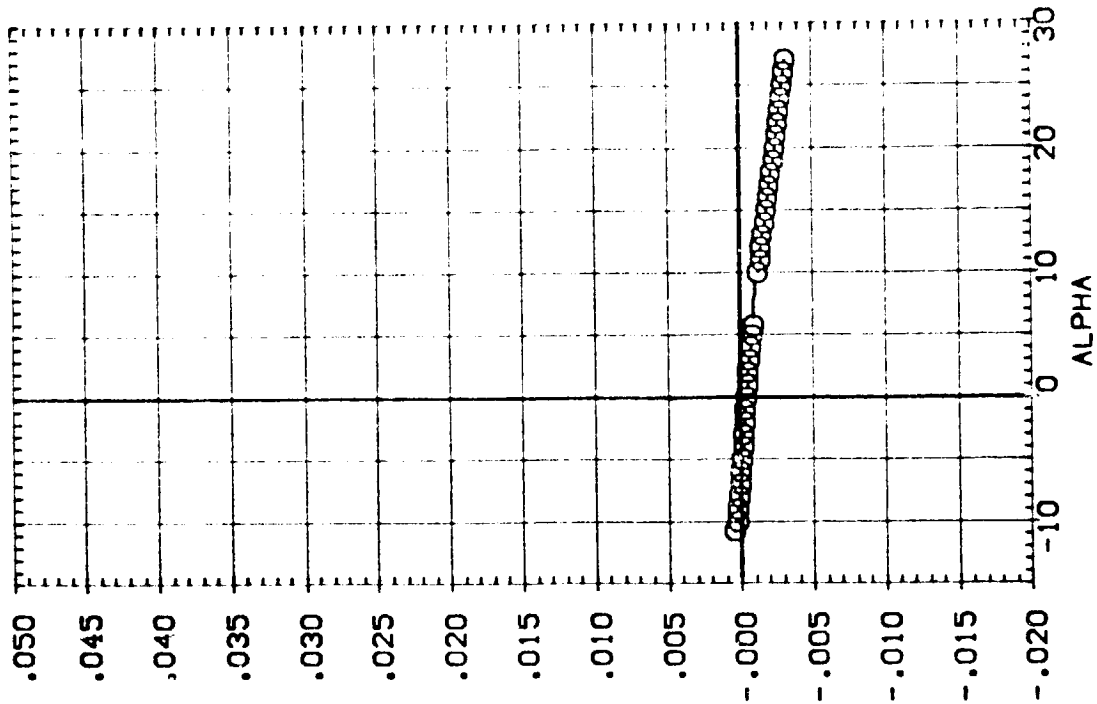

ISOLATED ORBITER AERODYNAMIC CHARACTERISTICS

(A)MACH = 4.52

DATA SET SYMBOL: [RT4500] [RT4501] [RT4502]
 CONFIGURATION DESCRIPTION: ISOLATED EXTERNAL TANK (T10)
 ISOLATED EXTERNAL TANK (T10)

PIOTAL: 110,000
 BETA: 5,000

SEE THE MAIN REPORT DOCUMENT FOR THESE CHARACTERISTICS FOR INDIVIDUAL DATASETS

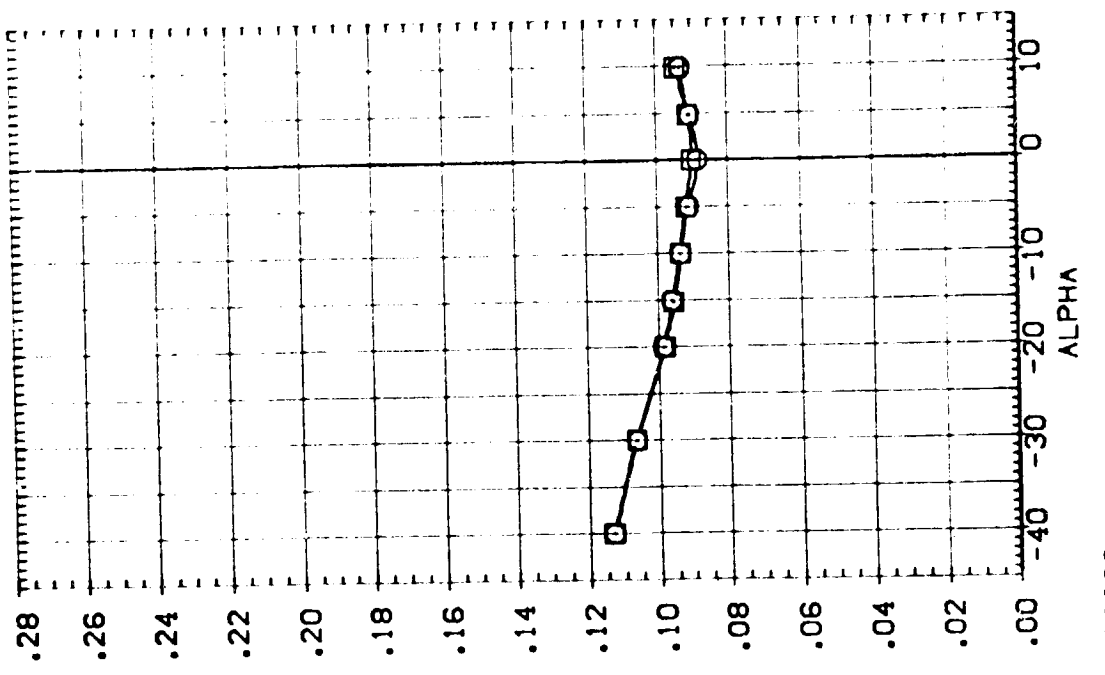
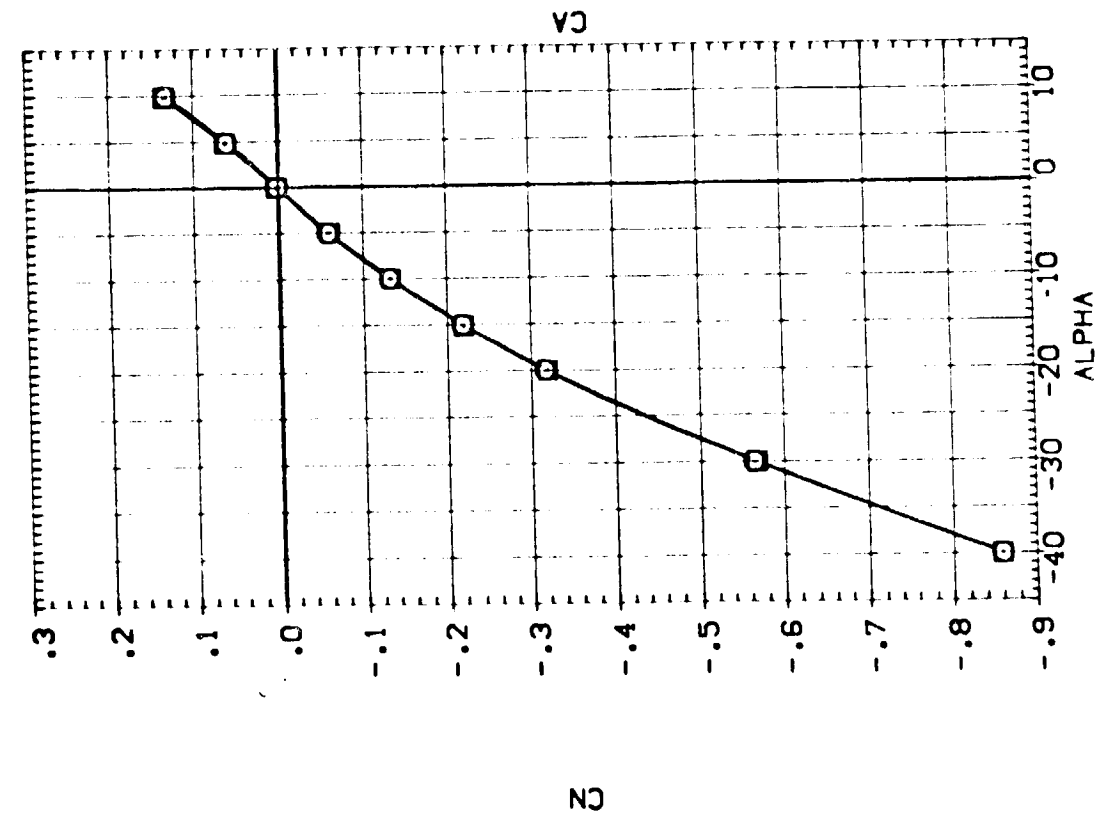

ISOLATED EXTERNAL TANK AERODYNAMIC CHARACTERISTICS

(A) MACH = 4.53



SEE THE ASSOCIATED DATA DOCUMENT FOR REFERENCE CHARACTERISTICS FOR INDIVIDUAL DATA'S

BETA TOTAL
 .000 110.000
 .000 110.000
 .000 110.000

DATA SET SYMBOL: []
 CONFIGURATION DESCRIPTION: [A13] ISOLATED EXTERNAL TANK [T10]
 [A13] ISOLATED EXTERNAL TANK [T10]

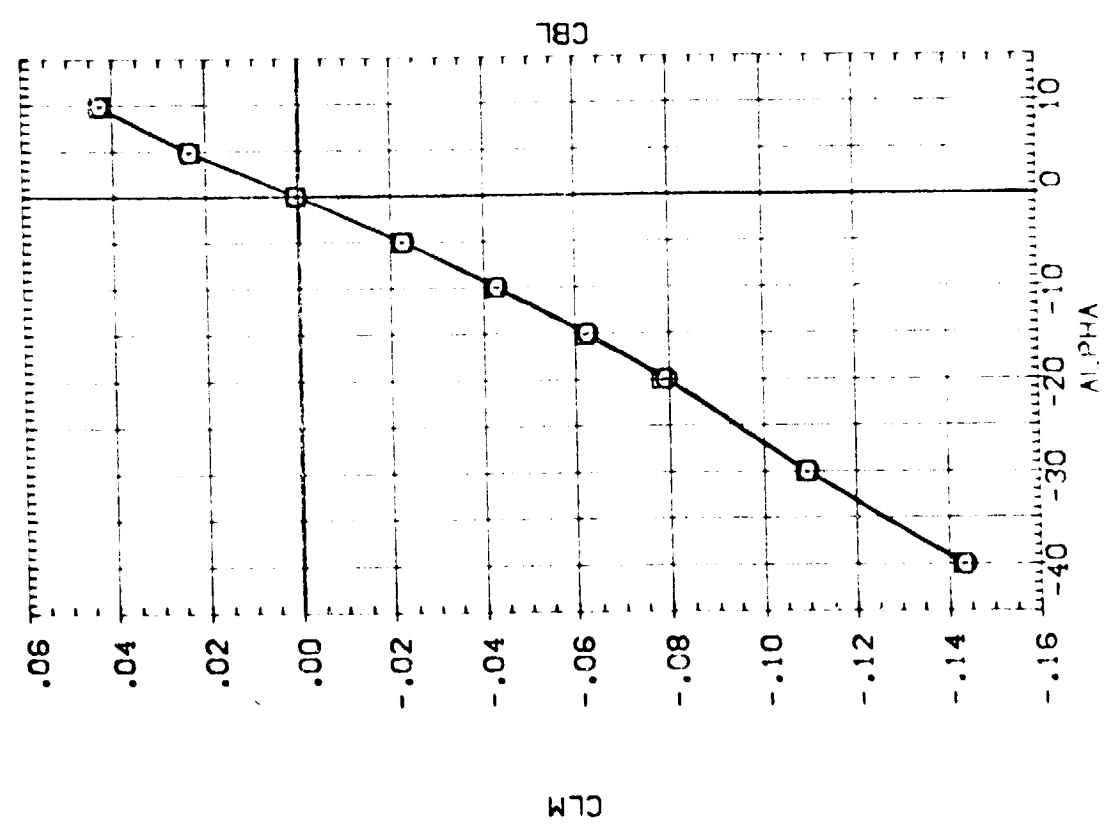
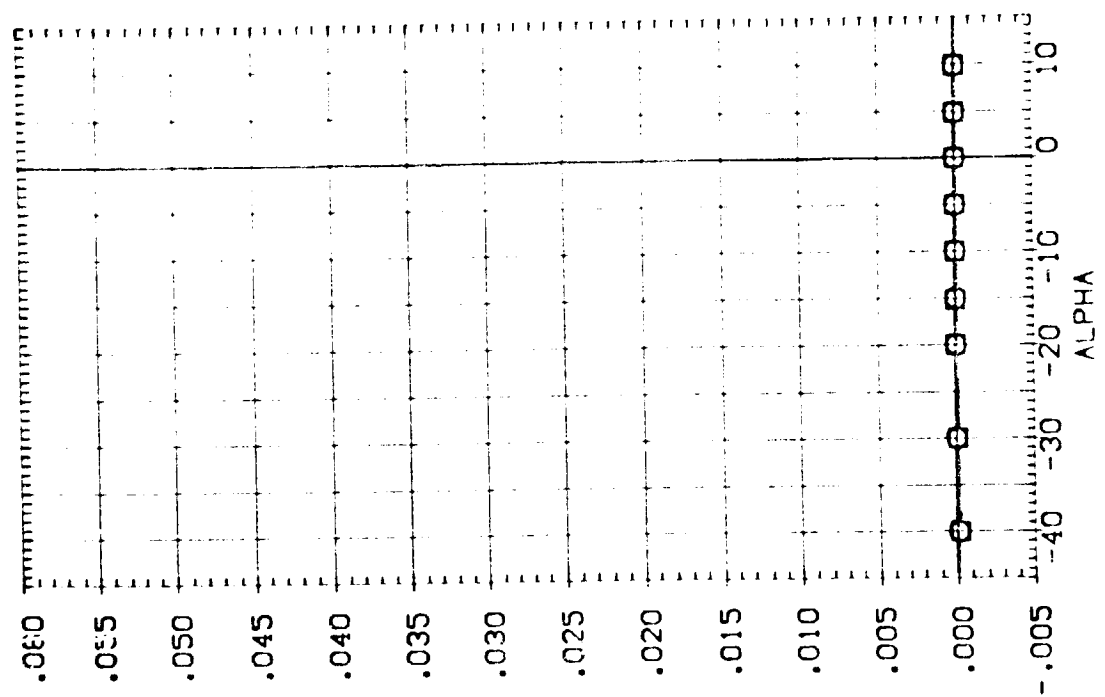

ISOLATED EXTERNAL TANK AERODYNAMIC CHARACTERISTICS

(A) MACH = 4.53

DATA SET SYMBOL CONFIGURATION DESCRIPTION
 (R7500) □ (A13) ISOLATED EXTERNAL TANK (T10)
 (R7501) □ (A13) ISOLATED EXTERNAL TANK (T10)

BETA TOTAL
 .000 110.000
 5.000 110.000

SEE THE ASSEMBLY
 DRAWING FOR
 CHARACTERISTICS FOR
 INDIVIDUAL DATA SET

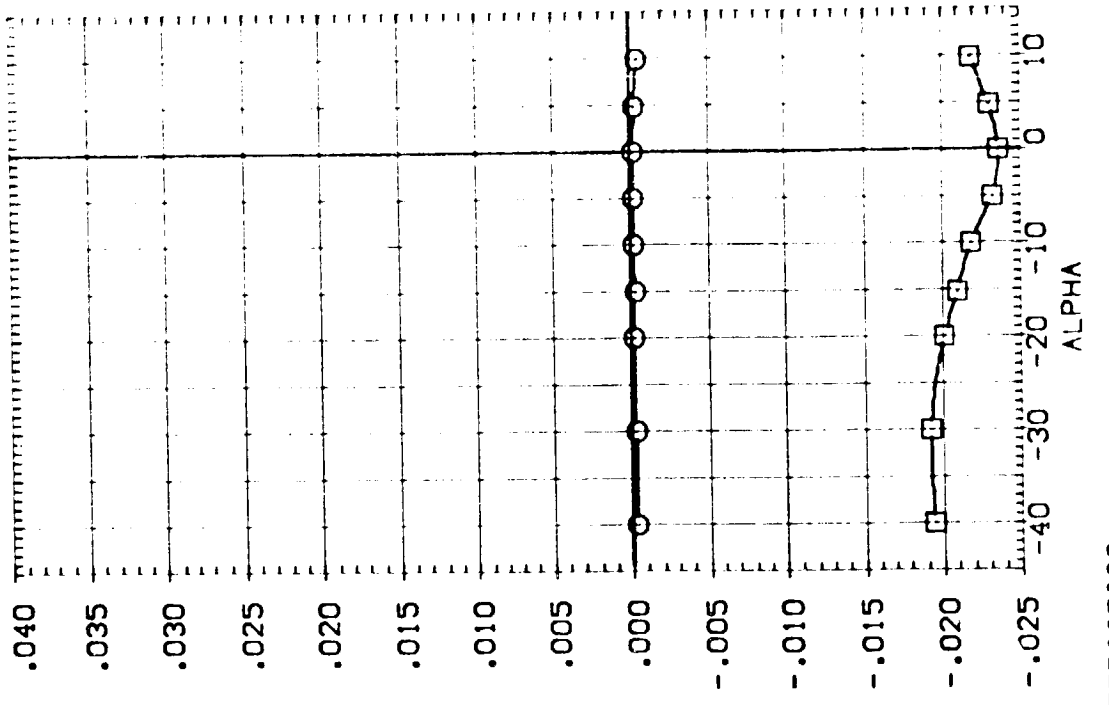
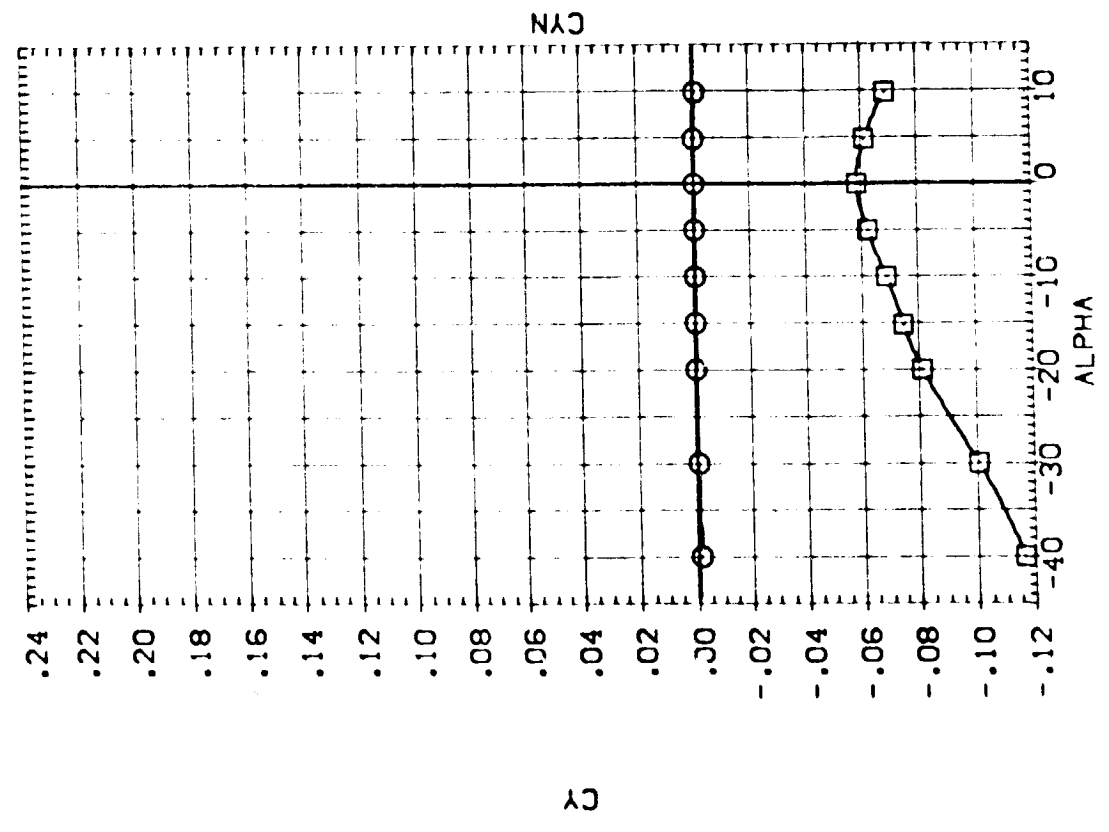

ISOLATED EXTERNAL TANK AERODYNAMIC CHARACTERISTICS

(A) MACH = 4.53



DATA SET SYMBOL CONFIGURATION DESCRIPTION
 (R1508) □ I13 ISOLATED ORBITTER WITH EXTERNAL TANK(09110)
 (R1509) □ I13 ISOLATED ORBITTER WITH EXTERNAL TANK(09110)

BETA .000
 ELEVTR .000
 ALIRON .000
 POTAL 28,900
 .000 28,900
 .000 28,900

SEE THE ASSOCIATED DATA DOCUMENT FOR REFERENCE CHARACTERISTICS FOR INDIVIDUAL DATA SETS

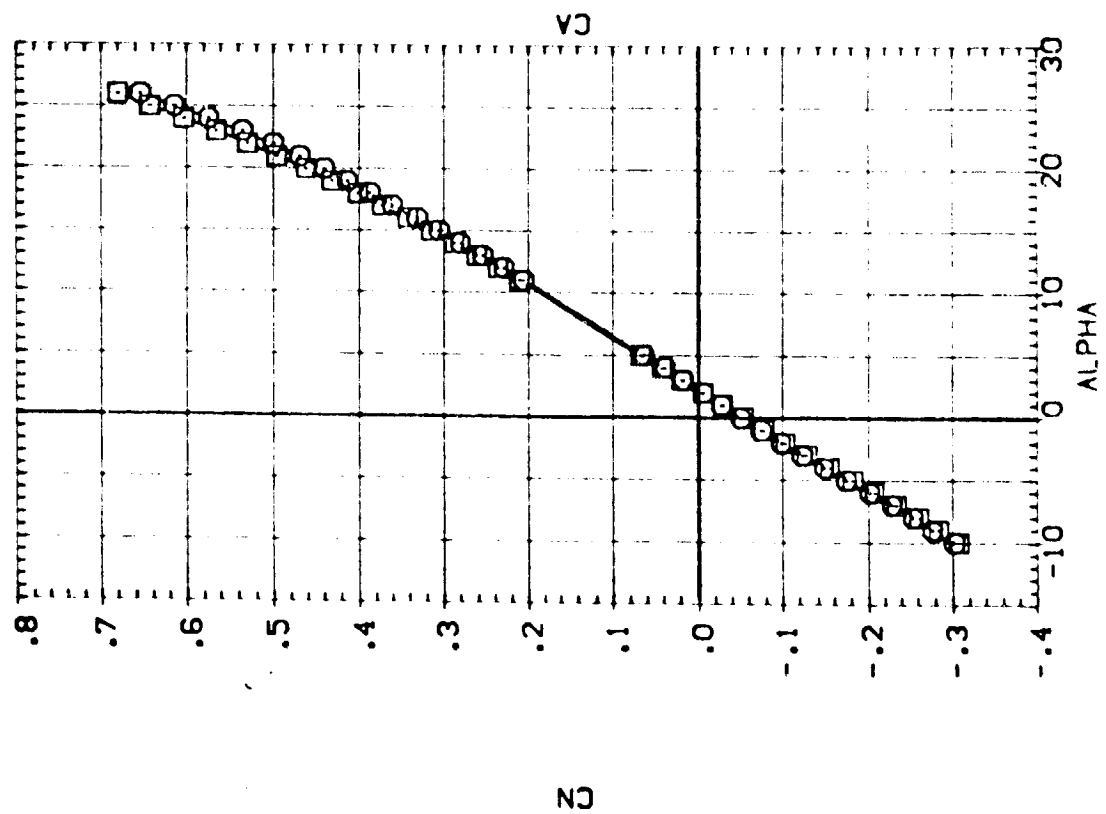
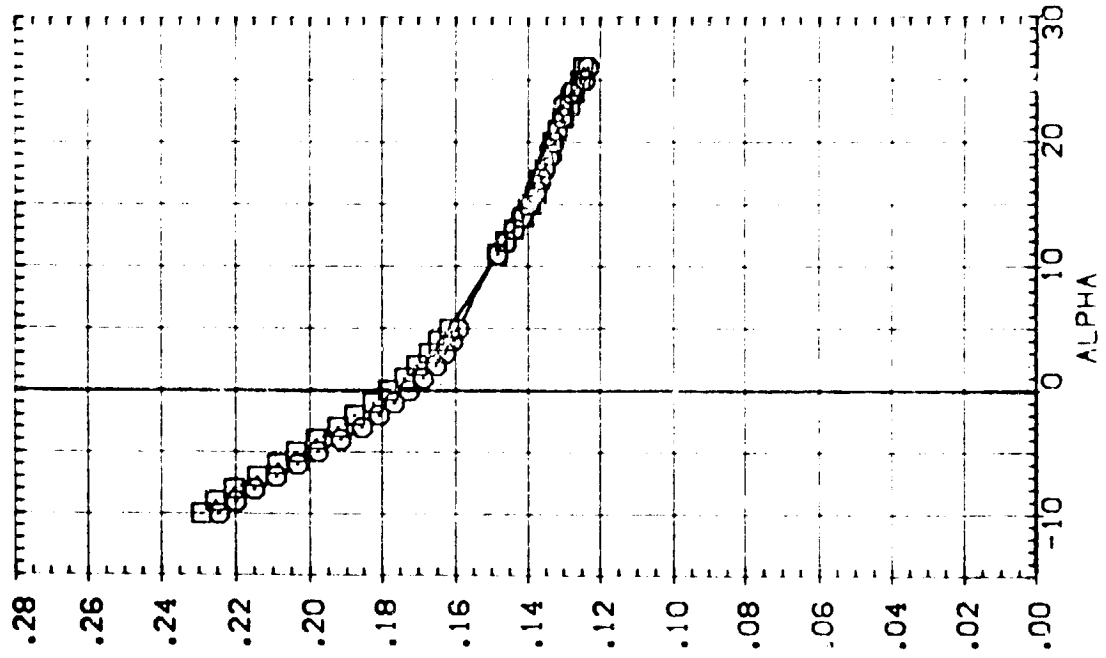

ISOLATED ORBITTER/EXTERNAL TANK AERODYNAMIC CHARACTERISTICS

(A)MACH = 4.51

DATA SET SYMBOL: Q
 CONFIGURATION DESCRIPTION: ISOLATED ORBITER WITH EXTERNAL TANK (09110)
 (RTJ508) : A13 : SOLATED ORBITER WITH EXTERNAL TANK (09110)
 (RTJ509) : A13 : SOLATED ORBITER WITH EXTERNAL TANK (09110)

BETA: .000
 ELEVTR: .000
 ATILRN: .000
 POTAL: 28,900
 28,900
 28,900

SEE THE IS...
 DOCUMENT...
 CHARACTERISTICS FOR
 INDIVIDUAL DATASETS

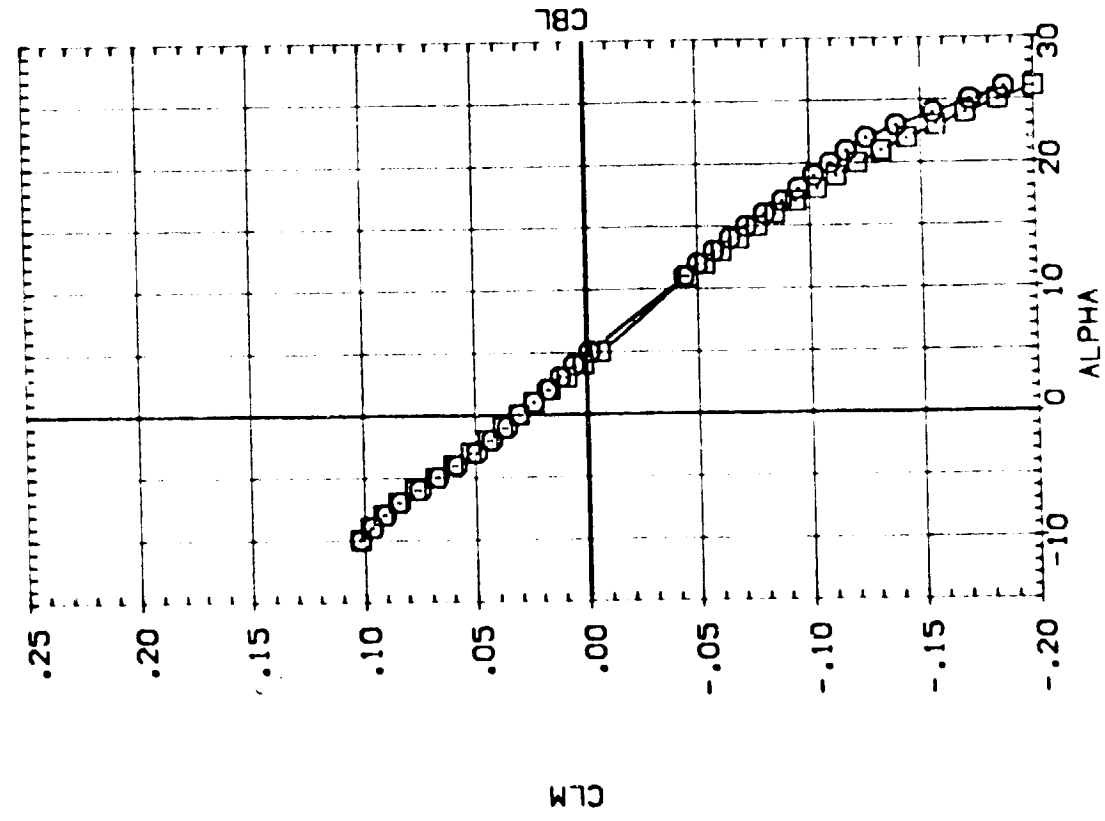
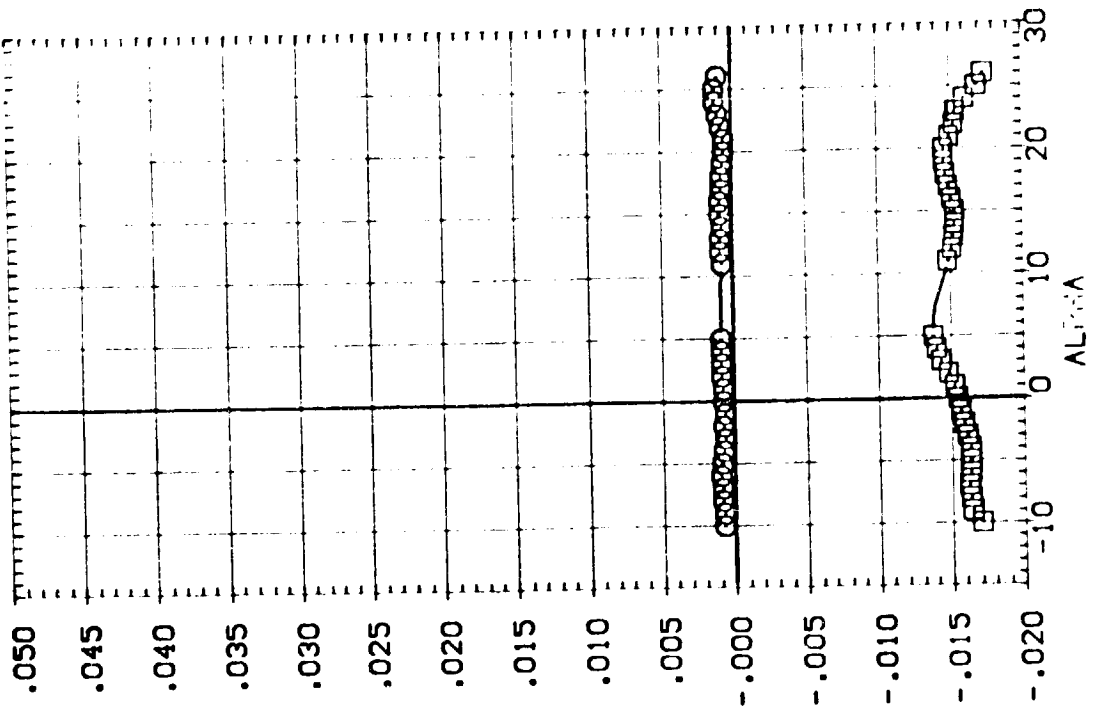

ISOLATED ORBITER/EXTERNAL TANK AERODYNAMIC CHARACTERISTICS

(M)MACH = 4.51



DATA SET SYMBOL: (R1508) (R1509)
 CONFIGURATION DESCRIPTION: ISOLATED ORBITER WITH EXTERNAL TANK (09110) ISOLATED ORBITER WITH EXTERNAL TANK (09110)
 BETA: .000 .000
 ELEVTR: .000 .000
 AIRRON: .000 .000
 PTOTAL: 28,900 28,900
 SEE THE ASSOCIATED DATA DOCUMENT FOR REFERENCE CHARACTERISTICS FOR INDIVIDUAL DATA SETS

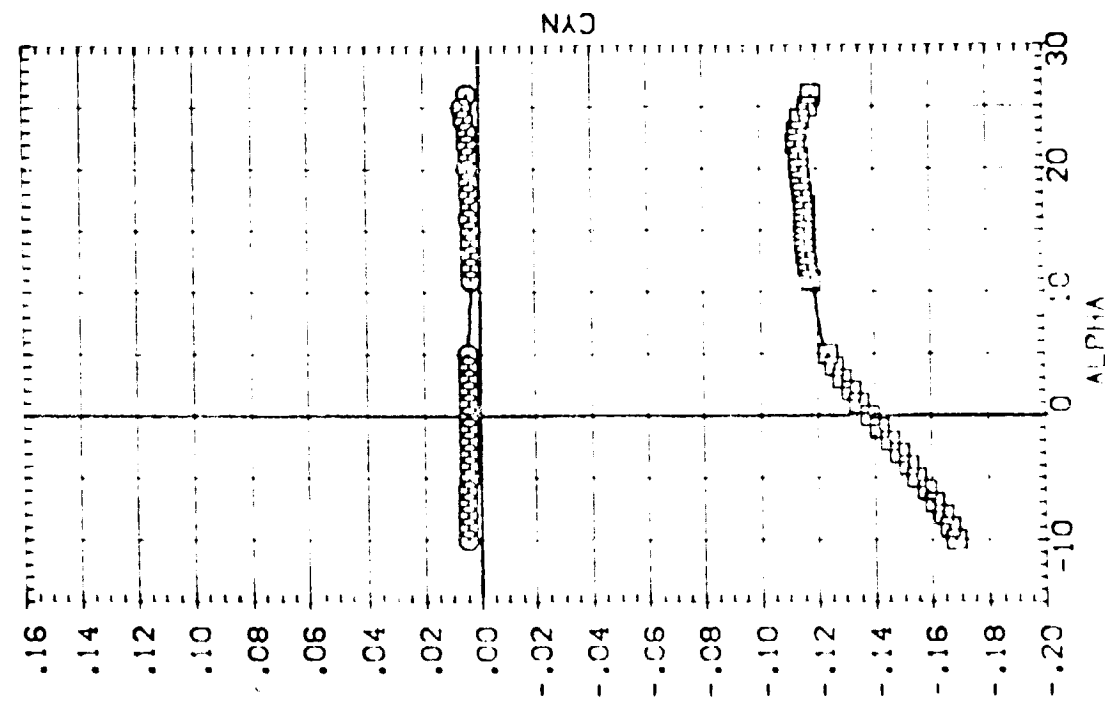
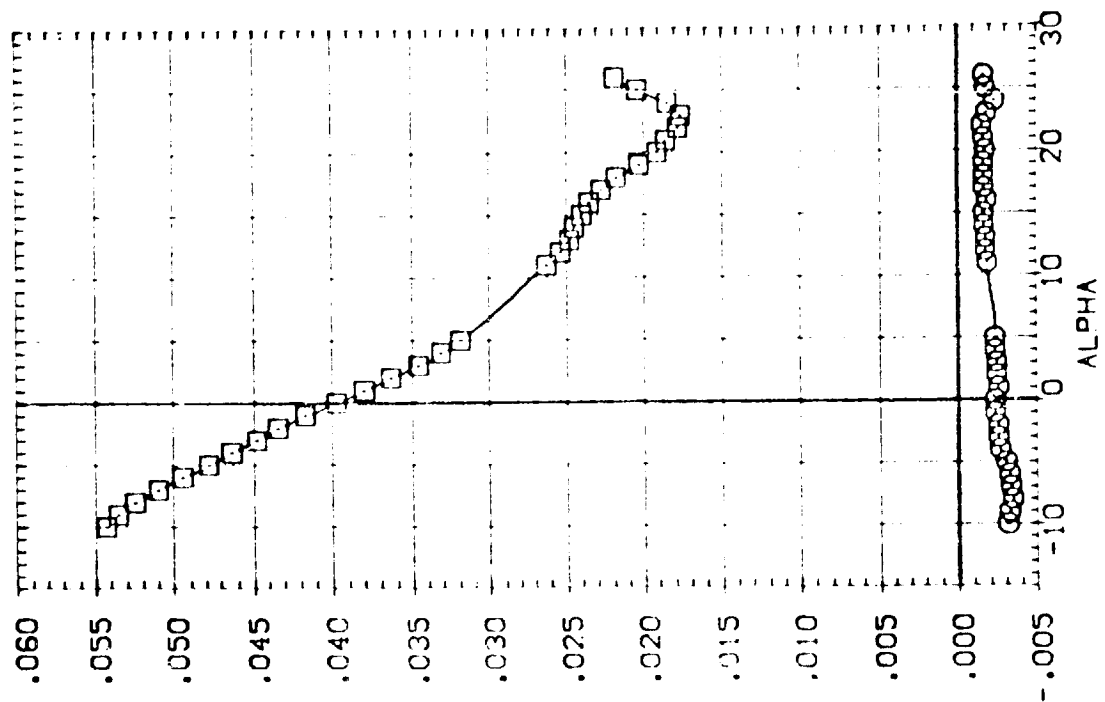

ISOLATED ORBITER WITH EXTERNAL TANK AERODYNAMIC CHARACTERISTICS

DATA SET SYMBOL CONFIGURATION DESCRIPTION BOOSTER(SB) V/O PLUMES BETA P/TOTAL P/C-MBR SEE THE ASSOCIATED MAIN DOCUMENT FOR THE BASIC CHARACTERISTICS FOR INDIVIDUAL DATA SETS

(P)S10	(A)13 SOLATED SOLID ROCKET	BOOSTER(SB) V/O PLUMES	-10.000	10.000	.000
(P)S11	(A)13 SOLATED SOLID ROCKET	BOOSTER(SB) V/O PLUMES	0.000	0.000	.000
(P)S12	(A)13 SOLATED SOLID ROCKET	BOOSTER(SB) V/O PLUMES	5.000	0.000	.000
(P)S13	(A)13 SOLATED SOLID ROCKET	BOOSTER(SB) V/O PLUMES	10.000	0.000	.000
(P)S14	(A)13 SOLATED SOLID ROCKET	BOOSTER(SB) V/O PLUMES	20.000	0.000	.000

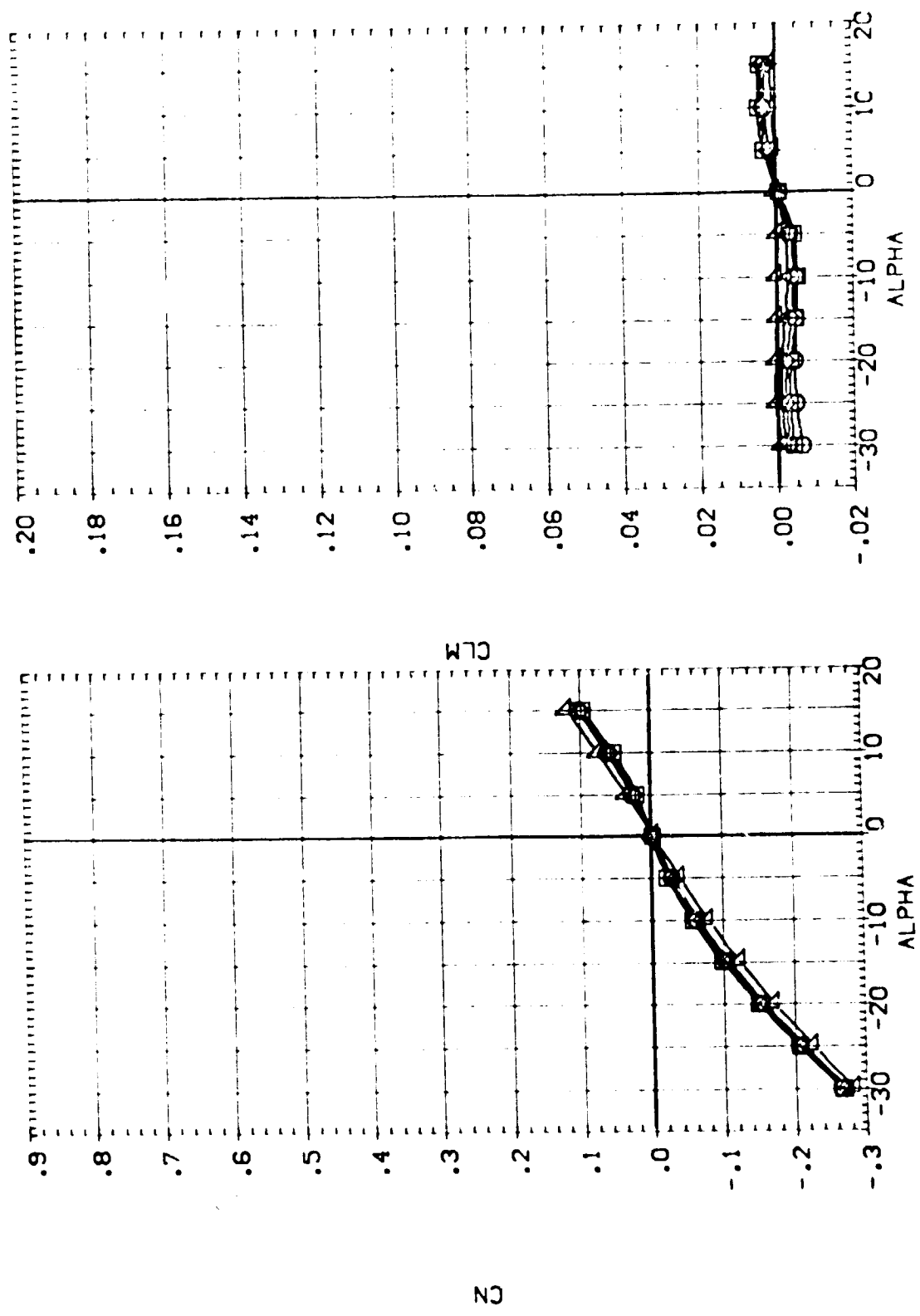

ISOLATED SOLID ROCKET BOOSTER W/O PLUMES AERODYNAMIC CHARACTERISTICS

SEE THE ASSOCIATED DATA DOCUMENT OR REFERENCE CHARACTERISTICS FOR INDIVIDUAL DATA SETS

BETA P/TOTAL P/THR

-10.000 110.000 .000

5.000 110.000 .000

10.000 110.000 .000

20.000 110.000 .000

DATA SET SYMBO. CONFIGURATION DESCRIPTION

(R/S:1) ○ SOLATED SOLID ROCKET BOOSTER(SB) W/O PLUMES

(R/S:2) ⊗ SOLATED SOLID ROCKET BOOSTER(SB) W/O PLUMES

(R/S:3) ⊕ SOLATED SOLID ROCKET BOOSTER(SB) W/O PLUMES

(R/S:4) △ SOLATED SOLID ROCKET BOOSTER(SB) W/O PLUMES

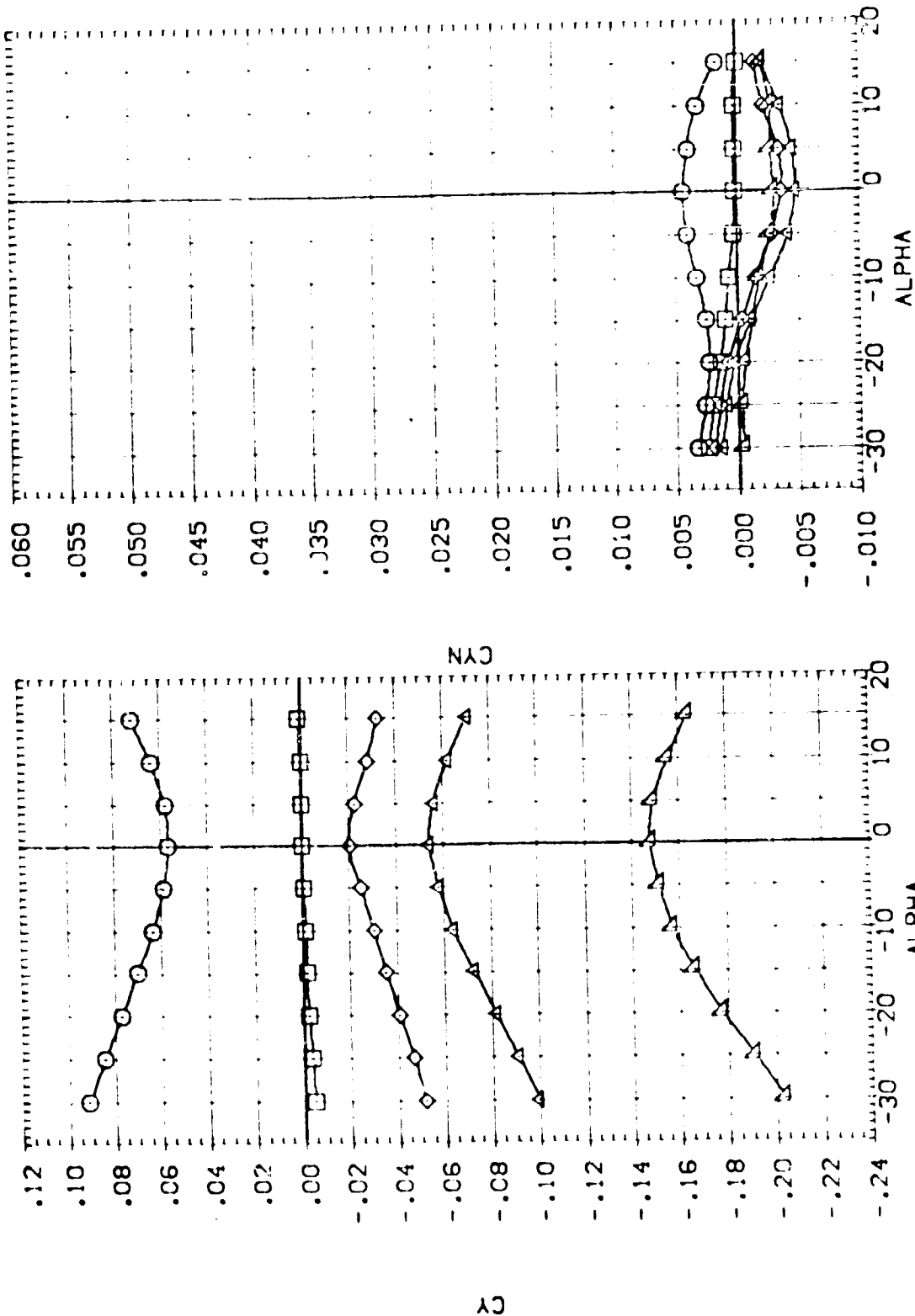

ISOLATED SOLID ROCKET BOOSTER W/O PLUMES AERODYNAMIC CHARACTERISTICS

DATA SET SYMBOL CONFIGURATION DESCRIPTION

R.5.5	A13	SOLATED SOLID	ROCKET	BOOSTER(SB)V/OF	UPES
R.5.6	A13	SOLATED SOLID	ROCKET	BOOSTER(SB)V/OF	JNES
R.5.7	A13	SOLATED SOLID	ROCKET	BOOSTER(SB)V/OF	JNES
R.5.8	A13	SOLATED SOLID	ROCKET	BOOSTER(SB)V/OF	JNES
R.5.9	A13	SOLATED SOLID	ROCKET	BOOSTER(SB)V/OF	JNES

BETA

PTOTAL	58.000
PC-HFR	.000
PC-HFR	.000
PC-HFR	.000
PC-HFR	.000
PC-HFR	.000
PC-HFR	.000
PC-HFR	.000

SEE THE A
 COUNTRY
 PARALLEL
 INDIVIDUAL

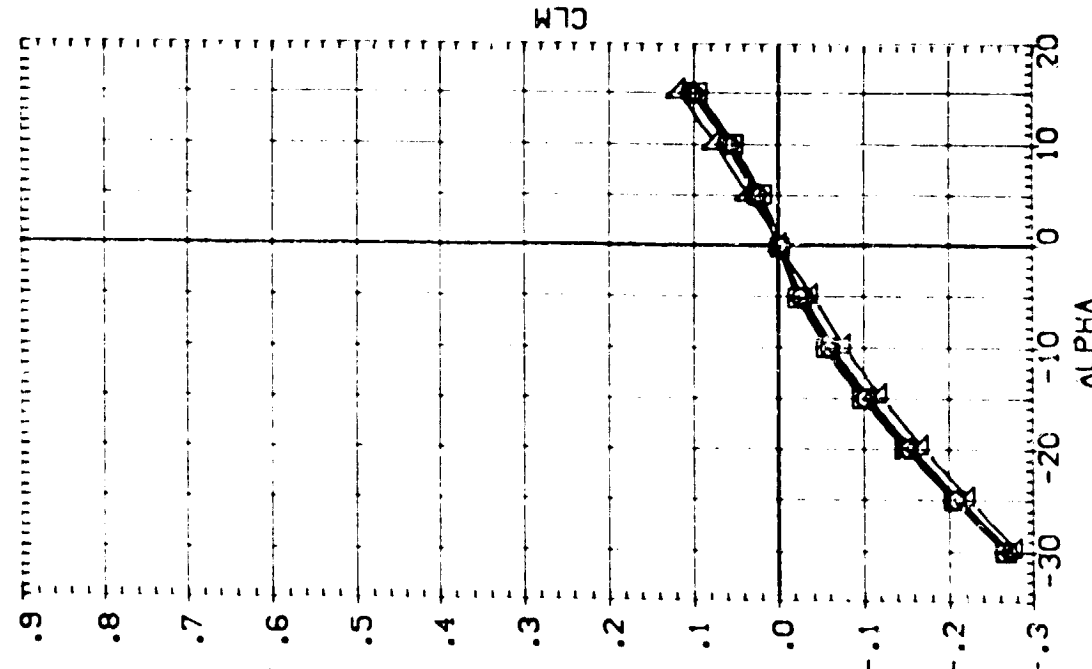
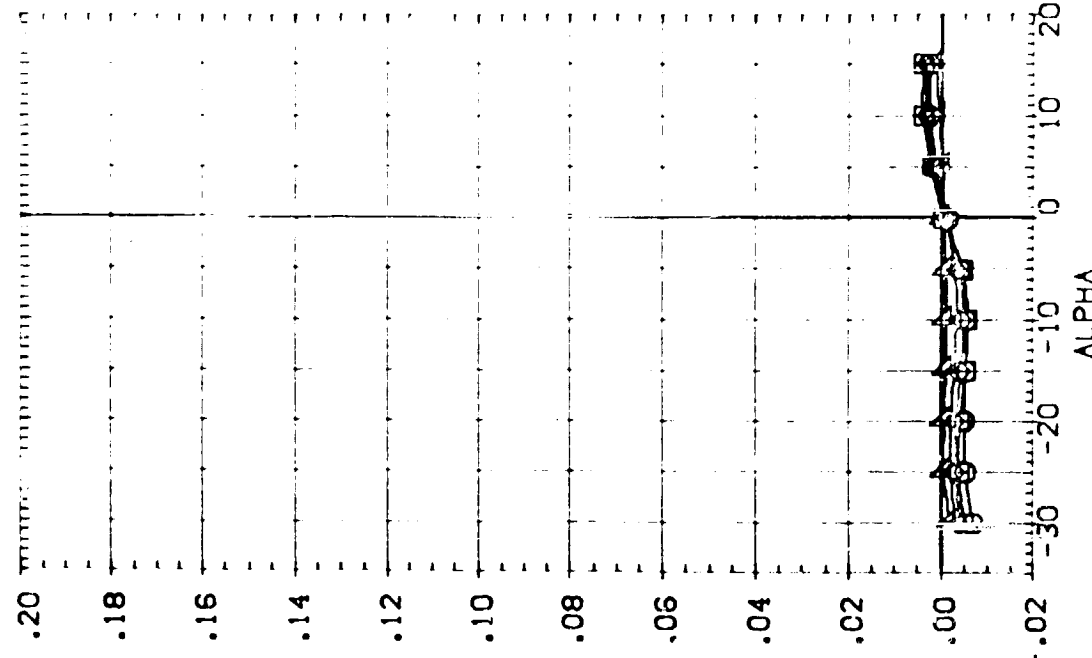

C_D

C_L

ISOLATED SOLID ROCKET BOOSTER W/O PLUMES AERODYNAMIC CHARACTERISTICS

CAVMACH = 4.52



SEE THE ASSOCIATED DATA DOCUMENT FOR REFERENCE CHARACTERISTICS FOR INDIVIDUAL DATASETS

BETA TOTAL PC-MBR
 -10.000 58.000 .000
 5.000 58.000 .000
 10.000 58.000 .000
 20.000 58.000 .000

DATA SET SYMBOL CONFIGURATION DESCRIPTION BOOSTER(SB) V/O PLUMES
 (R) (S) (5) (A) (3) ISOLATED SOLID ROCKET BOOSTER(SB) V/O PLUMES
 (R) (S) (5) (B) (A) (3) ISOLATED SOLID ROCKET BOOSTER(SB) V/O PLUMES
 (R) (S) (5) (7) (A) (3) ISOLATED SOLID ROCKET BOOSTER(SB) V/O PLUMES
 (R) (S) (5) (8) (A) (3) ISOLATED SOLID ROCKET BOOSTER(SB) V/O PLUMES
 (R) (S) (5) (9) (A) (3) ISOLATED SOLID ROCKET BOOSTER(SB) V/O PLUMES

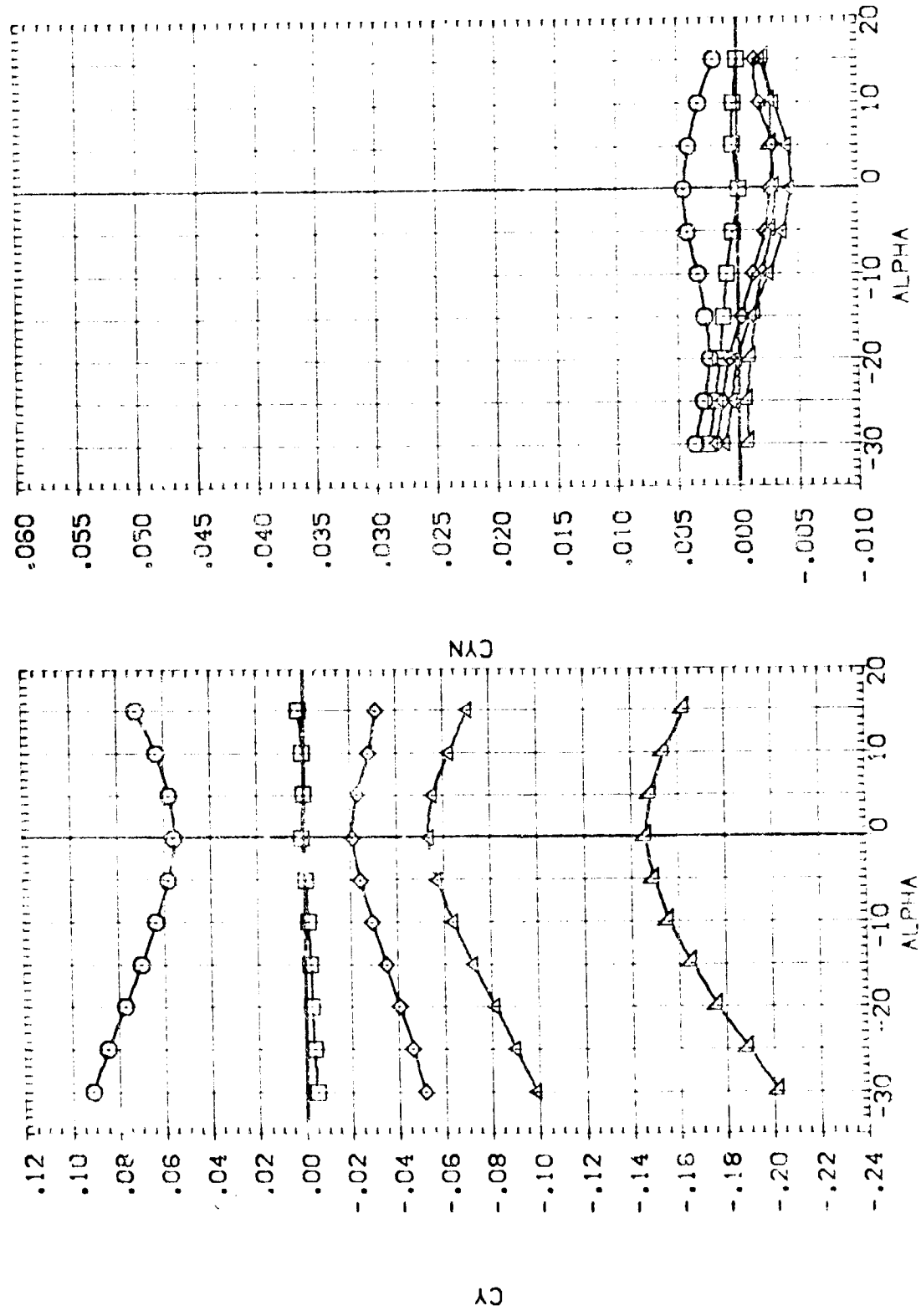

ISOLATED SOLID ROCKET BOOSTER W/O PLUMES AERODYNAMIC CHARACTERISTICS

(A) MACH = 4.52

SEE THE ASSOCIATED DOCUMENT FOR THE INDIVIDUAL DATA

PTOTAL	PC-MFR	BETA
28,900	.000	-10,000
28,900	.000	5,000
28,900	.000	10,000
28,900	.000	20,000

DATA SET SYMBOL	CONFIGURATION DESCRIPTION	BOOSTER(SB)/OPLINES
(R) 520	SOLATED SOLID ROCKET	BOOSTER(SB)/OPLINES
(R) 521	SOLATED SOLID ROCKET	BOOSTER(SB)/OPLINES
(R) 522	SOLATED SOLID ROCKET	BOOSTER(SB)/OPLINES
(R) 523	SOLATED SOLID ROCKET	BOOSTER(SB)/OPLINES
(R) 524	SOLATED SOLID ROCKET	BOOSTER(SB)/OPLINES

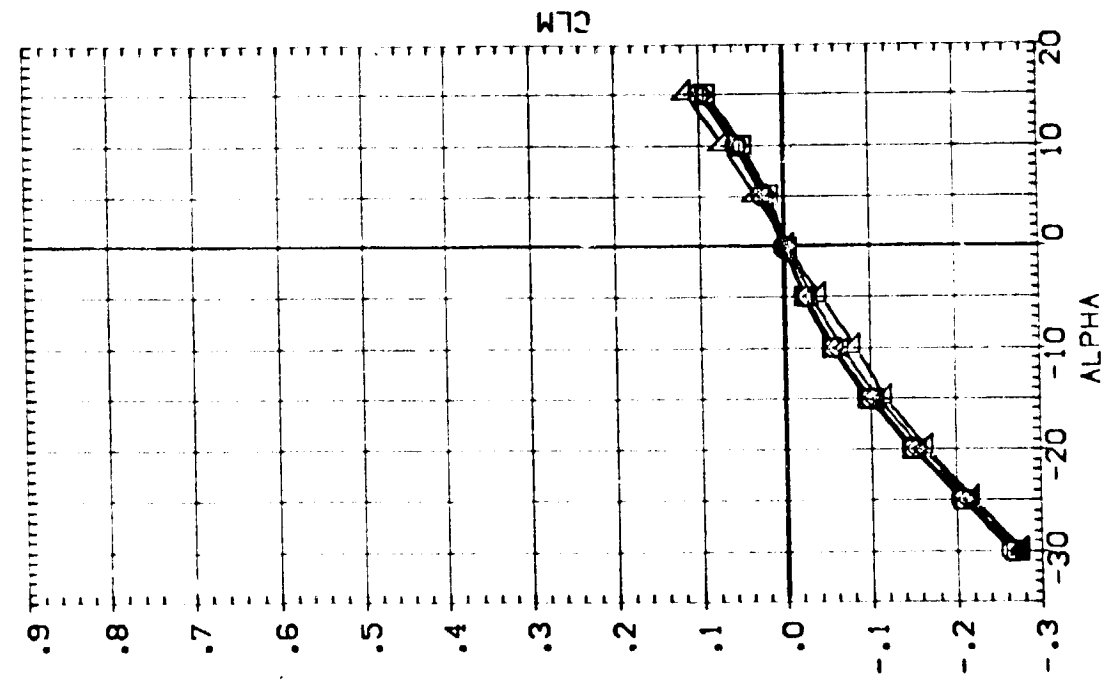
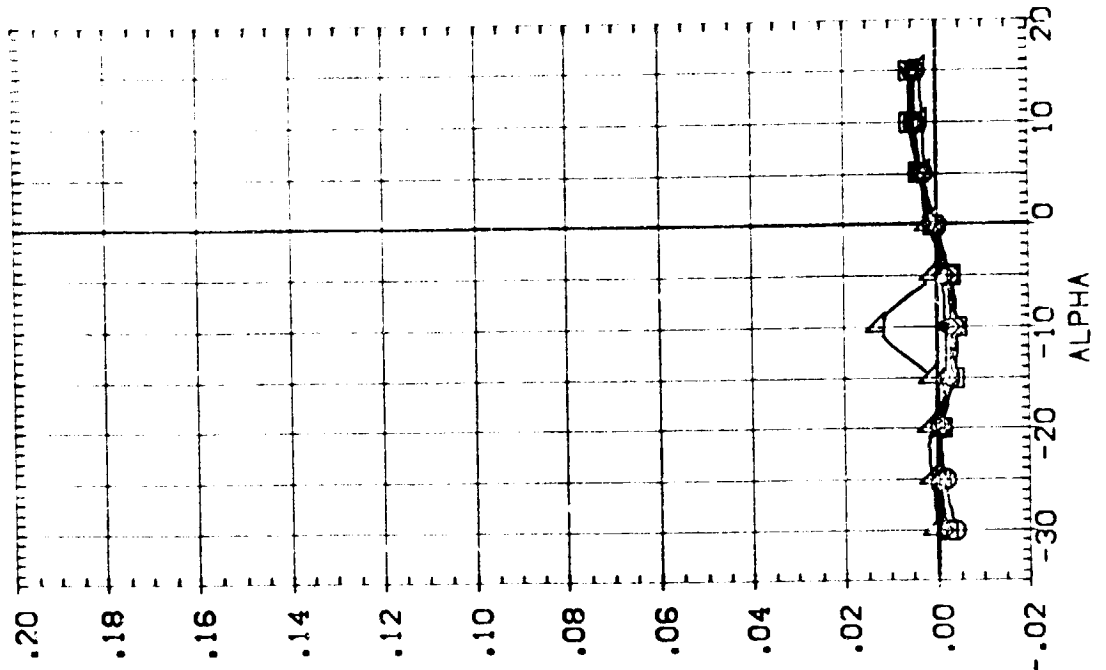

ISOLATED SOLID ROCKET BOOSTER W/O PLUMES AERODYNAMIC CHARACTERISTICS

(A)MACH = 4.51



SEE THE ASSOCIATED DATA DOCUMENT FOR REFERENCE CHARACTERISTICS FOR INDIVIDUAL DATASETS

BETA TOTAL POWER
 -10.000 28.900
 5.000 28.900
 10.000 28.900
 20.000 28.900

DATA SET SYMBOL CONFIGURATION DESCRIPTION
 (RT4520) [A13] SOLATED SOLID ROCKET BOOSTER(SB)IV/DPLUMES
 (RT4521) [A13] SOLATED SOLID ROCKET BOOSTER(SB)IV/DPLUMES
 (RT4522) [A13] SOLATED SOLID ROCKET BOOSTER(SB)IV/DPLUMES
 (RT4523) [A13] SOLATED SOLID ROCKET BOOSTER(SB)IV/DPLUMES
 (RT4524) [A13] SOLATED SOLID ROCKET BOOSTER(SB)IV/DPLUMES

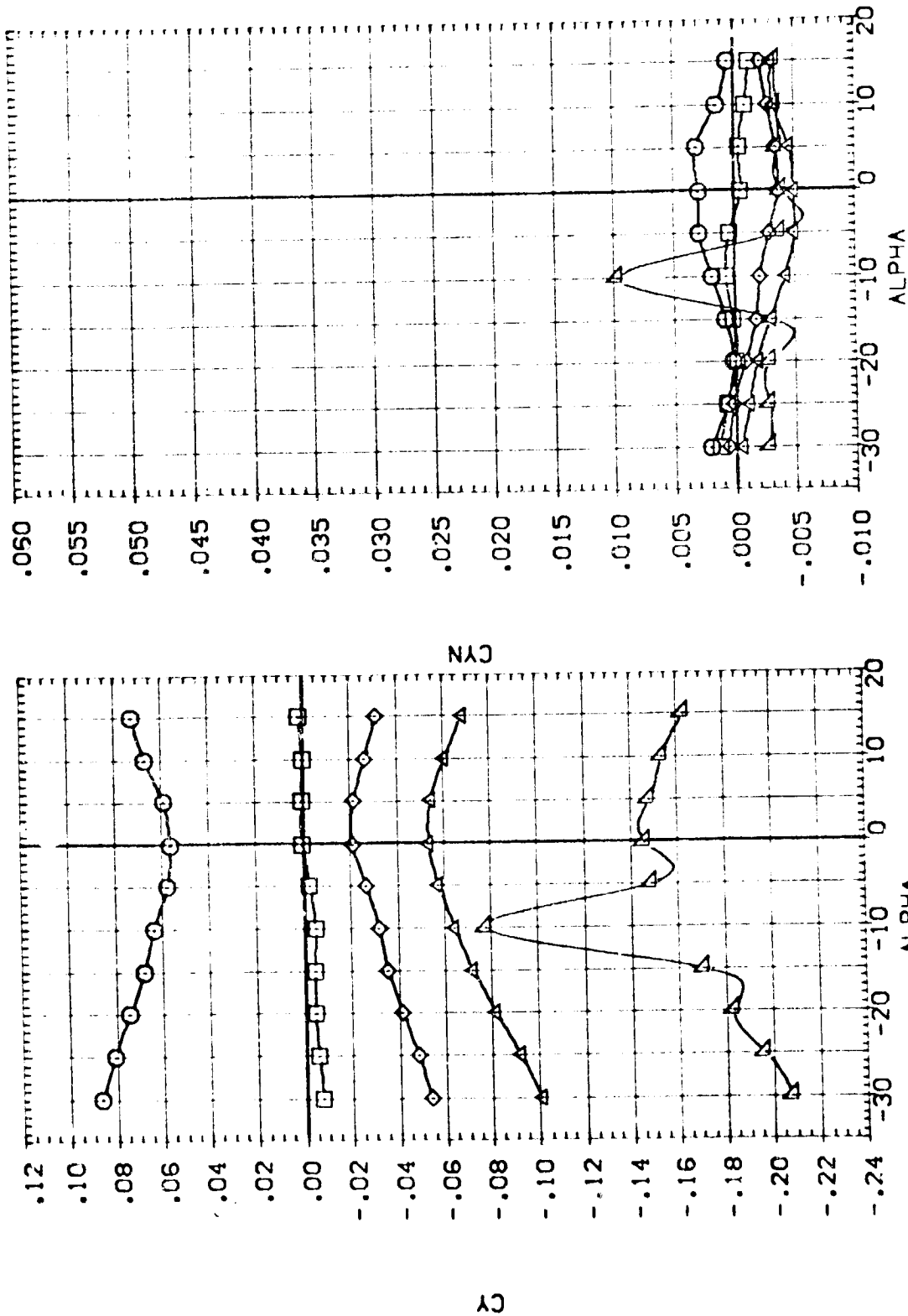

ISOLATED SOLID ROCKET BOOSTER W/O PLUMES AERODYNAMIC CHARACTERISTICS

CaMACH = 4.51

SEE THE ASSOCIATED DOCUMENT FOR THE CHARACTERISTICS OF INDIVIDUAL DATA SET

BETA TOTAL PD-MGR
 .000 110.000
 .000 58.000
 .000 28.900

DATA SET SYMBOL CONFIGURATION DESCRIPTION
 (17511) 1 SOLATED LIID ROCKET BOOSTER(SB)W/O PLUMES
 (17516) 1 SOLATED LIID ROCKET BOOSTER(SB)W/O PLUMES
 (17521) 1 SOLATED LIID ROCKET BOOSTER(SB)W/O PLUMES

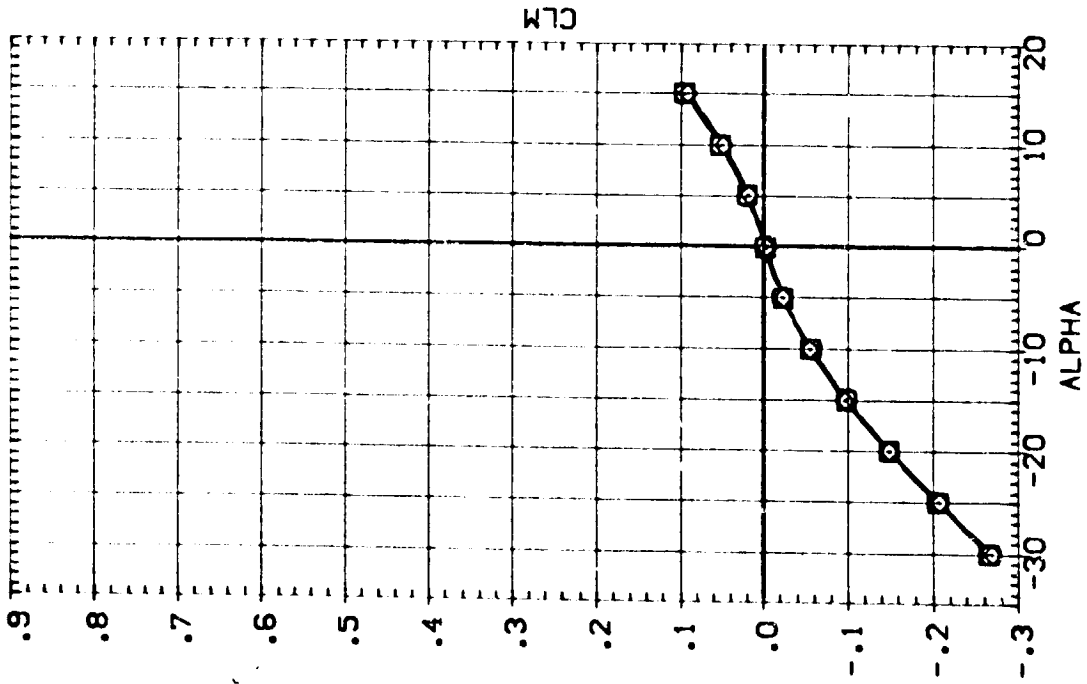
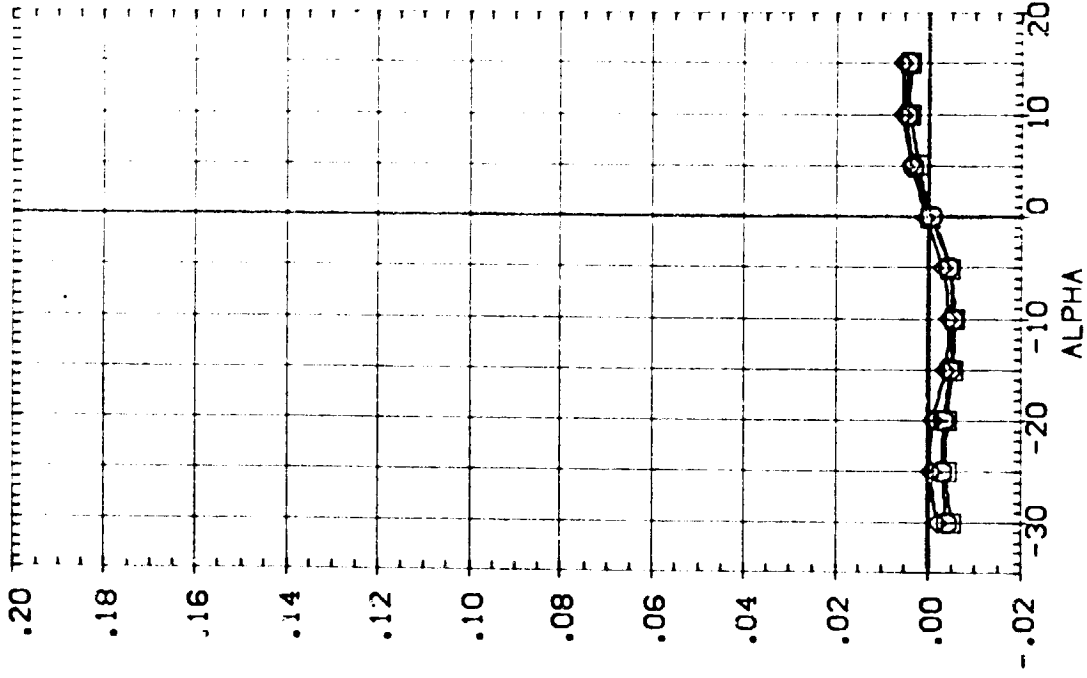

ISOLATED SOLID ROCKET BOOSTER W/O PLUMES AERODYNAMIC CHARACTERISTICS

CAJ MACH = 4.53



SEE THE ASSOCIATED DATA DOCUMENT FOR REFERENCE CHARACTERISTICS FOR INDIVIDUAL DATA SETS

BETA TOTAL POWER
 .000 110.000 .000
 .000 58.000 .000
 .000 28.900 .000

BOOSTER(S) W/O PLUMES
 BOOSTER(S) W/O PLUMES
 BOOSTER(S) W/O PLUMES

CONFIGURATION DESCRIPTION
 ISOLATED SOLID ROCKET
 ISOLATED SOLID ROCKET
 ISOLATED SOLID ROCKET

DATA SET SYMBOL
 (RT) (S11) □
 (RT) (S16) ◇
 (RT) (S21) ◇

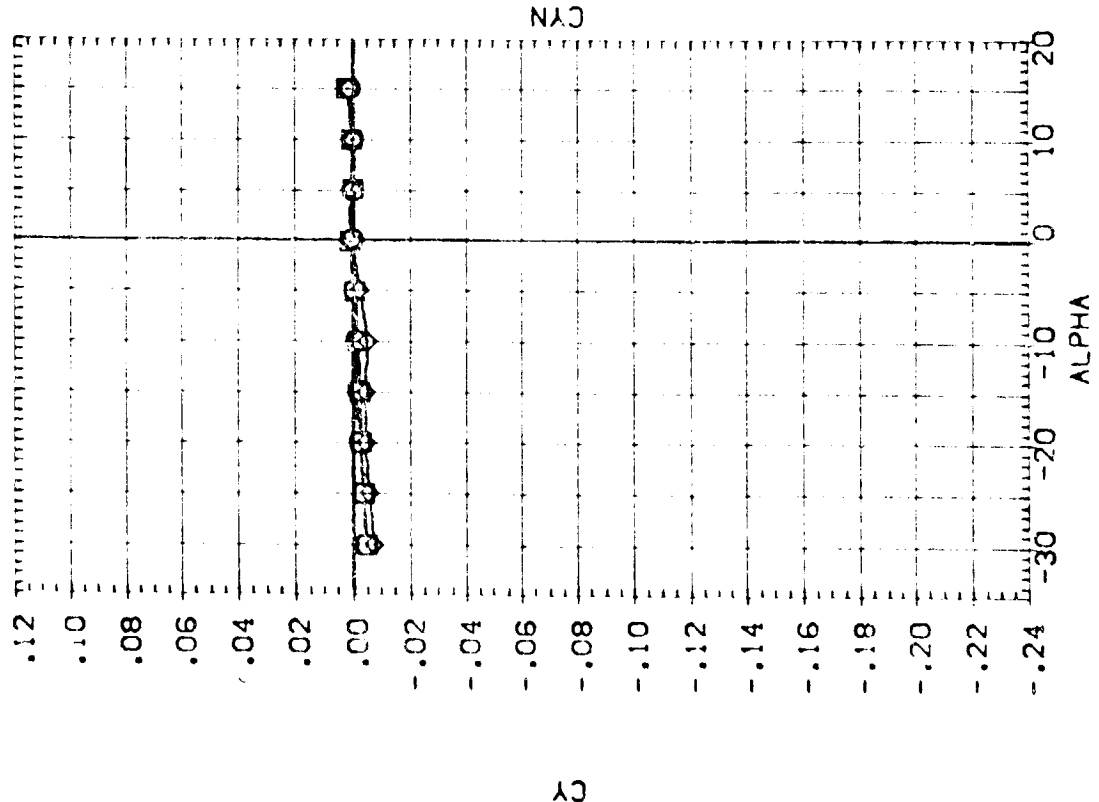
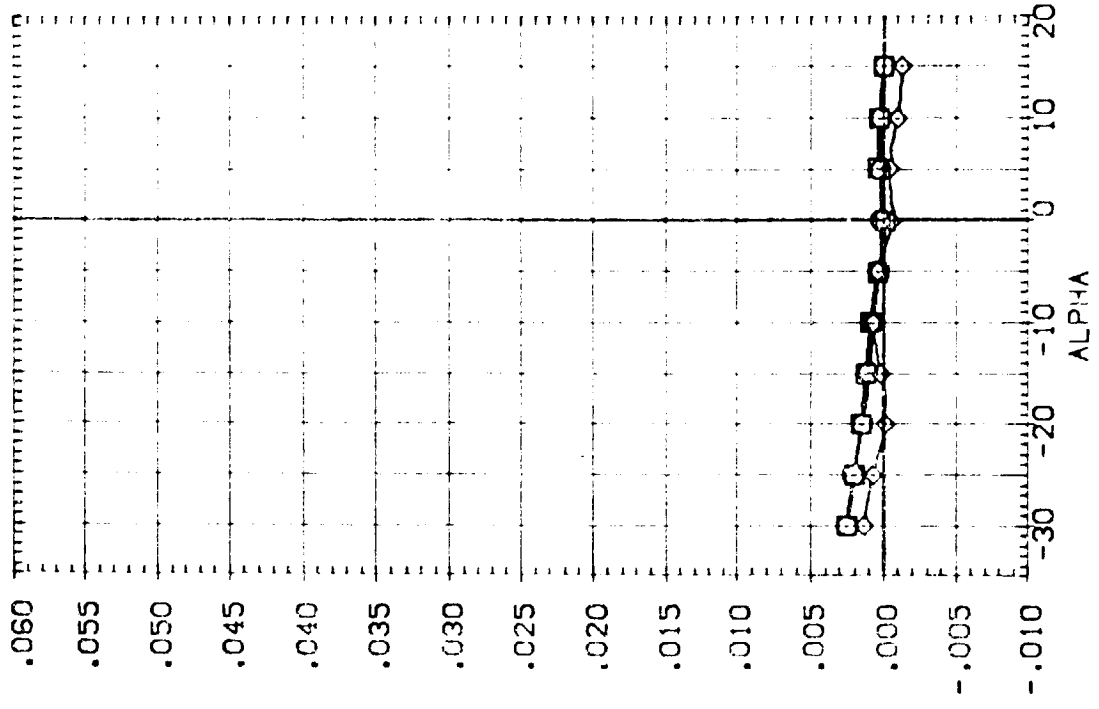

ISOLATED SOLID ROCKET BOOSTER W/O PLUMES AERODYNAMIC CHARACTERISTICS

(M)MACH = 4.53

SEE P. 5
FOR
CHARACTERISTICS
INDIVIDUAL DATA

BETA TOTAL NO FOR
-10,000 28,900 750,000
5,000 28,900 750,000
10,000 28,900 750,000
20,000 28,900 750,000

BOOSTER(S) W/ PLUMES
BOOSTER(S) W/ PLUMES
BOOSTER(S) W/ PLUMES
BOOSTER(S) W/ PLUMES
BOOSTER(S) W/ PLUMES

CONFIGURATION DESCRIPTION
[A13] SOLID ROCKET
[A13] SOLID ROCKET
[A13] SOLID ROCKET
[A13] SOLID ROCKET
[A13] SOLID ROCKET

DATA SET SYMBOL
[R1527] O
[R1528] X
[R1529] Z
[R1530] Y
[R1531] W

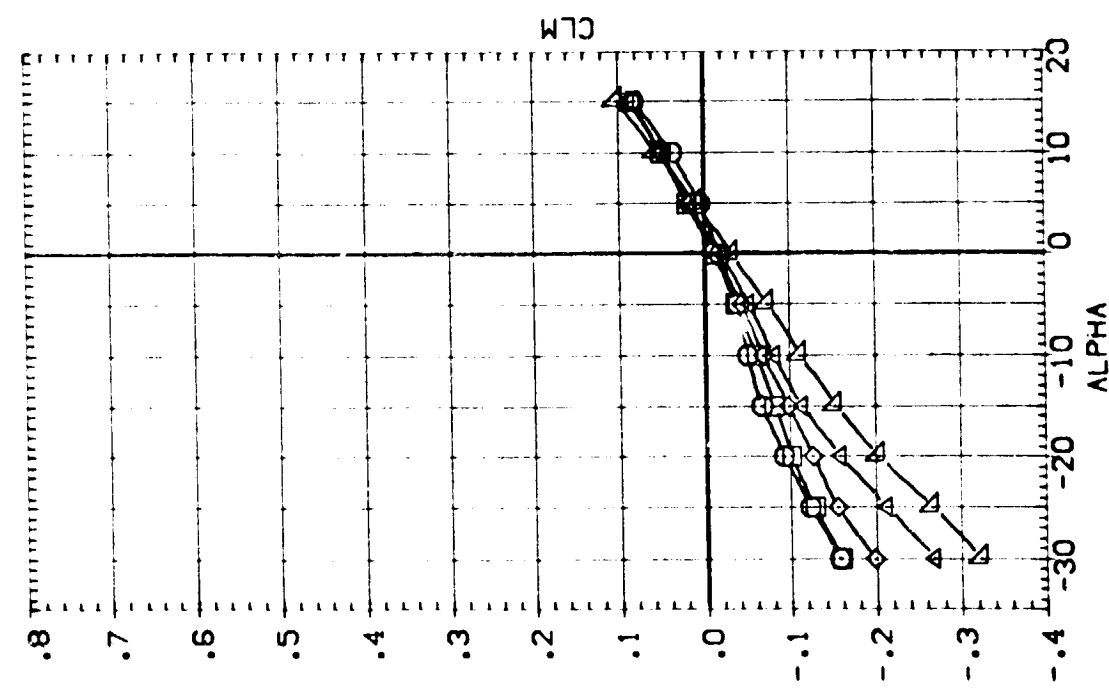
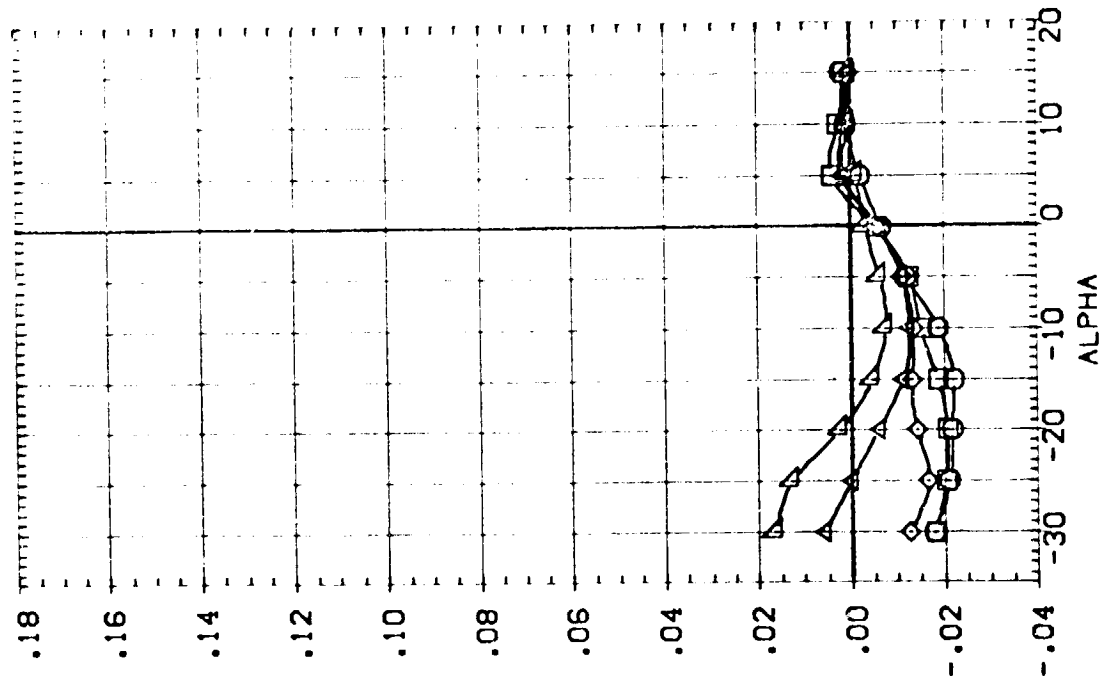

ISOLATED SOLID ROCKET BOOSTER W/ PLUMES AERODYNAMIC CHARACTERISTICS

(M)MACH = 4.51

SEE THE ASSOCIATED DATA DOCUMENT FOR REFERENCE CHARACTERISTICS FOR INDIVIDUAL DATASETS

BETA TOTAL PC-MGR
 -10.000 28.900 750.000
 .000 28.900 750.000
 5.000 28.900 750.000
 10.000 28.900 750.000
 20.000 28.900 750.000

DATA SET SYMBOL CONFIGURATION DESCRIPTION
 (RT577) O SOLATED SOLID ROCKET BOOSTER(S8)W/PLUMES
 (RT578) X SOLATED SOLID ROCKET BOOSTER(S8)W/PLUMES
 (RT579) A SOLATED SOLID ROCKET BOOSTER(S8)W/PLUMES
 (RT580) A SOLATED SOLID ROCKET BOOSTER(S8)W/PLUMES
 (RT581) A SOLATED SOLID ROCKET BOOSTER(S8)W/PLUMES

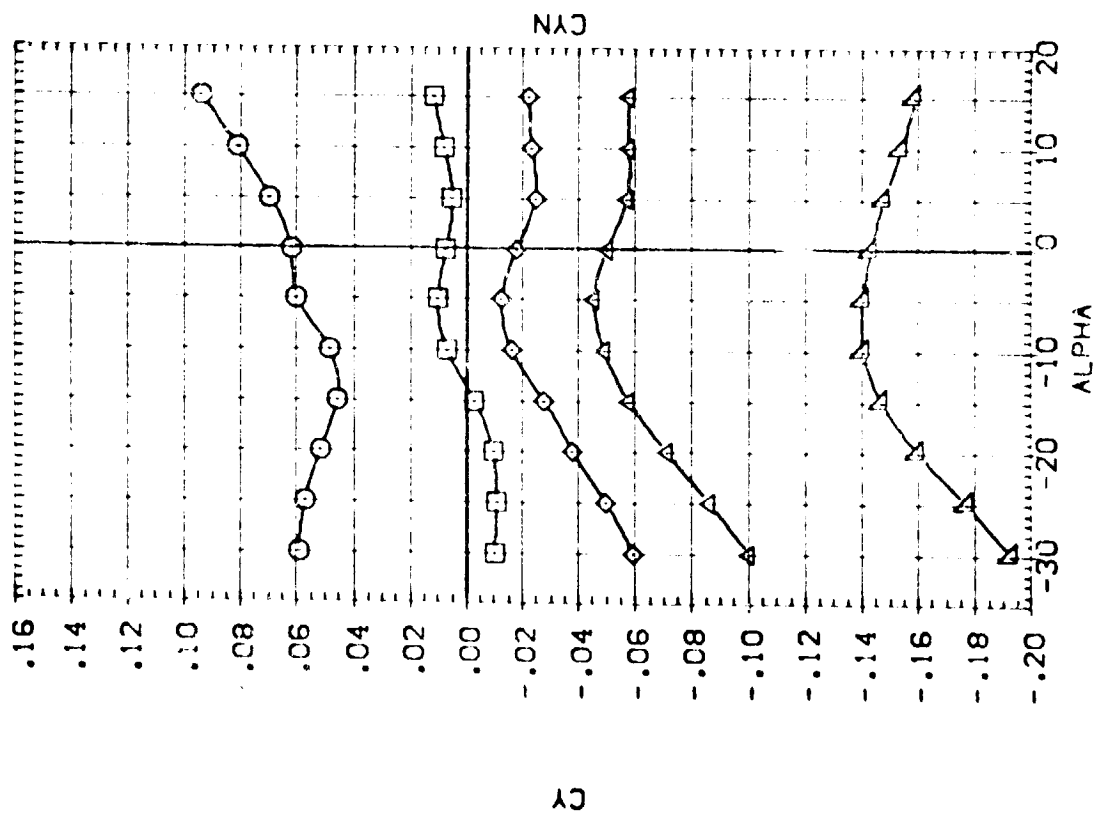
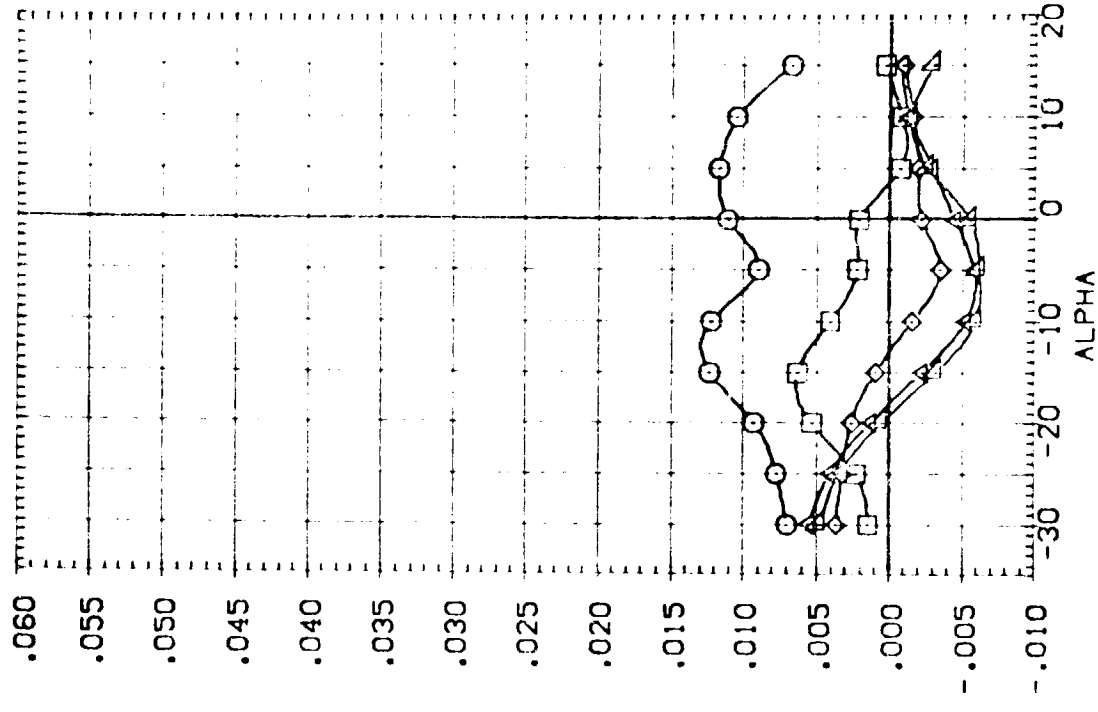

ISOLATED SOLID ROCKET BOOSTER W/PLUMES AERODYNAMIC CHARACTERISTICS

(A) MACH = 4.51

SEE THE
 DOCUMENT FOR
 CHARACTERISTICS
 INDIVIDUAL DATASETS

PC-PBR
 1900.000
 1500.000
 1500.000
 1500.000
 1500.000
 1500.000
 1500.000

BOOSTER(SB) W/ PLUMES
 BOOSTER(SB) W/ PLUMES
 BOOSTER(SB) W/ PLUMES
 BOOSTER(SB) W/ PLUMES
 BOOSTER(SB) W/ PLUMES
 BOOSTER(SB) W/ PLUMES

CONFIGURATION DESCRIPTION
 SOLID SOLID SOLID SOLID SOLID SOLID
 SOLID SOLID SOLID SOLID SOLID SOLID
 SOLID SOLID SOLID SOLID SOLID SOLID
 SOLID SOLID SOLID SOLID SOLID SOLID

SET SYMBOL
 (R) (S) (X) (Z)

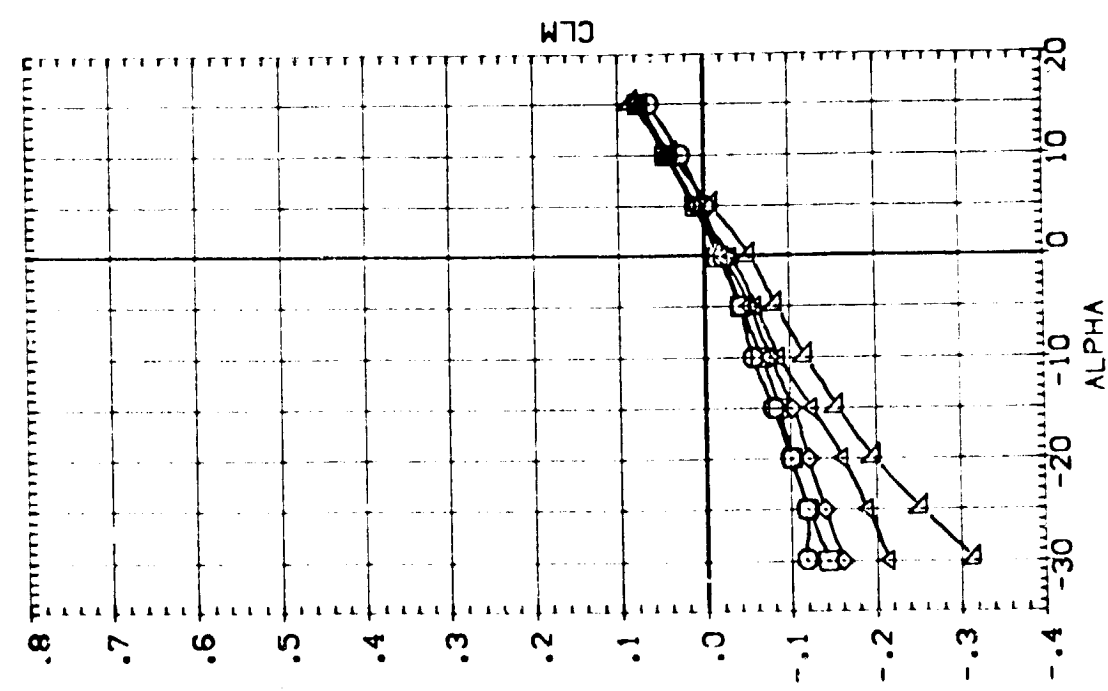
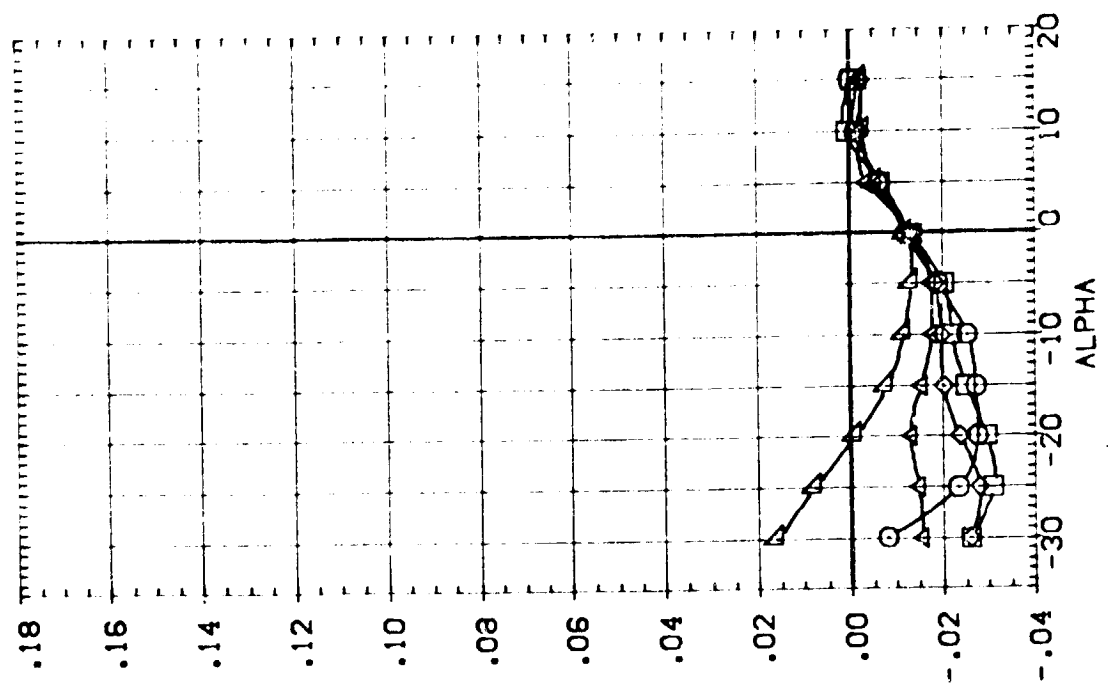

ISOLATED SOLID ROCKET BOOSTER W/ PLUMES AERODYNAMIC CHARACTERISTICS

(A) MACH = 4.51



DATA SET SYMBOL CONFIGURATION DESCRIPTION BETA P/TOTAL P/C-M/R SEE THE ASSOCIATED DATA DOCUMENT FOR REFERENCE CHARACTERISTICS FOR INDIVIDUAL DATASETS

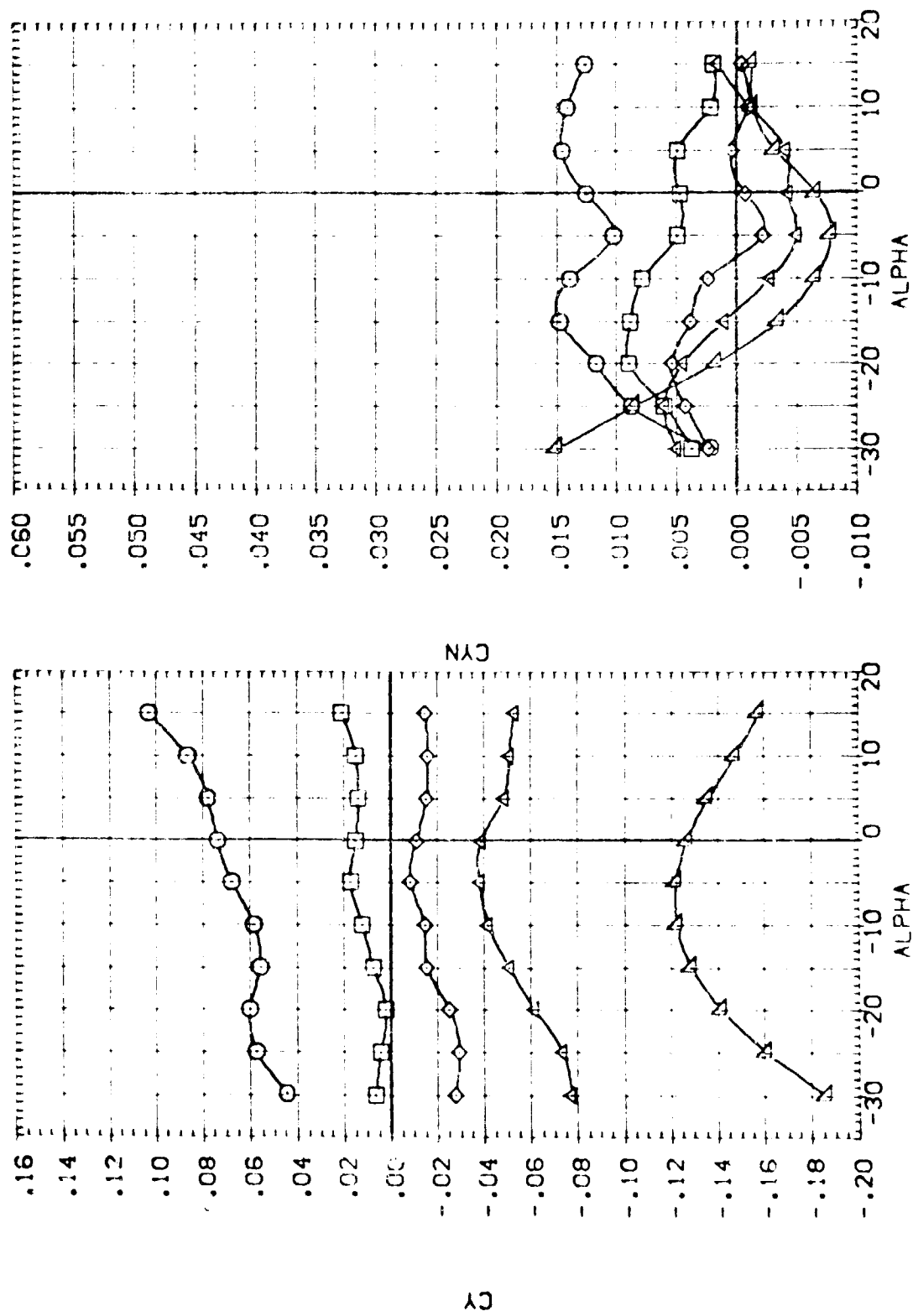

ISOLATED SOLID ROCKET BOOSTER W/PLUMES AERODYNAMIC CHARACTERISTICS

(MACH = 4.5)

FIG. 3. EXTERNAL TANK SEPARATION FROM ORB. 09 (RTJ001)

SEE THE ASSOCIATED DATA DOCUMENT FOR REFERENCE CHARACTERISTICS FOR INDIVIDUAL DATA SETS

SYMBOL	X	PARAMETRIC VALUES				
		MACH	ALPHA	BETA	DELTA	ELEVTR
○	.290	4.530	110.000	.000	.000	.000
◇	400.180	.000	.000	.000	.000	.000
△	800.610	5.000	.000	.000	.000	.000
	1200.500	.000	.000	.000	.000	.000

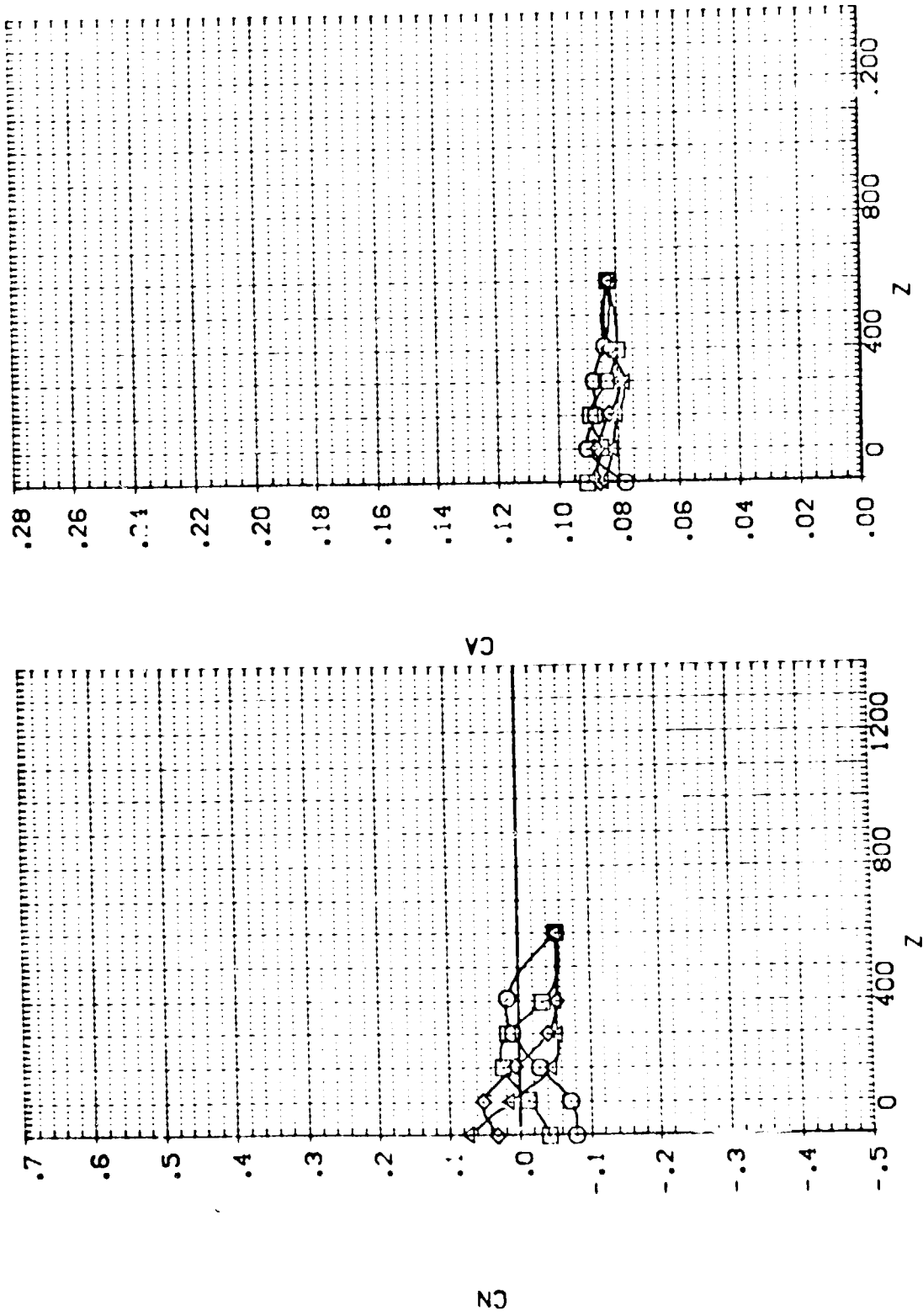

EFFECT OF EXTERNAL TANK SEPARATION ON ORBITER AERODYNAMIC CHARACTERISTICS



1A13,EXTERNAL TANK(11)SEPARATING FROM ORB, 09 (RTJ001)

SEE THE ASSOCIATED DATA DOCUMENT FOR REFERENCE CHARACTERISTICS FOR INDIVIDUAL DATASETS

SYMBOL		PARAMETRIC VALUES	
X	.790	MACH	1.530
Y	400.480	PTOTAL	110.000
Z	800.610	BETA	.000
U	1700.500	ALPHA	5.000
V		DBETA	.000
		ALPHON	.000
		ELEV 2	.000
		Y	.000

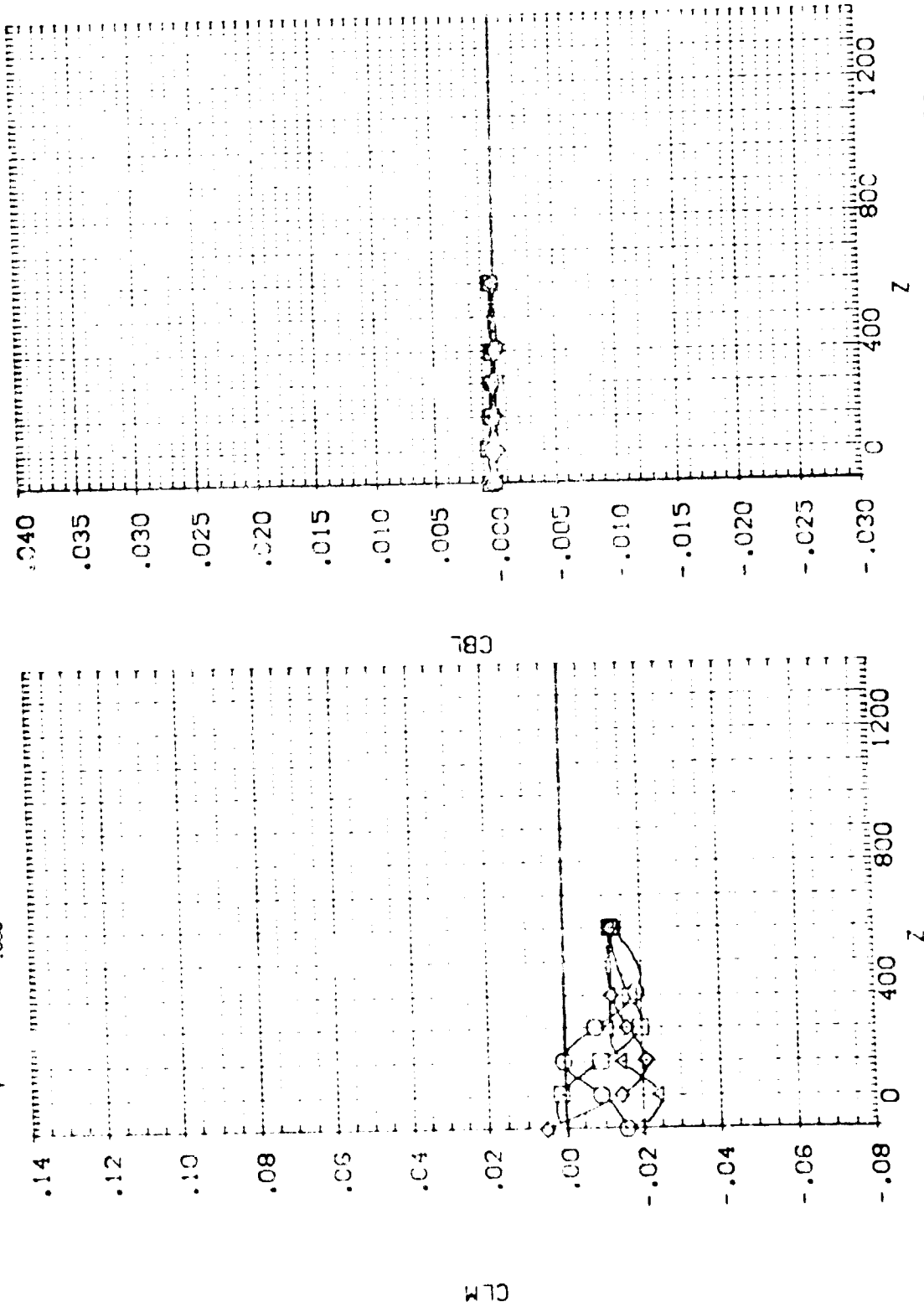

EFFECT OF EXTERNAL TANK SEPARATION ON ORBITER AERODYNAMIC CHARACTERISTICS

1:13,EXTERNAL TANK(110)SEPARATING FROM ORB. 09 (RTJ001)

SEE THE ASSOCIATED REFERENCE DOCUMENT FOR REFERENCE CHARACTERISTICS FOR INDIVIDUAL DATA SETS

SYMBOL		X		PARAMETRIC VALUES			
○	○	.290	MACH	4.530	PTOTAL	110.000	
◇	◇	100.160	ALPHA	.000	BETA	.000	
△	△	800.610	DALPHA	5.000	DBETA	.000	
		1200.500	ELEVTR	.000	ALLRON	.000	
			Y	.000			

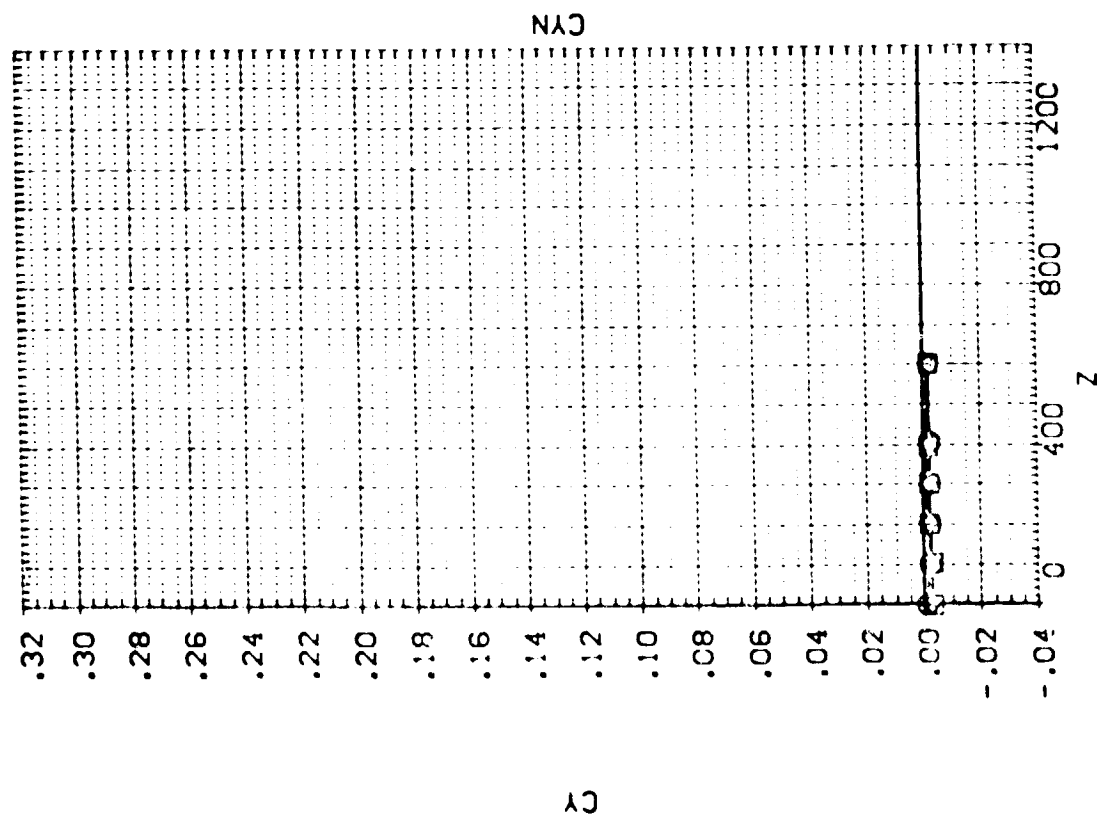
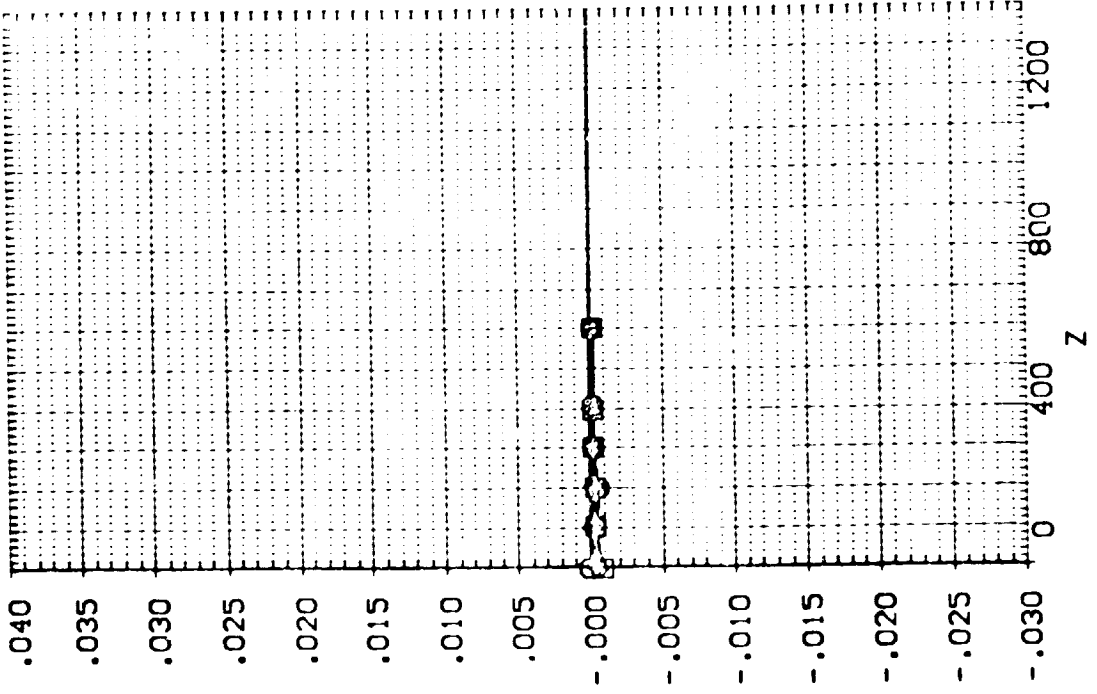

EFFECT OF EXTERNAL TANK SEPARATION ON ORBITER AERODYNAMIC CHARACTERISTICS

1A:3.EXTERNAL TANK(T10)SEPARATING FROM ORB. 09 (RTJ002)

SEE THE ASSOCIATED DATA DOCUMENT FOR REFERENCE CHARACTERISTICS FOR INDIVIDUAL DATA'S

SYMBOL		PARAMETRIC VALUES	
O	X	MACH	4.530
O	Y	ALPHA	110.000
O	Z	BETA	.000
O	DBETA	DBETA	.000
O	ALFON	ALFON	.000
O	ELEVTR	ELEVTR	.000

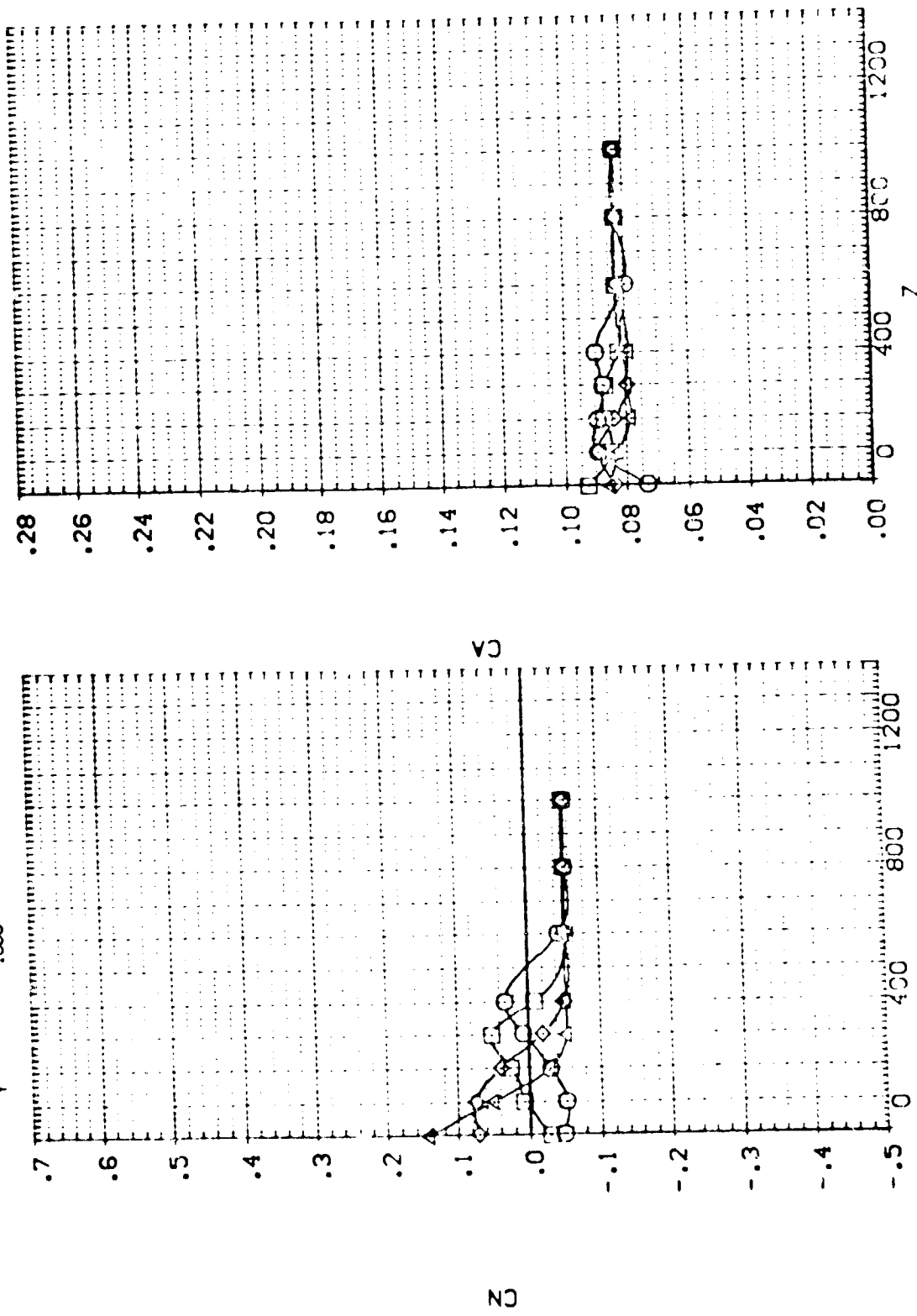

1A13. EXTERNAL TANK(T10) SEPARATING FROM ORB. 09 (RTJ002)

SEE THE ASSOCIATED DOCUMENT FOR THE CHARACTERISTICS OF INDIVIDUAL DATA SETS

SYMBOL		PARAMETRIC VALUES	
○	X	MACH	P/TOTAL
□	400.180	ALPHA	110.000
◇	800.460	BETA	.000
△	1700.800	DELTA	.000
		ELEVTR	.000
		Y	.000

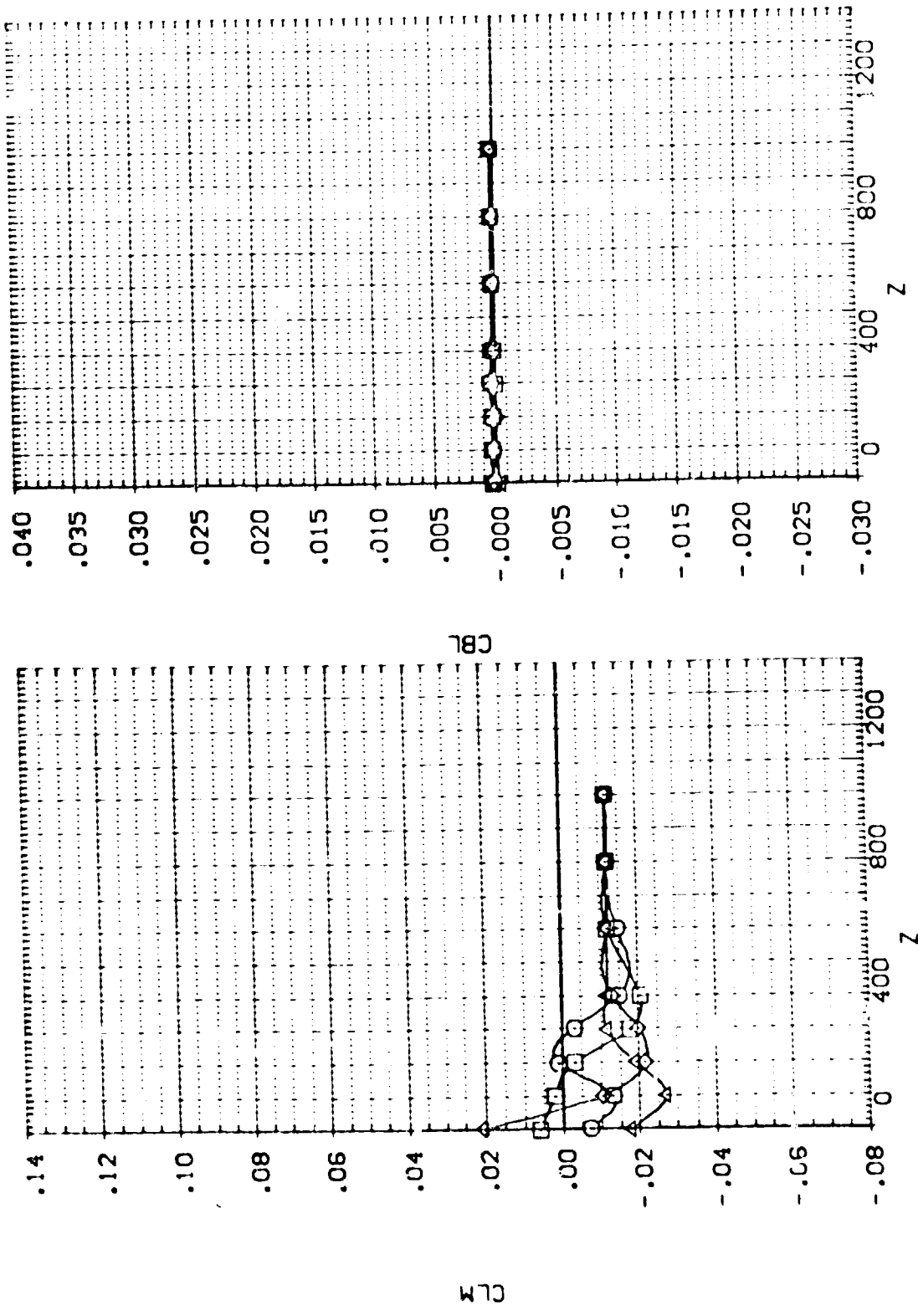

EFFECT OF EXTERNAL TANK SEPARATION ON ORBITER AERODYNAMIC CHARACTERISTICS



1A13.EXTERNAL TANK(T10)SEPARATING FROM ORB. 09 (RTJ002)

SEE THE ASSOCIATED DATA DOCUMENT FOR REFERENCE CHARACTERISTICS FOR INDIVIDUAL DATASETS

SYMBOL	X	MACH	PARAMETRIC VALUES
○	.046	4.530	PTOTAL 110.000
□	400.180	.000	BETA .000
◇	600.460	.000	DBETA .000
△	1200.800	.000	AILRON .000
		Y	.000

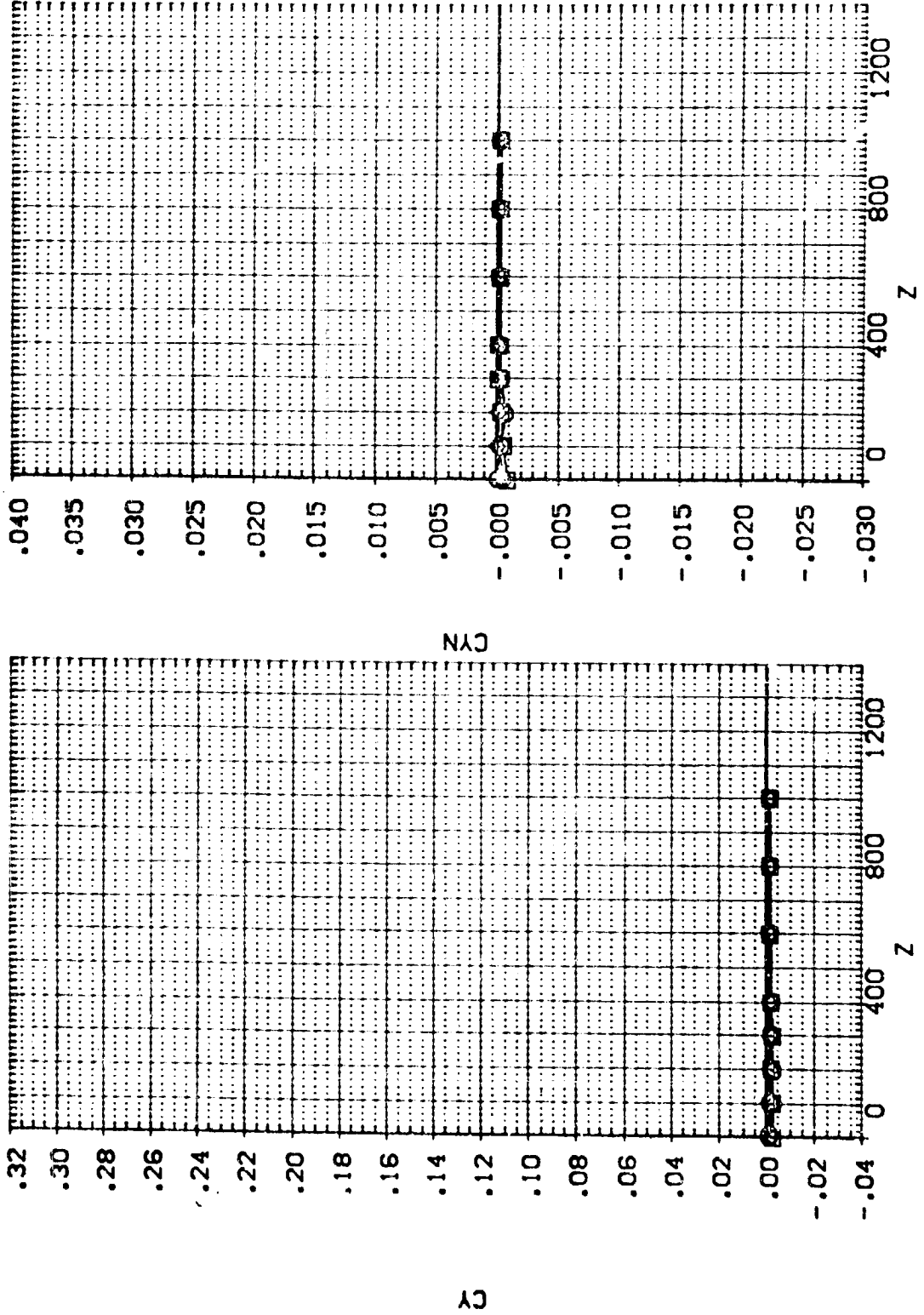

EFFECT OF EXTERNAL TANK SEPARATION ON ORBITER AERODYNAMIC CHARACTERISTICS

SEE THE ASSOCIATED DATA DOCUMENT FOR REFERENCE CHARACTERISTICS FOR INDIVIDUAL DATASETS

SYMBOL		PARAMETRIC VALUES			
○	x	MACH	4.530	PTOTAL	110.000
□	400.330	ALPHA	.000	BETA	.000
◇	800.510	DALPHA	.000	DBETA	.000
△	1200.700	ELEVTR	.000	AILRON	.000
	y		200.000		

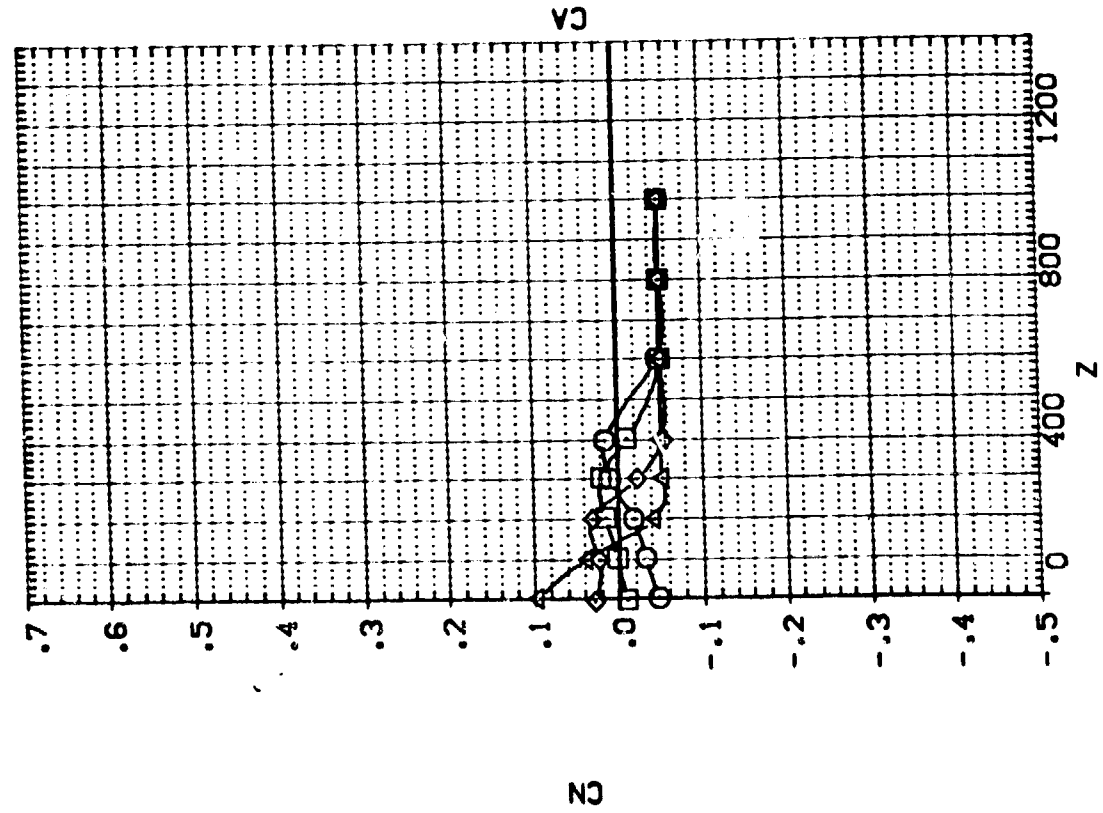
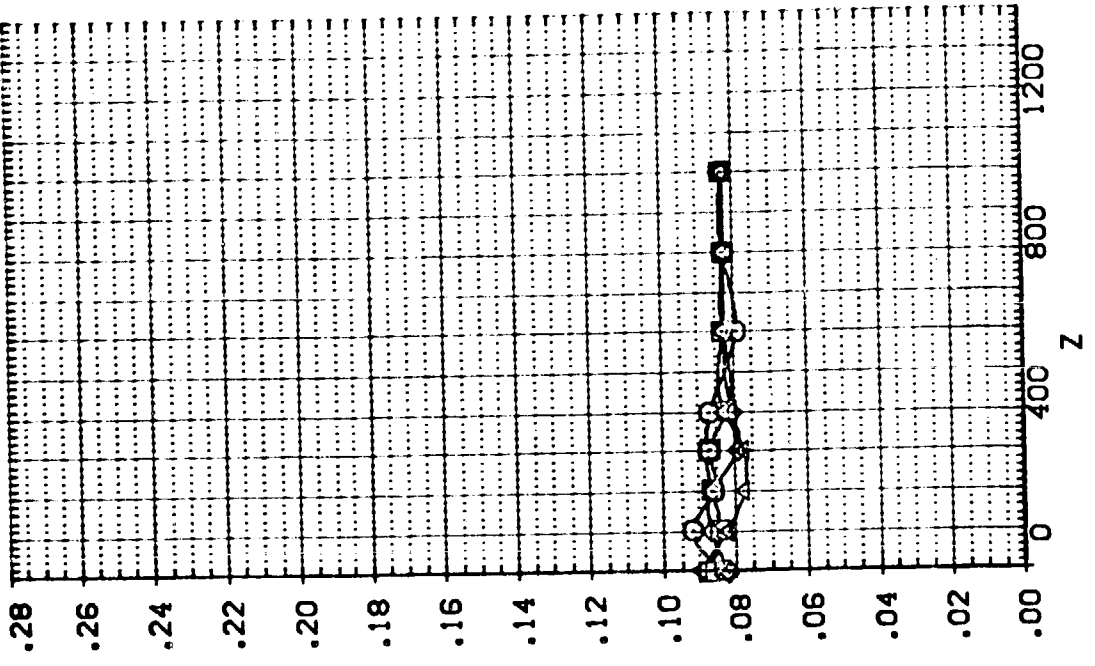

EFFECT OF EXTERNAL TANK SEPARATION ON ORBITER AERODYNAMIC CHARACTERISTICS

1A13.EXTERNAL TANK(T10)SEPARATING FROM ORB. 09 (RTJ003)

SEE THE ASSOCIATED DATA DOCUMENT FOR REFERENCE CHARACTERISTICS FOR INDIVIDUAL DATASETS

SYMBOL		PARAMETRIC VALUES				
○	X	-0.003	MACH	4.530	PTOTAL	110.000
□	Y	400.330	ALPHA	.000	BETA	.000
◇	Z	800.510	DALPHA	.000	DBETA	.000
△	Y	1200.700	ELEVTR	.000	ALTRON	.000
				200.000		

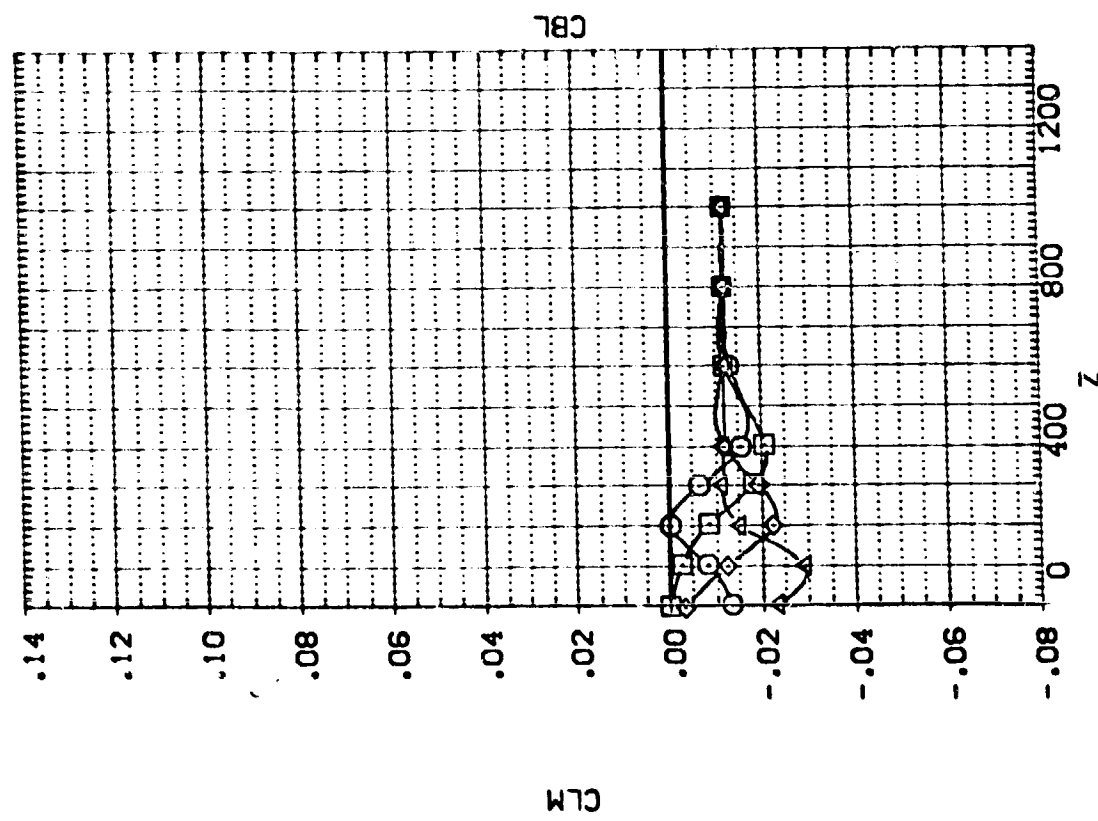
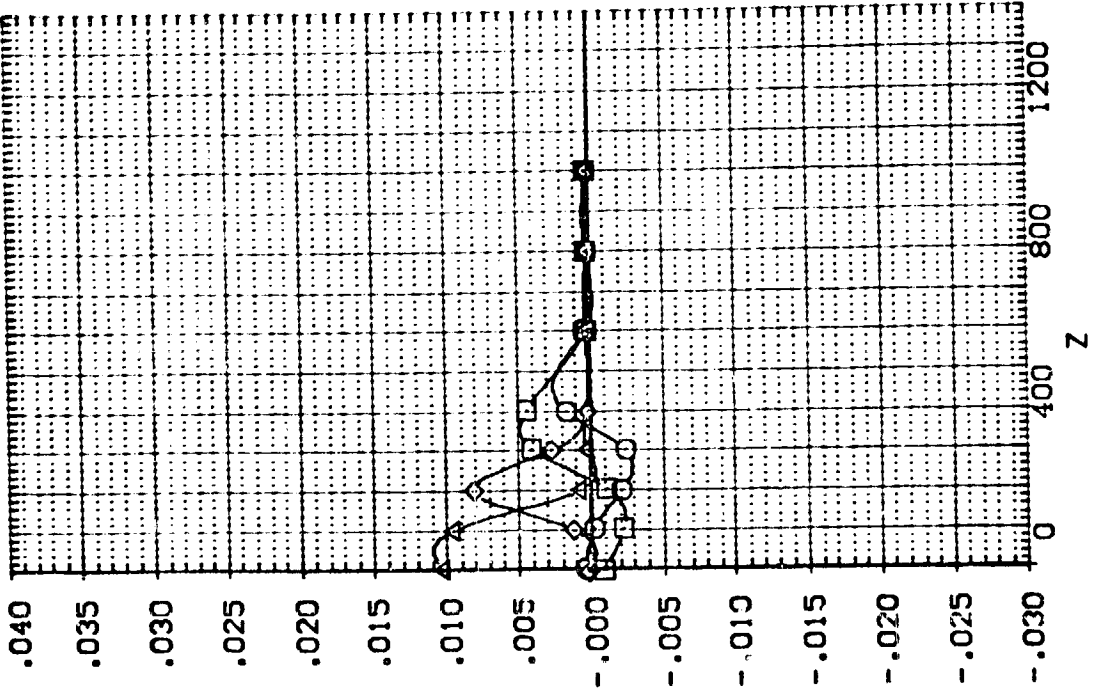

IA13-EXTERNAL TANK(T10)SEPARATING FROM ORB. 09 (RTJ003)

SEE THE ASSOCIATED DATA DOCUMENT FOR REFERENCE CHARACTERISTICS FOR INDIVIDUAL DATASETS

SYMBOL		PARAMETRIC VALUES	
x	- .003	MACH	4.530
	400.33C	ALPHA	.000
	800.510	DALPHA	.000
	1200.700	ELEVTR	.000
		Y	200.000
		PITOTL	110.000
		BETA	.000
		DBETA	.000
		AILRON	.000

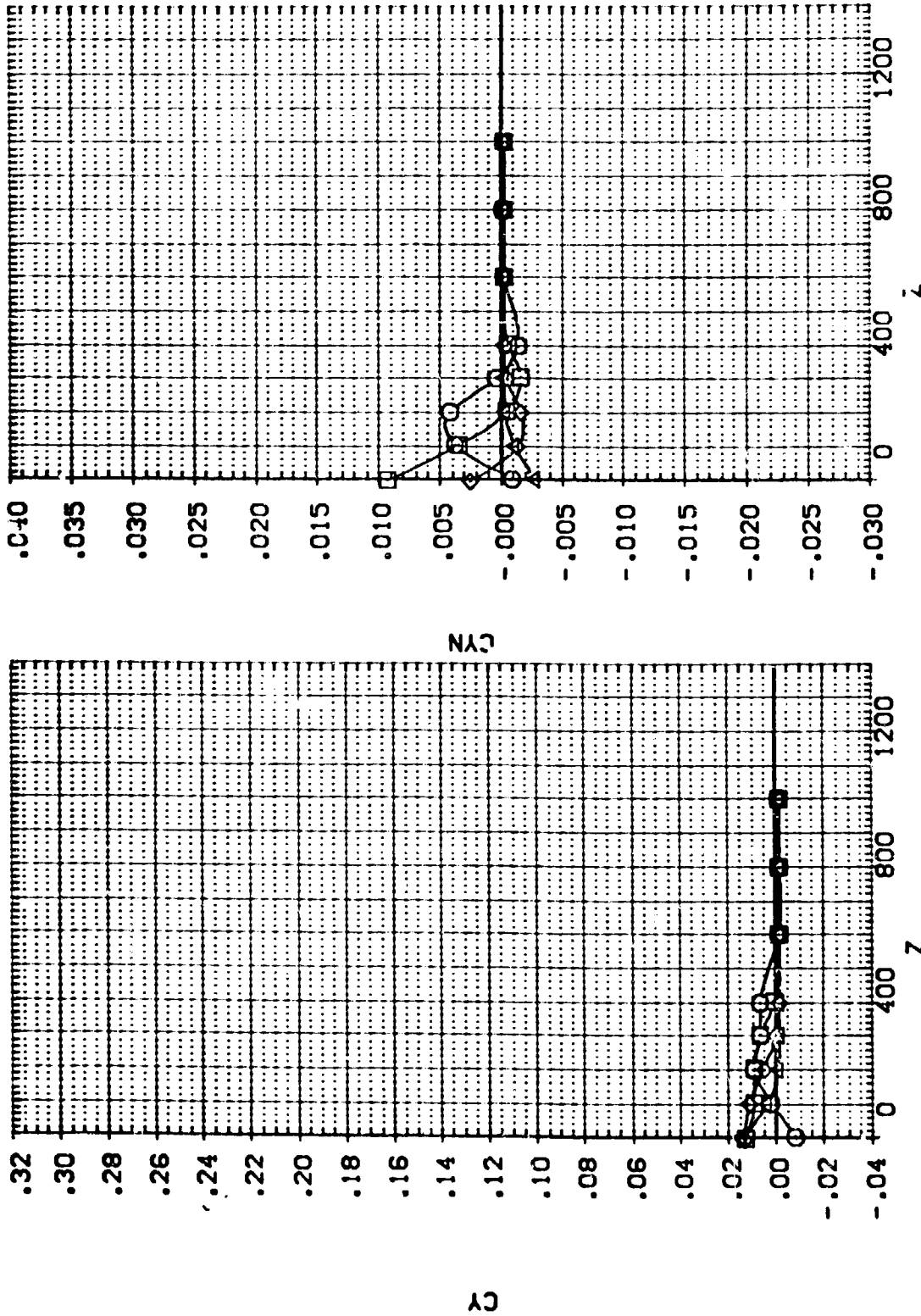

EFFECT OF EXTERNAL TANK SEPARATION ON ORBITER AERODYNAMIC CHARACTERISTICS



IA13, EXTERNAL TANK (T10) SEPARATING FROM ORB. 09 (RTJ004)

SEE THE ASSOCIATED DATA DOCUMENT FOR REFERENCE CHARACTERISTICS FOR INDIVIDUAL DATASETS

SYMBOL		PARAMETRIC VALUES	
○	X	MACH	110.000
□	Y	ALPHA	.000
◇	Z	DALPHA	5.000
△		ELEVTR	.000
			200.000

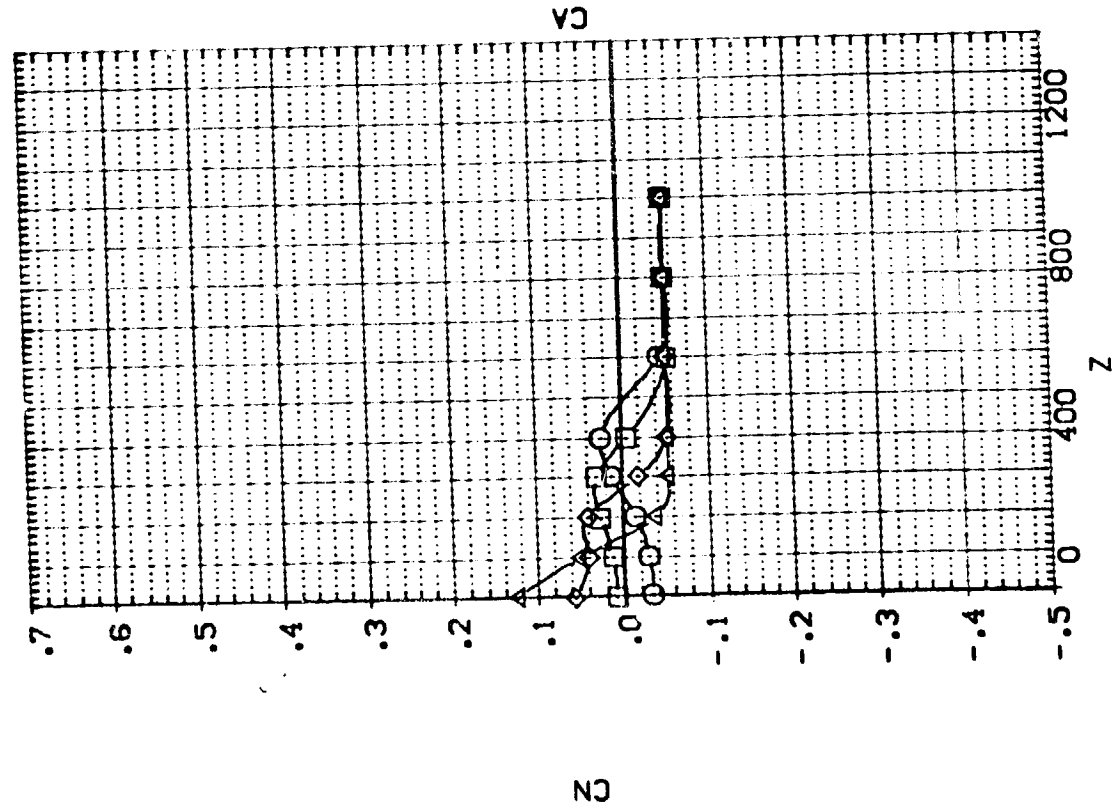
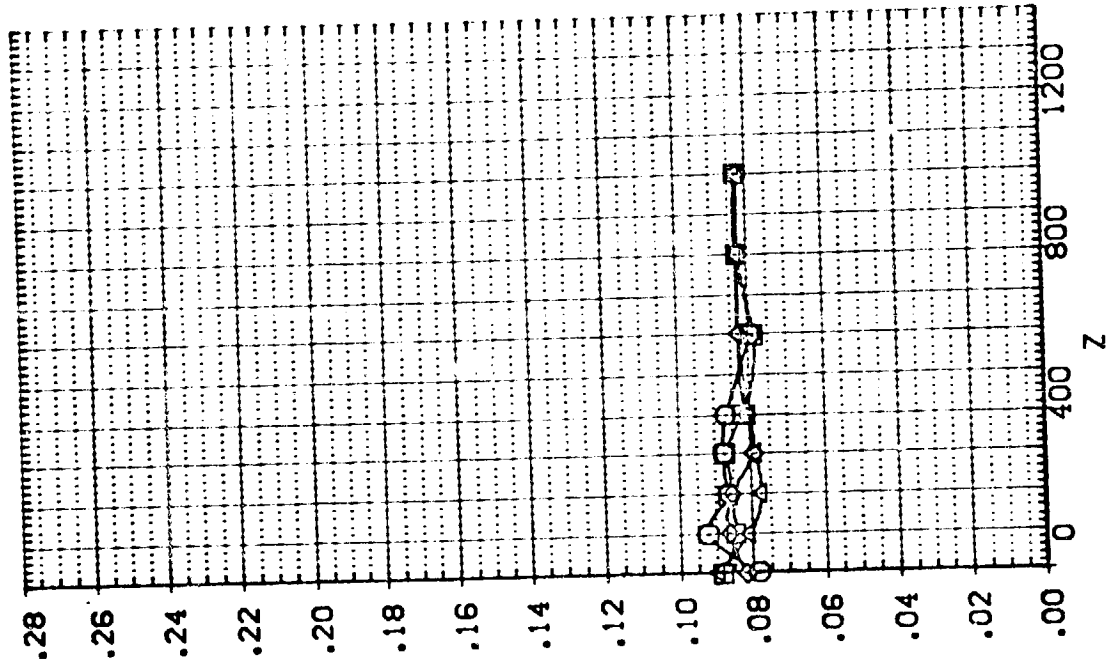

IA13, EXTERNAL TANK (T10) SEPARATING FROM ORB. 09 (RTJ004)

SEE THE ASSOCIATED DOCUMENT FOR A COMPLETE LIST OF CHARACTERISTICS FOR INDIVIDUAL DATA SETS

Symbol	x	MACH	PIOTAL	PIOTAL
○	.088	4.530	.000	110.000
□	400.280	.000	.000	.000
◇	800.430	.000	.000	5.000
△	1200.700	.000	.000	AILRON
	y			200.000

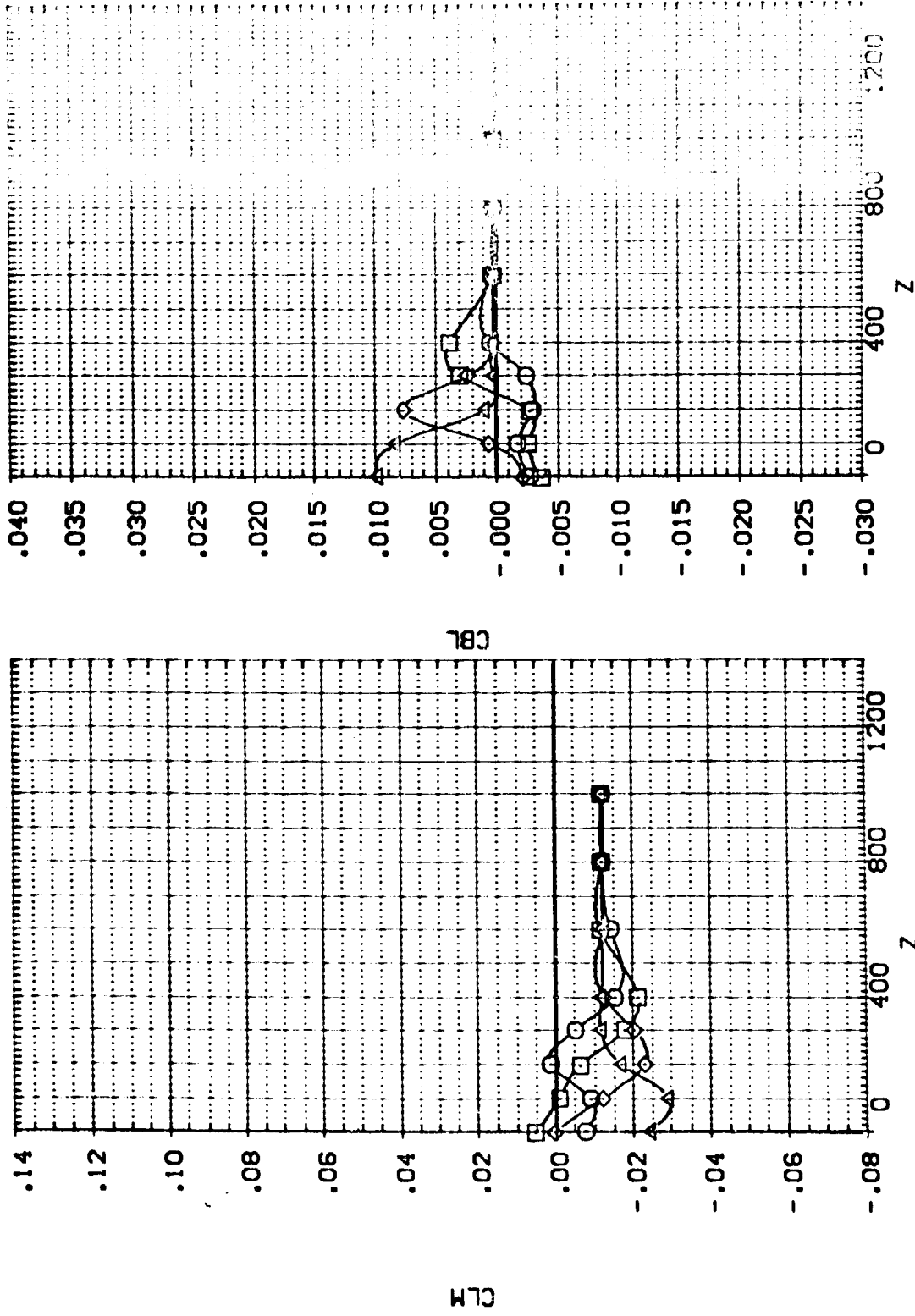

EFFECT OF EXTERNAL TANK SEPARATION ON ORBITER AERODYNAMIC CHARACTERISTICS

1A13. EXTERNAL TANK(T10)SEPARATING FROM ORB. 09 (RTJ004)

SEE THE ASSOCIATED DATA DOCUMENT FOR REFERENCE CHARACTERISTICS FOR INDIVIDUAL DATASETS

SYMBOL		PARAMETRIC VALUES	
○	x	MACH	110.000
□	400.280	ALPHA	.000
◇	600.430	DALPHA	5.000
△	1200.700	ELEVTR	.000
		Y	200.000

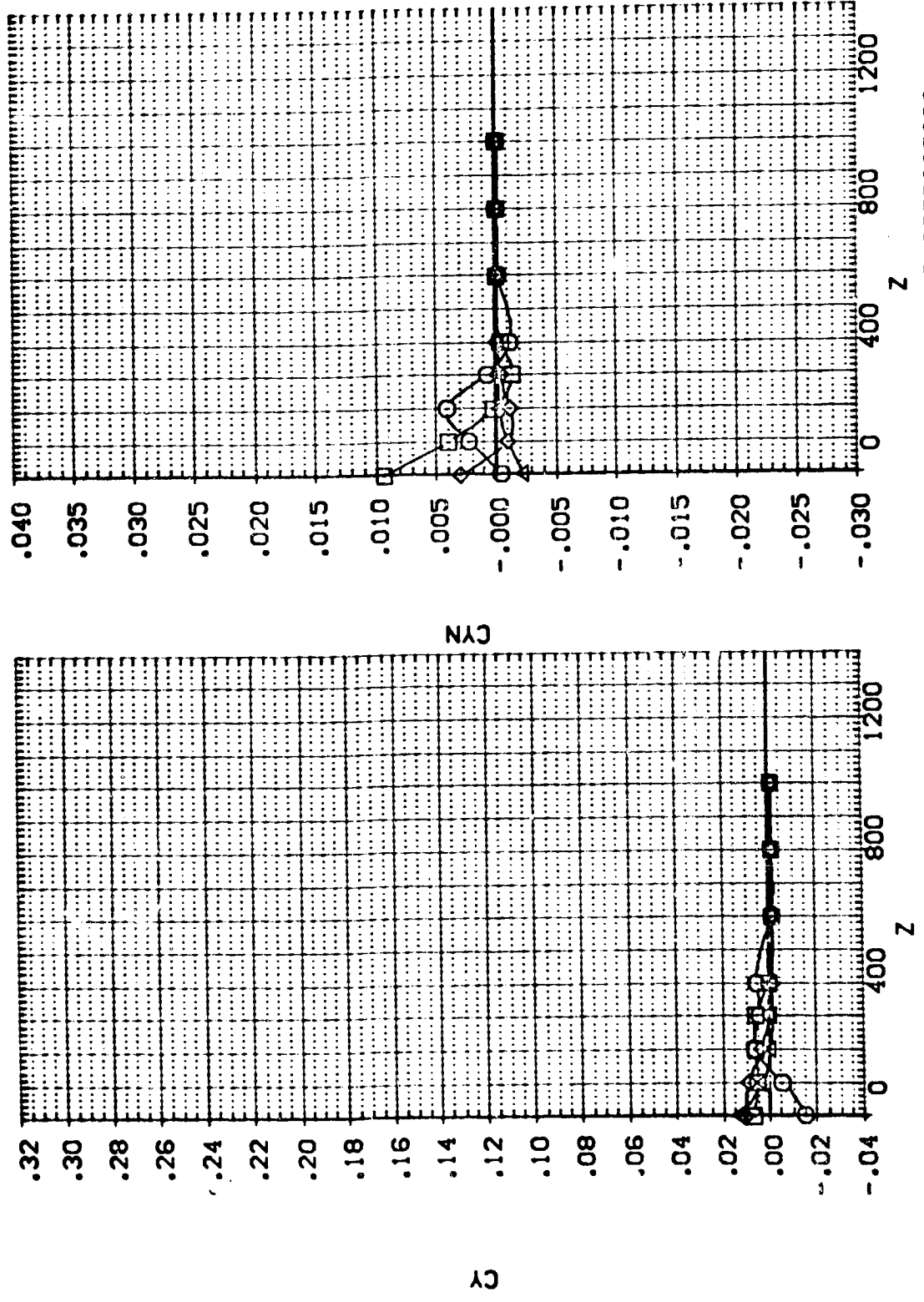

EFFECT OF EXTERNAL TANK SEPARATION ON ORBITER AERODYNAMIC CHARACTERISTICS

SEE THE ASSOCIATED DATA DOCUMENT FOR REFERENCE CHARACTERISTICS FOR INDIVIDUAL DATASETS

SYMBOL		PARAMETRIC VALUES	
○	X	MACH	110.000
□	400.480	ALPHA	.000
◇	800.570	DALPHA	.000
△	1200.600	ELEVTR	.000
		Y	.000
		POTOTAL	110.000
		BETA	.000
		DBETA	5.000
		AILRON	.000

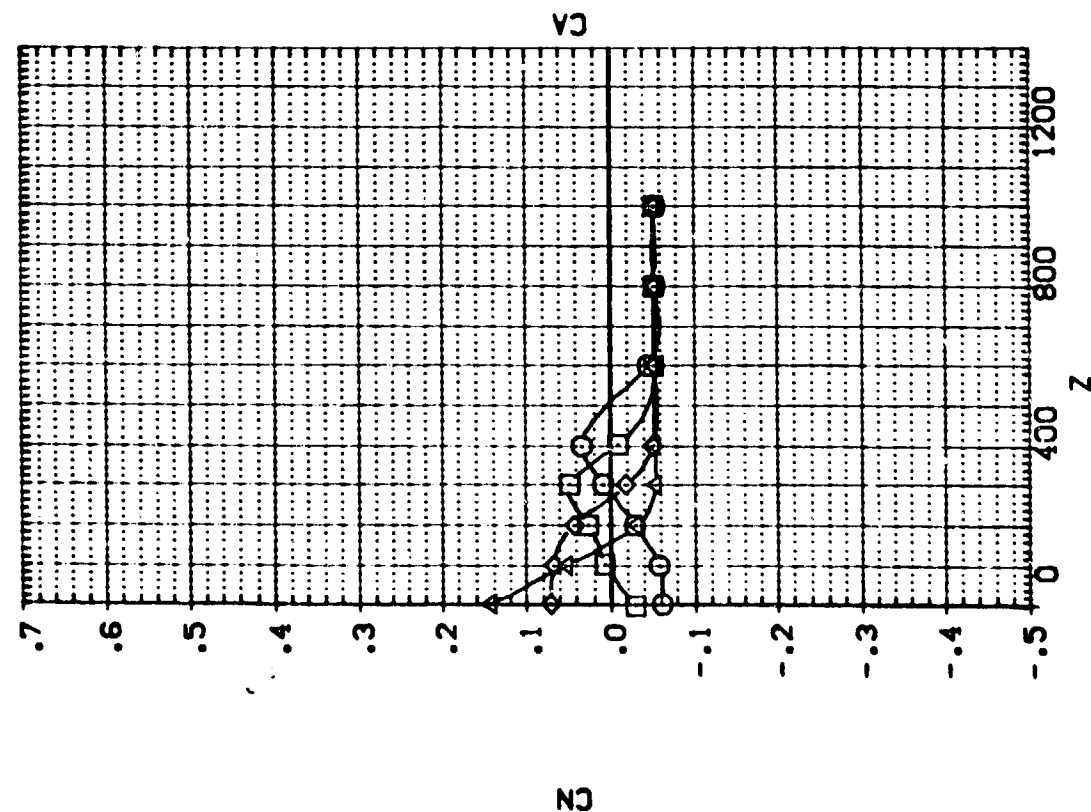
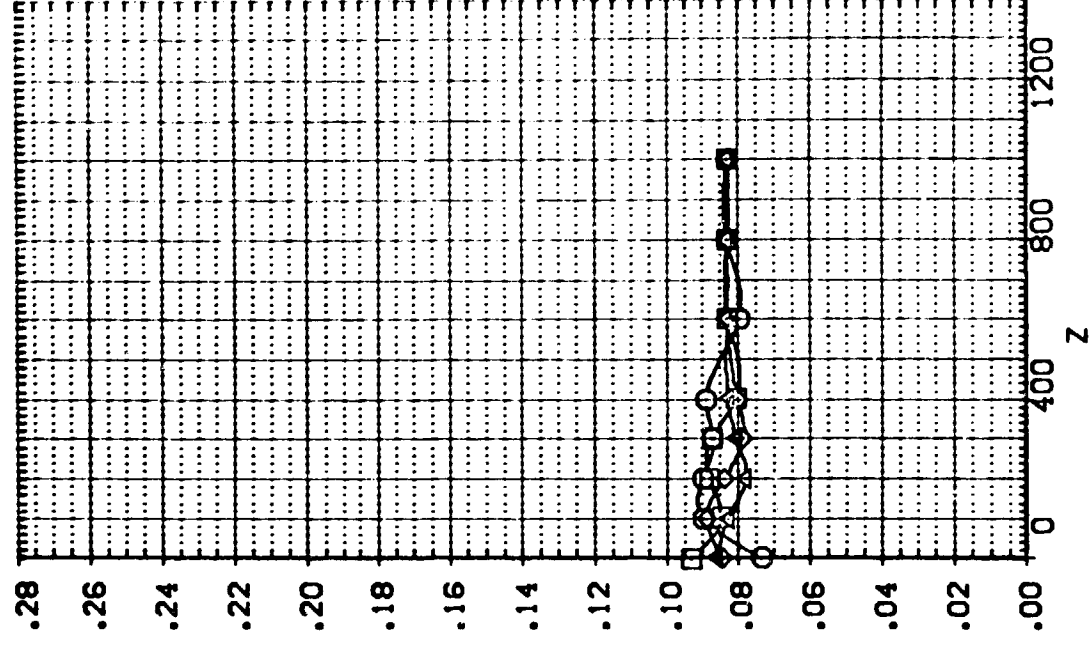

EFFECT OF EXTERNAL TANK SEPARATION ON ORBITER AERODYNAMIC CHARACTERISTICS

IA13. EXTERNAL TANK(T10)SEPARATING FROM ORB. 09 (RTJ005)

SEE THE ASSOCIATED DATA DOCUMENT FOR REFERENCE CHARACTERISTICS FOR INDIVIDUAL DATASETS

SYMBOL		PARAMETRIC VALUES	
X	□	MACH	110.000
	○	ALPHA	.000
	◇	DALPHA	5.000
	△	ELEVTR	.000
		Y	.000

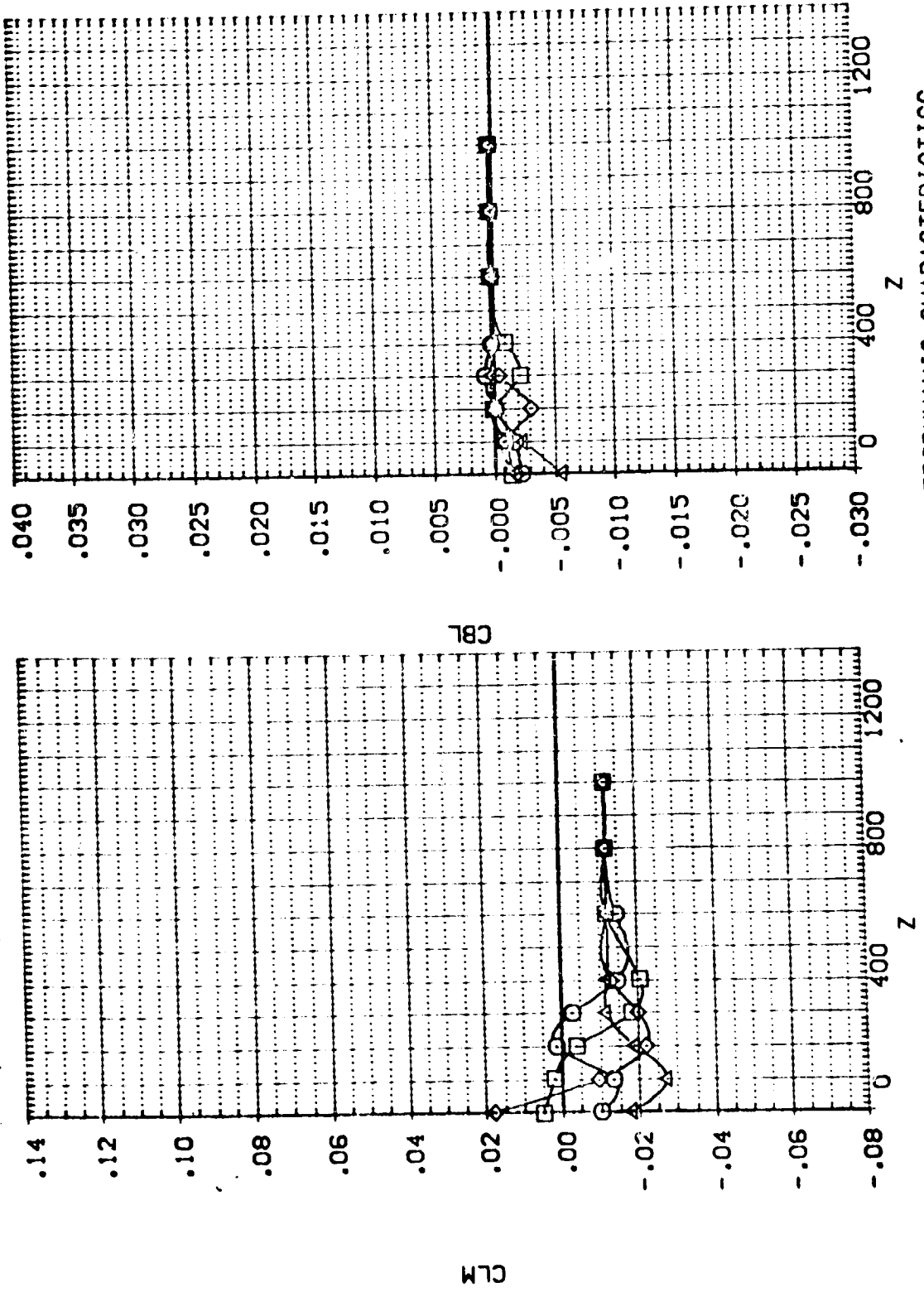

IA13. EXTERNAL TANK(T10)SEPARATING FROM ORB. 09 (RTJ005)

SEE THE ASSOCIATED CASE DOCUMENT FOR REFERENCE CHARACTERISTICS FOR INDIVIDUAL DATASETS

SYMBOL		PARAMETRIC VALUES			
X	- .057	MACH	4.530	PTOTAL	110.000
	400.480	ALPHA	.000	BETA	.000
	600.570	DALPHA	.000	DBETA	5.000
	1200.600	ELEVTR	.000	AILRON	.000
Y					

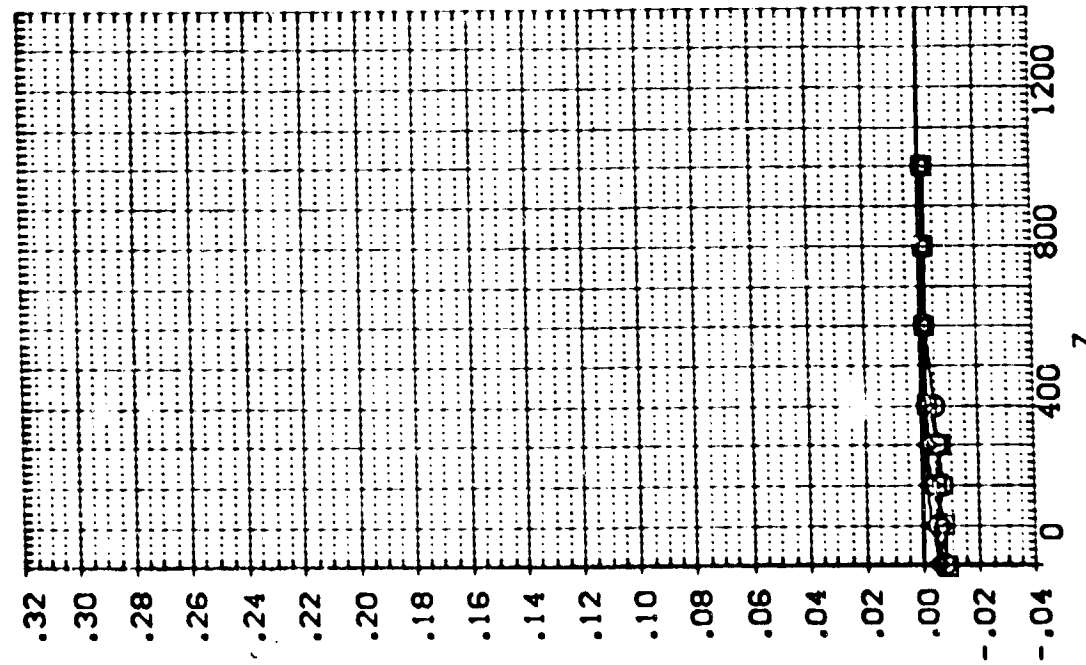
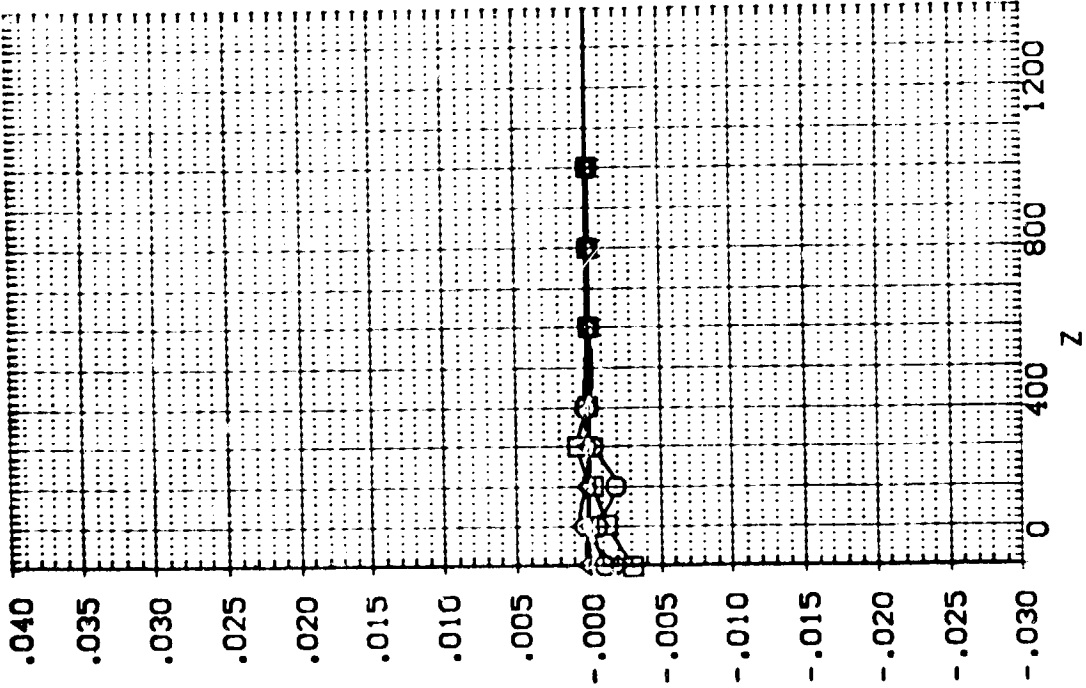

EFFECT OF EXTERNAL TANK SEPARATION ON ORBITER AERODYNAMIC CHARACTERISTICS

1A13.EXTERNAL TANK(T10)SEPARATING FROM ORB. 09 (RTJ006)

SEE THE ASSOCIATED DATA DOCUMENT FOR REFERENCE CHARACTERISTICS FOR INDIVIDUAL DATASETS

SYMBOL		PARAMETRIC VALUES	
x	.117	MACH	4.530
400	.310	ALPHA	.000
800	.510	DBETA	-5.000
1200	.900	AILLON	.000
y		PTOTAL	110.000
		BETA	.000
		DBETA	.000
		AILLON	.000

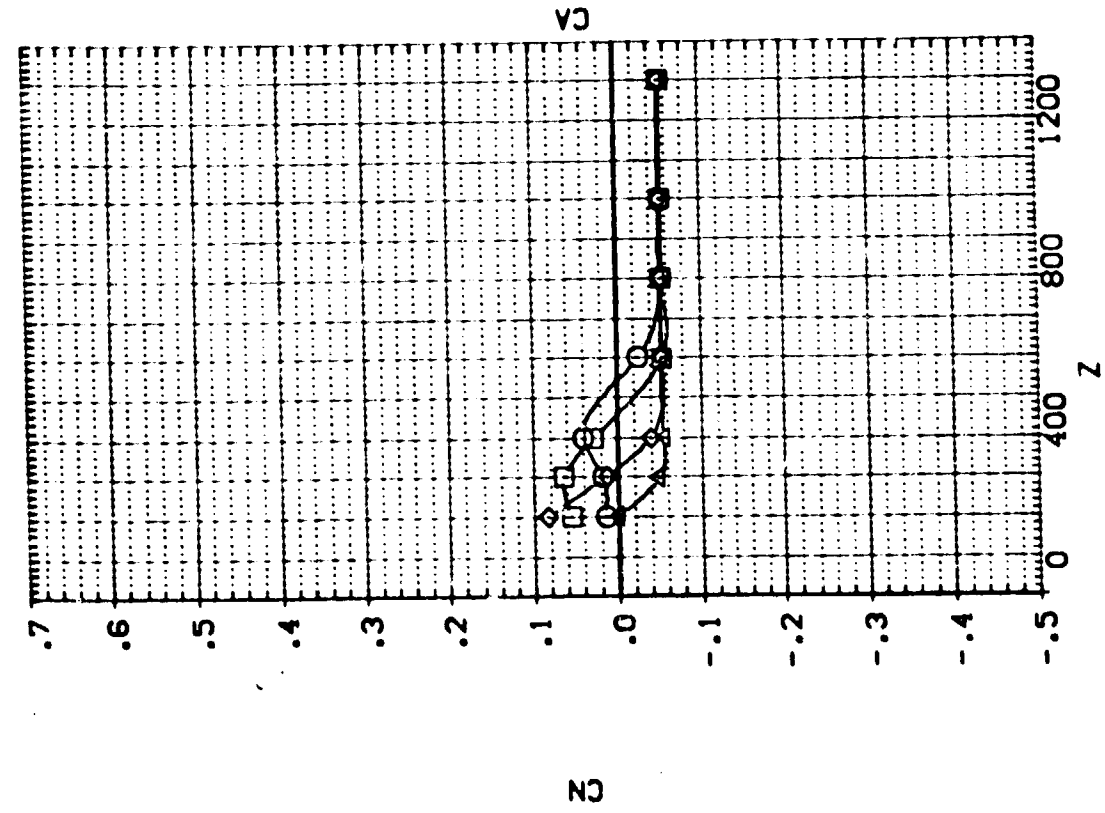
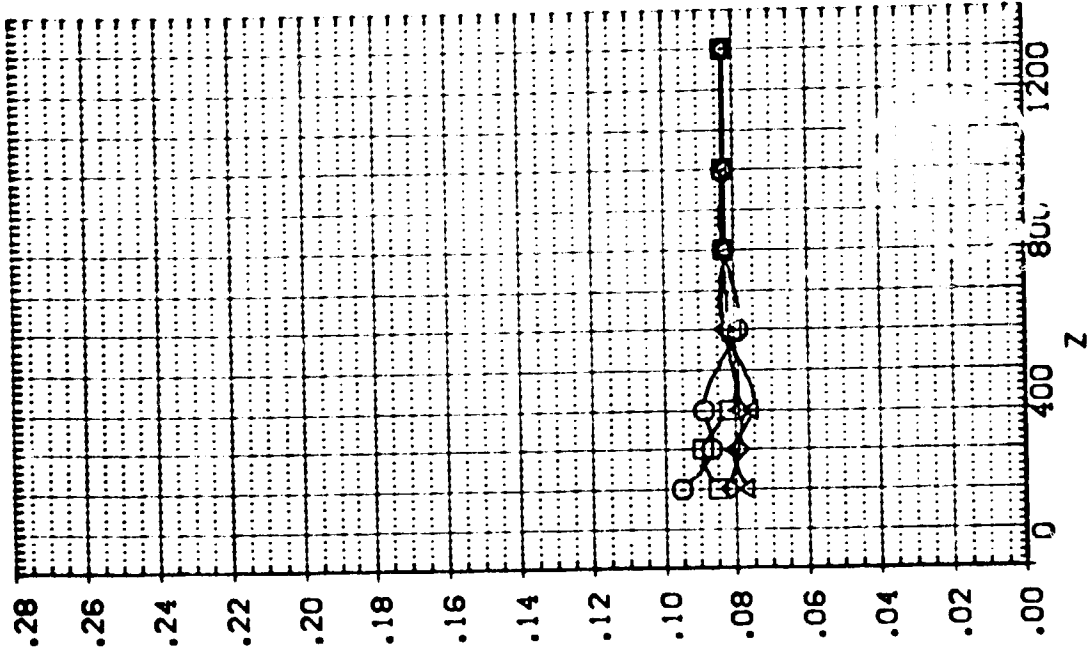

EFFECT OF EXTERNAL TANK SEPARATION ON ORBITER AERODYNAMIC CHARACTERISTICS

SEE THE ASSOCIATED DATA DOCUMENT FOR REFERENCE CHARACTERISTICS FOR INDIVIDUAL DATASETS

SYMCL		PARAMETRIC VALUES	
X	.117	MACH	4.530
		PTOTAL	110.000
400.310	ALPHA	.000	BETA
800.510	DALPHA	-5.000	DBETA
1200.900	ELEVTR	.000	AILRON
	Y	.000	

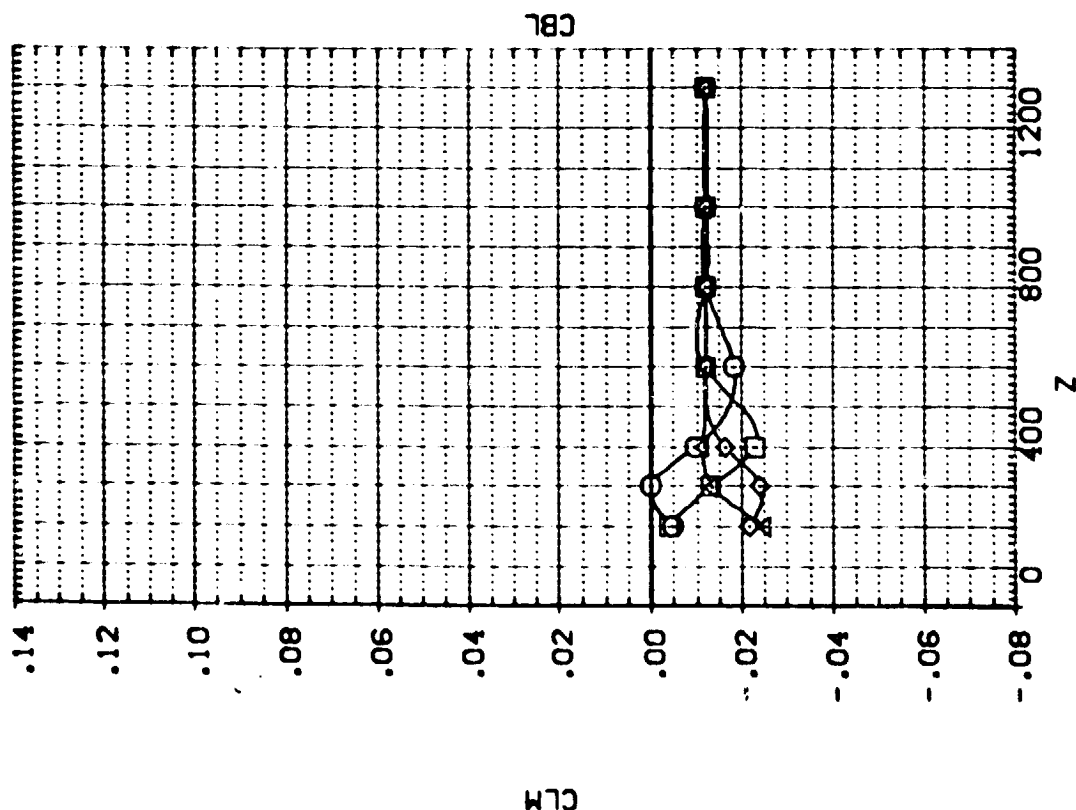
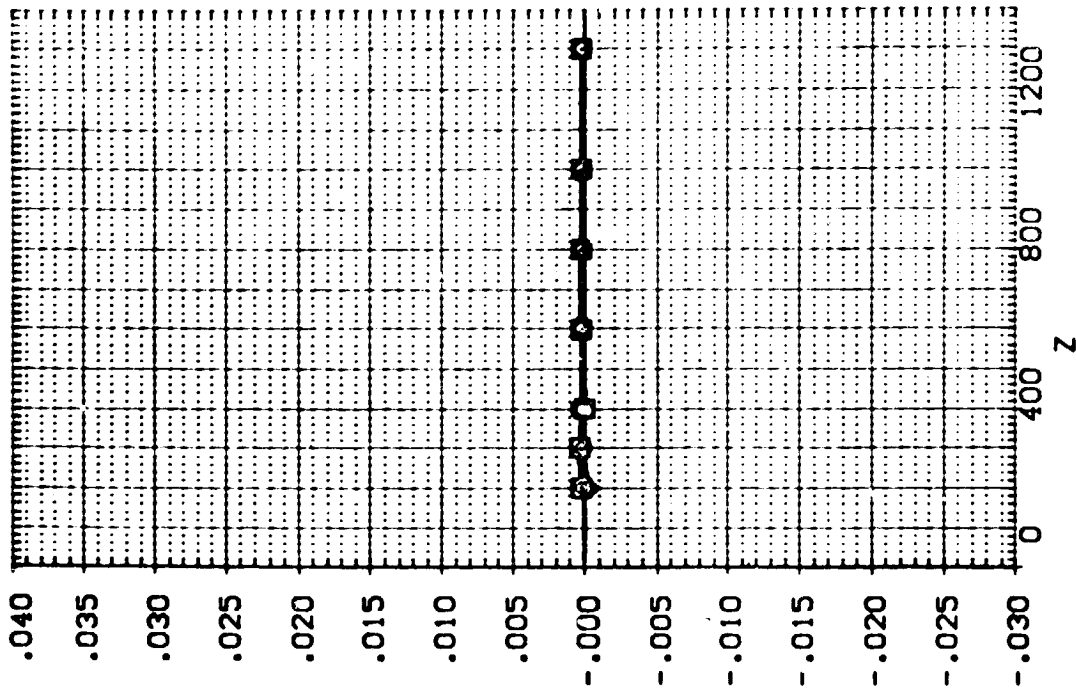

EFFECT OF EXTERNAL TANK SEPARATION ON ORBITER AERODYNAMIC CHARACTERISTICS



1A13.EXTERNAL TANK(T10)SEPARATING FROM ORB. 09 (RTJ006)

SEE THE ASSOCIATED DATA DOCUMENT FOR REFERENCE CHARACTERISTICS FOR INDIVIDUAL DATASETS

SYMBOL	X	Y	PARAMETRIC VALUES
○	.117	MA04	4.530 PTOTAL 110.000
□	400.310	ALPHA	.000 BETA .000
◇	800.510	DALPHA	-3.000 DBETA .000
△	1200.900	ELEVTR	.000 AILRON .000

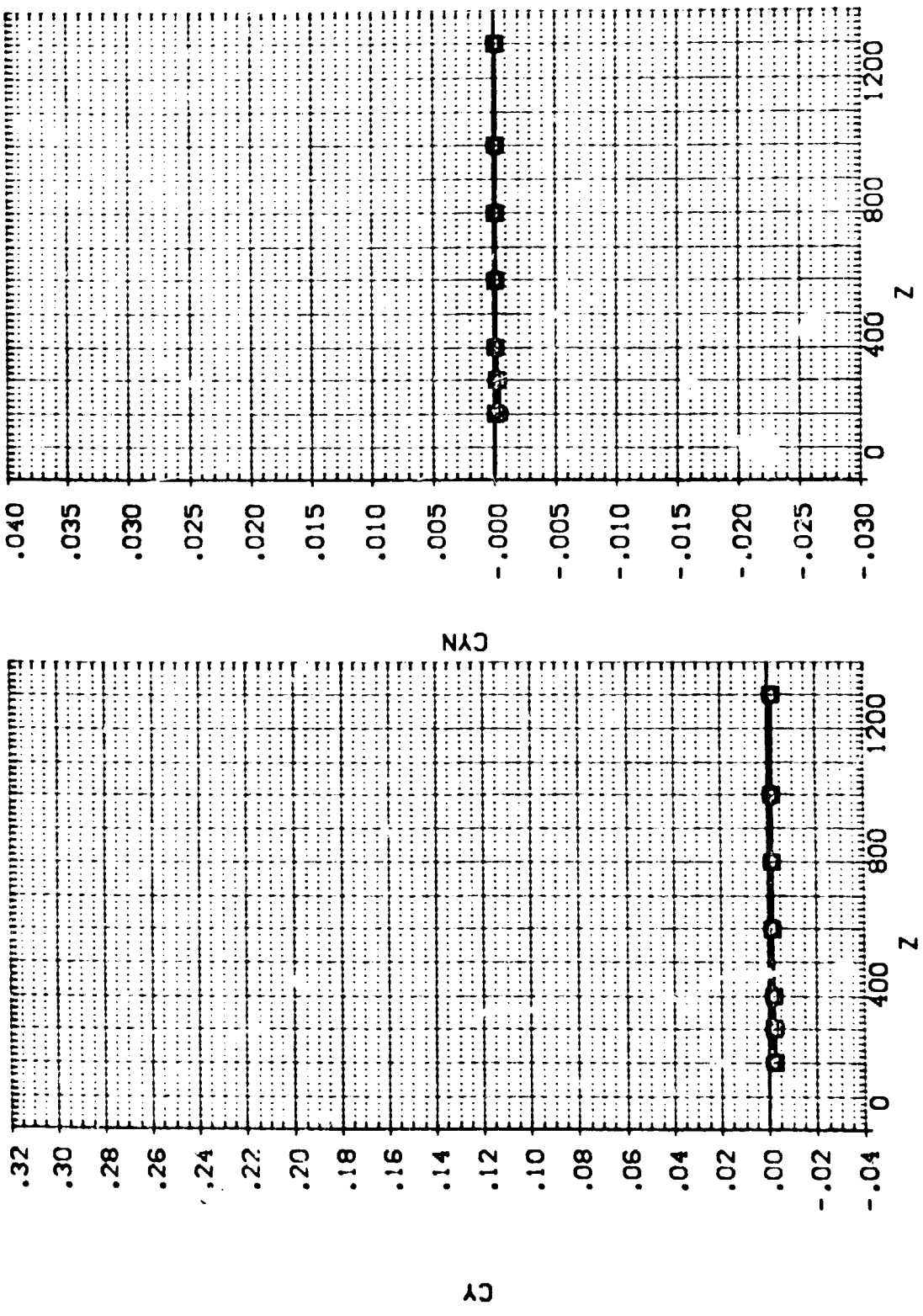

EFFECT OF EXTERNAL TANK SEPARATION ON ORBITER AERODYNAMIC CHARACTERISTICS

SEE THE ASSOCIATED DATA DOCUMENT FOR REFERENCE CHARACTERISTICS FOR INDIVIDUAL DATASETS

SYMBOL	X	MACH	PARAMETRIC VALUES
○	.057	4.530	PICITAL 110.000
□	400.430	.000	BETA .000
◇	800.500	-10.000	DBETA .000
△	1200.700	.000	ATLRON .000

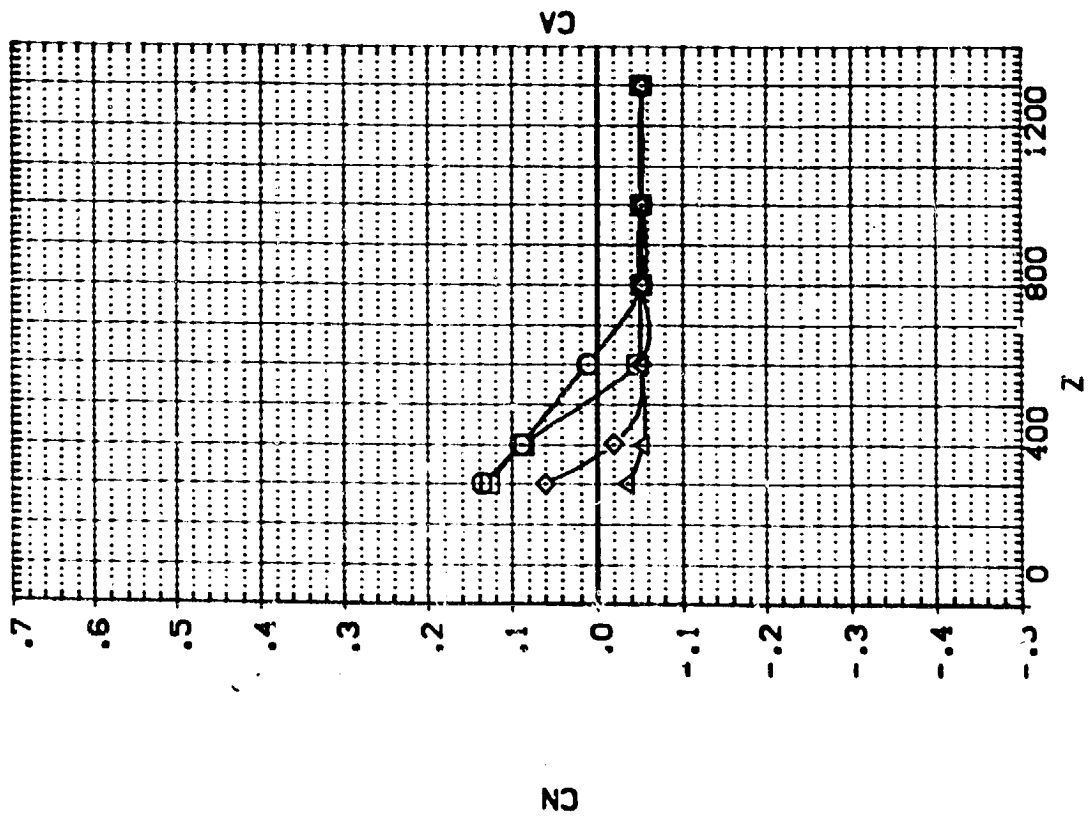
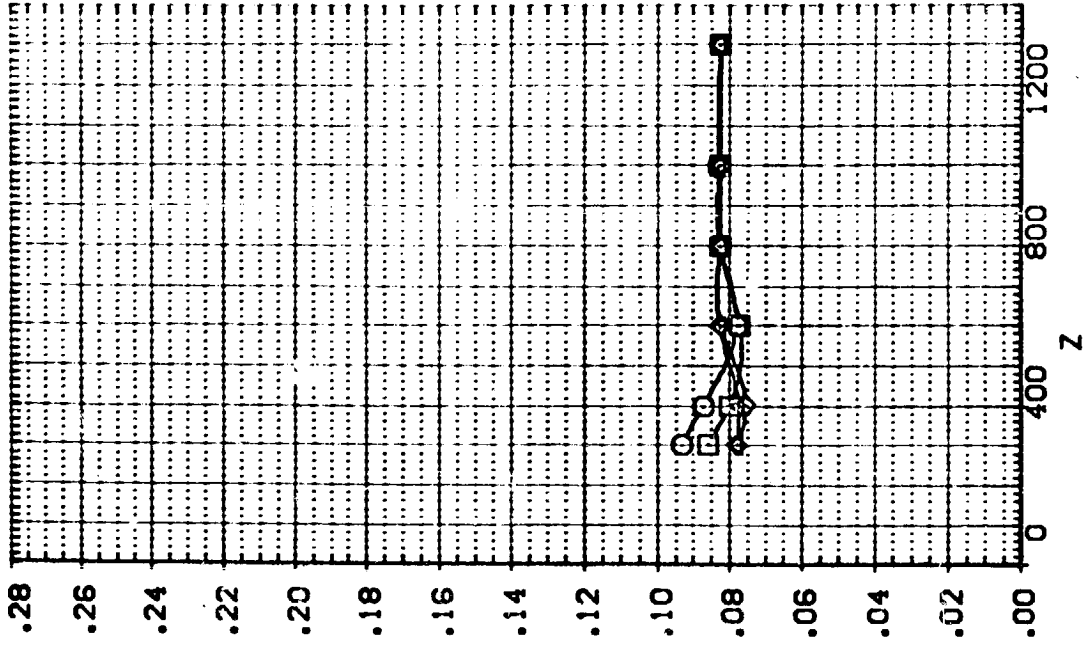

IA13.EXTERNAL TANK(T10)SEPARATING FROM ORB. 09 (RTJ007)

SEE THE ASSOCIATED DATA DOCUMENT FOR REFERENCE CHARACTERISTICS FOR INDIVIDUAL DATASETS

SYMBOL		X	PARAMETRIC VALUES			
○		.057	MACH	4.530	PTOTAL	110.000
□		400.430	ALPHA	.000	BETA	.000
◇		800.500	DALPHA	-10.000	DBETA	.000
△		1200.700	ELEVTR	.000	ALFRON	.000
			Y	.000		

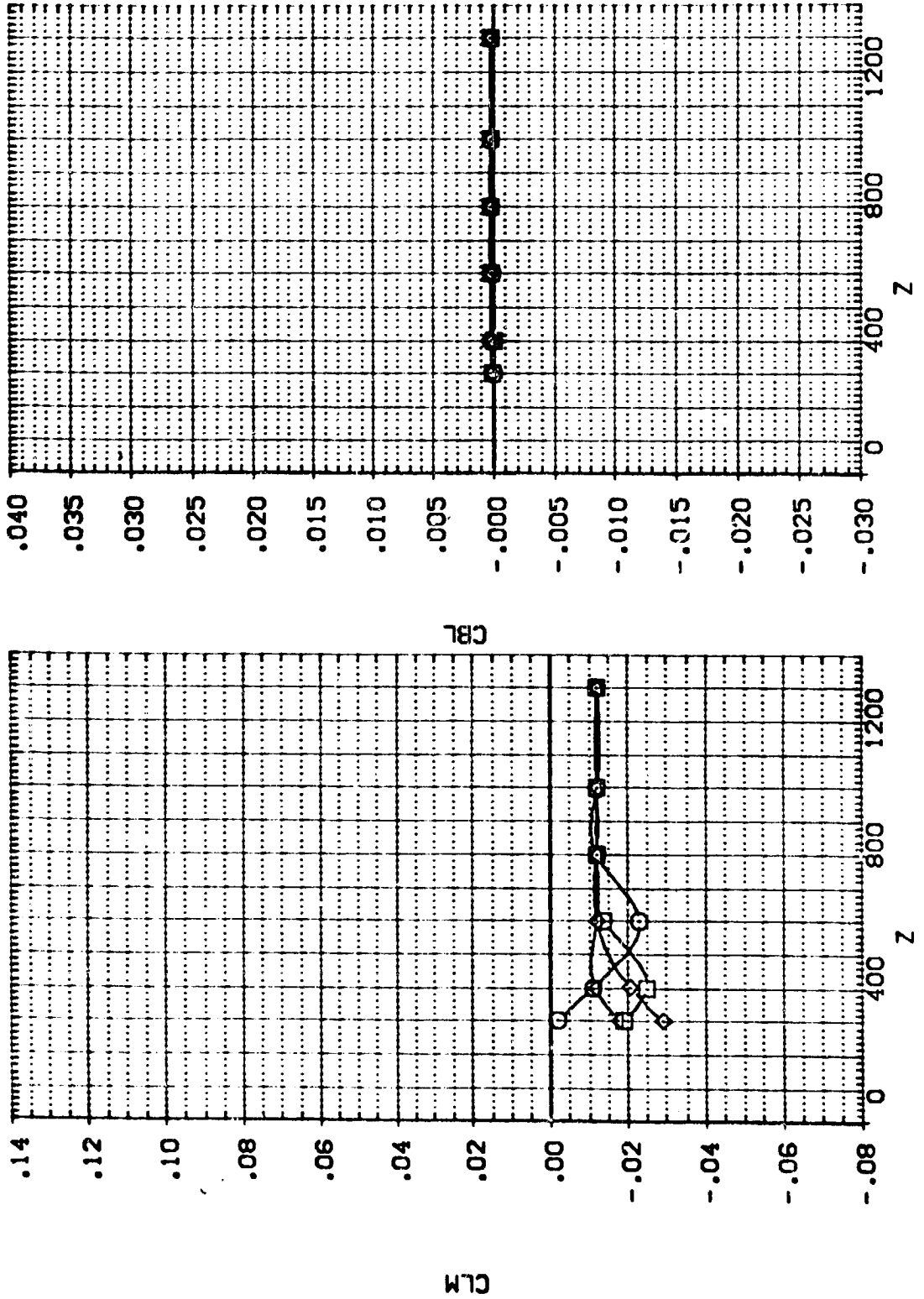

IA13, EXTERNAL TANK(T10)SEPARATING FROM ORB. 09 (RTJ007)

SEE THE ASSOCIATED DATA DOCUMENT FOR REFERENCE CHARACTERISTICS FOR INDIVIDUAL DATASETS

SYMBOL	X	MACH	PARAMETRIC VALUES
○	.057	4.530	PIOTAL 110.000
□	400.430	.000	BETA .000
◇	600.500	-10.000	DBETA .000
△	1200.700	.000	AIRLON .000
		.000	Y .000

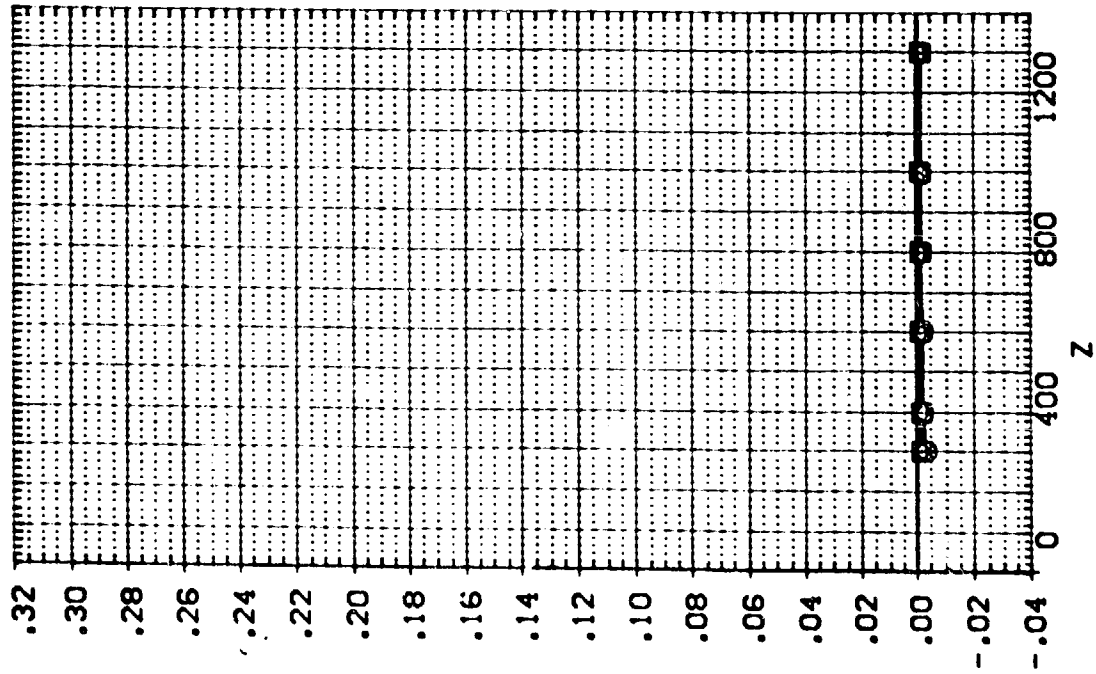
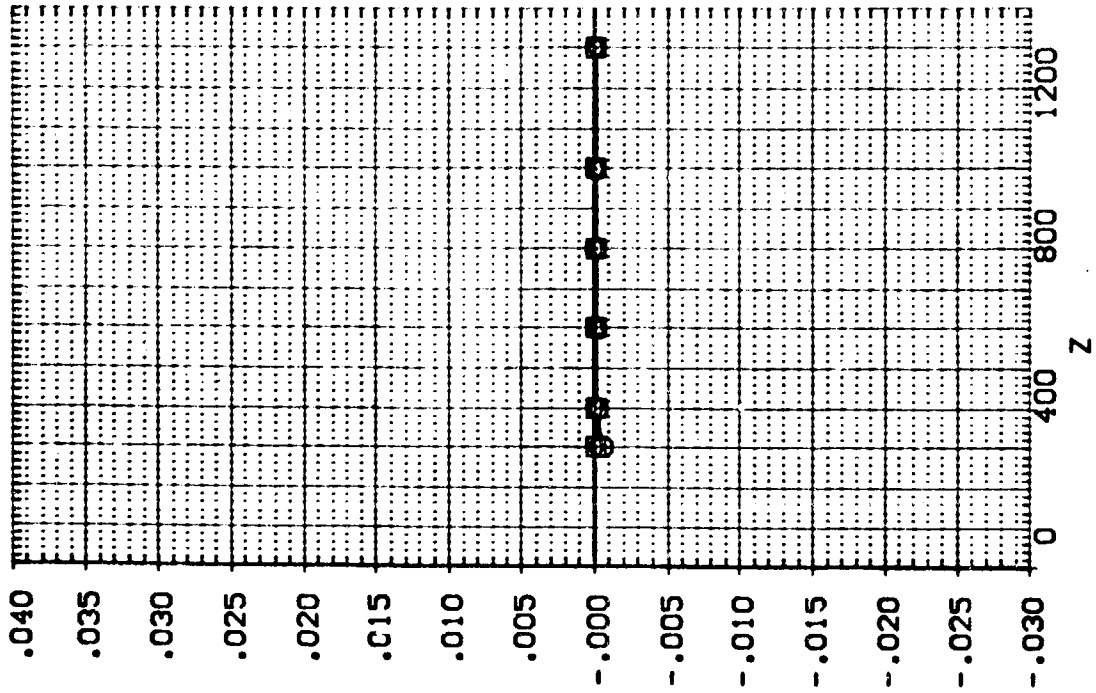

EFFECT OF EXTERNAL TANK SEPARATION ON ORBITER AERODYNAMIC CHARACTERISTICS

1A13.EXTERNAL TANK(T10)SEPARATING FROM ORB. 09 (RTJ008)

SEE THE ASSOCIATED DATA DOCUMENT FOR REFERENCE CHARACTERISTICS FOR INDIVIDUAL DATASETS

SYMBOL		PARAMETRIC VALUES	
○	MACH	4.530	PITCHAL 110.000
□	ALPHA	.000	BETA .000
◇	DALPHA	-10.000	DBETA .000
△	ELEVTR	.000	AILRON .000
	Y	200.000	

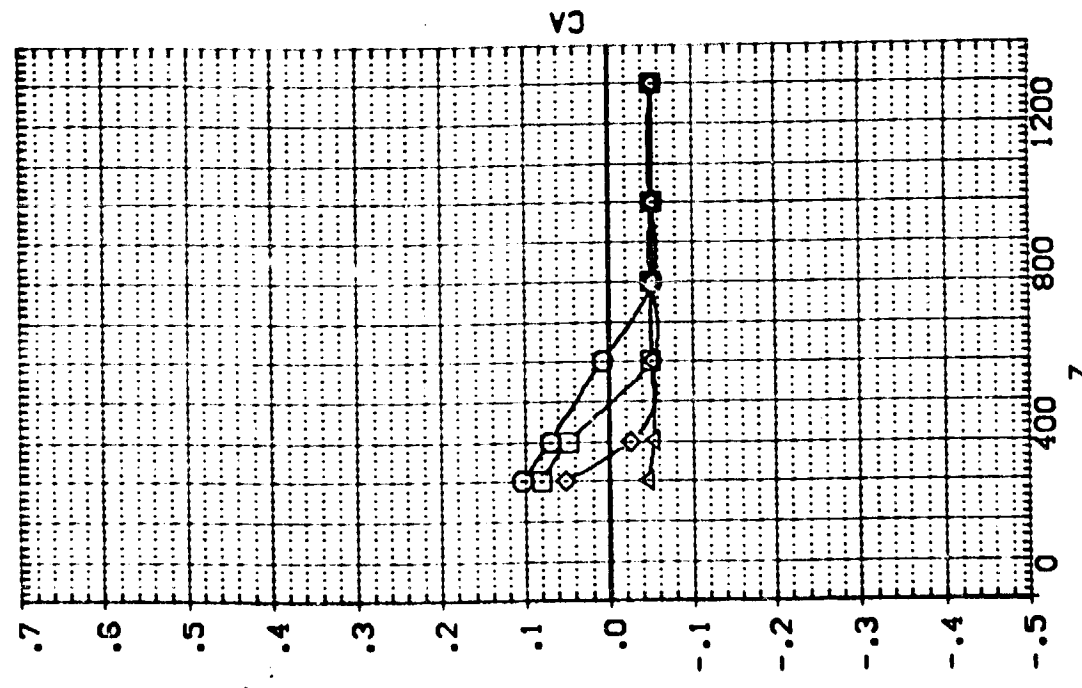
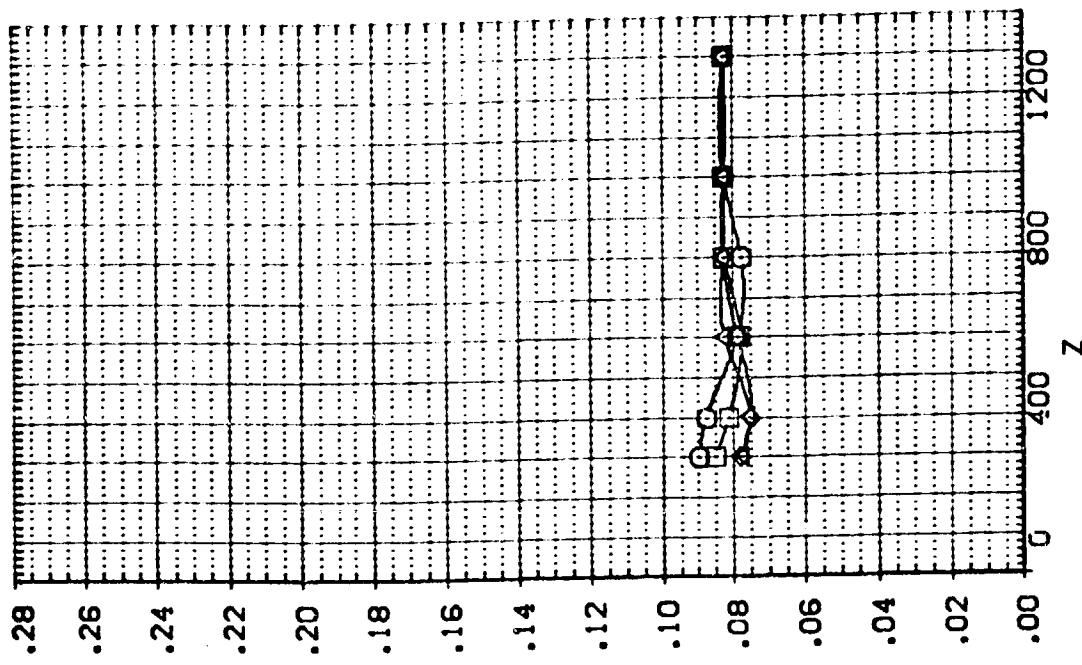

EFFECT OF EXTERNAL TANK SEPARATION ON ORBITER AERODYNAMIC CHARACTERISTICS

1A13.EXTERNAL TANK(T10)SEPARATING FROM ORB. 09 (RTJ008)

SEE THE ASSOCIATED DATA DOCUMENT FOR THE CHARACTERISTICS FOR INDIVIDUAL DATASETS

SYMBOL		PARAMETRIC VALUES	
○	MACH	4.530	PTOTAL 110.000
□	ALPHA	.000	BETA .000
◇	DALPHA	-10.000	DBETA .000
△	ELEVTR	.000	AILRON .000
	Y	200.000	

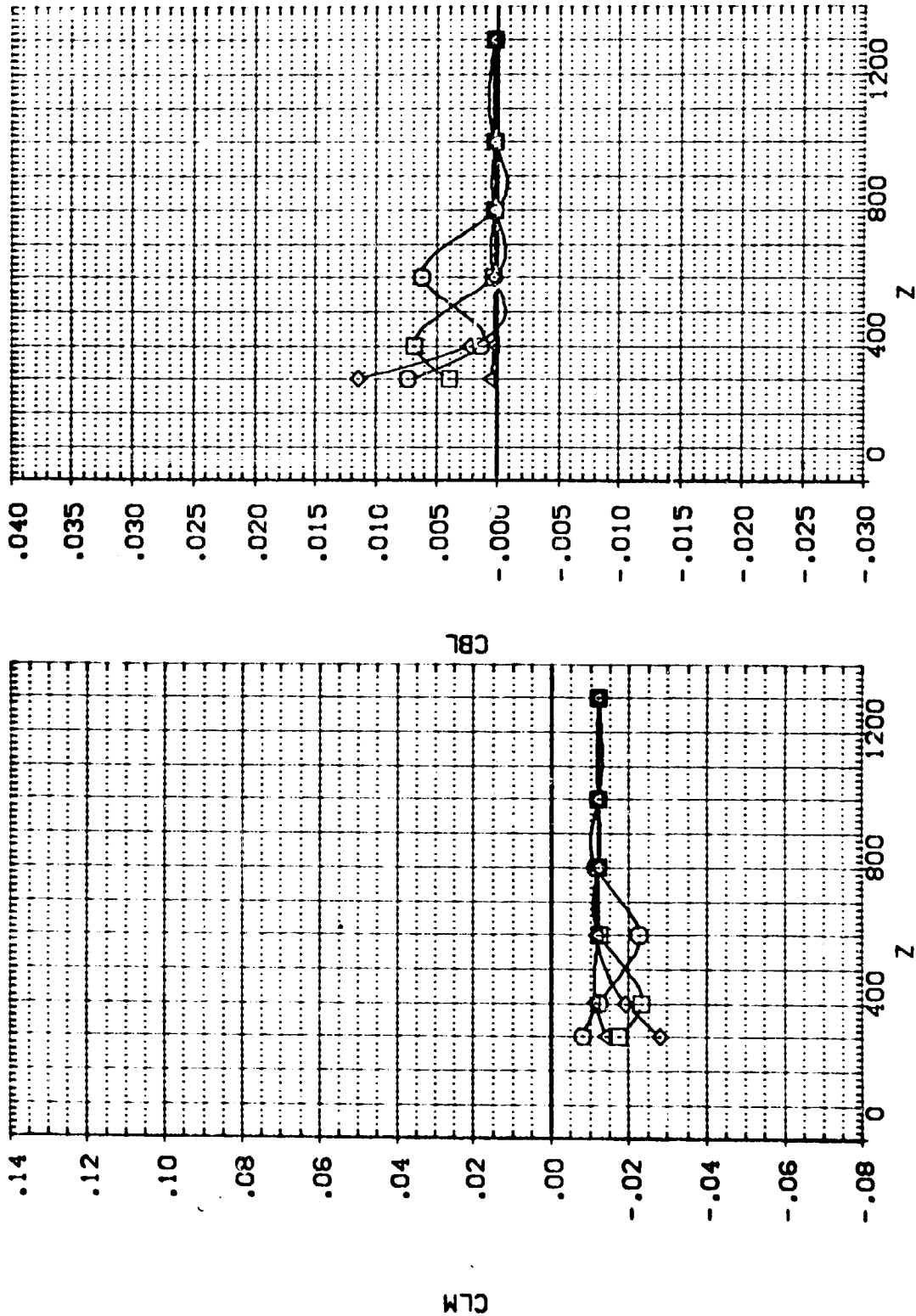

EFFECT OF EXTERNAL TANK SEPARATION ON ORBITER AERODYNAMIC CHARACTERISTICS



1A13. EXTERNAL TANK(T10)SEPARATING FROM ORB. 09 (RTJ008)

SEE THE ASSOCIATED DATA DOCUMENT FOR REFERENCE CHARACTERISTICS FOR INDIVIDUAL DATASETS

PARAMETRIC VALUES	
MACH	4.530
PTOTAL	110.000
BETA	.000
DBETA	.000
AILRON	.000
AILRPN	.000
Y	200.000
X	.062
ALPHA	400.260
DELTA	800.620
ELEVTR	1200.700

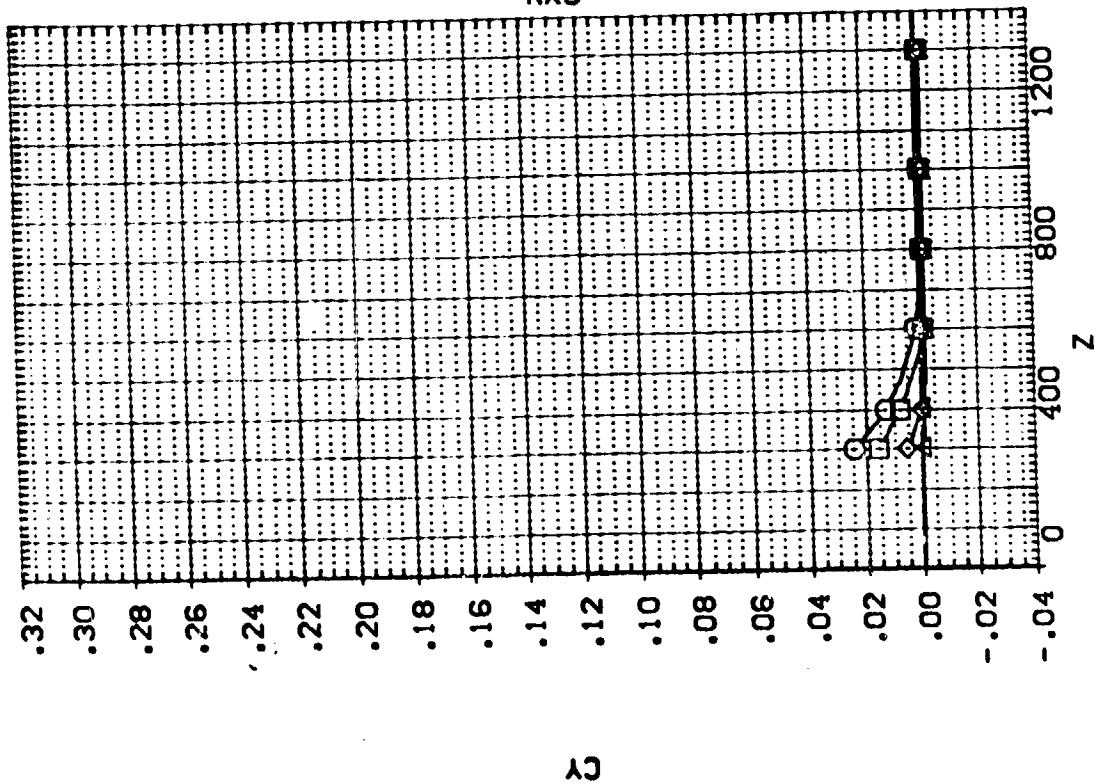
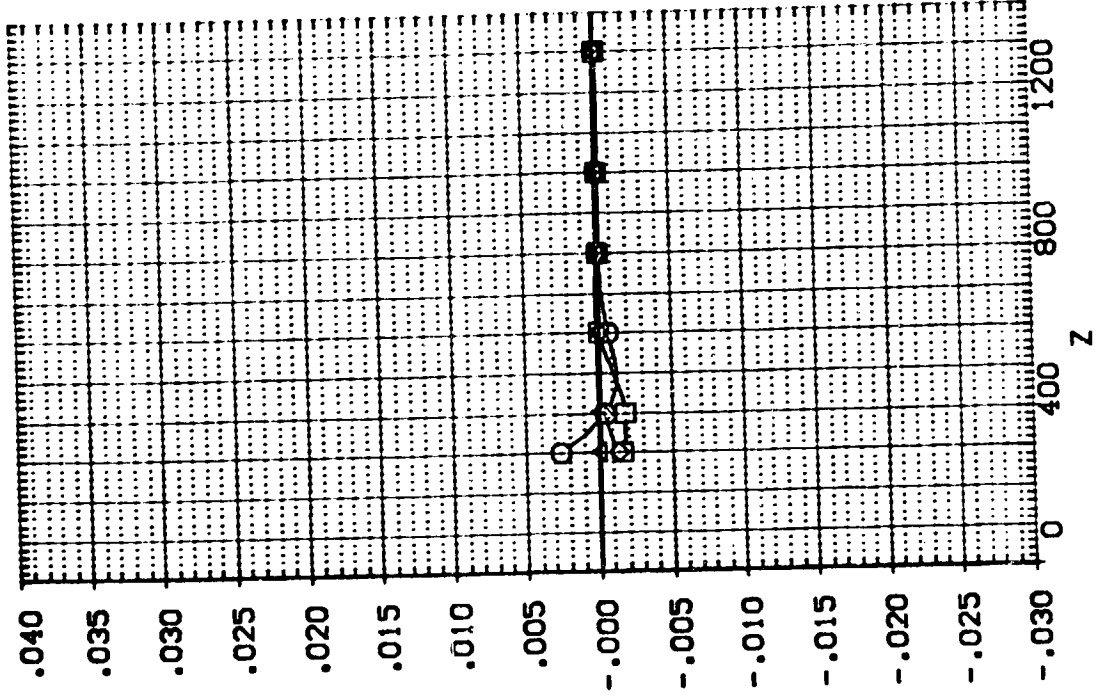

SEE THE ASSOCIATED DATA DOCUMENT FOR REFERENCE CHARACTERISTICS FOR INDIVIDUAL DATASETS

SYMBOL		PARAMETRIC VALUES	
○	x	MACH	110.000
□	400.510	ALPHA	.000
◇	800.420	DALPHA	-10.000
△	1200.800	ELEVTR	.000
	y	PTOTAL	5.000
		BETA	.000
		DBETA	.000
		AIRLON	.000
		Y	200.000

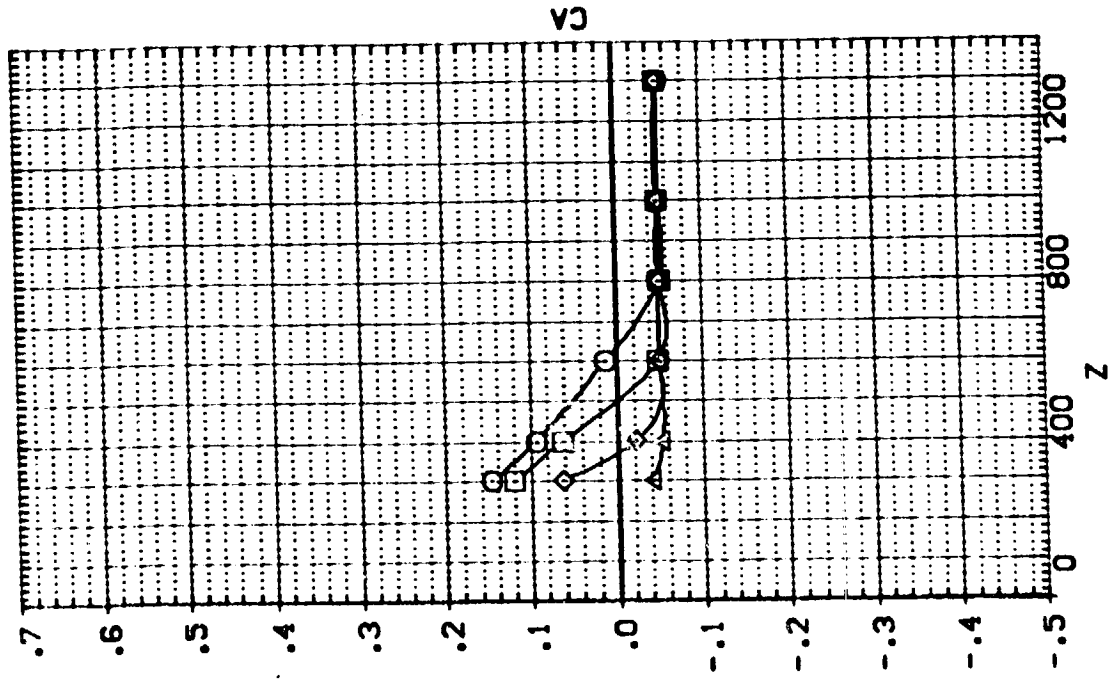
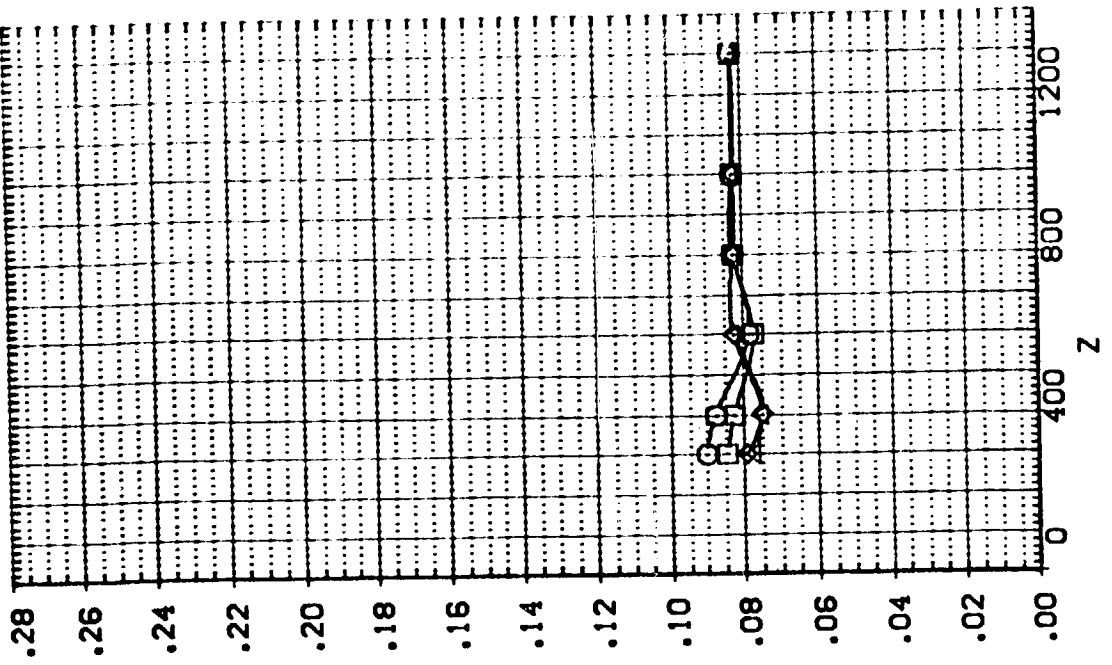

EFFECT OF EXTERNAL TANK SEPARATION ON ORBITER AERODYNAMIC CHARACTERISTICS

IA13.EXTERNAL TANK(T10)SEPARATING FROM ORB. 09 (RTJ009)

SEE THE ASSOCIATED DATA DOCUMENT FOR REFERENCE CHARACTERISTICS FOR INDIVIDUAL DATASETS

SYMBOL		PARAMETRIC VALUES	
○	X	MACH	PTOTAL
□	400.510	4.530	110.000
◇	800.420	.000	BETA
△	1200.800	-10.000	DETA
		.000	AILRON
		200.000	Y

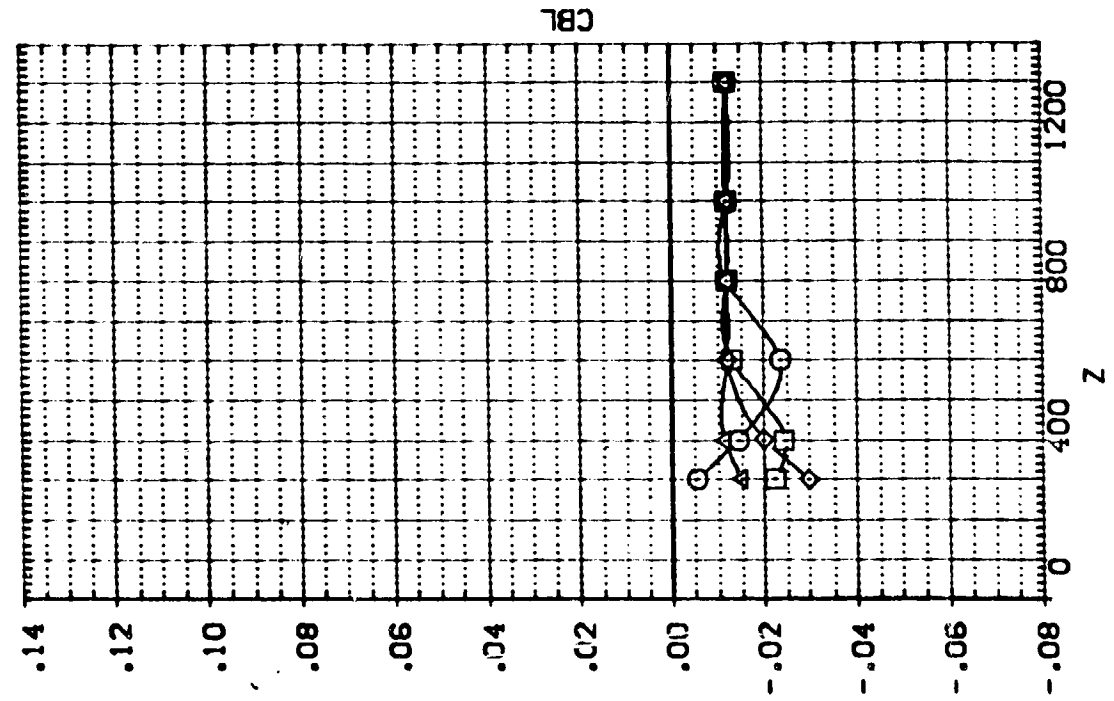
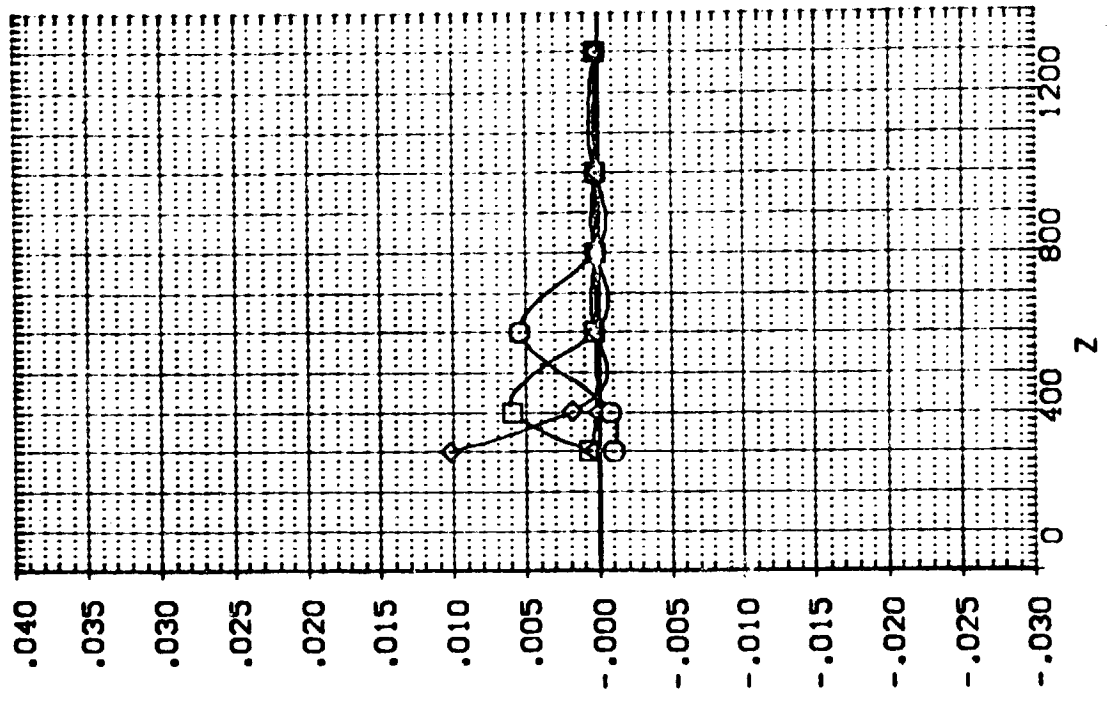

IA13. EXTERNAL TANK(T10)SEPARATING FROM ORB. 09 (RTJ009)

SEE THE ASSOCIATED DATA DOCUMENT FOR REFERENCE CHARACTERISTICS FOR INDIVIDUAL DATASETS

PARAMETRIC VALUES	
MACH	4.530
PIDTAL	110.000
BETA	.000
DETA	5.000
AIRON	.000
Y	200.000
X	-.033
ALPHA	400.510
DALPHA	600.420
ELEVTR	1200.800

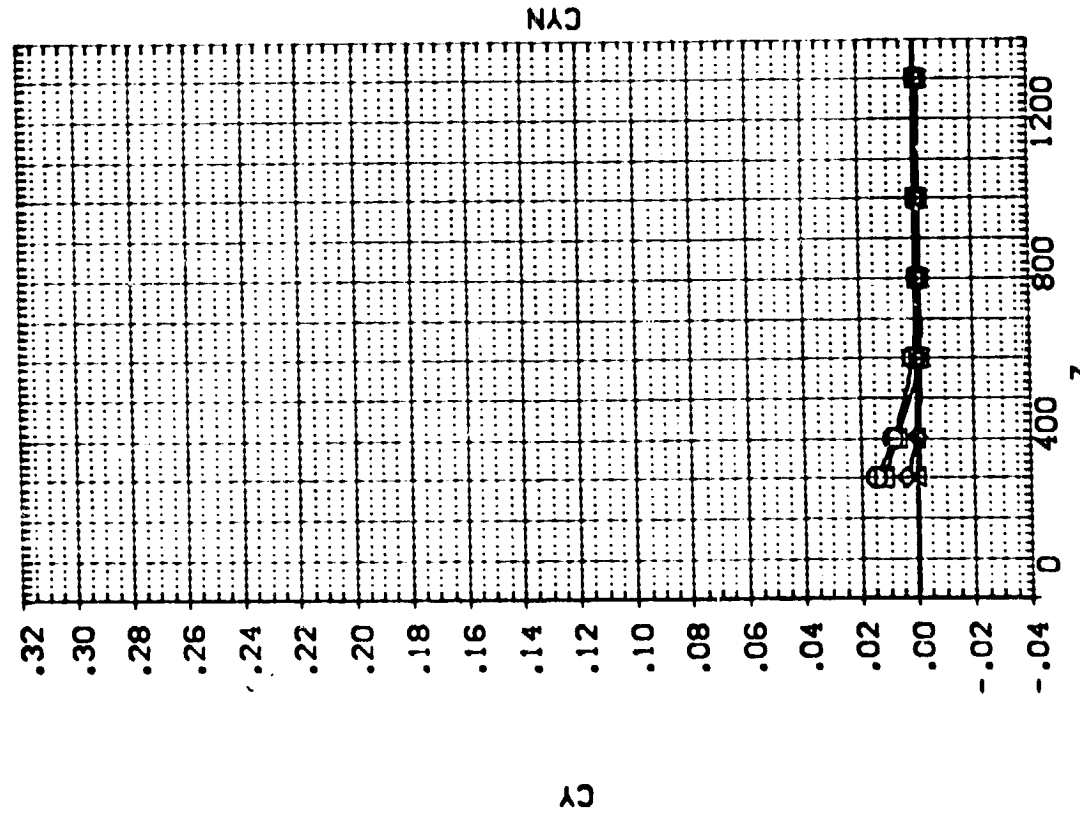
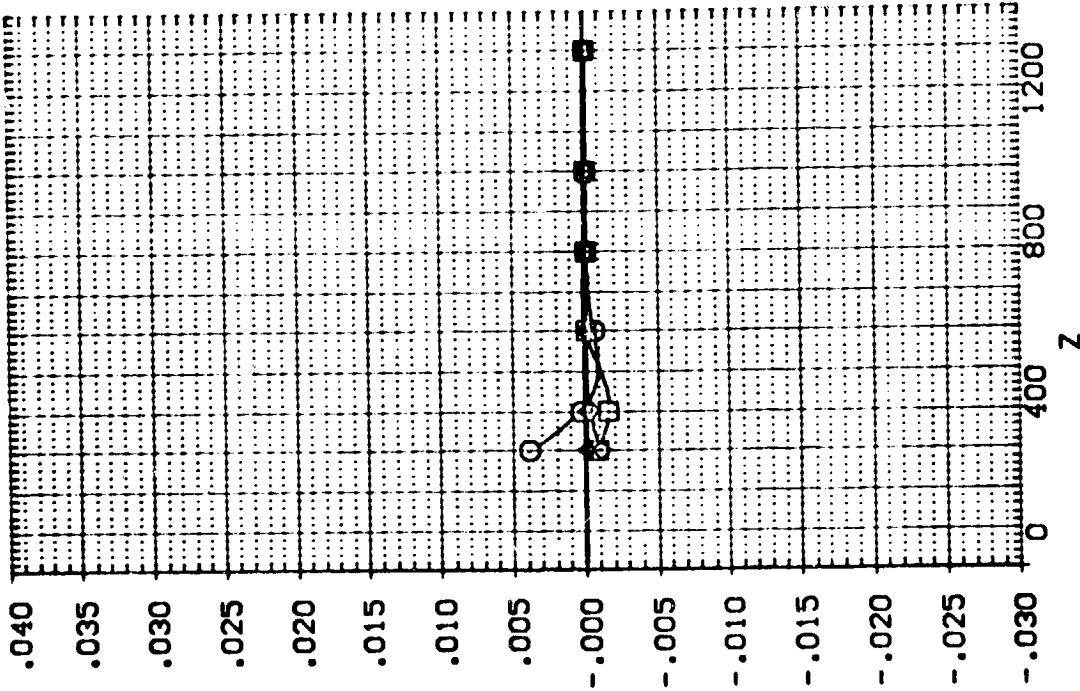

EFFECT OF EXTERNAL TANK SEPARATION ON ORBITER AERODYNAMIC CHARACTERISTICS

1A13.EXTERNAL TANK(T10)SEPARATING FROM ORB. 09 (RTJ010)

SEE THE ASSOCIATED DATA DOCUMENT FOR REFERENCE CHARACTERISTICS FOR INDIVIDUAL DATASETS

PARAMETRIC VALUES	
MACH	4.530
PTOTAL	110.000
ALPHA	.000
BETA	.000
DALPHA	-10.000
DBETA	5.000
ELEVTR	.000
AILRON	.000
Y	.000

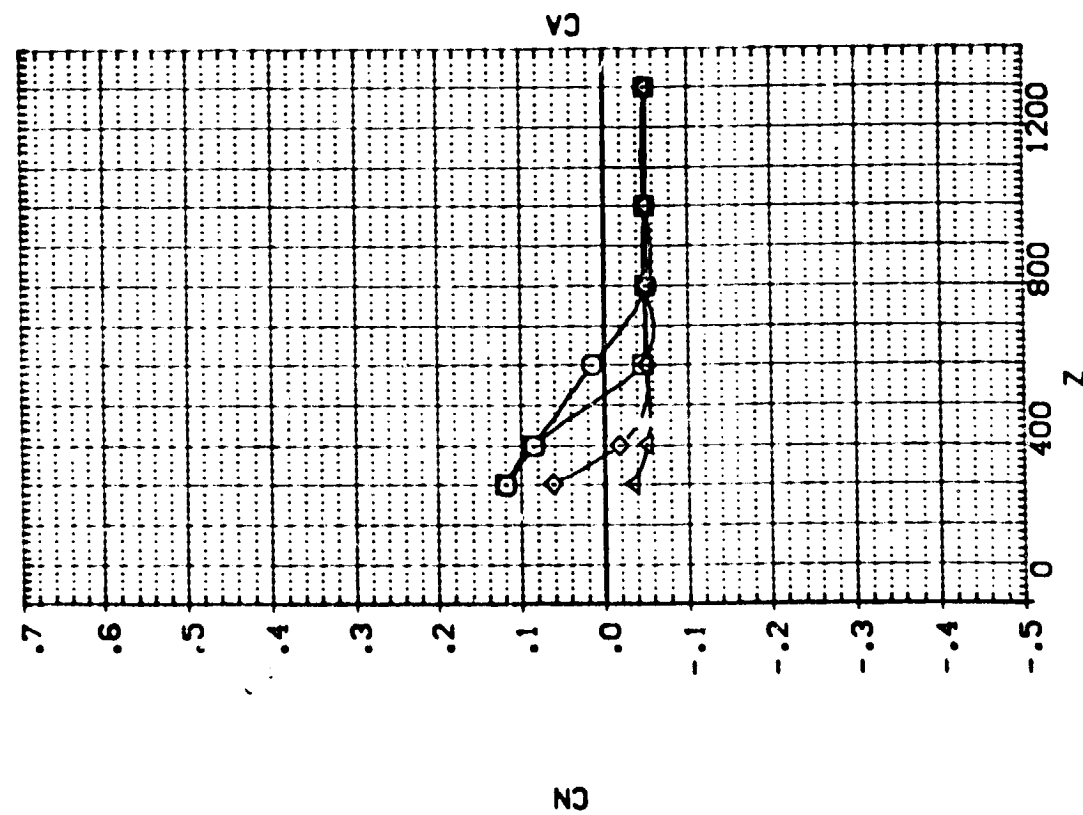
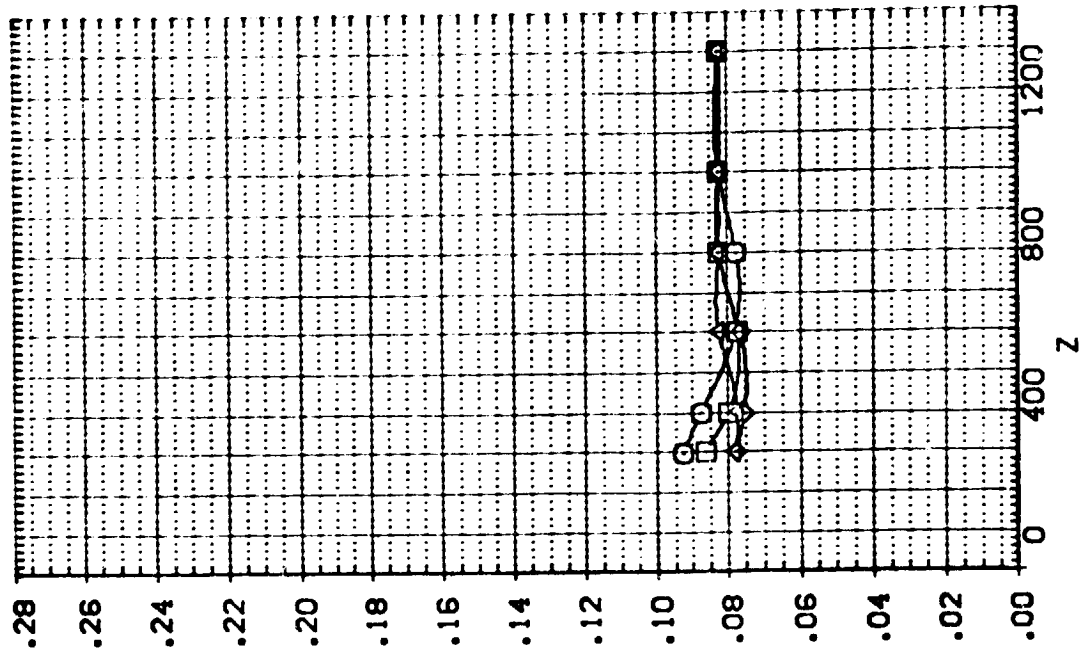

EFFECT OF EXTERNAL TANK SEPARATION ON ORBITER AERODYNAMIC CHARACTERISTICS

SEE THE ASSOCIATED DATA DOCUMENT FOR REFERENCE CHARACTERISTICS FOR INDIVIDUAL DATASETS

Symbol	x	MACH	PARAMETRIC VALUES	PTOTAL	110.000
○	-.043	4.530	BETA	.000	.000
□	400.200	.000	DBETA	5.000	.000
◇	800.550	-10.000	AILFRON	.000	.000
△	1200.800	.000	Y	.000	.000

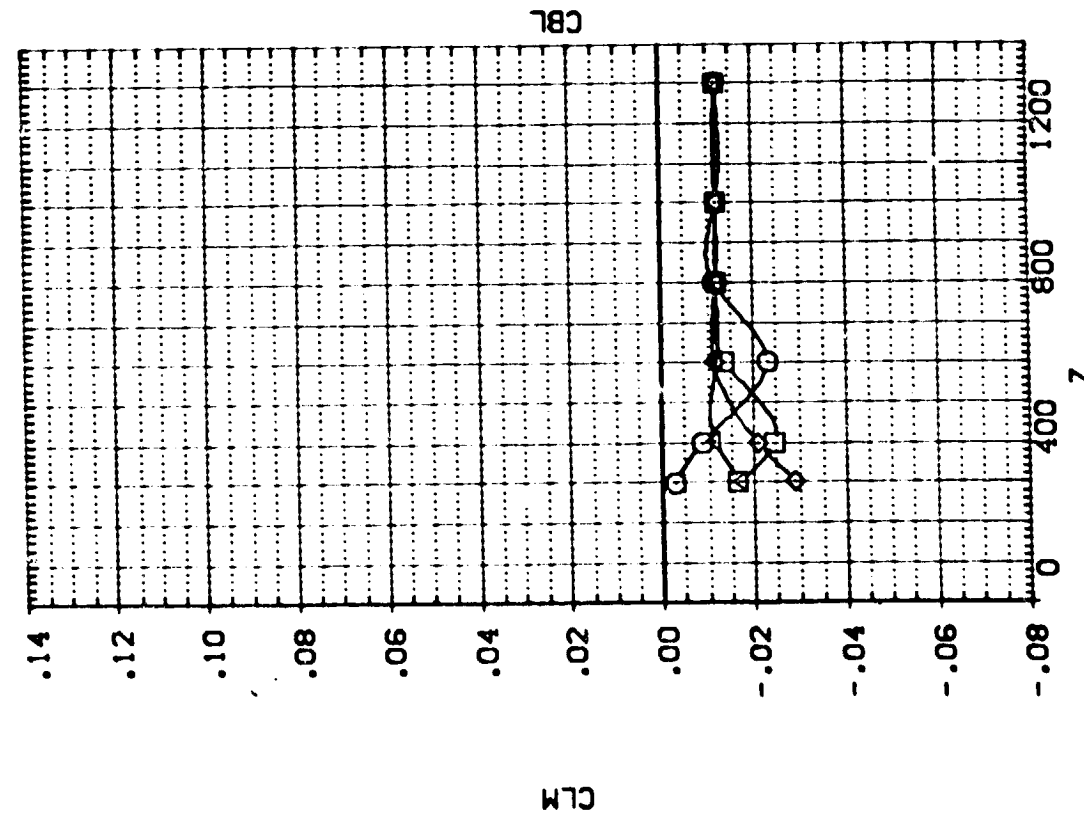
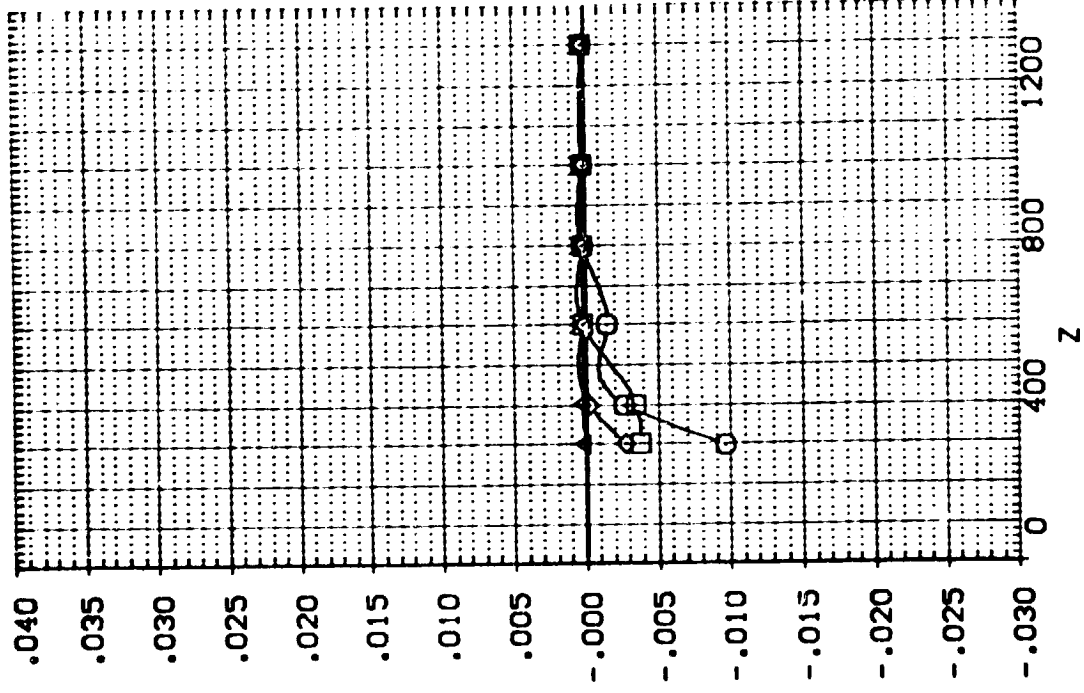

EFFECT OF EXTERNAL TANK SEPARATION ON ORBITER AERODYNAMIC CHARACTERISTICS



IA13.EXTERNAL TANK(T10)SEPARATING FROM ORB. 09 (RTJ010)

SEE THE ASSOCIATED DATA DOCUMENT FOR REFERENCE CHARACTERISTICS FOR INDIVIDUAL DATASETS

SYMBOL		PARAMETRIC VALUES	
○	X	MACH	PTOTAL
□	400.200	ALPHA	BETA
◇	600.550	DALPHA	DBETA
△	1,207.800	ELEVTR	AIRCFT
		Y	

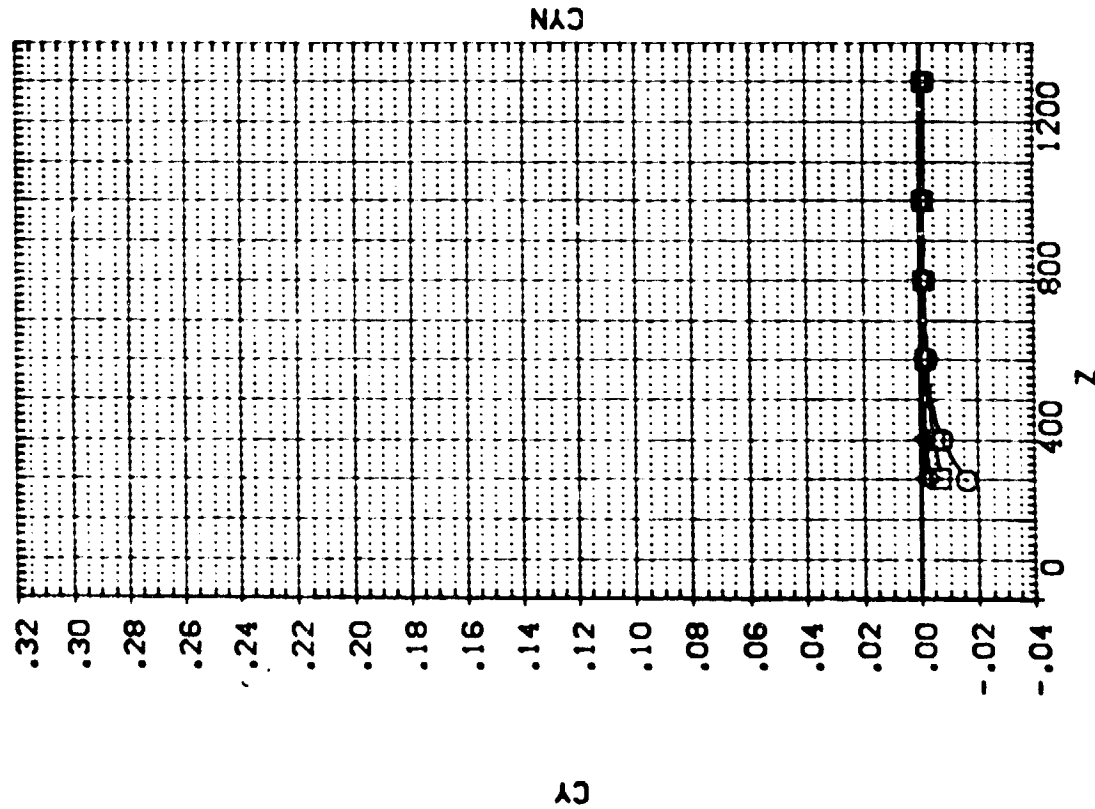
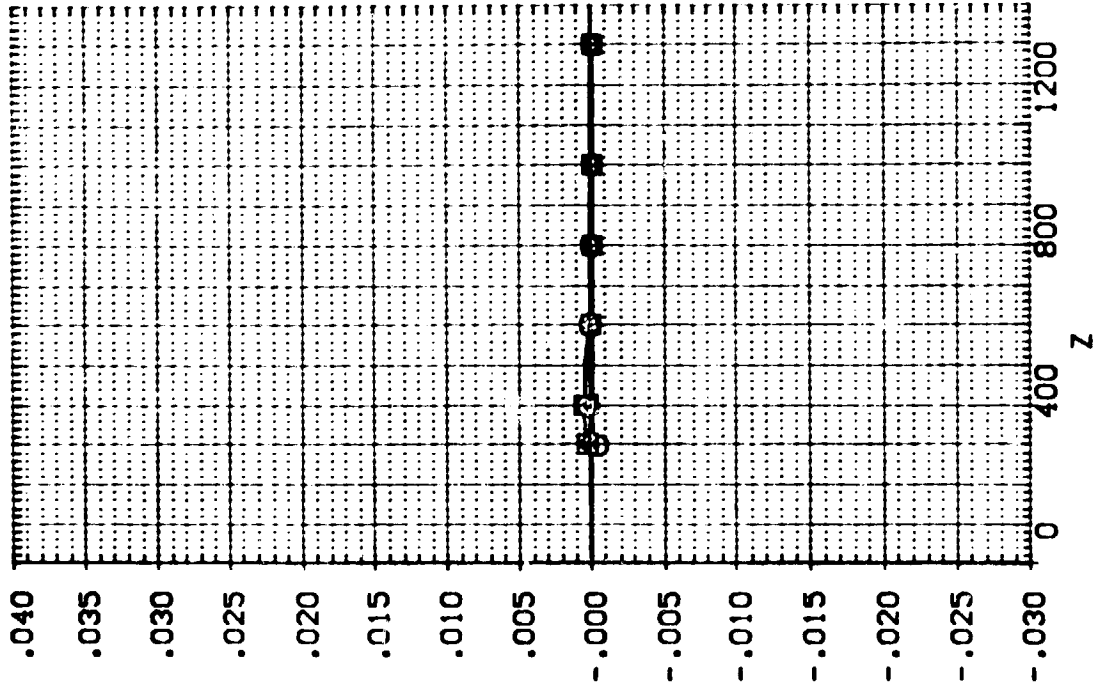

EFFECT OF EXTERNAL TANK SEPARATION ON ORBITER AERODYNAMIC CHARACTERISTICS

IA13, EXTERNAL TANK(T10)SEPARATING FROM ORB. 09 (RTJ011)

SEE THE ASSOCIATED DATA DOCUMENT FOR REFERENCE CHARACTERISTICS FOR INDIVIDUAL DATASETS

PARAMETRIC VALUES	
MACH	110.000
PIOTAL	.000
BETA	.000
DBETA	.000
AILRON	.000
Y	.000
X	
-0.876	
401.340	
800.910	
1200.600	

SYMBOL
 ○
 □
 ◇
 △

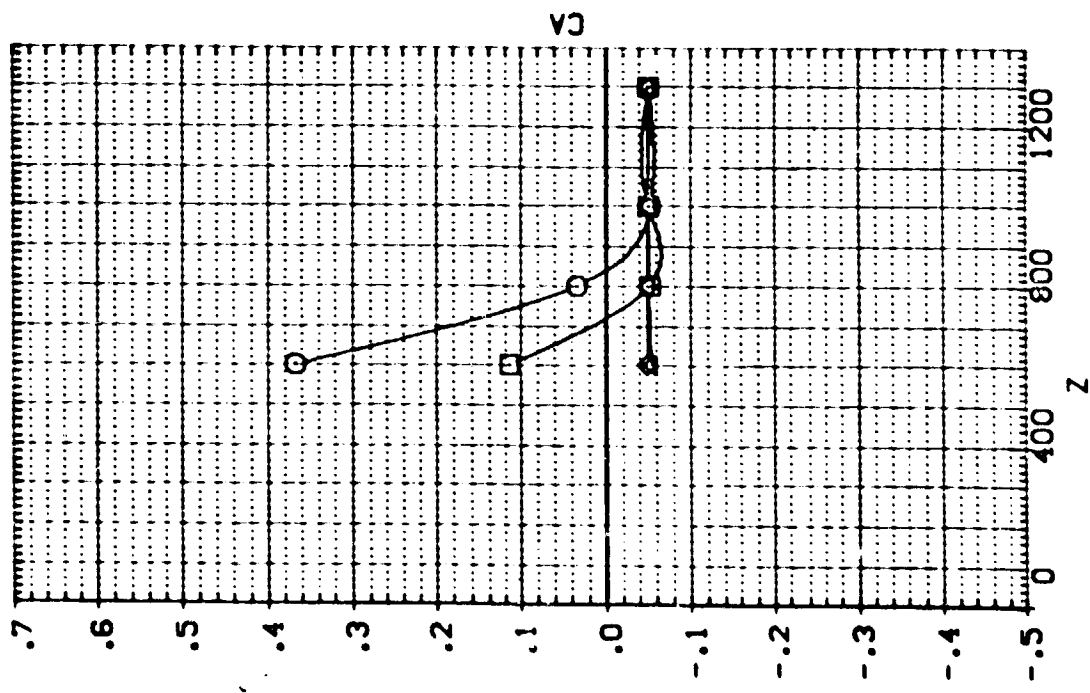
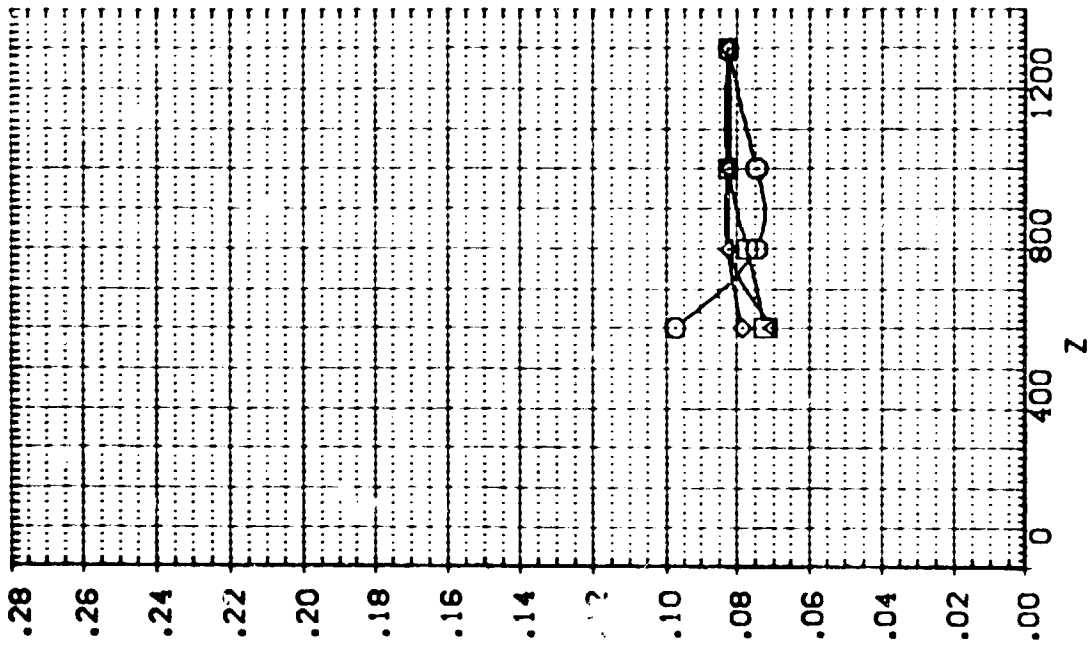

EFFECT OF EXTERNAL TANK SEPARATION ON ORBITER AERODYNAMIC CHARACTERISTICS

IA13, EXTERNAL TANK(T10) SEPARATING FROM ORB. 09 (RTJ011)

SEE THE ASSOCIATED DATA DOCUMENT FOR REFERENCE CHARACTERISTICS FOR INDIVIDUAL DATASETS

SYMBOL		PARAMETRIC VALUES	
○	X	MACH	110.000
□		ALPHA	.000
◇		DALPHA	.000
△		ELEVTR	.000
		Y	.000

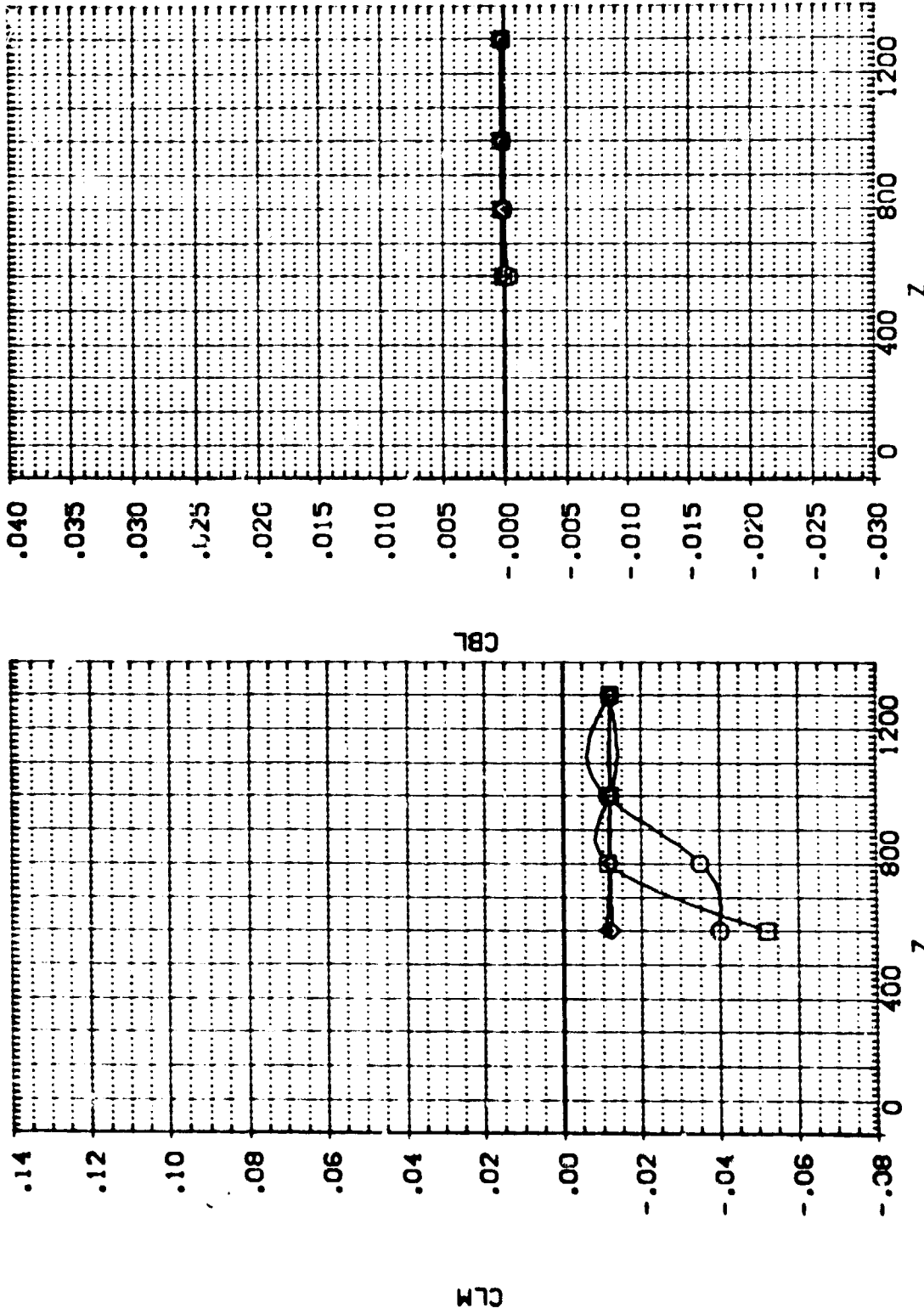

EFFECT OF EXTERNAL TANK SEPARATION ON ORBITER AERODYNAMIC CHARACTERISTICS

IA13. EXTERNAL TANK(T10)SEPARATING FROM ORB. 09 (RTJ011)

SEE THE ASSOCIATED DATA DOCUMENT FOR REFERENCE CHARACTERISTICS FOR INDIVIDUAL DATASETS

SYMBOL		PARAMETRIC VALUES	
○	X	MACH	4.530
□	Y	ALPHA	0.000
◇	Z	DALPHA	-20.000
△	Y	ELEVTR	0.000
		PTOTAL	110.000
		BETA	0.000
		DBETA	0.000
		AILRON	0.000
		AILRON	0.000

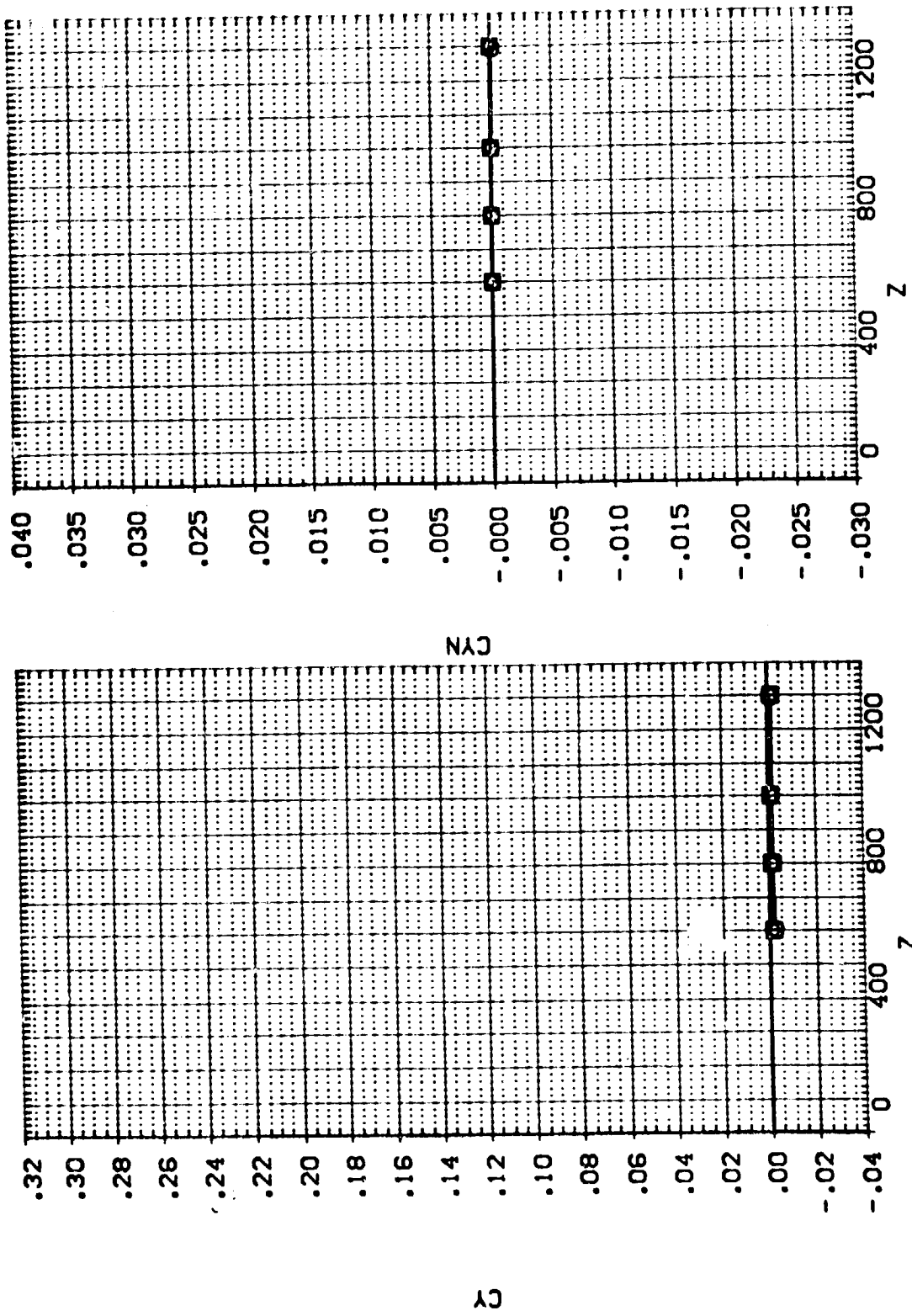

EFFECT OF EXTERNAL TANK SEPARATION ON ORBITER AERODYNAMIC CHARACTERISTICS

IA13. EXTERNAL TANK(T10)SEPARATING FROM ORB. 09 (RTJ012)

SEE THE ASSOCIATED DATA DOCUMENT FOR REFERENCE CHARACTERISTICS FOR INDIVIDUAL DATASETS

SYMBOL	X	MACH	PARAMETRIC VALUES
○	-.503	4.530	PIOTAL 110.000
□	400.530	.000	BETA .000
◇	800.210	-20.000	DBETA .000
△	1201.000	.000	AIRTON .000
		Y	200.000

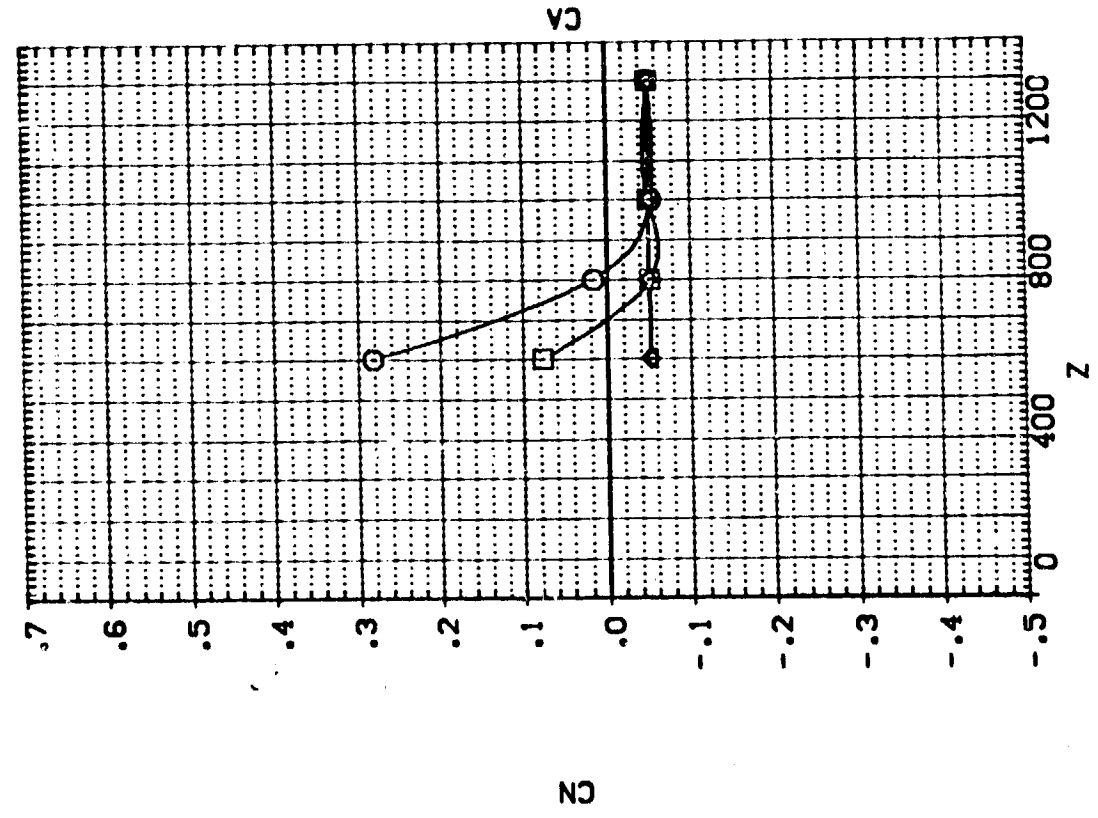
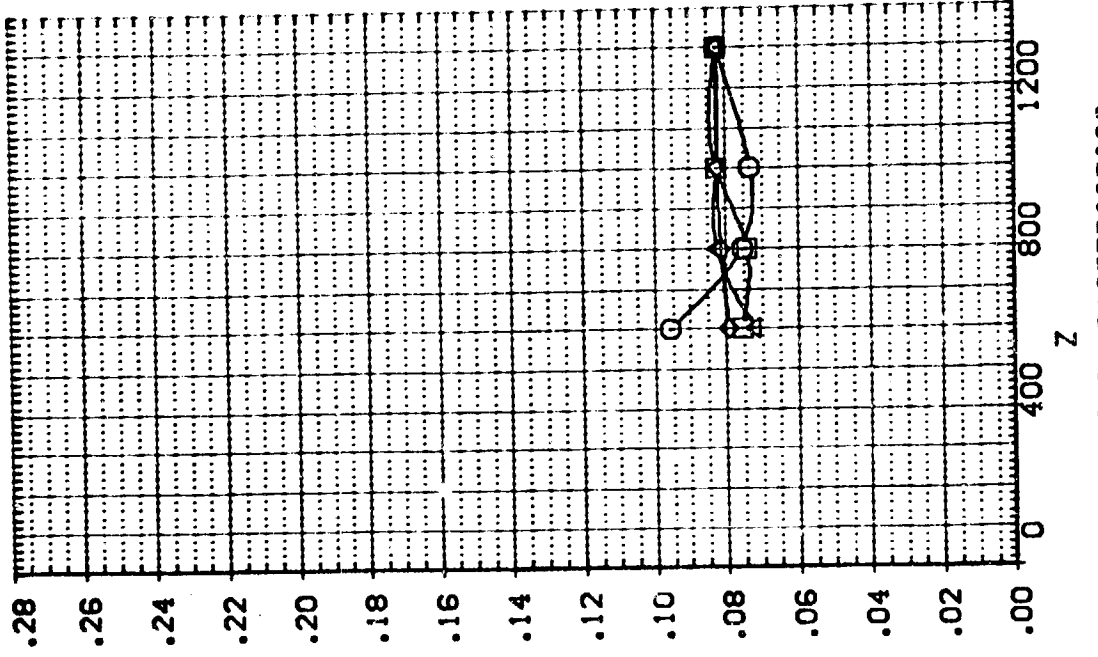

IA13. EXTERNAL TANK(T10)SEPARATING FROM ORB. 09 (RTJ012)

SEE THE ASSOCIATED DATA DOCUMENT FOR REFERENCE CHARACTERISTICS FOR INDIVIDUAL DATASETS

SYMBOL		PARAMETRIC VALUES	
○	X	MACH	PTOTAL
□	400.530	ALPHA	BETA
◇	800.210	DALPHA	DBETA
△	1201.000	ELEVTR	AILRON
		Y	200.000

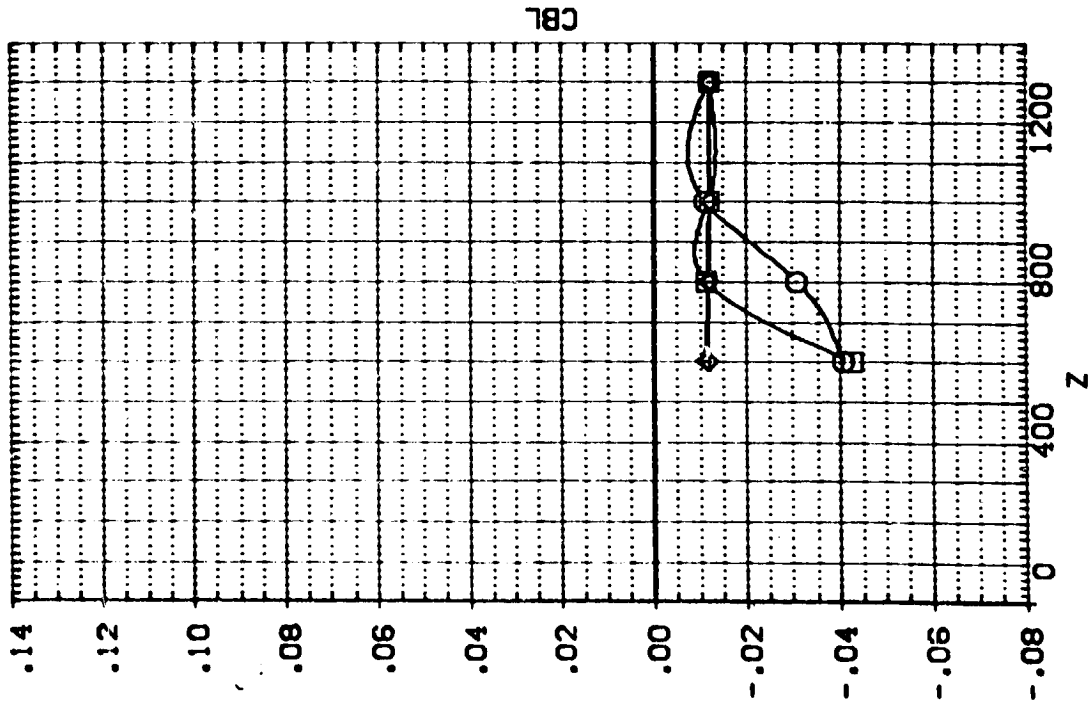
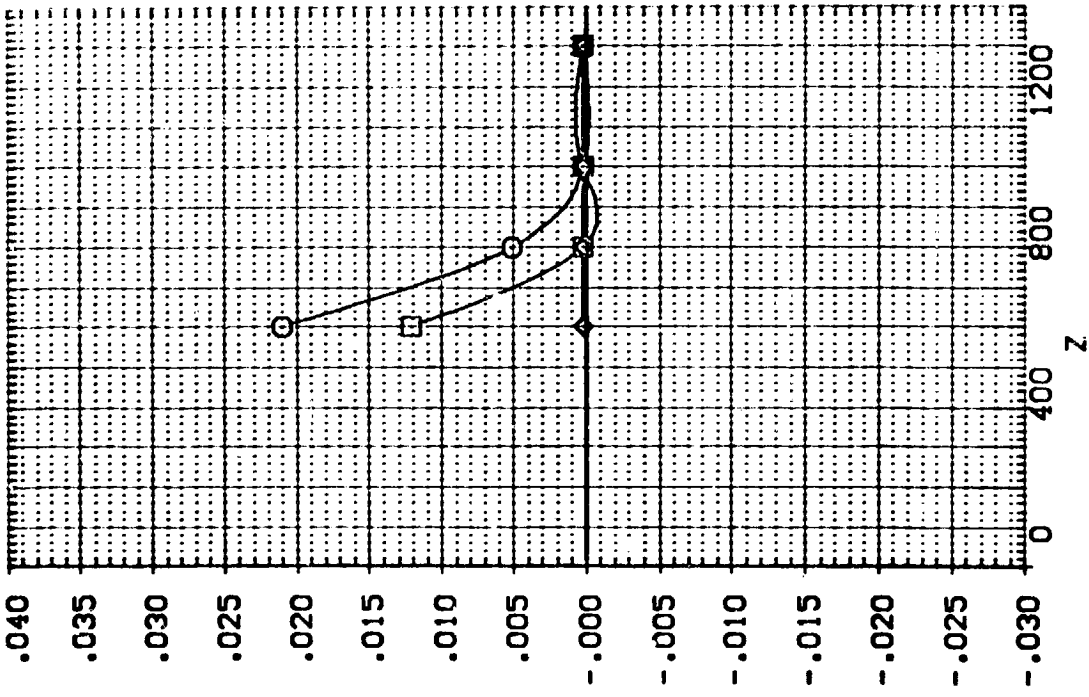

EFFECT OF EXTERNAL TANK SEPARATION ON ORBITER AERODYNAMIC CHARACTERISTICS

1A13.EXTERNAL TANK(T10)SEPARATING FROM ORB. 09 (RTJ012)

SEE THE ASSOCIATED DATA DOCUMENT FOR REFERENCE CHARACTERISTICS FOR INDIVIDUAL DATASETS

PARAMETRIC VALUES	
X	- .503
MACH	4.530
PIDOTAL	110.000
BETA	.000
ALPHA	.000
DALPHA	-20.000
BETA	.000
AIRLON	.000
ELEVTR	200.000
Y	

SYMB.
 ○
 □
 △

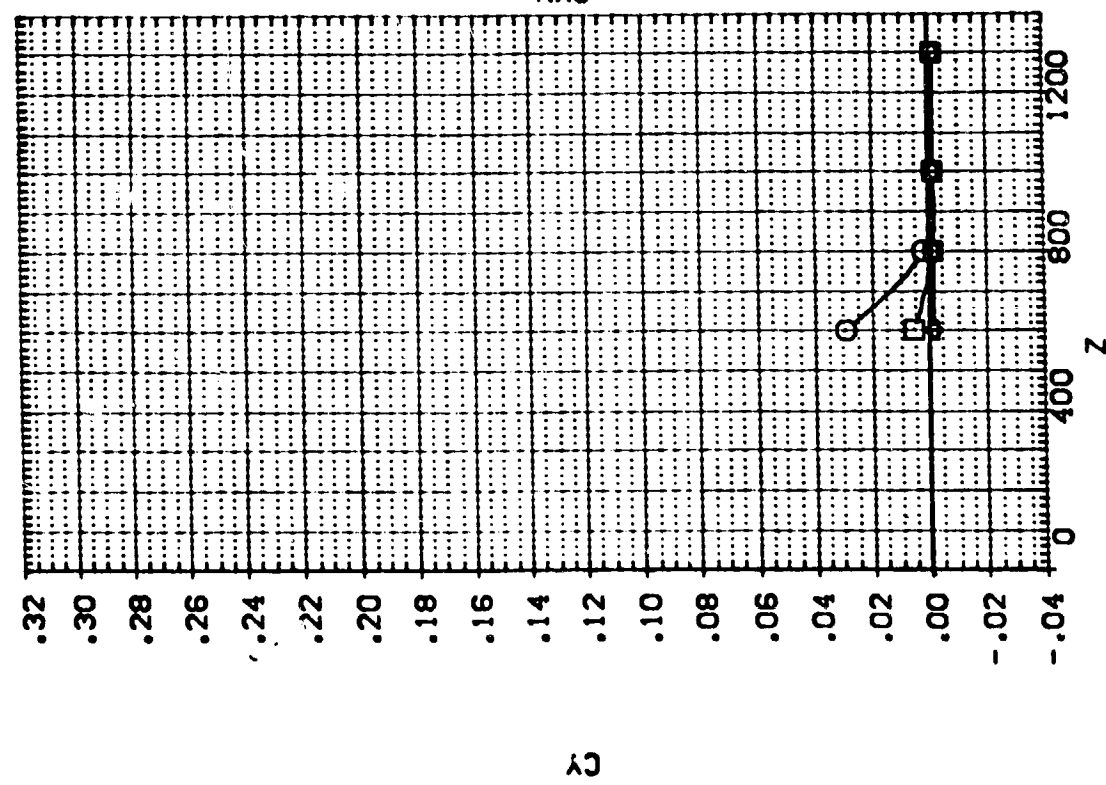
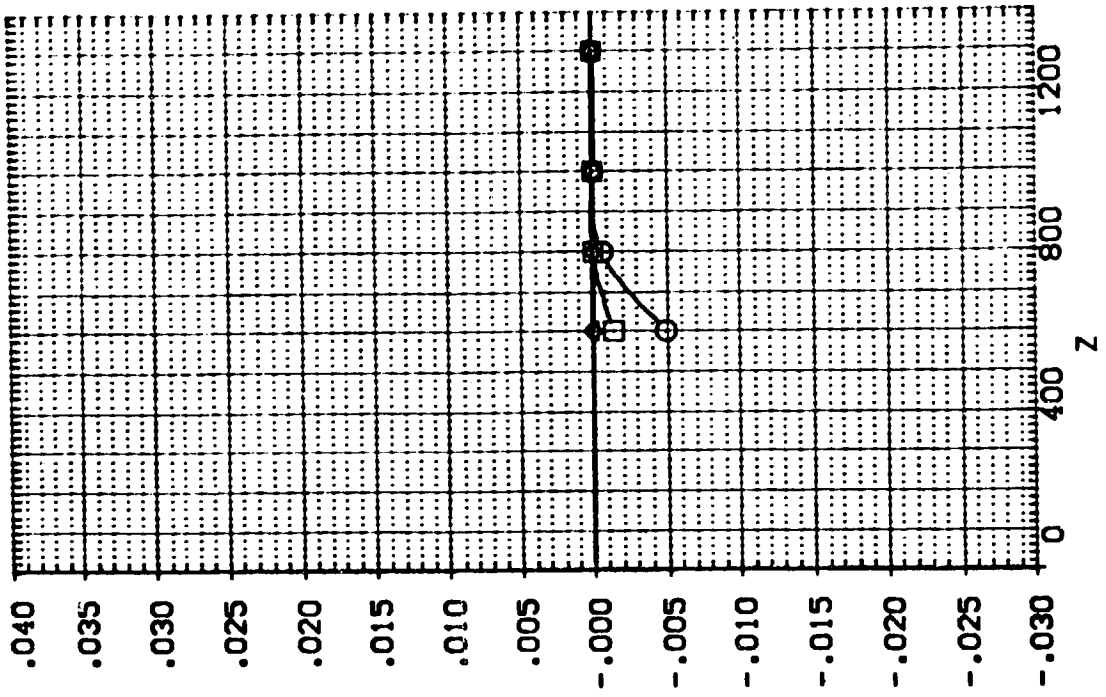

EFFECT OF EXTERNAL TANK SEPARATION ON ORBITER AERODYNAMIC CHARACTERISTICS

IA13.EXTERNAL TANK(T10)SEPARATING FROM ORB. 09 (RTJ013)

SEE THE ASSOCIATED DATA DOCUMENT FOR REFERENCE CHARACTERISTICS FOR INDIVIDUAL DATASETS

SYMBOL		PARAMETRIC VALUES			
○	X	MACH	4.530	PTOTAL	110.000
□	Y	ALPHA	.000	BETA	.000
◇	Z	DALPHA	-20.000	DBETA	5.000
△	Y	ELEVTR	.000	AILRON	.000
			200.000		

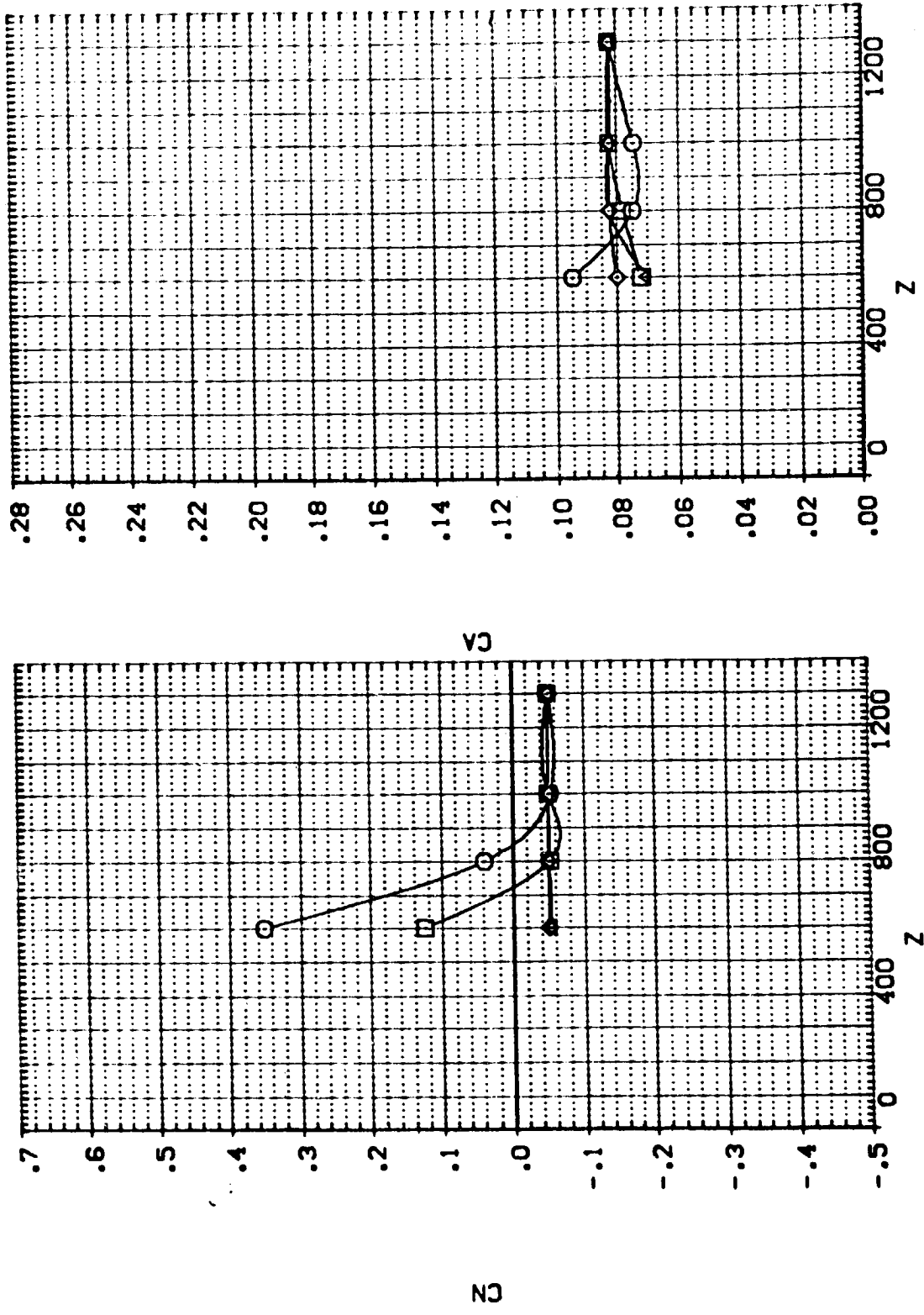

EFFECT OF EXTERNAL TANK SEPARATION ON ORBITER AERODYNAMIC CHARACTERISTICS

IA13. EXTERNAL TANK(T10)SEPARATING FROM ORB. 09 (RTJ013)

SEE THE ASSOCIATED DATA DOCUMENT FOR REFERENCE CHARACTERISTICS FOR INDIVIDUAL DATASETS

SYMBOL		PARAMETRIC VALUES	
x	- .706	MACH	4.530
	401.230	ALPHA	.000
	800.840	DALPHA	-20.000
	1200.600	ELEVTR	.000
		Y	200.000
		PITOTL	110.000
		BETA	.000
		DBETA	5.000
		AILRON	.000

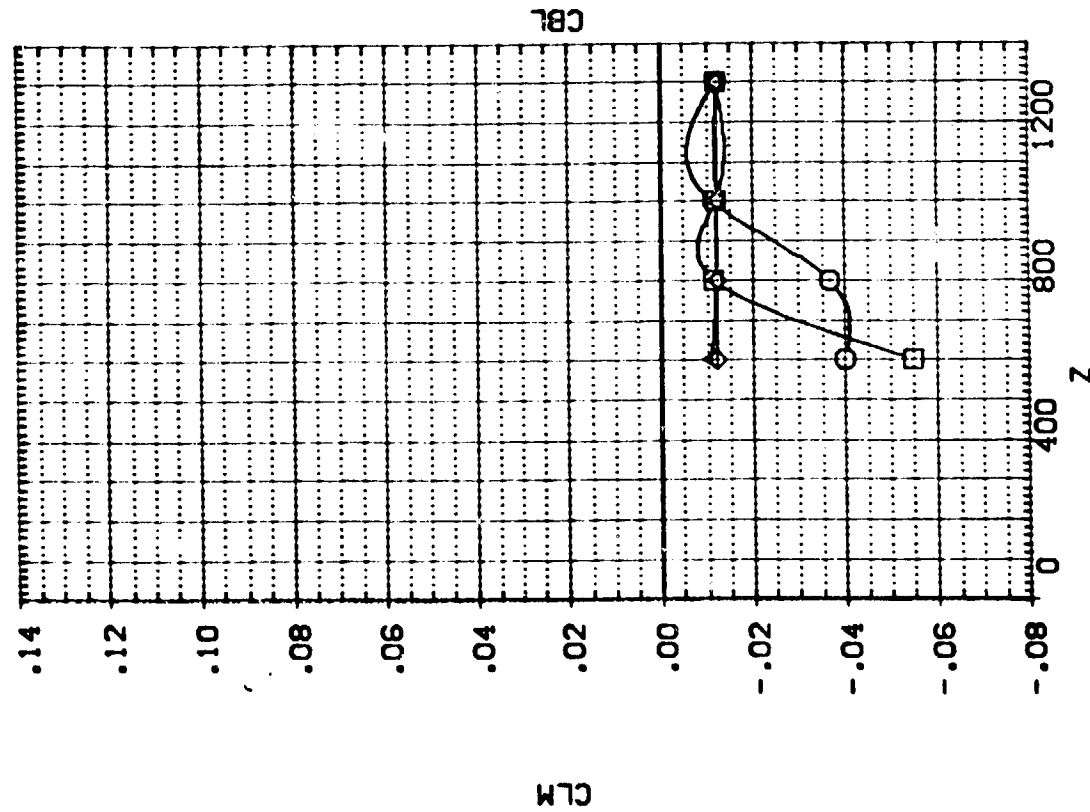
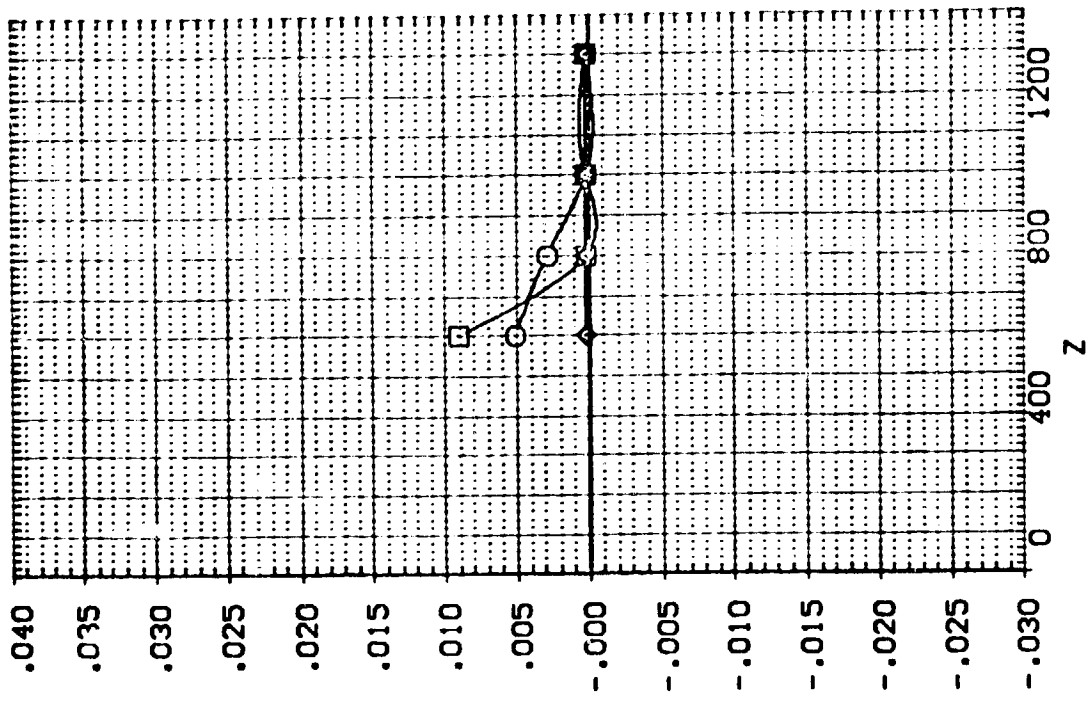

EFFECT OF EXTERNAL TANK SEPARATION ON ORBITER AERODYNAMIC CHARACTERISTICS

IA13.EXTERNAL TANK(T10)SEPARATING FROM ORB. 09 (RTJ013)

SEE THE ASSOCIATED DATA DOCUMENT FOR REFERENCE CHARACTERISTICS FOR INDIVIDUAL DATASETS

PARAMETRIC VALUES	
MACH	4.530
PTOTAL	110.000
BETA	.000
DBETA	5.000
AILRON	.000
ELEVTR	200.000
Y	200.000
X	-1.706
ALPHA	401.230
DALPHA	600.840
ELEVTR	1200.600

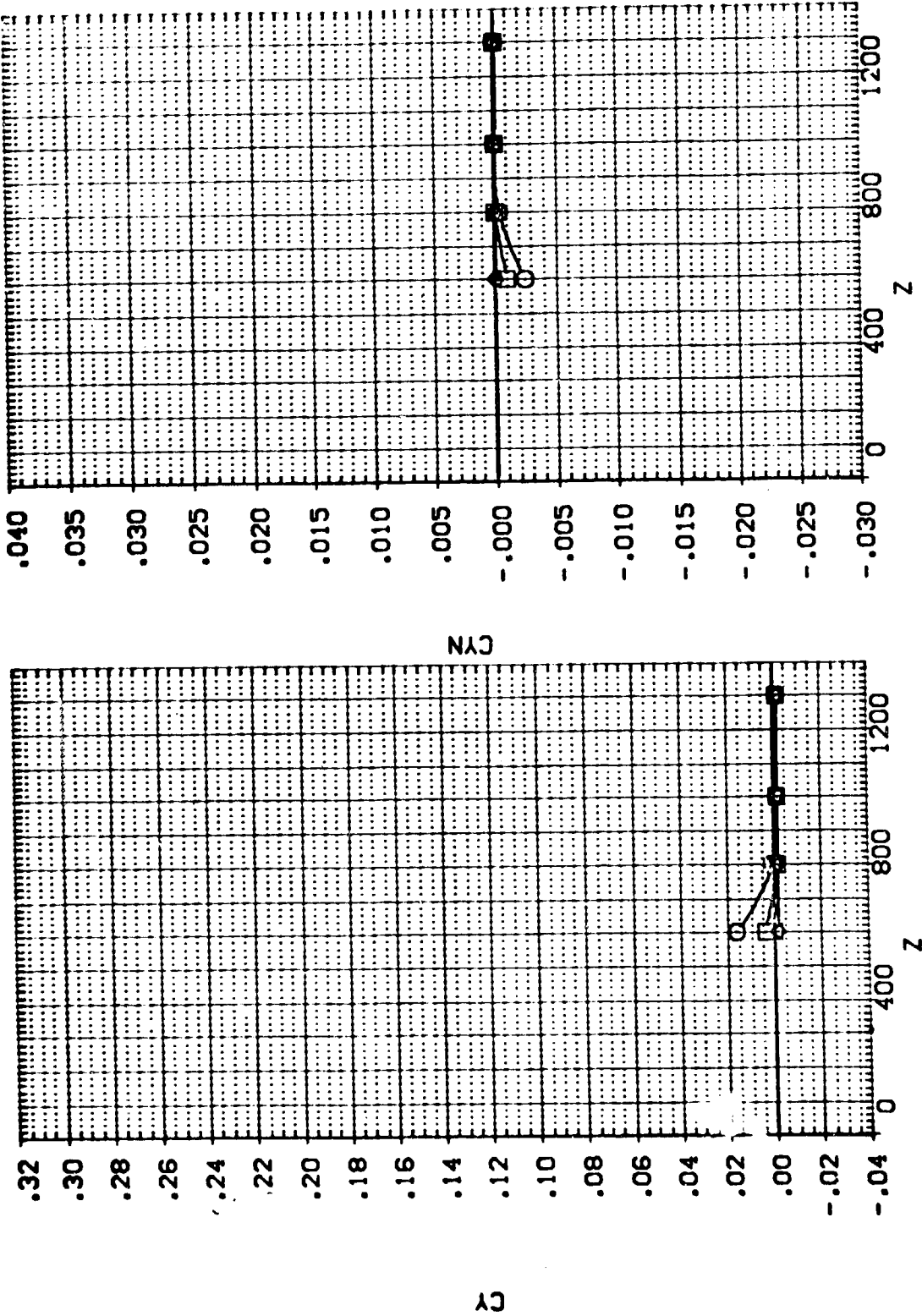

EFFECT OF EXTERNAL TANK SEPARATION ON ORBITER AERODYNAMIC CHARACTERISTICS

IA13.EXTERNAL TANK(T10)SEPARATING FROM ORB. 09 (RTJ014)

SEE THE ASSOCIATED DATA DOCUMENT FOR REFERENCE CHARACTERISTICS FOR INDIVIDUAL DATA SETS

SYMBOL		PARAMETRIC VALUES	
○	x	MACH	110.000
□	400.550	ALPHA	.000
◇	800.340	DALPHA	-20.000
△	1201.000	ELEVTR	.000
		PTOTAL	.000
		BETA	5.000
		DBETA	.000
		AIRRON	.000
		Y	.000

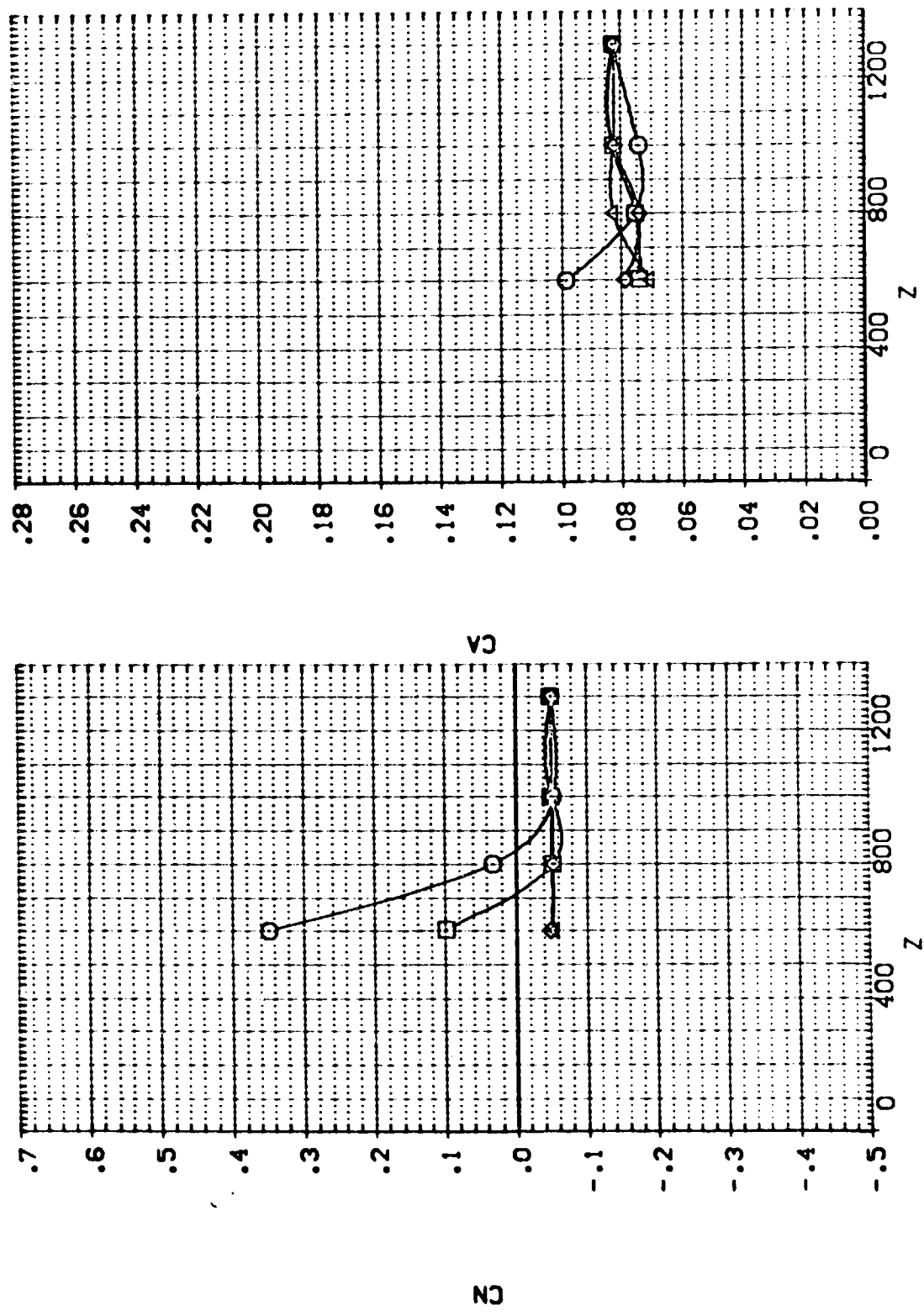

EFFECT OF EXTERNAL TANK SEPARATION ON ORBITER AERODYNAMIC CHARACTERISTICS

SEE THE ASSOCIATED DATA DOCUMENT FOR REFERENCE CHARACTERISTICS FOR INDIVIDUAL DATASETS

SYMBOL		PARAMETRIC VALUES	
x	○	MACH	4.530
	□	ALPHA	.000
	△	BETA	110.000
		DBETA	5.000
		AILLRN	.000
		ELEVTR	.000
		Y	.000
		PITOTL	110.000

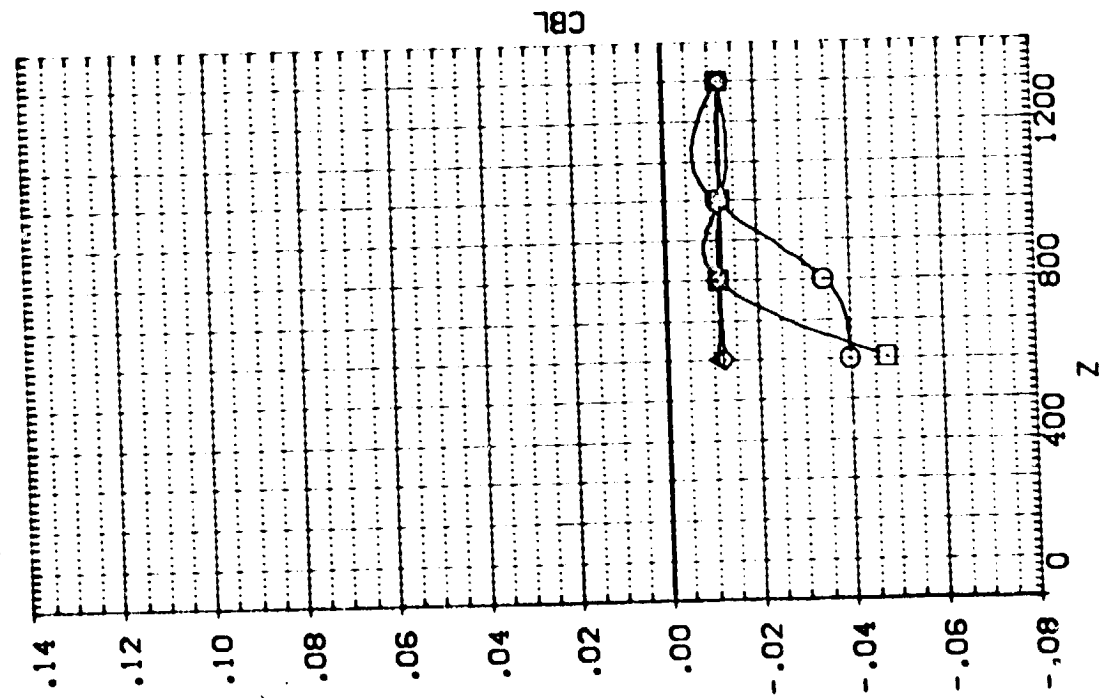
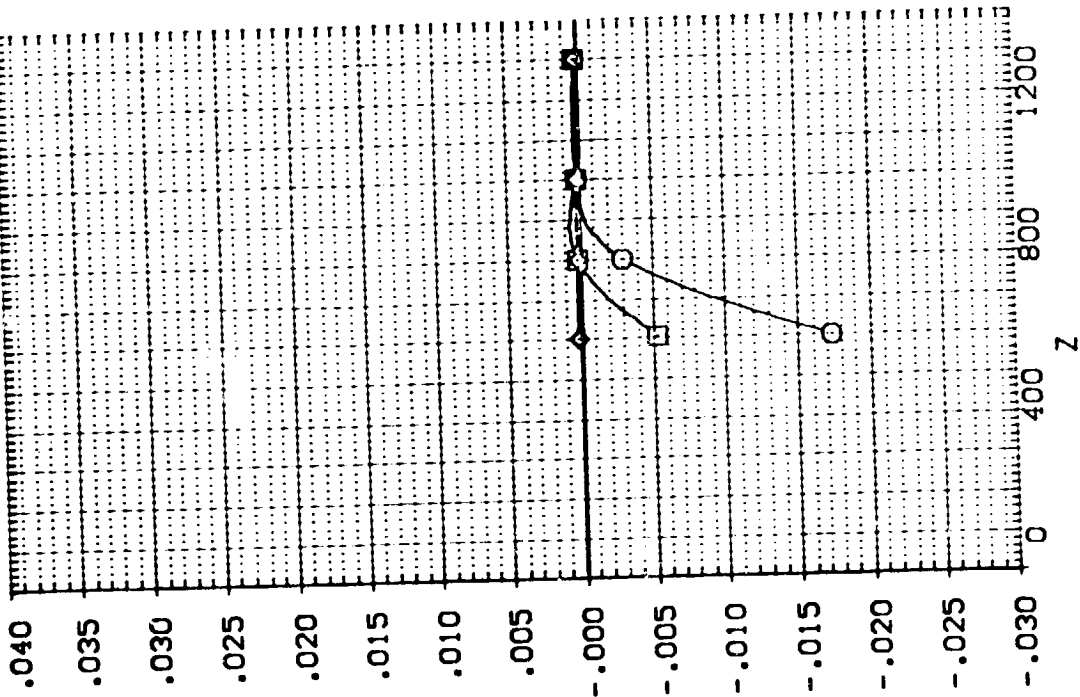

EFFECT OF EXTERNAL TANK SEPARATION ON ORBITER AERODYNAMIC CHARACTERISTICS

1A13. EXTERNAL TANK(T10)SEPARATING FROM ORB. 09 (RTJ014)

SEE THE ASSOCIATED DATA DOCUMENT FOR REFERENCE CHARACTERISTICS FOR INDIVIDUAL DATASETS

Sym-60L		PARAMETRIC VALUES	
X	-.921	MACH	4.530
	400.550	ALPHA	.000
	800.340	DALPHA	-20.000
	1201.000	ELEVTR	.000
		Y	.000
		PTOTAL	110.000
		BETA	.000
		DBETA	5.000
		ALRON	.000

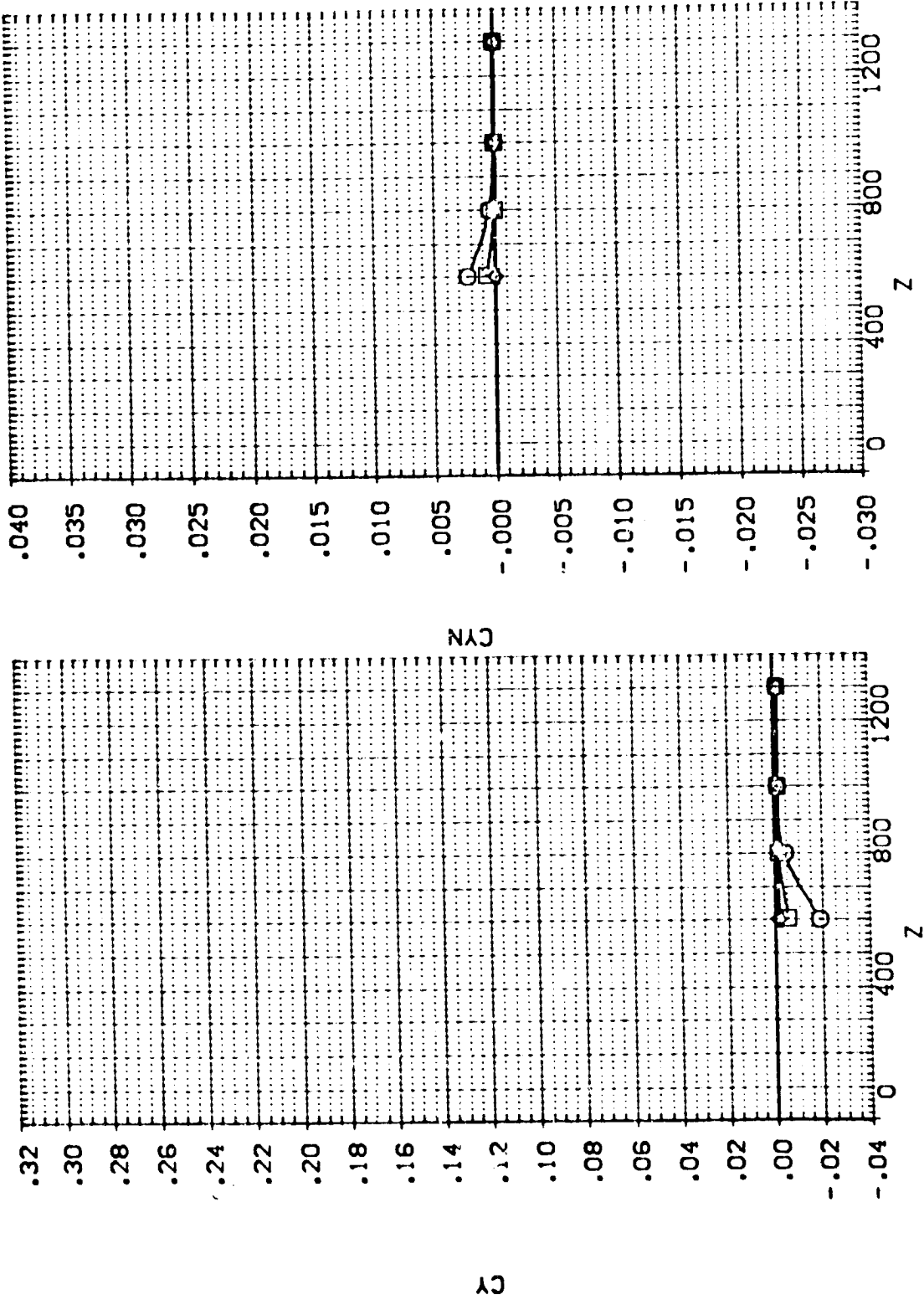

EFFECT OF EXTERNAL TANK SEPARATION ON ORBITER AERODYNAMIC CHARACTERISTICS

SEE THE ASSOCIATED DATA DOCUMENT FOR REFERENCE CHARACTERISTICS FOR INDIVIDUAL DATA'S

SYMBOL		PARAMETRIC VALUES	
○	x	MACH	4.530
○	400.230	ALPHA	.000
◇	800.060	DALPHA	-30.000
△	1200.900	ELEVTR	.000
		PTOTAL	110.000
		BETA	.000
		DBETA	.000
		AILTRON	.000
		Y	.000

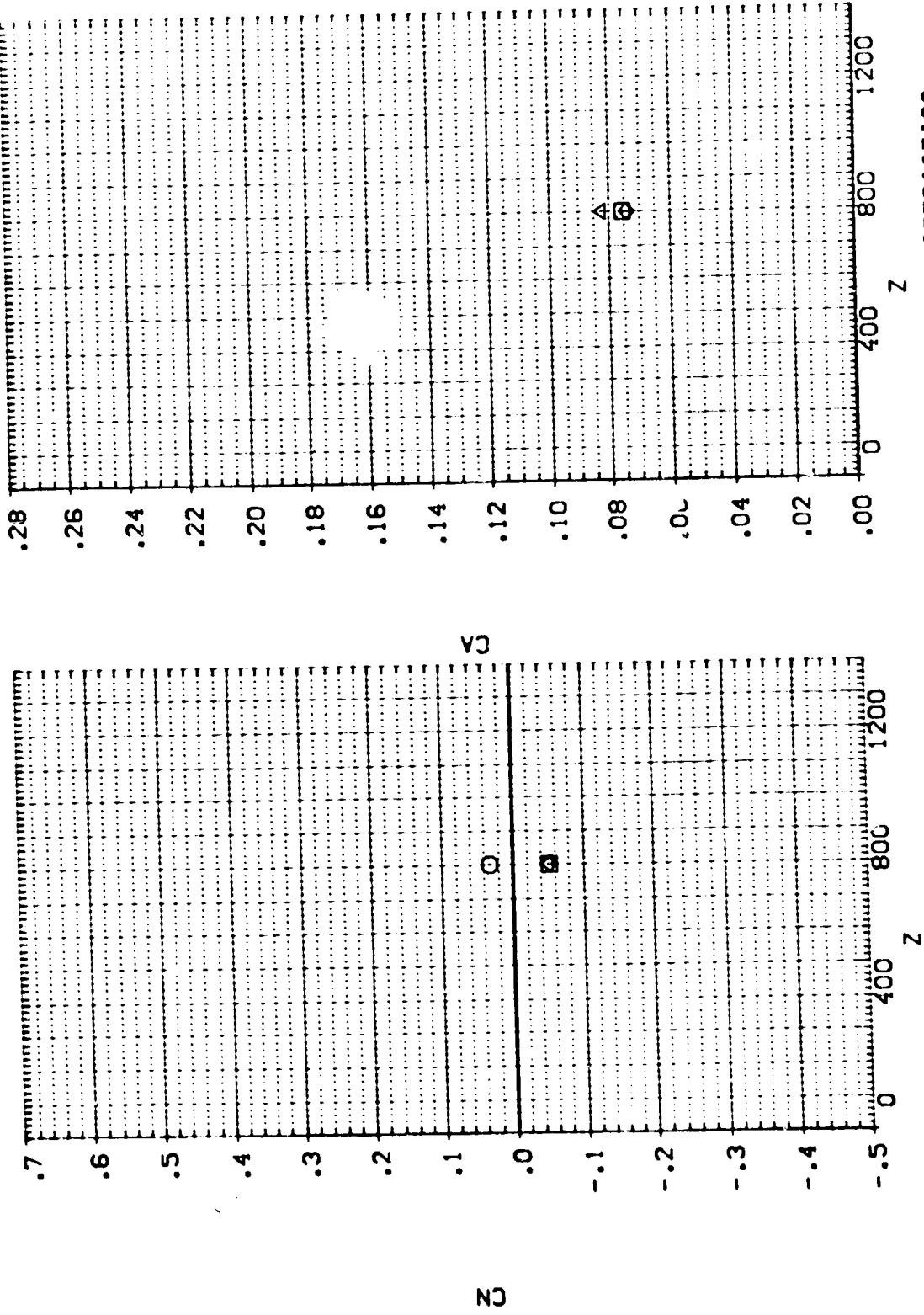

EFFECT OF EXTERNAL TANK SEPARATION ON ORBITER AERODYNAMIC CHARACTERISTICS

!A13,EXTERNAL TANK(T10)SEPARATING FROM ORB. 09 (RTJ015)

SEE THE ASSOCIATED DATA DOCUMENT FOR REFERENCE CHARACTERISTICS FOR INDIVIDUAL DATASETS

SYMBOL		PARAMETRIC VALUES	
○	.561	MACH	4.530
□	400.230	ALPHA	.000
◇	800.060	DALPHA	-30.000
△	1200.900	ELEVTR	.000
		Y	.000
		PTOTAL	110.000
		BETA	.000
		DEBTA	.000
		AILRON	.000

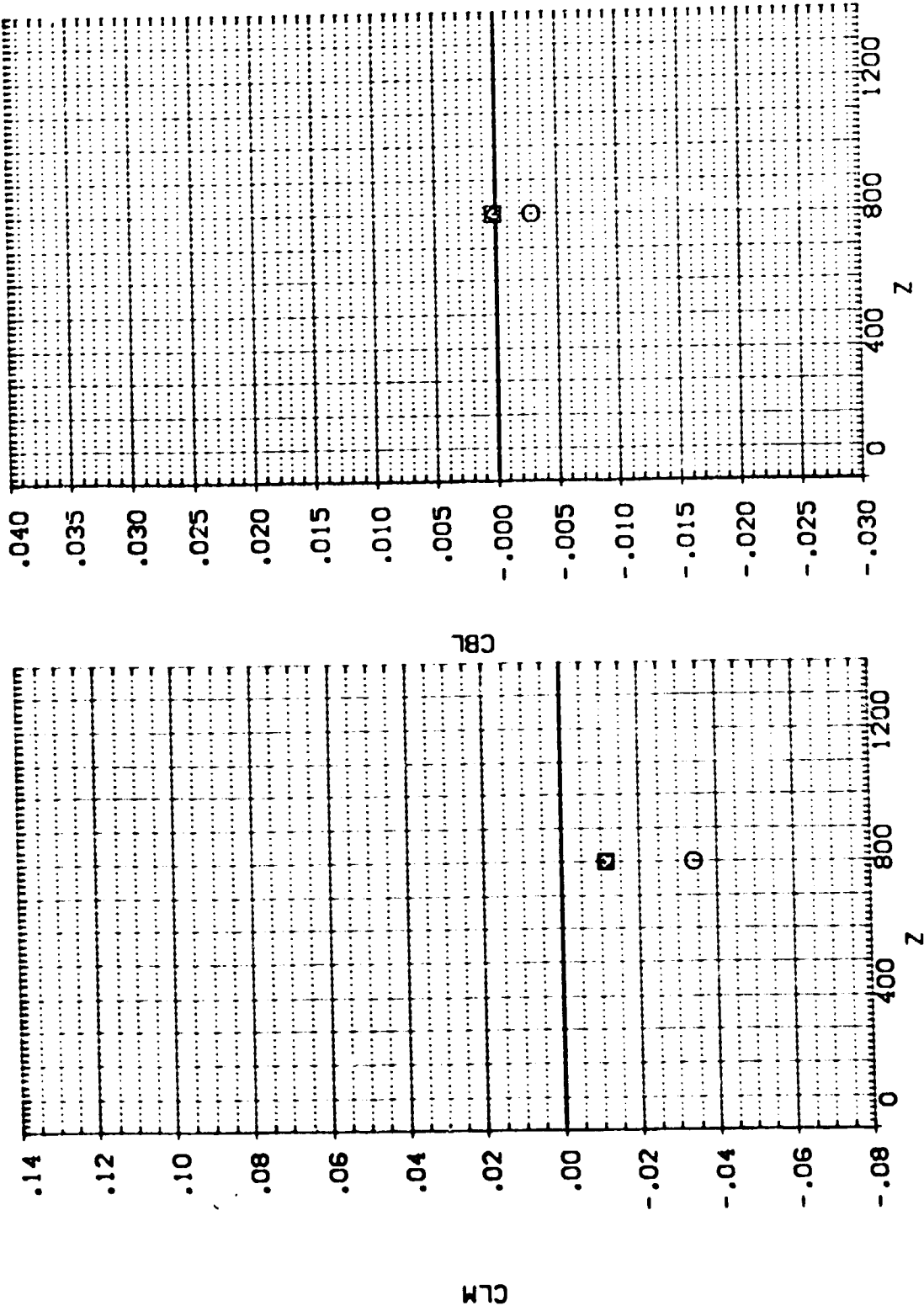

EFFECT OF EXTERNAL TANK SEPARATION ON ORBITER AERODYNAMIC CHARACTERISTICS

1.13. EXTERNAL TANK(110)SEPARATING FROM CRB. 09 (RTJ015)

SEE THE ASSOCIATED DATA DOCUMENT FOR REFERENCE CHARACTERISTICS FOR INDIVIDUAL DATASETS

SYMBOL		PARAMETRIC VALUES	
X	.861	MACH	4.530
		PTOTAL	110.000
		BETA	.000
		DETA	.000
		AIRION	.000
		Y	.000

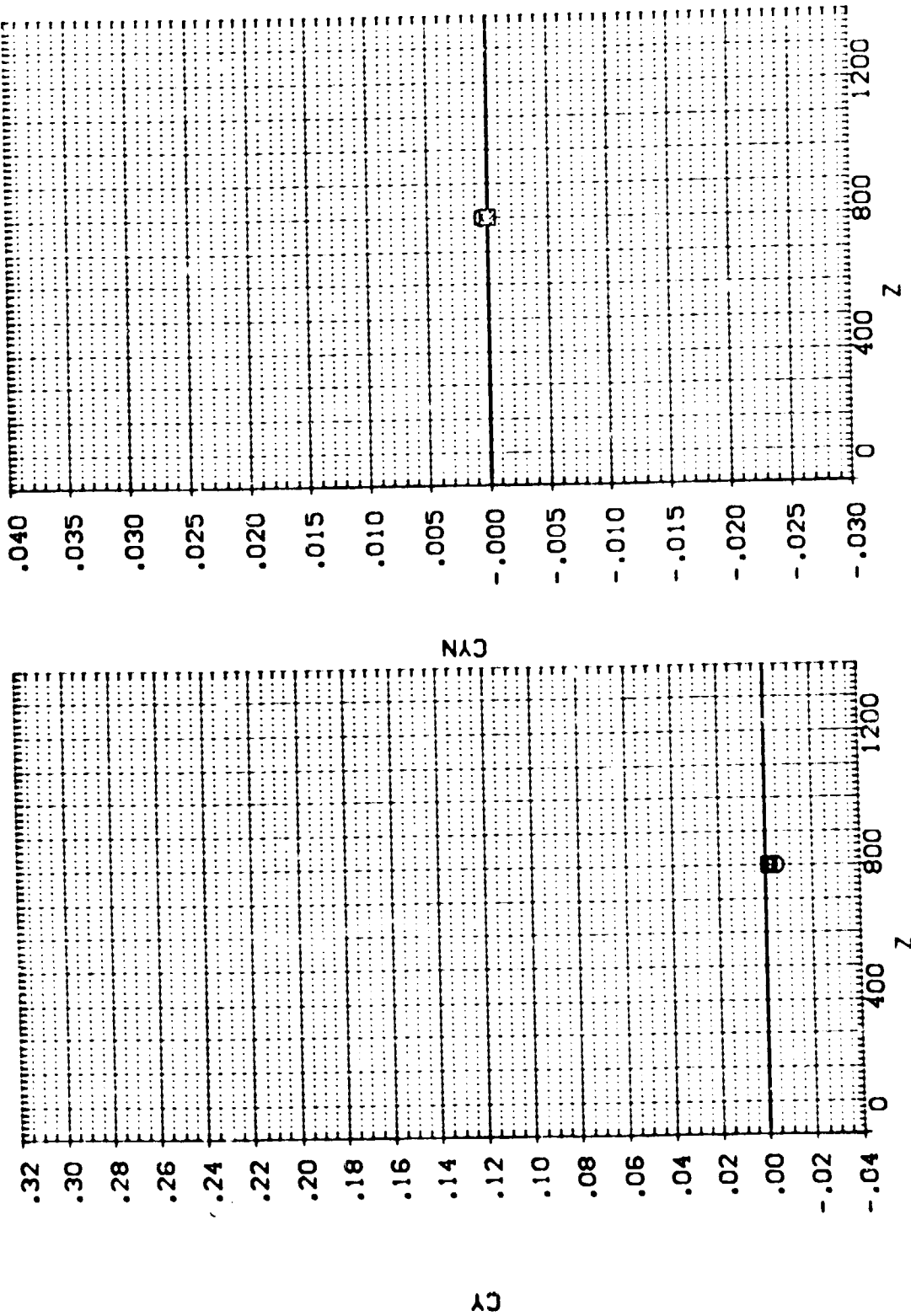

EFFECT OF EXTERNAL TANK SEPARATION ON ORBITER AERODYNAMIC CHARACTERISTICS



13. EXTERNAL TANK(T10)SEPARATING FROM ORB. 03 (RTJ016)

SEE THE ASSOCIATED DATA DOCUMENT FOR REFERENCE CHARACTERISTICS FOR INDIVIDUAL DATASETS

SYMBOL		PARAMETRIC VALUES			
○	x	MACH	4.530	P TOTAL	110.000
□	400.160	ALPHA	-5.000	BETA	.000
◇	800.590	CALPHA	5.000	DBETA	.000
△	1200.600	ELEVTR	.000	ALRON	.000
		Y	.000		

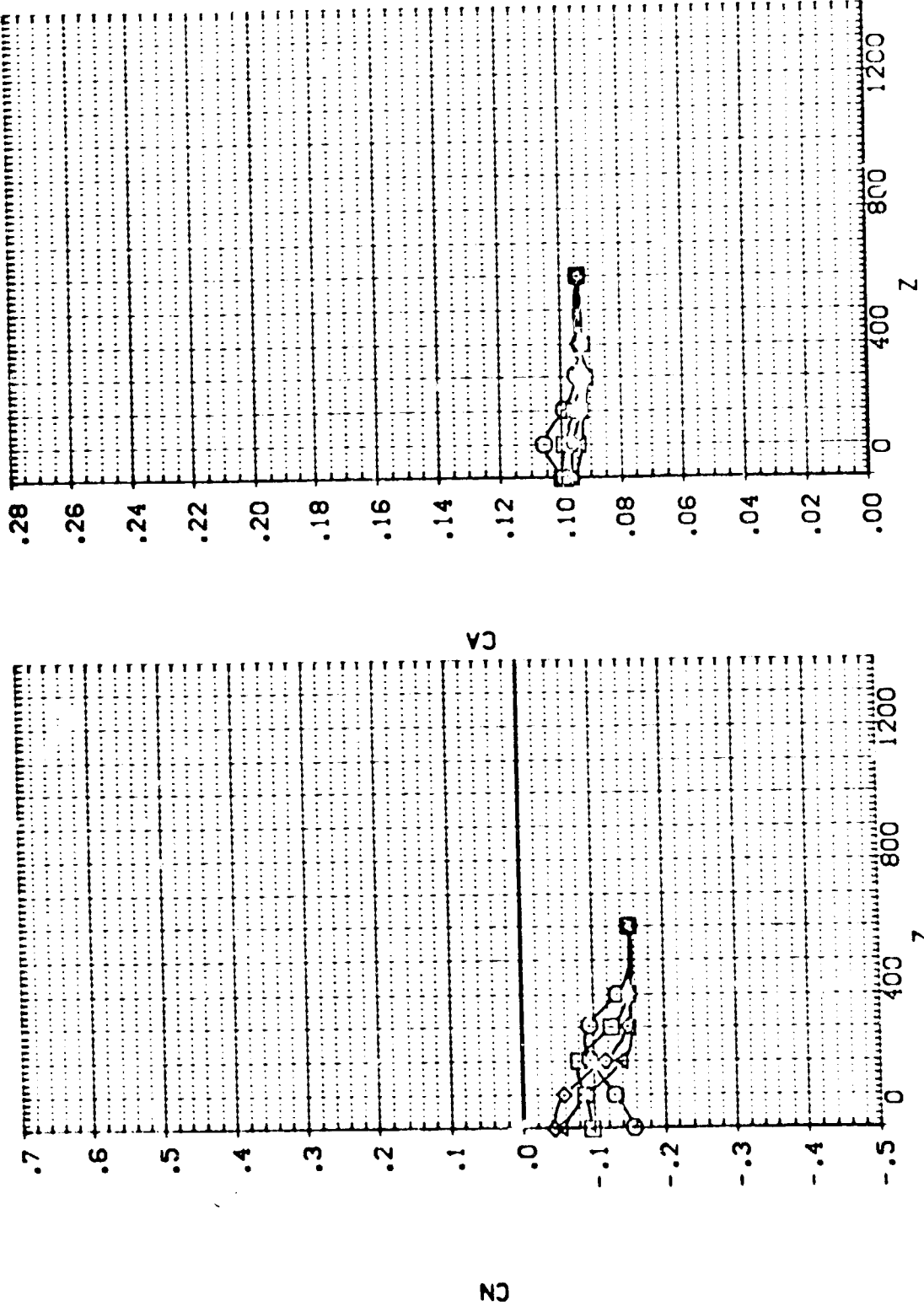

EFFECT OF EXTERNAL TANK SEPARATION ON ORBITER AERODYNAMIC CHARACTERISTICS

1A13.EXTERNAL TANK(T10)SEPARATING FROM ORB. 09 (RTJ016)

SEE THE ASSOCIATED DOCUMENT FOR REFERENCE CHARACTERISTICS FOR INDIVIDUAL DATASETS

SYMBOL		PARAMETRIC VALUES	
x	.228	MACH	4.530
		PTOTAL	110.000
400.160		BETA	.000
800.590		DBETA	.000
1200.600		ALLRON	.000
		ELEVTR	.000
		Y	.000

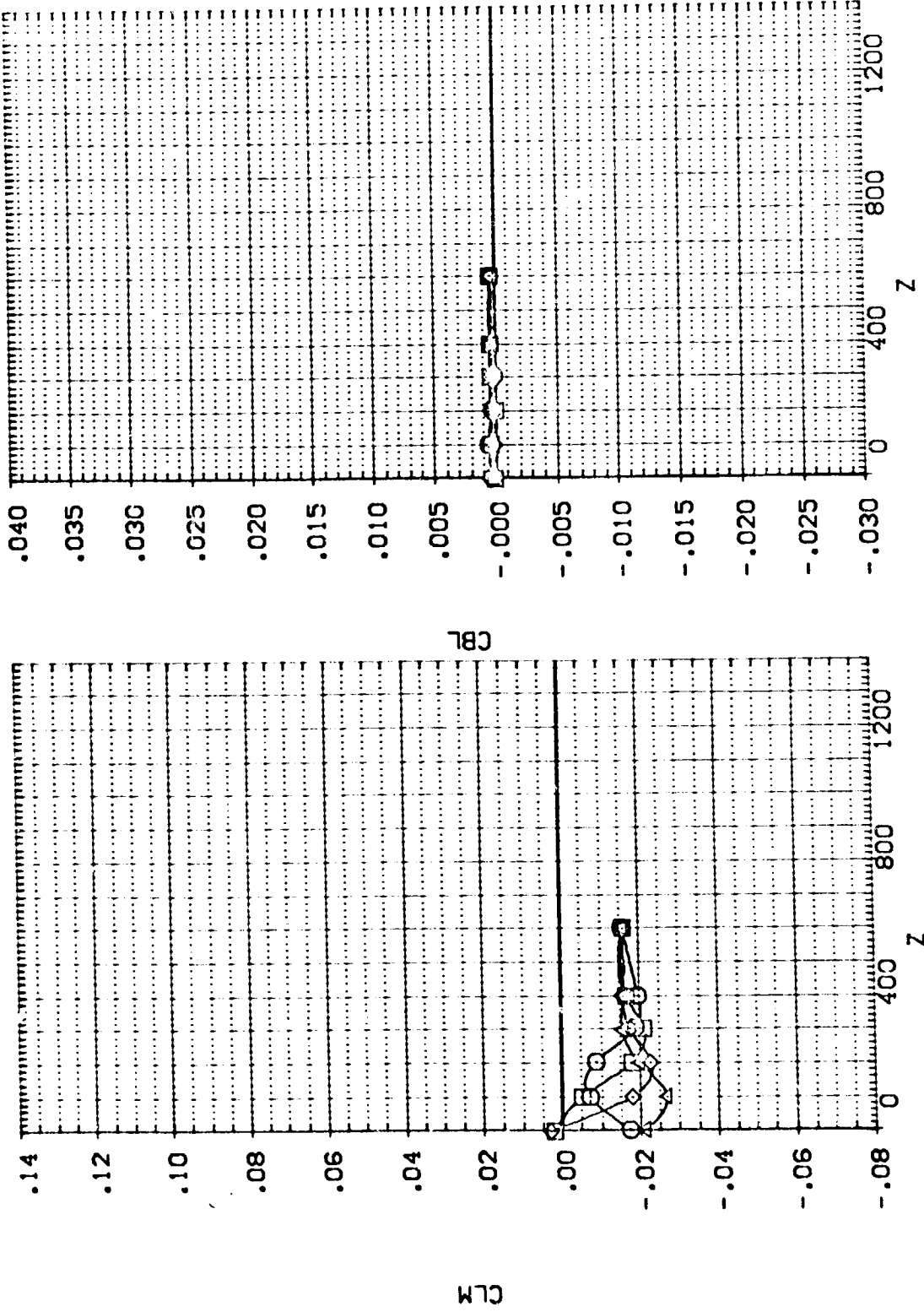

EFFECT OF EXTERNAL TANK SEPARATION ON ORBITER AERODYNAMIC CHARACTERISTICS

IA13. EXTERNAL TANK(T10)SEPARATING FROM ORB. 09 (RTJ016)

SEE THE ASSOCIATED DATA DOCUMENT FOR REFERENCE CHARACTERISTICS FOR INDIVIDUAL DATASETS

SYMBOL		PARAMETRIC VALUES	
○	X	MACH	4.530
□	Y	ALPHA	-5.000
◇	Z	DALPHA	5.000
△		ELEVTR	.000
		PTOTAL	110.000
		BETA	.000
		DBETA	.000
		AILRON	.000
		Y	.000

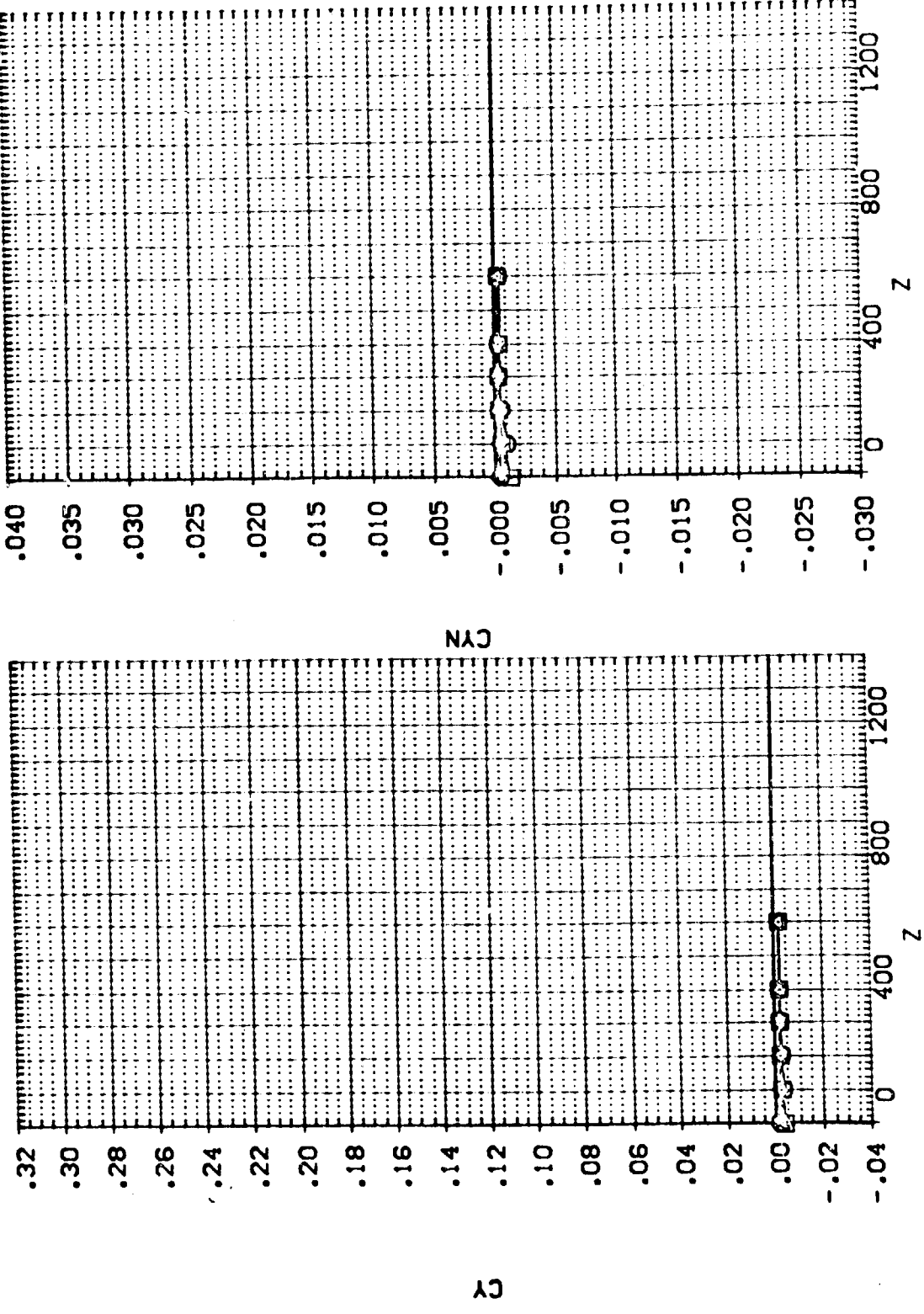

EFFECT OF EXTERNAL TANK SEPARATION ON ORBITER AERODYNAMIC CHARACTERISTICS

IA13. EXTERNAL TANK(T10)SEPARATING FROM ORB. 09 (RTJ017)

SEE THE ASSOCIATED DATA DOCUMENT FOR REFERENCE CHARACTERISTICS FOR INDIVIDUAL DATASETS

SYMBOL		PARAMETRIC VALUES			
○	MACH	4.530	PITOTAL	110.000	
□	ALPHA	-5.000	BETA	.000	
◇	DALPHA	.000	DBETA	.000	
	ELEVTR	.000	AIRTON	.000	
	Y	.000			

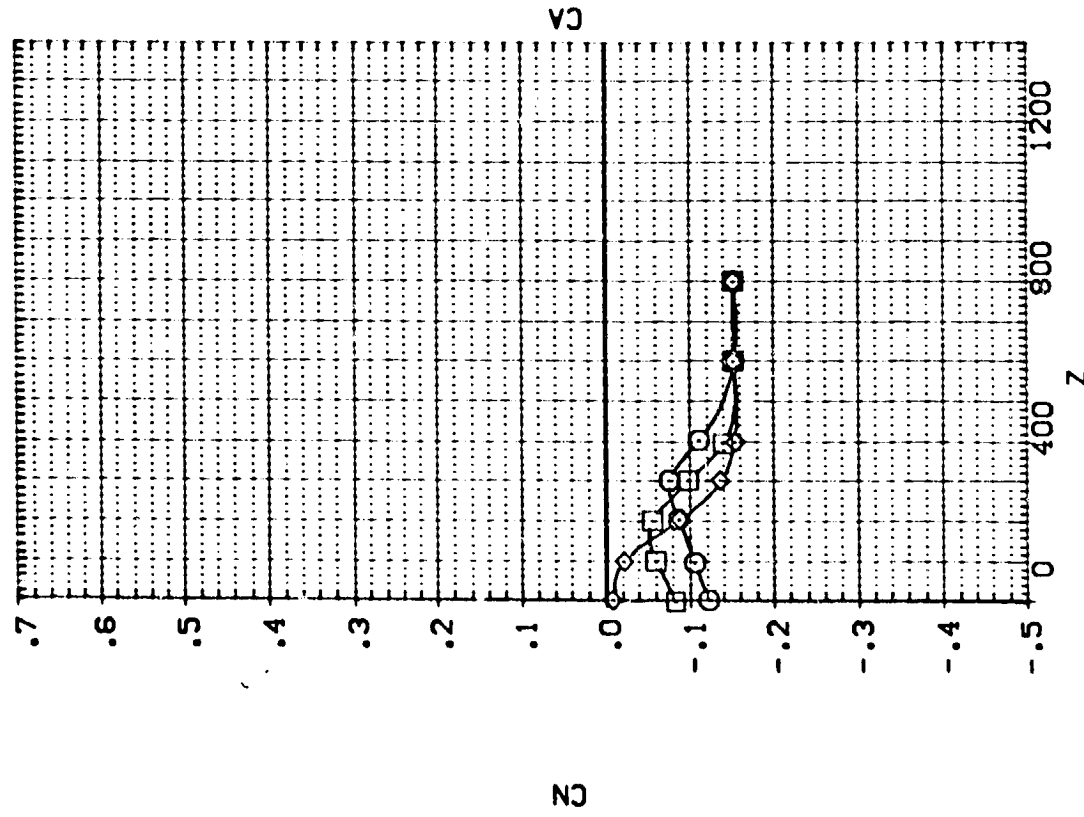
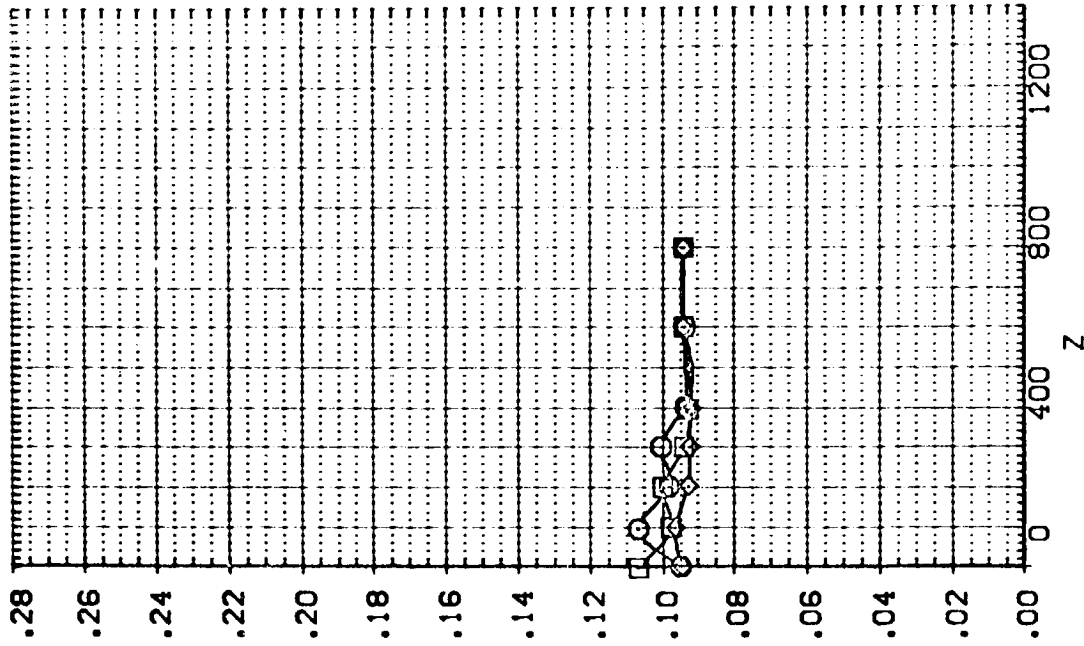

IA13,EXTERNAL TANK(T10)SEPARATING FROM ORB. 09 (RTJ017)

SEE THE ASSOCIATED DATA DOCUMENT FOR REFERENCE CHARACTERISTICS FOR INDIVIDUAL DATASETS

SYMBOL		PARAMETRIC VALUES				
○	X	.155	MACH	4.530	PTOTAL	110.000
□	ALPHA	400.390	ALPHA	-5.000	BETA	.000
◇	ELEVTR	800.620	DALPHA	.000	DBETA	.000
	Y		ELEVTR	.000	ALLRON	.000
				.000		

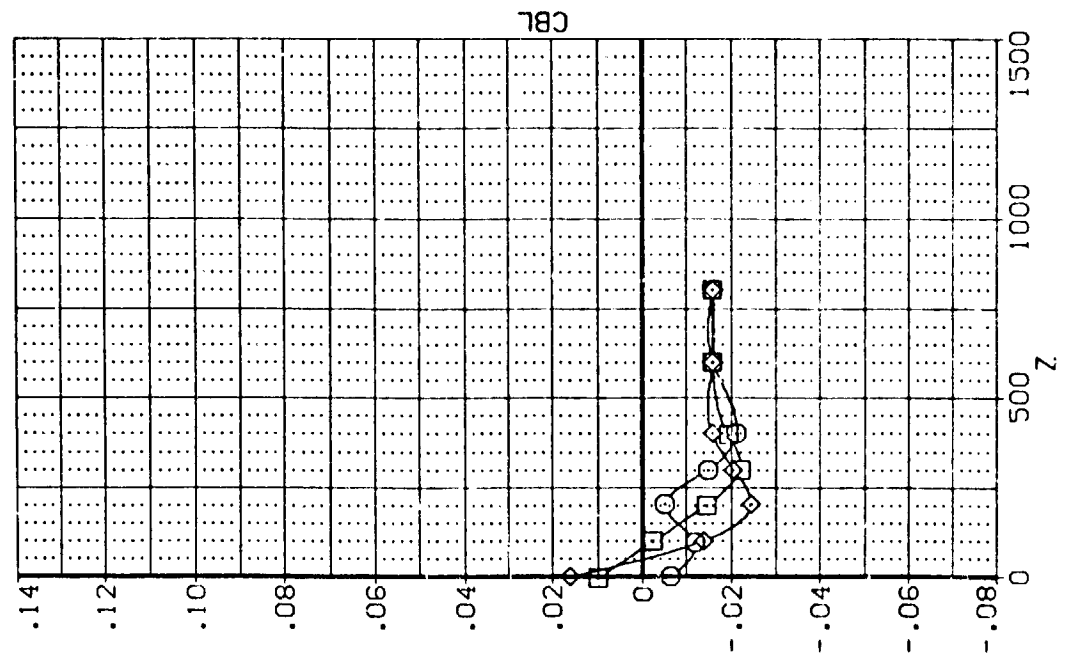
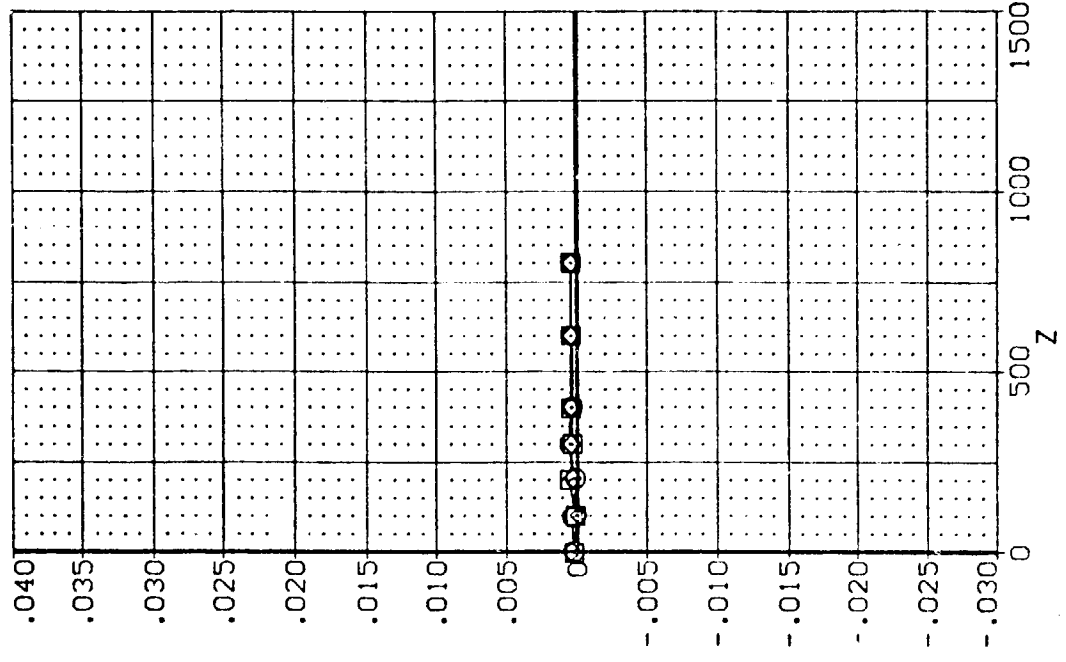

EFFECT OF EXTERNAL TANK SEPARATION ON ORBITER AERODYNAMIC CHARACTERISTICS

1A13.EXTERNAL TANK(T10)SEPARATING FROM ORB. 09 (RTJ017)

SEE THE ASSOCIATED DATA DOCUMENT FOR RELEVANT CHARACTERISTICS FOR INDIVIDUAL CASES

PARAMETRIC VALUES	
MACH	4.530
PTOTAL	110.000
ALPHA	-5.000
BETA	.000
DALPHA	.000
DBETA	.000
ELEVTR	.000
Y	.000

SYMBOL
 O
 ◇

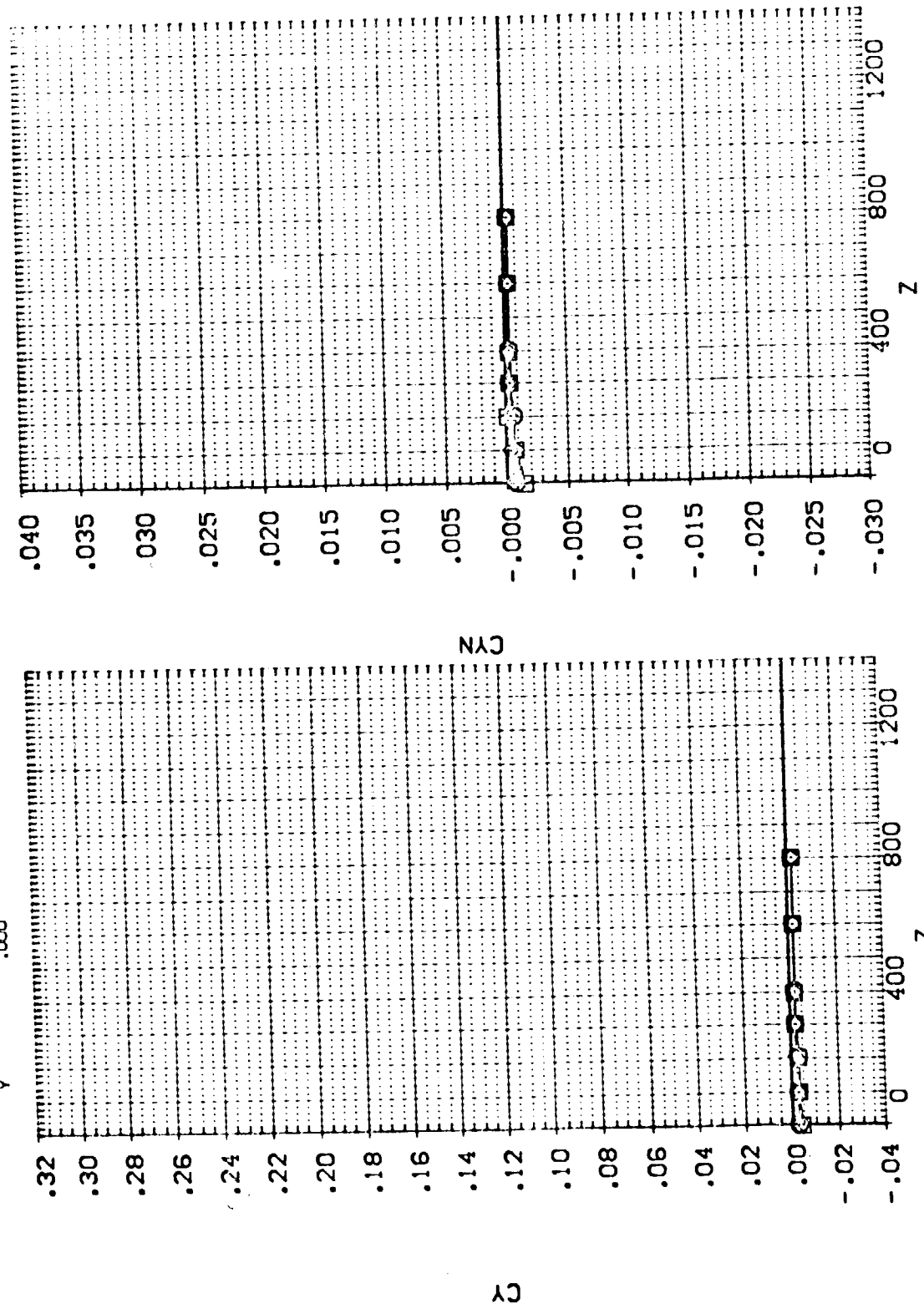

EFFECT OF EXTERNAL TANK SEPARATION ON ORBITER AERODYNAMIC CHARACTERISTICS

1A13. EXTERNAL TANK(T10)SEPARATING FROM ORB. 09 (RTJ018)

SEE THE ASSOCIATED DATA DOCUMENT FOR REFERENCE CHARACTERISTICS FOR INDIVIDUAL DATASETS

SYMBOL		PARAMETRIC VALUES				
○	x	.170	MACH	4.530	PTOTAL	110.000
□	400.300	ALPHA	-5.000	BETA	.000	
◇	800.530	DALPHA	.000	DBETA	.000	
△	1200.900	ELEVTR	.000	AILRON	.000	

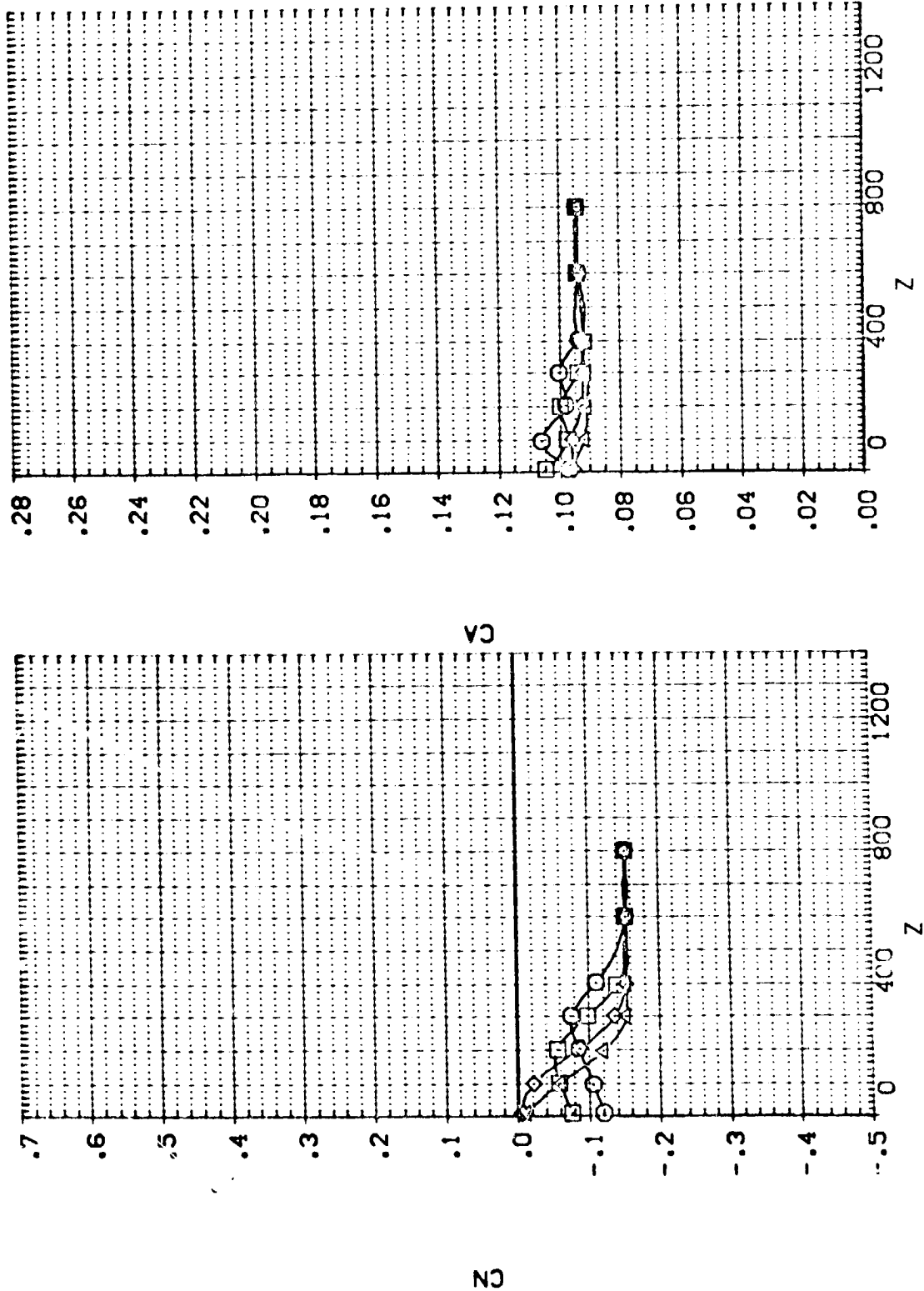

1A13.EXTERNAL TANK(T10)SEPARATING FROM ORB. 09 (RTJ018)

SYMBOL
 O
 □
 ◇
 △

PARAMETRIC VALUES
 MACH .170
 ALPHA 400.300
 DIALPHA 800.530
 ELEVTR 1200.900
 Y .000
 P/TOTAL 110.000
 BETA -5.000
 DBETA .000
 AILRON .000

SEE THE ASSOCIATED DATA DOCUMENT FOR THE CHARACTERISTICS FOR INDIVIDUAL DATASETS

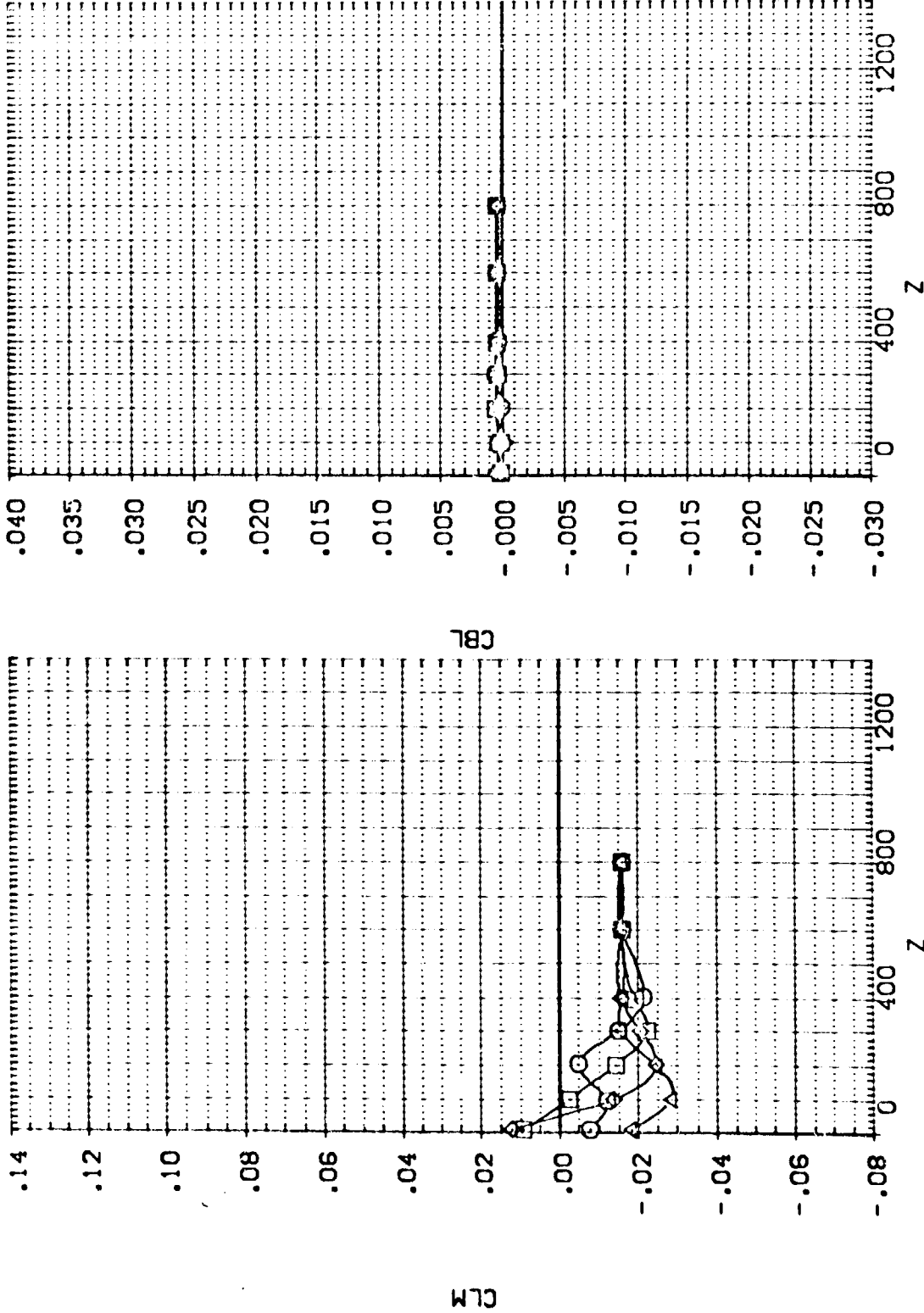

EFFECT OF EXTERNAL TANK SEPARATION ON ORBITER AERODYNAMIC CHARACTERISTICS

1413. EXTERNAL TANK(T10)SEPARATING FROM ORB. 09 (RTJ018)

SEE THE ASSOCIATED DATA DOCUMENT FOR REFERENCE CHARACTERISTICS FOR INDIVIDUAL DATASETS

SYMBOL		X		PARAMETRIC VALUES	
○	○	.170	MACH	4.530	P TOTAL
○	○	400.500	ALPHA	-5.000	BETA
○	○	800.530	DALPHA	.000	DBETA
○	○	1200.900	ELEVTR	.000	ATLRON
				.000	

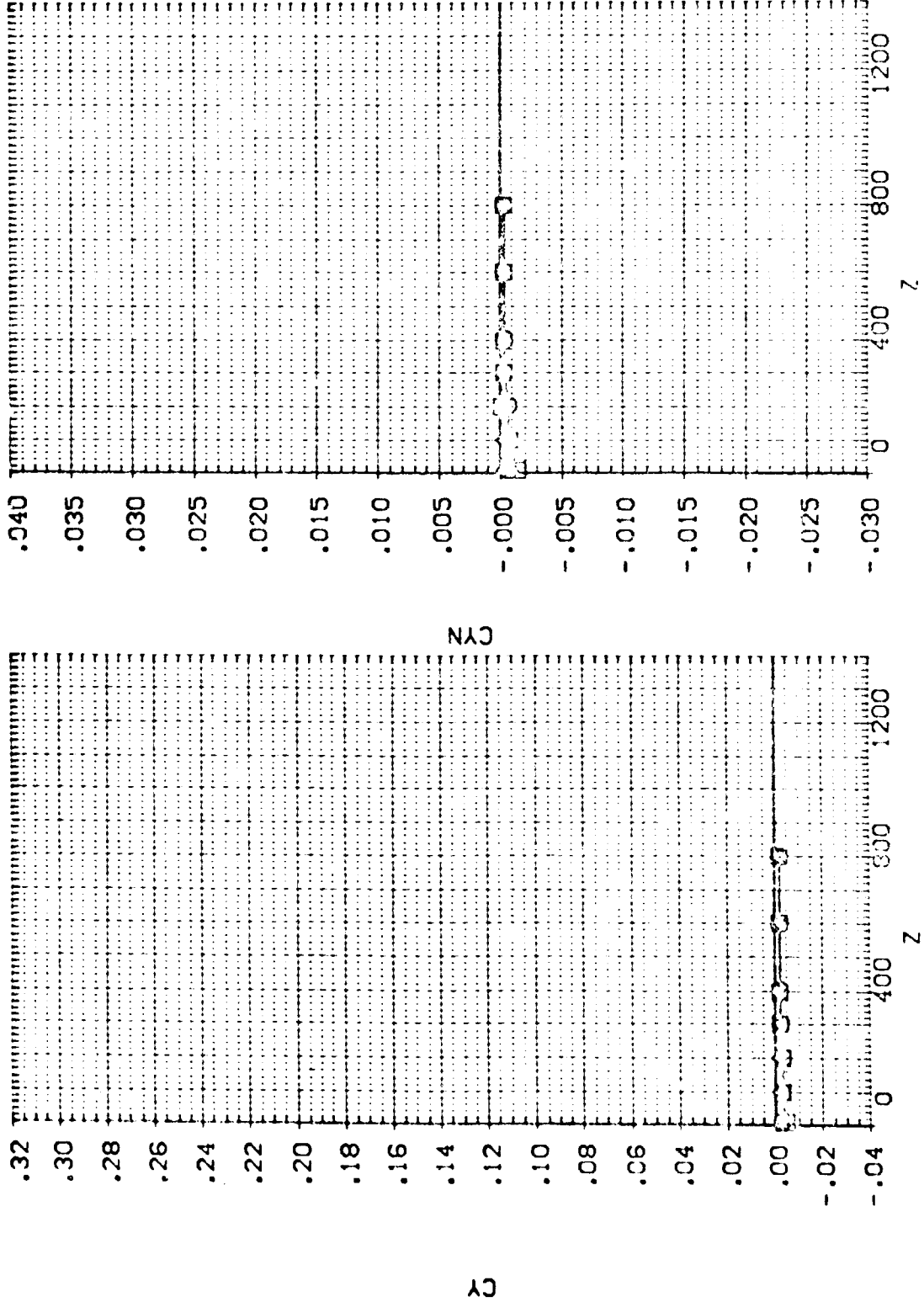
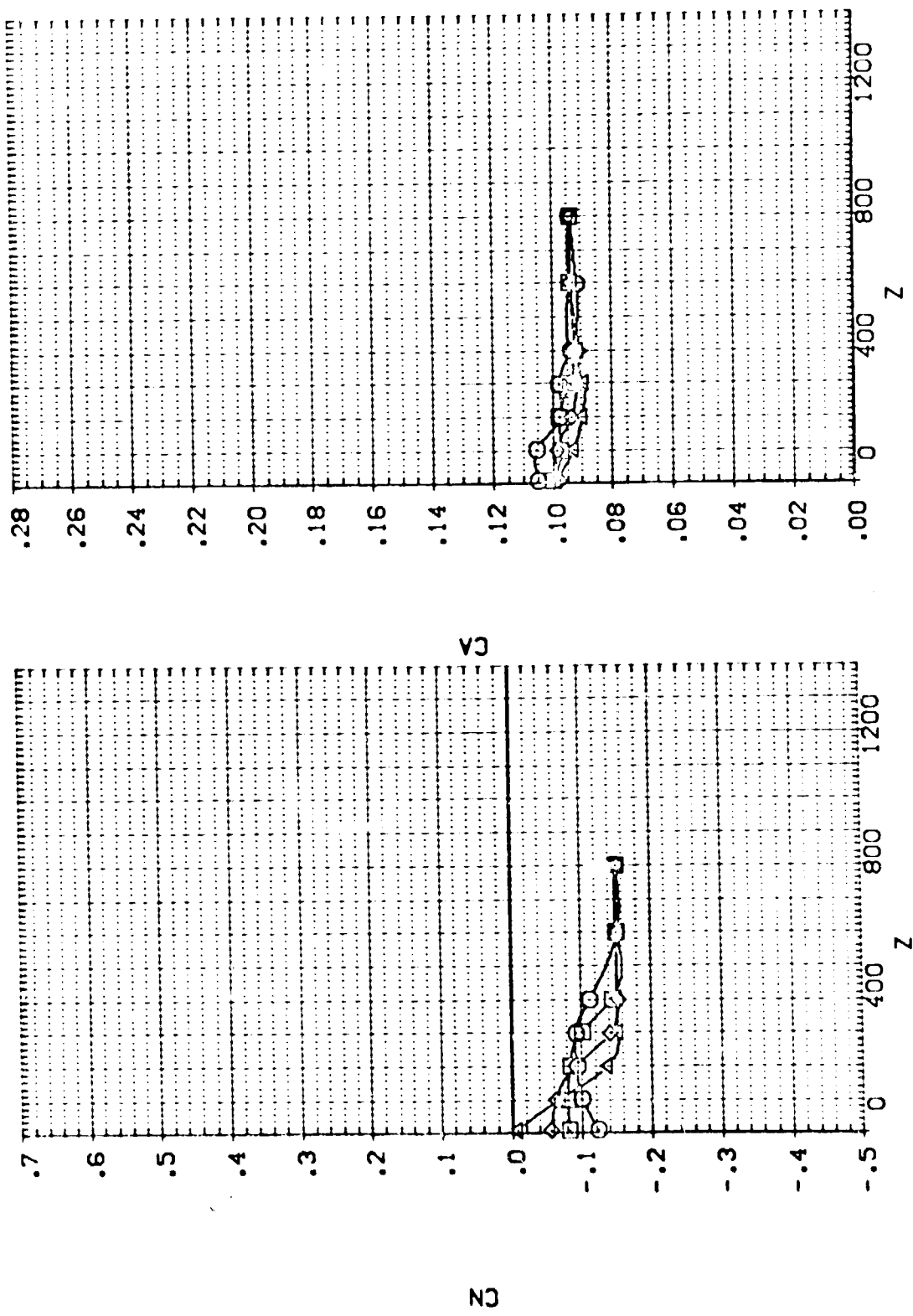

FIG. 13. EXTERNAL TANK (T10) SEPARATING FROM CR3. 09 (RTJ019)

SEE THE ASSUMED
DOCUMENT FOR
CHARACTERISTICS FOR
INDIVIDUAL DATA SETS

SYMBOL		PARAMETRIC VALUES	
○	X	MACH	4.530
○	Y	PTOTAL	110.000
○	Z	BETA	.000
○	W	DBETA	.000
○	V	ALTRON	.000
○	U	ELEVTR	200.000
○	T	Y	200.000



EFFECT OF EXTERNAL TANK SEPARATION ON ORBITER AERODYNAMIC CHARACTERISTICS

1A13.EXTERNAL TANK(T10)SEPARATING FROM ORB. 09 (RTJ019)

SEE THE ASSOCIATED DATA DOCUMENT FOR REFERENCE CHARACTERISTICS FOR INDIVIDUAL DATASETS

SYMBOL		PARAMETRIC VALUES	
x	.223	MACH	4.530
o	400,450	ALPHA	-5.000
◇	600,600	DALPHA	.000
△	1200,700	ELEVTR	.000
		Y	200,000
		PTOTAL	110,000
		BETA	.000
		DBETA	.500
		ALTRON	.000

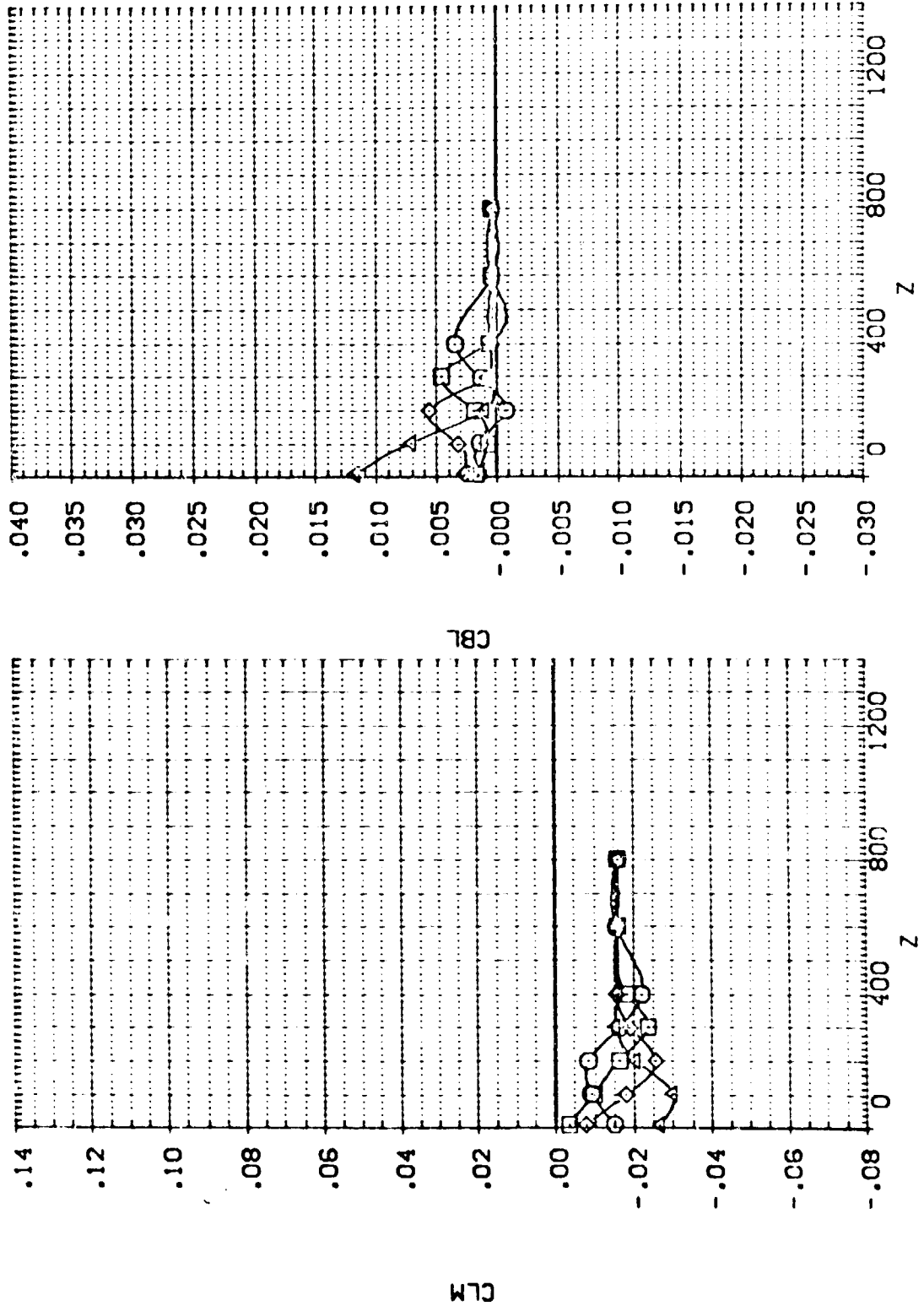

1A13. EXTERNAL TANK(T10)SEPARATING FROM ORB. C9 (RTJ019)

SEE THE ASSOCIATED DATA DOCUMENT FOR REFERENCE CHARACTERISTICS FOR INDIVIDUAL DATA SETS

SYMBOL		X		MACH		PARAMETRIC VALUES	
○	○	400.420	.223	4.530	PTOTAL	110.000	
◇	◇	800.600	ALPHA	-5.000	BETA	.000	
△	△	1200.700	DALPHA	.300	DBETA	.000	
			ELEVTR	.000	ATLRON	.000	
			Y	200.000			

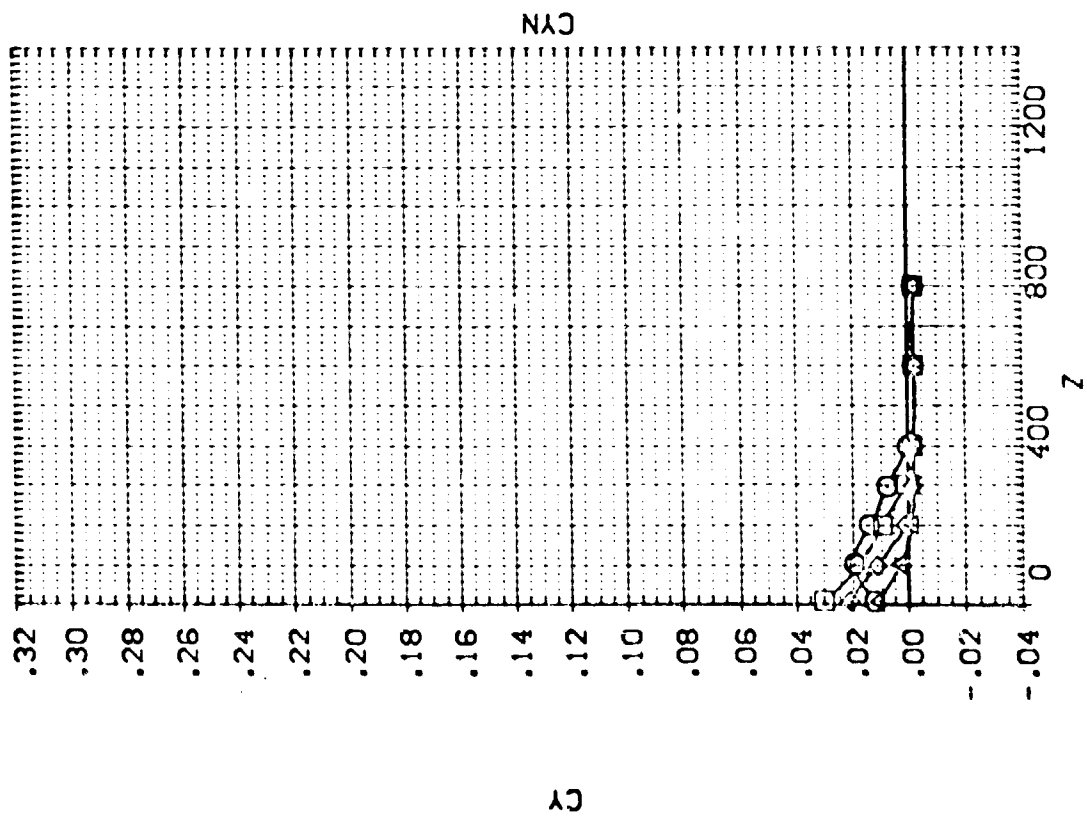
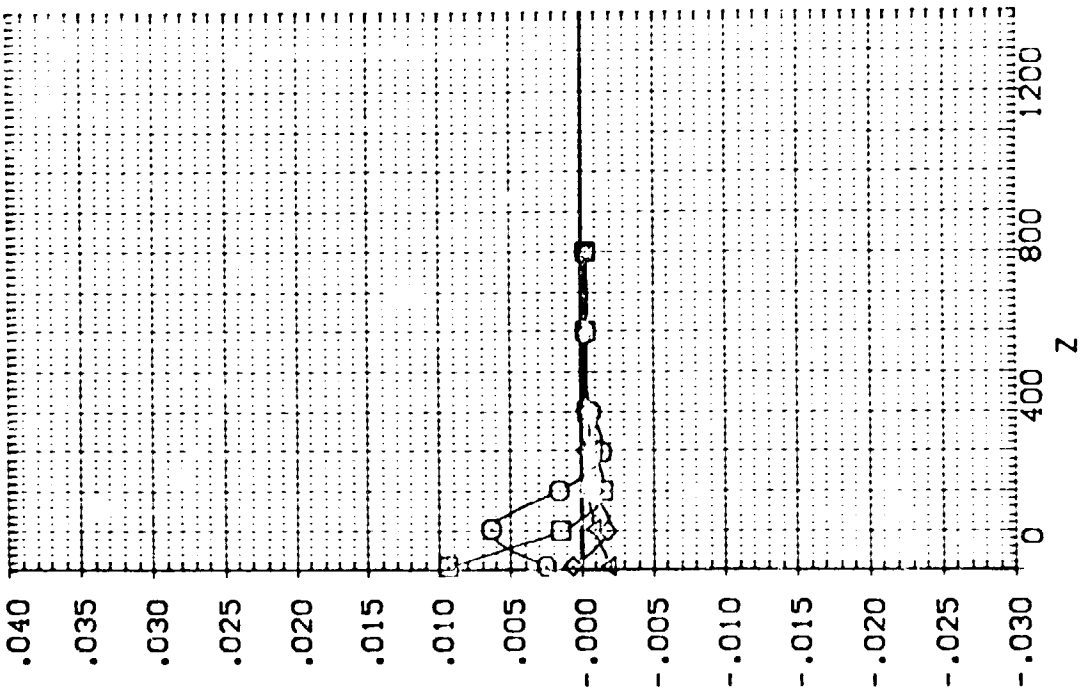

EFFECT OF EXTERNAL TANK SEPARATION ON ORBITER AERODYNAMIC CHARACTERISTICS

1A13. EXTERNAL TANK(T10)SEPARATING FROM ORB. 09 (RTJ020)

SEE THE ASSOCIATED DATA DOCUMENT FOR REFERENCE CHARACTERISTICS FOR INDIVIDUAL DATASETS

SYMBOL		PARAMETRIC VALUES	
○	X	MACH	PTOTAL
○	400	4.530	110.000
○	800	-5.000	BETA
○	1,200	.000	DBETA
○	1,900	.000	AILRON
○	2,600	.000	AILTRN
○	3,300	200.000	Y

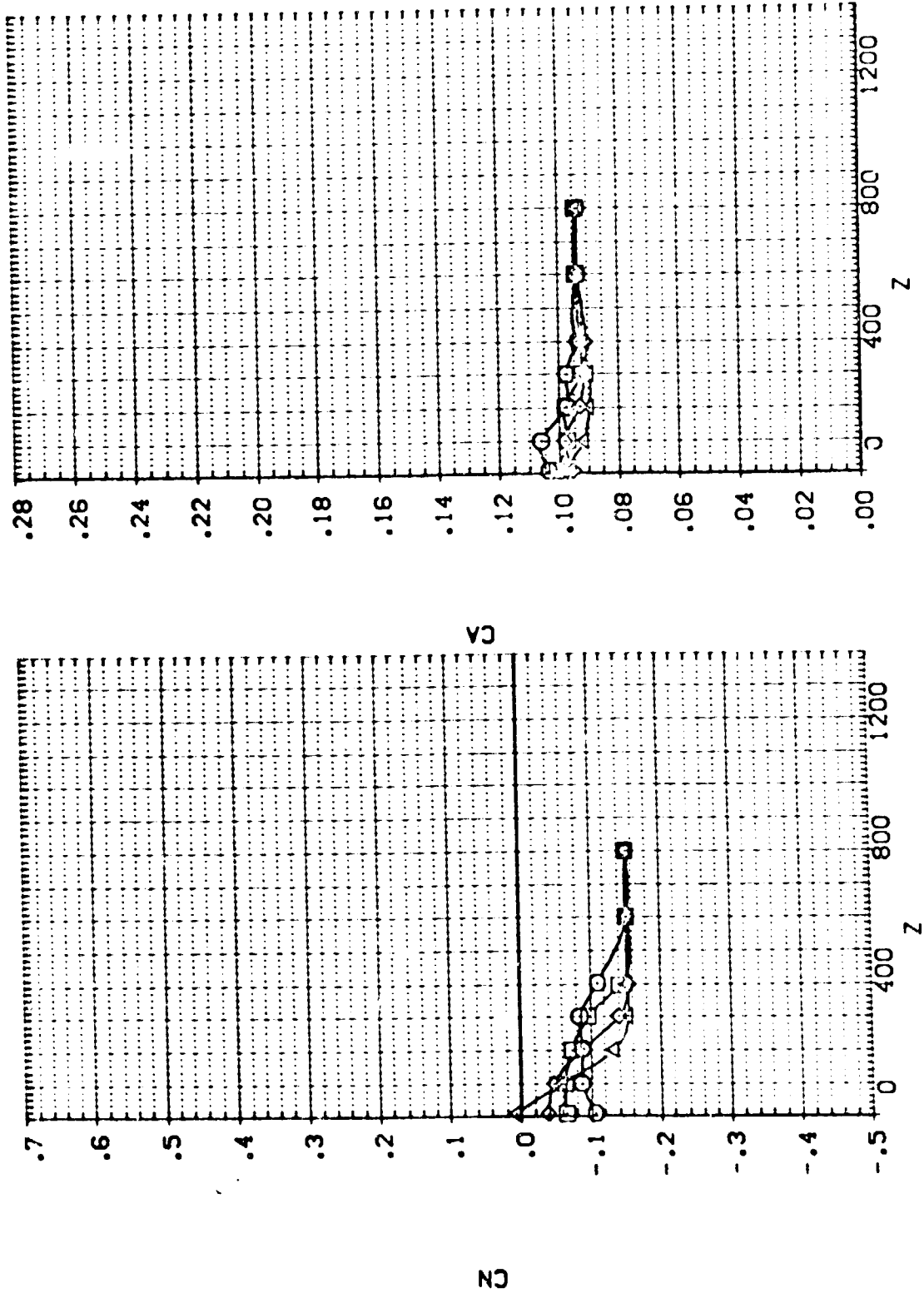

EFFECT OF EXTERNAL TANK SEPARATION ON ORBITER AERODYNAMIC CHARACTERISTICS

1A13. EXTERNAL TANK(T10)SEPARATING FROM ORB. 09 (RTJ020)

SEE THE ACQUAITY DOCUMENT FOR CHARACTERISTICS OR INDIVIDUAL DATA'S

SYMBOL		PARAMETRIC VALUES	
X	.175	MACH	4.530
O	400.230	ALPHA	-5.000
◇	800.370	DALPHA	.000
△	1200.900	ELEVTR	.000
		Y	200.000
		PTOTAL	110.000
		BETA	.000
		DBETA	5.000
		AILLRON	.000

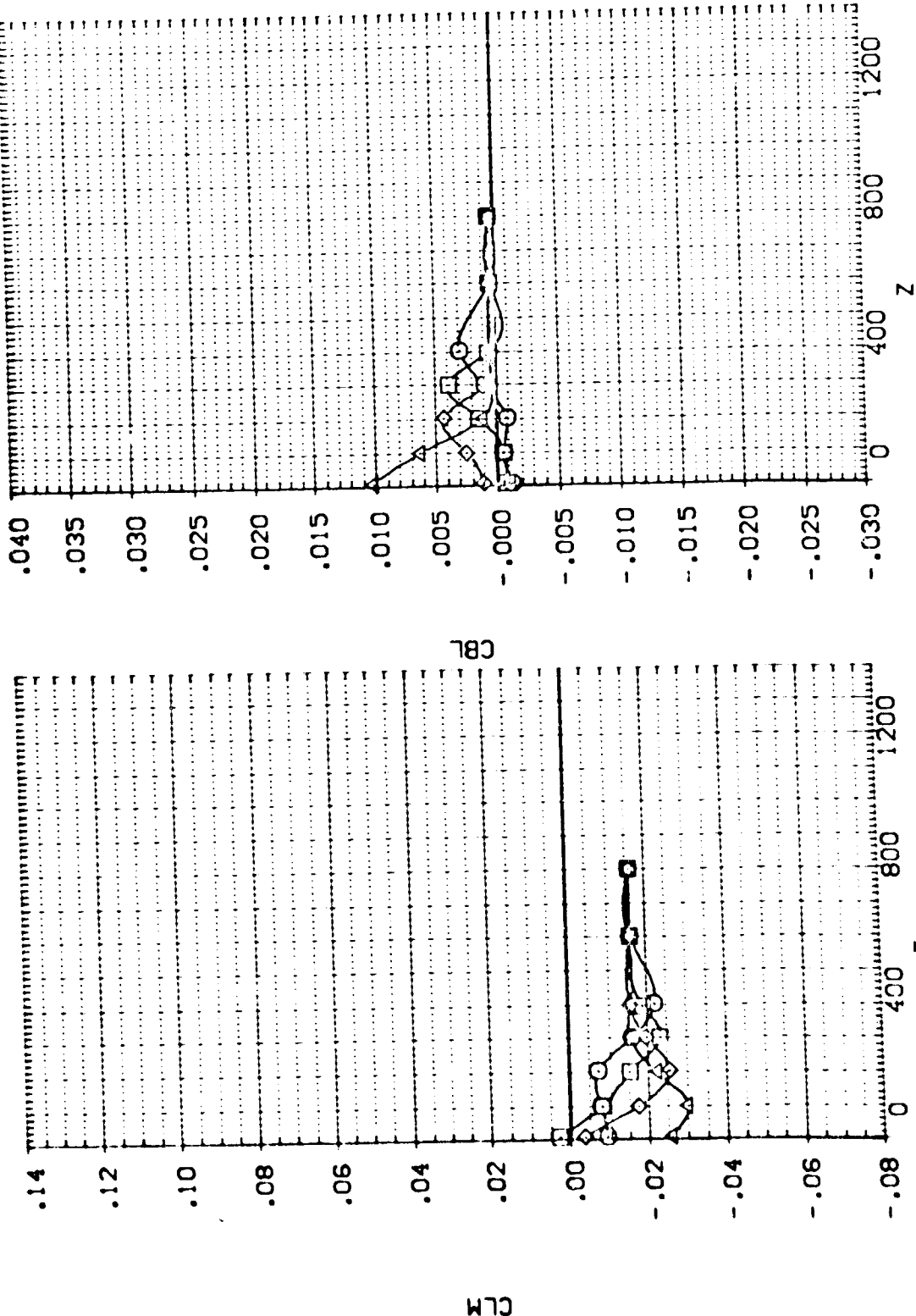

EFFECT OF EXTERNAL TANK SEPARATION ON ORBITER AERODYNAMIC CHARACTERISTICS

1A13.EXTERNAL TANK(T10)SEPARATING FROM ORB. 09 (RTJ020)

SEE THE ASSOCIATED DATA DOCUMENT FOR REFERENCE CHARACTERISTICS FOR INDIVIDUAL DATASETS

PARAMETRIC VALUES	
MACH	4.530
PTOTAL	110.000
BETA	-5.000
DBETA	5.000
AIRRON	.000
ELEVTR	200.000
Y	

SYMBOL	X
○	.175
□	400.230
◇	800.370
△	1200.900

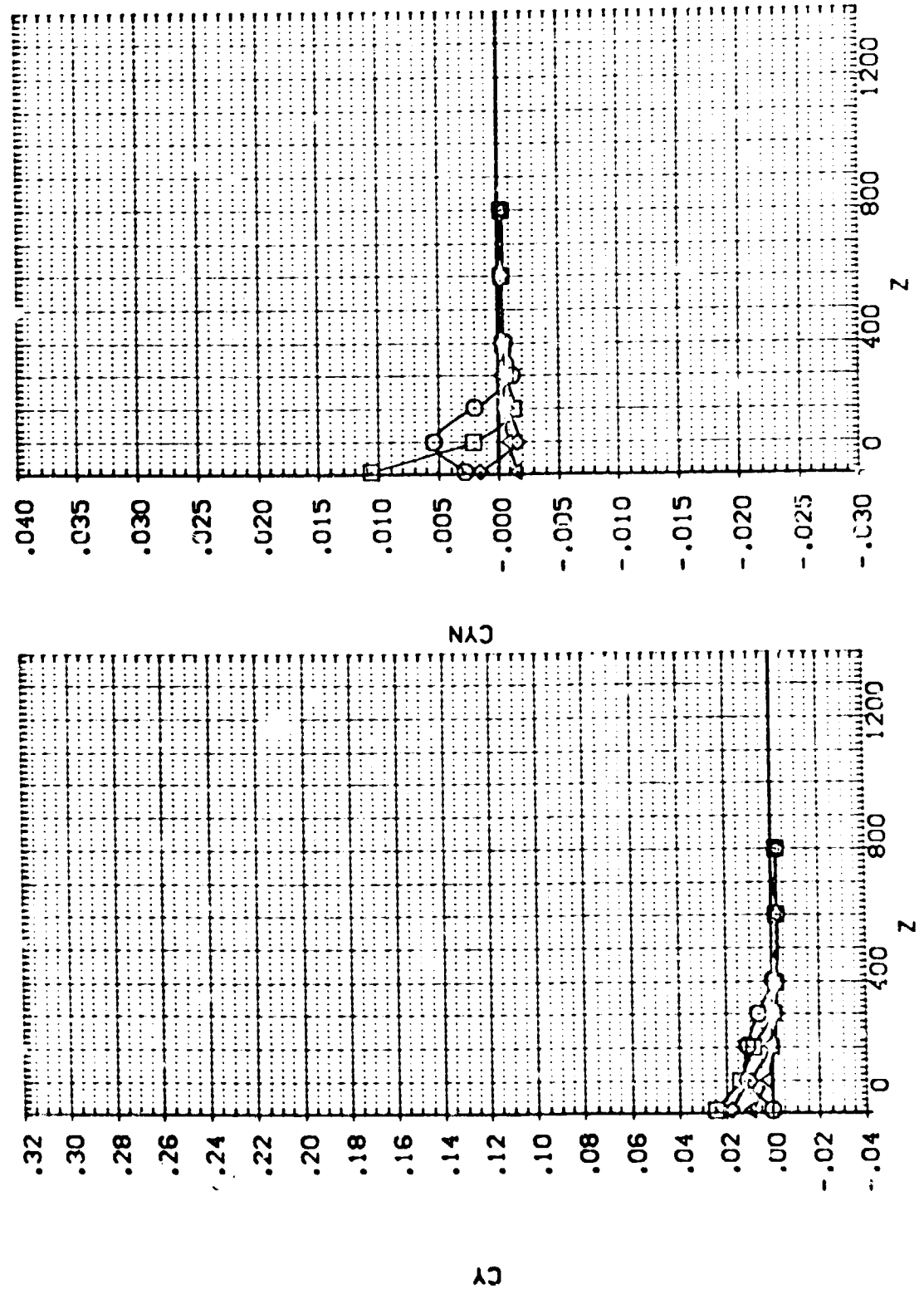

EFFECT OF EXTERNAL TANK SEPARATION ON ORBITER AERODYNAMIC CHARACTERISTICS

SEE THE ASSOCIATED DATA DOCUMENT FOR THE NAME CHARACTERISTICS FOR INDIVIDUAL DATASETS

SYMBOL	X	MACH	PARAMETRIC VALUES
○	.308	4.530	PTOTAL 110.000
◇	400.370	-5.000	BETA .000
△	800.700	.000	DELTA 5.000
	1200.600	.000	AILRON .000
		Y	

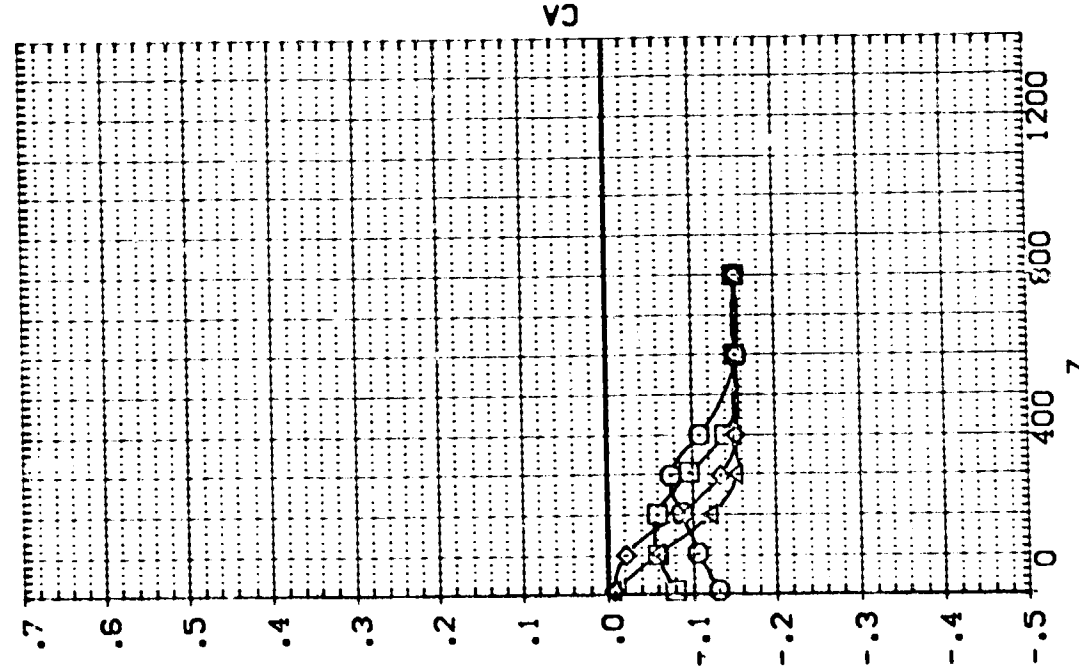
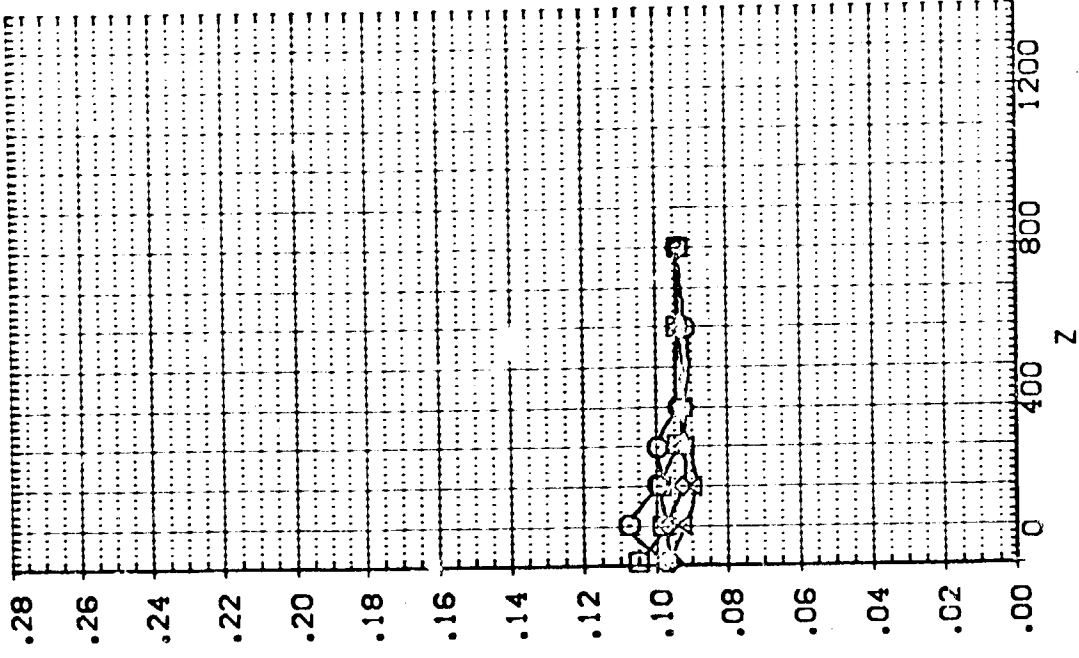

EFFECT OF EXTERNAL TANK SEPARATION ON ORBITER AERODYNAMIC CHARACTERISTICS

1A13, EXTERNAL TANK(T10)SEPARATING FROM ORB. 09 (RTJ021)

SEE THE ASSOCIATED DATA DOCUMENT FOR REFERENCE CHARACTERISTICS FOR INDIVIDUAL DATASETS

SYMBOL		PARAMETRIC VALUES			
○	X	MACH	4.530	PTOTAL	110.000
□	400.370	ALPHA	-5.000	BETA	.000
◇	800.700	DALPHA	.000	CBETA	5.000
△	1200.800	ELEVTR	.000	ALTRON	.000
		Y	.000		

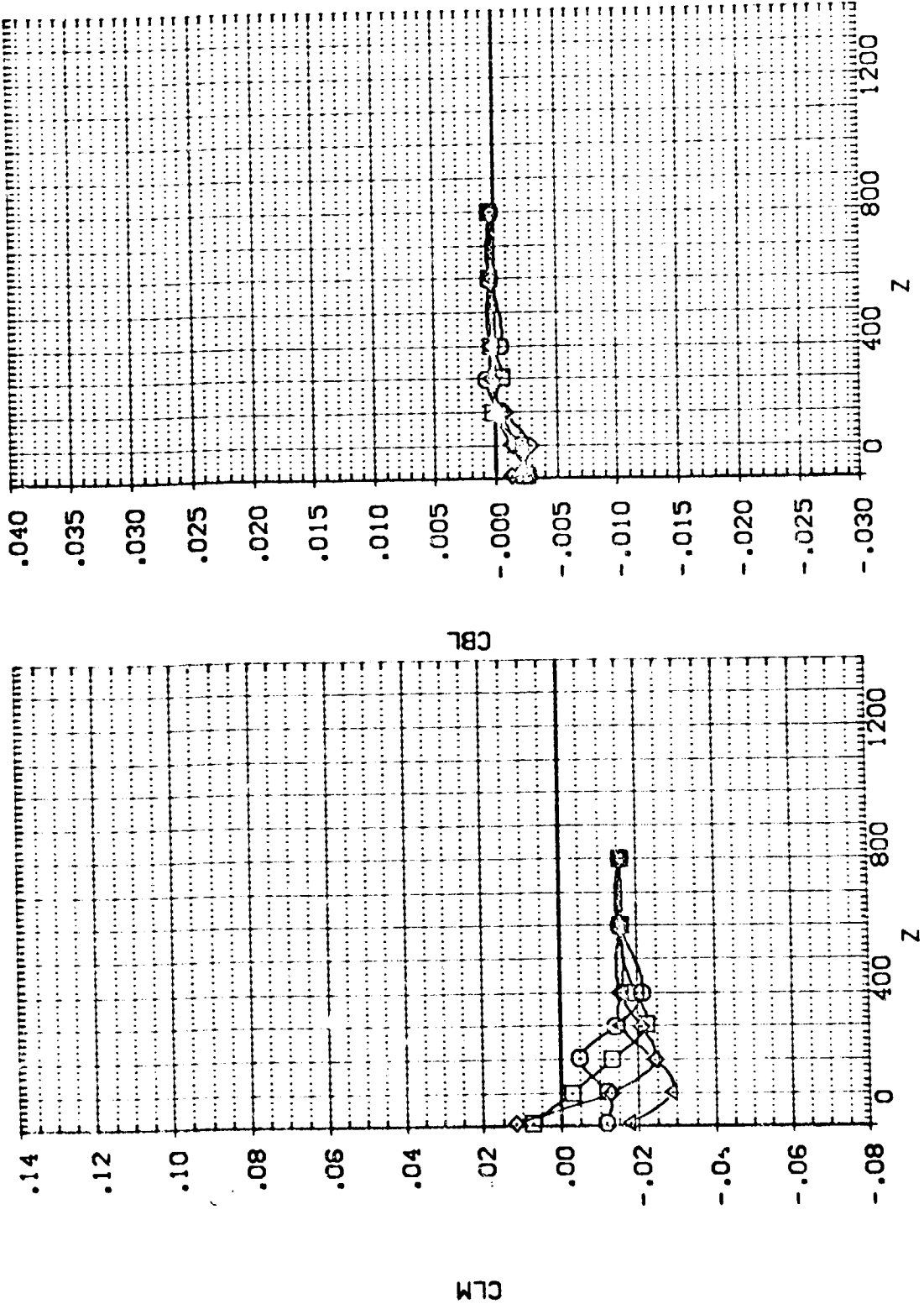

EFFECT OF EXTERNAL TANK SEPARATION ON ORBITER AERODYNAMIC CHARACTERISTICS

IA13, EXTERNAL TANK(T10)SEPARATING FROM ORB. 09 (RIJ021)

SEE THE ASSOCIATED T10A DOCUMENT FOR CHARACTERISTICS FOR INDIVIDUAL DATASETS

SYMBOL		PARAMETRIC VALUES	
○	X	MACH	4.530
□	Y	ALPHA	-5.000
◇	Z	DALPHA	.000
△		ELEVTR	.000
		A'LRON	.000
		PITOTAL	110.000
		BETA	.000
		DBETA	5.000
		A'LRON	.000

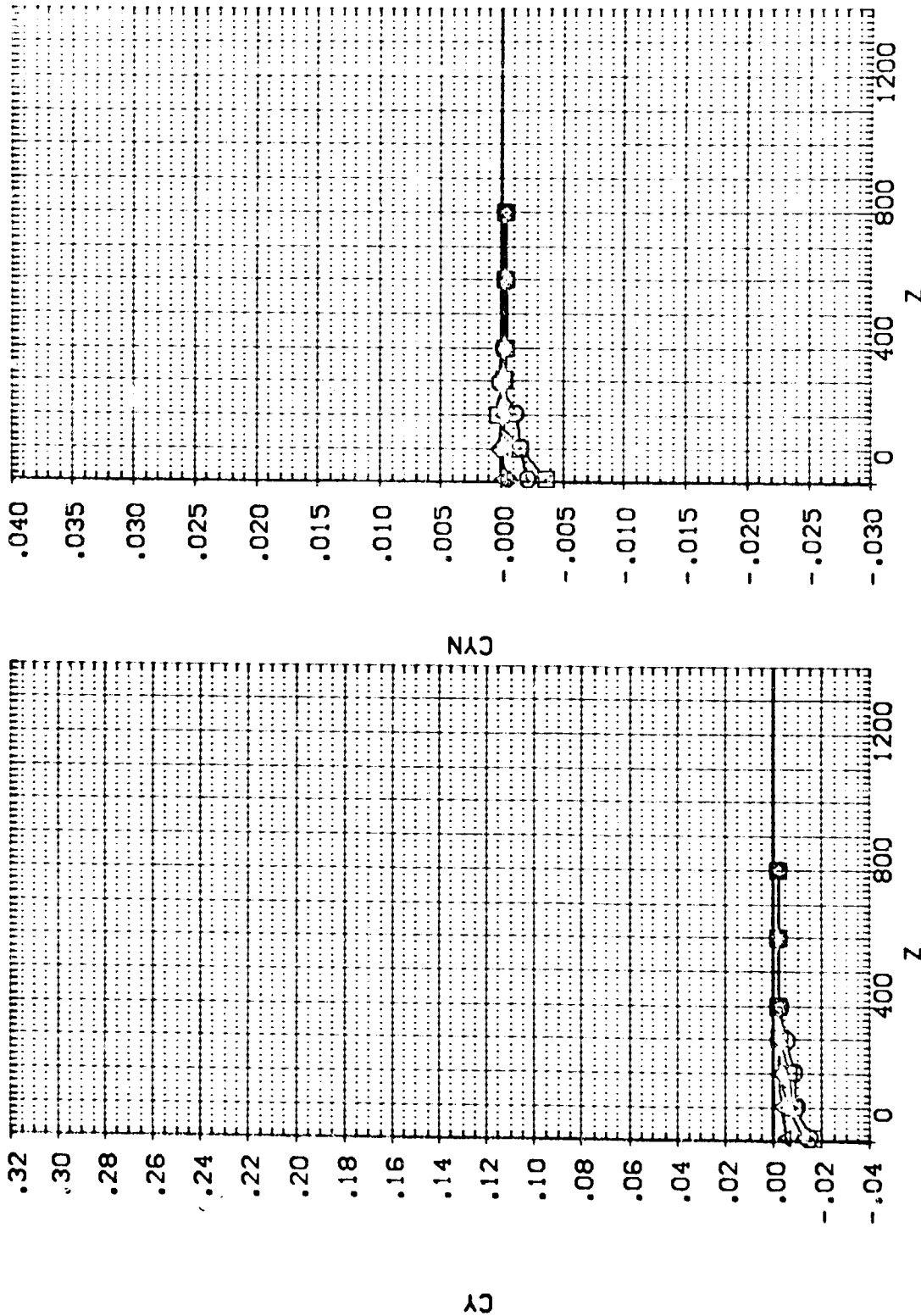

EFFECT OF EXTERNAL TANK SEPARATION ON ORBITER AERODYNAMIC CHARACTERISTICS

IA13.EXTERNAL TANK(T10)SEPARATING FROM ORB. 09 (RTJ022)

SEE THE ASSOCIATED DATA DOCUMENT FOR REFERENCE CHARACTERISTICS FOR INDIVIDUAL DATASETS

SY60.	X	MACH	ALPHA	DALPHA	ELEVTR	Y	PARAMETRIC VALUES
	.089	4.530	-5.000	-5.000	.000	.000	PTOTAL 110.000
○	400.520						BETA .000
□	800.490						DBETA .000
◇	1200.800						AILRON .000
△							

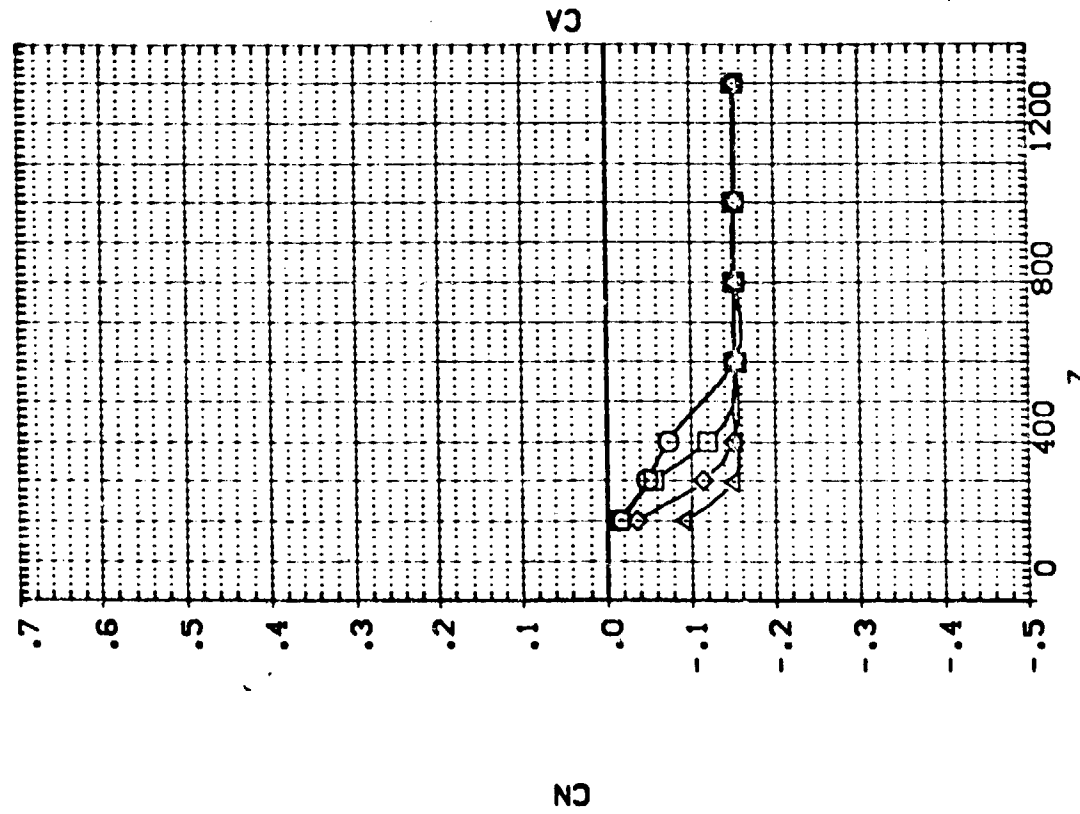
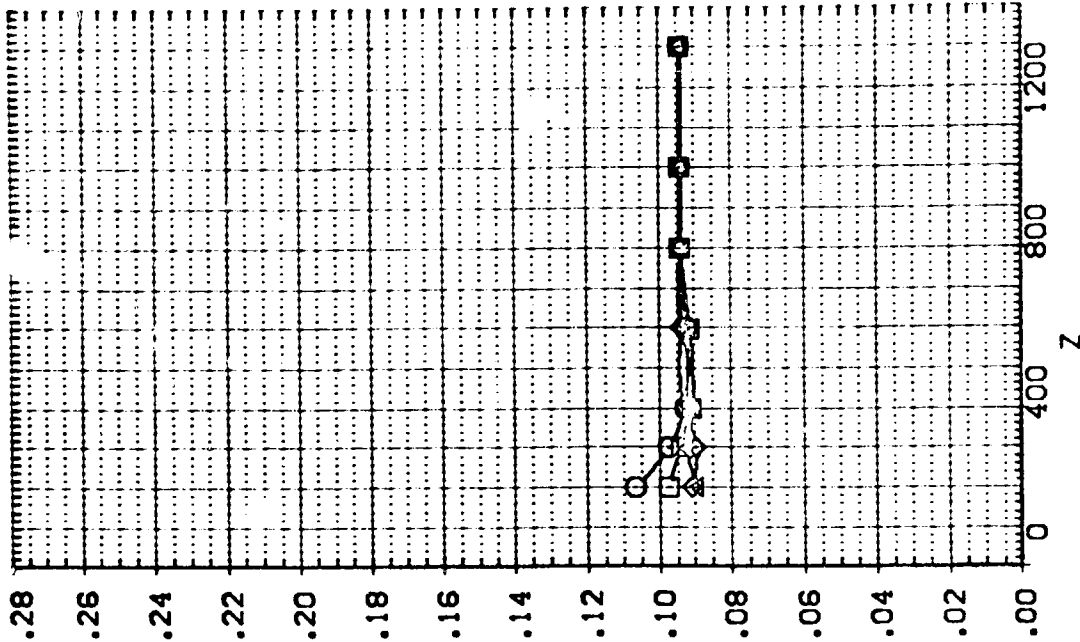

1A13. EXTERNAL TANK (110) SEPARATING FROM ORB. C9 (RTJ022)

SEE THE ASSOCIATED DATA DOCUMENT FOR REFERENCE CHARACTERISTICS FOR INDIVIDUAL DATASETS

PARAMETRIC VALUES

MACH	4.530	PTOTAL	110.000
ALPHA	-5.000	BETA	.000
DELTA	-5.000	DBETA	.000
ELEVTR	.000	AIRTON	.000
Y	.000		

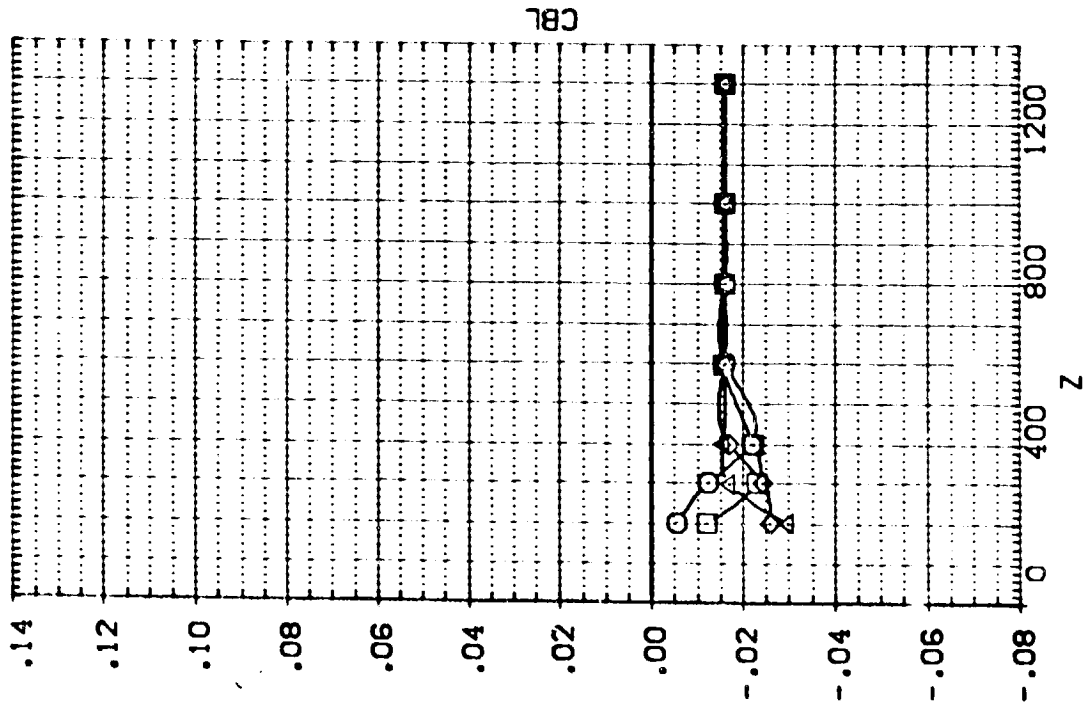
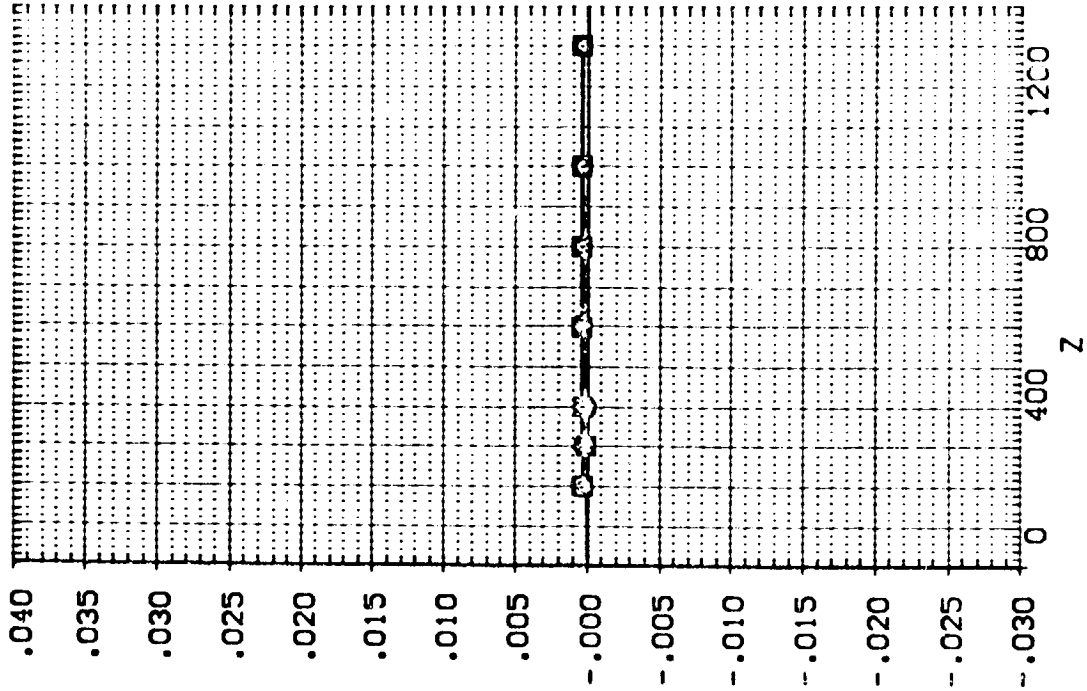

EFFECT OF EXTERNAL TANK SEPARATION ON ORBITER AERODYNAMIC CHARACTERISTICS

1A13, EXTERNAL TANK(T10)SEPARATING FROM ORB. 09 (RTJ022)

SEE THE ASSOCIATED DATA DOCUMENT FOR REFERENCE CHARACTERISTICS FOR INDIVIDUAL DATASETS

SYMBOL		PARAMETRIC VALUES	
X	.089	MACH	4.530
	400,520	ALPHA	-5.000
	800,490	DALPHA	-5.000
	1200,600	ELEVTR	.000
		Y	.000
		PTOTAL	110,000
		BETA	.000
		DBETA	.000
		ALTRON	.000

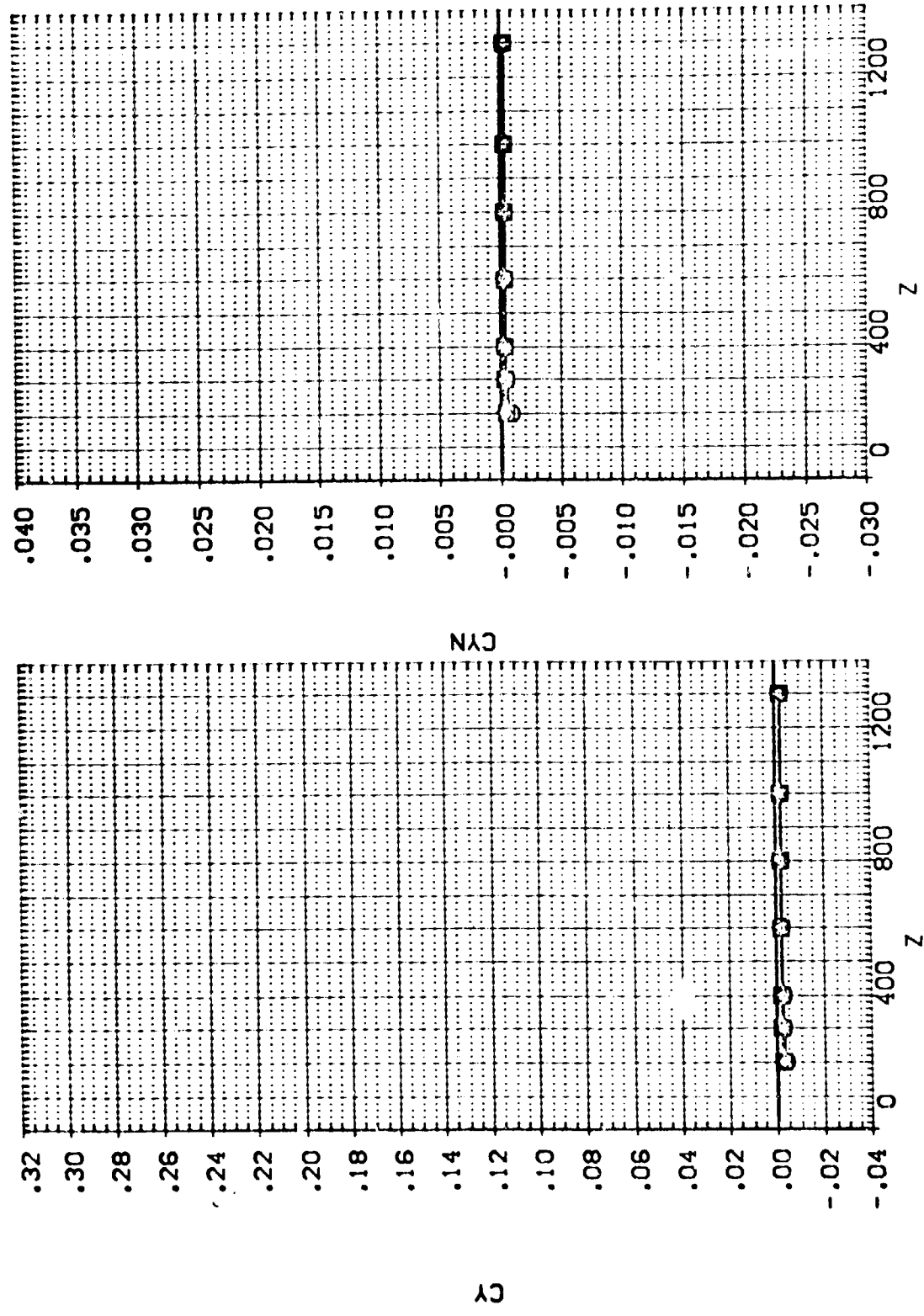

EFFECT OF EXTERNAL TANK SEPARATION ON ORBITER AERODYNAMIC CHARACTERISTICS

IA13, EXTERNAL TANK(T10)SEPARATING FROM ORB. 09 (RTJ023)

SEE THE ASSOCIATED DOCUMENT FOR CHARACTERISTICS FOR INDIVIDUAL DATA'S

PARAMETRIC VALUES	
MACH	4.530
PITOTAL	110.000
ALPHA	-5.000
BETA	.000
DALPHA	-10.000
DBETA	.000
ELEVTR	.000
Y	.000

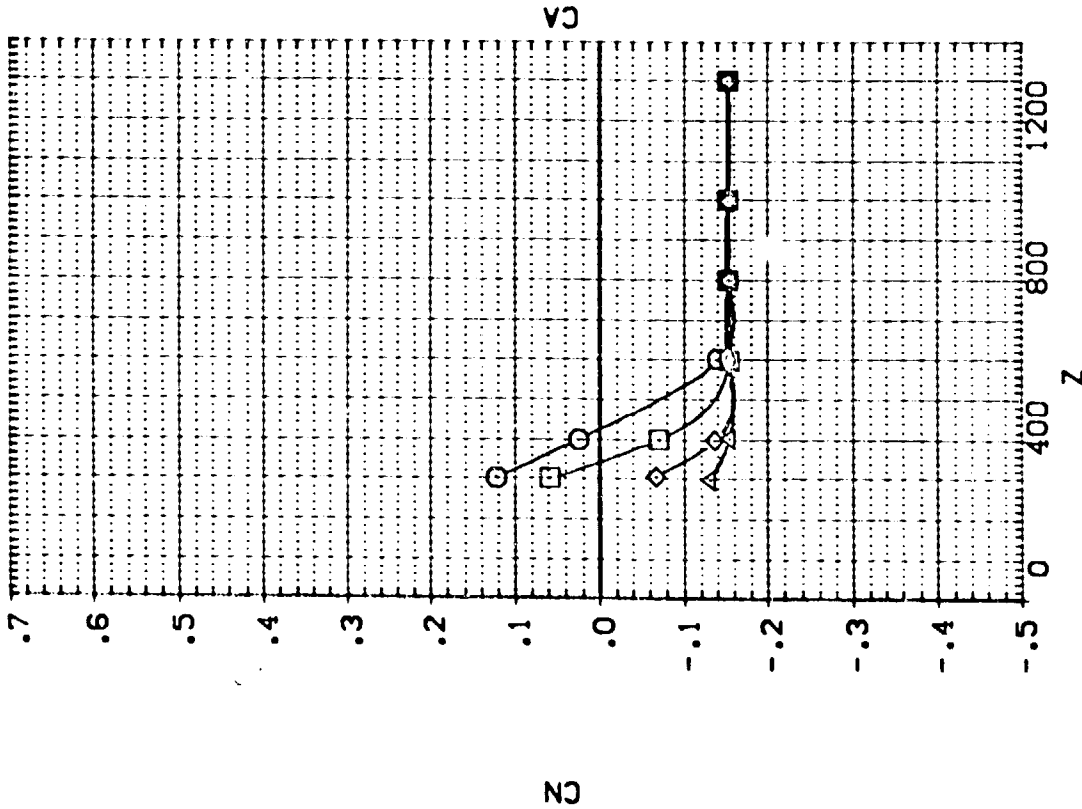
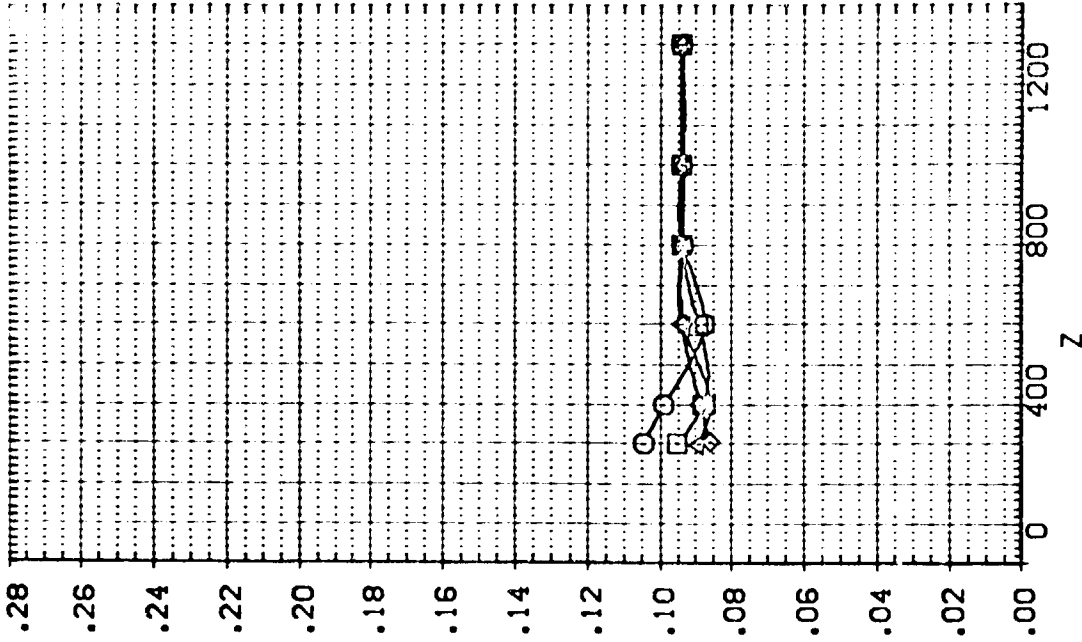

EFFECT OF EXTERNAL TANK SEPARATION ON ORBITER AERODYNAMIC CHARACTERISTICS

1A13. EXTERNAL TANK(T10)SEPARATING FROM ORB. 09 (RTJ023)

SEE THE ASSOCIATED DATA DOCUMENT FOR REFERENCE CHARACTERISTICS FOR INDIVIDUAL DATASETS

SYMBOL		PARAMETRIC VALUES	
○	X	MACH	4.530
□	400	PIOTAL	110.000
◇	800	BETA	-5.000
△	1200	DALPHA	-10.000
		DBETA	.700
		ELEVTR	.000
		AILRDY	.000
		Y	.000

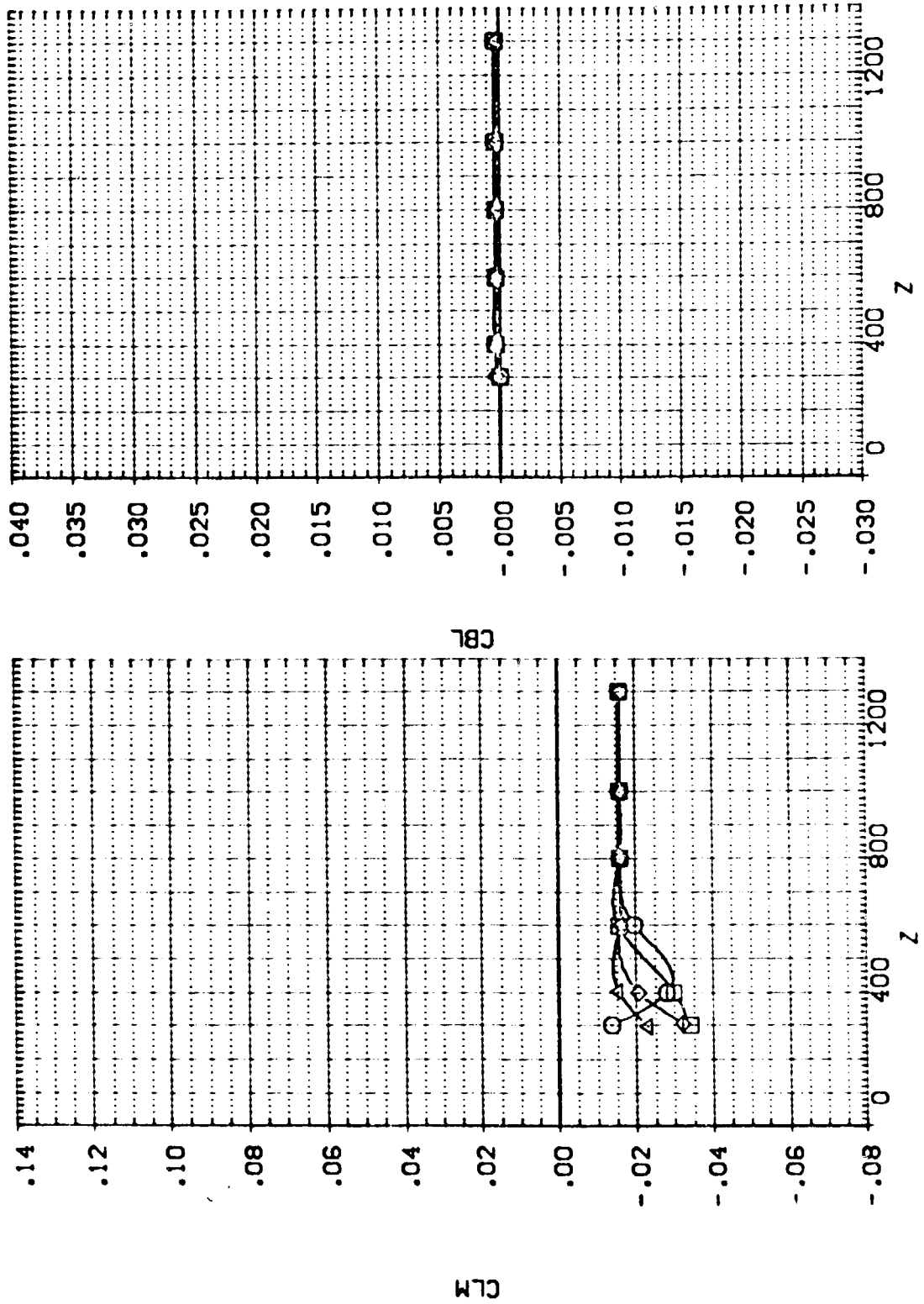

EFFECT OF EXTERNAL TANK SEPARATION ON ORBITER AERODYNAMIC CHARACTERISTICS

1A13, EXTERNAL TANK(T1U)SEPARATING FROM ORB. 09 (RTJ023)

SEE THE ASSOCIATED DOCUMENT FOR RELEVANT CHARACTERISTICS FOR INDIVIDUAL DATASETS

PARAMETRIC VALUES	
MACH	4.530
PIOTAL	110.000
BETA	-5.000
DBETA	10.000
ALURON	.000
Y	.000

PARAMETRIC VALUES	
MACH	4.530
PIOTAL	110.000
BETA	-5.000
DBETA	10.000
ALURON	.000
Y	.000

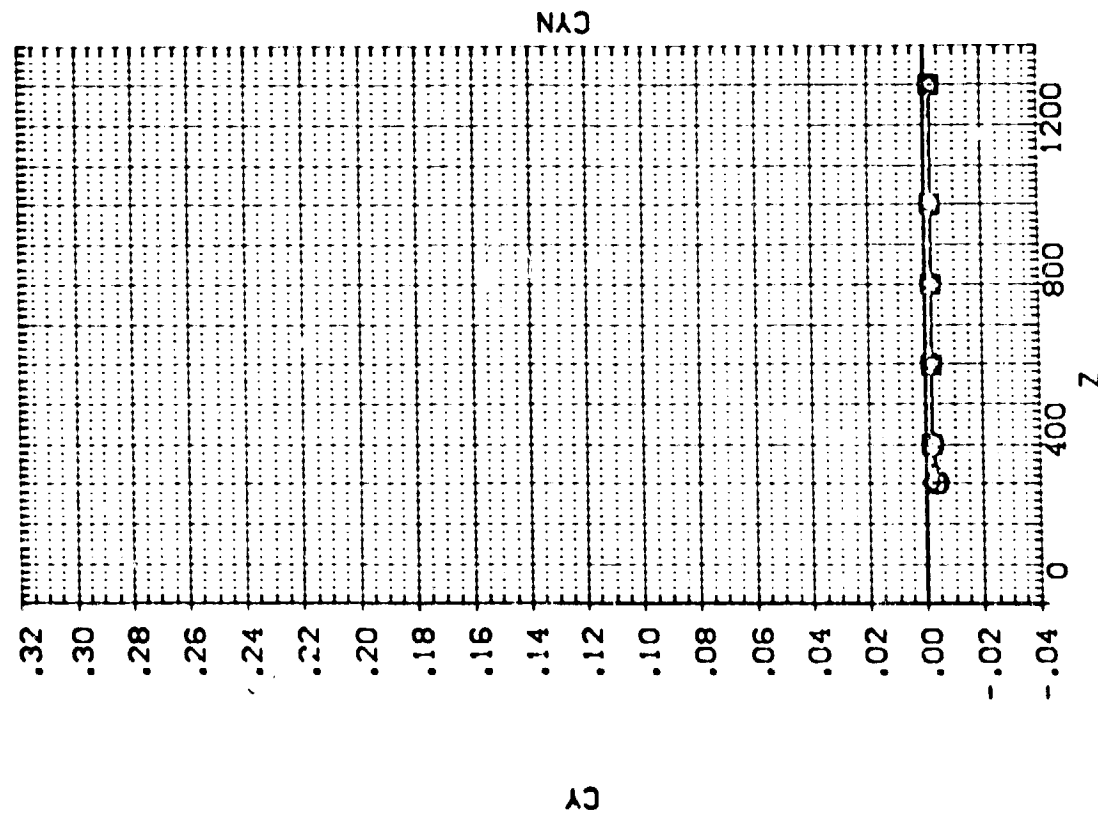
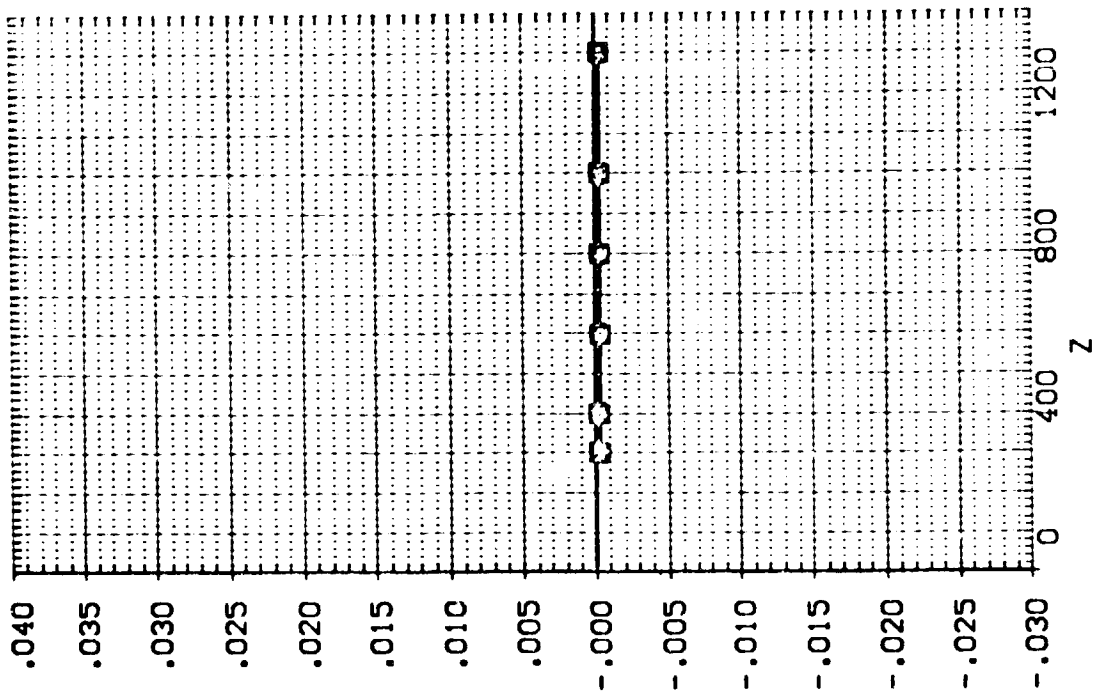

EFFECT OF EXTERNAL TANK SEPARATION ON ORBITER AERODYNAMIC CHARACTERISTICS

1.13. EXTERNAL TANK(110)SEPARATING FROM ORB. 09 (RTJ024)

SEE THE ASSOCIATED DATA DOCUMENT FOR REFERENCE CHARACTERISTICS FOR INDIVIDUAL DATASETS

SYMBOL	λ	MACH	PARAMETRIC VALUES
○	.023	4.530	PITOTAL 110.000
□	400.310	-5.000	BETA .000
◇	800.670	-10.000	DBETA .000
△	1200.700	.000	AILLON .000
		Y	200.000

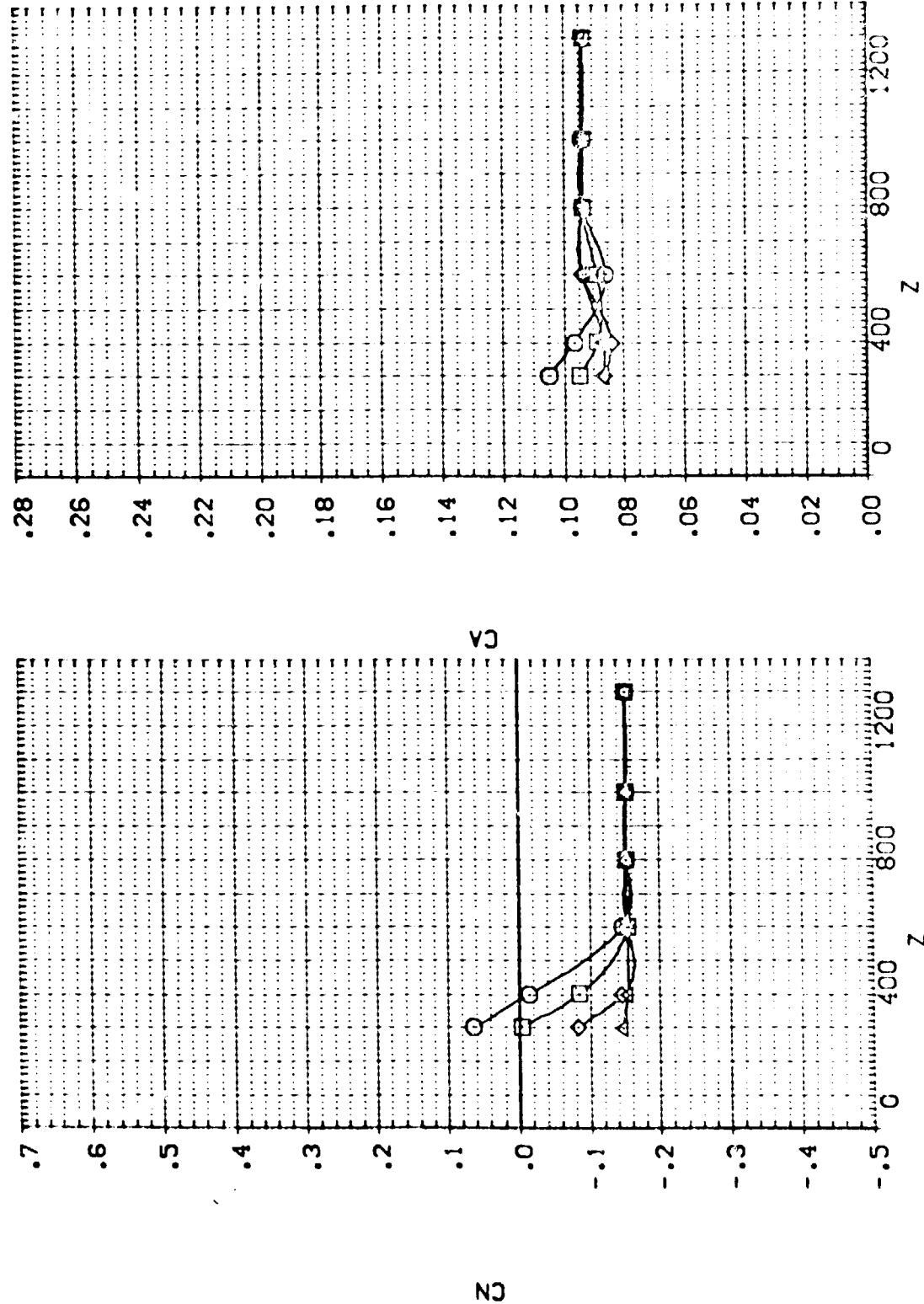

EFFECT OF EXTERNAL TANK SEPARATION ON ORBITER AERODYNAMIC CHARACTERISTICS

1.13. EXTERNAL TANK(110)SEPARATING FROM ORB. 09 (RTJ024)

SEE THE NEXT PLATE FOR
 A SUMMARY OF
 CHARACTERISTICS FOR
 INDIVIDUAL DATA SETS

SYMBOL	MACH	PARAMETRIC VALUES
○	4.530	PICITAL 110.000
◇	4.000	BETA .000
△	-10.000	DBETA .000
	200.000	ATLURON .000

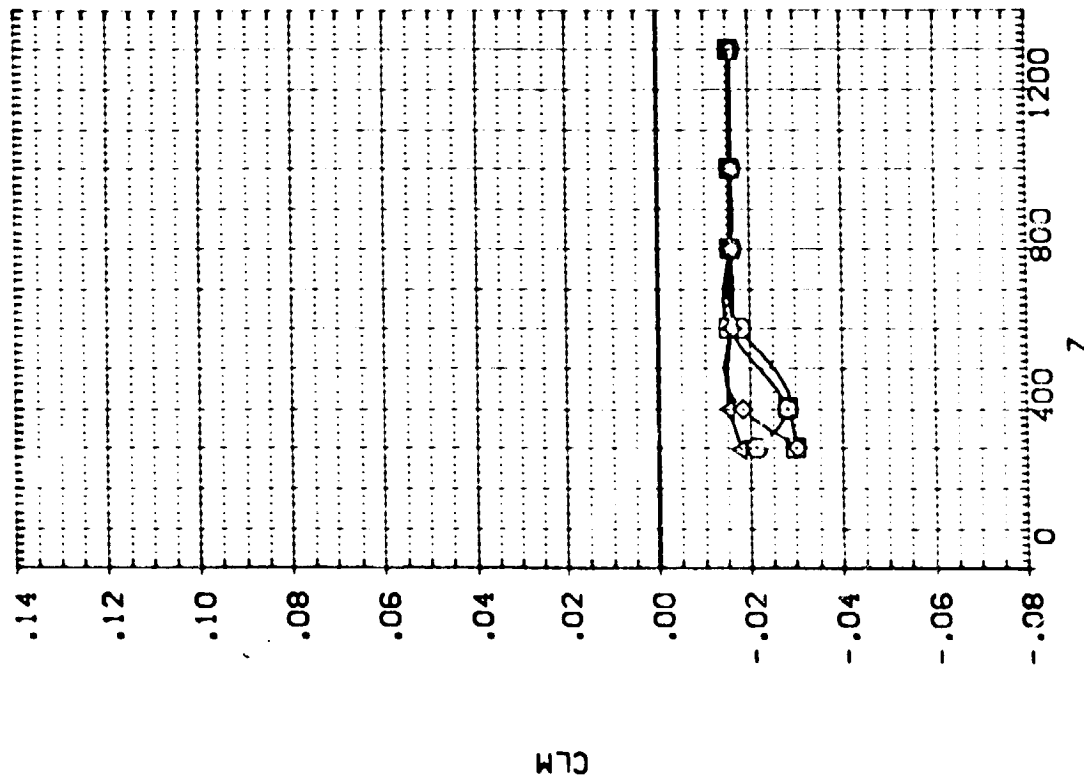
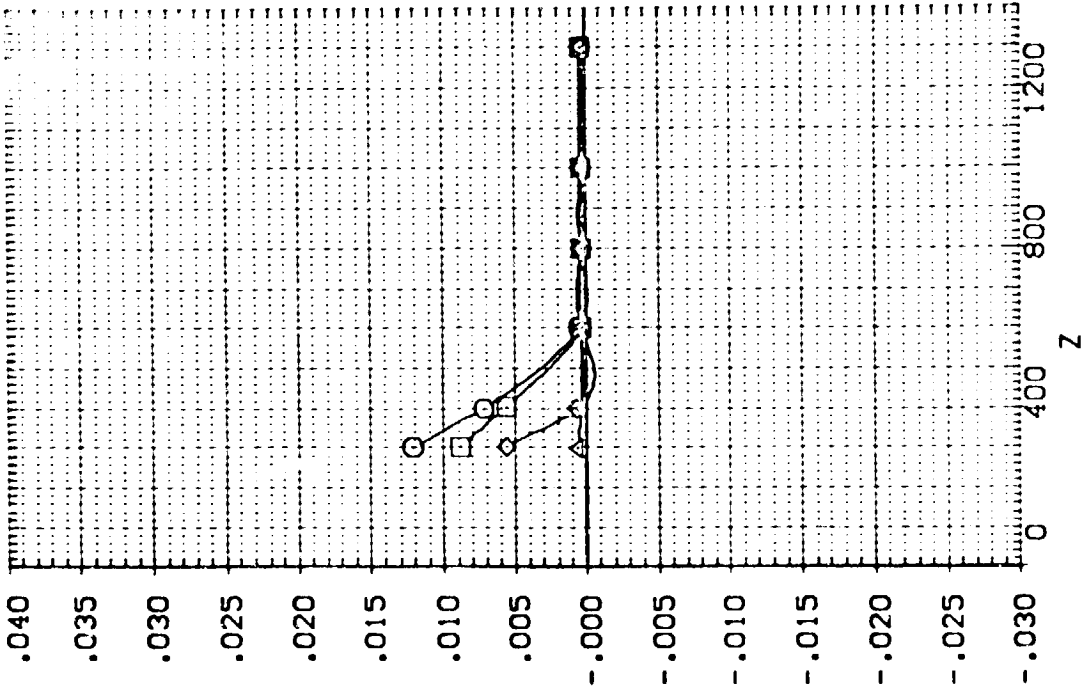

EFFECT OF EXTERNAL TANK SEPARATION ON ORBITER AERODYNAMIC CHARACTERISTICS

1A13.EXTERNAL TANK(T10)SEPARATING FROM ORB. 09 (RTJ024)

SEE THE ASSOCIATED DATA DOCUMENT FOR REFERENCE CHARACTERISTICS FOR INDIVIDUAL DATASETS

SYMBOL		PARAMETRIC VALUES	
X	.023	MACH	4.530
		PITOTAL	110.000
○	400.310	BETA	.000
◇	800.670	DETA	.000
△	1200.700	AILRON	.000
		Y	200.000

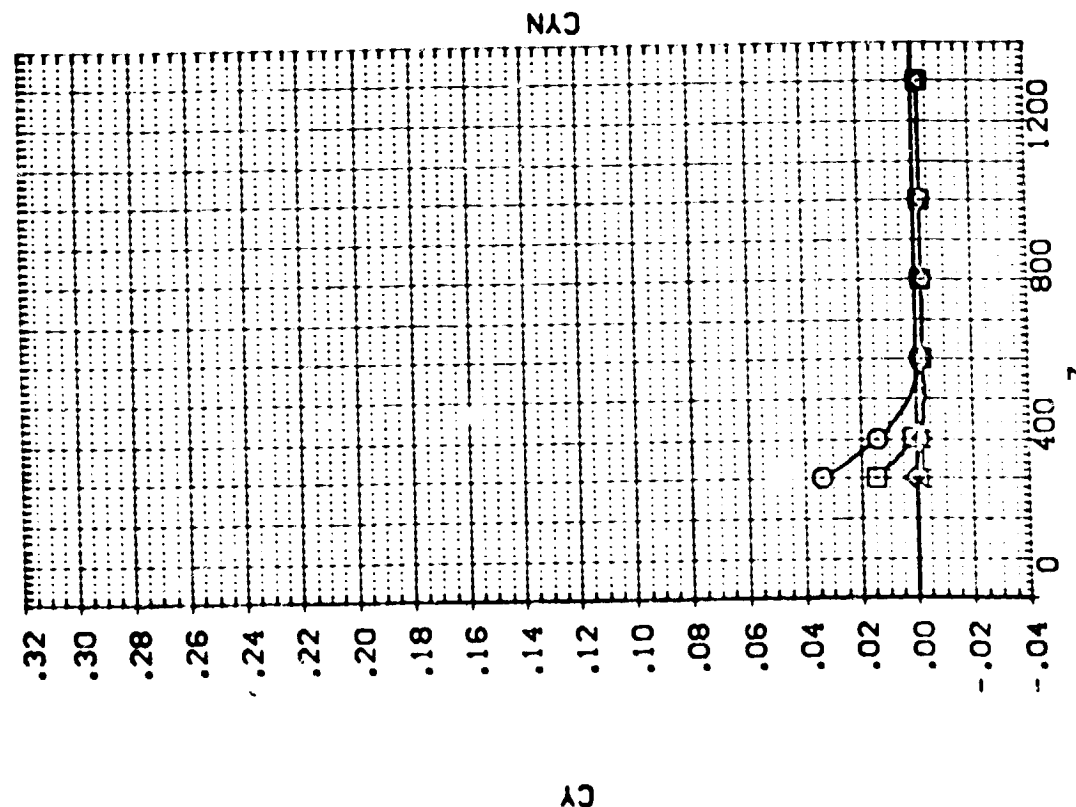
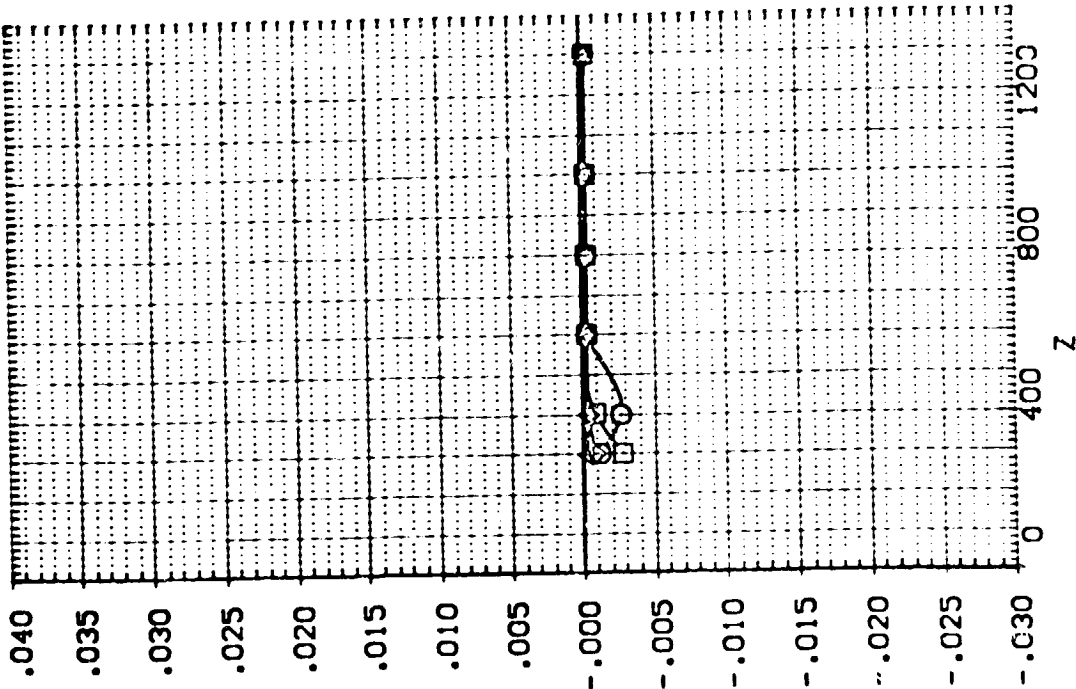

EFFECT OF EXTERNAL TANK SEPARATION ON ORBITER AERODYNAMIC CHARACTERISTICS

1.13. EXTERNAL TANK SEPARATING FROM ORB. 09 (R1J025)

SEE THE ASSOCIATED DOCUMENT FOR REFERENCE CHARACTERISTICS FOR INDIVIDUAL DATASETS

PARAMETRIC VALUES	
MACH	4.530
PTOTAL	110.000
BETA	.000
DBETA	5.000
ALPHAX	-10.000
ALPHAY	.000
ELEVTR	.000
ALLCON	.000
Y	200.000

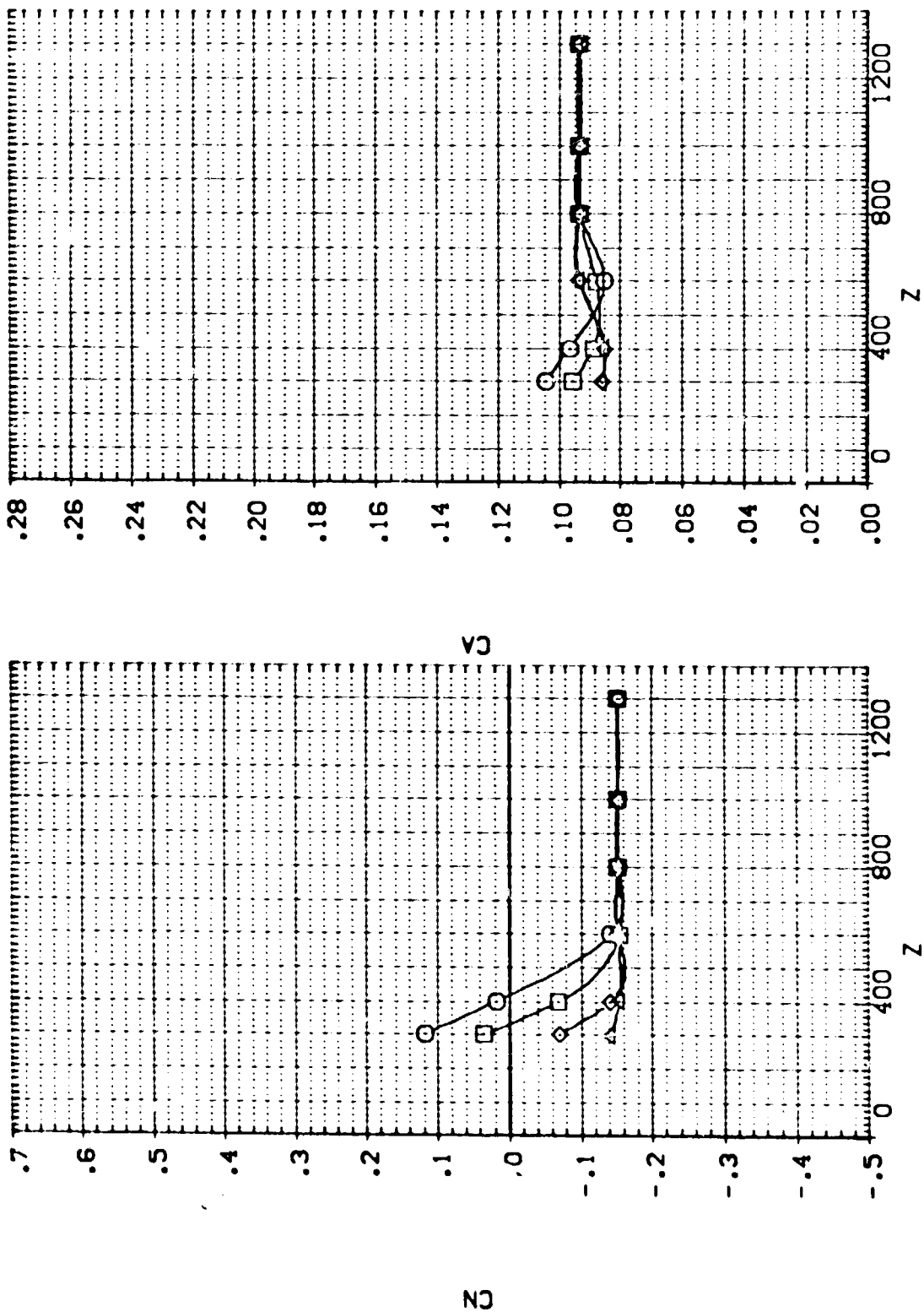

EFFECT OF EXTERNAL TANK SEPARATION ON ORBITER AERODYNAMIC CHARACTERISTICS

1A13, EXTERNAL TANK(T10)SEPARATING FROM ORB. 09 (RTJ025)

SEE THE ASSOCIATED DATA DOCUMENT FOR REFERENCE CHARACTERISTICS FOR INDIVIDUAL DATASETS

Symbol	X	Y	PARAMETRIC VALUES
○	-0.076	110.000	MACH
□	400.690	.000	PTOTAL
◇	800.560	5.000	BETA
△	1200.500	.000	DELTA
		200.000	ELEVTR
			AILRON

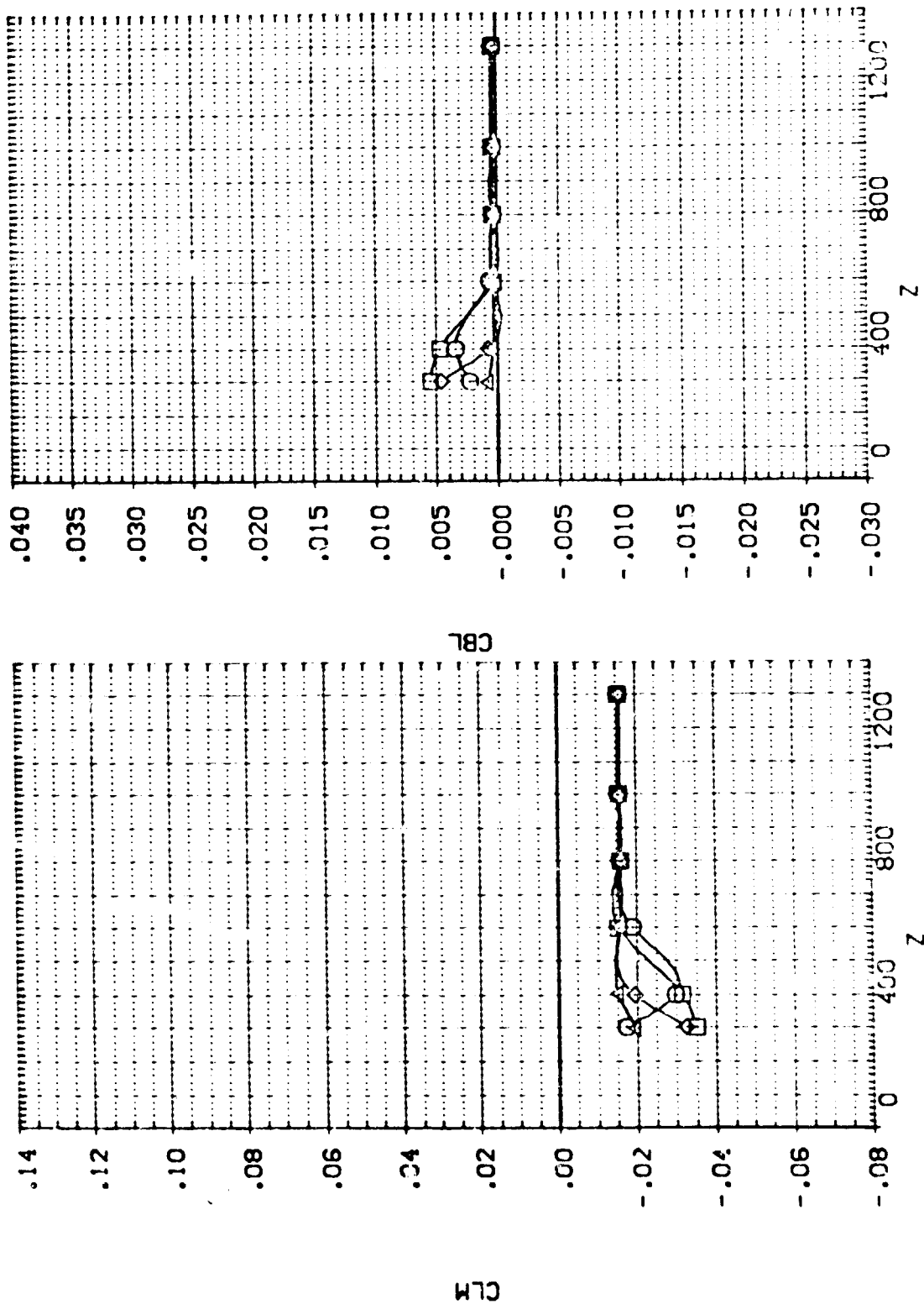

IA13. EXTERNAL TANK(T10)SEPARATING FROM ORB. 09 (RTJ025)

SEE THE ASSOCIATED REFERENCE DOCUMENT FOR REFERENCE CHARACTERISTICS FOR INDIVIDUAL DATASETS

SYMBOL		X		MACH		PARAMETRIC VALUES	
○	□	-0.076	400.690	4.530	PTOTAL	110.000	
◇	△	800.560	1200.500	-5.000	BETA	.000	
				-10.000	DBETA	5.000	
				.000	AILRON	.000	
				200.000	Y		

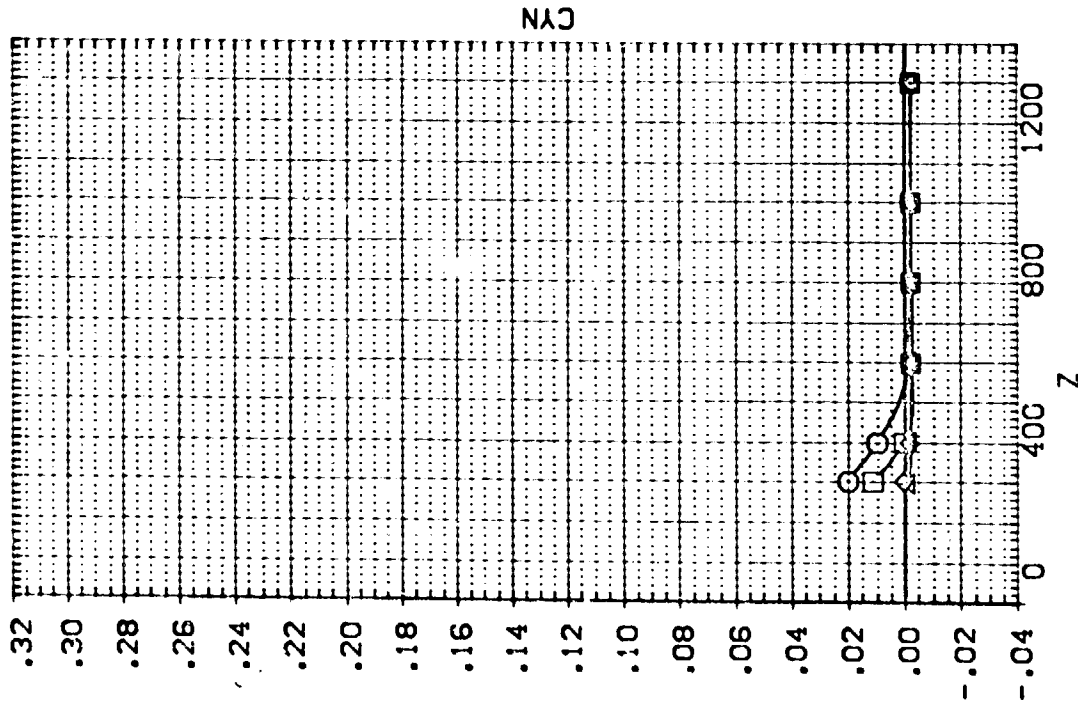
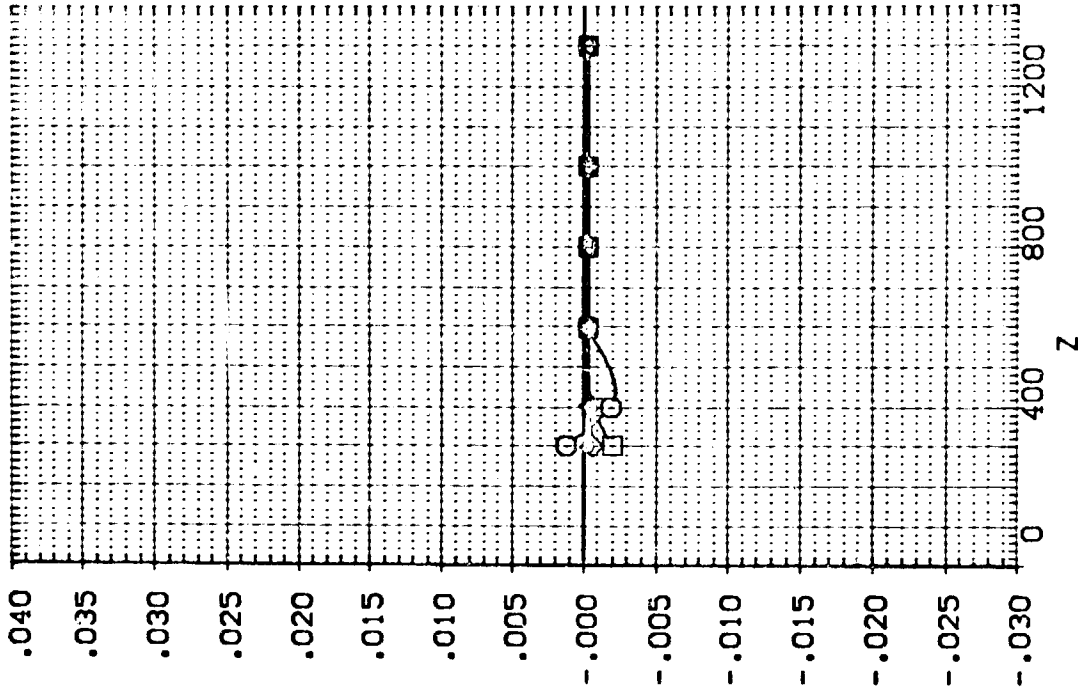

EFFECT OF EXTERNAL TANK SEPARATION ON ORBITER AERODYNAMIC CHARACTERISTICS

IA13,EXTERNAL TANK(T10)SEPARATING FROM ORB. 09 (RTJ026)

SEE THE ASSOCIATED DATA DOCUMENT FOR REFERENCE CHARACTERISTICS FOR INDIVIDUAL DATASETS

SYMBOL		PARAMETRIC VALUES	
X	.074	MACH	4.530
	400.230	ALPHA	-5.000
	800.780	CALPHA	-10.000
	1200.800	ELEVTR	.000
		Y	.000
		P/TOTAL	110.000
		BETA	.000
		DBETA	5.000
		AILRON	.000

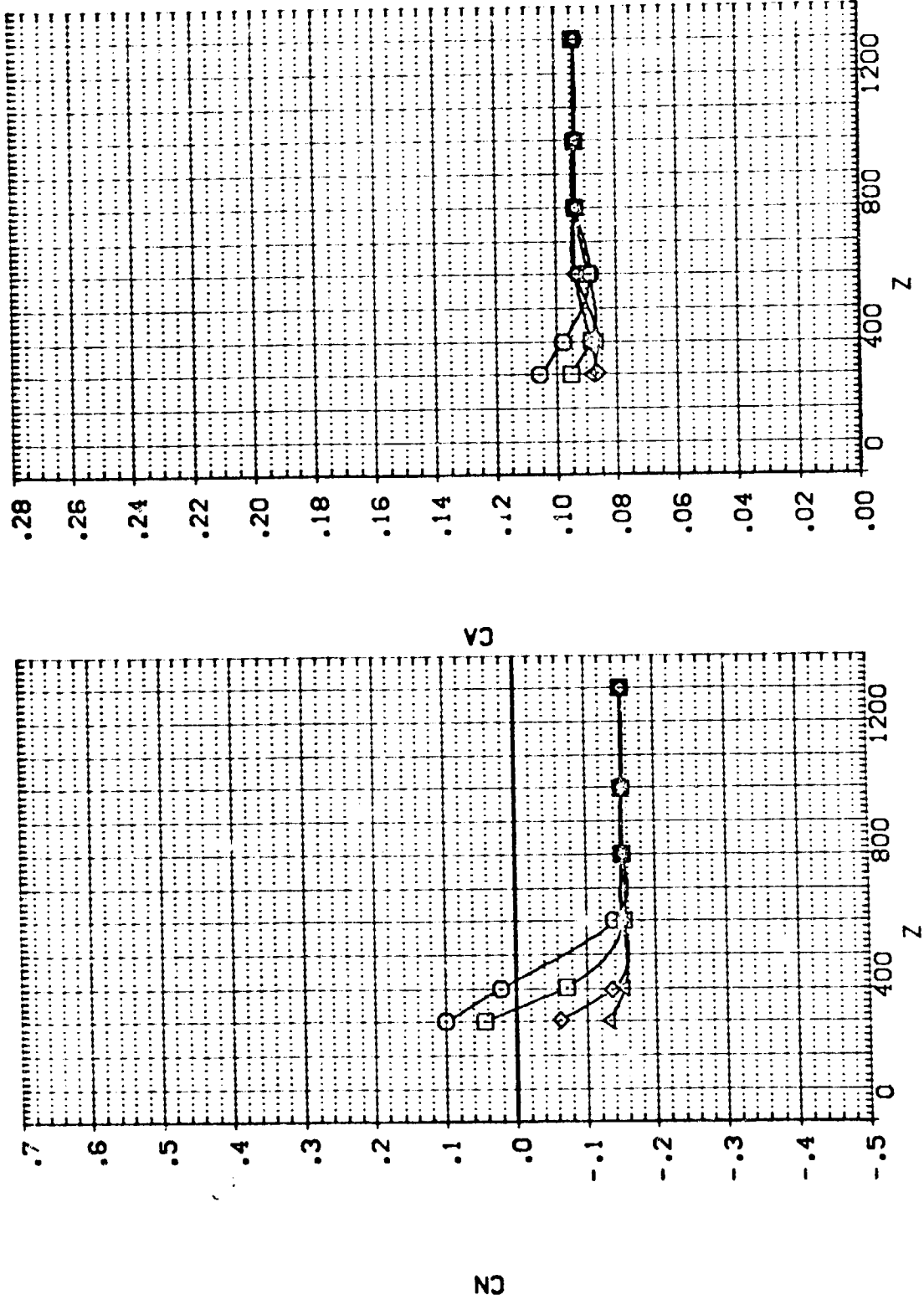

EFFECT OF EXTERNAL TANK SEPARATION ON ORBITER AERODYNAMIC CHARACTERISTICS

IA13.EXTERNAL TANK(T10)SEPARATING FROM ORB. 09 (RTJ026)

SEE THE ASSOCIATED REFERENCE DOCUMENT FOR REFERENCE CHARACTERISTICS FOR INDIVIDUAL DATASETS

SYMBOL		PARAMETRIC VALUES	
x	.074	MACH	4.530
	100.230	ALPHA	-5.000
	800.780	DALPHA	-10.000
	1200.800	ELEVTR	.000
		Y	.000
		PTOTAL	110.000
		BETA	.000
		DBETA	5.000
		AIRRON	.000

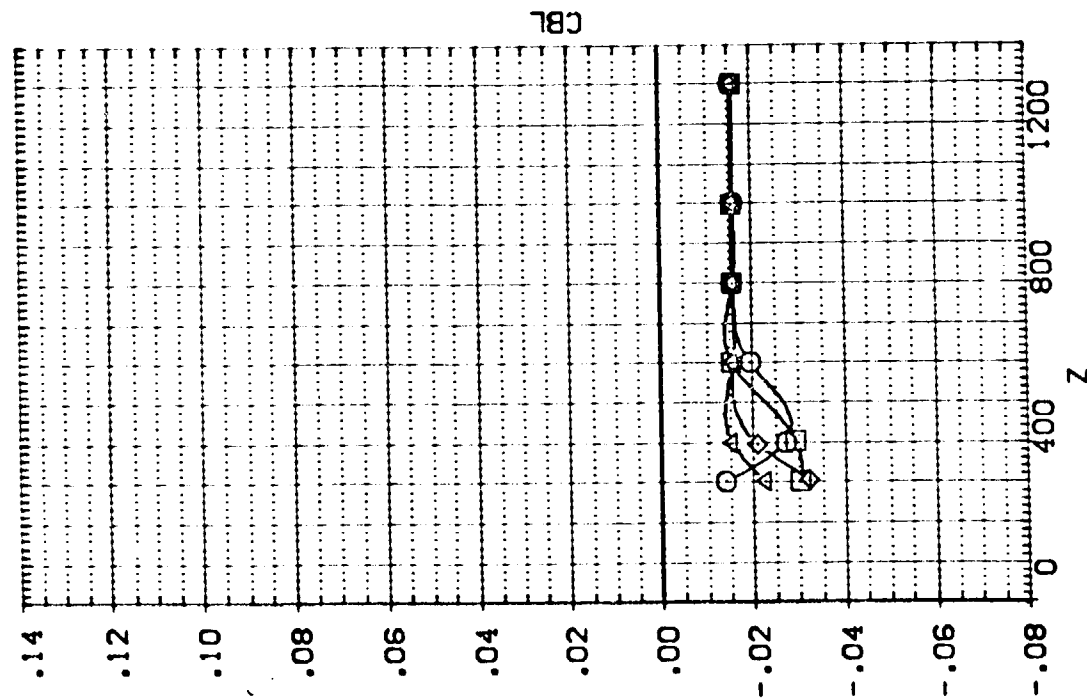
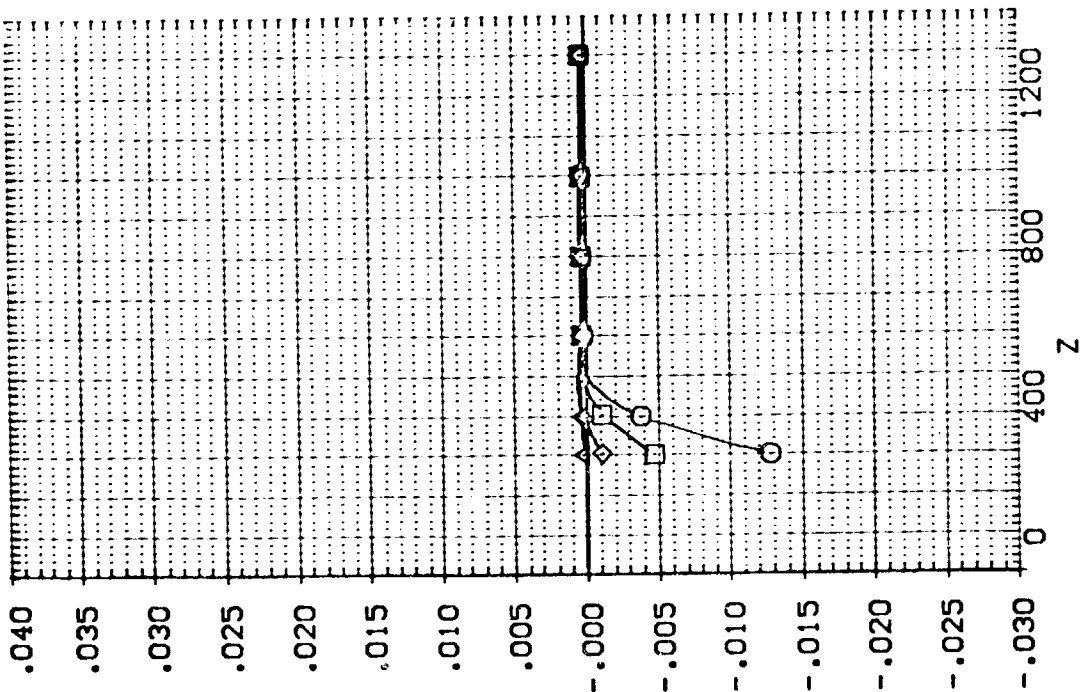

EFFECT OF EXTERNAL TANK SEPARATION ON ORBITER AERODYNAMIC CHARACTERISTICS



IA13.EXTERNAL TANK(T10)SEPARATING FROM ORB. 09 (RTJ026)

SEE THE ASSOCIATED DATA DOCUMENT FOR REFERENCE CHARACTERISTICS FOR INDIVIDUAL DATASETS

SYMBOL	X	MACH	PARAMETRIC VALUES
○	.074	4.530	PTOTAL 110.000
□	400.230	-5.000	BETA .000
◇	800.780	-10.000	DBETA 5.000
△	1200.800	.000	ALLRON .000
		Y	.000

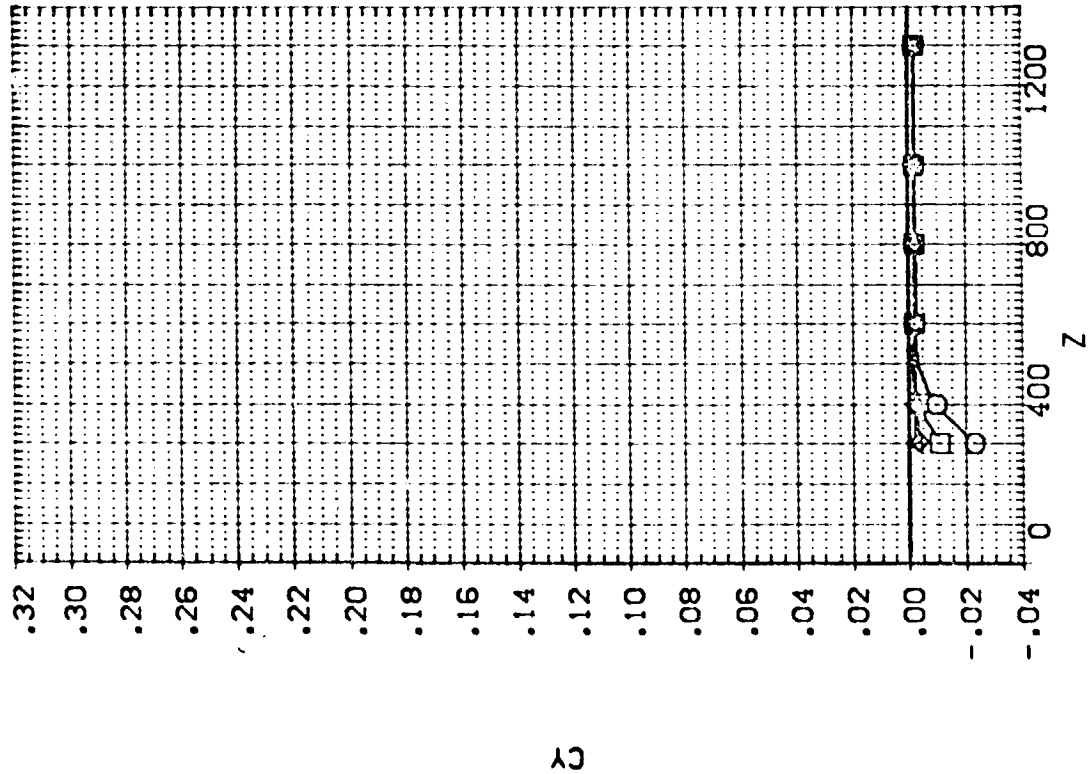
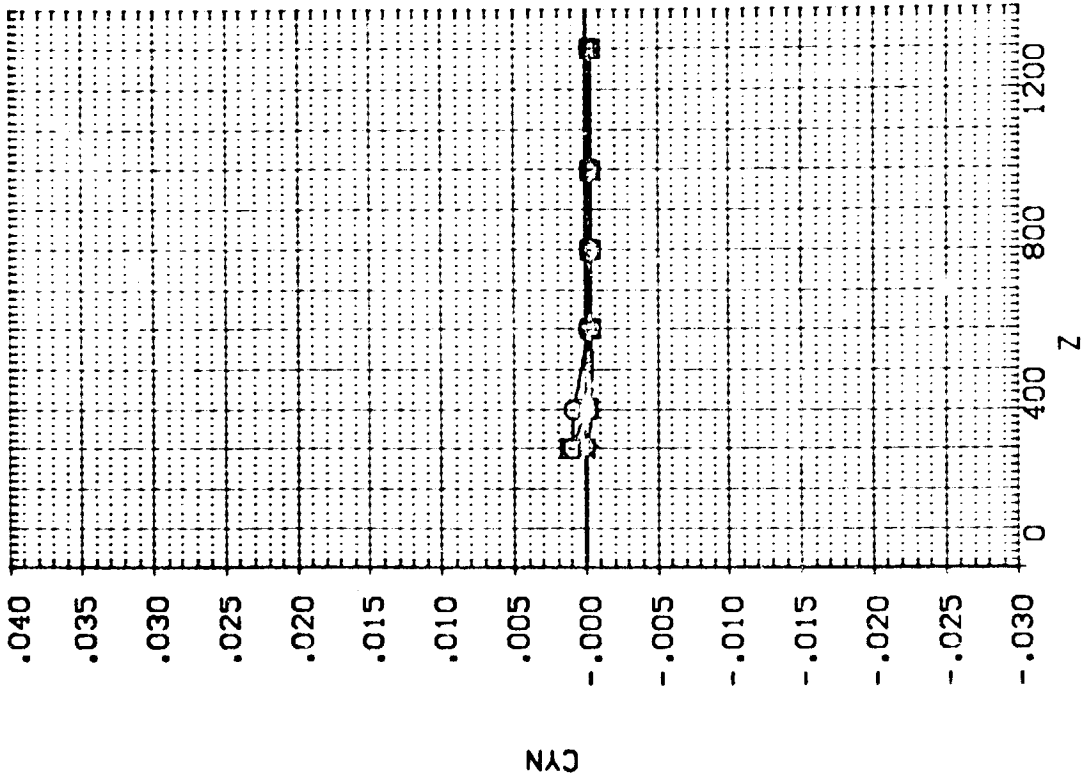

SEE THE ATTACHED VIA DOCUMENTATION FOR CHARACTERISTICS FOR INDIVIDUAL RUNS

PARAMETRIC VALUES
 MACH 4.530 PITOTAL 110.000
 ALPHA -5.000 BETA .000
 D ALPHA -20.000 DBETA .000
 ELEVTR .000 AILRON .000
 Y .000

SYMBOL
 O
 □
 ◇
 △

X
 -1.133
 401.620
 800.510
 1200.400

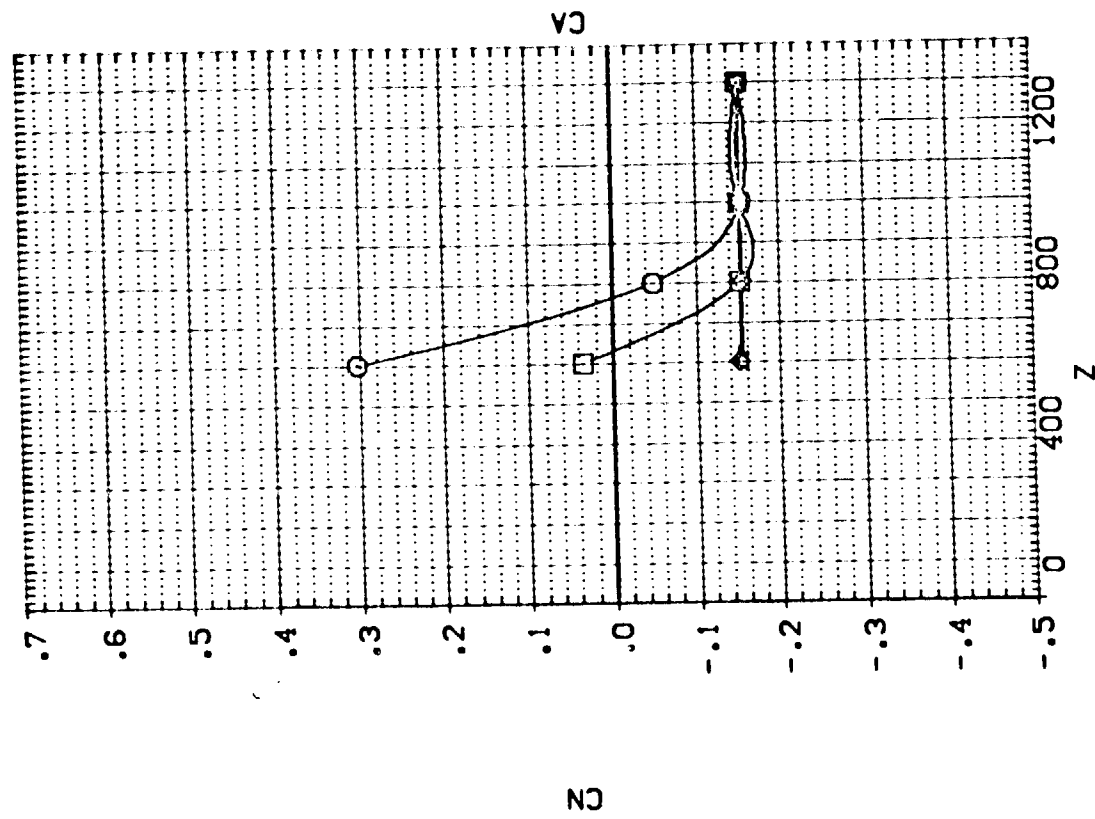
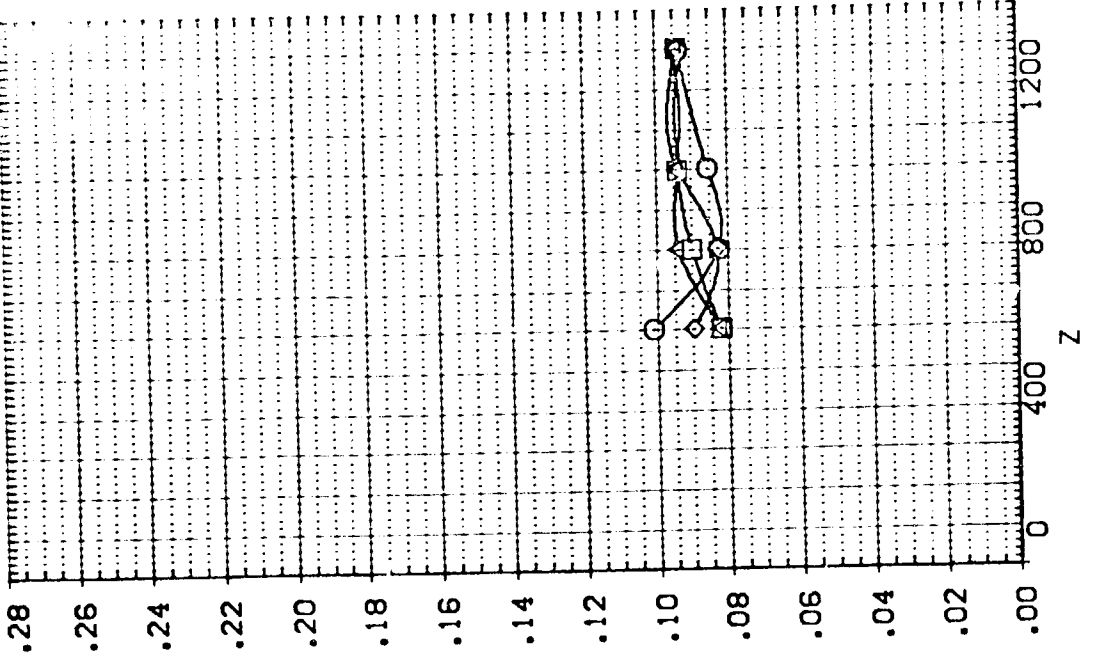

EFFECT OF EXTERNAL TANK SEPARATION ON ORBITER AERODYNAMIC CHARACTERISTICS

1A13.EXTERNAL TANK(T10)SEPARATING FROM ORB. 09 (RTJ027)

SEE THE ASSOCIATED DATA DOCUMENT FOR REFERENCE CHARACTERISTICS FOR INDIVIDUAL DATASETS

SYMBOL		PARAMETRIC VALUES	
○	X	MACH	PIOTAL
□	Y	ALPHA	BETA
◇	Z	DALPHA	DBETA
△		ELEVTR	AILRON
		Y	

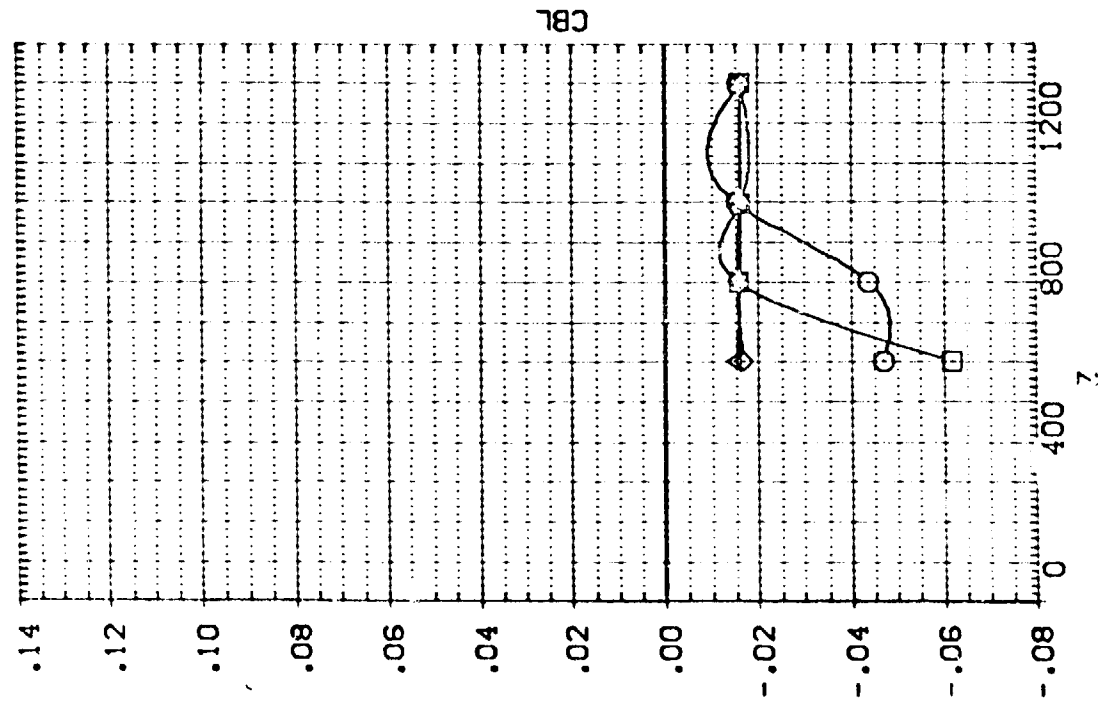
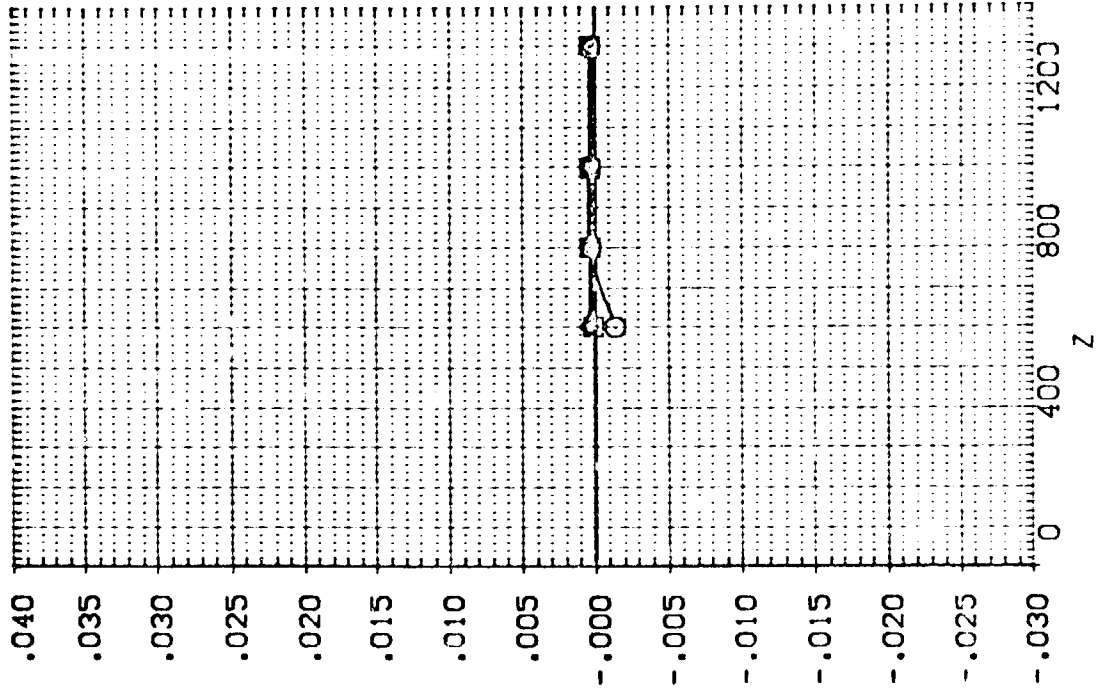

1A13.EXTERNAL TANK(T10)SEPARATING FROM CRB. 09 (RTJ027)

SEE THE ASSOCIATED
DOCUMENT FOR THE
CHARACTERISTICS OF
INDIVIDUAL DATA SERIES

SYMBOL	X	MACH	PARAMETRIC VALUES
○	-1.133	4.530	PTOTAL 110.000
□	401.630	-5.000	BETA .000
◇	800.510	-20.000	DBETA .000
△	1200.400	.000	ATL-RON .000
		Y	.000

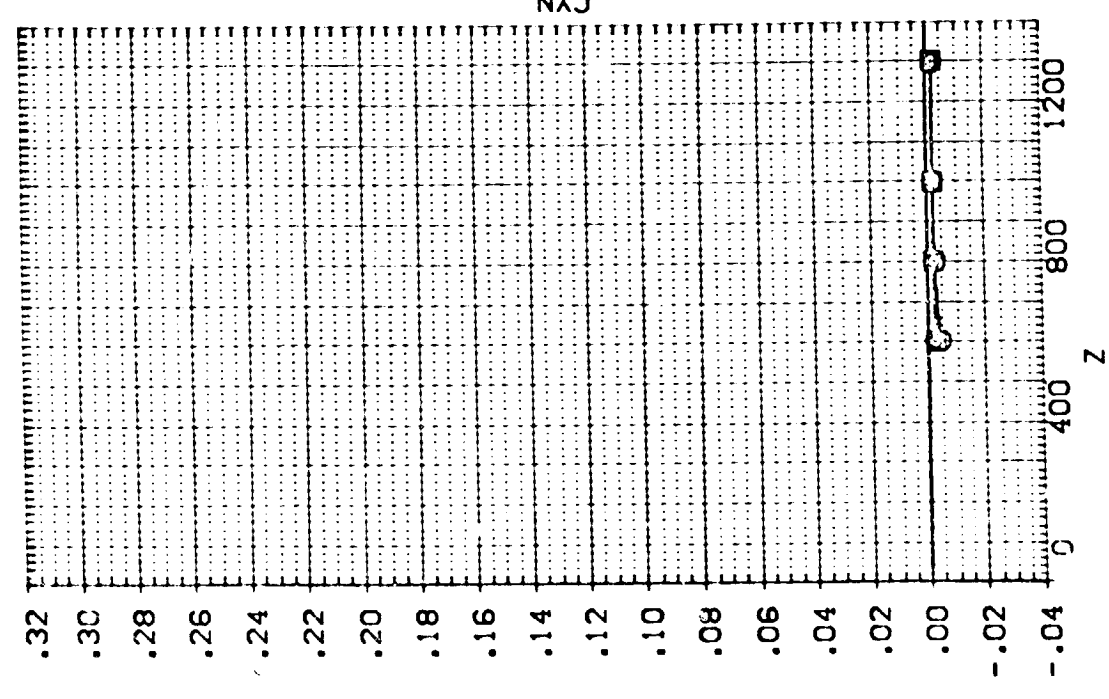
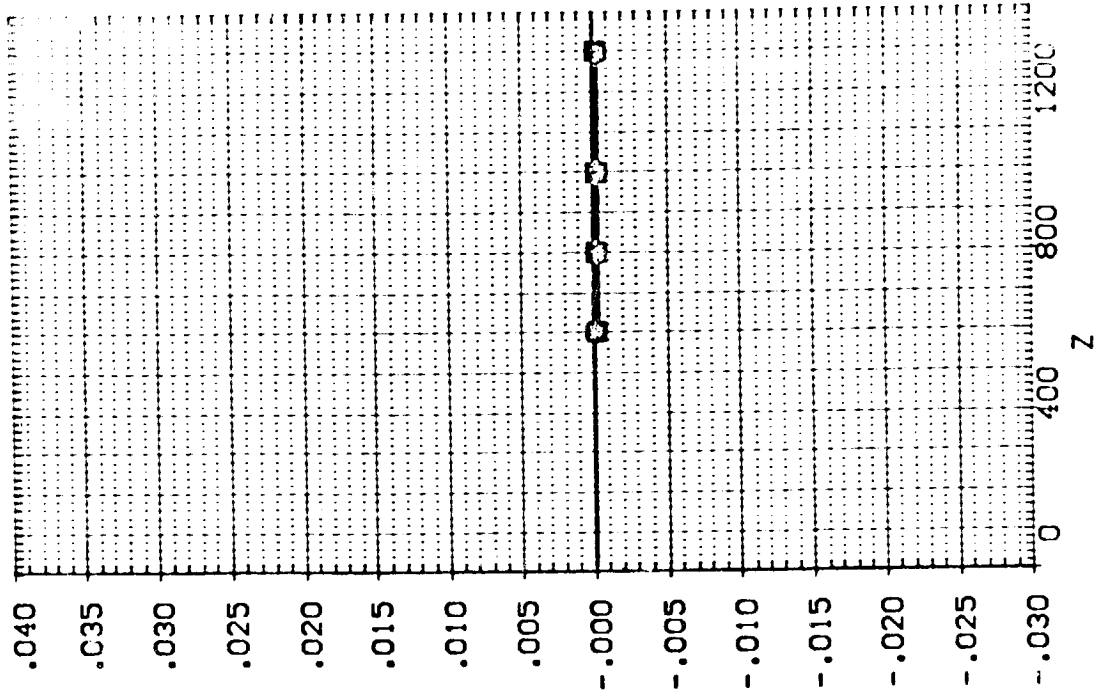

EFFECT OF EXTERNAL TANK SEPARATION ON ORBITER AERODYNAMIC CHARACTERISTICS

1A13. EXTERNAL TANK(T10)SEPARATING FROM ORB. 09 (RTJ028)

SEE THE ASSOCIATED DATA DOCUMENT FOR REFERENCE CHARACTERISTICS FOR INDIVIDUAL DATASETS

SYMBOL		PARAMETRIC VALUES			
○	X	MACH	3.530	PTOTAL	110.000
□	400.610	ALPHA	-5.000	BETA	.000
◇	800.600	DALPHA	-20.000	DSEETA	.000
△	1200.700	ELEVTR	.000	AIRLEN	.000
		Y	200.000		

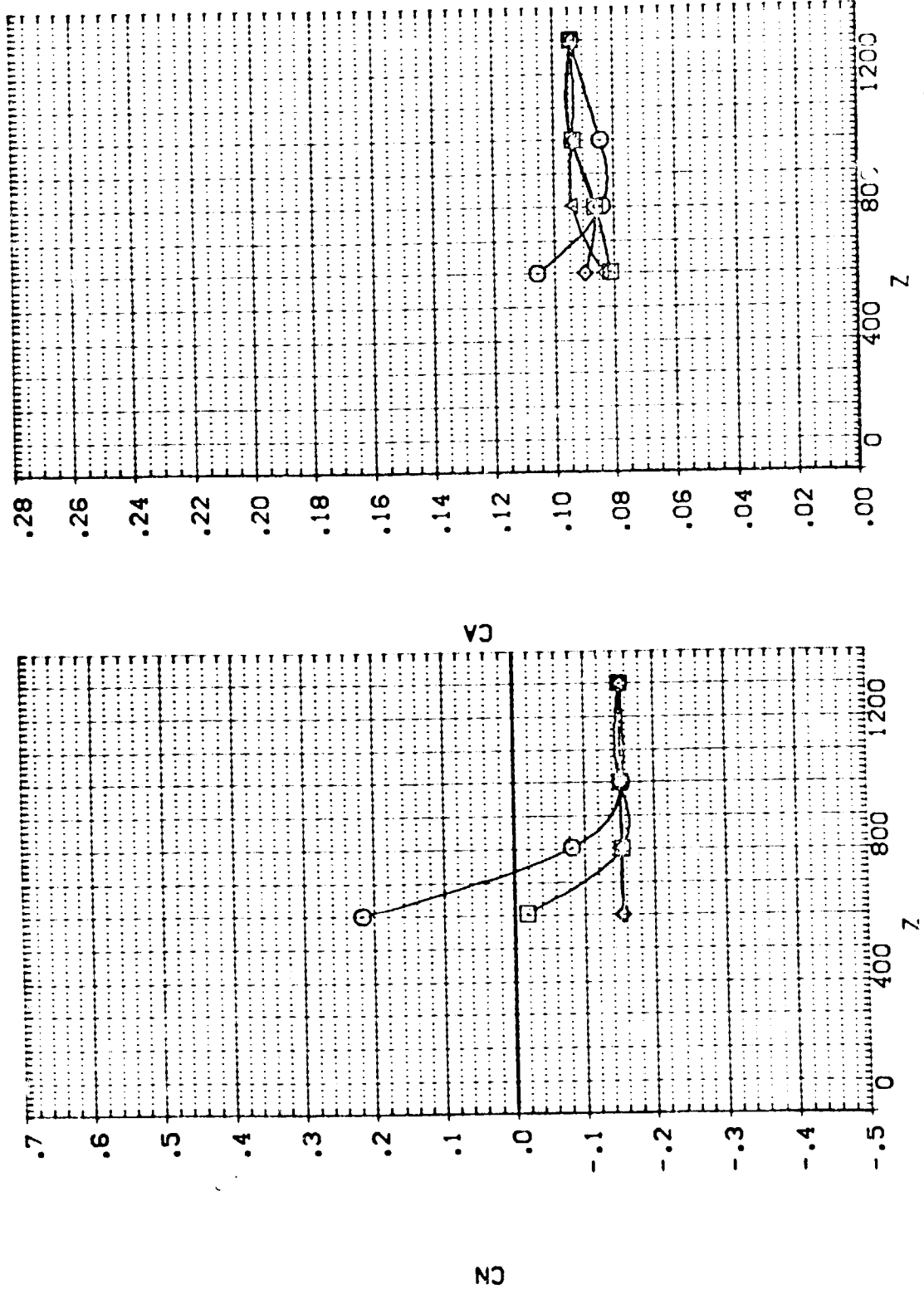

EFFECT OF EXTERNAL TANK SEPARATION ON ORBITER AERODYNAMIC CHARACTERISTICS

IA13. EXTERNAL TANK(T10)SEPARATING FROM ORB. 09 (RTJ028)

SEE THE ASSOCIATED DATA DOCUMENT FOR THE CHARACTERISTICS OF INDIVIDUAL STAGES

PARAMETRIC VALUES	
MACH	4.530
P TOTAL	110.000
ALPHA	-5.000
BETA	.000
DALPHA	-20.000
DBETA	.000
ELEVTR	.000
ALLRON	.000
Y	200.000

SYMBOL X
 O 400.610
 □ 800.600
 △ 1200.700

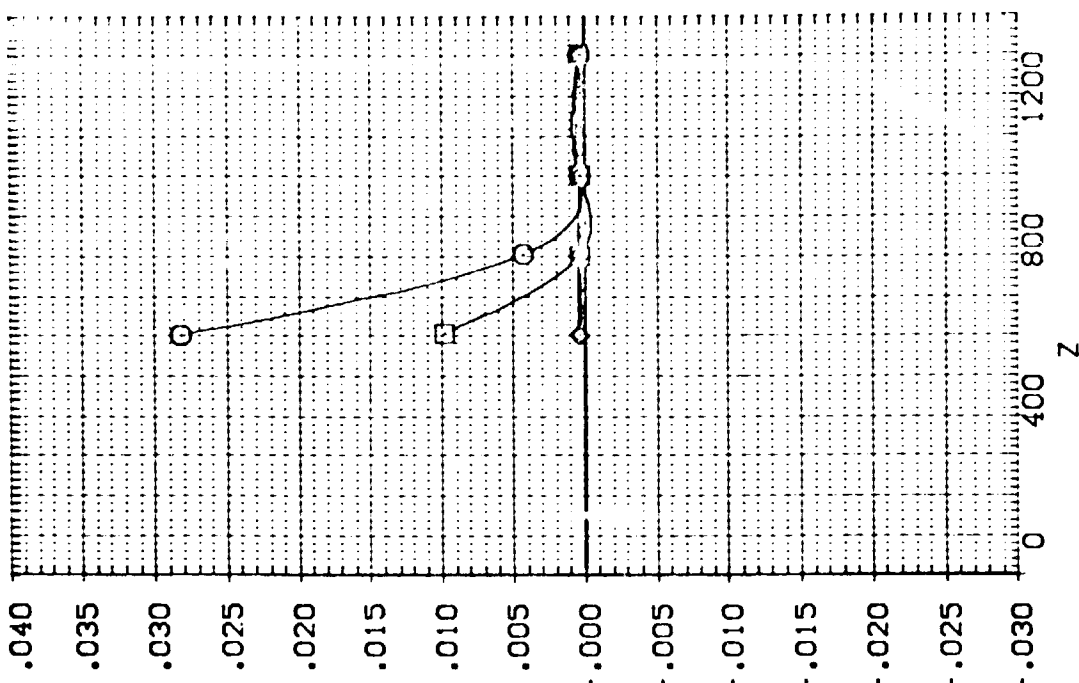
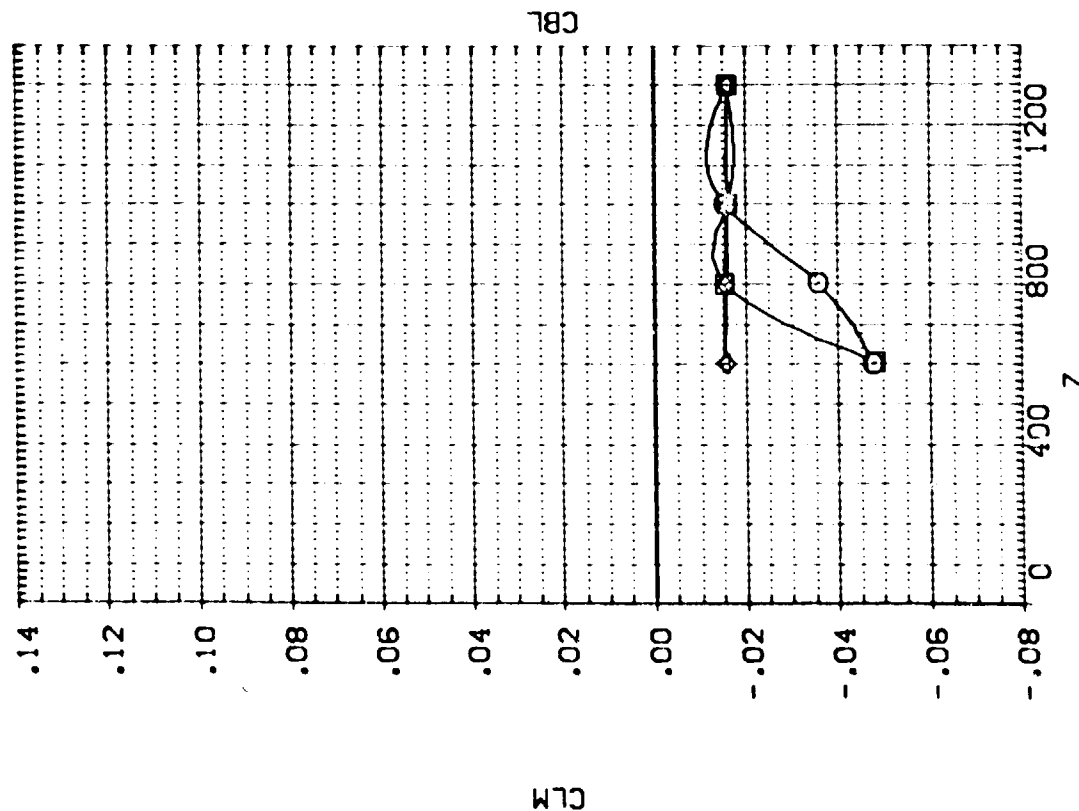

EFFECT OF EXTERNAL TANK SEPARATION ON ORBITER AERODYNAMIC CHARACTERISTICS

1A13, EXTERNAL TANK(T10)SEPARATING FROM ORB. 09 (RTJ028)

SEE THE ASSOCIATED DATA DOCUMENT FOR REFERENCE CHARACTERISTICS FOR INDIVIDUAL DATASETS

SYMBOL	X	MACH	PARAMETRIC VALUES
○	-1.582	4.530	PTOTAL 110.000
◇	400.610	-5.000	BETA .000
△	800.600	-20.000	DBETA .000
	1200.700	.000	AIRTON .000
		200.000	Y

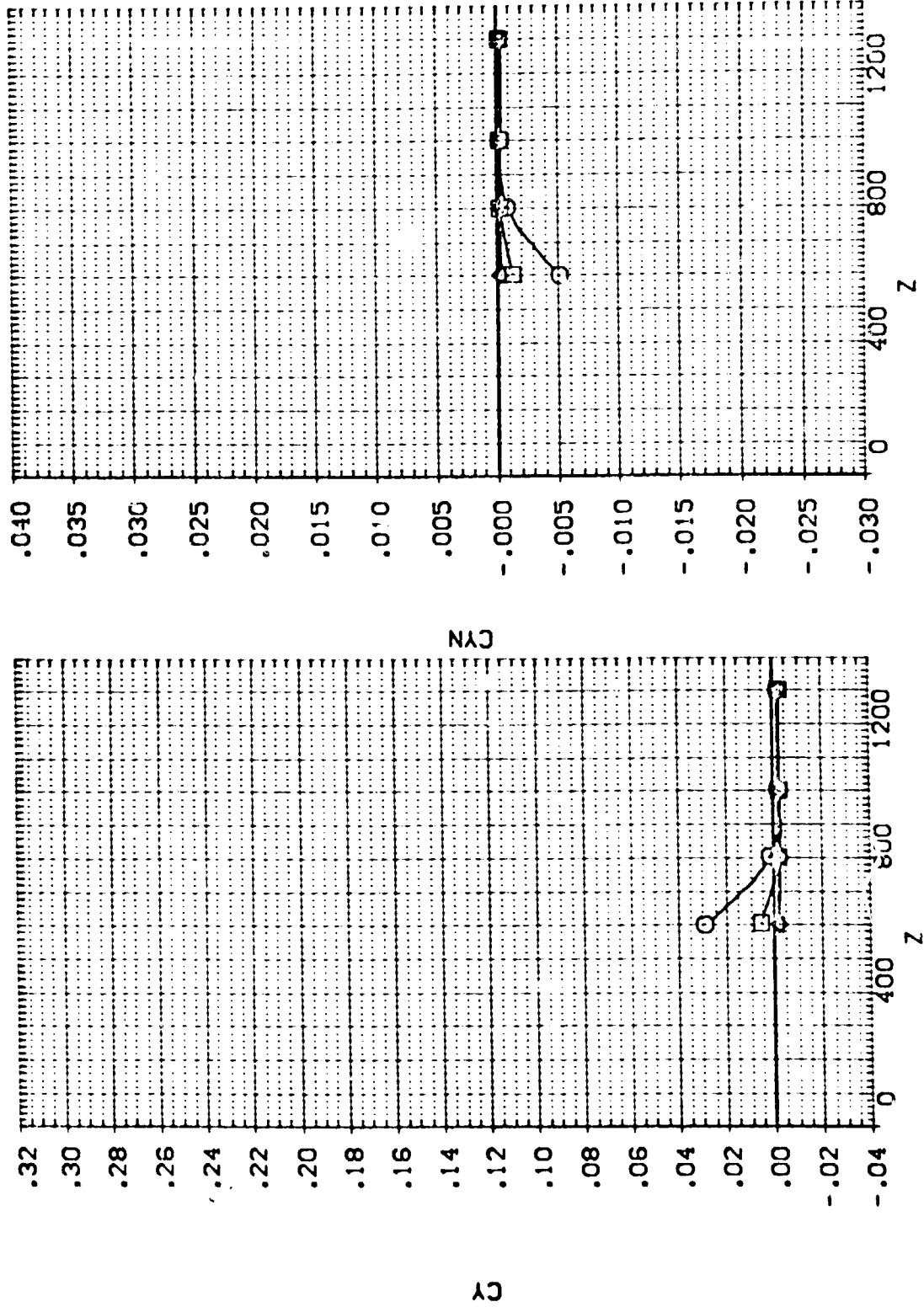

EFFECT OF EXTERNAL TANK SEPARATION ON ORBITER AERODYNAMIC CHARACTERISTICS

IA13.EXTERNAL TANK(T10)SEPARATING FROM ORB. 09 (RTJ029)

SYMBOL

x -1.217
 O 401.690
 800.780
 1200.500

MACH
 ALPHA
 CALPHA
 ELEVTR
 Y

PARAMETRIC VALUES

4.530 PTOTAL 110.000
 -5.000 BETA .000
 -20.000 DBETA 5.000
 .000 AILRON .000
 200.000

SEE THE ASSOCIATED DATA DOCUMENT FOR THE USE CHARACTERISTICS FOR INDIVIDUAL DATA SETS

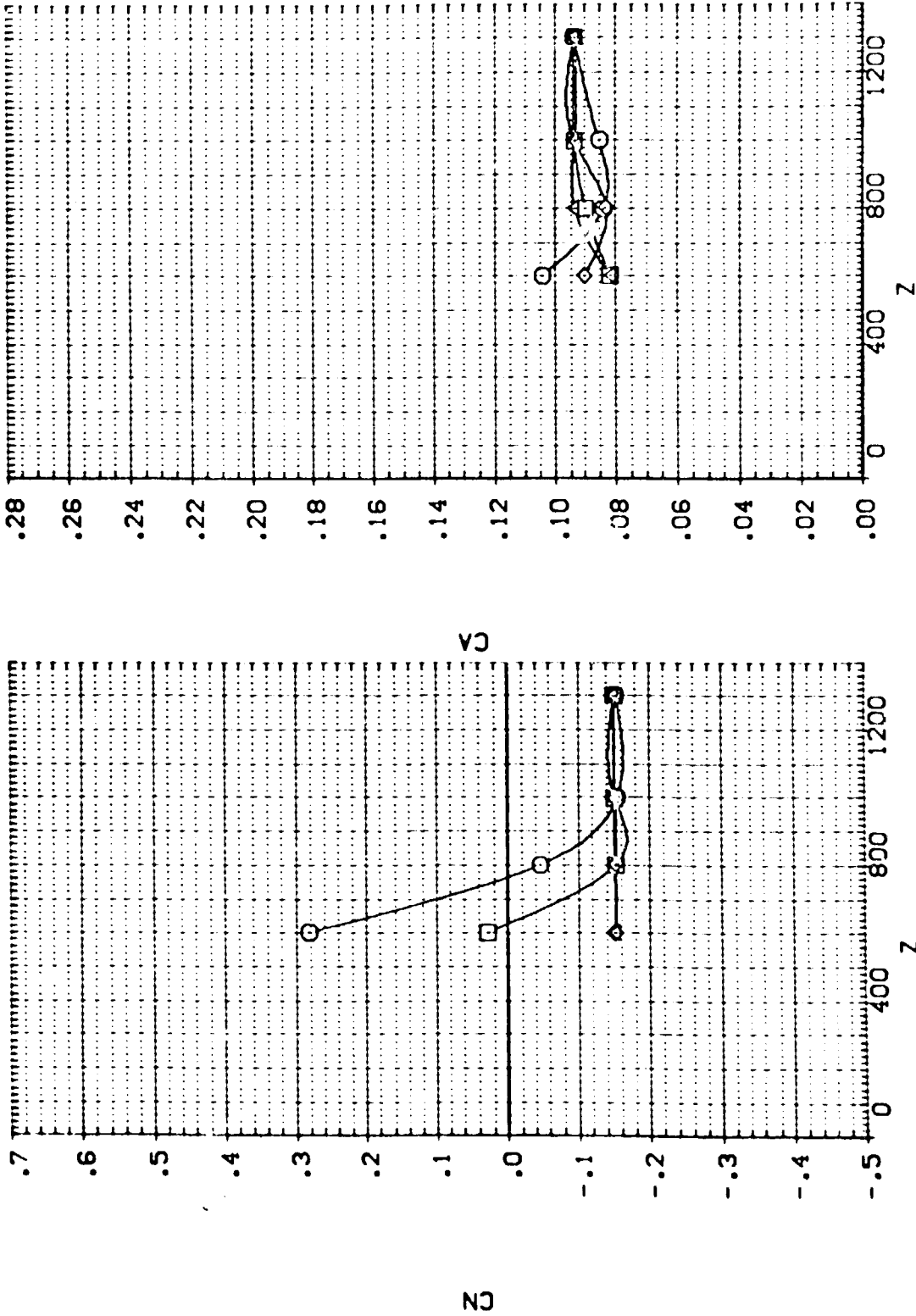

EFFECT OF EXTERNAL TANK SEPARATION ON ORBITER AERODYNAMIC CHARACTERISTICS

1A13. EXTERNAL TANK(T10)SEPARATING FROM ORB. 09 (RTJ029)

SEE THE ASSOCIATED DATA DOCUMENT FOR REFERENCE CHARACTERISTICS FOR INDIVIDUAL DATA'S

PARAMETRIC VALUES	
X	-1.217
Y	200.000
Z	1200.500
MACH	4.530
ALPHA	-5.000
BETA	-20.000
BETA	5.000
DELTA	0.000
ELEV	0.000
ROLL	0.000
PITCH	110.000
YAW	0.000

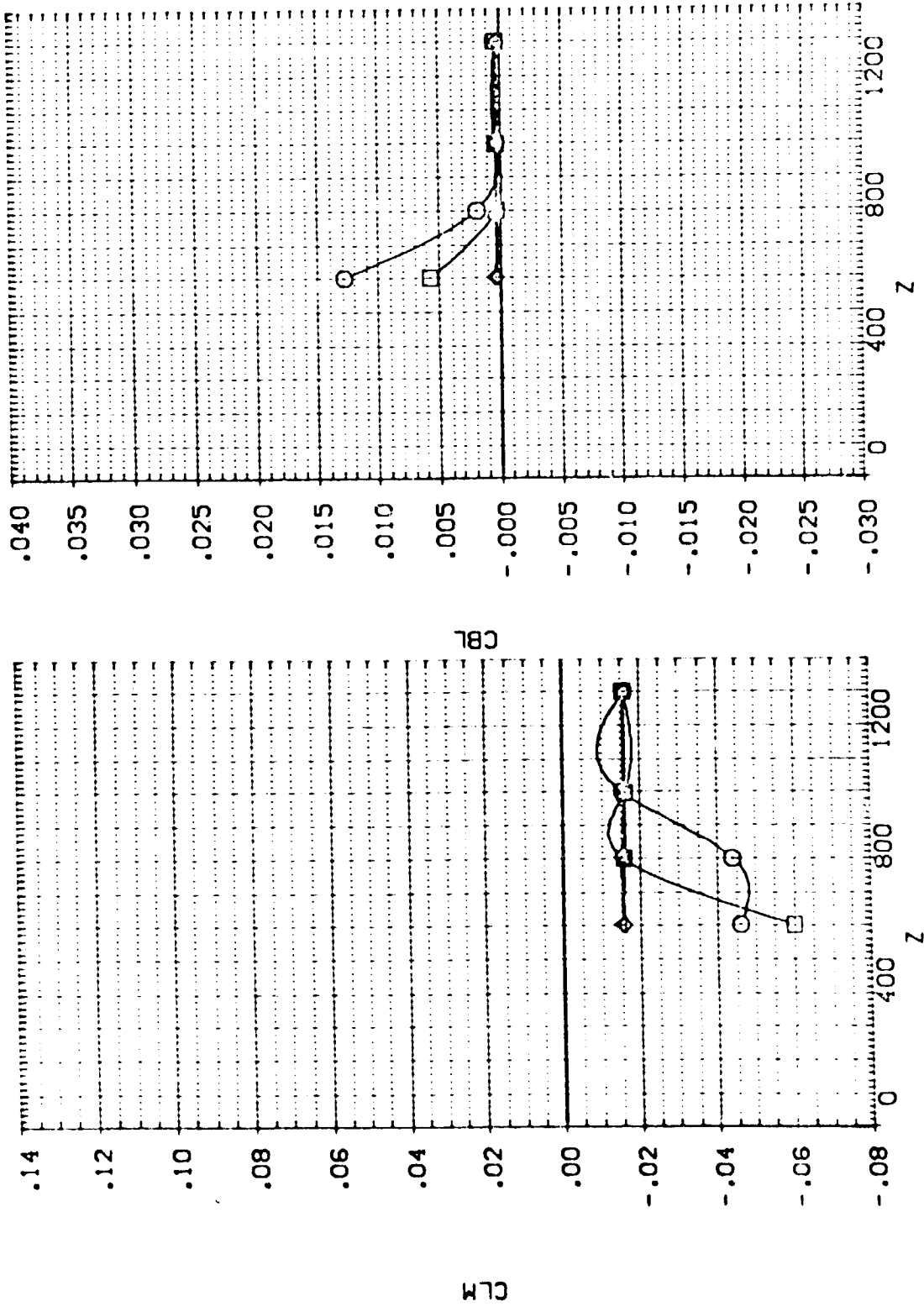

1A13. EXTERNAL TANK(T10)SEPARATING FROM CRB. 09 (RTJ029)

SEE THE AS DOCUMENT FOR CHARACTERISTICS FOR INDIVIDUAL DATA SETS

SYMBOL		PARAMETRIC VALUES	
○	X	MACH	4.530
○	401.680	ALPHA	-0.000
○	800.780	BETA	110.000
○	1200.500	CALPHA	-20.000
○		DETA	5.000
○		ELEVTR	000
○		ALTRON	200.000
○		Y	

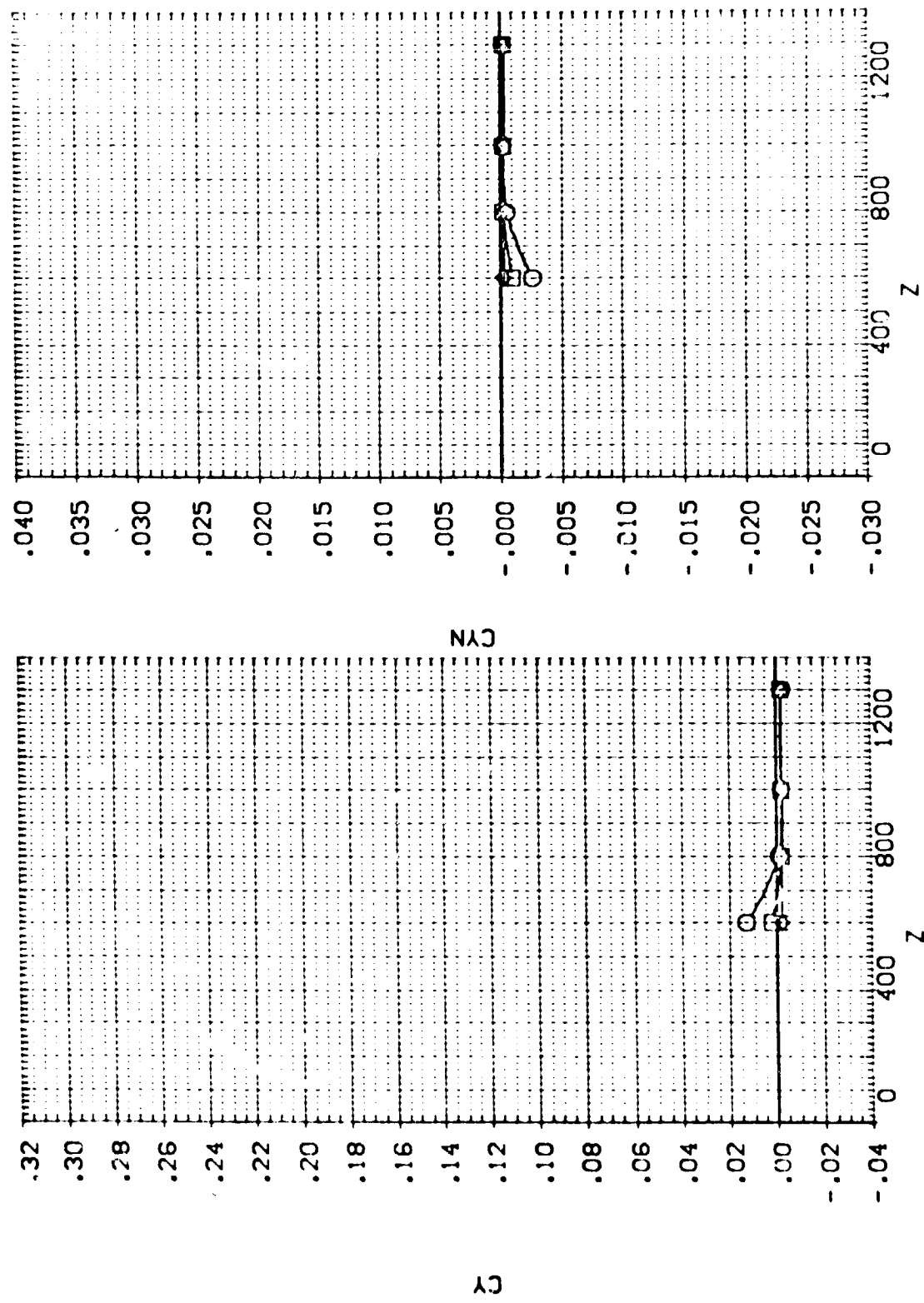

EFFECT OF EXTERNAL TANK SEPARATION ON ORBITER AERODYNAMIC CHARACTERISTICS

1A13. EXTERNAL TANK (110) SEPARATING FROM ORB. 09 (RTJ030)

SEE THE ASSOCIATED DATA DOCUMENT FOR REFERENCE CHARACTERISTICS FOR INDIVIDUAL DATASETS

SYMBOL		PARAMETRIC VALUES			
○	X	MACH	4.530	P/TOTAL	110.000
□	Y	ALPHA	-5.000	BETA	.000
◇	Z	CALPHA	-20.000	DBETA	5.000
△	W	ELEVTR	.000	AIRRON	.000
		Y	.000		

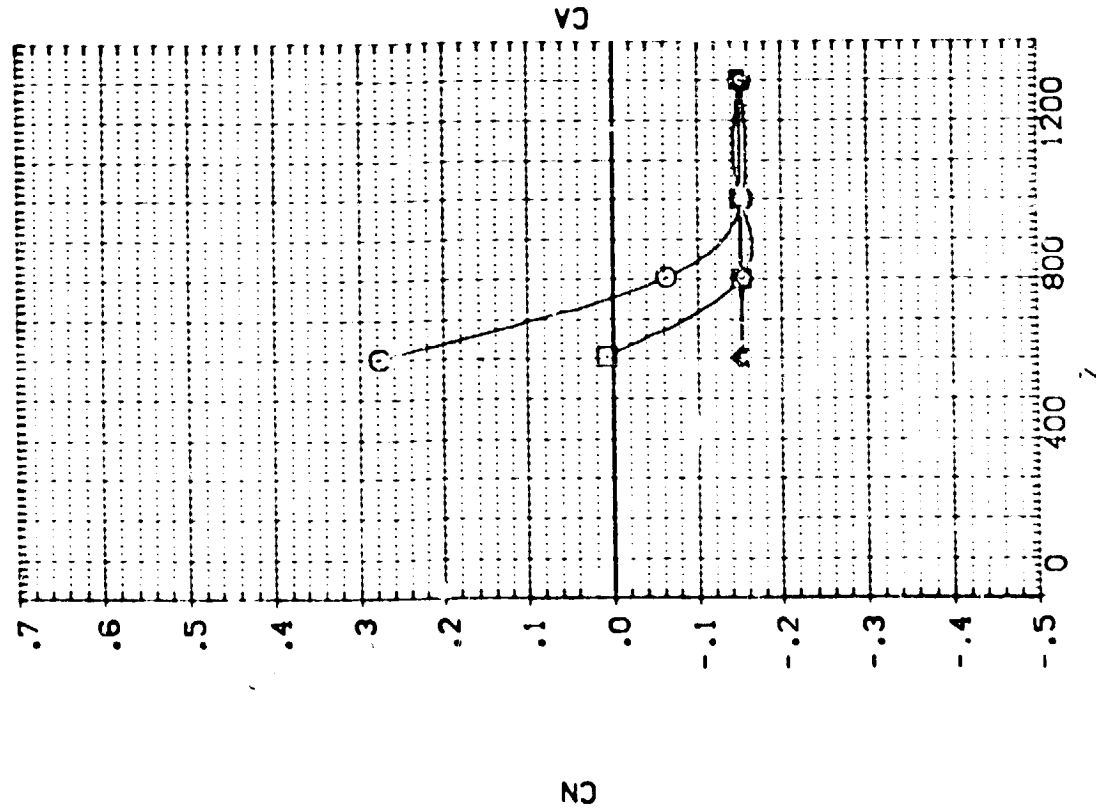
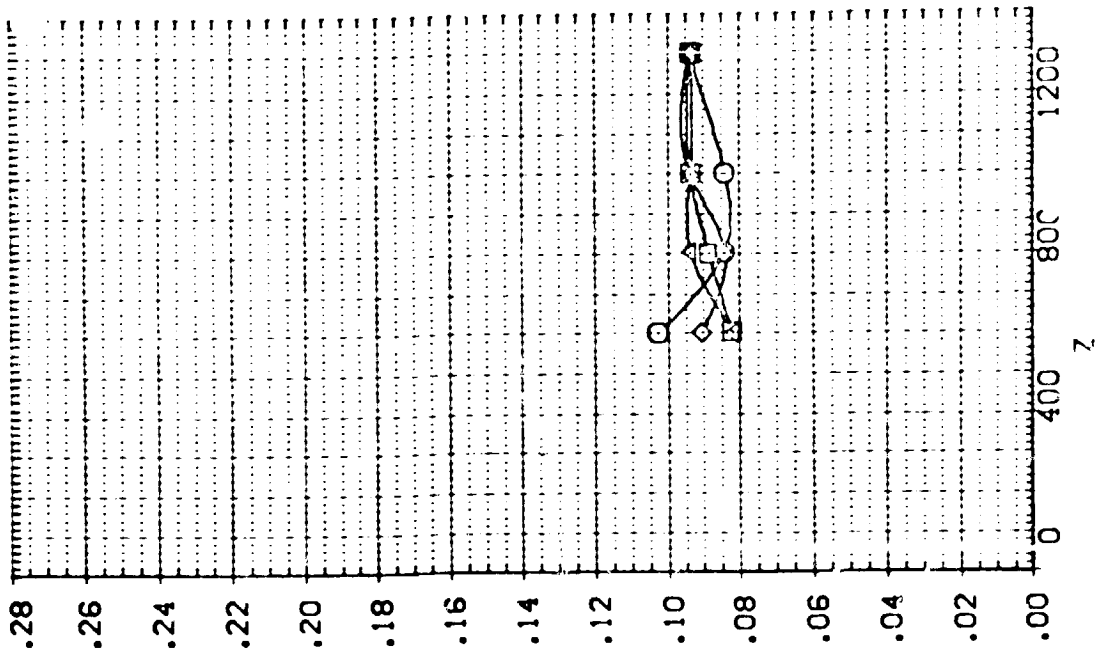

EFFECT OF EXTERNAL TANK SEPARATION ON ORBITER AERODYNAMIC CHARACTERISTICS

IA13. EXTERNAL TANK(T10)SEPARATING FROM ORB. 09 (RTJ030J)

SEE THE ASSOCIATED DATA DOCUMENT FOR THE COMPLETE CHARACTERISTICS FOR INDIVIDUAL DATASETS

SYMBOL		PARAMETRIC VALUES	
X	- .917	MACH	4.530
		P/TOTAL	110.000
		BETA	.000
		DBETA	5.000
		AILRON	.000
		Y	.000

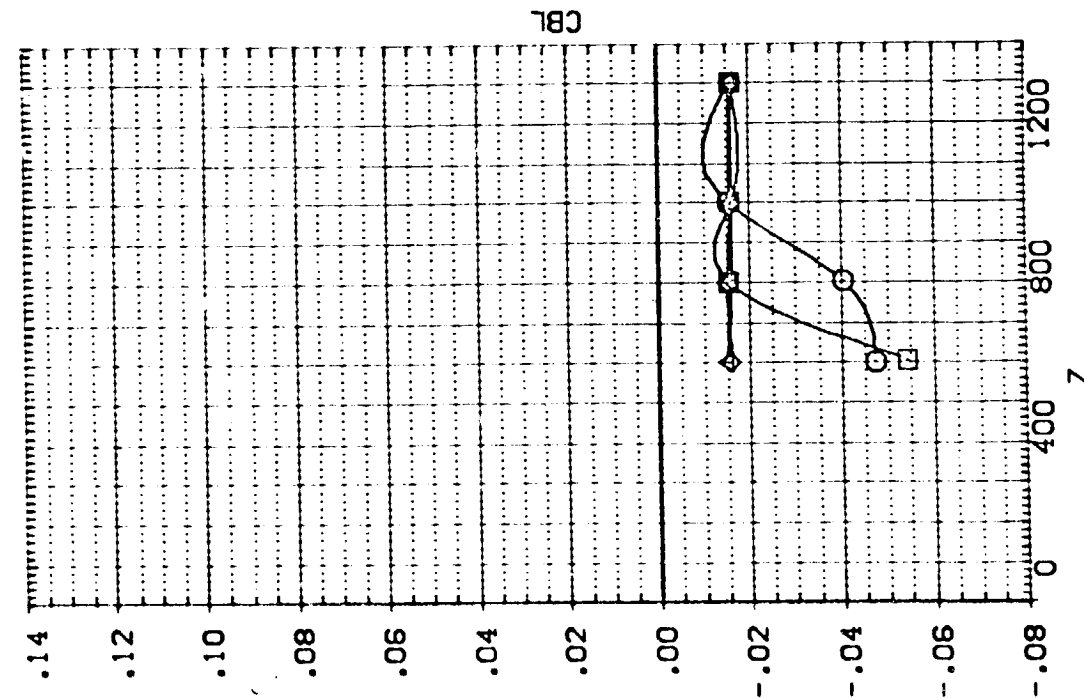
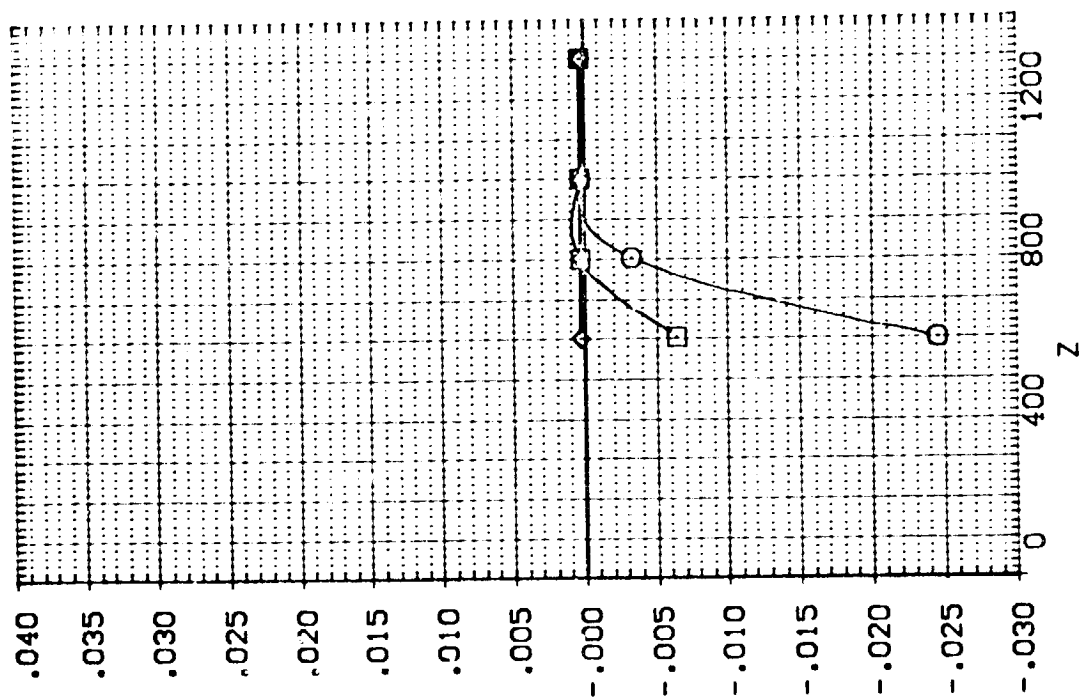

EFFECT OF EXTERNAL TANK SEPARATION ON ORBITER AERODYNAMIC CHARACTERISTICS

1A13. EXTERNAL TANK(T10)SEPARATING FROM ORB. 09 (RTJ030)

SEE THE ASSOCIATED DATA DOCUMENT FOR REFERENCE CHARACTERISTICS FOR INDIVIDUAL DATASETS

SYMBOL		PARAMETRIC VALUES	
○	X	MACH	4.530
□	Y	ALPHA	-5.000
◇	Z	DALPHA	-20.000
△		ELEVTR	.000
		P TOTAL	110.000
		BETA	.000
		DBETA	5.000
		AIRRON	.000

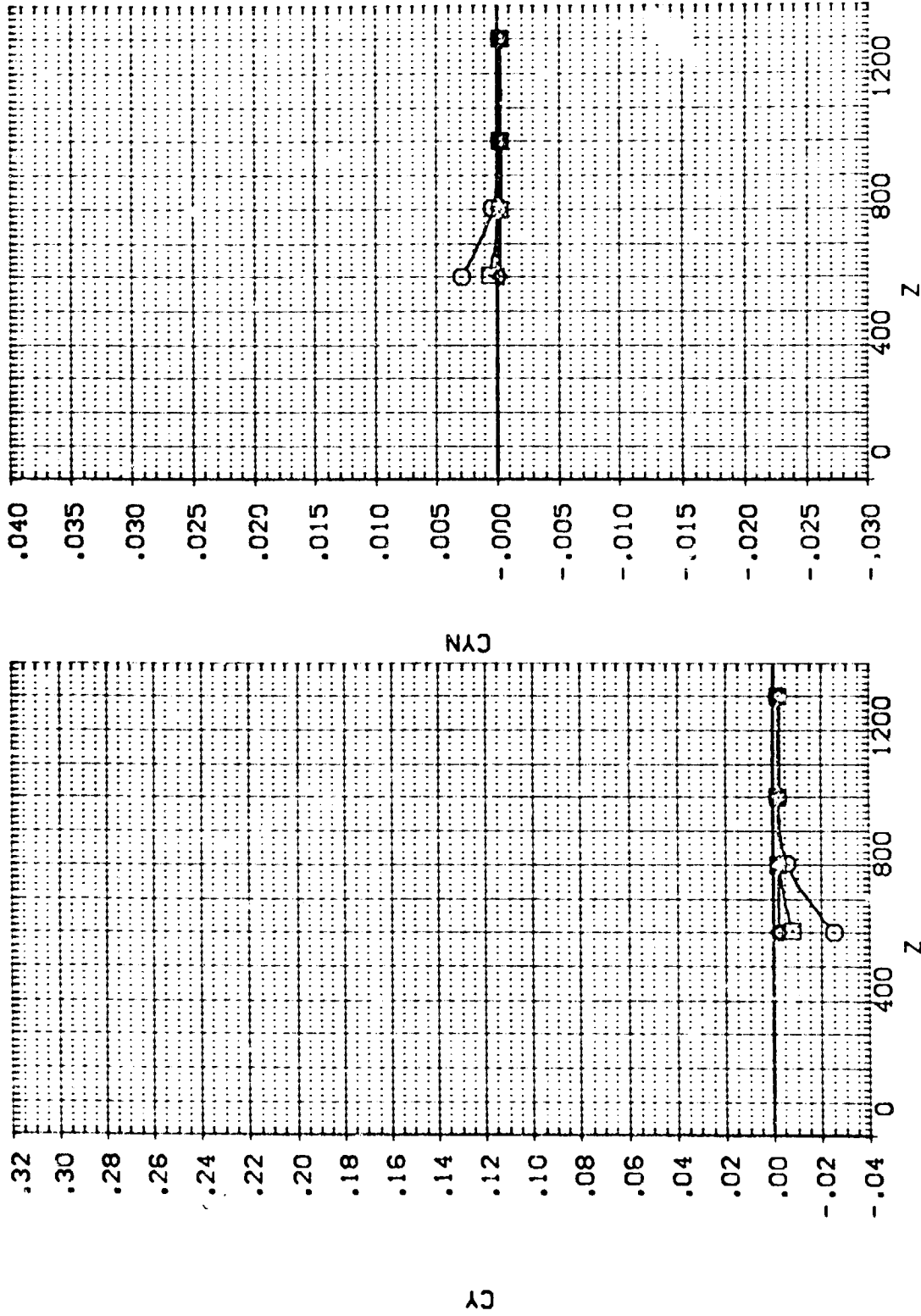

EFFECT OF EXTERNAL TANK SEPARATION ON ORBITER AERODYNAMIC CHARACTERISTICS

1A13. EXTERNAL TANK(T10)SEPARATING FROM ORB. 09 (RTJ031)

SEE THE ASSOCIATED DOCUMENT FOR THE CHARACTERISTICS FOR INDIVIDUAL DATA SETS

SYMBOL	X	MACH	PARAMETRIC VALUES
○	1.175	4.530	PTOTAL 110.000
◇	400.570	-5.000	BETA .000
△	800.760	-30.000	DBETA 5.000
	1201.100	.700	ALTRON .000
		.000	Y .000

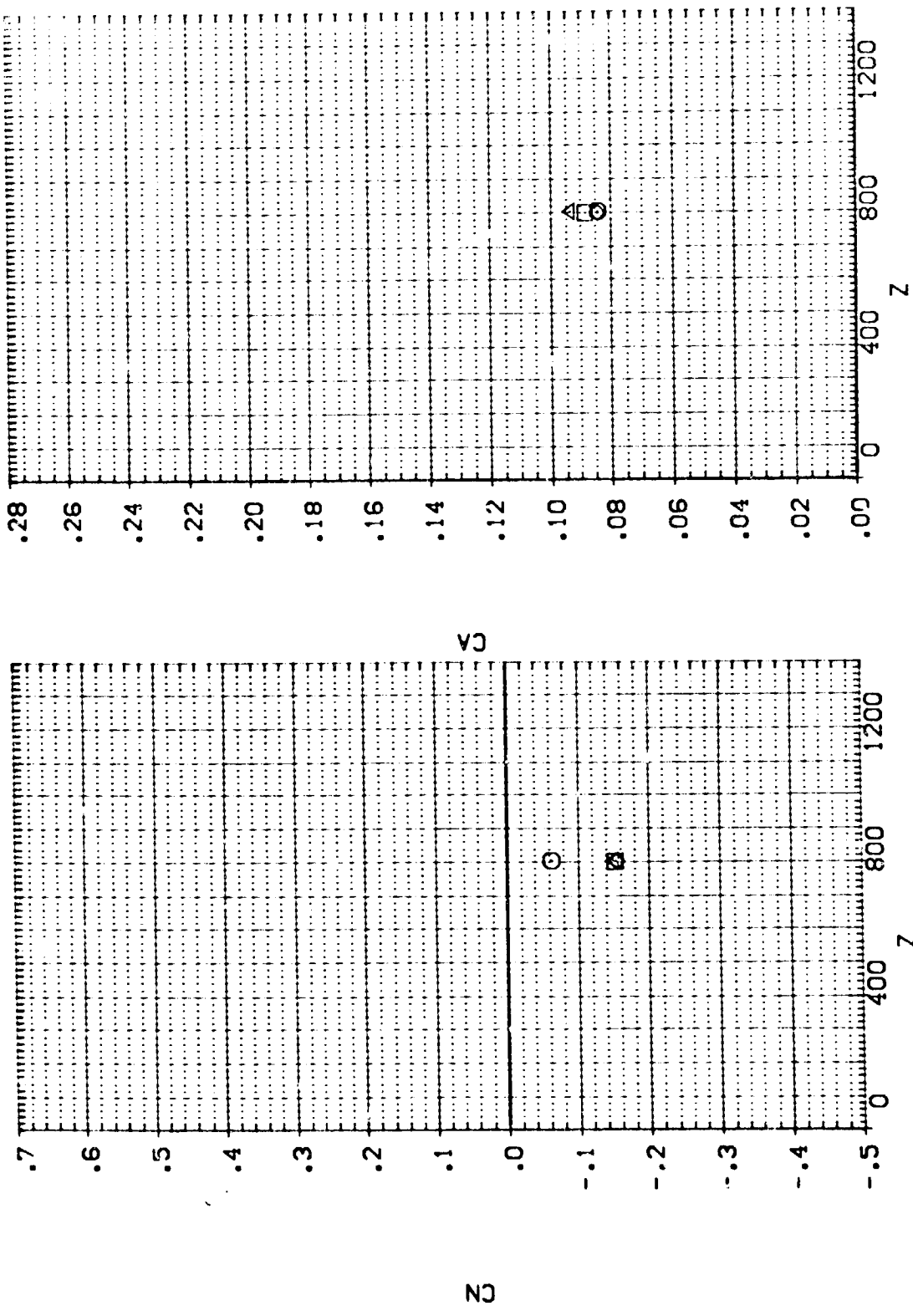

EFFECT OF EXTERNAL TANK SEPARATION ON ORBITER AERODYNAMIC CHARACTERISTICS

IA13. EXTERNAL TANK(T10)SEPARATING FROM ORB. 09 (RTJ031)

SEE THE ASSOCIATED DATA DOCUMENT FOR REFERENCE CHARACTERISTICS FOR INDIVIDUAL DATASETS

SYMBOL		PARAMETRIC VALUES	
X	1.165	MACH	4.530
Y	1201.100	PTOTAL	110.000
□	400.570	BETA	-5.000
◇	800.760	DBETA	5.000
△	1201.100	AIRLON	.000

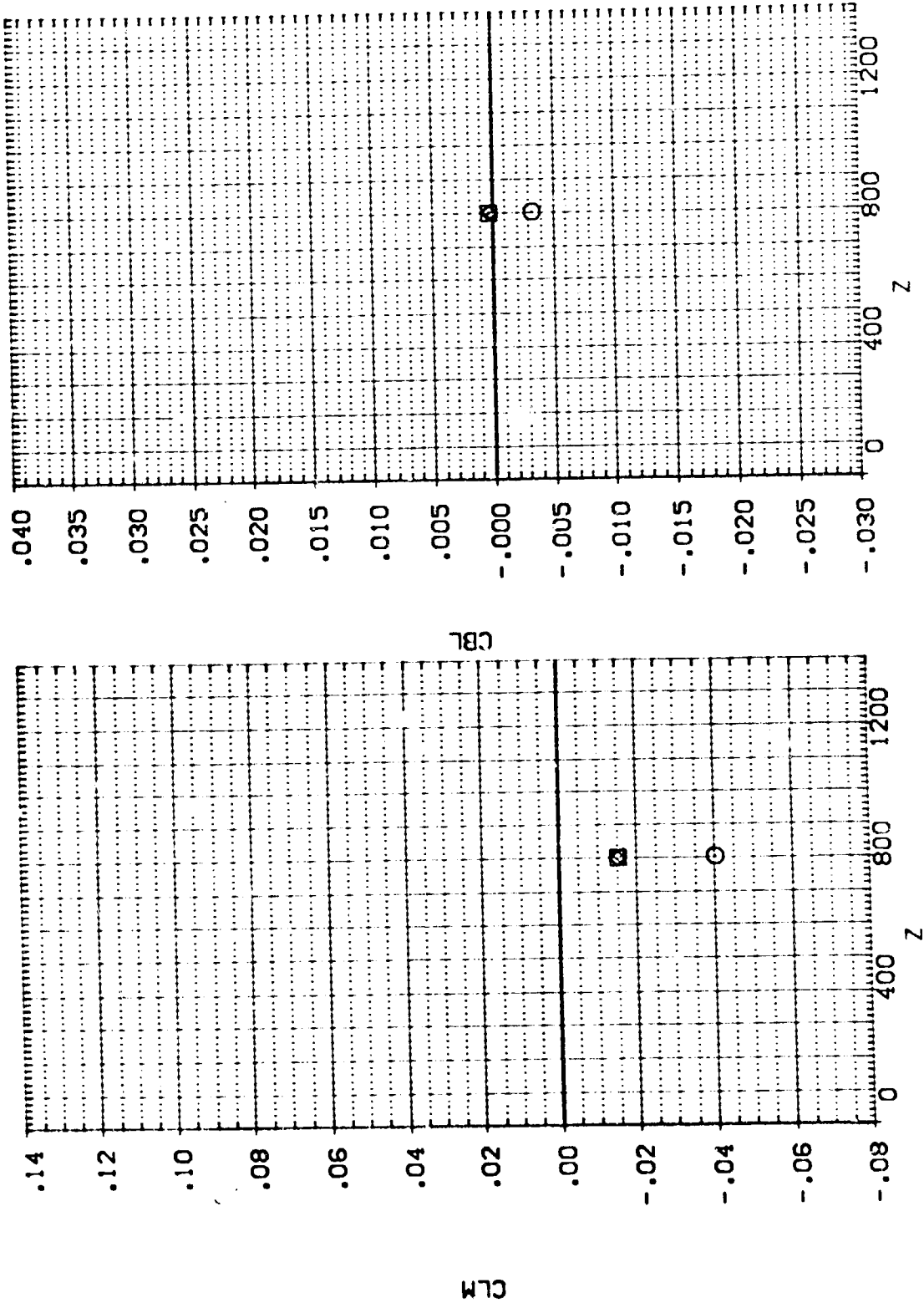

EFFECT OF EXTERNAL TANK SEPARATION ON ORBITER AERODYNAMIC CHARACTERISTICS

1A13. EXTERNAL TANK(S) SEPARATING FROM ORB. 09 (RTJ031)

SEE THE ASSOCIATED DATA DOCUMENT FOR REFERENCE CHARACTERISTICS FOR INDIVIDUAL DATASETS

SYMBOL	X	MACH	PARAMETRIC VALUES
○	1.165	4.530	PTOTAL 110.000
□	400.570	-5.000	BETA .000
◇	600.760	-30.000	DBETA 5.000
△	1201.100	.000	AILRON .000
		Y	.000

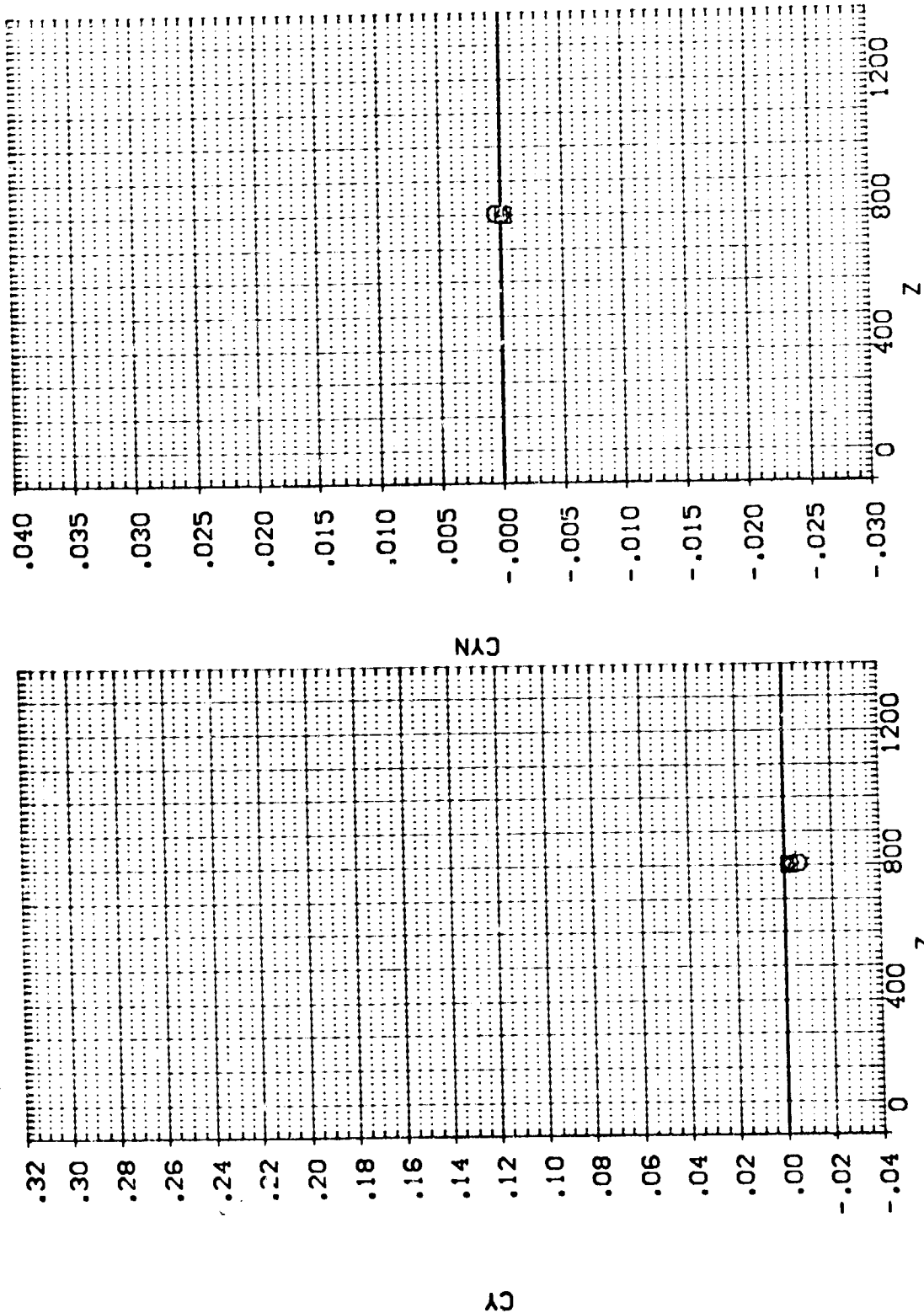

[A13,EXTERNAL TANK(T10)SEPARATING FROM ORB. 09 (RTJ032)]

SEE THE ASSOCIATED DATA DOCUMENT FOR REFERENCE CHARACTERISTICS FOR INDIVIDUAL DATASETS

SYMBOL	X	MACH	PARAMETRIC VALUES
○	.290	4.520	PITOTAL 80.000
□	400.490	-10.000	BETA .000
◇	800.980	5.000	DBETA .000
△	1200.700	.000	AIRLON .000
			ELEVTR .000

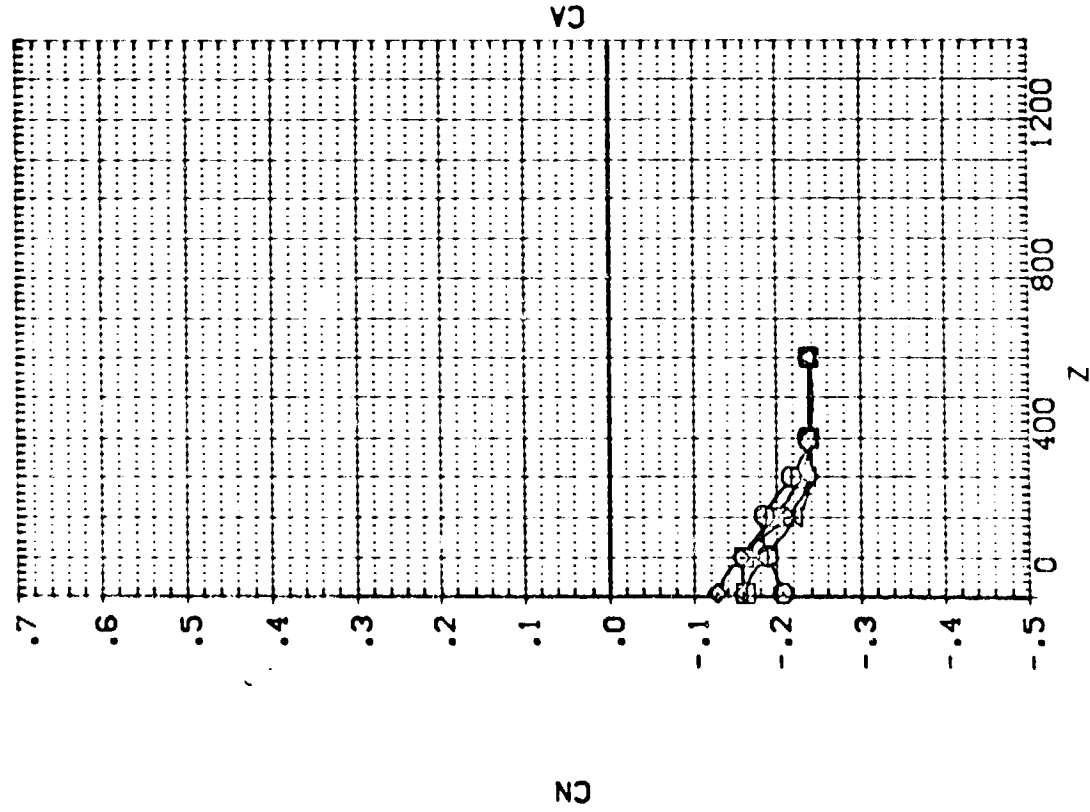
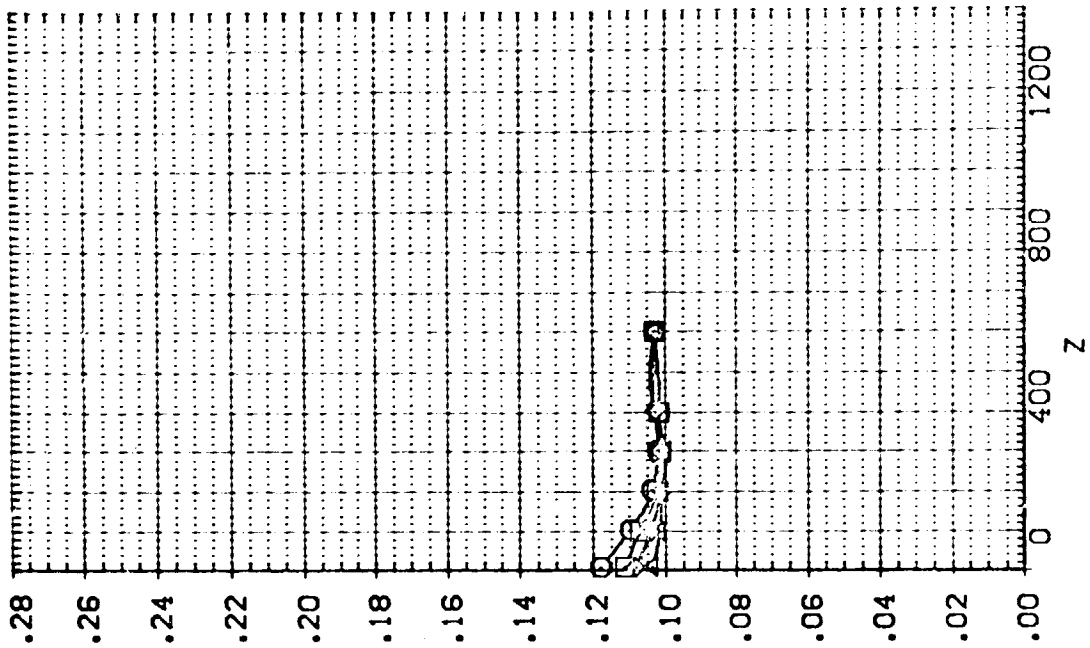

IA13. EXTERNAL TANK(T10)SEPARATING FROM ORB. 09 (RTJ032)

SEE THE ASSOCIATED DOCUMENT FOR THE CHARACTERISTICS FOR INDIVIDUAL CURVES

SYMBOL		PARAMETRIC VALUES	
○	X	MICH	PI TOTAL
□	400.490	ALPHA	BETA
◇	600.660	DALPHA	DBETA
△	1200.700	ELEVTR	AILRON
		Y	

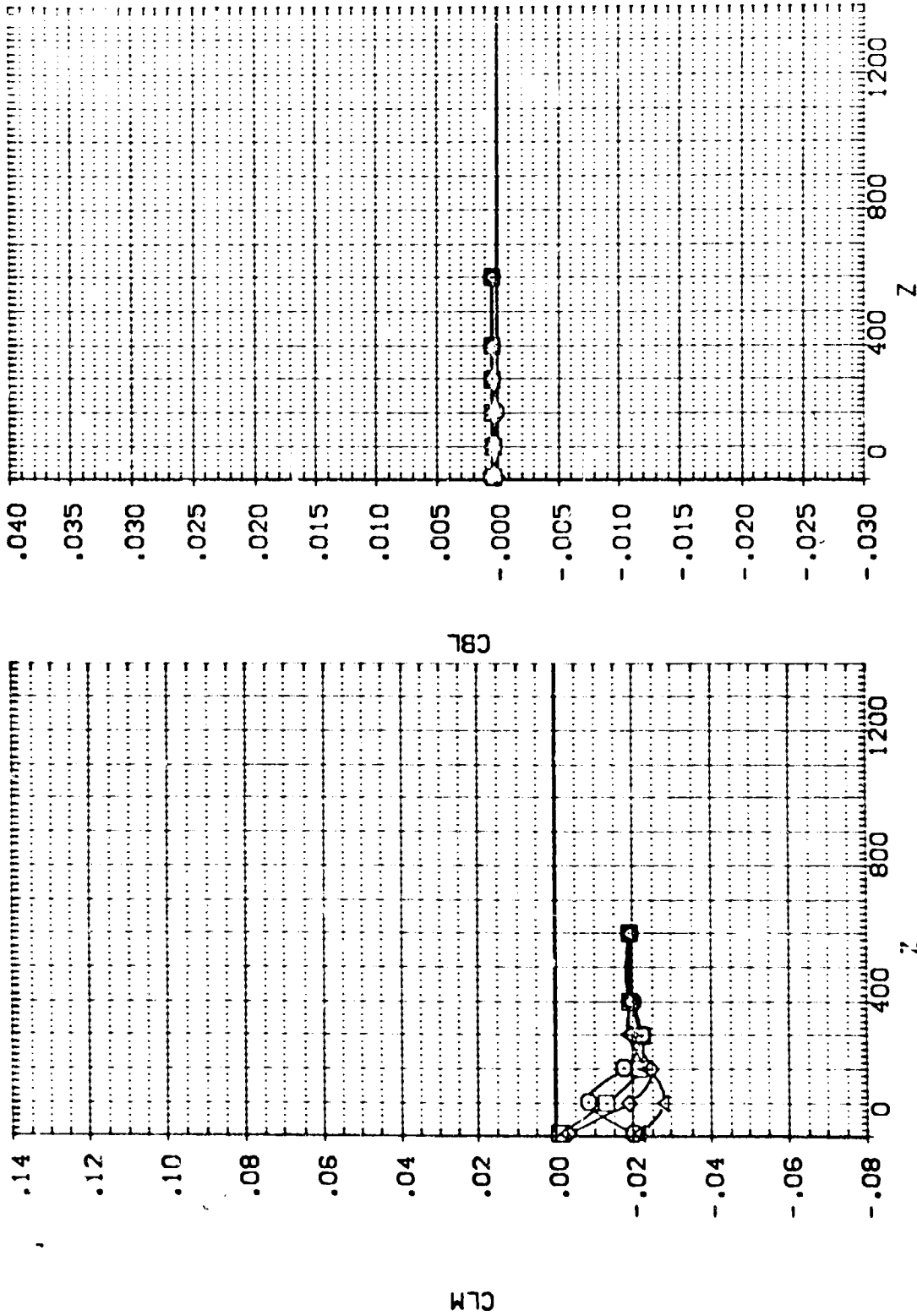

EFFECT OF EXTERNAL TANK SEPARATION ON ORBITER AERODYNAMIC CHARACTERISTICS

IA13.EXTERNAL TANK(T10)SEPARATING FROM ORB. 09 (RTJ032)

SEE THE ASSOCIATED DATA DOCUMENT FOR REFERENCE CHARACTERISTICS FOR INDIVIDUAL DATASETS

SYMBOL	X	MACH	PARAMETRIC VALUES
○	.290	4.520	PTOTAL 80.000
□	400.490	-10.000	BETA .000
◇	800.660	5.000	CBETA .000
△	1200.700	.000	AIRRON .000
		Y	

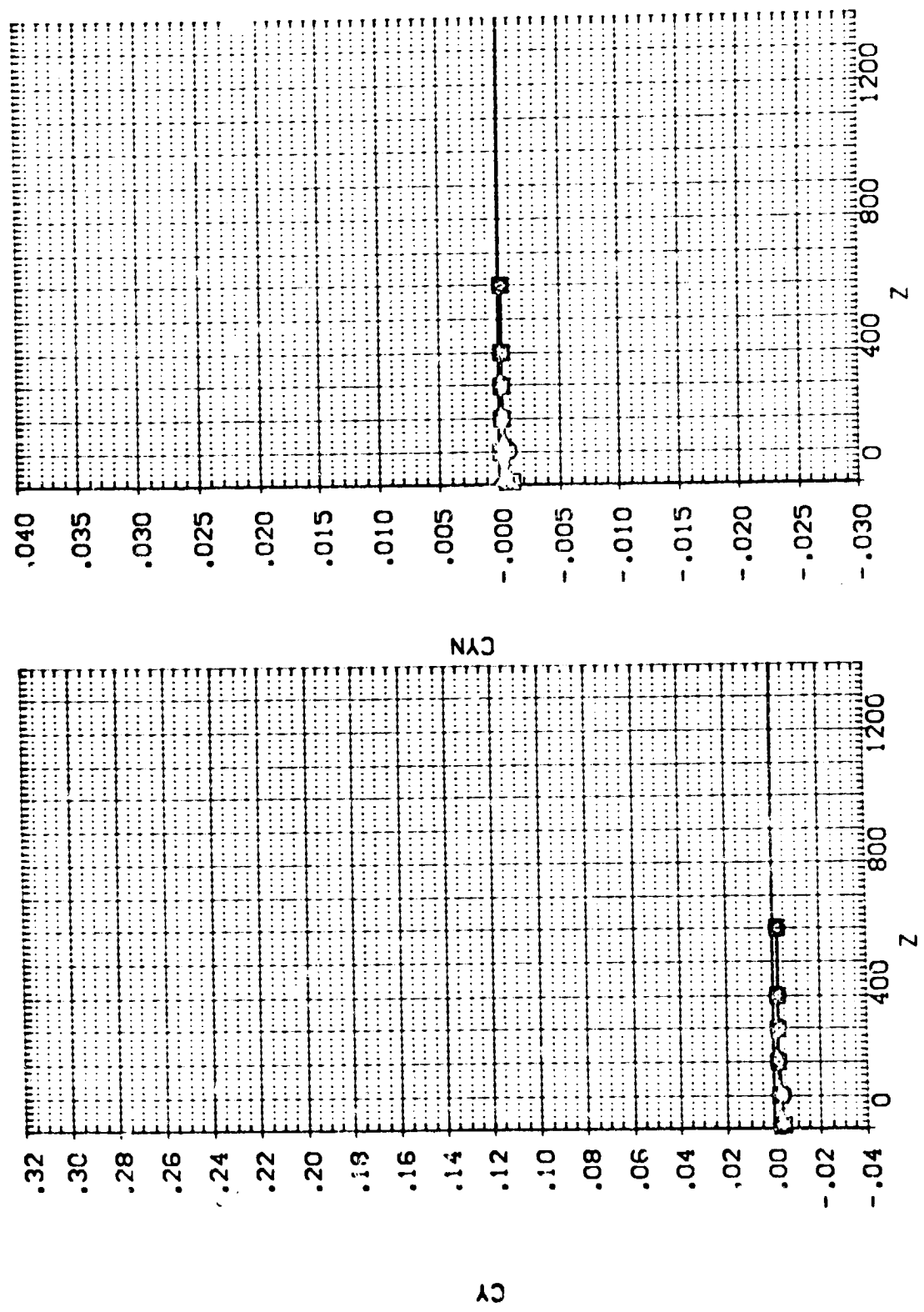

EFFECT OF EXTERNAL TANK SEPARATION ON ORBITER AERODYNAMIC CHARACTERISTICS

1A13.EXTERNAL TANK(T10)SEPARATING FROM ORB. 09 (RTJ033)

SYMBOL		PARAMETRIC VALUES			
○	.248	MACH	4.520	PITCH	60.000
□	400,440	ALPHA	-10.000	BETA	.000
◇	800,560	DALPHA	.000	DBETA	.000
△	1201,000	ELEVTR	.000	AILRON	.000
		Y	.000		

SEE THE ASSOCIATED DATA DOCUMENT FOR CHARACTERISTICS FOR INDIVIDUAL DATASETS

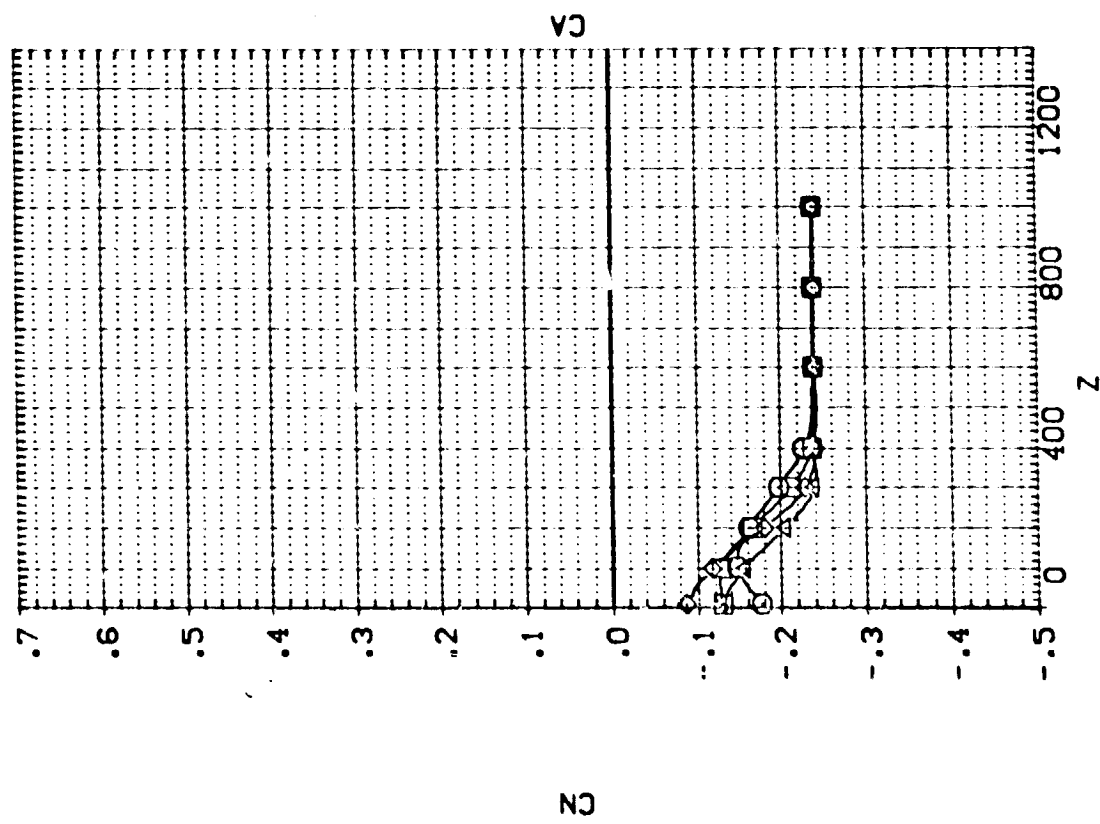
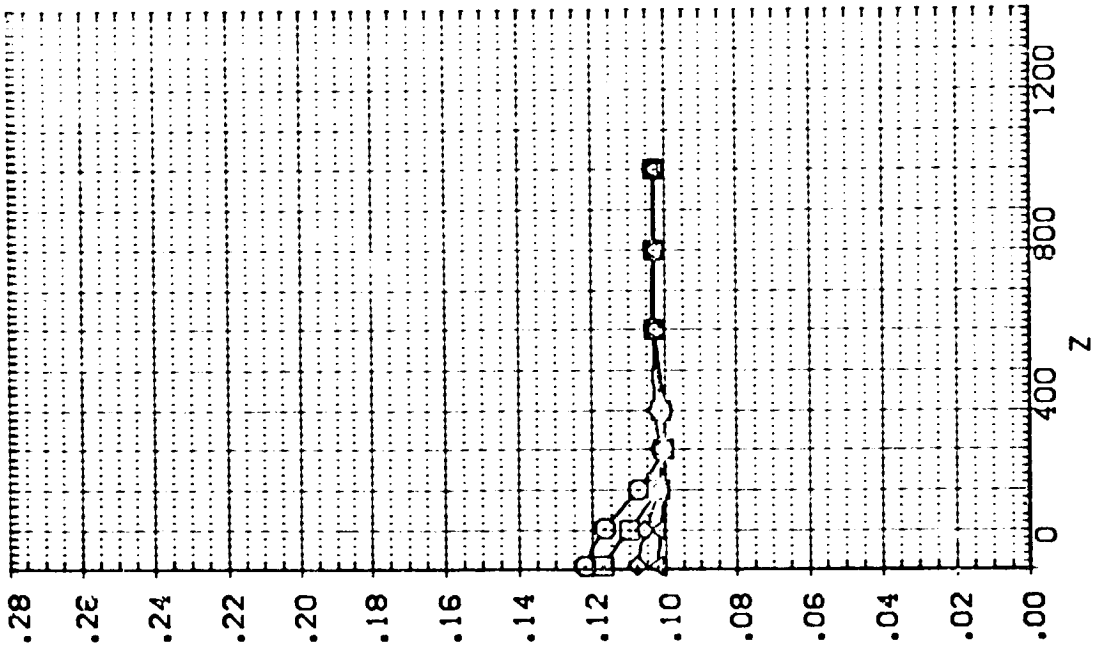

EFFECT OF EXTERNAL TANK SEPARATION ON ORBITER AERODYNAMIC CHARACTERISTICS

1A13, EXTERNAL TANK(T10)SEPARATING FROM ORB. 09 (RTJ033)

SEE THE ASSOCIATED DATA DOCUMENT FOR REFERENCE CHARACTERISTICS FOR INDIVIDUAL DATASET.

S ¹⁰⁰⁰ X		PARAMETRIC VALUES			
○	.248	MACH	4.520	PIOTAL	60.000
◇	400.440	ALPHA	-10.000	BETA	.000
△	900.560	DALPHA	.000	DBETA	.000
△	1201.000	ELEVTR	.000	AILRON	.000
		Y	.000		

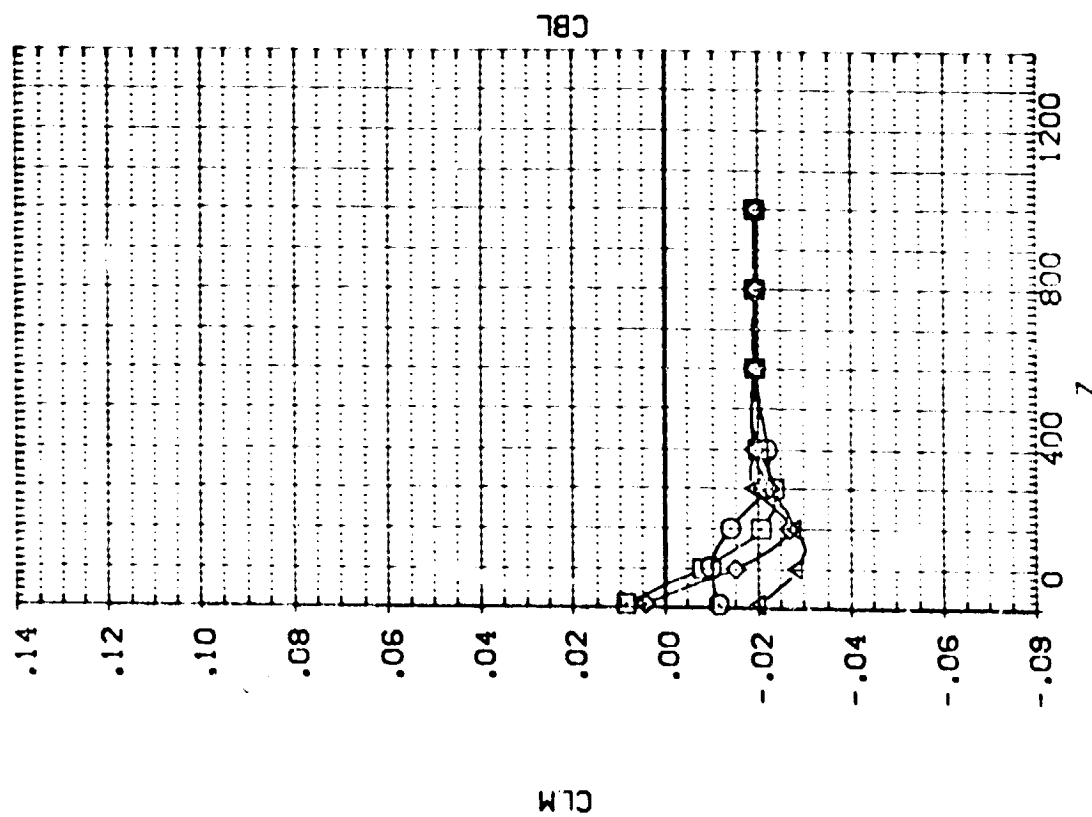
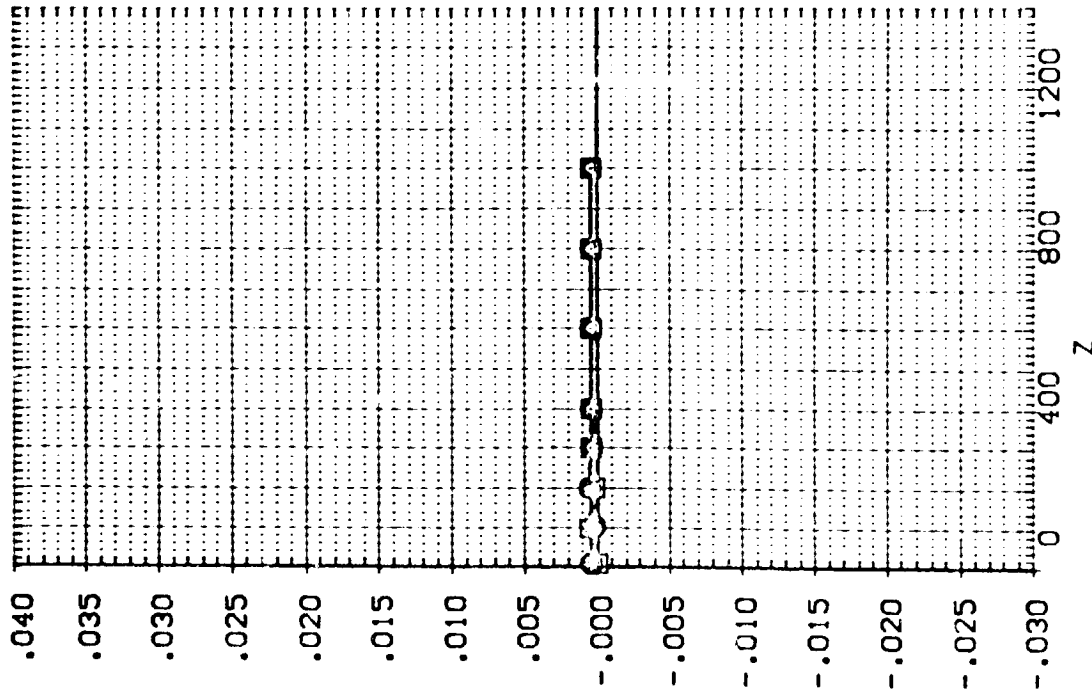

1A13. EXTERNAL TANK(S) SEPARATING FROM ORB. 09 (RTJ033)

SEE THE ASSOCIATED DATA DOCUMENT FOR CHARACTERISTICS OF INDIVIDUAL DATA'S

SYMBOL		PARAMETRIC VALUES	
○	X	MACH	4.520
○	Y	ALPHA	-10.000
○	Z	BETA	.000
○	PTOTAL	BETA	.000
○	ALPHA	DBETA	.000
○	BETA	ALTRON	.000
○	PTOTAL	ALTRON	.000
○	ALPHA	ALTRON	.000
○	BETA	ALTRON	.000
○	PTOTAL	ALTRON	.000

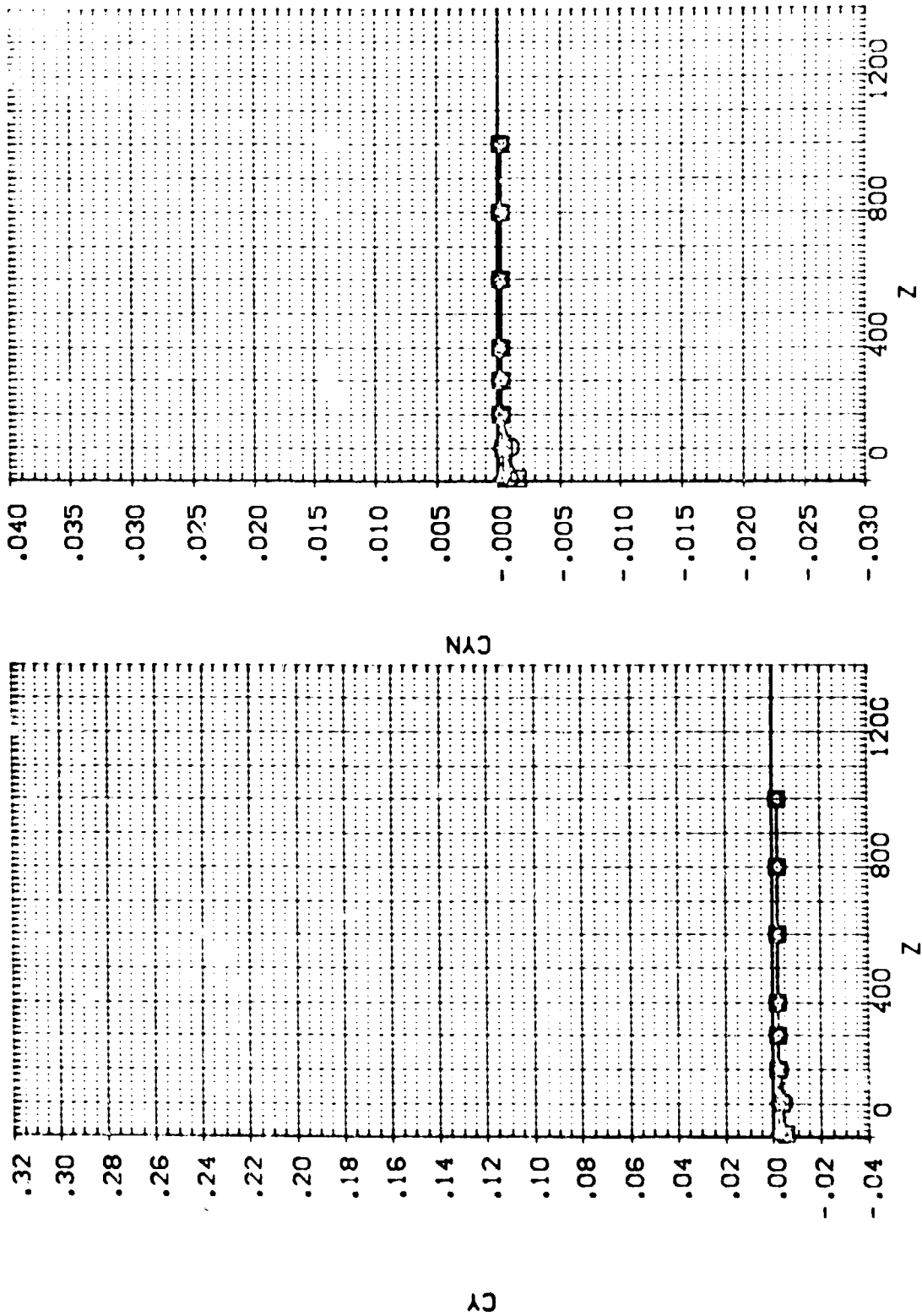

EFFECT OF EXTERNAL TANK SEPARATION ON ORBITER AERODYNAMIC CHARACTERISTICS



1A13, EXTERNAL TANK (110) SEPARATING FROM ORB. 09 (RTJ034)

SEE THE ASSOCIATED DATA DOCUMENT FOR REFERENCE CHARACTERISTICS FOR INDIVIDUAL DATASETS

PARAMETRIC VALUES	
MACH	4.520
PIOTAL	80.000
ALPHA	-10.000
BETA	.000
DALPHA	.000
DBETA	.000
ELEVTR	200.000
Y	200.000

SYMBOL X
 O 400.160
 □ 800.610
 △ 1200.900

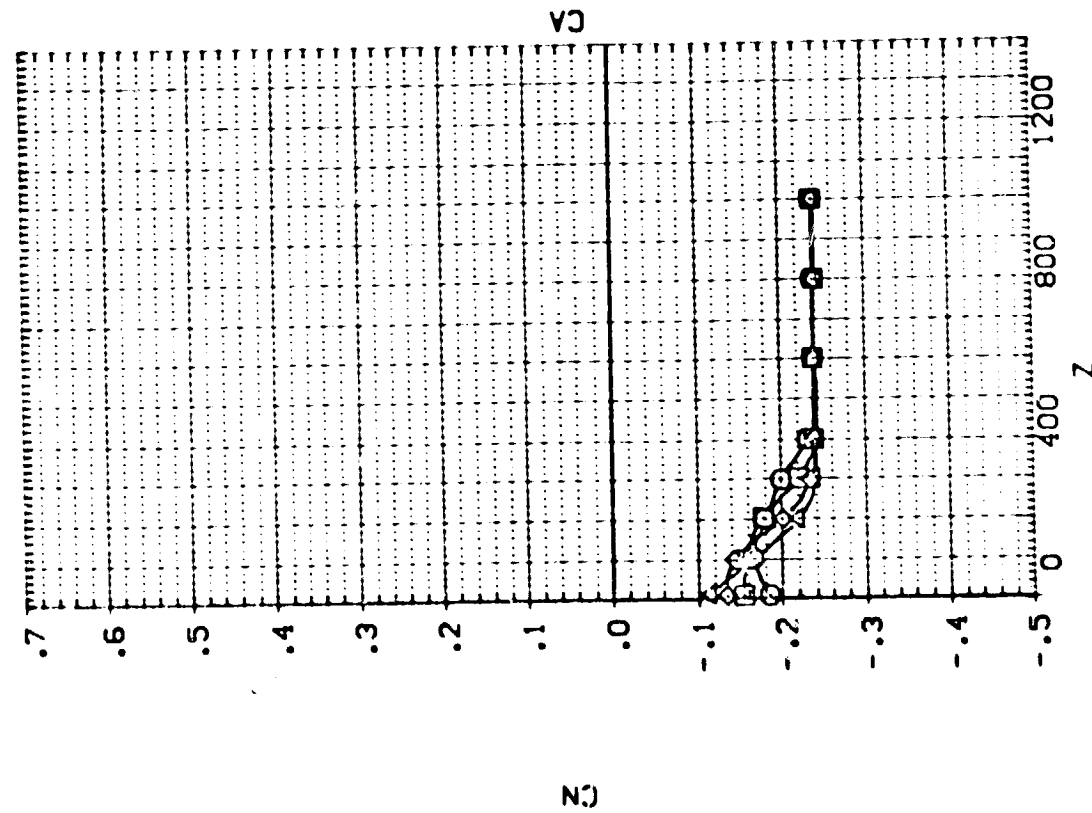
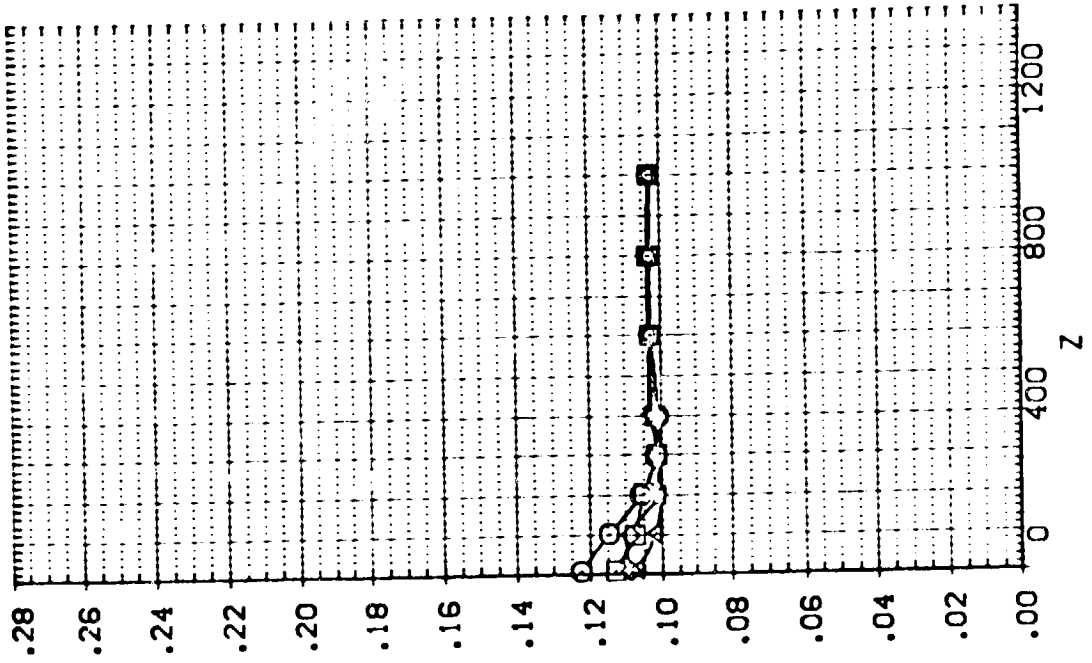

IA13, EXTERNAL TANK(T10) SEPARATING FROM ORB. C9 (RTJ034)

SEE THE ASSOCIATED DOCUMENT FOR MORE CHARACTERISTICS FOR INDIVIDUAL DATA SETS

SYMBOL		PARAMETRIC VALUES	
○	X	MACH	4.520
○	Y	PTOTAL	60.000
○	Z	BETA	.000
◇	CLM	ALPHA	-10.000
◇	CLB	DALPHA	.000
△		ELEVTR	.000
		AILTRON	.000
		Y	200.000

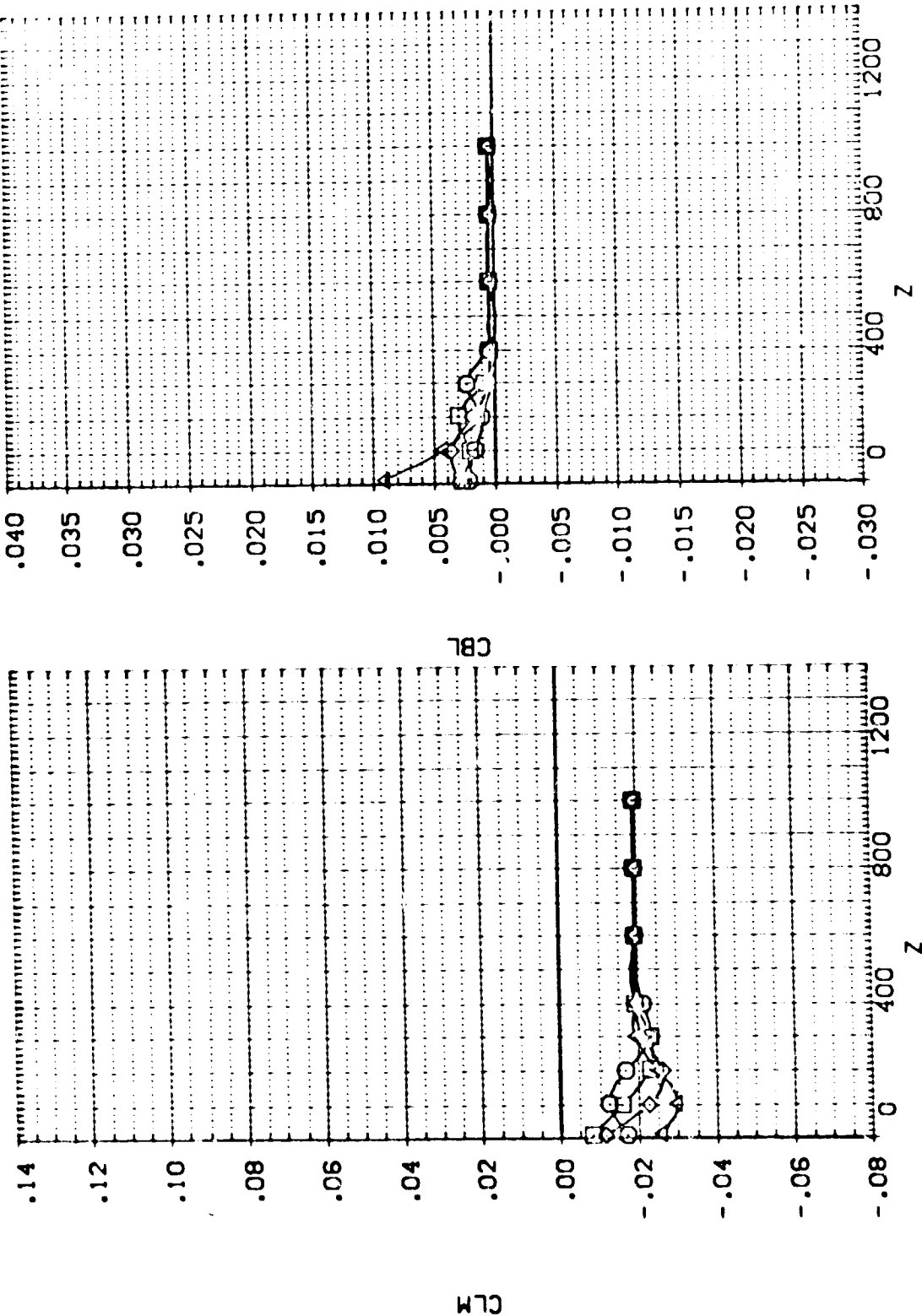

EFFECT OF EXTERNAL TANK SEPARATION ON ORBITER AERODYNAMIC CHARACTERISTICS

1A13.EXTERNAL TANK(T10)SEPARATING FROM ORB. 09 (RTJ034)

SEE THE ASSOCIATED DATA DOCUMENT FOR REFERENCE CHARACTERISTICS FOR INDIVIDUAL DATASETS

SYMBOL		PARAMETRIC VALUES	
X	.210	MACH	4.520
Y	100.460	ALPHA	-10.000
Z	800.610	BETA	.000
	1200.900	DBETA	.000
		ALFRON	.000
		Y	200.000
		PTOTAL	60.000

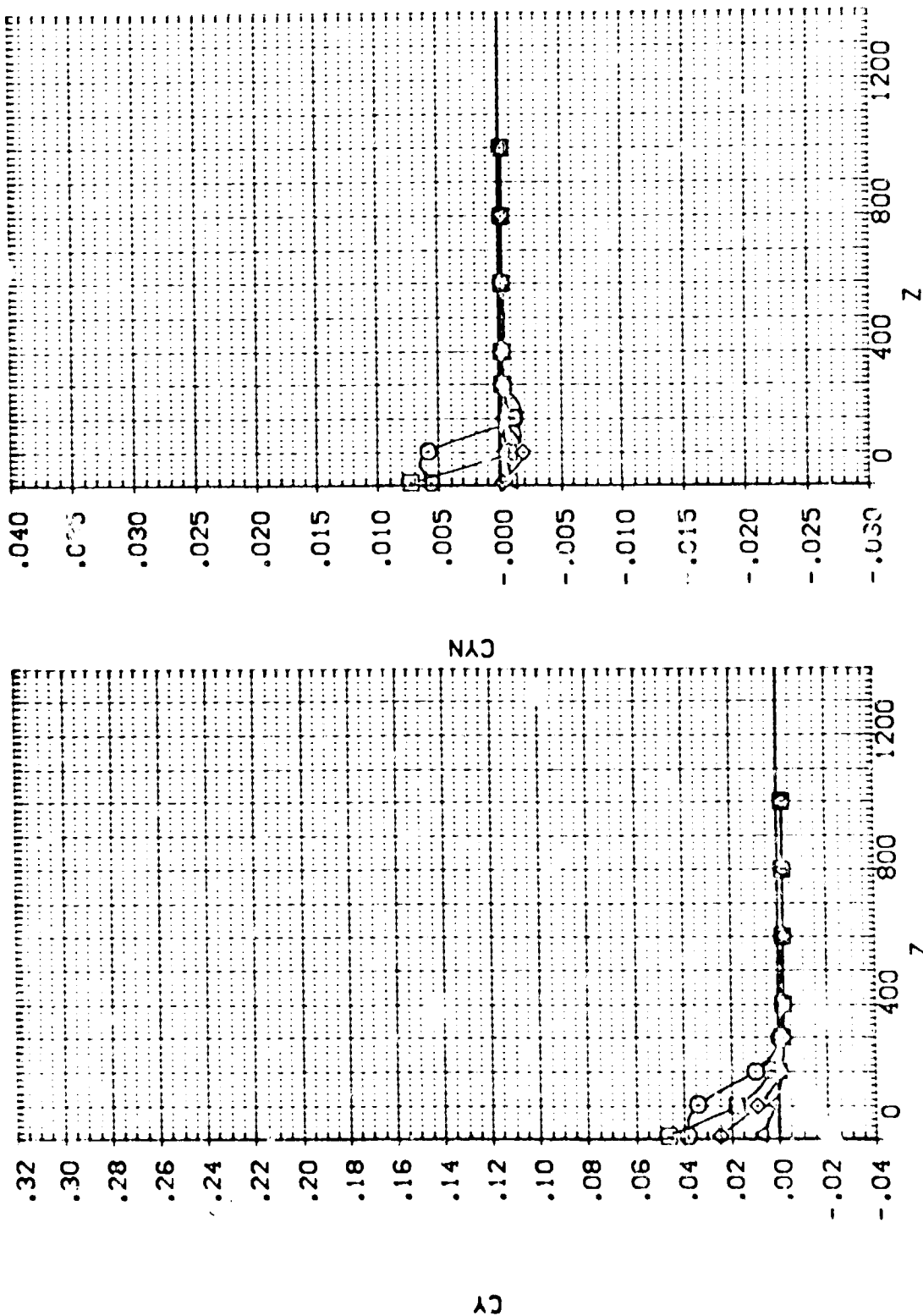

EFFECT OF EXTERNAL TANK SEPARATION ON ORBITER AERODYNAMIC CHARACTERISTICS

IA13. EXTERNAL TANK(T10)SEPARATING FROM ORB. 09 (RTJ035)

SEE THE ASSOCIATED DOCUMENT FOR REFERENCE CHARACTERISTICS FOR INDIVIDUAL DATASETS

SYMBOL		PARAMETRIC VALUES	
○	X	MACH	PTOTAL
□	400.360	ALPHA	BETA
◇	800.550	DALPHA	DBETA
△	1200.900	ELEVTR	AILRON
		Y	200.000
			80.000
			.000
			5.000
			.000

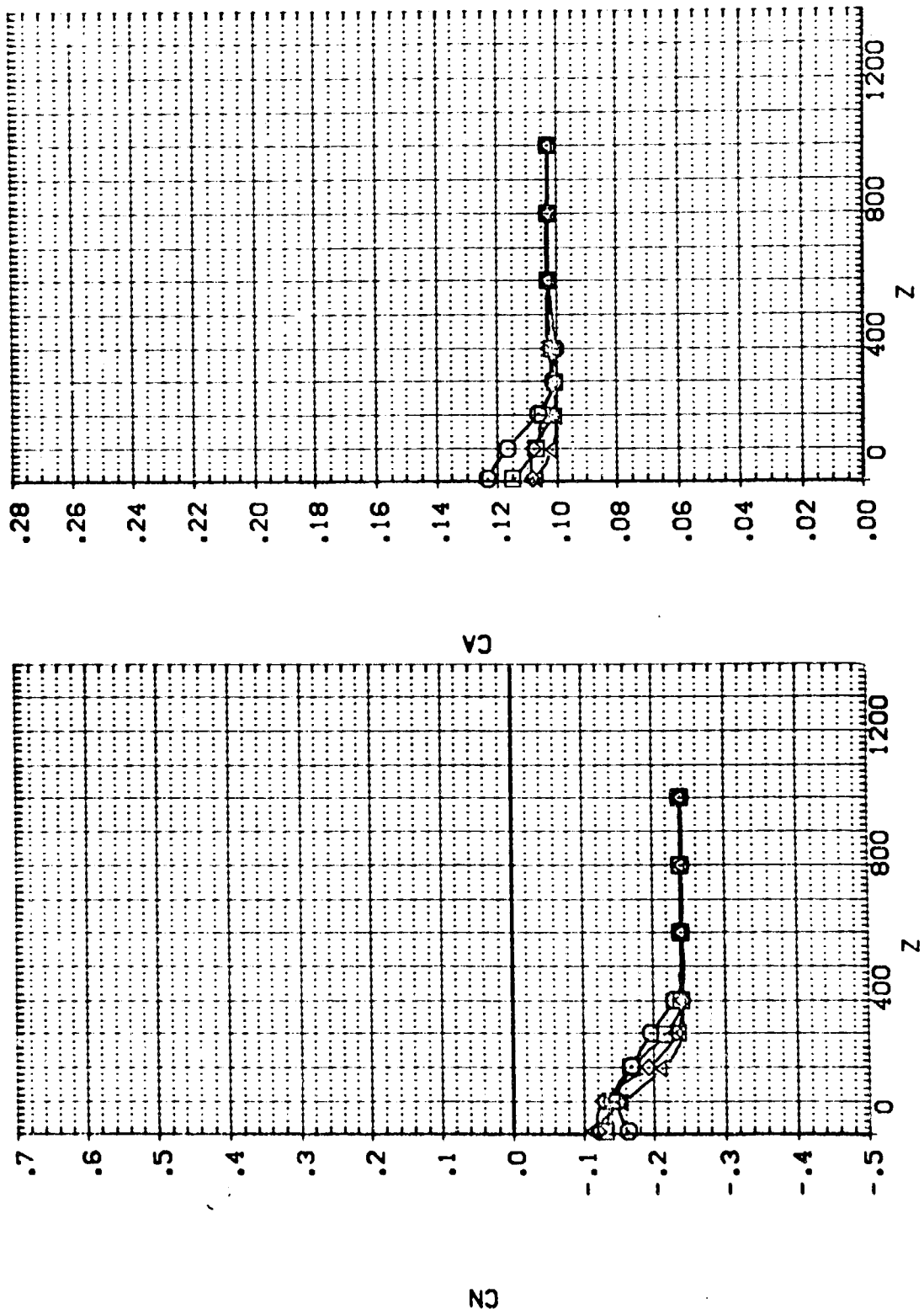

EFFECT OF EXTERNAL TANK SEPARATION ON ORBITER AERODYNAMIC CHARACTERISTICS

1A13. EXTERNAL TANK(T10) SEPARATING FROM ORB. 09 (RTJ035)

SEE THE ASSOCIATED DATA DOCUMENT FOR REFERENCE CHARACTERISTICS FOR INDIVIDUAL DATASETS

SYMBOL		PARAMETRIC VALUES	
○	X	MACH	4.520
□	Y	ALPHA	-10.000
◇	Z	DALPHA	.000
		ELEVTR	.000
		Y	200.000
		PIDTAL	80.000
		BETA	.000
		DBETA	5.000
		AIRLON	.000

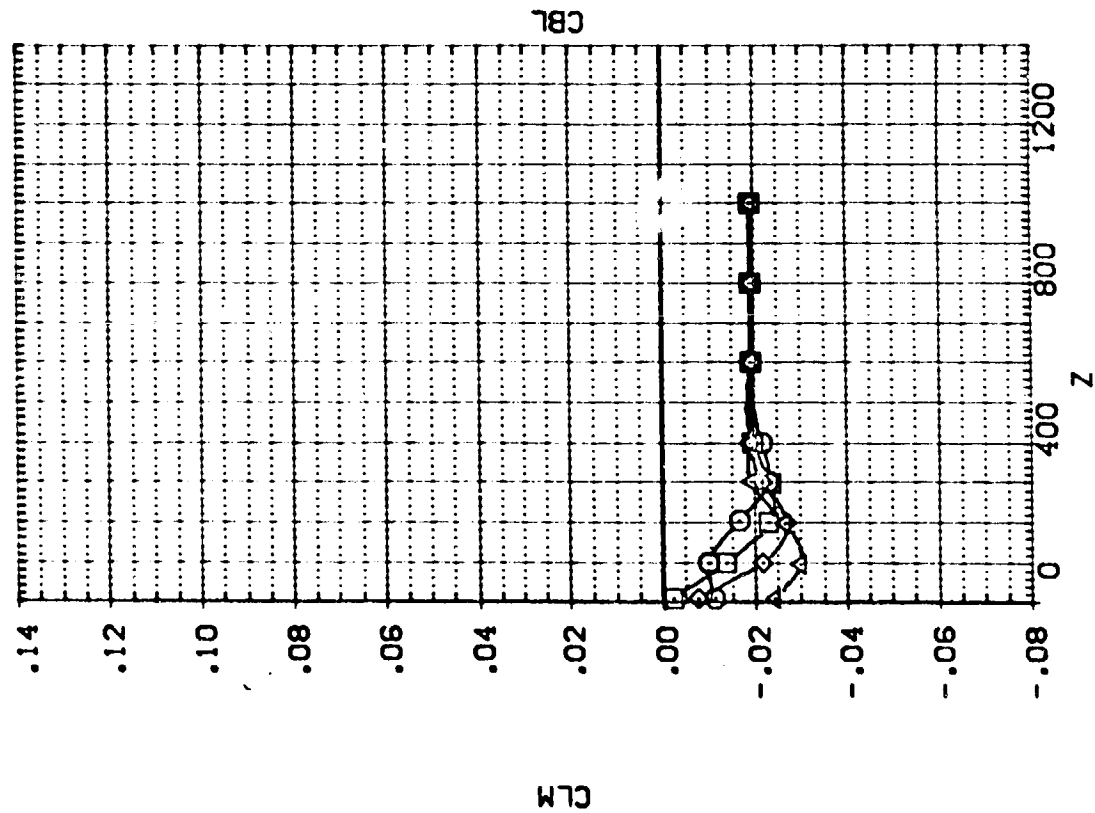
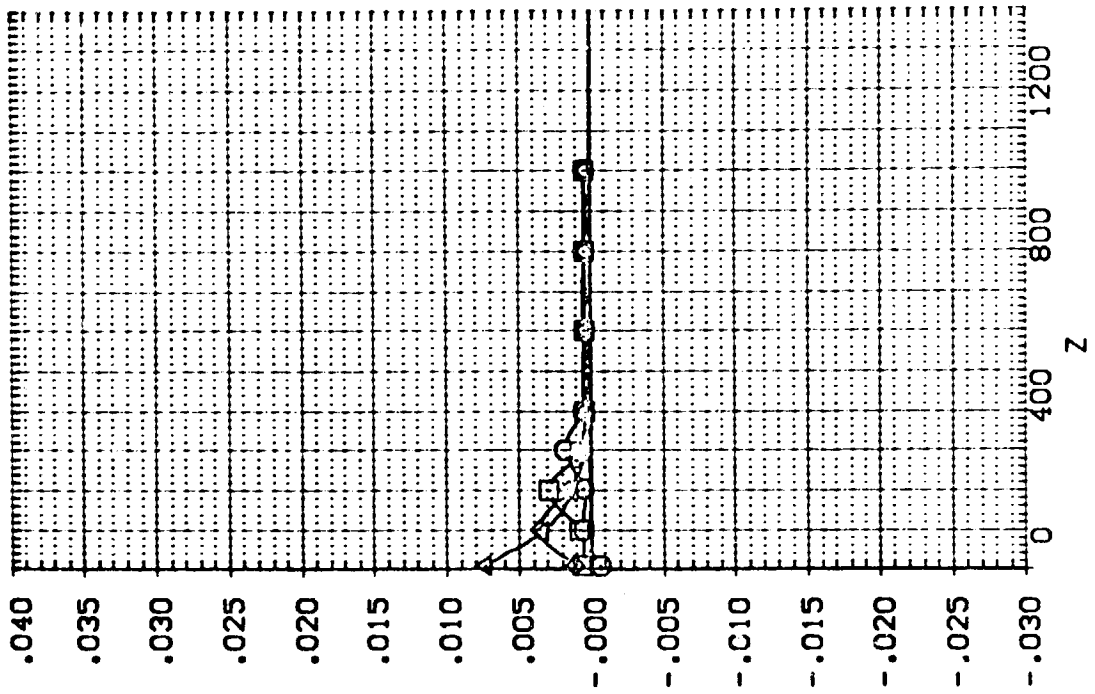

1.13. EXTERNAL TANK(T10)SEPARATING FROM ORB. 09 (RTJ035)

SEE THE ASSOCIATED
DOCUMENT FOR
CHARACTERISTICS FOR
INDIVIDUAL DATASETS

SYMBOL		PARAMETRIC VALUES	
○	x	MACH	4.520
□	400.360	ALPHA	-10.000
◇	800.550	DALPHA	.000
△	1200.900	ELEVTR	.000
		Y	200.000
		PITOTAL	80.000
		BETA	.000
		DBETA	5.000
		AIRTON	.000

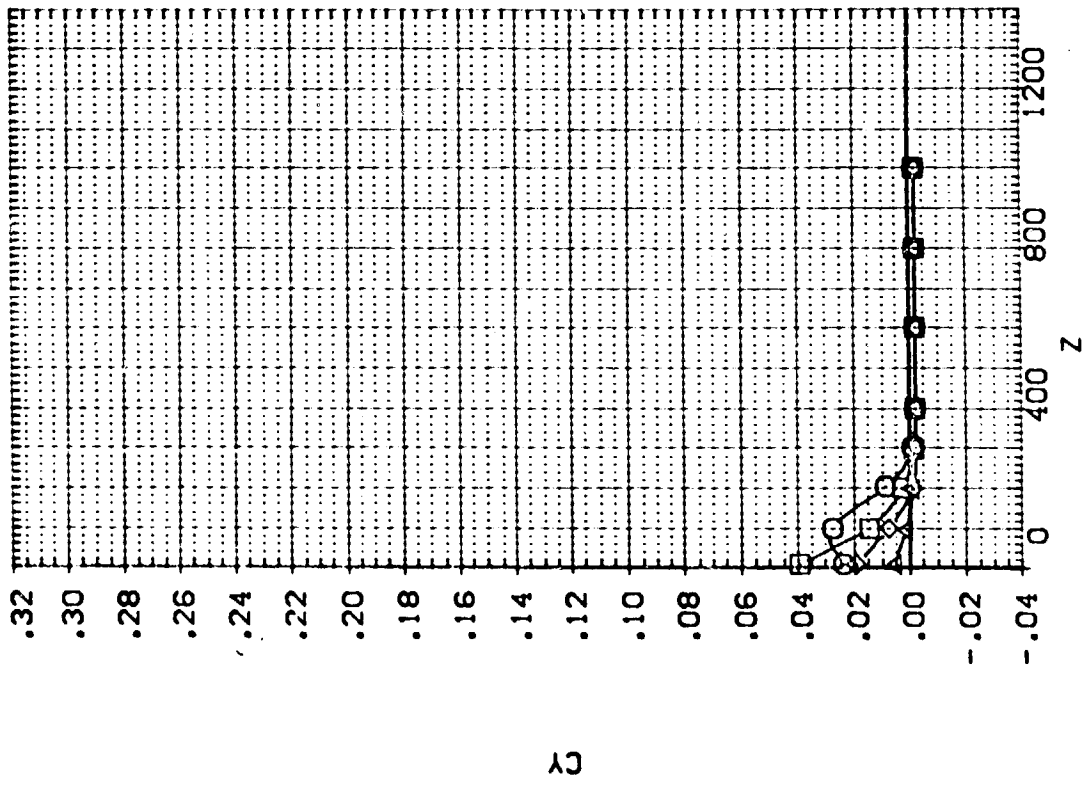
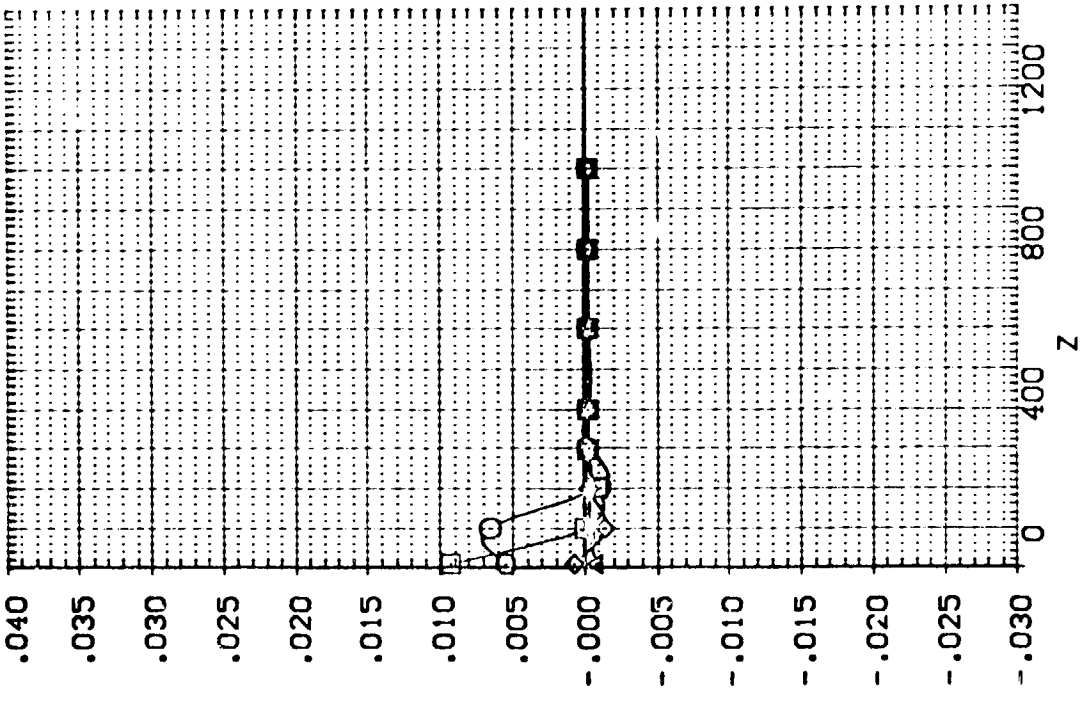

EFFECT OF EXTERNAL TANK SEPARATION ON ORBITER AERODYNAMIC CHARACTERISTICS



1A13, EXTERNAL TANK(T10)SEPARATING FROM ORB. 09 (RTJ036)

SEE THE ASSOCIATED DATA DOCUMENT FOR REFERENCE CHARACTERISTICS FOR INDIVIDUAL DATASETS

SYMBOL	X	PARAMETRIC VALUES			
		MACH	4.520	PTOTAL	80.000
○	400.460	ALPHA	-10.000	BETA	.000
□	800.530	DALPHA	.000	DBETA	5.000
◇	1200.700	ELEVTR	.000	AILTRON	.000
△		Y	.000		

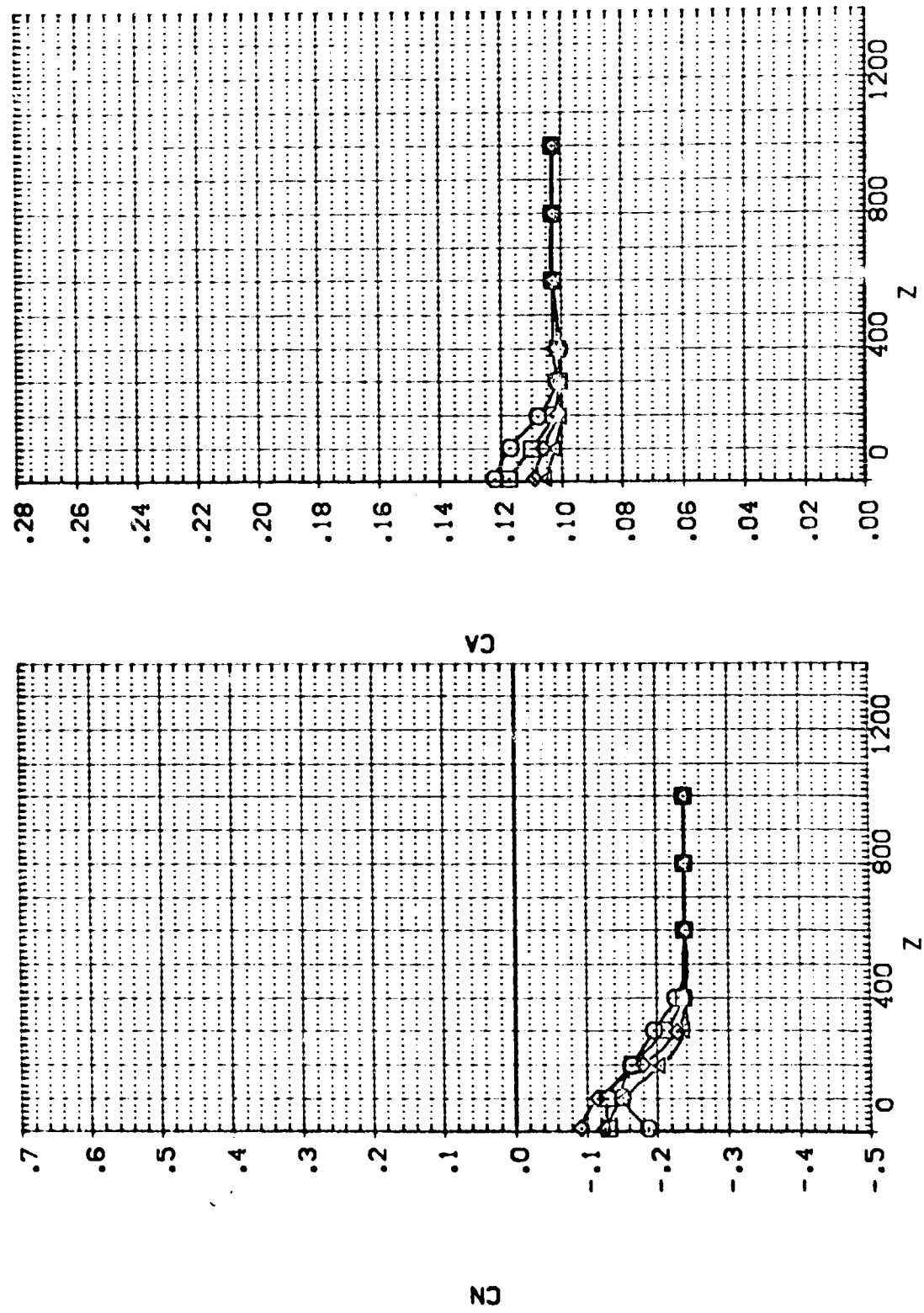

EFFECT OF EXTERNAL TANK SEPARATION ON ORBITER AERODYNAMIC CHARACTERISTICS

IA13.EXTERNAL TANK(T10)SEPARATING FROM ORB. 09 (RTJ036)

SEE THE ASSOCIATED DOCUMENT FOR REVIEW CHARACTERISTICS FOR INDIVIDUAL DATASETS

SYMBOL	X	MACH	PARAMETRIC VALUES	Y
○	.237	4.520	P/TOTAL	80.000
□	100.460	-10.000	BETA	.000
◇	800.530	.000	DBETA	5.000
△	1200.730	.000	AILRON	.000

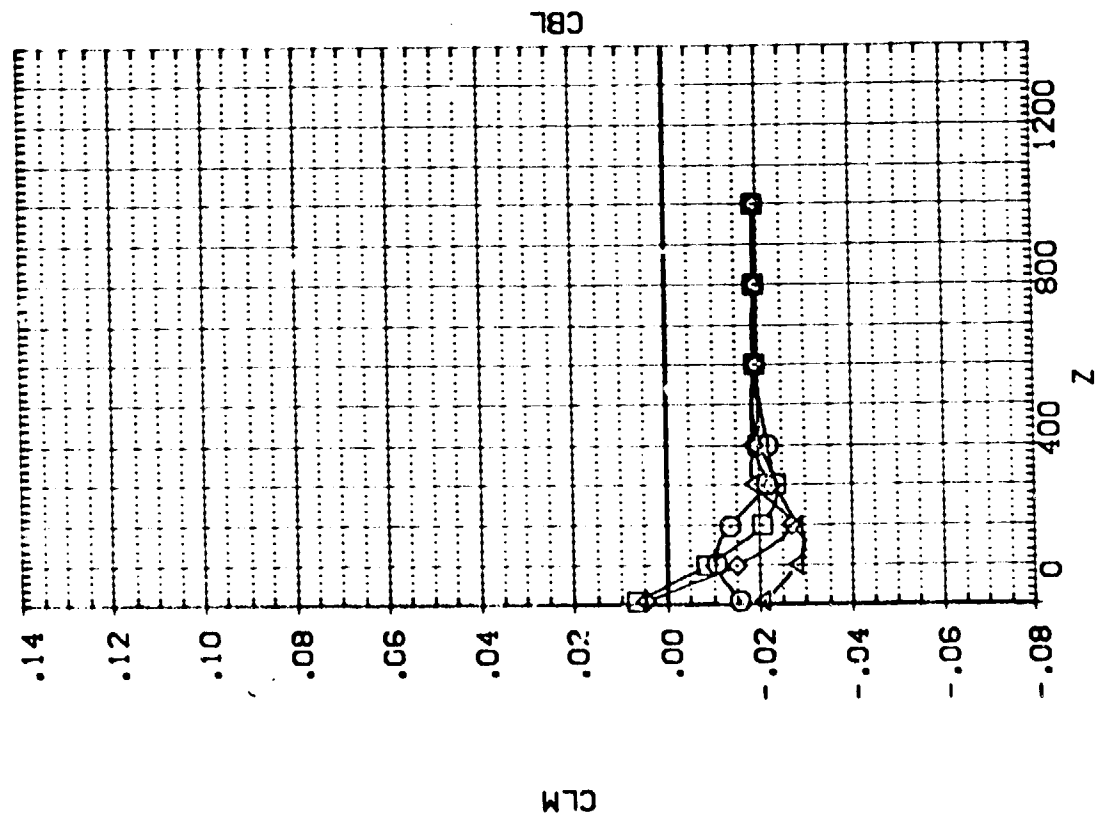
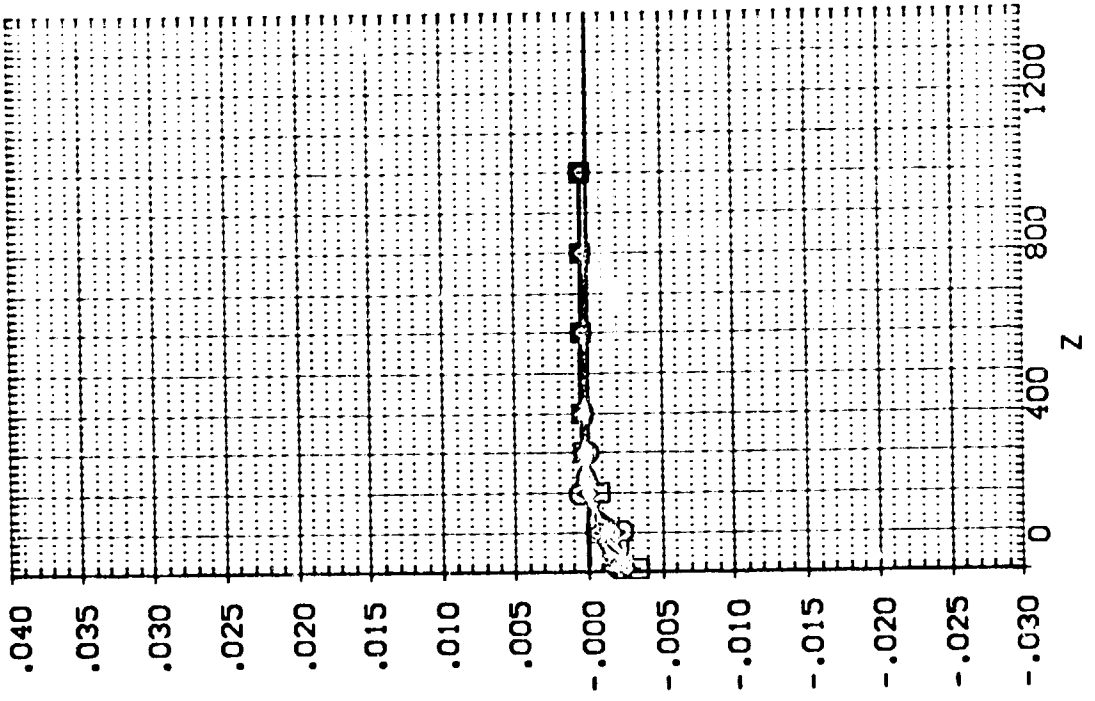

EFFECT OF EXTERNAL TANK SEPARATION ON ORBITER AERODYNAMIC CHARACTERISTICS

IA13.EXTERNAL TANK(T10)SEPARATING FROM ORB. 09 (RTJ036)

SEE THE ASSOCIATED DATA DOCUMENT FOR REFERENCE CHARACTERISTICS FOR INDIVIDUAL DATASETS

SYMBOL	X	MACH	PARAMETRIC VALUES	Y
○	.237	4.520	POTAL	60.000
□	400.460	-10.000	BETA	.000
◇	800.530	.000	DBETA	5.000
△	1200.700	.000	AIRRON	.000

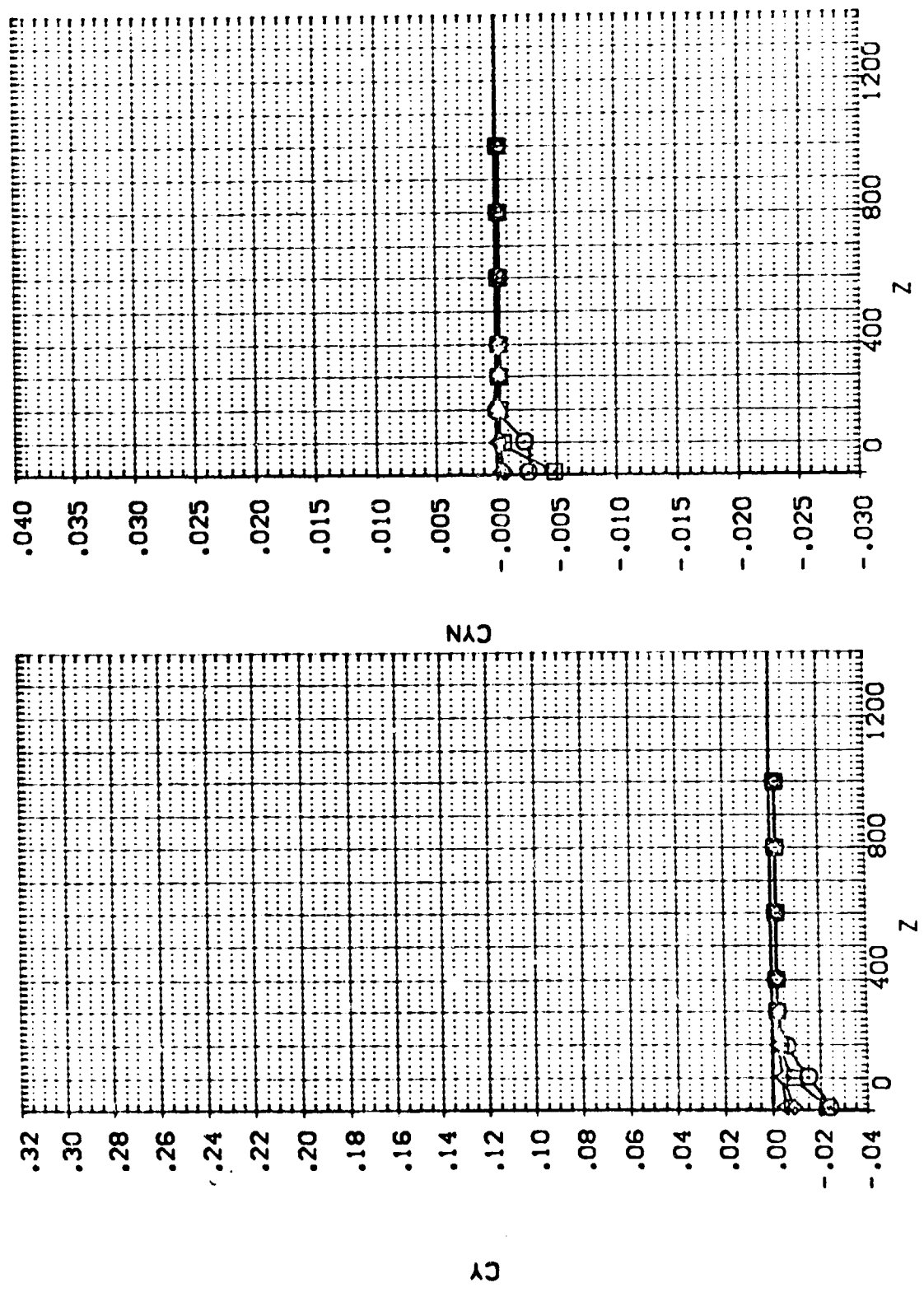

EFFECT OF EXTERNAL TANK SEPARATION ON ORBITER AERODYNAMIC CHARACTERISTICS

IA13. EXTERNAL TANK(T10)SEPARATING FROM ORB. 09 (RTJ037)

SEE THE ASSOCIATED DATA DOCUMENT FOR REFERENCE CHARACTERISTICS FOR INDIVIDUAL DATA SETS

SYMBOL		PARAMETRIC VALUES	
○	x	MACH	4.520
□	400.450	ALPHA	-10.000
◇	800.550	DALPHA	-5.000
△	1201.000	ELEVTR	.000
		PIOTAL	60.000
		BETA	.000
		DBETA	.000
		AIRLON	.000
		Y	.000

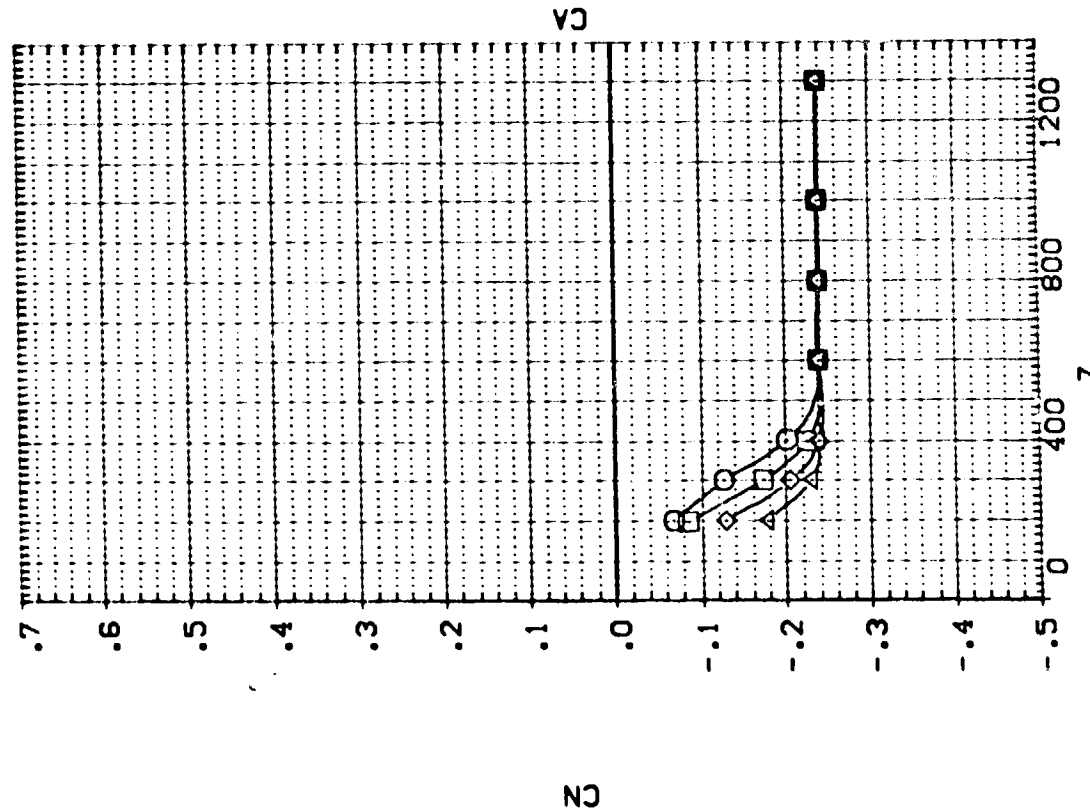
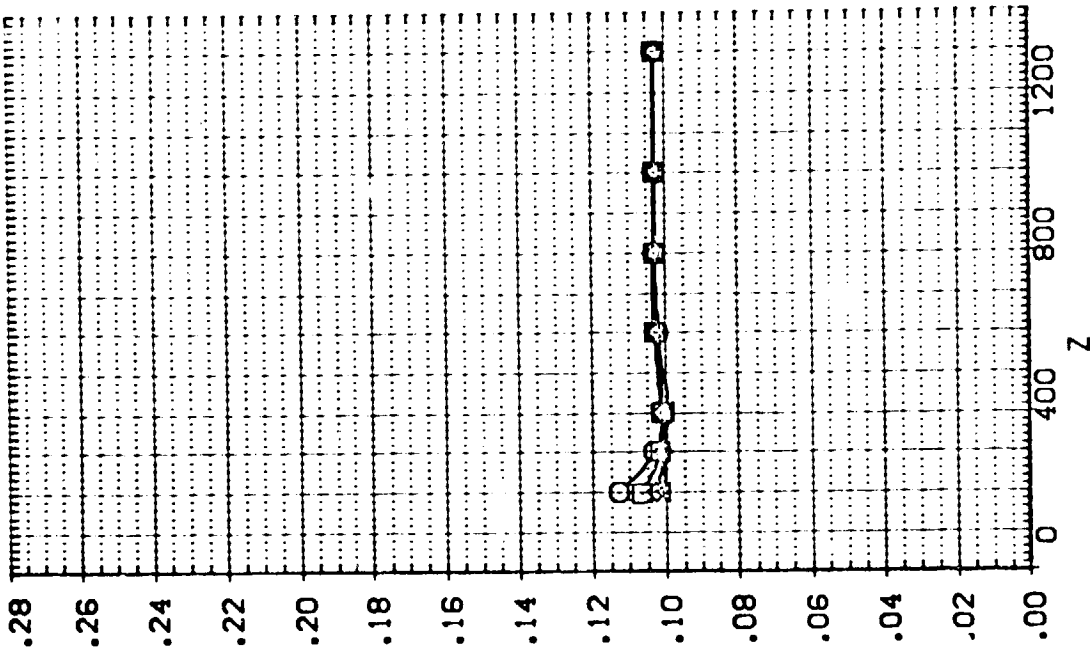

EFFECT OF EXTERNAL TANK SEPARATION ON ORBITER AERODYNAMIC CHARACTERISTICS

1A13. EXTERNAL TANK(T10)SEPARATING FROM ORB. 09 (RTJ037)

SEE THE ASSOCIATED DATA DOCUMENT FOR REFERENCE CHARACTERISTICS FOR INDIVIDUAL DATASETS

PARAMETRIC VALUES	
MACH	4.520
PTOTAL	80.000
BETA	.000
DBETA	.000
AIRLON	.000
ELEVTR	.000
Y	.000

S1480-
 ○
 ◇
 △

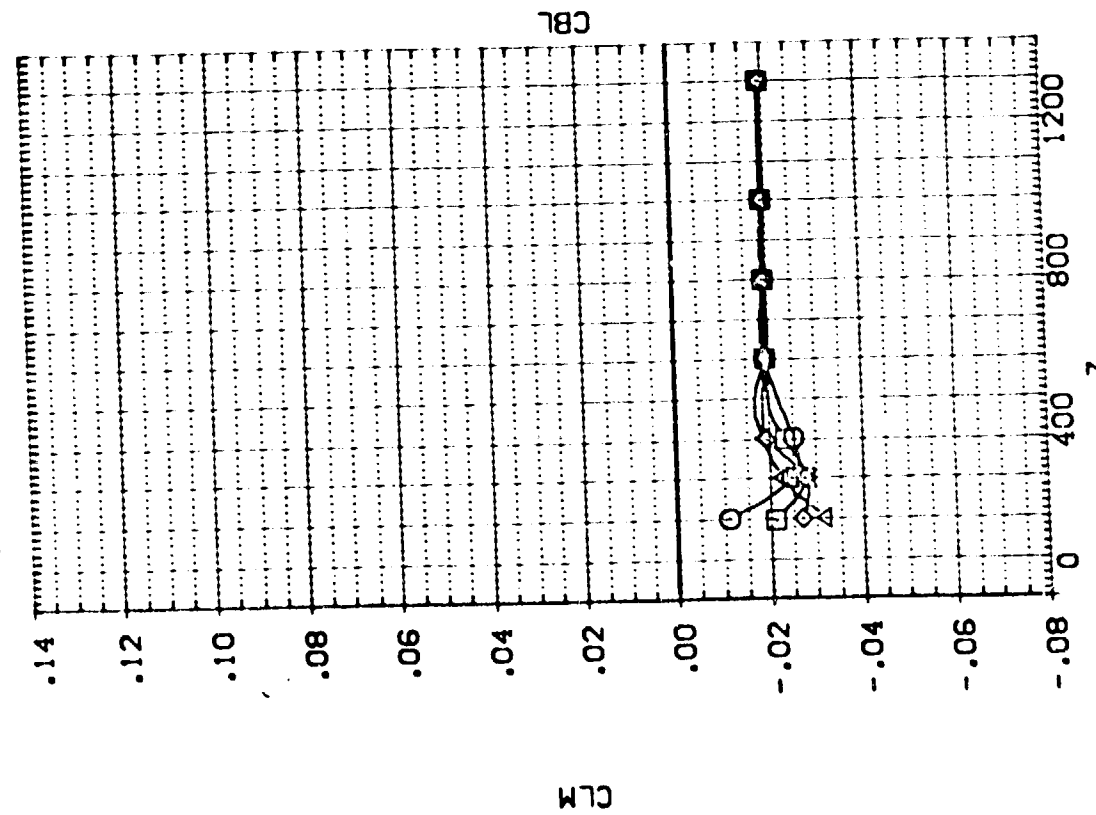
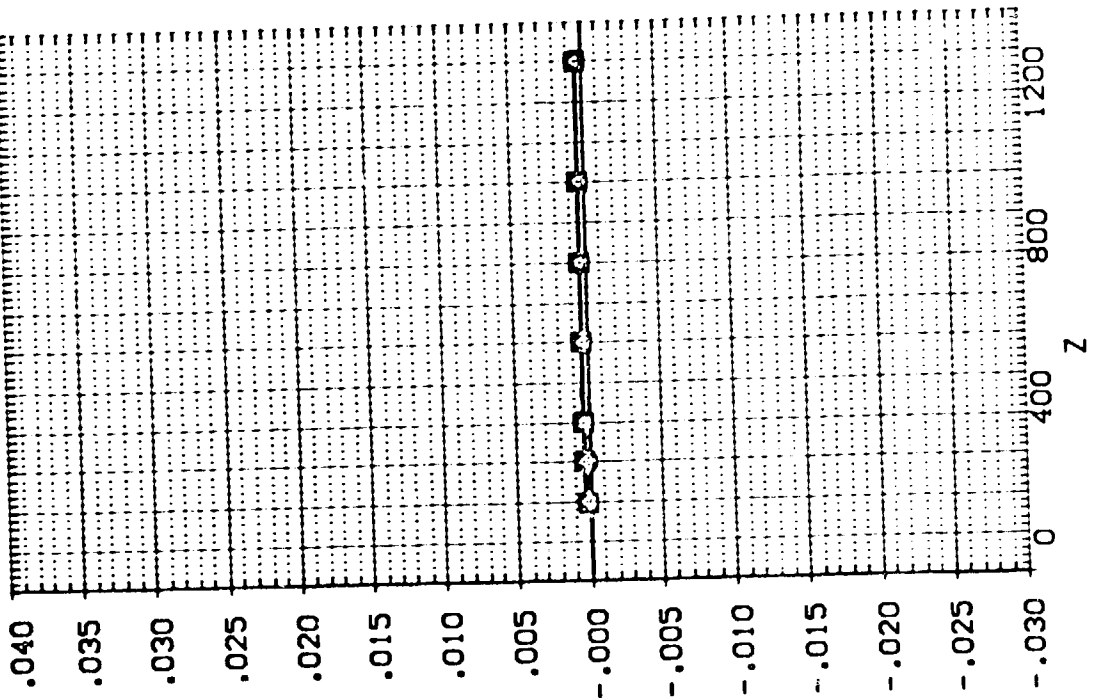

EFFECT OF EXTERNAL TANK SEPARATION ON ORBITER AERODYNAMIC CHARACTERISTICS

1A13. EXTERNAL TANK(T10)SEPARATING FROM ORB. 09 (RTJ037)

SYMBOL	X	MACH	PARAMETRIC VALUES
○	.201	4.520	PIOTAL 60.000
◇	400.450	-10.000	BETA .000
△	600.550	-5.000	DBETA .000
	1201.000	.000	A:LRON .000
			Y .000

SEE THE ASSOCIATED DOCUMENT FOR THE CHARACTERISTICS FOR INDIVIDUAL DATASETS

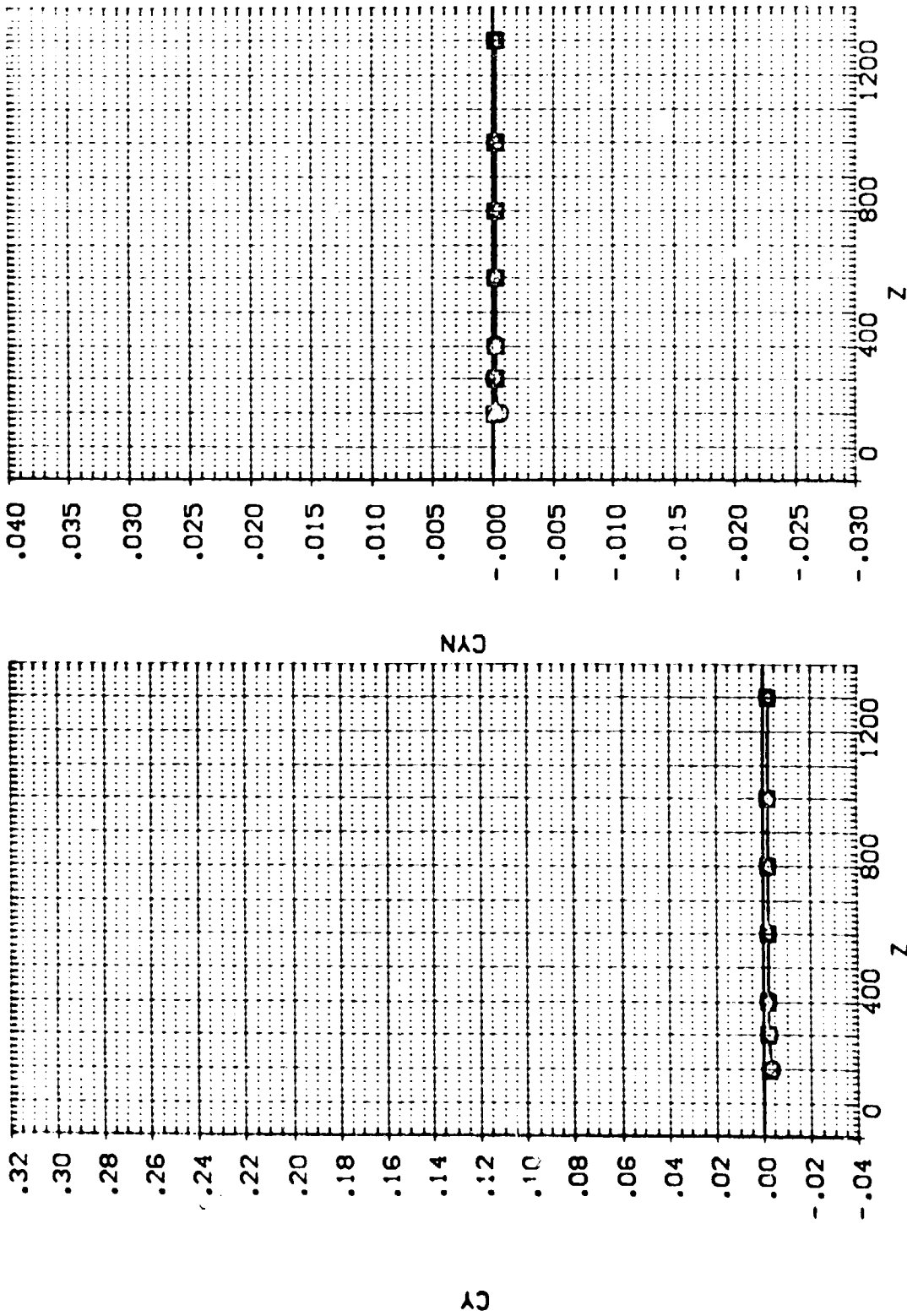

EFFECT OF EXTERNAL TANK SEPARATION ON ORBITER AERODYNAMIC CHARACTERISTICS

IA13. EXTERNAL TANK(T10)SEPARATING FROM ORB. 09 (RTJ038)

SEE THE ASSOCIATED DATA DOCUMENT FOR REFERENCE CHARACTERISTICS FOR INDIVIDUAL DATA SETS

SYMBOL		PARAMETRIC VALUES	
○	X	MACH	PTOTAL
□	400	4.520	60.000
◇	800	10.000	BETA
△	1200	10.000	DBETA
		ELEVTR	AILRON
		Y	.000

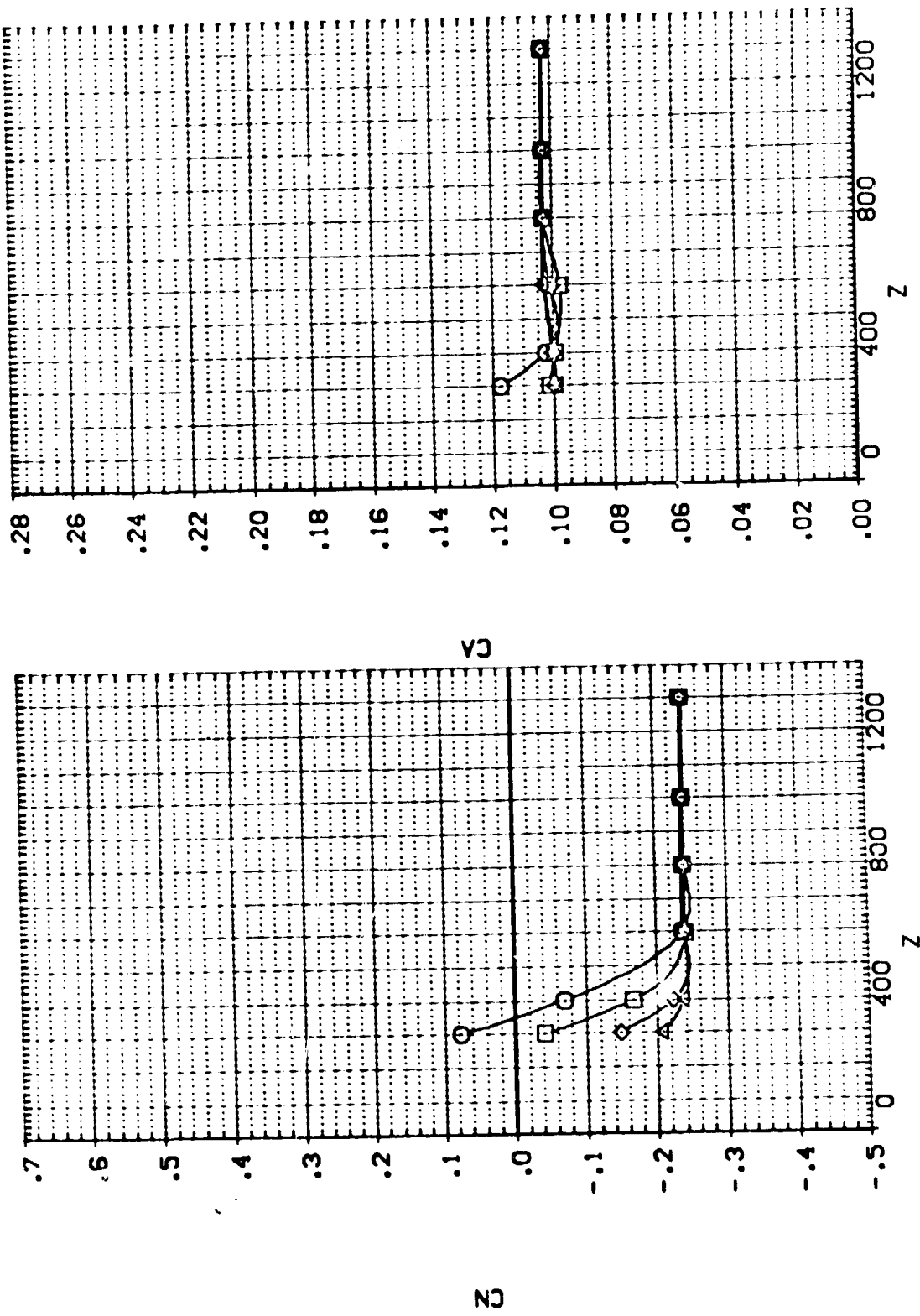

EFFECT OF EXTERNAL TANK SEPARATION ON ORBITER AERODYNAMIC CHARACTERISTICS

1A13. EXTERNAL TANK(T10)SEPARATING FROM ORB. 09 (RTJ038)

SEE THE ASSOCIATED DOCUMENT FOR THE CHARACTERISTICS FOR INDIVIDUAL DATASETS

SYMBOL	X	MACH	PARAMETRIC VALUES	PIOTAL	BETA	DBETA	AIRLON
○	.123	4.520		80.000	.000		
◇	400.560	-10.000			.000		
△	800.420	-10.000			.000		
	1200.900	.000			.000		
		Y					

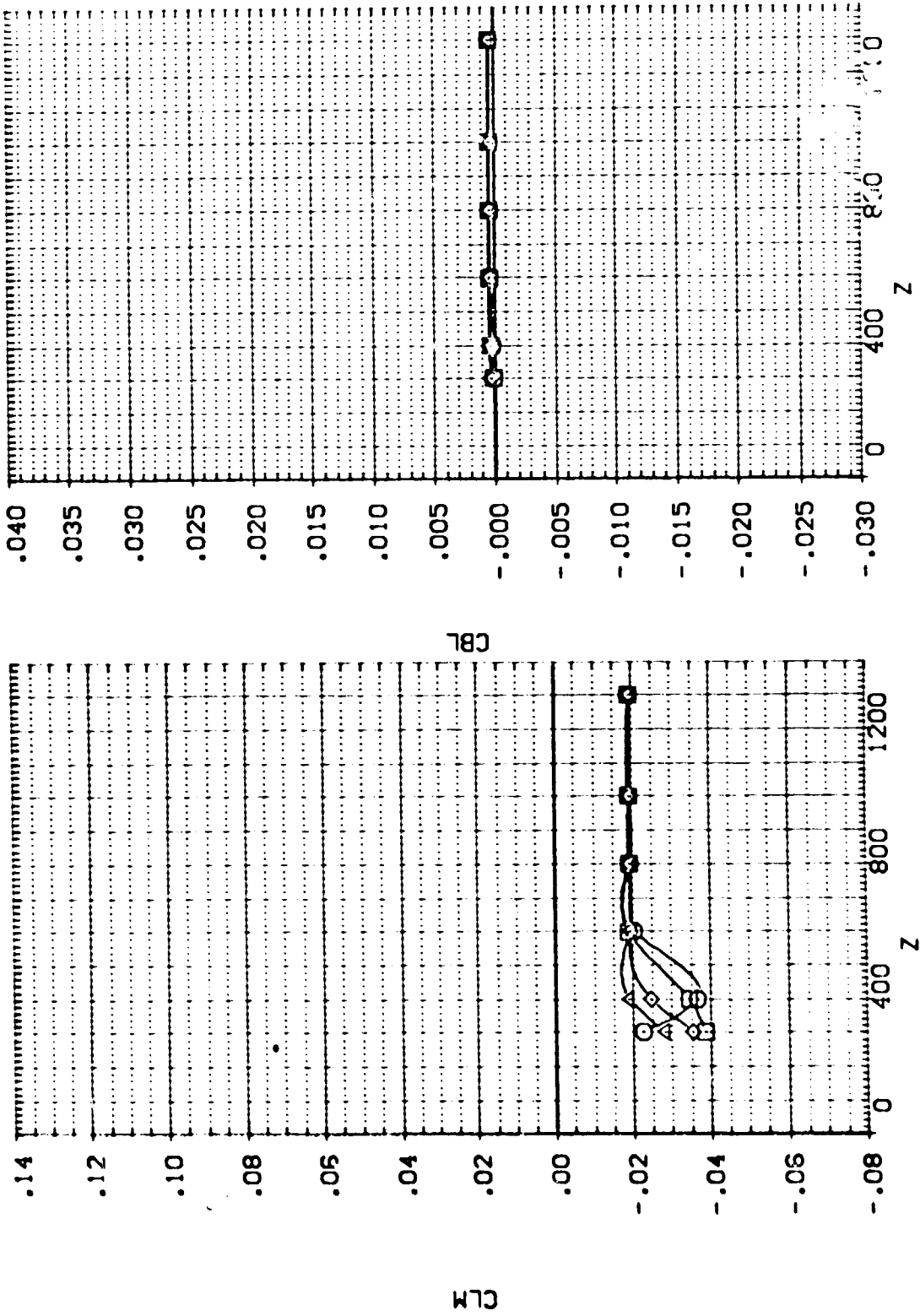

EFFECT OF EXTERNAL TANK SEPARATION ON ORBITER AERODYNAMIC CHARACTERISTICS

1A13.EXTERNAL TANK(T10)SEPARATING FROM ORB. 09 (RTJ038)

SEE THE ASSOCIATED DATA DOCUMENT FOR REFERENCE CHARACTERISTICS FOR INDIVIDUAL DATA'S

SYMBOL		PARAMETRIC VALUES	
x	.123	MACH	4.520
o	400.560	ALPHA	-10.000
◇	800.470	DALPHA	-10.000
△	1200.900	ELEVTR	.000
		PTOTAL	60.000
		BETA	.000
		DBETA	.000
		AILRON	.000
		Y	.000

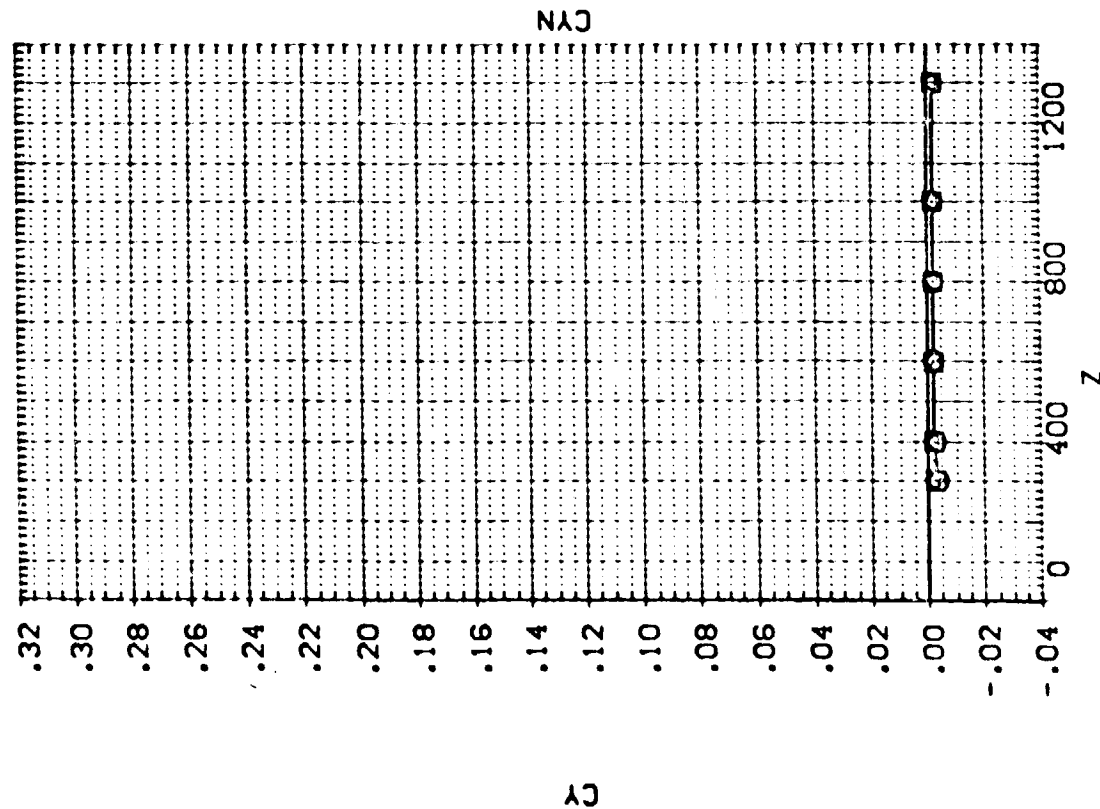
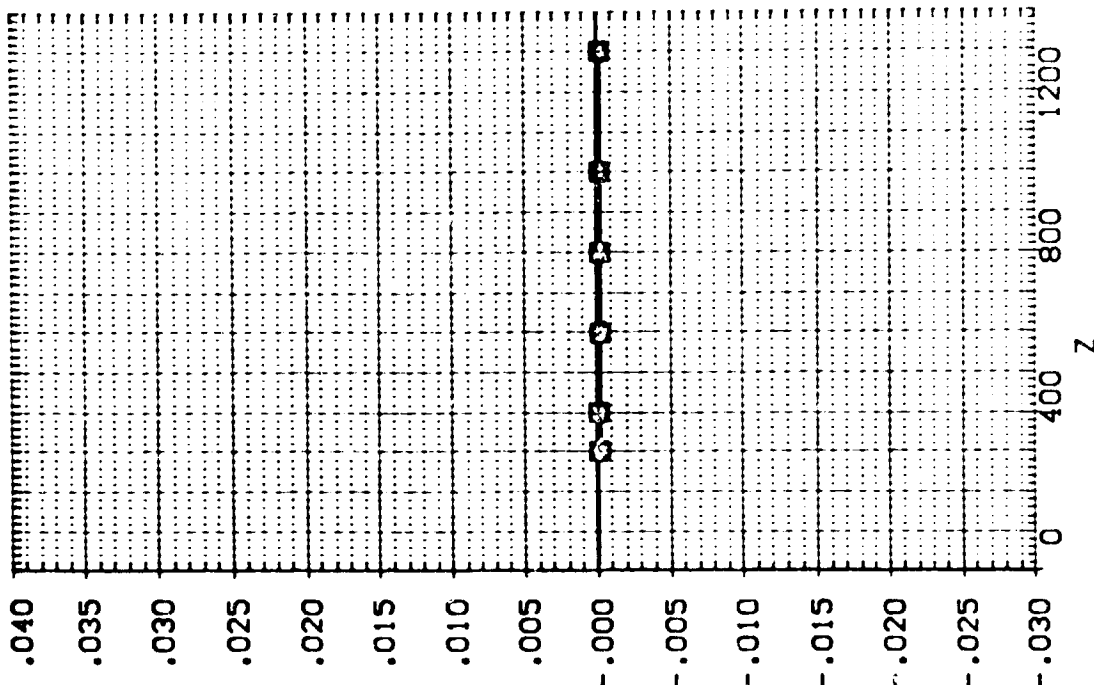
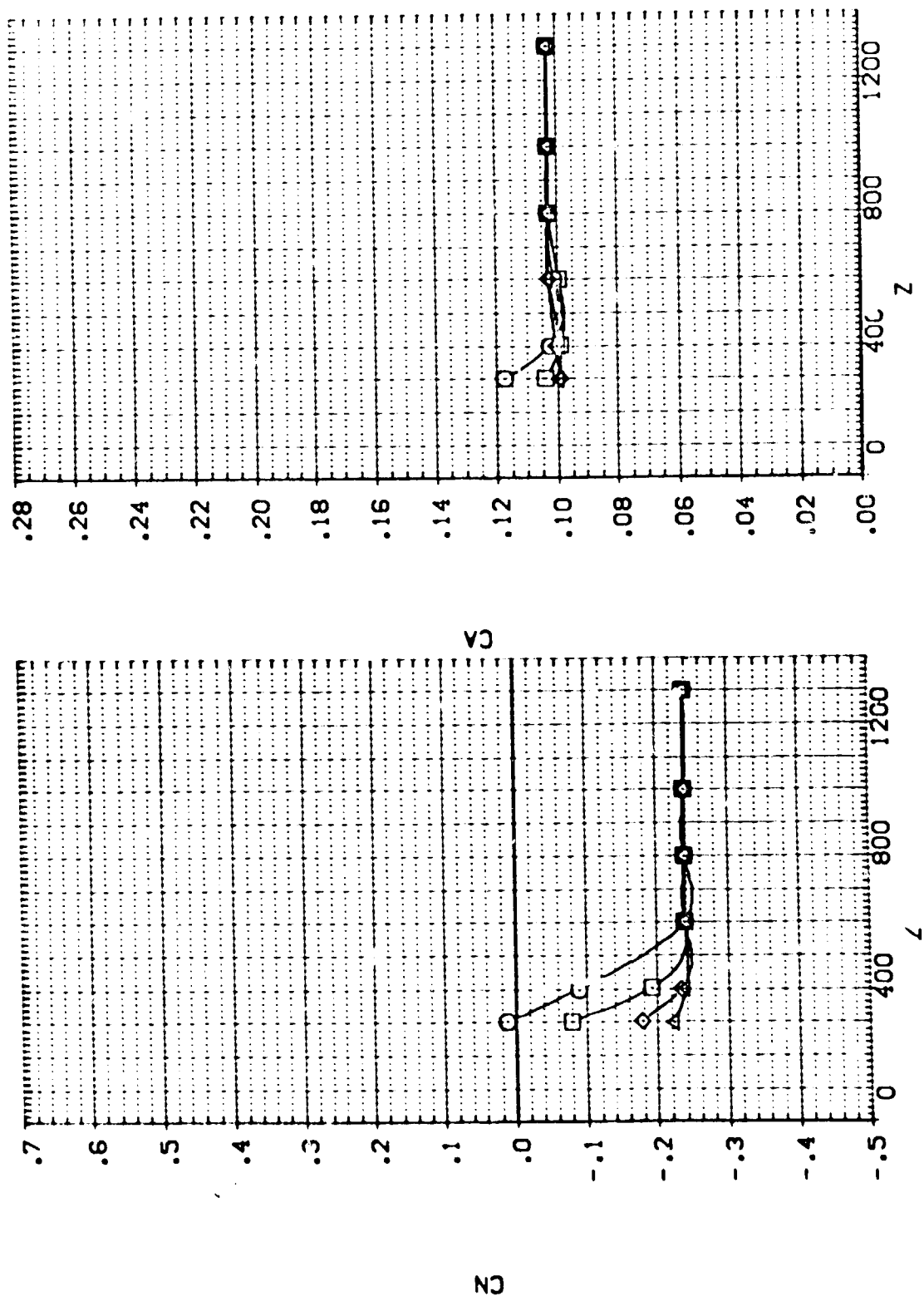

FIG. 13. EXTERNAL TANK (110) SEPARATING FROM ORB. 09 (RTJ039)

SEE THE ASSOCIATED DOCUMENT FOR A COMPLETE CHARACTERISTICS FOR INDIVIDUAL DATA SERIES

SYMBOL		PARAMETRIC VALUES			
○	X	MACH	4.520	P TOTAL	60.000
◇	ALPHA	-10.000	BETA	.000	
△	DELTA	-10.000	DBETA	.000	
	ELEVTR	.000	AILRON	.000	
	Y	200.000			



EFFECT OF EXTERNAL TANK SEPARATION ON ORBITER AERODYNAMIC CHARACTERISTICS

1A13. EXTERNAL TANK(T10)SEPARATING FROM ORB. 09 (RTJ039)

SEE THE ASSOCIATED DATA DOCUMENT FOR REFERENCE CHARACTERISTICS FOR INDIVIDUAL DATASETS

SYMBOL		X		PARAMETRIC VALUES	
○		.215	MACH	4.520	PTOTAL
□		400.370	ALPHA	-10.000	BETA
◇		800.650	DALPHA	-10.000	DBETA
△		1200.600	ELEVTR	.000	AILRON
			Y	200.000	

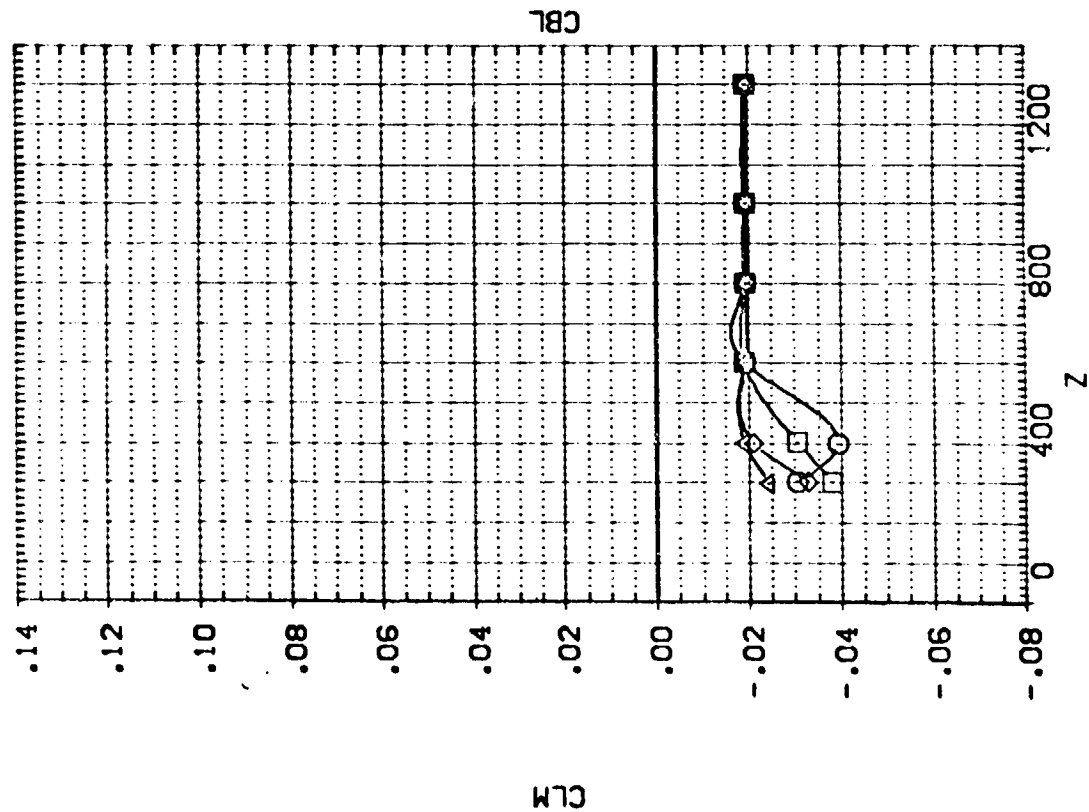
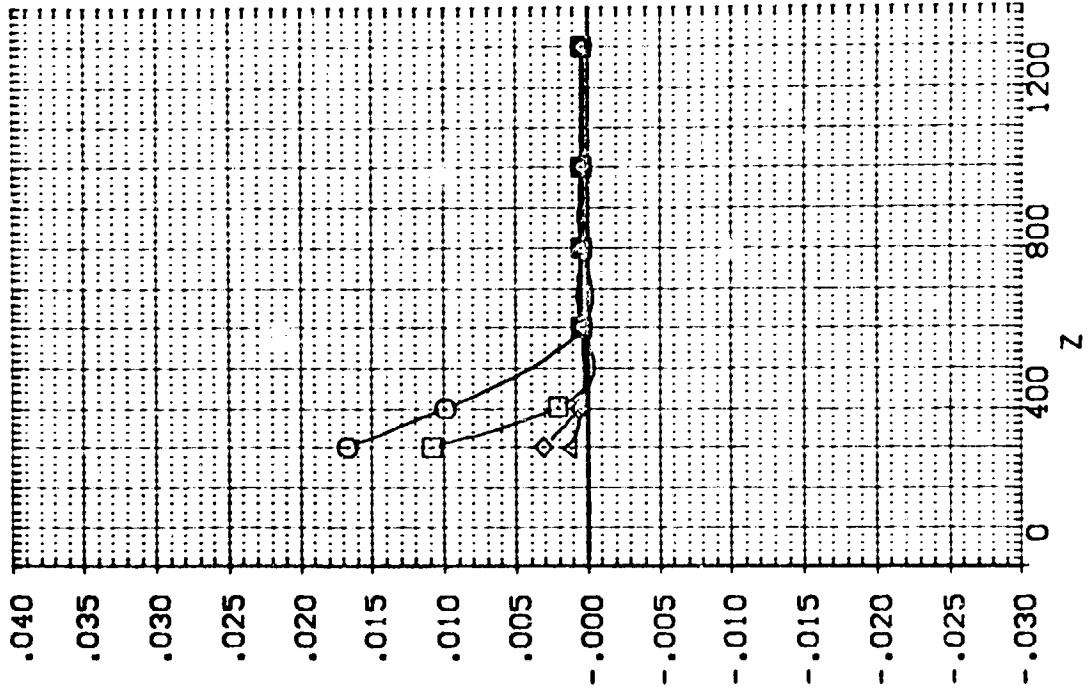

1413. EXTERNAL TANK (110) SEPARATING FROM ORBIT, 09 (R70039)

SYMBOL		PARAMETRIC VALUES	
O	X	MACH	4.520
O	Y	ALPHA	-10.000
O	Z	BETA	80.000
O	C	ALPHA	-10.000
O	D	BETA	-10.000
O	E	ALPHA	200.000
O	F	BETA	200.000

SEE THE NEXT DOCUMENT FOR INDIVIDUAL CHARACTERISTICS

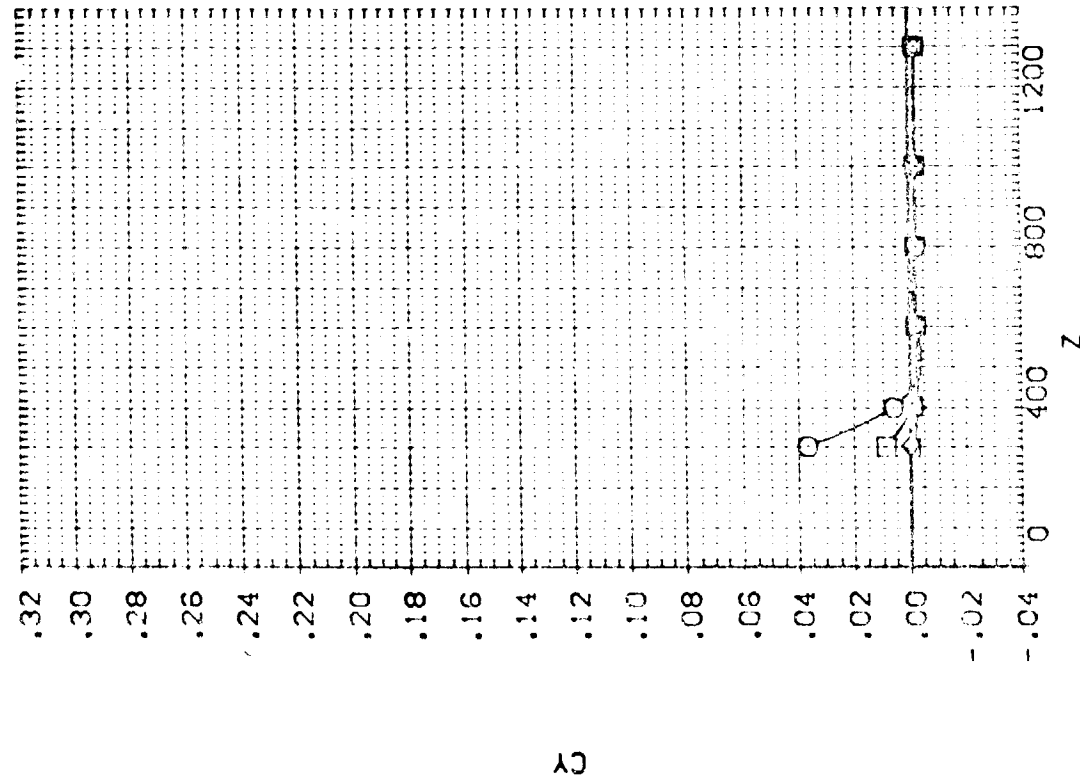
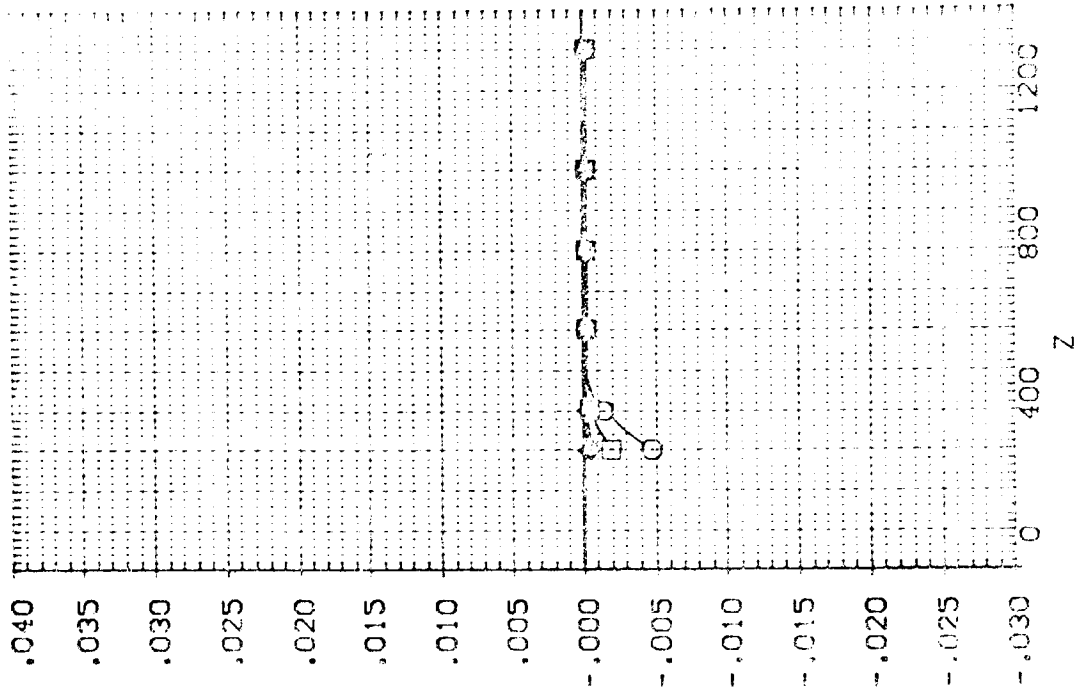

EFFECT OF EXTERNAL TANK SEPARATION ON ORBITER AERODYNAMIC CHARACTERISTICS

1A13. EXTERNAL TANK(110)SEPARATING FROM ORB. 09 (RTJ040)

SEE THE ASSOCIATED DATA DOCUMENT FOR REFERENCE CHARACTERISTICS FOR INDIVIDUAL DATASETS

SYMBOL		PARAMETRIC VALUES	
X	.034	MACH	4.520
		PITOTAL	60.000
400.570	ALPHA	-10.000	BETA
			.000
800.420	DALPHA	-10.000	DBETA
			5.000
1201.000	ELEVTR	.000	ATLPRN
	Y	200.000	

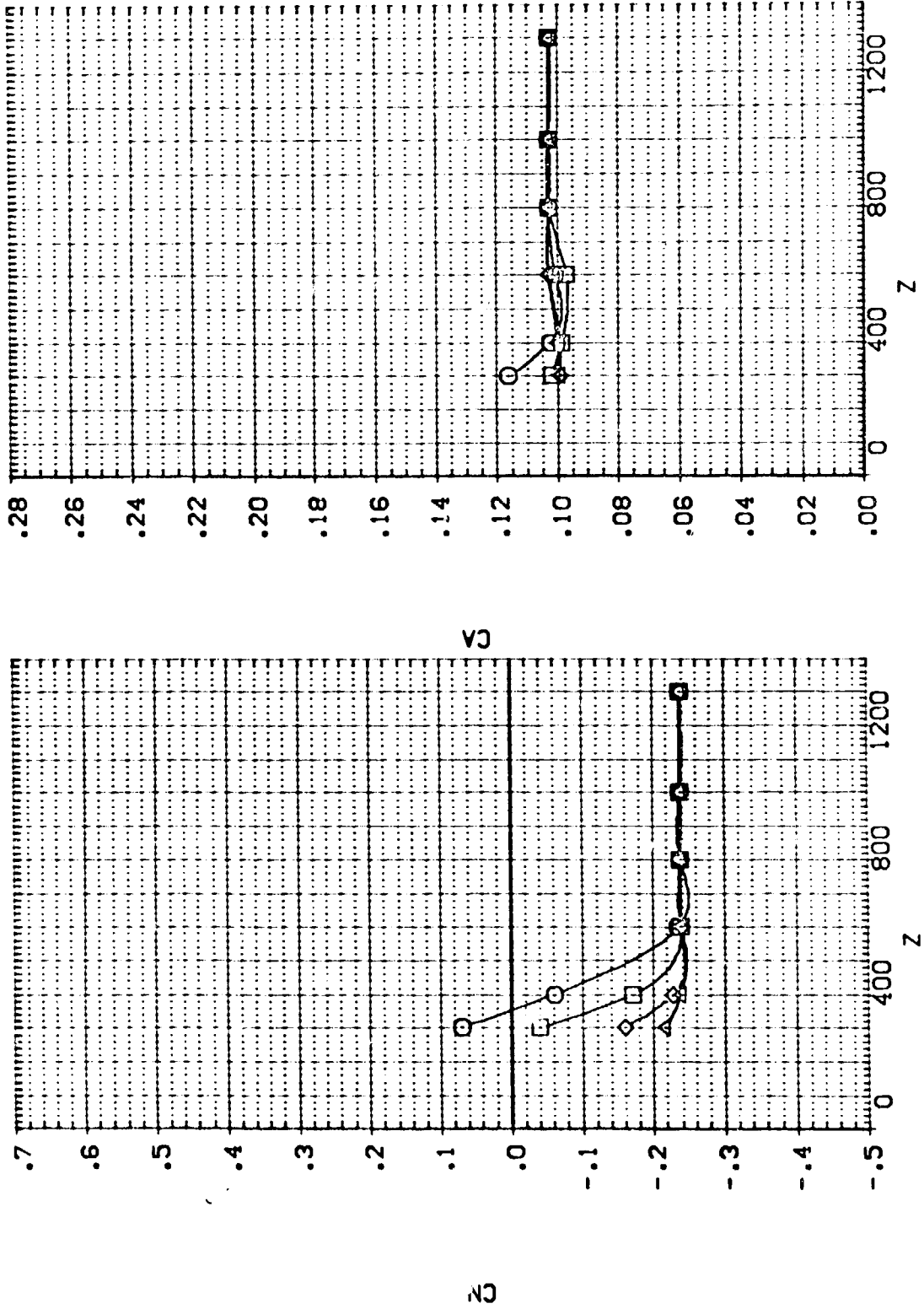

SEE THE ASSOCIATED DATA DOCUMENT FOR REFERENCE CHARACTERISTICS FOR INDIVIDUAL DATASETS

SYMBOL		PARAMETRIC VALUES	
X	.034	MACH	4.520
	400.570	ALPHA	-10.000
	800.420	DALPHA	-10.000
	1201.000	ELEVTR	.000
Y	200.000	AIRLON	5.000
		PTOTAL	80.000
		BETA	.000
		DEBTA	.000
		AIRLON	.000

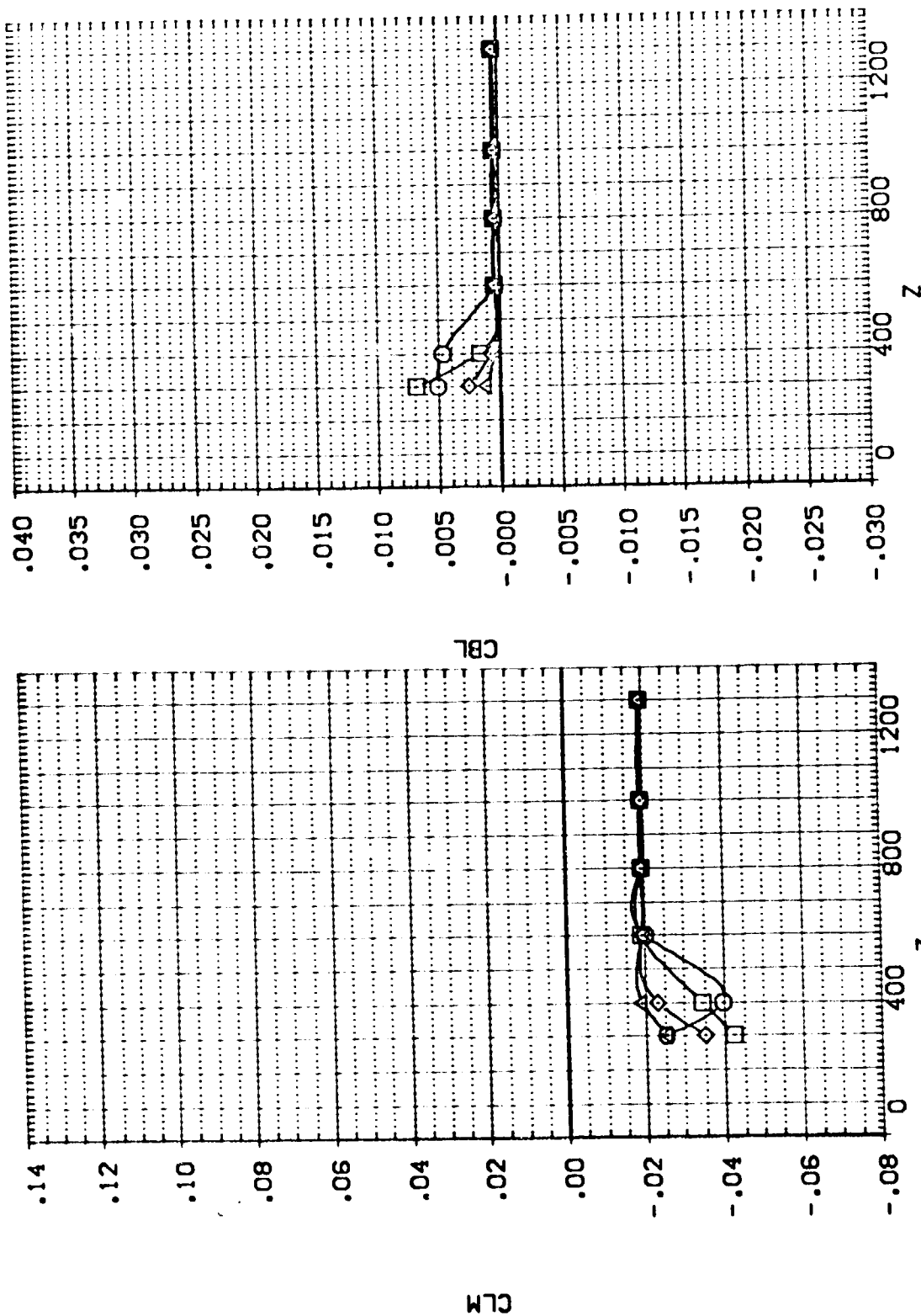

EFFECT OF EXTERNAL TANK SEPARATION ON ORBITER AERODYNAMIC CHARACTERISTICS

1A13.EXTERNAL TANK(T10)SEPARATING FROM ORB. 09 (RTJ040)

SEE THE ASSOCIATED DATA DOCUMENT FOR REFERENCE CHARACTERISTICS FOR INDIVIDUAL DATASETS

PARAMETRIC VALUES	
MACH	4.520
PTOTAL	80.000
BETA	.000
DSETA	5.000
ATLRON	.000
Y	200.000

PARAMETRIC VALUES	
X	.034
ALPHA	400.570
DALPHA	800.420
ELEVTR	1201.000

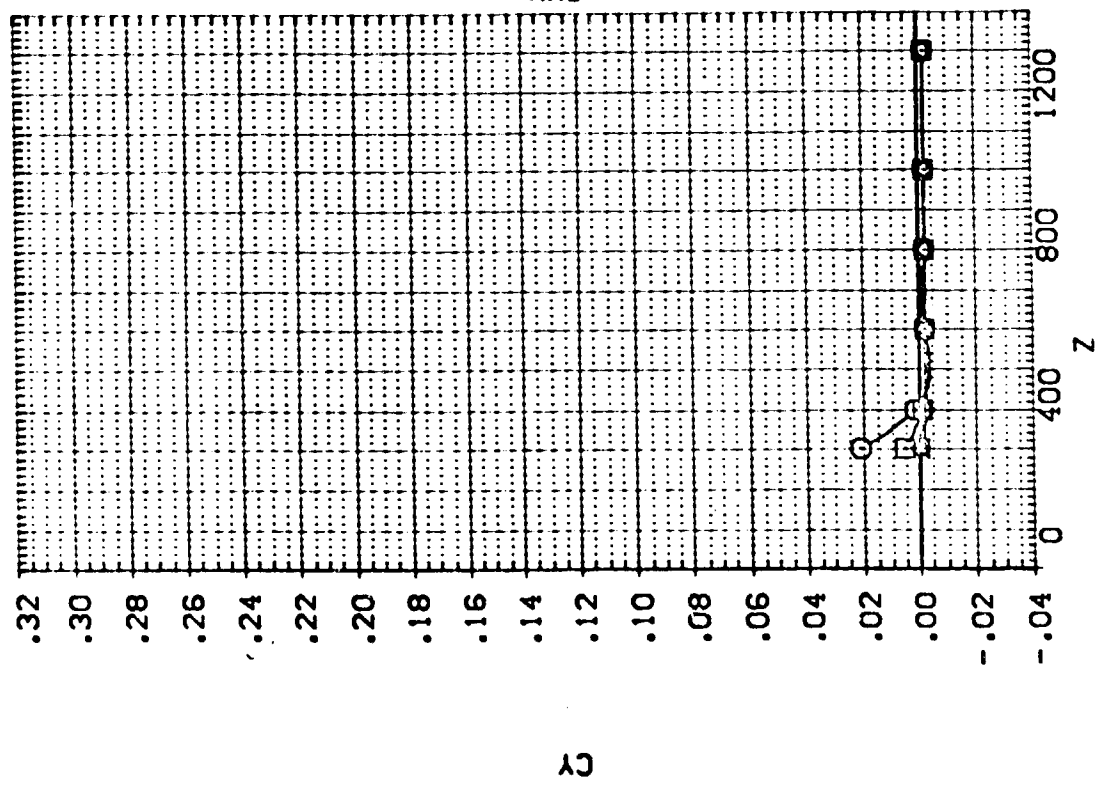
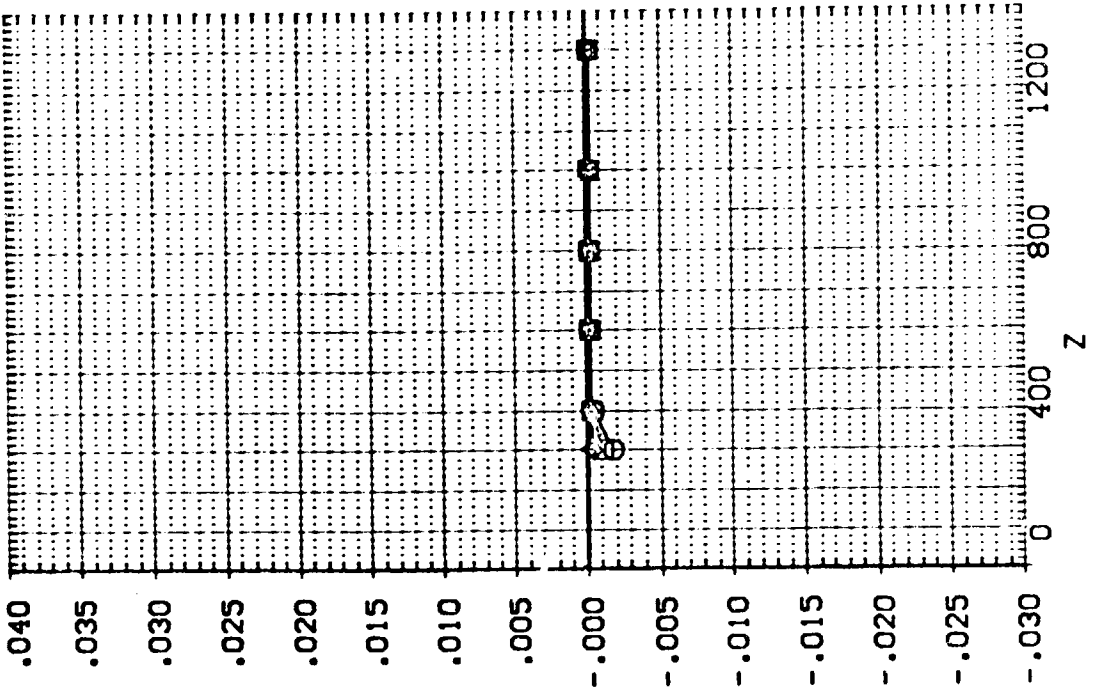

EFFECT OF EXTERNAL TANK SEPARATION ON ORBITER AERODYNAMIC CHARACTERISTICS

IA13. EXTERNAL TANK(T10)SEPARATING FROM ORB. 09 (RTJ041)

SEE THE ASSOCIATED DATA DOCUMENT FOR REFERENCE CHARACTERISTICS FOR INDIVIDUAL DATASETS

SYMBOL		PARAMETRIC VALUES	
○	.128	MACH	60.000
□	400.290	ALPHA	.000
◇	800.420	DALPHA	5.000
△	1200.800	ELEVTR	.000
		PTOTAL	.000
		BETA	.000
		DBETA	.000
		AILRON	.000
		Y	.000

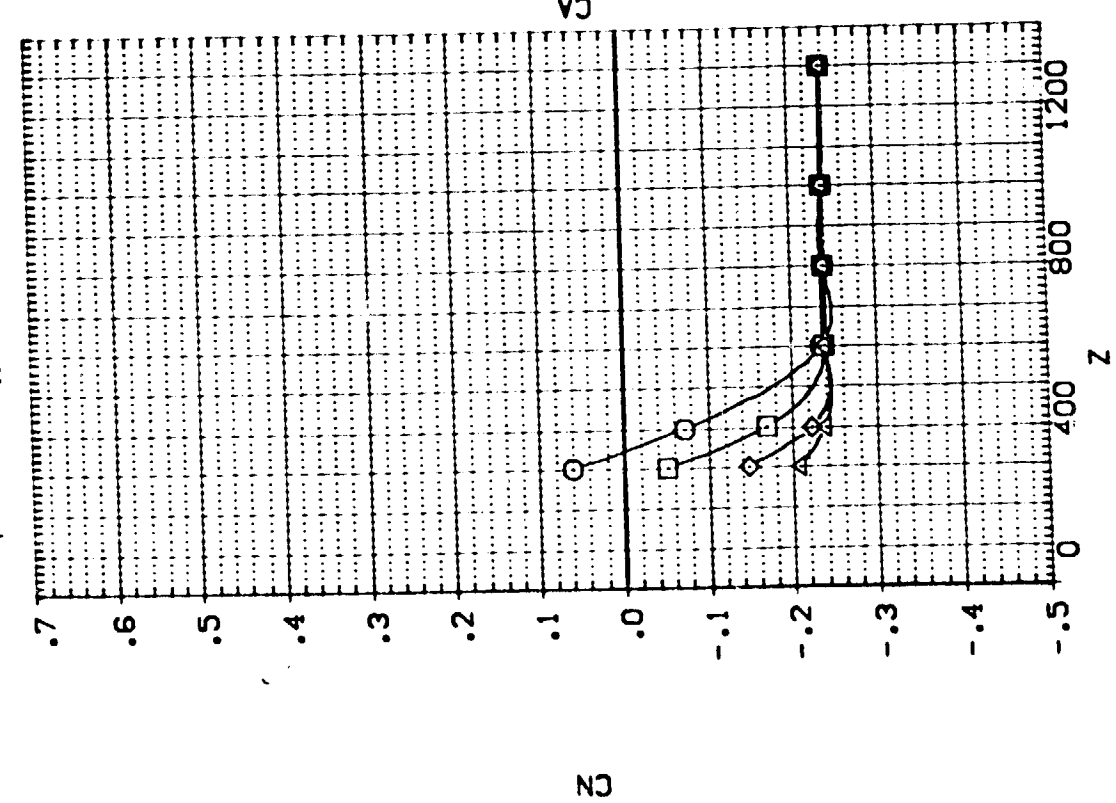
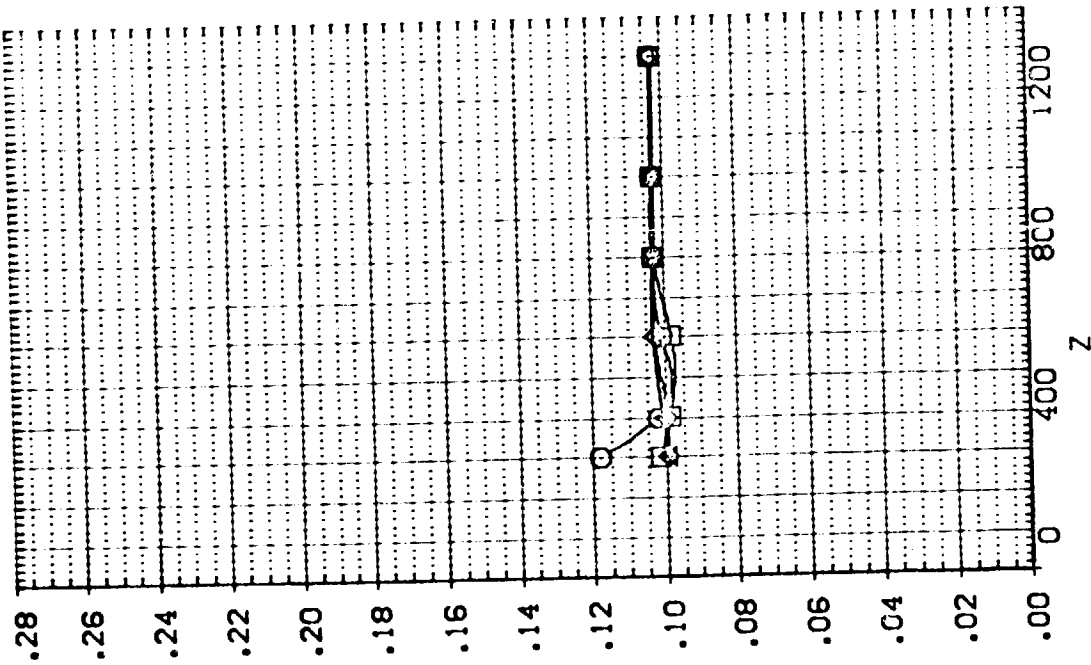

EFFECT OF EXTERNAL TANK SEPARATION ON ORBITER AERODYNAMIC CHARACTERISTICS

IA13.EXTERNAL TANK(T10)SEPARATING FROM ORB. 09 (RTJ041)

SEE THE ASSOCIATED DATA DOCUMENT FOR REFERENCE CHARACTERISTICS FOR INDIVIDUAL DATASETS

SYMBOL		PARAMETRIC VALUES	
○	X	MACH	4.520
□	Y	ALPHA	-10.000
◇	Z	DALPHA	-10.000
△		ELEVTR	.000
		Y	.000
		P TOTAL	60.000
		BETA	.000
		DBETA	5.000
		AILRON	.000

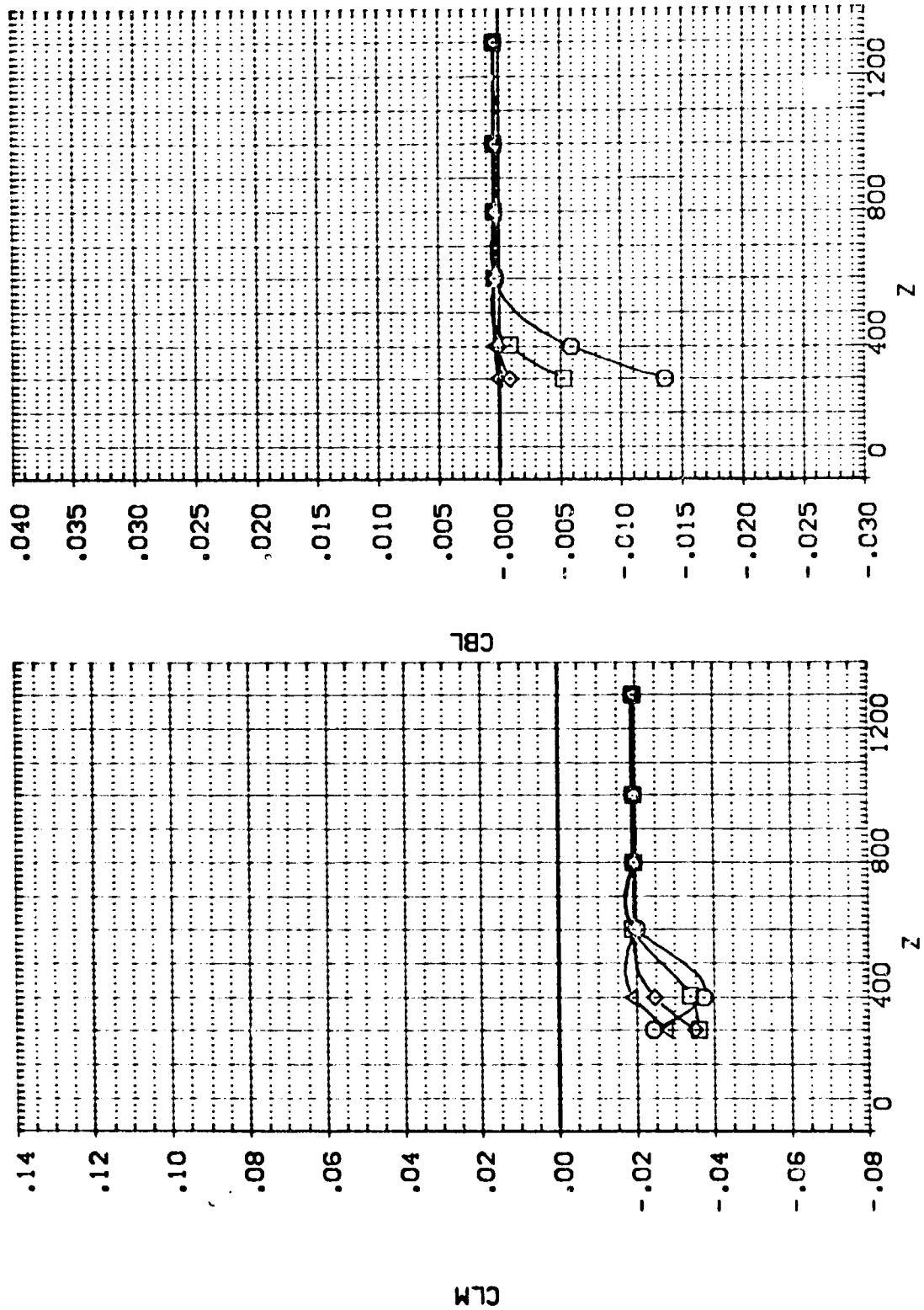

IA13. EXTERNAL TANK(T10)SEPARATING FROM ORB. 09 (RTJ041)

SYMBOL

-
-
- ◇
- △

PARAMETRIC VALUES

X	MACH	4.520	PTOTAL	60.000
400.290	ALPHA	-10.000	BETA	.000
800.420	DALPHA	-10.000	DBETA	5.000
1200.800	ELEVTR	.000	AILRON	.000
	Y	.000		

SEE THE ASSOCIATED DOCUMENT FOR REFERENCE CHARACTERISTICS FOR INDIVIDUAL DATASETS

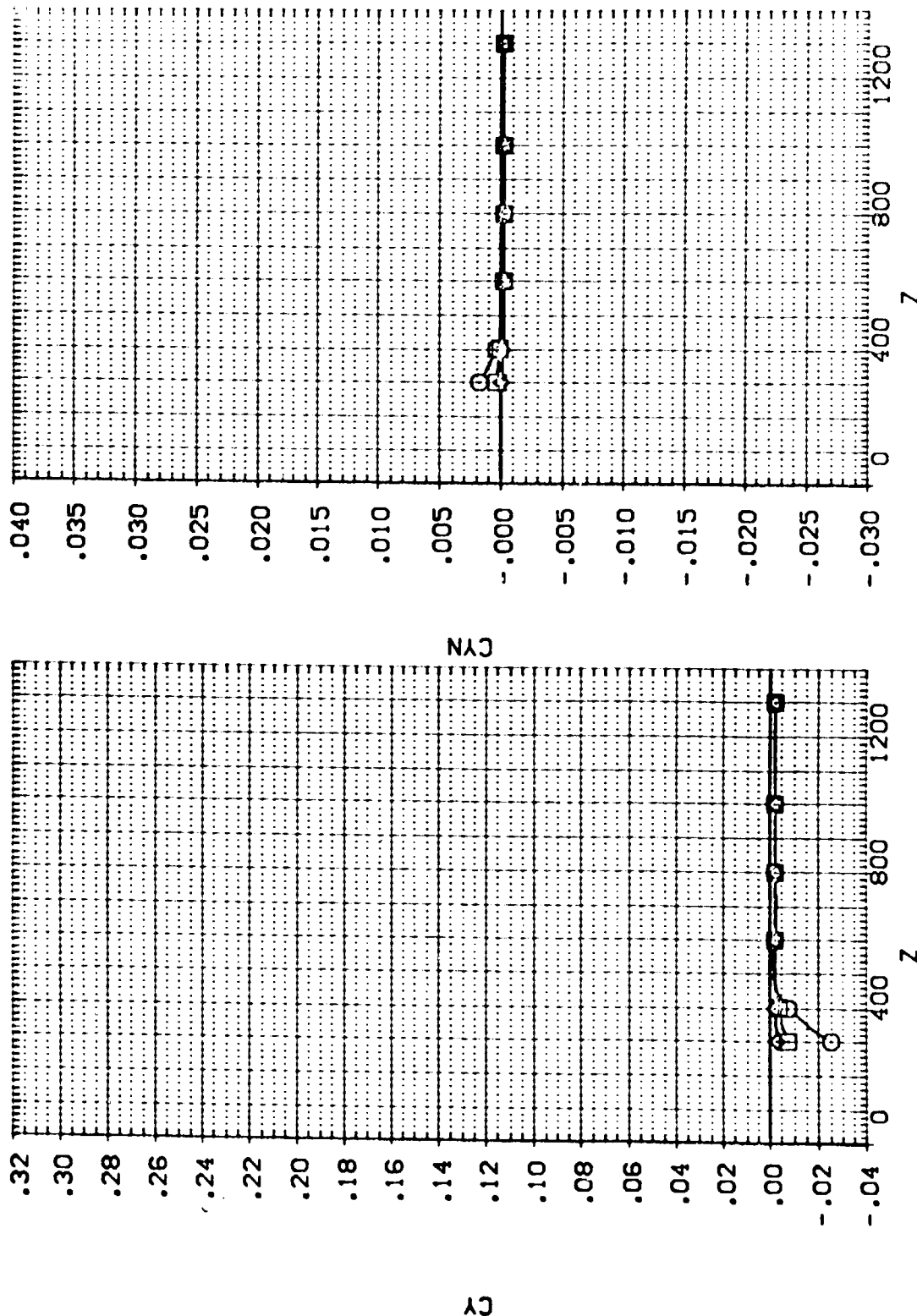

EFFECT OF EXTERNAL TANK SEPARATION ON ORBITER AERODYNAMIC CHARACTERISTICS



1A13.EXTERNAL TANK(T10)SEPARATING FROM ORB. 09 (RTJ042)

SEE THE ASSOCIATED DATA DOCUMENT FOR REFERENCE CHARACTERISTICS FOR INDIVIDUAL DATASETS

SYMBOL	X	MACH	PARAMETRIC VALUES	PTOTAL
○	.164	4.520	BETA	80.000
□	400.680	-10.000	DBETA	.000
◇	800.610	-20.000	AILRON	.000
△	1200.500	.000	ELEVTR	.000

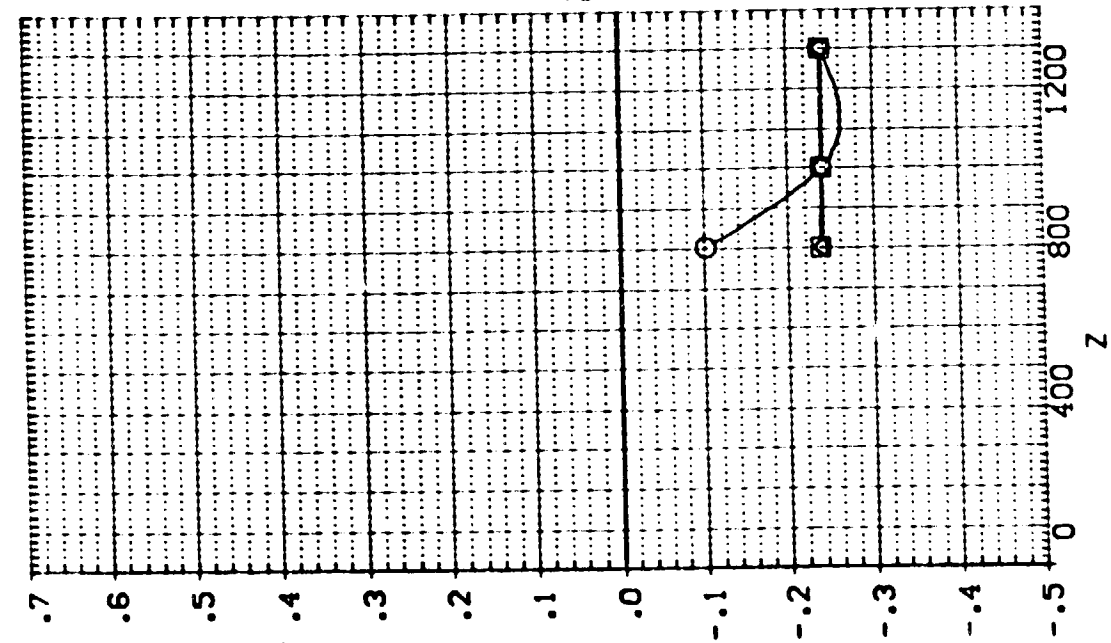
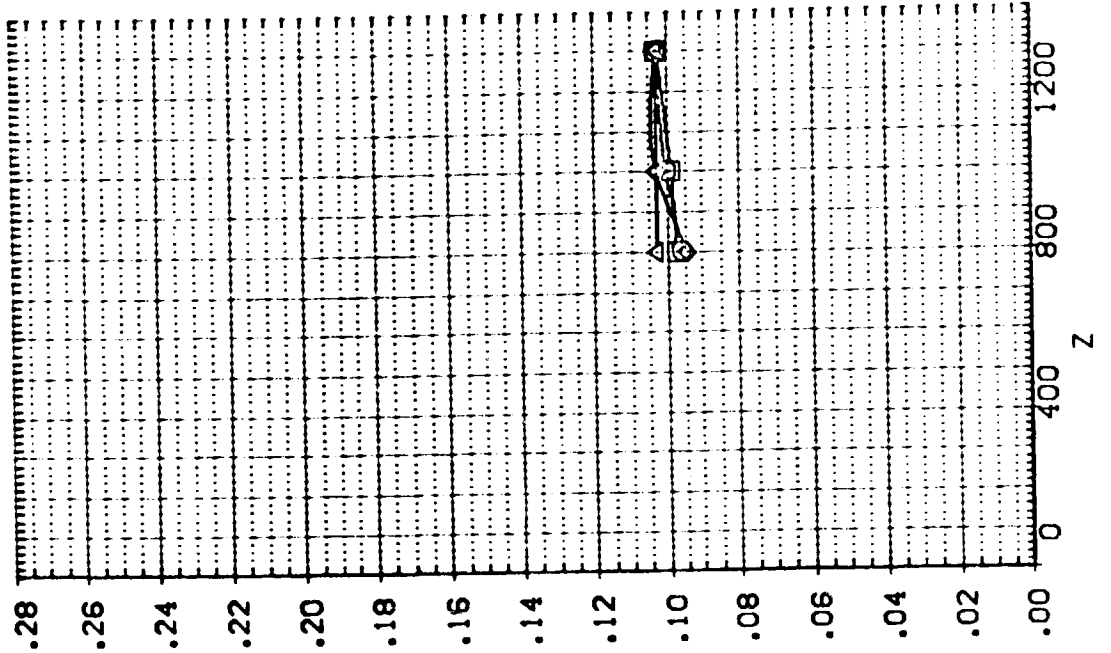

TA13, EXTERNAL TANK(T10)SEPARATING FROM ORB. 09 (RTJ042)

SEE THE ASSOCIATED DATA DOCUMENT FOR THE CHARACTERISTICS FOR INDIVIDUAL DATASETS

SYMBOL		PARAMETRIC VALUES			
○	x	MACH	4.520	PTOTAL	60.000
□	400.680	ALPHA	-10.000	BETA	.000
◇	800.610	DALPHA	-20.000	DBETA	.000
△	1200.500	ELEVTR	.000	AILRON	.000
		y	.000		

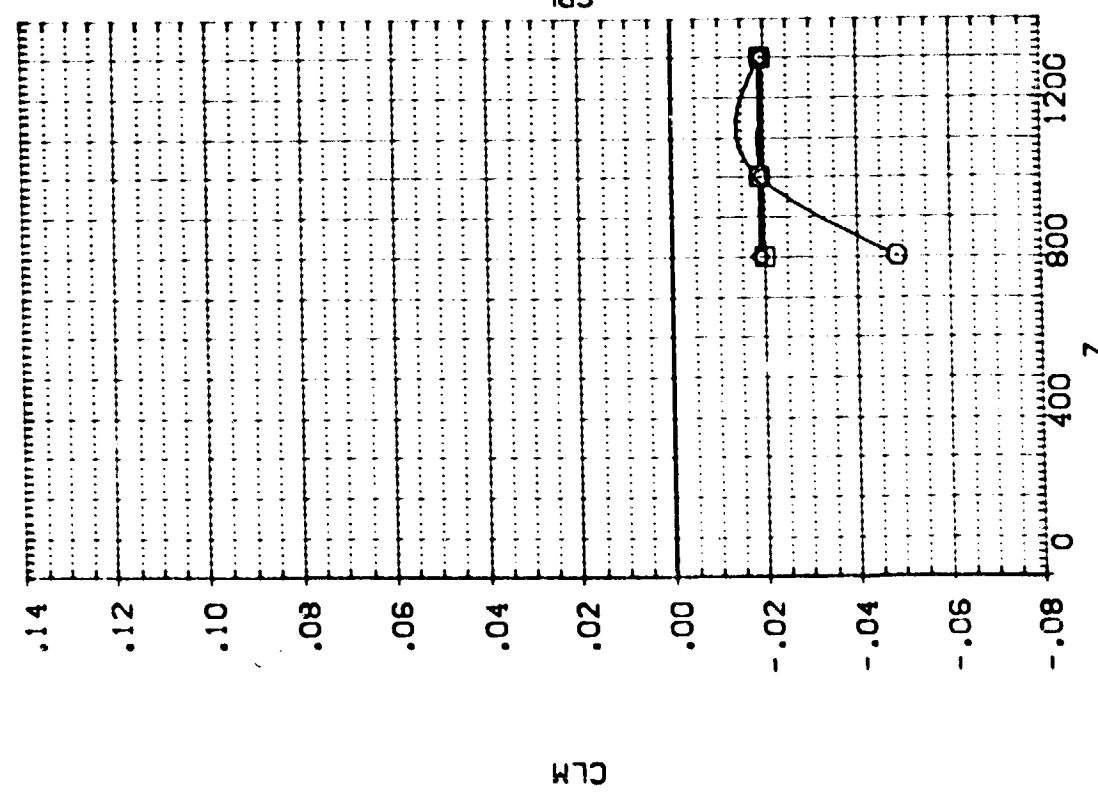
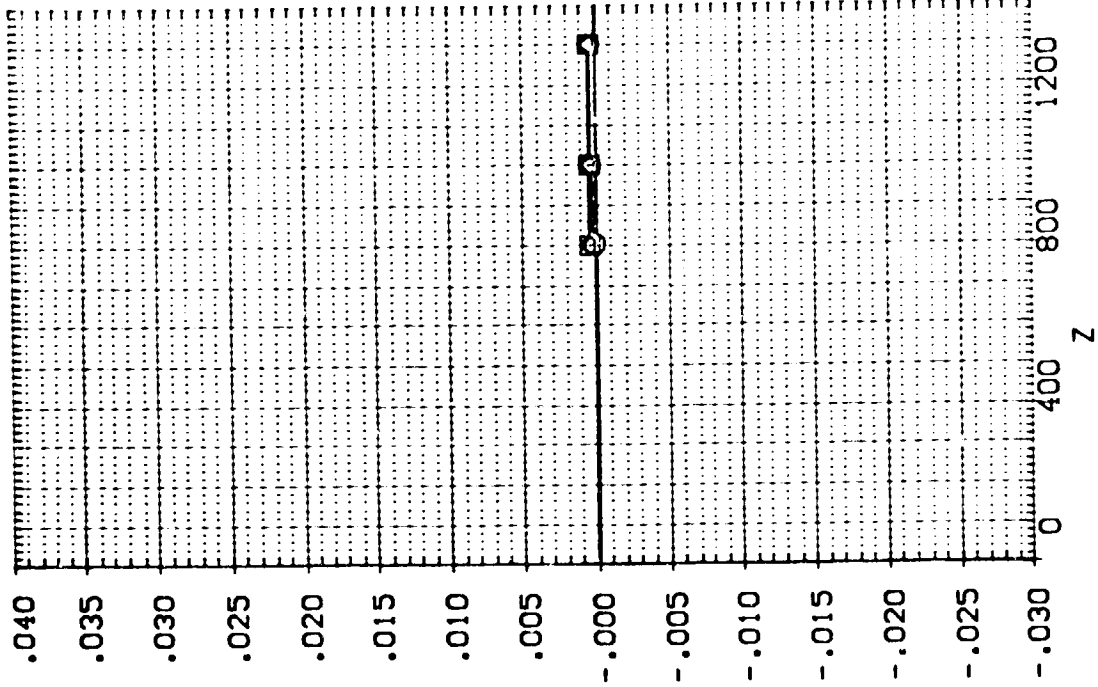

EFFECT OF EXTERNAL TANK SEPARATION ON ORBITER AERODYNAMIC CHARACTERISTICS

1A13. EXTERNAL TANK(T10)SEPARATING FROM ORB. 09 (RTJ042)

SEE THE ASSOCIATED DATA DOCUMENT FOR REFERENCE CHARACTERISTICS FOR INDIVIDUAL DATASETS

SYMBOL		X	MACH	PARAMETRIC VALUES			
○		.164	4.520	P/DOTAL	80.000		
◇		400.680	ALPHA	-10.000	BETA	.000	
◇		800.610	DALPHA	-20.000	DBETA	.000	
△		1200.500	ELEVTR	.000	ALTRON	.000	
			Y	.000			

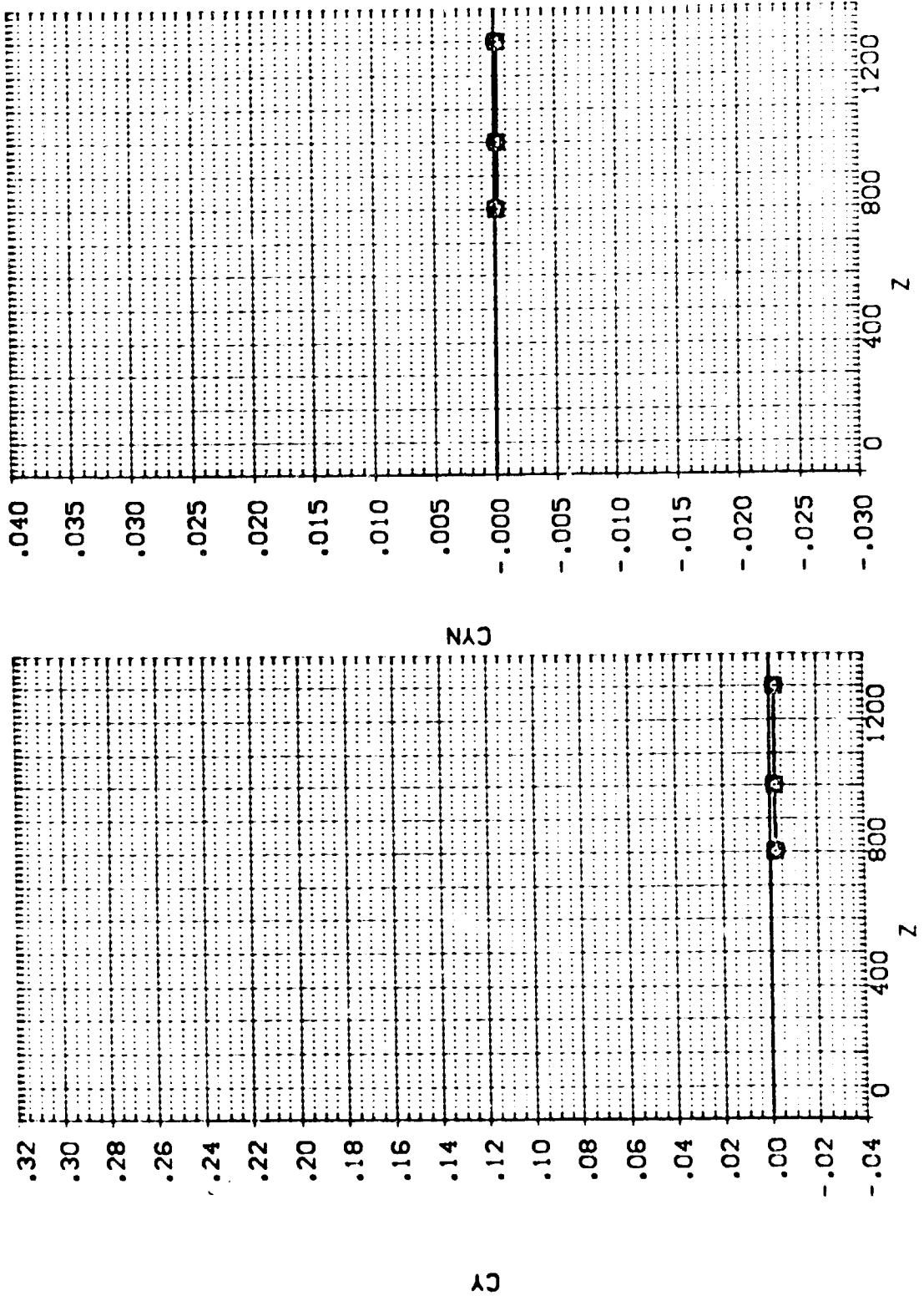

!A13.EXTERNAL TANK(T10)SEPARATING FROM ORB. 09 (RTJ043)

SYMBOL		PARAMETRIC VALUES	
x	.054	MACH	4.520
o	400.490	ALPHA	-10.000
□	800.440	BETA	-20.000
△	1200.700	DELTA	.000
		ELEVTR	.000
		Y	200.000
		PITOTL	60.000
		BETA	.000
		DELTA	.000
		AIRLON	.000

SEE THE ASSOCIATED DOCUMENT FOR THE CHARACTERISTICS FOR INDIVIDUAL DATA SETS

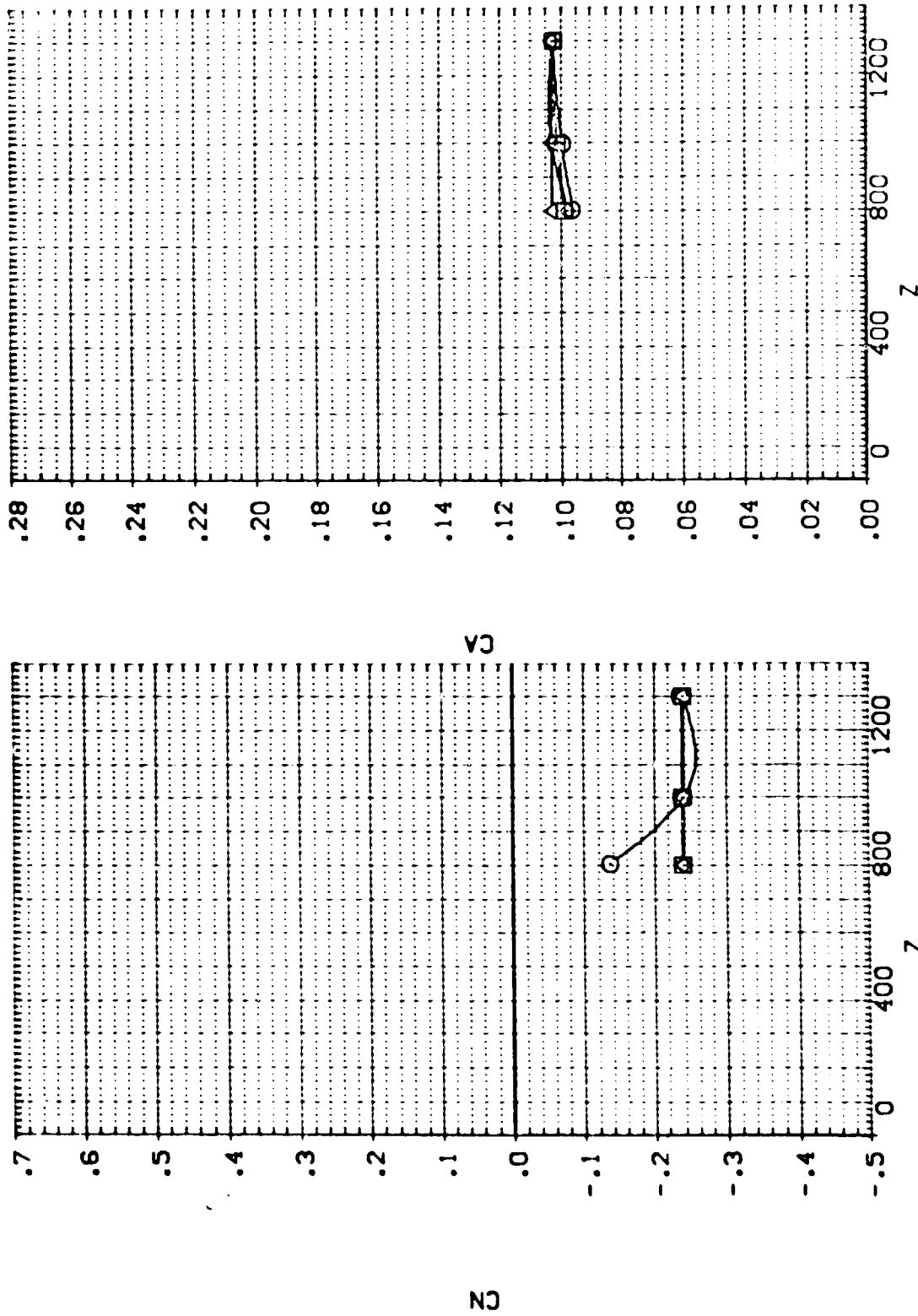

EFFECT OF EXTERNAL TANK SEPARATION ON ORBITER AERODYNAMIC CHARACTERISTICS

1A13.EXTERNAL TANK(T10)SEPARATING FROM ORB. 09 (RTJ043)

SEE THE ASSOCIATED DATA DOCUMENT FOR REFERENCE CHARACTERISTICS FOR INDIVIDUAL DATASETS

SYMBOL	X	MACH	PARAMETRIC VALUES	PTOTAL	60,000
○	400.49C	ALPHA	4.570	BETA	.000
□	800.440	DALPHA	-10.000	CBETA	.000
△	1200.700	ELEVTR	.000	ALTRON	.000
		Y	200.000		

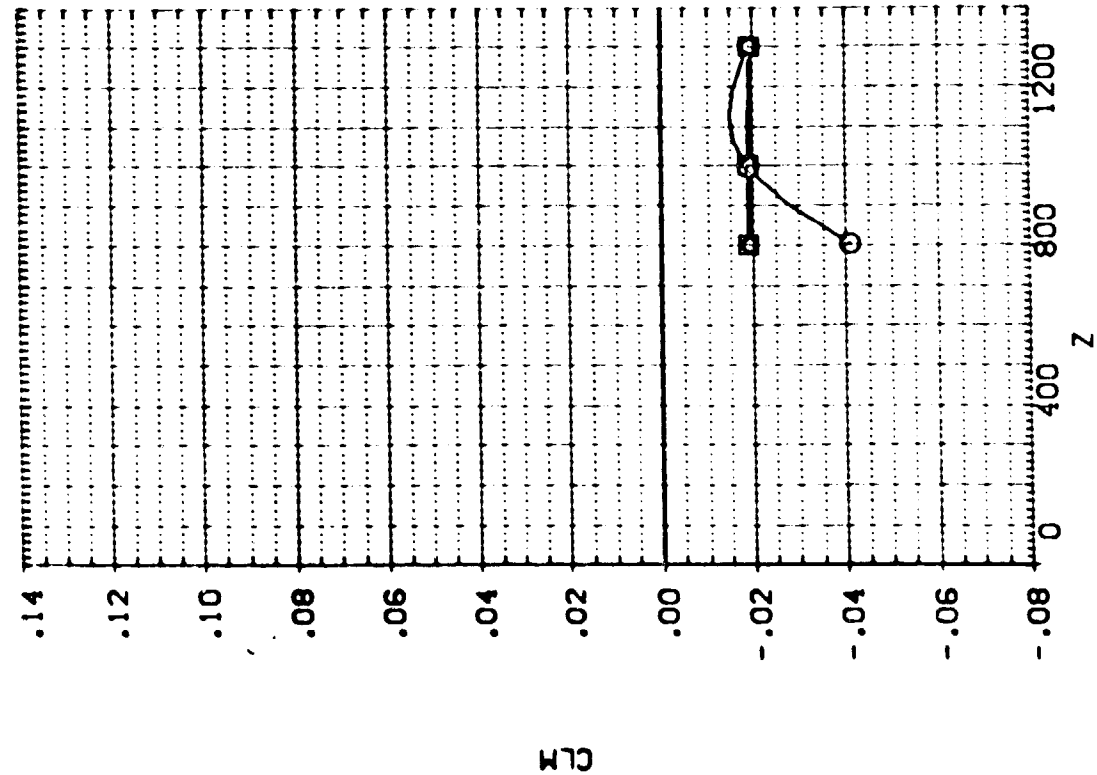
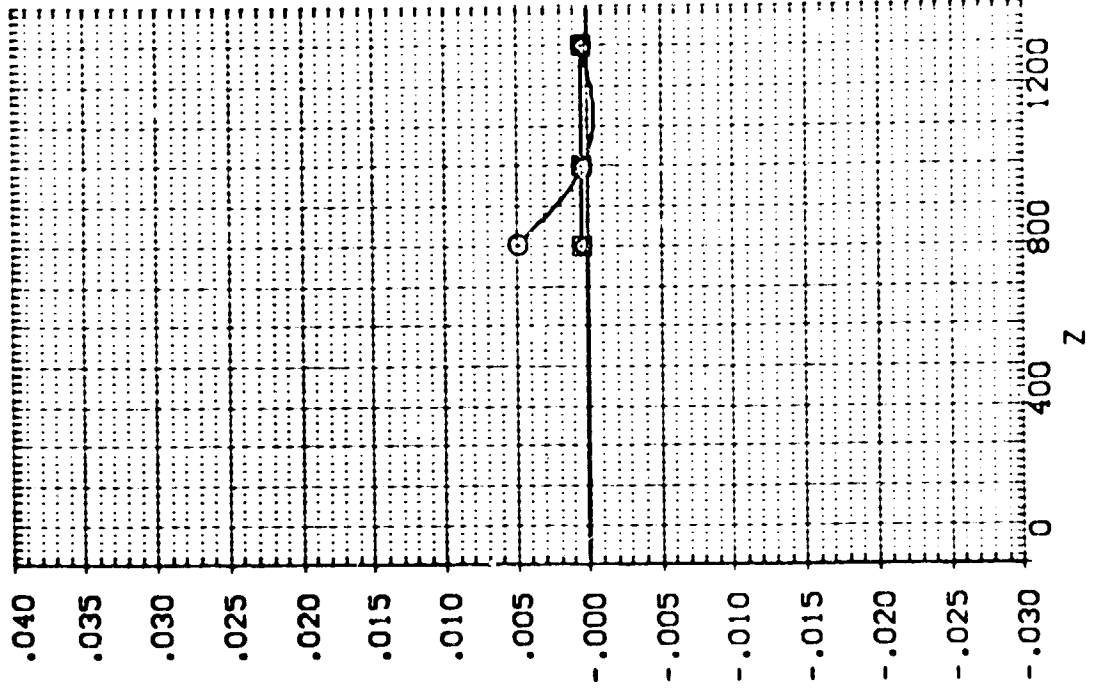

1A13. EXTERNAL TANK(T10)SEPARATING FROM ORB. 09 (RTJ043)

SEE THE ASSOCIATED DATA DOCUMENT FOR REFERENCE CHARACTERISTICS FOR INDIVIDUAL DATA SETS

SYMBOL		PARAMETRIC VALUES	
○	X	MACH	4.520
○	400.490	ALPHA	-10.000
○	800.440	BETA	-20.000
○	1200.700	DEBETA	.000
○		ELEVTR	.000
○		ALURON	.000
○		Y	200.000
○		POTIAL	60.000
○		BETA	.000
○		DEBETA	.000
○		ALURON	.000

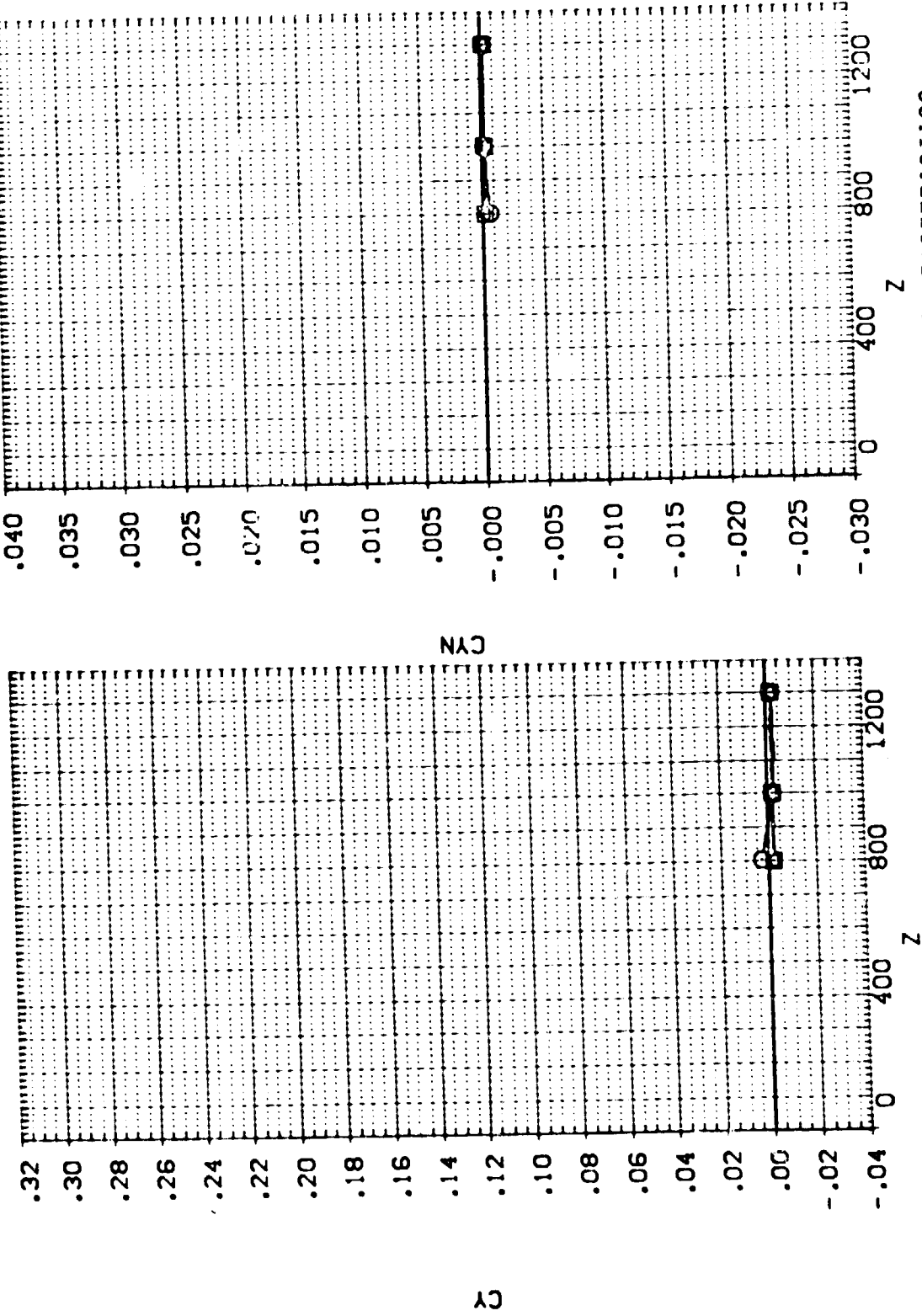

EFFECT OF EXTERNAL TANK SEPARATION ON ORBITER AERODYNAMIC CHARACTERISTICS

1A13.EXTERNAL TANK(T10)SEPARATING FROM ORB. 09 (RTJ044)

SEE THE ASSOCIATED DATA DOCUMENT FOR REFERENCE CHARACTERISTICS FOR INDIVIDUAL DATASETS

SYMBOL		PARAMETRIC VALUES	
x	.094	MACH	4.520
	400.710	ALPHA	-10.000
	800.610	BETA	5.000
	1200.400	DELTA	5.000
		ELEVTR	.000
		Y	200.000
		PIOTAL	80.000
			.000
			.000
			.000

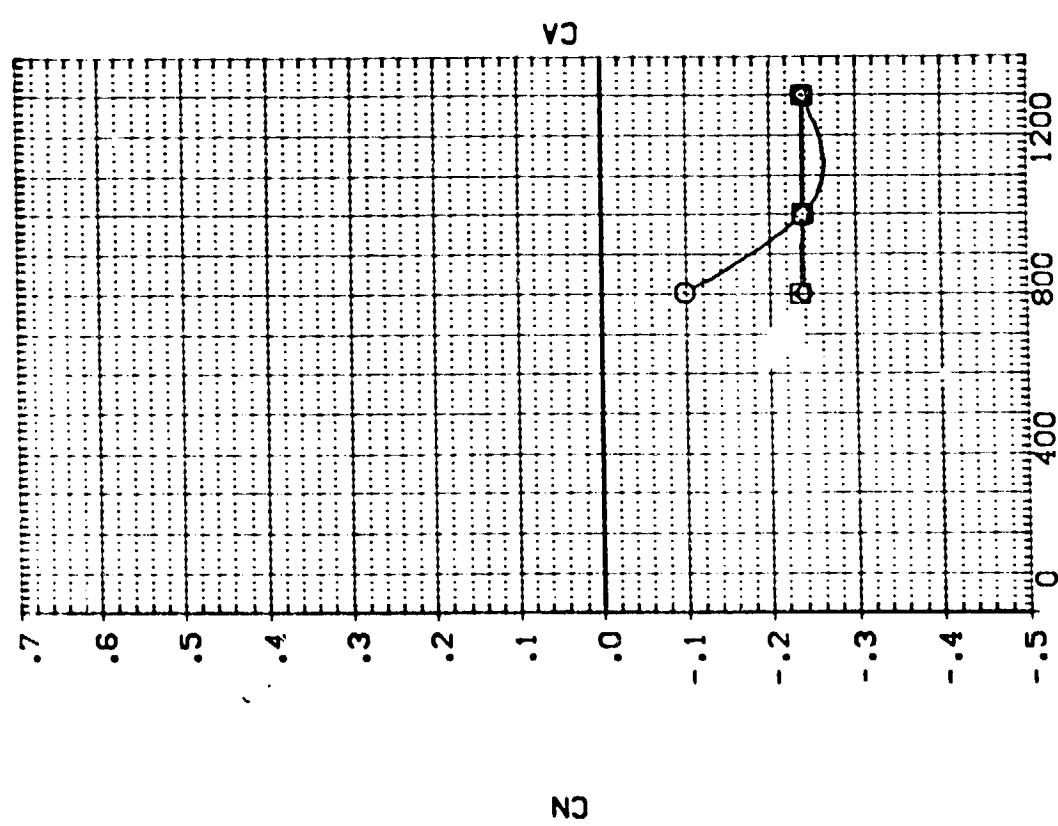
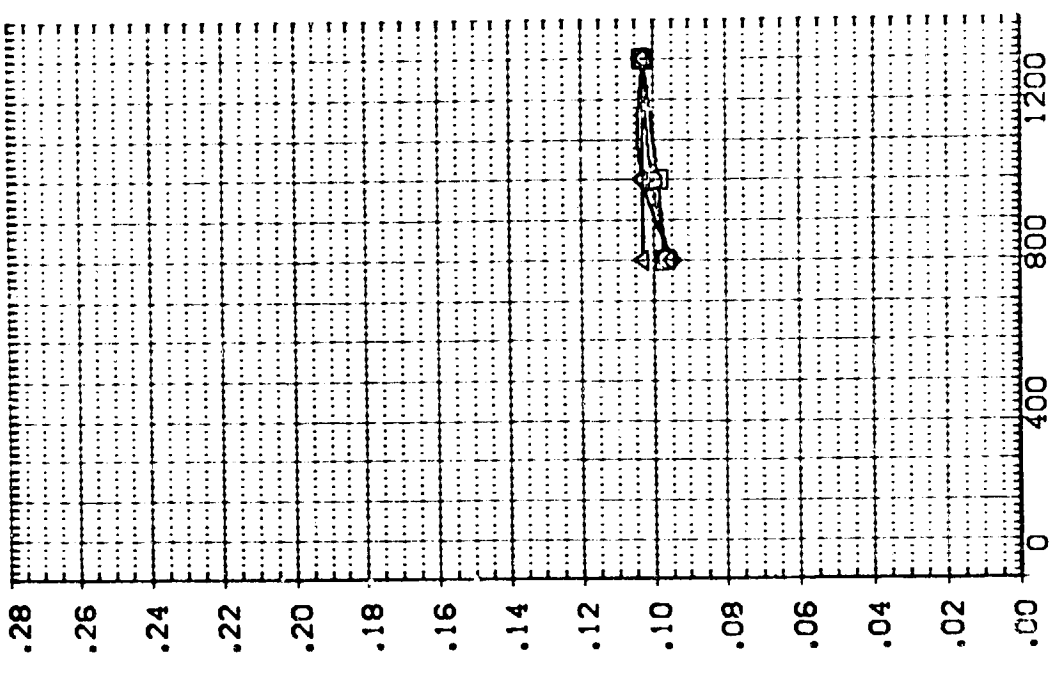

1A13, EXTERNAL TANK (T10) SEPARATING FROM ORB. 09 (RTJ044)

SEE THE ASSOCIATED DATA DOCUMENT FOR REFERENCE CHARACTERISTICS FOR INDIVIDUAL CASES

SYMBOL	X	MACH	PARAMETRIC VALUES
○	.094	4.520	PIOTAL 80.000
□	400.710	-10.000	BETA .000
◇	800.610	-20.000	DBETA 5.000
△	1200.400	.000	AILRON .000
		200.000	

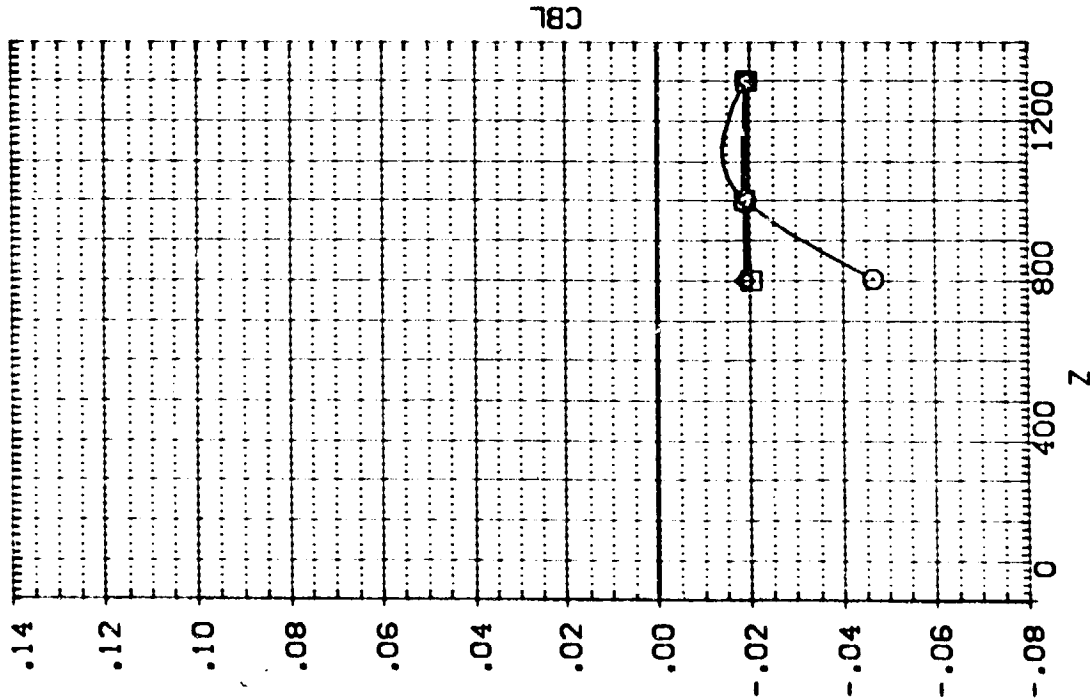
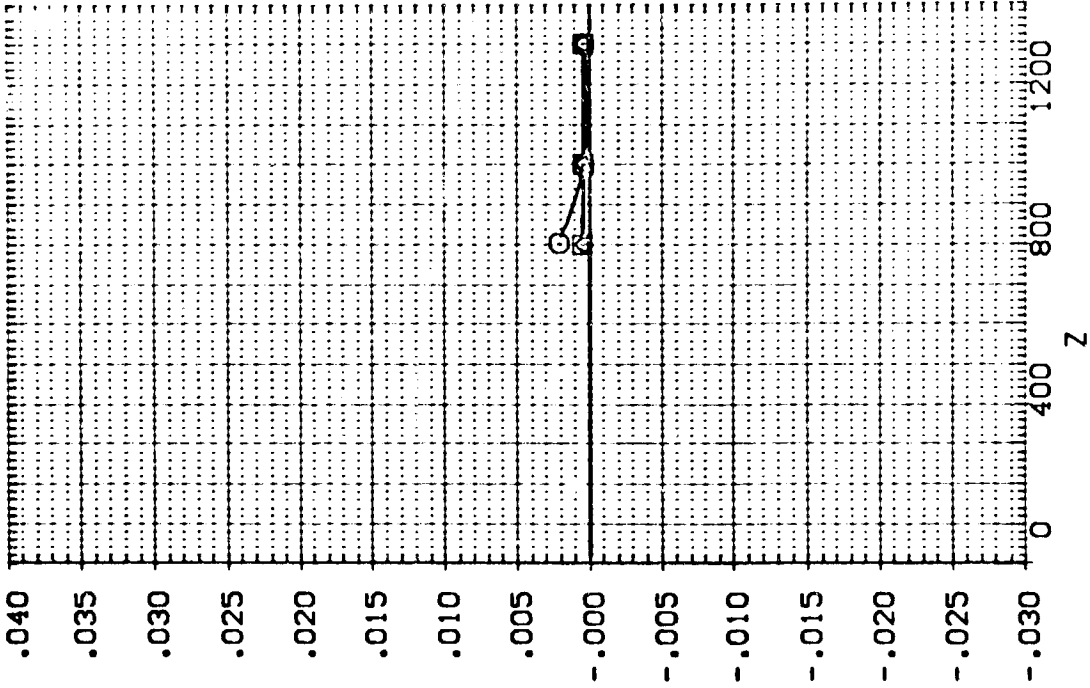

EFFECT OF EXTERNAL TANK SEPARATION ON ORBITER AERODYNAMIC CHARACTERISTICS

1A13.EXTERNAL TANK(T10)SEPARATING FROM ORB. 09 (RTJ044)

SEE THE ASSOCIATED DATA DOCUMENT FOR REFERENCE CHARACTERISTICS FOR INDIVIDUAL DATASETS

SYMBOL		X		MACH		PARAMETRIC VALUES	
○	□	400.710	.094	ALPHA	4.520	PTOTAL	60.000
◇	△	800.610		DALPHA	-10.000	BETA	.000
		1200.400		ELEVTR	-20.000	DBETA	5.000
				Y	.000	AILRON	.000
					200.000		

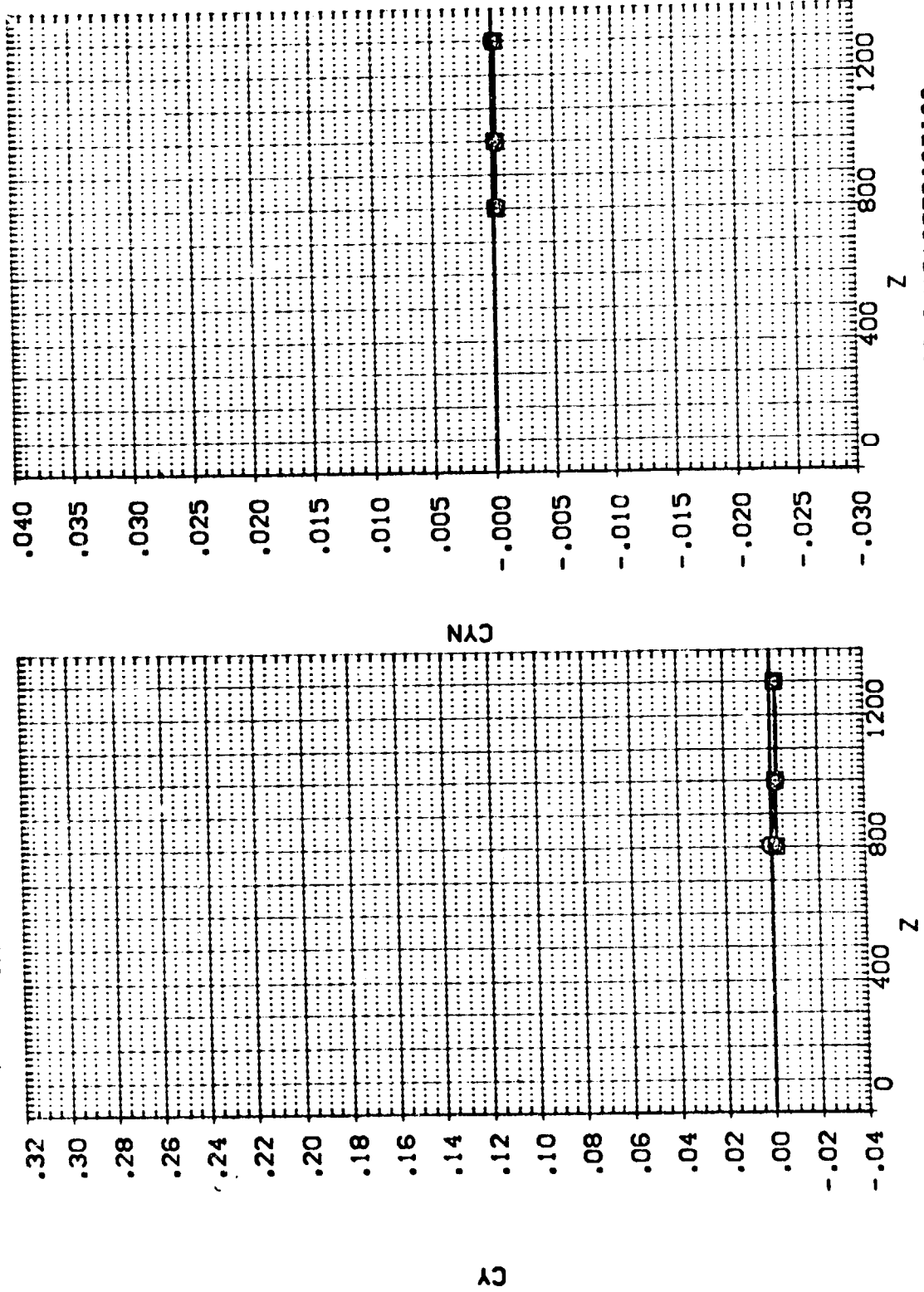

EFFECT OF EXTERNAL TANK SEPARATION ON ORBITER AERODYNAMIC CHARACTERISTICS

IA13.EXTERNAL TANK(T10)SEPARATING FROM ORB. 09 (RTJ045)

SEE THE ASSOCIATED NASA DOCUMENT FOR REFERENCE CHARACTERISTICS FOR INDIVIDUAL DATASETS

SYMBOL	X	MACH	PARAMETRIC VALUES
○	.110	4.520	PITOTAL 80.000
□	400.660	-10.000	BETA .000
◇	800.230	-20.000	DBETA 5.000
△	1200.600	.000	AILRON .000

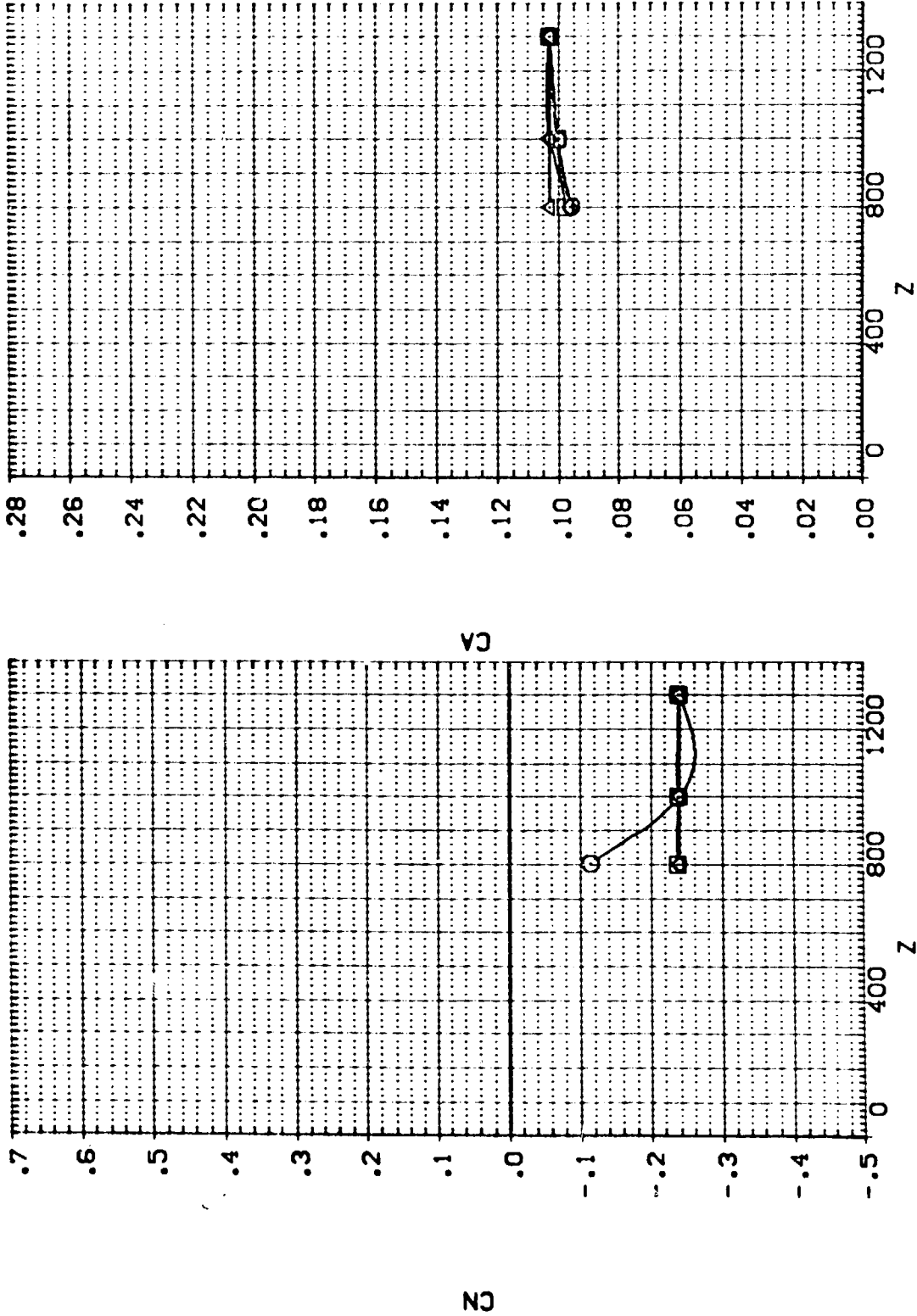

EFFECT OF EXTERNAL TANK SEPARATION ON ORBITER AERODYNAMIC CHARACTERISTICS

1A13. EXTERNAL TANK(T10)SEPARATING FROM ORB. 09 (RTJ045)

SEE THE ASSOCIATED DATA DOCUMENT FOR REFERENCE CHARACTERISTICS FOR INDIVIDUAL DATASETS

SYMBOL		PARAMETRIC VALUES					
X	.110	MACH	4.520	P TOTAL	80.000		
□	400.660	ALPHA	-10.000	BETA	.000		
◇	800.230	DALPHA	-20.000	DBETA	5.000		
△	1200.600	ELEVTR	.000	ALRON	.000		
		Y	.000				

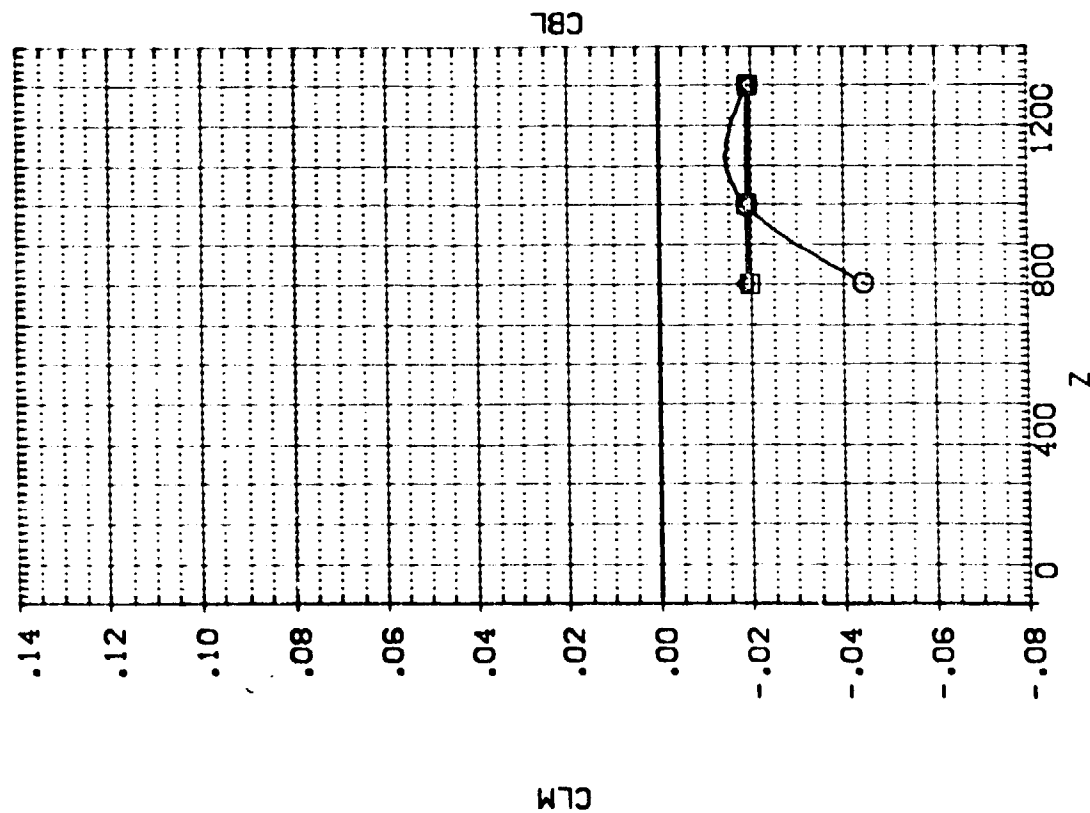
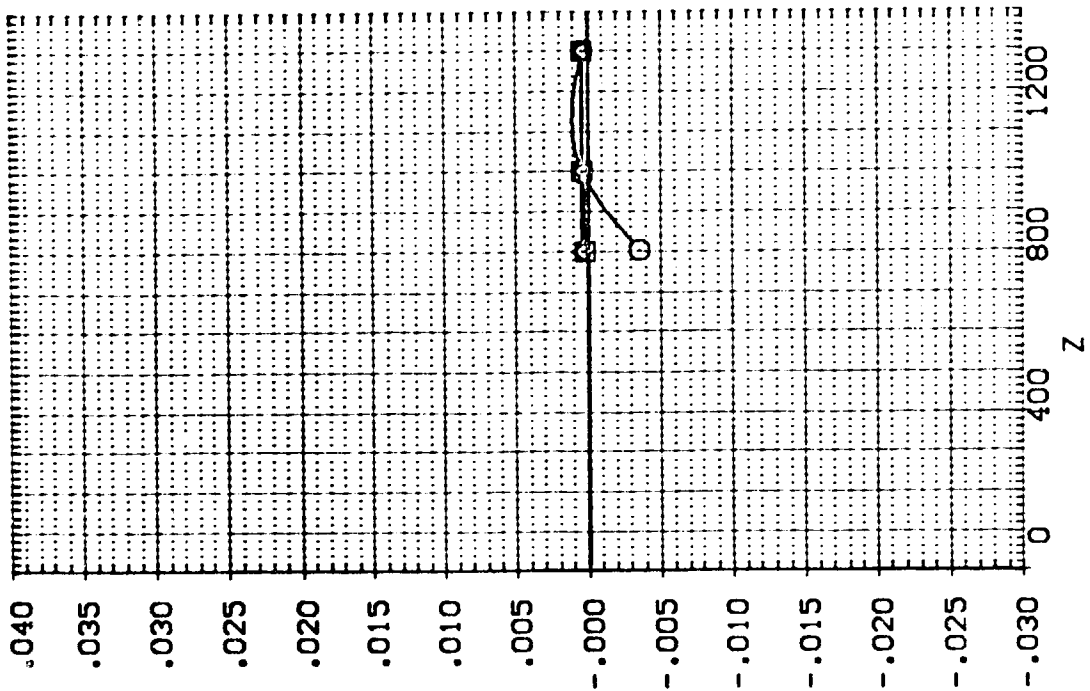

EFFECT OF EXTERNAL TANK SEPARATION ON ORBITER AERODYNAMIC CHARACTERISTICS

1A13.EXTERNAL TANK(T10)SEPARATING FROM ORB. 09 (RTJ045)

SEE THE ASSOCIATED DATA DOCUMENT FOR REFERENCE CHARACTERISTICS FOR INDIVIDUAL DATASETS

SYMBOL		PARAMETRIC VALUES	
○	X	MACH	4.520
□	400.660	ALPHA	-10.000
◇	800.230	DALPHA	-20.000
△	1200.600	ELEVTR	.000
		PTOTAL	60.000
		BETA	.000
		DBETA	5.000
		AILRON	.000
		Y	.000

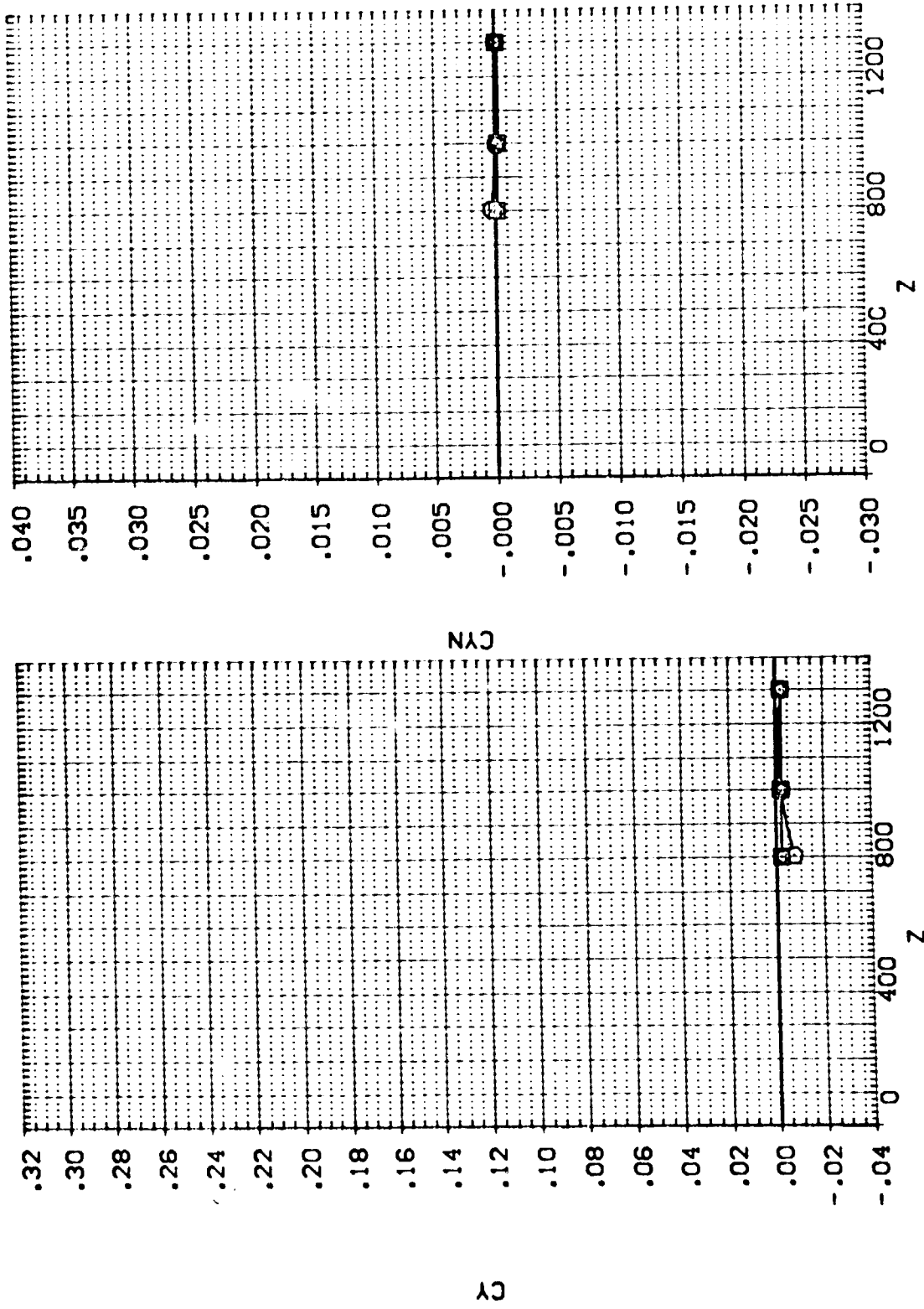

EFFECT OF EXTERNAL TANK SEPARATION ON ORBITER AERODYNAMIC CHARACTERISTICS

IA13.EXTERNAL TANK(T10)SEPARATING FROM ORB. 09 (RTJ046)

SEE THE ASSOCIATED DATA DOCUMENT FOR REFERENCE CHARACTERISTICS FOR INDIVIDUAL DATASETS

SYMBOL	X	MACH	PARAMETRIC VALUES	PTOTAL	60.000
○	.356	4.520	BETA	.000	
		-10.000	DBETA	.000	
		-30.000	AILRON	.000	
		.000	Y	.000	

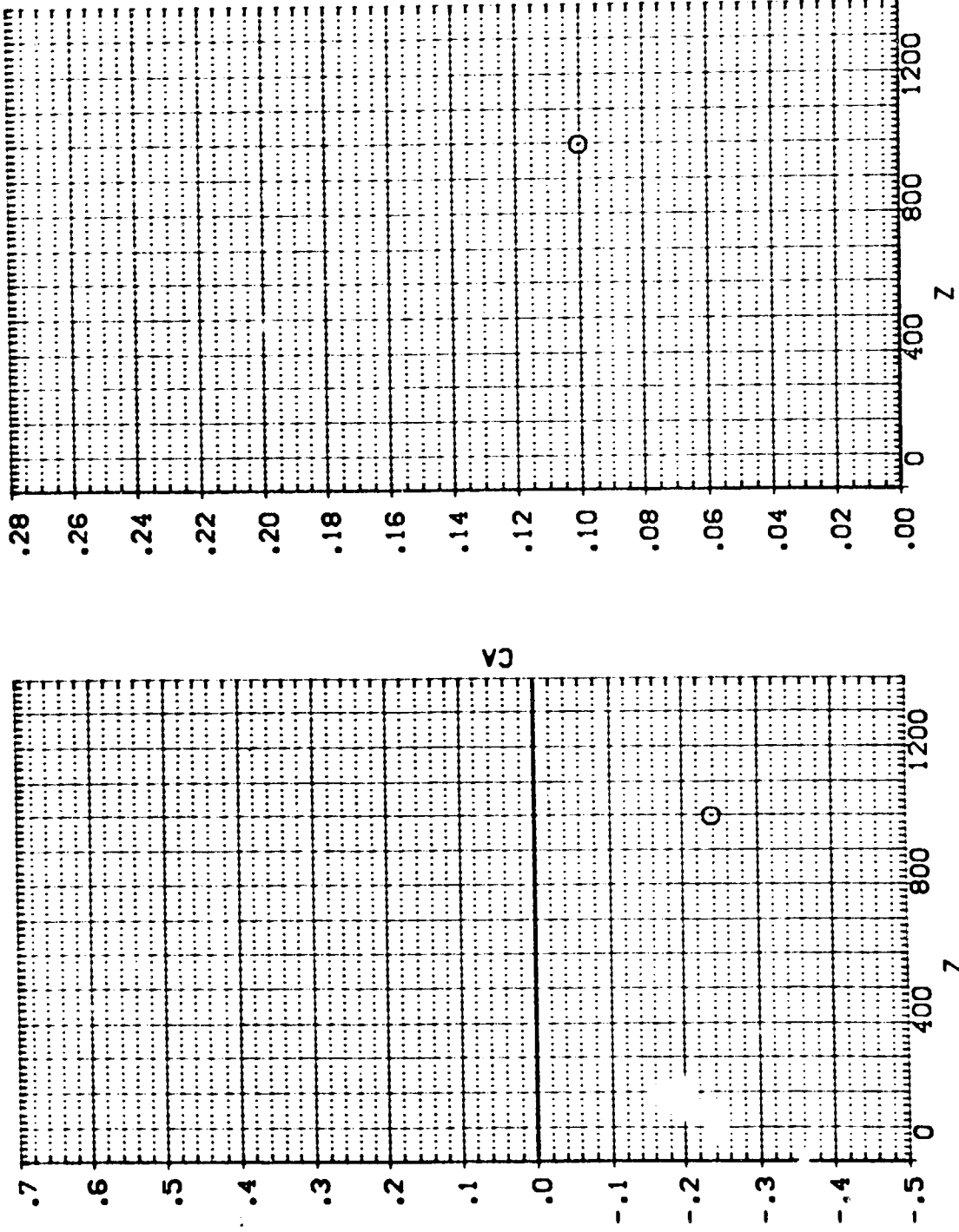

EFFECT OF EXTERNAL TANK SEPARATION ON ORBITER AERODYNAMIC CHARACTERISTICS

1A13. EXTERNAL TANK(T10)SEPARATING FROM ORB. 09 (RTJ046)

SEE THE ASSOCIATED DATA DOCUMENT FOR MORE CHARACTERISTICS FOR INDIVIDUAL DATASETS

SYMBOL		PARAMETRIC VALUES	
0	X	MACH	4.520
		ALPHA	-10.000
		DALPHA	-30.000
		ELEVTR	.000
		Y	.000
		PTOTAL	60.000
		BETA	.000
		DBETA	.000
		AILRON	.000

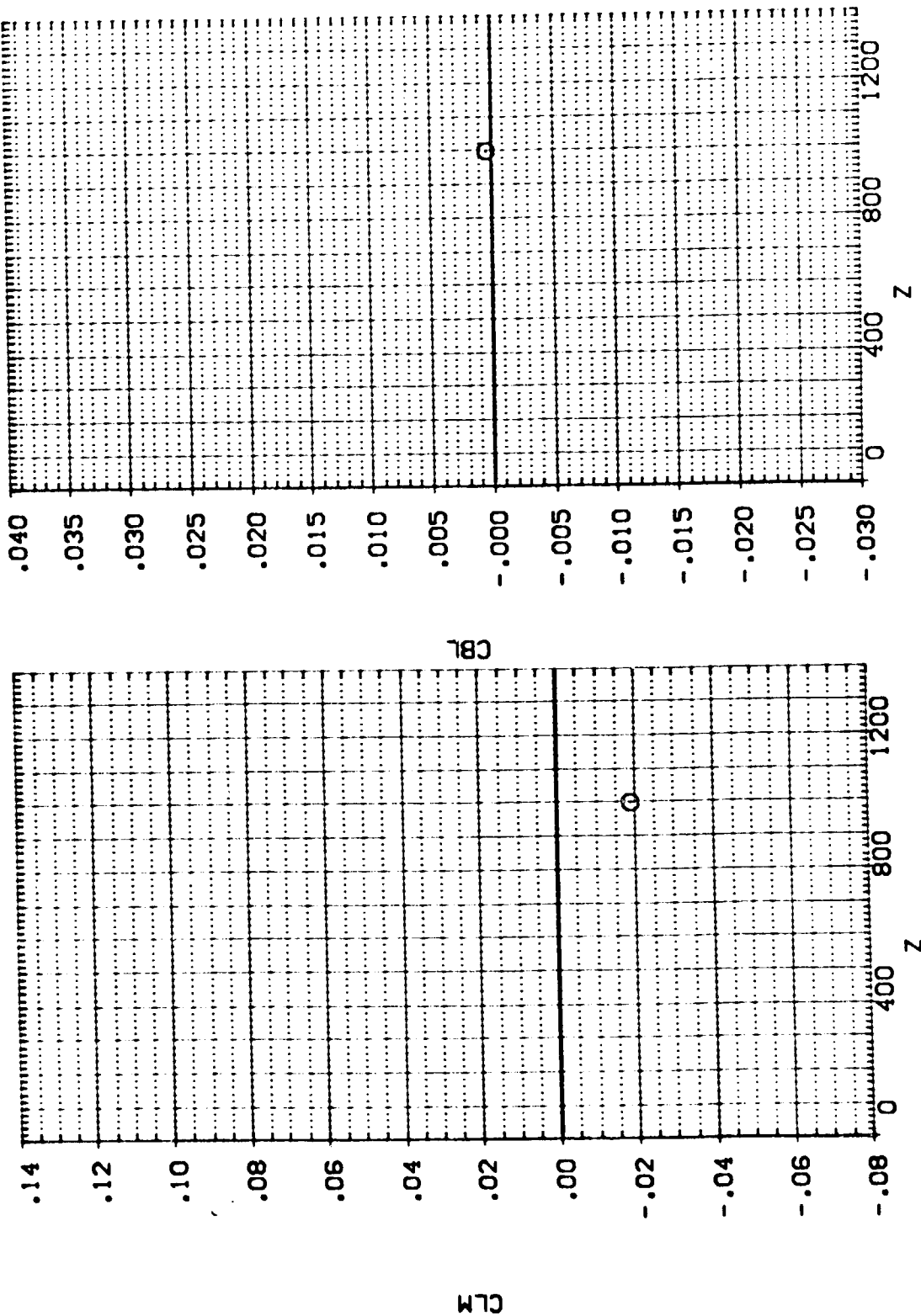

EFFECT OF EXTERNAL TANK SEPARATION ON ORBITER AERODYNAMIC CHARACTERISTICS

IA13, EXTERNAL TANK(T10)SEPARATING FROM ORB. 09 (RTJ046)

SEE THE ASSOCIATED DATA DOCUMENT FOR REFERENCE CHARACTERISTICS FOR INDIVIDUAL DATASETS

SYMBOL		PARAMETRIC VALUES	
O	X	MACH	4.520
		ALPHA	-10.000
		BETA	-30.000
		ELEVTR	.000
		Y	.000
		TOTAL	80.000
		BETA	.000
		DBETA	.000
		AILRON	.000
		Y	.000

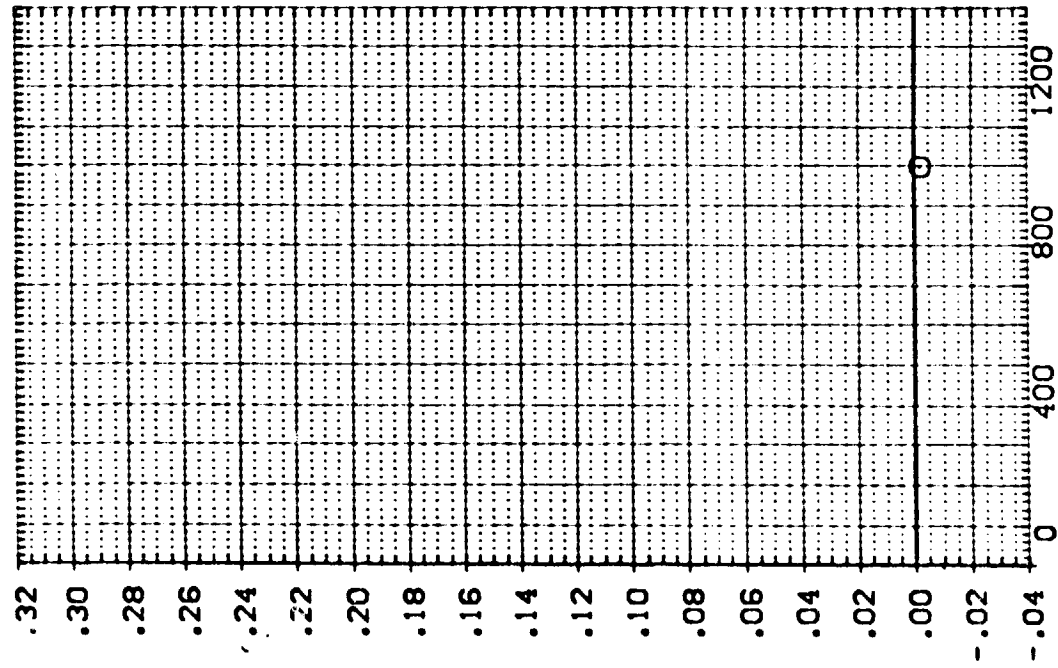
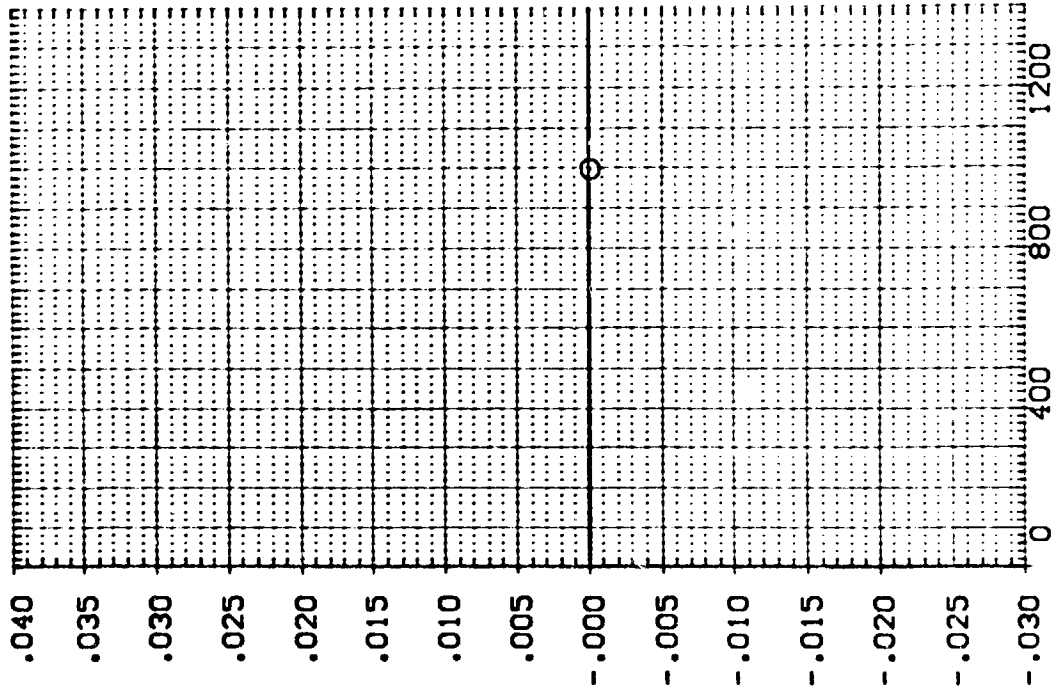

1A13. EXTERNAL TANK(T10)SEPARATING FROM ORB. 09 (RTJ047)

SEE THE ASSOCIATED DATA DOCUMENT FOR THE CHARACTERISTICS OF INDIVIDUAL CASES

SYMBOL		PARAMETRIC VALUES	
x	.105	MACH	4.520
	400.680	ALPHA	-21.000
	800.710	BETA	6.000
	1200.800	DELTA	.000
		ELEVTR	.000
		Y	.000

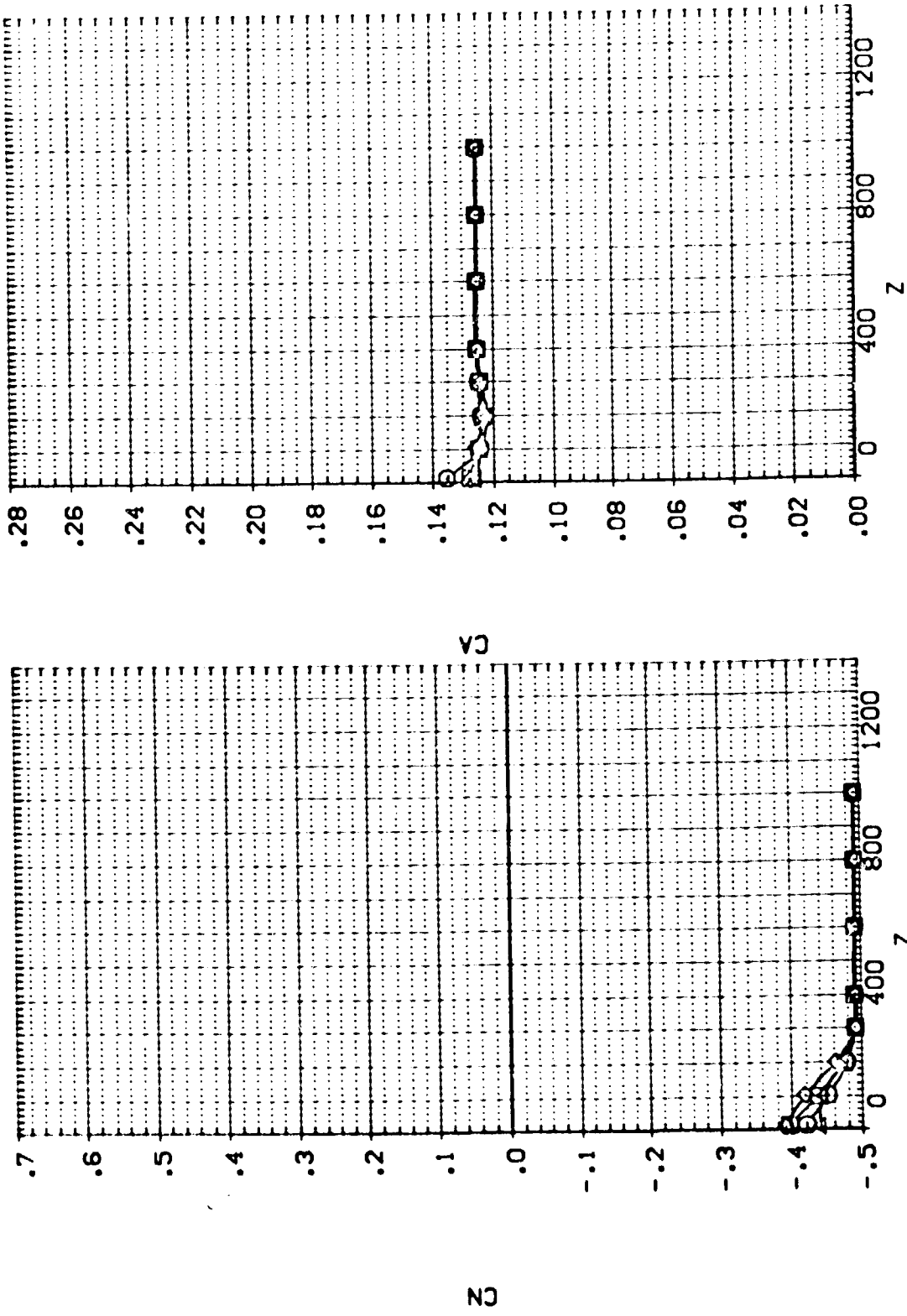

EFFECT OF EXTERNAL TANK SEPARATION ON ORBITER AERODYNAMIC CHARACTERISTICS

1.13. EXTERNAL TANK(T10)SEPARATING FROM ORB. 09 (RTJ047)

SEE THE ASSOCIATED DATA DOCUMENT FOR REFERENCE CHARACTERISTICS FOR INDIVIDUAL DATASETS

SYMBOL		PARAMETRIC VALUES			
x	.405	MACH	4.520	PTOTAL	80.000
o	400.680	ALPHA	-21.000	BETA	.000
□	800.710	DALPHA	6.000	DBETA	.000
△	1200.800	ELEVTR	.000	ALLRON	.000
		Y	.000		

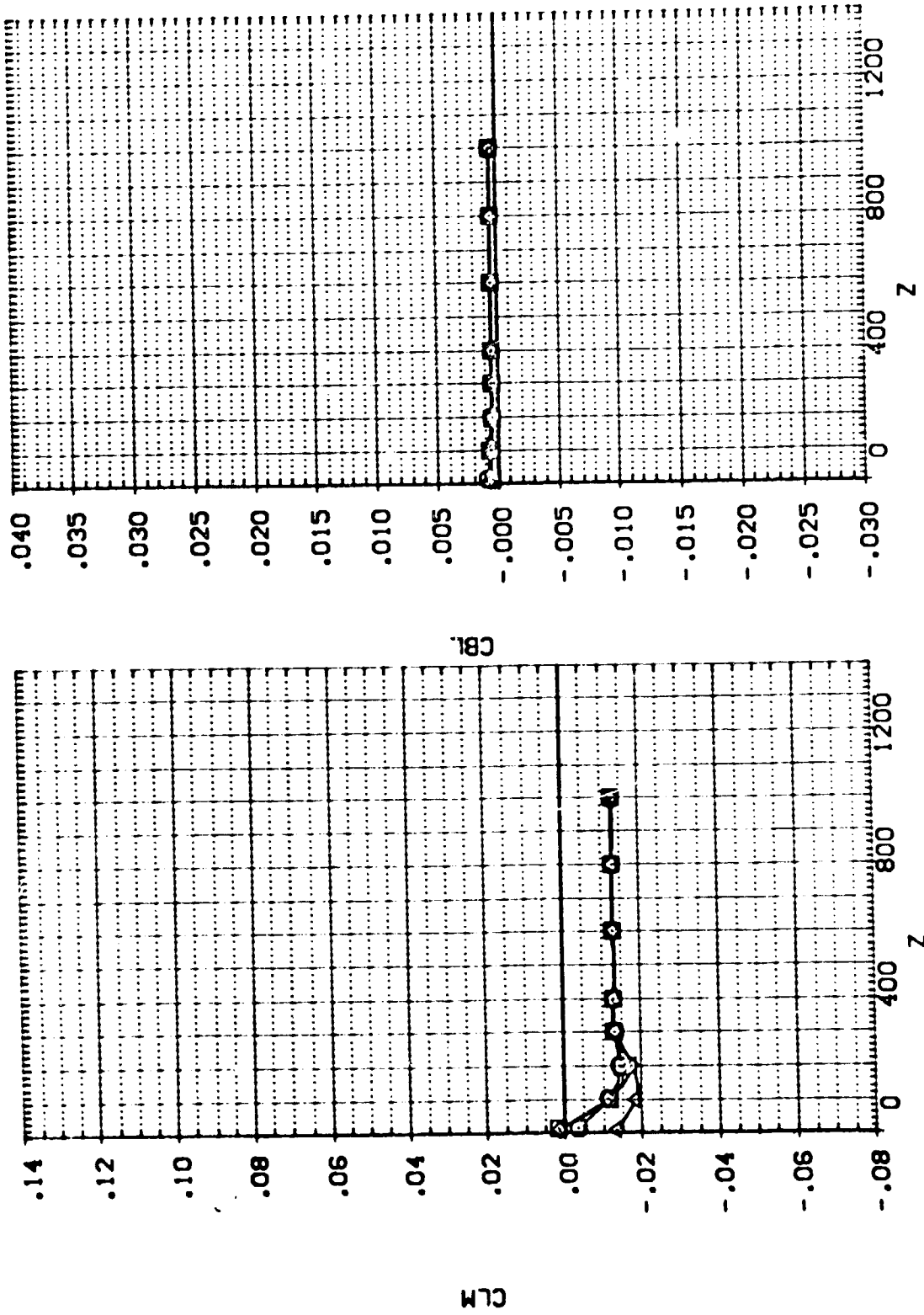

EFFECT OF EXTERNAL TANK SEPARATION ON ORBITER AERODYNAMIC CHARACTERISTICS

1A13.EXTERNAL TANK(T10)SEPARATING FROM ORB. 09 (RTJ047)

SEE THE ASSOCIATED DATA DOCUMENT FOR REFERENCE CHARACTERISTICS FOR INDIVIDUAL DATASETS

PARAMETRIC VALUES	
MACH	4.520
PTOTAL	60.000
BETA	.000
DBETA	.000
AIRFRON	.000
Y	.000
X	.405
MACH	4.000
ALPHA	-21.000
DALPHA	6.000
ELEVTR	.000
Y	.000

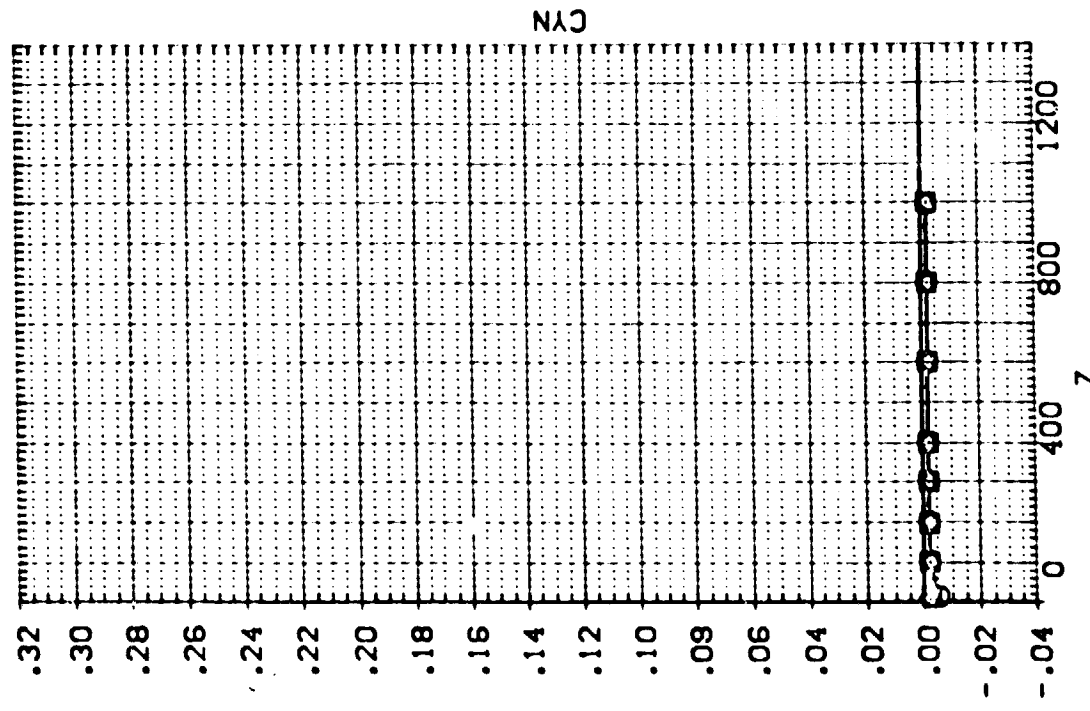
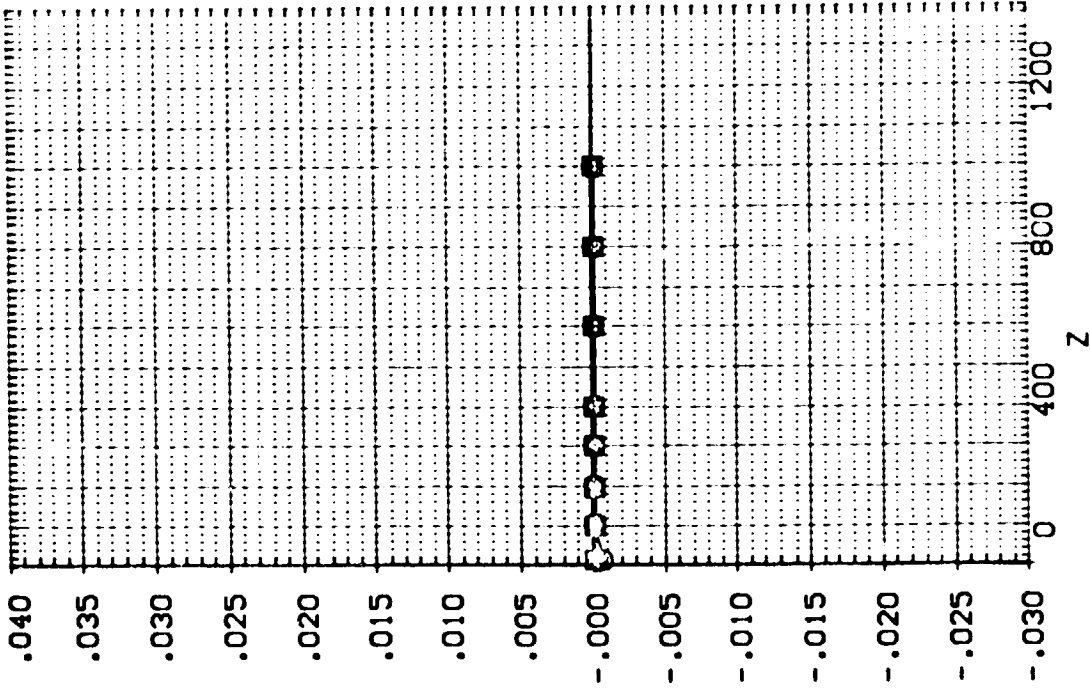

EFFECT OF EXTERNAL TANK SEPARATION ON ORBITER AERODYNAMIC CHARACTERISTICS

1A13. EXTERNAL TANK(T10)SEPARATING FROM ORB. 09 (RTJ048)

SEE THE ASSOCIATED DATA DOCUMENT FOR REFERENCE CHARACTERISTICS FOR INDIVIDUAL DATASETS

SYMBOL		PARAMETRIC VALUES	
○	.276	MACH	4.520
□	400.44C	PTOTAL	60.000
◇	800.59C	BETA	.000
△	1200.70C	CAPHA	1.000
		ELEVTR	.000
		Y	.000

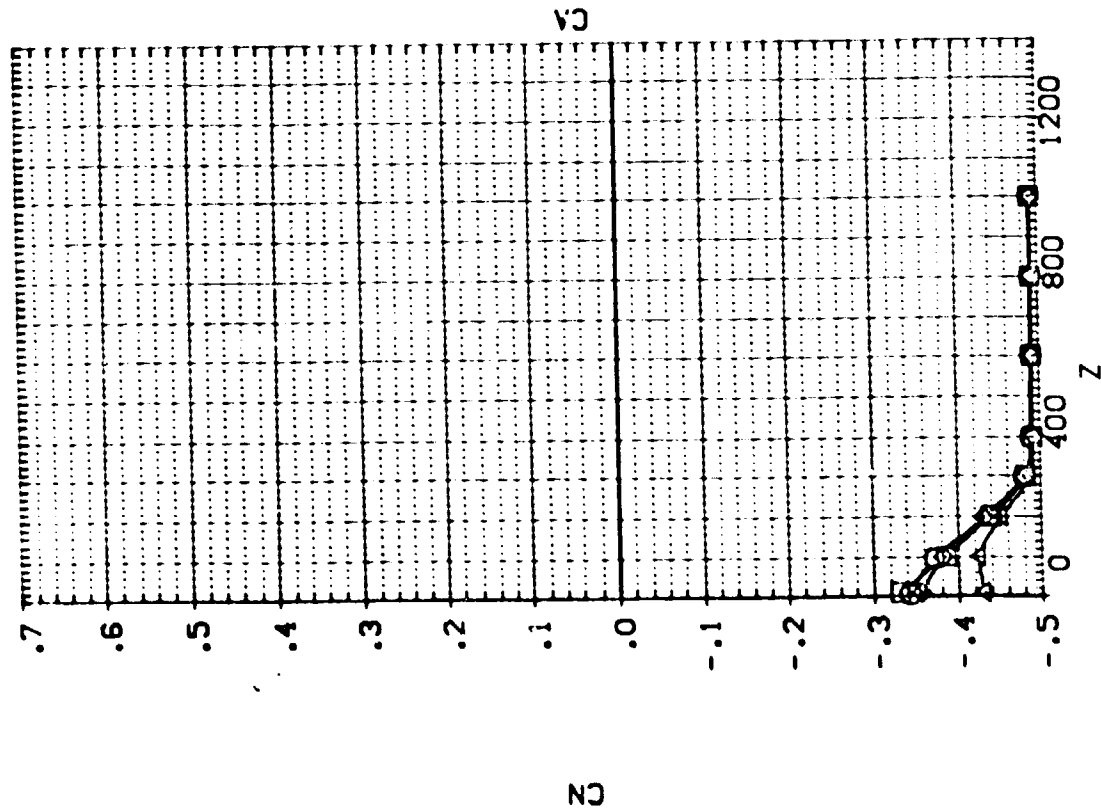
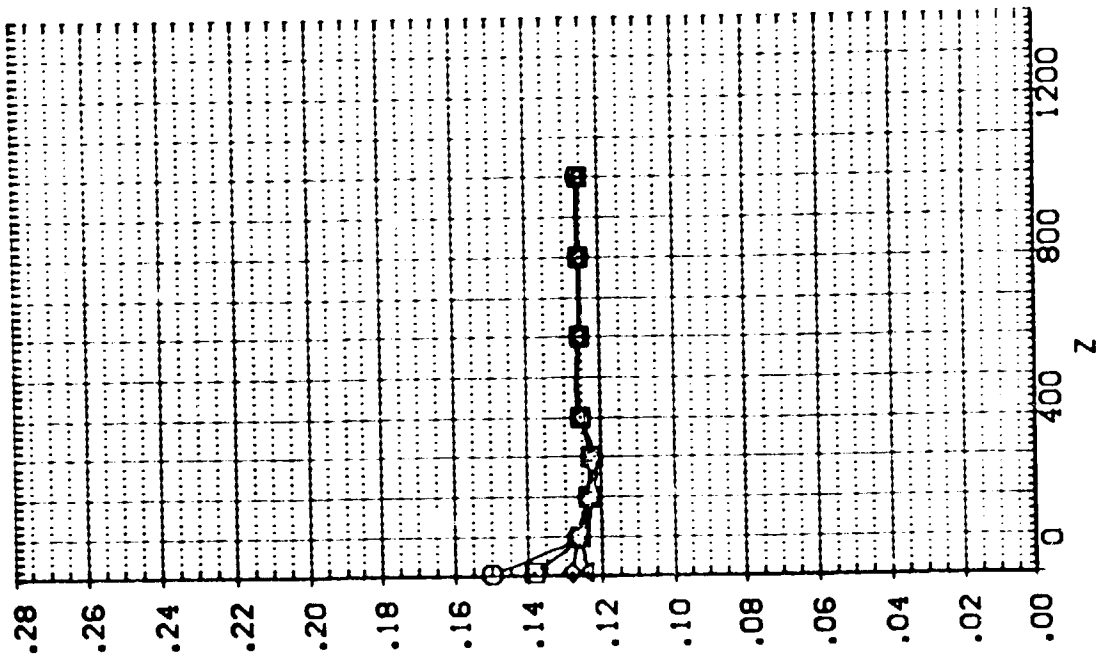

1A13. EXTERNAL TANK(10)SEPARATING FROM ORB. 09 (RTJ048)

SEE THE ASSOCIATED DATA DOCUMENT FOR REFERENCE CHARACTERISTICS FOR INDIVIDUAL DATASETS

SYMB.	X	MACH	PARAMETRIC VALUES
○	400.410	4.520	PTOTAL 80.000
◇	600.590	-21.000	BETA .000
△	1200.700	1.000	DBETA .000
			ATLRON .000
			Y .000

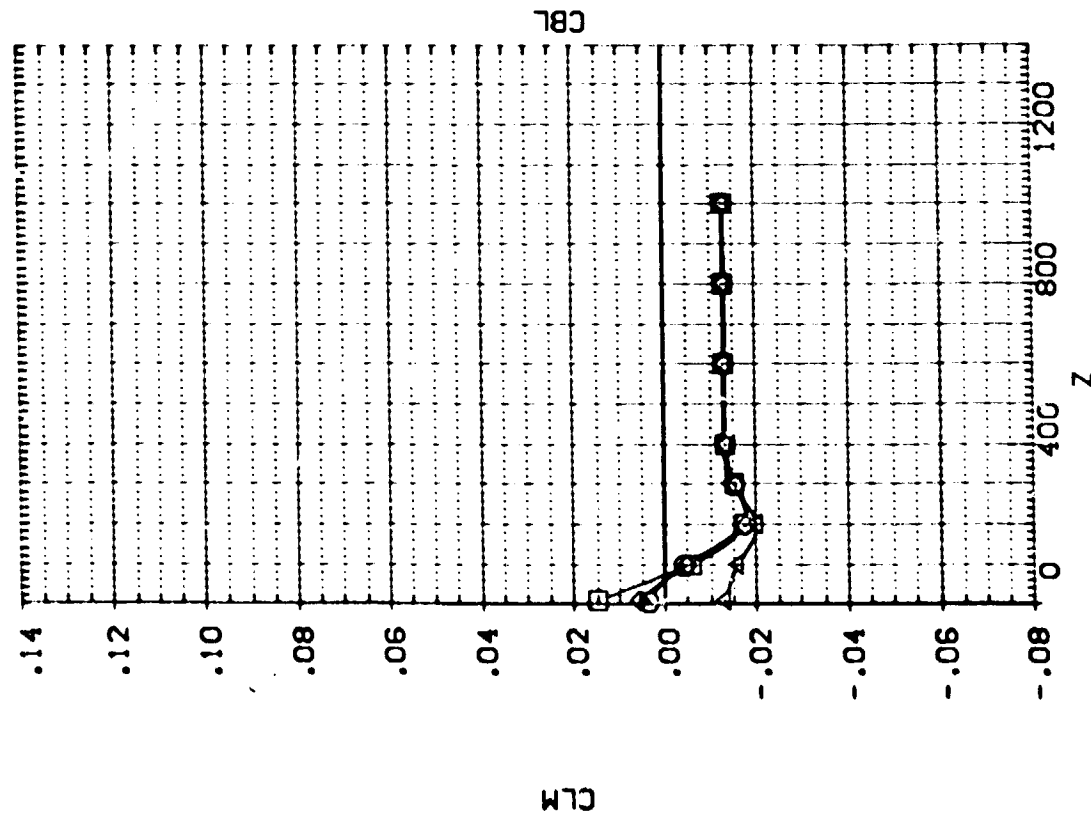
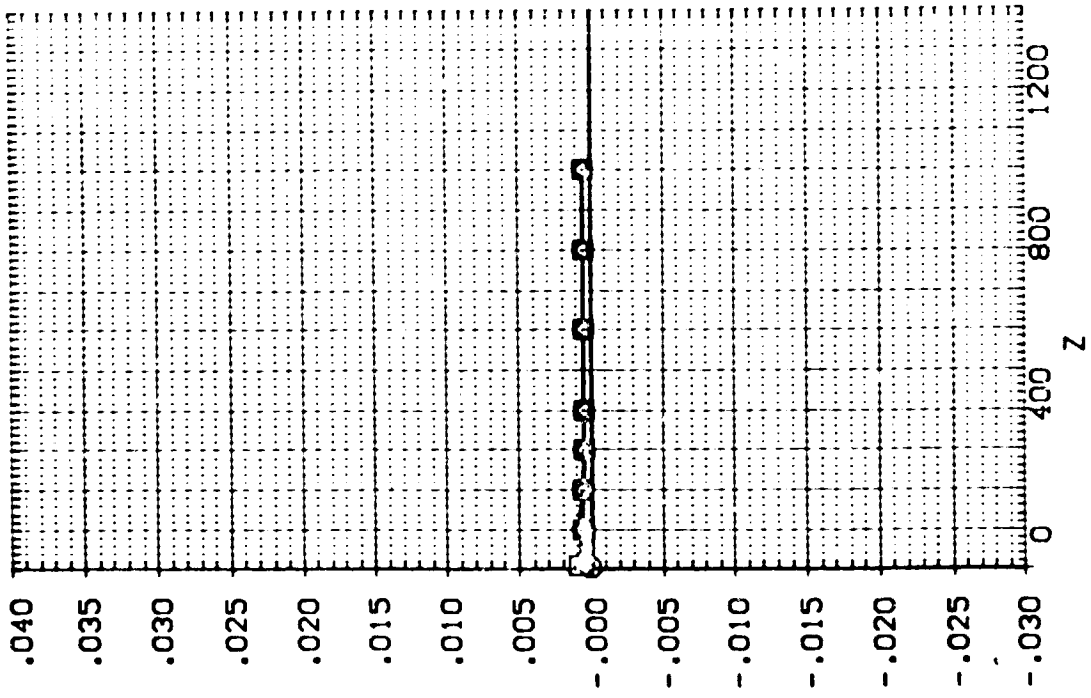

EFFECT OF EXTERNAL TANK SEPARATION ON ORBITER AERODYNAMIC CHARACTERISTICS

IA13.EXTERNAL TANK(T10)SEPARATING FROM ORB. 09 (RTJ048)

SEE THE ASSOCIATED DATA DOCUMENT FOR REFERENCE CHARACTERISTICS FOR INDIVIDUAL DATASETS

SYMBOL	X	MACH	PARAMETRIC VALUES
□	.276	4.520	PTOTAL 80.000
◇	400.140	-21.000	BETA .000
△	800.590	1.000	DBETA .000
	1200.700	.000	AILRON .000
		Y	

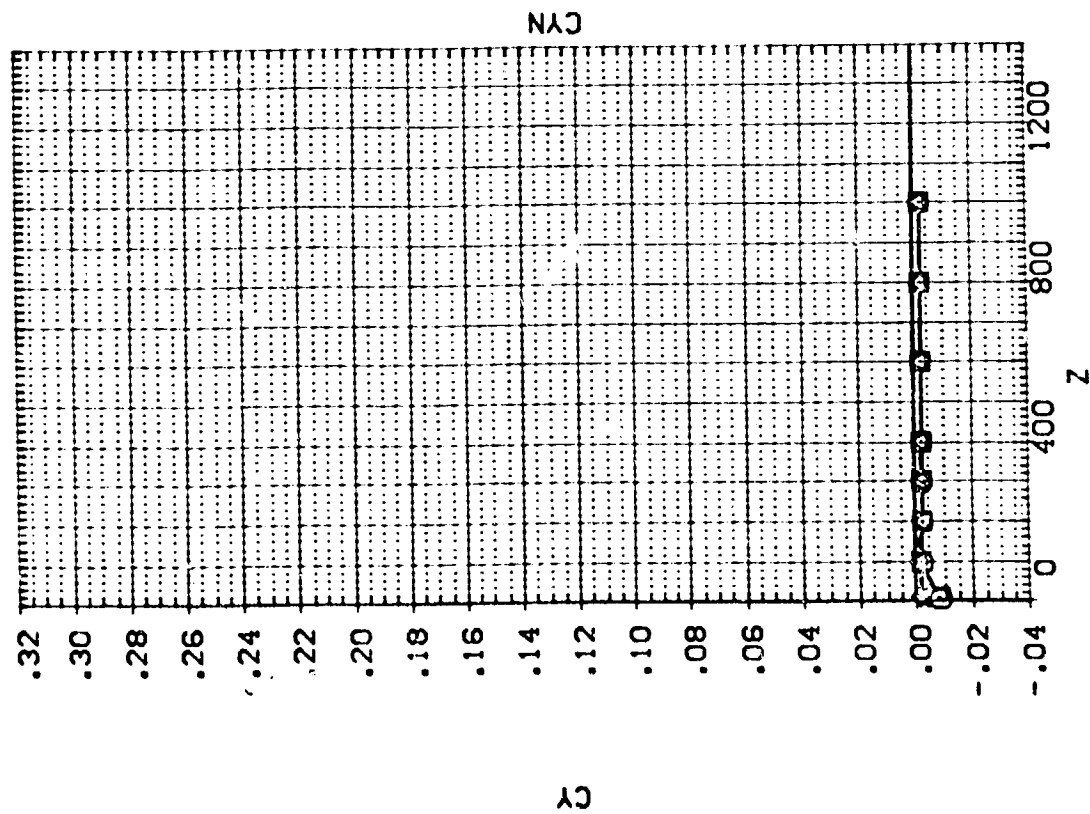
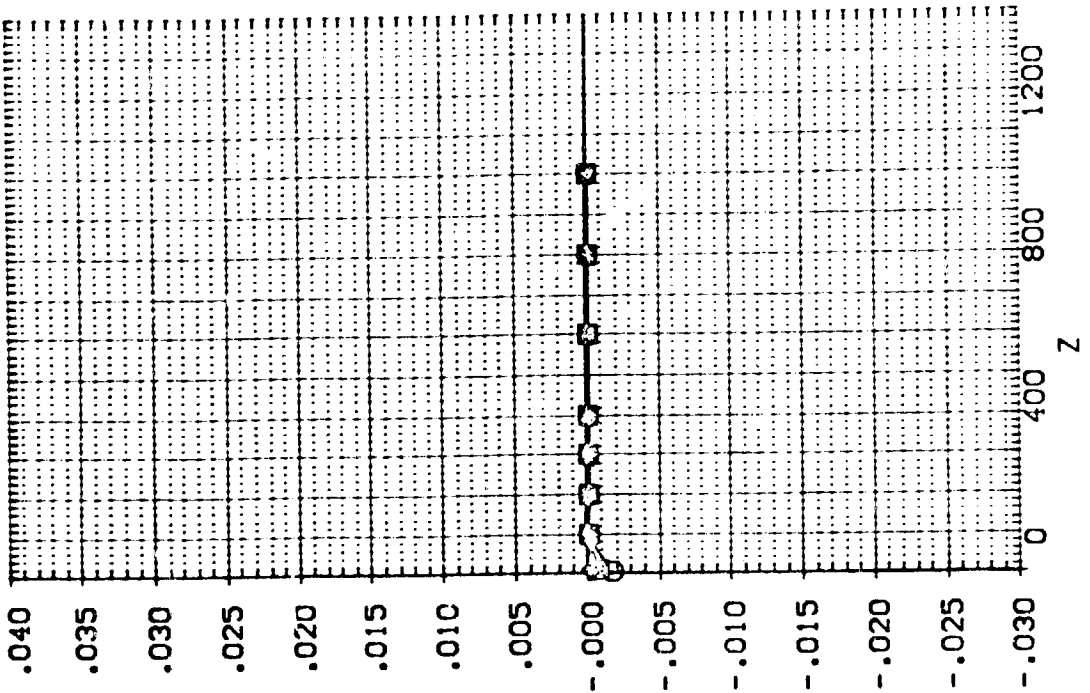

IA13,EXTERNAL TANK(T10)SEPARATING FROM ORB. 09 (RTJ049)

SEE THE ASSOCIATED DATA DOCUMENT FOR COMPLETE CHARACTERISTICS FOR INDIVIDUAL DATASETS

SYMBOL		PARAMETRIC VALUES	
○	x	MACH	4.520
○	y	ALPHA	-21.000
◇	z	DALPHA	-4.000
△		ELEVTR	.000
		PTOTAL	80.000
		BETA	.000
		DBETA	.000
		ATLRON	.000

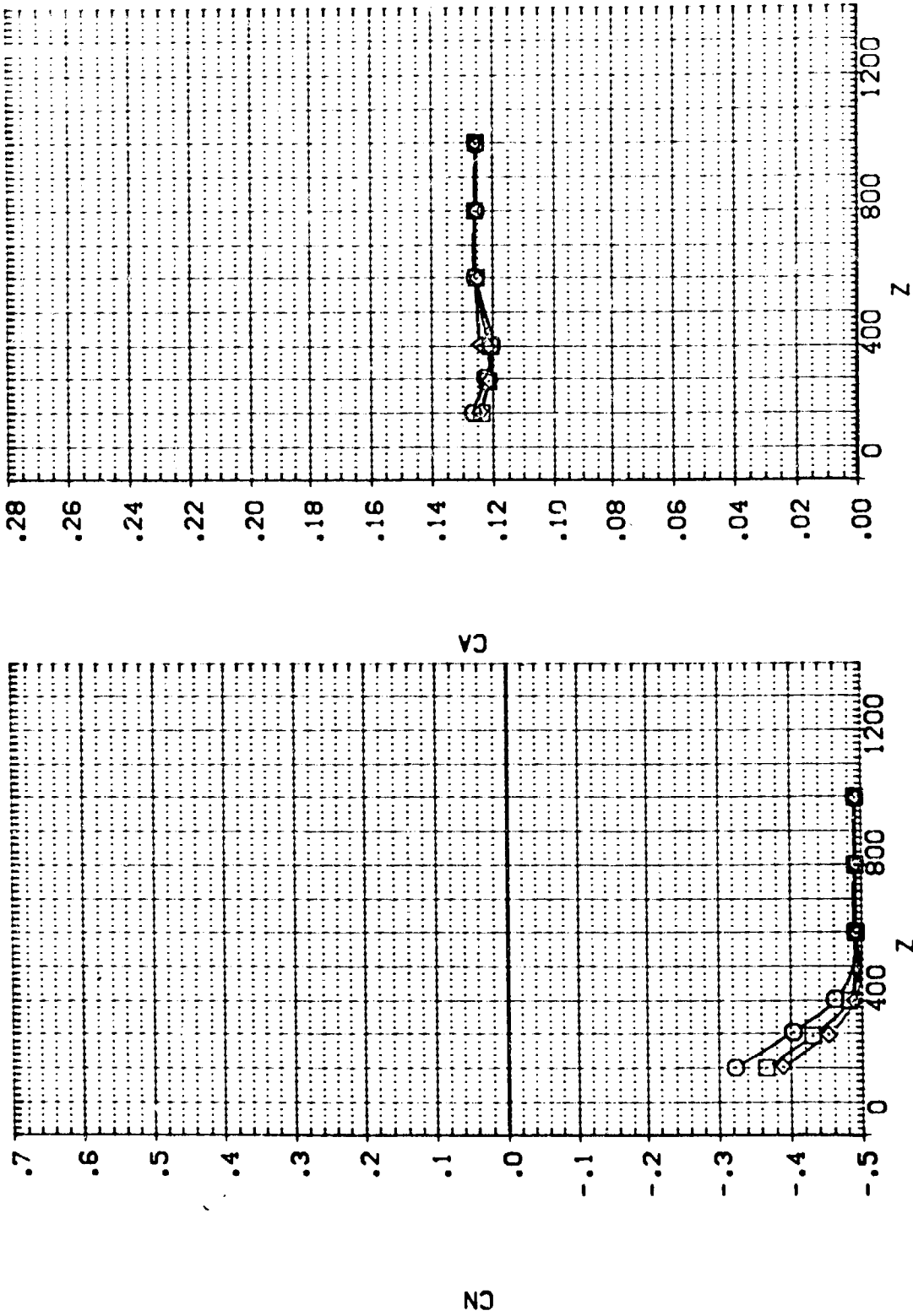

EFFECT OF EXTERNAL TANK SEPARATION ON ORBITER AERODYNAMIC CHARACTERISTICS

IA13. EXTERNAL TANK(110)SEPARATING FROM ORB. 09 (RTJ049)

SEE THE ASSOCIATED DATA DOCUMENT FOR REFERENCE CHARACTERISTICS FOR INDIVIDUAL DATASETS

SYMBOL		X		MACH		PARAMETRIC VALUES	
○	□	400.570	800.340	1200.800	.285	4.520	PIOTAL 60.000
◇	△					-21.000	BETA .000
						-4.000	DBETA .000
						.000	AIRLON .000
						.000	Y .000

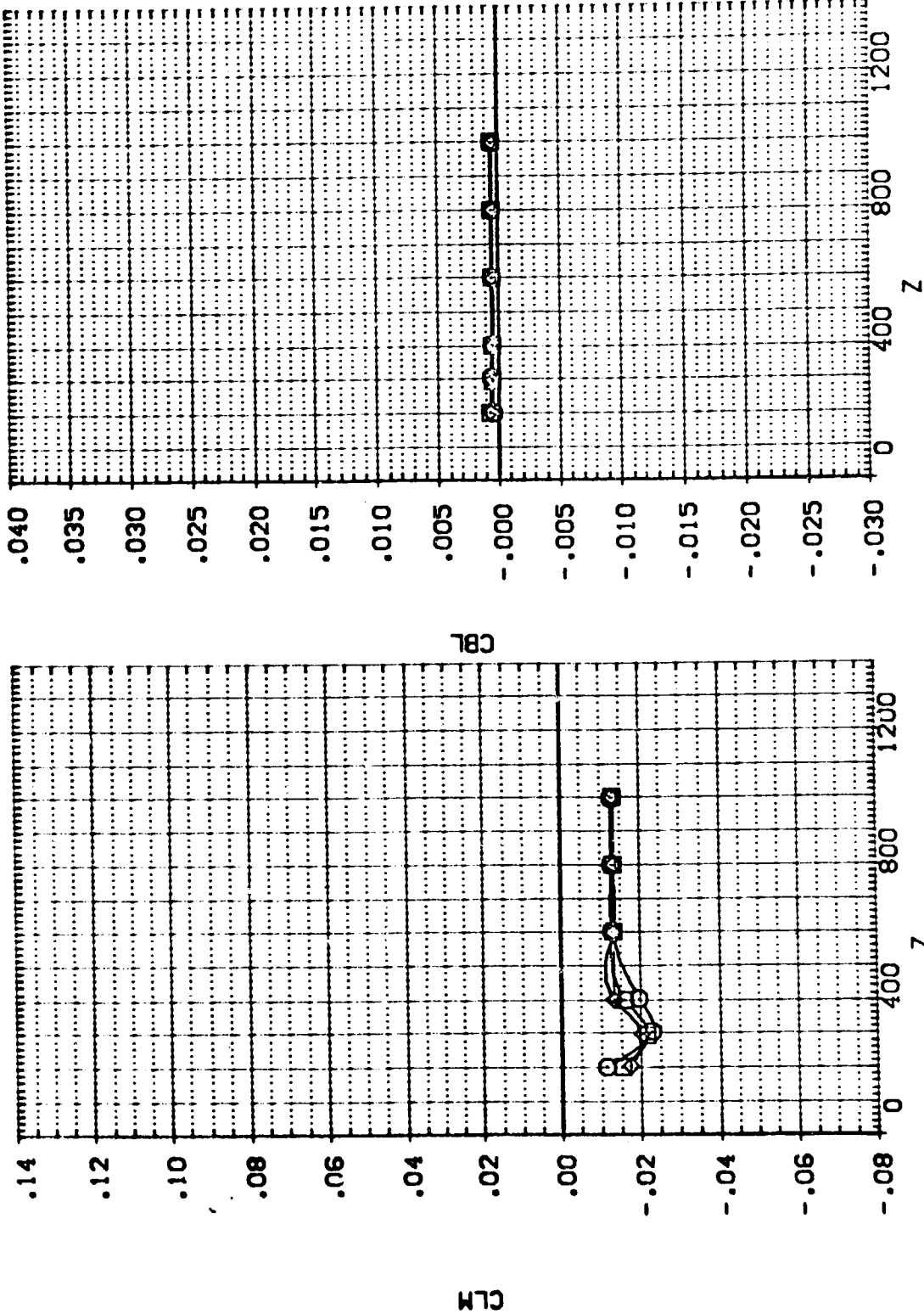

EFFECT OF EXTERNAL TANK SEPARATION ON ORBITER AERODYNAMIC CHARACTERISTICS

IA13. EXTERNAL TANK (110) SEPARATING FROM ORB. 09 (RTJ049)

SEE THE ASSOCIATED DATA DOCUMENT FOR REFERENCE CHARACTERISTICS FOR INDIVIDUAL DATASETS

PARAMETRIC VALUES	
MACH	4.520
PIOTAL	60.000
ALPHA	-21.000
BETA	.000
DALPHA	-1.000
DBETA	.000
ELEVTR	.000
AILRON	.000
Y	.000

X
 .265
 400.570
 600.340
 1200.600

Symbol
 ○ □ ◇ △

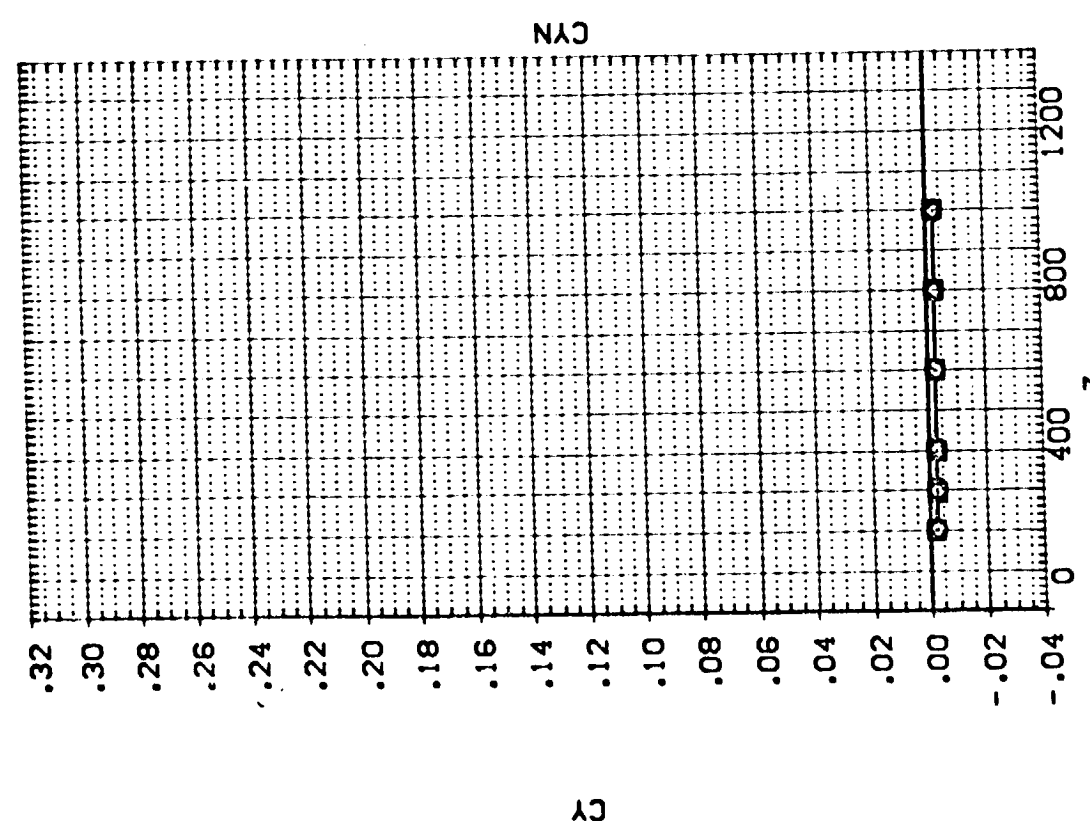
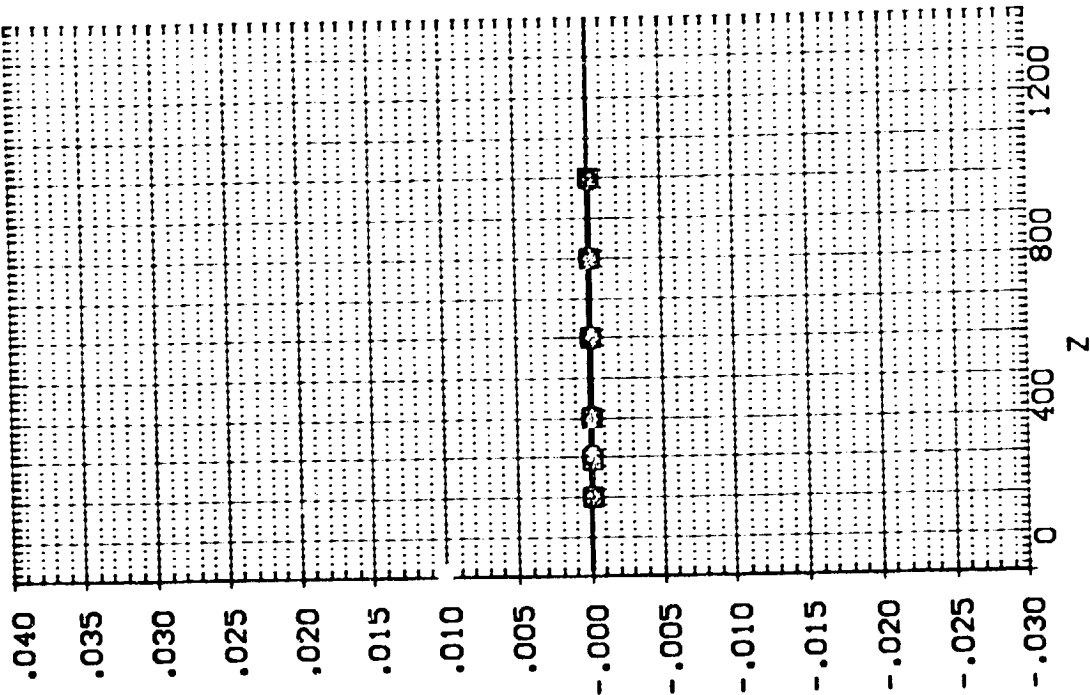

EFFECT OF EXTERNAL TANK SEPARATION ON ORBITER AERODYNAMIC CHARACTERISTICS

1A13.EXTERNAL TANK(10)SEPARATING FROM ORB. 09 (RTJ050)

SEE THE ASSOCIATED DATA DOCUMENT FOR REFERENCE CHARACTERISTICS FOR INDIVIDUAL DATASETS

SYMBOL		PARAMETRIC VALUES	
X	.174	MACH	4.520
		PTOTAL	80.000
400.460	ALPHA	BETA	.000
800.230	DALPHA	DBETA	.000
1200.600	ELEVTR	AILRON	.000
	Y		.000

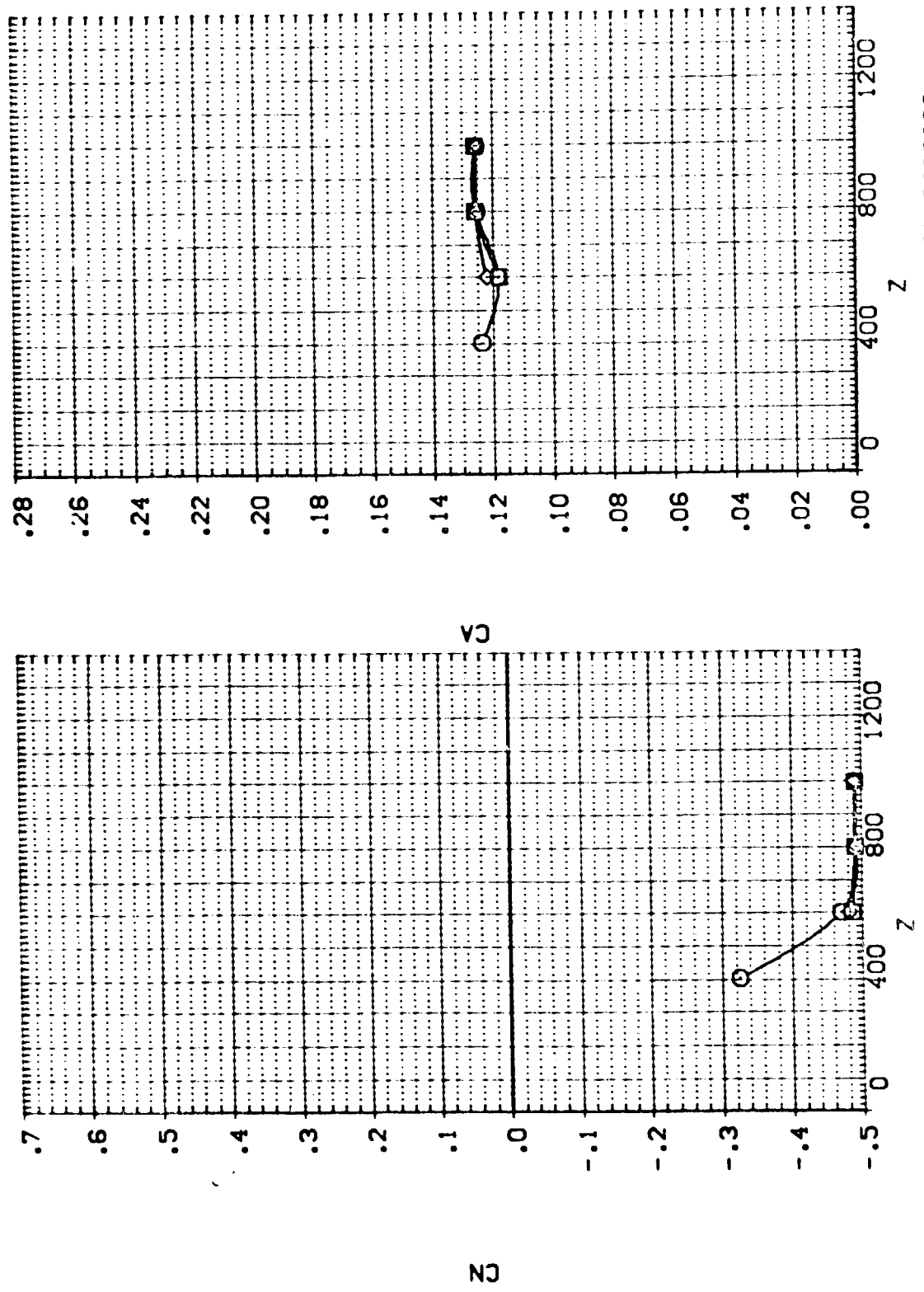

IA13. EXTERNAL TANK(T10)SEPARATING FROM ORB. 09 (RTJ050)

SEE THE ASSOCIATED DATA DOCUMENT FOR THE CHARACTERISTICS FOR INDIVIDUAL DATASETS

SYMBOL		MACH		PARAMETRIC VALUES	
○	x	.174	4.520	PTOTAL	80.000
◇	400.460	ALPHA	-21.000	BETA	.000
◇	800.730	DALPHA	-9.000	DBETA	.000
△	1200.600	ELEVTR	.000	AILLRON	.000
		Y	.000		

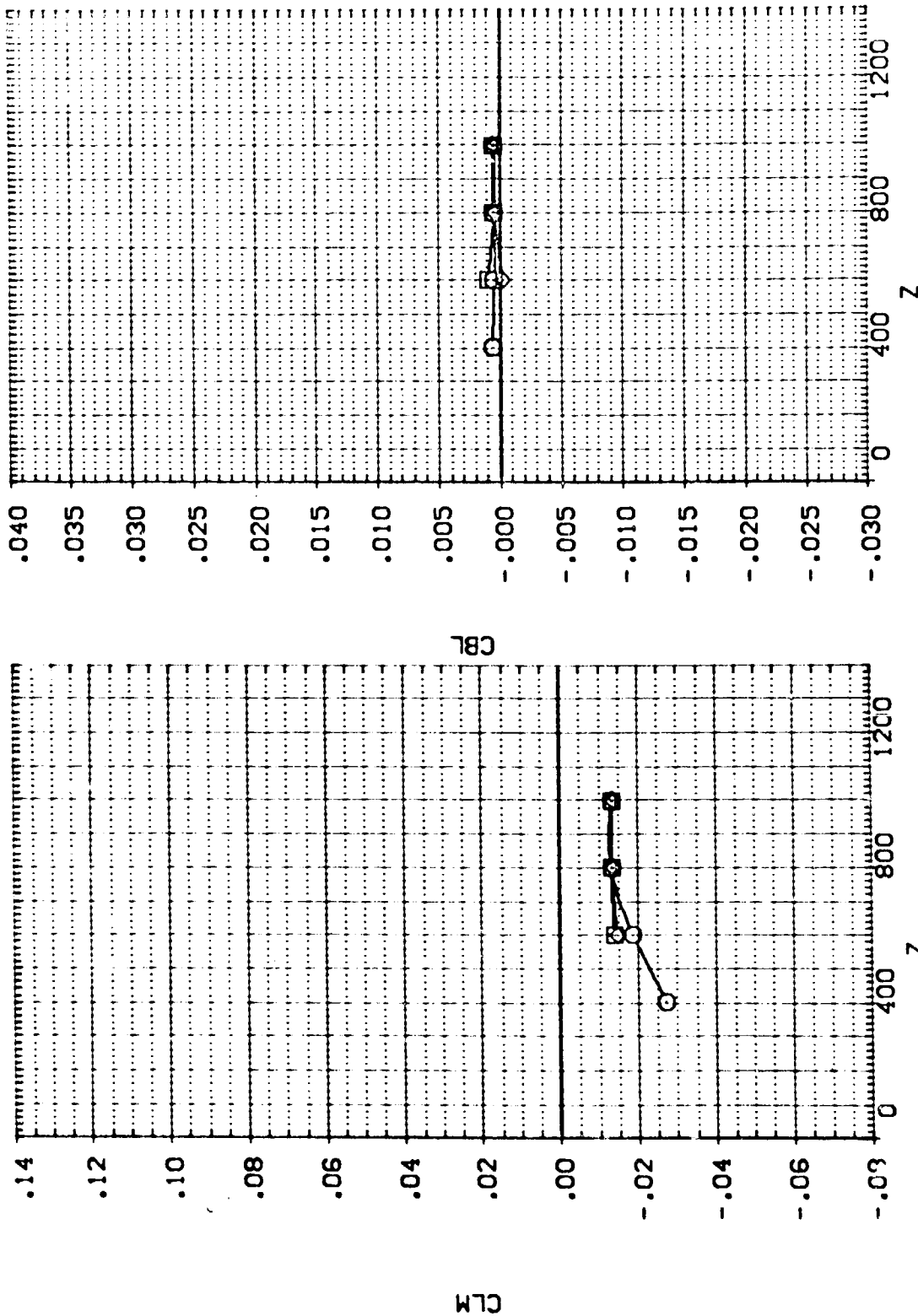

EFFECT OF EXTERNAL TANK SEPARATION ON ORBITER AERODYNAMIC CHARACTERISTICS

IA13.EXTERNAL TANK(T10)SEPARATING FROM ORB. 09 (RTJ050)

SEE THE ASSOCIATED DATA DOCUMENT FOR REFERENCE CHARACTERISTICS FOR INDIVIDUAL DATASETS

SYMBOL		PARAMETRIC VALUES	
○	X	MACH	PTOTAL
□	100.150	4.520	80.000
◇	800.230	-21.000	BETA
△	1200.600	-9.000	DBETA
		.000	AILRON
		.000	Y

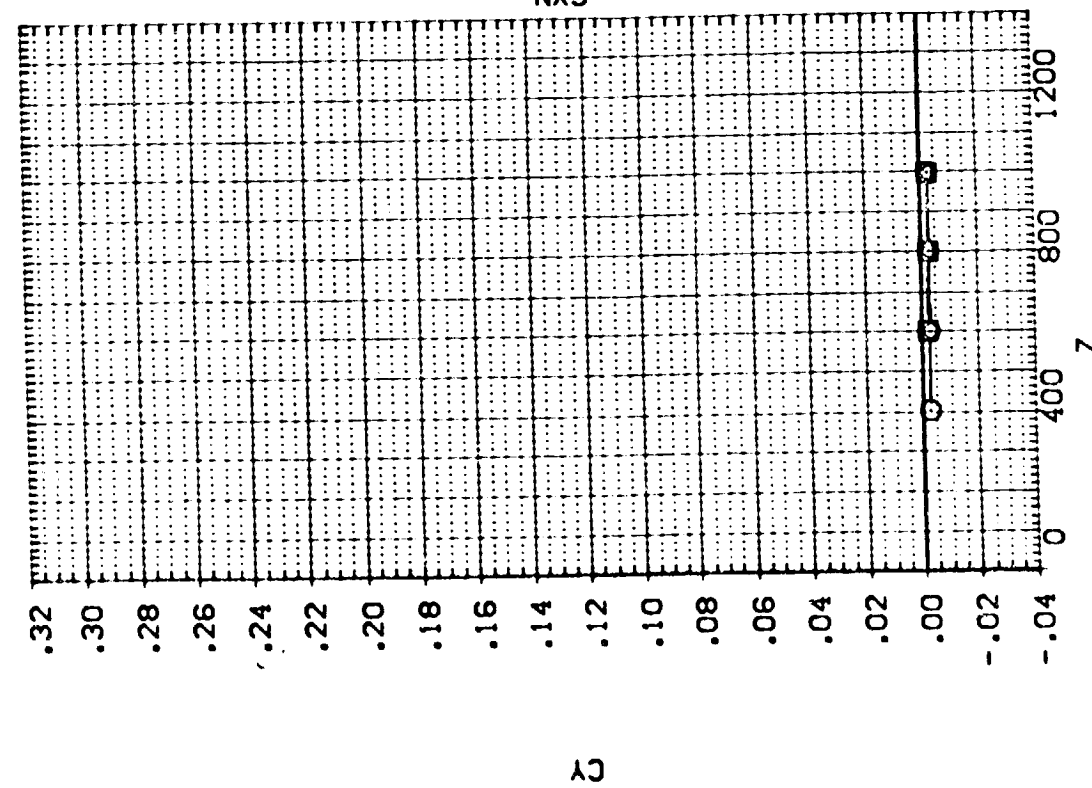
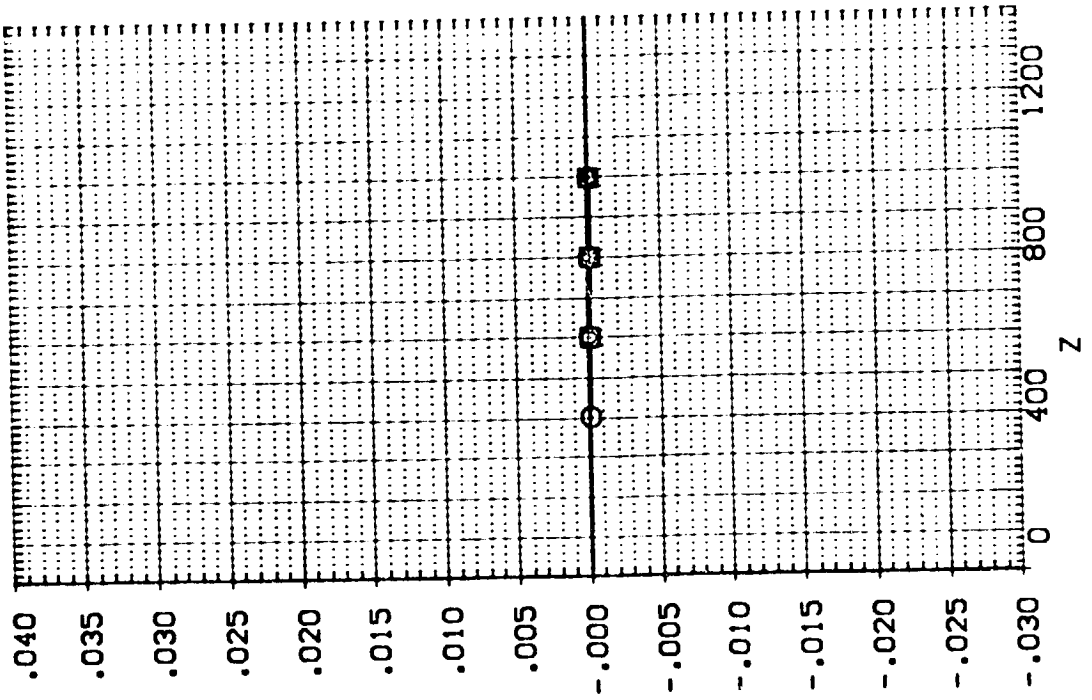

EFFECT OF EXTERNAL TANK SEPARATION ON ORBITER AERODYNAMIC CHARACTERISTICS

IA13.EXTERNAL TANK(T10)SEPARATING FROM ORB. 09 (RTJ051)

SEE THE ASSOCIATED DATA DOCUMENT FOR REFERENCE CHARACTERISTICS FOR INDIVIDUAL DATASETS

SYMBOL x .299
 O MACH 4.520 PTOTAL 80.000
 ALPHA -21.000 BETA .000
 DALPHA -19.000 DBETA .000
 ELEVTR .000 AILRON .000
 Y .000

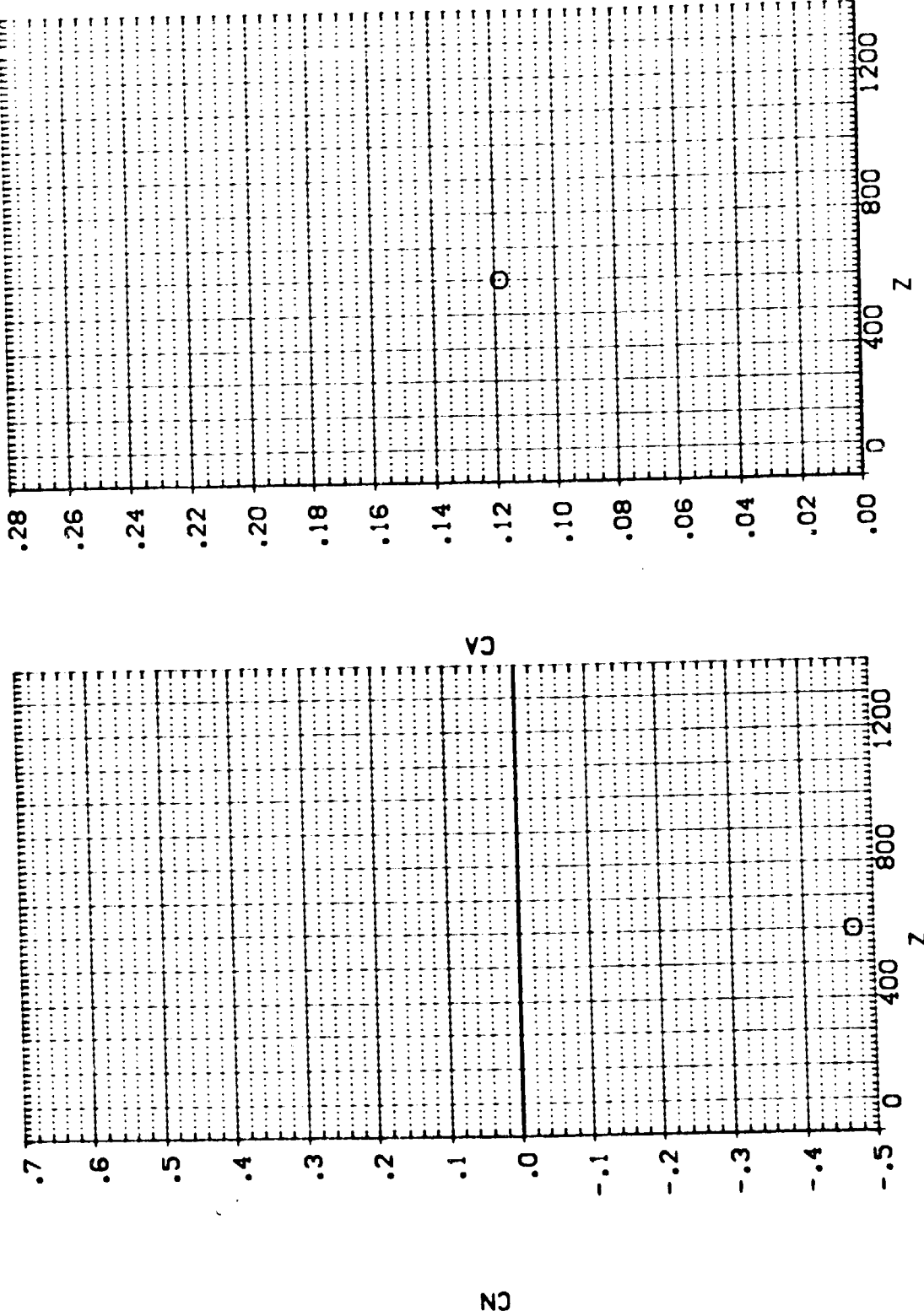

EFFECT OF EXTERNAL TANK SEPARATION ON ORBITER AERODYNAMIC CHARACTERISTICS

IA13.EXTERNAL TANK(T10)SEPARATING FROM ORB. 09 (RTJ051)

SEE THE ASSOCIATED DATA DOCUMENT FOR REFERENCE CHARACTERISTICS FOR INDIVIDUAL DATASETS

SYMBOL	X	MACH	PARAMETRIC VALUES
O	.299	4.520	PTOTAL 80.000
		-21.000	BETA .000
		-19.000	DBETA .000
		.000	AILRON .000
		.000	Y

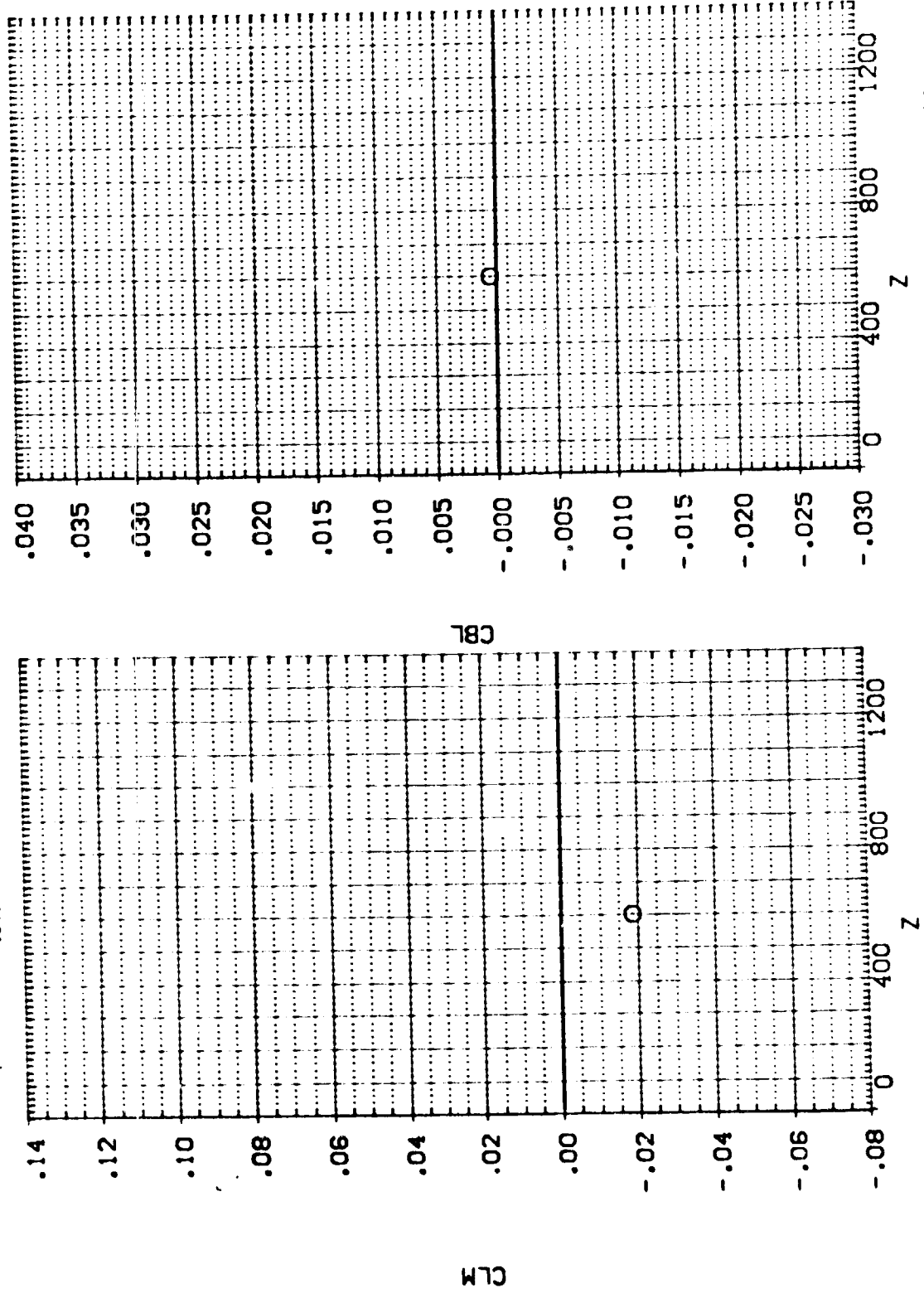

1A13-EXTERNAL TANK(T10)SEPARATING FROM ORB. 09 (RTJ051)

SEE THE ASSOCIATED DATA DOCUMENT FOR ORBITER CHARACTERISTICS FOR INDIVIDUAL DATA SETS

PARAMETRIC VALUES
 MACH 4.520 PITCHAL 60.000
 ALPHA -21.000 BETA .000
 DELTA -19.000 DBETA .000
 ELEVTR .000 AILRON .000
 Y .000

SYMBOL x .299
 O

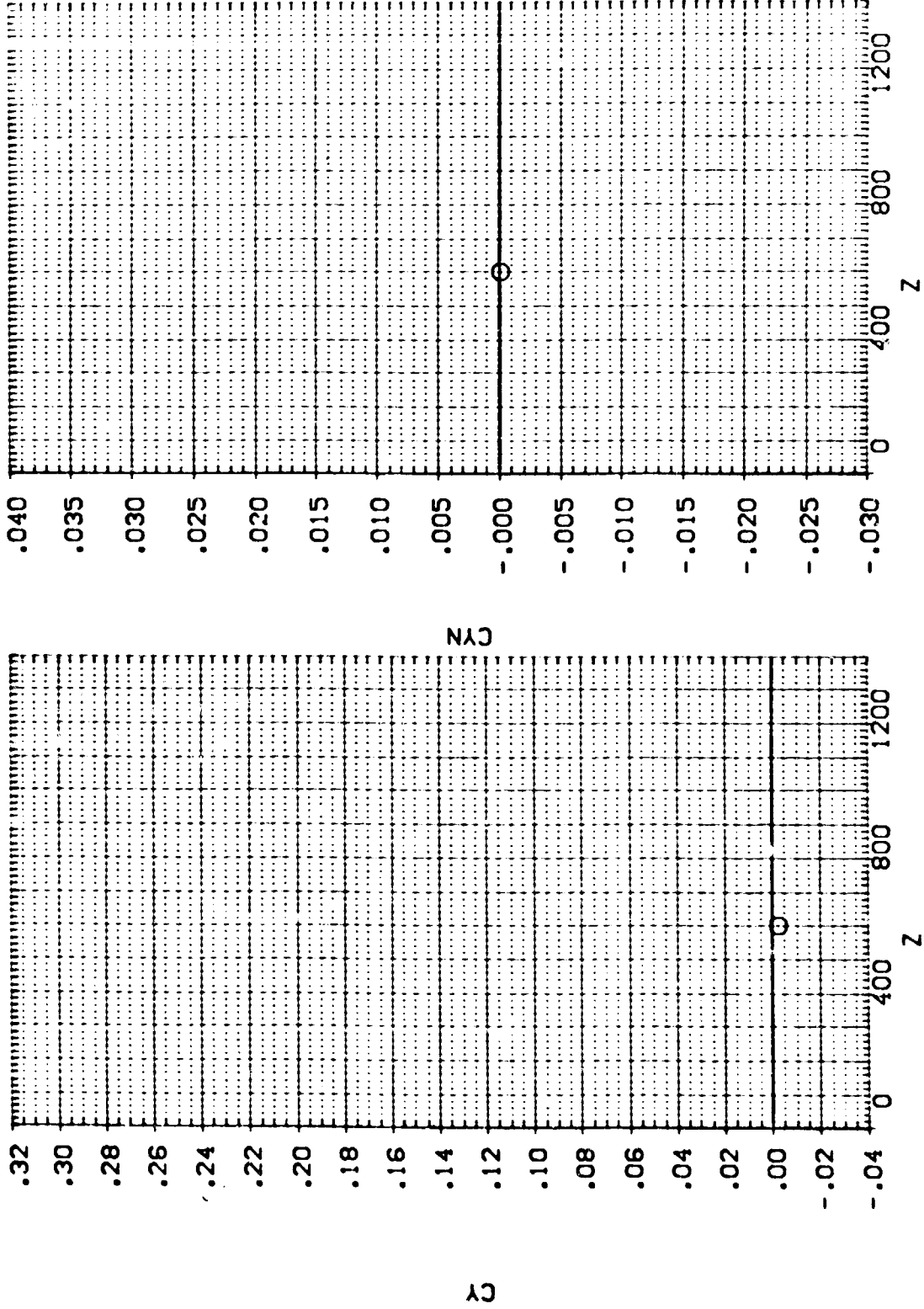

EFFECT OF EXTERNAL TANK SEPARATION ON ORBITER AERODYNAMIC CHARACTERISTICS



1A13.EXTERNAL TANK(T10)SEPARATING FROM ORB. 09 (RTJ052)

SEE THE ASSOCIATED DATA DOCUMENT FOR REFERENCE CHARACTERISTICS FOR INDIVIDUAL DATASETS

SYMBOL	x	.102	MACH	4.530	PTOTAL	110.000
			ALPHA	.000	BETA	.000
			DALPHA	.000	DBETA	.000
			ELEVTR	.000	AILLON	10.000
			Y	-200.000		

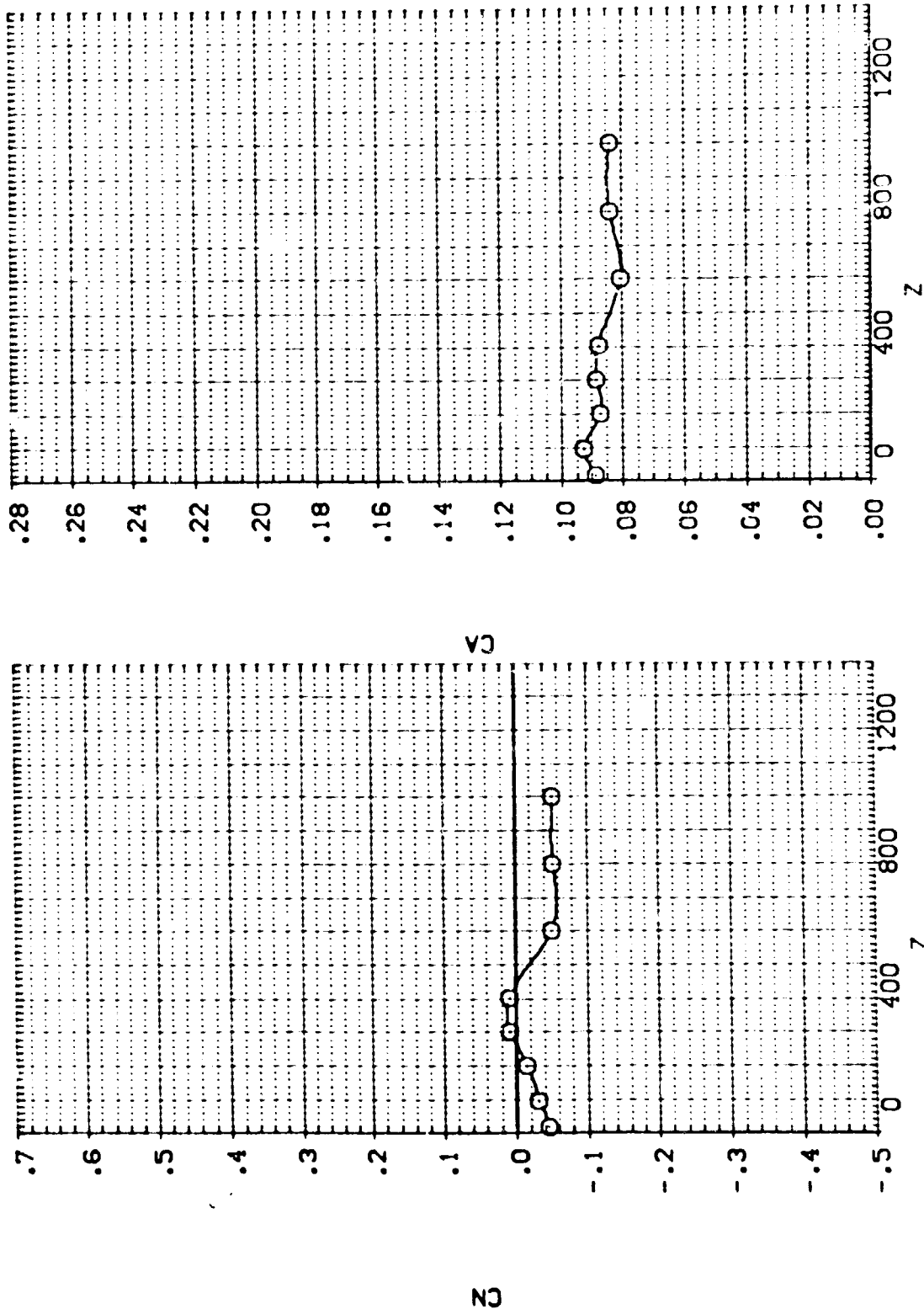

TA13, EXTERNAL TANK(T10)SEPARATING FROM CRB. 09 (RTJ052)

SEE THE ASSOC.
DOCUMENT FOR
CHARACTERISTICS FOR
INDIVIDUAL DATA SETS

SYMBOL X PARAMETRIC VALUES
O .102 MACH 4.530 PTOTAL 110.000
ALPHA .000 BETA .000
DALPHA .000 DBETA .000
ELEVTR .000 ALLRON 10.000
Y -200.000

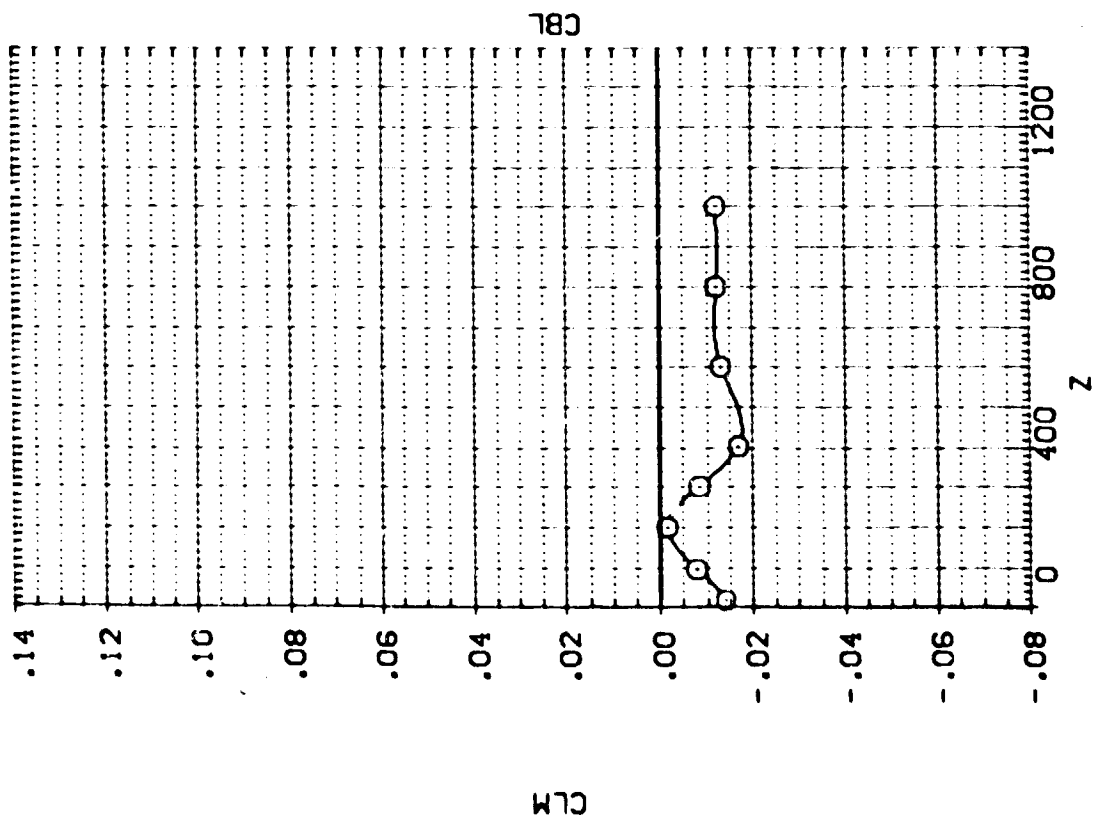
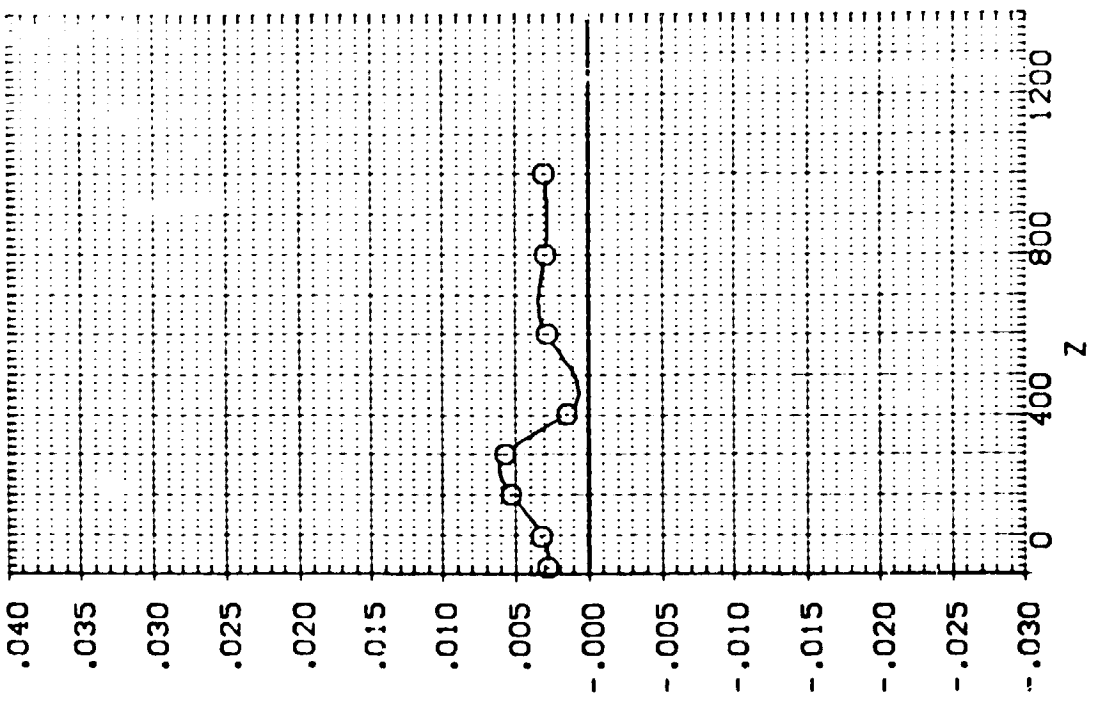

EFFECT OF EXTERNAL TANK SEPARATION ON ORBITER AERODYNAMIC CHARACTERISTICS



1A13. EXTERNAL TANK(T10)SEPARATING FROM ORB. 09 (RTJ052)

SEE THE ASSOCIATED DATA DOCUMENT FOR REFERENCE CHARACTERISTICS FOR INDIVIDUAL DATASETS

SYMBOL		PARAMETRIC VALUES	
x	.102	MACH	4.530
		ALPHA	.000
		DALPHA	.000
		ELEVTR	.000
		Y	-200.000
		BETA	.000
		DBETA	.000
		ALURON	10.000
		TOTAL	110.000

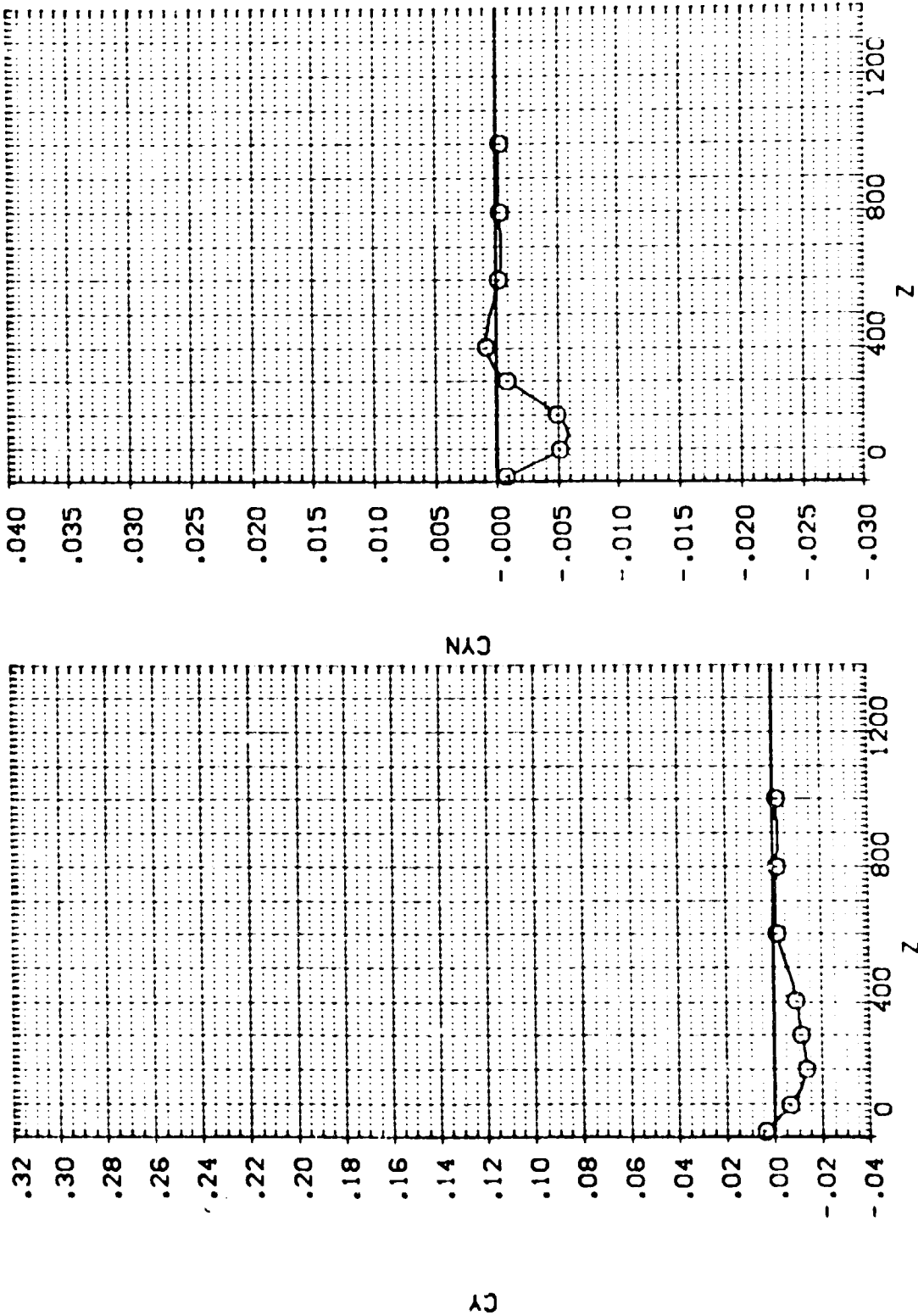

EFFECT OF EXTERNAL TANK SEPARATION ON ORBITER AERODYNAMIC CHARACTERISTICS

1A13, EXTERNAL TANK(T10)SEPARATING FROM ORB. 09 (RTJ053)

SYMBOL x .136 PARAMETRIC VALUES
 O MACH 4.530 PITCH 110.000
 ALPHA .000 BETA .000
 DALPHA .000 DBETA .000
 ELEVT 0.000 AILRON 10.000
 Y .000

SEE THE ASSOCIATED DATA DOCUMENT FOR CHARACTERISTICS FOR INDIVIDUAL CASES

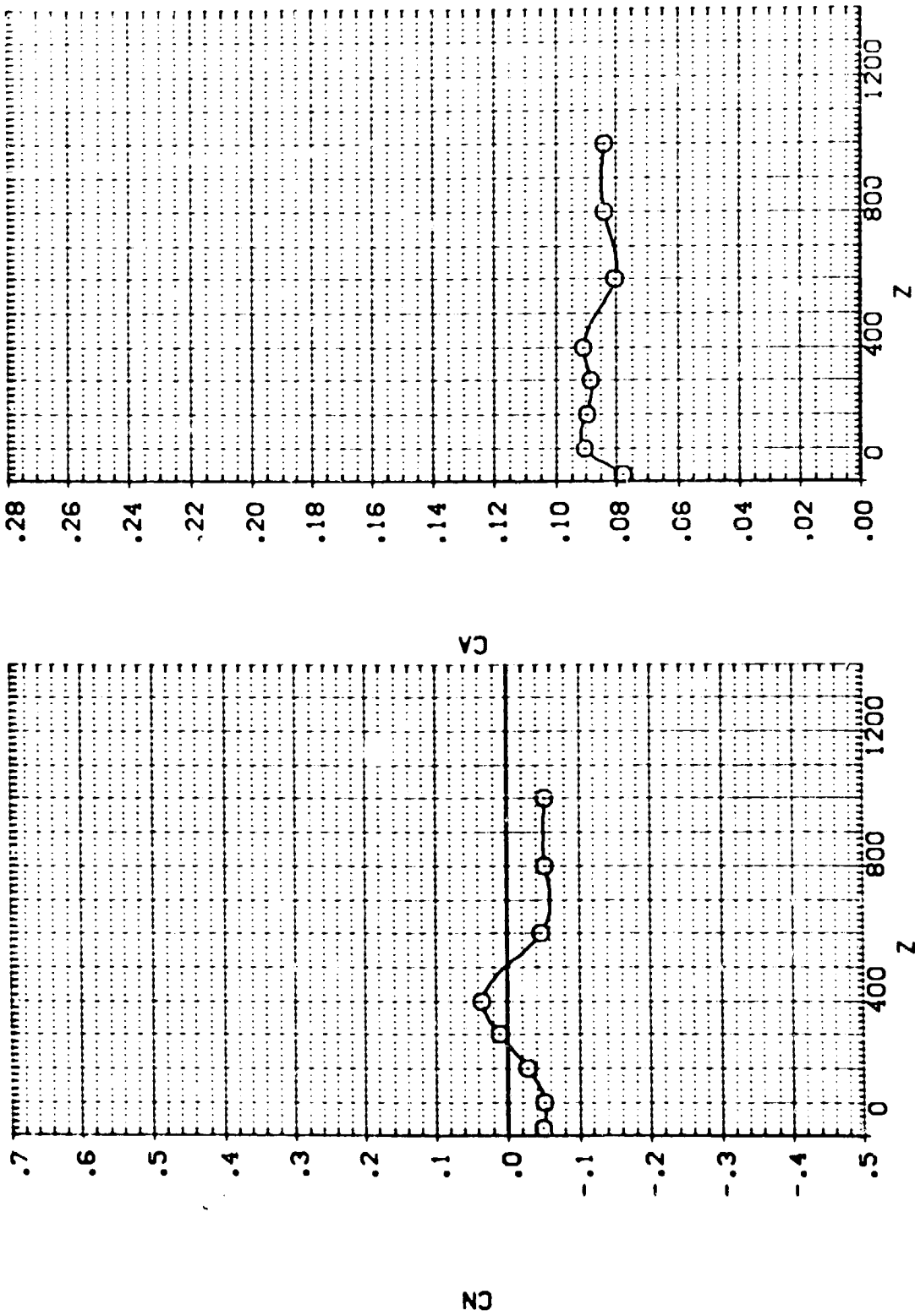

EFFECT OF EXTERNAL TANK SEPARATION ON ORBITER AERODYNAMIC CHARACTERISTICS

IA13-EXTERNAL TANK(T10)SEPARATING FROM ORB. 09 (RTJ053)

SEE THE ASSOCIATED DATA DOCUMENT FOR REFERENCE CHARACTERISTICS FOR INDIVIDUAL DATASETS

SYMBOL x .136 MACH 4.530 PITCHAL :10.000
 O ALPHA .000 BETA .000
 DALPHA .000 DBETA .000
 ELEVTX .000 AILRON 10.000
 Y .000

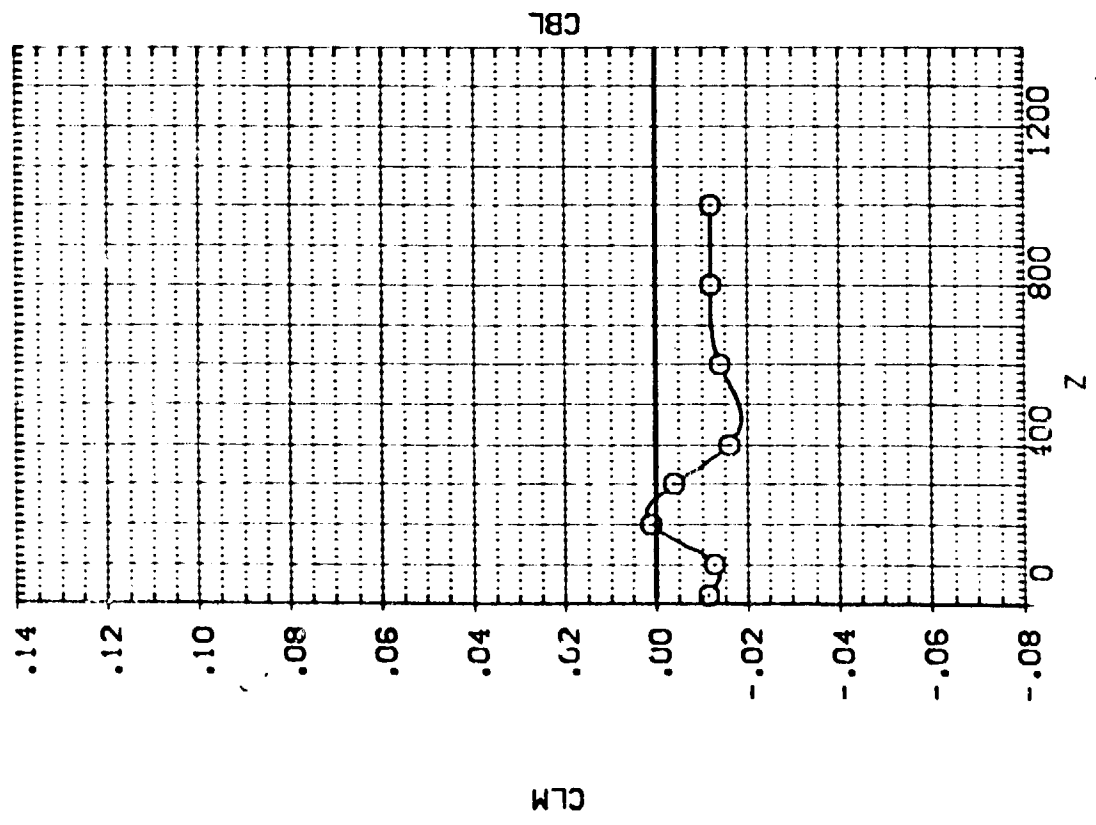
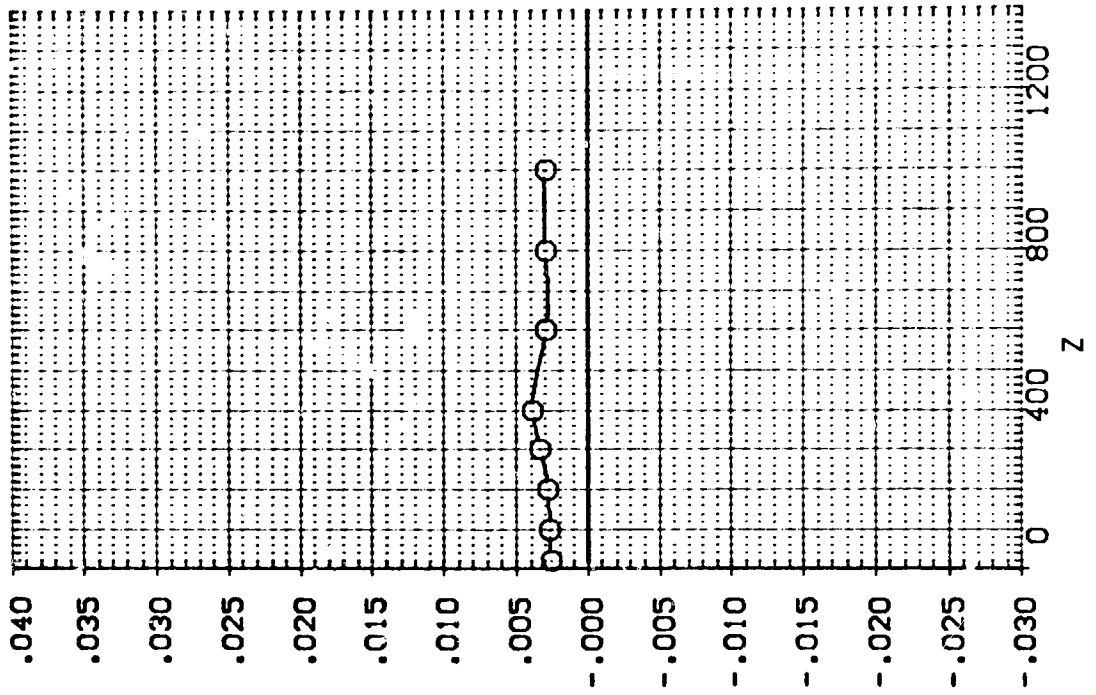

IA13.EXTERNAL TANK(T10)SEPARATING FROM ORB. 09 (RTJ053)

SEE THE ASSOCIATED DOCUMENT FOR THE CHARACTERISTICS FOR INDIVIDUAL DATASETS

SYMBOL		PARAMETRIC VALUES	
○	x	MACH	4.530
		PTOTAL	110.000
		ALPHA	.000
		BETA	.000
		DBETA	.000
		ELEVTR	.000
		Y	10.000
		AILRON	.000

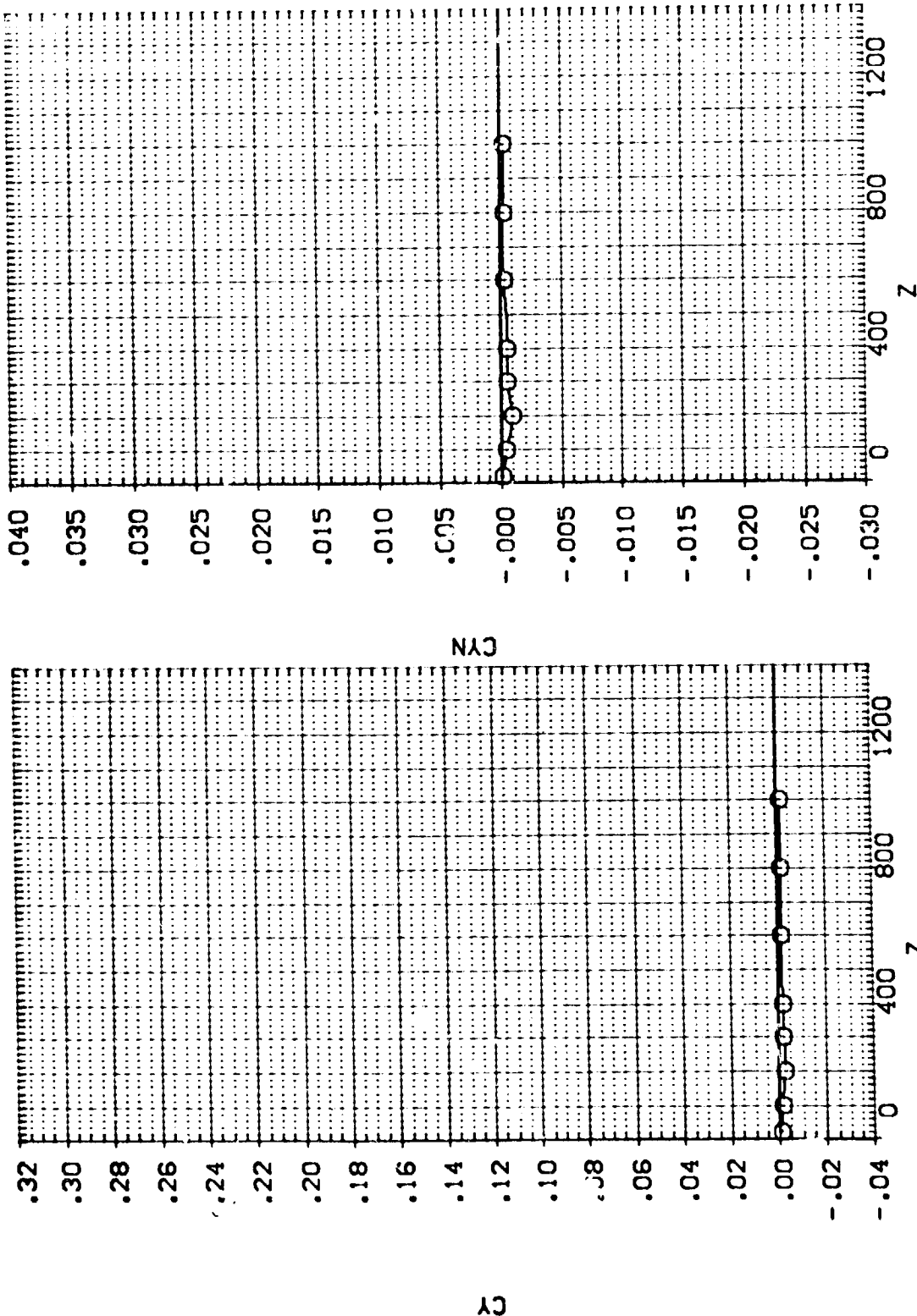

EFFECT OF EXTERNAL TANK SEPARATION ON ORBITER AERODYNAMIC CHARACTERISTICS

1A13.EXTERNAL TANK(T10)SEPARATING FROM ORB. 09 (RTJ054)

SYMBOL
O

PARAMETRIC VALUES
 MACH 4.530 PTOTAL 0.000
 ALPHA .000 BETA .000
 DALPHA .000 DBETA .000
 ELEVTR .000 AILRON 10.000
 Y 200.000

SEE THE ASSOCIATED DATA
 DOCUMENT FOR REFERENCE
 CHARACTERISTICS FOR
 INDIVIDUAL DATASETS

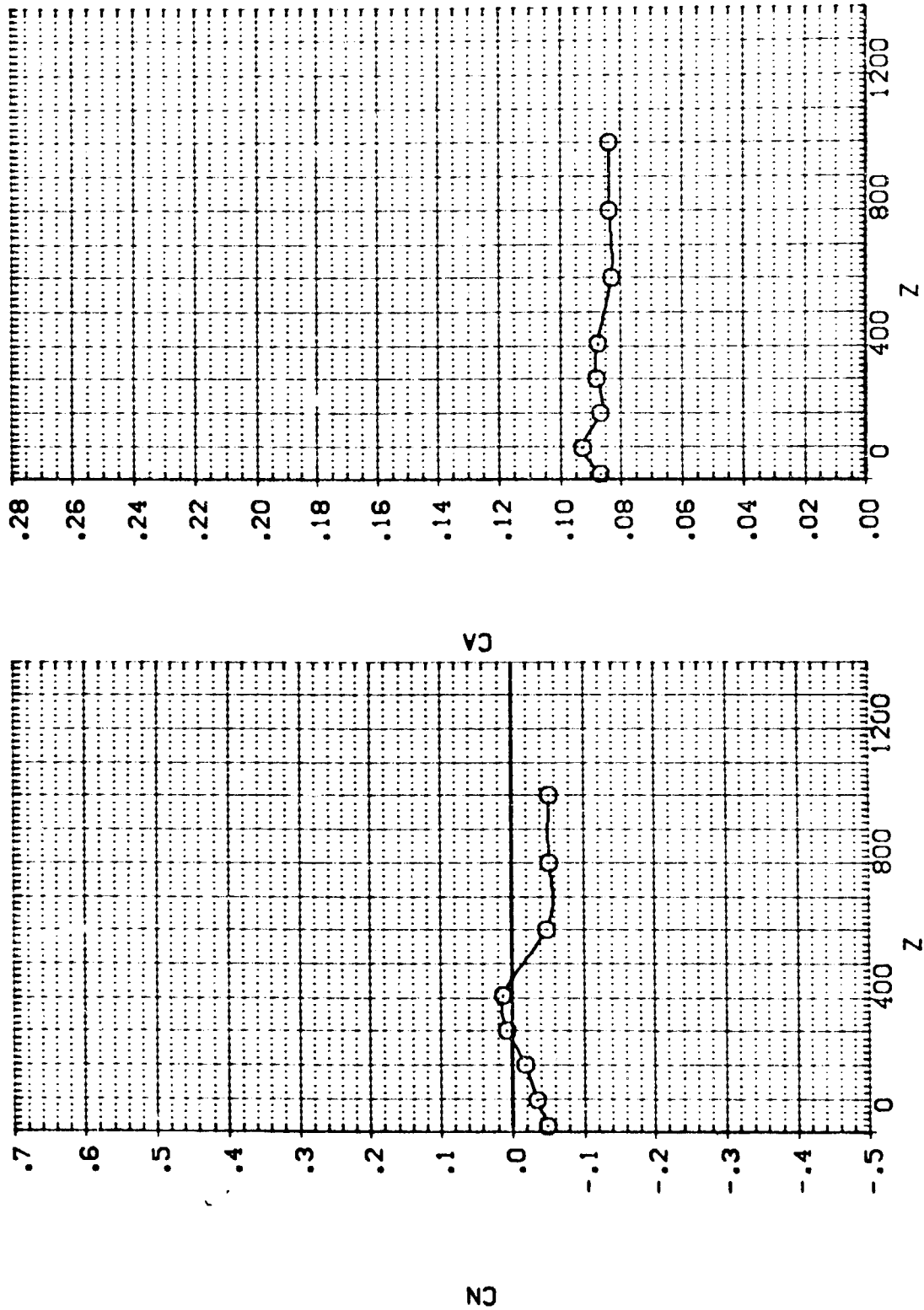

EFFECT OF EXTERNAL TANK SEPARATION ON ORBITER AERODYNAMIC CHARACTERISTICS

1A13.EXTERNAL TANK(T10)SEPARATING FROM ORB. 09 (RTJ054)

SEE THE ASSOCIATED
DOCUMENT FOR THE
CHARACTERISTICS FOR
INDIVIDUAL DATASETS

PARAMETRIC VALUES

MACH	4.530	PTOTAL	110.000
ALPHA	.000	BETA	.000
DALPHA	.000	DBETA	.000
ELEVTR	.000	AILRON	10.000
Y	200.000		

SYMBOL
O

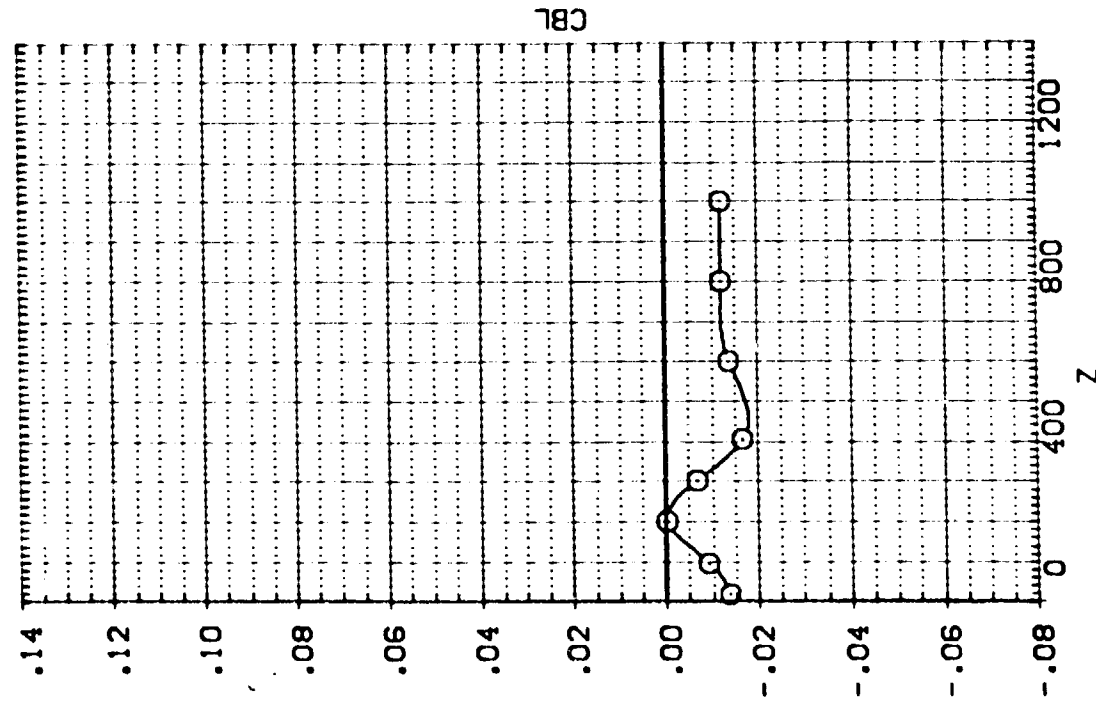
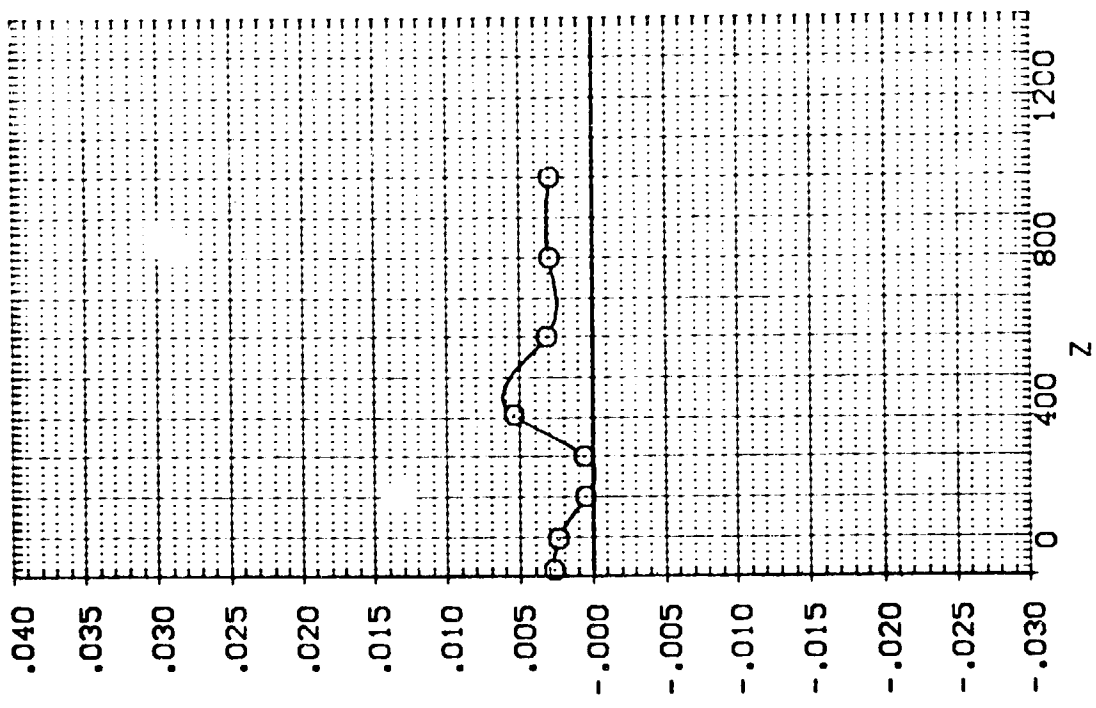

EFFECT OF EXTERNAL TANK SEPARATION ON ORBITER AERODYNAMIC CHARACTERISTICS

IA13.EXTERNAL TANK(T10)SEPARATING FROM ORB. 09 (RTJ054)

SEE THE ASSOCIATED DATA DOCUMENT FOR REFERENCE CHARACTERISTICS FOR INDIVIDUAL DATASETS

SYMBOL		PARAMETRIC VALUES	
x	.020	MACH	4.530
o		ALPHA	.000
		DALPHA	.000
		ELEVTR	.000
		Y	200.000
		BETA	.000
		DBETA	.000
		AILRON	10.000
		POTAL	110.000

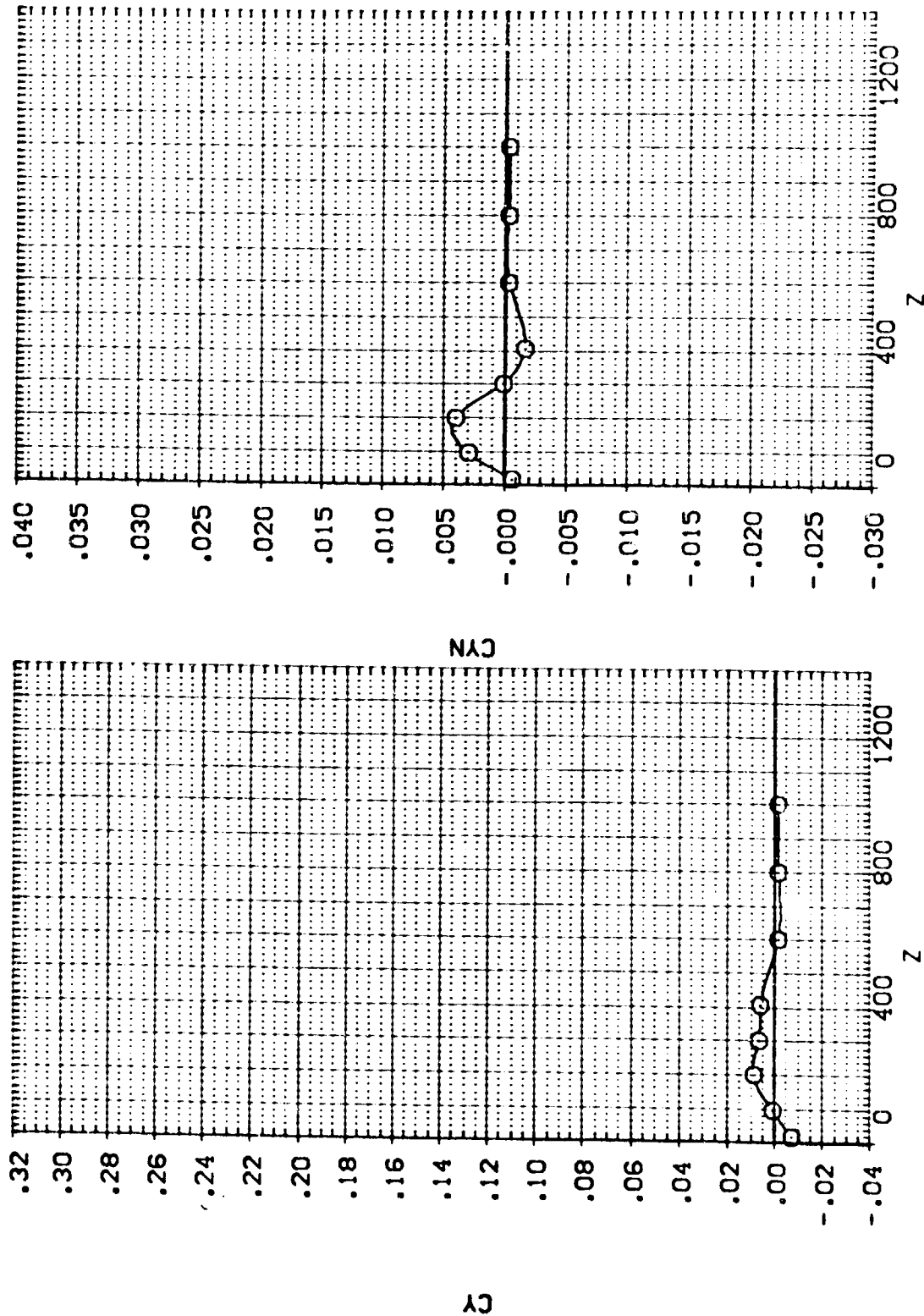

EFFECT OF EXTERNAL TANK SEPARATION ON ORBITER AERODYNAMIC CHARACTERISTICS

1A13.EXTERNAL TANK(T10)SEPARATING FROM ORB. 09 (RTJ055)

SYMBOL x .051
 O

PARAMETRIC VALUES	
MACH	4.530
ALPHA	.000
DALPHA	.000
ELEVTR	.000
Y	-200.000
PTOTAL	110.000
BETA	.000
DBETA	-5.000
AILRON	10.000

SEE THE ASSOCIATED DOCUMENT FOR REFERENCE CHARACTERISTICS FOR INDIVIDUAL DATA SETS

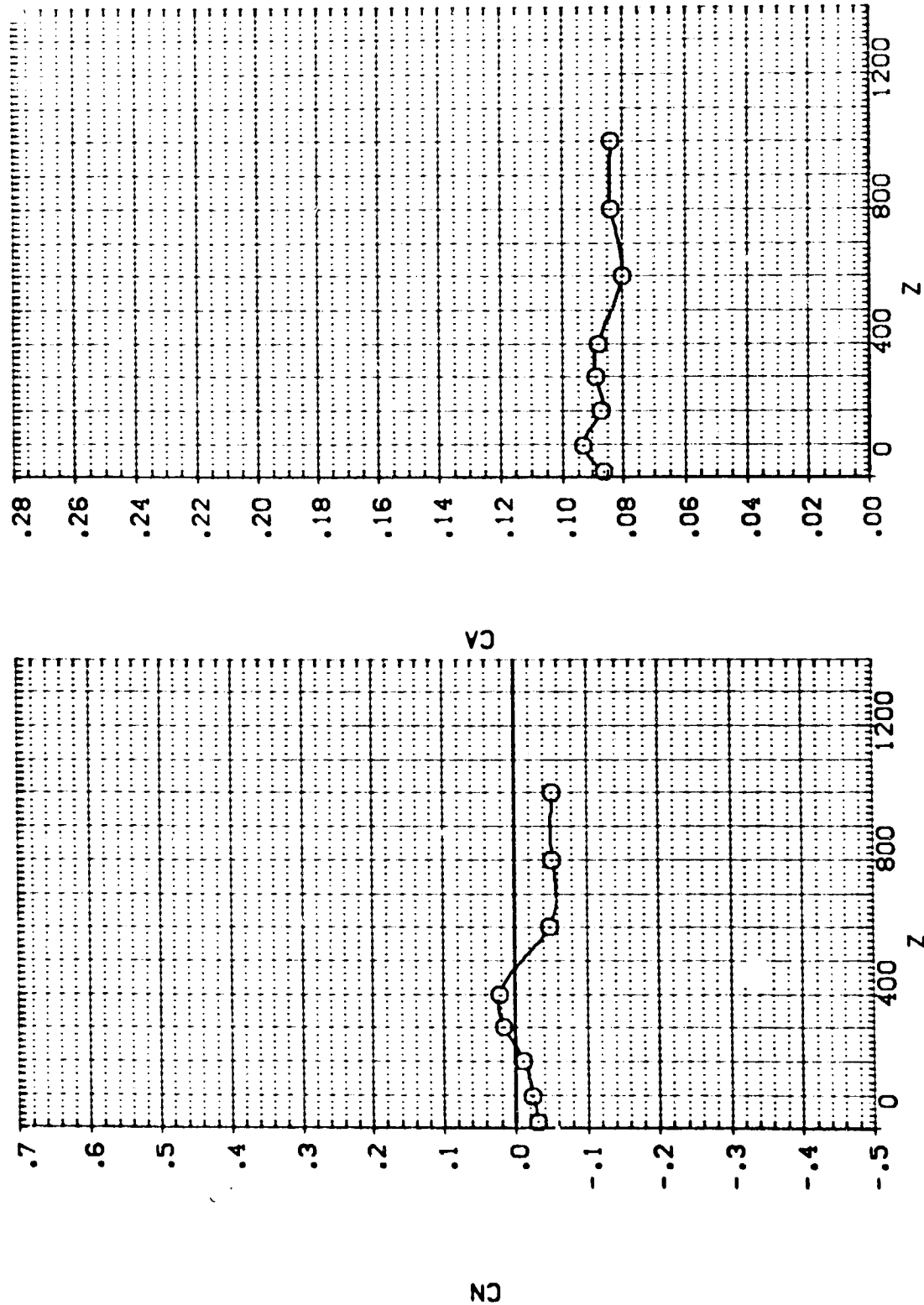

EFFECT OF EXTERNAL TANK SEPARATION ON ORBITER AERODYNAMIC CHARACTERISTICS

IA13, EXTERNAL TANK(T10)SEPARATING FROM ORB. 09 (RTJ055)

SEE THE ASSOCIATED DATA DOCUMENT FOR REFERENCE CHARACTERISTICS FOR INDIVIDUAL DATASETS

SYMBOL		PARAMETRIC VALUES	
O	X	MACH	PIOTAL
		4.530	110.000
		ALPHA	BETA
		.000	.000
		DALPHA	DBETA
		.000	-5.000
		ELEVTR	AIRTON
		Y	10.000
			-200.000

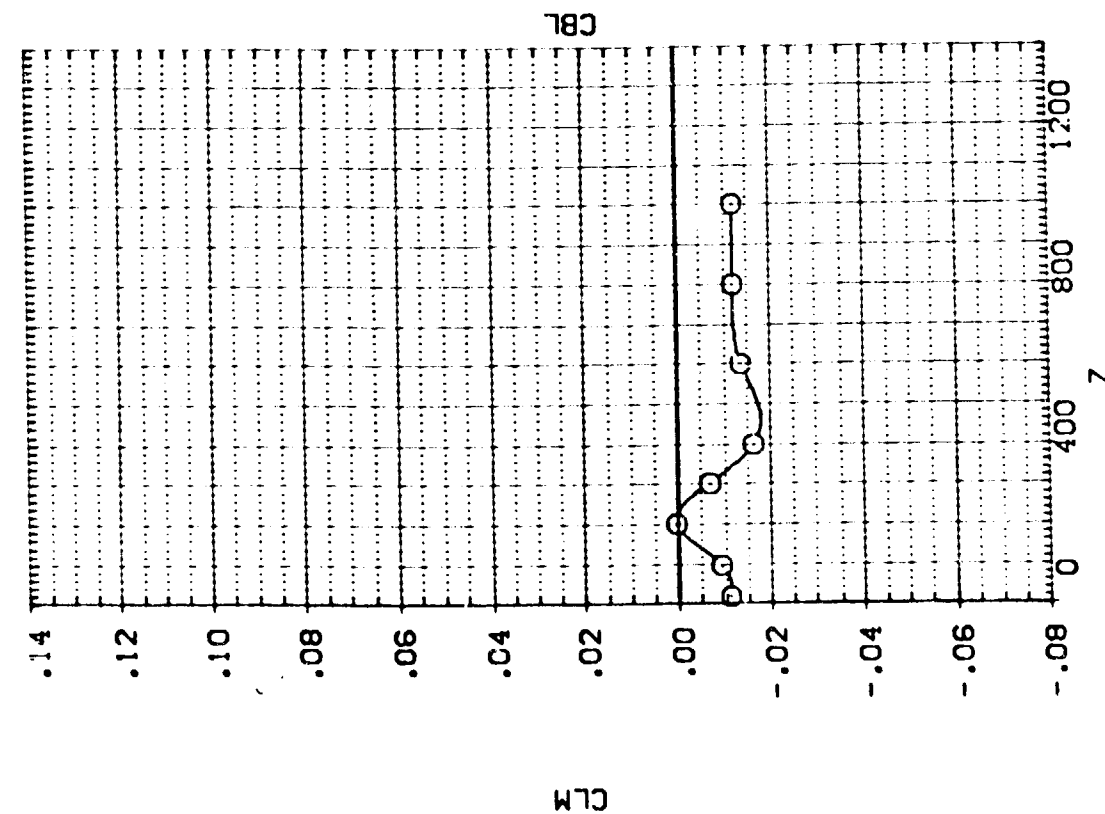
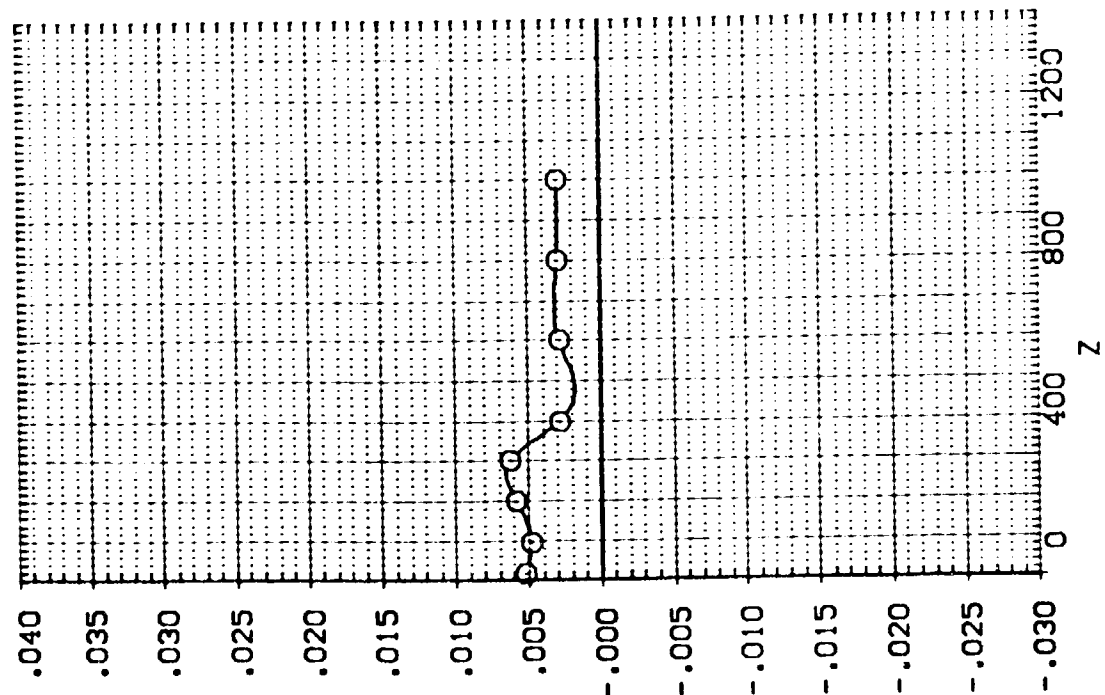

1A13-EXTERNAL TANK(T10)SEPARATING FROM ORB. 09 (RTJ055)

SEE THE ASSOCIATED DATA DOCUMENT FOR REFERENCE CHARACTERISTICS FOR INDIVIDUAL DATA SETS

SYMBOL		MACH		PARAMETRIC VALUES			
○	x	.051	4.530	PTOTAL	110.000		
	ALPHA		.000	BETA	.000		
	DALPHA		.000	DBETA	-5.000		
	ELEVTR		.000	ATLON	10.000		
	Y		-200.000				

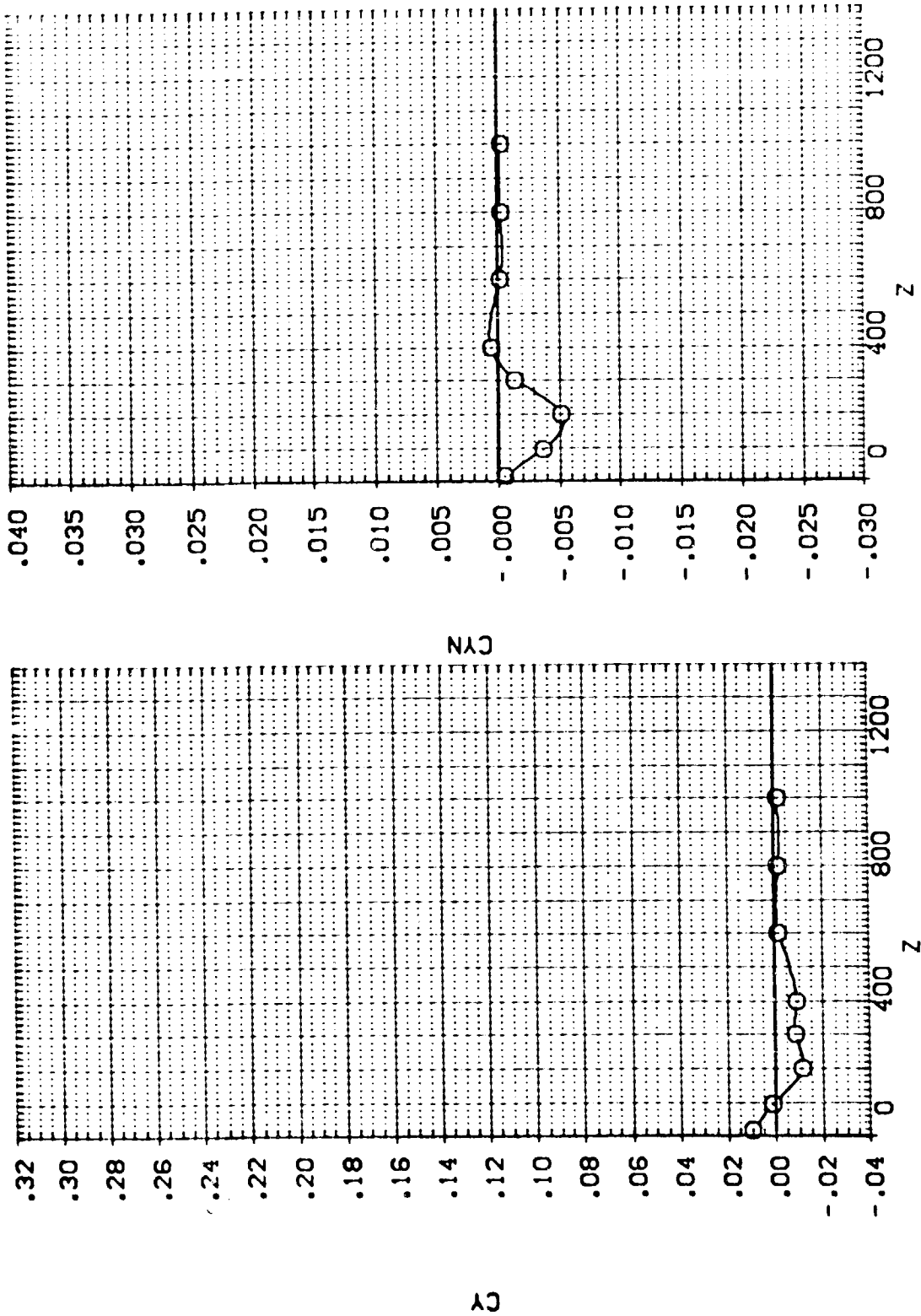

EFFECT OF EXTERNAL TANK SEPARATION ON ORBITER AERODYNAMIC CHARACTERISTICS

1A13.EXTERNAL TANK(110)SEPARATING FROM ORB. 09 (RTJ056)

SEE THE ASSOCIATED DATA DOCUMENT FOR REFERENCE CHARACTERISTICS FOR INDIVIDUAL DATASETS

SYMBOL		PARAMETRIC VALUES	
O	X	MACH	PTOTAL
		4.530	110.000
		ALP A	BETA
		.000	.000
		C -A	DBETA
		.000	5.000
		ELEVTR	AILRON
		.000	10.000
		Y	
		.000	

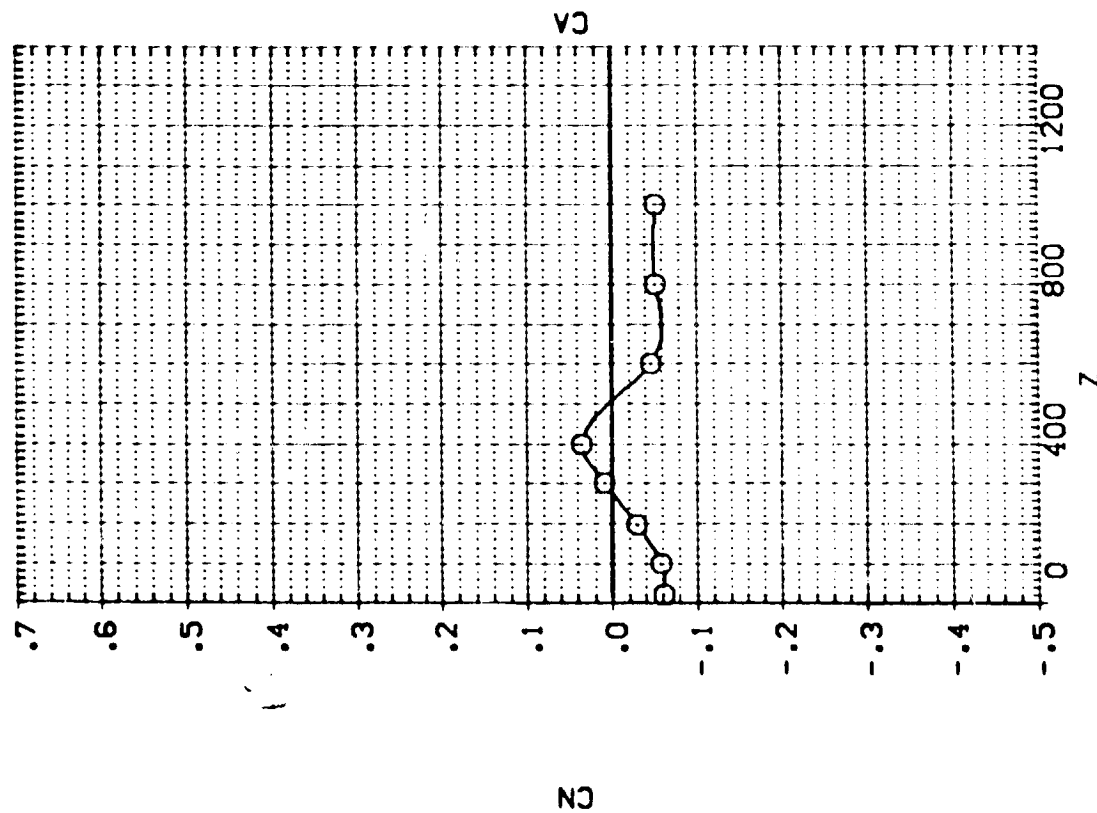
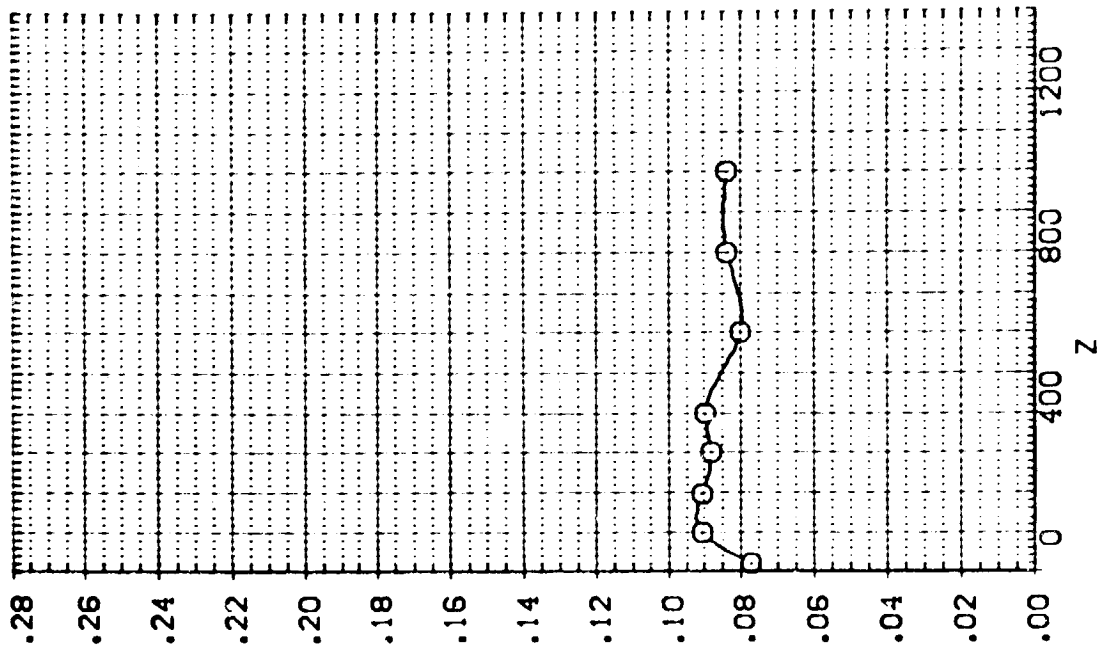

EFFECT OF EXTERNAL TANK SEPARATION ON ORBITER AERODYNAMIC CHARACTERISTICS

IA13. EXTERNAL TANK(T10)SEPARATING FROM ORB. 09 (RTJ056)

SYMBOL
O

PARAMETRIC VALUES
 MACH 4.530 PTDOTAL 110.000
 ALPHA .000 BETA .000
 DALPHA .000 DBETA 5.000
 ELEVTYR .000 AILRON 10.000
 Y .000

SEE THE ASSOCIATED
 DOCUMENT FOR REFERENCE
 CHARACTERISTICS FOR
 INDIVIDUAL DATASETS

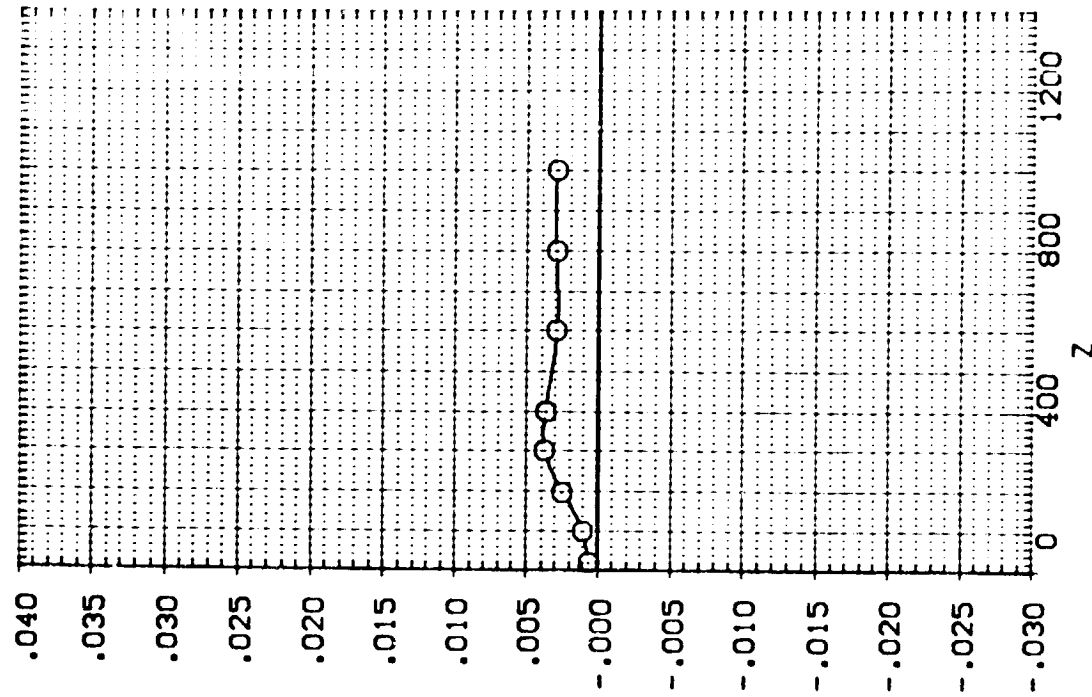
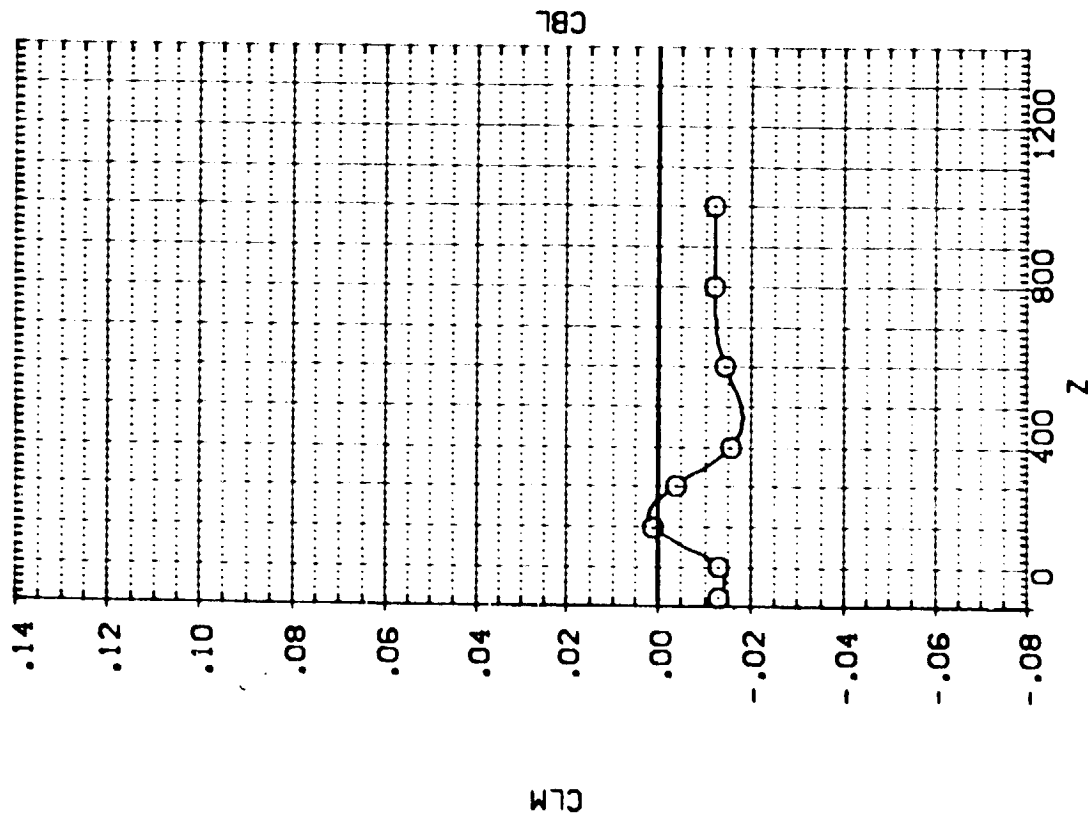

EFFECT OF EXTERNAL TANK SEPARATION ON ORBITER AERODYNAMIC CHARACTERISTICS

1A13. EXTERNAL TANK(T10)SEPARATING FROM ORB. 09 (RTJ056)

SEE THE ASSOCIATED DATA DOCUMENT FOR REFERENCE CHARACTERISTICS FOR INDIVIDUAL DATASETS

SYMBOL		PARAMETRIC VALUES	
x	.106	MACH	4.530
		PTOTAL	110.000
		BETA	.000
		DBETA	5.000
		AILRON	10.000
		Y	.000

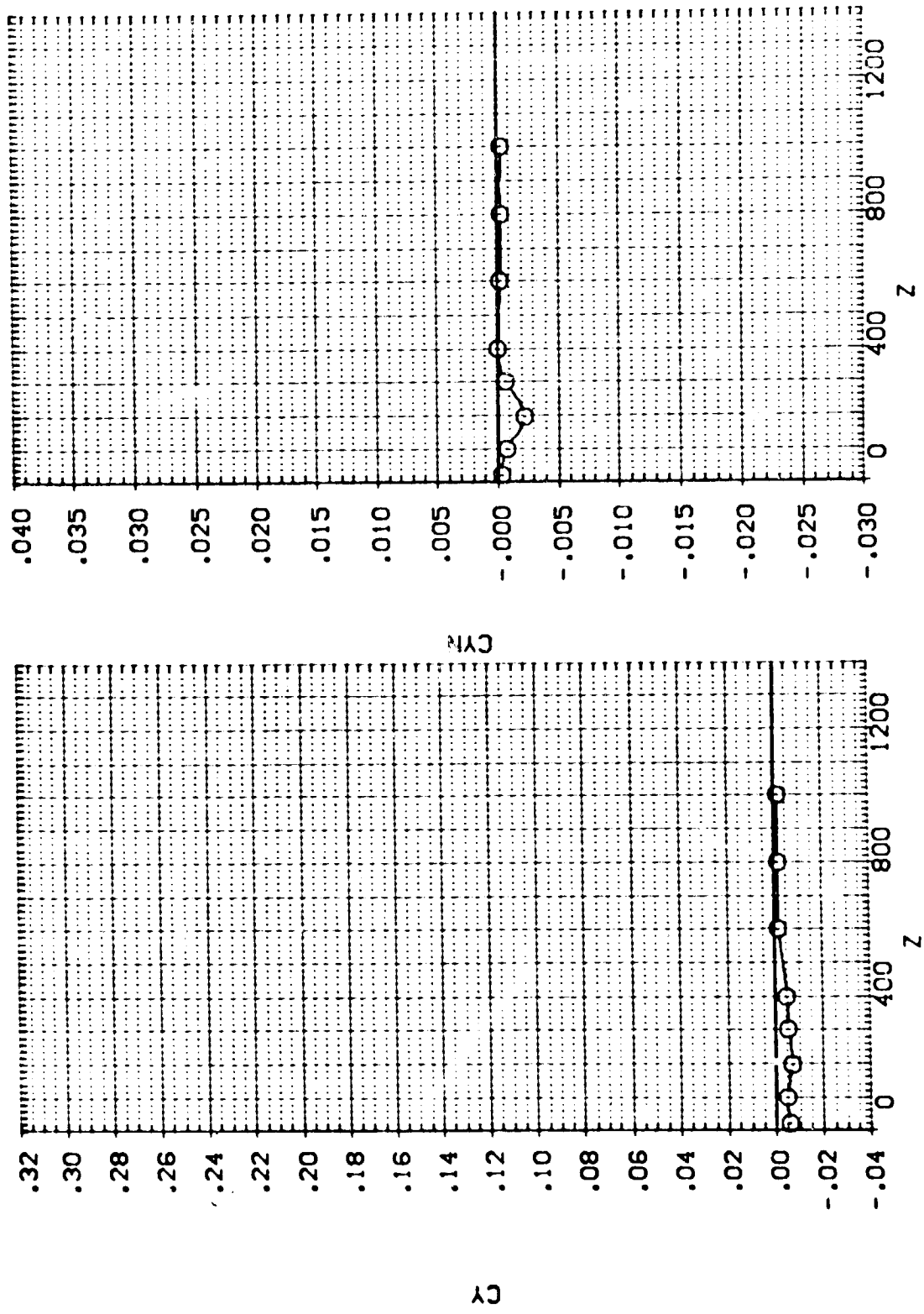

EFFECT OF EXTERNAL TANK SEPARATION ON ORBITER AERODYNAMIC CHARACTERISTICS

1.13. EXTERNAL TANK (110) SEPARATING FROM ORB. OS (RTJ057)

SEE THE ASSOCIATED
DOCUMENT FOR REFERENCE
CHARACTERISTICS FOR
INDIVIDUAL DATASETS

PARAMETRIC VALUES	
MACH	4.530
ALPHA	.000
DALPHA	.000
ELEVTR	.000
Y	200.000
PTOTAL	110.000
BETA	.000
DBETA	5.000
ALFRON	10.000

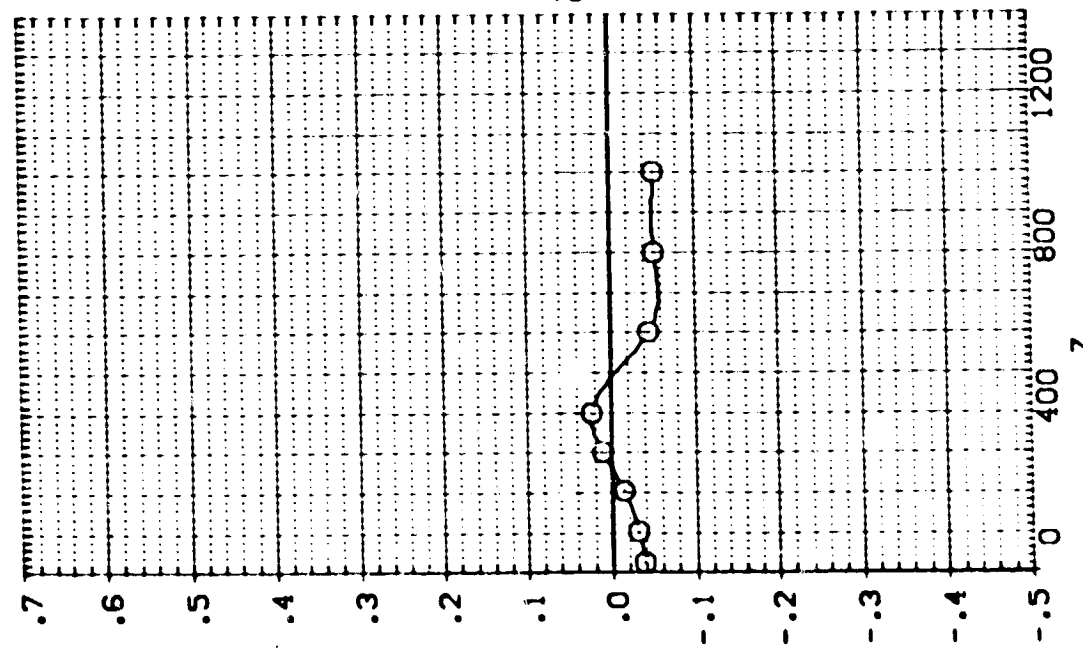
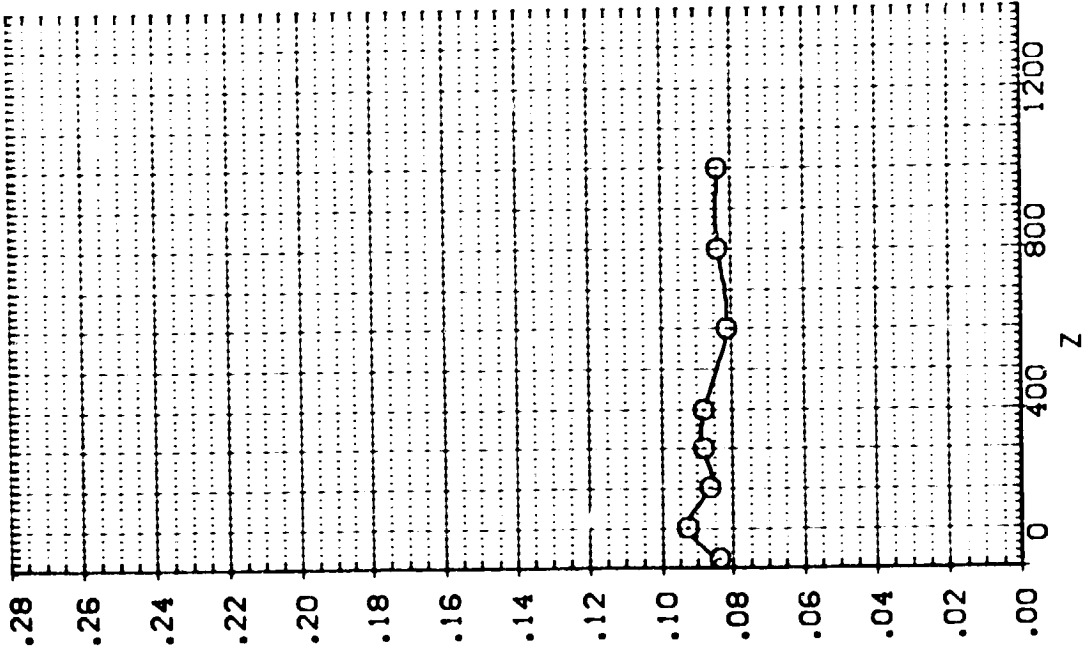

EFFECT OF EXTERNAL TANK SEPARATION ON ORBITER AERODYNAMIC CHARACTERISTICS

1.13. EXTERNAL TANK(T10)SEPARATING FROM ORB. 09 (R.J057)

SEE THE ASSOCIATED DATA DOCUMENT FOR REFERENCE CHARACTERISTICS FOR INDIVIDUAL DATA SETS

SYMBOL		PARAMETRIC VALUES			
x	.268	MACH	4.530	PTOTAL	110.000
		ALPHA	.000	BETA	.000
		DALPHA	.000	DBETA	5.000
		ELEVTR	.000	AILRON	10.000
y	200.000				

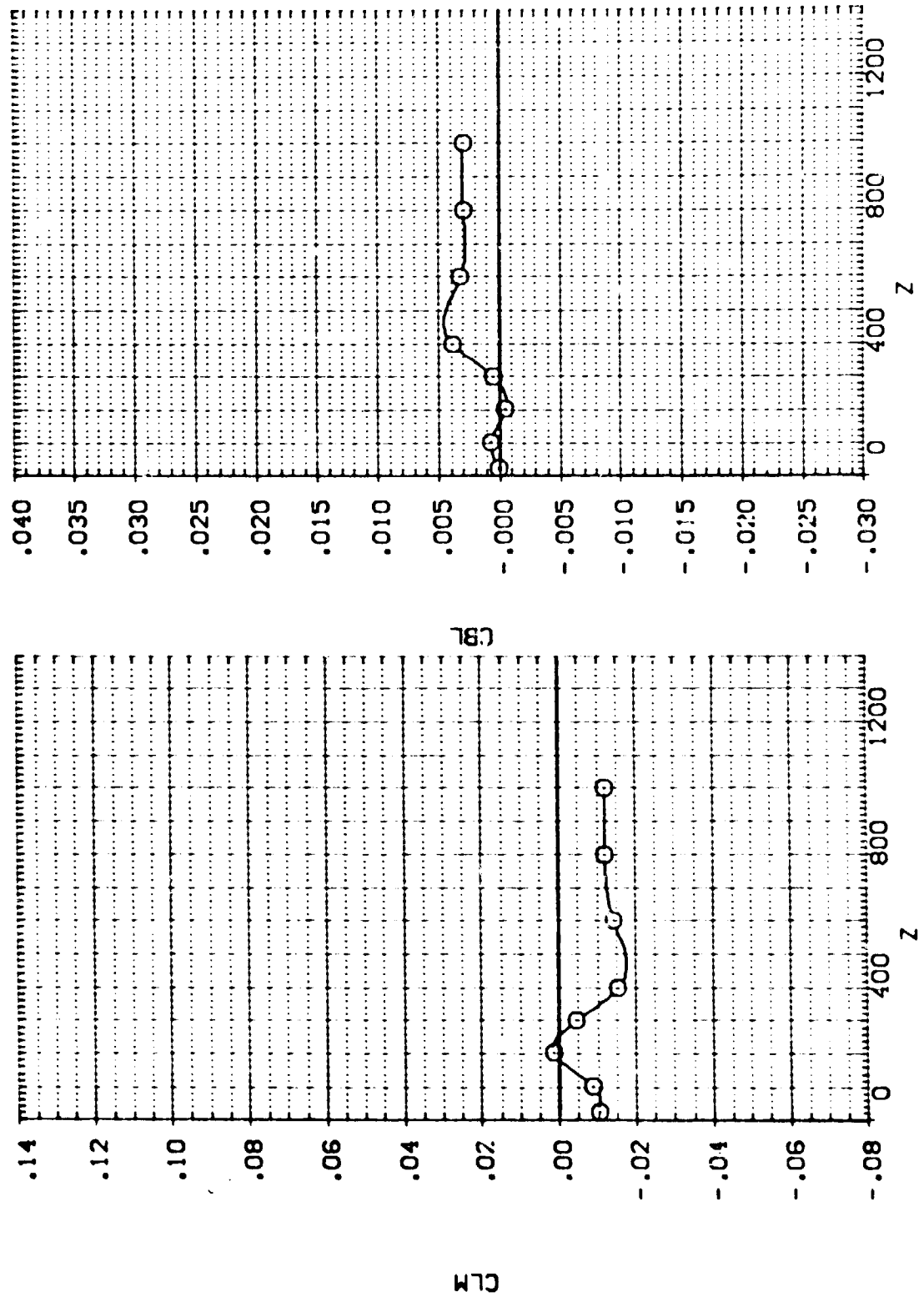

EFFECT OF EXTERNAL TANK SEPARATION ON ORBITER AERODYNAMIC CHARACTERISTICS

1A13.EXTERNAL TANK(TO)SEPARATING FROM ORB. 09 (RTJ057)

SEE THE ATTACHED DOCUMENT FOR CHARACTERISTICS FOR INDIVIDUAL DATA SETS

PARAMETRIC VALUES	
MACH	4.530
ALPHA	.000
BETA	.000
DELTA	.000
ELEVTR	.000
Y	200.000
PTOTAL	110.000
DBETA	5.000
AILRON	10.000

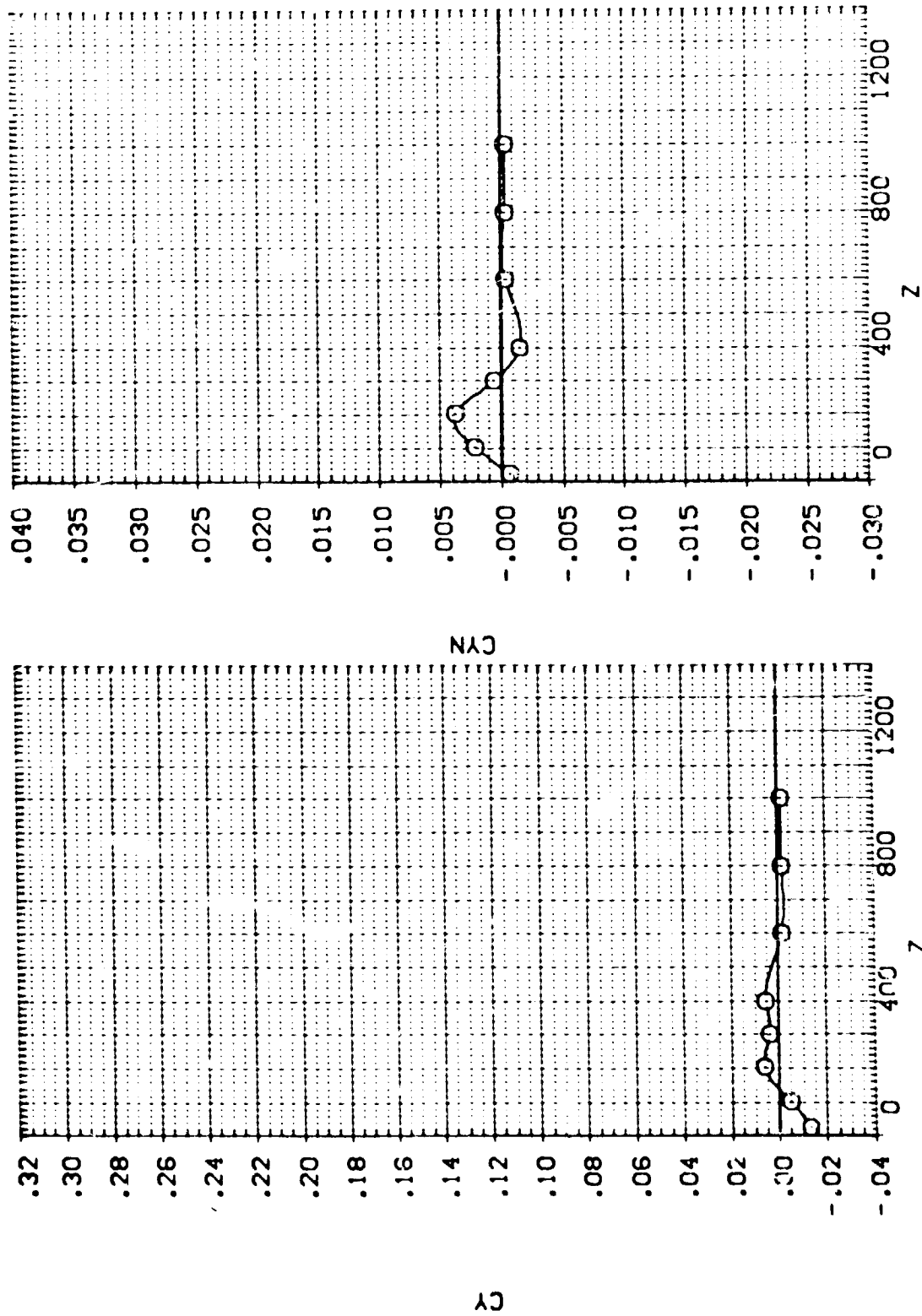

EFFECT OF EXTERNAL TANK SEPARATION ON ORBITER AERODYNAMIC CHARACTERISTICS

IA13, EXTERNAL TANK(T10) SEPARATING FROM ORB. 09 (RTJ058)

SYMBOL		PARAMETRIC VALUES			
O	X	MACH	4.530	P-TOTAL	1110.000
		ALPHA	.000	BETA	.000
		ELEVTR	-10.000	DBETA	.000
		Y	-200.000	AILRON	10.000

SEE THE ASSOCIATED DATA DOCUMENT FOR REFERENCE CHARACTERISTICS FOR INDIVIDUAL DATASETS

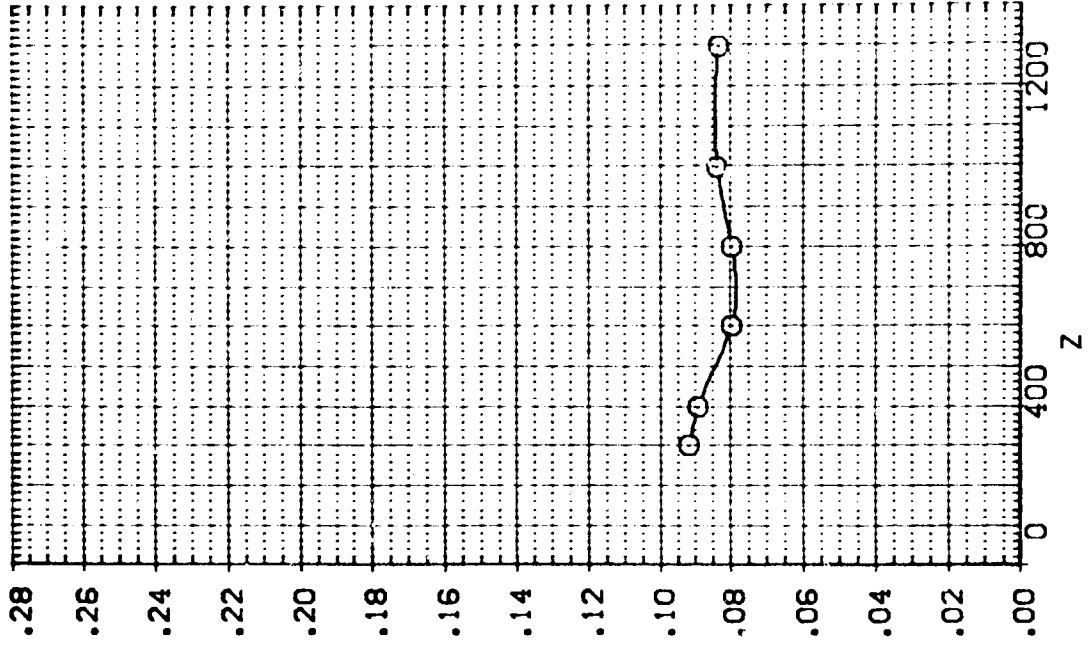
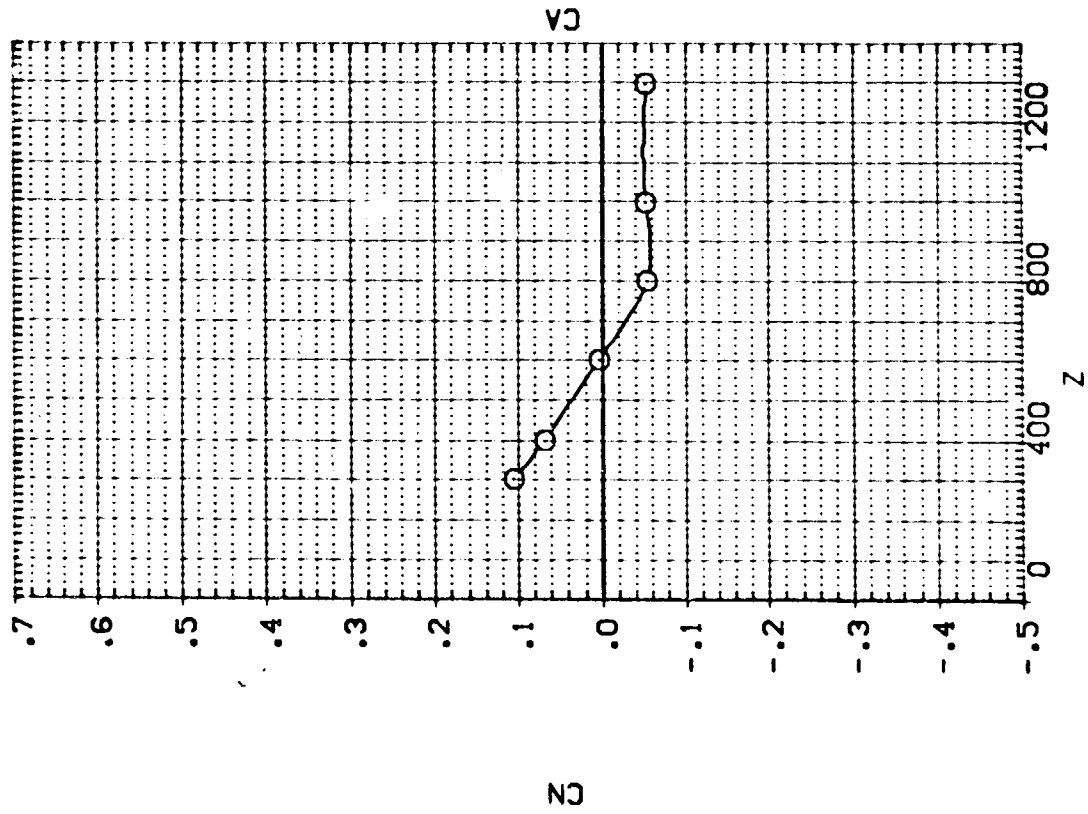

IA13, EXTERNAL TANK (T10) SEPARATING FROM ORB. 09 (RTJ058)

SEE THE ASSOCIATED DOCUMENT FOR MORE CHARACTERISTICS FOR INDIVIDUAL DATASETS

SYMBOL x .158
O

PARAMETRIC VALUES
 MACH 4.530 PTOTAL 110.000
 ALPHA .000 BETA .000
 DALPHA -10.000 DBETA .000
 ELEVTR .000 AILPON 10.000
 Y -200.000

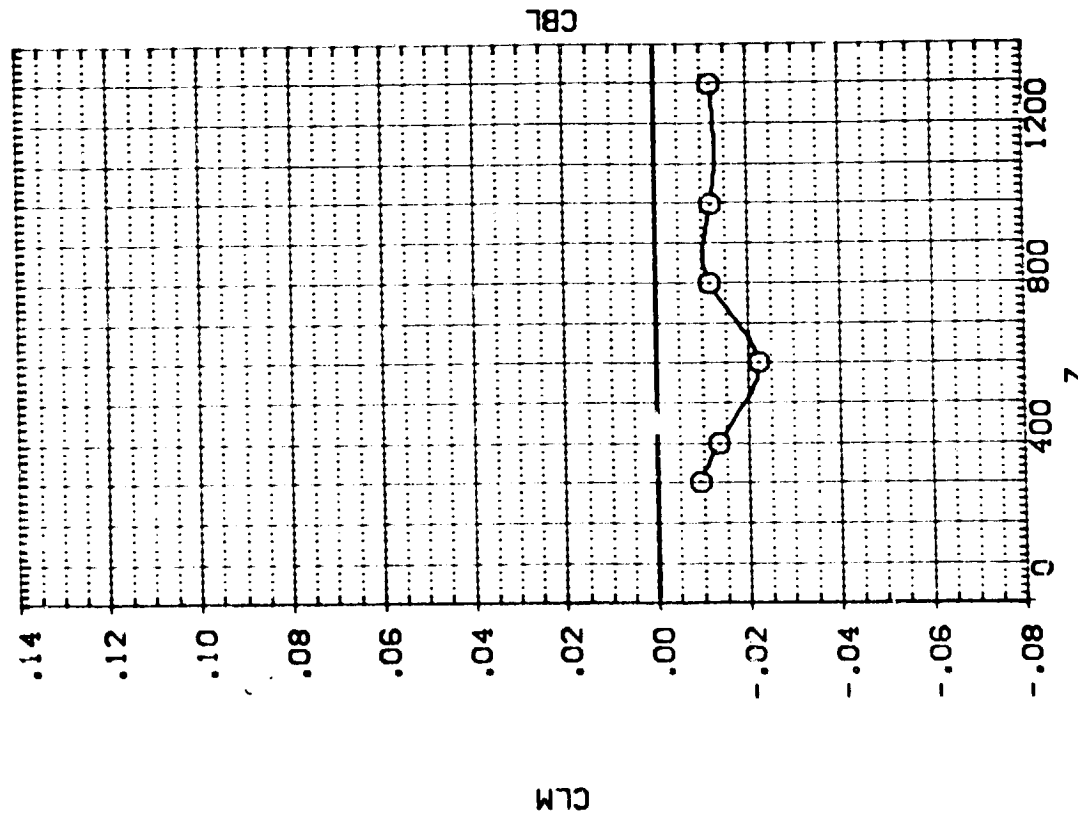
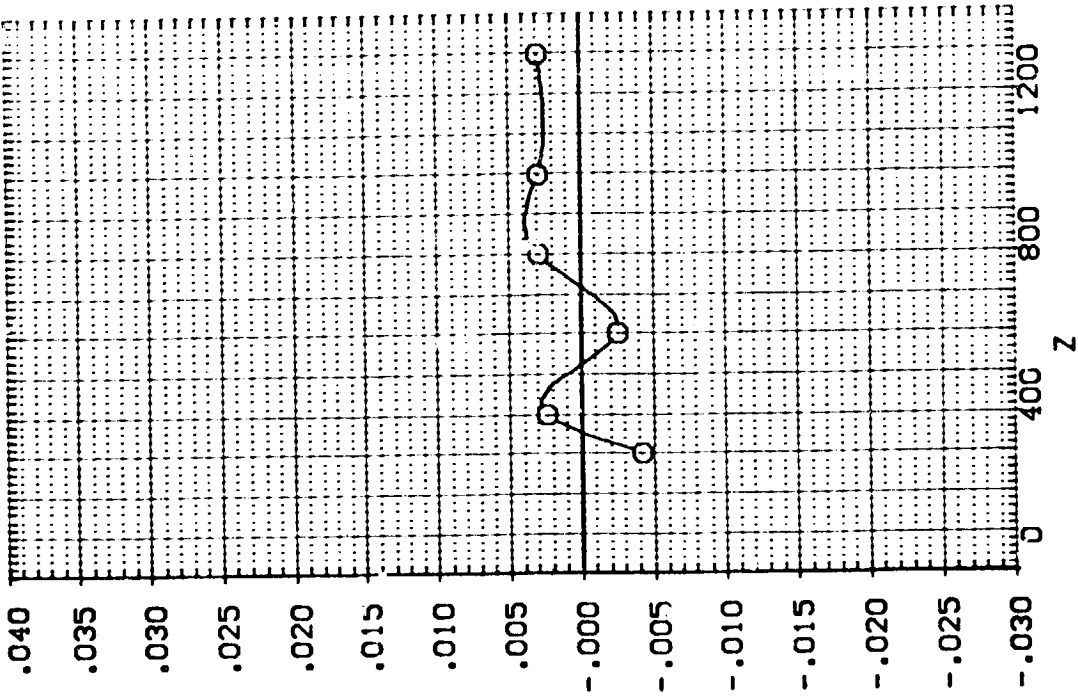

EFFECT OF EXTERNAL TANK SEPARATION ON ORBITER AERODYNAMIC CHARACTERISTICS

1A13.EXTERNAL TANK(T10)SEPARATING FROM ORB. 09 (RTJ058)

SEE THE ASSOCIATED DATA DOCUMENT FOR REFERENCE CHARACTERISTICS FOR INDIVIDUAL DATASETS

SYMBOL		PARAMETRIC VALUES	
O	X	MACH	110.000
		ALPHA	.000
		BETA	.000
		DBETA	10.000
		ELEVTR	.000
		AILRON	10.000
		Y	-200.000

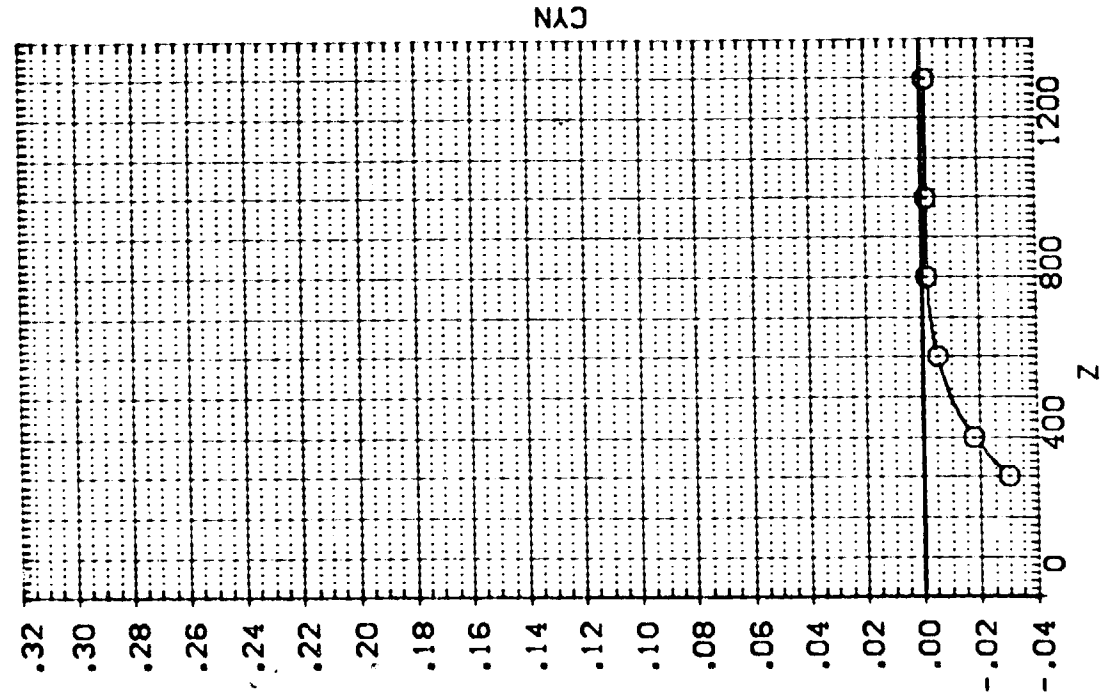
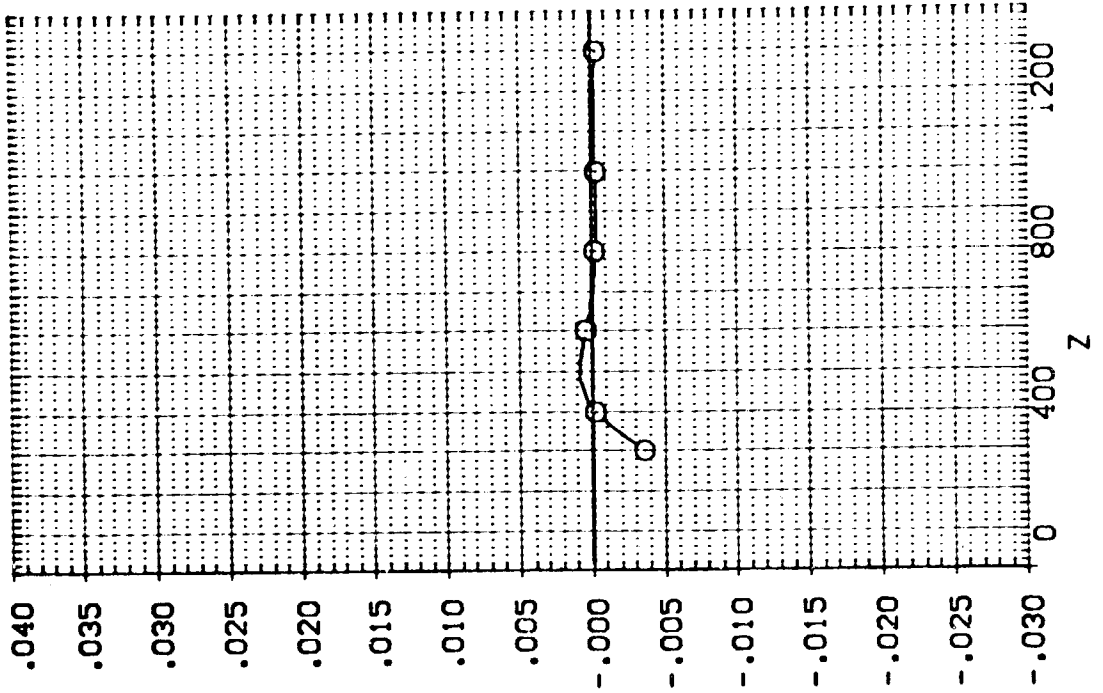

IA13. EXTERNAL TANK(T10)SEPARATING FROM ORB. 09 (RTJ059)

SYMBOL X
O

PARAMETRIC VALUES		
MACH	4.530	PTOTAL 110.000
ALPHA	.000	BETA .000
DALPHA	-10.000	DBETA .000
ELEVTR	.000	AILRON 10.000
Y	.000	

SEE THE ACCOMPANYING DOCUMENT FOR THE CHARACTERISTICS FOR INDIVIDUAL DATA SETS

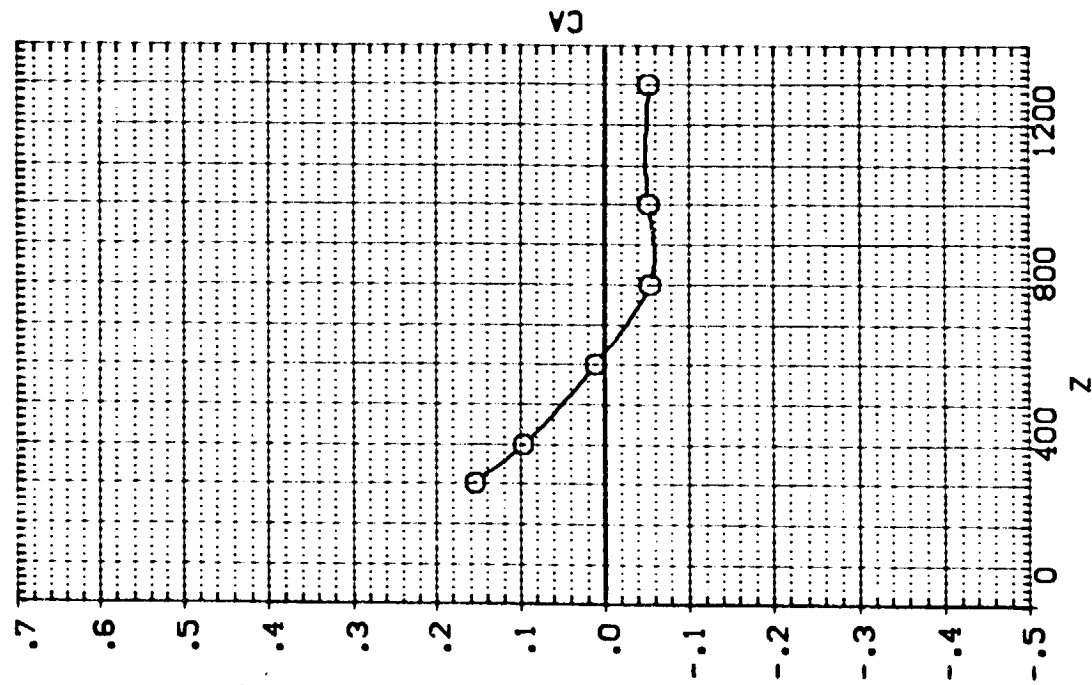
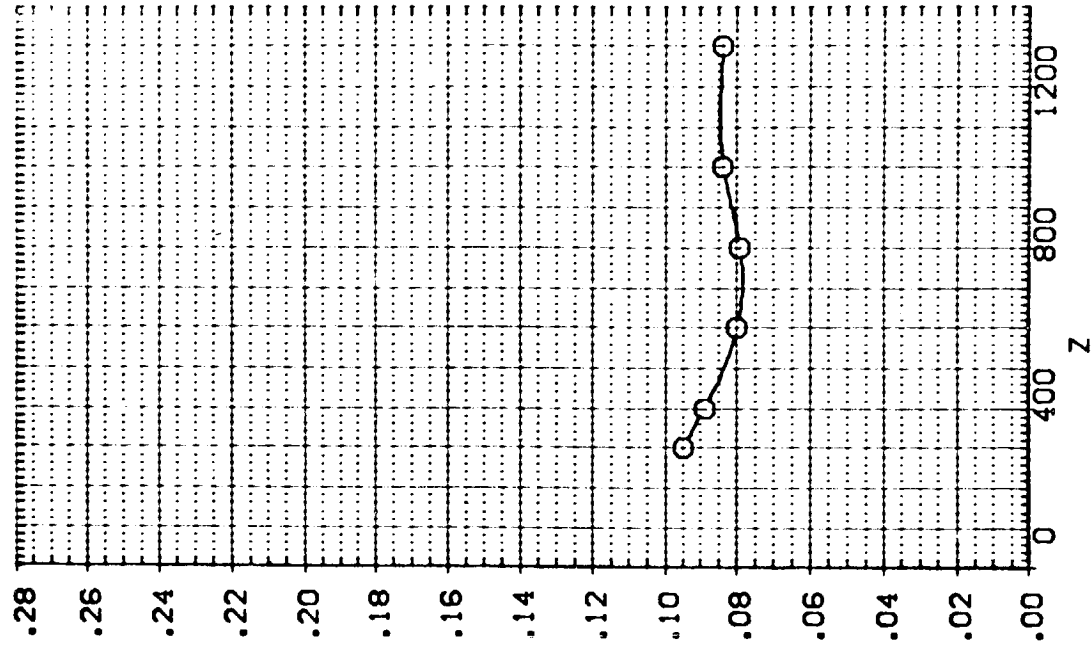

EFFECT OF EXTERNAL TANK SEPARATION ON ORBITER AERODYNAMIC CHARACTERISTICS

1A13.EXTERNAL TANK(T10)SEPARATING FROM ORB. 09 (RTJ059)

SEE THE ASSOCIATED DATA DOCUMENT FOR REFERENCE CHARACTERISTICS FOR INDIVIDUAL DATASETS

SYMBOL		PARAMETRIC VALUES	
x	.151	MACH	4.530
o		PIOTAL	110.000
		BETA	.000
		DBETA	.000
		AILRON	10.000
		Y	.000

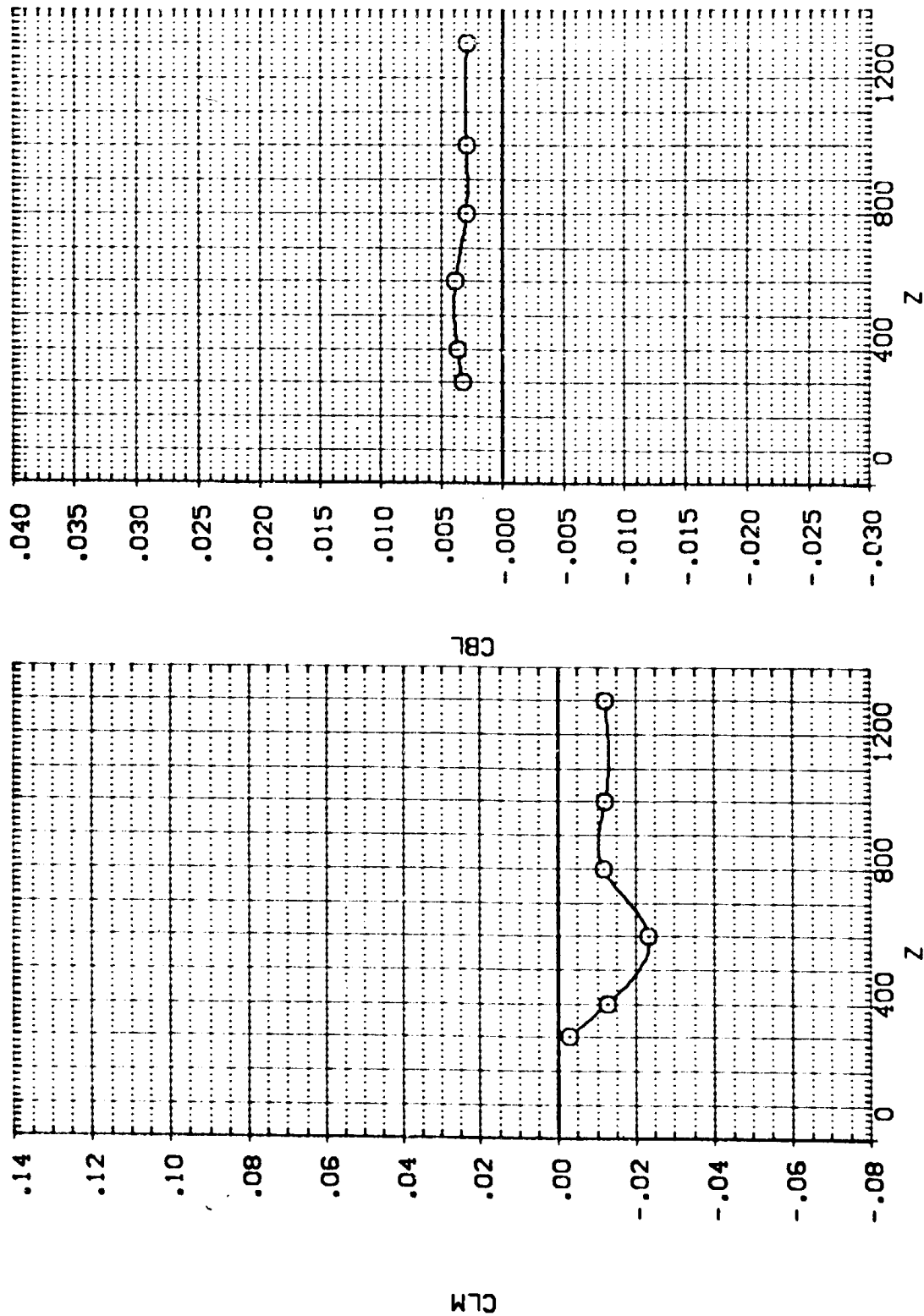

EFFECT OF EXTERNAL TANK SEPARATION ON ORBITER AERODYNAMIC CHARACTERISTICS

IA13, EXTERNAL TANK(T10)SEPARATING FROM ORB. 09 (RTJ059)

SEE THE ASSOCIATED
DOCUMENT FOR REFERENCE
CHARACTERISTICS FOR
INDIVIDUAL DATASETS

PARAMETRIC VALUES		
MACH	4.530	PTOTAL 110.000
ALPHA	.000	BETA .000
DALPHA	-10.000	DBETA .000
ELEVTR	.000	AILRON 10.000
Y	.000	

SYMBOL x .151

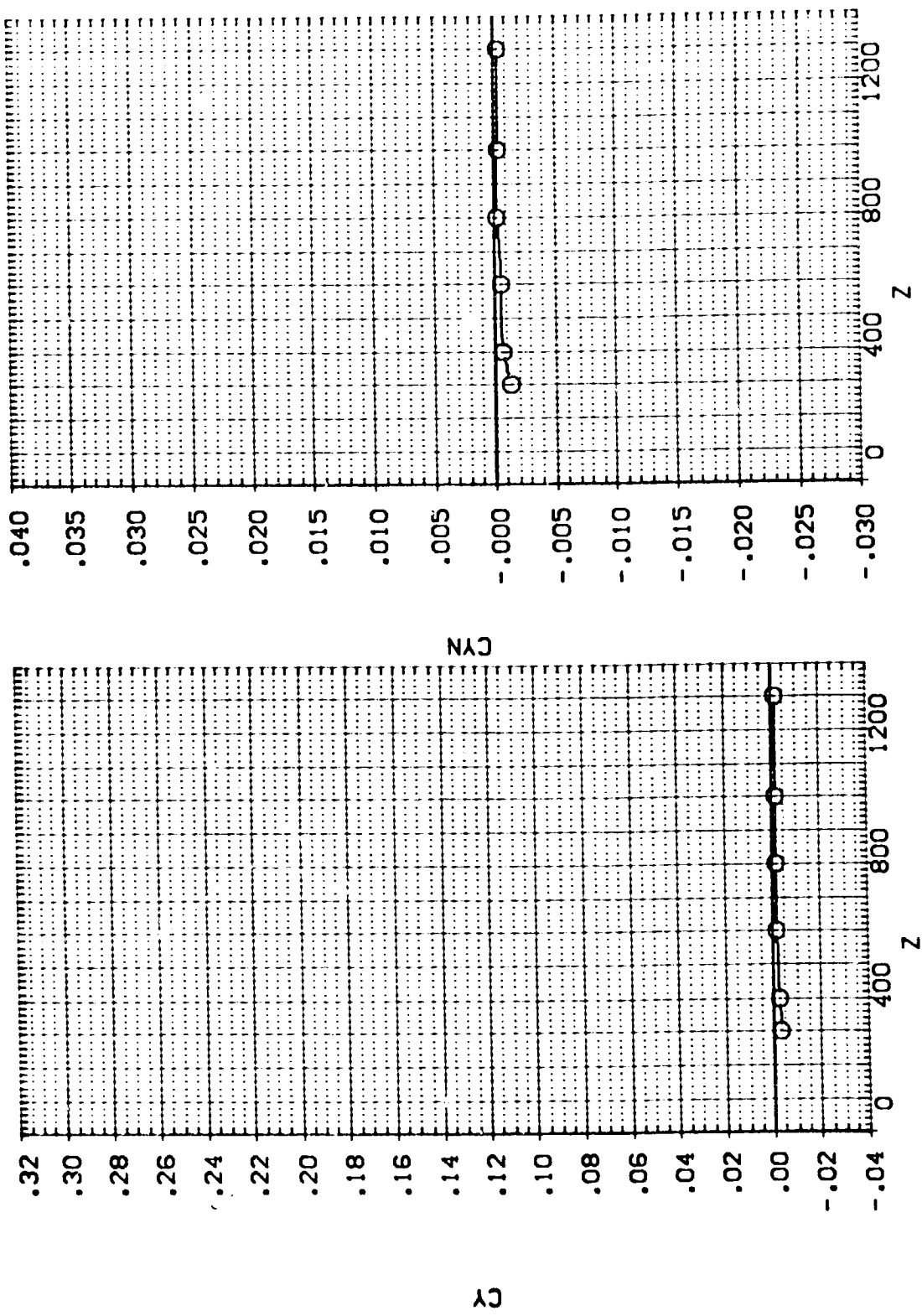

EFFECT OF EXTERNAL TANK SEPARATION ON ORBITER AERODYNAMIC CHARACTERISTICS

IA13, EXTERNAL TANK (10) SEPARATING FROM ORB. 09 (RTJ060)

SYMBOL		PARAMETRIC VALUES	
x	.174	MACH	4.530
o		PTOTAL	110.000
		ALPHA	.000
		BETA	.000
		DBETA	.000
		ELEVTR	-10.000
		AILRON	10.000
		Y	200.000

SEE THE ASSOCIATED DATA DOCUMENT FOR REFERENCE CHARACTERISTICS FOR INDIVIDUAL DATASETS

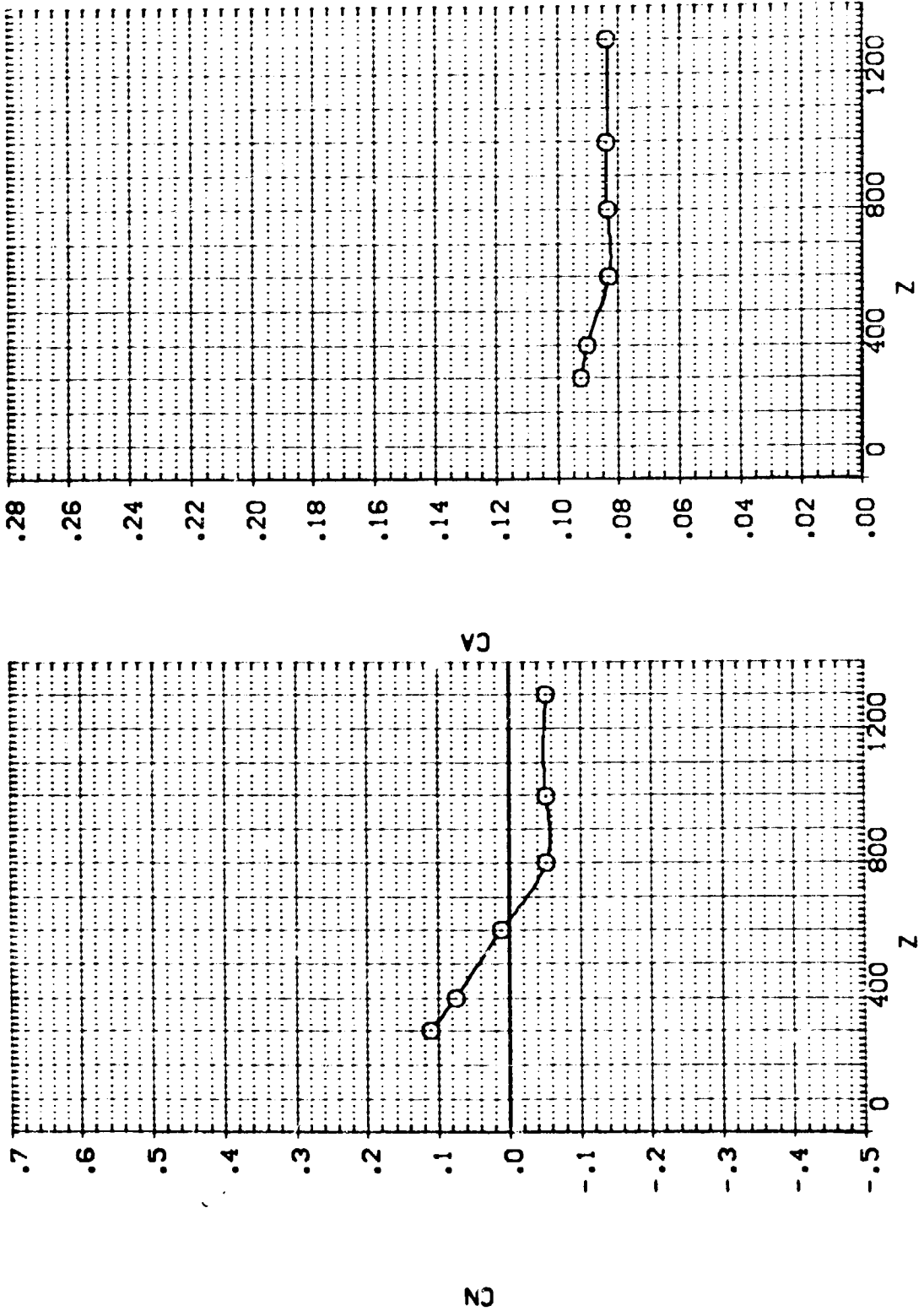

IA13.EXTERNAL TANK(T10)SEPARATING FROM ORB. 09 (RTJ060)

SEE THE ASSOCIATED DOCUMENT FOR REFERENCE CHARACTERISTICS FOR INDIVIDUAL DATASETS

SYMBOL		PARAMETRIC VALUES	
x	.174	MACH	4.530
○		ALPHA	.000
		BETA	.000
		DELTA	.000
		ELEVTR	.000
		AILTRON	10.000
		Y	200.000
		POTIAL	110.000

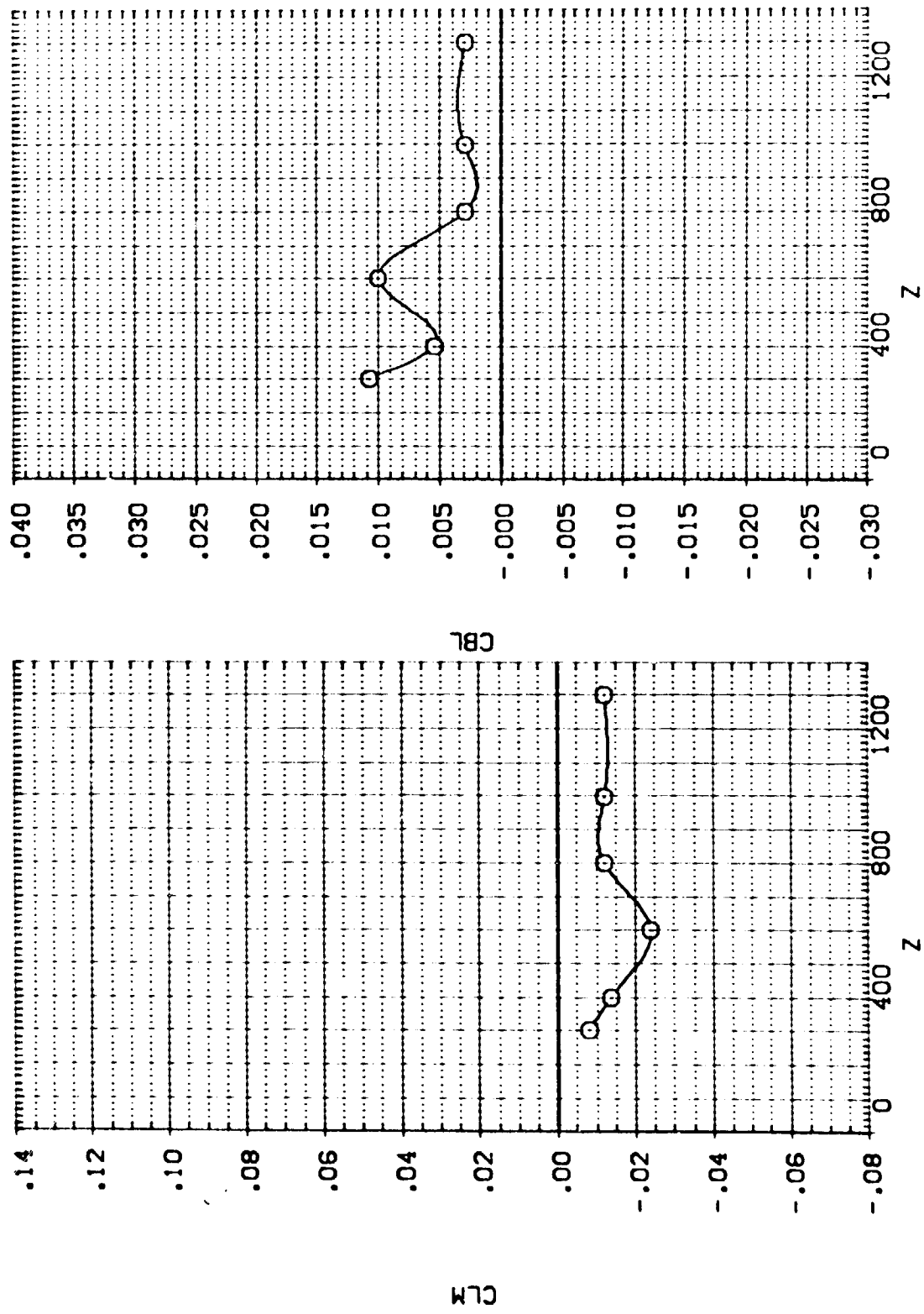

EFFECT OF EXTERNAL TANK SEPARATION ON ORBITER AERODYNAMIC CHARACTERISTICS

IA13. EXTERNAL TANK(T10)SEPARATING FROM ORB. 09 (RTJ060)

SEE THE ASSOCIATED DATA DOCUMENT FOR REFERENCE CHARACTERISTICS FOR INDIVIDUAL DATASETS

SYMBOL		PARAMETRIC VALUES	
O	X	MACH	4.530
		PIOTAL	110.000
		BETA	.000
		DBETA	.000
		AILRON	10.000
		ELEVTR	200.000
		Y	

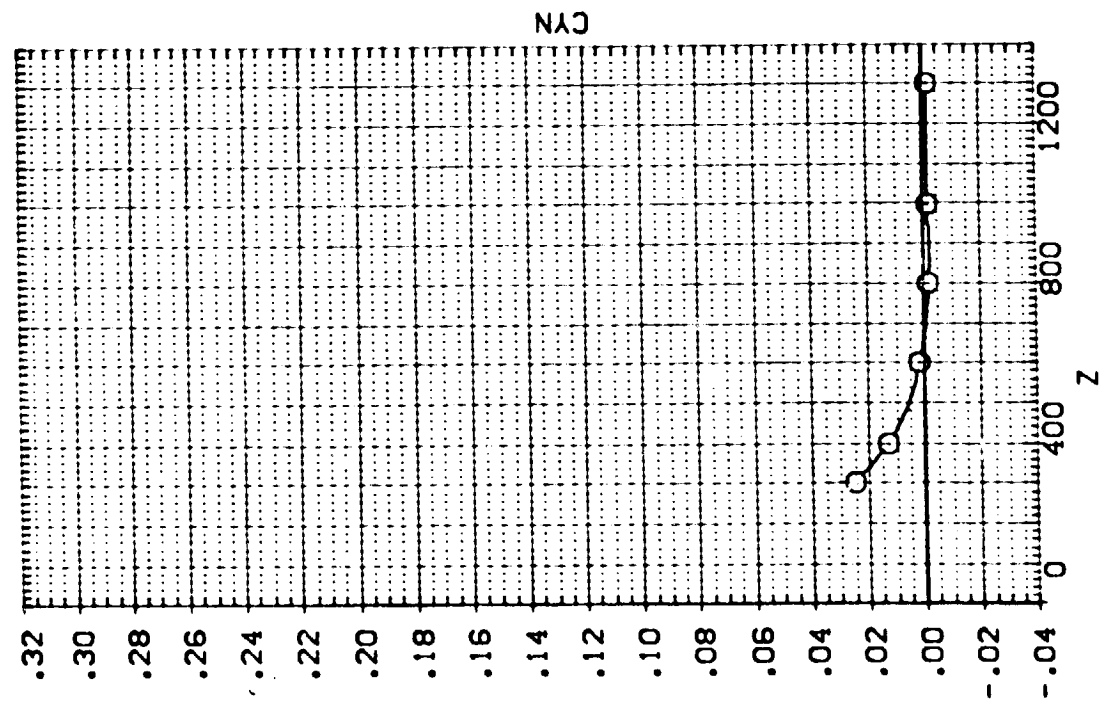
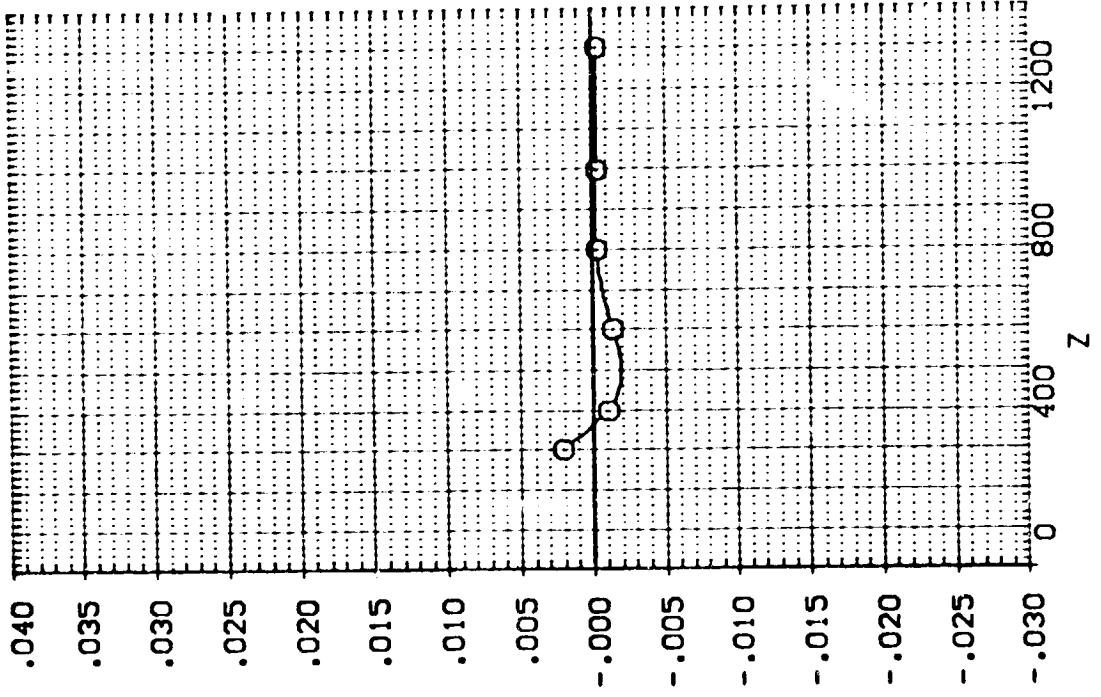

1A13.EXTERNAL TANK(T10)SEPARATING FROM ORB. 09 (RTJ061)

SEE THE ASSOCIATED DOCUMENT FOR RELEVANT CHARACTERISTICS FOR INDIVIDUAL DATASETS

SYMBOL x .246 PARAMETRIC VALUES
 O MACH 4.530 PTOTAL 110.000
 ALPHA .000 BETA .000
 DALPHA -10.000 DBETA -5.000
 ELEVTR .000 ALLRON 10.000
 Y -200.000

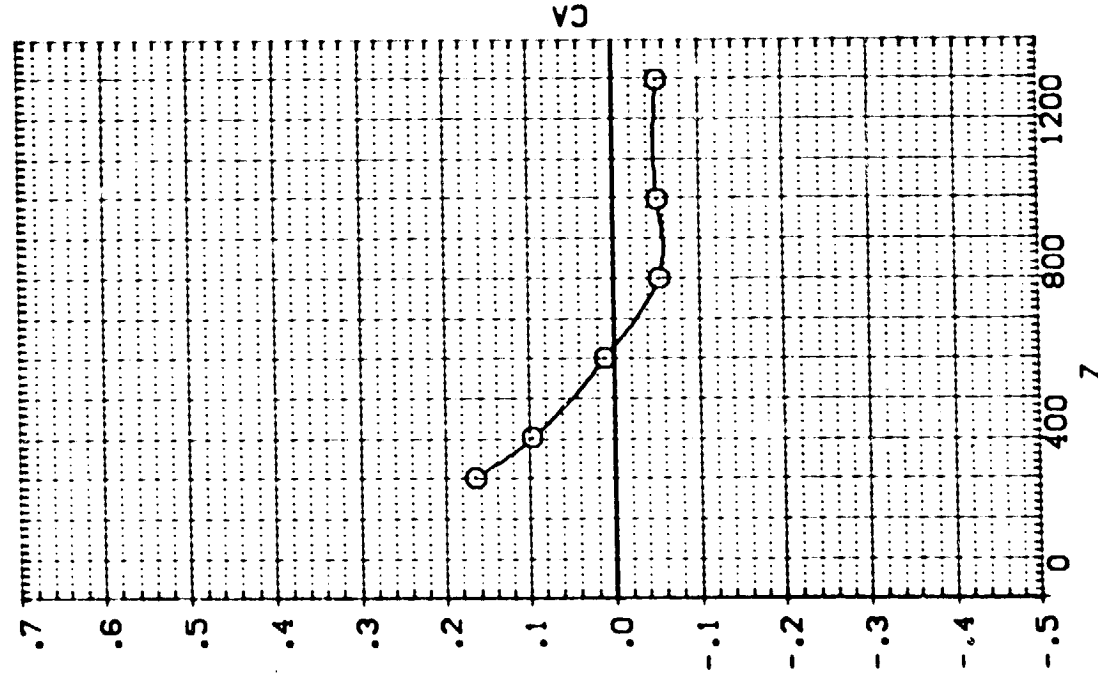
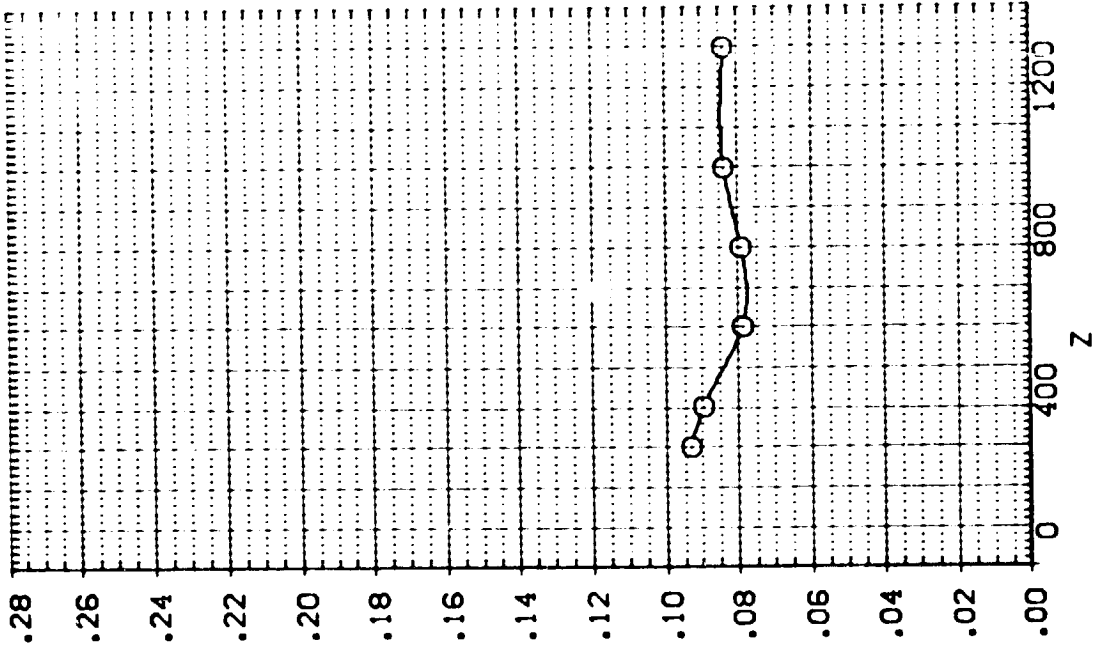

EFFECT OF EXTERNAL TANK SEPARATION ON ORBITER AERODYNAMIC CHARACTERISTICS

1A13, EXTERNAL TANK (10) SEPARATING FROM ORB. 09 (RTJ061)

SEE THE ASSOCIATED DATA DOCUMENT FOR REFERENCE CHARACTERISTICS FOR INDIVIDUAL DATASETS

SYMBOL	x	.216	MACH	4.530	PARAMETRIC VALUES	PTOTAL	110.000
O			ALPHA	.000	BETA	.000	
			DALPHA	-10.000	DBETA	-5.000	
			ELEVTR	.000	AIRPORN	10.000	
			Y	-200.000			

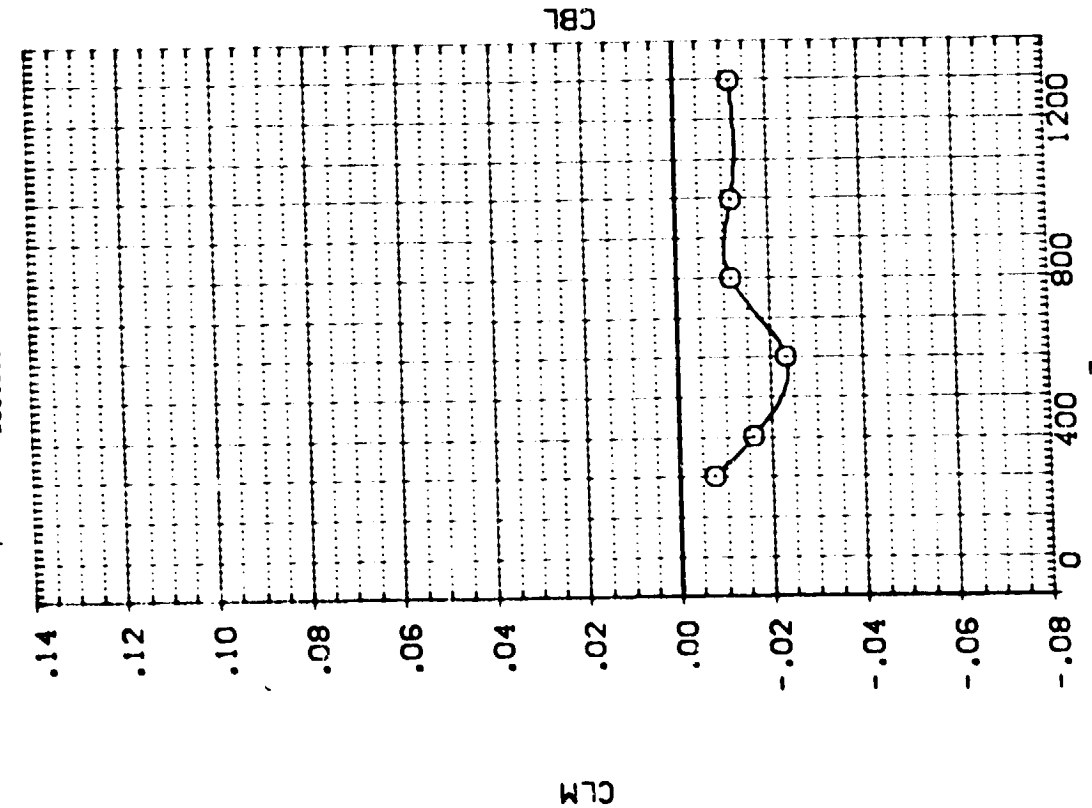
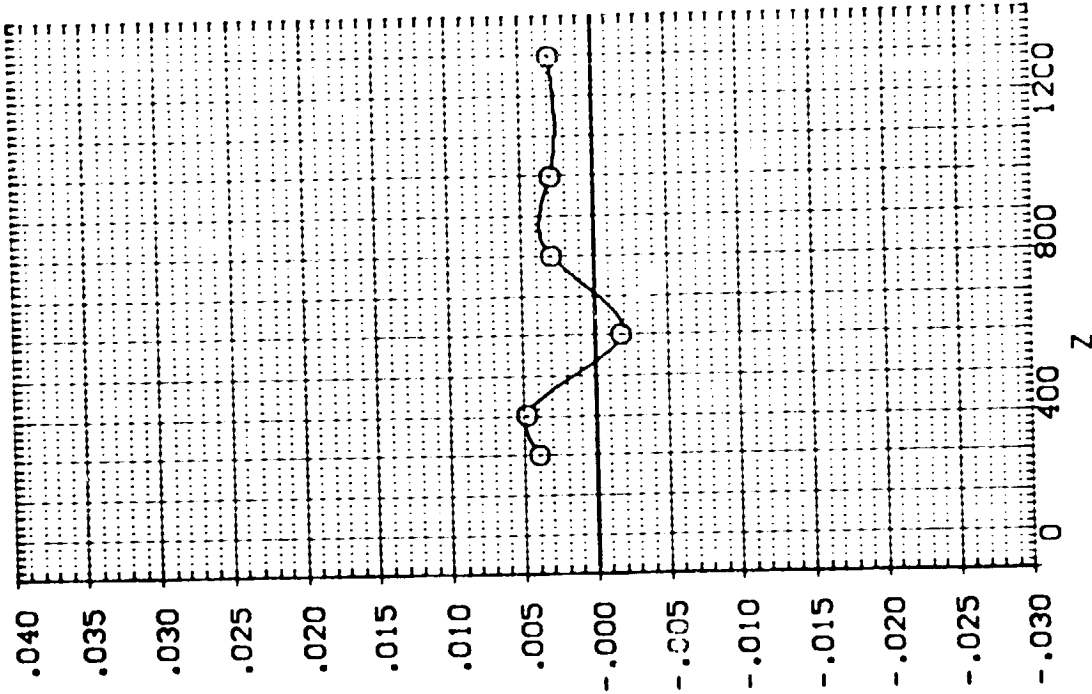

EFFECT OF EXTERNAL TANK SEPARATION ON ORBITER AERODYNAMIC CHARACTERISTICS

1.13. EXTERNAL TANK(T10)SEPARATING FROM ORB. 09 (RTJ061)

SEE THE ASSOCIATED DOCUMENT FOR REFERENCE CHARACTERISTICS FOR INDIVIDUAL ORASSETS

PARAMETRIC VALUES	
MACH	4.530
PTOTAL	110.000
ALPHA	.000
BETA	.000
DELTA	-10.000
ELEVTR	.000
Y	-200.000
ALFRON	10.000

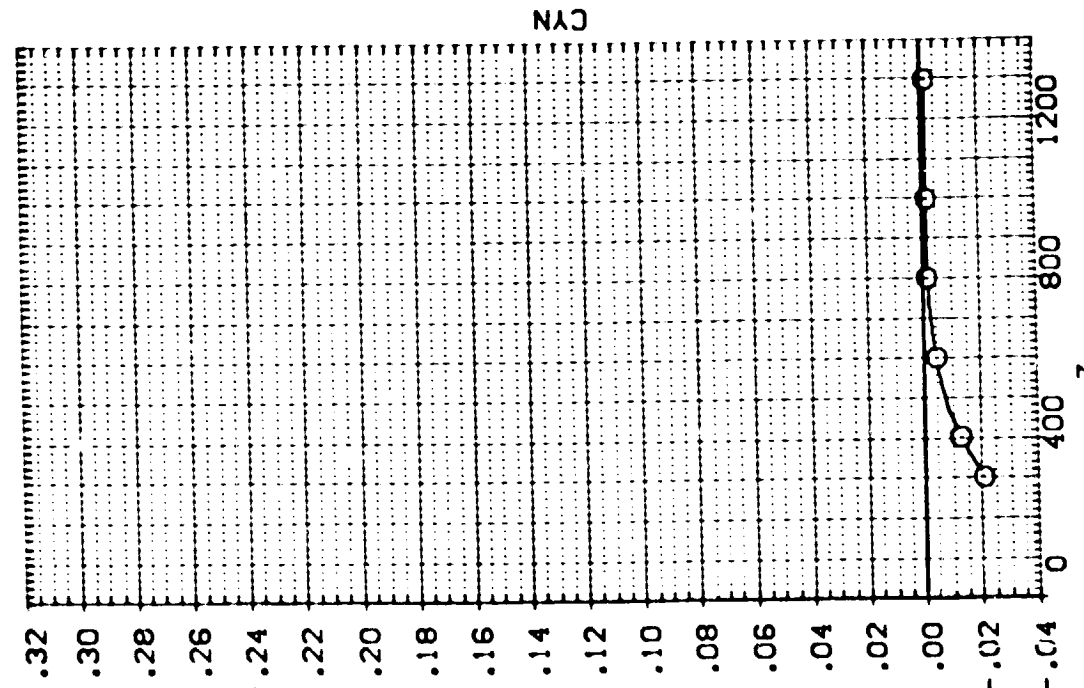
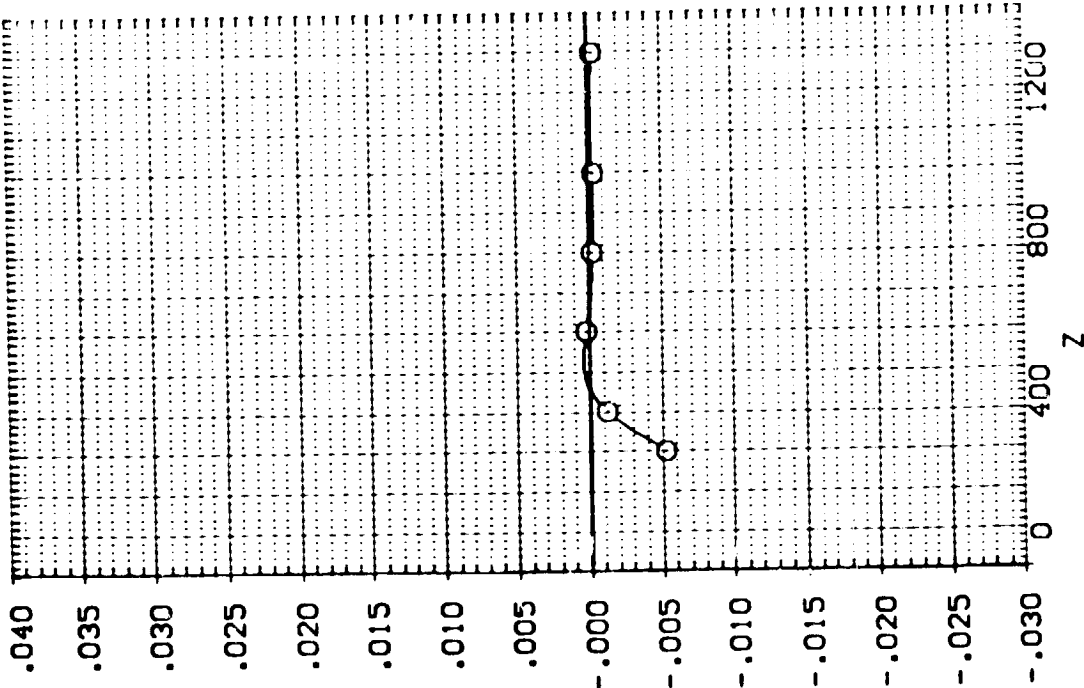

EFFECT OF EXTERNAL TANK SEPARATION ON ORBITER AERODYNAMIC CHARACTERISTICS

1A13. EXTERNAL TANK(T10)SEPARATING FROM ORB. 09 (RTJ062)

SEE THE ASSOCIATED DATA DOCUMENT FOR REFERENCE CHARACTERISTICS FOR INDIVIDUAL DATA SETS

SYMBOL		PARAMETRIC VALUES	
O	X	MACH	4.530
		ALPHA	.000
		BETA	.000
		DBETA	5.000
		ELEVTR	.000
		AILLON	10.000
		Y	.000
		PTOTAL	110.000

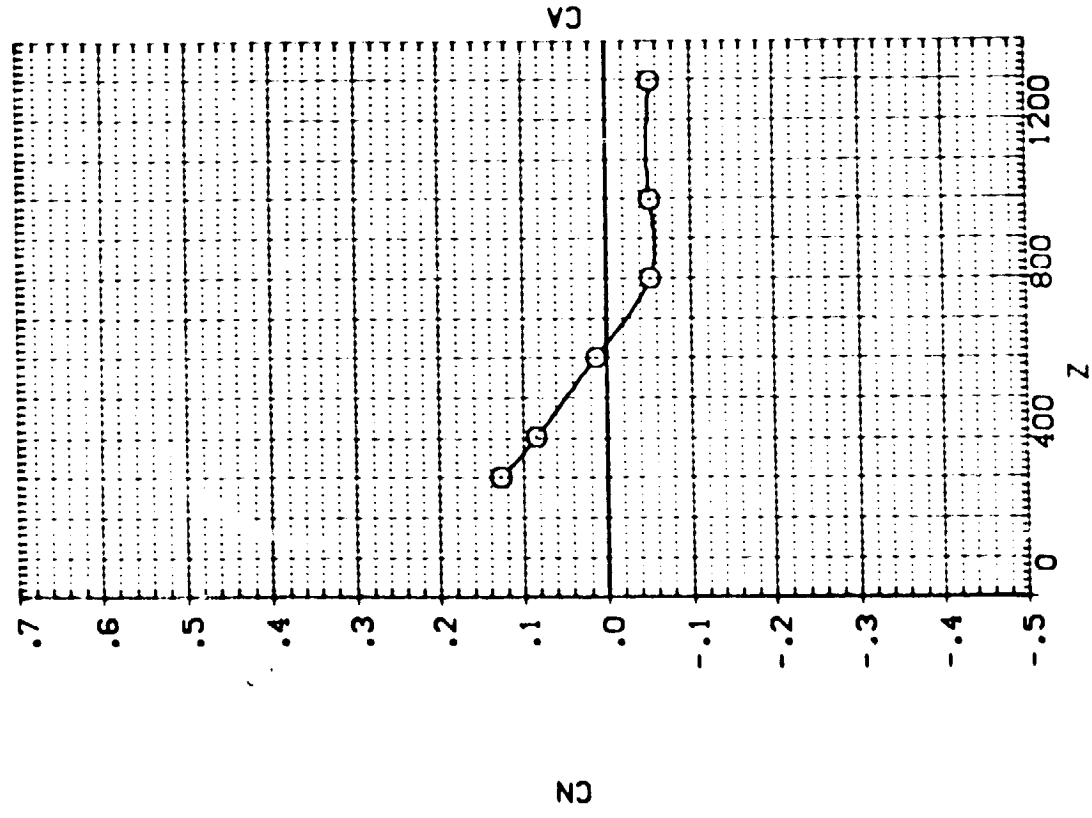
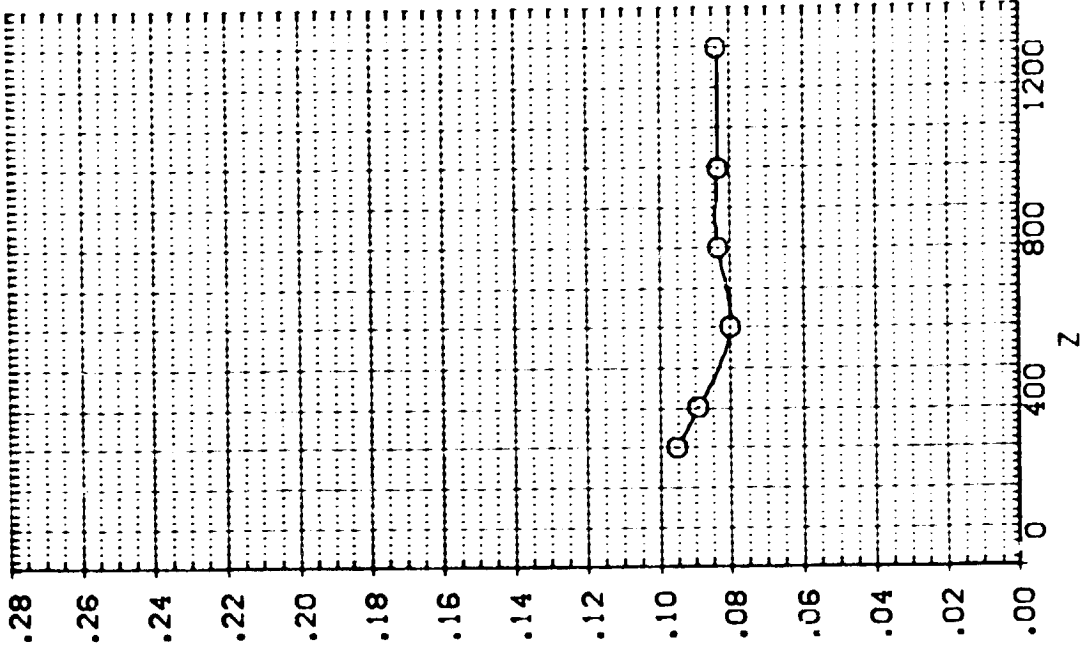

1A13. EXTERNAL TANK (10) SEPARATING FROM ORB. 09 (RTJ062)

SEE THE ASSOCIATED DOCUMENT FOR THE CHARACTERISTICS FOR INDIVIDUAL DATA SETS

SYMBOL		PARAMETRIC VALUES	
○	x	MACH	4.530
		ALPHA	.000
		BETA	.000
		DALPHA	-10.000
		DBETA	5.000
		ELEVTR	.000
		ALLRON	10.000
		Y	.000
		PTOTAL	110.000

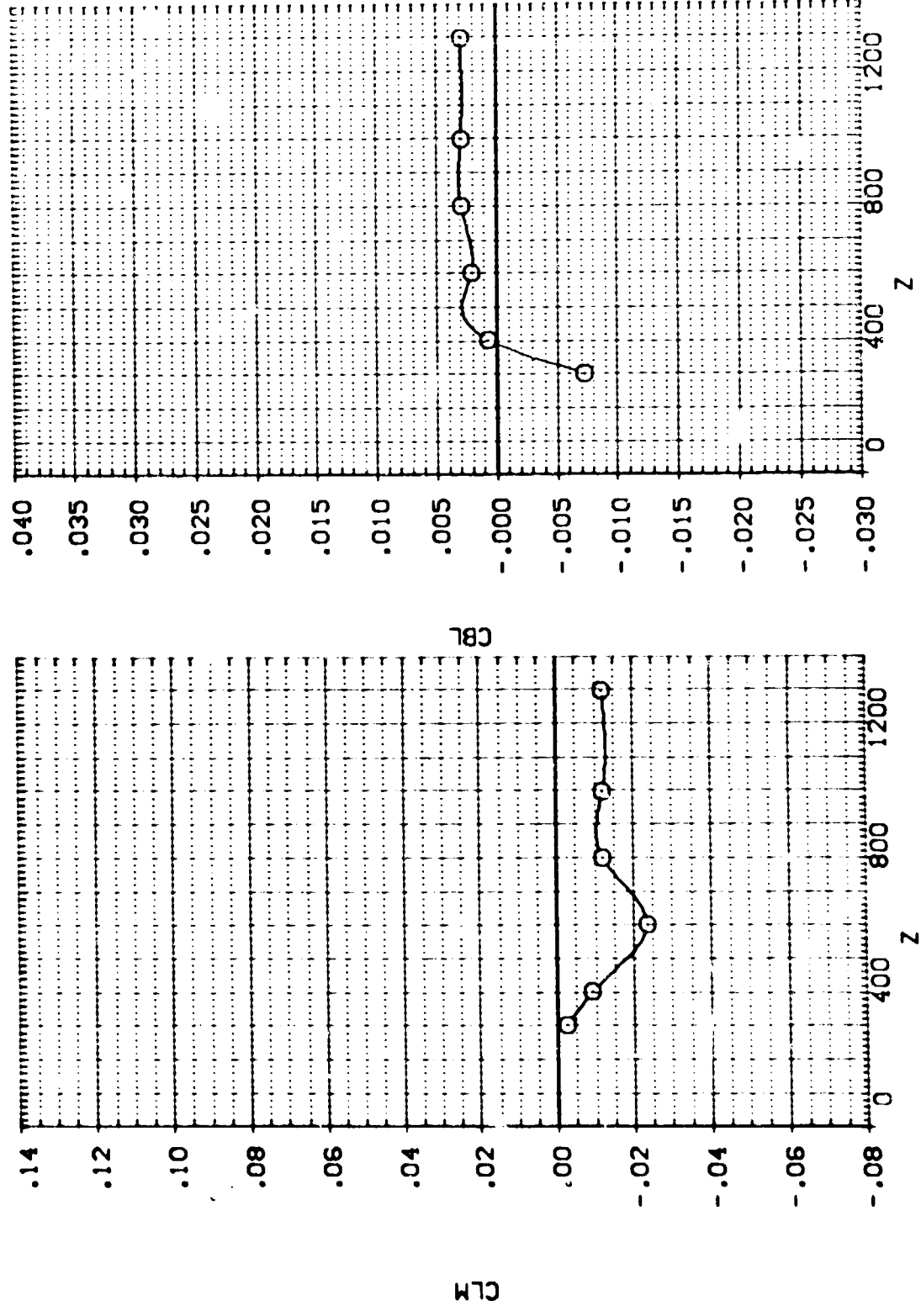

EFFECT OF EXTERNAL TANK SEPARATION ON ORBITER AERODYNAMIC CHARACTERISTICS

IA13, EXTERNAL TANK(T10)SEPARATING FROM ORB. 09 (RTJ062)

SYMBOL
O

X .172

PARAMETRIC VALUES

MACH	4.530	PTOTAL	110.000
ALPHA	.000	BETA	.000
DALPHA	-10.000	DBETA	5.000
ELEVTR	.000	AIRRN	10.000
Y	.000		

SEE THE ASSOCIATED DATA DOCUMENT FOR REFERENCE CHARACTERISTICS FOR INDIVIDUAL DATASETS

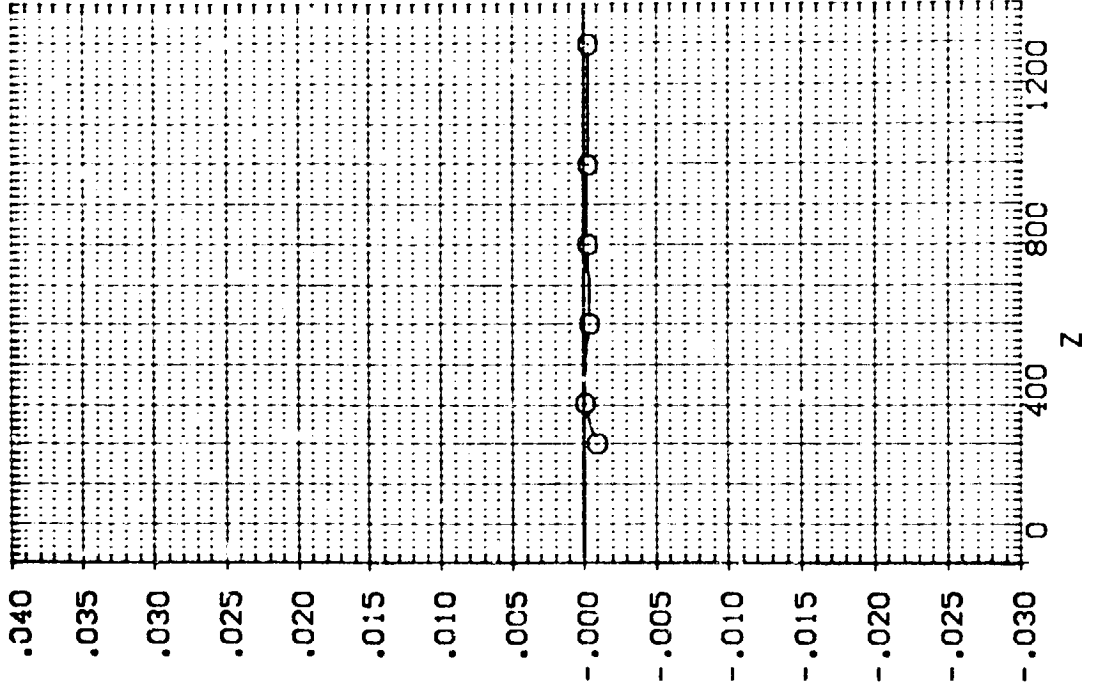
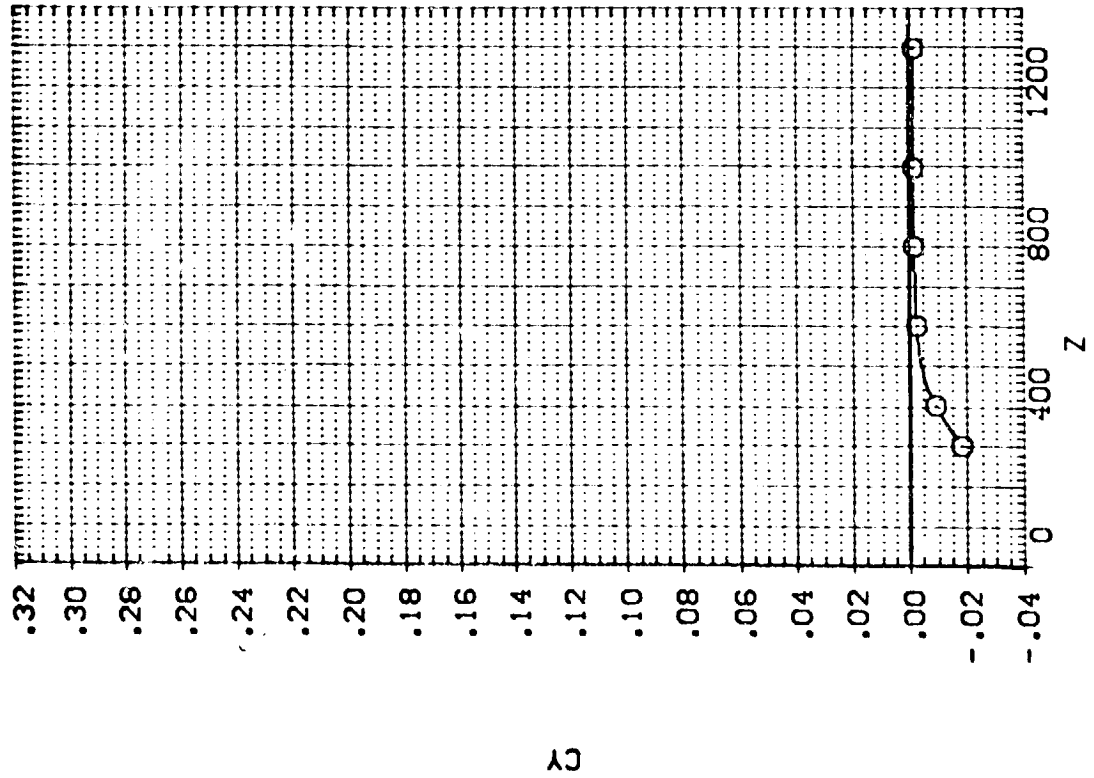

EFFECT OF EXTERNAL TANK SEPARATION ON ORBITER AERODYNAMIC CHARACTERISTICS

IA13. EXTERNAL TANK(T10)SEPARATING FROM ORB. 09 (RTJ063)

SYMBOL		PARAMETRIC VALUES	
x	.161	MACH	4.530
		ALPHA	.000
		DBETA	-10.000
		ELEVTR	.000
		Y	200.000
		POTIAL	110.000
		BETA	.000
		DBETA	5.000
		ALLRON	10.000

SEE THE ASSOCIATED DOCUMENT FOR REFERENCE CHARACTERISTICS FOR INDIVIDUAL DATASETS

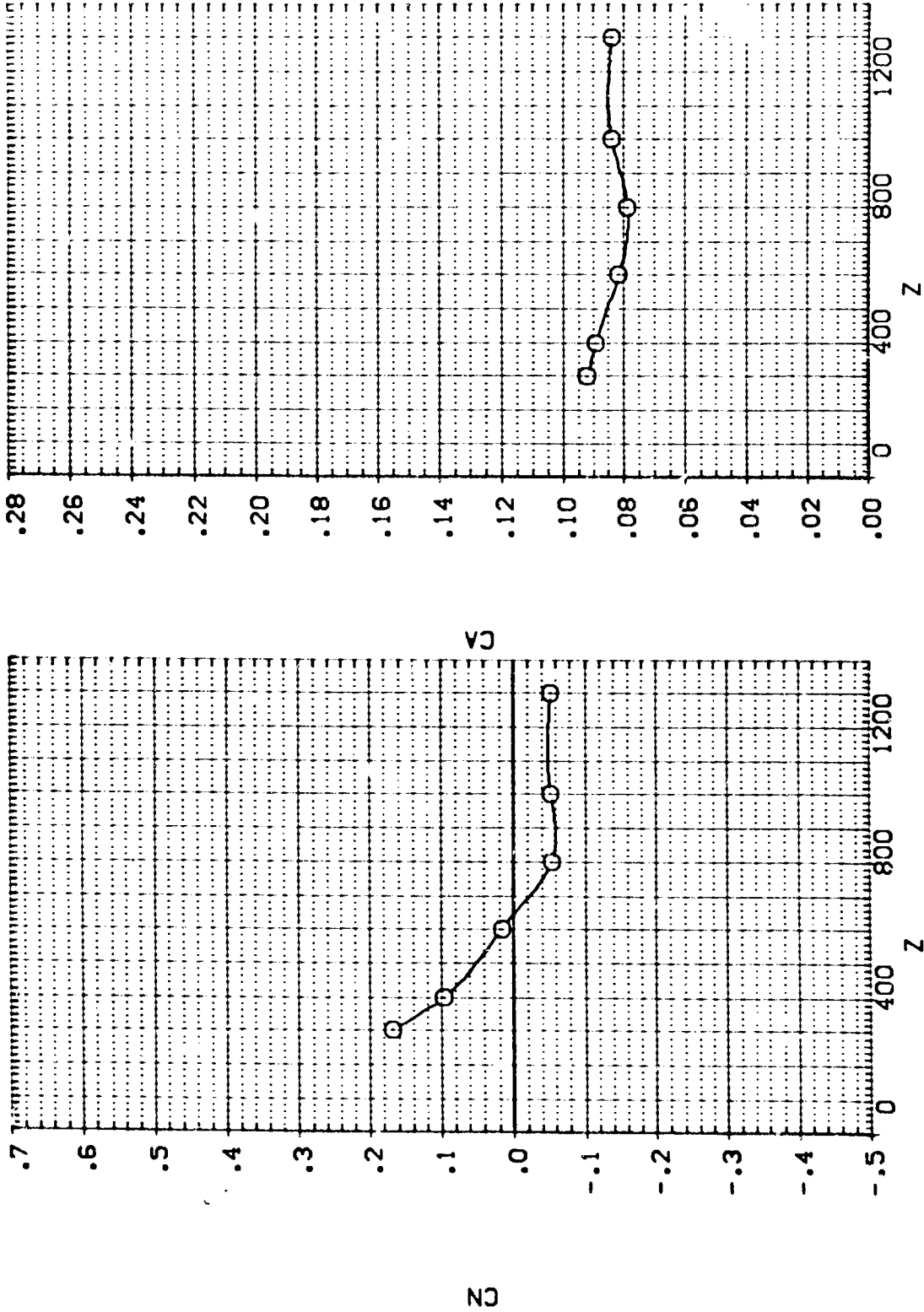

EFFECT OF EXTERNAL TANK SEPARATION ON ORBITER AERODYNAMIC CHARACTERISTICS

1A13.EXTERNAL TANK(T10)SEPARATING FROM ORB. 09 (RTJ063)

SEE THE ASSOCIATED DATA DOCUMENT FOR REFERENCE CHARACTERISTICS FOR INDIVIDUAL DATASETS

SYMBOL		PARAMETRIC VALUES	
x	.161	MACH	4.530
o		ALPHA	.000
		DALPHA	-10.000
		ELEVTR	.000
		Y	200.000
		P TOTAL	110.000
		BETA	.000
		DBETA	5.000
		AILRON	10.000

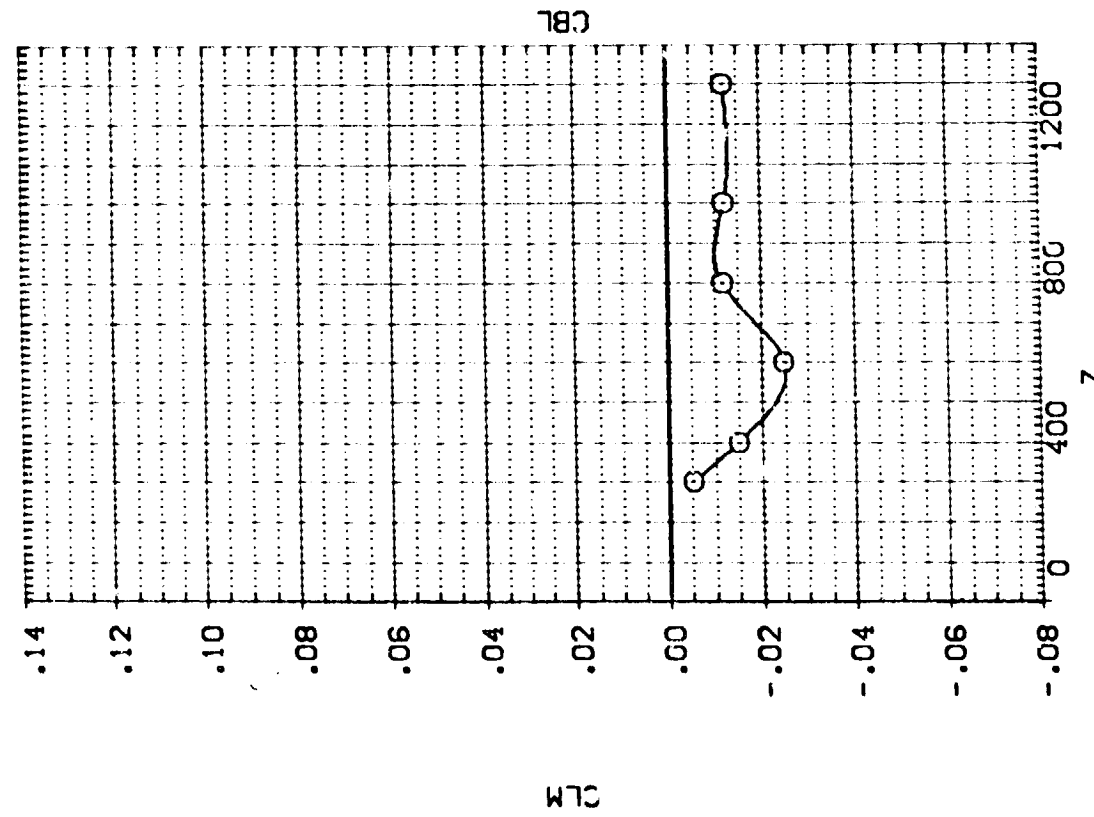
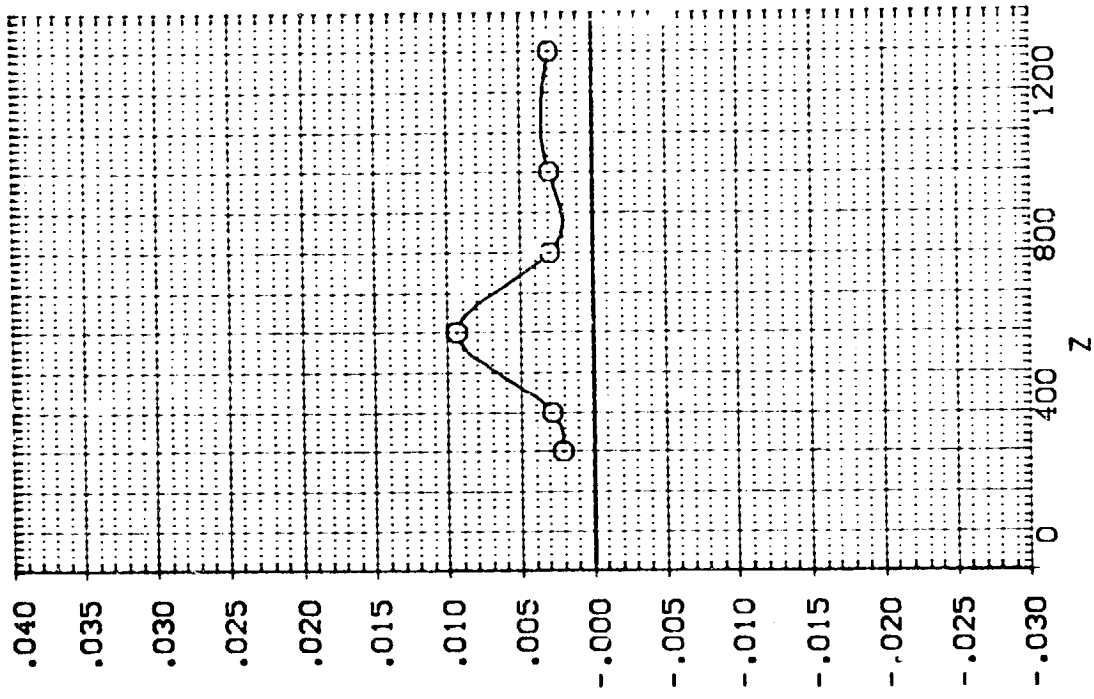

IA13, EXTERNAL TANK (110) SEPARATING FROM ORG. 09 (RTJ063)

SEE THE ASSOCIATED DOCUMENT FOR REFERENCE CHARACTERISTICS FOR INDIVIDUAL DATA SETS

PARAMETRIC VALUES	
MACH	4.530
PIOTAL	110.000
BETA	.000
DBETA	5.000
AILRON	10.000
ELEVTR	200.000
Y	

SYMBOL
O

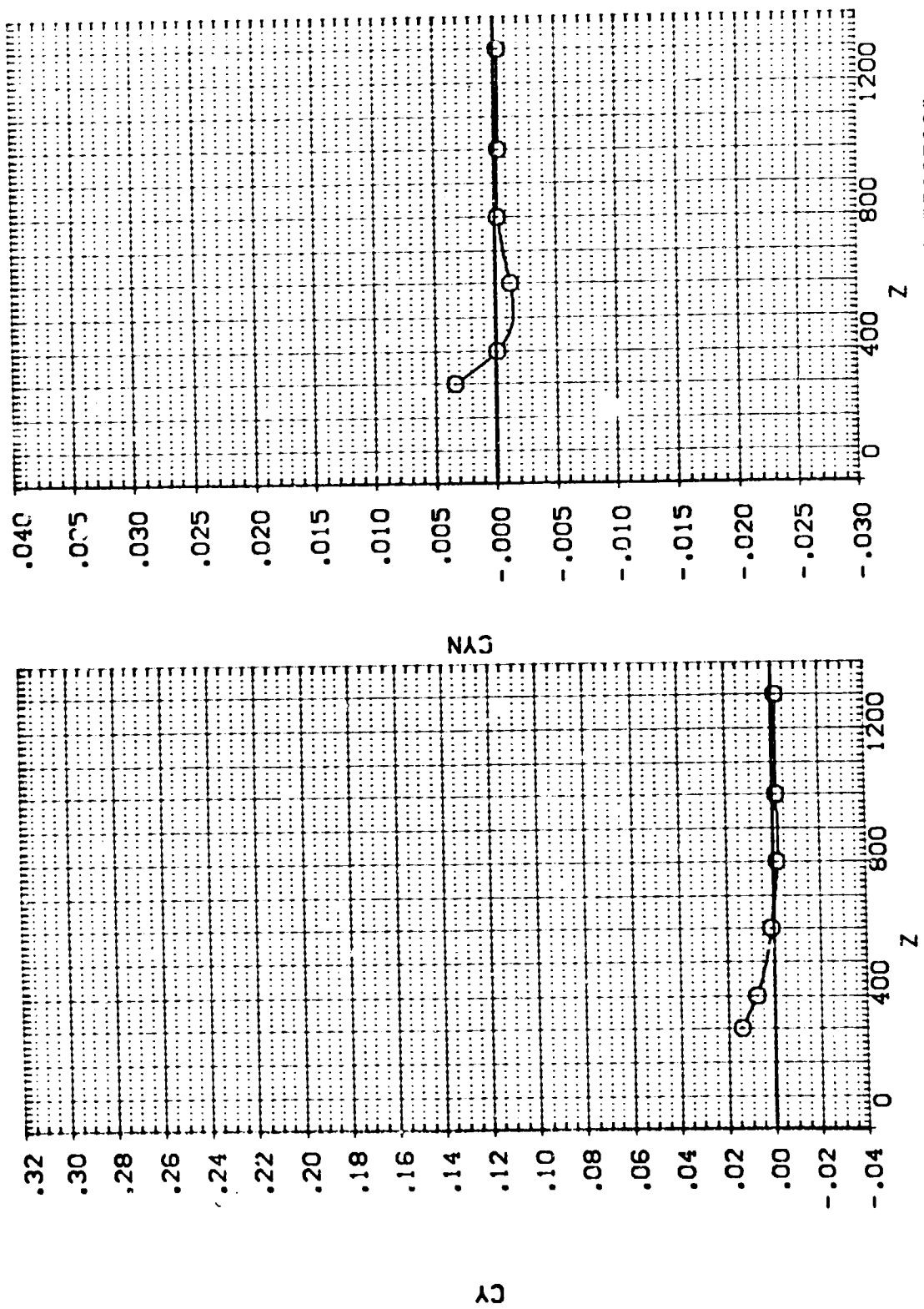

EFFECT OF EXTERNAL TANK SEPARATION ON ORBITER AERODYNAMIC CHARACTERISTICS

1A13.EXTERNAL TANK(T10)SEPARATING FROM ORB. 09 (RTJ064)

SEE THE ASSOCIATED DATA DOCUMENT FOR REFERENCE CHARACTERISTICS FOR INDIVIDUAL DATASETS

PARAMETRIC VALUES	
MACH	4.530
PITOTAL	110.000
ALPHA	.000
BETA	.000
DALPHA	-20.000
DBETA	.000
ELEVTR	.000
AILRON	10.000
Y	-200.000

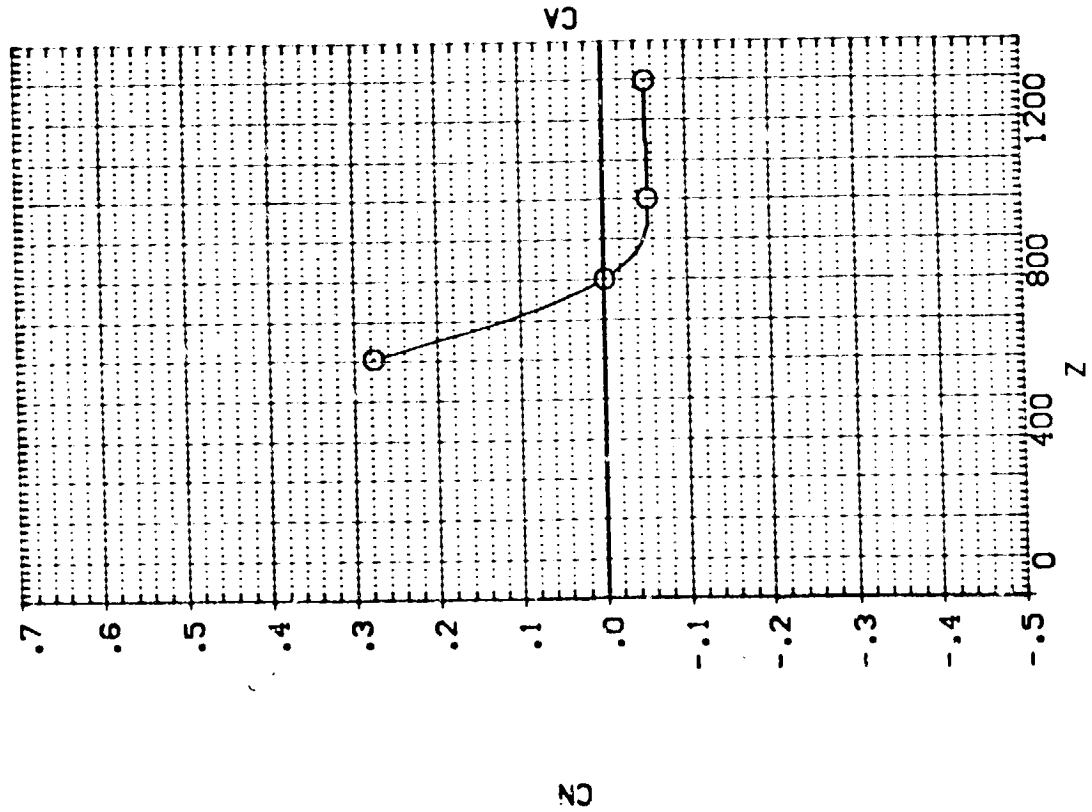
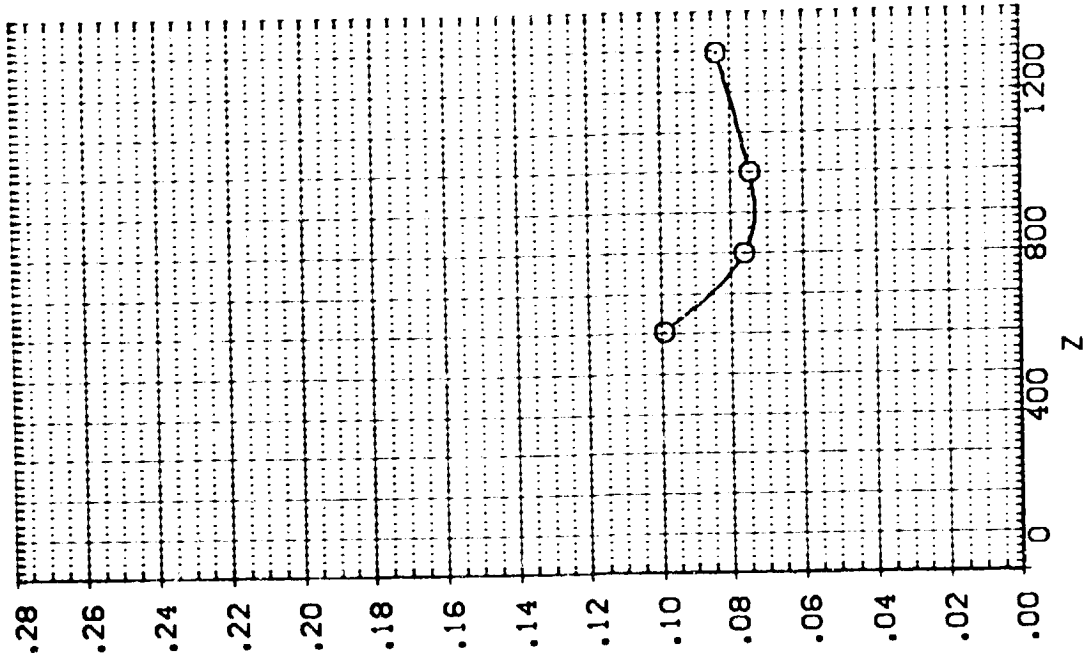

EFFECT OF EXTERNAL TANK SEPARATION ON ORBITER AERODYNAMIC CHARACTERISTICS

1A13.EXTERNAL TANK(T10)SEPARATING FROM ORB. 09 (RTJ064)

SYMBOL
O

PARAMETRIC VALUES
 MACH 4.530 PTOTAL 110.000
 ALPHA .000 BETA .000
 DALPHA -20.000 CBETA .000
 ELEVTR .000 AILRON 10.000
 Y -200.000

SEE THE ASSOCIATED
 DOCUMENT FOR THE
 CHARACTERISTICS FOR
 INDIVIDUAL DATASETS

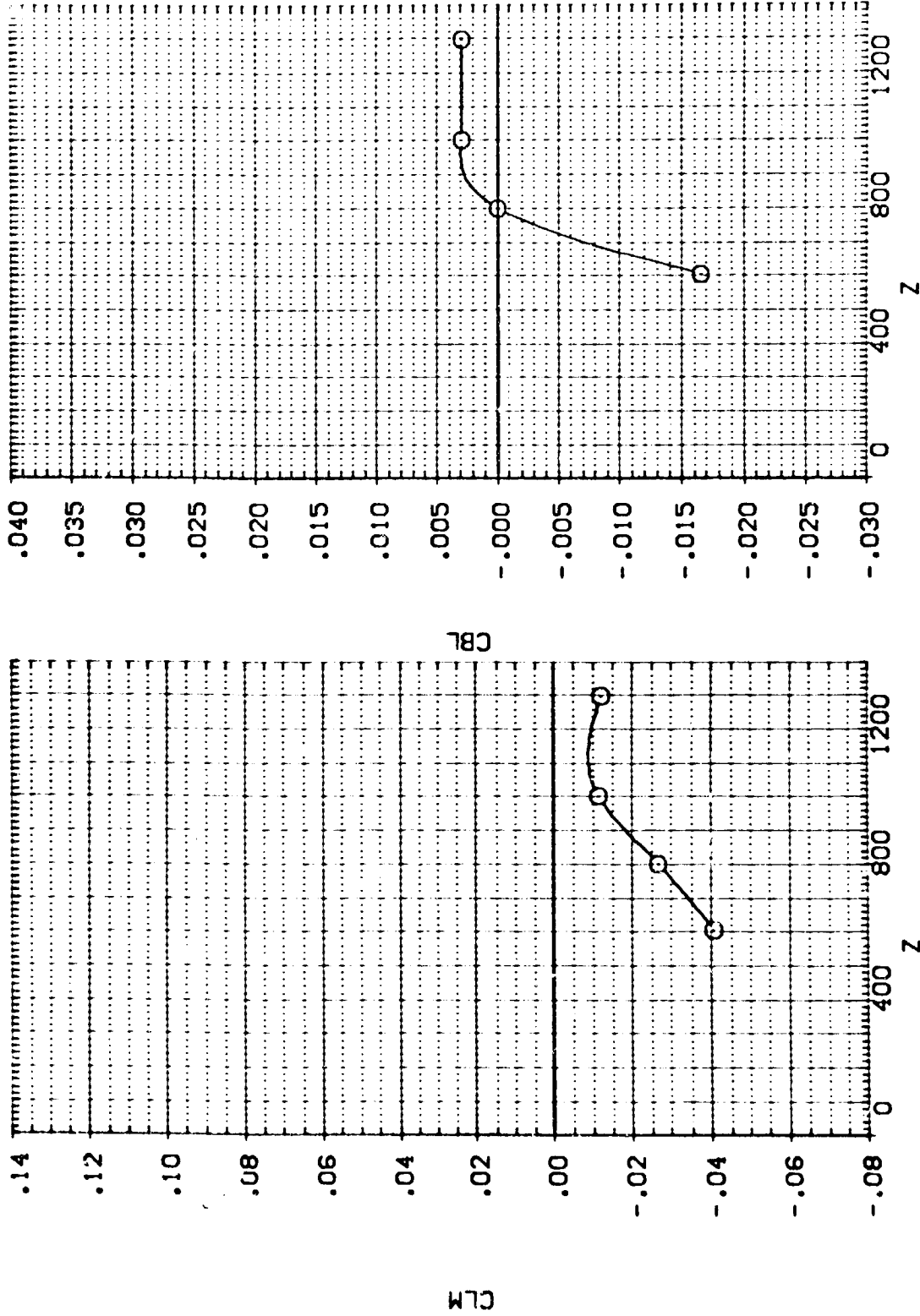

EFFECT OF EXTERNAL TANK SEPARATION ON ORBITER AERODYNAMIC CHARACTERISTICS

1A13, EXTERNAL TANK(T10)SEPARATING FROM ORB. 09 (RTJ064)

SEE THE ASSOCIATED DATA DOCUMENT FOR REFERENCE CHARACTERISTICS FOR INDIVIDUAL DATASETS

SYMBOL		PARAMETRIC VALUES	
X	.173	MACH	4.530
		PITOT	110.000
		BETA	.000
		DBETA	.000
		AIRRON	19.000
		ELEVTR	-200.000
		V	

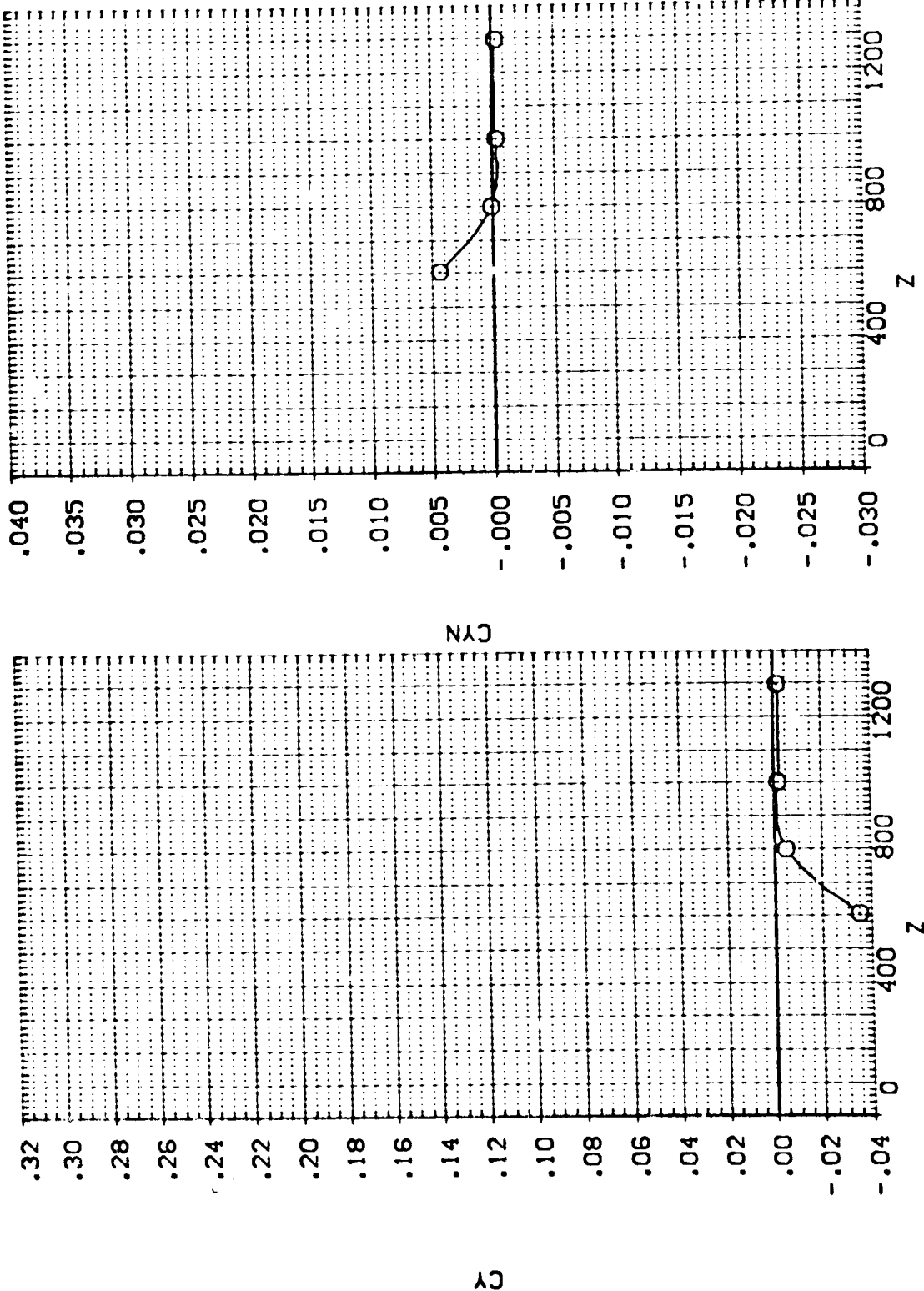

EFFECT OF EXTERNAL TANK SEPARATION ON ORBITER AERODYNAMIC CHARACTERISTICS

1A13.EXTERNAL TANK(T10)SEPARATING FROM ORB. 09 (RTJ065)

SEE THE ASSOCIATED DOCUMENT FOR THE CHARACTERISTICS FOR INDIVIDUAL DATASETS

SYMBOL		PARAMETRIC VALUES			
O	X	MACH	4.530	PTOTAL	110.000
		ALPHA	.000	BETA	.000
		DALPHA	-20.000	DBETA	.000
		ELEVTR	.000	AILRON	10.000
		Y	.000		

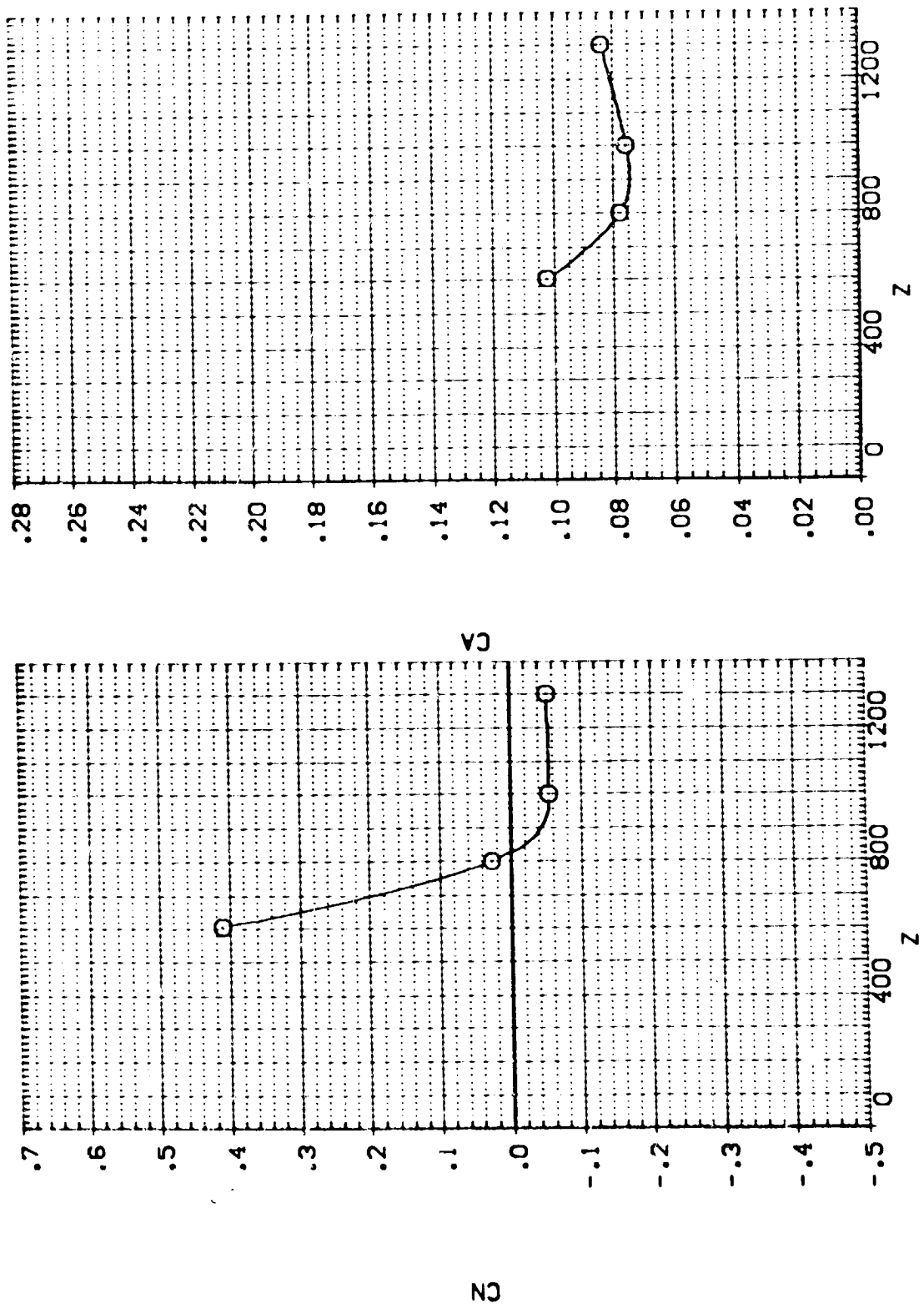

EFFECT OF EXTERNAL TANK SEPARATION ON ORBITER AERODYNAMIC CHARACTERISTICS

!A13.EXTERNAL TANK(T10)SEPARATING FROM ORB. 09 (RTJ065)

SEE THE ASSOCIATED DATA DOCUMENT FOR REFERENCE CHARACTERISTICS FOR INDIVIDUAL DATASETS

SYMBOL		PARAMETRIC VALUES	
O	X	MACH	4.530
		ALPHA	.000
		DALPHA	-20.000
		ELEVTR	.000
	Y	BETA	.000
		DBETA	.000
		AILRON	10.000
		Y	.000
		PTOTAL	110.000

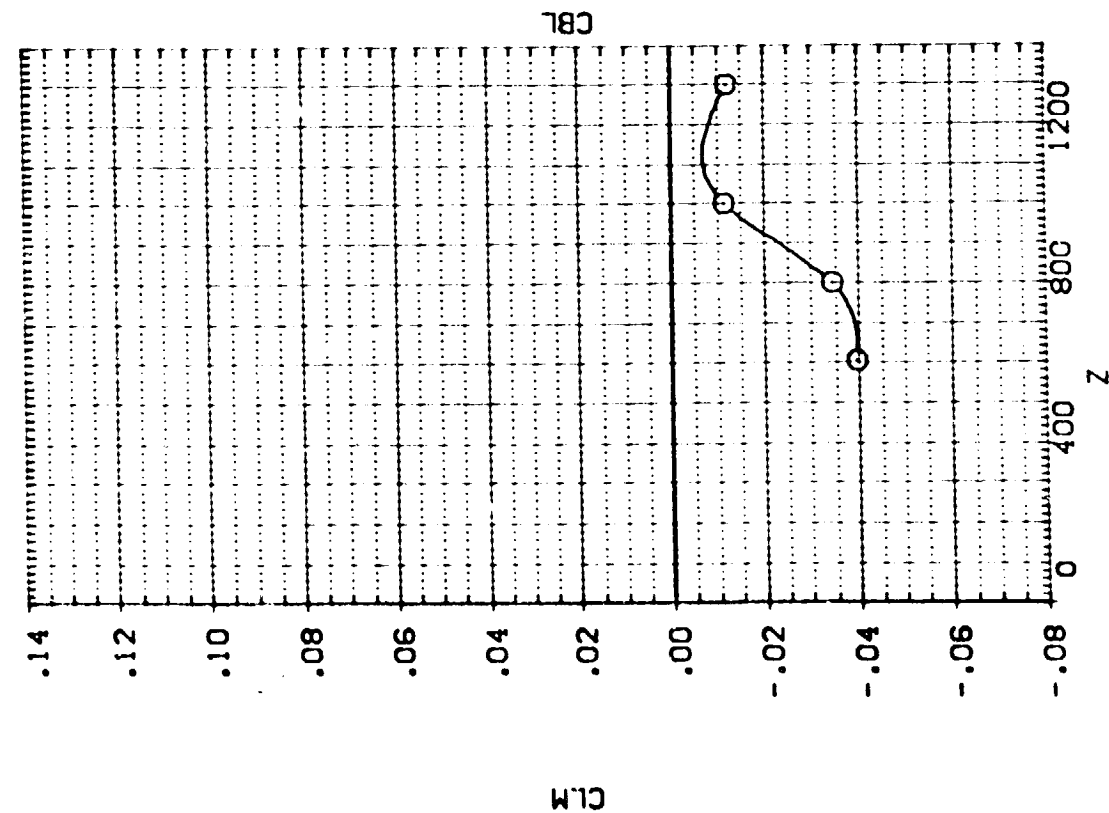
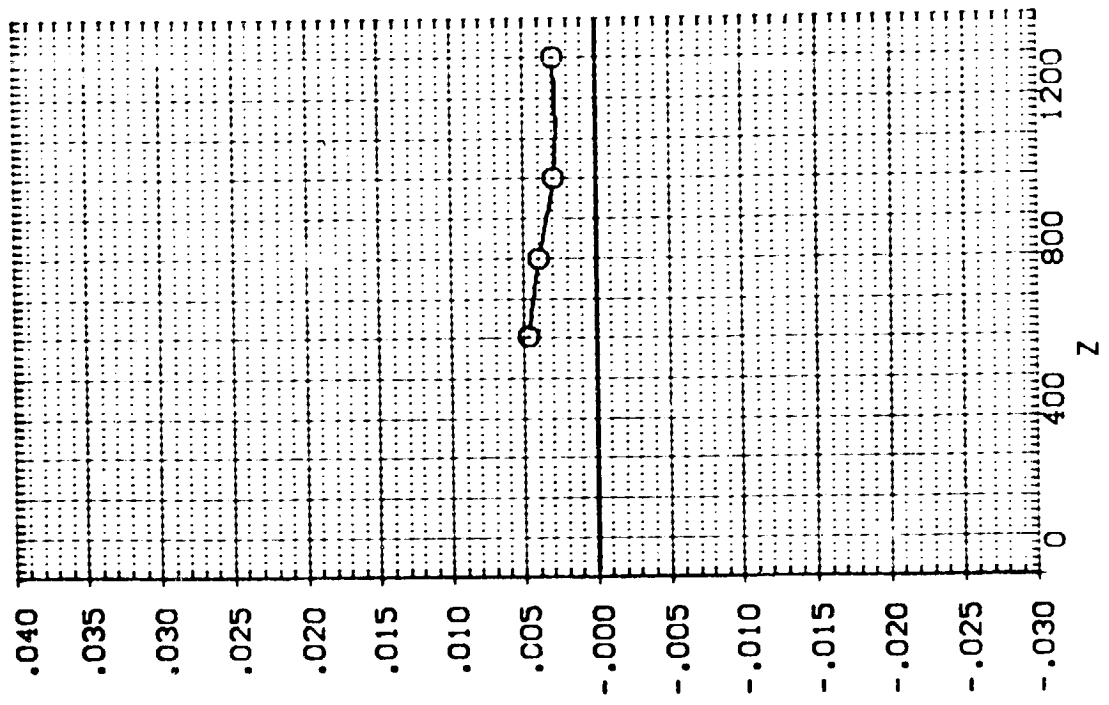

1A13, EXTERNAL TANK(T10)SEPARATING FROM ORB. 09 (RTJ065)

SEE THE ASSOCIATED DATA DOCUMENT FOR REFERENCE CHARACTERISTICS FOR INDIVIDUAL DATASETS

SYMBOL		X	.040	PARAMETRIC VALUES			
O		MACH	4.530	PTOTAL	110.000		
		ALPHA	.000	BETA	.000		
		DALPHA	-20.000	DBETA	.000		
		ELEVTR	.000	AILRON	10.000		
		Y	.000				

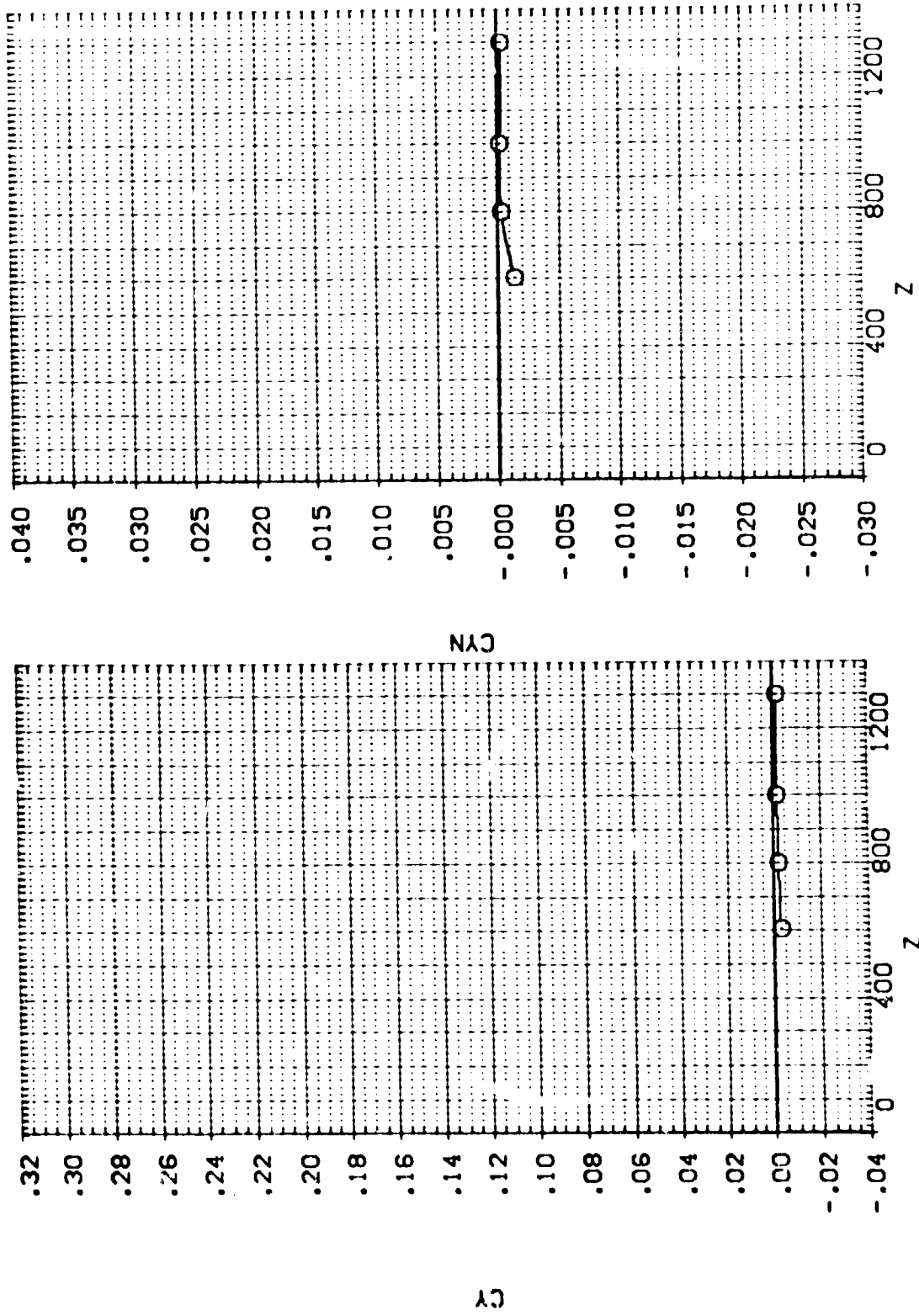

EFFECT OF EXTERNAL TANK SEPARATION ON ORBITER AERODYNAMIC CHARACTERISTICS

1A13. EXTERNAL TANK(T10)SEPARATING FROM ORB. 09 (RTJ066)

SYMBOL

○

PARAMETRIC VALUES	
MACH	4.530
PTOTAL	110.000
ALPHA	.000
BETA	.000
DALPHA	-20.000
CBETA	.000
ELEVTR	.000
Y	200.000
AILRON	10.000

SEE THE ASSOCIATED DATA DOCUMENT FOR REFERENCE CHARACTERISTICS FOR INDIVIDUAL DATASETS

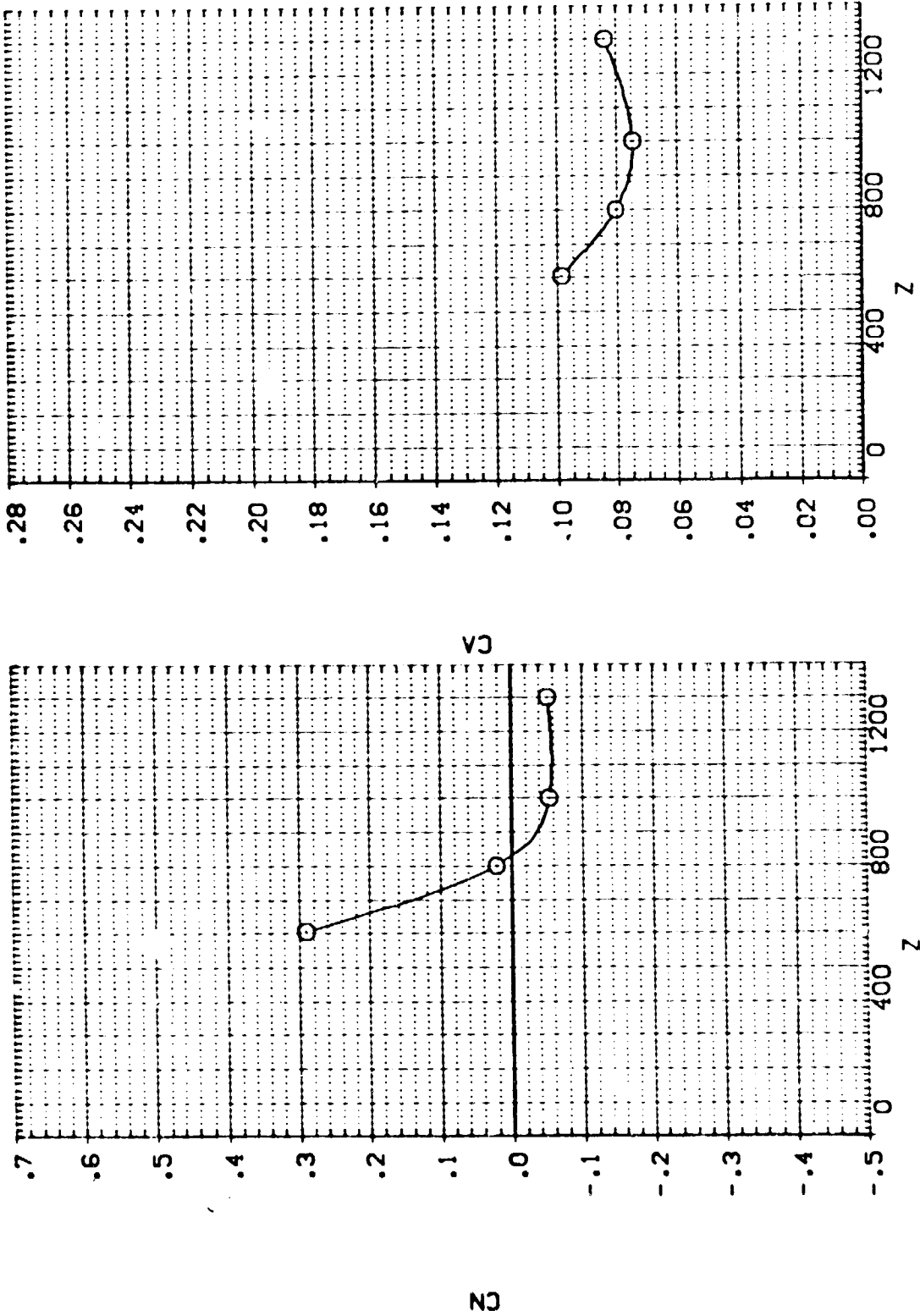

EFFECT OF EXTERNAL TANK SEPARATION ON ORBITER AERODYNAMIC CHARACTERISTICS

!A13. EXTERNAL TANK(T10)SEPARATING FROM ORB. 09 (RTJ066)

SYMBOL X
O .167

PARAMETRIC VALUES
MACH 4.530 PTOTAL 110.000
ALPHA .000 BETA .000
DALPHA -20.000 DBETA .000
ELEVTR .000 AILRON 10.000
Y 200.000

SEE THE ASSOCIATED DOCUMENT FOR CHARACTERISTICS FOR INDIVIDUAL DATA SETS

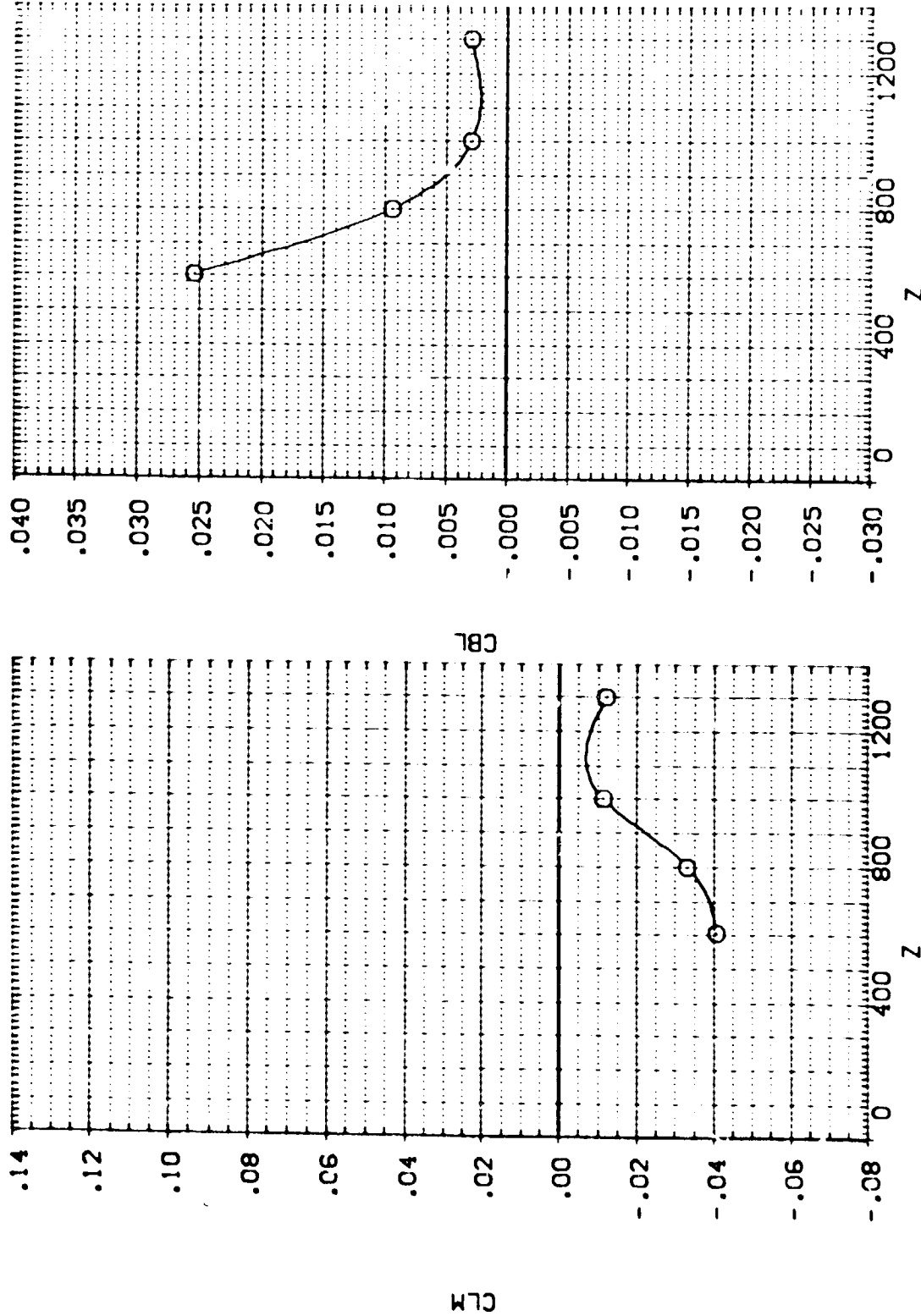

EFFECT OF EXTERNAL TANK SEPARATION ON ORBITER AERODYNAMIC CHARACTERISTICS

1A13. EXTERNAL TANK(T10)SEPARATING FROM ORB. 09 (RTJ066)

SEE THE ASSOCIATED DATA DOCUMENT FOR REFERENCE CHARACTERISTICS FOR INDIVIDUAL DATASETS

SYMBOL		PARAMETRIC VALUES	
X	.167	MACH	1.530
		ALPHA	.000
		DALPHA	-20.000
		ELEVTR	.000
		Y	200.000
		PITOTAL	110.000
		BETA	.000
		DBETA	.000
		ALFBN	10.000

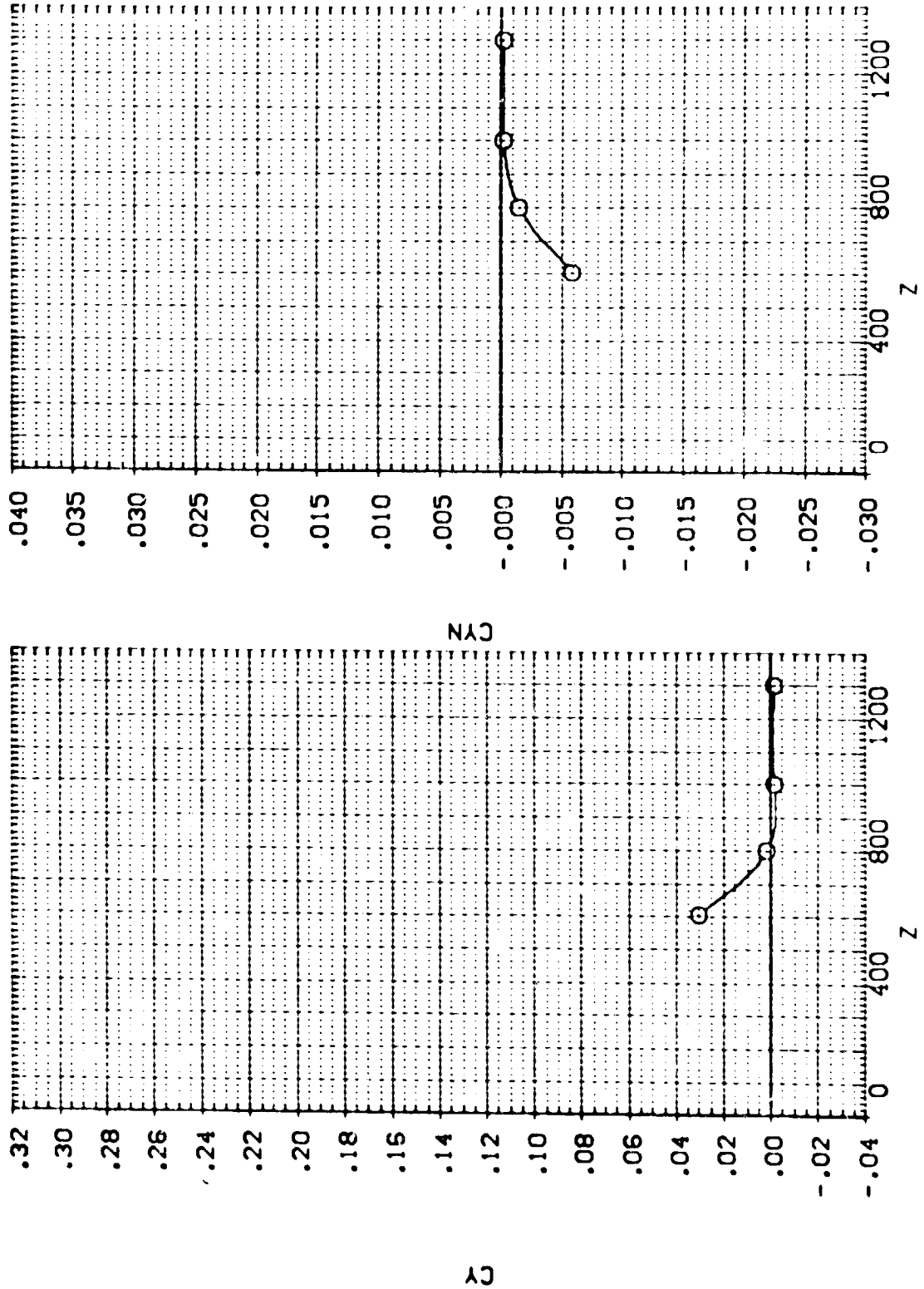

EFFECT OF EXTERNAL TANK SEPARATION ON ORBITER AERODYNAMIC CHARACTERISTICS

1A13. EXTERNAL TANK(110)SEPARATING FROM ORB. 09 (RTJ067)

SEE THE ASSOCIATED DOCUMENT FOR REFERRED CHARACTERISTICS FOR INDIVIDUAL DATASETS

SYMBOL		PARAMETRIC VALUES	
X	.142	MACH	4.530
O		PITOTAL	110.000
		BETA	.000
		DBETA	-5.000
		ALFESN	10.000
		Y	-200.000

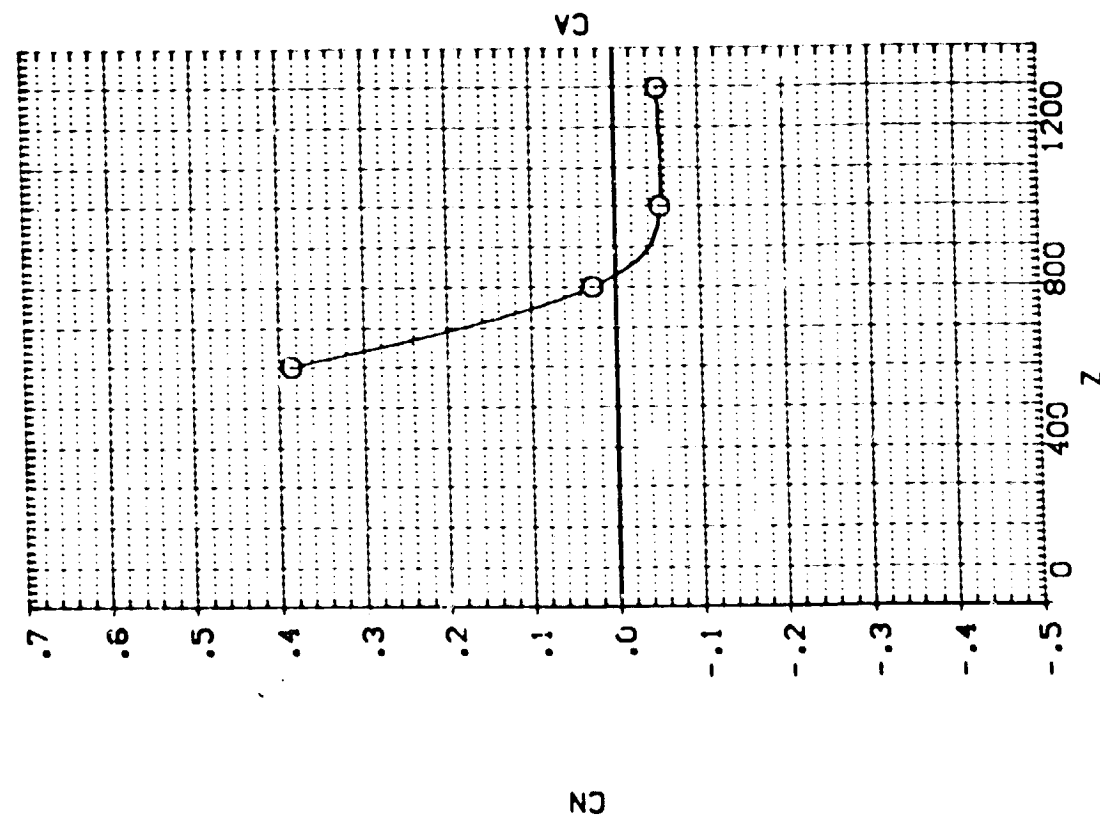
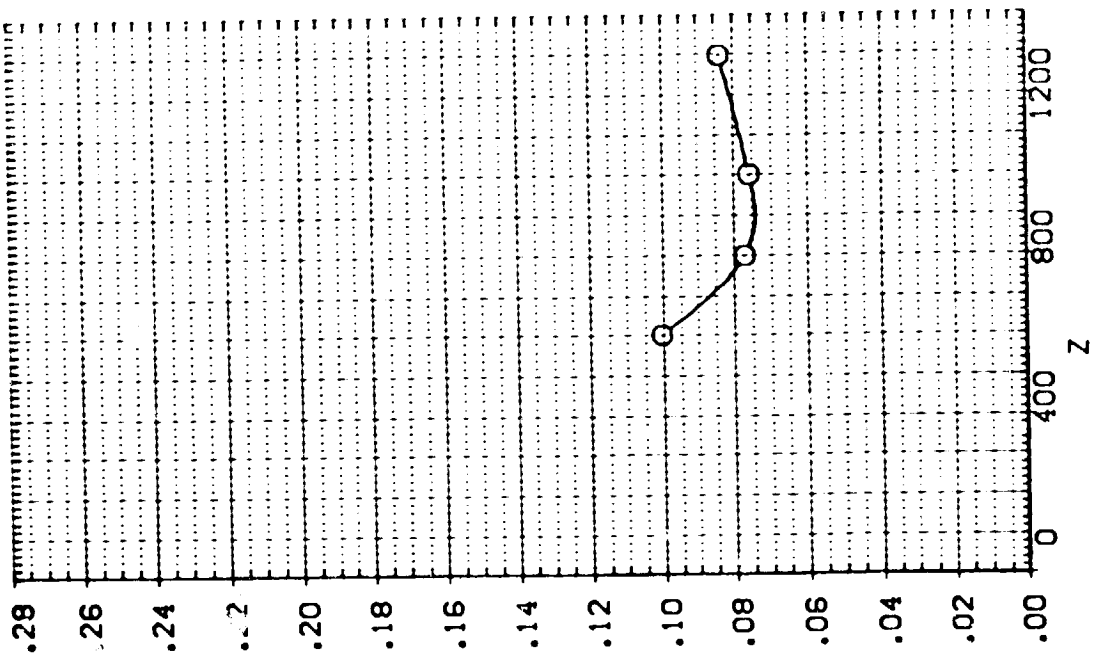

EFFECT OF EXTERNAL TANK SEPARATION ON ORBITER AERODYNAMIC CHARACTERISTICS



IA13.EXTERNAL TANK(T10)SEPARATING FROM ORB. 09 (RTJ067)

SEE THE ASSOCIATED DATA DOCUMENT FOR REFERENCE CHARACTERISTICS FOR INDIVIDUAL DATASETS

SYMBOL		PARAMETRIC VALUES	
x	.142	MACH	4.530
0		PIOTAL	110.000
		BETA	.000
		DBETA	-5.000
		AILRON	10.000
		Y	-200.000

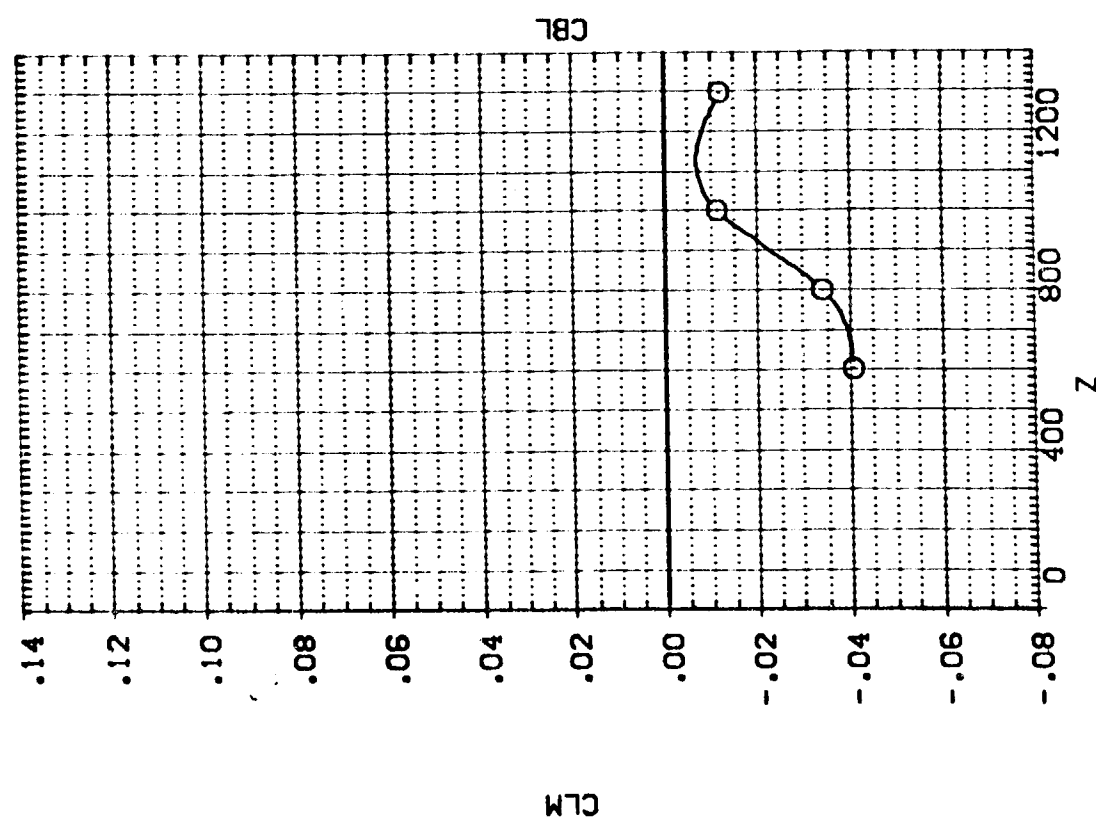
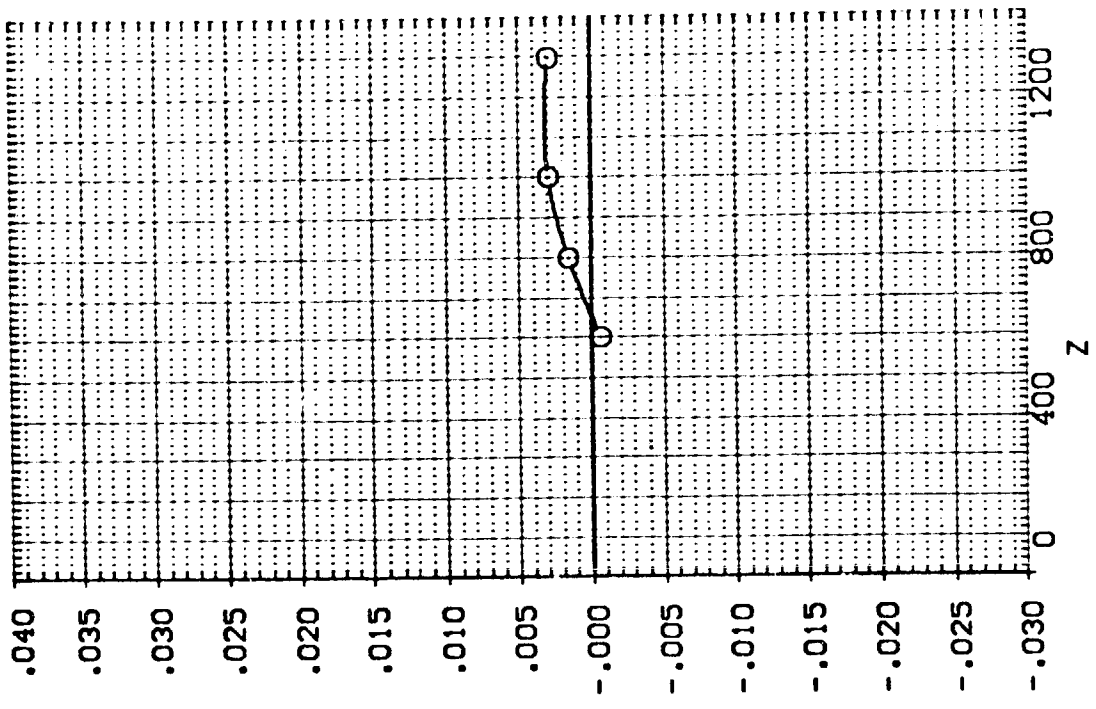

EFFECT OF EXTERNAL TANK SEPARATION ON ORBITER AERODYNAMIC CHARACTERISTICS

IA13, EXTERNAL TANK(T10)SEPARATING FROM ORB. 09 (RTJ067)

SEE THE ASSOCIATED DATA DOCUMENT FOR THE USE CHARACTERISTICS FOR INDIVIDUAL DATASETS

SYMBOL		PARAMETRIC VALUES	
0	x	MACH	110.000
		ALPHA	.000
		BETA	-5.000
		DBETA	10.000
		AILLRN	
		Y	-200.000
		PTOTAL	
		BETA	
		DBETA	
		AILLRN	
		Y	

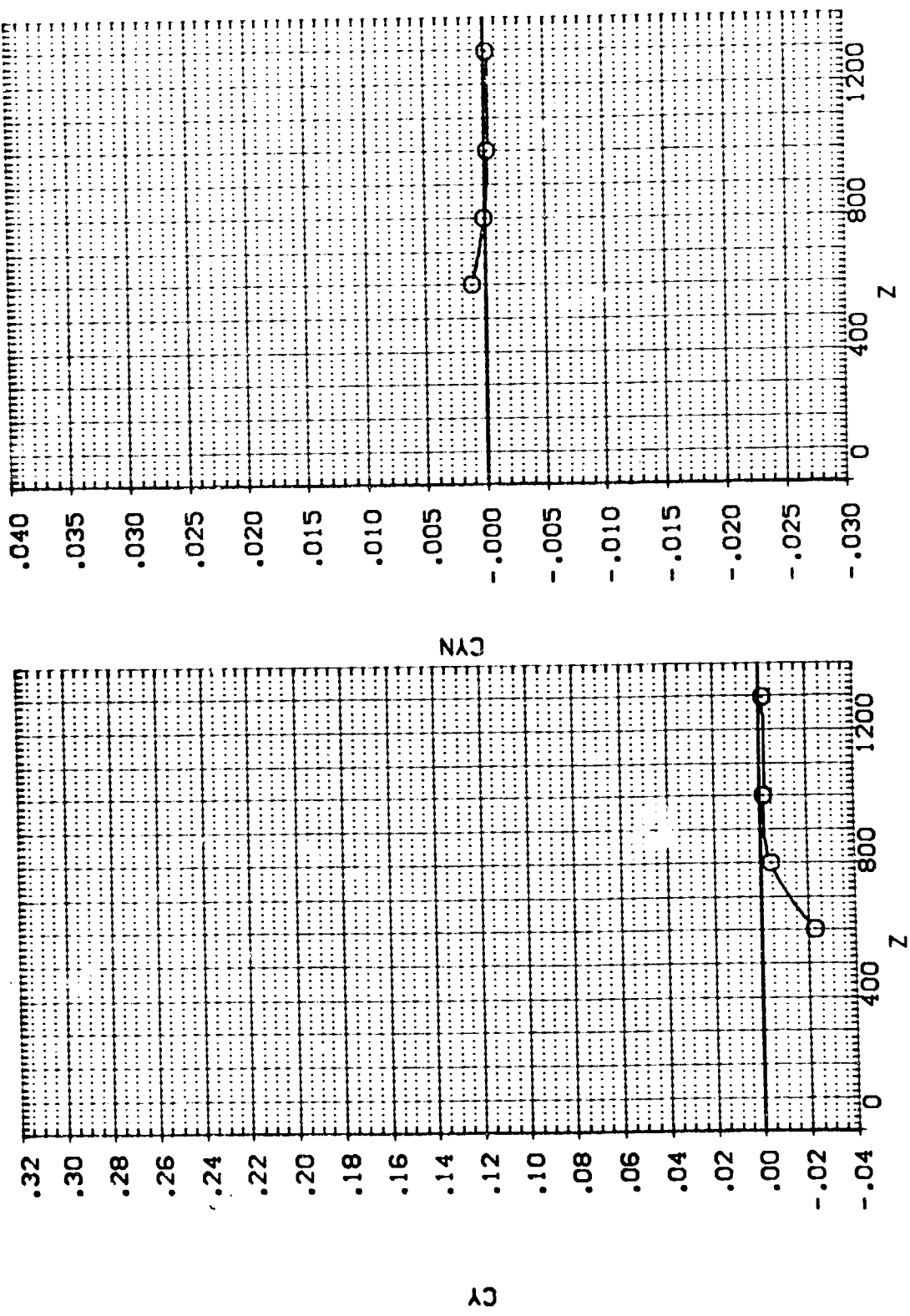

EFFECT OF EXTERNAL TANK SEPARATION ON ORBITER AERODYNAMIC CHARACTERISTICS

IA13.EXTERNAL TANK(T10)SEPARATING FROM ORB. 09 (RTJ068)

SEE THE ASSOCIATED DATA DOCUMENT FOR REFERENCE CHARACTERISTICS FOR INDIVIDUAL DATASETS

SYMBOL		PARAMETRIC VALUES	
x	.014	MACH	4.530
U		ALPHA	.000
		DALPHA	-20.000
		ELEVTR	.000
		Y	.000
		PITOTL	110.000
		BETA	.000
		DBETA	5.000
		AILRON	10.000

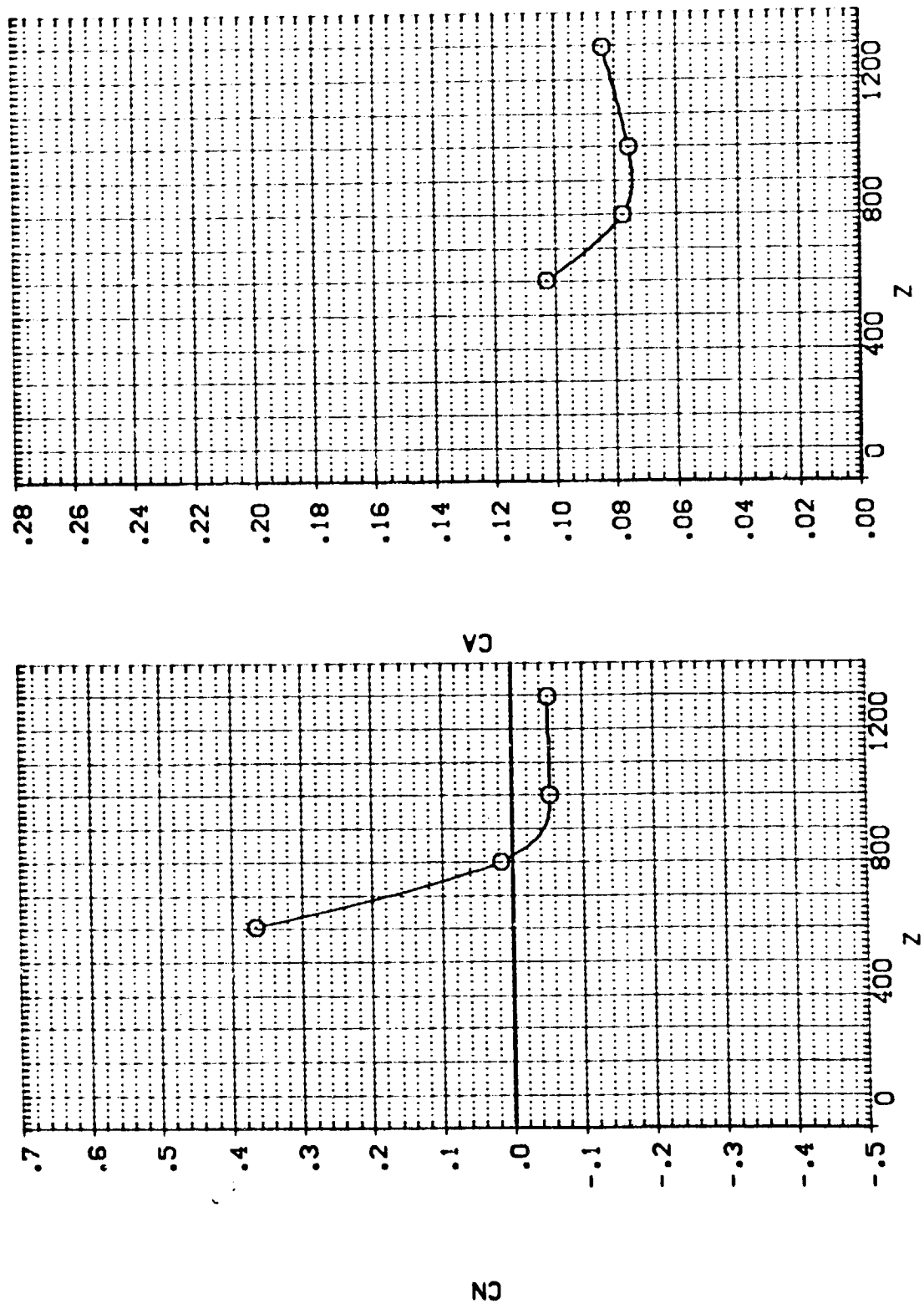

1A13. EXTERNAL TANK(T10)SEPARATING FROM ORB. 09 (RTJ068)

SEE THE ASSOCIATED REFERENCE DOCUMENT FOR MORE CHARACTERISTICS FOR INDIVIDUAL DATASETS

PARAMETRIC VALUES	
MACH	4.530
PTOTAL	110.000
BETA	.000
DBETA	5.000
AILRON	10.000
ELEVTR	.000
Y	.003

SYMBOL X .014

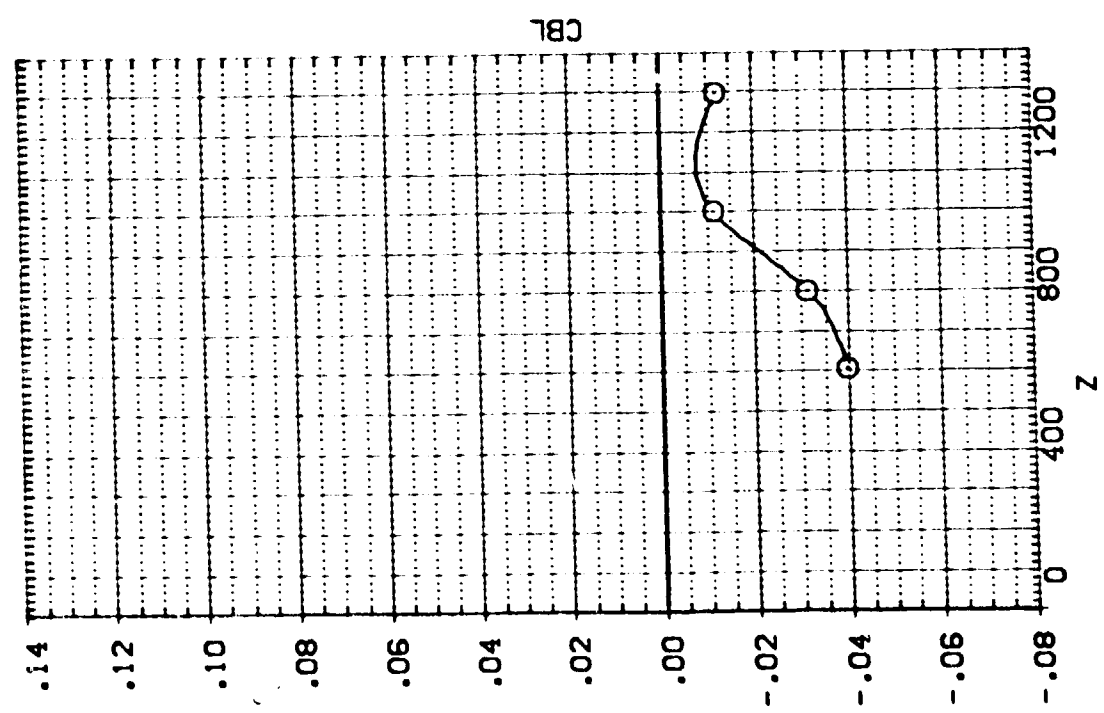
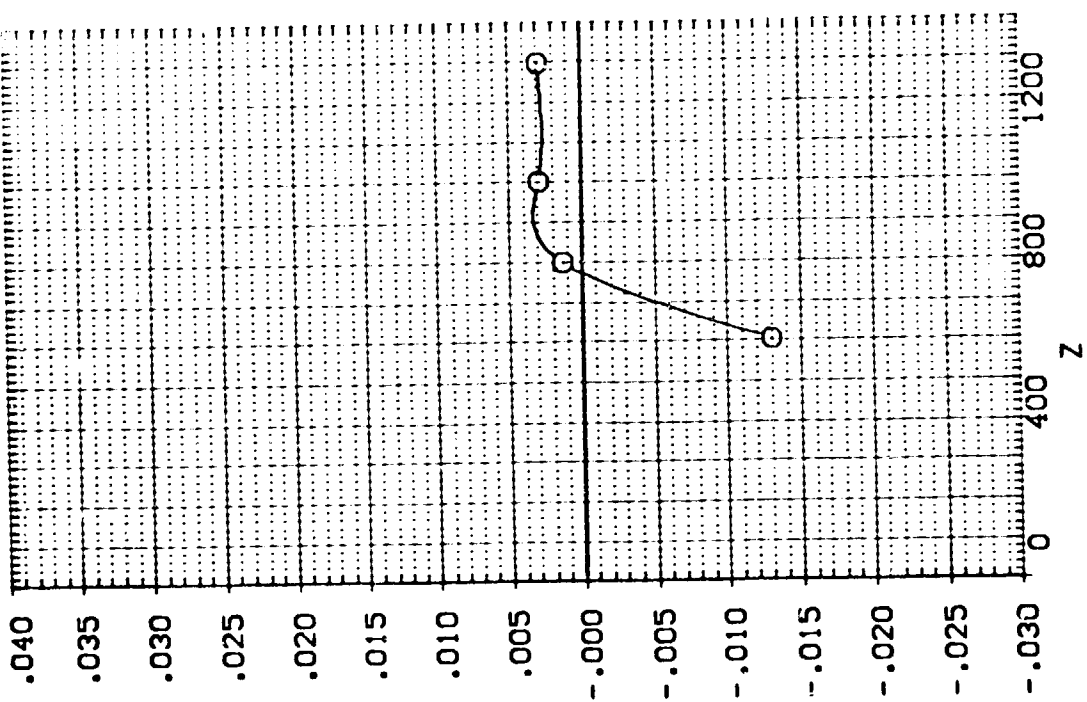

EFFECT OF EXTERNAL TANK SEPARATION ON ORBITER AERODYNAMIC CHARACTERISTICS



1A13, EXTERNAL TANK(T10)SEPARATING FROM ORB. 09 (RTJ068)

SEE THE ASSOCIATED DATA DOCUMENT FOR REFERENCE CHARACTERISTICS FOR INDIVIDUAL DATASETS

SYMBOL		PARAMETRIC VALUES	
O	.014	MACH	4.530
		PTOTAL	110.000
		BETA	.000
		DBETA	5.000
		ALTRON	10.000
		ALPHA	-20.000
		ELEVTR	.000
		Y	.000

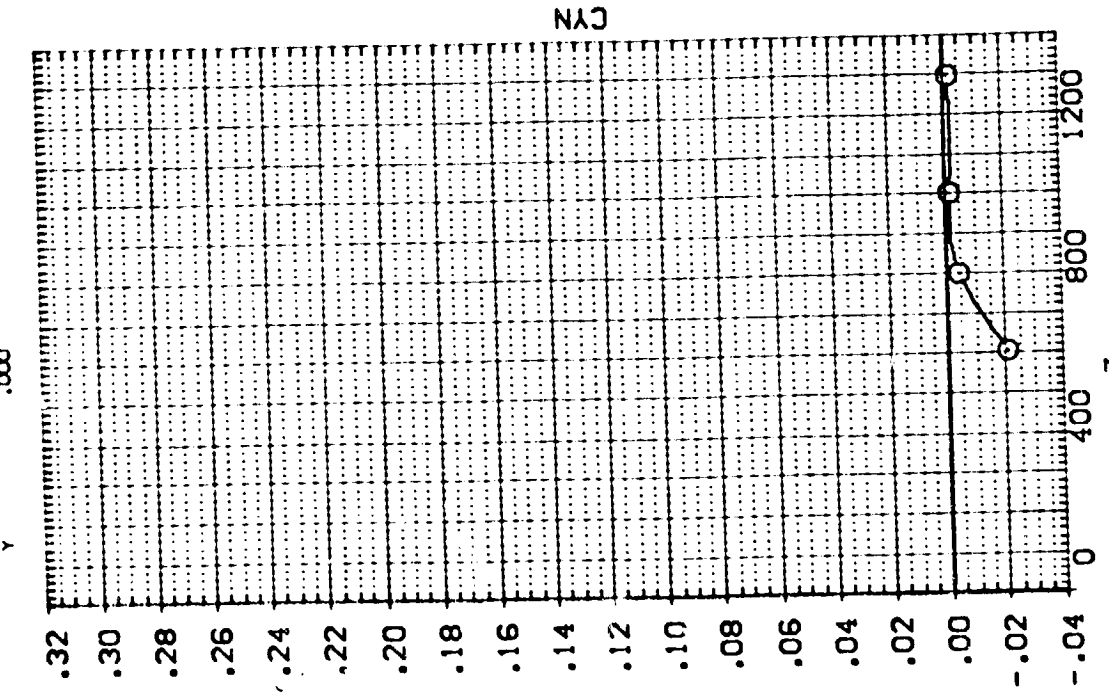
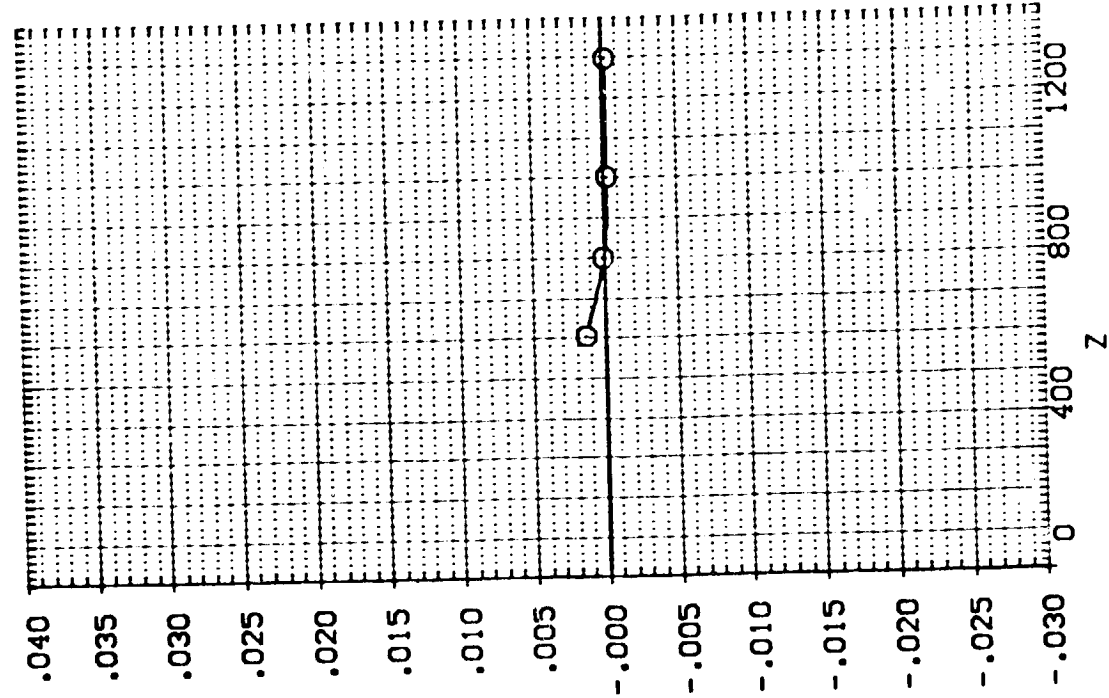

EFFECT OF EXTERNAL TANK SEPARATION ON ORBITER AERODYNAMIC CHARACTERISTICS

1A13. EXTERNAL TANK (110) SEPARATING FROM ORB. 09 (RTJ069)

SEE THE ASSOCIATED DOCUMENT FOR REFERENCE CHARACTERISTICS FOR INDIVIDUAL DATA SETS

PARAMETRIC VALUES	
MACH	4.530
PI TOTAL	110.000
BETA	.000
DBETA	5.000
AIRTON	10.000
Y	200.000

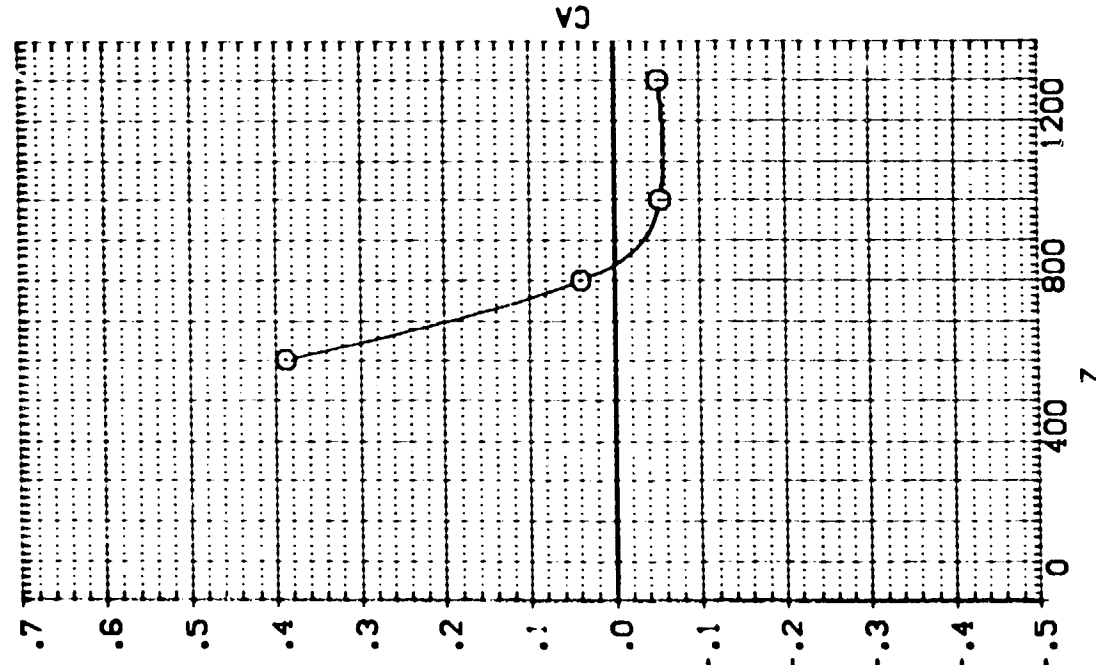
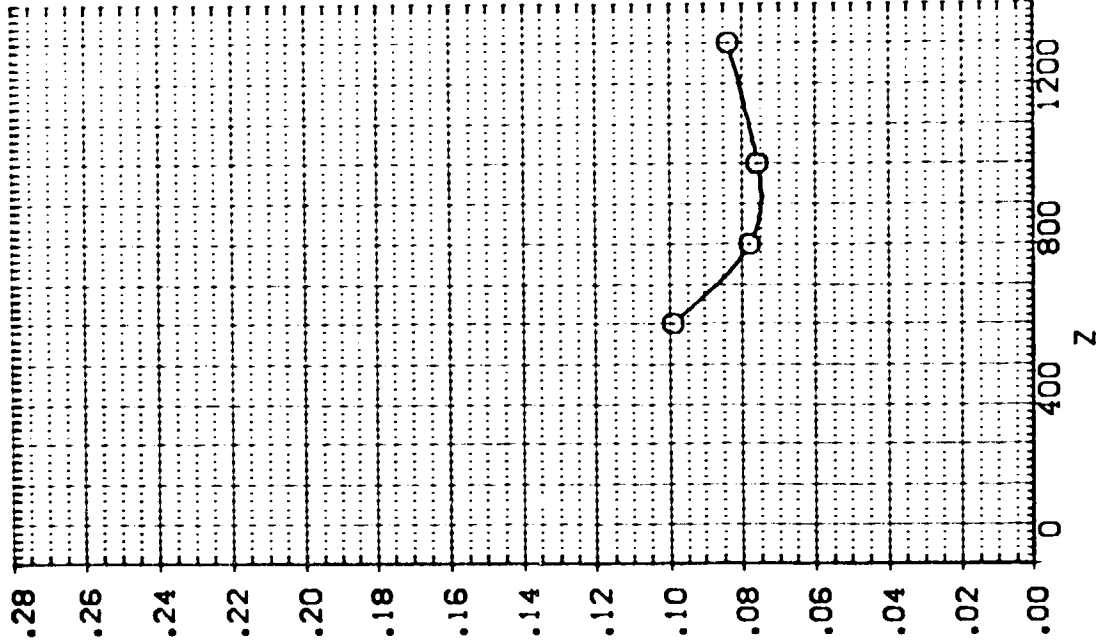

EFFECT OF EXTERNAL TANK SEPARATION ON ORBITER AERODYNAMIC CHARACTERISTICS

IA13.EXTERNAL TANK(T10)SEPARATING FROM ORB. 09 (RTJ069)

SEE THE ASSOCIATED DATA DOCUMENT FOR REFERENCE CHARACTERISTICS FOR INDIVIDUAL DATASETS

SYMBOL		PARAMETRIC VALUES	
x	.050	MACH	4.530
o		ALPHA	.000
		DALPHA	-20.000
		ELEVTR	.000
		Y	200.000
		STOTAL	110.000
		BETA	.000
		DBETA	5.000
		AILRON	10.000

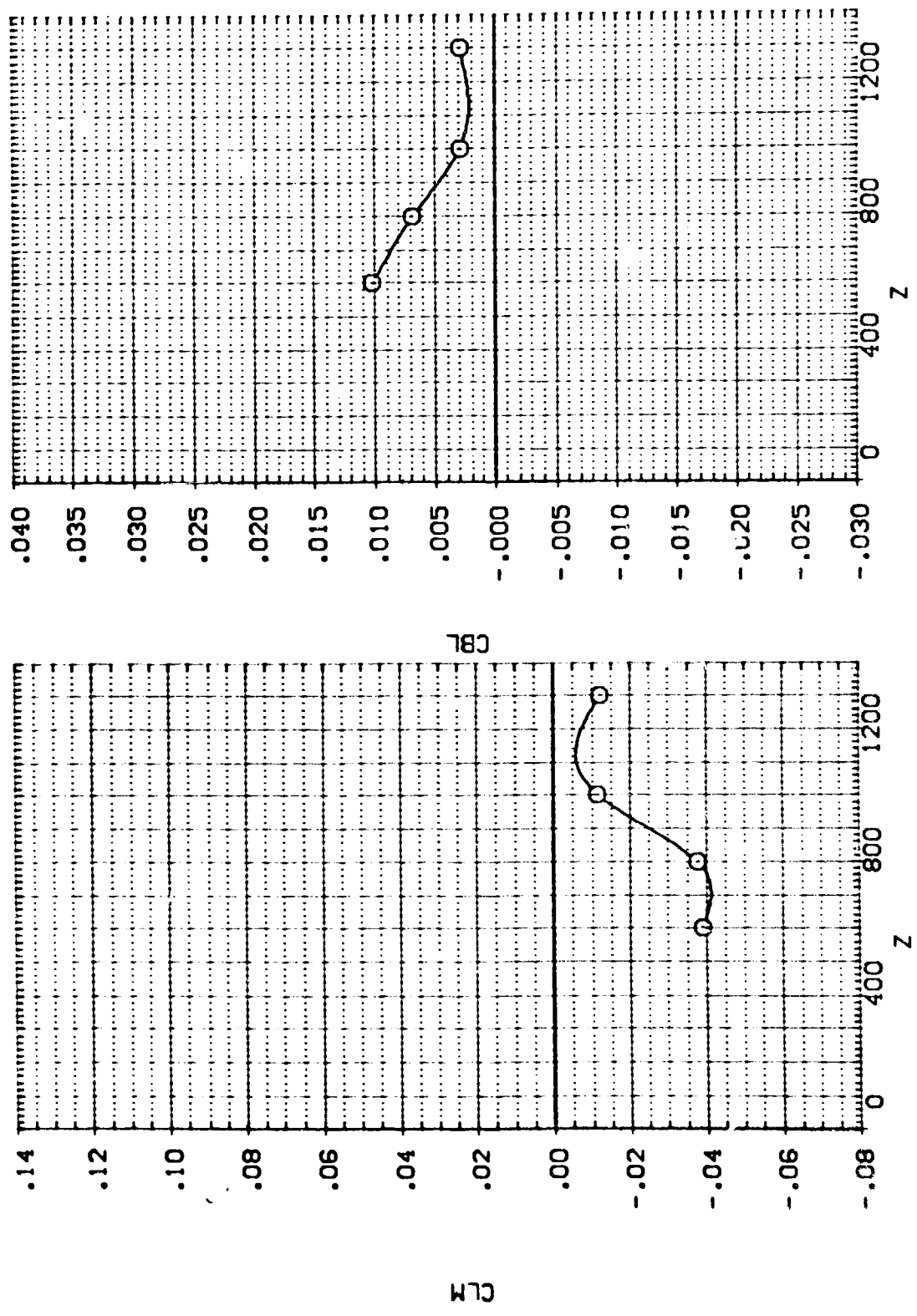

EFFECT OF EXTERNAL TANK SEPARATION ON ORBITER AERODYNAMIC CHARACTERISTICS

1A13.EXTERNAL TANK(T10)SEPARATING FROM ORB. 09 (RTJ069)

SEE THE ASSOCIATED DOCUMENT FOR REFERENCE CHARACTERISTICS FOR INDIVIDUAL DATASETS

SYMBOL		PARAMETRIC VALUES	
O	X	MACH	4.530
		ALPHA	.000
		DALF/A	-20.000
		ELEVTR	.000
		Y	200.000
		PTOTAL	110.000
		BETA	.000
		DBETA	5.000
		AILRON	10.000

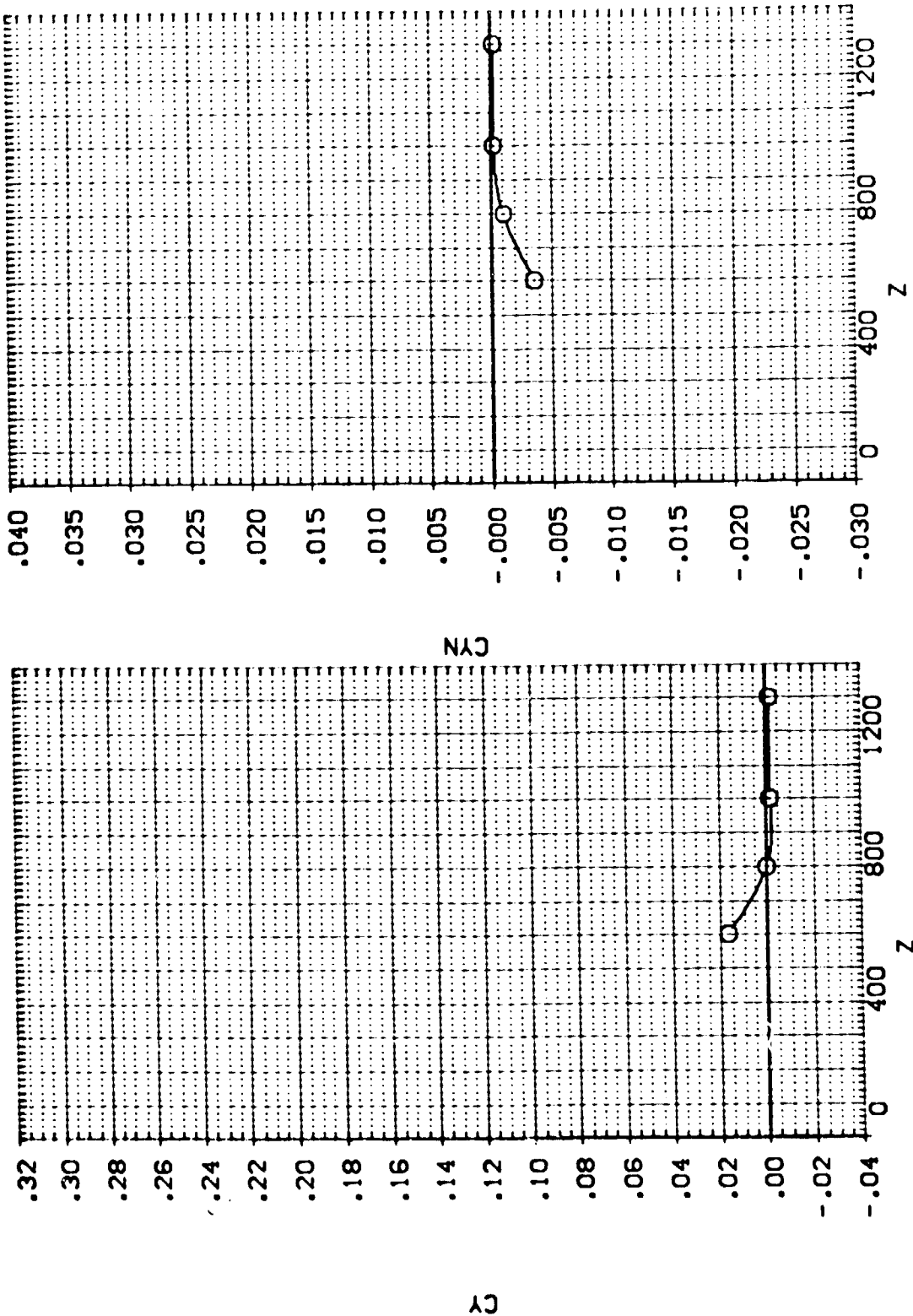

EFFECT OF EXTERNAL TANK SEPARATION ON ORBITER AERODYNAMIC CHARACTERISTICS



1:13, EXTERNAL TANK(T10)SEPARATING FROM ORB. 09 (RTJ070)

SEE THE ASSOCIATED DATA DOCUMENT FOR REFERENCE CHARACTERISTICS FOR INDIVIDUAL DATASETS

SYMBOL		PARAMETRIC VALUES	
x	.256	MACH	4.520
o		ALPHA	-5.000
		BETA	.000
		DALPHA	.000
		ELEVTR	.000
		AILRON	10.000
		Y	-200.000
		PIDTAL	60.000

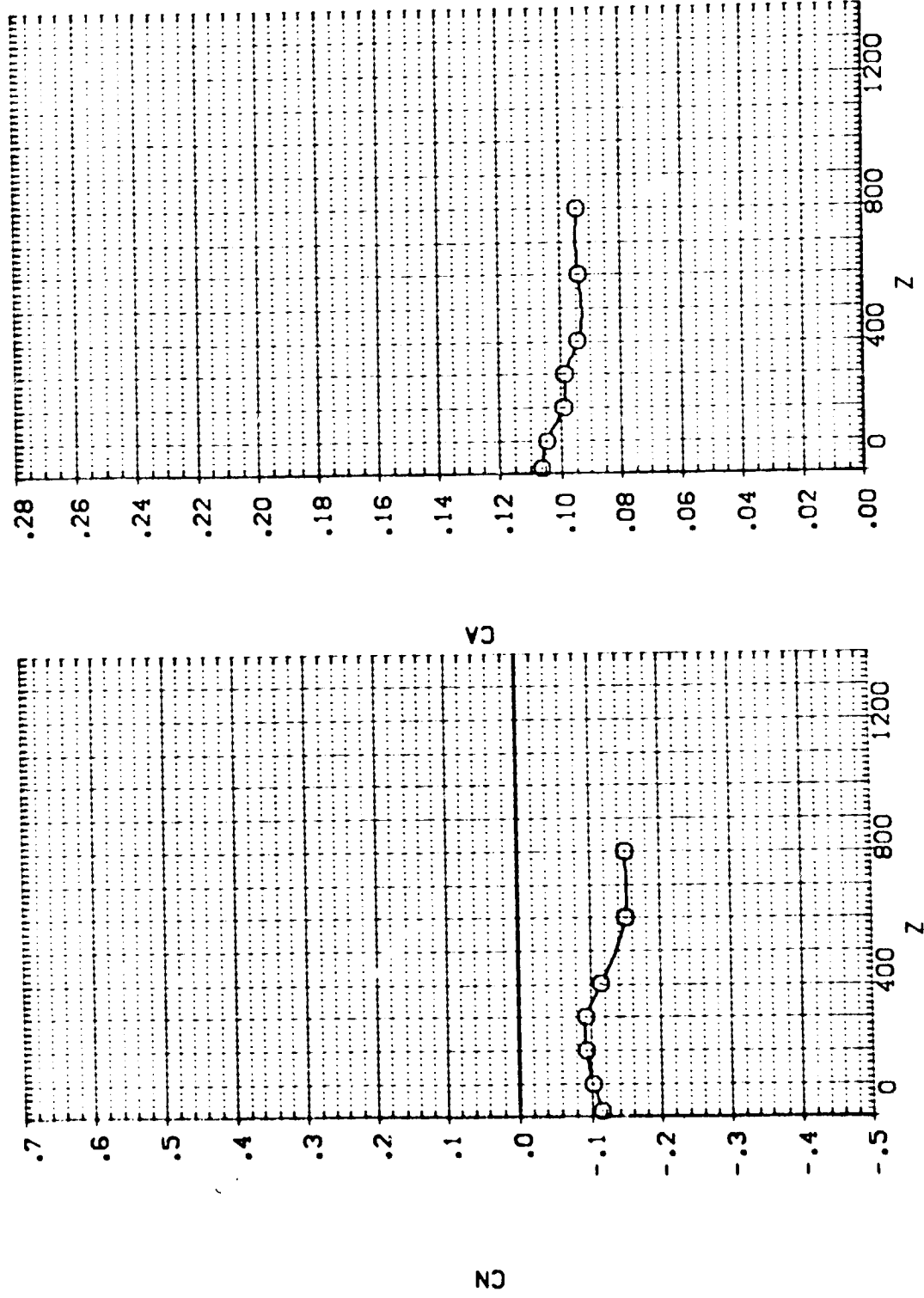

EFFECT OF EXTERNAL TANK SEPARATION ON ORBITER AERODYNAMIC CHARACTERISTICS

1A13. EXTERNAL TANK (110) SEPARATING FROM ORB. 09 (RTJ070)

SEE THE ASSOCIATED DATA DOCUMENT FOR RANGES OF CHARACTERISTICS FOR INDIVIDUAL DATASETS

SYMBOL O MACH .256 PARAMETRIC VALUES 80.000
 ALPHA .000 BETA .000 P TOTAL
 DALPHA .000 DBETA .000 ALPHA
 ELEVTR .000 AILRON 10.000 BETA
 Y -200.000 AILRON

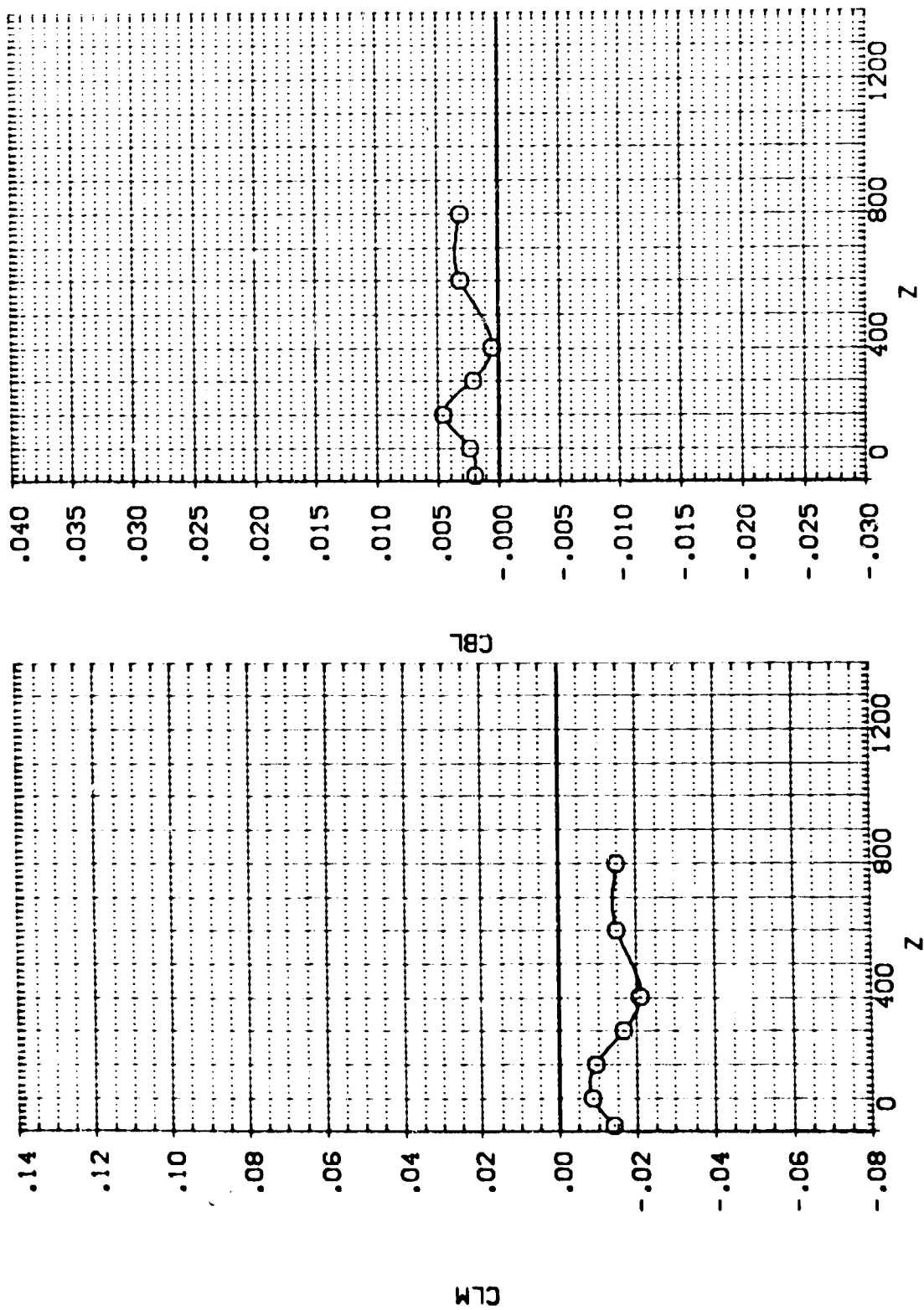

EFFECT OF EXTERNAL TANK SEPARATION ON ORBITER AERODYNAMIC CHARACTERISTICS

1A13-EXTERNAL TANK(T10)SEPARATING FROM ORB. 09 (RTJ070)

SEE THE ASSOCIATED DATA DOCUMENT FOR REFERENCE CHARACTERISTICS FOR INDIVIDUAL DATA'S

SYMBOL		PARAMETRIC VALUES	
O	X	MACH	1.520
		ALPHA	-5.000
		ELEVTR	.000
		Y	-200.000
		PITOTL	60.000
		BETA	.000
		DELTA	.000
		AIRDRN	10.000

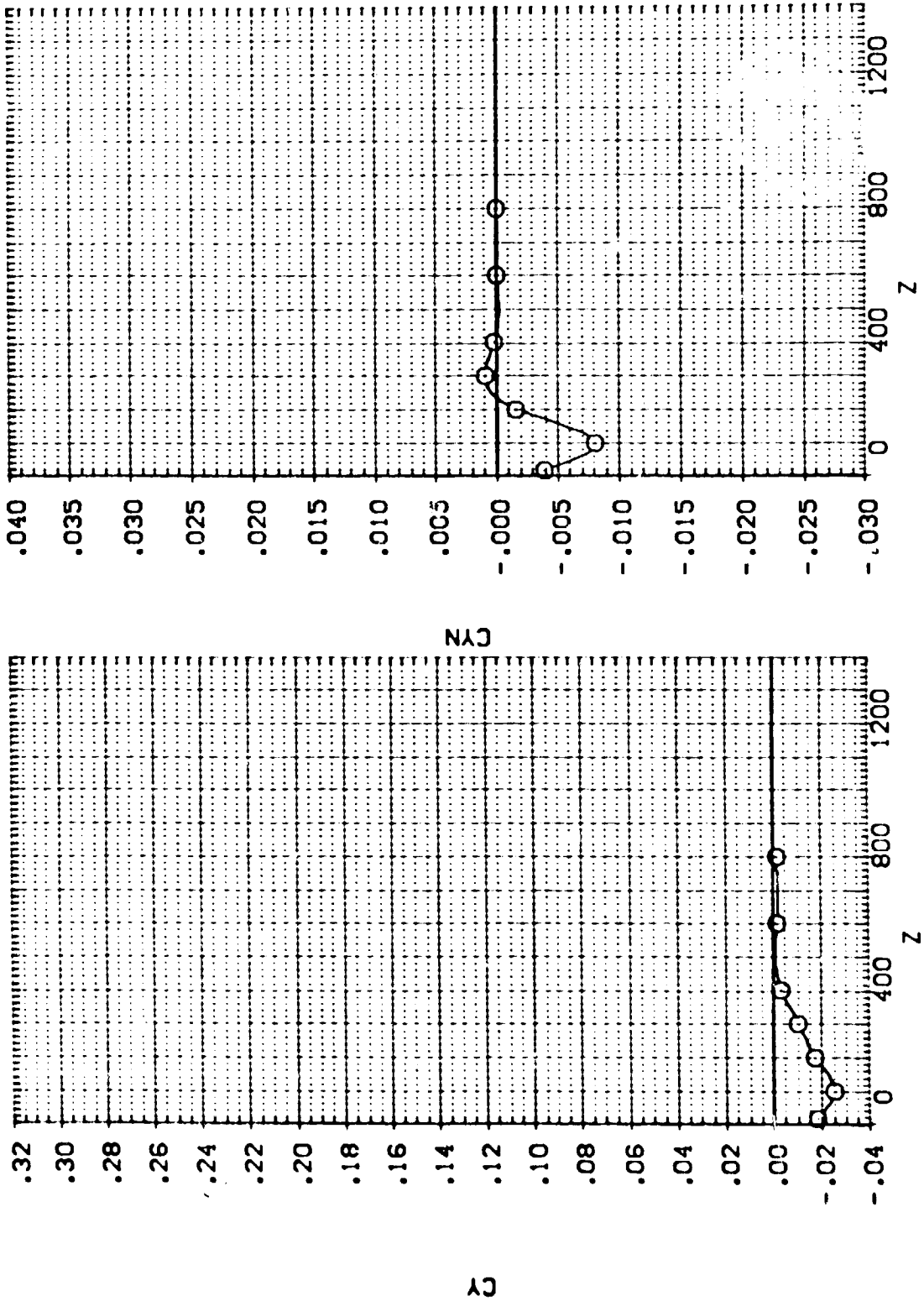

EFFECT OF EXTERNAL TANK SEPARATION ON ORBITER AERODYNAMIC CHARACTERISTICS

1A13.EXTERNAL TANK(T10)SEPARATING FROM ORB. 09 (RTJ071)

SEE THE ASSOCIATED DATA DOCUMENT FOR GENERAL CHARACTERISTICS FOR INDIVIDUAL DATA SETS

SYMBOL		PARAMETRIC VALUES	
x	.191	MACH	4.520
O		PISTAL	60.000
		BETA	.000
		DBETA	.000
		AILRON	10.000
		Y	.000

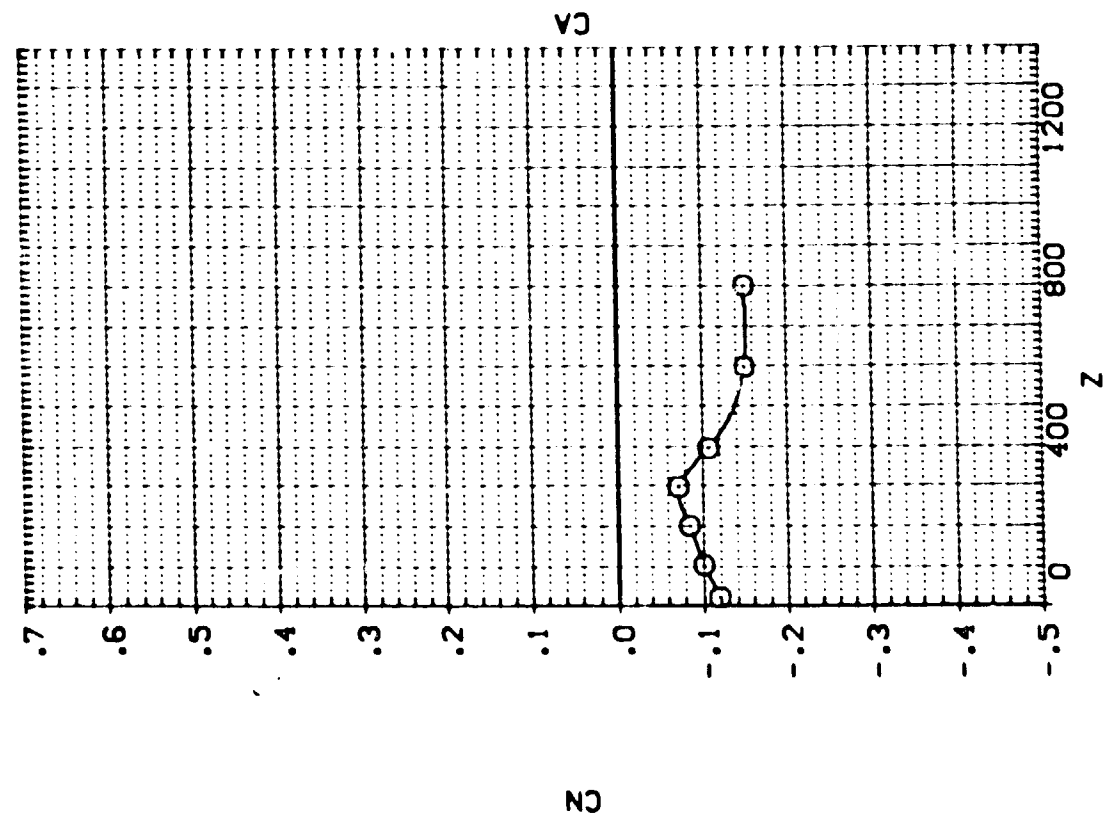
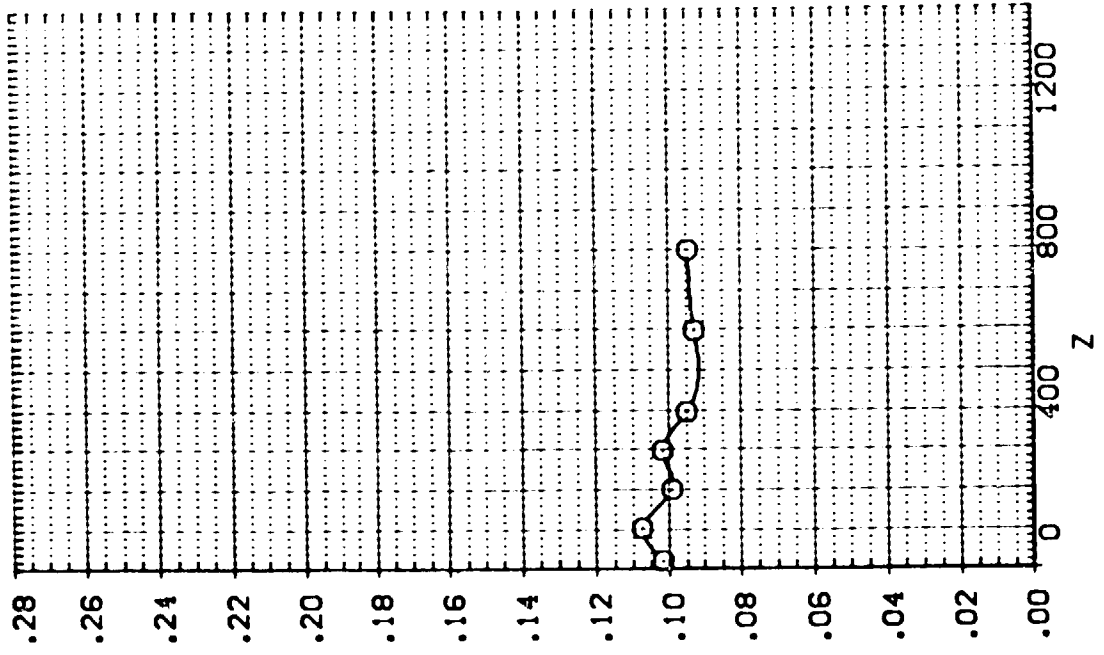

EFFECT OF EXTERNAL TANK SEPARATION ON ORBITER AERODYNAMIC CHARACTERISTICS

1.3. EXTERNAL TANK(110) SEPARATING FROM ORB. 09 (RTJ071)

SEE THE ASSOCIATED DATA DOCUMENT FOR REFERENCE CHARACTERISTICS FOR INDIVIDUAL DATASETS

SYMBOL		PARAMETRIC VALUES	
x	.191	MACH	4.570
o		ALPHA	-5.000
		DALPHA	.000
		ELEVTR	.000
		Y	.000
		PITOTL	60.000
		BETA	.000
		DBETA	.000
		AIRRON	10.000

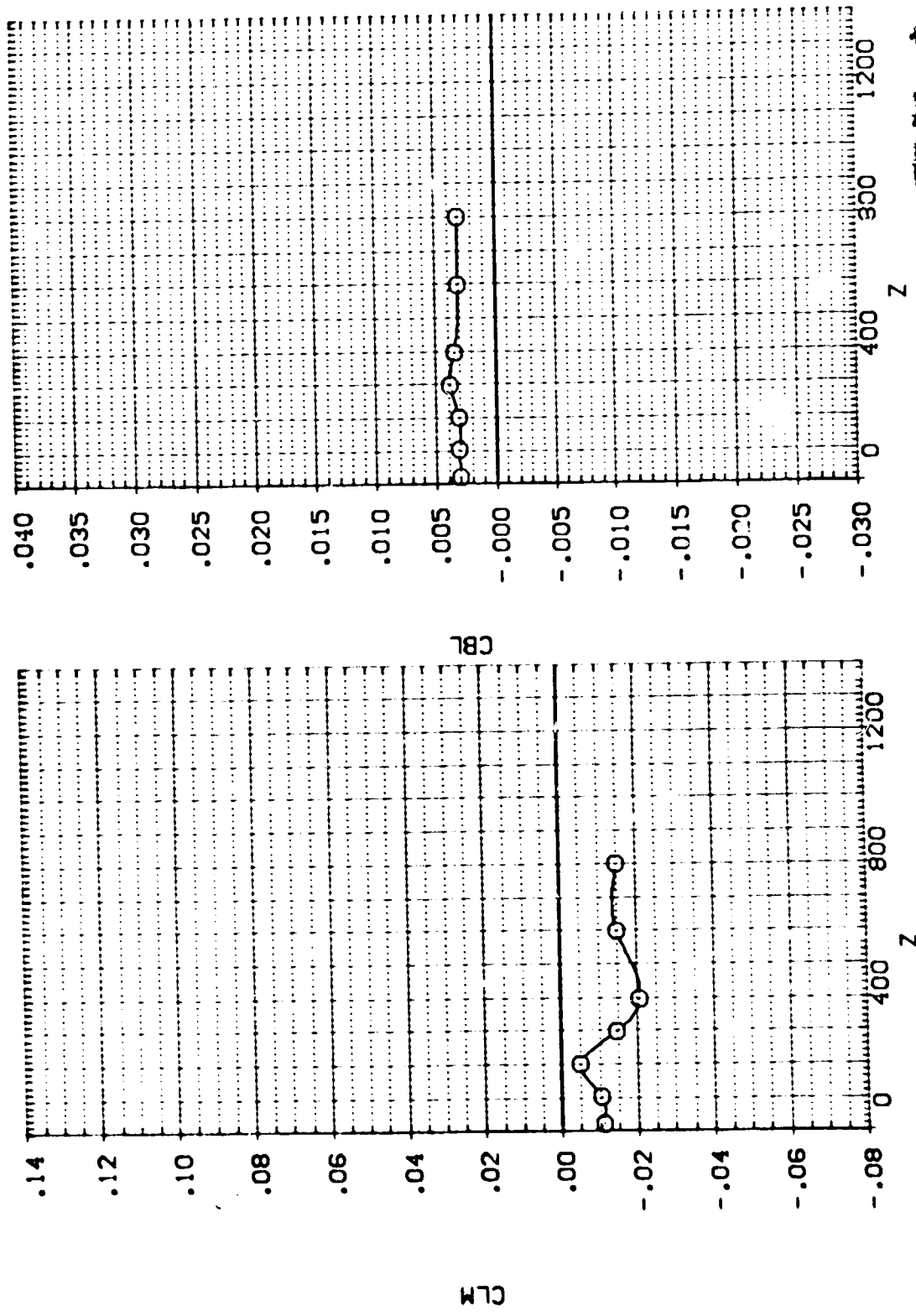

IA13.EXTERNAL TANK(T10)SEPARATING FROM ORB. 09 (RTJ071)

SEE THE ASSOCIATED DATA DOCUMENT FOR REFERENCE CHARACTERISTICS FOR INDIVIDUAL DATASETS

SYMBOL	X	.191	MACH	4.520	PTOTAL	80.000
O			ALPHA	-5.000	BETA	.000
			DALPHA	.000	DBETA	.000
			ELEVTR	.000	AILRON	10.000
			Y	.000		

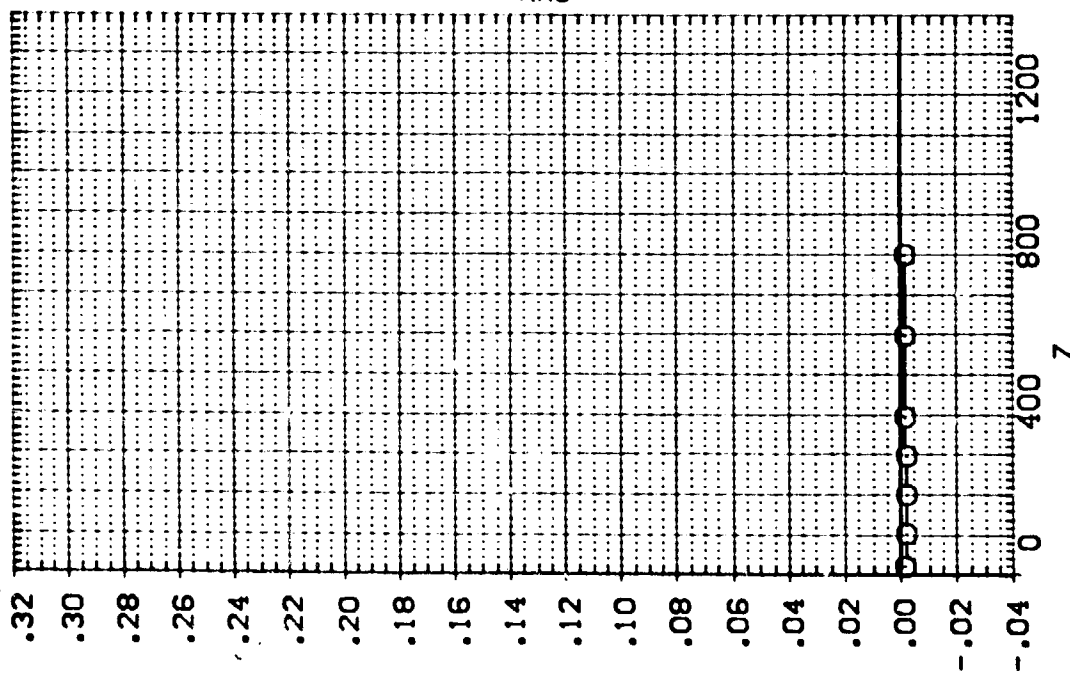
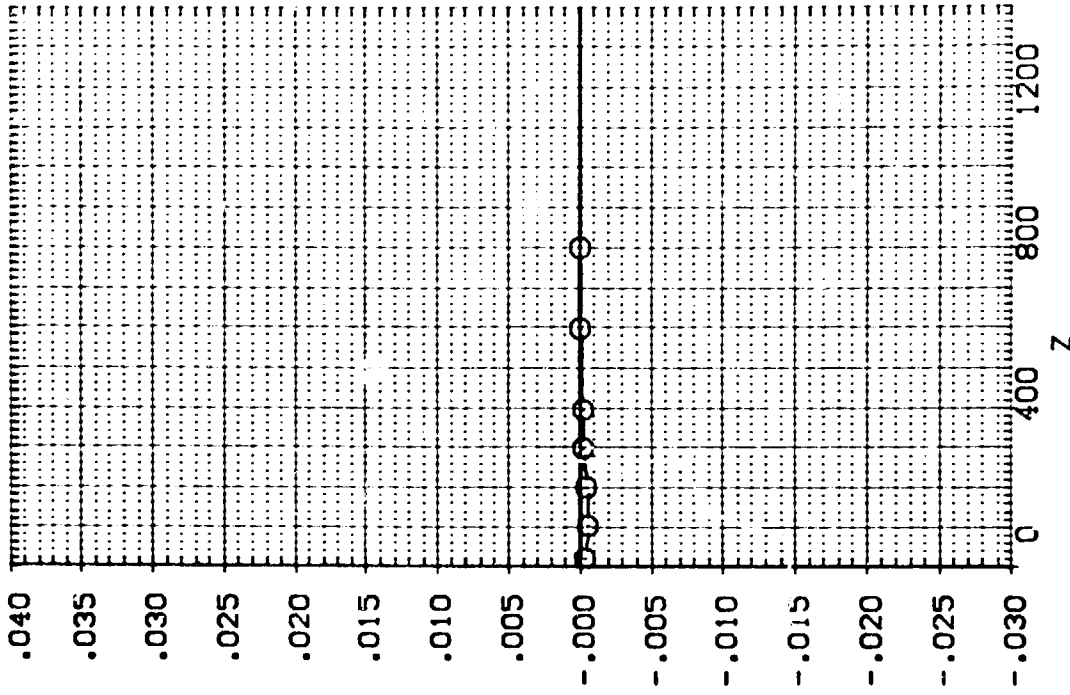

EFFECT OF EXTERNAL TANK SEPARATION ON ORBITER AERODYNAMIC CHARACTERISTICS



IA13.EXTERNAL TANK(T10)SEPARATING FROM ORB. 09 (RTJ072)

SEE THE ASSOCIATED DATA DOCUMENT FOR REFERENCE CHARACTERISTICS FOR INDIVIDUAL DATASETS

PARAMETRIC VALUES
 MACH 4.520 PTOTAL 60 700
 ALPHA -5.000 BETA .000
 DALPHA .000 DBETA .000
 ELEVTYR .000 AILRON 10.000
 Y 200.000

SYMBOL X

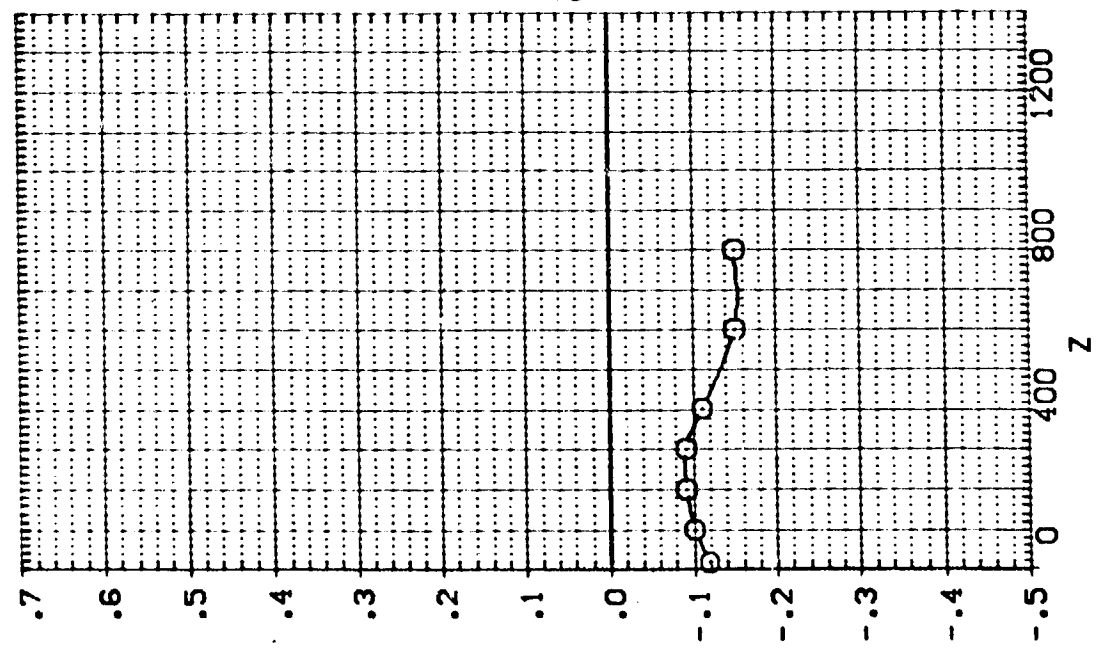
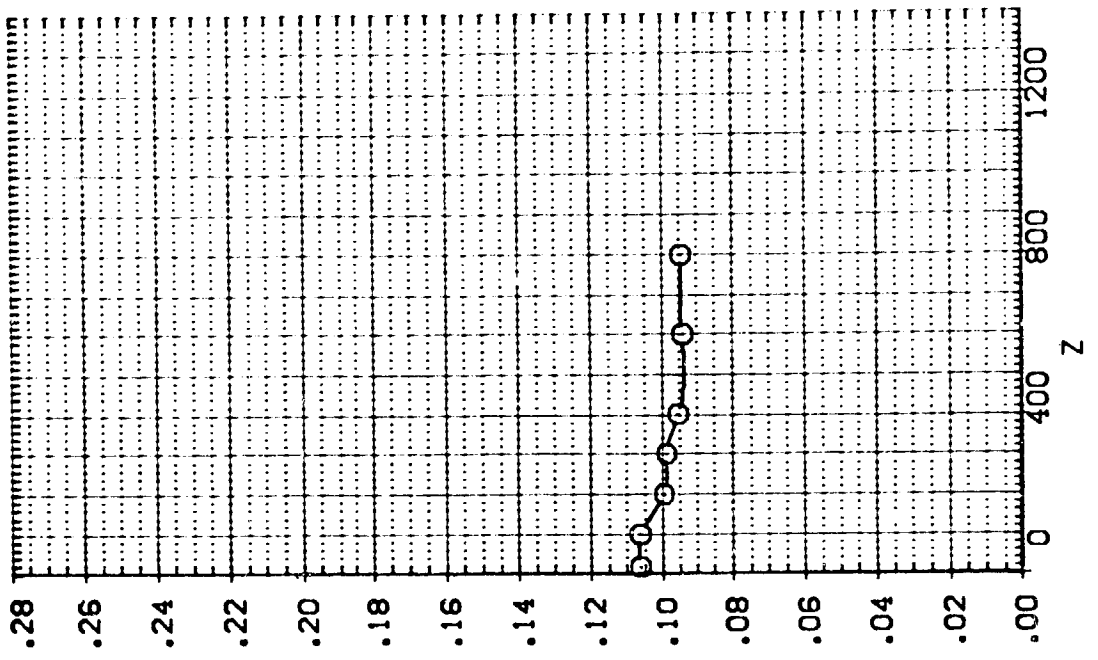

EFFECT OF EXTERNAL TANK SEPARATION ON ORBITER AERODYNAMIC CHARACTERISTICS

IA13. EXTERNAL TANK(T10)SEPARATING FROM ORB. 09 (RTJ072)

SEE THE ASSOCIATED DATA DOCUMENT FOR REFERENCE CHARACTERISTICS FOR INDIVIDUAL DATASETS

SYMBOL x .171 MACH 4.520 P TOTAL 80.000
 O ALPHA -5.000 BETA .000
 DALPHA .000 DBETA .000
 ELEVTR .000 AIRRN 10.000
 Y 200.000

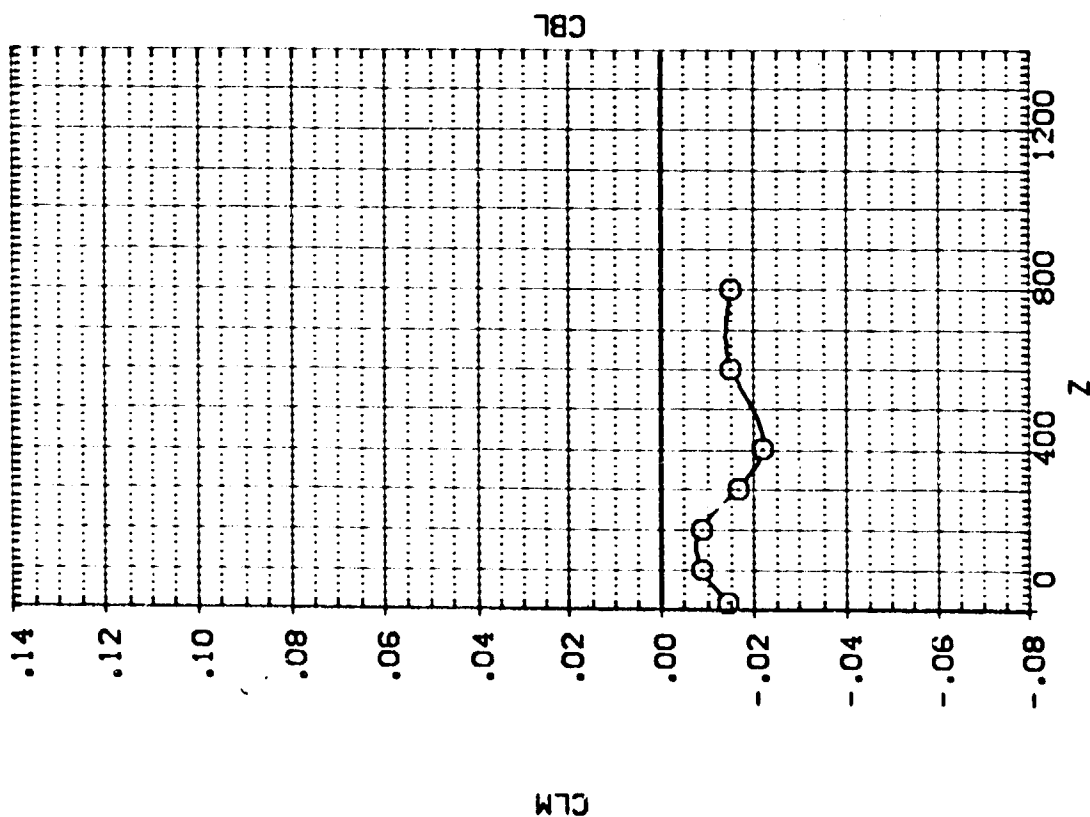
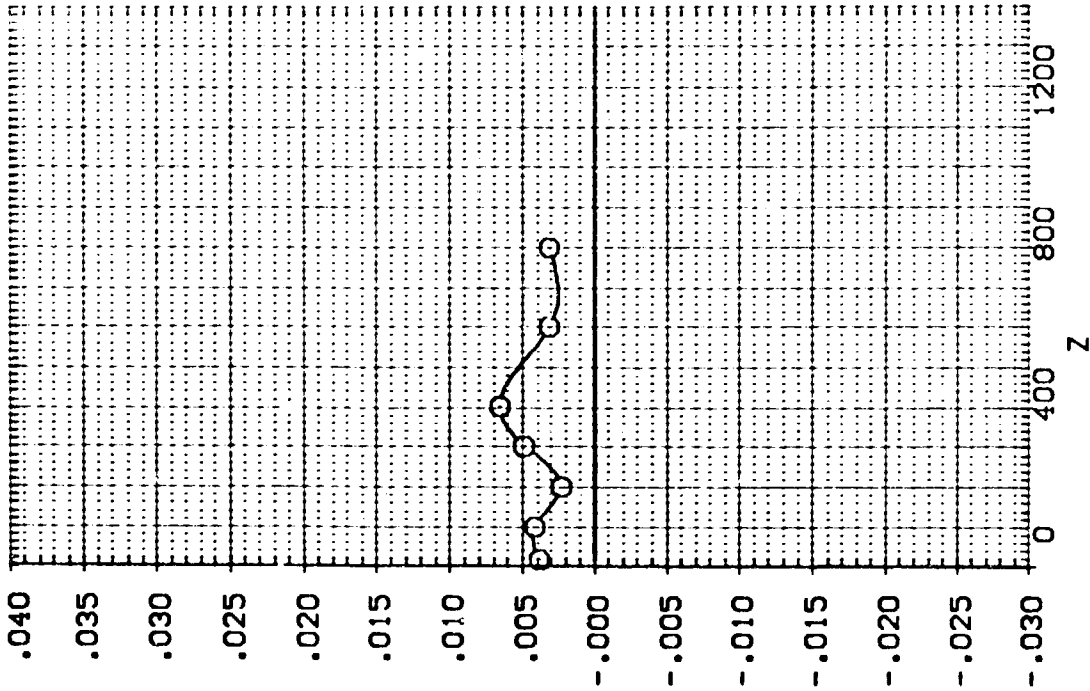

EFFECT OF EXTERNAL TANK SEPARATION ON ORBITER AERODYNAMIC CHARACTERISTICS

1A:3-EXTERNAL TANK(T10)SEPARATING FROM ORB. 09 (RTJ072)

SEE THE ASSOCIATED DATA DOCUMENT FOR REFERENCE CHARACTERISTICS FOR INDIVIDUAL DATASETS

SYMBOL	x	.171	MACH	4.520	PTOTAL	60.000
○			ALPHA	-5.000	BETA	.000
			DALPHA	.000	DBETA	.000
			ELEVTR	.000	AIRLON	10.000
			Y	200.000		

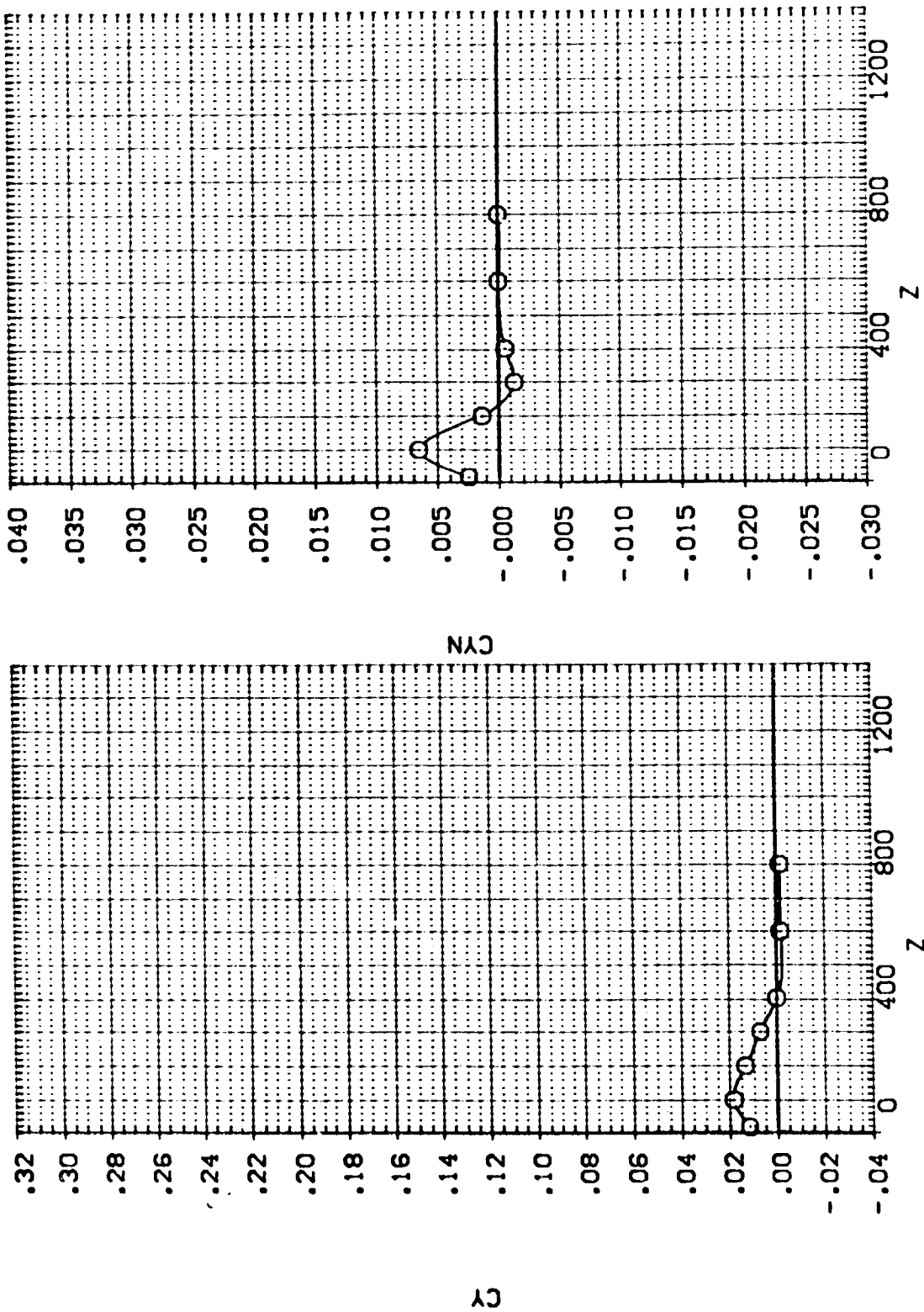

EFFECT OF EXTERNAL TANK SEPARATION ON ORBITER AERODYNAMIC CHARACTERISTICS

IA13.EXTERNAL TANK(T10)SEPARATING FROM ORB. 09 (RTJ073)

SEE THE ASSOCIATED DOCUMENT FOR REFERRED CHARACTERISTICS FOR INDIVIDUAL DATASETS

SYMBOL		PARAMETRIC VALUES	
O	X	MACH	4.520
		ALPHA	-5.000
		DALPHA	.000
		ELEVTR	.000
		Y	-200.000
		PTOTAL	80.000
		BETA	.000
		DBETA	-5.000
		AIRON	10.000

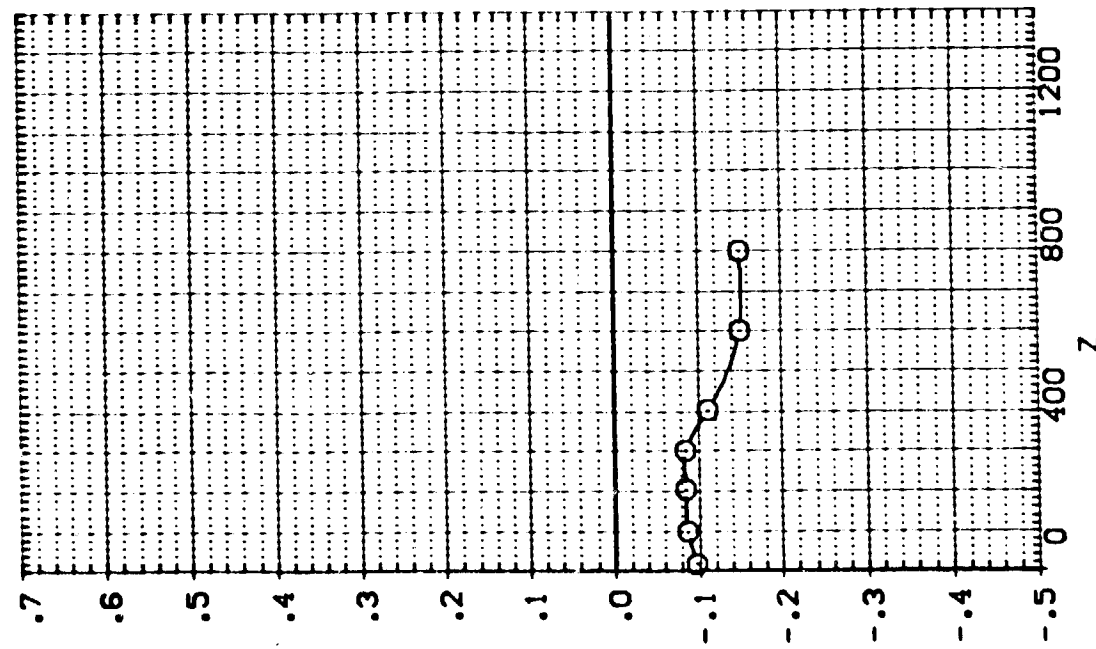
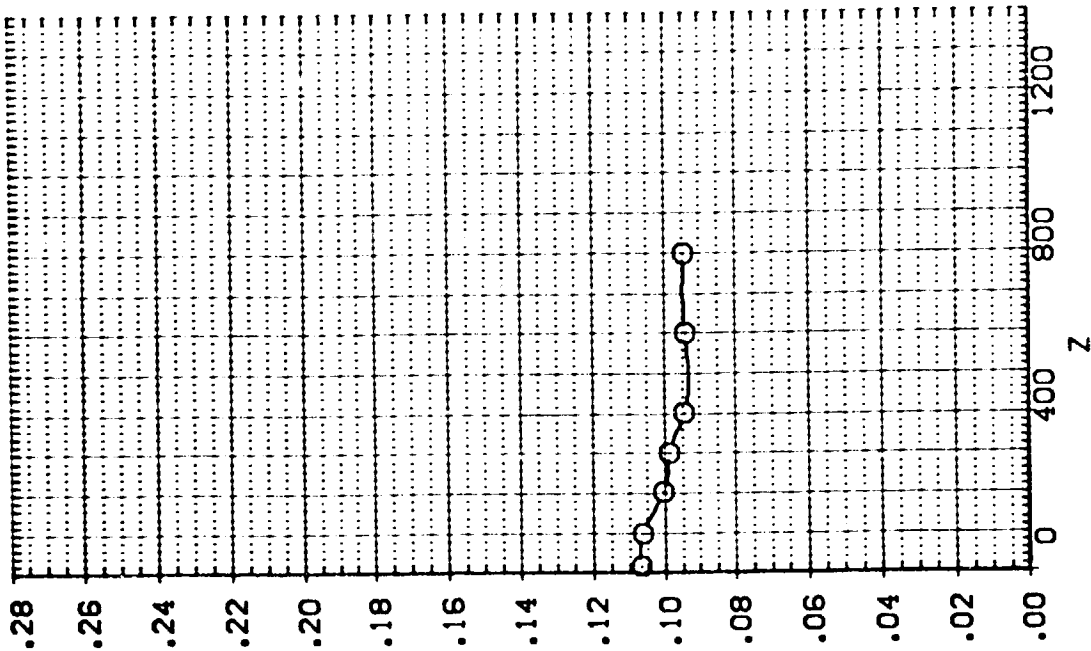

EFFECT OF EXTERNAL TANK SEPARATION ON ORBITER AERODYNAMIC CHARACTERISTICS

IA13.EXTERNAL TANK(T10)SEPARATING FROM ORB. 09 (RTJ073)

SEE THE ASSOCIATED DATA DOCUMENT FOR REFERENCE CHARACTERISTICS FOR INDIVIDUAL DATASETS

SYMBOL		PARAMETRIC VALUES	
O	x	MACH	4.520
		ALPHA	-5.000
		DALPHA	.000
		ELEVTR	.000
		Y	-200.000
		PIDTAL	90.000
		BETA	.000
		DBETA	-5.000
		AILRON	10.000

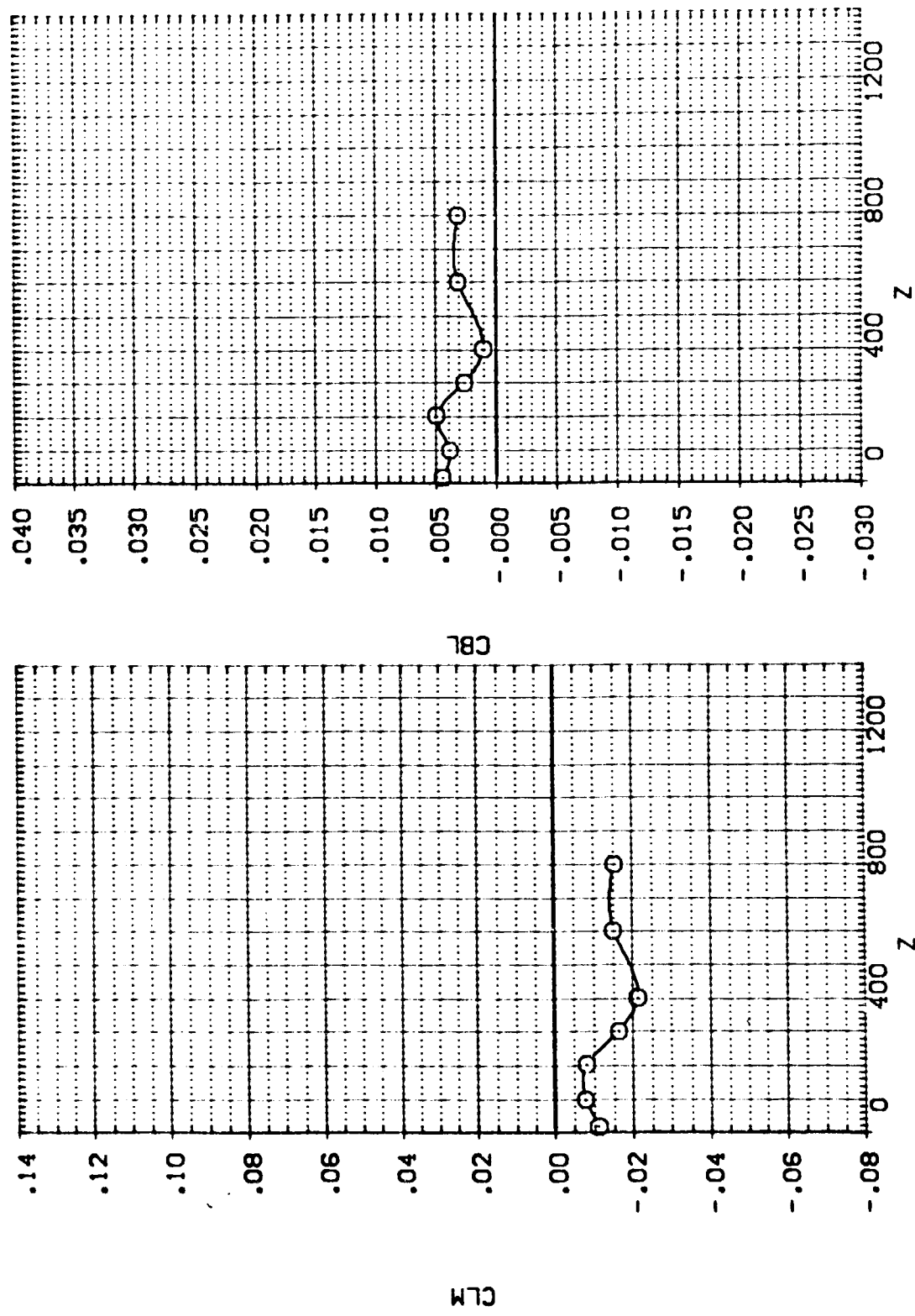

EFFECT OF EXTERNAL TANK SEPARATION ON ORBITER AERODYNAMIC CHARACTERISTICS

IA13.EXTERNAL TANK(T10)SEPARATING FROM ORB. 09 (RTJ073)

SYMBOL x .236
 O

PARAMETRIC VALUES	
MACH	4.520
ALPHA	-5.000
DALPHA	.000
ELEVTR	.000
Y	-200.000
PTOTAL	80.000
BETA	.000
DBETA	-5.000
AILRON	10.000

SEE THE ASSOCIATED CASE DOCUMENT FOR RELEVANT CHARACTERISTICS FOR INDIVIDUAL DATASETS

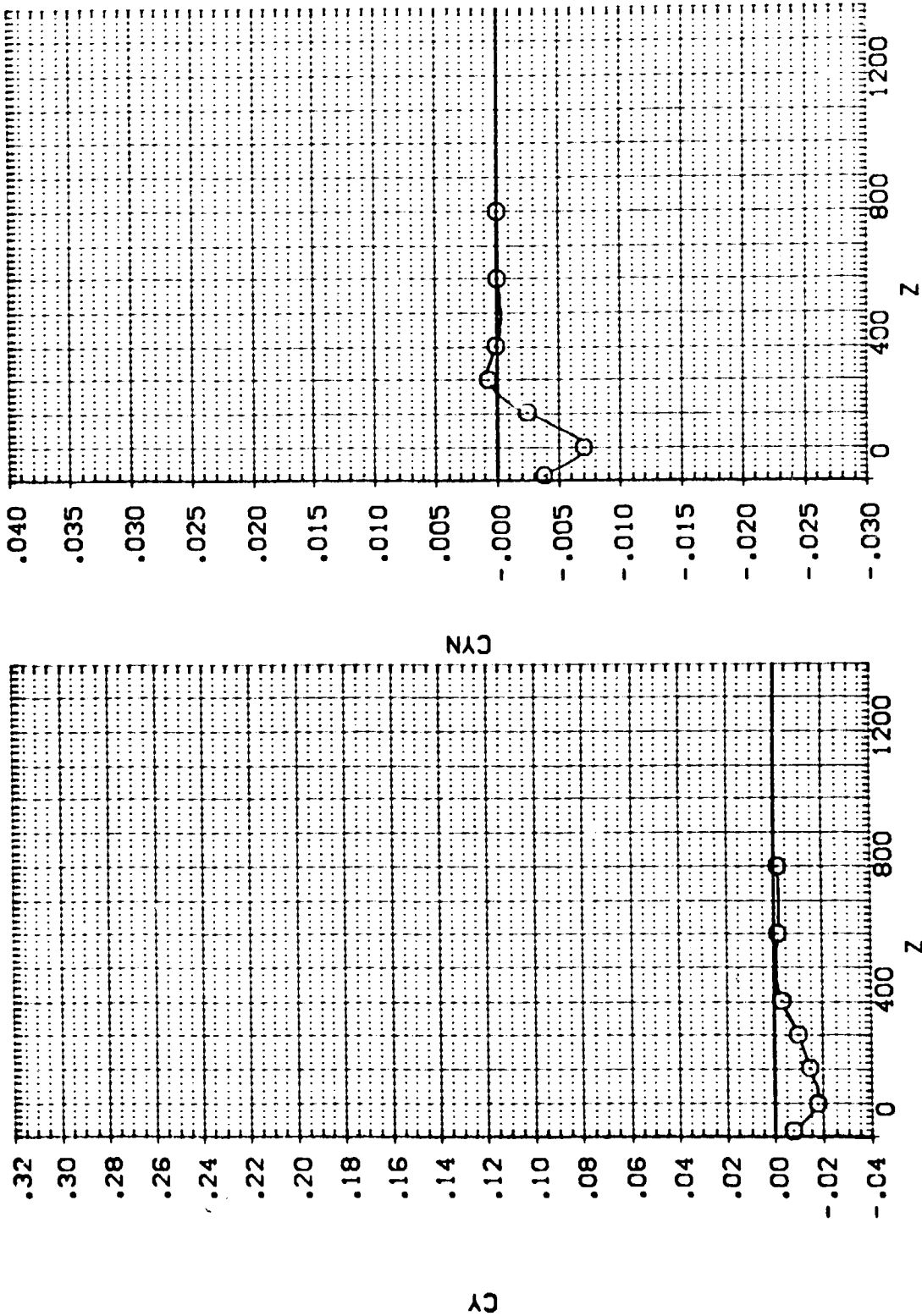

EFFECT OF EXTERNAL TANK SEPARATION ON ORBITER AERODYNAMIC CHARACTERISTICS

1A13, EXTERNAL TANK(T10)SEPARATING FROM ORB. 09 (RTJ074)

SEE THE ASSOCIATED DATA DOCUMENT FOR REFERENCE CHARACTERISTICS FOR INDIVIDUAL DATASETS

PARAMETRIC VALUES	
MACH	4.520
PIOTAL	60.000
BETA	.000
DBETA	5.000
ALURON	10.000
Y	.000

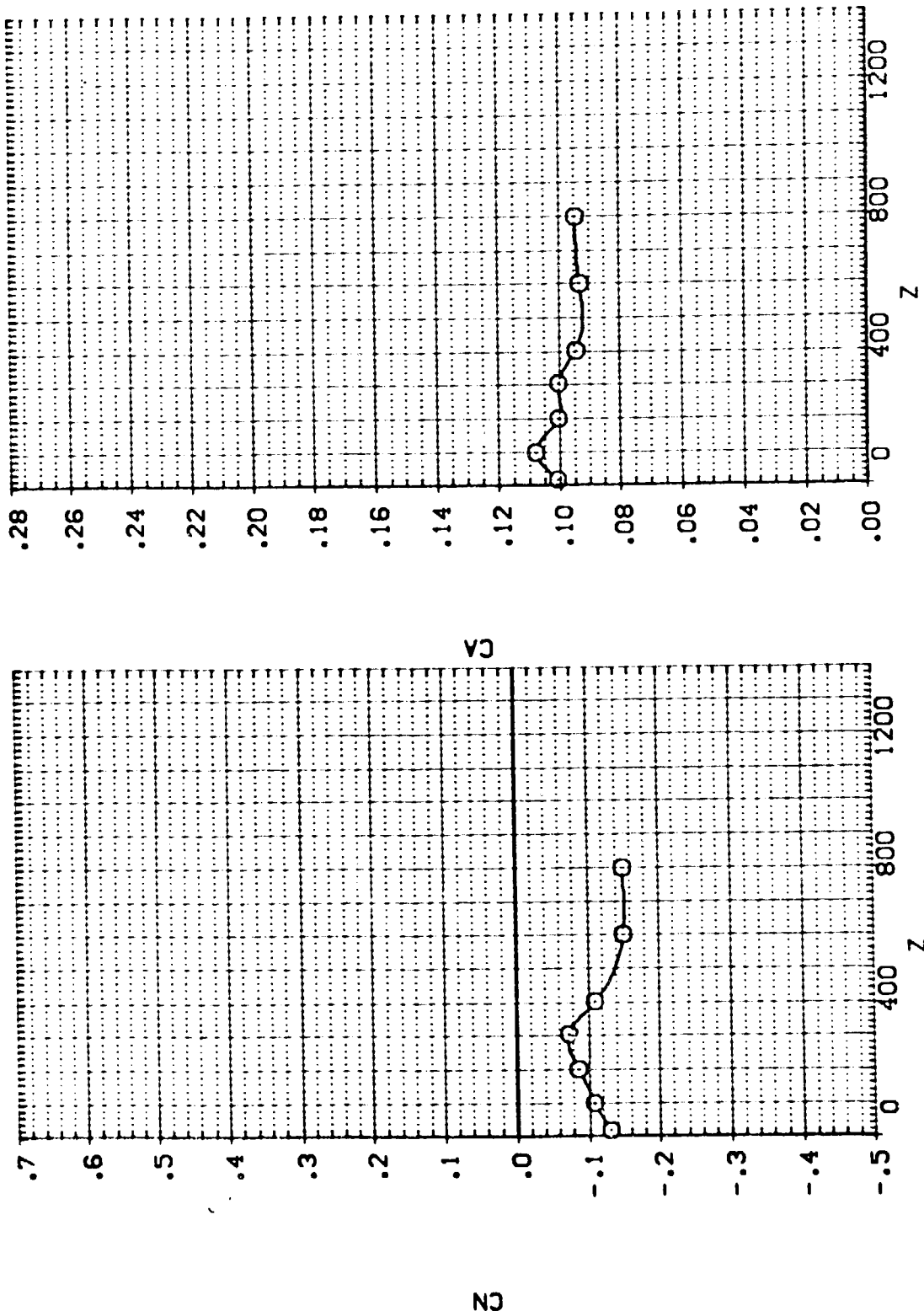

EFFECT OF EXTERNAL TANK SEPARATION ON ORBITER AERODYNAMIC CHARACTERISTICS

1A13.EXTERNAL TANK(T10)SEPARATING FROM ORB. 09 (RTJ074)

SEE THE ASSOCIATED DATA DOCUMENT FOR FURTHER CHARACTERISTICS FOR INDIVIDUAL DATASETS

SYMBOL		PARAMETRIC VALUES	
x	.252	MACH	4.520
o		PIOTAL	60.000
		ALPHA	-5.000
		BETA	.000
		DBETA	5.000
		A1LRON	10.000
		ELEVTR	.000
		Y	.000

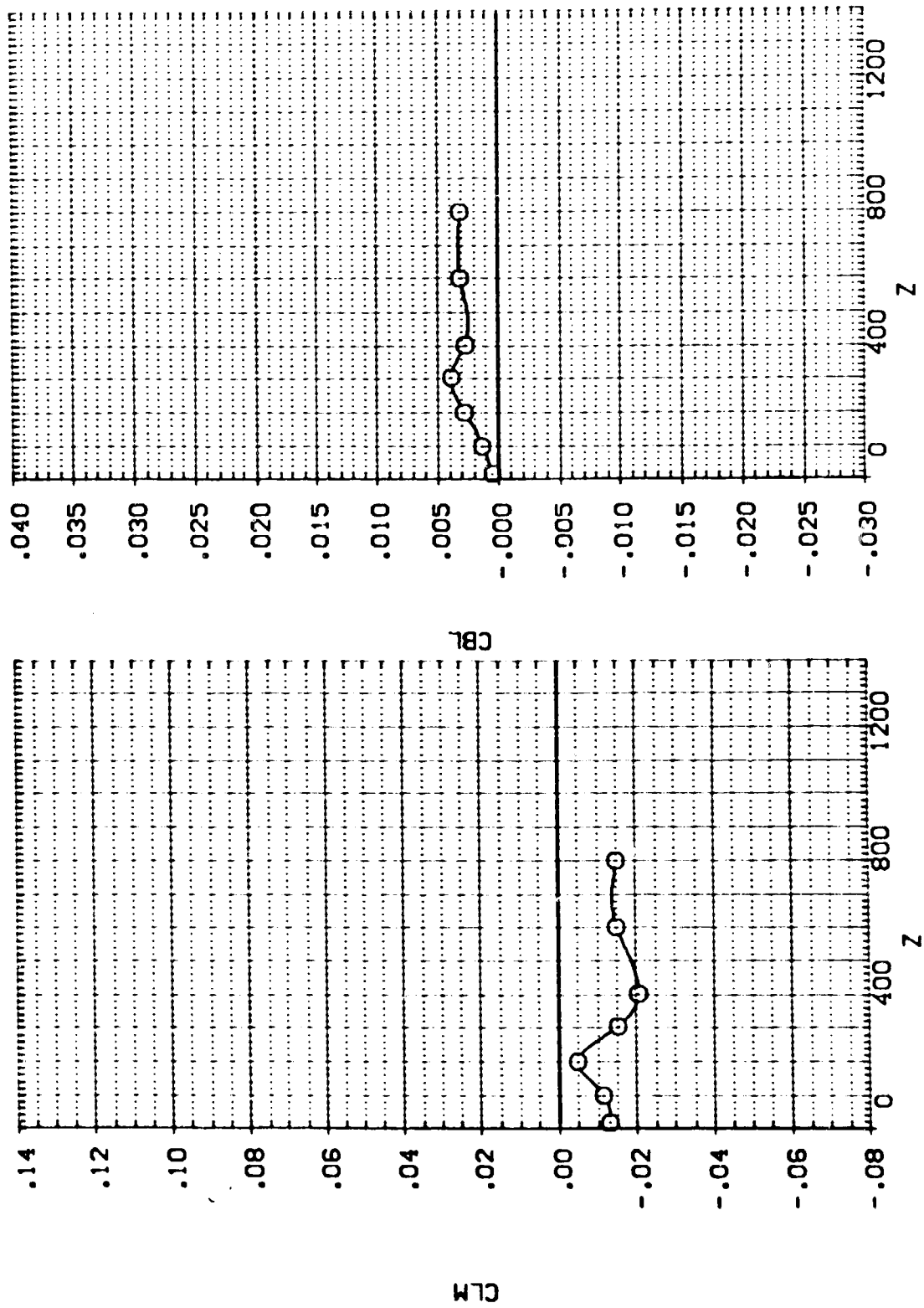

EFFECT OF EXTERNAL TANK SEPARATION ON ORBITER AERODYNAMIC CHARACTERISTICS

1A13.EXTERNAL TANK(10)SEPARATING FROM ORB. 09 (RTJ074)

SEE THE ASSOCIATED DATA DOCUMENT FOR REFERENCE CHARACTERISTICS FOR INDIVIDUAL DATASETS

SYMBOL		MACH		PARAMETRIC VALUES	
○	x	.752	PTOTAL	80.000	
			BETA	.000	
			DBETA	5.000	
			AILRON	10.000	
			Y	.000	

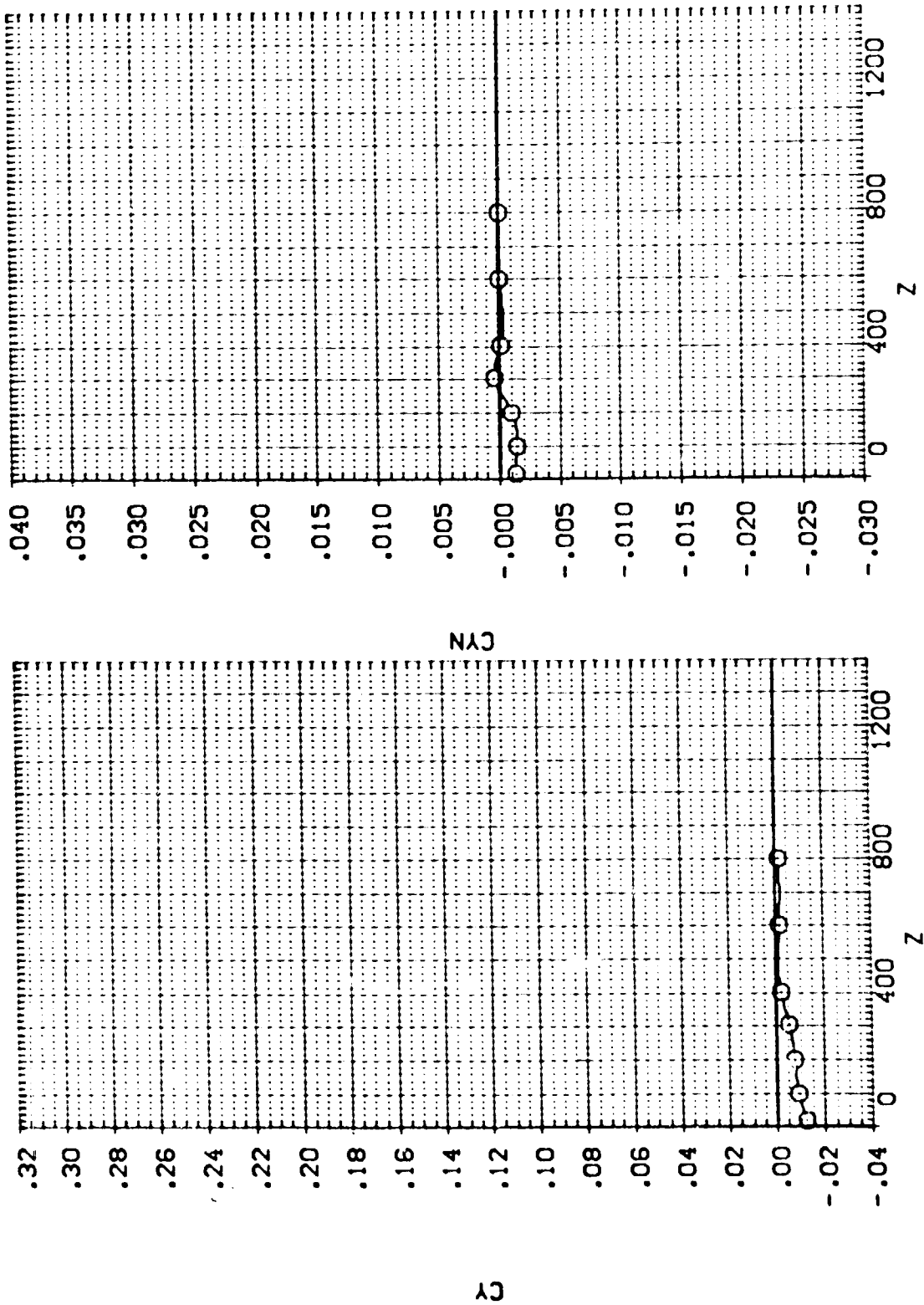

EFFECT OF EXTERNAL TANK SEPARATION ON ORBITER AERODYNAMIC CHARACTERISTICS

1A13.EXTERNAL TANK(10)SEPARATING FROM ORB. 09 (RTJ075)

SEE THE ASSOCIATED DATA DOCUMENT FOR REFERENCE CHARACTERISTICS FOR INDIVIDUAL DATASETS

SYMBOL		PARAMETRIC VALUES	
○	x	MACH	4.520
		ALPHA	-5.000
		DALPHA	.000
		ELEVTR	.000
		Y	200.000
		POTIAL	60.000
		BETA	.000
		DBETA	5.000
		ALURON	10.000

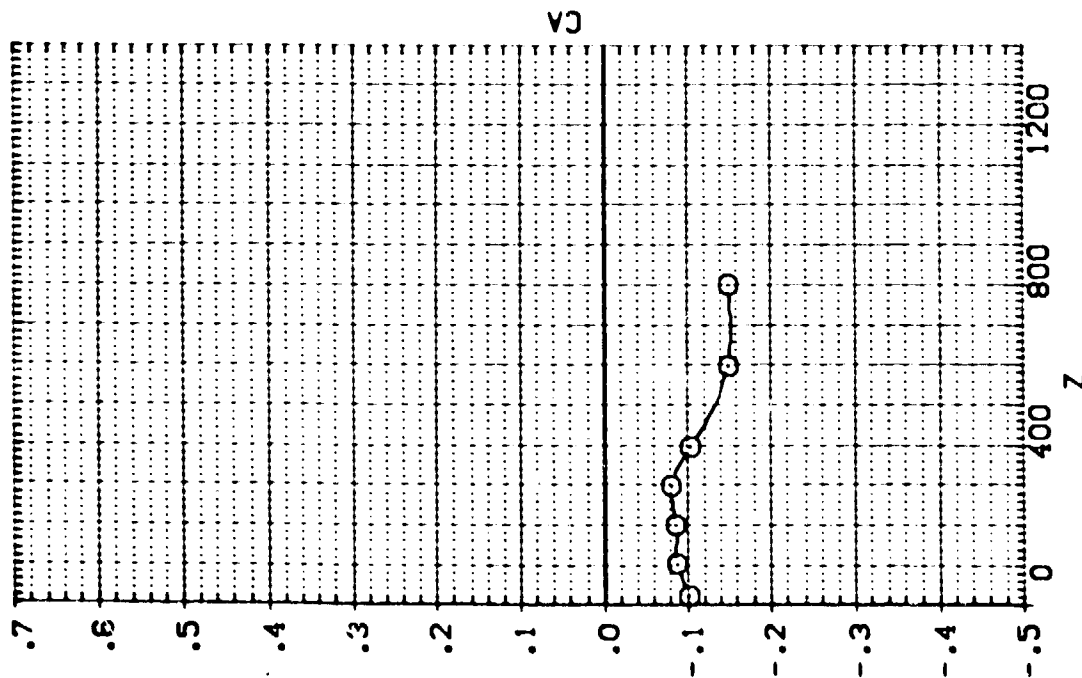
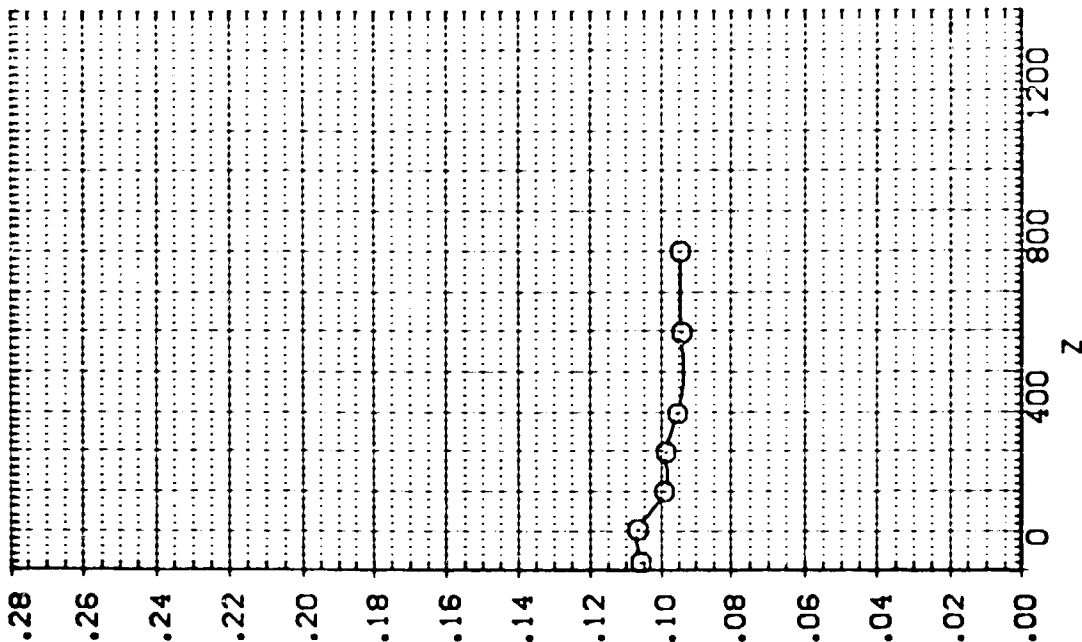

EFFECT OF EXTERNAL TANK SEPARATION ON ORBITER AERODYNAMIC CHARACTERISTICS

1A13.EXTERNAL TANK(T10)SEPARATING FROM ORB. 09 (RTJ075)

SEE THE ASSOCIATED DATA DOCUMENT FOR REFERENCE CHARACTERISTICS FOR INDIVIDUAL DATASETS

SYMBOL		X		MACH		PARAMETRIC VALUES	
○		.254		4.520		PITOT	60.000
				ALPHA		BETA	.000
				DALPHA		DBETA	5.000
				ELEVTR		AIRDRN	10.000
				Y			200.000

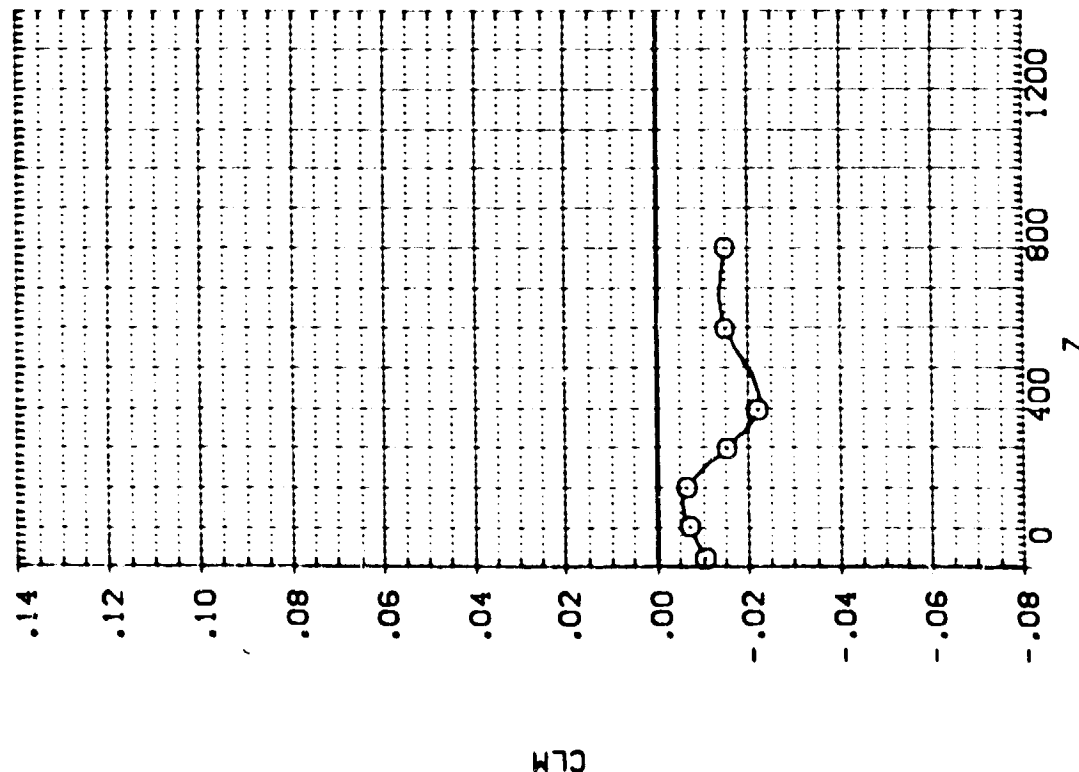
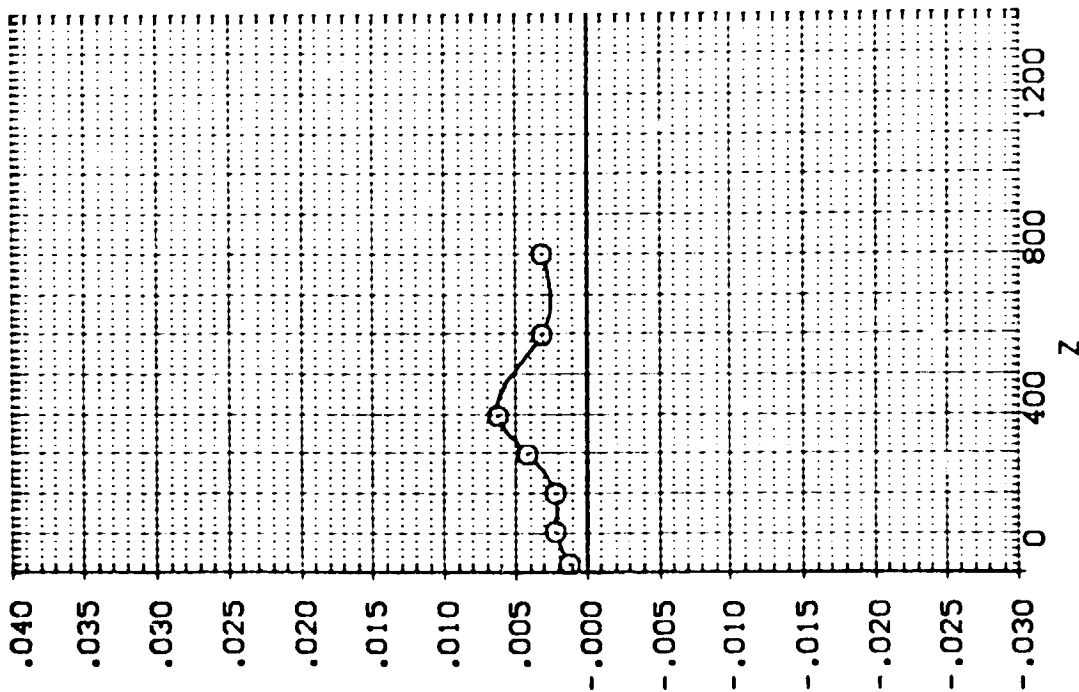

1.1.5. EXTERNAL TANK(T10)SEPARATING FROM ORB. 09 (RTJ075)

SEE THE ASSOCIATED DATA DOCUMENT FOR REFERENCE CHARACTERISTICS FOR INDIVIDUAL DATASETS

SYMBOL X .251
 O
 PARAMETRIC VALUES
 MACH 4.520 PIGTAL 60.000
 ALPHA -5.000 BETA .000
 DIALPHA .000 DBETA 5.000
 ELEVTB .000 ALLRON 10.000
 Y 200.000

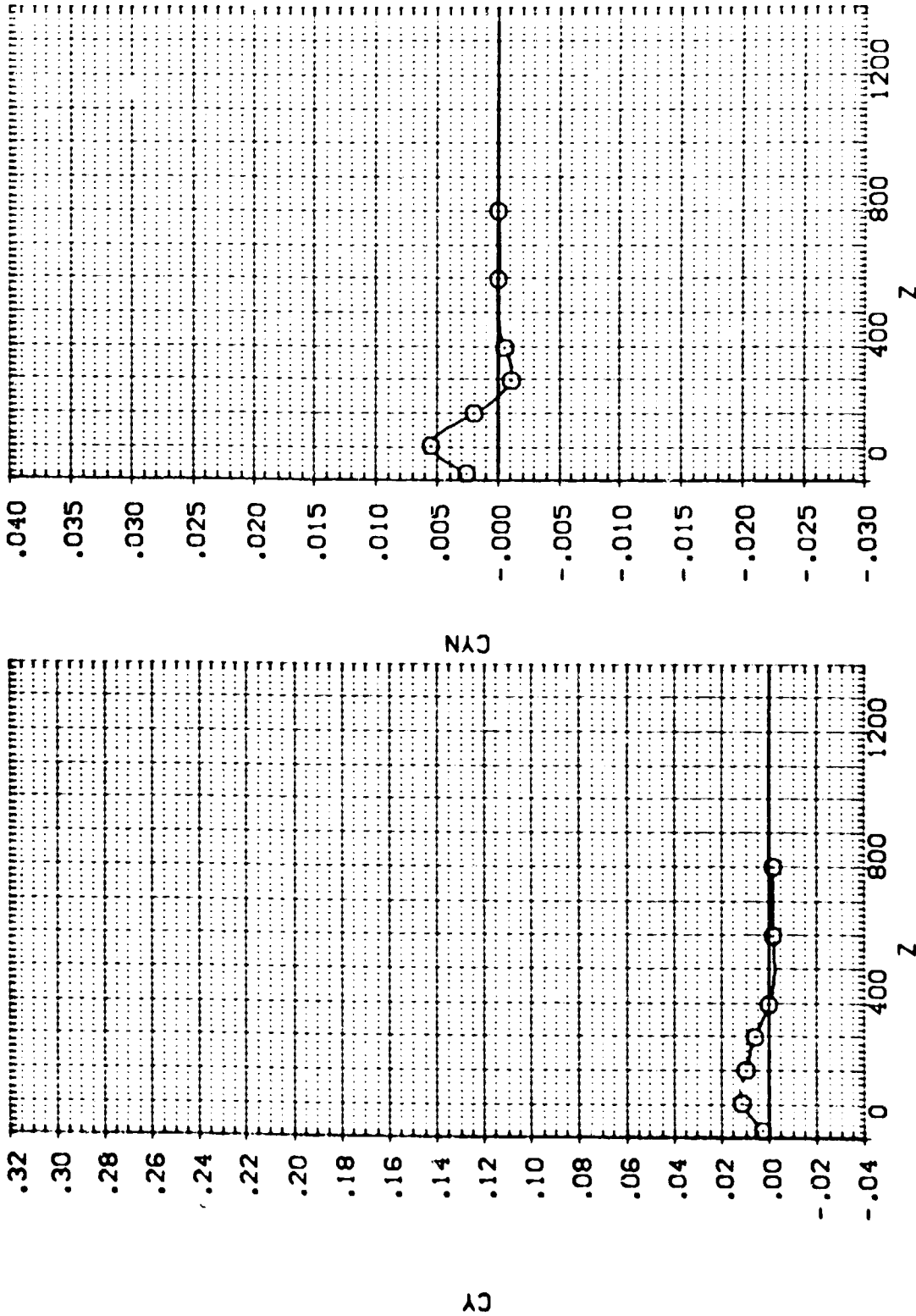

EFFECT OF EXTERNAL TANK SEPARATION ON ORBITER AERODYNAMIC CHARACTERISTICS

IA13. EXTERNAL TANK(T10)SEPARATING FROM ORB. 09 (RTJ076)

SEE THE ASSOCIATED DATA DOCUMENT FOR REFERENCE CHARACTERISTICS FOR INDIVIDUAL DATASETS

SYMBOL		PARAMETRIC VALUES	
x	.273	MACH	4.520
		PIDTAL	80.000
		ALPHA	-5.000
		BETA	.000
		DALPHA	-10.000
		DBETA	.000
		ELEVTR	.000
		AILRON	10.000
y			-200.000

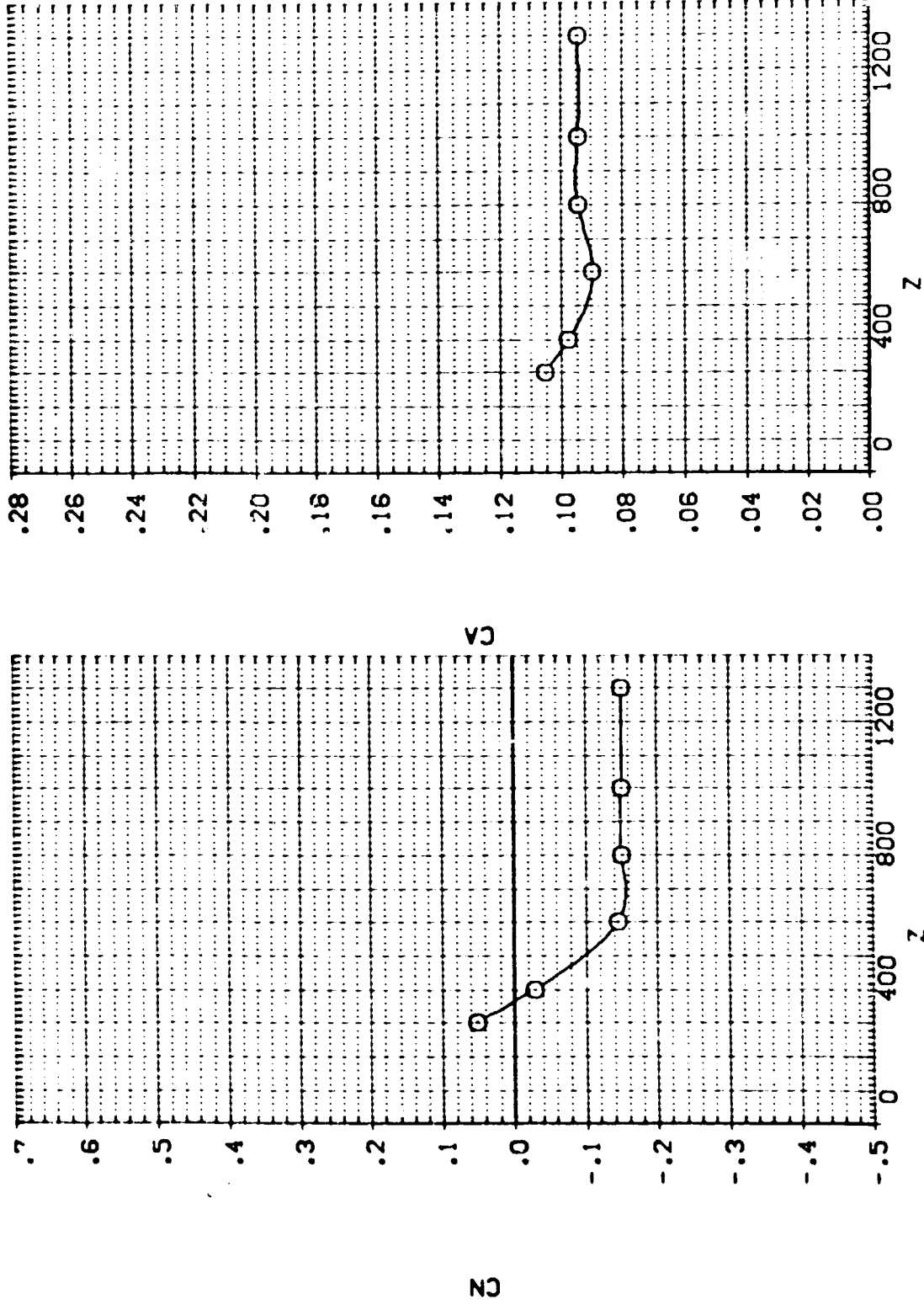

EFFECT OF EXTERNAL TANK SEPARATION ON ORBITER AERODYNAMIC CHARACTERISTICS

1A13. EXTERNAL TANK(T10)SEPARATING FROM ORB. 09 (RTJ076)

SEE THE ASSOCIATED DATA DOCUMENT FOR REFERENCE CHARACTERISTICS FOR INDIVIDUAL DATASETS

SYMBOL x .273
 O
 PARAMETRIC VALUES
 MACH 4.520 PTOTAL 60.000
 ALPHA -5.000 BETA .000
 DALPHA -10.000 DBETA .000
 ELEVTR .000 AILRON 10.000
 Y -200.000

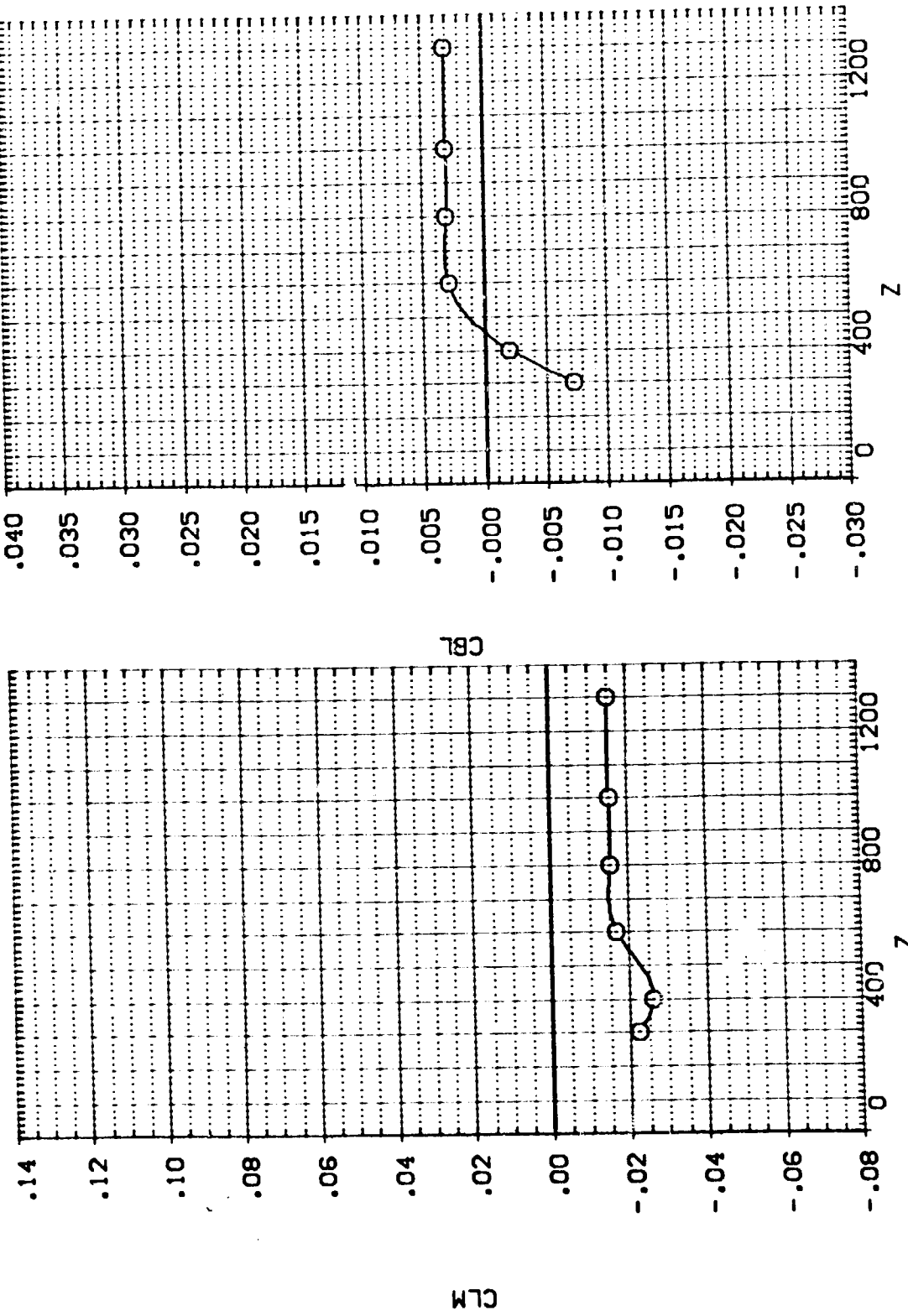

EFFECT OF EXTERNAL TANK SEPARATION ON ORBITER AERODYNAMIC CHARACTERISTICS



1A13. EXTERNAL TANK(T10)SEPARATING FROM ORB. 09 (RTJ076)

SEE THE ASSOCIATED DATA DOCUMENT FOR REFERENCE CHARACTERISTICS FOR INDIVIDUAL DATASETS

SYMBOL		PARAMETRIC VALUES	
X	.273	MACH	4.520
O		PITOT	60.000
		BETA	.000
		DETA	.000
		AILRON	10.000
		Y	-200.000

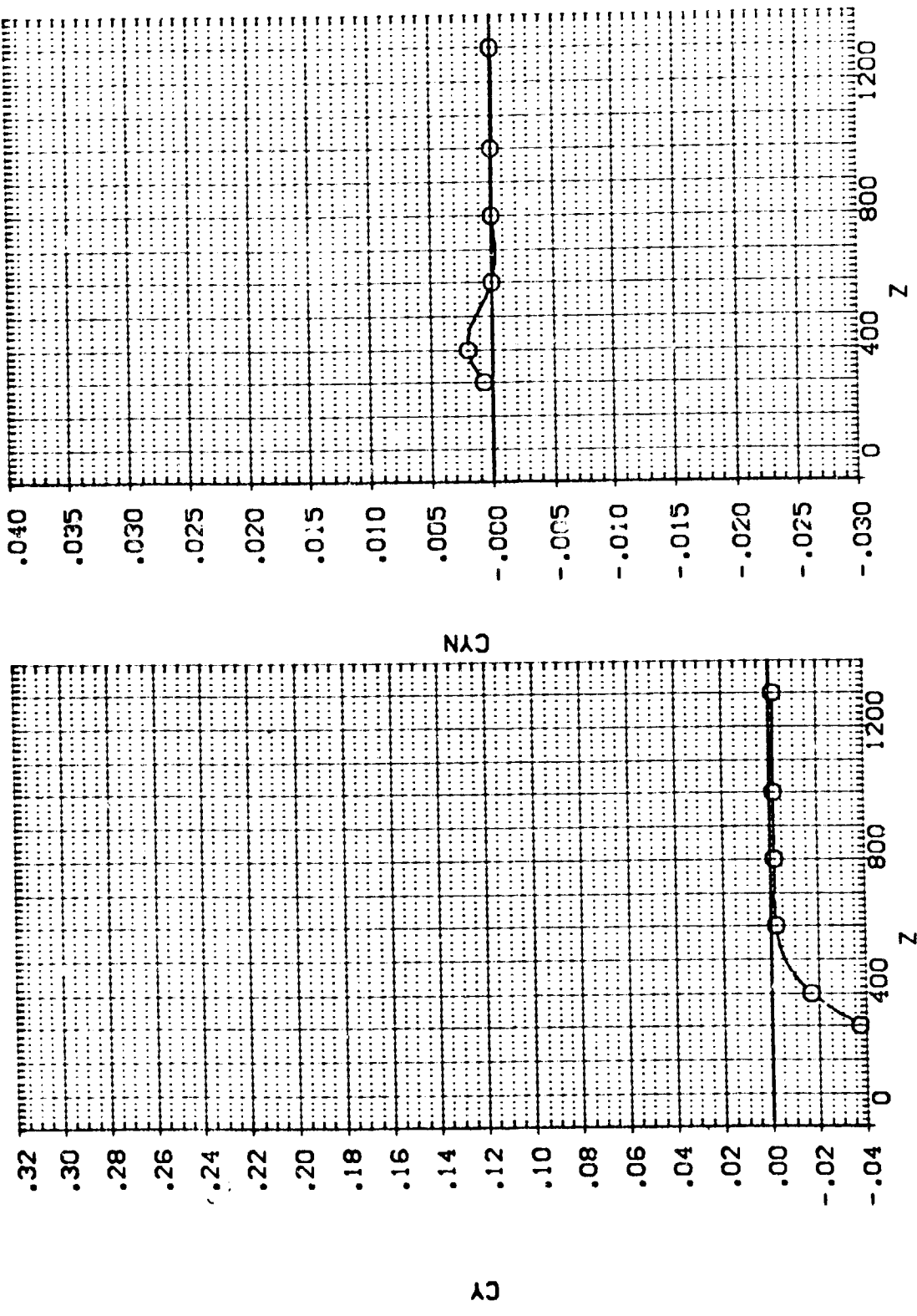

EFFECT OF EXTERNAL TANK SEPARATION ON ORBITER AERODYNAMIC CHARACTERISTICS

IA13. EXTERNAL TANK(T10)SEPARATING FROM ORB. 09 (RTJ077)

SEE THE ASSOCIATED DATA DOCUMENT FOR REFERENCE CHARACTERISTICS FOR INDIVIDUAL DATASETS

SYMBOL		PARAMETRIC VALUES	
x	.253	MACH	4.520
		PTOTAL	80.000
		BETA	.000
		DBETA	.000
		AILRON	10.000
y		ELEVTR	.000
			.000

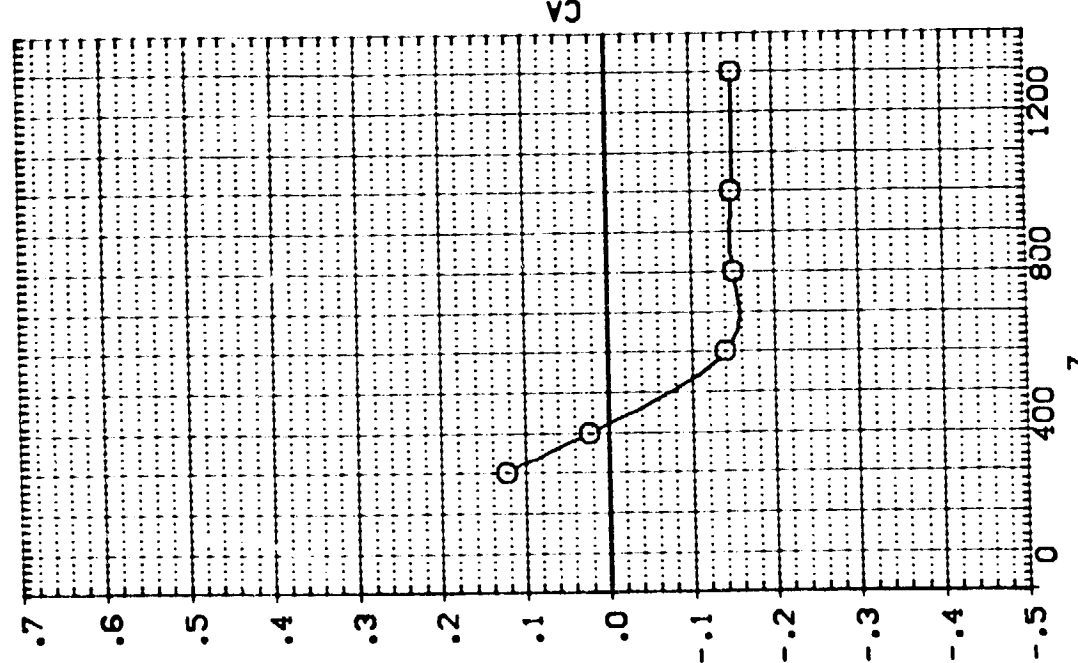
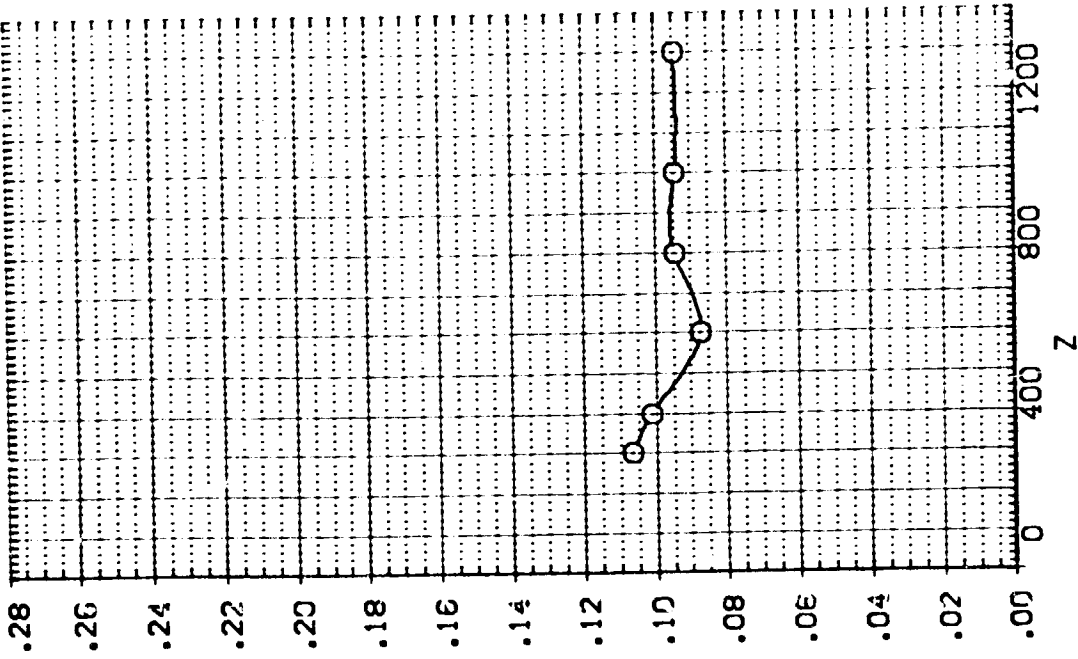

EFFECT OF EXTERNAL TANK SEPARATION ON ORBITER AERODYNAMIC CHARACTERISTICS

IA13.EXTERNAL TANK(T10)SEPARATING FROM ORB. 09 (RTJ077)

SYMBOL X

PARAMETRIC VALUES	
MACH	4.520
ALPHA	-5.000
DALPHA	-10.000
ELEVTR	.000
Y	.000
PIDTAL	60.000
BETA	.000
DBETA	.000
AIRLON	10.000

SEE THE ASSOCIATED DATA DOCUMENT FOR REFERENCE CHARACTERISTICS FOR INDIVIDUAL DATASETS

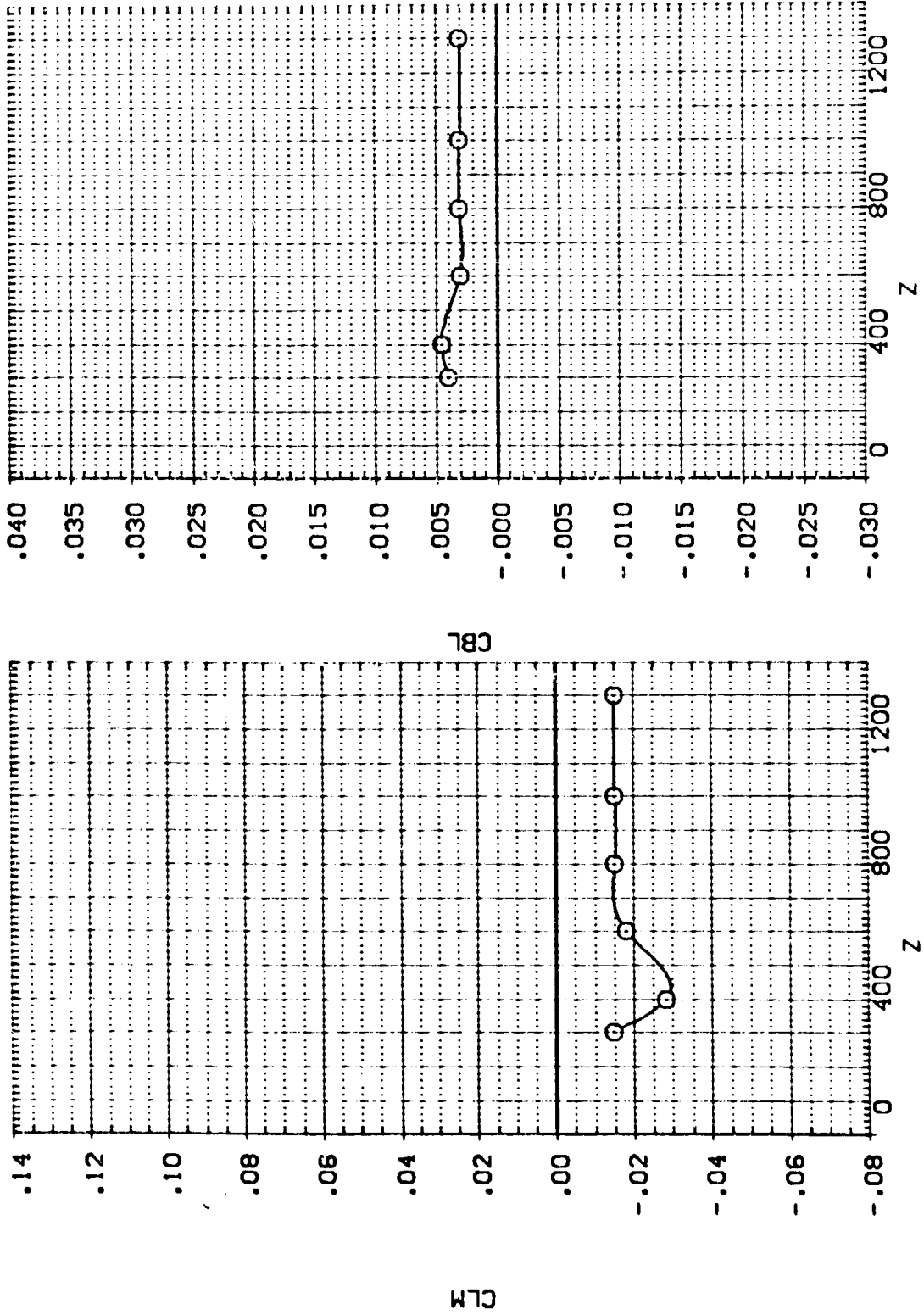

EFFECT OF EXTERNAL TANK SEPARATION ON ORBITER AERODYNAMIC CHARACTERISTICS

IA13. EXTERNAL TANK(T10)SEPARATING FROM ORB. 09 (RTJ077)

SEE THE ASSOCIATED DATA DOCUMENT FOR REFERENCE CHARACTERISTICS FOR INDIVIDUAL DATASETS

Symbol	x	MACH	PARAMETRIC VALUES	PTOTAL
○	.253	4.520	BETA	.000
		-5.000	DBETA	.000
		-10.000	AILRON	10.000
		.000	Y	.000

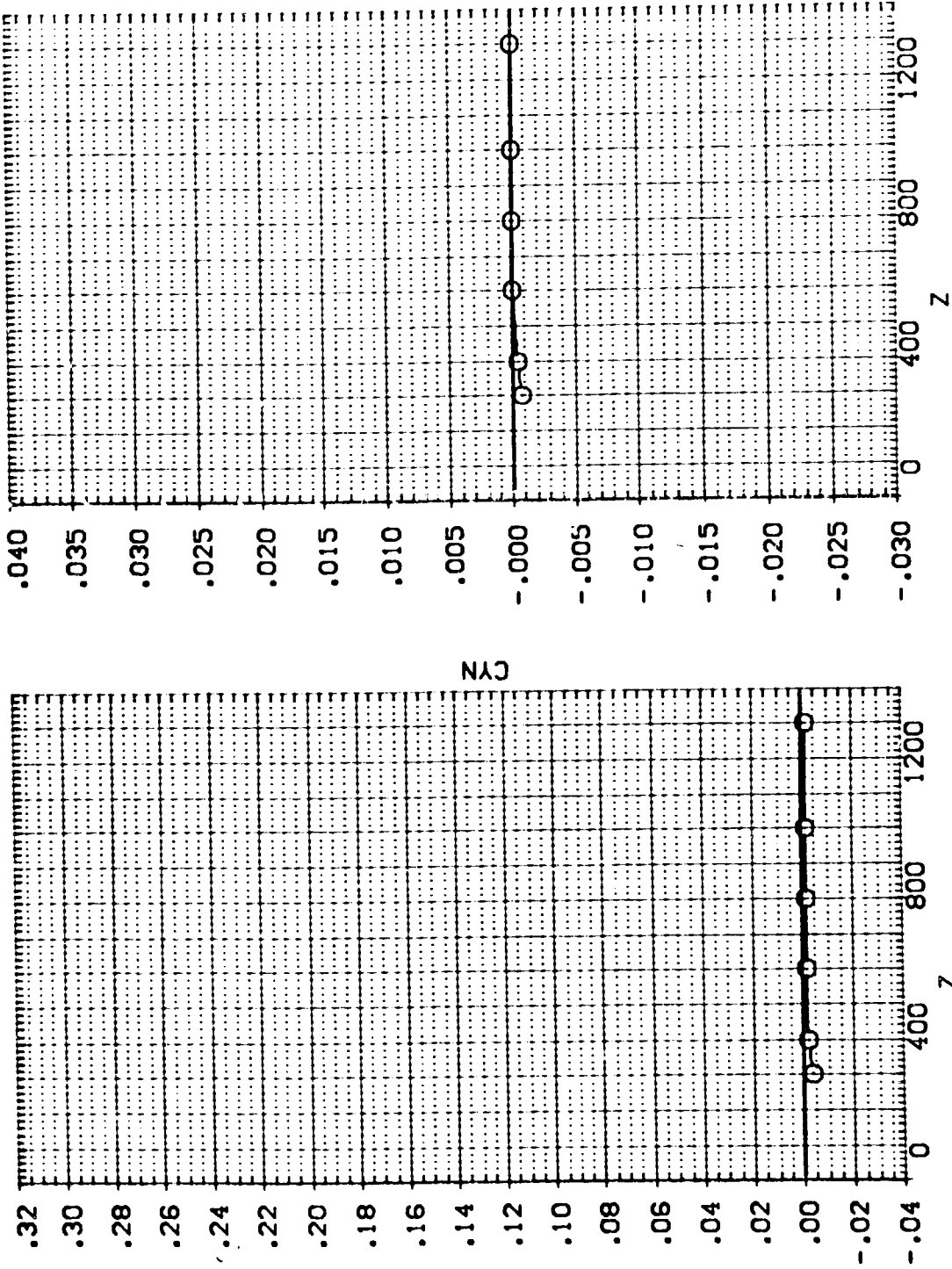

EFFECT OF EXTERNAL TANK SEPARATION ON ORBITER AERODYNAMIC CHARACTERISTICS

1A13.EXTERNAL TANK(T10)SEPARATING FROM ORB. 09 (RTJ078)

SEE THE ASSOCIATED DATA DOCUMENT FOR REFERENCE CHARACTERISTICS FOR INDIVIDUAL DATASETS

SYMBOL		PARAMETRIC VALUES	
O	X	MACH	4.520
		ALPHA	-5.000
		DALPHA	-10.000
		ELEVTR	.000
		Y	200.000
		PITOTL	60.000
		BETA	.000
		DBETA	.000
		AILRON	10.000

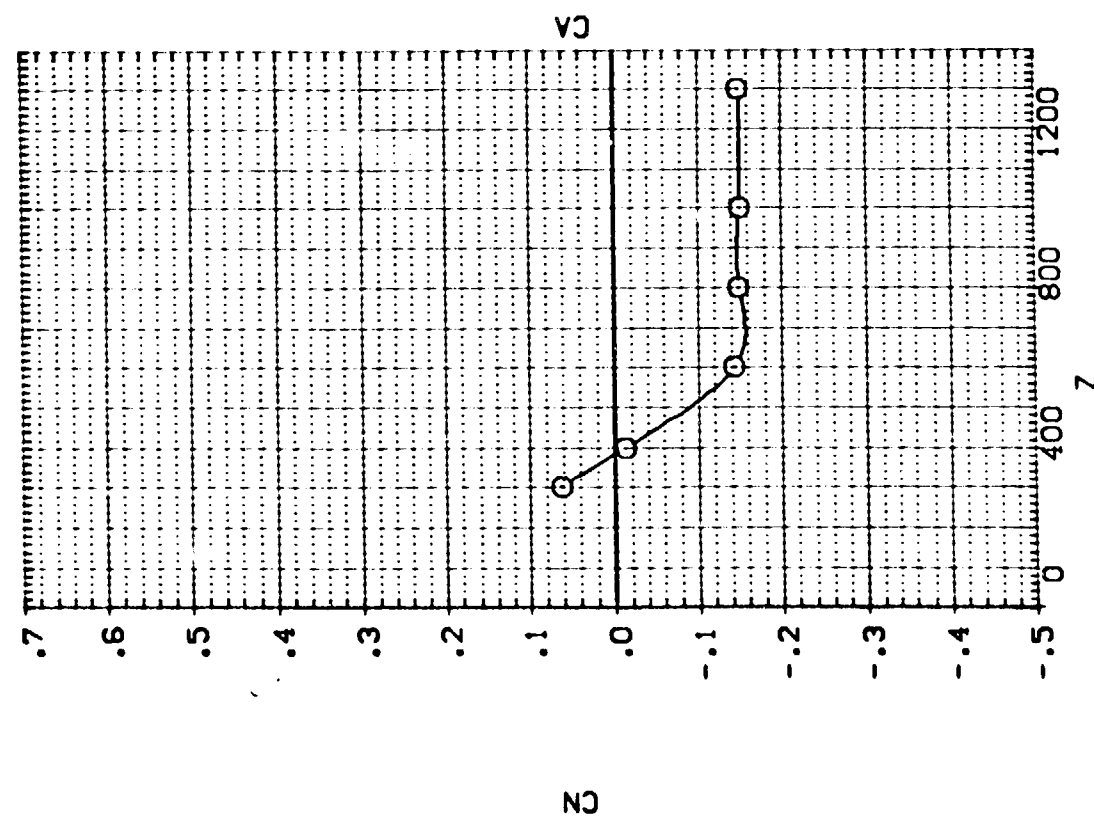
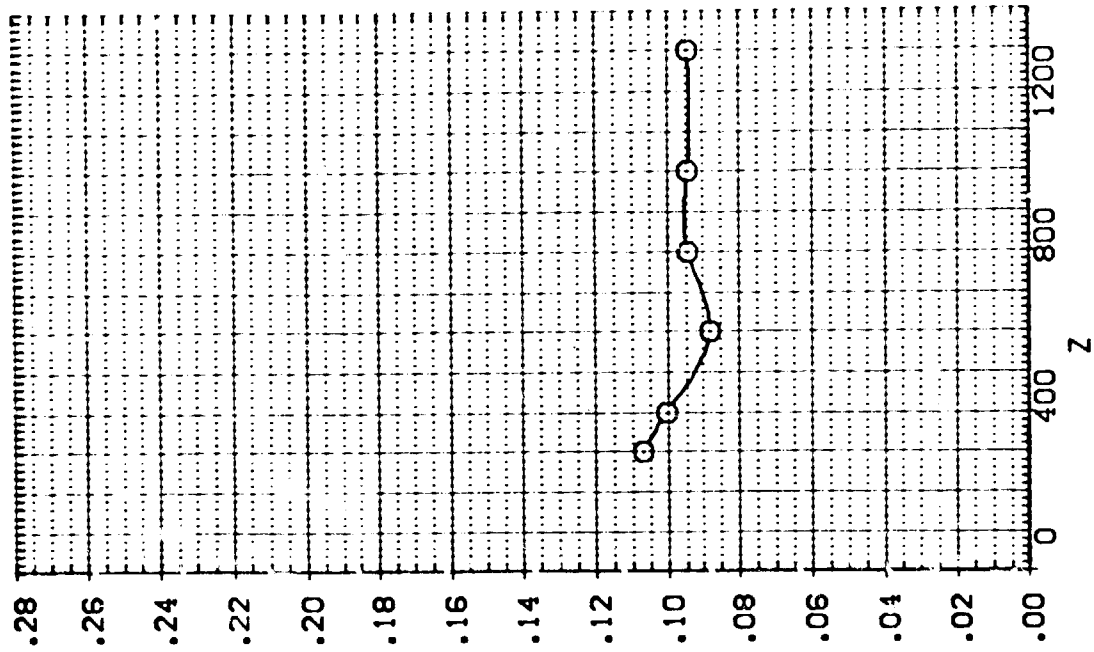

IA13. EXTERNAL TANK(T10)SEPARATING FROM ORB. 09 (RTJ078)

SYMBOL
○

PARAMETRIC VALUES	
MACH	4.520
ALPHA	-5.000
DALPHA	-10.000
ELEVTR	.000
Y	200.000
P TOTAL	80.000
BETA	.000
DBETA	.000
AILRON	10.000

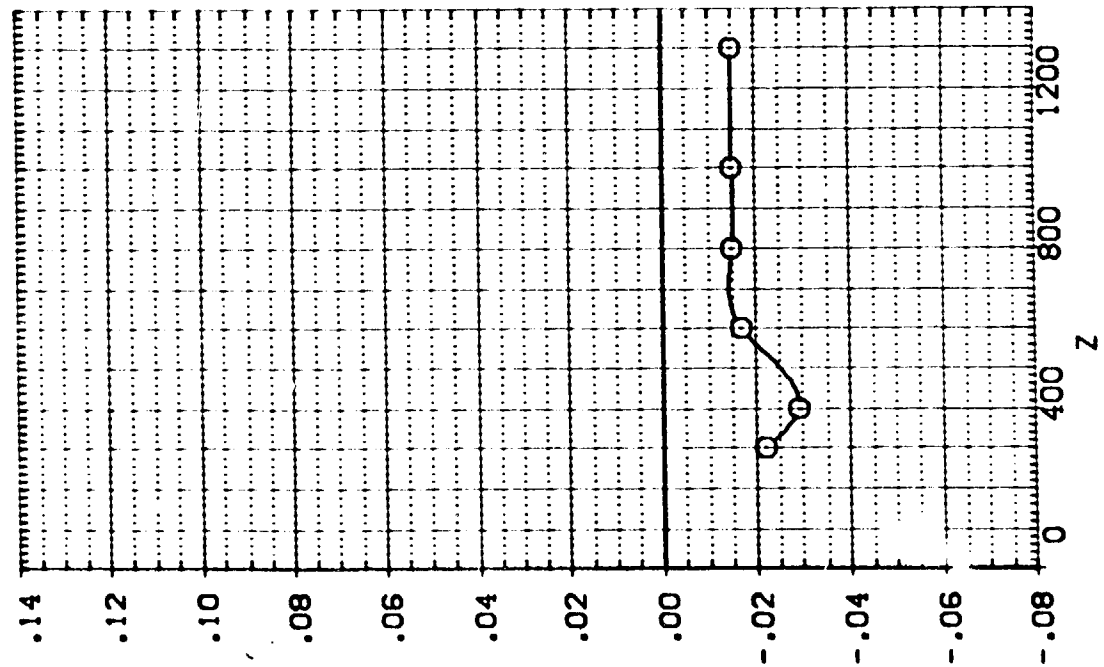

CLM

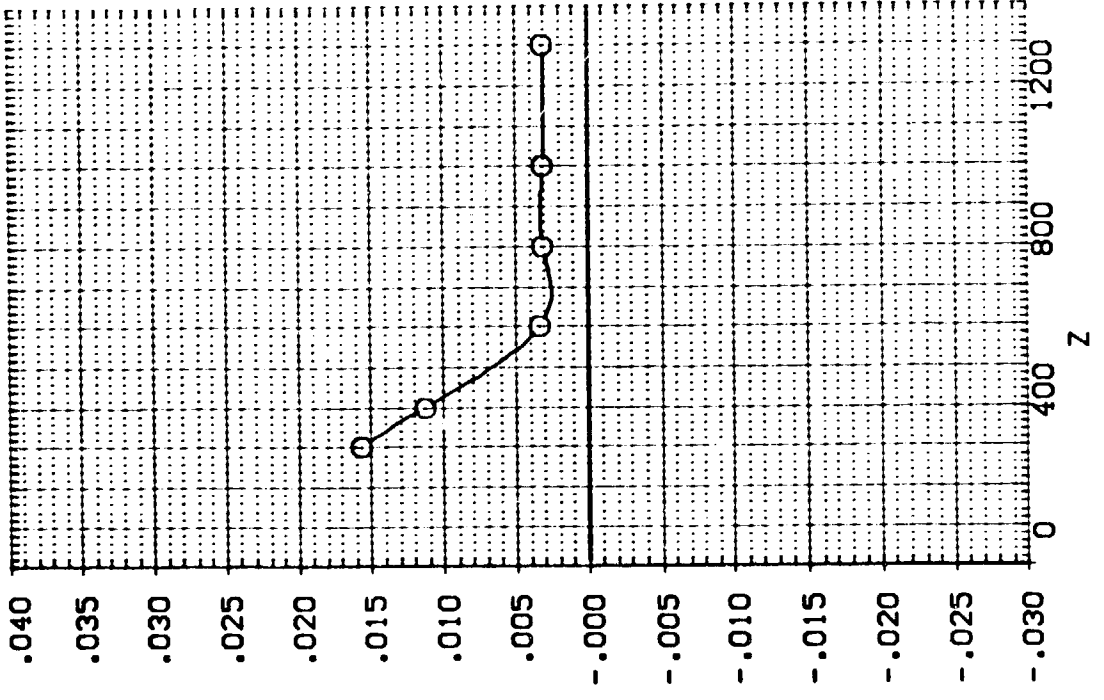

CBL

SEE THE ASSOCIATED DATA DOCUMENT FOR REFERENCE CHARACTERISTICS FOR INDIVIDUAL DATASETS

IA13. EXTERNAL TANK(T10)SEPARATING FROM ORB. 09 (RTJ078)

SEE THE ASSOCIATED DATA DOCUMENT FOR REFERENCE CHARACTERISTICS FOR INDIVIDUAL DATASETS

SYMBOL		PARAMETRIC VALUES	
x	.219	MACH	1.520
		ALPHA	-5.000
		BETA	-10.000
		DELTA	.000
		ELEVTR	.000
		AILRON	10.000
		Y	200.000
		PITOT	80.000
			.000
			.000
			10.000

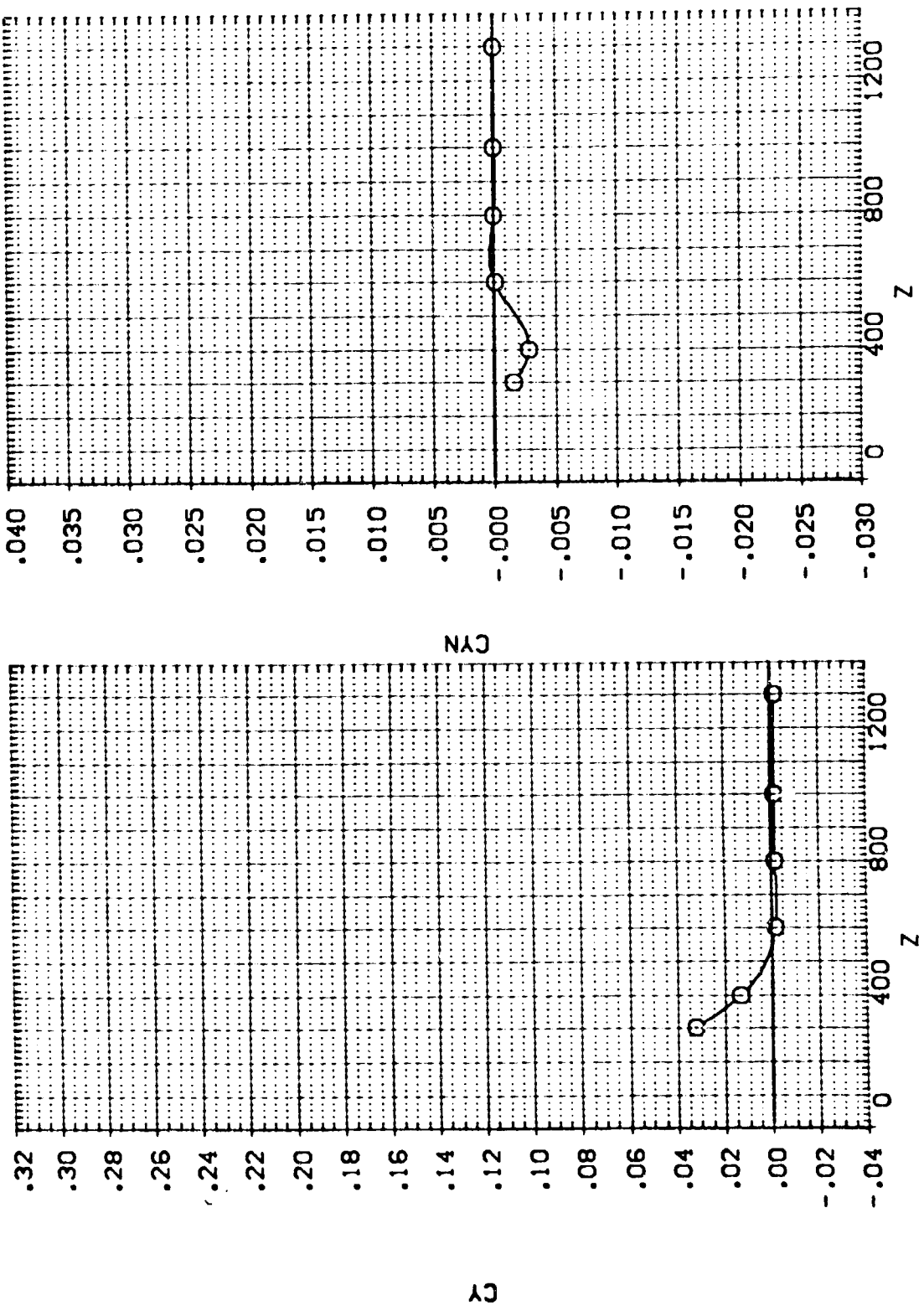

IA13.EXTERNAL TANK(T10)SEPARATING FROM ORB. 09 (RTJ079)

SEE THE ASSOCIATED DATA DOCUMENT FOR REFERENCE CHARACTERISTICS FOR INDIVIDUAL DATASETS

PARAMETRIC VALUES	
MACH	4.520
PTOTAL	80.000
ALPHA	-5.000
BETA	.000
DALPHA	-10.000
OBETA	-5.000
ELEVTR	.000
AILRON	10.000
Y	-200.000

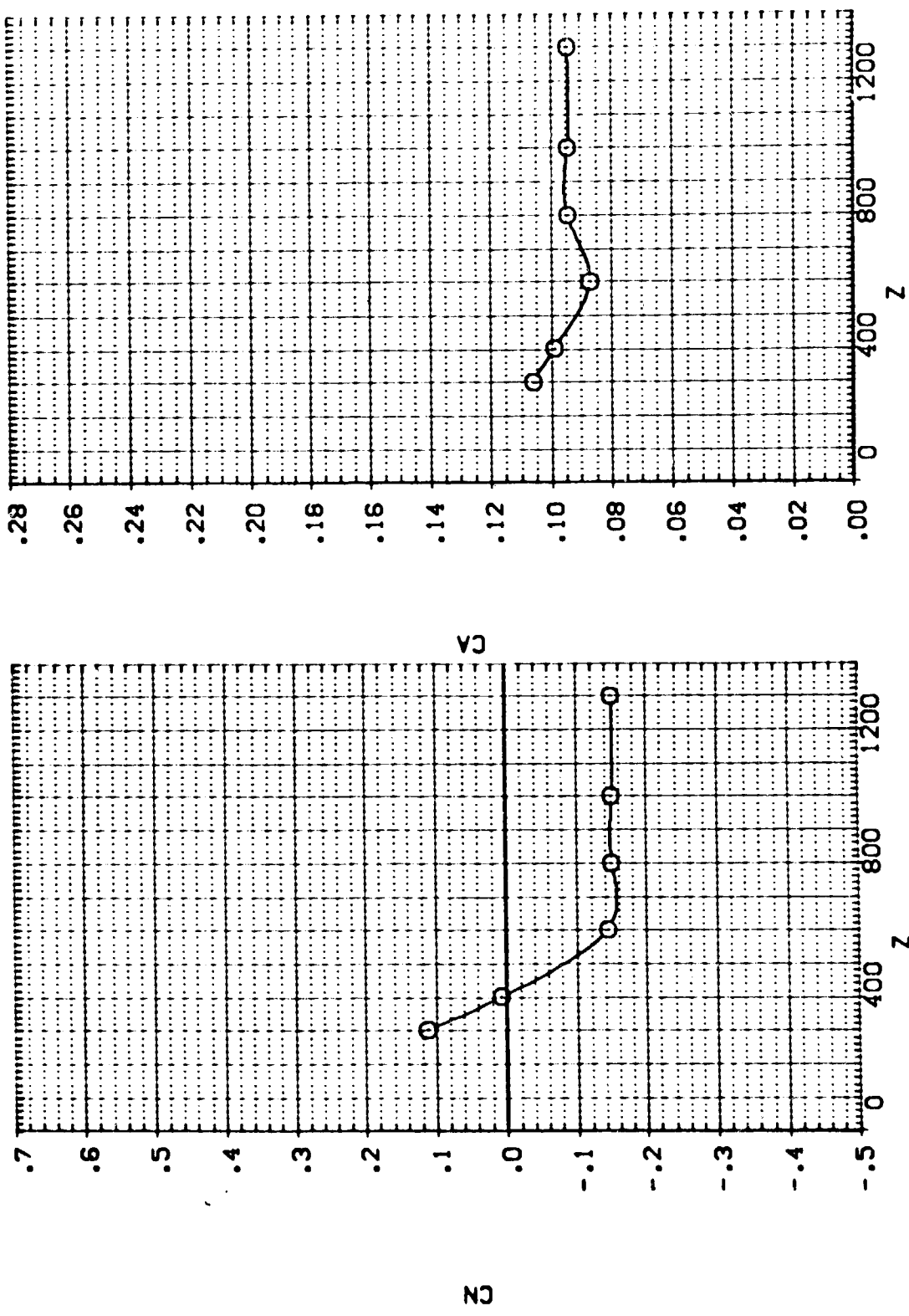

EFFECT OF EXTERNAL TANK SEPARATION ON ORBITER AERODYNAMIC CHARACTERISTICS

1A13 EXTERNAL TANK(T10)SEPARATING FROM ORB. 09 (RTJ079)

SEE THE ASSOCIATED DATA DOCUMENT FOR REFERENCE CHARACTERISTICS FOR INDIVIDUAL DATASETS

PARAMETRIC VALUES
 MACH 4.520 P/TOTAL 60.000
 ALPHA -5.000 BETA .000
 DALPHA -10.000 DBETA -5.000
 ELEVTX .000 AILRON 10.000
 Y -200.000

SYMBOL X
 O

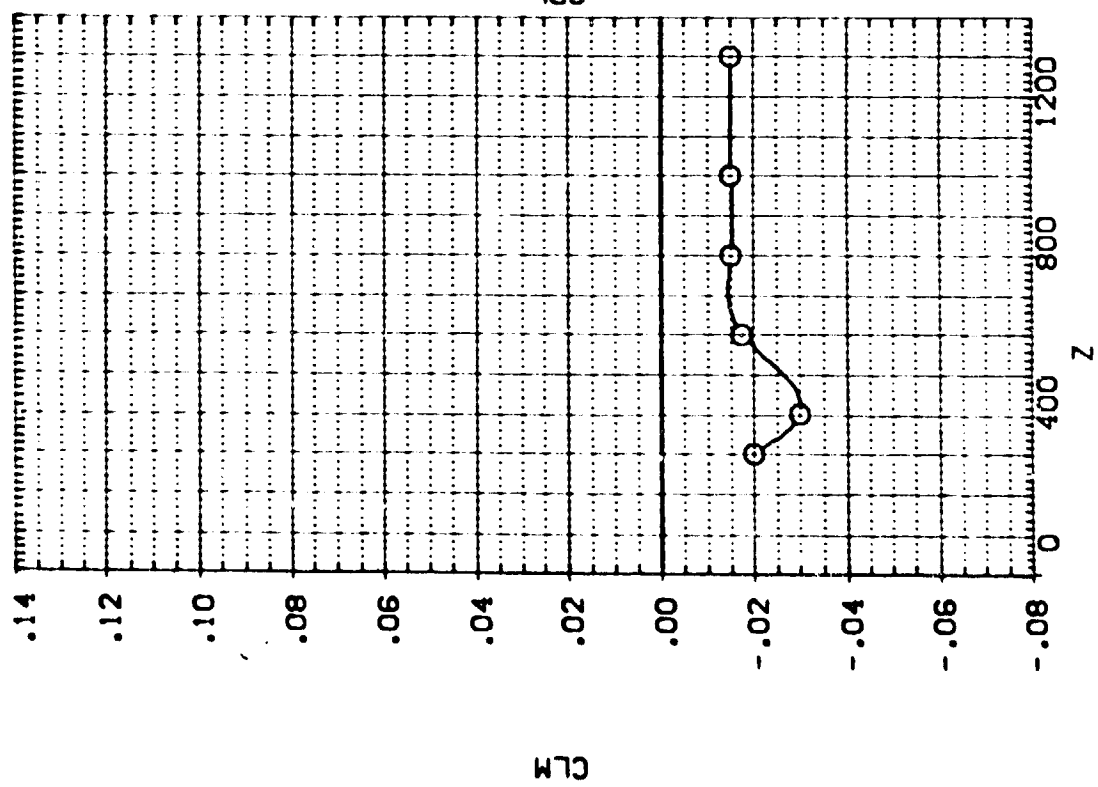
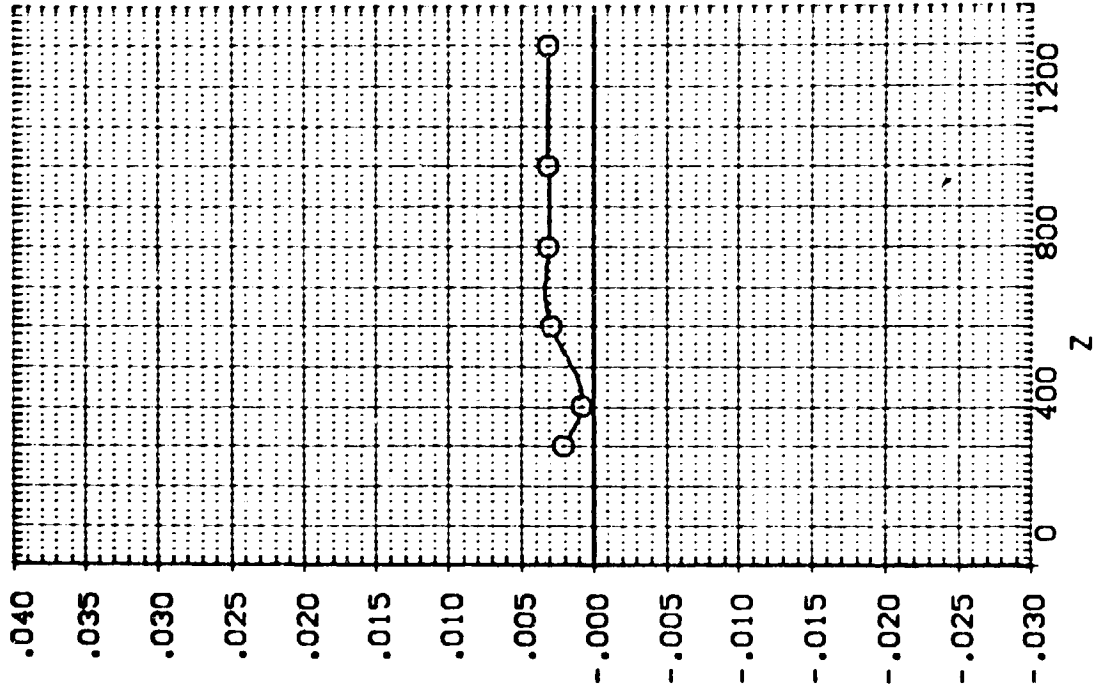

EFFECT OF EXTERNAL TANK SEPARATION ON ORBITER AERODYNAMIC CHARACTERISTICS

IA13. EXTERNAL TANK(T10)SEPARATING FROM ORB. 09 (RTJ079)

SEE THE ASSOCIATED DATA DOCUMENT FOR REFERENCE CHARACTERISTICS FOR INDIVIDUAL DATA SETS

SYMBOL	X	MACH	PARAMETRIC VALUES
○	.255	4.520	PITOTAL 60.000
		-5.000	BETA .000
		-10.000	DBETA -5.000
		.000	AIRLON 10.000
		-200.000	Y

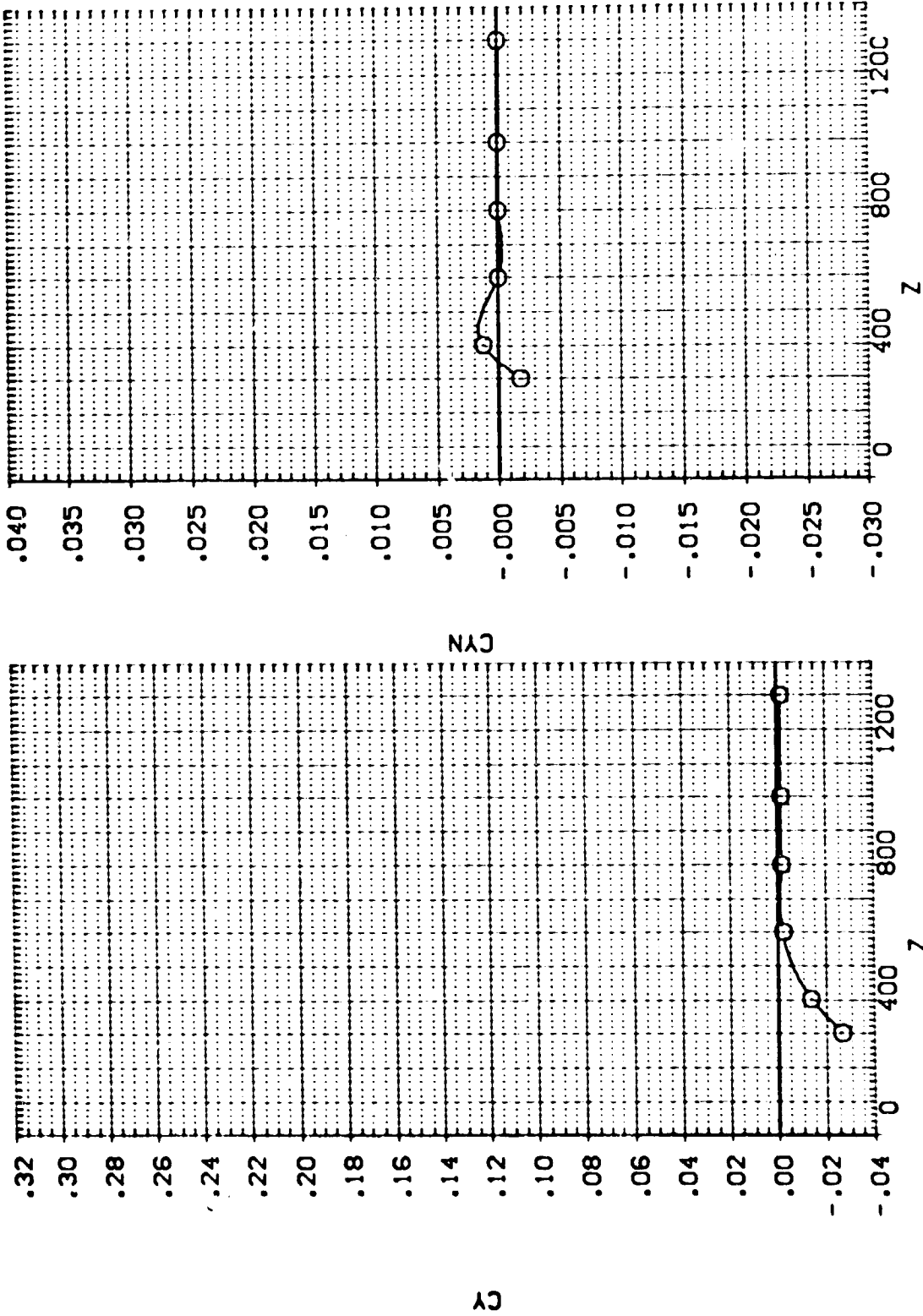

EFFECT OF EXTERNAL TANK SEPARATION ON ORBITER AERODYNAMIC CHARACTERISTICS

1A13.EXTERNAL TANK(T10)SEPARATING FROM ORB. 09 (RTJ080)

SEE THE ASSOCIATED DATA DOCUMENT FOR REFERENCE CHARACTERISTICS FOR INDIVIDUAL DATASETS

SYMBOL		PARAMETRIC VALUES	
○	.300	MACH	4.520
		ALPHA	-5.000
		BETA	-10.000
		ELEVTR	.000
		AILRON	.000
		PTOTAL	80.000
		DETA	5.000
		AILRON	10.000

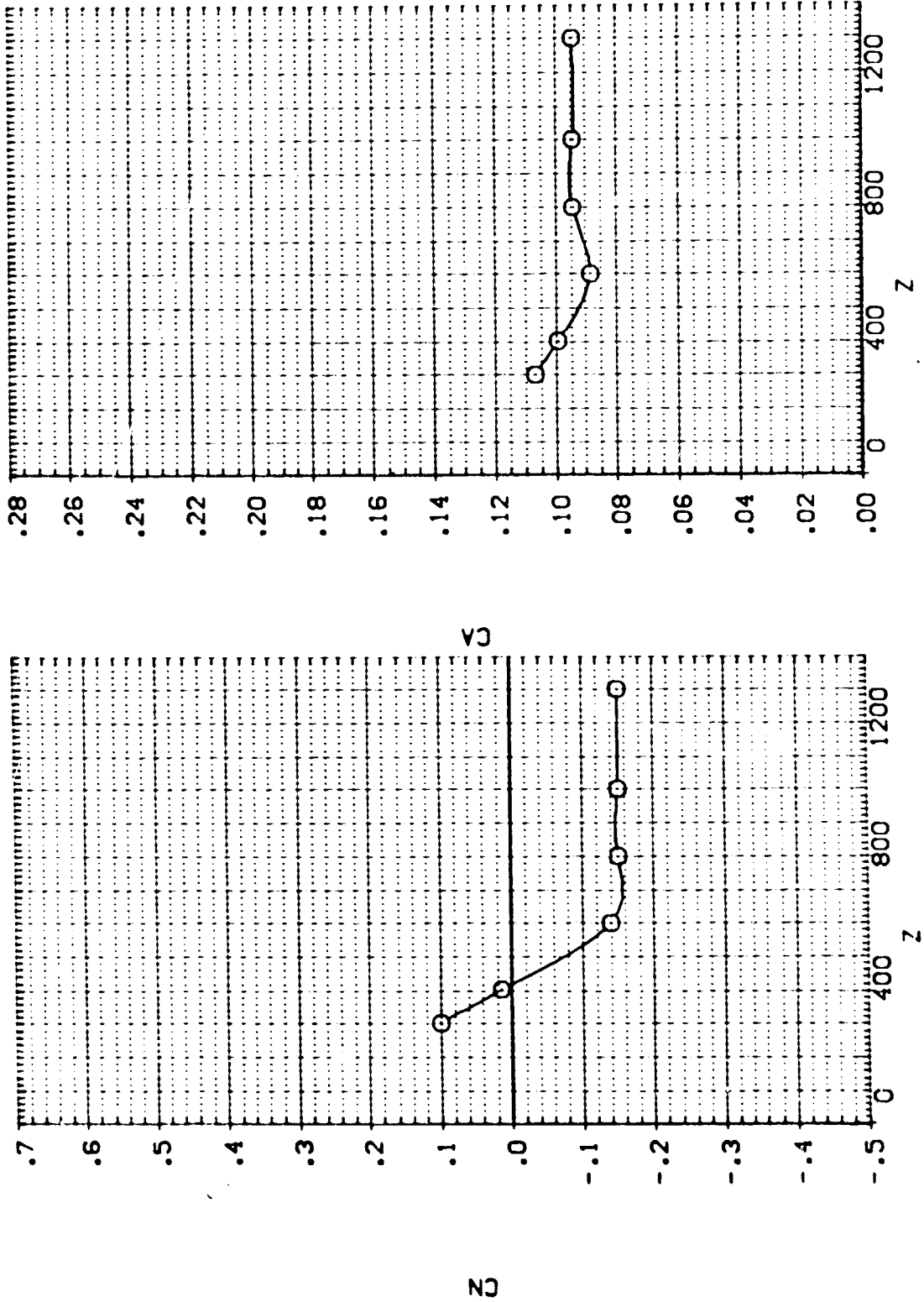

EFFECT OF EXTERNAL TANK SEPARATION ON ORBITER AERODYNAMIC CHARACTERISTICS

1A13. EXTERNAL TANK (T10) SEPARATING FROM ORB. 09 (RTJ080)

SEE THE ASSOCIATED DATA DOCUMENT FOR REFERENCE CHARACTERISTICS FOR INDIVIDUAL DATASETS

PARAMETRIC VALUES	
MACH	4.570
PTOTAL	60.000
BETA	.000
ALPHA	-5.000
DBETA	5.000
ELEVTR	.000
AILRON	10.000
Y	.000

SYMBOL X .300

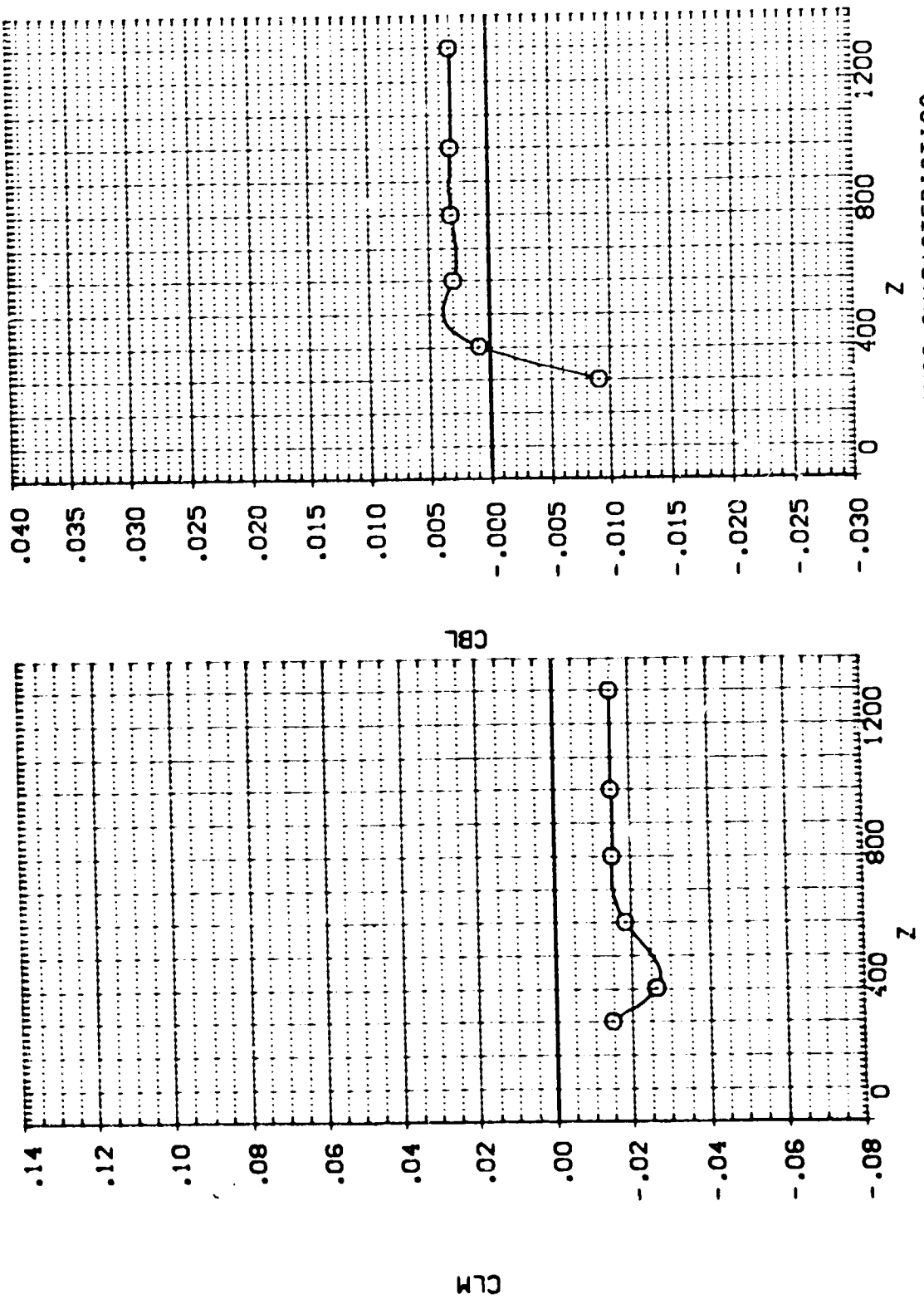

EFFECT OF EXTERNAL TANK SEPARATION ON ORBITER AERODYNAMIC CHARACTERISTICS

1A13. EXTERNAL TANK (110) SEPARATING FROM ORB. C9 (RTJ080)

SEE THE ASSOCIATED DATA DOCUMENT FOR REFERENCE CHARACTERISTICS FOR INDIVIDUAL DATA SETS

PARAMETRIC VALUES	
MACH	60.000
PI/DIAL	.000
BETA	5.000
DEBETA	10.000
AL/RON	.000
AL/EVTR	.000

SYMBOL X .300

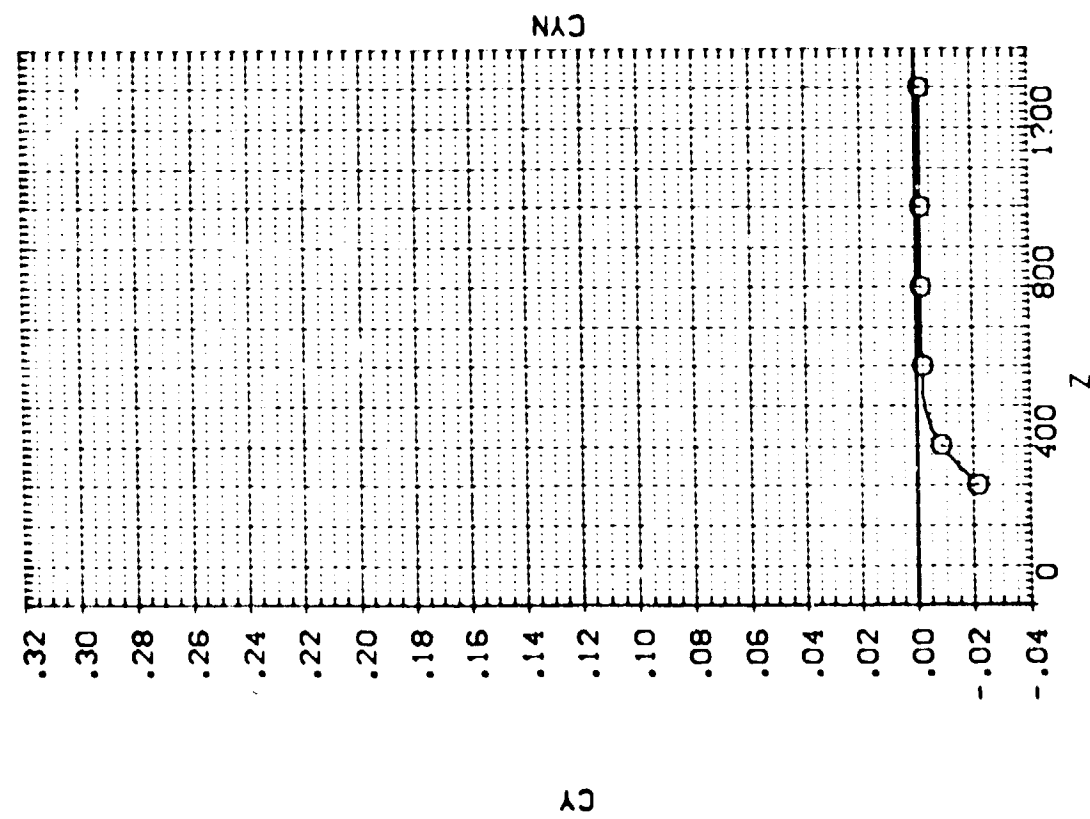
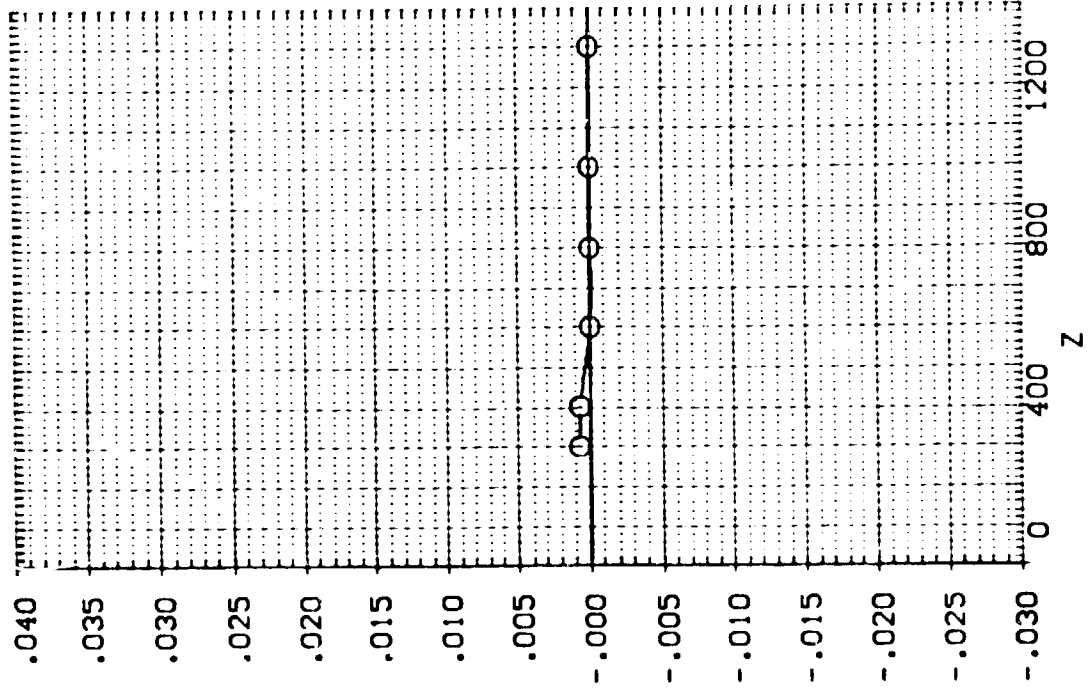

EFFECT OF EXTERNAL TANK SEPARATION ON ORBITER AERODYNAMIC CHARACTERISTICS

IA13. EXTERNAL TANK(T10)SEPARATING FROM ORB. 09 (RTJ081)

SEE THE ASSOCIATED DATA DOCUMENT FOR REFERENCE CHARACTERISTICS FOR INDIVIDUAL DATASETS

SYMBOL		PARAMETRIC VALUES	
x	.140	MACH	4.520
o		ALPHA	-5.000
		DALPHA	-10.000
		ELEVTR	.000
		Y	200.000
		BETA	.000
		DBETA	5.000
		AILRON	10.000
		TOTAL	80.000

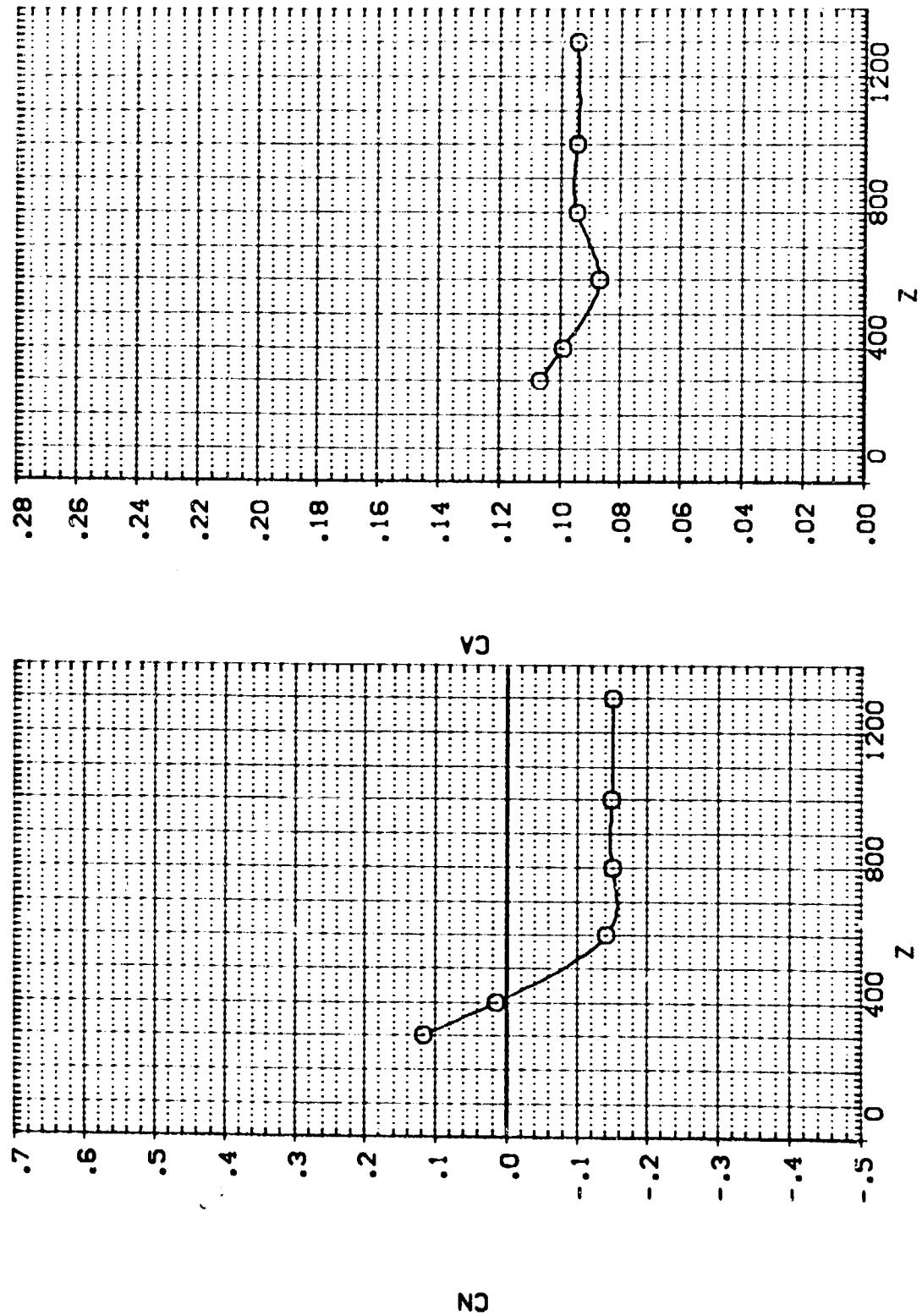

EFFECT OF EXTERNAL TANK SEPARATION ON ORBITER AERODYNAMIC CHARACTERISTICS



IA13.EXTERNAL TANK(T10)SEPARATING FROM ORB. 09 (RTJ081)

SEE THE ASSOCIATED DATA DOCUMENT FOR REFERENCE CHARACTERISTICS FOR INDIVIDUAL DATASETS

PARAMETRIC VALUES
 MACH 4.520 PIGAL 60.000
 ALPHA -5.000 BETA .000
 DALPHA -10.000 DBETA 5.000
 ELEVTR .000 AIRTON 10.000
 Y 200.000

SYMBOL X
 O .140

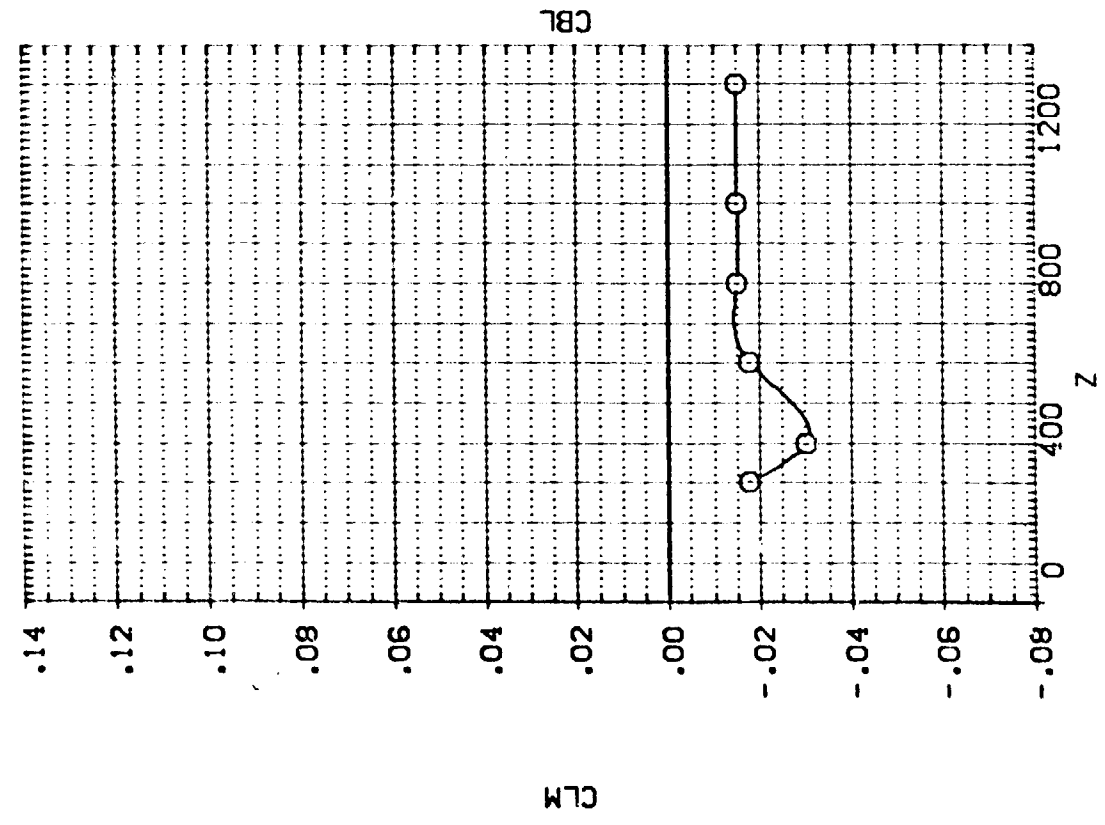
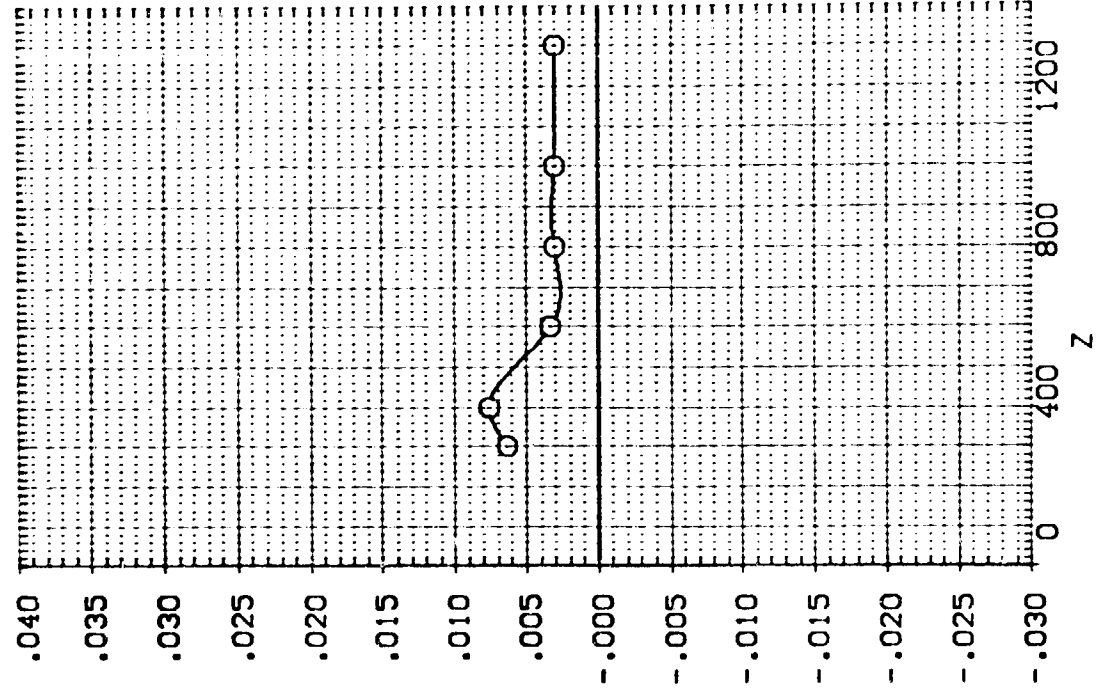

EFFECT OF EXTERNAL TANK SEPARATION ON ORBITER AERODYNAMIC CHARACTERISTICS

IA13. EXTERNAL TANK(T10)SEPARATING FROM ORB. 09 (RTJ081)

SEE THE ASSOCIATED DATA DOCUMENT FOR REFERENCE CHARACTERISTICS FOR INDIVIDUAL DATASETS

PARAMETRIC VALUES	
MACH	4.520
PI TOTAL	60.000
BETA	.000
DBETA	5.000
ATLRON	10.000
Y	200.000

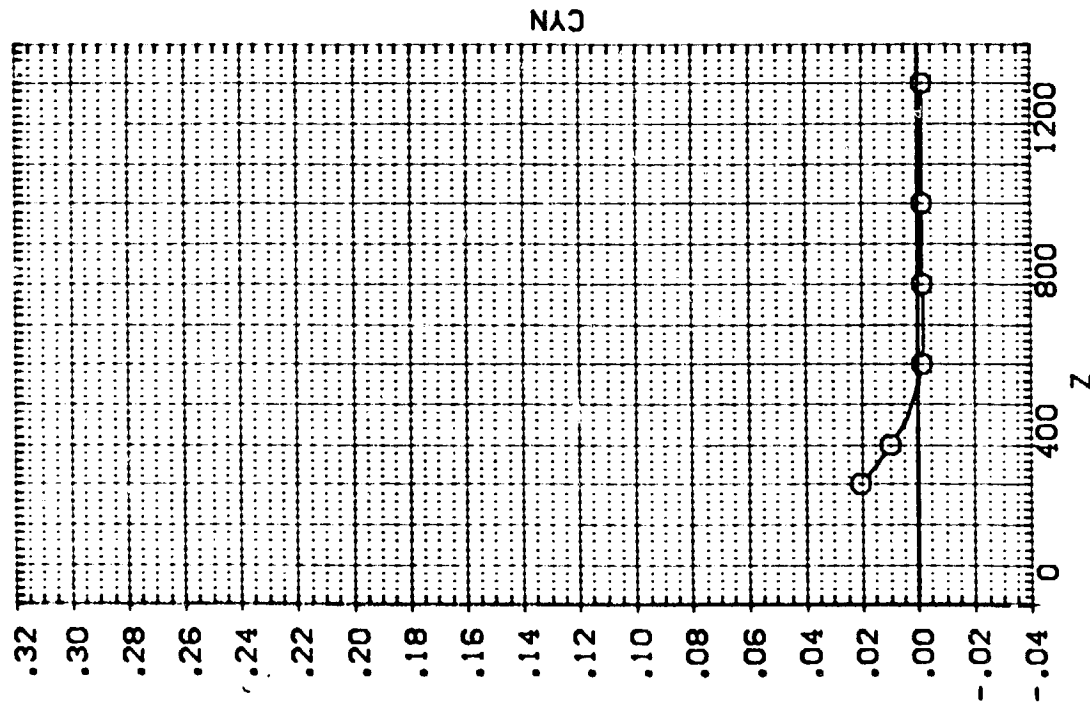
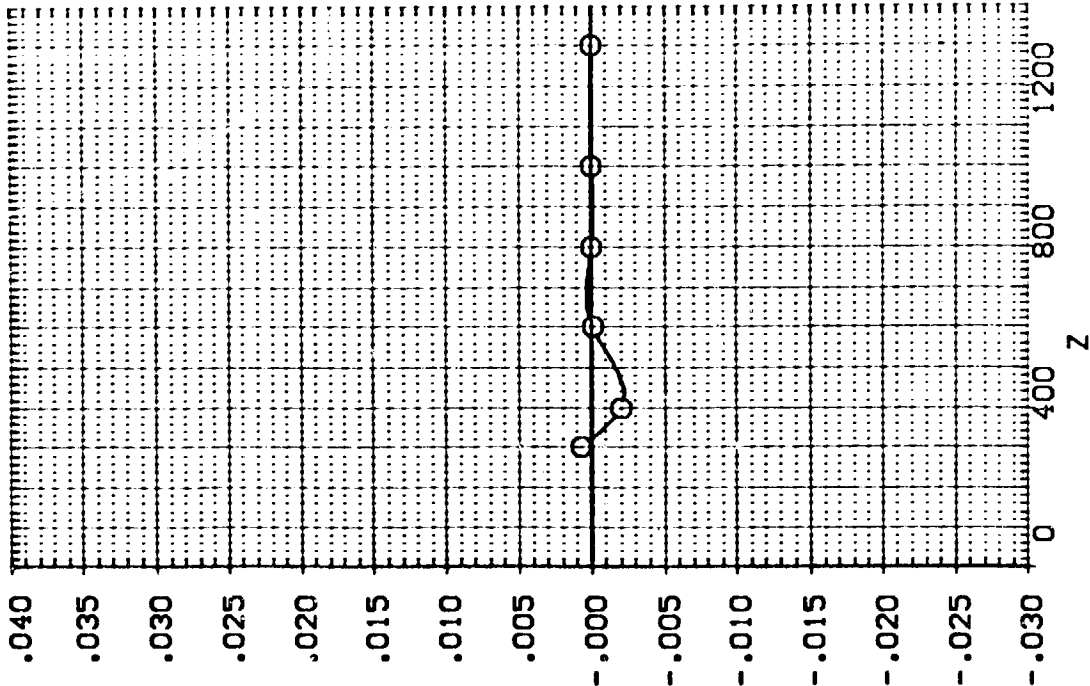

EFFECT OF EXTERNAL TANK SEPARATION ON ORBITER AERODYNAMIC CHARACTERISTICS

1A13, EXTERNAL TANK(T10)SEPARATING FROM ORB. 09 (RTJ082)

SYMBOL X .178 MACH 4.520 P/TOTAL 80.000
 O ALPHA -5.000 BETA .000
 D ALPHA -20.000 DBETA .000
 ELEVTR .000 AIRLON 10.000
 Y -200.000

SEE THE ASSOCIATED DATA DOCUMENT FOR REFERENCE CHARACTERISTICS FOR INDIVIDUAL DATASETS

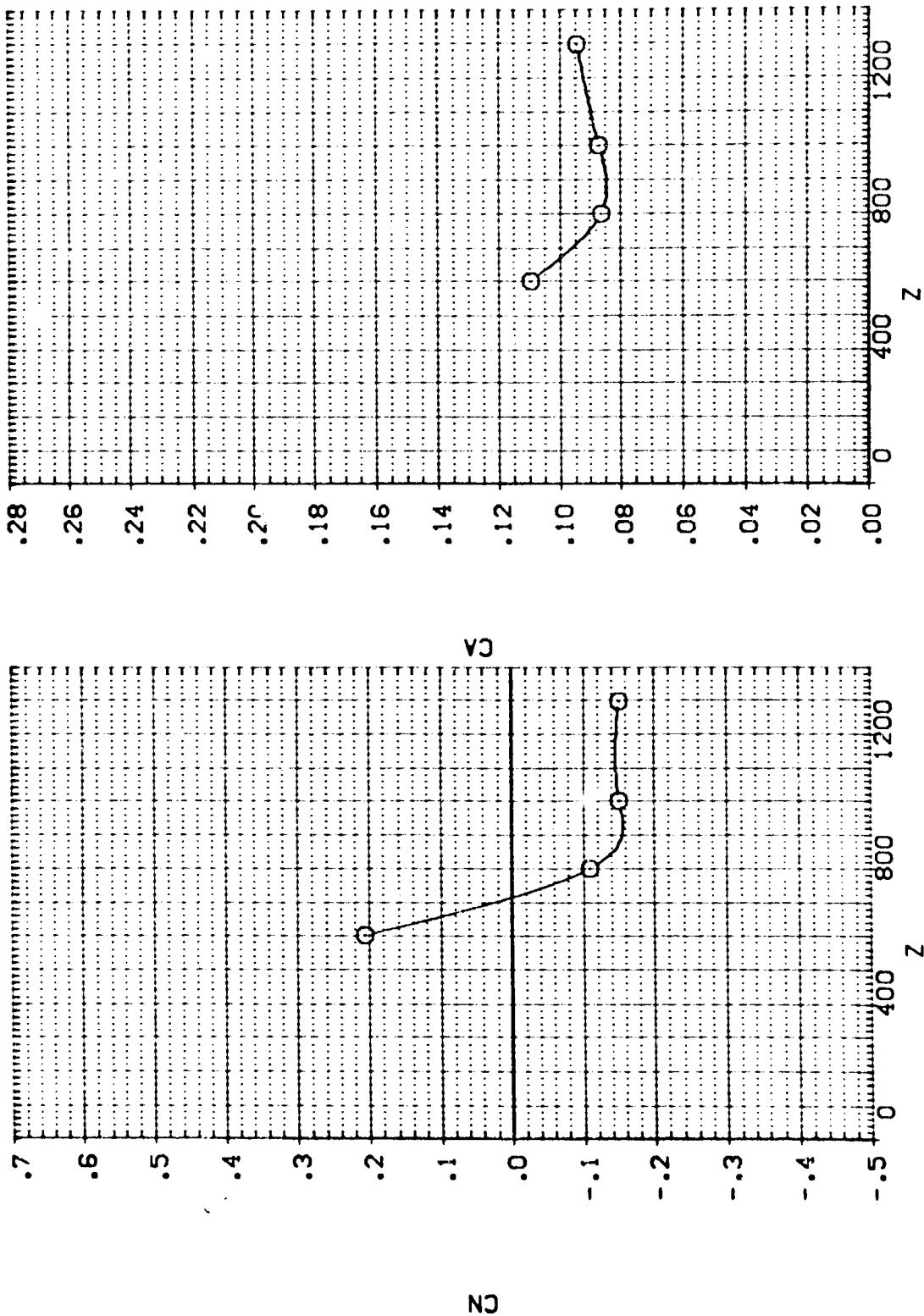

IA13. EXTERNAL TANK(T10)SEPARATING FROM ORB. 09 (RTJ082)

SEE THE ASSOCIATED DATA DOCUMENT FOR REFERENCE CHARACTERISTICS FOR INDIVIDUAL DATASETS

SYMBOL x .178 MACH 4.520 PITCHAL 80.000
 O ALPHA -5.000 BETA .000
 DALPHA -20.000 DBETA .000
 ELEVTR .000 AILRON 10.000
 Y -200.000

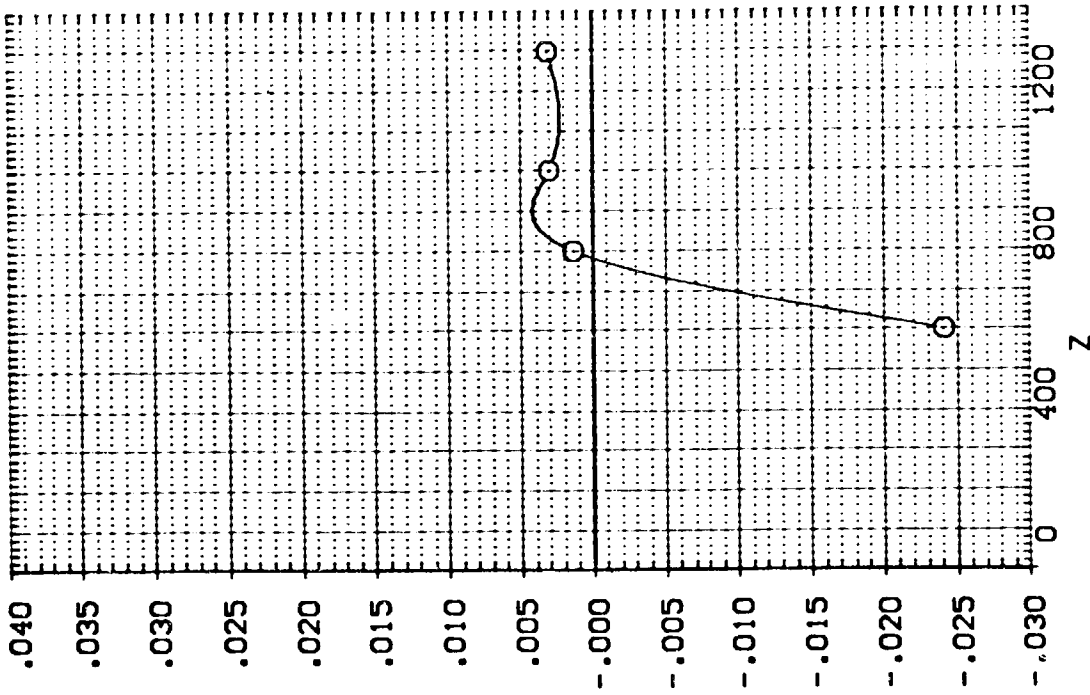
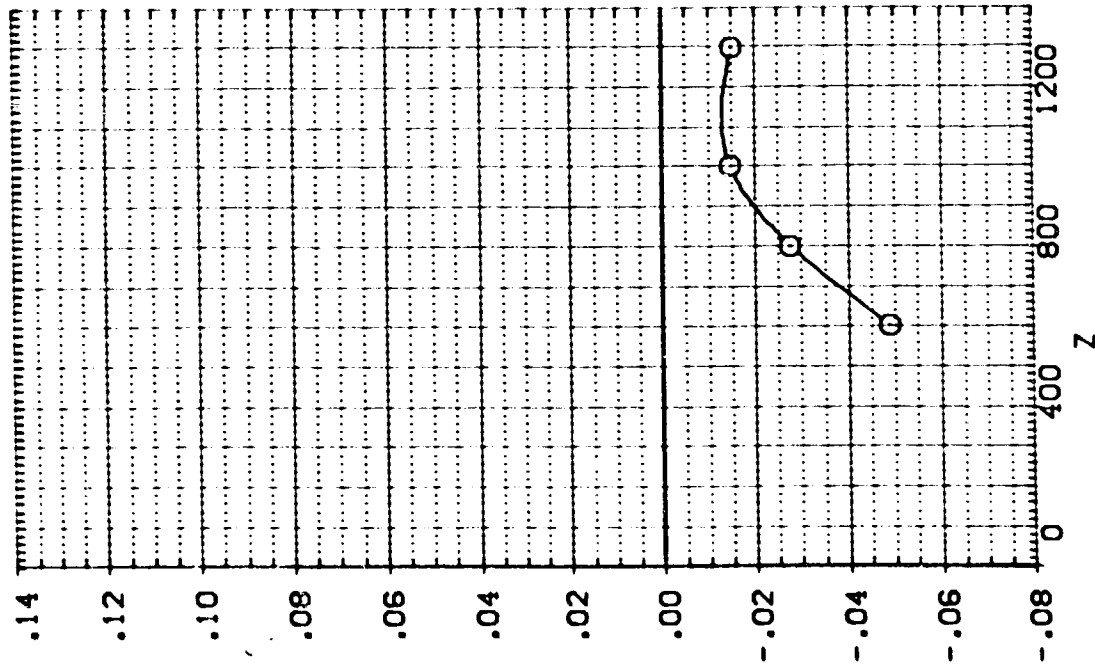

EFFECT OF EXTERNAL TANK SEPARATION ON ORBITER AERODYNAMIC CHARACTERISTICS

1A13, EXTERNAL TANK(T10)SEPARATING FROM ORB. 09 (RTJ082)

SEE THE ASSOCIATED DATA DOCUMENT FOR REFERENCE CHARACTERISTICS FOR INDIVIDUAL DATASETS

SYMBOL		PARAMETRIC VALUES	
x	.178	MACH	4.520
		ALPHA	-5.000
		DALPHA	20.000
		ELEVTR	.000
		Y	-200.000
		PTOTAL	80.000
		BETA	.000
		OBETA	.000
		AIRON	10.000

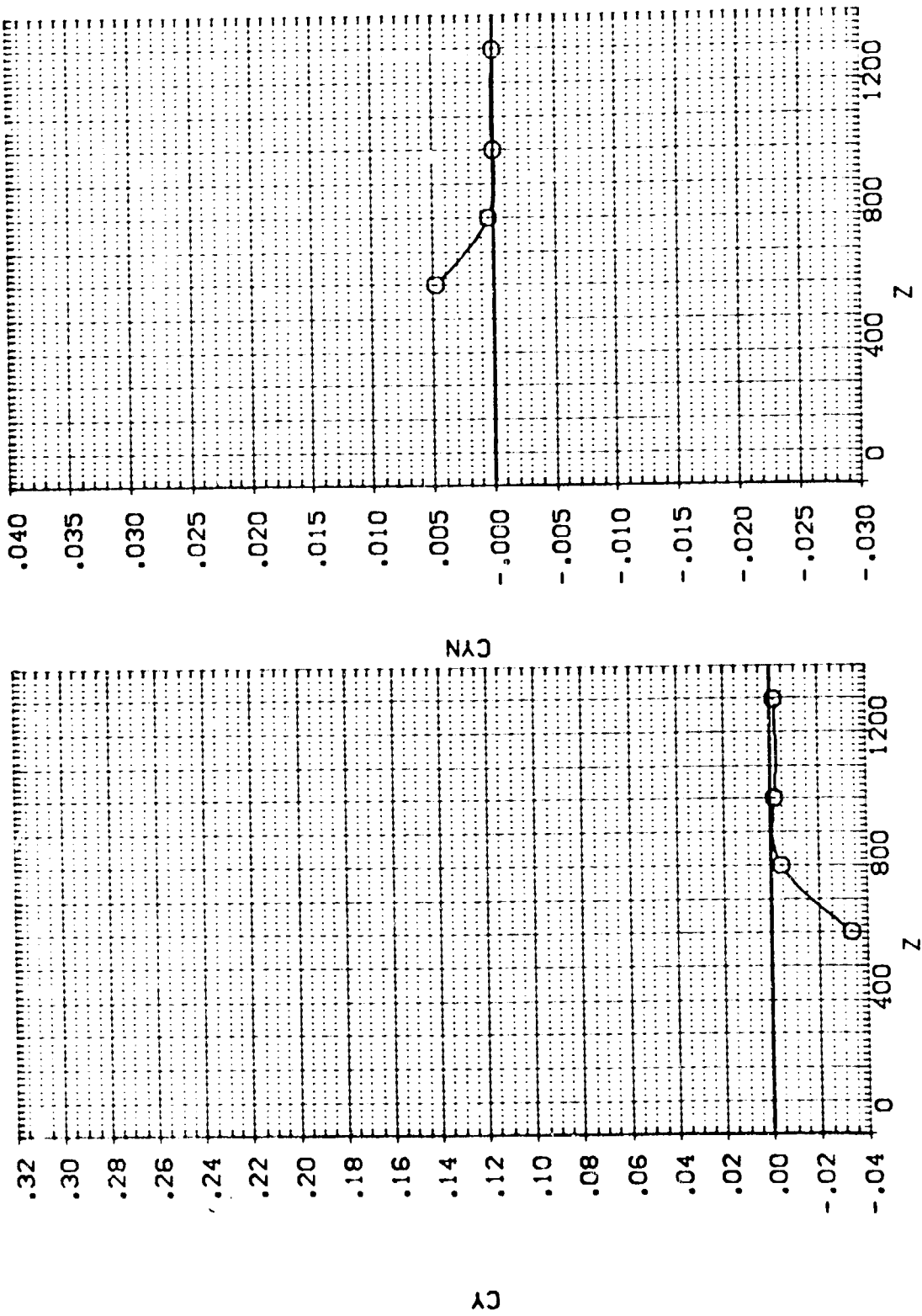

EFFECT OF EXTERNAL TANK SEPARATION ON ORBITER AERODYNAMIC CHARACTERISTICS

IA13.EXTERNAL TANK(T10)SEPARATING FROM ORB. 09 (RTJ083)

SYMBOL X
O

MACH	0.165	PARAMETRIC VALUES	60.000
ALPHA	4.520	PTOTAL	.000
DALPHA	-5.000	BETA	.000
ELEVTR	-20.000	DBETA	.000
Y	.000	AILRON	10.000

SEE THE ASSOCIATED DATA DOCUMENT FOR REFERENCE CHARACTERISTICS FOR INDIVIDUAL DATASETS

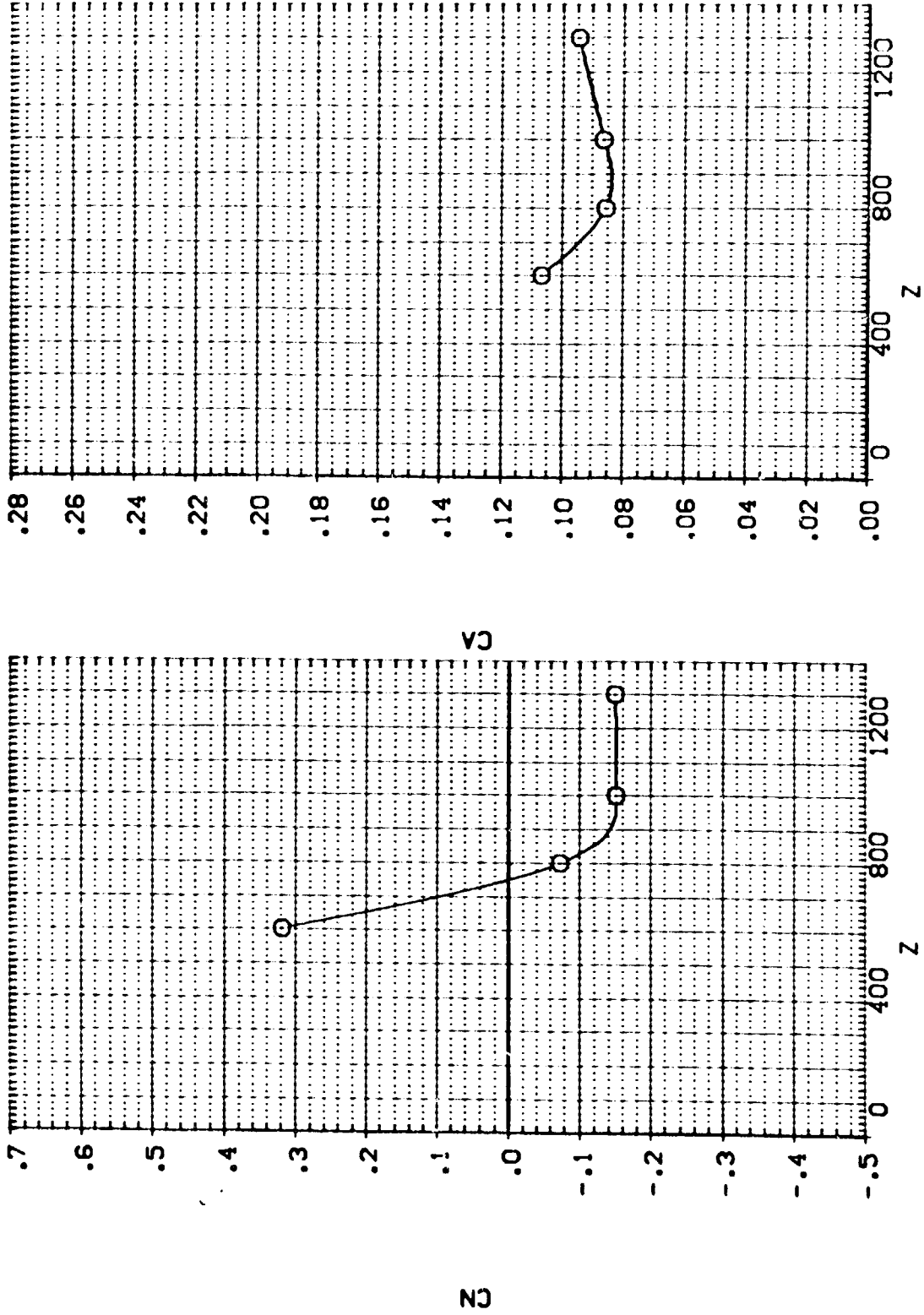

EFFECT OF EXTERNAL TANK SEPARATION ON ORBITER AERODYNAMIC CHARACTERISTICS

1A13-EXTERNAL TANK(T10)SEPARATING FROM ORB. 09 (RTJ083)

SEE THE ASSOCIATED DATA DOCUMENT FOR REFERENCE CHARACTERISTICS FOR INDIVIDUAL DATASETS

SYMBOL		PARAMETRIC VALUES	
○	X	MACH	60.000
		ALPHA	.000
		BETA	.000
		ELEVTR	10.000
		AILTRN	.000
		Y	.000

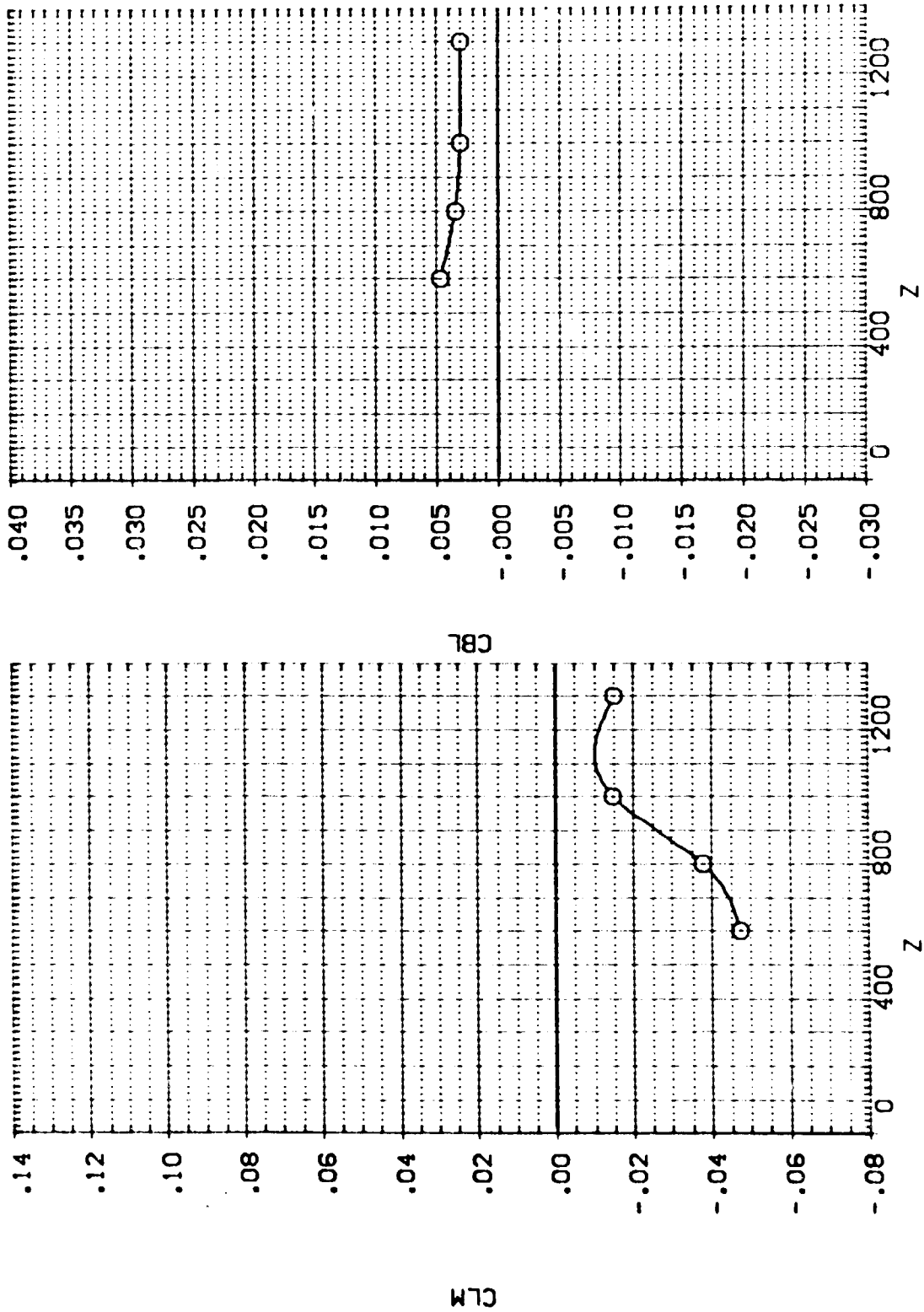

IA13. EXTERNAL TANK(T10)SEPARATING FROM ORB. 09 (RTJ083)

SEE THE ASSOCIATED DATA DOCUMENT FOR REFERENCE CHARACTERISTICS FOR INDIVIDUAL DATASETS

SYMBOL		PARAMETRIC VALUES	
○	X	MACH	4.520
		ALPHA	-5.000
		DBETA	-20.000
		ELEVTR	.000
		Y	.000
		PTOTAL	80.000
		BETA	.000
		DBETA	.000
		AILRON	10.000

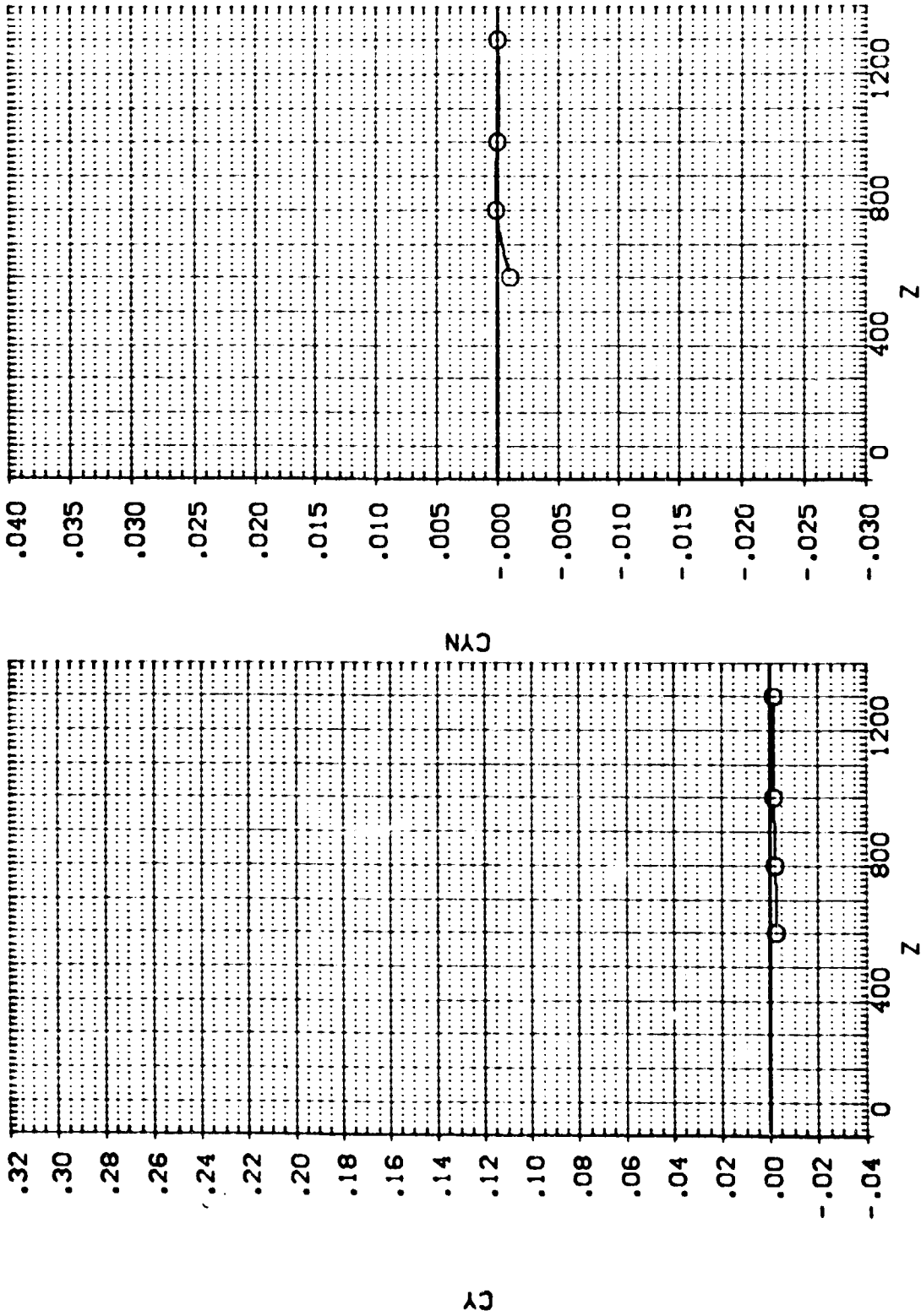

EFFECT OF EXTERNAL TANK SEPARATION ON ORBITER AERODYNAMIC CHARACTERISTICS

1A13.EXTERNAL TANK(T10)SEPARATING FROM ORB. 09 (RTJ084)

SEE THE ASSOCIATED DATA DOCUMENT FOR REFERENCE CHARACTERISTICS FOR INDIVIDUAL DATASETS

SYMBOL		PARAMETRIC VALUES	
○	X	MACH	4.520
		ALPHA	-5.000
		DALPHA	-20.000
		ELEVTR	.000
		Y	200.000
		PIDOTAL	60.000
		BETA	.000
		DBETA	.000
		AIRRCN	10.000

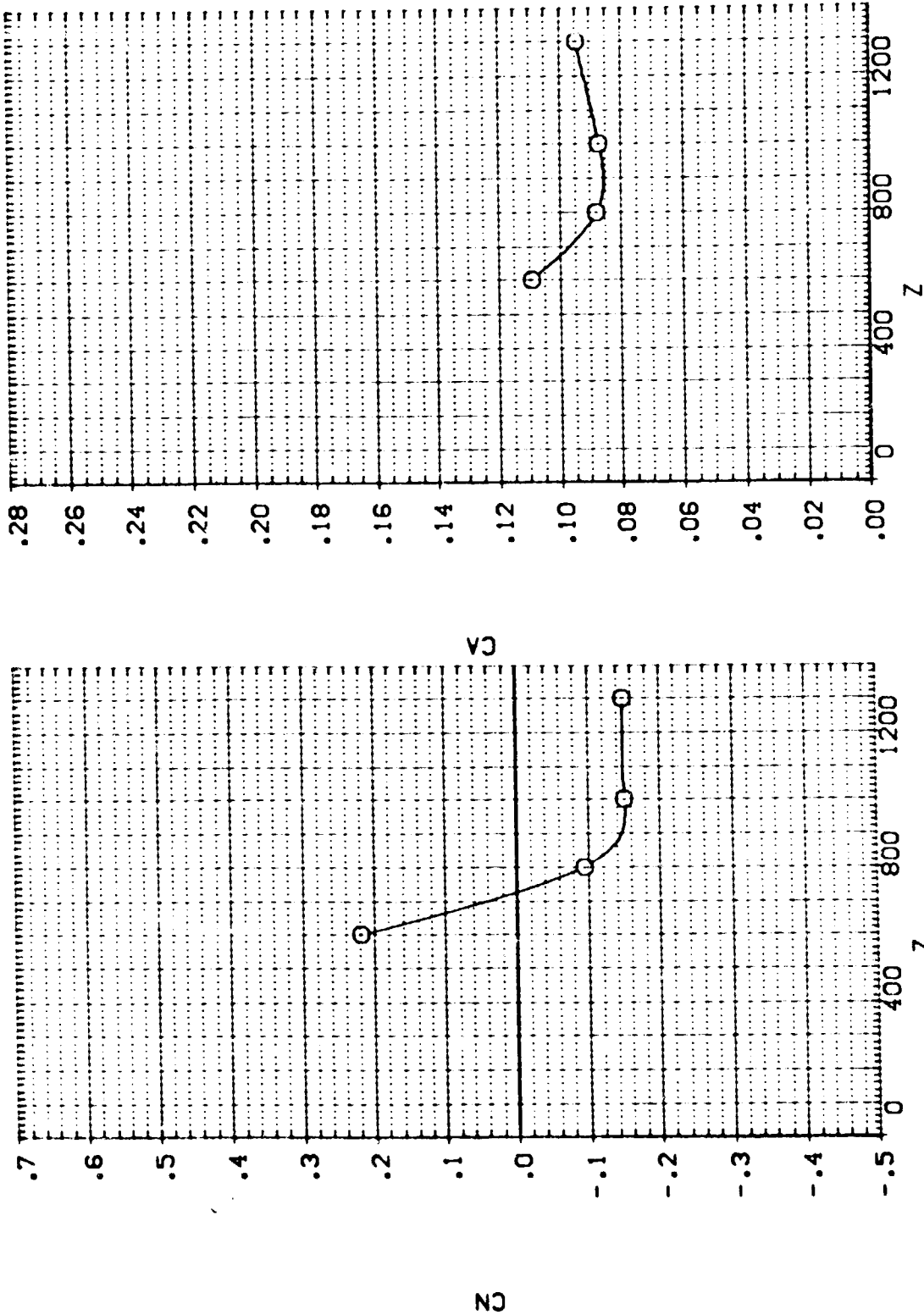

IA13, EXTERNAL TANK(T10)SEPARATING FROM ORB. 09 (RTJ084)

SYMBOL X

PARAMETRIC VALUES
 MACH 4.520 PTOTAL 80.000
 ALPHA -5.000 BETA .000
 DALPHA -20.000 DBETA .000
 ELEVTR .000 AILRON 10.000
 Y 200.000

SEE THE ASSOCIATED DATA DOCUMENT FOR REFERENCE CHARACTERISTICS FOR INDIVIDUAL DATASETS

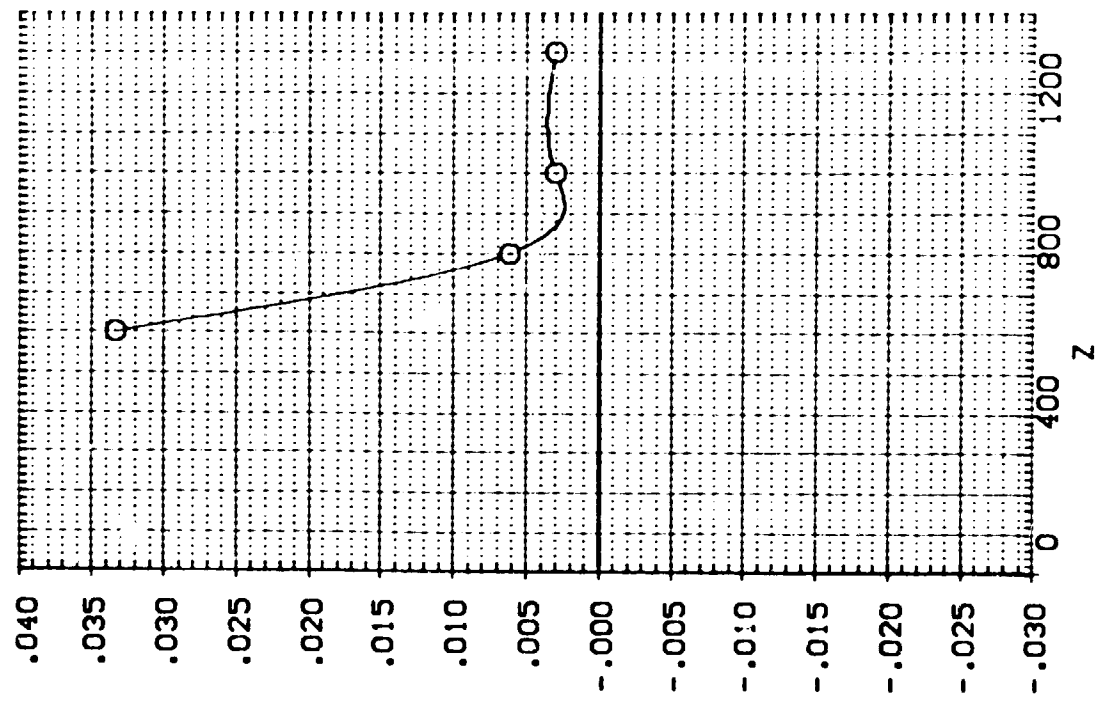
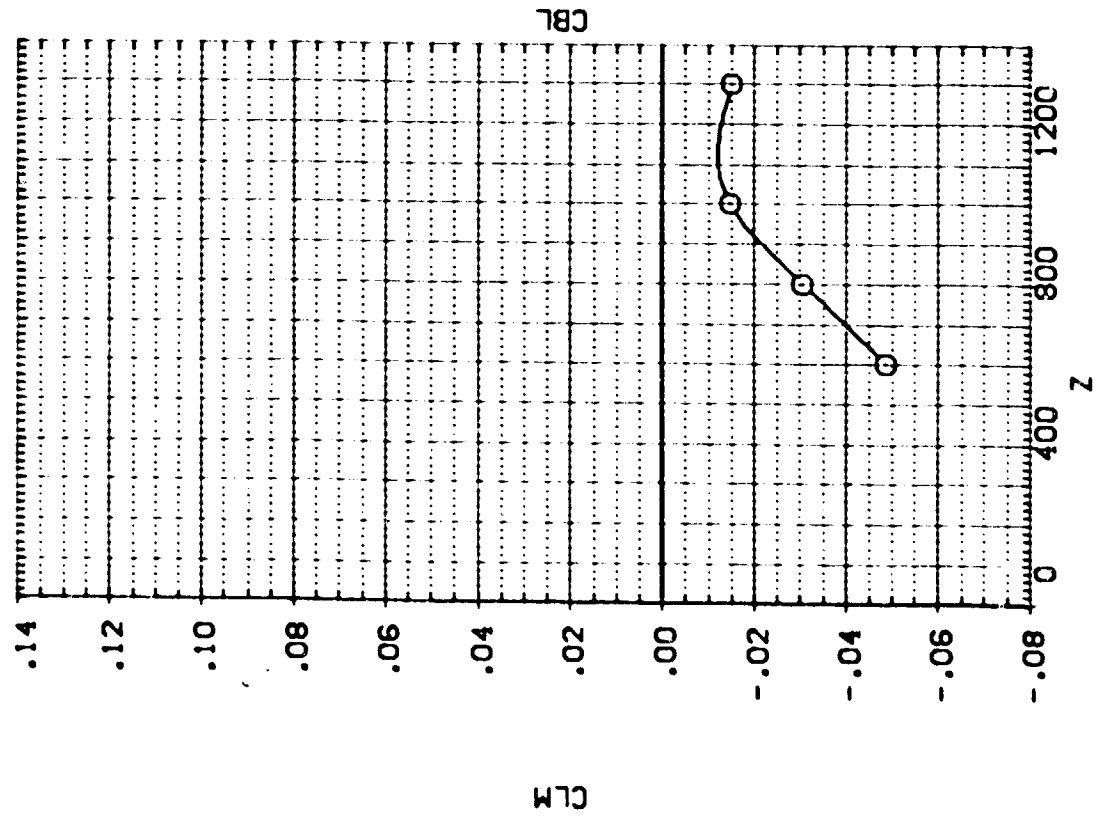

EFFECT OF EXTERNAL TANK SEPARATION ON ORBITER AERODYNAMIC CHARACTERISTICS

1.13. EXTERNAL TANK(T10)SEPARATING FROM ORB. 09 (R:J084)

SEE THE ASSOCIATED DATA DOCUMENT FOR REFERENCE CHARACTERISTICS FOR INDIVIDUAL DATASETS

SYMBOL		PARAMETRIC VALUES	
X	.210	MACH	4.520
		P TOTAL	60.000
		ALPHA	-5.000
		BETA	.000
		DALPHA	-20.000
		DBETA	.000
		ELEVTR	.000
		ALTRCN	10.000
		Y	200.000

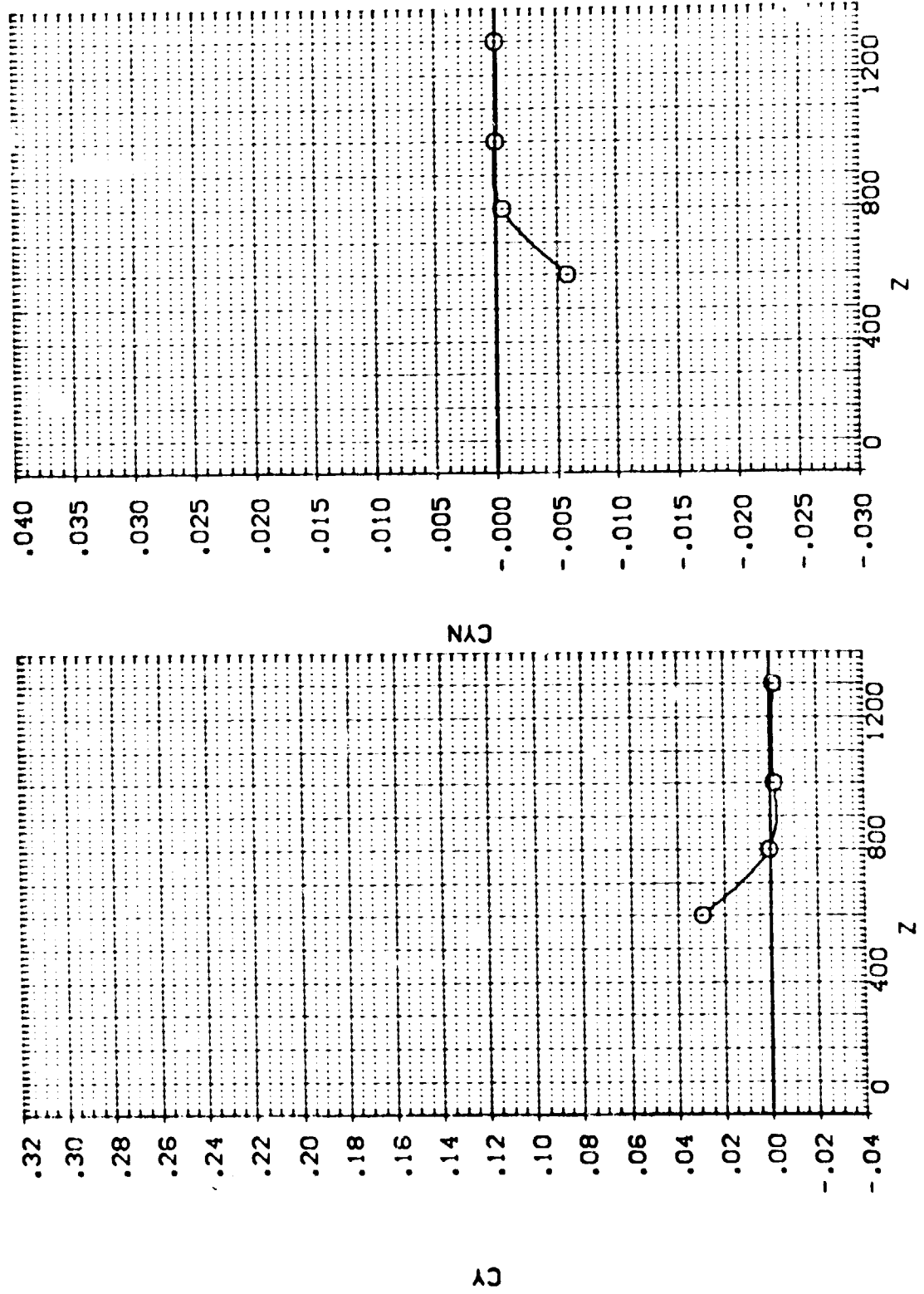

1A13. EXTERNAL TANK(T10)SEPARATING FROM ORB. 09 (RTJ085)

SEE THE ASSOCIATED DATA DOCUMENT FOR REFERENCE CHARACTERISTICS FOR INDIVIDUAL DATA SETS

PARAMETRIC VALUES

MACH	4.520	PTOTAL	80.000
ALPHA	-5.000	BETA	.000
DALPHA	-20.000	DBETA	-5.000
ELEVTR	.000	AILRON	10.000
Y	-200.000		

SYMBOL * - .007
 O

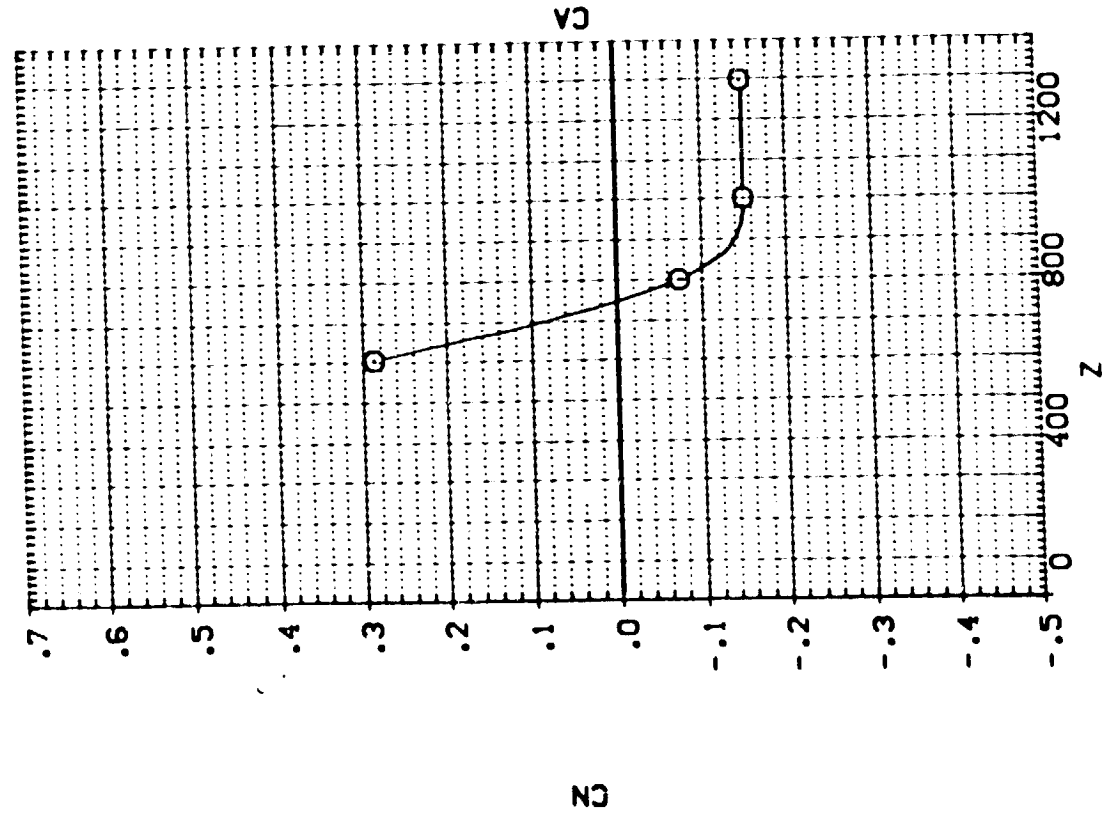
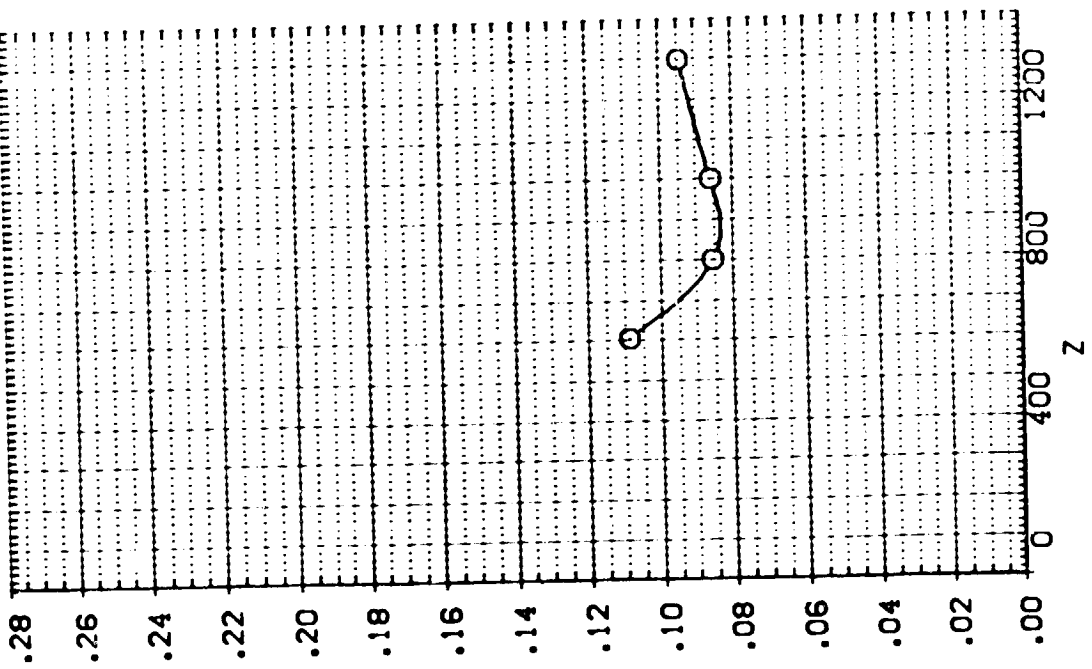

EFFECT OF EXTERNAL TANK SEPARATION ON ORBITER AERODYNAMIC CHARACTERISTICS

IA13.EXTERNAL TANK(T10)SEPARATING FROM ORB. 09 (RTJ085)

SEE THE ASSOCIATED DATA DOCUMENT FOR REFERENCE CHARACTERISTICS FOR INDIVIDUAL DATASETS

SYMBOL X
O -0.007

PARAMETRIC VALUES	
MACH	4.520
PTOTAL	80.000
BETA	.000
ALPHA	-5.000
DBETA	-5.000
ALPHA	-20.000
ALPHON	10.000
ELEVTR	.000
Y	-200.000

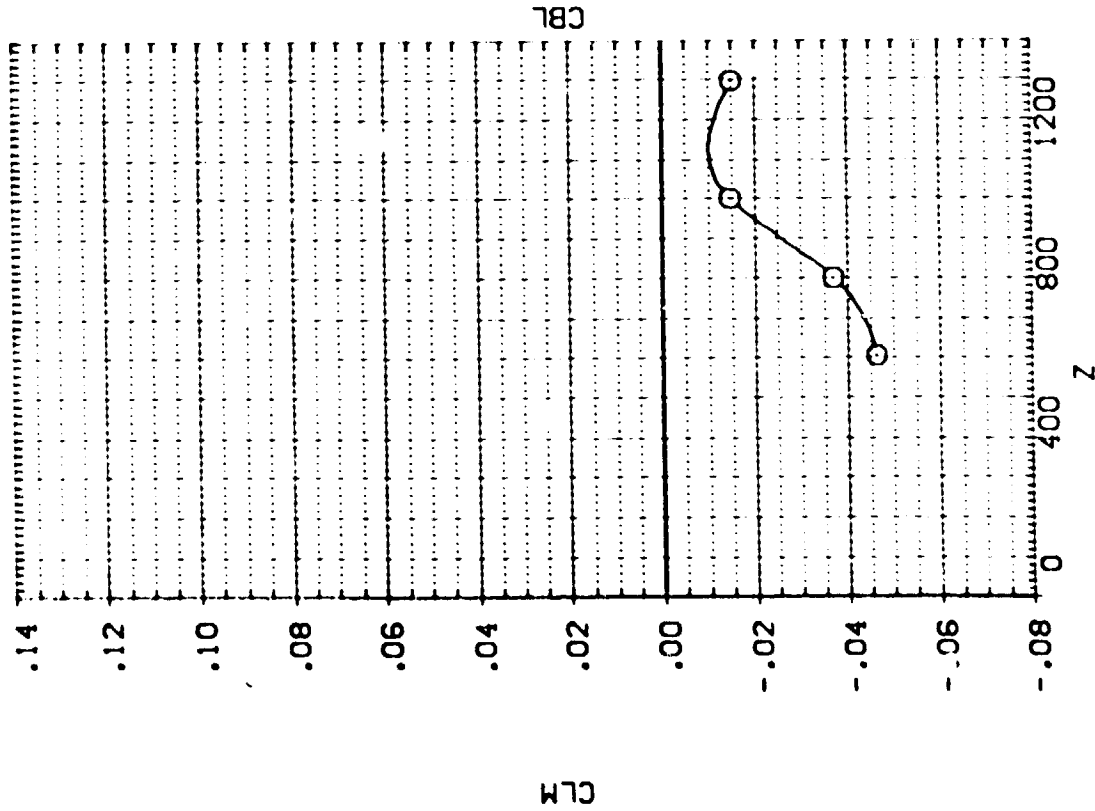
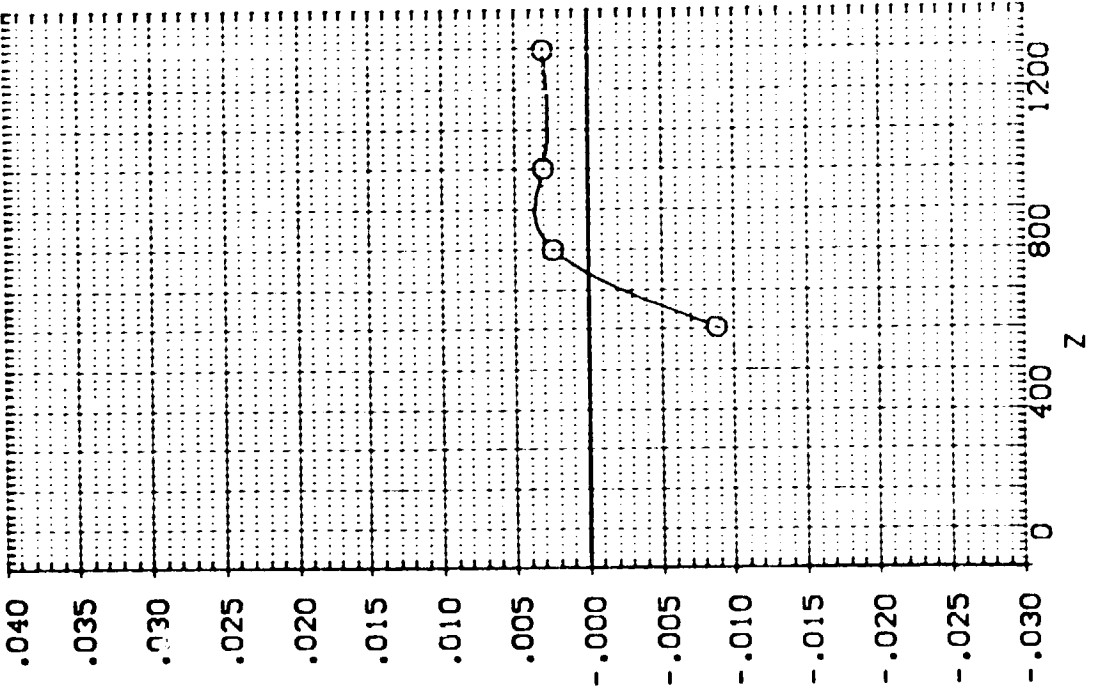

EFFECT OF EXTERNAL TANK SEPARATION ON ORBITER AERODYNAMIC CHARACTERISTICS

IA13.EXTERNAL TANK(T10)SEPARATING FROM ORB. 09 (RTJ085)

SEE THE ASSOCIATED DATA DOCUMENT FOR REFERENCE CHARACTERISTICS FOR INDIVIDUAL DATASETS

SYMBOL		PARAMETRIC VALUES	
X	-0.007	MACH	4.520
O		ALPHA	-5.000
		DALPHA	-20.000
		ELEVTR	.000
		Y	-200.000
		PTOTAL	60.000
		BETA	.000
		DBETA	-5.000
		AILRON	10.000

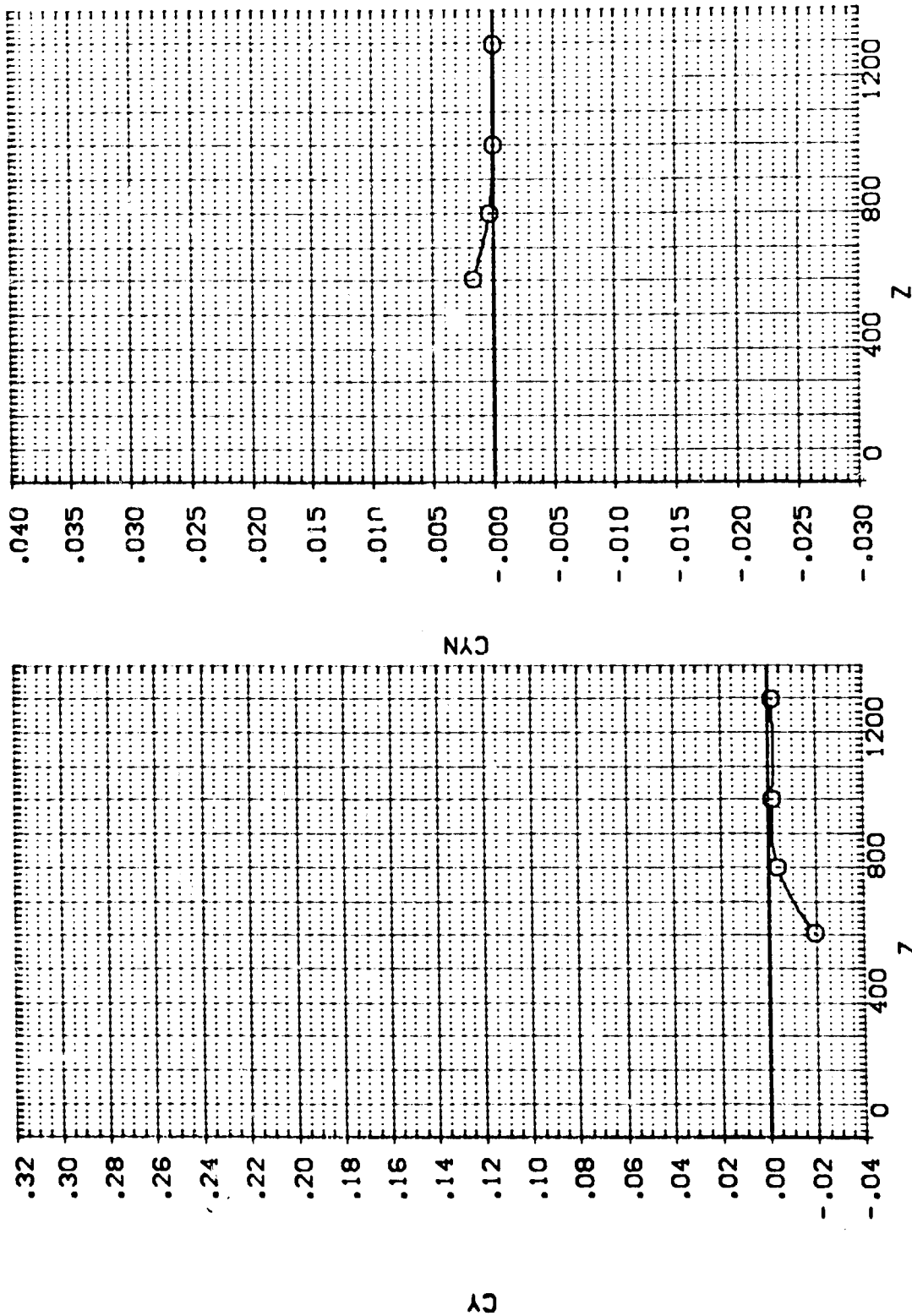

EFFECT OF EXTERNAL TANK SEPARATION ON ORBITER AERODYNAMIC CHARACTERISTICS

IA13, EXTERNAL TANK(T10)SEPARATING FROM ORB. 09 (RTJ086)

SEE THE ASSOCIATED DATA DOCUMENT FOR REFERENCE CHARACTERISTICS FOR INDIVIDUAL DATASETS

SYMBOL		PARAMETRIC VALUES	
○	x	MACH	80,000
		PIOTAL	.000
		BETA	5,000
		ALPHA	10,000
		ELEVTR	.000
		AILRON	.000
		Y	

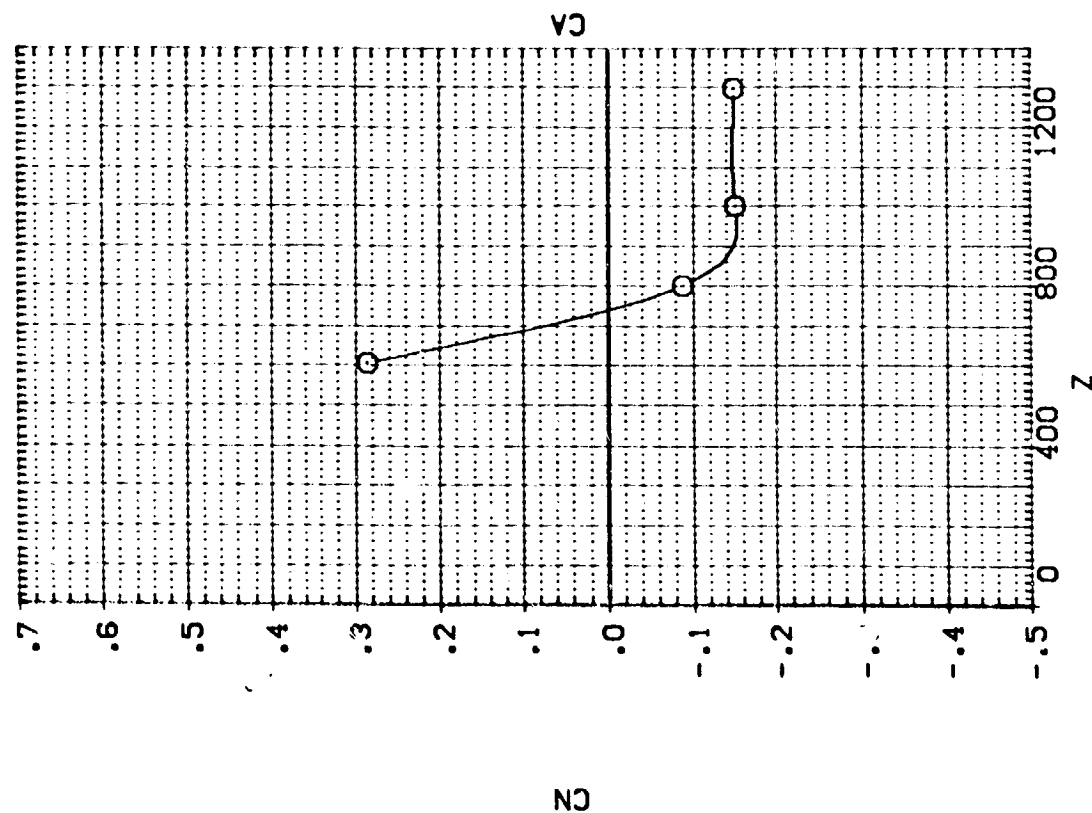
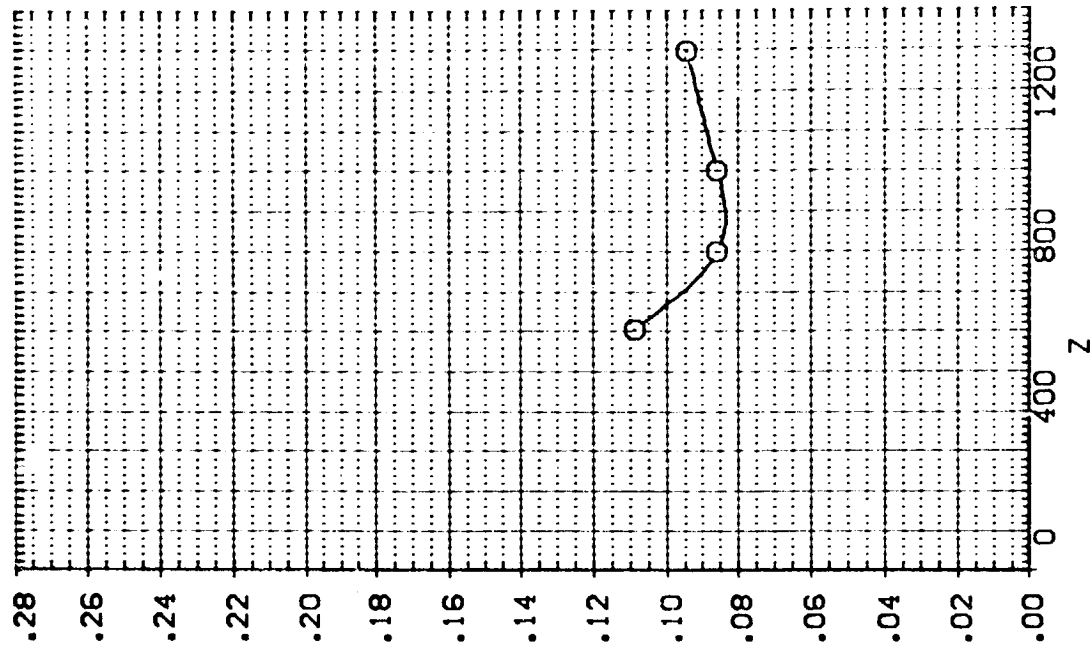

EFFECT OF EXTERNAL TANK SEPARATION ON ORBITER AERODYNAMIC CHARACTERISTICS

IA13.EXTERNAL TANK(T10)SEPARATING FROM ORB. 09 (RTJ086)

SEE THE ASSOCIATED DOCUMENT FOR REFERENCE CHARACTERISTICS FOR INDIVIDUAL DATASETS

SYMBOL		PARAMETRIC VALUES	
X	.205	MACH	4.520
O		ALPHA	-5.000
		DALPHA	-20.000
		ELEVTR	.000
		Y	.000
		PITOTL	80.000
		BETA	.000
		DBETA	5.000
		AILR	10.000

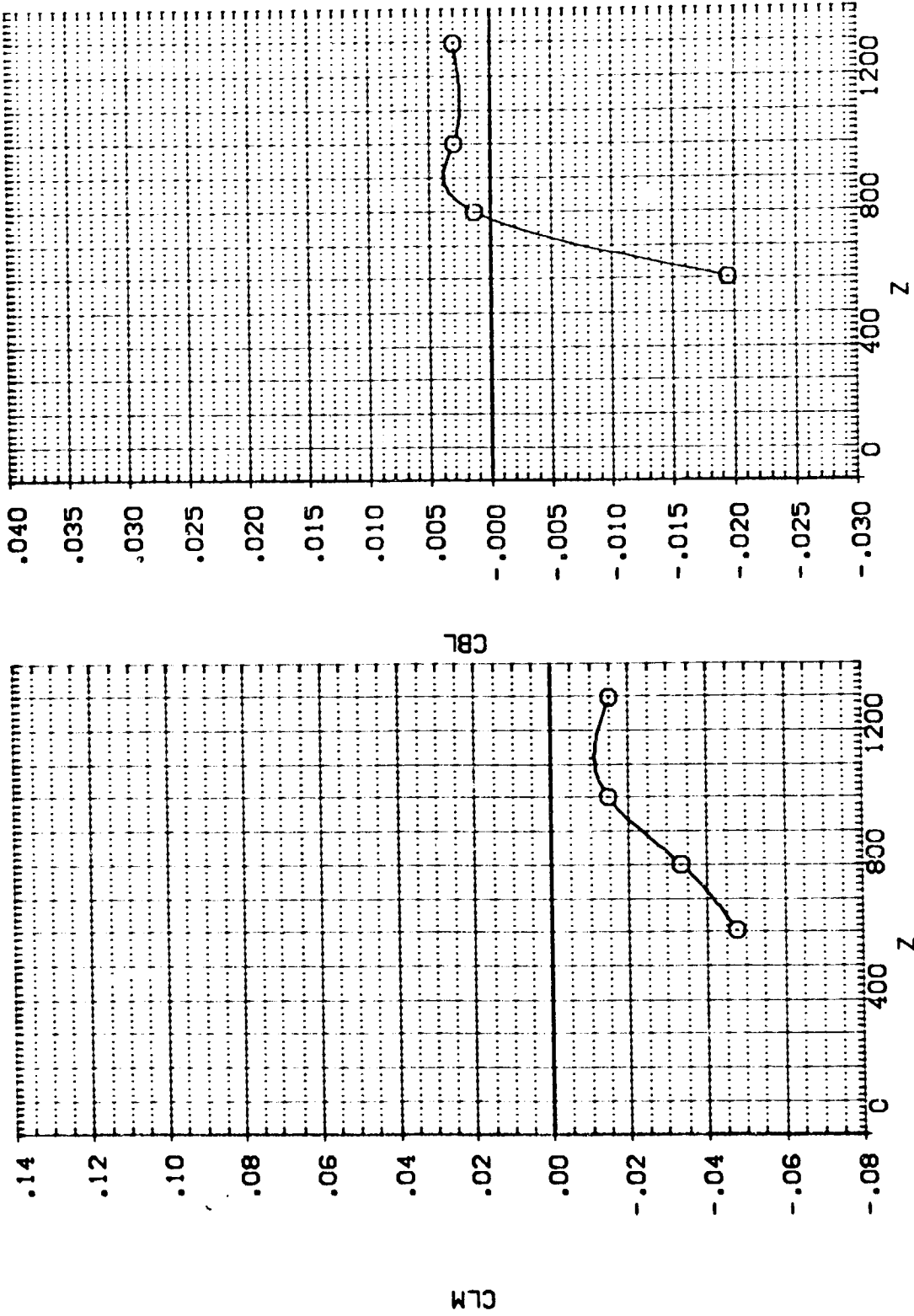

EFFECT OF EXTERNAL TANK SEPARATION ON ORBITER AERODYNAMIC CHARACTERISTICS

1A13. EXTERNAL TANK(110)SEPARATING FROM ORB. 09 (R1J086)

SEE THE ASSOCIATED DATA DOCUMENT FOR REFERENCE CHARACTERISTICS FOR INDIVIDUAL DATASETS

SYMBOL		PARAMETRIC VALUES	
x	.205	MACH	4.520
o		PIOTAL	80.000
		ALPHA	-5.000
		BETA	.000
		DBETA	5.000
		ELEVTR	.000
		AILRON	10.000
		Y	.000

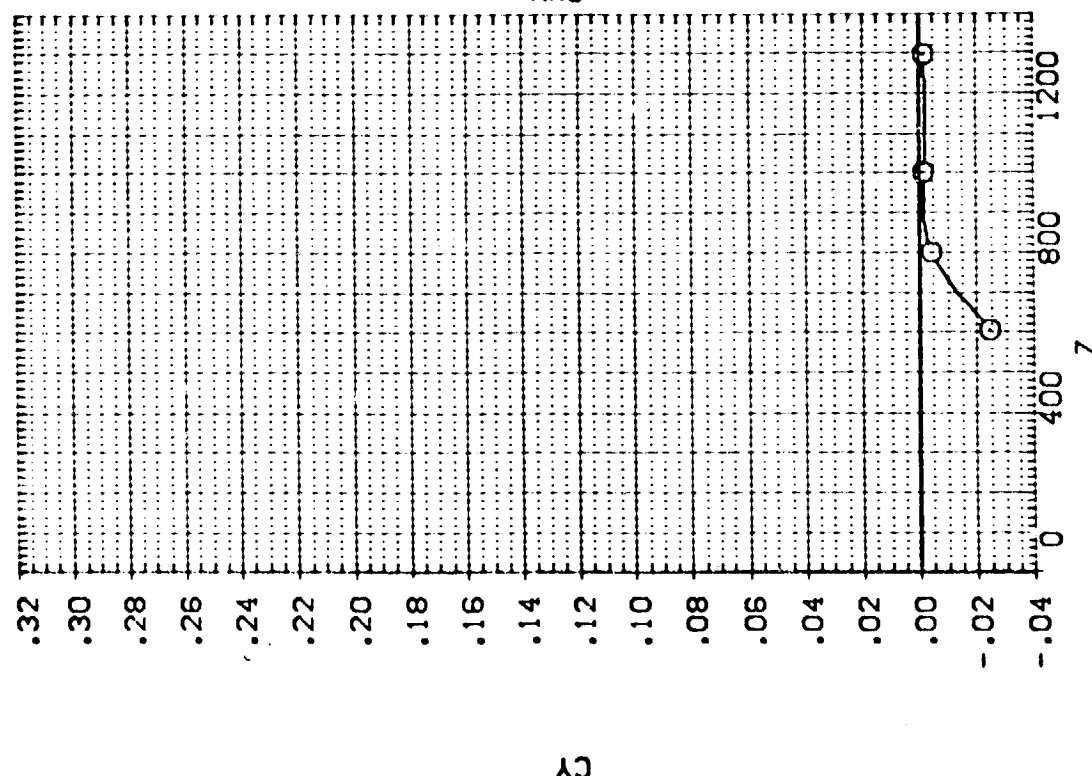
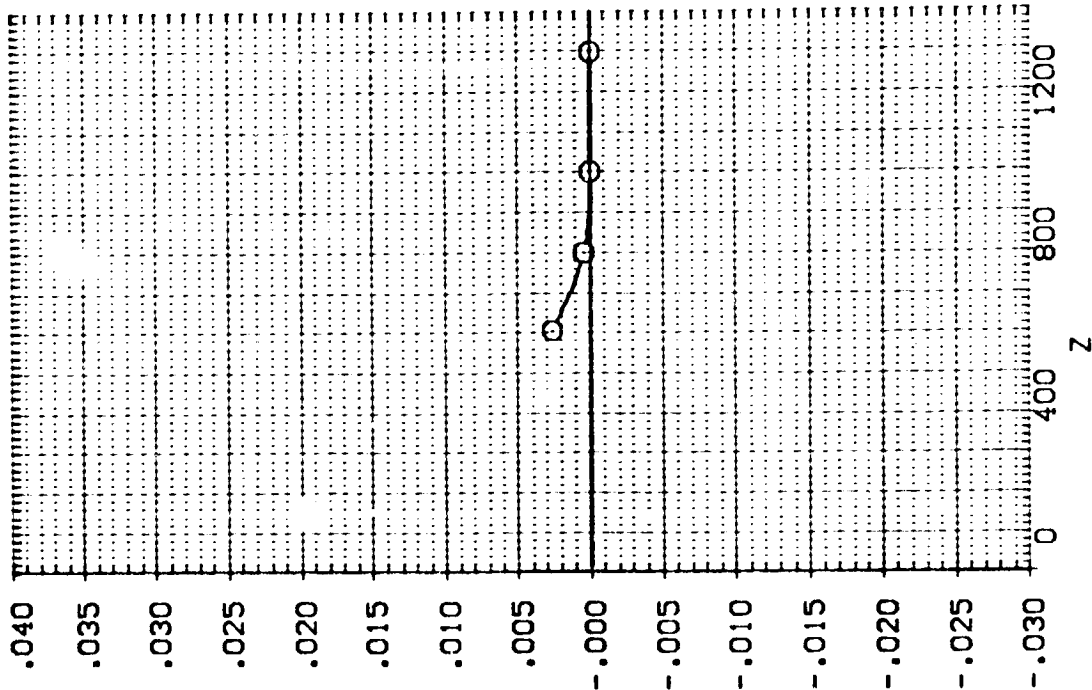

EFFECT OF EXTERNAL TANK SEPARATION ON ORBITER AERODYNAMIC CHARACTERISTICS

1.13. EXTERNAL TANK(110)SEPARATING FROM ORB. 09 (RTJ087)

SEE THE ASSOCIATED DATA DOCUMENT FOR REFERENCE CHARACTERISTICS FOR INDIVIDUAL DATA SETS

SYMBOL		PARAMETRIC VALUES	
x	.277	MACH	4.520
		PIOTAL	60.000
		BETA	.000
		DBETA	5.000
		AILRON	10.000
y	200.000		

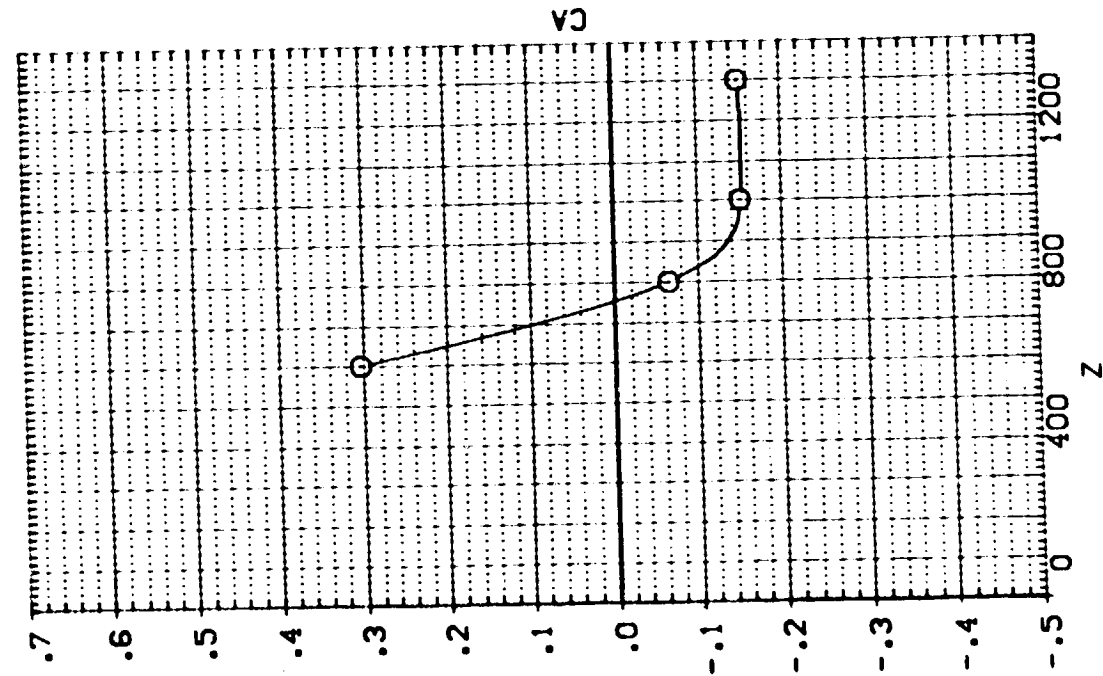
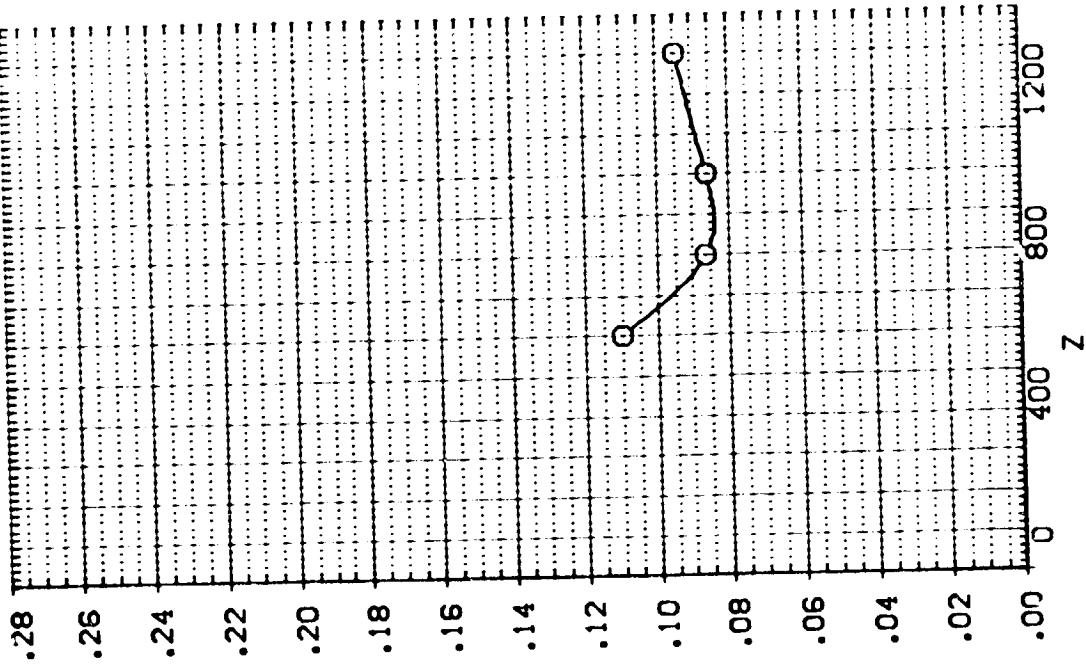

EFFECT OF EXTERNAL TANK SEPARATION ON ORBITER AERODYNAMIC CHARACTERISTICS

1A13. EXTERNAL TANK (T10) SEPARATING FROM ORB. 09 (RTJ087)

SEE THE ASSOCIATED DATA DOCUMENT FOR REFERENCE CHARACTERISTICS FOR INDIVIDUAL DATASETS

SYMBOL x .227
 O
 PARAMETRIC VALUES
 MACH 4.520 P/TOTAL 80.000
 ALPHA -5.000 BETA .000
 DALPHA -20.000 DBETA 5.000
 ELEVTR .000 AILTRON 10.000
 Y 200.000

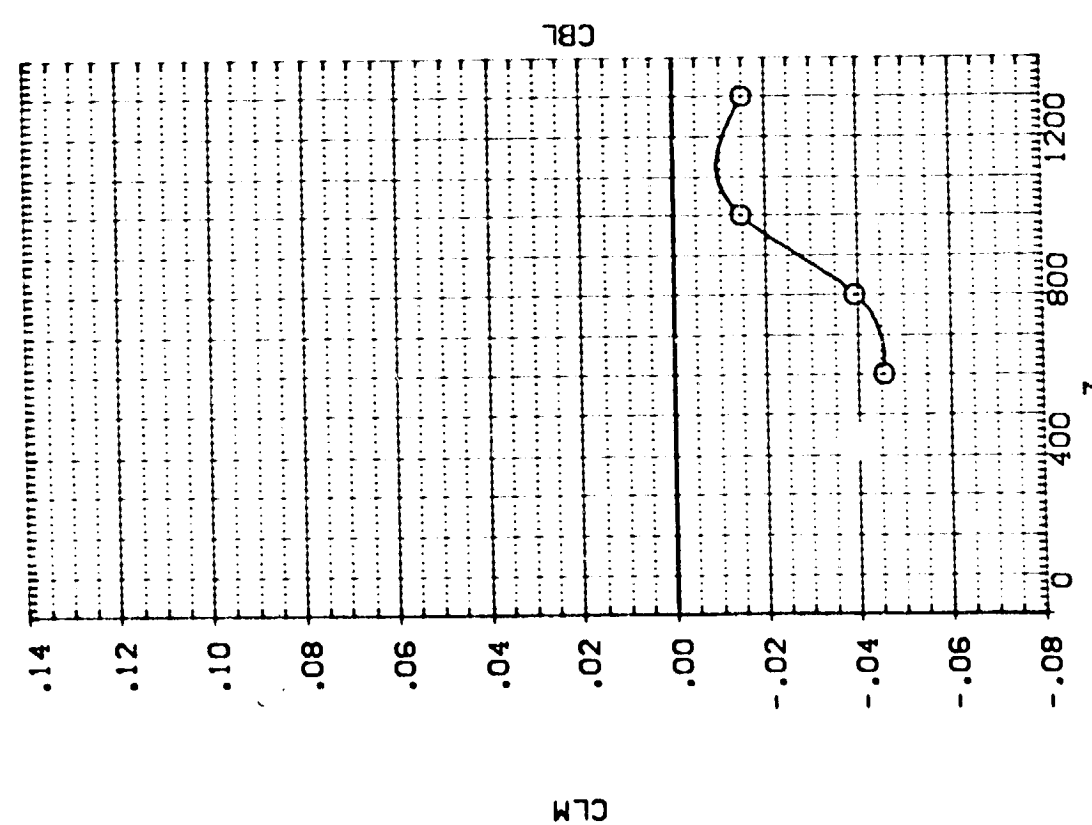
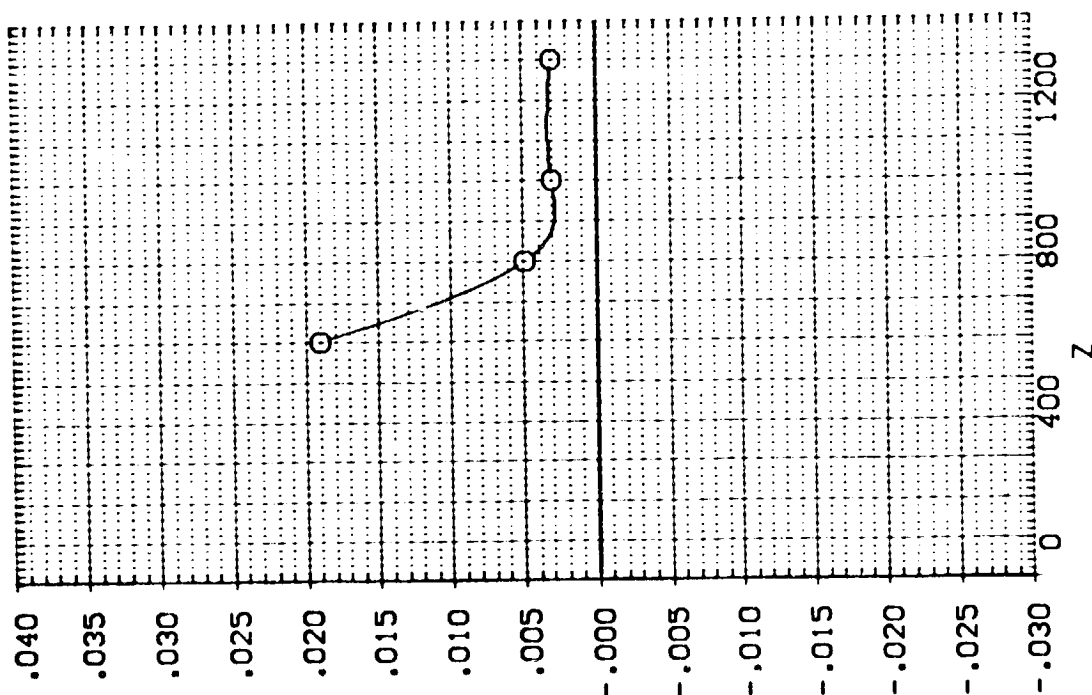

EFFECT OF EXTERNAL TANK SEPARATION ON ORBITER AERODYNAMIC CHARACTERISTICS

1A13. EXTERNAL TANK(T10)SEPARATING FROM CRB. 09 (RTJ087)

SYMBOL	X	MACH	PARAMETRIC VALUES
○	.227	4.520	P/DOTAL 80.000
		ALPHA -5.000	BETA .000
		DALPHA -20.000	DBETA 5.000
		ELEVTR .000	AIRCRN 10.000
		Y 200.000	

SEE THE ASSOCIATED DOCUMENT FOR AERODYNAMIC CHARACTERISTICS OF INDIVIDUAL CONFIGURE

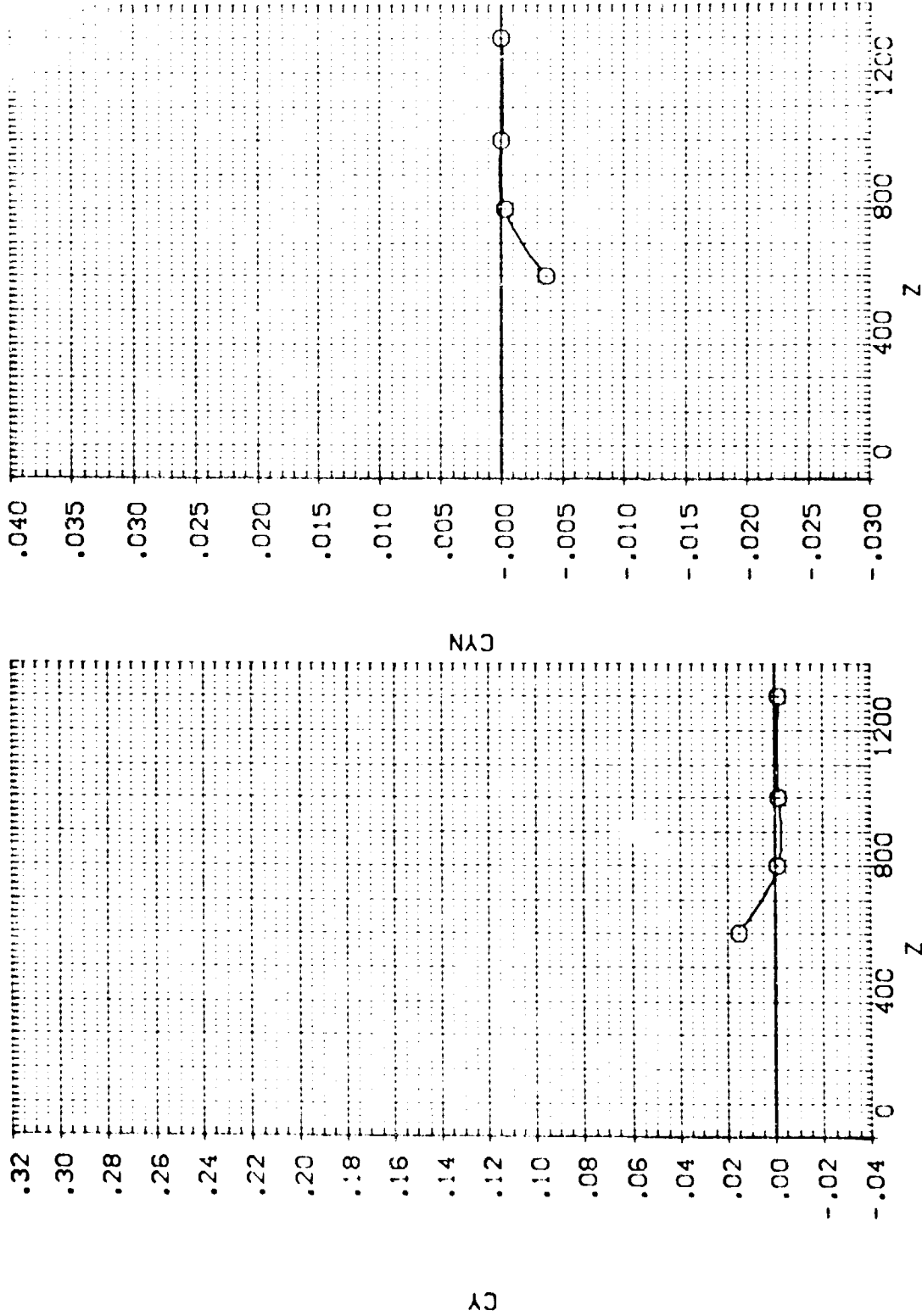

EFFECT OF EXTERNAL TANK SEPARATION ON ORBITER AERODYNAMIC CHARACTERISTICS

1A13.EXTERNAL TANK(T10)SEPARATING FROM ORB. 09 (RTJ088)

SEE THE ASSOCIATED DATA DOCUMENT FOR REFERENCE CHARACTERISTICS FOR INDIVIDUAL DATASETS

SYMBOL	X	MACH	PARAMETRIC VALUES
○	.123	4.530	PICOTAL 110.000
◇	400.390	.000	BETA .000
△	800.600	.000	DBETA .000
▽	1200.800	10.000	AIRTON .000

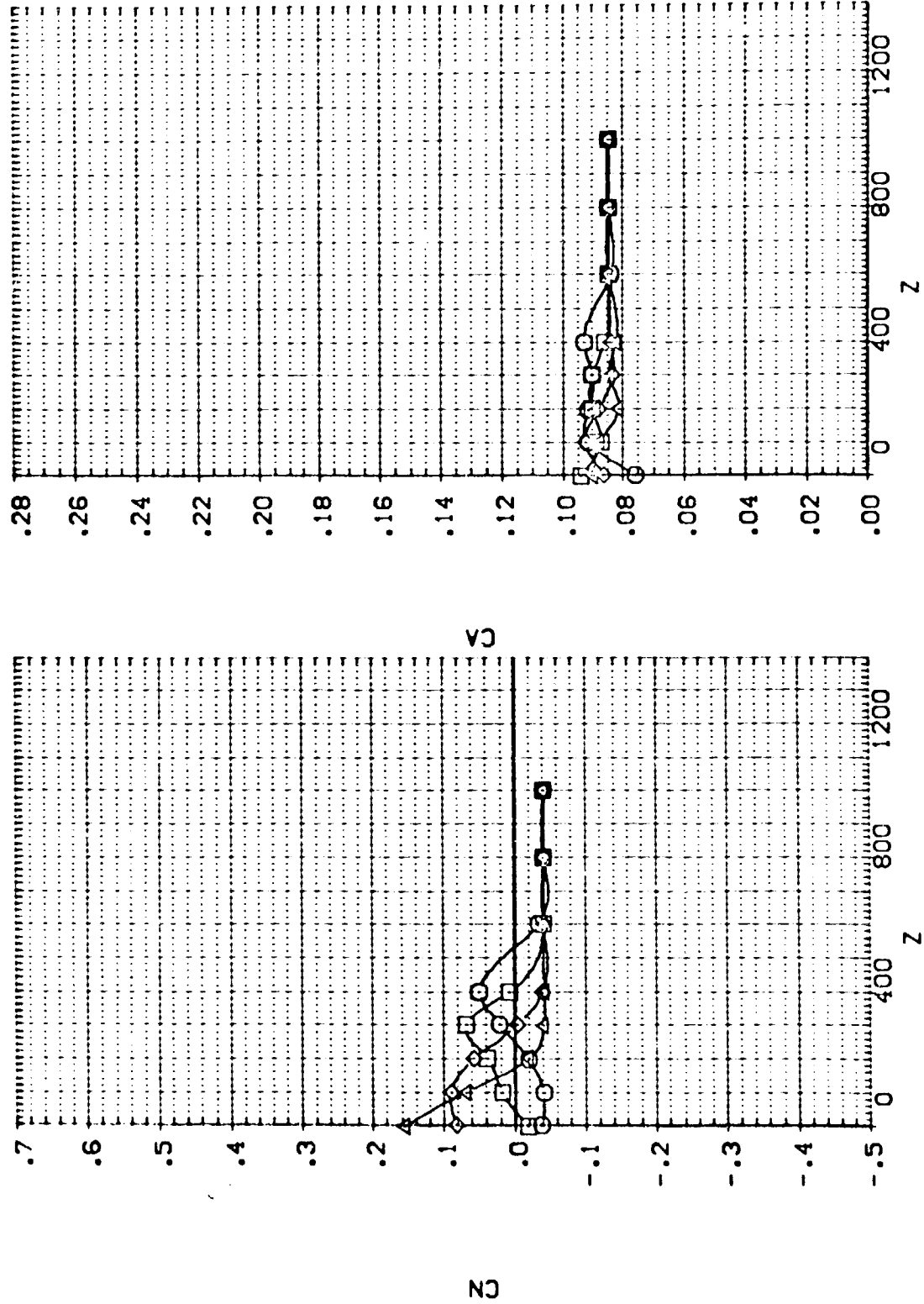

EFFECT OF EXTERNAL TANK SEPARATION ON ORBITER AERODYNAMIC CHARACTERISTICS

1.13. EXTERNAL TANK(T10)SEPARATING FROM ORB. C9 (RTJ088)

SEE THE ASSOCIATED DOCUMENT FOR CHARACTERISTICS FOR INDIVIDUAL DATA

SYMBOL		PARAMETRIC VALUES	
x	.123	MACH	4.530
o	400.390	ALPHA	.000
o	800.600	BETA	.000
o	1200.800	GAMMA	.000
o		DELTA	.000
o		ELEVTR	10.000
o		ATLRON	.000
o		Y	.000
o		P/TOTAL	110.000
o		BETA	.000
o		GAMMA	.000
o		DELTA	.000
o		ELEVTR	.000
o		ATLRON	.000
o		Y	.000

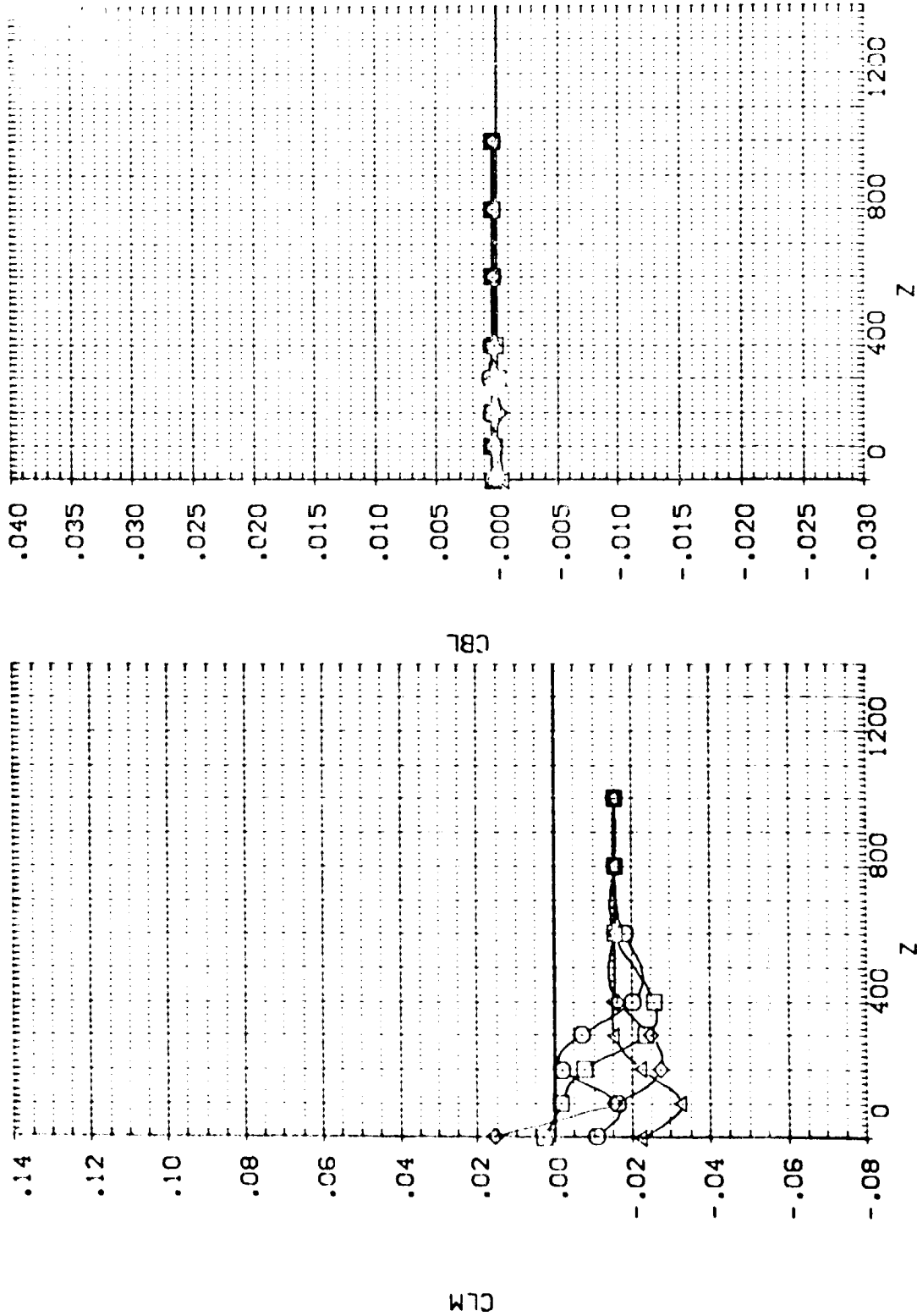

EFFECT OF EXTERNAL TANK SEPARATION ON ORBITER AERODYNAMIC CHARACTERISTICS

1.13. EXTERNAL TANK(S) SEPARATING FROM ORB. 09 (RTJ088)

SEE THE ASSOCIATED DATA DOCUMENT FOR REFERENCE CHARACTERISTICS FOR INDIVIDUAL DATASETS

SYMBOL	X	MACH	PARAMETRIC VALUES
□	.173	4.530	P TOTAL 110.000
◇	400.390	.000	BETA .000
△	800.600	.000	DBETA .000
	1200.800	10.000	ALLRON .000
		Y	

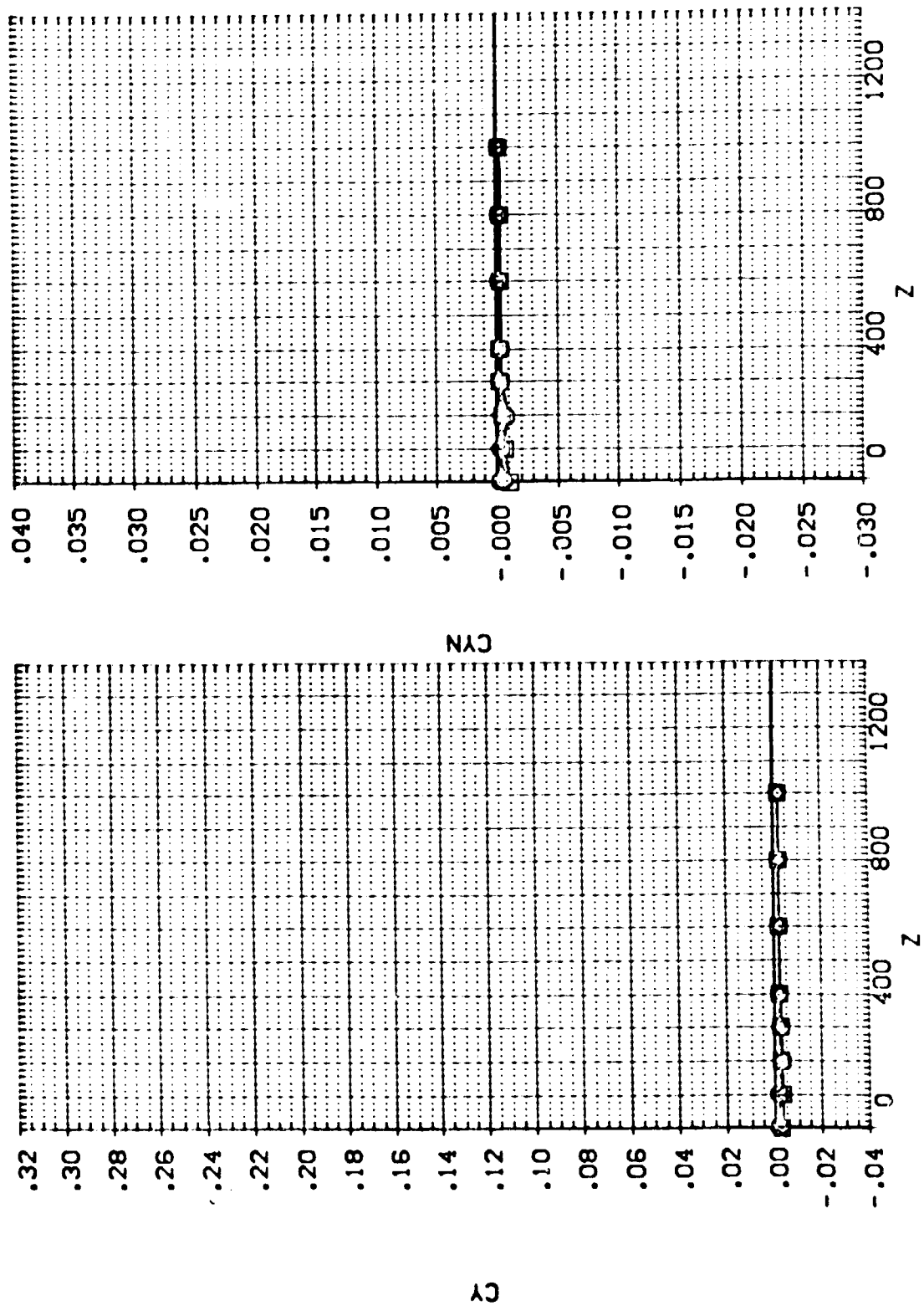

EFFECT OF EXTERNAL TANK SEPARATION ON ORBITER AERODYNAMIC CHARACTERISTICS

1A13.EXTERNAL TANK(T10)SEPARATING FROM ORB. 09 (RTJ089)

SEE THE ASSOCIATED
DOCUMENT FOR REFERENCE
CHARACTERISTICS FOR
INDIVIDUAL CASES

SYMBOL	X	MACH	PARAMETRIC VALUES
○	400.410	4.530	PTOTAL 110.000
◇	800.750	10.000	BETA .000
△	1200.500	10.000	DELTA .000
			ELEVTR 10.000
			ALFRON .000
			Y .000

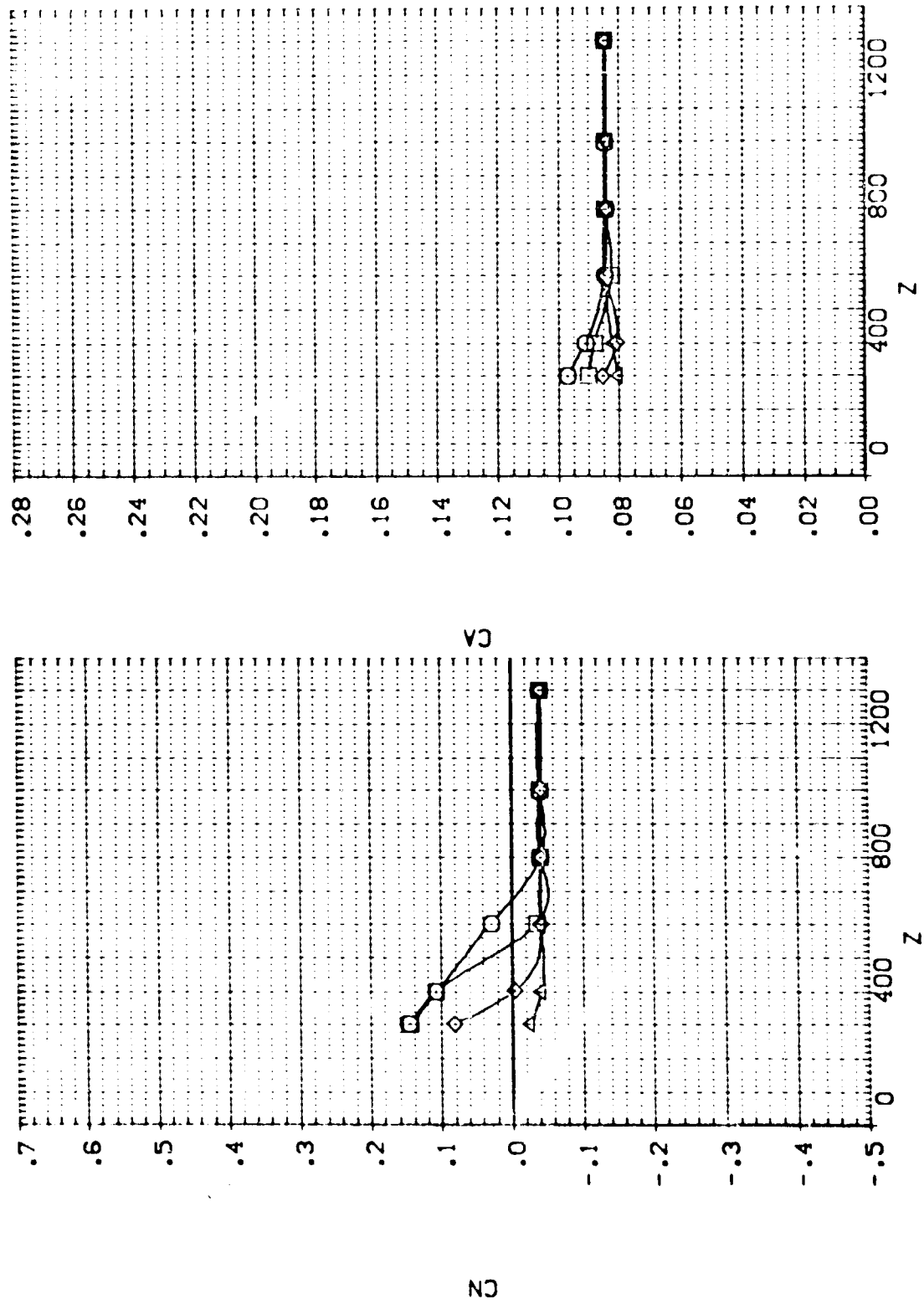

EFFECT OF EXTERNAL TANK SEPARATION ON ORBITER AERODYNAMIC CHARACTERISTICS

1A13. EXTERNAL TANK(110) SEPARATING FROM ORB. 09 (RTJ089)

SEE THE ASSOCIATED DATA DOCUMENT FOR REFERENCE CHARACTERISTICS FOR INDIVIDUAL DATASETS

SYMBOL		PARAMETRIC VALUES	
○	x	MACH	1.530
◇	α	ALPHA	.000
△	β	BETA	-10.000
	γ	ALPHA	10.000
	δ	BETA	.000
	ε	ALPHA	110.000
	ζ	BETA	.000
	η	BETA	.000
	θ	BETA	.000

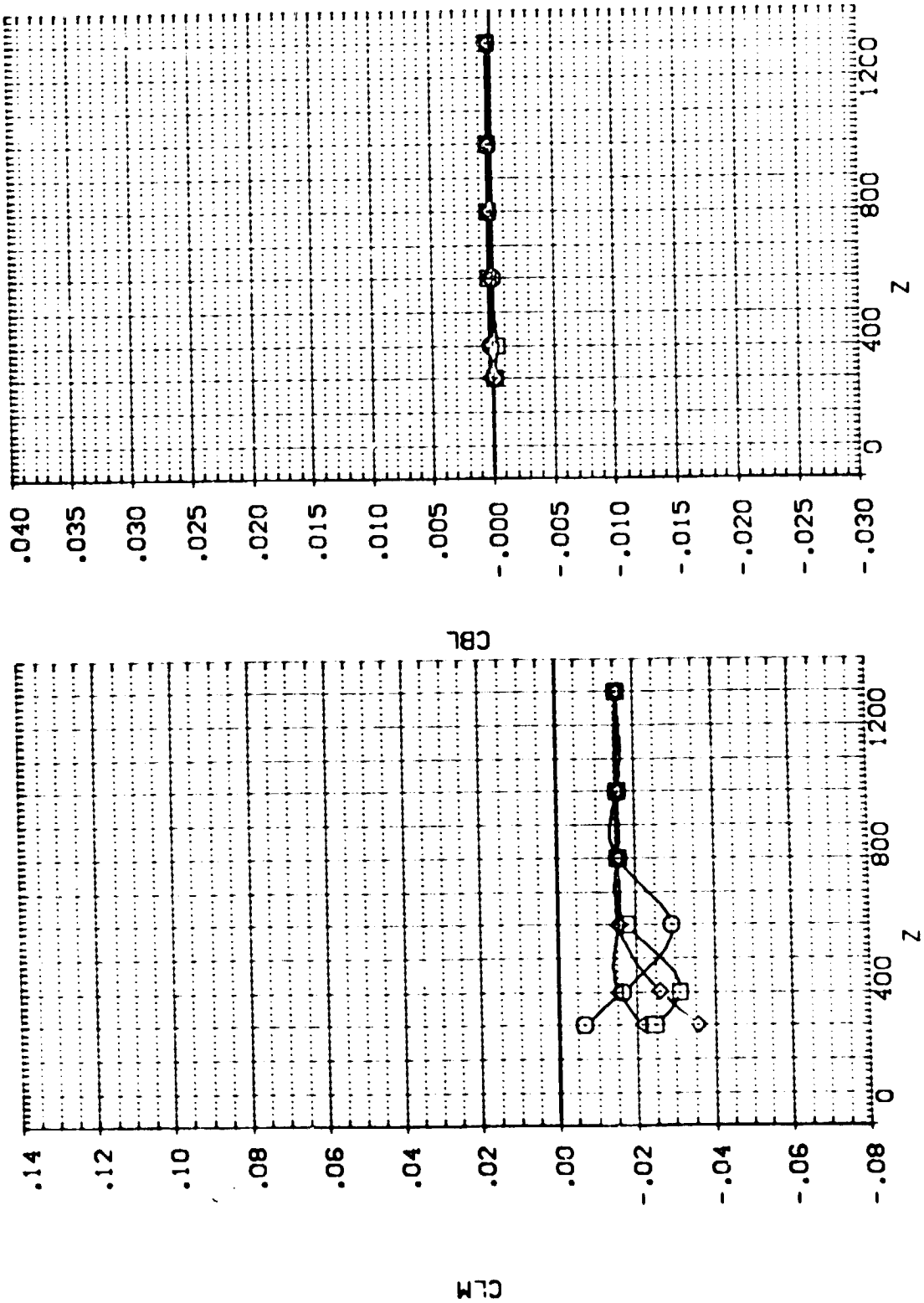

EFFECT OF EXTERNAL TANK SEPARATION ON ORBITER AERODYNAMIC CHARACTERISTICS

1A13. EXTERNAL TANK(T10)SEPARATING FROM ORB. 09 (RTJ089)

SEE THE ASSOCIATED DOCUMENT FOR REFERRED CHARACTERISTICS IN INDIVIDUAL DATA

SYMBOL	X	MACH	PARAMETRIC VALUES
○	.185	4.530	PTOTAL 110.000
○	400.440	.000	BETA .000
○	600.750	-10.000	COSYTA .000
○	1200.500	10.000	ALFRON .000
			Y .000

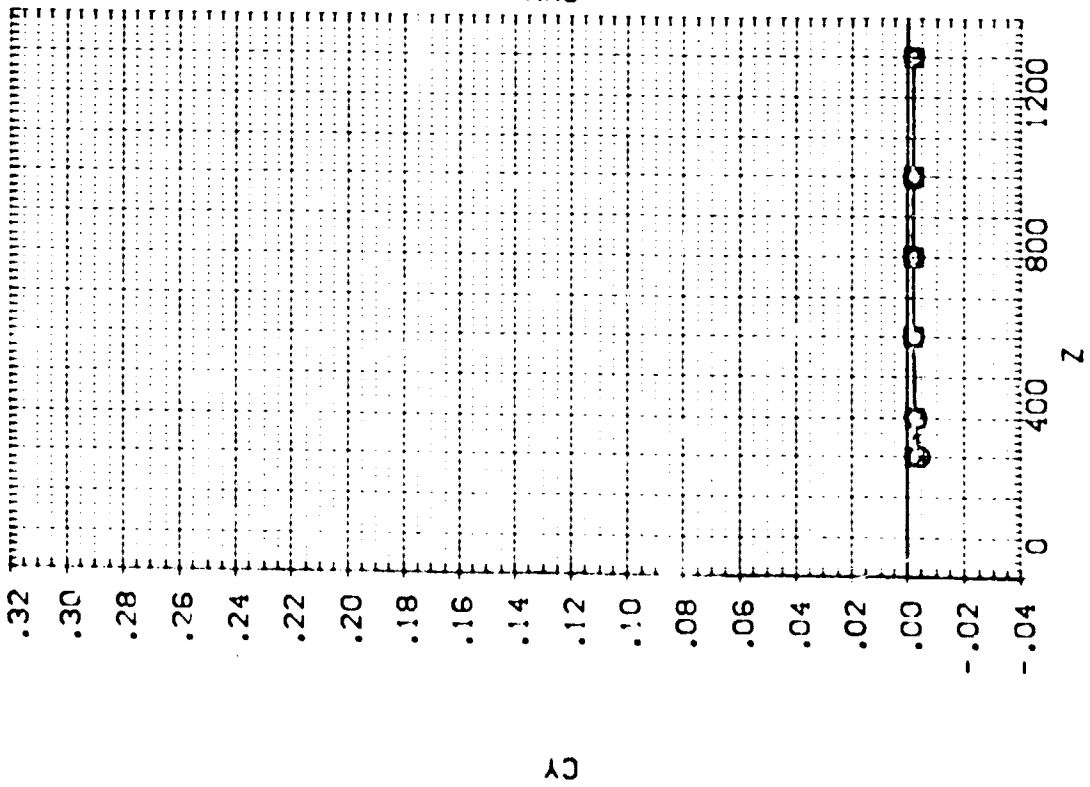
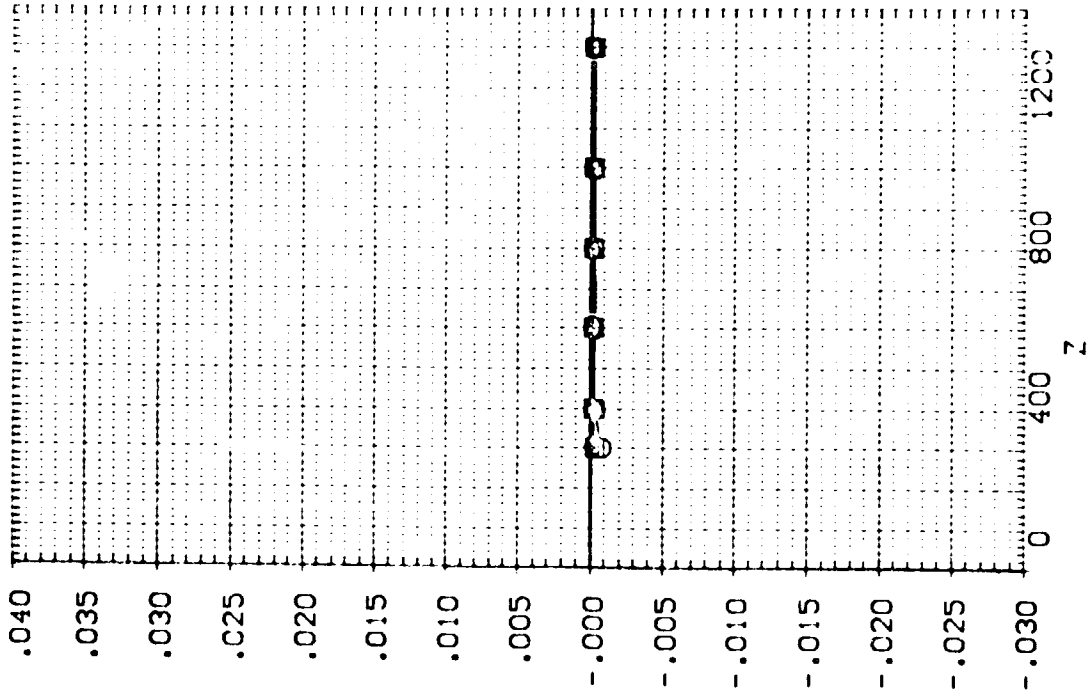

EFFECT OF EXTERNAL TANK SEPARATION ON ORBITER AERODYNAMIC CHARACTERISTICS

1A13. EXTERNAL TANK(T10)SEPARATING FROM ORB. 09 (RTJ090)

SEE THE ASSOCIATED DATA DOCUMENT FOR REFERENCE CHARACTERISTICS FOR INDIVIDUAL DATASETS

SYMBOL		PARAMETRIC VALUES				
x	- .643	MACH	4.530	PTOTAL	110.000	
	401.500	ALPHA	.000	BETA	.000	
	800.470	DALPHA	-20.000	DBETA	.000	
	1200.800	ELEVTR	13.000	A1LRON	.000	
		Y	.000			

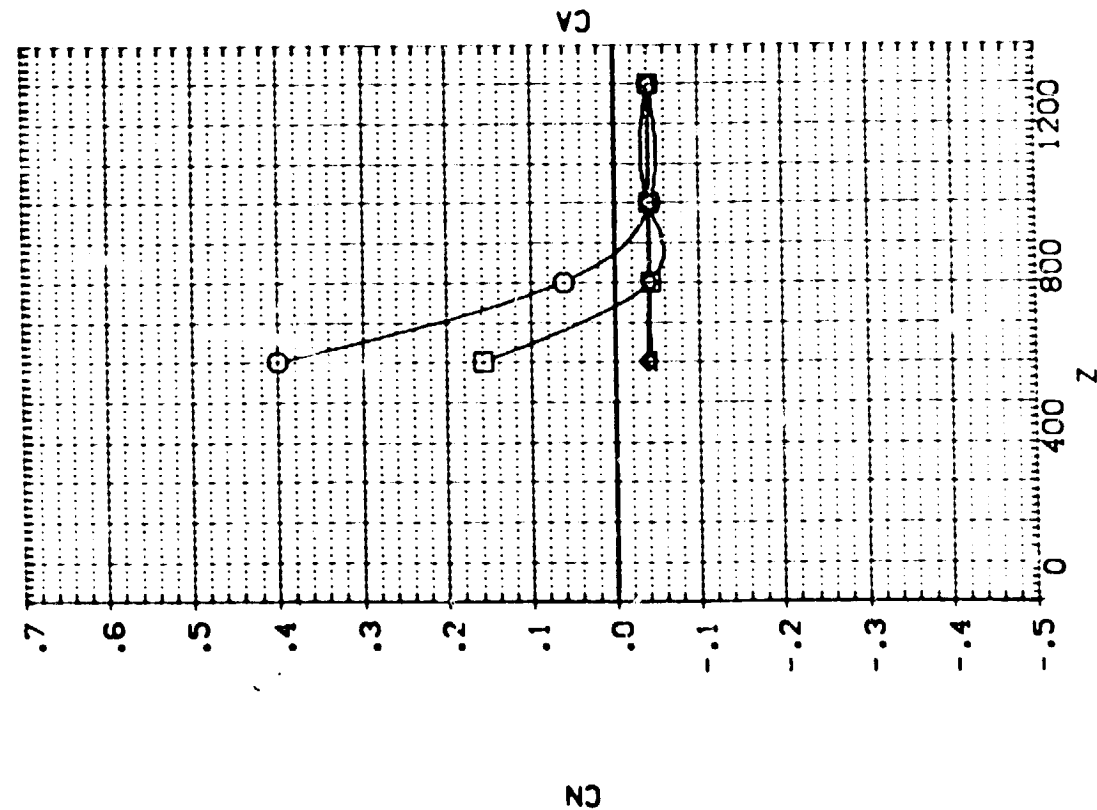
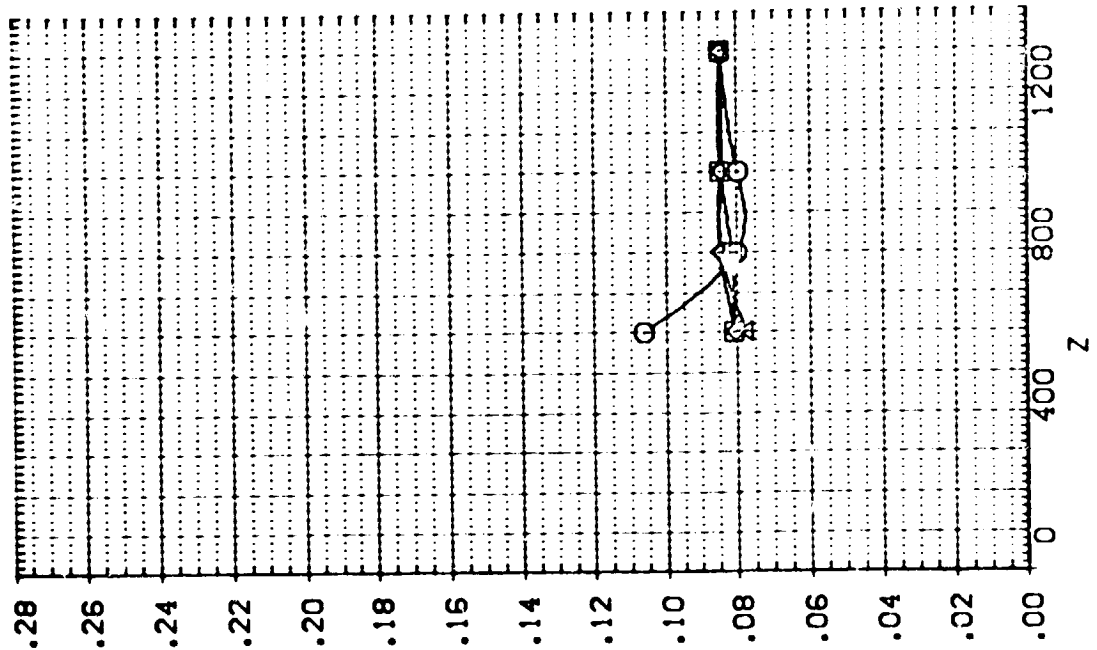

EFFECT OF EXTERNAL TANK SEPARATION ON ORBITER AERODYNAMIC CHARACTERISTICS

IA13. EXTERNAL TANK(T10)SEPARATING FROM ORB. 09 (RTJ090)

SEE THE ASSOCIATED REFERENCE DOCUMENT FOR REFERENCE CHARACTERISTICS FOR INDIVIDUAL DATASETS

SYMBOL		PARAMETRIC VALUES			
○	X	MACH	4.530	PI TOTAL	1.0.000
□	Y	ALPHA	.000	BETA	.000
◇	Z	DALPHA	-20.000	DBETA	.000
△		ELEVTR	10.000	AIRRON	.000
			.000		

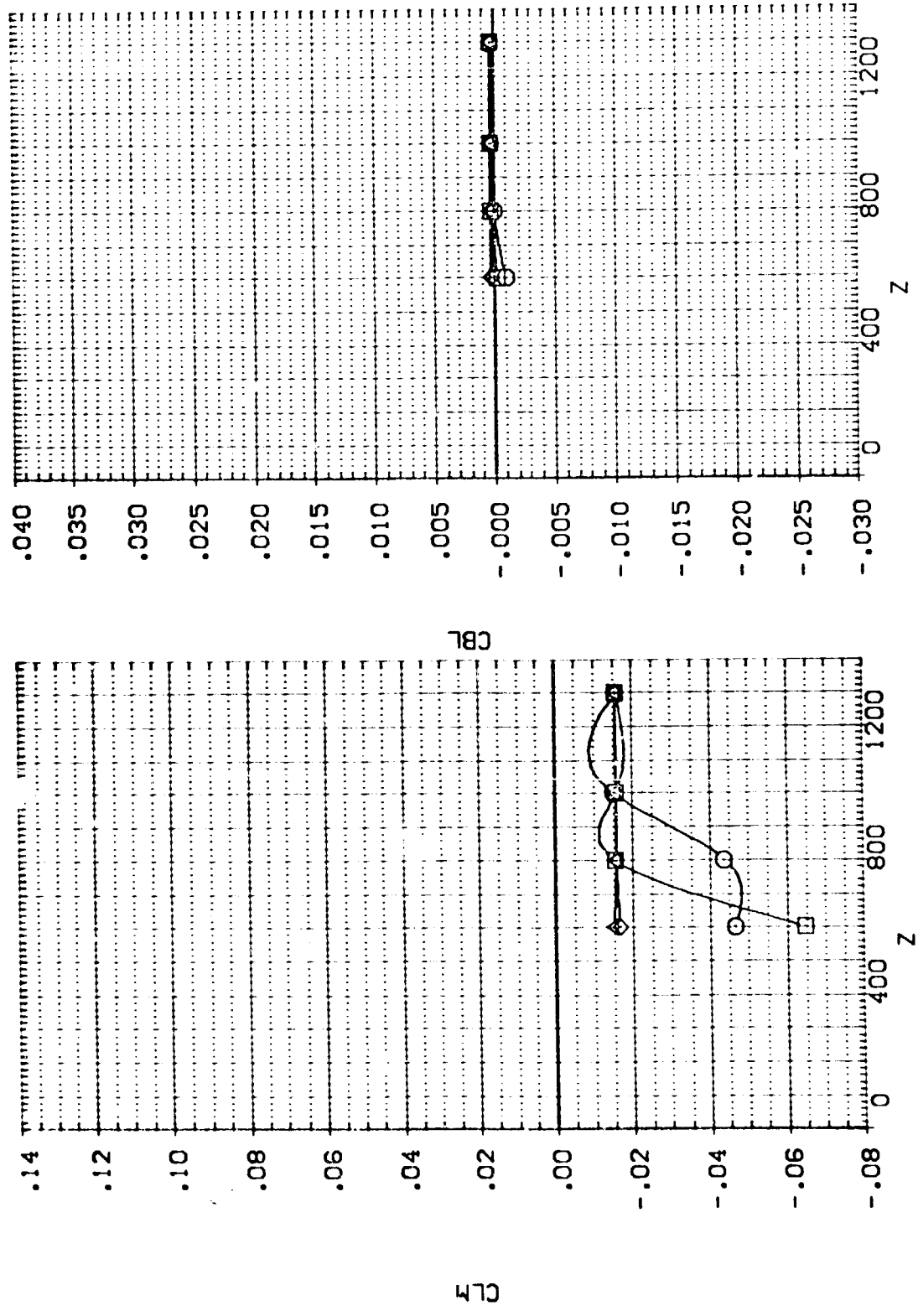

EFFECT OF EXTERNAL TANK SEPARATION ON ORBITER AERODYNAMIC CHARACTERISTICS

1A13. EXTERNAL TANK(T10)SEPARATING FROM ORB. 09 (RTJ090)

SEE THE ASSOCIATED DATA DOCUMENT FOR REFERENCE CHARACTERISTICS FOR INDIVIDUAL DATASETS

SYMBOL		PARAMETRIC VALUES	
X	-0.643	MACH	4.530
Y	401.500	ALPHA	0.000
Z	800.970	DALPHA	-20.000
	1200.800	ELEV/R	10.000
		Y	0.000
		PTOTAL	110.000
		BETA	0.000
		DBETA	0.000
		AILRON	0.000

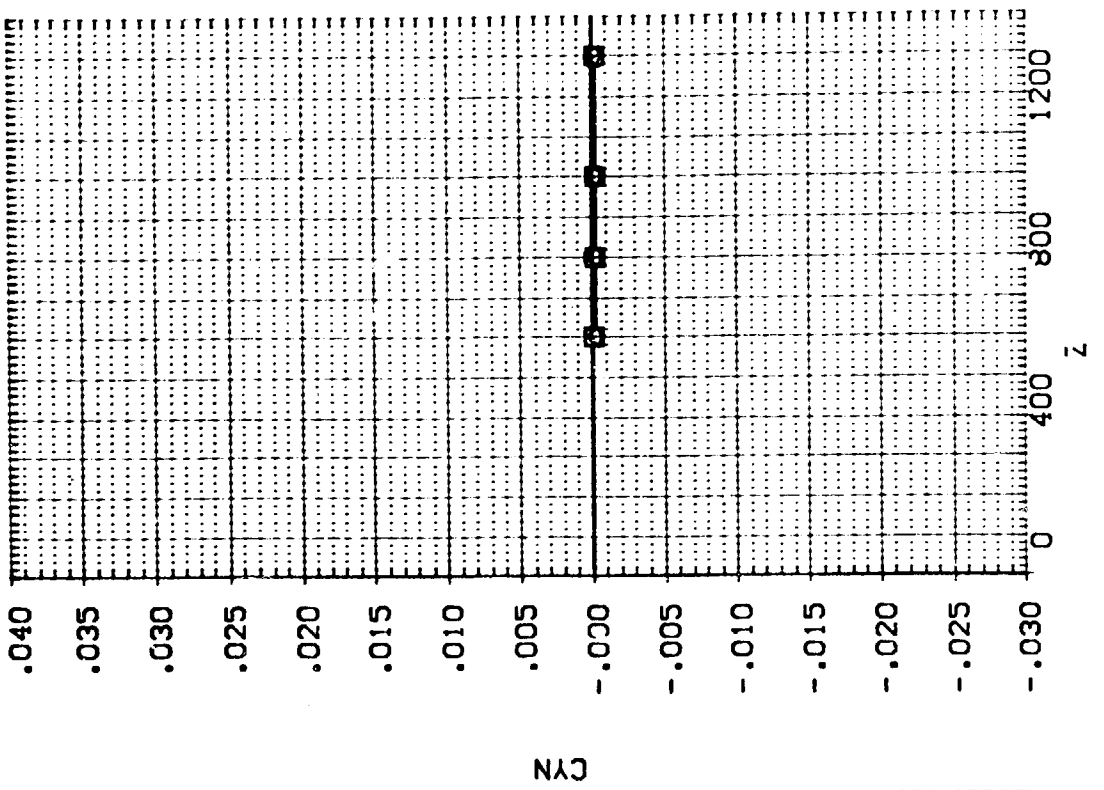
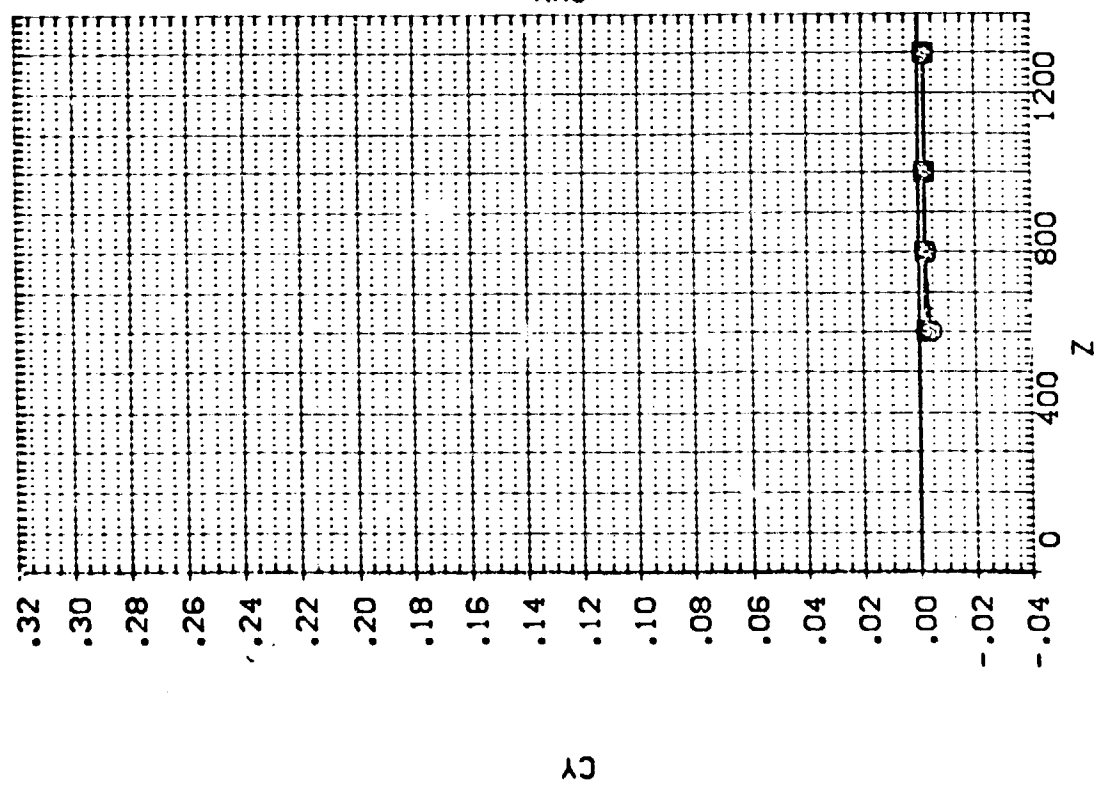

IA13, EXTERNAL TANK(T10)SEPARATING FROM ORB. 09 (RTJ091)

SEE THE ASSOCIATED DATA DOCUMENT FOR REFERENCE CHARACTERISTICS FOR INDIVIDUAL DATASETS

SYMBOL		PARAMETRIC VALUES			
x	.057	MACH	4.530	PTOTAL	110.000
	400.350	ALPHA	.000	BETA	.000
	800.650	DALPHA	.000	DBETA	.000
	1200.700	ELEVTR	10.000	AILRON	.000
		Y	200.000		

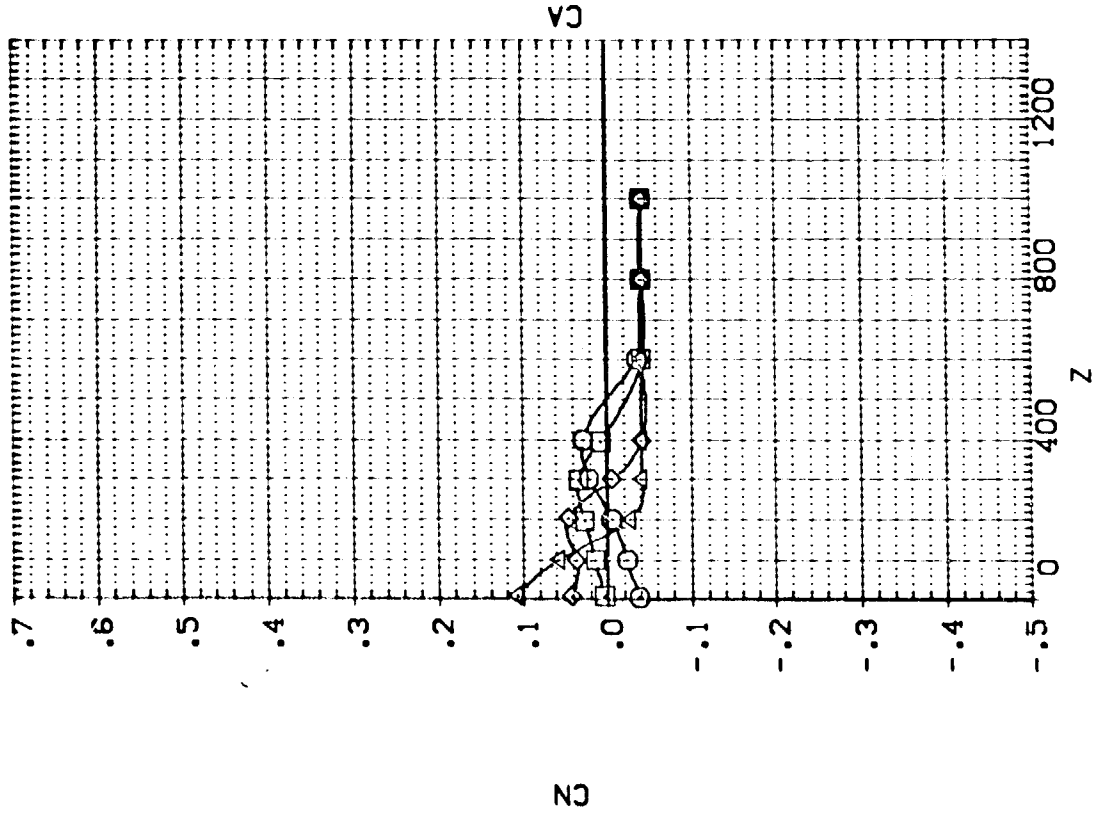
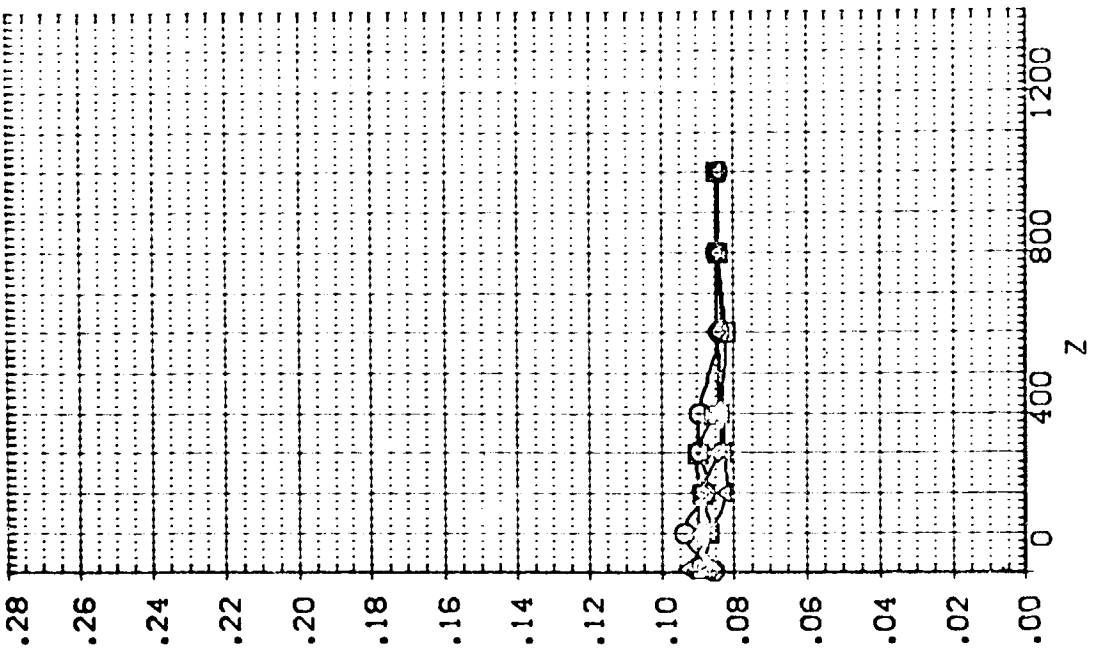

EFFECT OF EXTERNAL TANK SEPARATION ON ORBITER AERODYNAMIC CHARACTERISTICS

IA13, EXTERNAL TANK(T10)SEPARATING FROM ORB. 09 (RTJ091)

SEE THE ASSOCIATED DATA DOCUMENT FOR REFERENCE CHARACTERISTICS FOR INDIVIDUAL DATASETS

SYMBOL		PARAMETRIC VALUES	
X	.097	MACH	4.530
		P TOTAL	110.000
		BETA	.000
		DBETA	.000
		AIRRON	.000
		Y	200.000

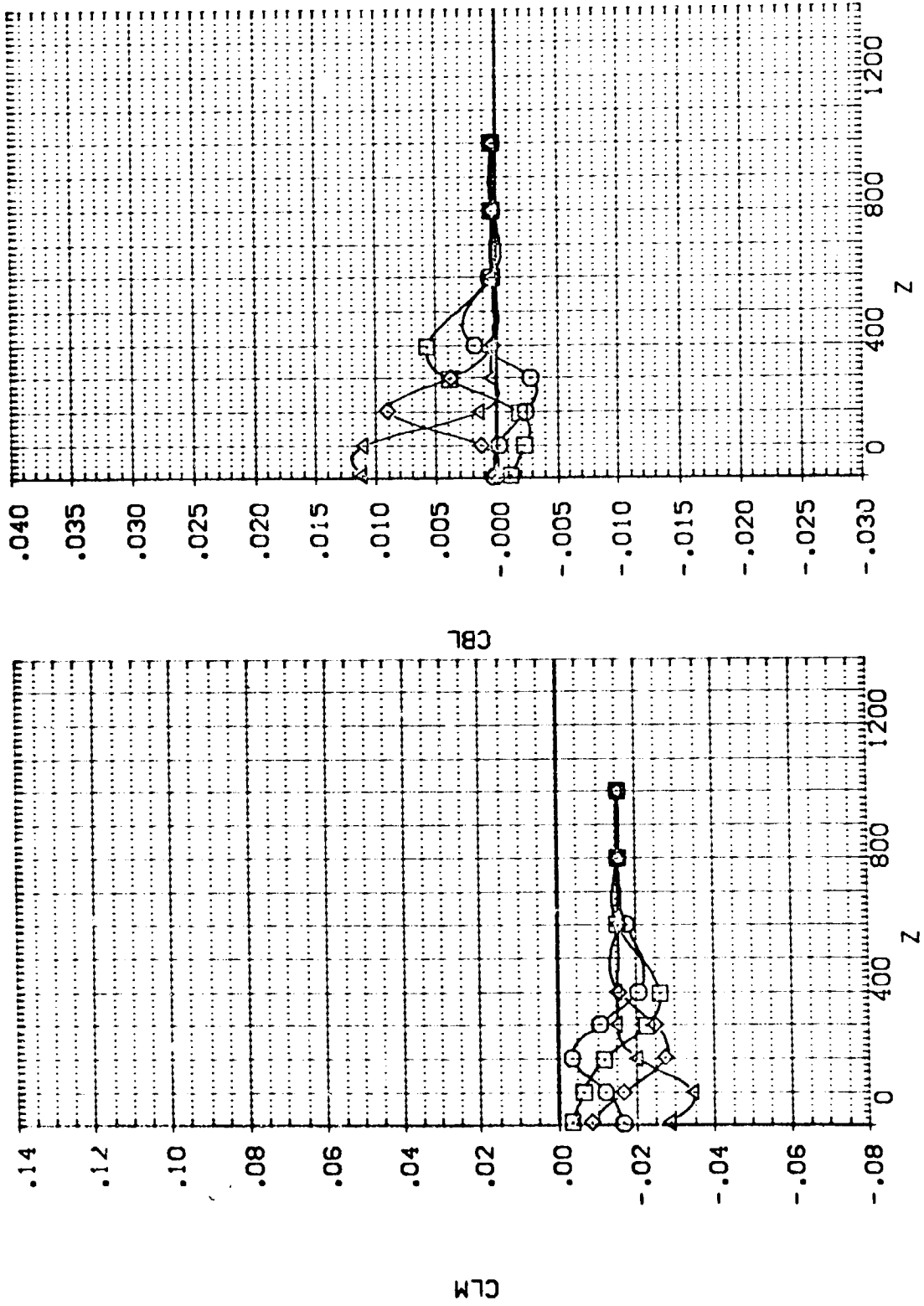

EFFECT OF EXTERNAL TANK SEPARATION ON ORBITER AERODYNAMIC CHARACTERISTICS

1A13. EXTERNAL TANK (T10) SEPARATING FROM ORB. 09 (RTJ091)

SEE THE ASSOCIATED DOCUMENT FOR REFERENCE CHARACTERISTICS FOR INDIVIDUAL DATA SETS

SYMBOL		PARAMETRIC VALUES	
X	.097	MACH	4.530
O	400,350	ALPHA	.000
□	800,660	BETA	.000
◇	1200,700	DALPHA	10.000
Y	200,000	ELEVTR	200.000
		ATLRON	.000

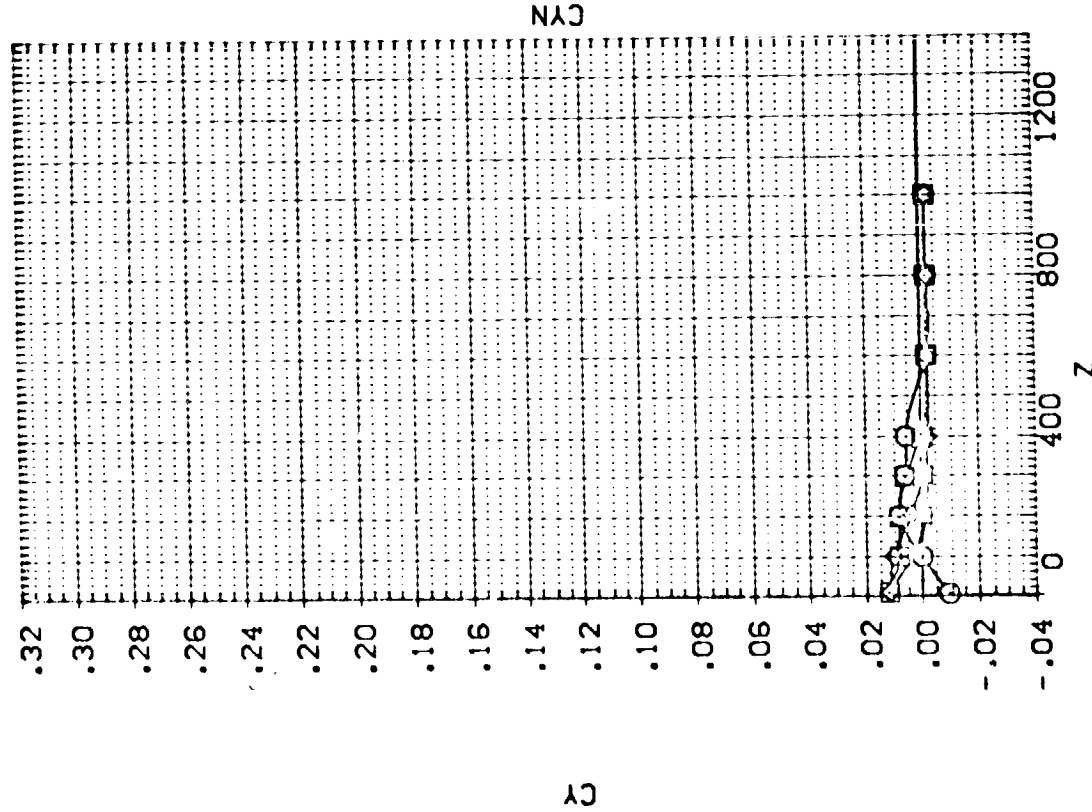
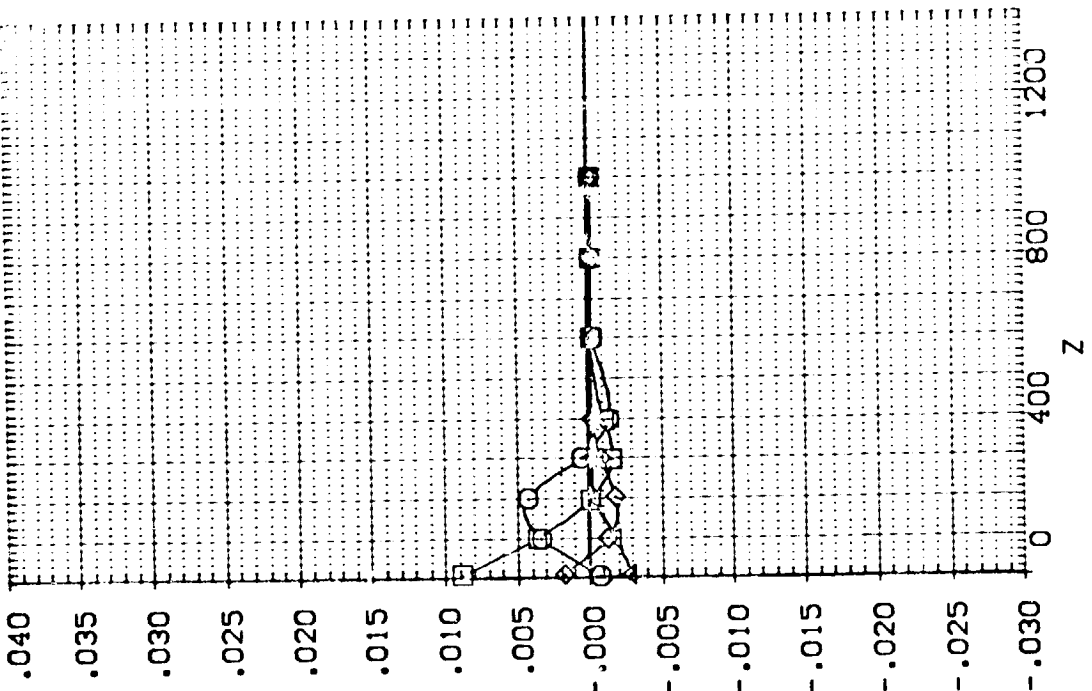

EFFECT OF EXTERNAL TANK SEPARATION ON ORBITER AERODYNAMIC CHARACTERISTICS

IA13, EXTERNAL TANK (10) SEPARATING FROM ORB. 09 (RTJ092)

SEE THE ASSOCIATED DATA DOCUMENT FOR REFERENCE CHARACTERISTICS FOR INDIVIDUAL DATA SETS

SYMBOL		PARAMETRIC VALUES			
○	X	MACH	4.530	PTOTAL	110.000
◇	400.440	ALPHA	.000	BETA	.000
△	800.600	DALPHA	-10.000	DBETA	.000
	1200.800	ELEVTR	10.000	ALTRON	.000
		Y	200.000		

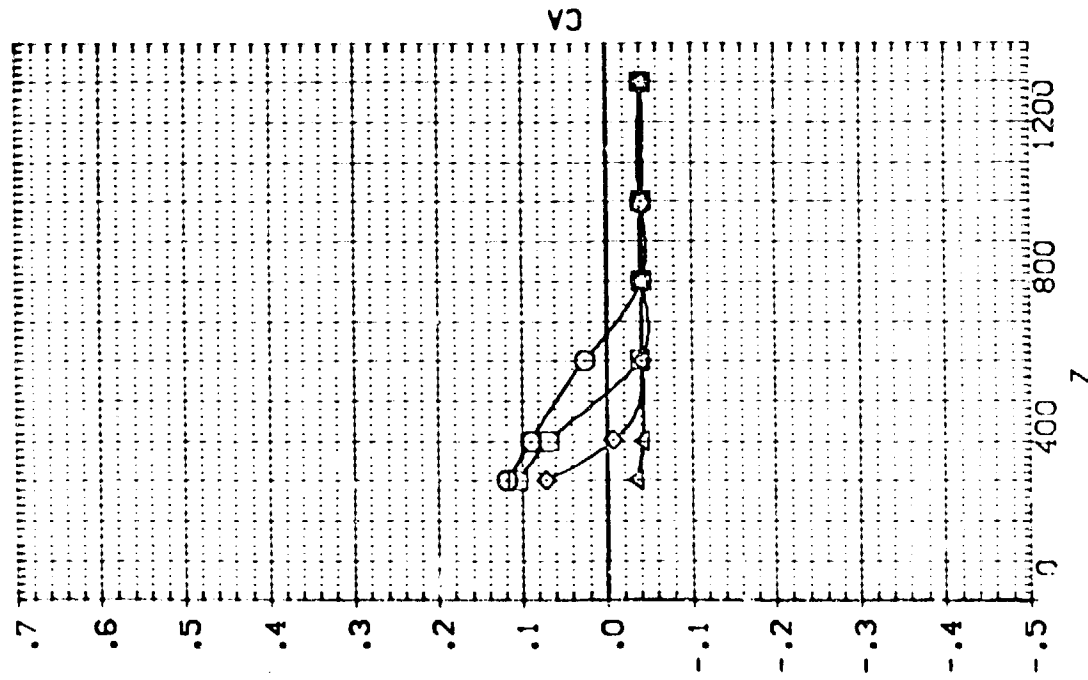
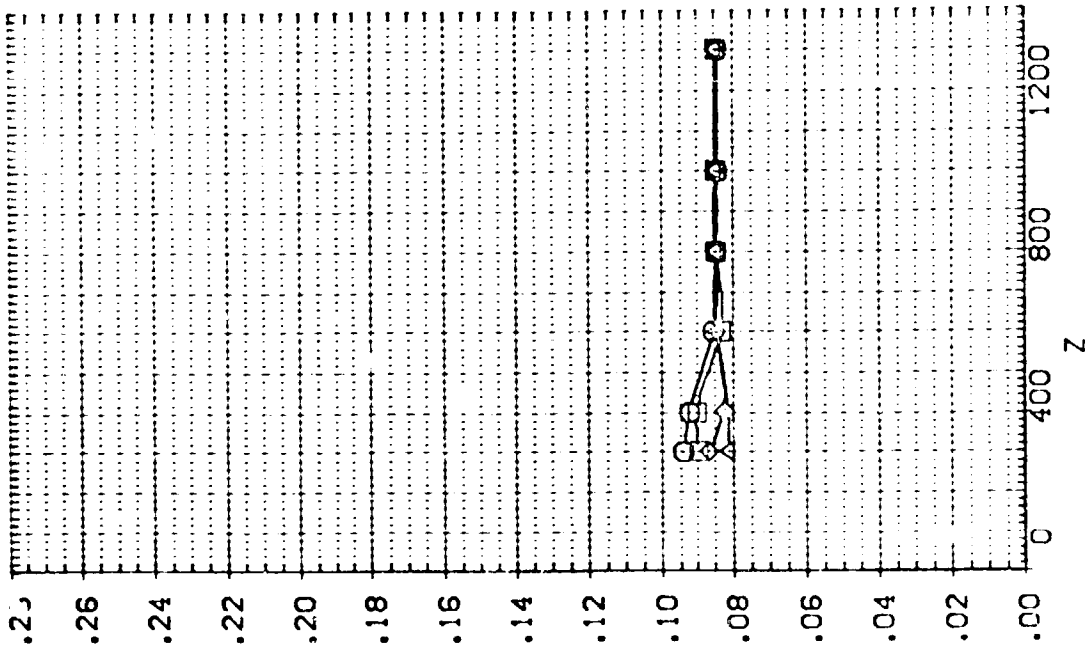

1.13. EXTERNAL TANK(T10)SEPARATING FROM ORB. 09 (RTJ092)

SEE THE ASSOCIATED DOCUMENT FOR THE CHARACTERISTICS FOR INDIVIDUAL DATA POINTS

SYMBOL		PARAMETRIC VALUES	
○	X	MACH	4.530
□	Y	ALPHA	110.000
◇	Z	BETA	.000
△	Y	DALPHA	-10.000
		ELEV'R	10.000
		Y	200.000

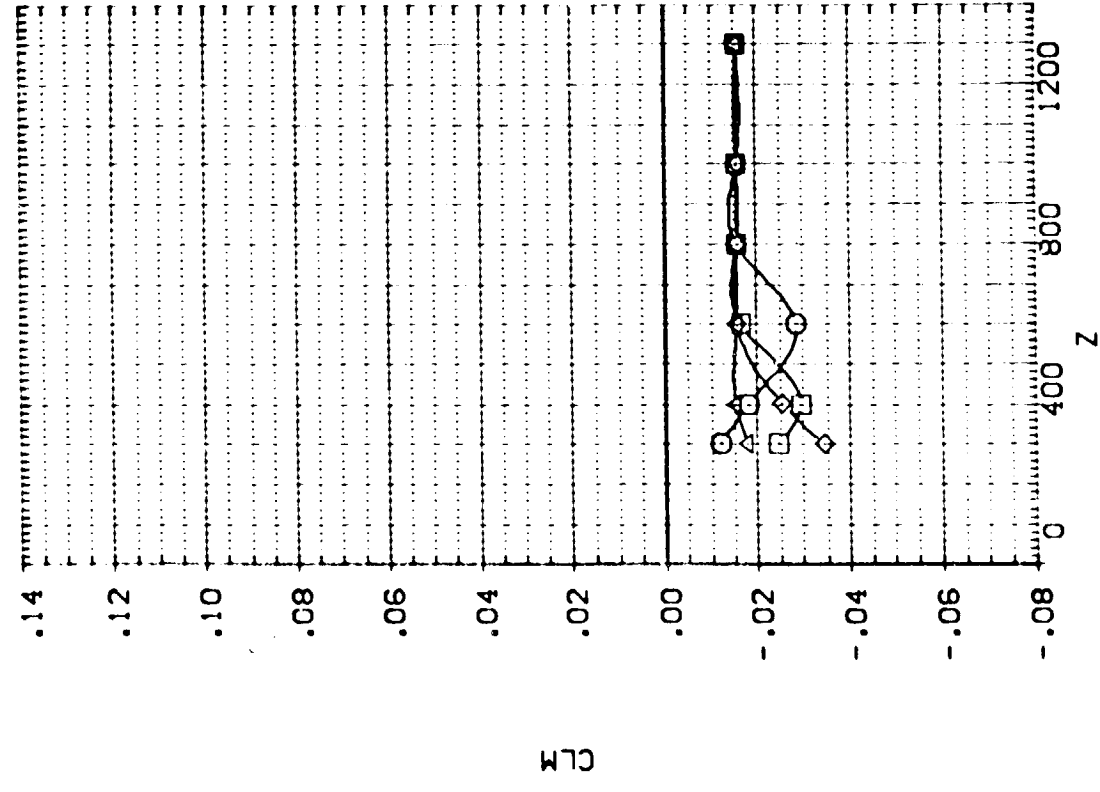
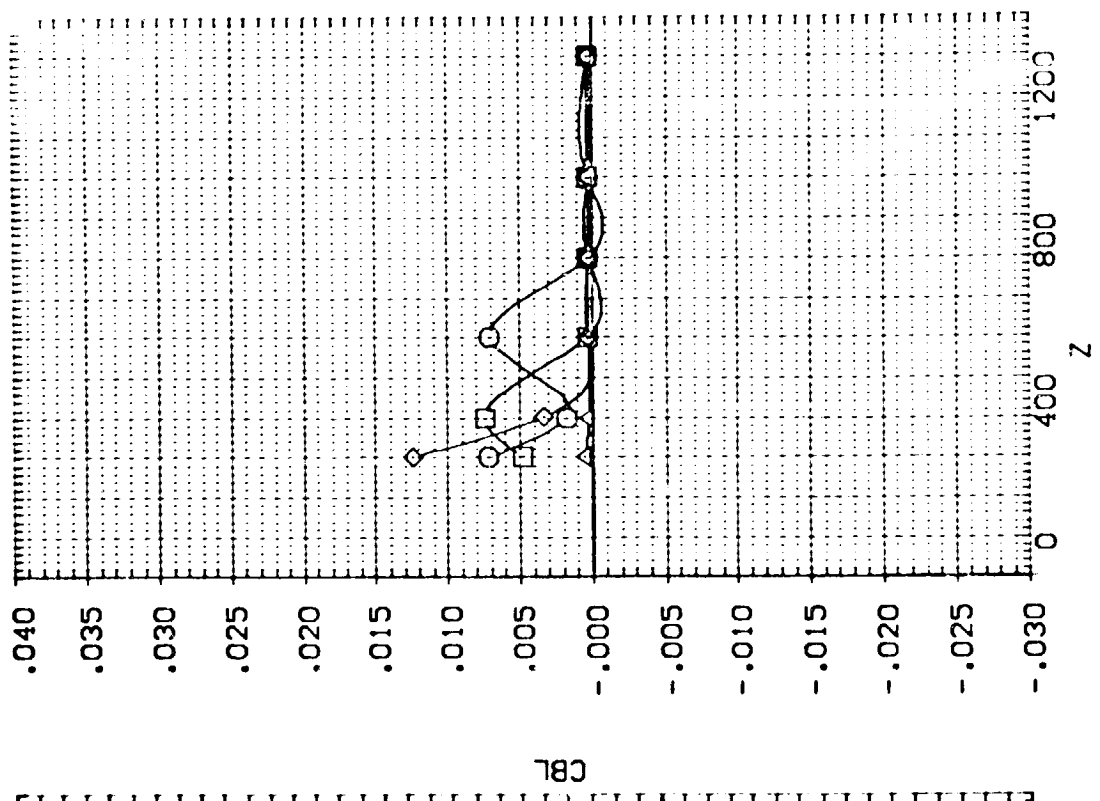

EFFECT OF EXTERNAL TANK SEPARATION ON ORBITER AERODYNAMIC CHARACTERISTICS

13. EXTERNAL TANK (10) SEPARATING FROM ORB. 09 (RTJ092)

SEE THE ASSOCIATED DATA DOCUMENT FOR REFERENCE CHARACTERISTICS FOR INDIVIDUAL DATASETS

SYMBOL	X	MACH	PARAMETRIC VALUES
O	.115	4.530	PIOTAL 110.000
□	400.440	.000	BETA .000
◇	800.600	-10.000	DBETA .000
△	1200.800	10.000	AILRON .000
		Y	200.000

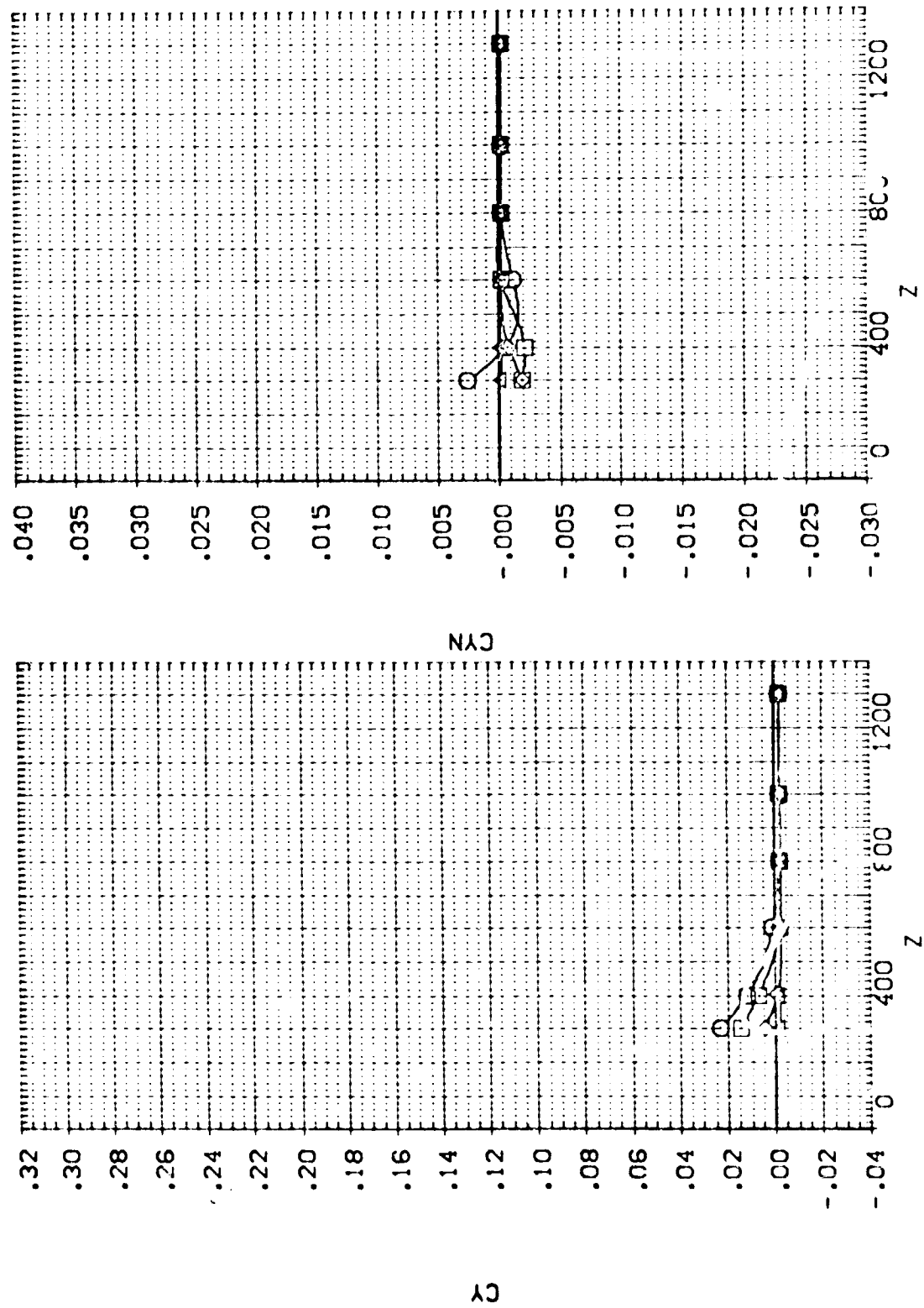

EFFECT OF EXTERNAL TANK SEPARATION ON ORBITER AERODYNAMIC CHARACTERISTICS

IA13, EXTERNAL TANK (10) SEPARATING FROM ORB. 09 (RTJ093)

SYMBOL

-
- ◇
- △

PARAMETRIC VALUES	
MACH	4.530
PI TOTAL	110.000
ALPHA	.000
BETA	.000
DALPHA	-20.000
DBETA	.000
ELEVTR	10.000
Y	200.000

SEE THE ASSULIA CASE DOCUMENT FOR RELEVANT CHARACTERISTICS AND INDIVIDUAL DATA'S

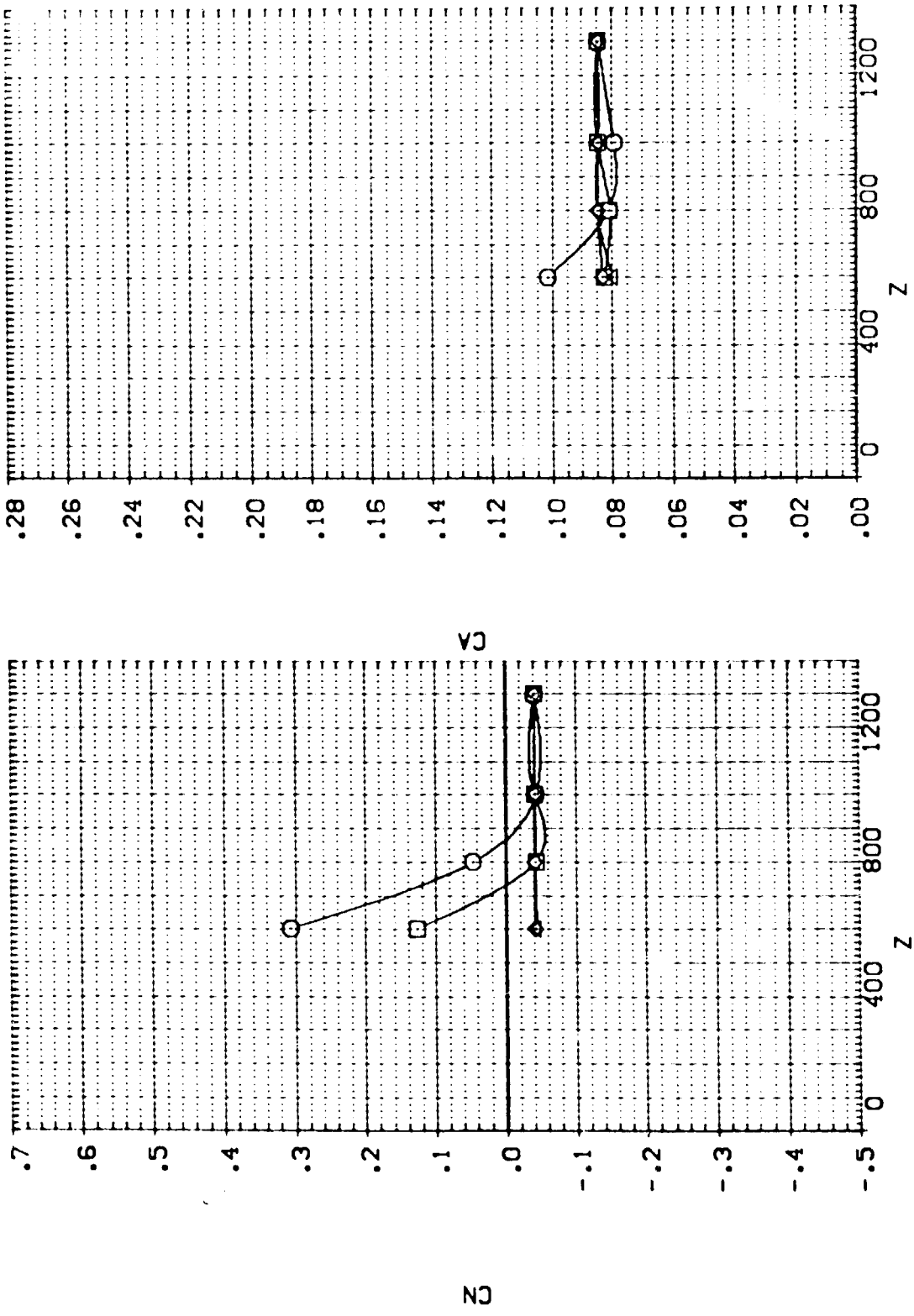

EFFECT OF EXTERNAL TANK SEPARATION ON ORBITER AERODYNAMIC CHARACTERISTICS

TA13, EXTERNAL TANK(T10)SEPARATING FROM ORB. 09 (RTJ093)

SEE THE ASSOCIATED DATA DOCUMENT FOR REFERENCE CHARACTERISTICS FOR INDIVIDUAL DATASETS

SYMBOL	X	PARAMETRIC VALUES
○	-1.395	MACH 4.530 P/TOTAL 110.000
◇	401.110	ALPHA .000 BETA .000
△	800.690	CALPHA -20.000 DBETA .000
	1200.900	ELEVTR 10.000 AIRLON .000
		Y 200.000

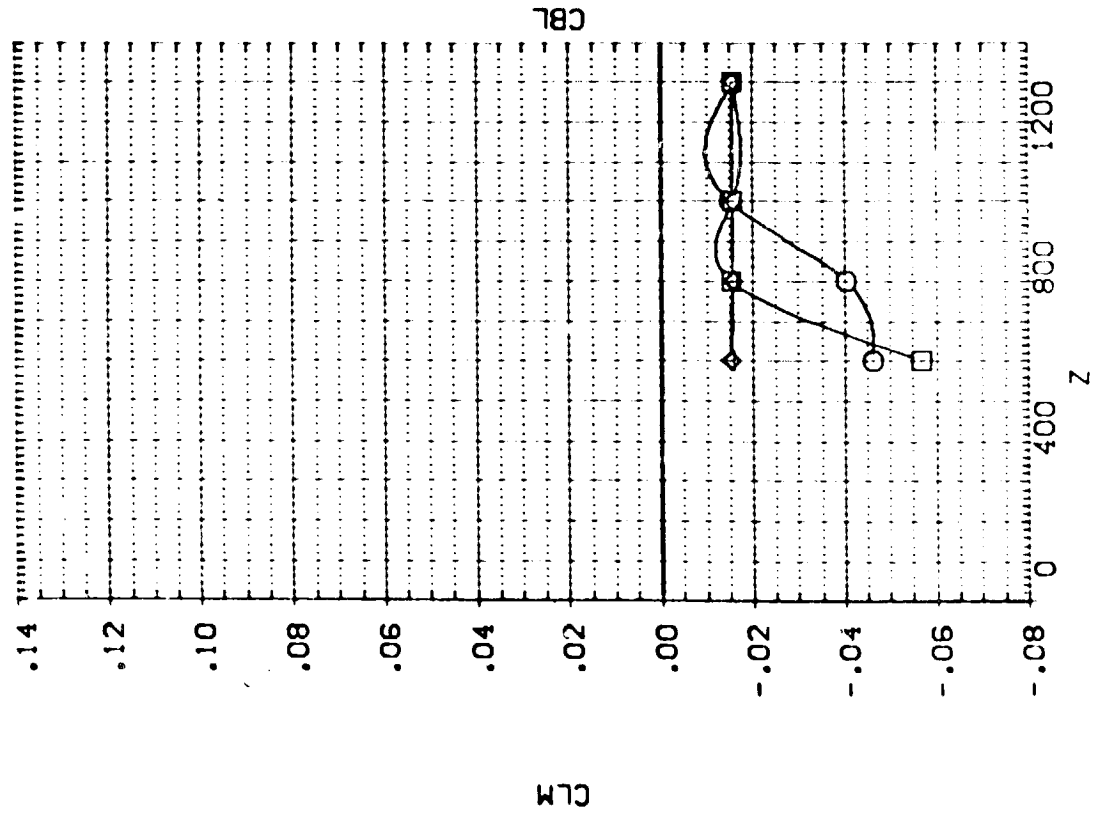
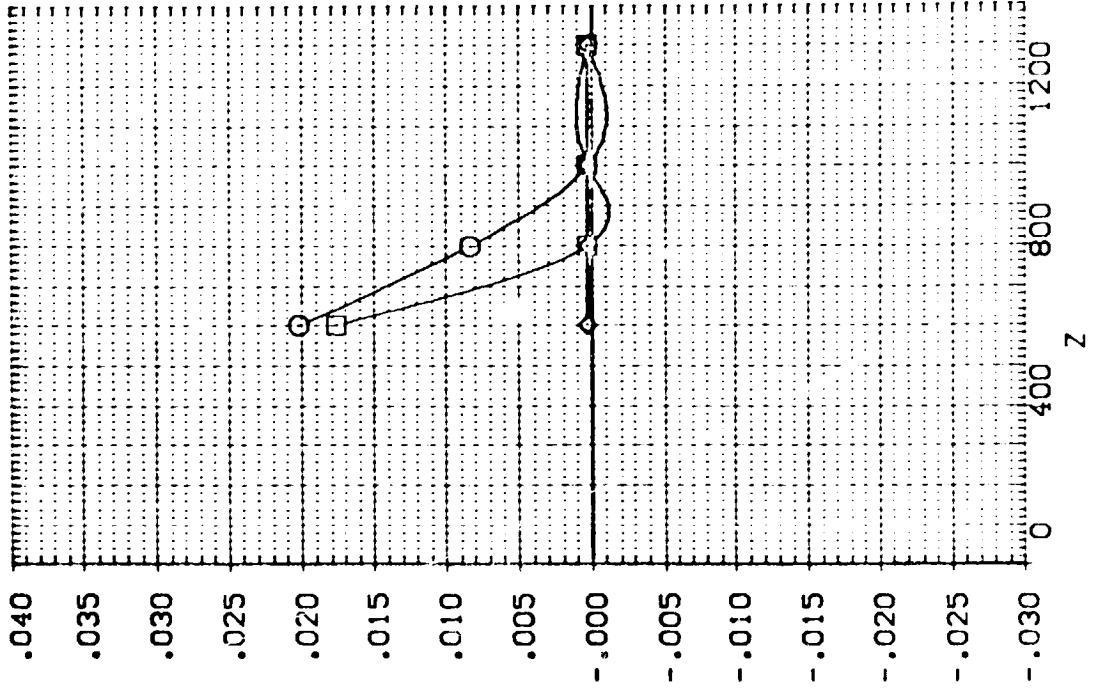

EFFECT OF EXTERNAL TANK SEPARATION ON ORBITER AERODYNAMIC CHARACTERISTICS

1A13, EXTERNAL TANK(110)SEPARATING FROM ORB. 09 (RTJ093)

SEE THE ASSOCIATED DATA DOCUMENT FOR REFERENCE CHARACTERISTICS FOR INDIVIDUAL DATA'S

SYMBOL		PARAMETRIC VALUES	
x	-0.395	MACH	4.530
		PIOTAL	110.000
o	401.110	ALPHA	.000
		BETA	.000
◇	800.690	DALPHA	-20.000
		DBETA	.000
△	1200.900	ELEVTR	10.000
		ALTRON	.000
		Y	200.000

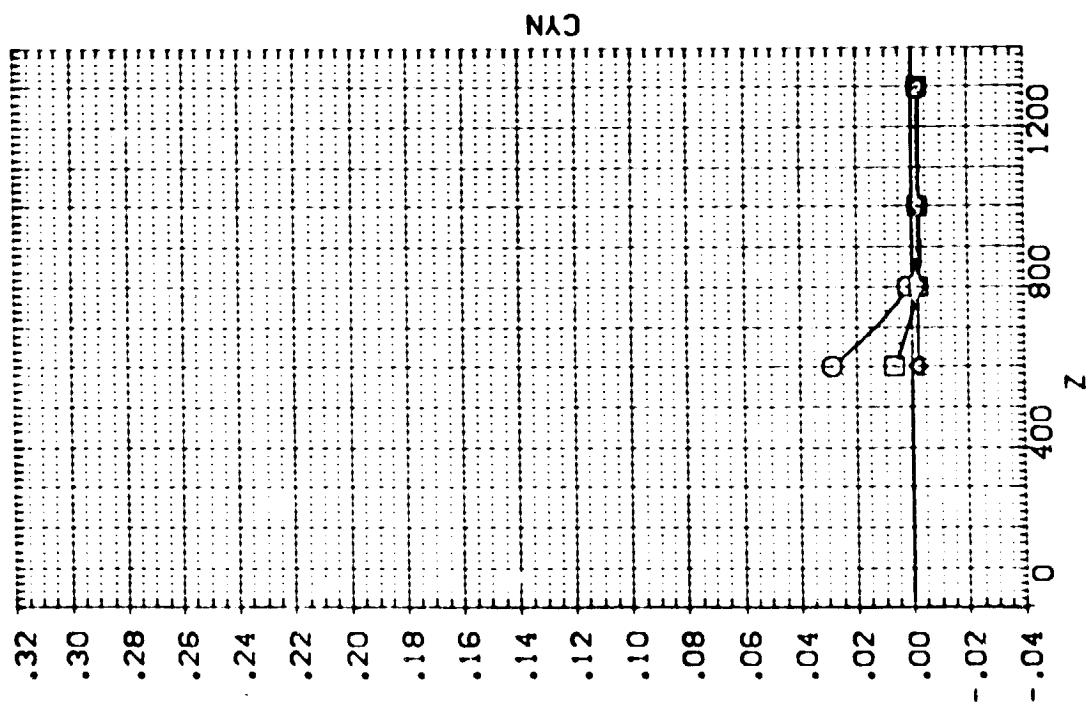
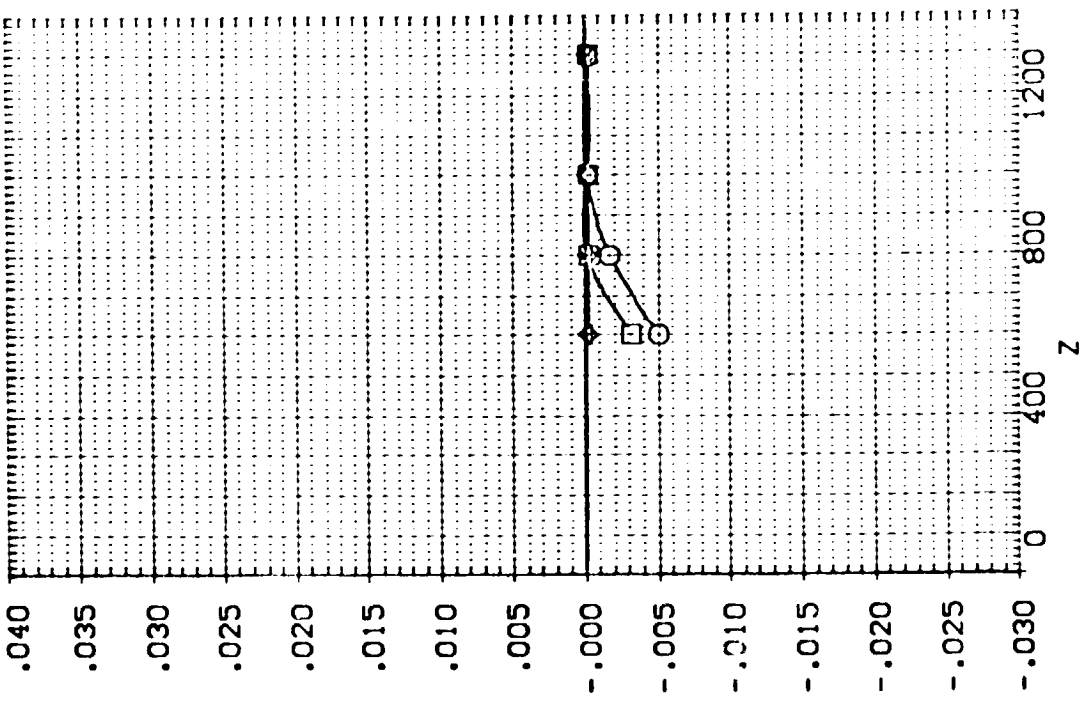

EFFECT OF EXTERNAL TANK SEPARATION ON ORBITER AERODYNAMIC CHARACTERISTICS

1A:3.EXTERNAL TANK(T10)SEPARATING FROM ORB. 09 (RTJ094)

SEE THE ASSOCIATED DATA DOCUMENT FOR REFERENCE CHARACTERISTICS FOR INDIVIDUAL DATASETS

SYMBOL	X	MACH	PARAMETRIC VALUES
○	.009	1.530	P/TOTAL 110.000
◇	400.360	.000	BETA .000
△	800.560	.000	DBETA .000
	1200.800	-40.000	AILRON .000
		200.000	Y

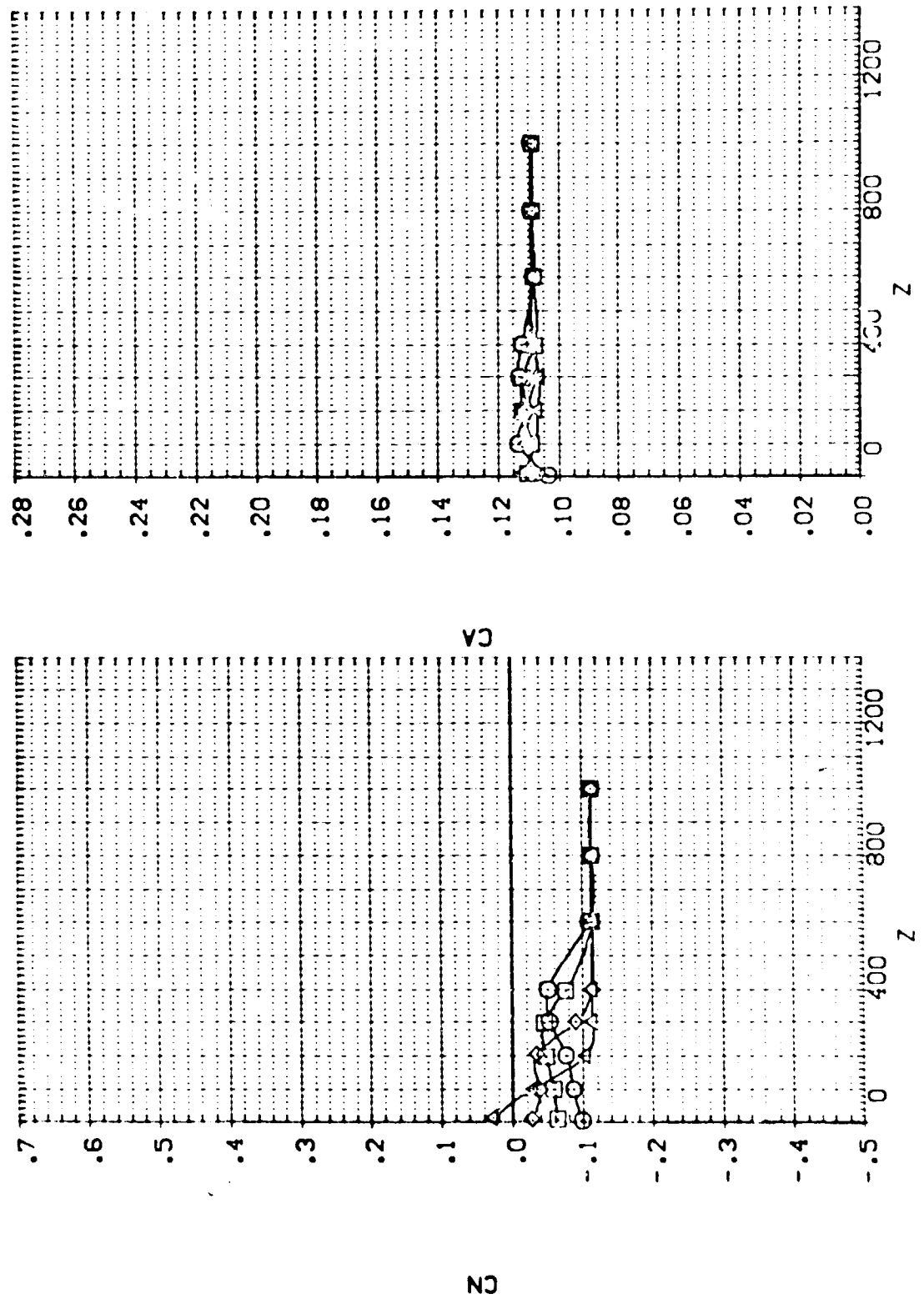

EFFECT OF EXTERNAL TANK SEPARATION ON ORBITER AERODYNAMIC CHARACTERISTICS

TA13. EXTERNAL TANK(T10) SEPARATING FROM ORB. 09 (RTJ094)

SEE THE ASSOCIATED DOCUMENT FOR REFERENCE CHARACTERISTICS FOR INDIVIDUAL DATASETS

SYMBOL		PARAMETRIC VALUES	
○	.009	MACH	4.530
□	400.360	ALPHA	.000
◇	600.580	DALPHA	.000
△	1200.800	ELEVTR	-40.000
		Y	200.000
		PITOTL	110.000
		BETA	.000
		DBETA	.000
		AI RCN	.000

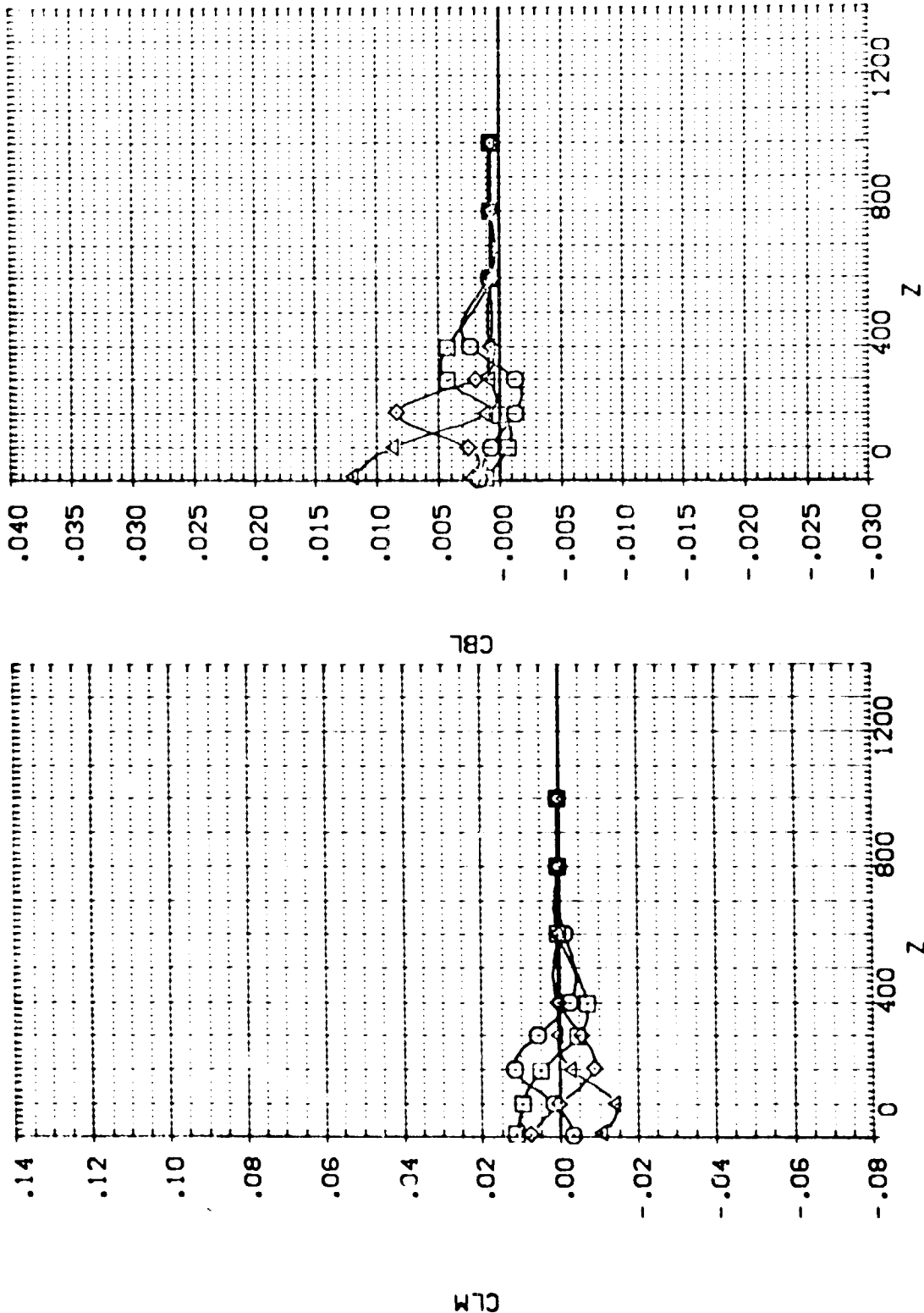

EFFECT OF EXTERNAL TANK SEPARATION ON ORBITER AERODYNAMIC CHARACTERISTICS

1.13. EXTERNAL TANK(S) SEPARATING FROM ORB. 09 (RTJ094)

SEE THE ASSOCIATED DATA DOCUMENT FOR REFERENCE CHARACTERISTICS FOR INDIVIDUAL DATASETS

SYMBOL		PARAMETRIC VALUES	
X	.009	MACH	4.530
O	100.360	ALPHA	110.000
◇	600.580	BETA	.000
△	1200.800	CBETA	.000
		ELEVTR	-40.000
		AILRON	.000
		Y	200.000

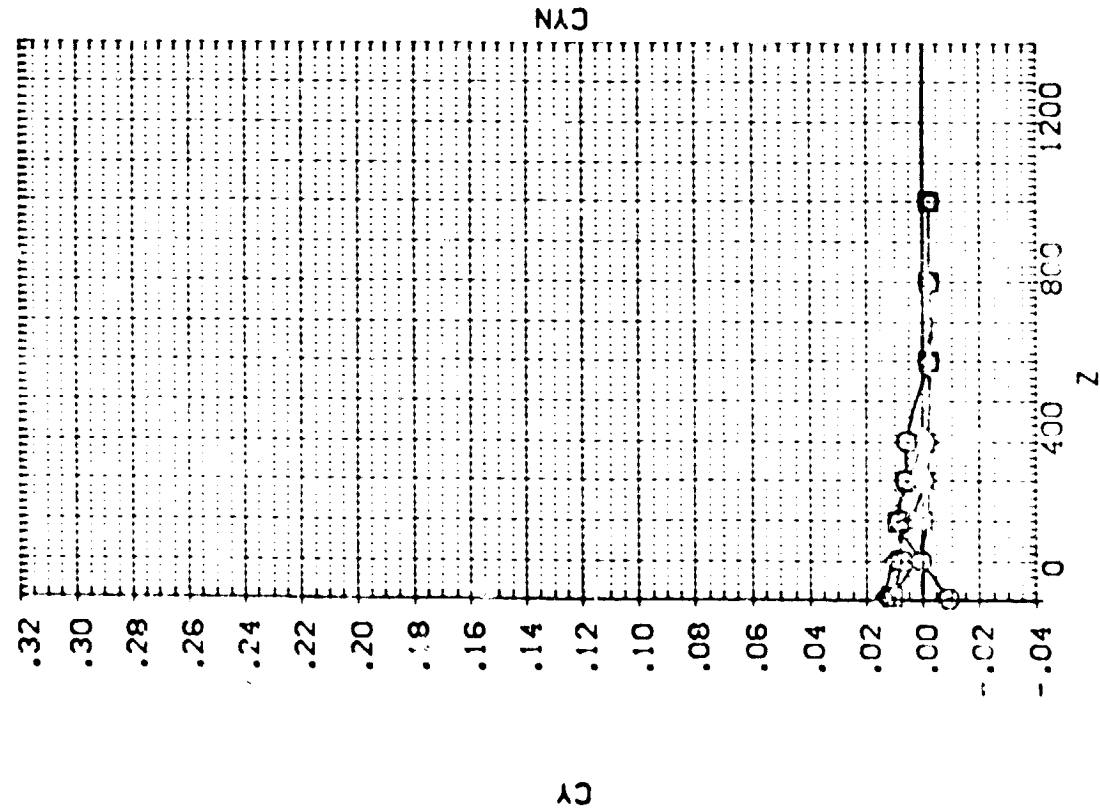
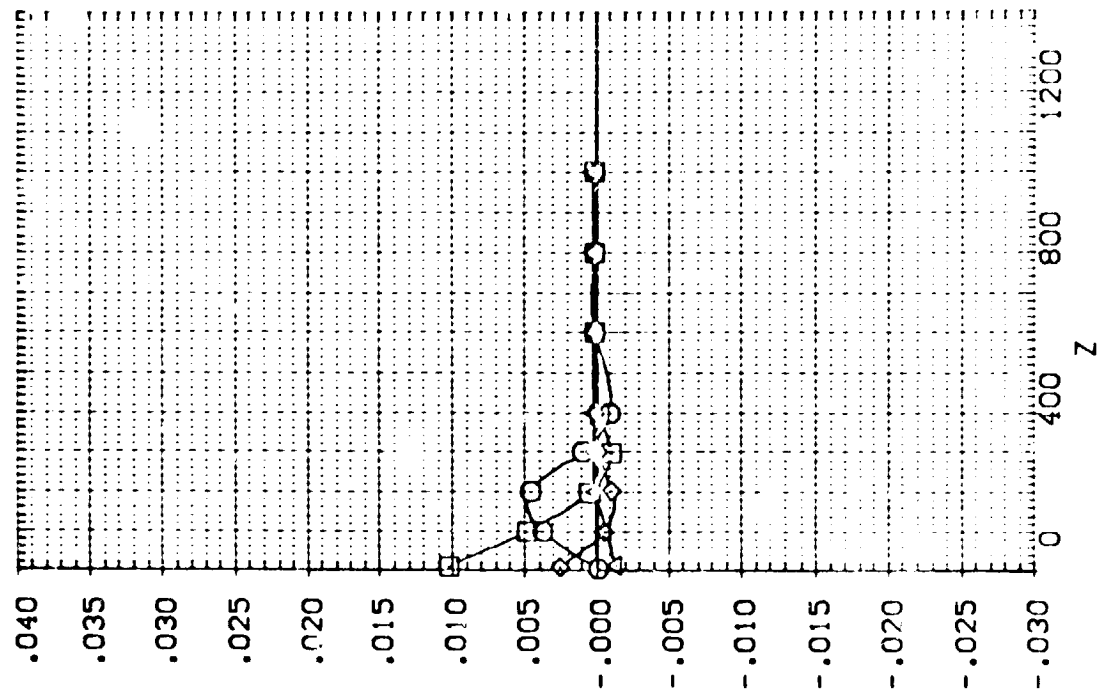

EFFECT OF EXTERNAL TANK SEPARATION ON ORBITER AERODYNAMIC CHARACTERISTICS

1A13. EXTERNAL TANK(T10)SEPARATING FROM ORB. 09 (RTJ095)

SEE THE ASSOCIATED DATA DOCUMENT FOR REFERENCE CHARACTERISTICS FOR INDIVIDUAL DATASETS

SYMBOL		PARAMETRIC VALUES	
○	0.214	MACH	4.530
□	400,170	ALPHA	.000
◇	800,340	DALPHA	-10.000
△	1,200,500	ELEVTR	-40.000
		Y	200.000
		PITOTAL	110.000
		BETA	.000
		DBETA	.000
		AILRON	.000

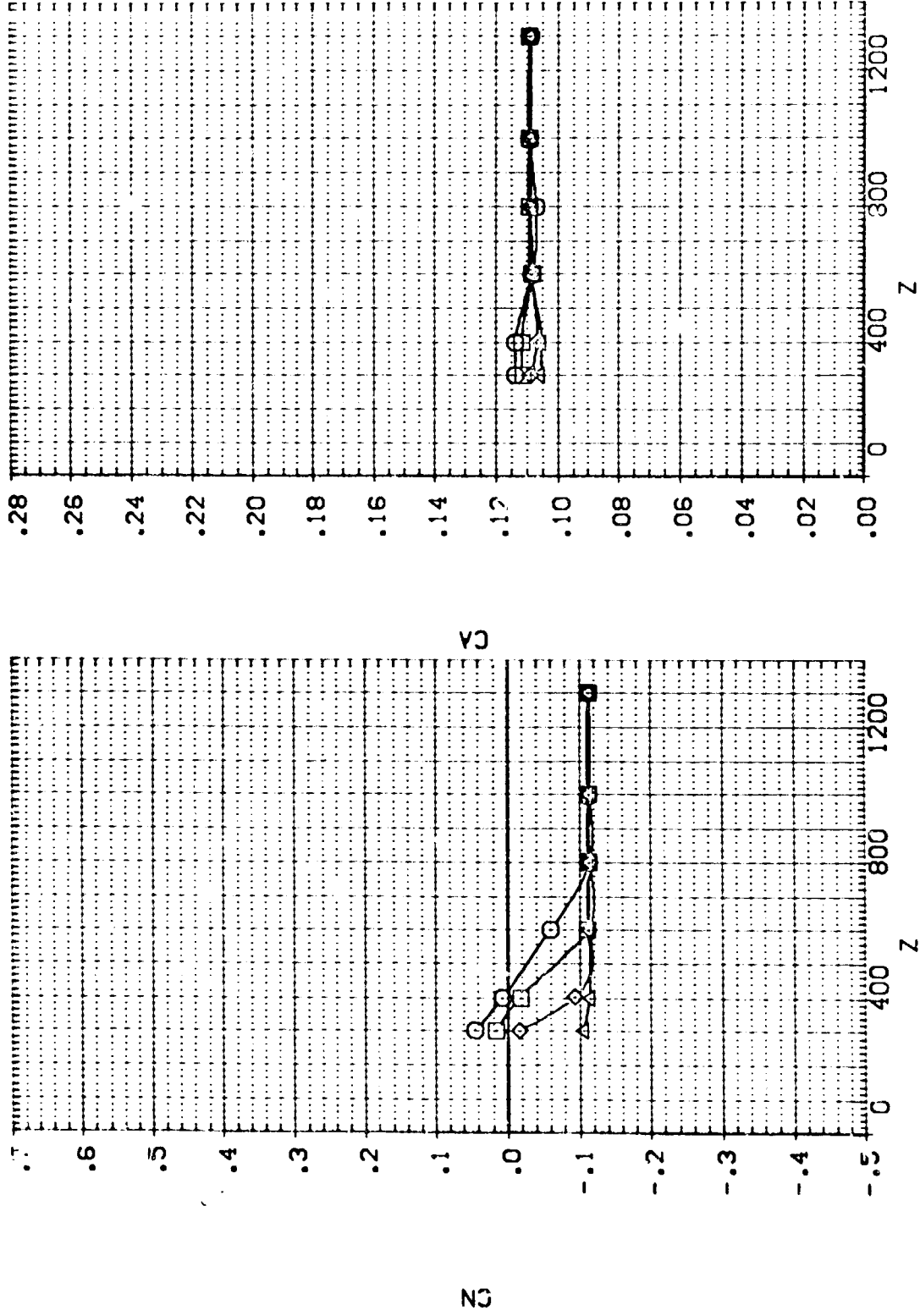

EFFECT OF EXTERNAL TANK SEPARATION ON ORBITER AERODYNAMIC CHARACTERISTICS

1A13, EXTERNAL TANK(T10)SEPARATING FROM ORB. 09 (RTJ095)

SYMBOL		PARAMETRIC VALUES				
○	X	.214	MACH	4.530	PICTAL	110.000
□	ALPHA	400.370	ALPHA	.000	BETA	.000
◇	BETA	800.680	DALPHA	-10.000	DBETA	.000
△	ELEVTR	1200.800	ELEVTR	-40.000	A1LRON	.000
	Y	200.000				

SEE THE ASSOCIATED DATA DOCUMENT FOR REFERENCE CHARACTERISTICS FOR INDIVIDUAL DATASETS

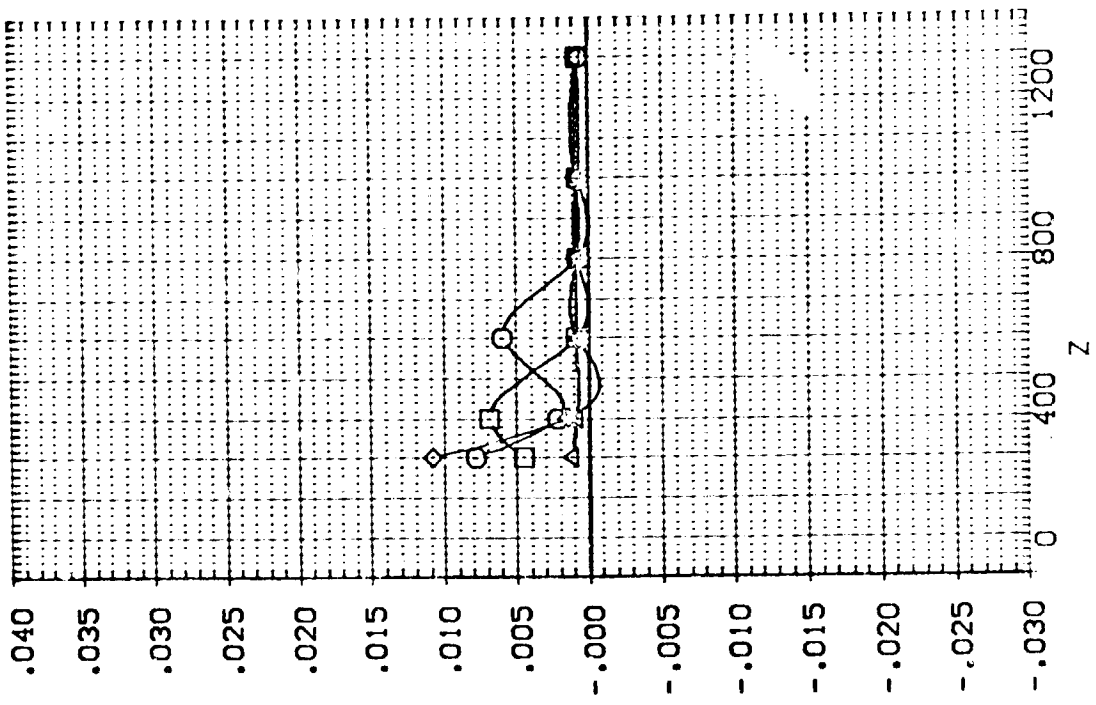
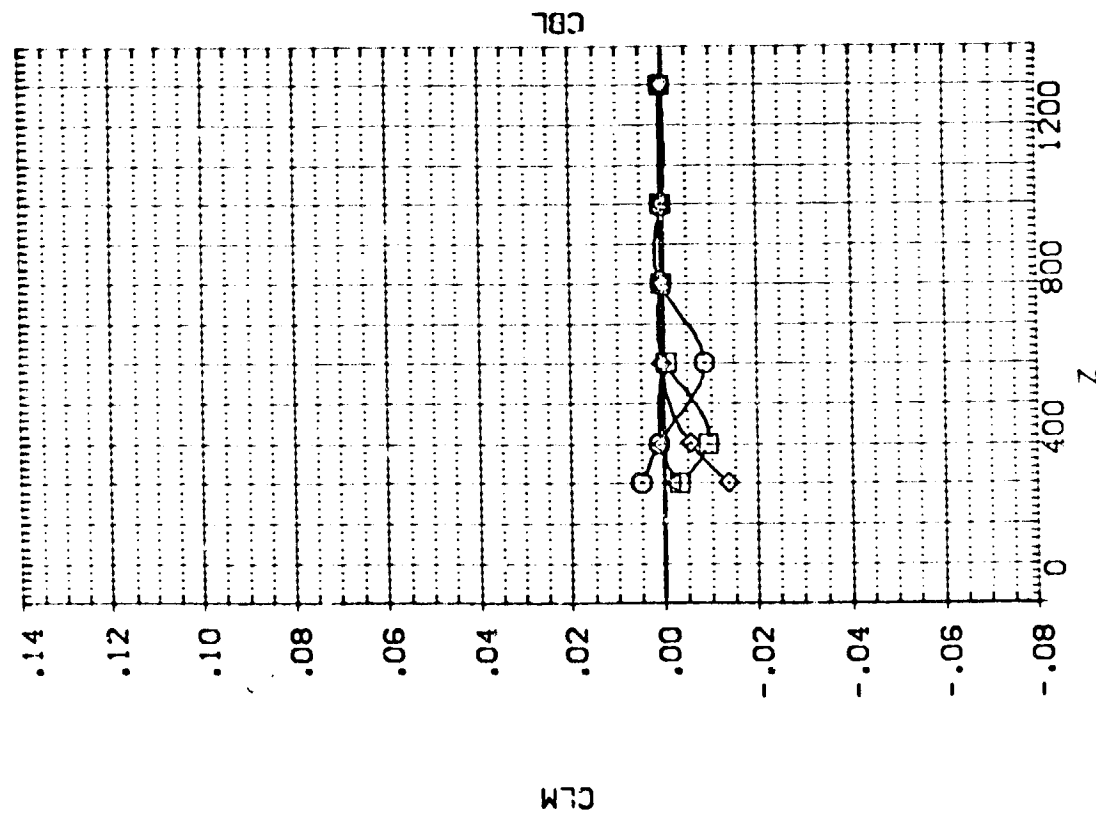

1A13. EXTERNAL TANK(T10)SEPARATING FROM ORB. 09 (RTJ095)

SYMBOL

-
-
- ◇
- △

PARAMETRIC VALUES	
MACH	4.530
P/TOTAL	110.000
ALPHA	.000
BETA	.000
DALPHA	-10.000
CBETA	.000
ELEVTR	-40.000
AILTRON	.000
Y	200.000

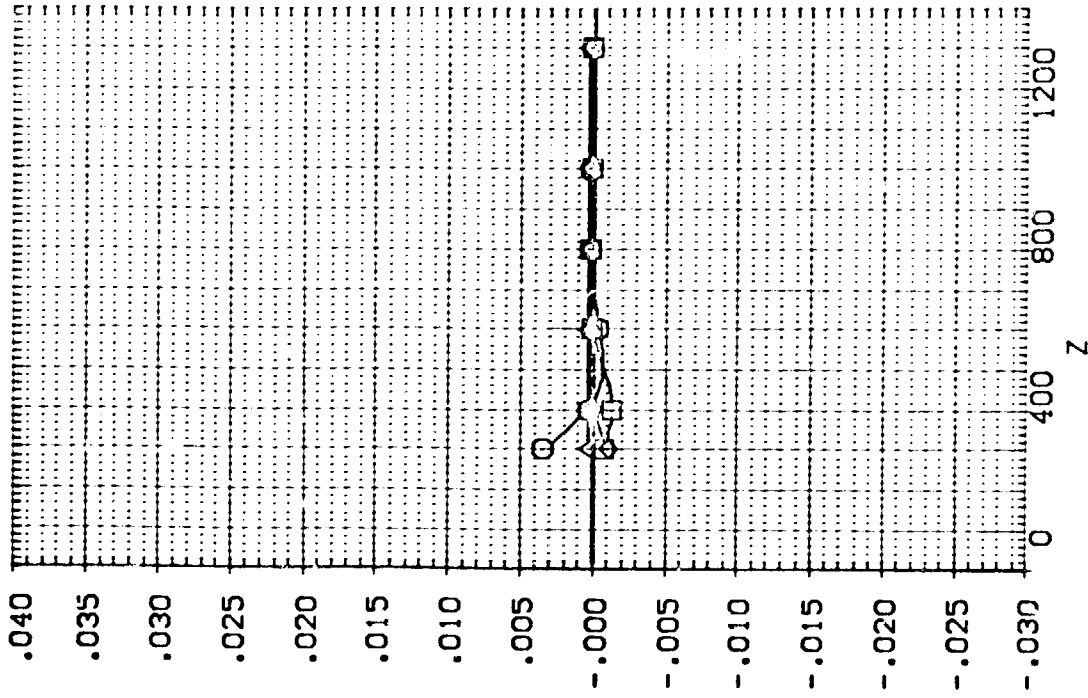
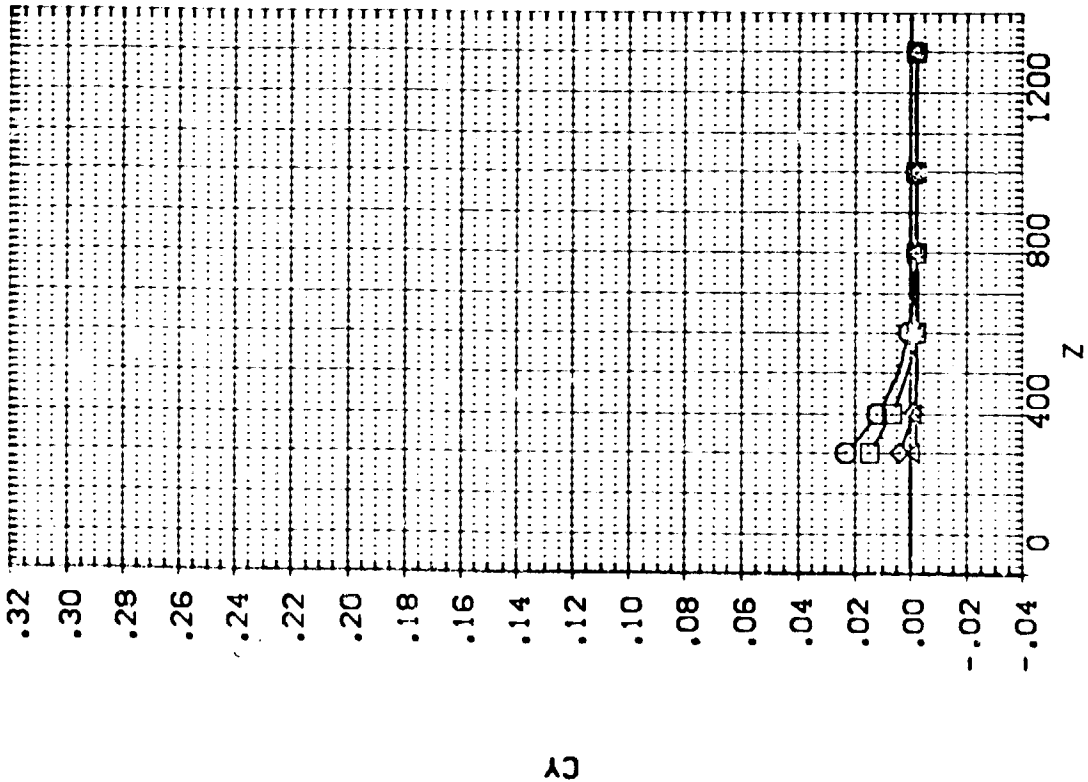

SEE THE ASSOCIATED DOCUMENT FOR REFERENCE CHARACTERISTICS FOR INDIVIDUAL DATASETS

EFFECT OF EXTERNAL TANK SEPARATION ON ORBITER AERODYNAMIC CHARACTERISTICS

1A13. EXTERNAL TANK(S) SEPARATING FROM ORB. 09 (RTJ096)

SEE THE ASSOCIATED DATA DOCUMENT FOR REFERENCE CHARACTERISTICS FOR INDIVIDUAL DATASETS

SYMBOL		PARAMETRIC VALUES			
○	X	MACH	4.530	PI TOTAL	110.000
□	ALPHA	ALPHA	.000	BETA	.000
◇	DALPHA	DALPHA	-20.000	DBETA	.000
△	ELEVTR	ELEVTR	-40.000	AILRON	.000
	Y	Y	200.000		

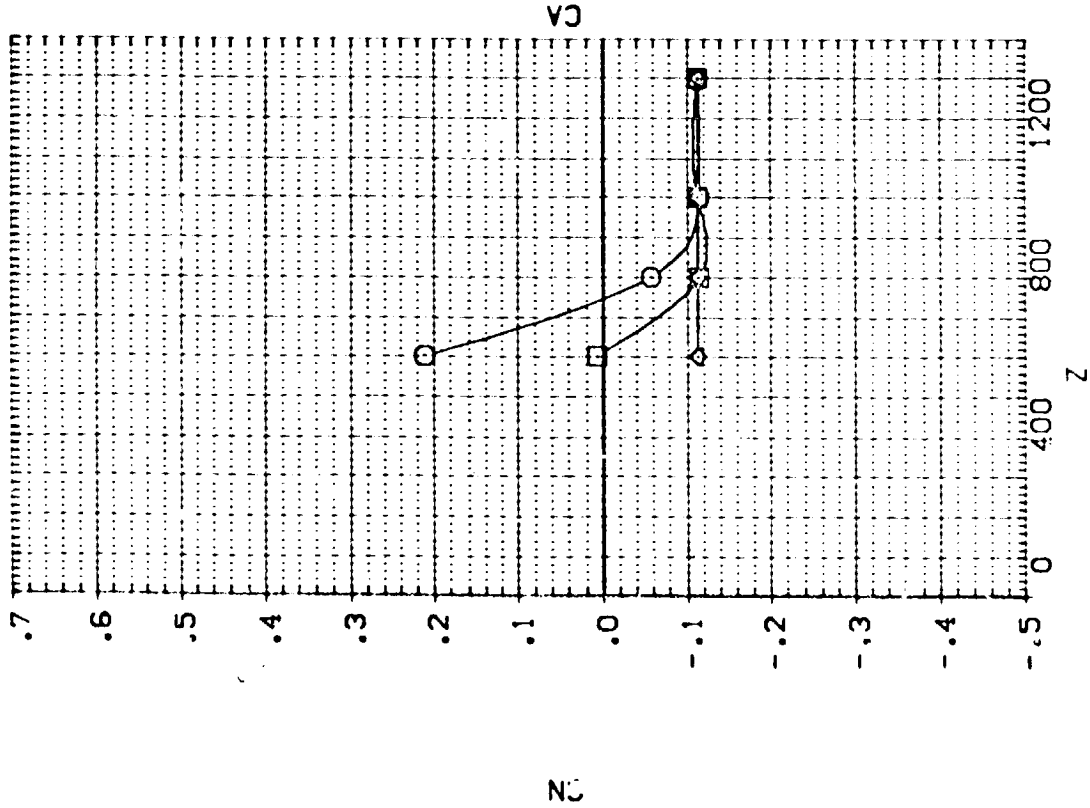
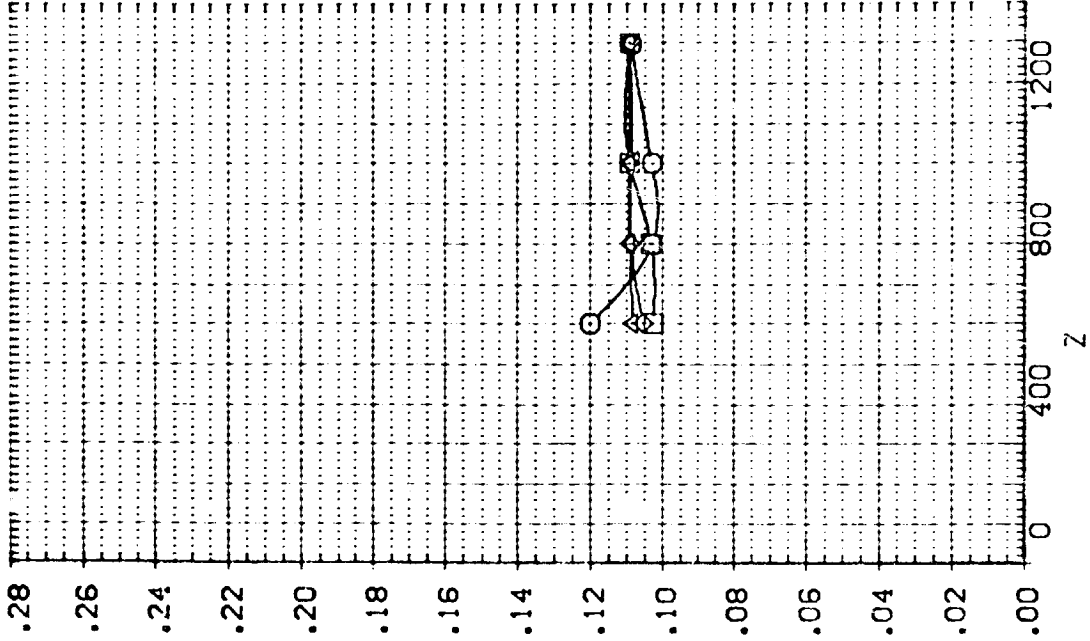

1A13. EXTERNAL TANK(T10)SEPARATING FROM ORB. 09 (RTJ096)

SYMBOL		PARAMETRIC VALUES			
x	-1.505	MACH	4.530	PTOTAL	110.000
	401.110	ALPHA	.000	BETA	.000
	800.940	DALPHA	-20.000	DBETA	.000
	1201.000	ELEVTR	-40.000	AILRON	.000
y			200.000		

SEE THE ASSOCIATED DATA DOCUMENT FOR THE EFFECTIVE CHARACTERISTICS FOR INDIVIDUAL DATASETS

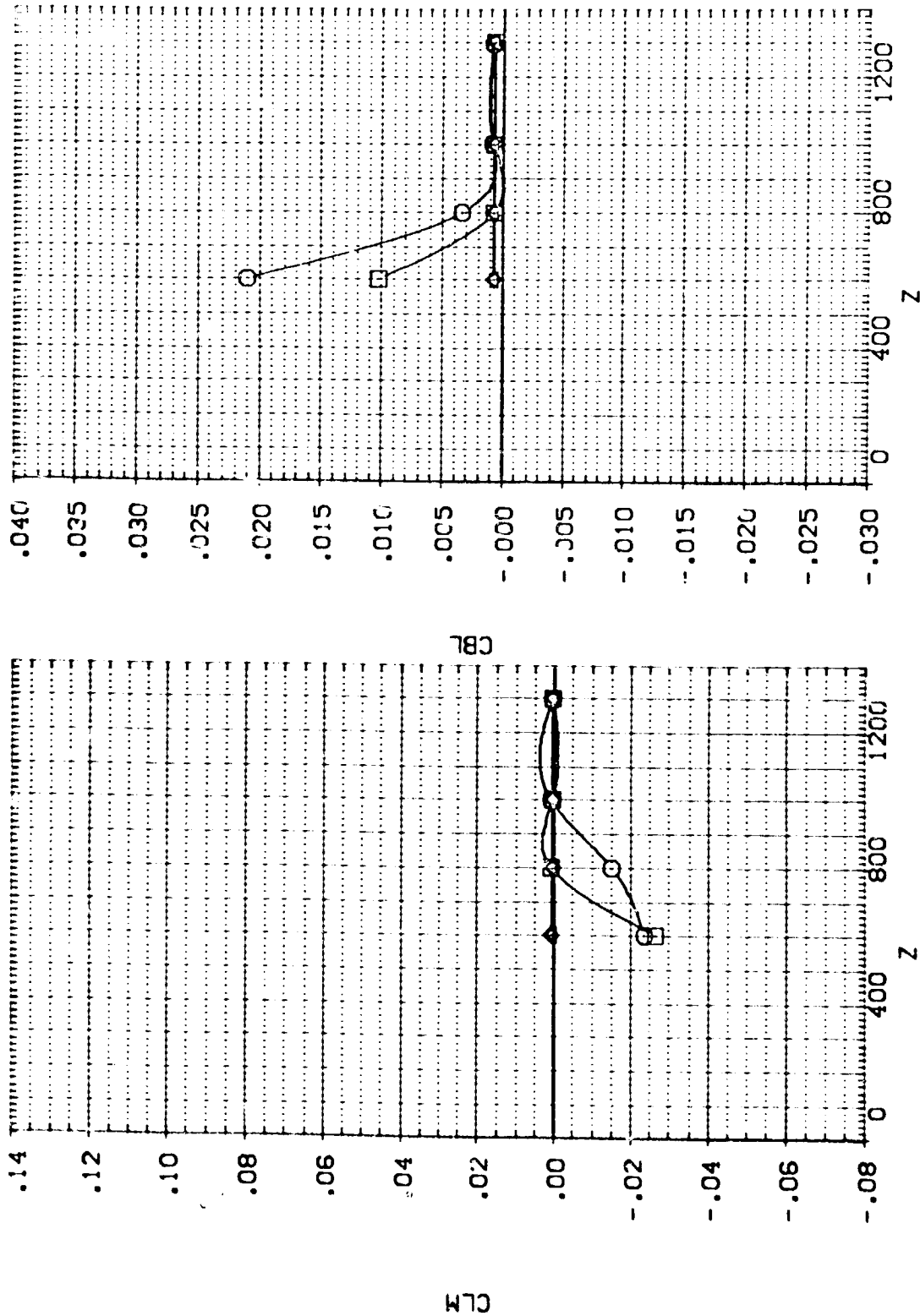

EFFECT OF EXTERNAL TANK SEPARATION ON ORBITER AERODYNAMIC CHARACTERISTICS

1A13. EXTERNAL TANK(110)SEPARATING FROM ORB. 09 (RTJ096)

SEE THE ASSOCIATED DATA DOCUMENT FOR REFERENCE CHARACTERISTICS FOR INDIVIDUAL DATASETS

SYMBOL		PARAMETRIC VALUES	
X	-0.505	MACH	4.530
		PTOTAL	110.000
		BETA	.000
		DELTA	-20.000
		ALTRON	-40.000
		Y	200.000

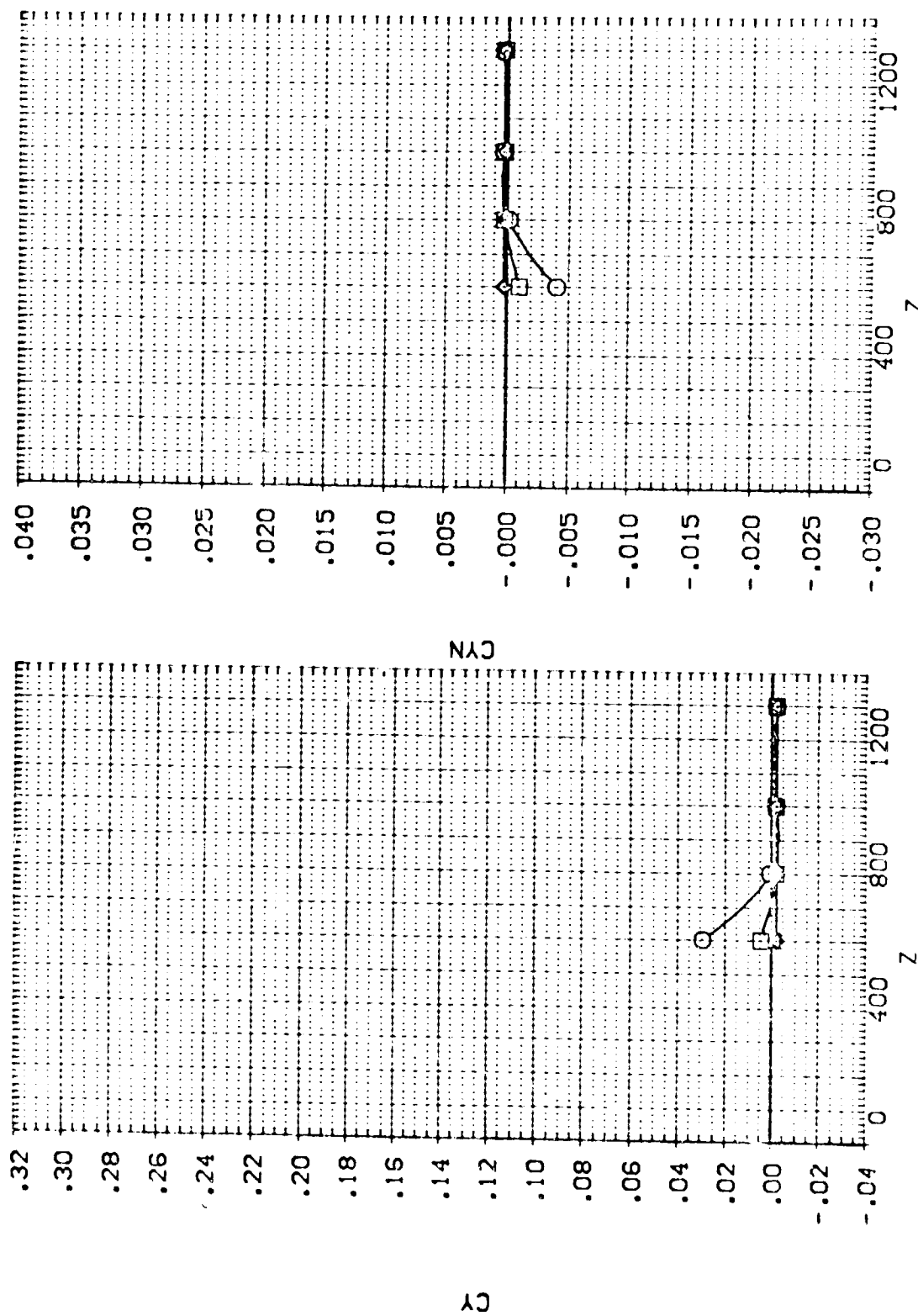

EFFECT OF EXTERNAL TANK SEPARATION ON ORBITER AERODYNAMIC CHARACTERISTICS

1A13, EXTERNAL TANK(T10)SEPARATING FROM ORB. 09 (RTJ097)

SEE THE ASSOCIATED DOCUMENT FOR REFERENCE CHARACTERISTICS FOR INDIVIDUAL DATASETS

SYMBOL	X	MACH	PARAMETRIC VALUES
○	.174	4.530	PITOTAL 110.000
□	100.390	.000	BETA .000
◇	800.520	.000	DBETA .000
△	1200.800	-40.000	AILRON .000
		Y	.000

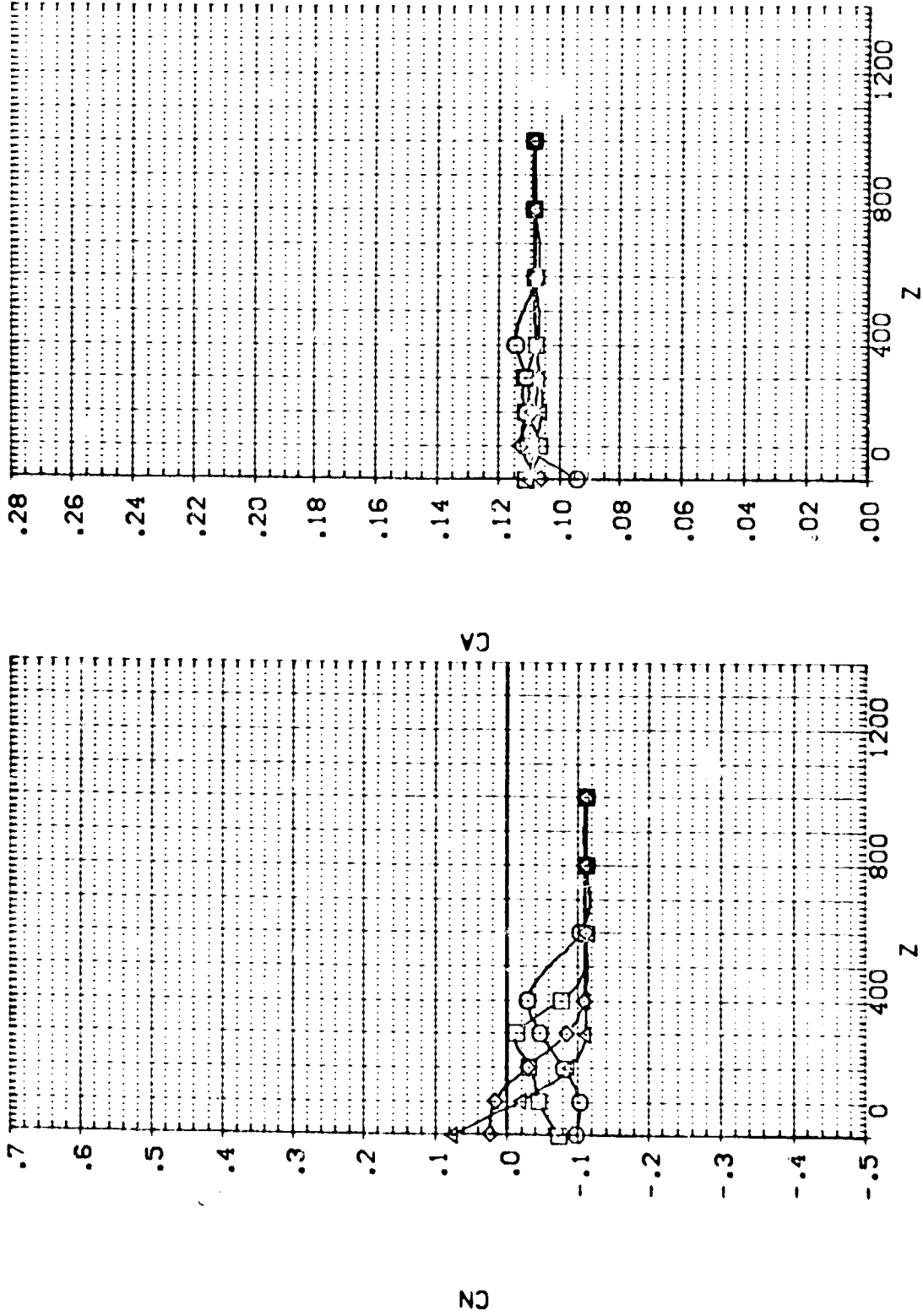

EFFECT OF EXTERNAL TANK SEPARATION ON ORBITER AERODYNAMIC CHARACTERISTICS

1A13.EXTERNAL TANK(T10)SEPARATING FROM ORB. 09 (RTJ097)

SEE THE ASSOCIATED DATA DOCUMENT FOR REFERENCE CHARACTERISTICS FOR INDIVIDUAL DATASETS

SYMBOL		PARAMETRIC VALUES	
○	.174	MACH	4.530
□	400.390	ALPHA	110.000
◇	800.570	CALPHA	BETA
△	1200.800	ELEVTR	-40.000
		Y	.000

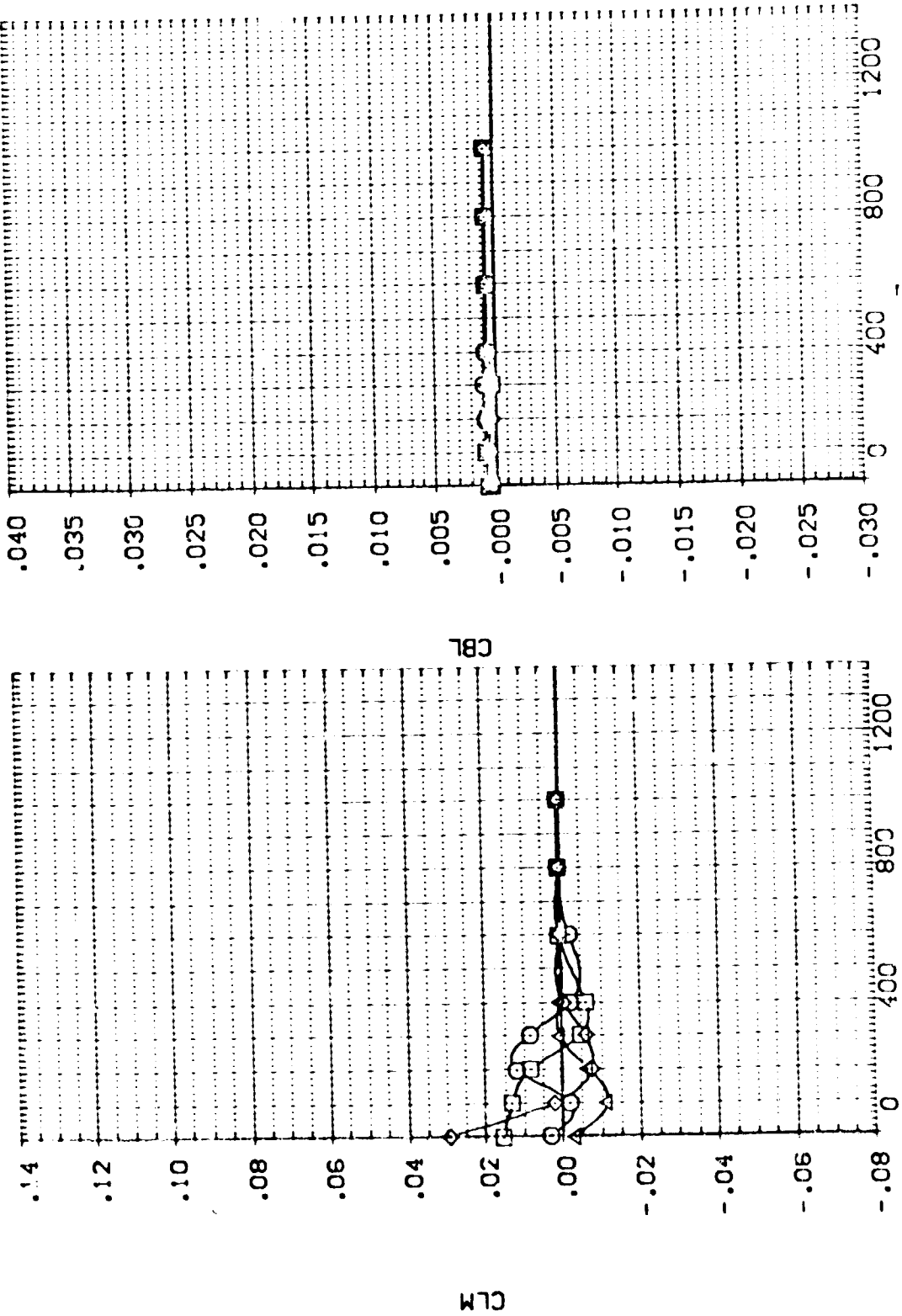

EFFECT OF EXTERNAL TANK SEPARATION ON ORBITER AERODYNAMIC CHARACTERISTICS

1A13.EXTERNAL TANK(T10)SEPARATING FROM ORB. 09 (RTJ097)

SEE THE ASSOCIATED DOCUMENT FOR REFERENCE CHARACTERISTICS FOR INDIVIDUAL BASE'S

SYMBOL		PARAMETRIC VALUES	
○	X	MACH	PTOTAL
○	400.390	4.530	110.000
◇	800.570	ALPHA	BETA
◇	1200.800	.000	.000
△		DALPHA	OBETA
△		.000	.000
		ELEVTR	ATLRON
		-40.000	.000
		Y	.000

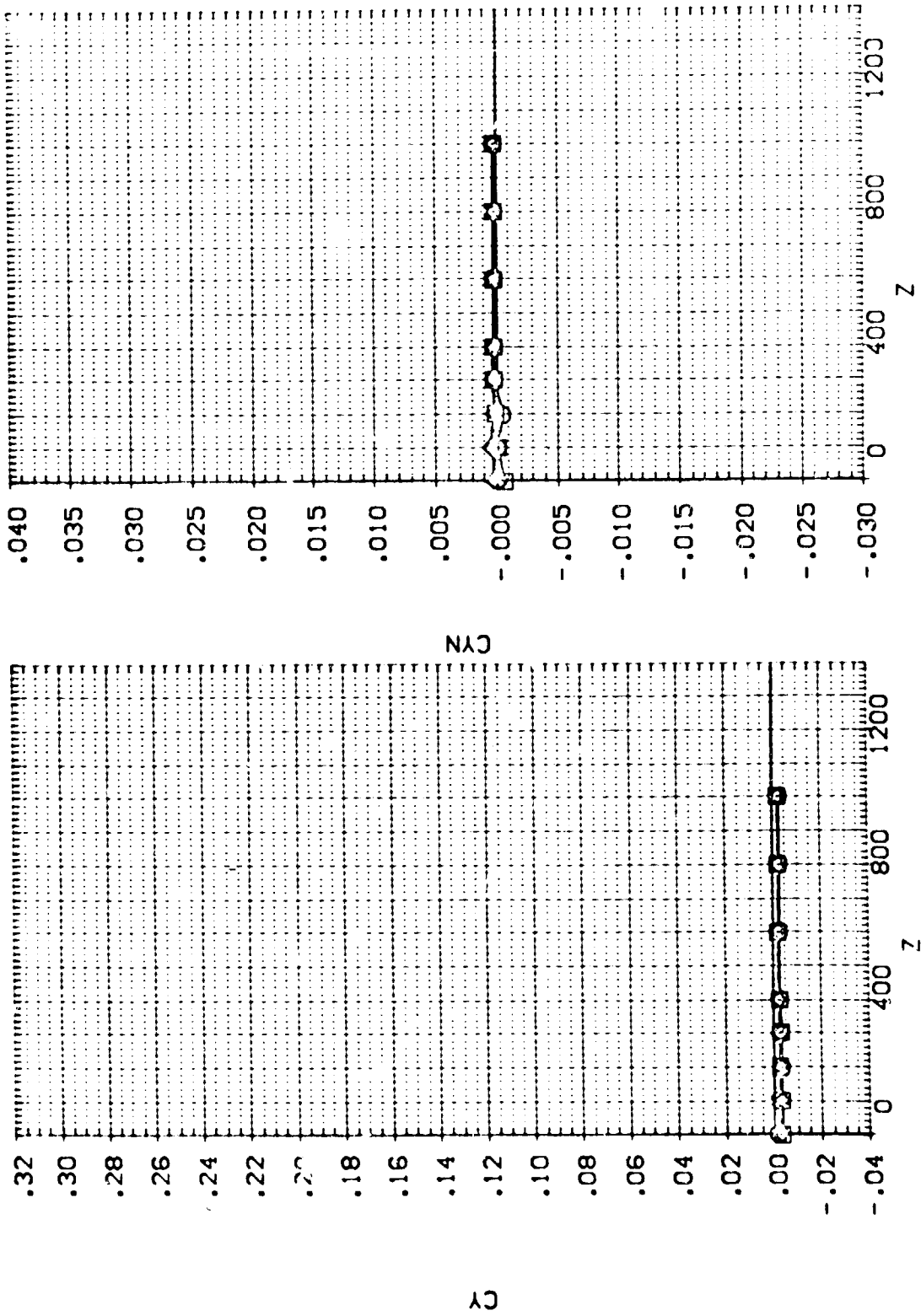

EFFECT OF EXTERNAL TANK SEPARATION ON ORBITER AERODYNAMIC CHARACTERISTICS

1A13.EXTERNAL TANK(T10)SEPARATING FROM ORB. 09 (RTJ098)

SEE THE ASSOCIATED DATA DOCUMENT FOR REFERENCE CHARACTERISTICS FOR INDIVIDUAL DATASETS

SYMBOL		PARAMETRIC VALUES	
x	.150	MACH	4.530
		PTCL-L	110.000
o	400.160	ALPHA	.000
		BETA	.000
□	800.710	DALPHA	-10.000
		DBETA	.000
△	1200.900	ELEVTR	-40.000
		AILRON	.000
		Y	.000

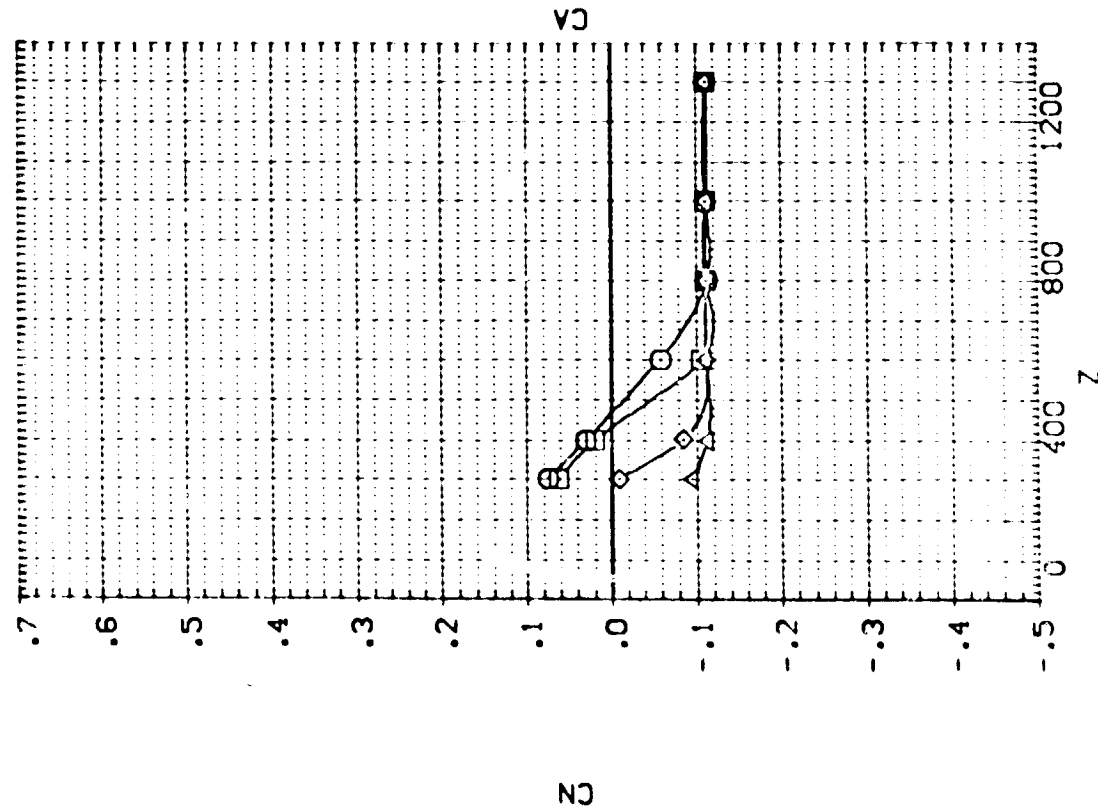
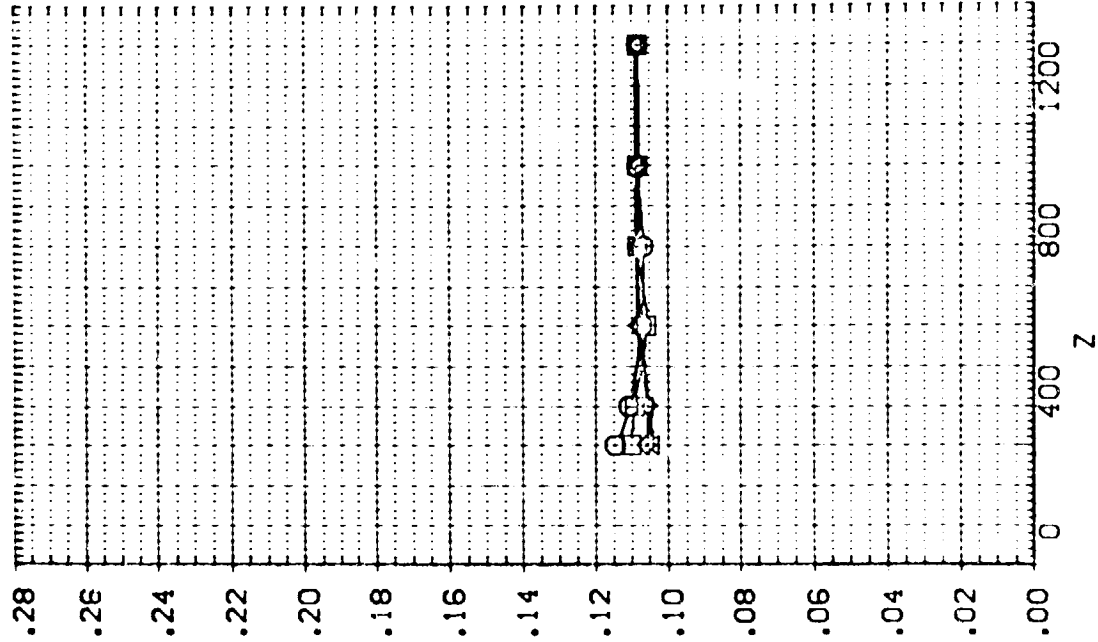

1A13. EXTERNAL TANK(T10)SEPARATING FROM ORB. 09 (RTJ098)

SEE THE ASSOCIATED USER DOCUMENT FOR REFERENCE CHARACTERISTICS FOR INDIVIDUAL DATASETS

SYMBOL		PARAMETRIC VALUES	
○	.150	MACH	4.530
◇	400.460	ALPHA	.000
△	800.710	DALPHA	-10.000
	1200.900	ELEVTR	-40.000
		Y	.000
		PIDTAL	110.000
		BETA	.000
		DELTA	.000
		ALTRON	.000

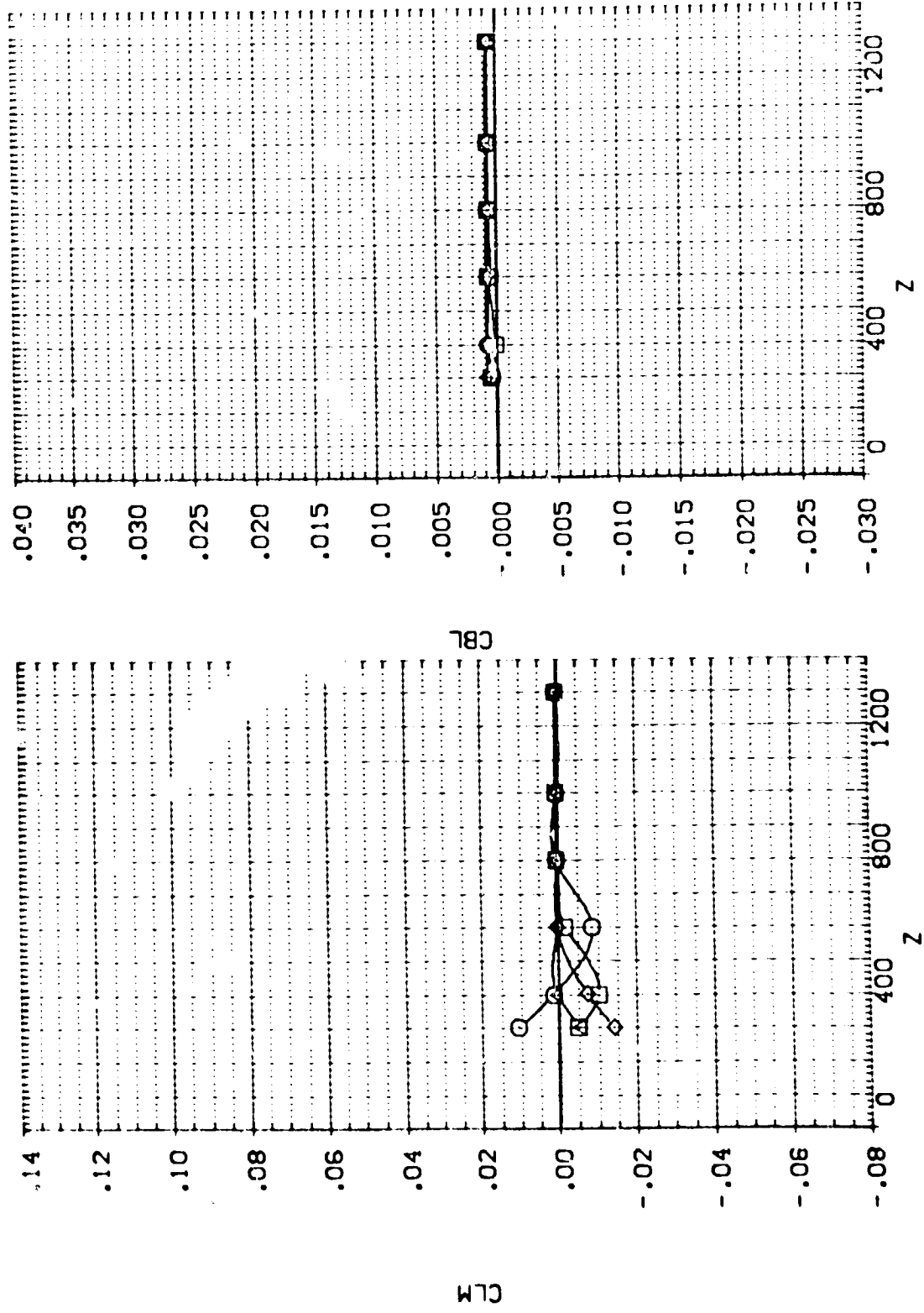

EFFECT OF EXTERNAL TANK SEPARATION ON ORBITER AERODYNAMIC CHARACTERISTICS

!A13,EXTERNAL TANK(T10)SEPARATING FROM ORB. 09 (RTJ098)

SEE THE ASSOCIATED DATA DOCUMENT FOR REFERENCE CHARACTERISTICS FOR INDIVIDUAL DATASETS

SYMBOL	X	MACH	PARAMETRIC VALUES
○	.150	4.530	PIOTAL 110.000
○	400.460	.000	BETA .000
○	800.710	-10.000	DBETA .000
○	1200.900	-40.000	AILRON .000
			Y .000

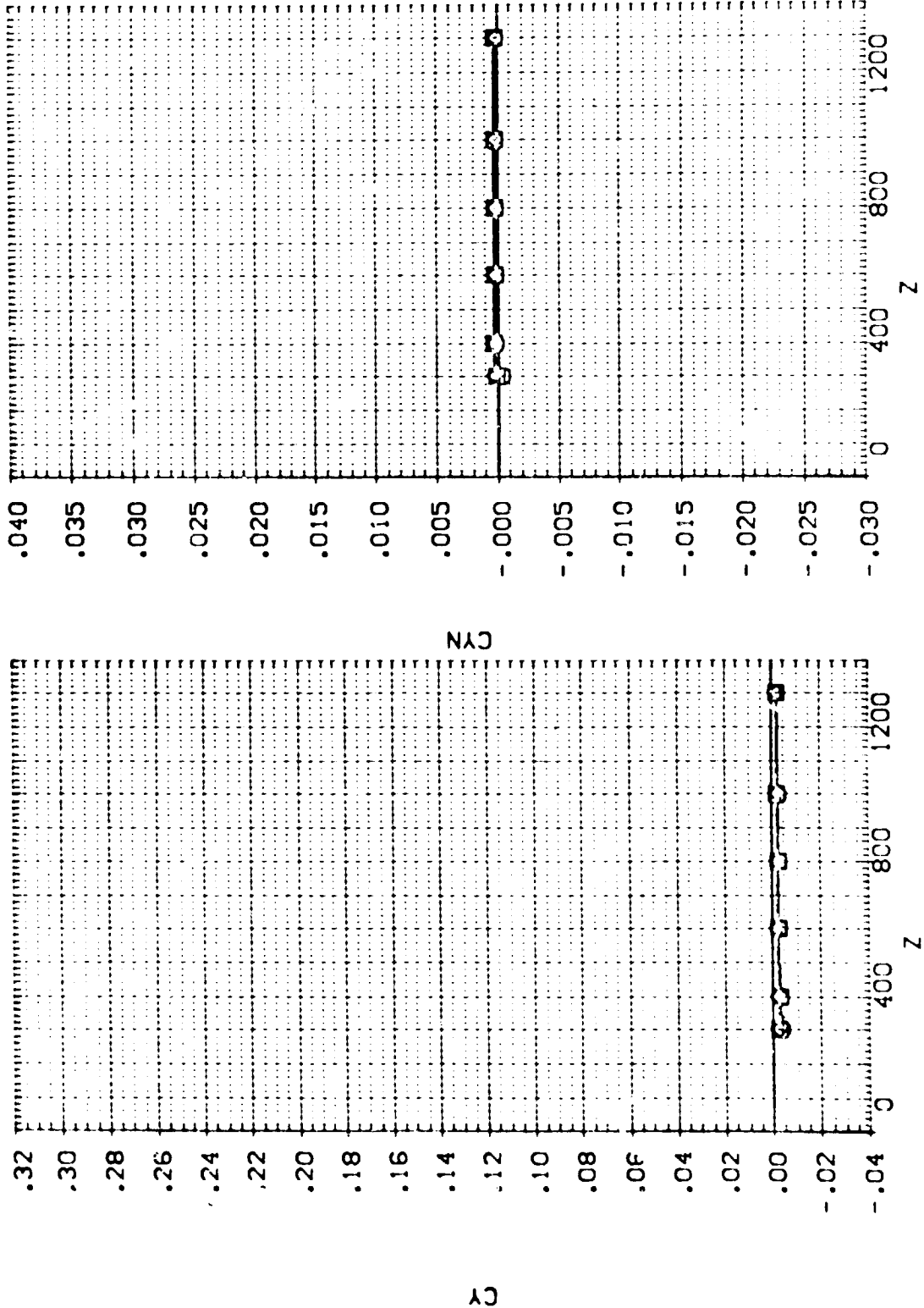

EFFECT OF EXTERNAL TANK SEPARATION ON ORBITER AERODYNAMIC CHARACTERISTICS

1A13.EXTERNAL TANK(110)SEPARATING FROM ORB. 09 (RTJ099)

SEE THE ASSOCIATED DATA DOCUMENT FOR REFERENCE CHARACTERISTICS FOR INDIVIDUAL DATA SETS

SYMBOL	X	MACH	PARAMETRIC VALUES
○	-7.17	4.530	PTOTAL 110.000
◇	401.410	.000	BETA .000
△	801.010	-20.000	BETA .000
	1200.600	-40.000	ALLRON .000

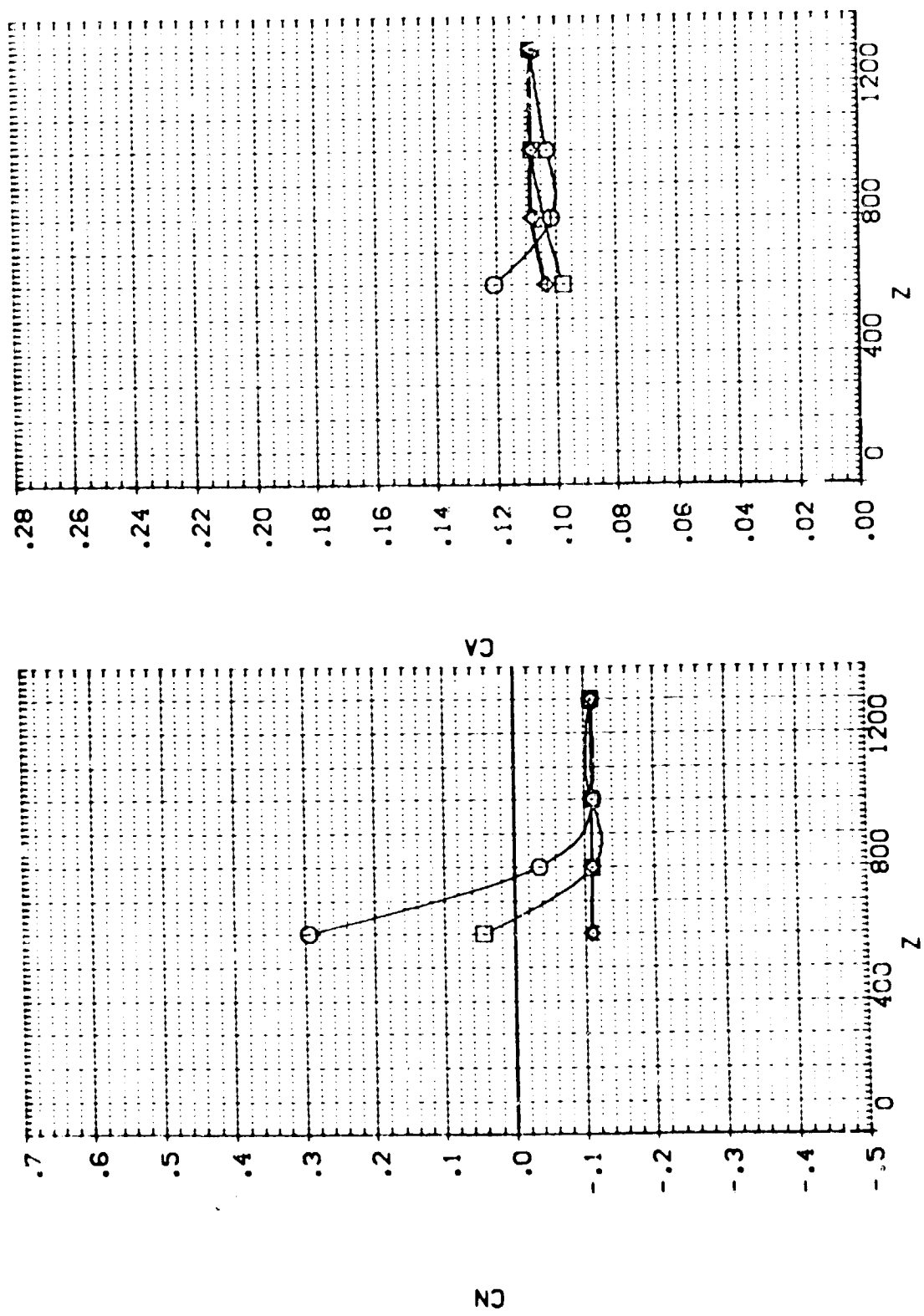

EFFECT OF EXTERNAL TANK SEPARATION ON ORBITER AERODYNAMIC CHARACTERISTICS

1A13-EXTERNAL TANK(110)SEPARATING FROM CRB. 09 (RTJ099)

SYMBOL X

PARAMETRIC VALUES	
-0.717	MACH
401.410	ALPHA
801.010	BETA
1200.800	ELEVTR
110.000	PIOTAL
.000	BETA
.000	DBETA
.000	AILPON
.000	Y

SEE THE ASSOCIATED DATA DOCUMENT FOR REFERENCE CHARACTERISTICS FOR INDIVIDUAL DATASETS

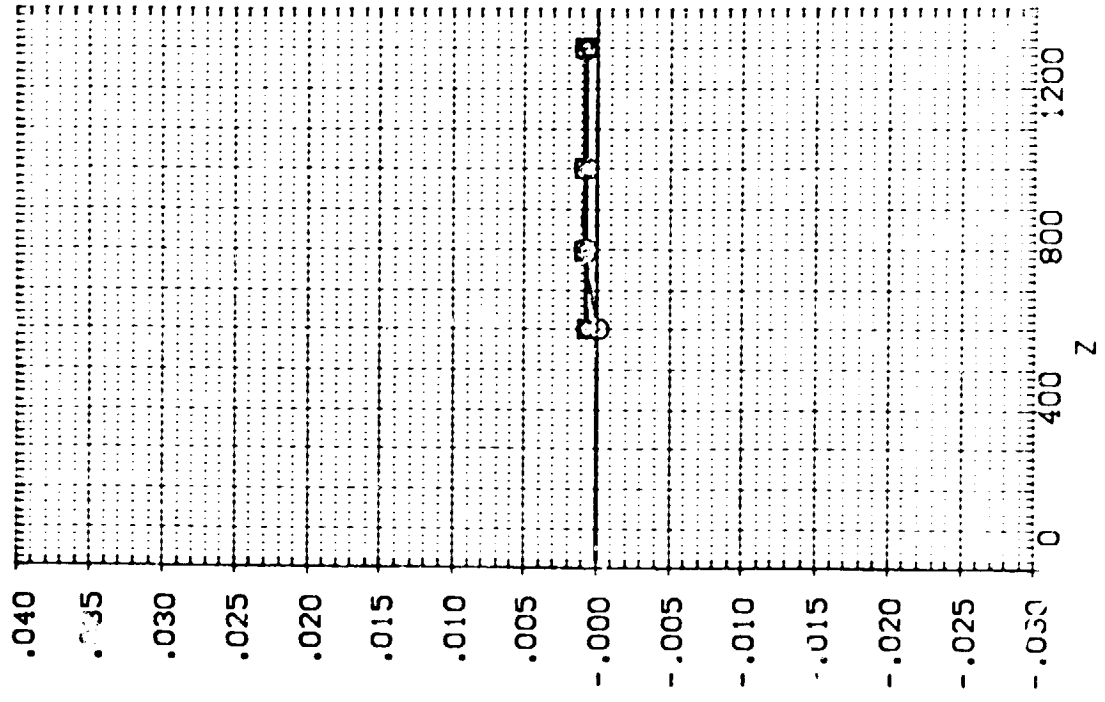
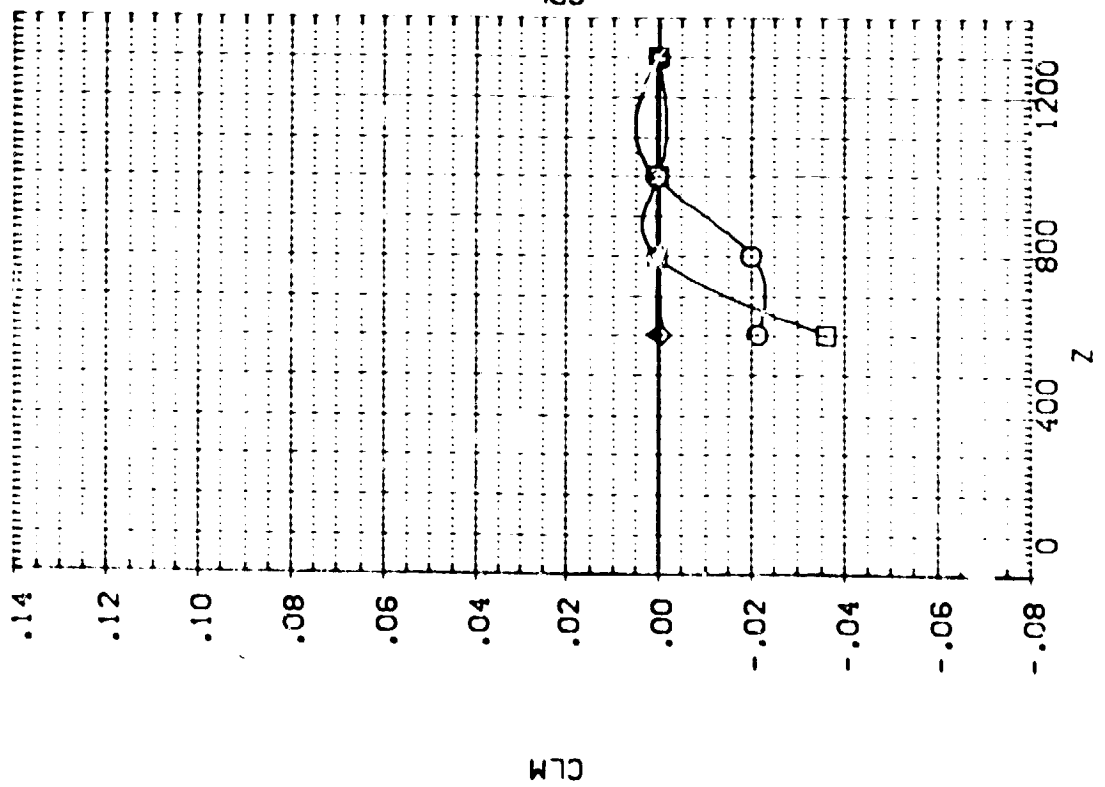

113. EXTERNAL TANK SEPARATING FROM ORB. 09 (RTJ099)

SYMBOL

-
-
- ◇
- △

PARAMETRIC VALUES	
X	-0.717
MACH	4.530
PTOTAL	110.000
ALPHA	0.000
BETA	0.000
DALPHA	-20.000
DBETA	0.000
ELEVTR	-40.000
AILRON	0.000
Y	0.000

SEE THE ASSOCIATED DATA DOCUMENT FOR REFERENCE CHARACTERISTICS FOR INDIVIDUAL DATASETS

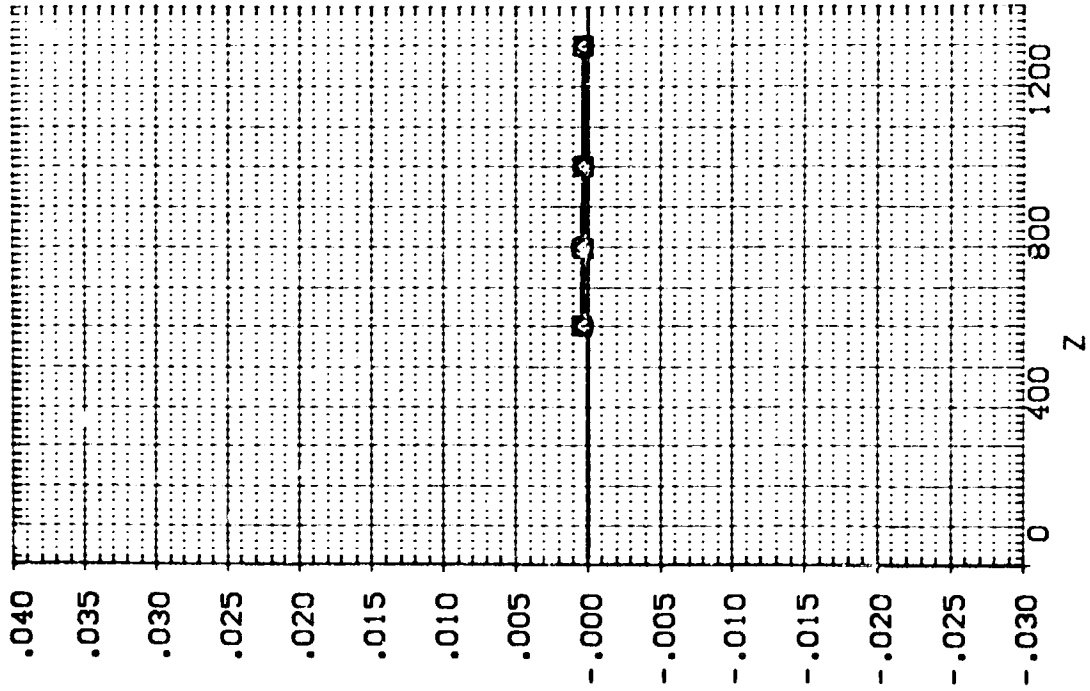
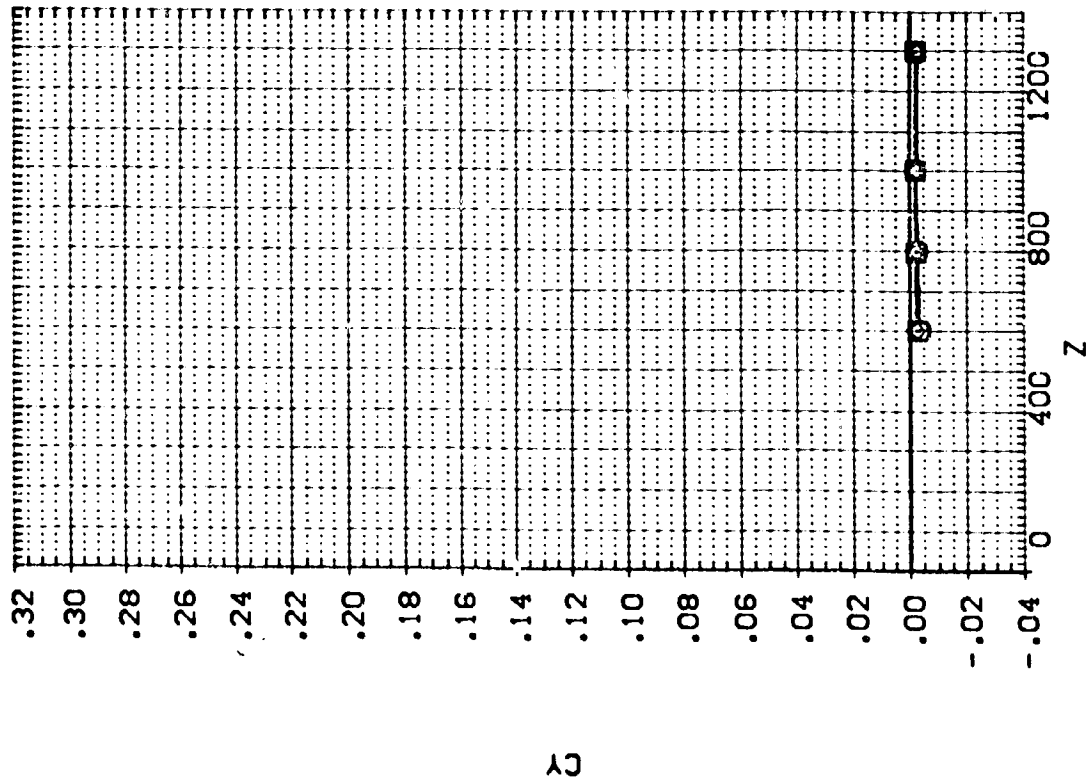

EFFECT OF EXTERNAL TANK SEPARATION ON ORBITER AERODYNAMIC CHARACTERISTICS

IA13,EXTERNAL TANK(T10)SEPARATING FROM ORB. 09 (RTJT01)

SEE THE ASSOCIATED DATA DOCUMENT FOR REFERENCE CHARACTERISTICS FOR INDIVIDUAL DATASETS

SYMBOL		PARAMETRIC VALUES			
○	X	MACH	4.530	P/TOTAL	110.000
□	400.480	ALPHA	.000	BETA	.000
◇	800.610	DALPHA	5.000	DBETA	.000
△	1200.500	ELEVTR	.000	AILRON	.000
	Y		.000		.000

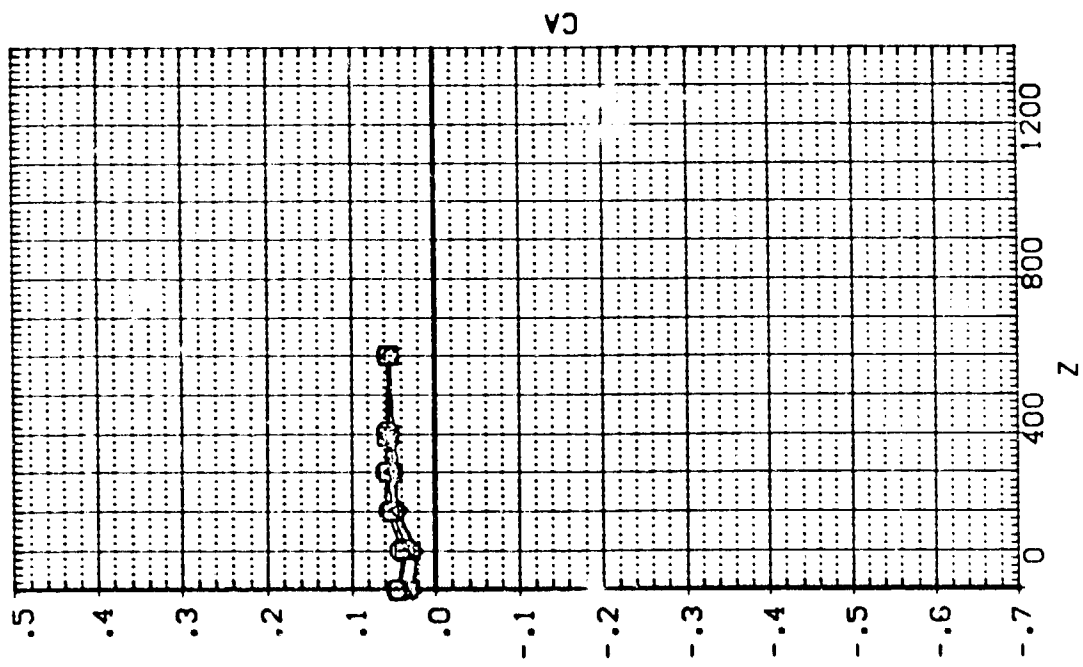
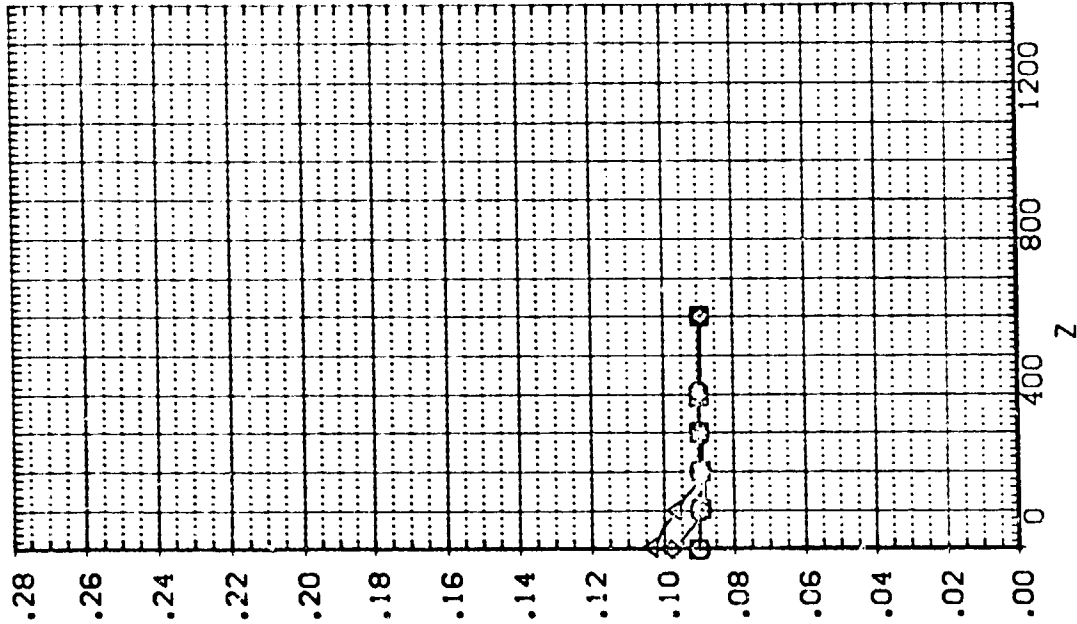

EXTERNAL TANK AERODYNAMIC CHARACTERISTICS DURING SEPARATION FROM ORBITER

1A13.EXTERNAL TANK(T10)SEPARATING FROM ORB. 09 (RTJT01)

SEE THE ASSOCIATED DATA DOCUMENT FOR REFERENCE CHARACTERISTICS FOR INDIVIDUAL DATASETS

SYMBOL		PARAMETRIC VALUES	
○	x	MACH	4.530
□	400.480	ALPHA	.000
◇	800.610	DALPHA	5.000
△	1200.500	ELEVTR	.000
		Y	.000
		PTOTAL	110.000
		BETA	.000
		DBETA	.000
		A1LRON	.000

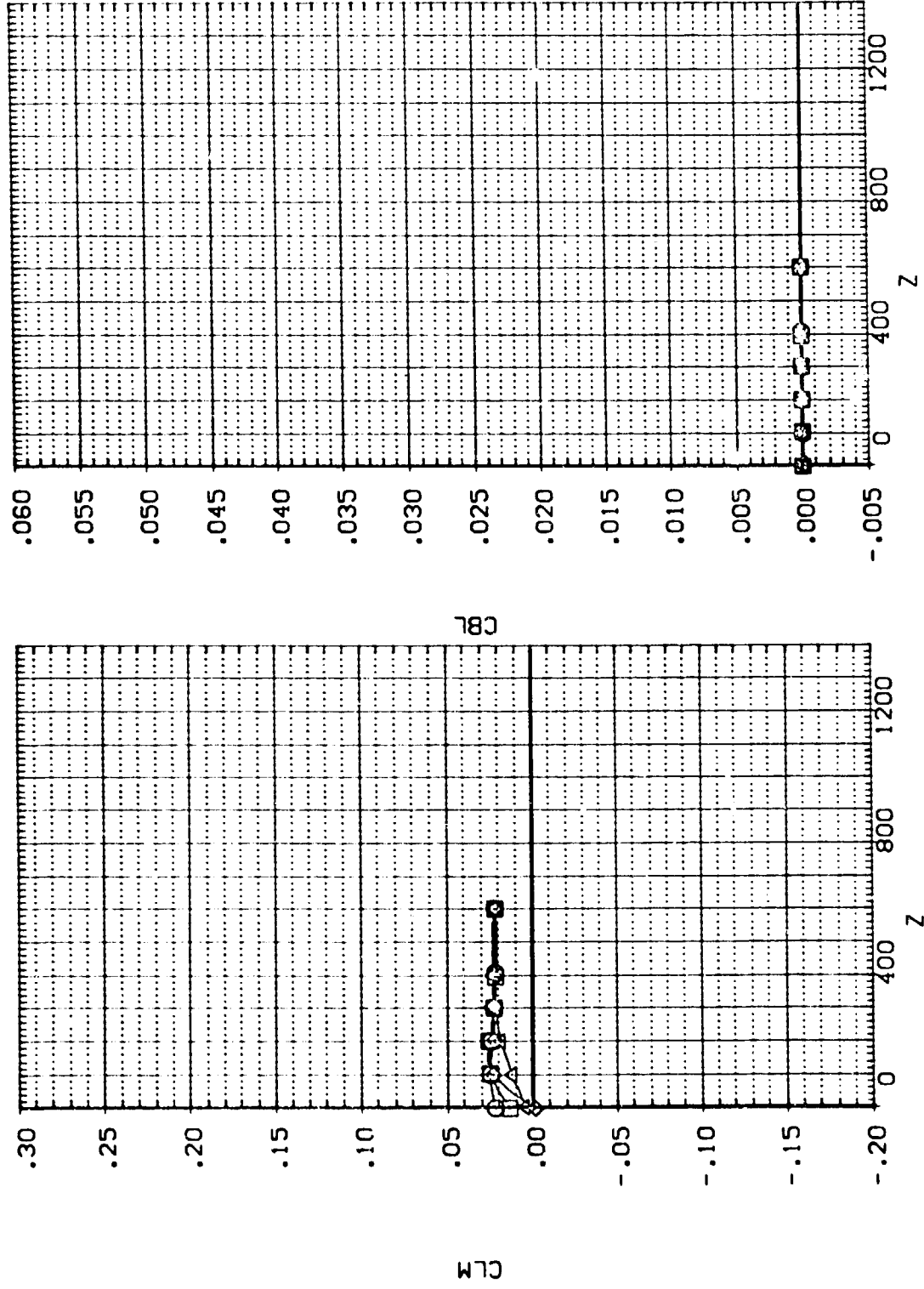

EXTERNAL TANK AERODYNAMIC CHARACTERISTICS DURING SEPARATION FROM ORBITER

IA13.EXTERNAL TANK(T10)SEPARATING FROM ORB. 09 (RTJT01)

SEE THE ASSOCIATED DATA DOCUMENT FOR REFERENCE CHARACTERISTICS FOR INDIVIDUAL DATASETS

SYMBOL X
 ○
 □
 ◇
 △

PARAMETRIC VALUES	
MACH	4.530
PTOTAL	110.000
ALPHA	.000
BETA	.000
DALPHA	5.000
DBETA	.000
ELEVTR	.000
A1LRON	.000
Y	.000

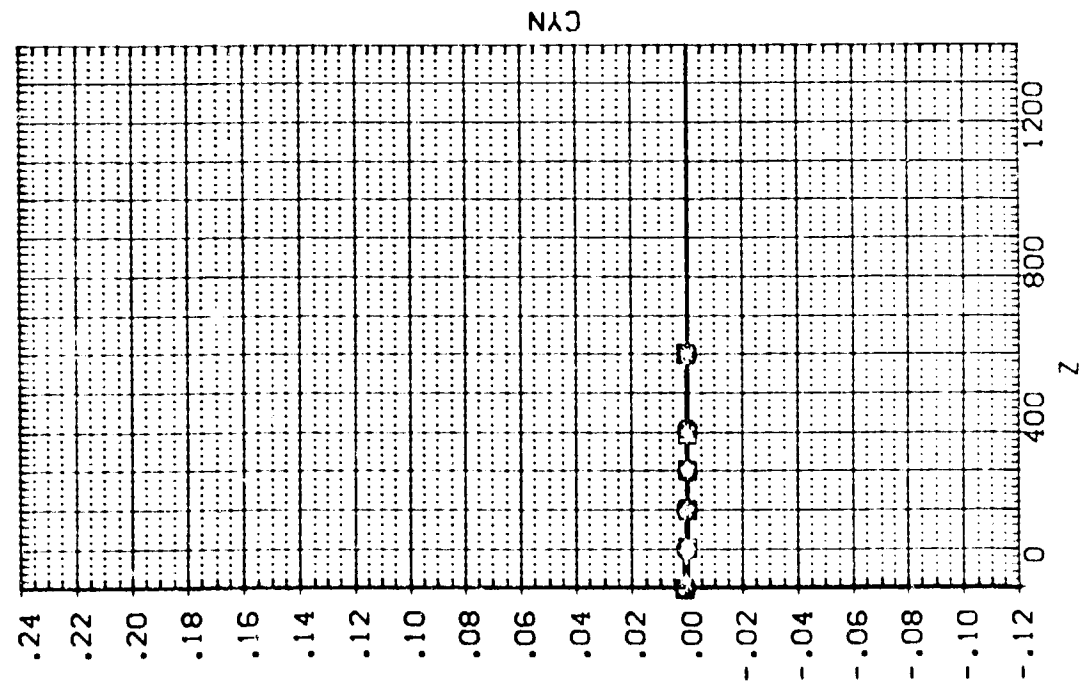
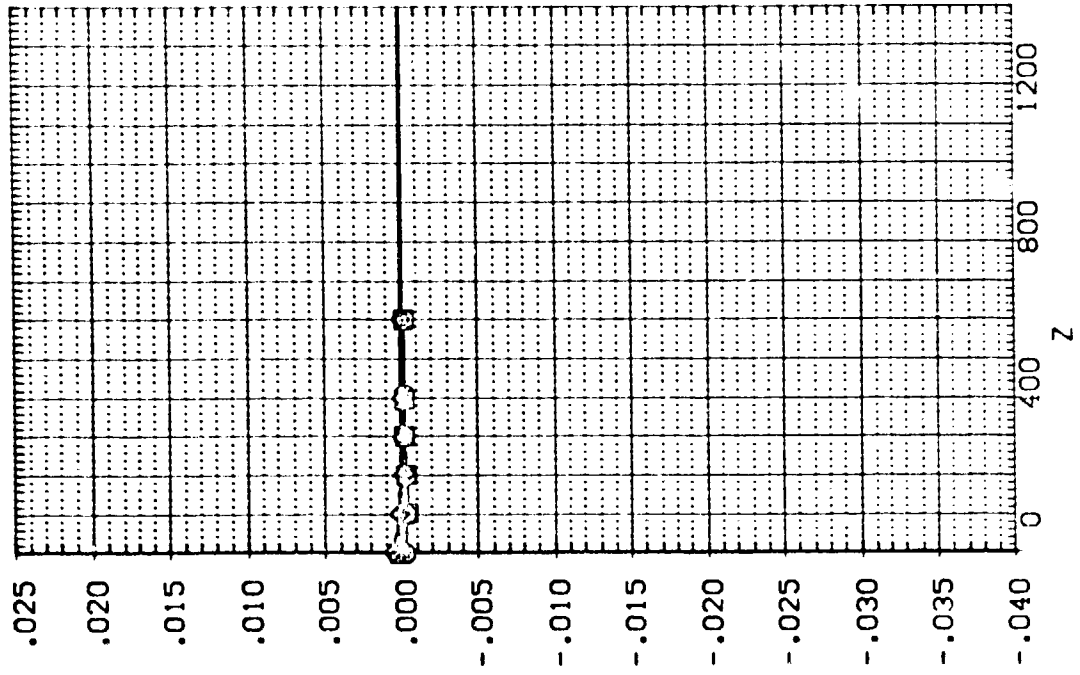

EXTERNAL TANK AERODYNAMIC CHARACTERISTICS DURING SEPARATION FROM ORBITER

IA13.EXTERNAL TANK(T10)SEPARATING FROM ORB. 09 (RTJTG2)

SYMBOL X

-
-
- ◇
- △

PARAMETRIC VALUES

400.180	MACH	4.530	PTOTAL	110.000
800.460	ALPHA	.000	BETA	.000
1200.800	DALPHA	.000	DBETA	.000
	ELEVTR	.000	ATLRON	.000
	Y	.000		

SEE THE ASSOCIATED DATA DOCUMENT FOR REFERENCE CHARACTERISTICS FOR INDIVIDUAL DATASETS

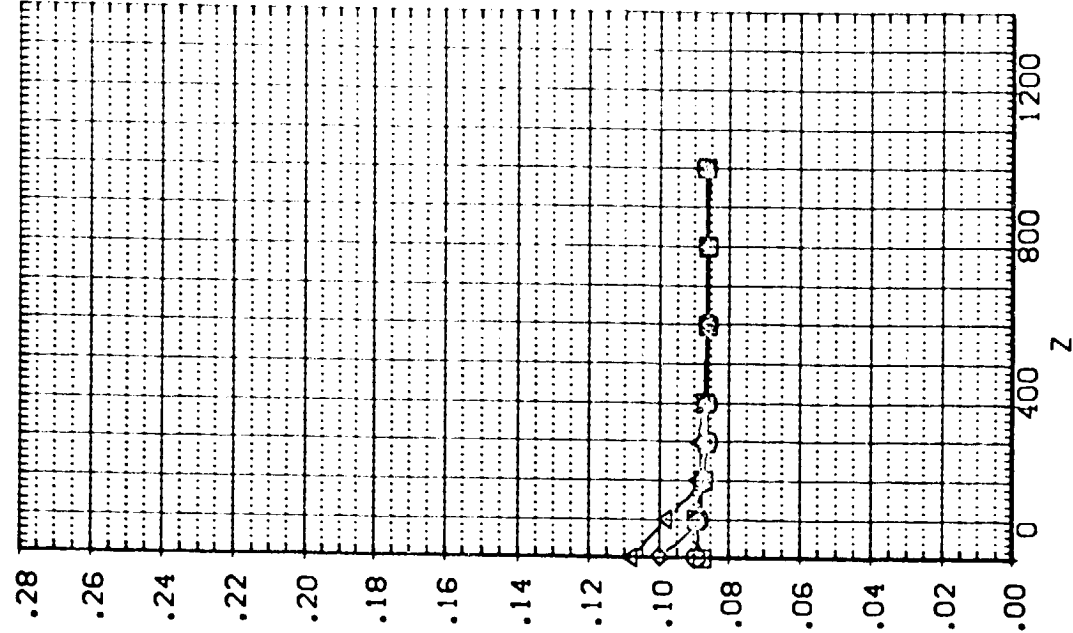
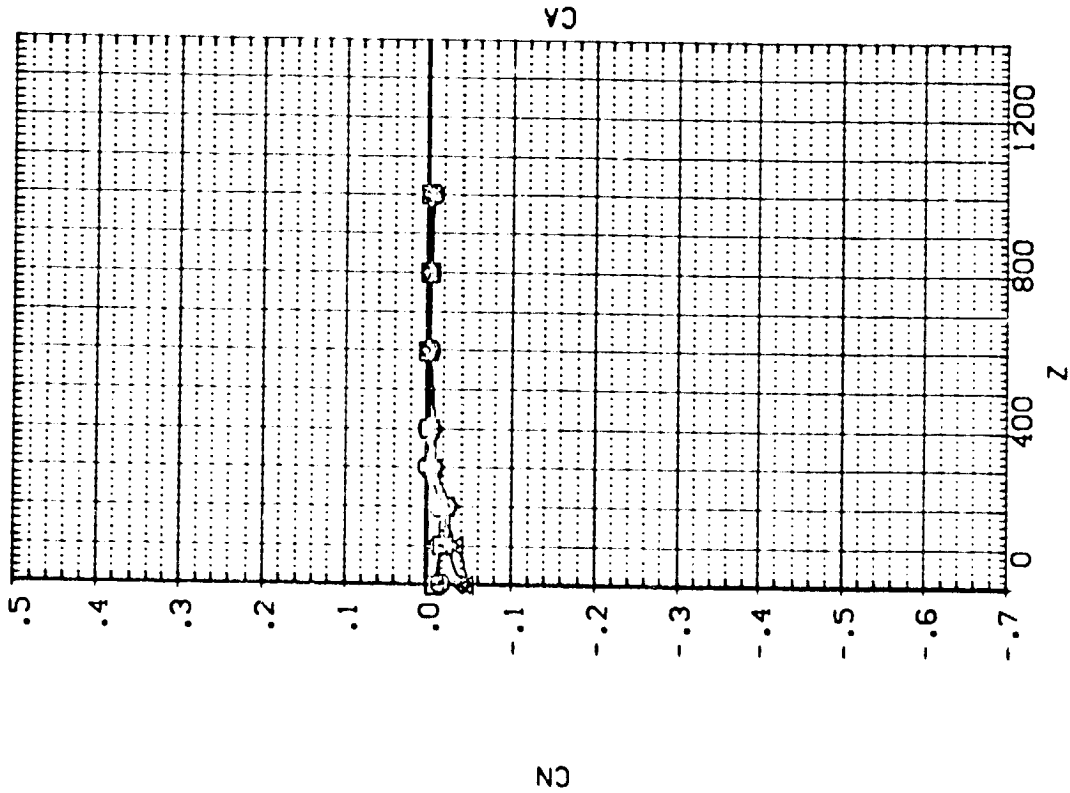

EXTERNAL TANK AERODYNAMIC CHARACTERISTICS DURING SEPARATION FROM ORBITER

[A13-EXTERNAL TANK(T10)SEPARATING FROM ORB. 09 (RTJTO2)

SYMBOL

-
-
- ◇
- △

PARAMETRIC VALUES

MACH	4.530	P TOTAL	110.000
ALPHA	.000	BETA	.000
DALPHA	.000	DBETA	.000
ELEVTR	.000	ATLRON	.000
Y	.000		

SEE THE ASSOCIATED DATA DOCUMENT FOR REFERENCE CHARACTERISTICS FOR INDIVIDUAL DATASETS

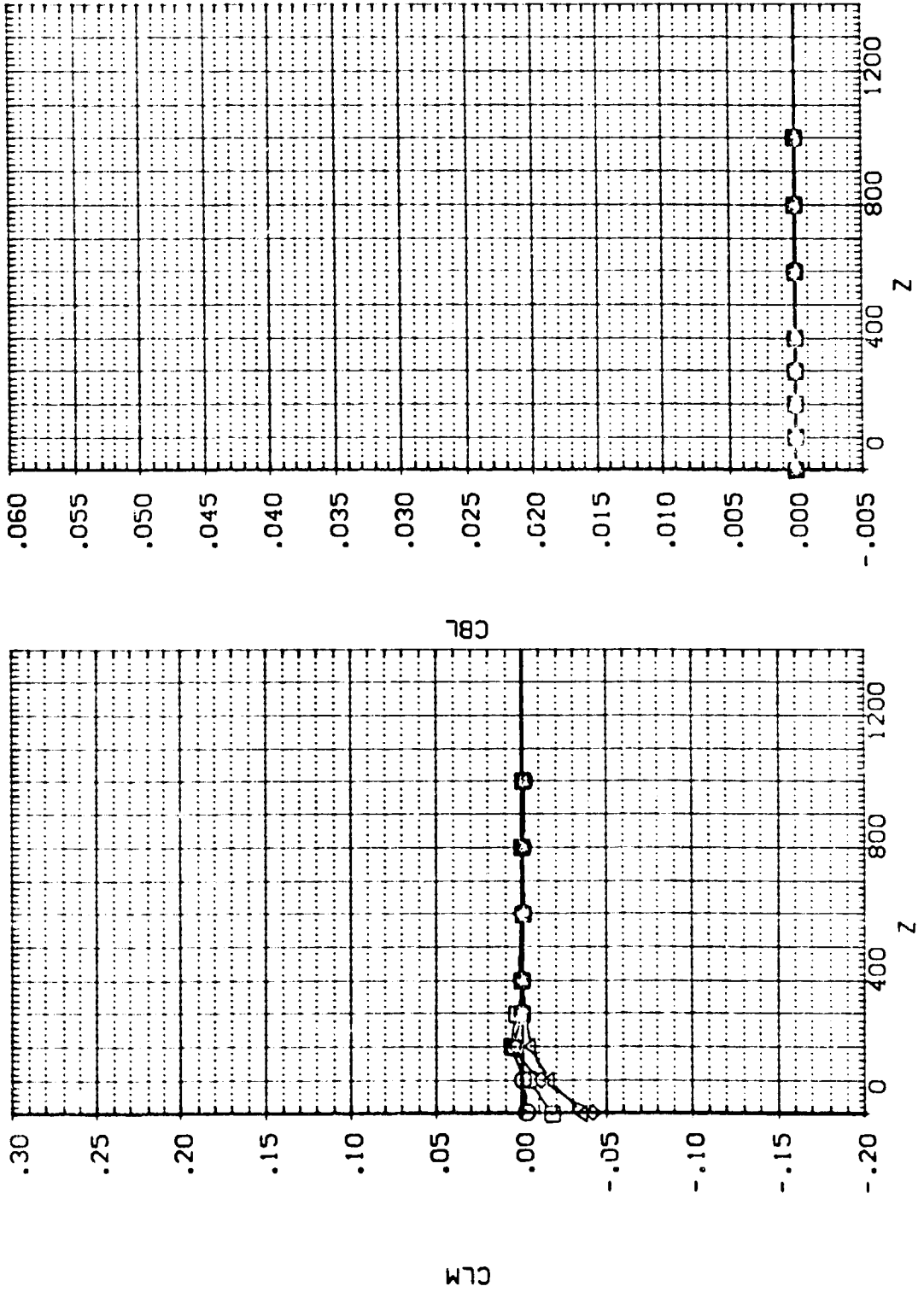

IA13.EXTERNAL TANK(T10)SEPARATING FROM ORB. 09 (RTJT02)

SYMBOL

-
-
- ◇
- △

PARAMETRIC VALUES

X	.046	MACH	4.530	PTOTAL	110.000
400.180	.000	ALPHA	.000	BETA	.000
800.460	.000	DALPHA	.000	DBETA	.000
1200.800	.000	ELEVTR	.000	A1LRON	.000
	.000	Y			

SEE THE ASSOCIATED DATA DOCUMENT FOR REFERENCE CHARACTERISTICS FOR INDIVIDUAL DATASETS

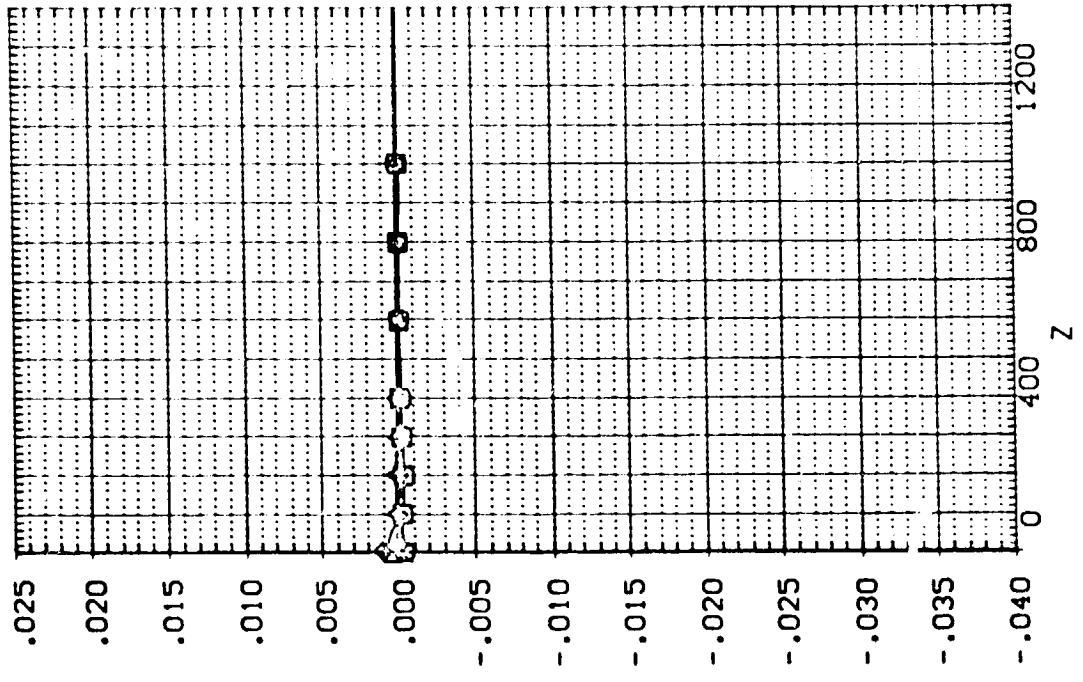
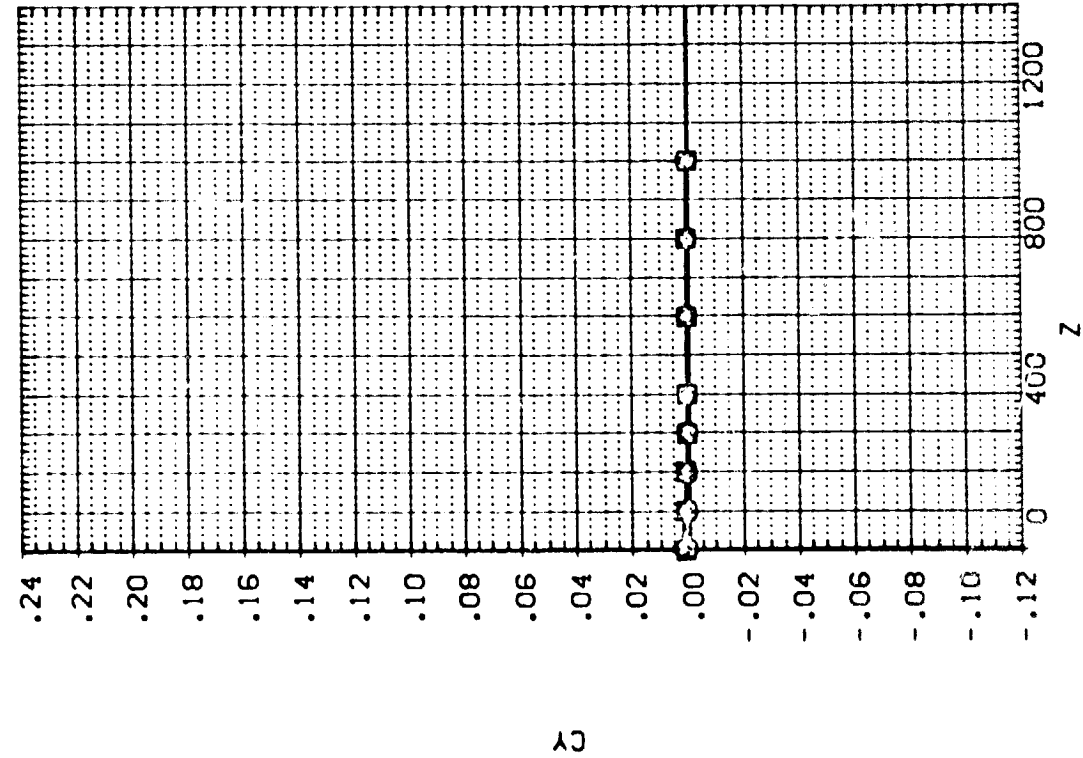

EXTERNAL TANK AERODYNAMIC CHARACTERISTICS DURING SEPARATION FROM ORBITER

IA13.EXTERNAL TANK(T10)SEPARATING FROM ORB. 09 (RTJT03)

SEE THE ASSOCIATED DATA DOCUMENT FOR REFERENCE CHARACTERISTICS FOR INDIVIDUAL DATASETS

SYMBOL		PARAMETRIC VALUES			
○	X	MACH	PTOTAL	110.000	
◇	ALPHA	4.530	BETA	.000	
△	800.510	DALPHA	DBETA	.000	
	1200.700	ELEVTR	AILTRON	.000	
	Y	200.000			

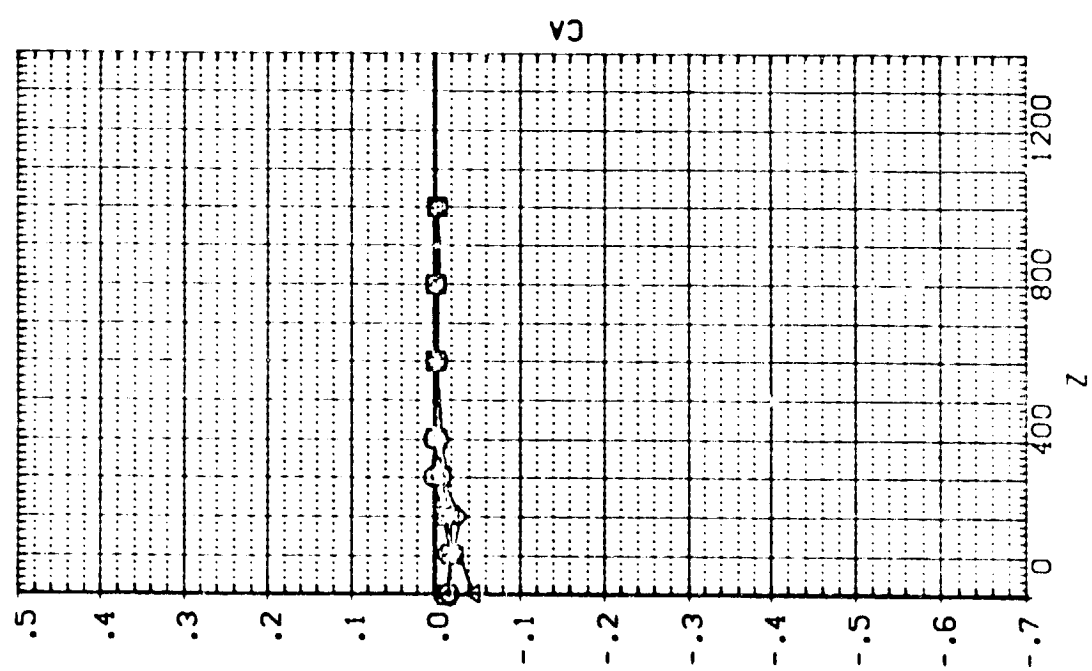
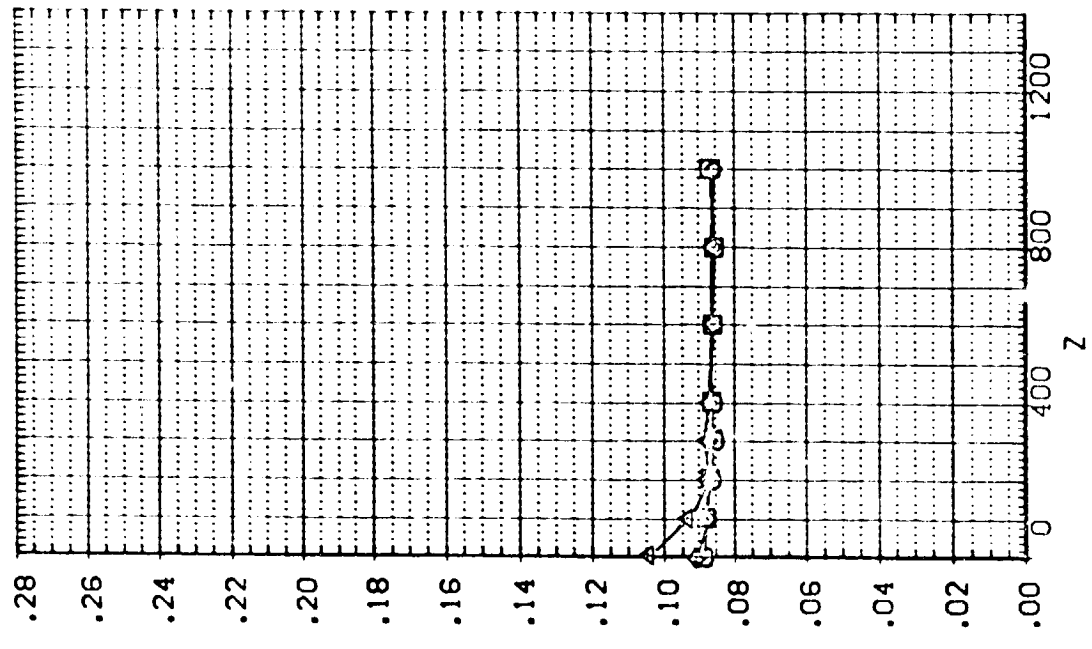

IA13, EXTERNAL TANK(T10)SEPARATING FROM ORB. 09 (RTJ103)

SEE THE ASSOCIATED DATA DOCUMENT FOR REFERENCE CHARACTERISTICS FOR INDIVIDUAL DATASETS

SYMBOL	X	MACH	ALPHA	DALPHA	ELEVTR	Y	PARAMETRIC VALUES	PTOTAL	110.000
○	-.003	4.530	.000	BETA	.000				
□	400.330	.000	.000	DBETA	.000				
◇	800.510	.000	.000	ALIRON	.000				
△	1200.700	.000	.000			200.000			

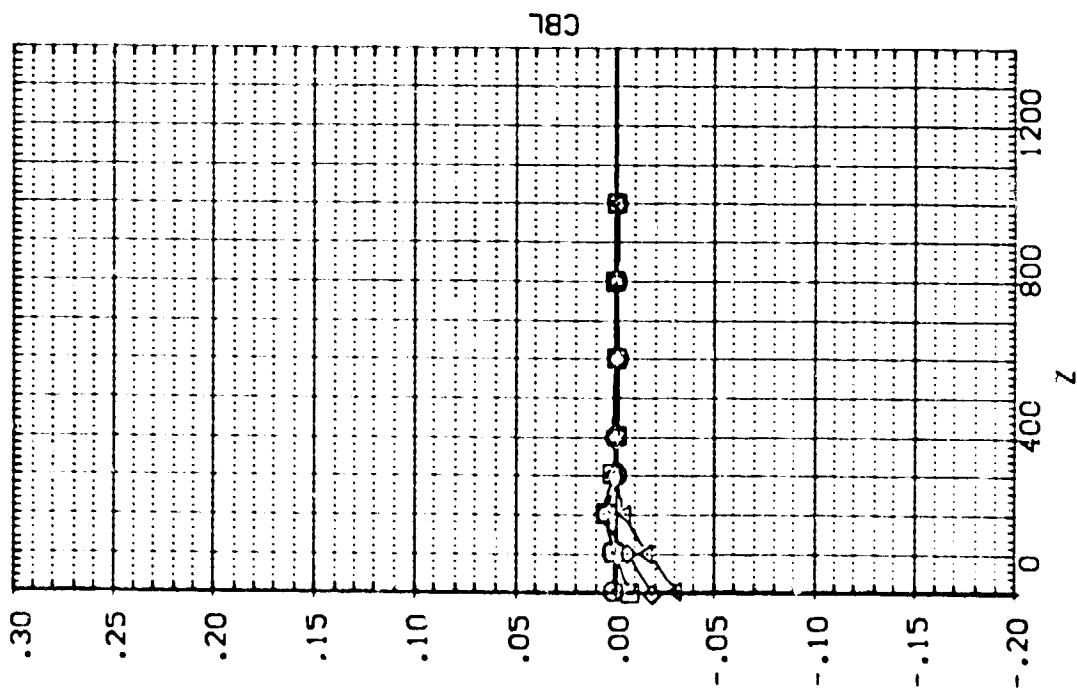
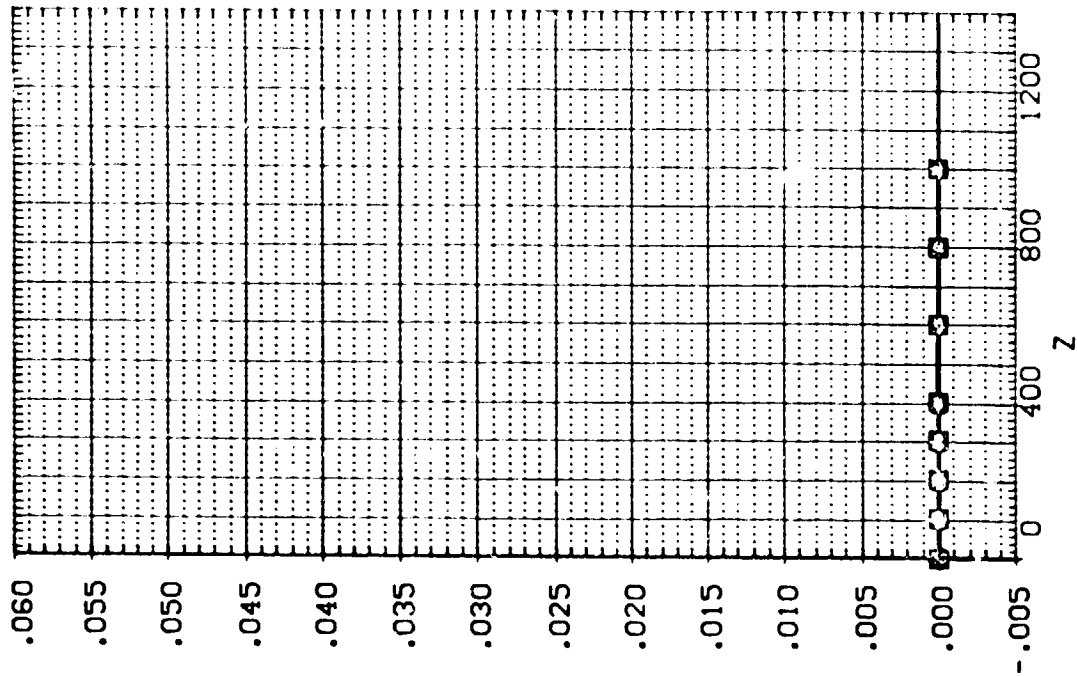

EXTERNAL TANK AERODYNAMIC CHARACTERISTICS DURING SEPARATION FROM ORBITER

1A13. EXTERNAL TANK(110) SEPARATING FROM ORB. 09 (RTJT03)

SEE THE ASSOCIATED DATA DOCUMENT FOR REFERENCE CHARACTERISTICS FOR INDIVIDUAL DATASETS

SYMBOL		PARAMETRIC VALUES	
x	-1.003	MACH	4.530
	400.330	ALPHA	.000
	600.510	DALPHA	.000
	1200.700	ELEVTR	.000
		Y	200.000
		PTOTAL	110.000
		BETA	.000
		DBETA	.000
		A1LPON	.000

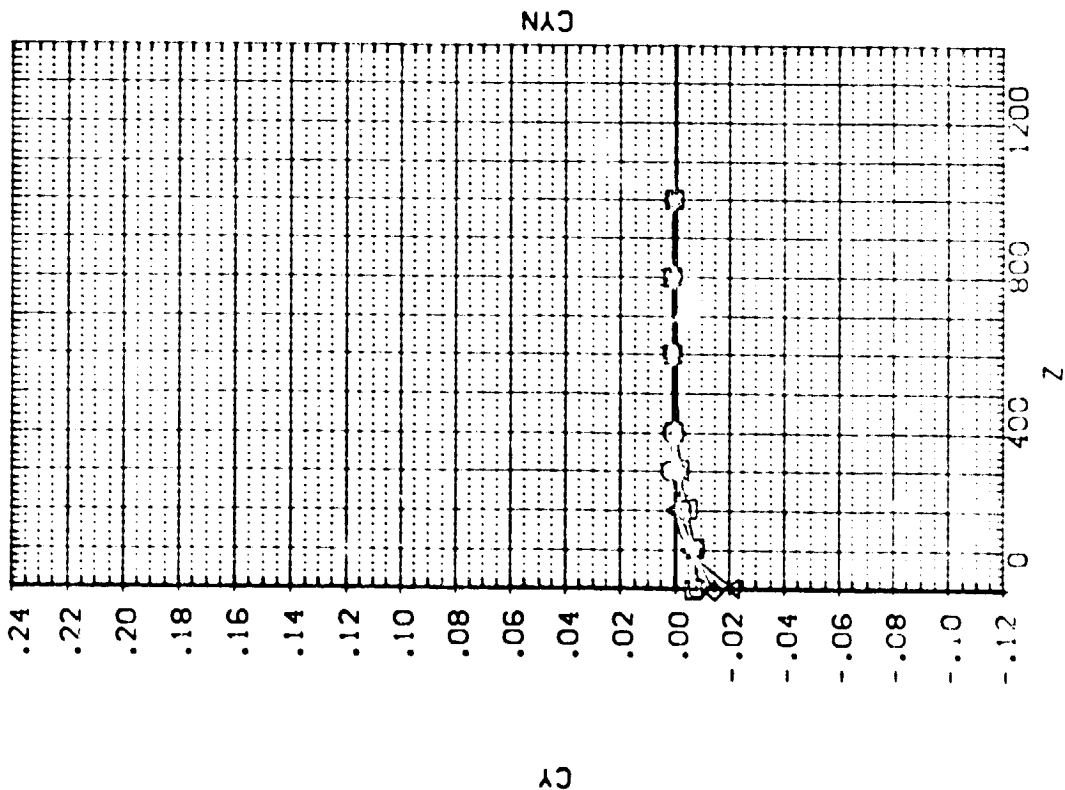
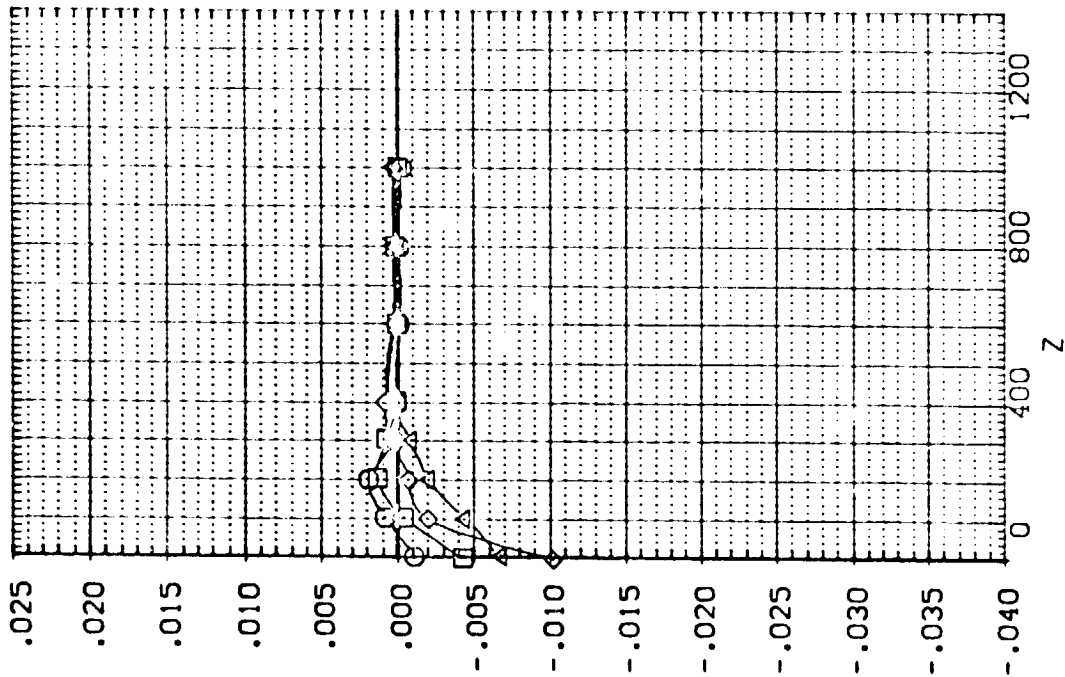

EXTERNAL TANK AERODYNAMIC CHARACTERISTICS DURING SEPARATION FROM ORBITER

IA13.EXTERNAL TANK(T10)SEPARATING FROM ORB. 09 (RIJT04)

SYMBOL x

-
-
- ◇
- △

PARAMETRIC VALUES

MACH	4.530	TOTAL	110.000
ALPHA	.000	BETA	.000
DALPHA	.000	DBETA	5.000
ELEVTR	.000	AIRTON	.000
Y	200.000		

SEE THE ASSOCIATED DATA DOCUMENT FOR REFERENCE CHARACTERISTICS FOR INDIVIDUAL DATASETS

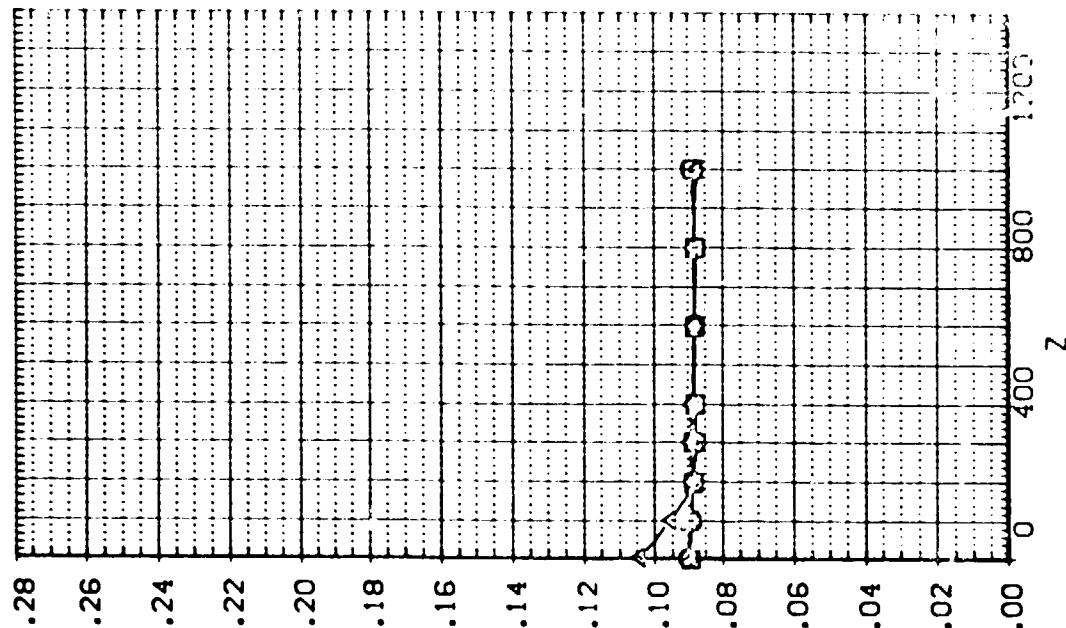
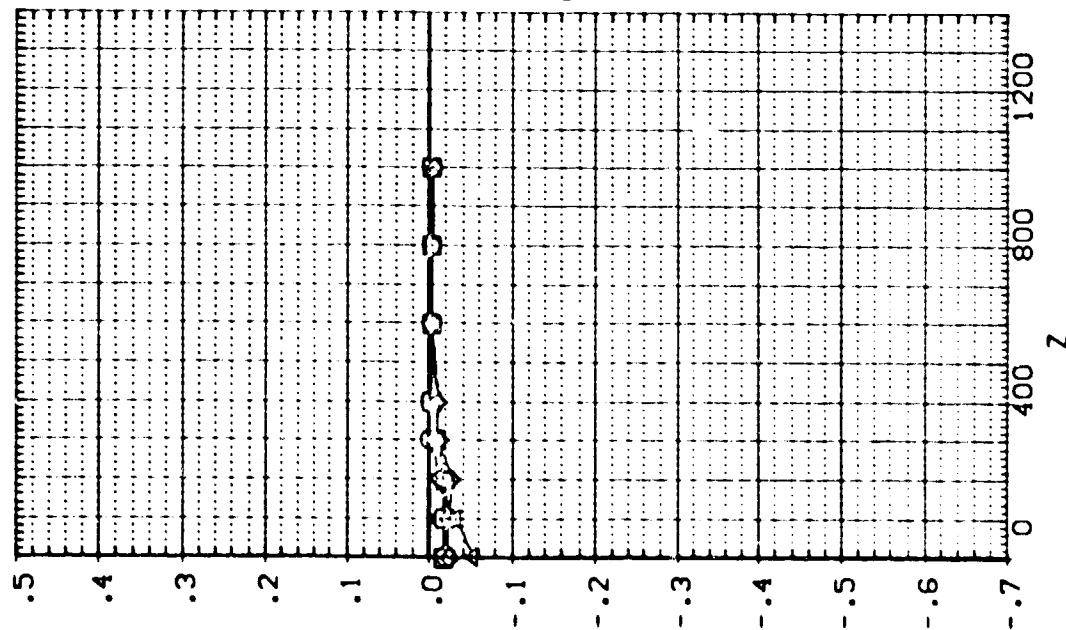

EXTERNAL TANK AERODYNAMIC CHARACTERISTICS DURING SEPARATION FROM ORBITER

1A13.EXTERNAL TANK(T10)SEPARATING FROM ORB. 09 (RTJTO4)

SEE THE ASSOCIATED DATA DOCUMENT FOR REFERENCE CHARACTERISTICS FOR INDIVIDUAL DATASETS

SYMBOL		PARAMETRIC VALUES	
○	x	MACH	4.530
□	400.280	ALPHA	.000
◇	800.430	BETA	.000
△	1200.700	DALPHA	5.000
		ELEVTR	.000
		AILRON	.000
		Y	200.000
		P.TOTAL	110.000
		BETA	.000
		DALPHA	5.000
		AILRON	.000
		Y	200.000

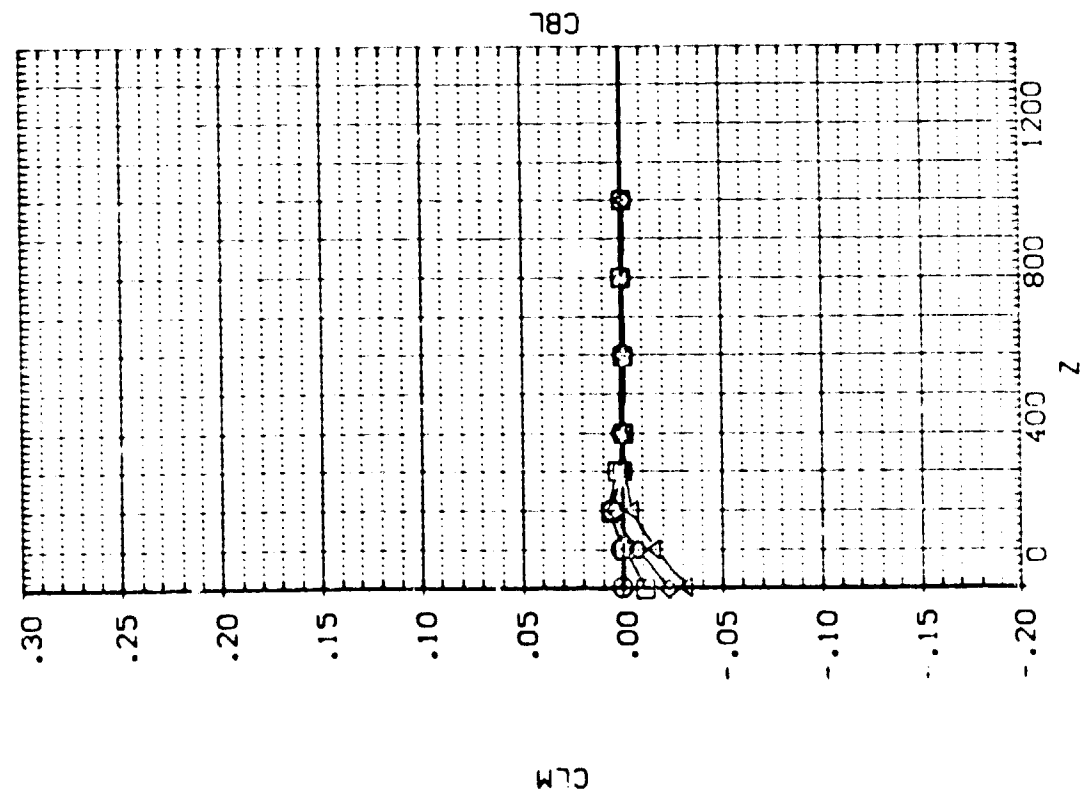
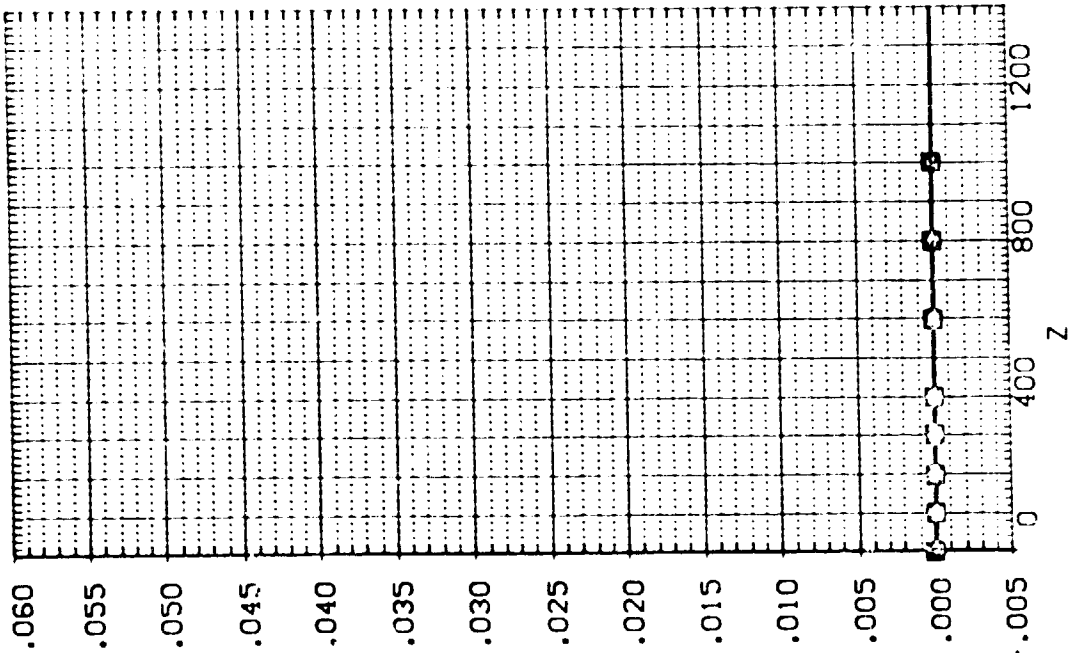

!A13.EXTERNAL TANK(T10)SEPARATING FROM ORB. 09 (RTJT04)

SYMBOL X
 ○ 400.263
 □ 800.430
 ◇ 1200.700

PARAMETRIC VALUES
 MACH 4.530 P/TOTAL 110.000
 ALPHA .000 BE .000
 DALPHA .000 DBETA 5.000
 ELEVTR .000 A11R04 .000
 Y 200.000

SEE THE ASSOCIATED DATA DOCUMENT FOR REFERENCE CHARACTERISTICS FOR INDIVIDUAL DATASETS

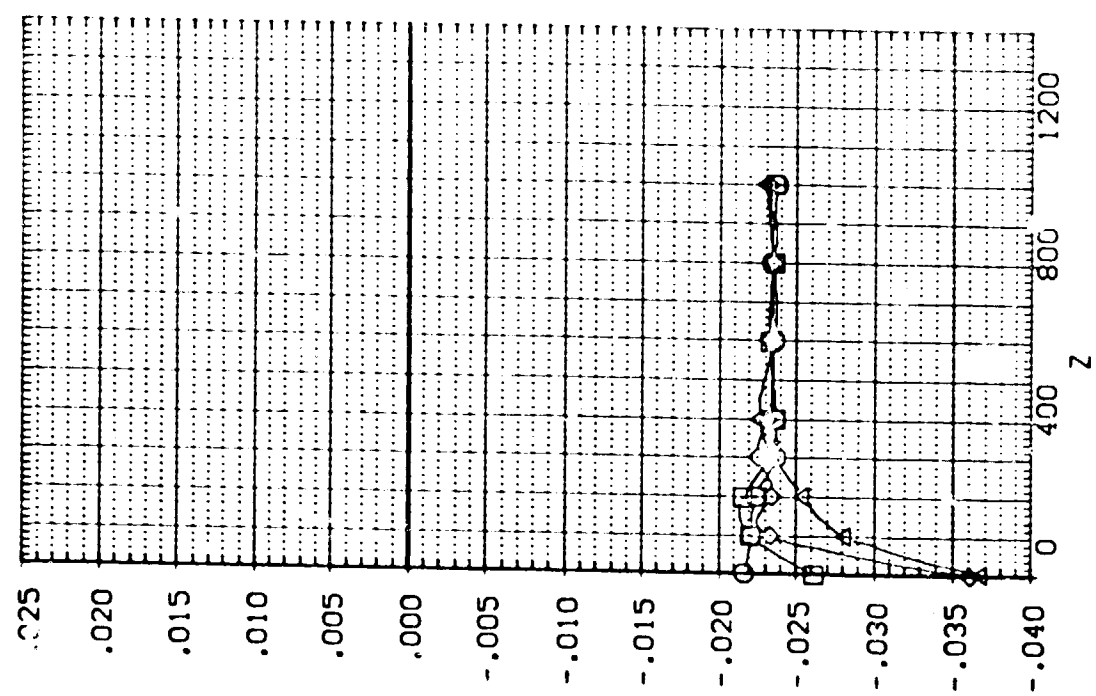
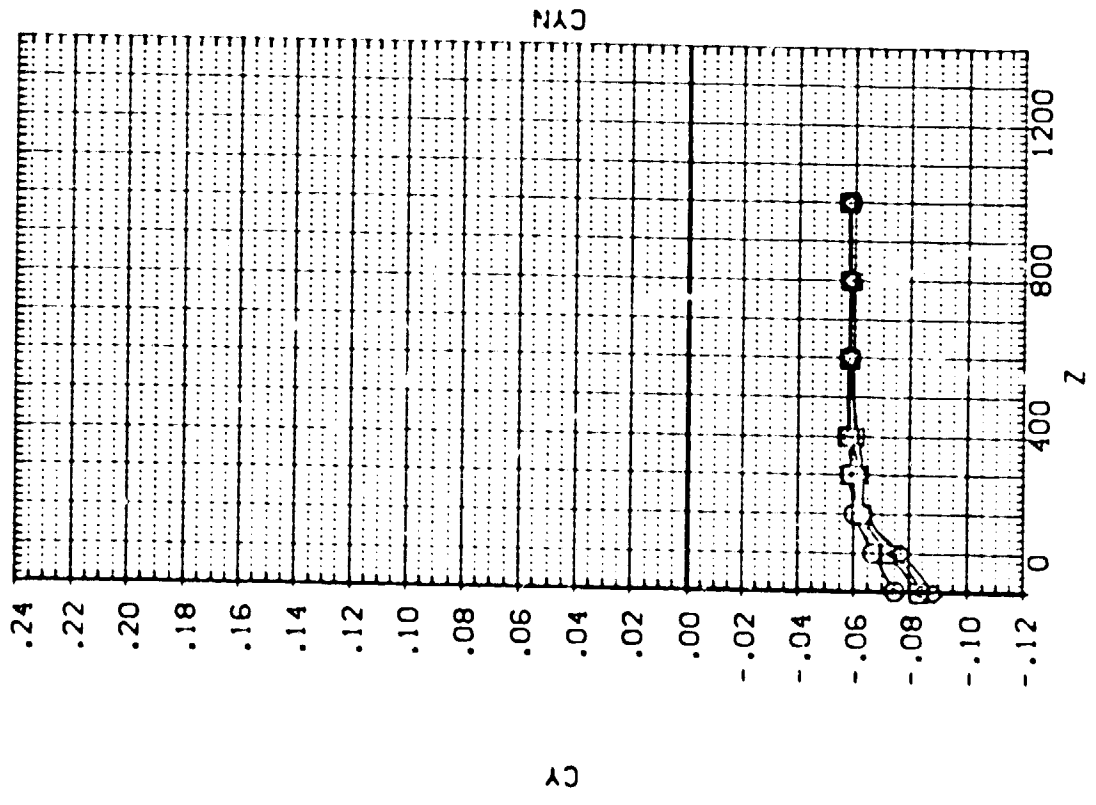

EXTERNAL TANK AERODYNAMIC CHARACTERISTICS DURING SEPARATION FROM ORBITER

IA13, EXTERNAL TANK(T10) SEPARATING FROM ORB. 09 (RTJ105)

SEE THE ASSOCIATED DATA DOCUMENT FOR REFERENCE CHARACTERISTICS FOR INDIVIDUAL DATASETS

SYMBOL X
 ○
 □
 ◇
 △

PARAMETRIC VALUES
 4.530 PTOTAL 110.000
 .000 BETA .000
 .000 CBETA 5.000
 .000 AILRON .000
 .000

MACH
 ALPHA
 DALPHA
 ELEVTR
 Y

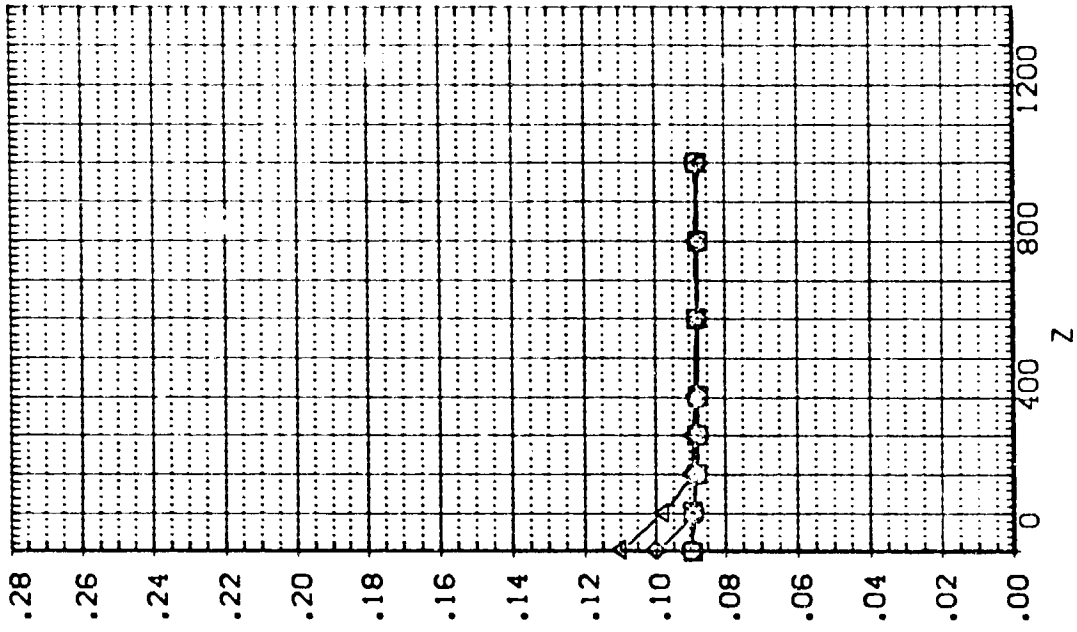
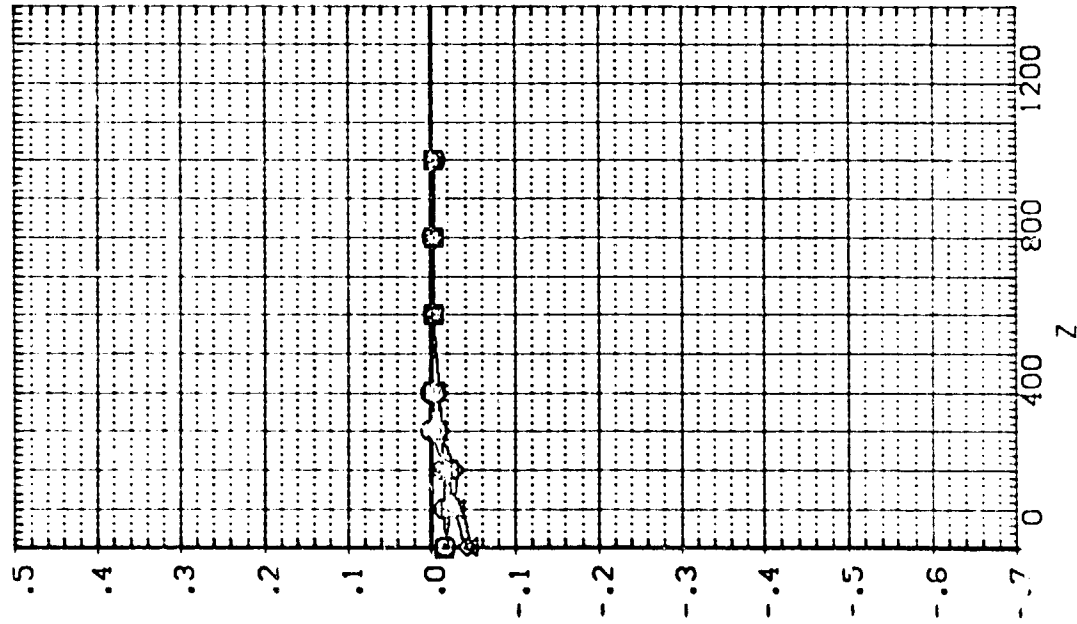

IA13, EXTERNAL TANK (110) SEPARATING FROM ORB. 09 (RTJT05)

SEE THE ASSOCIATED DATA DOCUMENT FOR REFERENCE CHARACTERISTICS FOR INDIVIDUAL DATASETS

SYMBOL	X	PARAMETRIC VALUES			
		MACH	PTOTAL	110.000	
○	400.480	ALPHA	.000	BETA	.000
□	800.570	DALPHA	.000	DBETA	5.000
◇	1200.600	ELEVTR	.000	ATLRON	.000
△		Y	.000		

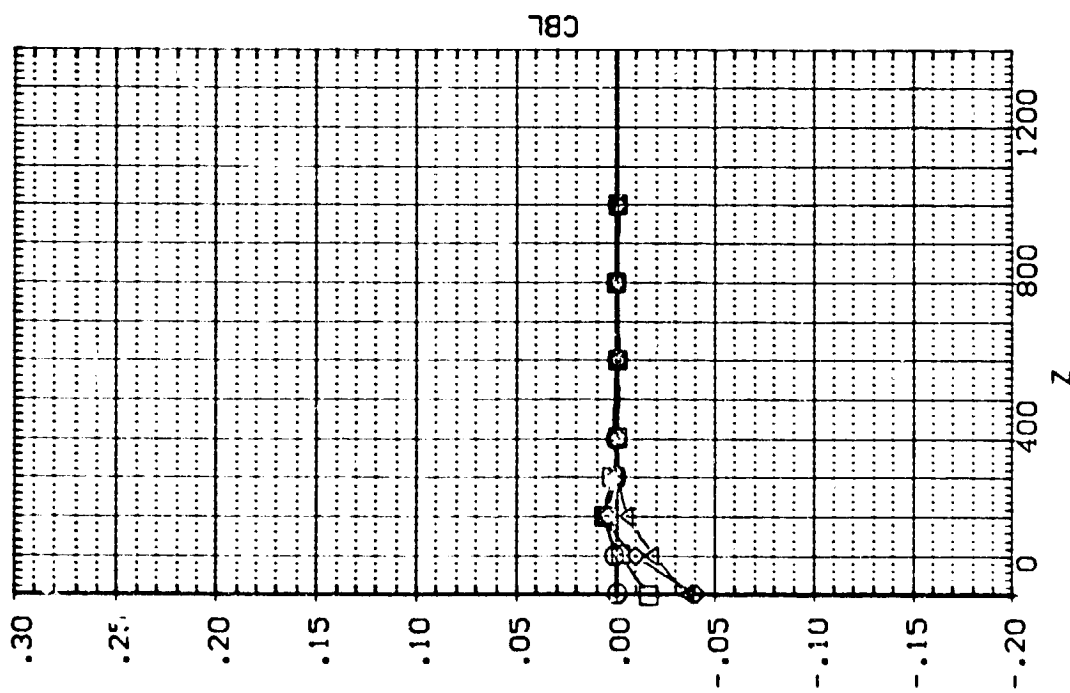
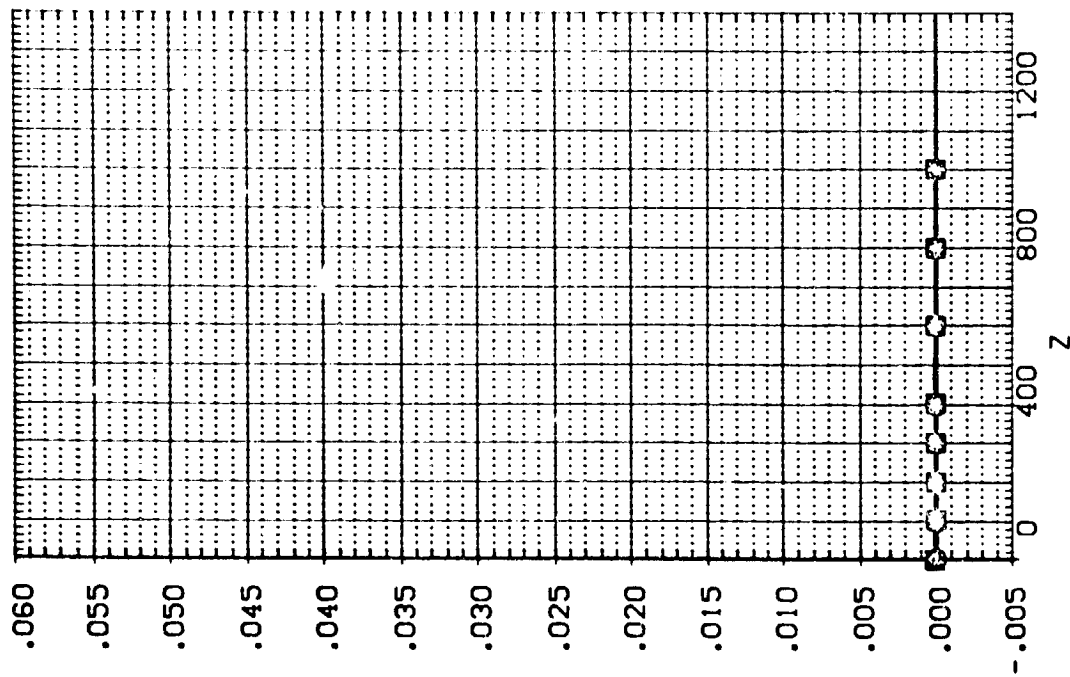

EXTERNAL TANK AERODYNAMIC CHARACTERISTICS DURING SEPARATION FROM ORBITER

[A13,EXTERNAL TANK(T10)SEPARATING FROM ORB, 09 (RTJT05)]

SEE THE ASSOCIATED DATA DOCUMENT FOR REFERENCE CHARACTERISTICS FOR INDIVIDUAL DATASETS

SYMBOL		PARAMETRIC VALUES			
○	X	MACH	PTOTAL	BETA	Y
□	400,480	4.530	110.000	.000	.000
◇	800,570	.000	DBETA	5.000	
△	1200,600	.000	ATLORN	.000	

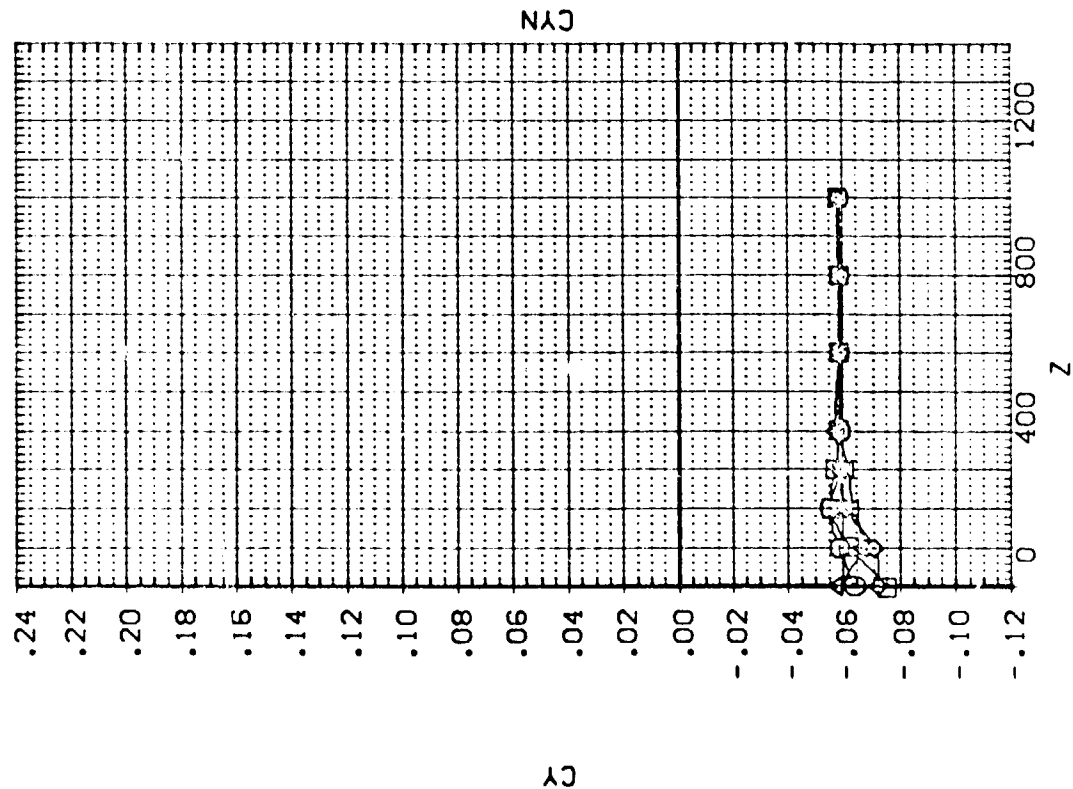
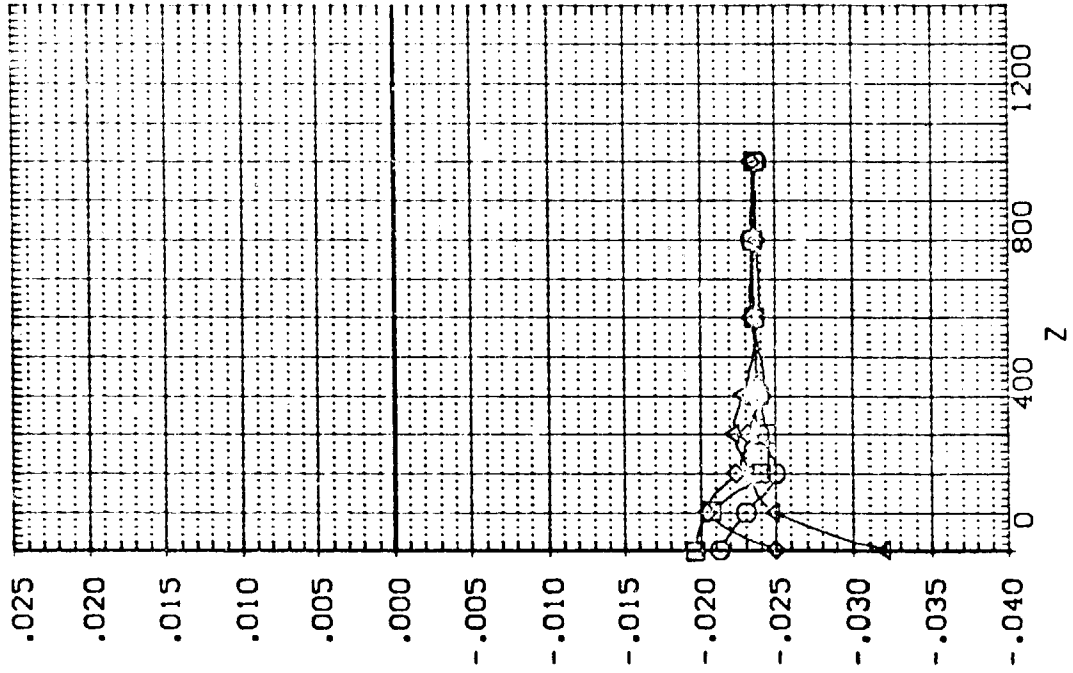

IA13, EXTERNAL TANK(T10) SEPARATING FROM ORB. 09 (RTJT06)

SEE THE ASSOCIATED DATA DOCUMENT FOR REFERENCE CHARACTERISTICS FOR INDIVIDUAL DATASETS

SYMBOL		PARAMETRIC VALUES	
○	X	MACH	4.530
□	Y	PIOTAL	110.000
◇	Z	BETA	.000
△		DBETA	.000
		AILRON	.000
		ELEVTR	.000
		Y	.000

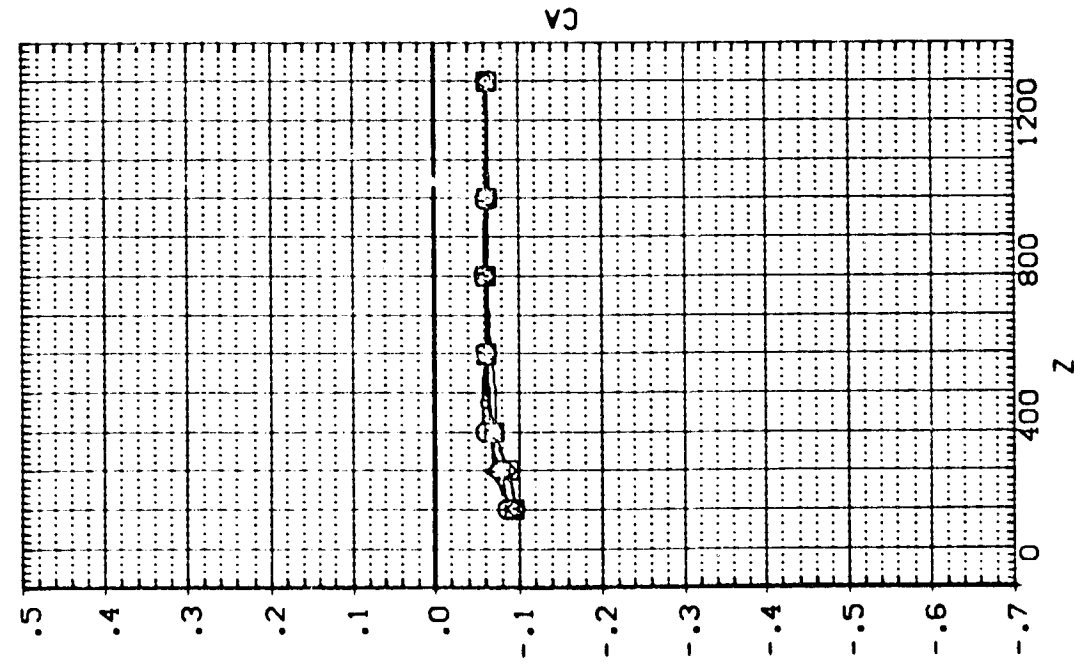
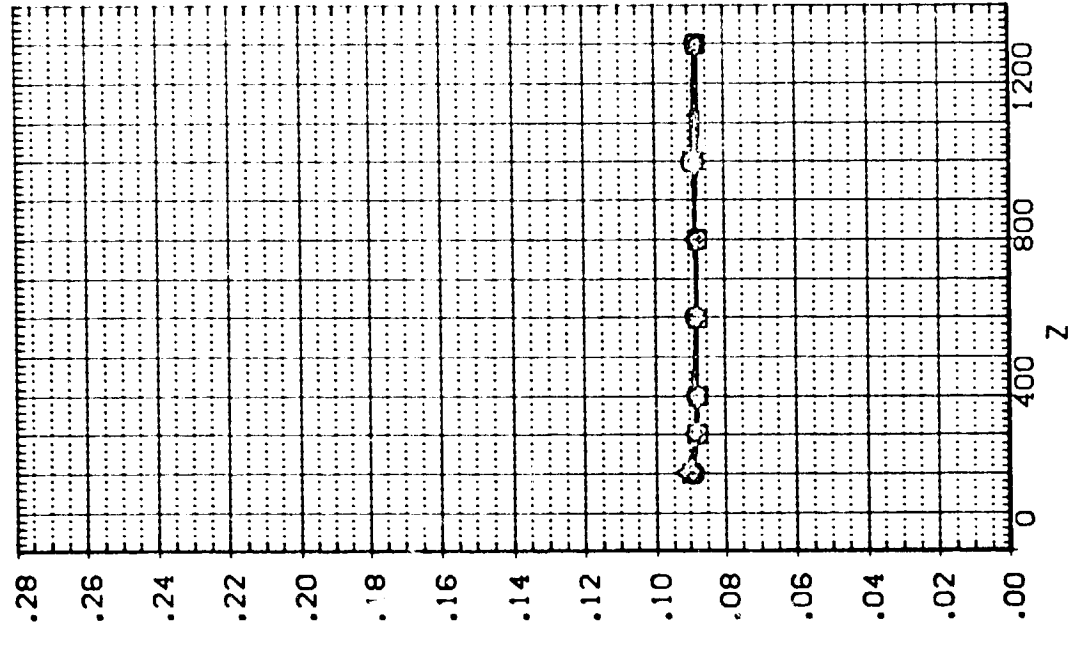

EXTERNAL TANK AERODYNAMIC CHARACTERISTICS DURING SEPARATION FROM ORBITER

[A13. EXTERNAL TANK(T10) SEPARATING FROM ORB. 09 (RTJT06)]

SEE THE ASSOCIATED DATA DOCUMENT FOR REFERENCE CHARACTERISTICS FOR INDIVIDUAL DATASETS

SYMBOL		PARAMETRIC VALUES				
○	x	.17	MACH	4.530	PTOTAL	110.000
□	400.310	ALPHA	.000	BETA	.000	
◇	800.510	DALPHA	-5.000	DBETA	.000	
△	1200.900	ELEVTR	.000	AIRTON	.000	
		Y	.000			

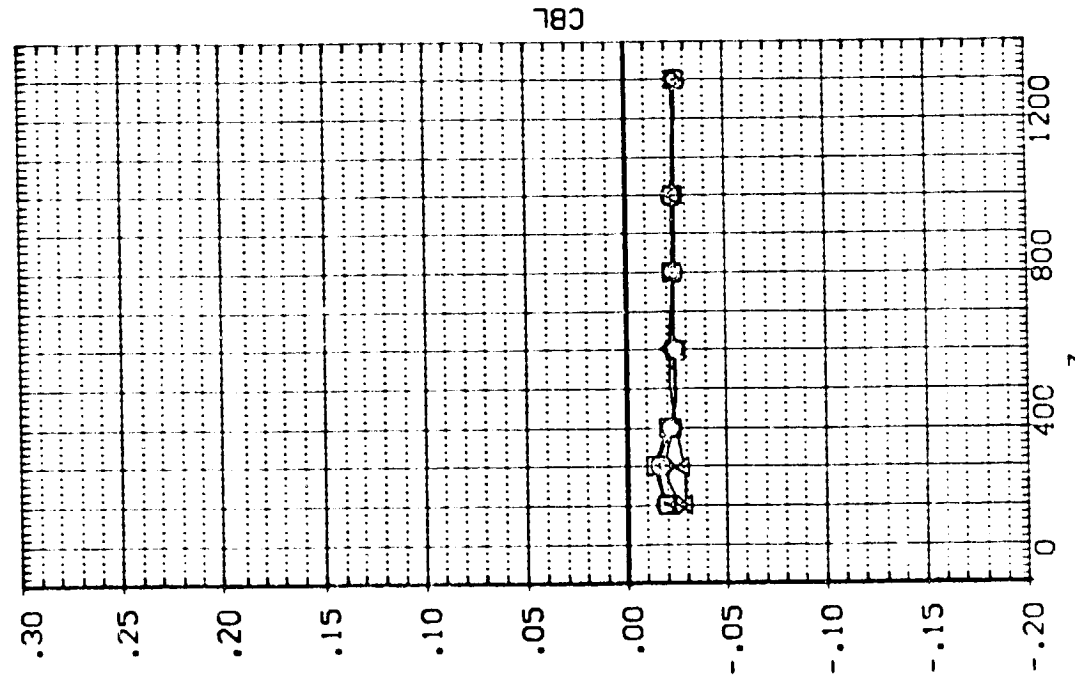
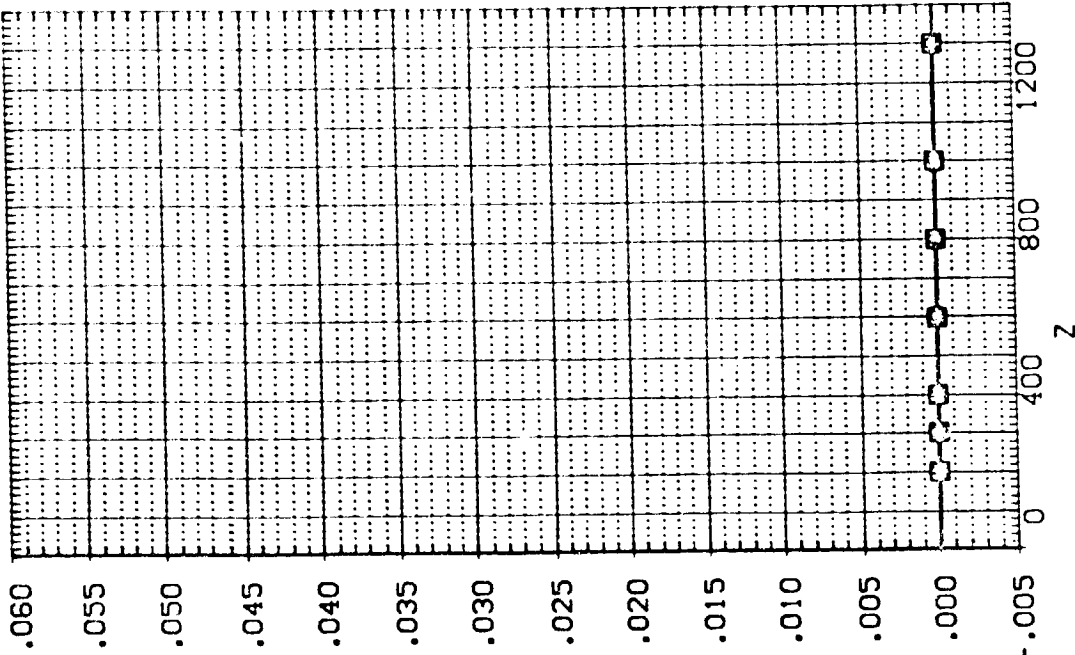

EXTERNAL TANK AERODYNAMIC CHARACTERISTICS DURING SEPARATION FROM ORBITER

IA13.EXTERNAL TANK(T10)SEPARATING FROM ORB. 09 (RTJT06)

SYMBOL
 ○
 □
 ◇
 △

PARAMETRIC VALUES
 X .117 MACH 4.530 PTOTAL 110.000
 400.310 ALPHA .000 BETA .000
 800.510 DALPHA -5.000 DBETA .000
 1200.900 ELEVTR .000 AILRON .000
 Y .000

SEE THE ASSOCIATED DATA DOCUMENT FOR REFERENCE CHARACTERISTICS FOR INDIVIDUAL DATASETS

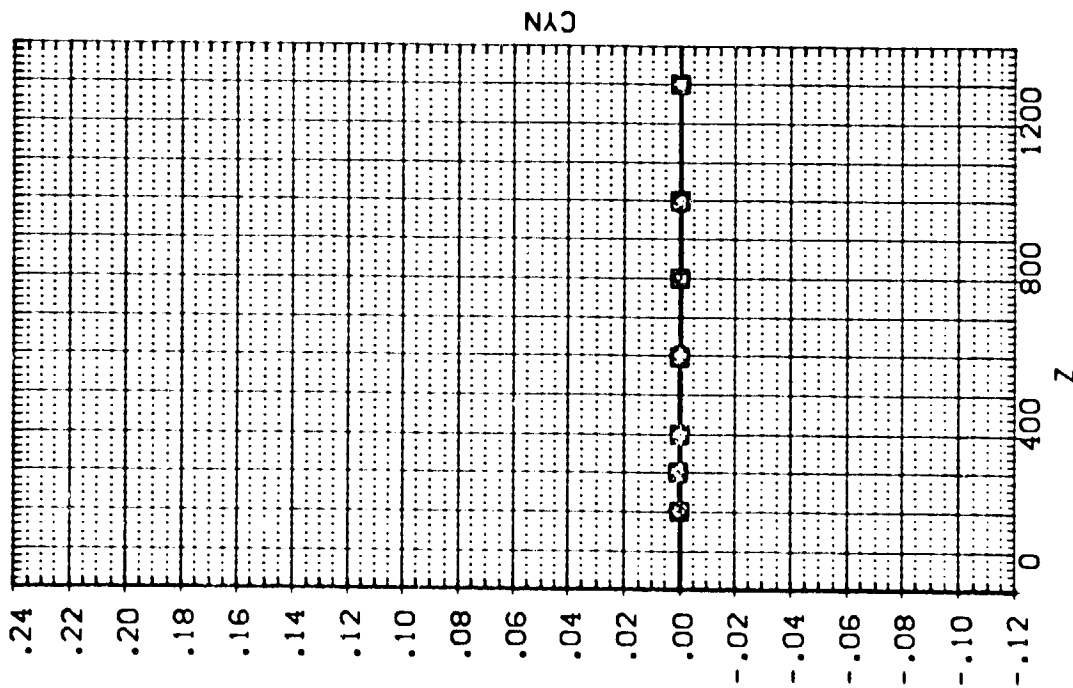
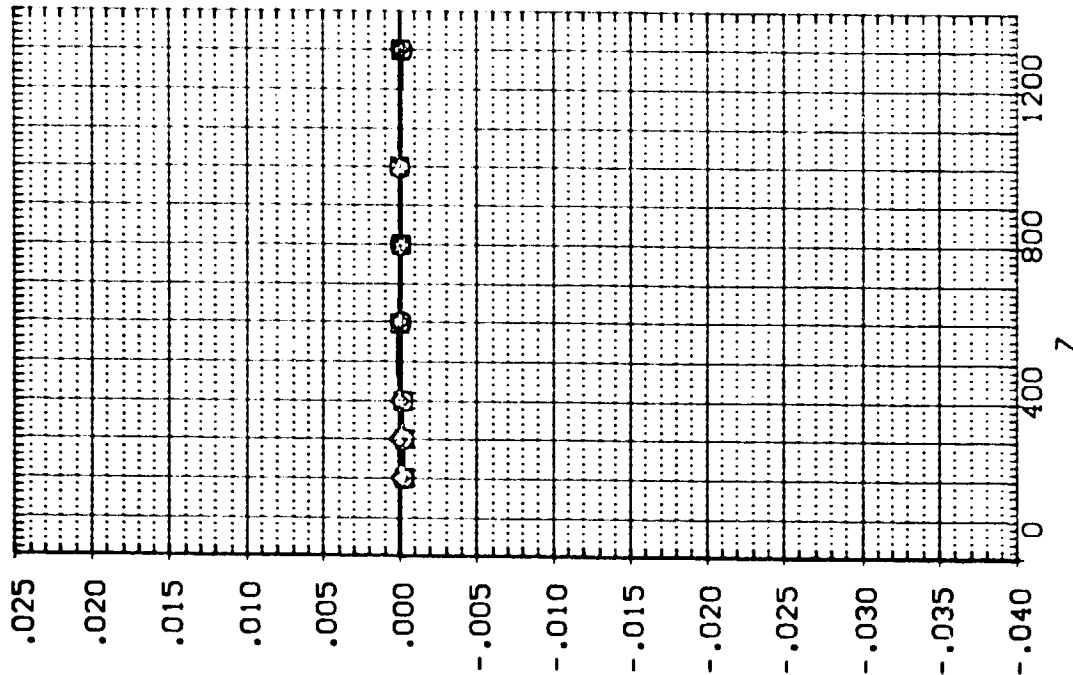

EXTERNAL TANK AERODYNAMIC CHARACTERISTICS DURING SEPARATION FROM ORBITER

1A13.EXTERNAL TANK(T10)SEPARATING FROM ORB. 09 (RTJT07)

SEE THE ASSOCIATED DATA DOCUMENT FOR REFERENCE CHARACTERISTICS FOR INDIVIDUAL DATASETS

SYMBOL		PARAMETRIC VALUES	
x	.057	MACH	4.530
		P TOTAL	110.000
□	400.130	ALPHA	.000
		BETA	.000
◇	800.500	DALPHA	-10.000
		DBETA	.000
△	1200.700	ELEVTR	.000
		AILLON	.000
		Y	.000

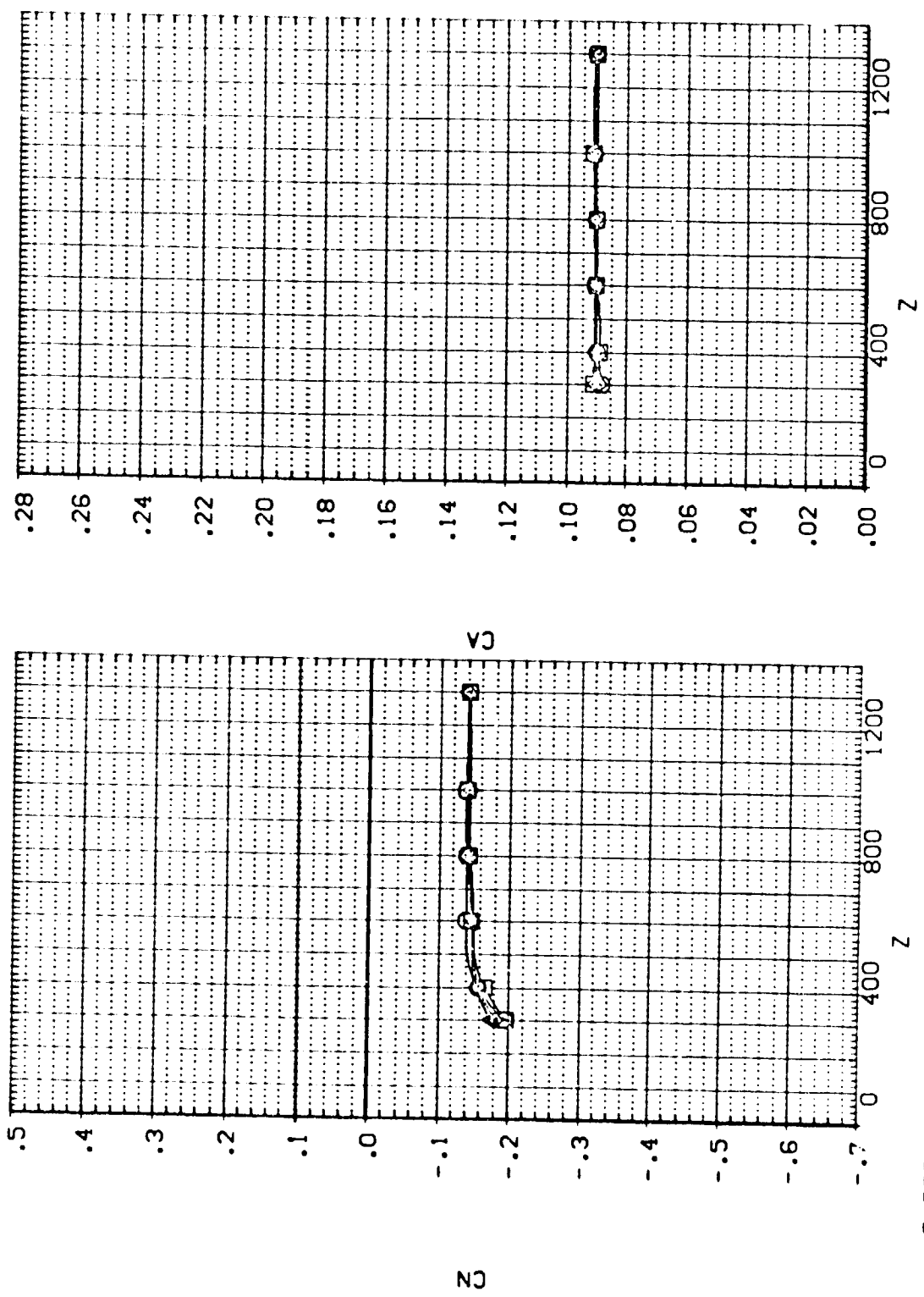

EXTERNAL TANK AERODYNAMIC CHARACTERISTICS DURING SEPARATION FROM ORBITER

IA13.EXTERNAL TANK(T10)SEPARATING FROM ORB. 09 (RTJT07)

SEE THE ASSOCIATED DATA DOCUMENT FOR REFERENCE CHARACTERISTICS FOR INDIVIDUAL DATASETS

SYMBOL		PARAMETRIC VALUES	
○	.057	MACH	4.530
□	400.430	ALPHA	.000
◇	800.500	DALPHA	-10.000
△	1200.700	ELEVTR	.000
		Y	.000
		P/TOTAL	110.000
		BETA	.000
		DBETA	.000
		AILRON	.000
		Y	.000

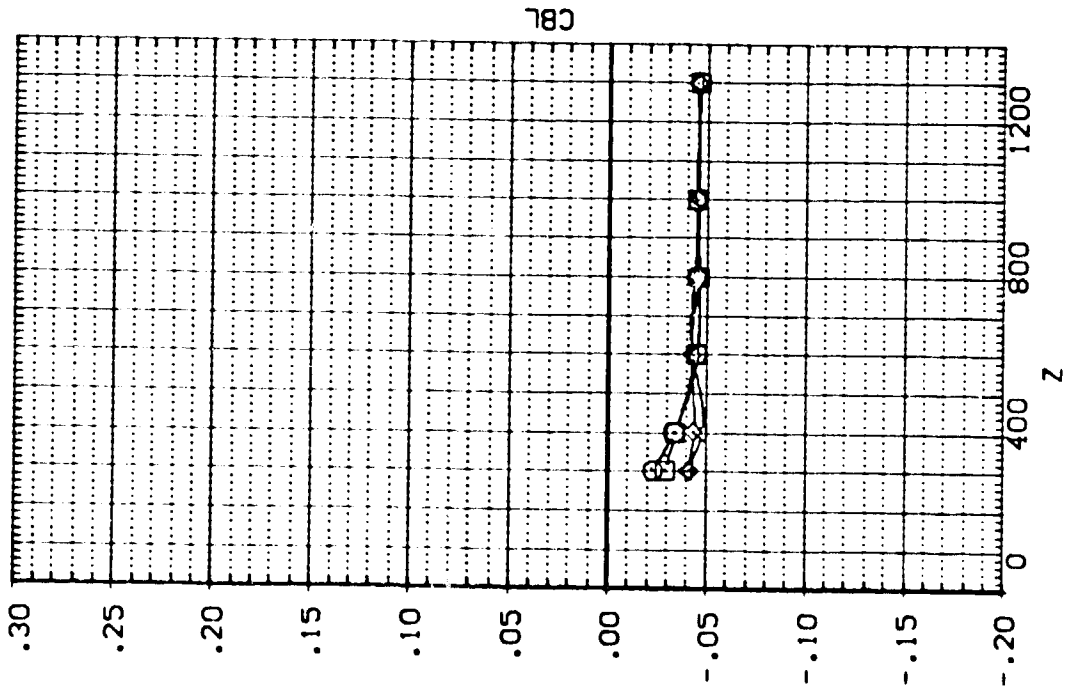
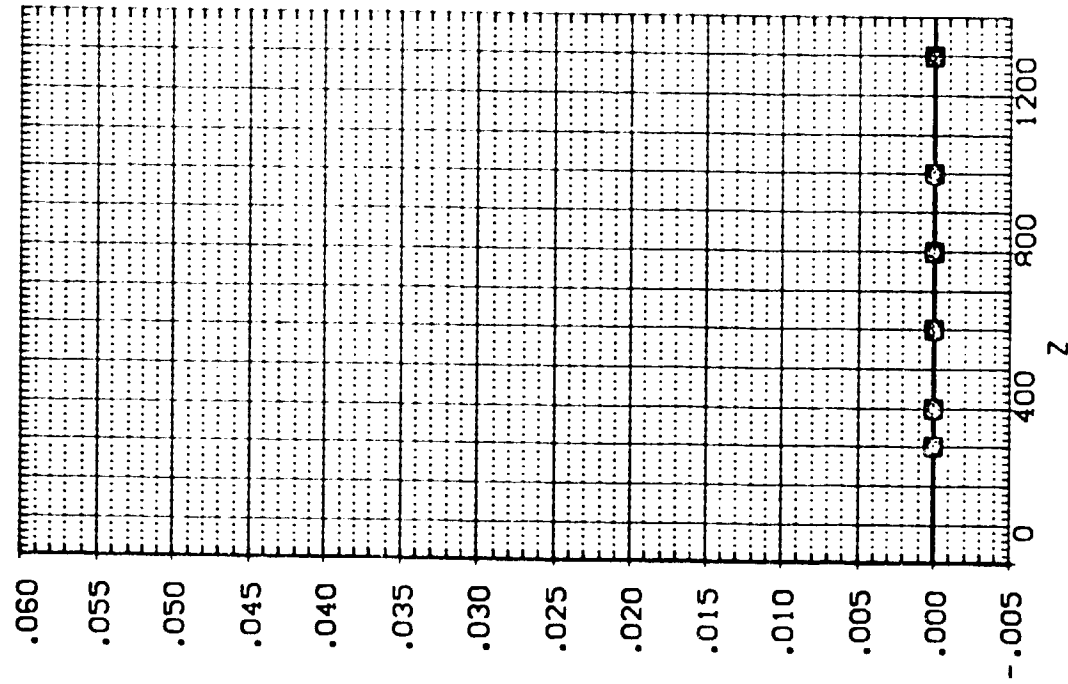

EXTERNAL TANK AERODYNAMIC CHARACTERISTICS DURING SEPARATION FROM ORBITER

[A13,EXTERNAL TANK(T10)SEPARATING FROM ORB. 09 (RTJT07)

SYMBOL
 ○
 □
 ◇
 △

PARAMETRIC VALUES
 MACH 4.530 PIGITAL 110.000
 ALPHA .000 BETA .000
 DALPHA -10.000 DBETA .000
 ELEVTR .000 ATLRON .000
 Y .000

SEE THE ASSOCIATED DATA DOCUMENT FOR REFERENCE CHARACTERISTICS FOR INDIVIDUAL DATASETS

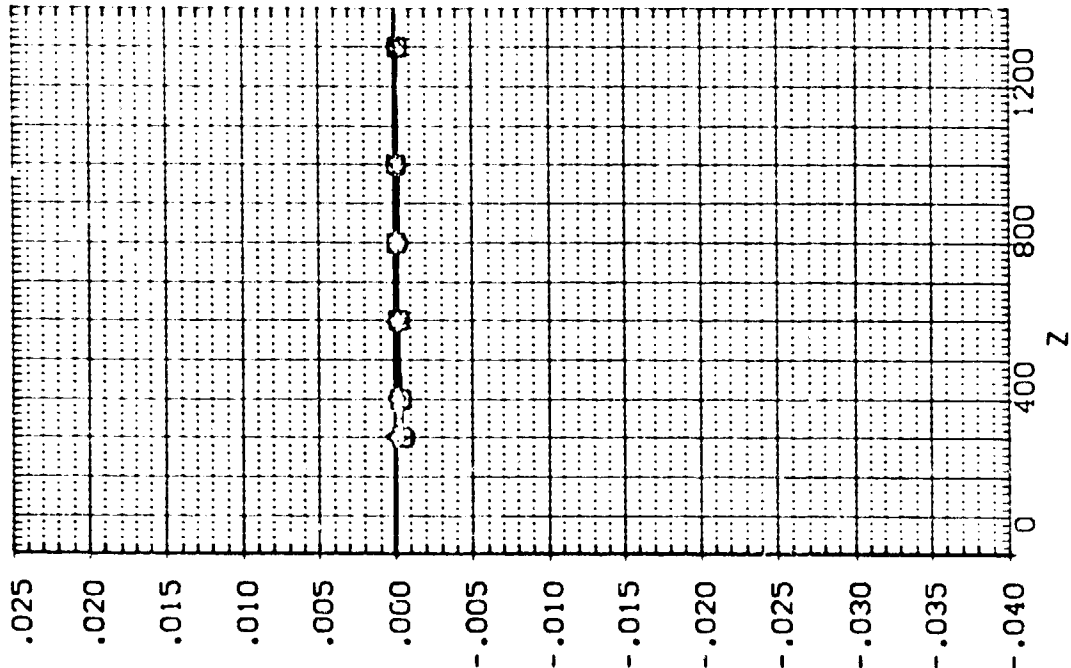
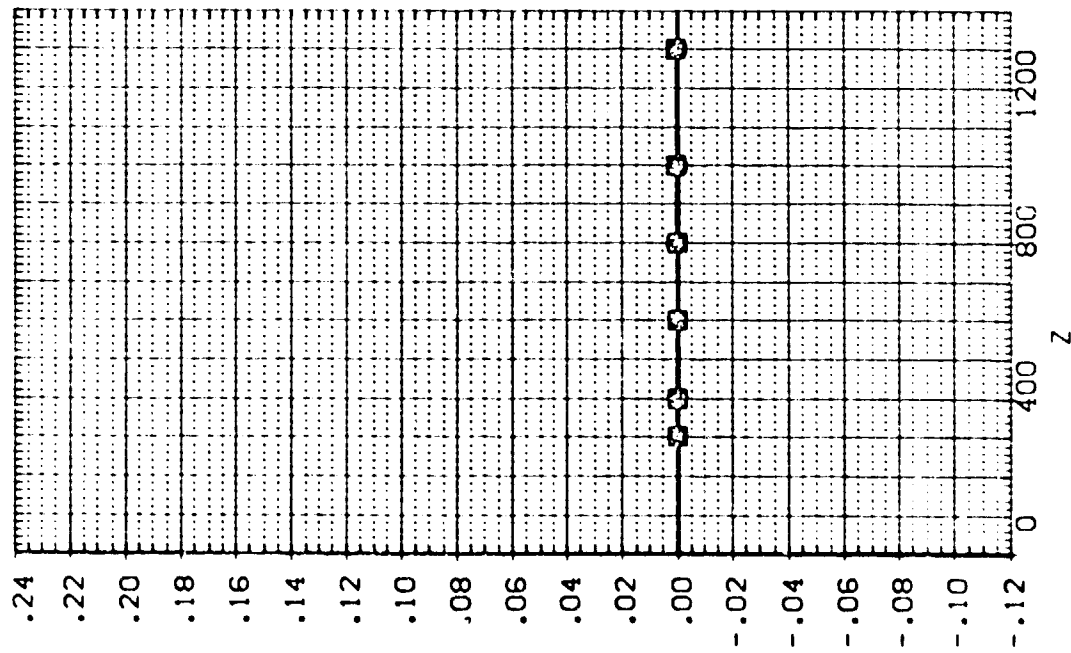

EXTERNAL TANK AERODYNAMIC CHARACTERISTICS DURING SEPARATION FROM ORBITER

IA13-EXTERNAL TANK(T10)SEPARATING FROM ORB. 09 (RTJT08)

SYMBOL X
 ○
 ◇
 △

PARAMETRIC VALUES
 MACH 4.530 P/TOTAL 110.000
 ALPHA .000 BETA .000
 DALPHA -10.000 DBETA .000
 ELEVTR .000 A/LRON .000
 Y 200.000

SEE THE ASSOCIATED DATA DOCUMENT FOR REFERENCE CHARACTERISTICS FOR INDIVIDUAL DATASETS

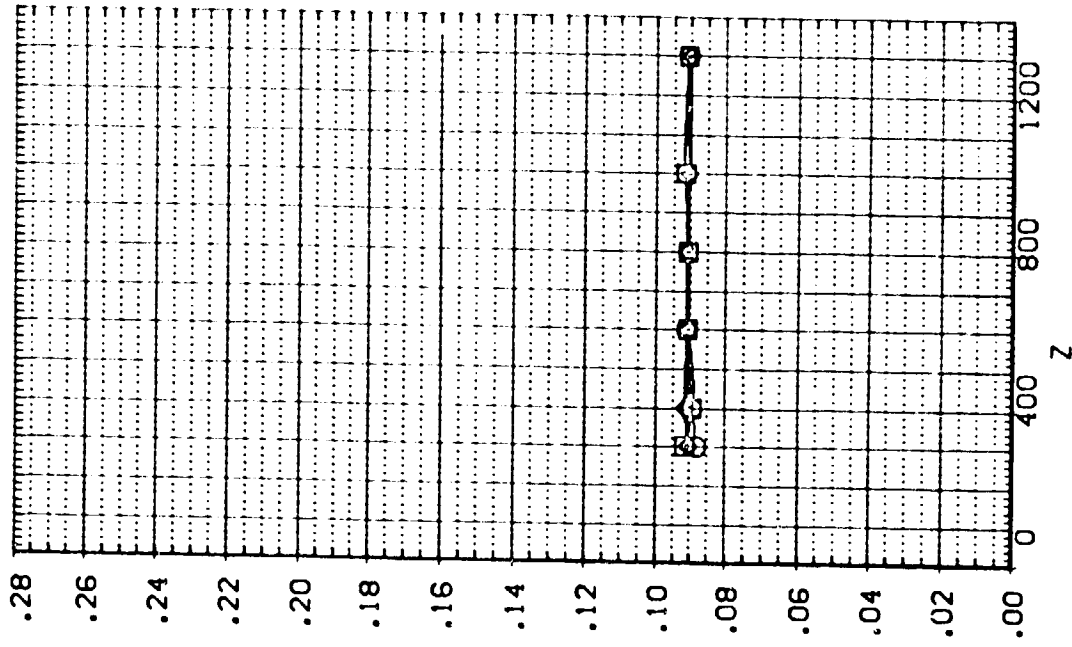
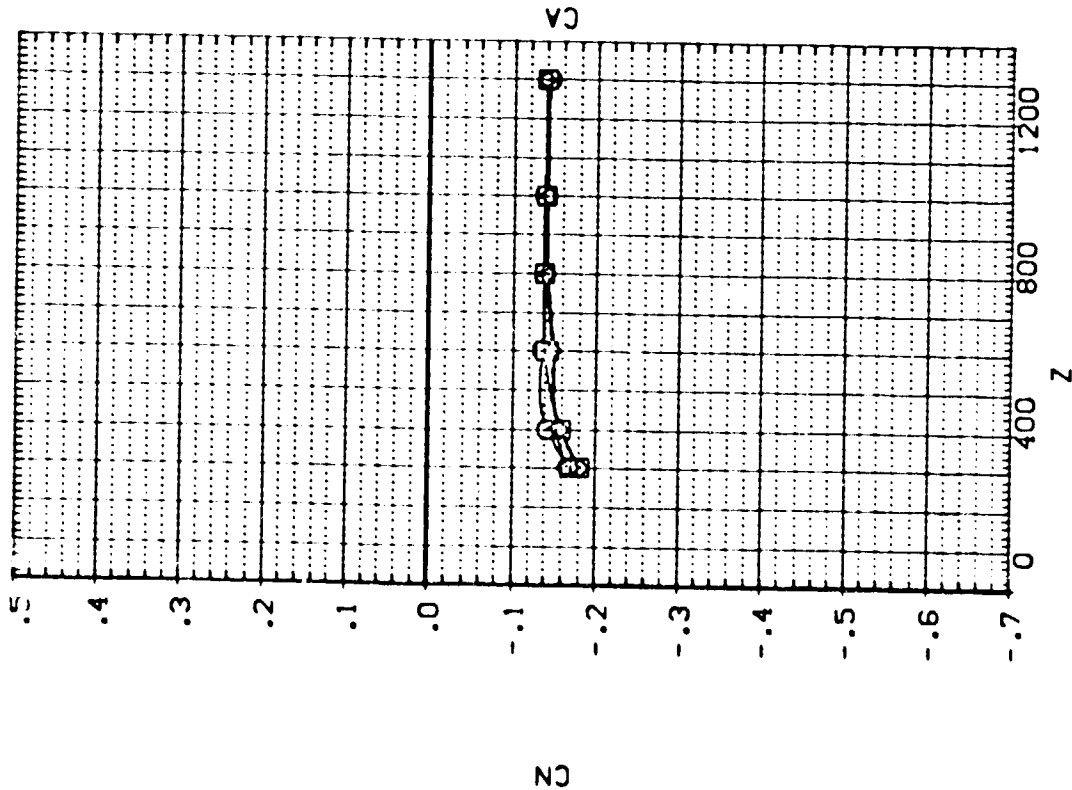

EXTERNAL TANK AERODYNAMIC CHARACTERISTICS DURING SEPARATION FROM ORBITER

1A13. EXTERNAL TANK(10) SEPARATING FROM ORB. 09 (RTJT08)

SEE THE ASSOCIATED DATA DOCUMENT FOR REFERENCE CHARACTERISTICS FOR INDIVIDUAL DATASETS

SYMBOL		PARAMETRIC VALUES				
○	X	.062	MACH	4.530	PTOTAL	110.000
○	Y	409.260	ALPHA	.000	BETA	.000
○	Z	800.620	DALPHA	-10.000	DBETA	.000
△	Y	1200.700	DELTA	.000	ALTRON	.000
				200.000		

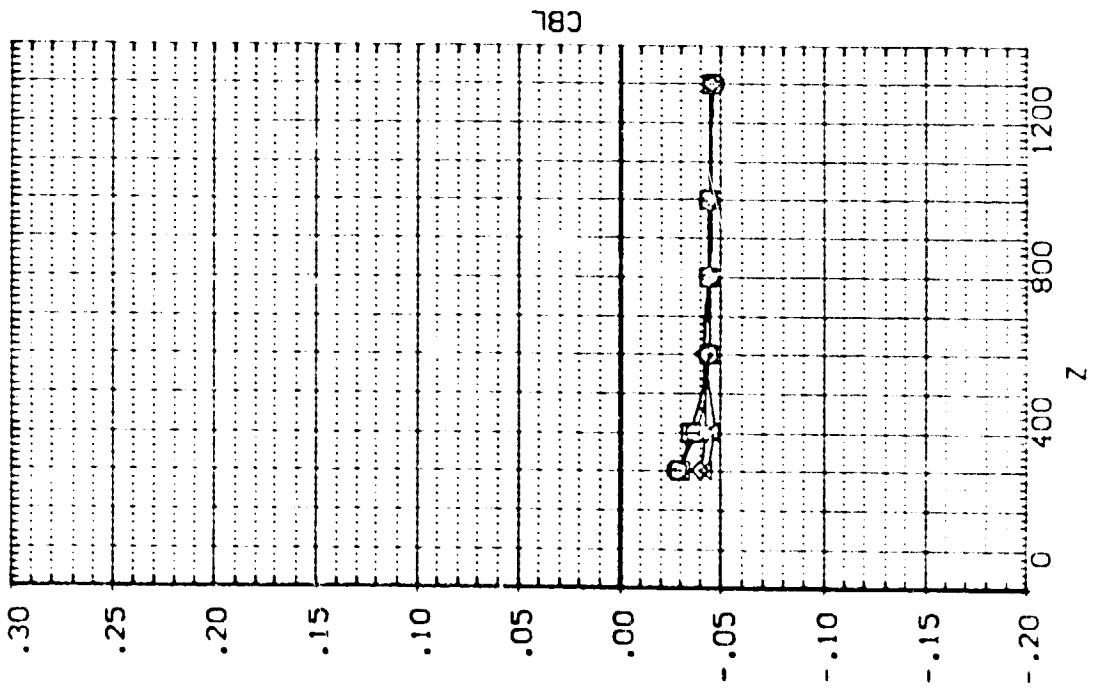
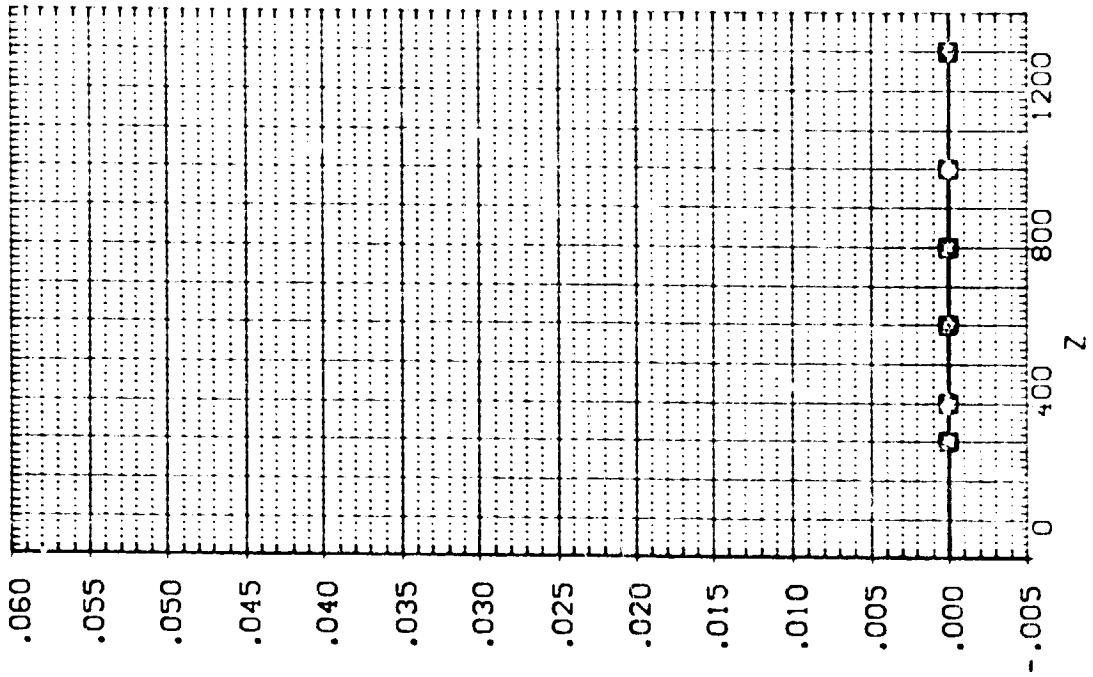

EXTERNAL TANK AERODYNAMIC CHARACTERISTICS DURING SEPARATION FROM ORBITER

SYMBOL
 ○
 ◇
 △

PARAMETRIC VALUES
 MACH 4.530 P TOTAL 110.000
 ALPHA .000 BETA .000
 DALPHA -10.000 DBETA .000
 ELEVTR .000 AILRON .000
 Y 200.000

SEE THE ASSOCIATED DATA DOCUMENT FOR REFERENCE CHARACTERISTICS FOR INDIVIDUAL DATASETS

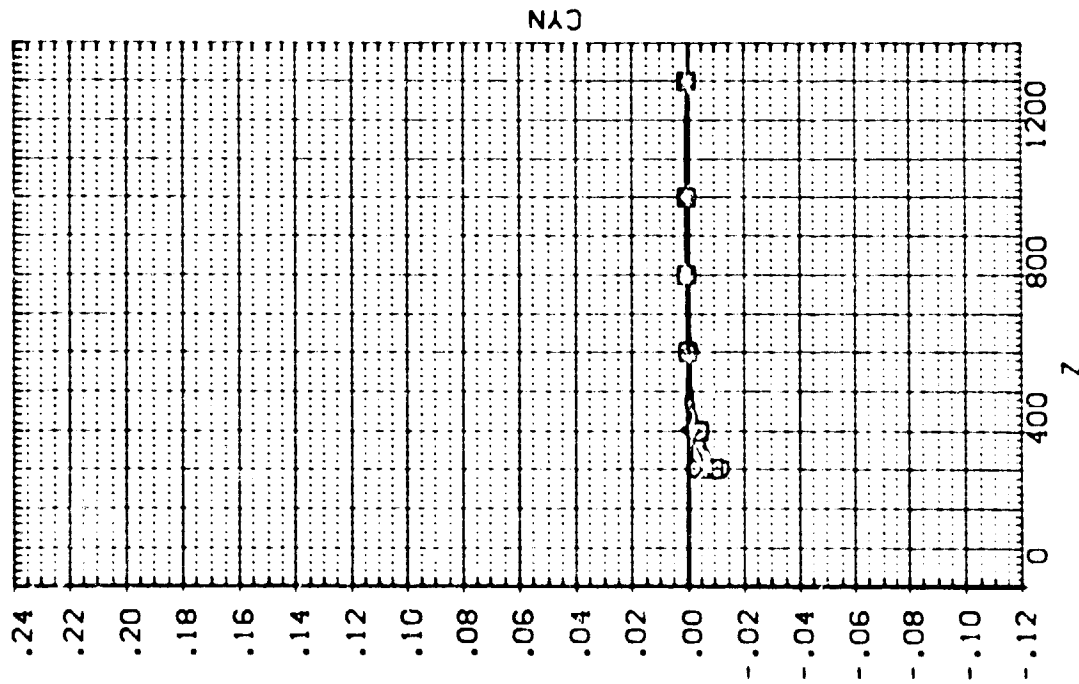
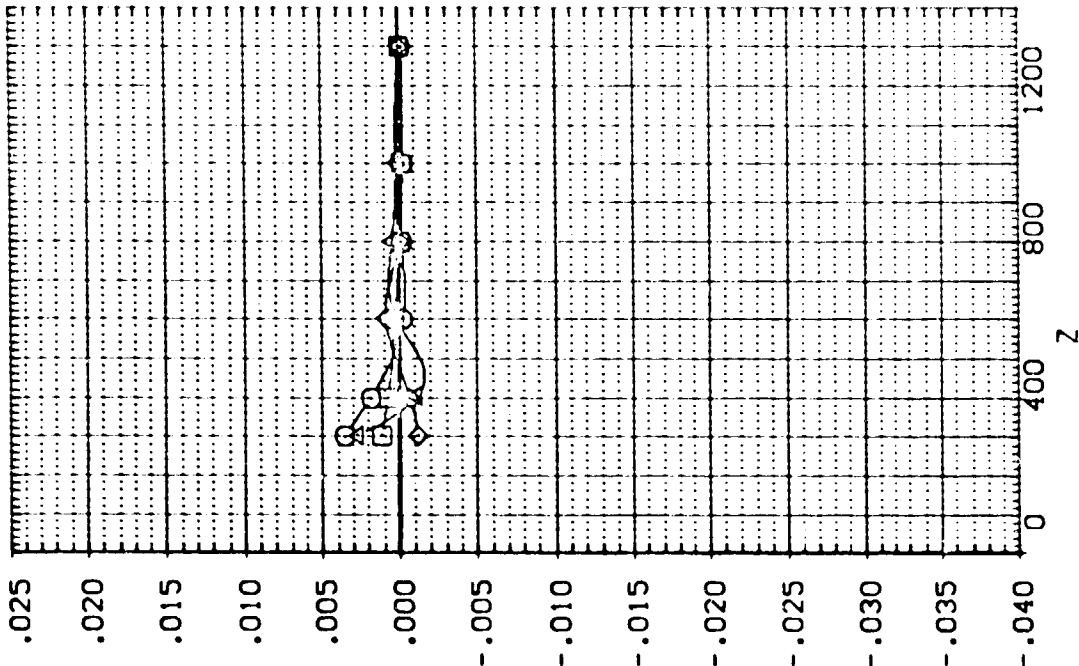

EXTERNAL TANK AERODYNAMIC CHARACTERISTICS DURING SEPARATION FROM ORBITER

1A.3. EXTERNAL TANK (10) SEPARATING FROM ORB. 09 (RTJ109)

SEE THE ASSOCIATED DATA DOCUMENT FOR REFERENCE CHARACTERISTICS FOR INDIVIDUAL DATA SETS

SYMBOL		PARAMETRIC VALUES	
○	X	MACH	110.000
○	Y	ALPHA	.000
○	Z	BETA	.000
○	U	DELTA	5.000
○	V	ELEVTR	.000
○	W	ATLRON	.000
○		PIOTAL	200.000

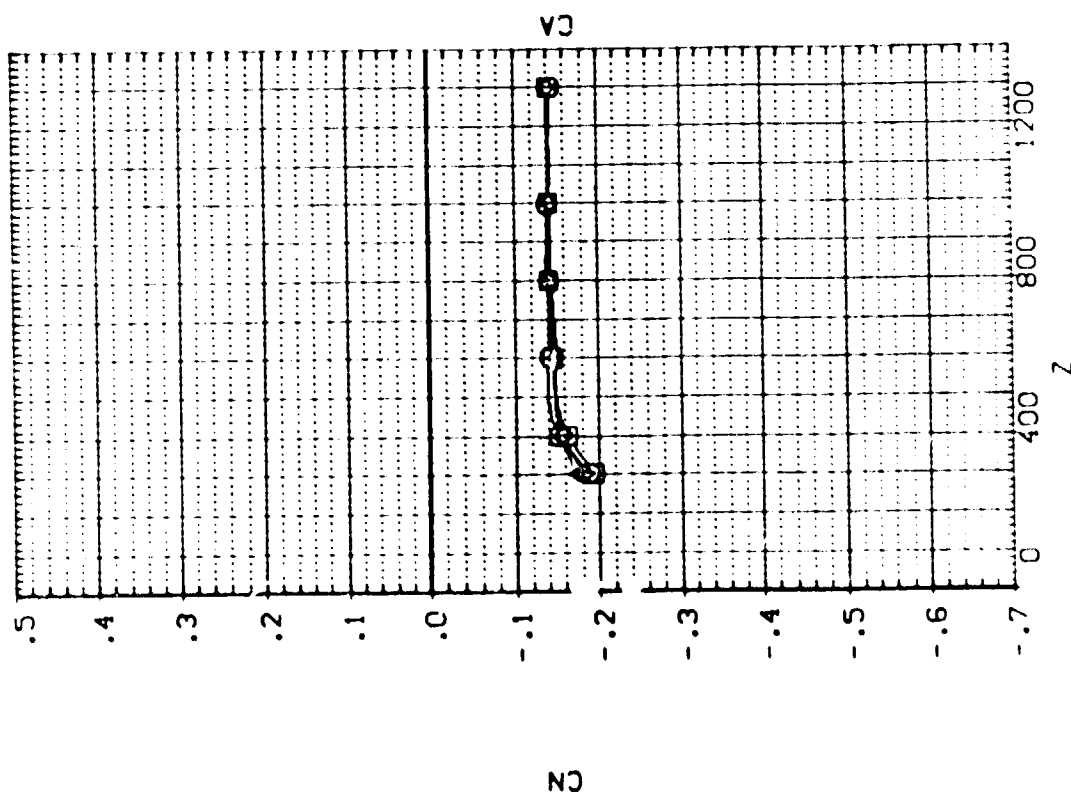
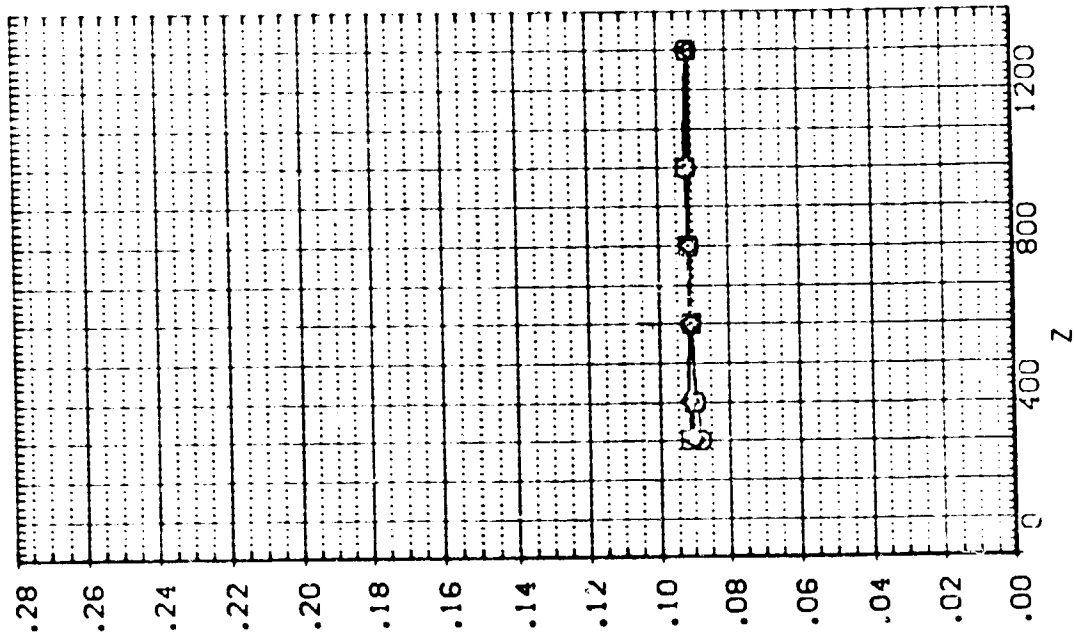

EXTERNAL TANK AERODYNAMIC CHARACTERISTICS DURING SEPARATION FROM ORBITER

:A13.EXTERNAL TANK(T10)SEPARATING FROM ORB. 09 (RIJT09)

SEE THE ASSOCIATED DATA DOCUMENT FOR REFERENCE CHARACTERISTICS FOR INDIVIDUAL DATASETS

SYMBOL	X	MACH	PARAMETRIC VALUES
○	-0.033	4.530	PTOTAL 110.000
□	400.510	ALPHA .000	BETA .000
◇	800.420	DALPHA -10.000	DBETA 5.000
△	1200.1800	ELEVTR .000	ALTRON .000
		Y	200.000

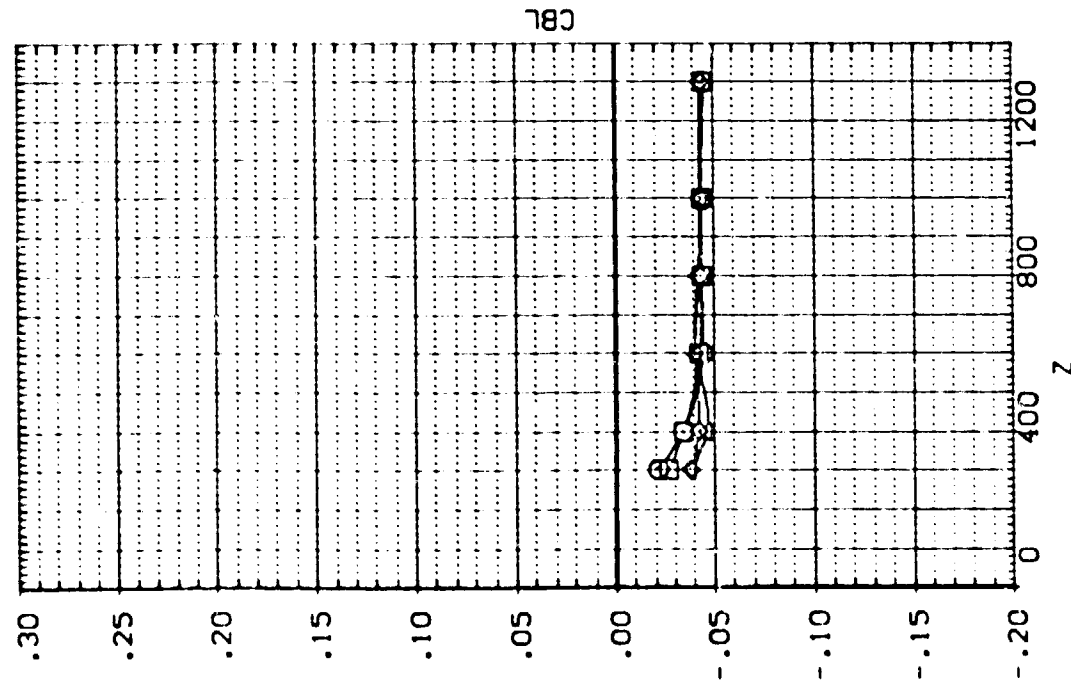
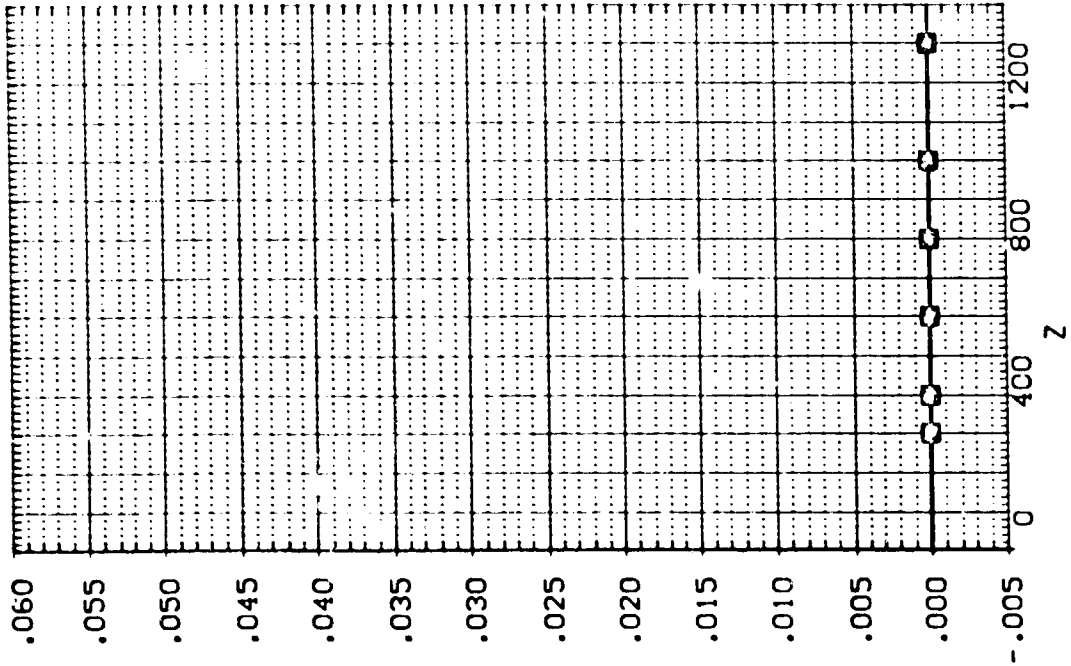

EXTERNAL TANK AERODYNAMIC CHARACTERISTICS DURING SEPARATION FROM ORBITER

IA13. EXTERNAL TANK(T10) SEPARATING FROM ORB. 09 (RTJTO9)

SEE THE ASSOCIATED DATA DOCUMENT FOR REFERENCE CHARACTERISTICS FOR INDIVIDUAL DATASETS

PARAMETRIC VALUES	
X	- .033
MACH	4.530
PTOTAL	110.000
ALPHA	.000
BETA	.000
DALPHA	-10.000
DBETA	5.000
ELEVTR	.000
AILRON	.000
Y	200.000

SYMBOL
 ○
 ◇
 △

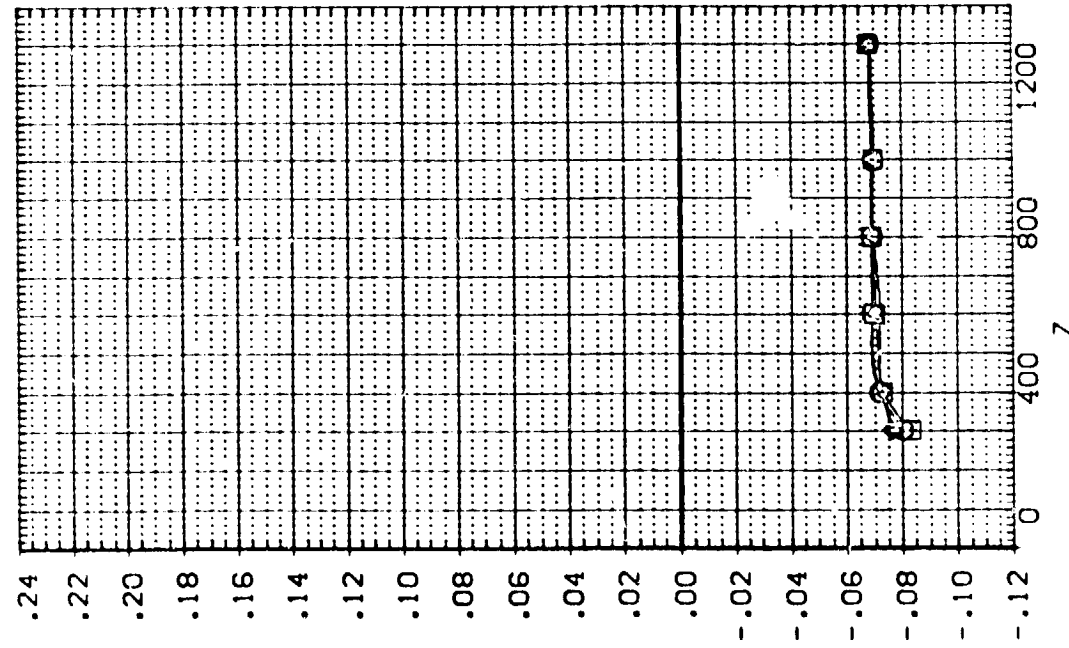
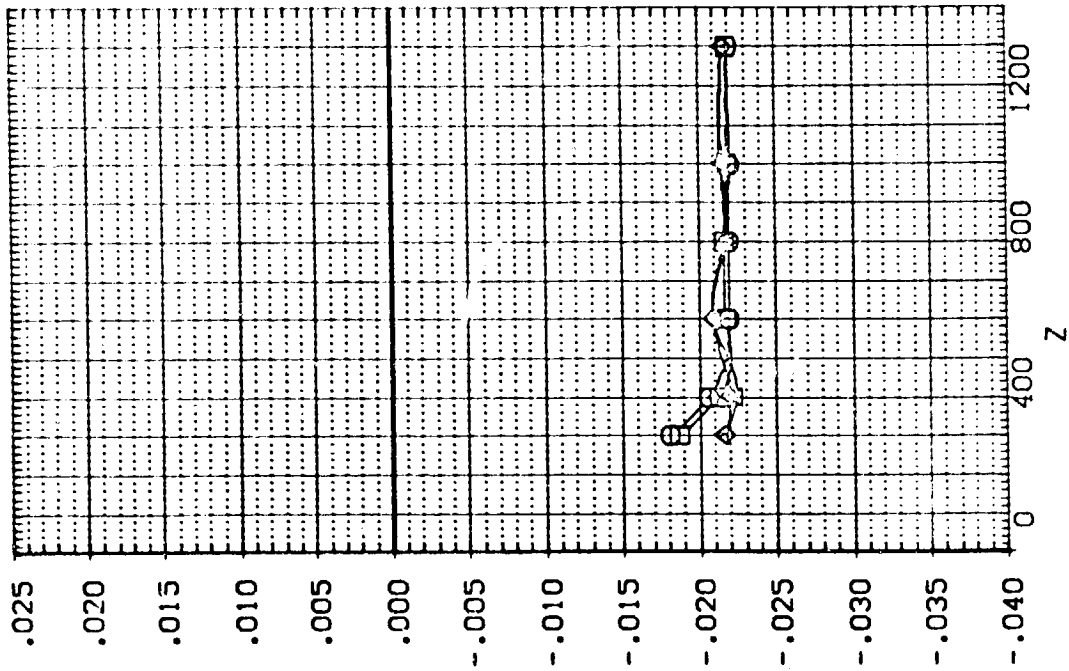

EXTERNAL TANK AERODYNAMIC CHARACTERISTICS DURING SEPARATION FROM ORBITER

IA13, EXTERNAL TANK(T10) SEPARATING FROM ORB. 09 (RTJT10)

SYMBOL

-
-
- ◇
- △

PARAMETRIC VALUES

MACH	4.530	PITOTAL	110.000
ALPHA	.000	BETA	.000
DALPHA	-10.000	DBETA	5.000
ELEVTR	.000	AIRON	.000
Y	.000		

SEE THE ASSOCIATED DATA DOCUMENT FOR REFERENCE CHARACTERISTICS FOR INDIVIDUAL DATASETS

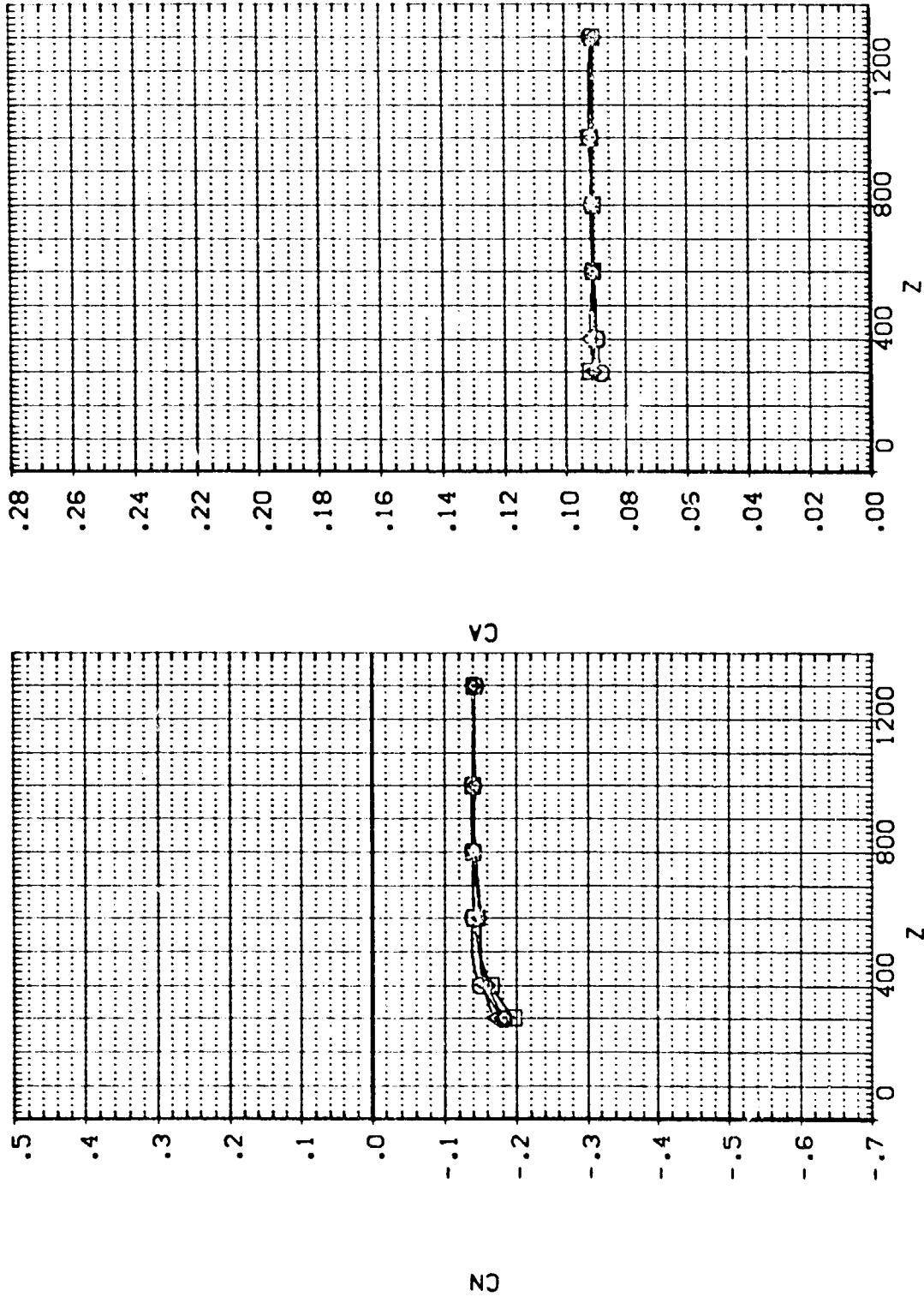

EXTERNAL TANK AERODYNAMIC CHARACTERISTICS DURING SEPARATION FROM ORBITER

IA13.EXTERNAL TANK(T10)SEPARATING FROM ORB. 09 (RTJT10)

SEE THE ASSOCIATED DATA DOCUMENT FOR REFERENCE CHARACTERISTICS FOR INDIVIDUAL DATASETS

SYMBOL		PARAMETRIC VALUES	
x	- .043	MACH	110.000
o	400.200	ALPHA	.000
□	800.550	DA ALPHA	5.000
◇	1200.1800	ELEVTR	.000
△		Y	.000

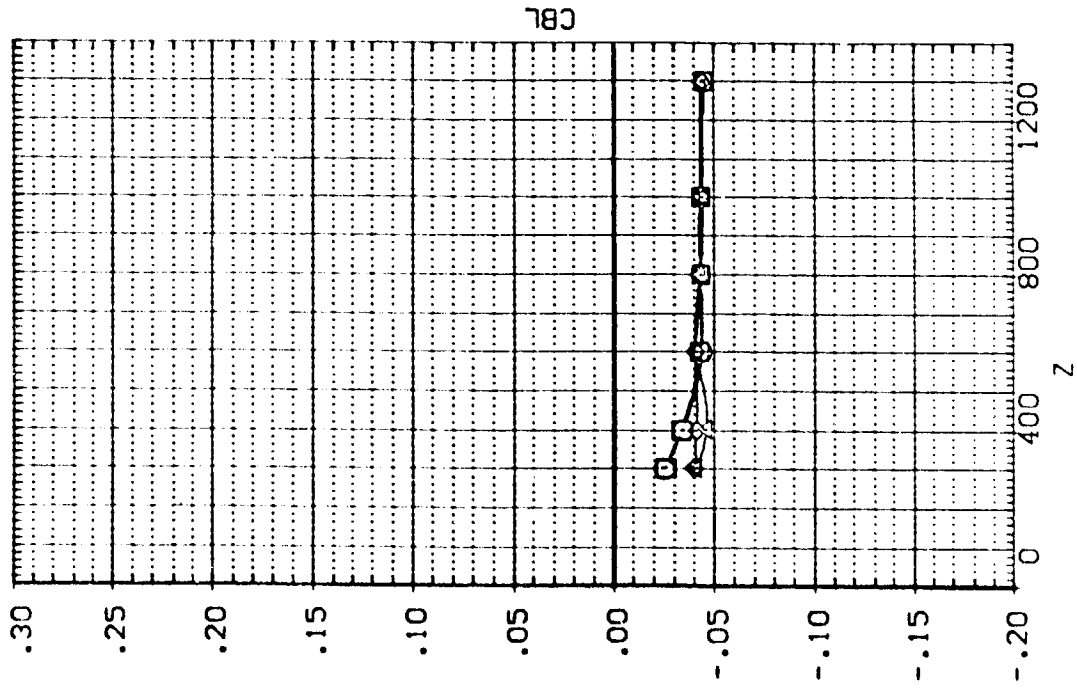
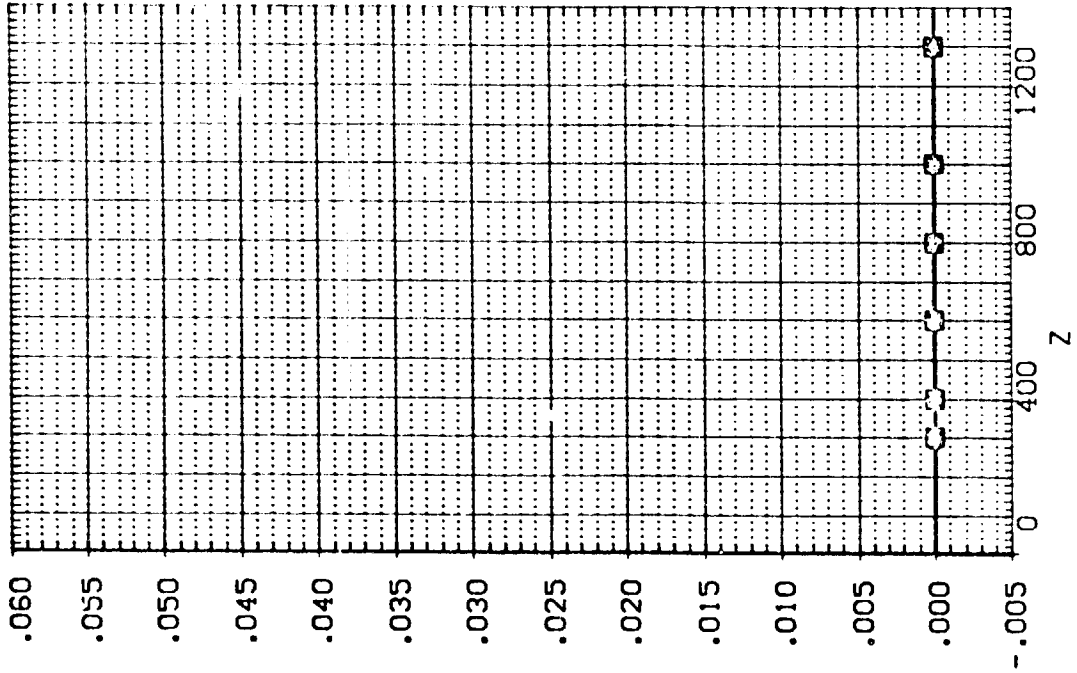

EXTERNAL TANK AERODYNAMIC CHARACTERISTICS DURING SEPARATION FROM ORBITER

IA13-EXTERNAL TANK(T10)SEPARATING FROM ORB. 09 (RTJT10)

SEE THE ASSOCIATED DATA DOCUMENT FOR REFERENCE CHARACTERISTICS FOR INDIVIDUAL DATASETS

SYMBOL		PARAMETRIC VALUES			
○	X	MACH	PTOTAL	BETA	ALTRON
□	Y	4.530	110.000	.000	.000
◇	ALPHA	.000	.000	5.000	.000
◇	BETA	-10.000	.000	.000	.000
△	DELTA	.000	.000	.000	.000
△	CLEVTX	.000	.000	.000	.000
△	Y	.000	.000	.000	.000

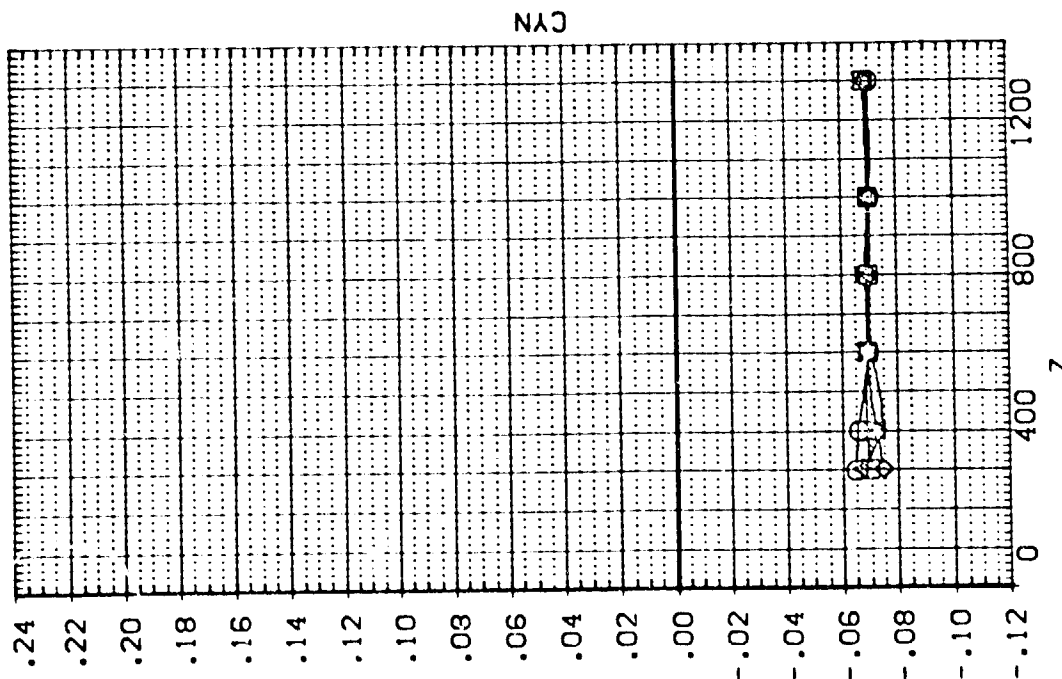
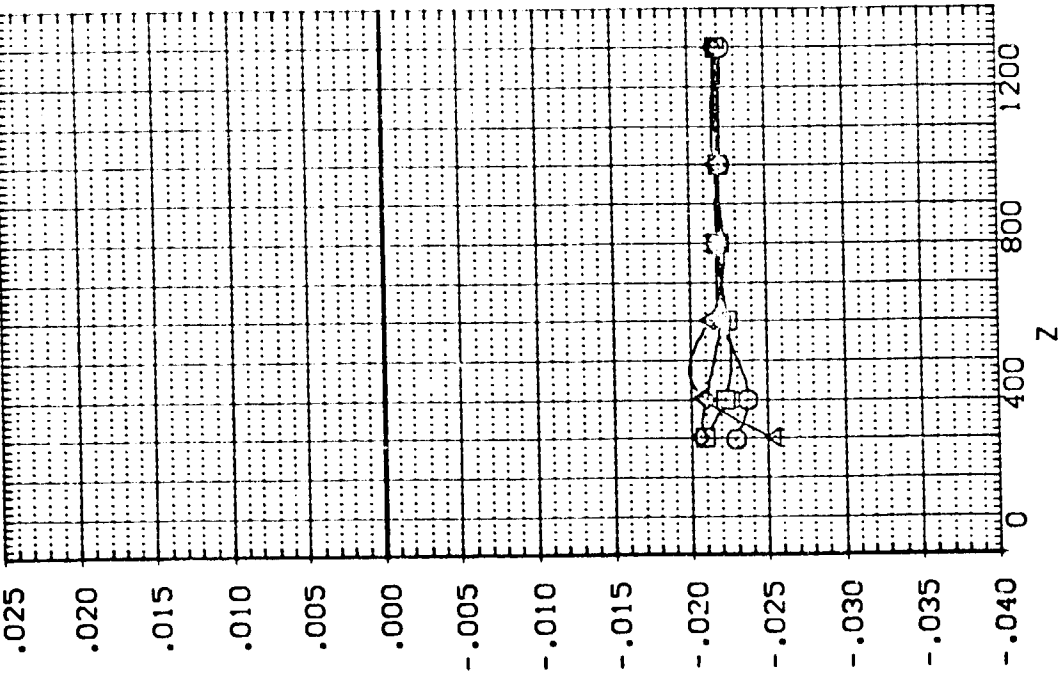

IA13-EXTERNAL TANK(T10)SEPARATING FROM ORB. 09 (RTJT11)

SEE THE ASSOCIATED DATA DOCUMENT FOR REFERENCE CHARACTERISTICS FOR INDIVIDUAL DATASETS

SYMBOL	X	MACH	PARAMETRIC VALUES
○	-0.876	4.530	P TOTAL 110.000
◇	401.340	.000	BETA .000
△	800.910	-20.000	DBETA .000
	1200.800	.000	AILRON .000
		.000	Y .000

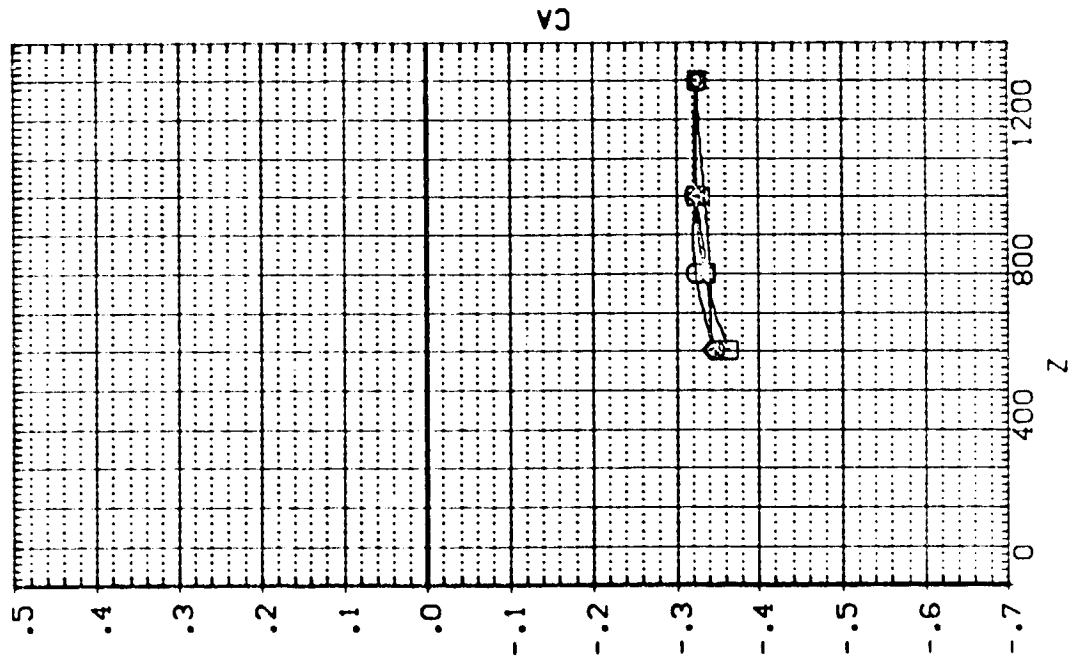
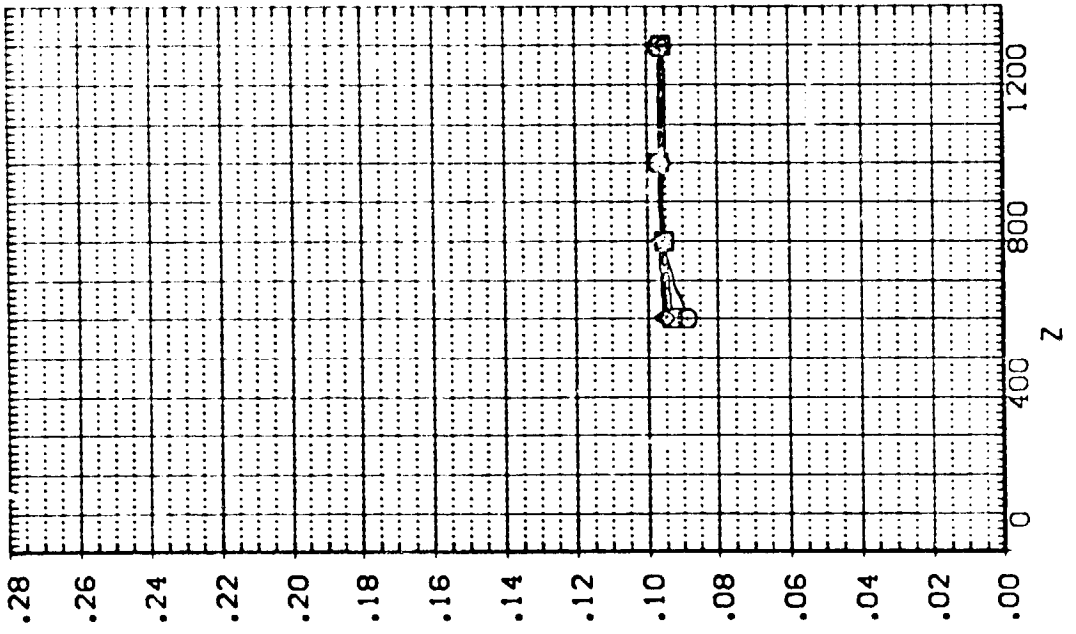

!A13,EXTERNAL TANK(T10)SEPARATING FROM ORB. 09 (RTJT11)

SEE THE ASSOCIATED DATA DOCUMENT FOR REFERENCE CHARACTERISTICS FOR INDIVIDUAL DATASETS

SYMBOL	X	MACH	PTOTAL	110.000
○	- .876	4.530	BETA	.000
□	401.340	.000	DBETA	.000
◇	800.910	-20.000	ALLRON	.000
△	1200.800	.000		

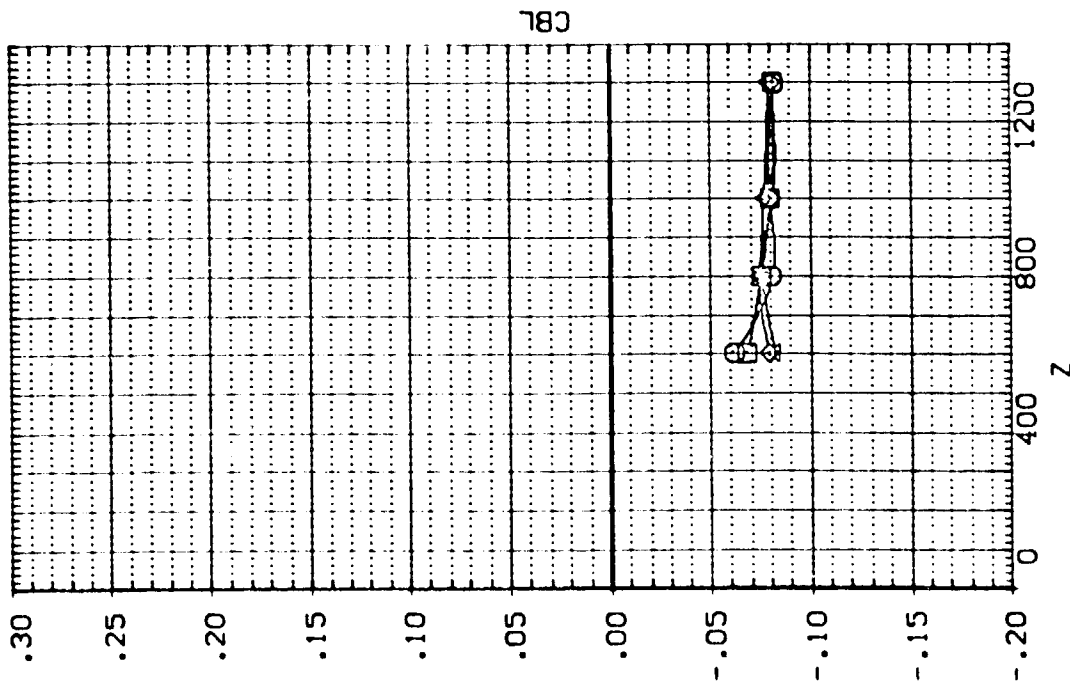
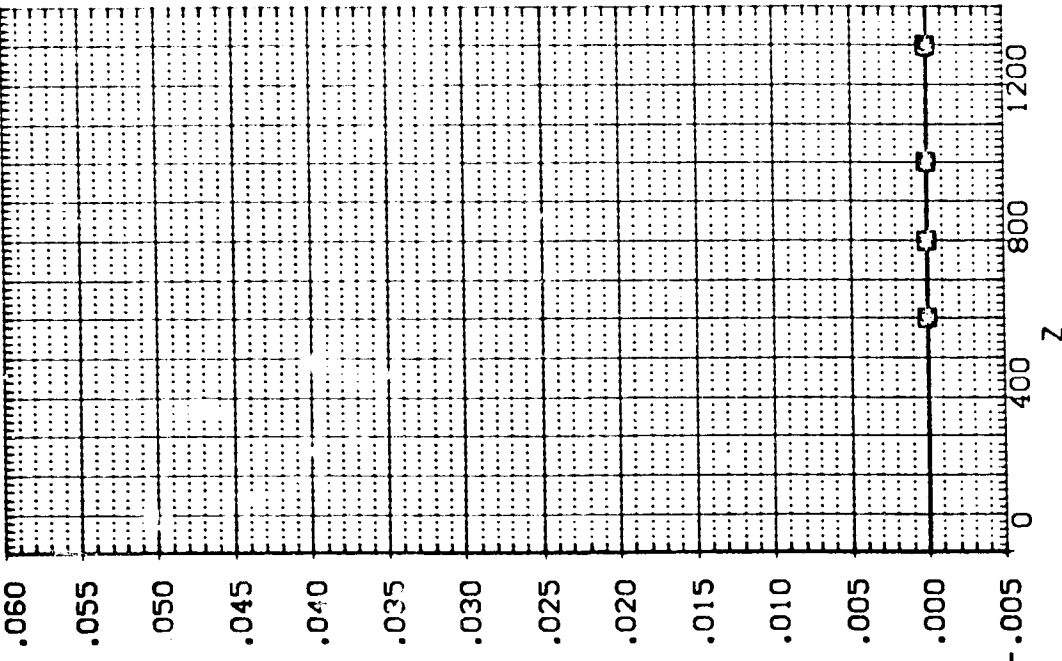

EXTERNAL TANK AERODYNAMIC CHARACTERISTICS DURING SEPARATION FROM ORBITER

1A13, EXTERNAL TANK(T10)SEPARATING FROM ORB. 09 (RIJT11)

SEE THE ASSOCIATED DATA DOCUMENT FOR REFERENCE CHARACTERISTICS FOR INDIVIDUAL DATA SETS

SYMBOL		PARAMETRIC VALUES	
○	X	MACH	4.530
□	Y	ALPHA	.000
◇	Z	DALPHA	-20.000
△		ELEVTR	.000
		PTOTAL	110.000
		BETA	.000
		DBETA	.000
		AILRON	.000
		Y	.000

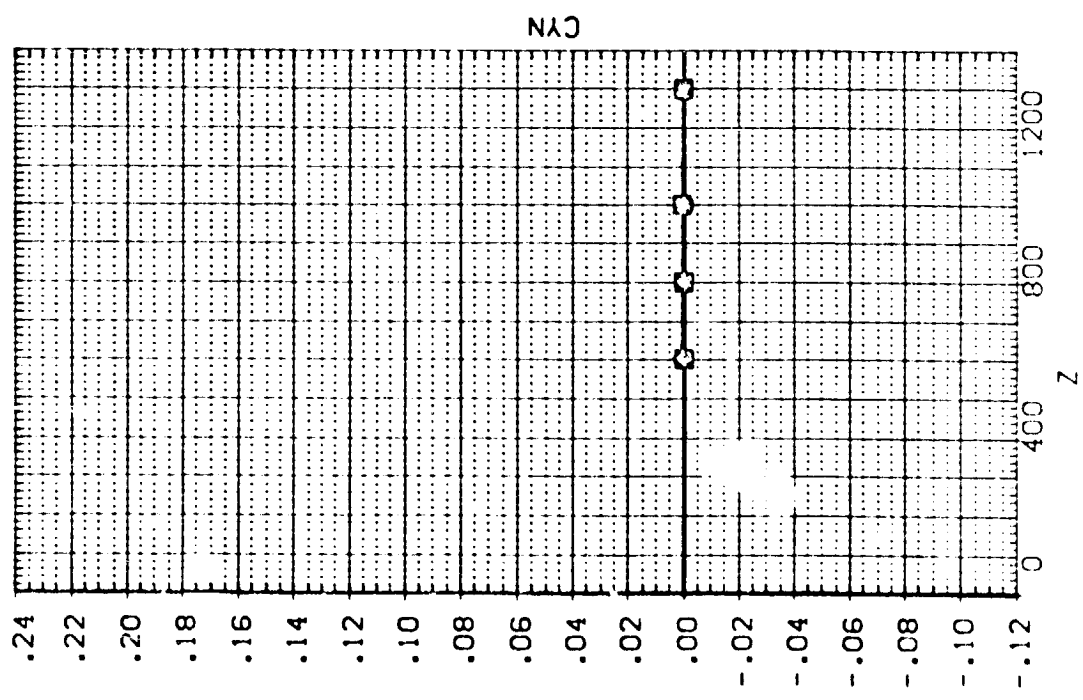
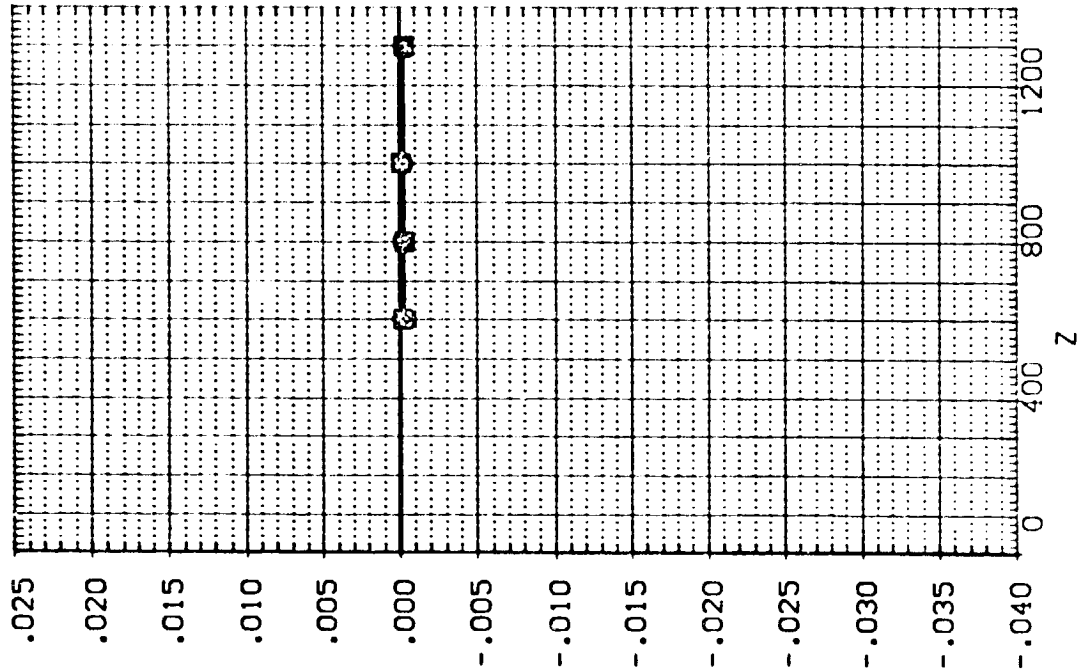

IA13, EXTERNAL TANK(T10) SEPARATING FROM ORB. 09 (RTJT12)

SEE THE ASSOCIATED DATA DOCUMENT FOR REFERENCE CHARACTERISTICS FOR INDIVIDUAL DATASETS

SYMBOL	X	PARAMETRIC VALUES
○	- .503	MACH 4.530 P/TOTAL 110.000
□	400.530	ALPHA .000 BETA .000
◇	800.210	DALPHA -20.000 DBETA .000
△	1201.000	ELEVTR .000 AILTRON .000
	Y	200.000

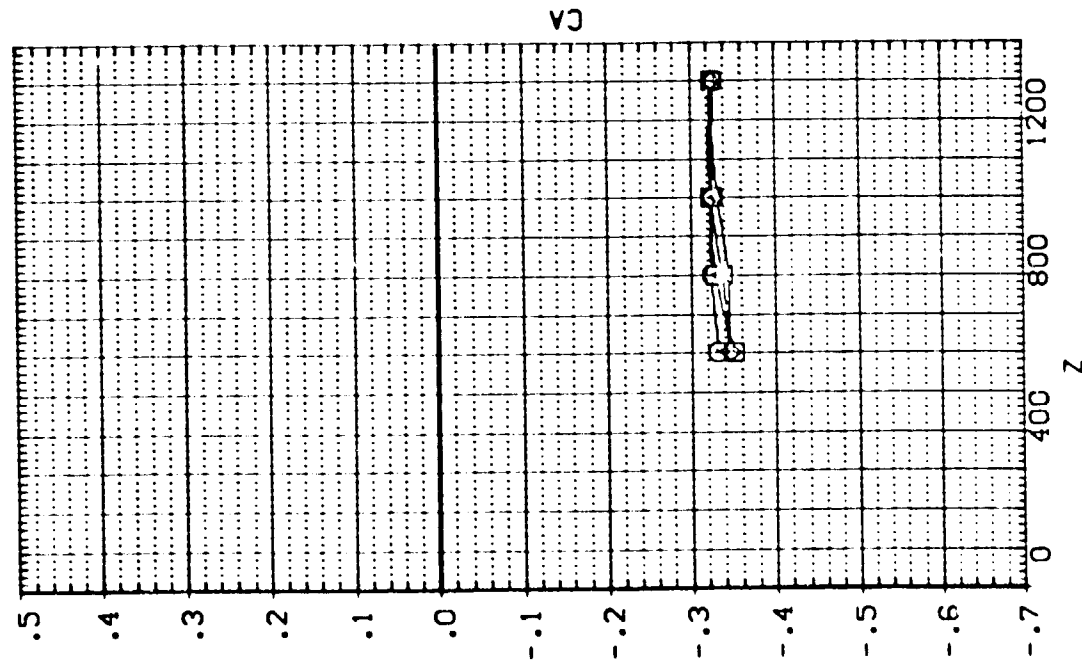
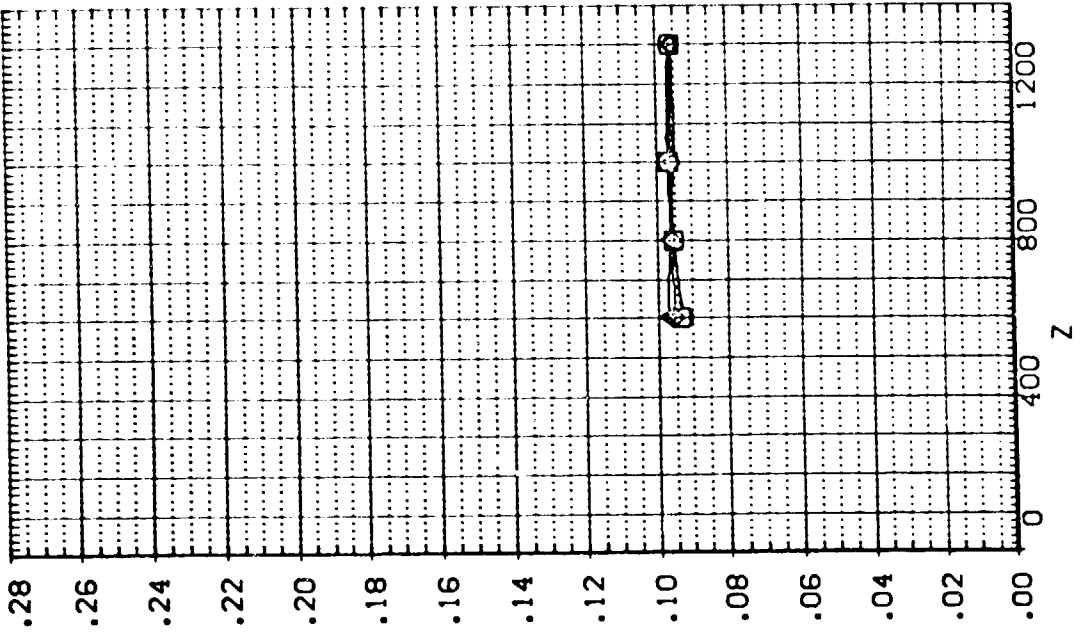

EXTERNAL TANK AERODYNAMIC CHARACTERISTICS DURING SEPARATION FROM ORBITER

IA13, EXTERNAL TANK(110) SEPARATING FROM ORB. 09 (RTJT12)

SEE THE ASSOCIATED DATA DOCUMENT FOR REFERENCE CHARACTERISTICS FOR INDIVIDUAL DATASETS

SYMBOL	X	MACH	PARAMETRIC VALUES
○	- .503	4.530	P TOTAL 110.000
□	400.530	.000	BETA .000
◇	800.210	-20.000	DBETA .000
△	1200.000	.000	AILRON .000
		200.000	Y

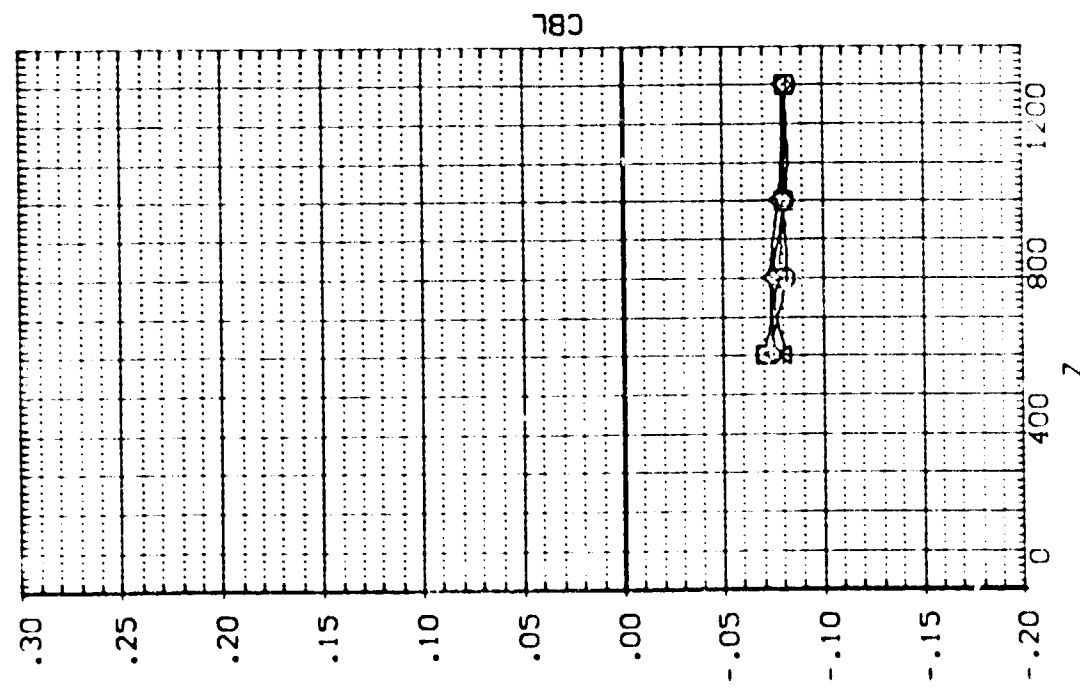
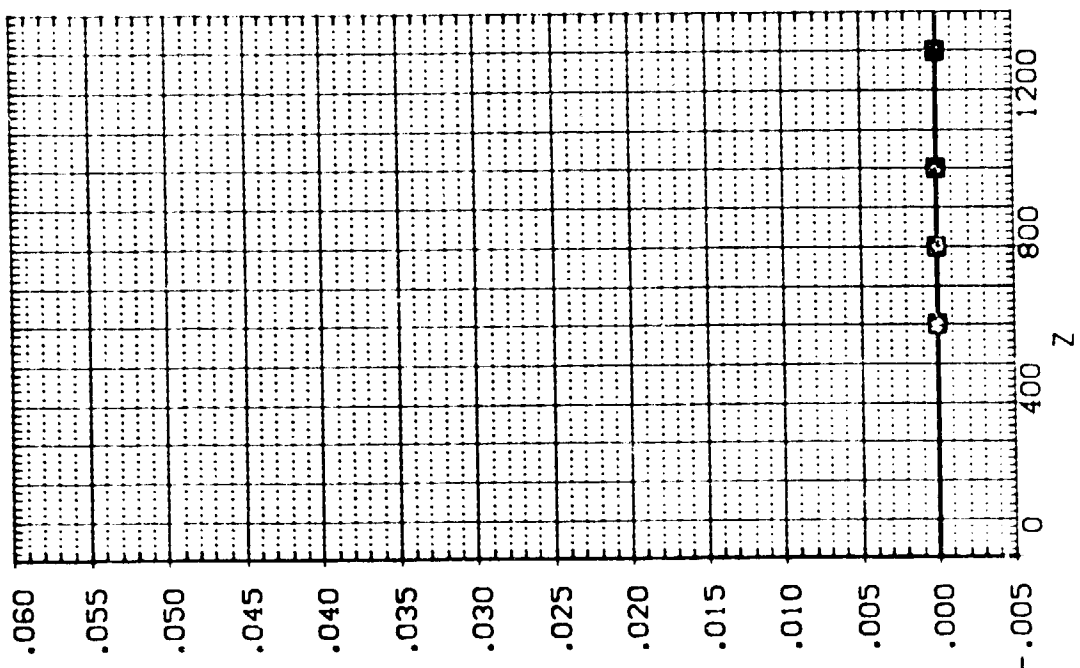

EXTERNAL TANK AERODYNAMIC CHARACTERISTICS DURING SEPARATION FROM ORBITER

IA13, EXTERNAL TANK(T10) SEPARATING FROM ORB. 09 (RIJT12)

SEE THE ASSOCIATED DATA DOCUMENT FOR REFERENCE CHARACTERISTICS FOR INDIVIDUAL DATA SETS

SYMBOL		PARAMETRIC VALUES	
○	X	MACH	110.000
○	Y	ALPHA	.000
○	Z	BETA	.000
○	C	DELTA	.000
○	ELEVTR	DELTA	.000
○	Y	DELTA	.000

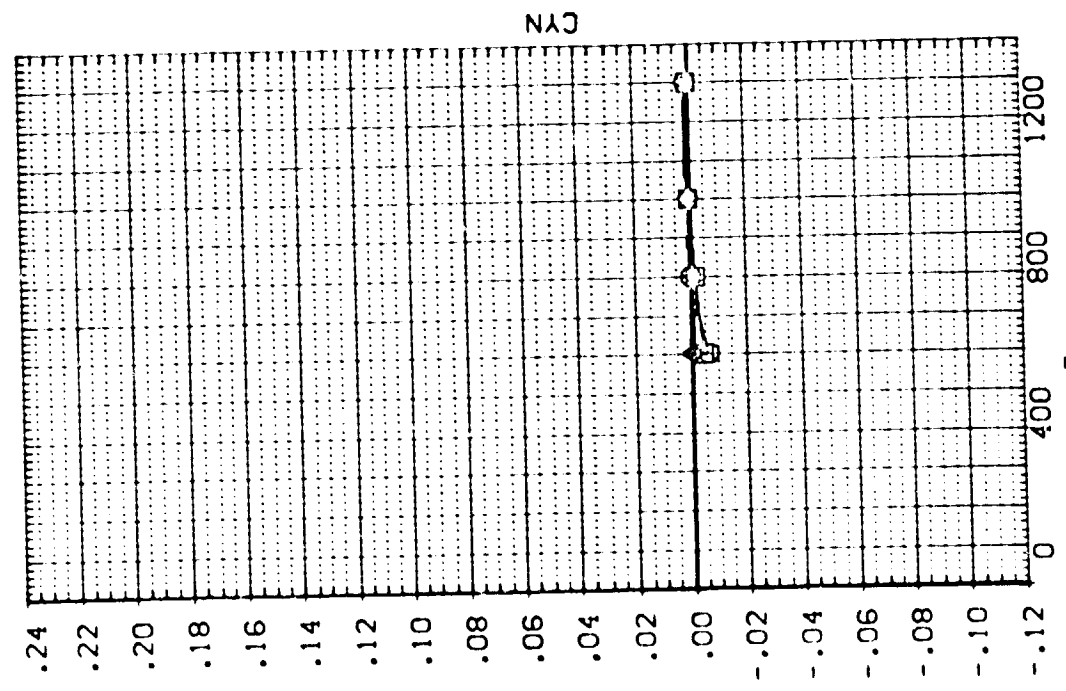
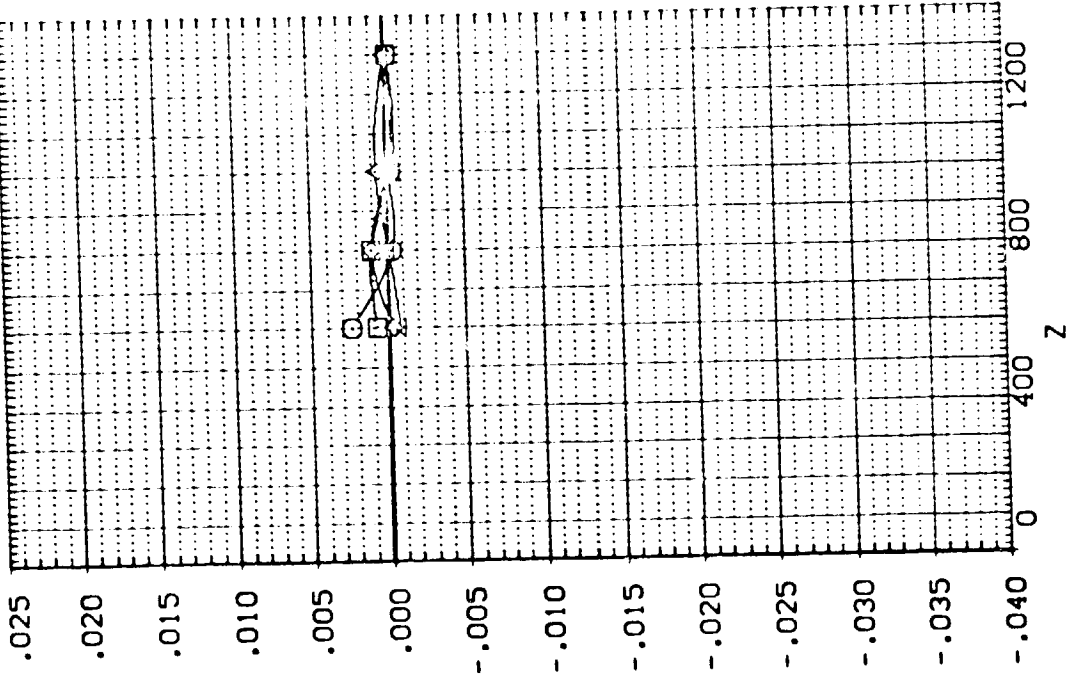

EXTERNAL TANK AERODYNAMIC CHARACTERISTICS DURING SEPARATION FROM ORBITER

A13.EXTERNAL TANK(T10)SEPARATING FROM ORB. 09 (RTJT13)

SEE THE ASSOCIATED DATA DOCUMENT FOR REFERENCE CHARACTERISTICS FOR INDIVIDUAL DATASETS

SYMBOL		PARAMETRIC VALUES	
○	X	MACH	4.530
○	Y	ALPHA	.000
○	Z	BETA	110.000
◇	U	DALPHA	-20.000
◇	V	DBETA	5.000
△	W	AILRON	.000
		ELEVTR	200.000

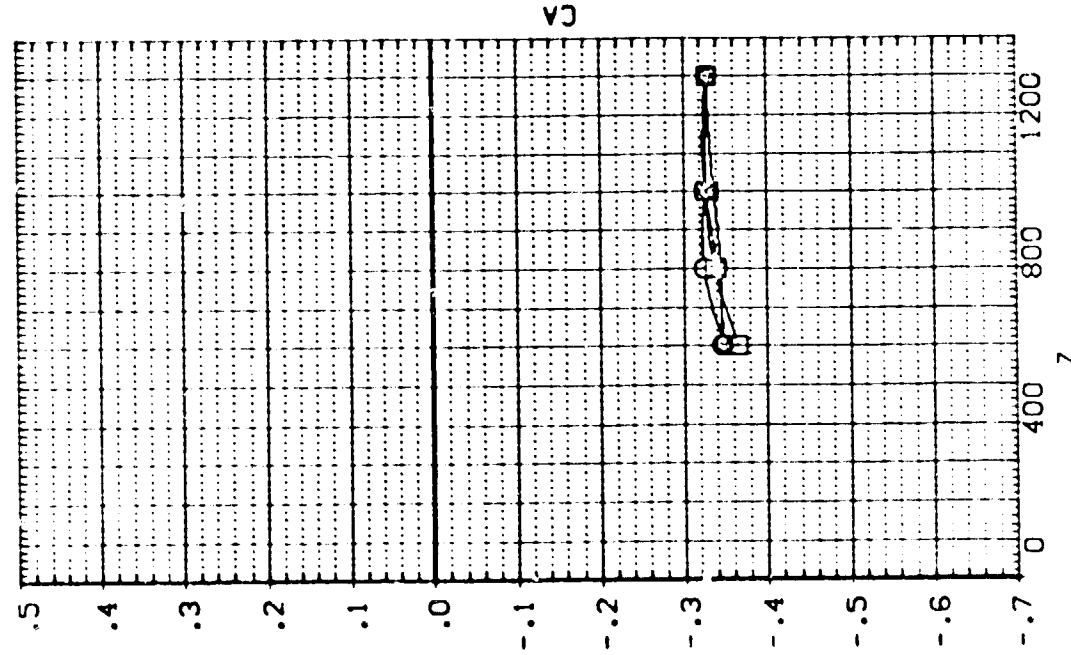
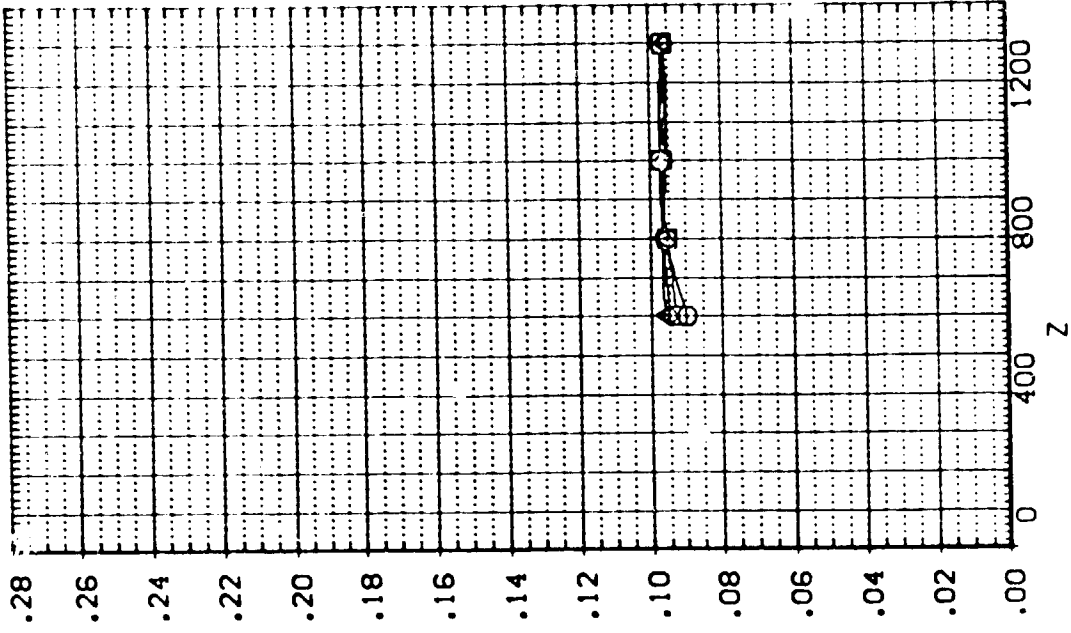

EXTERNAL TANK AERODYNAMIC CHARACTERISTICS DURING SEPARATION FROM ORBITER

IA13.EXTERNAL TANK(T10)SEPARATING FROM ORB. 09 (RTJT13)

SEE THE ASSOCIATED DATA DOCUMENT FOR REFERENCE CHARACTERISTICS FOR INDIVIDUAL DATASETS

SYMBOL		PARAMETRIC VALUES			
○	X	MACH	4.530	PTOTAL	110.000
□	ALPHA	ALPHA	.000	BETA	.000
◇	BETA	DALPHA	-20.000	DBETA	5.000
△	ELEVTR	ELEVTR	.000	AILTRON	.000
	Y	Y	200.000		

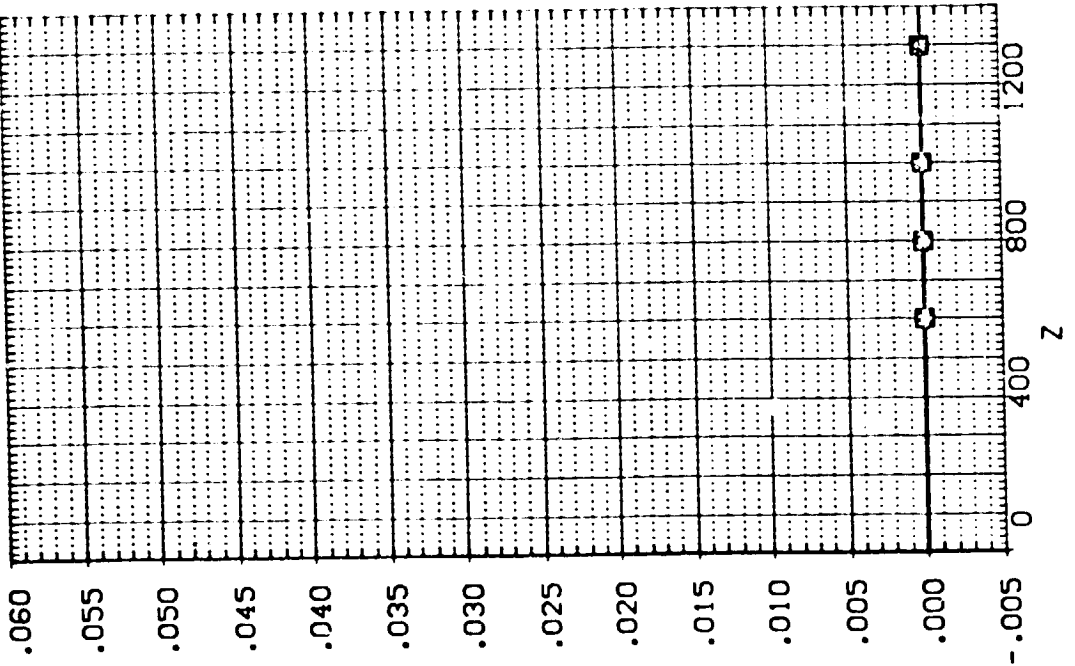
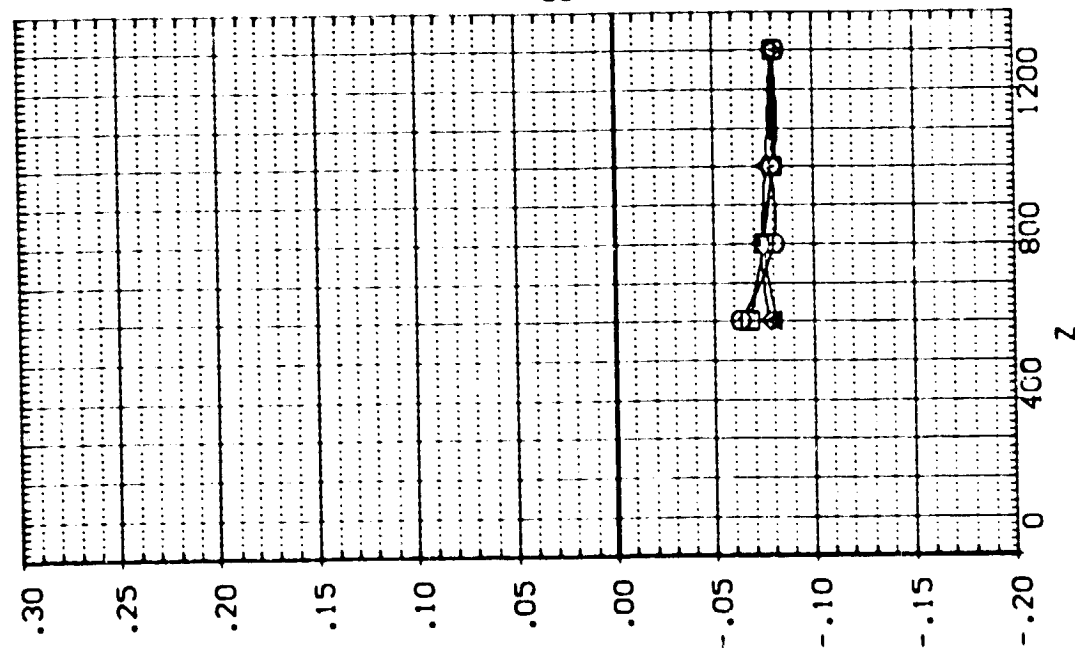

EXTERNAL TANK AERODYNAMIC CHARACTERISTICS DURING SEPARATION FROM ORBITER

1A13. EXTERNAL TANK(110)SEPARATING FROM ORB. 09 (RTJT113)

SEE THE ASSOCIATED DATA DOCUMENT FOR REFERENCE CHARACTERISTICS FOR INDIVIDUAL DATASETS

SYMBOL		PARAMETRIC VALUES	
○	X	MACH	4.530
○	Y	ALPHA	110.000
○	Z	BETA	.000
○	AX	DELTA	5.000
○	AY	ELEVTR	.000
○	AZ	ROLLON	200.000

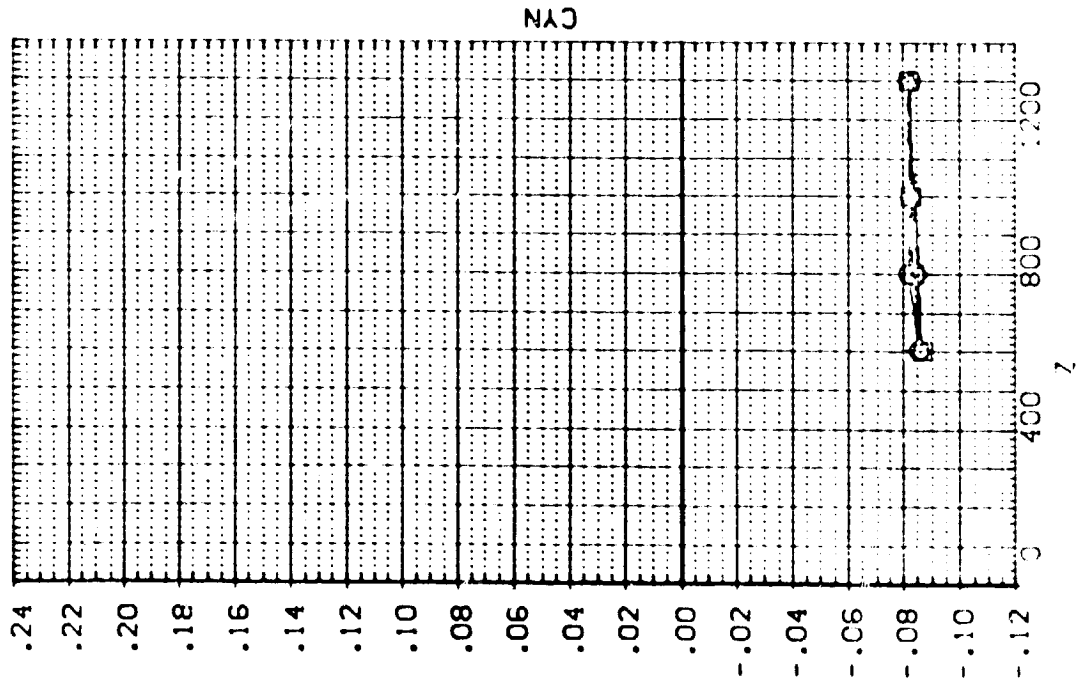
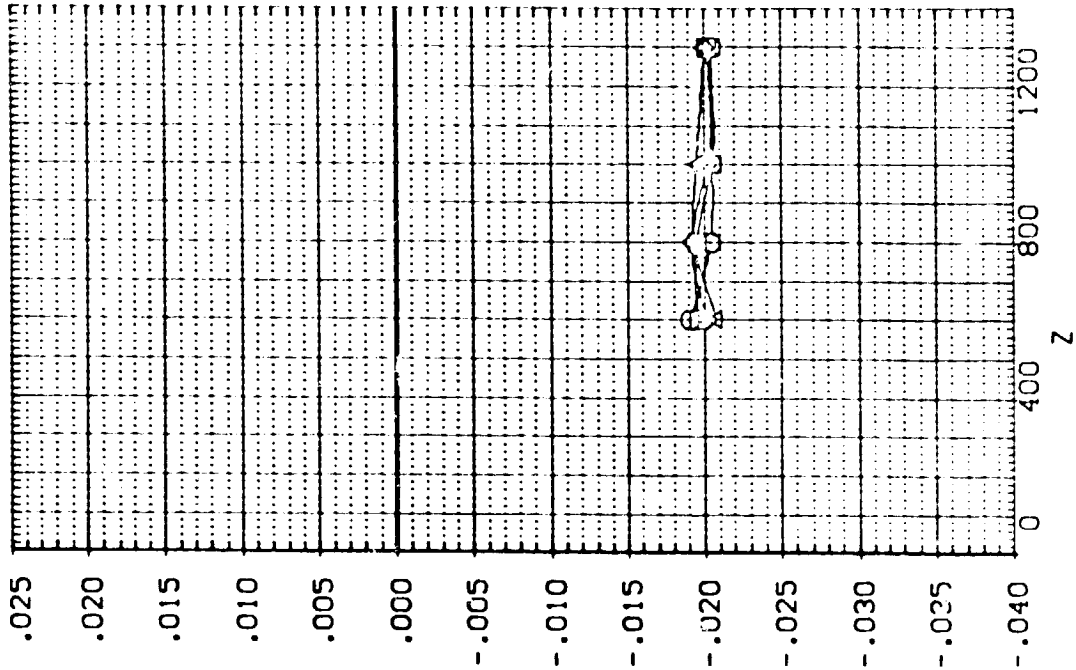

1A13.EXTERNAL TANK(T10)SEPARATING FROM ORB. 09 (RTJT14)

SEE THE ASSOCIATED DATA DOCUMENT FOR REFERENCE CHARACTERISTICS FOR INDIVIDUAL DATASETS

SYMBOL		PARAMETRIC VALUES				
○	X	-0.921	MACH	4.530	PTOTAL	110.000
□	Y	400.550	ALPHA	.000	BETA	.000
◇	Z	800.340	DALPHA	-20.000	DBETA	5.000
△	Y	1201.000	ELEVTR	.000	AILRON	.000

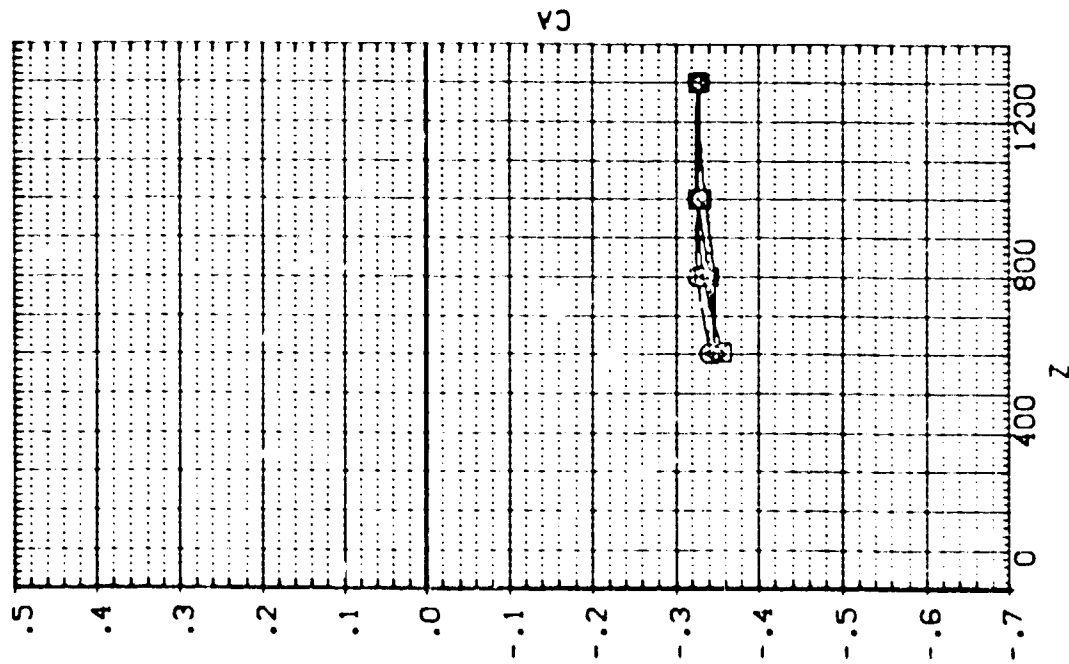
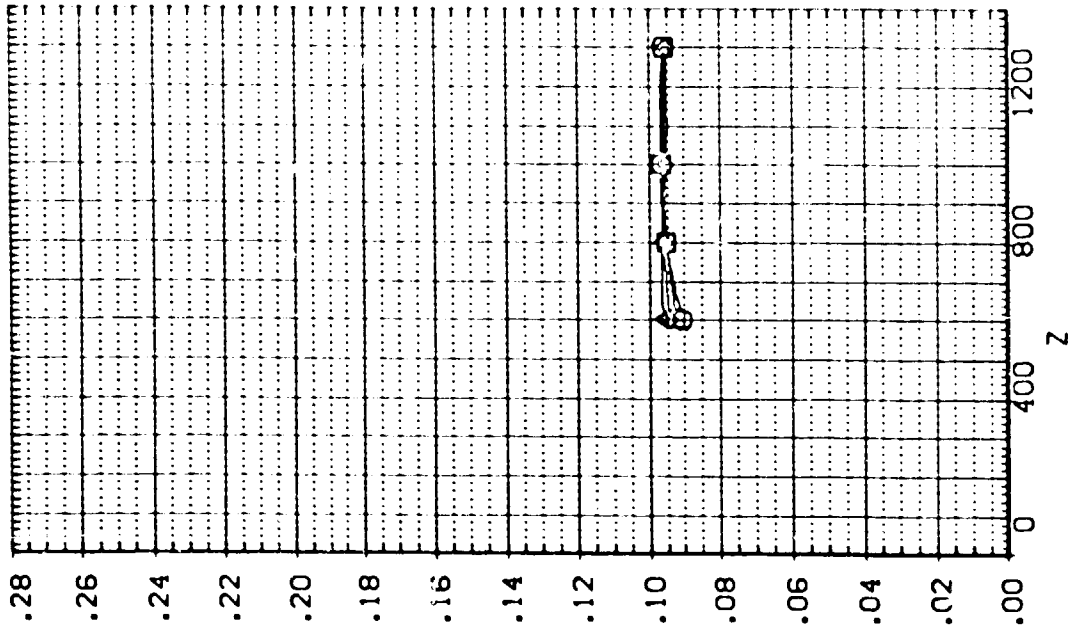

EXTERNAL TANK AERODYNAMIC CHARACTERISTICS DURING SEPARATION FROM ORBITER

IA13. EXTERNAL TANK(T10) SEPARATING FROM ORB. 09 (RTJT14)

SEE THE ASSOCIATED DATA DOCUMENT FOR REFERENCE CHARACTERISTICS FOR INDIVIDUAL DATASETS

SYMBOL		PARAMETRIC VALUES			
○	x	MACH	4.530	P TOTAL	110.000
□	α	ALPHA	.000	BETA	.000
◇	β	DALPHA	-20.000	DBETA	5.000
△	γ	ELEVTR	.000	AULRON	.000

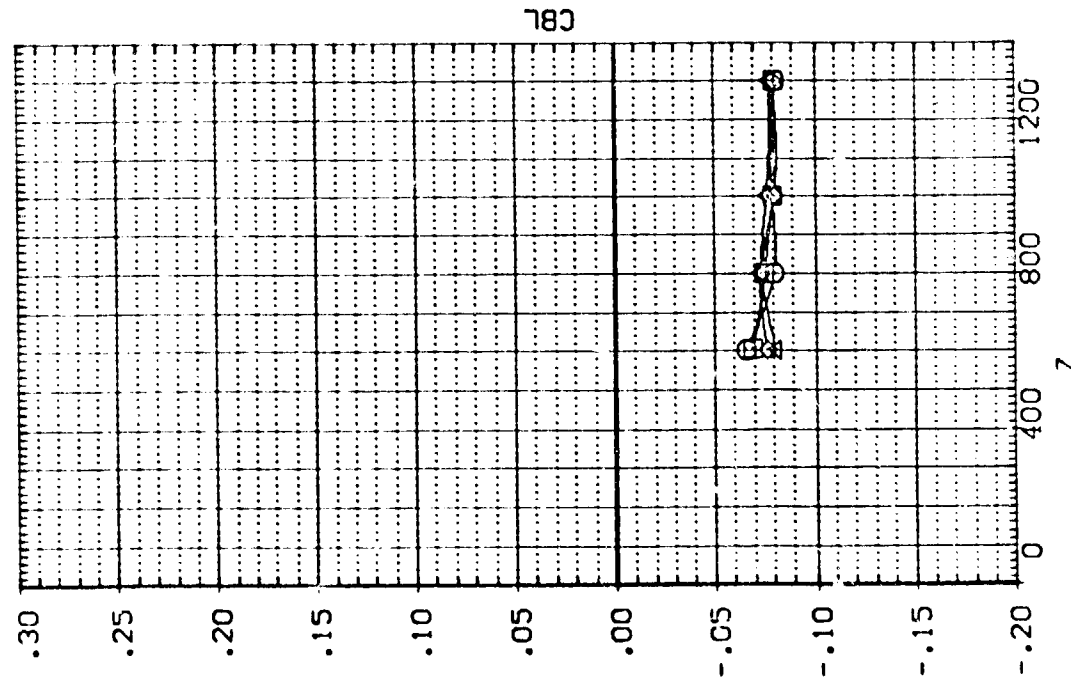
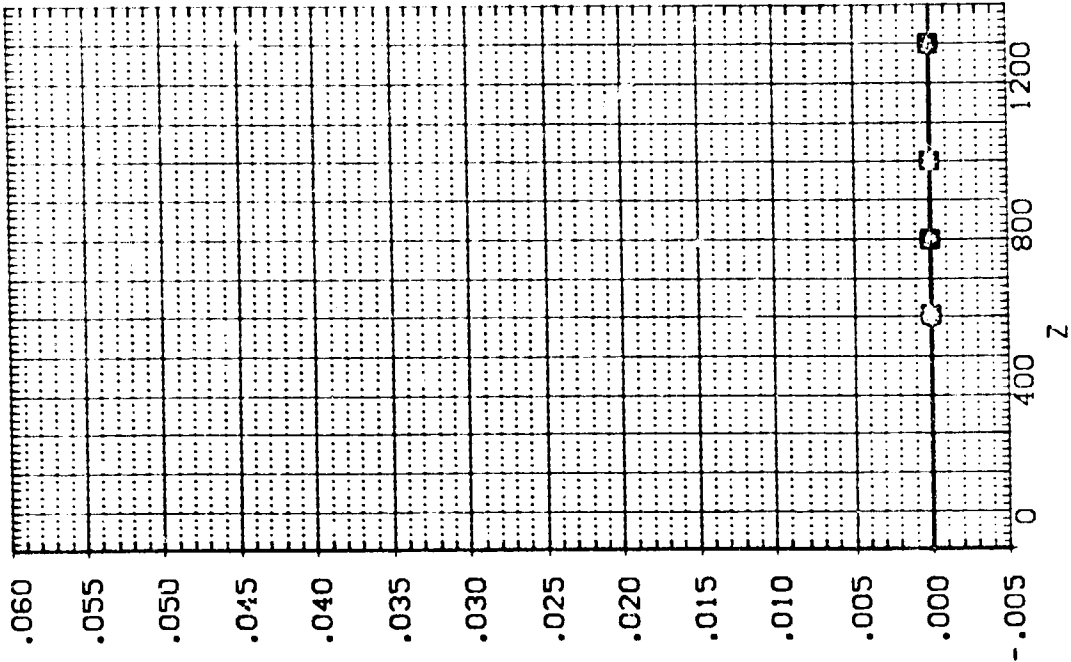

IA13, EXTERNAL TANK(T10) SEPARATING FROM ORB. 09 (RTJT14)

SEE THE ASSOCIATED DATA DOCUMENT FOR REFERENCE CHARACTERISTICS FOR INDIVIDUAL DATASETS

SYMBOL
 ○
 □
 ◇
 △

X
 -0.921
 400.550
 800.340
 1201.000

MACH
 ALPHA
 DALPHA
 ELEVTR
 Y

PARAMETRIC VALUES
 4.530
 .000
 -20.000
 .000
 .000

P TOTAL
 BETA
 DBETA
 AILRON
 .000
 .000
 .000
 .000

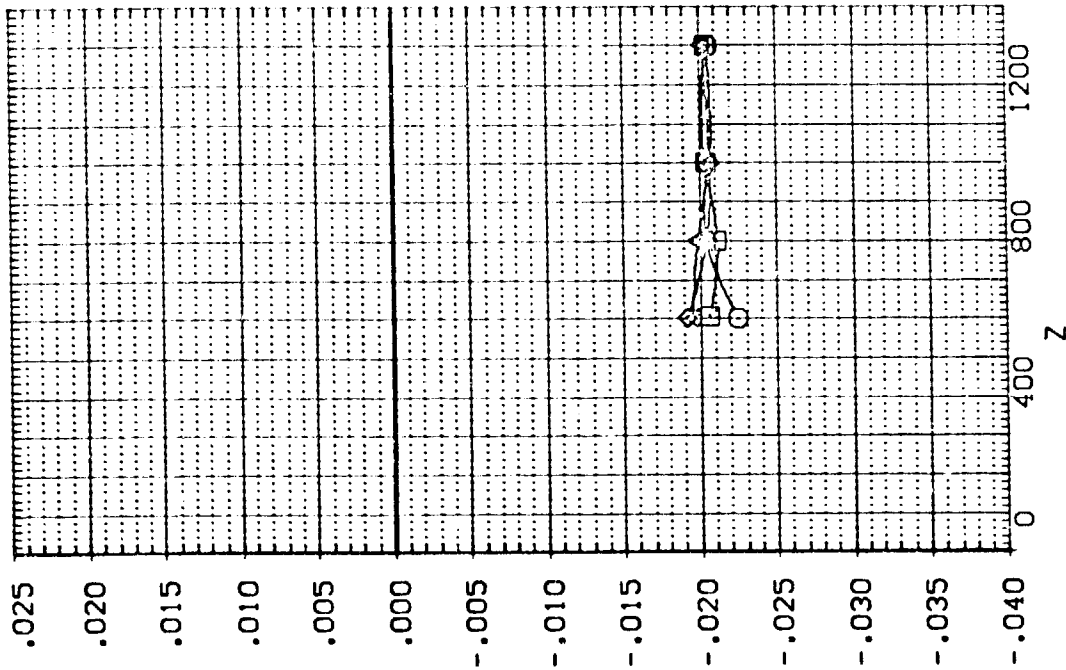
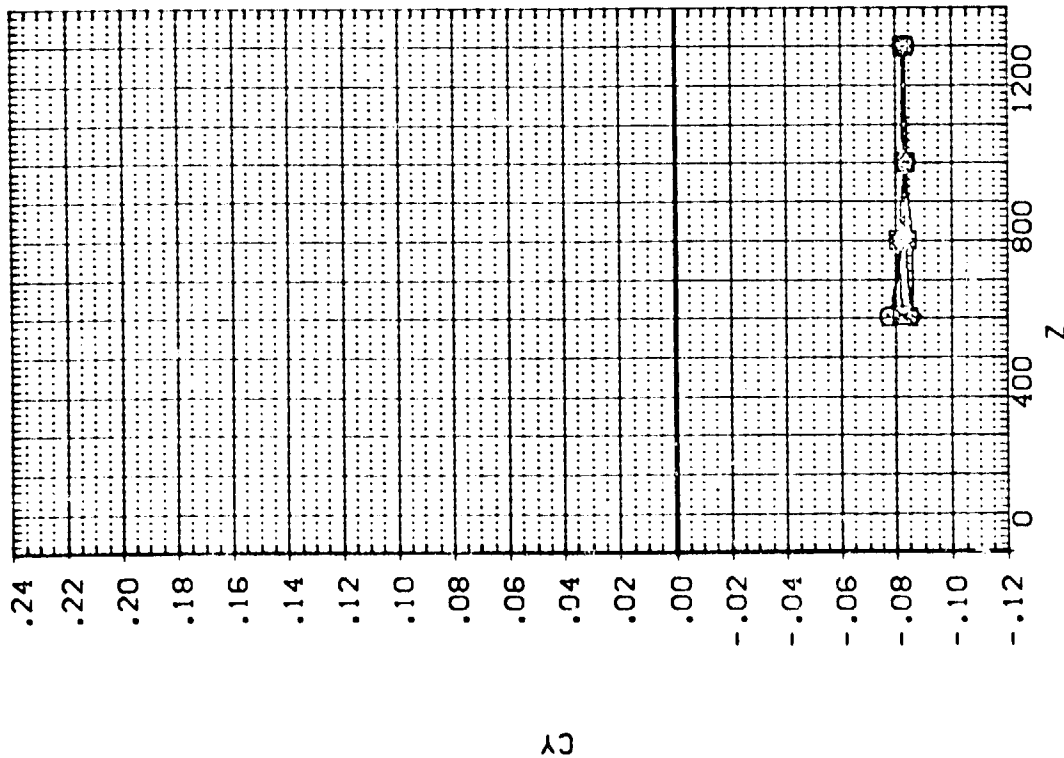

EXTERNAL TANK AERODYNAMIC CHARACTERISTICS DURING SEPARATION FROM ORBITER

IA13, EXTERNAL TANK(T10)SEPARATING FROM ORB. 09 (RTJT15)

SEE THE ASSOCIATED DATA DOCUMENT FOR REFERENCE CHARACTERISTICS FOR INDIVIDUAL DATASETS

SYMBOL		PARAMETRIC VALUES	
X	.861	MACH	4.530
		PTOTAL	110.000
400	.230	ALPHA	.000
		BETA	.000
800	.060	DALPHA	-30.000
		DBETA	.000
1200	.900	ELEVTR	.000
		AILLRON	.000
		Y	.000

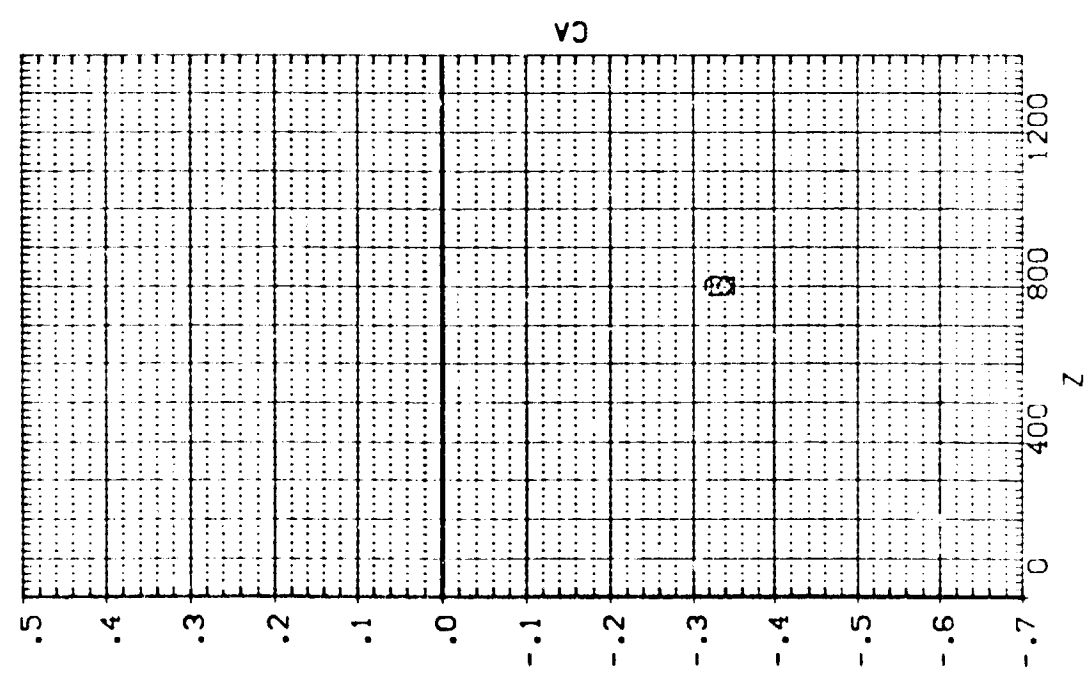
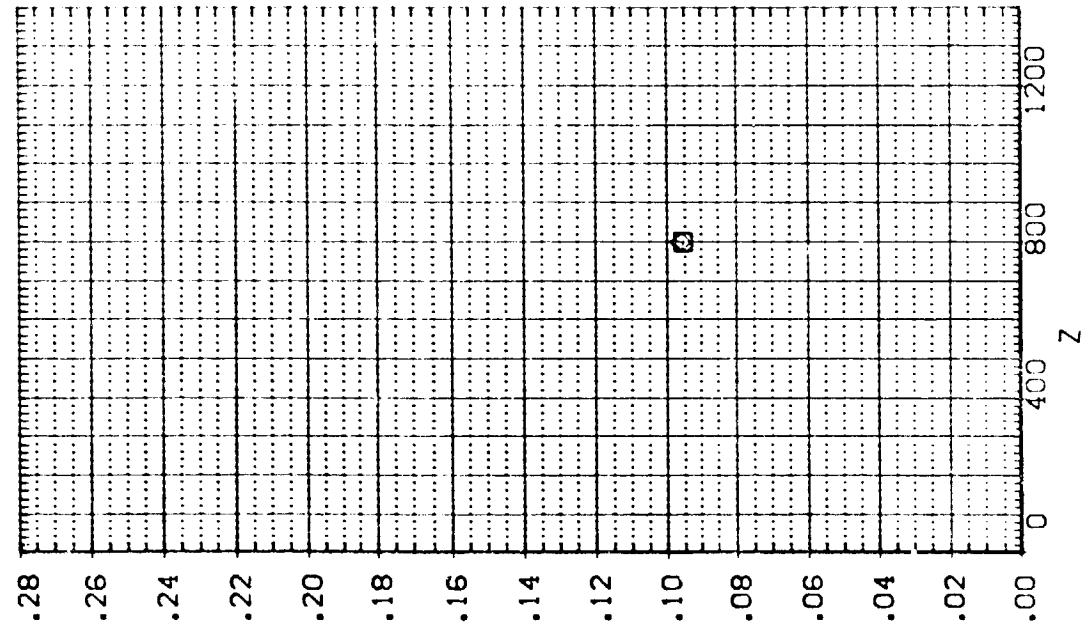

EXTERNAL TANK AERODYNAMIC CHARACTERISTICS DURING SEPARATION FROM ORBITER

IA13.EXTERNAL TANK(T10)SEPARATING FROM ORB. 09 (RTJT15)

SEE THE ASSOCIATED DATA DOCUMENT FOR REFERENCE CHARACTERISTICS FOR INDIVIDUAL DATASETS

SYMBOL	X	MACH	ALPHA	DALPHA	ELEVTR	Y	PARAMETRIC VALUES
○	.861	4.530	.000	-30.000	.000	.000	PTOTAL 110.000
□	400.230	.000	.000	.000	.000	.000	BETA .000
◇	800.060	.000	.000	.000	.000	.000	DBETA .000
△	1200.900	.000	.000	.000	.000	.000	ALLRON .000

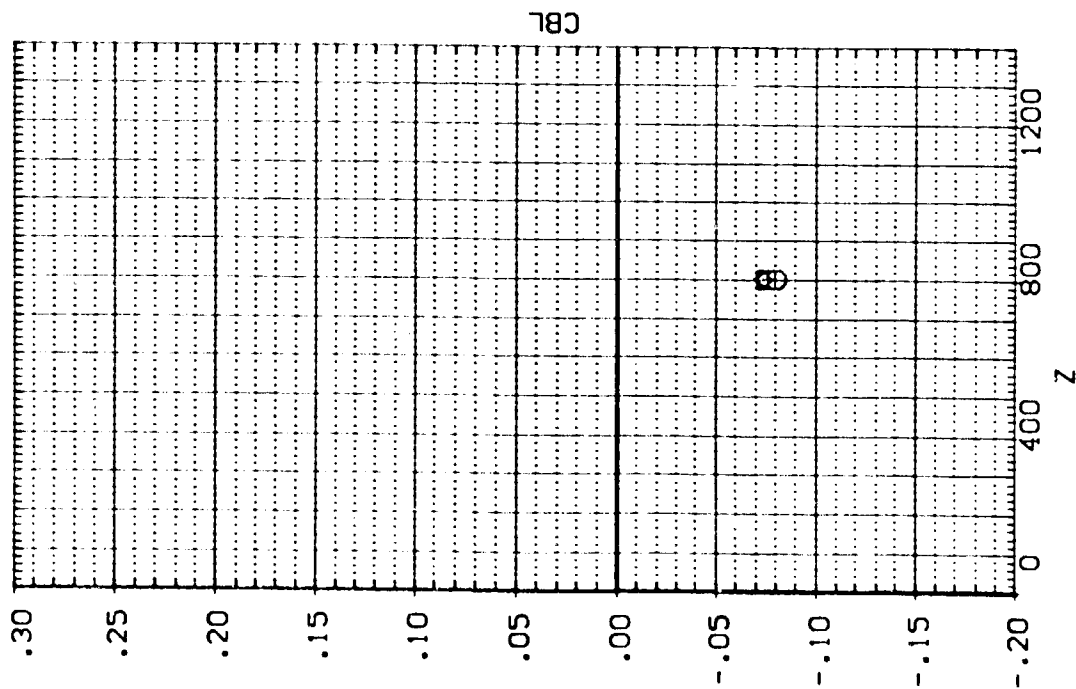
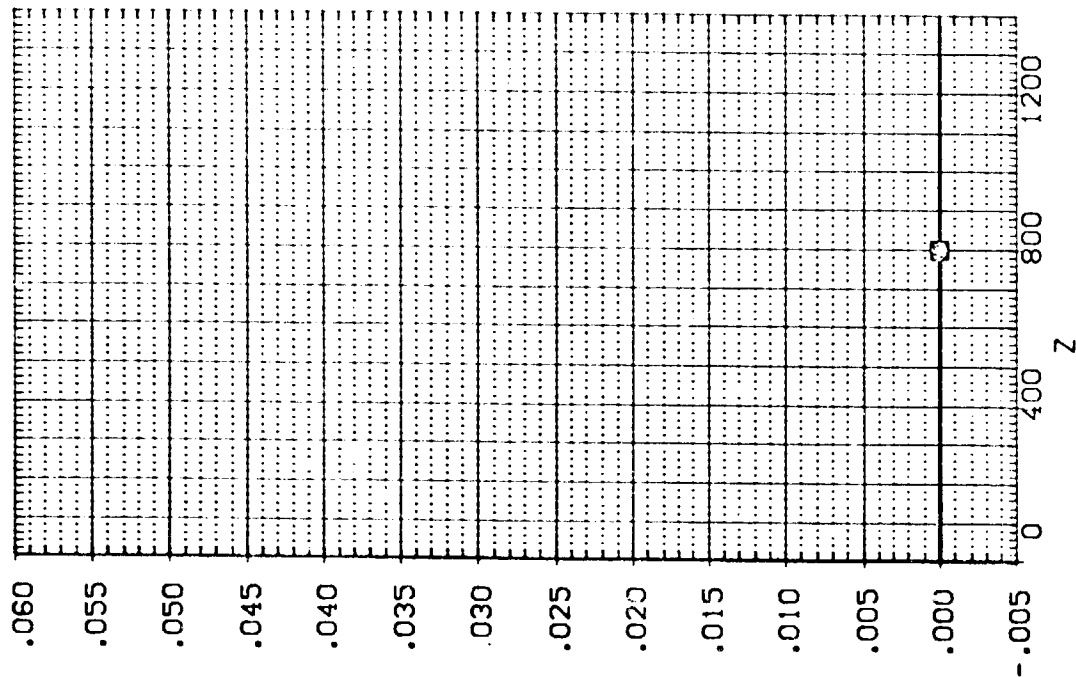

EXTERNAL TANK AERODYNAMIC CHARACTERISTICS DURING SEPARATION FROM ORBITER

IA13, EXTERNAL TANK(T10) SEPARATING FROM ORB. 09 (RTJT15)

SEE THE ASSOCIATED DATA DOCUMENT FOR REFERENCE CHARACTERISTICS FOR INDIVIDUAL DATASETS

S-900L		PARAMETRIC VALUES	
X	.861	MACH	4.530
Y	400.230	ALPHA	.000
Z	800.060	BETA	.000
	1200.900	DBETA	.000
		ELEVTR	.000
		ATLRON	.000
		Y	.000
		PTOTAL	110.000

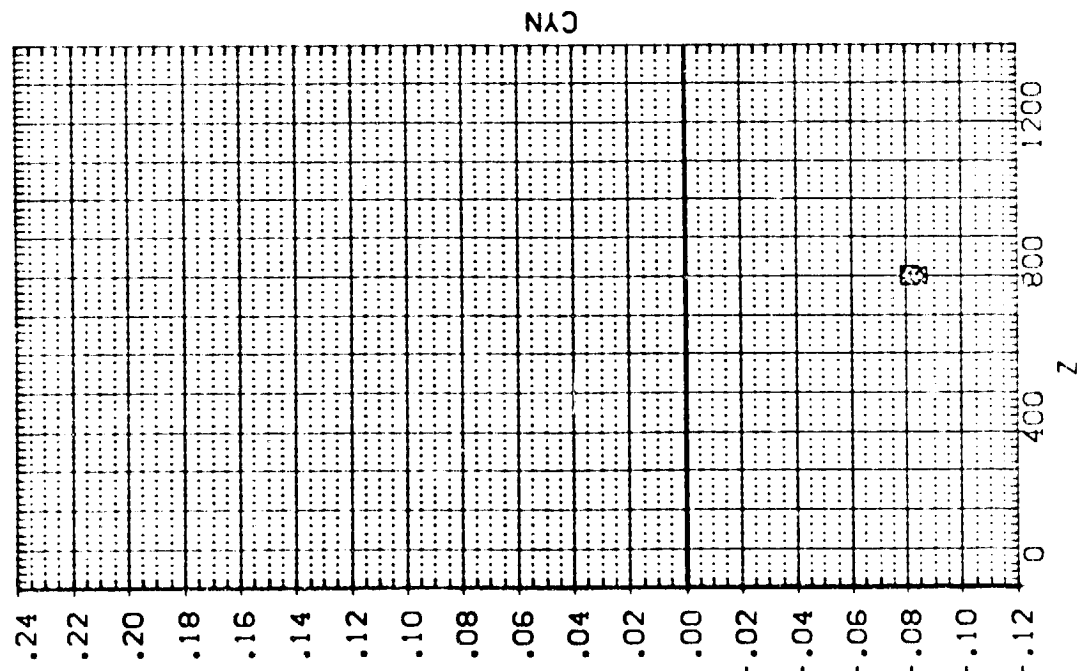
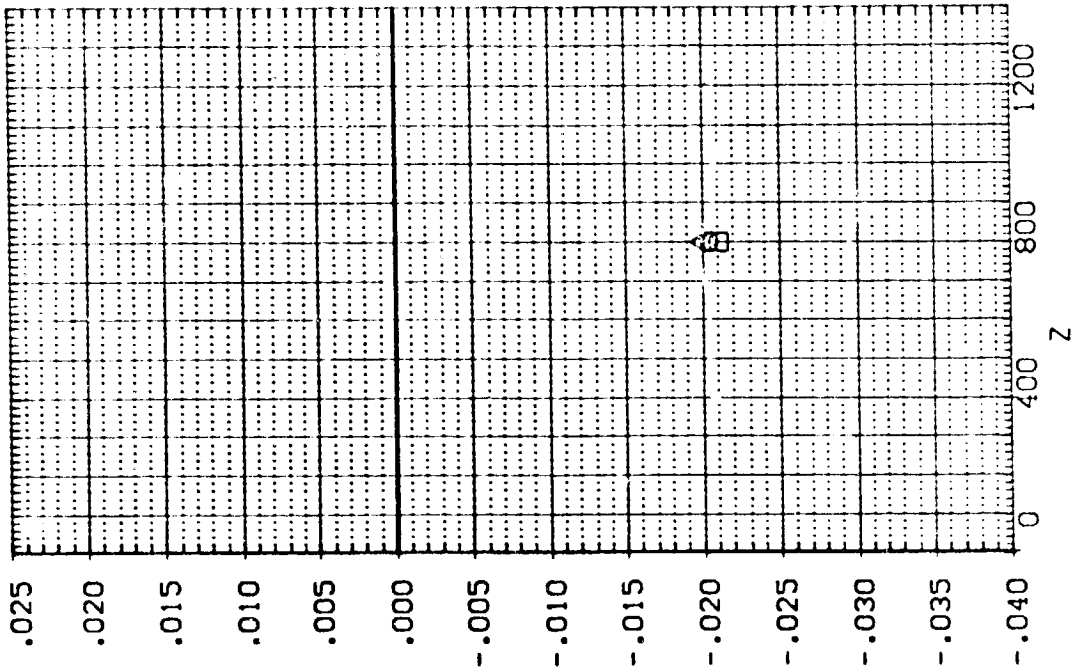

EXTERNAL TANK AERODYNAMIC CHARACTERISTICS DURING SEPARATION FROM ORBITER

IA13, EXTERNAL TANK(T10) SEPARATING FROM ORB. 09 (RTJT16)

SEE THE ASSOCIATED DATA DOCUMENT FOR REFERENCE CHARACTERISTICS FOR INDIVIDUAL DATASETS

SYMBOL		PARAMETRIC VALUES				
○	X	.278	MACH	4.530	PTOTAL	110.000
□	400	.460	ALPHA	-5.000	BETA	.000
◇	800	.590	DALPHA	5.000	DBETA	.000
△	1200	.600	ELEVTR	.000	AIRLON	.000
	Y			.000		

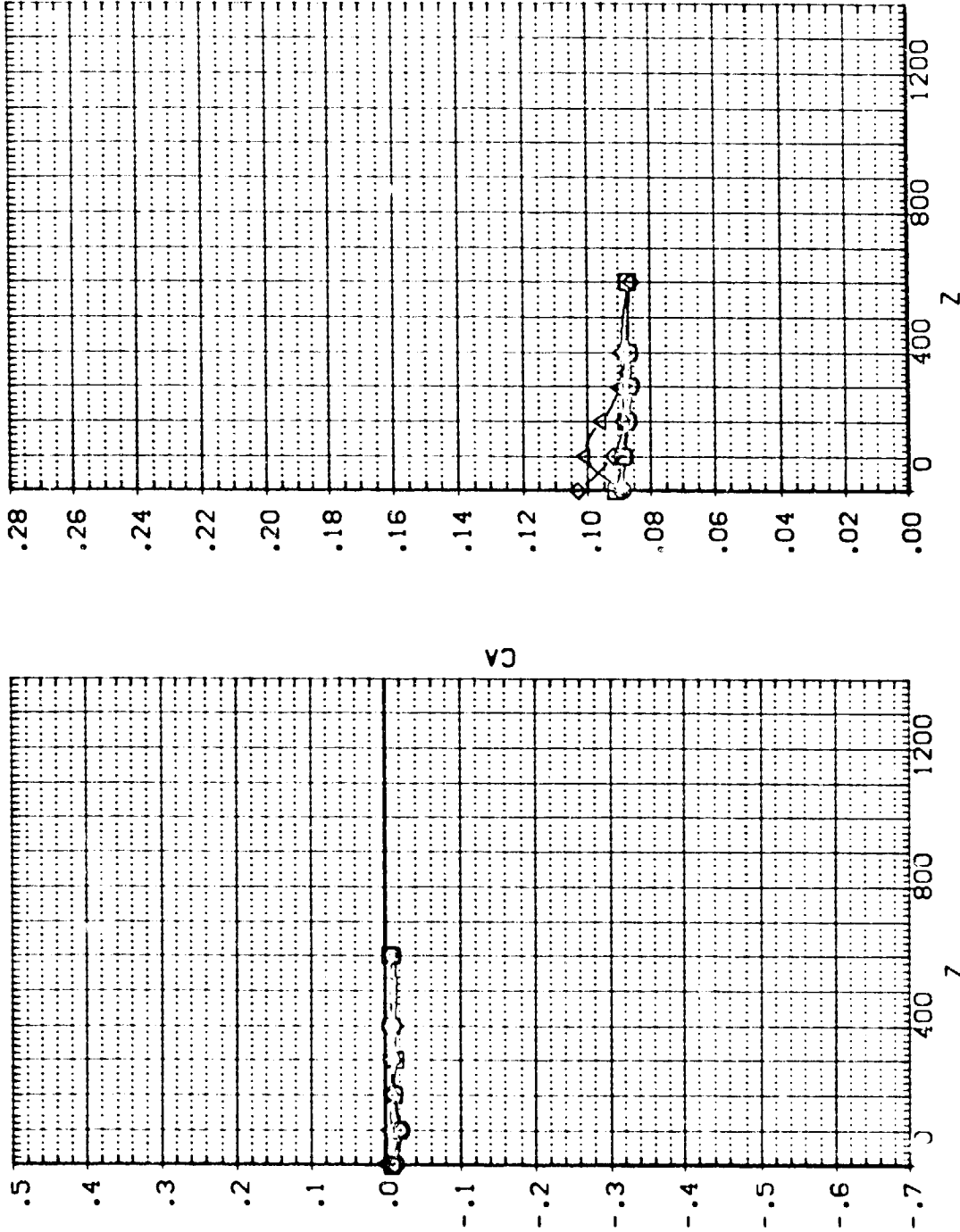

EXTERNAL TANK AERODYNAMIC CHARACTERISTICS DURING SEPARATION FROM ORBITER

1A13, EXTERNAL TANK(10) SEPARATING FROM ORB. 09 (RTJT16)

SEE THE ASSOCIATED DATA DOCUMENT FOR REFERENCE CHARACTERISTICS FOR INDIVIDUAL DATASETS

PARAMETRIC VALUES	
MACH	4.530
PTOTAL	110.000
BETA	.000
BETA	.000
ALPHA	5.000
ALPHA	.000
ELEVTR	.000
ELEVTR	.000
Y	.000
Y	.000

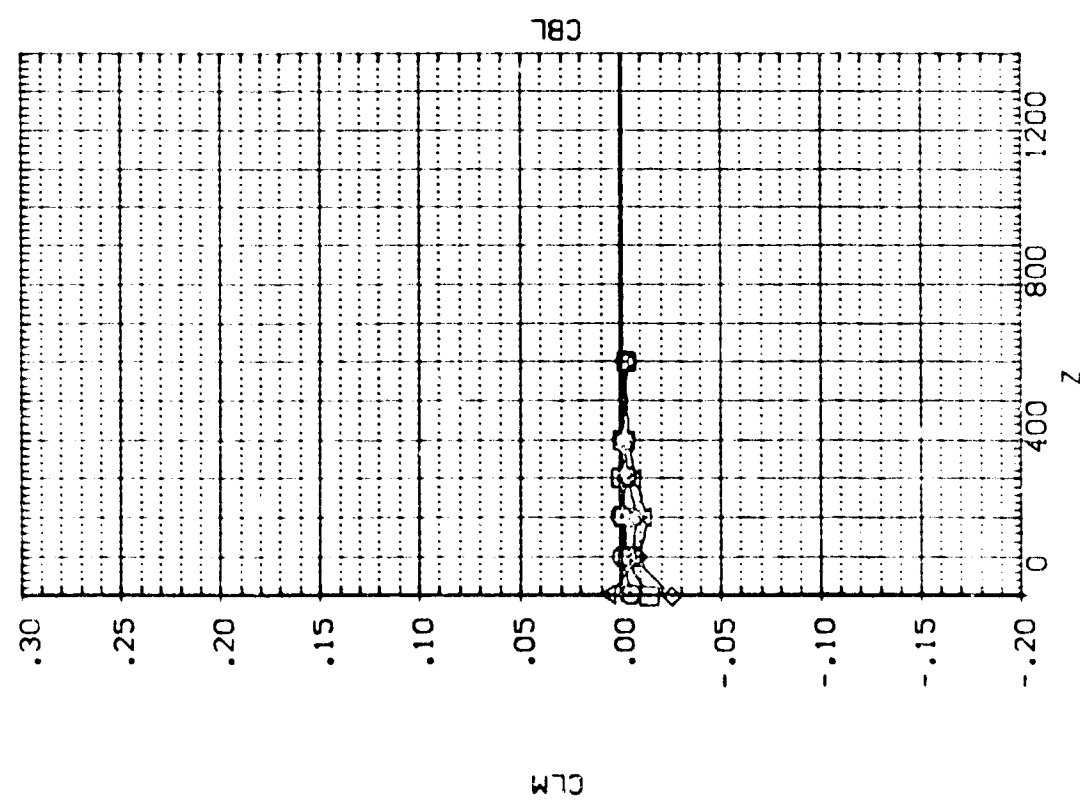
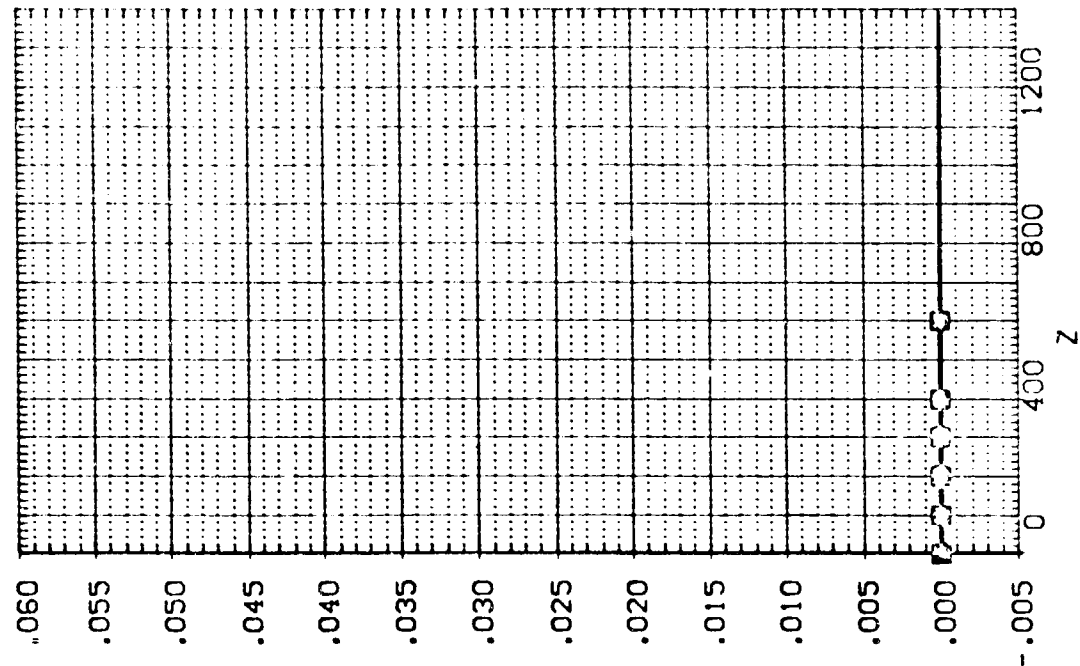

IA13, EXTERNAL TANK(T10)SEPARATING FROM ORB. 09 (RTJT16)

SEE THE ASSOCIATED DATA DOCUMENT FOR REFERENCE CHARACTERISTICS FOR INDIVIDUAL DATASETS

SYMBOL		PARAMETRIC VALUES				
○	X	.228	MACH	4.57	PIDTAL	110.000
□	Y	100.460	ALPHA	-5.000	BETA	.000
◇	Z	800.590	DALPHA	5.000	DBETA	.000
△	Y	1200.600	ELEVTR	.000	AILRON	.000

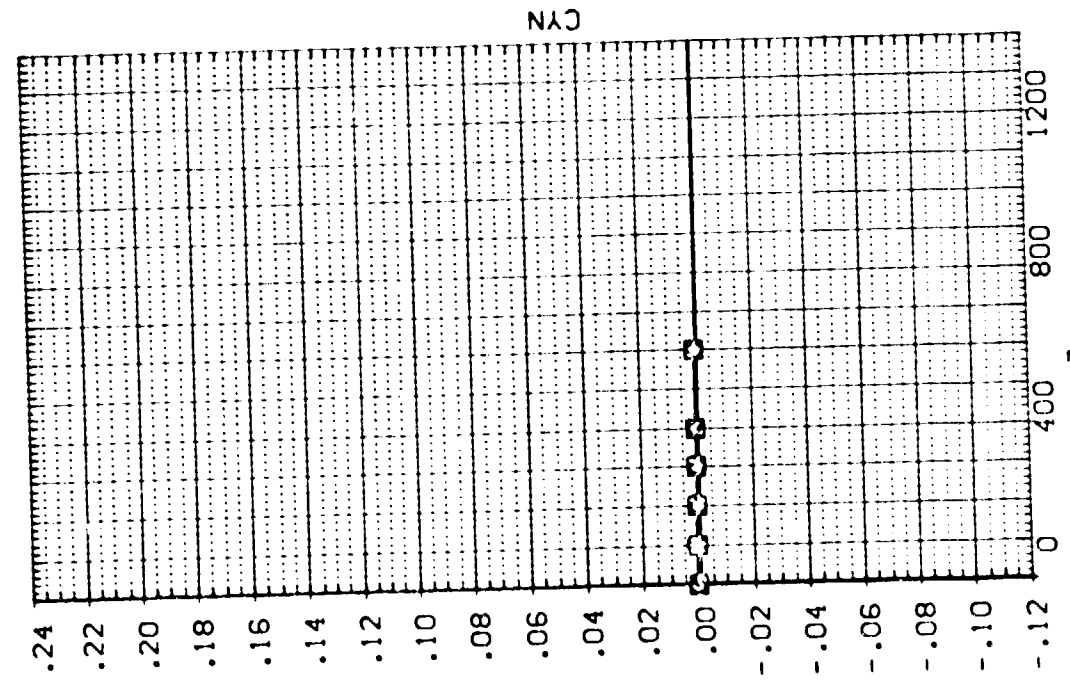
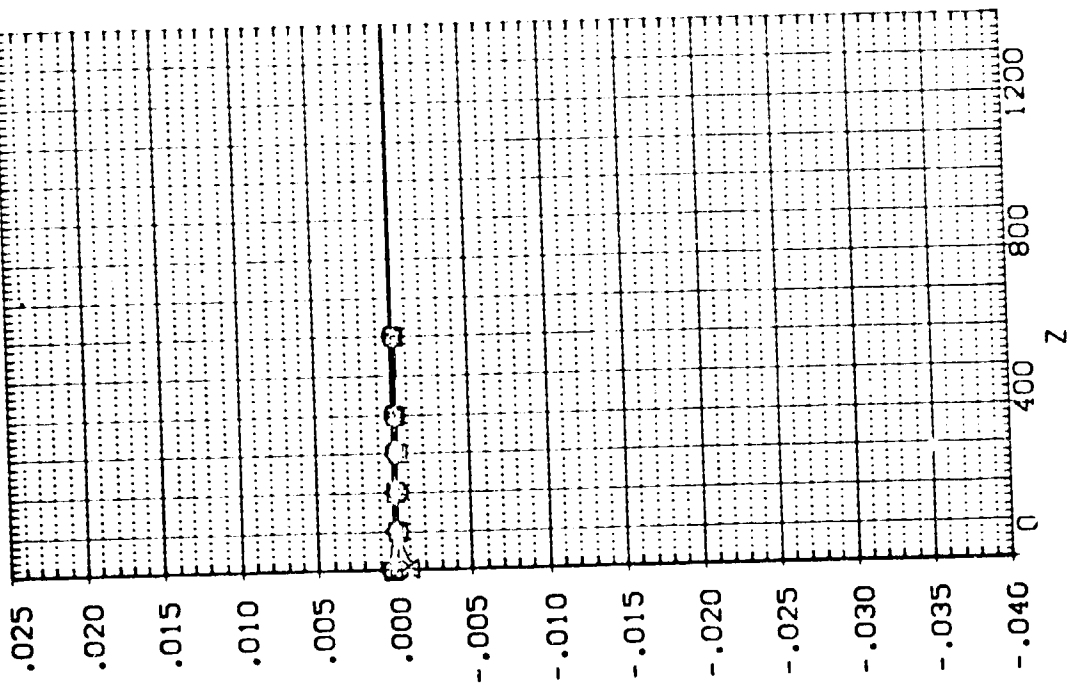

1A13. EXTERNAL TANK(T10)SEPARATING FROM ORB. 09 (RTJT17)

SEE THE ASSOCIATED DATA DOCUMENT FOR REFERENCE CHARACTERISTICS FOR INDIVIDUAL DATASETS

SYMBOL		PARAMETRIC VALUES				
○	X	MACH	4.500	P/DIAL	110.000	
□	400.350	ALPHA	-5.000	BETA	.000	
◇	800.520	DALPHA	.000	DBETA	.000	
		ELEVTR	.000	AILRON	.000	
		Y	.000			

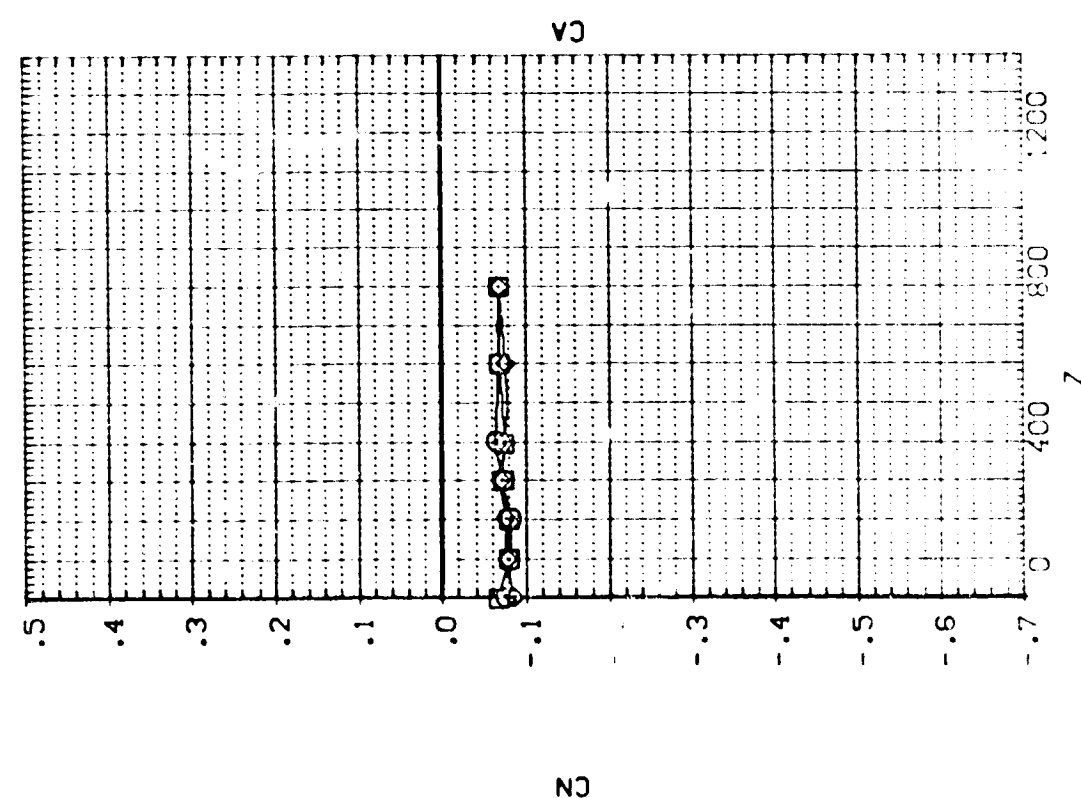
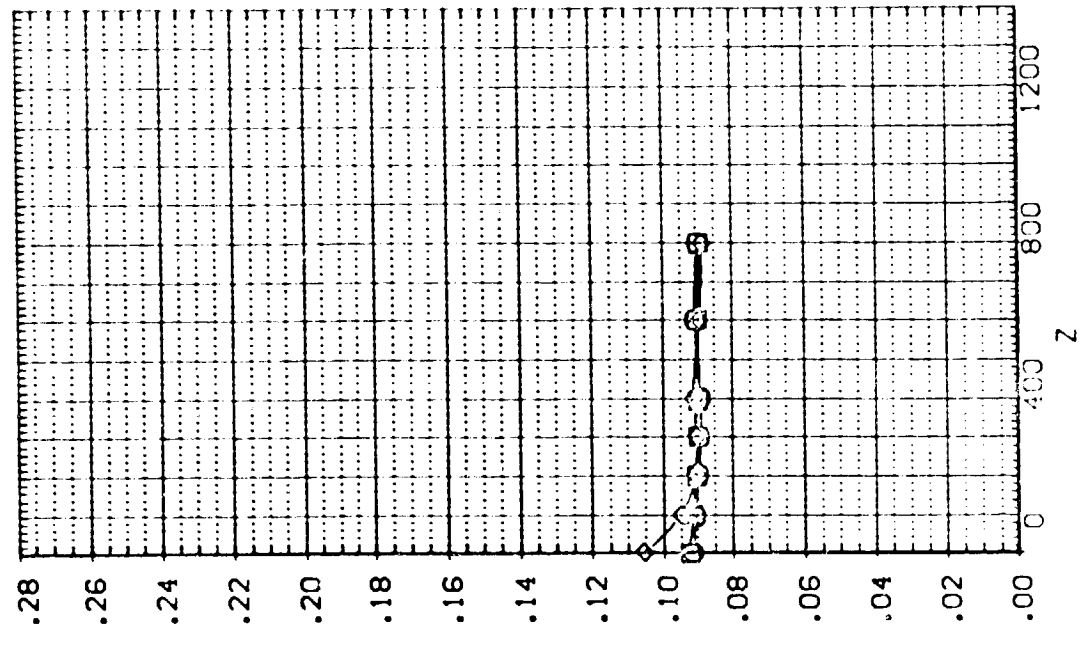

EXTERNAL TANK AERODYNAMIC CHARACTERISTICS DURING SEPARATION FROM ORBITER

LA13. EXTERNAL TANK (110) SEPARATING FROM ORB. 09 (RTJT17)

SEE THE ASSOCIATED DATA DOCUMENT FOR REFERENCE CHARACTERISTICS FOR INDIVIDUAL DATASETS

SYMBOL	x	MACH	PARAMETRIC VALUES		
		400.390	4.530	PTOTAL	110.000
		800.620	-5.000	BETA	.000
			.000	DBETA	.000
			.000	ALLRON	.000
		ELEVTR			
		y			

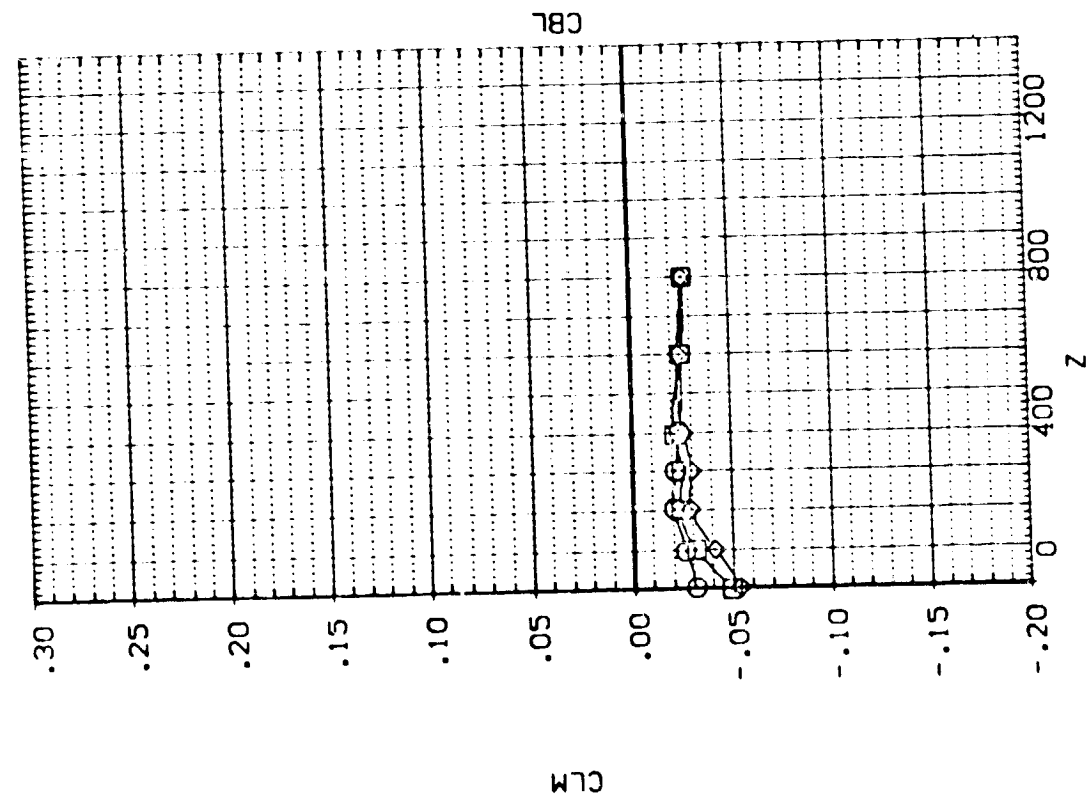
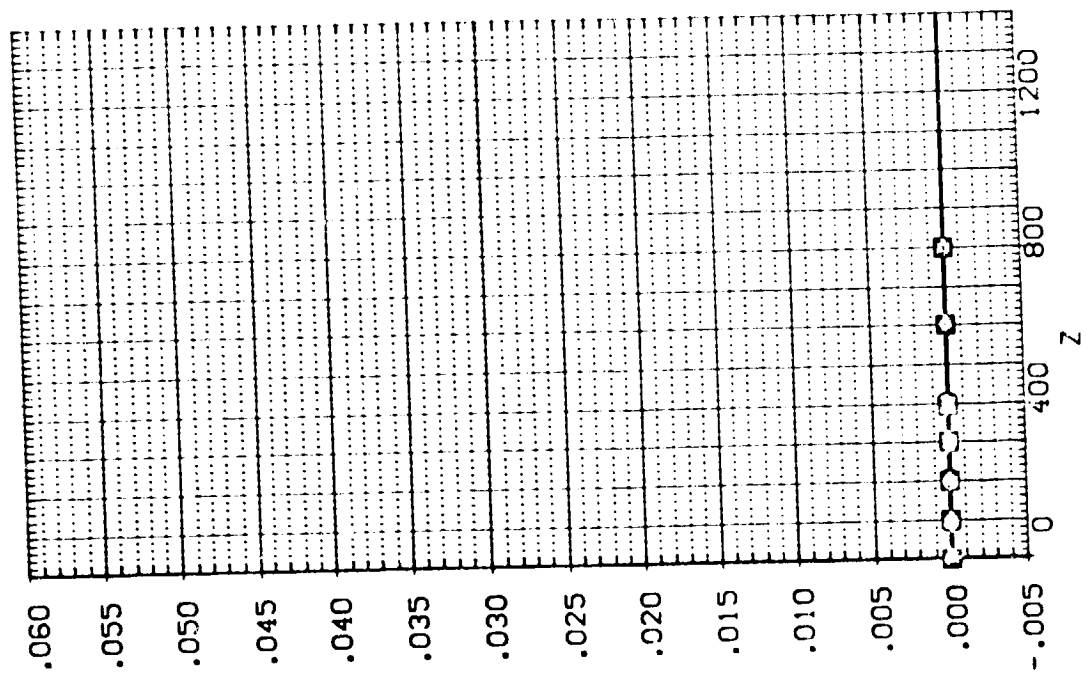

EXTERNAL TANK AERODYNAMIC CHARACTERISTICS DURING SEPARATION FROM ORBITER

1:13.EXTERNAL TANK(T10)SEPARATING FROM ORB. 09 (RTJT17)

SYMBOL
 ○
 □
 ◇

PARAMETRIC VALUES
 .155 MACH 4.530 PTOTAL 110.000
 400.390 ALPHA -5.000 BETA .000
 800.620 DALPHA .000 DBETA .000
 ELEVTR .000 ATLRON .000
 Y .000

SEE THE ASSOCIATED DATA DOCUMENT FOR REFERENCE CHARACTERISTICS FOR INDIVIDUAL DATASETS

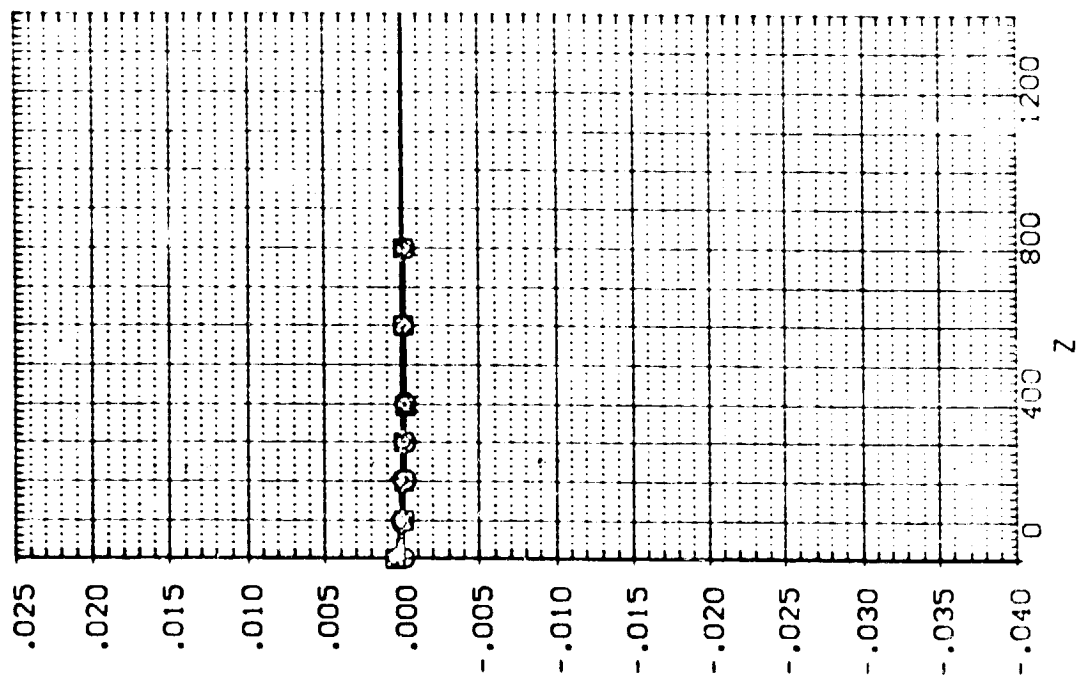
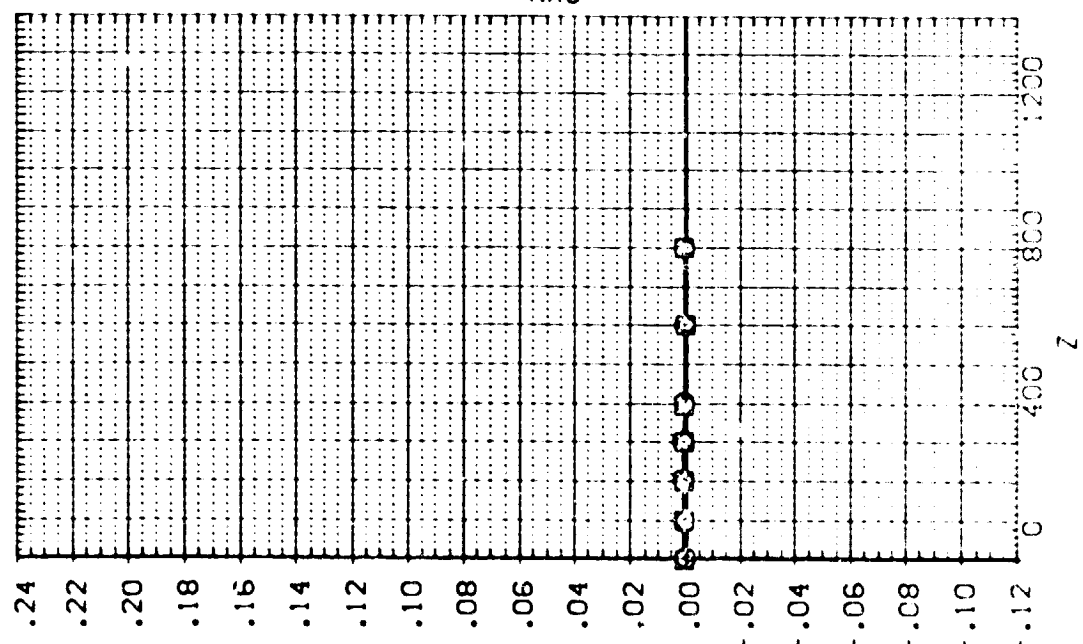

EXTERNAL TANK AERODYNAMIC CHARACTERISTICS DURING SEPARATION FROM ORBITER

1A13.EXTERNAL TANK(110)SEPARATING FROM ORB. 09 (RTJ118)

SYMBOL

-
-
- ◇
- △

PARAMETRIC VALUES

MACH	4.530	PITOTAL	110.000
ALPHA	-5.000	BETA	.000
DALPHA	.000	DBETA	.000
ELEVTR	.000	A1URON	.000
Y	.000		

SEE THE ASSOCIATED DATA DOCUMENT FOR REFERENCE CHARACTERISTICS FOR INDIVIDUAL DATASETS

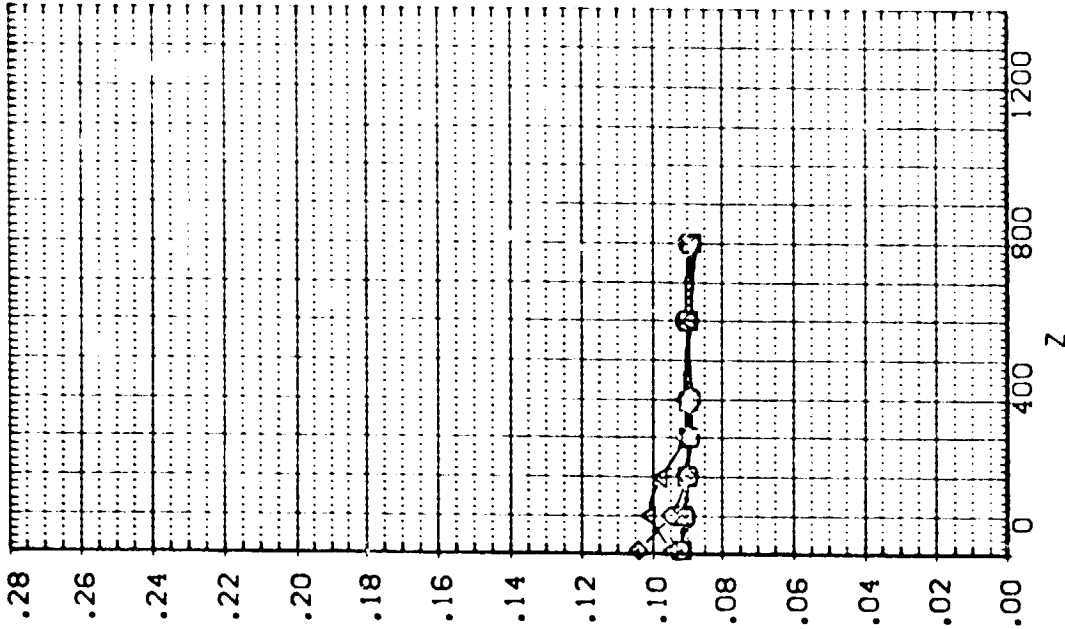
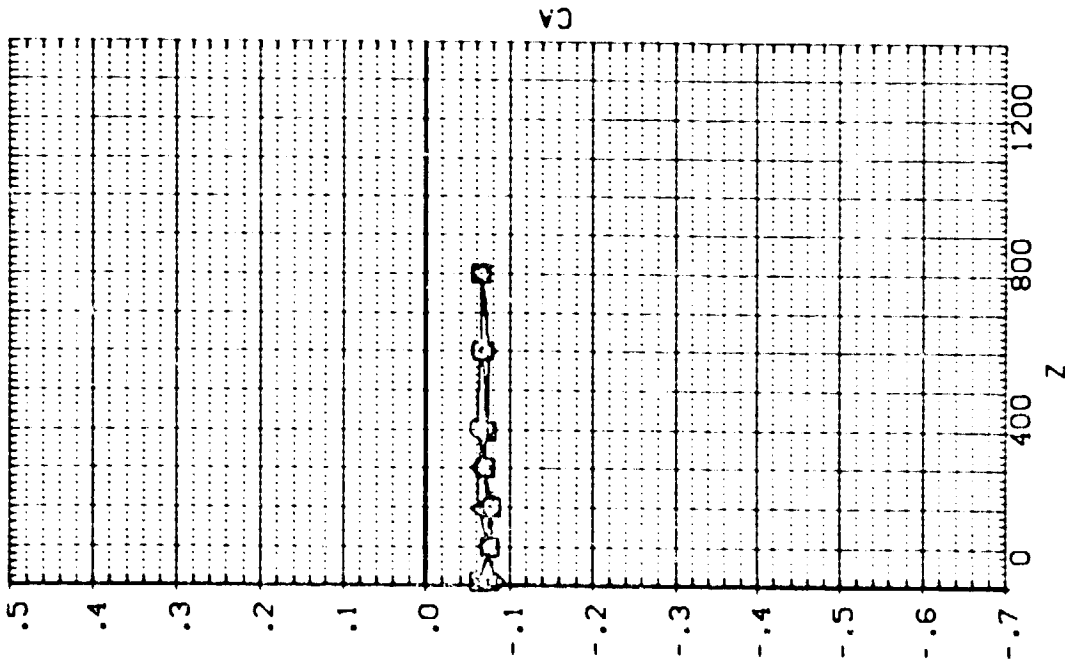

EXTERNAL TANK AERODYNAMIC CHARACTERISTICS DURING SEPARATION FROM ORBITER

FIG. 13. EXTERNAL TANK (110) SEPARATING FROM ORB. 09 (PTJ118)

SEE THE ASSOCIATED DATA DOCUMENT FOR REFERENCE CHARACTERISTICS FOR INDIVIDUAL DATASETS

SYMBOL		PARAMETRIC VALUES					
○	X	MACH	4.530	P/DOTAL	110.000		
□	Y	ALPHA	-5.000	BETA	.000		
◇	Z	DALPHA	.000	DBETA	.000		
△		ELEVTR	.000	AILRON	.000		
		Y	.000				

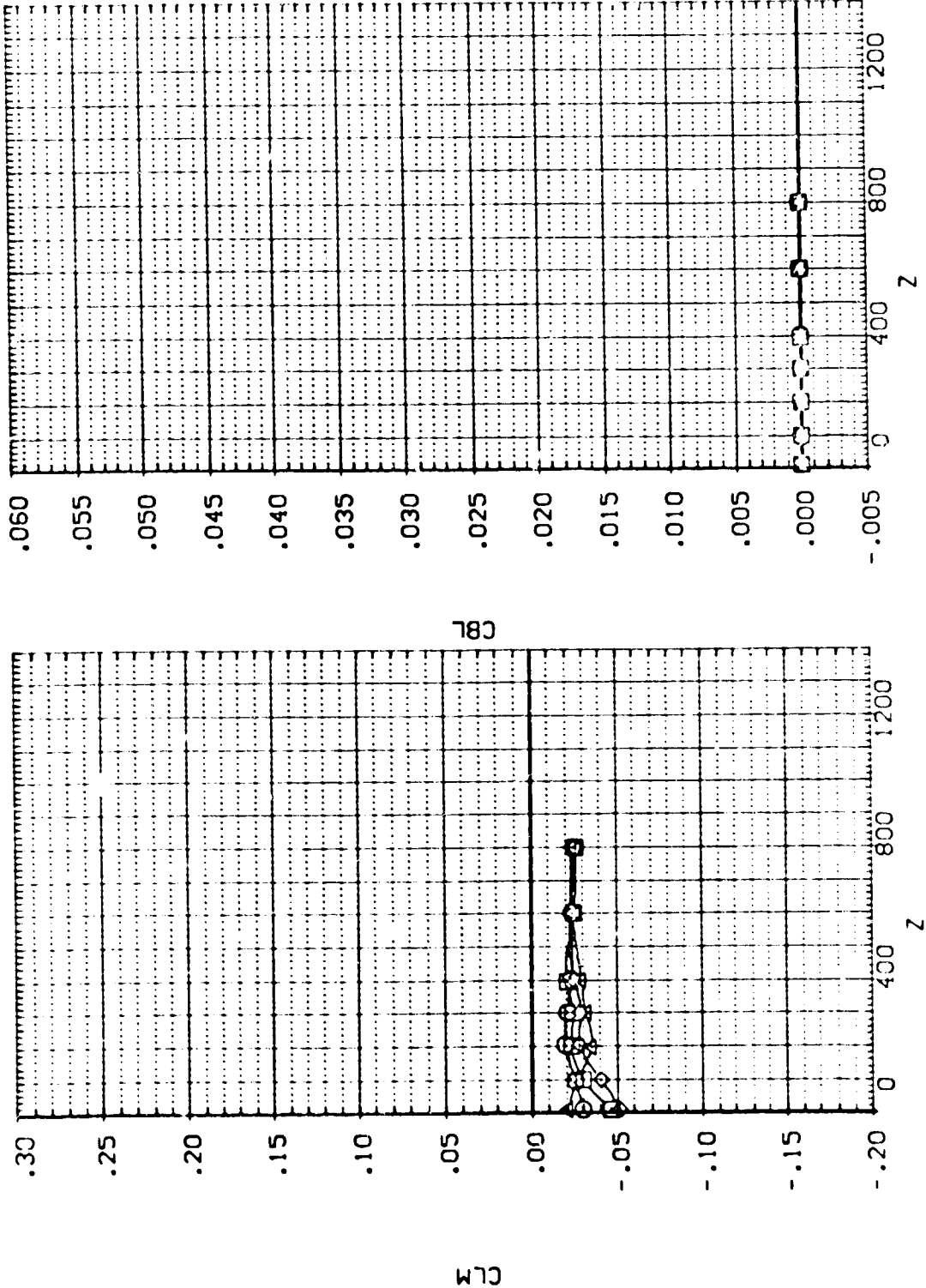

EXTERNAL TANK AERODYNAMIC CHARACTERISTICS DURING SEPARATION FROM ORBITER

1A13. EXTERNAL TANK(T10)SEPARATING FROM ORB. C9 (RTJ118)

SYMBOL

-
-
-
- △

PARAMETRIC VALUES

x	.170	MACH	4.530	PTOTAL	110.000
○	400.300	ALPHA	-5.000	BETA	.000
○	800.530	DA-PHA	.000	DBETA	.000
△	1200.900	ELEVTR	.000	ALLRON	.000
		Y	.000		

SEE THE ASSOCIATED DATA DOCUMENT FOR REFERENCE CHARACTERISTICS FOR INDIVIDUAL DATASETS

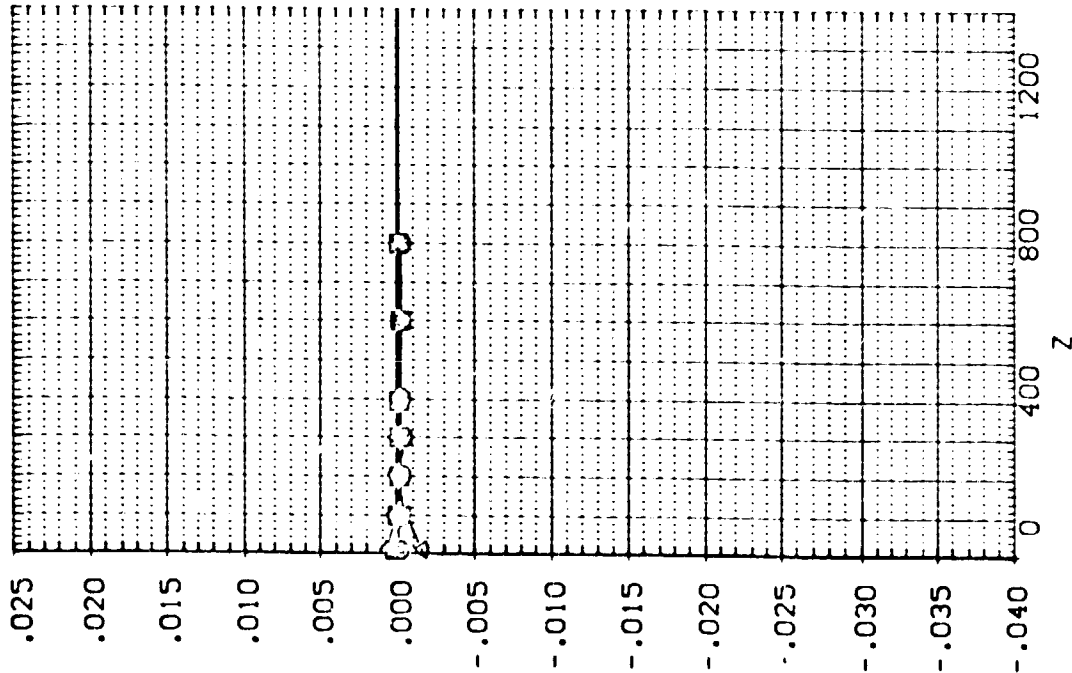
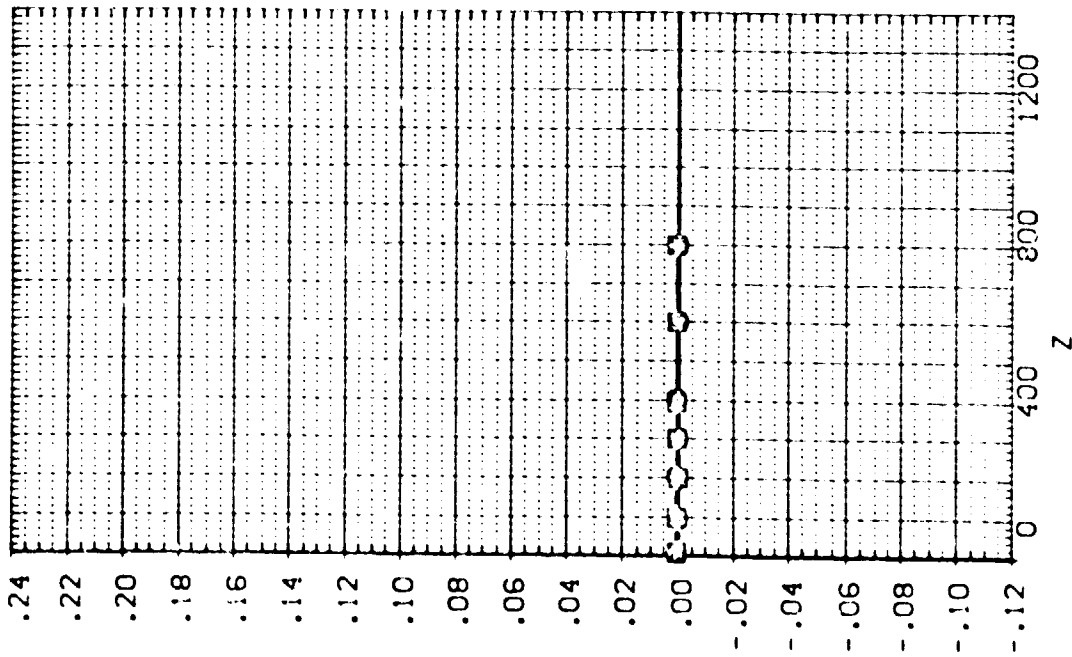

EXTERNAL TANK AERODYNAMIC CHARACTERISTICS DURING SEPARATION FROM ORBITER

IA13, EXTERNAL TANK(T10) SEPARATING FROM ORB. 09 (RTJT19)

SEE THE ASSOCIATED DATA DOCUMENT FOR REFERENCE CHARACTERISTICS FOR INDIVIDUAL DATASETS

SYMBOL		PARAMETRIC VALUES	
○	.223	MACH	4.530
□	400.420	ALPHA	-5.000
◇	800.600	DALPHA	.300
△	1200.700	ELEVTR	.300
		Y	200.000
		P(TOTAL)	110.000
		BETA	.000
		DBETA	.000
		A(LRON)	.000

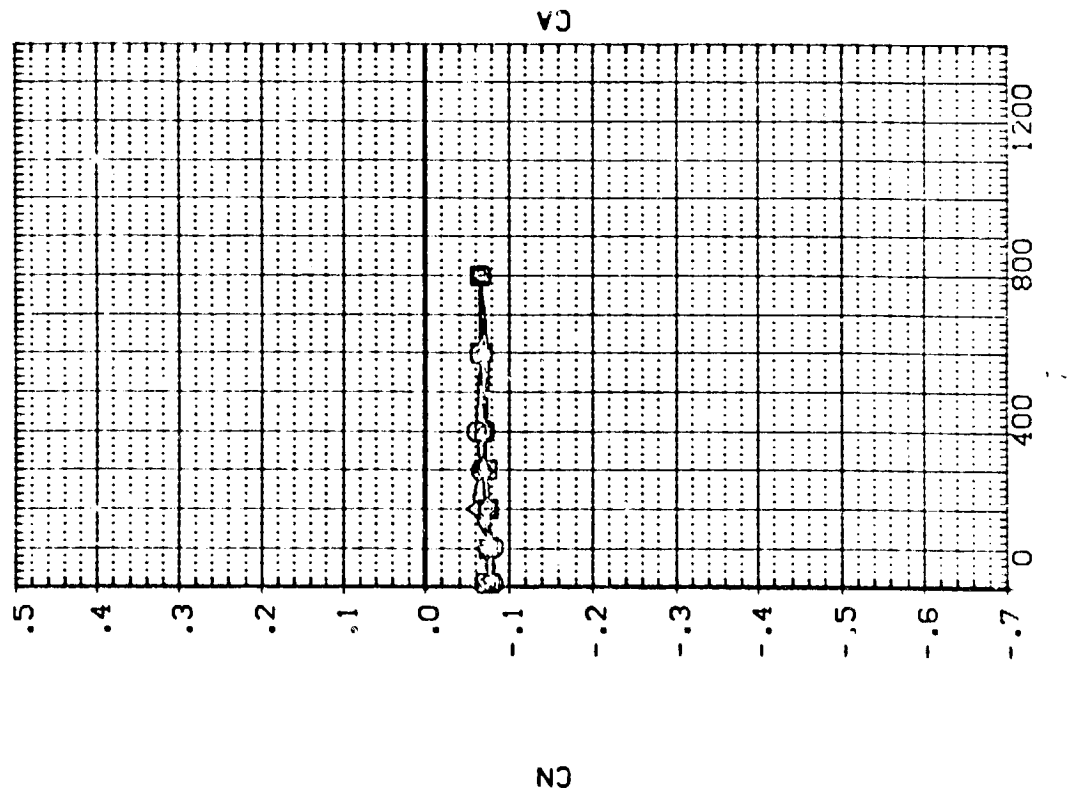
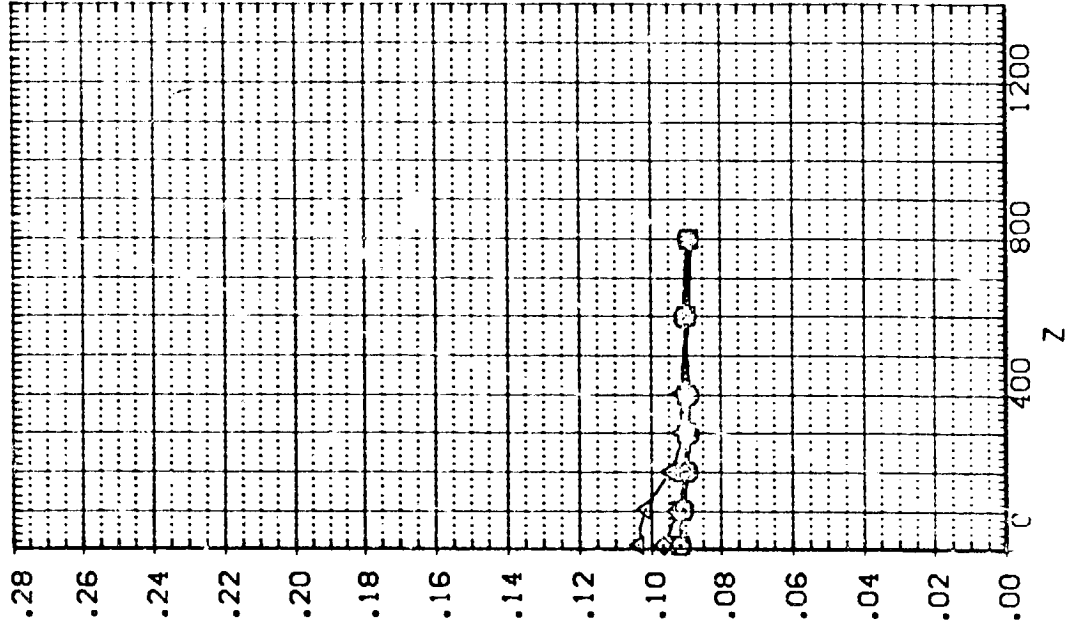

IA13, EXTERNAL TANK(T10)SEPARATING FROM ORB. 09 (RTJ19)

SEE THE ASSOCIATED DATA DOCUMENT FOR REFERENCE CHARACTERISTICS FOR INDIVIDUAL DATASETS

SYMBOL	X	MACH	PARAMETRIC VALUES
○	.222	4.530	PTOTAL 110.000
□	400.420	ALPHA -5.000	BETA .000
◇	800.600	DALPHA .000	DBETA .000
△	1200.700	ELEVTR 200.000	A1LRON .000

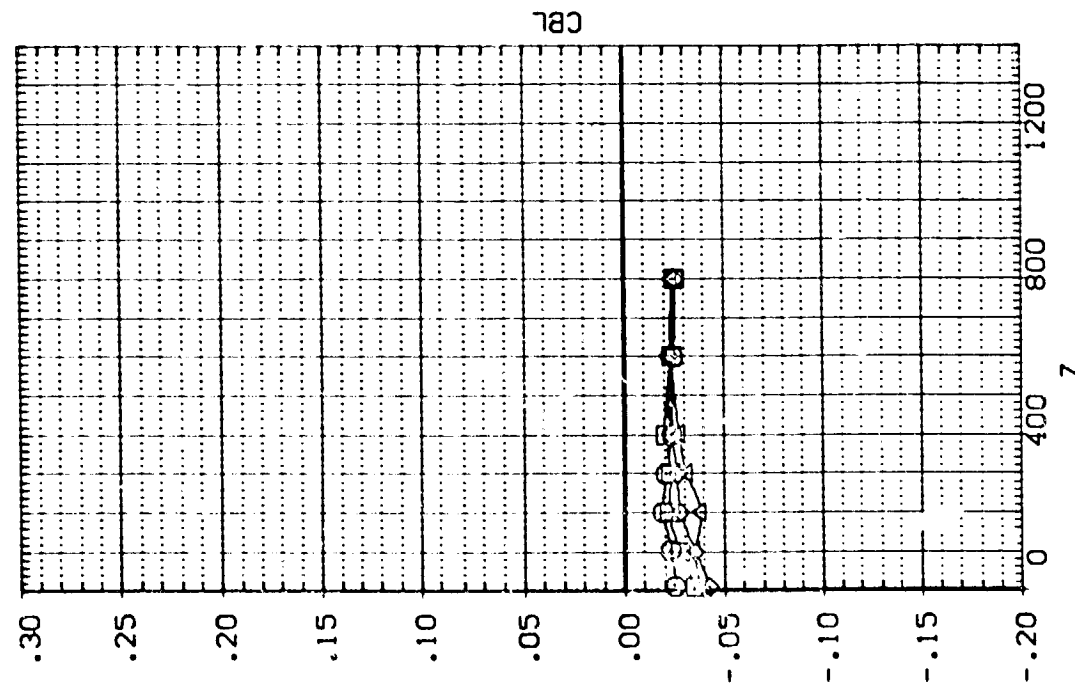
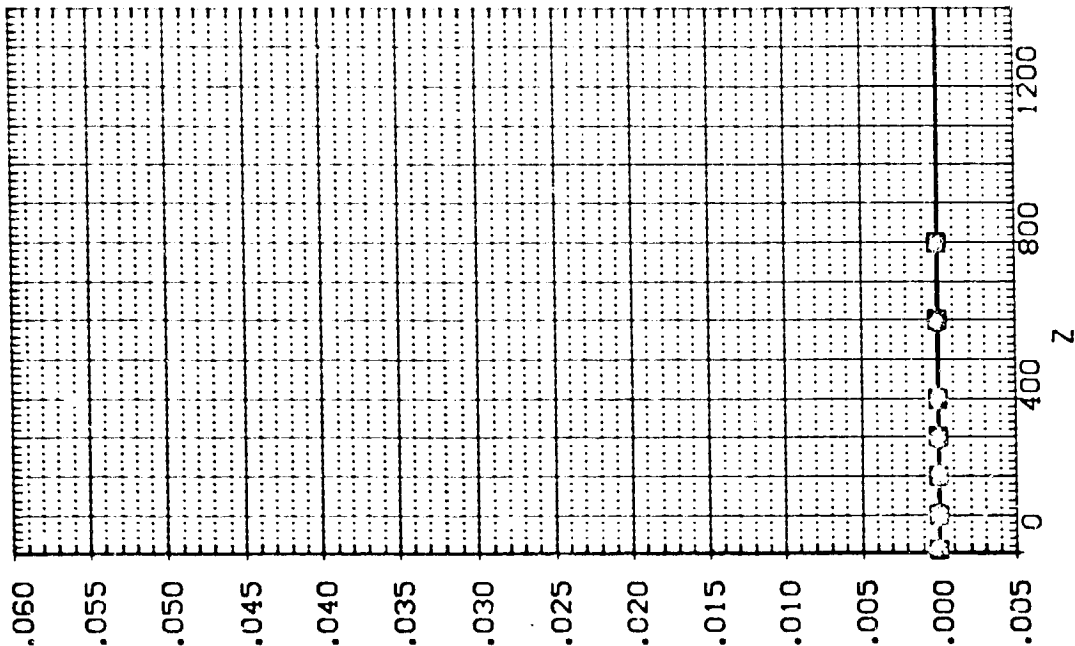

EXTERNAL TANK AERODYNAMIC CHARACTERISTICS DURING SEPARATION FROM ORBITER

IA13, EXTERNAL TANK(T10)SEPARATING FROM ORB. 09 (RTJT19)

SEE THE ASSOCIATED DATA DOCUMENT FOR REFERENCE CHARACTERISTICS FOR INDIVIDUAL DATASETS

SYMBOL		PARAMETRIC VALUES			
○	.223	MACH	4.530	P TOTAL	110.000
□	400.420	ALPHA	-5.000	BETA	.000
◇	800.600	DALPHA	.000	DBETA	.000
△	1200.700	ELEVTR	.000	AILRON	.000
		Y	200.000		

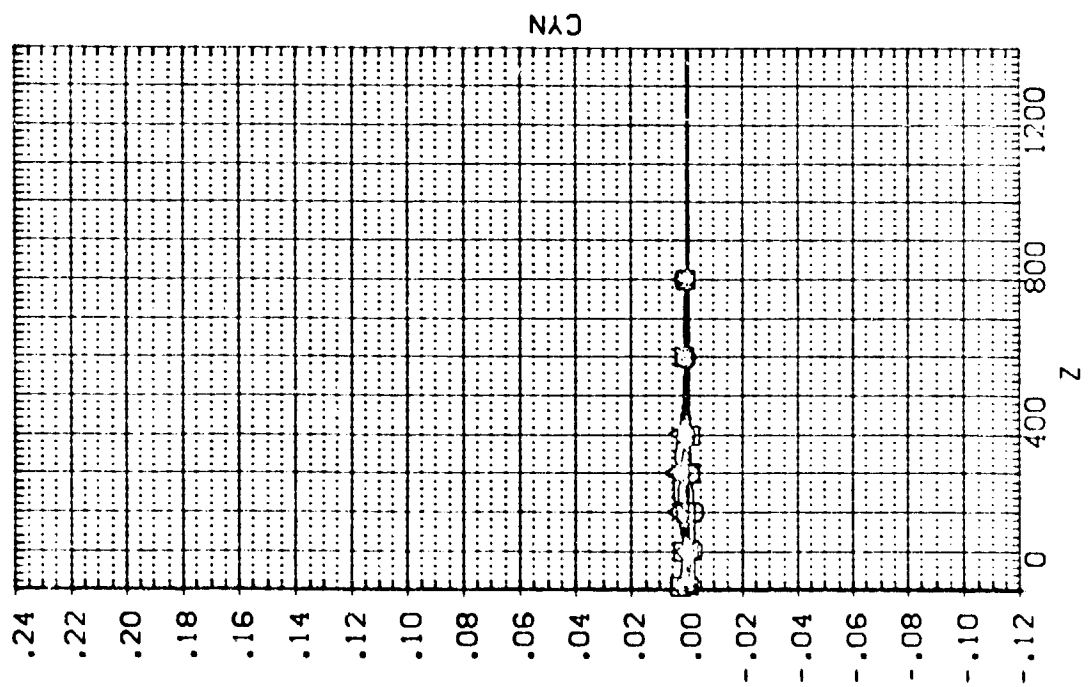
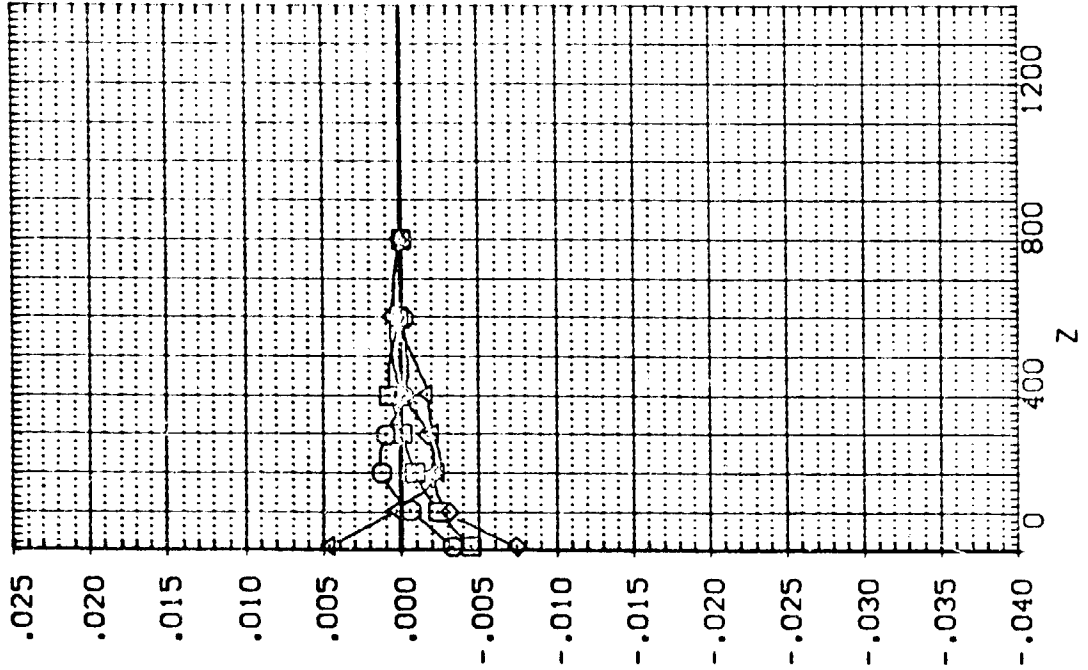

IA13.EXTERNAL TANK(T10)SEPARATING FROM ORB. 09 (RTJT20)

SEE THE ASSOCIATED DATA DOCUMENT FOR REFERENCE CHARACTERISTICS FOR INDIVIDUAL DATASETS

SYMBOL		PARAMETRIC VALUES			
○	X	MACH	4.530	P TOTAL	110.000
□	Y	ALPHA	-5.000	BETA	.000
◇	Z	DALPHA	.000	DBETA	5.000
△	Y	ELEVTR	.000	AILLRON	.000
			200.000		

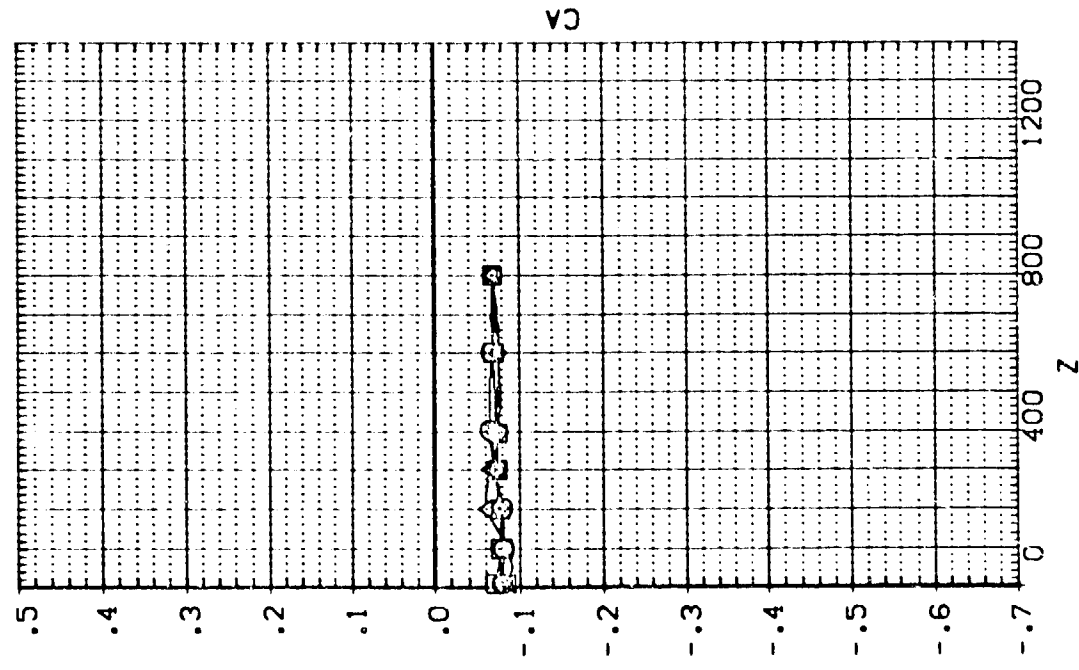
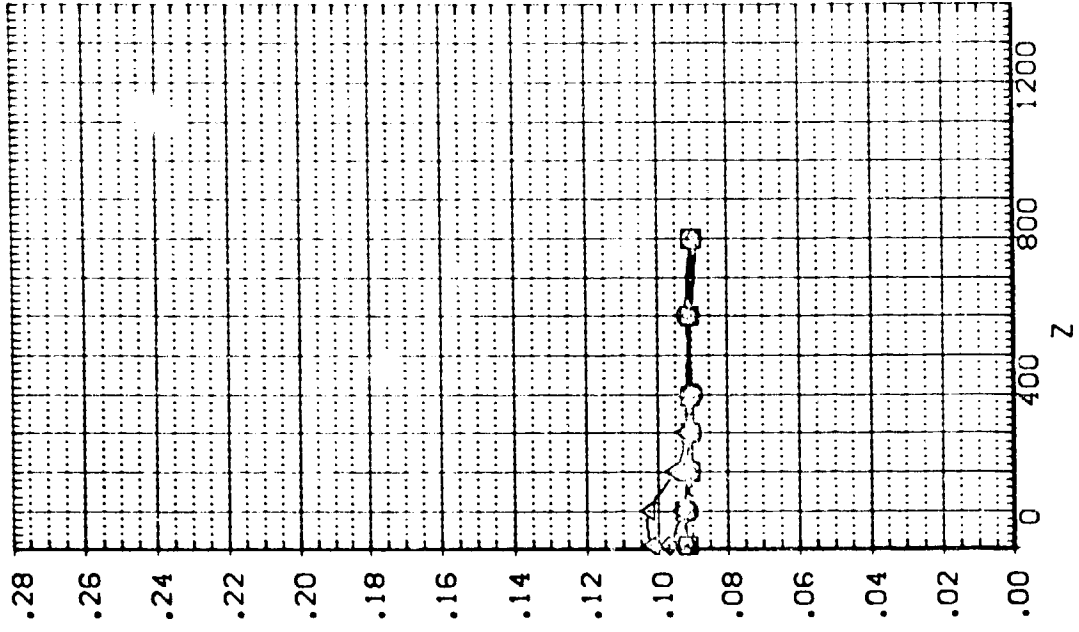

EXTERNAL TANK AERODYNAMIC CHARACTERISTICS DURING SEPARATION FROM ORBITER

IA13.EXTERNAL TANK(T10)SEPARATING FROM ORB. 09 (RTJT20)

SEE THE ASSOCIATED DATA DOCUMENT FOR REFERENCE CHARACTERISTICS FOR INDIVIDUAL DATASETS

SYMBOL		PARAMETRIC VALUES				
○	X	.175	MACH	4.530	PTOTAL	110.000
□	ALPHA	400.230		-5.000	BETA	.000
◇	DALPHA	800.370		.000	DBETA	5.000
△	ELEVTR	1200.900		.000	AILRON	.000
	Y	200.000				

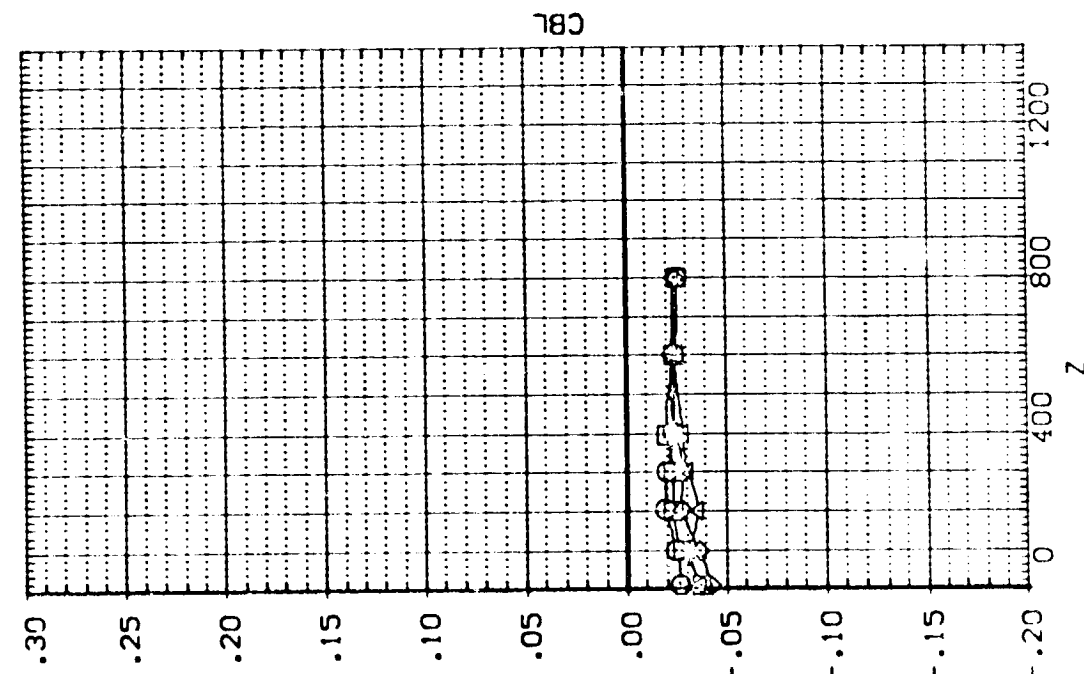
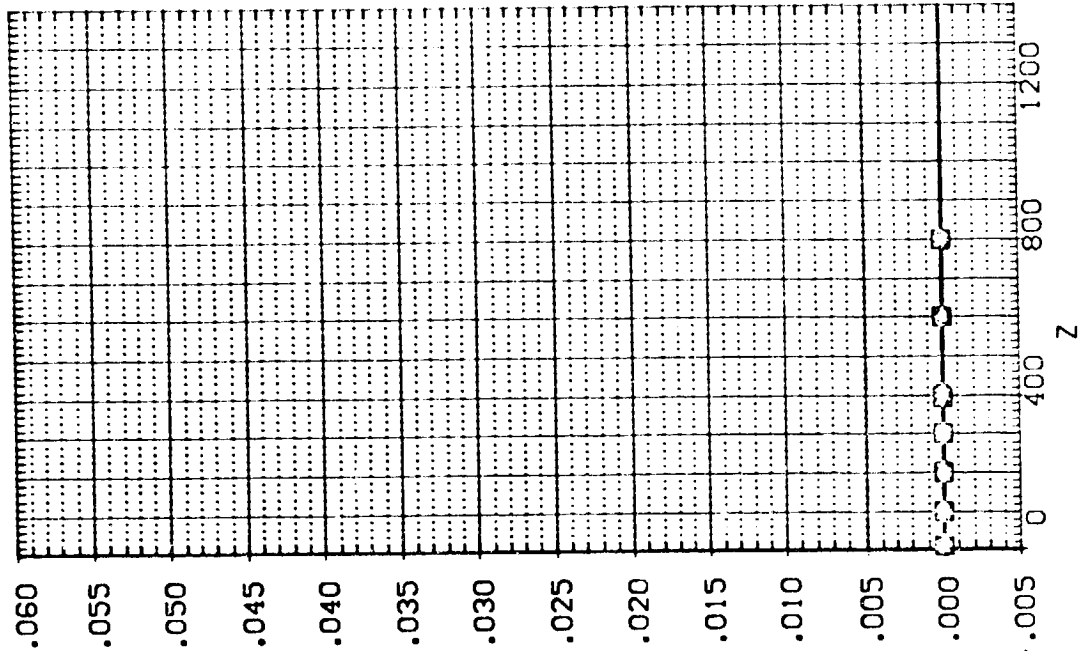

EXTERNAL TANK AERODYNAMIC CHARACTERISTICS DURING SEPARATION FROM ORBITER

IA13.EXTERNAL TANK(T10)SEPARATING FROM ORB. 09 (RTJT20)

SYMBOL X

-
- ◇
- △

.175 MACH
400.230 ALPHA
800.370 DALPHA
1200.900 ELEVTR
Y

PARAMETRIC VALUES

4.530 P/TOTAL 110.000
-5.000 BETA .000
.003 DBETA 5.000
.000 AILRON .000
200.000 Y

SEE THE ASSOCIATED DATA DOCUMENT FOR REFERENCE CHARACTERISTICS FOR INDIVIDUAL DATASETS

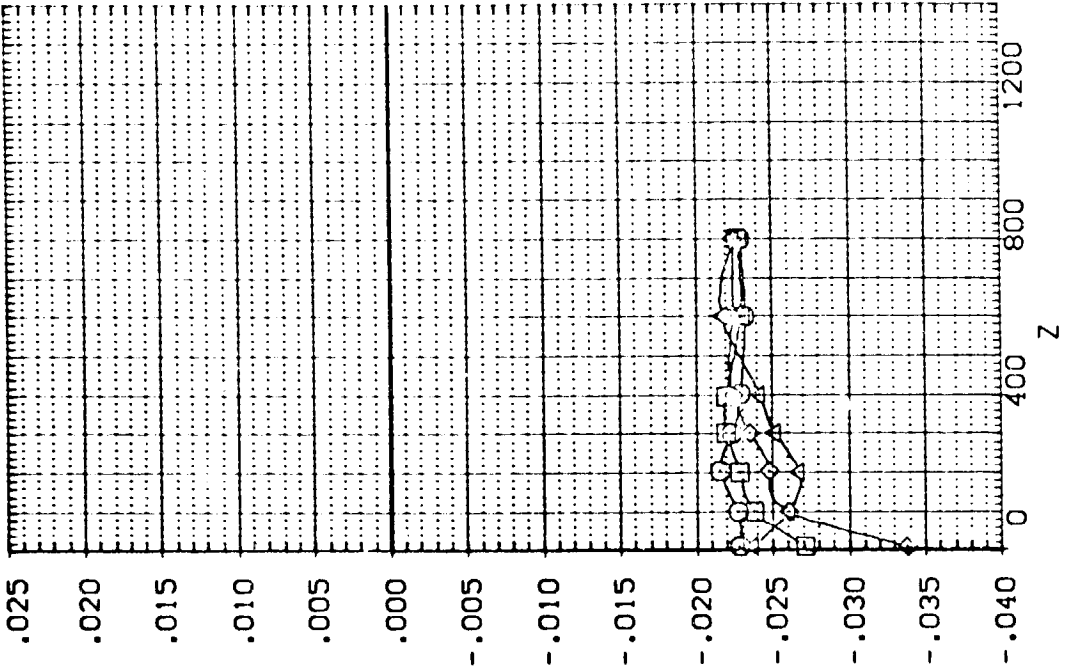
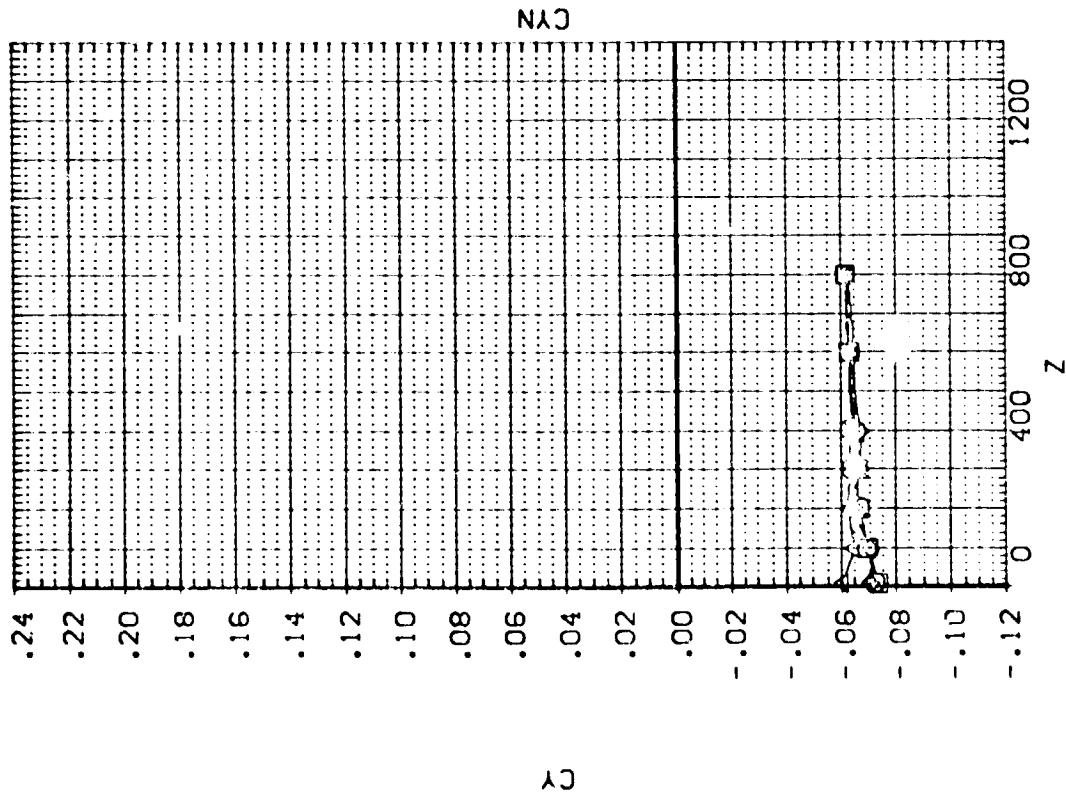

EXTERNAL TANK AERODYNAMIC CHARACTERISTICS DURING SEPARATION FROM ORBITER

IA13.EXTERNAL TANK(T10)SEPARATING FROM ORB. 09 (RTJT21)

SEE THE ASSOCIATED DATA DOCUMENT FOR REFERENCE CHARACTERISTICS FOR INDIVIDUAL DATASETS

SYMBOL		PARAMETRIC VALUES	
○	.308	MACH	4.530
□	400.370	ALPHA	-5.000
◇	800.700	DALPHA	.000
△	1200.800	ELEVTR	.000
		Y	.000
		POTAL	110.000
		BETA	.000
		DBETA	5.000
		ALLRON	.000

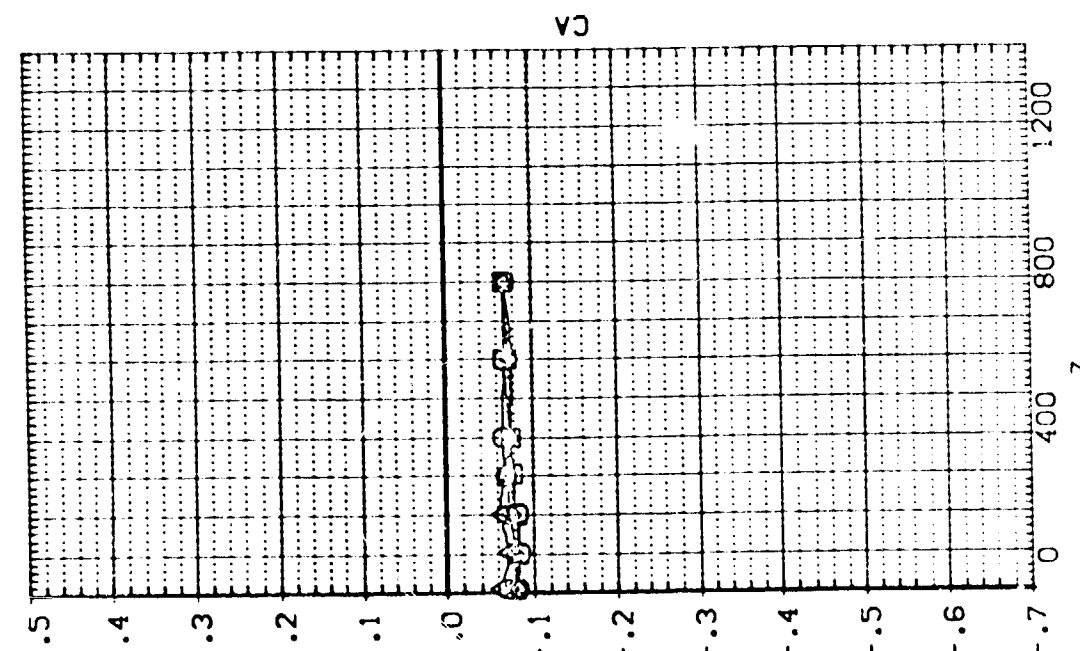
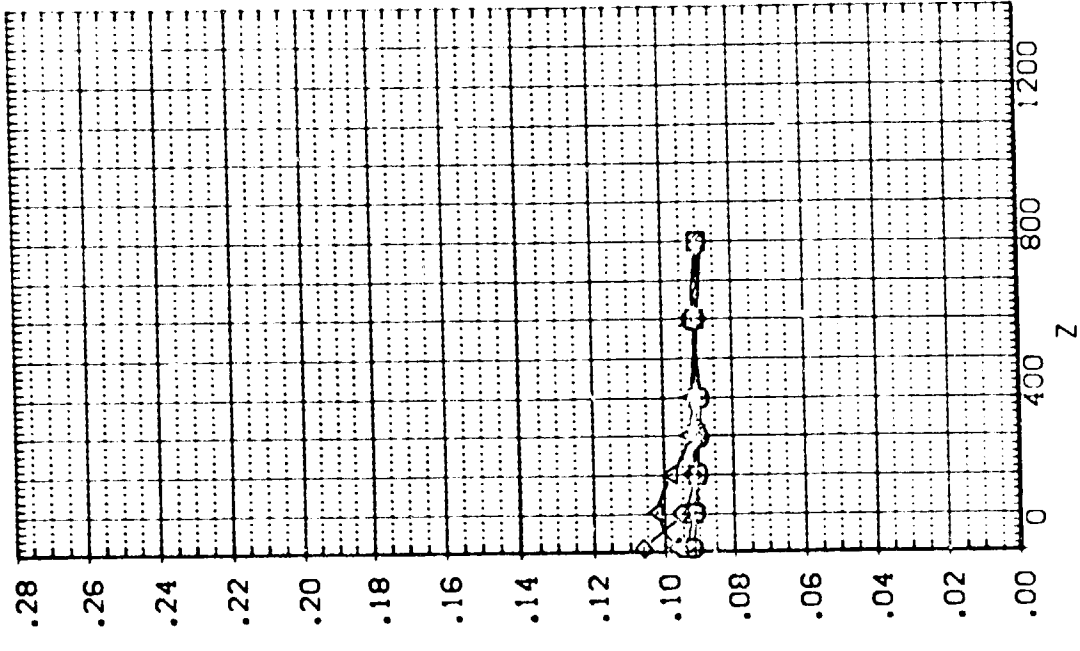

IA13. EXTERNAL TANK (T10) SEPARATING FROM ORB. 09 (RTJ121)

SYMBOL	X	MACH	PARAMETRIC VALUES
○	.308	4.530	P TOTAL 110.000
□	400.370	-5.000	BETA .000
◇	800.700	.000	DBETA 5.000
△	1200.800	.000	AILRON .000
		Y	.000

SEE THE ASSOCIATED DATA DOCUMENT FOR REFERENCE CHARACTERISTICS FOR INDIVIDUAL DATASETS

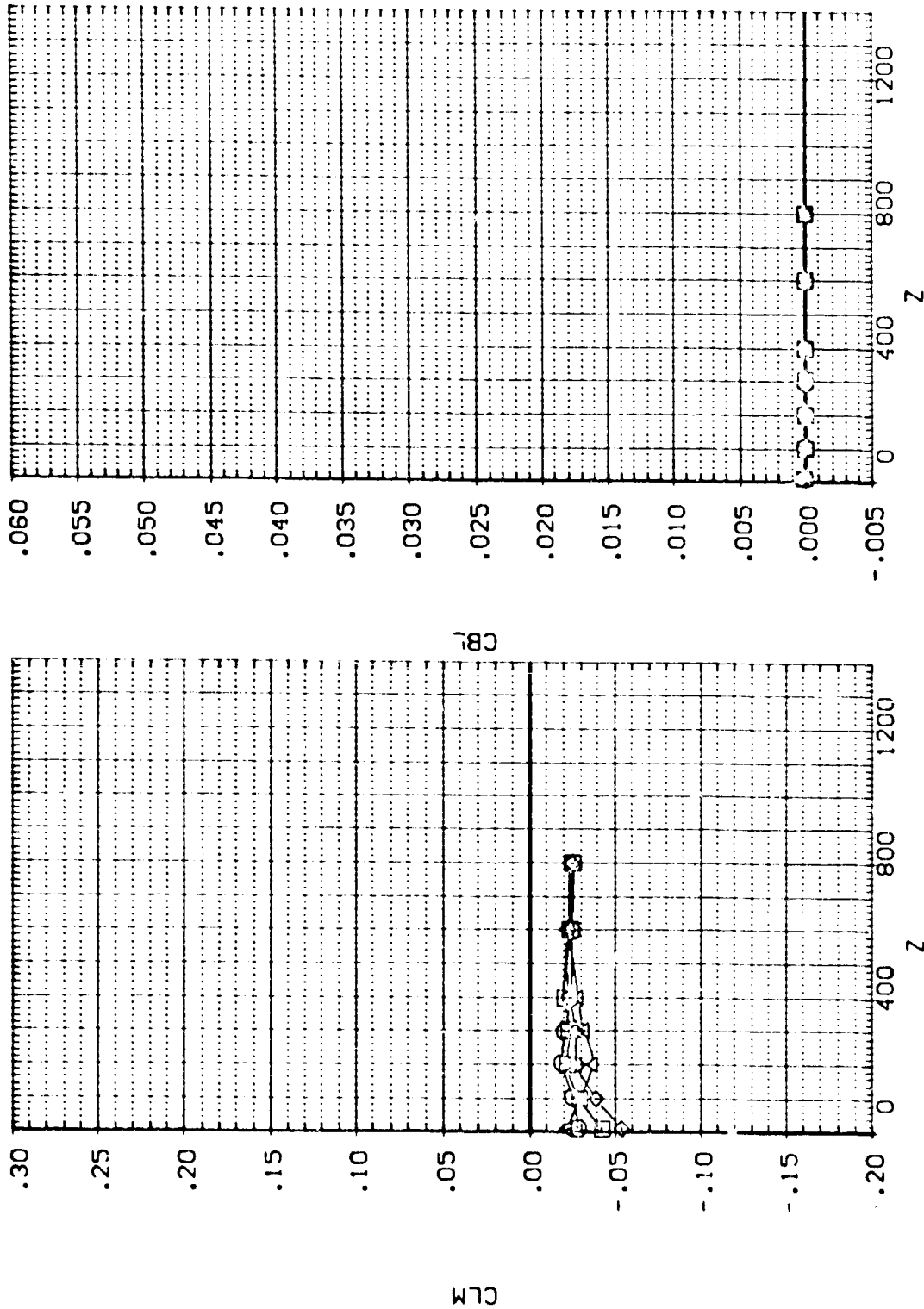

EXTERNAL TANK AERODYNAMIC CHARACTERISTICS DURING SEPARATION FROM ORBITER

IA13.EXTERNAL TANK(T10)SEPARATING FROM ORB. 09 (RTJT21)

SEE THE ASSOCIATED DATA DOCUMENT FOR REFERENCE CHARACTERISTICS FOR INDIVIDUAL DATASETS

SYMBOL		PARAMETRIC VALUES	
○	X	MACH	4.530
□	Y	ALPHA	-5.000
◇	Z	BETA	.000
△	C	DBETA	5.000
		ELEVTR	.000
		ATLRON	.000
		PTOTAL	110.000

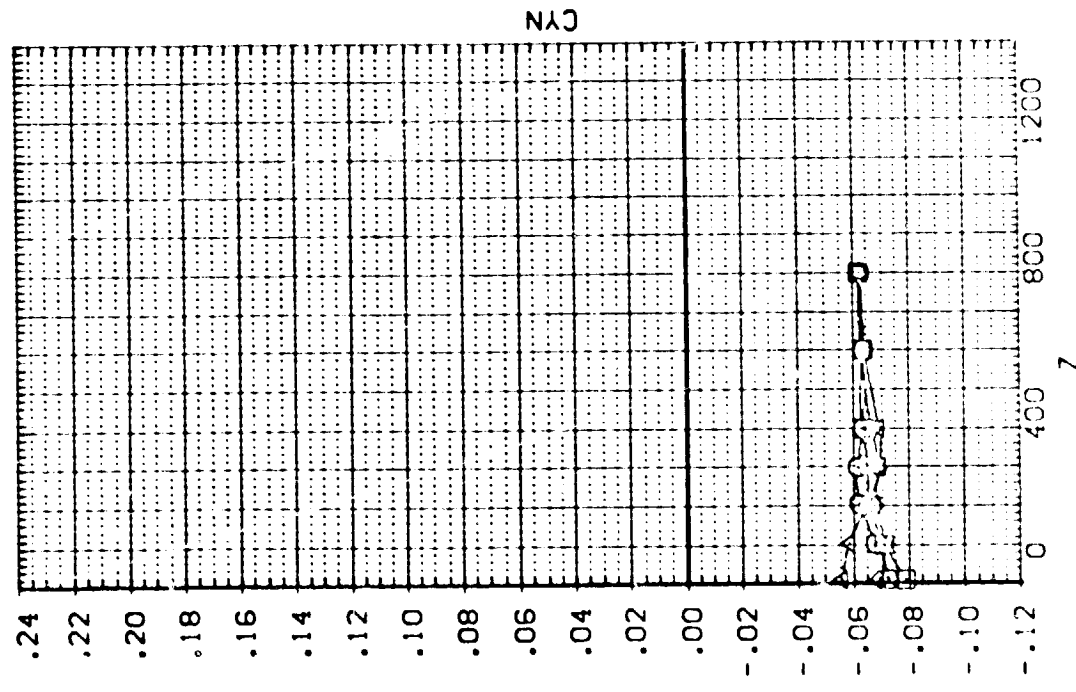
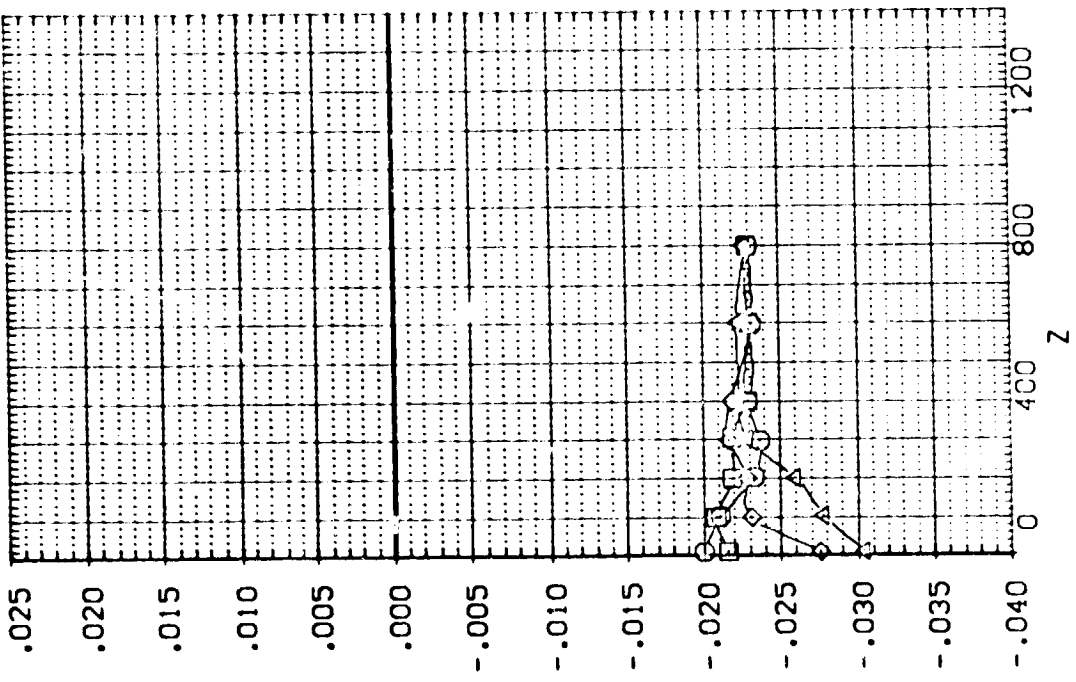

EXTERNAL TANK AERODYNAMIC CHARACTERISTICS DURING SEPARATION FROM ORBITER

1A13.EXTERNAL TANK(T10)SEPARATING FROM ORB. 09 (RTJT22)

SYMBOL

-
-
- ◇
- △

PARAMETRIC VALUES	
X	.089
MACH	4.530
PTOTAL	110.000
ALPHA	-5.000
BETA	.000
DALPHA	-5.000
DBETA	.000
ELEVTR	.000
AILRON	.000
Y	.000

SEE THE ASSOCIATED DATA DOCUMENT FOR REFERENCE CHARACTERISTICS FOR INDIVIDUAL DATASETS

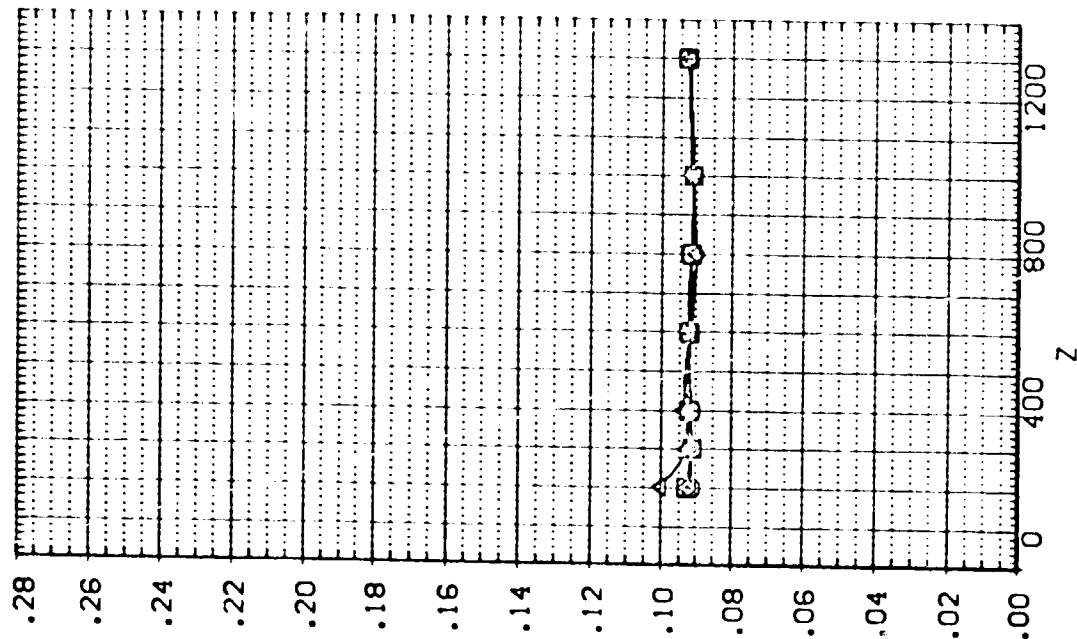
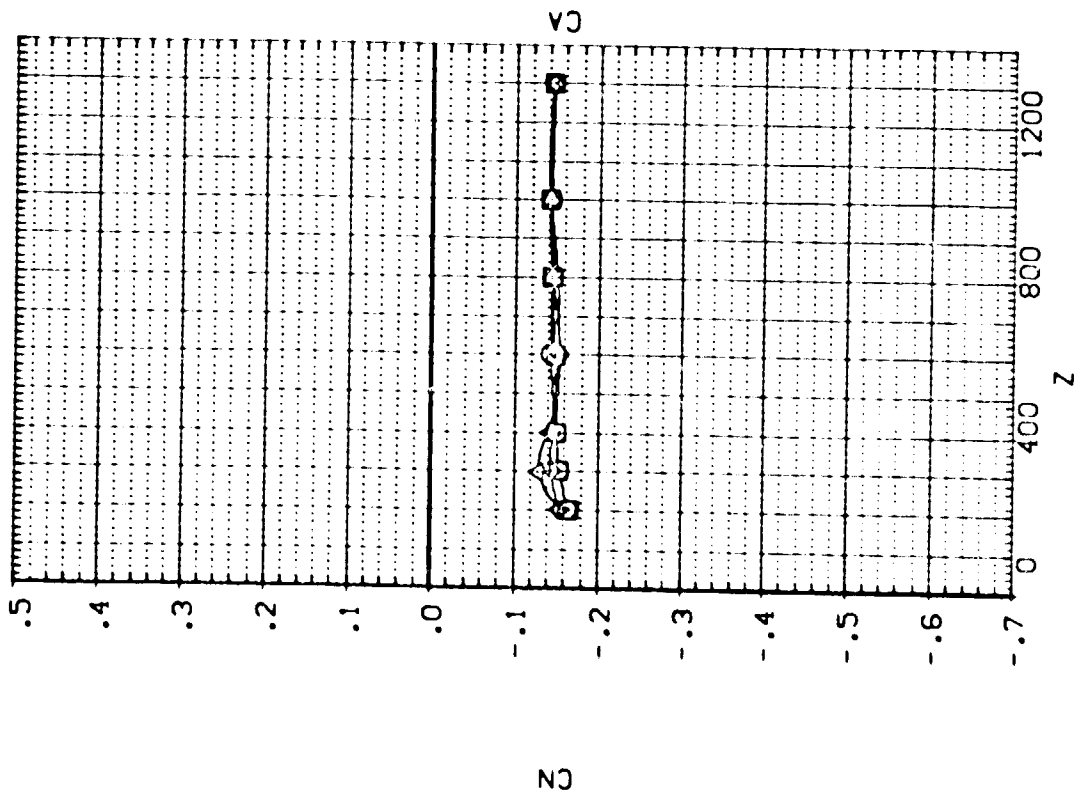

EXTERNAL TANK AERODYNAMIC CHARACTERISTICS DURING SEPARATION FROM ORBITER

1A13.EXTERNAL TANK(110)SEPARATING FROM ORB. 09 (RTJT22)

SEE THE ASSOCIATED DATA DOCUMENT FOR REFERENCE CHARACTERISTICS FOR INDIVIDUAL DATASETS

SYMBOL		PARAMETRIC VALUES			
x	.089	MACH	4.530	PTOTAL	110.000
o	400.520	ALPHA	-5.000	BETA	.000
o	800.490	DALPHA	-1.000	DBETA	.000
o	1200.800	ELEVTR	.000	ATLSPN	.000
		Y	.000		

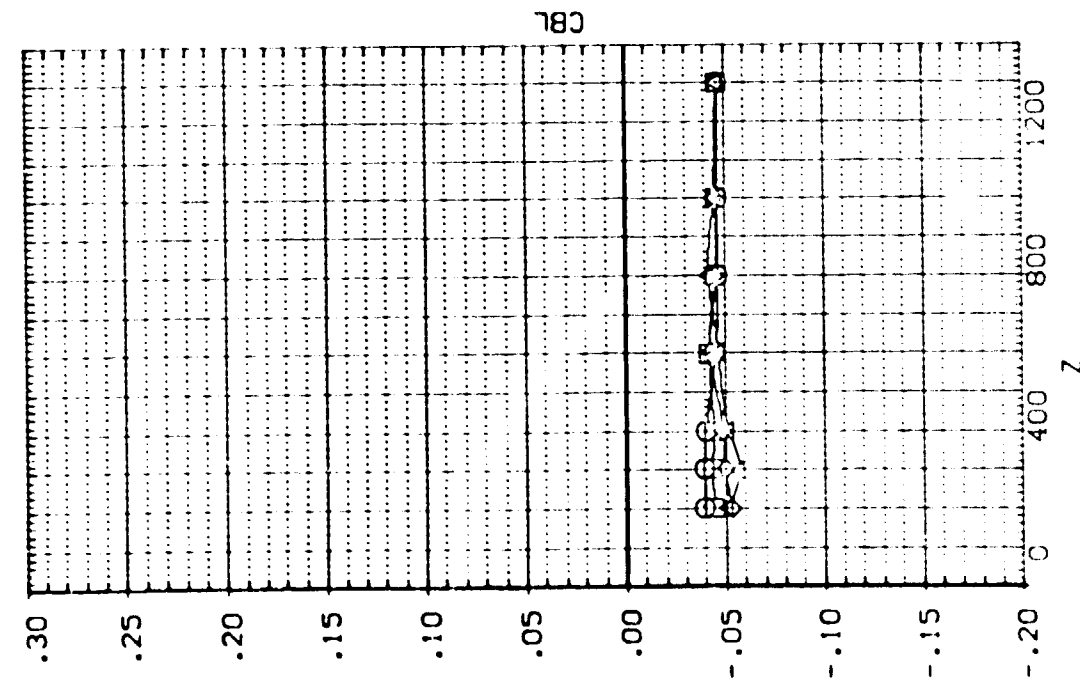
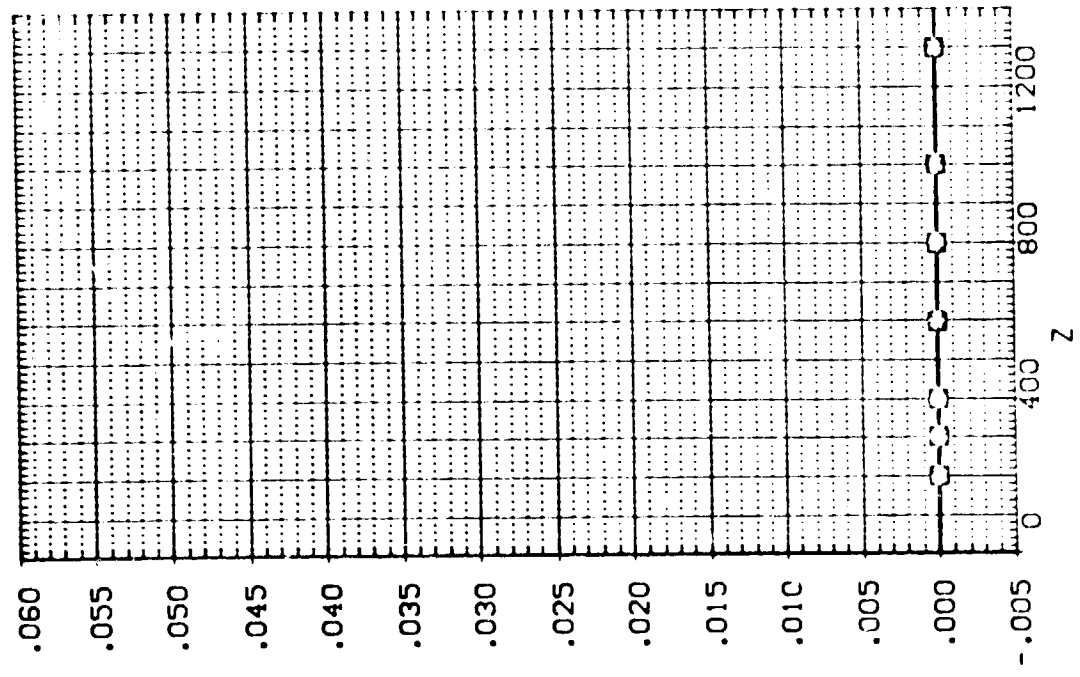

TA13, EXTERNAL TANK (110) SEPARATING FROM ORB. 09 (RTJ22)

SEE THE ASSOCIATED DATA DOCUMENT FOR REFERENCE CHARACTERISTICS FOR INDIVIDUAL DATA SETS

SYMBOL		PARAMETRIC VALUES			
○	X	MACH	4.530	P/TOTAL	110.000
□	100	ALPHA	-5.000	BETA	.000
◇	800	DALPHA	-5.000	DBETA	.000
△	1200	ELEVTR	.000	AILLRON	.000
		Y	.000		

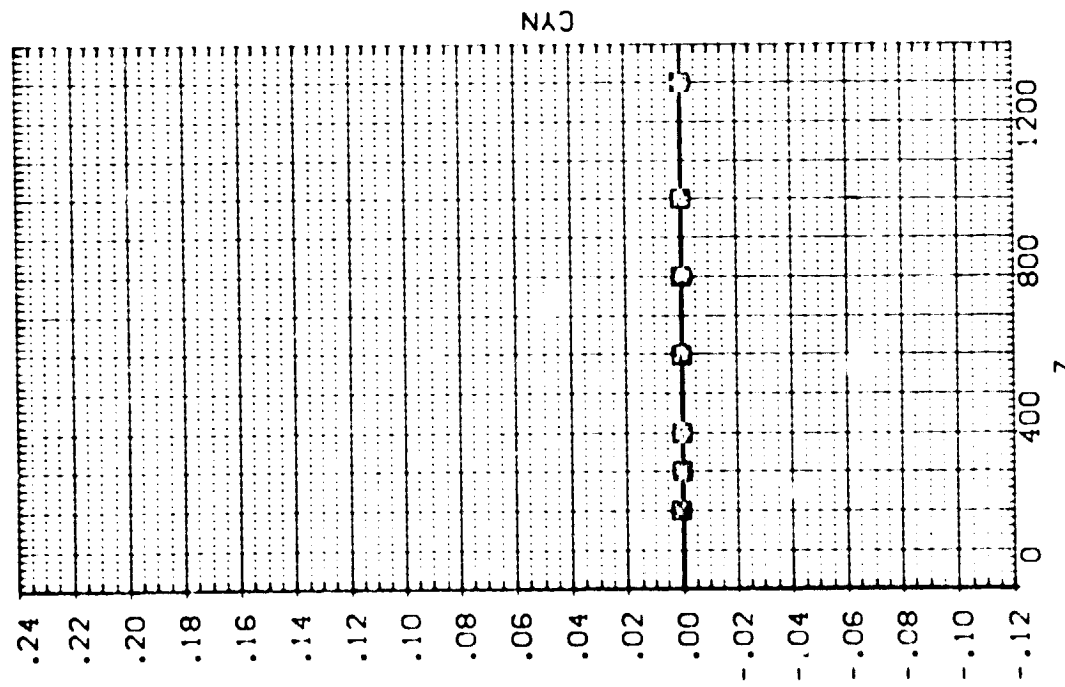
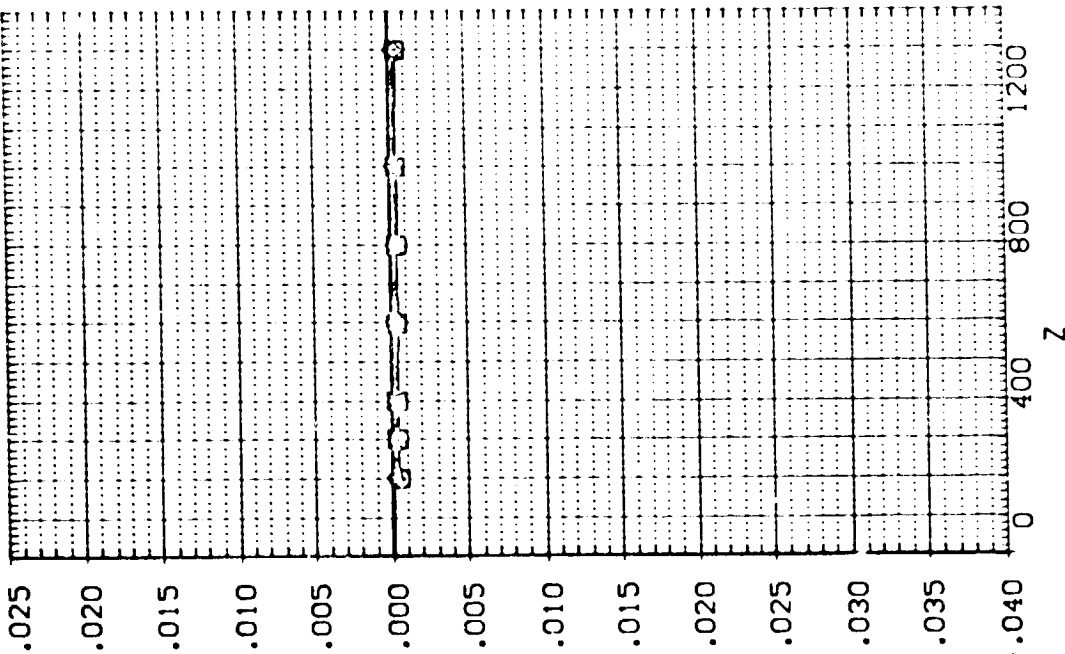

EXTERNAL TANK AERODYNAMIC CHARACTERISTICS DURING SEPARATION FROM ORBITER

!A13.EXTERNAL TANK(!)SEPARATING FROM ORB. 09 (RTJT23)

SEE THE ASSOCIATED DATA DOCUMENT FOR REFERENCE CHARACTERISTICS FOR INDIVIDUAL DATASETS

SYMBOL
 ○
 ◇
 △

PARAMETRIC VALUES
 X MACH ALPHA ELEVTR Y
 400.600 4.530 -5.000 .000 110.000
 800.730 4.530 -5.000 .000 .000
 1200.500 4.530 -5.000 .000 .000

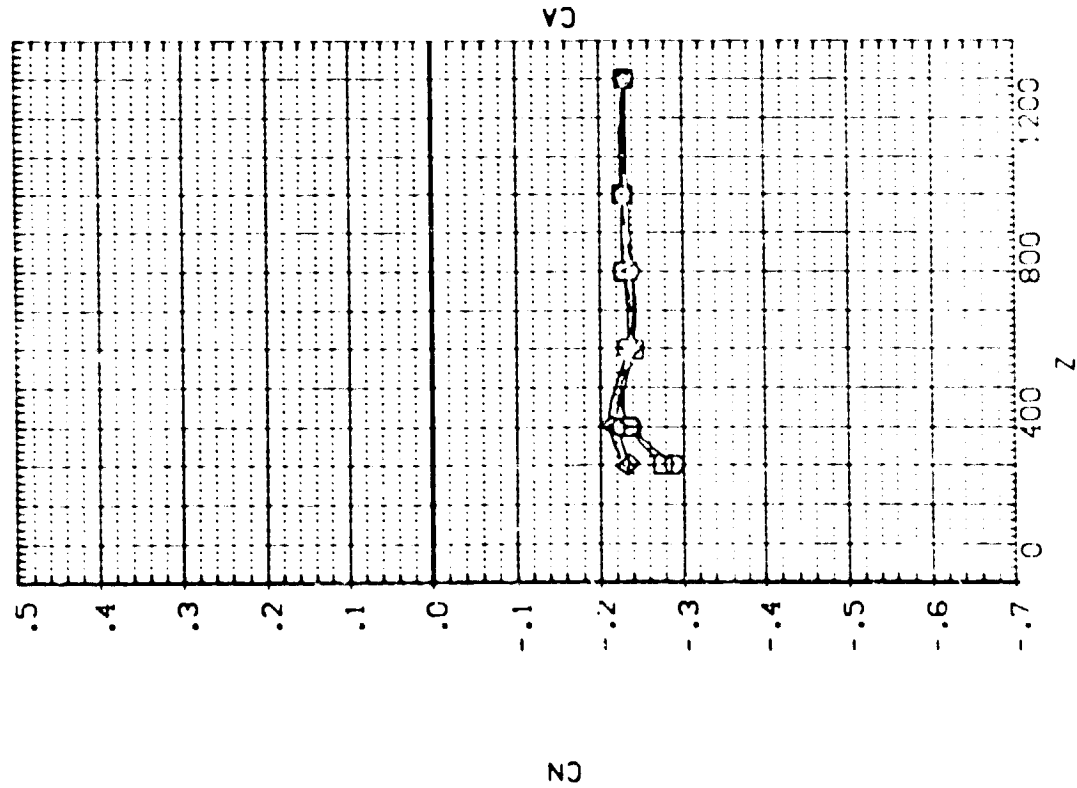
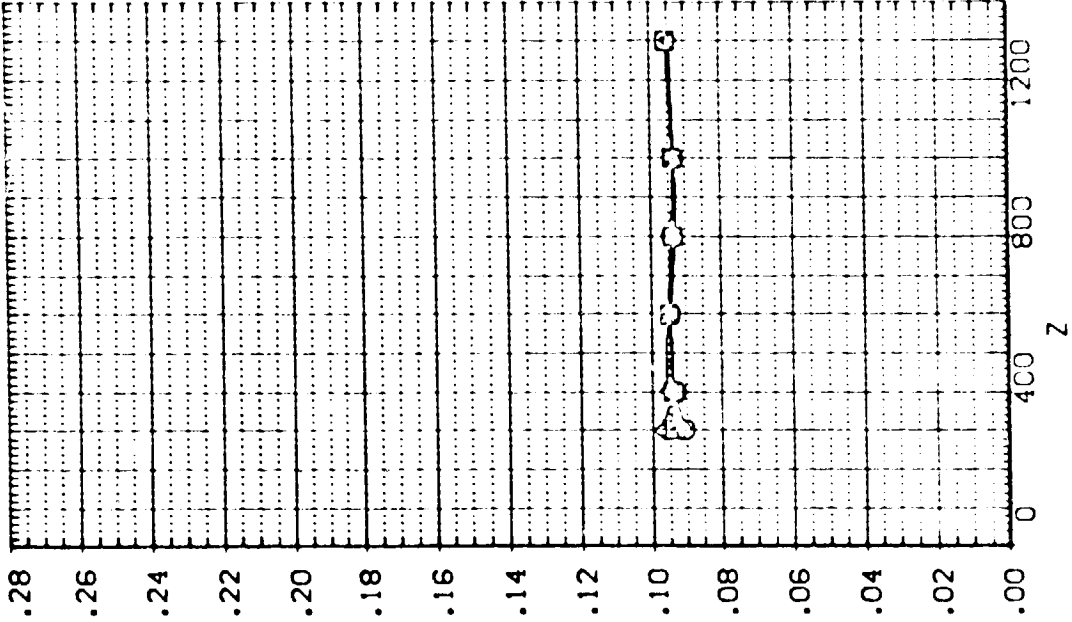

1A13. EXTERNAL TANK(10)SEPARATING FROM ORB. 09 (RTJ'23)

SEE THE ASSOCIATED DATA DOCUMENT FOR REFERENCE CHARACTERISTICS AND INDIVIDUAL DATA'S

SYMBOL		PARAMETRIC VALUES	
○	X	MACH	4.530
○	Y	PTOTAL	110.000
○	Z	ALPHA	-5.000
○	β	BETA	.000
○	α	DBETA	-13.000
○	γ	ALPHON	.000
○	δ	ELEVTR	.000
○	ε	γ	.000

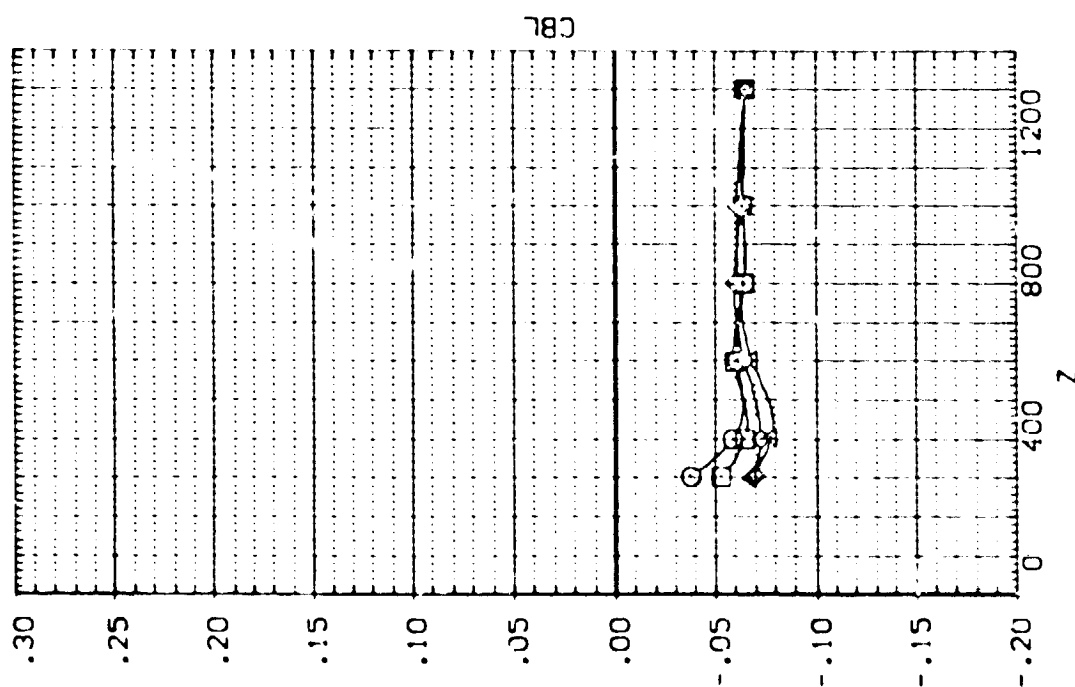
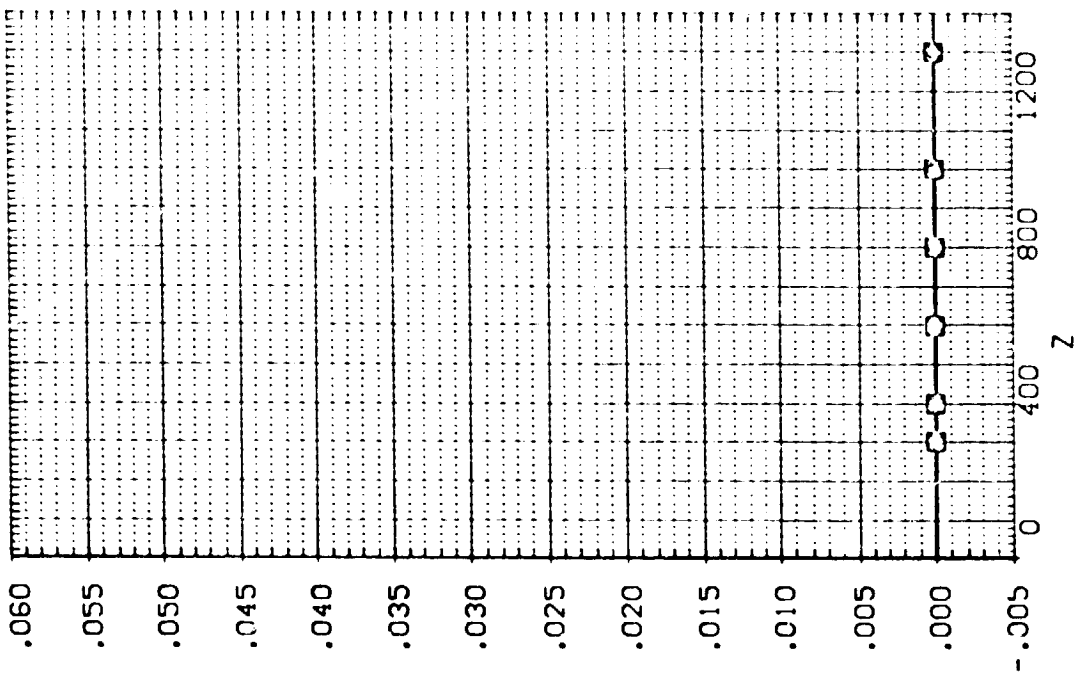

EXTERNAL TANK AERODYNAMIC CHARACTERISTICS DURING SEPARATION FROM ORBITER

[A13.EXTERNAL TANK(T10)SEPARATING FROM ORB. 09 (RTJT23)]

SEE THE ASSOCIATED DATA DOCUMENT FOR REFERENCE CHARACTERISTICS FOR INDIVIDUAL DATASETS

SYMBOL	X	MACH	PARAMETRIC VALUES
○	-.023	4.530	P/DISTAL 110.000
□	400.500	ALPHA -5.000	BETA .000
◇	800.730	DALPHA -10.000	DBETA .000
△	1200.500	ELEVTR .000	A/TLRN .000
		Y	.000

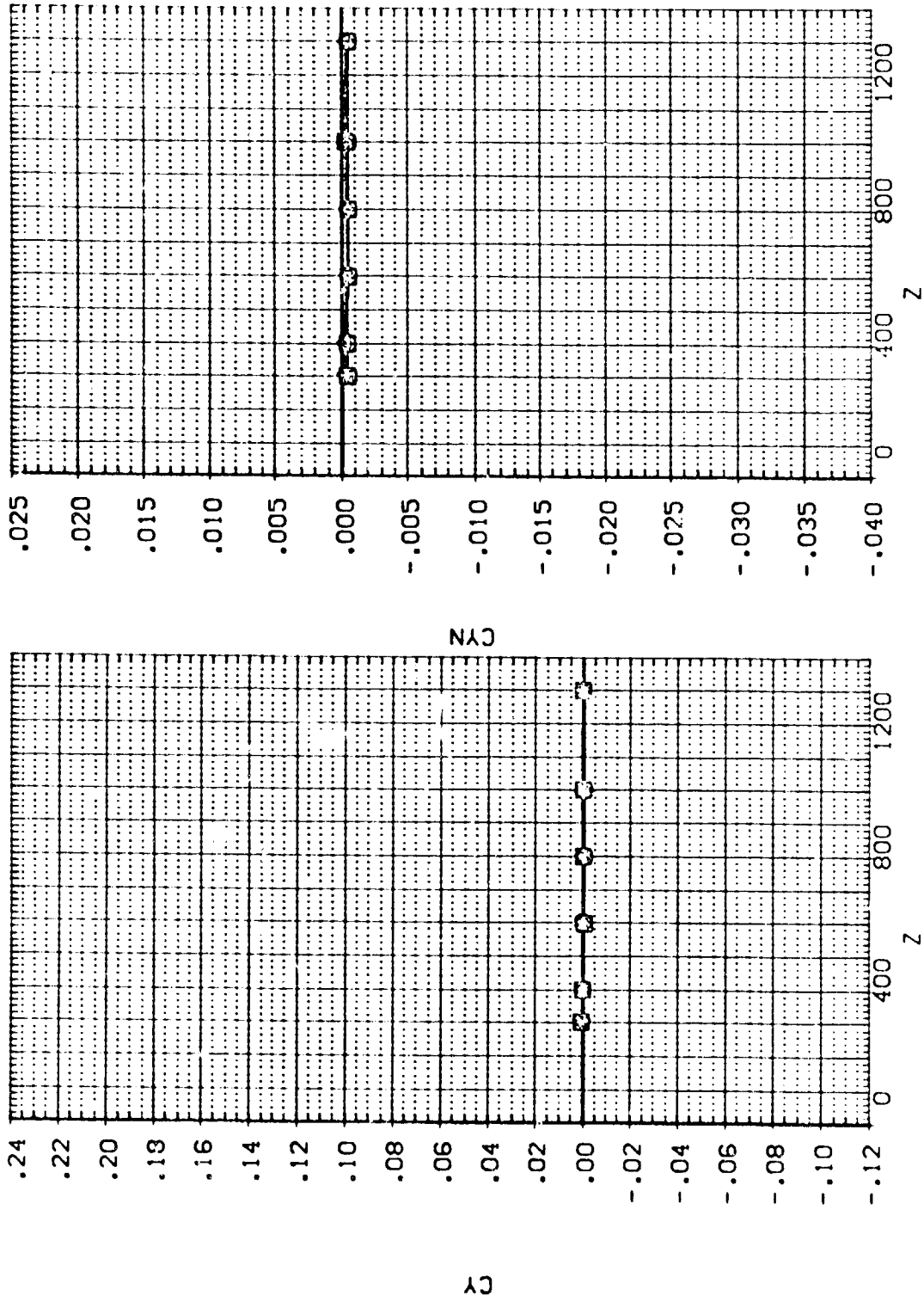

EXTERNAL TANK AERODYNAMIC CHARACTERISTICS DURING SEPARATION FROM ORBITER

IA13. EXTERNAL TANK (T10) SEPARATING FROM ORB. 09 (RTJT24)

SEE THE ASSOCIATED DATA DOCUMENT FOR REFERENCE CHARACTERISTICS FOR INDIVIDUAL DATASETS

SYMBOL X MACH ALPHA DIALPHA ELEVTR Y
 ○ 0.023 400.340 800.870 1200.700
 □ 4.530 -5.000 -10.000 .000
 △ 110.000 BETA DBETA AILTRON .000
 PARAMETRIC VALUES

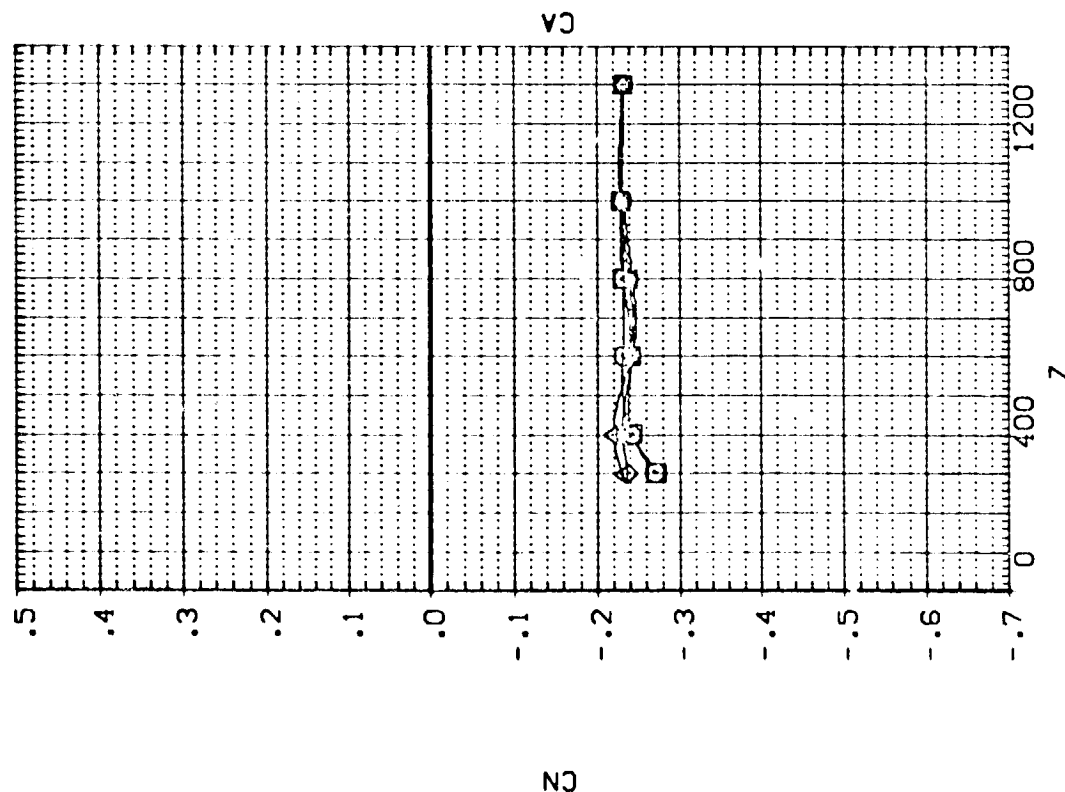
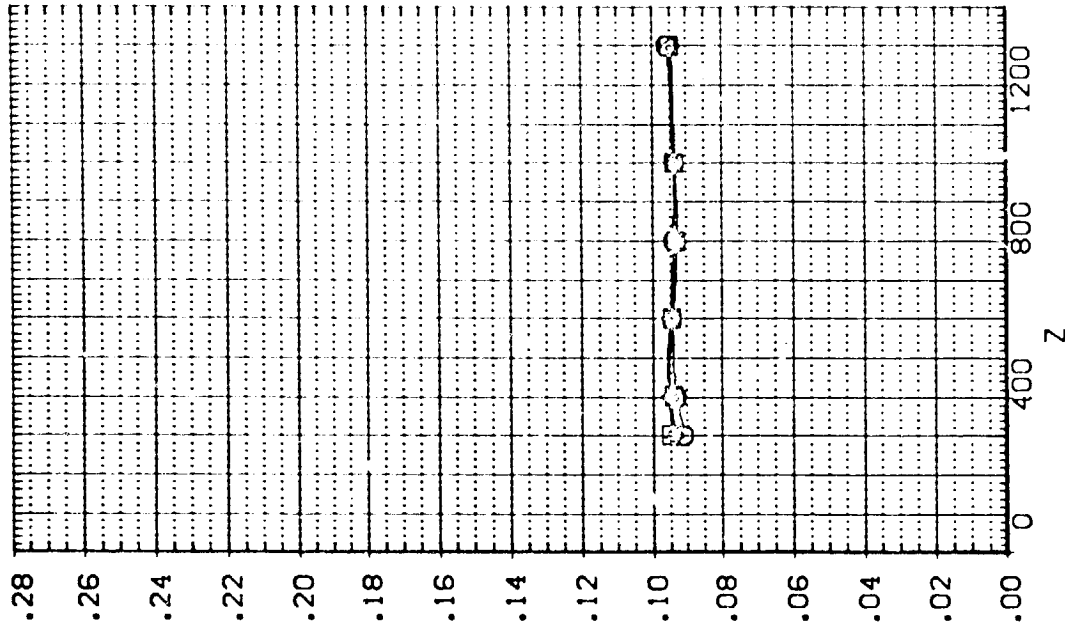

EXTERNAL TANK AERODYNAMIC CHARACTERISTICS DURING SEPARATION FROM ORBITER

IA13, EXTERNAL TANK(T10) SEPARATING FROM ORB. 09 (RTJT24)

SEE THE ASSOCIATED DATA DOCUMENT FOR REFERENCE CHARACTERISTICS FOR TANK(T10) UNFACTS

SYMBOL		PARAMETRIC VALUES	
○	X	MACH	4.530
□	Y	ALPHA	-5.000
◇	Z	DALPHA	-10.000
△	Y	ELEVTR	.000
		PI TOTAL	110.000
		BETA	.000
		DBETA	.000
		A TLRCN	.000
		Y	200.000

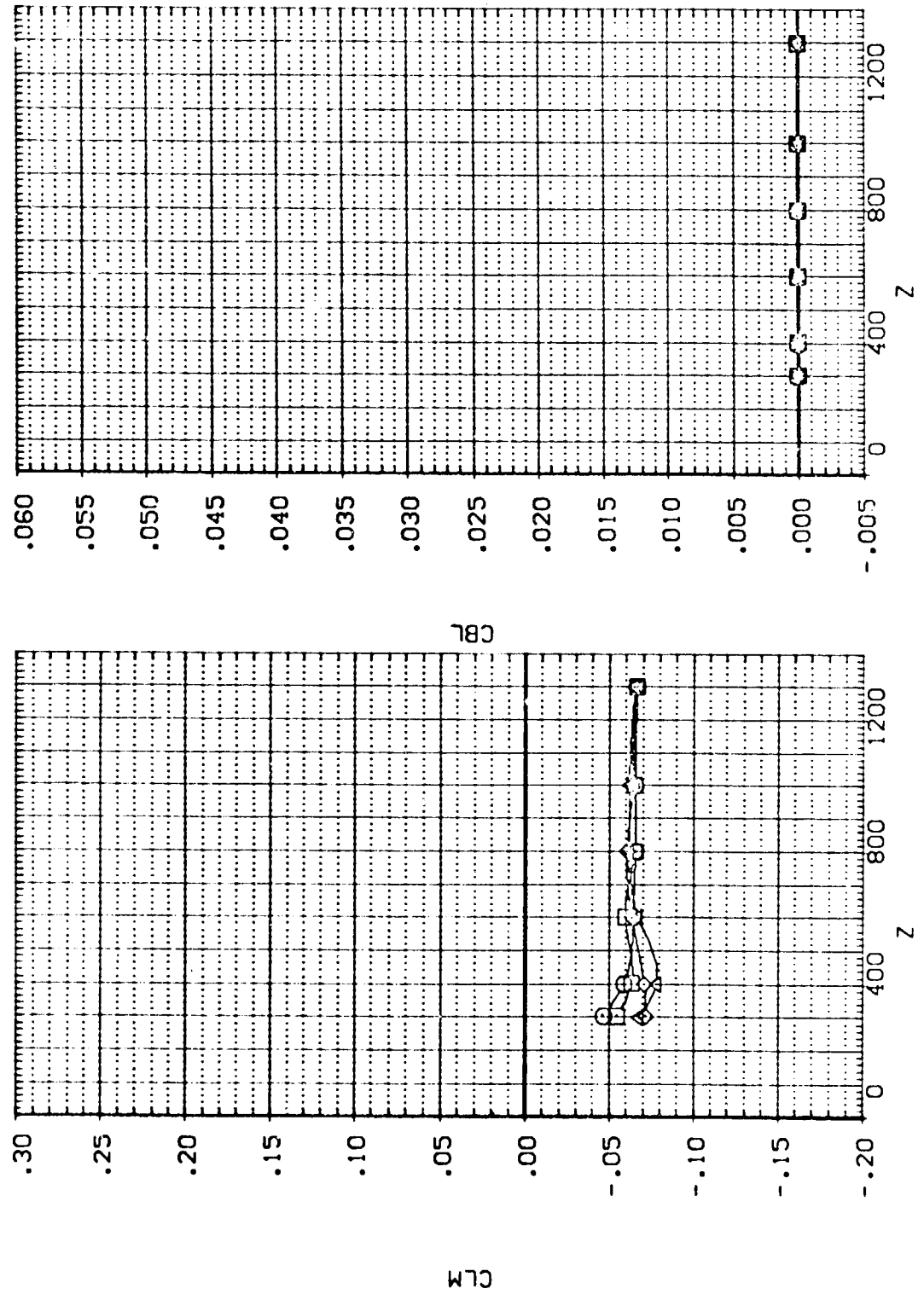

!A13.EXTERNAL TANK(T10)SEPARATING FROM ORB. 09 (RTJT24)

SEE THE ASSOCIATED DATA DOCUMENT FOR REFERENCE CHARACTERISTICS FOR INDIVIDUAL DATASETS

SYMBOL		PARAMETRIC VALUES				
○	X	.023	MACH	4.530	PICITAL	110.000
□	Y	400.340	ALPHA	-5.000	BETA	.000
◇	Z	800.870	DALPHA	-10.000	DBETA	.000
△	Y	1200.700	ELEVTR	.000	AILURON	.000
				200.000		

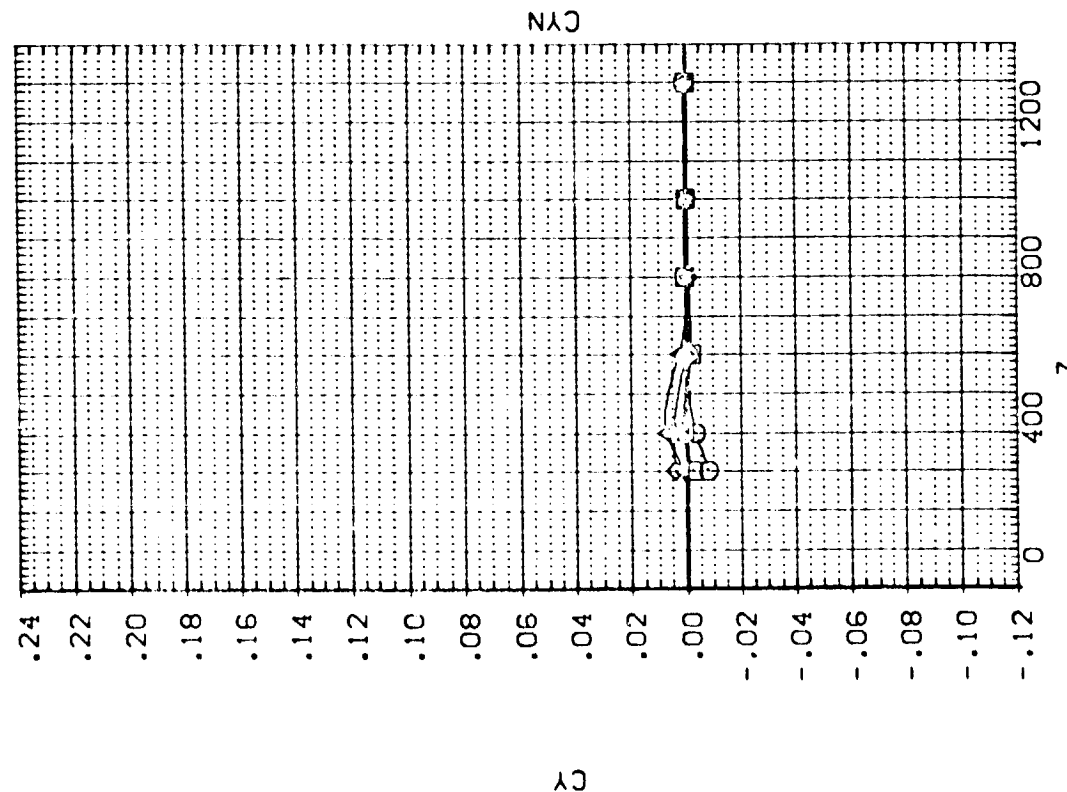
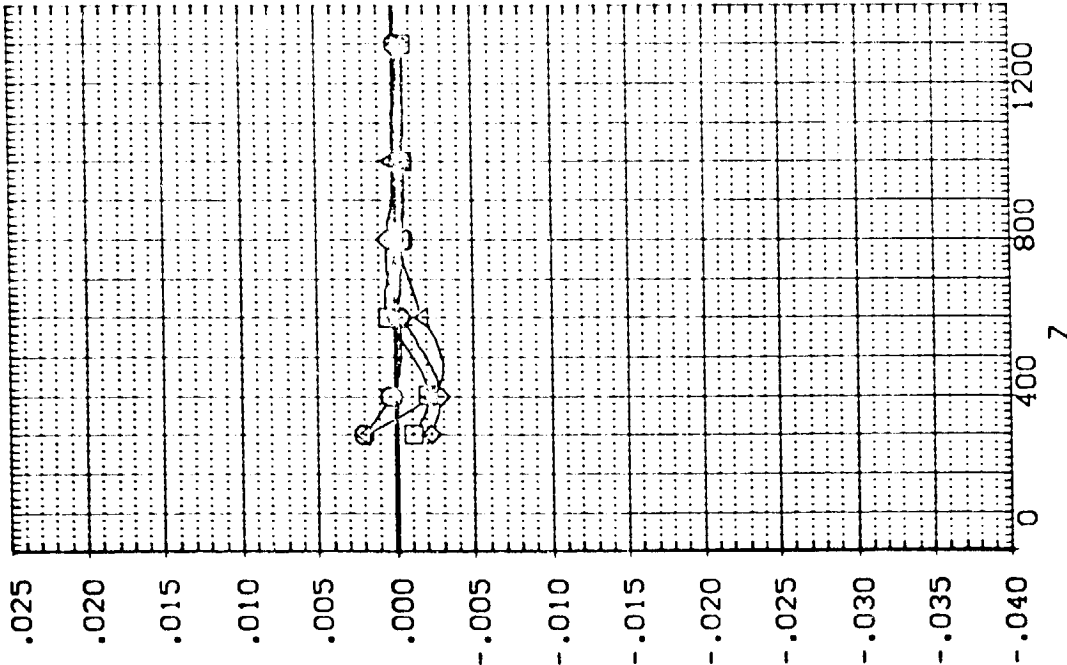

EXTERNAL TANK AERODYNAMIC CHARACTERISTICS DURING SEPARATION FROM ORBITER

[A13. EXTERNAL TANK (10) SEPARATING FROM ORB. 09 (RTJT25)]

SEE THE ASSOCIATED DATA DOCUMENT FOR REFERENCE CHARACTERISTICS FOR INDIVIDUAL DATASETS

SYMBOL		PARAMETER VALUES	
X	- .076	MACH	4.030
	400.690	ALPHA	-5.000
	800.550	DALPHA	-10.000
	1200.500	ELEVTR	.000
Y	200.000	ATLPOB	110.000
		BETA	.000
		DBETA	5.000

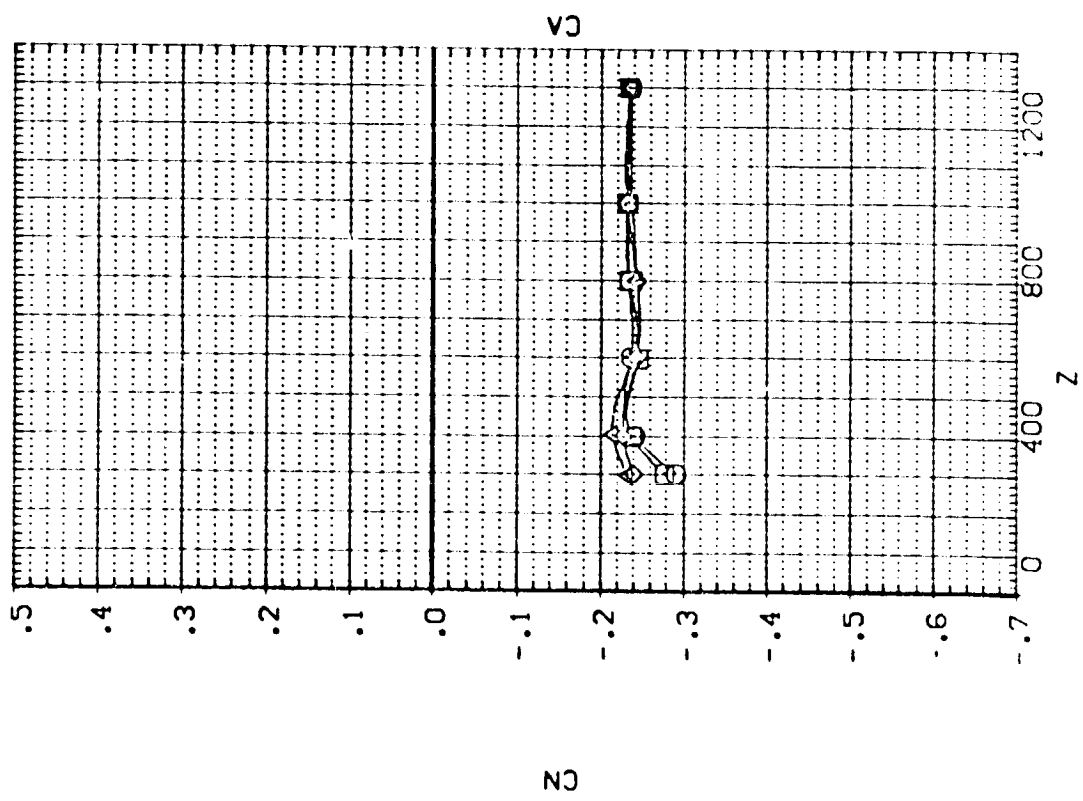
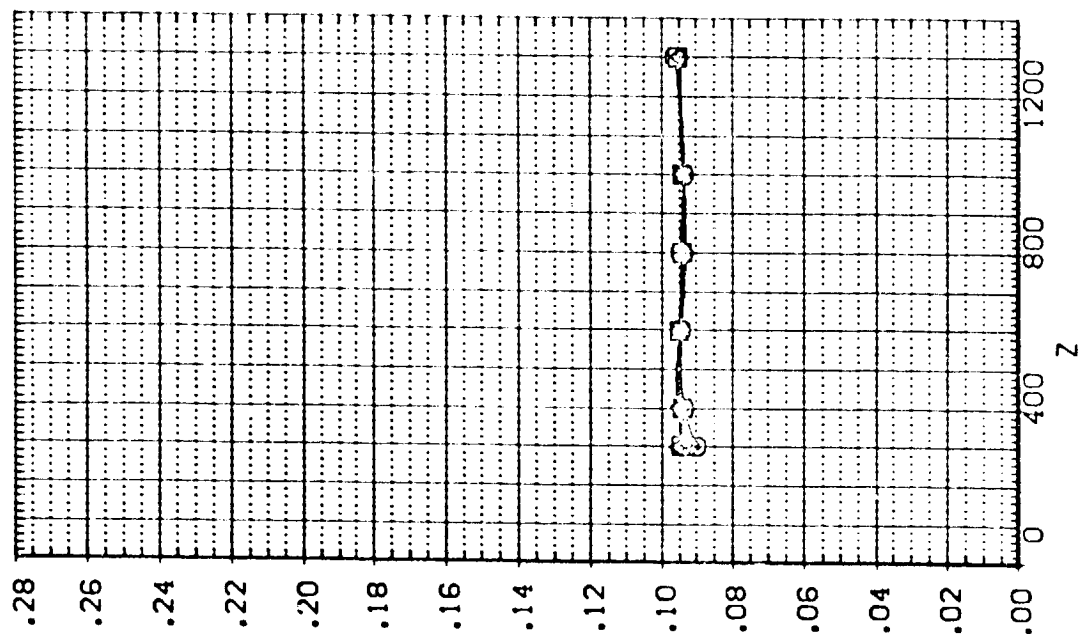

IA13.EXTERNAL TANK(T10)SEPARATING FROM ORB. 09 (RTJT25)

SEE THE ASSOCIATED DATA DOCUMENT FOR REFERENCE CHARACTERISTICS FOR INDIVIDUAL DATASETS

SYMBOL		PARAMETRIC VALUES					
○	x	MACH	4.530	PITOTAL	110.000		
□	400.690	ALPHA	-5.000	BETA	.000		
◇	800.560	DALPHA	-10.000	DBETA	5.000		
△	1200.500	ELEVTR	.000	AILRON	.000		
	y		200.000				

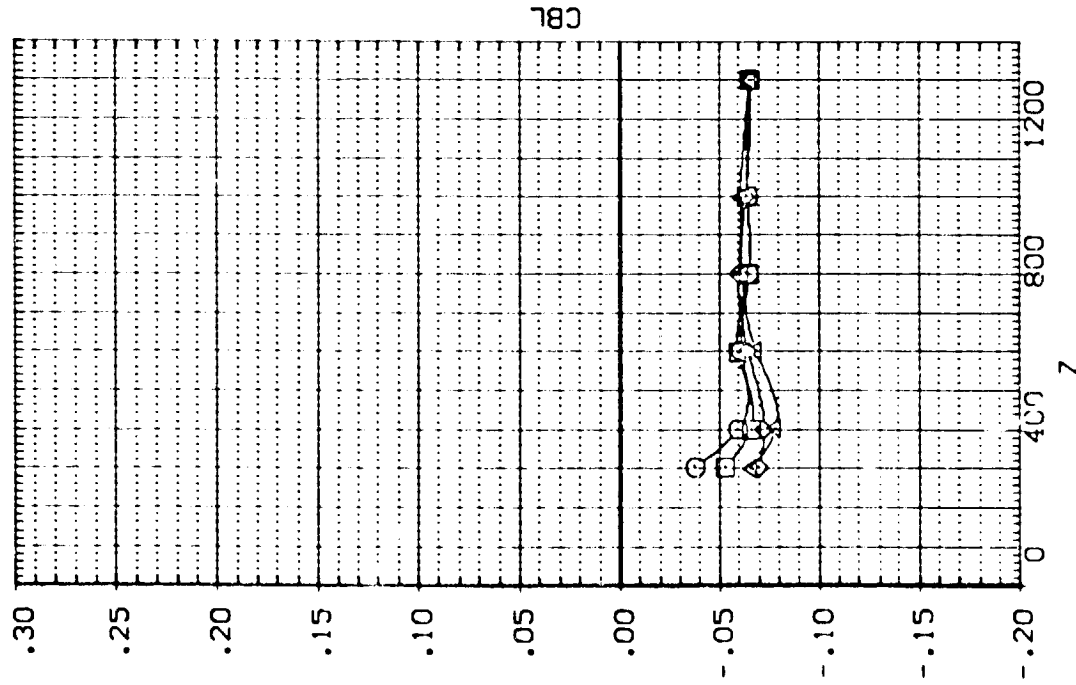
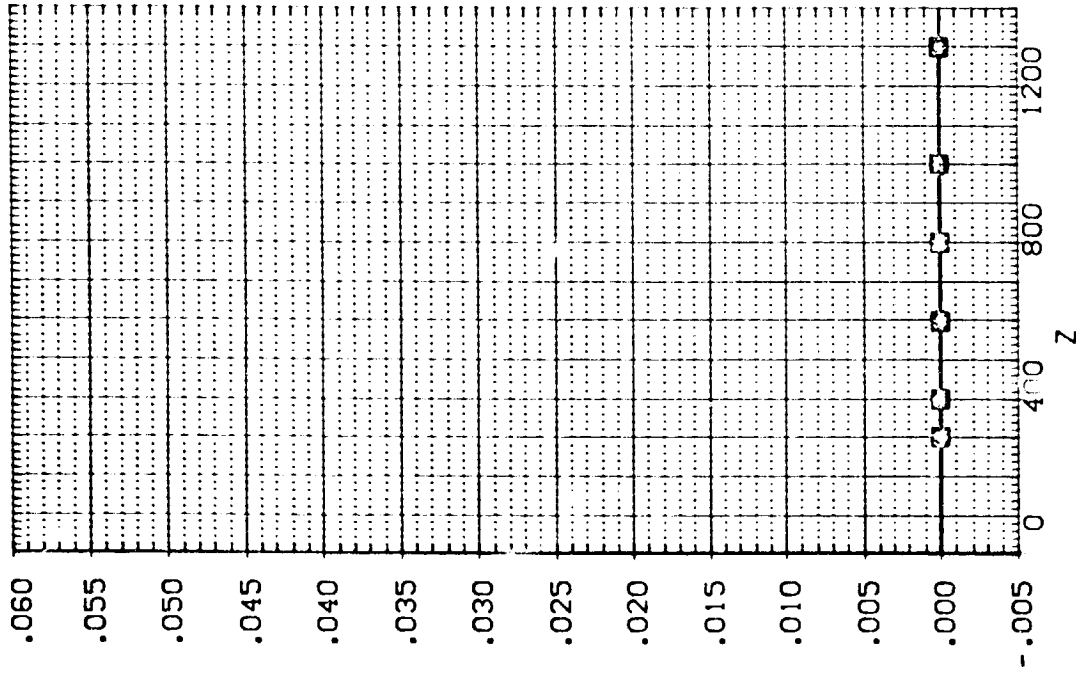

EXTERNAL TANK AERODYNAMIC CHARACTERISTICS DURING SEPARATION FROM ORBITER

1A13.EXTERNAL TANK(T10)SEPARATING FROM ORB. 09 (RTJT25)

SEE THE ASSOCIATED DATA DOCUMENT FOR REFERENCE CHARACTERISTICS FOR INDIVIDUAL DATASETS

SYMBOL		PARAMETRIC VALUES	
○	X	MACH	4.530
□	Y	PTOTAL	110.000
◇	Z	BETA	.000
△	Y	ALPHA	-5.000
		DALPHA	-10.000
		DBETA	5.000
		AIRTON	.000
		ELEVTR	200.000

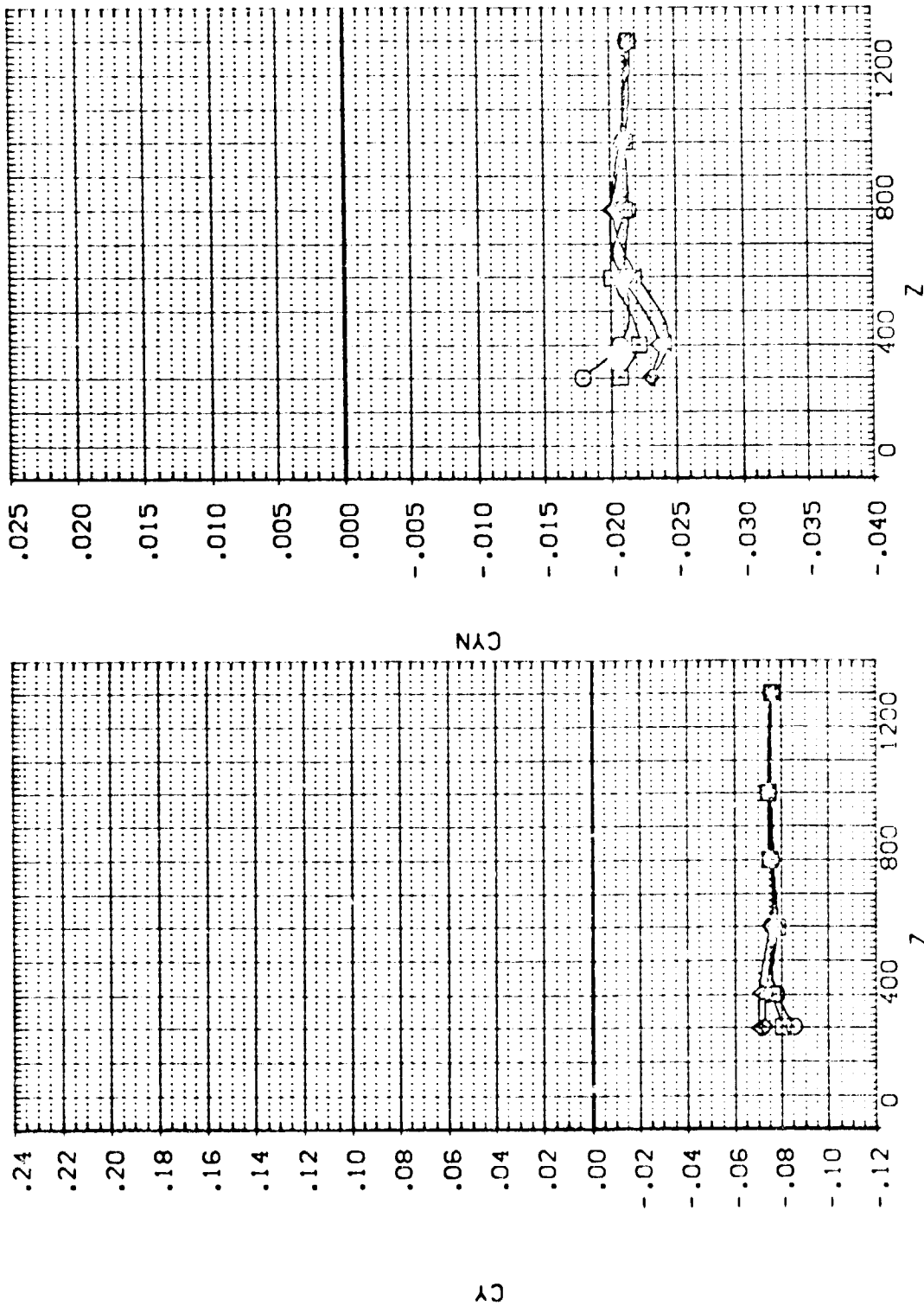

EXTERNAL TANK AERODYNAMIC CHARACTERISTICS DURING SEPARATION FROM ORBITER

IA13.EXTERNAL TANK(T10)SEPARATING FROM ORB. 09 (RTJ126)

SEE THE ASSOCIATED DATA DOCUMENT FOR REFERENCE CHARACTERISTICS FOR INDIVIDUAL DATASETS

SYMBOL		PARAMETRIC VALUES	
○	x	MACH	4.530
□	400.230	ALPHA	-5.000
◇	800.780	DALPHA	-10.000
△	1200.800	ELEVTR	.000
		PTOTAL	110.000
		BETA	.000
		DBETA	5.000
		A1URON	.000
		Y	.000

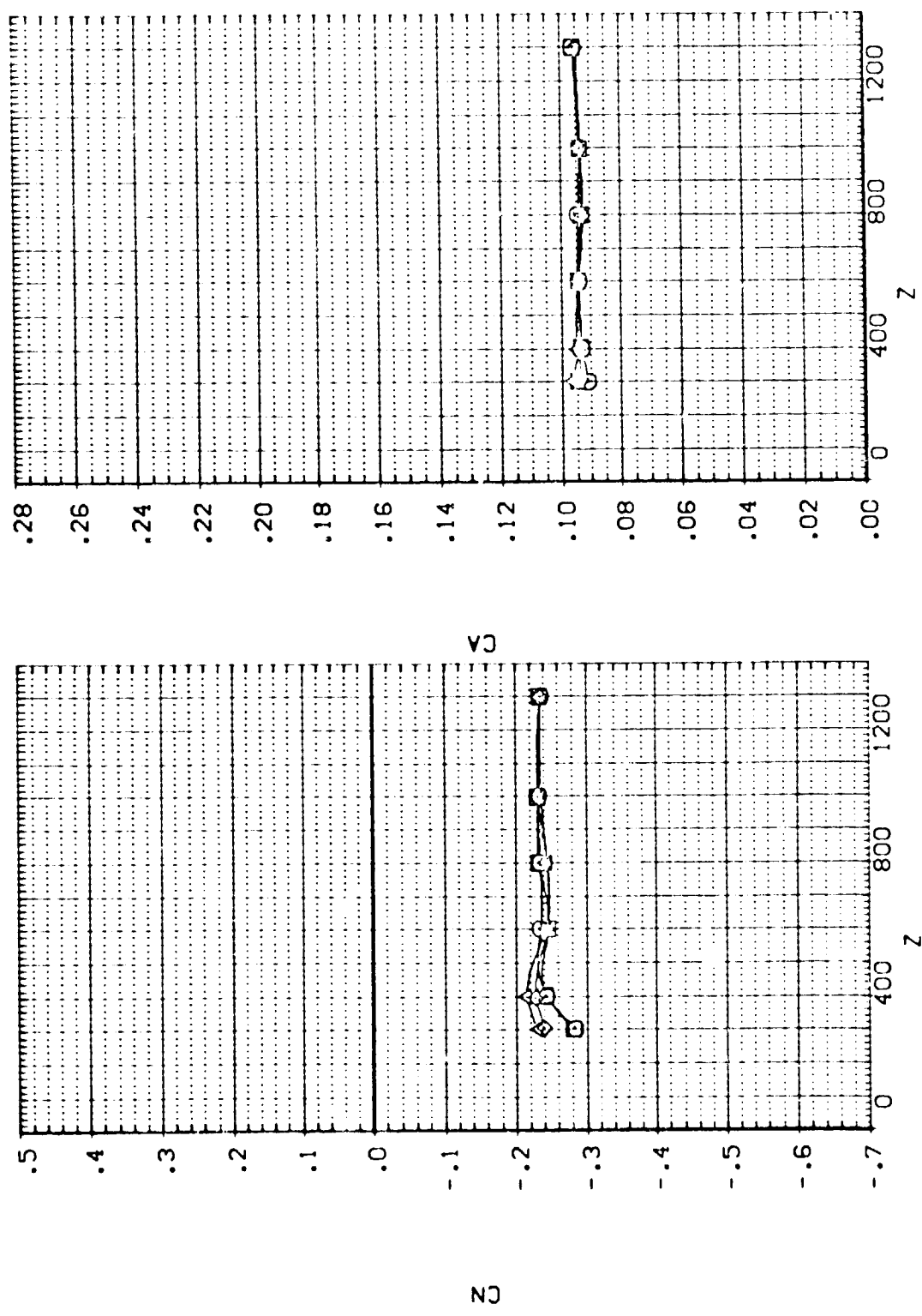

EXTERNAL TANK AERODYNAMIC CHARACTERISTICS DURING SEPARATION FROM ORBITER

IA13. EXTERNAL TANK (10) SEPARATING FROM ORB. 09 (RTJT26)

SEE THE ASSOCIATED DATA DOCUMENT FOR REFERENCE CHARACTERISTICS FOR INDIVIDUAL DATASETS

SYMBOL	X	MACH	PARAMETRIC VALUES
○	.074	4.530	PCTAL 110.000
◇	400.230	-5.000	BETA .000
△	805.780	-10.000	DBETA 5.000
	1200.800	.000	AILRON .000
		.000	Y .000

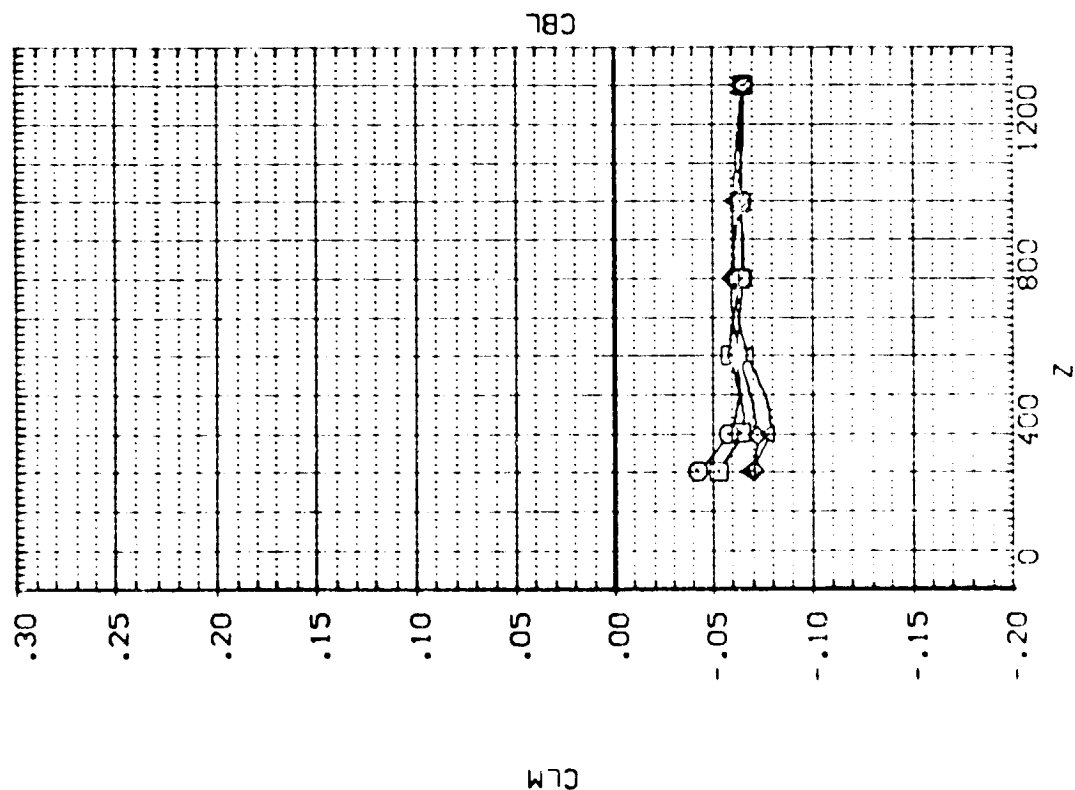
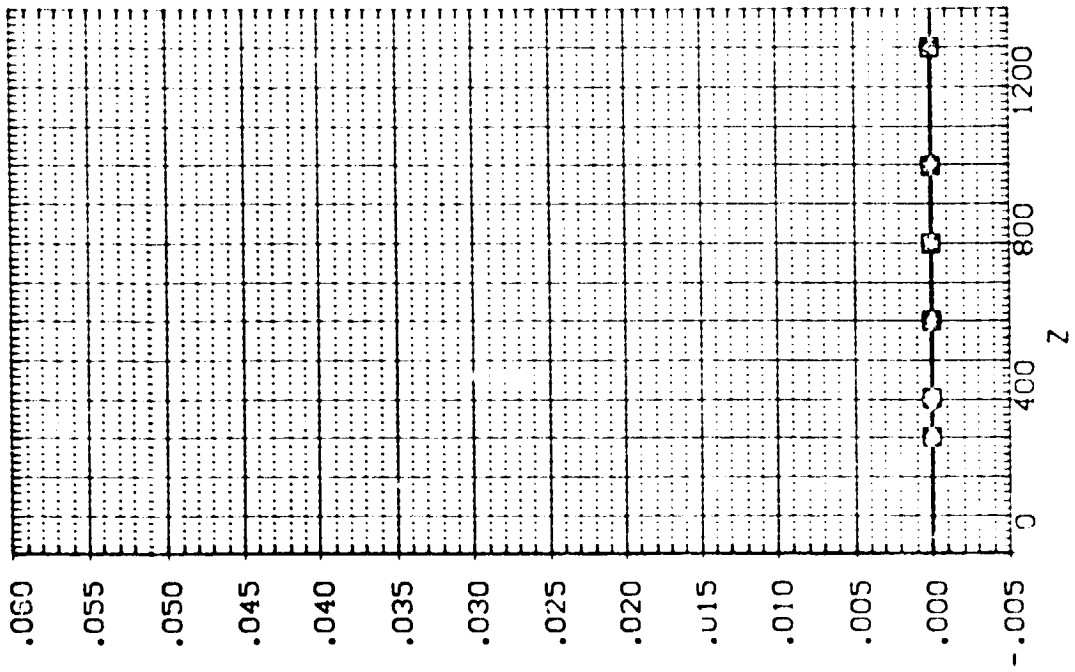

EXTERNAL TANK AERODYNAMIC CHARACTERISTICS DURING SEPARATION FROM ORBITER

1A13. EXTERNAL TANK (110) SEPARATING FROM ORB. 09 (RTJT26)

SEE THE ASSOCIATED DATA DOCUMENT FOR REFERENCE CHARACTERISTICS FOR INDIVIDUAL DATA SETS

SYMBOL	X	MACH	PARAMETRIC VALUES	PITOTAL
○	.074	4.530	ALPHA	110.000
◇	400.230	-5.000	BETA	.000
△	800.780	-10.000	DBETA	5.000
	1200.800	.000	AILRON	.000
		.000	Y	.000

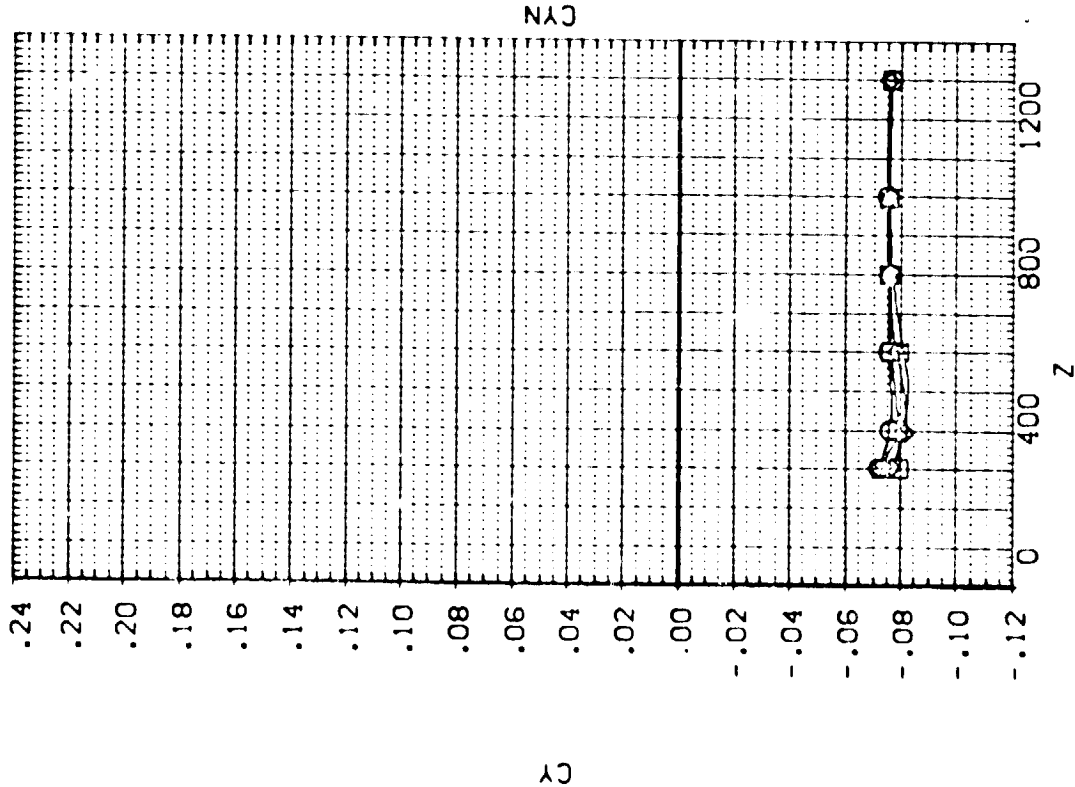
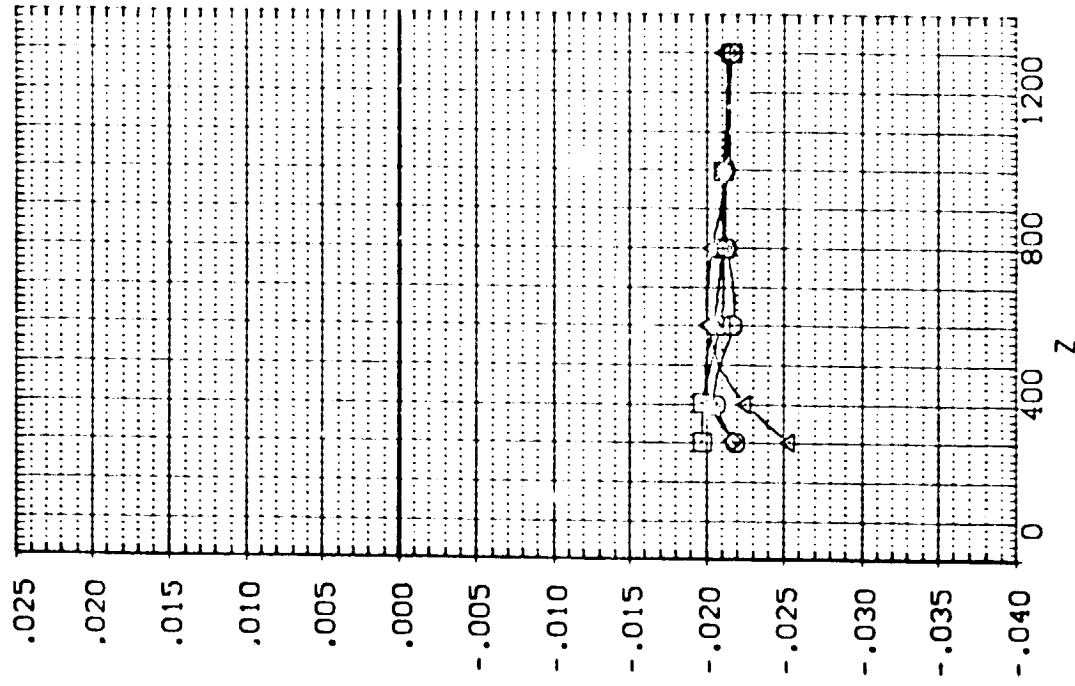

EXTERNAL TANK AERODYNAMIC CHARACTERISTICS DURING SEPARATION FROM ORBITER

1A13.EXTERNAL TANK(T10)SEPARATING FROM ORB. 09 (RTJT27)

SEE THE ASSOCIATED DATA DOCUMENT FOR REFERENCE CHARACTERISTICS OR INDIVIDUAL DATA SETS

SYMBOL		PARAMETRIC VALUES	
○	X	MACH	PTOTAL
◇	Y	ALPHA	BETA
△	Z	DALPHA	DBETA
		ELEVTR	AILTRN

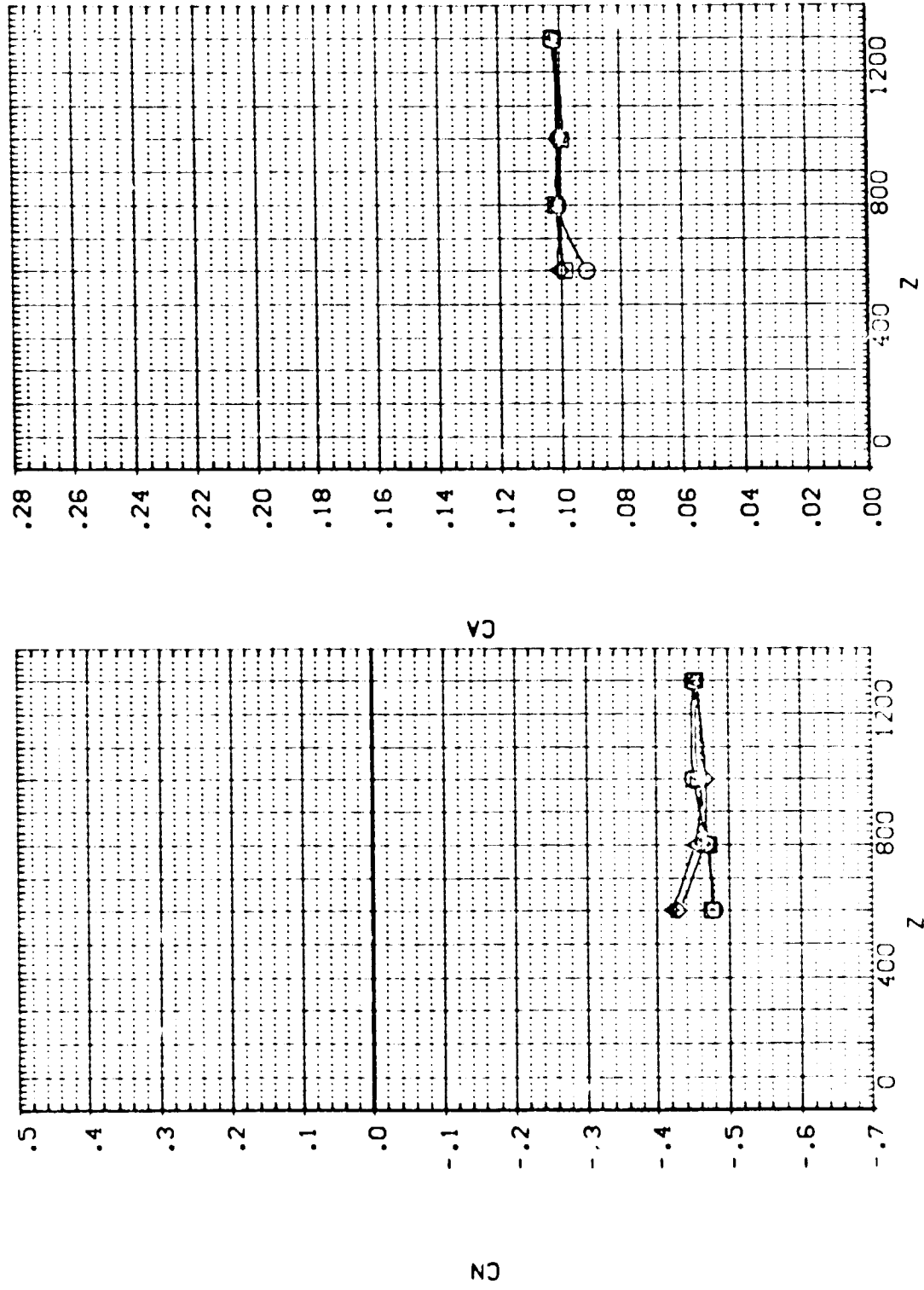

EXTERNAL TANK AERODYNAMIC CHARACTERISTICS DURING SEPARATION FROM ORBITER

TA13 EXTERNAL TANK (110) SEPARATING FROM ORB. 09 (RTJ127)

SEE THE ASSOCIATED DATA
 DOCUMENT FOR REFERENCE
 CHARACTERISTICS FOR
 ALL DATASETS

SYMBOL	X	MACH	PARAMETRIC VALUES
○	-1.133	4.530	PTOTAL 110.000
◇	401.620	-5.000	BETA .000
△	800.510	-20.000	DBETA .000
	1200.400	.000	A1LRON .000
			Y .000

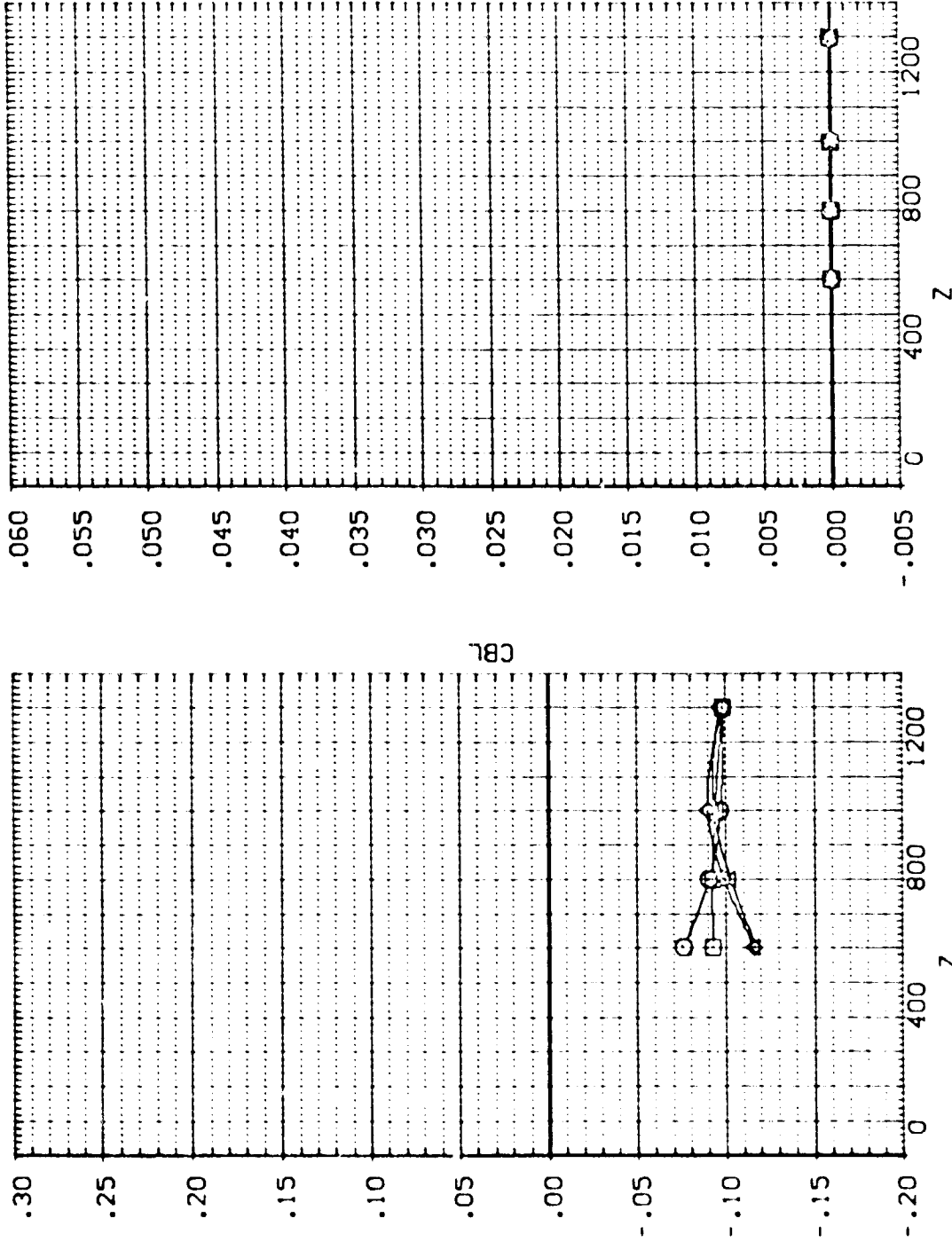

EXTERNAL TANK AERODYNAMIC CHARACTERISTICS DURING SEPARATION FROM ORBITER

1A13.EXTERNAL TANK(T10)SEPARATING FROM ORB. 09 (RTJT27)

SEE THE ASSOCIATED DATA DOCUMENT FOR REFERENCE CHARACTERISTICS FOR INDIVIDUAL DATA SETS

SYMBOL	X	MACH	PARAMETRIC VALUES
○	-1.133	4.530	PIC/TAL 110.000
◇	451.670	-5.000	BETA .000
△	800.510	-20.000	DBETA .000
	1200.400	.000	AIR/TON .000
		.000	ELEVTR .000
			Y

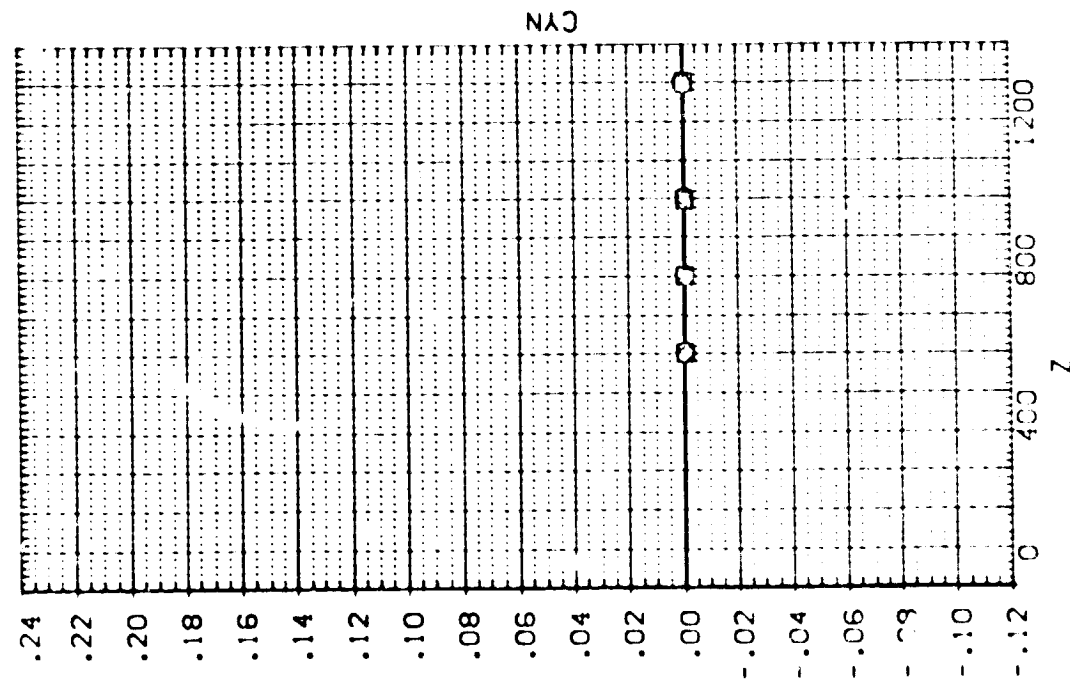
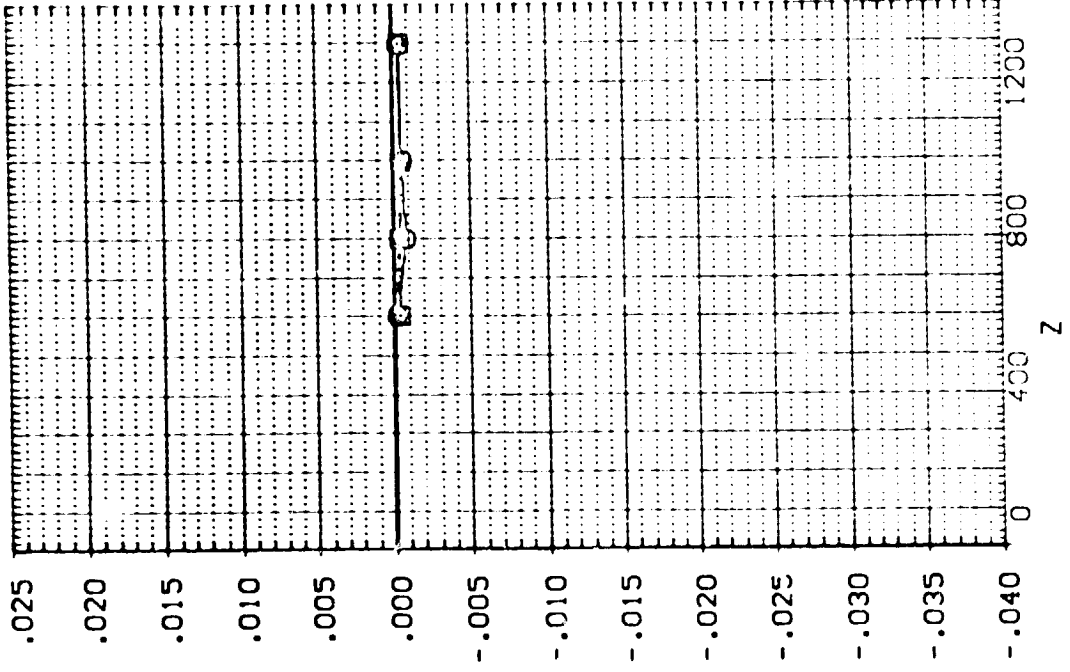

EXTERNAL TANK AERODYNAMIC CHARACTERISTICS DURING SEPARATION FROM ORBITER

IA13,EXTERNAL TANK(T10)SEPARATING FROM ORB. 09 (RTJT28)

SEE THE ASSOCIATED DATA DOCUMENT FOR REFERENCE CHARACTERISTICS FOR INDIVIDUAL DATASETS

SYMBOL
 ○
 ◇
 △

PARAMETRIC VALUES
 MACH 4.530 P/TOTAL 1110.000
 ALPHA -5.000 BETA .000
 DALPHA -20.000 DBETA .000
 ELEVTR .000 AILTRON .000
 Y 200.000

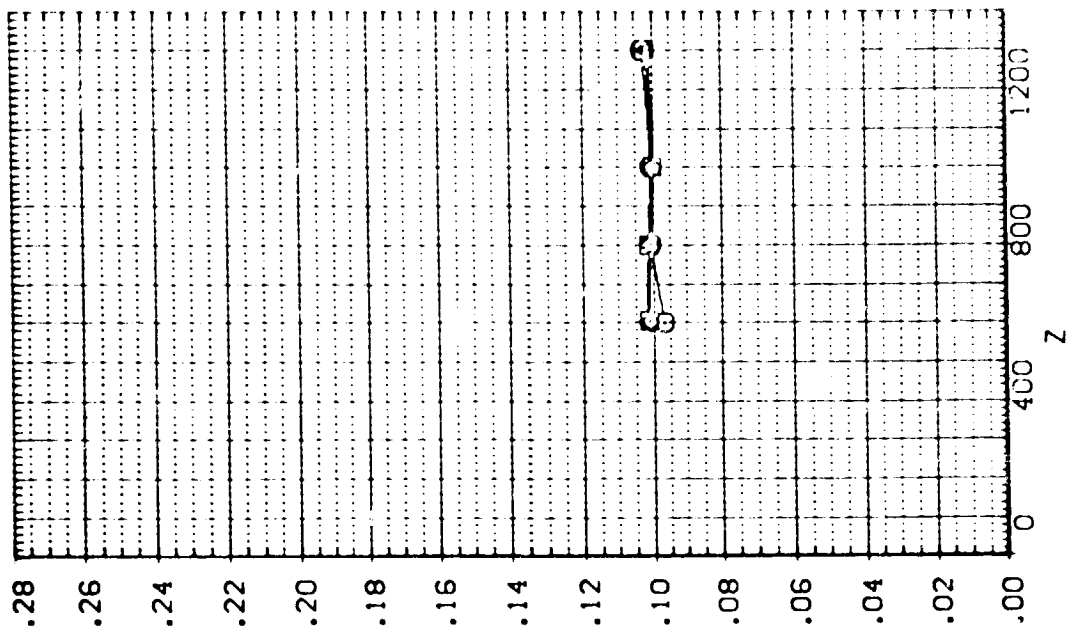
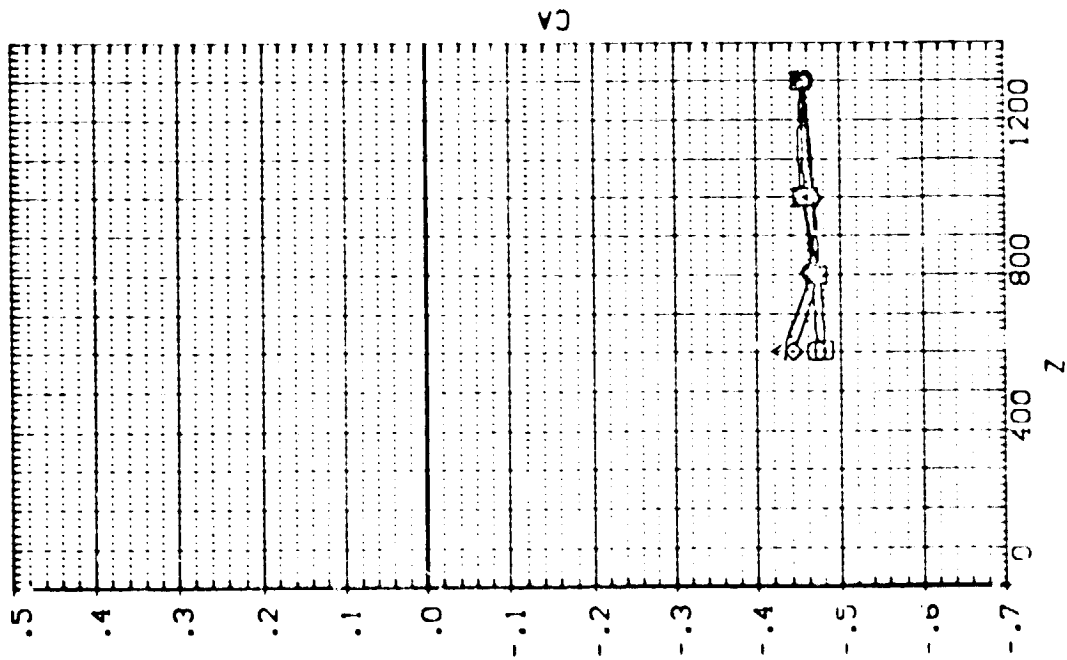

EXTERNAL TANK AERODYNAMIC CHARACTERISTICS DURING SEPARATION FROM ORBITER

IA13, EXTERNAL TANK (110) SEPARATING FROM ORB. 09 (RTJ128)

SEE THE ASSOCIATED DATA DOCUMENT FOR REFERENCE CHARACTERISTICS FOR INDIVIDUAL DATASETS

SYMBOL		PARAMETRIC VALUES			
○	X	MACH	4.530	PTOTAL	110.000
□	400.610	ALPHA	-5.000	BETA	.000
◇	800.600	DALPHA	-20.000	DBETA	.000
△	1200.700	ELEVTR	.000	AILTRON	.000
		Y	200.000		

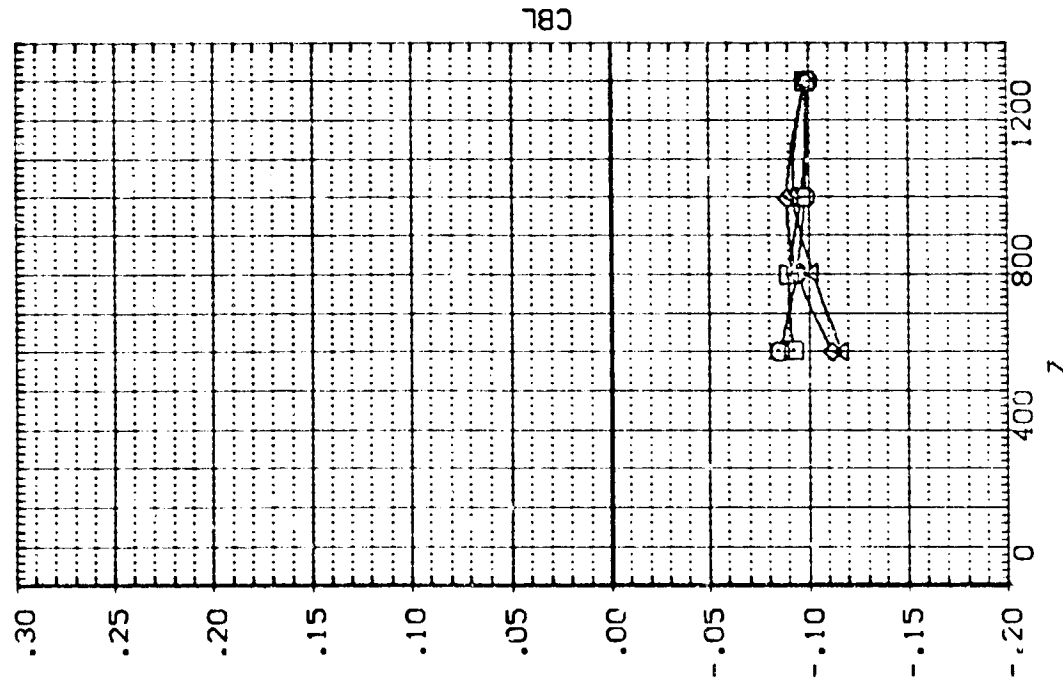
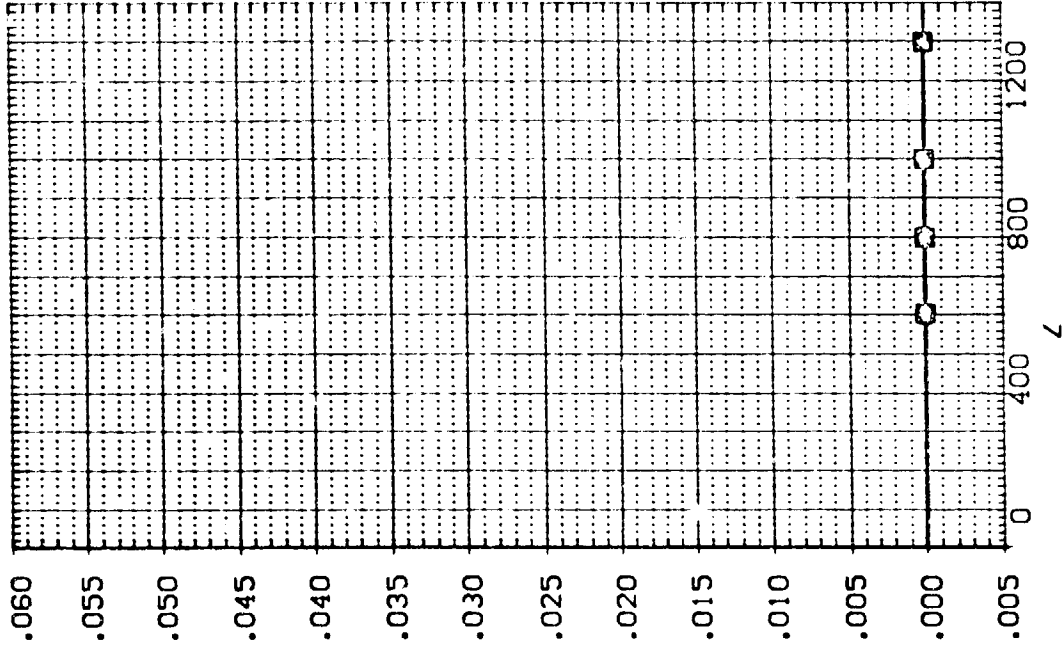

EXTERNAL TANK AERODYNAMIC CHARACTERISTICS DURING SEPARATION FROM ORBITER

1.13.EXTERNAL TANK(T10)SEPARATING FROM ORB. 09 (RTJT28)

SEE THE ASSOCIATED DATA DOCUMENT FOR REFERENCE CHARACTERISTICS FOR INDIVIDUAL DATASETS

SYMBOL		PARAMETRIC VALUES			
○	X	MACH	4.530	PTOTAL	110.000
□	400.610	ALPHA	-5.000	BETA	.000
◇	800.600	r PHA	-20.000	DBETA	.000
△	1200.700	ELEVTR	.000	AILRON	.000
	Y		200.000		

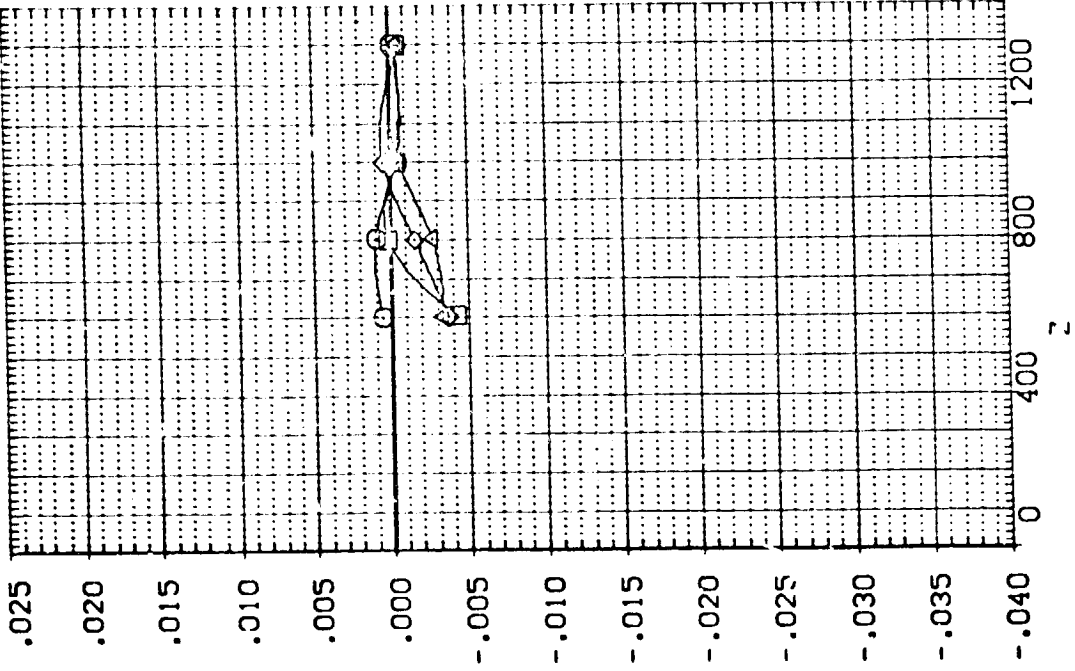
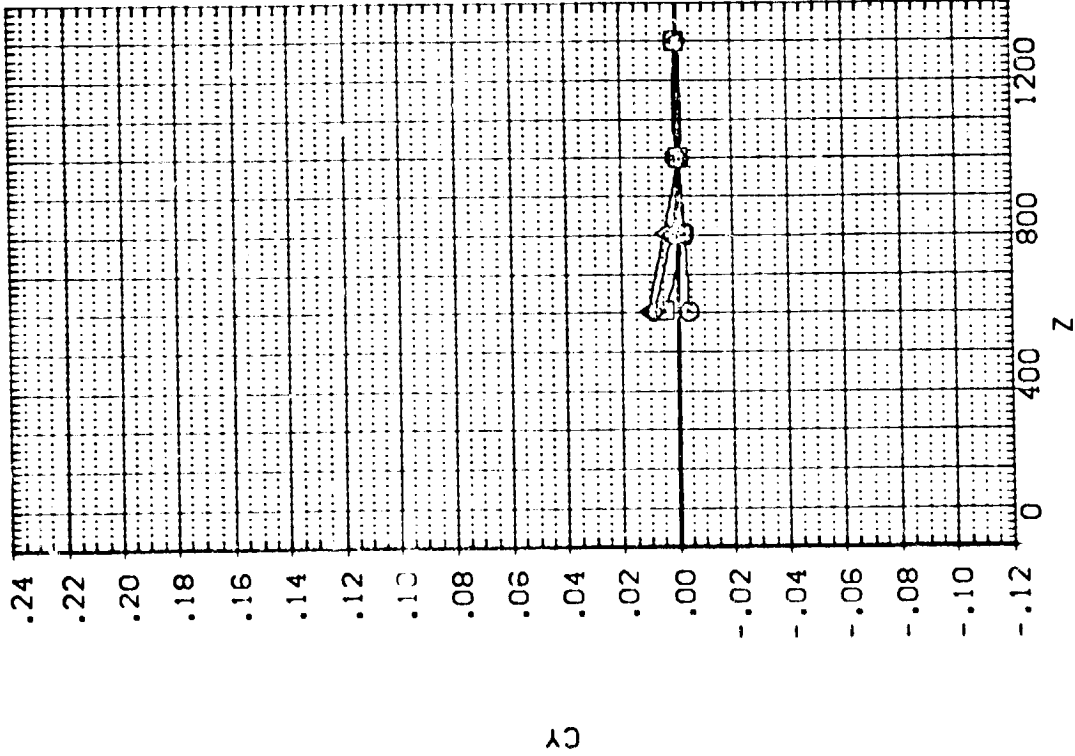

EXTERNAL TANK AERODYNAMIC CHARACTERISTICS DURING SEPARATION FROM ORBITER

IA13. EXTERNAL TANK(T10)SEPARATING FROM ORB. 09 (RTJT29)

SEE THE ASSOCIATED DATA DOCUMENT FOR REFERENCE CHARACTERISTICS FOR INDIVIDUAL DATASETS

SYMBOL		PARAMETRIC VALUES	
○	X	MACH	110.000
□	Y	ALPHA	.000
◇	Z	DALPHA	5.000
△		ELEVTR	.000
		PTOTAL	200.000
		BETA	110.000
		DBETA	5.000
		ALLRON	.000

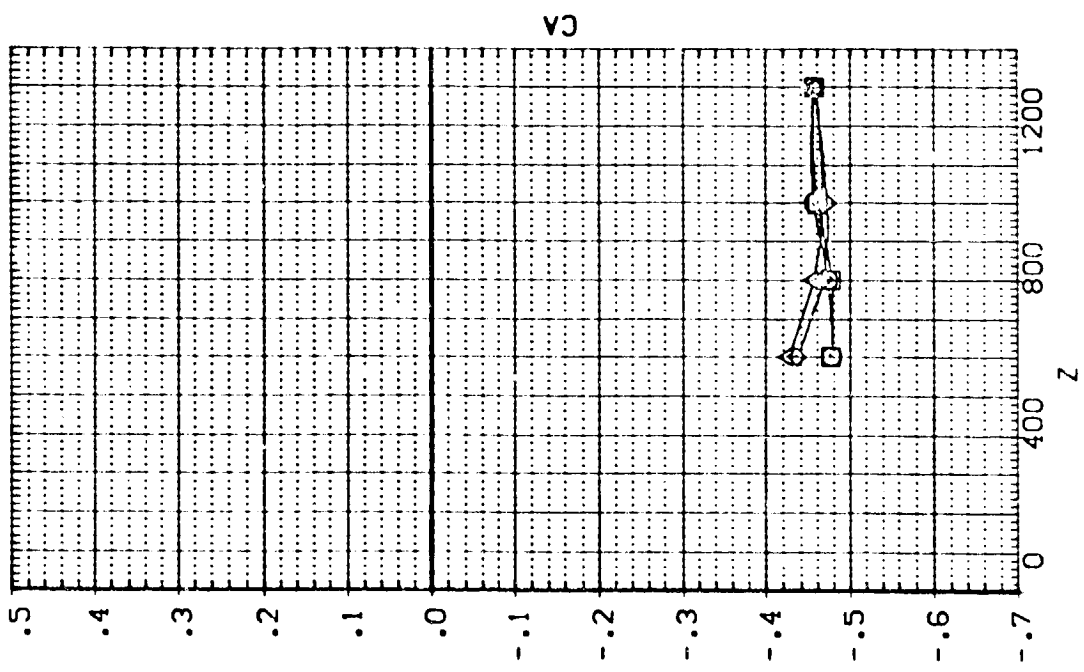
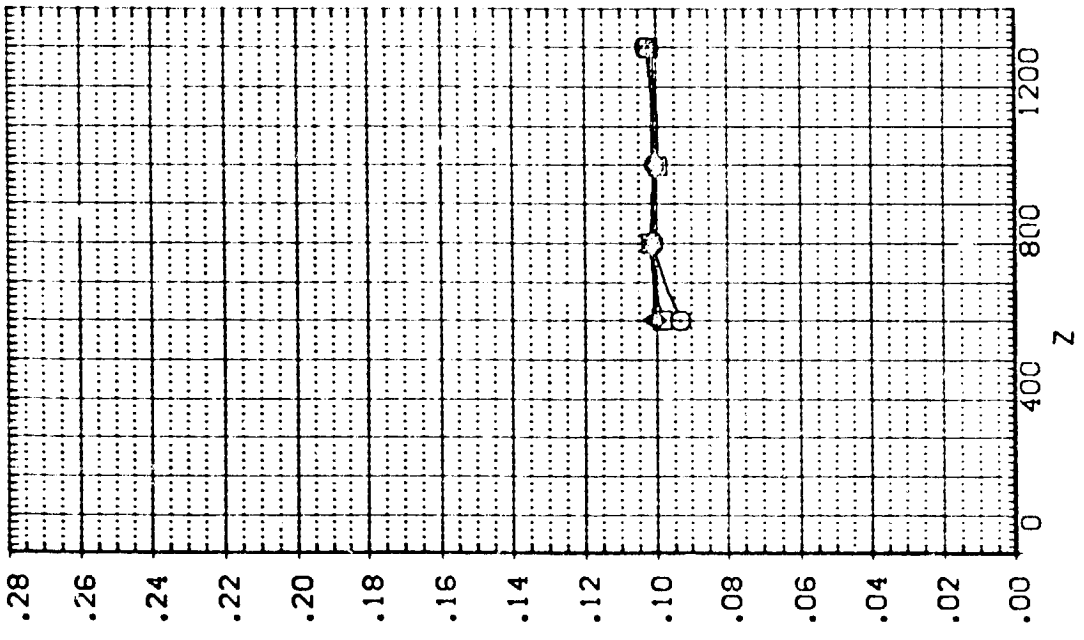

IA13, EXTERNAL TANK (110) SEPARATING FROM ORB. 09 (RTJT29)

SYMBOL X
 ○
 □
 ◇
 △

PARAMETRIC VALUES
 MACH 4.530 P/TOTAL 110.000
 ALPHA -5.000 BETA .000
 DALPHA -20.000 DBETA 5.000
 ELEVTR .000 AILRON .000
 Y 200.000

SEE THE ASSOCIATED DATA DOCUMENT FOR REFERENCE CHARACTERISTICS FOR INDIVIDUAL DATASETS

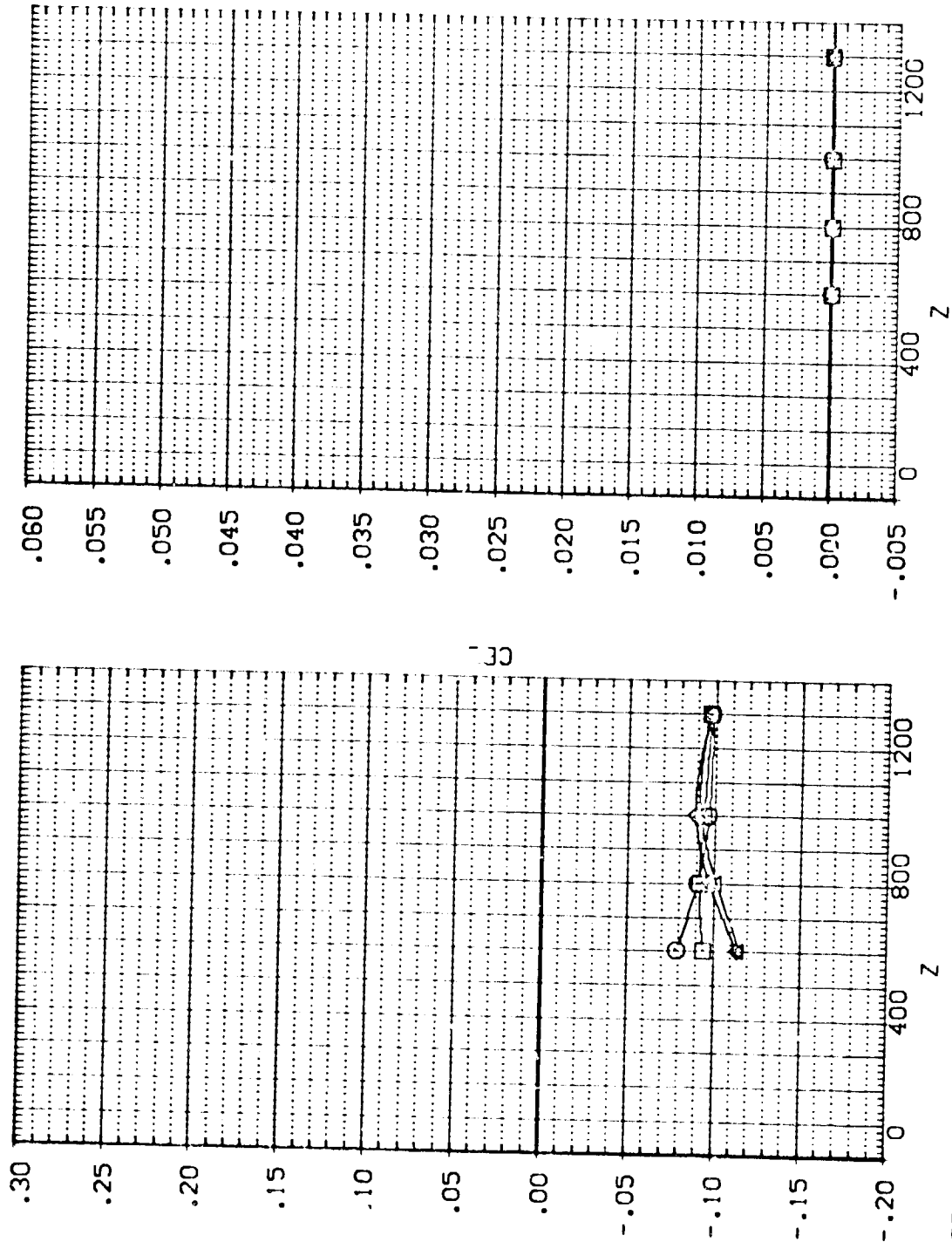

EXTERNAL TANK AERODYNAMIC CHARACTERISTICS DURING SEPARATION FROM ORBITER

:A13,EXTERNAL TANK(T10)SEPARATING FROM ORB. 09 (RIJT29)

SYMBOL

-
- ◇
- △

PARAMETRIC VALUES

X	MACH	PIOTAL	110.000
-1.217	4.530	BETA	.000
401.630	-5.000	DBETA	5.000
800.780	-20.000	ALTRON	.000
1200.500	ELEVTR	Y	200.000

SEE THE ASSOCIATED DATA DOCUMENT FOR REFERENCE CHARACTERISTICS FOR INDIVIDUAL DATASETS

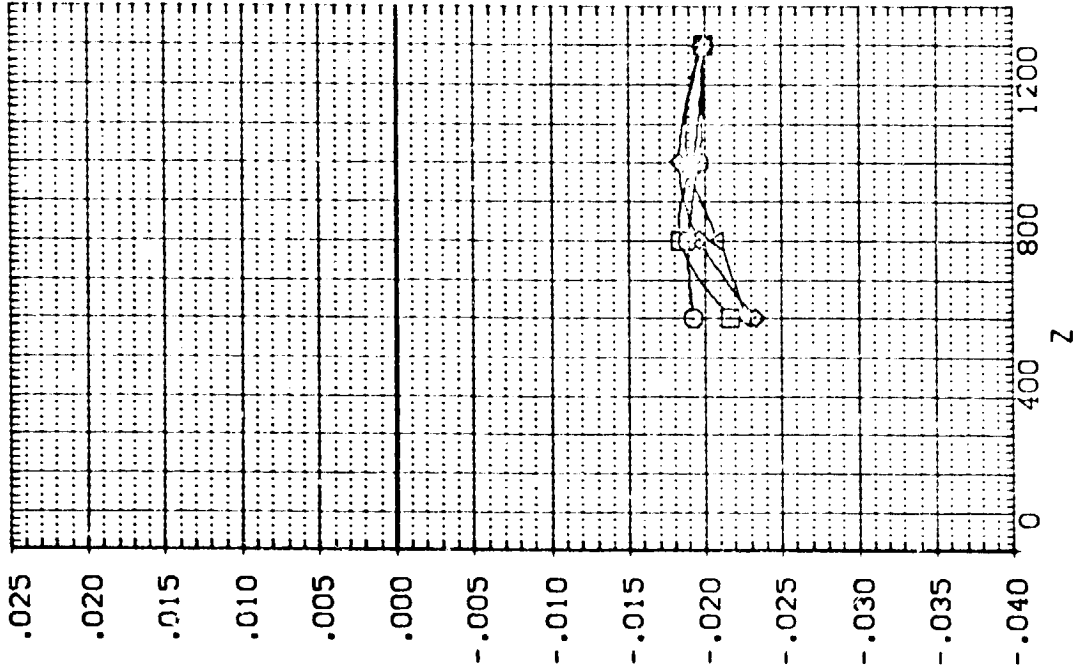
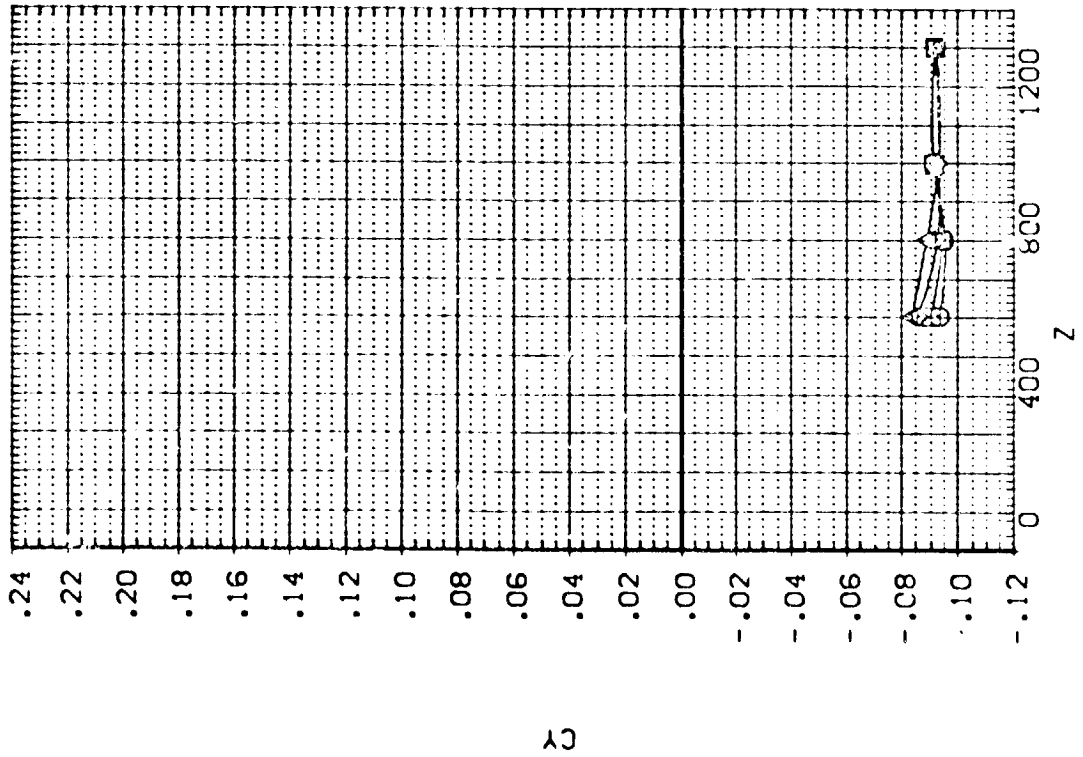

EXTERNAL TANK AERODYNAMIC CHARACTERISTICS DURING SEPARATION FROM ORBITER

IA13, EXTERNAL TANK (110) SEPARATING FROM ORB. C9 (RTJT30)

SYMBOL

X

PARAMETRIC VALUES

○	-.917	MACH	4.530	F-TOTAL	110.000
□	400.550	ALPHA	-5.000	BCTA	.000
◇	800.400	DALPHA	-20.000	DBETA	5.000
△	1200.700	ELEVTR	.000	A1LRON	.000
		Y	.000		

SEE THE ASSOCIATED DATA DOCUMENT FOR REFERENCE CHARACTERISTICS FOR INDIVIDUAL DATASETS

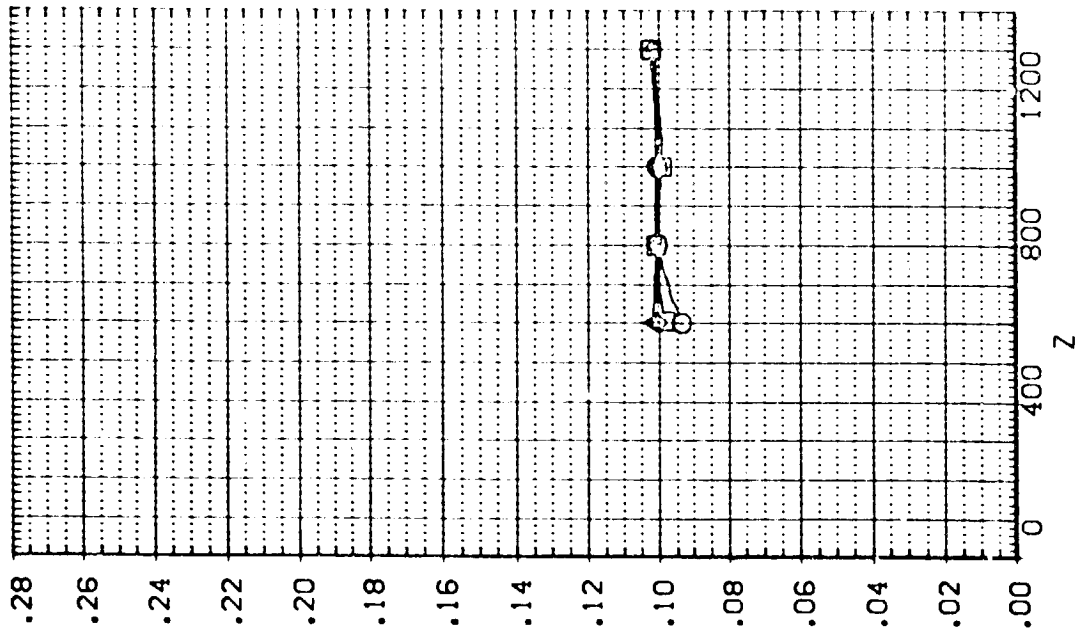
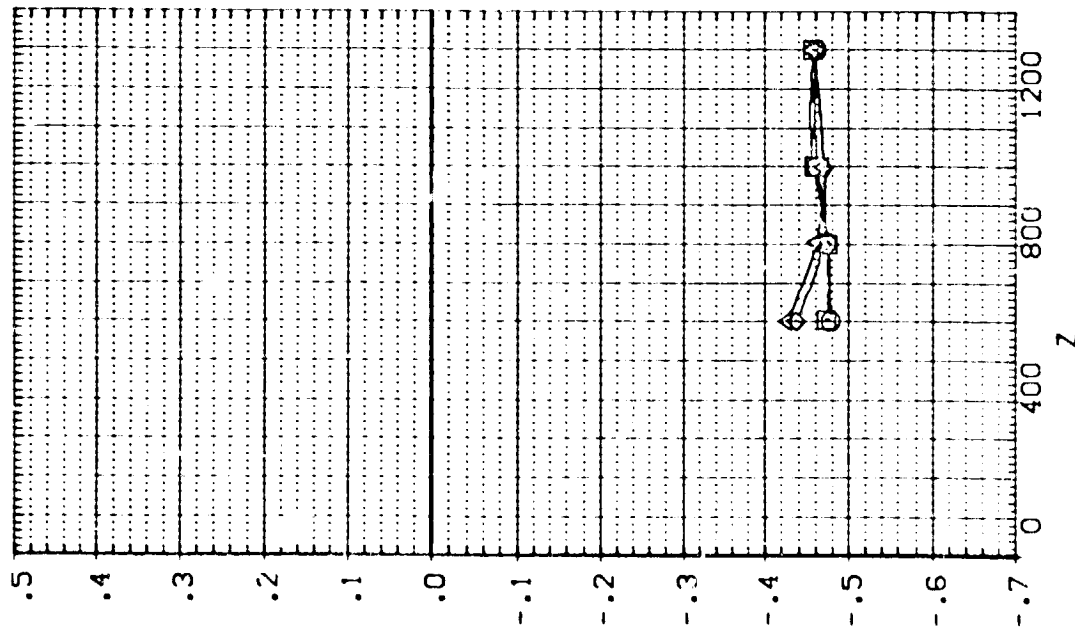

EXTERNAL TANK AERODYNAMIC CHARACTERISTICS DURING SEPARATION FROM ORBITER

IA13.EXTERNAL TANK(T10)SEPARATING FROM ORB. 09 (RTJT30)

SEE THE ASSOCIATED DATA DOCUMENT FOR REFERENCE CHARACTERISTICS FOR INDIVIDUAL DATASETS

SYMBOL	X	MACH	PARAMETRIC VALUES
○	-1.917	4.530	P/DOTAL 110.000
□	400.550	ALPHA -5.000	BETA .000
◇	800.400	DA_LPH	DBETA 5.000
△	1200.700	ELEVTR	A1LRON .000
		Y	.000

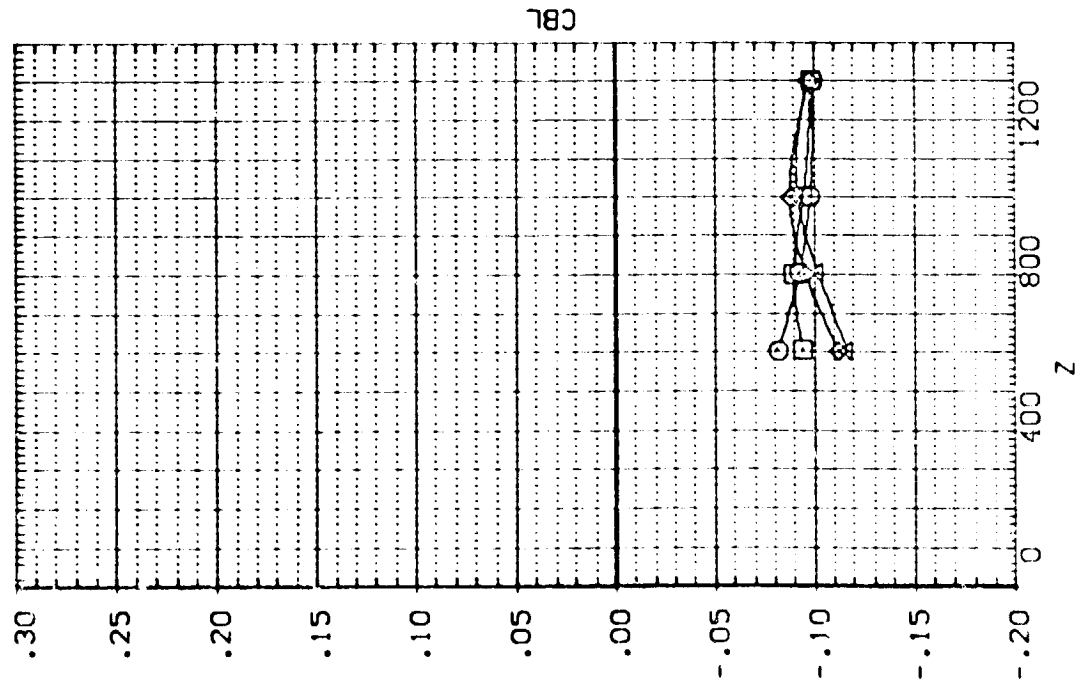
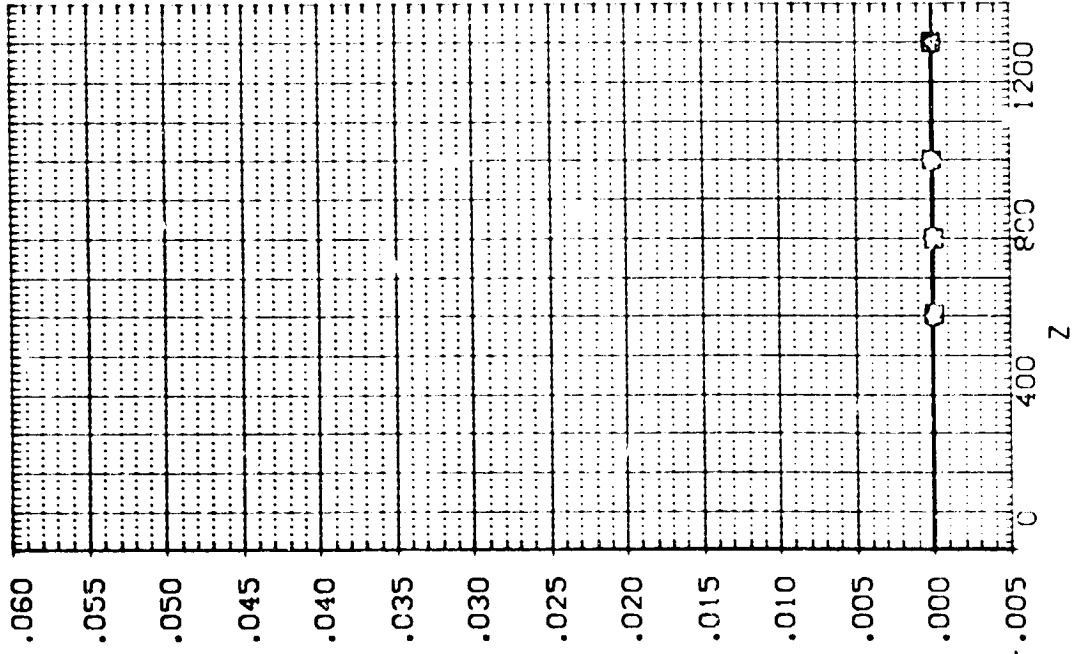

EXTERNAL TANK AERODYNAMIC CHARACTERISTICS DURING SEPARATION FROM ORBITER

IA13, EXTERNAL TANK(T110) SEPARATING FROM ORB. 09 (RTJT30)

SEE THE ASSOCIATED DATA DOCUMENT FOR REFERENCE CHARACTERISTICS FOR INDIVIDUAL DATASETS

SYMBOL		PARAMETRIC VALUES	
x	-0.917	MACH	4.530
y	100.550	ALPHA	-5.000
z	800.400	DALPHA	-20.000
	1200.700	ELEVTR	.000
		Y	.000
		PTOTAL	110.000
		BETA	.000
		CBETA	5.000
		AILLRON	.000
		Y	.000

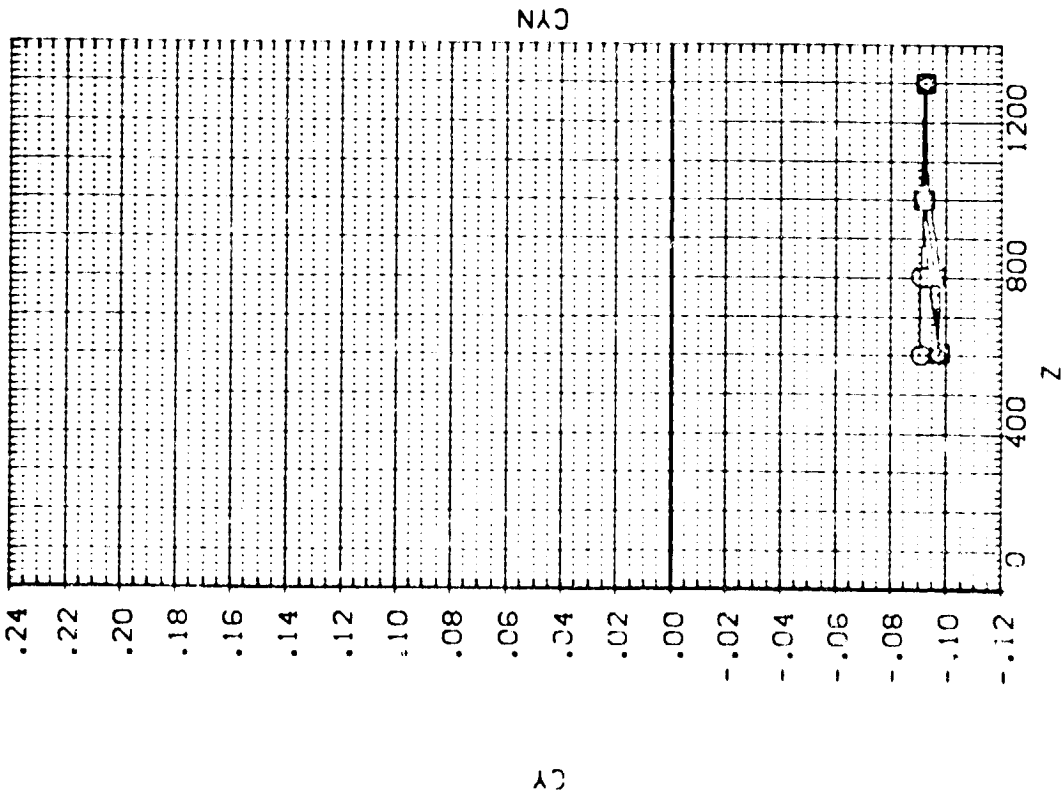
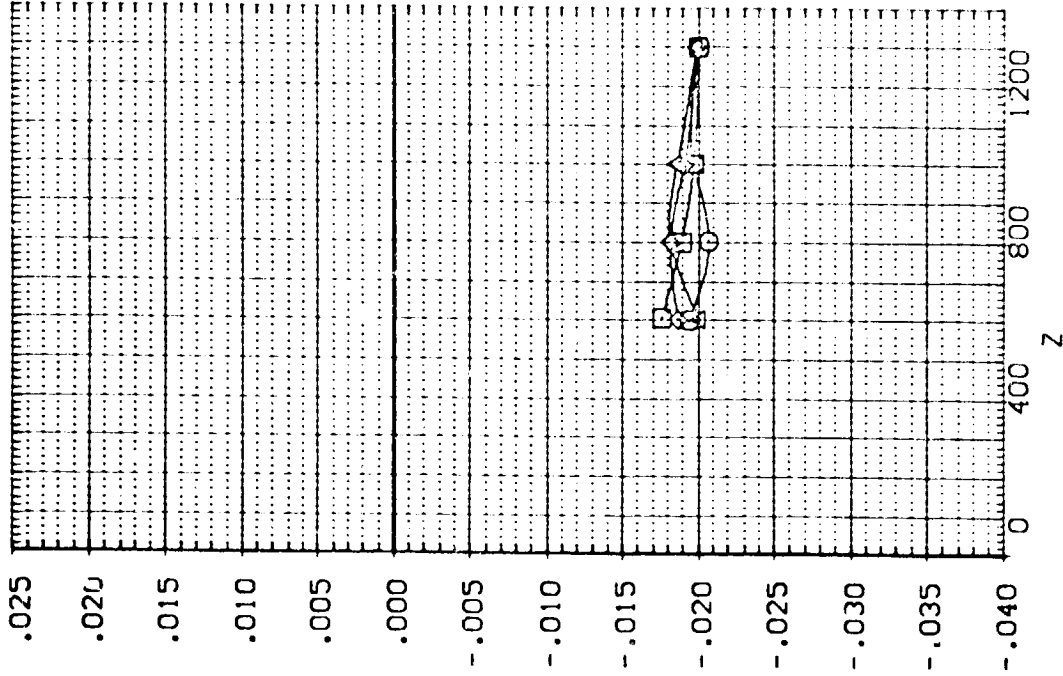

EXTERNAL TANK AERODYNAMIC CHARACTERISTICS DURING SEPARATION FROM ORBITER

1A13, EXTERNAL TANK (110) SEPARATING FROM ORB. 09 (RTJT31)

SEE THE ASSOCIATED DATA DOCUMENT FOR REFERENCE CHARACTERISTICS FOR INDIVIDUAL DATASETS

SYMBOL	X	MACH	PARAMETRIC VALUES
○	1.165	4.530	P TOTAL 110.000
□	400.570	ALPHA	BETA .000
◇	800.760	DALPHA	DBETA 5.000
△	1201.100	ELEVTR	AILRON .000
		Y	.000

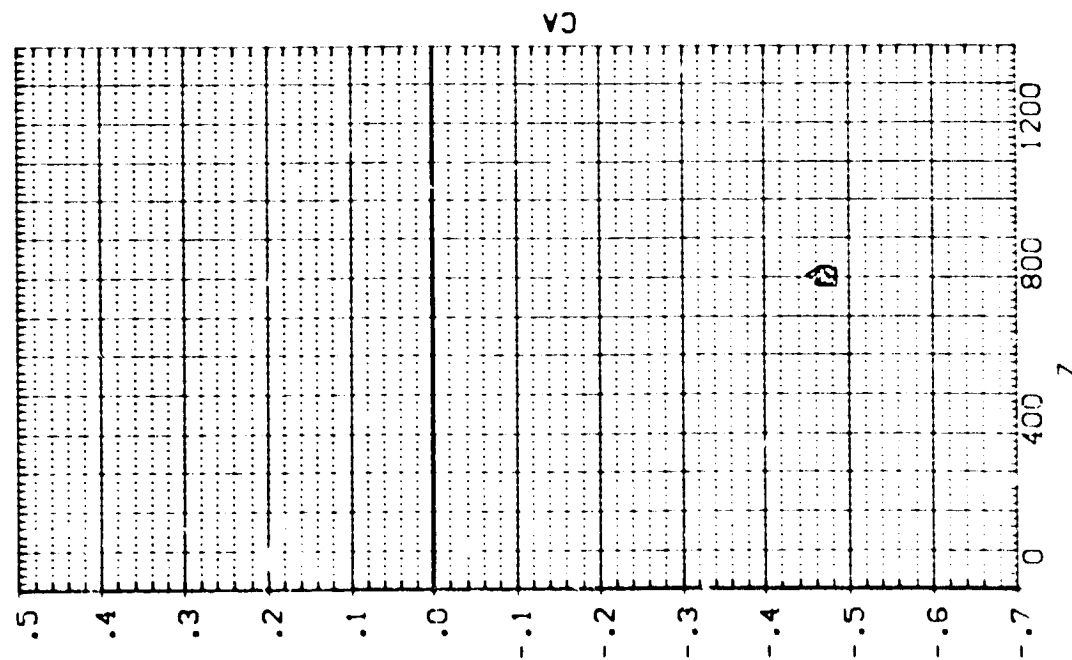
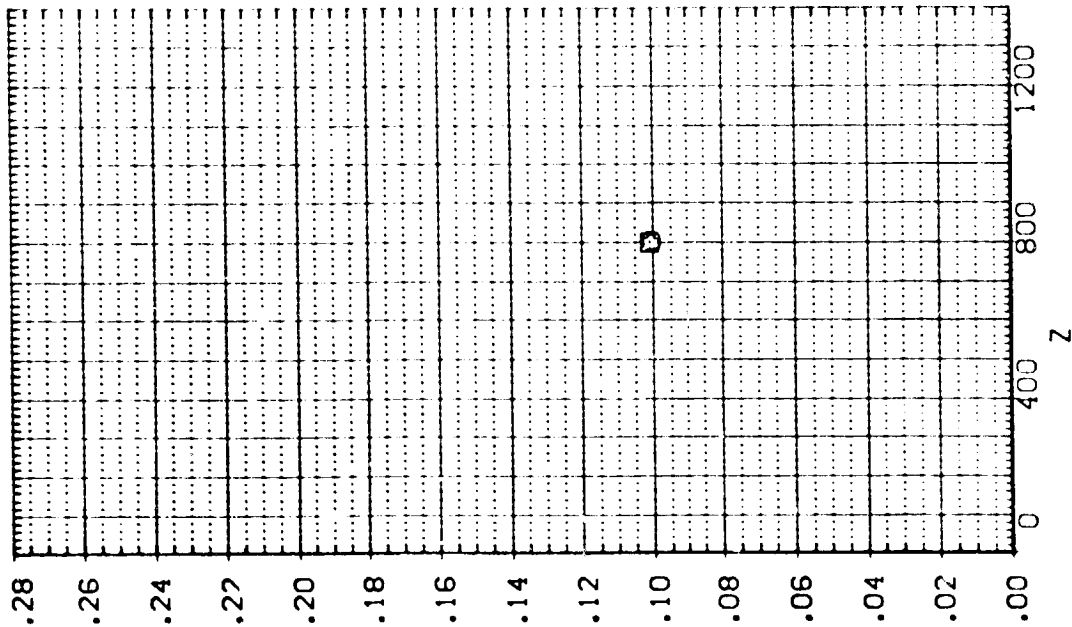

EXTERNAL TANK AERODYNAMIC CHARACTERISTICS DURING SEPARATION FROM ORBITER

IA13.EXTERNAL TANK(T10)SEPARATING FROM ORB. 09 (RTJT31)

SYMBOL

-
-
- ◇
- △

PARAMETRIC VALUES

X	1.165	MACH	4.530	POTAL	110.000
400.570	ALPHA	-5.000	BETA	.000	
800.760	DALPHA	-30.000	DBETA	5.000	
1200.100	ELEVTR	.000	ATLRON	.000	
	Y				

SEE THE ASSOCIATED DATA DOCUMENT FOR REFERENCE CHARACTERISTICS FOR INDIVIDUAL DATASETS

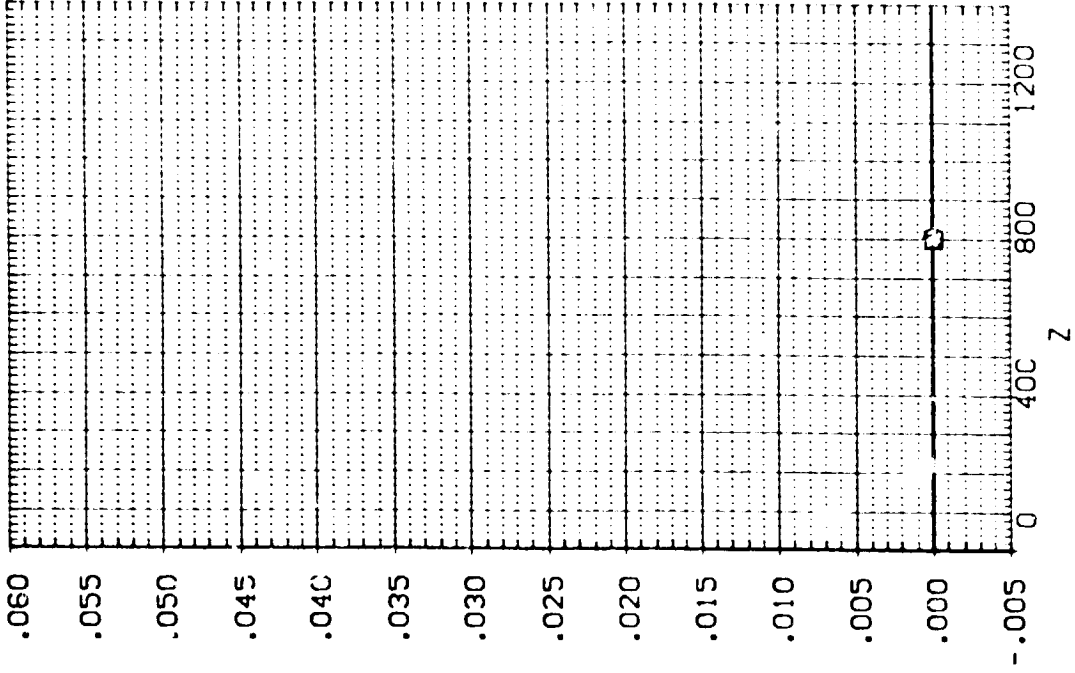
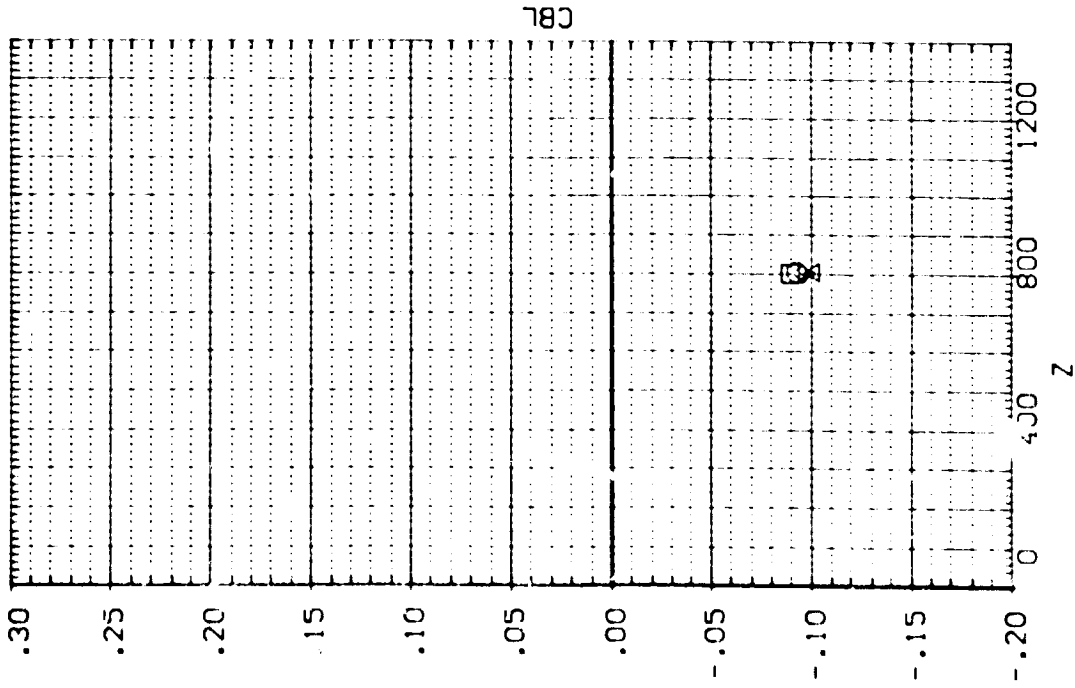

EXTERNAL TANK AERODYNAMIC CHARACTERISTICS DURING SEPARATION FROM ORBITER

3.3. EXTERNAL TANK DURING SEPARATION FROM ORBIT (RTJ32)

SEE THE ASSOCIATED DATA DOCUMENT FOR REFERENCE CHARACTERISTICS FOR INDIVIDUAL DATA SETS

SYMBOL	X	MACH	PARAMETRIC VALUES
○	.290	4.520	PTOTAL 80.000
○	400.490	ALPHA	BETA .000
○	800.980	GAMMA	DELTA .000
○	1200.700	ELEVTR	ALPHON .000
○		Y	.000

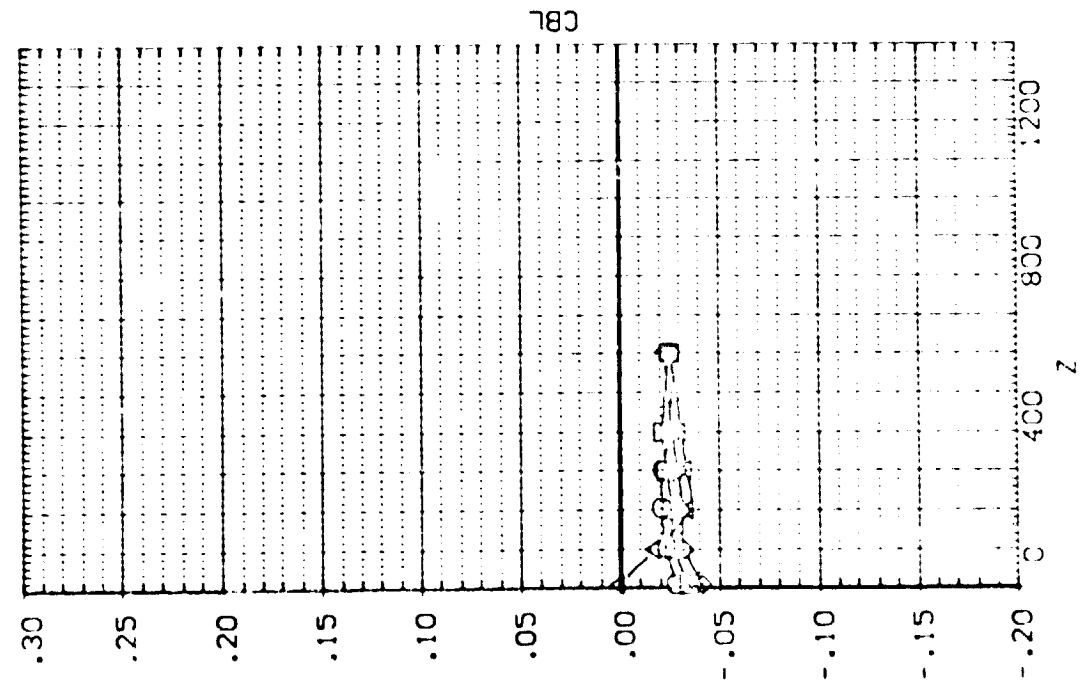
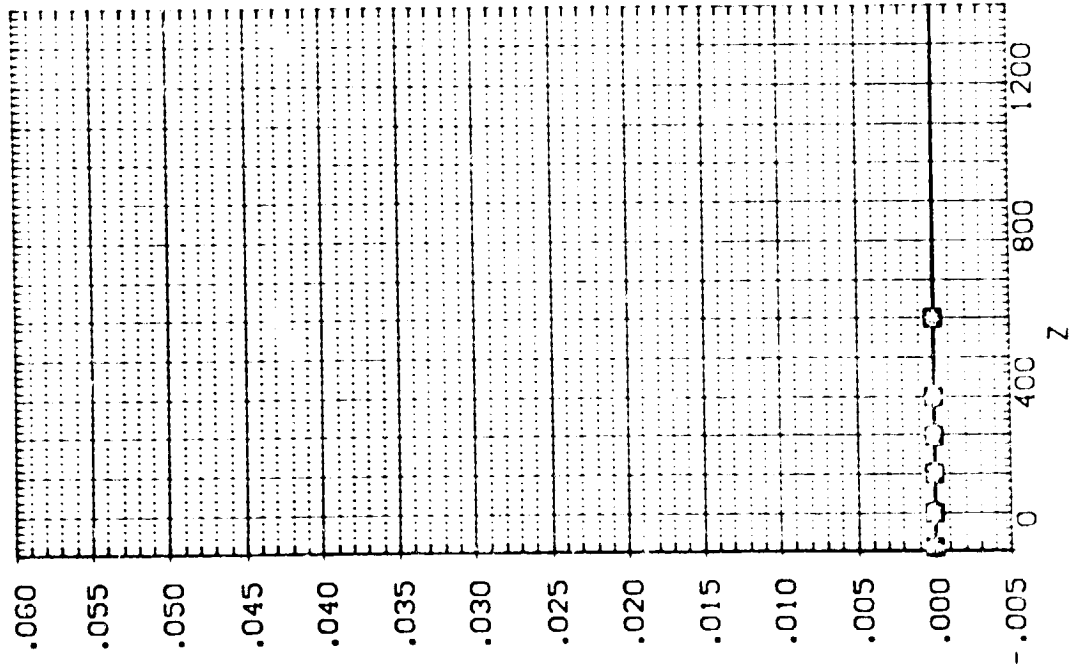

EXTERNAL TANK AERODYNAMIC CHARACTERISTICS DURING SEPARATION FROM ORBIT

PREVIOUS PAGE BLANK NOT FILMED

1A13.EXTERNAL TANK(10)SEPARATING FROM ORB. 09 (RTJT32)

SEE THE ASSOCIATED DATA DOCUMENT FOR REFERENCE CHARACTERISTICS FOR INDIVIDUAL DATASETS

SYMBOL	X	MACH	PARAMETRIC VALUES	PTOTAL	80.000
○	.290	ALPHA	4.520	BETA	.000
□	400.490	DALPHA	-10.000	DBETA	.000
◇	800.650	ELEVTR	5.000	AIRTON	.000
△	1200.700	Y	.000		

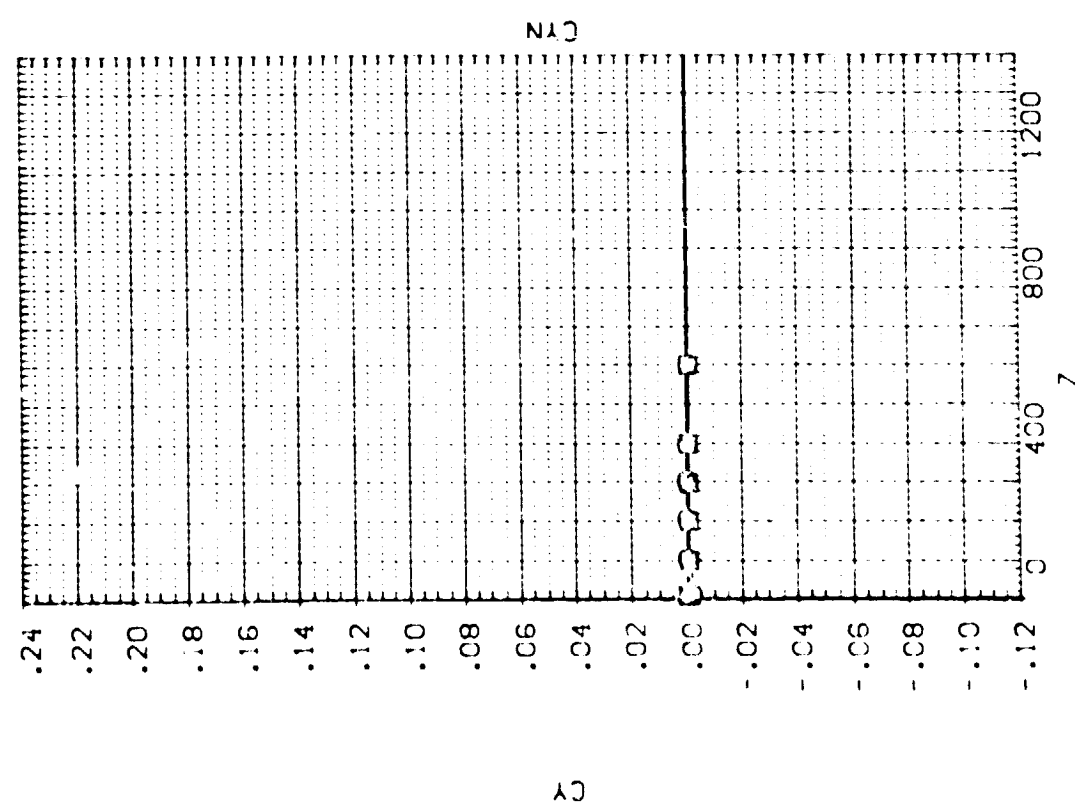
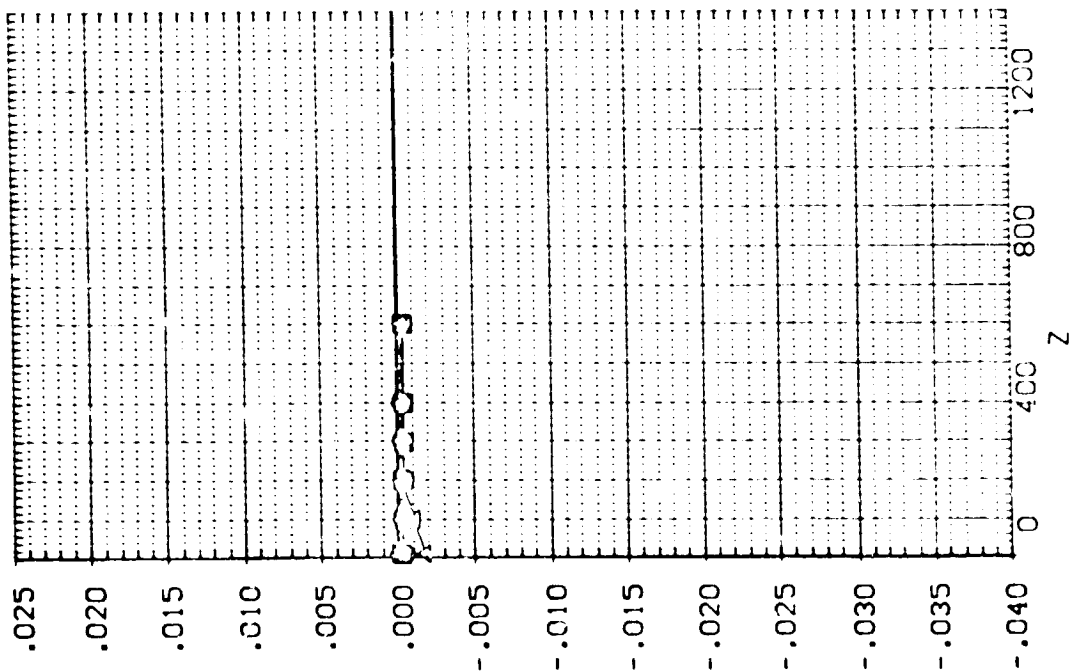

EXTERNAL TANK AERODYNAMIC CHARACTERISTICS DURING SEPARATION FROM ORBITER

1A:3.EXTERNAL TANK(T10)SEPARATING FROM ORB. 09 (RTJT33)

SEE THE ASSOCIATED DATA DOCUMENT FOR REFERENCE CHARACTERISTICS FOR INDIVIDUAL DATASETS

SYMBOL	X	MACH	PARAMETRIC VALUES
()	400,540	4.520	P TOTAL 80,000
()	800,150	4.520	BETA .000
()	1,201,000	4.520	ALPHA .000
()	1,701,000	4.520	COS TA .000
()	1,701,000	4.520	SIN TA .000
()	1,701,000	4.520	ELEVTR .000
()	1,701,000	4.520	Y .000

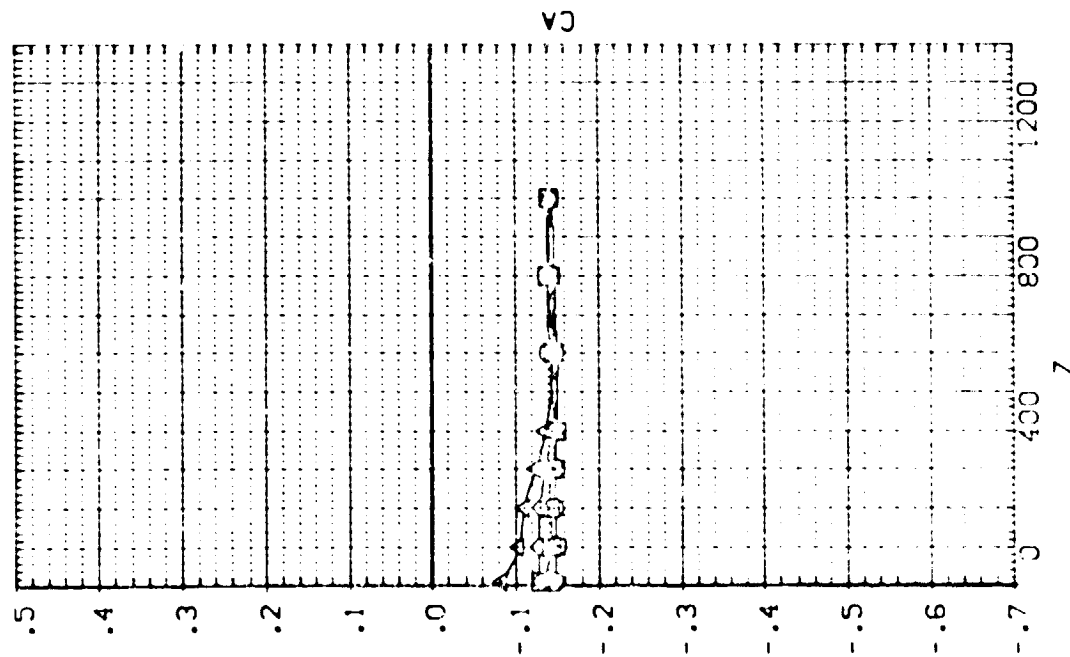
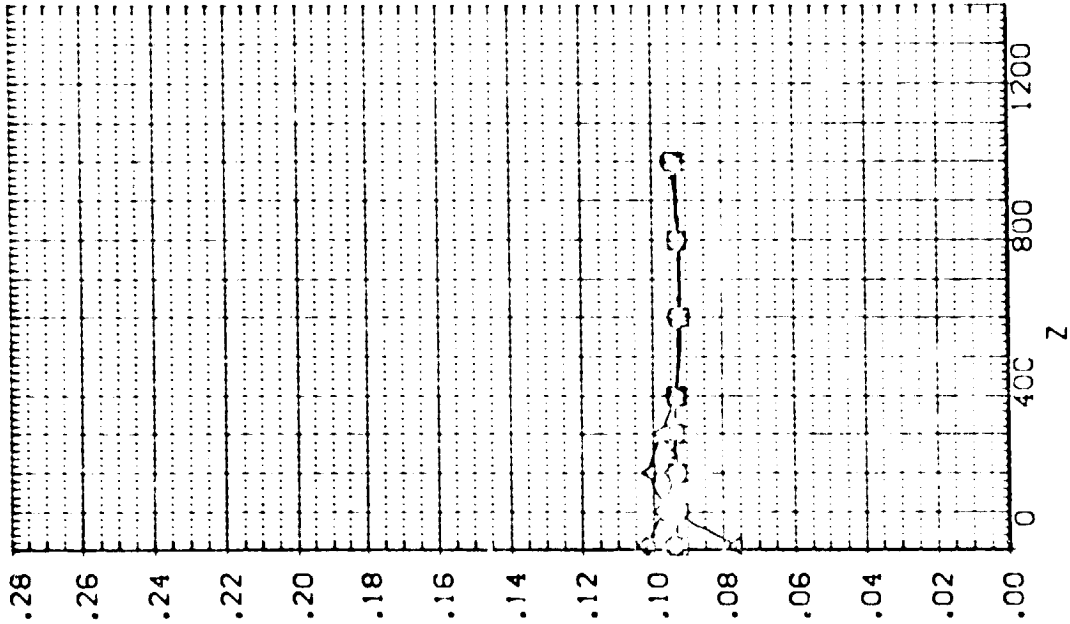

EXTERNAL TANK AERODYNAMIC CHARACTERISTICS DURING SEPARATION FROM ORBITER

FIG. 13. EXTERNAL TANK(10)SEPARATING FROM ORB. 09 (RTJT33)

SYMBOL

-
- ◇
- △

PARAMETRIC VALUES

.248	MACH	4.520	P TOTAL	80.000
400.440	ALPHA	-10.000	BETA	.000
800.560	CALPHA	.000	CBETA	.000
1200.000	ELEVTR	.000	ALLRON	.000
	V	.000		

SEE THE ASSOCIATED DATA DOCUMENT FOR REFERENCE CHARACTERISTICS FOR INDIVIDUAL DATA SETS

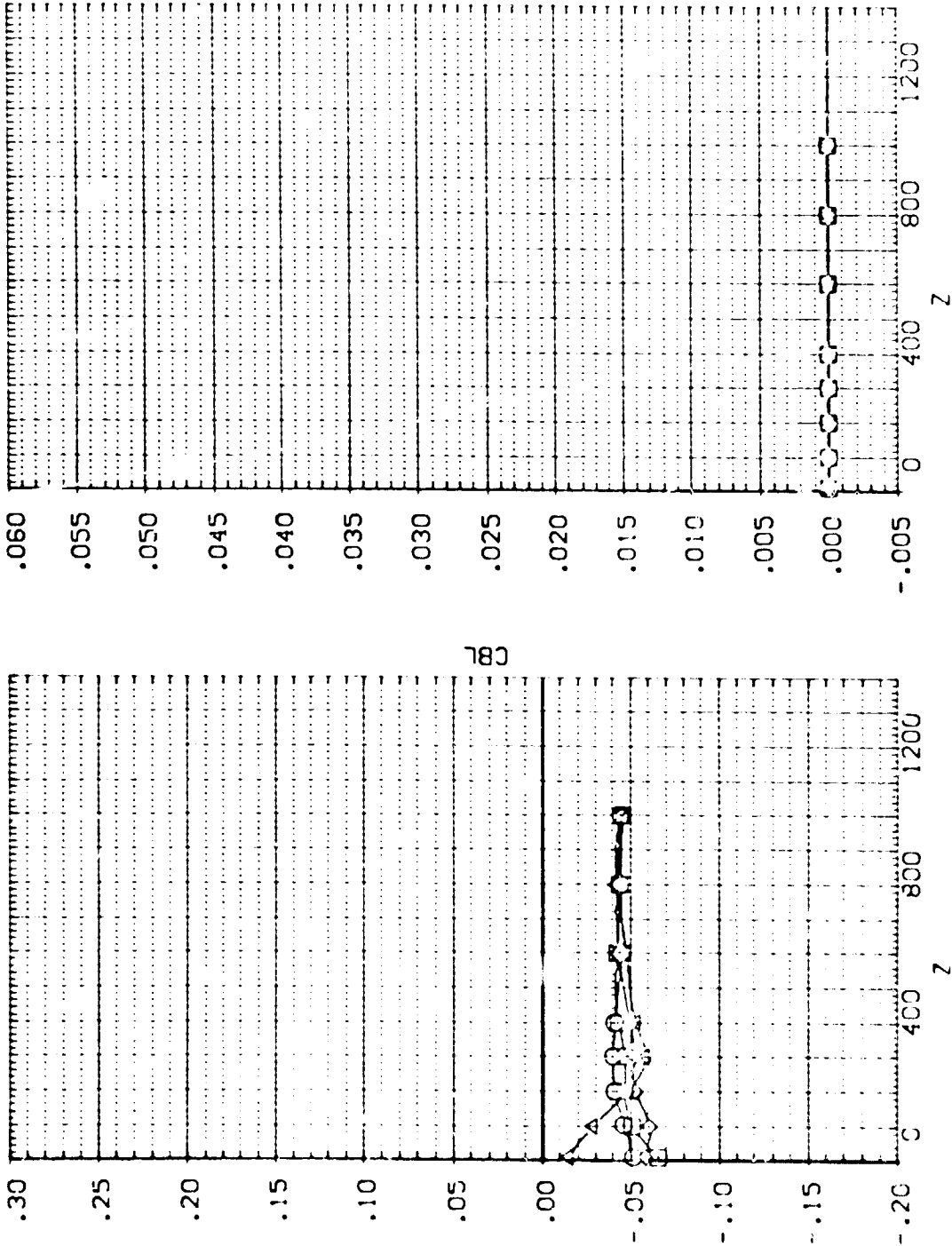

EXTERNAL TANK AERODYNAMIC CHARACTERISTICS DURING SEPARATION FROM ORBITER

IA13,EXTERNAL TANK(T10)SEPARATING FROM ORB. 09 (RTJT33)

SEE THE ASSOCIATED DATA DOCUMENT FOR REFERENCE CHARACTERISTICS FOR INDIVIDUAL DATASETS

SYMBOL		PARAMETRIC VALUES	
○	X	MACH	4.520
□	Y	PIOTAL	90.000
◇	Z	ALPHA	-10.000
△		DALPHA	.000
		BETA	.000
		DBETA	.000
		ELEVTR	.000
		AILRON	.000
		Y	.000

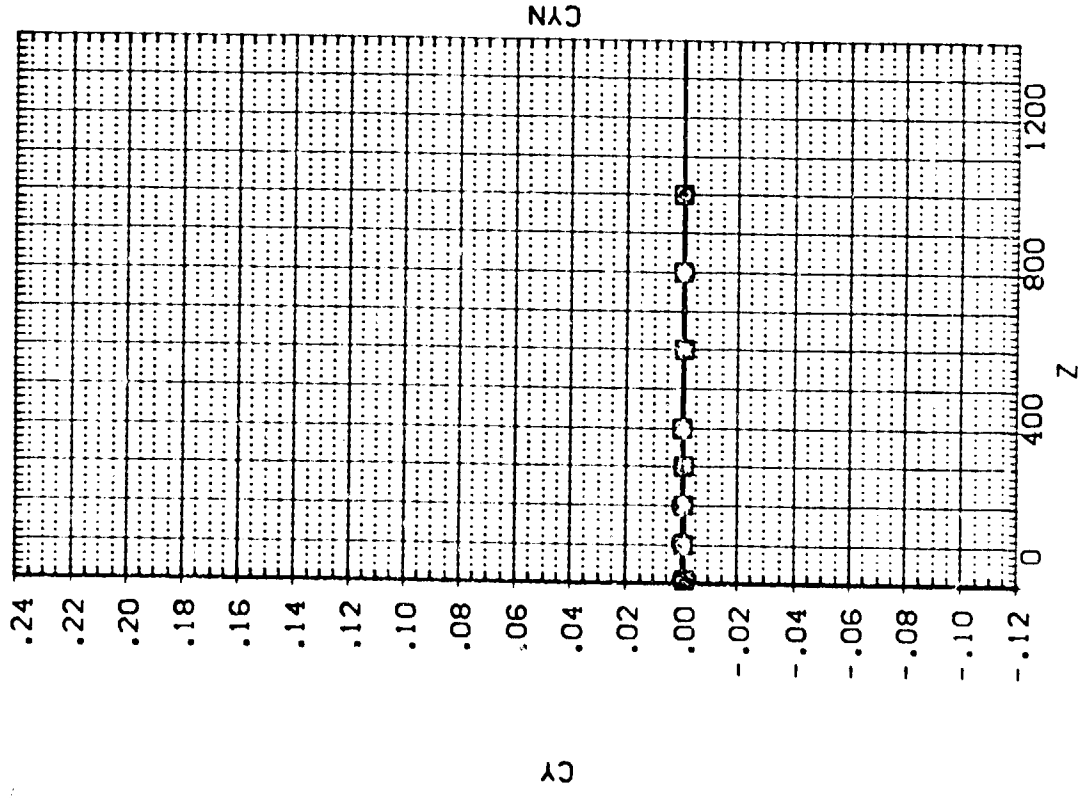
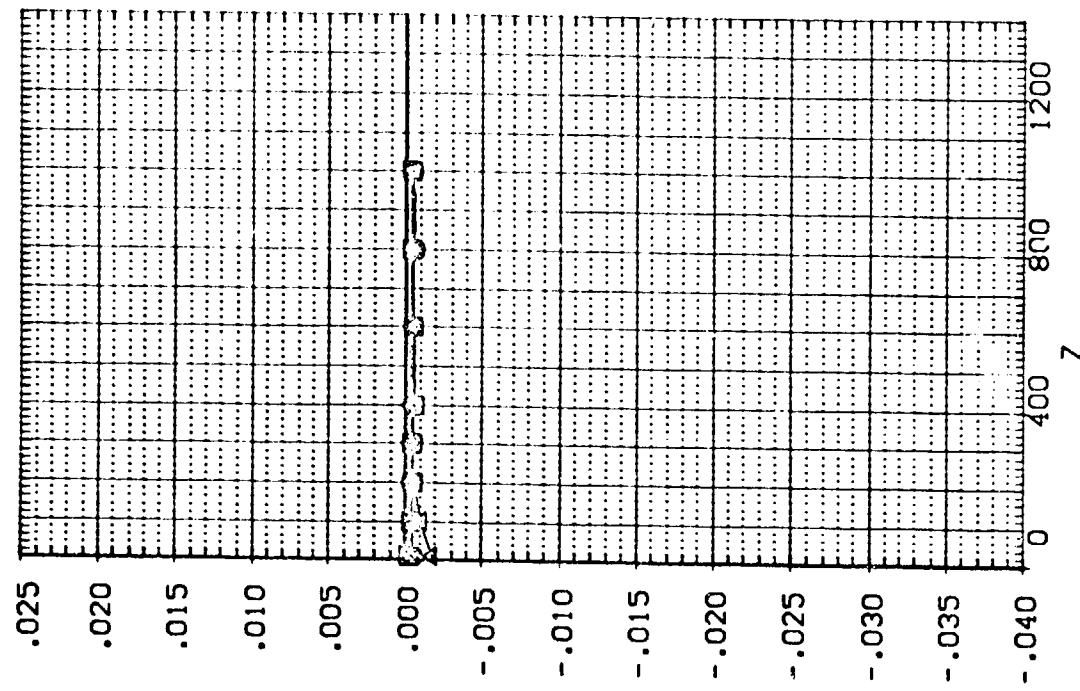

IA13.EXTERNAL TANK(T10)SEPARATING FROM ORB. 09 (RTJT34)

SYMBOL

-
-
- ◇
- △

PARAMETRIC VALUES

.210	MACH	4.520	PTOTAL	80.000
4C-.460	ALPHA	-10.000	BETA	.000
8CJ.610	DALPHA	.000	DBETA	.000
1200.900	ELEVTR	.000	AILRON	.000
Y		200.000		

SEE THE ASSOCIATED DATA DOCUMENT FOR REFERENCE CHARACTERISTICS FOR INDIVIDUAL DATASETS

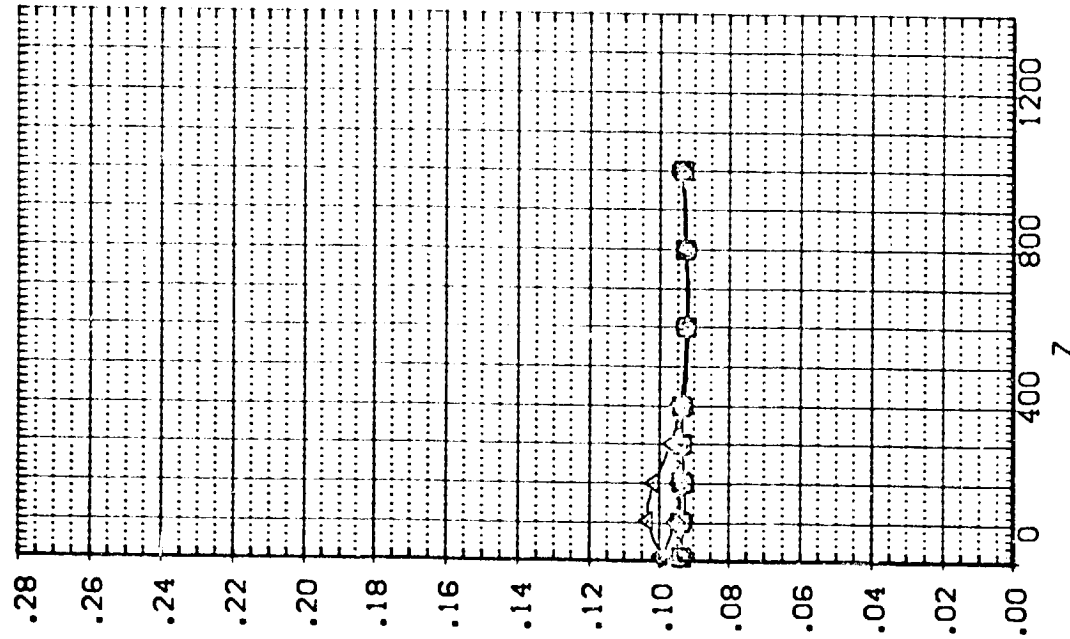
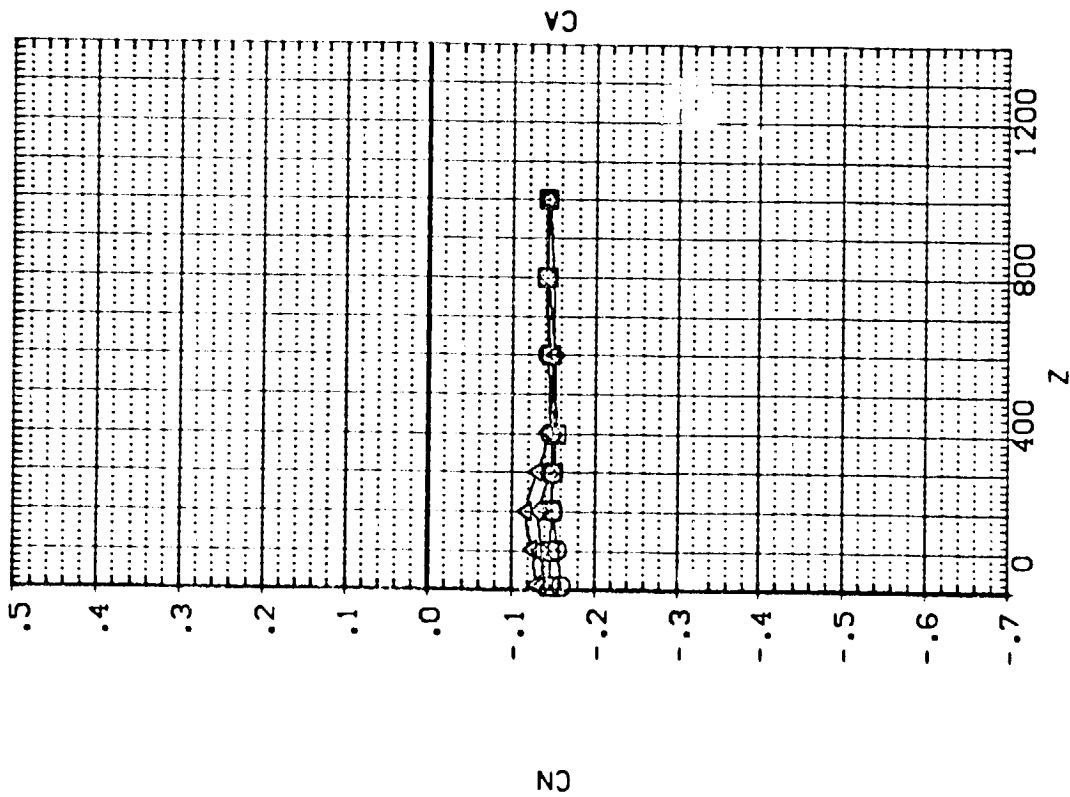

EXTERNAL TANK AERODYNAMIC CHARACTERISTICS DURING SEPARATION FROM ORBITER

IA13.EXTERNAL TANK(T10)SEPARATING FROM ORB. 09 (RTJT34)

SEE THE ASSOCIATED DATA DOCUMENT FOR REFERENCE CHARACTERISTICS FOR INDIVIDUAL DATASETS

SYMBOL	X	MACH	PARAMETRIC VALUES
□	.210	4.520	PTOTAL 80.000
◇	400.460	-10.000	BETA .000
△	800.610	.000	DBETA .000
	1200.900	.000	AILLRON .000
		Y	200.000

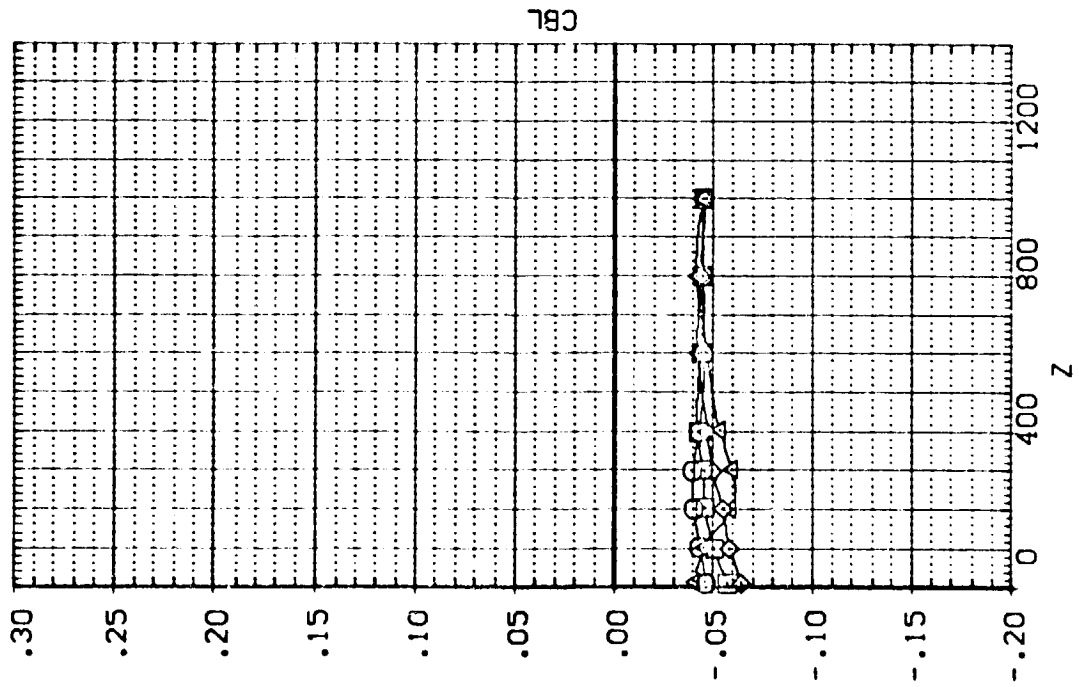
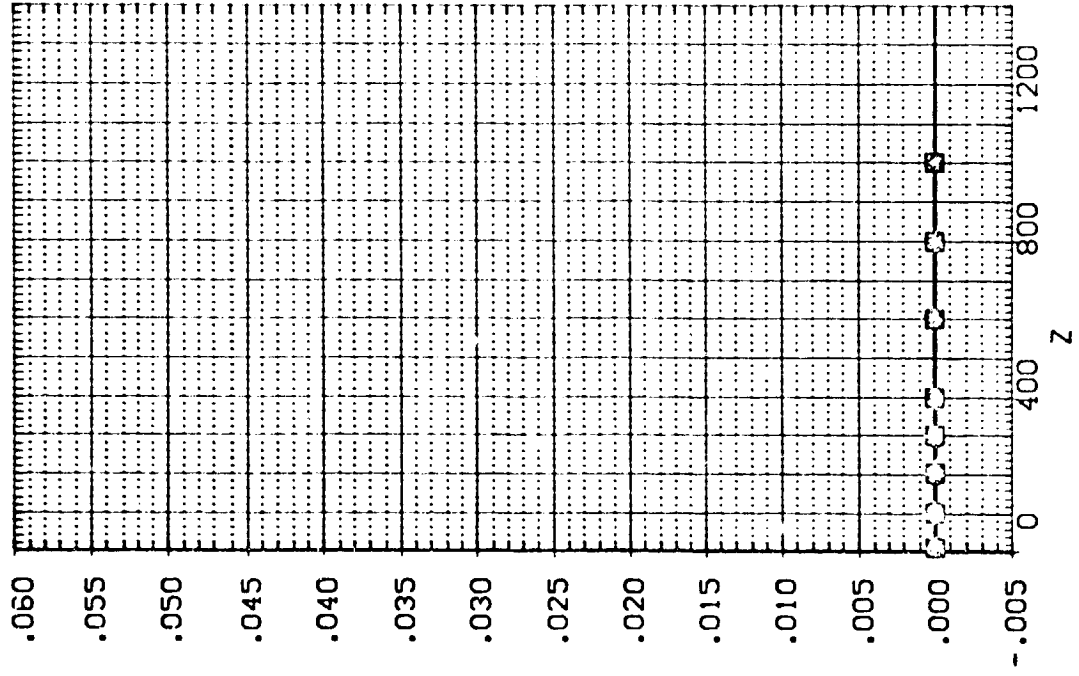

EXTERNAL TANK AERODYNAMIC CHARACTERISTICS DURING SEPARATION FROM ORBITER

[A13-EXTERNAL TANK(T10)SEPARATING FROM ORB. 09 (RTJT34)]

SEE THE ASSOCIATED DATA DOCUMENT FOR REFERENCE CHARACTERISTICS FOR INDIVIDUAL DATASETS

SYMBOL		PARAMETRIC VALUES	
○	x	MACH	4.520
□	400.460	ALPHA	-10.000
◇	800.610	BETA	.000
△	1200.900	DBETA	.000
	y	AILRON	.000
		PTOTAL	80.000
		BETA	.000
		AILRON	.000
		Y	200.000

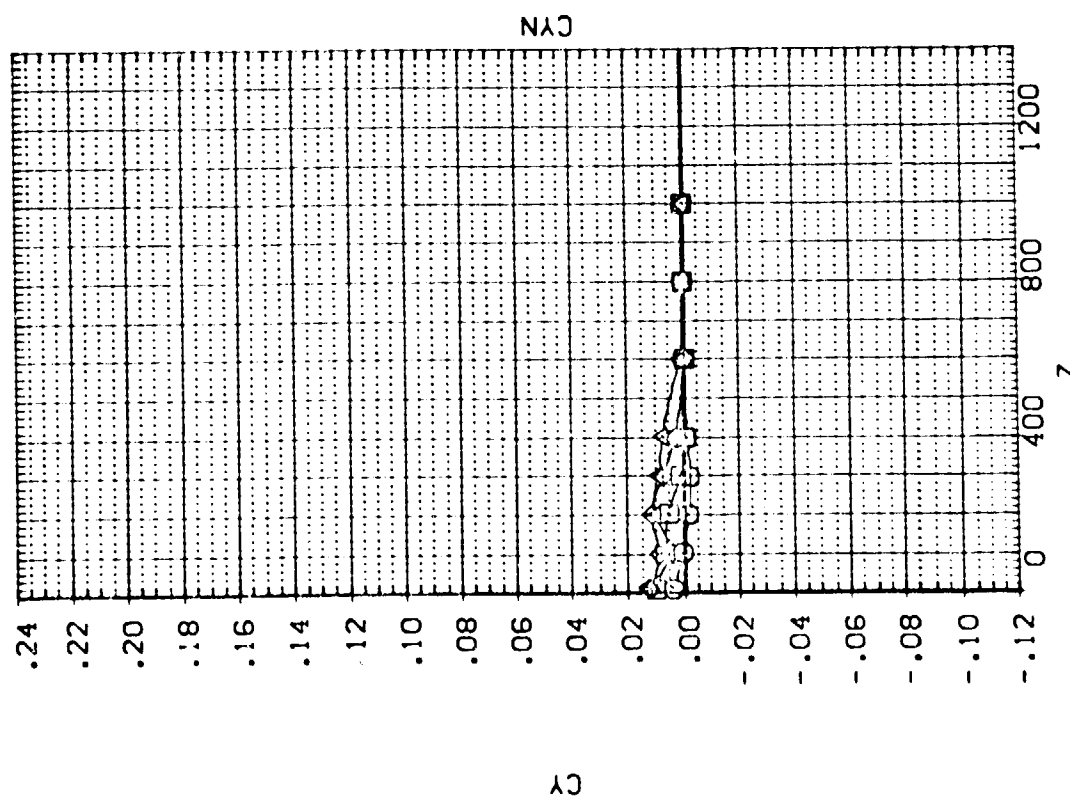
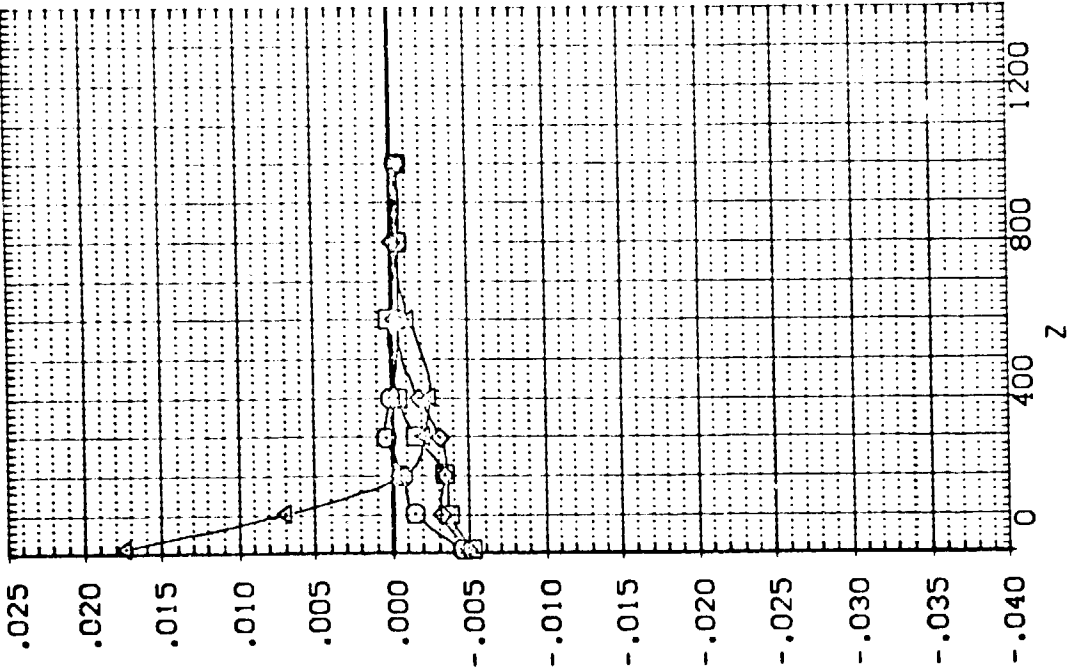

EXTERNAL TANK AERODYNAMIC CHARACTERISTICS DURING SEPARATION FROM ORBITER

IA13.EXTERNAL TANK(T10)SEPARATING FROM ORB. 09 (RTJT35)

SEE THE ASSOCIATED DATA DOCUMENT FOR REFERENCE CHARACTERISTICS FOR INDIVIDUAL DATASETS

SYMBOL		PARAMETRIC VALUES	
○	X	MACH	PTOTAL
□	400	.154	4.520
◇	800	ALPHA	BETA
△	1200	.360	-10.000
		DALPHA	DBETA
		.550	.000
		ELEVTR	ATLRON
		.900	.000
	Y		200.000

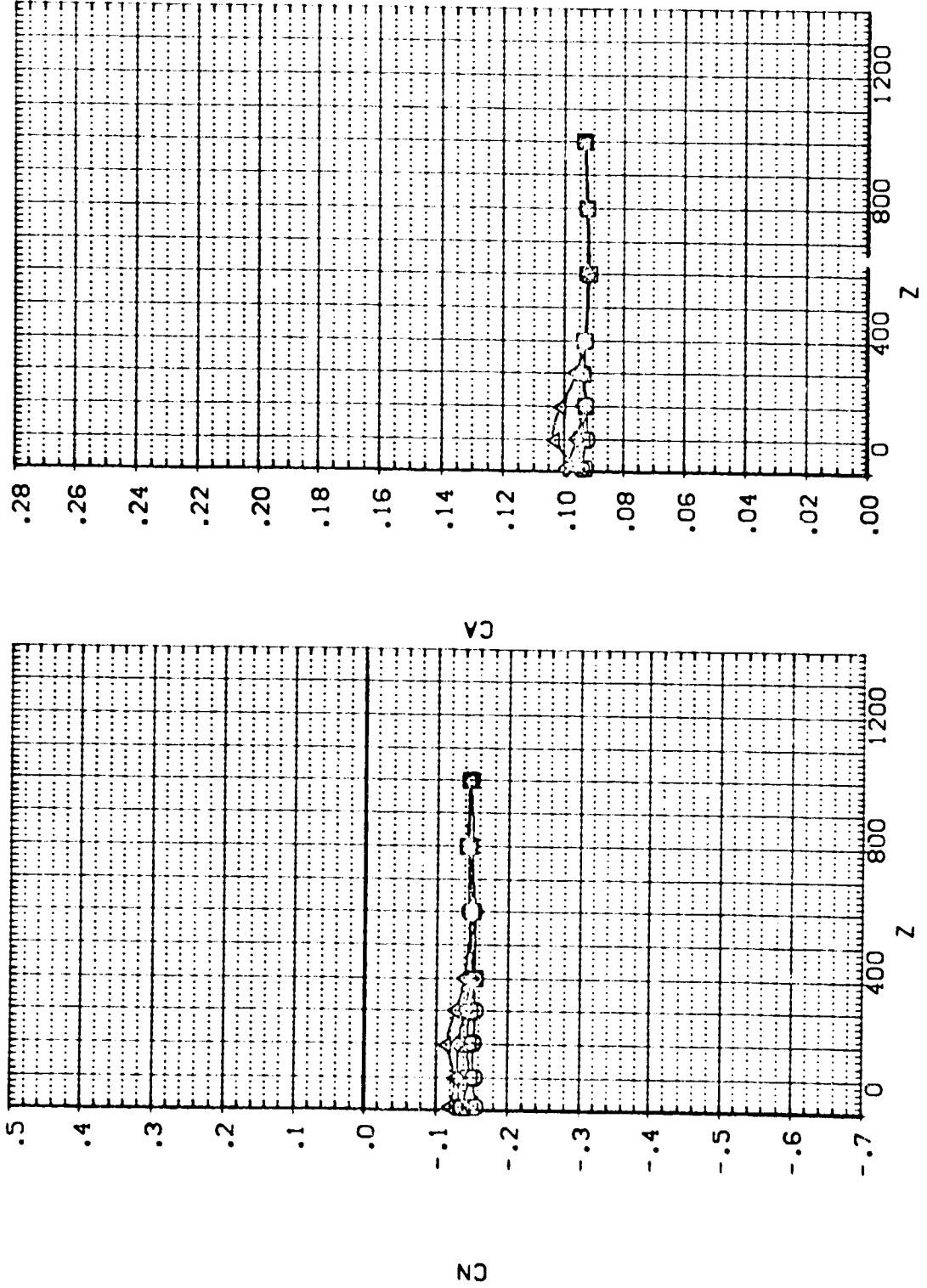

IA13-EXTERNAL TANK(T10)SEPARATING FROM ORB. 09 (RTJT35)

SYMBOL

-
-
- ◇
- △

x .154
400.360
800.550
1,200.900

MACH
ALPHA
DALPHA
ELEVTR
Y

PARAMETRIC VALUES

4.520
-10.000
.000
.000
200.000

PTOTAL
BETA
DBETA
AIIRON
80.000
.000
5.000
.000

SEE THE ASSOCIATED DATA DOCUMENT FOR REFERENCE CHARACTERISTICS FOR INDIVIDUAL DATASETS

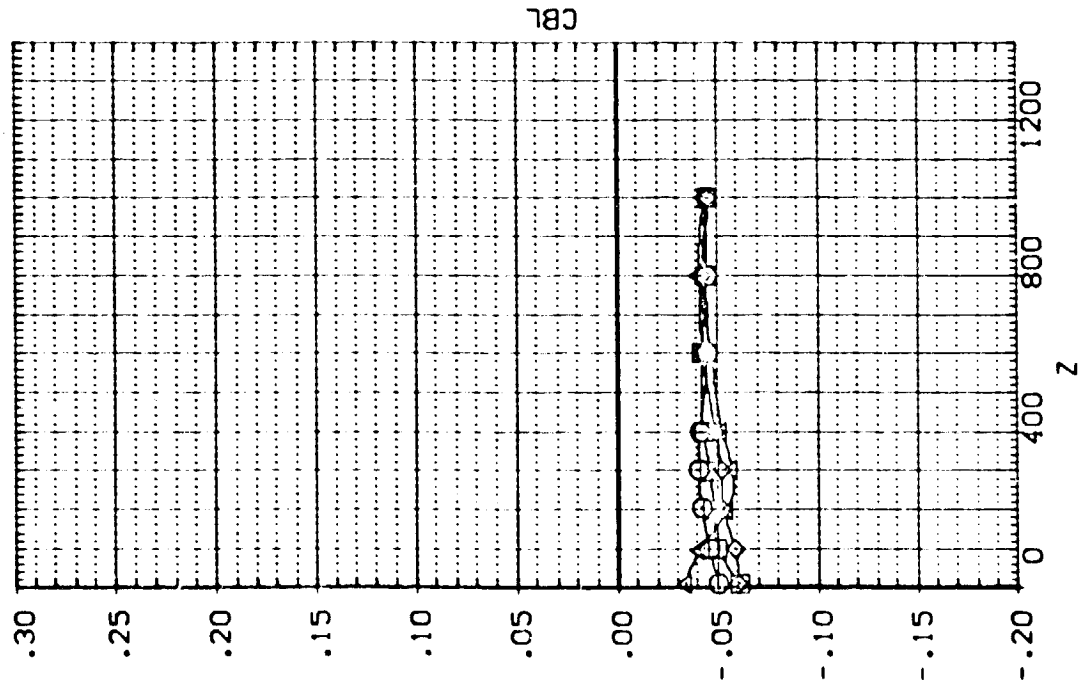

Cx

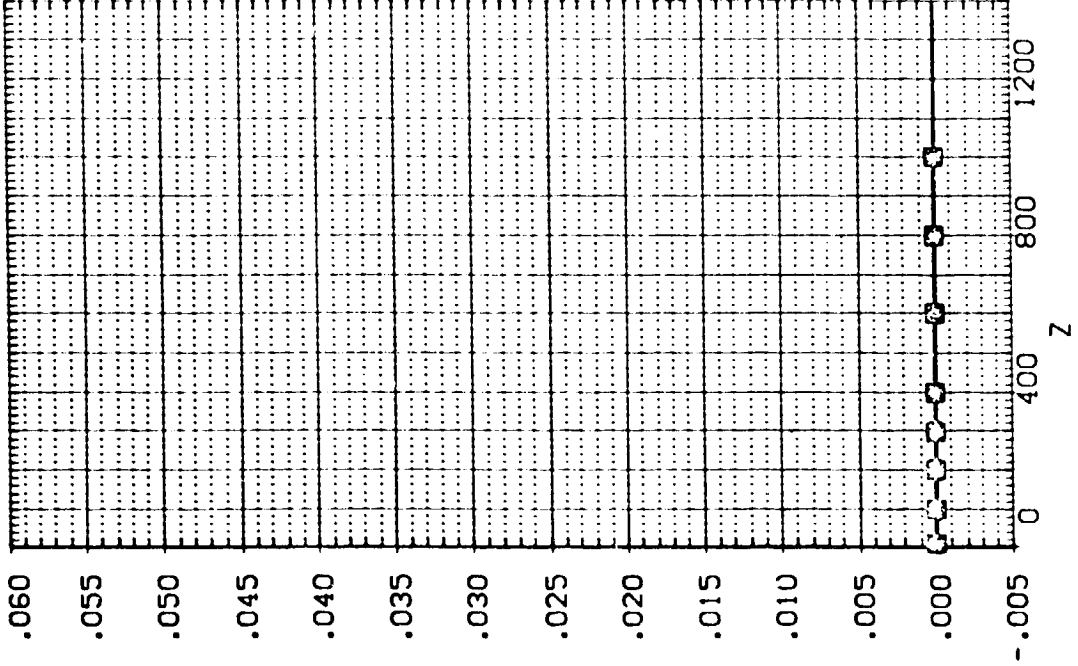

Cz

EXTERNAL TANK AERODYNAMIC CHARACTERISTICS DURING SEPARATION FROM ORBITER

1.13. EXTERNAL TANK(T10) SEPARATING FROM ORB. 09 (RTJT35)

SEE THE ASSOCIATED DATA DOCUMENT FOR REFERENCE CHARACTERISTICS FOR INDIVIDUAL DATASETS

SYMBOL: □ ◇ △

X	MACH	PTOTAL	80.000
.154	4.520	PTOTAL	80.000
400.360	-10.000	BETA	.000
800.550	.000	BETA	5.000
1200.900	.000	ALFON	.000
Y	200.000		

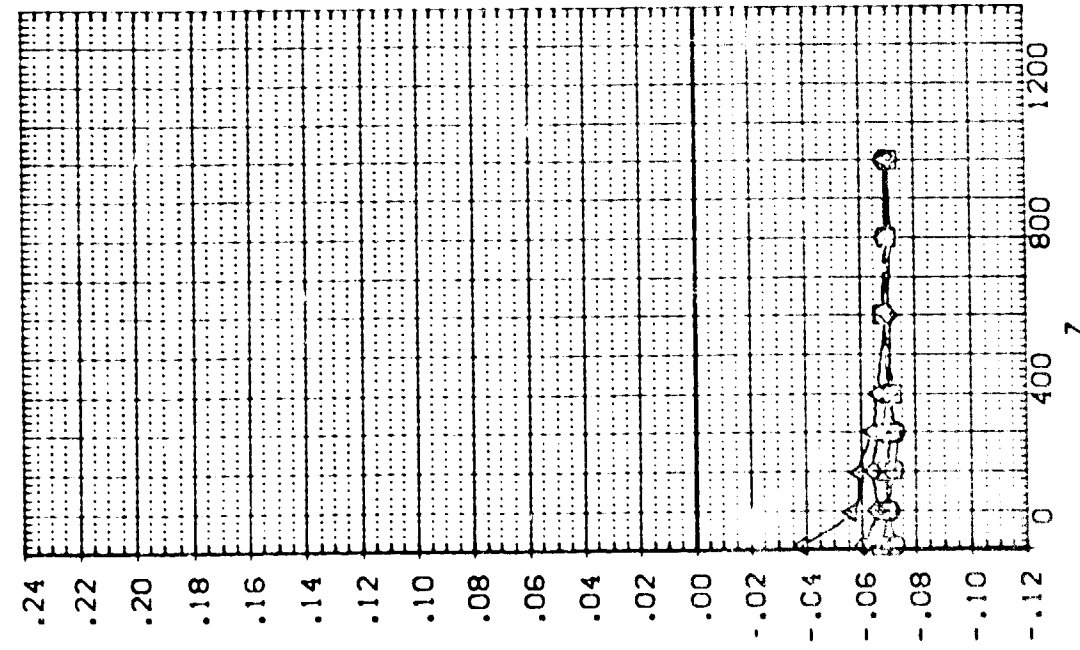
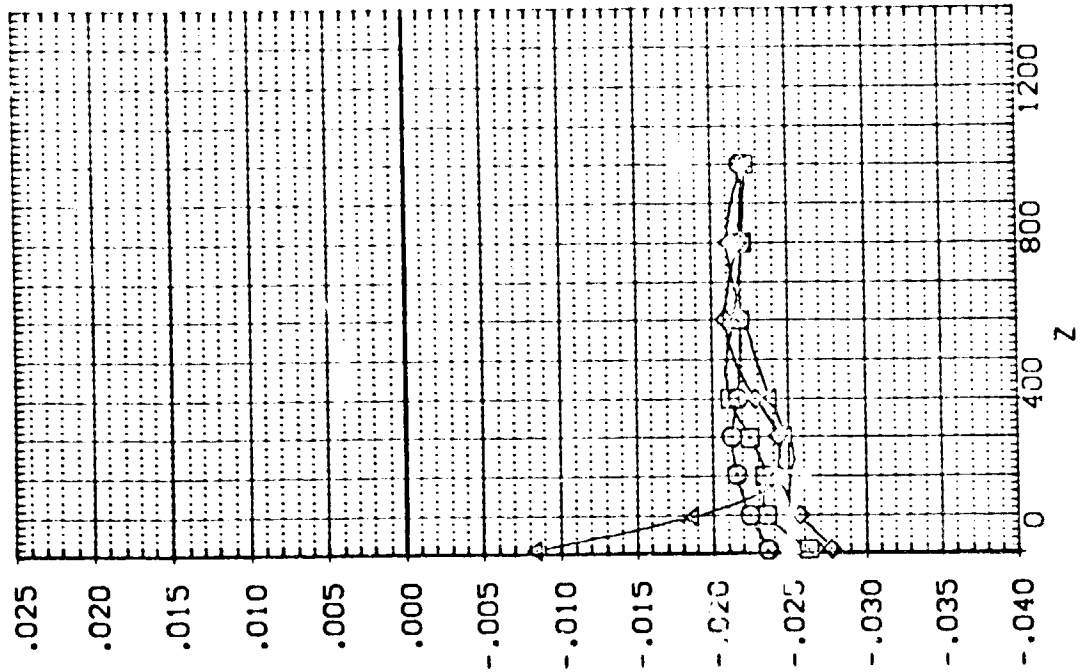

EXTERNAL TANK AERODYNAMIC CHARACTERISTICS DURING SEPARATION FROM ORBITER

IA13.EXTERNAL TANK(T10)SEPARATING FROM ORB. 09 (RTJT36)

SEE THE ASSOCIATED DATA DOCUMENT FOR REFERENCE CHARACTERISTICS FOR INDIVIDUAL DATASETS

SYMBOL		PARAMETRIC VALUES	
○	.237	MACH	4.520
□	400.460	ALPHA	-10.000
◇	800.530	DALPHA	.000
△	1200.700	ELEVTR	.000
		PTOTAL	60.000
		BETA	.000
		DBETA	5.000
		AILRON	.000
		Y	.000

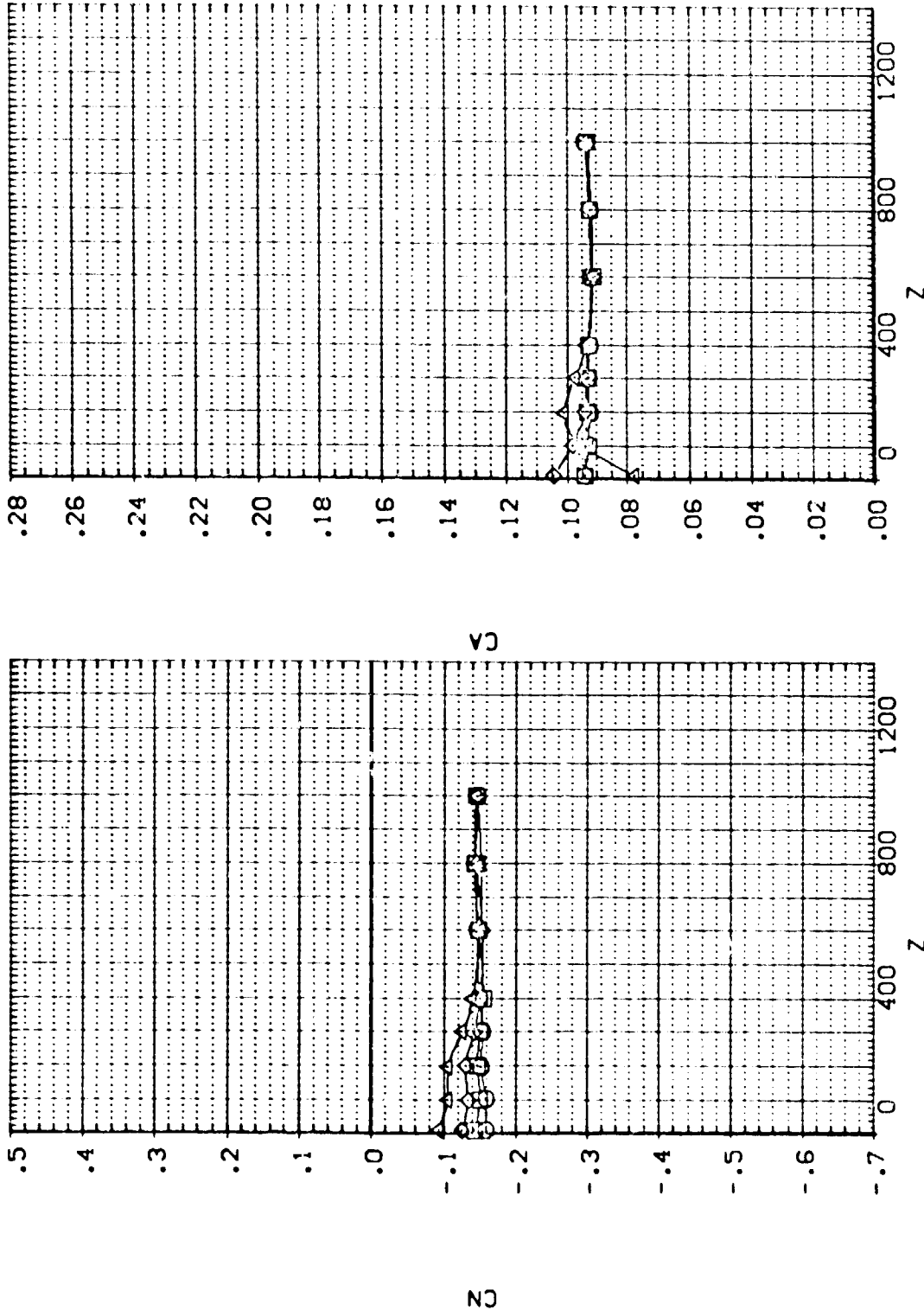

EXTERNAL TANK AERODYNAMIC CHARACTERISTICS DURING SEPARATION FROM ORBITER

1A13.EXTERNAL TANK(T10)SEPARATING FROM ORB. 09 (RTJT36)

SYMBOL

-
- ◇
- △

PARAMETRIC VALUES

X	.237	MACH	4.570	PTOTAL	80.000
100.160	ALPHA	-10.000	BETA	.000	
800.530	DALPHA	.000	DBETA	5.000	
1200.700	ELEVTR	.000	AILRON	.000	
	Y	.000			

SEE THE ASSOCIATED DATA DOCUMENT FOR REFERENCE CHARACTERISTICS FOR INDIVIDUAL DATASETS

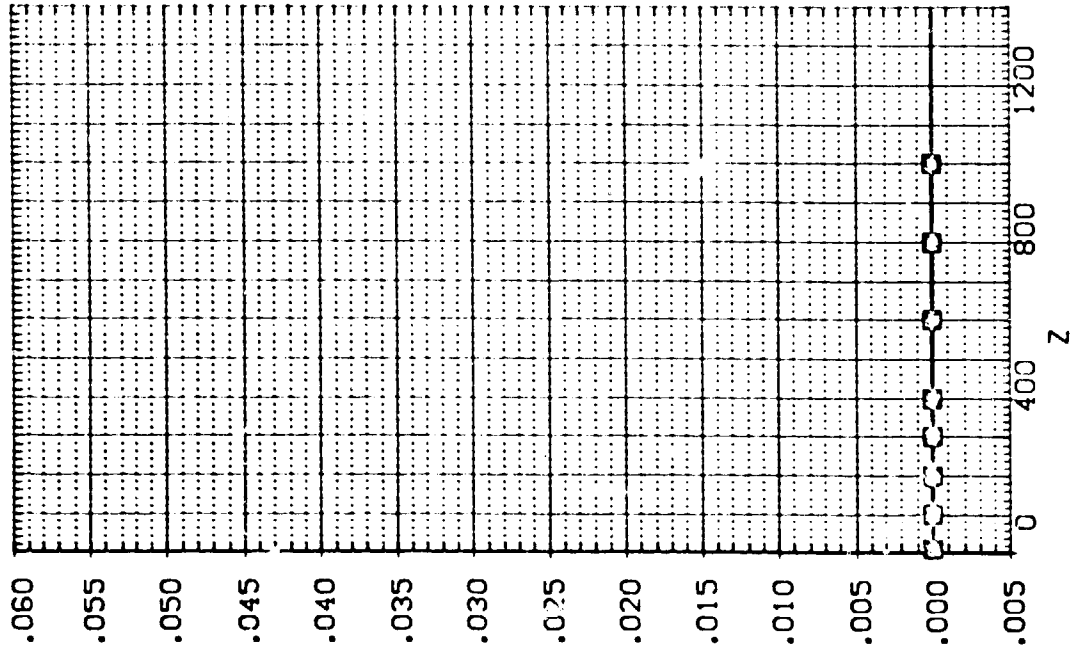
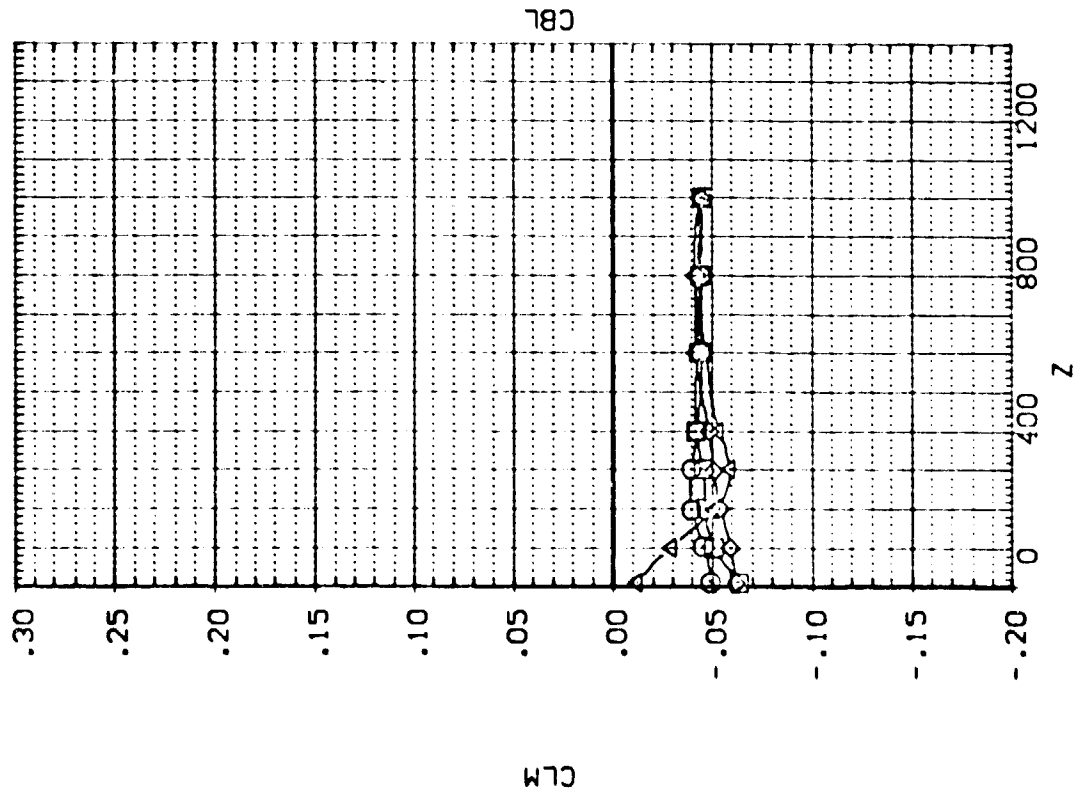

IA13, EXTERNAL TANK (T10) SEPARATING FROM ORB. 09 (RTJ136)

SEE THE ASSOCIATED DATA DOCUMENT FOR REFERENCE CHARACTERISTICS FOR INDIVIDUAL DATASETS

SYMBOL		PARAMETRIC VALUES	
○	X	MACH	4.520
◇	400.460	ALPHA	-10.000
◇	800.530	CALPHA	.000
△	1200.700	ELEVTR	.000
		PTOTAL	80.000
		BETA	.000
		DBETA	5.000
		ALLRON	.000
		Y	.000

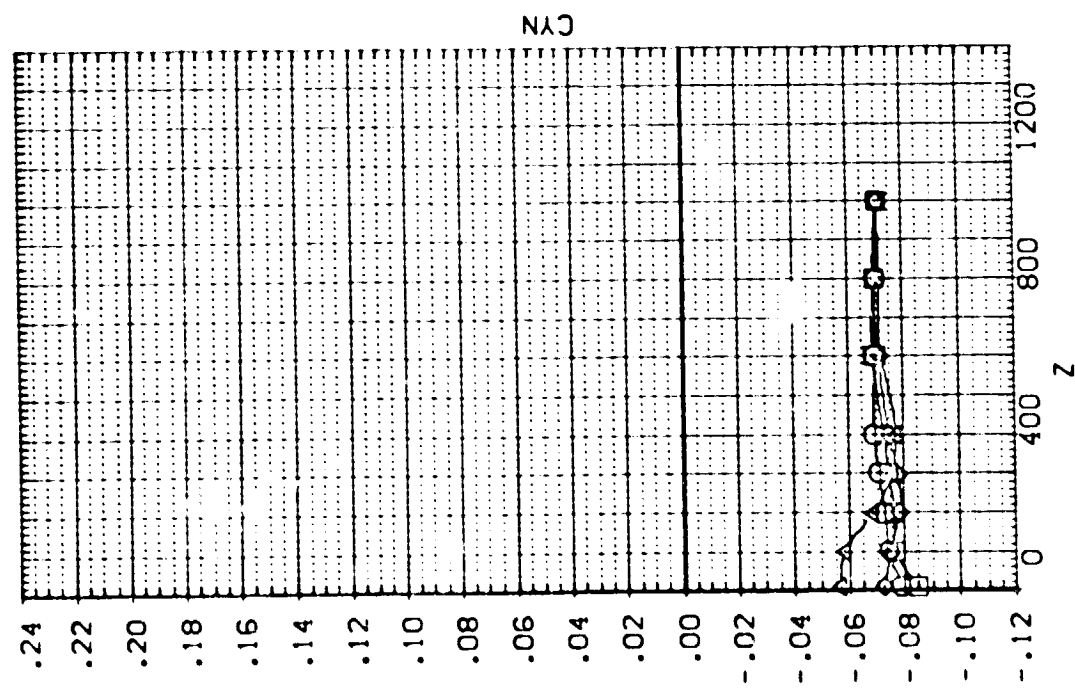
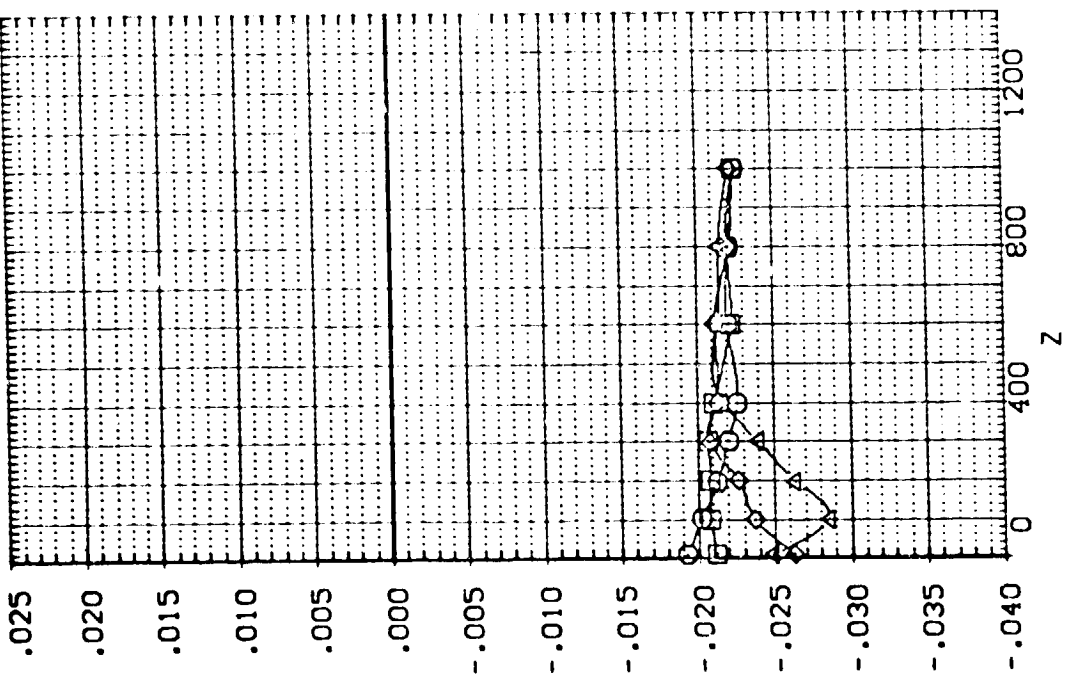

EXTERNAL TANK AERODYNAMIC CHARACTERISTICS DURING SEPARATION FROM ORBITER

113. EXTERNAL TANK (10) SEPARATING FROM ORB. 09 (RTJT37)

SEE THE ASSOCIATED DATA DOCUMENT FOR REFERENCE CHARACTERISTICS FOR INDIVIDUAL DATASETS

SYMBOL		PARAMETRIC VALUES	
○	.201	MACH	4.520
□	400.450	ALPHA	80.000
◇	800.550	DALPHA	-10.000
△	1201.000	ELEVTR	-5.000
		Y	.000
		PTOTAL	80.000
		BETA	.000
		DBETA	.000
		AIRTON	.000

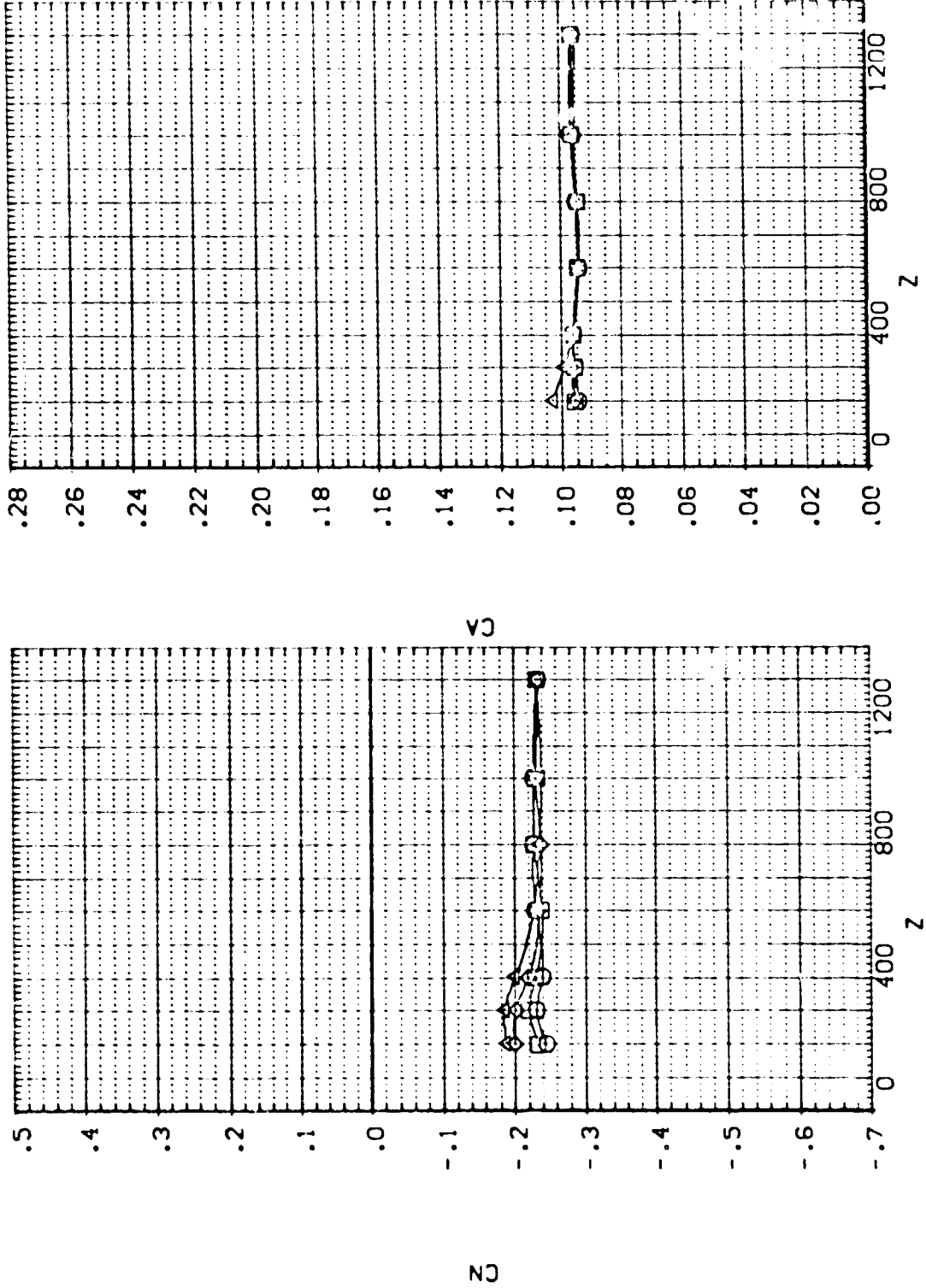

EXTERNAL TANK AERODYNAMIC CHARACTERISTICS DURING SEPARATION FROM ORBITER

1A13.EXTERNAL TANK(T10)SEPARATING FROM ORB. 09 (RTJT37)

SEE THE ASSOCIATED DATA DOCUMENT FOR REFERENCE CHARACTERISTICS FOR INDIVIDUAL DATASETS

SYMBOL		PARAMETRIC VALUES	
○	x	.201	MACH
○	400.450	4.520	P/TOTAL
○	800.550	-10.000	BETA
○	1201.000	-5.000	DBETA
△		.000	ALPHON
		.000	ELEVTR
		.000	Y

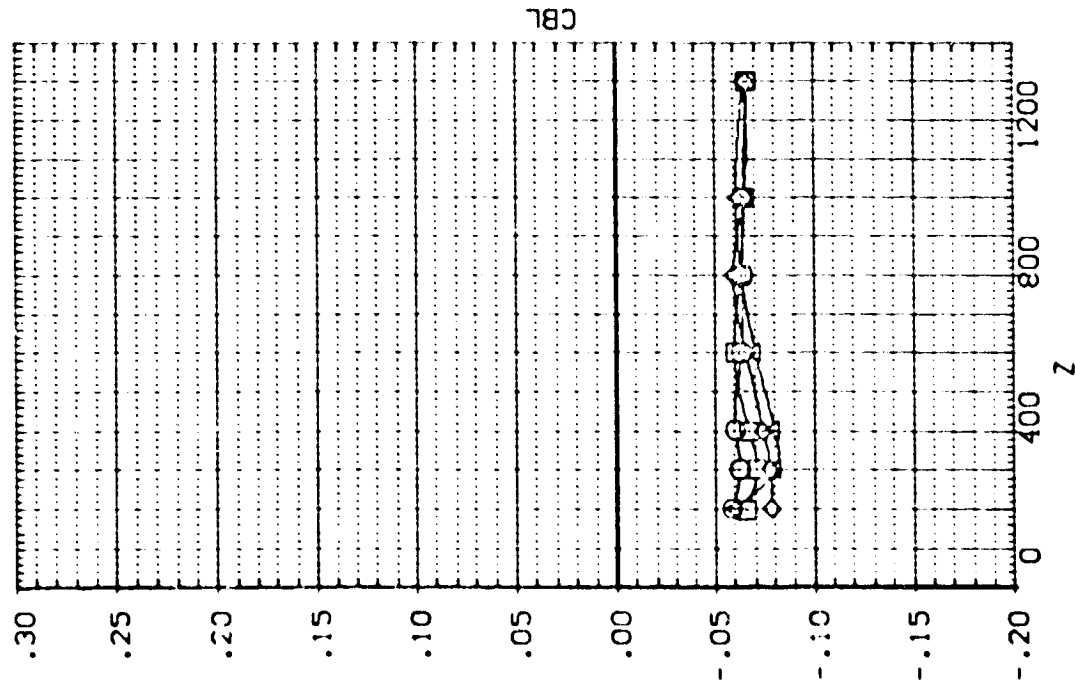
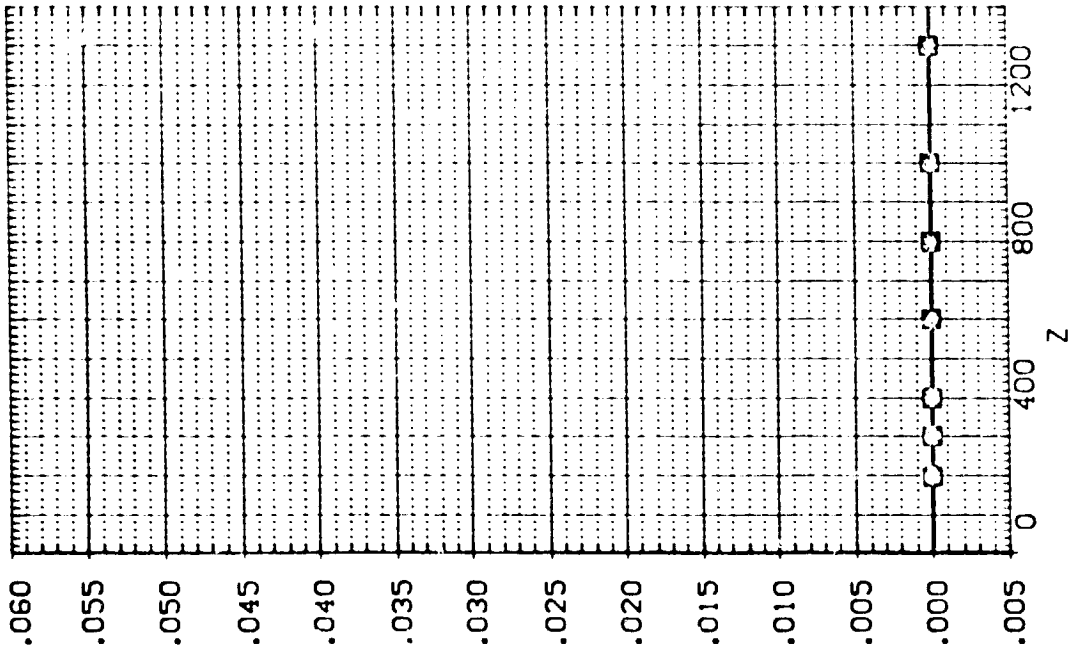

EXTERNAL TANK AERODYNAMIC CHARACTERISTICS DURING SEPARATION FROM ORBITER

1.13. EXTERNAL TANK(T10)SEPARATING FROM ORB. C9 (RIJT37)

SEE THE ASSOCIATED DATA DOCUMENT FOR REFERENCE CHARACTERISTICS FOR INDIVIDUAL DATASETS

SYMBOL		PARAMETRIC VALUES	
○	.201	MACH	4.520
○	100.450	ALPHA	-10.000
○	800.550	DALPHA	-5.000
○	1201.000	ELEVTR	.000
		P TOTAL	60.000
		BETA	.000
		DBETA	.000
		ALURON	.000
		Y	.000

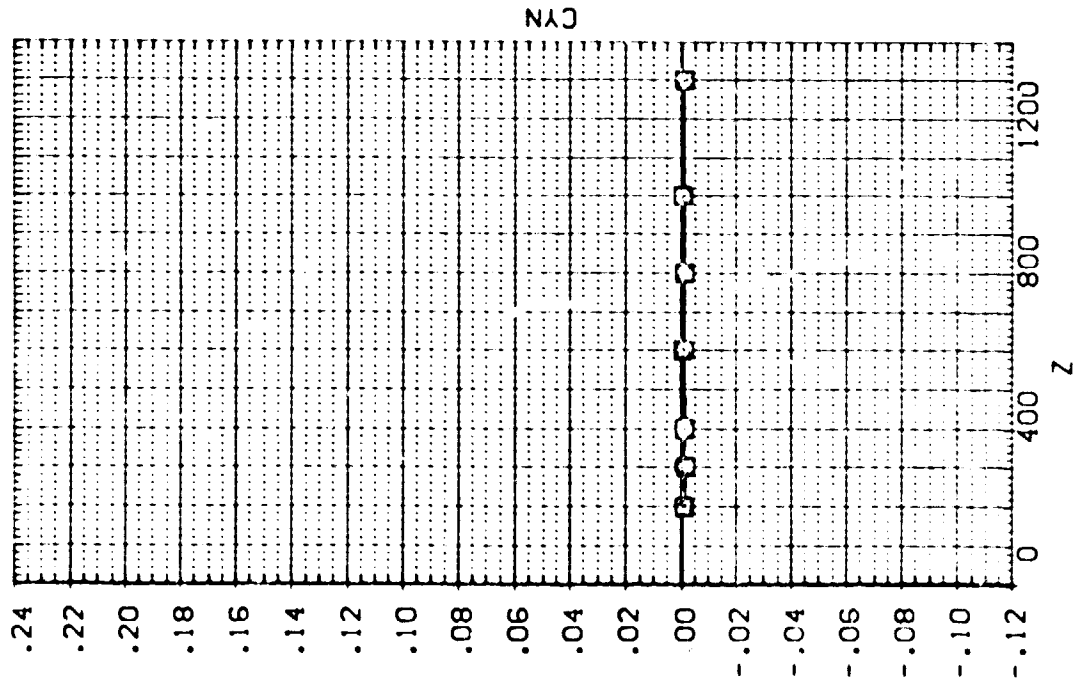
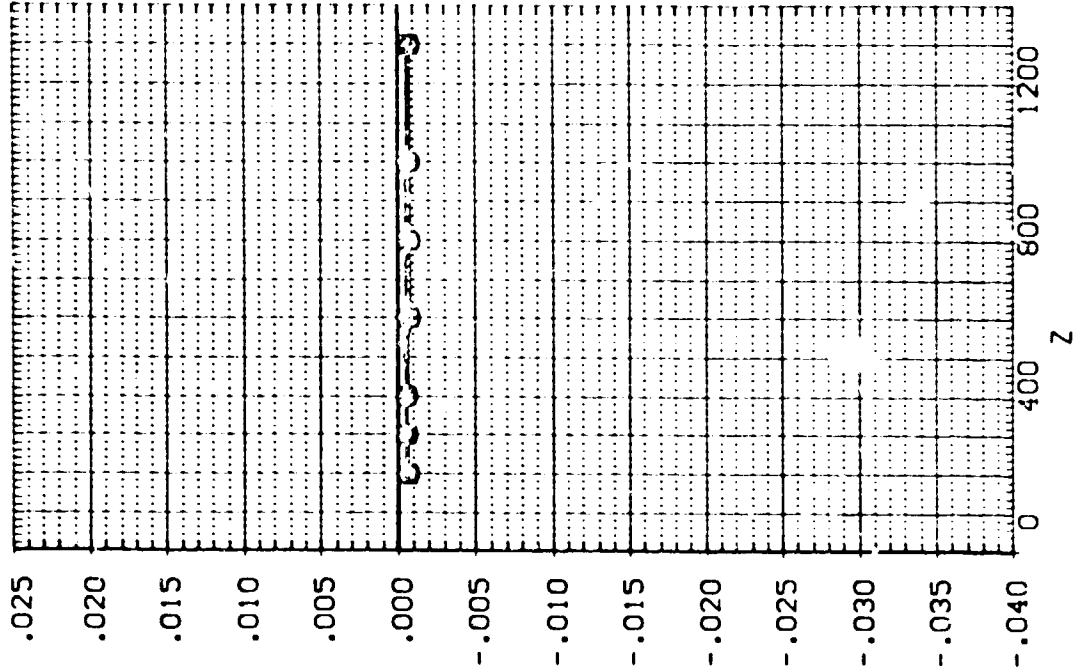

IA.3. EXTERNAL TANK(T10)SEPARATING FROM ORB. 09 (RTJT38)

SEE THE ASSOCIATED DATA DOCUMENT FOR REFERENCE CHARACTERISTICS FOR INDIVIDUAL DATASETS

SYMBOL		PARAMETRIC VALUES			
○	x	MACH	4.520	P TOTAL	80.000
□	400.560	ALPHA	-10.000	BETA	.000
◇	800.420	DALPHA	-10.000	DBETA	.000
△	1200.900	ELEVTR	.000	AILRON	.000
		Y	.000		

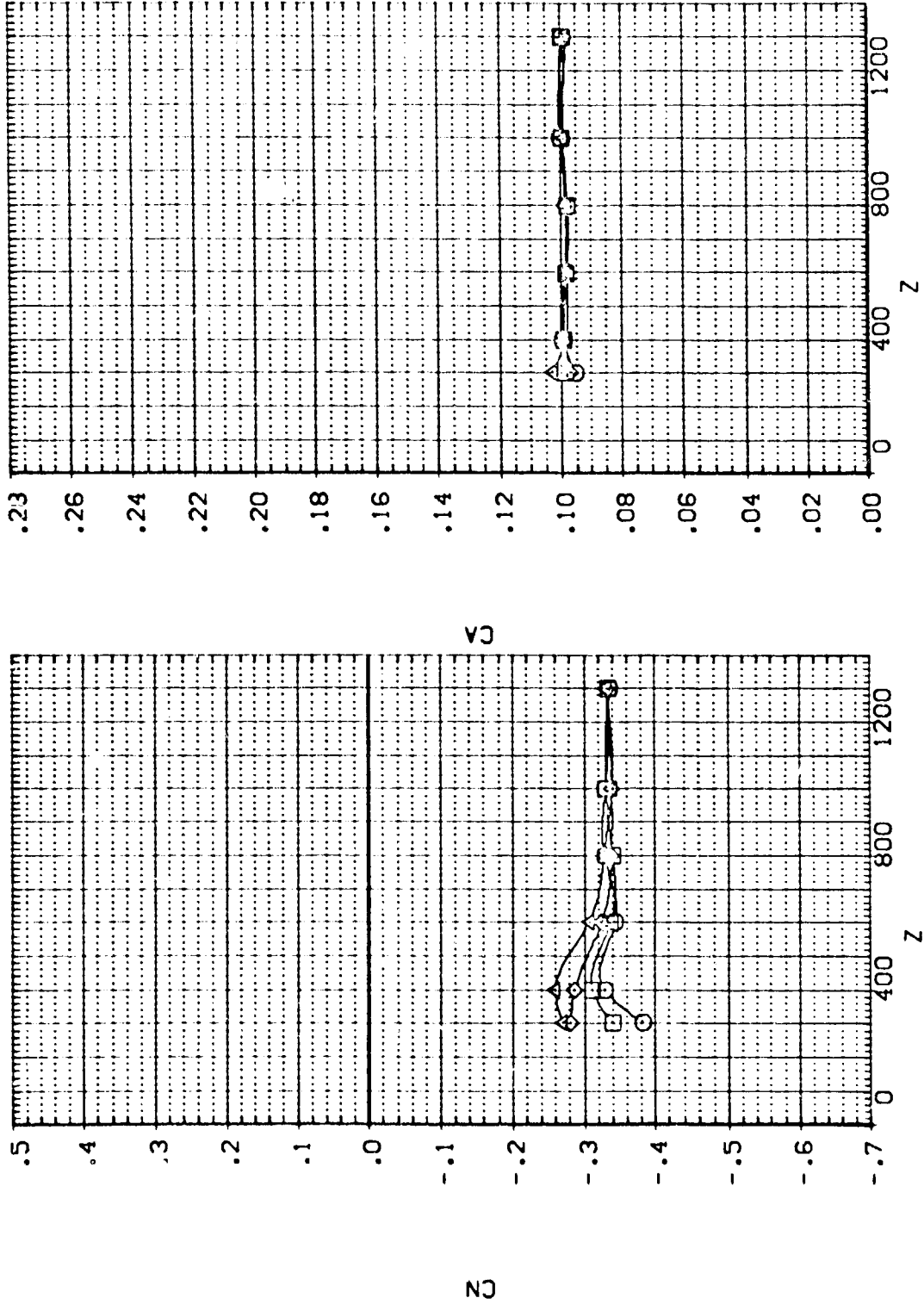

EXTERNAL TANK AERODYNAMIC CHARACTERISTICS DURING SEPARATION FROM ORBITER

IA13, EXTERNAL TANK (110) SEPARATING FROM ORB. 09 (RIJT38)

SEE THE ASSOCIATED DATA DOCUMENT FOR REFERENCE CHARACTERISTICS FOR INDIVIDUAL DATASETS

SYMBOL		PARAMETRIC VALUES	
○	X	MACH	4.520
□	Y	PTOTAL	80.000
◇	Z	BETA	-10.000
△		DBETA	-10.000
		ALPHA	10.000
		ELEVTR	.000
		AIRTON	.000
		Y	.000

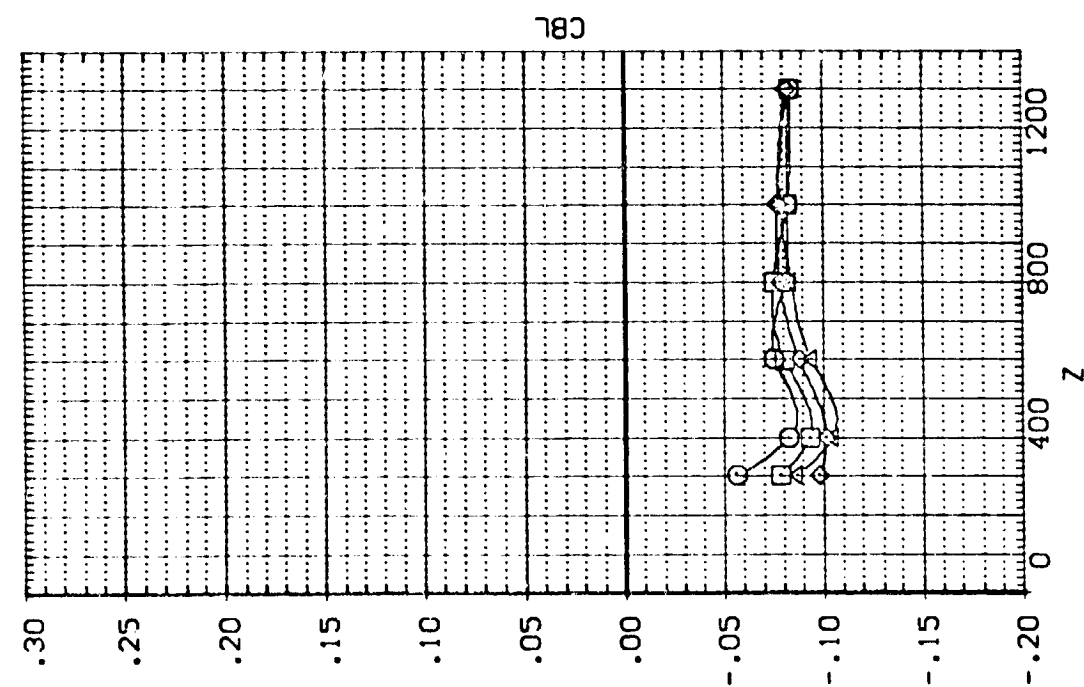
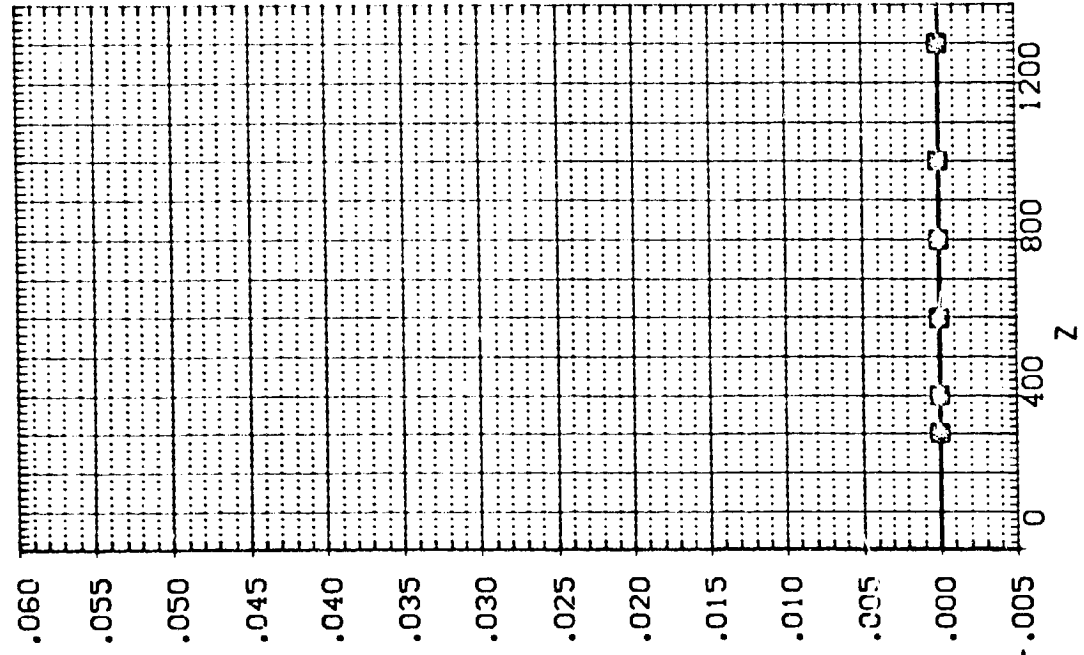

EXTERNAL TANK AERODYNAMIC CHARACTERISTICS DURING SEPARATION FROM ORBITER

IA13.EXTERNAL TANK(T10)SEPARATING FROM ORB. 09 (RTJT38)

SEE THE ASSOCIATED DATA DOCUMENT FOR REFERENCE CHARACTERISTICS FOR INDIVIDUAL DATASETS

SYMBOL		PARAMETRIC VALUES				
□	x	.123	MACH	4.520	PTOTAL	80.000
□	400.	.560	ALPHA	-10.000	BETA	.000
□	800.	.420	DALPHA	-10.000	DBETA	.000
□	1200.	.900	ELEVTR	.000	AILRON	.000
□	y			.000		

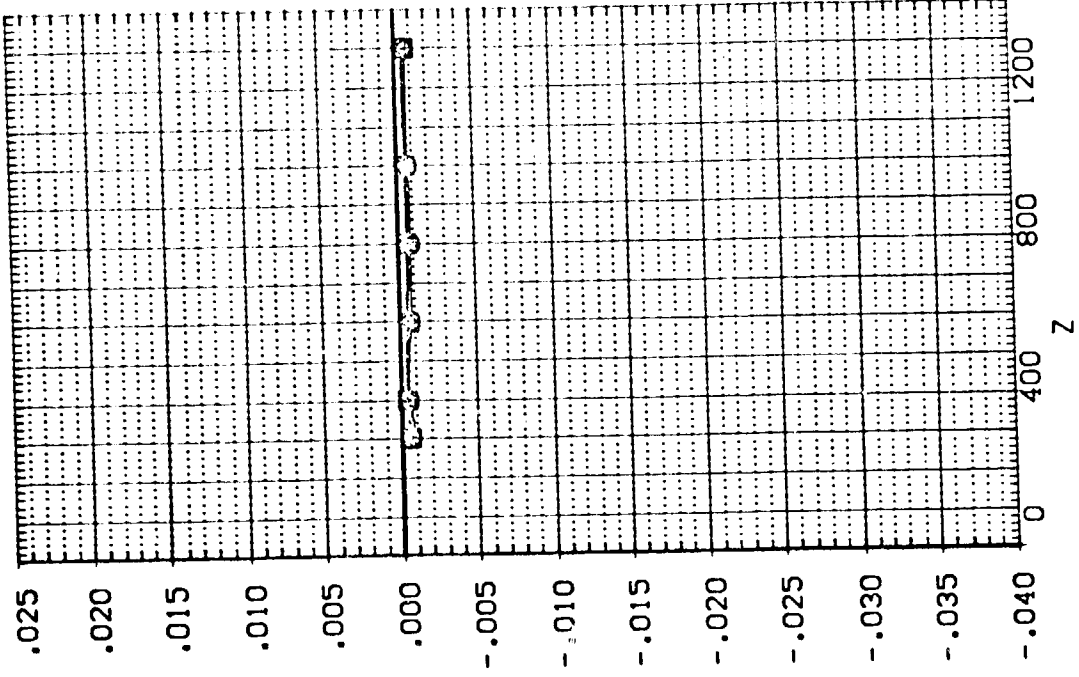
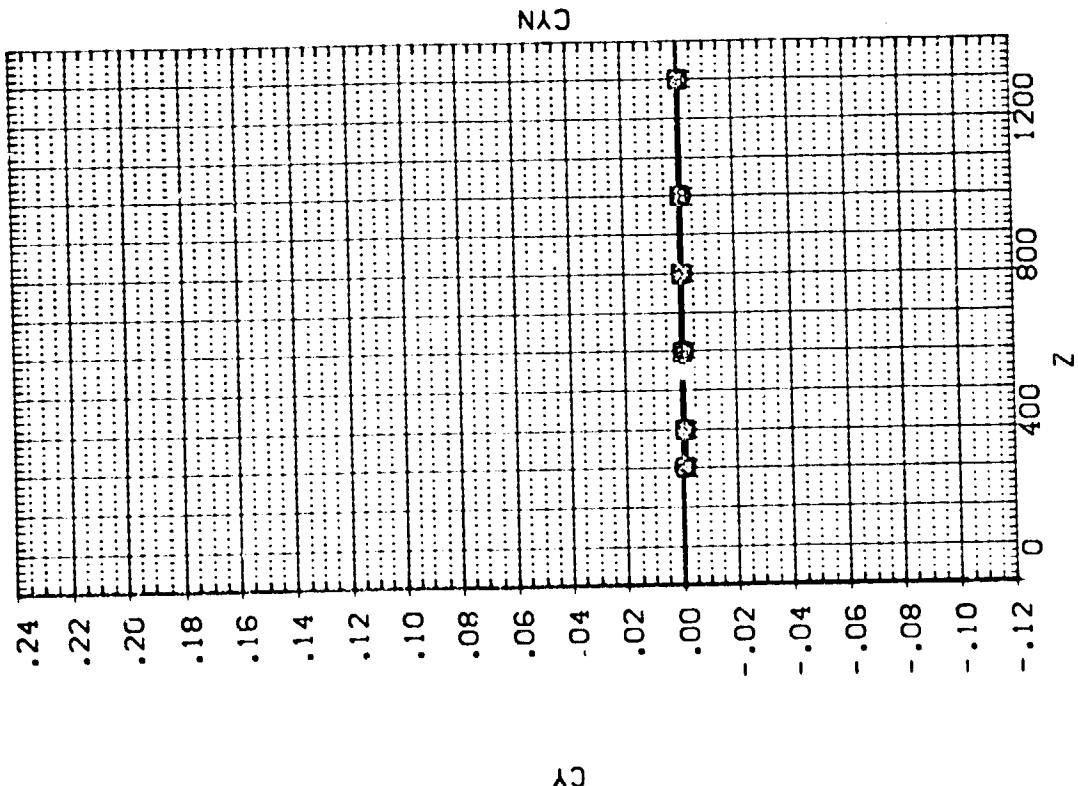

EXTERNAL TANK AERODYNAMIC CHARACTERISTICS DURING SEPARATION FROM ORBITER

IA13.EXTERNAL TANK(T10)SEPARATING FROM ORB. 09 (RTJT39)

SEE THE ASSOCIATED DATA DOCUMENT FOR REFERENCE CHARACTERISTICS FOR INDIVIDUAL DATASETS

SYMBOL		PARAMETRIC VALUES	
○	X	MACH	4.520
□	Y	ALPHA	-10.000
◇	Z	DALPHA	-10.000
△		ELEVTR	.000
		PTOTAL	80.000
		BETA	.000
		DBETA	.000
		AIRRON	.000
		Y	200.000

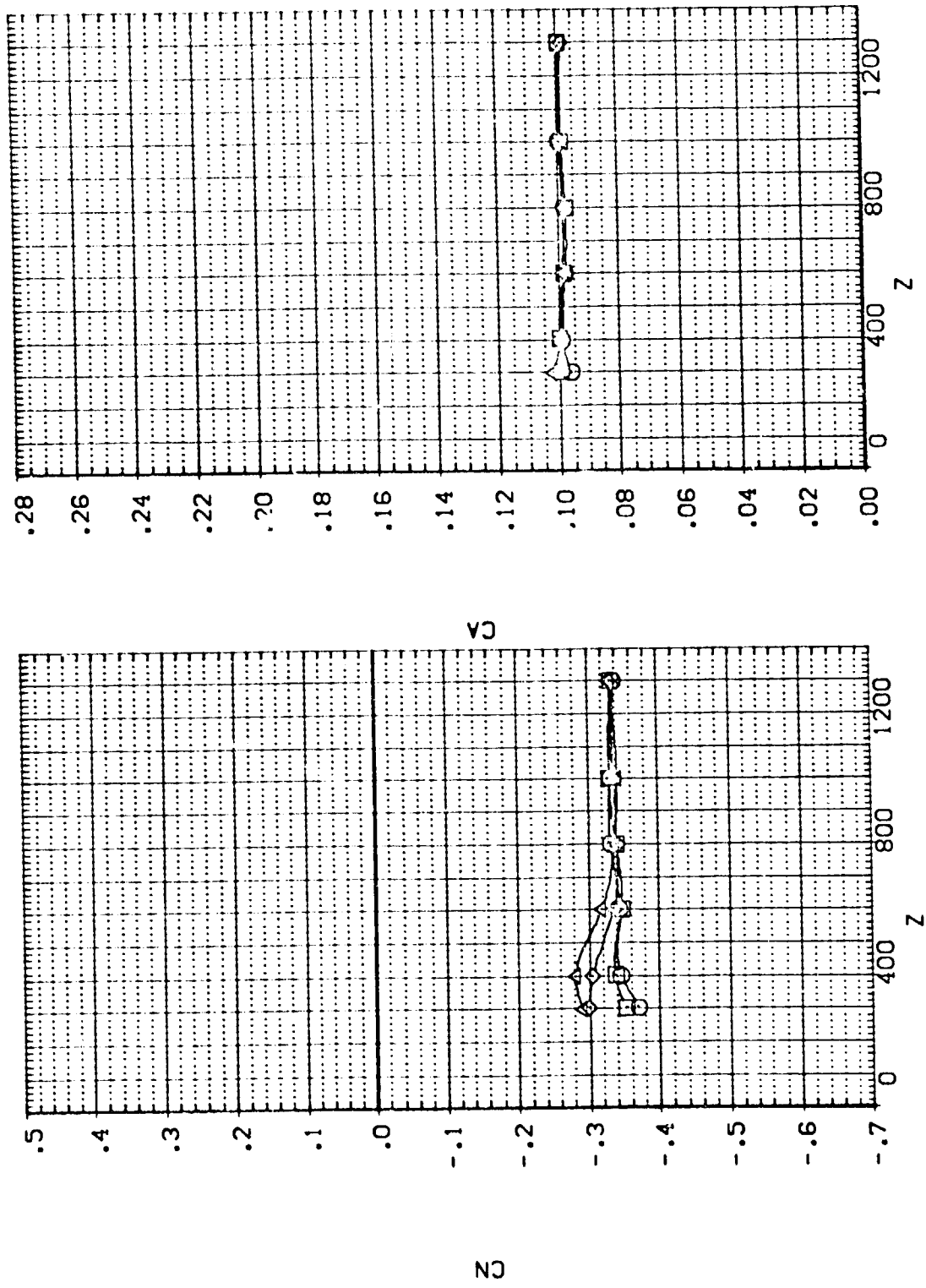

IA13. EXTERNAL TANK(T10)SEPARATING FROM ORB. 09 (RTJT39)

SEE THE ASSOCIATED DATA DOCUMENT FOR REFERENCE CHARACTERISTICS FOR INDIVIDUAL DATASETS

SYMBOL

-
- ◇
- △

PARAMETRIC VALUES

X	.215	MACH	4.520	P TOTAL	90.000
400.370	ALPHA	-10.000	BETA	.000	
800.850	DALPHA	-10.000	DBETA	.000	
1200.600	ELEVTR	.000	ALTRON	.000	
	Y	200.000			

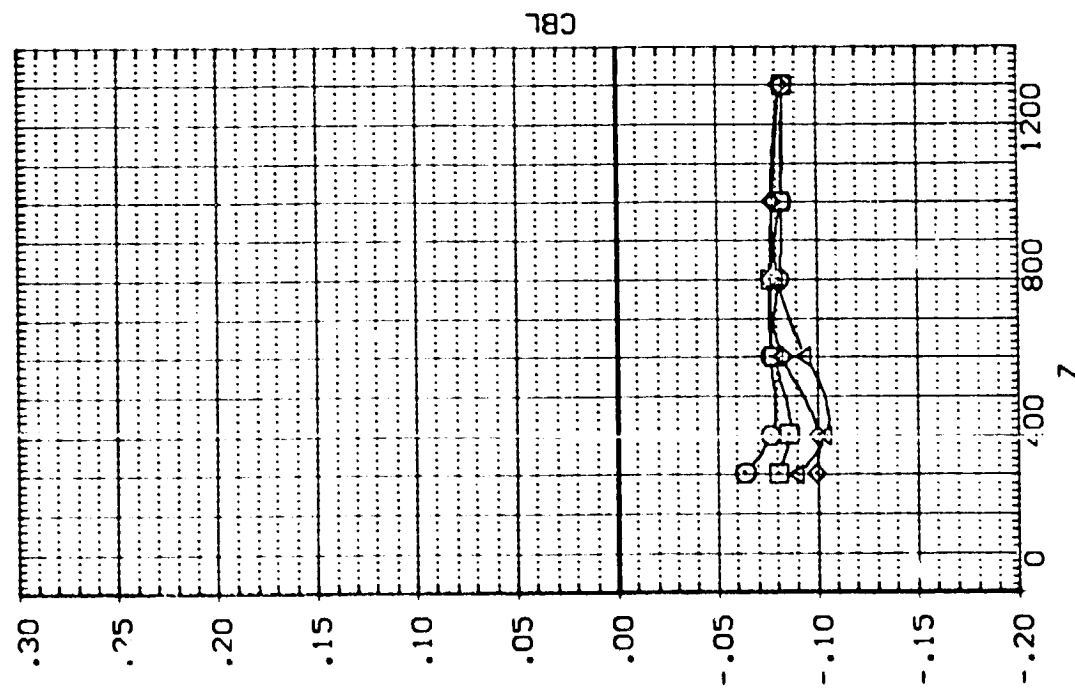
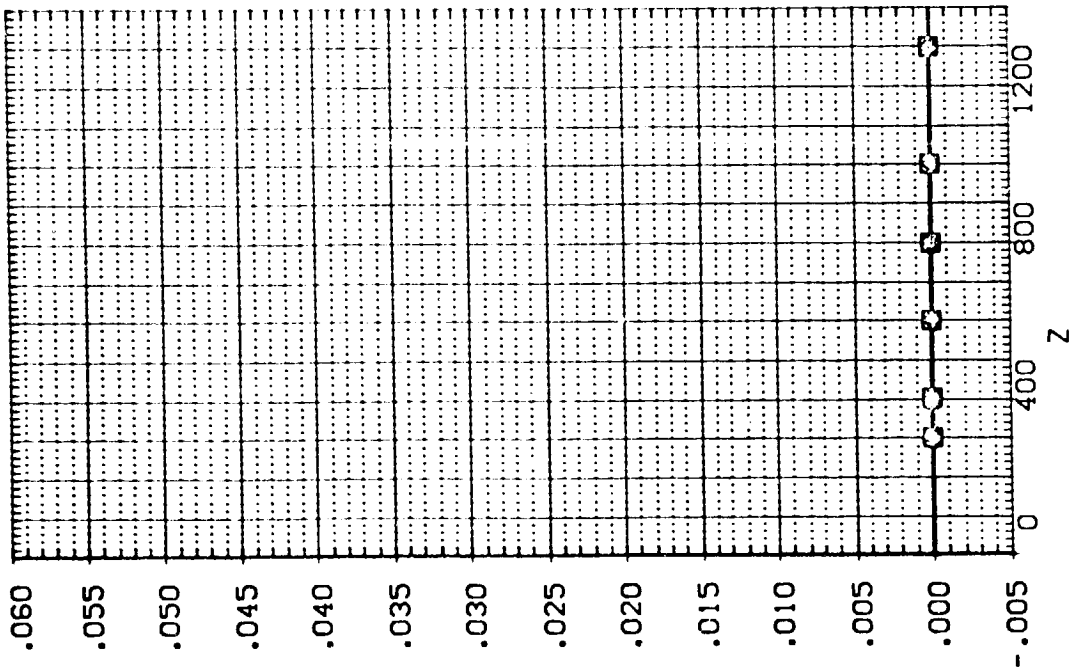

EXTERNAL TANK AERODYNAMIC CHARACTERISTICS DURING SEPARATION FROM ORBITER

[A13, EXTERNAL TANK(T10)SEPARATING FROM ORB. 09 (RTJT39)]

SEE THE ASSOCIATED DATA DOCUMENT FOR REFERENCE CHARACTERISTICS FOR INDIVIDUAL DATASETS

SYMBOL		PARAMETRIC VALUES		
x	.215	MACH	4.520	
	400.37C	ALPHA	-10.000	
	800.850	DALPHA	-10.000	
	1200.600	ELEVTR	.000	
		Y	200.000	
			PI TOTAL	80.000
			BETA	.000
			DBETA	.000
			A1LRON	.000

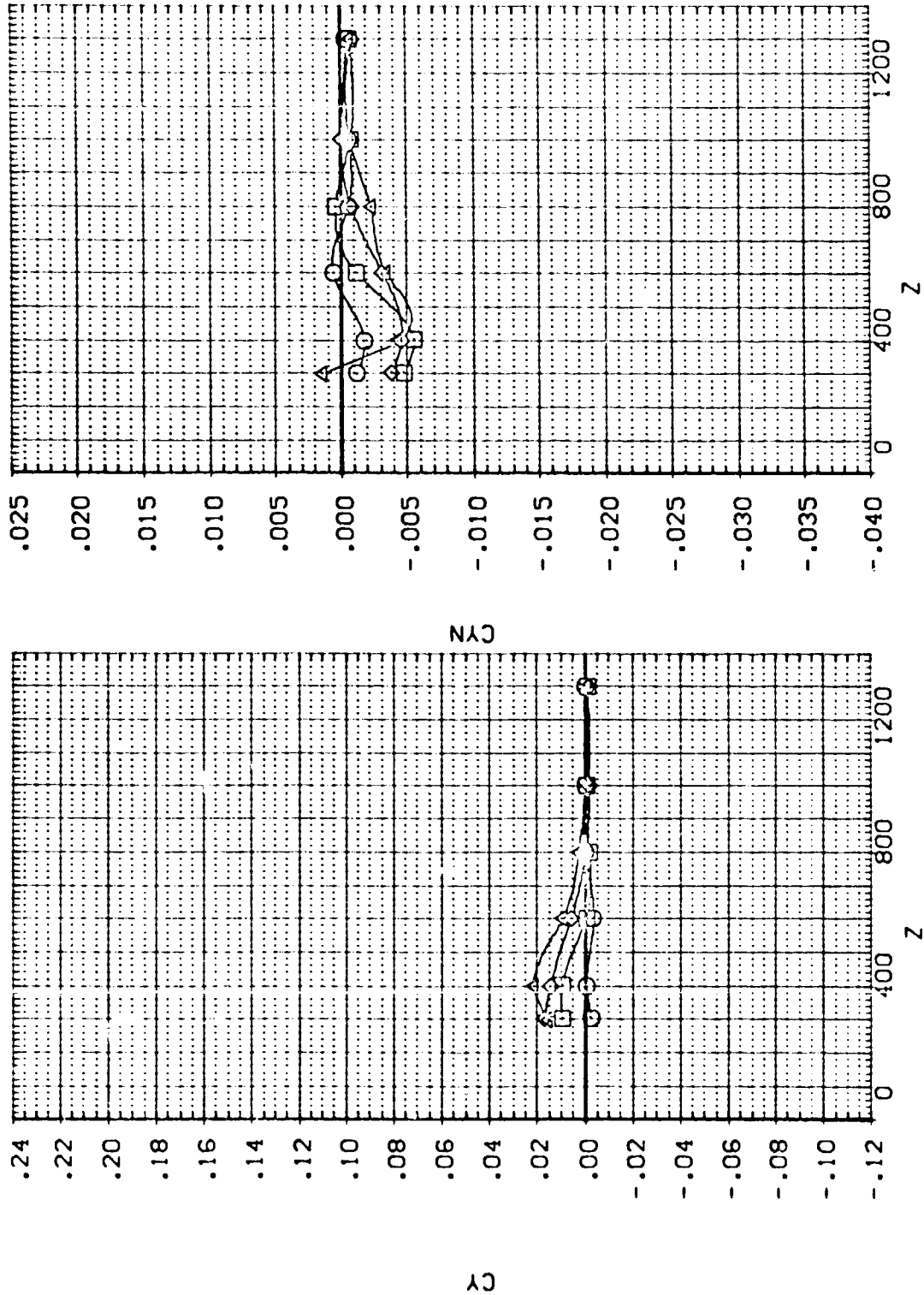

IA13, EXTERNAL TANK(T10)SEPARATING FROM ORB. 09 (RTJ140)

SYMBOL x
 ○
 □
 ◇
 △

PARAMETRIC VALUES
 MACH 4.520 P1OTAL 80.000
 ALPHA -10.000 BETA .000
 DALPHA -10.000 DBETA 5.000
 ELEVTB .000 AILRON .000
 Y 200.000

SEE THE ASSOCIATED DATA DOCUMENT FOR REFERENCE CHARACTERISTICS FOR INDIVIDUAL DATASETS

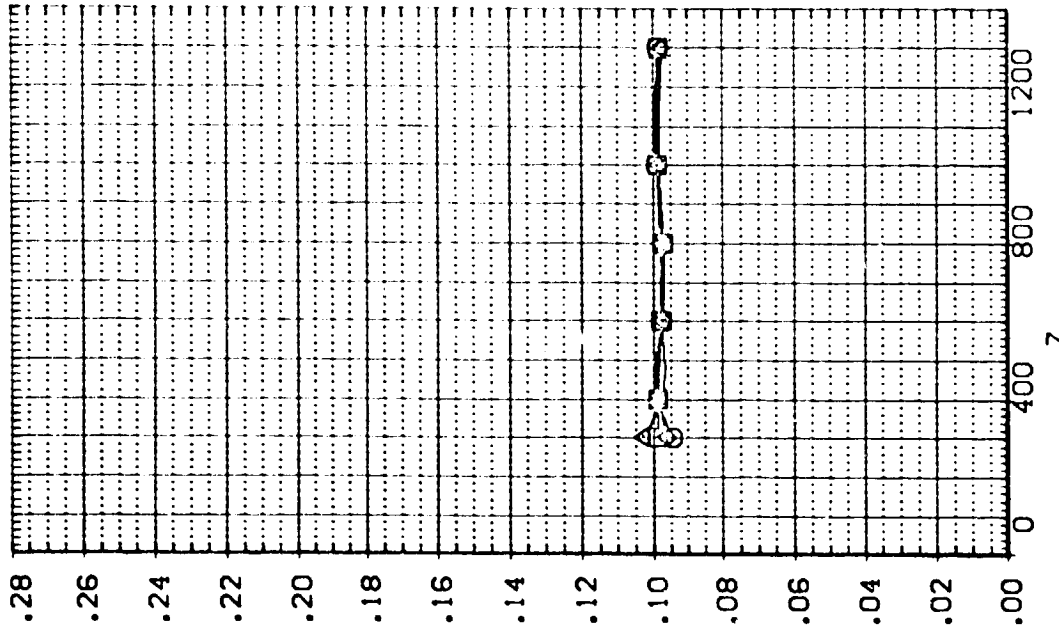
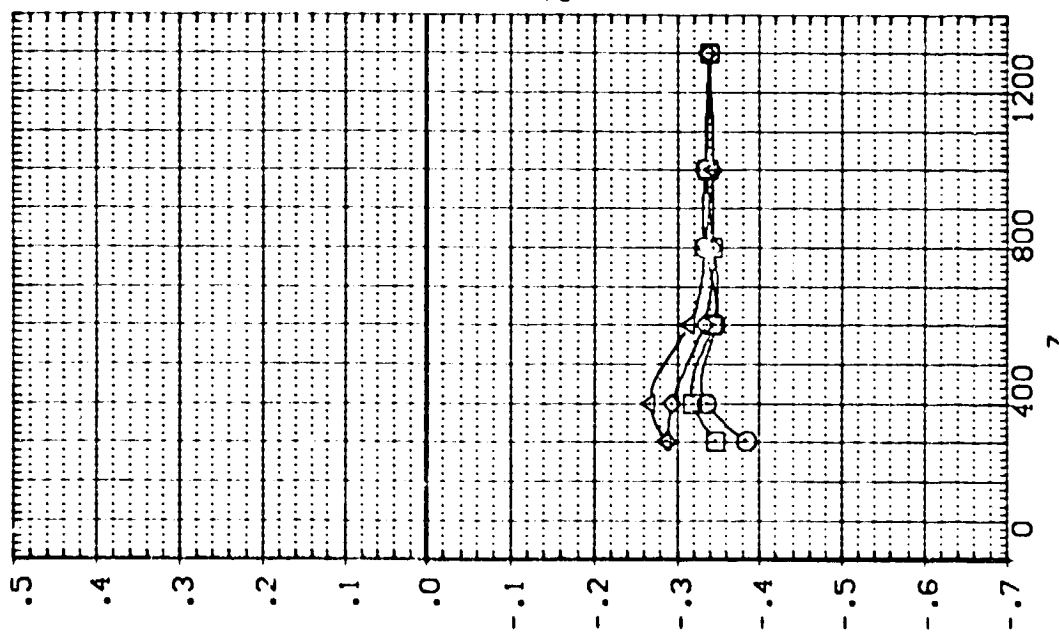

EXTERNAL TANK AERODYNAMIC CHARACTERISTICS DURING SEPARATION FROM ORBITER

1A13.EXTERNAL TANK(T10)SEPARATING FROM ORB. 09 (RTJT40)

SEE THE ASSOCIATED DATA DOCUMENT FOR REFERENCE CHARACTERISTICS FOR INDIVIDUAL DATASETS

SYMBOL		PARAMETRIC VALUES				
○	x	.034	MACH	4.520	PTOTAL	80.000
◇	400.570	ALPHA	-10.000	BETA	.000	
△	800.420	DALPHA	-10.000	DBETA	5.000	
	120.000	ELEVTR	.000	AILLRON	.000	
		Y	200.000			

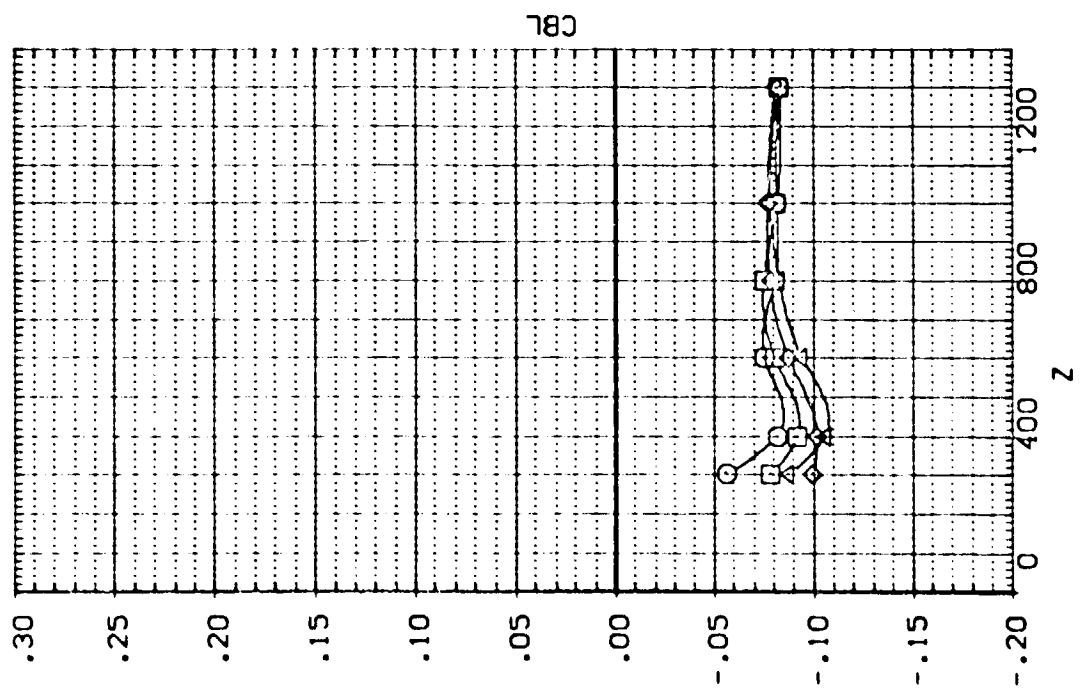
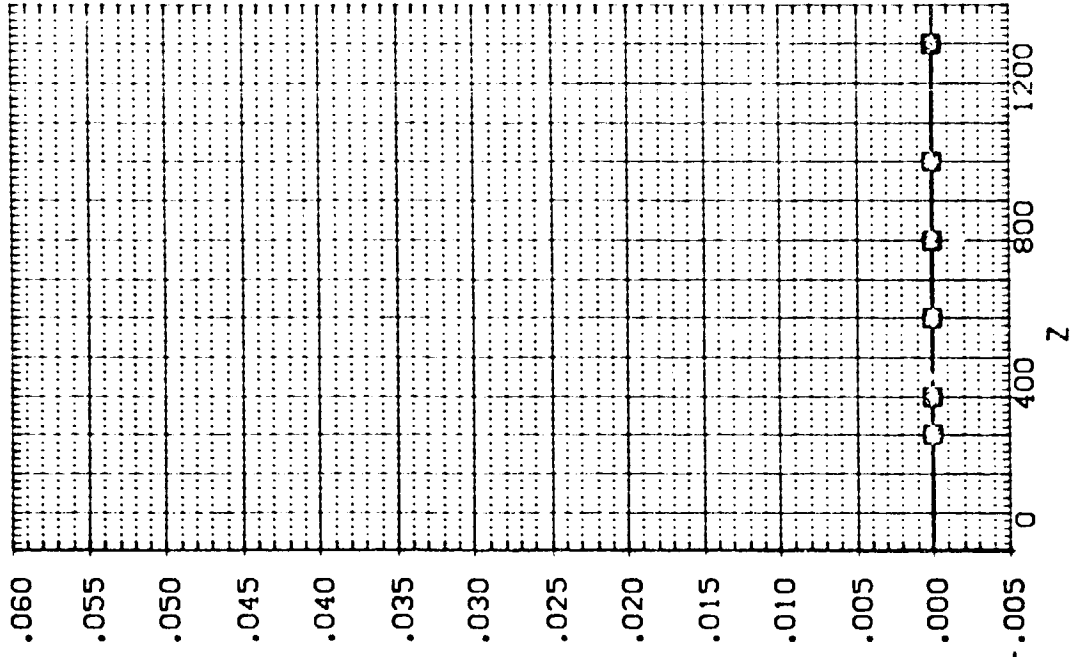

EXTERNAL TANK AERODYNAMIC CHARACTERISTICS DURING SEPARATION FROM ORBITER

[A:3,EXTERNAL TANK(T10)SEPARATING FROM ORB, 09 (RTJT40)]

SYMBOL

-
-
- ◇
- △

PARAMETRIC VALUES

	MACH	4.520	P TOTAL	80.000
○	ALPHA	-10.000	BETA	.000
□	CALPHA	-10.000	DBETA	5.000
◇	ELEVTR	.000	AILLRON	.000
△	Y	200.000		

SEE THE ASSOCIATED DATA DOCUMENT FOR REFERENCE CHARACTERISTICS FOR INDIVIDUAL DATA SETS

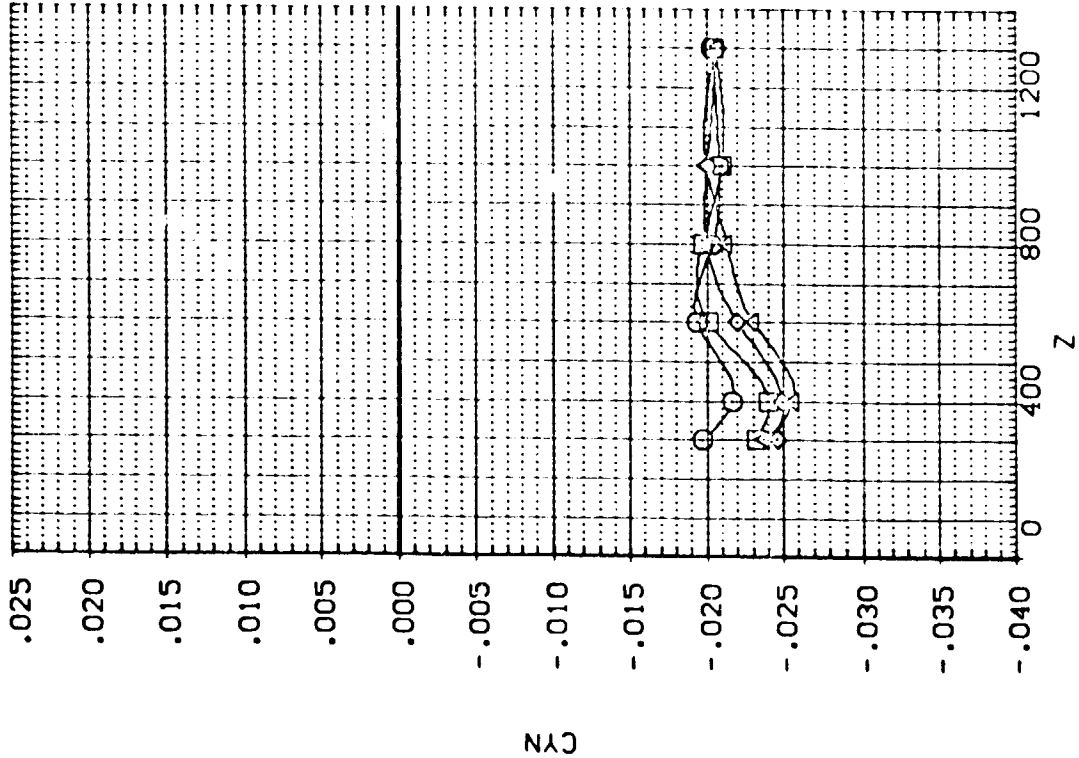
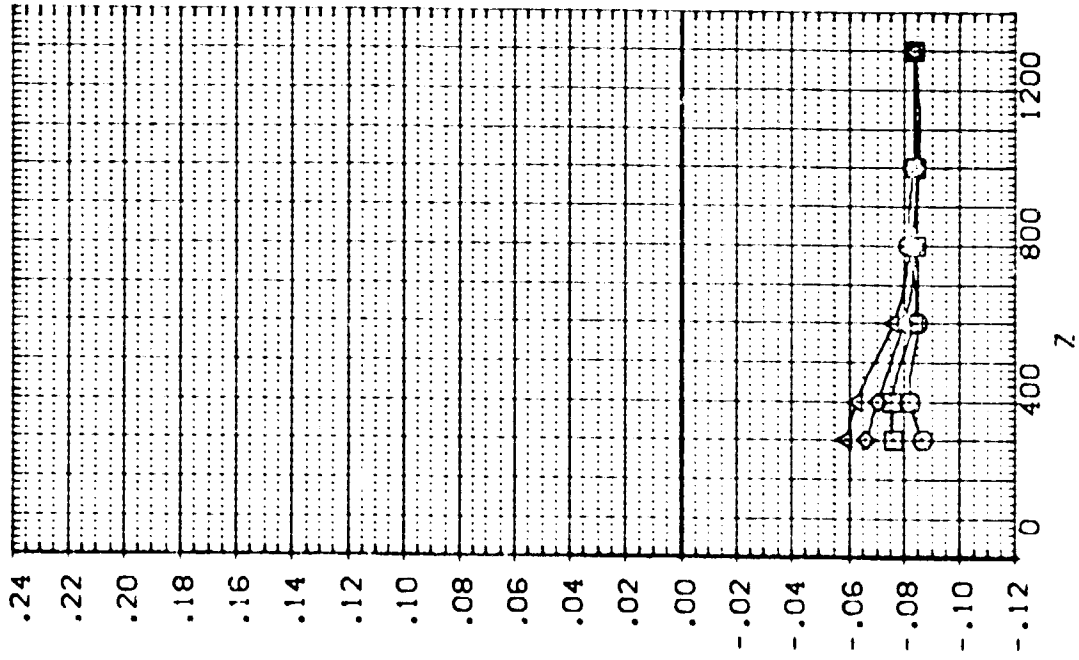

EXTERNAL TANK AERODYNAMIC CHARACTERISTICS DURING SEPARATION FROM ORBITER

1A13, EXTERNAL TANK(T10)SEPARATING FROM ORB. 09 (RTJT41)

SEE THE ASSOCIATED DATA DOCUMENT FOR REFERENCE CHARACTERISTICS FOR INDIVIDUAL DATASETS

SYMBOL	X	MACH	PARAMETRIC VALUES	PIOTAL	80.000
○	.126	ALPHA	4.520	BETA	.000
□	400.290	CALPHA	-10.000	CGBETA	5.000
◇	800.470	ELEVTR	.000	AILTRON	.000
△	:200.800	Y	.000		

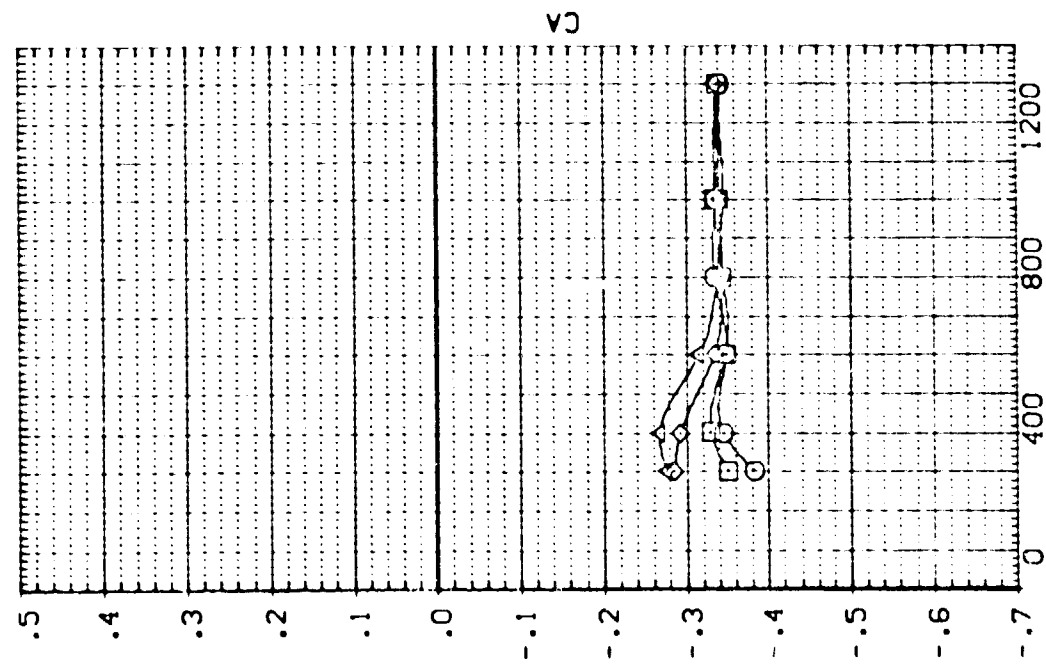
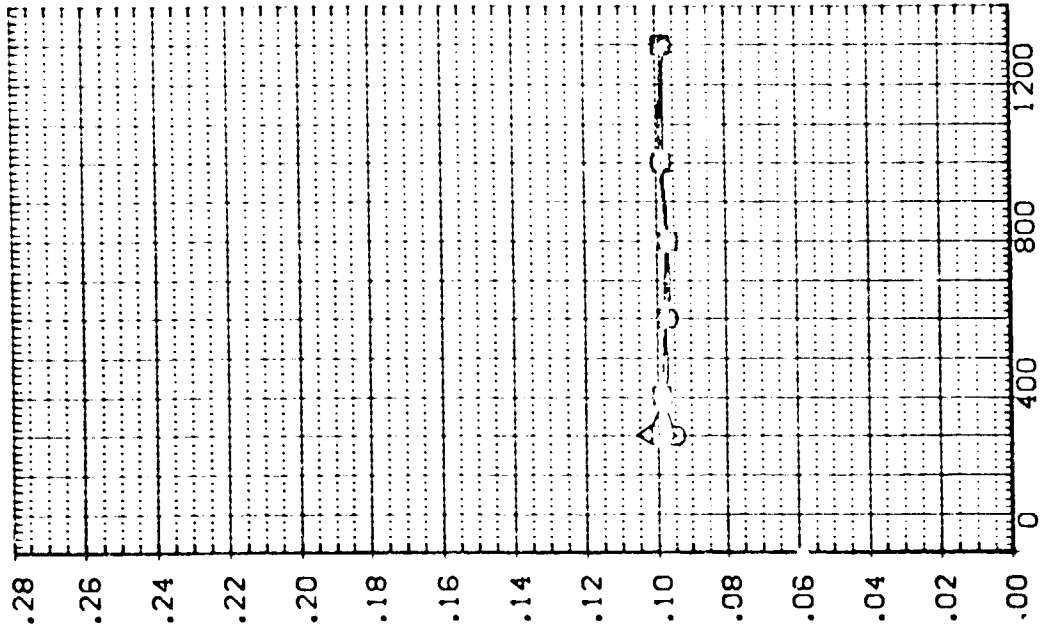

IA13. EXTERNAL TANK(T10)SEPARATING FROM ORB. 09 (RTJT41)

SEE THE ASSOCIATED DATA DOCUMENT FOR REFERENCE CHARACTERISTICS FOR INDIVIDUAL DATASETS

SYMBOL	x	MACH	PARAMETRIC VALUES
○	.128	4.520	PTOTAL 80.000
□	400.290	ALPHA -10.000	BETA .000
◇	800.420	DALPHA -10.000	DBETA 5.000
△	1200.800	ELEVTR .000	ATLRON .000

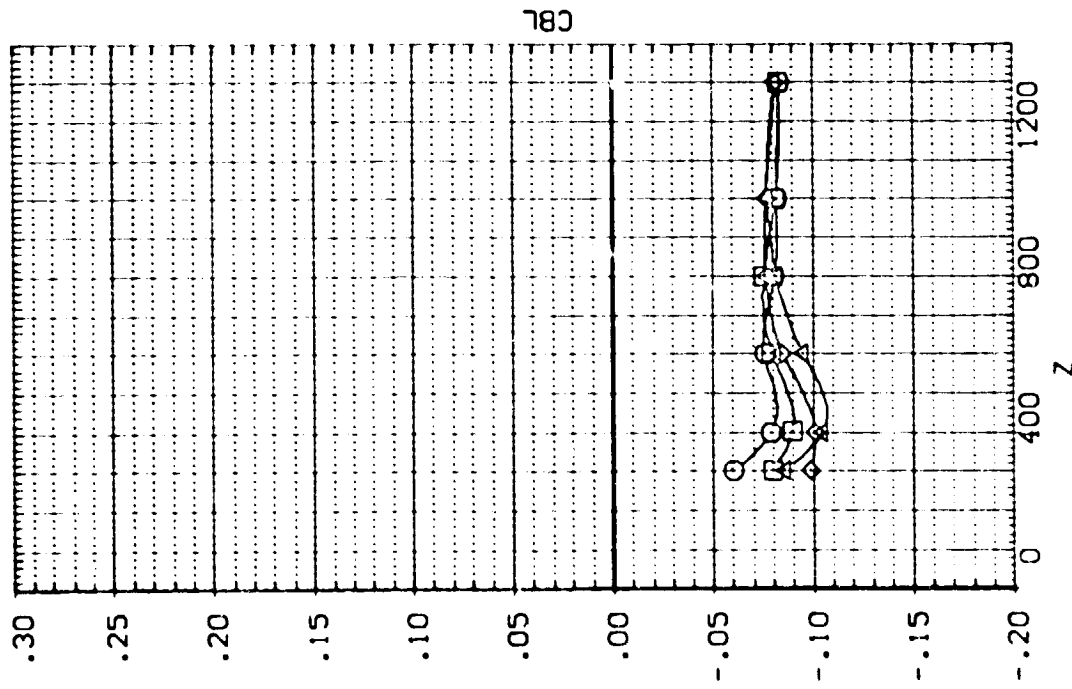
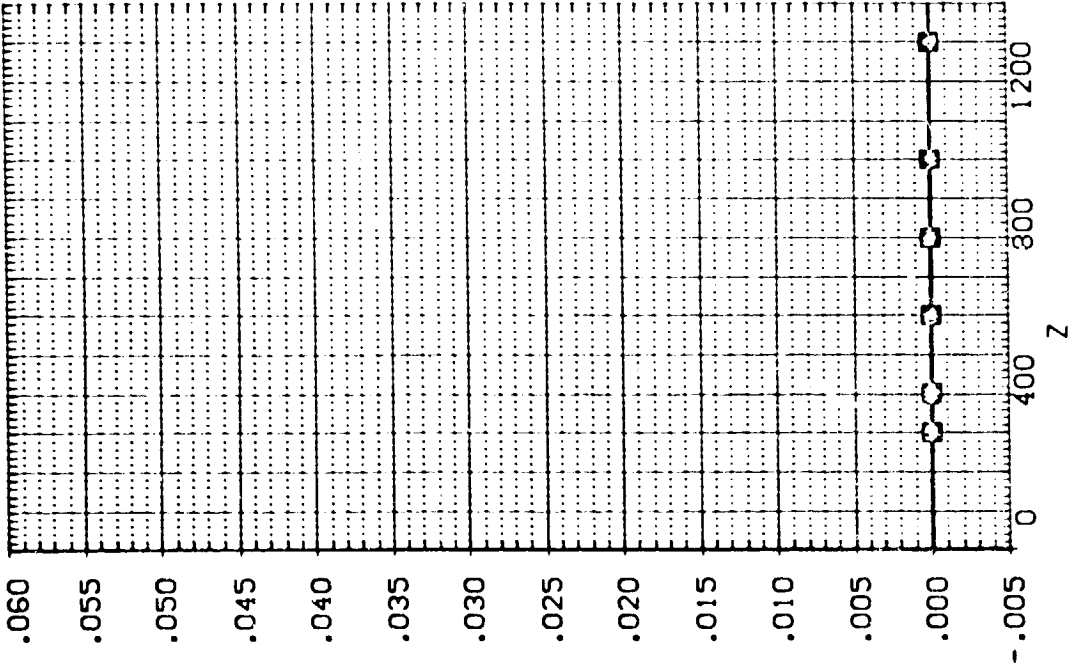

EXTERNAL TANK AERODYNAMIC CHARACTERISTICS DURING SEPARATION FROM ORBITER

1A13, EXTERNAL TANK(T10)SEPARATING FROM ORB. 09 (RTJT41)

SEE THE ASSOCIATED DATA DOCUMENT FOR REFERENCE CHARACTERISTICS FOR INDIVIDUAL DATASETS

SYMBOL	X	PARAMETRIC VALUES			
		MACH	4.520	PTOTAL	80.000
○	400.290	ALPHA	-10.000	BETA	.000
◇	800.420	CALPHA	-10.000	CBETA	5.000
△	1200.1600	CLEVR	.000	ALPRON	.000
					.000

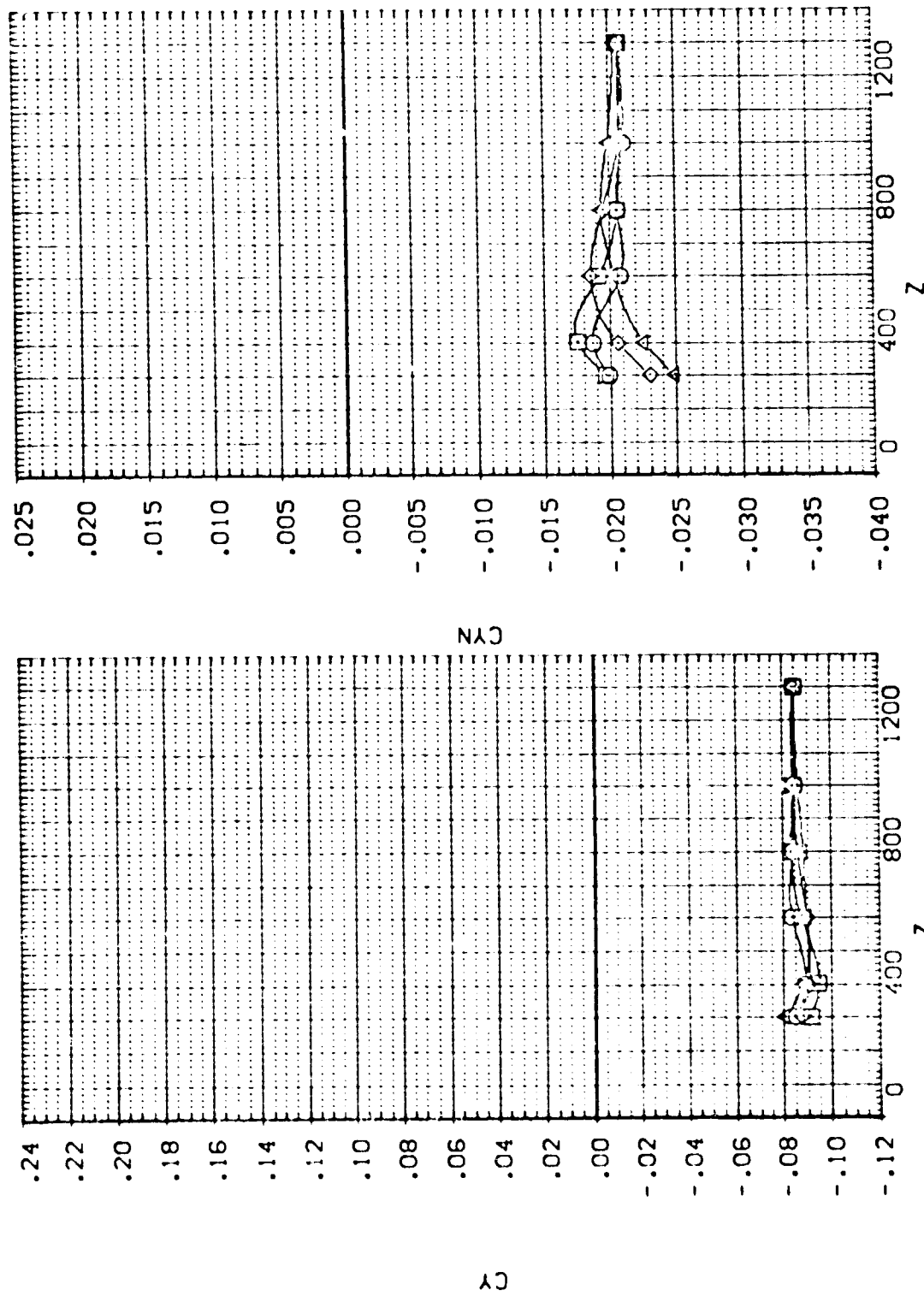

EXTERNAL TANK AERODYNAMIC CHARACTERISTICS DURING SEPARATION FROM ORBITER

1A13.EXTERNAL TANK(T10)SEPARATING FROM ORB. 09 (RIJT42)

SYMBOL

-
-
- ◇
- △

X	.164	MACH	4.520	PTOTAL	80.000
400.680	ALPHA	-10.000	BETA	.000	
800.610	DALPHA	-20.000	DBETA	.000	
1200.500	ELEVTR	.000	AILTRON	.000	
	Y	.000			

SEE THE ASSOCIATED DATA DOCUMENT FOR REFERENCE CHARACTERISTICS FOR INDIVIDUAL DATASETS

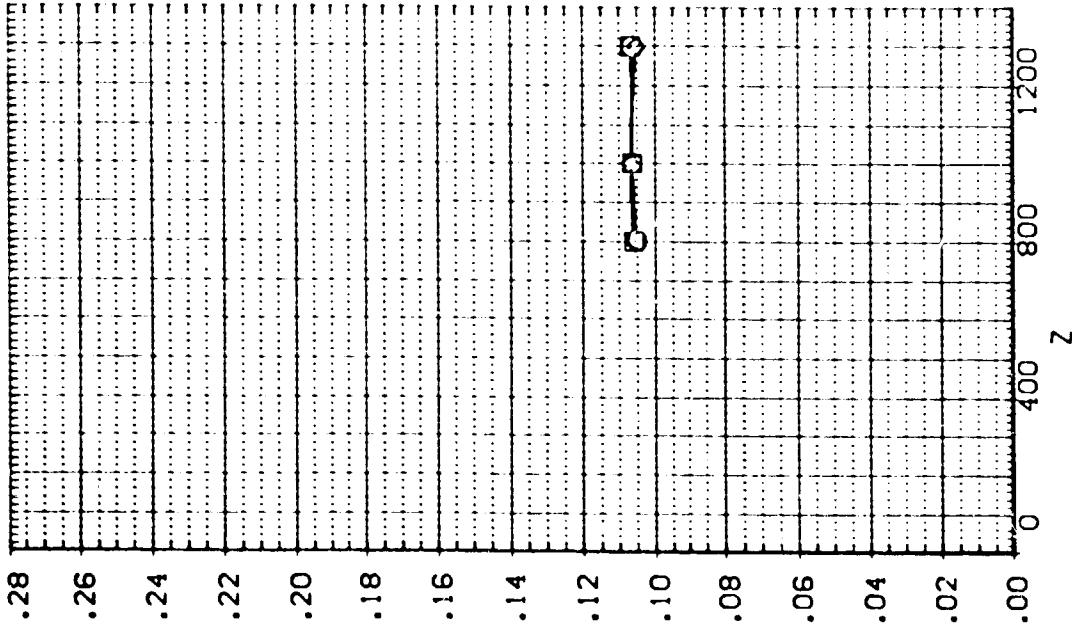
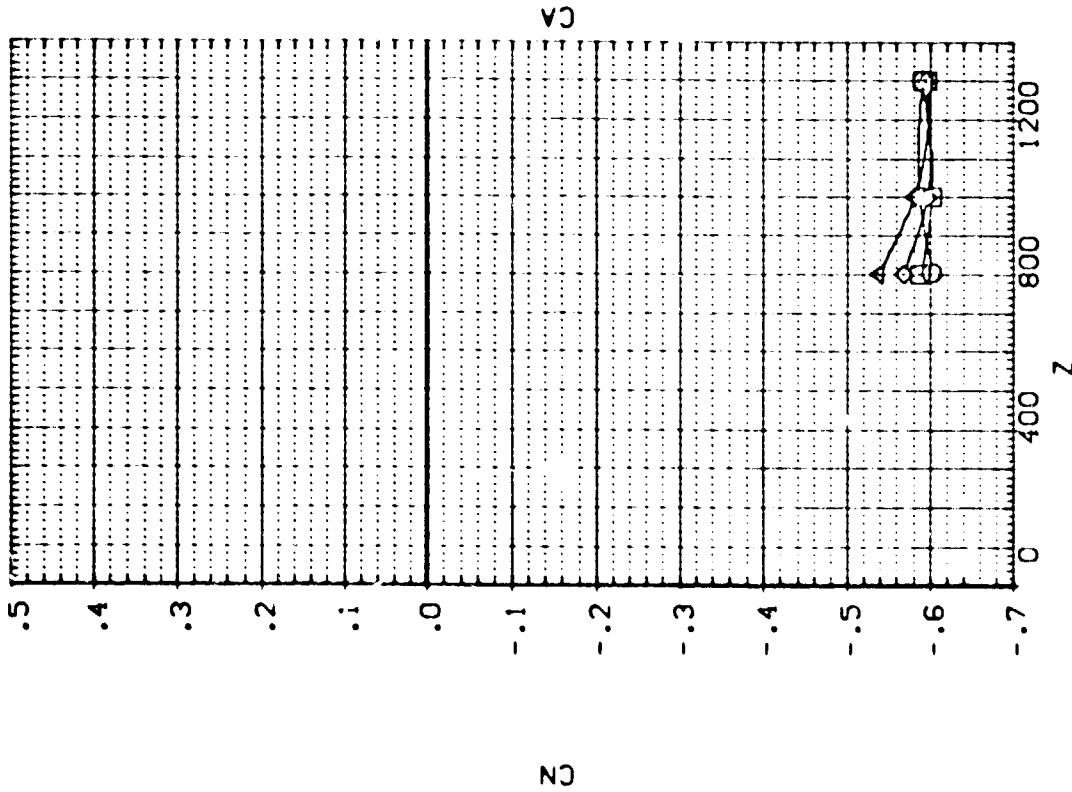

EXTERNAL TANK AERODYNAMIC CHARACTERISTICS DURING SEPARATION FROM ORBITER

TA13. EXTERNAL TANK(T10) SEPARATING FROM ORB. 09 (RTJT42)

SEE THE ASSOCIATED DATA DOCUMENT FOR REFERENCE CHARACTERISTICS FOR INDIVIDUAL DATA SETS

SYMBOL		PARAMETRIC VALUES	
○	X	MACH	4.570
○	Y	ALPHA	-10.000
○	Z	BETA	80.000
○	CL	DALPHA	-20.000
○	CM	UBETA	.000
○	CD	AILURON	.000
○	CM	Y	.000

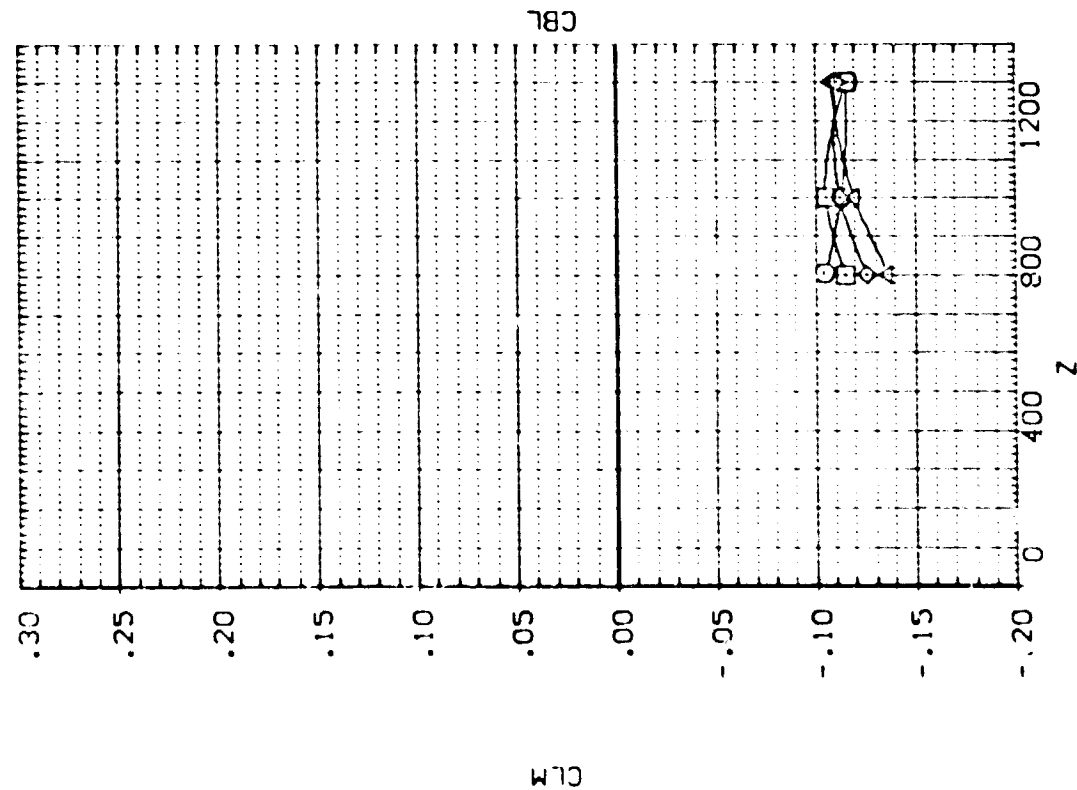
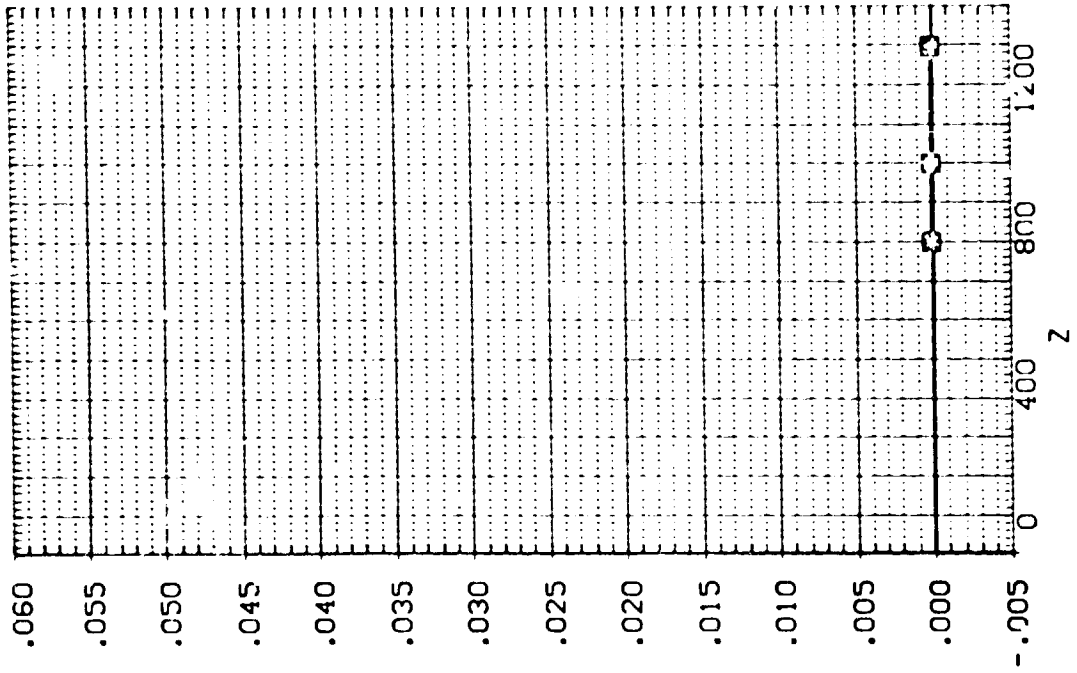

EXTERNAL TANK AERODYNAMIC CHARACTERISTICS DURING SEPARATION FROM ORBITER

IA13, EXTERNAL TANK(T10) SEPARATING FROM ORB. 09 (RTJT42)

SEE THE ASSOCIATED DATA DOCUMENT FOR REFERENCE CHARACTERISTICS FOR INDIVIDUAL DATASETS

SYMBOL X
 O
 ◇
 △

PARAMETRIC VALUES
 MACH 4.520 P1OTAL 80.000
 ALPHA -10.000 BETA .000
 DALPHA -20.000 DBETA .000
 ELEVTR .000 AILRON .000
 Y .000

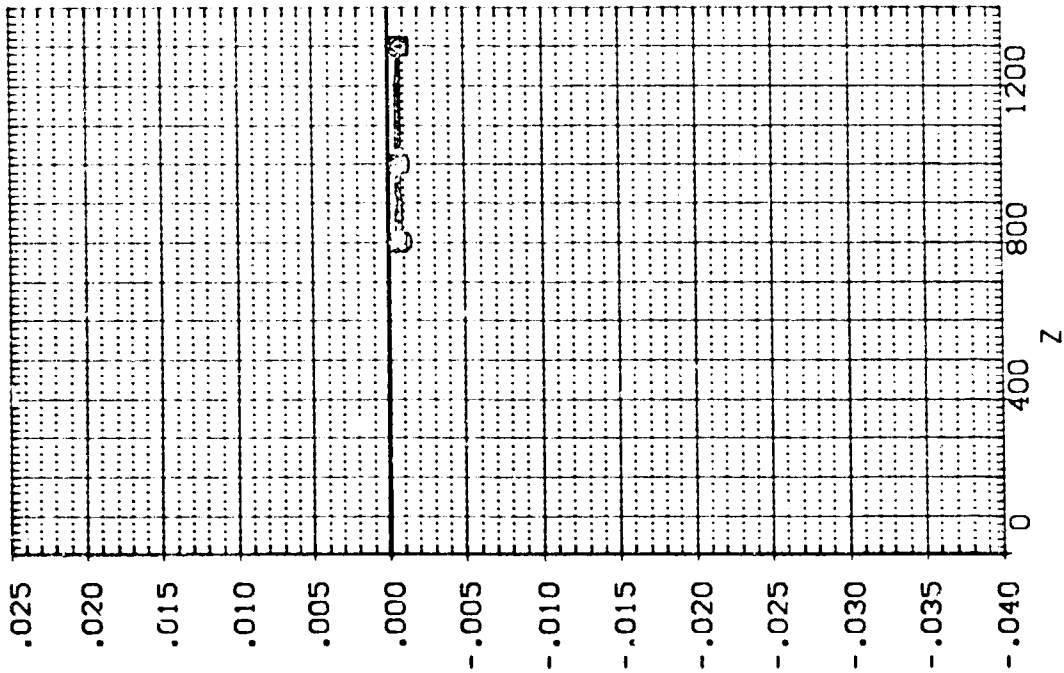
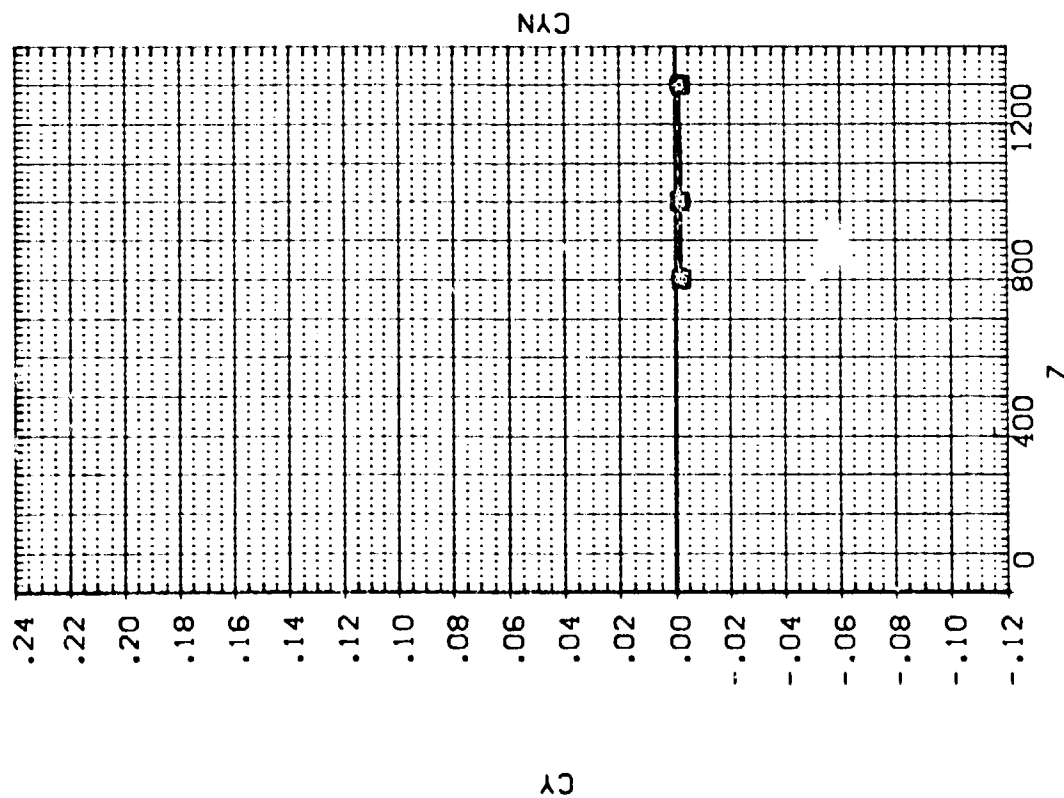

EXTERNAL TANK AERODYNAMIC CHARACTERISTICS DURING SEPARATION FROM ORBITER

IA13.EXTERNAL TANK(110)SEPARATING FROM ORB. 09 (RTJT43)

SEE THE ASSOCIATED DATA DOCUMENT FOR REFERENCE CHARACTERISTICS FOR INDIVIDUAL DATASETS

SYMBOL		PARAMETRIC VALUES	
○	.054	MACH	4.520
□	400.490	ALPHA	-10.000
◇	800.440	DALPHA	-20.000
△	1200.700	ELEVTR	.000
		Y	200.000
		PCTOTAL	80.000
		BETA	.000
		DBETA	.000
		AILRON	.000

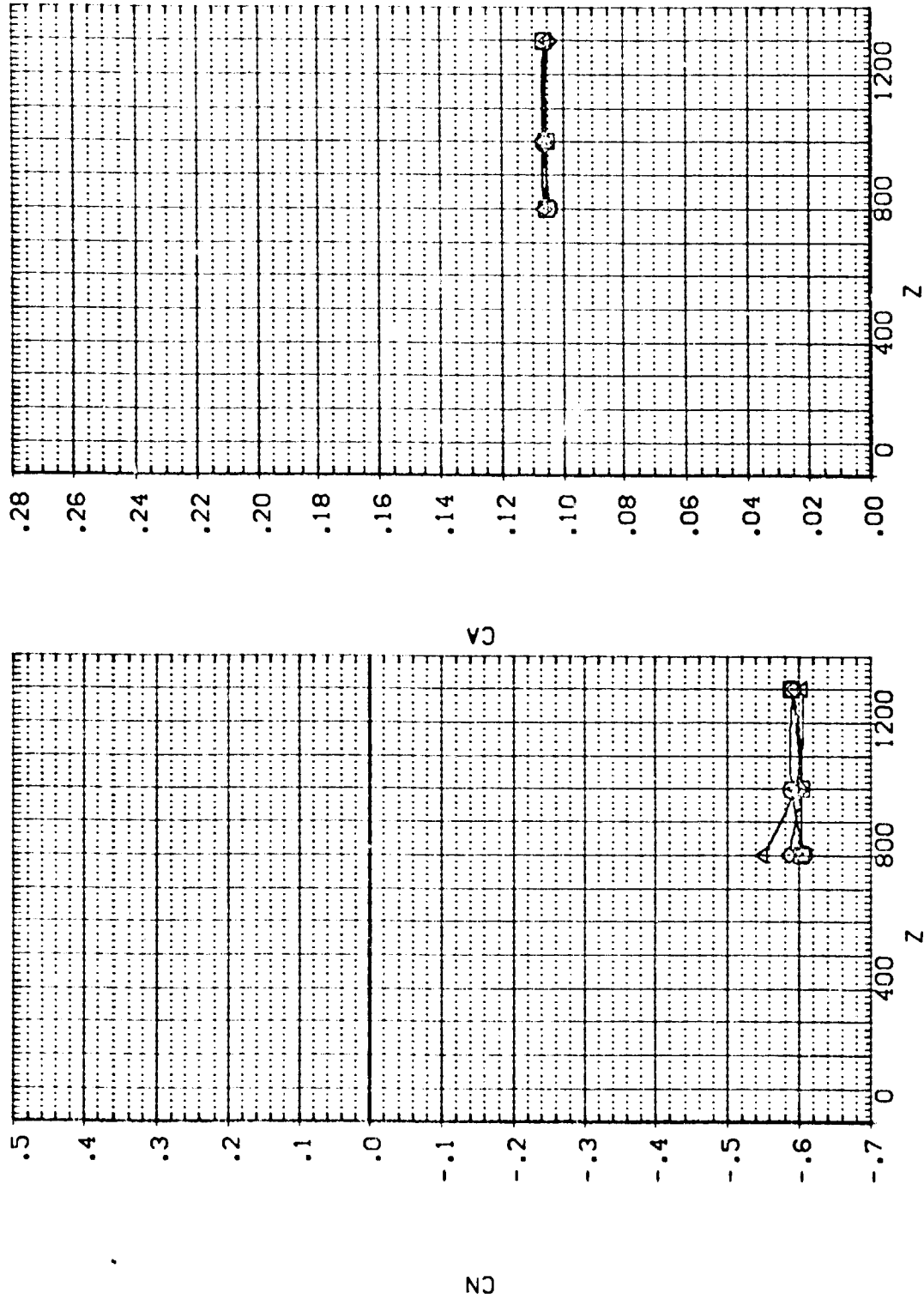

EXTERNAL TANK AERODYNAMIC CHARACTERISTICS DURING SEPARATION FROM ORBITER

IA13, EXTERNAL TANK(T10) SEPARATING FROM ORB. 09 (RTJT43)

SYMBOL

-
-
- ◇
- △

PARAMETRIC VALUES

MACH	4.520	P TOTAL	80.000
ALPHA	-10.000	BETA	.000
DALPHA	-20.000	DBETA	.000
ELEVTR	.000	AILRON	.000
Y	200.000		

SEE THE ASSOCIATED DATA DOCUMENT FOR REFERENCE CHARACTERISTICS FOR INDIVIDUAL DATASETS

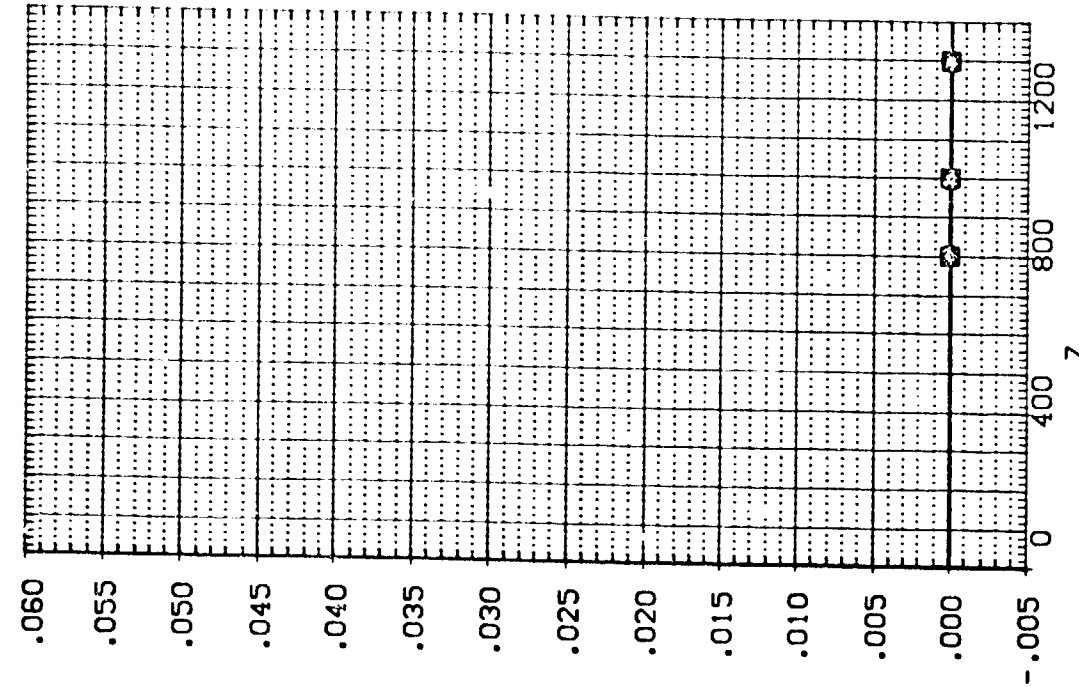
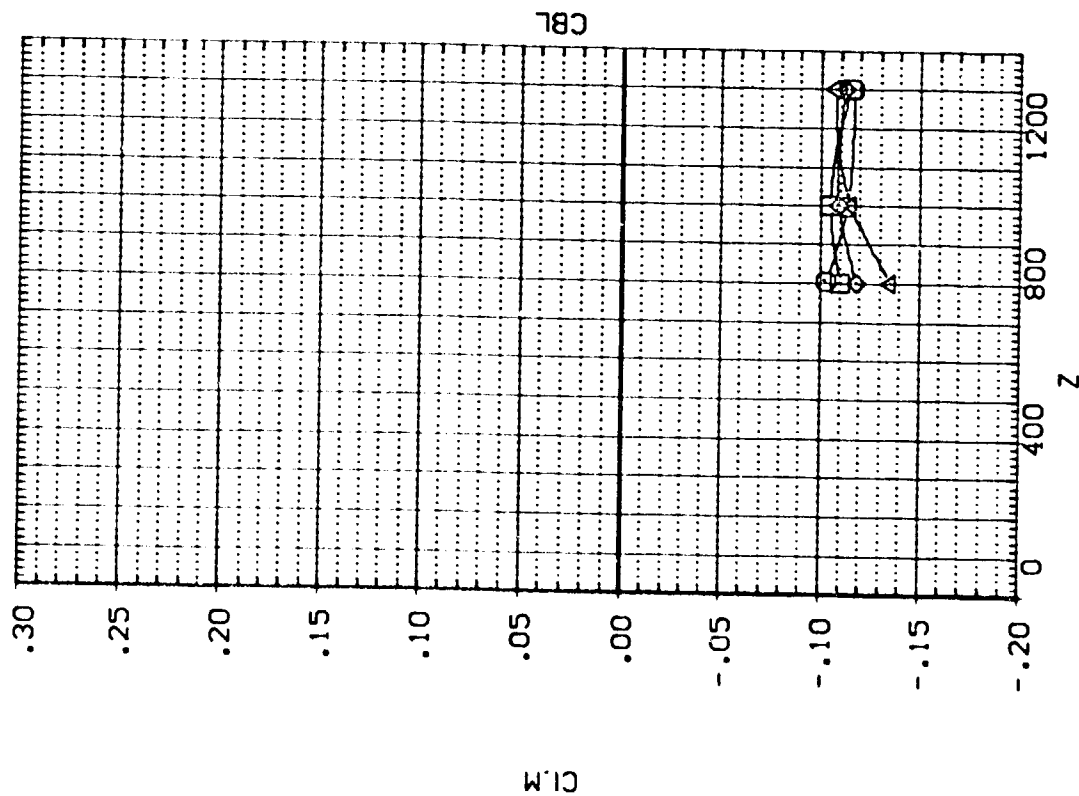

EXTERNAL TANK AERODYNAMIC CHARACTERISTICS DURING SEPARATION FROM ORBITER

IA13, EXTERNAL TANK(10) SEPARATING FROM ORB. 09 (RTJT43)

SEE THE ASSOCIATED DATA DOCUMENT FOR REFERENCE CHARACTERISTICS FOR INDIVIDUAL DATASETS

SYMBOL		PARAMETRIC VALUES	
X	.054	MACH	4.520
	400.490	ALPHA	-10.000
	800.440	DALPHA	-20.000
	1200.700	ELEVTR	.000
Y	200.000	ATLRON	.000
		PIOTAL	80.000
		BETA	.000
		DBETA	.000
		ATLRON	.000

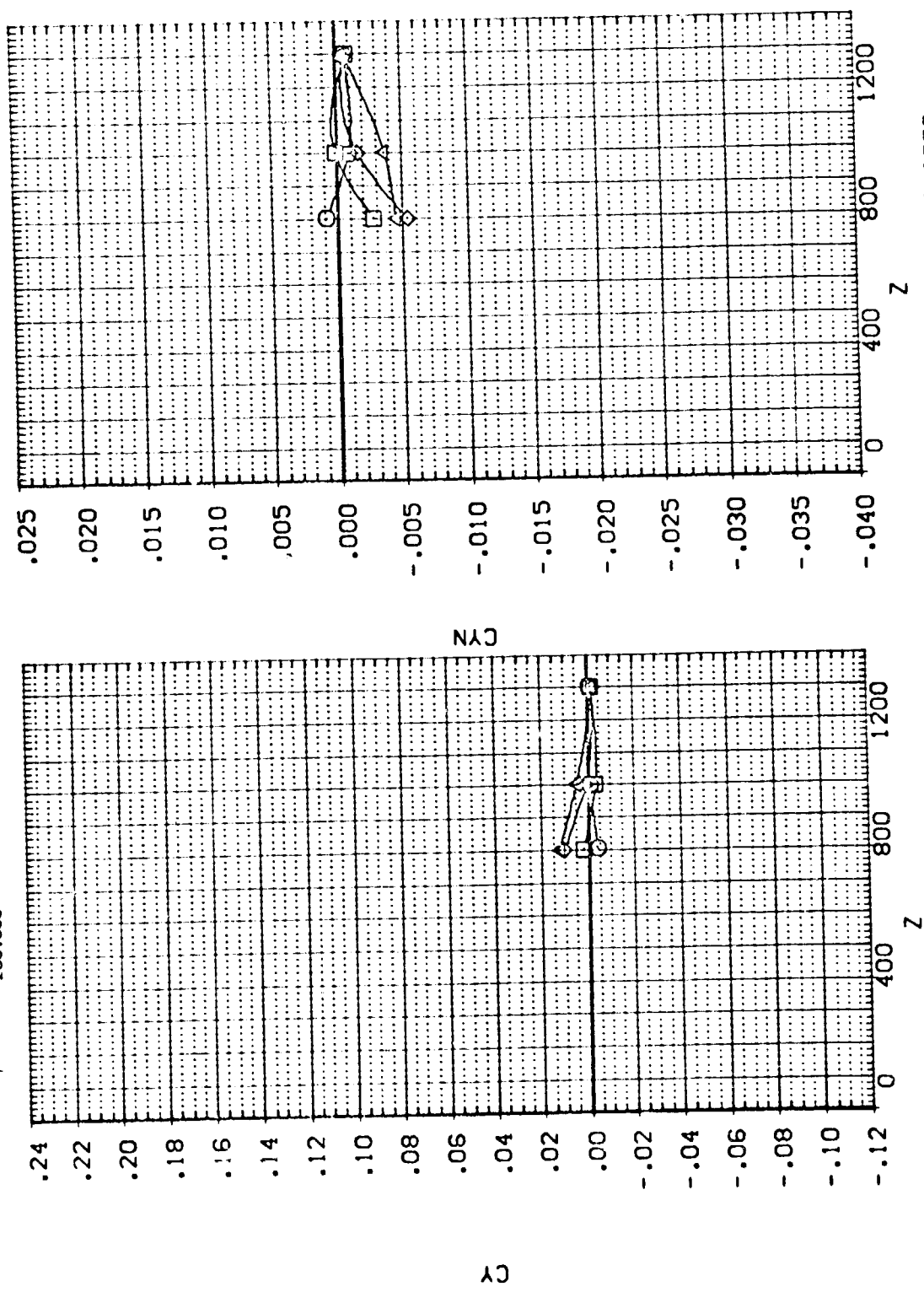

EXTERNAL TANK AERODYNAMIC CHARACTERISTICS DURING SEPARATION FROM ORBITER

IA13.EXTERNAL TANK(T10)SEPARATING FROM ORB. 09 (RTJT44)

SEE THE ASSOCIATED DATA DOCUMENT FOR REFERENCE CHARACTERISTICS FOR INDIVIDUAL DATASETS

SYMBOL		PARAMETRIC VALUES			
○	X	MACH	4.520	PTOTAL	80.000
□	400	ALPHA	-10.000	BETA	.000
◇	800	DALPHA	-20.000	DBETA	5.000
△	1200	ELEVTR	.000	AILRON	.000
	Y		200.000		

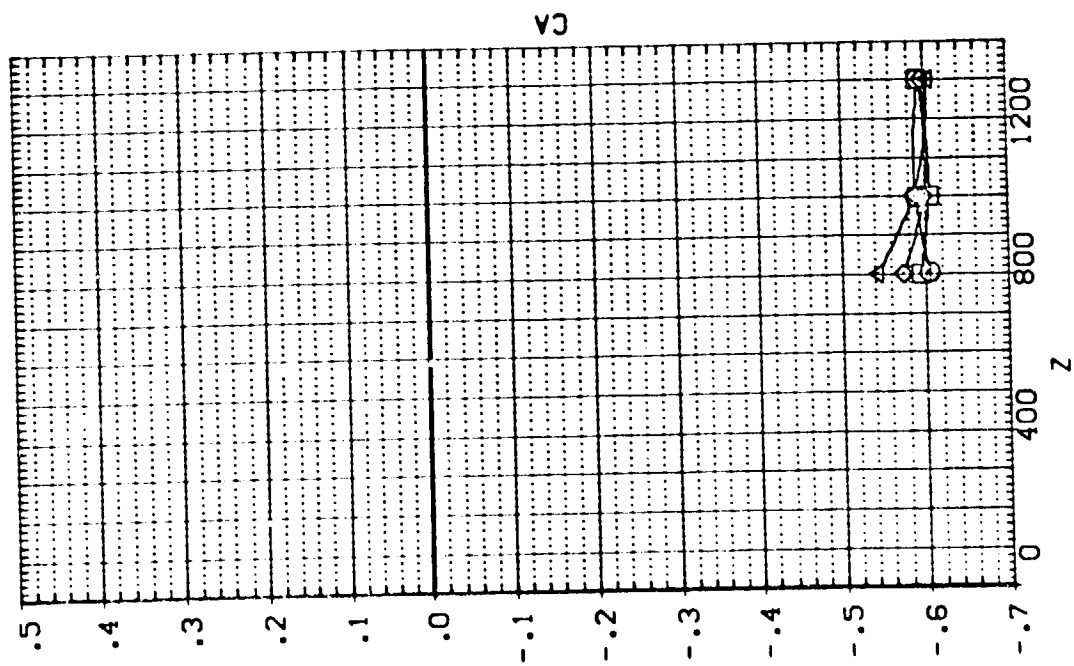
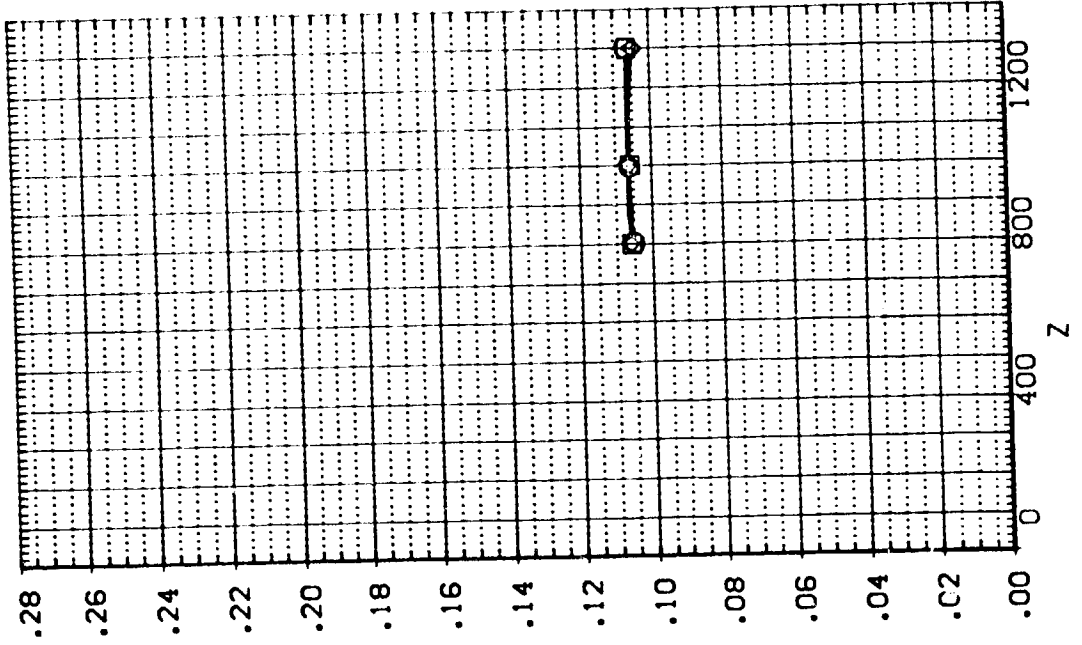

EXTERNAL TANK AERODYNAMIC CHARACTERISTICS DURING SEPARATION FROM ORBITER

1A:3,EXTERNAL TANK(1:0)SEPARATING FROM GRB. 09 (RTJT44)

SYMBOL
 ○
 □
 ◇
 △

PARAMETRIC VALUES
 MACH 4.520 P/TOTAL 80.000
 ALPHA -10.000 BETA .000
 DALPHA -20.000 DBETA 5.000
 ELEVTX .000 AILRON .000
 Y 200.000

SEE THE ASSOCIATED DATA DOCUMENT FOR REFERENCE CHARACTERISTICS FOR INDIVIDUAL DATASETS

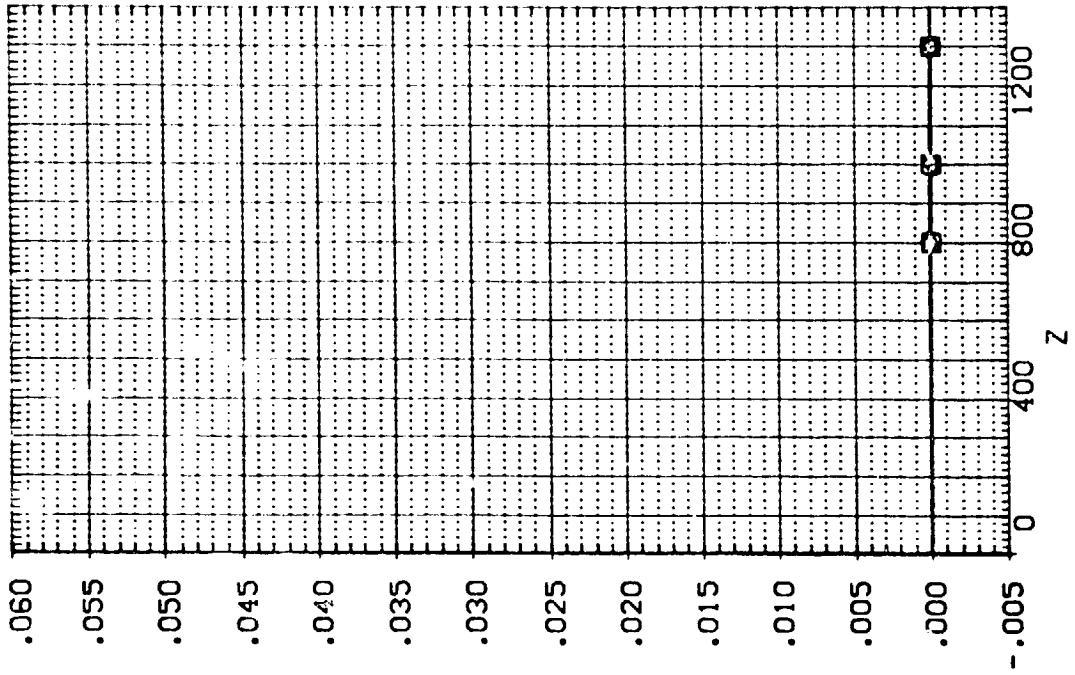
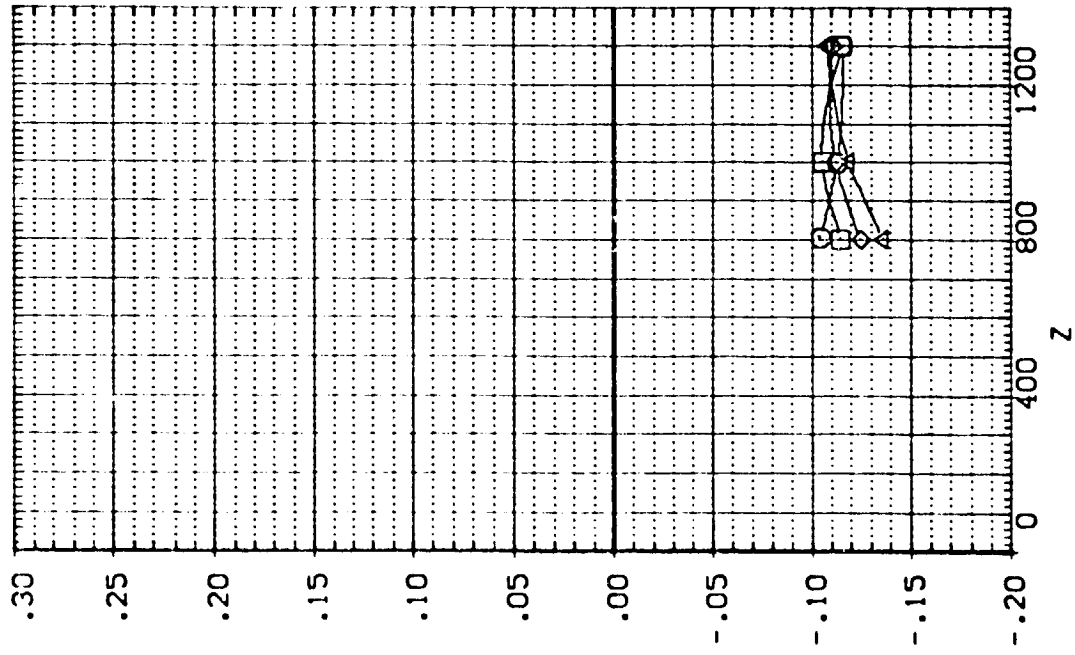

1A13, EXTERNAL TANK(T10)SEPARATING FROM ORB. 09 (RTJT44)

SEE THE ASSOCIATED DATA DOCUMENT FOR REFERENCE CHARACTERISTICS FOR INDIVIDUAL DATASETS

SYMBOL		PARAMETRIC VALUES			
X	.094	MACH	4.520	PIDTAL	60.000
	400.710	ALPHA	-10.000	BETA	.000
	800.610	DALPHA	-20.000	DBETA	5.000
	1200.400	ELEVTR	.000	AILRON	.000
Y	200.000				

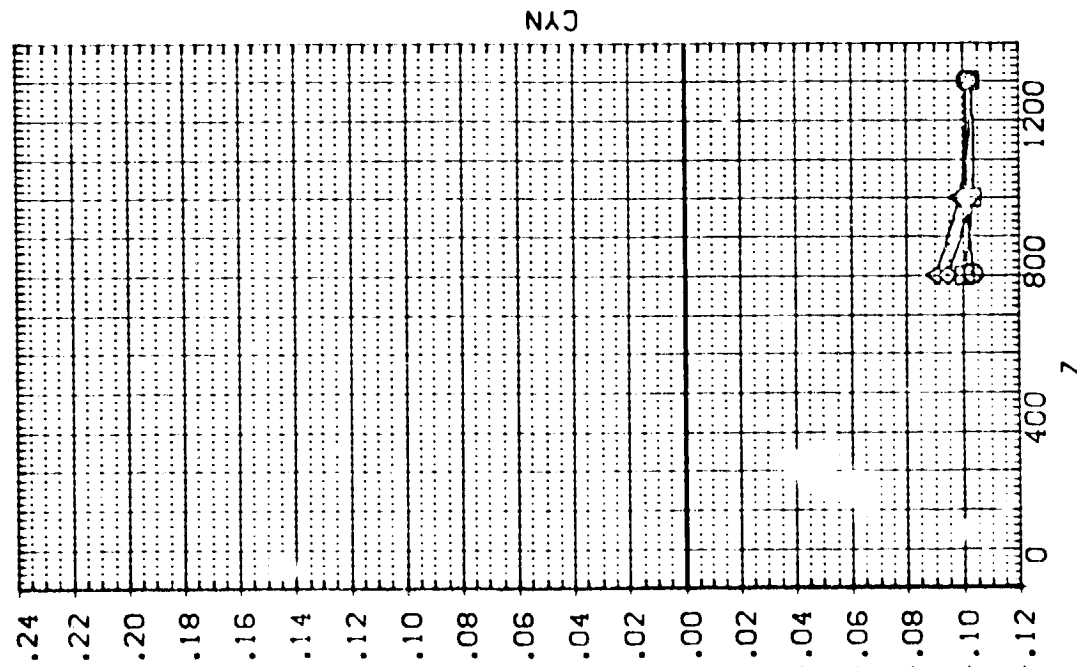
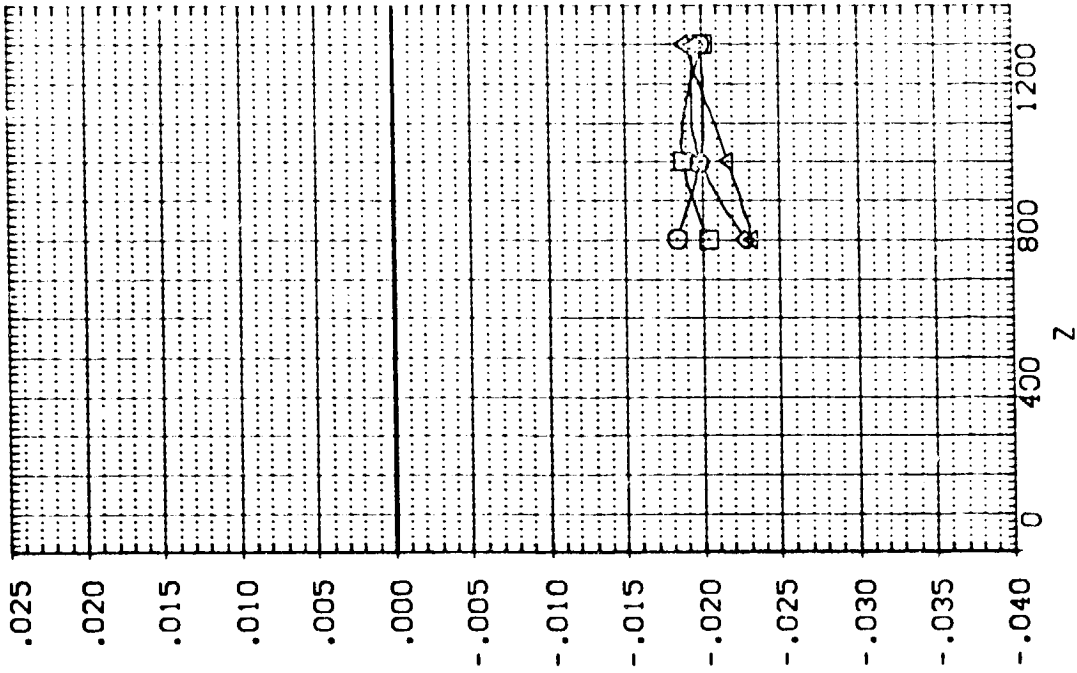

EXTERNAL TANK AERODYNAMIC CHARACTERISTICS DURING SEPARATION FROM ORBITER

IA13-EXTERNAL TANK(T10)SEPARATING FROM ORB. 09 (RTJT45)

SEE THE ASSOCIATED DATA DOCUMENT FOR REFERENCE CHARACTERISTICS FOR INDIVIDUAL DATASETS

SYMBOL	X	MACH	PARAMETRIC VALUES
○	.110	4.520	P TOTAL 80.000
◇	400.660	ALPHA -10.000	BETA .000
△	800.230	DALPHA -20.000	DBETA 5.000
	1200.600	ELEVTR .000	A1LRON .000
		Y	.000

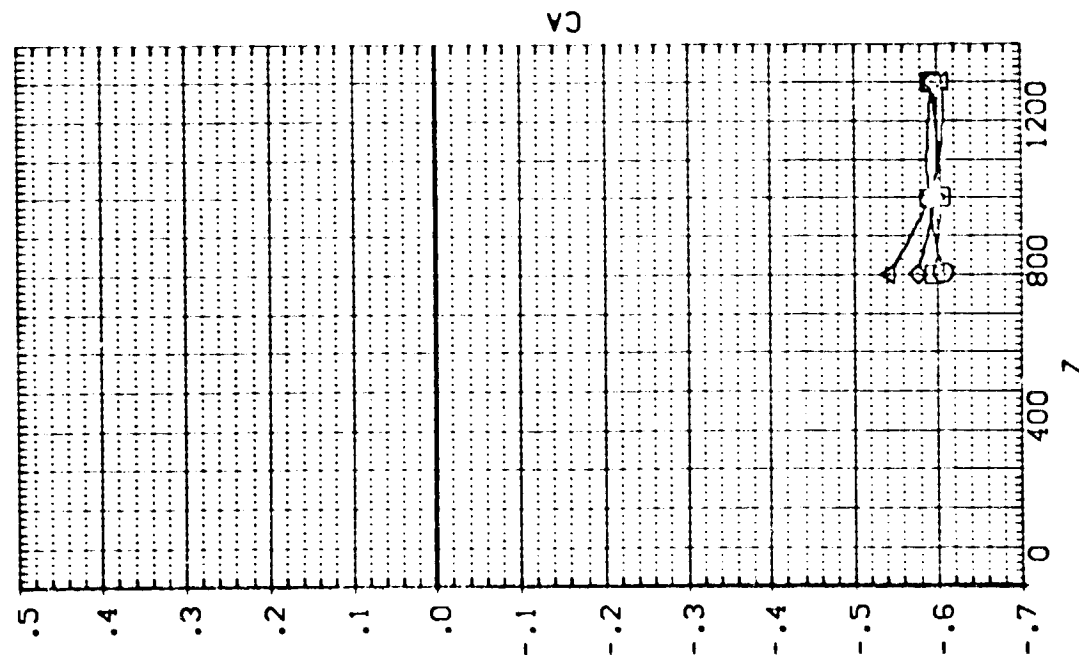
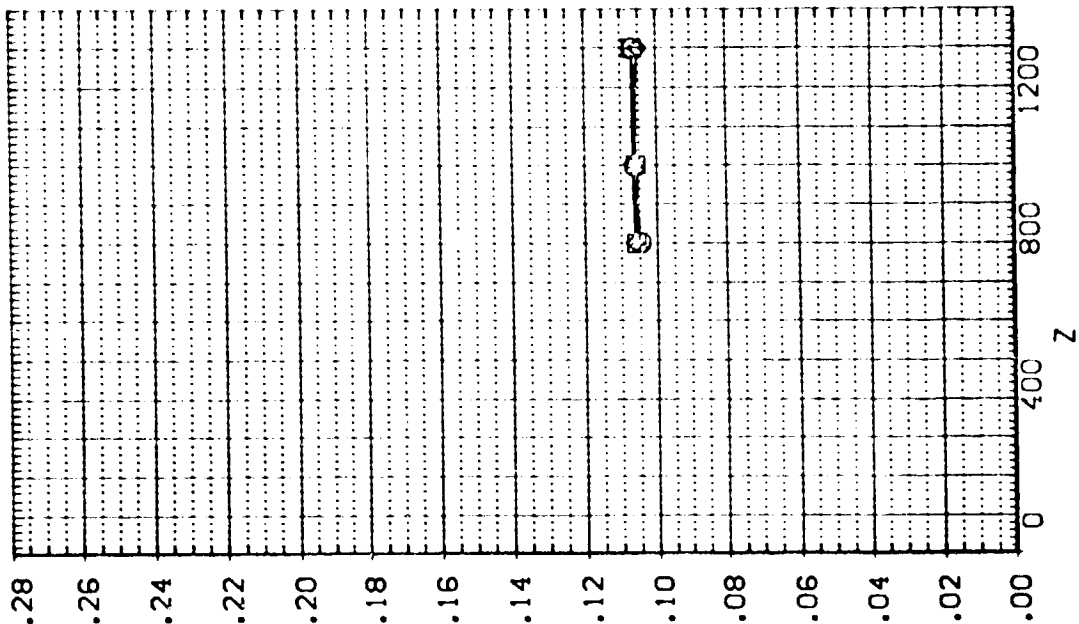

1A13, EXTERNAL TANK(T10)SEPARATING FROM ORB. 09 (RTJT45)

SEE THE ASSOCIATED DATA DOCUMENT FOR REFERENCE CHARACTERISTICS FOR INDIVIDUAL DATASETS

PARAMETRIC VALUES	
X	.110
MACH	4.520
PITOT	80.000
ALPHA	-10.000
BETA	.000
DALPHA	-20.000
DBETA	5.000
ELEVTR	.000
ATLRON	.000
Y	.000

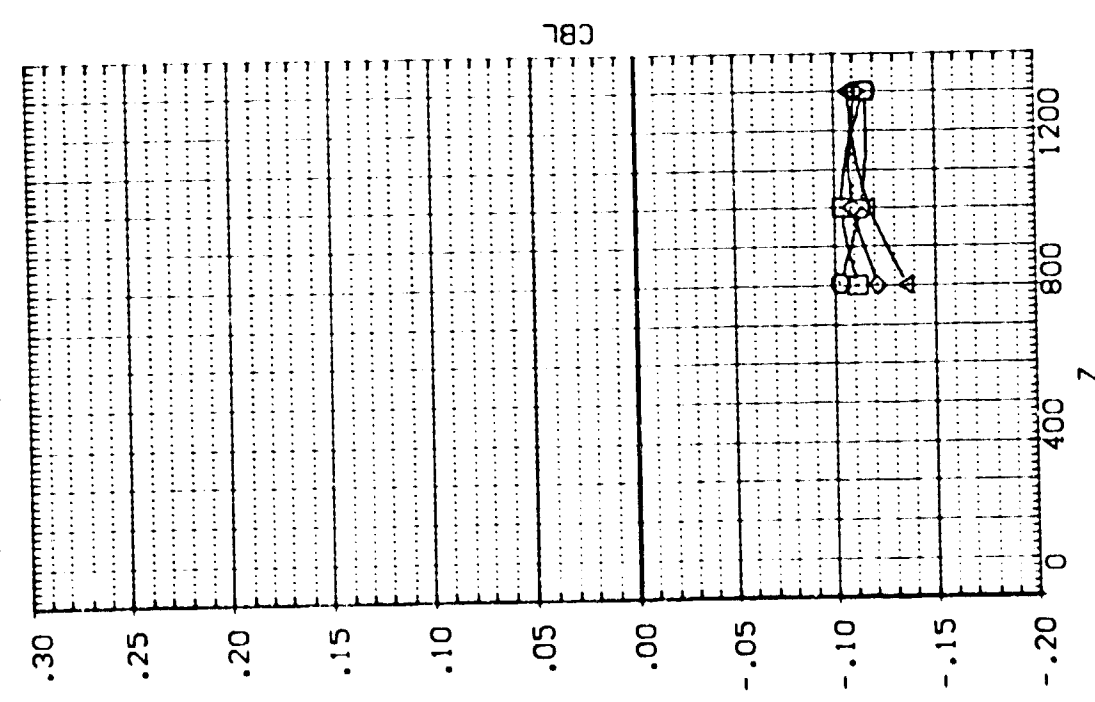
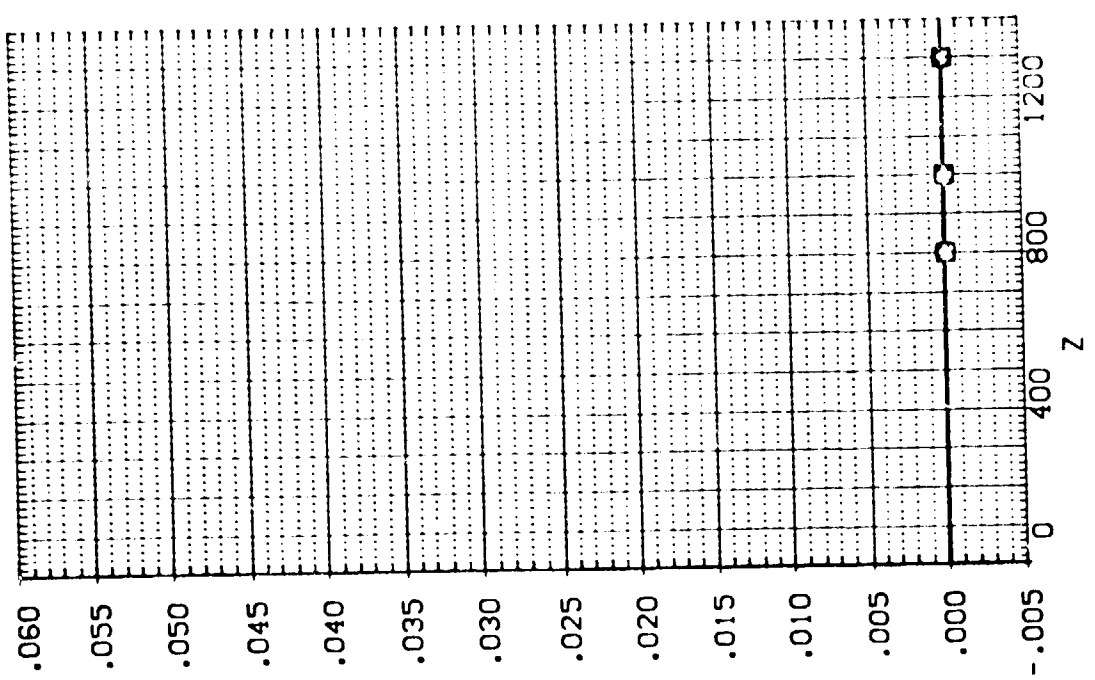

EXTERNAL TANK AERODYNAMIC CHARACTERISTICS DURING SEPARATION FROM ORBITER

1A.3. EXTERNAL TANK(10) SEPARATING FROM ORB. 09 (RTJ145)

SEE THE ASSOCIATED DATA DOCUMENT FOR REFERENCE CHARACTERISTICS FOR INDIVIDUAL DATASETS

SYMBOL		PARAMETRIC VALUES	
x	.110	MACH	4.520
10	400.66C	ALPHA	-10.000
10	800.230	BETA	-20.000
10	1200.600	ELEVTR	.000
		AITLRN	.000
		Y	.000

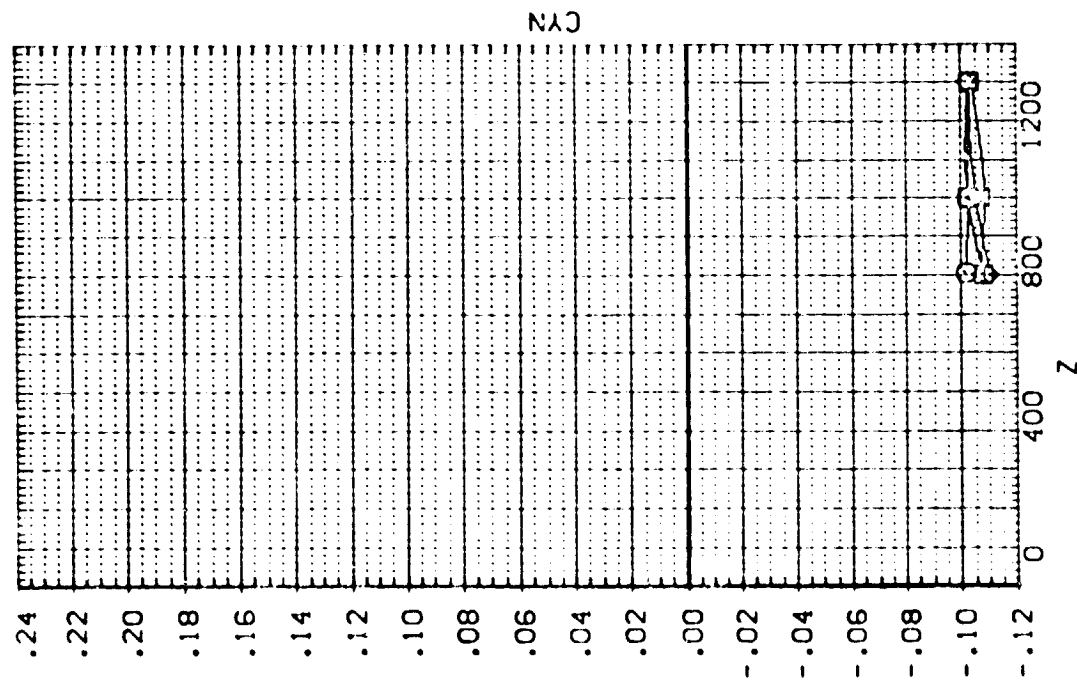
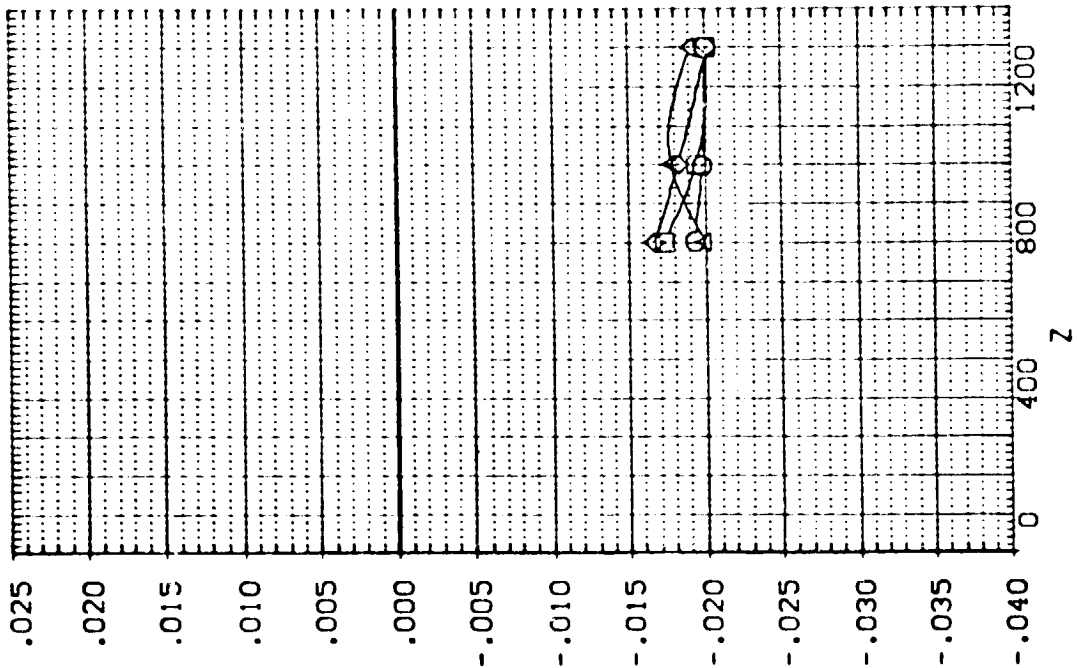

EXTERNAL TANK AERODYNAMIC CHARACTERISTICS DURING SEPARATION FROM ORBITER

IA:3,EXTERNAL TANK(T10)SEPARATING FROM ORB. 09 (RTJT46)

SEE THE ASSOCIATED DATA DOCUMENT FOR REFERENCE CHARACTERISTICS FOR INDIVIDUAL DATASETS

SYMBOL x PARAMETRIC VALUES

○	MACH	4.520	PTOTAL	80.000
	ALPHA	-10.000	BETA	.000
	DALPHA	-30.000	DBETA	.000
	ELEVTR	.000	AIRLON	.000
	Y	.000		

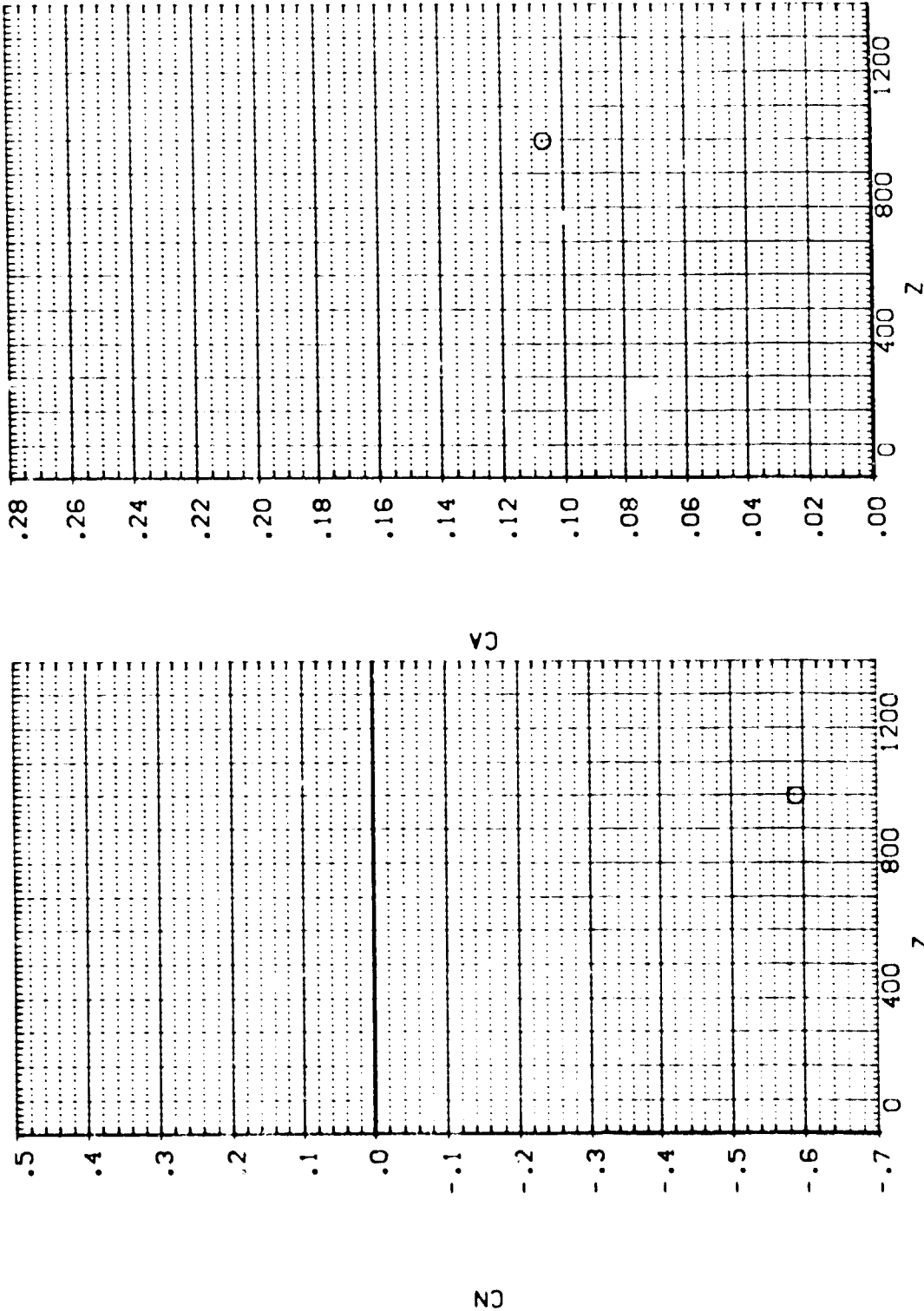

EXTERNAL TANK AERODYNAMIC CHARACTERISTICS DURING SEPARATION FROM ORBITER

FIG. 3. EXTERNAL TANK(10) SEPARATING FROM ORB. 09 (RIJ146)

SEE THE ASSOCIATED DATA DOCUMENT FOR REFERENCE CHARACTERISTICS FOR INDIVIDUAL DATASETS

SYMBOL x .356
 O

PARAMETRIC VALUES
 MACH 4.520 PITCH 80.000
 ALPHA -10.000 BETA .000
 CALPHA -30.000 DBETA .000
 ELEVTX .000 AILRON .000
 Y .000

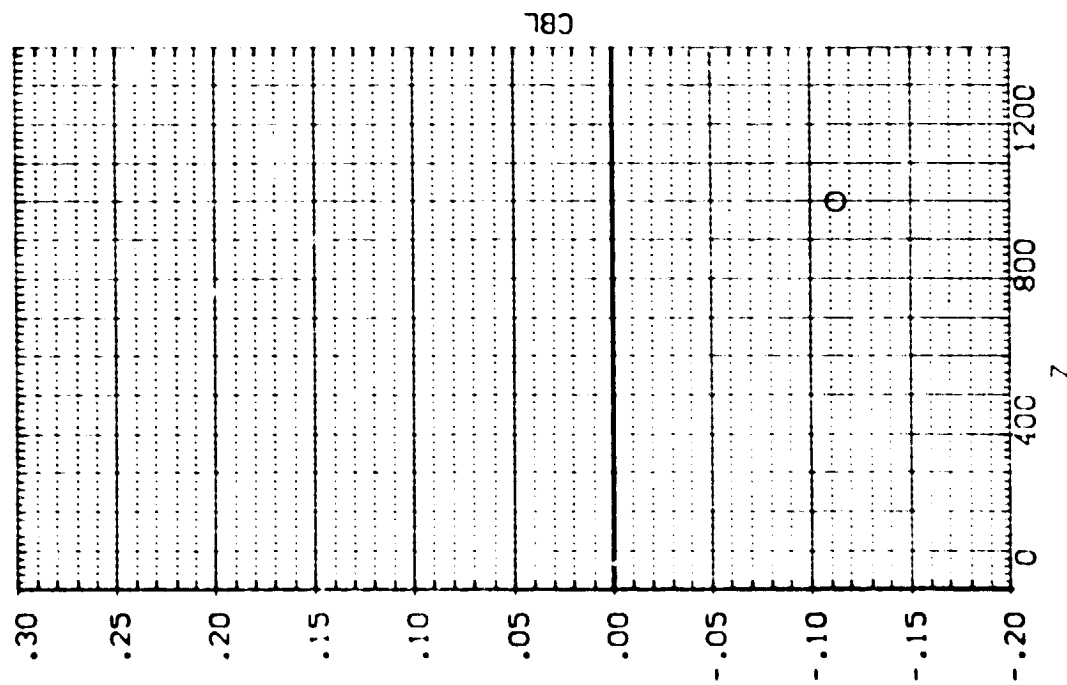
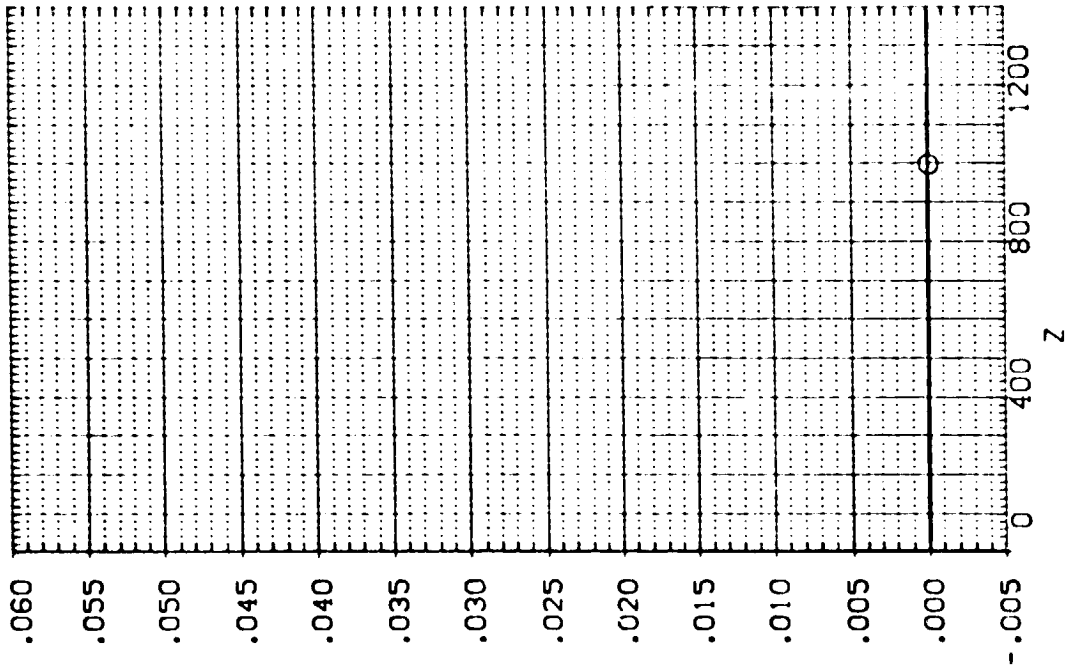

EXTERNAL TANK AERODYNAMIC CHARACTERISTICS DURING SEPARATION FROM ORBITER

1A.3. EXTERNAL TANK(10)SEPARATING FROM ORB. 09 (RTJ146)

SEE THE ASSOCIATED DATA DOCUMENT FOR REFERENCE CHARACTERISTICS FOR INDIVIDUAL CASES

SYMBOL		PARAMETRIC VALUES	
x	.35F	MACH	4.520
		ALPHA	-10.000
		BETA	-30.000
		DELTA	.000
		ELEVTR	.000
		Y	.000
		PYOTAL	80.000
		BETA	.000
		DELTA	.000
		AIRTON	.000

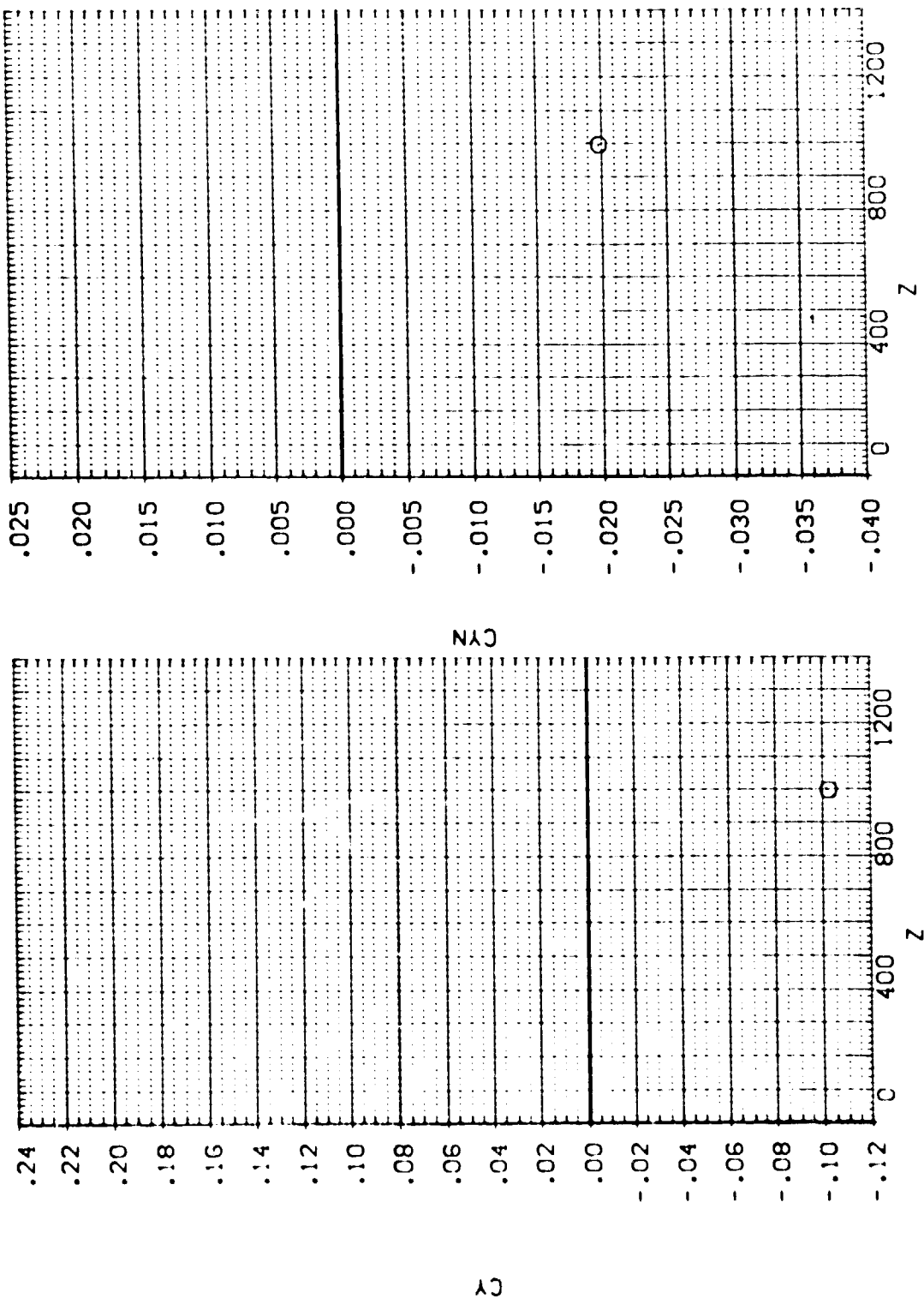

EXTERNAL TANK AERODYNAMIC CHARACTERISTICS DURING SEPARATION FROM ORBITER

3.3. EXTERNAL TANK(10) SEPARATING FROM ORB. C9 (RTJ147)

SEE THE ASSOCIATED DATA DOCUMENT FOR REFERENCE CHARACTERISTICS FOR INDIVIDUAL DATASETS

SYMBOL	X	MACH	PARAMETRIC VALUES	PTOTAL	80.000
○	400.680	ALPHA	4.520	PTOTAL	.000
◇	800.710	DALPHA	-21.000	BETA	.000
△	1200.800	ELEVTR	5.000	ALTRON	.000
		Y	.000		.000

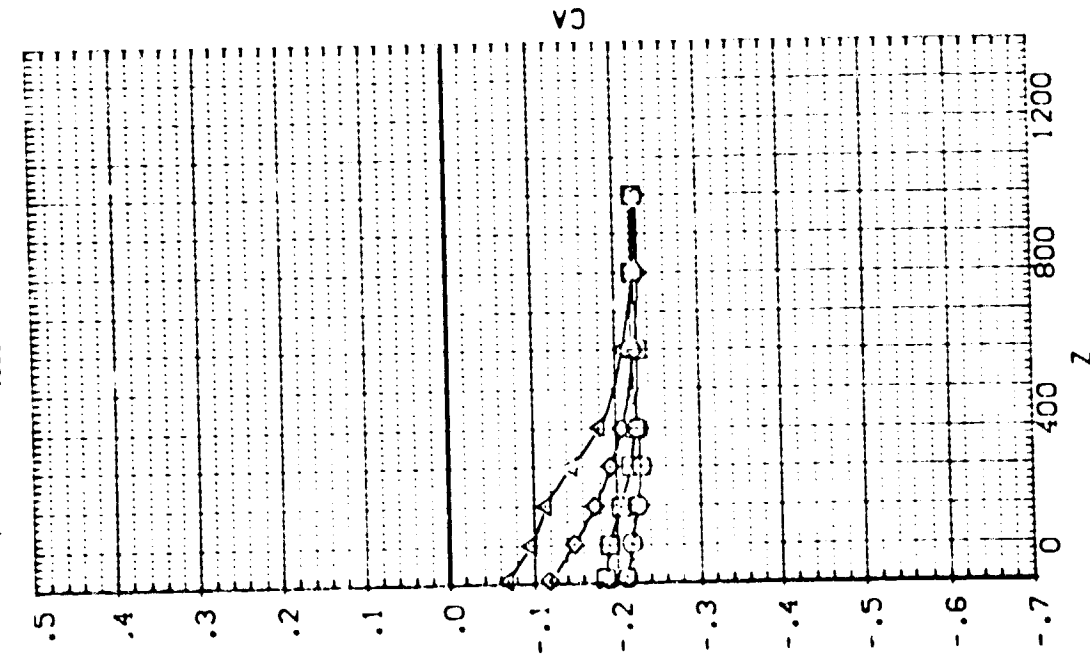
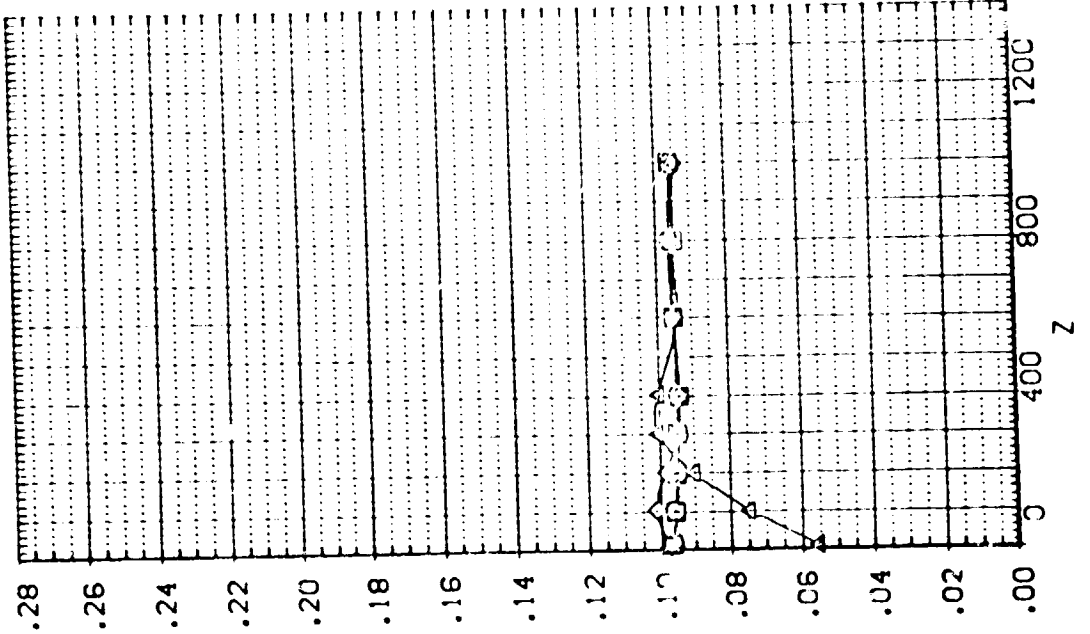

IA13, EXTERNAL TANK(110) SEPARATING FROM ORB. 09 (RTJT47)

SEE THE ASSOCIATED DATA DOCUMENT FOR REFERENCE CHARACTERISTICS FOR INDIVIDUAL DATASETS

SYMBOL		PARAMETRIC VALUES	
○	MACH	4.520	PTOTAL 80.000
◇	ALPHA	-21.000	BETA .000
△	DALPHA	6.000	DBETA .000
	ELEVTR	.000	A1LRON .000
	Y	.000	

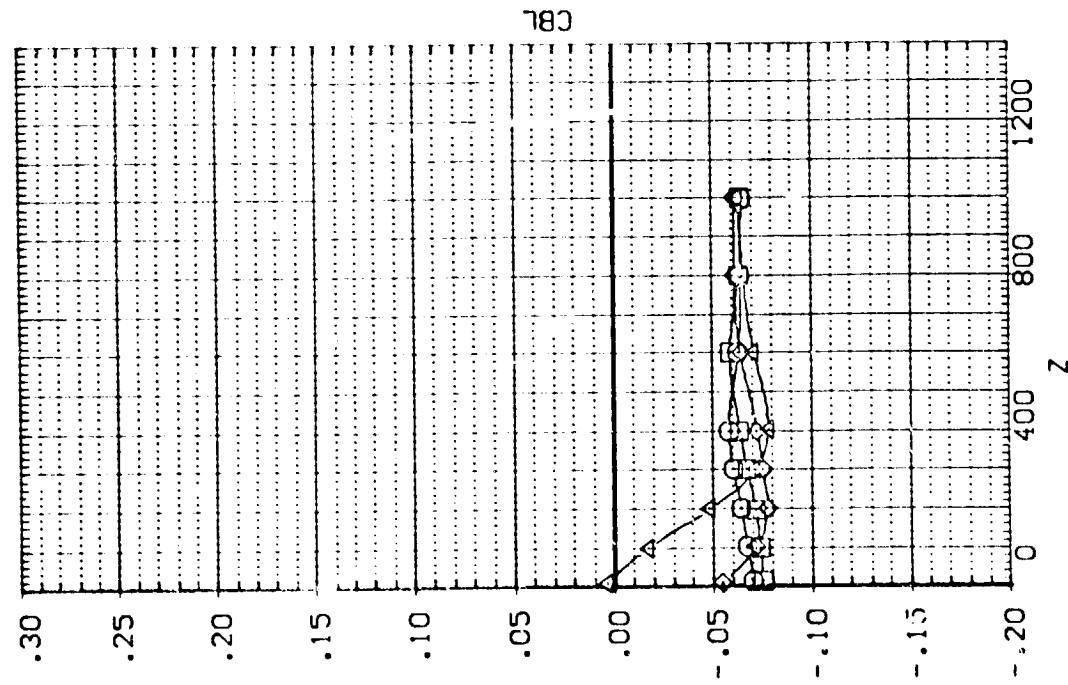
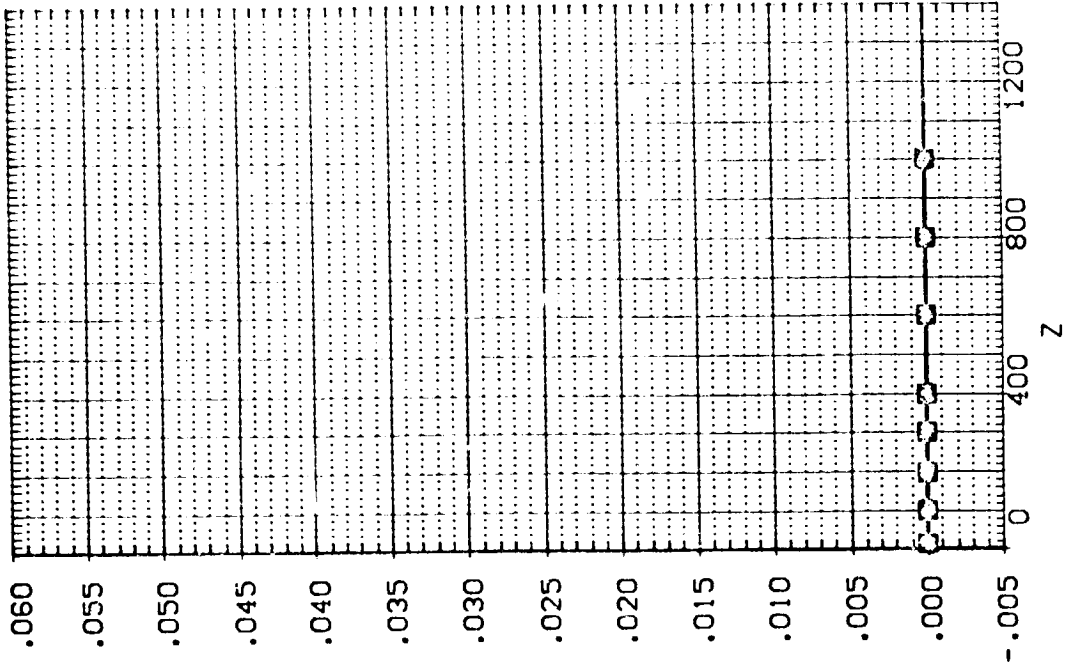

EXTERNAL TANK AERODYNAMIC CHARACTERISTICS DURING SEPARATION FROM ORBITER

FIG. 13. EXTERNAL TANK(A) SEPARATING FROM ORB. C9 (RTJT47)

SEE THE ASSOCIATED DATA DOCUMENT FOR REFERENCE CHARACTERISTICS FOR INDIVIDUAL DATASETS

SYMBOL		PARAMETRIC VALUES	
○	X	.405	MACH
□	400.68C	4.520	PTOTAL
◇	800.710	-21.000	BETA
△	1200.800	6.000	DBETA
		.000	AILRON
		.000	Y
		80.000	
		.000	
		.000	

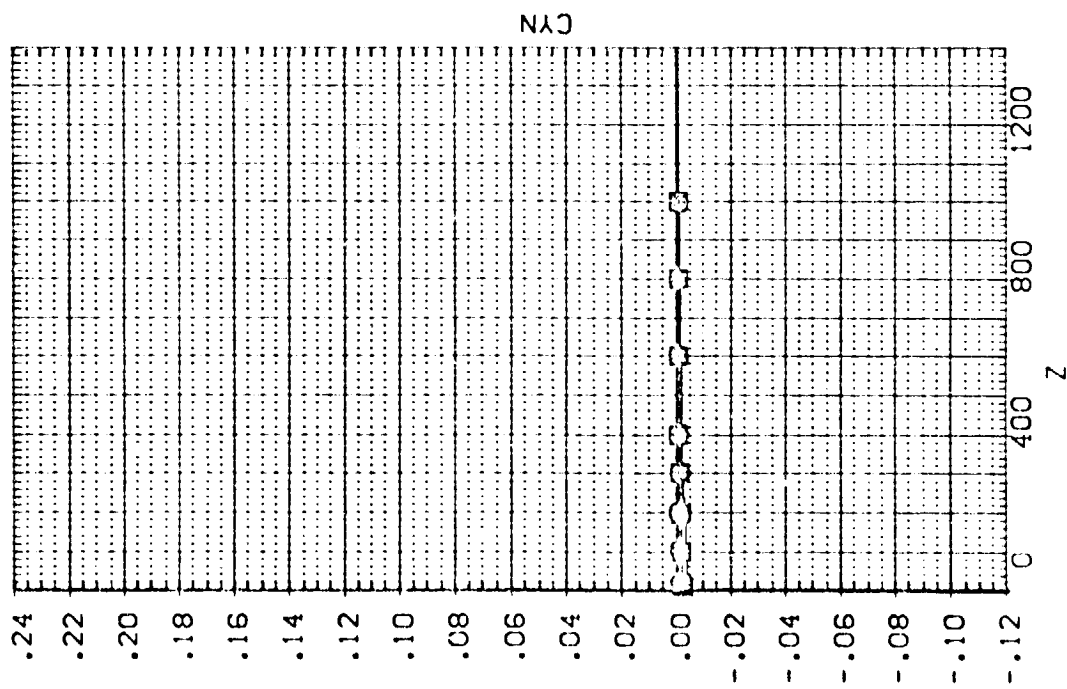
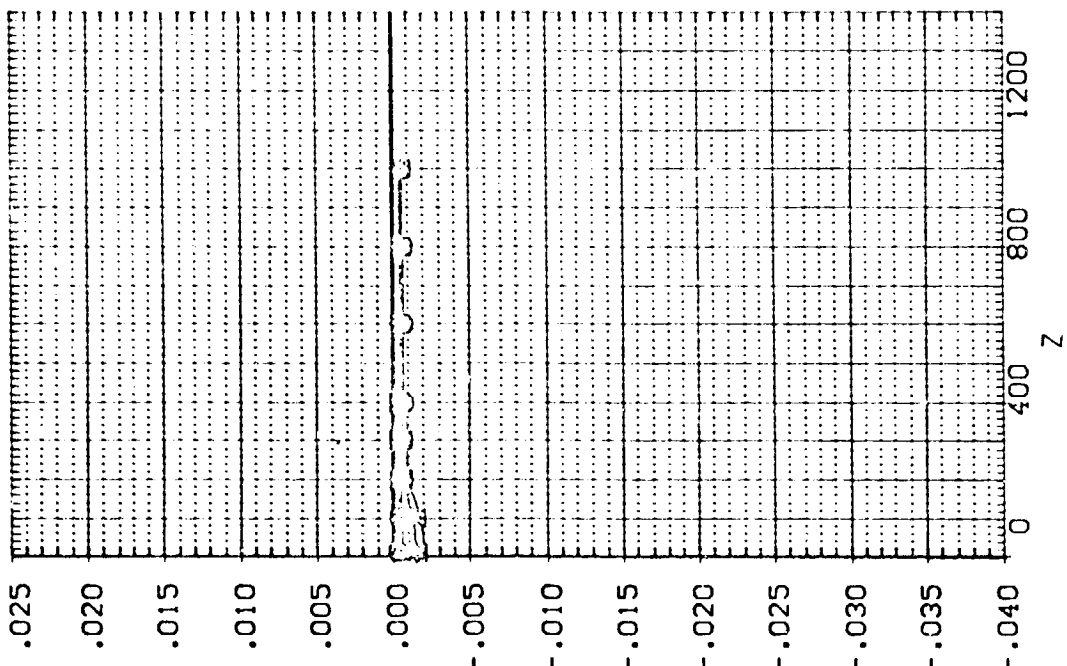

EXTERNAL TANK AERODYNAMIC CHARACTERISTICS DURING SEPARATION FROM ORBITER

IA13. EXTERNAL TANK(T10)SEPARATING FROM ORB. 09 (RTJT48)

SEE THE ASSOCIATED DATA DOCUMENT FOR REFERENCE CHARACTERISTICS FOR INDIVIDUAL DATASETS

SYMBOL		PARAMETRIC VALUES	
○	x	.276	MACH
□	400.440	4.520	PTOTAL
◇	800.590	-21.000	BETA
△	1200.700	1.000	DBETA
		.000	ALLRON
		.000	Y

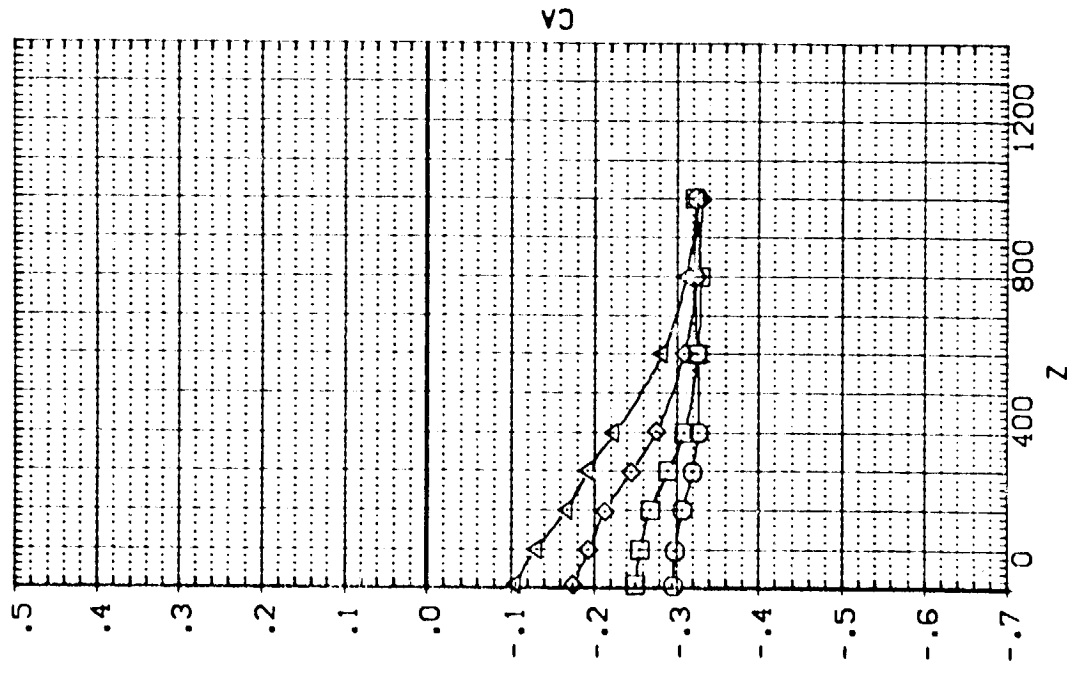
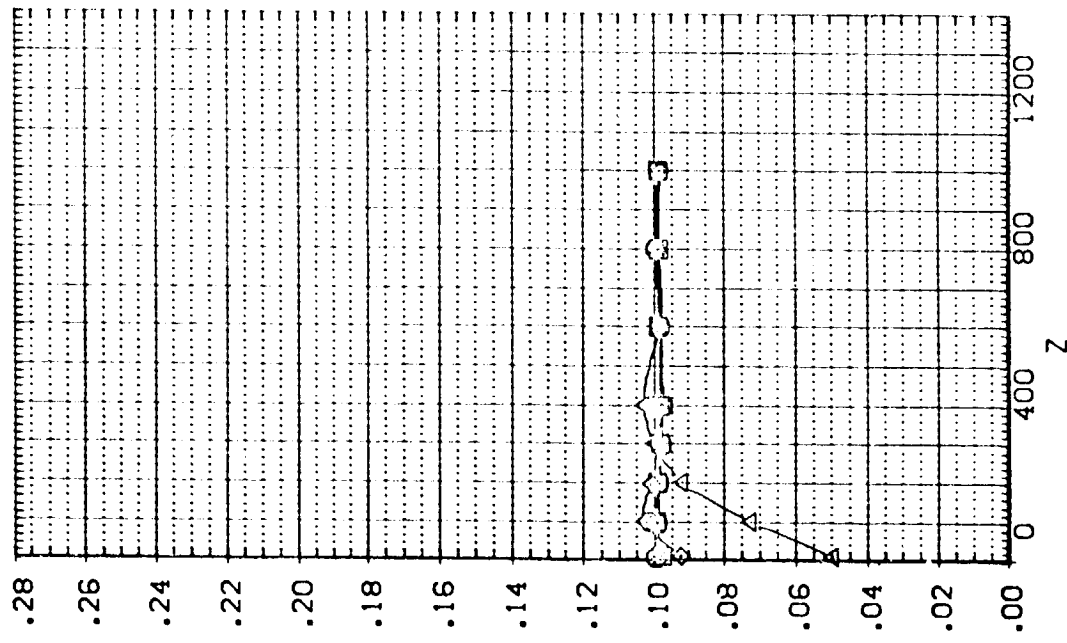

EXTERNAL TANK AERODYNAMIC CHARACTERISTICS DURING SEPARATION FROM ORBITER

1A13, EXTERNAL TANK(110)SEPARATING FROM ORB, 09 (RTJT48)

SEE THE ASSOCIATED DATA DOCUMENT FOR REFERENCE CHARACTERISTICS FOR INDIVIDUAL DATASETS

SYMBOL		PARAMETRIC VALUES	
○	X	MACH	4.520
○	Y	ALPHA	-21.000
○	Z	BETA	1.000
○	CLM	DBETA	.000
○	CLB	ATLRON	.000
○	CLY	ATLRON	.000

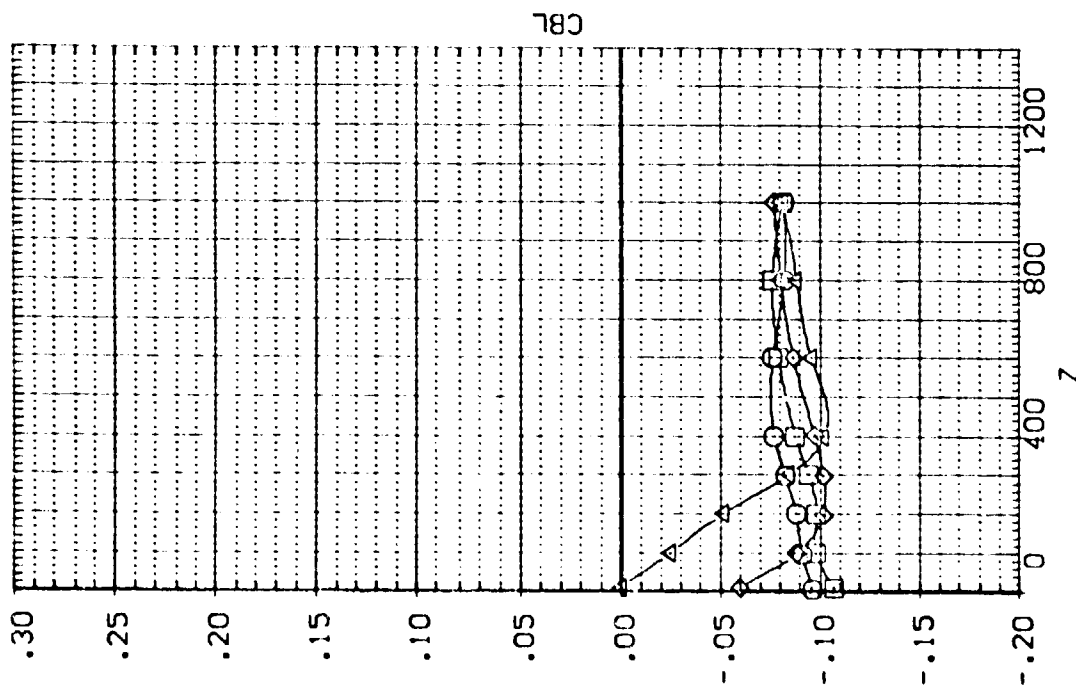
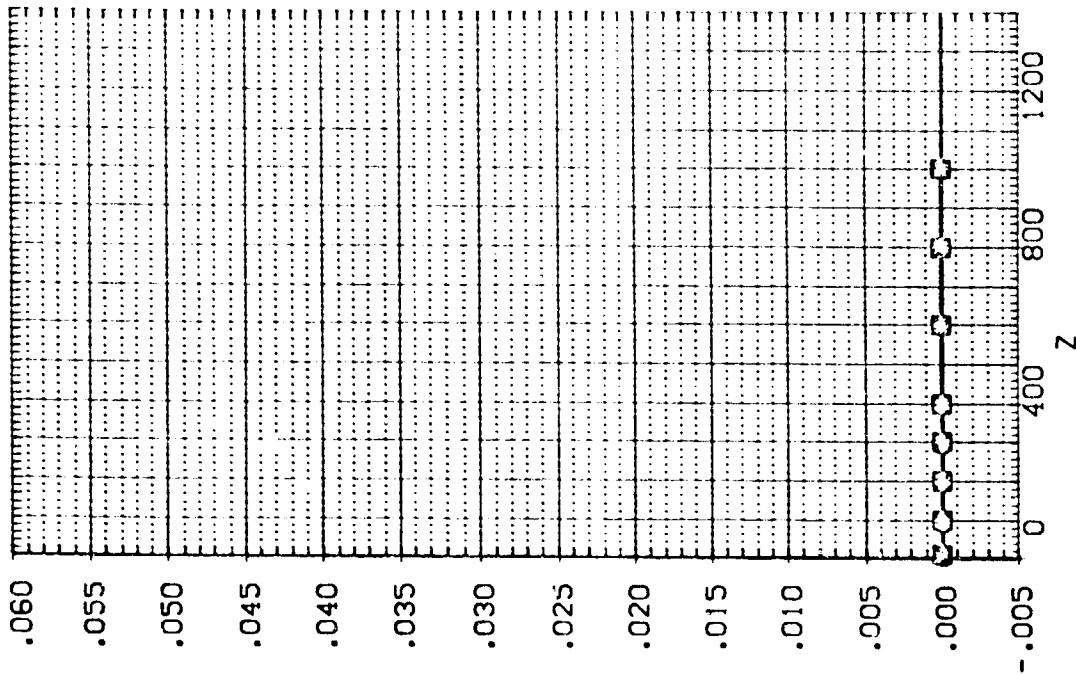

EXTERNAL TANK AERODYNAMIC CHARACTERISTICS DURING SEPARATION FROM ORBITER

13. EXTERNAL TANK(T10)SEPARATING FROM ORB. 09 (RTJ148)

SEE THE ASSOCIATED DATA DOCUMENT FOR REFERENCE CHARACTERISTICS FOR INDIVIDUAL DATASETS

SYMBOL	X	MACH	ALPHA	DALEPHA	ELEVTR	Y	PARAMETRIC VALUES
○	.276	4.520	PTOTAL	80.000			
○	400.440	-21.000	BETA	.000			
○	800.590	1.000	DBETA	.000			
○	1200.700	.000	AILRON	.000			

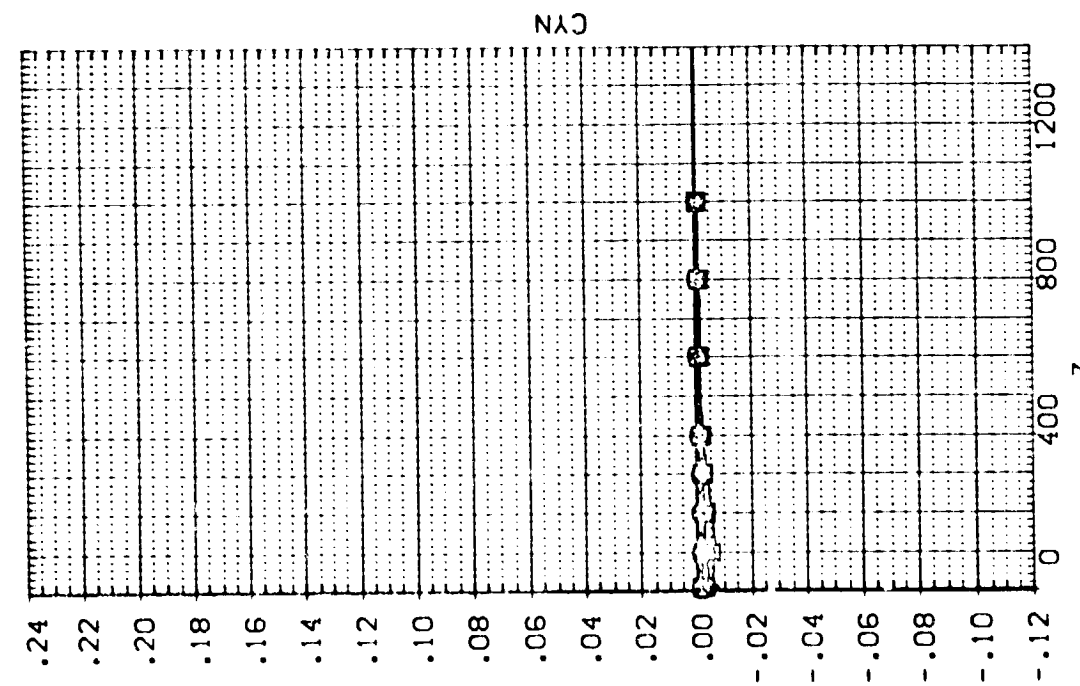
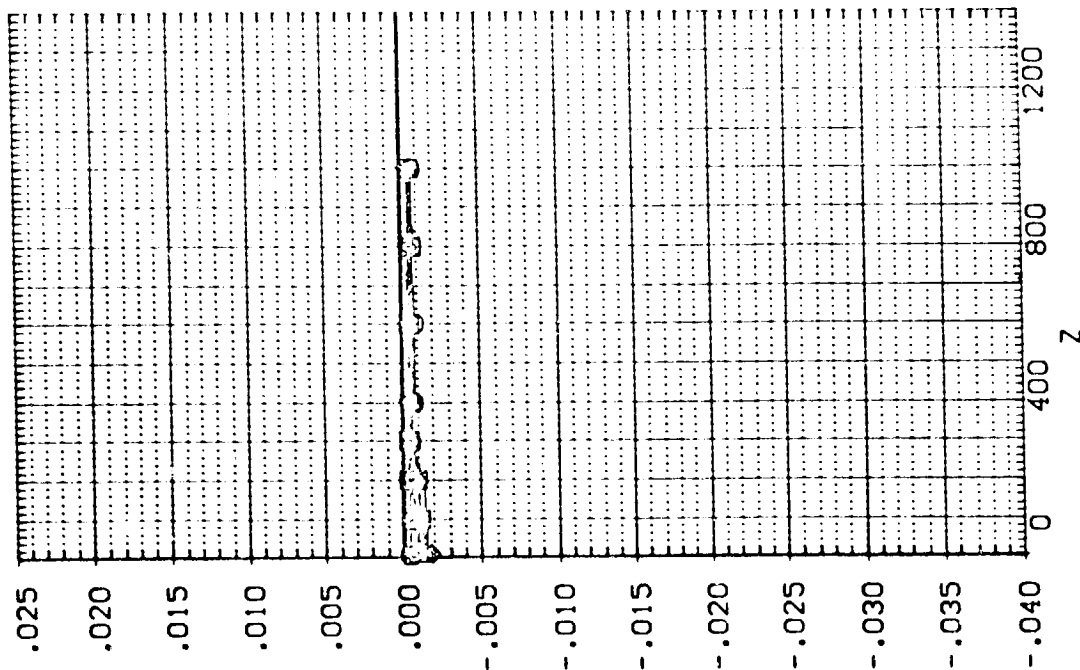

EXTERNAL TANK AERODYNAMIC CHARACTERISTICS DURING SEPARATION FROM ORBITER

1A13, EXTERNAL TANK (10) SEPARATING FROM ORB. 09 (RIJT49)

SEE THE ASSOCIATED DATA DOCUMENT FOR REFERENCE CHARACTERISTICS FOR INDIVIDUAL DATA SETS

SYMBOL	X	MACH	PARAMETRIC VALUES
○	400.57C	4.520	P/D T/L 80.000
◇	800.34C	-21.000	BETA .000
△	1200.80C	-4.000	DBETA .000
		.000	A/L/RON .000
		.000	Y .000

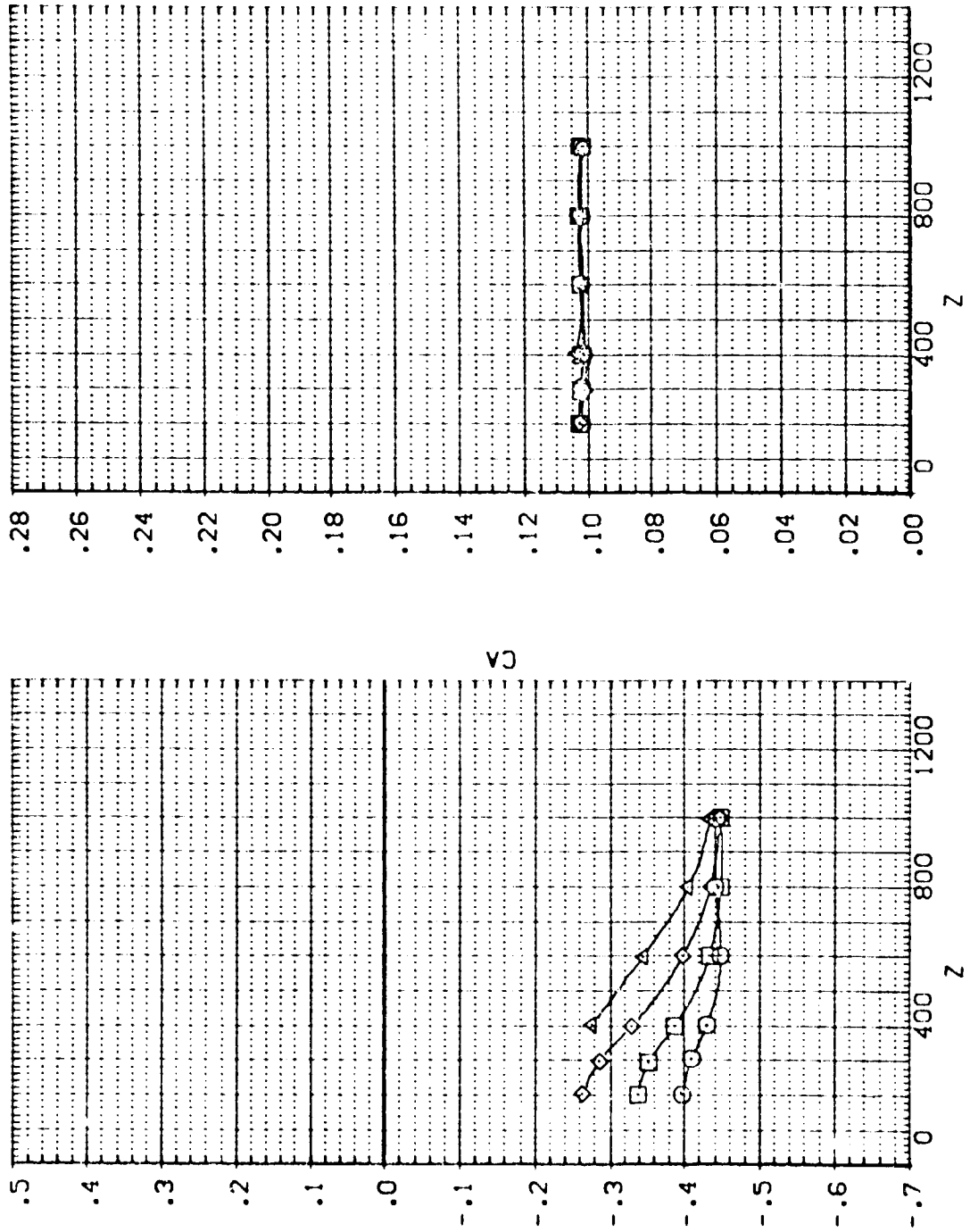

EXTERNAL TANK AERODYNAMIC CHARACTERISTICS DURING SEPARATION FROM ORBITER

1A13. EXTERNAL TANK (10) SEPARATING FROM ORB. 09 (RTJT49)

SEE THE ASSOCIATED DATA DOCUMENT FOR REFERENCE CHARACTERISTICS FOR INDIVIDUAL DATA SETS

SYMBOL	X	MACH	PARAMETRIC VALUES
○	.285	4.520	PIDTAL 80.000
□	400.570	-21.000	BETA .000
◇	800.340	-4.000	SBETA .000
△	1200.800	.000	ATLRON .000
		Y	.000

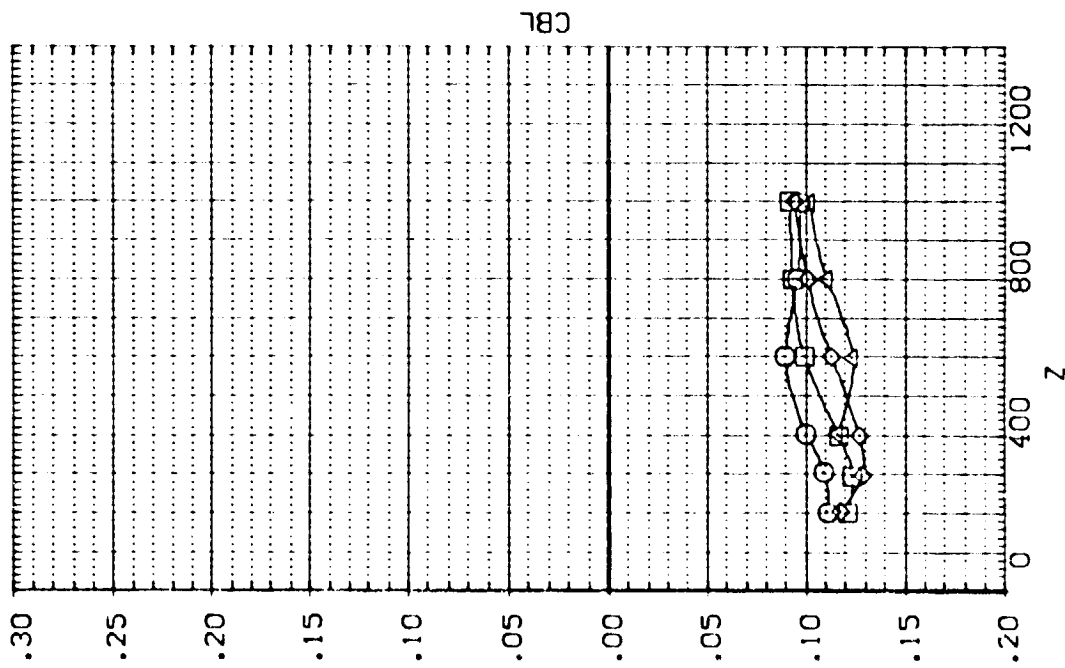
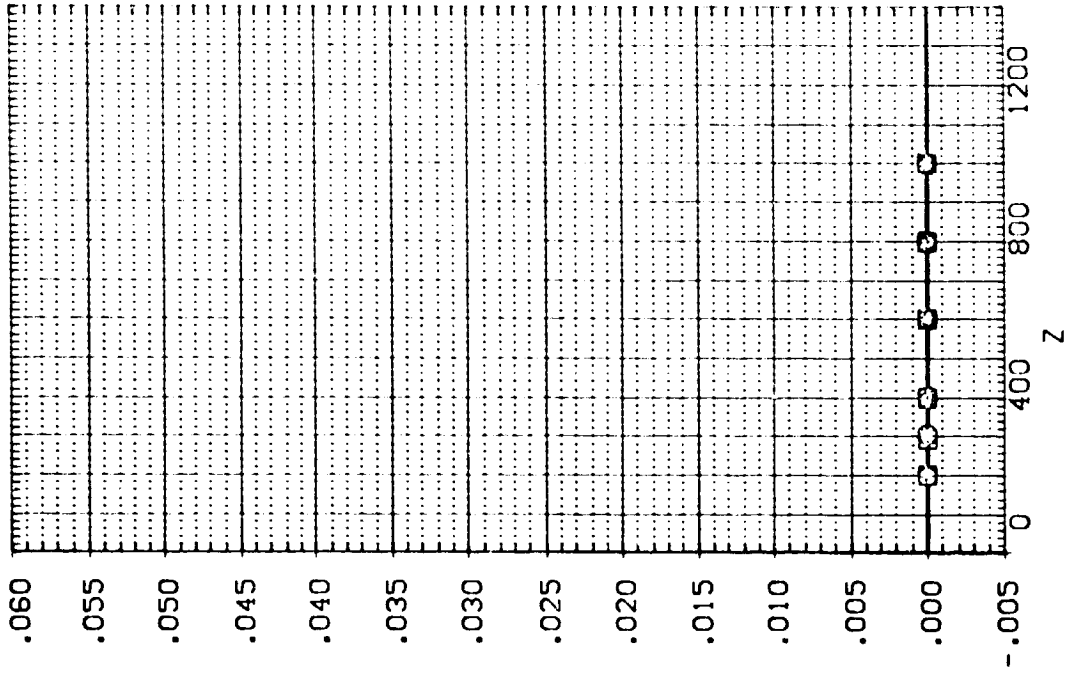

EXTERNAL TANK AERODYNAMIC CHARACTERISTICS DURING SEPARATION FROM ORBITER

1A13. EXTERNAL TANK(1) SEPARATING FROM ORB. 09 (RTJT49)

SEE THE ASSOCIATED DATA DOCUMENT FOR REFERENCE CHARACTERISTICS FOR INDIVIDUAL CASSETS

SYMBOL	X	MACH	ALPHA	DA, PHA	ELEVTR	Y	PARAMETRIC VALUES	P TOTAL	80,000
○	.285	4.520	-21.000	BETA	.000				
□	400.570		-4.000	DBETA	.000				
◇	800.340		.000	A1,IRON	.000				
△	1200.800		.000						

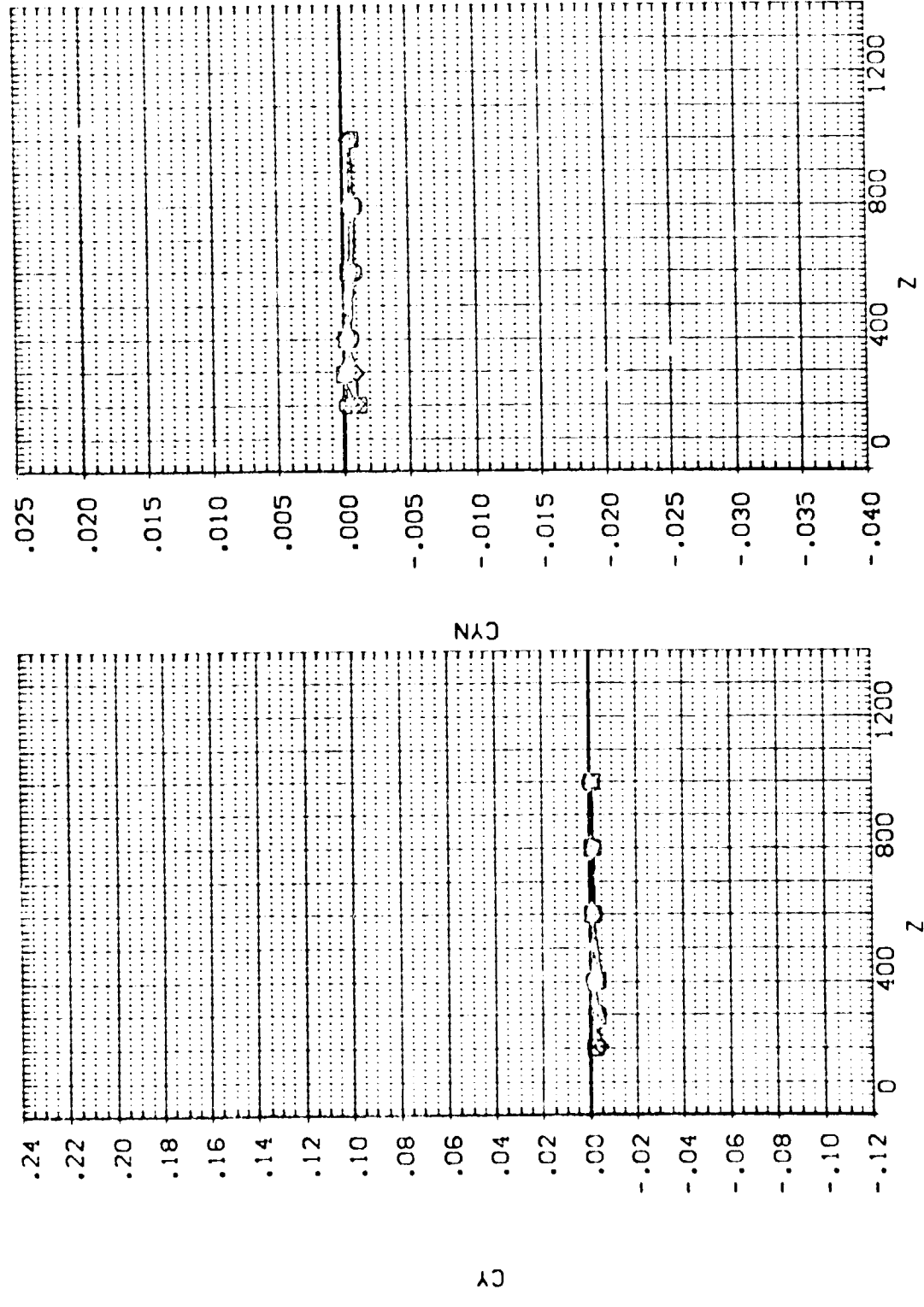

EXTERNAL TANK AERODYNAMIC CHARACTERISTICS DURING SEPARATION FROM ORBITER

1A13, EXTERNAL TANK(110)SEPARATING FROM ORB. 09 (RTJ150)

SEE THE ASSOCIATED DATA DOCUMENT FOR REFERENCE CHARACTERISTICS FOR INDIVIDUAL DATASETS

SYMBOL	X	MACH	PARAMETRIC VALUES
○	.174	4.520	P/DOTAL 80.000
◇	400.460	ALPHA -21.000	BETA .000
△	800.230	DELTA -9.000	DBETA .000
	1200.600	ELEVTR .000	AILRON .000
		Y .000	

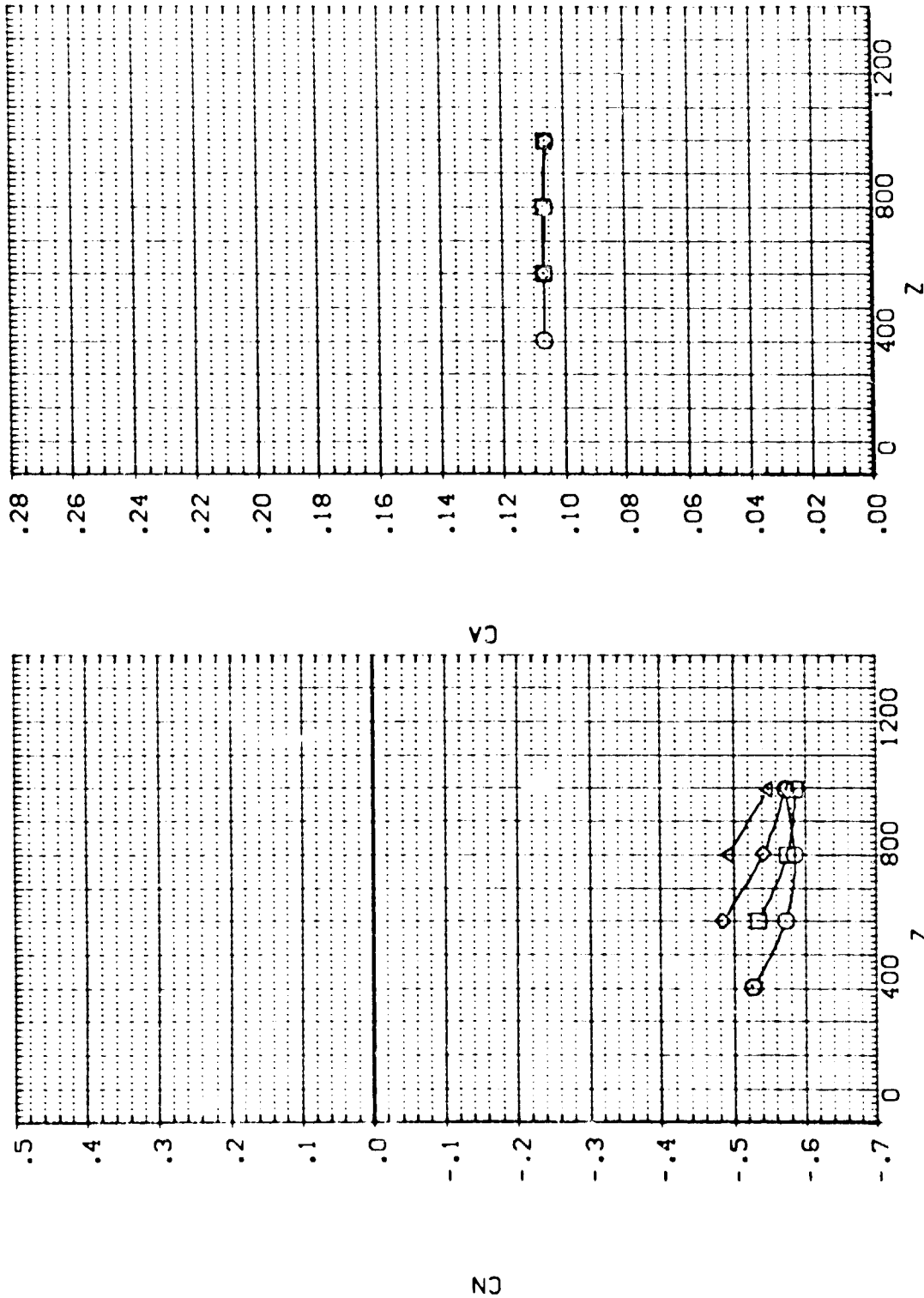

EXTERNAL TANK AERODYNAMIC CHARACTERISTICS DURING SEPARATION FROM ORBITER

EXTERNAL TANK AERODYNAMIC CHARACTERISTICS DURING SEPARATION FROM ORBIT (RT-7500)

SEE THE ASSOCIATED DATA DOCUMENT FOR REFERENCE CHARACTERISTICS FOR INDIVIDUAL ORBITS

PARAMETRIC VALUES	
MACH	4.520
ALPHA	-21.000
BETA	.000
DELTA	-9.000
ELEVTR	.000
Y	.000

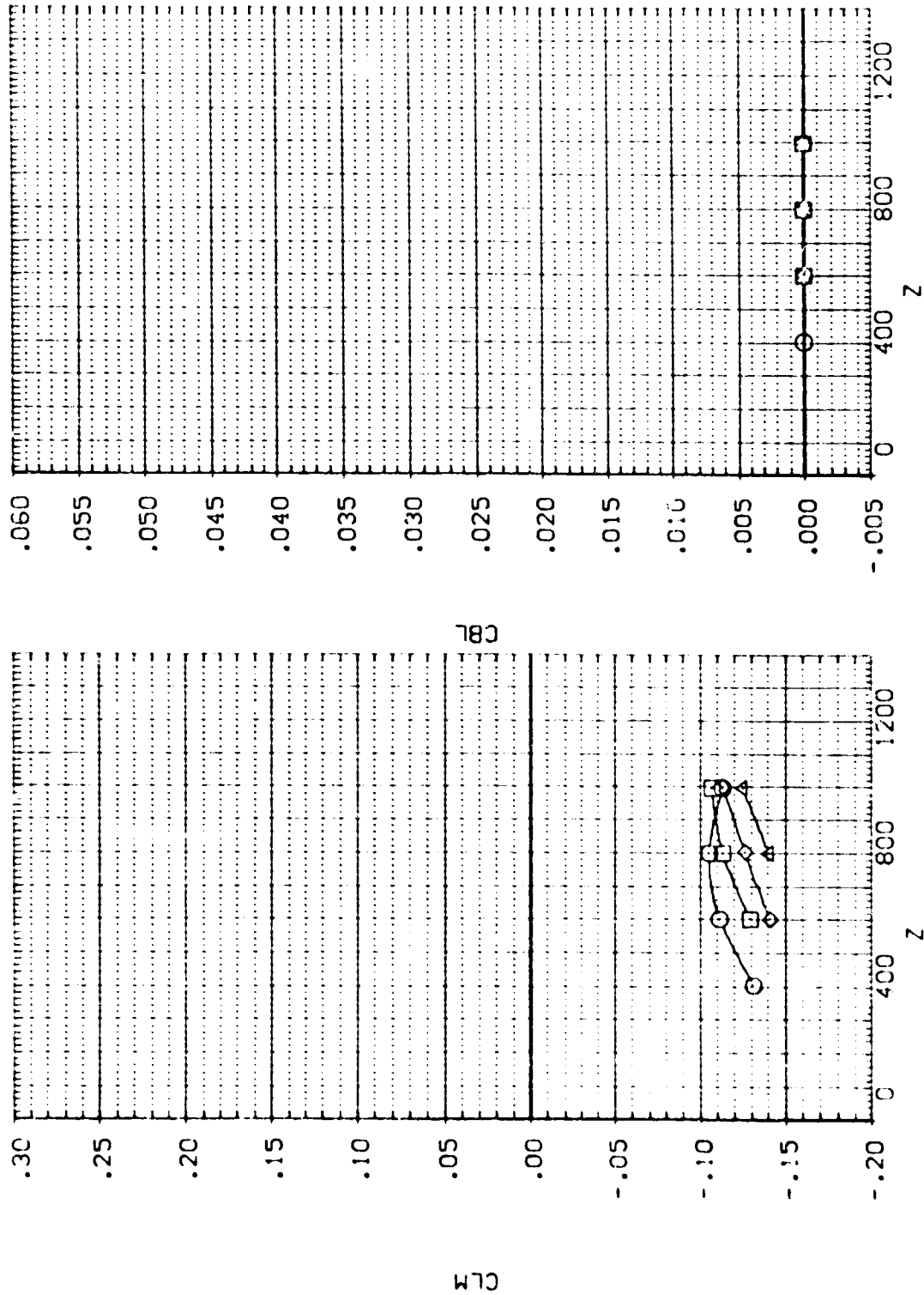

EXTERNAL TANK AERODYNAMIC CHARACTERISTICS DURING SEPARATION FROM ORBIT

1:13, EXTERNAL TANK(10) SEPARATING FROM ORB. C9 (RTJ 50)

SYMBOL

-
-
- ◇
- △

PARAMETRIC VALUES

X	.174	MACH	4.520	P TOTAL	60.000
400.460	ALPHA	-21.000	ETA	.000	
800.230	DALPHA	-9.000	DBETA	.000	
1200.600	ELEVTR	.000	ATLRON	.000	
	Y	.000			

SEE THE ASSOCIATED DATA DOCUMENT FOR REFERENCE CHARACTERISTICS FOR INDIVIDUAL DATA SETS

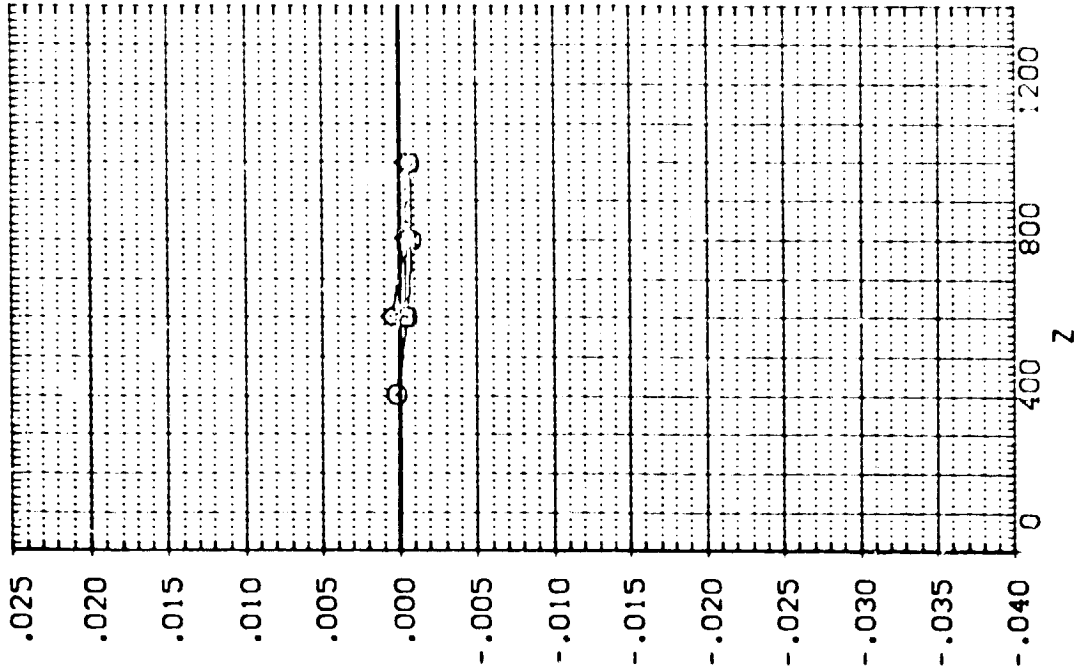
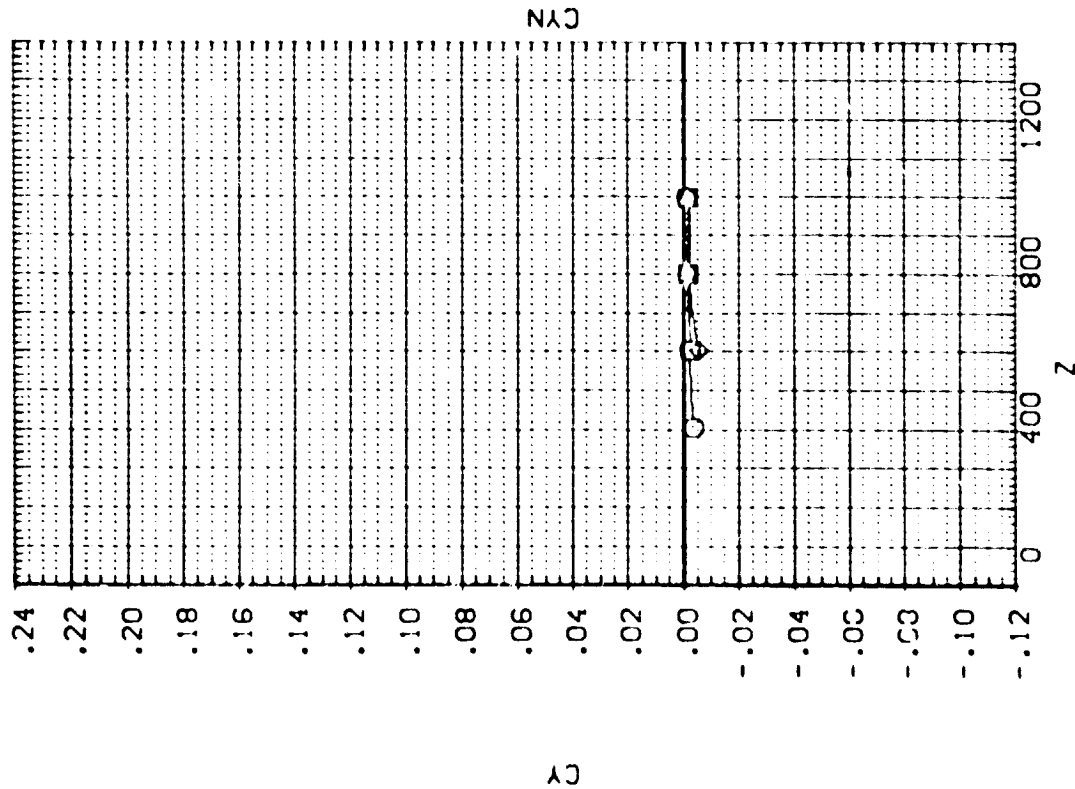

EXTERNAL TANK AERODYNAMIC CHARACTERISTICS DURING SEPARATION FROM ORBITER

EXTERNAL TANK AERODYNAMIC CHARACTERISTICS DURING SEPARATION FROM ORB. CG (RT) 010

SEE THE ASSOCIATED DATA DOCUMENT FOR REFERENCE CHARACTERISTICS FOR INDIVIDUAL DATA SETS

SYMBOL		PARAMETRIC VALUES	
x	.099	MACH	4.520
y		ALPHA	-21.000
z		BETA	.000
		DELTA	-19.000
		ELEVTR	.000
		ATLRON	.000
		PTOTAL	80.000

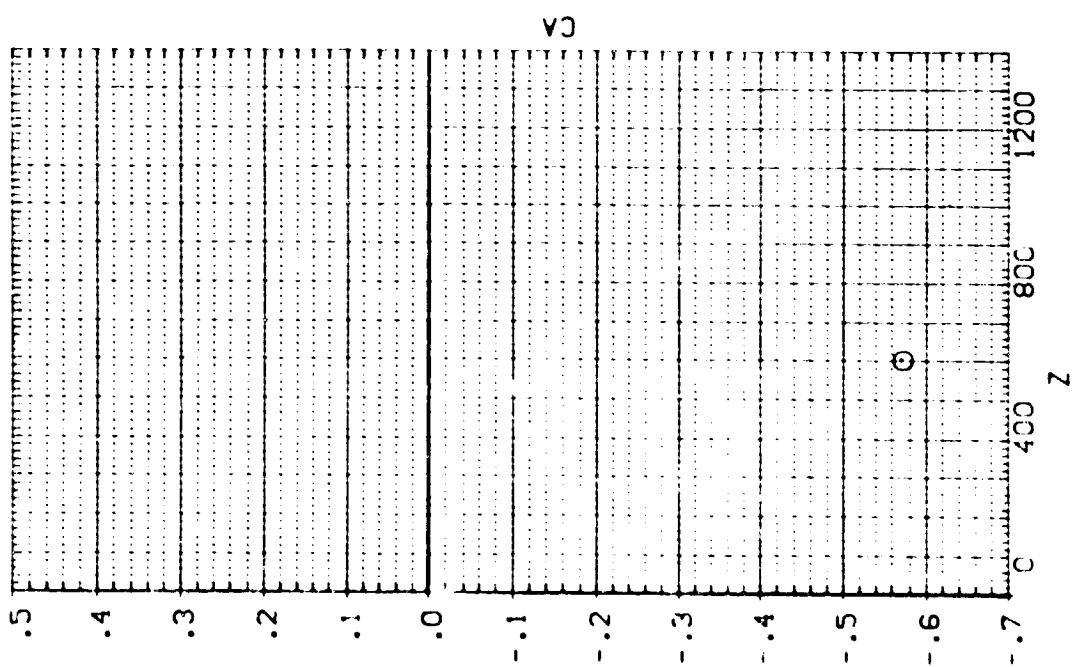
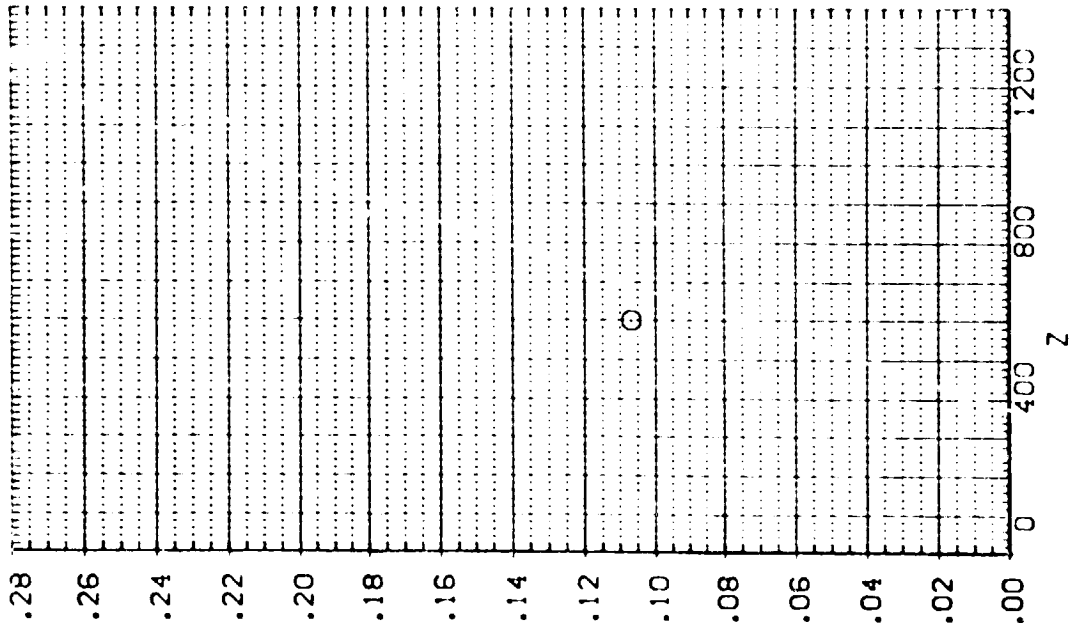

3

INTERNAL TANK(10)SEPARATING FROM ORB. 09 (RTJ51)

SYMBOL



PARAMETRIC VALUES	
MACH	4.520
ALPHA	-21.000
ELEVTR	.000
Y	.000
POTIAL	80.000
BETA	.000
CBETA	.000
ALRON	.000

SEE THE ASSOCIATED DATA DOCUMENT FOR REFERENCE CHARACTERISTICS FOR INDIVIDUAL CASES

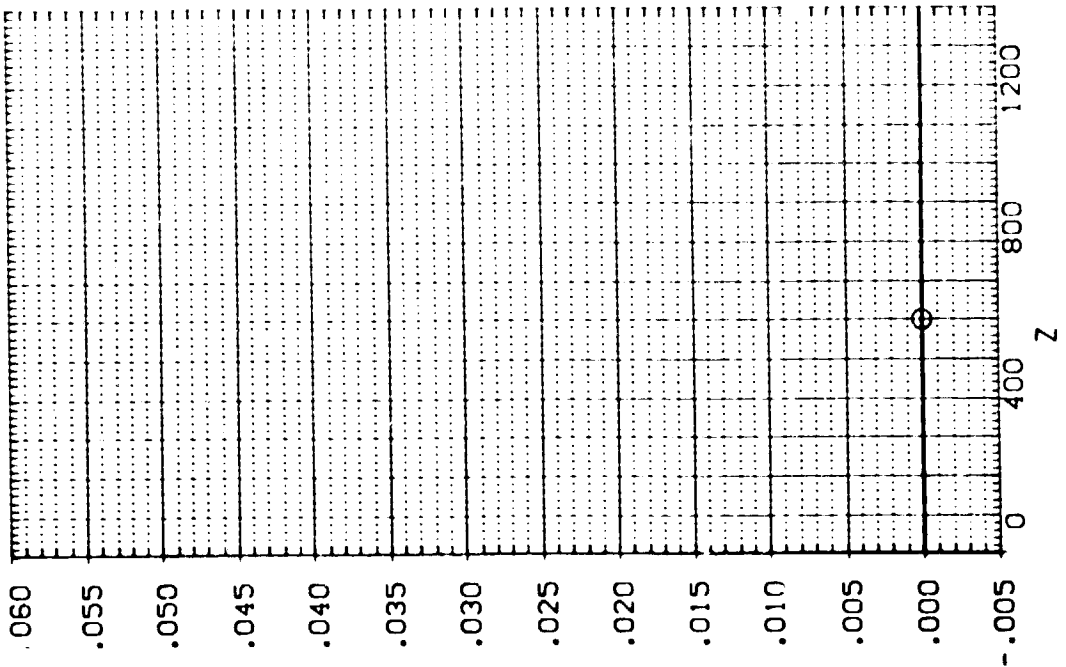
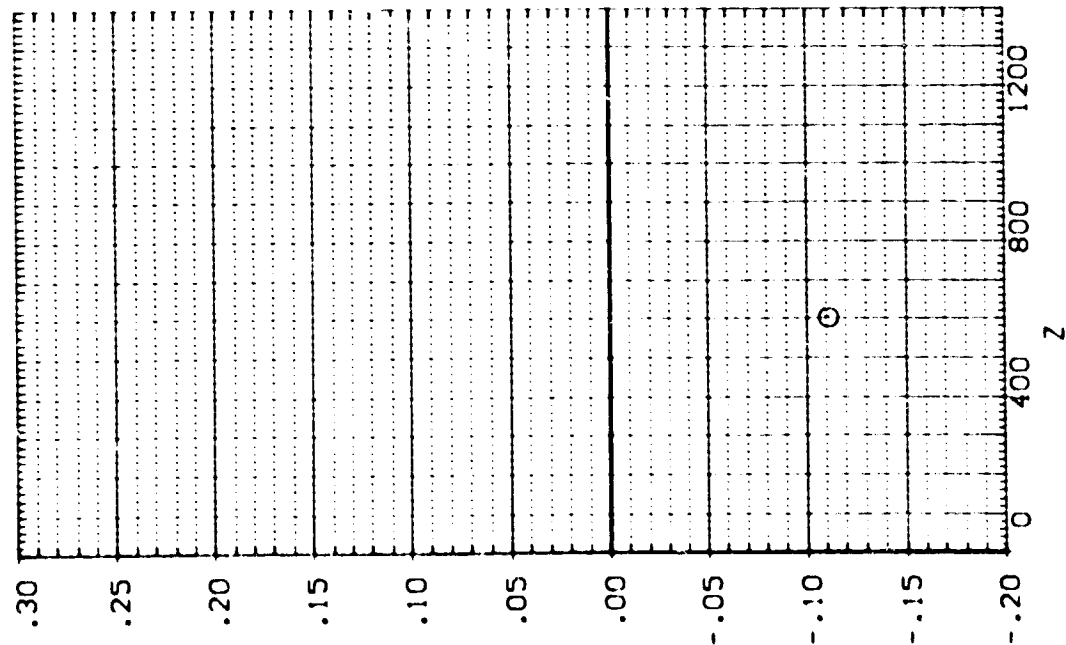

CL

183

EXTERNAL TANK AERODYNAMIC CHARACTERISTICS DURING SEPARATION FROM ORBITER

1A13: EXTERNAL TANK(T10)SEPARATING FROM ORB. 09 (RTJTS1)

SEE THE ASSOCIATED DATA DOCUMENT FOR REFERENCE CHARACTERISTICS FOR INDIVIDUAL DATA SETS

PARAMETRIC VALUES
 MACH 4.520 P*DTAL 80.000
 ALPHA -21.000 BETA .000
 D*ALPHA -19.000 D*BETA .000
 FLEVTR .000 AILRON .000
 V .000

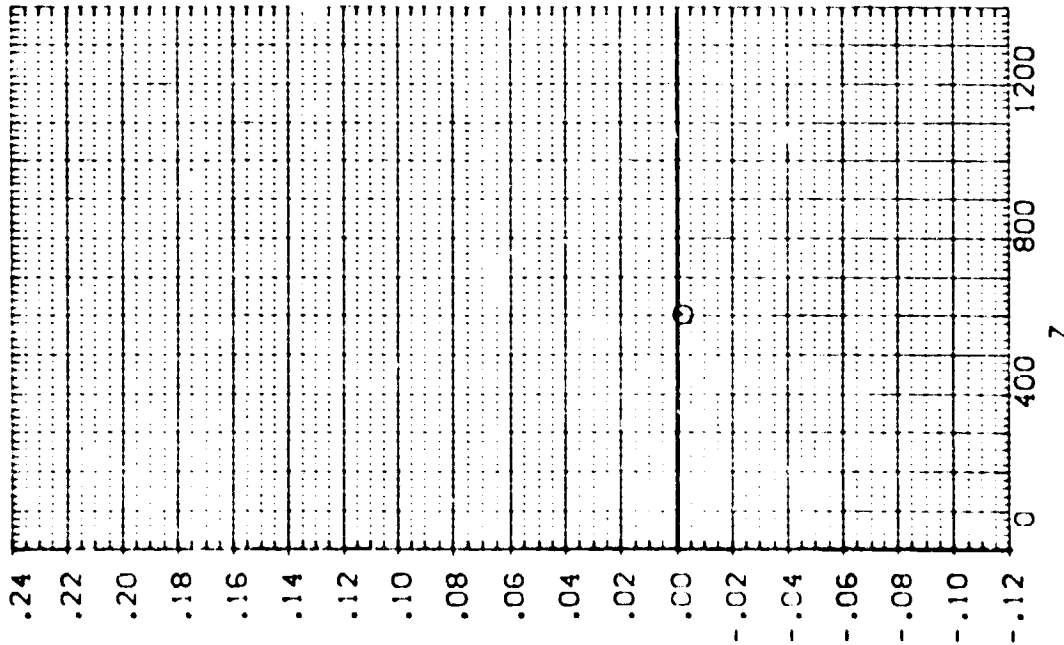
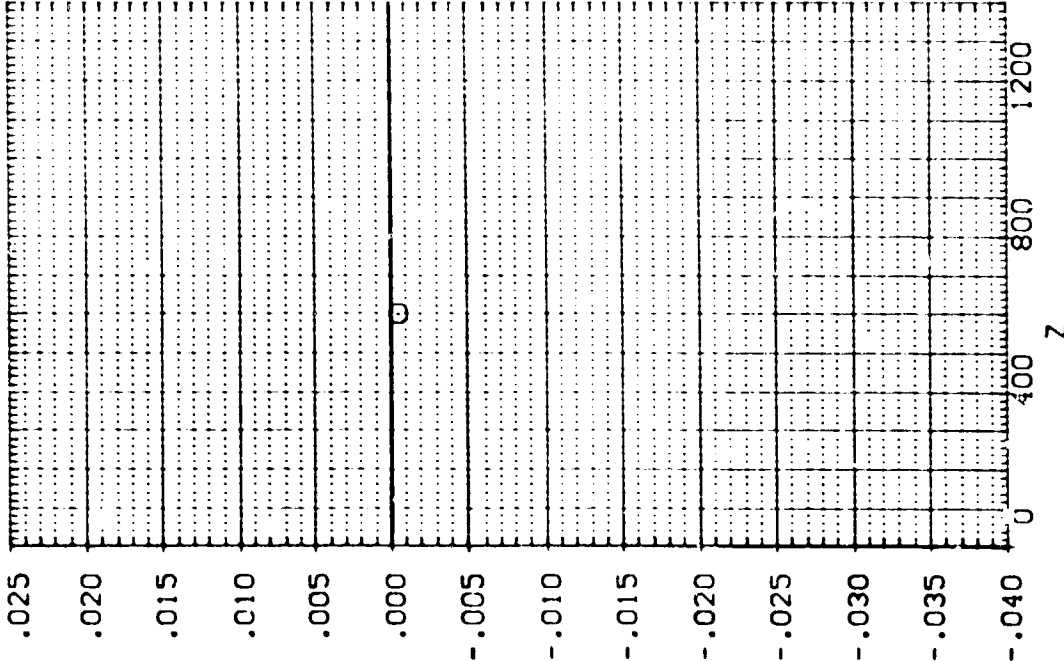

EXTERNAL TANK AERODYNAMIC CHARACTERISTICS DURING SEPARATION FROM ORBITER

TA13, EXTERNAL TANK(T10) SEPARATING FROM ORB. 09 (RIJTS2)

SYMBOL
○

	PARAMETRIC VALUES		
MACH	4.530	P/C TAL	110.000
ALPHA	.000	BETA	.000
DALPHA	.000	DBETA	.000
ELEVTR	.000	AILRON	10.000
Y	-200.000		

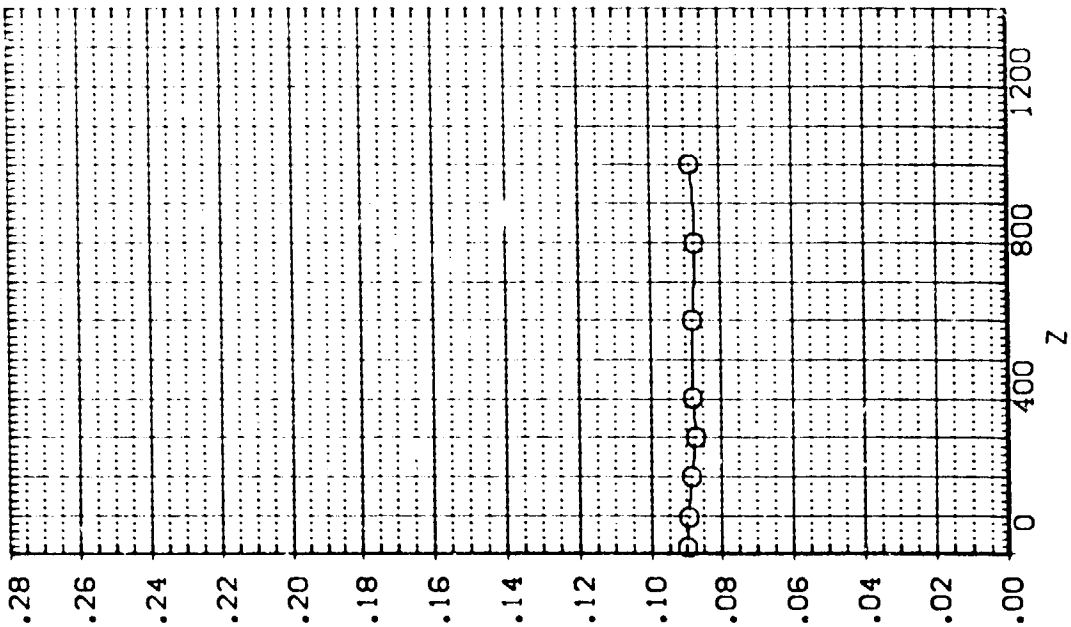
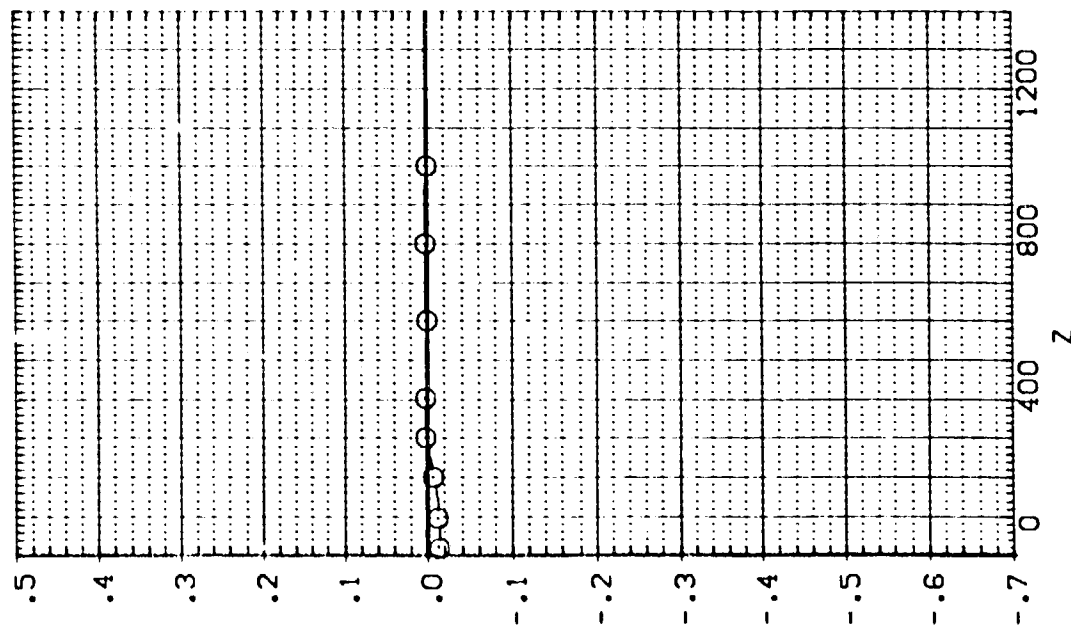

SEE THE ASSOCIATED DATA DOCUMENT FOR REFERENCE CHARACTERISTICS FOR INDIVIDUAL DATASETS

TA13, EXTERNAL TANK(10)SEPARATING FROM ORB. 09 (RTJTS2)

SEE THE ASSOCIATED DATA DOCUMENT FOR REFERENCE CHARACTERISTICS FOR INDIVIDUAL DATASETS

SYMBOL		PARAMETRIC VALUES	
○	X	MACH	4.530
		ALPHA	.000
		DBETA	.000
		ELEV	.000
		ATURN	10.000
		Y	-200.000
		POTAL	110.000
		BETA	.000
		DBETA	.000
		ATURN	10.000

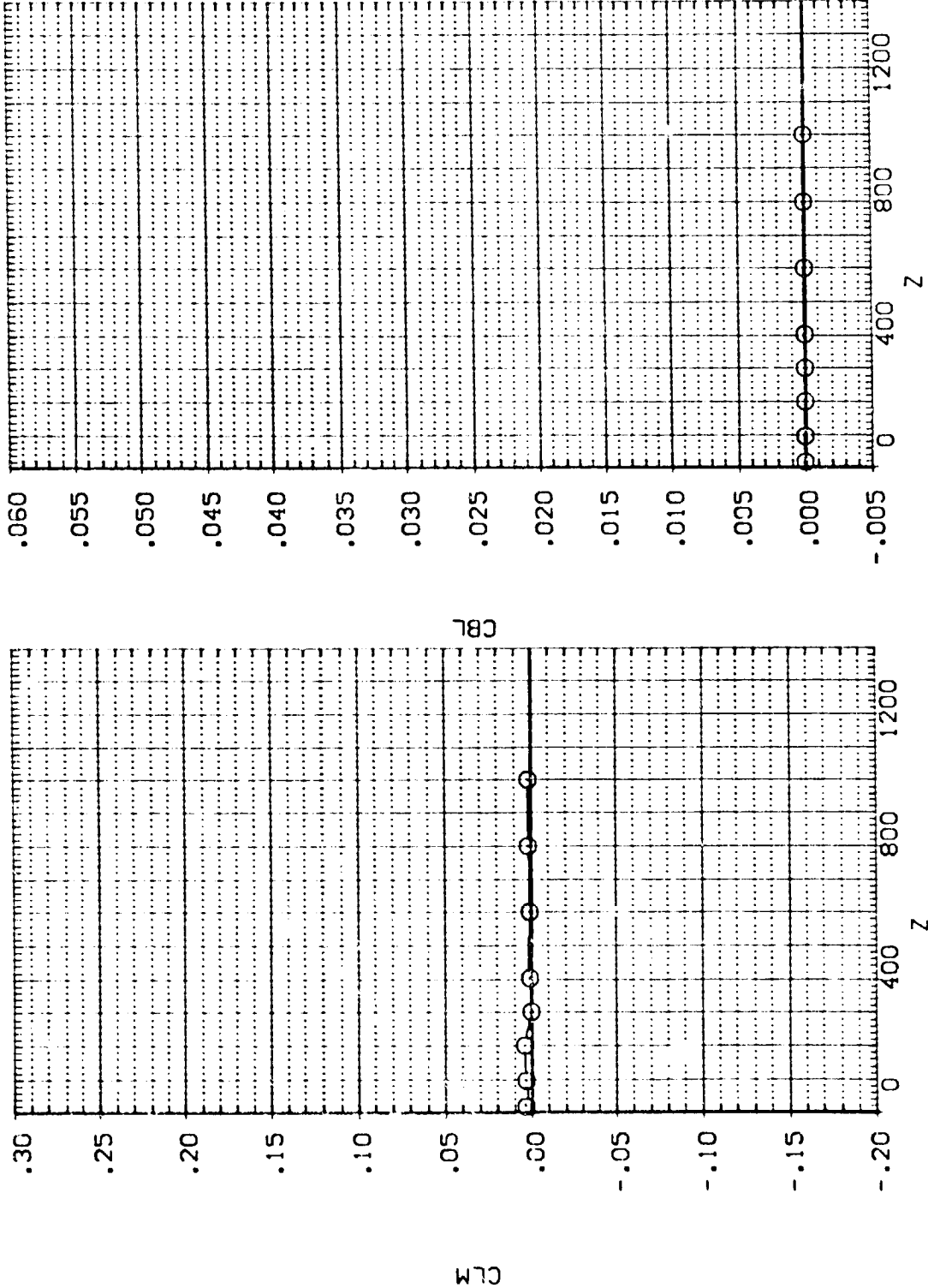

1A13. EXTERNAL TANK(T10)SEPARATING FROM ORB. 09 (RTJ152)

SYMBOL
○

PARAMETRIC VALUES	
MACH	4.530
PTOTAL	110.000
ALPHA	.000
BETA	.030
DBETA	.030
ELEVTR	.000
ATLRON	10.000
Y	-200.000

SEE THE ASSOCIATED DATA DOCUMENT FOR REFERENCE CHARACTERISTICS FOR INDIVIDUAL DATASETS

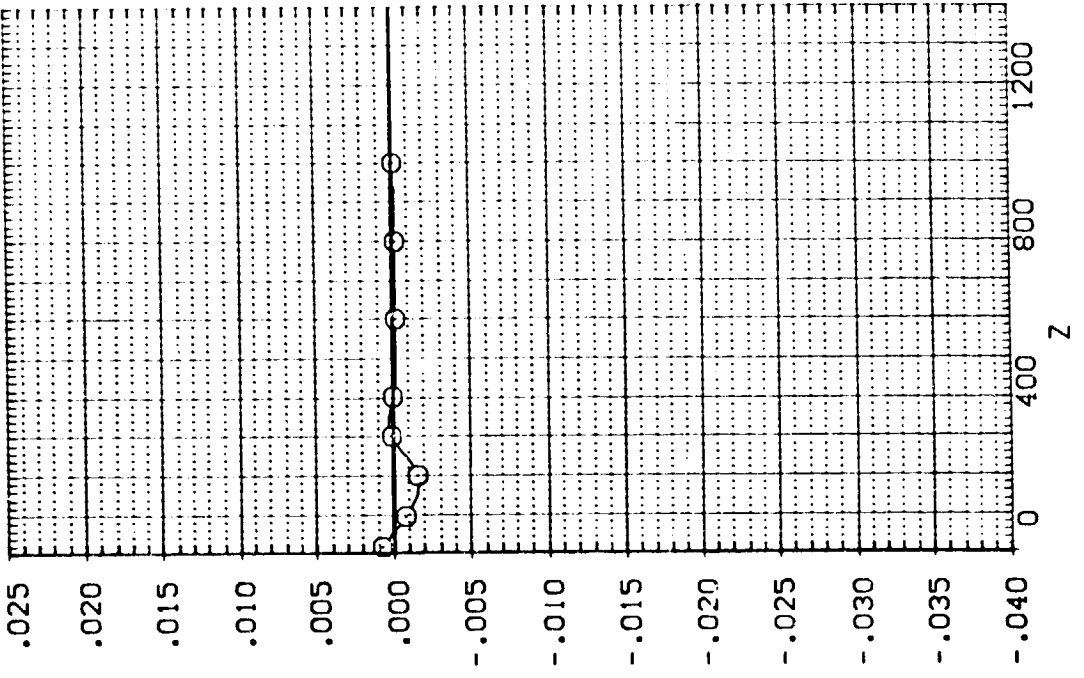
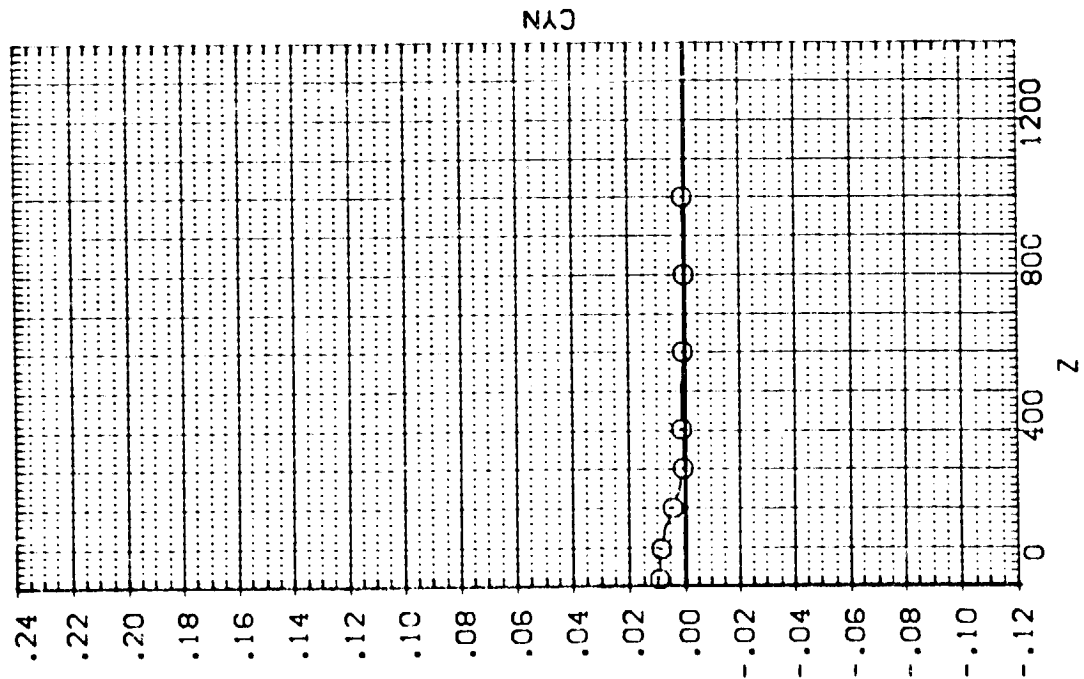

EXTERNAL TANK AERODYNAMIC CHARACTERISTICS DURING SEPARATION FROM ORBITER

1A13.EXTERNAL TANK(10)SEPARATING FROM ORB. 09 (RTJ153)

SEE THE ASSOCIATED DATA DOCUMENT FOR REFERENCE CHARACTERISTICS FOR INDIVIDUAL DATASETS

SYMBOL		PARAMETRIC VALUES	
X	.136	MACH	4.530
Y		ALPHA	.000
Z		DBETA	.000
		ELEVTR	.000
		AILRON	10.000
		PICOTL	110.000
		BETA	.000
		DBETA	.000
		AILRON	10.000
		Y	.000

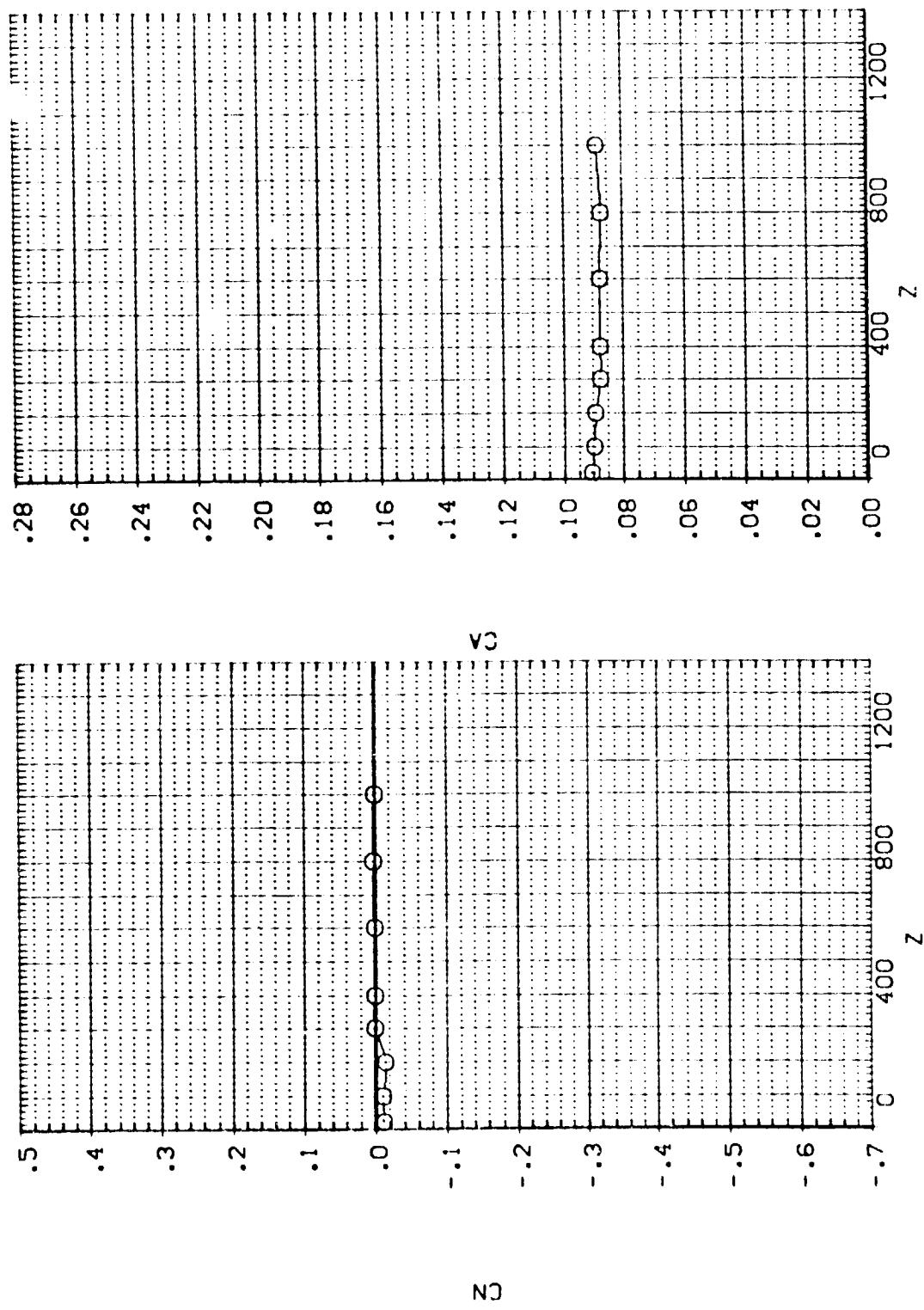

EXTERNAL TANK AERODYNAMIC CHARACTERISTICS DURING SEPARATION FROM ORBITER

1A13.EXTERNAL TANK(T10)SEPARATING FROM ORB. 09 (RTJ153)

SYMBOL x
○

PARAMETRIC VALUES	
MACH	4.530
PTOTAL	110.000
ALPHA	.000
BETA	.000
DBETA	.000
ELEVTR	.000
AILRON	10.000
Y	.000

SEE THE ASSOCIATED DATA DOCUMENT FOR REFERENCE CHARACTERISTICS FOR INDIVIDUAL DATASETS

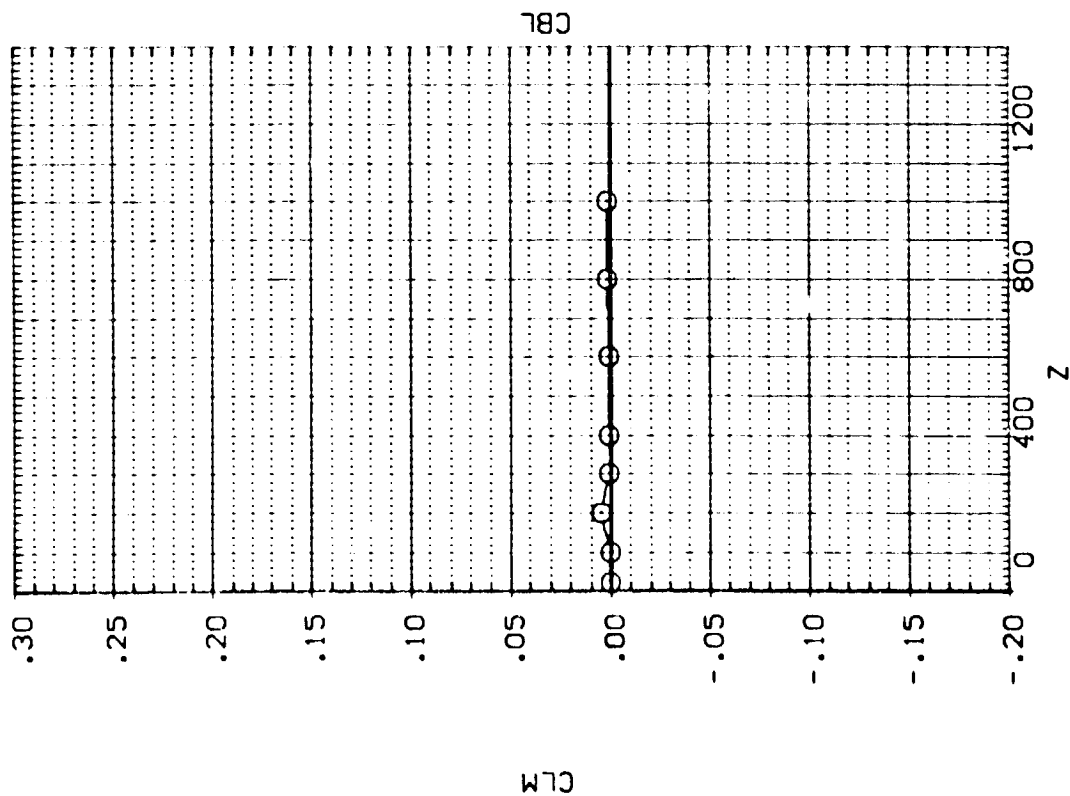

CLM

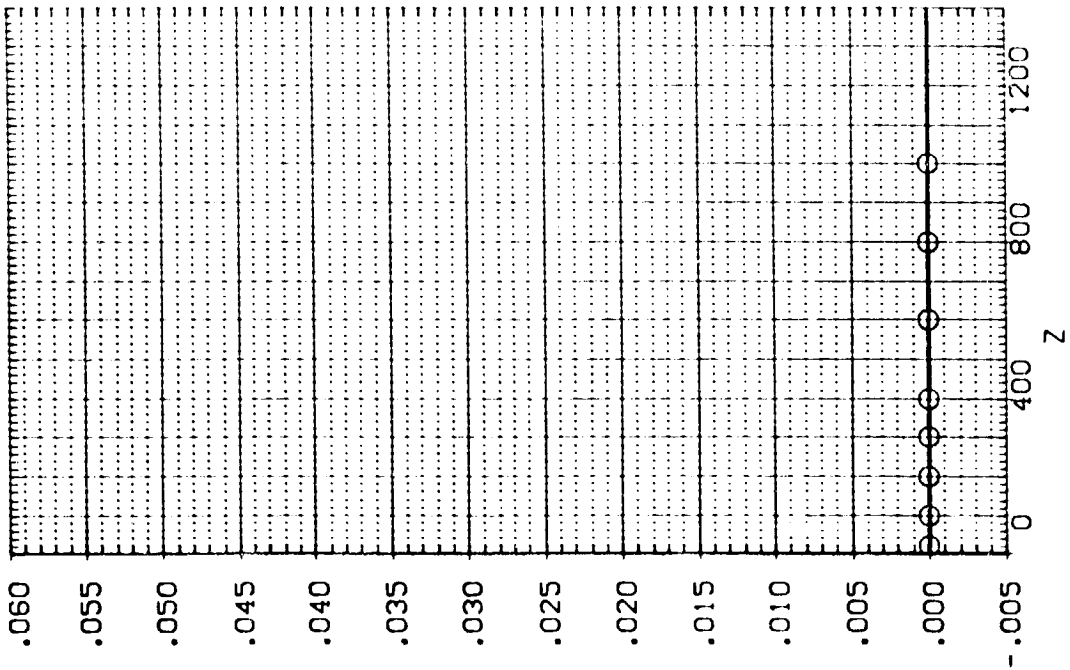

EXTERNAL TANK AERODYNAMIC CHARACTERISTICS DURING SEPARATION FROM ORBITER

1:1:3.EXTERNAL TANK(T:1)SEPARATING FROM ORB. 09 (RIJT53)

SEE THE ASSOCIATED DATA DOCUMENT FOR REFERENCE CHARACTERISTICS FOR INDIVIDUAL DATASETS

SYMBOL		PARAMETRIC VALUES	
x	.136	MACH	4.530
o		PIOTAL	110.000
		ALPHA	.000
		BETA	.000
		DALPHA	.000
		DBETA	.000
		ELEVTR	.000
		Y	10.000
		ATURCN	10.000
			.000

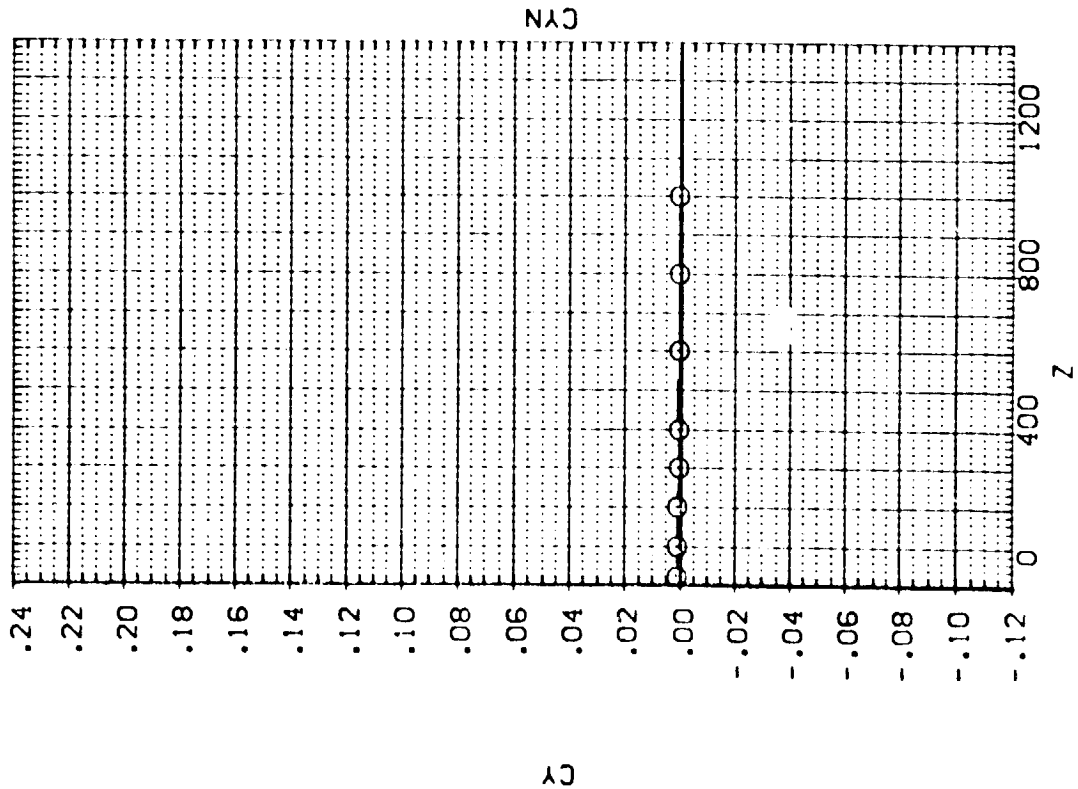
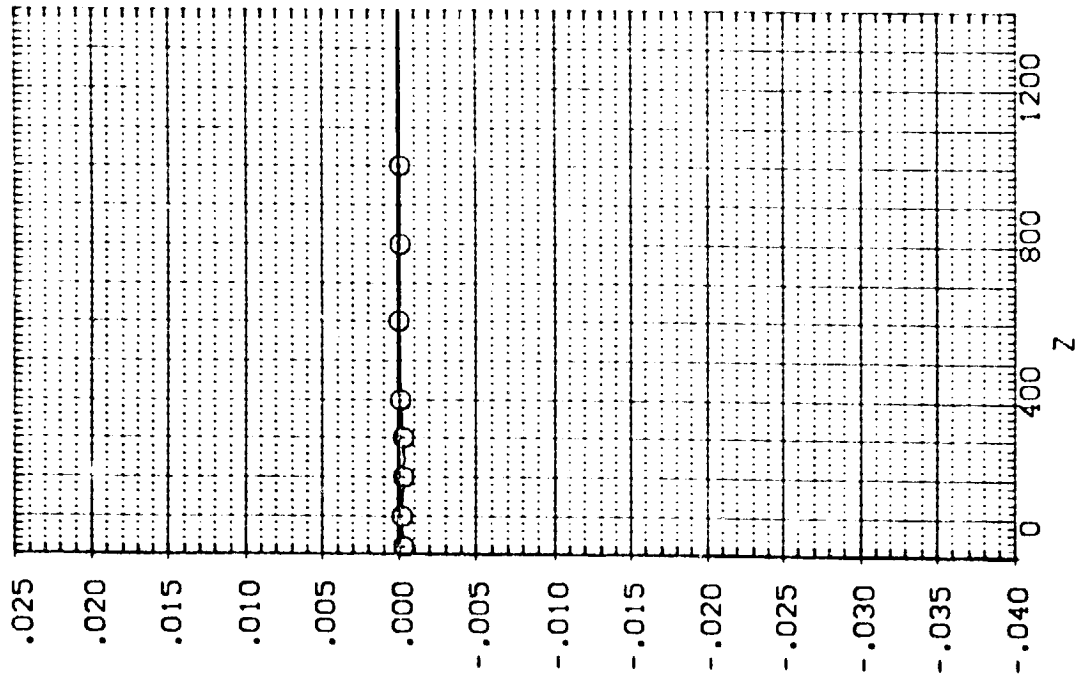

EXTERNAL TANK AERODYNAMIC CHARACTERISTICS DURING SEPARATION FROM ORBITER

1A13-EXTERNAL TANK(110)SEPARATING FROM ORB. 09 (RTJT54)

SEE THE ASSOCIATED DATA DOCUMENT FOR REFERENCE CHARACTERISTICS FOR INDIVIDUAL DATASETS

SYMBOL C

PARAMETRIC VALUES	
MACH	4.530
ALPHA	.000
BETA	.000
DBETA	.000
ELEVTR	.000
AILRON	10.000
Y	200.000
POTIAL	110.000

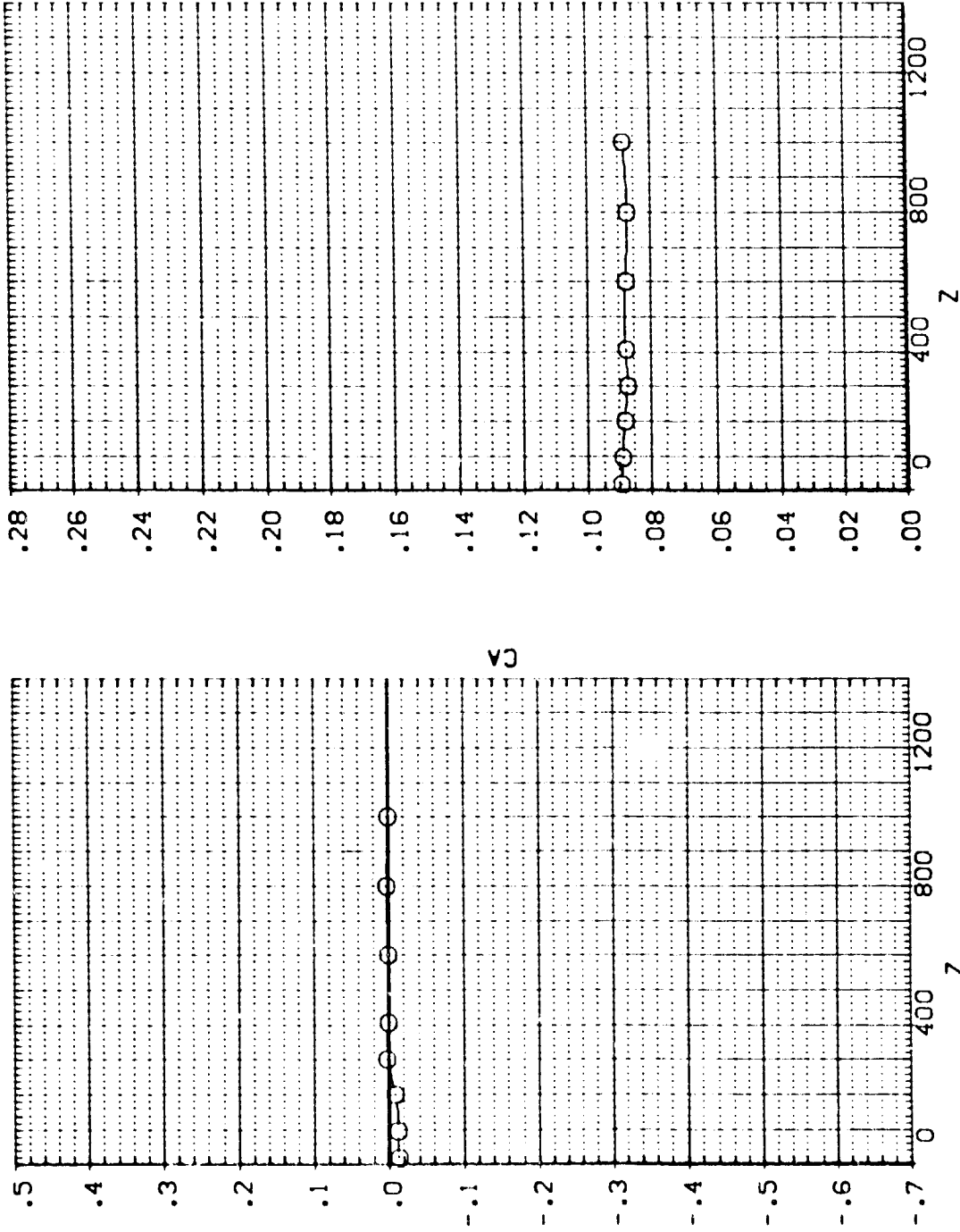

EXTERNAL TANK AERODYNAMIC CHARACTERISTICS DURING SEPARATION FROM ORBITER

FIG. 13. EXTERNAL TANK(1) SEPARATING FROM ORB. 09 (RTJ154)

SEE THE ASSOCIATED DATA DOCUMENT FOR REFERENCE CHARACTERISTICS FOR INDIVIDUAL DATASETS

PARAMETRIC VALUES
 MACH 4.530 PTOTAL 110.000
 ALPHA .000 BETA .000
 DALPHA .000 DBETA .030
 ELEVTX .000 AILTRN 10.000
 Y 200.000

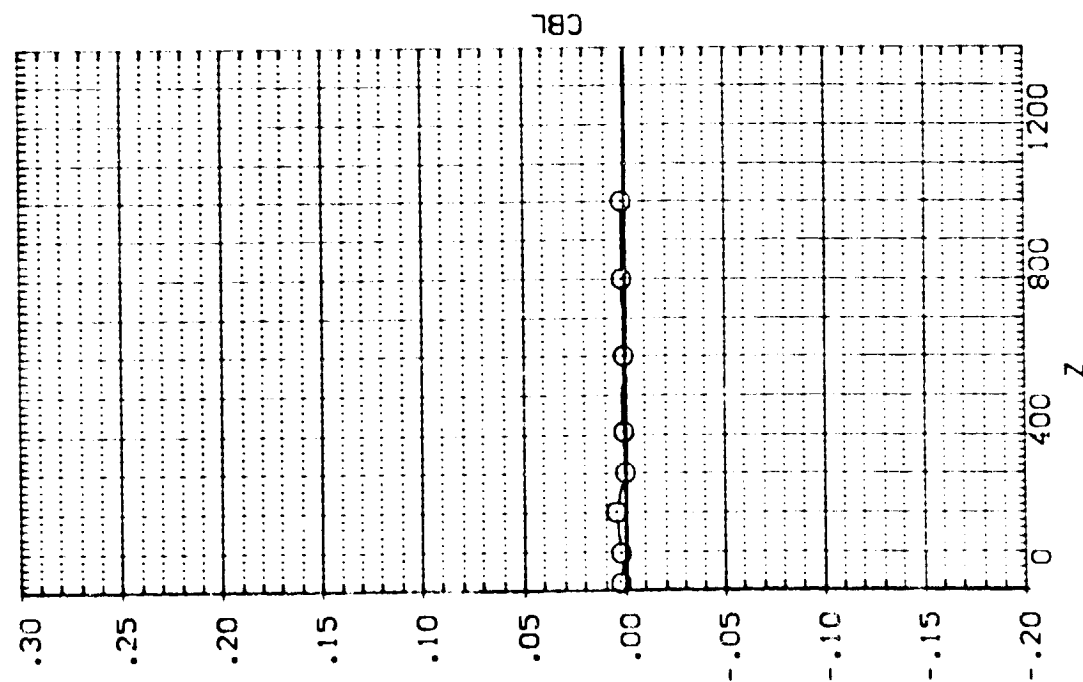
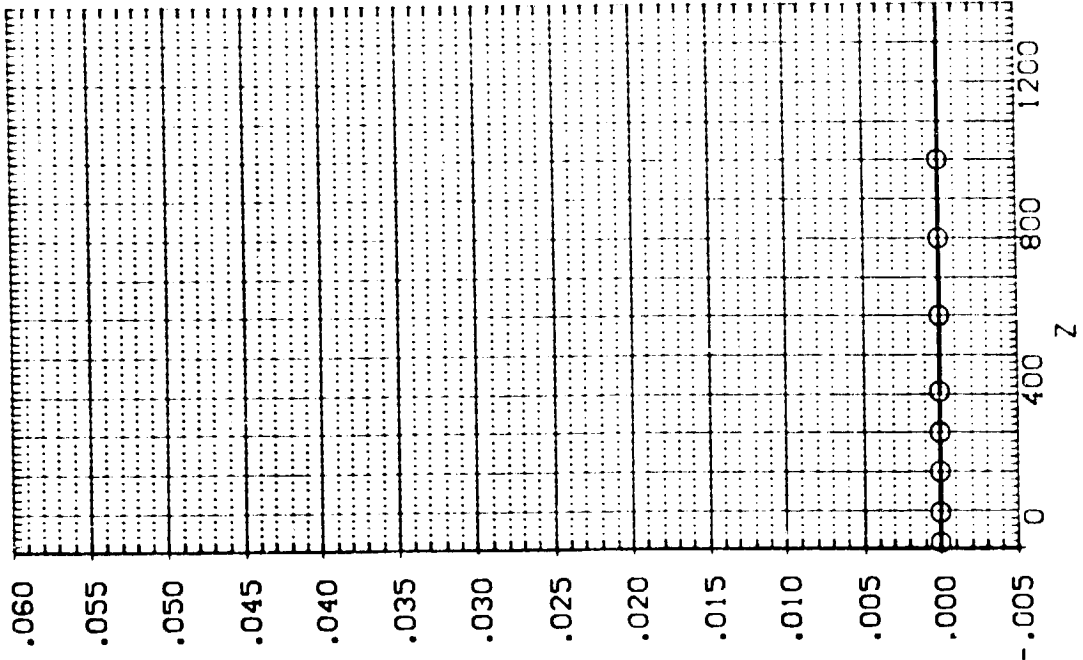

EXTERNAL TANK AERODYNAMIC CHARACTERISTICS DURING SEPARATION FROM ORBITER

!A13.EXTERNAL TANK(T10)SEPARATING FROM ORB. 09 (RTJT54)

SEE THE ASSOCIATED DATA DOCUMENT FOR REFERENCE CHARACTERISTICS FOR INDIVIDUAL DATASETS

PARAMETRIC VALUES
 MACH 4.530 PTOTAL 110.000
 ALPHA .000 BETA .000
 CALPHA .000 SBETA .000
 ELEVTR .000 A1LRON 10.000
 Y 200.000

SYMBOL X .020

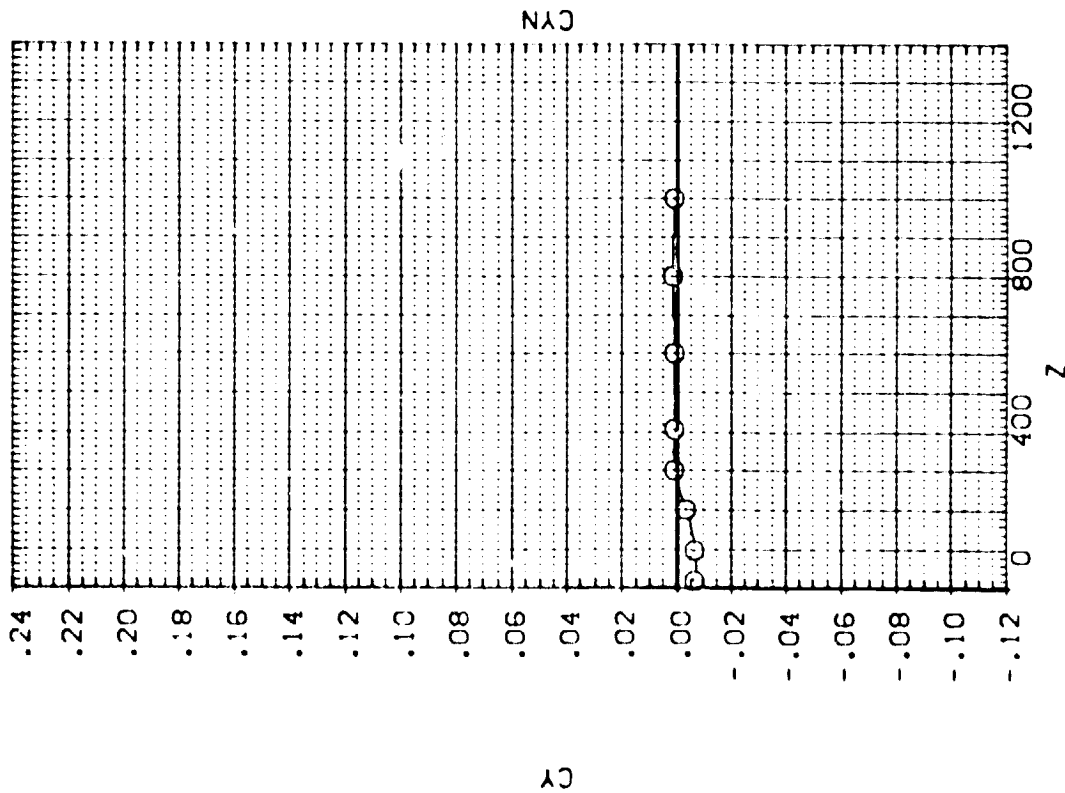
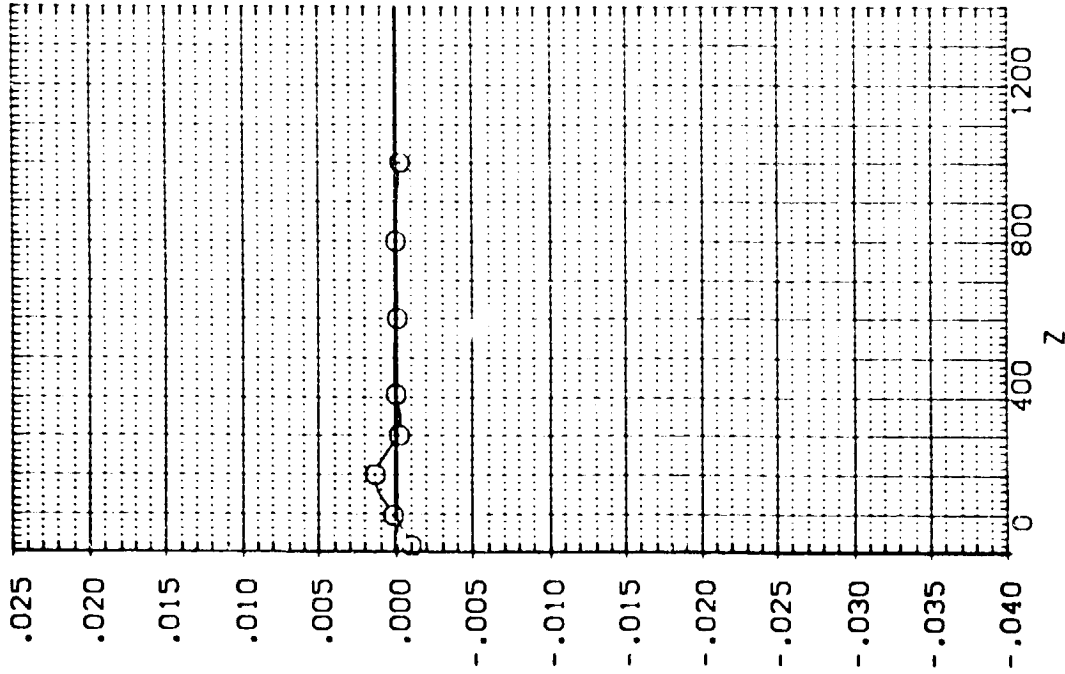

EXTERNAL TANK AERODYNAMIC CHARACTERISTICS DURING SEPARATION FROM ORBITER

SEE THE ASSOCIATED DATA DOCUMENT FOR REFERENCE CHARACTERISTICS FOR INDIVIDUAL DATASETS

0.05

PARAMETRIC VALUES
 MACH 4.530 PTOVAL 110.000
 ALPHA .000 BETA .000
 DALPHA .000 DBETA -5.000
 ELEVTX .000 ALLRON 10.000
 Y -200.000

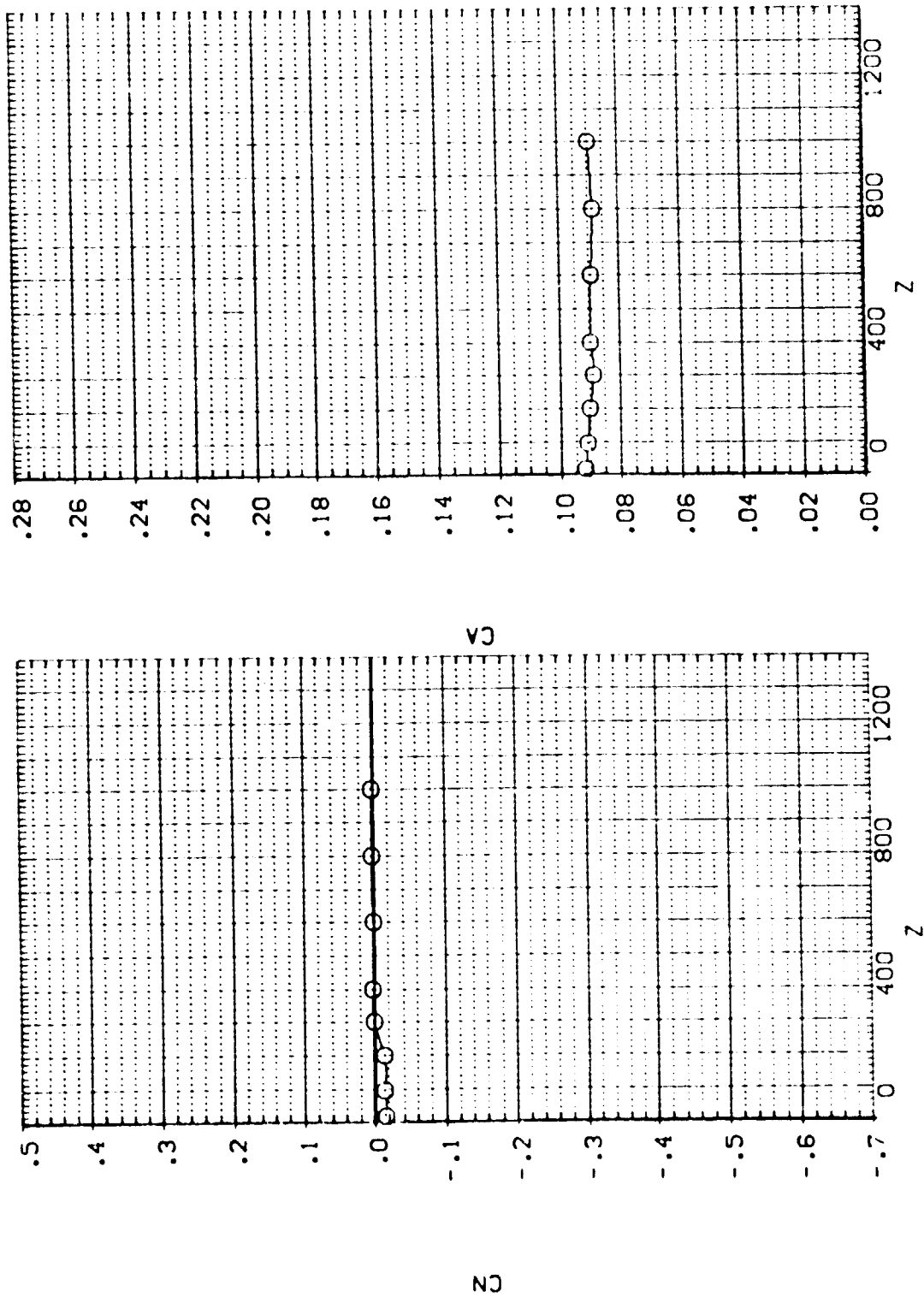

EXTERNAL TANK AERODYNAMIC CHARACTERISTICS DURING SEPARATION FROM ORBITER

1A13. EXTERNAL TANK(T10)SEPARATING FROM ORB. 09 (RTJ155)

SYMBOL x

PARAMETRIC VALUES

MACH	4.530	P/DYAL	110.000
ALPHA	.000	BETA	.000
CALPHA	.000	DBETA	-5.000
ELEVTR	.000	ALTRON	10.000
Y	-200.000		

SEE THE ASSOCIATED DATA DOCUMENT FOR REFERENCE CHARACTERISTICS FOR INDIVIDUAL DATA SETS

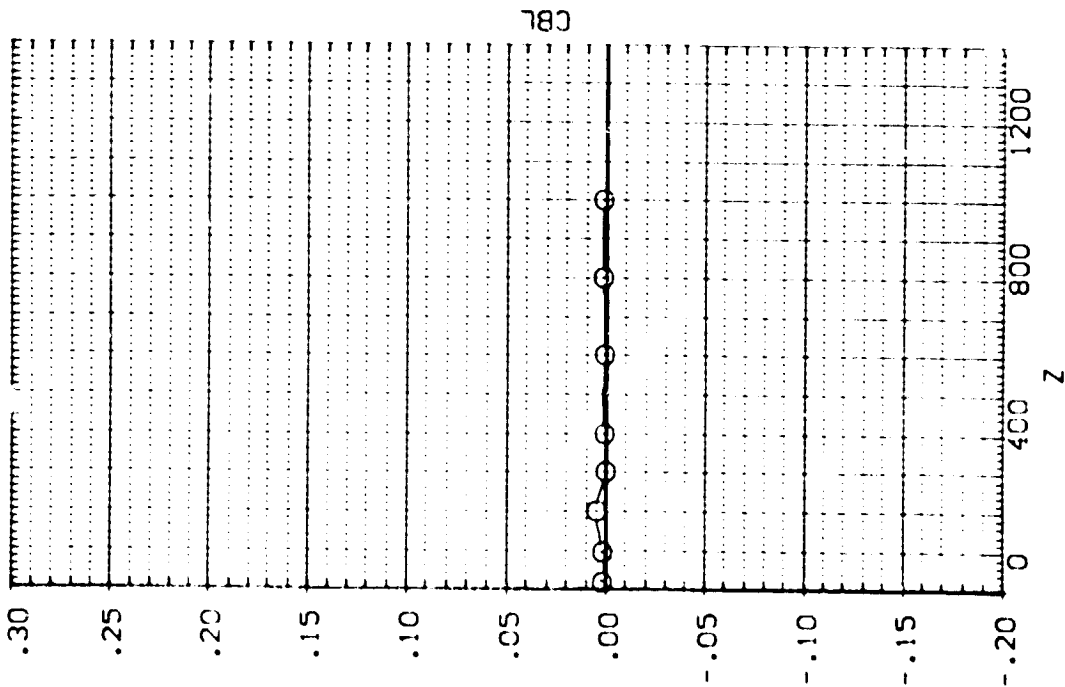
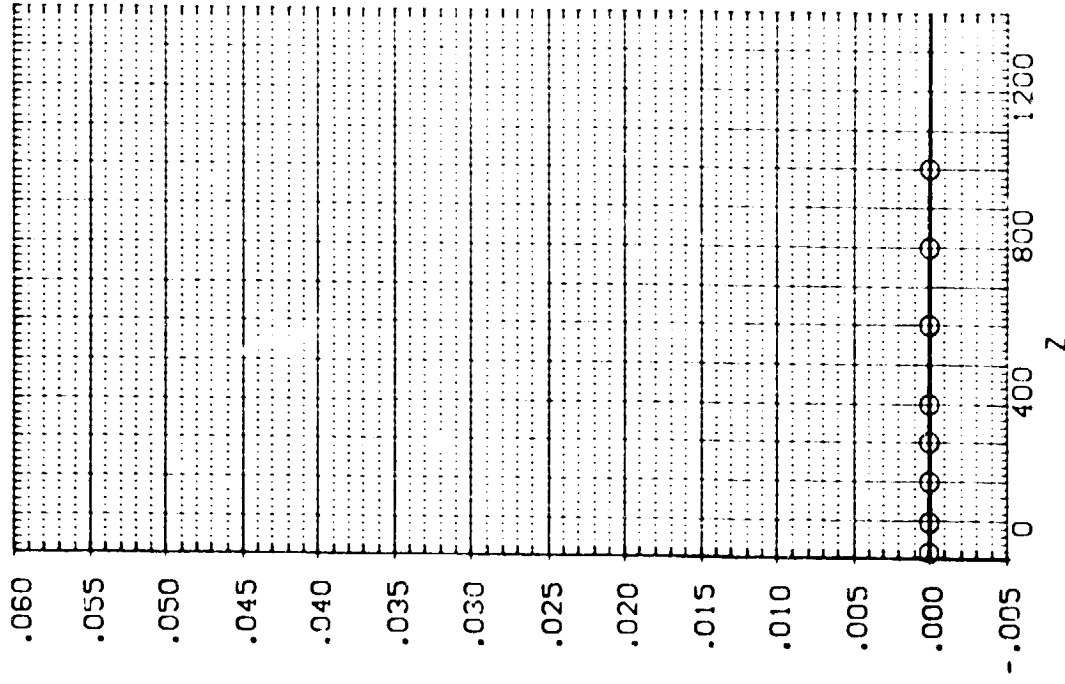

EXTERNAL TANK AERODYNAMIC CHARACTERISTICS DURING SEPARATION FROM ORBITER

:A13.EXTERNAL TANK(T1)SEPARATING FROM ORB. 09 (RTJTS5)

SEE THE ASSOCIATED DATA DOCUMENT FOR REFERENCE CHARACTERISTICS FOR INDIVIDUAL DATASETS

PARAMETRIC VALUES	
MACH	4.530
ALPHA	.000
DALPHA	.000
ELEVTR	.000
Y	-200.000
P TOTAL	110.000
BETA	.000
DBETA	-5.000
ALLPQN	10.000

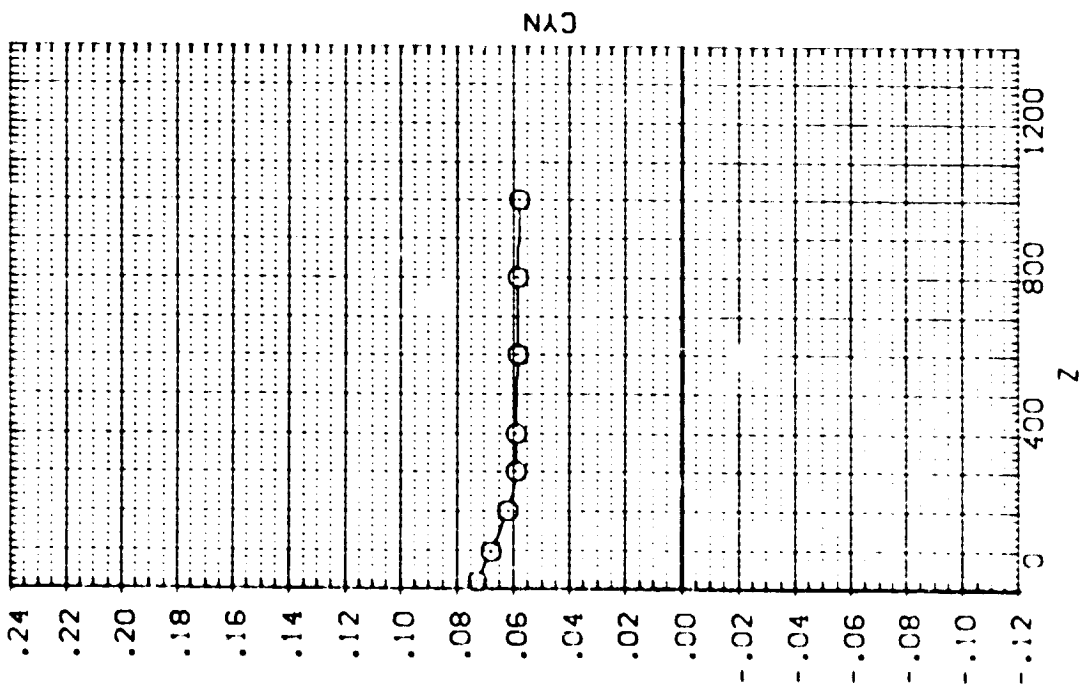
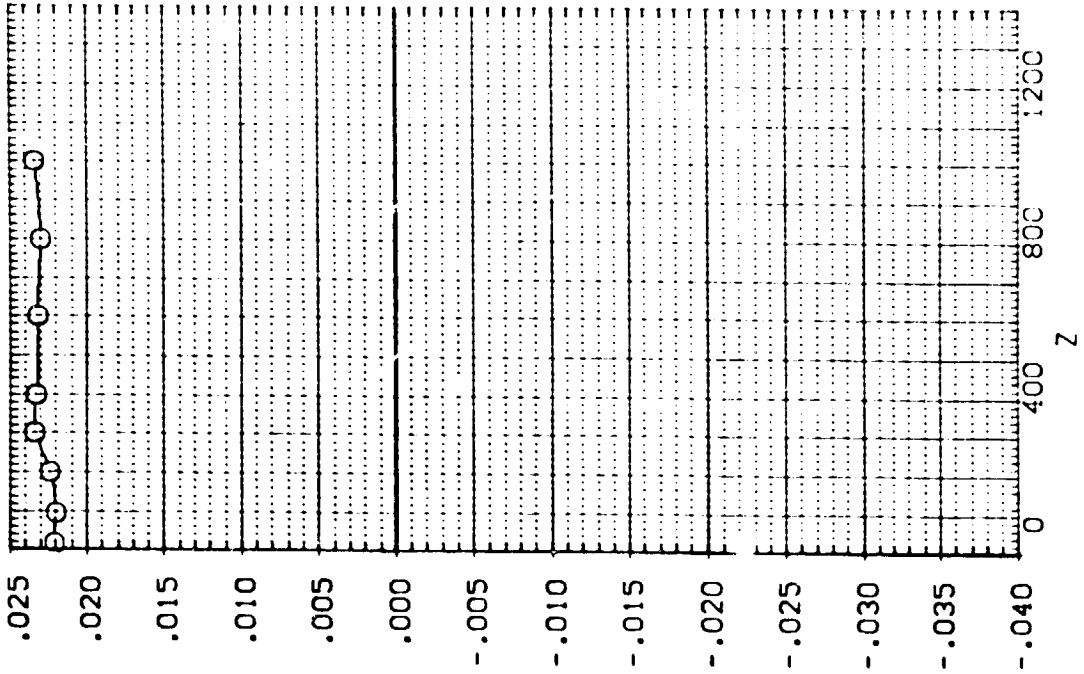

1:13, EXTERNAL TANK(110)SEPARATING FROM ORB. 09 (RIJT56)

Symbol

x

MACH

PARAMETRIC VALUES

4.530

PYOTAL

110.000

ALPHA

.000

BETA

.000

DALPHA

.000

DBETA

5.000

ELEVTR

.000

ALRON

10.000

Y

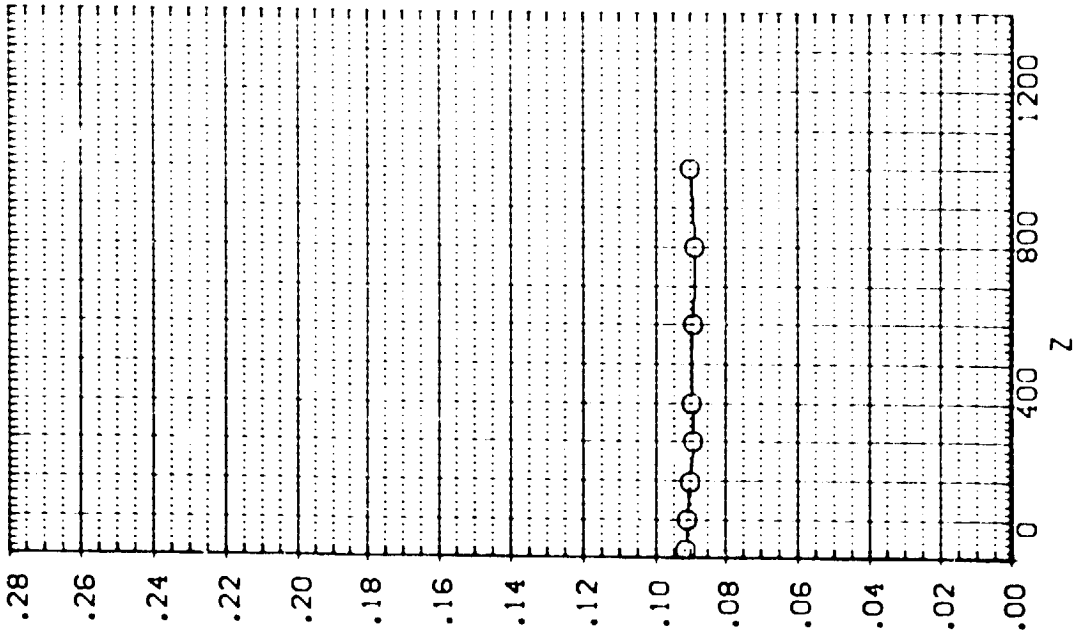
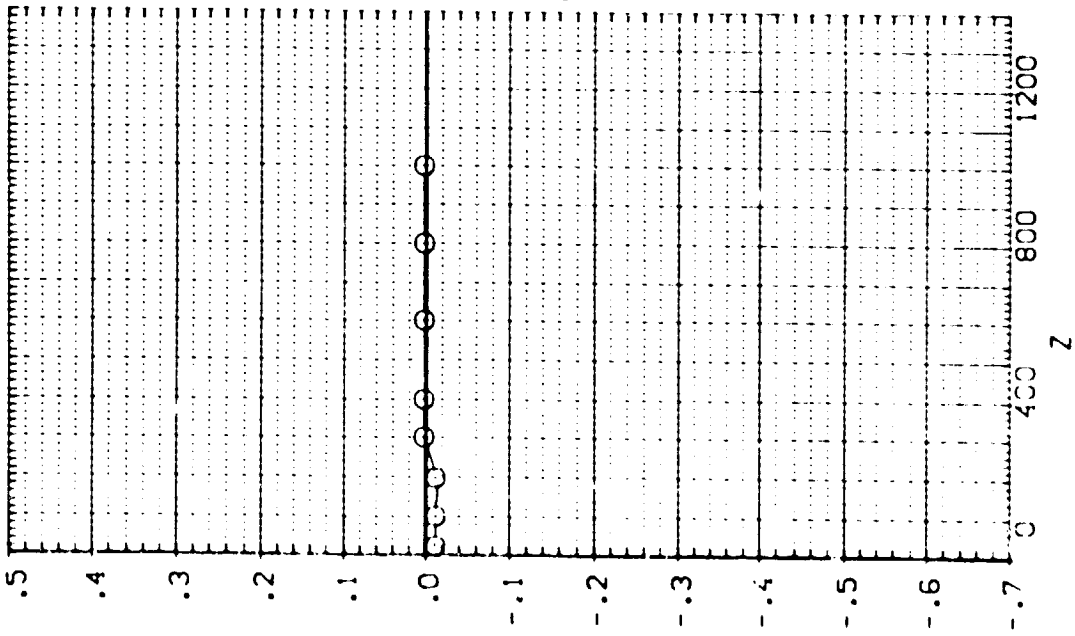

SEE THE ASSOCIATED DATA DOCUMENT FOR REFERENCE CHARACTERISTICS FOR INDIVIDUAL DATASETS

EXTERNAL TANK AERODYNAMIC CHARACTERISTICS DURING SEPARATION FROM ORBITER

1.1.3. EXTERNAL TANK(110) SEPARATING FROM ORB. 09 (RTJTS66)

SEE THE ASSOCIATED DATA DOCUMENT FOR REFERENCE CHARACTERISTICS FOR INDIVIDUAL DATASETS

SYMBOL		PARAMETRIC VALUES	
x	.106	MACH	4.530
		PTOTAL	110.000
		BETA	.000
		DBETA	5.000
		AIRTON	10.000
		Y	.000

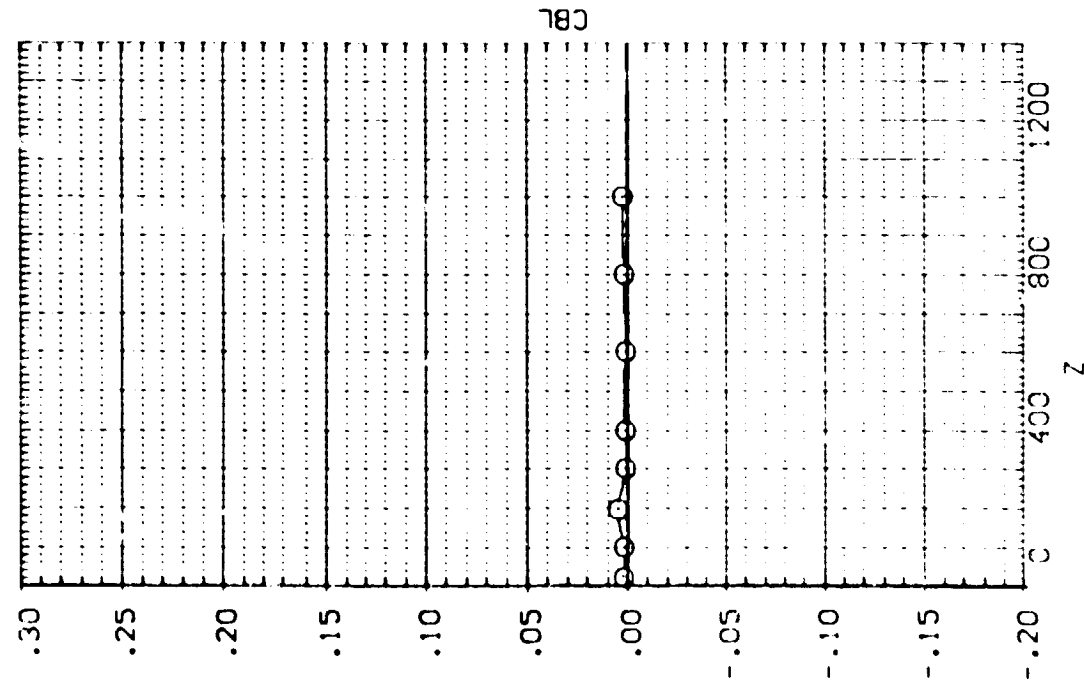
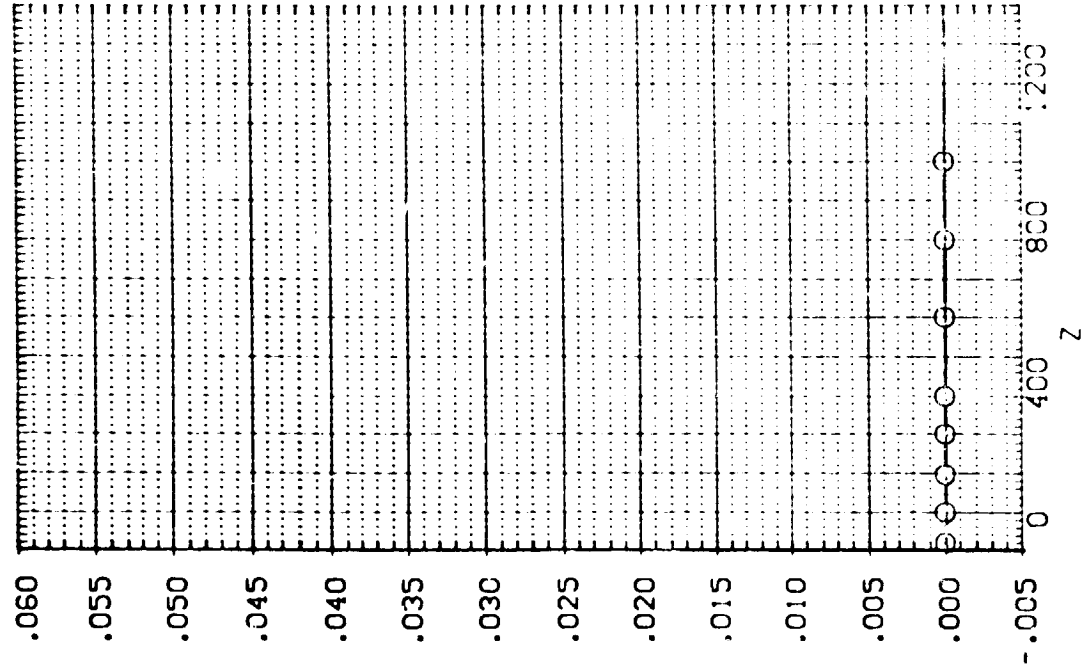

EXTERNAL TANK AERODYNAMIC CHARACTERISTICS DURING SEPARATION FROM ORBITER

1A13. EXTERNAL TANK(T10)SEPARATING FROM ORB. 09 (RTJT56)

SEE THE ASSOCIATED DATA DOCUMENT FOR REFERENCE CHARACTERISTICS FOR INDIVIDUAL DATASETS

PARAMETRIC VALUES
 MACH 4.530 PTOTAL 110.000
 ALPHA .000 BETA .000
 DALPHA .000 DBETA 5.000
 ELEVTR .000 AILRON 10.000
 Y .000

SYMBOL X .106

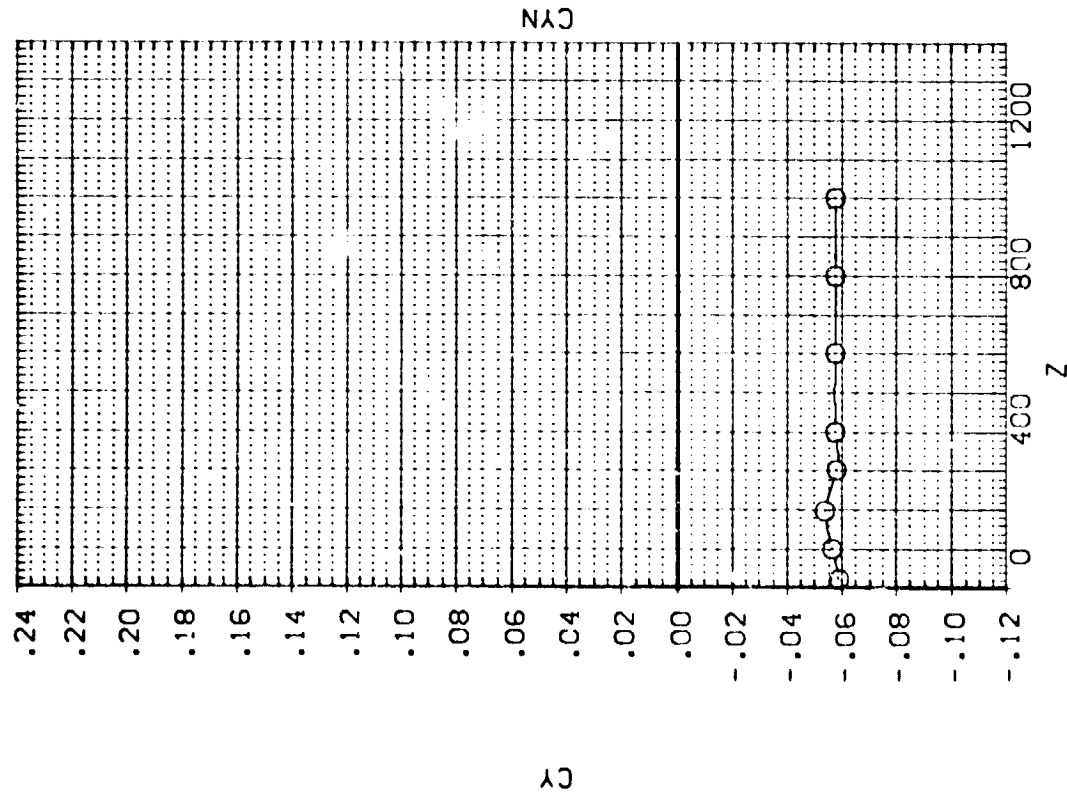
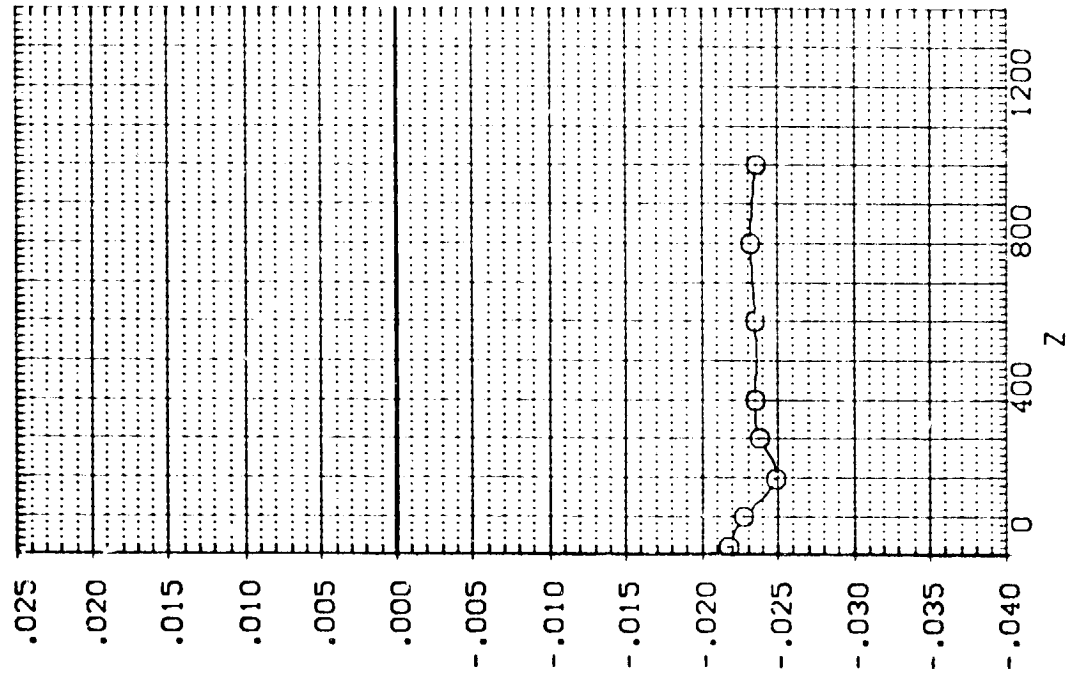

EXTERNAL TANK AERODYNAMIC CHARACTERISTICS DURING SEPARATION FROM ORBITER

1A.3. EXTERNAL TANK(T10)SEPARATING FROM ORB. 09 (RTJTS7)

SEE THE ASSOCIATED DATA DOCUMENT FOR REFERENCE CHARACTERISTICS FOR INDIVIDUAL DATASETS

SYMBOL		PARAMETRIC VALUES	
X	.268	MACH	4.530
		ALPHA	.000
		DALPHA	.000
		ELEVTR	.000
Y	200.000	P.TOTAL	110.000
		BETA	.000
		DBETA	5.000
		AILRON	10.000

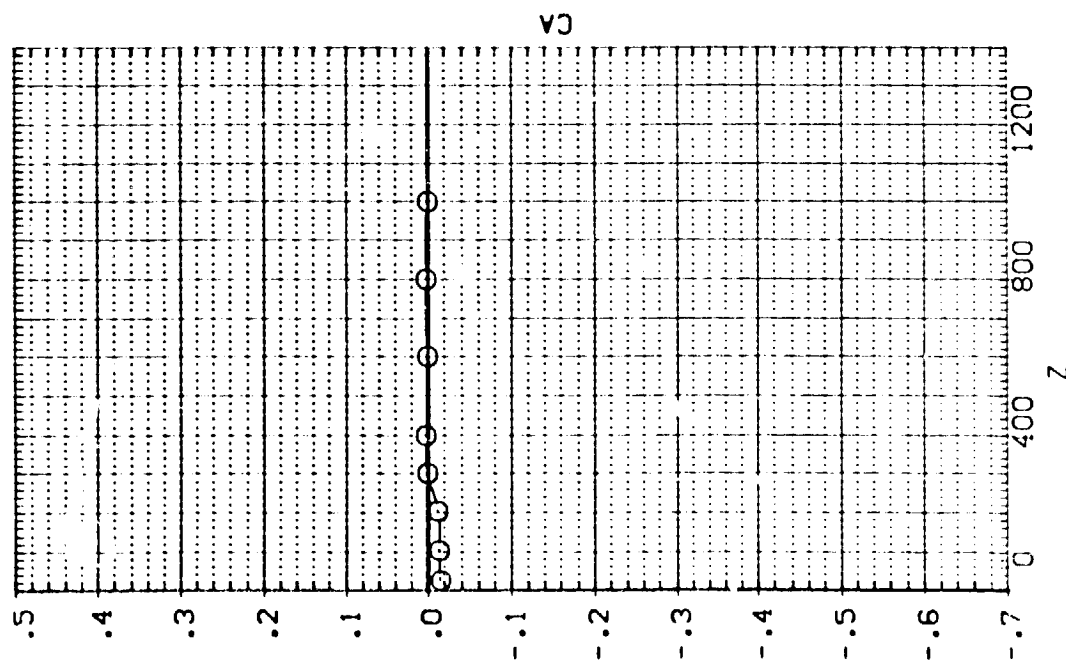
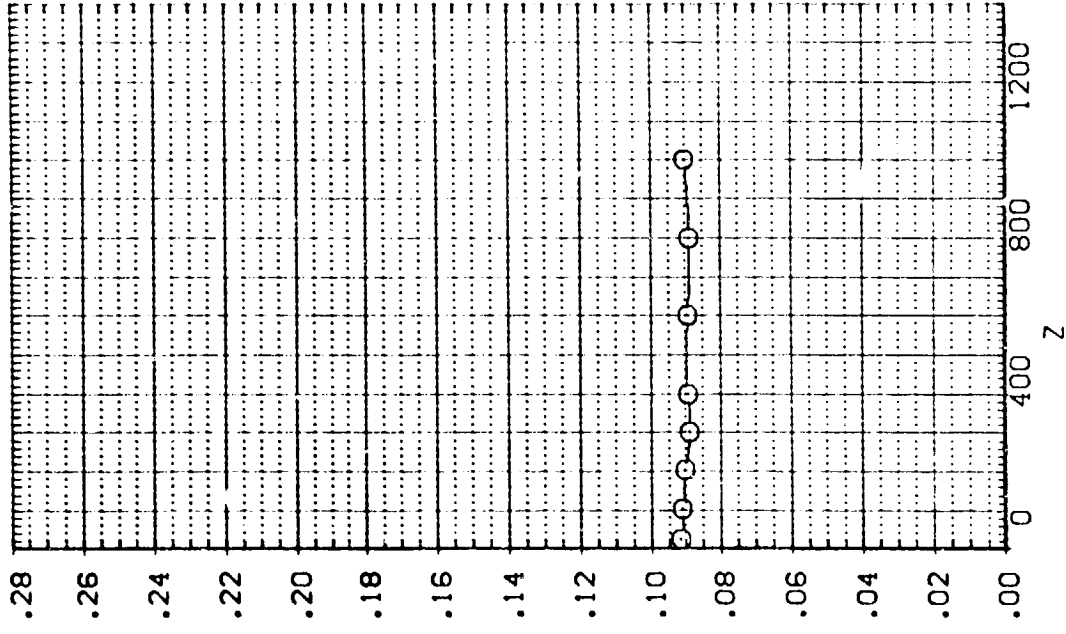

EXTERNAL TANK AERODYNAMIC CHARACTERISTICS DURING SEPARATION FROM ORBITER

IA13. EXTERNAL TANK(T10)SEPARATING FROM ORB. 09 (RTJTS7)

SYMBOL x
○

PARAMETRIC VALUES
 MACH 4.530 P/TOTAL 110.000
 ALPHA .000 BETA .000
 DALPHA .000 DBETA 5.000
 ELEVTB .000 AILRON 10.000
 Y 200.000

SEE THE ASSOCIATED DATA DOCUMENT FOR REFERENCE CHARACTERISTICS FOR INDIVIDUAL DATASETS

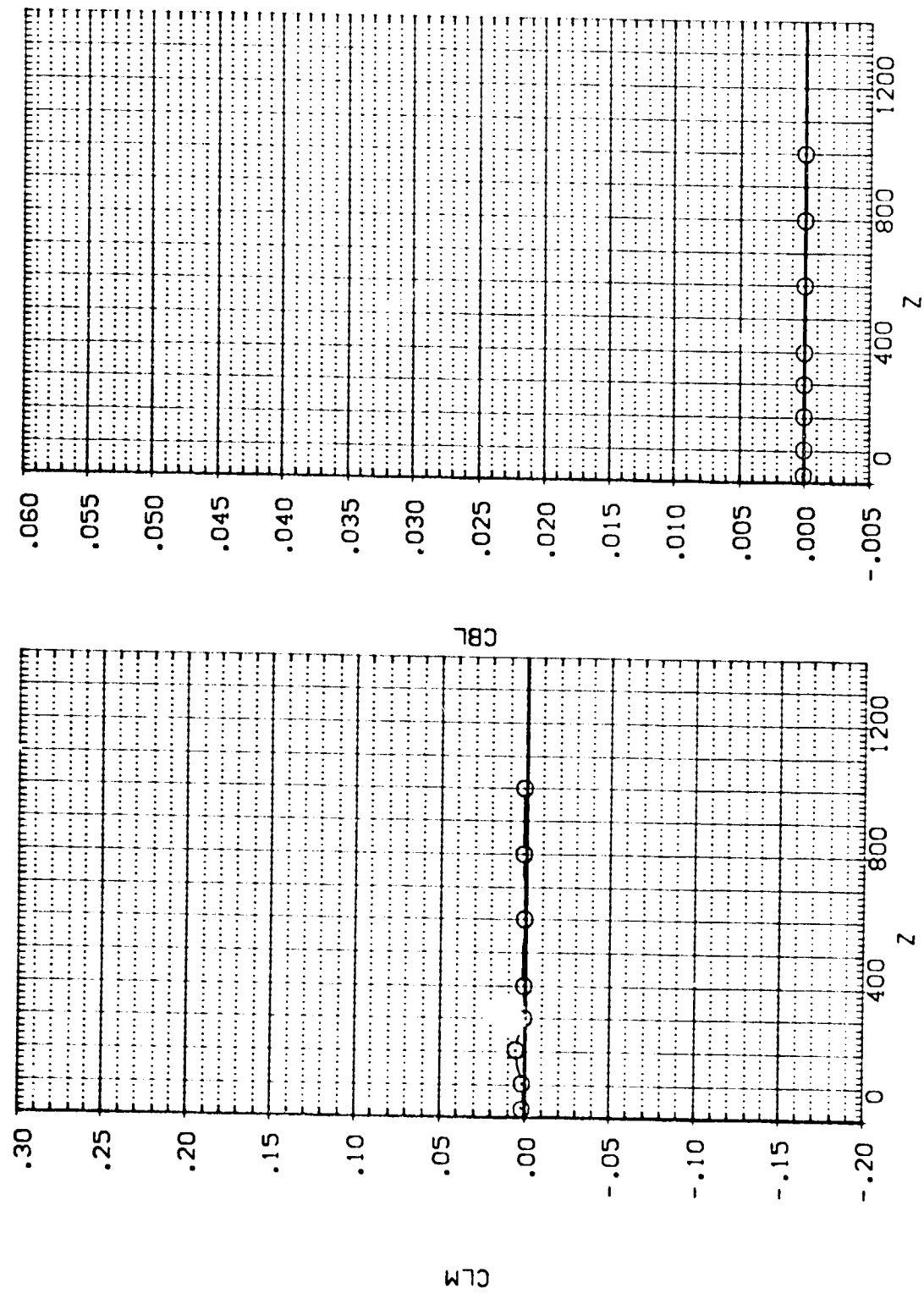

EXTERNAL TANK AERODYNAMIC CHARACTERISTICS DURING SEPARATION FROM ORBITER

1A13, EXTERNAL TANK(110)SEPARATING FROM CRB. 09 (RTJ157)

SEE THE ASSOCIATED DATA DOCUMENT FOR REFERENCE CHARACTERISTICS FOR INDIVIDUAL DATASETS

SYMBOL		F		PARAMETRIC VALUES	
X	.268	MACH	4.530	PIOTAL	110.000
O		ALPHA	.000	BETA	.000
		DALPHA	.000	DBETA	5.000
		ELEVTR	.000	AIRLON	10.000
		Y	200.000		

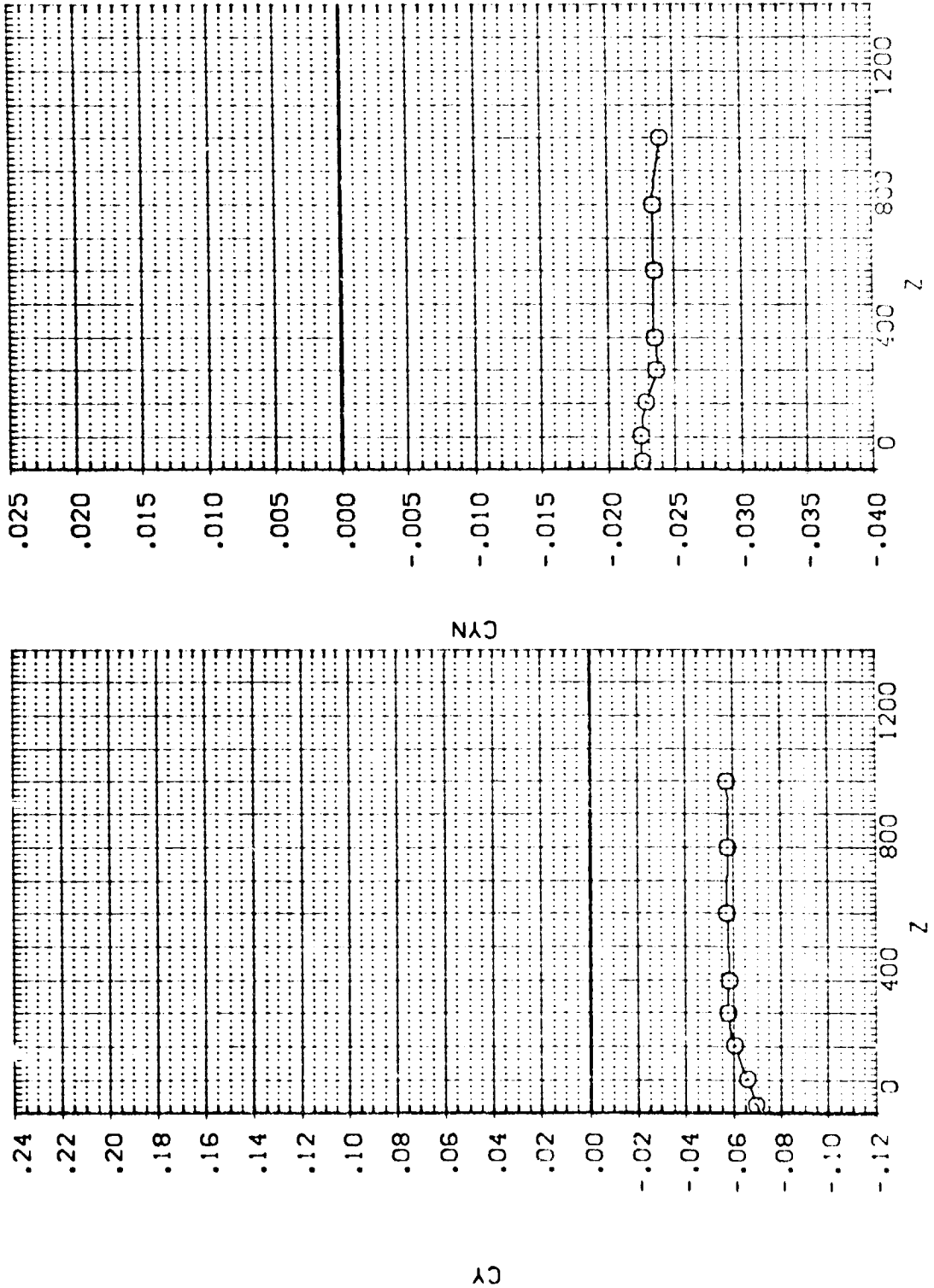

IA13, EXTERNAL TANK(110) SEPARATING FROM ORB. 09 (RTJT58)

SEE THE ASSOCIATED DATA DOCUMENT FOR REFERENCE CHARACTERISTICS FOR INDIVIDUAL DATASETS

SYMBOL		PARAMETRIC VALUES	
○	X	MACH	4.530
		ALPHA	.000
		DALPHA	-10.000
		ELEVTR	.000
		Y	-200.000
		PITOTAL	110.000
		BETA	.000
		DBETA	.000
		AIRTON	10.000

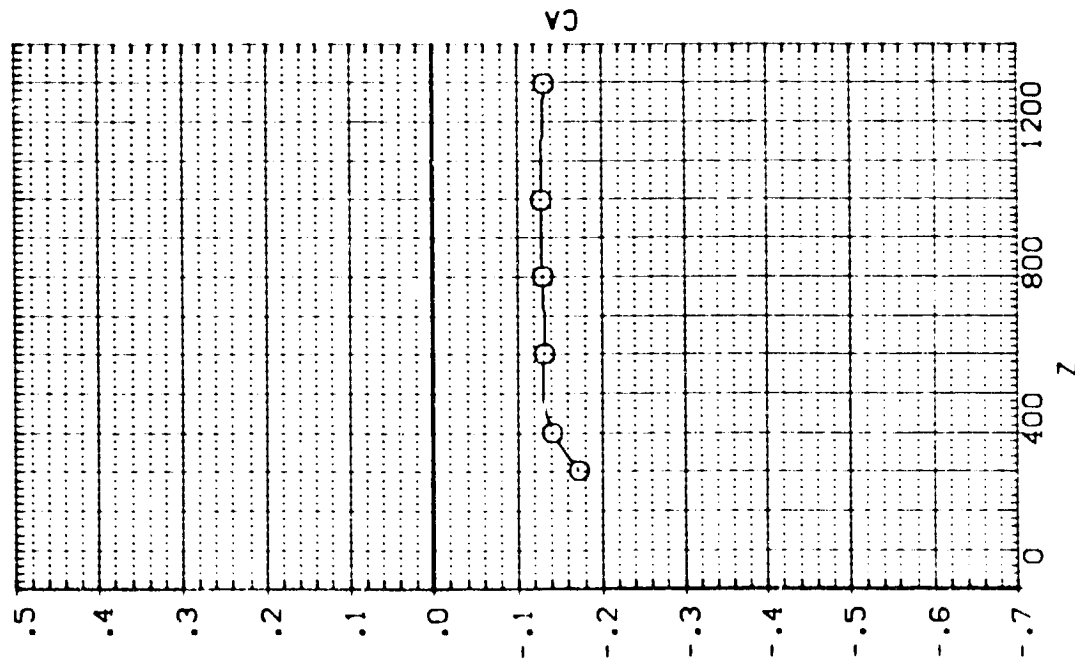
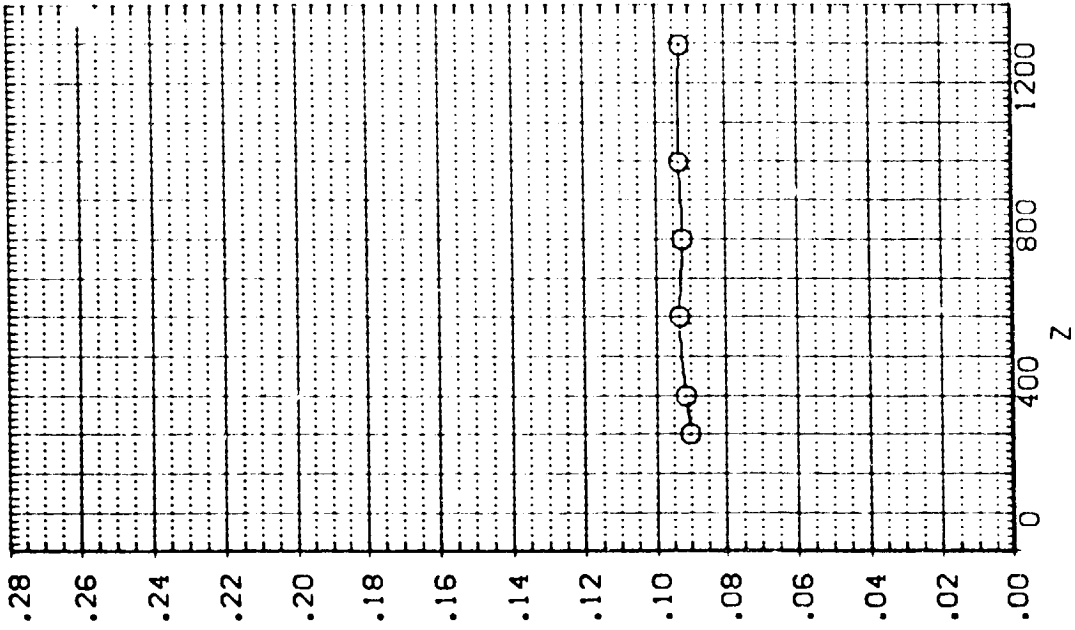

IA13.EXTERNAL TANK(10)SEPARATING FROM ORB. 09 (RTJT58)

SEE THE ASSOCIATED DATA DOCUMENT FOR REFERENCE CHARACTERISTICS FOR INDIVIDUAL DATASETS

PARAMETRIC VALUES

MACH	4.530	PTOTAL	110.000
ALPHA	.000	BETA	.000
DALPHA	-10.000	DBETA	.000
ELEVTR	.000	ATLRON	10.000
Y	-200.000		

SYMBOL X
O .158

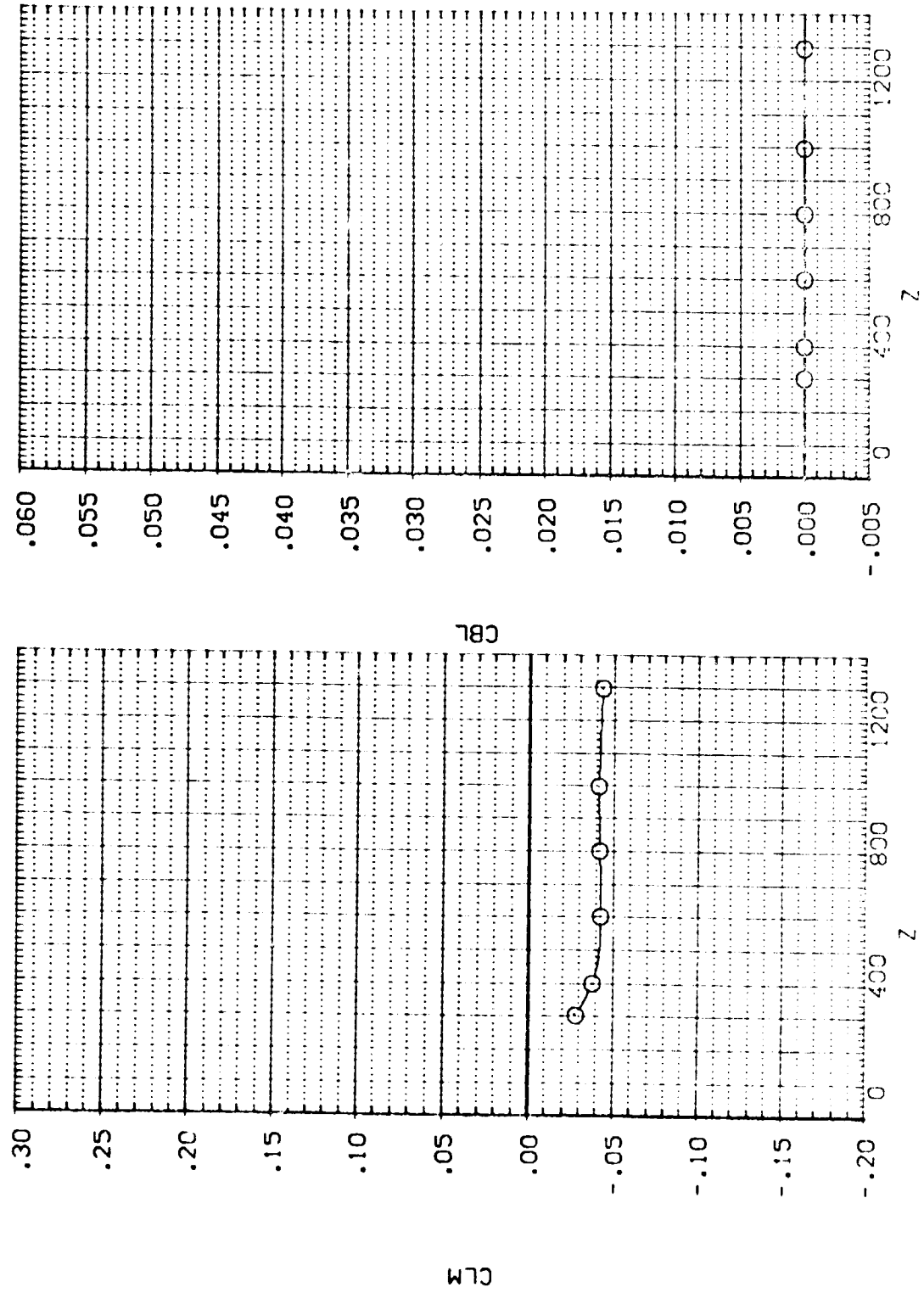

EXTERNAL TANK AERODYNAMIC CHARACTERISTICS DURING SEPARATION FROM ORBITER

IA13, EXTERNAL TANK(T10)SEPARATING FROM ORB. 09 (RTJ158)

SEE THE ASSOCIATED DATA DOCUMENT FOR REFERENCE CHARACTERISTICS FOR INDIVIDUAL DATA SETS

SYMBOL		PARAMETRIC VALUES			
X	.158	MACH	4.530	PITCH	110.000
C		ALPHA	.000	BETA	.000
		DALPHA	-10.000	DBETA	.000
		ELEVTR	.000	ALTRON	10.000
		Y	-200.000		

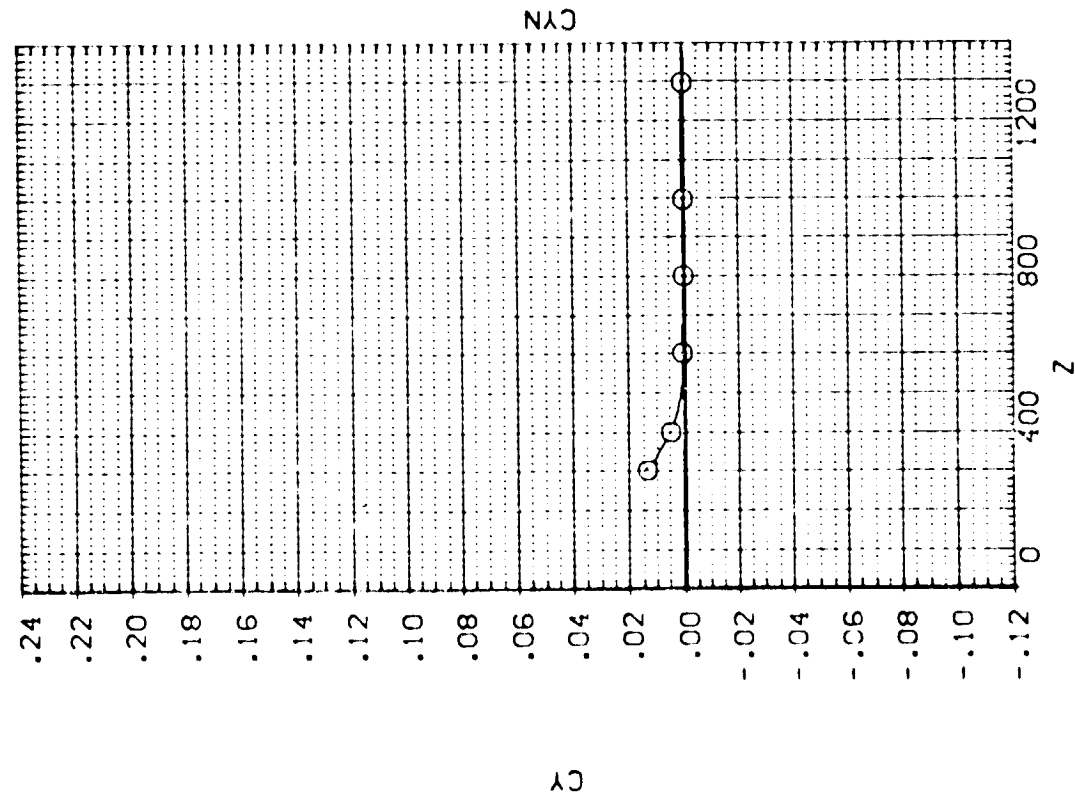
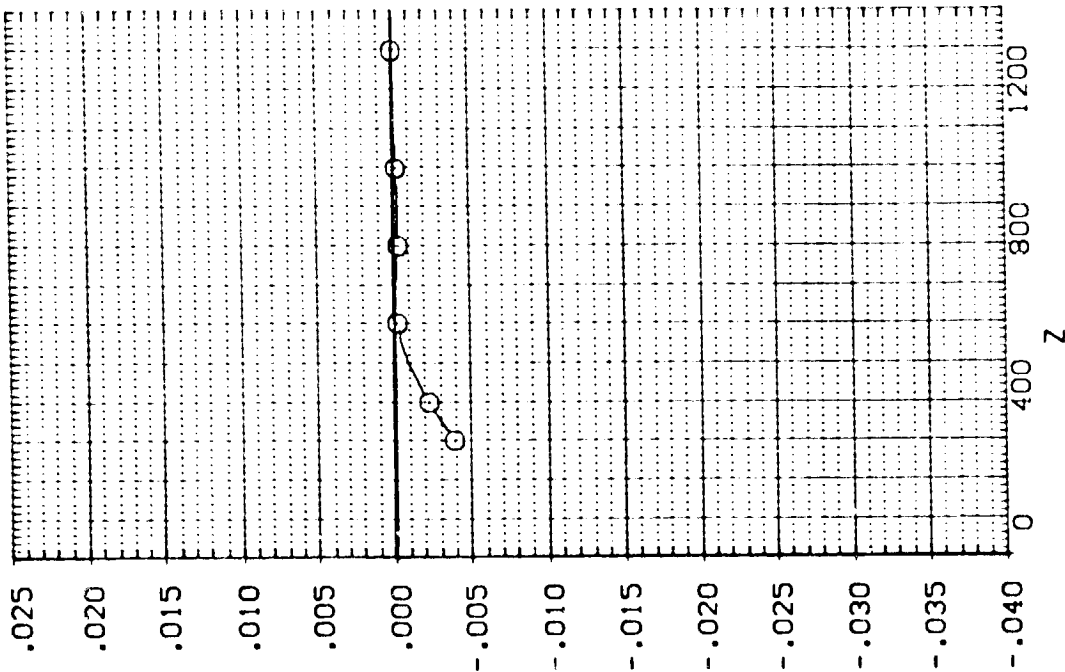

EXTERNAL TANK AERODYNAMIC CHARACTERISTICS DURING SEPARATION FROM ORBITER

1413. EXTERNAL TANK(10)SEPARATING FROM ORB. 09 (RTJ159)

SEE THE ASSOCIATED DATA DOCUMENT FOR REFERENCE CHARACTERISTICS FOR INDIVIDUAL DATA'S

PARAMETRIC VALUES	
MACH	4.530
ALPHA	.000
BETA	.000
CALPHA	110.000
CXBETA	10.000
ALURON	10.000
Y	.000

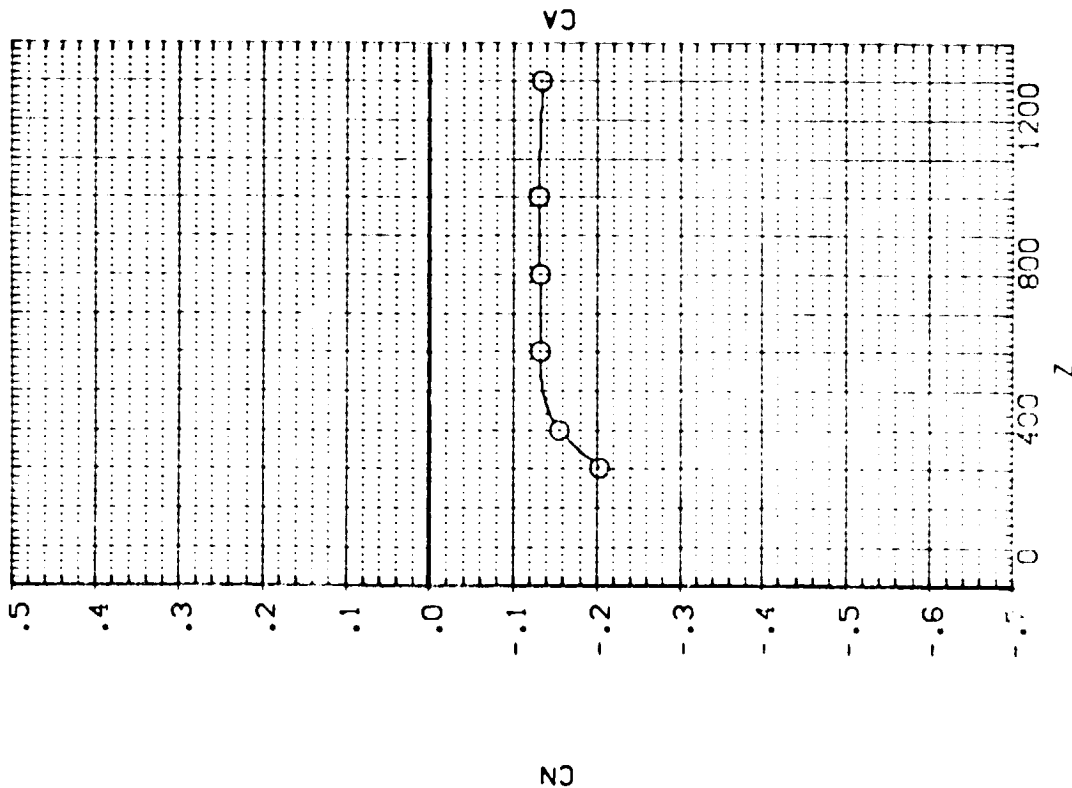
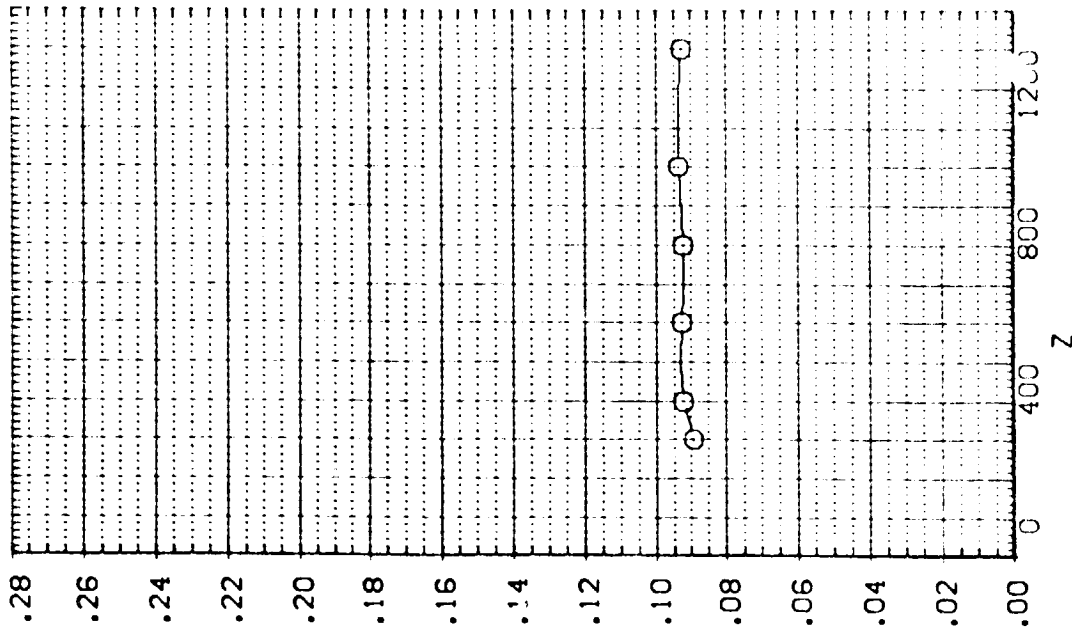

1A13. EXTERNAL TANK(S) SEPARATING FROM CRB. 09 (RTJ159)

SEE THE ASSOCIATED DATA DOCUMENT FOR REFERENCE CHARACTERISTICS FOR INDIVIDUAL DATASETS

SYMBOL	X	MACH	PARAMETRIC VALUES
C	.151	4.530	P/DYAL 110.000
		.000	BETA .000
		-10.000	GAMMA .000
		.000	ALPHA 10.000
		.000	ELEVTR
		.000	ALTRON
		.000	Y

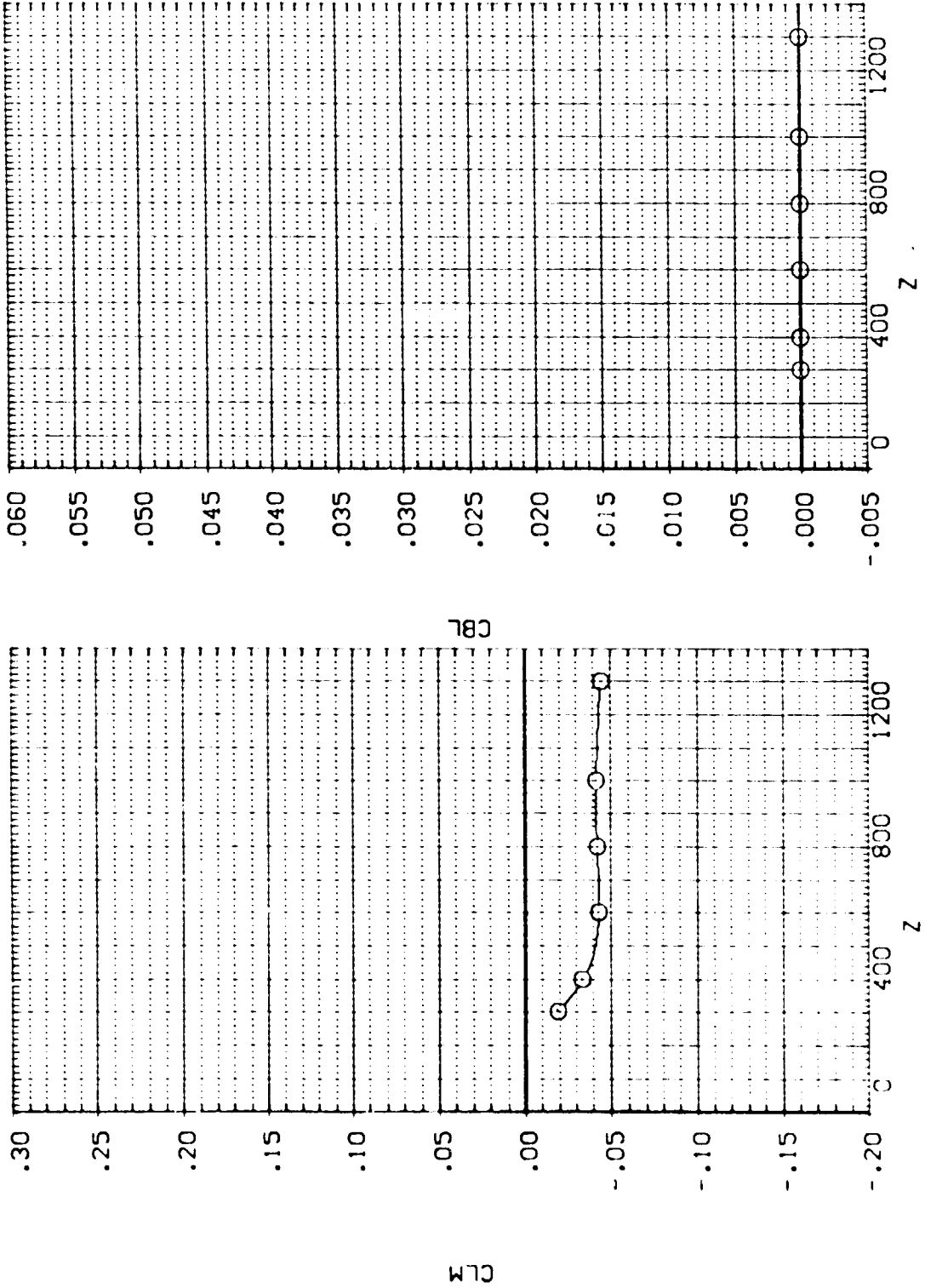

EXTERNAL TANK AERODYNAMIC CHARACTERISTICS DURING SEPARATION FROM ORBITER

MEASUREMENTS OF TRANSMITTANCE DURING SEPARATION FROM ORR. 09 (R'1'59)

SCIENTIFIC ASSOCIATES
 1000 UNIVERSITY AVENUE
 ANN ARBOR, MICHIGAN 48106

TRANSMITTANCE DATA
 4000 8000 10000
 1000 2000 3000
 4000 5000 6000
 7000 8000 9000
 10000 11000 12000

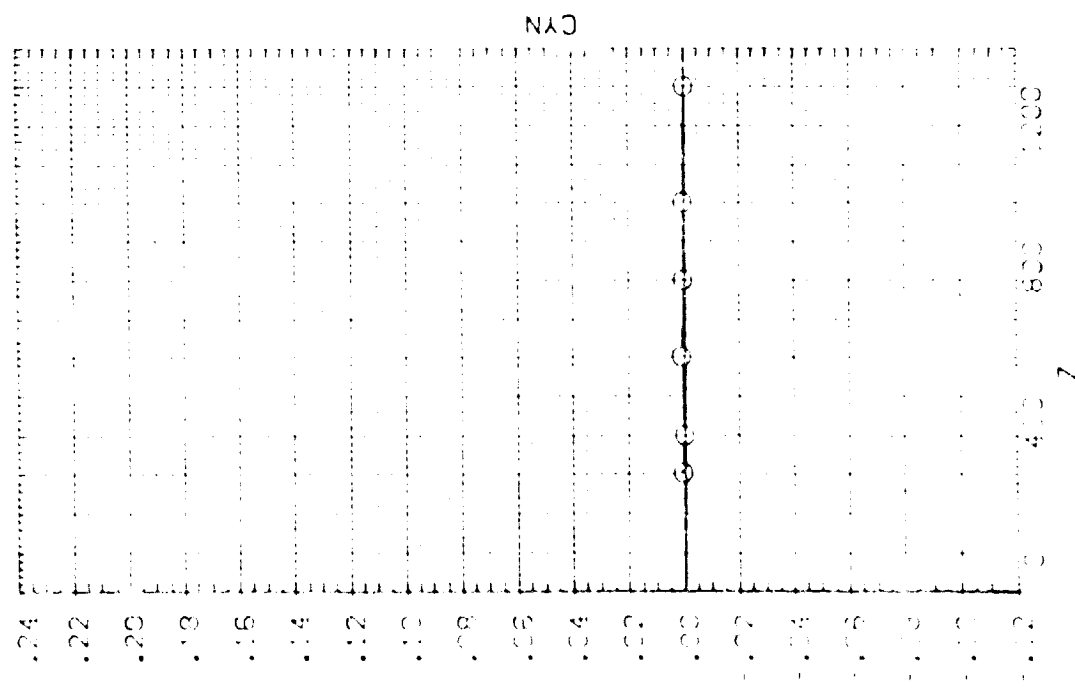
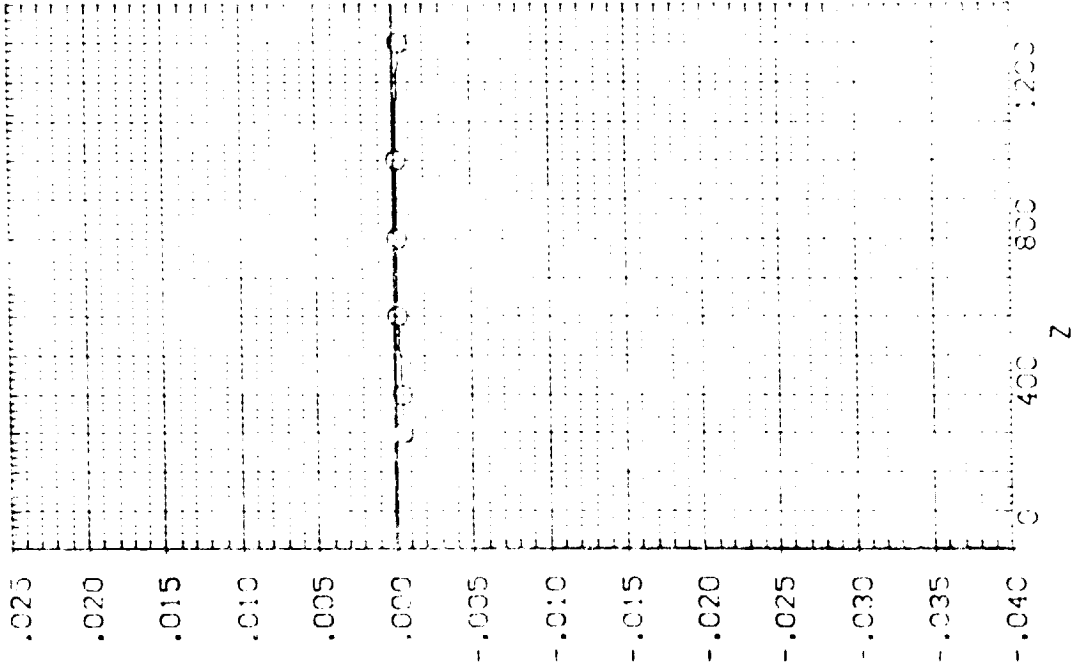

TRANSMITTANCE MEASUREMENTS DURING SEPARATION FROM ORR. 09

IA:3,EXTERNAL TANK(10)SEPARATING FROM CRB, 09 (RTJ160)

SEE THE ASSOCIATED DATA DOCUMENT FOR REFERENCE CHARACTERISTICS FOR INDIVIDUAL DATA SETS

SYMBOL X .174 MACH 4.530 P/TOTAL 110.000
 ALPHA .000 BETA .000
 GAMMA -10.000 EBETA .000
 ELEVTR .000 ATLRON 10.000
 V 200.000

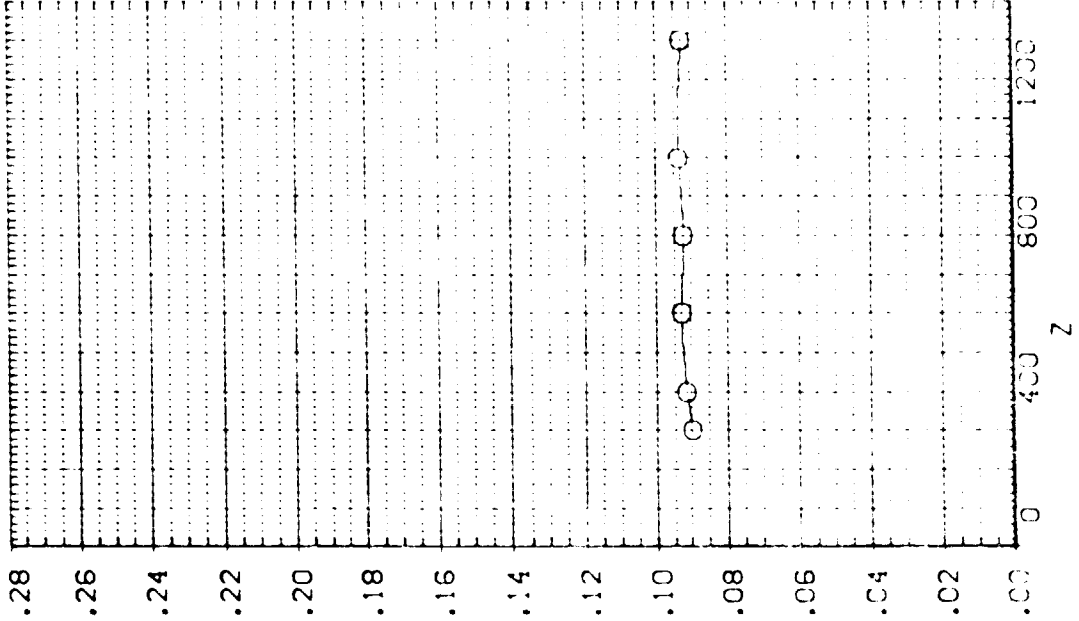
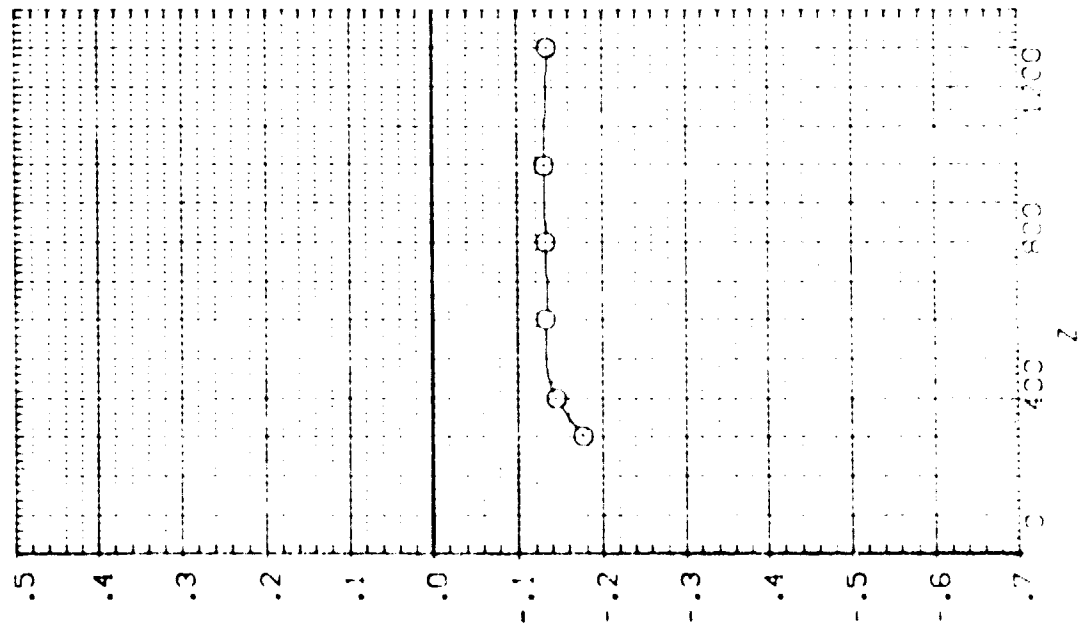

EXTERNAL TANK AERODYNAMIC CHARACTERISTICS DURING SEPARATION FROM ORBITER

1954, 1955, 1956, 1957, 1958, 1959, 1960, 1961, 1962, 1963, 1964, 1965

NAME: [unclear]
 ADDRESS: [unclear]
 CITY: [unclear]
 STATE: [unclear]
 ZIP: [unclear]

STATE: [unclear]
 COUNTY: [unclear]

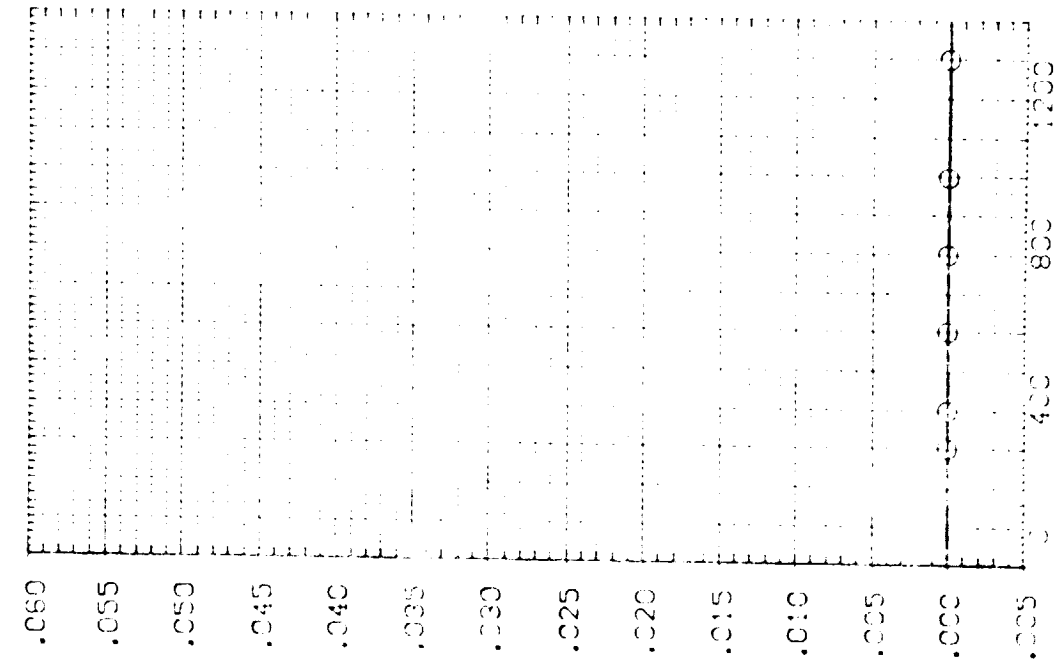
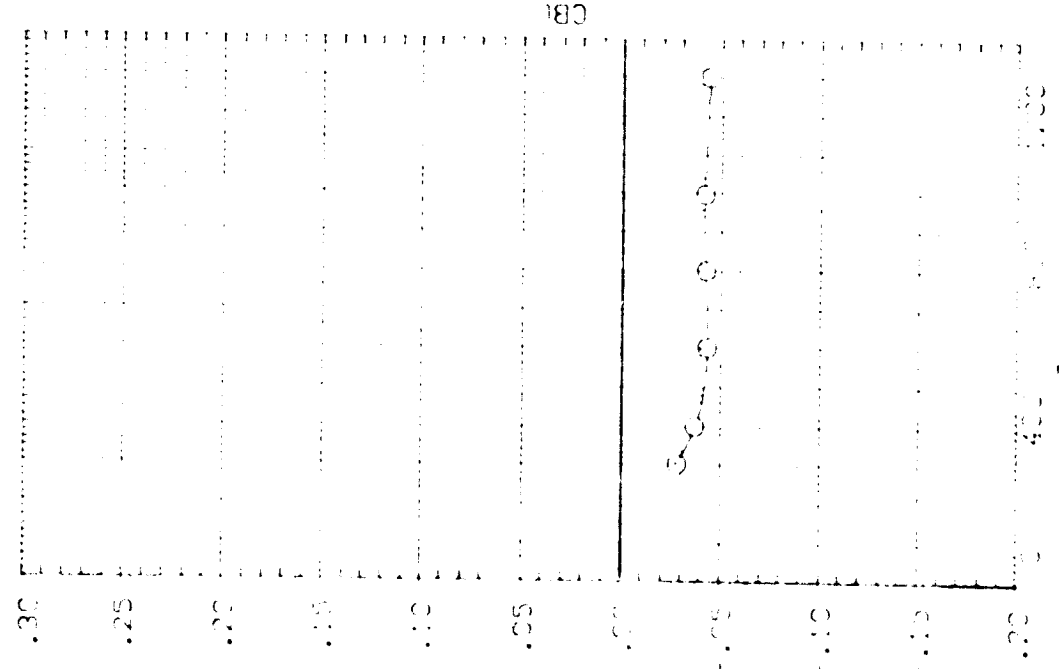

1954, 1955, 1956, 1957, 1958, 1959, 1960, 1961, 1962, 1963, 1964, 1965

TABLE 13. EXTERNAL TANK(10) SEPARATING FROM ORB. 09 (RTJ160)

SYMBOL

PARAMETRIC VALUES	
MACH	4.530
ALPHA	0.000
BETA	0.000
CALPHA	-10.000
CBETA	10.000
CETR	0.000
CEXT	10.000
CEXT	200.000

SEE THE ASSOCIATED DATA DOCUMENT FOR REFERENCE CHARACTERISTICS FOR INDIVIDUAL DATA'S

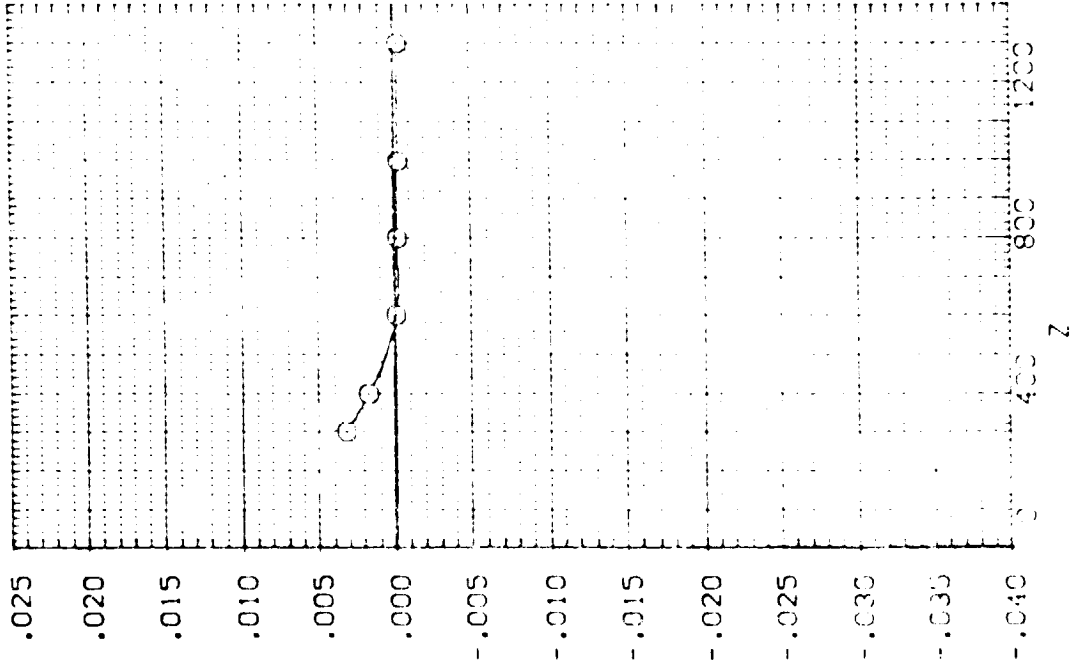
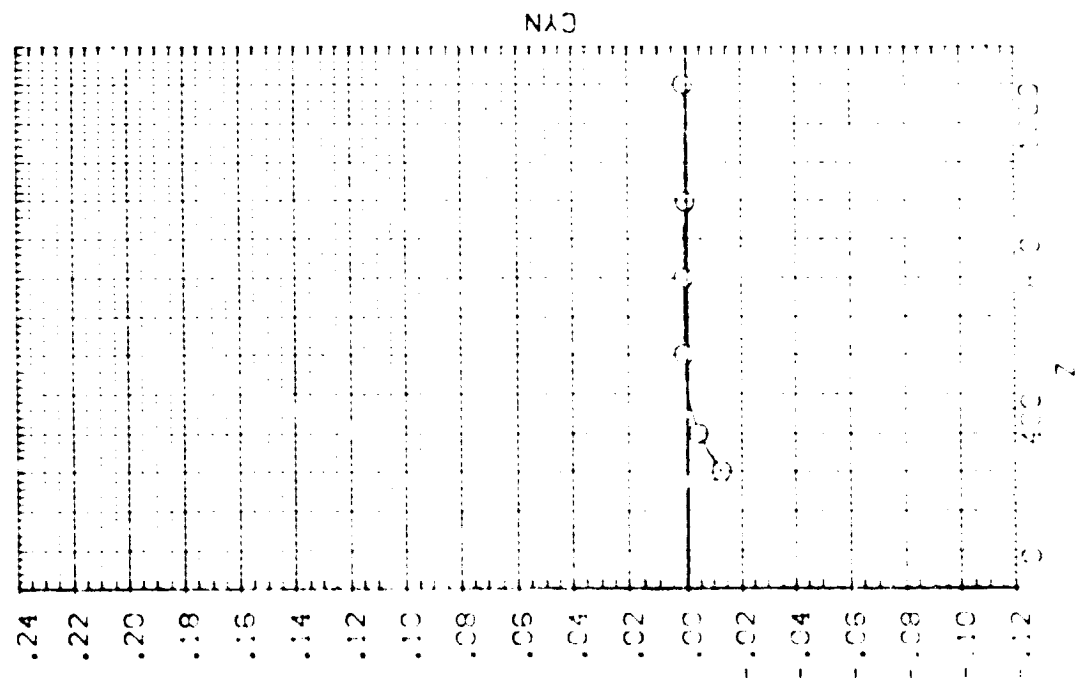

EXTERNAL TANK(10) SEPARATING FROM ORBITER

EXPERIMENTAL CHARACTERISTICS DURING SEPARATION FROM ORBIT

DATE: 10/15/68
 TIME: 10:00
 ALTITUDE: 10000
 SPEED: 10000
 LOCATION: 10000
 OPERATOR: 10000
 INSTRUMENT: 10000

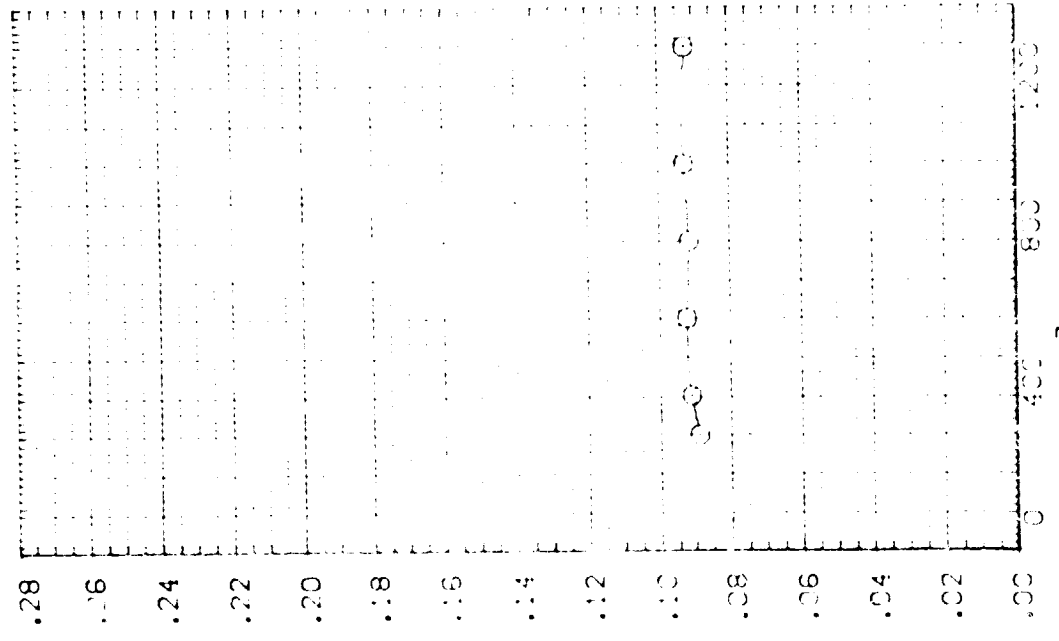
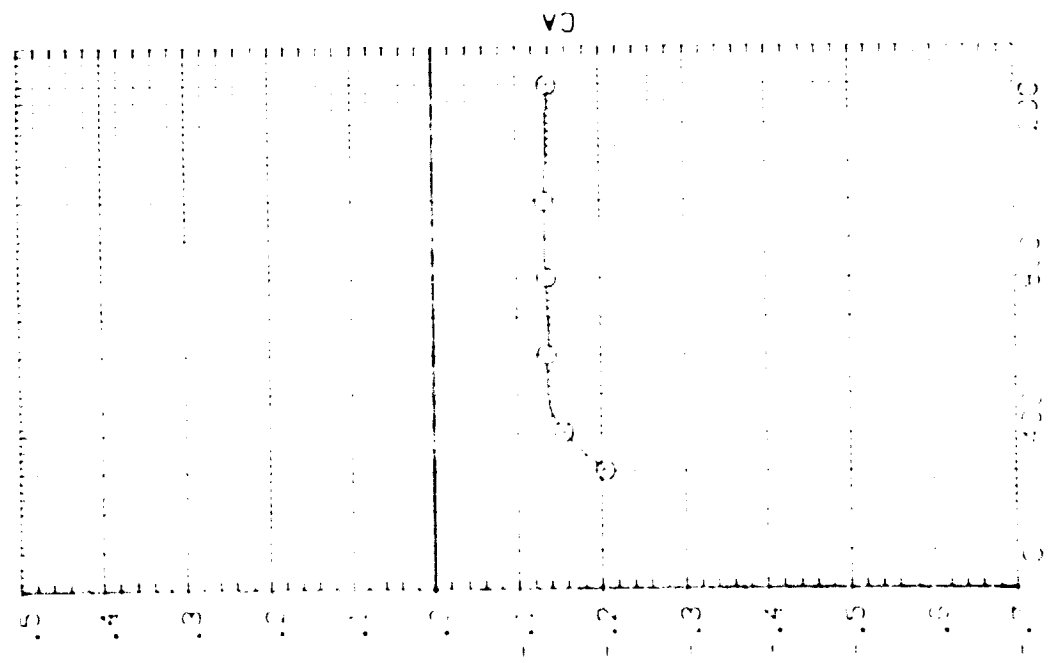

EXPERIMENTAL CHARACTERISTICS DURING SEPARATION FROM ORBIT

!A13,EXTERNAL TANK(T10)SEPARATING FROM ORB. 09 (RTJT6!)

SEE THE ASSOCIATED DATA DOCUMENT FOR REFERENCE CHARACTERISTICS FOR INDIVIDUAL DATA SETS

SYMBOL X .246
 ()
 PARAMETRIC VALUES
 MICH 4.530 P/TOTAL 110.000
 ALPHA .000 BETA .000
 DALPHA -10.000 DBETA -5.000
 ELCTR .000 ALLRON 10.000
 Y -200.000

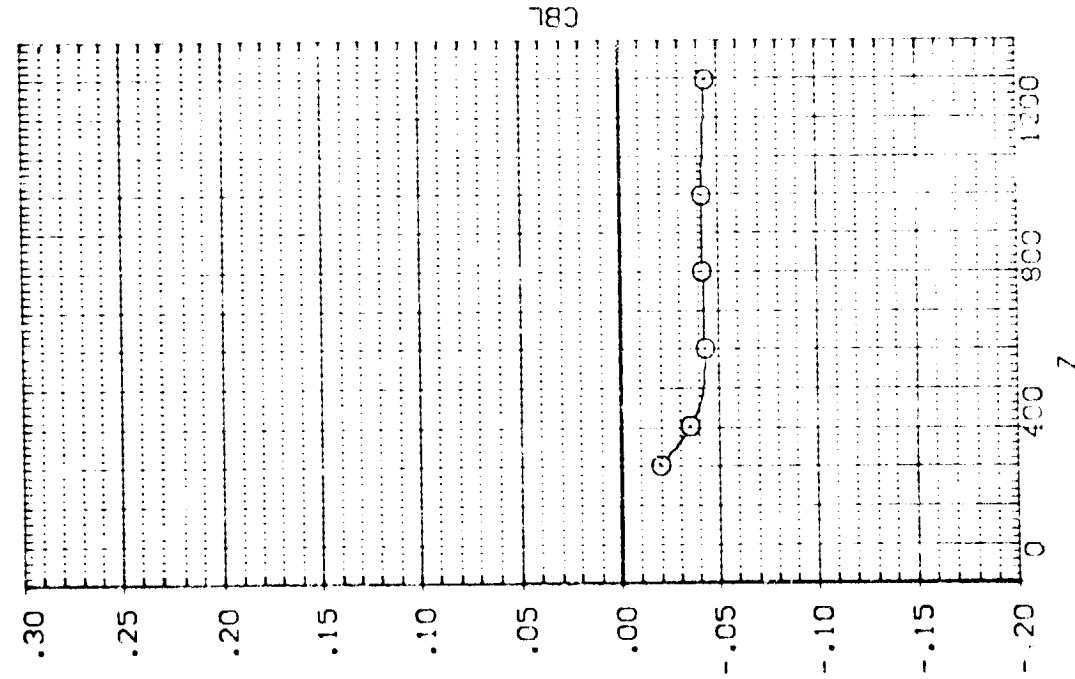
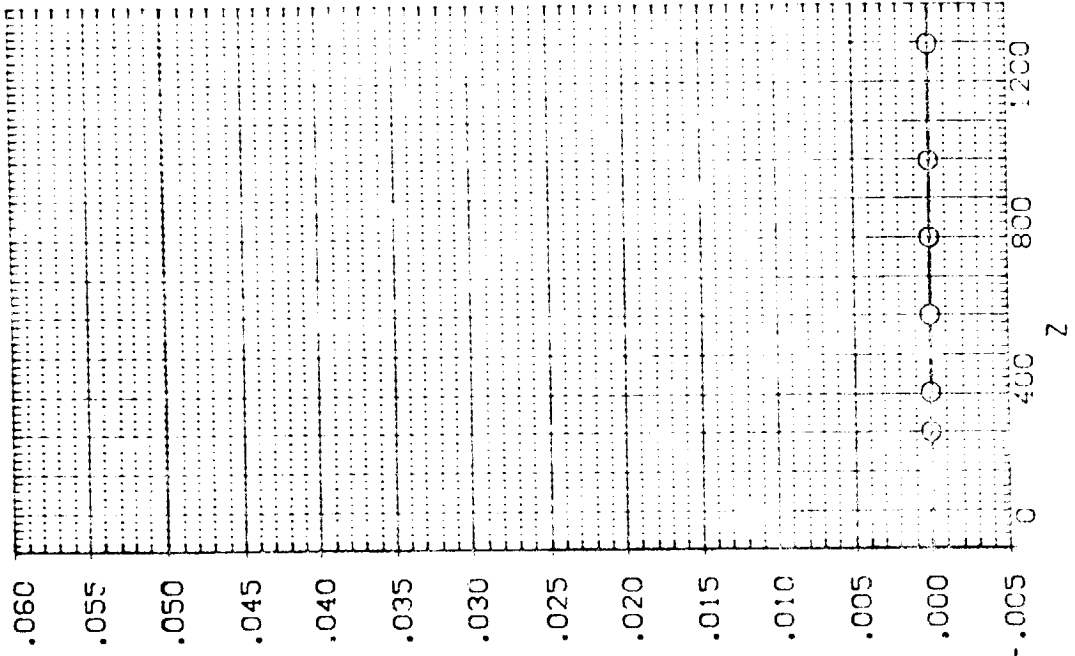

EXTERNAL TANK AERODYNAMIC CHARACTERISTICS DURING SEPARATION FROM ORBITER

FIG. 13. EXTERNAL TANK AERODYNAMIC CHARACTERISTICS DURING SEPARATION FROM ORB. 09 (RTUTB1)

91493-
C

PARAMETRIC VALUES	
MACH	4.500
ALPHA	1.000
BETA	1.000
DALPHA	-10.000
EBETA	-5.000
ELEVTR	.500
ALTRON	10.000
Y	-200.000

SEE THE ASSOCIATED DATA
SECTION FOR REFERENCE
CHARACTERISTICS FOR
INDIVIDUAL TARGETS

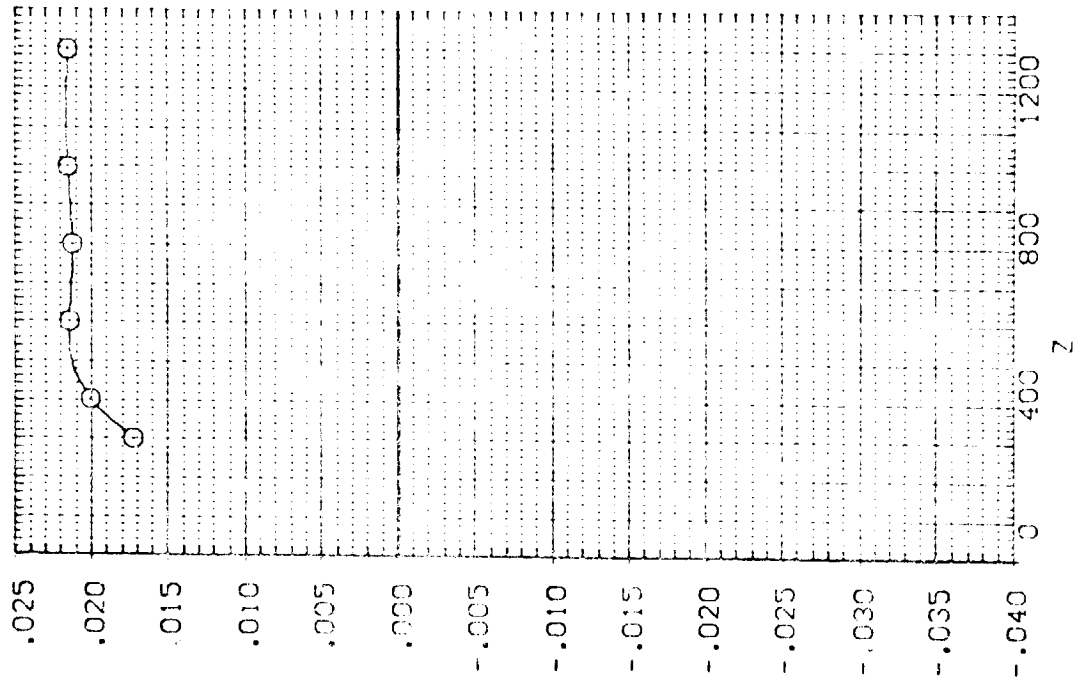
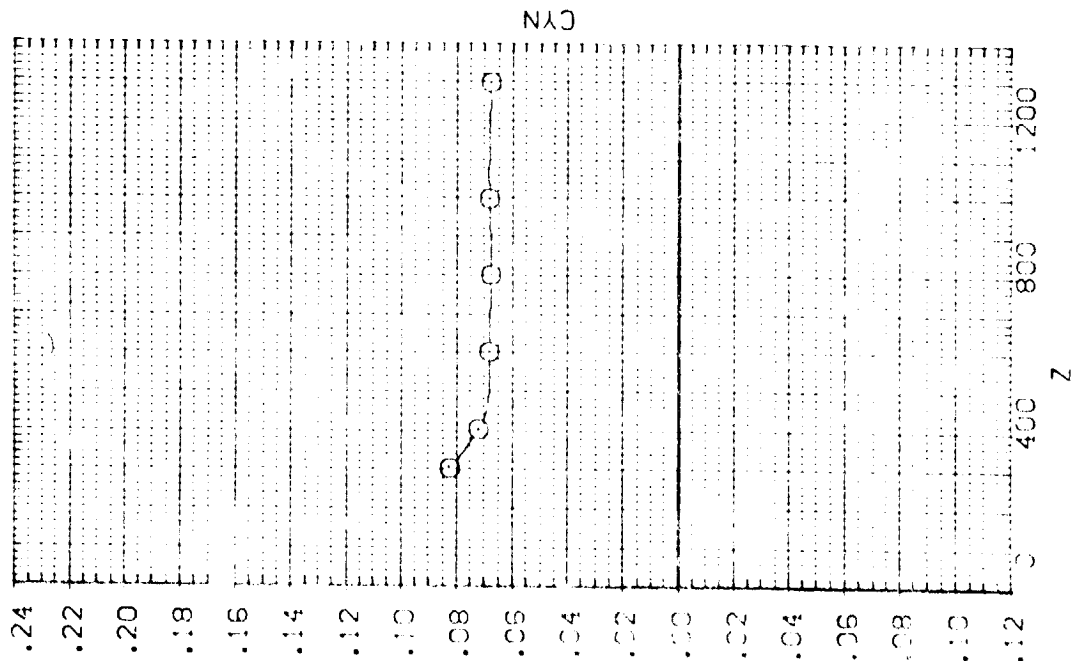
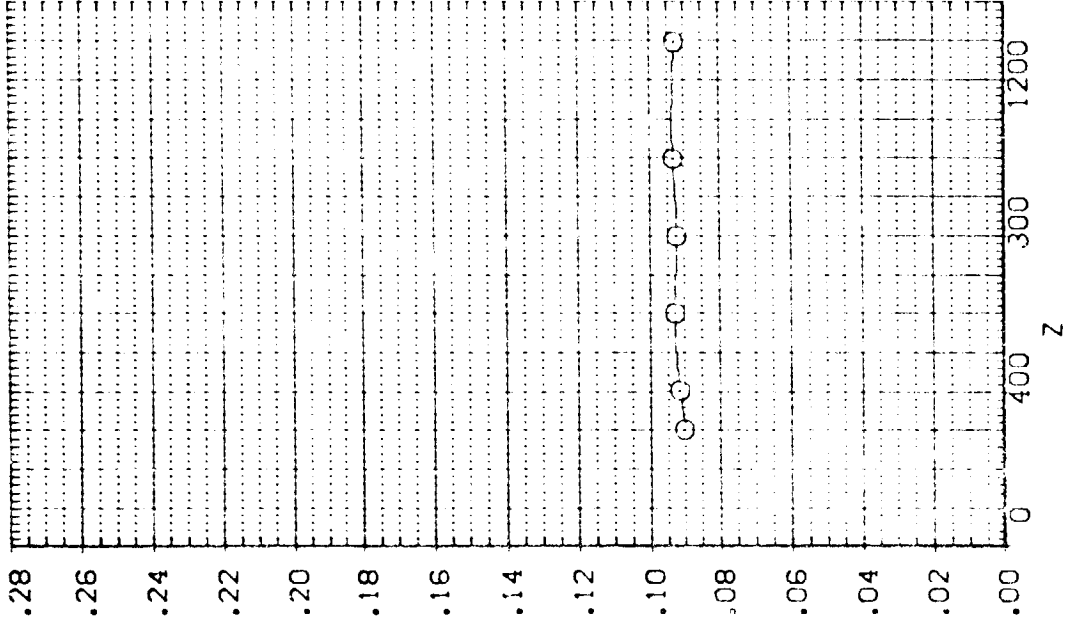
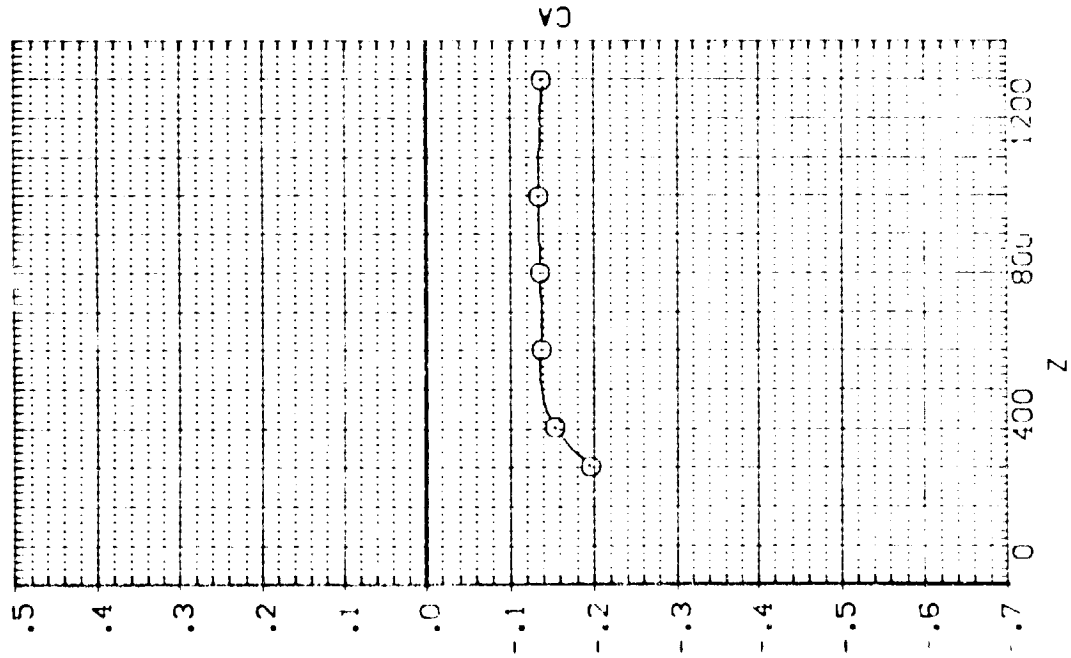

FIG. 13. EXTERNAL TANK(110) SEPARATING FROM ORB. 09 (RTJ162)

SYMBOL
○

PARAMETRIC VALUES	
MACH	4.530
ALPHA	.000
BETA	-10.000
D BETA	.000
ELEVTR	.000
Y	.000
PITOTL	110.000
BETA	.000
D BETA	5.000
AIRCON	10.000

SEE THE ASSOCIATED DATA DOCUMENT FOR REFERENCE CHARACTERISTICS FOR INDIVIDUAL DATASETS



EXTERNAL TANK AERODYNAMIC CHARACTERISTICS DURING SEPARATION FROM ORBITER

FIG. 3. EXTERNAL TANK DISSEPARATING FROM ORB. 09 (RTG 182)

SEE THE ASSOCIATED DATA
DOCUMENT FOR AN EXHAUSTIVE
CHARACTERIZATION OF
NON-TIDAL DATA

PARAMETER VALUES
MACH 4.130 INITIAL 100.000
ALPHA 0.000 BETA 0.000
GAMMA 0.000 DELTA 0.000
EQUATOR 0.000 ALTITUDE 10.000
Y

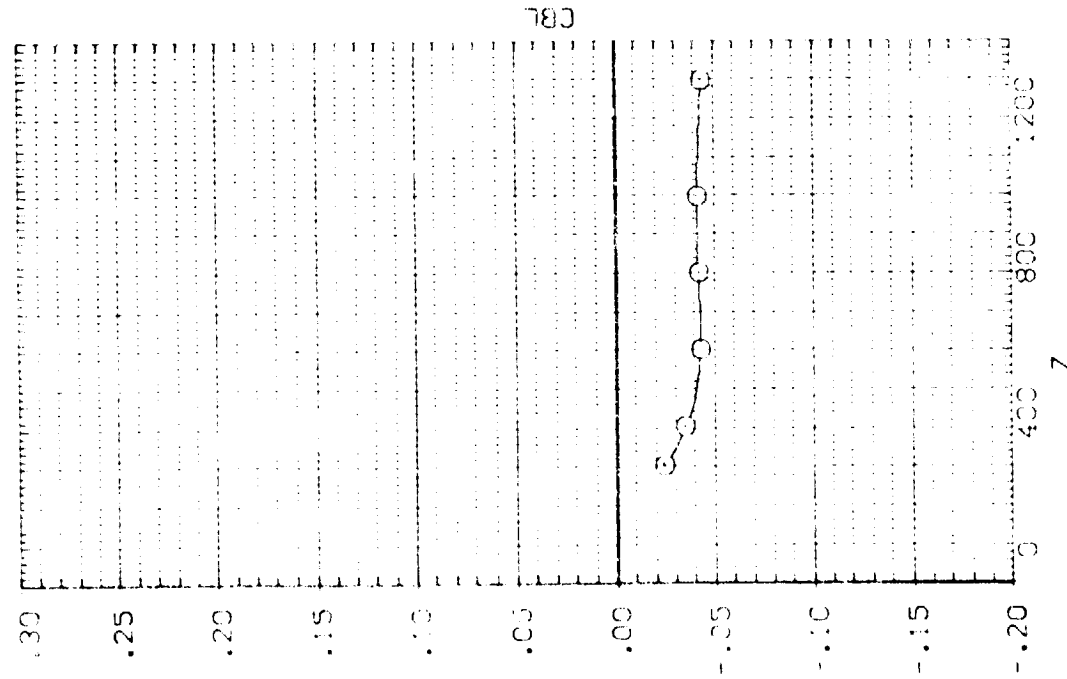
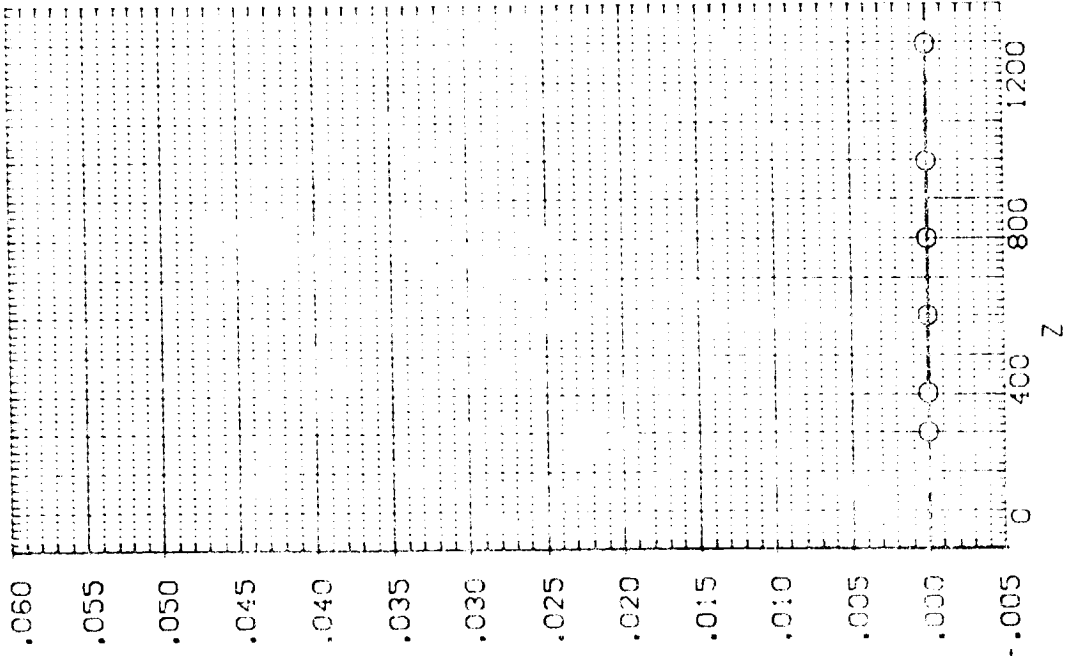

1A13-EXTERNAL TANK(110)SEPARATING FROM ORB. 09 (RTJ162)

SEE THE ASSOCIATED DATA DOCUMENT FOR REFERENCE CHARACTERISTICS FOR INDIVIDUAL DATASETS

SY:80L

PARAMETRIC VALUES	
MACH	4.530
ALPHA	.000
BETA	.000
DALPHA	-10.000
DBETA	5.000
ELEVTR	.000
AILRON	10.000
Y	.000
PTOTAL	110.000

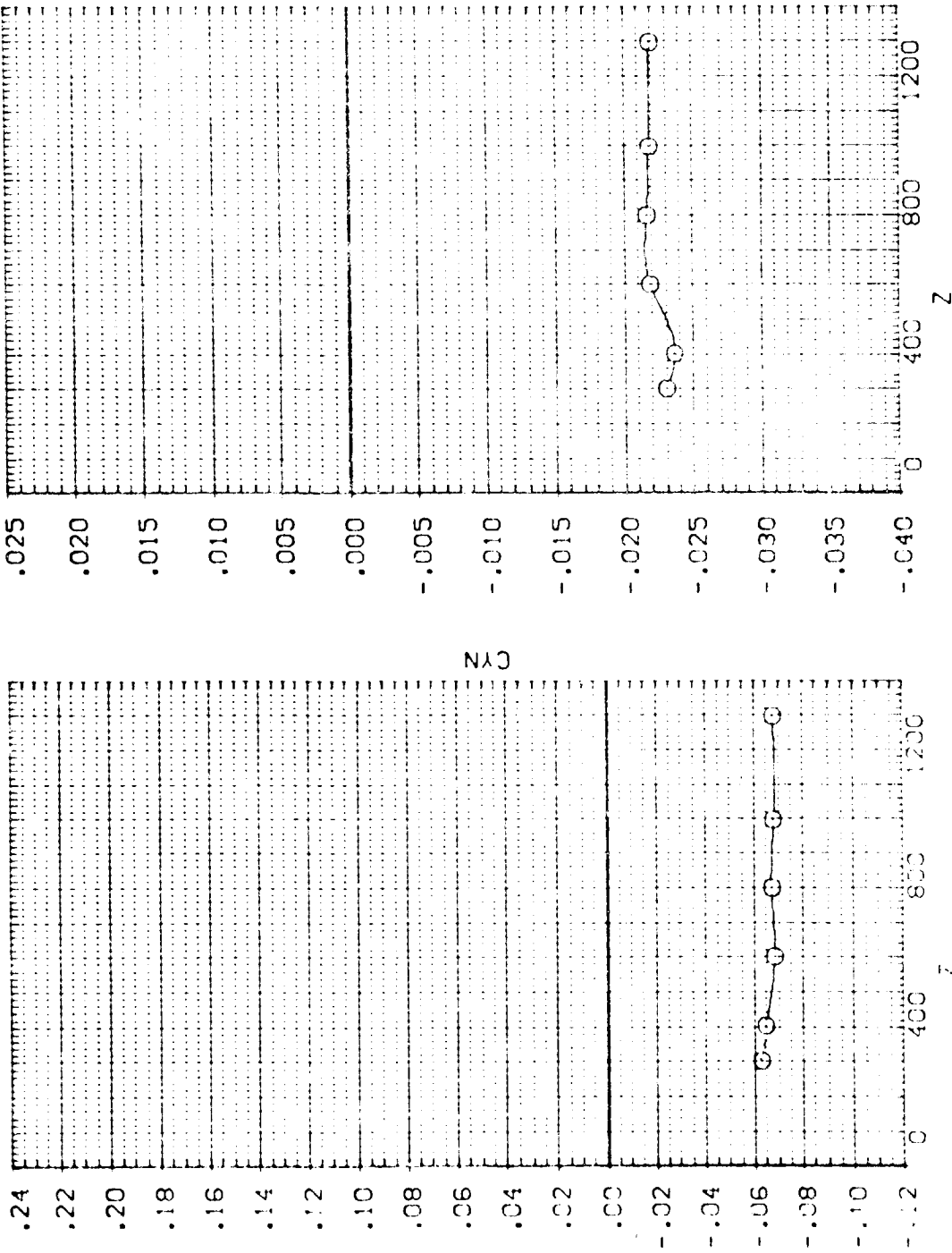

EXTERNAL TANK AERODYNAMIC CHARACTERISTICS DURING SEPARATION FROM ORBITER

EXTERNAL TANK AERODYNAMIC CHARACTERISTICS DURING SEPARATION FROM ORBITER

RESULTS ASSOCIATED DATA
 SOURCE: NASA/CR 1971-1101
 CONTRACT NUMBER: N00019-71-1-101

PARAMETER VALUE
 MACH 0.8
 ALTITUDE 10,000
 REYNOLDS NUMBER 1.0E+07
 ANGLE OF ATTACK 10.000
 ANGLE OF YAW 0.000

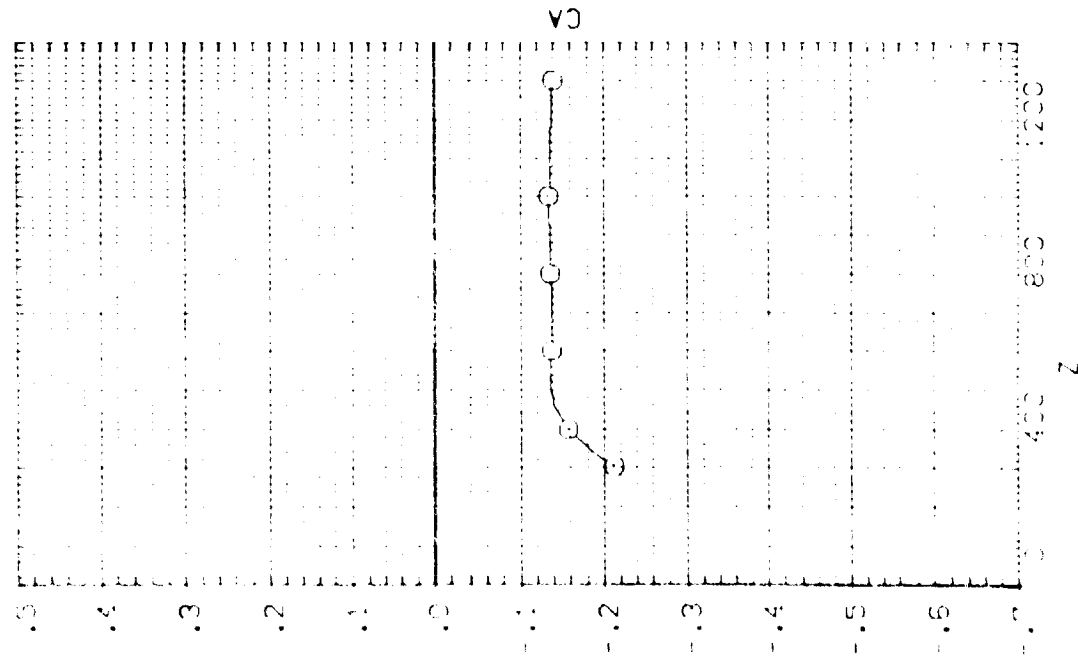
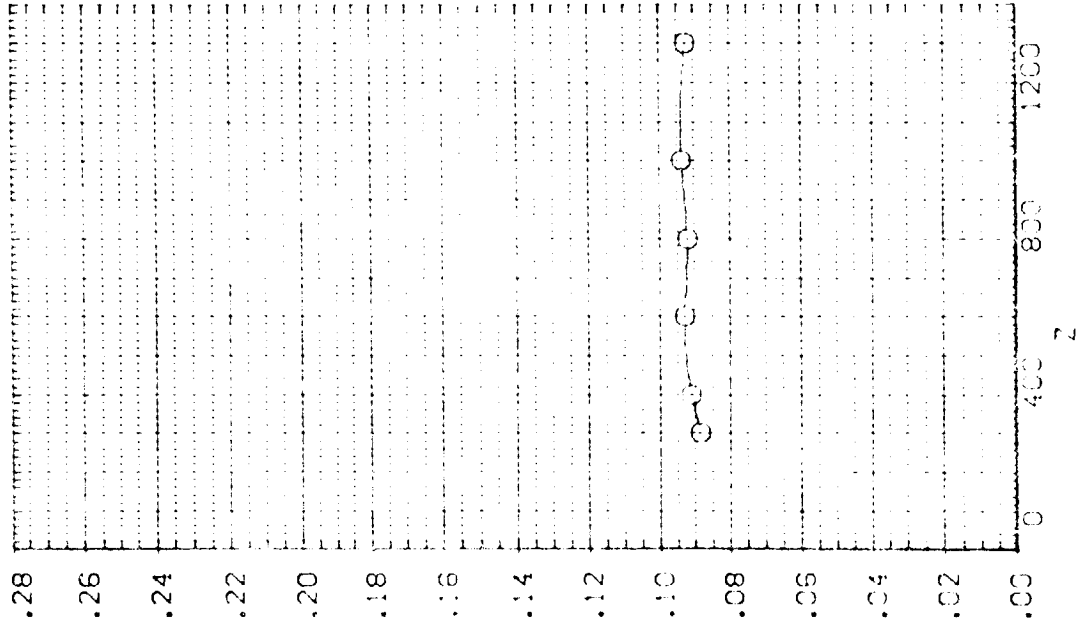

EXTERNAL TANK AERODYNAMIC CHARACTERISTICS DURING SEPARATION FROM ORB. CR (RTJ163)

SEE THE ASSOCIATED DATA DOCUMENT FOR REFERENCE CHARACTERISTICS FOR INDIVIDUAL DATASETS

SYMBOL X .161
 MACH 4.530
 ALPHA 1.000
 BETA 10.000
 GAMMA 1.000
 DELTA 1.000
 Epsilon 1.000
 Y 200.000

PARAMETRIC VALUES
 PYOTAL 110.000
 BETA 1.000
 GAMMA 5.000
 DELTA 10.000
 Epsilon 10.000

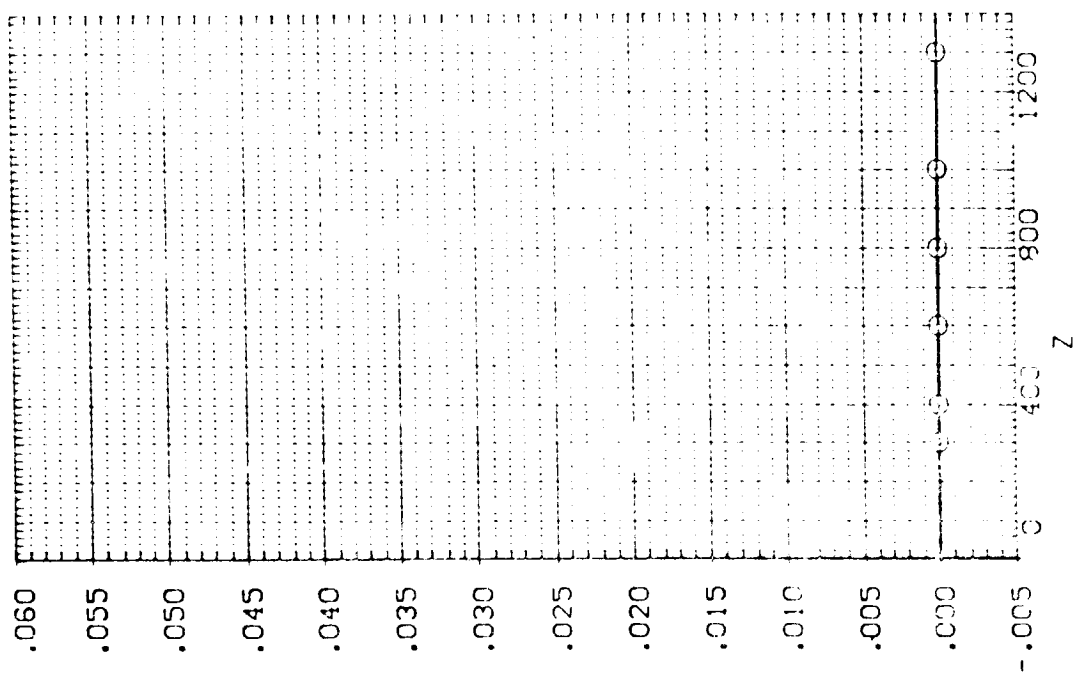
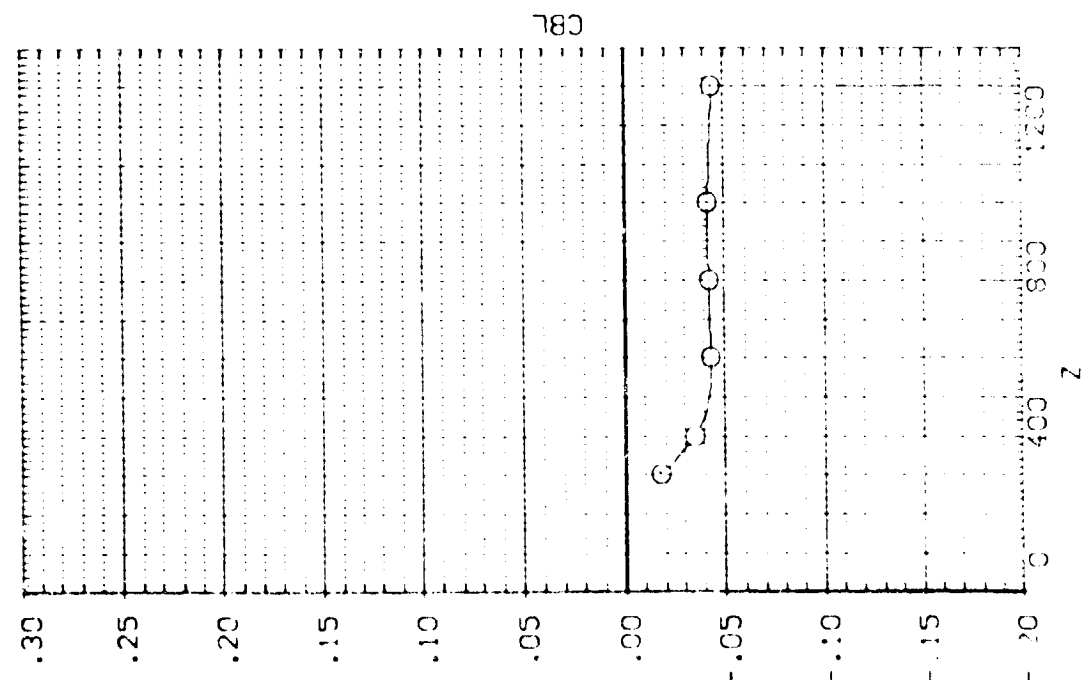

SEPARATING FROM CRP, 29 (R 1013)

1000 4.000
 2000 4.000
 3000 4.000
 4000 4.000
 5000 4.000
 6000 4.000
 7000 4.000
 8000 4.000
 9000 4.000
 10000 4.000

1000 4.000
 2000 4.000
 3000 4.000
 4000 4.000
 5000 4.000
 6000 4.000
 7000 4.000
 8000 4.000
 9000 4.000
 10000 4.000

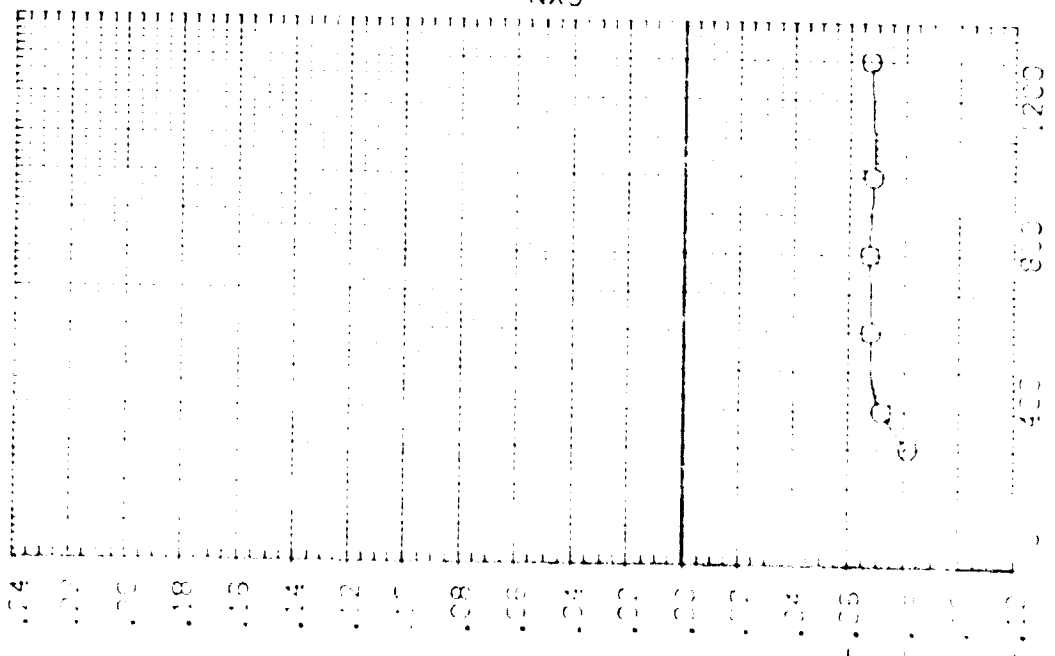

CYN

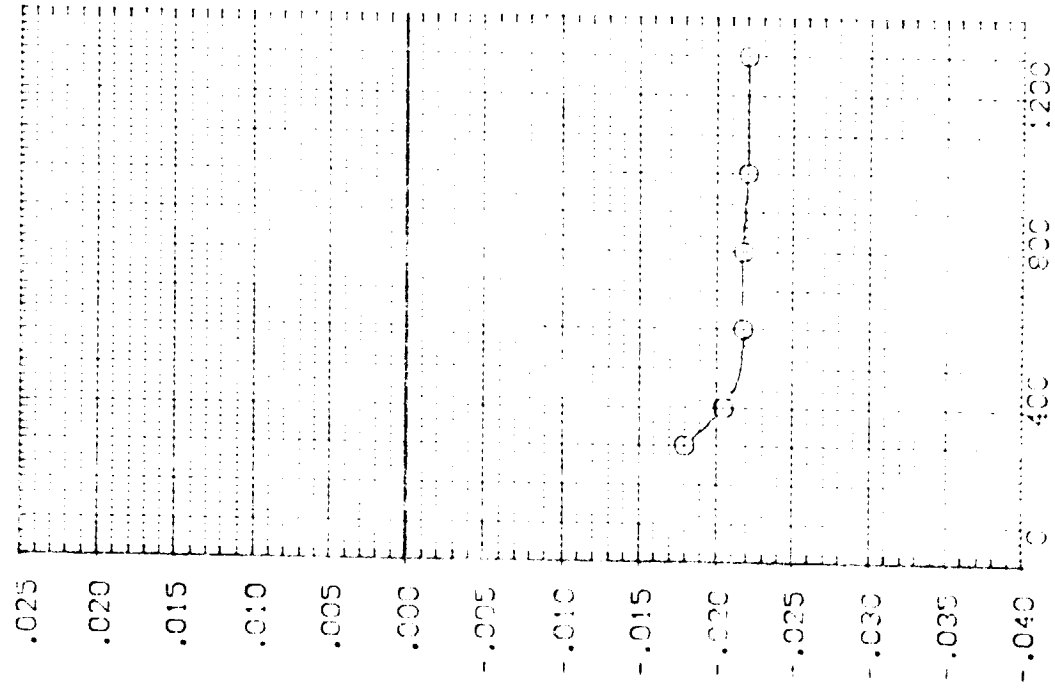

CHARACTERISTICS DURING SEPARATION FROM CRP, 29

1413. INTERNAL TRANSFER SEPARATING FROM CR3.09 (RTJ164)

SEE THE ASSOCIATED DATA DOCUMENT FOR REFERENCE CHARACTERISTICS FOR INDIVIDUAL DATA'S

SYMBOL X .073 MACH 41.330 P/TOTAL 110.000
 ALPHA .000 BETA .000
 GAMMA -70.000 DELTA .000
 ELEVTR .000 ALT-RGN 10.000
 Y -200.000

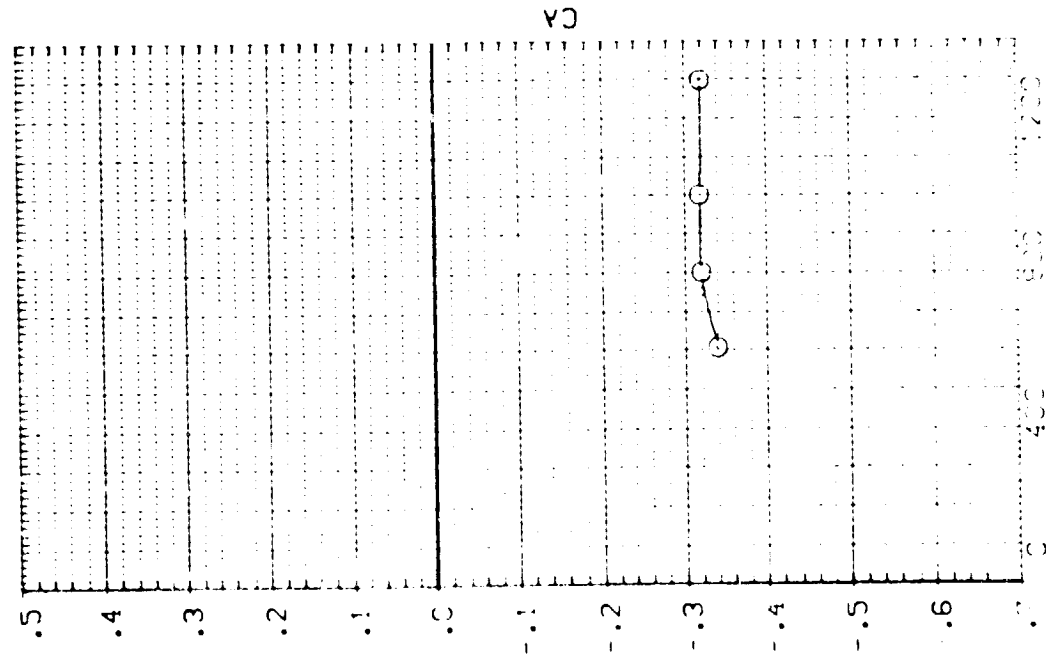
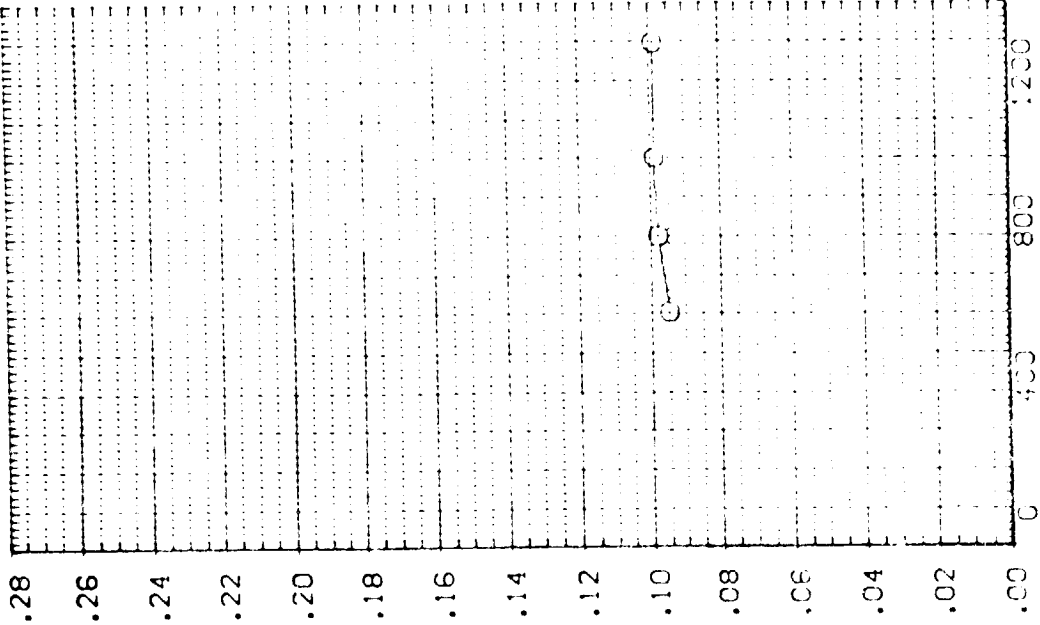

EXTERNAL MARK DYNAMIC CHARACTERISTICS DURING SEPARATION FROM CRBITER

EXPERIMENTAL DYNAMIC CHARACTERISTICS DURING SEPARATION FROM ORBITER

SCIENTIFIC ASSOCIATES, INC.
 2700 UNIVERSITY AVENUE
 BERKELEY, CALIF. 94704

PROJECT: SPACE SHUTTLE
 TASK: DYNAMIC CHARACTERISTICS
 SUBTASK: SEPARATION FROM ORBITER
 INSTRUMENTATION: 1000
 TEST POINT: 1000
 TEST DATE: 10/17/73
 TEST TIME: 08:00

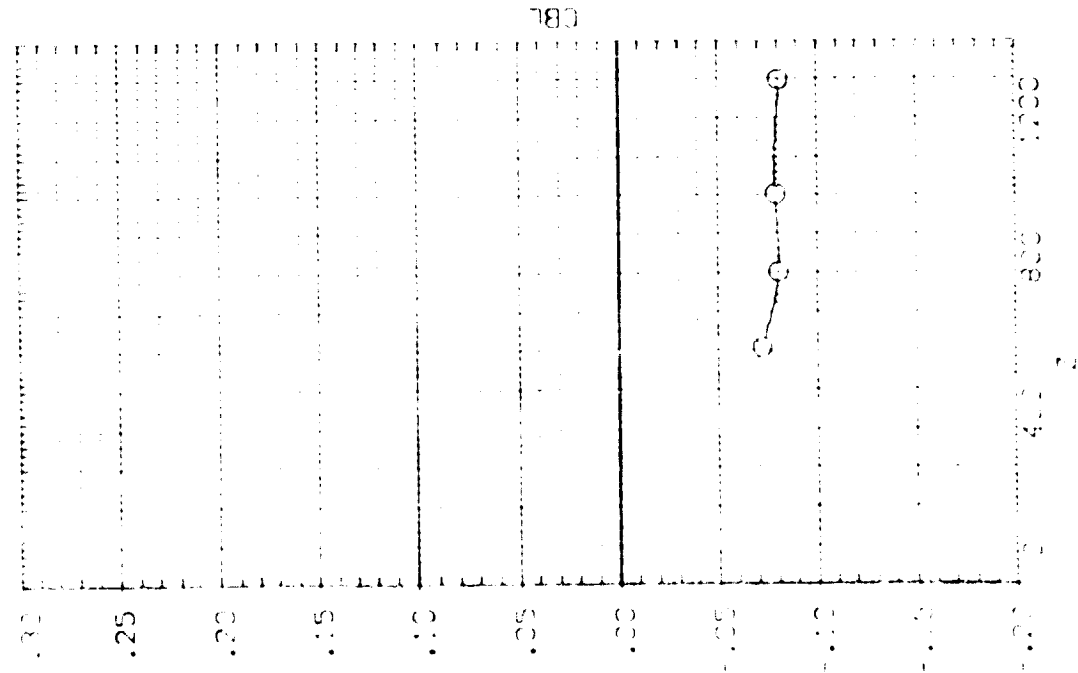
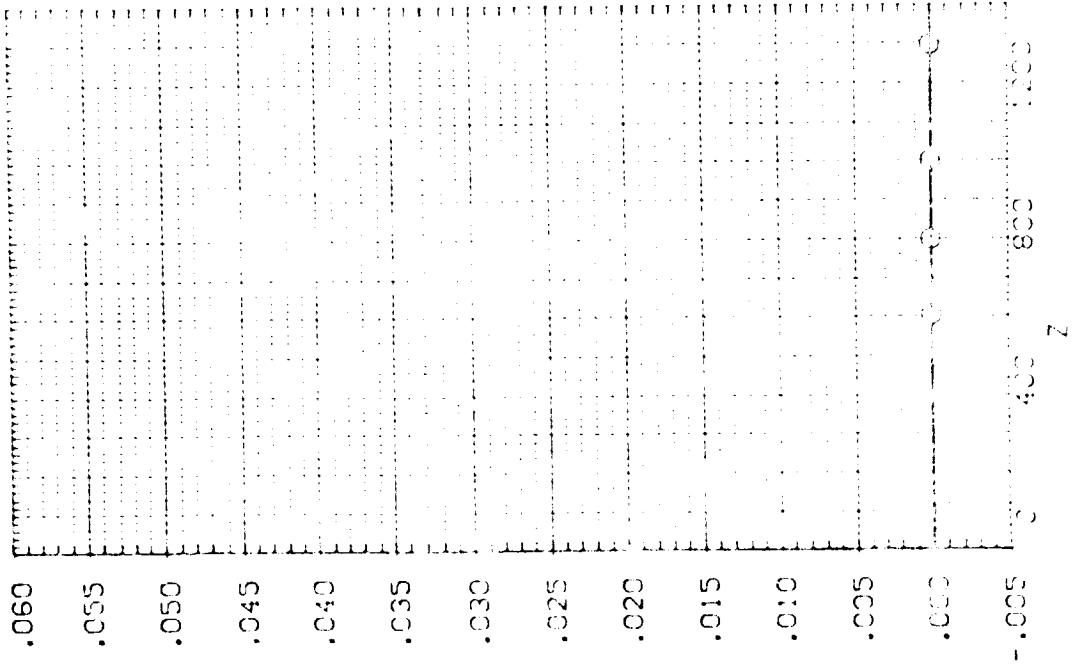

EXPERIMENTAL DYNAMIC CHARACTERISTICS DURING SEPARATION FROM ORBITER

EXTERNAL TANK(10)SEPARATING FROM ORB. 09 (RTJ184)

SEE THE ASSOCIATED DATA DOCUMENT FOR REFERENCE OF CHARACTERISTICS FOR INDIVIDUAL DATASETS

PARAMETRIC VALUES
 WASH 4.530 P*STAL 110.000
 ALPHA 1.000 BETA 1.000
 GAMMA -20.000 DBLTA 1.000
 EPRTR 1.000 ALLPON 10.000
 V -200.000

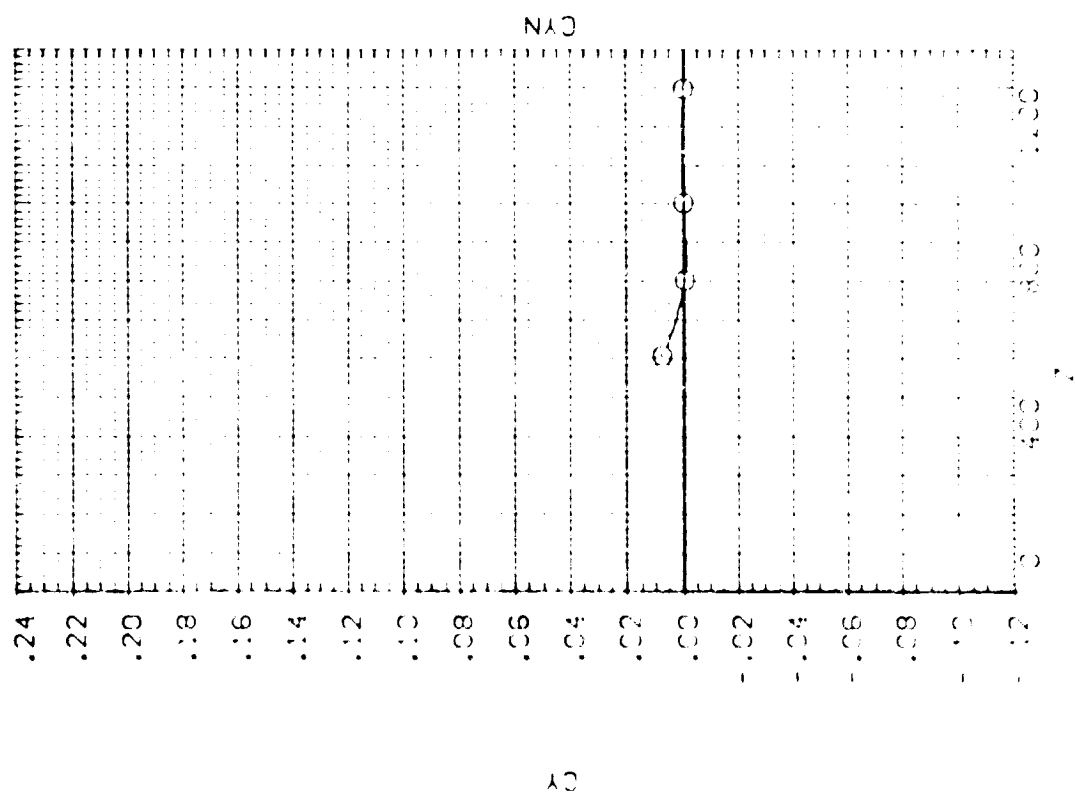
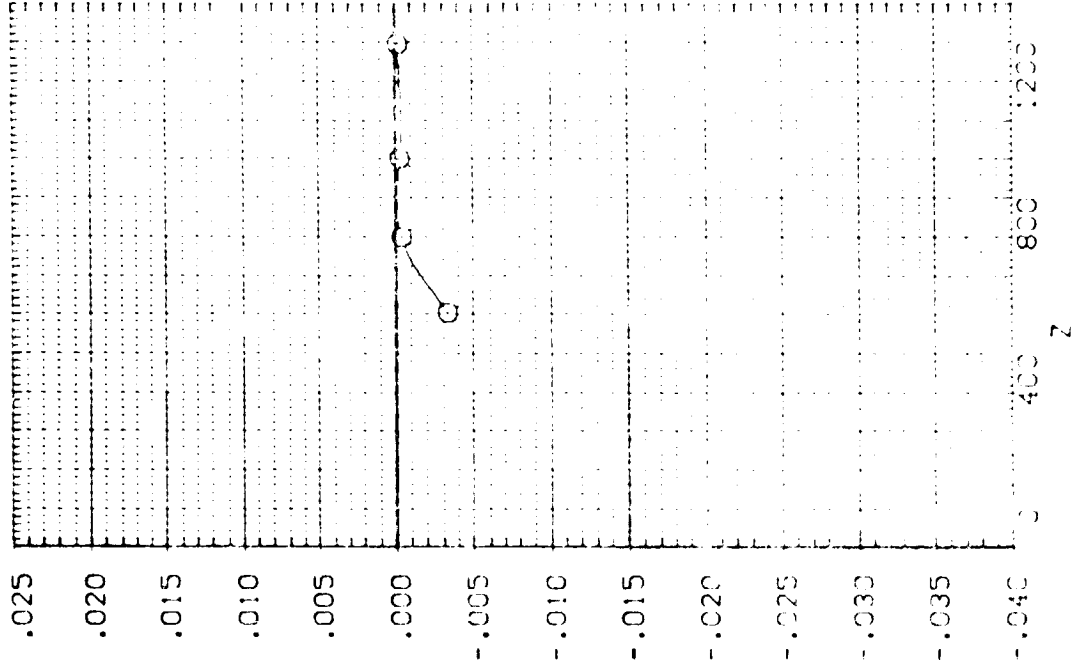

EXTERNAL TANK PROGRAMMING CHARACTERISTICS DURING SEPARATION FROM ORBITER

EXPERIMENTAL THERMAL CHARACTERISTICS DURING SEPARATION FROM CRISTHER

1. 4000
 2. 4000
 3. 4000
 4. 4000
 5. 4000
 6. 4000
 7. 4000
 8. 4000
 9. 4000
 10. 4000

1. 4000
 2. 4000
 3. 4000
 4. 4000
 5. 4000
 6. 4000
 7. 4000
 8. 4000
 9. 4000
 10. 4000

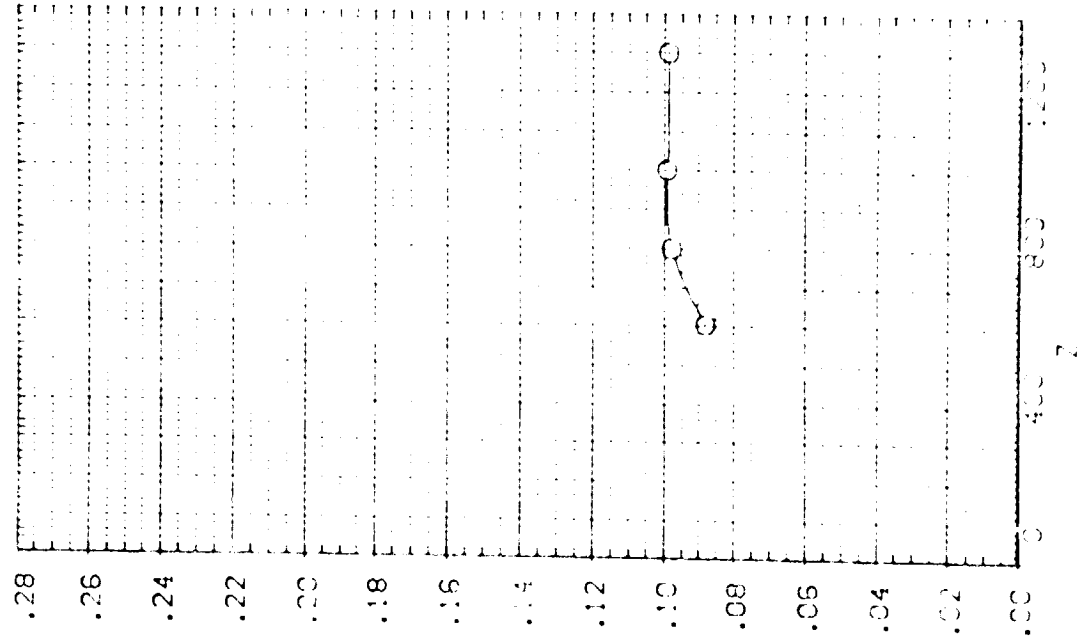
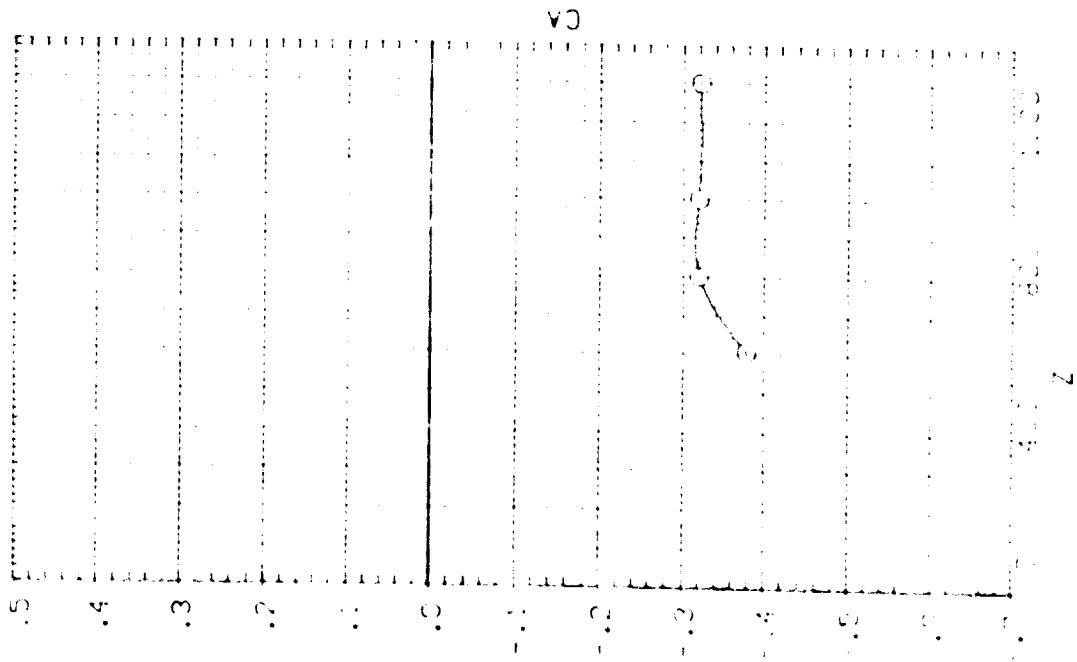

EXPERIMENTAL THERMAL CHARACTERISTICS DURING SEPARATION FROM CRISTHER

1. 4000
 2. 4000
 3. 4000
 4. 4000
 5. 4000
 6. 4000
 7. 4000
 8. 4000
 9. 4000
 10. 4000

FIG. 3. EXTERNAL FANCTIO) SEPARATING FROM CRB. 09 (RTJ 65)

SYMBOL
O

PARAMETRIC VALUES
 MACH 4.500 PIGTAL 110.000
 ALPHA .000 BETA .000
 GAMMA -20.000 DELTA .000
 EPSILON .000 AILRON 10.000
 Y .000

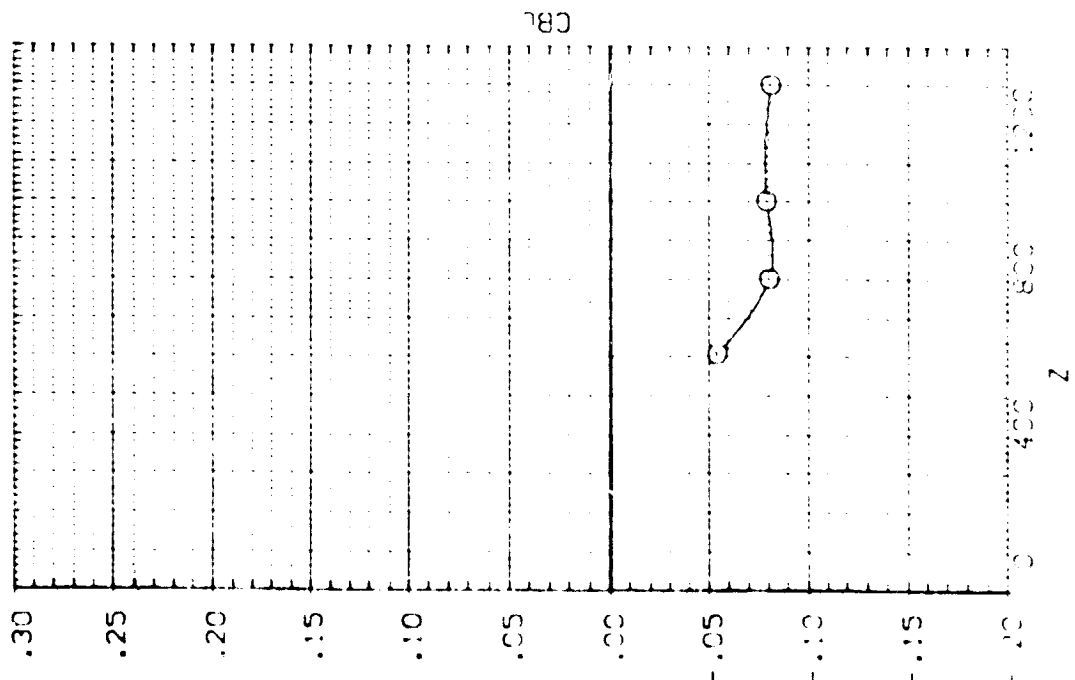

SEE THE ASSOCIATED DATA
 VOLUME FOR REFERENCE
 CHARACTERISTICS FOR
 INDIVIDUAL CASES

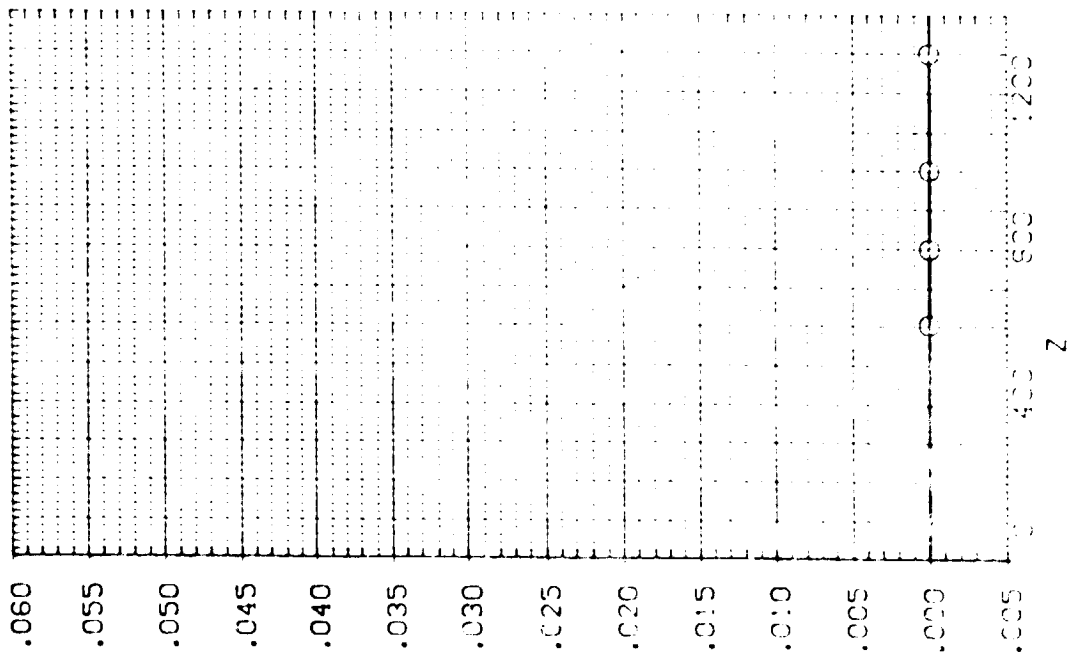

EXTERNAL FANCTIO) SEPARATING FROM CRB. 09 (RTJ 65)

... ..

... ..

... ..

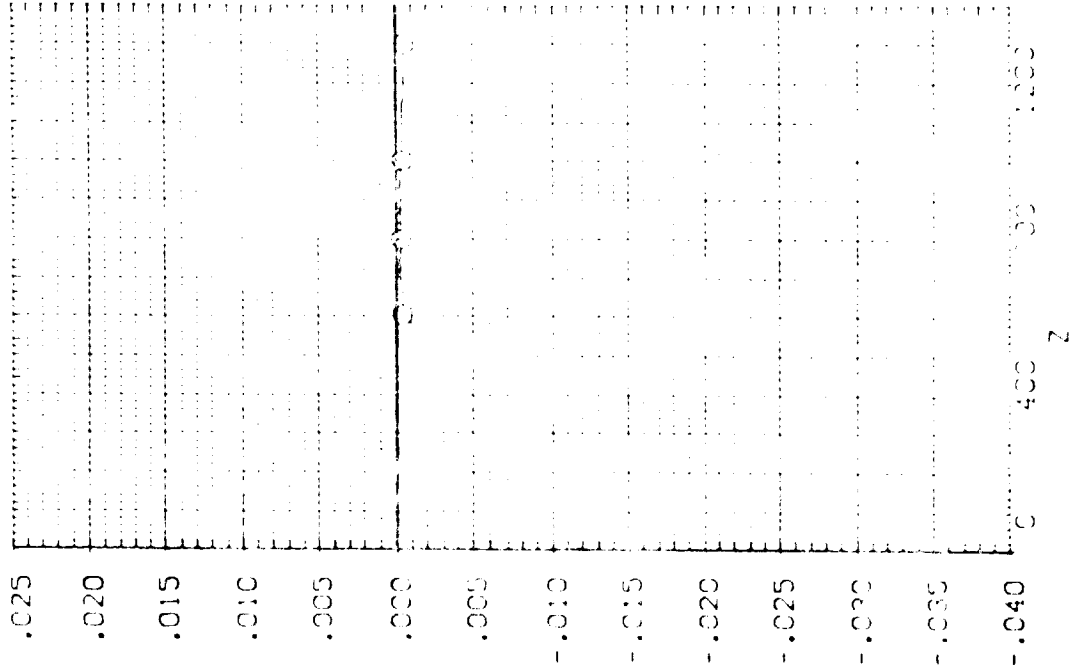
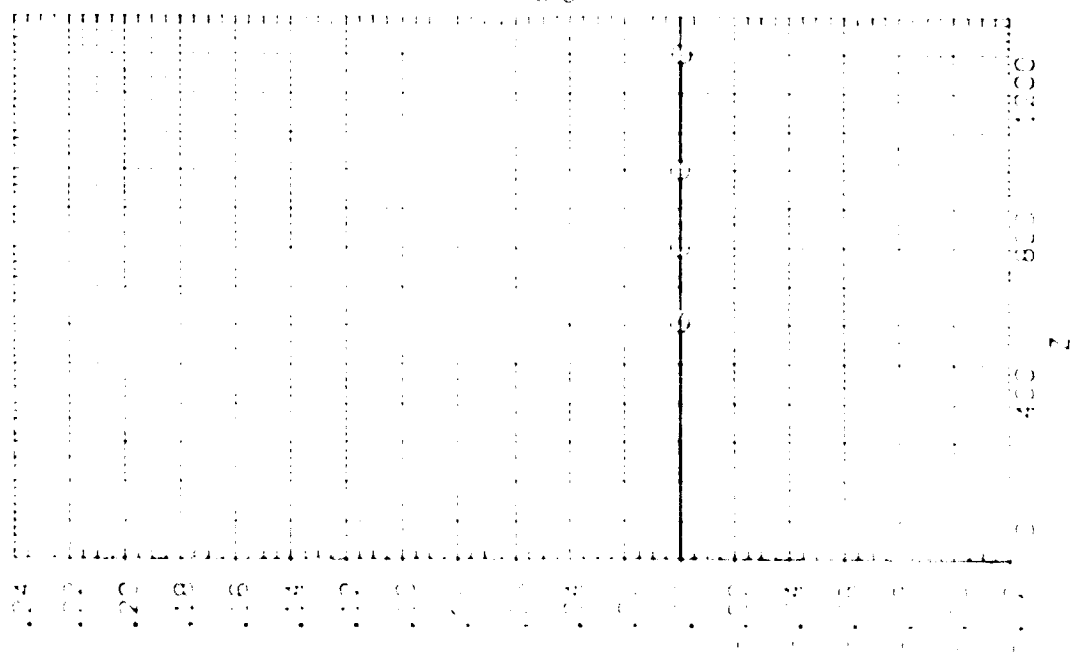

... ..

[A13, EXTERNAL TANK(T10)SEPARATING FROM ORB. 09 (RTJ'66)]

SYMBOL x
O

PARAMETRIC VALUES
 MACH 4.530 PTOTAL 110.000
 ALPHA .000 BETA .000
 DALPHA -20.000 DBETA .000
 ELEVTR .000 AIRRON 10.000
 Y 200.000

SEE THE ASSOCIATED DATA DOCUMENT FOR REFERENCE CHARACTERISTICS FOR INDIVIDUAL DATASETS

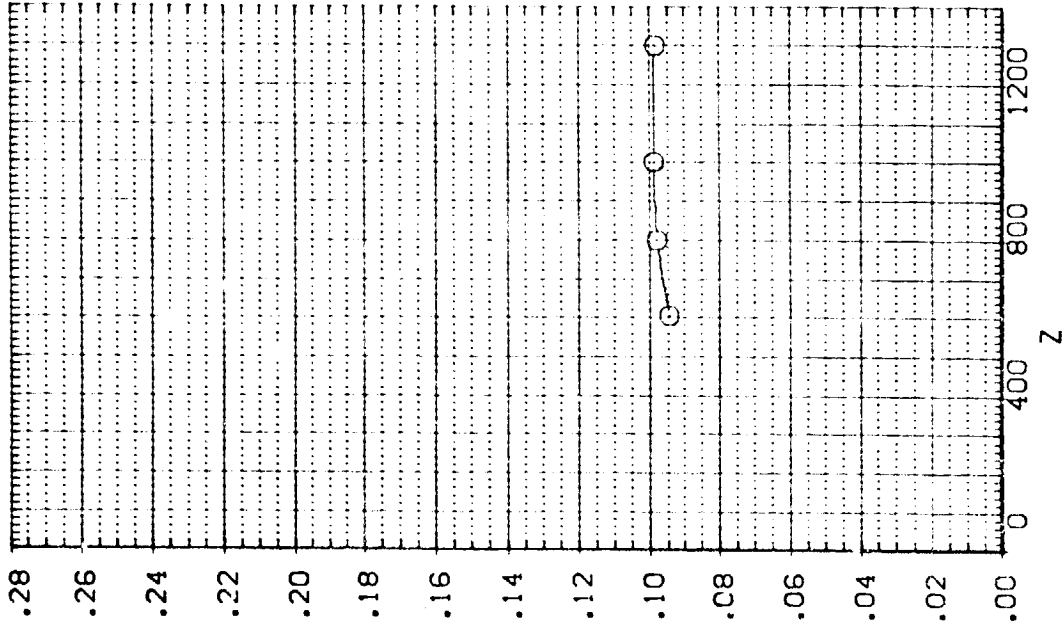
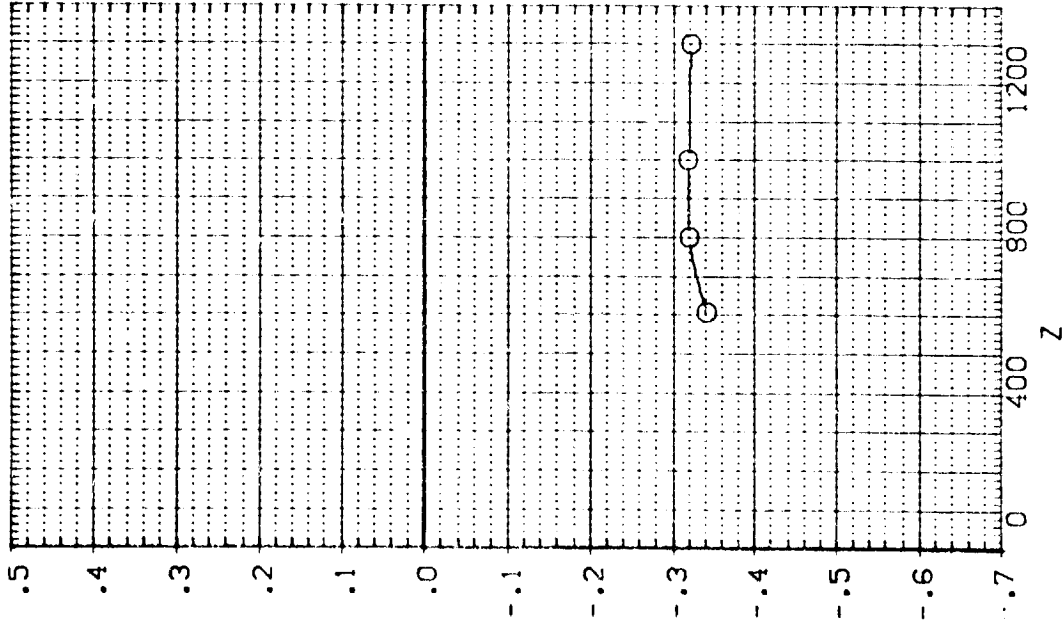

EXTERNAL TANK AERODYNAMIC CHARACTERISTICS DURING SEPARATION FROM ORBITER

IA13, EXTERNAL TANK (10) SEPARATING FROM ORB, 09 (RTJ166)

SEE THE ASSOCIATED DATA DOCUMENT FOR REFERENCE CHARACTERISTICS FOR INDIVIDUAL DATASETS

SYMBOL: 0167
 PARAMETRIC VALUES
 MACH 4.530 P/DIAL 110.000
 ALPHA .000 BETA .000
 D/ALPHA -20.000 C/BETA .000
 ELEVTR .000 A/LPOM 10.000
 Y 200.000

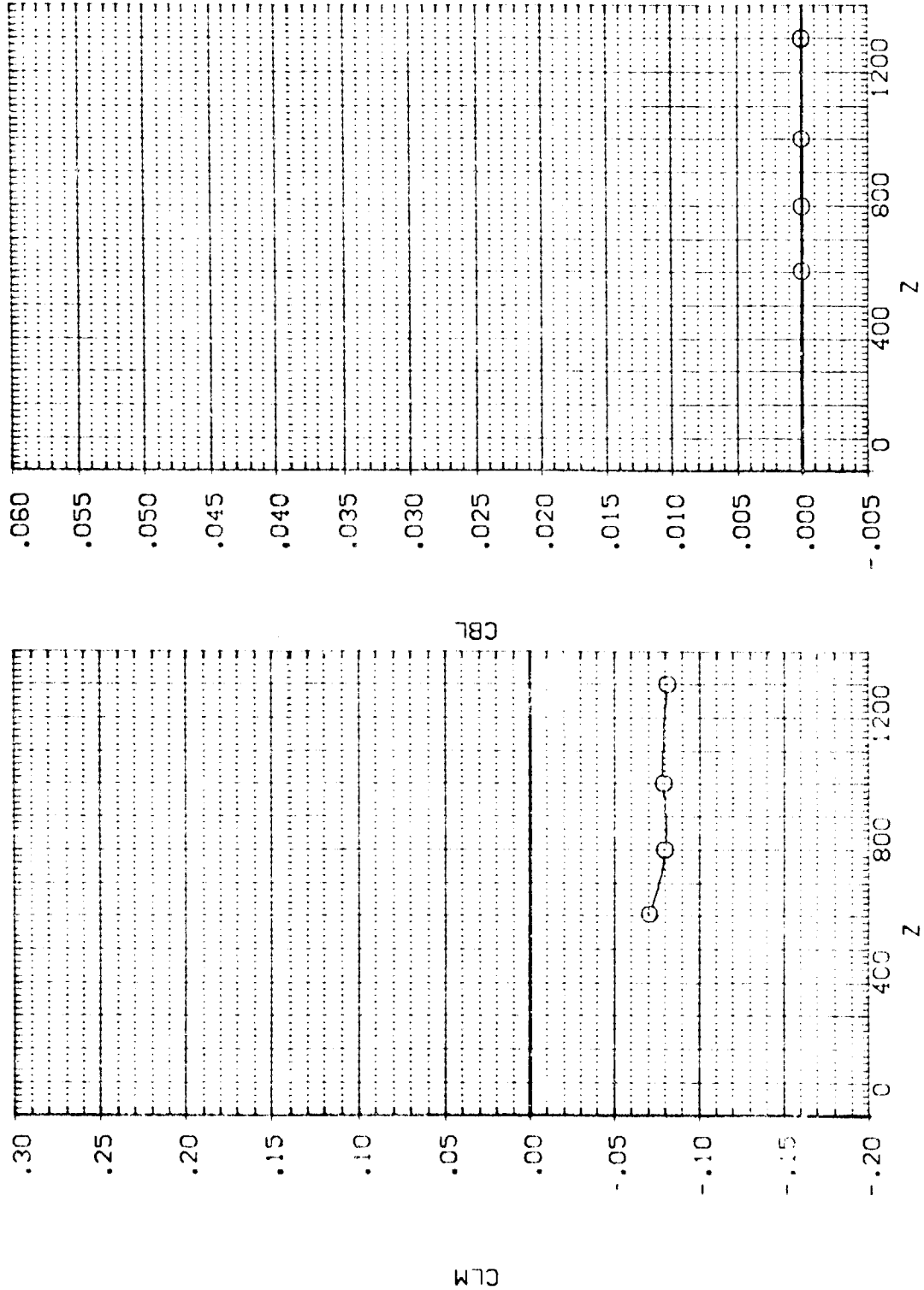

IA13,EXTERNAL TANK(T10)SEPARATING FROM ORB, 09 (RTJT66)

SYMBOL X
○

.167

PARAMETRIC VALUES

MACH	4.530	PTOTAL	110.000
ALPHA	.000	BETA	.000
DALPHA	-20.000	DBETA	.000
ELEVTR	.000	AILRON	10.000
Y	200.000		

SEE THE ASSOCIATED DATA DOCUMENT FOR REFERENCE CHARACTERISTICS FOR INDIVIDUAL DATASETS

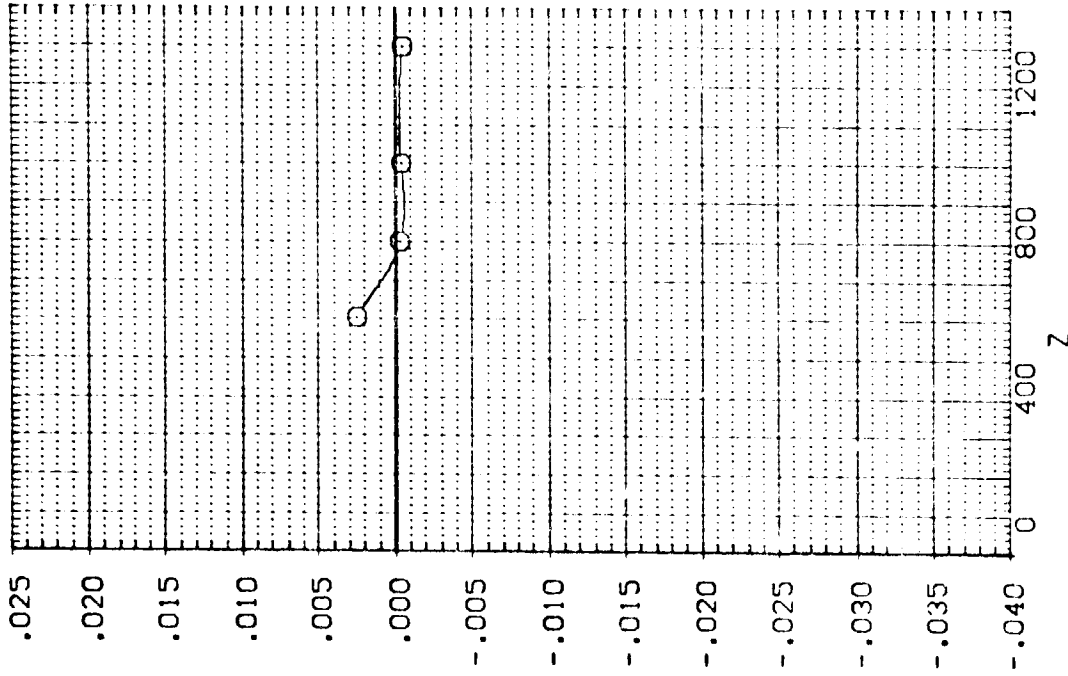
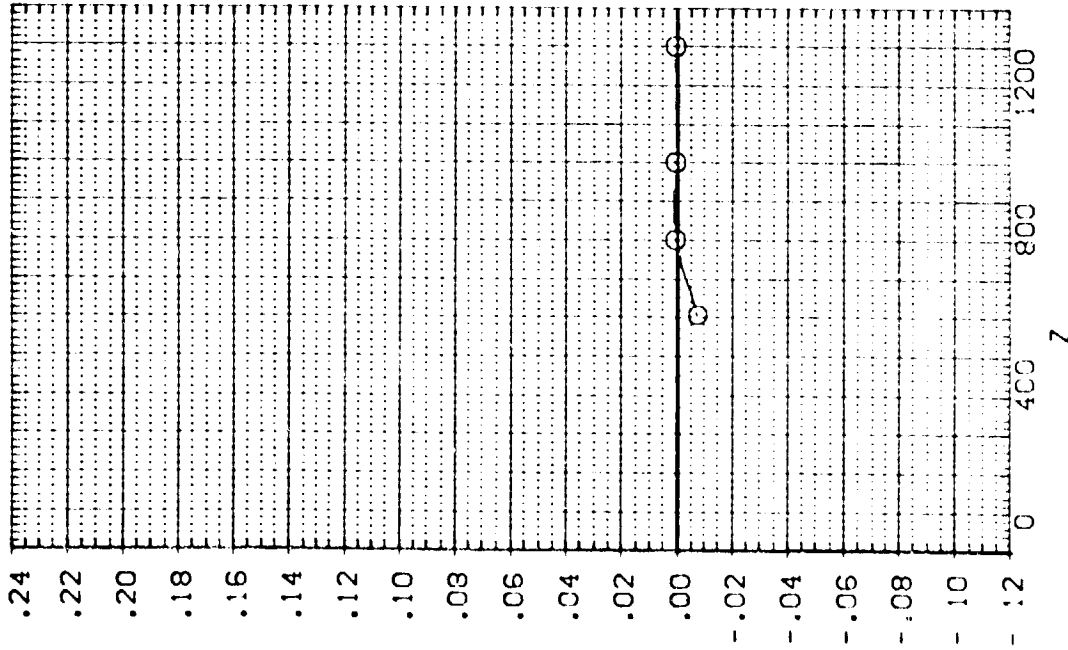

EXTERNAL TANK AERODYNAMIC CHARACTERISTICS DURING SEPARATION FROM ORBITER

FIG. 3. EXTERNAL AERODYNAMIC CHARACTERISTICS DURING SEPARATION FROM ORB. 09 (RTJ 167)

SEE THE ASSOCIATED DATA DOCUMENT FOR REFERENCE CHARACTERISTICS FOR INDIVIDUAL DATASETS

PARAMETRIC VALUES	
MACH	4.530
ALPHA	0.000
BETA	0.000
DELTA	-20.000
ELEVTR	0.000
Y	-200.000

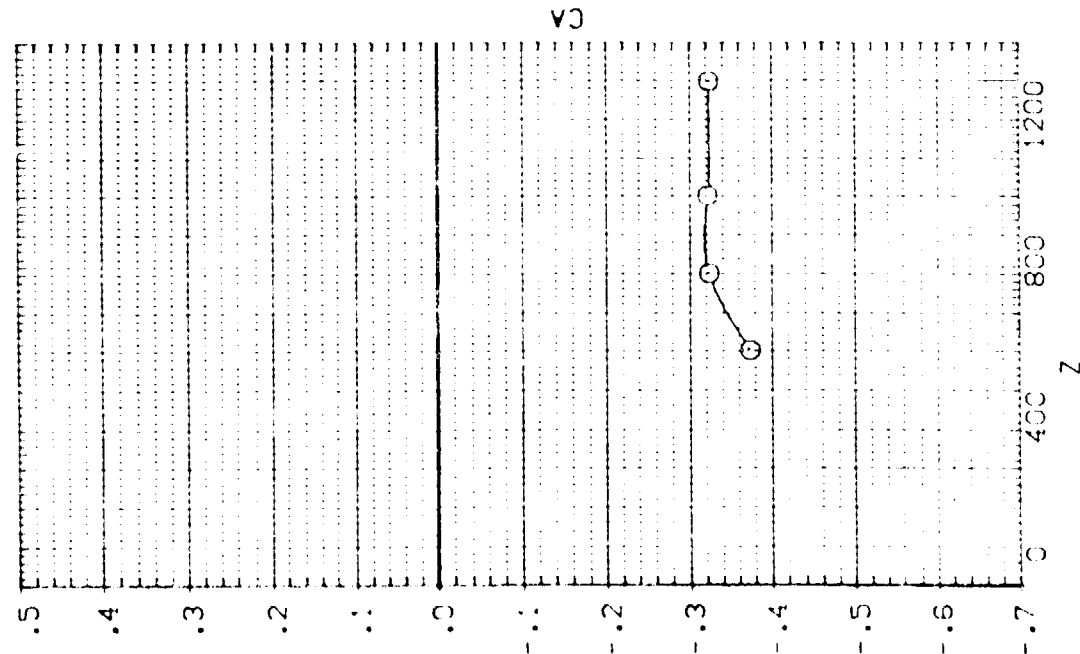
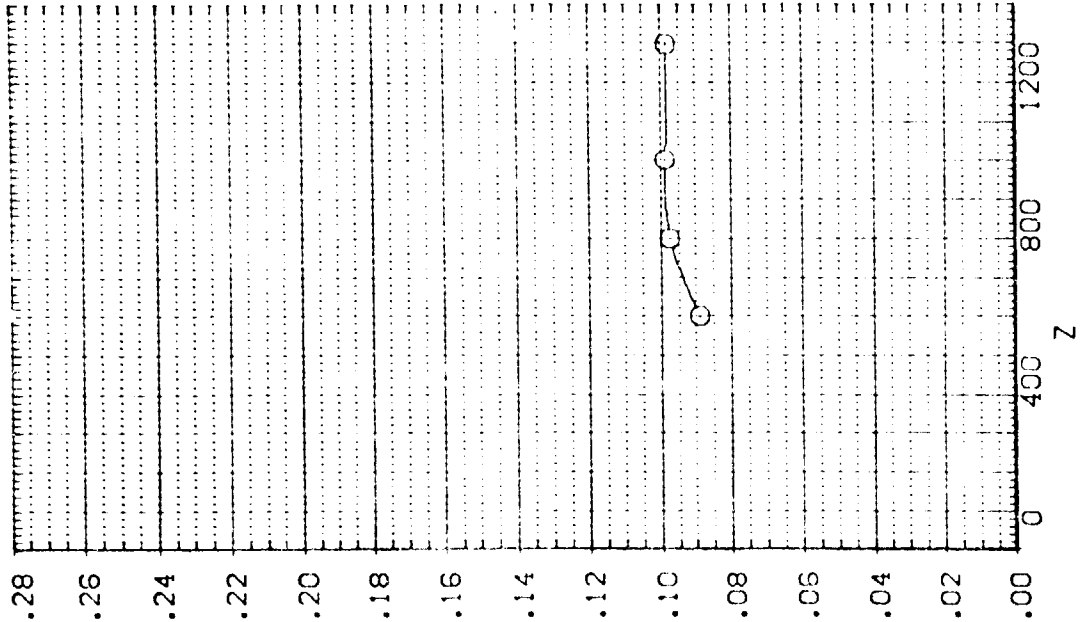

IA.3.EXTERNAL TANK(T10)SEPARATING FROM ORB. 09 (RTJT67)

SYMBOL x

PARAMETRIC VALUES
 MACH 4.530 PTOTAL 110.000
 ALPHA .000 BETA .000
 DALPHA -20.000 DBETA -5.000
 ELEVTX .000 AILRON 10.000
 Y -200.000

SEE THE ASSOCIATED DATA DOCUMENT FOR REFERENCE CHARACTERISTICS FOR INDIVIDUAL DATASETS

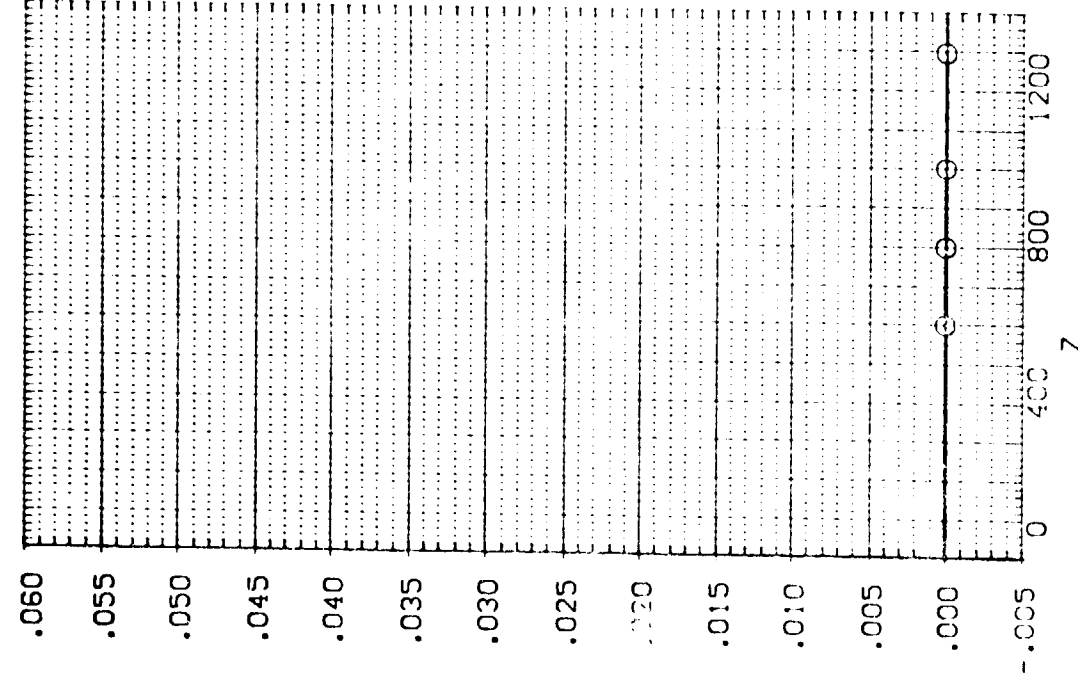
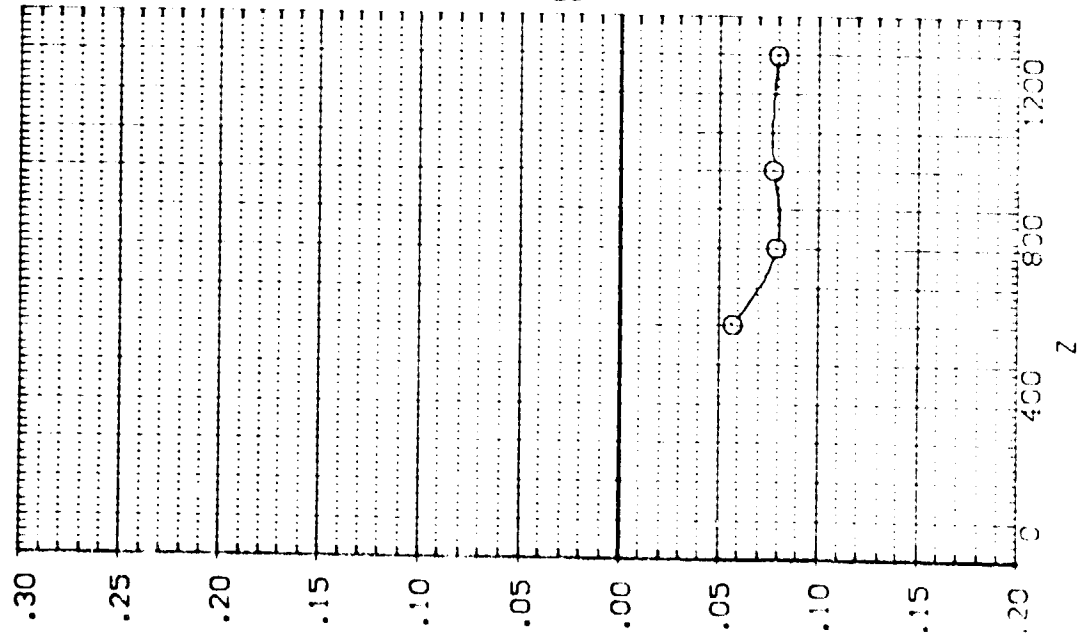

EXTERNAL TANK AERODYNAMIC CHARACTERISTICS DURING SEPARATION FROM ORBITER

1A13. EXTERNAL TANK(T10)SEPARATING FROM ORB. 09 (RTJT67)

SEE THE ASSOCIATED DATA DOCUMENT FOR REFERENCE CHARACTERISTICS FOR INDIVIDUAL DATASETS

SYMBOL		PARAMETRIC VALUES	
x	.142	MACH	4.530
		PIOTAL	110.000
		ALPHA	.000
		BETA	.000
		DIAPHA	-20.000
		DBETA	-5.000
		ELEVTR	.000
		AILRON	10.000
		Y	-200.000

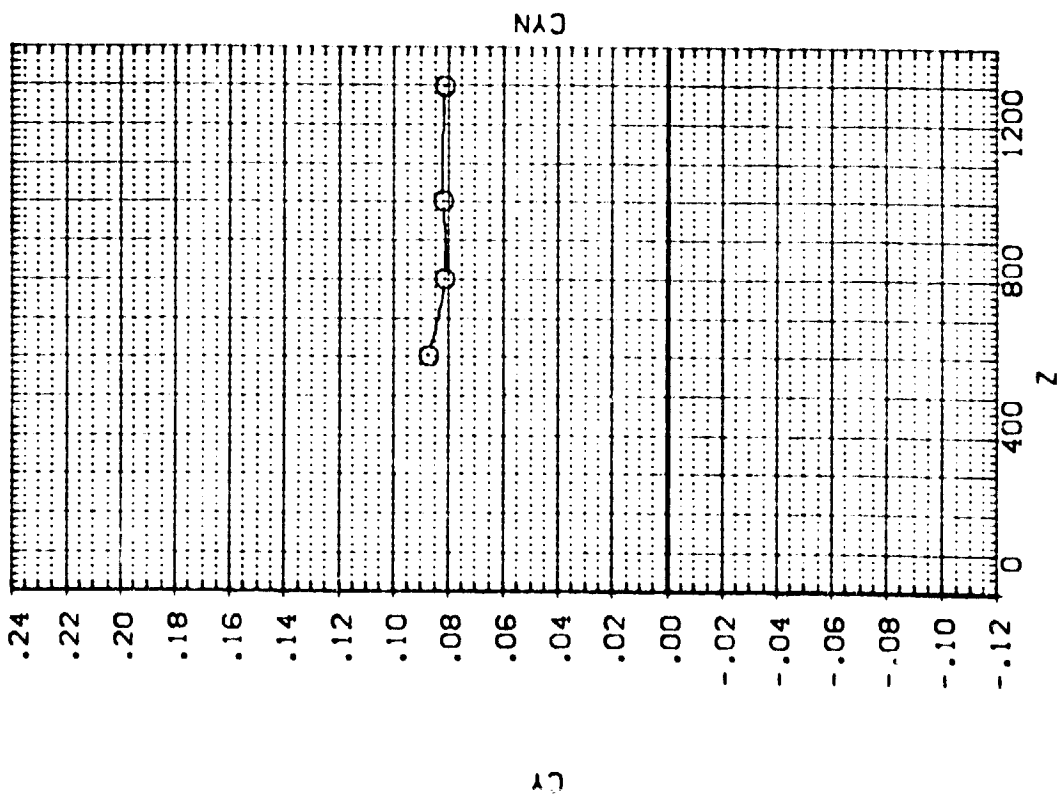
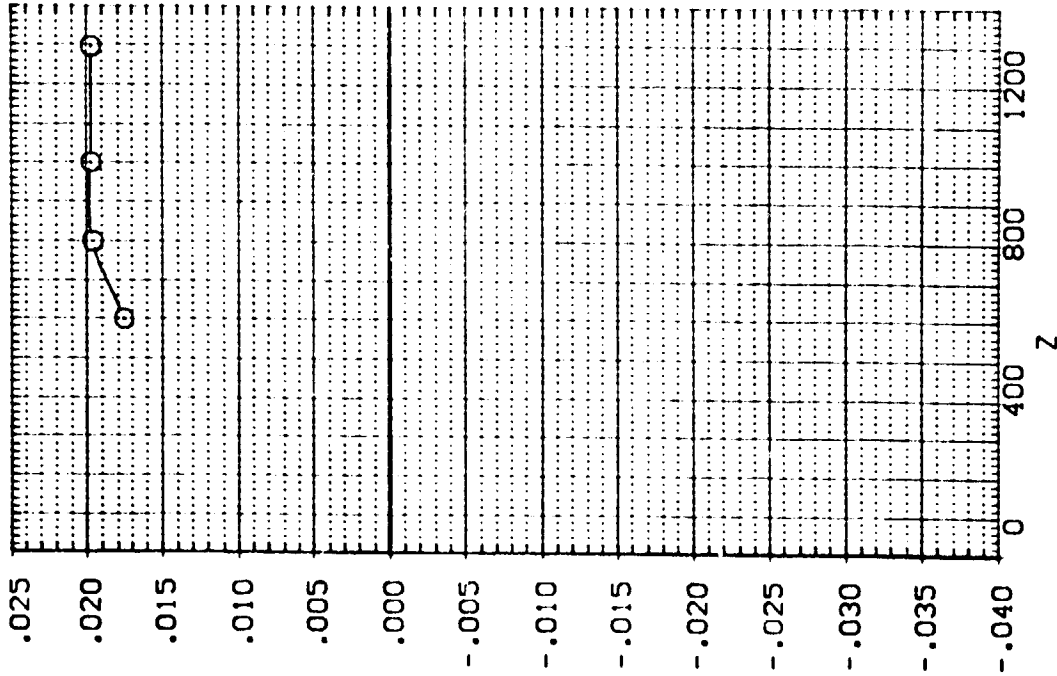

IA13.EXTERNAL TANK(10)SEPARATING FROM ORB. 09 (RTJT68)

SEE THE ASSOCIATED DATA DOCUMENT FOR REFERENCE CHARACTERISTICS FOR INDIVIDUAL DATASETS

SYMBOL		PARAMETRIC VALUES	
x	.014	MACH	4.530
		PTOTAL	110.000
		BETA	.000
		DBETA	5.000
		AIRFRN	10.000
		Y	.000

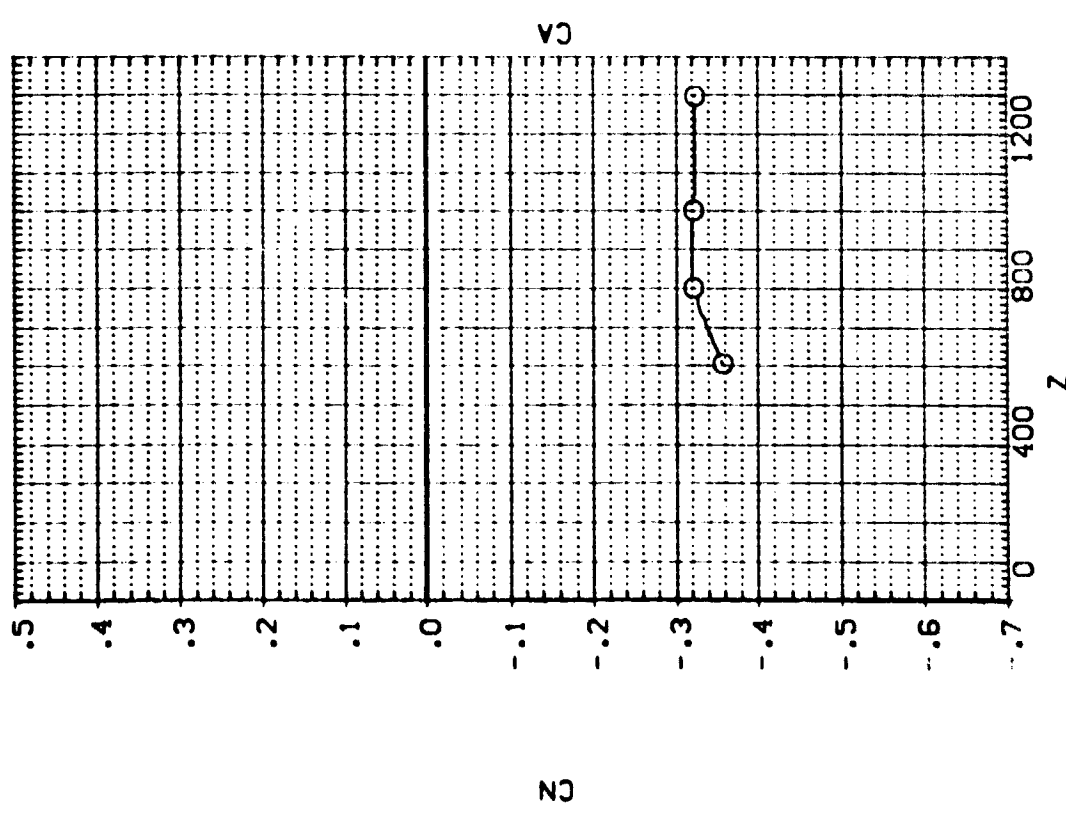
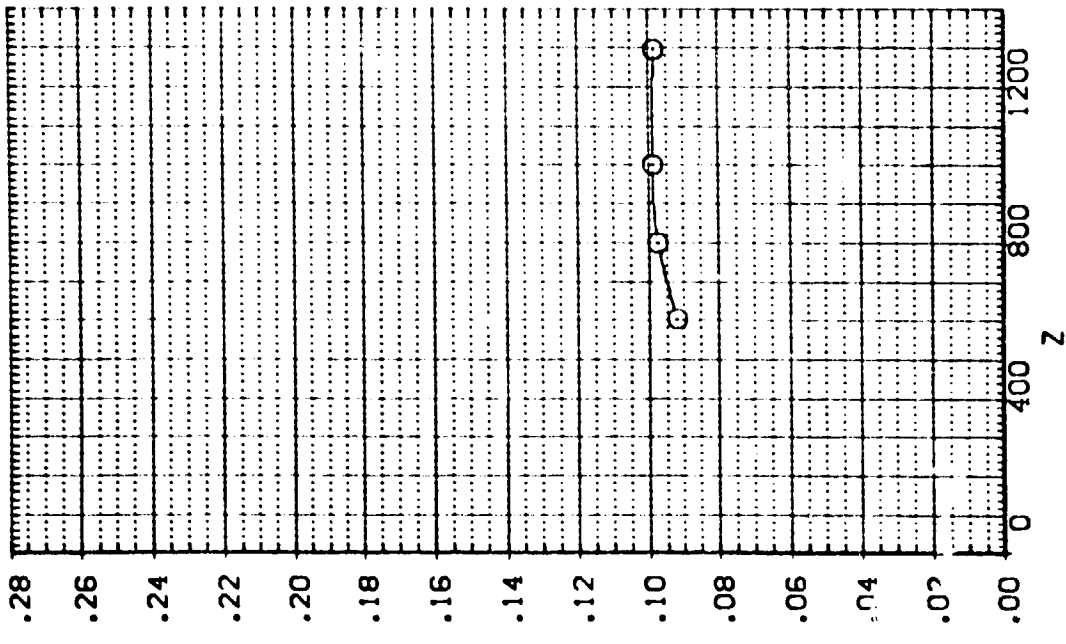

EXTERNAL TANK AERODYNAMIC CHARACTERISTICS DURING SEPARATION FROM ORBITER

IA13.EXTERNAL TANK(10)SEPARATING FROM ORB. 09 (RTJT68)

SEE THE ASSOCIATED DATA DOCUMENT FOR REFERENCE CHARACTERISTICS FOR INDIVIDUAL DATASETS

SYMBOL		PARAMETRIC VALUES	
X	.014	MACH	4.530
Y		ALPHA	.000
Z		DALPHA	-20.000
		ELEVTR	.000
		P/DISTAL	110.000
		BETA	.000
		DBETA	5.000
		ATLRON	10.000
		Y	.000

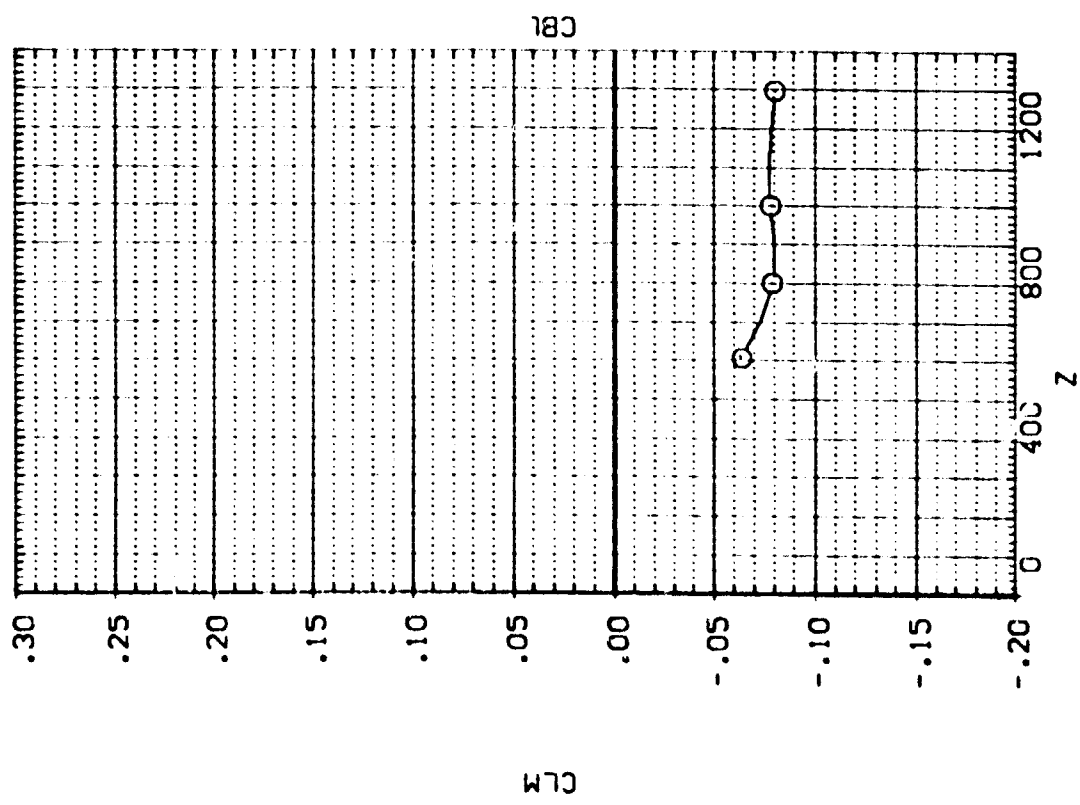
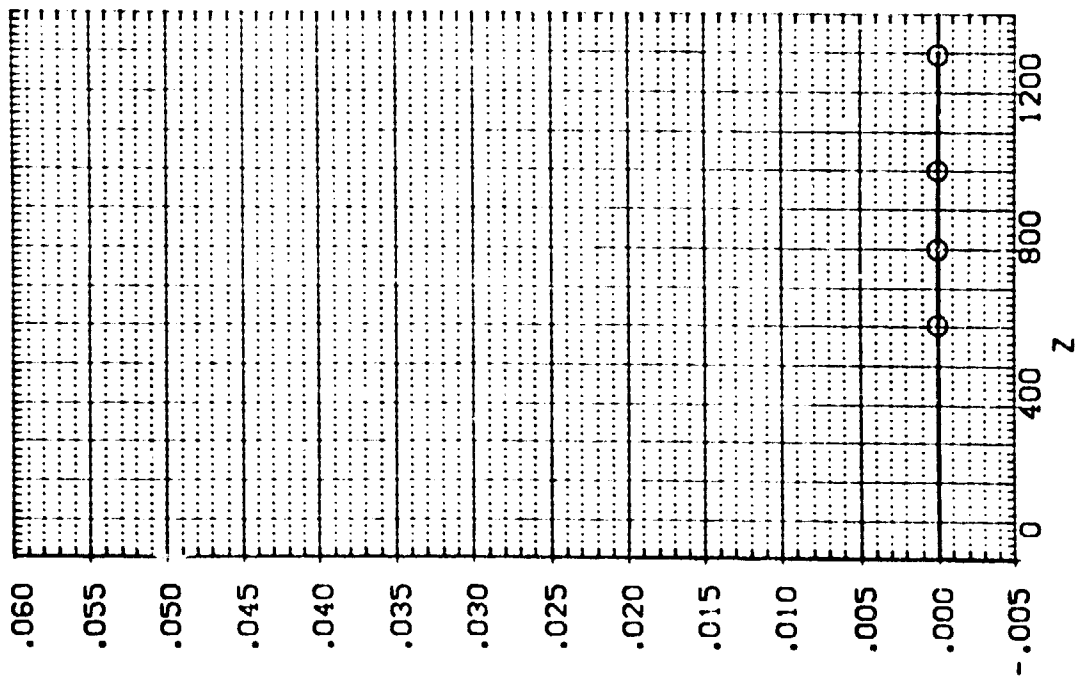

IA13. EXTERNAL TANK(T10)SEPARATING FROM ORB. 09 (RTJT68)

SEE THE ASSOCIATED DATA DOCUMENT FOR REFERENCE CHARACTERISTICS FOR INDIVIDUAL DATA SETS

SYMBOL		PARAMETRIC VALUES			
C	X	MACH	4.530	P TOTAL	110.000
		ALPHA	.000	BETA	.000
		DALPHA	-20.000	DBETA	5.000
		ELEVTR	.000	AILRON	10.000
		Y	.000		

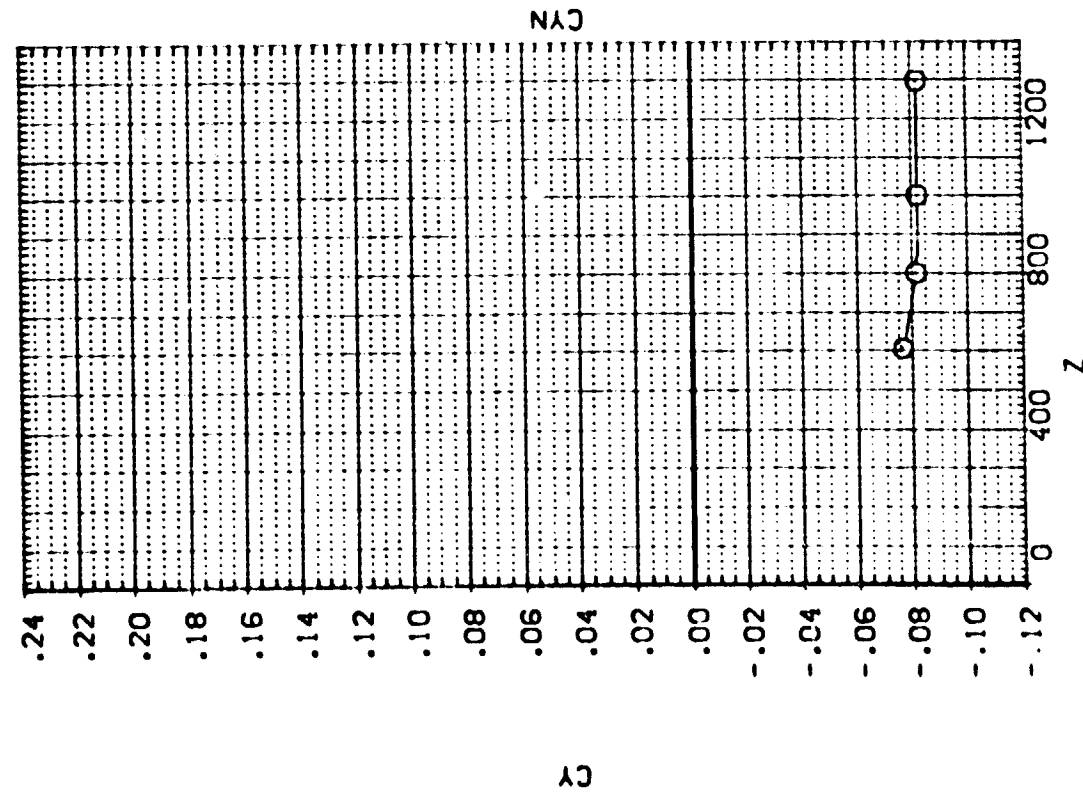
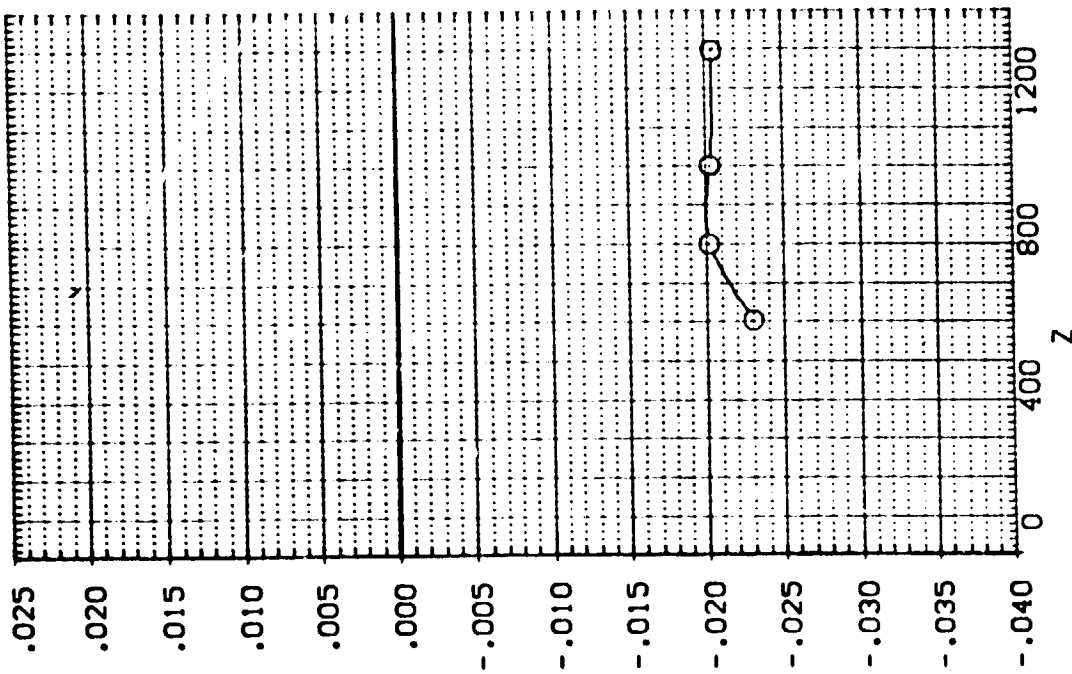

EXTERNAL TANK AERODYNAMIC CHARACTERISTICS DURING SEPARATION FROM ORBITER

1A13. EXTERNAL TANK(110)SEPARATING FROM ORB. 09 (RTJT69)

SYMBOL X
C

PARAMETRIC VALUES
 MACH 4.530 P/TOTAL 110.000
 ALPHA .000 BETA .000
 DALPHA -20.000 DBETA 5.000
 ELEVTR .000 A/LRON 10.000
 Y 200.000

SEE THE ASSOCIATED DATA DOCUMENT FOR REFERENCE CHARACTERISTICS FOR INDIVIDUAL DATASETS

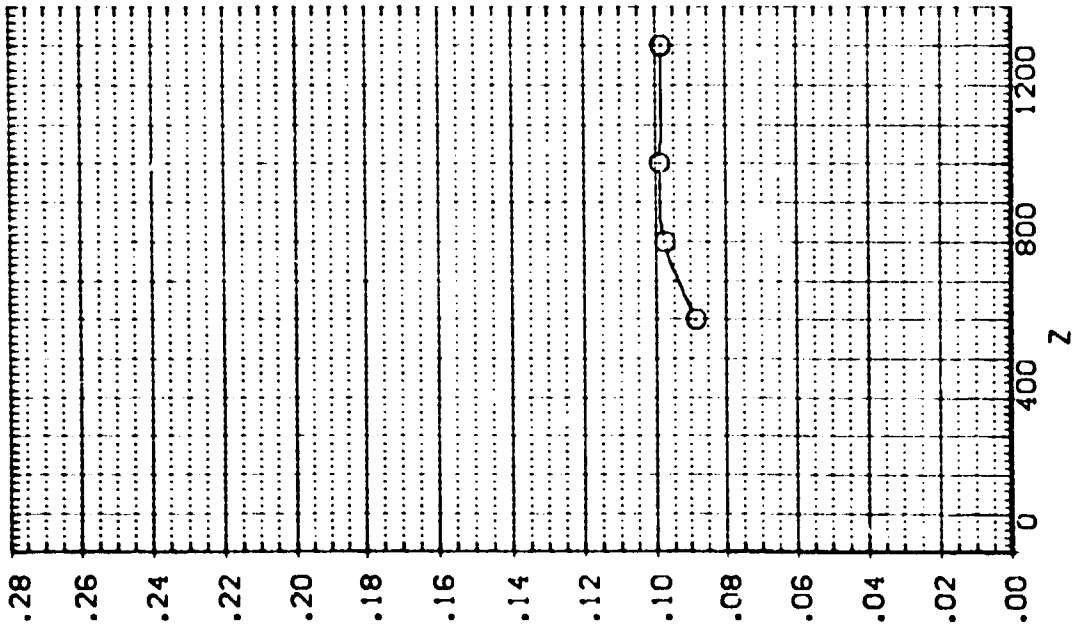
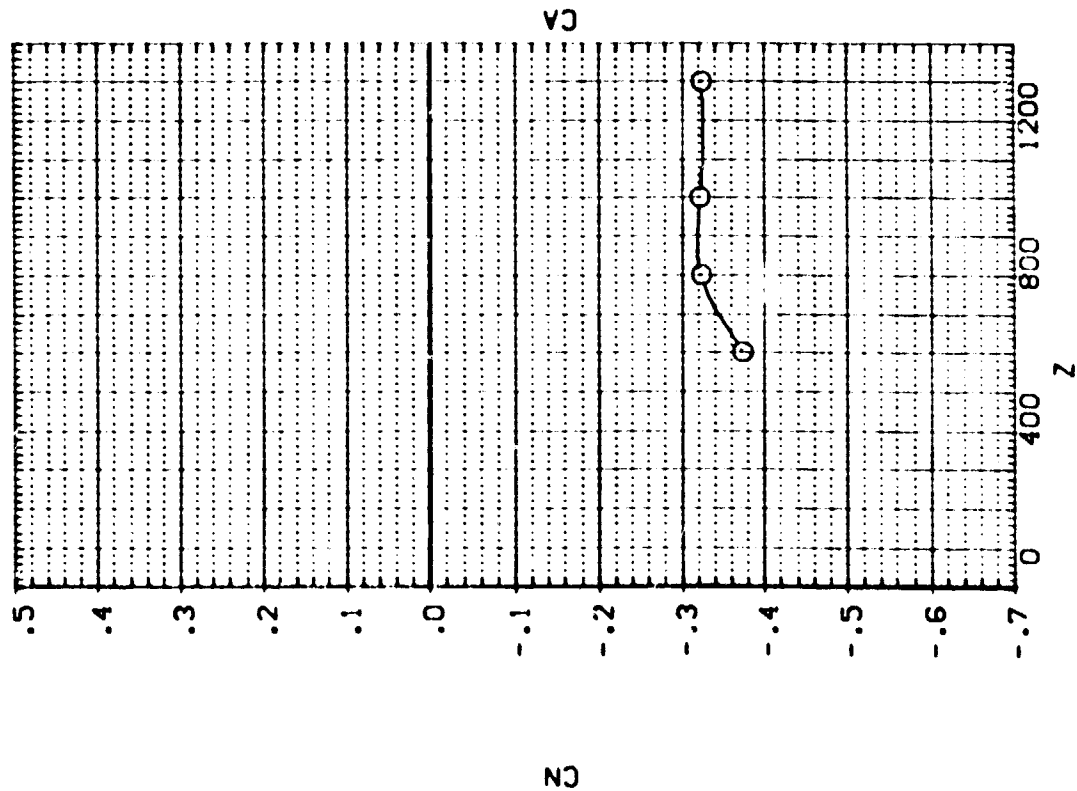

[A13.EXTERNAL TANK(T10)SEPARATING FROM ORB. 09 (RTJT69)]

SYMBOL x
o

MACH
ALPHA
DALPHA
ELEVTR
V

PARAMETRIC VALUES
4.530
.000
-20.000
.000
200.000

PTOTAL 110.000
BETA .000
ALTRON 5.000
10.000

SEE THE ASSOCIATED DATA DOCUMENT FOR REFERENCE CHARACTERISTICS FOR INDIVIDUAL DATASETS

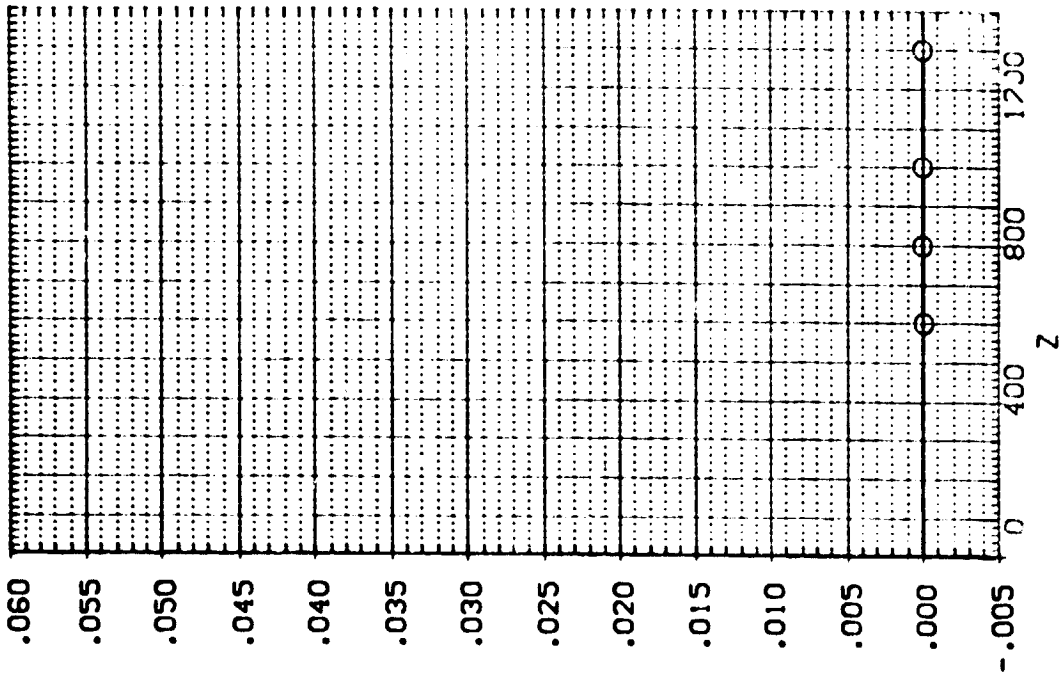
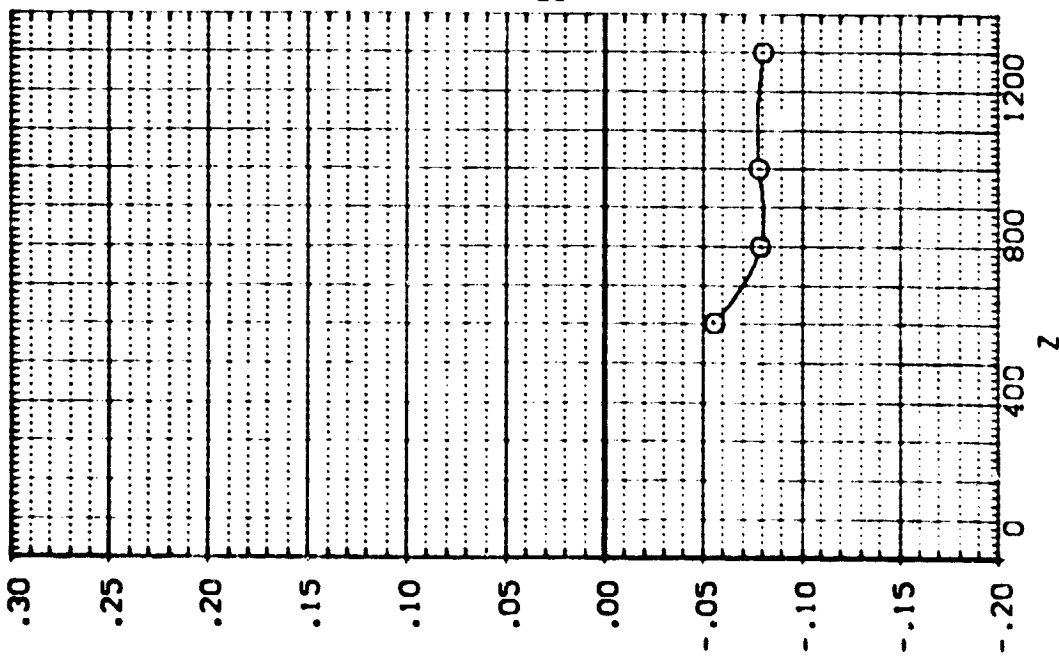

EXTERNAL TANK AERODYNAMIC CHARACTERISTICS DURING SEPARATION FROM ORBITER

1A13. EXTERNAL TANK(110)SEPARATING FROM ORB. 09 (RTJ'69)

SEE THE ASSOCIATED DATA DOCUMENT FOR REFERENCE CHARACTERISTICS FOR INDIVIDUAL DATASETS

SYMBOL		PARAMETRIC VALUES	
x	.050	MACH	4.530
		ALPHA	.000
		DALPHA	-20.000
		ELEVTR	.000
		Y	200.000
		BETA	.000
		DBETA	5.000
		AIRRON	10.000
			110.000

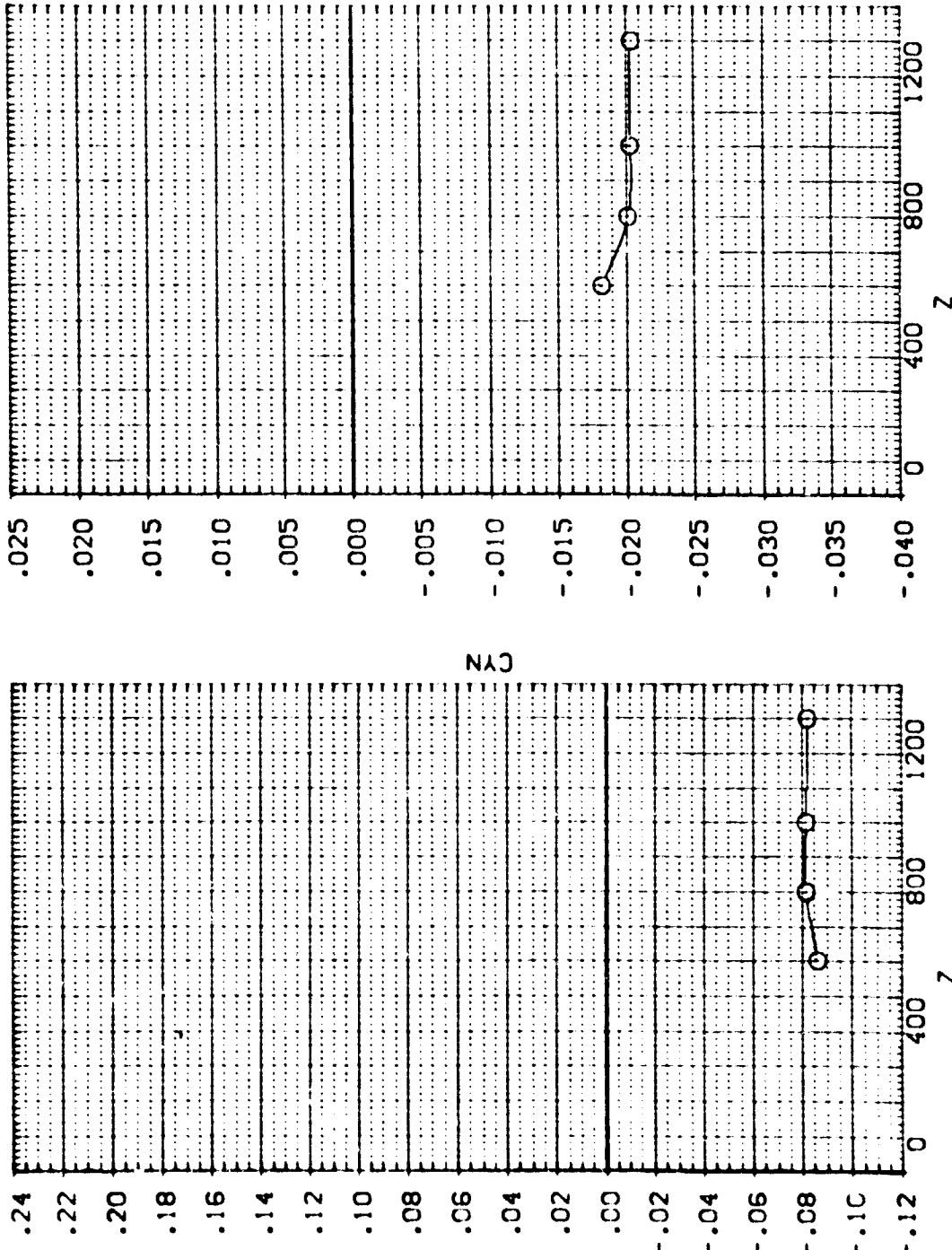

!A13.EXTERNAL TANK(T10)SEPARATING FROM ORB. 09 (RTJT70)

SYMBOL X

.256

PARAMETRIC VALUES

MACH 4.520 P/TOTAL 80.000
 ALPHA -5.000 BETA .000
 DALPHA .000 DBETA .000
 ELEVTX .000 A/TURDN 10.000
 Y -200.000

SEE THE ASSOCIATED DATA DOCUMENT FOR REFERENCE CHARACTERISTICS FOR INDIVIDUAL DATASETS

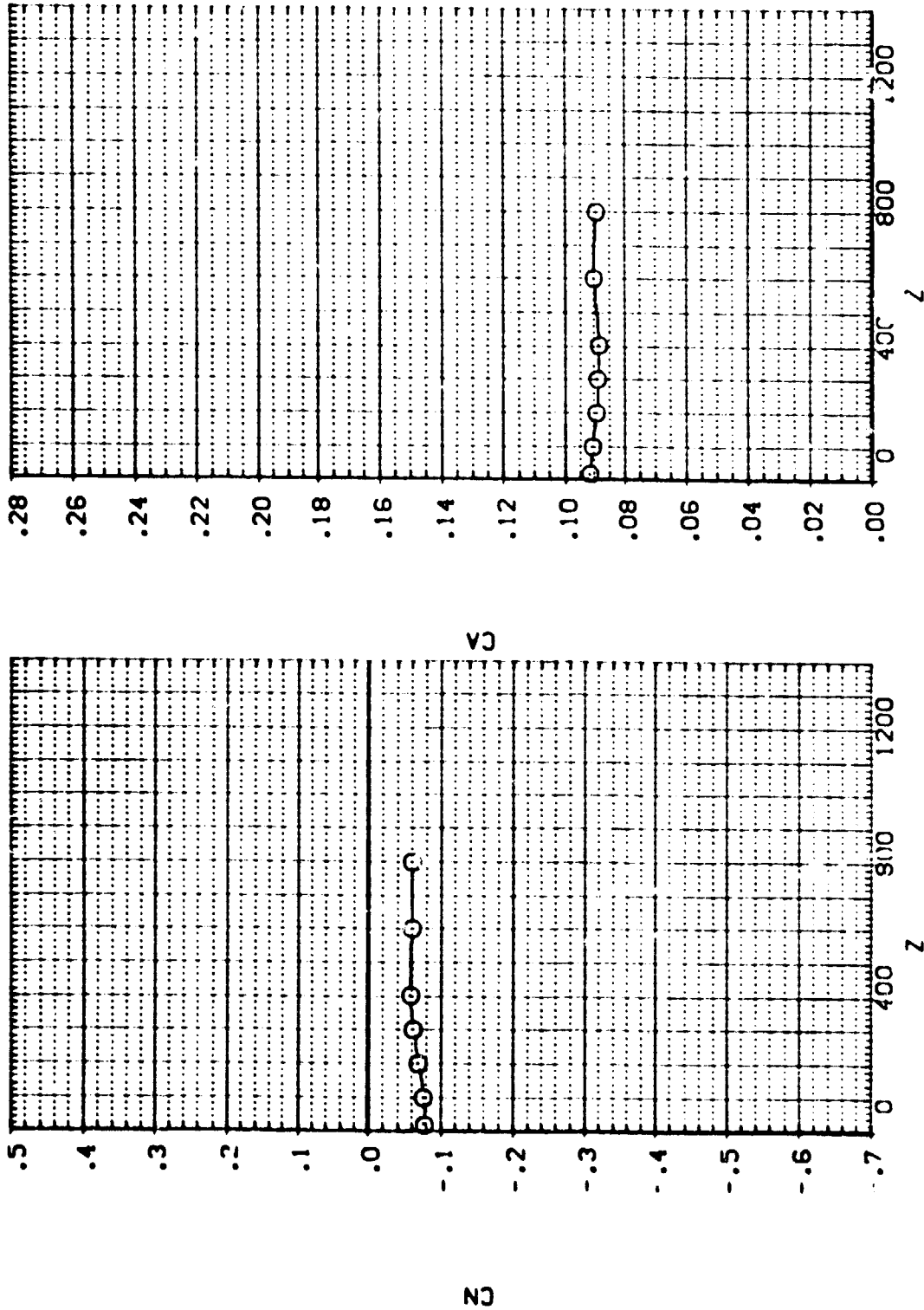

EXTERNAL TANK AERODYNAMIC CHARACTERISTICS DURING SEPARATION FROM ORBITER

IA13.EXTERNAL TANK(T10)SEPARATING FROM ORB. 09 (RTJT70)

SEE THE ASSOCIATED DATA DOCUMENT FOR REFERENCE CHARACTERISTICS FOR INDIVIDUAL DATASETS

SYMBOL X .256 MACH 4.520 PTOTAL 80.000
 O ALPHA -5.000 BETA .000
 DALPHA .000 DBETA .000
 ELEVTR .000 ALLRON 10.000
 Y -200.000

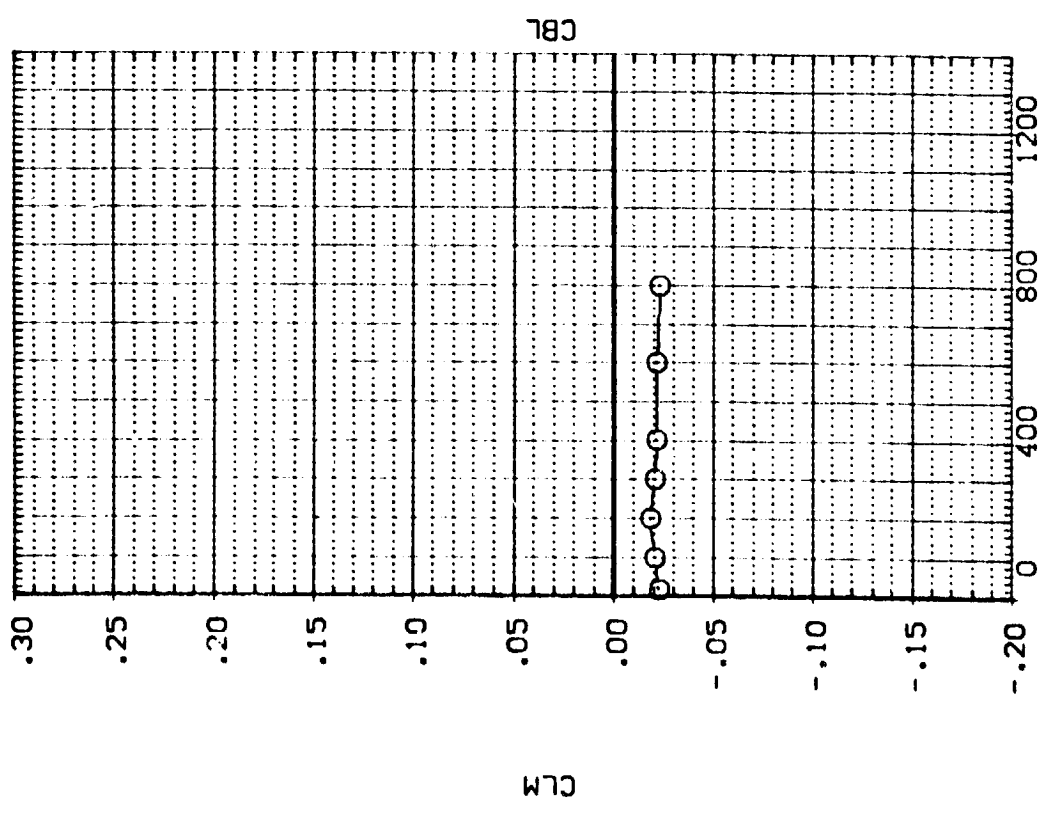
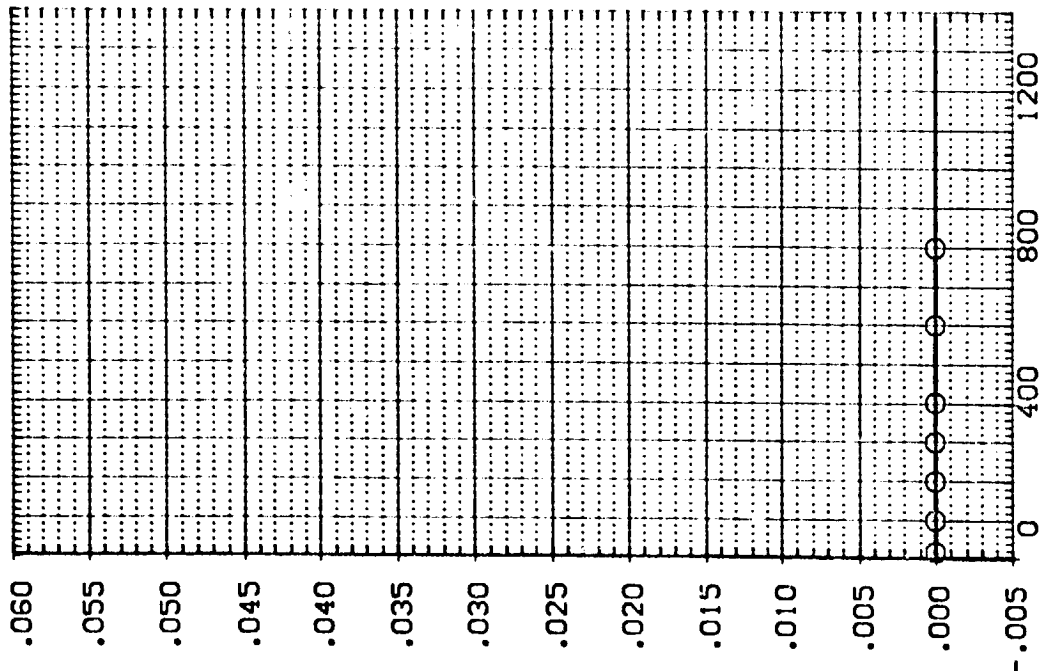

EXTERNAL TANK AERODYNAMIC CHARACTERISTICS DURING SEPARATION FROM ORBITER

IA13-EXTERNAL TANK(T10)SEPARATING FROM ORB. 09 (RTJT70)

SEE THE ASSOCIATED DATA DOCUMENT FOR REFERENCE CHARACTERISTICS FOR INDIVIDUAL DATASETS

SYMBOL		PARAMETRIC VALUES	
x	.256	MACH	4.520
o		ALPHA	-5.000
		DALPHA	.000
		ELEVTR	.000
		Y	-200.000
		PTOTAL	80.000
		BETA	.000
		DBETA	.000
		A1LRON	10.000

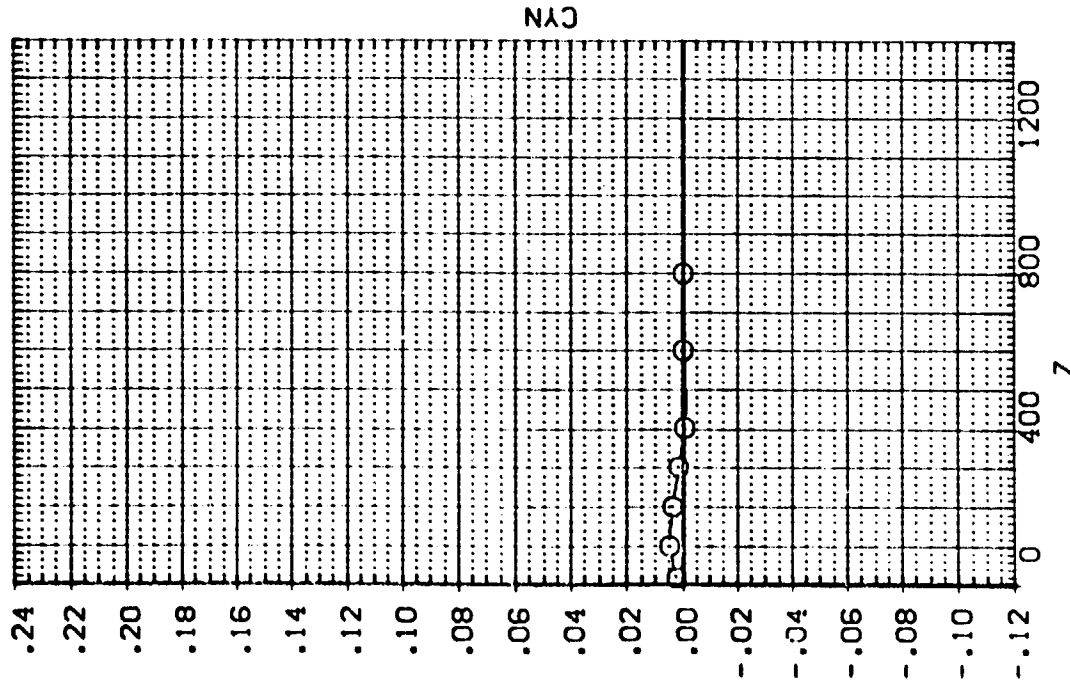
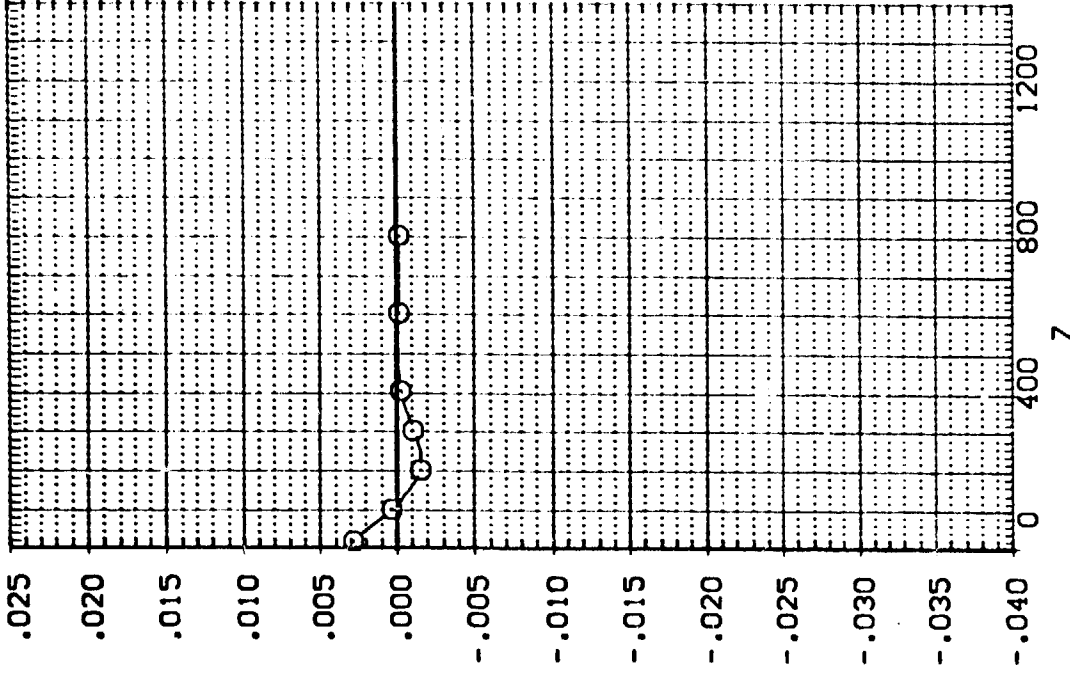

EXTERNAL TANK AERODYNAMIC CHARACTERISTICS DURING SEPARATION FROM ORBITER

IA13.EXTERNAL TANK(T10)SEPARATING FROM ORB. 09 (RTJT71)

SEE THE ASSOCIATED DATA DOCUMENT FOR REFERENCE CHARACTERISTICS FOR INDIVIDUAL DATASETS

PARAMETRIC VALUES	
MACH	4.520
PTOTAL	80.000
BETA	.000
DBETA	.000
ALTRON	10.000
ELEVTR	.000
Y	.000

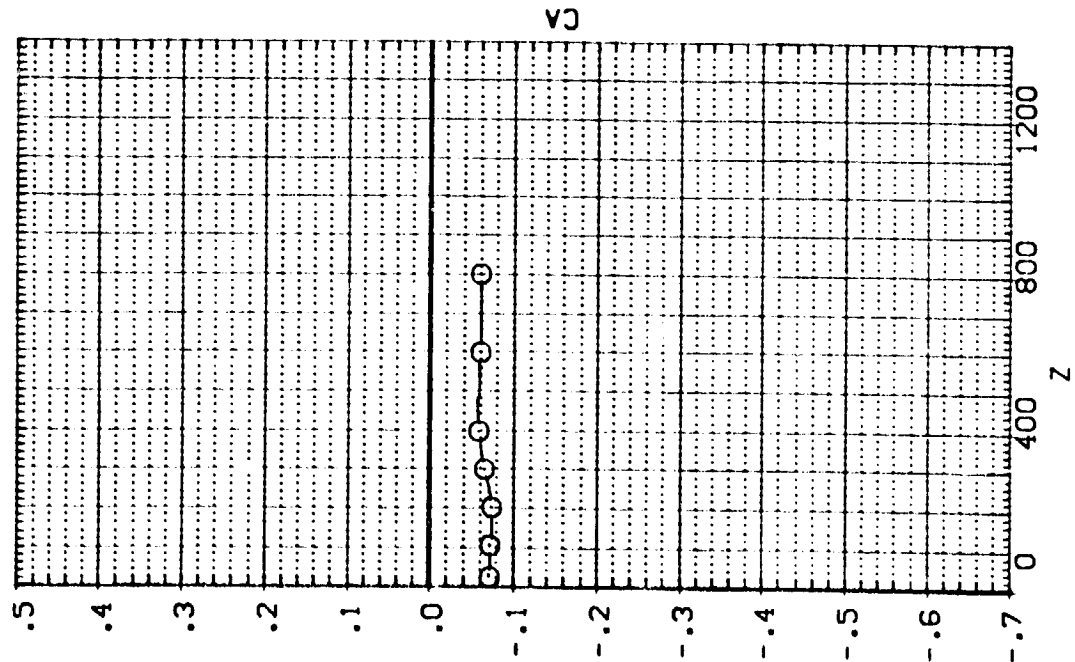
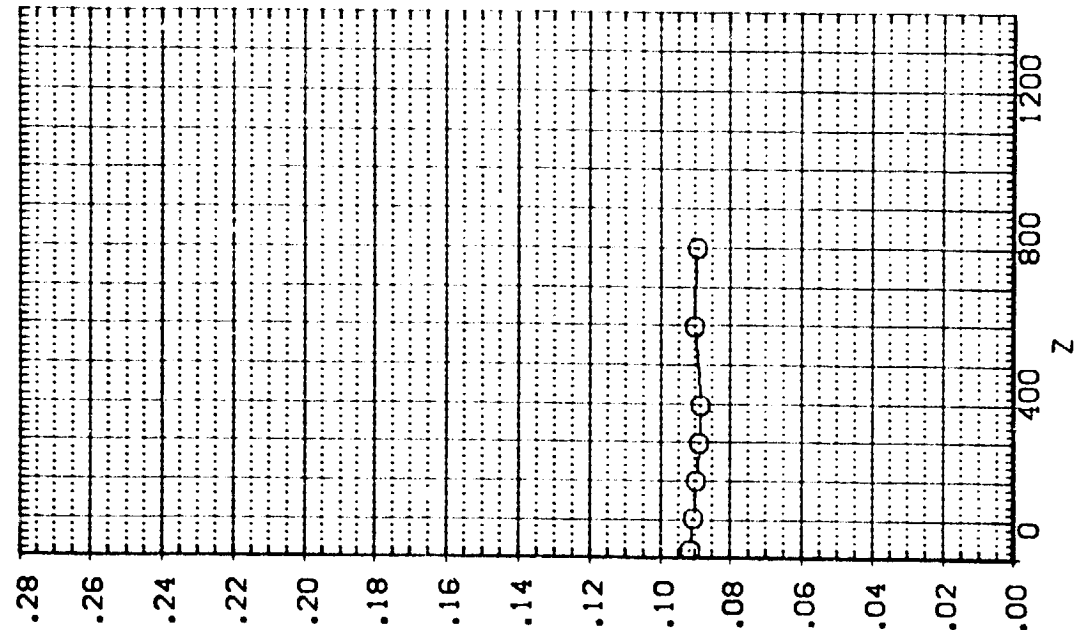

IA13.EXTERNAL TANK(T10)SEPARATING FROM ORB. 09 (RTJT71)

SEE THE ASSOCIATED DATA DOCUMENT FOR REFERENCE CHARACTERISTICS FOR INDIVIDUAL DATASETS

SYMBOL		PARAMETRIC VALUES	
x	.191	MACH	4.520
		ALPHA	-5.000
		DALPHA	.000
		ELEVTR	.000
		Y	.000
		P TOTAL	80.000
		BETA	.000
		DBETA	.000
		ALLRON	10.000
			.000

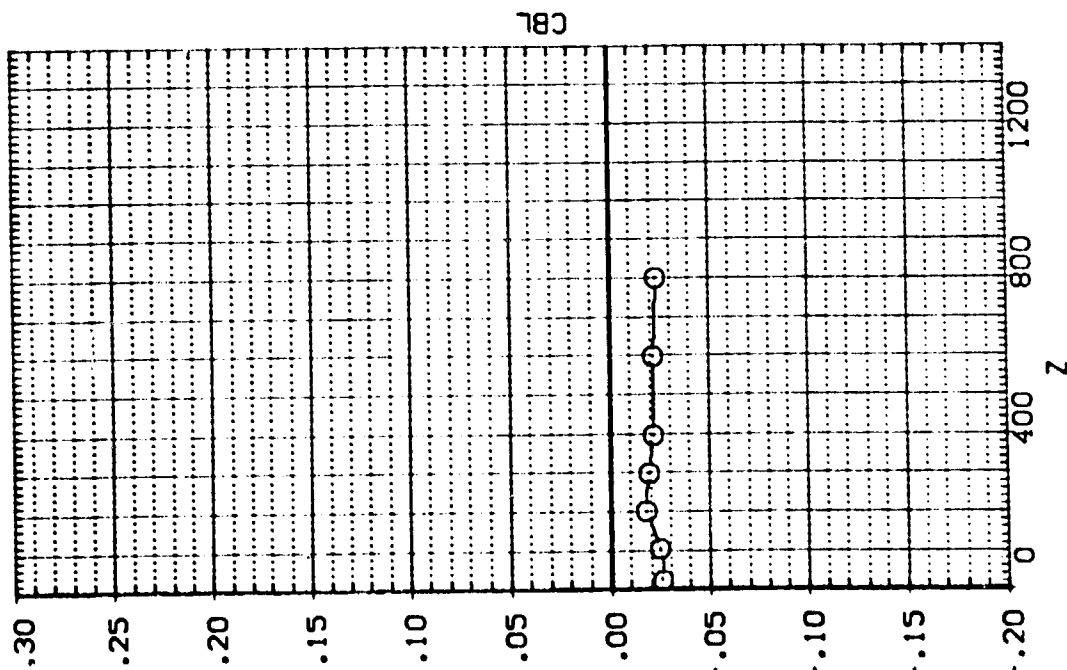
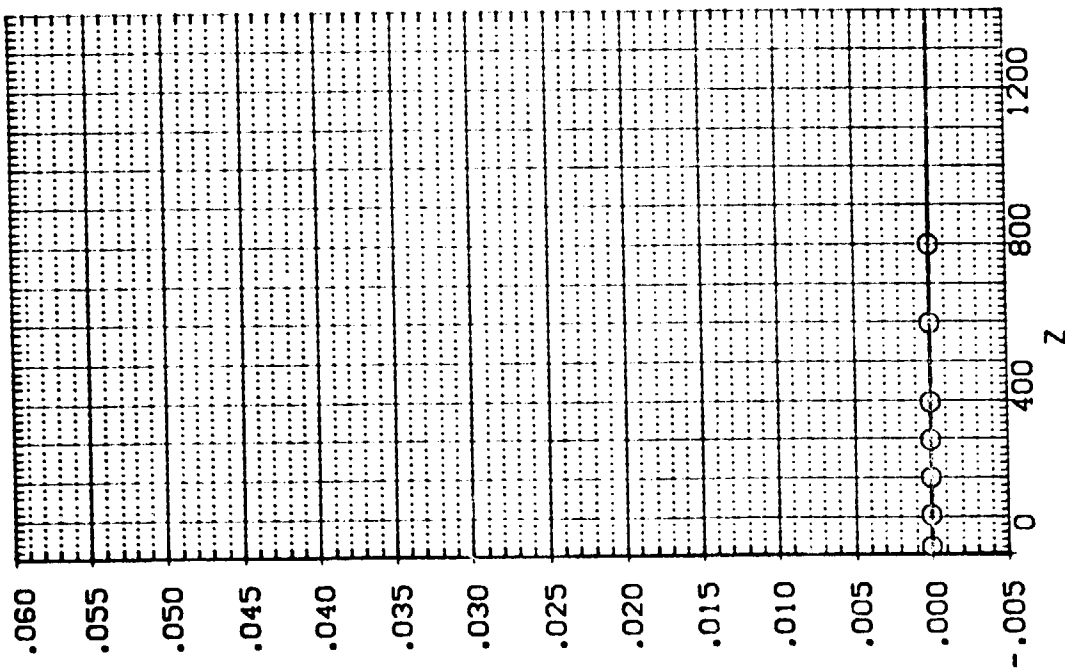

EXTERNAL TANK AERODYNAMIC CHARACTERISTICS DURING SEPARATION FROM ORBITER

1A13. EXTERNAL TANK(T10)SEPARATING FROM ORB. 09 (RTJT71)

SYMBOL



PARAMETRIC VALUES
 MACH 4.520 P/TOTAL 80.000
 ALPHA -5.000 BETA .000
 DALPHA .000 DBETA .000
 FLEVTR .000 ALLRON 10.000
 Y .000

SEE THE ASSOCIATED DATA DOCUMENT FOR REFERENCE CHARACTERISTICS FOR INDIVIDUAL DATASETS

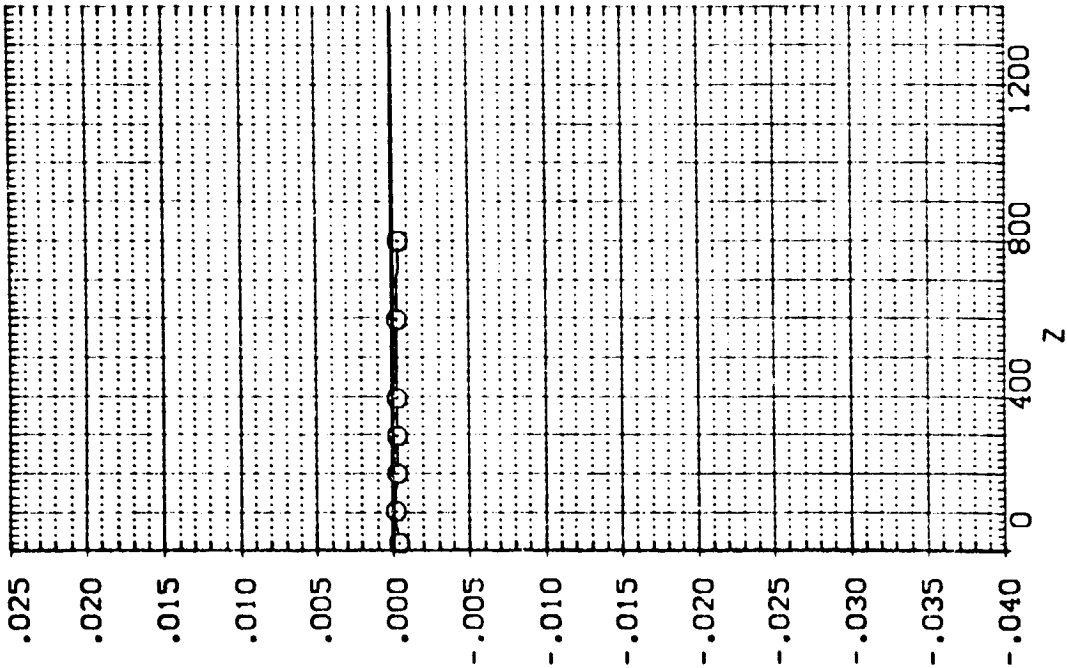
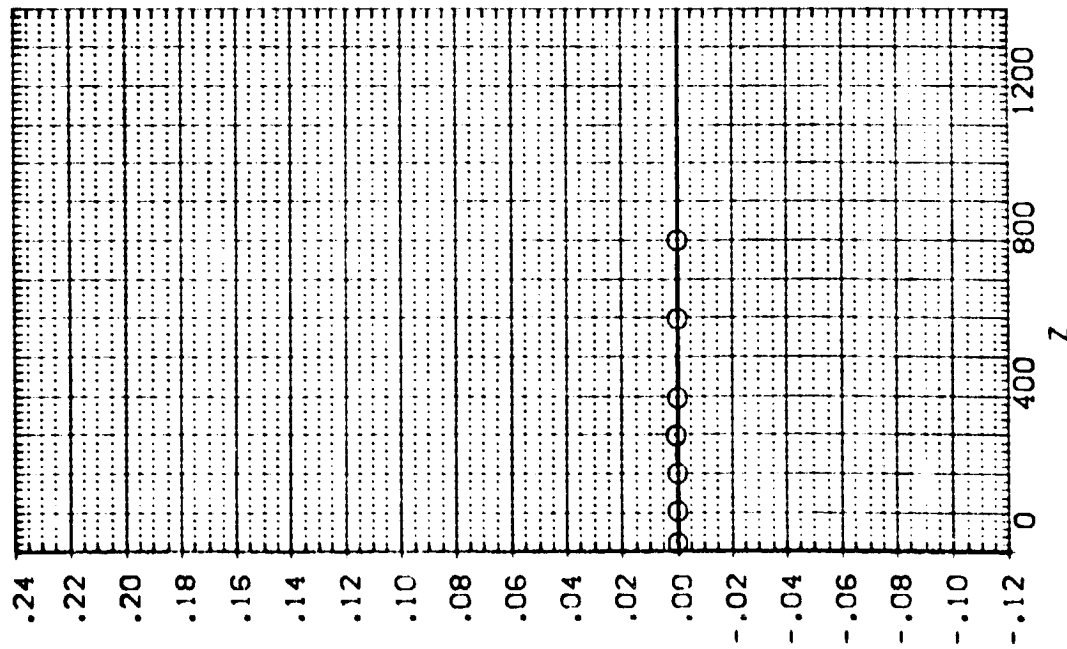

EXTERNAL TANK AERODYNAMIC CHARACTERISTICS DURING SEPARATION FROM ORBITER

IA13.EXTERNAL TANK(T10)SEPARATING FROM ORB. 09 (RTJT72)

SEE THE ASSOCIATED DATA DOCUMENT FOR REFERENCE CHARACTERISTICS FOR INDIVIDUAL DATASETS

PARAMETRIC VALUES	
MACH	4.520
PTOTAL	80.000
ALPHA	-5.000
BETA	.000
DALPHA	.000
DBETA	.000
AILRON	10.000
ELEVTR	.000
Y	200.000

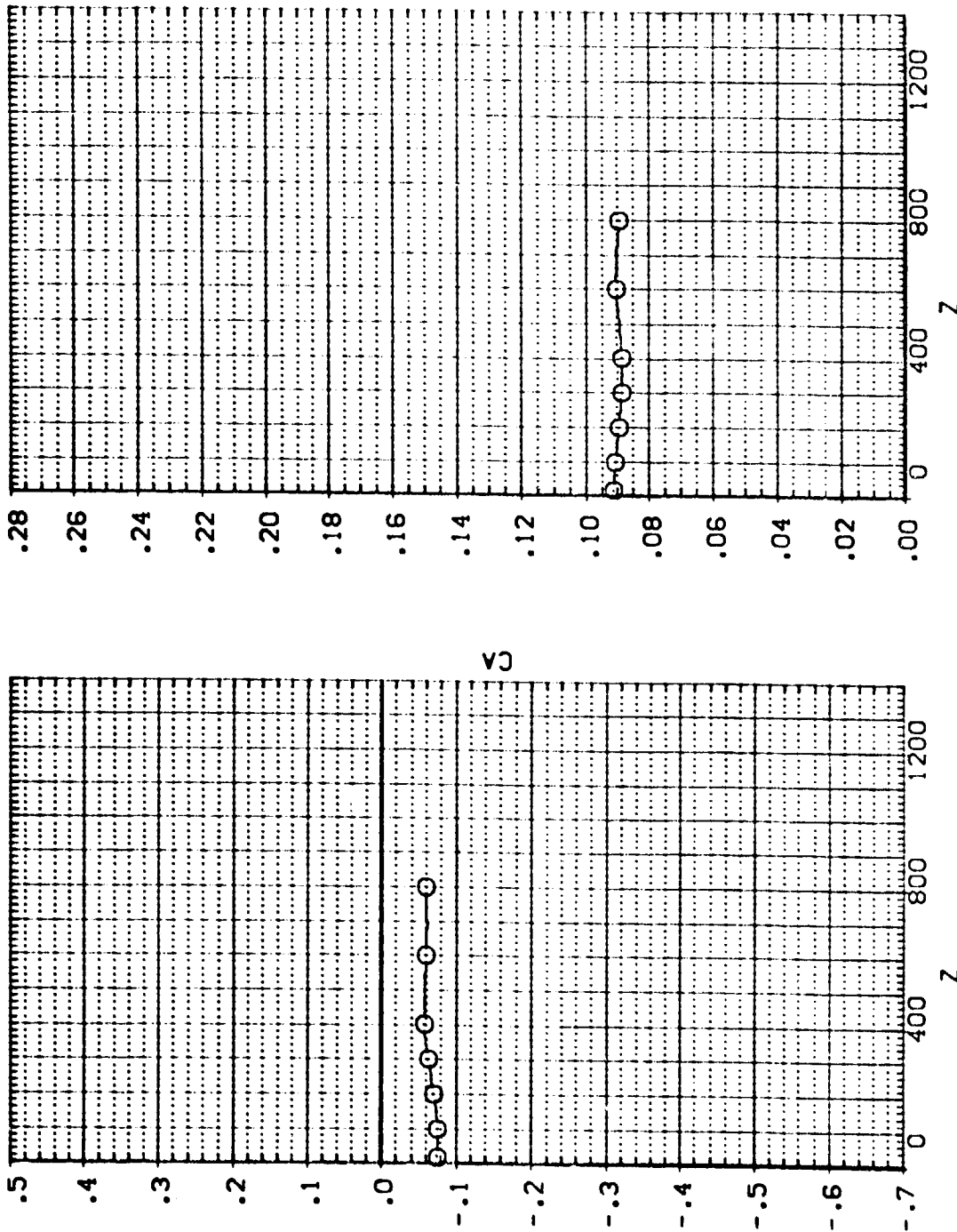

IA13.EXTERNAL TANK(T10)SEPARATING FROM ORB. 09 (RIJT72)

SEE THE ASSOCIATED DATA DOCUMENT FOR REFERENCE CHARACTERISTICS FOR INDIVIDUAL DATASETS

SYMBOL	X	.171	PARAMETRIC VALUES	
○	MACH	4.520	PTOTAL	80.000
	ALPHA	-5.000	BETA	.000
	DALPHA	.000	DBETA	.000
	ELEVTR	.000	AILRON	10.000
	Y	200.000		

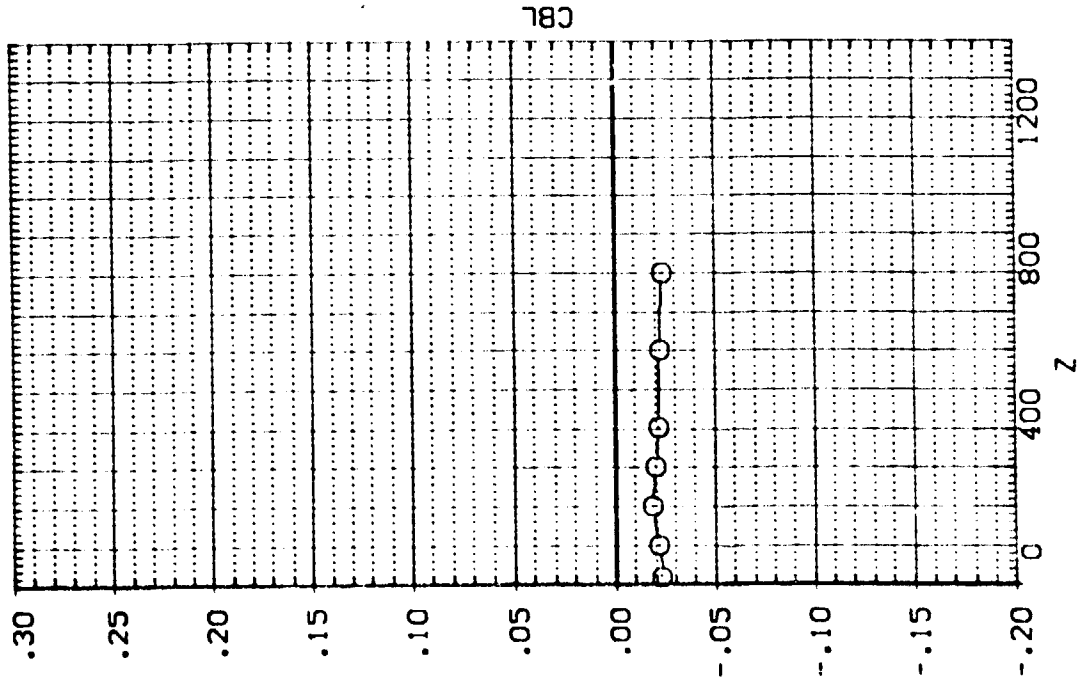
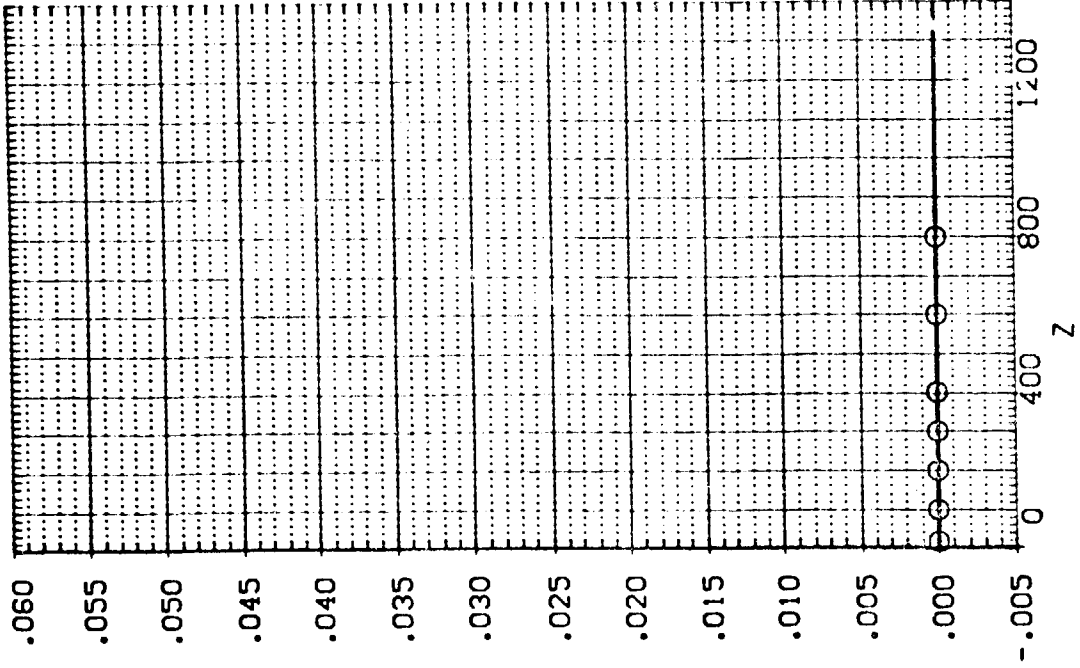

EXTERNAL TANK AERODYNAMIC CHARACTERISTICS DURING SEPARATION FROM ORBITER

!A13.EXTERNAL TANK(T10)SEPARATING FROM ORB. 09 (RTJT72)

SEE THE ASSOCIATED DATA DOCUMENT FOR REFERENCE CHARACTERISTICS FOR INDIVIDUAL DATASETS

SYMBOL
O

x .171

MACH
ALPHA
DALPHA
ELEVTR
Y

PARAMETRIC VALUES

4.520 PTOTAL 80.000
-5.000 BETA .000
.000 DBETA .000
.000 AILRON 10.000
200.000 Y

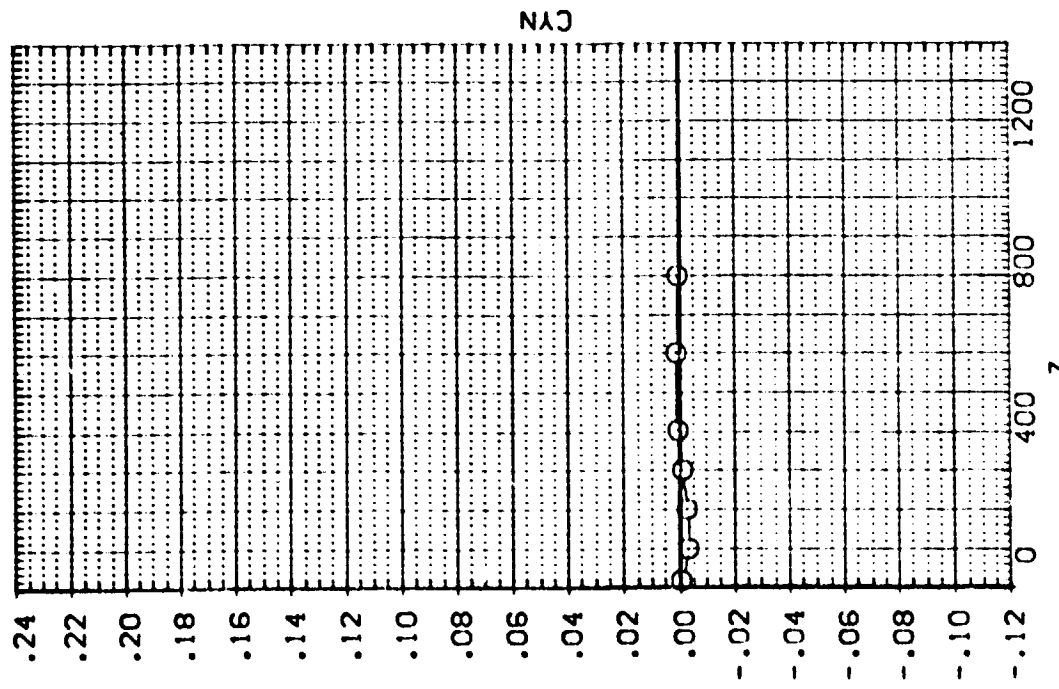
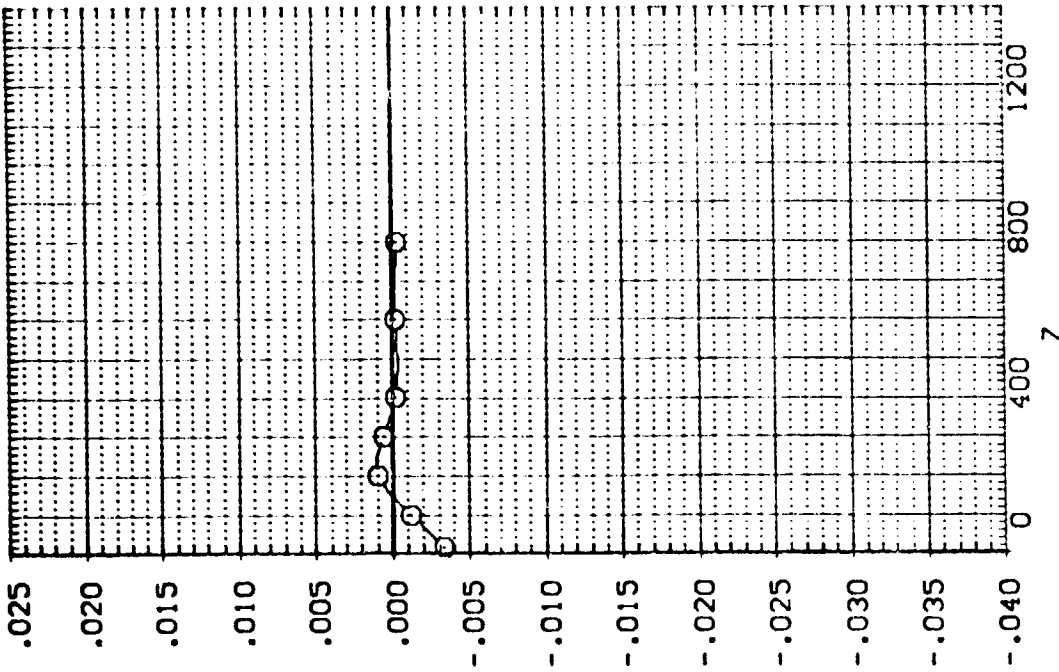

EXTERNAL TANK AERODYNAMIC CHARACTERISTICS DURING SEPARATION FROM ORBITER

IA13.EXTERNAL TANK(T10)SEPARATING FROM ORB. 09 (RTJT73)

SEE THE ASSOCIATED DATA DOCUMENT FOR REFERENCE CHARACTERISTICS FOR INDIVIDUAL DATASETS

SYMBOL C .236 MACH 4.520 P/TOTAL 80.000
 ALPHA -5.000 BETA .000 DBETA -5.000
 ELEVTR .000 A1LRON 10.000
 Y -200.000

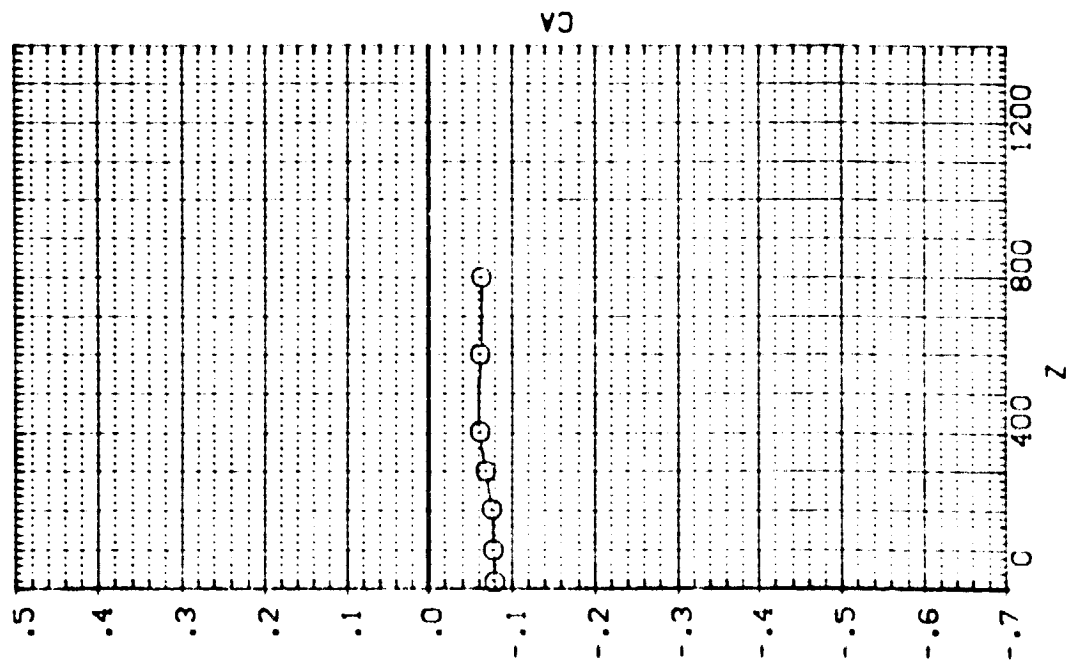
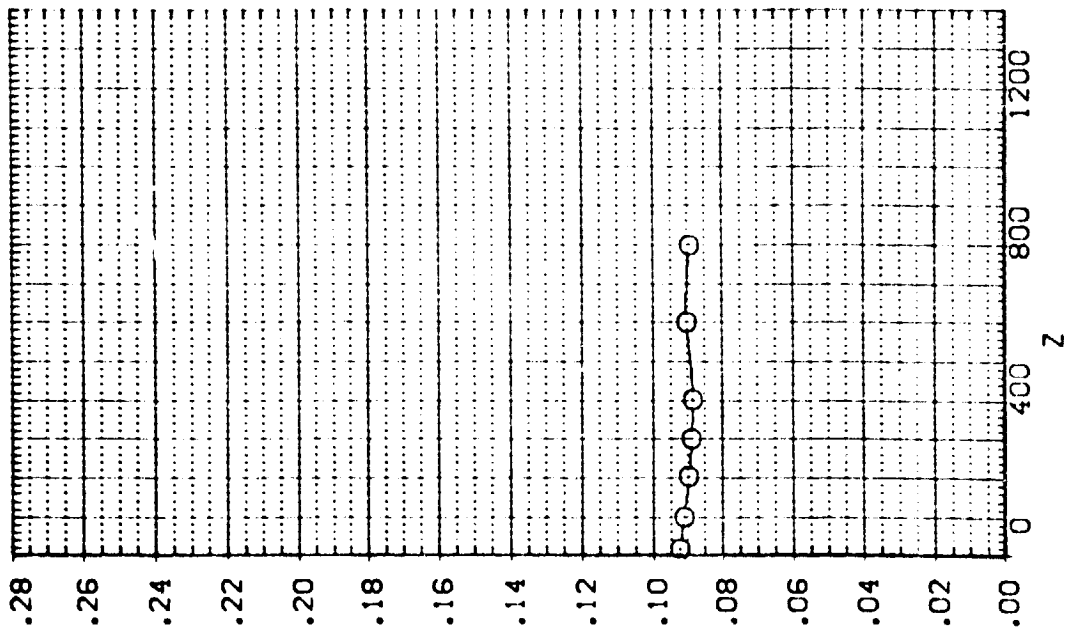

IA13.EXTERNAL TANK(T10)SEPARATING FROM ORB. 09 (RTJT73)

SYMBOL
O

PARAMETRIC VALUES
 MACH 4.520 PTOTAL 80.000
 ALPHA -5.000 BETA .000
 DALPHA .000 DBETA -5.000
 ELEVTR .000 AIRDRN 10.000
 Y -200.000

SEE THE ASSOCIATED DATA DOCUMENT FOR REFERENCE CHARACTERISTICS FOR INDIVIDUAL DATASETS

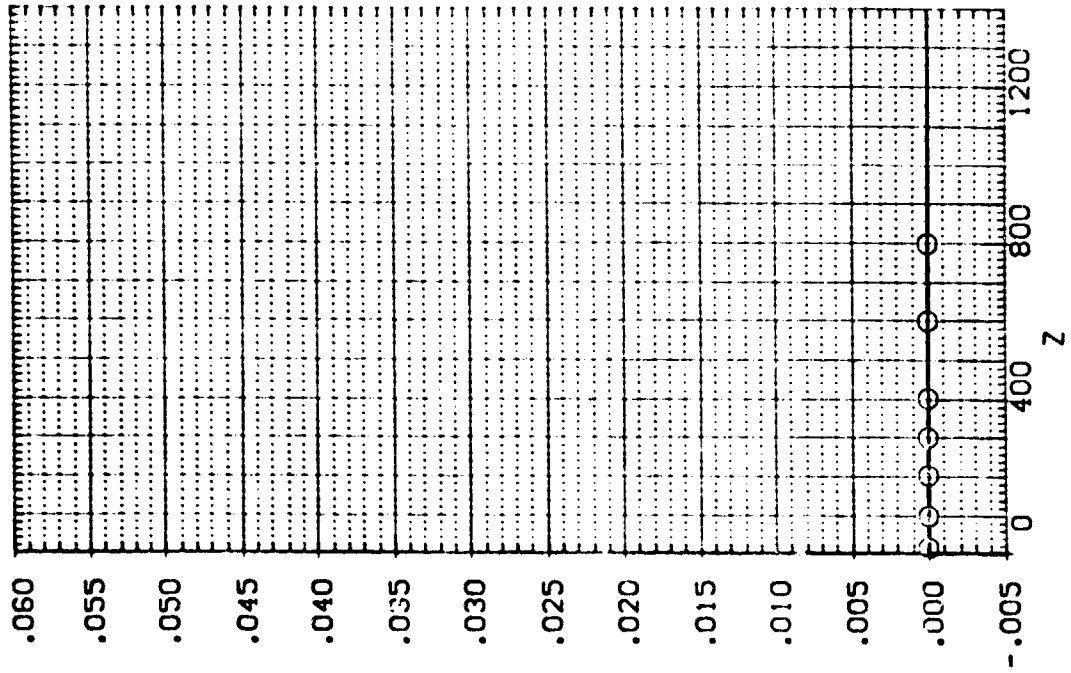
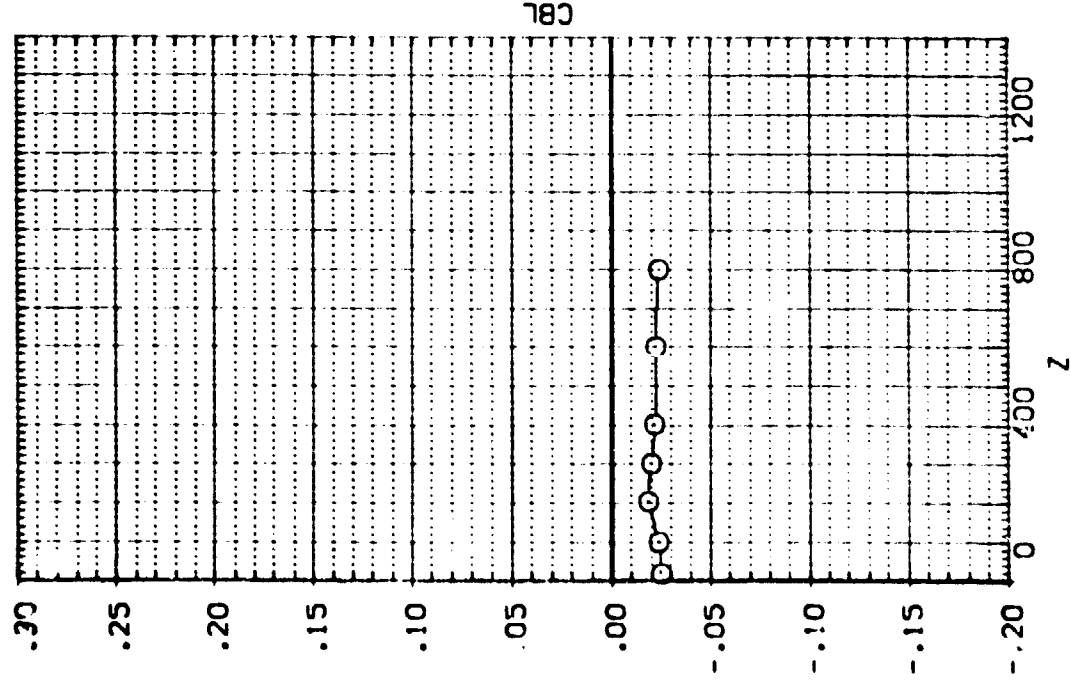

EXTERNAL TANK AERODYNAMIC CHARACTERISTICS DURING SEPARATION FROM ORBITER

1:3. EXTERNAL TANK(10)SEPARATING FROM ORB. 09 (RIJ173)

SEE THE ASSOCIATED DATA DOCUMENT FOR REFERENCE CHARACTERISTICS FOR INDIVIDUAL DATA'S

SYMBOL		PARAMETRIC VALUES	
X	.236	MACH	4.520
		ALPHA	-5.000
		DALPHA	.000
		ELEVTR	.000
		Y	-200.000
		PIDOTAL	80.000
		BETA	.000
		DBETA	-5.000
		AIRTON	10.000

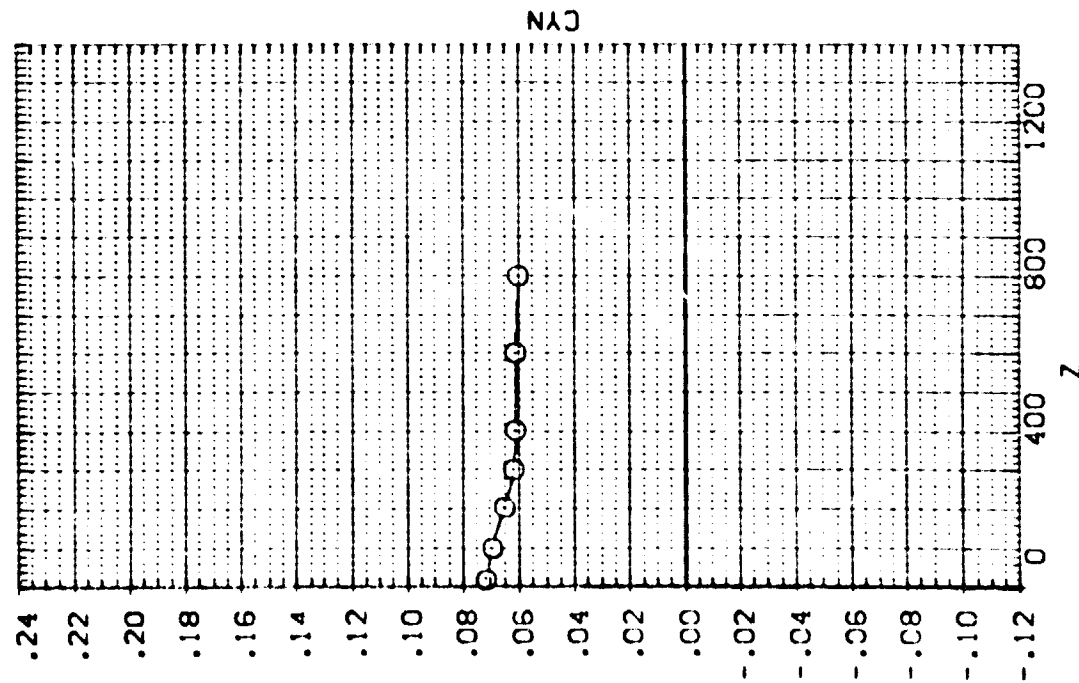
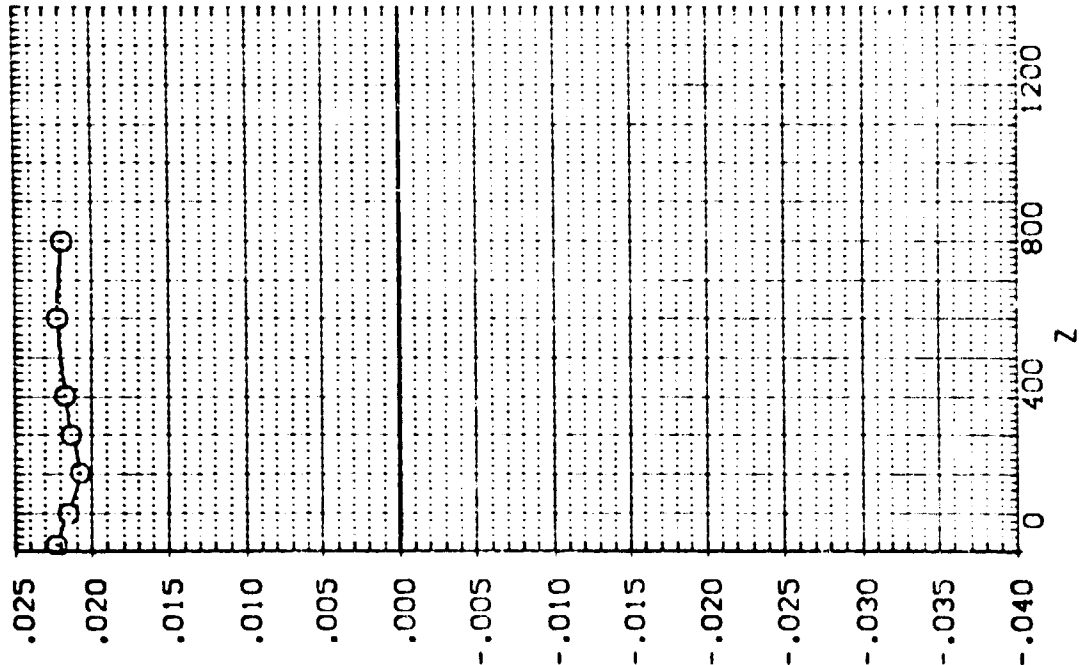

1A13.EXTERNAL TANK(10)SEPARATING FROM ORB. 09 (RTJT74)

SYMBOL
○

PARAMETRIC VALUES
 MACH 4.520 PTOTAL 60.000
 ALPHA -5.000 BETA .000
 DALPHA .000 DBETA 5.000
 ELEVR .000 AILRON 10.000
 Y

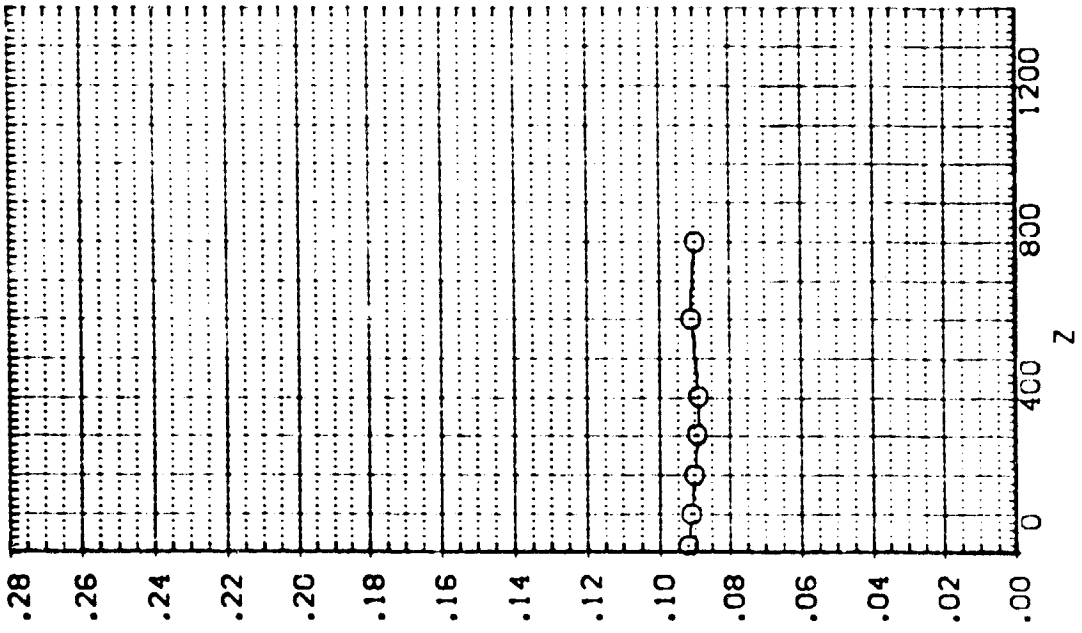
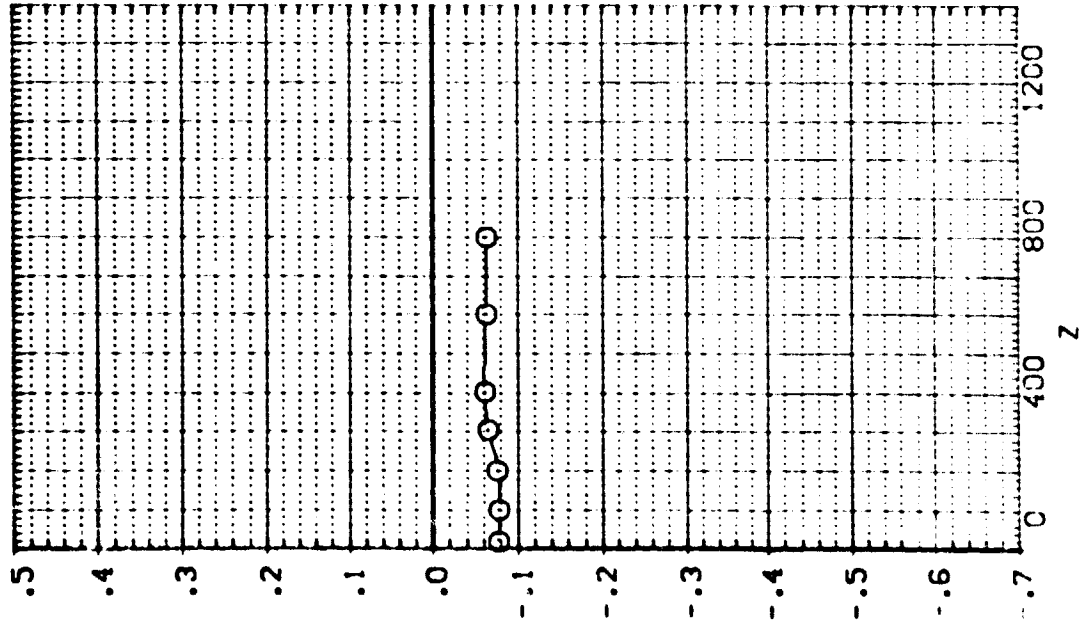

SEE THE ASSOCIATED DATA DOCUMENT FOR REFERENCE CHARACTERISTICS FOR INDIVIDUAL DATASETS

EXTERNAL TANK AERODYNAMIC CHARACTERISTICS DURING SEPARATION FROM ORBITER

1.3. EXTERNAL TANK(10)SEPARATING FROM ORB. 09 (RTJT74)

SEE THE ASSOCIATED DATA DOCUMENT FOR REFERENCE CHARACTERISTICS FOR INDIVIDUAL DATASETS

PARAMETRIC VALUES	
MACH	4.520
PTOTAL	60.000
ALPHA	-5.000
BETA	.000
DALPHA	.000
DBETA	5.000
ELEVTR	.000
ALTRON	10.000
V	.000

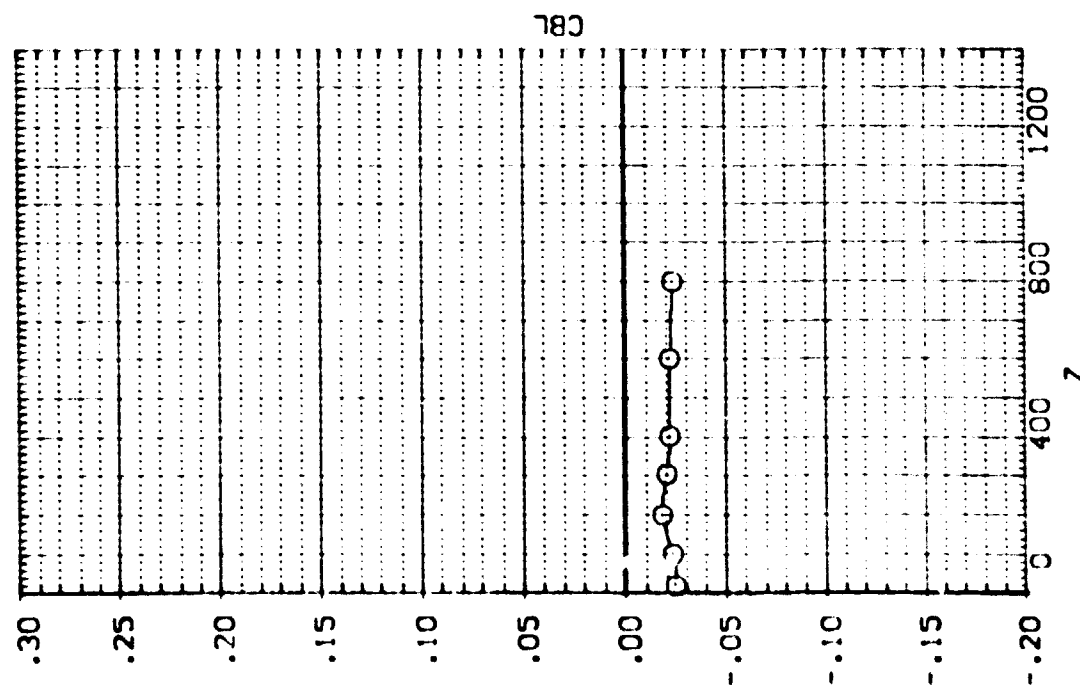
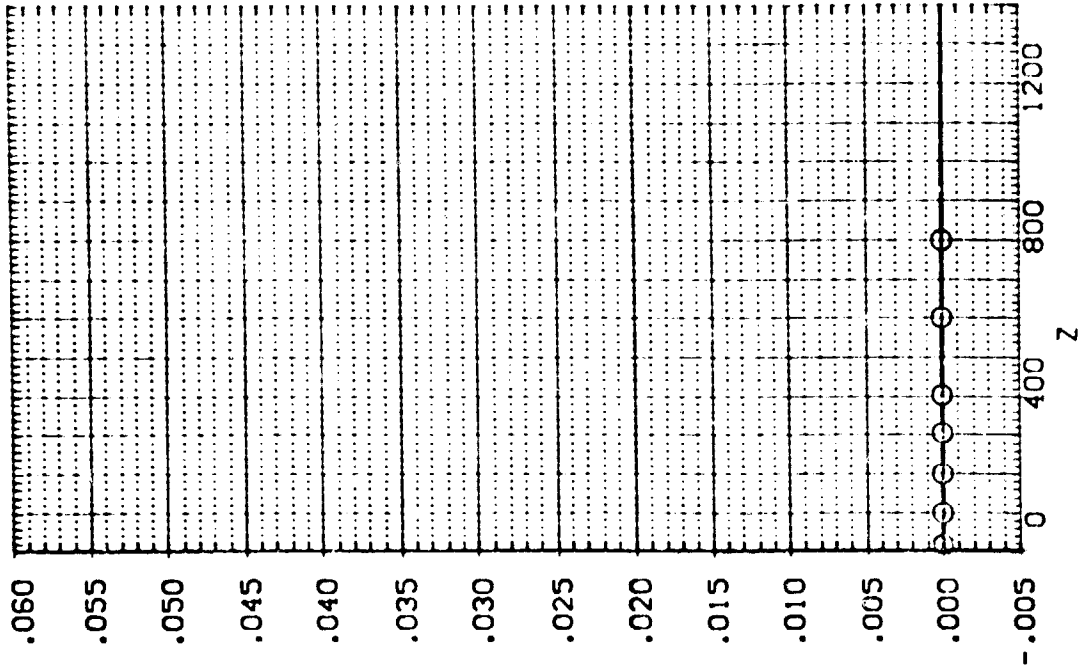

1A13. EXTERNAL TANK(T10)SEPARATING FROM ORB. 09 (RTJ74)

SEE THE ASSOCIATED DATA DOCUMENT FOR REFERENCE CHARACTERISTICS FOR INDIVIDUAL DATA SETS

PARAMETRIC VALUES

MACH	4.520	P TOTAL	80.000
ALPHA	-5.000	BETA	.000
DALPHA	.000	G BETA	5.000
ELEVTR	.000	AIRRON	10.000
Y	.000		

SYMBOL X .252

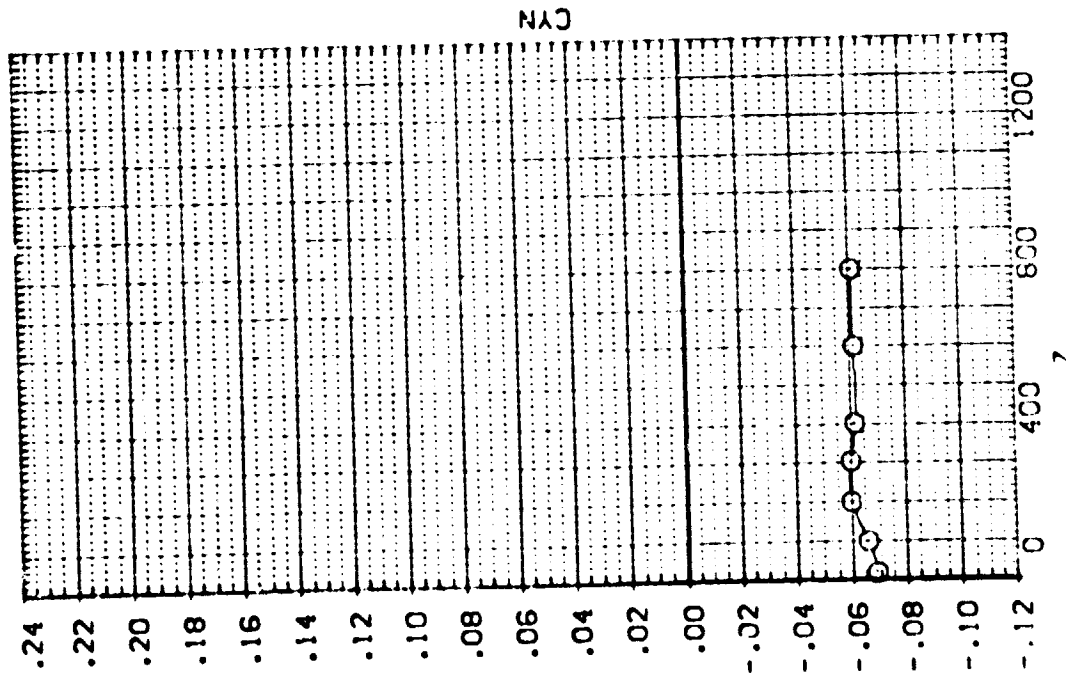
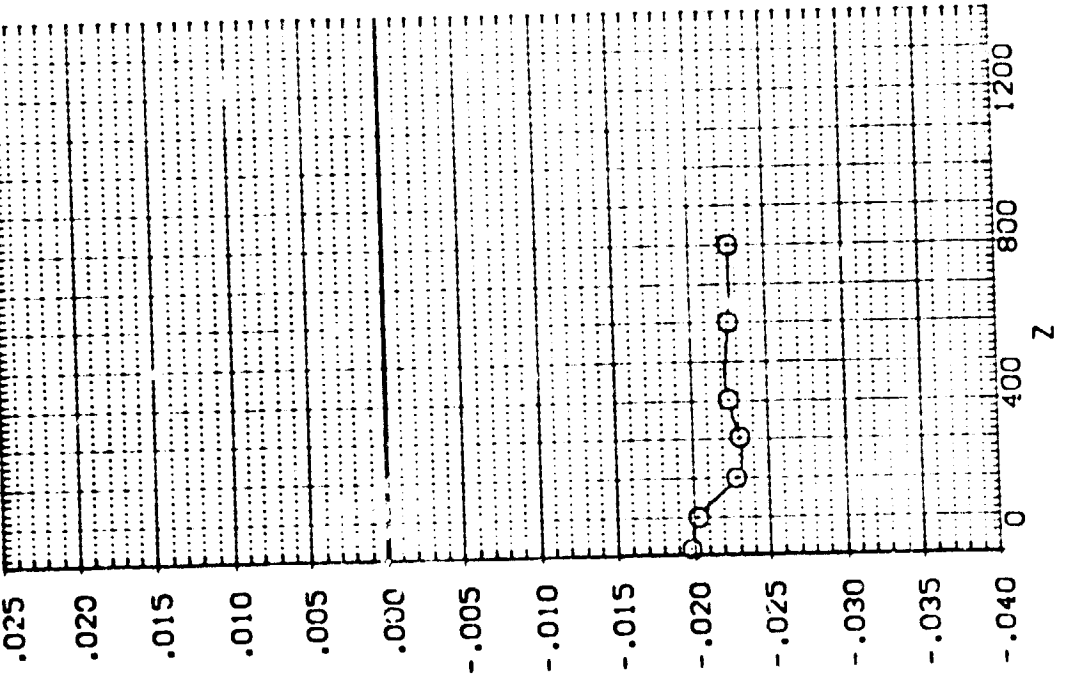

EXTERNAL TANK AERODYNAMIC CHARACTERISTICS DURING SEPARATION FROM ORBITER

1A13.EXTERNAL TANK(T10)SEPARATING FROM ORB. 09 (RTJ175)

SYMBOL x

.254

PARAMETRIC VALUES

MACH 4.520 P/DIGAL 80.000
 ALPHA -5.000 BETA .000
 DALPHA .000 DBETA 5.000
 ELEVTR .000 AILRON 10.000
 Y 200.000

SEE THE ASSOCIATED DATA DOCUMENT FOR REFERENCE CHARACTERISTICS FOR INDIVIDUAL DATASETS

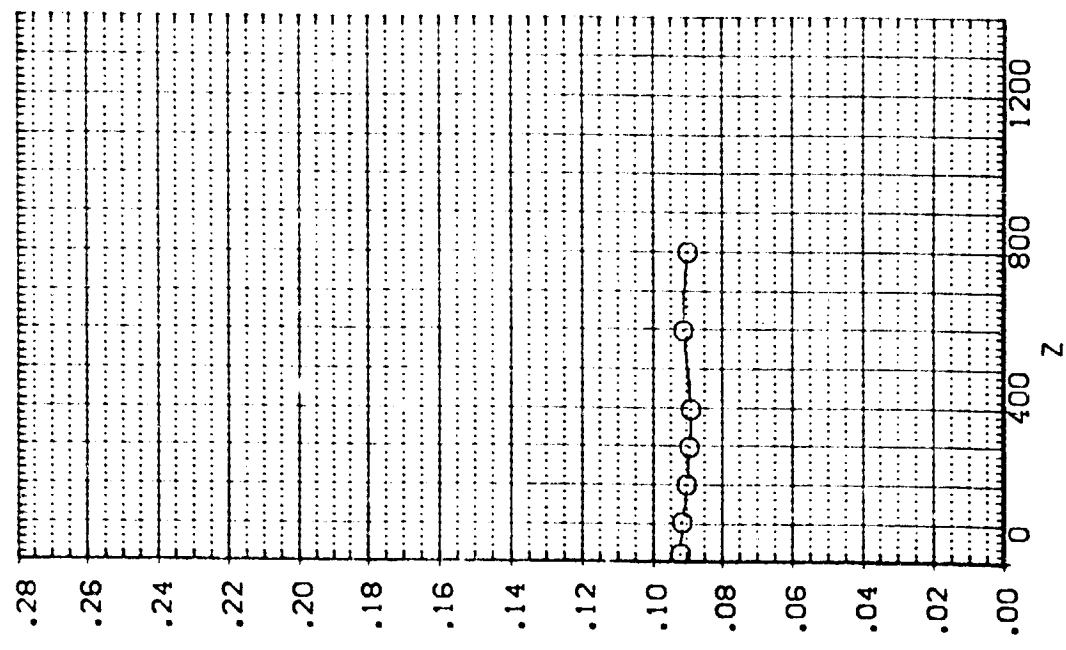
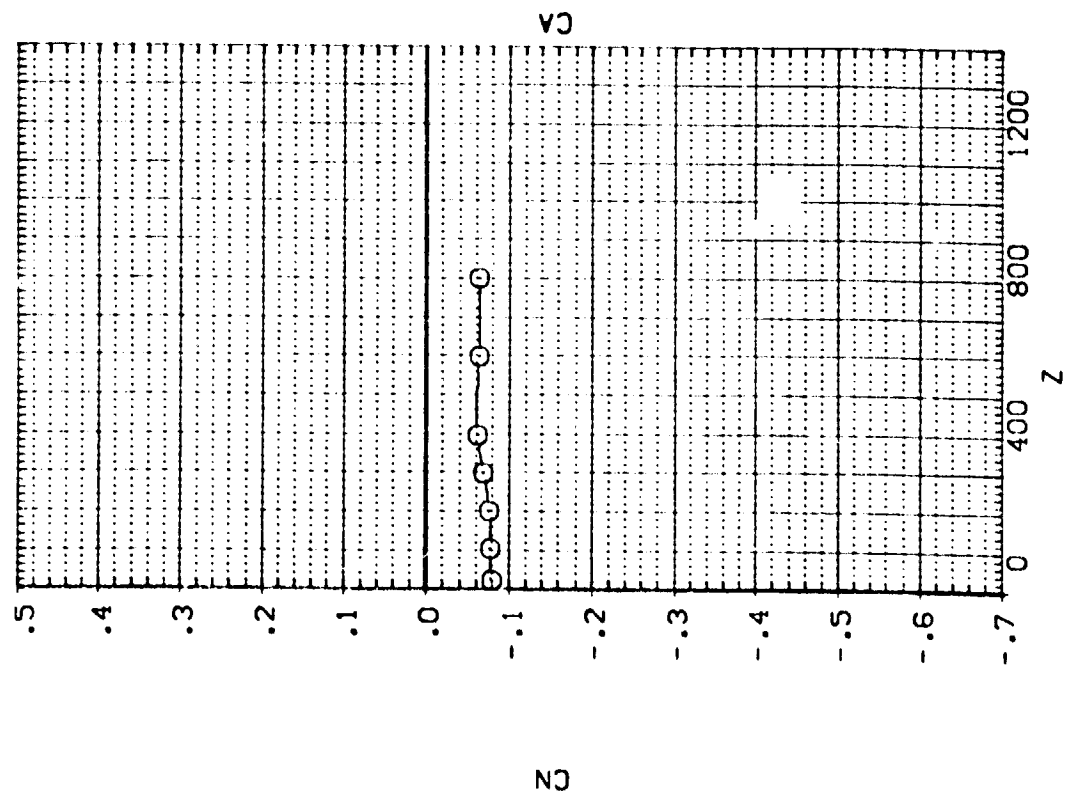

IA13, EXTERNAL TANK (T10) SEPARATING FROM ORB. 09 (RTJ75)

SYMBOL x
o

PARAMETRIC VALUES
 MACH 4.520
 ALPHA -5.000
 BETA .000
 C/Delta .000
 ELEVTR .000
 Y 200.000

P/TOTAL 80.000
 BETA .000
 C/Delta 5.000
 A/TURON 10.000

SEE THE ASSOCIATED DATA DOCUMENT FOR REFERENCE CHARACTERISTICS FOR INDIVIDUAL DATASETS

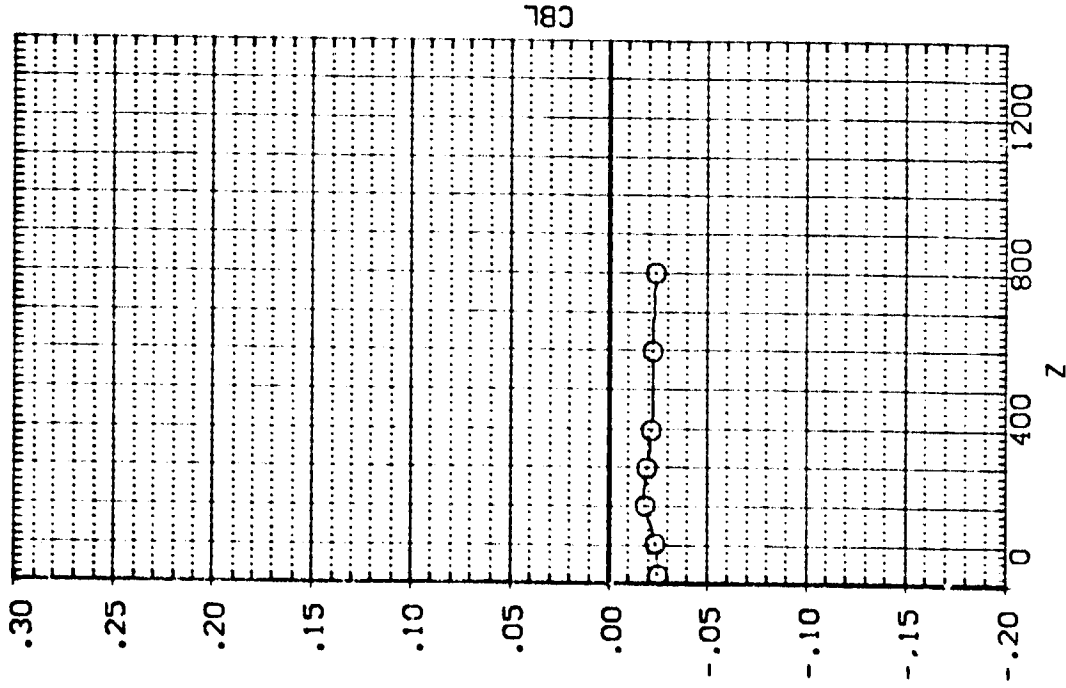

X Z

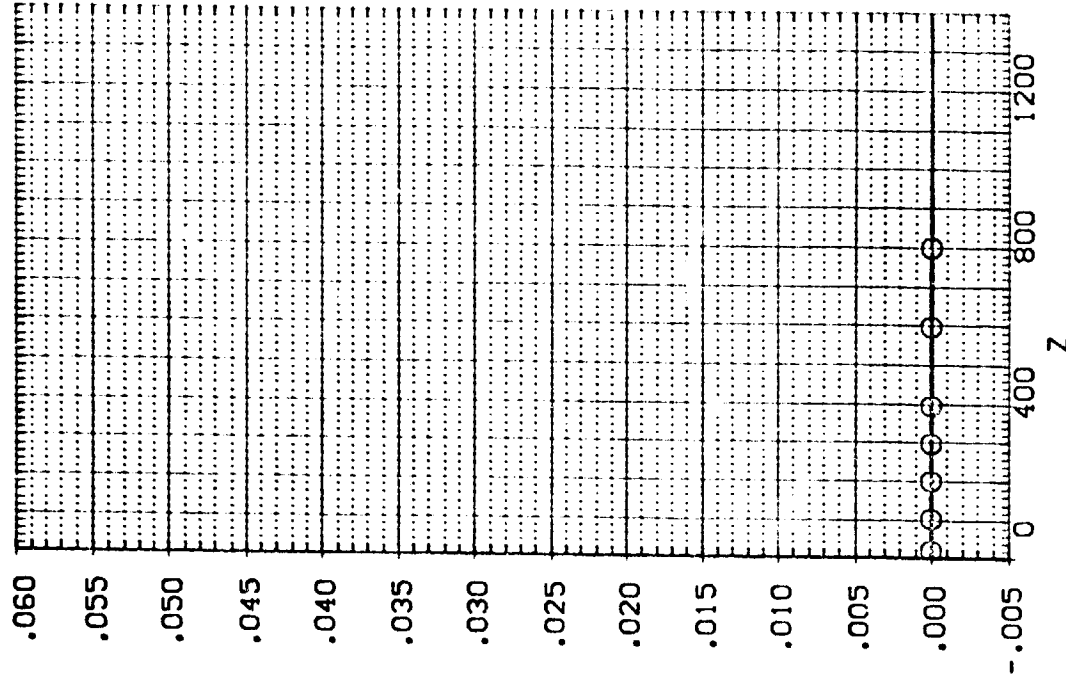

EXTERNAL TANK AERODYNAMIC CHARACTERISTICS DURING SEPARATION FROM ORBITER

1A13.EXTERNAL TANK(T10)SEPARATING FROM ORB. 09 (RTJT75)

SEE THE ASSOCIATED DATA DOCUMENT FOR REFERENCE CHARACTERISTICS FOR INDIVIDUAL DATASETS

PARAMETRIC VALUES
 MACH 4.520 P/TOTAL 80.000
 ALPHA -5.000 BETA .000
 DALPHA .000 DBETA 5.000
 ELEVTR .000 ATLRON 10.000
 Y 200.000

SYMBOL x .254

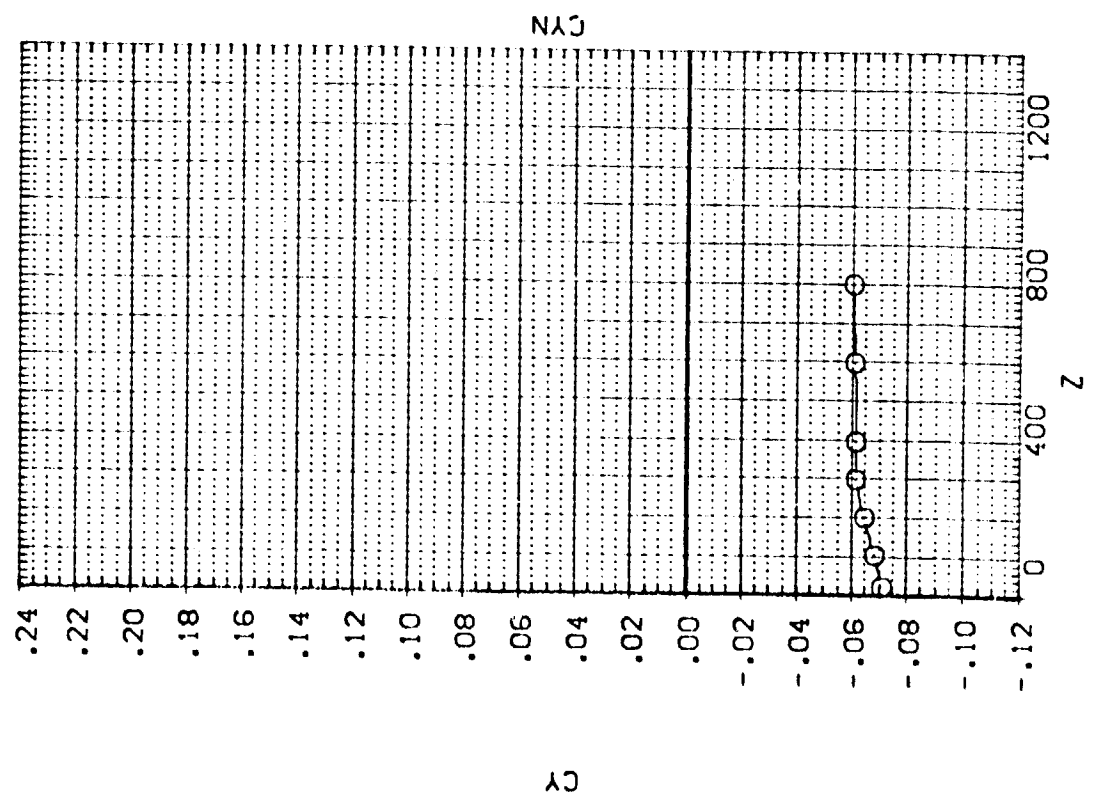
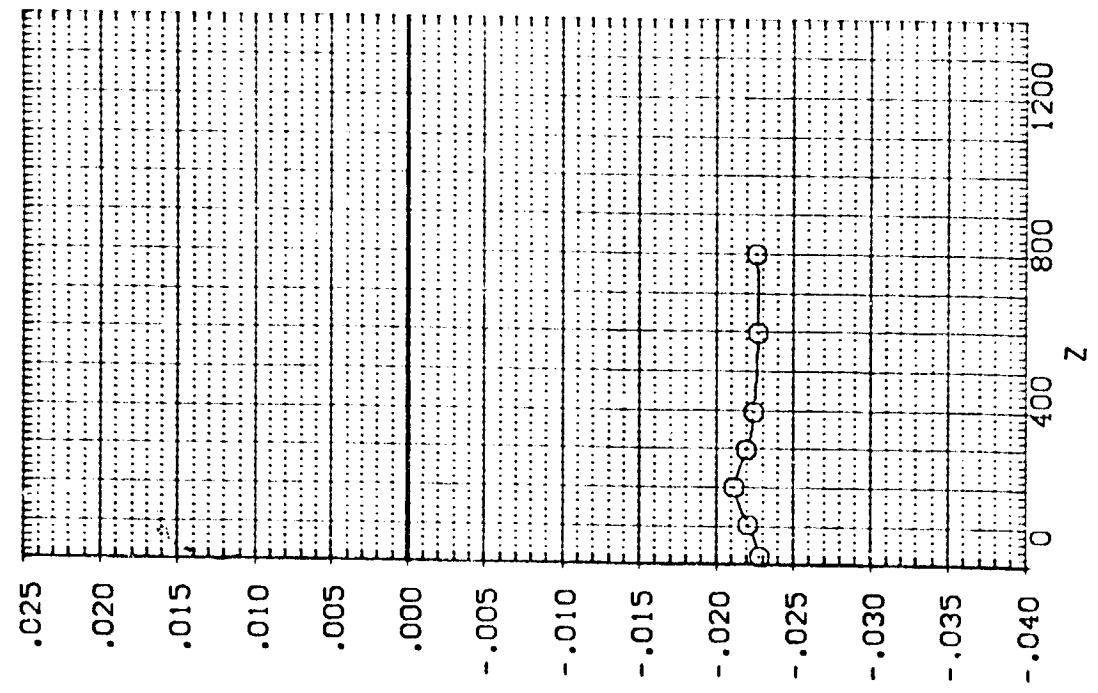

IA13.EXTERNAL TANK(T10)SEPARATING FROM ORB. 09 (RTJT76)

SEE THE ASSOCIATED DATA DOCUMENT FOR REFERENCE CHARACTERISTICS FOR INDIVIDUAL DATASETS

SYMBOL
O

PARAMETRIC VALUES	
MACH	4.520
PTOTAL	80.000
BETA	.000
ALPHA	-5.000
DBETA	-10.000
DBETA	.000
ELEVTR	.000
AILRON	10.000
Y	-200.000

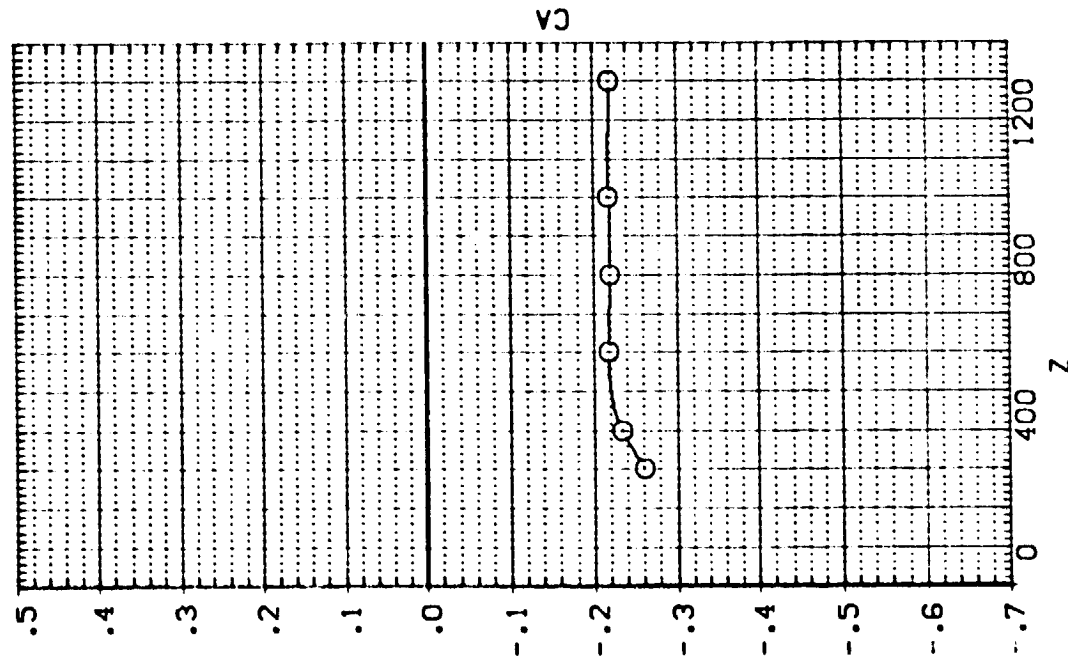
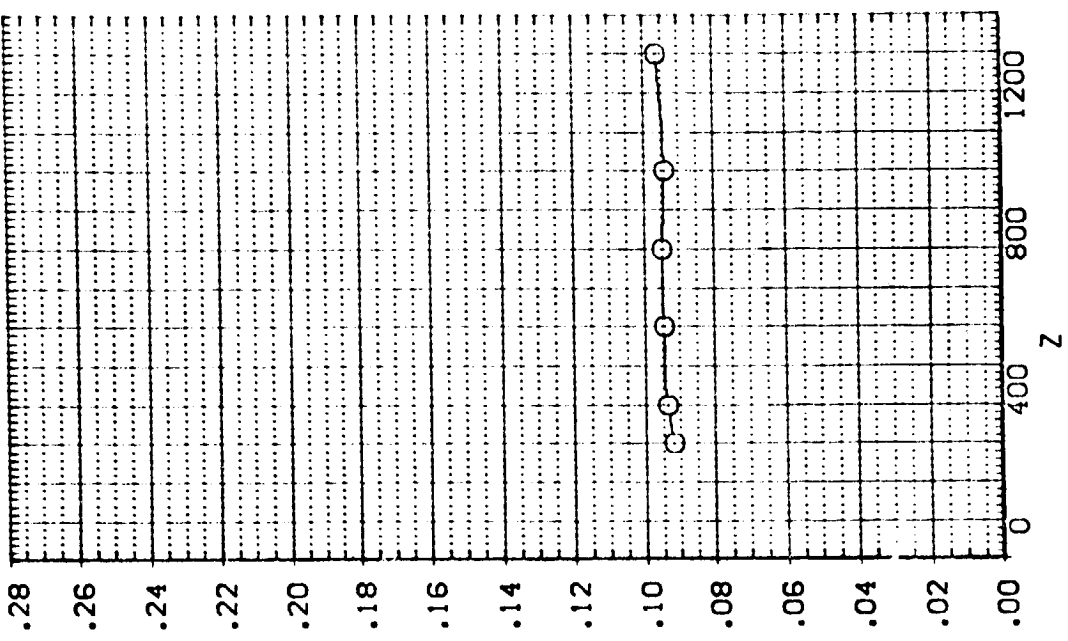

EXTERNAL TANK AERODYNAMIC CHARACTERISTICS DURING SEPARATION FROM ORBITER

1.13. EXTERNAL TANK(110)SEPARATING FROM ORB. 09 (RTJT76)

SEE THE ASSOCIATED DATA DOCUMENT FOR REFERENCE CHARACTERISTICS FOR INDIVIDUAL DATASETS

PARAMETRIC VALUES
 MACH 4.520 POTAL 60.000
 ALPHA -5.000 BETA .000
 CALPHA -10.000 DBETA .000
 ELEVTR .000 AILRON 10.000
 Y -200.000

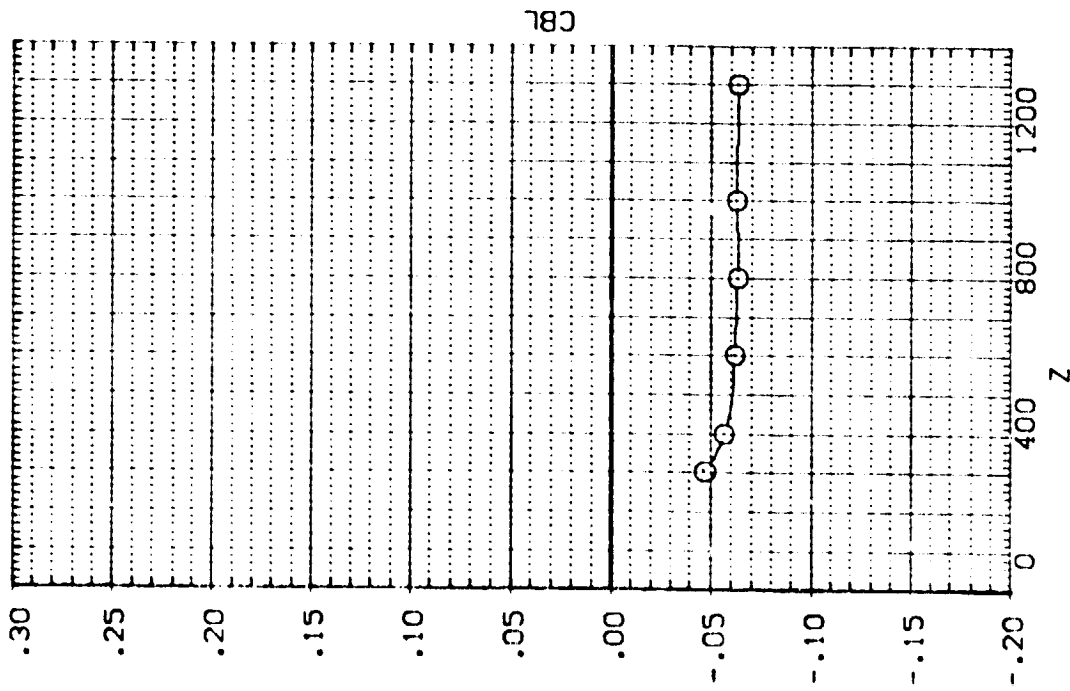
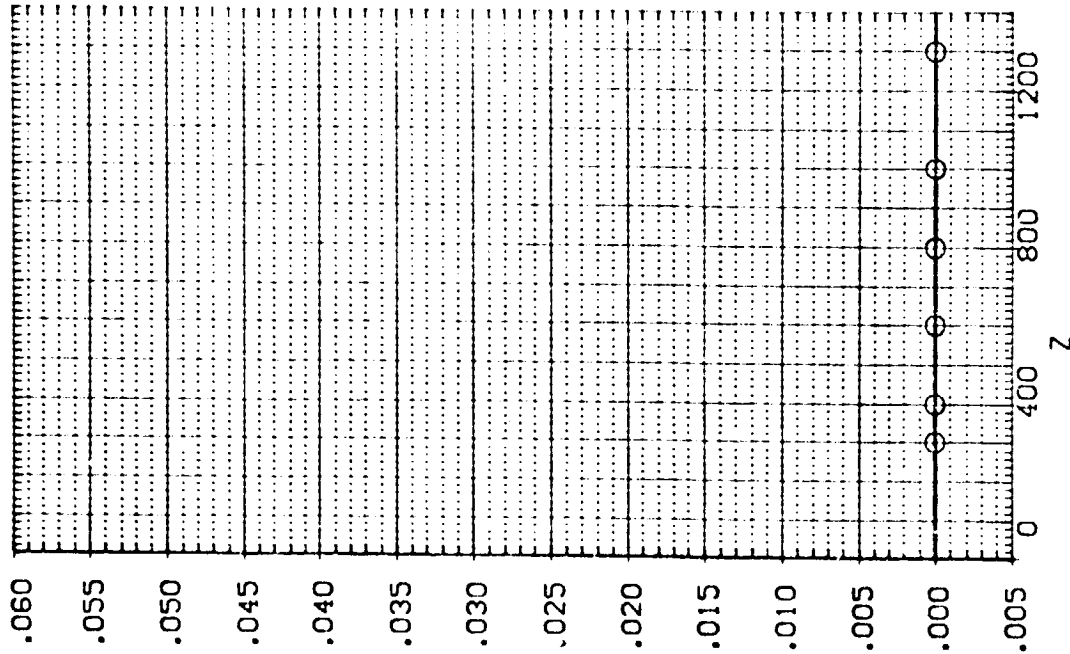

EXTERNAL TANK AERODYNAMIC CHARACTERISTICS DURING SEPARATION FROM ORBITER

IA13,EXTERNAL TANK(T10)SEPARATING FROM ORB. 09 (RTJT76)

SEE THE ASSOCIATED DATA DOCUMENT FOR REFERENCE CHARACTERISTICS FOR INDIVIDUAL DATASETS

SYMBOL x .273

PARAMETRIC VALUES
 MACH 4.520 P/TOTAL 60.000
 ALPHA -5.000 BETA .000
 DALPHA -10.000 DBETA .000
 ELEVTR .000 A/TLRON 10.000
 Y -200.000

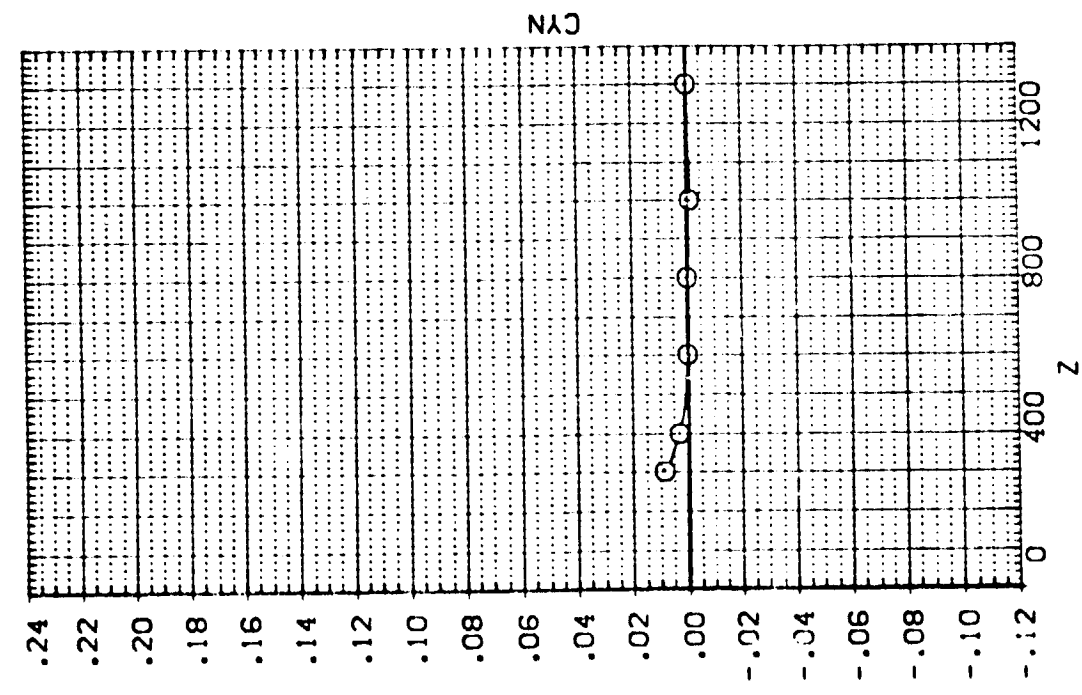
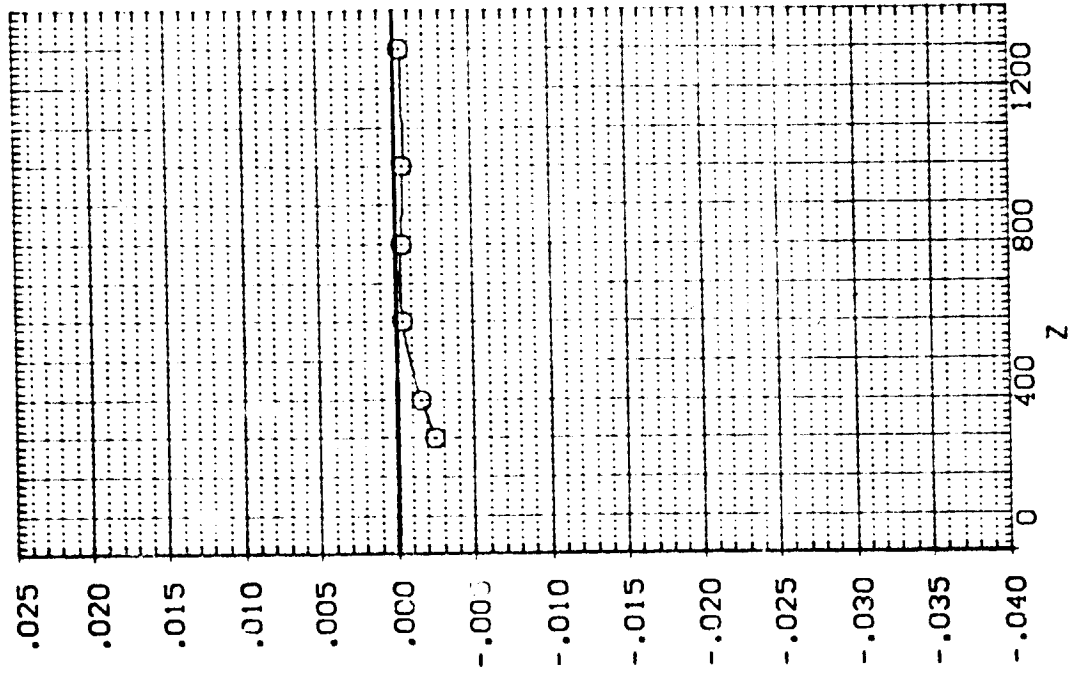

EXTERNAL TANK AERODYNAMIC CHARACTERISTICS DURING SEPARATION FROM ORBITER

IA13.EXTERNAL TANK(T10)SEPARATING FROM ORB. 09 (RTJT77)

SEE THE ASSOCIATED DATA DOCUMENT FOR REFERENCE CHARACTERISTICS FOR INDIVIDUAL DATASETS

SYMBOL		PARAMETRIC VALUES	
O	x	MACH	80.000
		ALPHA	.000
		DALPHA	.000
		ELEVTR	10.000
		Y	.000
		BETA	.000
		ALTRON	10.000
		PTOTAL	.000

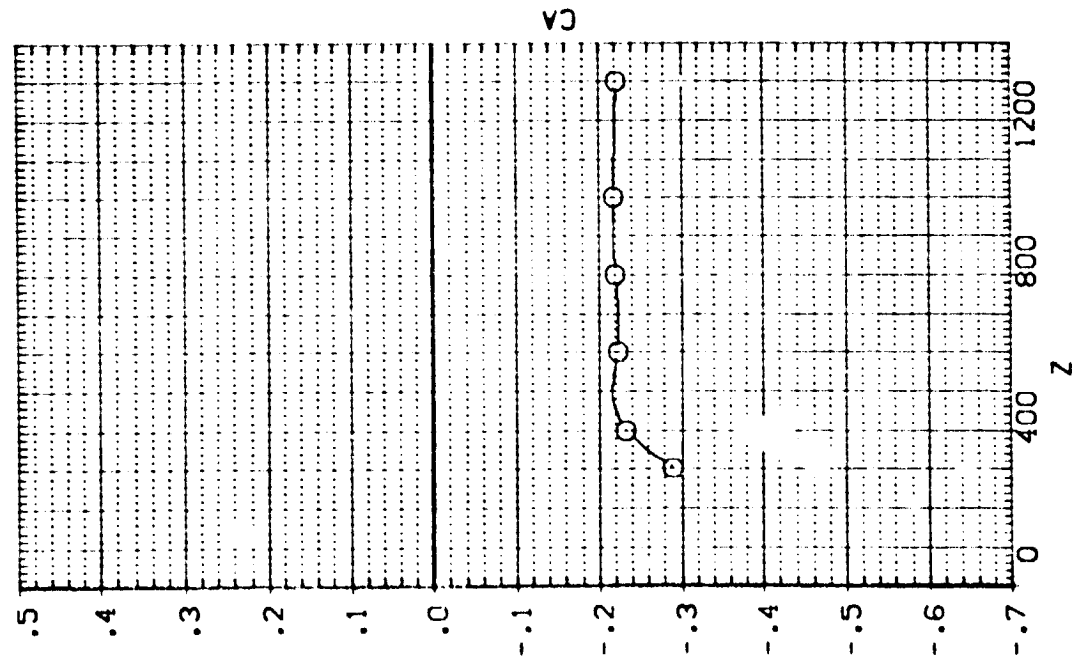
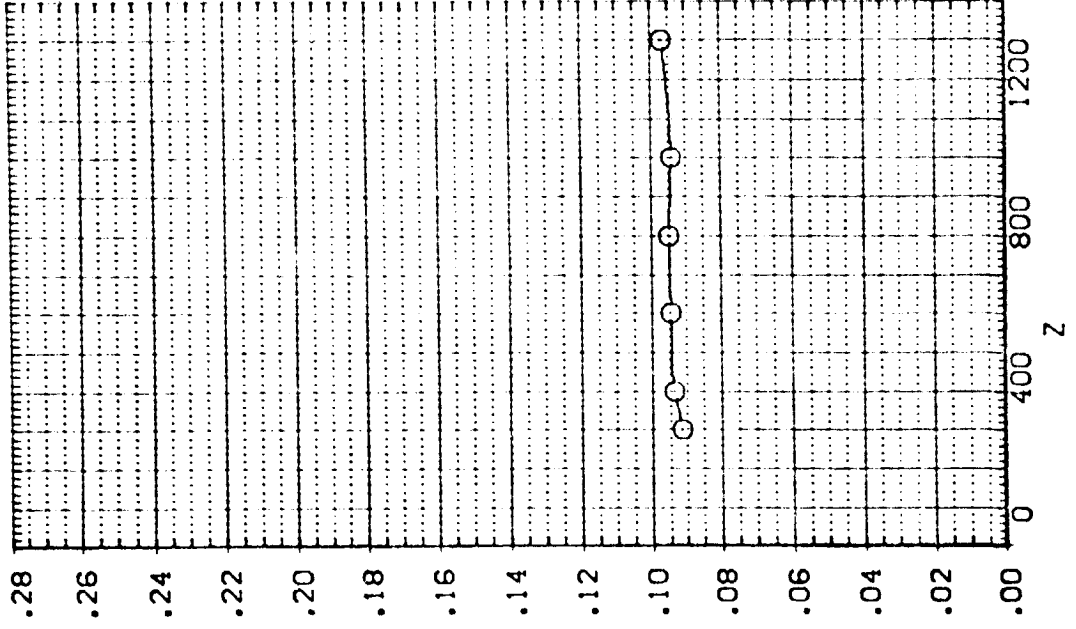

IA13.EXTERNAL TANK(I10)SEPARATING FROM ORB. 09 (RTJT77)

SYMBOL x
O

.253

MACH
ALPHA
DALPHA
ELEVTR
Y

PARAMETRIC VALUES
4.520 P10TAL
-5.000 BETA
-10.000 DBETA
.000 AILRON
.000 Y

80.000
.000
10.000

SEE THE ASSOCIATED DATA DOCUMENT FOR REFERENCE CHARACTERISTICS FOR INDIVIDUAL DATASETS

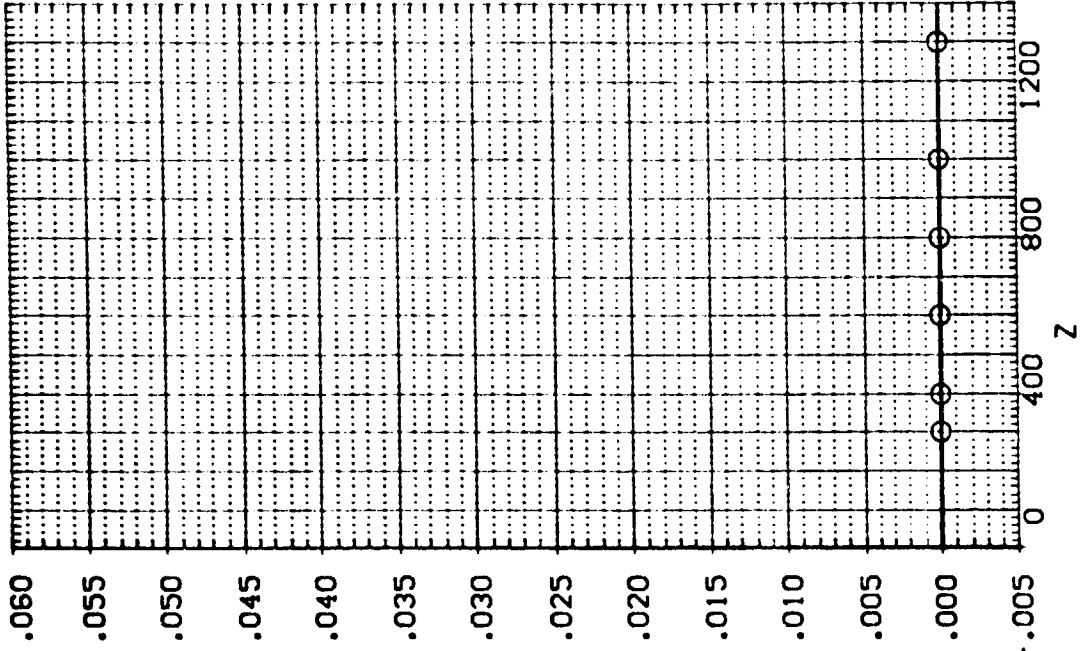
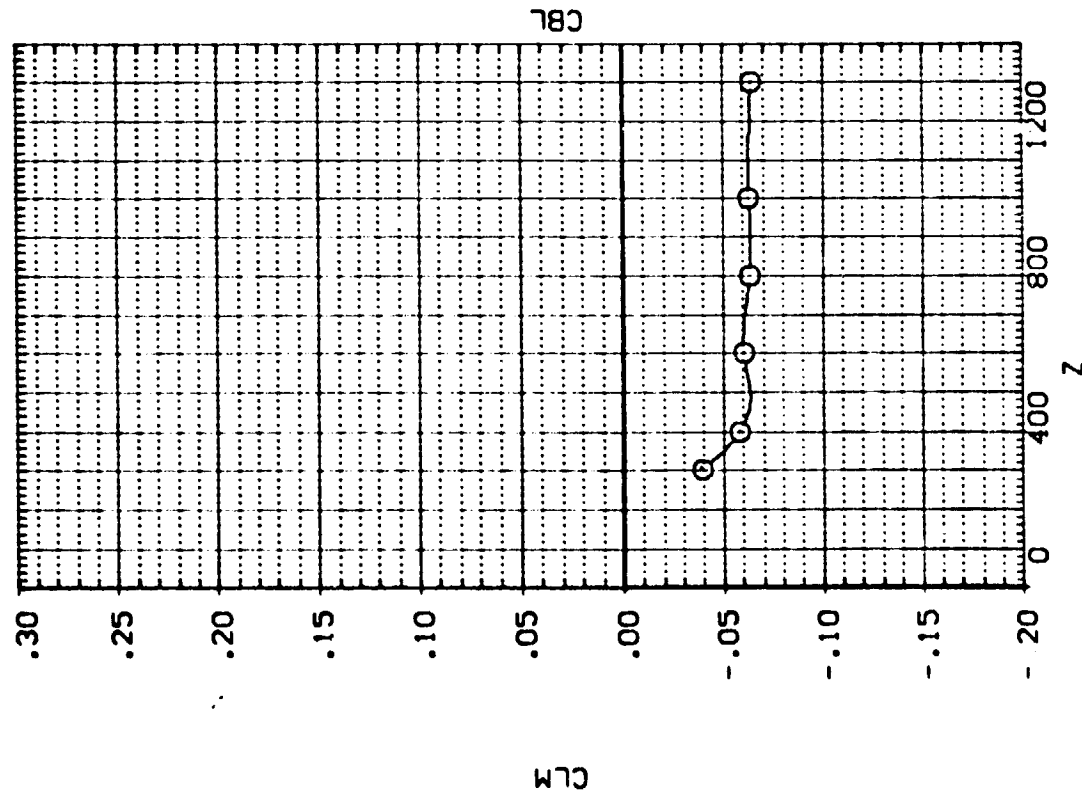

EXTERNAL TANK AERODYNAMIC CHARACTERISTICS DURING SEPARATION FROM ORBITER

IA13.EXTERNAL TANK(T10)SEPARATING FROM ORB. 09 (RTJT77)

SEE THE ASSOCIATED DATA DOCUMENT FOR REFERENCE CHARACTERISTICS FOR INDIVIDUAL DATASETS

PARAMETRIC VALUES	
MACH	4.520
PI TOTAL	80.000
ALPHA	-5.000
BETA	.000
DALPHA	-10.000
DBETA	.000
ELEVTR	.000
AIRION	10.000
Y	.000

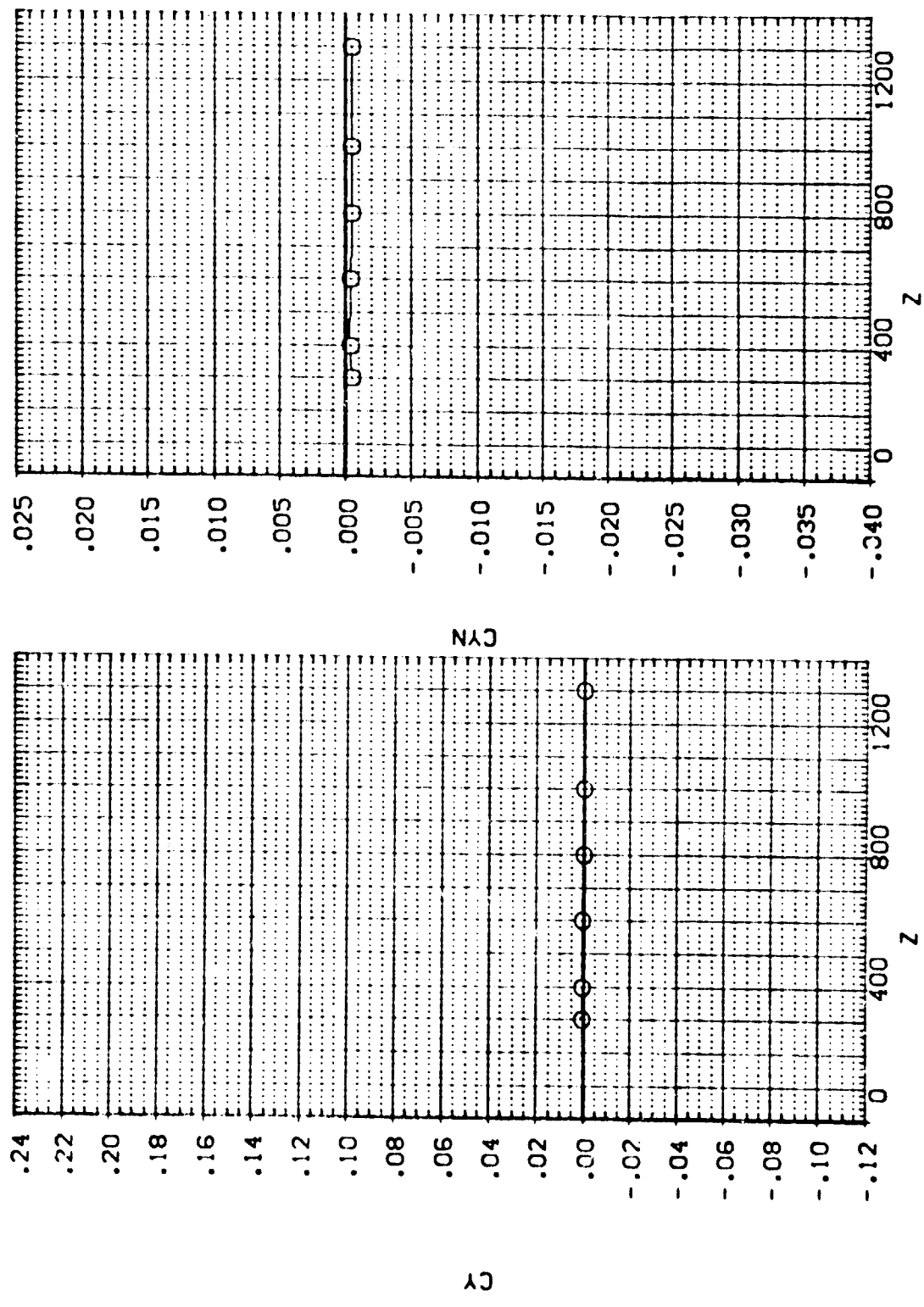

IA13.EXTERNAL TANK(T10)SEPARATING FROM ORB. 09 (RTJT78)

SEE THE ASSOCIATED DATA DOCUMENT FOR REFERENCE CHARACTERISTICS FOR INDIVIDUAL DATASETS

PARAMETRIC VALUES

MACH	4.520	PITOTAL	80.000
ALPHA	-5.000	BETA	.000
DALPHA	-10.000	DBETA	.000
ELEVTR	.000	AILRON	10.000
Y	200.000		

SYMBOL x
○

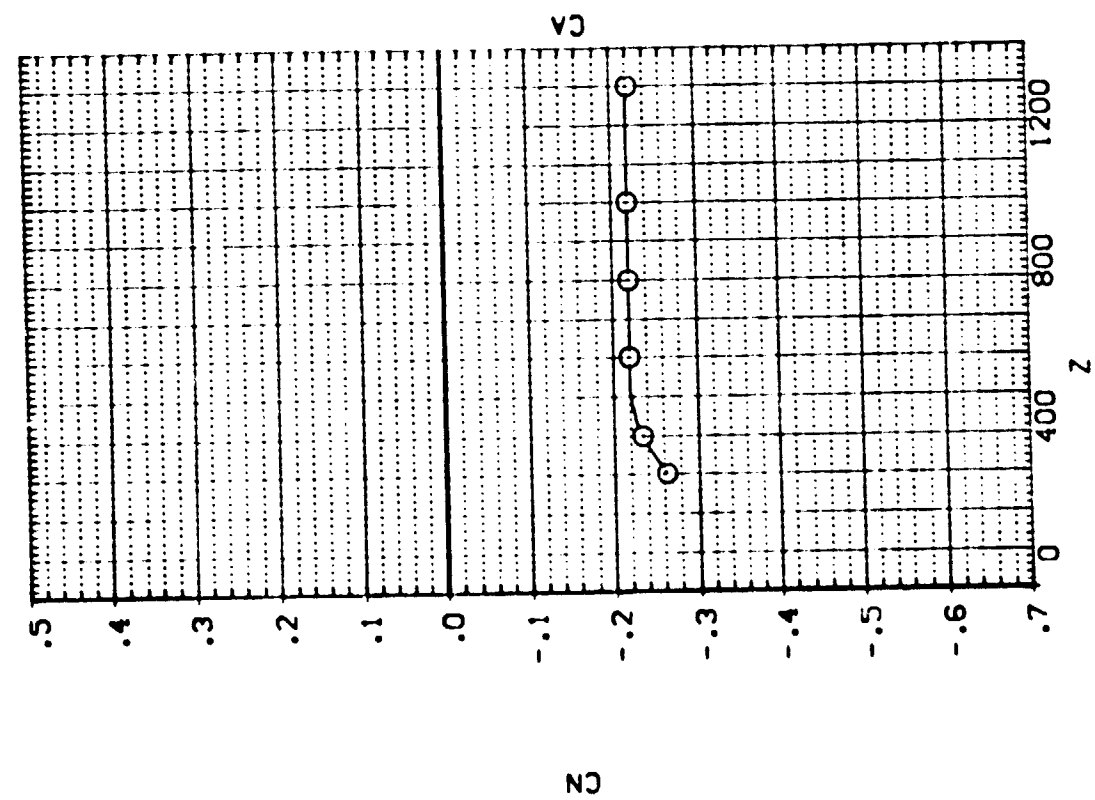
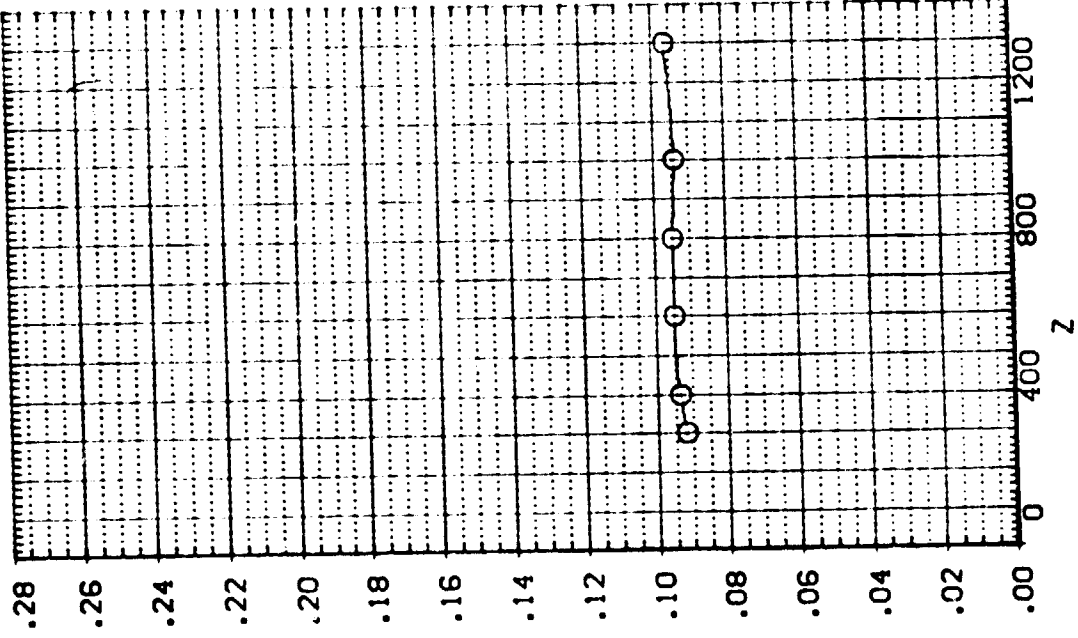

EXTERNAL TANK AERODYNAMIC CHARACTERISTICS DURING SEPARATION FROM ORBITER

1A13.EXTERNAL TANK(1D)SEPARATING FROM ORB. 09 (RTJT78)

SEE THE ASSOCIATED DATA DOCUMENT FOR REFERENCE CHARACTERISTICS FOR INDIVIDUAL DATASETS

PARAMETRIC VALUES	
MACH	4.570
ALPHA	-5.000
DALPHA	-10.000
ELEVTR	.000
Y	200.000
PTOTAL	80.000
BETA	.000
DBETA	.000
AIRRON	10.000

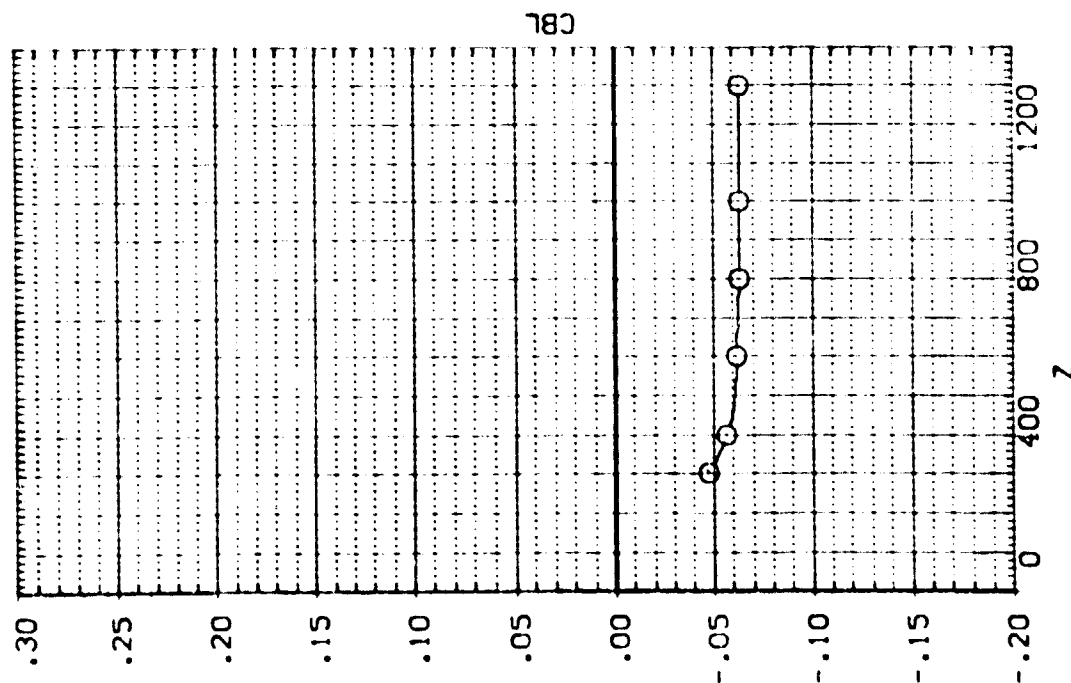
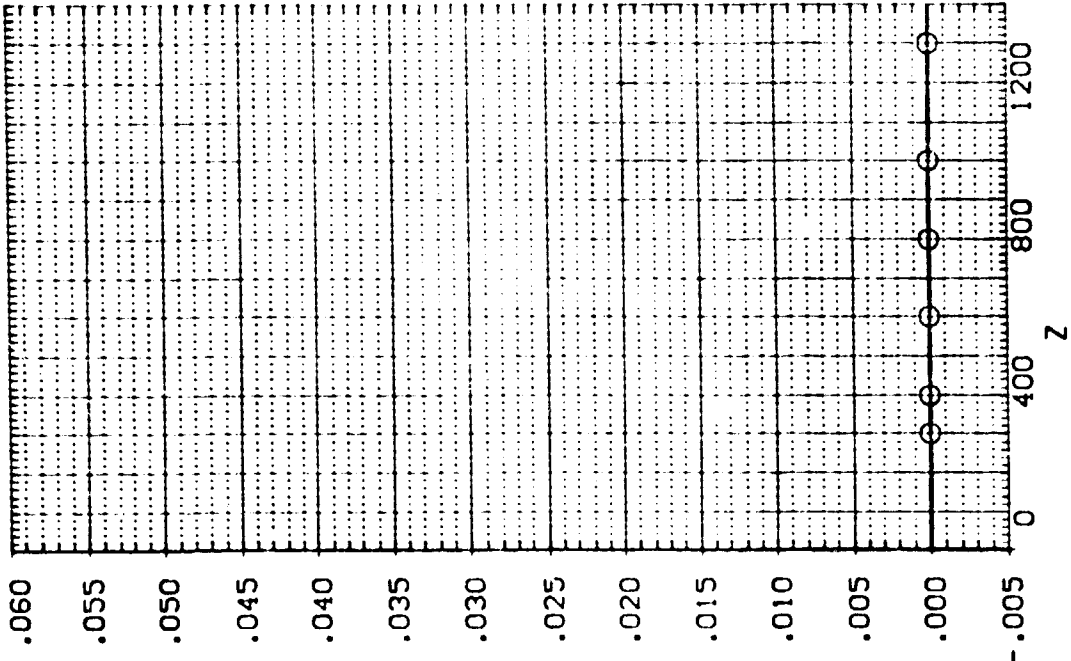

IA13.EXTERNAL TANK(T10)SEPARATING FROM ORB. 09 (RTJT78)

SEE THE ASSOCIATED DATA DOCUMENT FOR REFERENCE CHARACTERISTICS FOR INDIVIDUAL DATASETS

SYMBOL
O

PARAMETRIC VALUES
 MACH 4.520 P/TOTAL 80.000
 ALPHA -5.000 BETA .000
 DALPHA -10.000 DBETA .000
 ELEVTR .000 AILTRON 10.000
 Y 200.000

.219
 .219
 .219

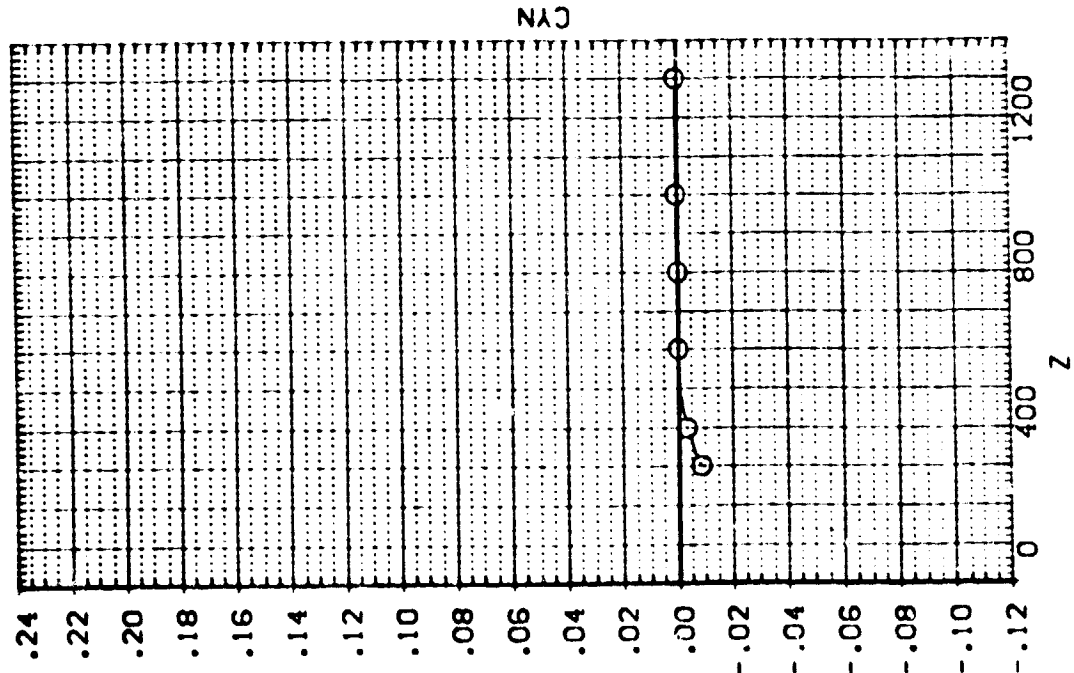
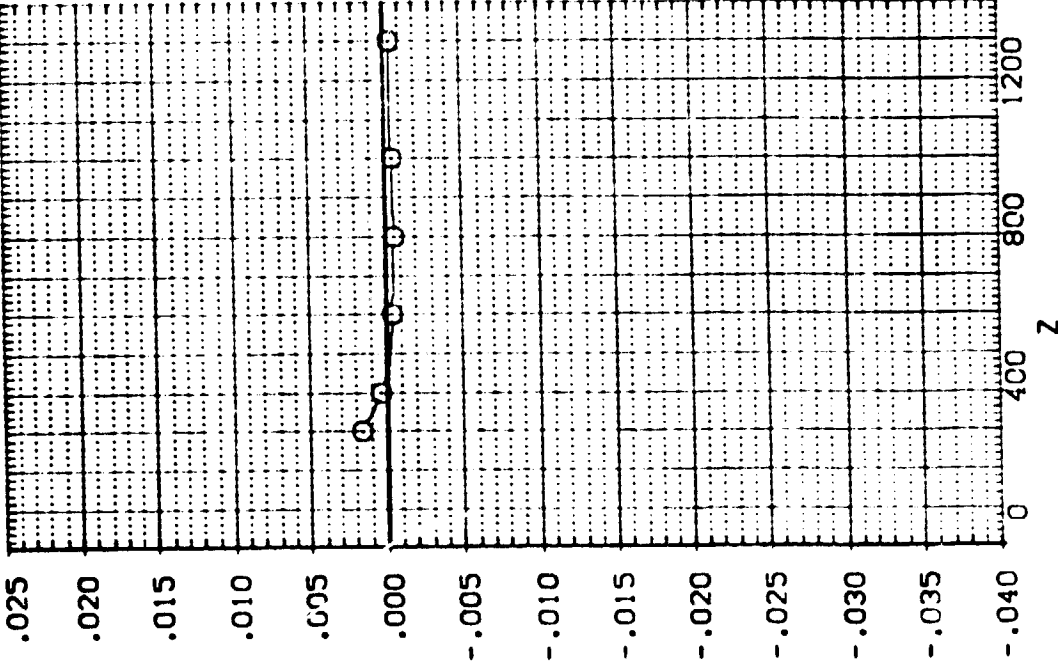

EXTERNAL TANK AERODYNAMIC CHARACTERISTICS DURING SEPARATION FROM ORBITER

13. EXTERNAL TANK(1) SEPARATING FROM ORB. 09 (RTJ79)

SEE THE ASSOCIATED DATA DOCUMENT FOR REFERENCE CHARACTERISTICS FOR INDIVIDUAL DATASETS

PARAMETRIC VALUES	
MACH	4.520
ALPHA	-5.000
BETA	.000
DELTA	-10.000
ELEV	.000
Y	-200.000

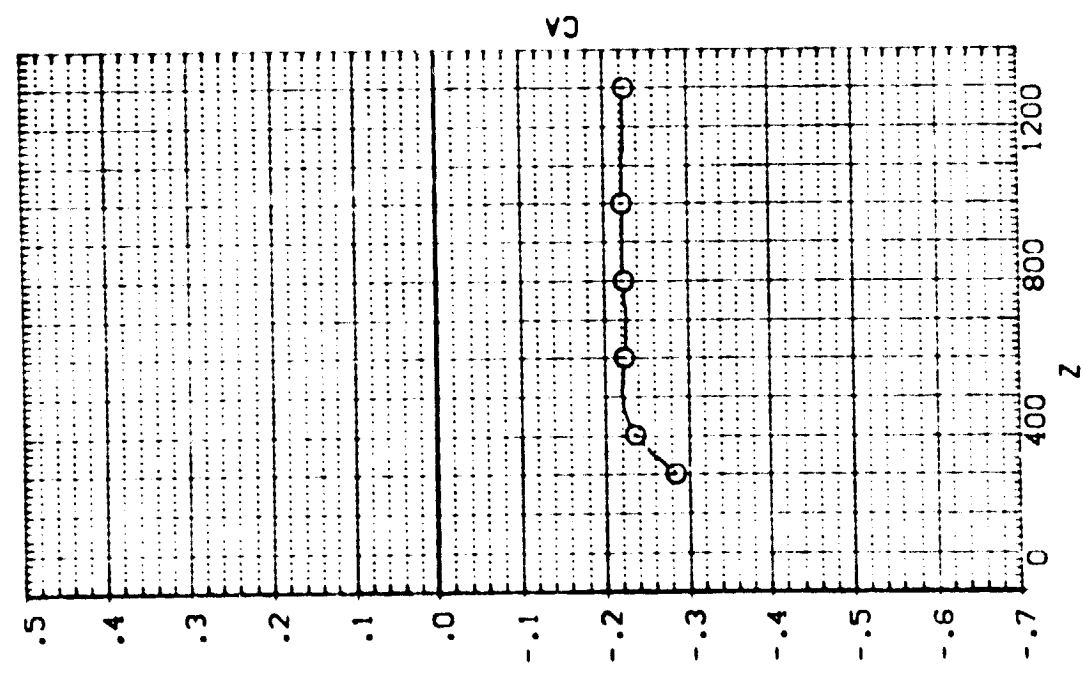
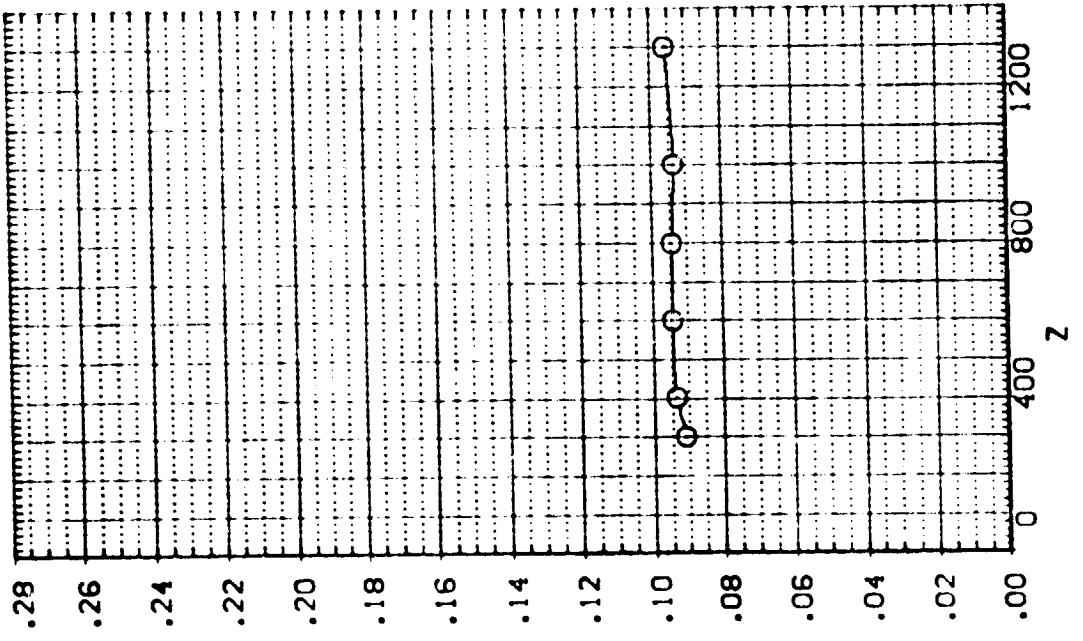

IA13.EXTERNAL TANK(T10)SEPARATING FROM ORB. 09 (RTJT79)

SEE THE ASSOCIATED DATA DOCUMENT FOR REFERENCE CHARACTERISTICS FOR INDIVIDUAL DATASETS

SYMBOL
O

PARAMETRIC VALUES
MACH 4.520 P/TOTAL 80.000
ALPHA -5.000 BETA .000
DALPHA -10.000 DBETA -5.000
ELEVTR .000 AILRON 10.000
Y -200.000

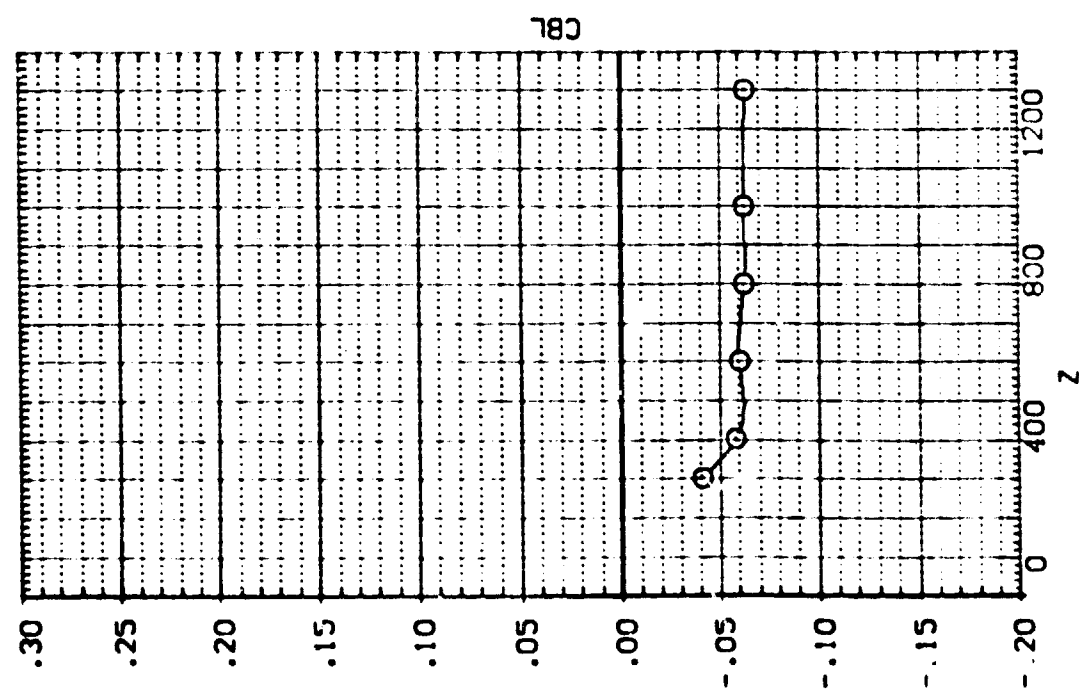
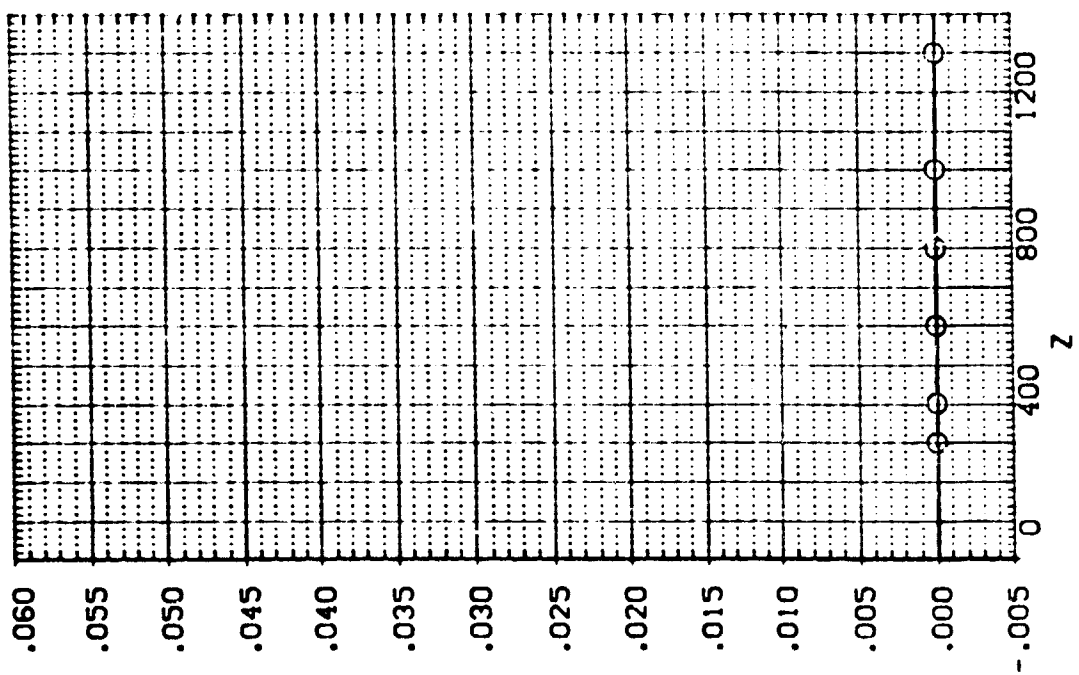

EXTERNAL TANK AERODYNAMIC CHARACTERISTICS DURING SEPARATION FROM ORBITER

IA13.EXTERNAL TANK(T10)SEPARATING FROM ORB. 09 (RTJT79)

SEE THE ASSOCIATED DATA DOCUMENT FOR REFERENCE CHARACTERISTICS FOR INDIVIDUAL DATASETS

SYMBOL		PARAMETRIC VALUES	
x	.255	MACH	4.520
o		PTOTAL	80.000
		BETA	.000
		DBETA	-5.000
		AILRON	10.000
		Y	-200.000

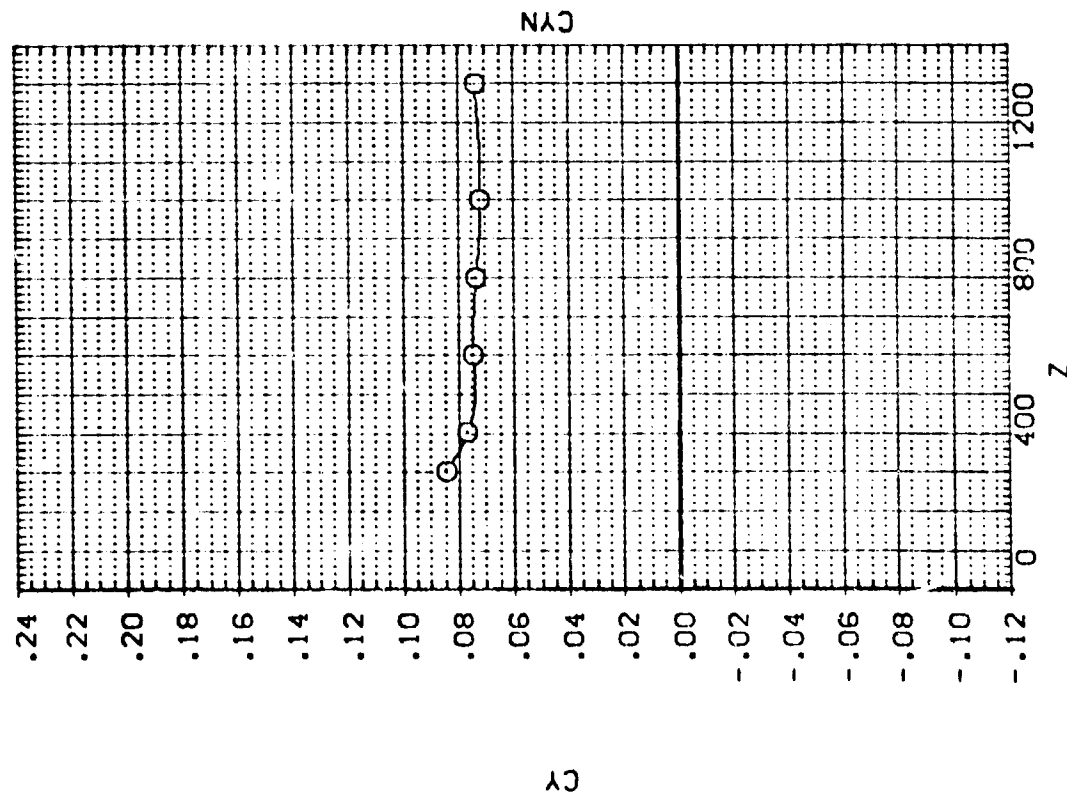
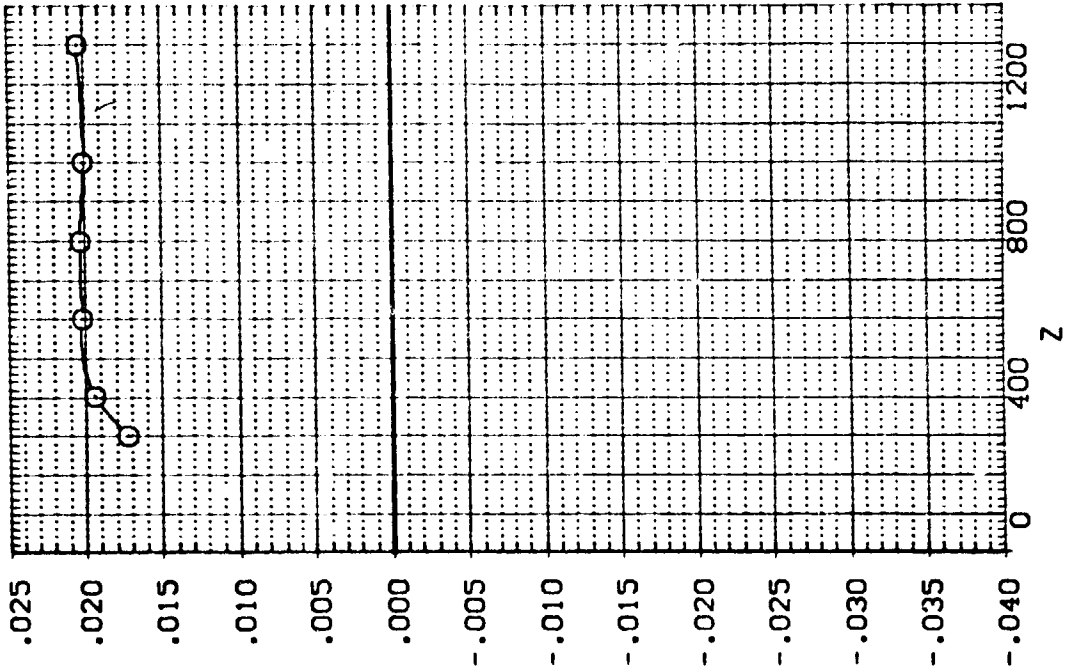

IA13.EXTERNAL TANK(T10)SEPARATING FROM ORB. 09 (RTJT80)

SEE THE ASSOCIATED DATA DOCUMENT FOR REFERENCE CHARACTERISTICS FOR INDIVIDUAL DATASETS

SYMBOL		PARAMETRIC VALUES	
x	.300	MACH	4.520
		PTOTAL	80.000
		BETA	.000
		DBETA	5.000
		AILRON	10.000
		ELEVTR	.000
		Y	.000

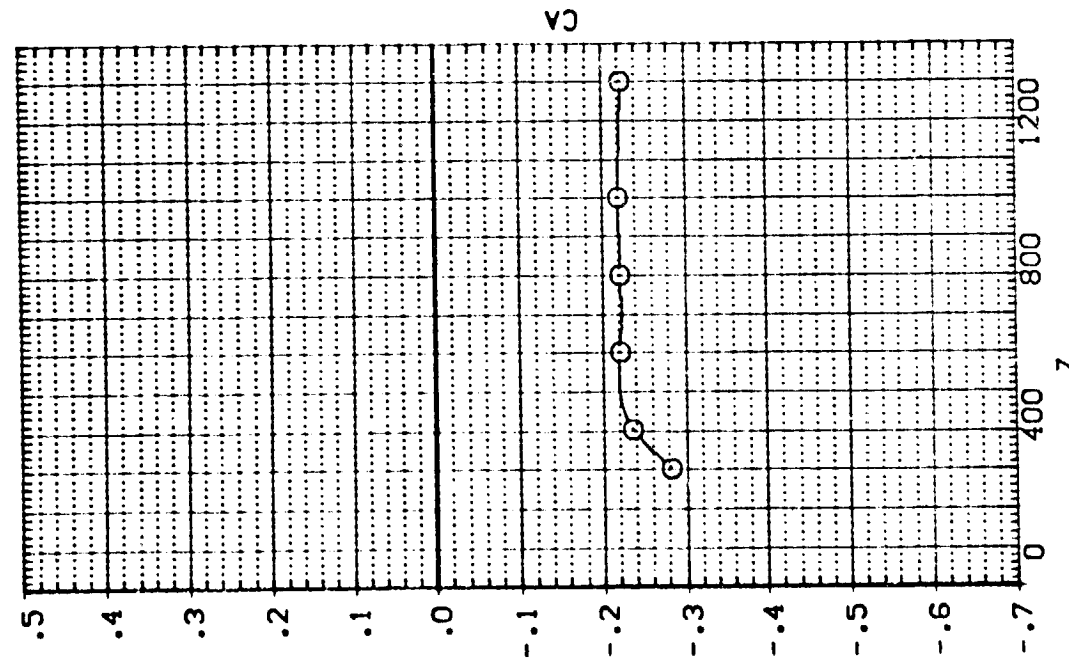
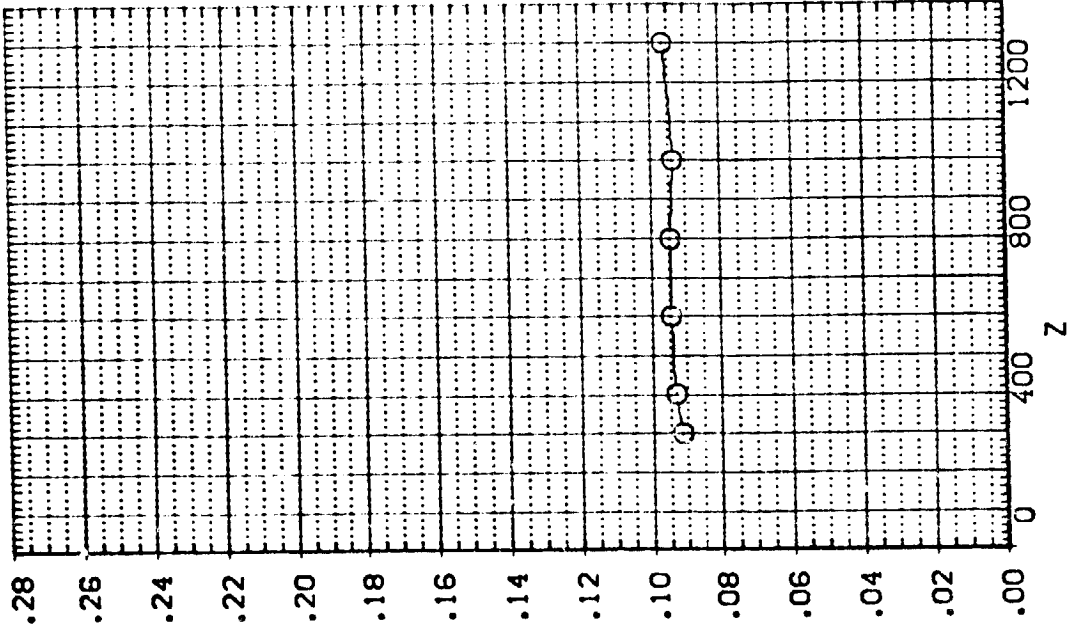

EXTERNAL TANK AERODYNAMIC CHARACTERISTICS DURING SEPARATION FROM ORBITER

3.3. EXTERNAL TANK (10) SEPARATING FROM ORB. 09 (RTJ180)

SEE THE ASSOCIATED DATA DOCUMENT FOR REFERENCE CHARACTERISTICS FOR INDIVIDUAL DATA SETS

PARAMETRIC VALUES	
MACH	4.520
ALPHA	-5.000
DALPHA	-10.000
ELEVTR	.000
Y	.000
DTOTAL	60.000
BETA	.000
DBETA	5.000
A:LRON	10.000

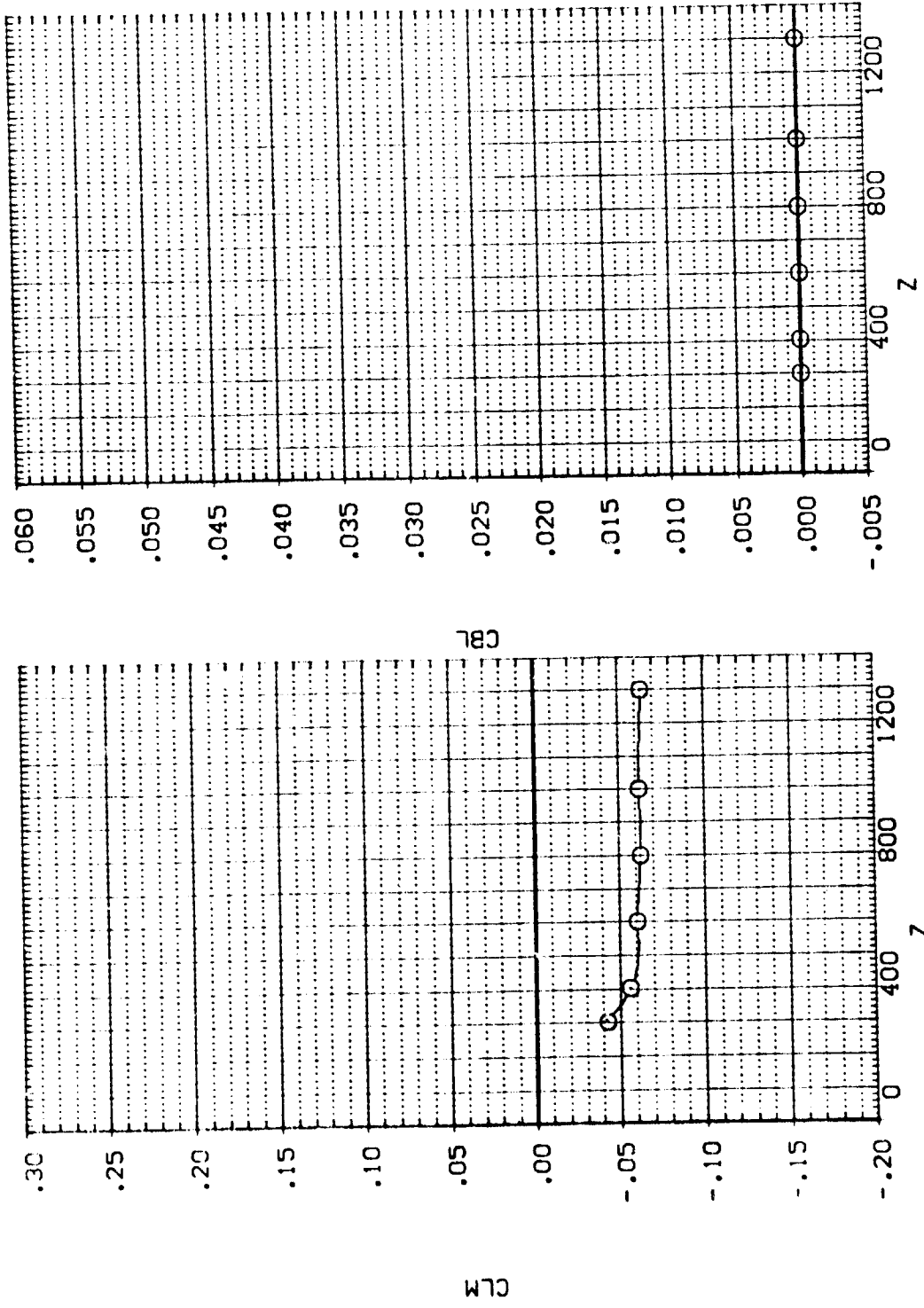

EXTERNAL TANK AERODYNAMIC CHARACTERISTICS DURING SEPARATION FROM ORBITER

IA13. EXTERNAL TANK(T10)SEPARATING FROM ORB. 09 (RTJT80)

SEE THE ASSOCIATED DATA DOCUMENT FOR REFERENCE CHARACTERISTICS FOR INDIVIDUAL DATASETS

SYMBOL x .300
 O
 PARAMETRIC VALUES
 MACH 4.520 PTOTAL 80.000
 ALPHA -5.000 BETA .000
 DALPHA -10.000 DBETA 5.000
 ELEVTR .000 AILRON 10.000
 Y .000

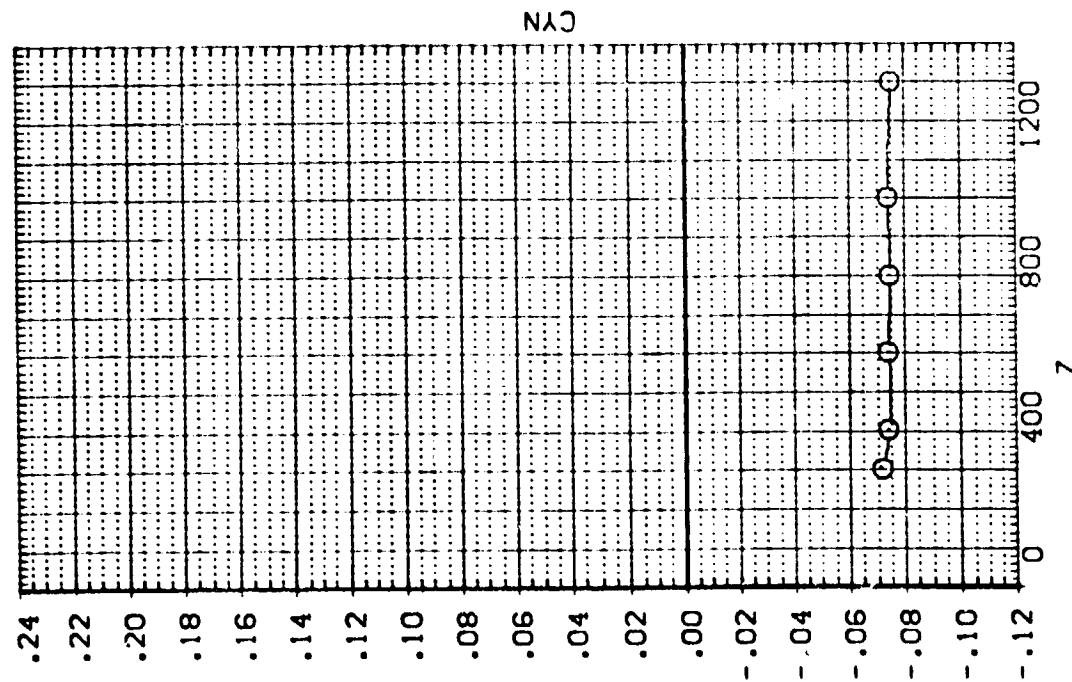
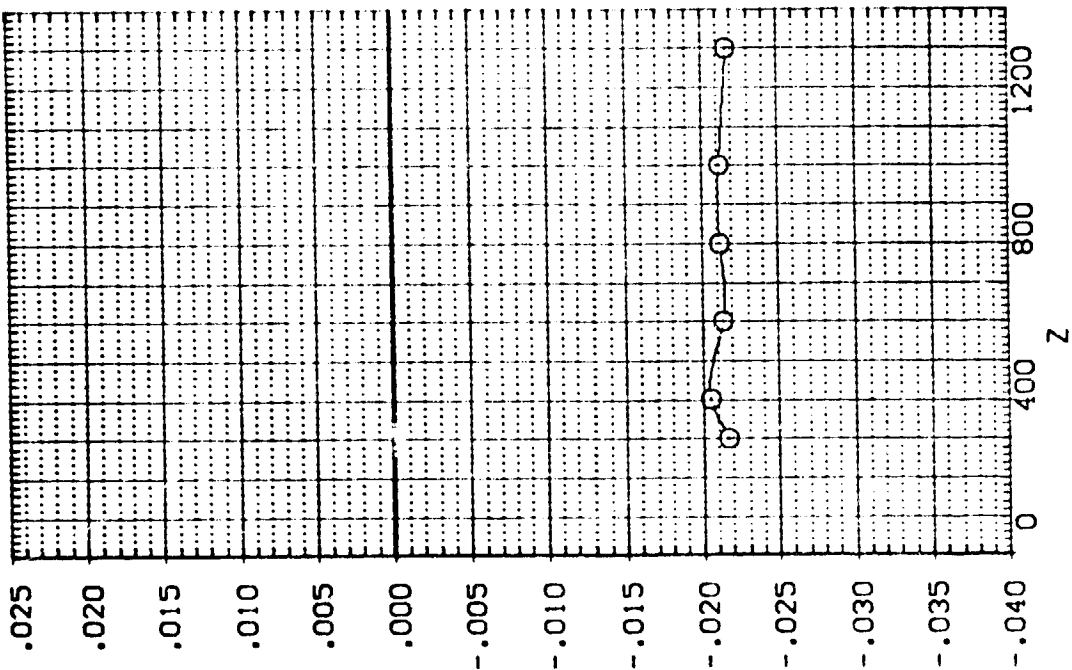

EXTERNAL TANK AERODYNAMIC CHARACTERISTICS DURING SEPARATION FROM ORBITER

IA13.EXTERNAL TANK(T10)SEPARATING FROM ORB. 09 (RTJT81)

SY-30L X

PARAMETRIC VALUES	
MACH	4.520
ALPHA	-5.000
DALPHA	-10.000
ELEVTR	.000
Y	200.000
PTOTAL	80.000
BETA	.000
DBETA	5.000
ALLRON	10.000

SEE THE ASSOCIATED DATA DOCUMENT FOR REFERENCE CHARACTERISTICS FOR INDIVIDUAL DATASETS

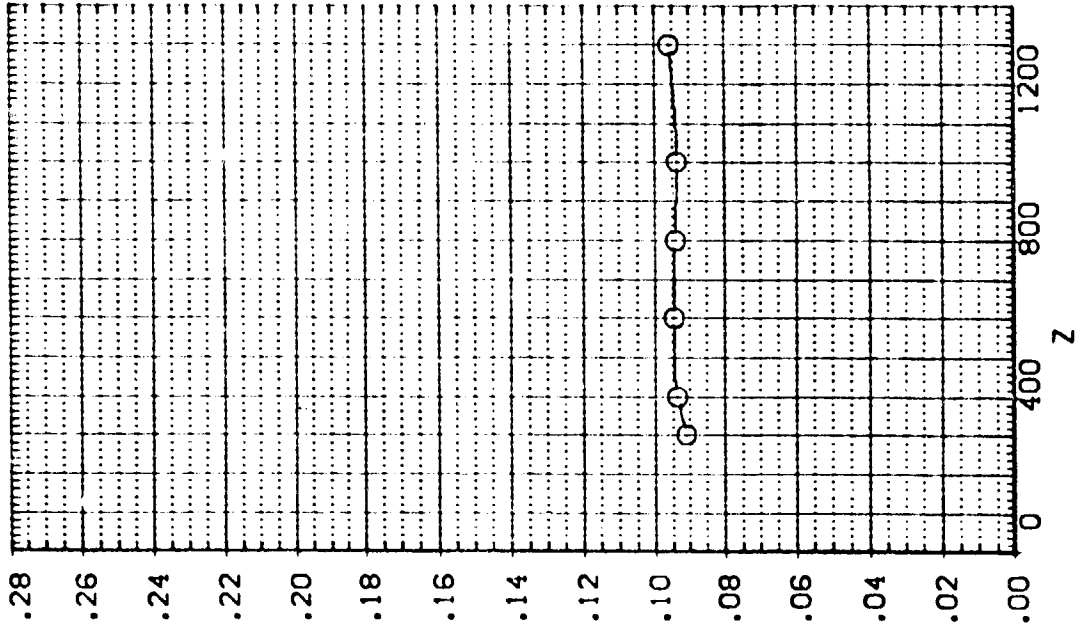
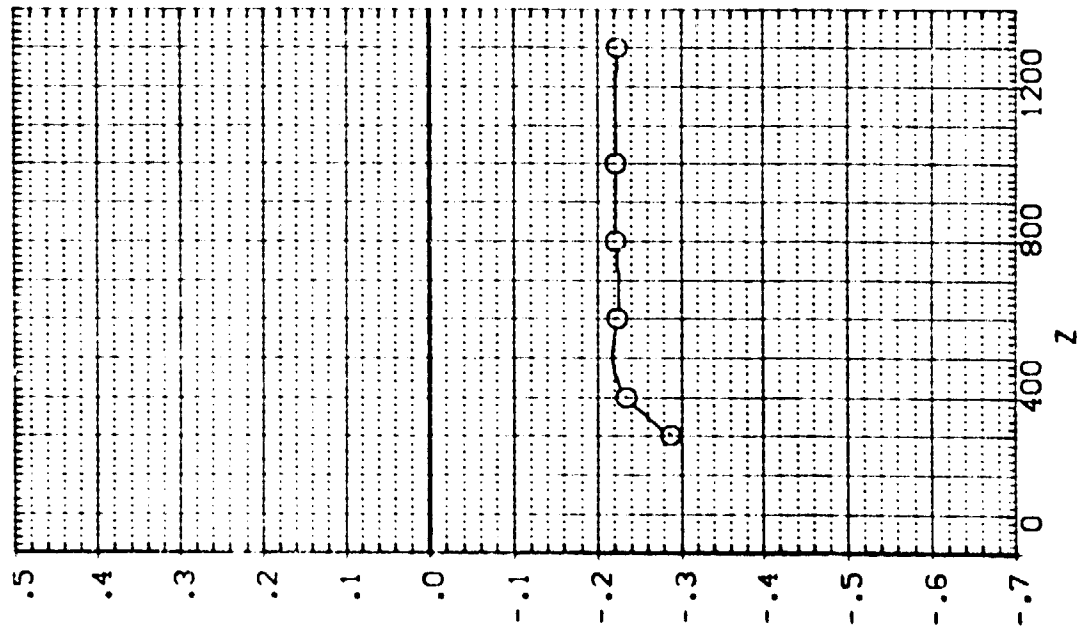

IA13.EXTERNAL TANK(T10)SEPARATING FROM ORB. 09 (RTJT81)

SEE THE ASSOCIATED DATA DOCUMENT FOR REFERENCE CHARACTERISTICS FOR INDIVIDUAL DATASETS

SYMBOL x .140 MACH 4.520 P TOTAL 80.000
 O ALPHA -5.000 BETA .000
 DALPHA -10.000 DBETA 5.000
 ELEVTR .000 AILRON 10.000
 Y 200.000

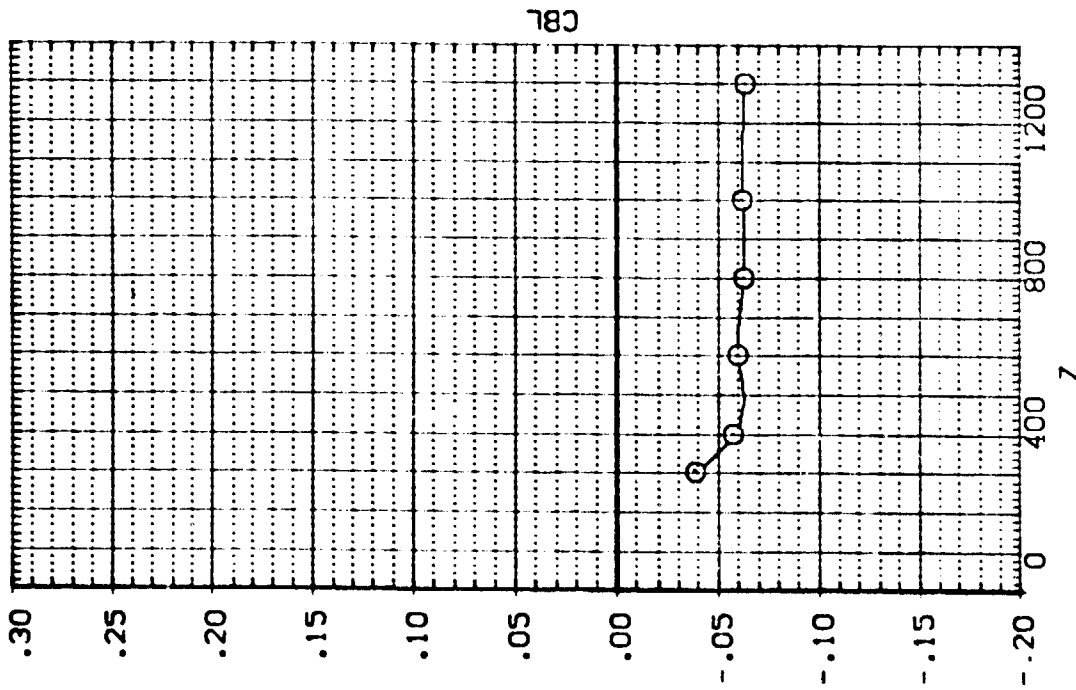
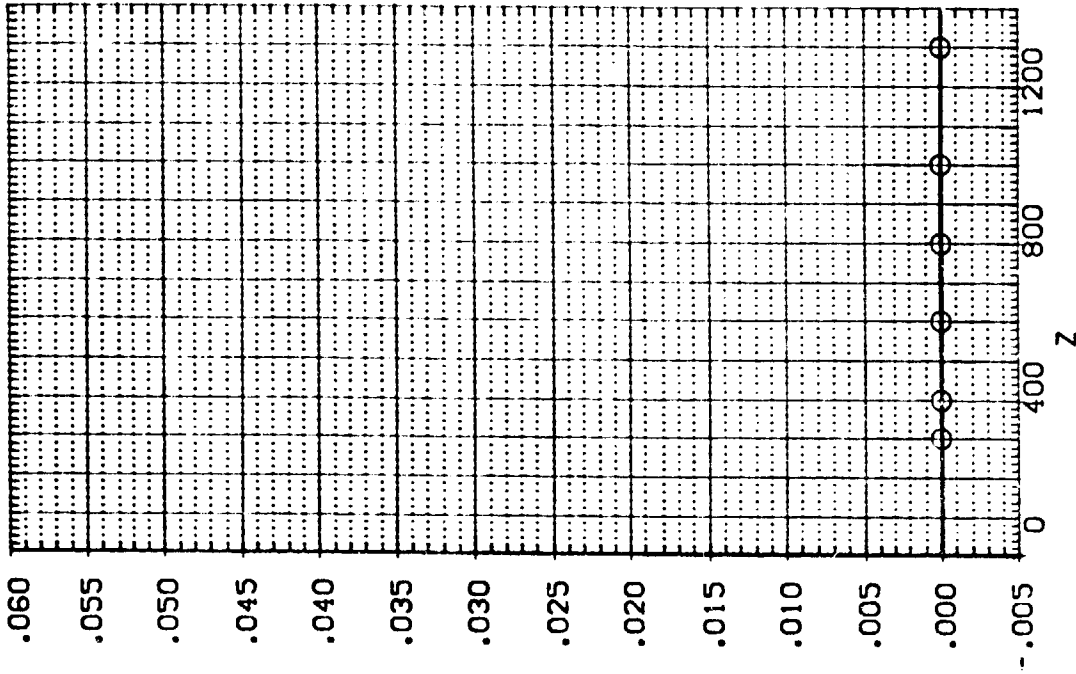

EXTERNAL TANK AERODYNAMIC CHARACTERISTICS DURING SEPARATION FROM ORBITER

!A13.EXTERNAL TANK(T10)SEPARATING FROM ORB. 09 (RTJT81)

SYMBOL: X
O

PARAMETRIC VALUES

MACH	4.520	P TOTAL	80.000
ALPHA	-5.000	BETA	.000
DALPHA	-10.000	DBETA	5.000
ELEVTR	.000	A1LRON	10.000
Y	200.000		

SEE THE ASSOCIATED DATA DOCUMENT FOR REFERENCE CHARACTERISTICS FOR INDIVIDUAL DATASETS

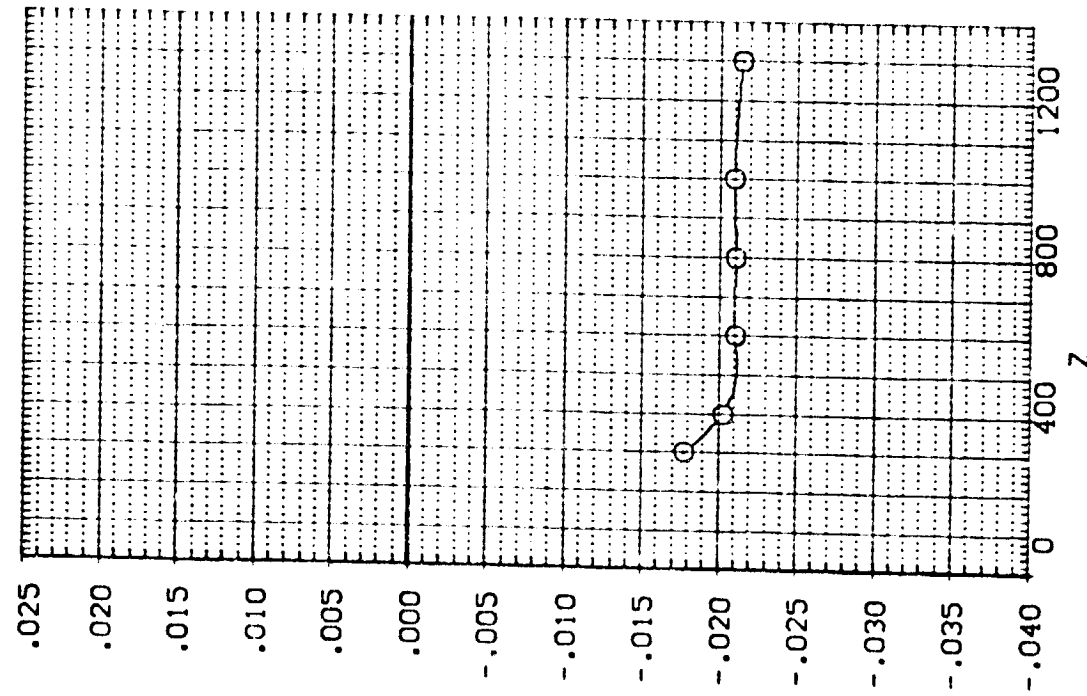
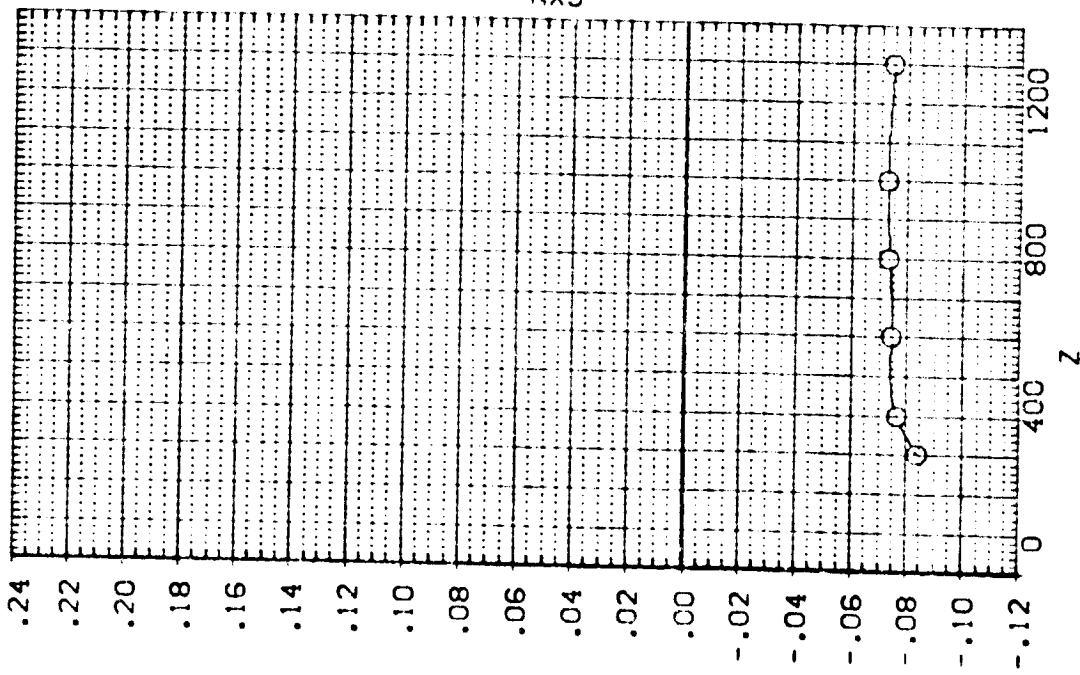

EXTERNAL TANK AERODYNAMIC CHARACTERISTICS DURING SEPARATION FROM ORBITER

1A13. EXTERNAL TANK(T10)SEPARATING FROM ORB. 09 (RTJT82)

SYMBOL x
O

PARAMETRIC VALUES
MACH 4.520 P1TOTAL 80.000
ALPHA -5.000 BETA .000
DALPHA -20.000 DBETA .000
ELEVTR .000 AILRON 10.000
Y -200.000

SEE THE ASSOCIATED DATA DOCUMENT FOR REFERENCE CHARACTERISTICS FOR INDIVIDUAL DATASETS

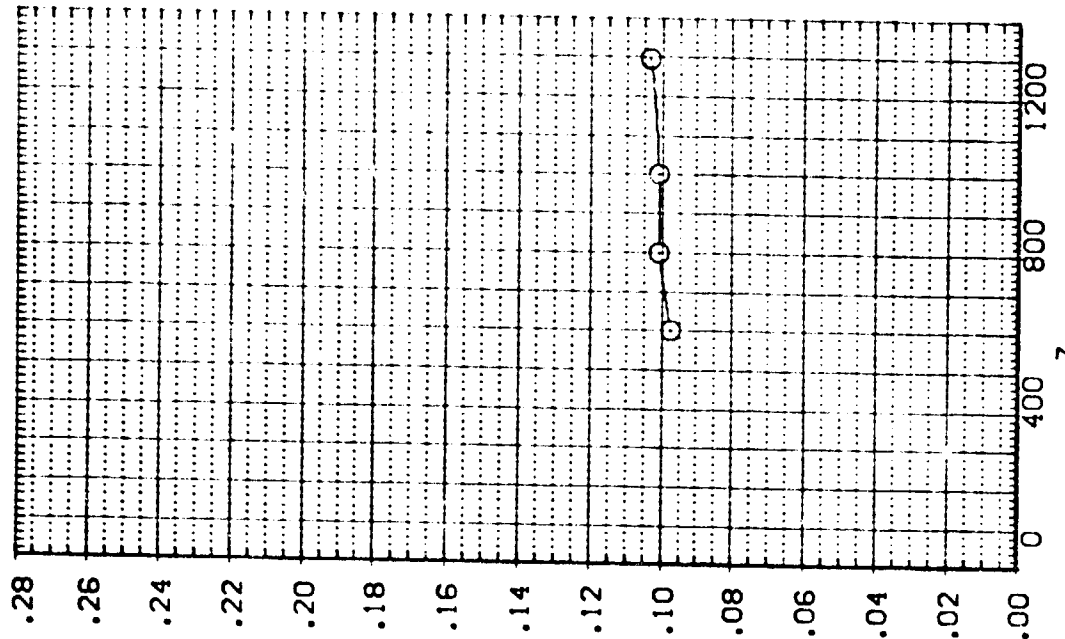
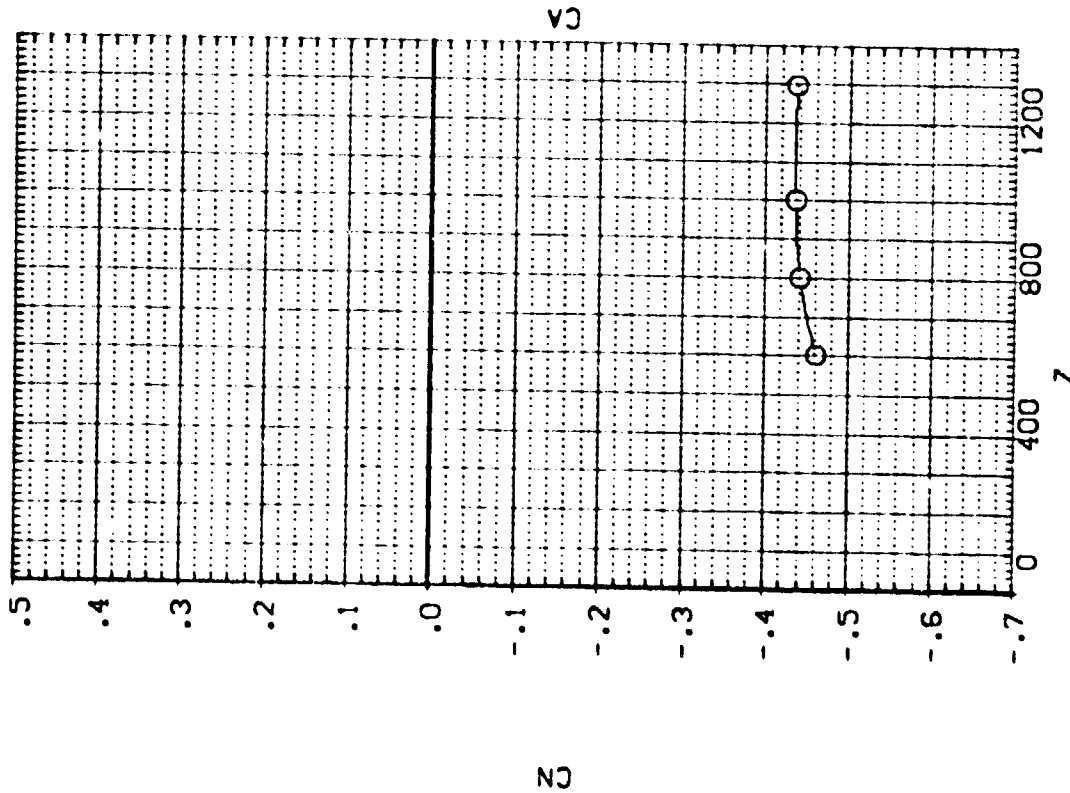

EXTERNAL TANK AERODYNAMIC CHARACTERISTICS DURING SEPARATION FROM ORBITER

IA13, EXTERNAL TANK(T10)SEPARATING FROM ORB. 09 (RTJT82)

SYMBOL \circ

PARAMETRIC VALUES
 MACH 4.520 PTOTAL 80.000
 ALPHA -5.000 BETA .000
 DALPHA -20.000 DBETA .000
 ELEVTR .000 ALLRON 10.000
 V -200.000

SEE THE ASSOCIATED DATA DOCUMENT FOR REFERENCE CHARACTERISTICS FOR INDIVIDUAL DATASETS

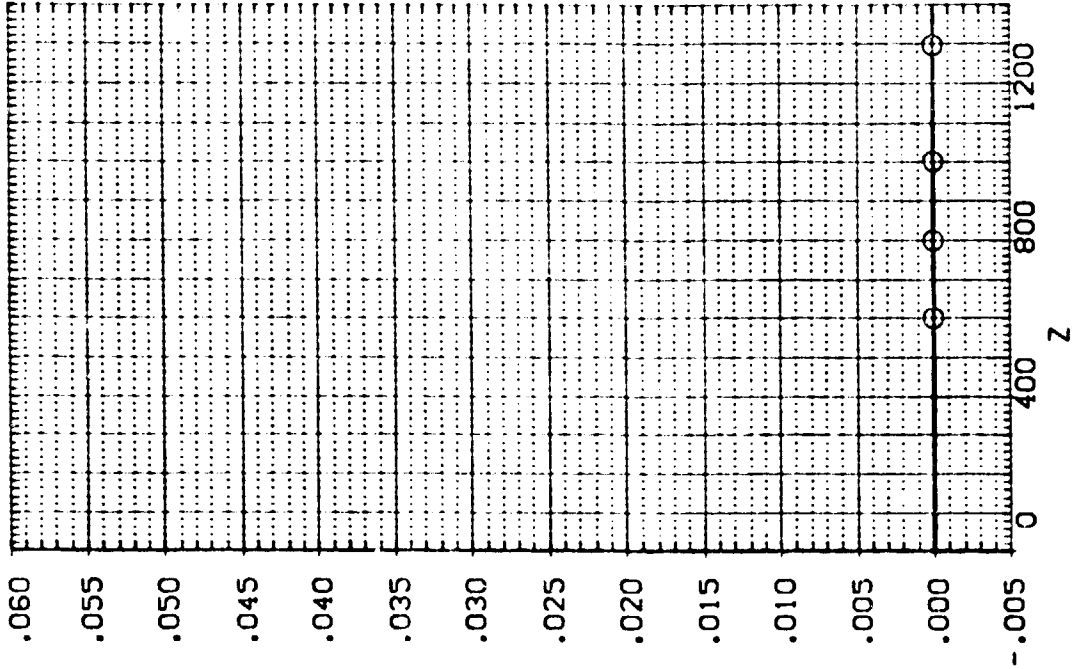
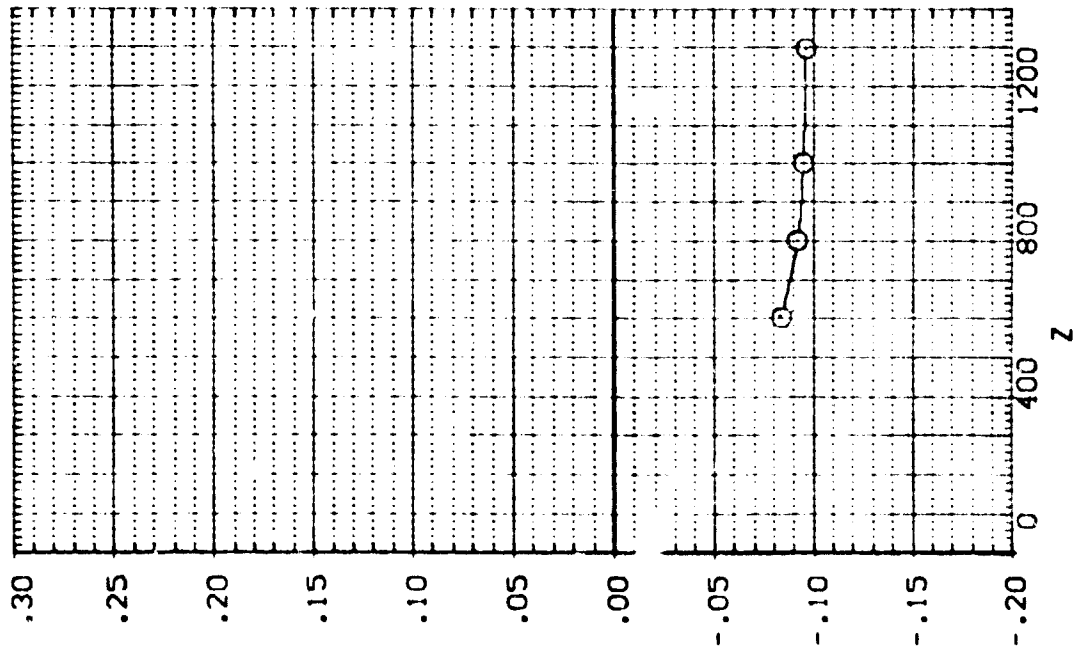

IA13.EXTERNAL TANK(T10)SEPARATING FROM ORB. 09 (RTJT82)

SYMBOL X
O

PARAMETRIC VALUES
 MACH 4.520
 ALPHA -5.000
 DALPHA -20.000
 ELEVTR .000
 Y -200.000
 PTOTAL 80.000
 BETA .000
 DBETA .000
 AILRON 10.000

SEE THE ASSOCIATED DATA DOCUMENT FOR REFERENCE CHARACTERISTICS FOR INDIVIDUAL DATASETS

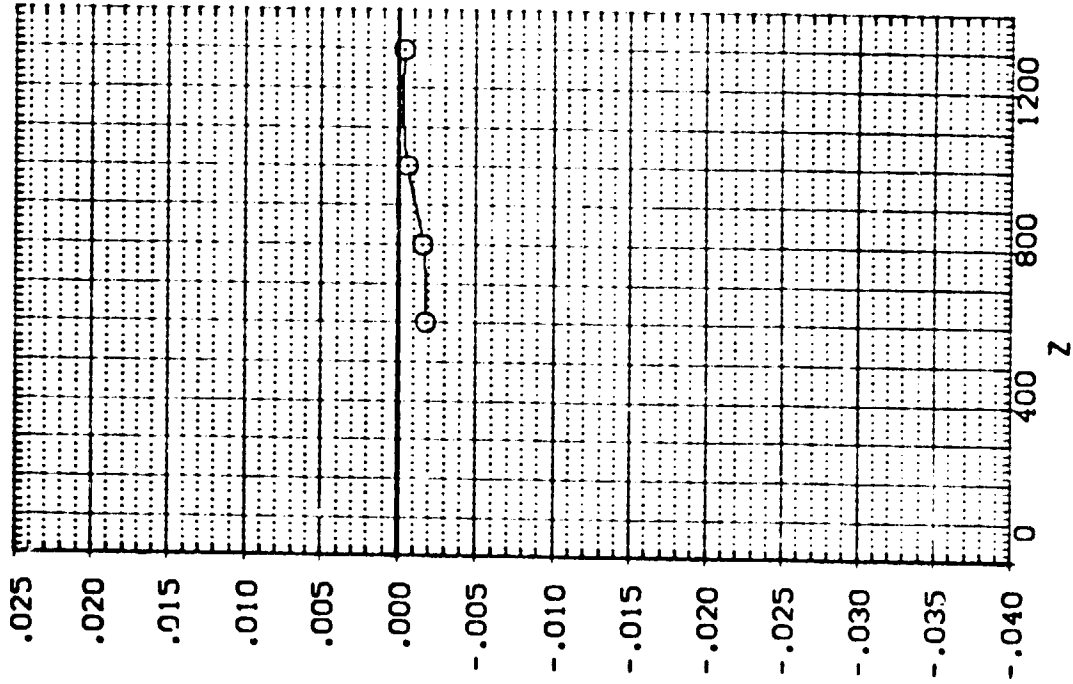
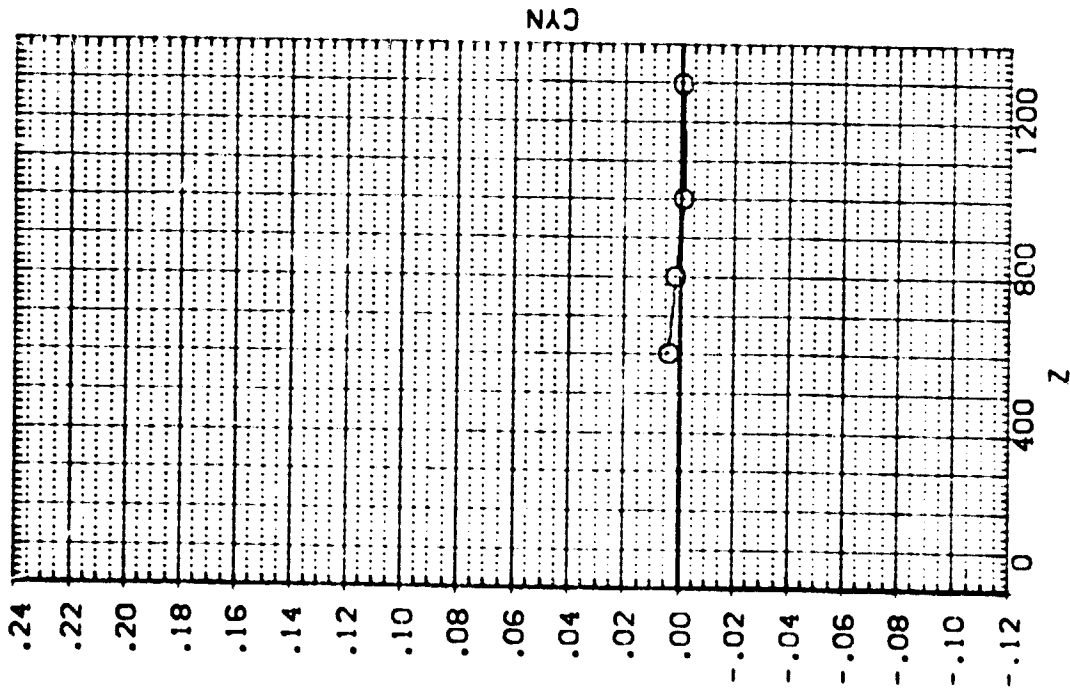

EXTERNAL TANK AERODYNAMIC CHARACTERISTICS DURING SEPARATION FROM ORBITER

1A13, EXTERNAL TANK(10) SEPARATING FROM ORB. 09 (RTJT83)

SEE THE ASSOCIATED DATA DOCUMENT FOR REFERENCE CHARACTERISTICS FOR INDIVIDUAL DATASETS

SYMBOL	X	MACH	PARAMETRIC VALUES
C	.165	4.570	P/DIAL 80.000
		ALPHA	BETA .000
		DALPHA	DBETA .000
		ELEVTR	ALTRON 10.000
		Y	.000

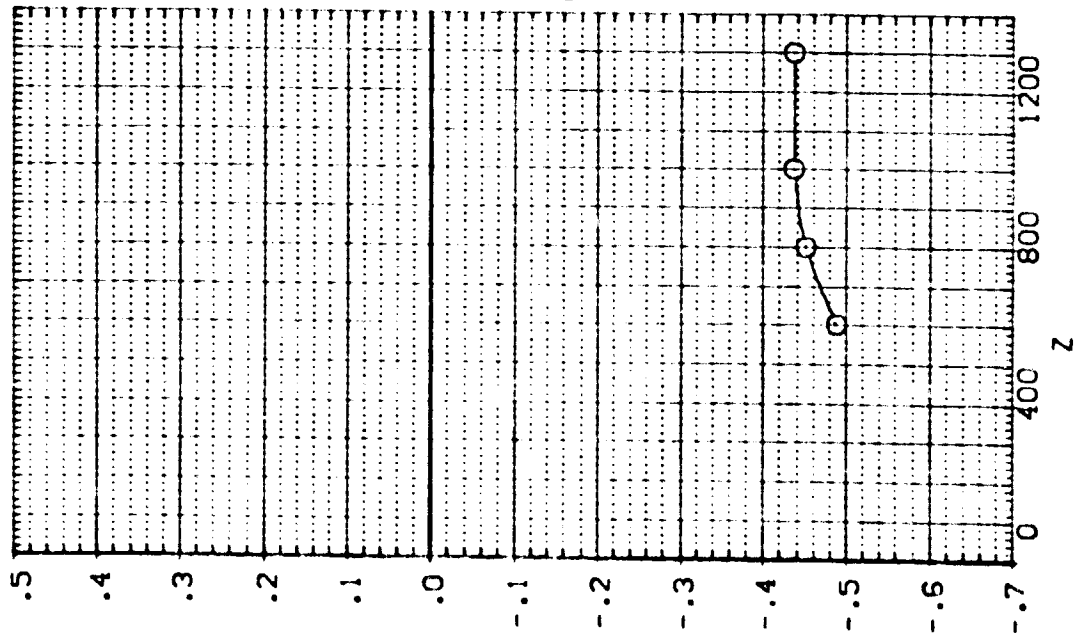
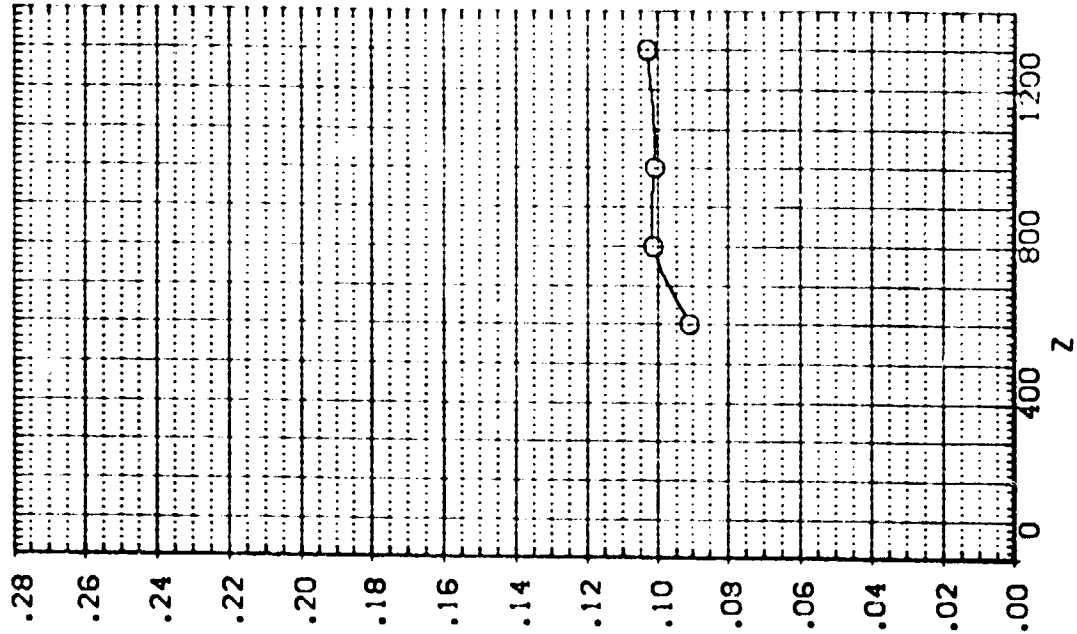

1A13.EXTERNAL TANK(110)SEPARATING FROM ORB. 09 (RTJT83)

SEE THE ASSOCIATED DATA DOCUMENT FOR REFERENCE CHARACTERISTICS FOR INDIVIDUAL DATASETS

SYMBOL
O

X .165

MACH
ALPHA
DALPHA
ELEVTR
Y

PARAMETRIC VALUES
4.520 PTOTAL
-5.000 BETA
-20.000 DBETA
.000 AILRON
.000

80.000
.000
.000
10.000

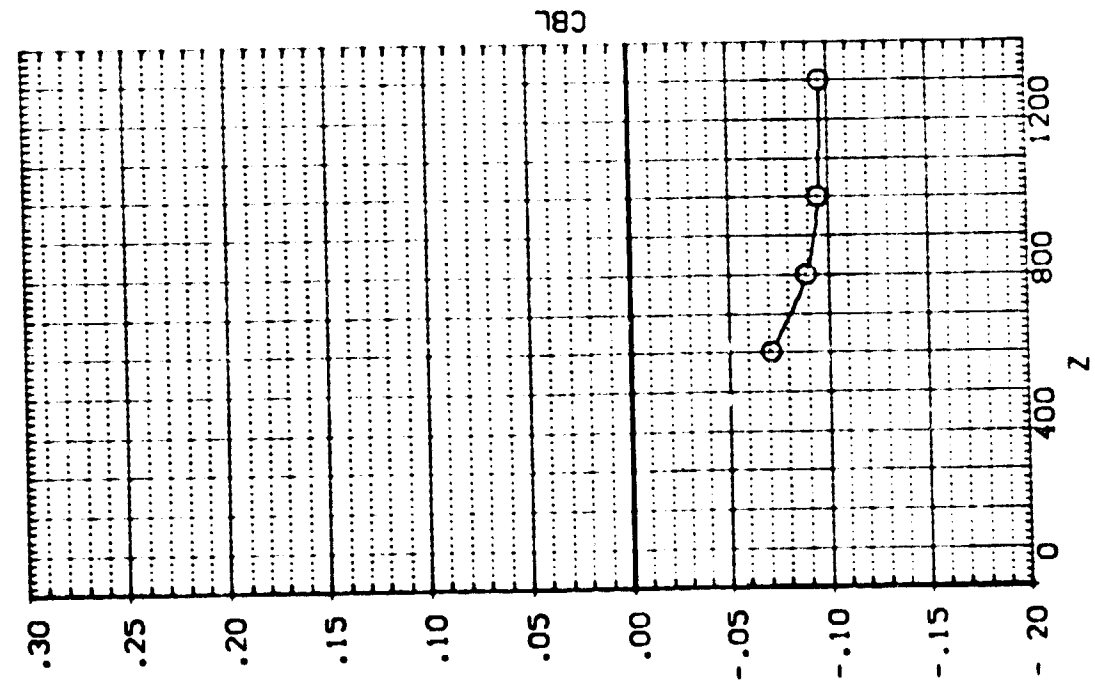
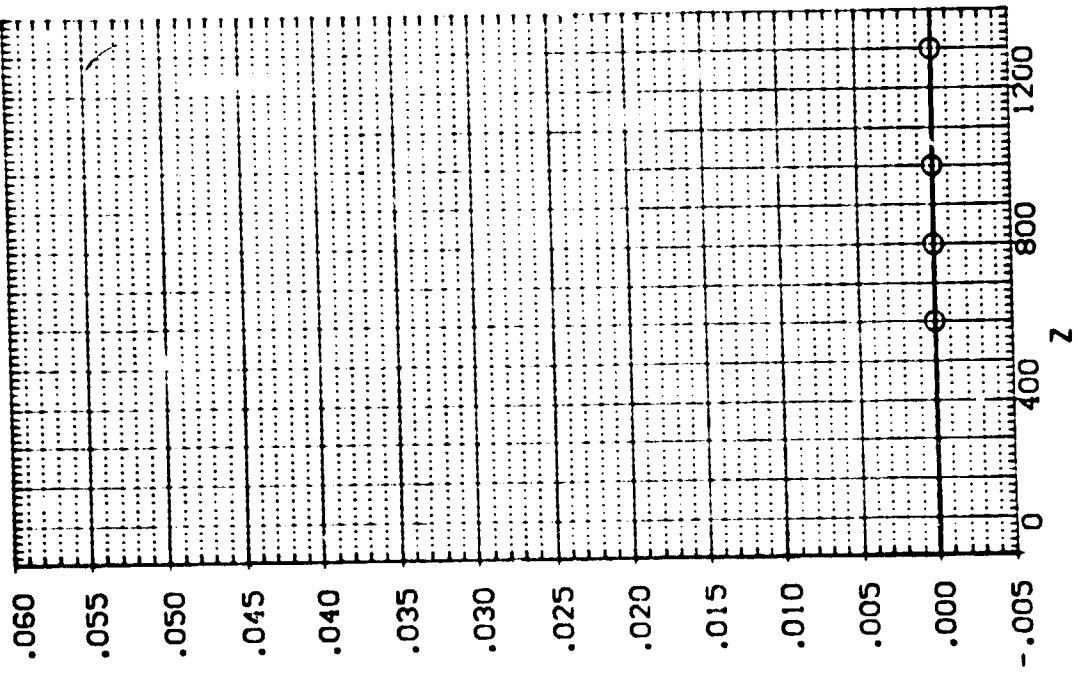

EXTERNAL TANK AERODYNAMIC CHARACTERISTICS DURING SEPARATION FROM ORBITER

1.13. EXTERNAL TANK DURING SEPARATION FROM ORB. C9 (RTJTB3)

SEE THE ASSOCIATED DATA DOCUMENT FOR REFERENCE CHARACTERISTICS FOR INDIVIDUAL DATASETS

SYMBOL X .165 PARAMETRIC VALUES
 MAGN ALPHA BETA C D E F G H I J K L M N O P Q R S T U V W X Y Z

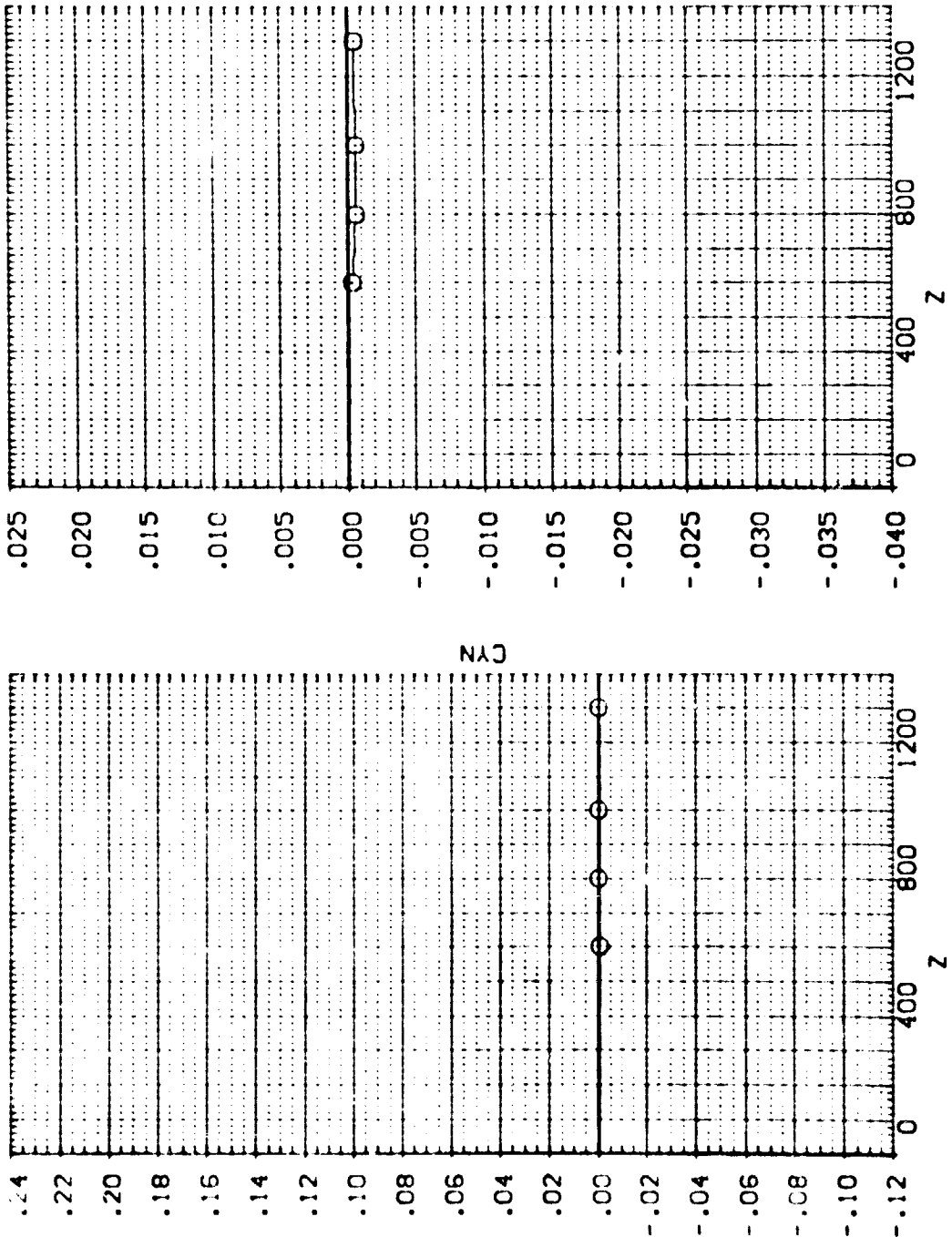

EXTERNAL TANK AERODYNAMIC CHARACTERISTICS DURING SEPARATION FROM ORBITER

IA13.EXTERNAL TANK(T10)SEPARATING FROM ORB. 09 (RTJ184)

SYMBOL X
O .218

PARAMETRIC VALUES
MACH 4.520 PIGTAL 60.000
ALPHA -5.000 BETA .000
DALPHA -20.000 DBETA .000
ELEVTR .000 AILRON 10.000
Y 200.000

SEE THE ASSOCIATED DATA DOCUMENT FOR REFERENCE CHARACTERISTICS FOR INDIVIDUAL DATASETS

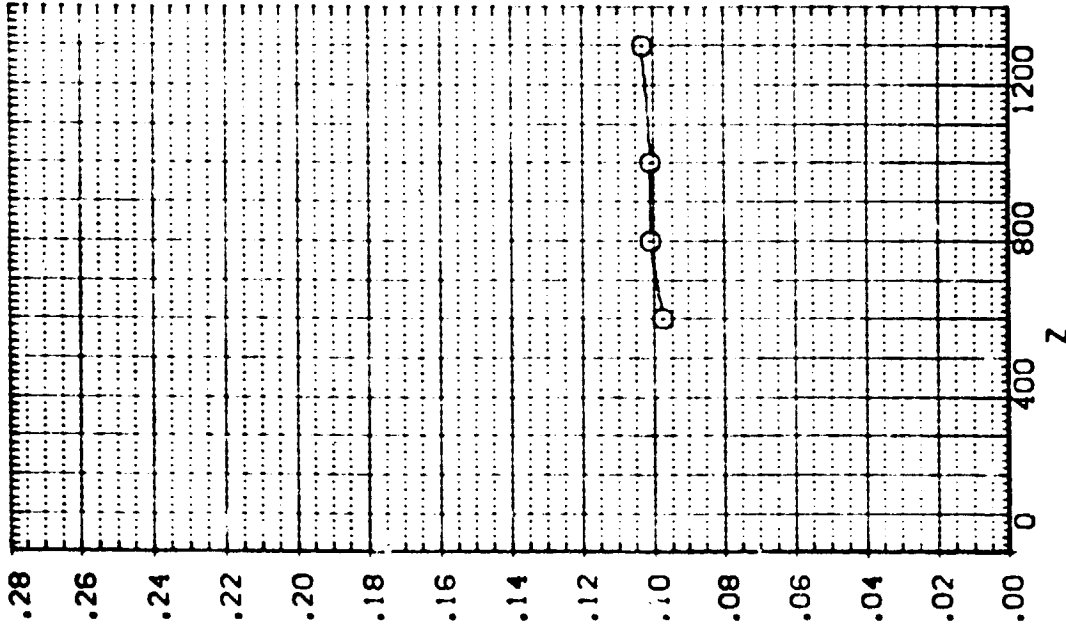
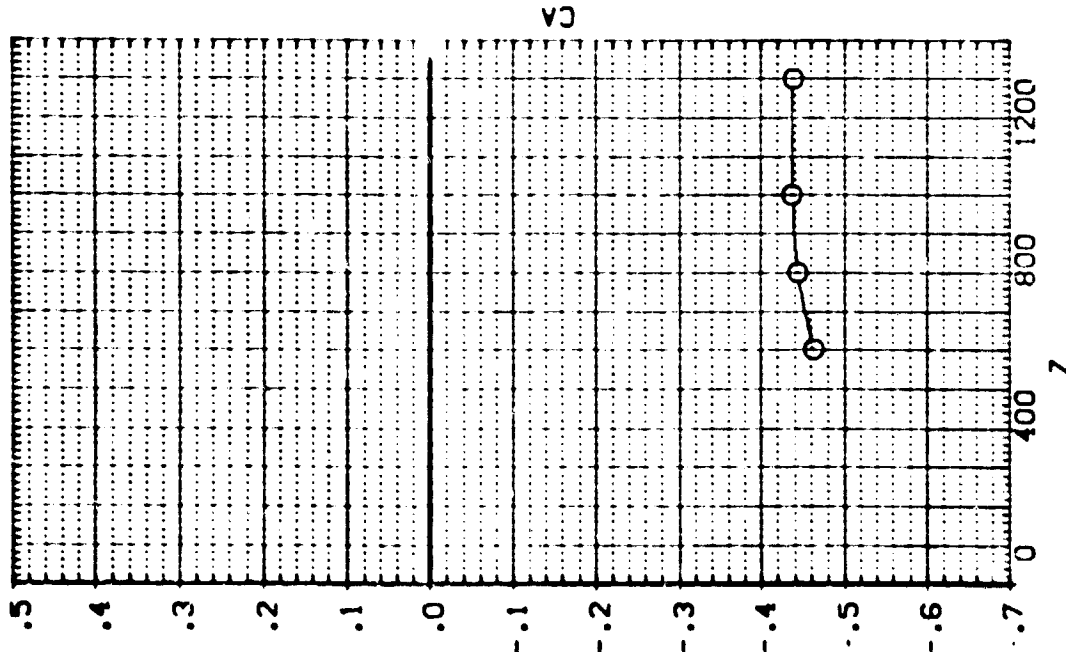

EXTERNAL TANK AERODYNAMIC CHARACTERISTICS DURING SEPARATION FROM ORBITER

IA13.EXTERNAL TANK(T:0)SEPARATING FROM ORB. 09 (RTJT84)

SEE THE ASSOCIATED DATA DOCUMENT FOR REFERENCE CHARACTERISTICS FOR INDIVIDUAL DATASETS

SYMBOL		PARAMETRIC VALUES	
x	.218	MACH	4.520
o		PTOTAL	80.000
		BETA	.000
		DBETA	.000
		AILRON	10.000
		ELEVTR	.000
		Y	200.000

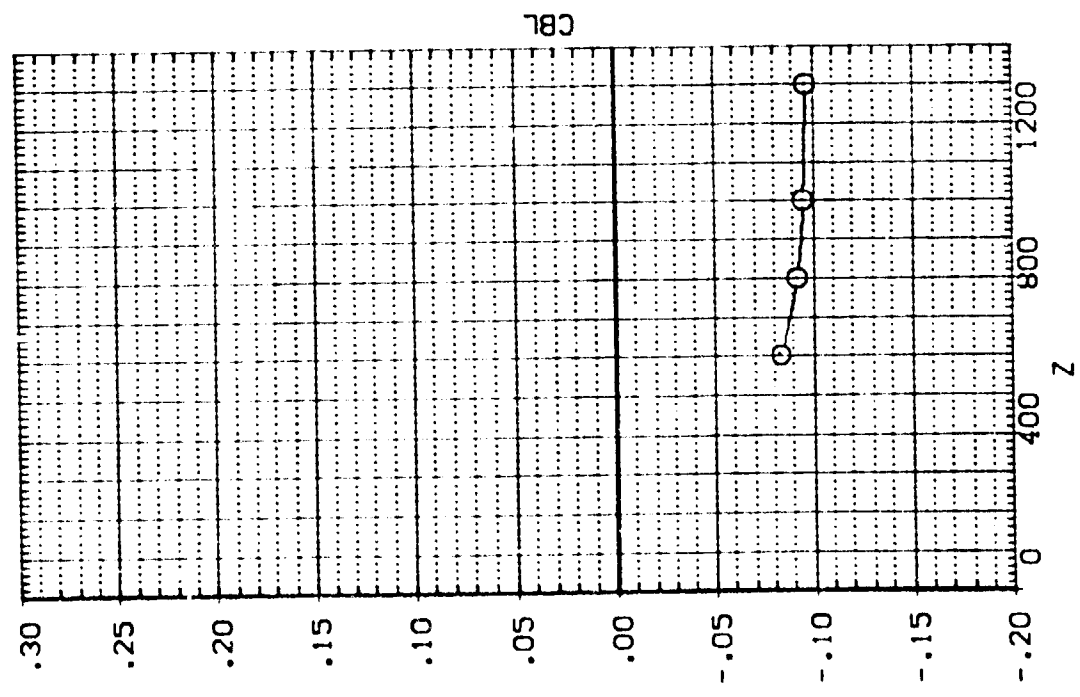
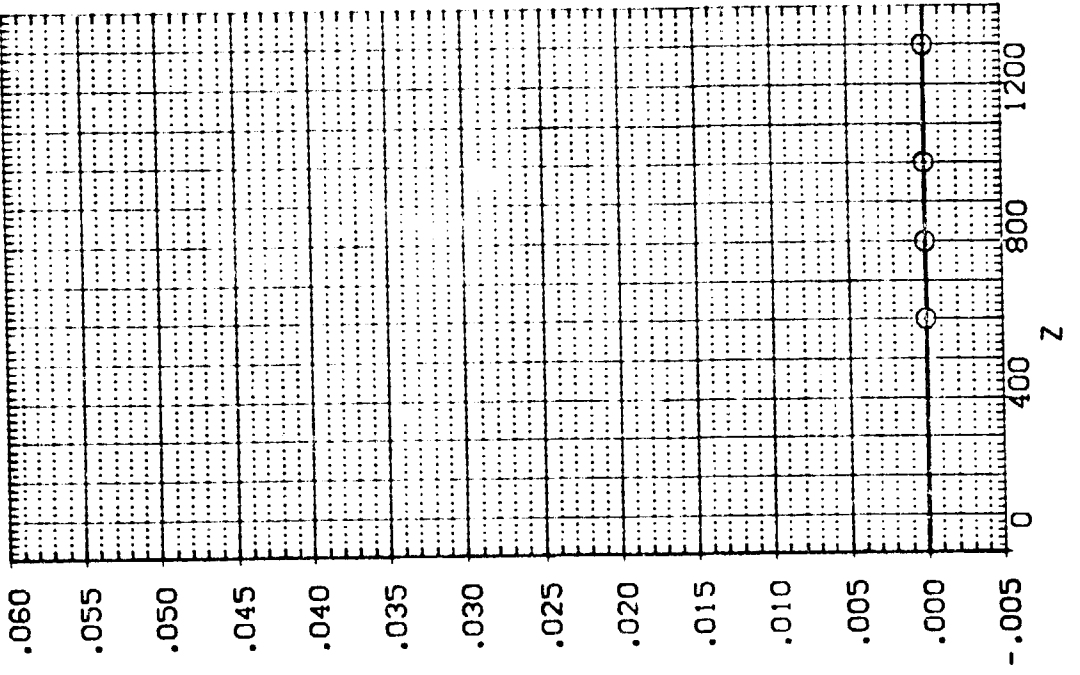

EXTERNAL TANK AERODYNAMIC CHARACTERISTICS DURING SEPARATION FROM ORBITER

IA13.EXTERNAL TANK(T10)SEPARATING FROM ORB. 09 (RTJT84)

SEE THE ASSOCIATED DATA DOCUMENT FOR REFERENCE CHARACTERISTICS FOR INDIVIDUAL DATASETS

SYMBOL x .218 MACH 4.520 PITCH 60.000
 O ALPHA -5.000 BETA .000
 DELTA -20.000 DBETA .000
 ELEVTR .000 AILRON 10.000
 Y 200.000

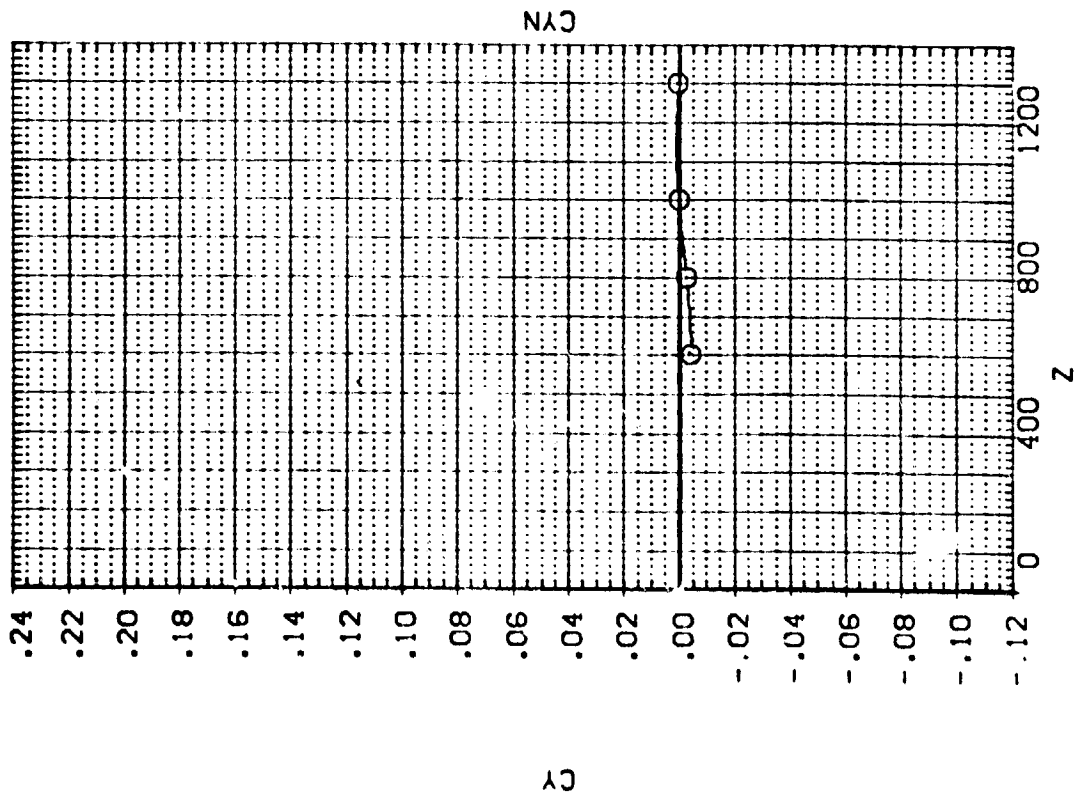
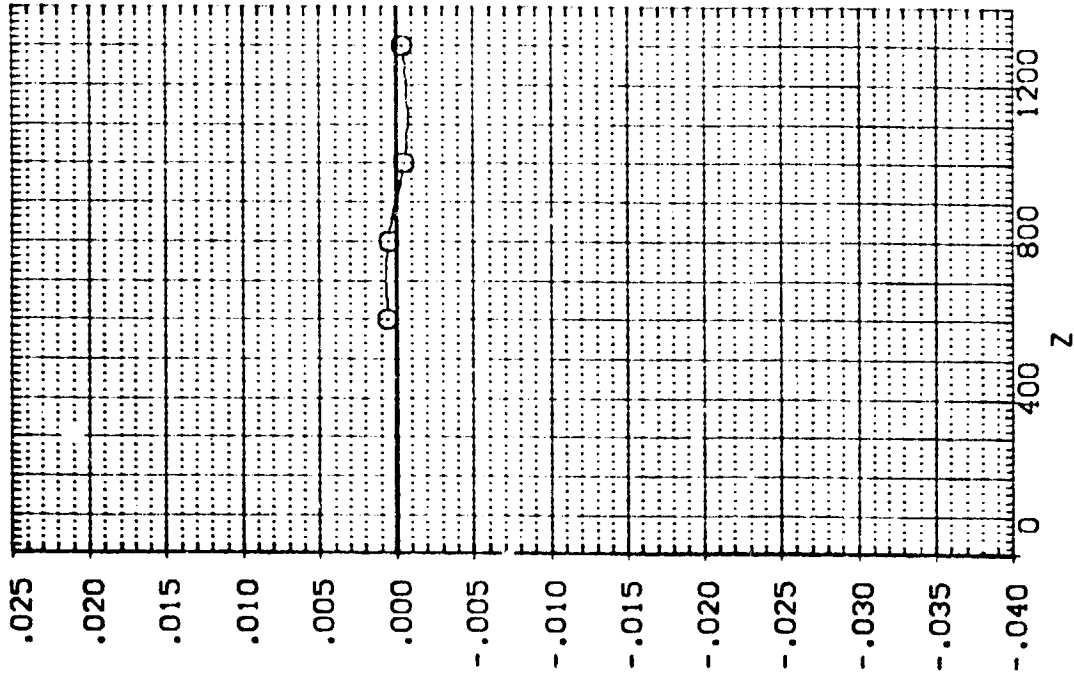

EXTERNAL TANK AERODYNAMIC CHARACTERISTICS DURING SEPARATION FROM ORBITER

TA13, EXTERNAL TANK (10) SEPARATING FROM ORB. 09 (RTJ185)

SEE THE ASSOCIATED DATA DOCUMENT FOR REFERENCE CHARACTERISTICS FOR INDIVIDUAL DATASETS

PARAMETRIC VALUES	
MACH	4.520
ALPHA	-5.000
DALPHA	-20.000
ELEVTR	.000
Y	-200.000
PIC/TAL	80.000
BETA	.000
DBETA	-5.000
A1LRON	10.000

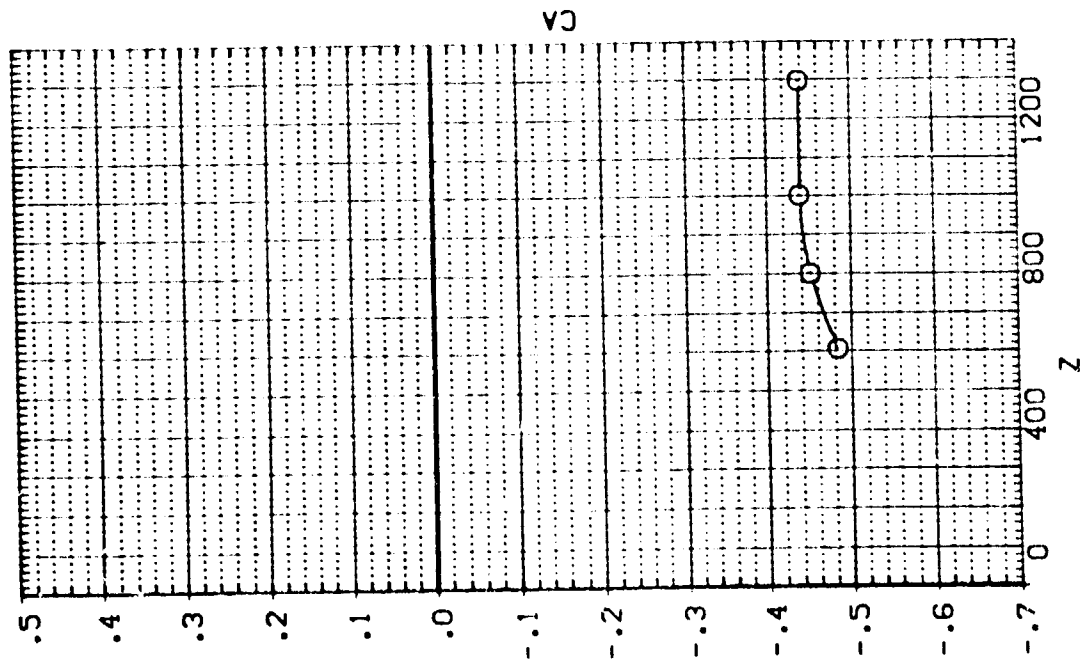
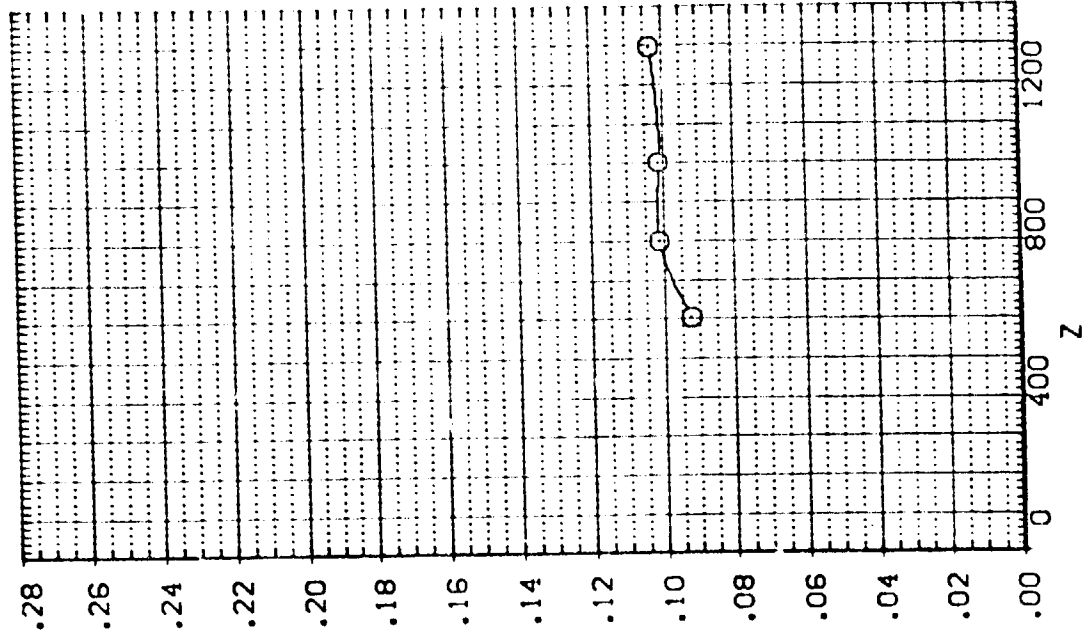

1A13. EXTERNAL TANK(10)SEPARATING FROM ORB. 09 (RTJT85)

SEE THE ASSOCIATED DATA DOCUMENT FOR REFERENCE CHARACTERISTICS FOR INDIVIDUAL DATASETS

SYMBOL		PARAMETRIC VALUES	
x	-0.07	MACH	80.000
o		ALPHA	.000
		DALPHA	-5.000
		ELEVTR	10.000
		Y	-200.000
		P TOTAL	80.000
		BETA	.000
		DBETA	-5.000
		AILRON	10.000

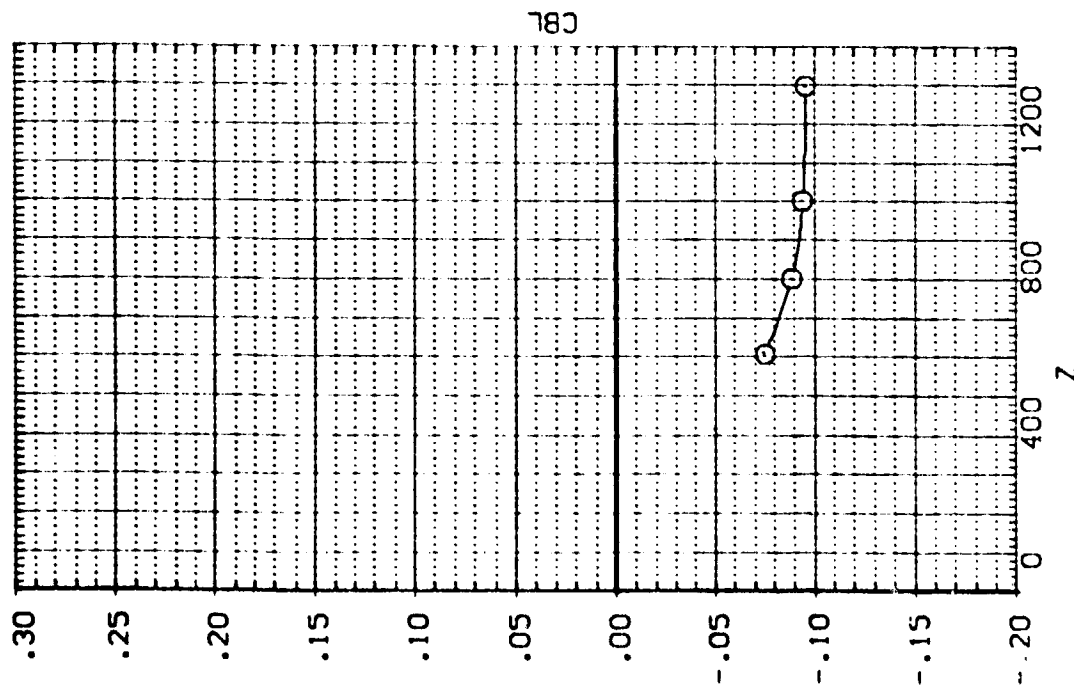
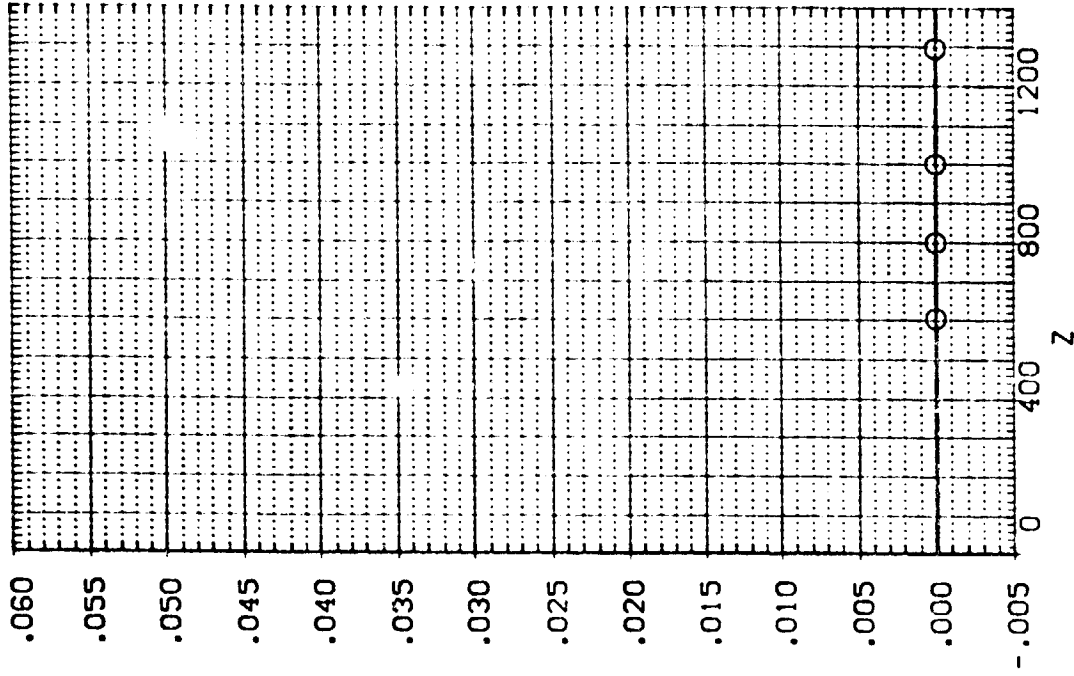

EXTERNAL TANK AERODYNAMIC CHARACTERISTICS DURING SEPARATION FROM ORBITER

1A.3-EXTERNAL TANK(T10)SEPARATING FROM ORB. 09 (RTJTB5)

SY32- X -1.007
 MACH 4.520
 ALPHA -5.000
 DIALPHA -20.000
 ELEVTR .000
 Y -200.000

SEE THE ASSOCIATED DATA DOCUMENT FOR REFERENCE CHARACTERISTICS FOR INDIVIDUAL DATASETS

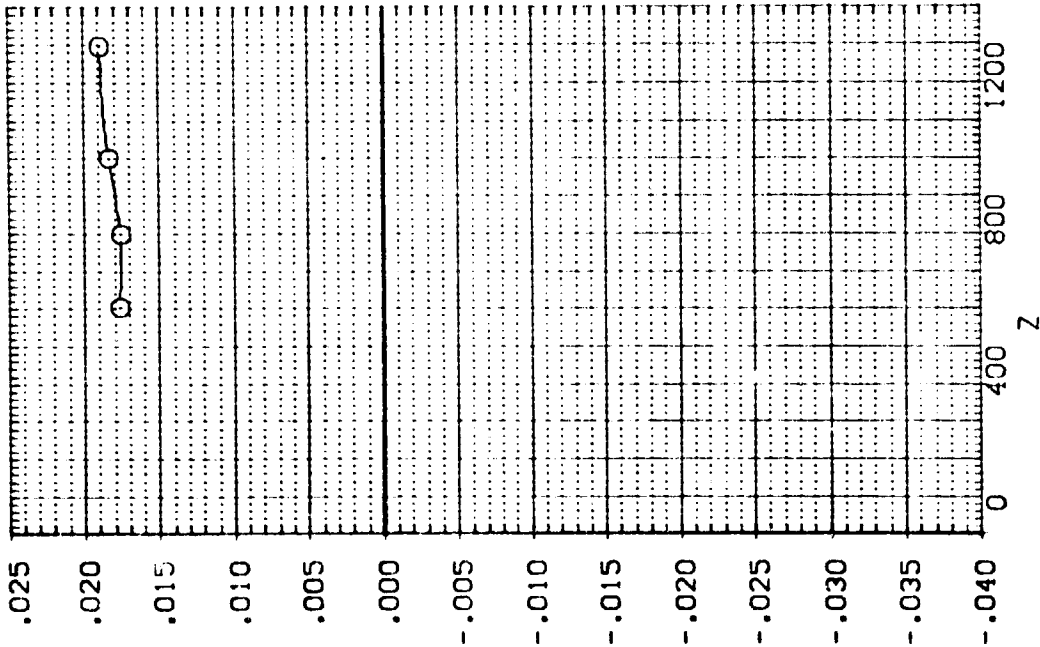
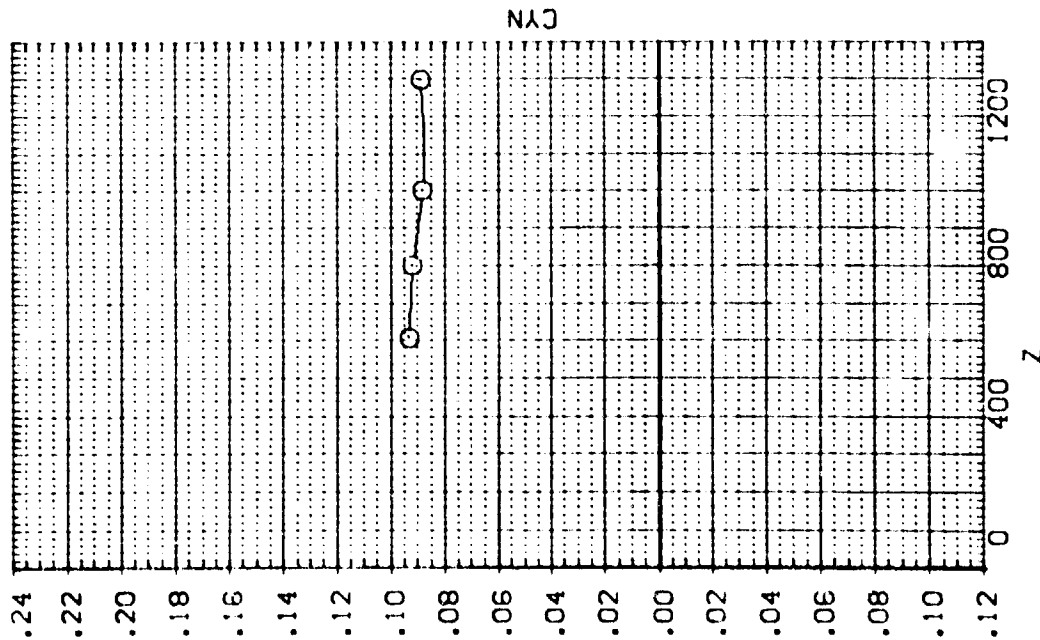

EXTERNAL TANK AERODYNAMIC CHARACTERISTICS DURING SEPARATION FROM ORBITER

IA13, EXTERNAL TANK (T10) SEPARATING FROM ORB. 09 (RTJT86)

SYMBOL x
O

PARAMETRIC VALUES
 MACH 4.520 P/TOTAL 80.000
 ALPHA -5.000 BETA .000
 CALPHA -20.000 DBETA 5.000
 ELEVTX .000 AILRON 10.000
 Y .000

SEE THE ASSOCIATED DATA DOCUMENT FOR REFERENCE CHARACTERISTICS FOR INDIVIDUAL DATASETS

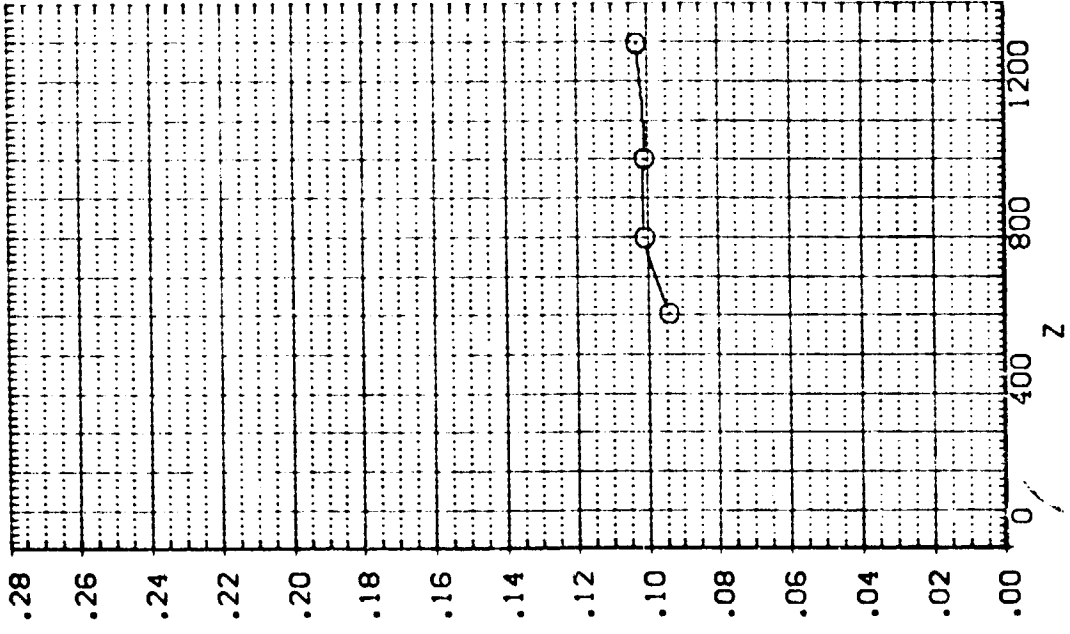
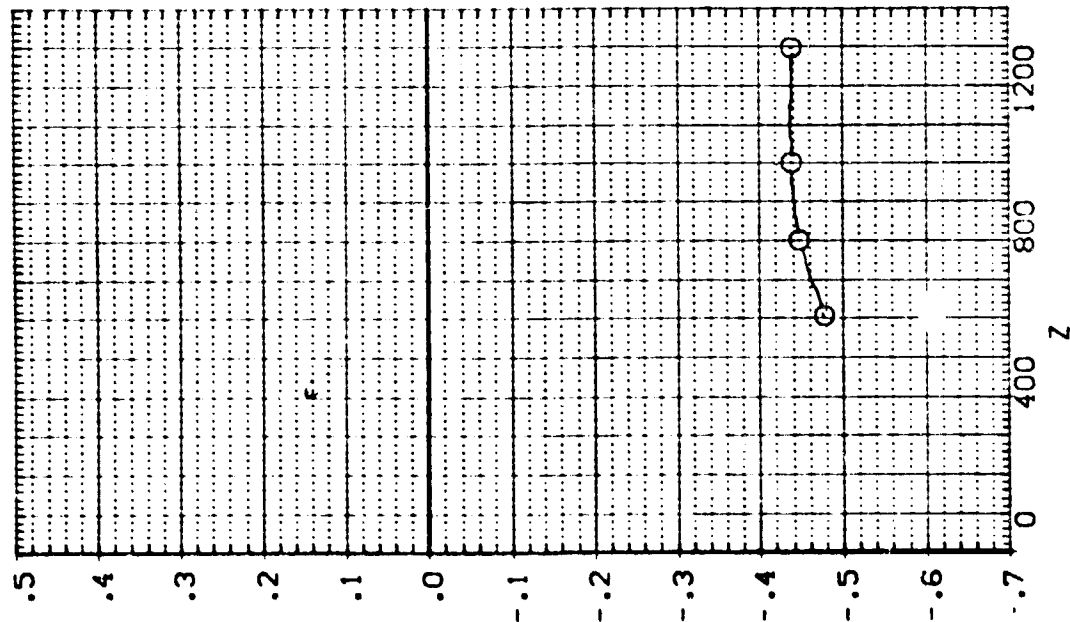

EXTERNAL TANK AERODYNAMIC CHARACTERISTICS DURING SEPARATION FROM ORBITER

1A13.EXTERNAL TANK(110)SEPARATING FROM ORB. 09 (RTJT86)

SEE THE ASSOCIATED DATA DOCUMENT FOR REFERENCE CHARACTERISTICS FOR INDIVIDUAL DATASETS

SYMBOL x .205

PARAMETRIC VALUES
 MACH 4.52C PISTAL 80.000
 ALPHA -5.000 BETA .000
 DALPHA -20.000 DBETA 5.000
 ELEVTX .000 ATLPON 10.000
 Y .000

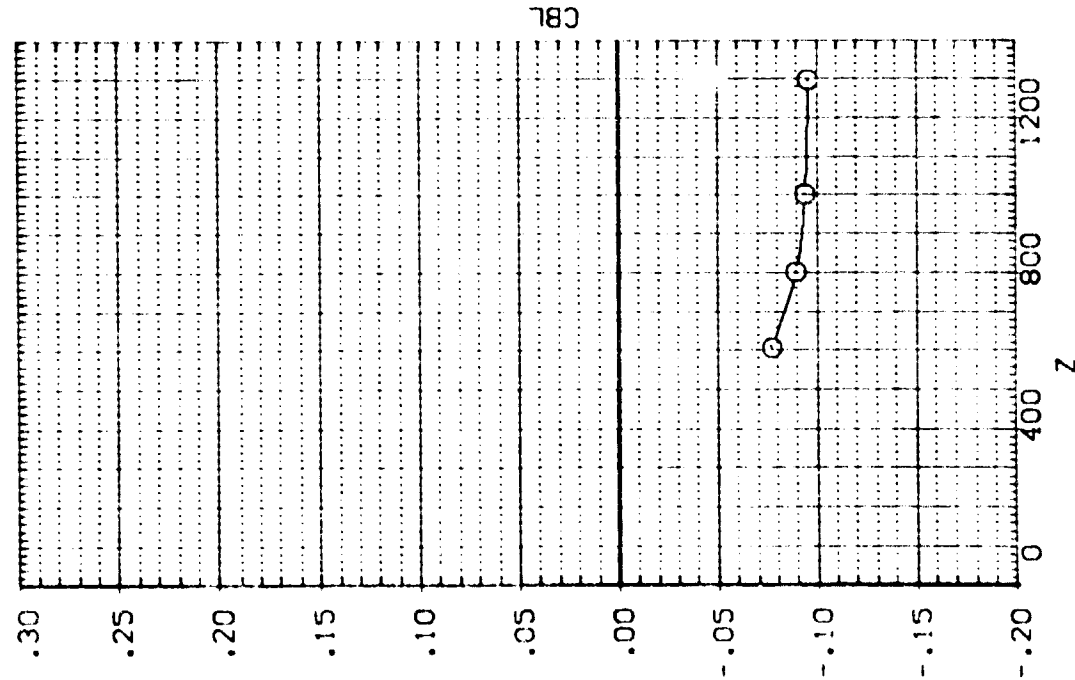
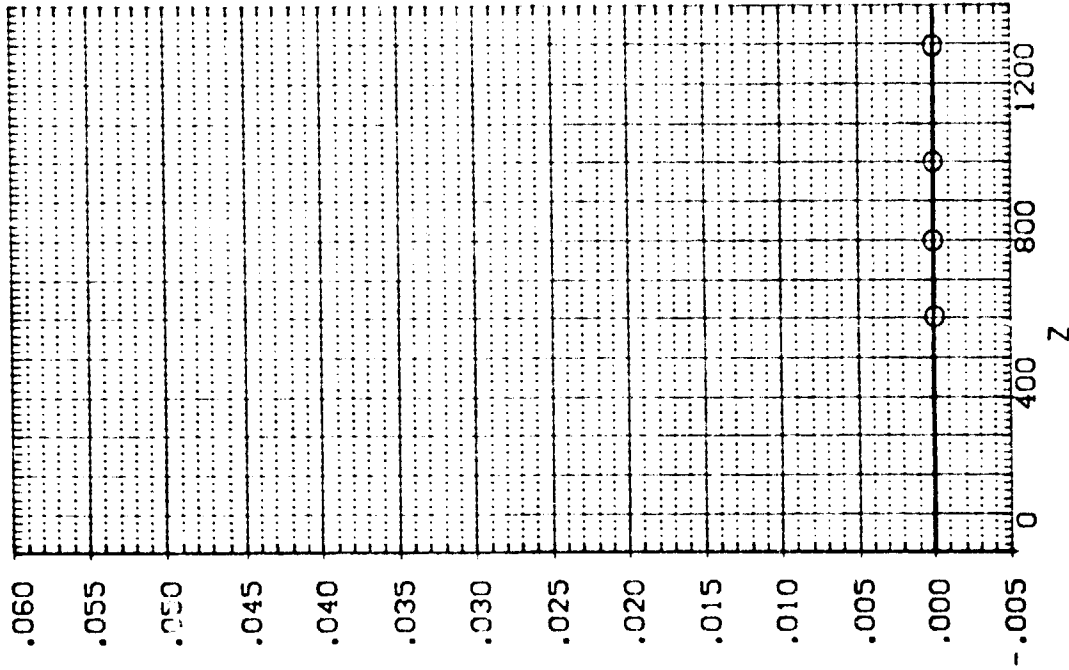

IA13.EXTERNAL TANK(T10)SEPARATING FROM ORB. 09 (RTJT86)

SEE THE ASSOCIATED DATA DOCUMENT FOR REFERENCE CHARACTERISTICS FOR INDIVIDUAL DATASETS

SYMBOL		PARAMETRIC VALUES	
x	.205	MACH	4.520
		ALPHA	-5.000
		DALPHA	-20.000
		ELEVTR	.000
		Y	.000
		PITOTAL	80.000
		BETA	.000
		DBETA	5.000
		AIRLON	10.000

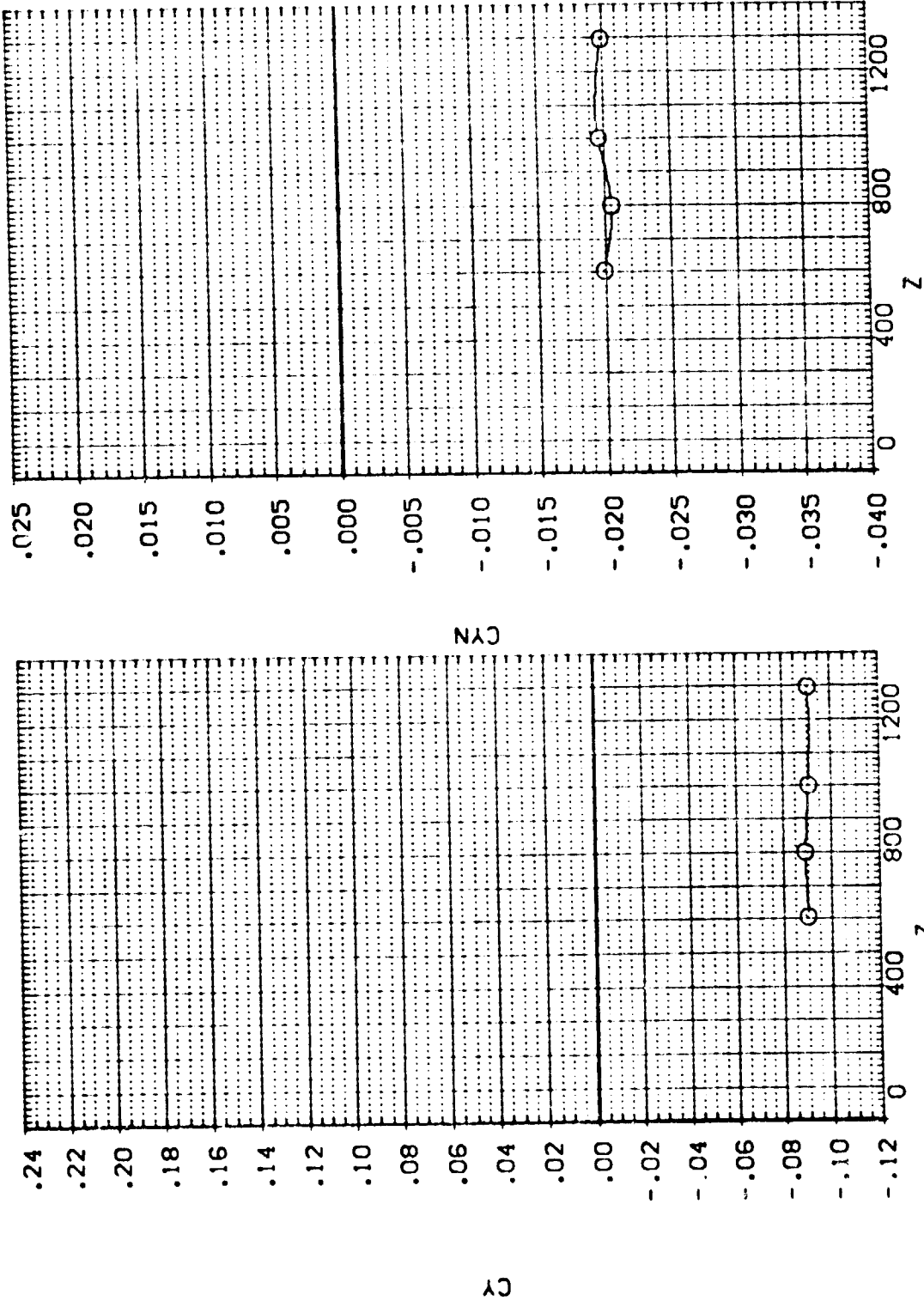

EXTERNAL TANK AERODYNAMIC CHARACTERISTICS DURING SEPARATION FROM ORBITER

TA13. EXTERNAL TANK(T10)SEPARATING FROM ORB. 09 (RIJT87)

SYMBOL



PARAMETRIC VALUES

MACH	4.520	P/DOTAL	80.000
ALPHA	-5.000	BETA	.000
DALPHA	-20.000	DBETA	5.000
ELEVTR	.000	ATURN	10.000
Y	200.000		

SEE THE ASSOCIATED DATA DOCUMENT FOR REFERENCE CHARACTERISTICS FOR INDIVIDUAL DATASETS

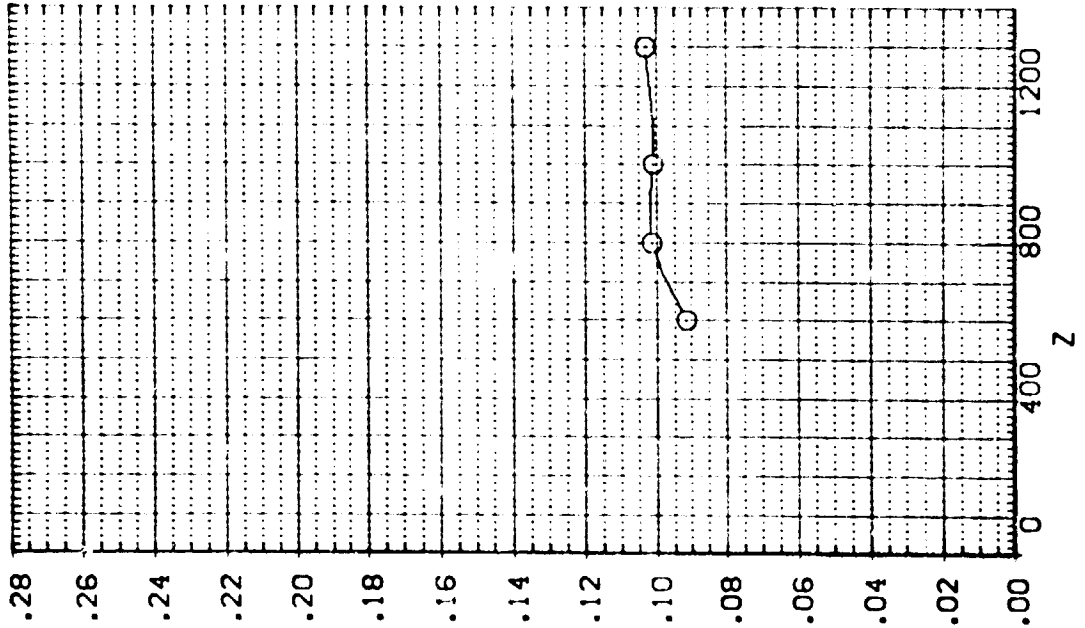
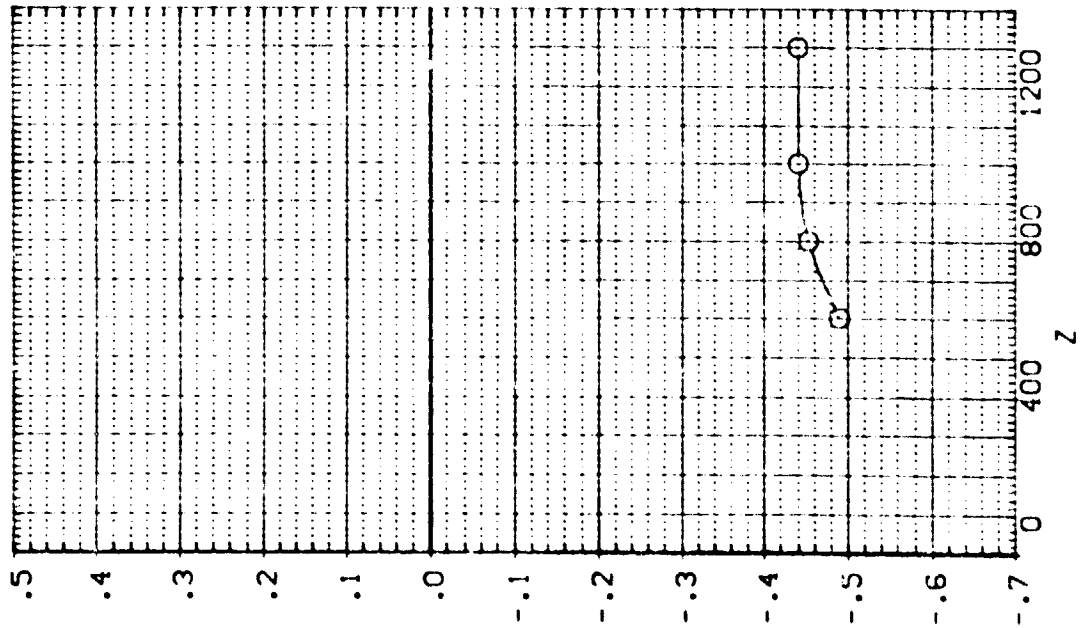

IA13.EXTERNAL TANK(T10)SEPARATING FROM ORB. 09 (RTJT87)

SEE THE ASSOCIATED DATA DOCUMENT FOR REFERENCE CHARACTERISTICS FOR INDIVIDUAL DATASETS

SYMBOL x .227
 O

PARAMETRIC VALUES	
MACH	4.520
ALPHA	-5.000
DALPHA	-20.000
ELEVTR	.000
Y	200.000
PITOTAL	80.000
BETA	.000
DBETA	5.000
ALLRON	10.000

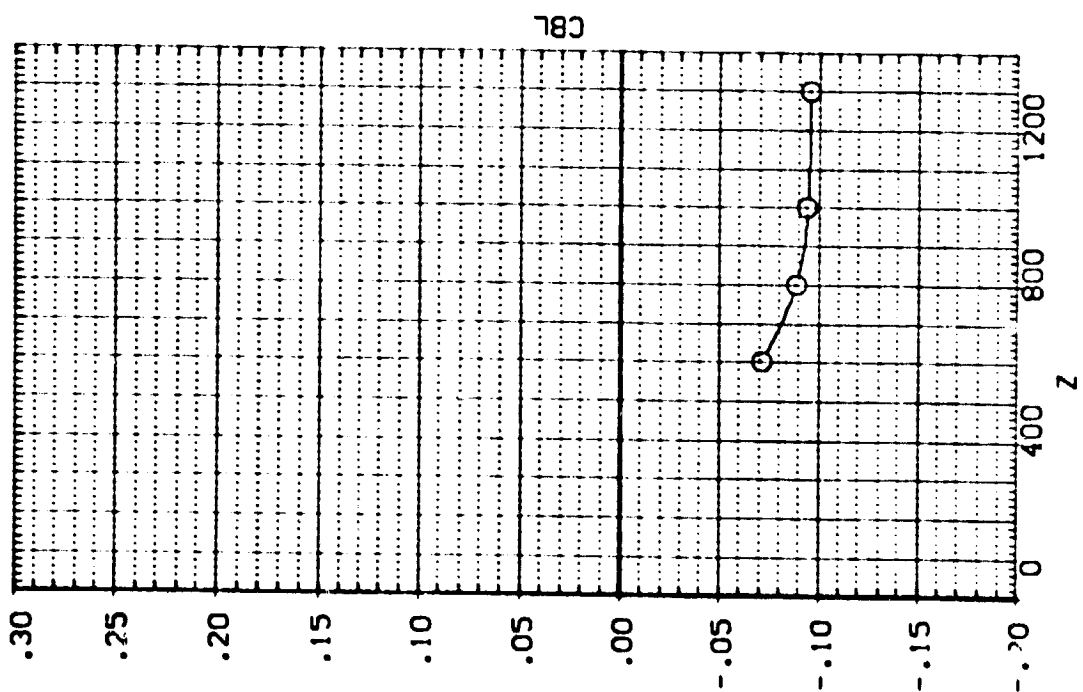
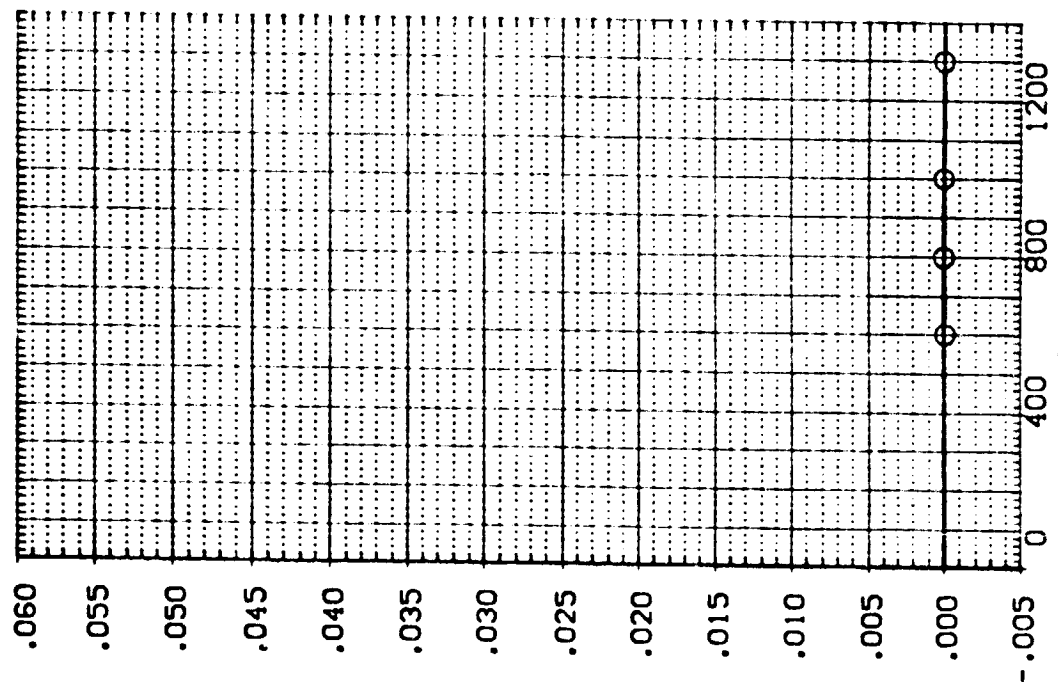

EXTERNAL TANK AERODYNAMIC CHARACTERISTICS DURING SEPARATION FROM ORBITER

IA13.EXTERNAL TANK(T10)SEPARATING FROM ORB. 09 (RTJ187)

SEE THE ASSOCIATED DATA DOCUMENT FOR REFERENCE CHARACTERISTICS FOR INDIVIDUAL DATASETS

PARAMETRIC VALUES	
MACH	4.520
ALPHA	-5.000
DALPHA	-20.000
ELEVTR	000
Y	20.000
PITOTAL	80.000
BETA	.000
DBETA	5.000
AIRON	10.000

SYMBD X .227

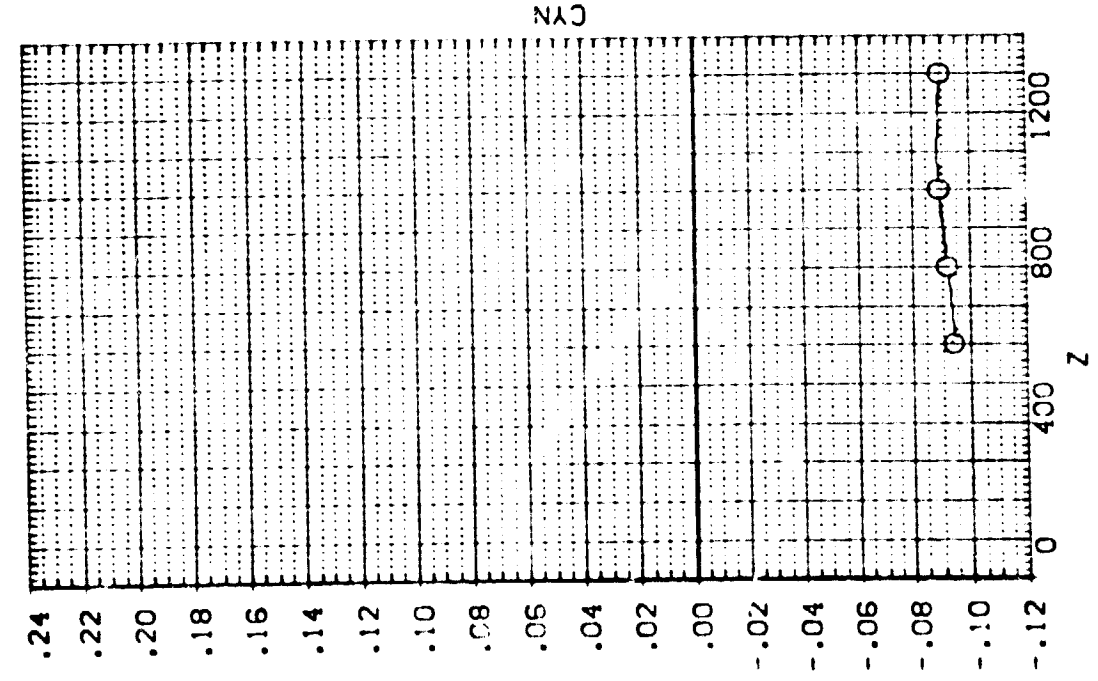
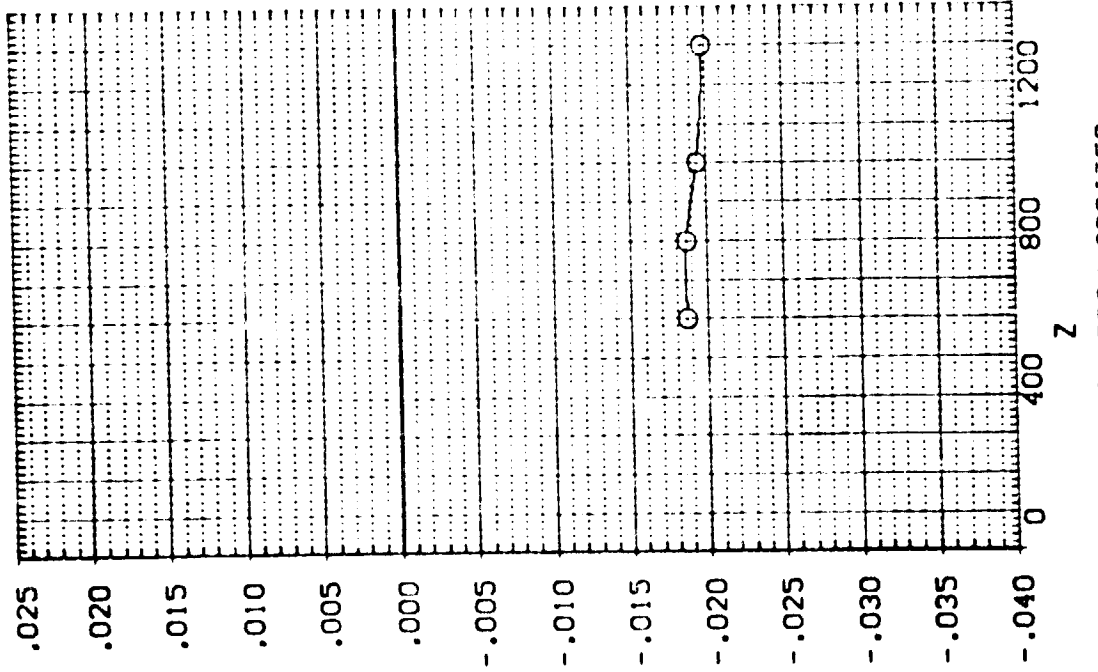

1A13-EXTERNAL TANK(T10)SEPARATING FROM ORB. 09 (RTJ'88)

SEE THE ASSOCIATED DATA DOCUMENT FOR REFERENCE CHARACTERISTICS FOR INDIVIDUAL DATASETS

SYMBOL		PARAMETRIC VALUES	
○	K	MACH	PTOTAL
□	400.750	ALPHA	BETA
◇	800.600	DALPHA	DBETA
△	1200.600	ELEVTR	AILRON
		Y	

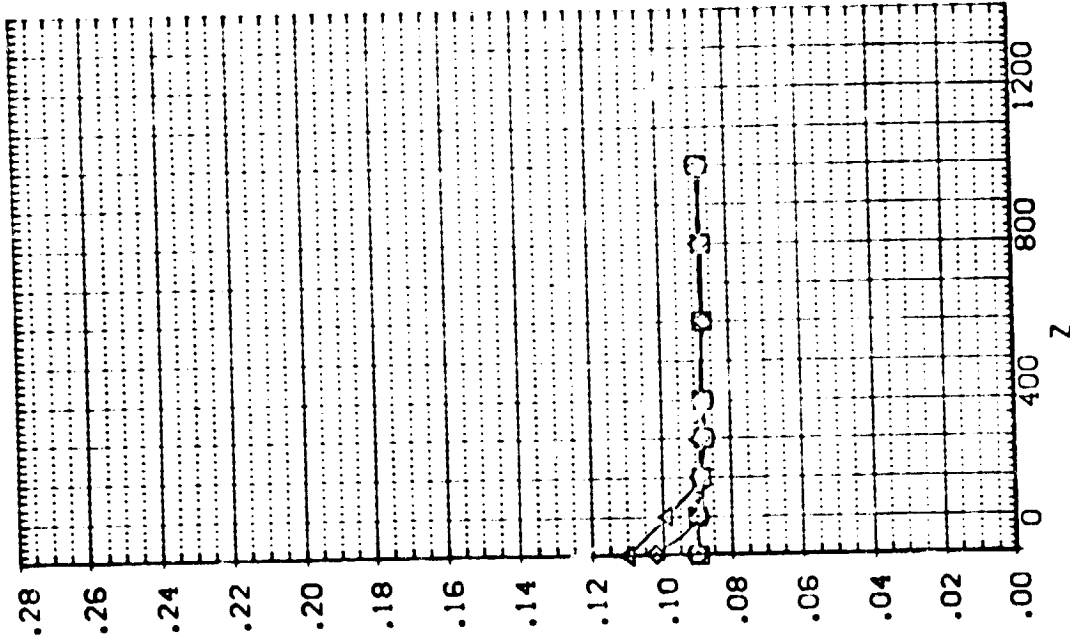
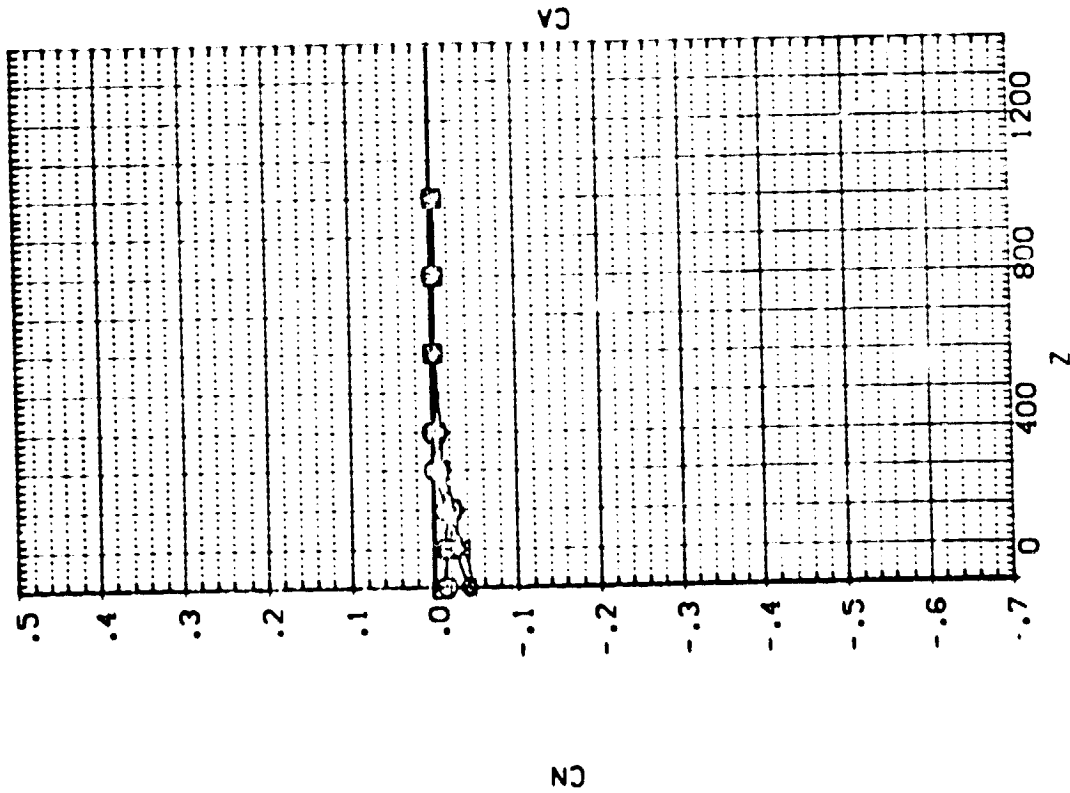

EXTERNAL TANK AERODYNAMIC CHARACTERISTICS DURING SEPARATION FROM ORBITER

1.13. EXTERNAL TANK(S) SEPARATING FROM ORB. 09 (RTJT88)

SEE THE ASSOCIATED DATA DOCUMENT FOR REFERENCE CHARACTERISTICS FOR INDIVIDUAL DATASETS

SYMBOL		PARAMETRIC VALUES	
○	.123	MACH	4.530
○	400.090	ALPHA	.000
○	800.600	DALPHA	.000
○	1200.800	ELEVTR	10.000
○		PTOTAL	110.000
○		BETA	.000
○		CBETA	.000
○		ALIRON	.000
○		Y	.000

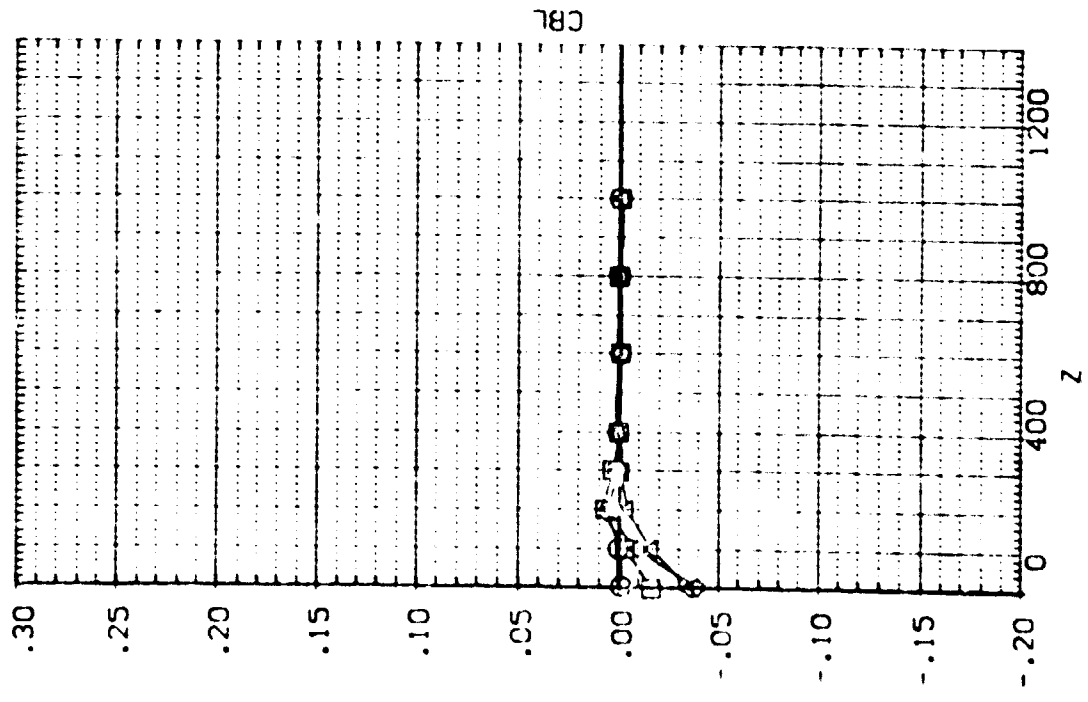
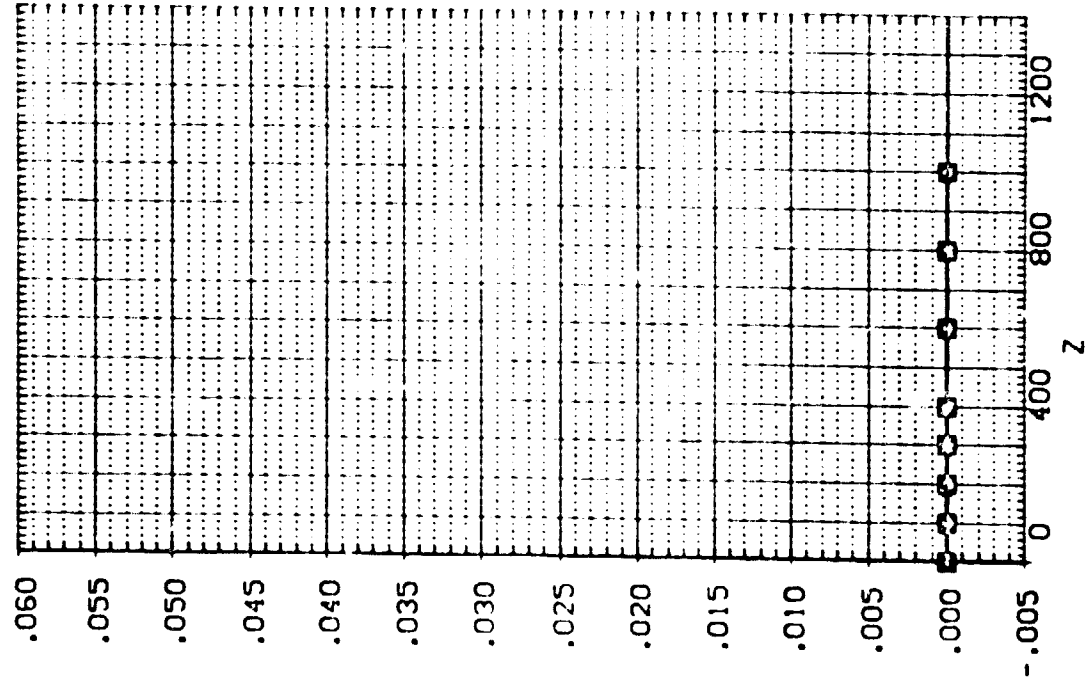

EXTERNAL TANK AERODYNAMIC CHARACTERISTICS DURING SEPARATION FROM ORBITER

IA13.EXTERNAL TANK(T10)SEPARATING FROM ORB. 09 (RTJT88)

SYMBOL X

-
-
- ◇
- △

.123
400.350
800.600
1,200.800

MACH
ALPHA
DALPHA
ELEVTR
Y

PARAMETRIC VALUES

4.530 PIGTAL 110.000
.000 BETA .000
.000 DBETA .000
10.000 ATLRON .000
.000

SEE THE ASSOCIATED DATA DOCUMENT FOR REFERENCE CHARACTERISTICS FOR INDIVIDUAL DATASETS

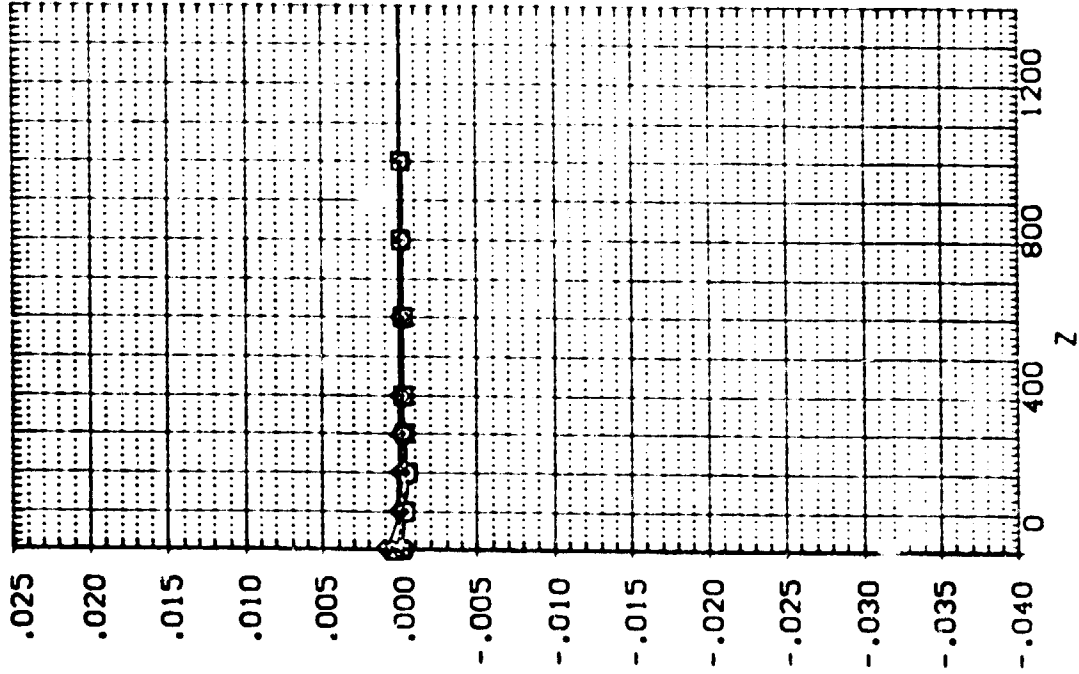
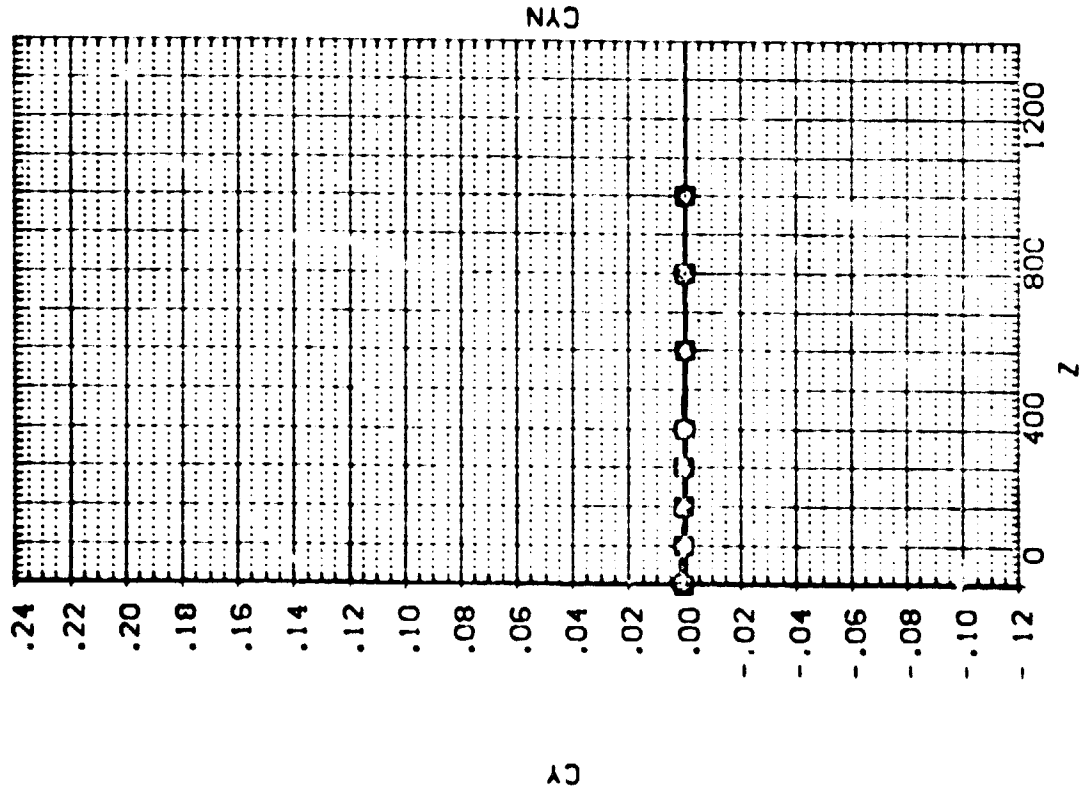

EXTERNAL TANK AERODYNAMIC CHARACTERISTICS DURING SEPARATION FROM ORBITER

1:13.EXTERNAL TANK(10)SEPARATING FROM ORB. 09 (RTJT89)

PARAMETRIC VALUES

MACH	.185	PTOTAL	110.000
ALPHA	.000	BETA	.000
DALPHA	-10.000	DBETA	.000
ELEVTR	10.000	AILRON	.000
Y	.000		

SEE THE ASSOCIATED DATA DOCUMENT FOR REFERENCE CHARACTERISTICS FOR INDIVIDUAL DATA SETS

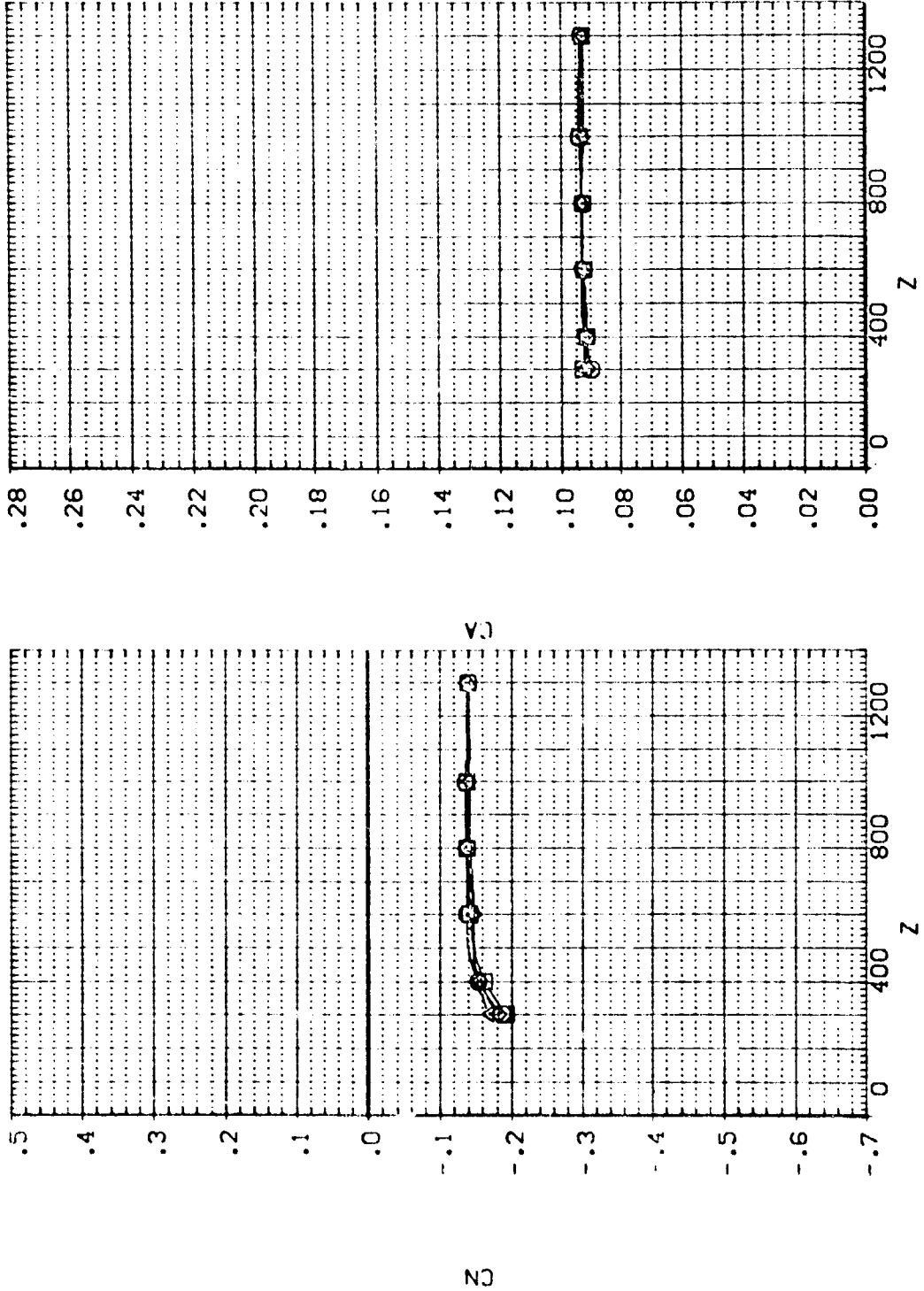

EXTERNAL TANK AERODYNAMIC CHARACTERISTICS DURING SEPARATION FROM ORBITER

IA13. EXTERNAL TANK(T10)SEPARATING FROM ORB. 09 (RTJT89)

SEE THE ASSOCIATED DATA DOCUMENT FOR REFERENCE CHARACTERISTICS FOR INDIVIDUAL DATASETS

SYMBOL		PARAMETRIC VALUES			
○	X	MACH	4.530	PTOTAL	110.000
□	Y	ALPHA	.000	BETA	.000
◇	Z	DALPHA	-10.000	DBETA	.000
△		ELEVTR	10.000	AILRON	.000
		Y	.000		

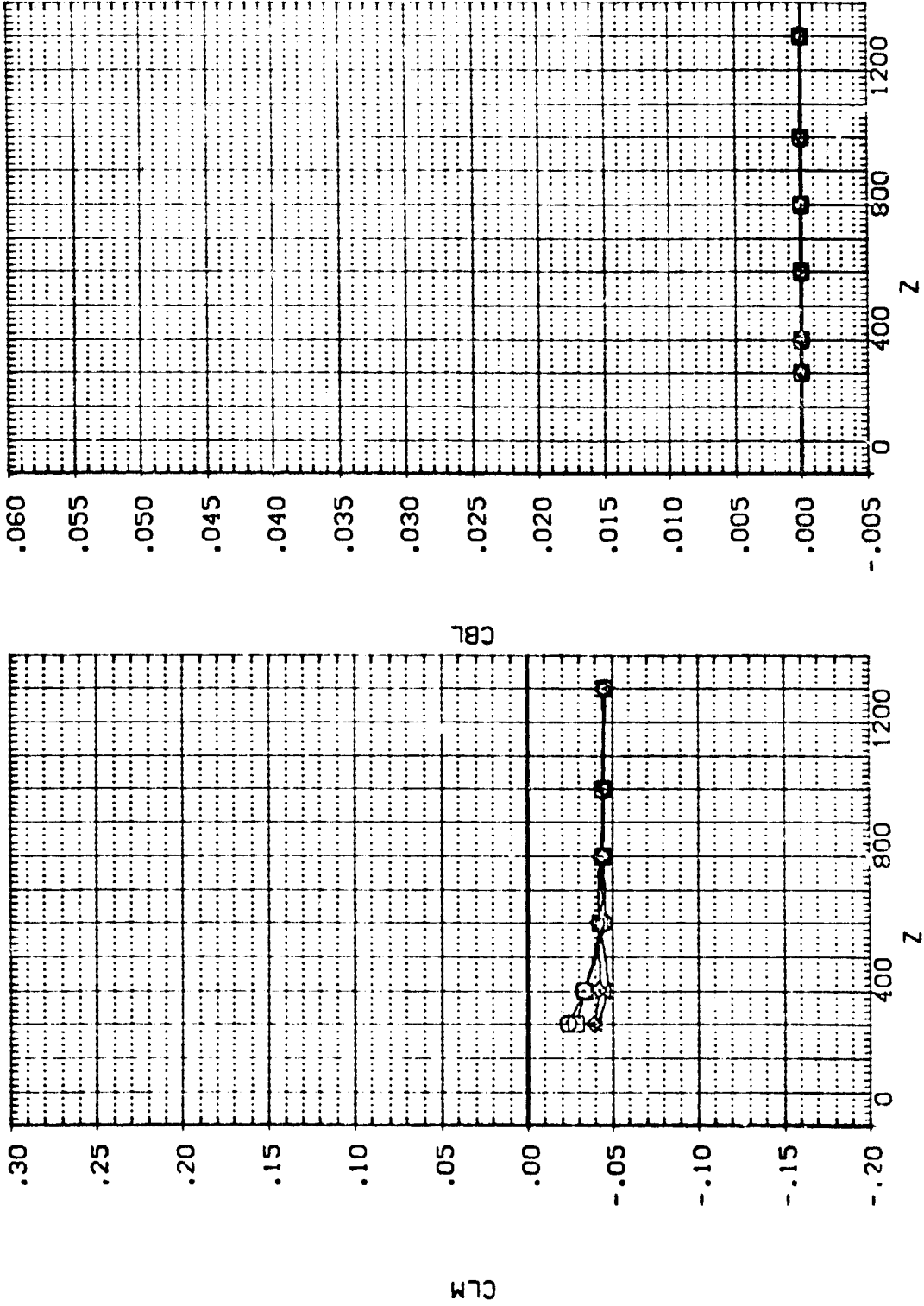

EXTERNAL TANK AERODYNAMIC CHARACTERISTICS DURING SEPARATION FROM ORBITER

IA13,EXTERNAL TANK(I10)SEPARATING FROM ORB. 09 (RTJT89)

SYMBOL X
 ○
 ◇
 △

PARAMETRIC VALUES
 MACH 4.530 P/TOTAL 110.000
 ALPHA .000 BETA .000
 DALPHA -10.000 DBETA .000
 ELEVTX 10.000 ATLRON .000
 Y

SEE THE ASSOCIATED DATA DOCUMENT FOR REFERENCE CHARACTERISTICS FOR INDIVIDUAL DATASETS

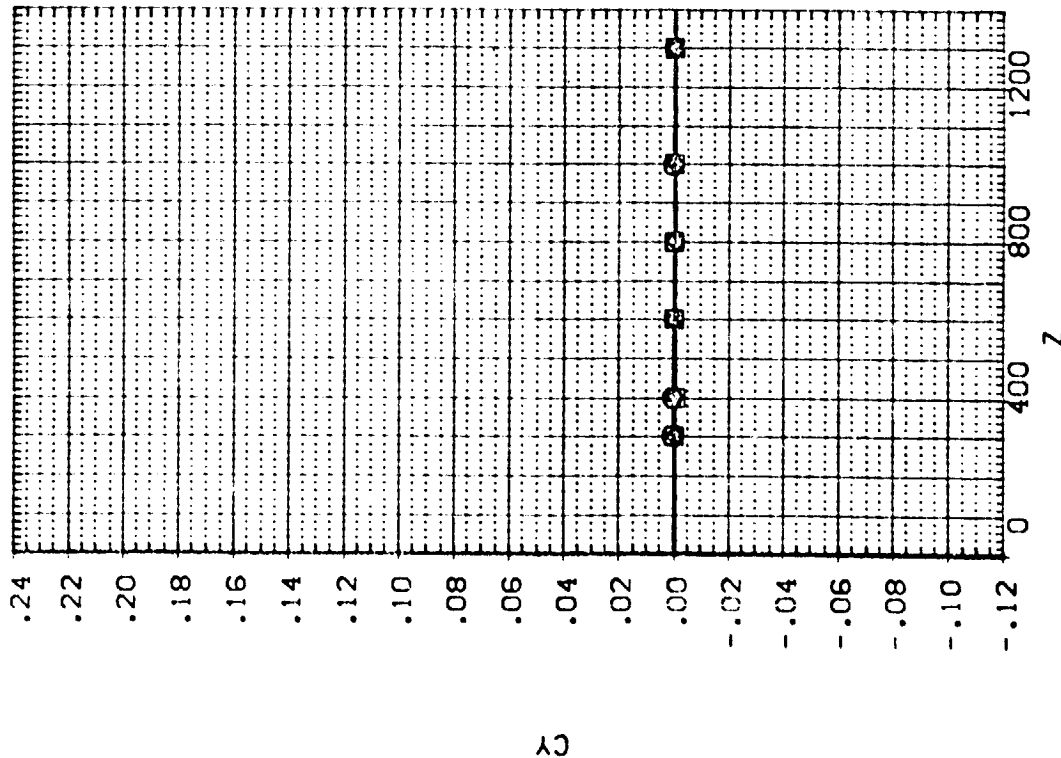

Cx

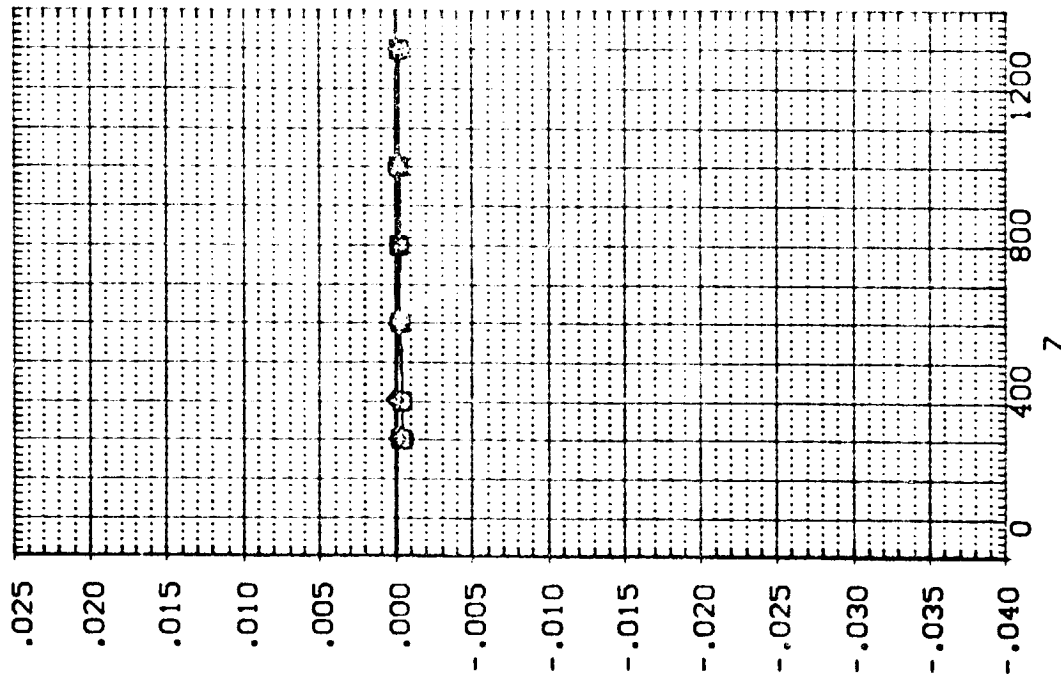

Cyn

IA13.EXTERNAL TANK(T10)SEPARATING FROM ORB. 09 (RTJT90)

SEE THE ASSOCIATED DATA DOCUMENT FOR REFERENCE CHARACTERISTICS FOR INDIVIDUAL DATASETS

SYMBOL	X	MACH	ALPHA	DALPHA	ELEVTR	Y	PARAMETRIC VALUES
○	-.643	4.530	.000	-20.000	10.000	.000	PTOTAL 110.000
□	401.500	.000	.000	.000	.000	.000	BETA .000
◇	800.970	.000	.000	.000	.000	.000	DBETA .000
△	1200.800	.000	.000	.000	.000	.000	AILRON .000

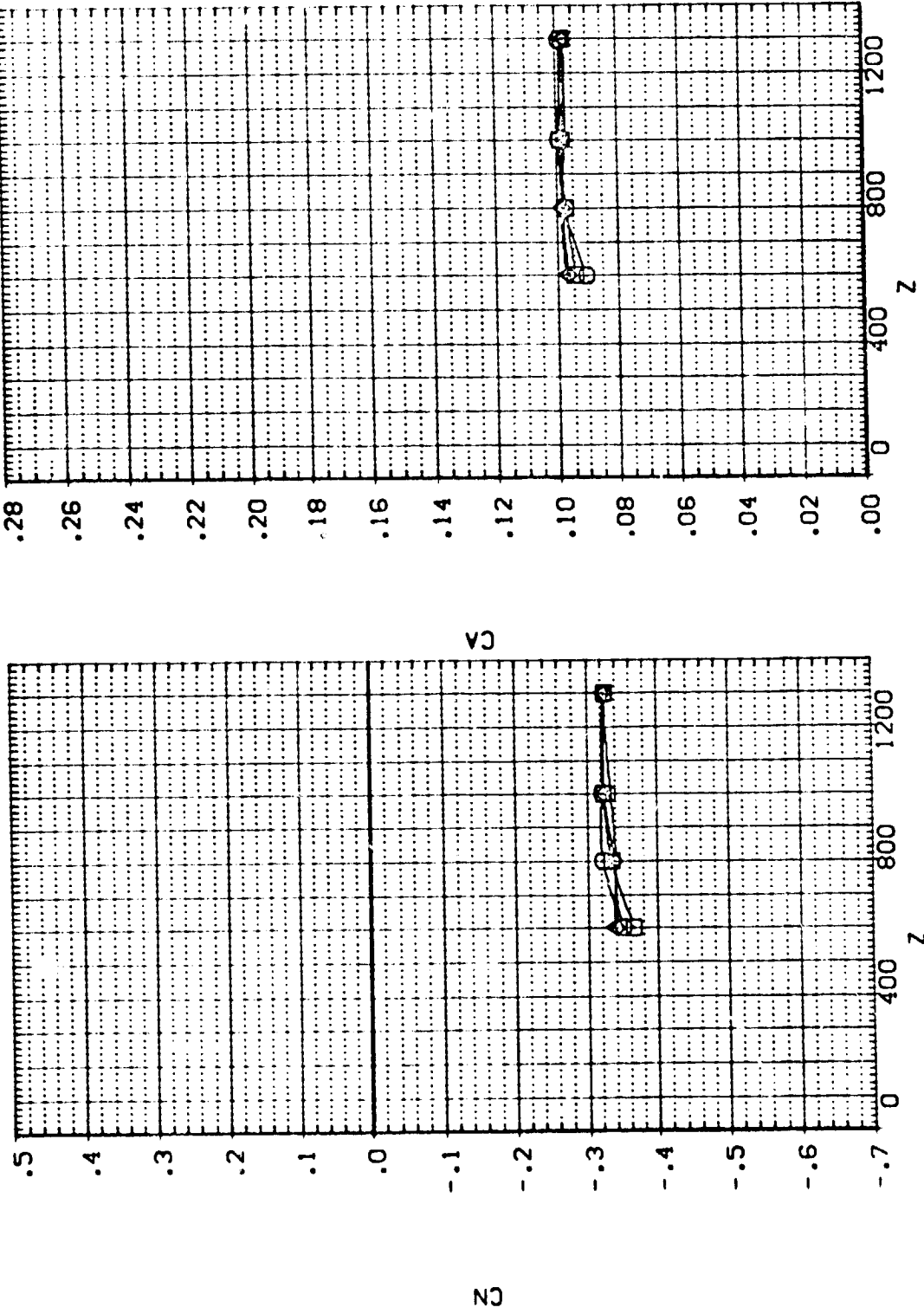

EXTERNAL TANK AERODYNAMIC CHARACTERISTICS DURING SEPARATION FROM ORBITER

IA13.EXTERNAL TANK(T10)SEPARATING FROM CRB. 09 (RTJT90)

SEE THE ASSOCIATED DATA DOCUMENT FOR REFERENCE CHARACTERISTICS FOR INDIVIDUAL DATASETS

SY-90		PARAMETRIC VALUES			
1.643	MACH	4.530	PTOTAL	110.000	
401.500	ALPHA	.000	BETA	.000	
800.970	DALPHA	-20.000	DBETA	.000	
1200.800	ELEVTR	10.000	ATLRON	.000	
	Y	.000			

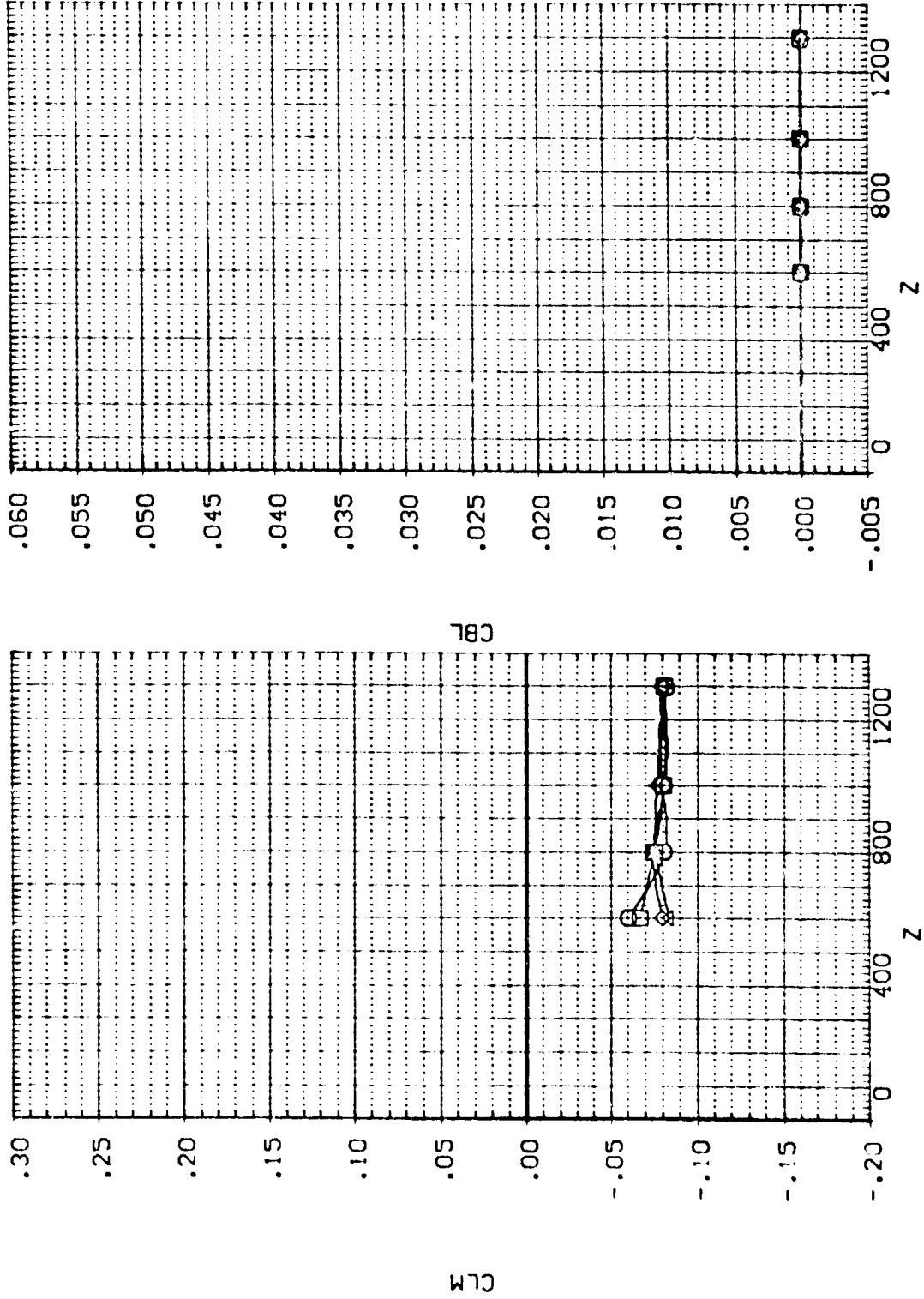

IA13.EXTERNAL TANK(T10)SEPARATING FROM ORB. 09 (RTJT90)

SEE THE ASSOCIATED DATA DOCUMENT FOR REFERENCE CHARACTERISTICS FOR INDIVIDUAL DATASETS

SYMBOL	X	MACH	PARAMETRIC VALUES
○	-.643	4.530	PTOTAL 110.000
□	401.500	.000	BETA .000
◇	800.970	-20.000	DBETA .000
△	1200.800	10.000	AIRLON .000
		Y	.000

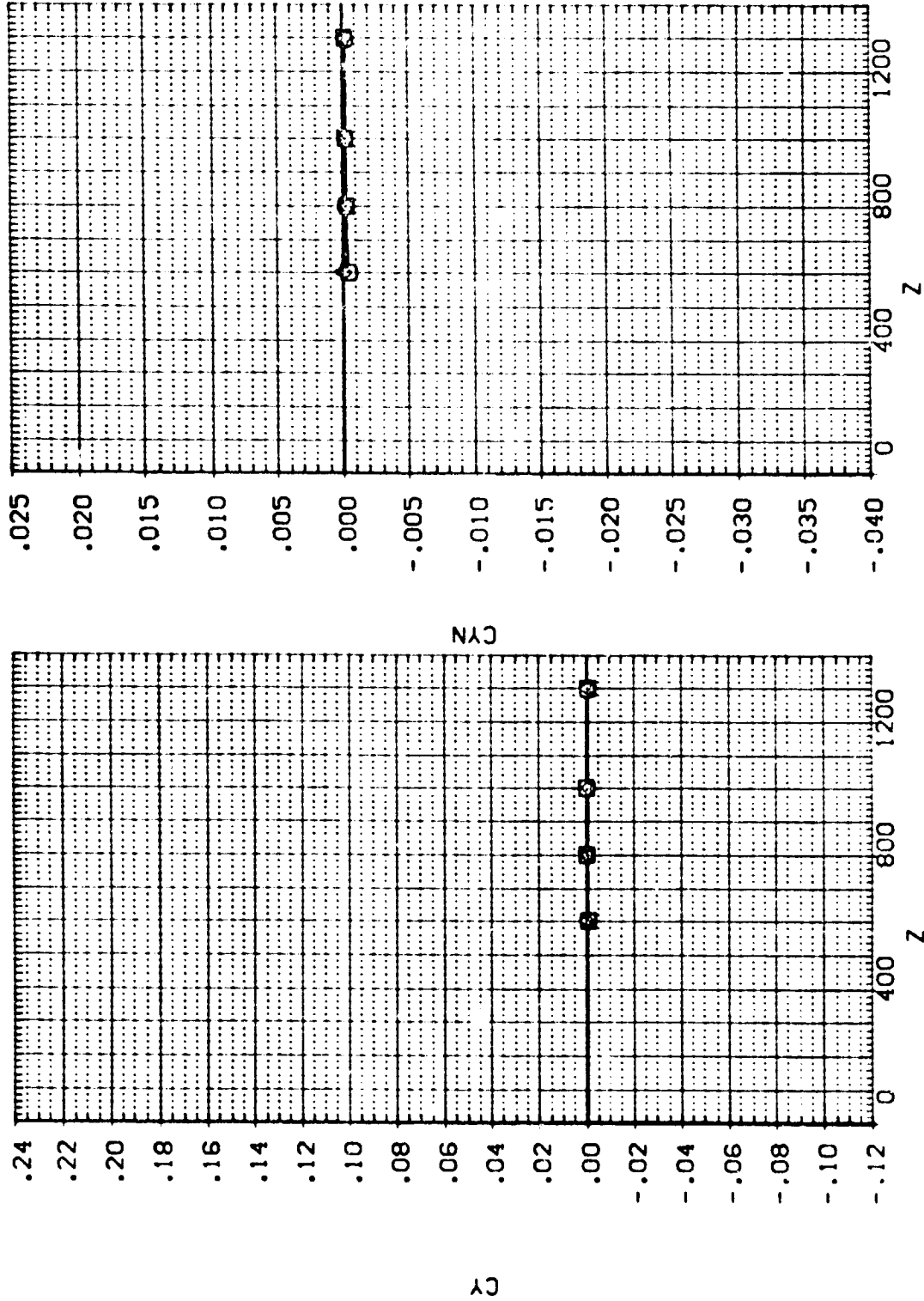

EXTERNAL TANK AERODYNAMIC CHARACTERISTICS DURING SEPARATION FROM ORBITER

IA13.EXTERNAL TANK(T1)SEPARATING FROM ORB. 09 (RTJ191)

SEE THE ASSOCIATED DATA DOCUMENT FOR REFERENCE CHARACTERISTICS FOR INDIVIDUAL DATASETS

SYMBOL		PARAMETRIC VALUES	
x	.097	MACH	4.530
	400.350	ALPHA	.000
	800.650	DALPHA	.000
	1200.700	ELEVTR	10.000
		Y	200.000
		P TOTAL	110.000
		BETA	.000
		DBETA	.000
		ALLRON	.000

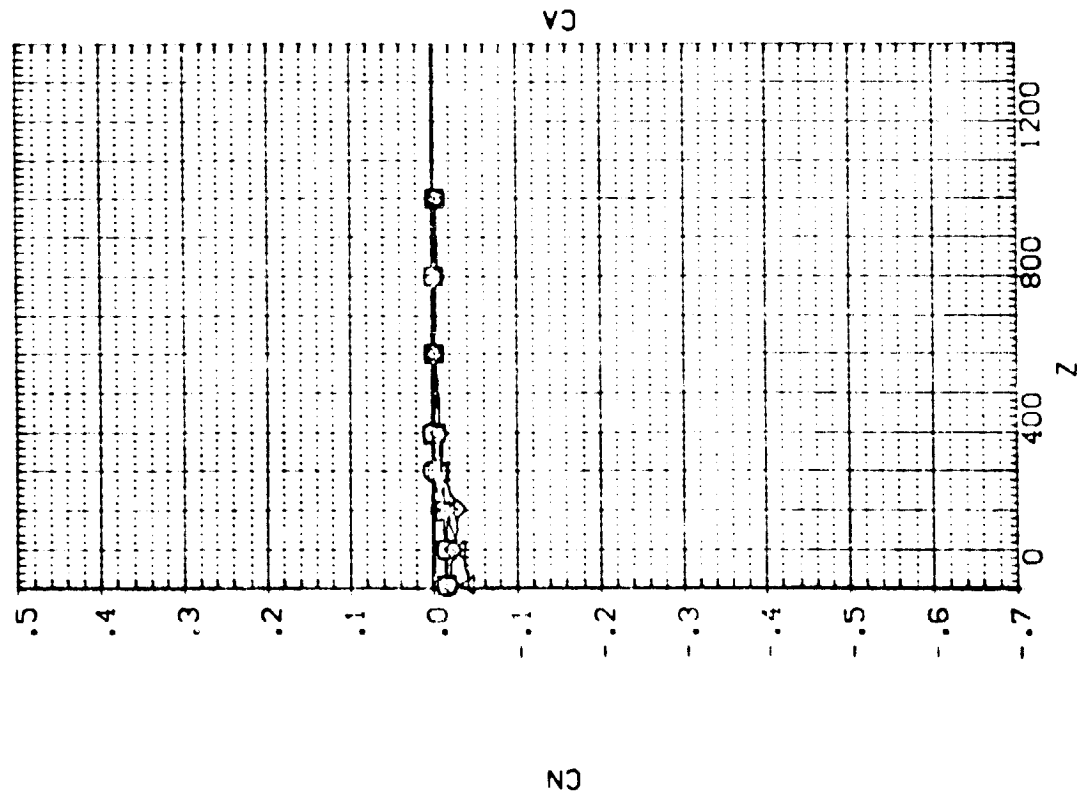
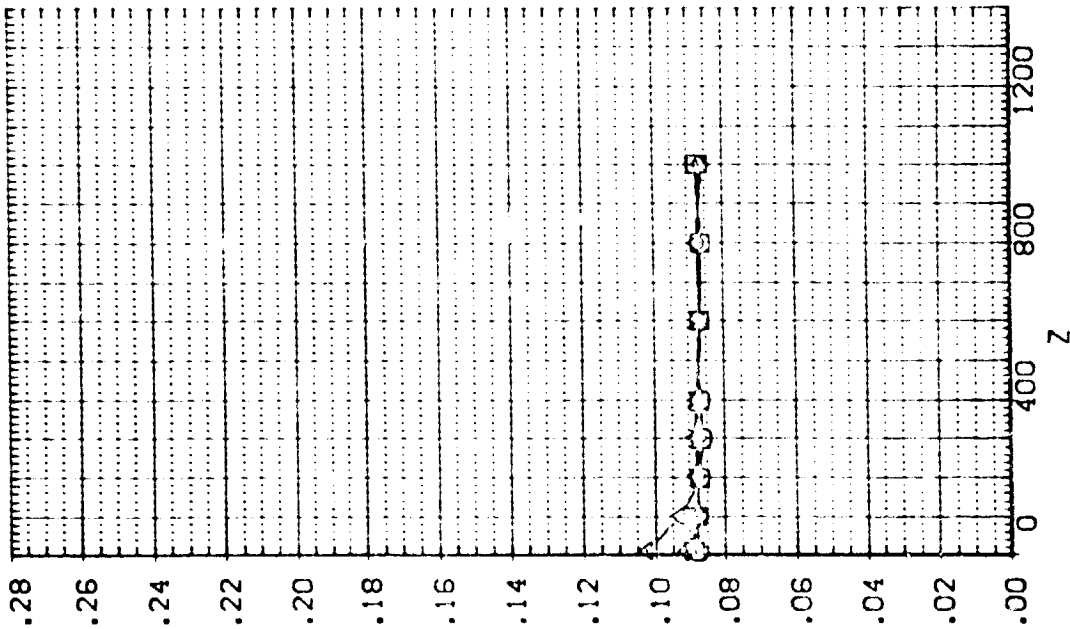

[A13,EXTERNAL TANK(T10)SEPARATING FROM ORB. 09 (RTJT91)]

SEE THE ASSOCIATED DATA DOCUMENT FOR REFERENCE CHARACTERISTICS FOR INDIVIDUAL DATASETS

SYMBOL		PARAMETRIC VALUES	
○	MACH	4.530	P/TOTAL
□	ALPHA	.000	BETA
◇	DALPHA	.000	DBETA
△	ELEVTR	10.000	A1LRON
	Y	200.000	

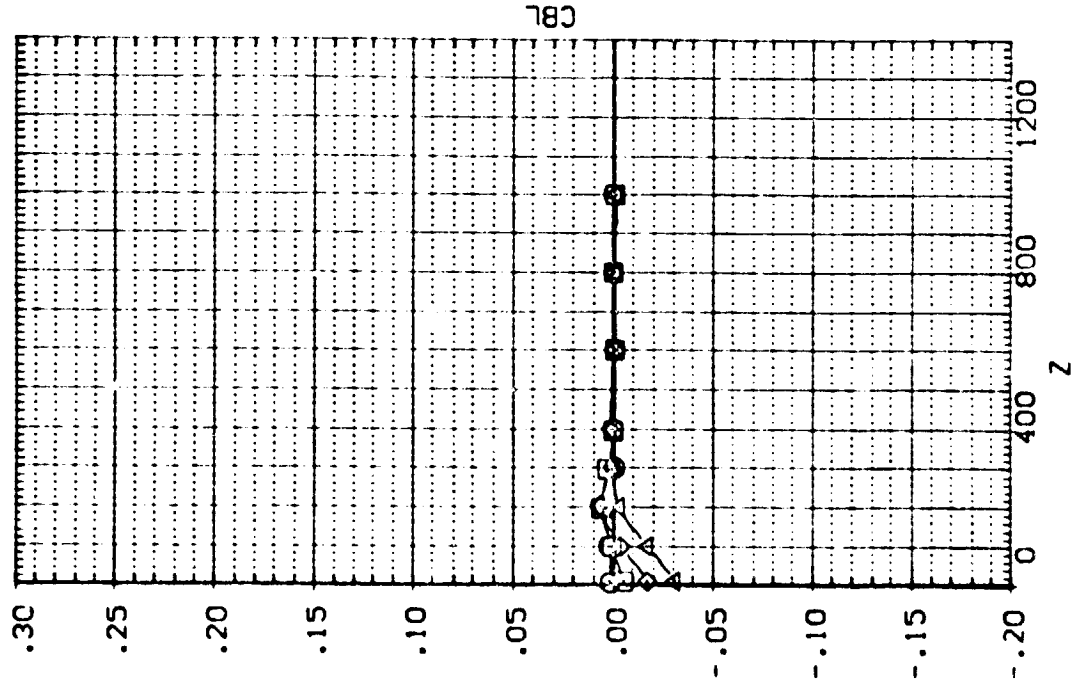
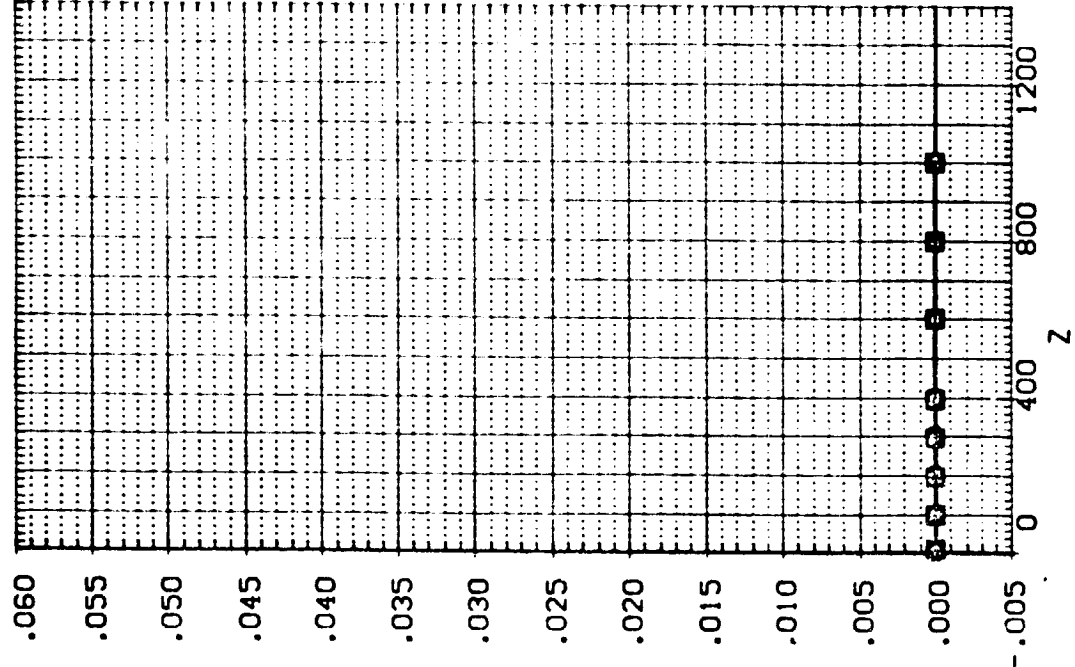

EXTERNAL TANK AERODYNAMIC CHARACTERISTICS DURING SEPARATION FROM ORBITER

1A13.EXTERNAL TANK(T10)SEPARATING FROM ORB. 09 (RTJT91)

SEE THE ASSOCIATED DATA DOCUMENT FOR REFERENCE CHARACTERISTICS FOR INDIVIDUAL DATASETS

SYMBOL		PARAMETRIC VALUES			
X	.097	MACH	4.530	PTOTAL	110.000
	400.350	ALPHA	.000	BETA	.000
	800.660	CALPHA	.000	DBETA	.000
	1200.700	ELEVTR	10.000	AIRLON	.000
Y	200.000				

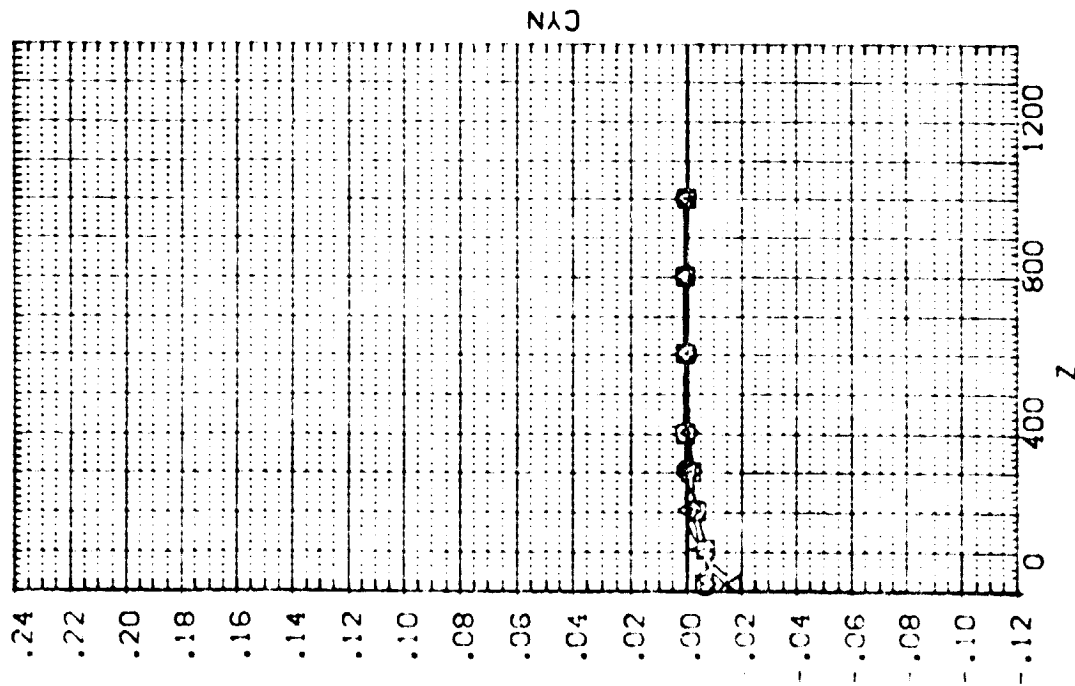
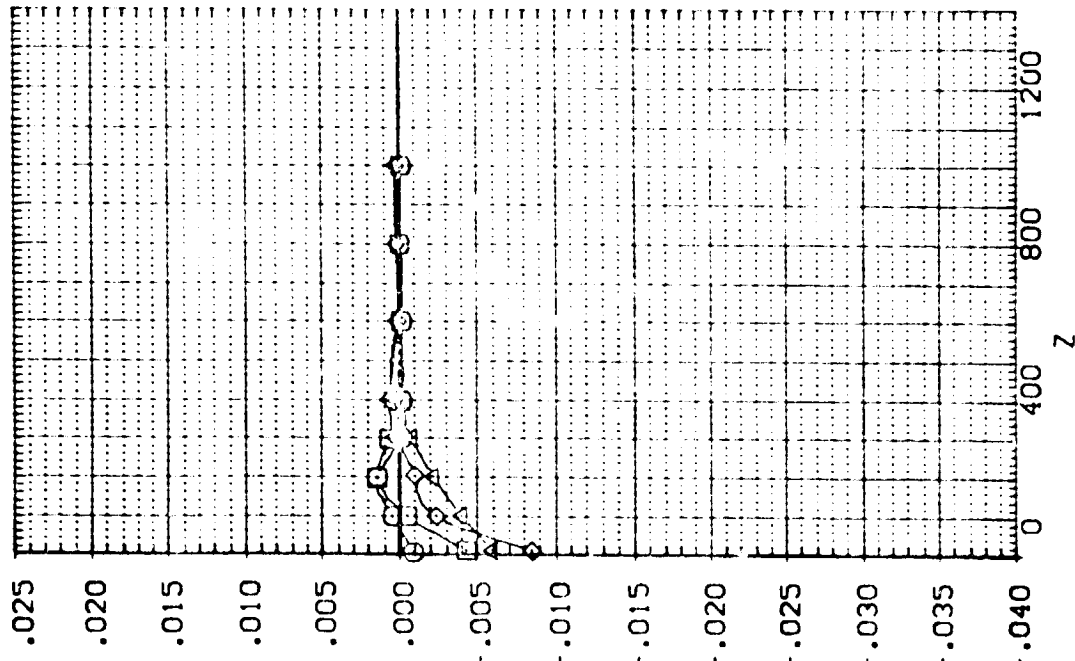

IA13, EXTERNAL TANK(T10) SEPARATING FROM ORB. 09 (RTJ192)

SEE THE ASSOCIATED DATA DOCUMENT FOR REFERENCE CHARACTERISTICS FOR INDIVIDUAL DATASETS

SYMBOL		PARAMETRIC VALUES	
○	X	MACH	PTOTAL
□	400.440	4.530	110.000
◇	800.600	.000	BETA
△	1200.800	-10.000	DBETA
		10.000	AILRON
		200.000	Y

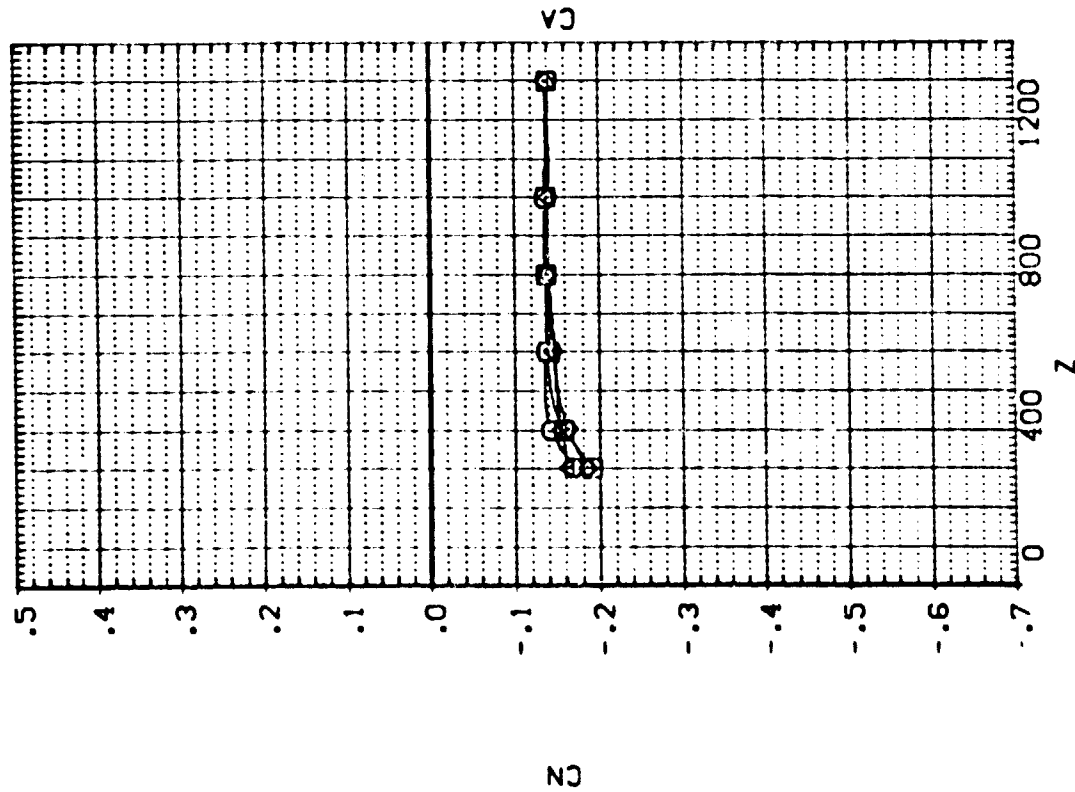
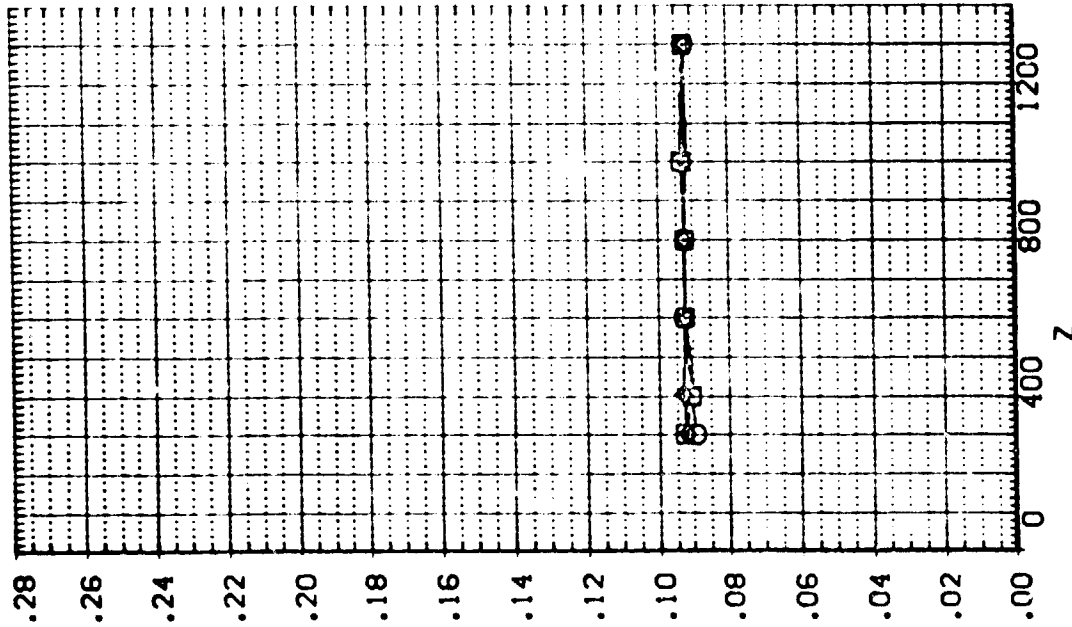

EXTERNAL TANK AERODYNAMIC CHARACTERISTICS DURING SEPARATION FROM ORBITER

1A13.EXTERNAL TANK(110)SEPARATING FROM ORB. 09 (RTJT192)

SEE THE ASSOCIATED DATA DOCUMENT FOR REFERENCE CHARACTERISTICS FOR INDIVIDUAL DATA SETS

SYMBOL	PARAMETRIC VALUES
λ	.115
MACH	4.530
P:OTAL	110.000
400.440	.000
BETA	.000
800.600	-10.000
DBETA	.000
1200.800	10.000
AILRON	.000
γ	200.000

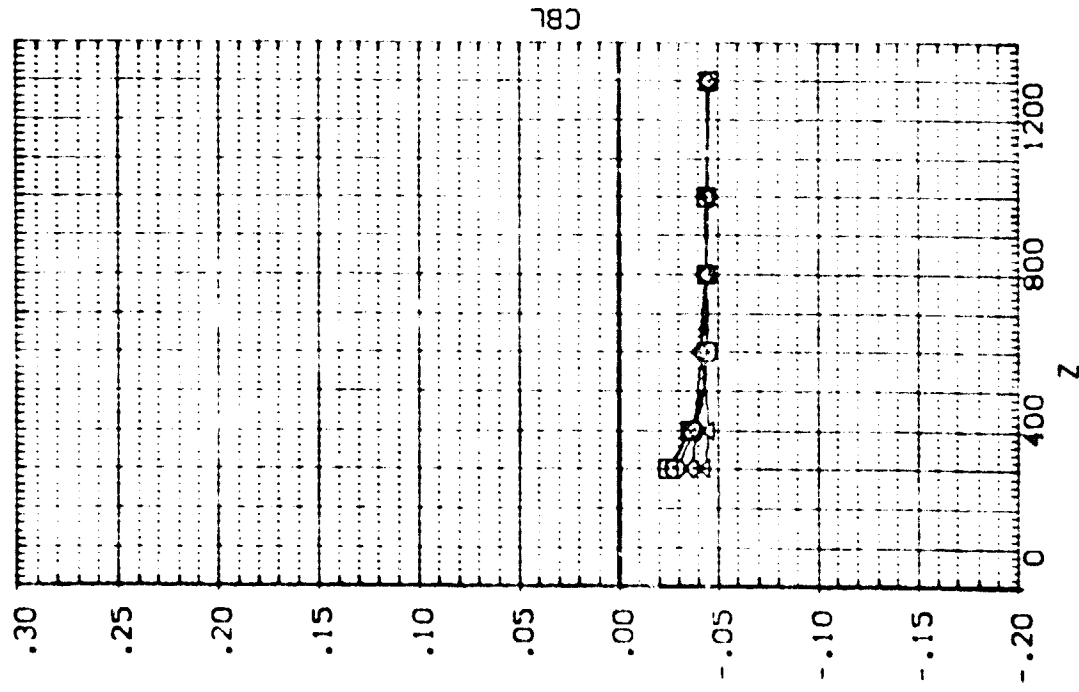
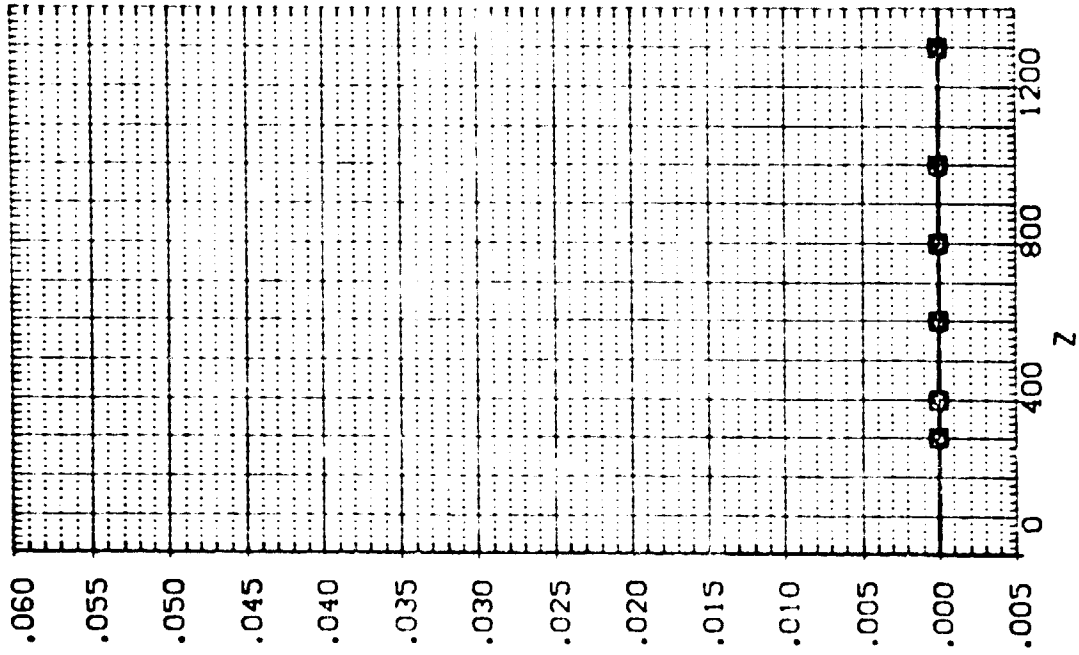

IA13, EXTERNAL TANK(T10) SEPARATING FROM ORB. 09 (RTJT92)

SEE THE ASSOCIATED DATA DOCUMENT FOR REFERENCE CHARACTERISTICS FOR INDIVIDUAL DATASETS

SYMBOL		PARAMETRIC VALUES				
○	X	.115	MACH	4.530	PIOTAL	110.000
□		400.440	ALPHA	.000	BETA	.000
◇		800.600	DALPHA	-10.000	DBETA	.000
△		1200.800	ELEVTR	10.000	AILRON	.000
			Y	200.000		

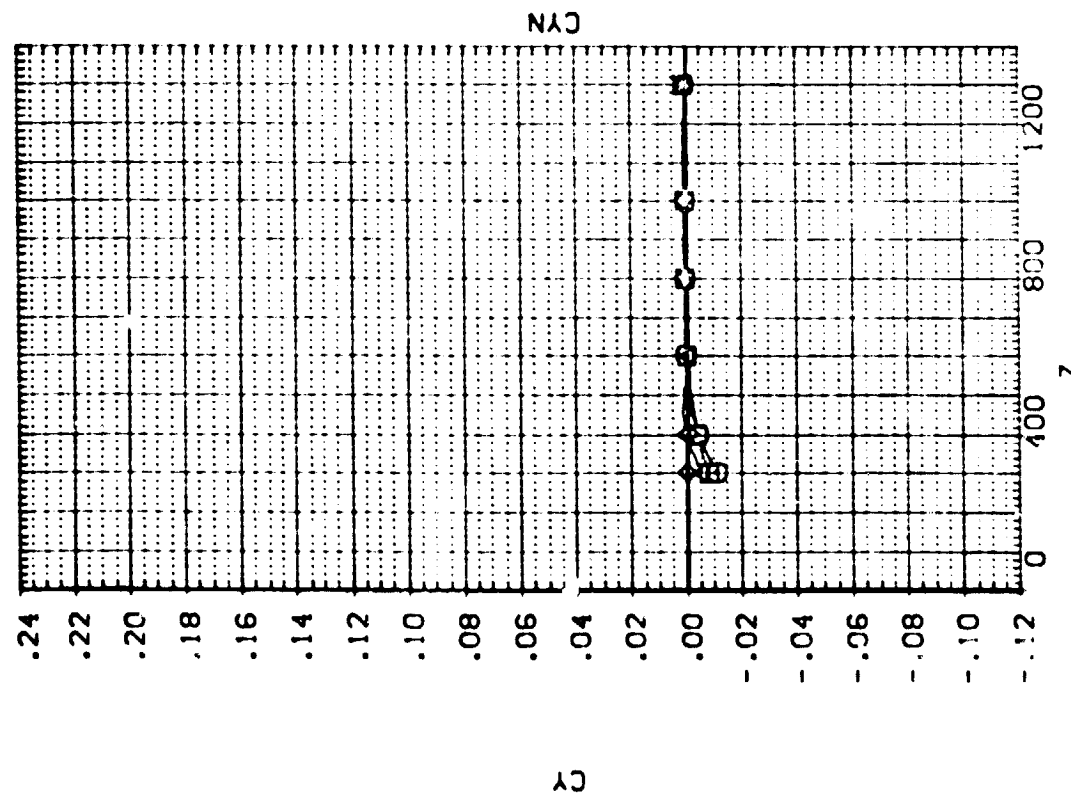
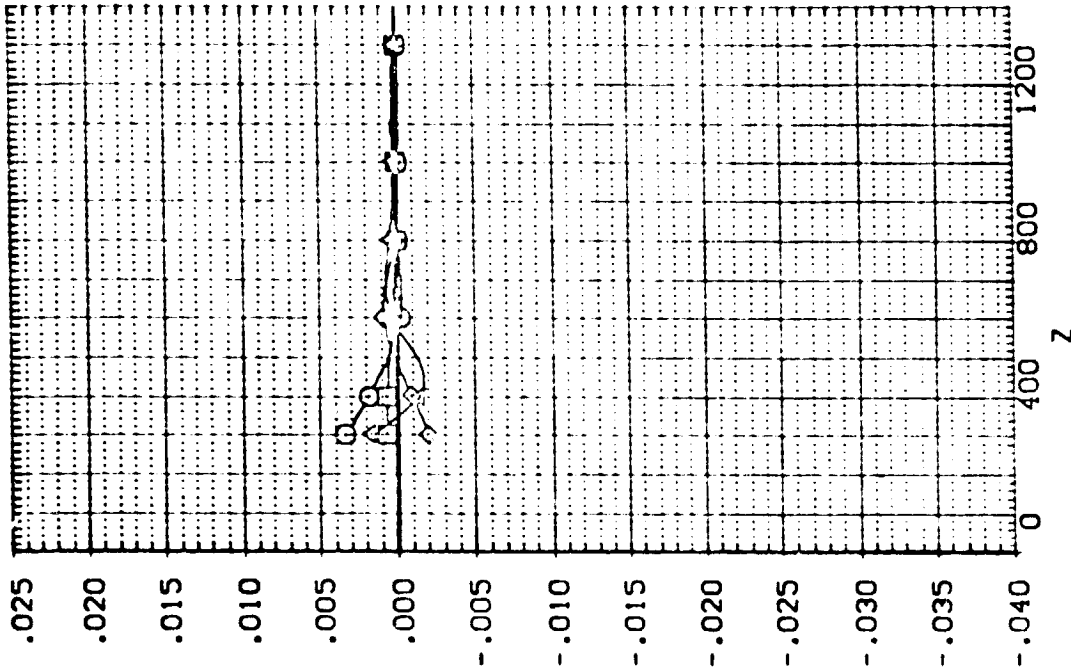

1A13.EXTERNAL TANK(10)SEPARATING FROM ORB. 09 (RTJT93)

SEE THE ASSOCIATED DATA DOCUMENT FOR REFERENCE CHARACTERISTICS FOR INDIVIDUAL DATASETS

SYMBOL	K	MACH	ALPHA	BETA	ALPHA	BETA	ELEVTR	ELEVTR	Y
	-0.395	4.530	0.000	0.000	110.000	0.000	0.000	0.000	0.000
	40.110	0.000	0.000	0.000	0.000	0.000	0.000	0.000	0.000
	100.890	0.000	0.000	0.000	0.000	0.000	0.000	0.000	0.000
	100.900	0.000	0.000	0.000	0.000	0.000	0.000	0.000	0.000
	200.000	0.000	0.000	0.000	0.000	0.000	0.000	0.000	0.000

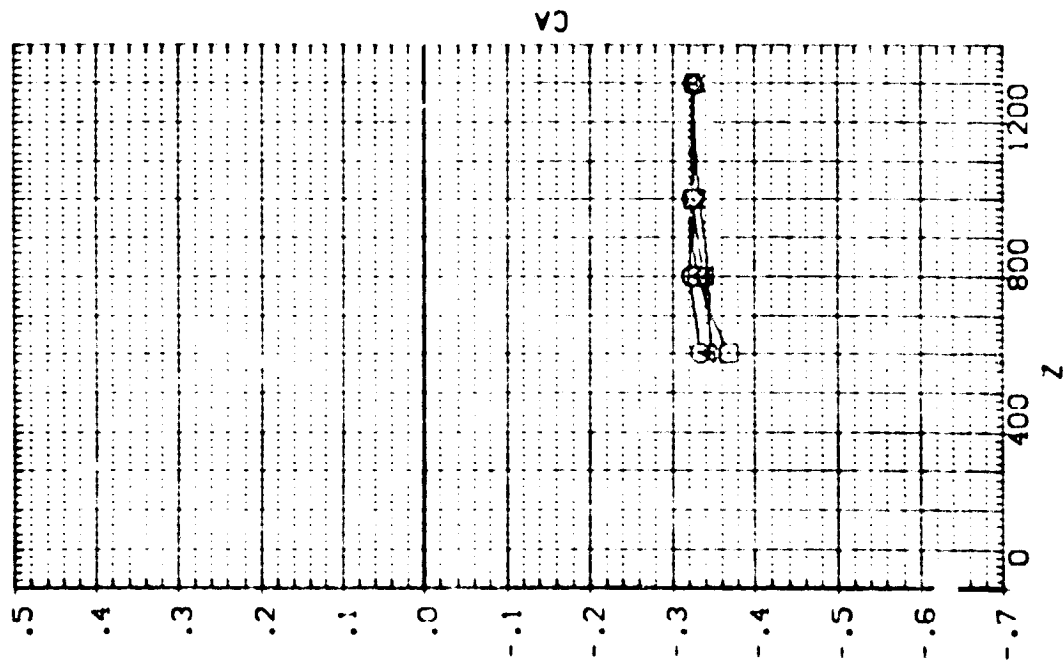
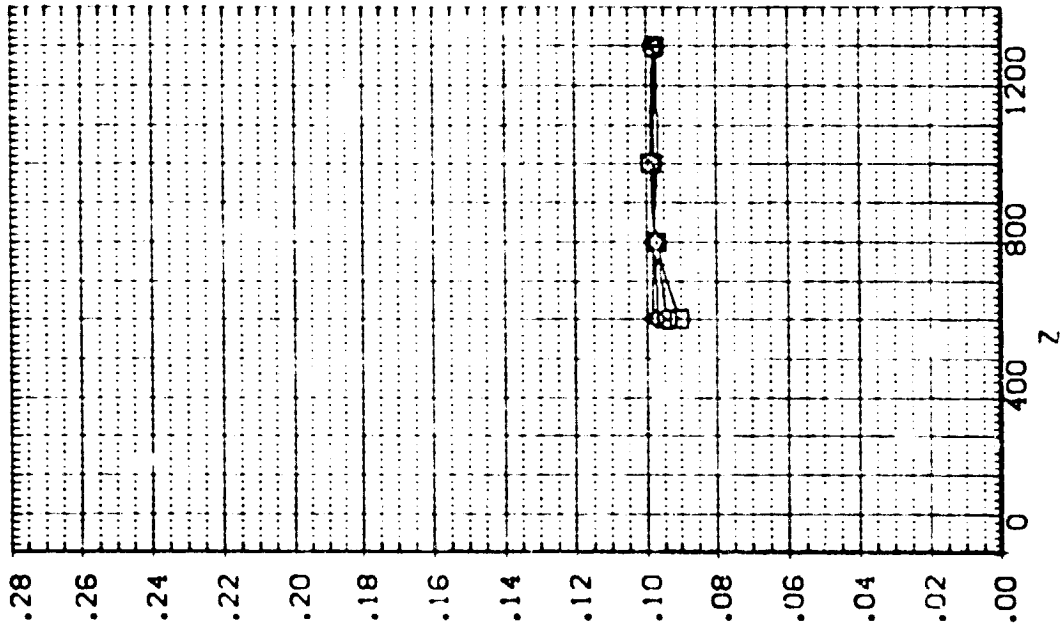

[A13.EXTERNAL TANK(T10)SEPARATING FROM ORB. 09 (RTJT93)

SEE THE ASSOCIATED DATA DOCUMENT FOR REFERENCE CHARACTERISTICS FOR INDIVIDUAL DATASETS

SYMBOL		PARAMETRIC VALUES	
○	X	MACH	4.530
□	401.110	ALPHA	.000
◇	800.890	DALPHA	-20.000
△	1200.900	ELEVTR	10.000
	Y	ALLRON	200.000
		PITOTL	110.000
		BETA	.000
		DBETA	.000
		ALLRON	.000

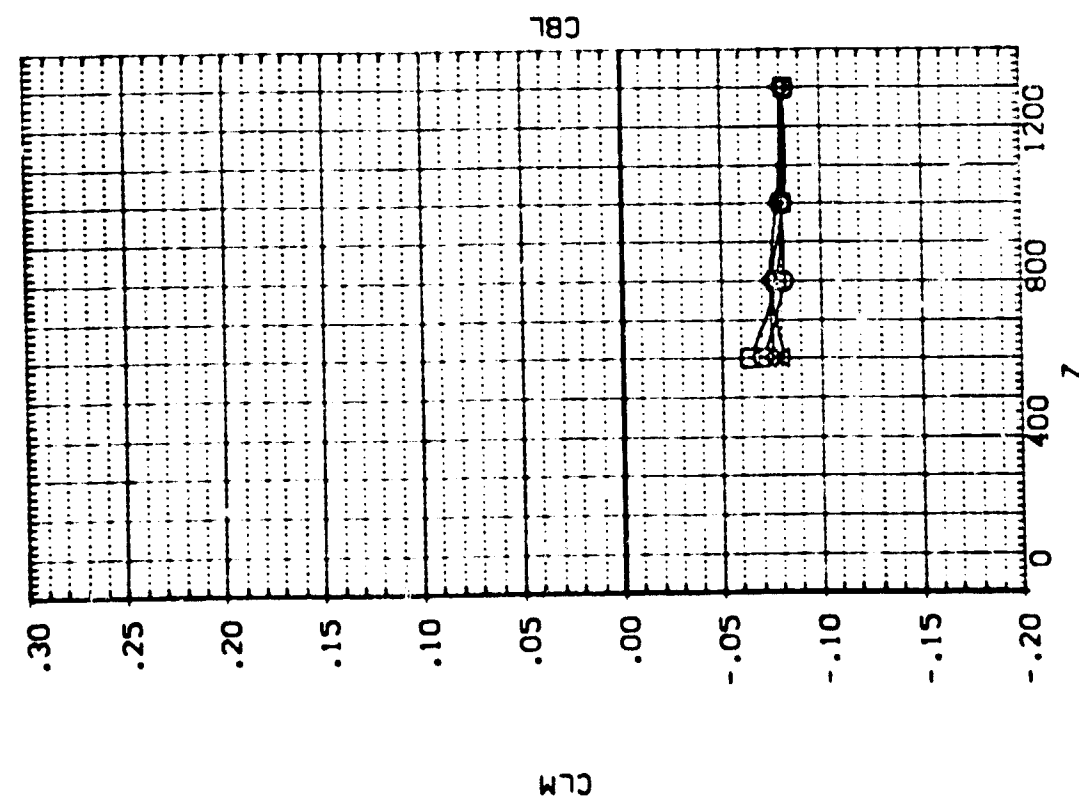
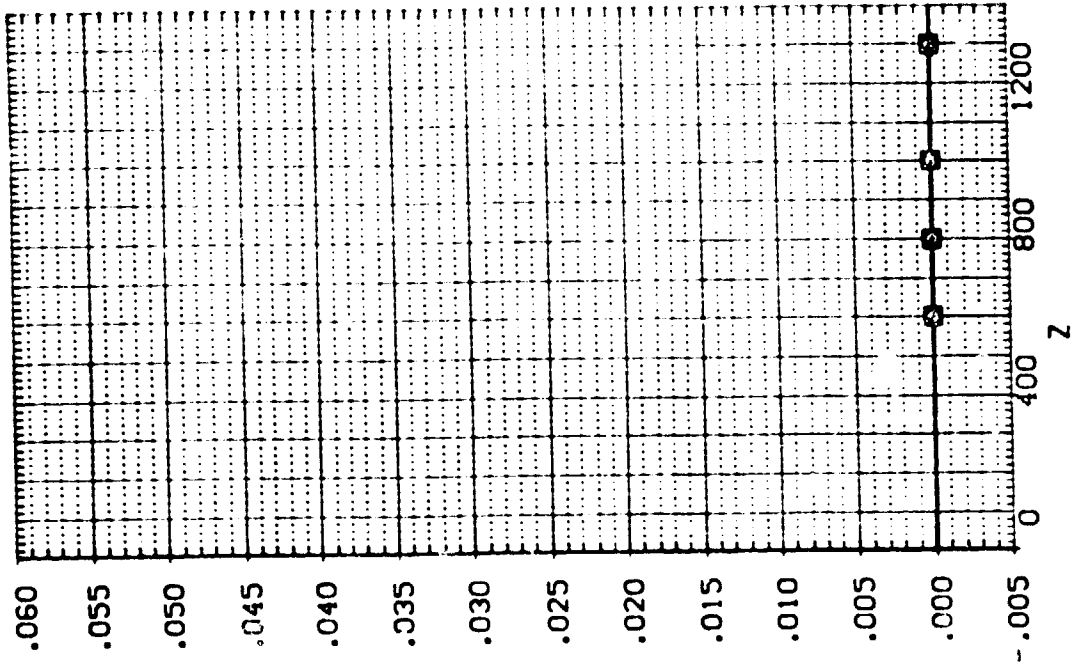

EXTERNAL TANK AERODYNAMIC CHARACTERISTICS DURING SEPARATION FROM ORBITER

1A13.EXTERNAL TANK(110)SEPARATING FROM ORB. 09 (RTJ193)

SEE THE ASSOCIATED DATA DOCUMENT FOR REFERENCE CHARACTERISTICS FOR INDIVIDUAL DATASETS

PARAMETRIC VALUES
 MACH 4.530 PITCH 110.000
 ALPHA .000 BETA .000
 DALTIA -20.000 DBETA .000
 CLYTR 10.000 AILTRON .000
 Y 200.000

SYMBOL X
 ○ □ ◇ △

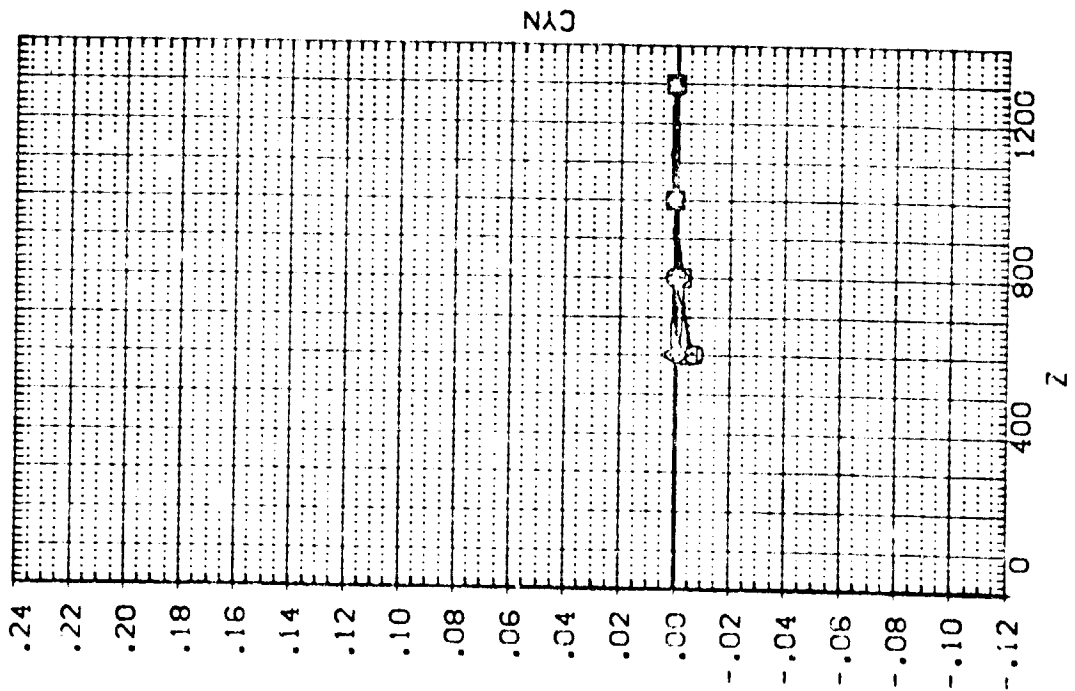
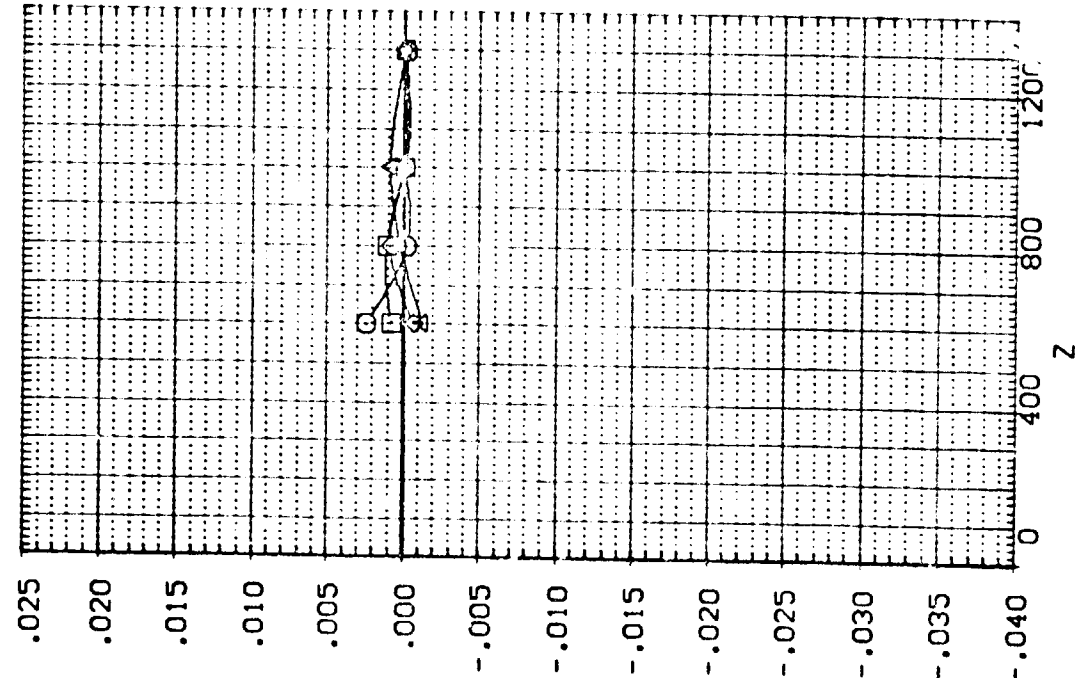

IA13, EXTERNAL TANK (T10) SEPARATING FROM ORB. 09 (RTJT94)

SEE THE ASSOCIATED DATA DOCUMENT FOR REFERENCE CHARACTERISTICS FOR INDIVIDUAL DATASETS

SYMBOL		PARAMETRIC VALUES	
○	x	MACH	PIOTAL
□	400.360	ALPHA	110.000
◇	800.530	BETA	.000
△	1200.800	DBETA	.000
		EVTR	AITRON
		γ	-40.000
			200.000

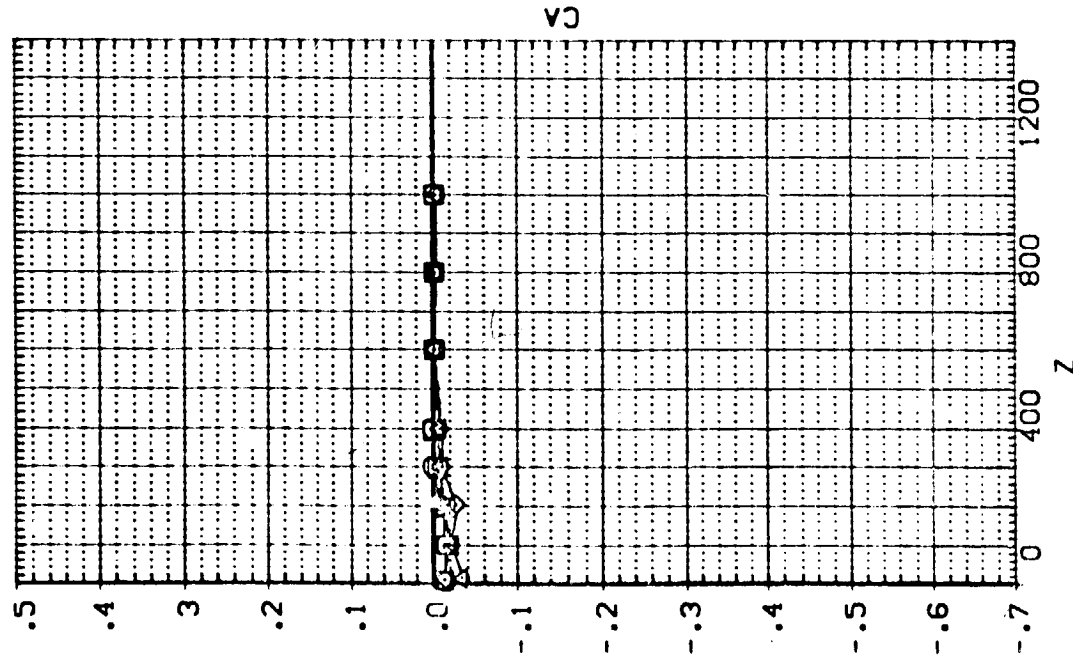
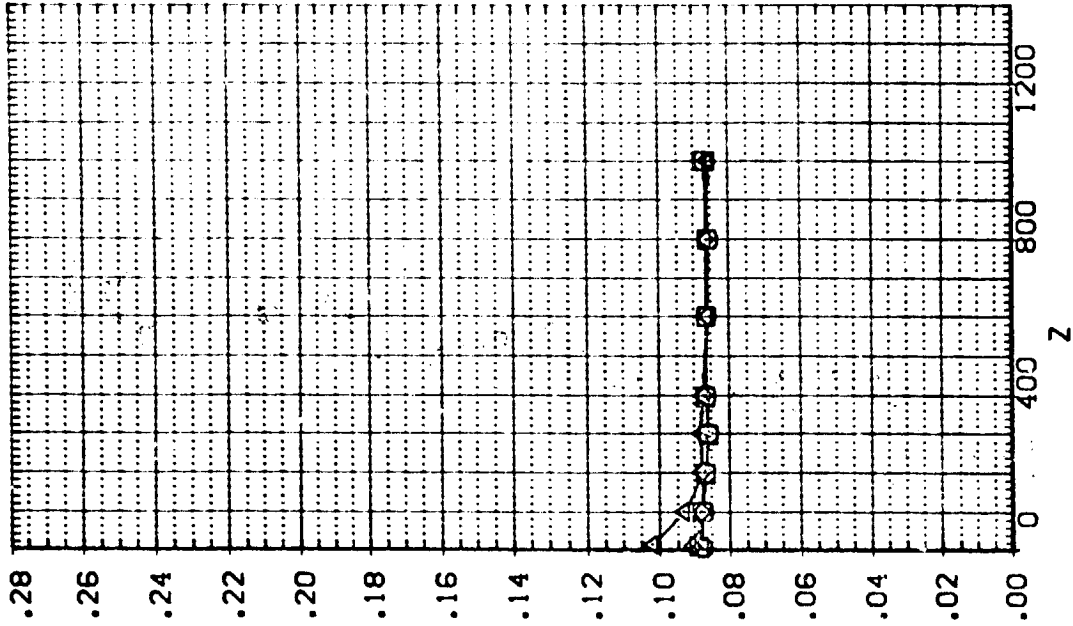

EXTERNAL TANK AERODYNAMIC CHARACTERISTICS DURING SEPARATION FROM ORBITER

IA13.EXTERNAL TANK(T10)SEPARATING FROM ORB. 09 (RTJT94)

SEE THE ASSOCIATED DATA DOCUMENT FOR REFERENCE CHARACTERISTICS FOR INDIVIDUAL DATASETS

SYMBOL
 ○
 □
 ◇
 △

PARAMETRIC VALUES
 X .309 MACH 4.530 PTOTAL 110.000
 400.360 ALPHA .000 BETA .000
 800.590 DALPHA .000 DBETA .000
 1200.900 ELEVTR -40.000 AILRON .000
 Y 200.000

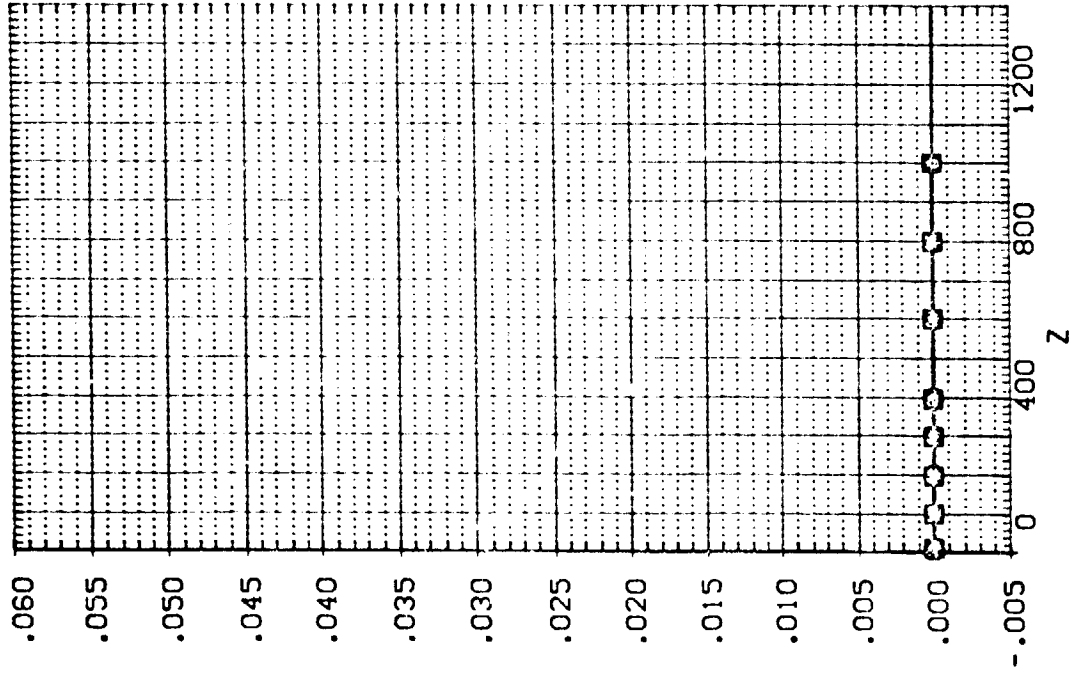
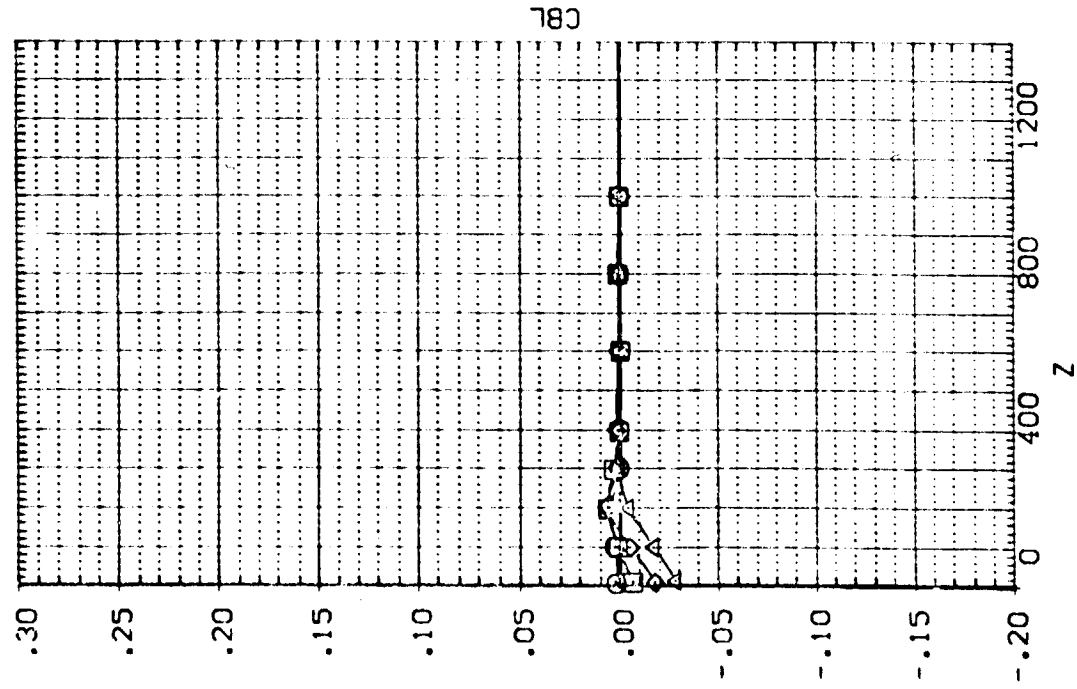

EXTERNAL TANK AERODYNAMIC CHARACTERISTICS DURING SEPARATION FROM ORBITER

IA13.EXTERNAL TANK(T10)SEPARATING FROM ORB. 09 (RTJT94)

SYMBOL X
 ○
 □
 ◇
 △

PARAMETRIC VALUES
 MACH 4.530 P/TOTAL 110.000
 ALPHA .000 BETA .000
 DALPHA .000 DBETA .000
 ELEVTR -40.000 AILRON .000
 Y 200.000

SEE THE ASSOCIATED DATA DOCUMENT FOR REFERENCE CHARACTERISTICS FOR INDIVIDUAL DATASETS

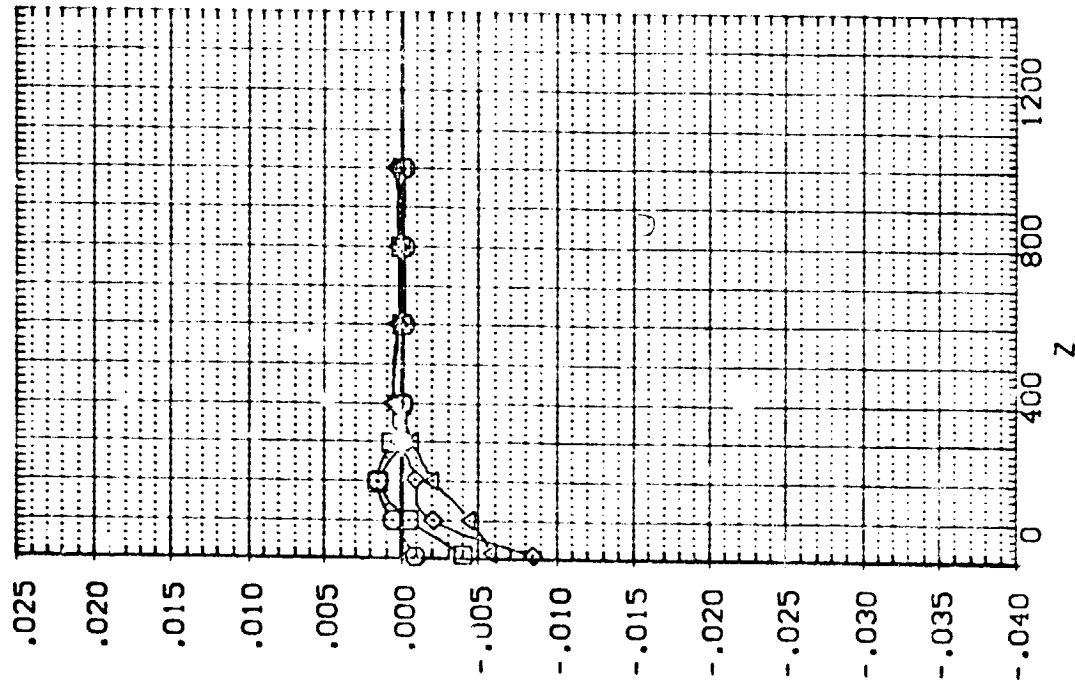
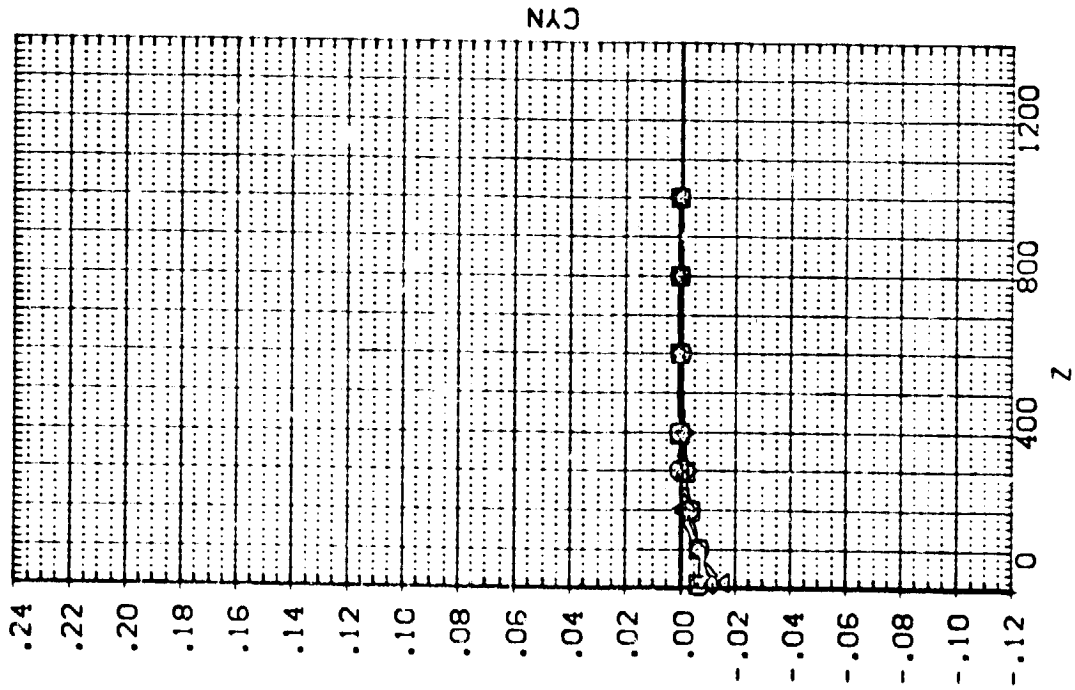

EXTERNAL TANK AERODYNAMIC CHARACTERISTICS DURING SEPARATION FROM ORBITER

IA13-EXTERNAL TANK(T10)SEPARATING FROM ORB. 09 (RTJ195)

SYMBOL

-
-
- ◇
- △

PARAMETRIC VALUES

	MACH	PTOTAL	110,000
x	.214	4.530	
400.370	ALPHA	.000	BETA
800.680	DALPHA	-10,000	DBETA
1200.800	ELEVTR	-40,000	AILRON
	Y	200,000	

SEE THE ASSOCIATED DATA DOCUMENT FOR REFERENCE CHARACTERISTICS FOR INDIVIDUAL DATASETS

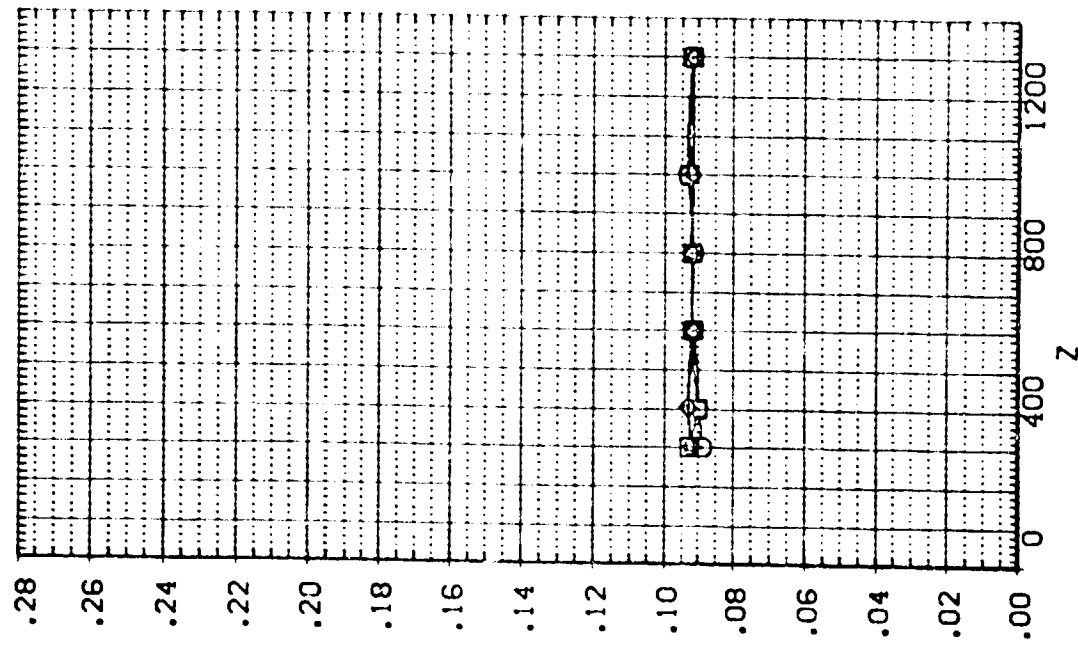
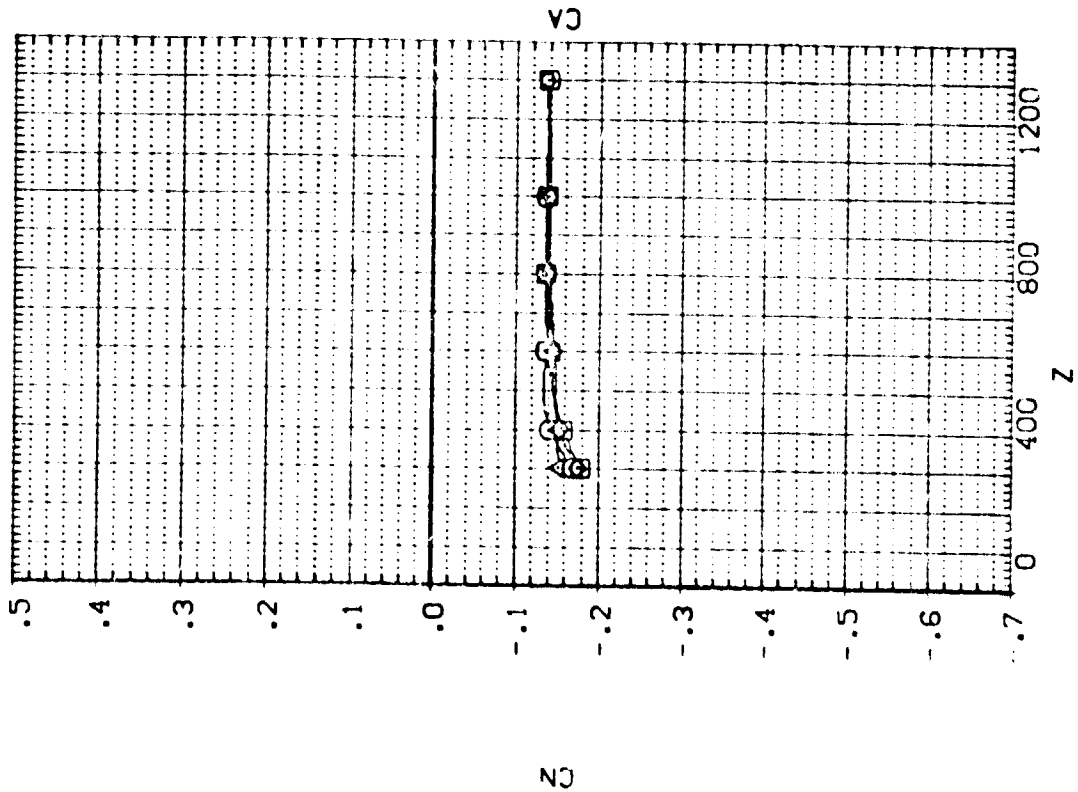

IA13.EXTERNAL TANK(I10)SEPARATING FROM ORB. 09 (RTJT95)

SEE THE ASSOCIATED DATA DOCUMENT FOR REFERENCE CHARACTERISTICS FOR INDIVIDUAL DATASETS

SYMBOL		PARAMETRIC VALUES				
○	X	.214	MACH	4.530	P/TOTAL	110.000
□	400.370	ALPHA	.000	BETA	.000	
◇	800.680	DALPHA	-10.000	DBETA	.000	
△	1200.800	ELEVTR	-40.000	ATLRON	.000	
	Y				200.000	

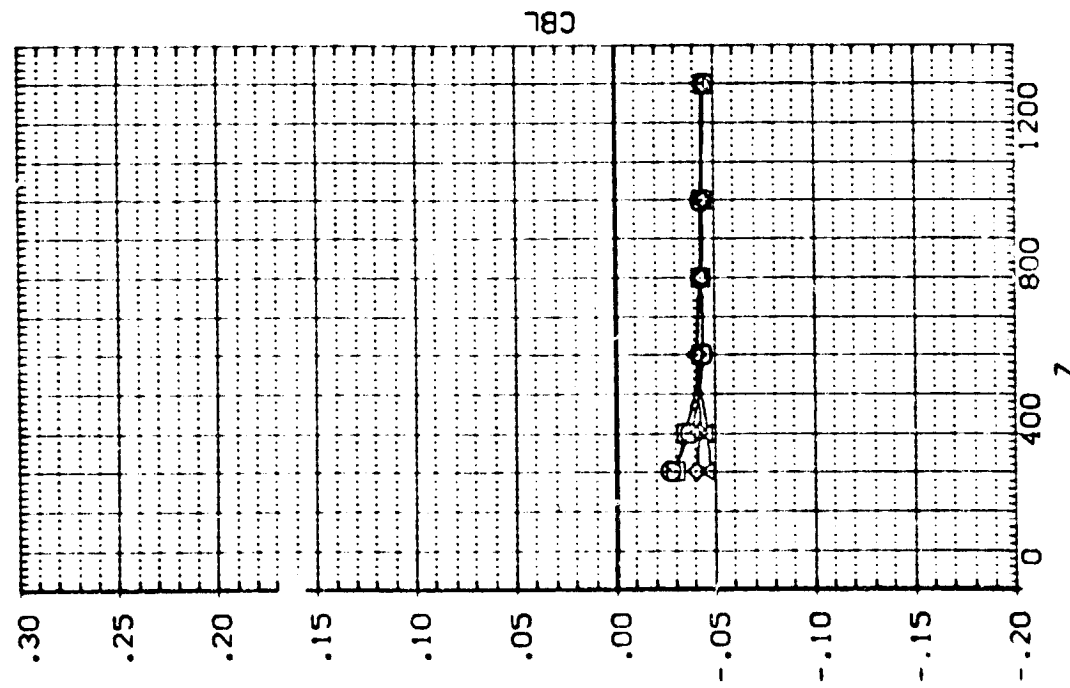
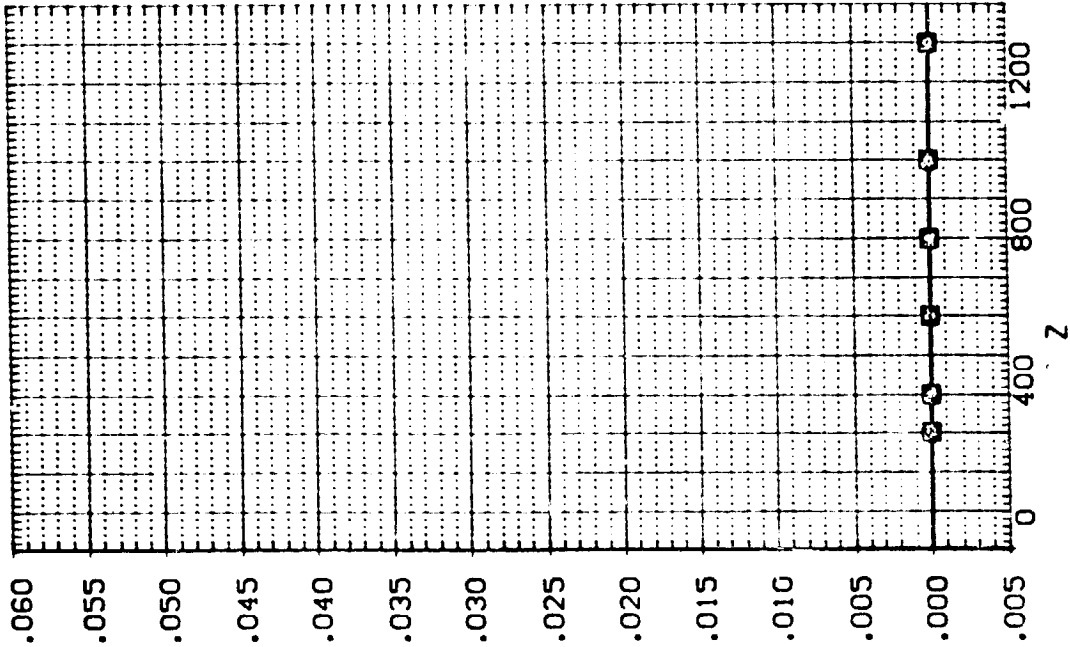

EXTERNAL TANK AERODYNAMIC CHARACTERISTICS DURING SEPARATION FROM ORBITER

1A13-EXTERNAL TANK(T10)SEPARATING FROM ORB. 09 (RTJ195)

SYMBOL	PARAMETRIC VALUES
○	MACH 4.530 PTOTAL 110.000
◇	ALPHA .000 BETA .000
△	DALPHA -10.000 DBETA .000
□	ELEVTR -40.000 ALLRON .000
Y	200.000

SEE THE ASSOCIATED DATA DOCUMENT FOR REFERENCE CHARACTERISTICS FOR INDIVIDUAL DATASETS

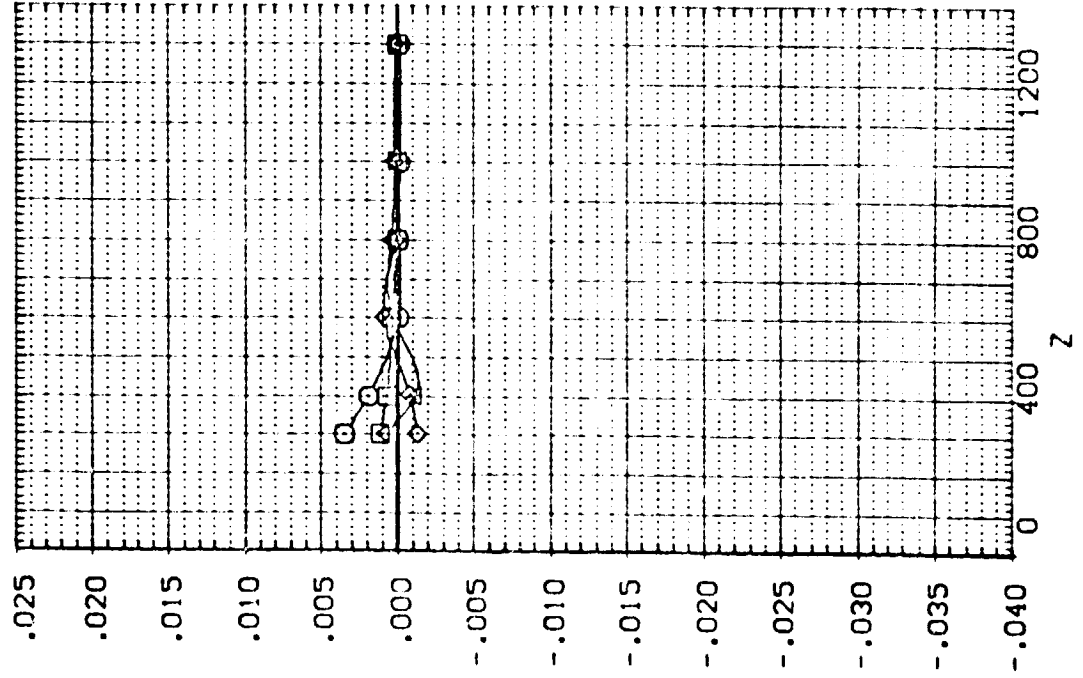
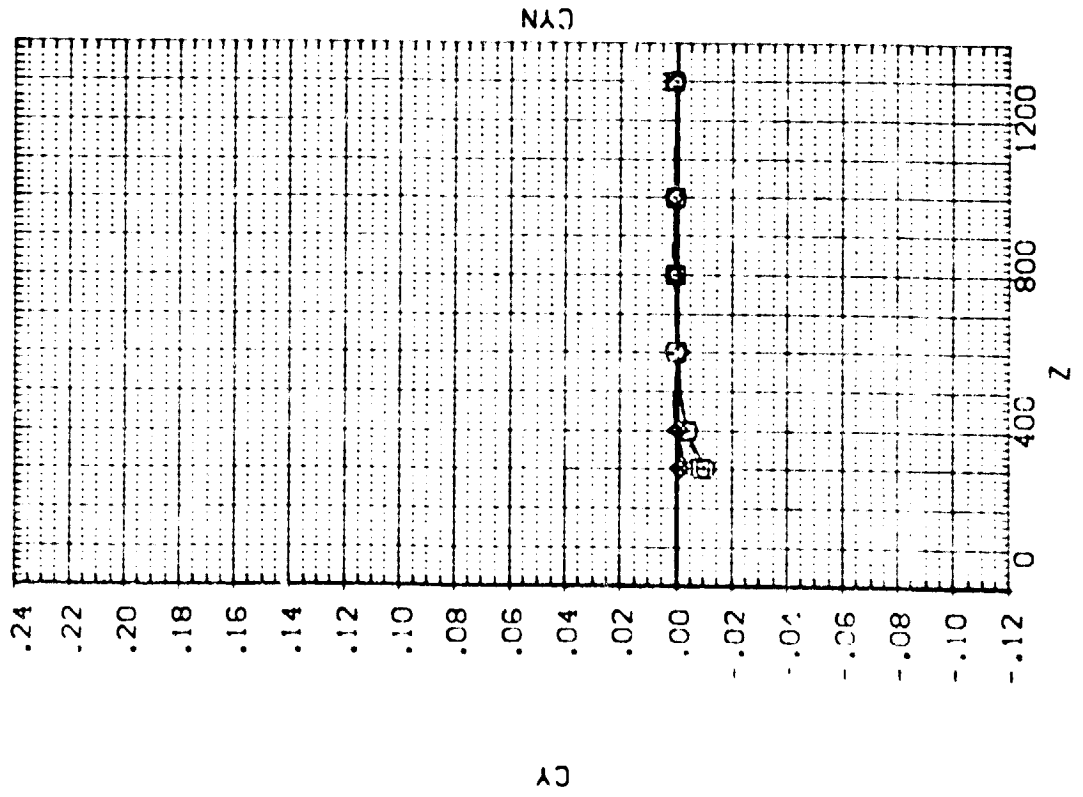

IA13, EXTERNAL TANK(T10)SEPARATING FROM ORB. 09 (RTJT96)

SEE THE ASSOCIATED DATA DOCUMENT FOR REFERENCE CHARACTERISTICS FOR INDIVIDUAL DATASETS

SYMBOL		PARAMETRIC VALUES	
○	x	MACH	4.530
□	α	PTOTAL	110.000
◇	β	BETA	.000
△	δ	DBETA	.000
	ε	ALTRON	.000
	ν	200.000	

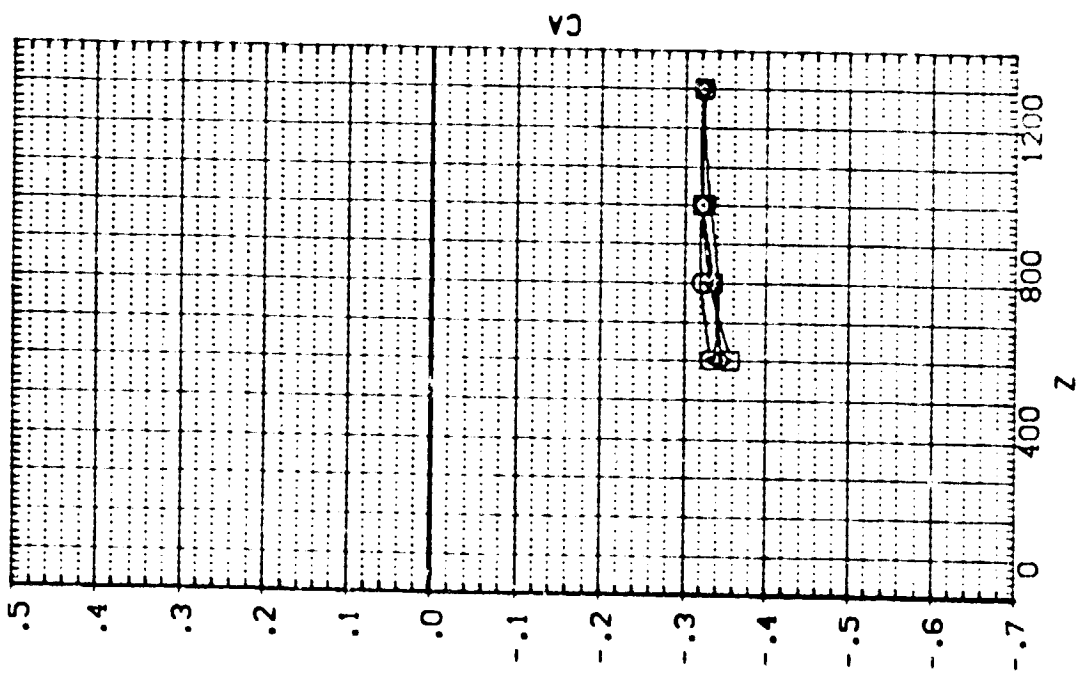
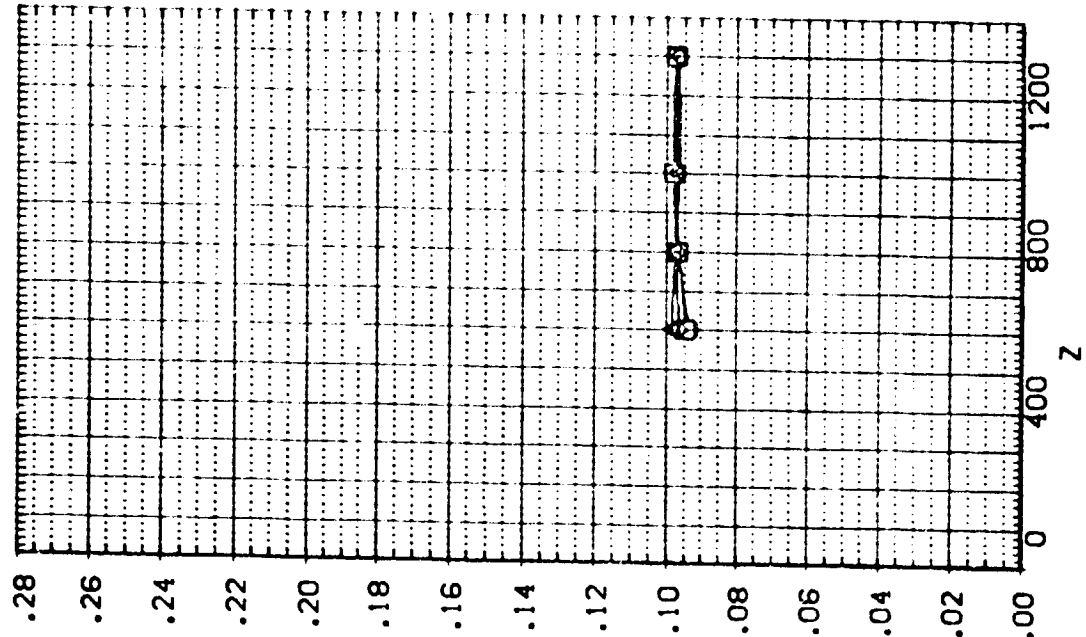

EXTERNAL TANK AERODYNAMIC CHARACTERISTICS DURING SEPARATION FROM ORBITER

FIG. 13. EXTERNAL TANK CHARACTERISTICS DURING SEPARATION FROM ORB. CG (PT. 196)

SYMBOL X PARAMETRIC VALUES
 1.305 MACH 4.500 PITCH 110.000
 40.110 ALPHA .000 BETA .000
 800.800 DA ALPHA -25.000 DBETA .000
 120.000 ELEVTR -40.000 AIRON .000
 Y 200.000

SEE THE ASSOCIATED DATA DOCUMENT FOR REFERENCE CHARACTERISTICS FOR INDIVIDUAL DATA SETS

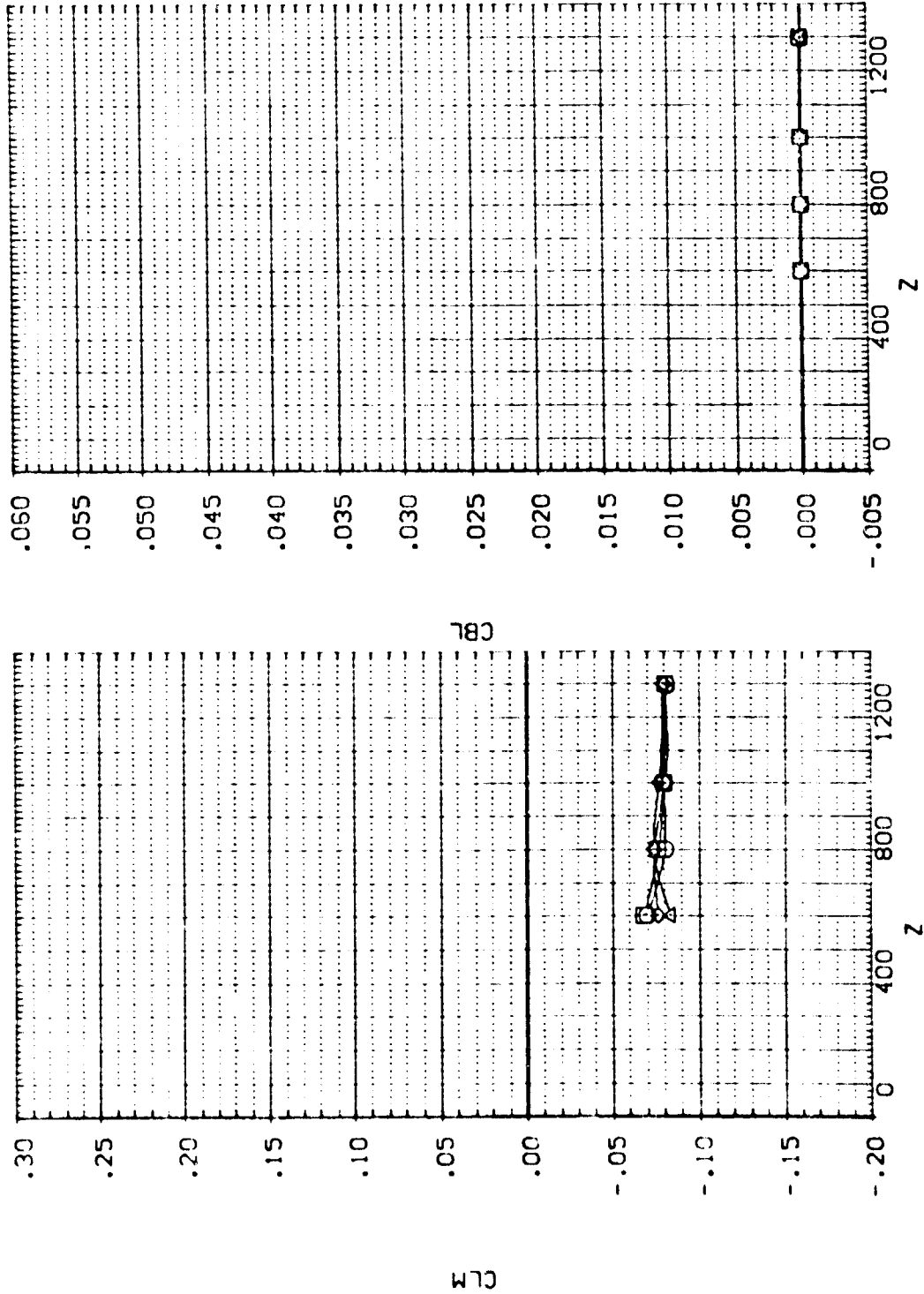

IA13.EXTERNAL TANK(T10)SEPARATING FROM ORB. 09 (RIJT96)

SEE THE ASSOCIATED DATA DOCUMENT FOR REFERENCE CHARACTERISTICS FOR INDIVIDUAL DATASETS

SYMB.
 ○
 □
 ◇
 △

X
 -.505
 401.110
 800.540
 1201.000

MACH
 ALPHA
 DALPHA
 ELEVTR
 Y

PARAMETRIC VALUES
 4.530
 .000
 -20.000
 -40.000
 200.000

P TOTAL 110.000
 BETA .000
 DBETA .000
 AILRON .000

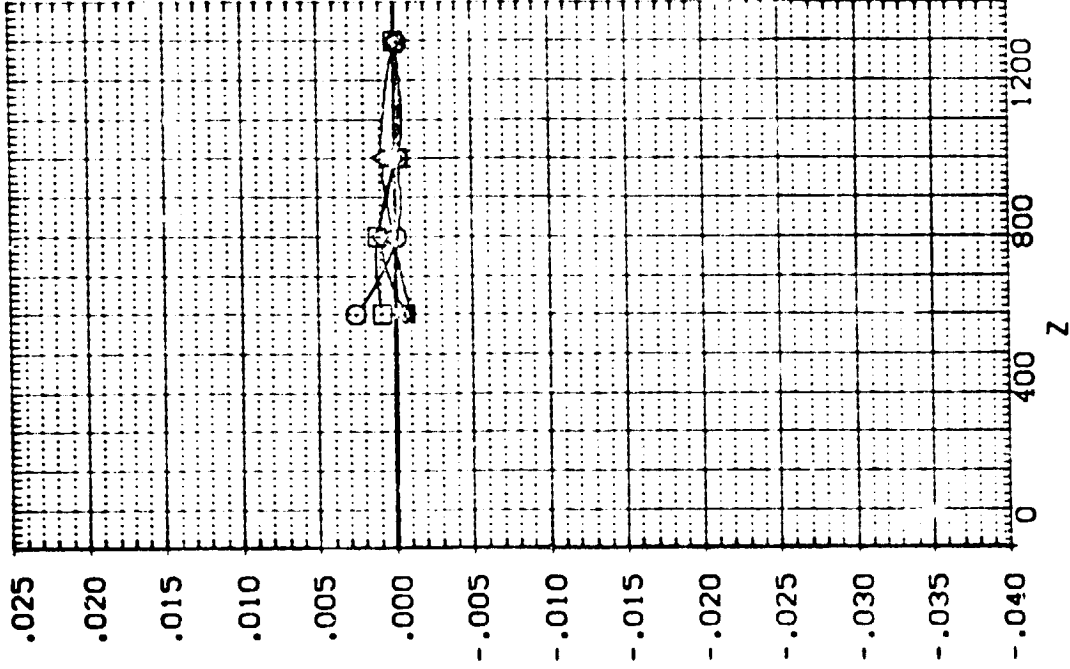
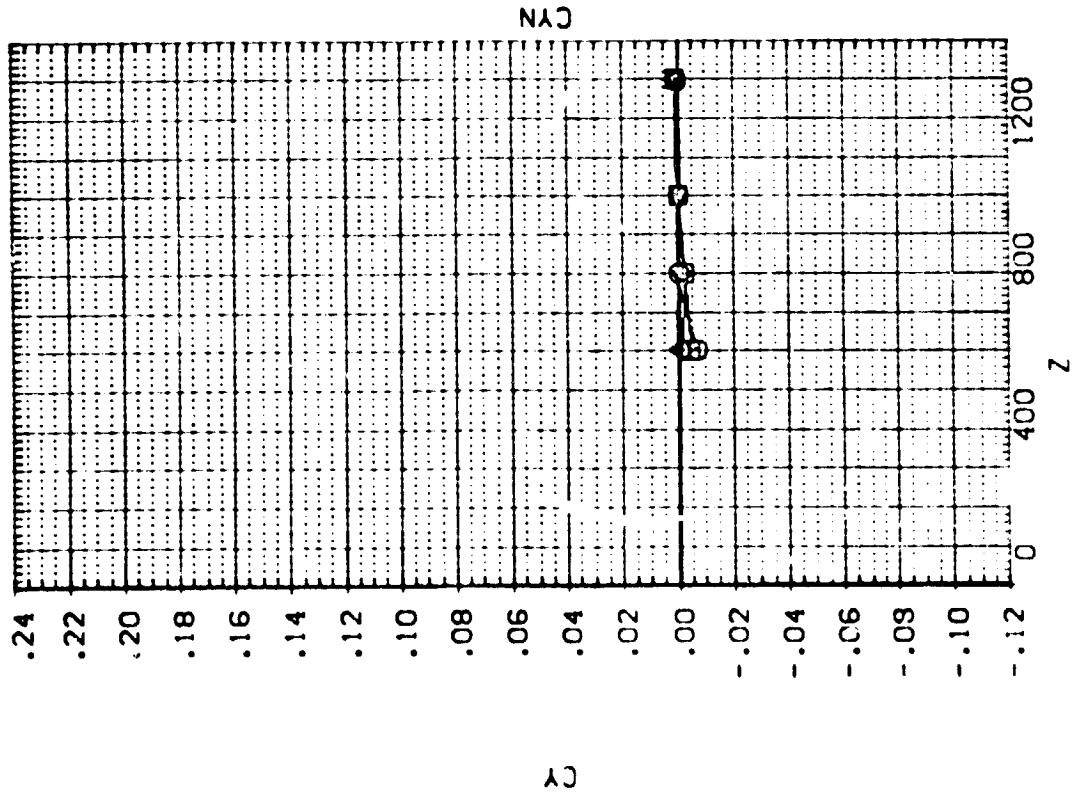

EXTERNAL TANK AERODYNAMIC CHARACTERISTICS DURING SEPARATION FROM ORBITER

1A13.EXTERNAL TANK(T:0)SEPARATING FROM ORB. C9 (RTJ197)

SEE THE ASSOCIATED DATA DOCUMENT FOR REFERENCE CHARACTERISTICS FOR INDIVIDUAL DATASETS

PARAMETRIC VALUES	
MACH	1.530
PITOT	110.000
BETA	.000
ALPHA	.000
DELTA	.000
ELEVTR	-40.000
AURON	.003
Y	.000

SYMBOL X
 ○ 400.395
 ◇ 600.520
 △ 1200.800

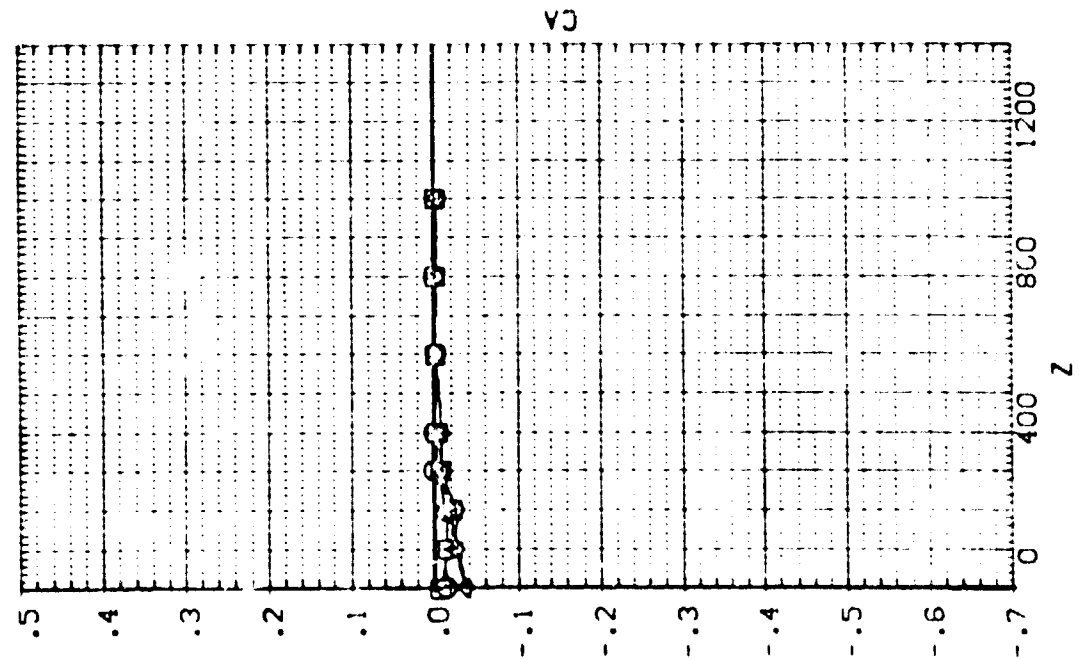
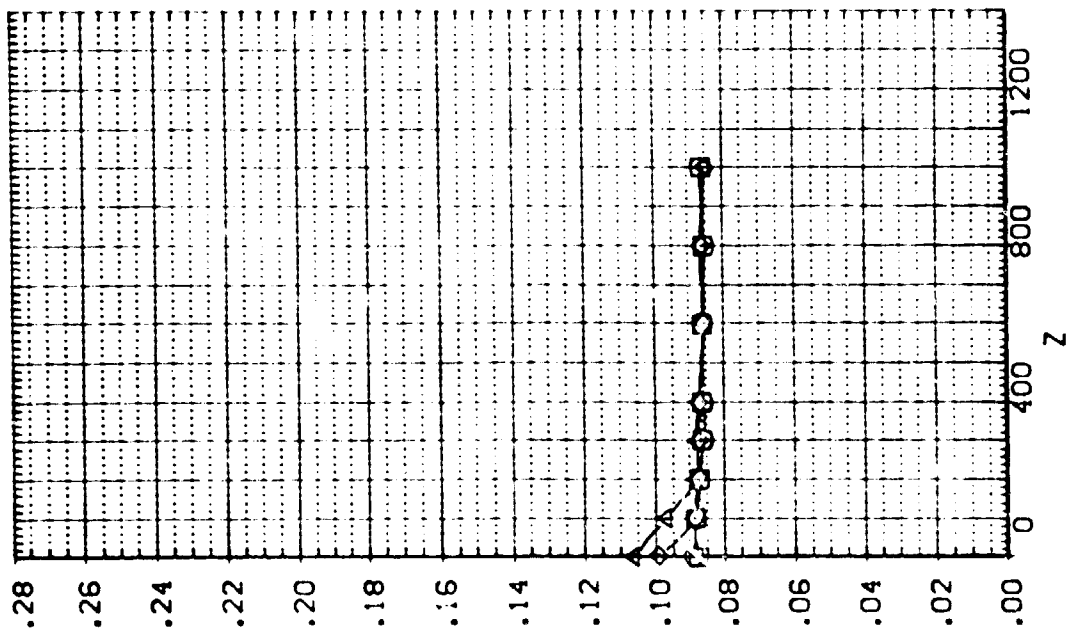

!A13.EXTERNAL TANK(T10)SEPARATING FROM ORB. 09 (RTJT97)

SEE THE ASSOCIATED DATA DOCUMENT FOR REFERENCE CHARACTERISTICS FOR INDIVIDUAL DATASETS

SYMBOL	X	MACH	PARAMETRIC VALUES
○	.174	4.530	PTOTAL 110.000
□	400.790	.000	BETA .000
◇	800.520	.000	DBETA .000
△	1200.800	-40.000	AILRON .000
			Y .000

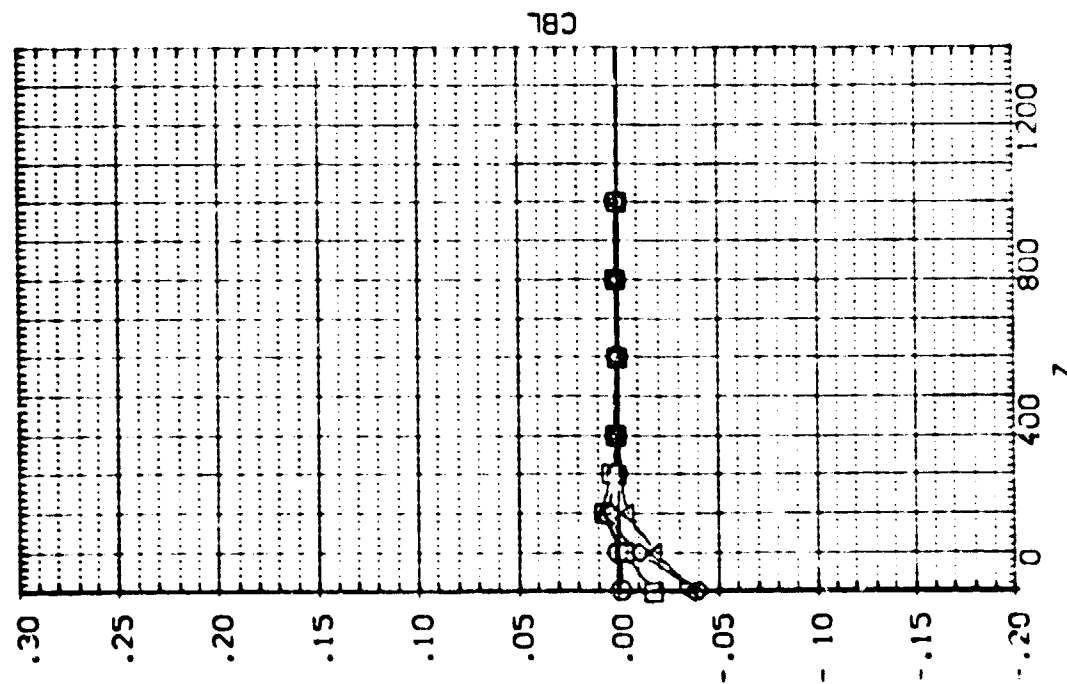
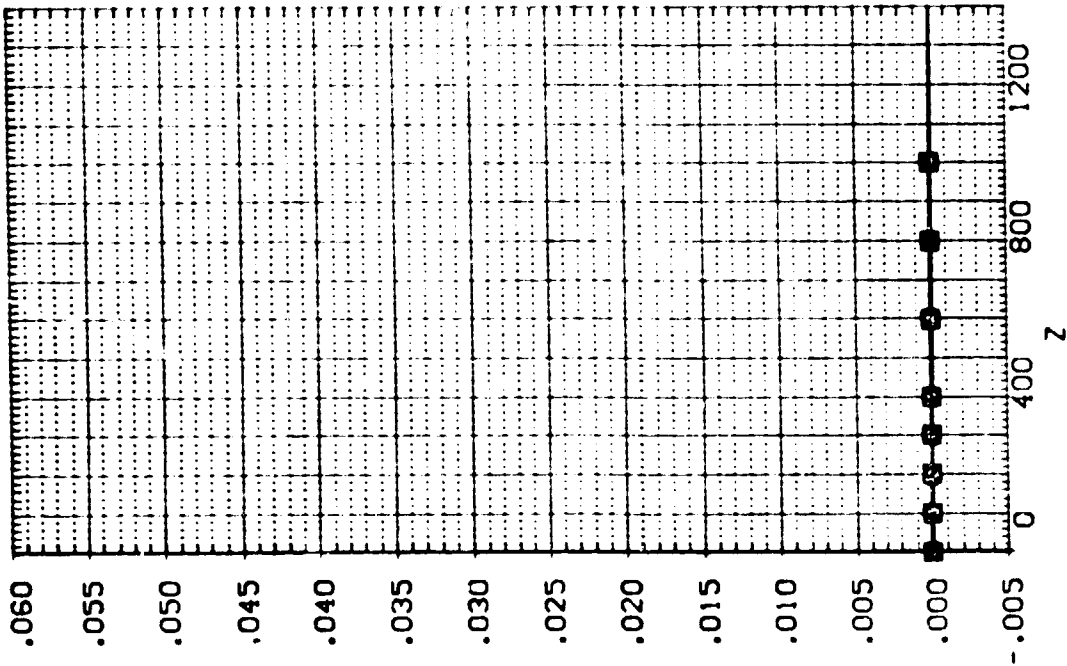

EXTERNAL TANK AERODYNAMIC CHARACTERISTICS DURING SEPARATION FROM ORBITER

1A:3:EXTERNAL TANK(T10)SEPARATING FROM ORB. 09 (RTJT97)

SEE THE ASSOCIATED DATA DOCUMENT FOR REFERENCE CHARACTERISTICS FOR INDIVIDUAL DATASETS

SYMBOL	X	MACH	PARAMETRIC VALUES
()	.174	4.530	TOTAL 110.000
()	400.390	.000	BETA .000
()	870.570	.000	DRIFT .000
()	1200.800	-40.000	ALTRON .000
			Y .000

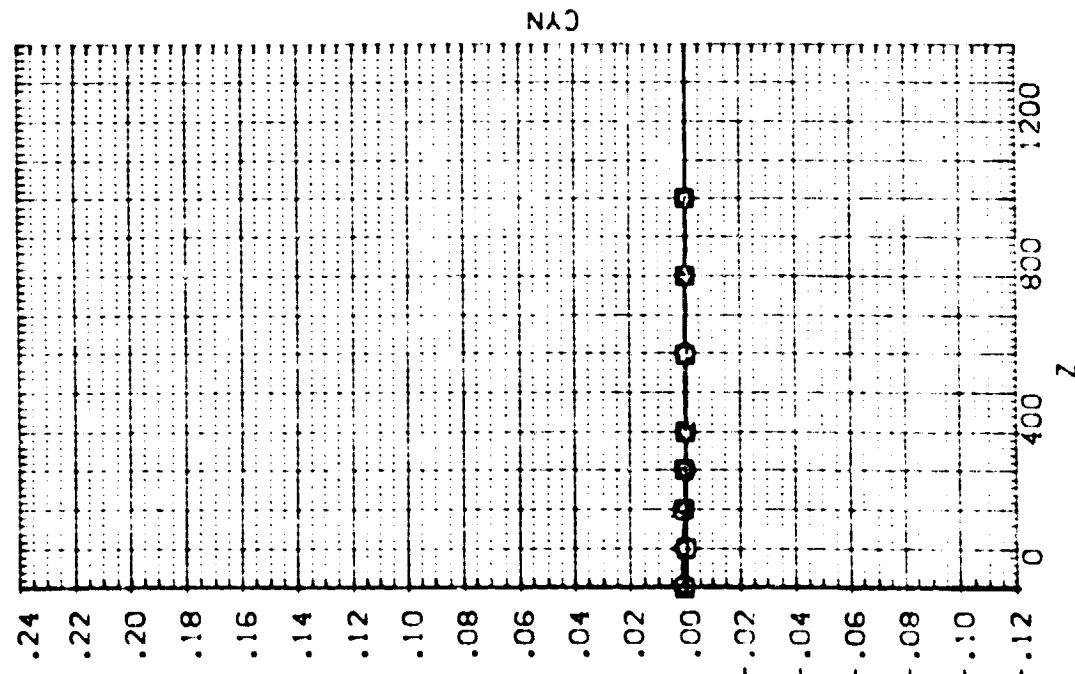
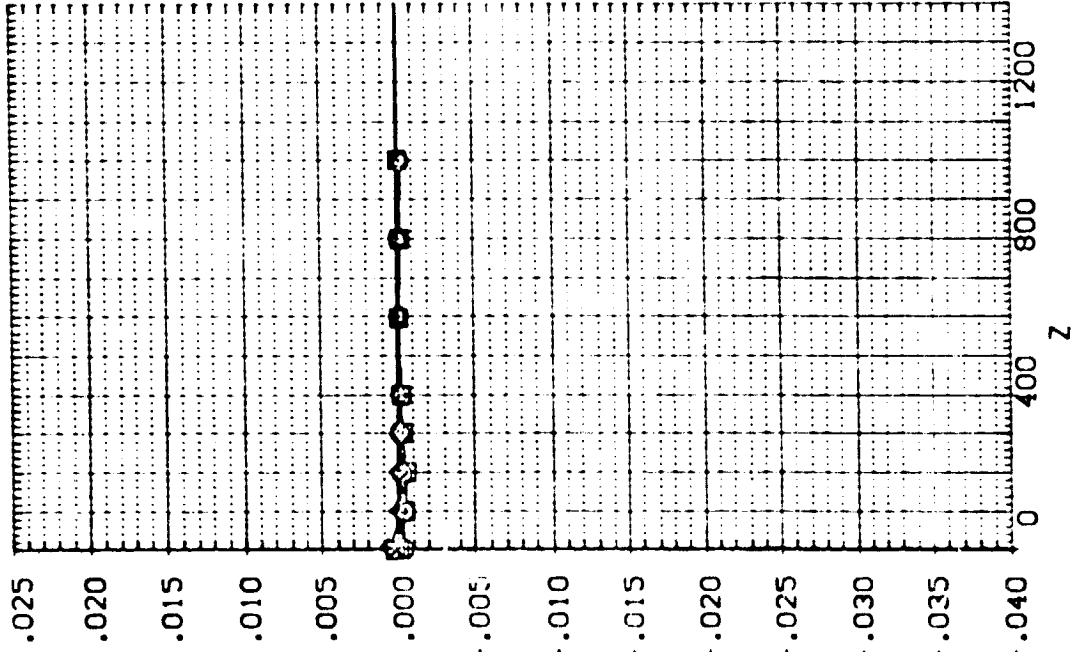

TA13. EXTERNAL TANK(T10) SEPARATING FROM ORB. 05 (RTJT98)

SEE THE ASSOCIATED DATA DOCUMENT FOR REFERENCE CHARACTERISTICS FOR INDIVIDUAL DATASETS

PARAMETRIC VALUES	
MACH	4.530
PTOTAL	110.000
BETA	.000
DBETA	.000
ALPHA	.000
DALPHA	-10.000
ALLRON	.000
ELEVTR	-40.000
Y	.000

-
-
- ◇
- △

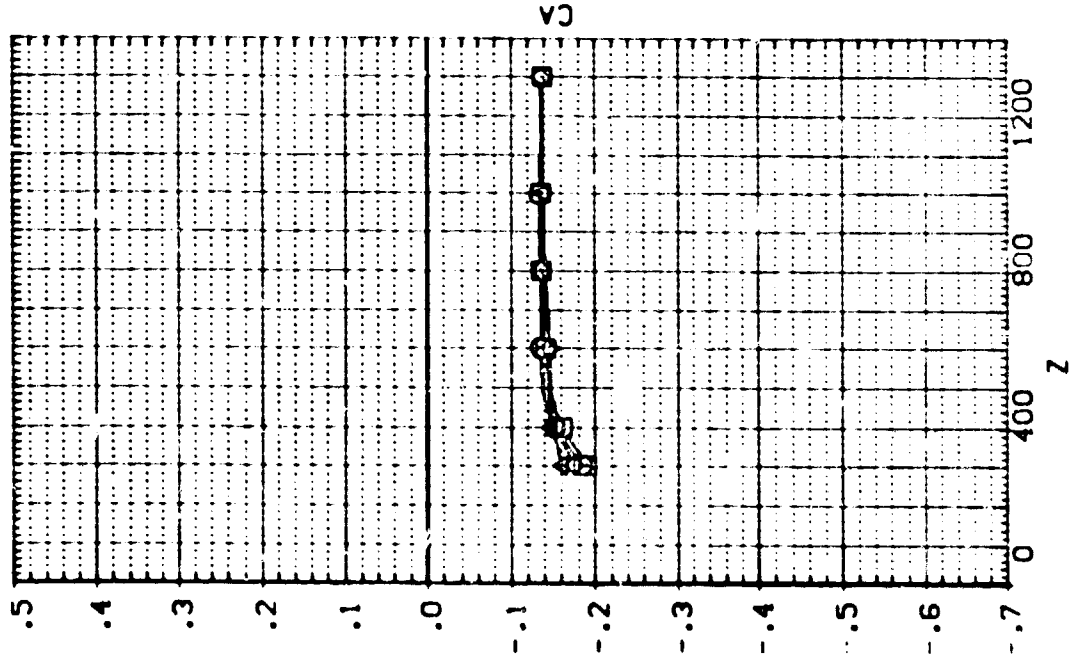
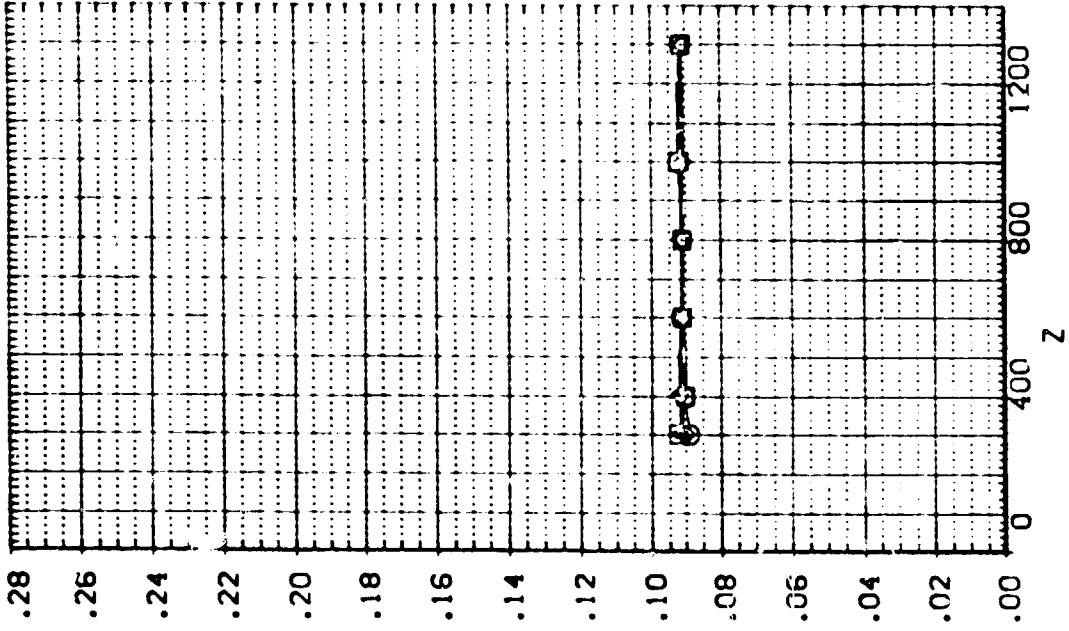

EXTERNAL TANK AERODYNAMIC CHARACTERISTICS DURING SEPARATION FROM ORBITER

IA13.EXTERNAL TANK(T10)SEPARATING FROM ORB. 09 (RTJT98)

SEE THE ASSOCIATED DATA DOCUMENT FOR REFERENCE CHARACTERISTICS FOR INDIVIDUAL DATASETS

SYMBOL		PARAMETRIC VALUES			
x	.150	MACH	4.530	PTOTAL	110.000
o	400.460	ALPHA	.000	BETA	.000
□	800.710	DALPHA	-10.000	DBETA	.000
△	1200.900	ELEVTR	-40.000	AILRON	.000
		Y	.000		

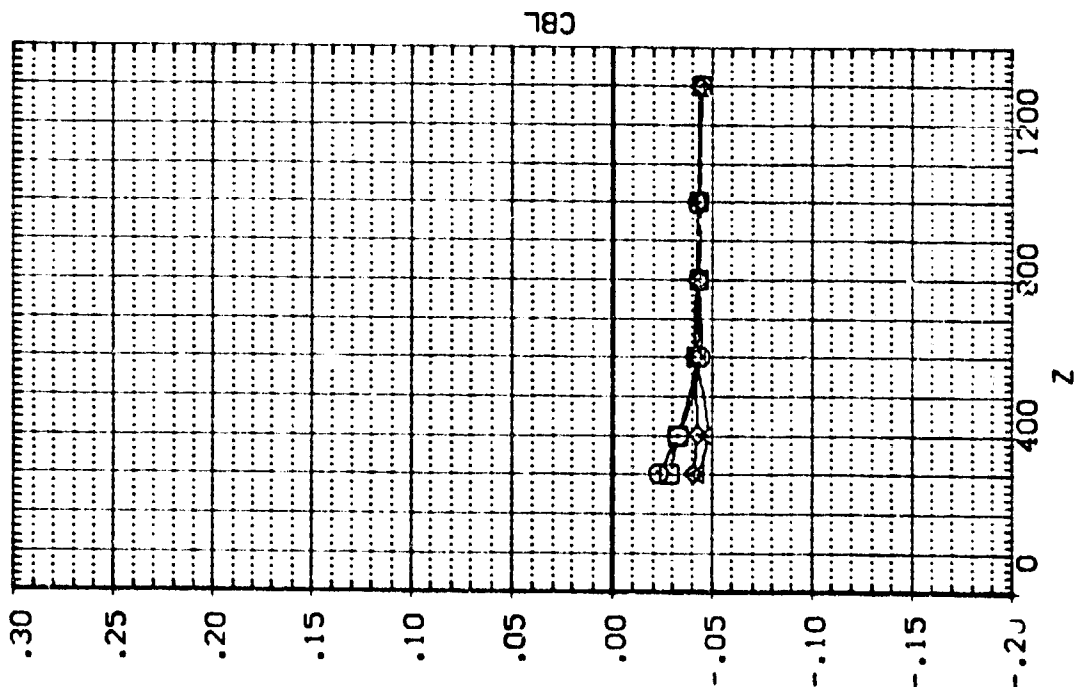
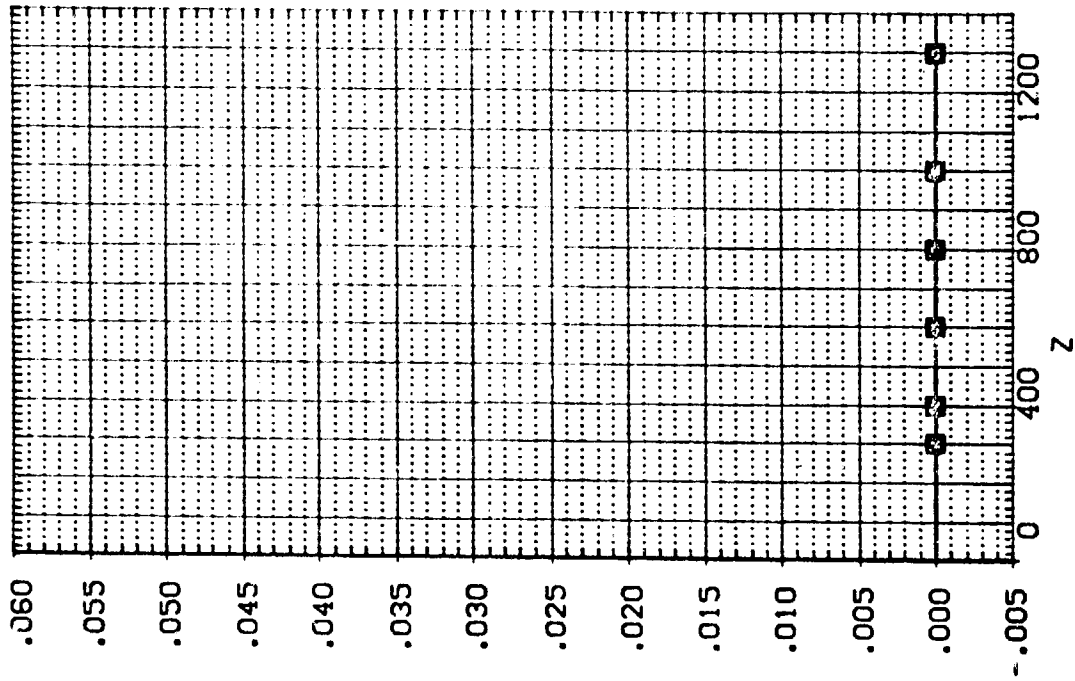

IA13.EXTERNAL TANK(T10)SEPARATING FROM ORB. 09 (RTJT98)

SEE THE ASSOCIATED DATA DOCUMENT FOR REFERENCE CHARACTERISTICS FOR INDIVIDUAL DATASETS

SYMBOL		PARAMETRIC VALUES	
○	x	MACH	4.530
□	PIOTAL	BETA	110.000
◇	ALPHA	DBETA	.000
◇	800.710	ELEVTR	-10.000
△	1200.900	A1LRON	-40.000
	y		.000

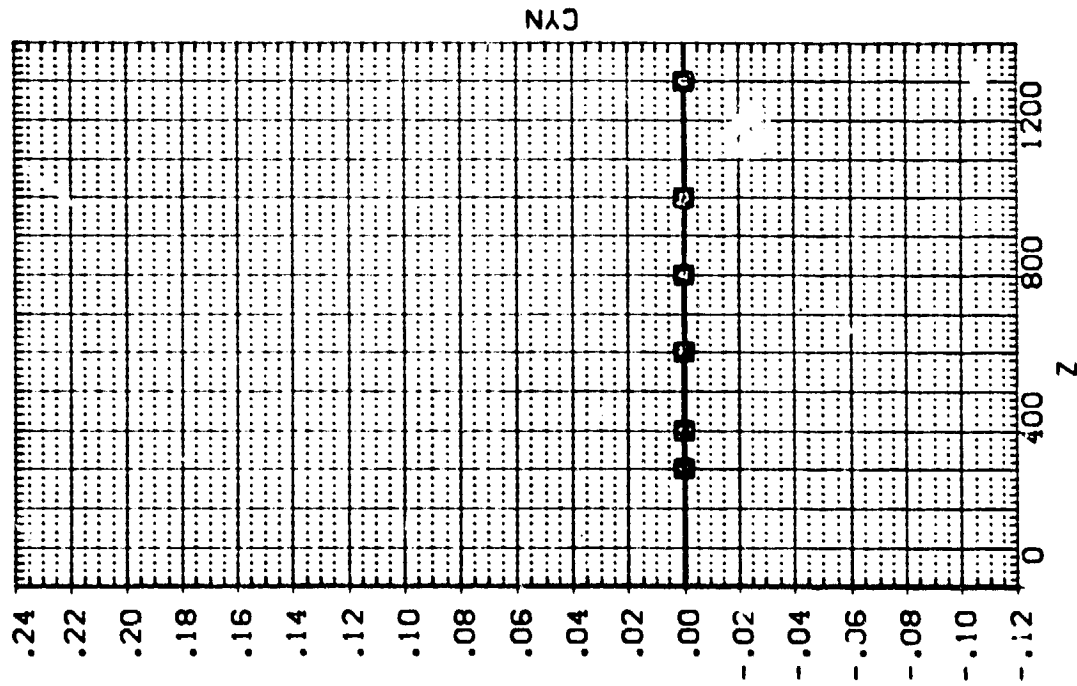
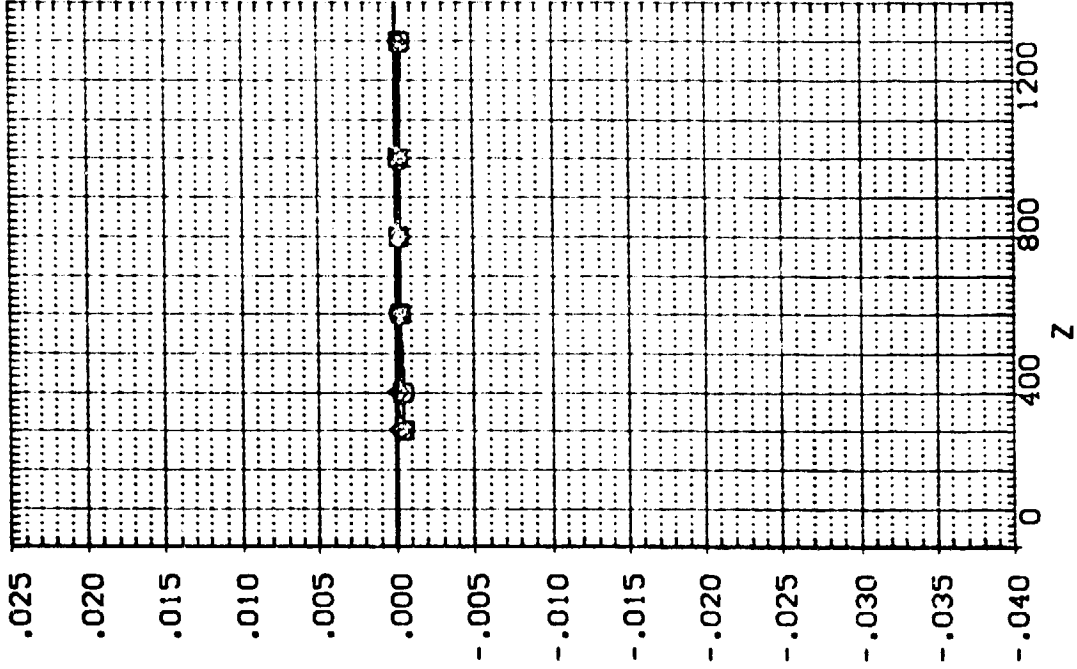

EXTERNAL TANK AERODYNAMIC CHARACTERISTICS DURING SEPARATION FROM ORBITER

IA13.EXTERNAL TANK(T10)SEPARATING FROM ORB. 09 (RTJT99)

SEE THE ASSOCIATED DATA DOCUMENT FOR REFERENCE CHARACTERISTICS FOR INDIVIDUAL DATASETS

SYMBOL		PARAMETRIC VALUES	
x	-0.717	MACH	4.530
o	401.410	ALPHA	.000
□	801.010	DALPHA	-20.000
△	1200.800	ELEVTR	-40.000
		PTOTAL	110.000
		BETA	.000
		DBETA	.000
		AILLRON	.000
		Y	.000

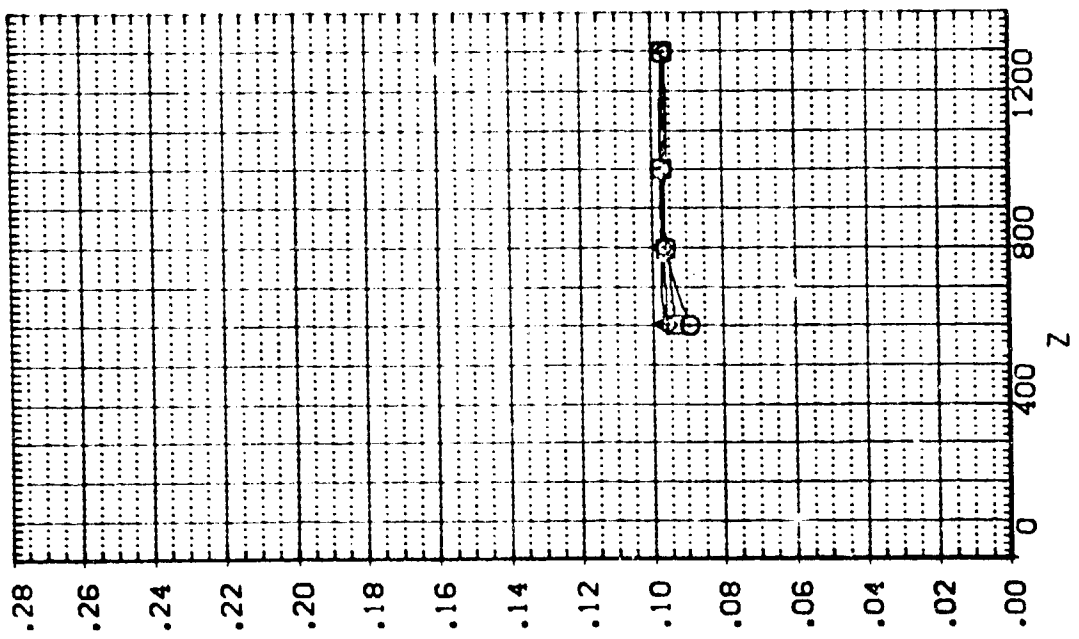
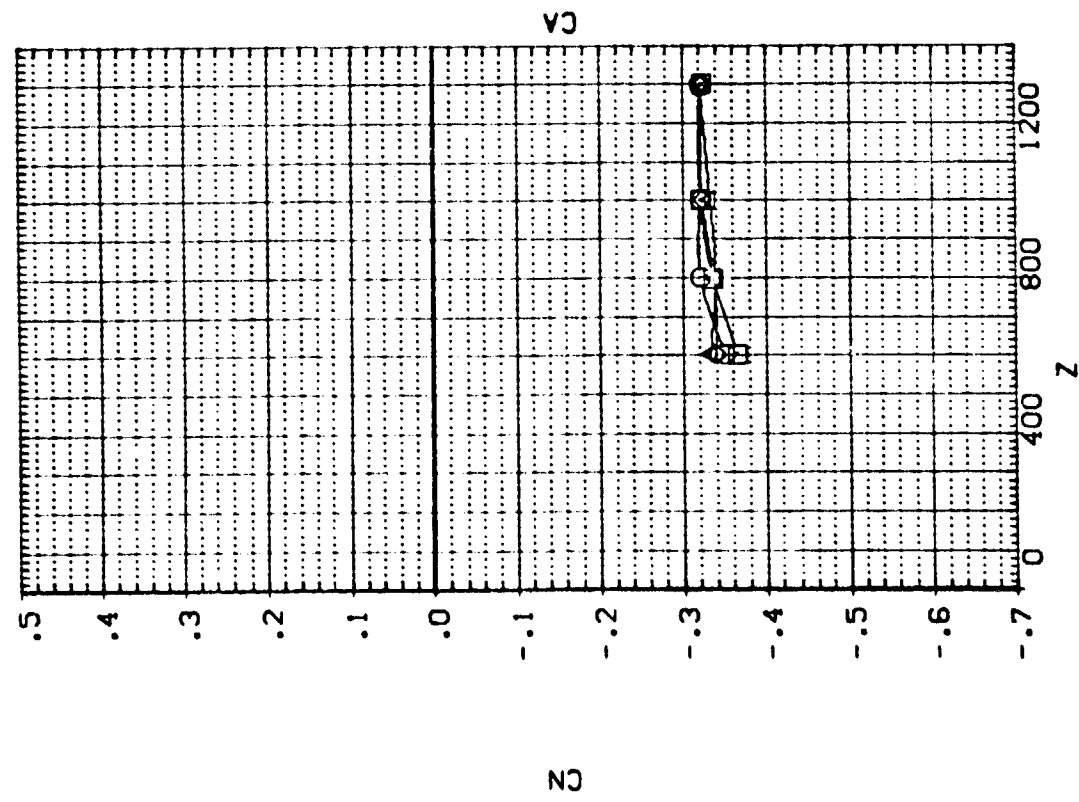

IA13.EXTERNAL TANK(T10)SEPARATING FROM ORB. 09 (RTJT99)

SEE THE ASSOCIATED DATA DOCUMENT FOR REFERENCE CHARACTERISTICS FOR INDIVIDUAL DATASETS

SYMBOL	X	MACH	PARAMETRIC VALUES
○	-0.717	4.530	PTOTAL 110.000
□	401.410	.000	BETA .000
◇	801.010	-20.000	DBETA .000
△	1200.800	-40.000	ALLRON .000
		Y	.000

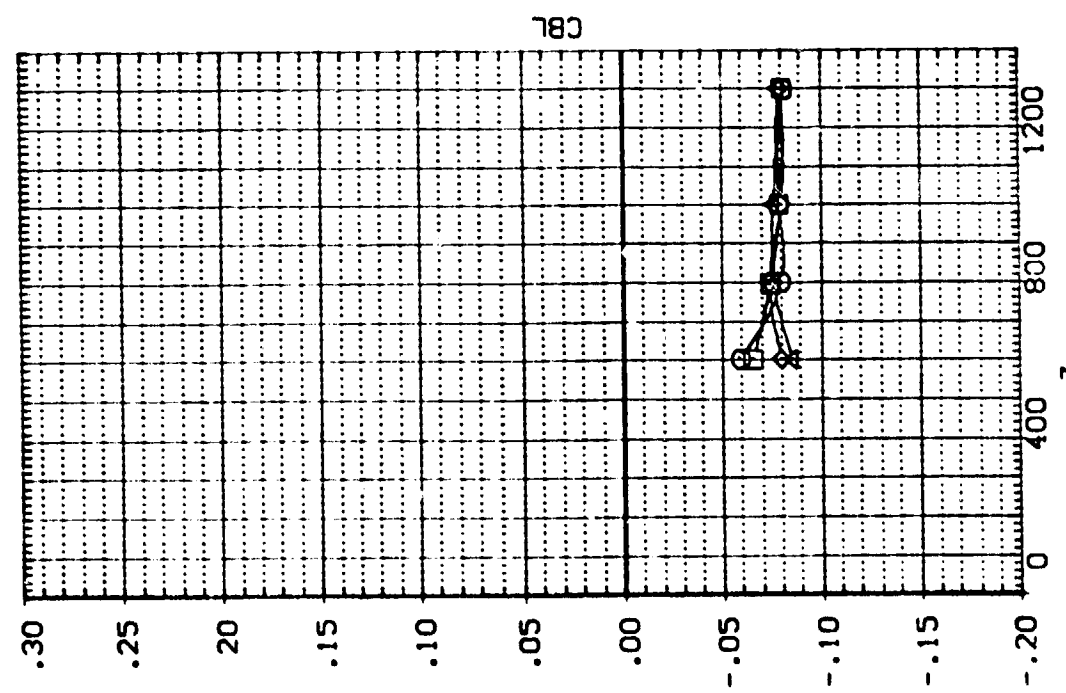
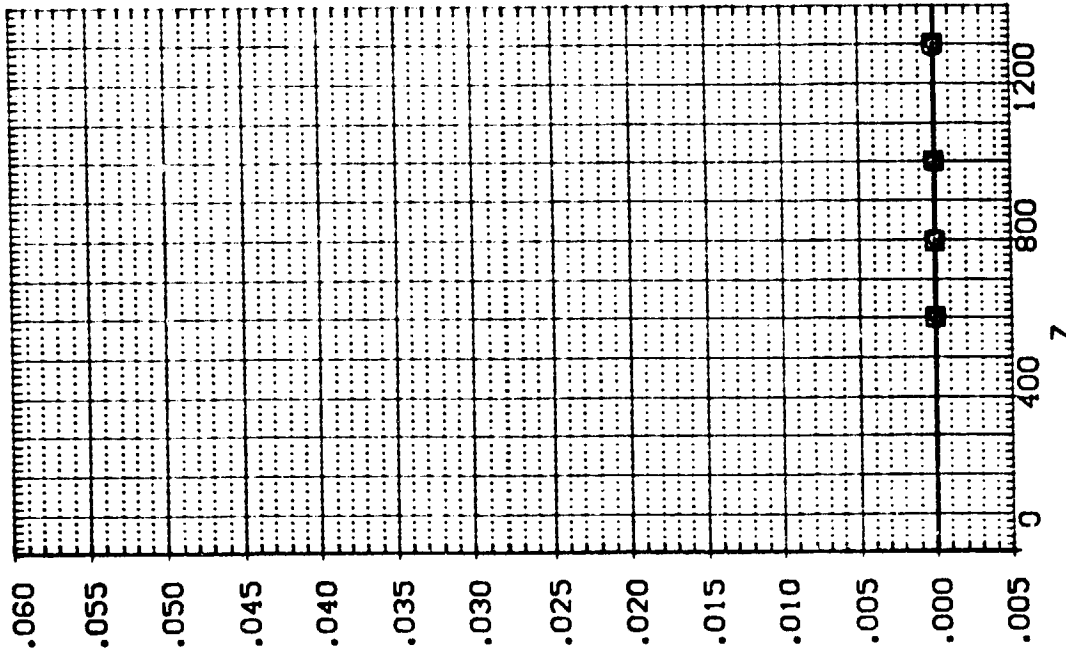

EXTERNAL TANK AERODYNAMIC CHARACTERISTICS DURING SEPARATION FROM ORBITER

1A13.EXTERNAL TANK(T10)SEPARATING FROM ORB. 09 (RTJT99)

SEE THE ASSOCIATED DATA DOCUMENT FOR REFERENCE CHARACTERISTICS FOR INDIVIDUAL DATASETS

SYMBOL		PARAMETRIC VALUES	
○	X	MACH	4.530
□	Y	ALPHA	.000
◇	Z	DALPHA	-20.000
△		ELEVTR	-40.000
		Y	.000
		PIDOTAL	110.000
		BETA	.000
		DBETA	.000
		A1LRON	.000

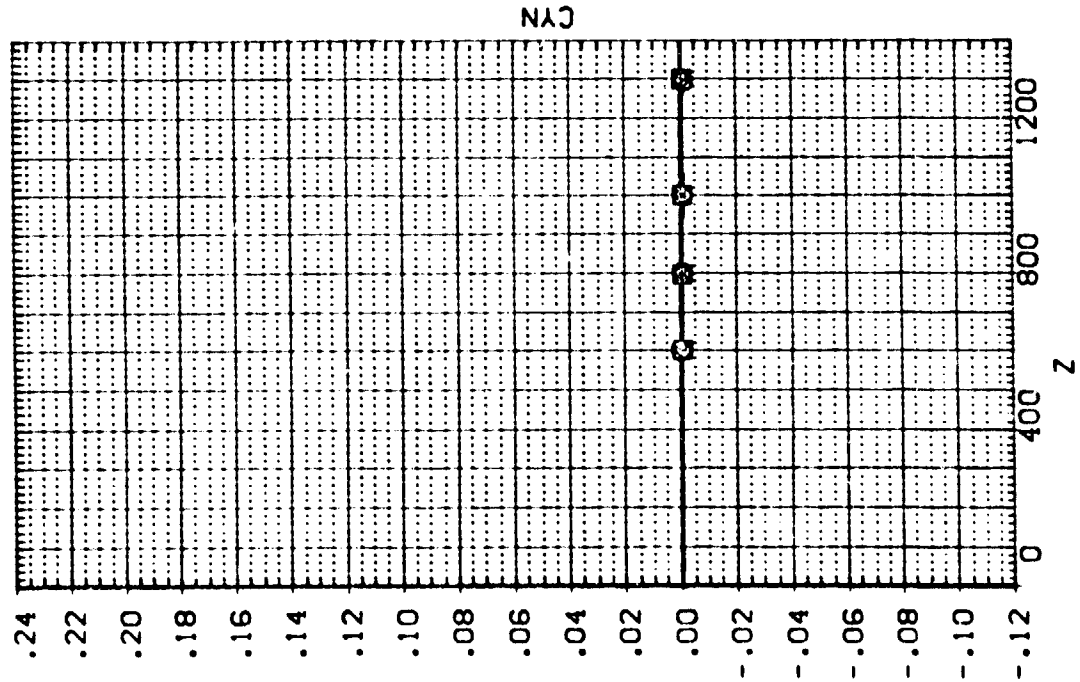
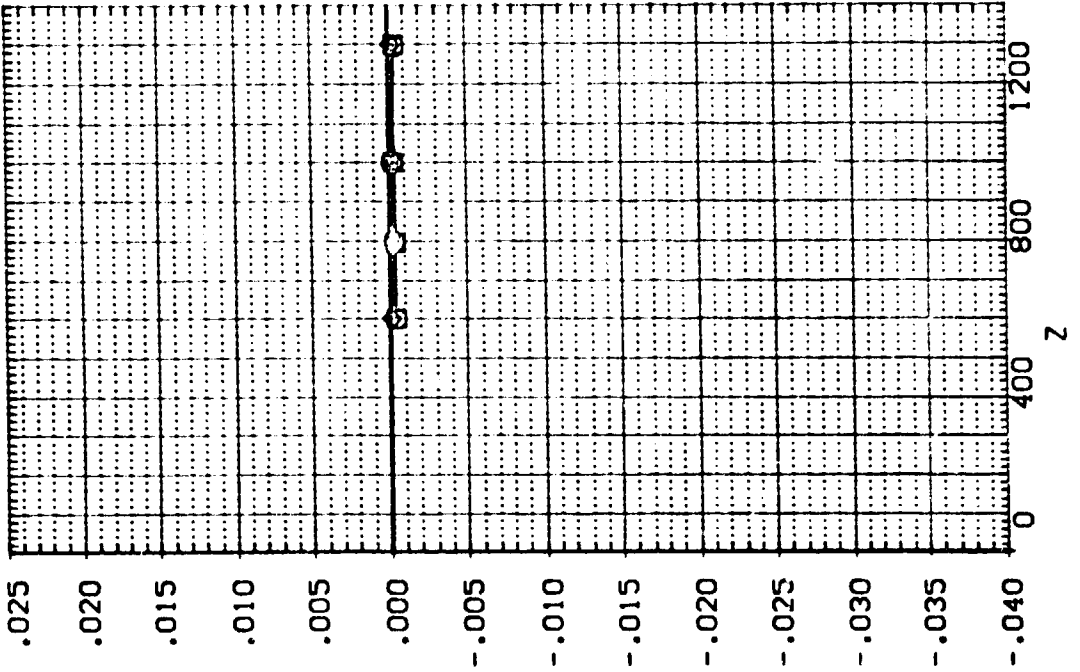

IA13 SRB(S8) W/O PLUMES SEPARATING FROM 09T10 (RTJ120)

SYMBOL
 ○
 □
 ◇
 △

PARAMETRIC VALUES
 X .253 MACH 4.530 PTOTAL 110.000
 300.420 ALPHA .000 BETA .000
 600.520 DALPHA .000 DBETA .000
 900.740 Y .000 PC-MBR .000

SEE THE ASSOCIATED DATA DOCUMENT FOR REFERENCE CHARACTERISTICS FOR INDIVIDUAL DATASETS

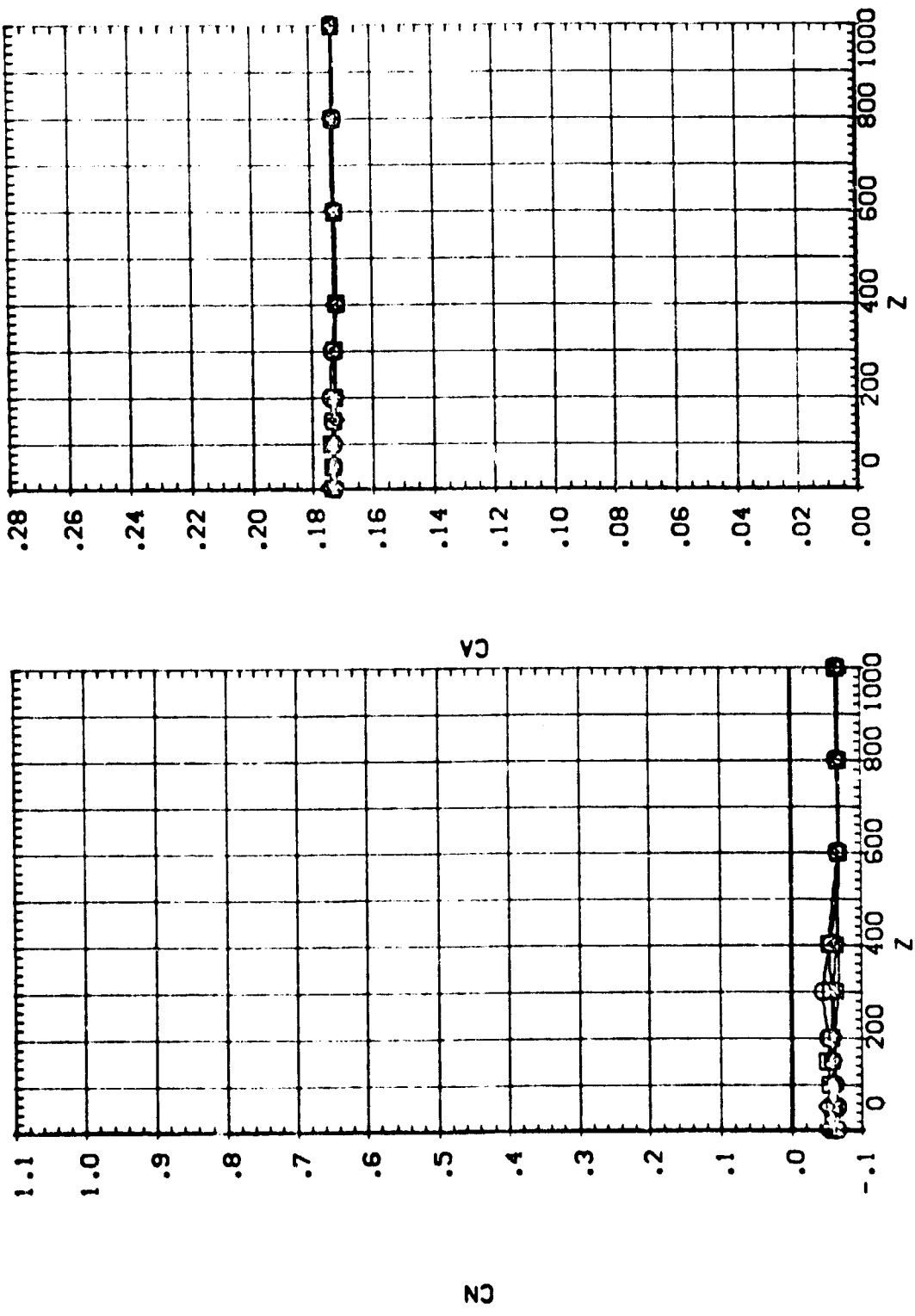

EFFECT OF SRB W/O PLUMES SEPARATION ON ORB/ET AERODYNAMIC CHARACTERISTICS

IA13 SRB(S8) W/O PLUMES SEPARATING FROM ORT.0 (RTJ120)

SEE THE ASSOCIATED DATA DOCUMENT FOR REFERENCE CHARACTERISTICS FOR INDIVIDUAL DATASETS

SYMBOL	X	MACH	PARAMETRIC VALUES
○	.253		4.530 PTOTAL 110.000
□	300.420	ALPHA	.000 BETA .000
◇	600.520	DALPHA	.000 DBETA .000
△	900.740	Y	.000 PC-MBR .000

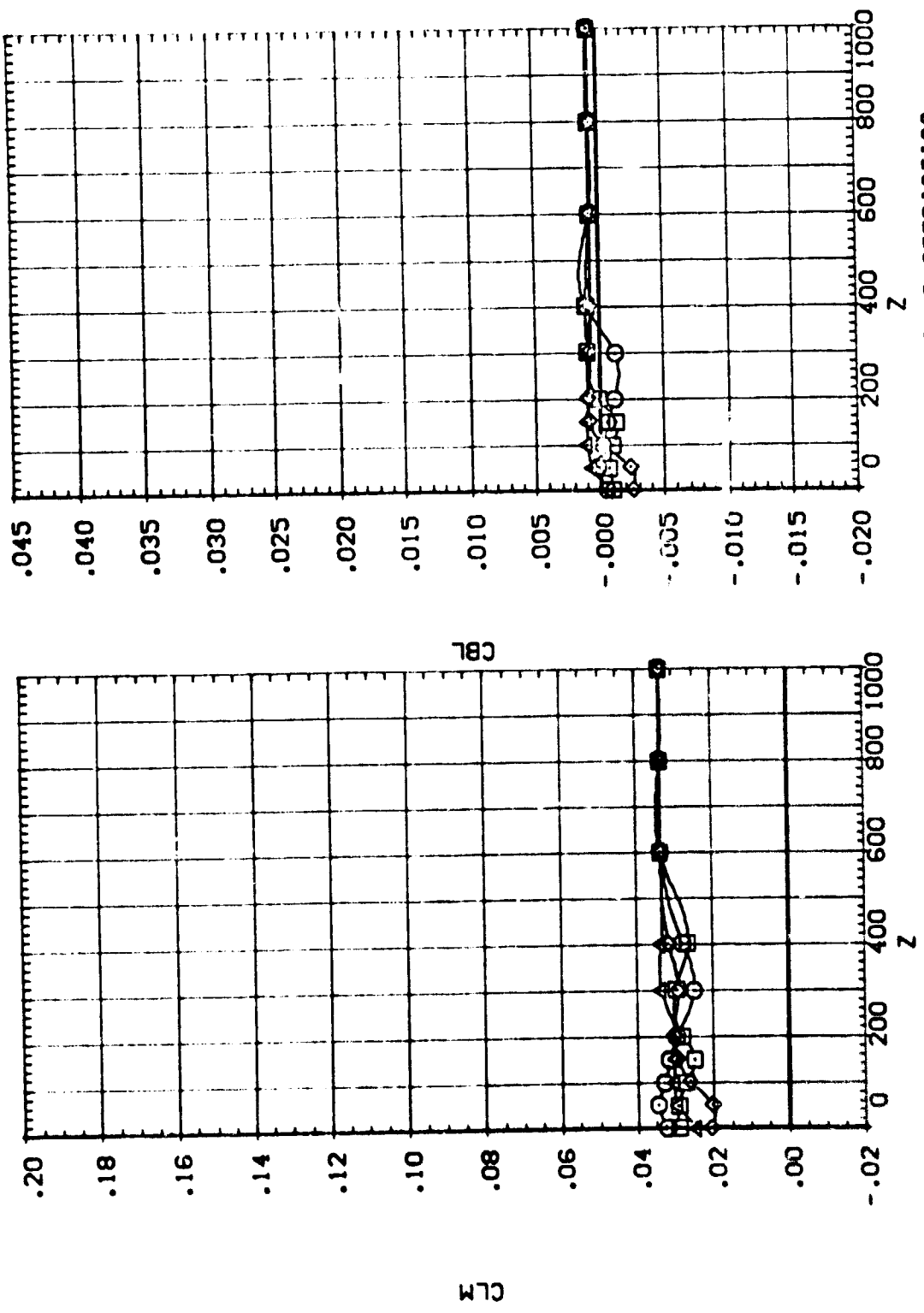

EFFECT OF SRB W/O PLUMES SEPARATION ON ORB/ET AERODYNAMIC CHARACTERISTICS

JA13 SRB(S8) W/O PLUMES SEPARATING FROM 09T10 (RTJ120)

SEE THE ASSOCIATED DATA DOCUMENT FOR REFERENCE CHARACTERISTICS FOR INDIVIDUAL DATASETS

SYMBOL	X	PARAMETRIC VALUES			
		MACH	PITOTAL	BETA	PC+PBR
○	.253	.530	110.000	.000	.000
□	300.420	.000	.000	.000	.000
◇	600.520	.000	.000	.000	.000
△	900.740	.000	.000	.000	.000

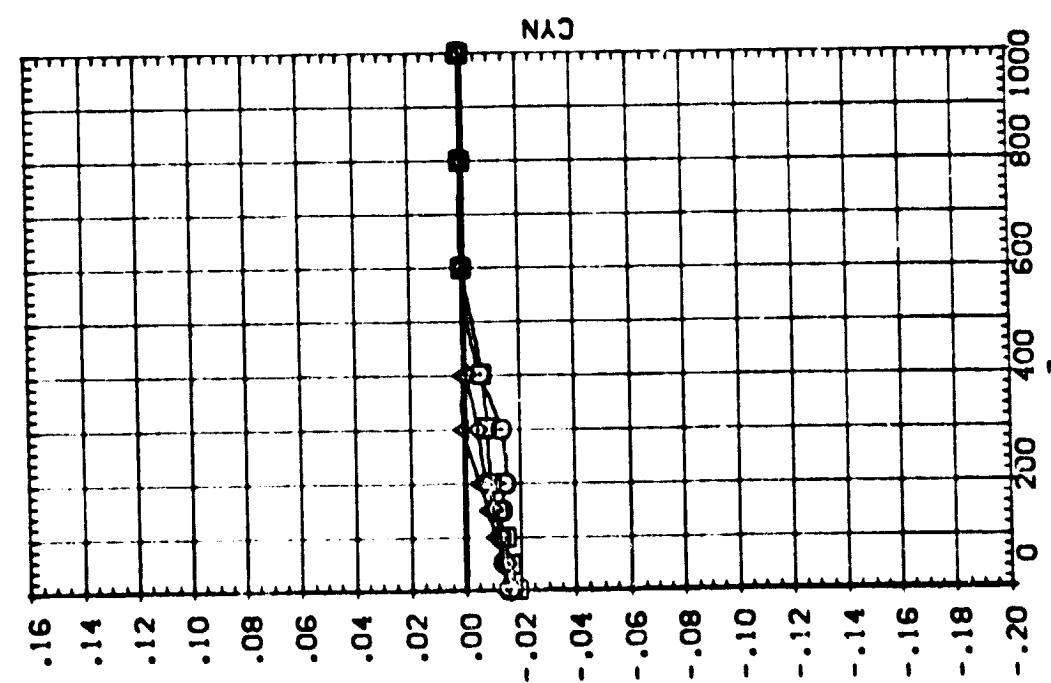
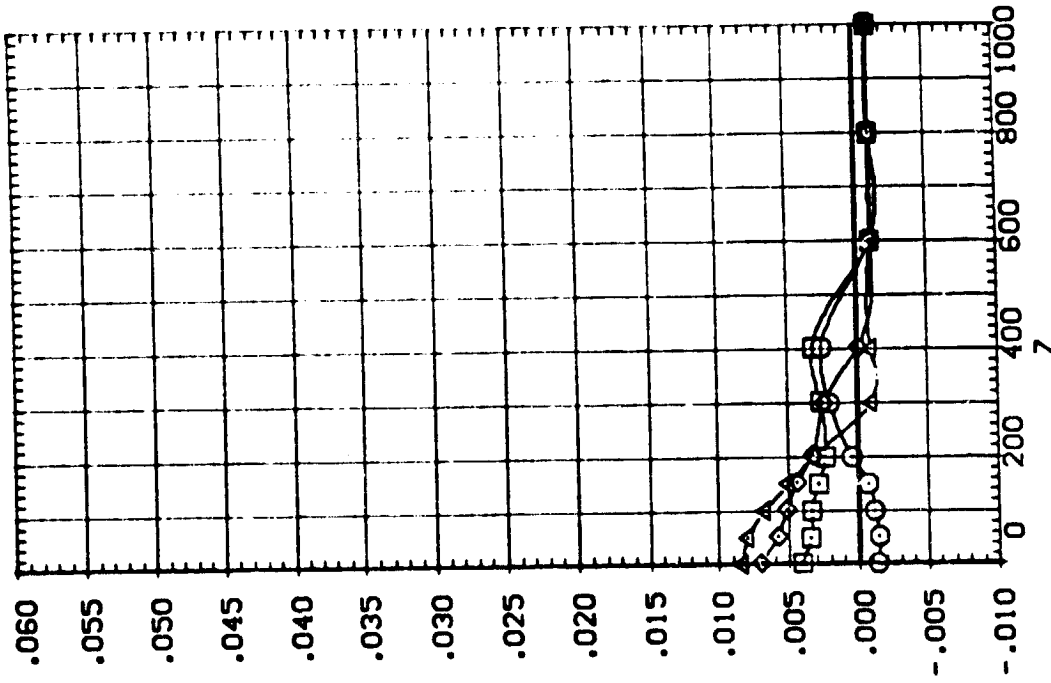

EFFECT OF SRB W/O PLUMES SEPARATION ON ORB/ET AERODYNAMIC CHARACTERISTICS

[A13 SRB(S8) W/O PLUMES SEPARATING FROM 09T10 (RTJ121)]

SEE THE ASSOCIATED DATA DOCUMENT FOR REFERENCE CHARACTERISTICS FOR INDIVIDUAL DATASETS

SYM-BOL	X	PARAMETRIC VALUES			
		MACH	PITOTAL	BETA	PC+PBR
○	.318	4.530	110.000	.000	.000
□	300.450	.000	.000	.000	.000
◇	600.480	.000	.000	.000	.000
△	900.590	200.000	.000	.000	.000

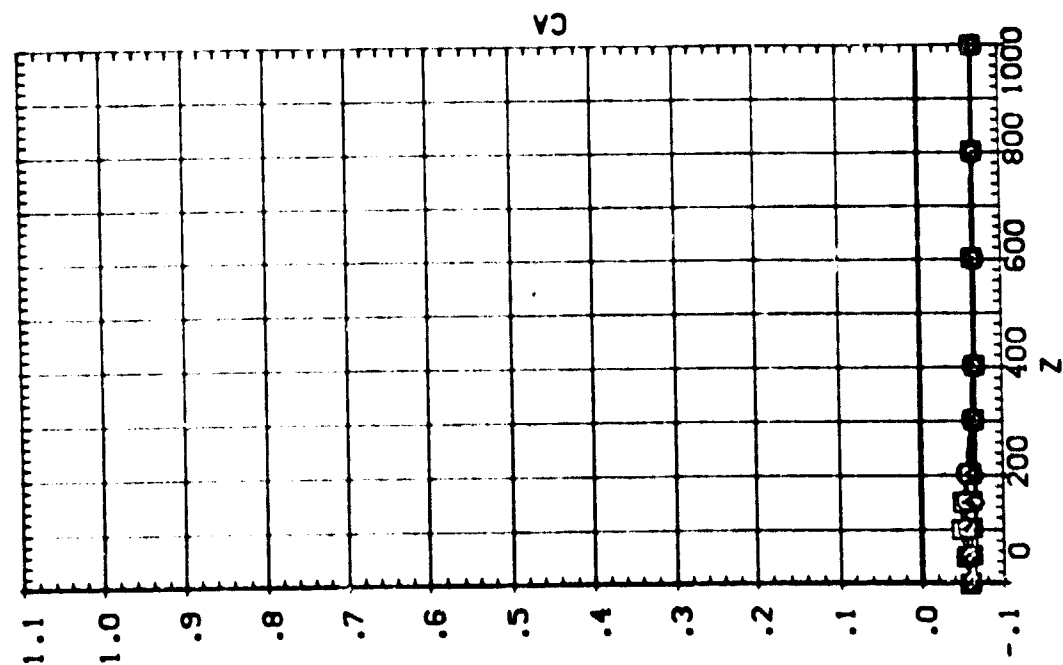
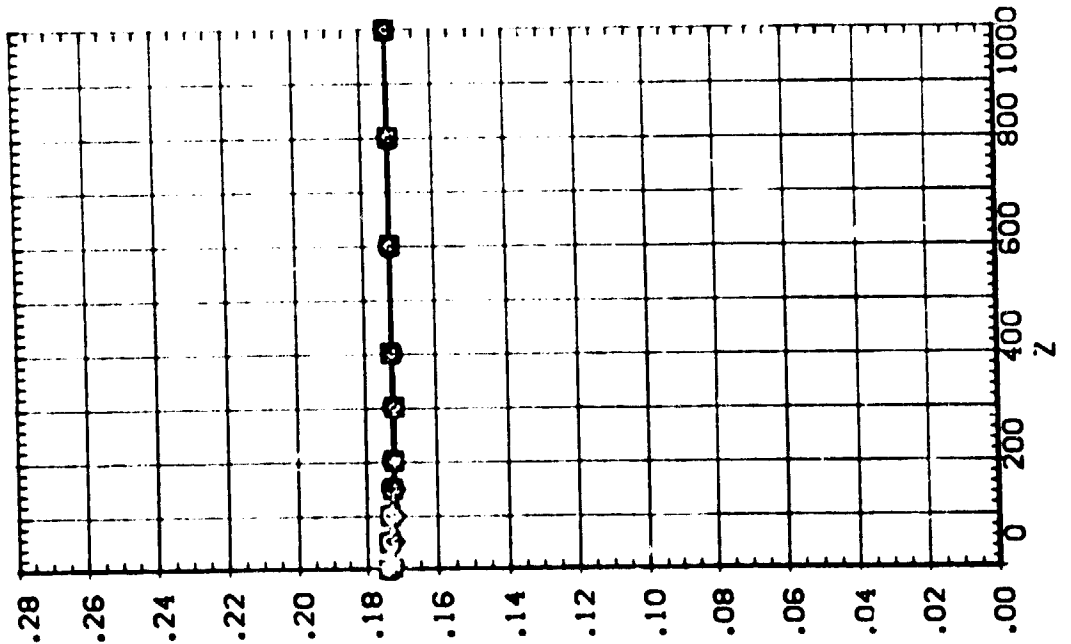

EFFECT OF SRB W/O PLUMES SEPARATION ON ORB/ET AERODYNAMIC CHARACTERISTICS

IA13 SRB(S8) W/O PLUMES SEPARATING FROM 09T10 (RTJ121)

SEE THE ASSOCIATED DATA DOCUMENT FOR REFERENCE CHARACTERISTICS FOR INDIVIDUAL DATASETS

SYMBOL		PARAMETRIC VALUES				
○	X	.318	MACH	4.530	PTOTAL	110.000
□	300.150	.000	ALPHA	.000	BETA	.000
◇	600.480	.000	DALPHA	.000	DBETA	.000
△	900.590	200.000	Y	PC-PBR		.000

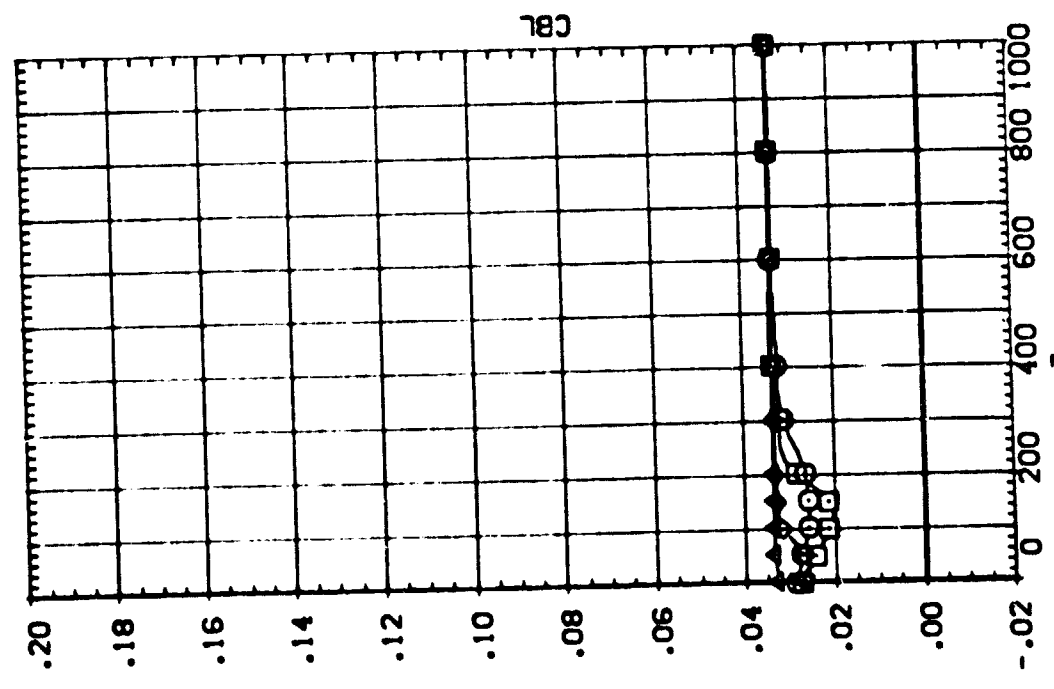
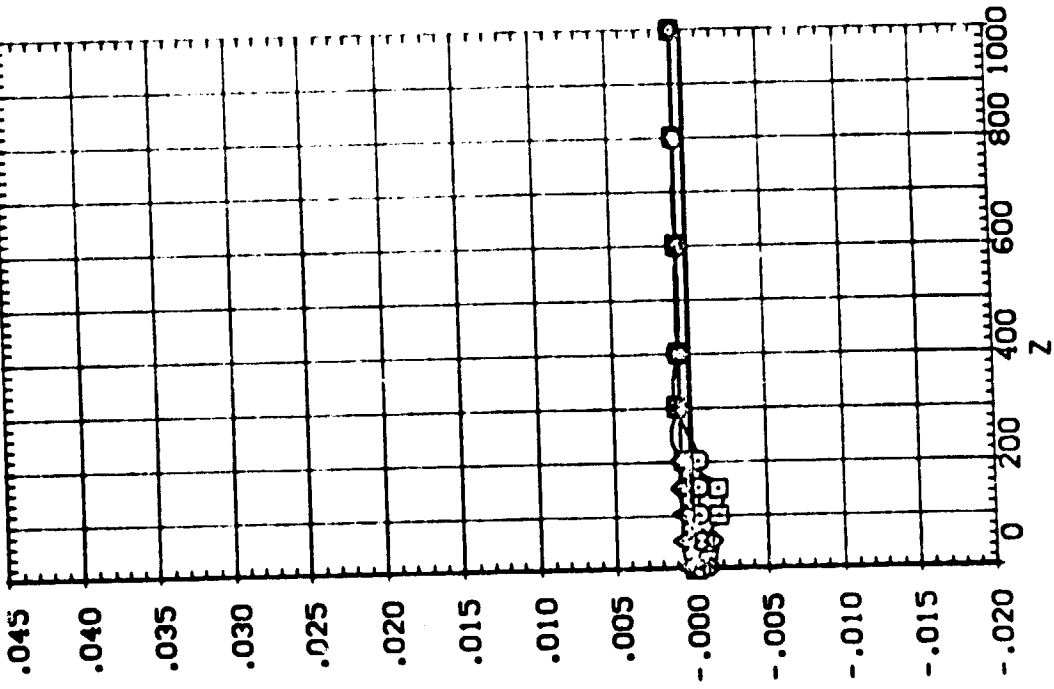

EFFECT OF SRB W/O PLUMES SEPARATION ON ORB/ET AERODYNAMIC CHARACTERISTICS

IA13 SRB(S8) W/O PLUMES SEPARATING FROM 09T10 (RTJ121)

SEE THE ASSOCIATED DATA DOCUMENT FOR REFERENCE CHARACTERISTICS FOR INDIVIDUAL DATASETS

SYMBOL	X	MACH	PIOTAL	110.000
□	300.450	ALPHA	.000	BETA
◇	607.480	DALPHA	.000	DBETA
△	900.550	Y	200.000	PC-MFR

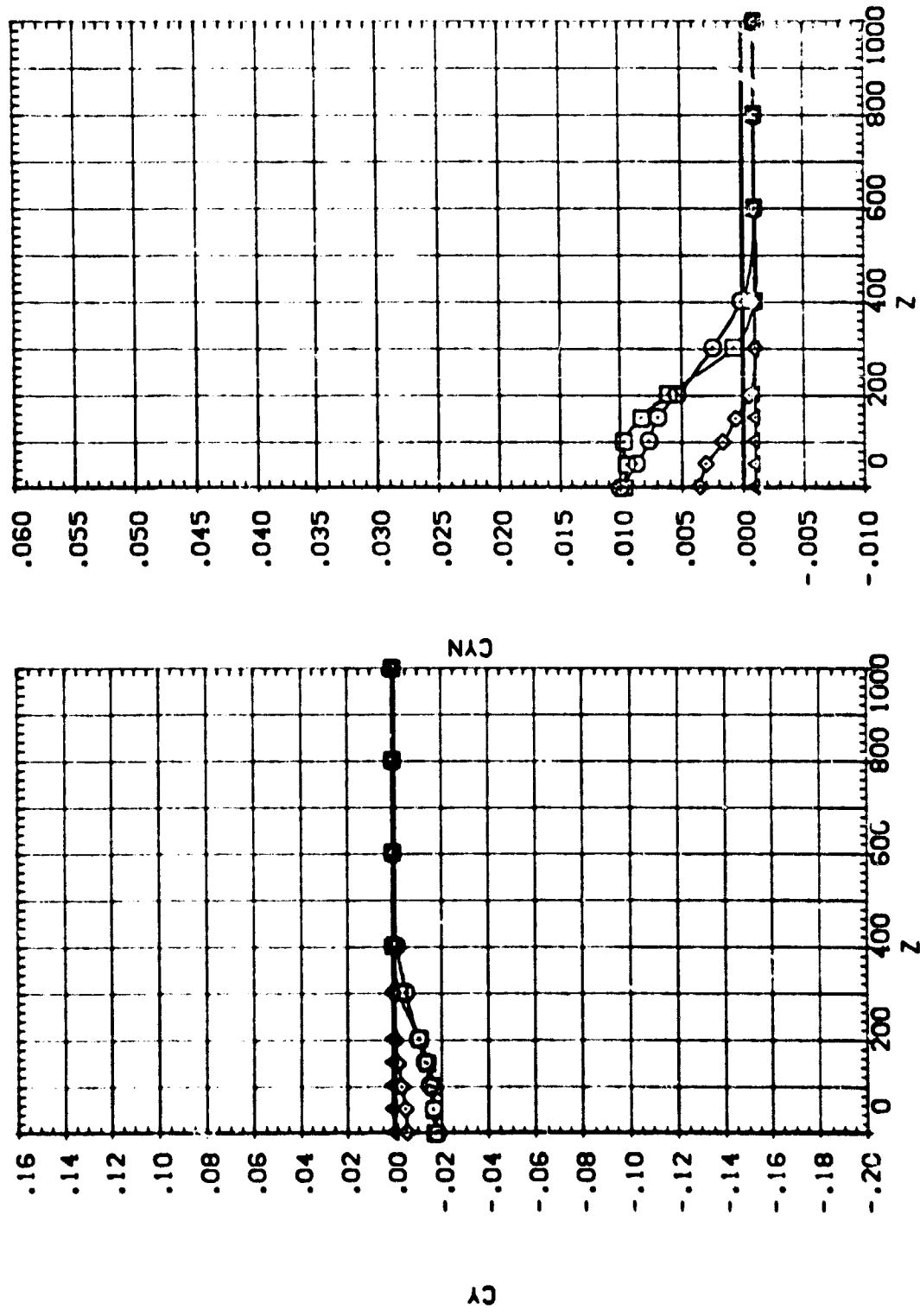

IA13 SRB(S8) W/O PLUMES SEPARATING FROM ORT:O (RTJ122)

SYMBOL

-
-
- ◇
- △

X
 .248
 300.350
 600.530
 900.670

PARAMETRIC VALUES
 MACH
 ALPHA
 DIALPHA
 Y

110.000
 .000
 .000
 .000

SEE THE ASSOCIATED DATA DOCUMENT FOR REFERENCE CHARACTERISTICS FOR INDIVIDUAL DATASETS

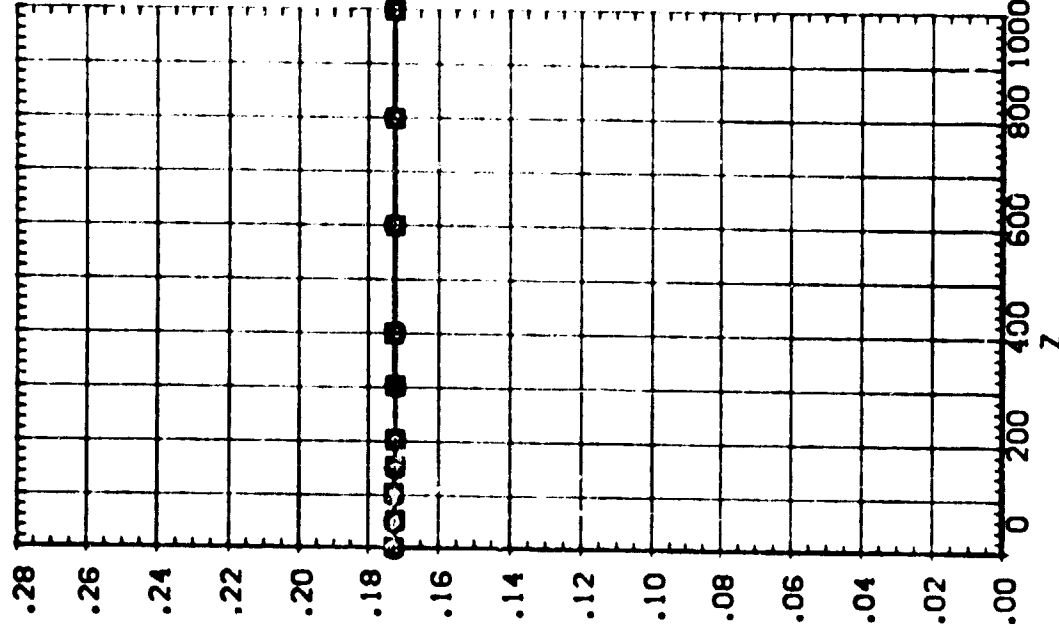
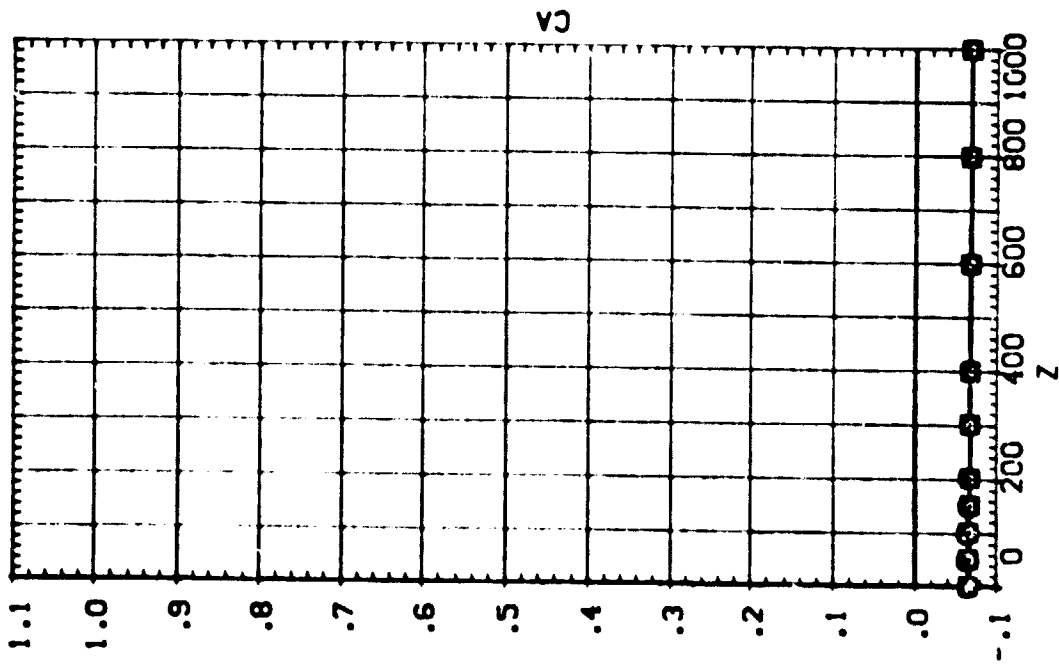

EFFECT OF SRB W/O PLUMES SEPARATION ON ORB/ET AERODYNAMIC CHARACTERISTICS



IA13 SR8(S8) W/O PLUMES SEPARATING FROM 09T10 (RTJ122)

SYMBOL

-
-
- ◇
- △

PARAMETRIC VALUES

X	MACH	PTOTAL	110.000
.248	4.530	BETA	.000
300.390	.000	DBETA	.000
600.530	.000	PC-PBR	.000
900.670	400.000		

SEE THE ASSOCIATED DATA DOCUMENT FOR REFERENCE CHARACTERISTICS FOR INDIVIDUAL DATASETS

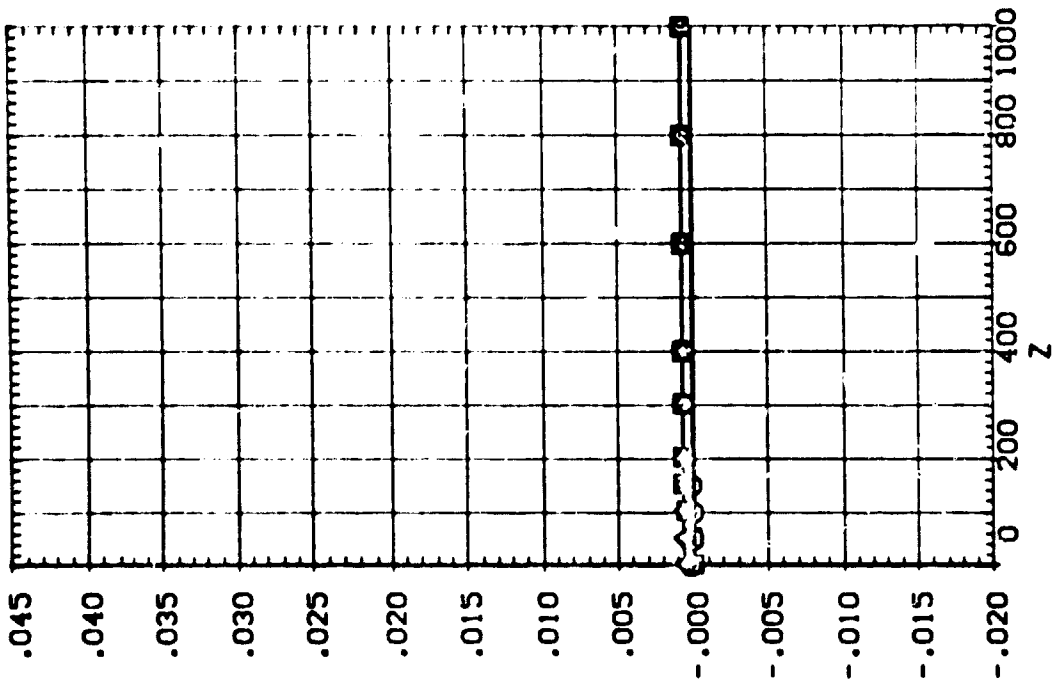
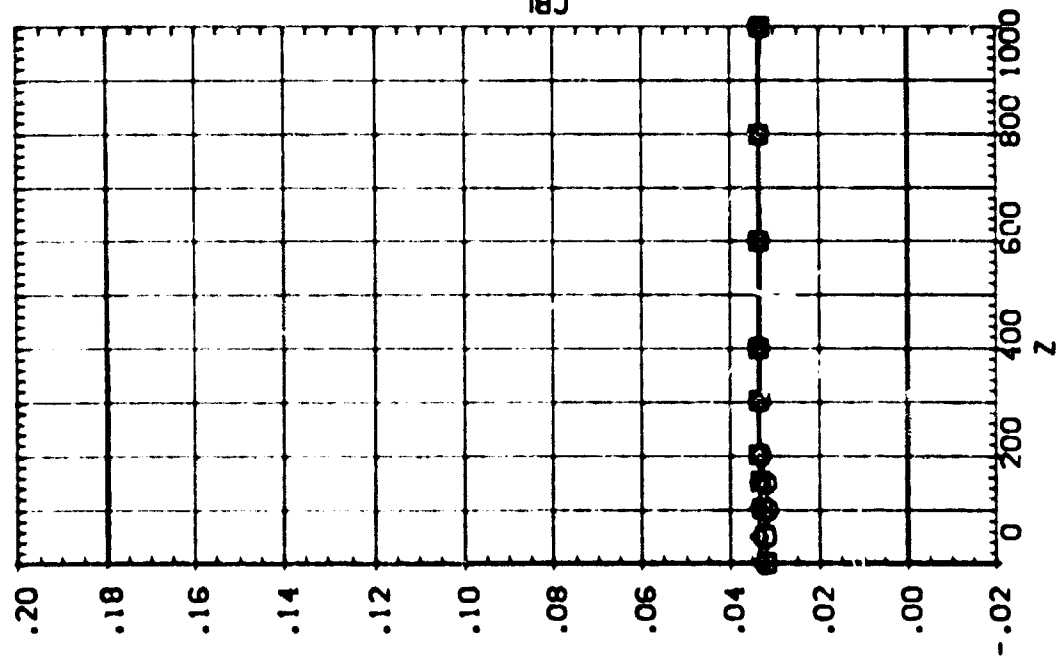

EFFECT OF SR8 W/O PLUMES SEPARATION ON ORB/ET AERODYNAMIC CHARACTERISTICS

IA13 SRB(S8) W/O PLUMES SEPARATING FROM 09T10 (RTJ122)

SYMBOL X
 ○ 300.350
 □ 600.530
 ◇ 900.670

PARAMETRIC VALUES
 MACH 4.530
 ALPHA .000
 DALP-A .000
 Y 400.000
 PTOTAL 110.000
 BETA .000
 DBETA .000
 POW-PR .000

SEE THE ASSOCIATED DATA DOCUMENT FOR REFERENCE CHARACTERISTICS FOR INDIVIDUAL DATASETS

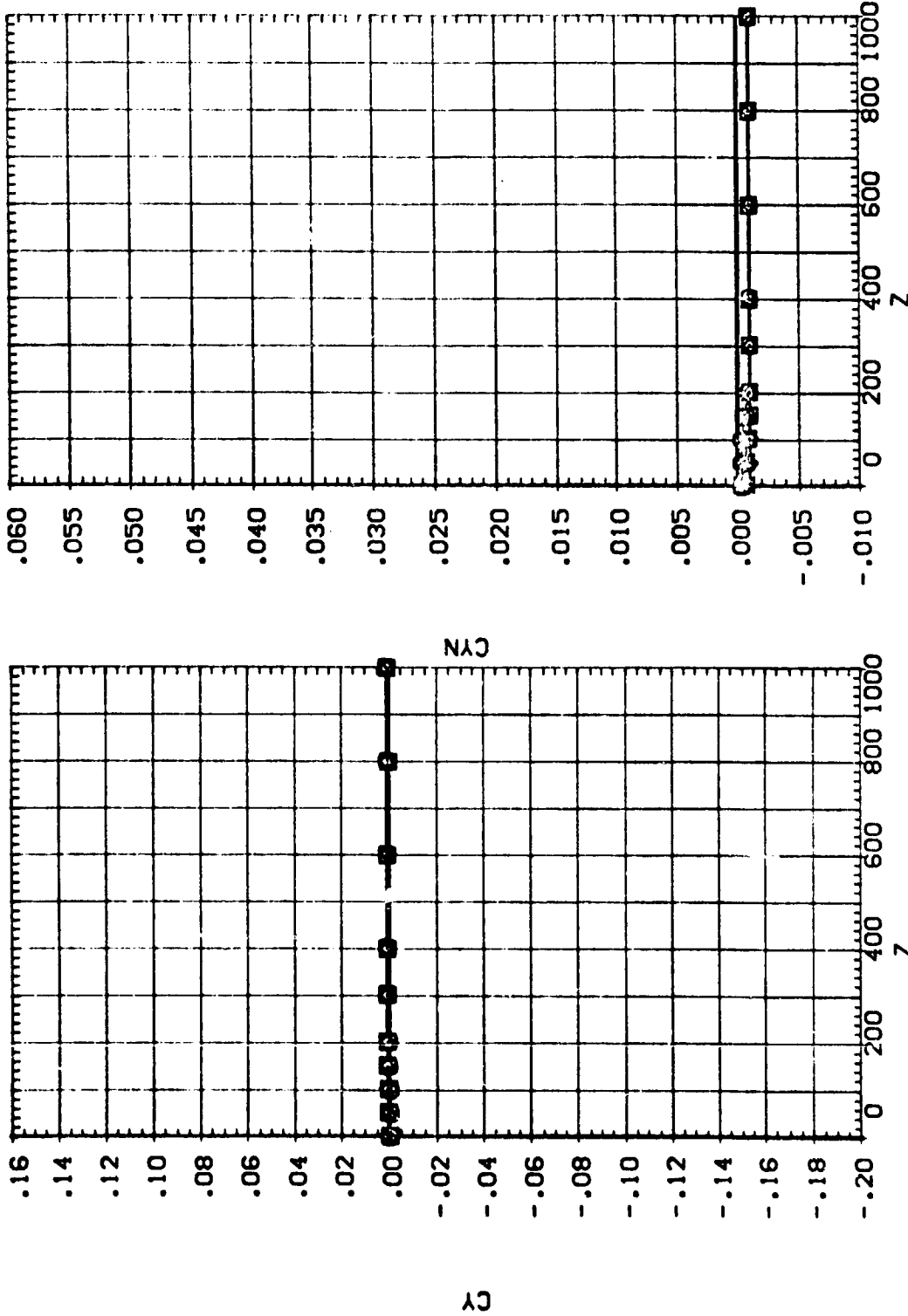

EFFECT OF SRB W/O PLUMES SEPARATION ON ORB/ET AERODYNAMIC CHARACTERISTICS

IA13 SRB(S8) W/O PLUMES SEPARATING FROM 09T10 (RTJ123)

SYMBOL X
 ○
 □
 ◇
 △

PARAMETRIC VALUES
 MACH 4.530 PTOTAL 110.000
 ALPHA .000 BETA .000
 DALPHA .000 DBETA .000
 Y 800.000 PC*BR .000

SEE THE ASSOCIATED DATA
 DOCUMENT FOR REFERENCE
 CHARACTERISTICS FOR
 INDIVIDUAL DATASETS

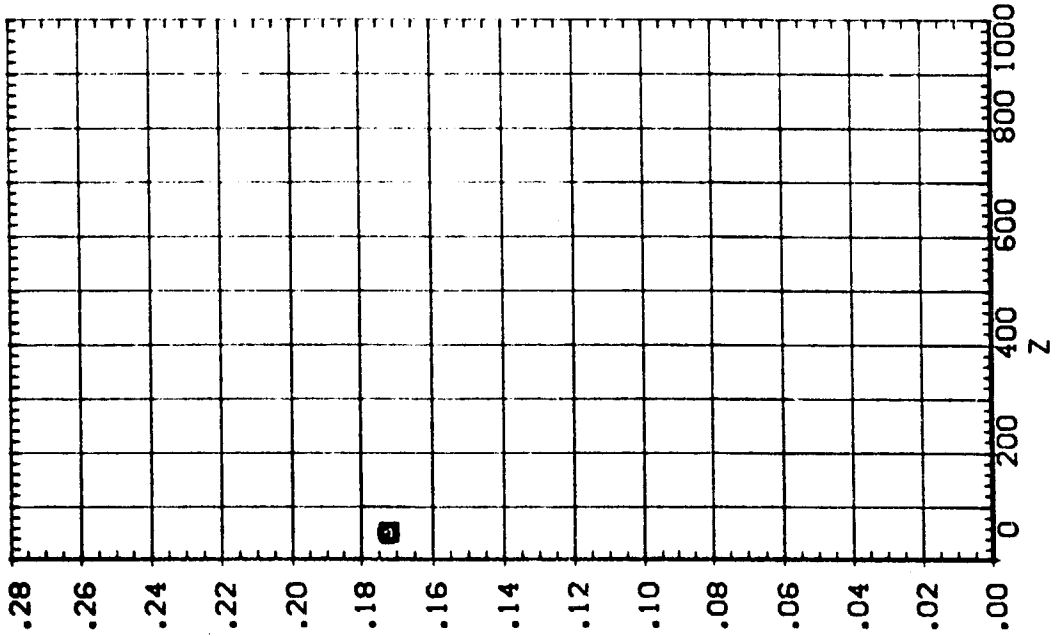
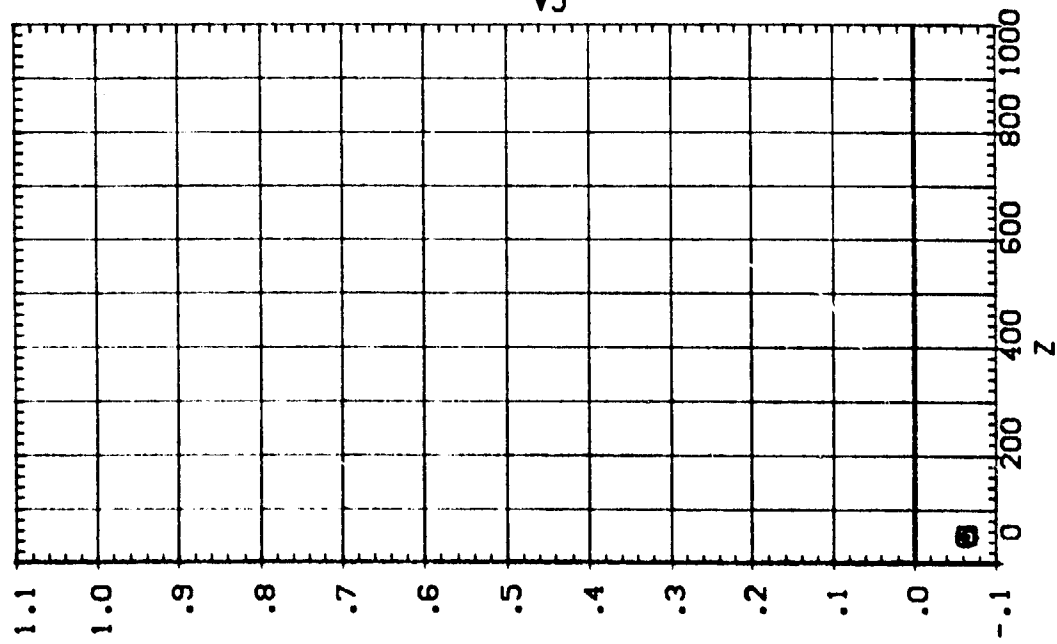

3

IA13 SRB(S8) W/O PLUMES SEPARATING FROM 09T10 (RTJ123)

SEE THE ASSOCIATED DATA DOCUMENT FOR REFERENCE CHARACTERISTICS FOR INDIVIDUAL DATASETS

SYMBOL		PARAMETRIC VALUES			
○	X	MACH	4.530	PTOTAL	110.000
□		ALPHA	.000	BETA	.000
◇		DALPHA	.000	DBETA	.000
△		Y	800.000	PC-MBR	.000

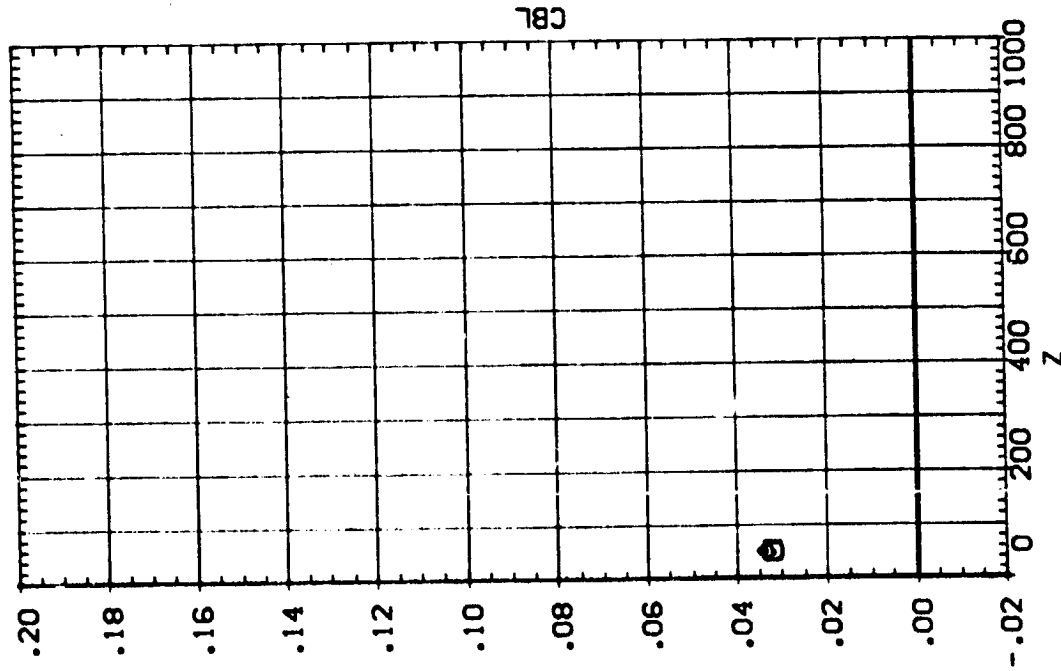
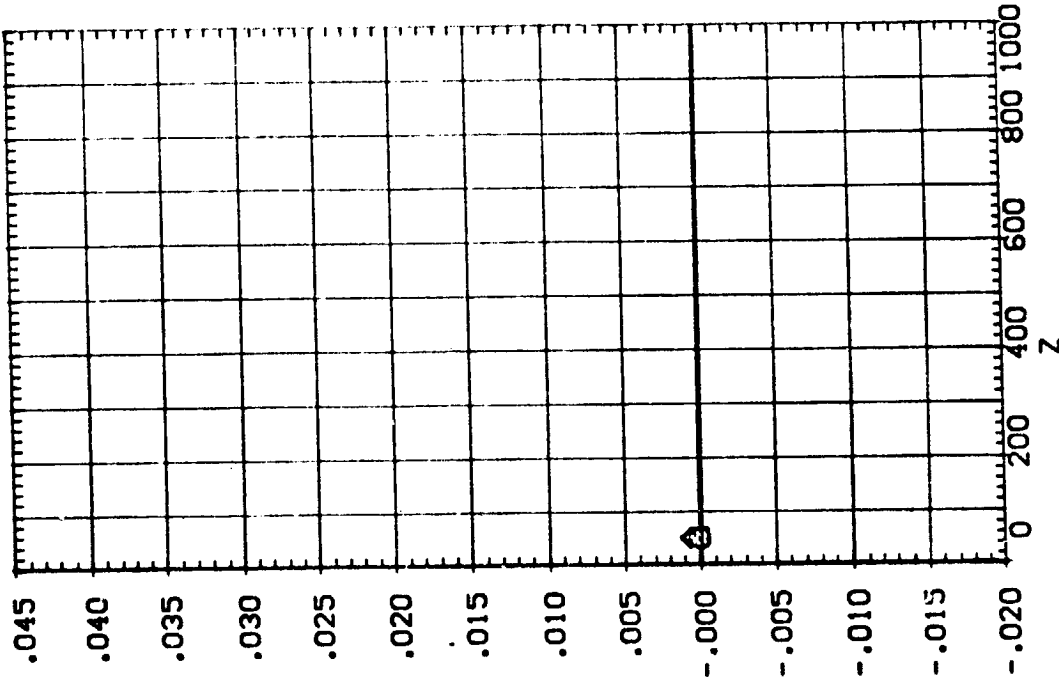

EFFECT OF SRB W/O PLUMES SEPARATION ON ORB/ET AERODYNAMIC CHARACTERISTICS

IA13 SRB(S8) W/O PLUMES SEPARATING FROM 09T10 (RTJ123)

SEE THE ASSOCIATED DATA DOCUMENT FOR REFERENCE CHARACTERISTICS FOR INDIVIDUAL DATASETS

SYMBOL	X	MACH	PARAMETRIC VALUES
○	.238	4.530	PTOTAL 110.000
□	300.380	.000	BETA .000
◇	600.510	.000	DBETA .000
△	900.680	800.000	PC-MBR .000

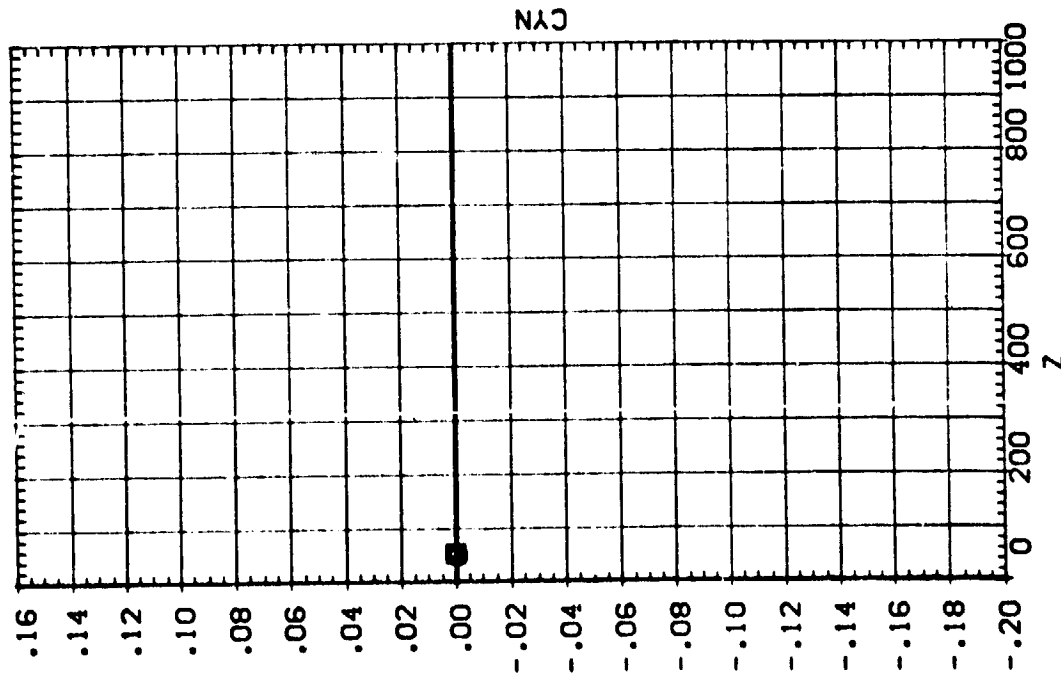
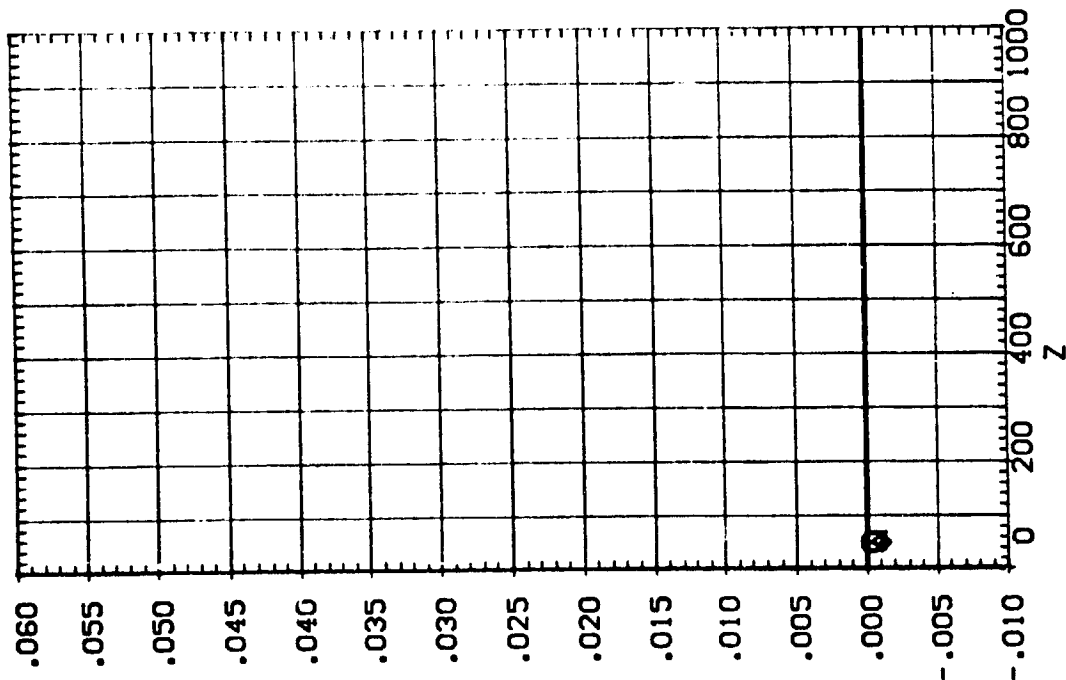

IA13 SRB(S8) W/O PLUMES SEPARATING FROM 09T10 (RTJ125)

SYMBOL x
 O 1600.900

PARAMETRIC VALUES
 MAC-I 4.530 PTOTAL 110.000
 ALP-A .000 BETA .000
 DALF-A .000 DBETA .000
 Y 400.000 PC-PR 0.000

SEE THE ASSOCIATED DATA DOCUMENT FOR REFERENCE CHARACTERISTICS FOR INDIVIDUAL DATASETS

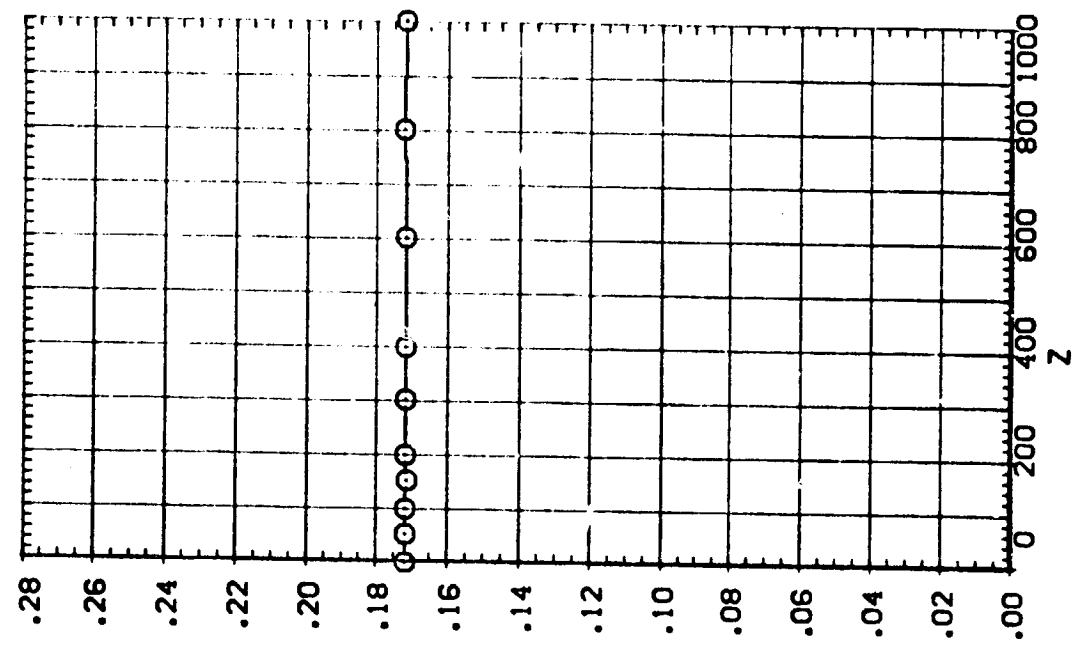
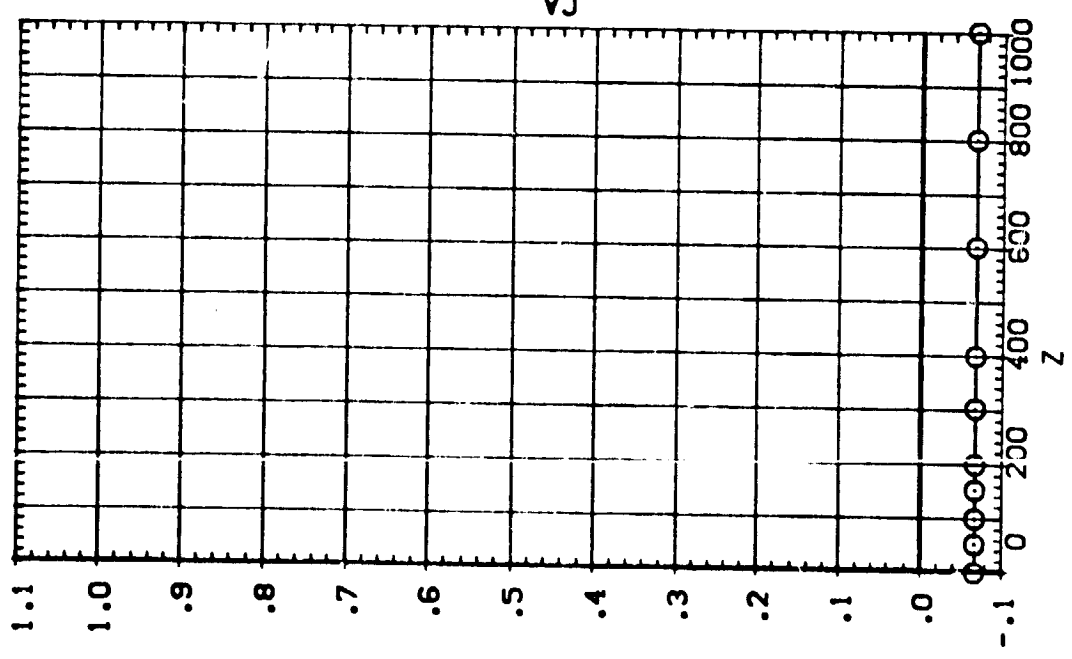

EFFECT OF SRB W/O PLUMES SEPARATION ON ORB/ET AERODYNAMIC CHARACTERISTICS

IA13 SRB(S8) W/O PLUMES SEPARATING FROM 09T10 (RTJ125)

SEE THE ASSOCIATED DATA DOCUMENT FOR REFERENCE CHARACTERISTICS FOR INDIVIDUAL DATASETS

SYMBOL X
 O 1600.500

PARAMETRIC VALUES			
MACH	4.530	P TOTAL	110.000
ALPHA	.000	BETA	.000
DALPHA	.000	DBETA	.000
Y	100.000	PC-MBR	.000

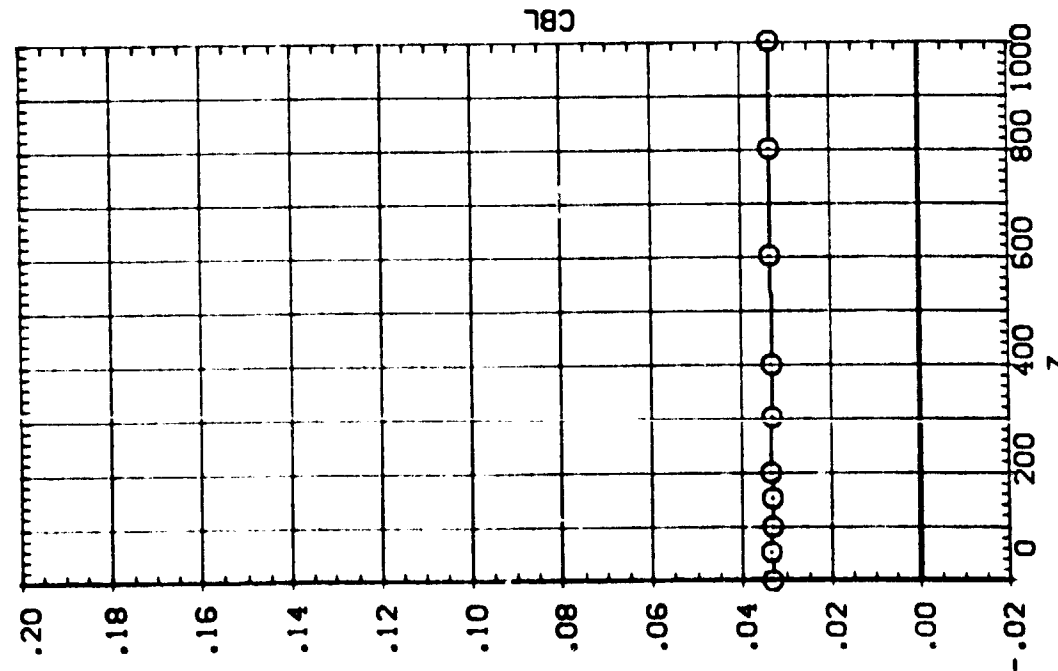
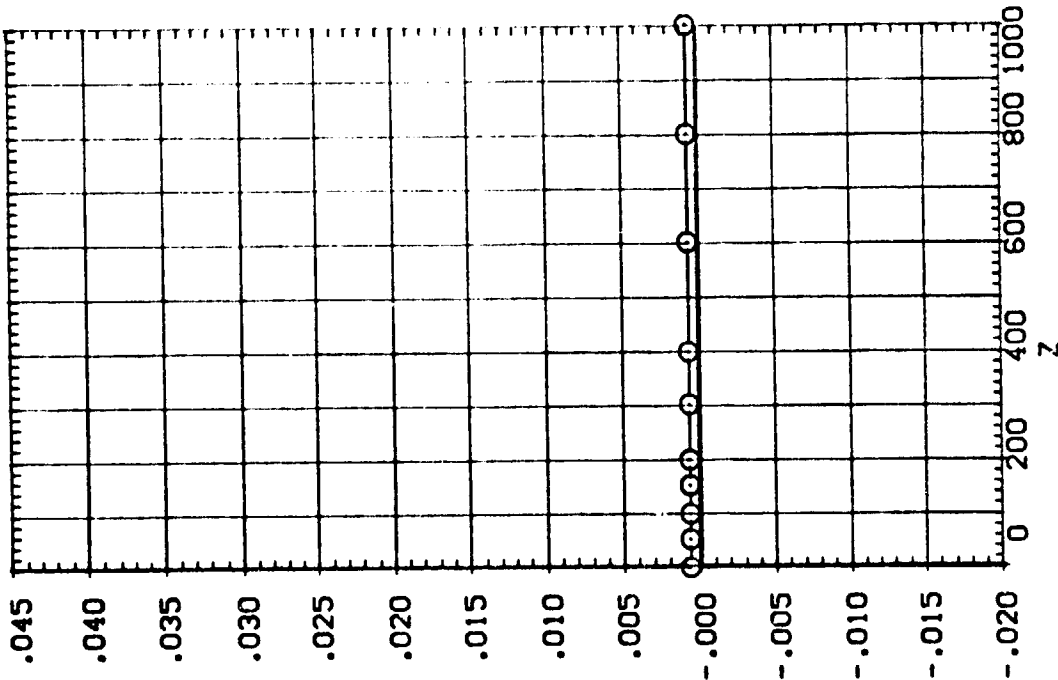

IA13 SRB(SB) W/O PLUMES SEPARATING FROM 09T10 (RTJ125)

SEE THE ASSOCIATED DATA DOCUMENT FOR REFERENCE CHARACTERISTICS FOR INDIVIDUAL DATASETS

SYMBOL X
 O 1600.900

PARAMETRIC VALUES
 MACH 4.530 PTOTAL 110.000
 ALPHA .000 BETA .000
 DALPHA .000 DBETA .000
 GAMMA 400.000 PCMBER .000

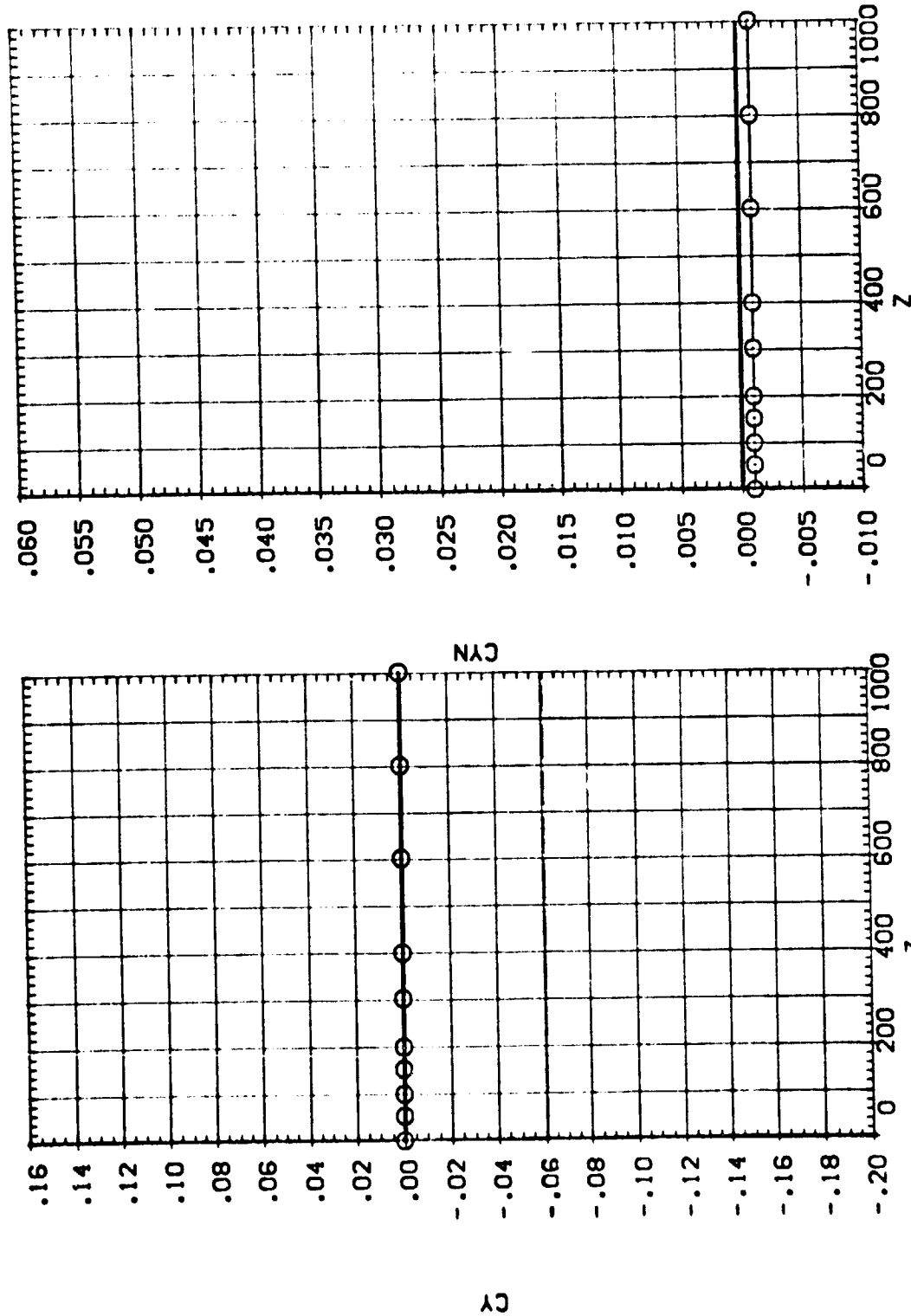

EFFECT OF SRB W/O PLUMES SEPARATION ON ORB/ET AERODYNAMIC CHARACTERISTICS

IA13 SRB(S8) W/O PLUMES SEPARATING FROM 09T10 (RTJ126)

SEE THE ASSOCIATED DATA DOCUMENT FOR REFERENCE CHARACTERISTICS FOR INDIVIDUAL DATASETS

SYMBOL		PARAMETRIC VALUES			
○	X	MACH	4.530	P-TOTAL	110.000
□	900.670	ALPHA	.000	BETA	.000
		DALPHA	5.000	DBETA	.000
		Y	.000	PC-MBR	.000

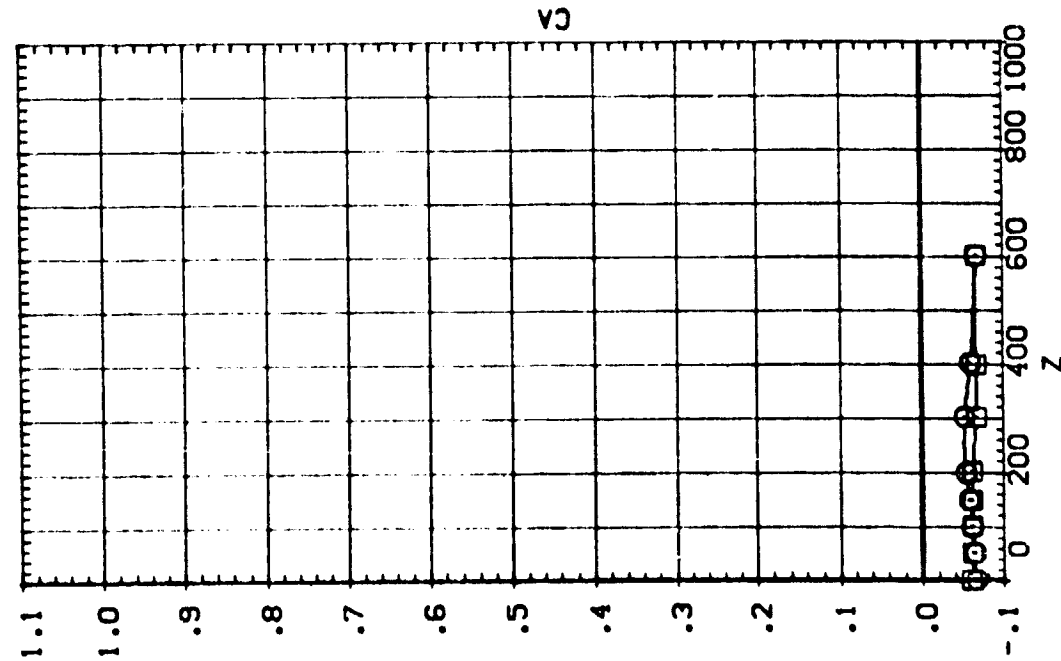
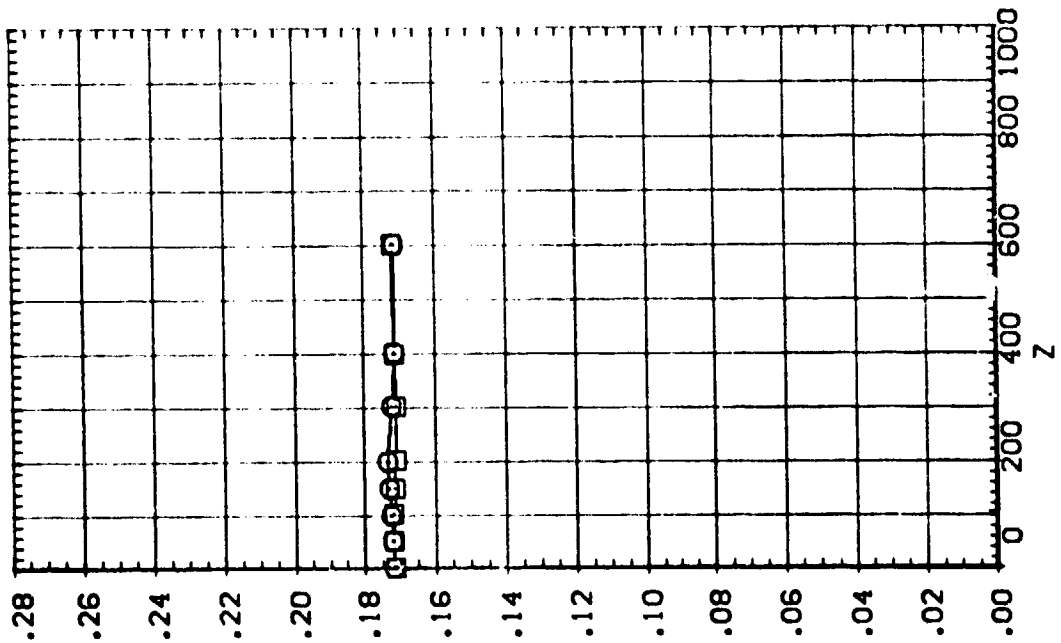

[A13 SRB(S8) W/O PLUMES SEPARATING FROM 09T10 (RTJ126)

SEE THE ASSOCIATED DATA DOCUMENT FOR REFERENCE CHARACTERISTICS FOR INDIVIDUAL DATASETS

SYMBOL	X	MACH	PARAMETRIC VALUES
○	.295	4.530	PTOTAL 110.000
□	900.670	.000	BETA .000
		5.000	DBETA .000
		.000	PCFBR .000

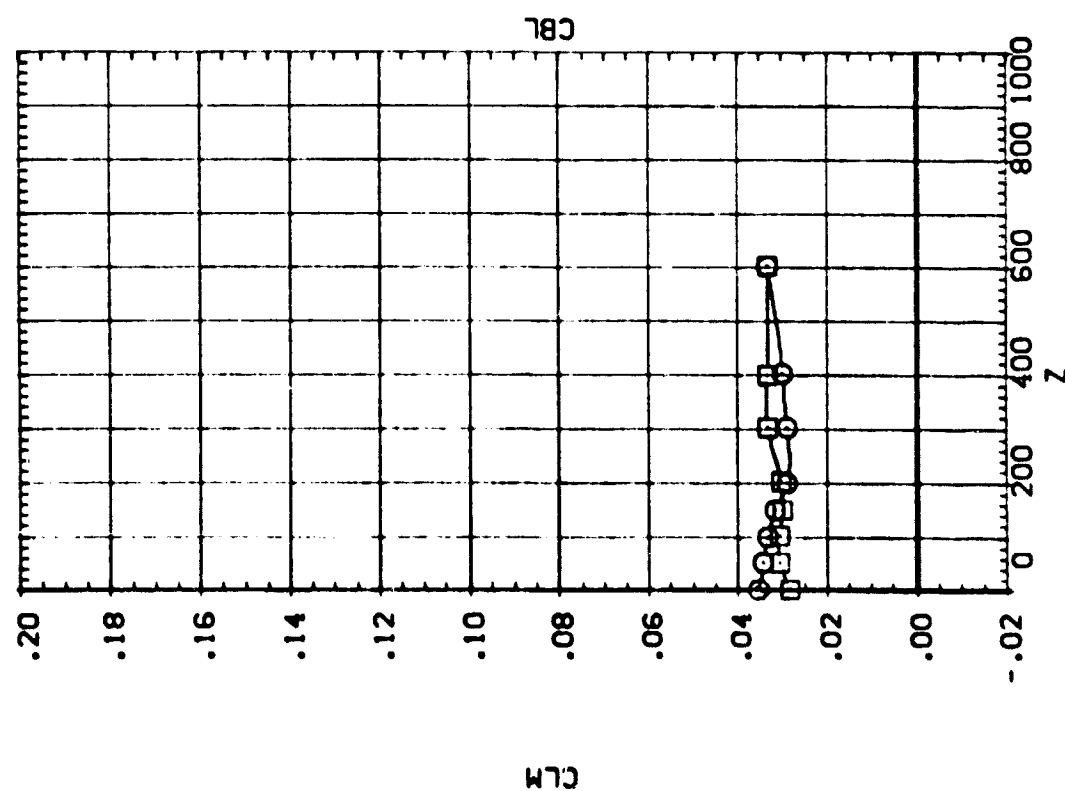
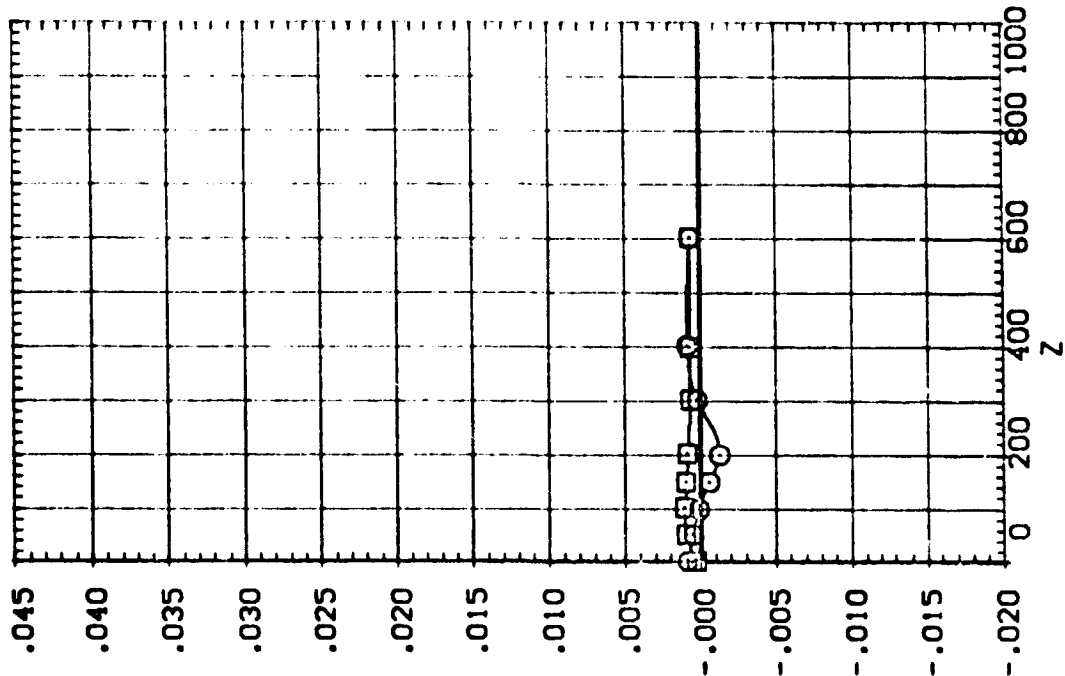

EFFECT OF SRB W/O PLUMES SEPARATION ON ORB/ET AERODYNAMIC CHARACTERISTICS

IA13 SRB(S8) W/O PLUMES SEPARATING FROM 09T10 (RTJ126)

SEE THE ASSOCIATED DATA DOCUMENT FOR REFERENCE CHARACTERISTICS FOR INDIVIDUAL DATASETS

SYMBOL γ 795
 900.6/0

PARAMETRIC VALUES	
MACH	4.530
PTOTAL	110.000
ALPHA	.000
BETA	.000
DALPHA	5.000
DBETA	.000
Y	.000
PC-MFR	.000

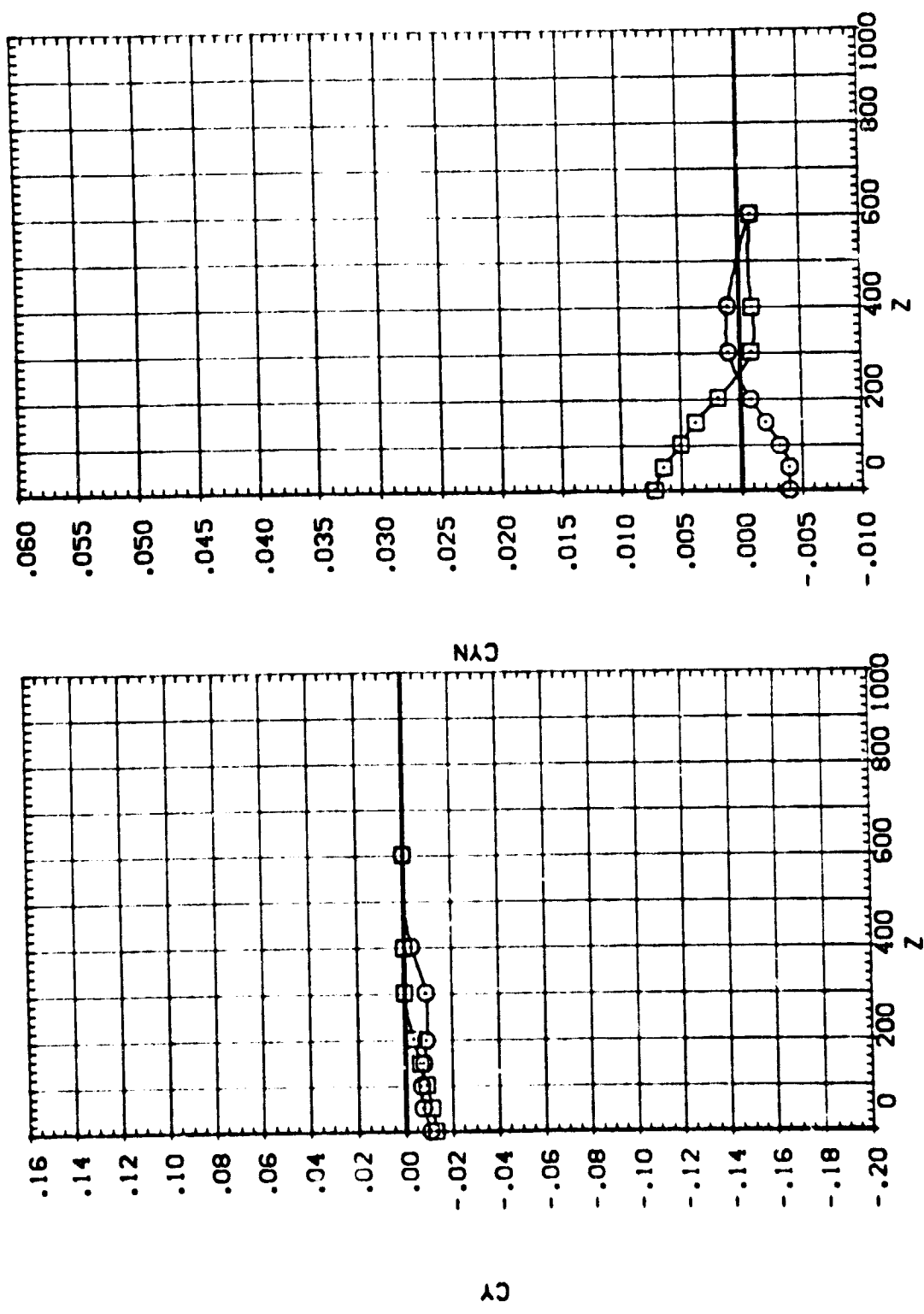

IA13 SRB(S8) W/O PLUMES SEPARATING FROM 09T10 (RTJ127)

SEE THE ASSOCIATED DATA DOCUMENT FOR REFERENCE CHARACTERISTICS FOR INDIVIDUAL DATASETS

511-80L	X	.440	MACH	4.530	P/TOTAL	110.000
□		900.670	ALPHA	.000	BETA	.000
			DALPHA	5.000	DBETA	.000
			Y	200.000	PC+GR	.000

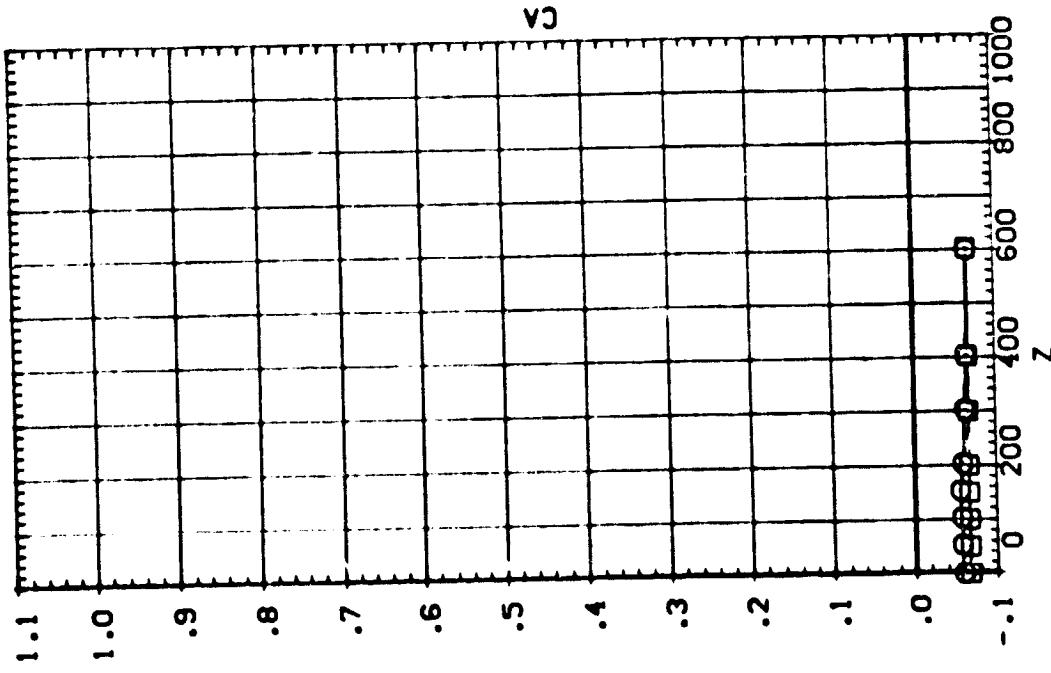
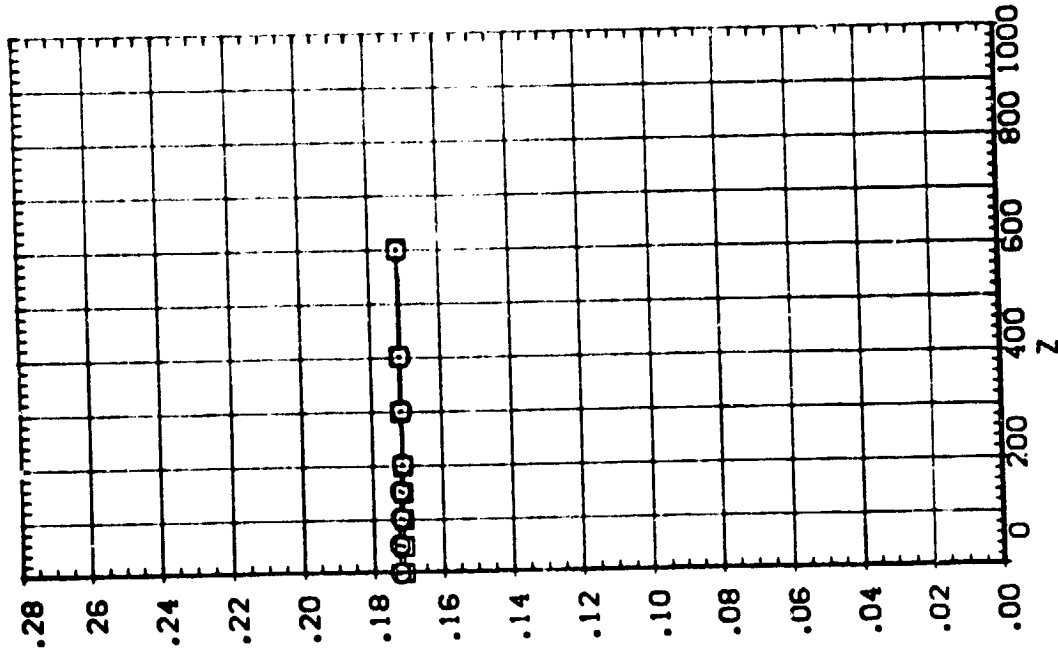

EFFECT OF SRB W/O PLUMES SEPARATION ON ORB/ET AERODYNAMIC CHARACTERISTICS

IA13 SRB(S8) W/O PLUMES SEPARATING FROM 09T10 (RTJ127)

SEE THE ASSOCIATED DATA DOCUMENT FOR REFERENCE CHARACTERISTICS FOR INDIVIDUAL DATASETS

SYMBOL X .140 MACH .000 P/TOTAL 110.000
 □ 900.670 ALPHA .000 BETA .000
 □ 200.000 DELTA 5.000 POWER .000

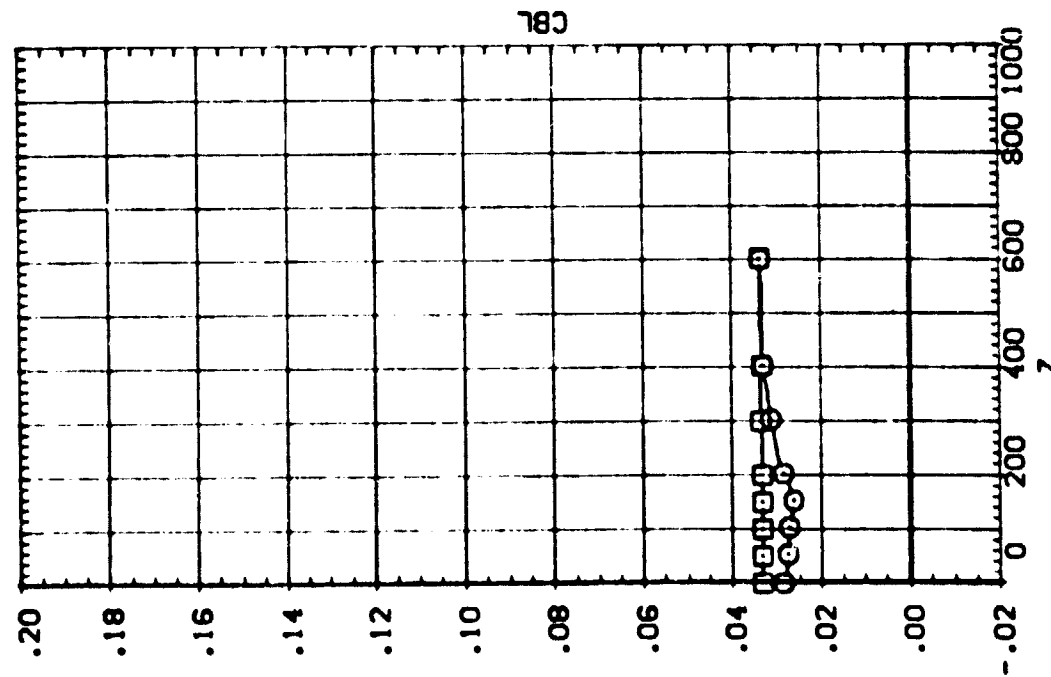
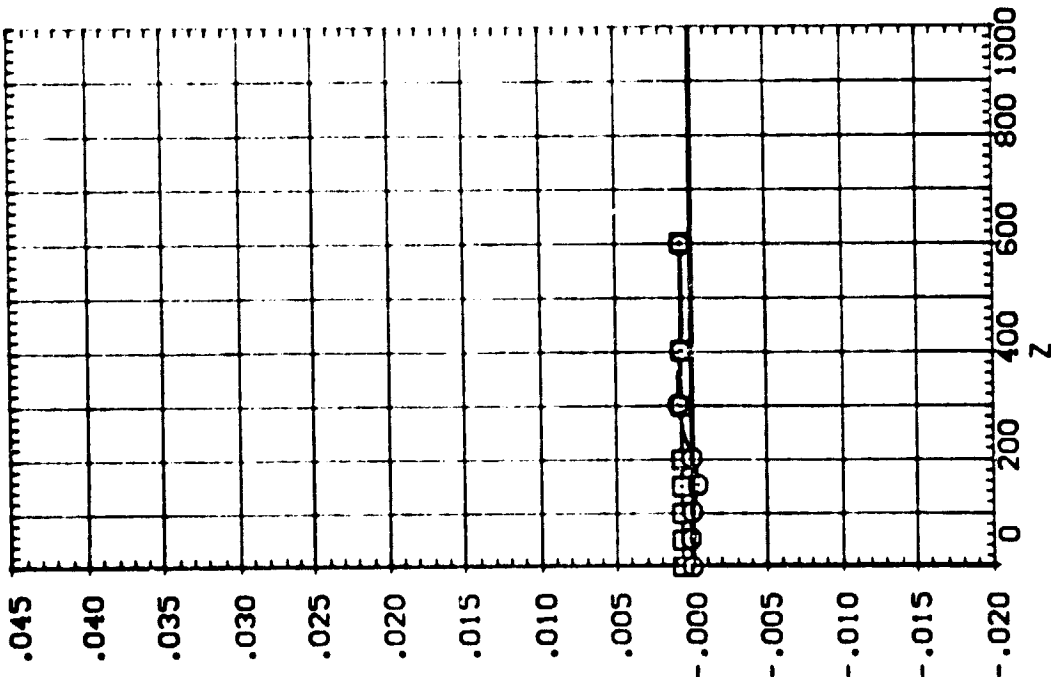

[A13 SRB(S8) W/O PLUMES SEPARATING FROM 09T10 (RTJ127)]

SYMBOL

-
-

PARAMETRIC VALUES

X	.440	MACH	4.530	P/TOTAL	110.000
Y	500.670	ALPHA	.000	BETA	.000
Z		DALPHA	5.000	DBETA	.000
		POWBR	200.000		

SEE THE ASSOCIATED DATA DOCUMENT FOR REFERENCE CHARACTERISTICS FOR INDIVIDUAL DATASETS

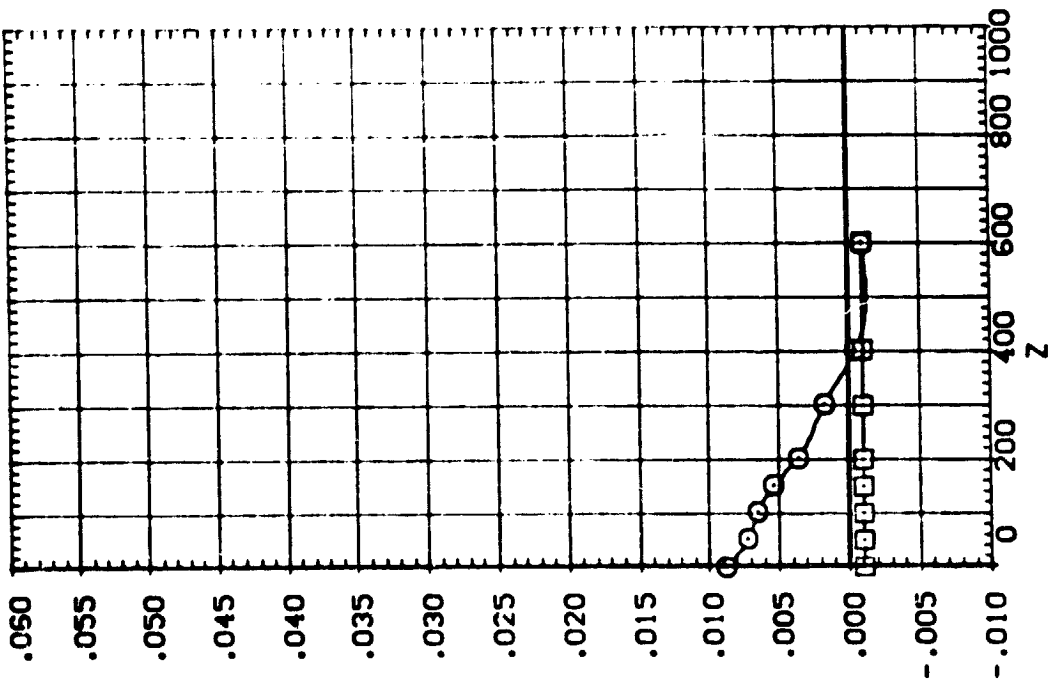
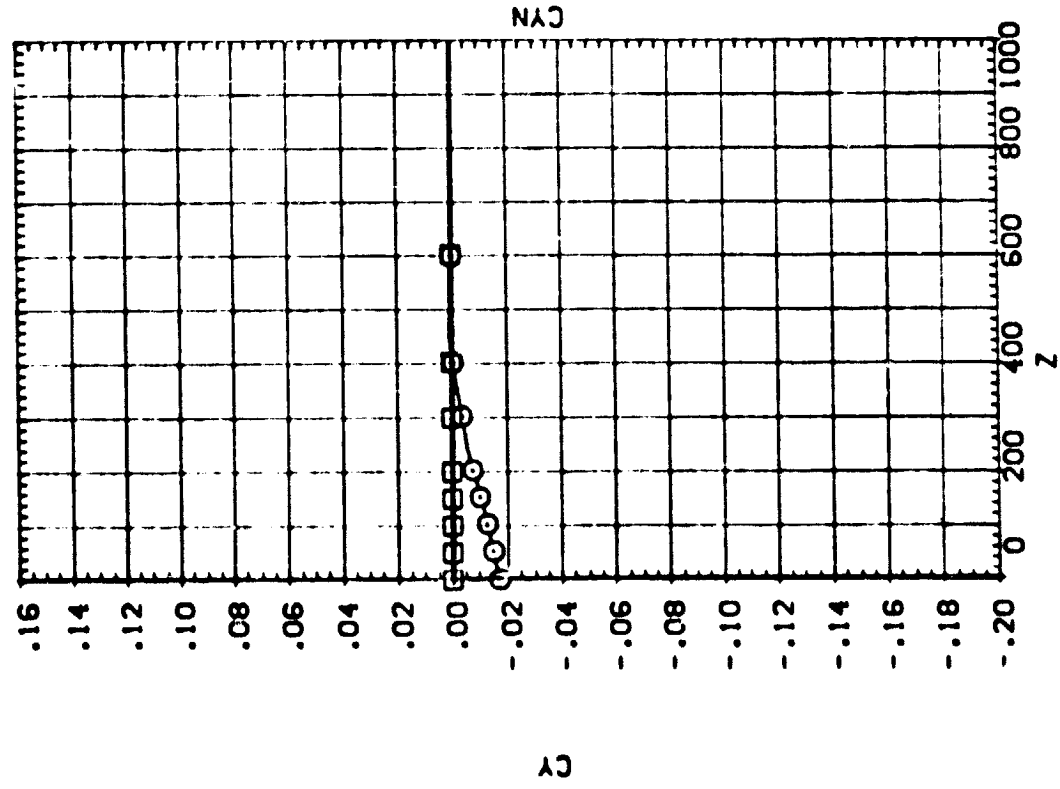

EFFECT OF SRB W/O PLUMES SEPARATION ON ORB/ET AERODYNAMIC CHARACTERISTICS

LA13 SRB(S8) W/O PLUMES SEPARATING FROM 09T10 (RTJ128)

SEE THE ASSOCIATED DATA DOCUMENT FOR REFERENCE CHARACTERISTICS FOR INDIVIDUAL DATASETS

SYMBOL		PARAMETRIC VALUES			
K	.303	MACH	4.530	PI TOTAL	110.000
	900.580	ALPHA	.000	BETA	.000
		DELTA	5.000	DETA	.000
		Y	400.000	PC+BR	.000

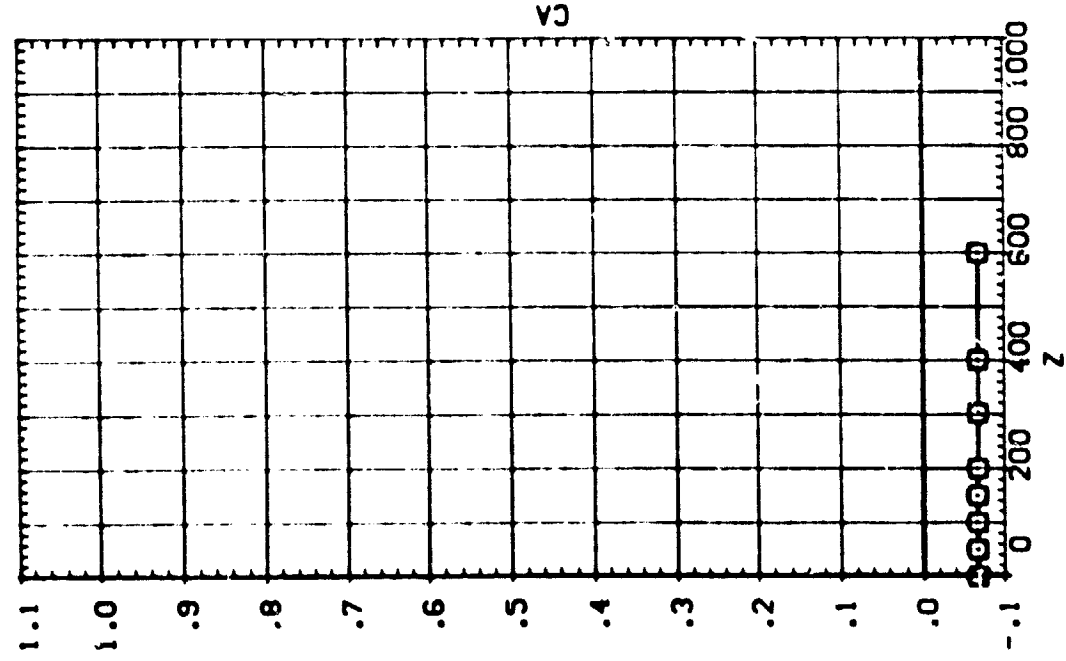
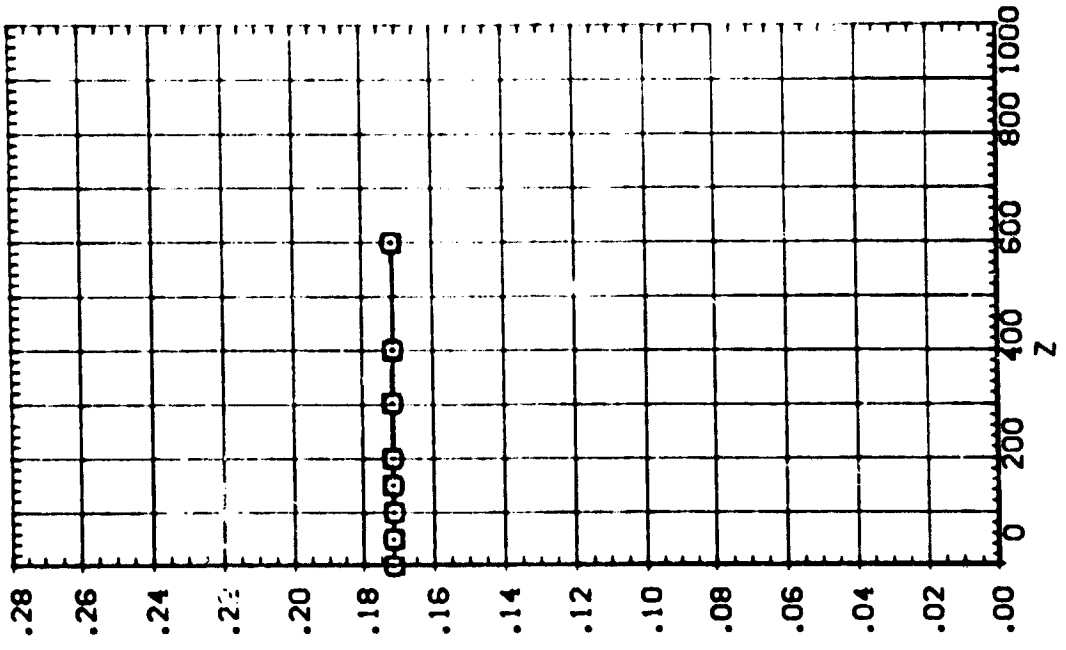

IA13 SRB(SB) W/O PLUMES SEPARATING FROM 09T10 (RTJ128)

SYMBOL X
 ○ 303
 □ 500.580

PARAMETRIC VALUES
 MACH 4.530 PTOTAL 110.000
 ALPHA .000 BETA .000
 DALPHA 5.000 DBETA .000
 Y 400.000 PCMBR .000

SEE THE ASSOCIATED DATA DOCUMENT FOR REFERENCE CHARACTERISTICS FOR INDIVIDUAL DATASETS

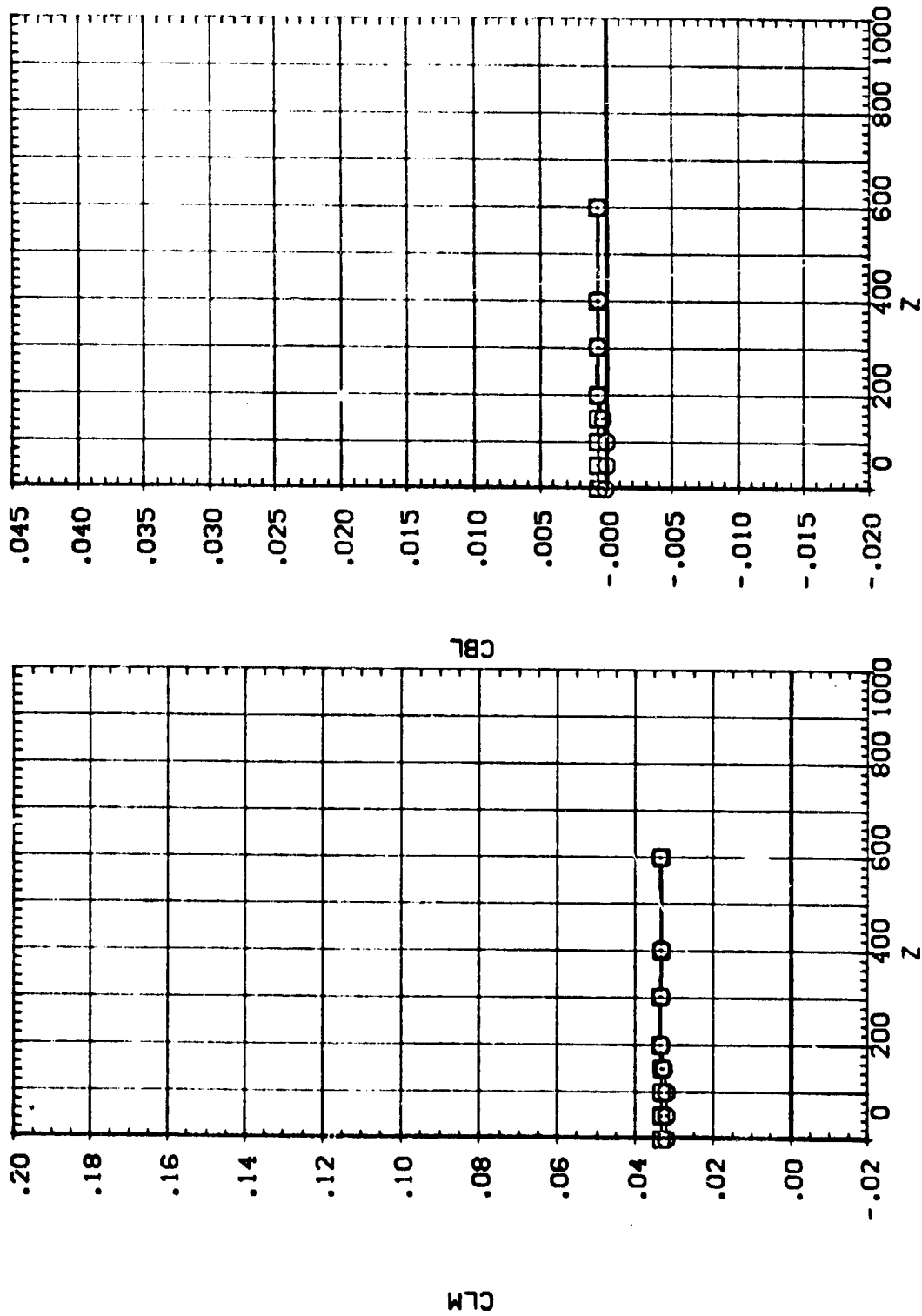

EFFECT OF SRB W/O PLUMES SEPARATION ON ORB/ET AERODYNAMIC CHARACTERISTICS

IA13 SRB(S8) W/O PLUMES SEPARATING FROM 09T10 (RTJ128)

SEE THE ASSOCIATED DATA DOCUMENT FOR REFERENCE CHARACTERISTICS FOR INDIVIDUAL DATASETS

SYMBOL		PARAMETRIC VALUES			
○	X	MACH	4.530	PTOTAL	110.000
□	Y	ALPHA	.000	BETA	.000
	Z	DALPHA	5.000	DBETA	.000
		Y	400.000	PCMBR	.000

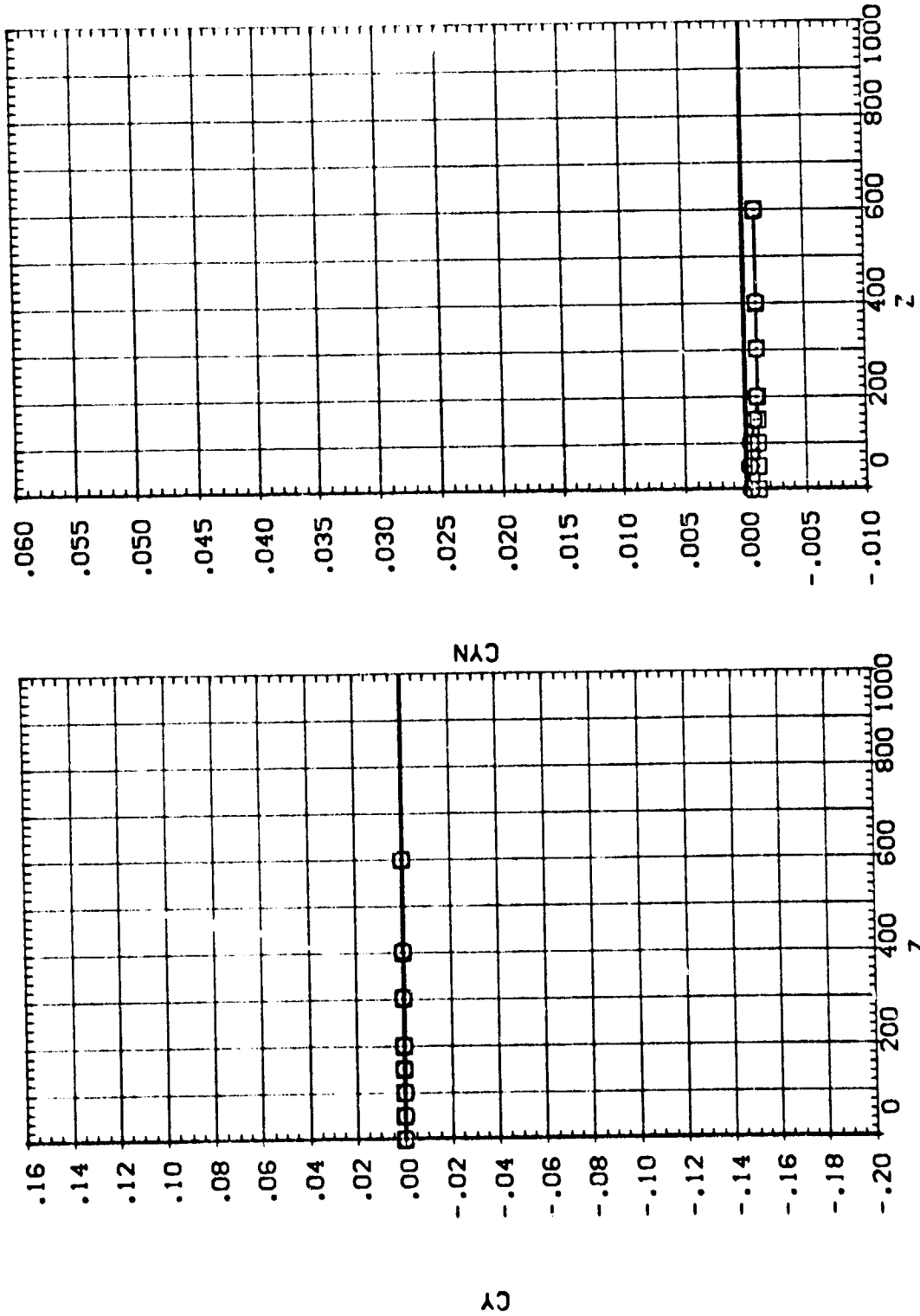

IA13 SRB(S8) W/O PLUMES SEPARATING FROM 09T10 (RTJ129)

SEE THE ASSOCIATED DATA DOCUMENT FOR REFERENCE CHARACTERISTICS FOR INDIVIDUAL DATASETS

SYMBOL	X	MACH	PARAMETRIC VALUES
□	.343	4.530	PTOTAL 110.000
◇	300.360	.000	BETA .000
△	600.660	-5.000	DBETA .000
	900.460	.000	PC-MBR .000

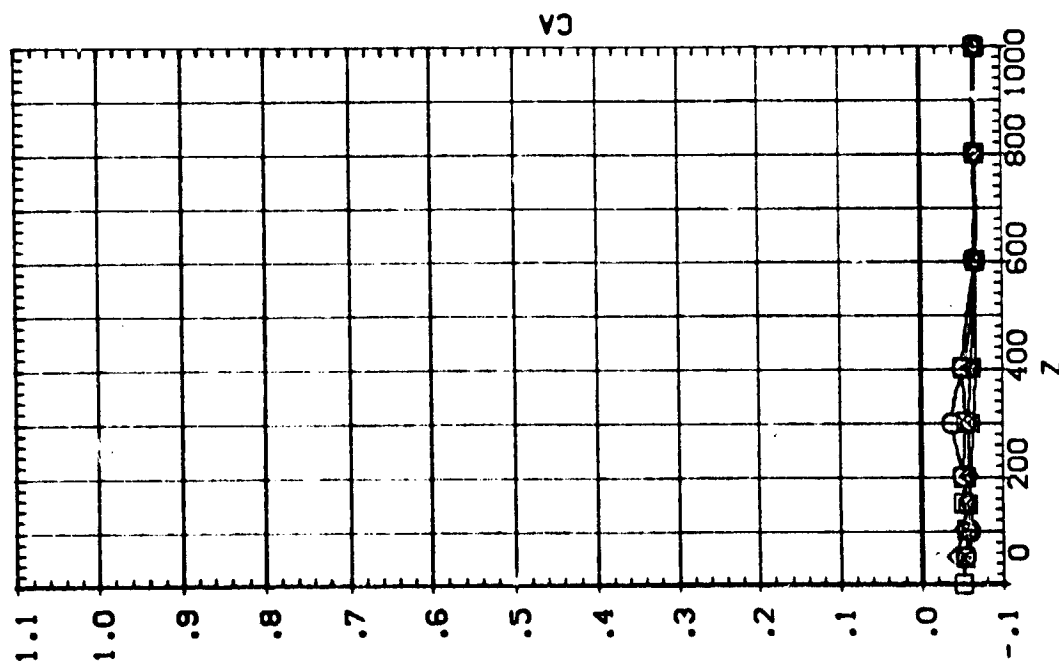
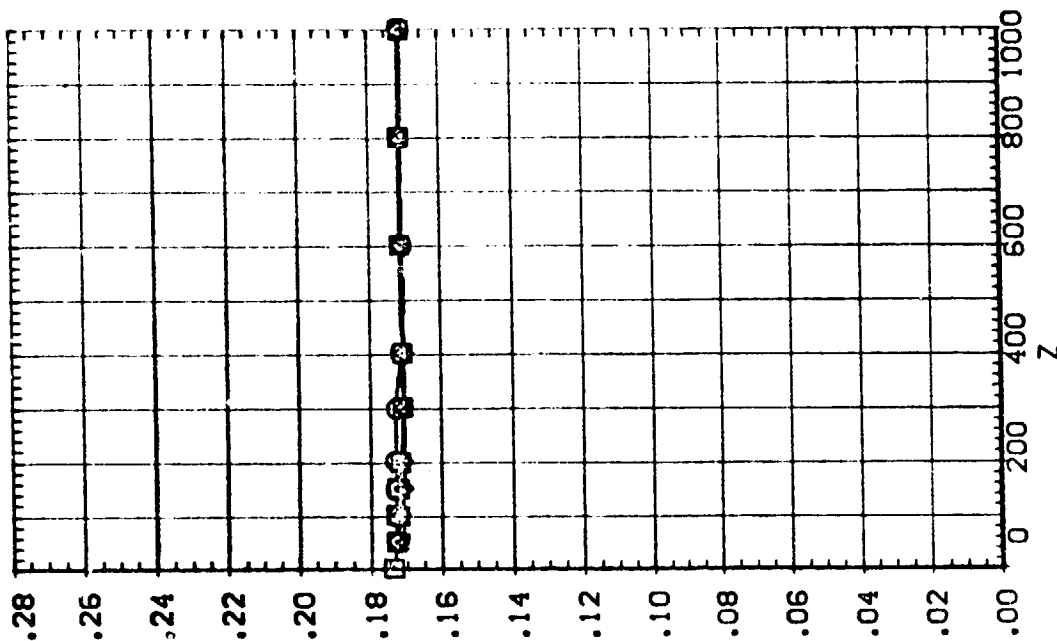

EFFECT OF SRB W/O PLUMES SEPARATION ON ORB/ET AERODYNAMIC CHARACTERISTICS

IA13 SRB(SB) W/O PLUMES SEPARATING FROM 09T10 (RTJ129)

SEE THE ASSOCIATED DATA DOCUMENT FOR REFERENCE CHARACTERISTICS FOR INDIVIDUAL DATASETS

SYMBOL		PARAMETRIC VALUES			
○	x	MACH	4.530	PTOTAL	110.000
□	300.360	ALPHA	.000	BETA	.000
◇	600.660	DALPHA	-5.000	DBETA	.000
△	900.460	Y	.000	PCHYER	.000

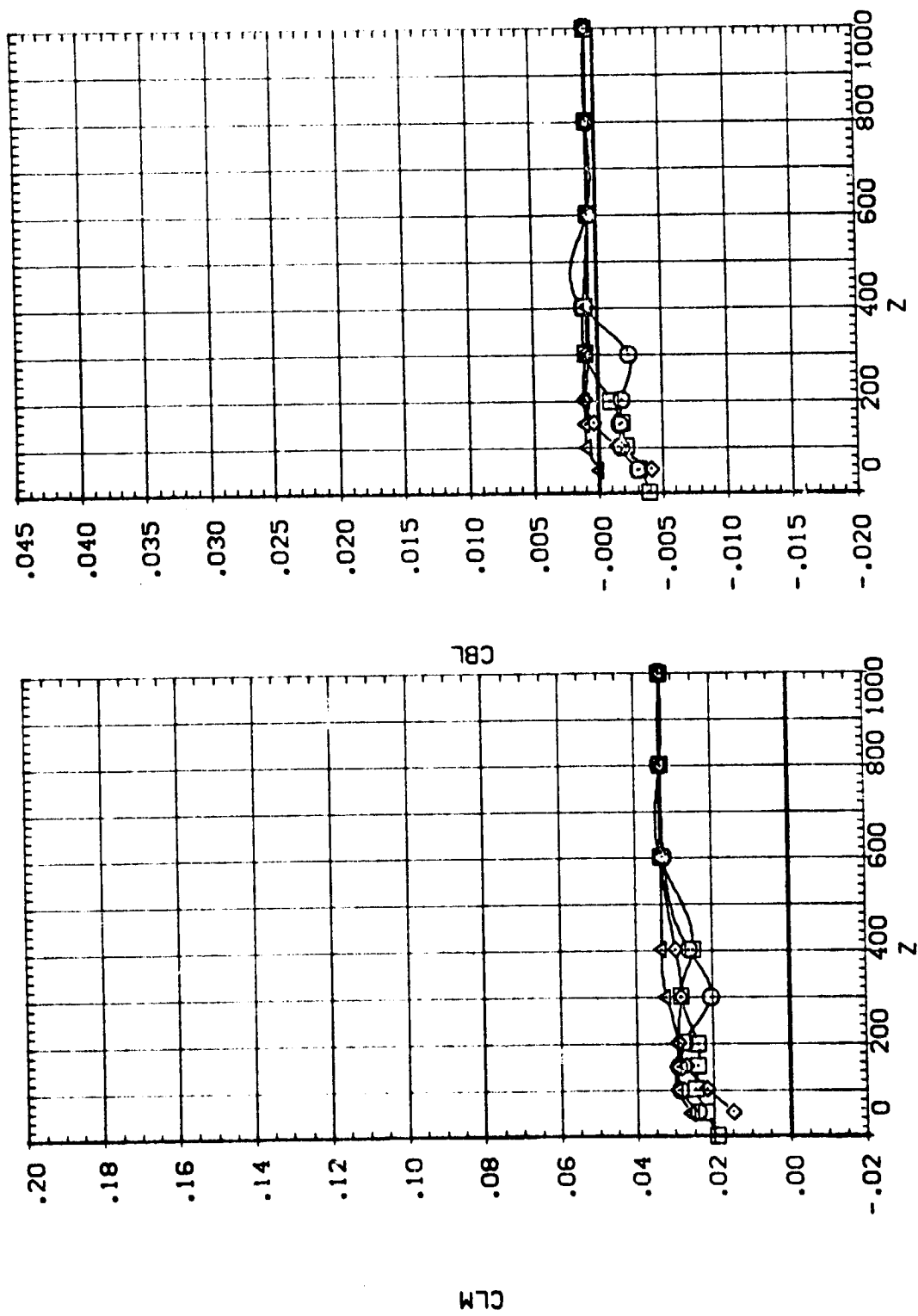

IA13 SRB(S8) W/O PLUMES SEPARATING FROM 09T10 (RTJ129)

SEE THE ASSOCIATED DATA DOCUMENT FOR REFERENCE CHARACTERISTICS FOR INDIVIDUAL DATASETS

SYMBOL	X	MACH	PARAMETRIC VALUES
○	300.360	4.530	PTOTAL 110.000
□	600.660	.000	BETA .000
◇	900.460	-5.000	DBETA .000
△		.000	PC-MBR .000

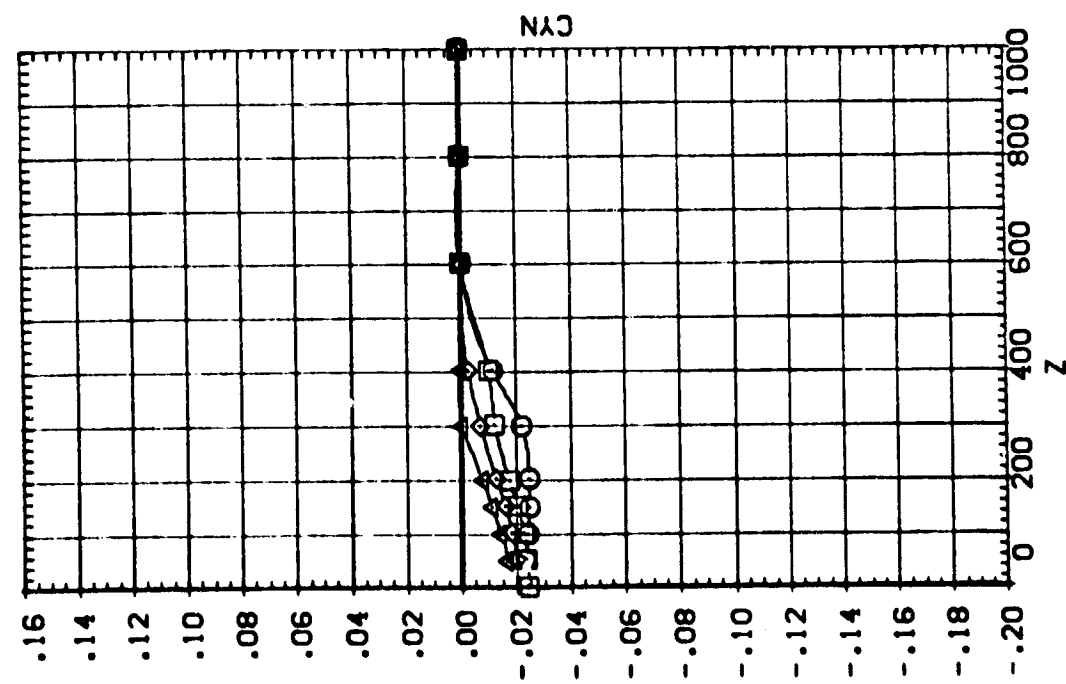
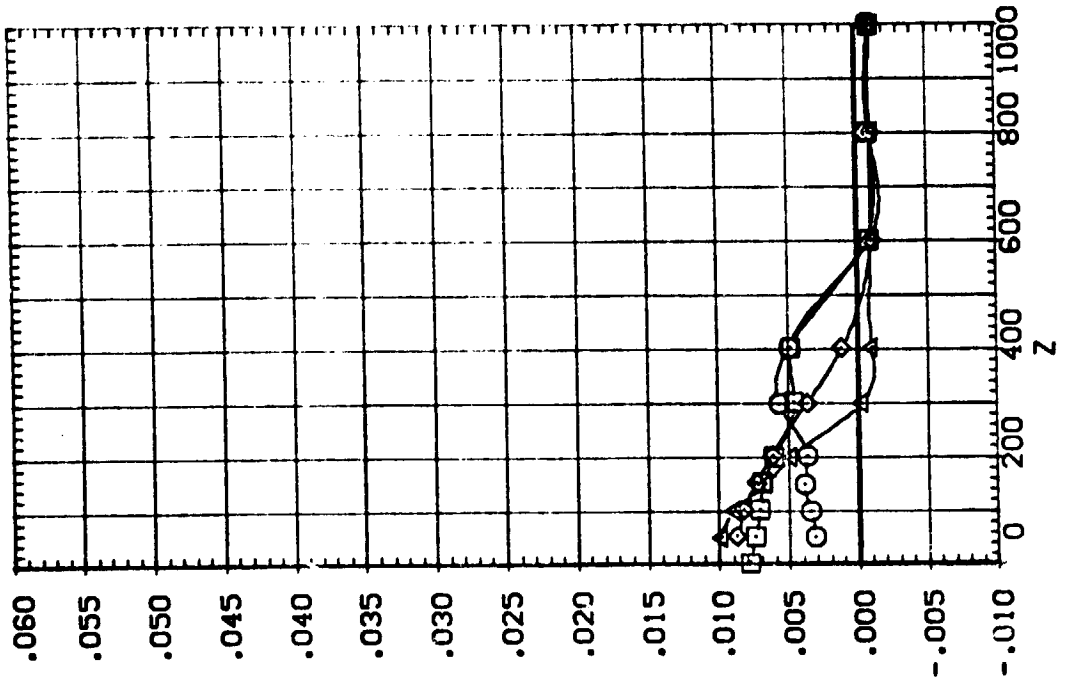

EFFECT OF SRB W/O PLUMES SEPARATION ON ORB/ET AERODYNAMIC CHARACTERISTICS

IA13 SRB(S8) W/O PLUMES SEPARATING FROM 09T10 (RTJ130)

SEE THE ASSOCIATED DATA DOCUMENT FOR REFERENCE CHARACTERISTICS FOR INDIVIDUAL DATASETS

SYMBOL	X	MACH	PARAMETRIC VALUES
○	.340	4.530	P TOTAL 110.000
□	300.400	.000	BETA .000
◇	600.490	-5.000	DBETA .000
△	900.750	200.000	PC+PBR .000

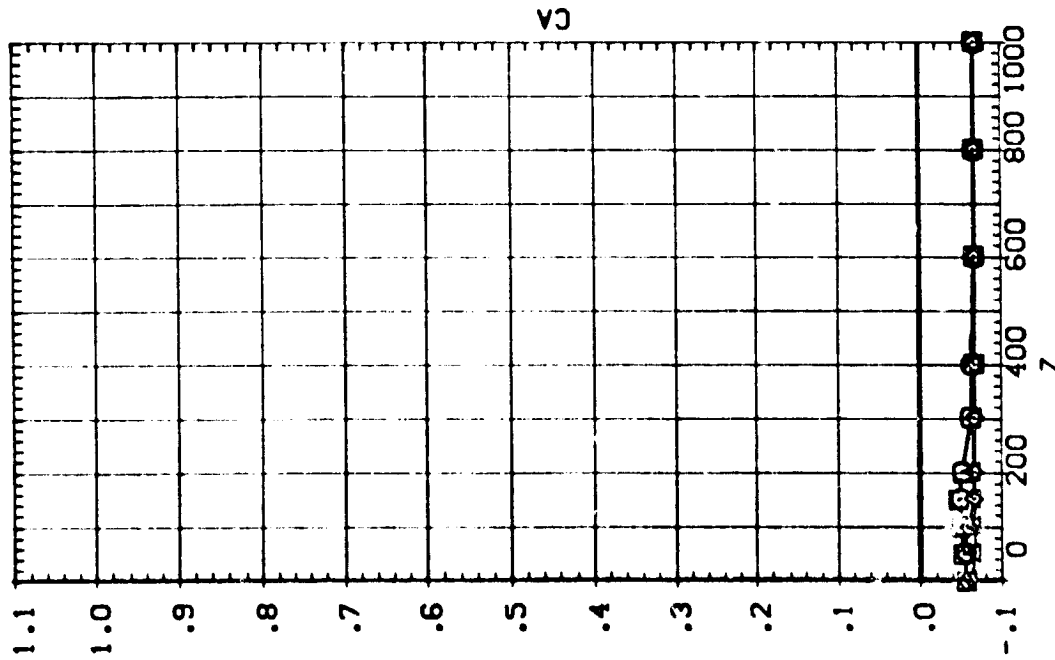
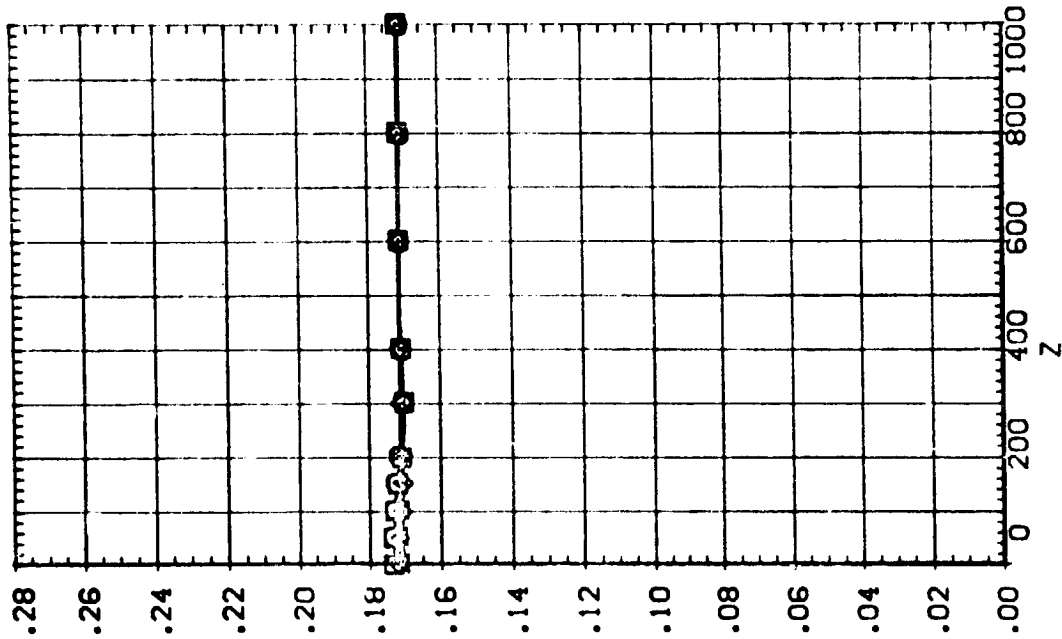

IA13 SRB(SB) W/O PLUMES SEPARATING FROM 09T10 (RTJ130)

SYMBOL X

-
-
- ◇
- △

.340 MACH
 .000 ALPHA
 600.490 D ALPHA
 900.750 Y

PARAMETRIC VALUES

4.530 PTOTAL 110.000
 .000 BETA
 -5.000 DBETA
 200.000 PC-HGR .000

SEE THE ASSOCIATED DATA DOCUMENT FOR REFERENCE CHARACTERISTICS FOR INDIVIDUAL DATASETS

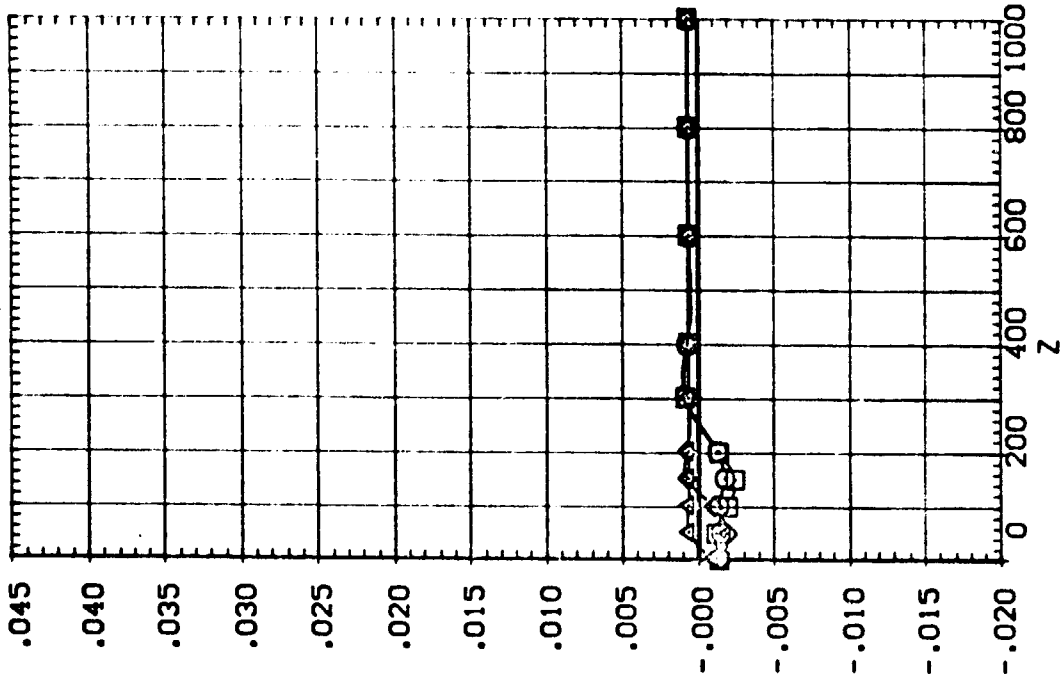
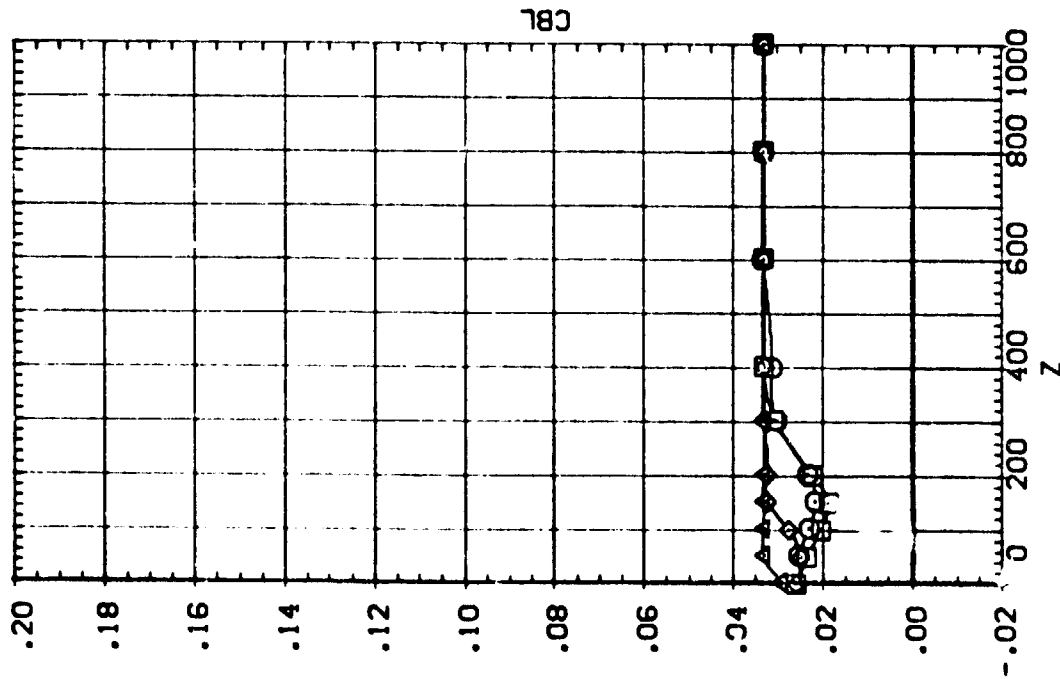

EFFECT OF SRB W/O PLUMES SEPARATION ON ORB/ET AERODYNAMIC CHARACTERISTICS

1A13 SRB(S8) W/O PLUMES SEPARATING FROM 09T10 (RTJ130)

SEE THE ASSOCIATED DATA DOCUMENT FOR REFERENCE CHARACTERISTICS FOR INDIVIDUAL DATASETS

SYMBOL	X	MACH	PARAMETRIC VALUES	PIOTAL	110.000
○	300.400	ALPHA	4.530	BETA	.000
◇	600.490	DALPHA	.000	DBETA	.000
△	900.750	Y	-5.000	PC-HBR	.000

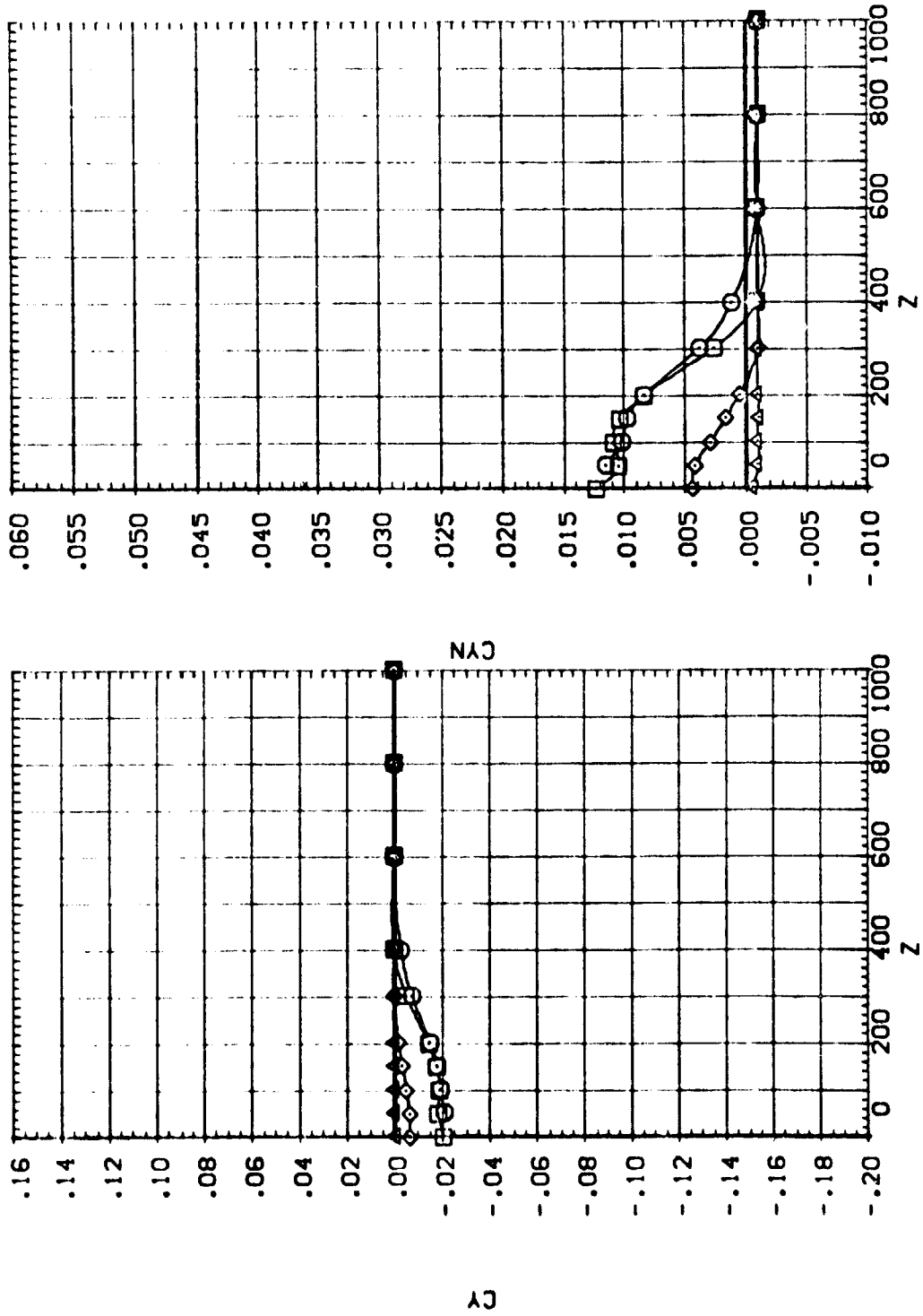

[A13 SRB(S8) W/O PLUMES SEPARATING FROM 09T10 (RTJ131)]

SEE THE ASSOCIATED DATA DOCUMENT FOR REFERENCE CHARACTERISTICS FOR INDIVIDUAL DATASETS

SYMBOL	X	MACH	PARAMETRIC VALUES
○	.178		PTOTAL 110.000
□	300.370	ALPHA	BETA .000
◇	600.510	DALPHA	DBETA -5.000
△	900.600	Y	PC-PBR 400.000

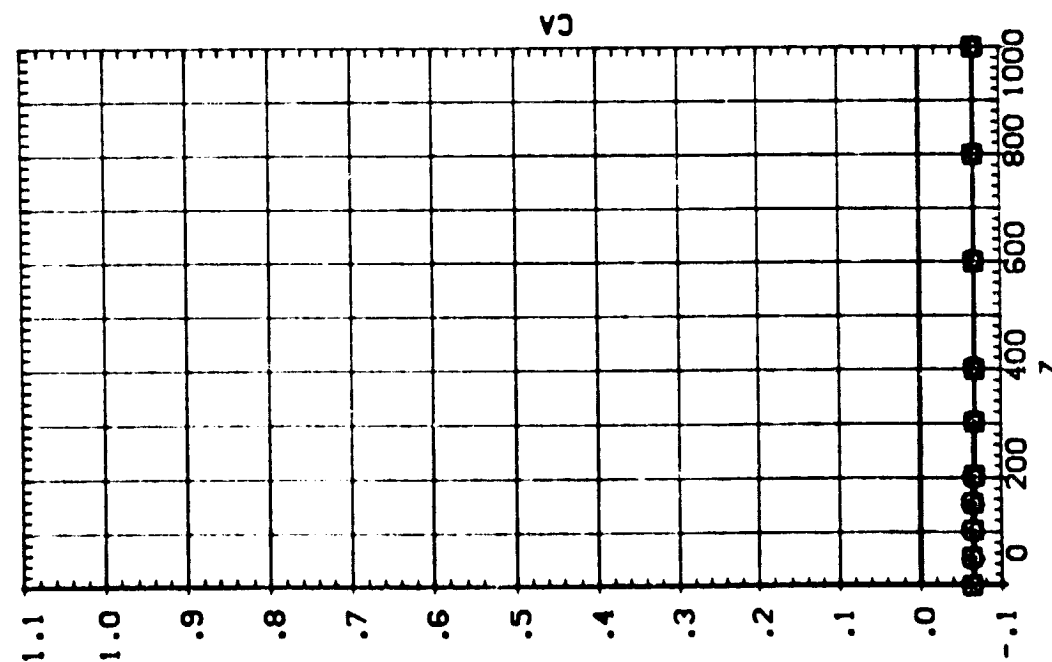
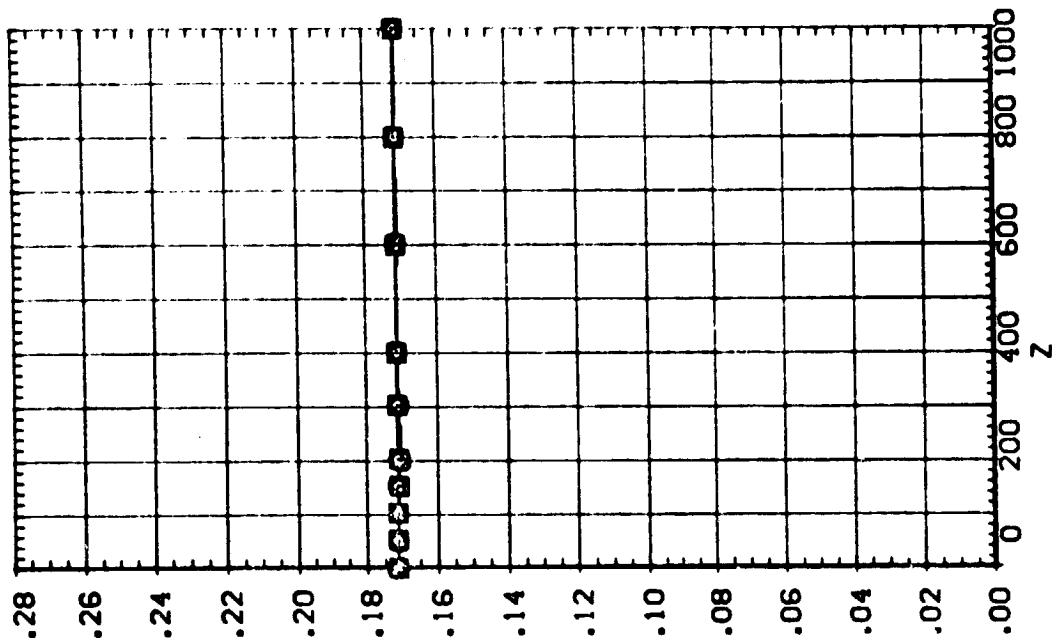

EFFECT OF SRB W/O PLUMES SEPARATION ON ORB/ET AERODYNAMIC CHARACTERISTICS

IA13 SRB(S8) W/O PLUMES SEPARATING FROM 09T10 (RTJ131)

SEE THE ASSOCIATED DATA DOCUMENT FOR REFERENCE CHARACTERISTICS FOR INDIVIDUAL DATASETS

SYMBOL	X	MACH	PARAMETRIC VALUES
□	.178	4.530	PTOTAL 110.000
◇	300.370	.000	BETA .000
◇	600.510	-5.000	DBETA .000
△	900.600	400.000	PC-FBR .000

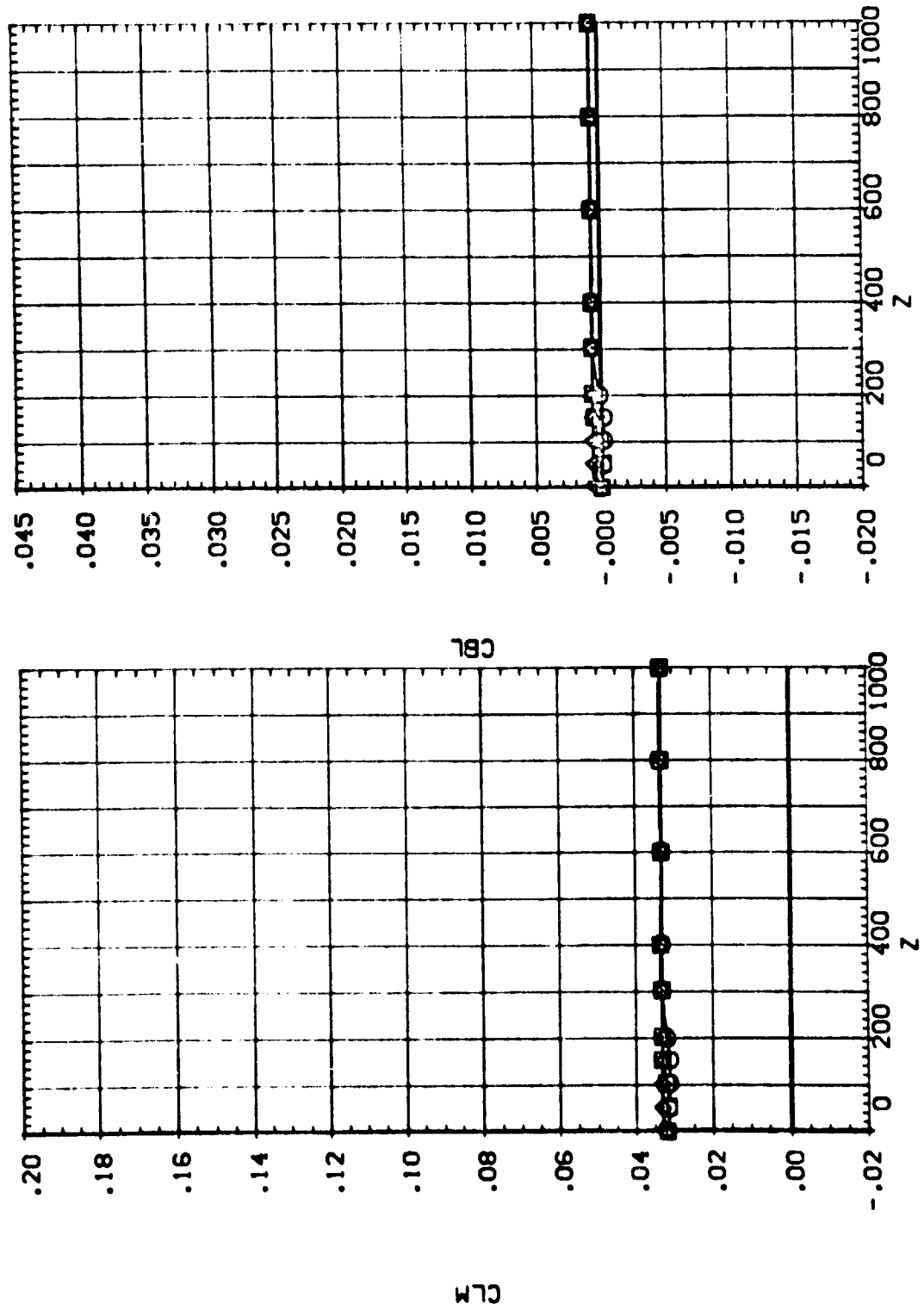

EFFECT OF SRB W/O PLUMES SEPARATION ON ORB/ET AERODYNAMIC CHARACTERISTICS

IA13 SRB(S8) W/O PLUMES SEPARATING FROM 09T10 (RTJ131)

SEE THE ASSOCIATED DATA DOCUMENT FOR REFERENCE CHARACTERISTICS FOR INDIVIDUAL DATASETS

SYMBOL	X	MACH	PARAMETRIC VALUES
○	.178		PTOTAL 110.000
□	300.370	ALPHA	BETA .000
◇	600.510	DALPHA	DBETA .000
△	900.600	Y	PO-PBR .000

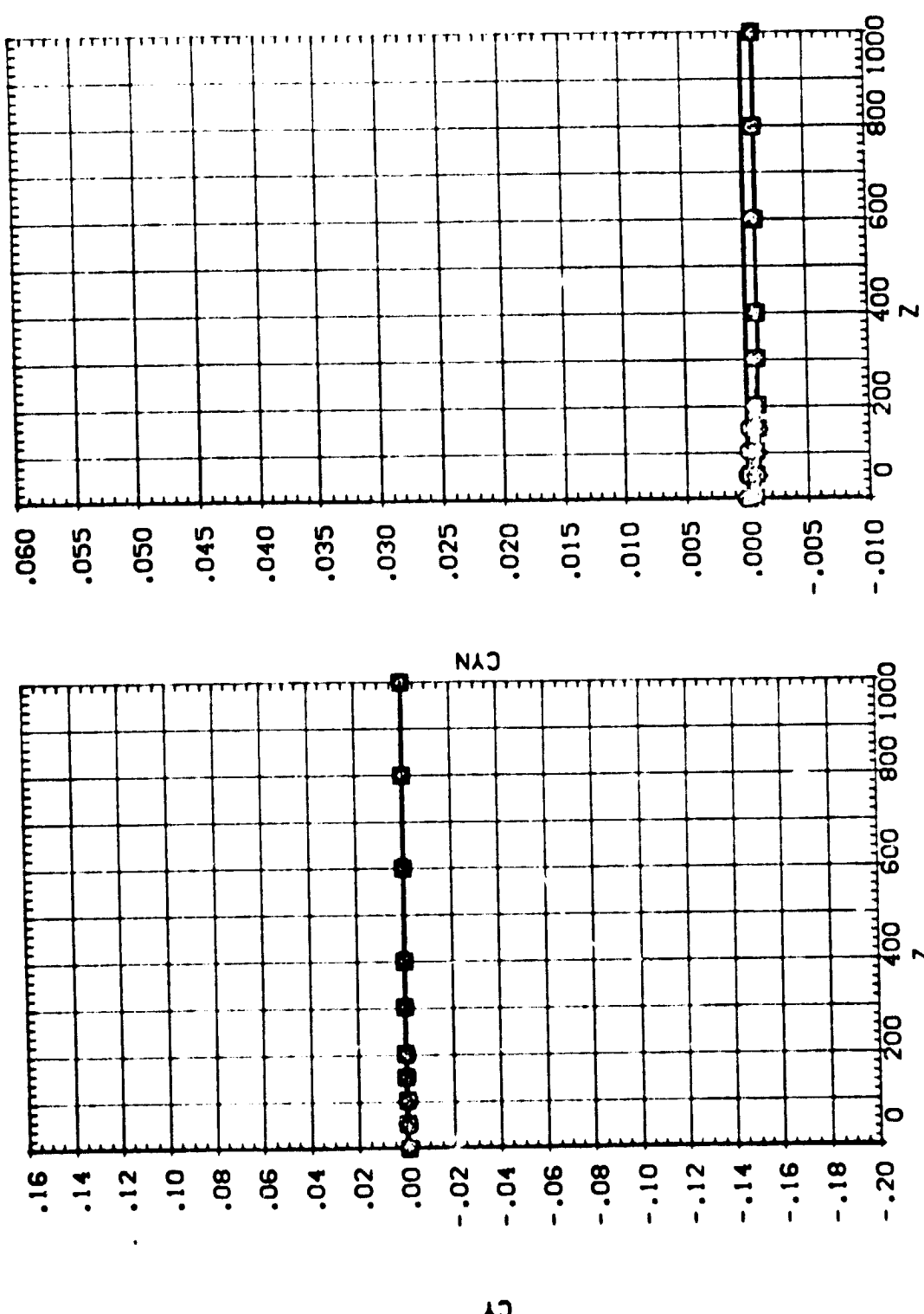

EFFECT OF SRB W/O PLUMES SEPARATION ON ORB/ET AERODYNAMIC CHARACTERISTICS

IA13 SRB(SB) W/O PLUMES SEPARATING FROM 09T10 (RTJ132)

SEE THE ASSOCIATED DATA DOCUMENT FOR REFERENCE CHARACTERISTICS FOR INDIVIDUAL DATASETS

SYMBOL X PARAMETRIC VALUES
 .117 MACH 4.530 PTOTAL 110.000
 300.350 ALPHA .000 BETA .000
 600.520 DALPHA -5.000 DBETA .000
 900.710 Y 800.000 PCWBR .000

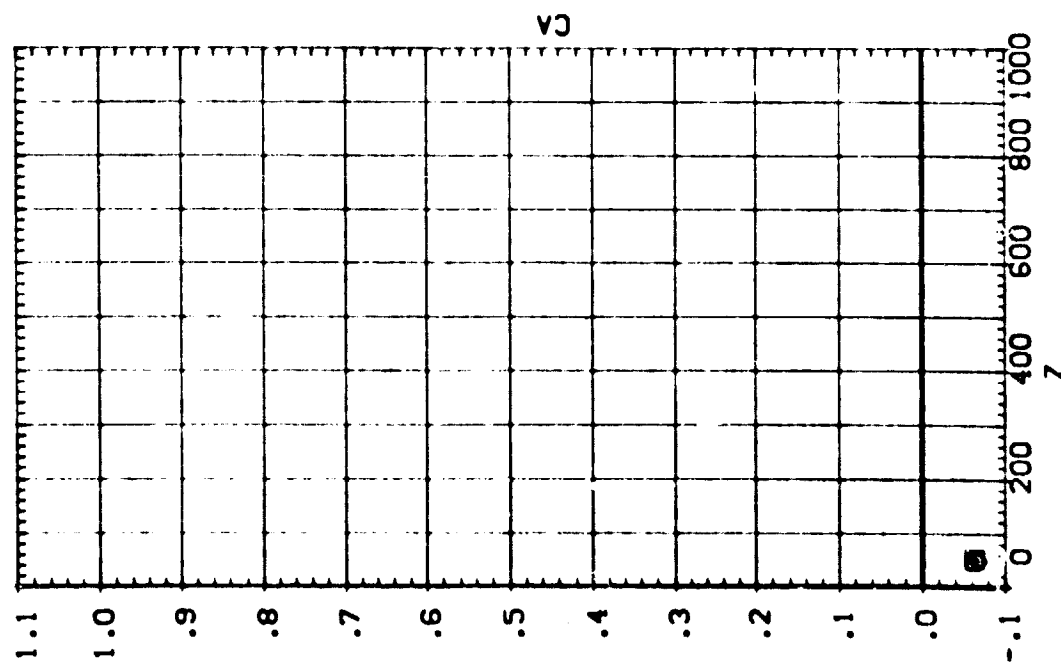
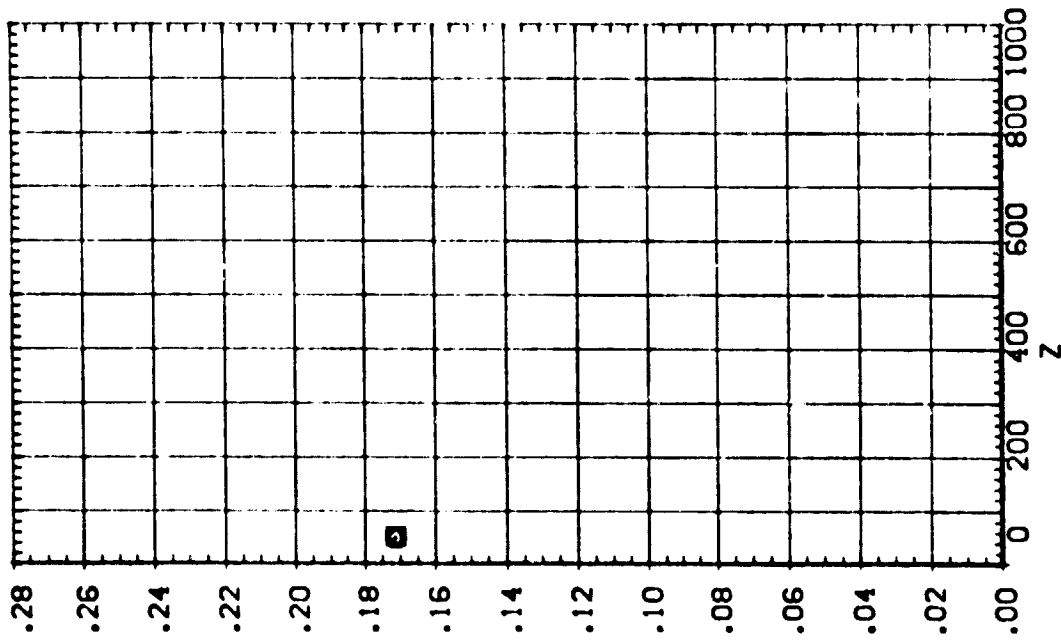

IA13 SRB(S8) W/O PLUMES SEPARATING FROM 09T10 (RTJ132)

SEE THE ASSOCIATED DATA DOCUMENT FOR REFERENCE CHARACTERISTICS FOR INDIVIDUAL DATASETS

SYMBOL		PARAMETRIC VALUES				
□	X	.117	MACH	4.530	P/TOTAL	110.000
□		300.350	ALPHA	.000	BETA	.000
◇		600.520	DALPHA	-5.000	DBETA	.000
△		900.710	Y	600.000	PC-MFR	.000

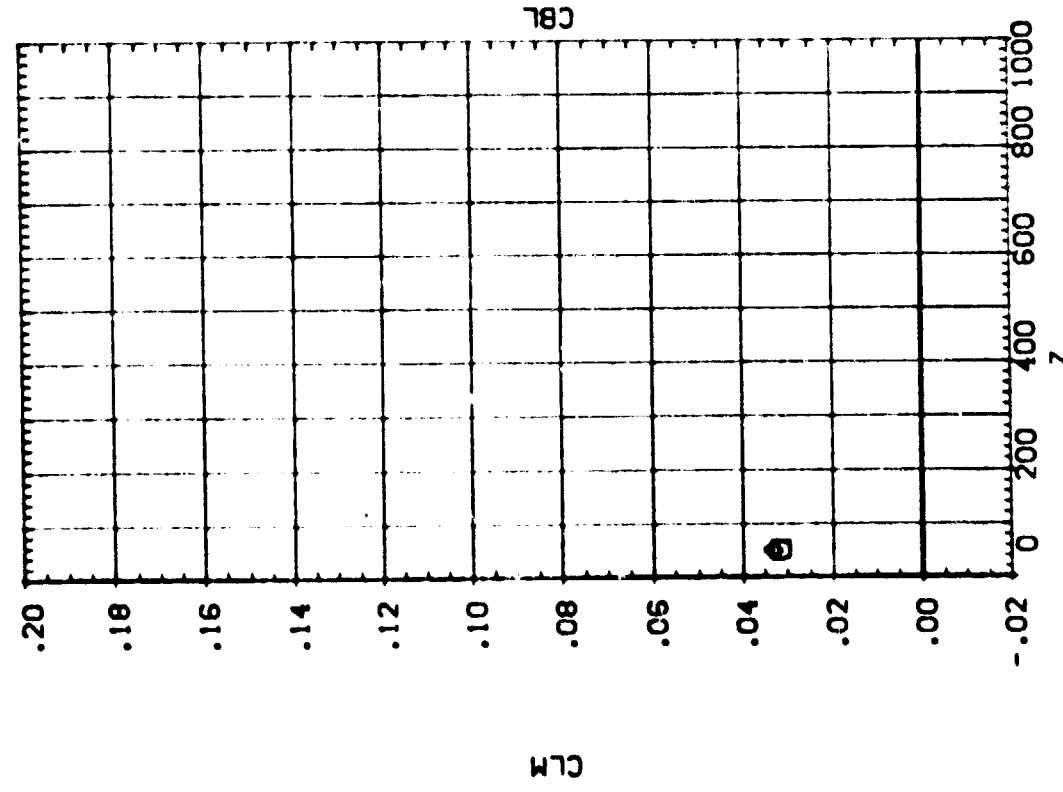
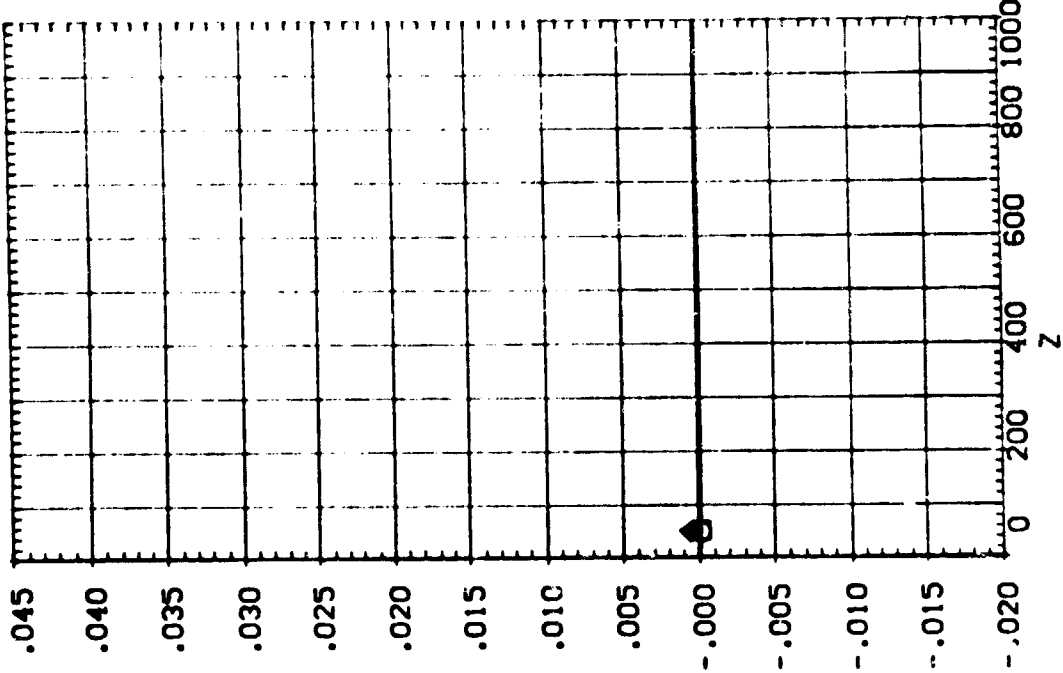

EFFECT OF SRB W/O PLUMES SEPARATION ON ORB/ET AERODYNAMIC CHARACTERISTICS

IA13 SRB(S8) W/O PLUMES SEPARATING FROM 09T10 (RTJ132)

SEE THE ASSOCIATED DATA DOCUMENT FOR REFERENCE CHARACTERISTICS FOR INDIVIDUAL DATASETS

SYMBOL		PARAMETRIC VALUES				
○	X	.117	MACH	4.530	PTOTAL	110.000
□	300.350	ALPHA	.000	BETA	.000	
◇	600.520	DALPHA	-5.000	DBETA	.000	
△	900.710	Y	800.000	PC-MBR	.000	

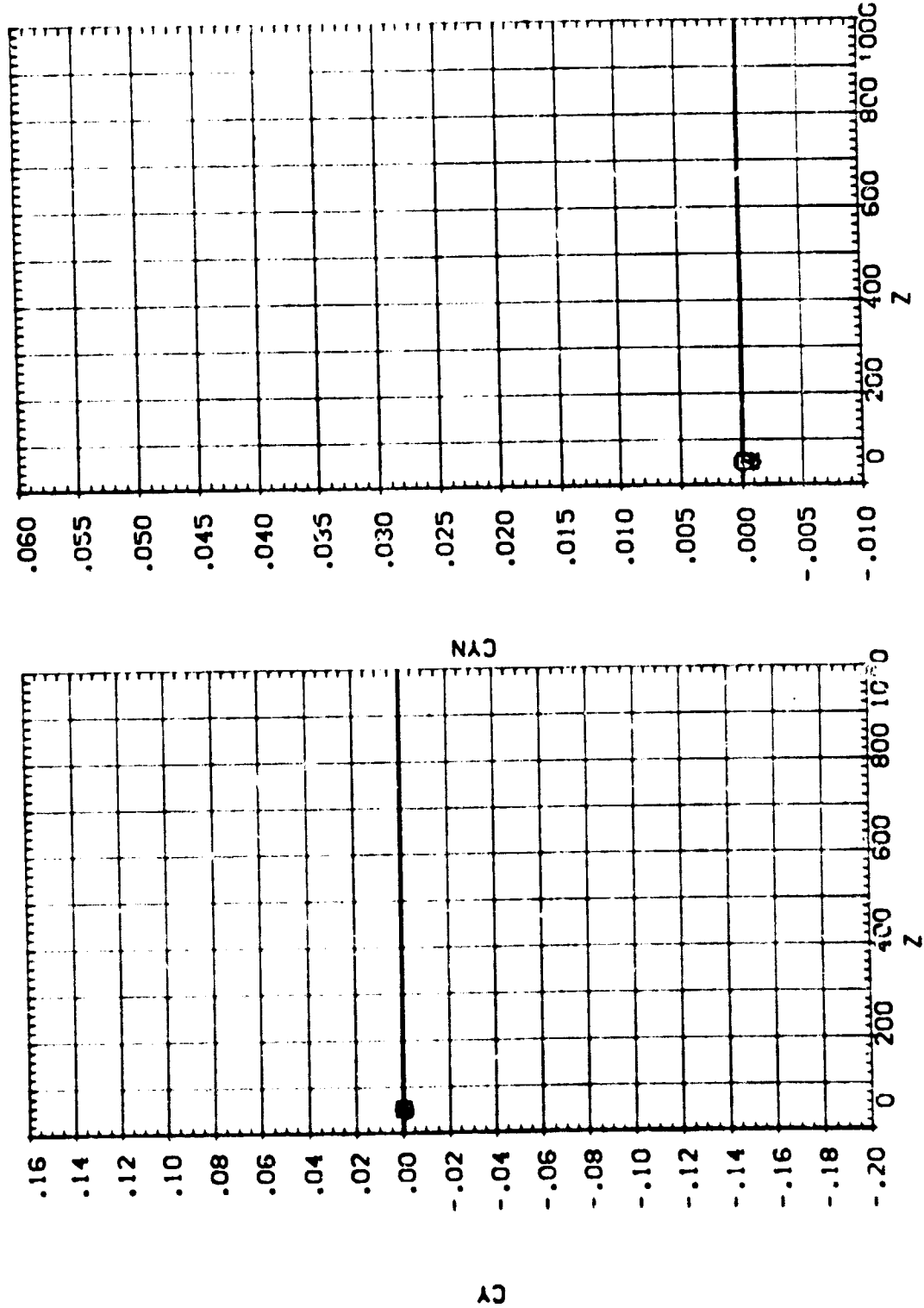

EFFECT OF S18 W/O PLUMES SEPARATION ON 08/ET AERODYNAMIC CHARACTERISTICS

[A13 SRB(S8) W/O PLUMES SEPARATING FROM 09T10 (RTJ134)]

SEE THE ASSOCIATED DATA DOCUMENT FOR REFERENCE CHARACTERISTICS FOR INDIVIDUAL DATASETS

SYMBOL	X	MACH	PARAMETRIC VALUES
○	.110	4.530	PI TOTAL 110.000
□	300.530	.000	BETA .000
◇	600.430	-10.000	DBETA .000
△	900.820	400.000	PC-MBR .000

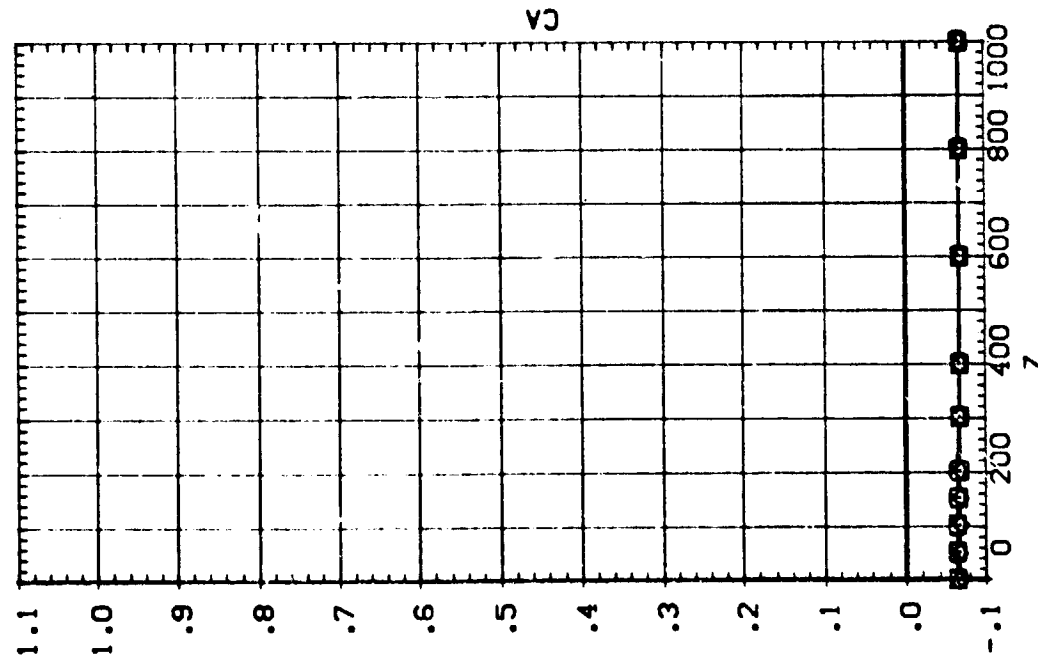
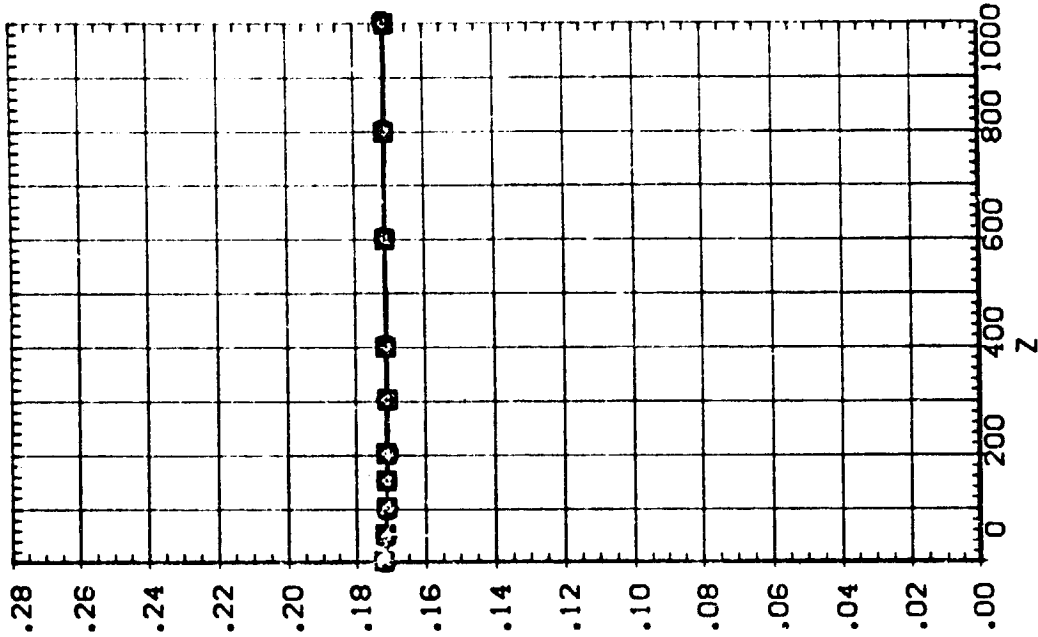

EFFECT OF SRB W/O PLUMES SEPARATION ON ORB/ET AERODYNAMIC CHARACTERISTICS

IA13 SRB(S8) W/O PLUMES SEPARATING FROM 09T10 (RTJ134)

SEE THE ASSOCIATED DATA DOCUMENT FOR REFERENCE CHARACTERISTICS FOR INDIVIDUAL DATASETS

SYMBOL		PARAMETRIC VALUES				
○	X	.110	MACH	4.530	PTOTAL	110.000
□	300.530	ALPHA	.000	BETA	.000	
◇	600.430	DALPHA	-10.000	DBETA	.000	
△	900.820	Y	400.000	PC-MFR	.000	

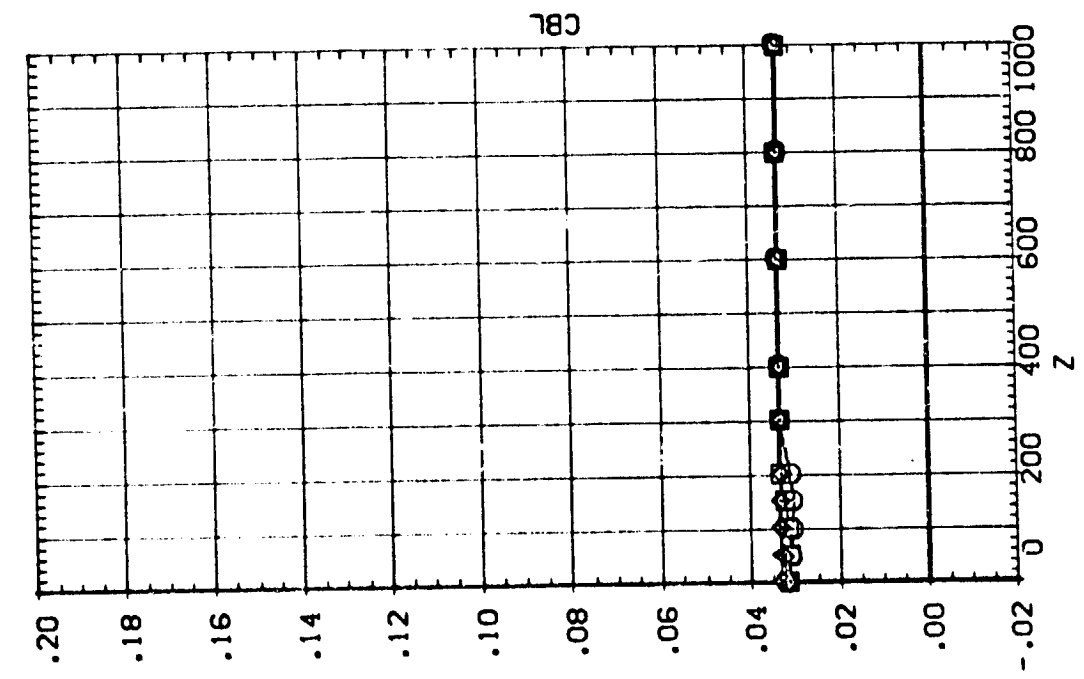
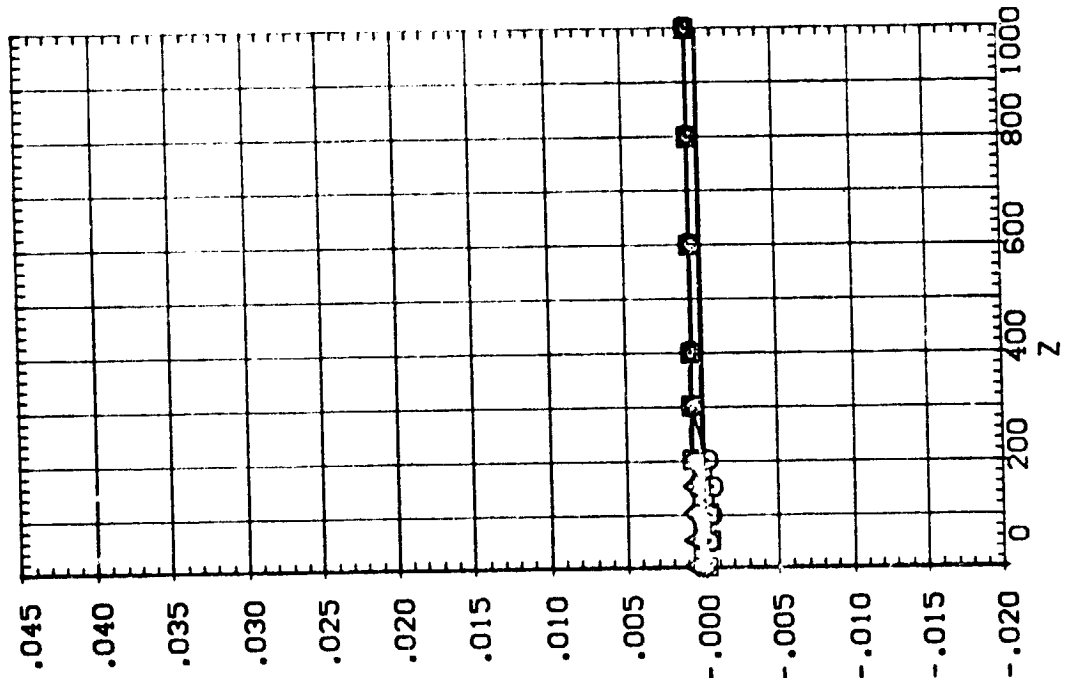

EFFECT OF SRB W/O PLUMES SEPARATION ON ORB/ET AERODYNAMIC CHARACTERISTICS

IA13 SRB(S8) W/O PLUMES SEPARATING FROM 09T10 (RTJ134)

SEE THE ASSOCIATED DATA DOCUMENT FOR REFERENCE CHARACTERISTICS FOR INDIVIDUAL DATASETS

SYMBOL	X	MACH	PARAMETRIC VALUES
○	.110	4.530	P TOTAL 110.000
□	300.530	.000	BETA .000
◇	600.430	-10.000	DBETA .000
△	900.820	400.000	PCHMBR .000

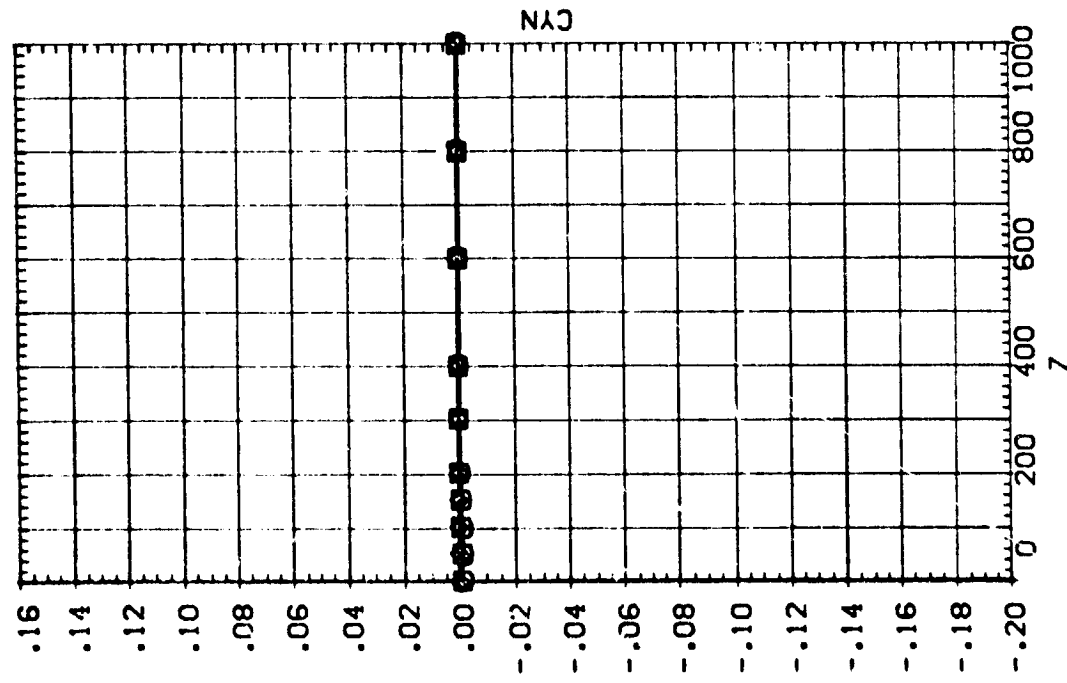
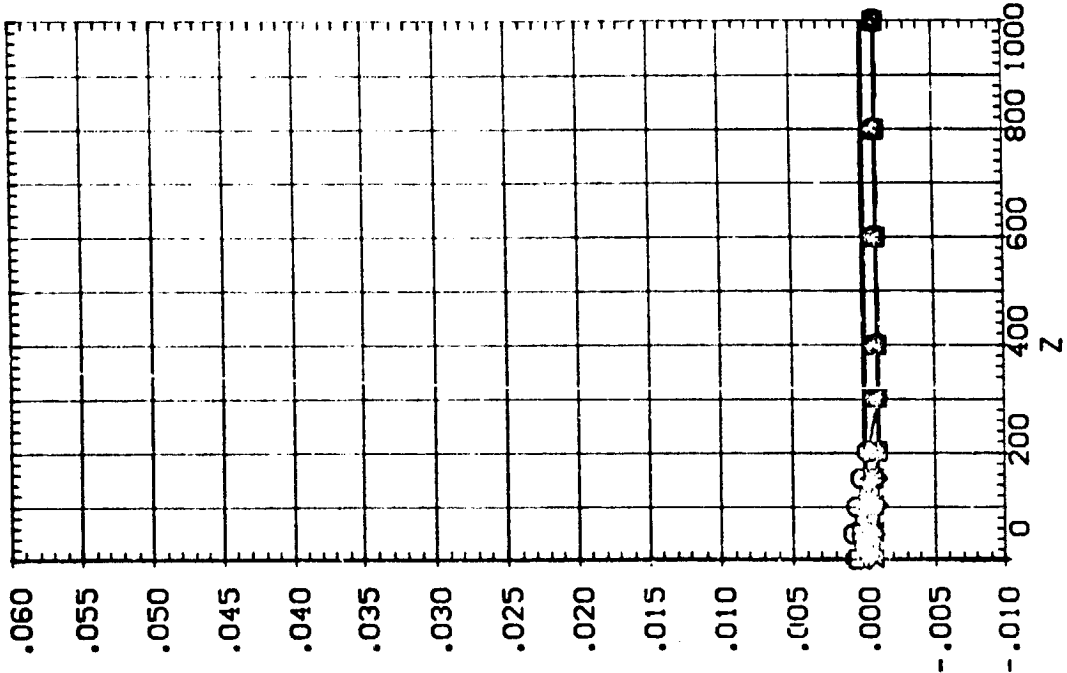

EFFECT OF SRB W/O PLUMES SEPARATION ON ORB/ET AERODYNAMIC CHARACTERISTICS

IA13 SRB(S8) W/O PLUMES SEPARATING FROM 09T10 (RTJ135)

SEE THE ASSOCIATED DATA DOCUMENT FOR REFERENCE CHARACTERISTICS FOR INDIVIDUAL DATASETS

PARAMETRIC VALUES	
MACH	4.530
PTOTAL	110.000
ALPHA	.000
BETA	.000
DALPHA	-10.000
DBETA	.000
Y	.000
PCHMR	.000

SYMBOL	X
○	.315
□	300.490
◇	600.610
△	900.830

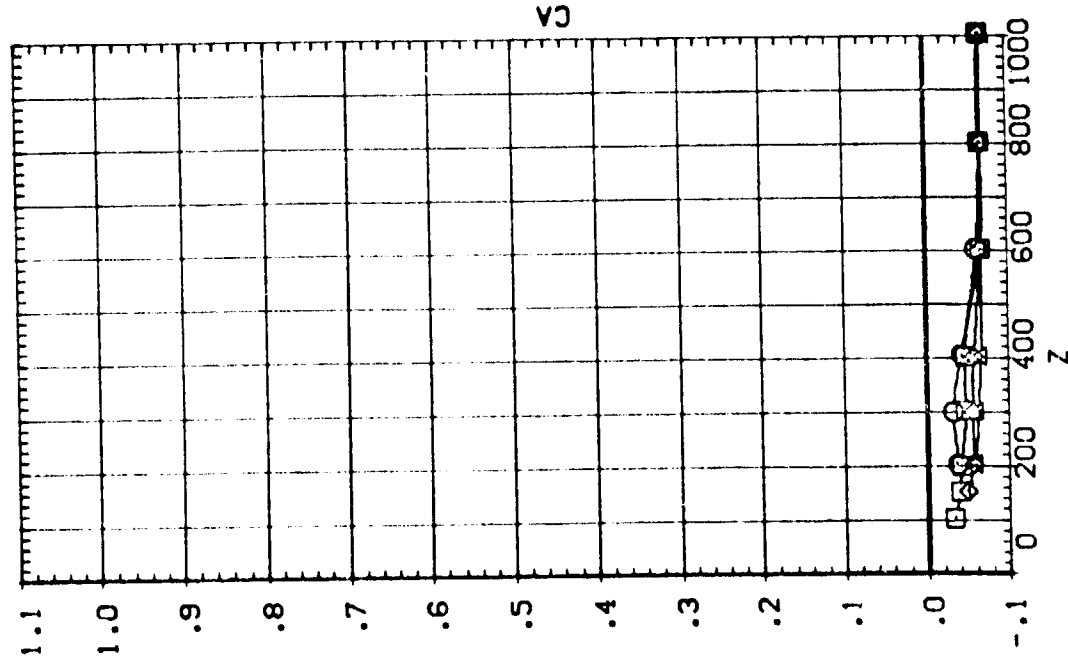
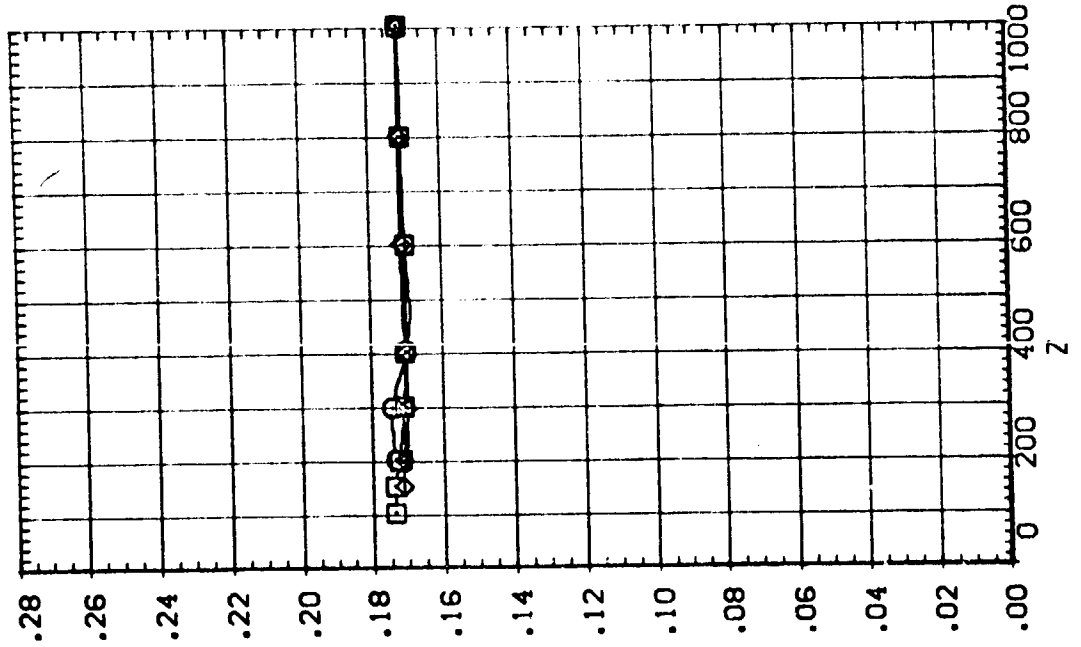

2

IA13 SRB(S8) W/O PLUMES SEPARATING FROM 09T10 (RTJ135)

SEE THE ASSOCIATED DATA DOCUMENT FOR REFERENCE CHARACTERISTICS FOR INDIVIDUAL DATASETS

PARAMETRIC VALUES	
X	.315
MACH	4.530
PTOTAL	110.000
ALPHA	.000
BETA	.000
DBETA	.000
Y	-10.000
PC-MER	.000

SYMBOL
 ○
 □
 ◇
 △

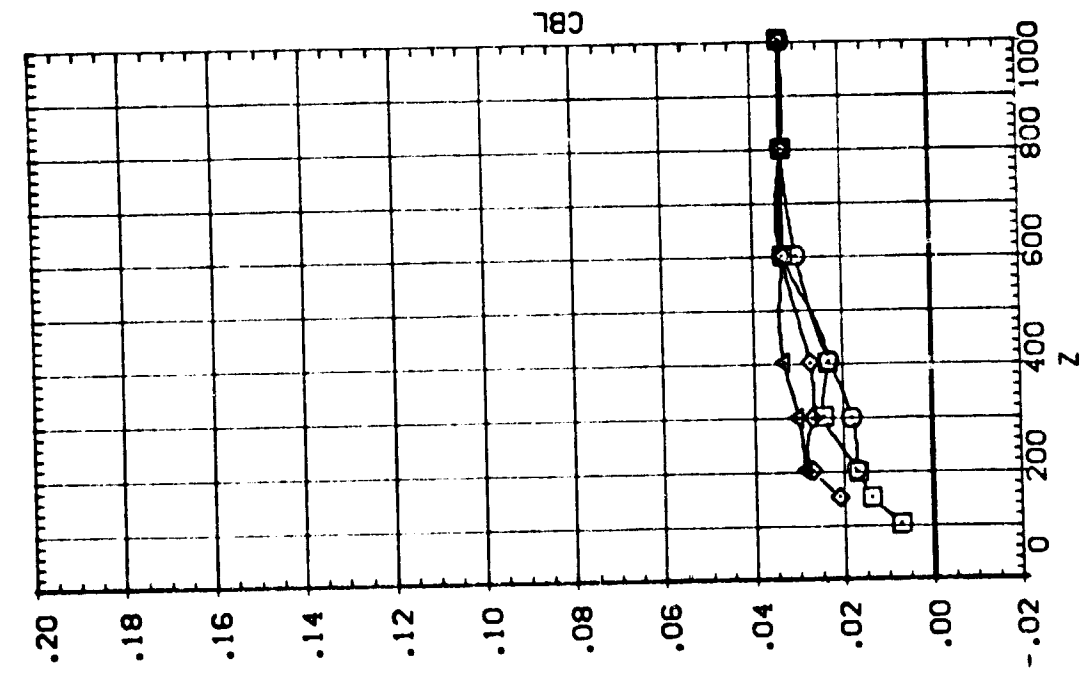
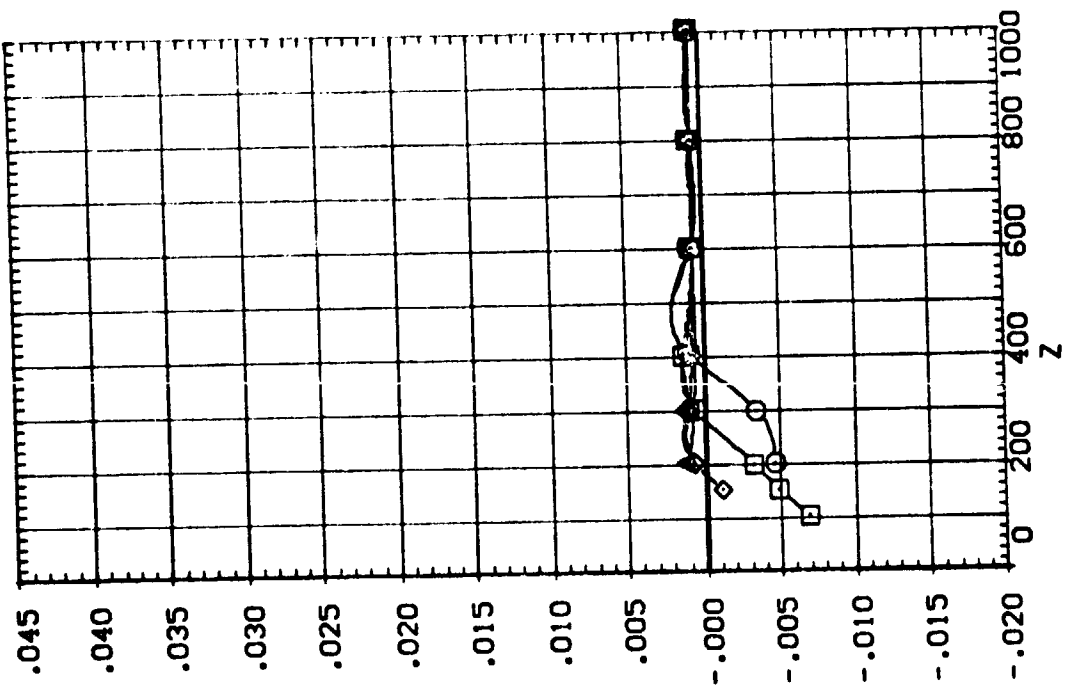

EFFECT OF SRB W/O PLUMES SEPARATION ON ORB/ET AERODYNAMIC CHARACTERISTICS PAGE 662

IA13 SRB(S8) W/O PLUMES SEPARATING FROM 09T10 (RTJ135)

SEE THE ASSOCIATED DATA DOCUMENT FOR REFERENCE CHARACTERISTICS FOR INDIVIDUAL DATASETS

SYMBOL		PARAMETRIC VALUES				
○	X	.315	MACH	4.530	PTOTAL	110.000
□	300.490	ALPHA	.000	BETA	.000	
◇	600.610	DALPHA	-10.000	DBETA	.000	
△	900.830	Y	.000	PC-MBR	.000	

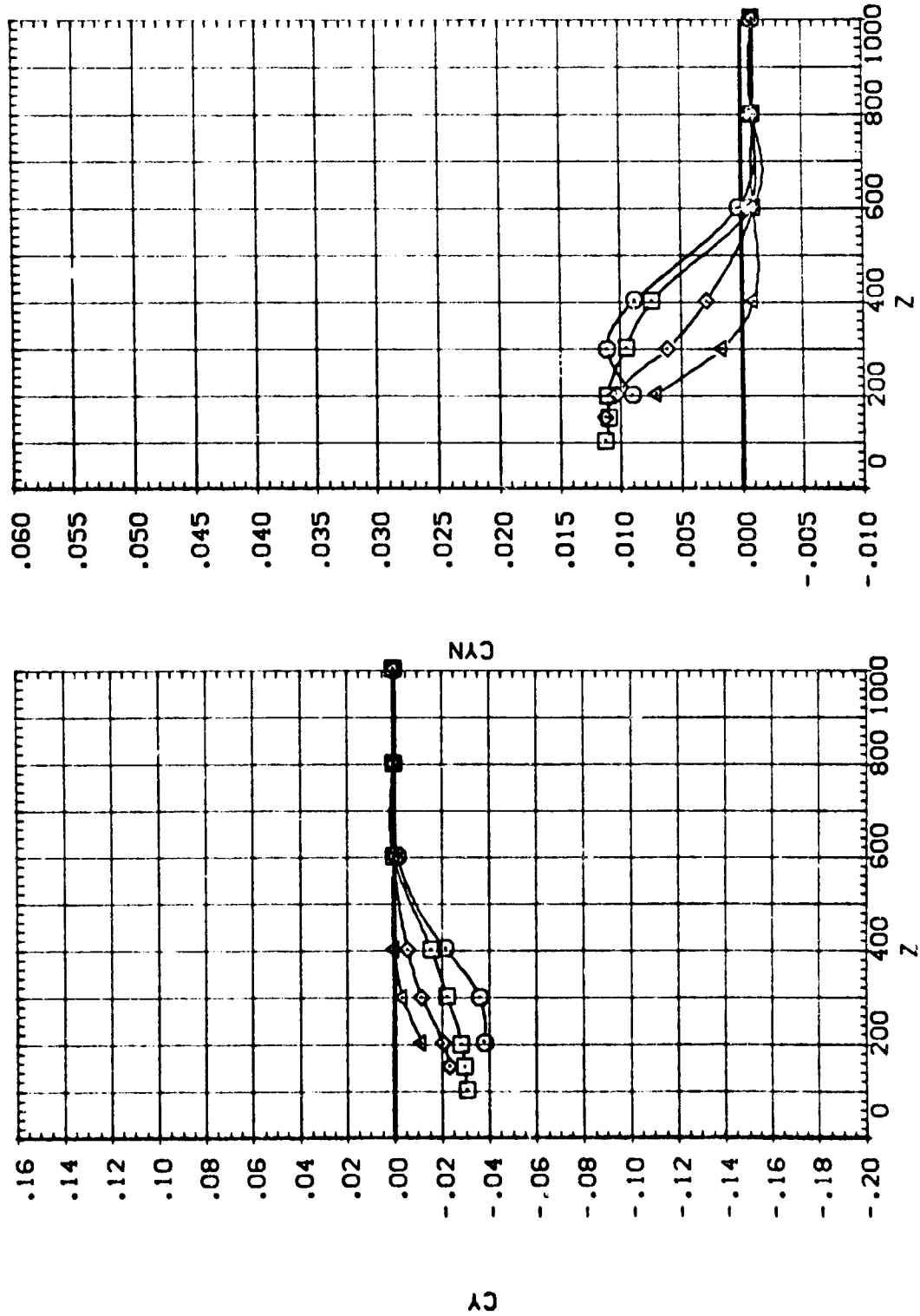

IA13 SRB(SB) W/O PLUMES SEPARATING FROM 09T10 (RTJ136)

SEE THE ASSOCIATED DATA DOCUMENT FOR REFERENCE CHARACTERISTICS FOR INDIVIDUAL DATASETS

SYMBOL		PARAMETRIC VALUES	
○	X	MACH	PTOTAL
□	300.650	4.530	110.000
◇	600.570	ALPHA	BETA
△	900.770	-10.000	.000
		200.000	PC-MBR
			.000

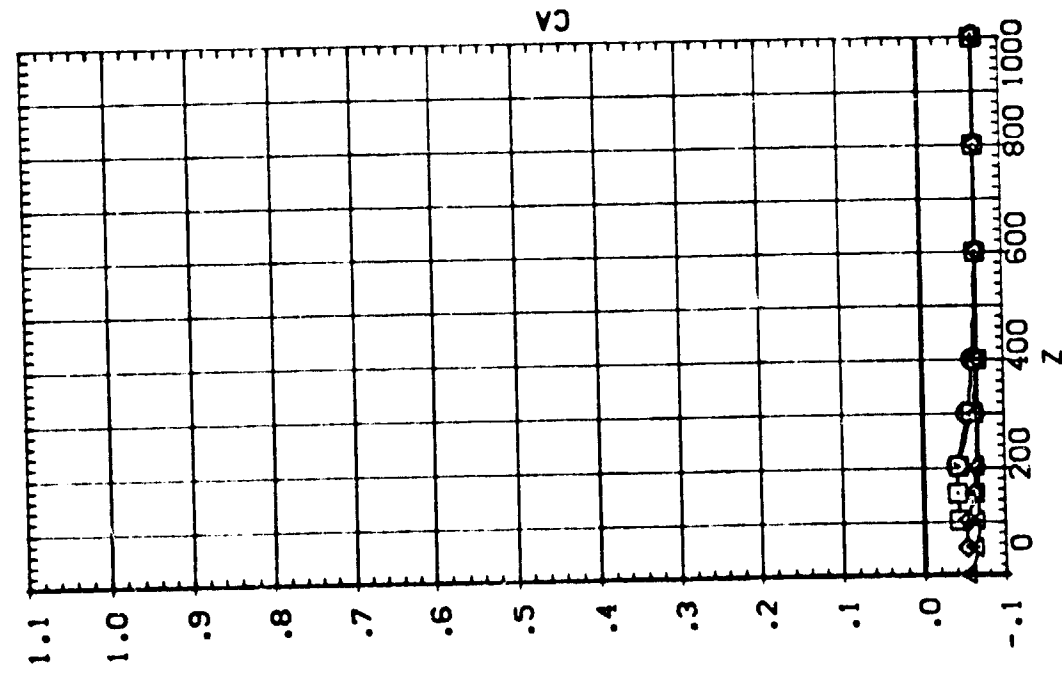
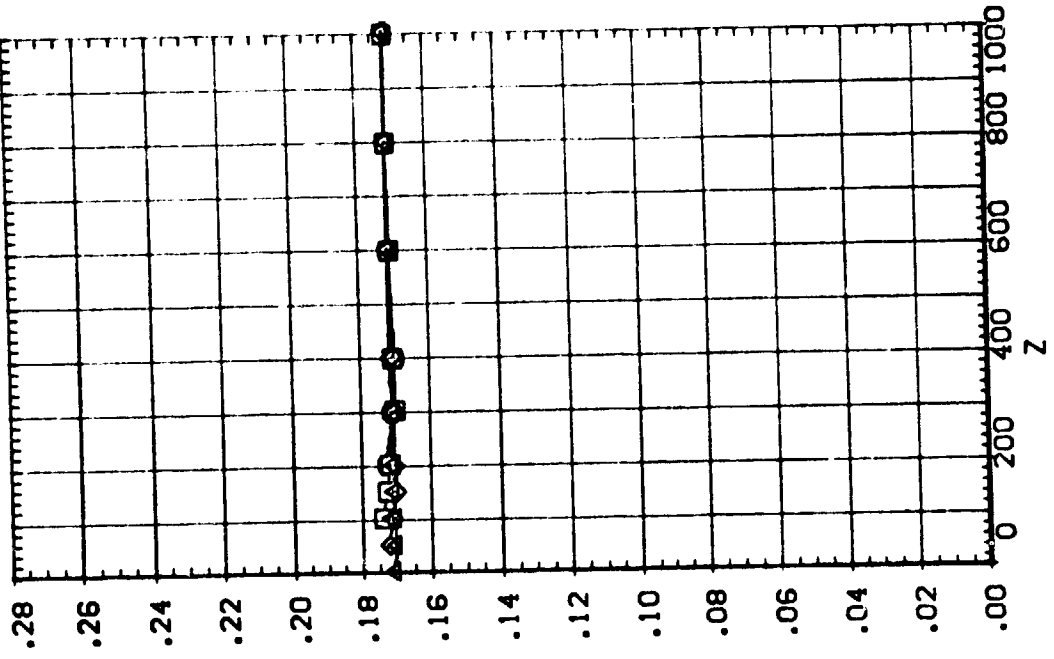

EFFECT OF SRB W/O PLUMES SEPARATION ON ORB/ET AERODYNAMIC CHARACTERISTICS

IA13 SRB(S8) W/O PLUMES SEPARATING FROM 09T10 (RTJ136)

SEE THE ASSOCIATED DATA DOCUMENT FOR REFERENCE CHARACTERISTICS FOR INDIVIDUAL DATASETS

PARAMETRIC VALUES	
MACH	4.530
PTOTAL	110.000
BETA	.000
DBETA	.000
PCHEER	.000
X	.220
ALPHA	.000
DALPHA	-10.000
Y	200.000
300.650	
600.570	
900.770	

SYMBOL
 ○ □ △

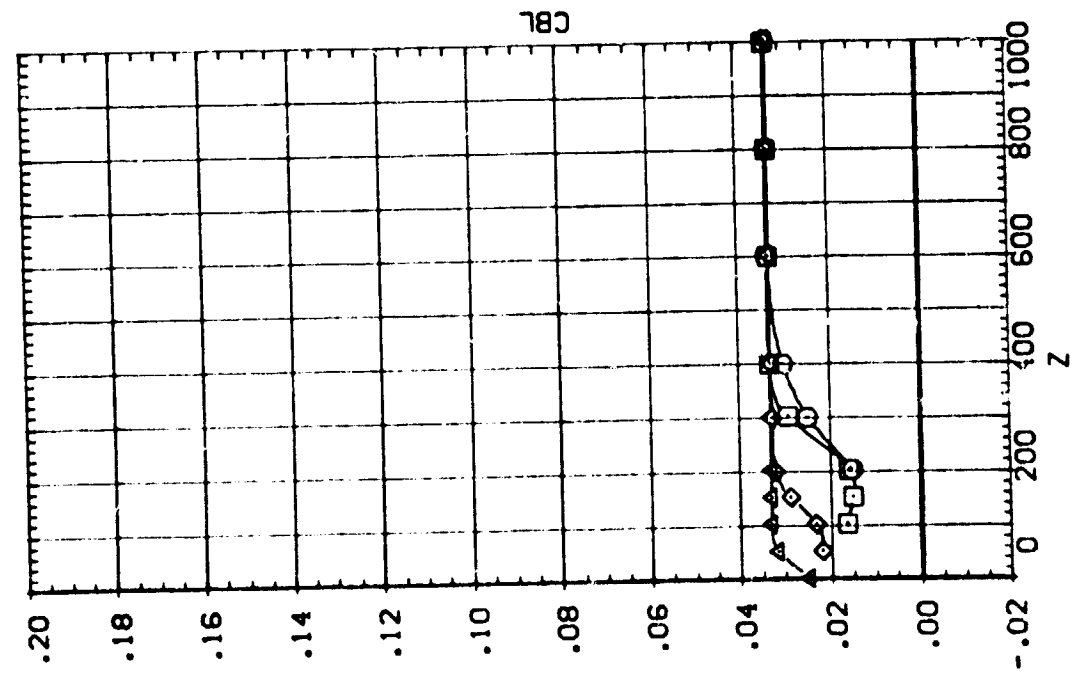
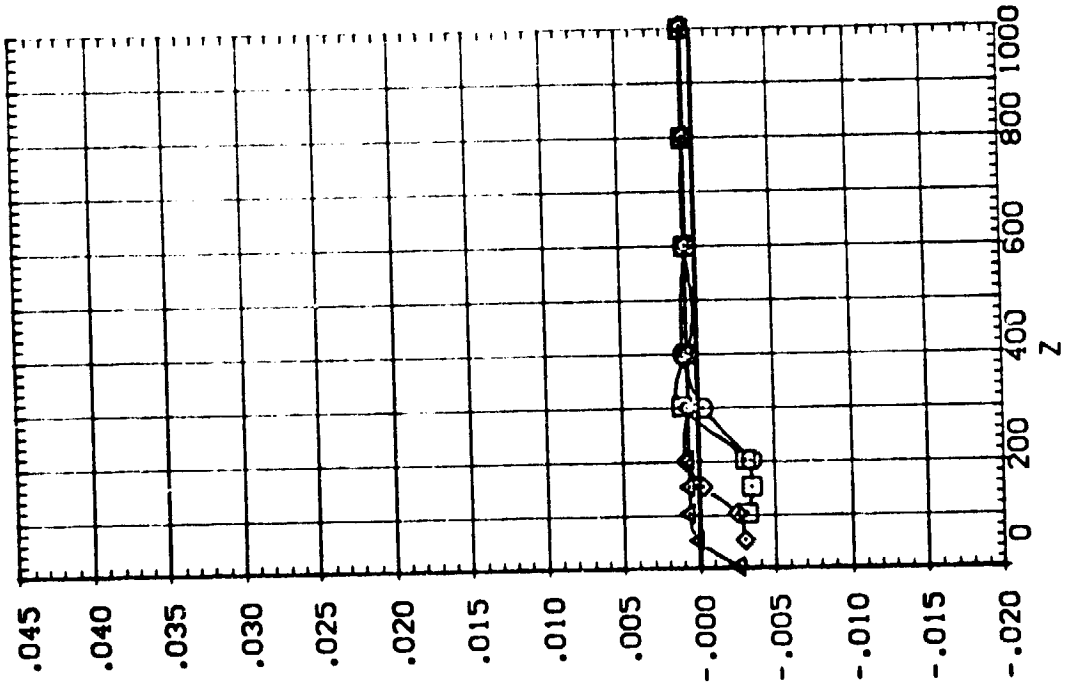

IA13 SRB(S8) W/O PLUMES SEPARATING FROM 09T10 (RTJ136)

SEE THE ASSOCIATED DATA DOCUMENT FOR REFERENCE CHARACTERISTICS FOR INDIVIDUAL DATASETS

PARAMETRIC VALUES	
X	.20
MACH	4.530
P/TOTAL	110.000
ALPHA	.000
BETA	.000
DBETA	.000
PC-MBR	200.000
Y	-10.000
Z	300.650
DBETA	600.570
PC-MBR	900.770

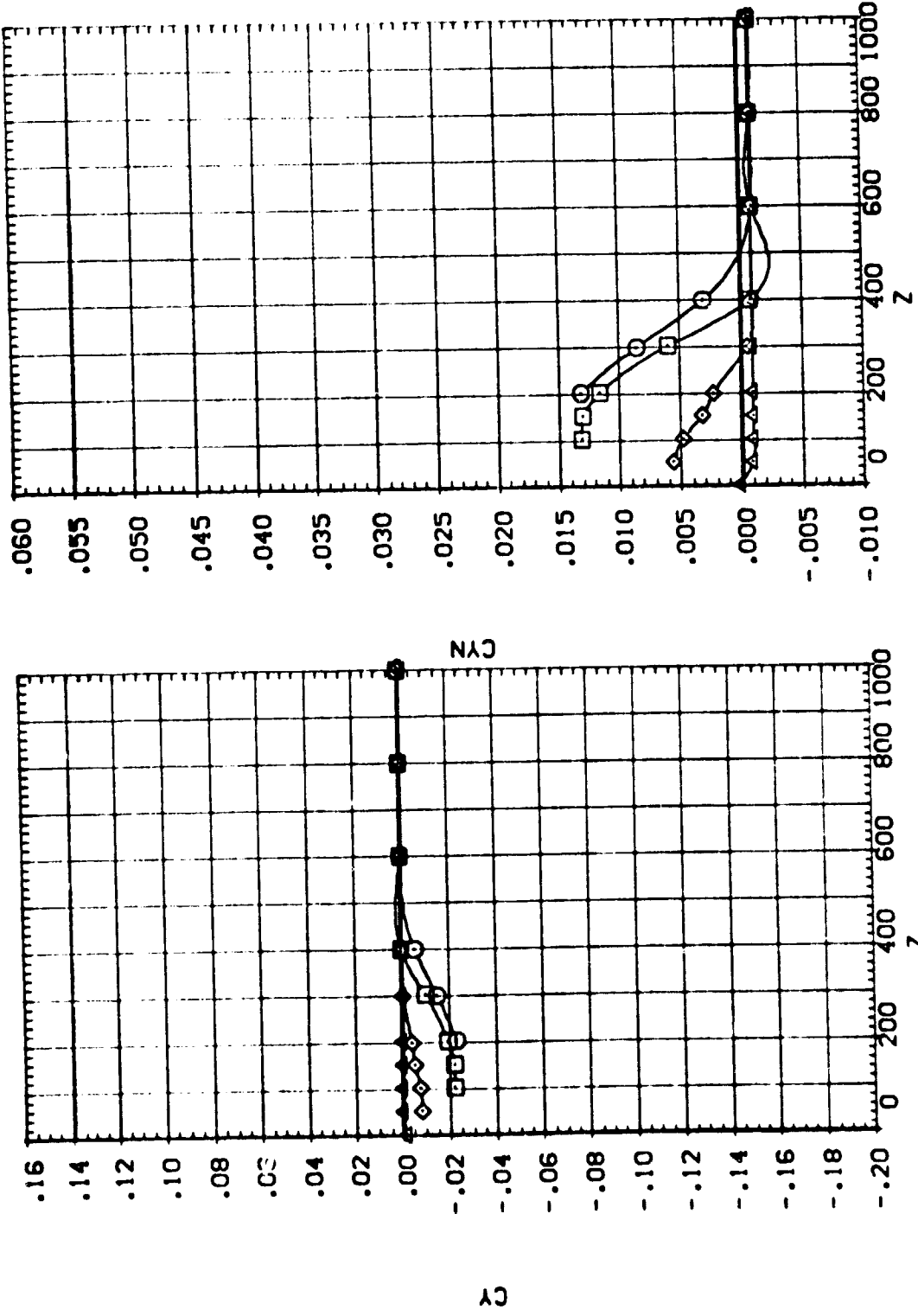

EFFECT OF SRB W/O PLUMES SEPARATION ON ORB/ET AERODYNAMIC CHARACTERISTICS

IA13 SRB(S8) W/O PLUMES SEPARATING FROM 09T10 (RTJ137)

SYMBOL

-
-
- ◇
- △

PARAMETRIC VALUES

X	MACH	PTOTAL	110,000
.471	4.530	BETA	.000
300.400	.000	DBETA	.000
600.700	-20.000	PCMBR	.000
899.730	.000		

SEE THE ASSOCIATED DATA DOCUMENT FOR REFERENCE CHARACTERISTICS FOR INDIVIDUAL DATASETS

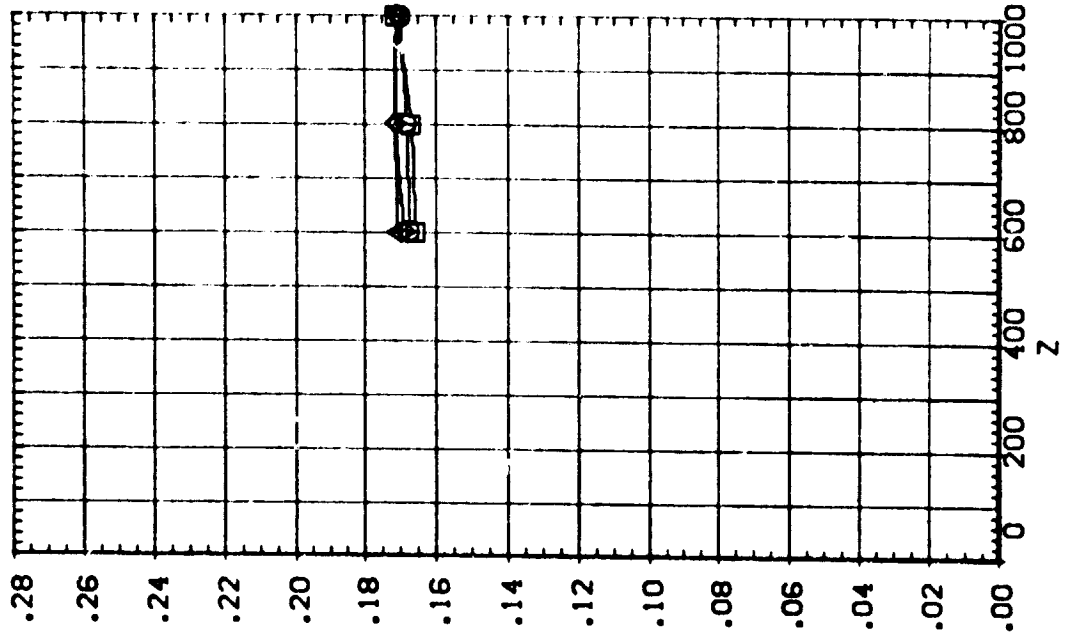
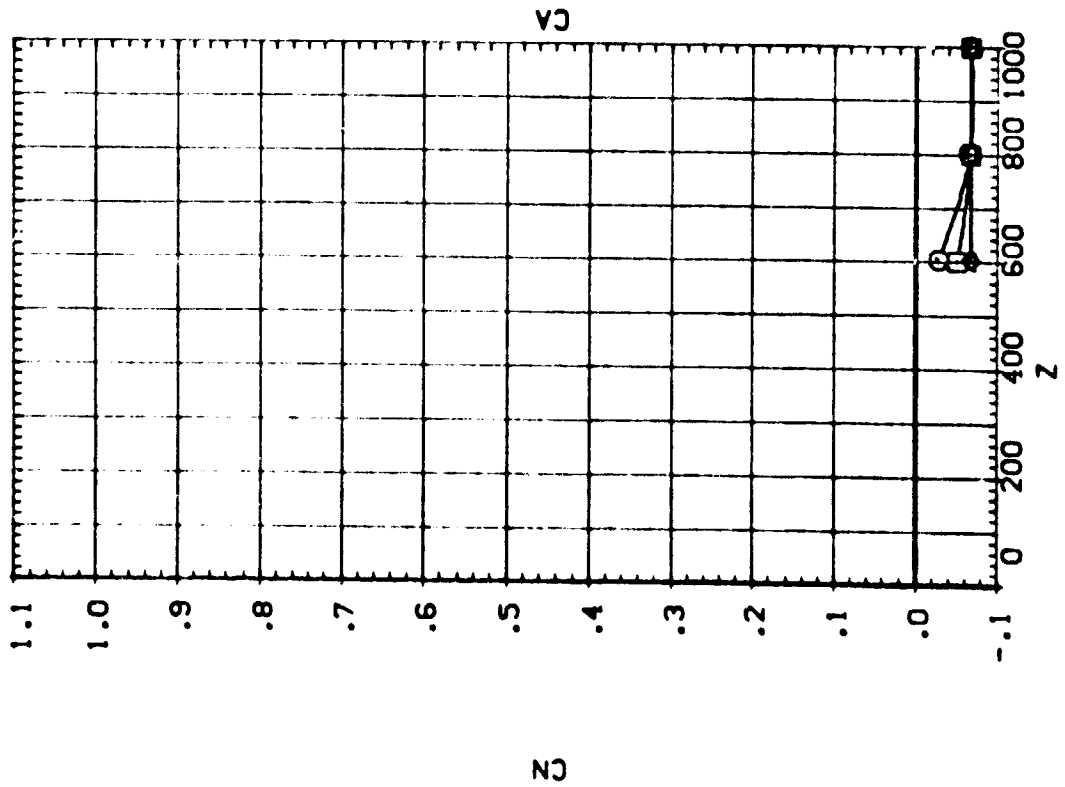

EFFECT OF SRB W/O PLUMES SEPARATION ON ORB/ET AERODYNAMIC CHARACTERISTICS

IA13 SRB(SB) W/O PLUMES SEPARATING FROM 09T10 (RTJ137)

SEE THE ASSOCIATED DATA DOCUMENT FOR REFERENCE CHARACTERISTICS FOR INDIVIDUAL DATASETS

SYMBOL	X	MACH	PARAMETRIC VALUES
○	.471		PITOTAL 110.000
□	300.400	ALPHA	.000
◇	600.700	DBETA	.000
△	899.730	POWBR	.000

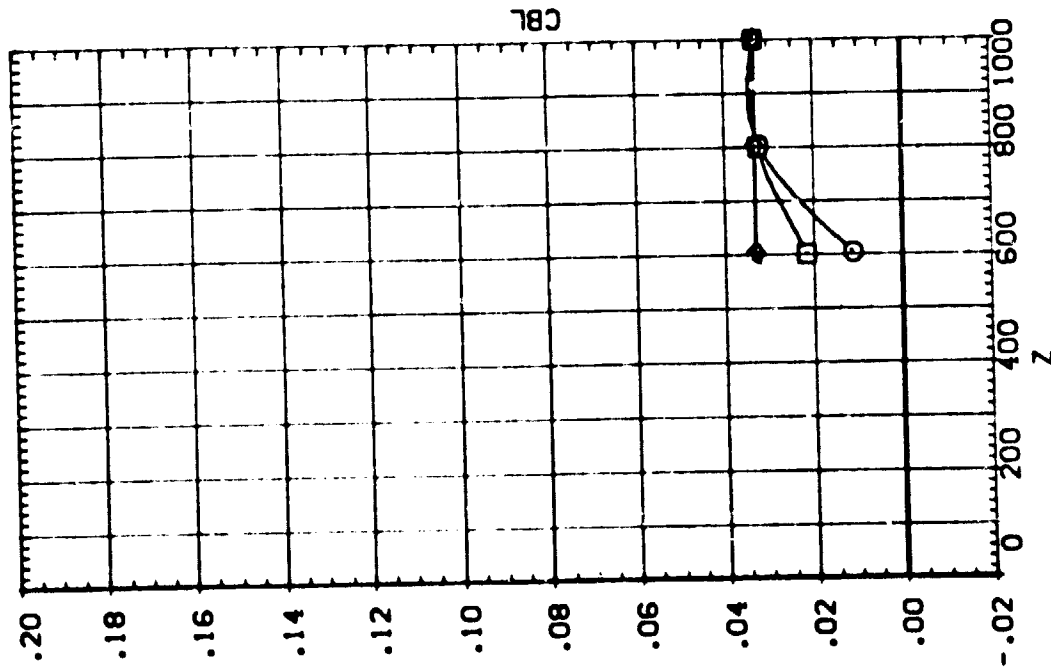
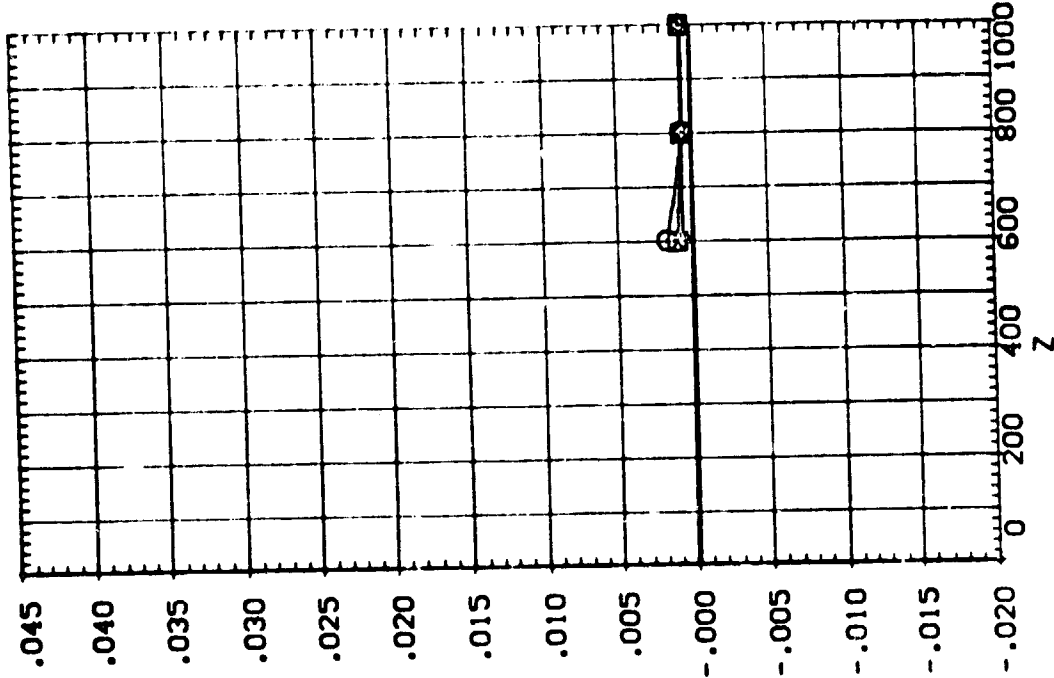

EFFECT OF SRB W/O PLUMES SEPARATION ON ORB/ET AERODYNAMIC CHARACTERISTICS

IA13 SRB(SB) W/O PLUMES SEPARATING FROM 09T10 (RTJ137)

SEE THE ASSOCIATED DATA DOCUMENT FOR REFERENCE CHARACTERISTICS FOR INDIVIDUAL DATASETS

SYMBOL	X	MACH	PARAMETRIC VALUES
○	300.400	.471	4.530
□	600.700	.000	PTOTAL
△	899.730	-20.000	BETA
		.000	OBETA
		.000	PO+PR
		.000	

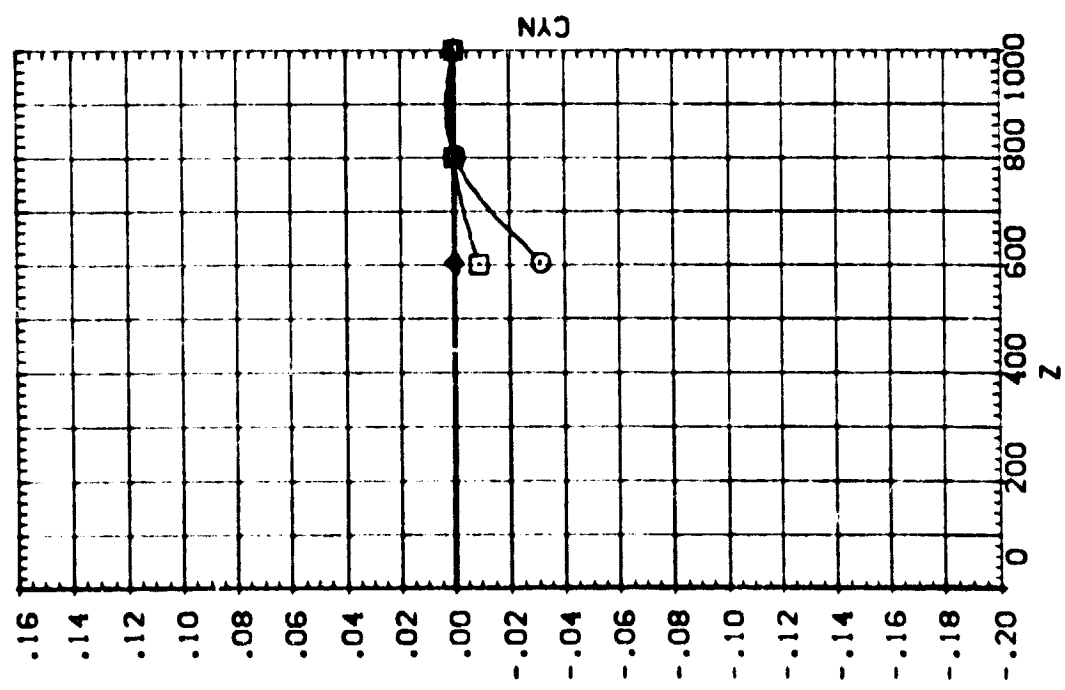
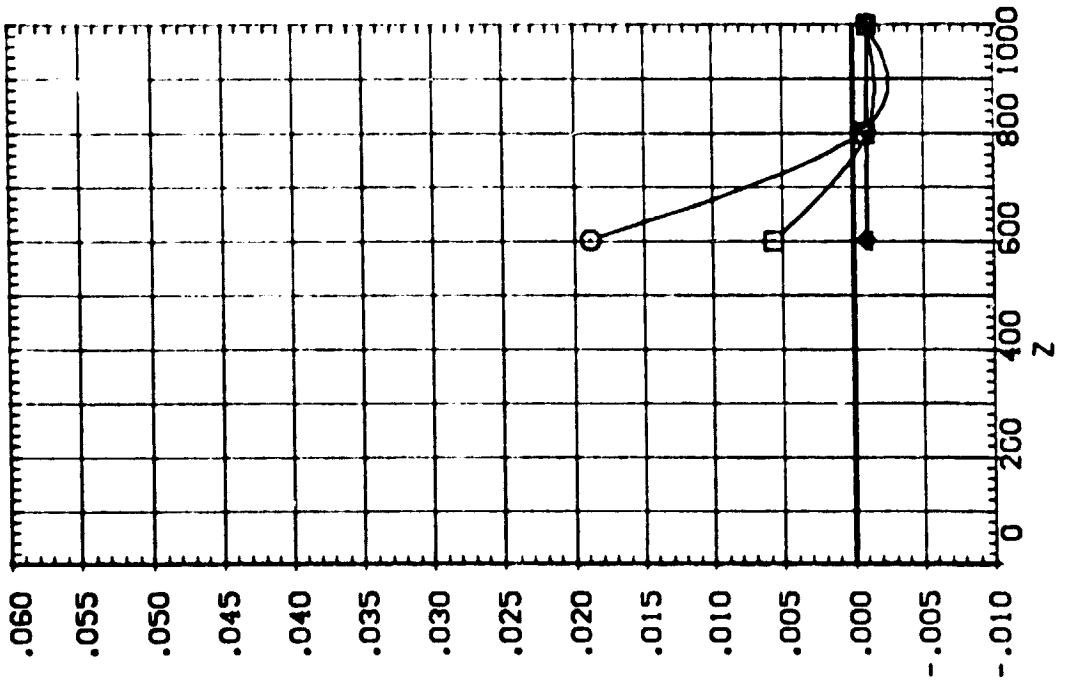

[A13 SRB(S8) W/O PLUMES SEPARATING FROM 09T10 (RTJ138)]

SEE THE ASSOCIATED DATA DOCUMENT FOR REFERENCE CHARACTERISTICS FOR INDIVIDUAL DATASETS

SYMBOL	X	MACH	PARAMETRIC VALUES
□	-.057	4.530	PTOTAL 110.000
○	300.640	.000	BETA .000
◇	600.080	-20.000	DBETA .000
△	901.080	200.000	PC-68R .000

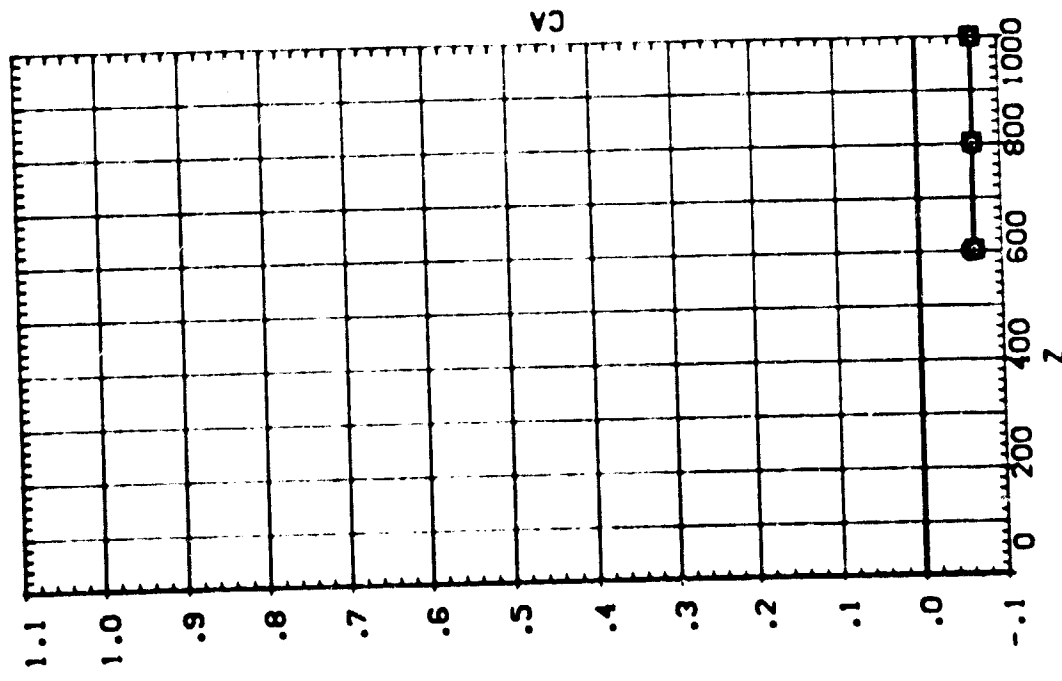
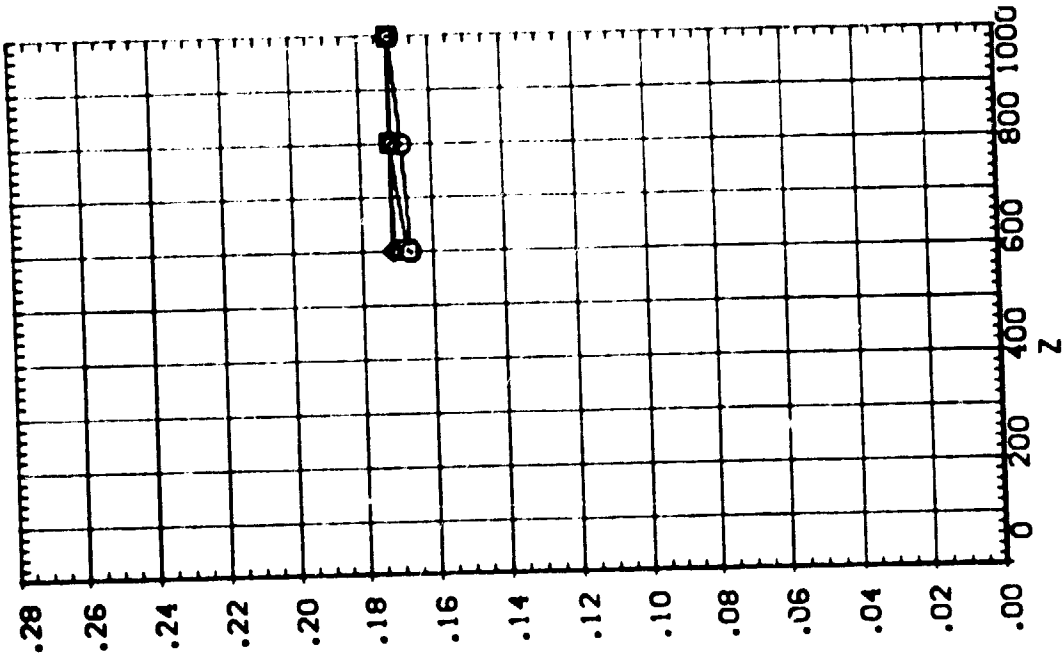

EFFECT OF SRB W/O PLUMES SEPARATION ON ORB/ET AERODYNAMIC CHARACTERISTICS

IA13 SRB(SB) W/O PLUMES SEPARATING FROM 09T10 (RTJ138)

SYMBOL X PARAMETRIC VALUES

○	-.057	MACH	4.530	PTOTAL	110.000
□	307.640	ALPHA	.000	BETA	.000
◇	620.080	DALPHA	-20.000	DBETA	.000
△	901.080	Y	200.000	PC-MBR	.000

SEE THE ASSOCIATED DATA DOCUMENT FOR REFERENCE CHARACTERISTICS FOR INDIVIDUAL DATASETS

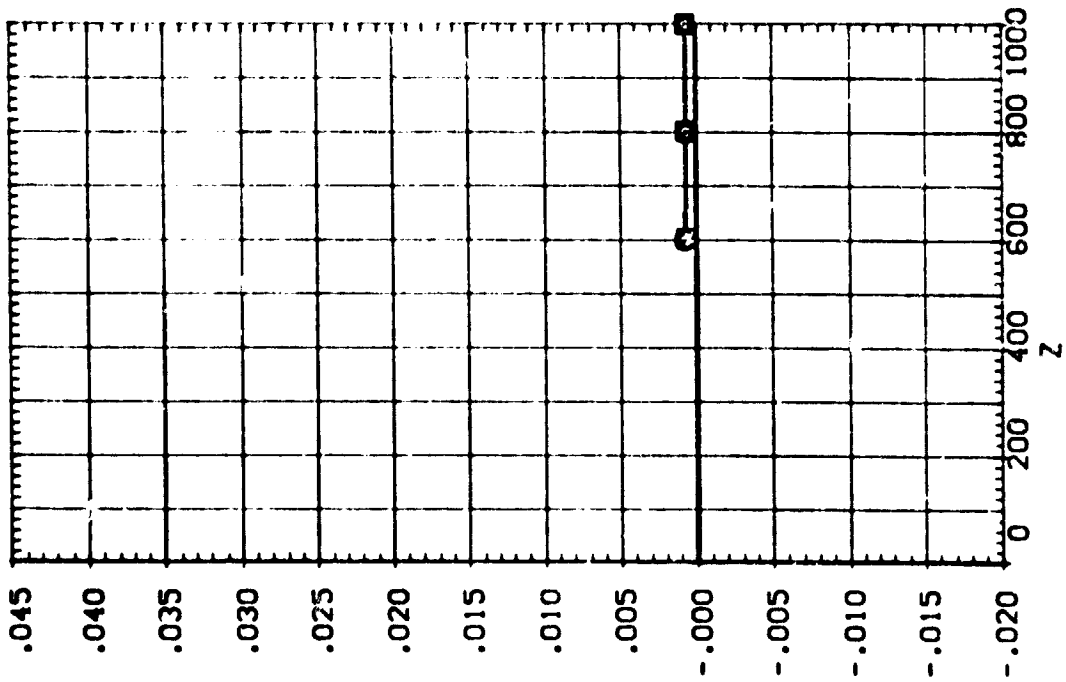
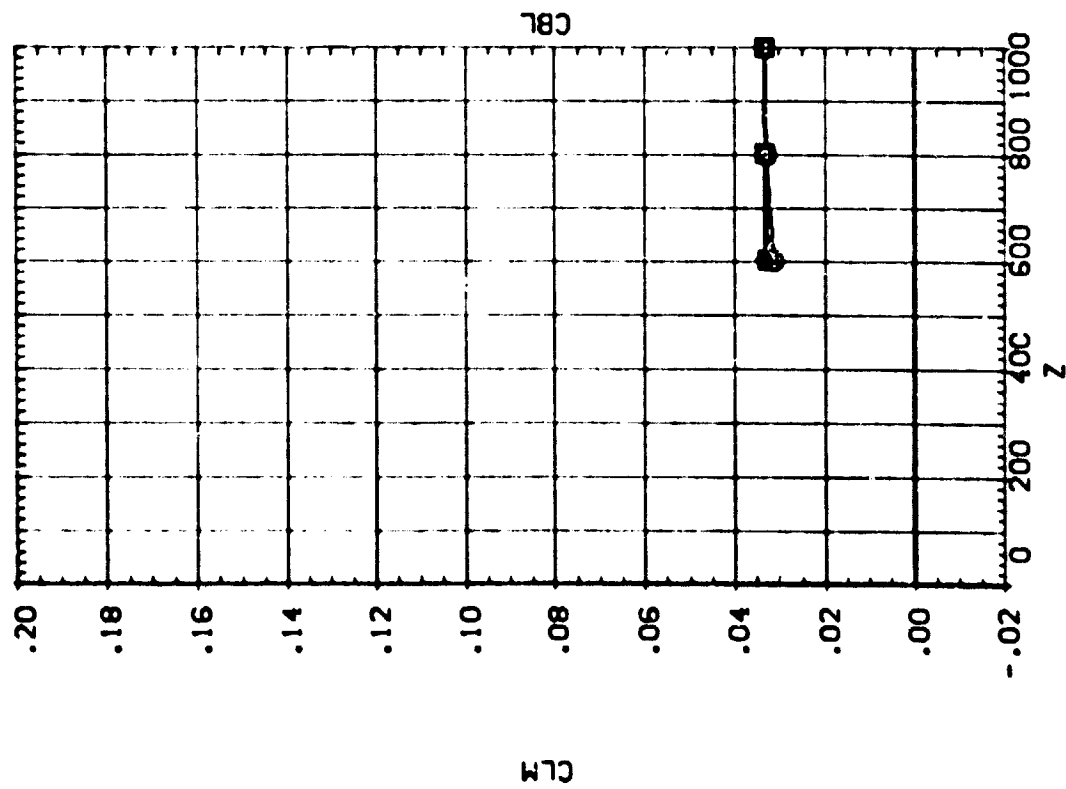

IA13 SRB(S8) W/O PLUMES SEPARATING FROM 09T10 (RTJ138)

SEE THE ASSOCIATED DATA DOCUMENT FOR REFERENCE CHARACTERISTICS FOR INDIVIDUAL DATASETS

SYMBOL	X	MACH	PARAMETRIC VALUES
□	-.057	4.530	PITOTAL 110.000
◇	300.640	.000	BETA .000
◇	600.080	-20.000	DBETA .000
△	901.080	200.000	PCMBR .000

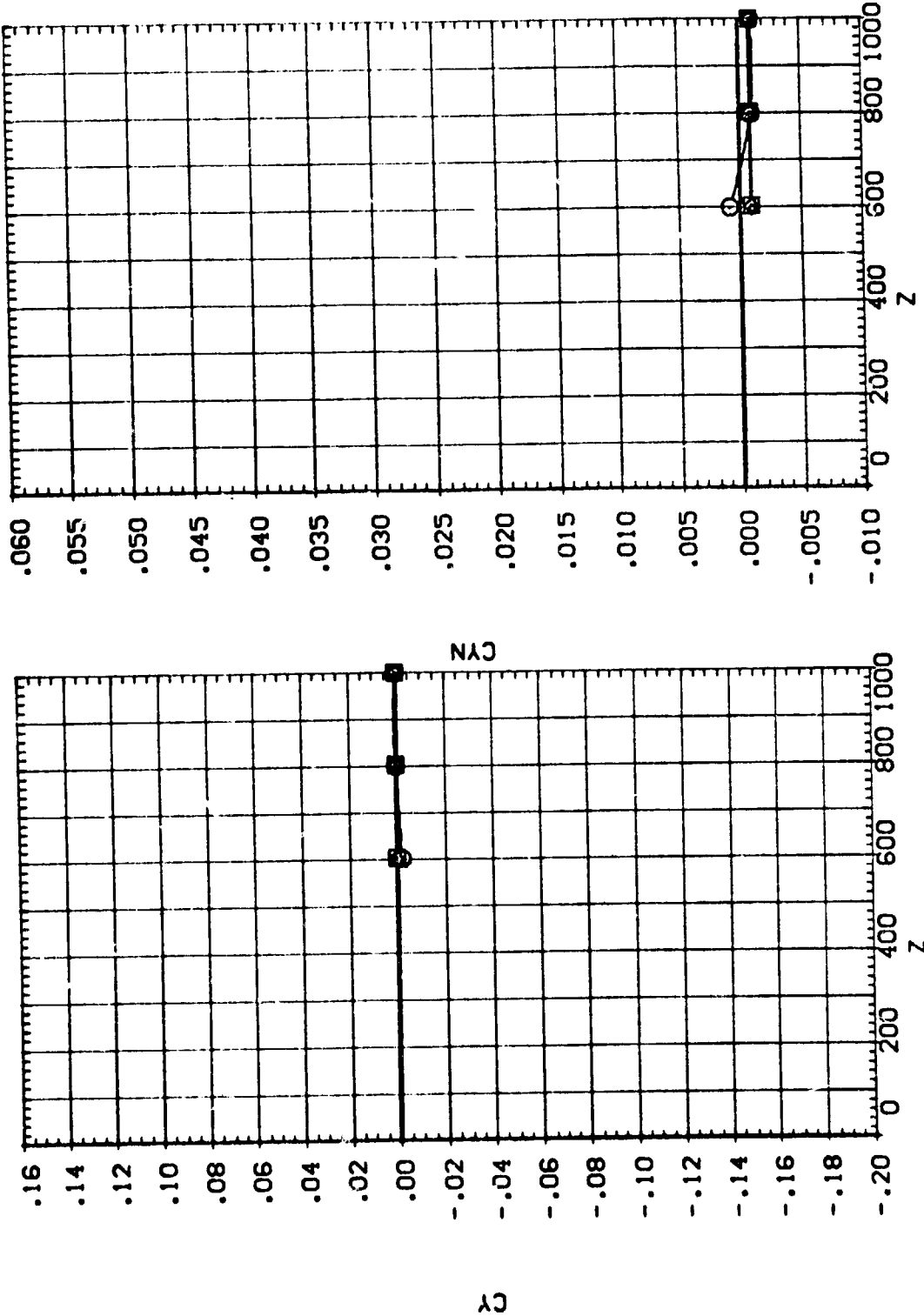

EFFECT OF SRB W/O PLUMES SEPARATION ON ORB/ET AERODYNAMIC CHARACTERISTICS

1A13 SRB(S8) W/O PLUMES SEPARATING FROM ORBIT (RTJ:39)

SEE THE ASSOCIATED DATA DOCUMENT FOR REFERENCE CHARACTERISTICS FOR INDIVIDUAL DATASETS

SYMBOL	X	MACH	PARABOLIC	PICTAL	110,000
○	300.510	.000	.000	.000	.000
◇	600.700	-20.000	.000	.000	.000
△	900.850	400.000	.000	.000	.000

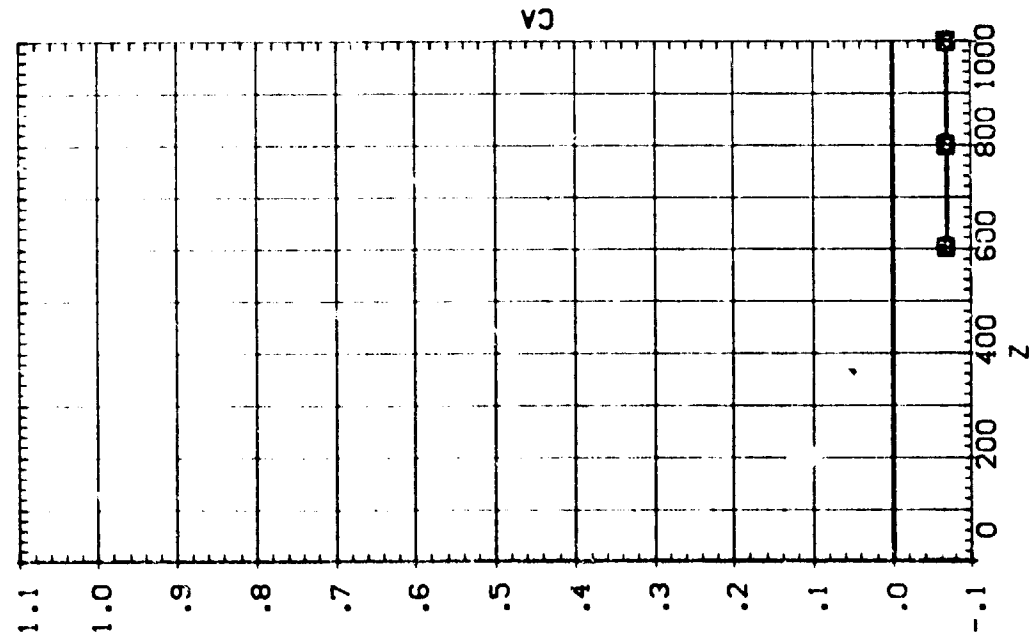
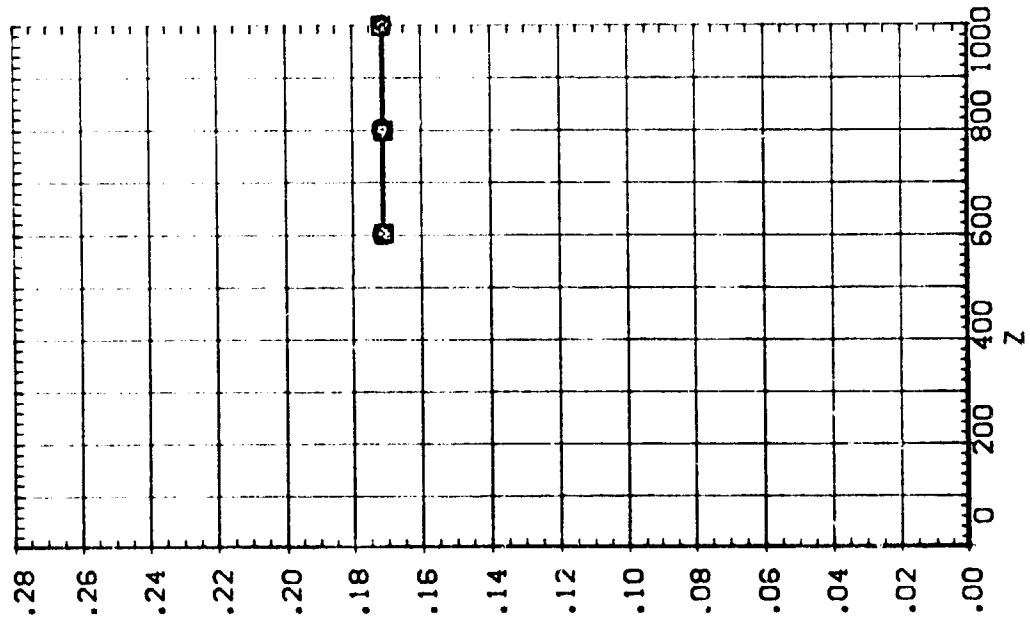

IA13 SRB(SB) W/O PLUMES SEPARATING FROM 99T10 (RTJ139)

SEE THE ASSOCIATED DATA DOCUMENT FOR REFERENCE CHARACTERISTICS FOR INDIVIDUAL DATASETS

SYMBOL	X	MACH	PARAMETRIC VALUES
○	.358	4.530	PTOTAL 110.000
□	300.510	.000	BETA .000
◇	600.700	-20.000	DBETA .000
△	900.850	400.000	PCMBER .000

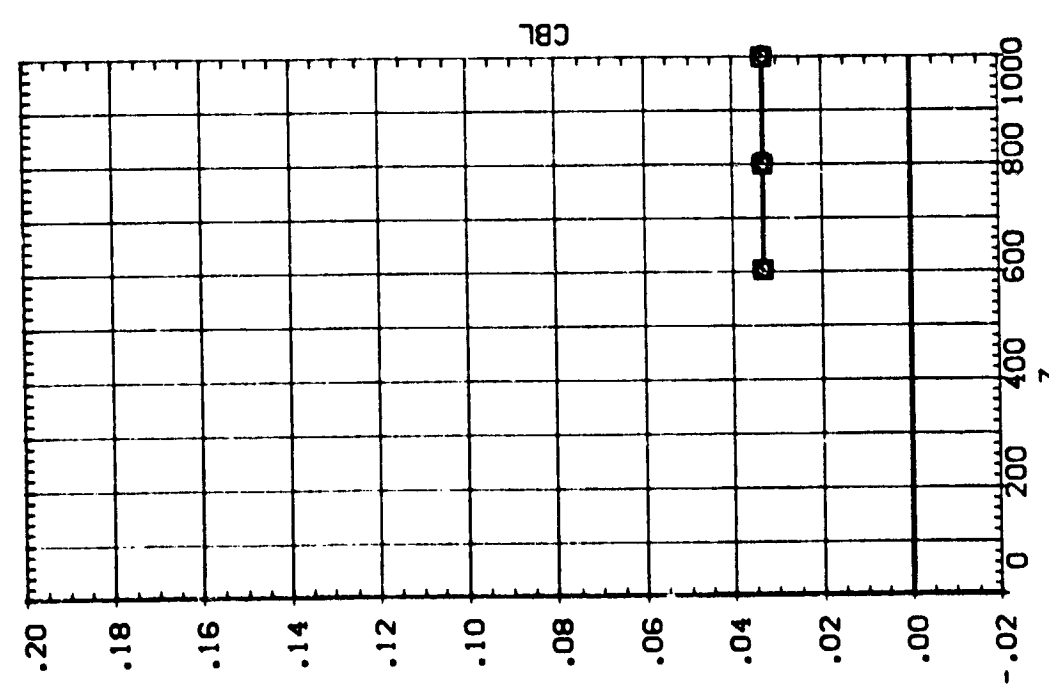
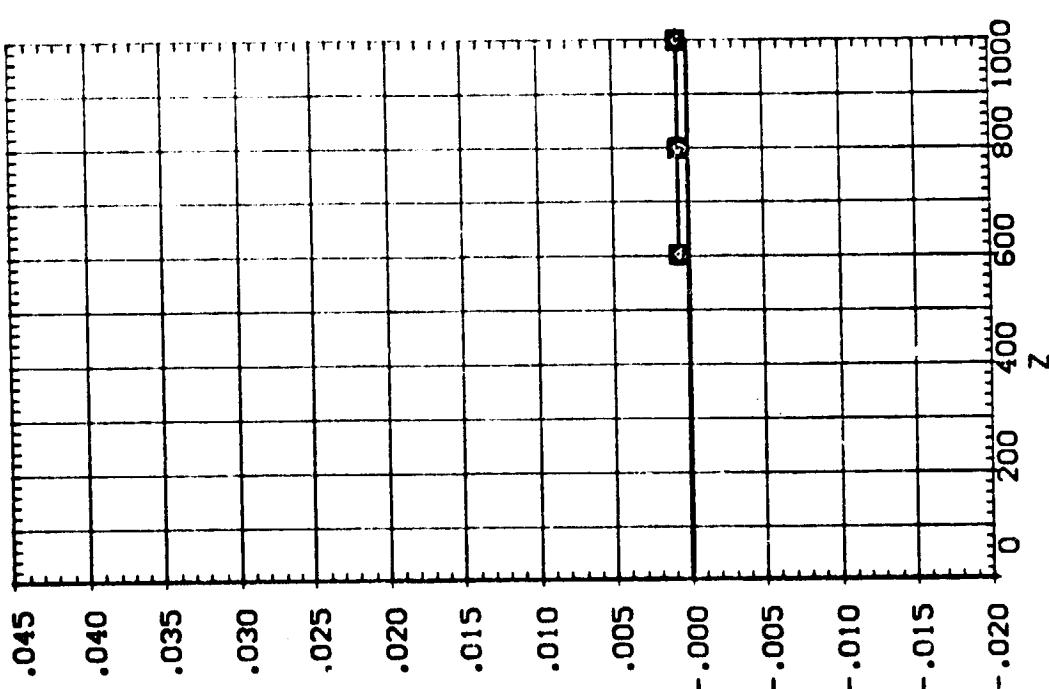

EFFECT OF SRB W/O PLUMES SEPARATION ON ORB/ET AERODYNAMIC CHARACTERISTICS

IA13 SRB(S8) W/O PLUMES SEPARATING FROM ORBIT (RTJ139)

SEE THE ASSOCIATED DATA DOCUMENT FOR REFERENCE CHARACTERISTICS FOR INDIVIDUAL DATA SETS

SYMBOL	X	MACH	ALPHA	DALPHA	Y	PARAMETRIC VALUES	P TOTAL	BETA	DBETA	PC-MER
()	.358	4.530	.000	-20.000	400.000	110.000	.000	.000	.000	.000
□	300.510									
◇	600.700									
△	900.850									

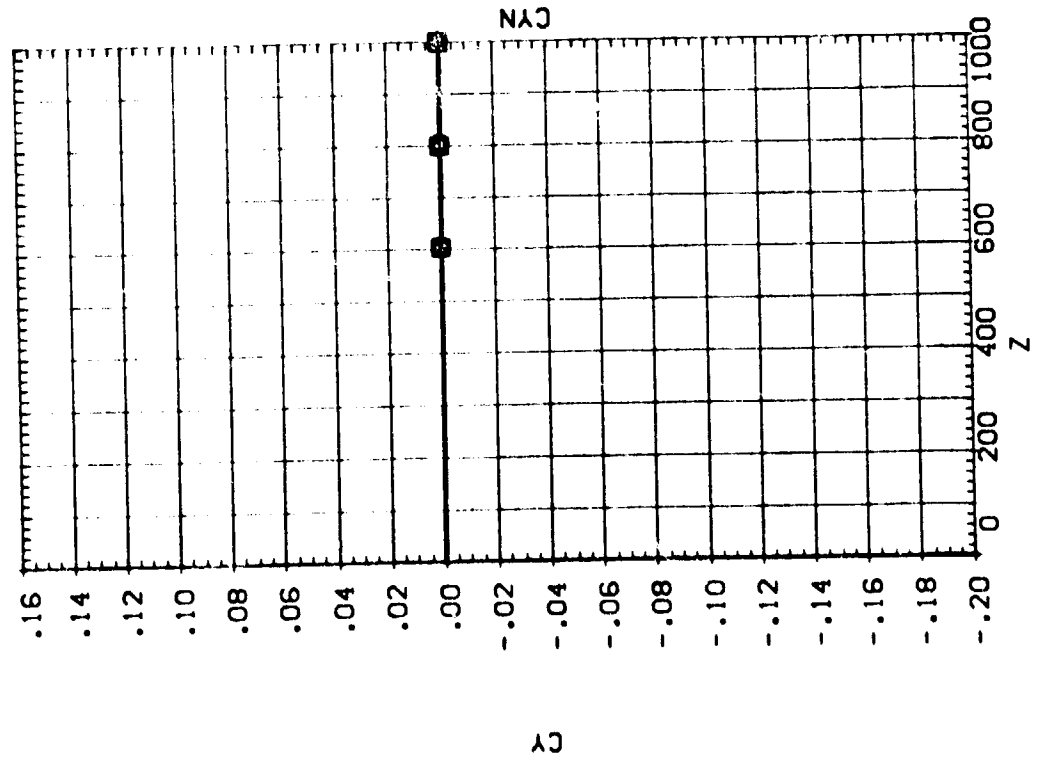
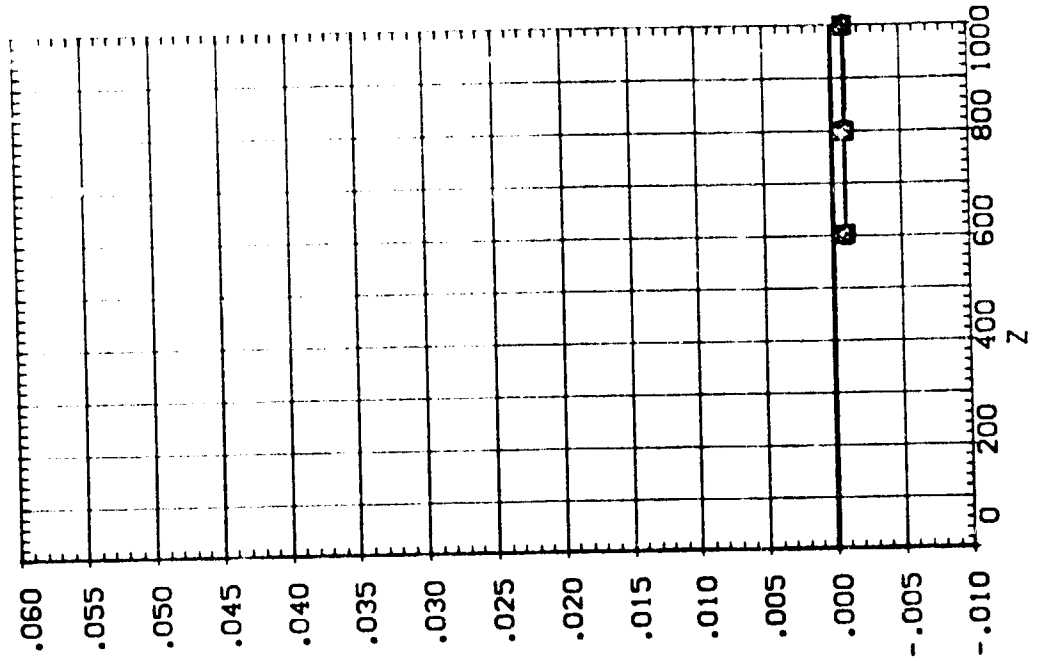

IA13 SRB(S8) W/O PLUMES SEPARATING FROM 09T10 (RTJ140)

SEE THE ASSOCIATED DATA DOCUMENT FOR REFERENCE CHARACTERISTICS FOR INDIVIDUAL DATASETS

SYMBOL	X	MACH	PARAMETRIC VALUES
□	-.057	4.530	PTOTAL 110.000
◇	300.110	.000	BETA .000
◇	600.540	-20.000	DBETA .000
△	900.280	400.000	PC-MFR .000

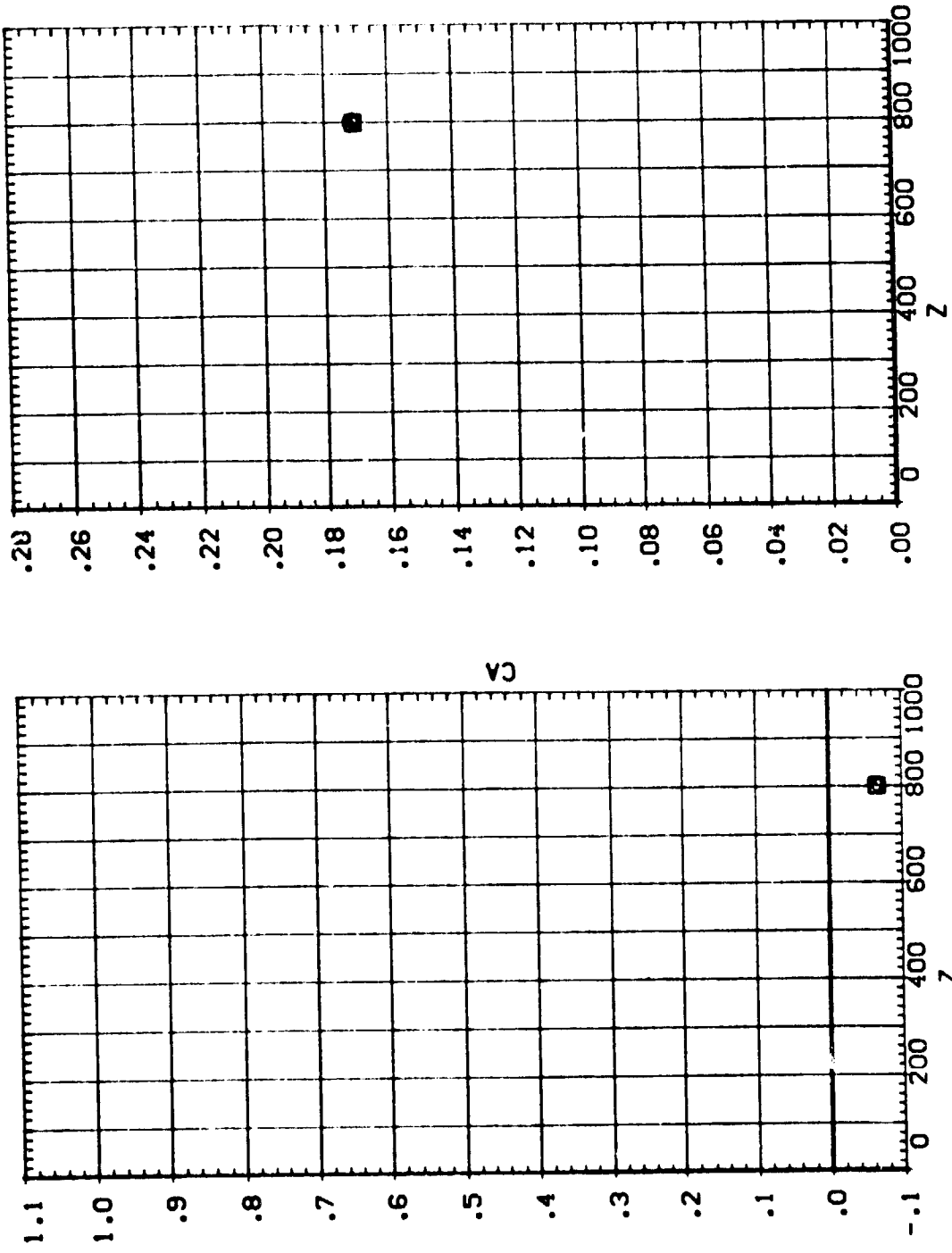

EFFECT OF SRB W/O PLUMES SEPARATION ON ORB/ET AERODYNAMIC CHARACTERISTICS

IA13 SRB(SB) W/O PLUMES SEPARATING FROM 09T10 (RTJ140)

SEE THE ASSOCIATED DATA DOCUMENT FOR REFERENCE CHARACTERISTICS FOR INDIVIDUAL DATASETS

SYMBOL		PARAMETRIC VALUES	
○	X	MACH	PTOTAL
□	300	4.530	110.000
◇	600	.000	BETA
△	900	-20.000	DAETA
		400.000	PC-FBR
		100.000	

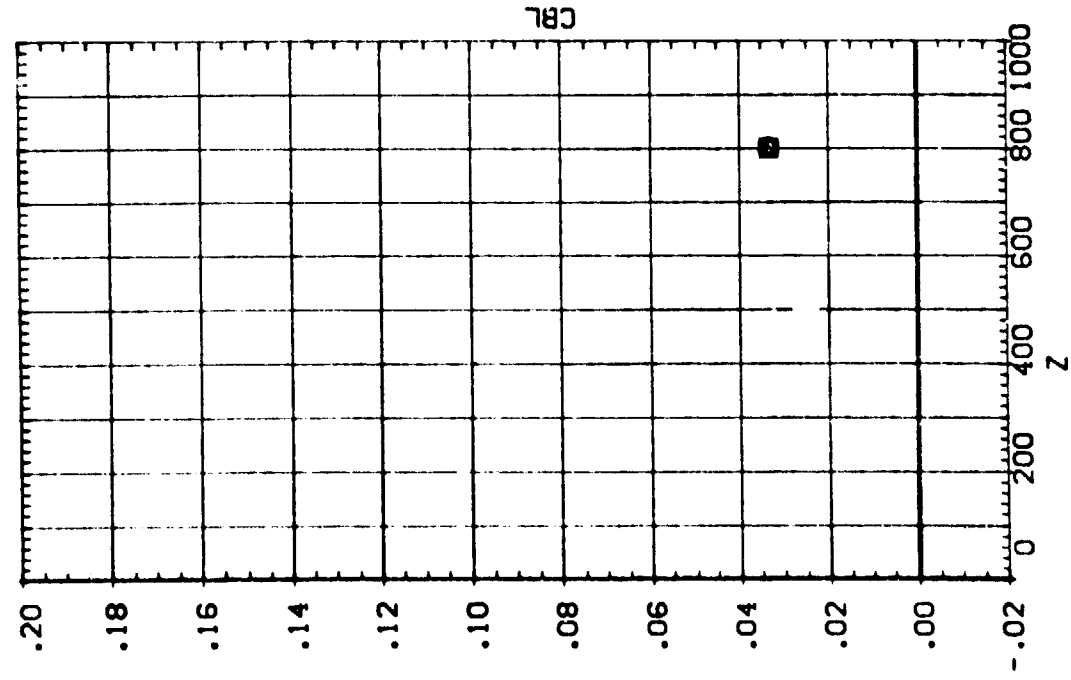
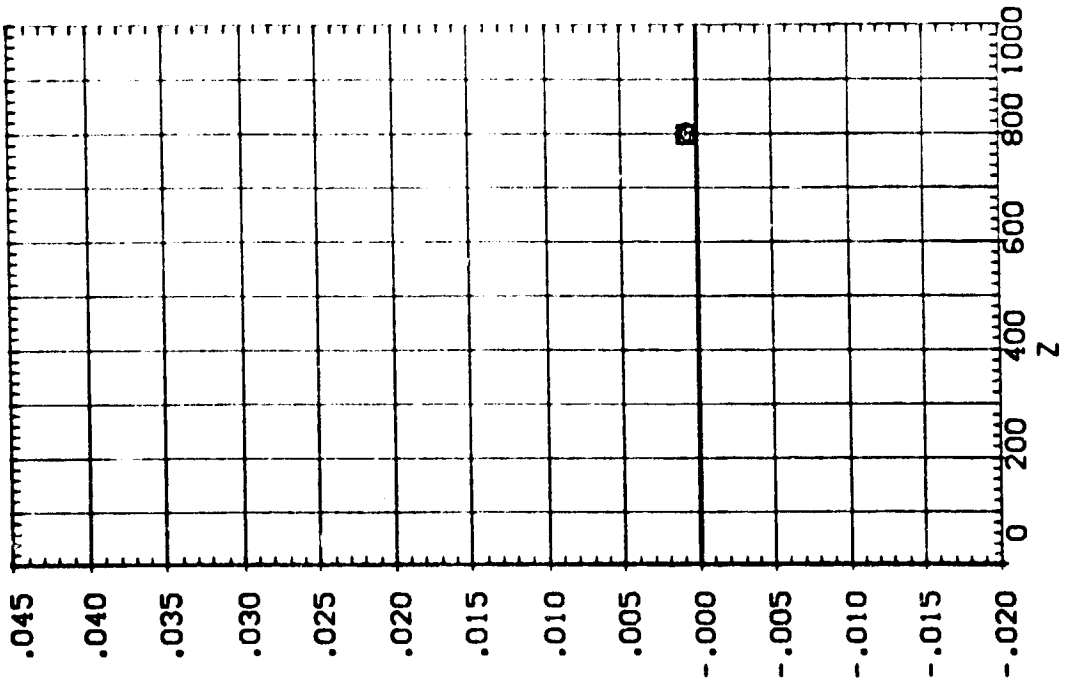

IA13 SRB(S8) W/O PLUMES SEPARATING FROM 09T10 (RTJ140)

SEE THE ASSOCIATED DATA DOCUMENT FOR REFERENCE CHARACTERISTICS FOR INDIVIDUAL DATASETS

SYMBOL
 ○ □ ◇ △

PARAMETRIC VALUES	
MACH	4.530
PTOTAL	110.000
BETA	.000
DBETA	.000
PC+PR	.000
X	-.057
Y	900.280
ALPHA	300.110
DALPHA	600.540

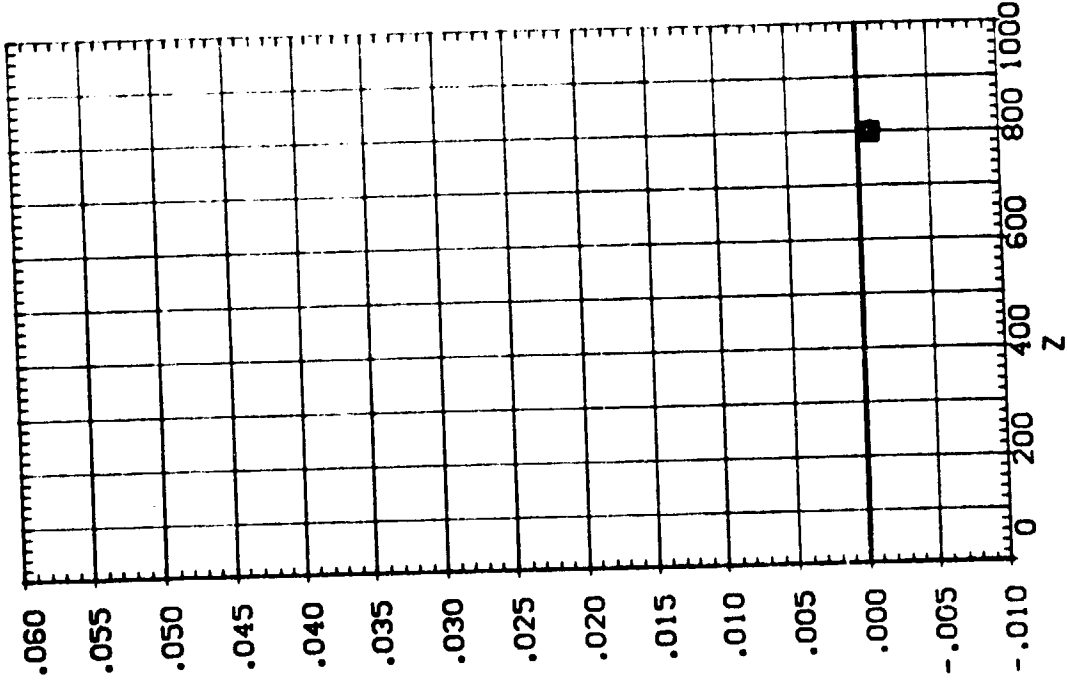
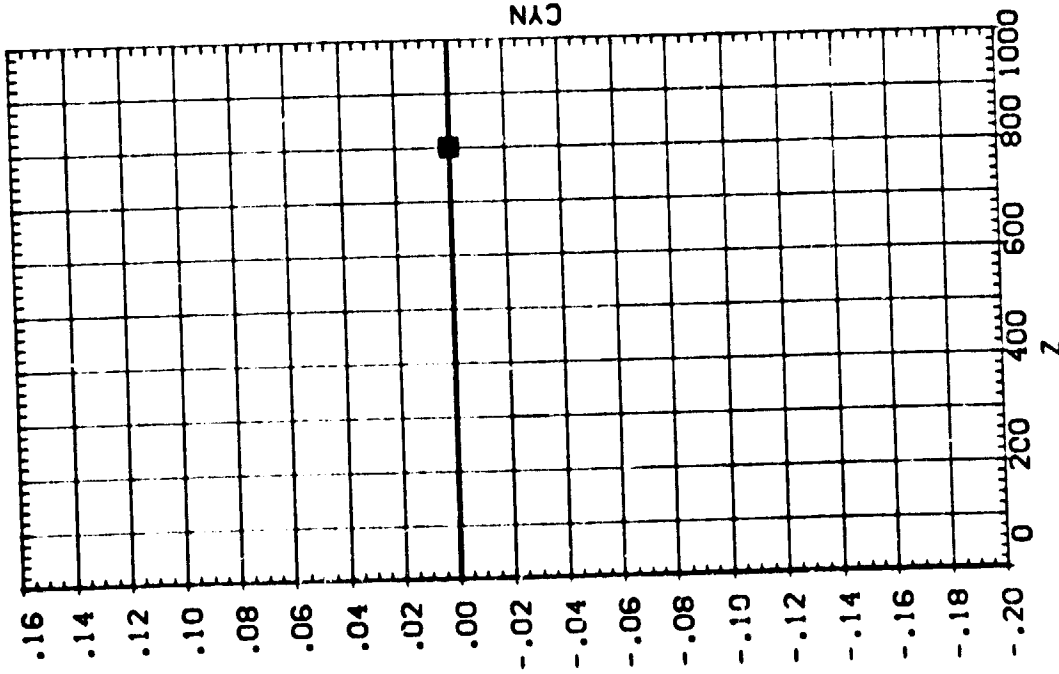

EFFECT OF SRB W/O PLUMES SEPARATION ON ORB/ET AERODYNAMIC CHARACTERISTICS

IA13 SRB(S8) W/O PLUMES SEPARATING FROM 09T10 (RTJ141)

SYMBOL

X	.195	MACH	4.530	PTOTAL	110.000
900.530	.000	ALPHA	.000	BETA	.000
	.000	DALPHA	.000	DBETA	5.000
Y				PCMBR	.000

SEE THE ASSOCIATED DATA DOCUMENT FOR REFERENCE CHARACTERISTICS FOR INDIVIDUAL DATASETS

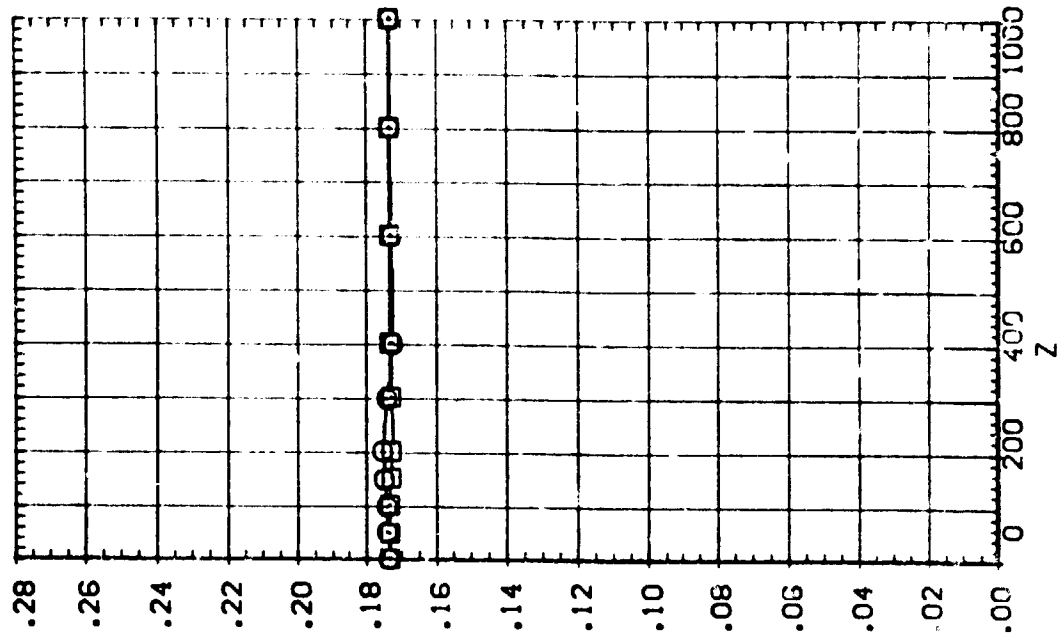
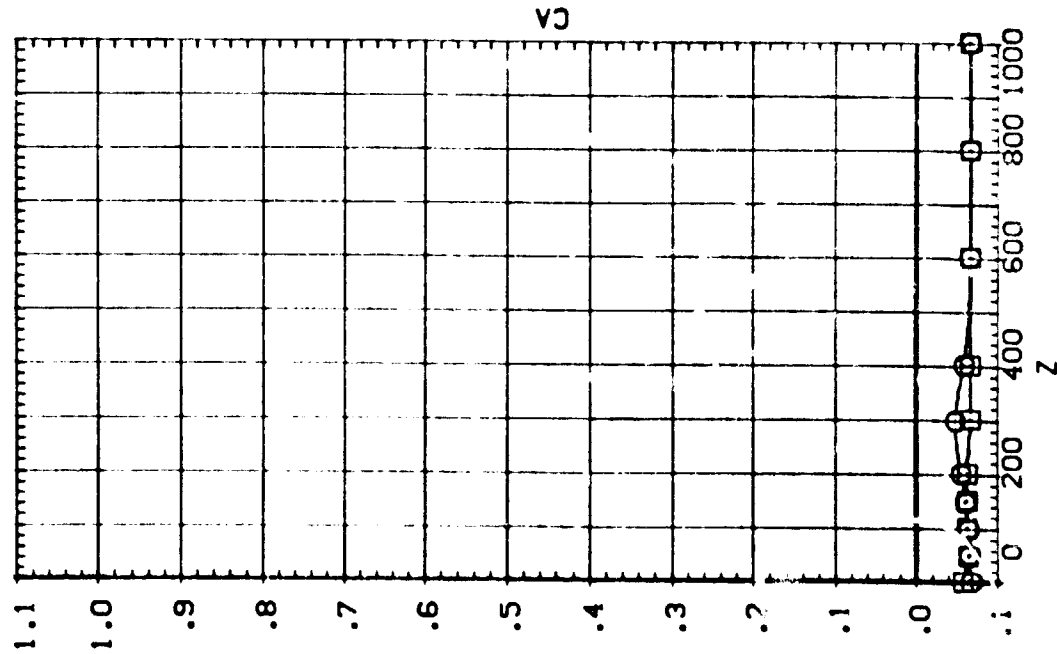

IA13 SRB(S8) W/O PLUMES SEPARATING FROM 09T10 (RTJ141)

SEE THE ASSOCIATED DATA DOCUMENT FOR REFERENCE CHARACTERISTICS FOR INDIVIDUAL DATASETS

SYM-BOL X .195 MACH PARAMETRIC VALUES
 ○ 500.530 .000 4.530 PTOTAL 110.000
 □ .000 .000 .000 BETA .000
 .000 .000 .000 DBETA 5.000
 .000 .000 .000 PC-MBR .000

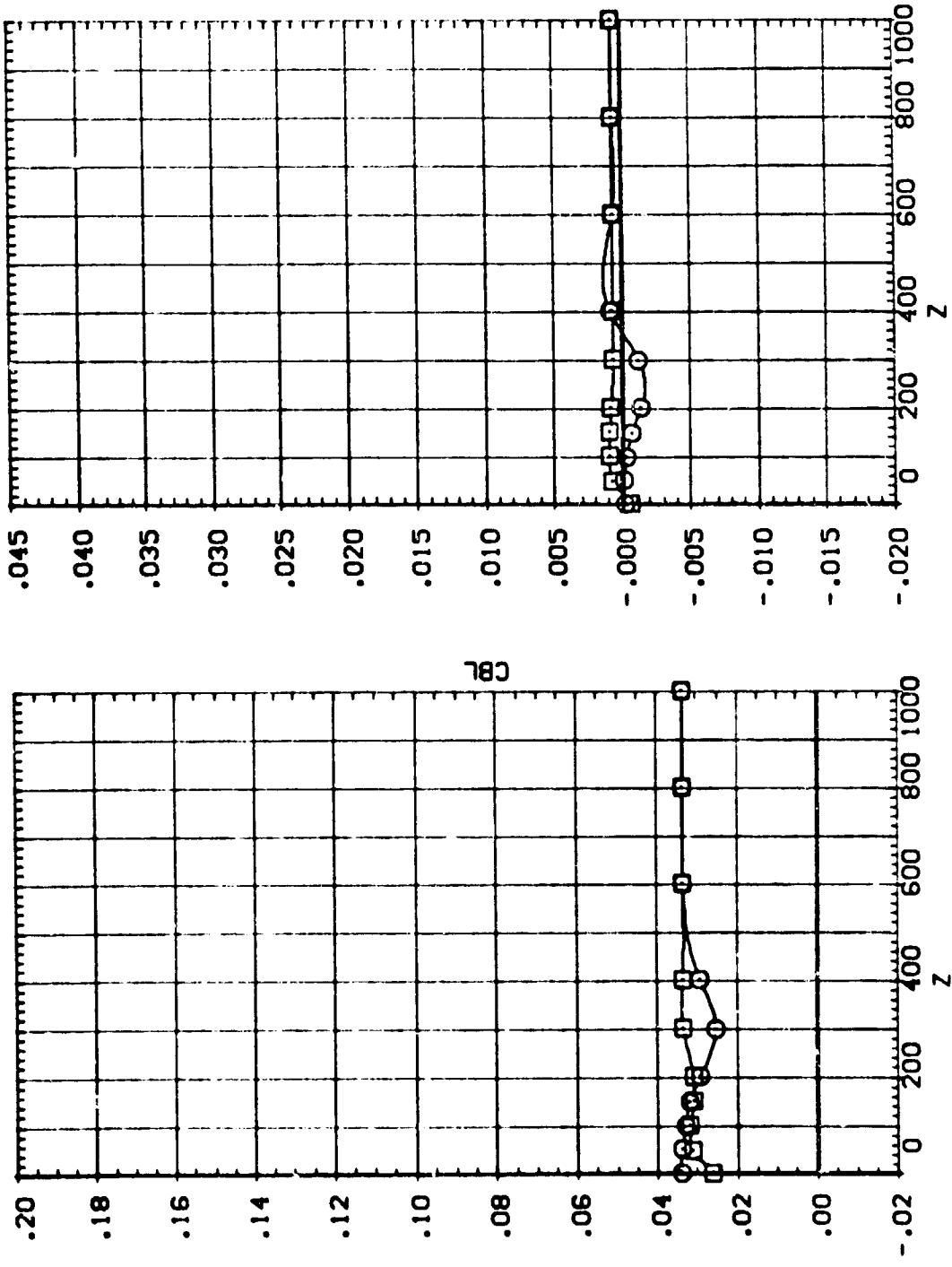

EFFECT OF SRB W/O PLUMES SEPARATION ON ORB/ET AERODYNAMIC CHARACTERISTICS

[A13 SRB(S8) W/O PLUMES SEPARATING FROM 09T10 (RTJ141)]

SEE THE ASSOCIATED DATA DOCUMENT FOR REFERENCE CHARACTERISTICS FOR INDIVIDUAL DATASETS

SYMBOL		PARAMETRIC VALUES				
○	x	.195	MACH	4.530	PTOTAL	110.000
□	900.530	.000	ALPHA	.000	BETA	.000
		.000	DALPHA	.000	DBETA	5.000
	y	.000	PCMBR	.000		.000

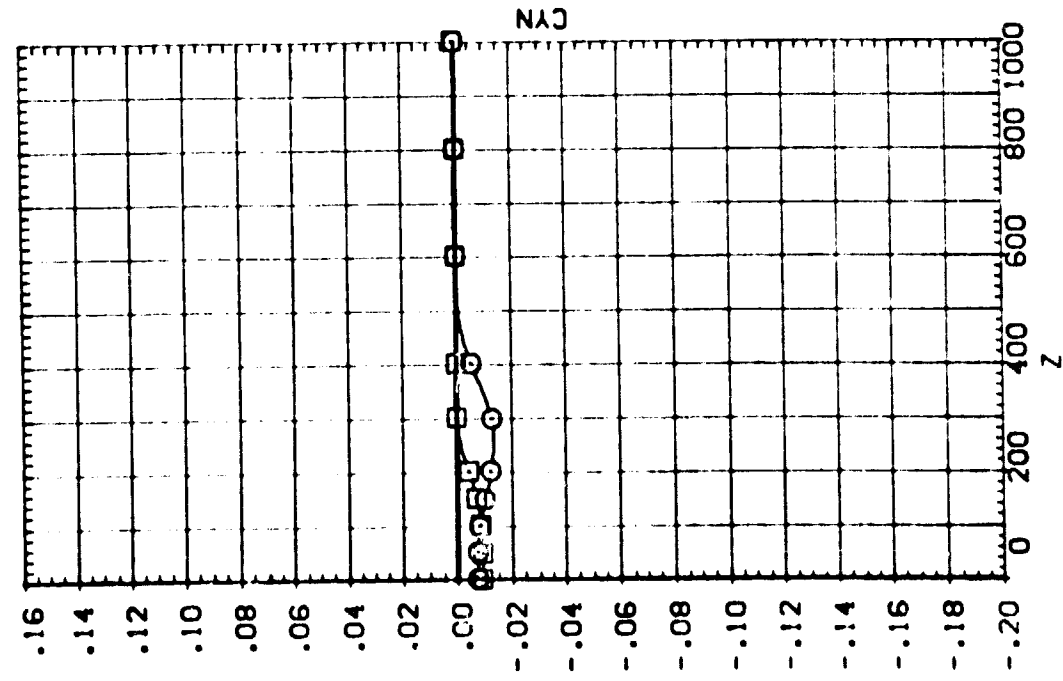
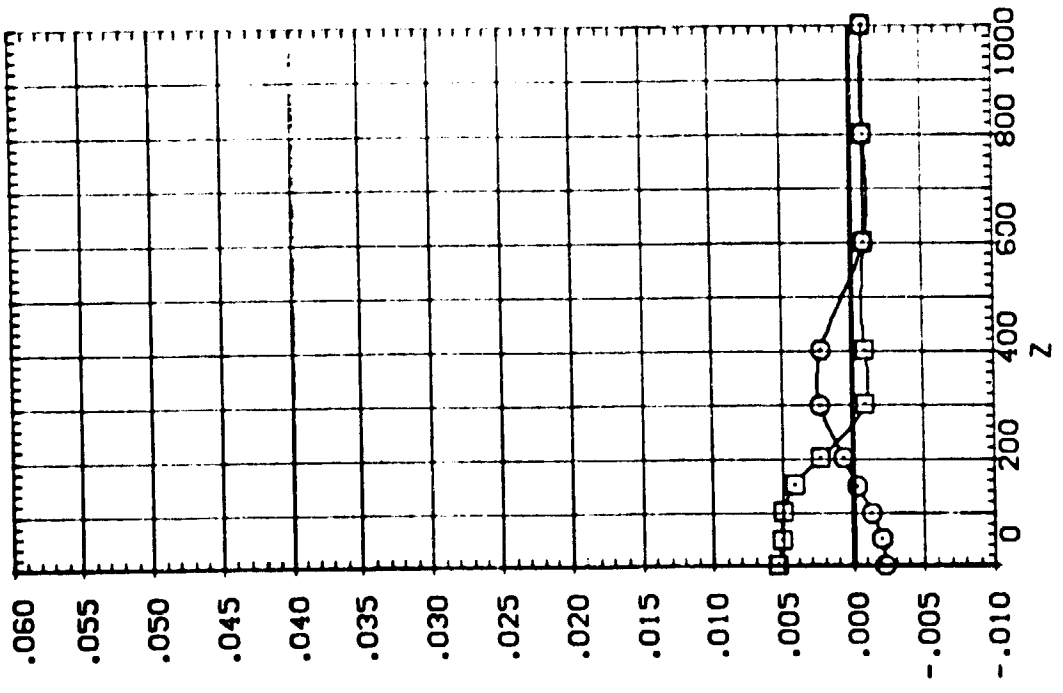

IA13 SRB(SB) W/O PLUMES SEPARATING FROM 09T10 (RTJ142)

SEE THE ASSOCIATED DATA DOCUMENT FOR REFERENCE CHARACTERISTICS FOR INDIVIDUAL DATASETS

SYMBOL	X	MACH	PARAMETRIC VALUES
□	-.132	4.530	TOTAL 110.000
□	900.500	.000	BETA .000
		.000	DBETA 5.000
		200.000	PO-PBR .000

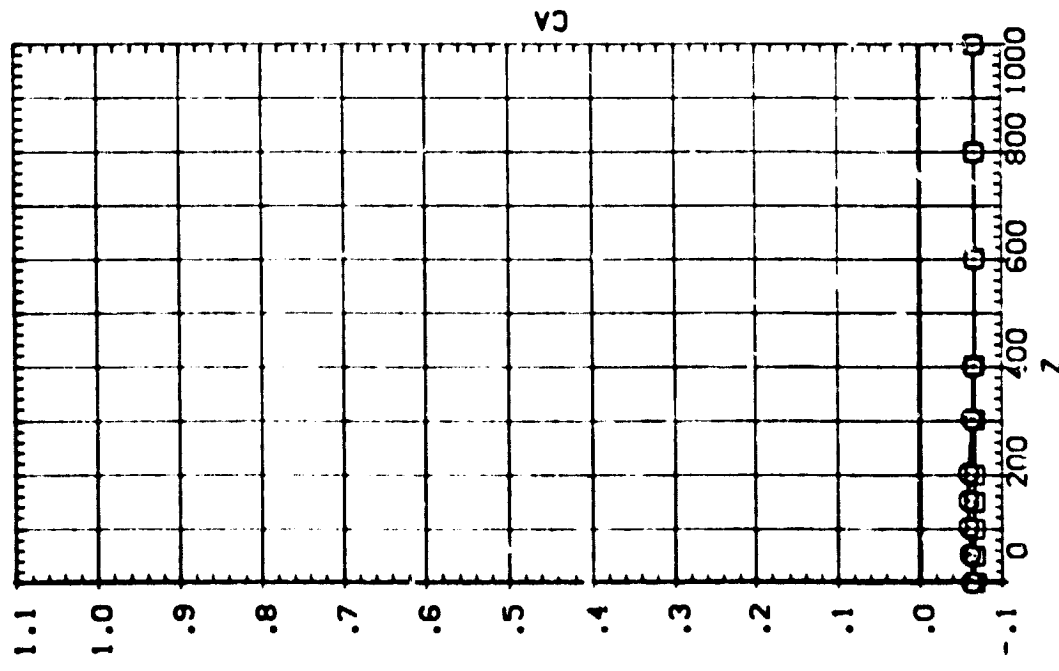
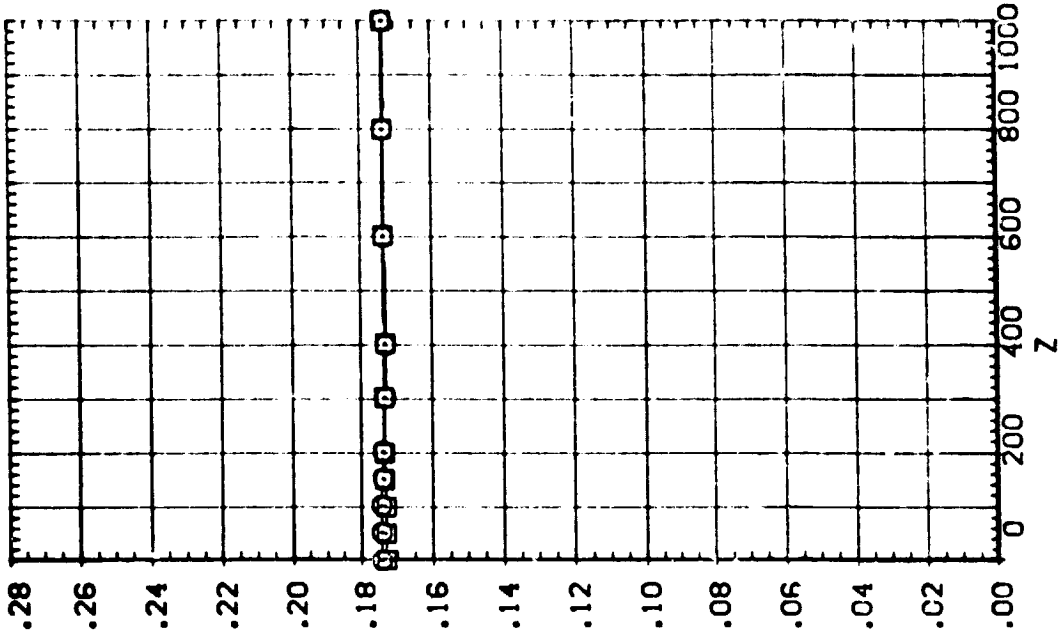

EFFECT OF SRB W/O PLUMES SEPARATION ON ORB/ET AERODYNAMIC CHARACTERISTICS

[A13 SRB(SB) W/O PLUMES SEPARATING FROM 09T10 (RTJ142)]

SYMBOL x
 ○ □

PARAMETRIC VALUES
 MACH 4.530 PTOTAL 110.000
 ALPHA .000 BETA .000
 DALPHA .000 DBETA 5.000
 V 200.000 PC+BR .000

SEE THE ASSOCIATED DATA DOCUMENT FOR REFERENCE CHARACTERISTICS FOR INDIVIDUAL DATASETS

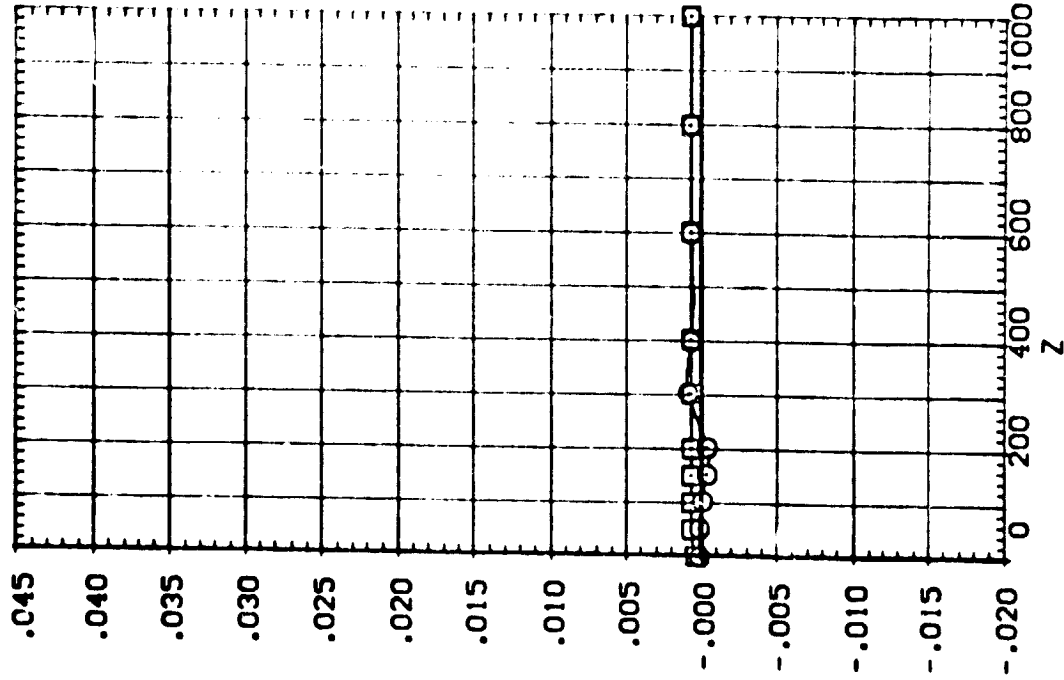
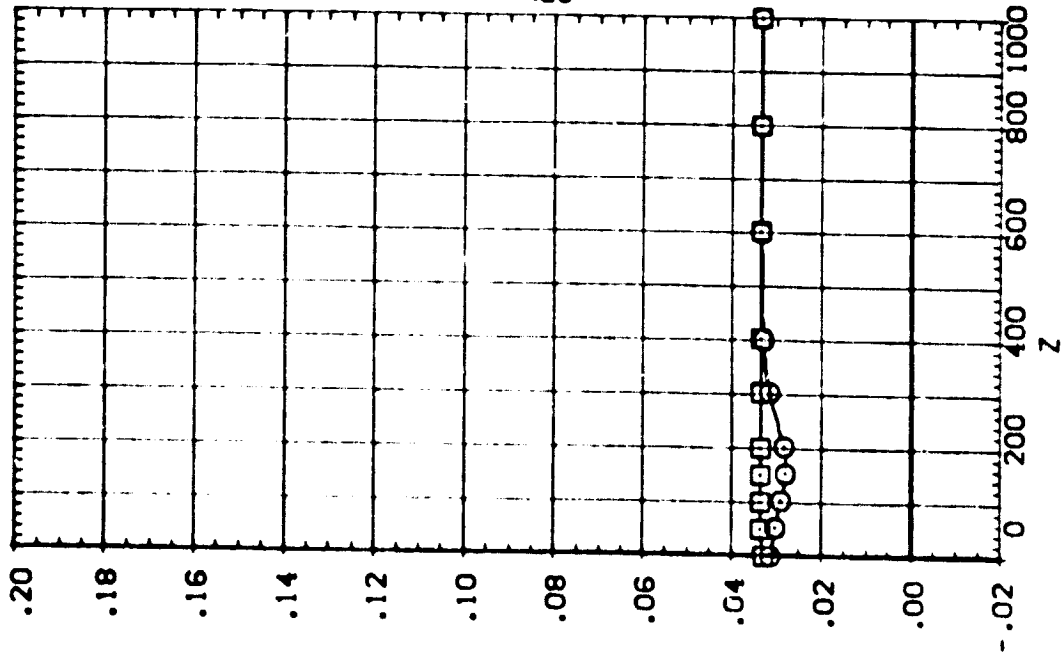

EFFECT OF SRB W/O PLUMES SEPARATION ON 09T10 AERODYNAMIC CHARACTERISTICS

IA13 SRB(S8) W/O PLUMES SEPARATING FROM 09T10 (RTJ142)

SEE THE ASSOCIATED DATA DOCUMENT FOR REFERENCE CHARACTERISTICS FOR INDIVIDUAL DATASETS

SYMBOL	X	PARAMETRIC VALUES
○	-0.132	MACH 4.530 P/TOTAL 110.000
□	900.500	ALPHA .000 BETA .000
		DALPHA .000 DBETA 5.000
		Y 200.000 PC-MBR .000

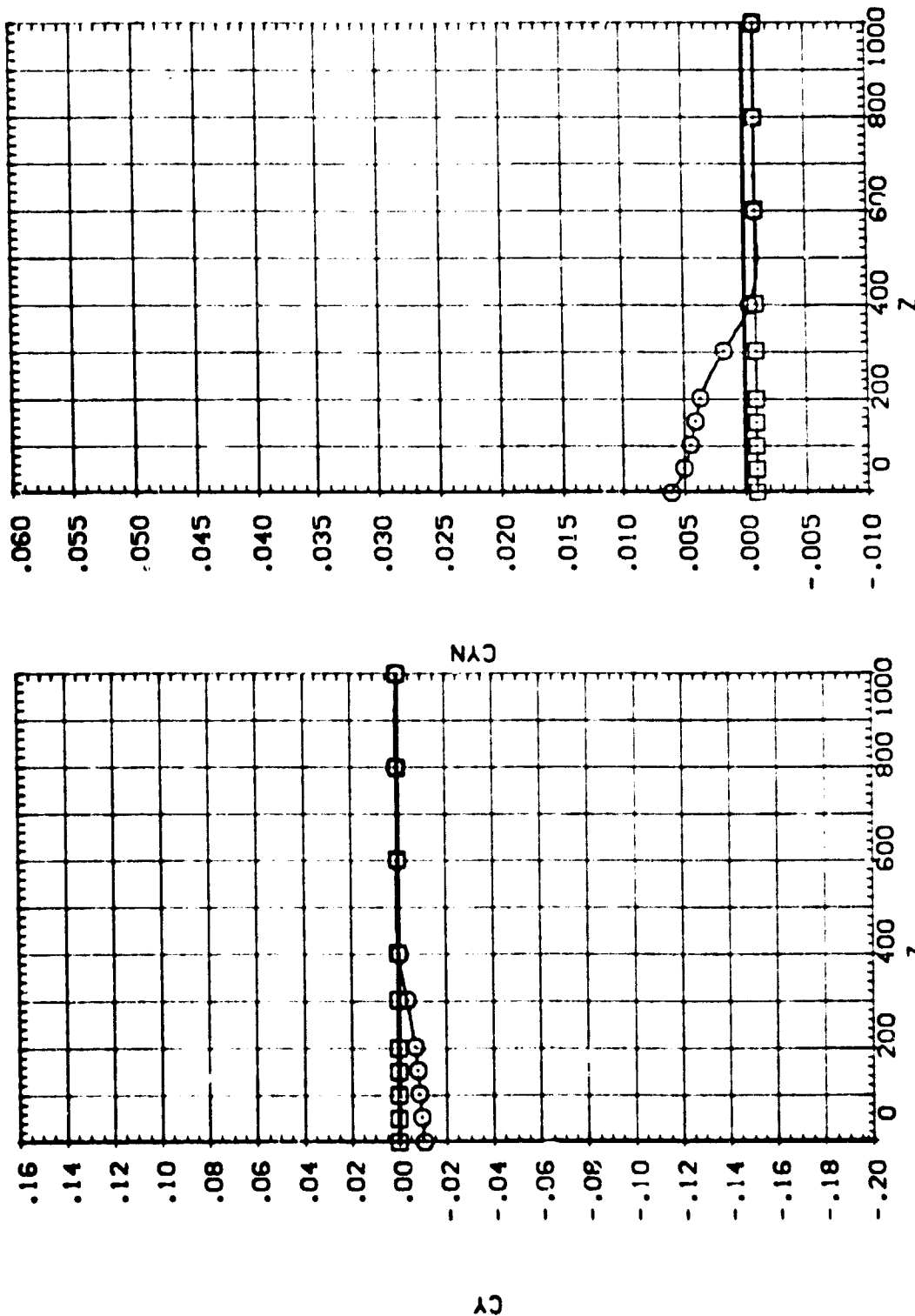

EFFECT OF SRB W/O PLUMES SEPARATION ON ORB/ET AERODYNAMIC CHARACTERISTICS

IA13 SRB(S8) W/O PLUMES SEPARATING FROM 09T10 (RTJ:43)

SEE THE ASSOCIATED DATA DOCUMENT FOR REFERENCE CHARACTERISTICS FOR INDIVIDUAL DATASETS

SYMBOL		PARAMETRIC VALUES			
X	.117	MACH	4.530	P/TOTAL	110.000
	900.660	ALPHA	.000	BETA	.000
		DALPHA	.000	DBETA	5.000
		Y	400.000	PC-MGR	.000

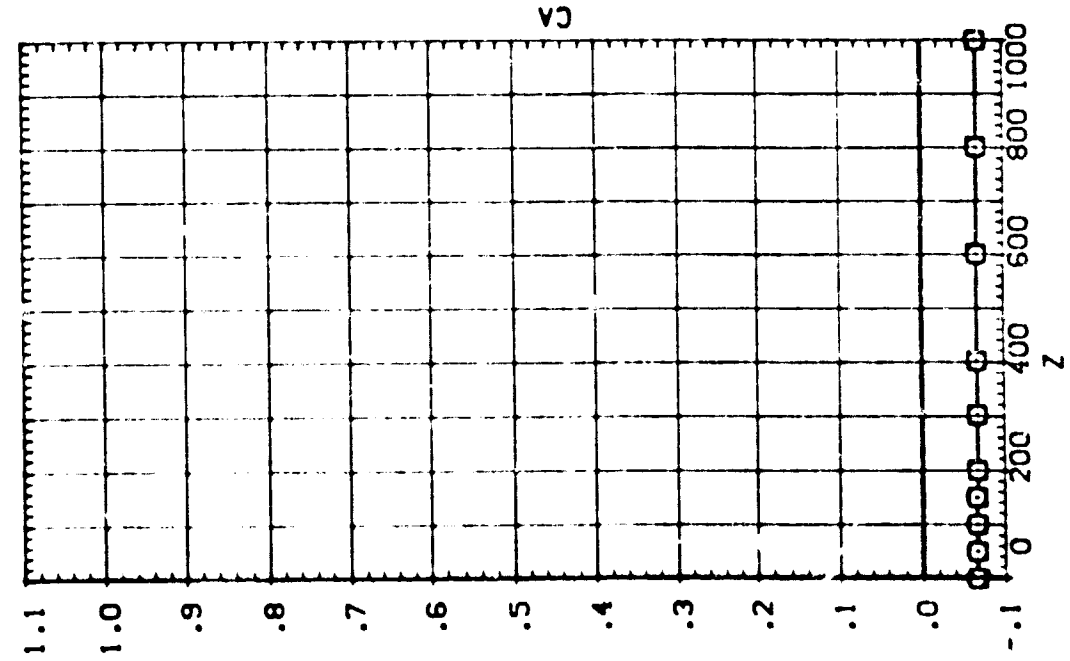
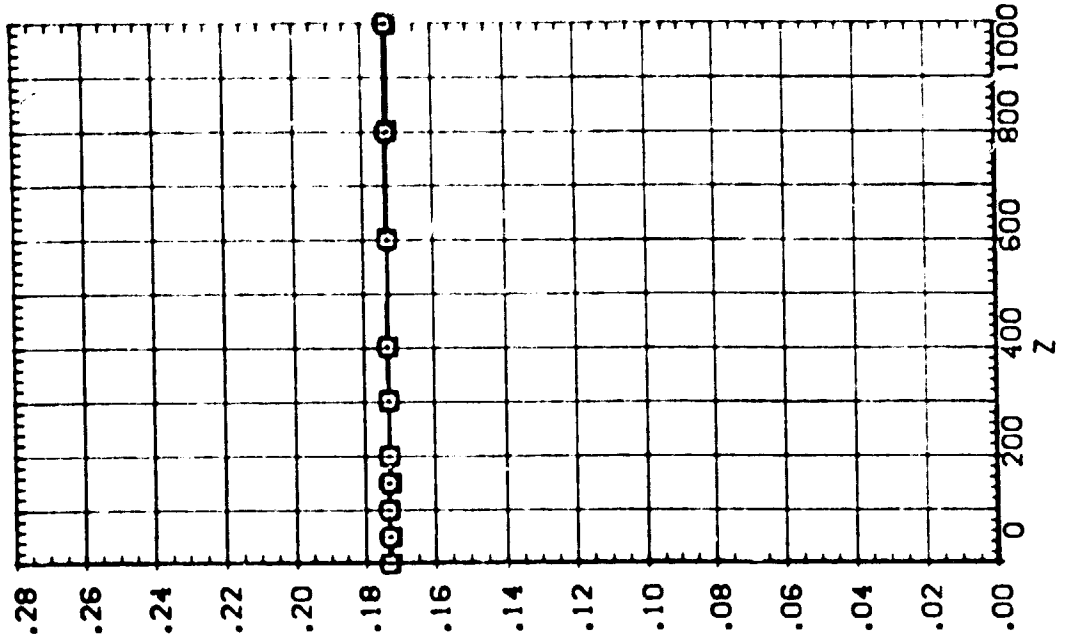

IA13 SRB(S8) W/O PLUMES SEPARATING FROM 09T10 (RTJ143)

SEE THE ASSOCIATED DATA DOCUMENT FOR REFERENCE CHARACTERISTICS FOR INDIVIDUAL DATASETS

SYMBOL X .117 MACH 4.530 PARAMETRIC VALUES PTOTAL 110.000
 □ 900.650 ALP-A .000 BETA .000
 D'ALPHA .000 DBETA 5.000
 Y 400.000 PC-MBR .000

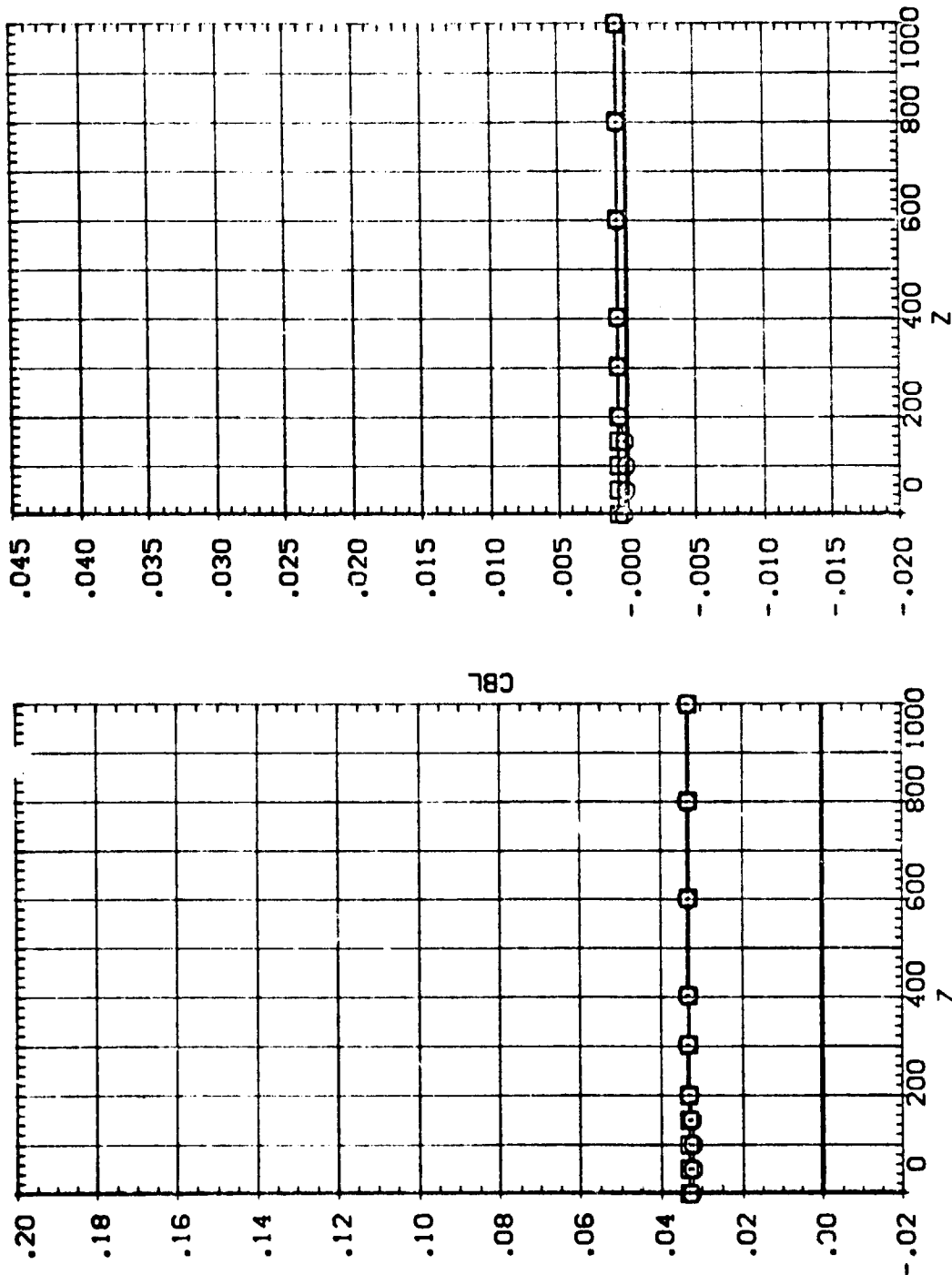

EFFECT OF SRB W/O PLUMES SEPARATION ON ORB/ET AERODYNAMIC CHARACTERISTICS

IA13 SRB(SB) W/O PLUMES SEPARATING FROM 09T10 (RTJ143)

SEE THE ASSOCIATED DATA DOCUMENT FOR REFERENCE CHARACTERISTICS FOR INDIVIDUAL DATASETS

SYMBOL	X	MACH	PARAMETRIC VALUES
○	.117	4.530	PTOTAL 110.000
□	900.660	ALPHA	BETA .000
		DALPHA	DBETA 5.000
		Y	PCHMBR .000

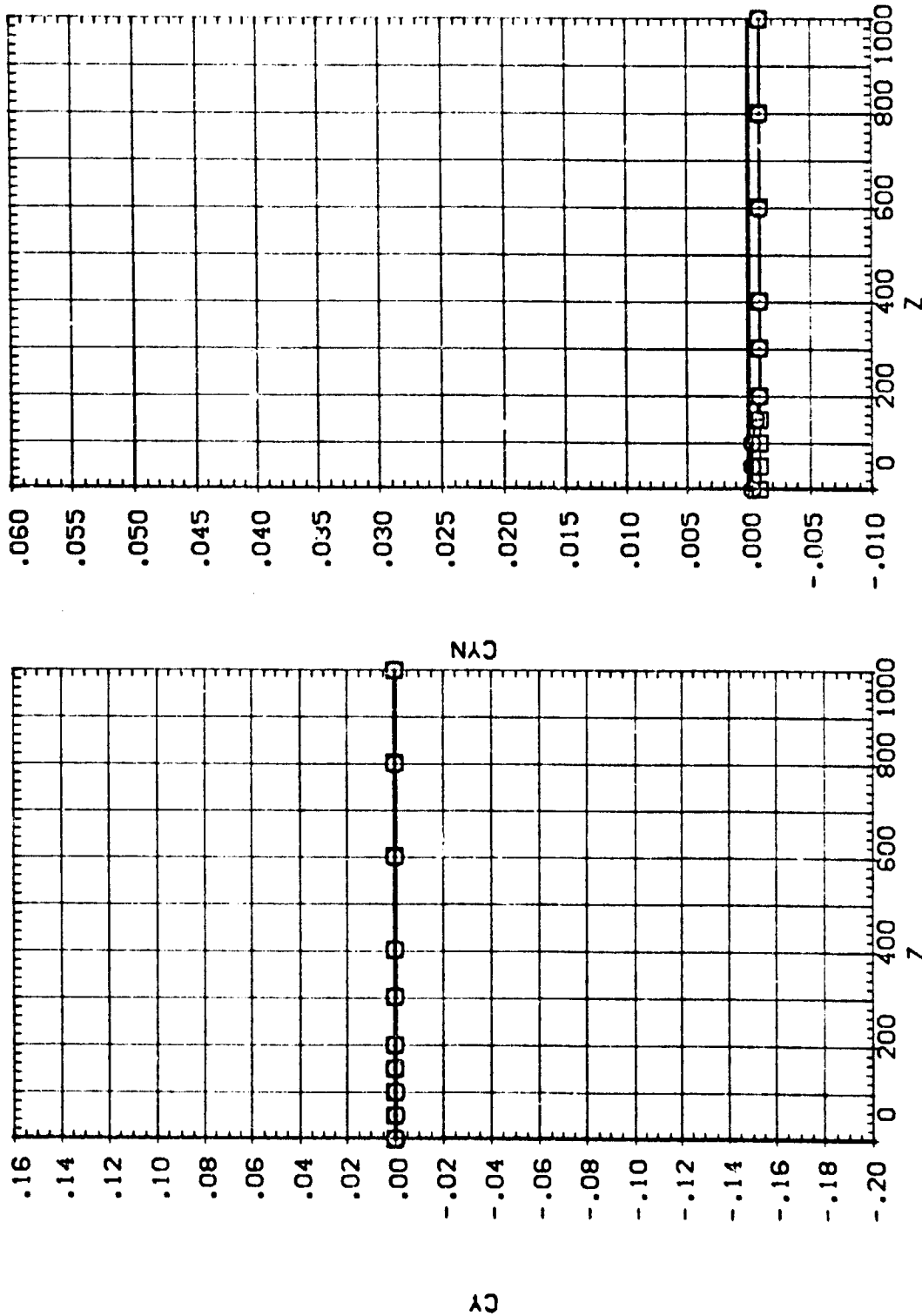

EFFECT OF SRB W/O PLUMES SEPARATION ON ORB/ET AERODYNAMIC CHARACTERISTICS

IA13 SRB(S8) W/O PLUMES SEPARATING FROM 09T10 (RTJ144)

SEE THE ASSOCIATED DATA DOCUMENT FOR REFERENCE CHARACTERISTICS FOR INDIVIDUAL DATASETS

SYMBOL	X	MACH	PARAMETRIC VALUES
○	300.140	.214	4.530 PTOTAL 110.000
□	600.570	.140	.000 BETA .000
◇	900.560	.560	.000 DBETA -5.000
△			200.000 PCMBR .000

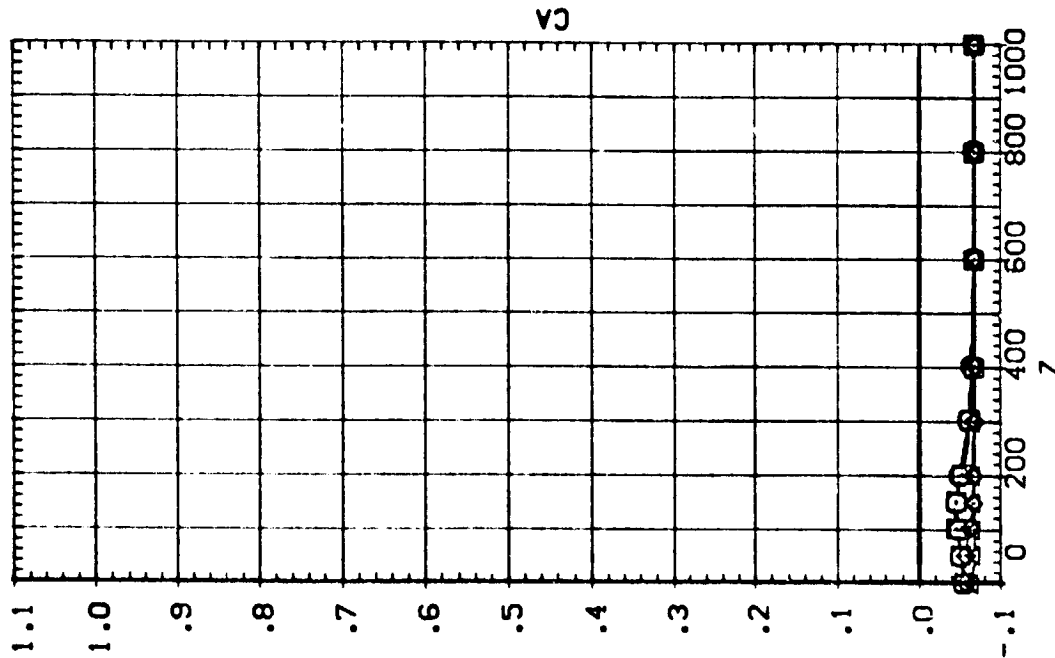
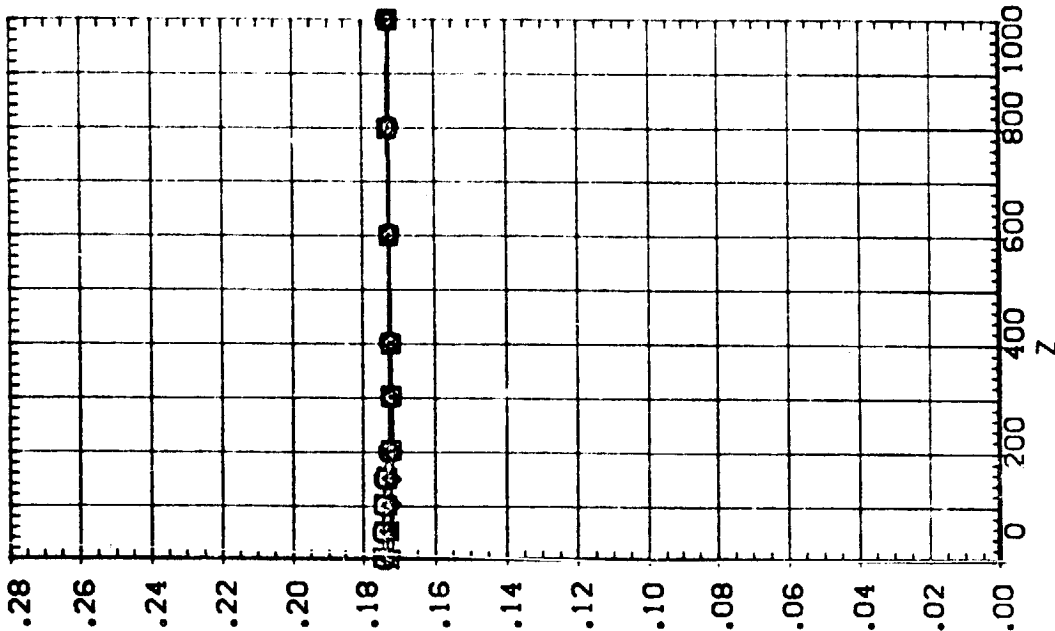

EFFECT OF SRB W/O PLUMES SEPARATION ON ORB/ET AERODYNAMIC CHARACTERISTICS

IA13 SRB(S8) W/O PLUMES SEPARATING FROM 09T10 (RTJ144)

SEE THE ASSOCIATED DATA DOCUMENT FOR REFERENCE CHARACTERISTICS FOR INDIVIDUAL DATASETS

SYMBOL		PARAMETRIC VALUES			
○	X	MACH	4.530	PITOTAL	110.000
□	300.140	ALPHA	.000	BETA	.000
◇	600.570	DALPHA	.000	DBETA	-5.000
△	900.560	Y	200.000	PC-MBR	.000

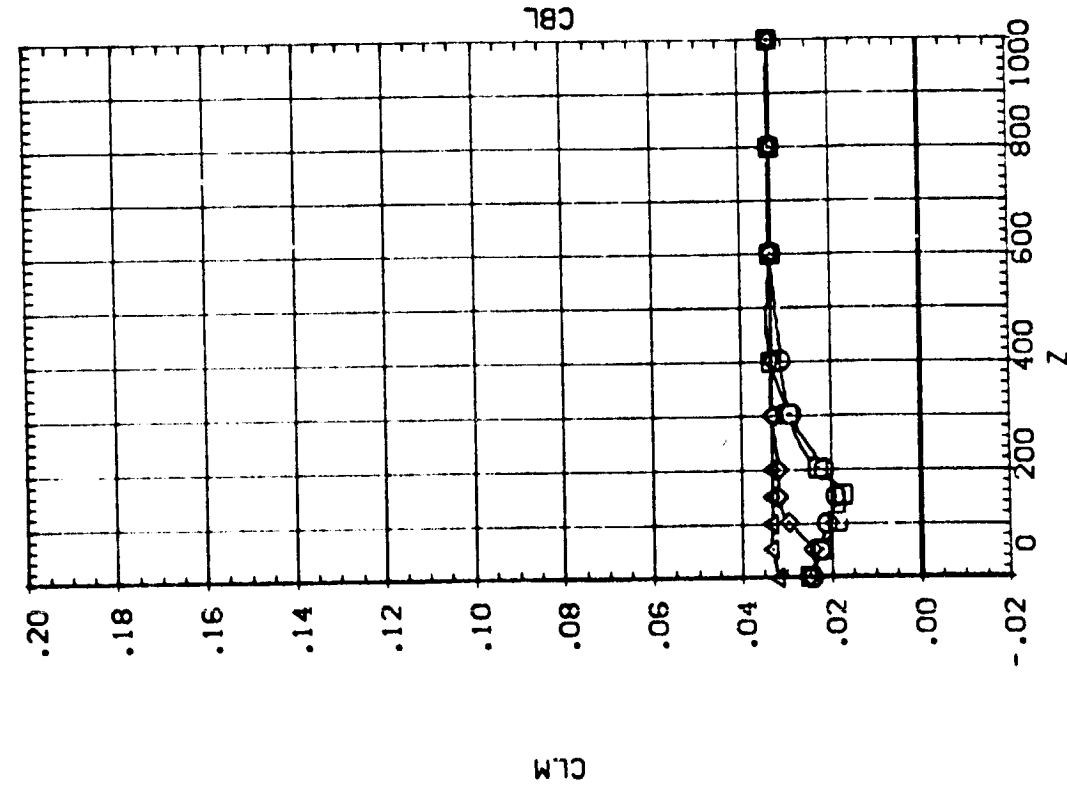
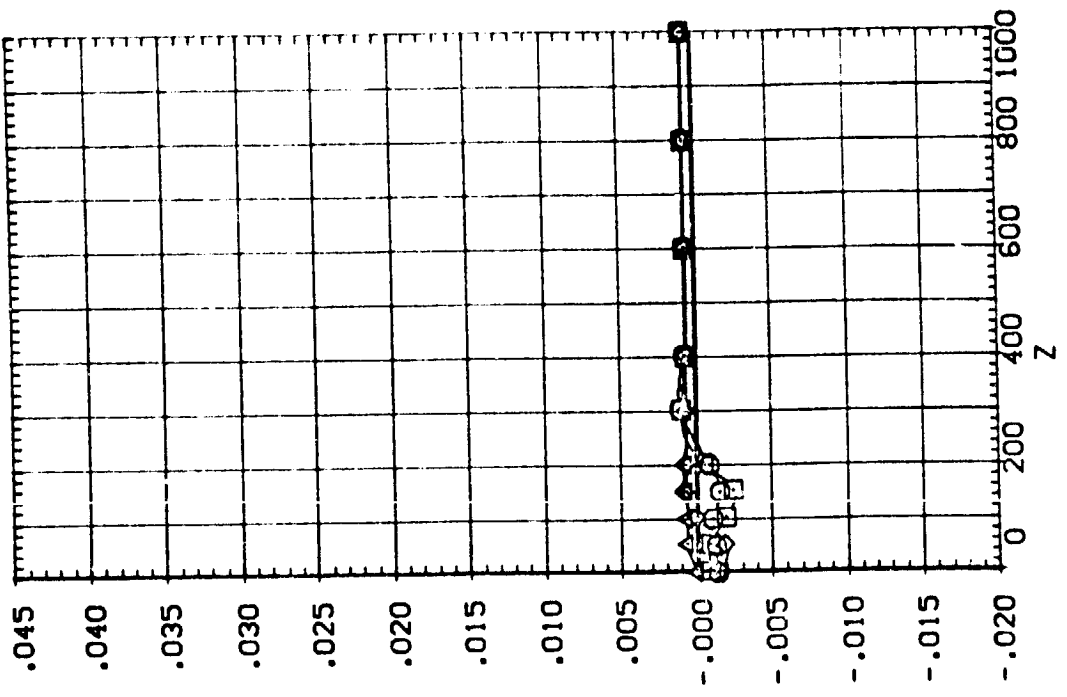

IA13 SRB(S8) W/O PLUMES SEPARATING FROM 09T1U (RTJ144)

SEE THE ASSOCIATED DATA DOCUMENT FOR REFERENCE CHARACTERISTICS FOR INDIVIDUAL DATASETS

SYMBOL	X	MACH	PARAMETRIC VALUES
○	.214	4.530	PITOTAL 110.000
□	300.140	.000	BETA .000
◇	600.570	.000	DBETA -5.000
△	900.560	200.000	PC-MBR .000

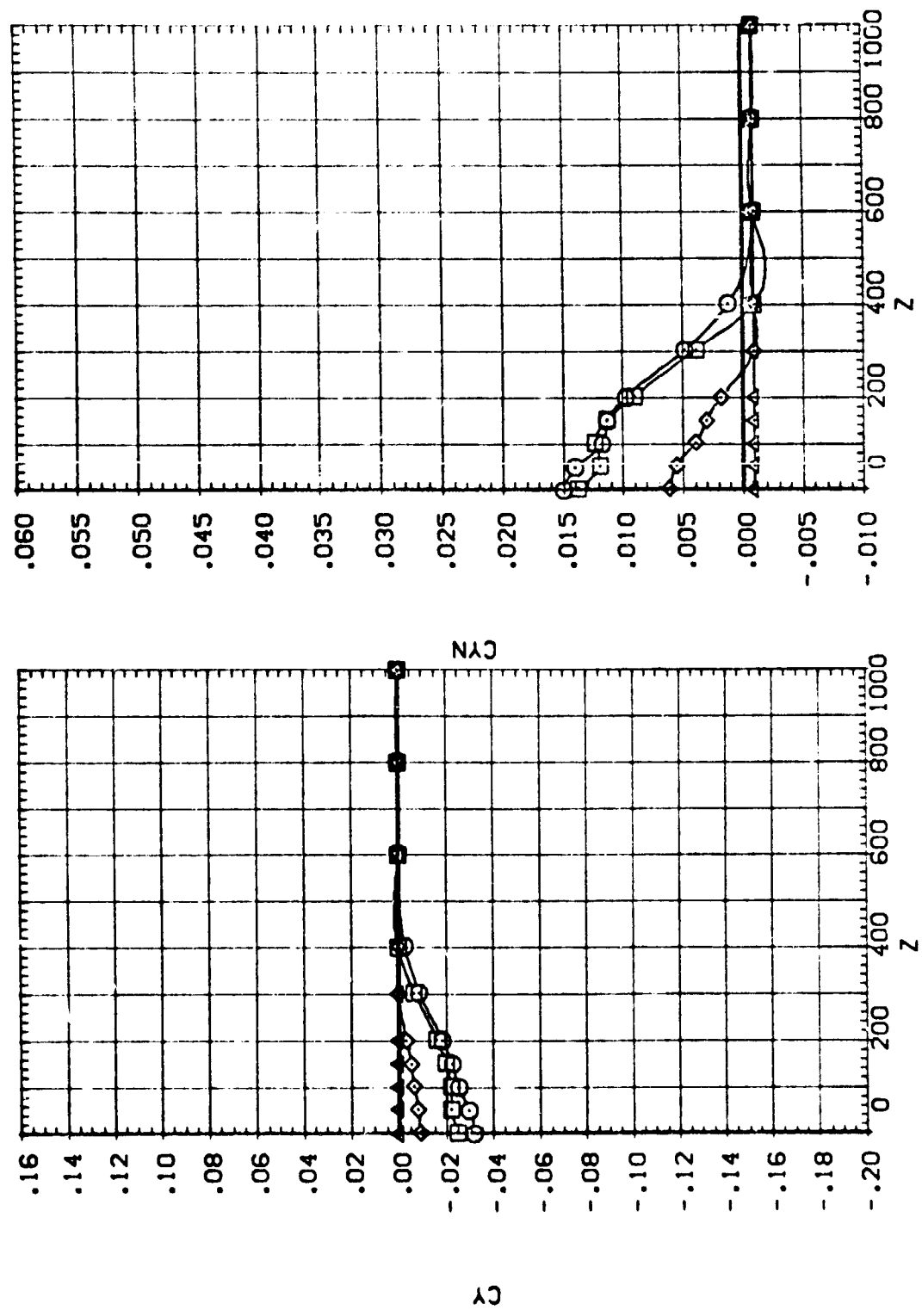

EFFECT OF SRB W/O PLUMES SEPARATION ON ORB/ET AERODYNAMIC CHARACTERISTICS

IA13 SRB(S8) W/O PLUMES SEPARATING FROM 09T10 (RTJ145)

SEE THE ASSOCIATED DATA DOCUMENT FOR REFERENCE CHARACTERISTICS FOR INDIVIDUAL DATASETS

SYMBOL		PARAMETRIC VALUES	
○	X	MACH	110.000
□	300,460	ALPHA	.000
◇	600,620	DALPHA	.000
△	900,620	Y	400.000
		PITCH	-5.000
		PCMBR	.000

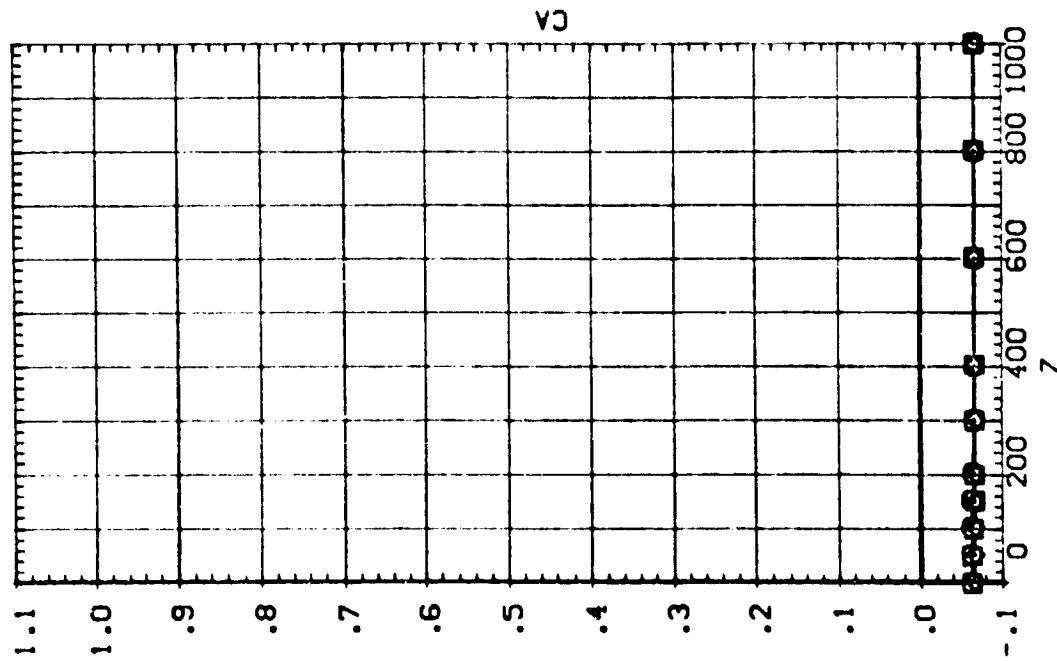
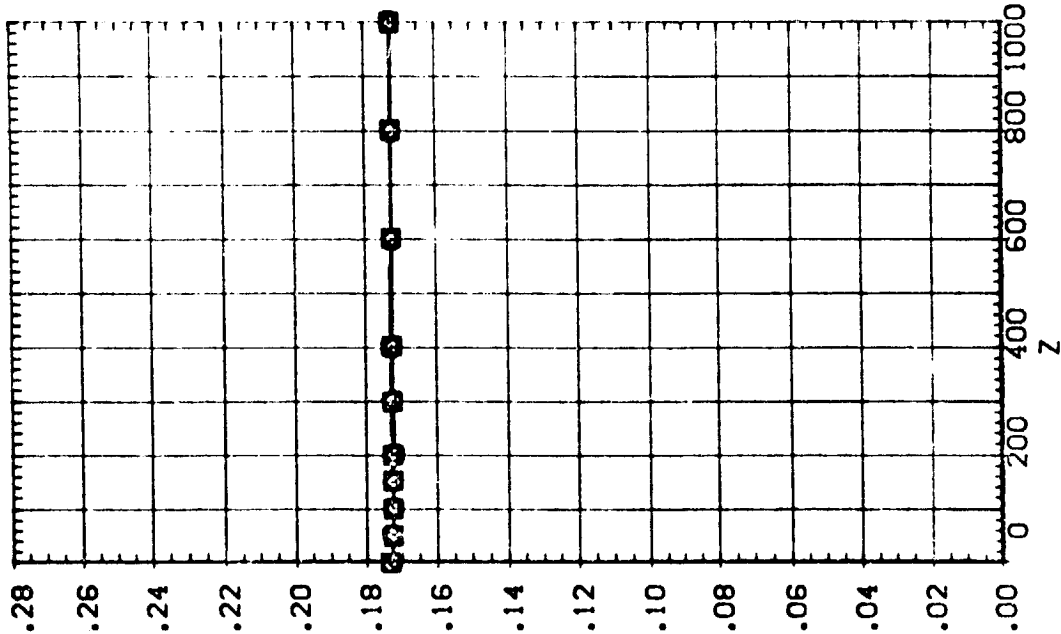

IA13 SRB(S8) W/O PLUMES SEPARATING FROM 09T10 (RTJ145)

SEE THE ASSOCIATED DATA DOCUMENT FOR REFERENCE CHARACTERISTICS FOR INDIVIDUAL DATASETS

SYMBOL X
 ○ 300.460
 □ 600.620
 ◇ 900.620

PARAMETRIC VALUES
 MACH 4.530
 ALPHA .000
 DALPHA .000
 Y 400.000

PITOTAL 110.000
 BETA .000
 DBETA -5.000
 PC-HBR .000

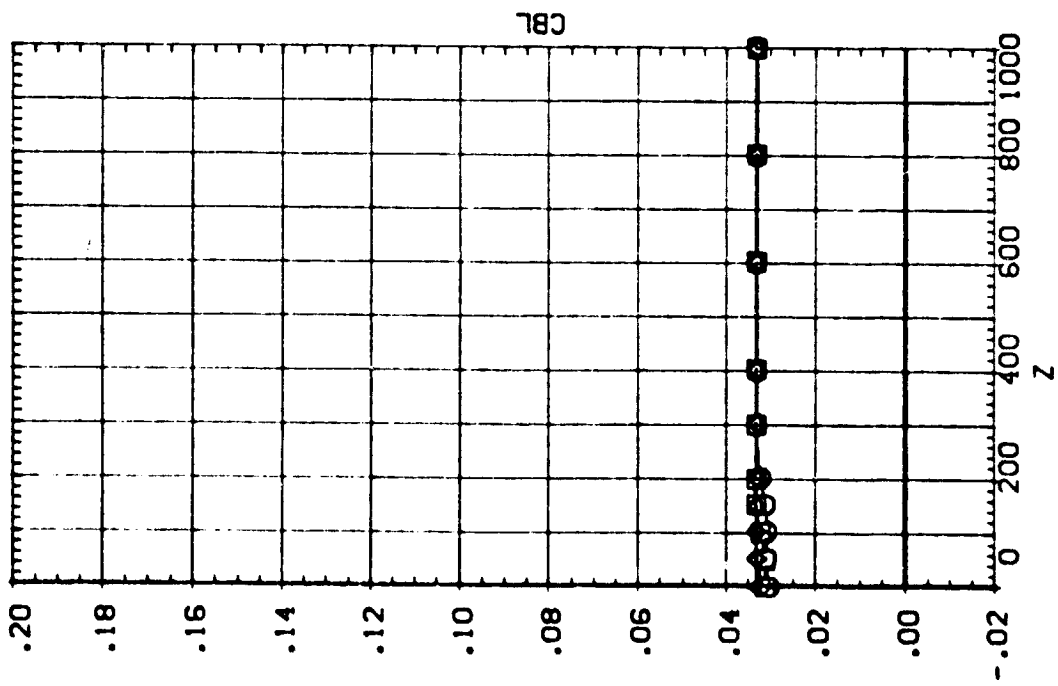
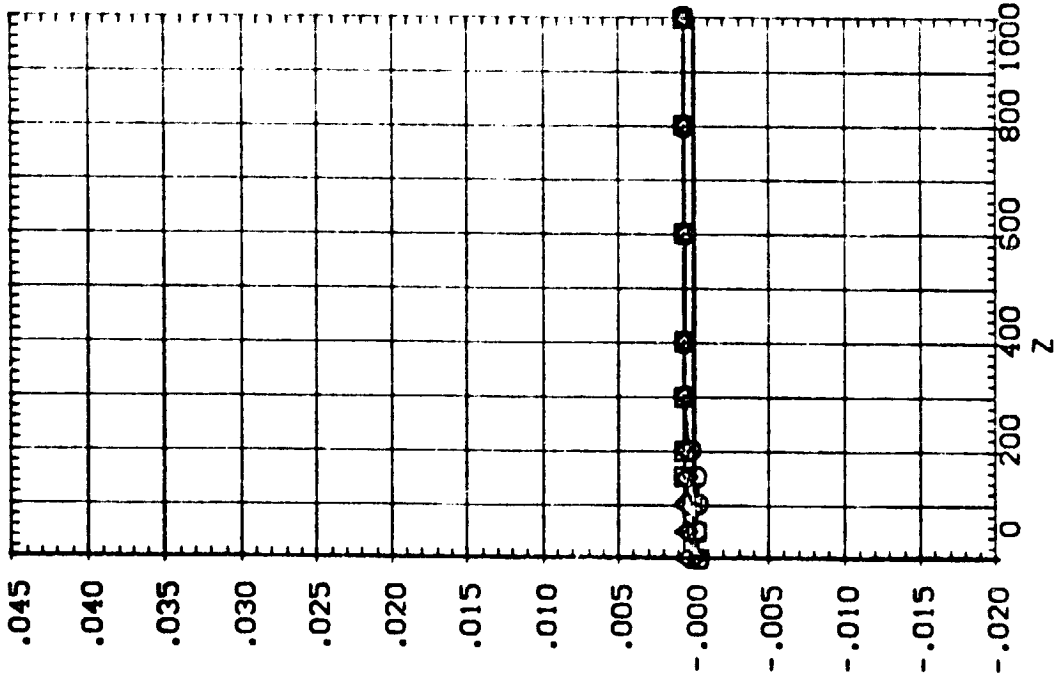

EFFECT OF SP8 W/O PLUMES SEPARATION ON ORB/ET AERODYNAMIC CHARACTERISTICS

IA13 SRB(S8) W/O PLUMES SEPARATING FROM 09T10 (RTJ145)

SEE THE ASSOCIATED DATA DOCUMENT FOR REFERENCE CHARACTERISTICS FOR INDIVIDUAL DATASETS

SYMBOL		PARAMETRIC VALUES	
○	x	MACH	PTOTAL
□	300.450	.000	BETA
◇	600.620	.000	OBETA
△	900.620	400.000	PC-HSR
			110.000
			.000
			-5.000
			.000

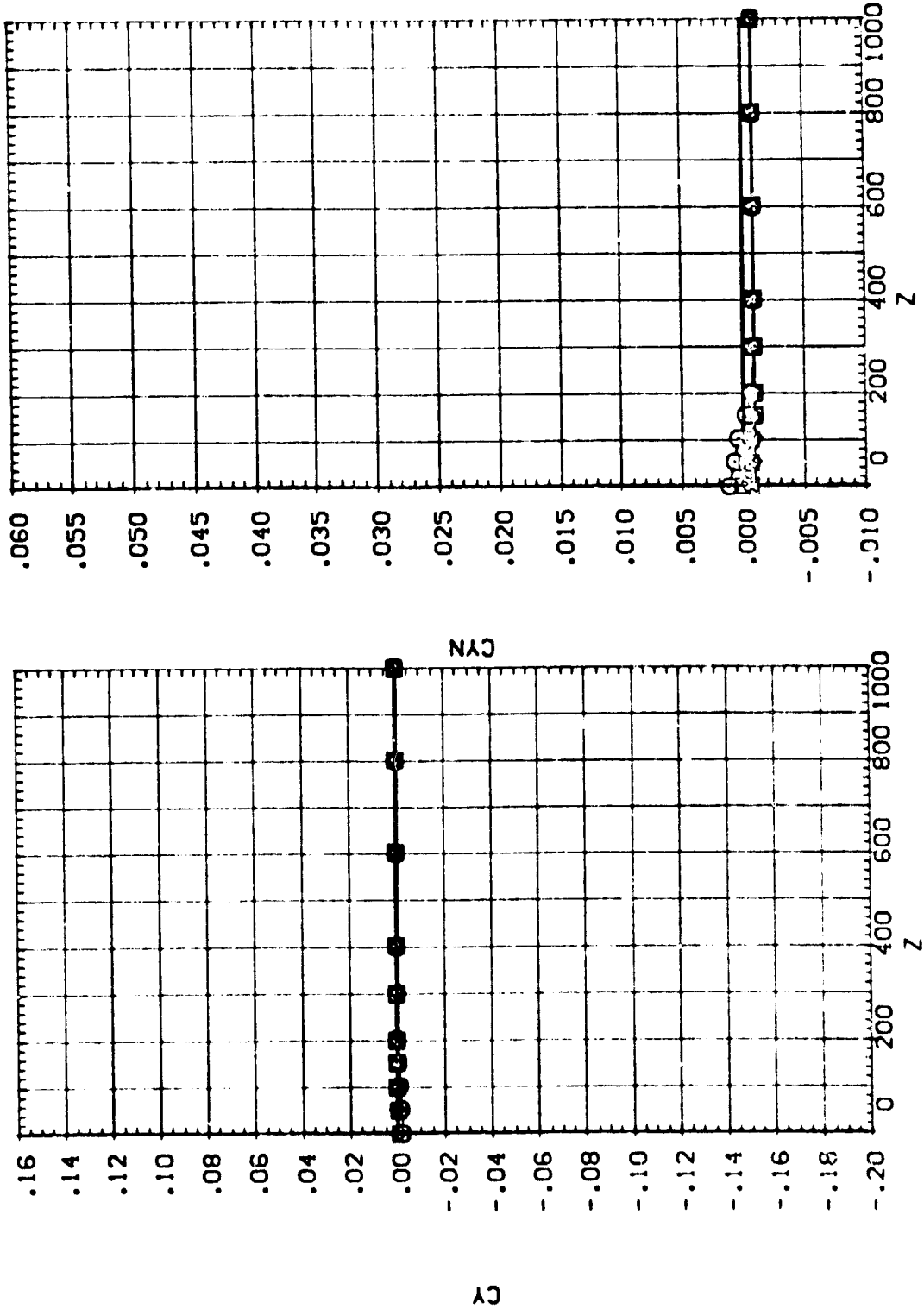

EFFECT OF SRB W/O PLUMES SEPARATION ON ORB/ET AERODYNAMIC CHARACTERISTICS

IA13 SRB(S8) W/O PLUMES SEPARATING FROM 09T10 (RTJ146)

SEE THE ASSOCIATED DATA DOCUMENT FOR REFERENCE CHARACTERISTICS FOR INDIVIDUAL DATASETS

SYMBOL		PARAMETRIC VALUES	
○	X	MACH	110.000
□	300.480	ALPHA	.000
◇	600.310	DALPHA	-5.000
△	900.550	Y	.000
		PCHBR	.000

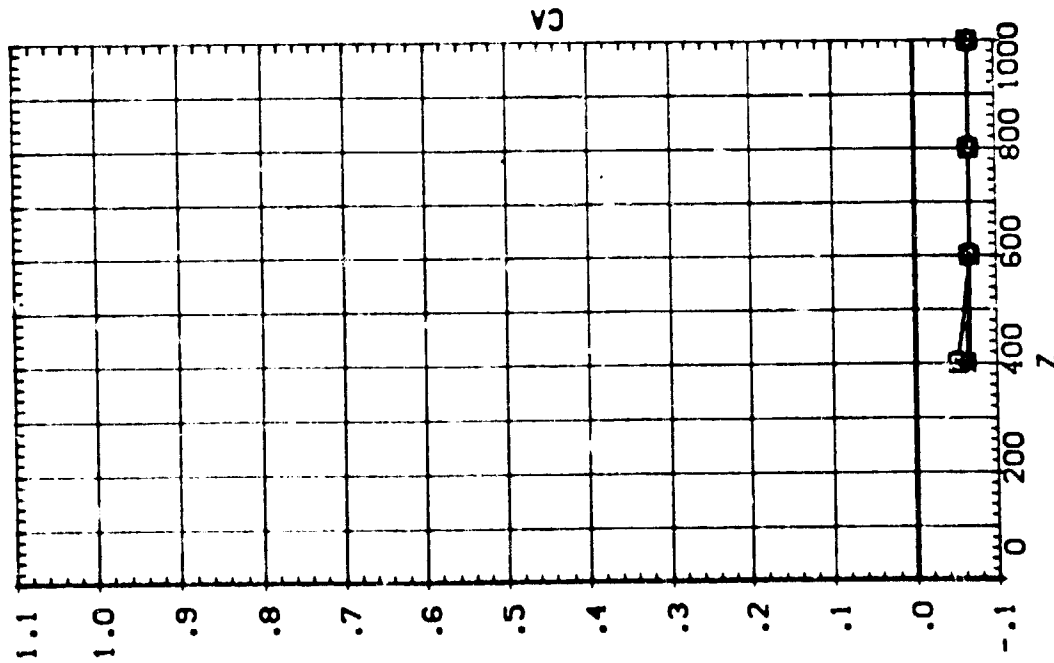
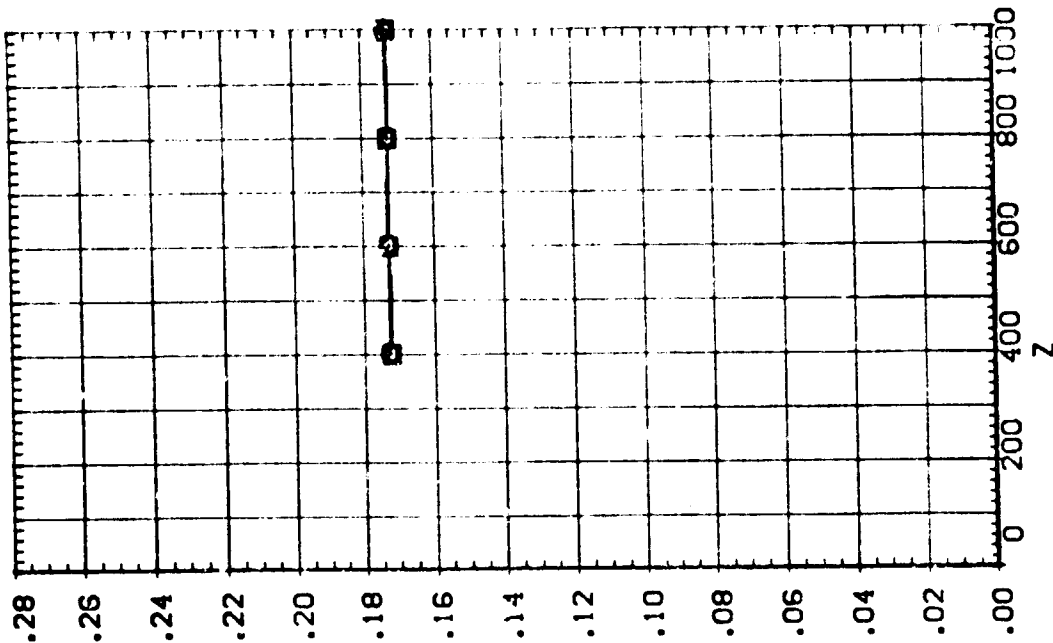

EFFECT OF SRB W/O PLUMES SEPARATION ON ORB/ET AERODYNAMIC CHARACTERISTICS

[A13 SRB(S8) W/O PLUMES SEPARATING FROM 09T10 (RTJ146)]

SEE THE ASSOCIATED DATA DOCUMENT FOR REFERENCE CHARACTERISTICS FOR INDIVIDUAL DATASETS

SYMBOL	X	MACH	PARAMETRIC VALUES	PITOTAL	110.000
□	.323	4.530	BETA	.000	.000
◇	300.480	.000	DBETA	-5.000	.000
△	600.310	.000	PC-MBR	.000	.000
	900.550	.000			

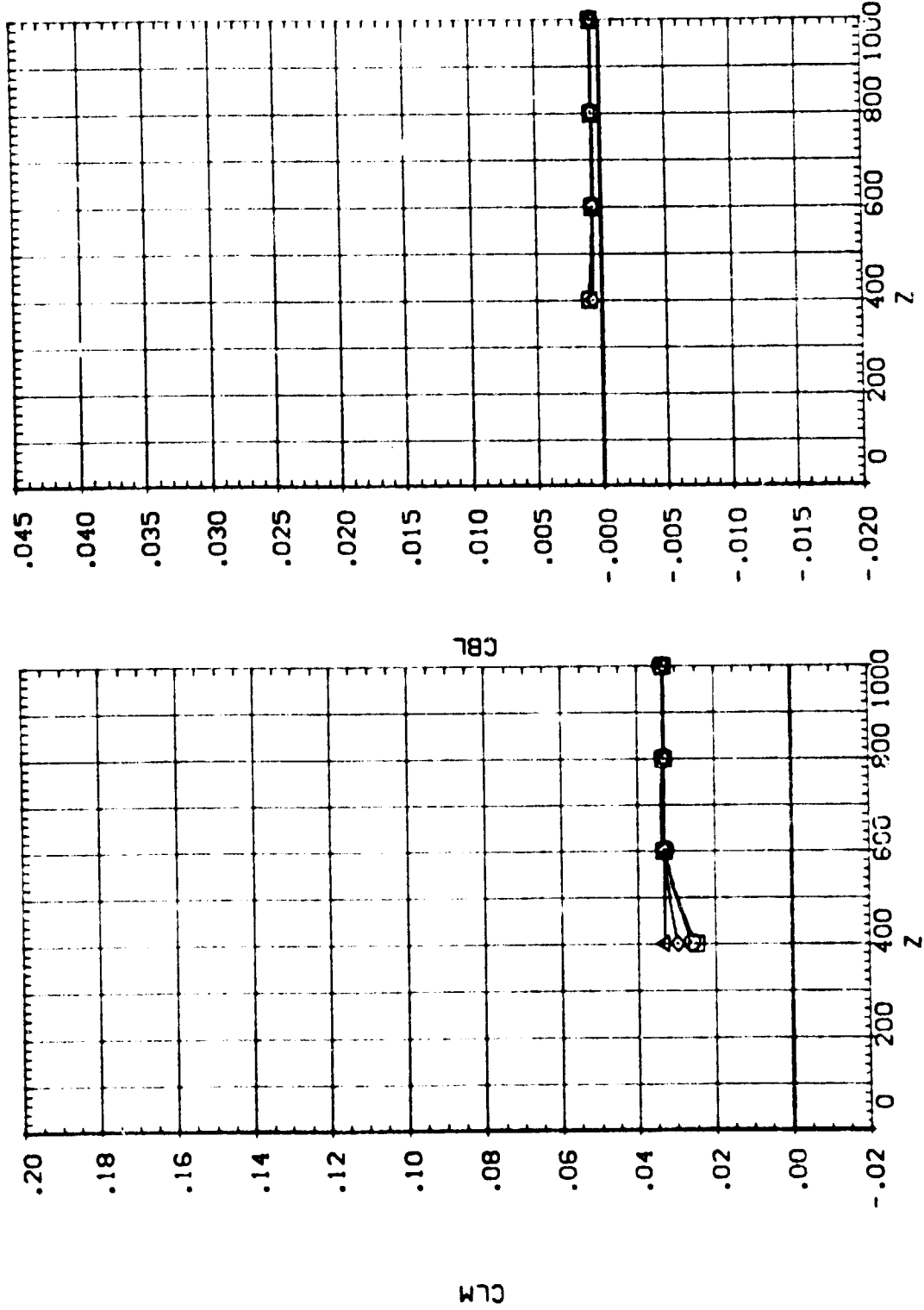

IA13 SRB(S8) W/O PLUMES SEPARATING FROM 09T10 (RTJ146)

SEE THE ASSOCIATED DATA DOCUMENT FOR REFERENCE CHARACTERISTICS FOR INDIVIDUAL DATASETS

SYMBOL	X	MACH	ALPHA	DA ALPHA	Y	PARAMETRIC VALUES	PITOTAL	BETA	DBETA	PC+PR
○	.323					4.530	110.000	.000	-5.000	.000
□	300.480					.000				
◇	600.310					.000				
△	900.550					.000				

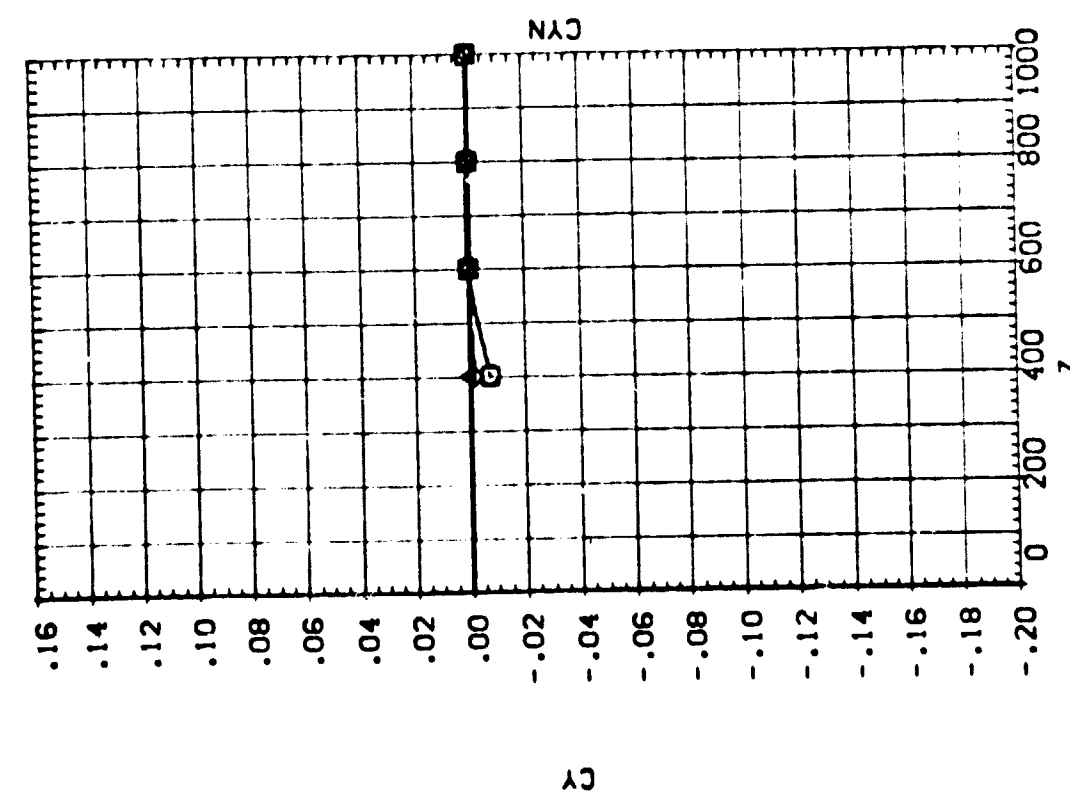
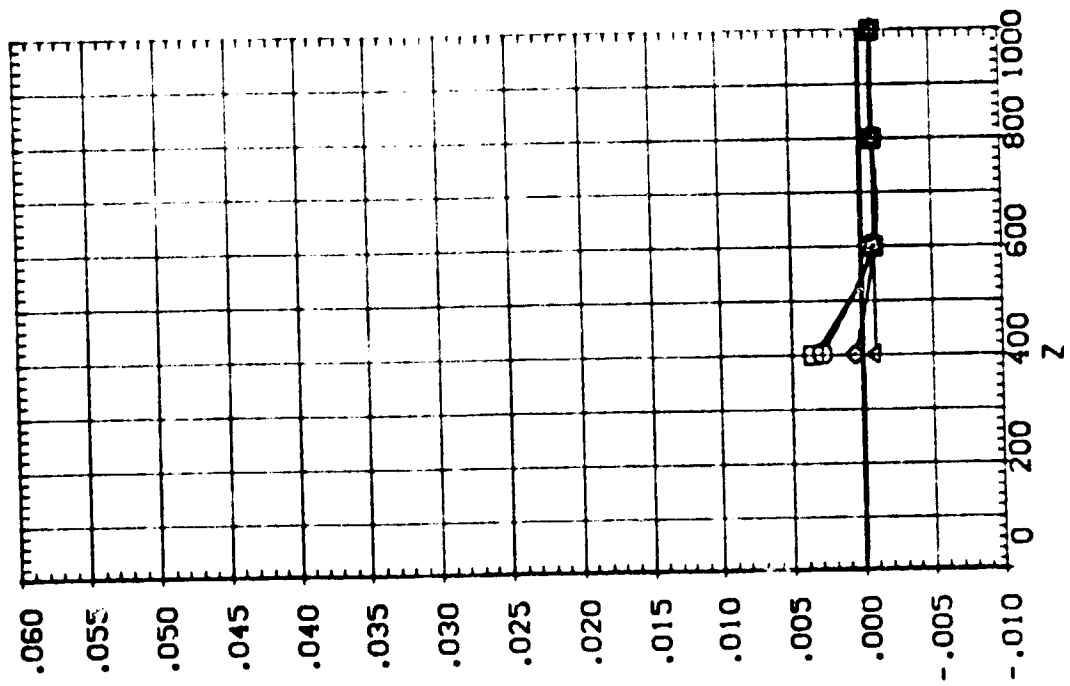

EFFECT OF SRB W/O PLUMES SEPARATION ON ORB/ET AERODYNAMIC CHARACTERISTICS

IA13 SRB(S8) W/O PLUMES SEPARATING FROM 09T10 (RTJ147)

SEE THE ASSOCIATED DATA DOCUMENT FOR REFERENCE CHARACTERISTICS FOR INDIVIDUAL DATASETS

SYMBOL	X	MACH	PARAMETRIC VALUES
○	.392	4.530	P/TOTAL 110.000
□	300.420	.000	BETA .000
◇	600.600	.000	DBETA -5.000
△	900.650	670.000	PC-MBR .000

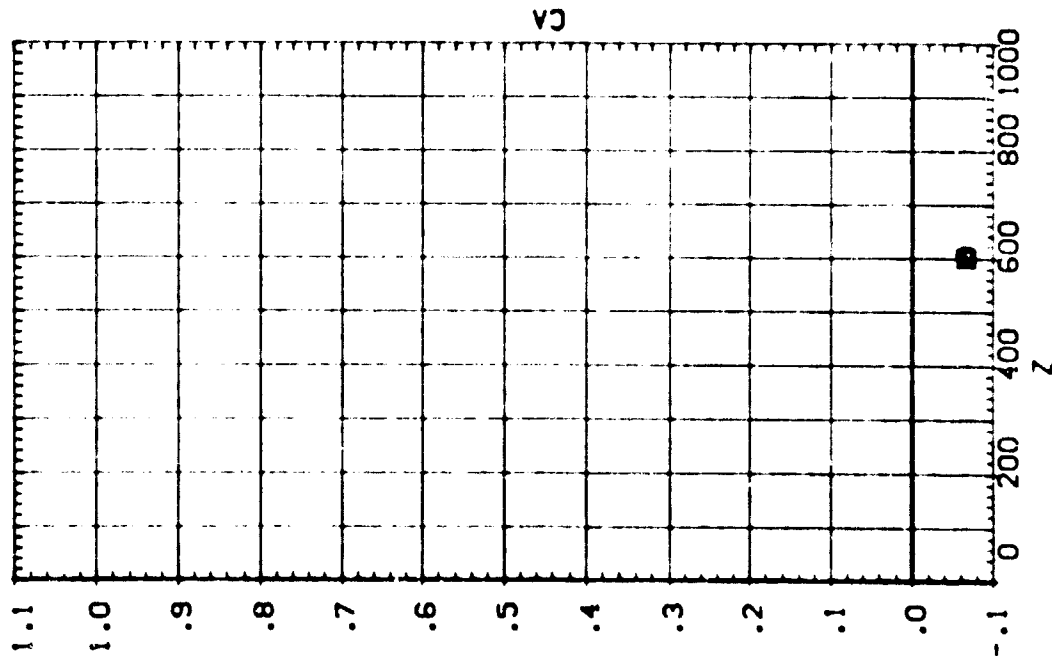
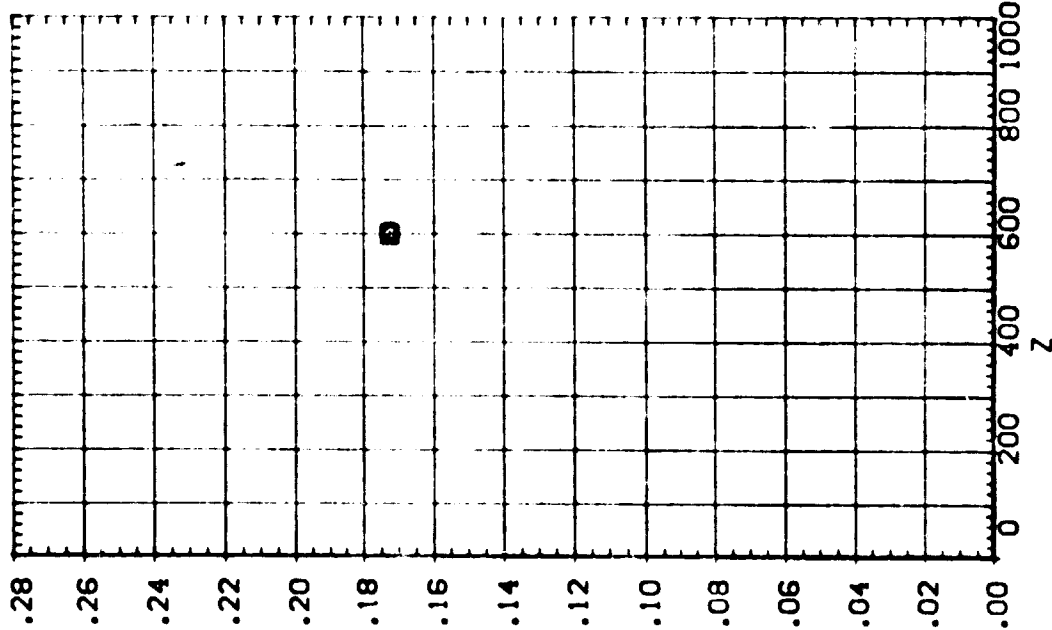

IA13 SRB(SB) W/O PLUMES SEPARATING FROM 09T10 (RIJI47)

SEE THE ASSOCIATED DATA DOCUMENT FOR REFERENCE CHARACTERISTICS FOR INDIVIDUAL DATASETS

SYMBOL		PARAMETRIC VALUES				
○	X	.322	MACH	4.530	P/TOTAL	110.000
□		300.420	ALPHA	.000	BETA	.000
◇		600.800	DALPHA	.000	DBETA	-5.000
△		900.650	Y	800.000	PC+PBR	.000

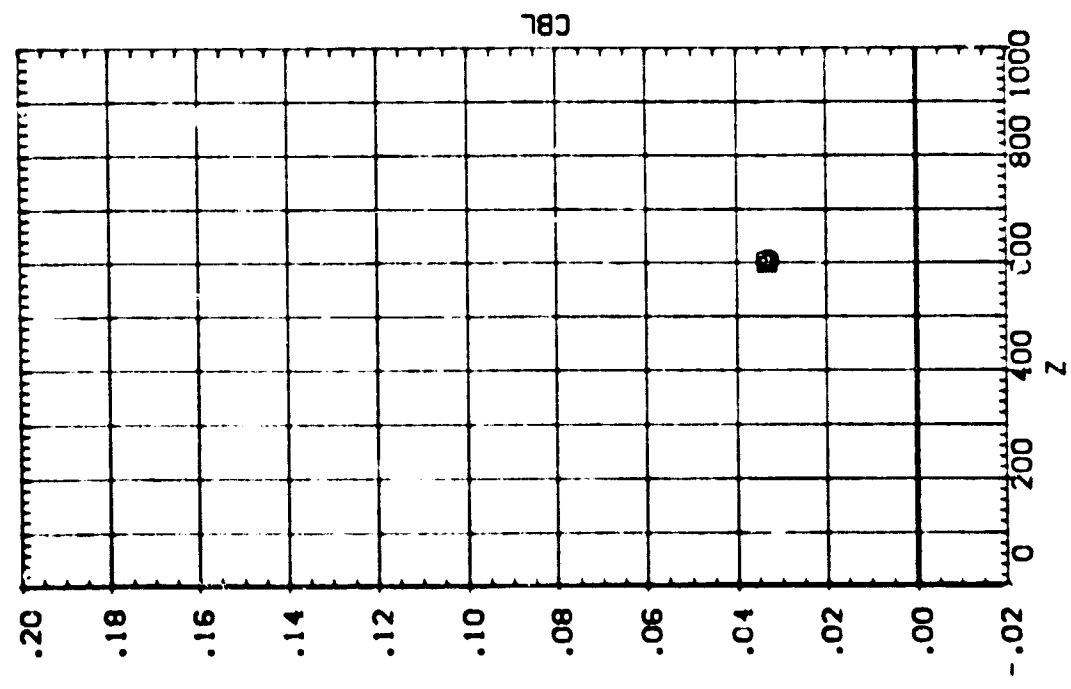
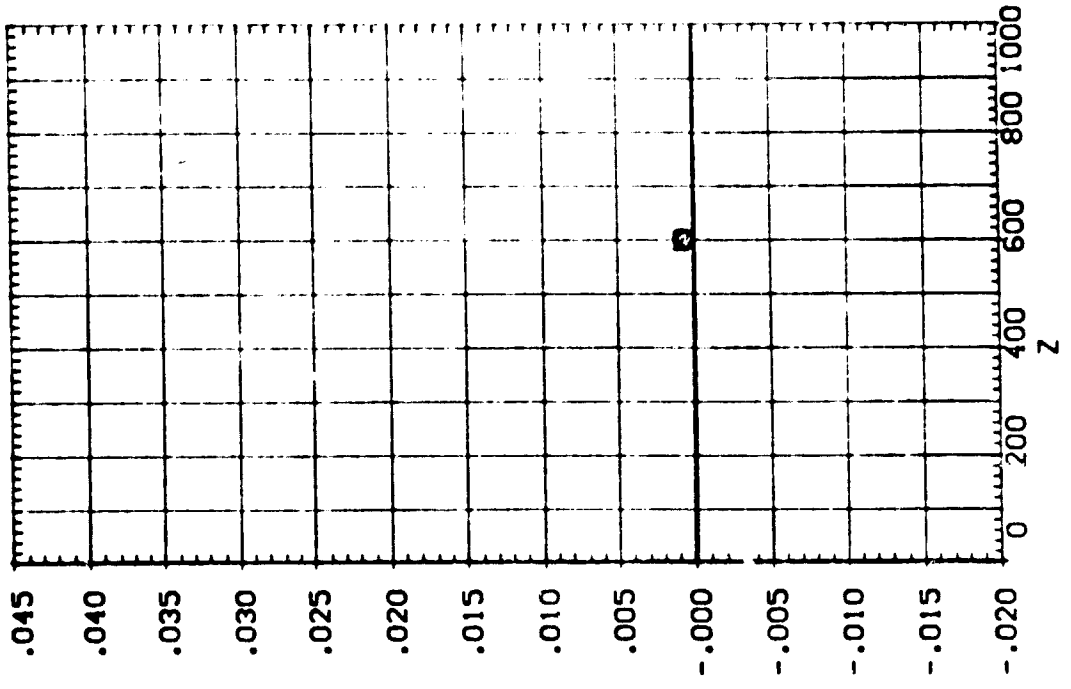

EFFECT OF SRB W/O PLUMES SEPARATION ON ORB/ET AERODYNAMIC CHARACTERISTICS

!A13 SR8(S8) W/O PLUMES SEPARATING FROM 09T10 (RTJ147)

SEE THE ASSOCIATED DATA DOCUMENT FOR REFERENCE CHARACTERISTICS FOR INDIVIDUAL DATASETS

SYMBOL	X	MACH	PARAMETRIC VALUES
○	.392	4.530	P TOTAL 110.000
□	300.420	.000	BETA .000
◇	600.600	.000	DBETA -5.000
△	900.850	800.000	PO+PBR .000

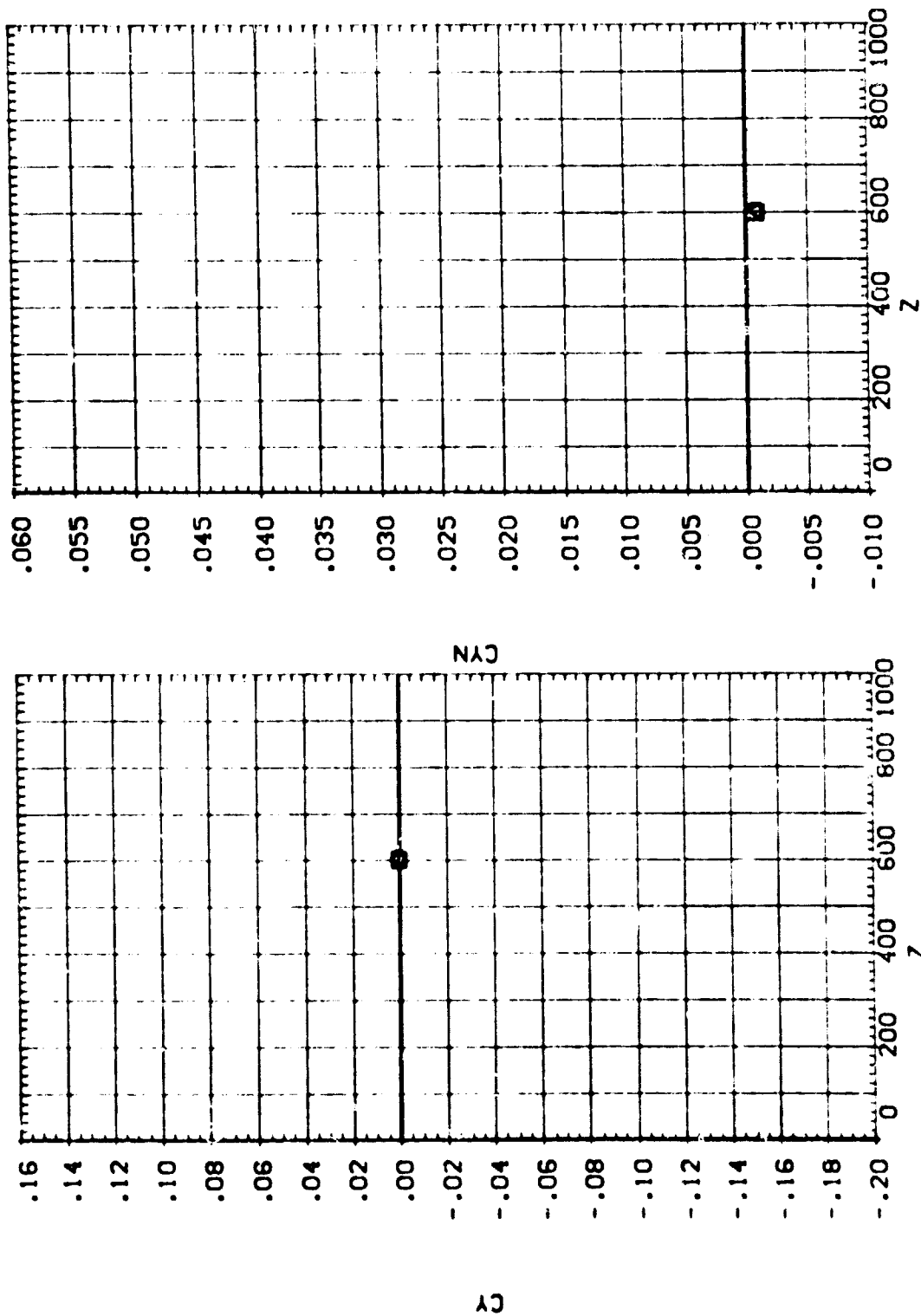

EFFECT OF SR8 W/O PLUMES SEPARATION ON ORB/ET AERODYNAMIC CHARACTERISTICS

IA13 SRB(SB) W/O PLUMES SEPARATING FROM 09T10 (RTJ148)

SEE THE ASSOCIATED DATA DOCUMENT FOR REFERENCE CHARACTERISTICS FOR INDIVIDUAL DATASETS

SYMBOL	X	MACH	PARAMETRIC VALUES
□	300.210	ALPHA	PTOTAL 110.000
◇	600.560	DALPHA	BETA .300
△	900.440	Y	DBETA -10.000
			PC+6K .000

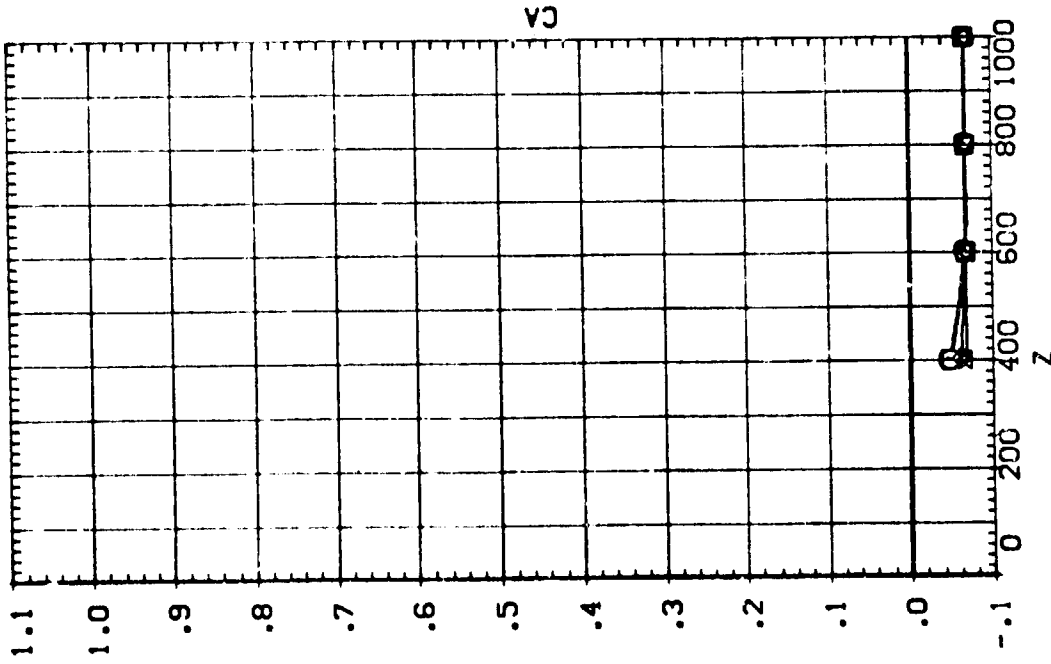
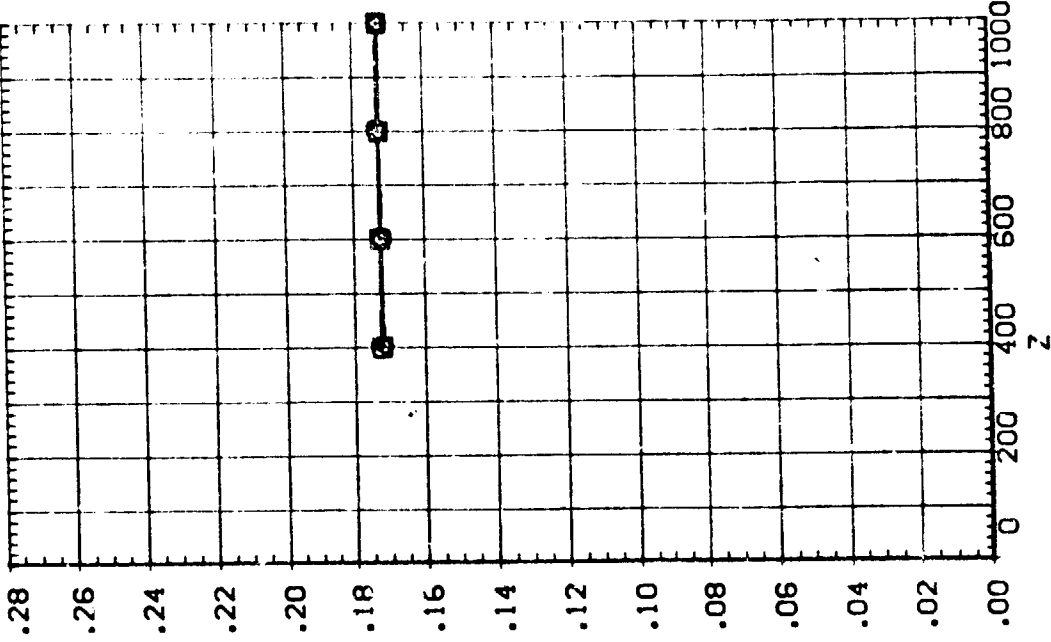

EFFECT OF SRB W/O PLUMES SEPARATION ON ORB/ET AERODYNAMIC CHARACTERISTICS

IA13 S1 (S8) W/O PLUMES SEPARATING FROM 09T10 (RTJ148)

SEE THE ASSOCIATED DATA DOCUMENT FOR REFERENCE CHARACTERISTICS FOR INDIVIDUAL DATASETS

SYMBOL		PARAMETRIC VALUES				
○	X	.236	MACH	4.530	PTOTAL	110.000
□	300.210	.000	ALPHA	.000	BETA	.000
◇	600.560	.000	DALPHA	.000	DBETA	-10.000
△	900.440	.000	Y	.000	PCHEG	.000

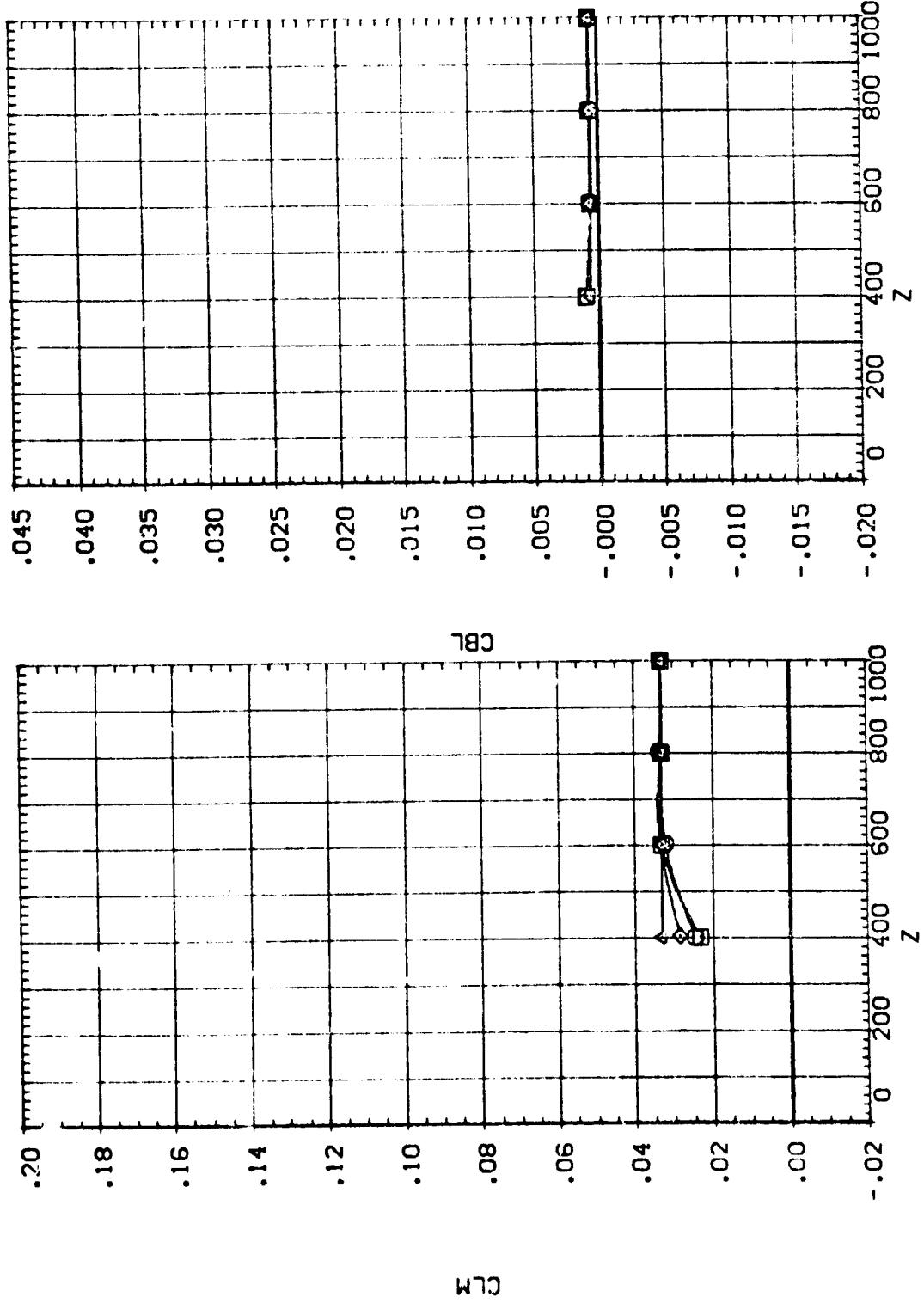

EFFECT OF SRB W/O PLUMES SEPARATION ON ORB/ET AERODYNAMIC CHARACTERISTICS

IA13 SRB(S8) W/O PLUMES SEPARATING FROM 09T10 (RTJ148)

SEE THE ASSOCIATED DATA DOCUMENT FOR REFERENCE CHARACTERISTICS FOR INDIVIDUAL DATASETS

SYMBOL X .236 MACH 4.530 PTDOTAL 110.000
 300.210 ALPHA .000 BETA .000
 600.560 DALPHA .000 DBETA -10.000
 900.140 Y .000 PCHMBR .000

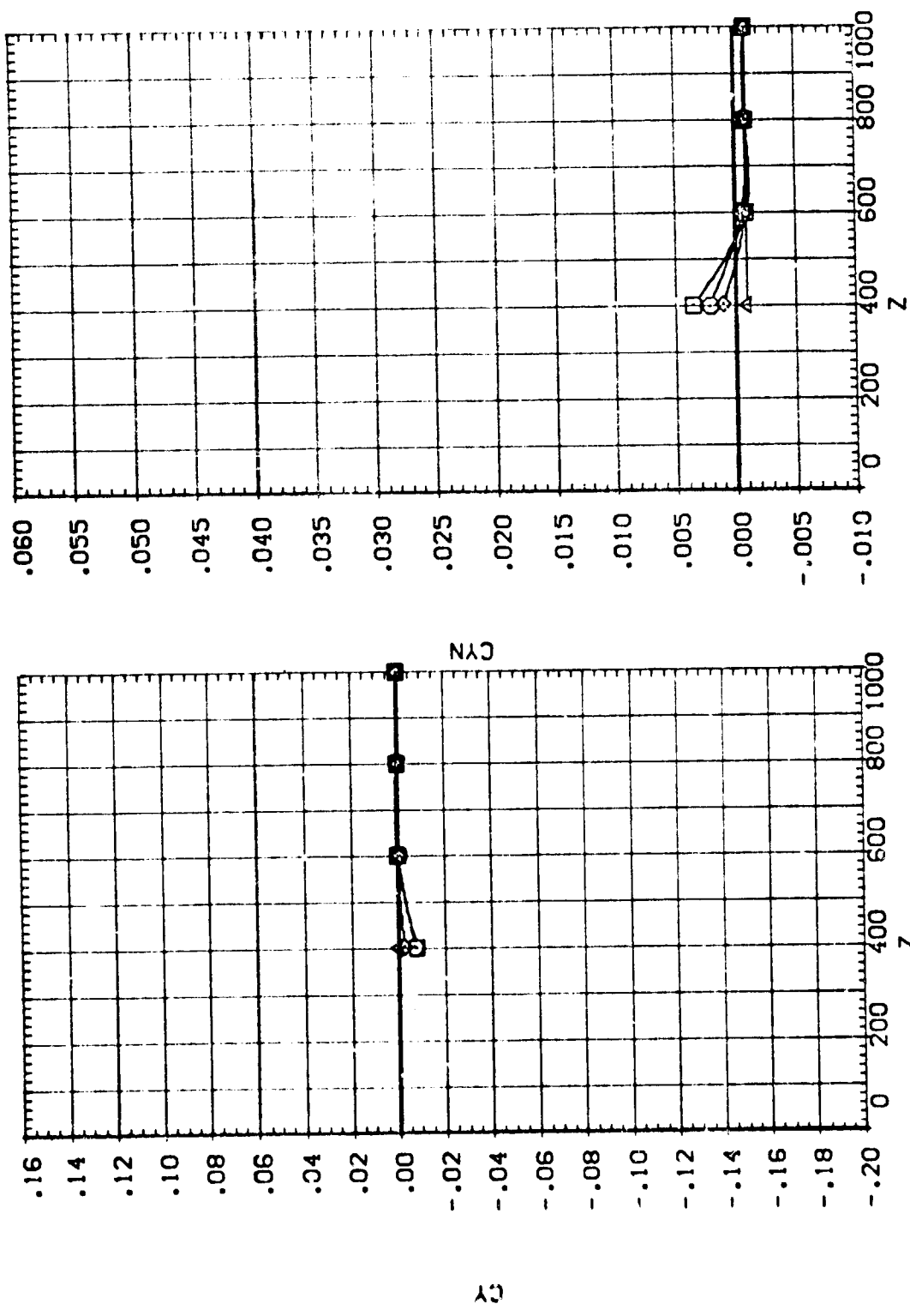

EFFECT OF SRB W/O PLUMES SEPARATION ON ORB/ET AERODYNAMIC CHARACTERISTICS

1A13 SRB(SB) W/O PLUMES SEPARATING FROM 09T10 (RTJ149)

SEE THE ASSOCIATED DATA DOCUMENT FOR REFERENCE CHARACTERISTICS FOR INDIVIDUAL DATASETS

SYMBOL	X	MACH	PARAMETRIC VALUES
○	.283	4.530	PTOTAL 110.000
□	300.370	.000	BETA .000
◇	600.600	.000	DBETA -10.000
△	900.820	Y	PC-MBR .000

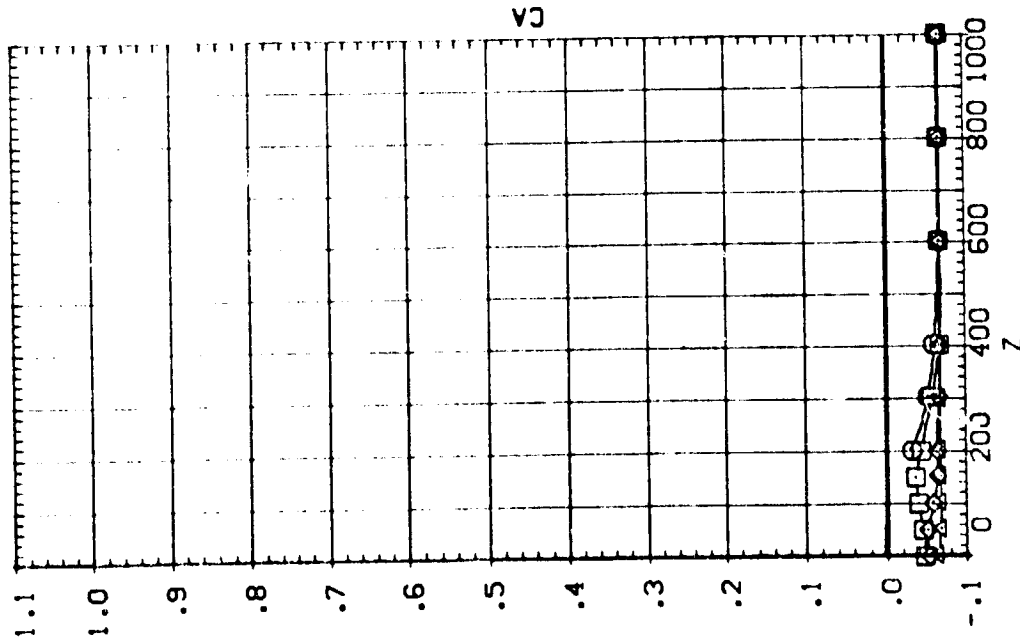
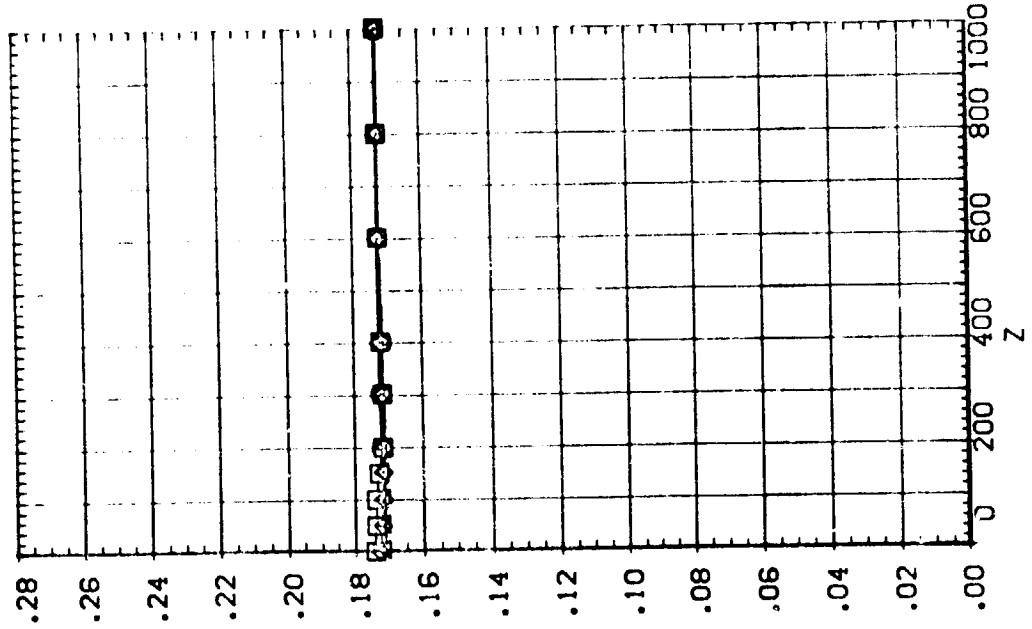

EFFECT OF SRB W/O PLUMES SEPARATION ON ORB/ET AERODYNAMIC CHARACTERISTICS

IA13 SRB(SB) W/O PLUMES SEPARATING FROM 09T10 (RTJ149)

SEE THE ASSOCIATED DATA DOCUMENT FOR REFERENCE CHARACTERISTICS FOR INDIVIDUAL DATASETS

SYMBOL		PARAMETRIC VALUES	
○	.283	MACH	4.530
□	300.370	ALPHA	.000
◇	670.600	DALPHA	.000
△	900.820	Y	200.000
		PTOTAL	110.000
		BETA	.000
		DBETA	-10.000
		PC#BR	.000

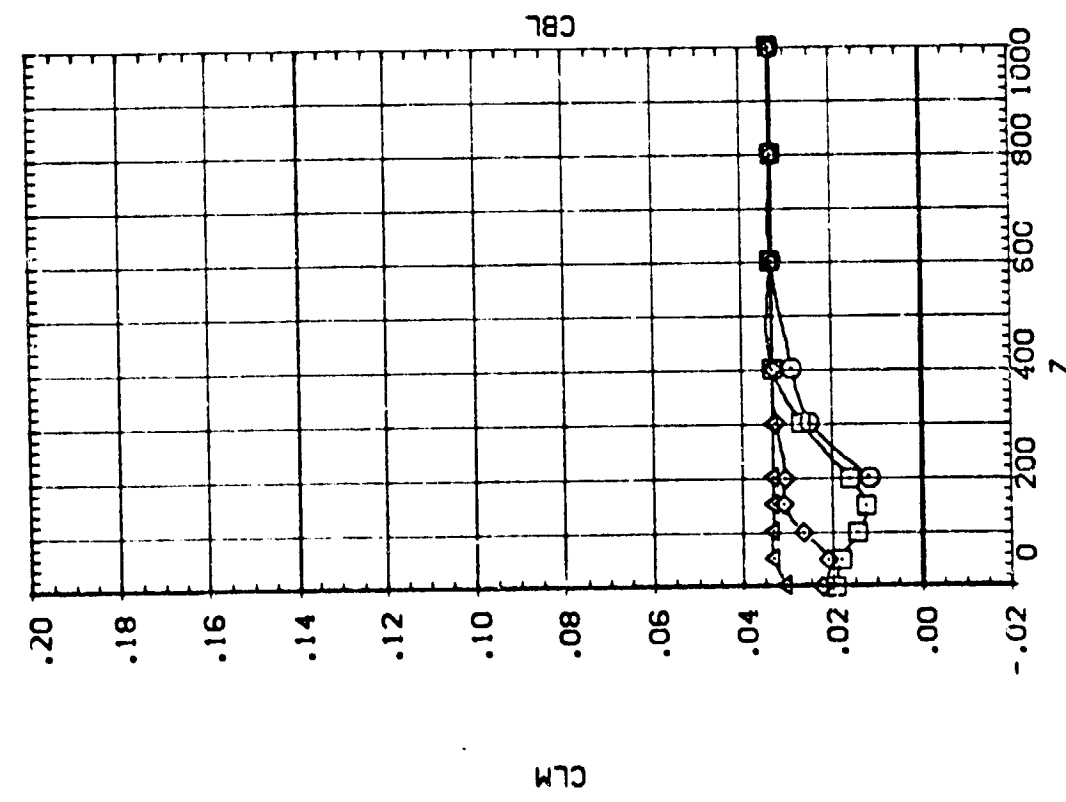
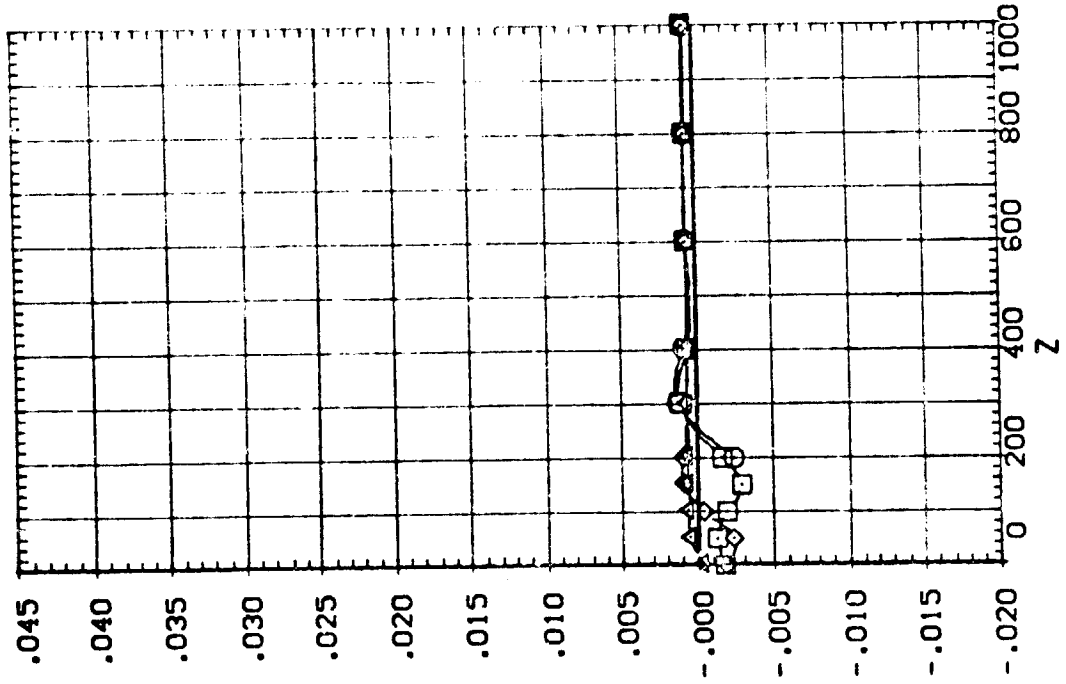

EFFECT OF SRB W/O PLUMES SEPARATION ON ORB/ET AERODYNAMIC CHARACTERISTICS

IA13 SRB(S8) W/O PLUMES SEPARATING FROM 09T10 (RTJ149)

SEE THE ASSOCIATED DATA DOCUMENT FOR REFERENCE CHARACTERISTICS FOR INDIVIDUAL DATASETS

SYMBOL	X	MACH	PARAMETRIC VALUES
○	.283	4.530	P TOTAL 110.000
□	300.370	.000	BETA .000
◇	500.600	.000	DBETA -10.000
△	900.820	200.000	PC+RBR .000

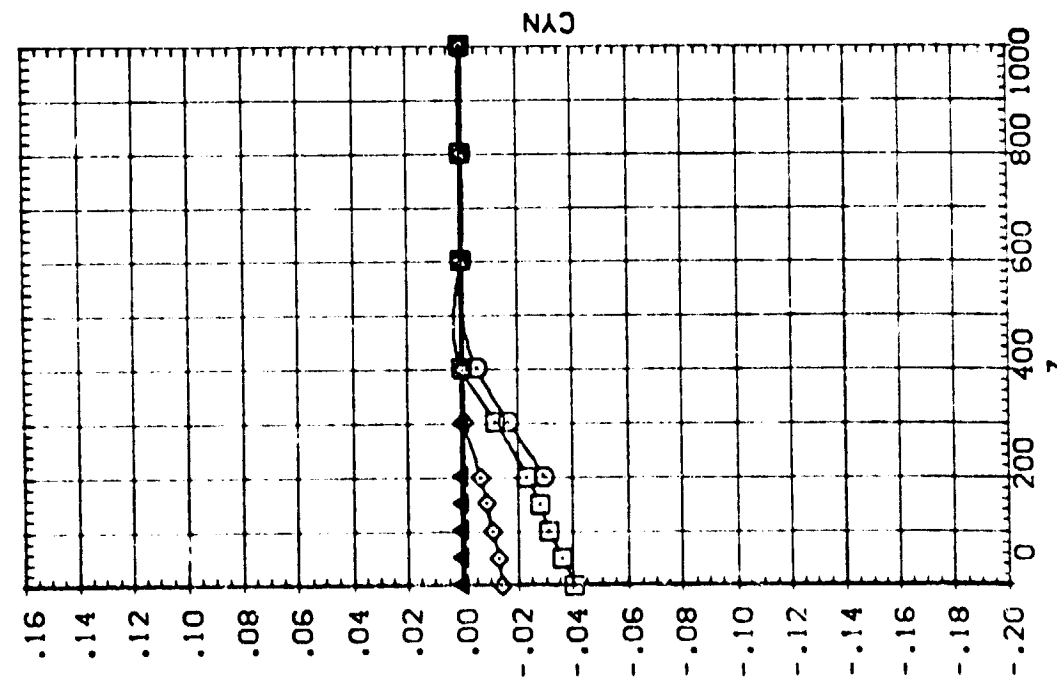
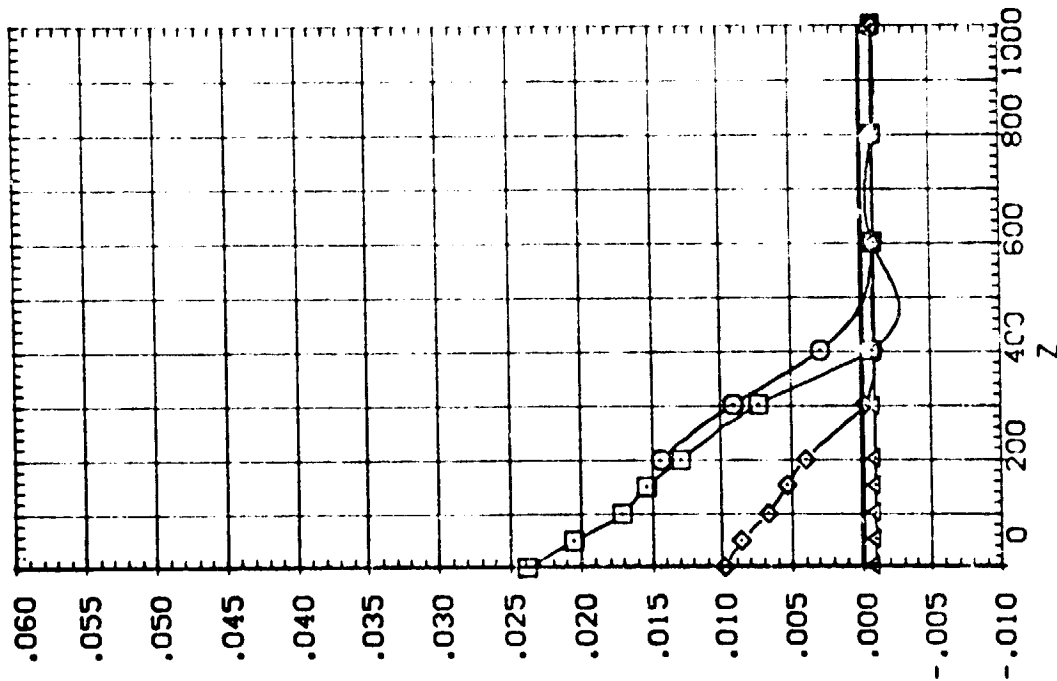

IA13 SRB(SB) W/O PLUMES SEPARATING FROM 09T10 (RTJ150)

SEE THE ASSOCIATED DATA DOCUMENT FOR REFERENCE CHARACTERISTICS FOR INDIVIDUAL DATASETS

SYMBOL		PARAMETRIC VALUES	
○	x	MACH	110.000
□	300.270	ALPHA	.000
◇	600.500	BETA	-10.000
△	900.460	PCMBR	.000

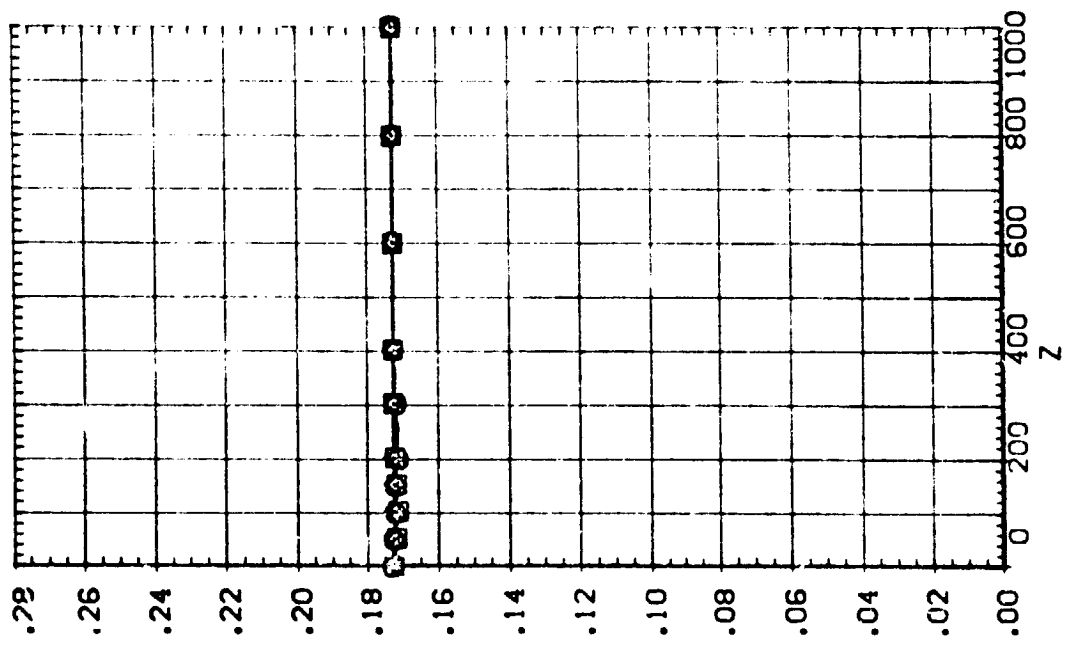
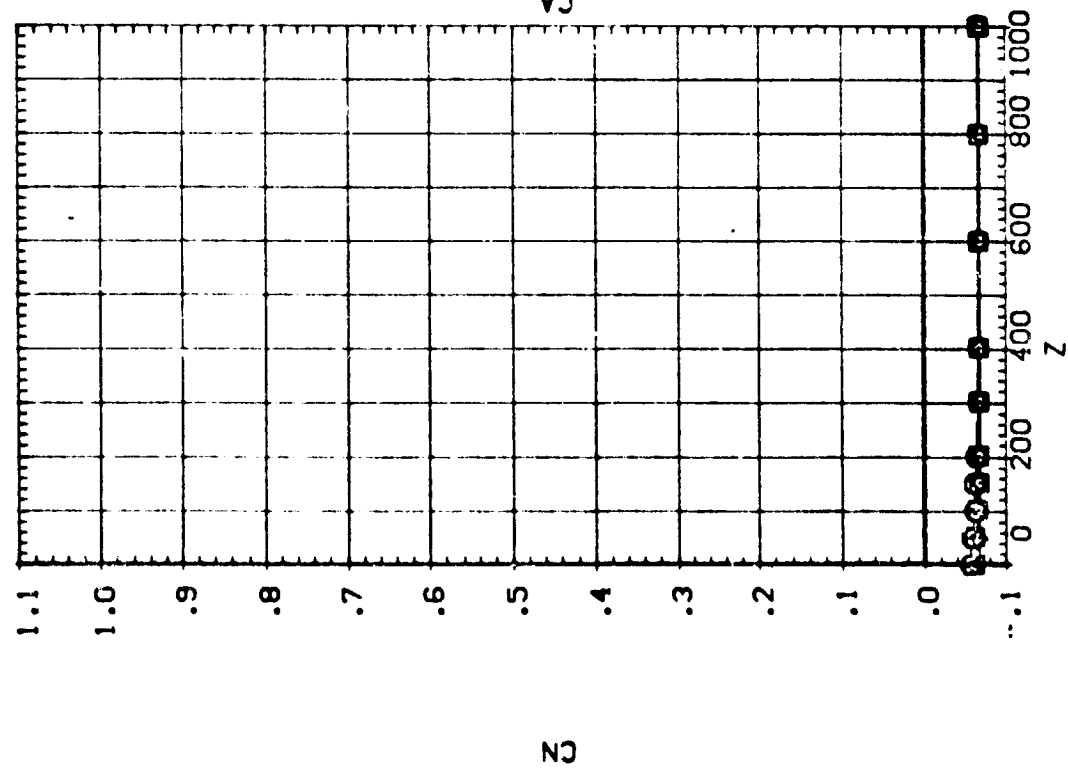

EFFECT OF SRB W/O PLUMES SEPARATION ON ORB/ET AERODYNAMIC CHARACTERISTICS

IA13 SRB(SB) W/O PLUMES SEPARATING FROM ORBIT (RTJ150)

SEE THE ASSOCIATED DATA DOCUMENT FOR REFERENCE CHARACTERISTICS FOR INDIVIDUAL DATASETS

SYMBOL	X	PARAMETRIC VALUES				
		MACH	ALPHA	Y	400,000	110,000
○	.176	.000	.000	.000	.000	.000
□	300.270	.000	.000	.000	.000	.000
◇	600.500	.000	.000	.000	.000	.000
△	900.460	.000	.000	.000	.000	.000

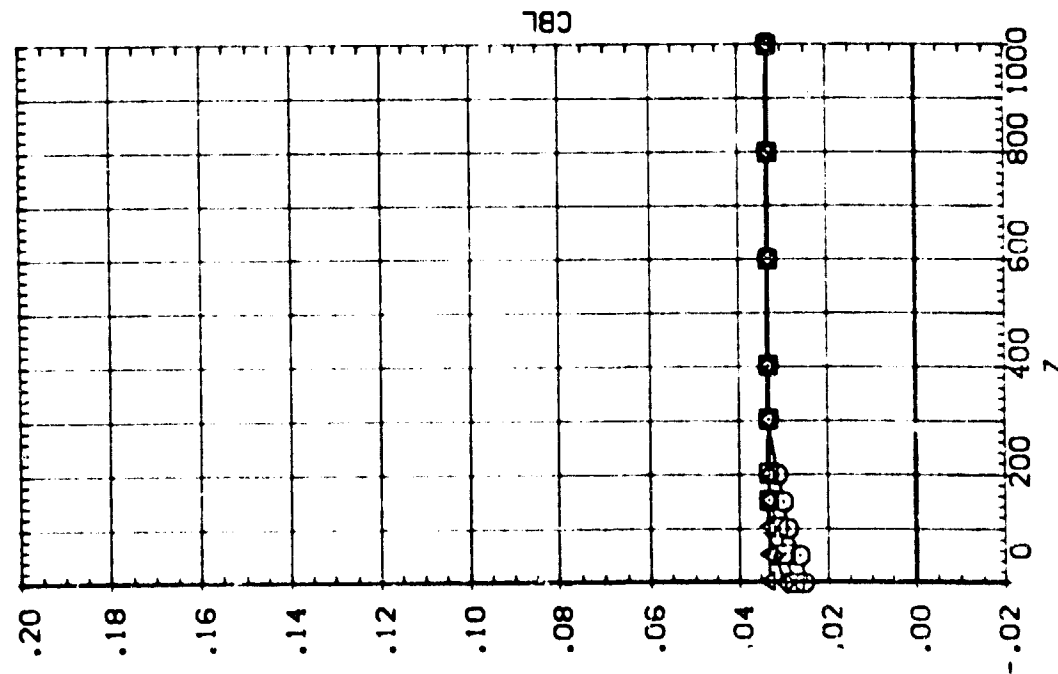
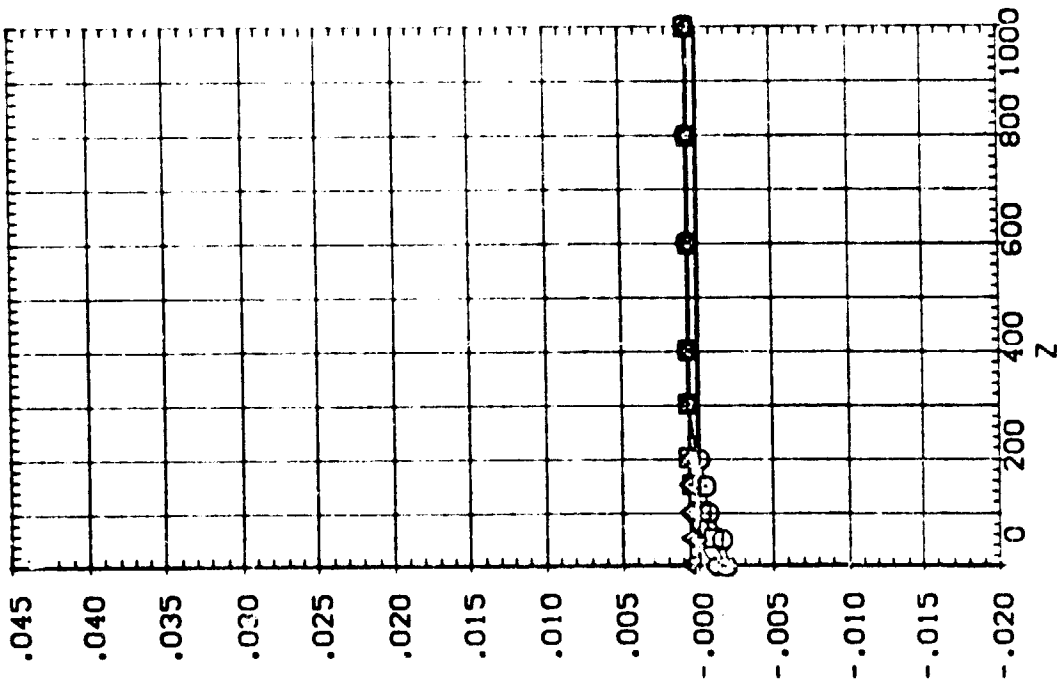

IA13 SRB(S8) W/O PLUMES SEPARATING FROM 09T10 (RTJ150)

SEE THE ASSOCIATED DATA DOCUMENT FOR REFERENCE CHARACTERISTICS FOR INDIVIDUAL DATASETS

SYMBOL		PARAMETRIC VALUES			
○	X	MACH	PTOTAL	110.000	
□		ALPHA	BETA	.000	
◇		DALPHA	DBETA	-10.000	
△	Y	PC1+PR		.000	

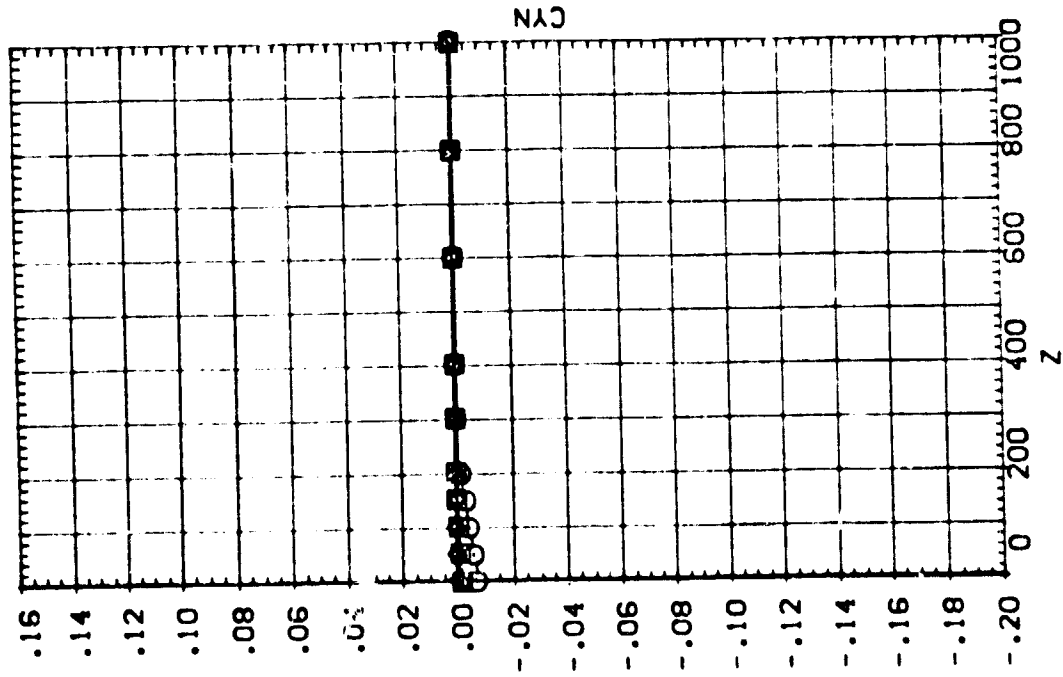
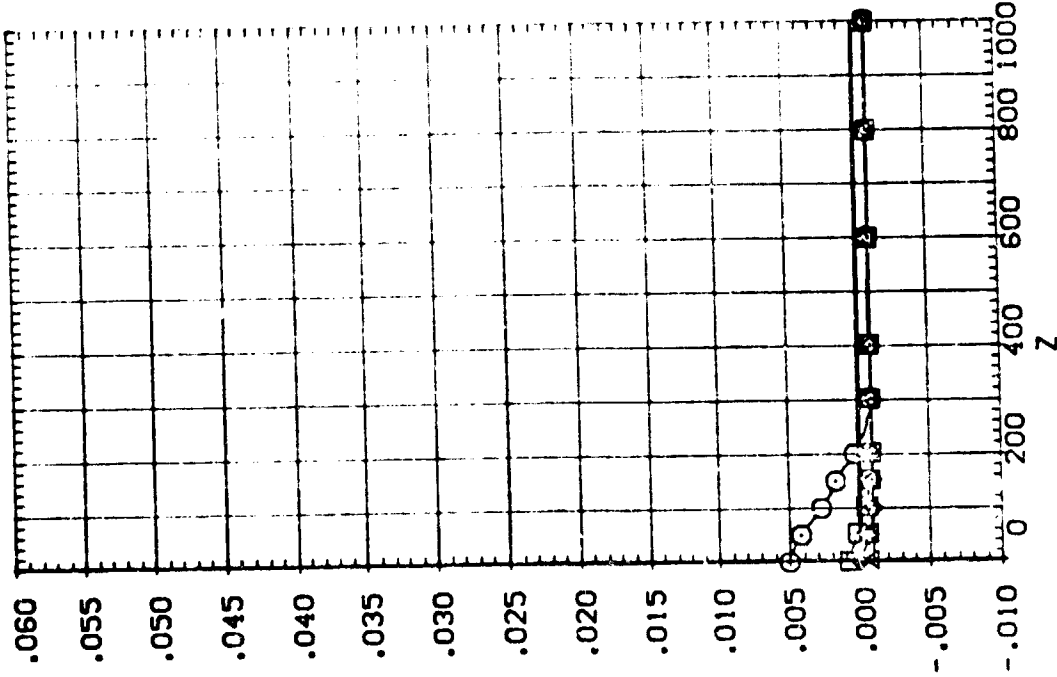

EFFECT OF SR8 W/O PLUMES SEPARATION ON ORB/ET AERODYNAMIC CHARACTERISTICS

1A13 SRB(SB) W/O PLUMES SEPARATING FROM ORT10 (RTJ151)

SEE THE ASSOCIATED DATA DOCUMENT FOR REFERENCE CHARACTERISTICS FOR INDIVIDUAL DATASETS

SYMBOL	X	PARAMETRIC VALUES
□	.272	MACH 110.000
○	300.310	4.530 PTOTAL .000
◇	600.490	.000 BETA -10.000
△	900.580	800.000 POHBR .000

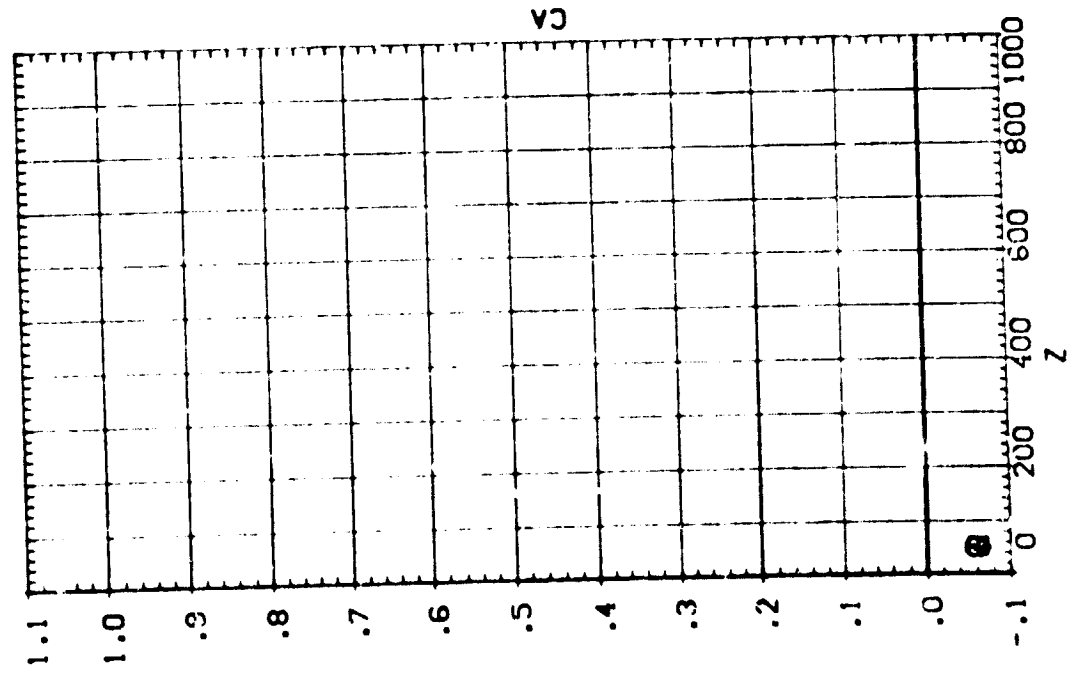
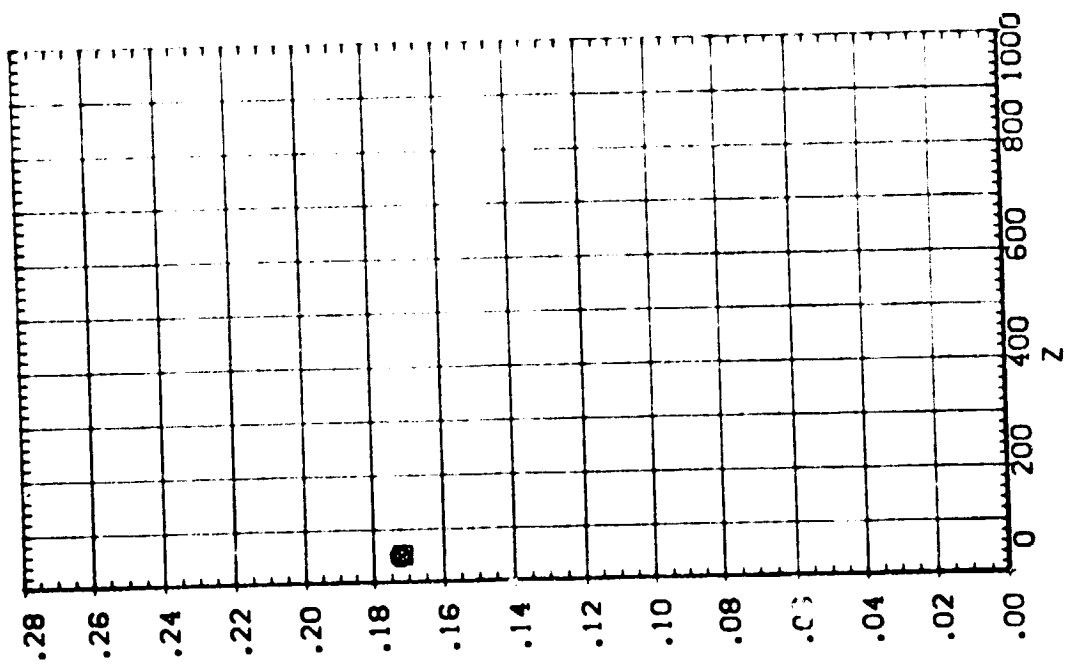

NS

IA13 SRB(SB) W/O PLUMES SEPARATING FROM 09T10 (RTJ151)

SEE THE ASSOCIATED DATA DOCUMENT FOR REFERENCE CHARACTERISTICS FOR INDIVIDUAL DATASETS

SYMBOL	X	MACH	PARAMETRIC VALUES
○	.272	4.530	PTOTAL 110.000
□	300.310	.000	BETA .000
◇	600.490	.000	DBE"A -10.000
△	900.580	Y	600.000 PC-MBR .000

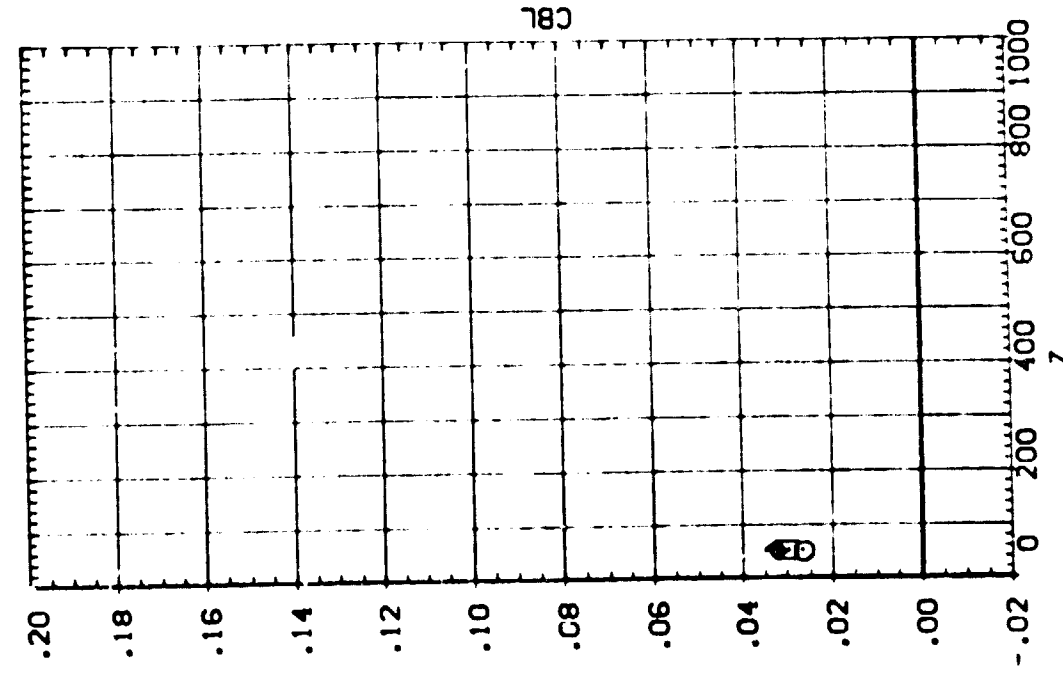
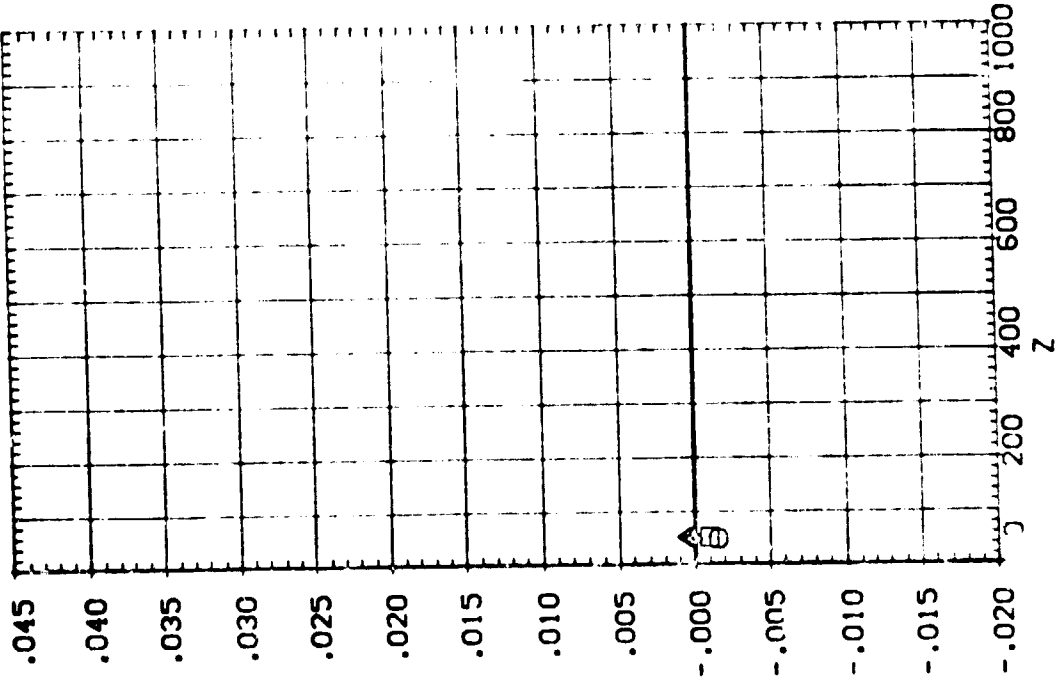

EFFECT OF SRB W/O PLUMES SEPARATION ON ORB/ET AERODYNAMIC CHARACTERISTICS

!A13 SRB(S8) W/O PLUMES SEPARATING FROM 09T10 (RTJ151)

SYMBOL X PARAMETRIC VALUES

○	.272	MACH	4.530	PTOTAL	110.000
◇	300.310	ALPHA	.000	BETA	.000
△	600.490	DALPHA	.000	DBETA	-10.000
	900.580	V	800.000	PCMPBR	.000

SEE THE ASSOCIATED DATA DOCUMENT FOR REFERENCE CHARACTERISTICS FOR INDIVIDUAL DATASETS

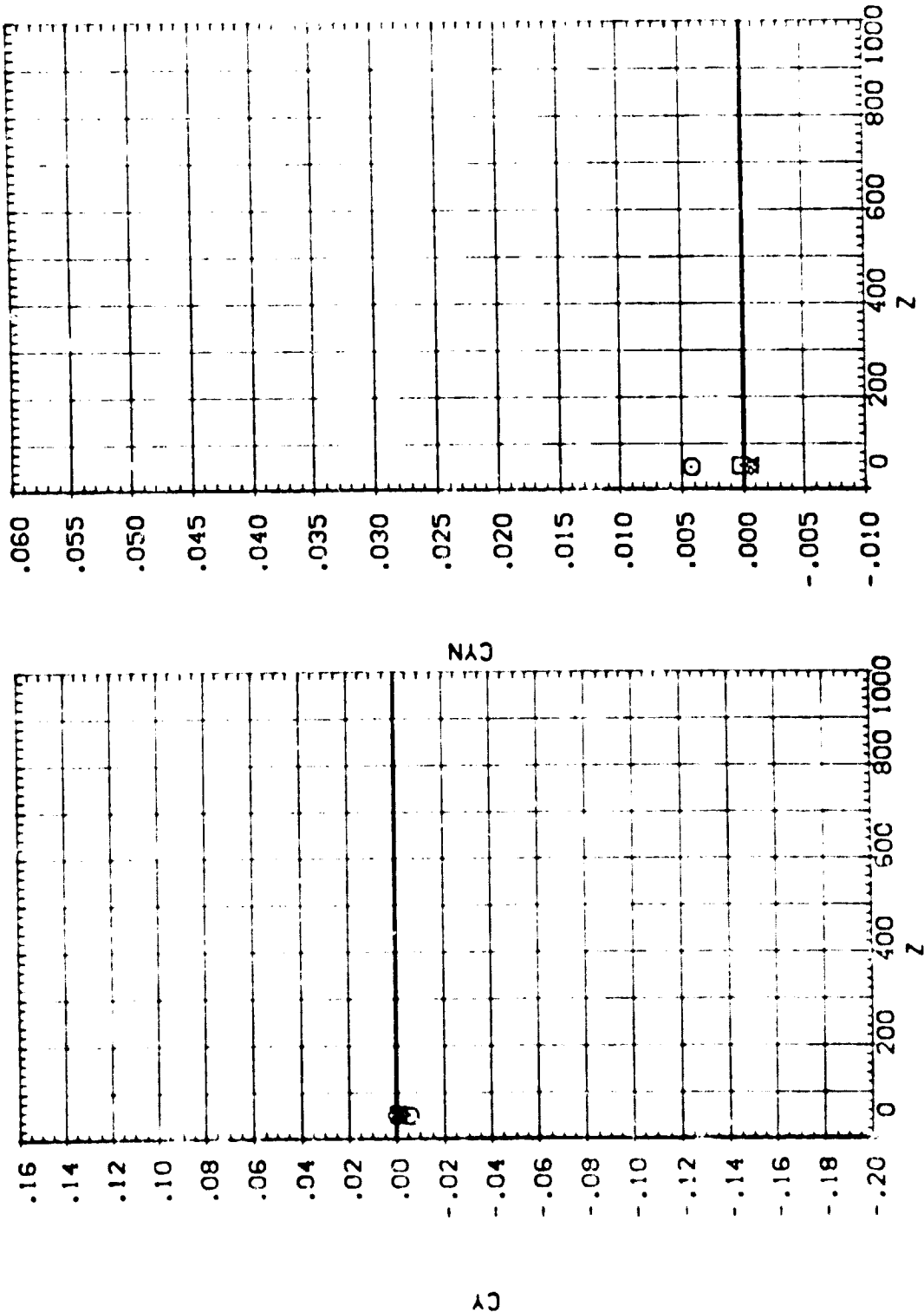

IA13 SRB(SB) W/O PLUMES SEPARATING FROM 09T10 (RTJ153)

SEE THE ASSOCIATED DATA DOCUMENT FOR REFERENCE CHARACTERISTICS FOR INDIVIDUAL DATASETS

SYMBOL		PARAMETRIC VALUES				
○	K	.097	MACH	4.530	PTOTAL	110.000
□	300.950	ALPHA	.000	BETA	.000	
◇	600.160	DALPHA	.000	DBETA	-20.000	
△	900.600	Y	400.000	PC-FSR	.000	

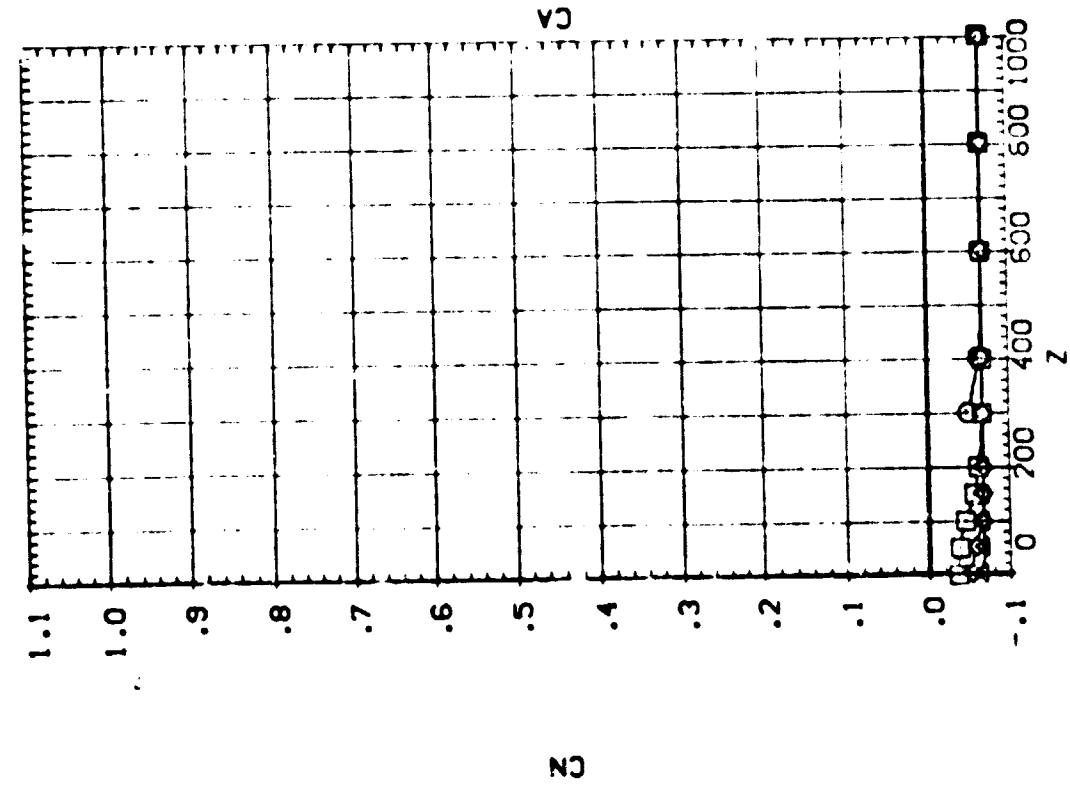
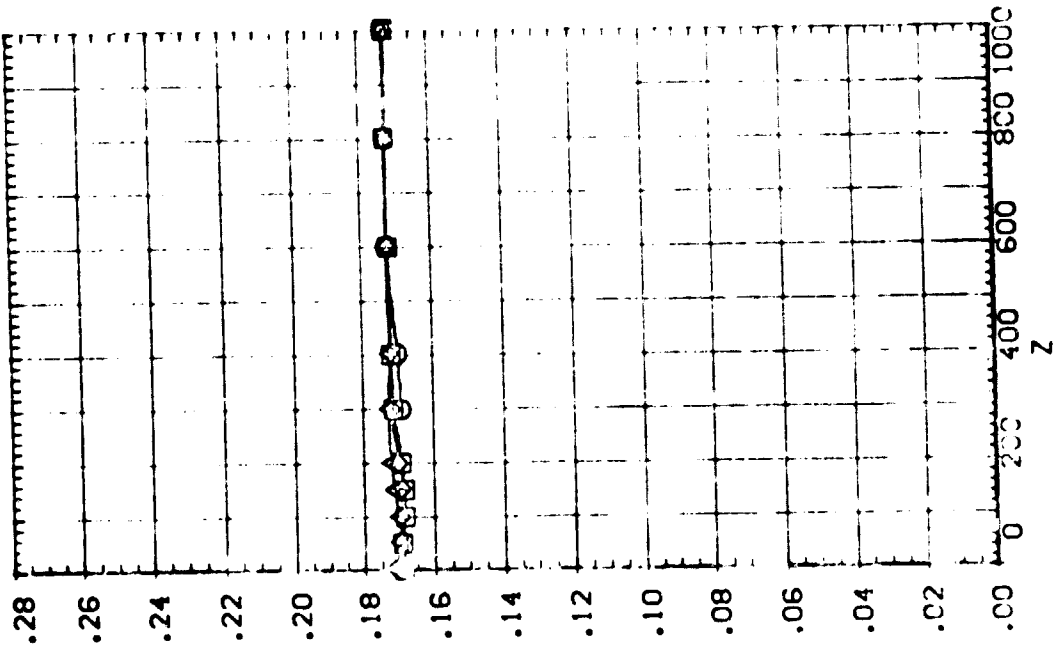

EFFECT OF SRB W/O PLUMES SEPARATION ON ORB/ET AERODYNAMIC CHARACTERISTICS

IA13 S18(S8) W/O PLUMES SEPARATING FROM 09T10 (RTJ153)

SEE THE ASSOCIATED DATA DOCUMENT FOR REFERENCE CHARACTERISTICS FOR INDIVIDUAL DATASETS

SYMBOL	X	MACH	PARAMETRIC VALUES	PITOTAL	110,000
○	.097	4.530	BETA	.000	.000
◇	300.550	.000	γBETA	-20.000	.000
△	600.160	.000	PC+PR	.000	.000
	900.600	400.000			

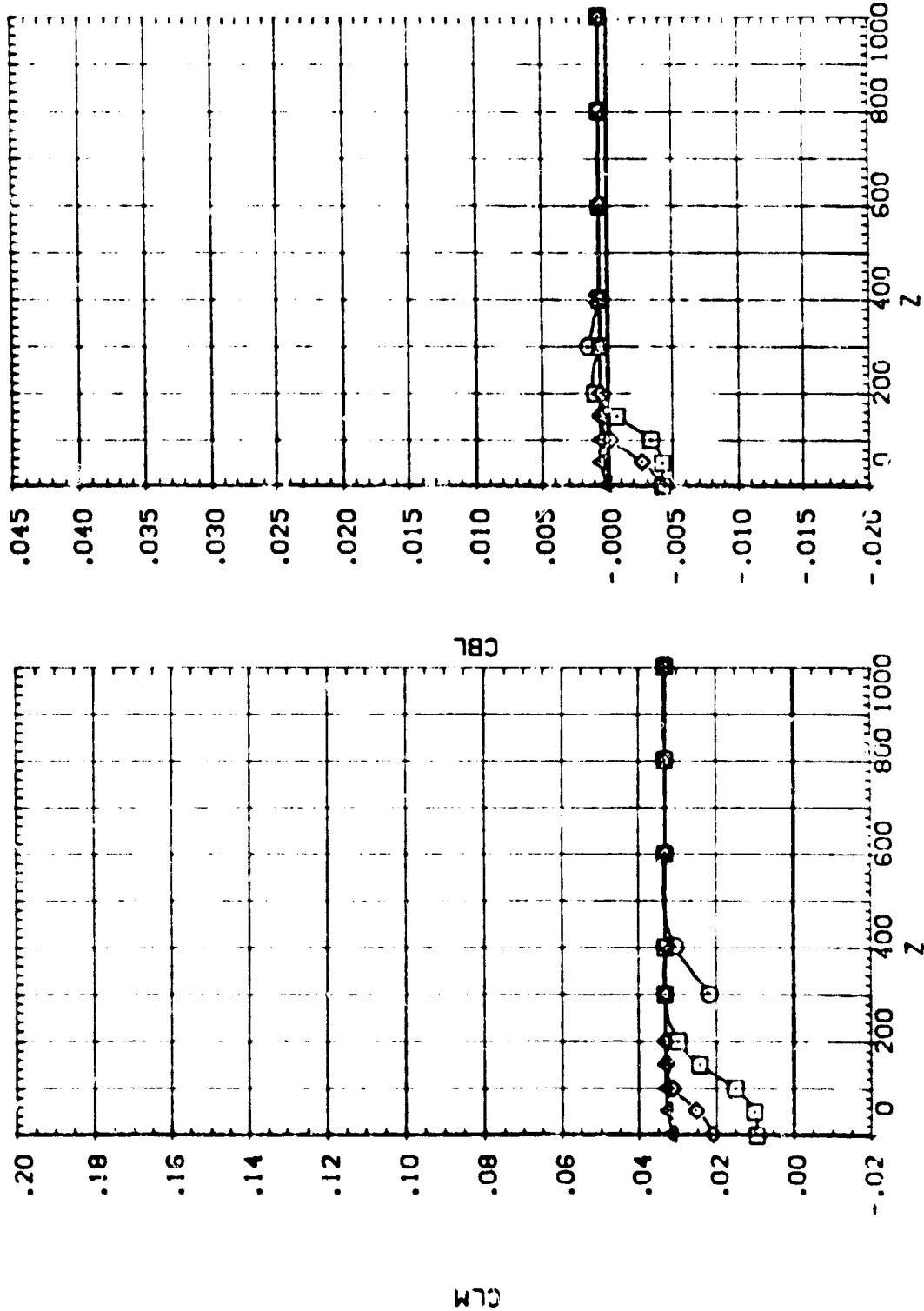

IA13 SRB(S8) W/O PLUMES SEPARATING FROM 09T10 (RTJ153)

SEE THE ASSOCIATED DATA DOCUMENT FOR REFERENCE CHARACTERISTICS FOR INDIVIDUAL DATASETS

PARAMETRIC VALUES	
MACH	4.530
PITOTAL	110.000
BETA	.000
DEBETA	-20.000
PC-MBR	.000
ALPHA	.000
DALPHA	.000
Y	400.000
X	900.600
X	300.550
X	600.160
X	.097

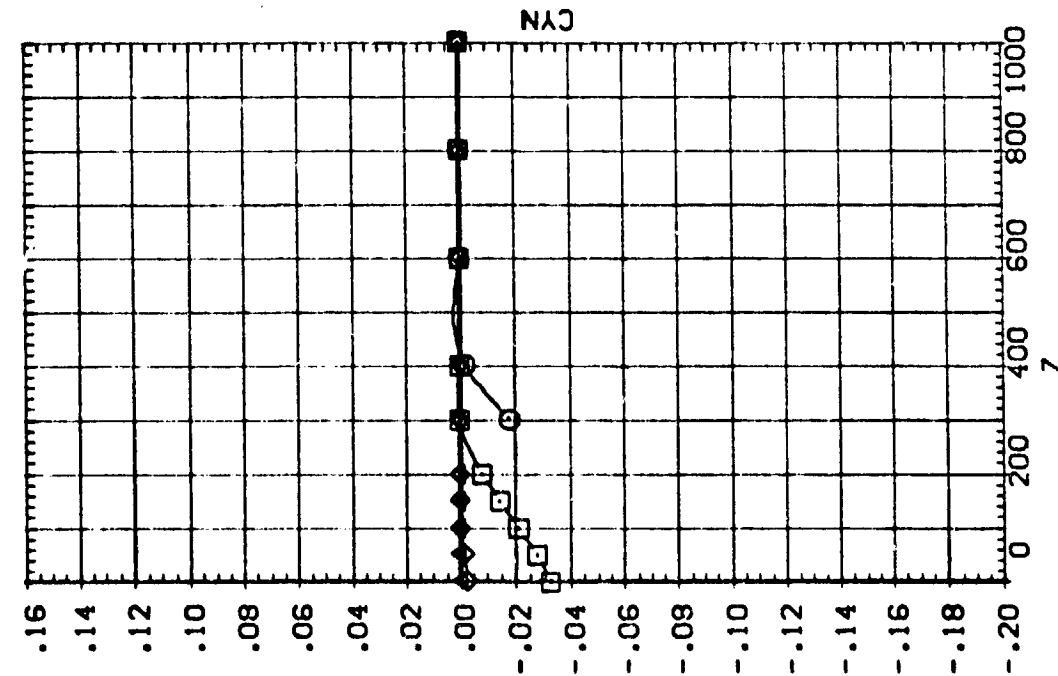
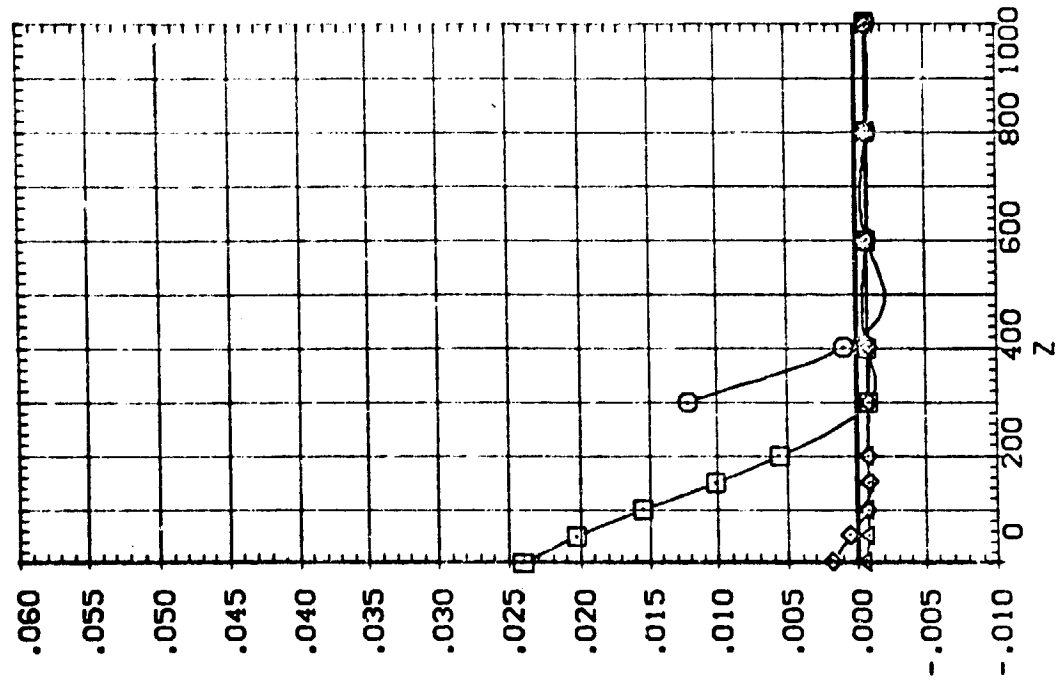

EFFECT OF SRB W/O PLUMES SEPARATION ON ORB/ET AERODYNAMIC CHARACTERISTICS

C-9



IA13 SRB(S8) W/O PLUMES SEPARATING FROM 09T10 (RTJ154)

SYMBOL X PARAMETRIC VALUES

○	.145	MACH	4.530	PTOTAL	110.000
□	299.780	ALPHA	.000	BETA	.000
◇	607.620	DALPHA	.000	DBETA	-20.000
△	899.990	Y	.000	PC-MBR	.000

SEE THE ASSOCIATED DATA DOCUMENT FOR REFERENCE CHARACTERISTICS FOR INDIVIDUAL DATASETS

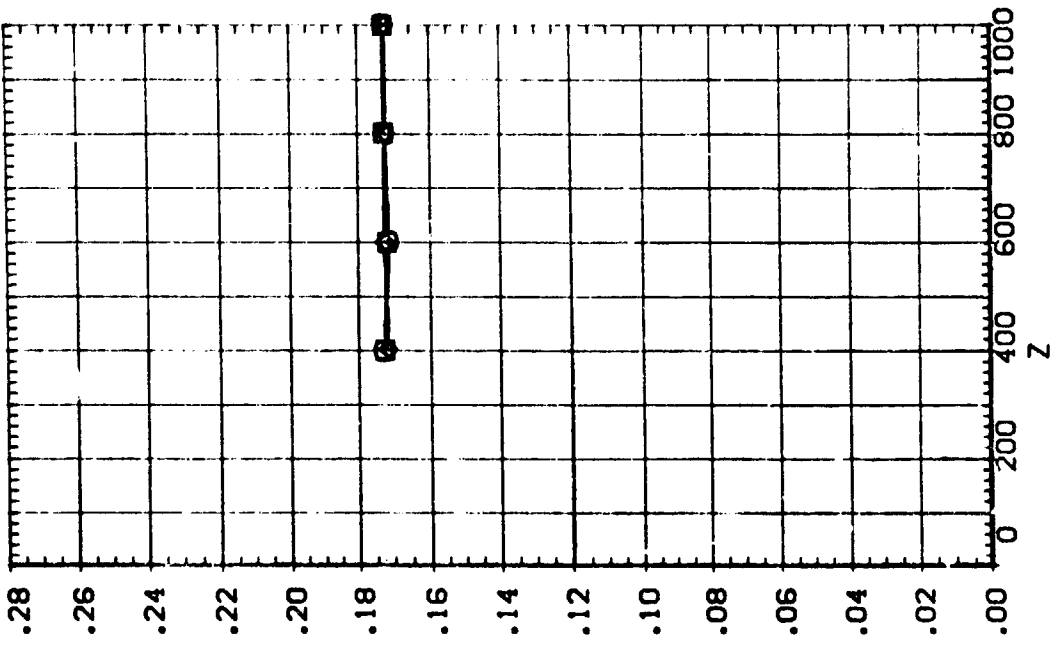
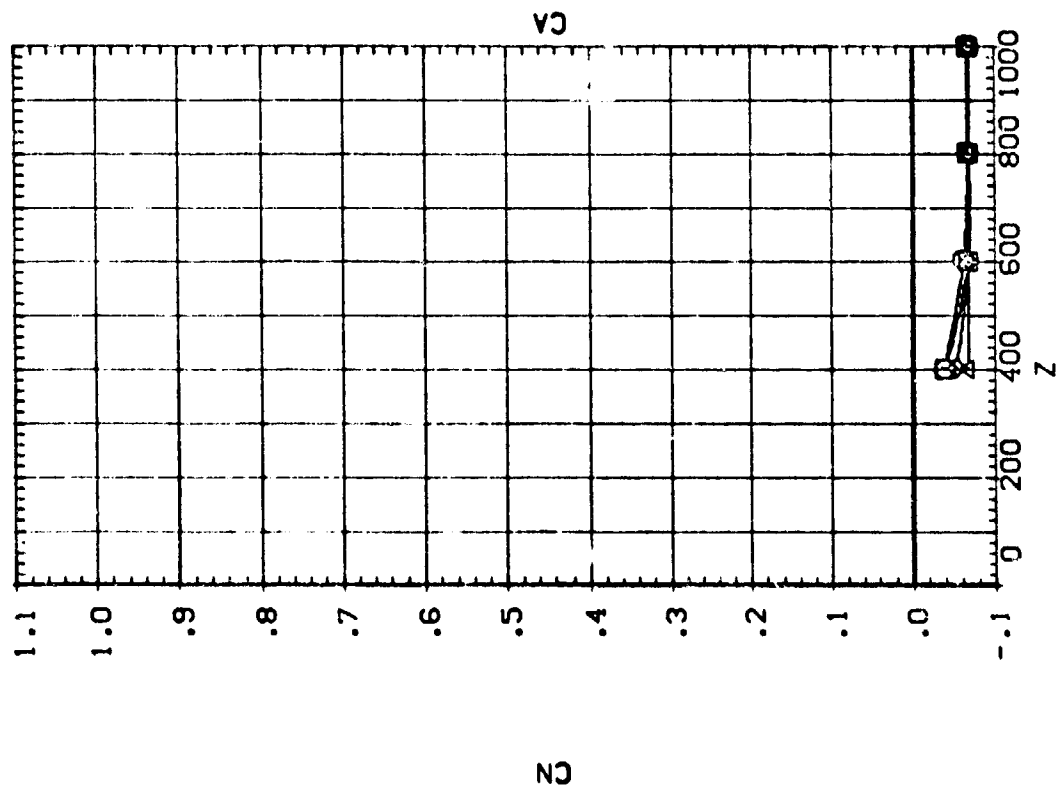

IA13 SRB(S8) W/O PLUMES SEPARATING FROM 09T10 (RTJ154)

SEE THE ASSOCIATED DATA DOCUMENT FOR REFERENCE CHARACTERISTICS FOR INDIVIDUAL DATASETS

SYMBOL		PARAMETRIC VALUES	
○	x	4.530	PTOTAL 110.000
□	299.780	.000	BETA .000
◇	600.620	.000	DBETA -.20.000
△	899.990	.000	PC-MBR .000

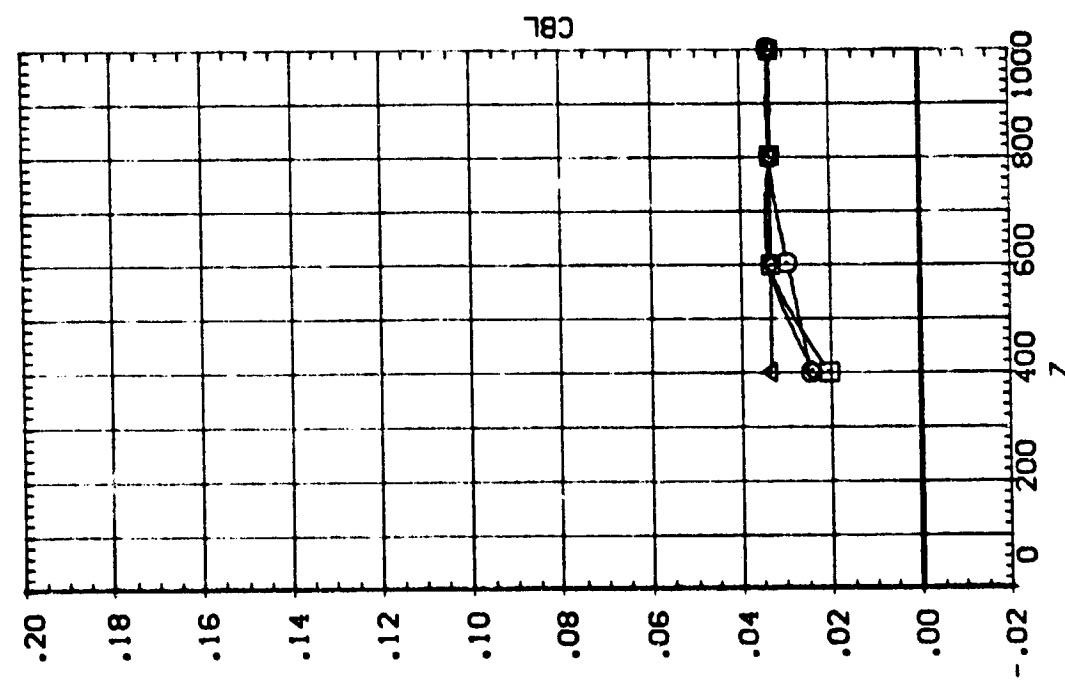
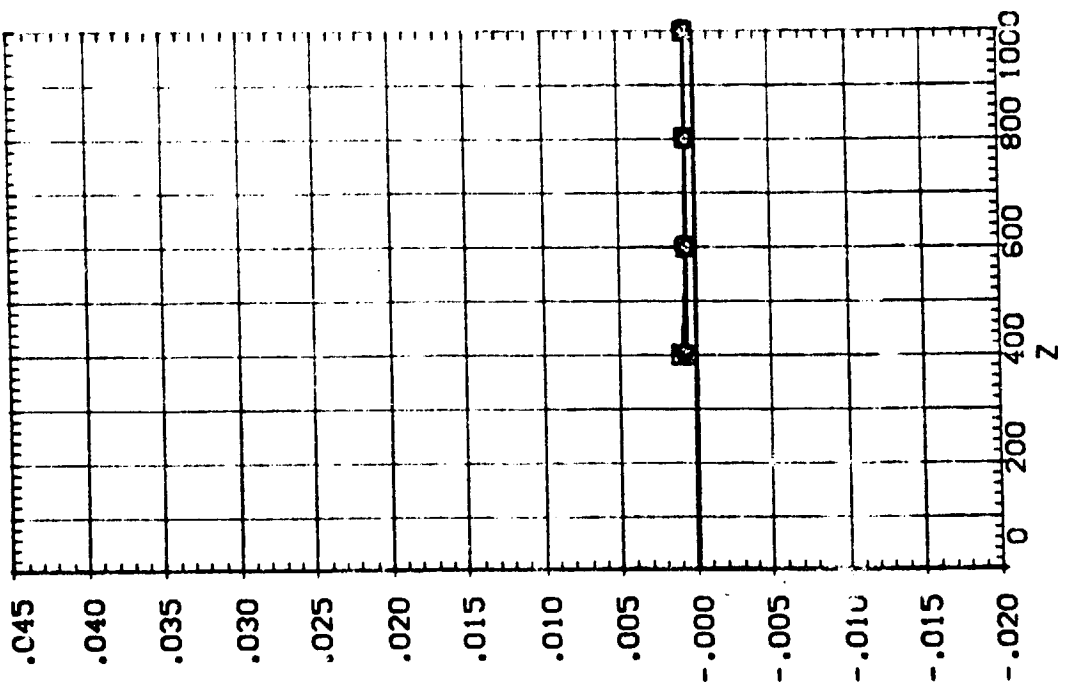

EFFECT OF SRB W/O PLUMES SEPARATION ON ORB/ET AERODYNAMIC CHARACTERISTICS

IA13 SRB(S8J) W/O PLUMES SEPARATING FROM 09T10 (RTJ154)

SEE THE ASSOCIATED DATA DOCUMENT FOR REFERENCE CHARACTERISTICS FOR INDIVIDUAL DATASETS

SYMBOL	X	PARAMETRIC VALUES			
		MACH	PTOTAL	BETA	PC+PR
○	.145	4.530	110.000	.000	.000
□	299.780	.000	.000	-20.000	.000
◇	600.620	.000	.000	.000	.000
△	899.990	.000	.000	.000	.000

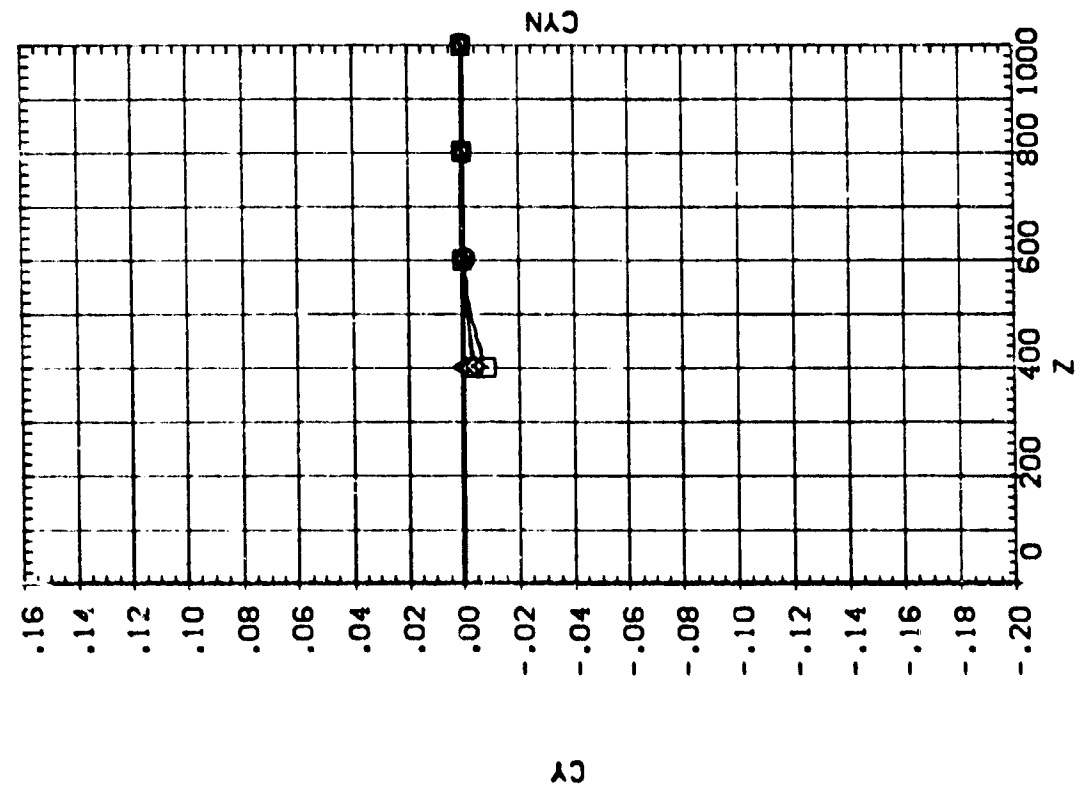
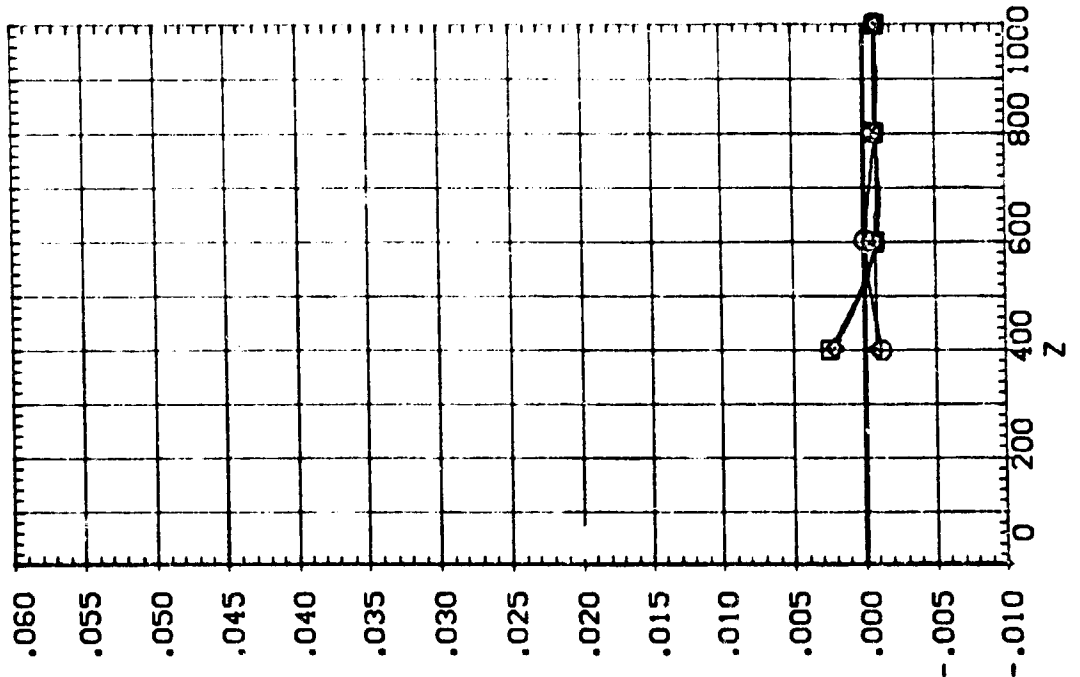

IA13 SRB(S8) W/O PLUMES SEPARATING FROM 09T10 (RTJ:55)

SEE THE ASSOCIATED DATA DOCUMENT FOR REFERENCE CHARACTERISTICS FOR INDIVIDUAL DATASETS

SYMBOL		PARAMETRIC VALUES			
□	X	MACH	4.530	PTOTAL	110.000
◇	300.910	ALPHA	.000	BETA	.000
△	600.640	DALPHA	.000	DBETA	-20.000
	900.760	Y	200.000	PCHMBR	.000

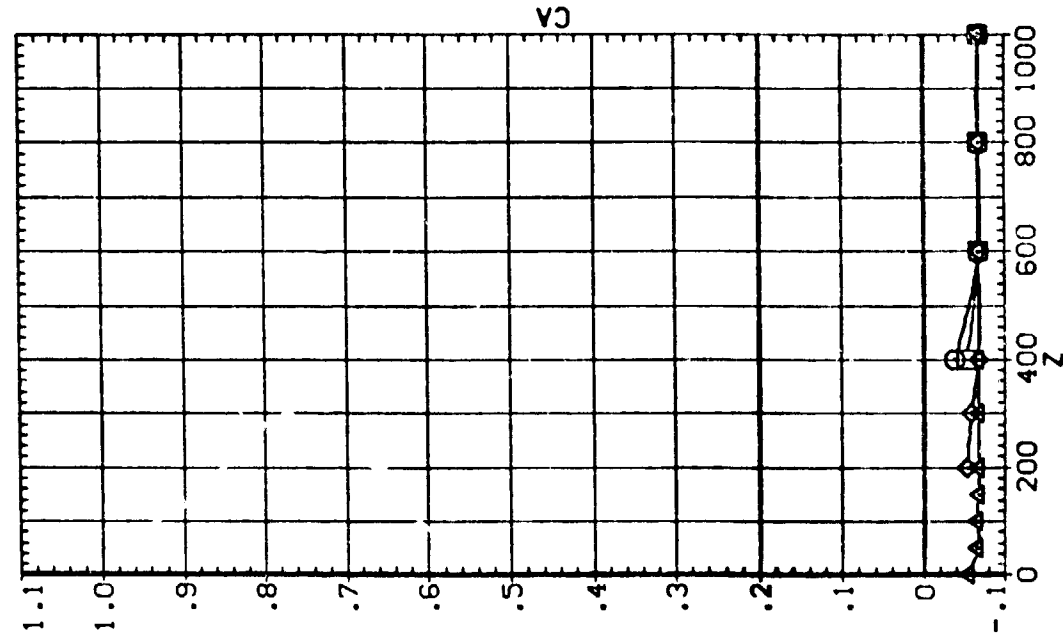
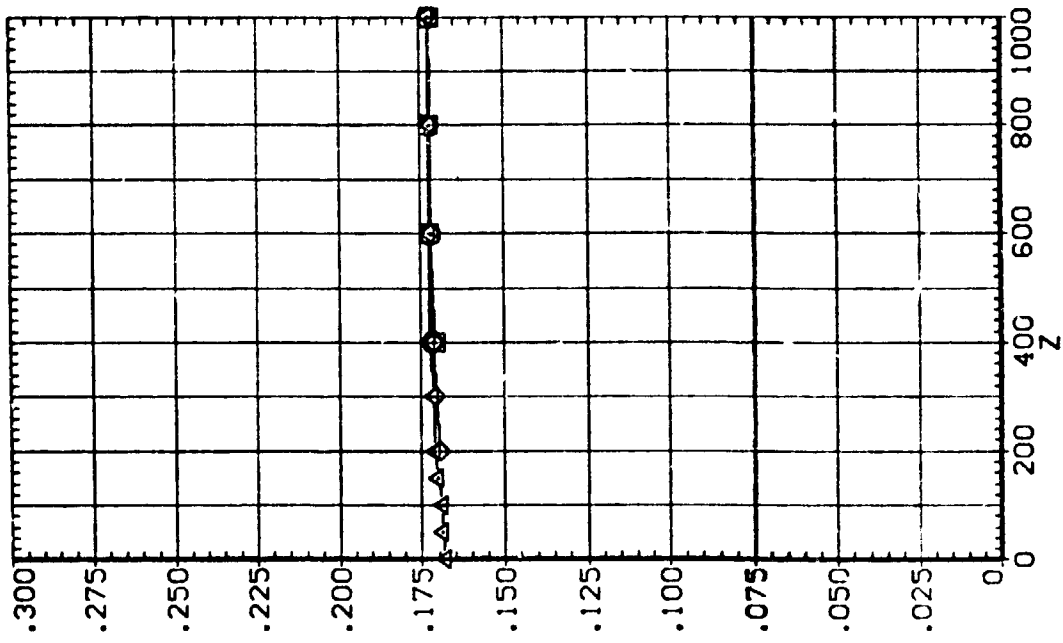

IA13 SRB(S8) W/O PLUMES SEPARATING FROM 09T10 (RTJ155)

SYMBOL	X	MACH	PARAMETRIC VALUES
○	.049	4.530	PTOTAL 110.000
□	300.910	.000	BETA .000
◇	600.640	.000	DBETA -20.000
△	900.760	200.000	PC-MFR .000

SEE THE ASSOCIATED DATA DOCUMENT FOR REFERENCE CHARACTERISTICS FOR INDIVIDUAL DATASETS

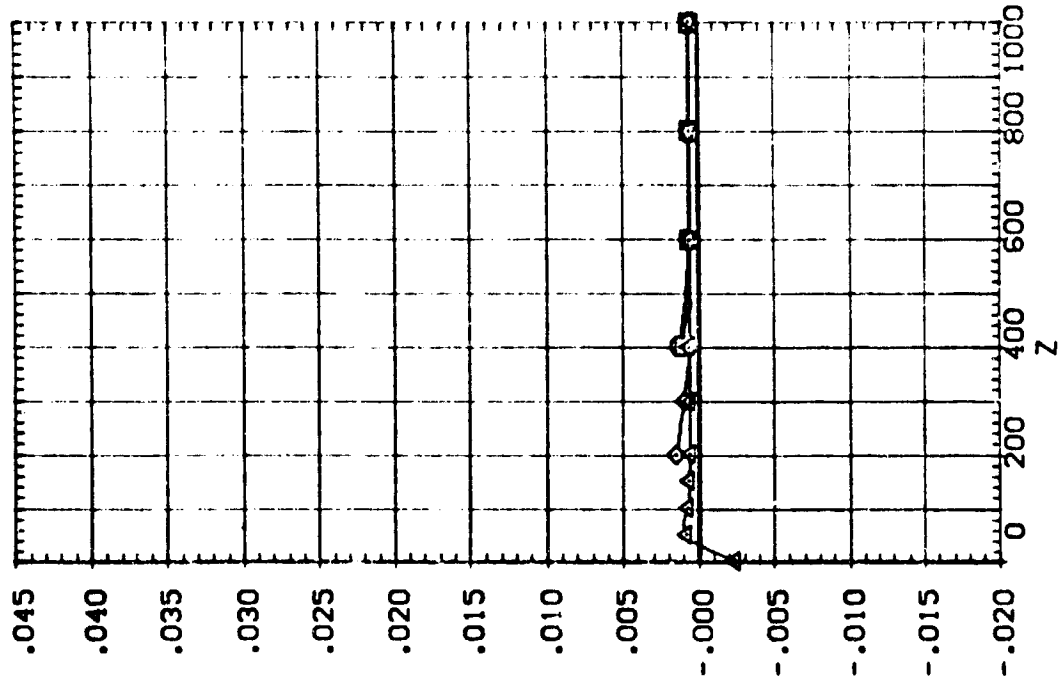
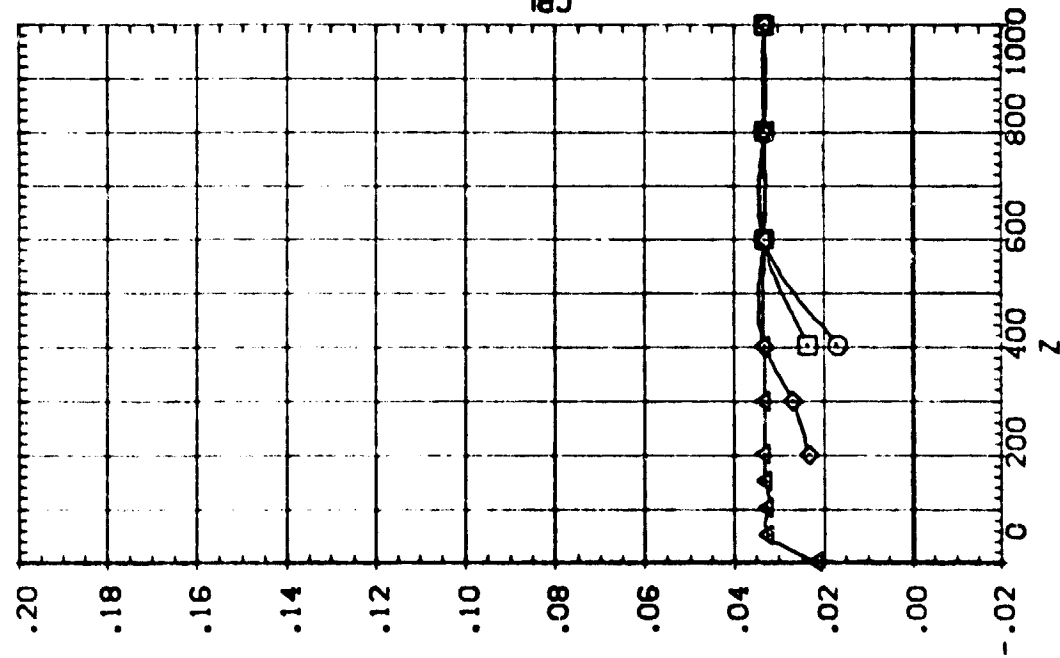

IA13 SRB(S8) W/O PLUMES SEPARATING FROM 097.0 (RTJ155)

SEE THE ASSOCIATED DATA DOCUMENT FOR REFERENCE CHARACTERISTICS FOR INDIVIDUAL DATASETS

PARAMETRIC VALUES	
MACH	4.530
PTOTAL	110.000
BETA	.000
DBETA	-20.000
PC-MFR	.000
ALPHA	.000
Y	200.000
DAUPHA	600.640
X	900.760
X	300.910
X	.045

SYMBOL
 ○
 □
 ◇
 △

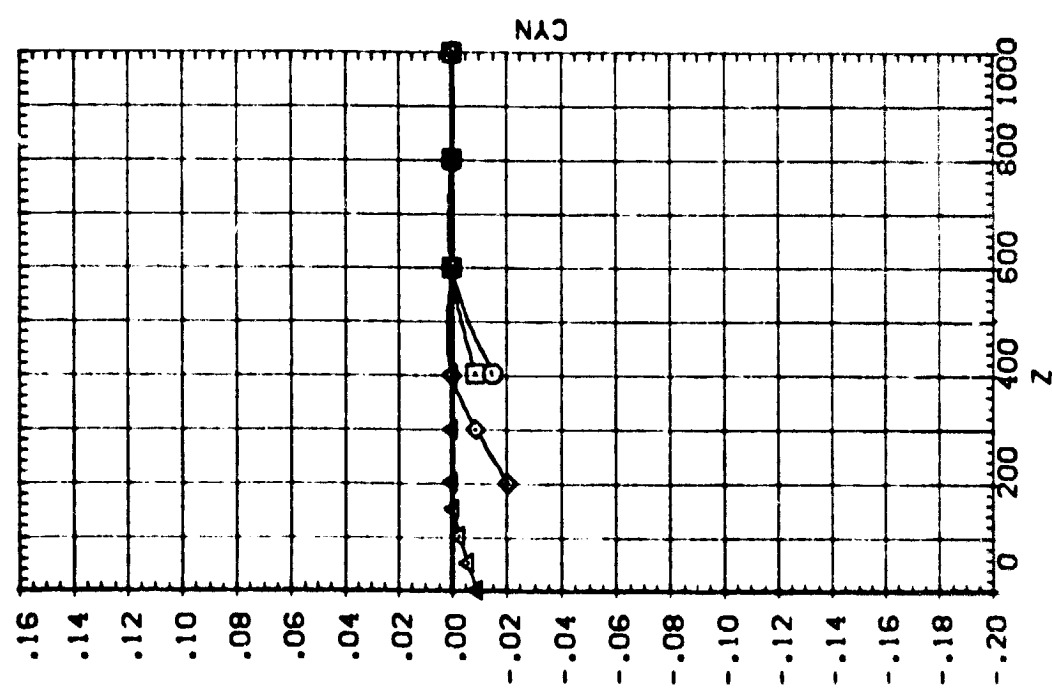
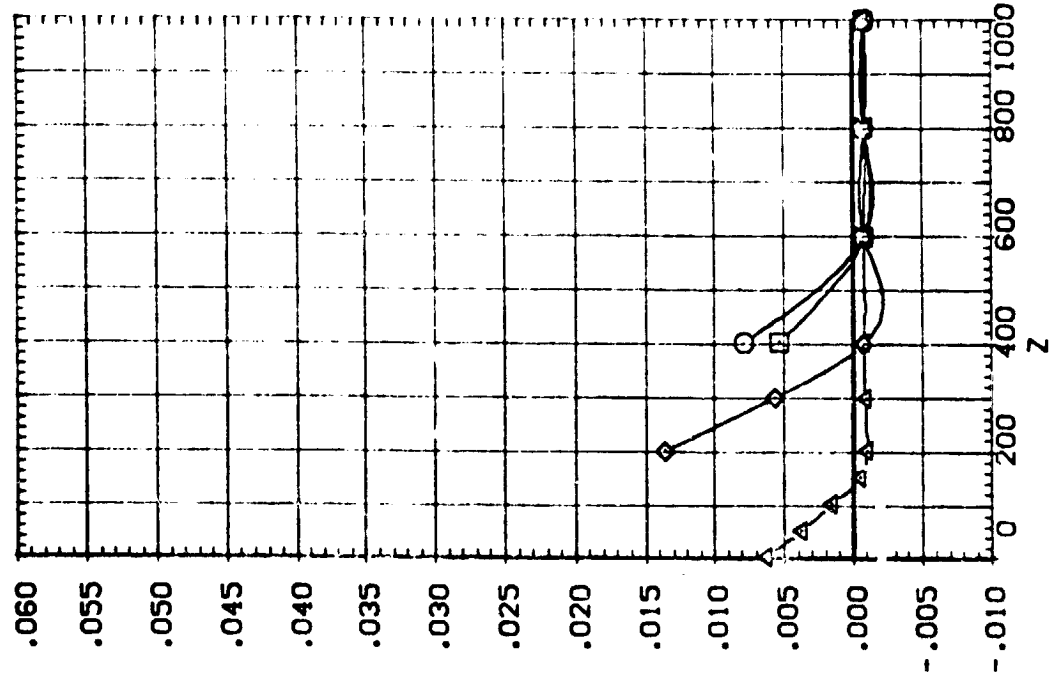

EFFECT OF SRB W/O PLUMES SEPARATION ON ORB/ET AERODYNAMIC CHARACTERISTICS

IA13 SRB(S8) W/O PLUMES SEPARATING FROM 09T10 (RTJ173)

SEE THE ASSOCIATED DATA DOCUMENT FOR REFERENCE CHARACTERISTICS FOR INDIVIDUAL DATASETS

SYMBOL		PARAMETRIC VALUES			
X	.316	MACH	4.530	PTOTAL	110.000
	900.810	ALPHA	.000	BETA	.000
		DALPHA	5.000	DBETA	5.000
		Y	.000	PC+PER	.000

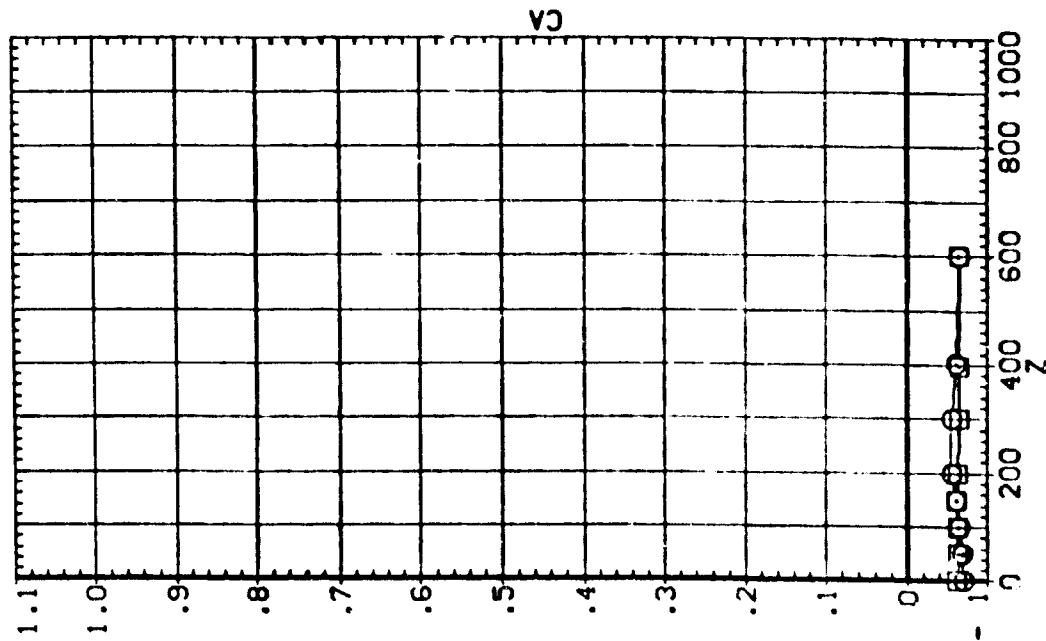
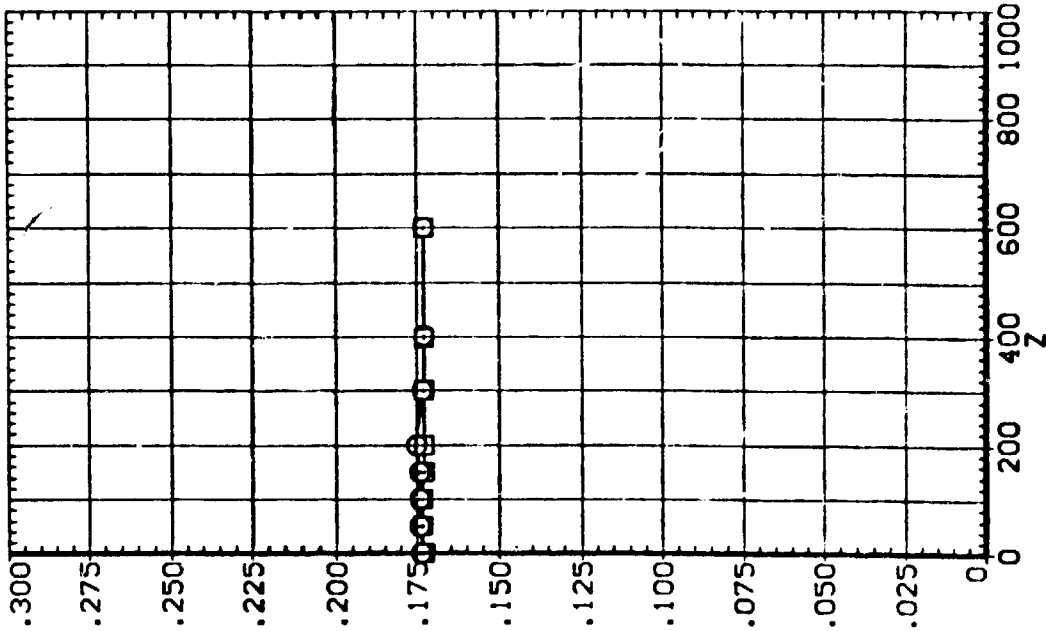

25

IA13 SRB(SB) W/O PLUMES SEPARATING FROM 09T10 (RTJ173)

SEE THE ASSOCIATED DATA DOCUMENT FOR REFERENCE CHARACTERISTICS FOR INDIVIDUAL DATASETS

SYMBOL	X	MACH	PARAMETRIC VALUES
○	.316	ALPHA	4.530
□	500.010	DBETA	110.000
		POWER	.000
			.000

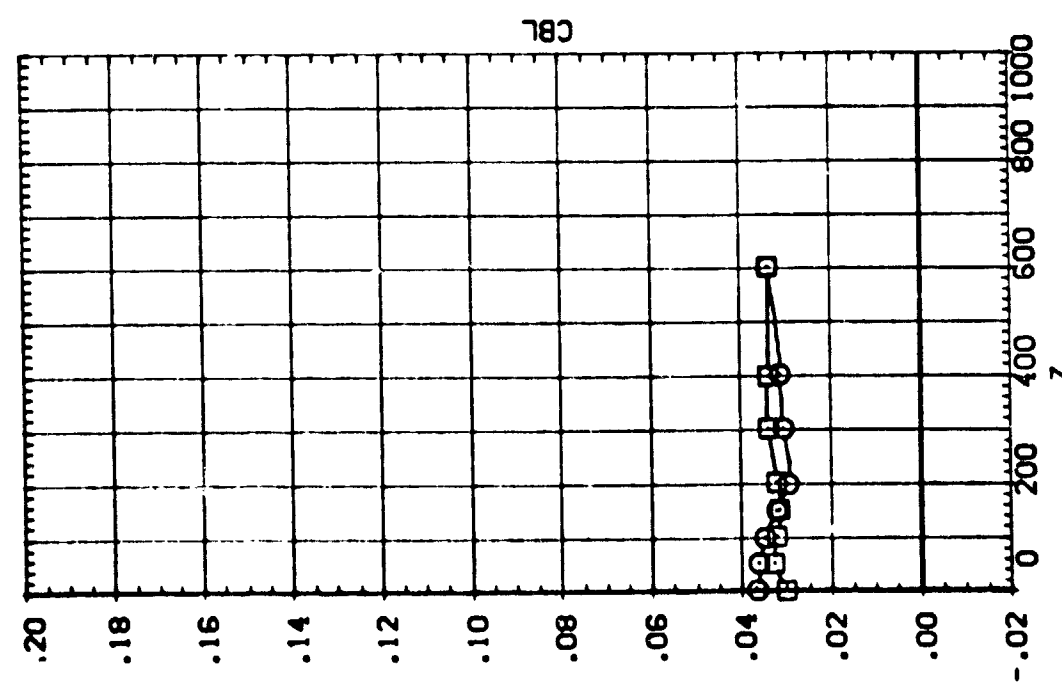
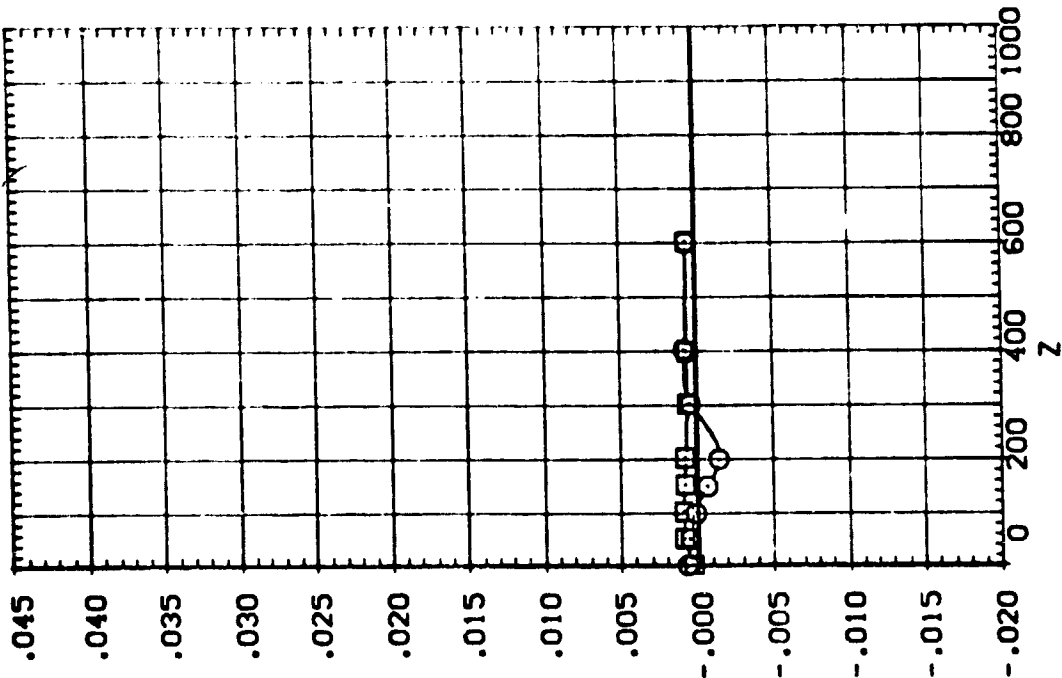

EFFECT OF SRB W/O PLUMES SEPARATION ON 09P/ET AERODYNAMIC CHARACTERISTICS

IA13 SRB(S8) W/O PLUMES SEPARATING FROM 09T10 (RTJ173)

SEE THE ASSOCIATED DATA DOCUMENT FOR REFERENCE CHARACTERISTICS FOR INDIVIDUAL DATASETS

SYMBOL	X	MACH	PARAMETRIC VALUES
○	.316	ALPHA	4.530 P/TOTAL 110.000
□	900.810	DALPHA	.000 BETA .000
		Y	5.000 DBETA 5.000
			.000 FC-PBR .000

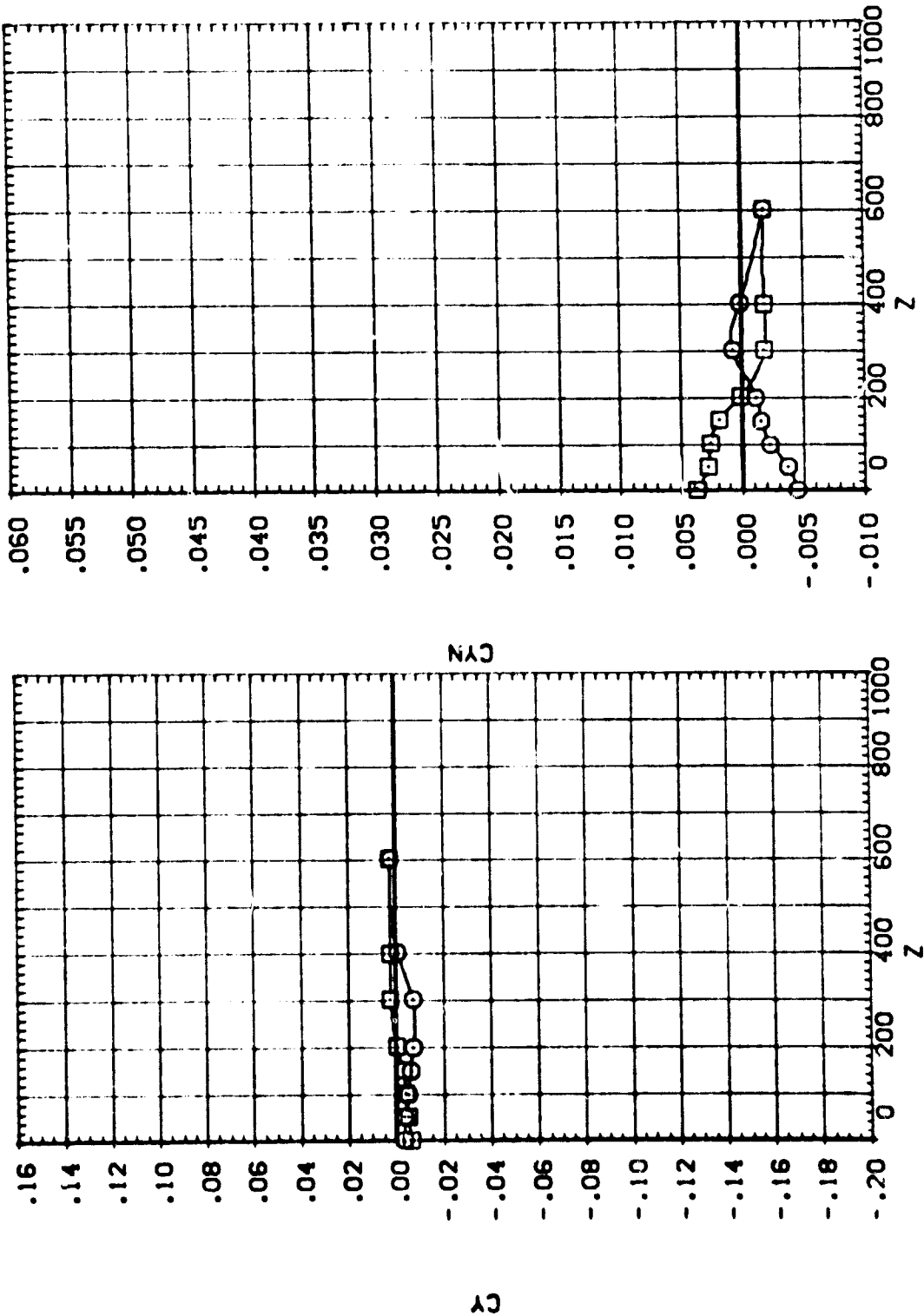

EFFECT OF SRB W/O PLUMES SEPARATION ON ORB/ET AERODYNAMIC CHARACTERISTICS

IA13 SRB(S8) W/O PLUMES SEPARATING FROM 09T10 (RTJ174)

SEE THE ASSOCIATED DATA DOCUMENT FOR REFERENCE CHARACTERISTICS FOR INDIVIDUAL DATASETS

SYMBOL		PARAMETRIC VALUES			
○	X	MACH	P/DOTAL	110.220	
□	900.690	ALPHA	BETA	.000	
		DALPHA	DBETA	5.000	
		Y	POWER	.000	

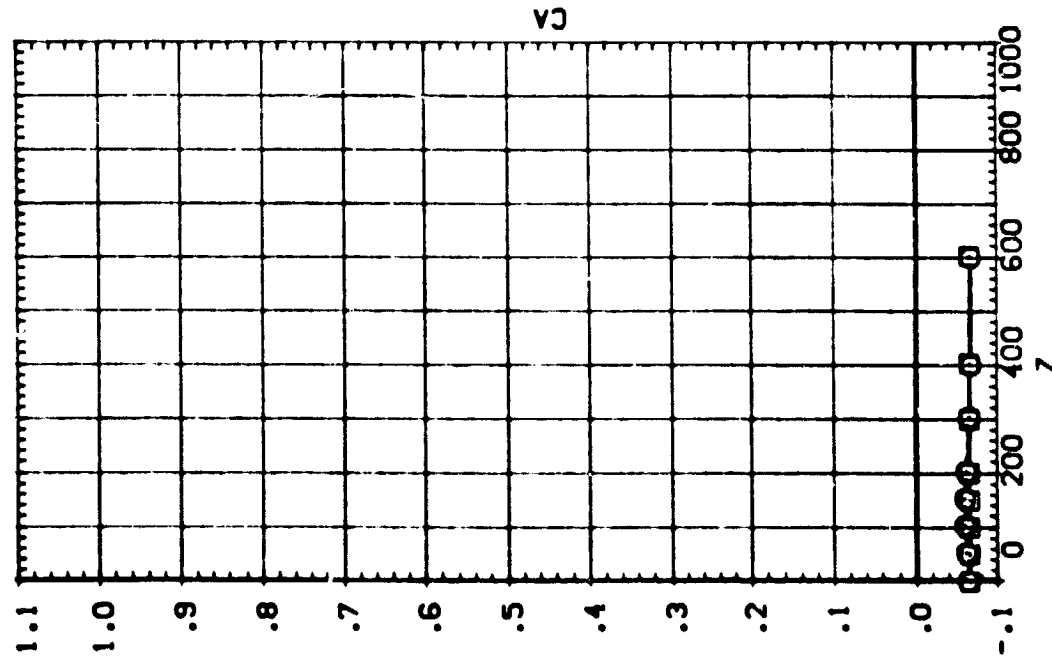
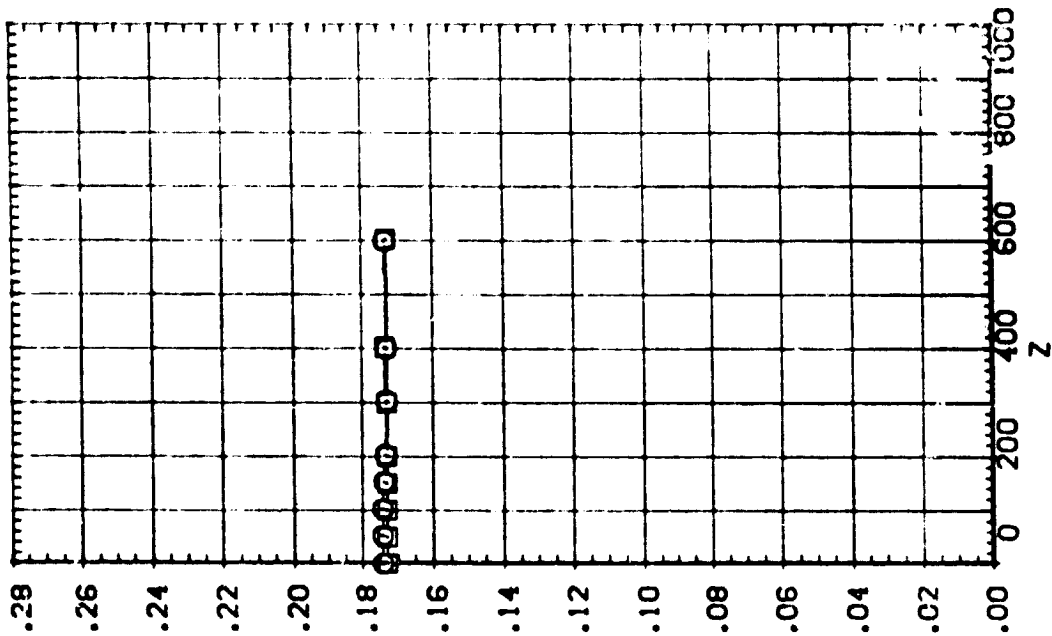

EFFECT OF SRB W/O PLUMES SEPARATION ON ORB/ET AERODYNAMIC CHARACTERISTICS

IA13 SRB(SB) W/O PLUMES SEPARATING FROM 09T10 (RTJ174)

SEE THE ASSOCIATED DATA DOCUMENT FOR REFERENCE CHARACTERISTICS FOR INDIVIDUAL DATASETS

SYMBOL	X	PARAMETRIC VALUES
○	.152	MACH 4.530
□	900.690	PTOTAL 110.000
		BETA .000
		DBETA 5.000
		PC-MBR .000
		Y 200.000

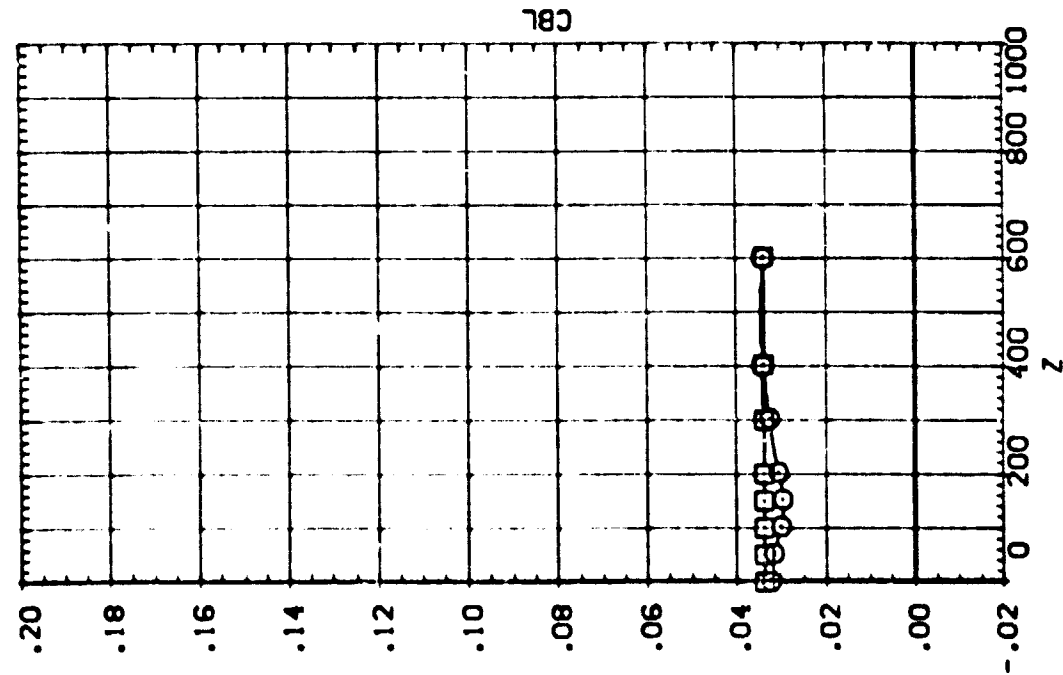
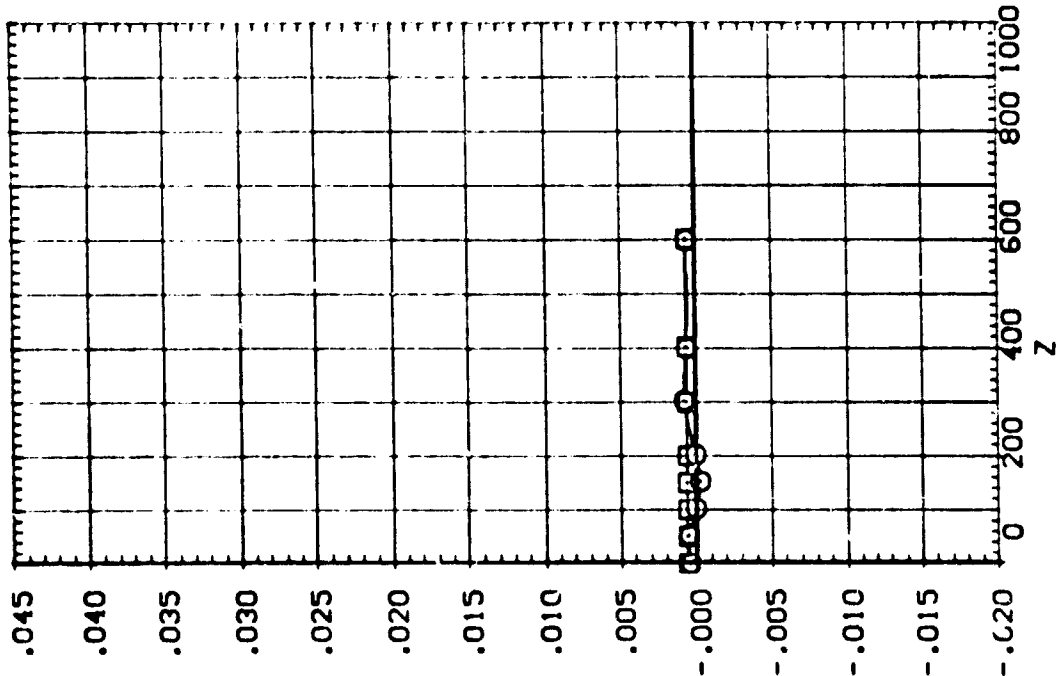

EFFECT OF SRB W/O PLUMES SEPARATION ON ORB/ET AERODYNAMIC CHARACTERISTICS

LA13 SR8(S8) W/O PLUMES SEPARATING FROM 09T10 (RTJ174)

SEE THE ASSOCIATED DATA DOCUMENT FOR REFERENCE CHARACTERISTICS FOR INDIVIDUAL DATASETS

SYMBOL	X	MACH	PARAMETRIC VALUES	PTOTAL	110.30
○	.157	4.530	ALPHA	.000	.000
□	500.690	5.000	BETA	5.000	5.000
		200.000	PC+PR		

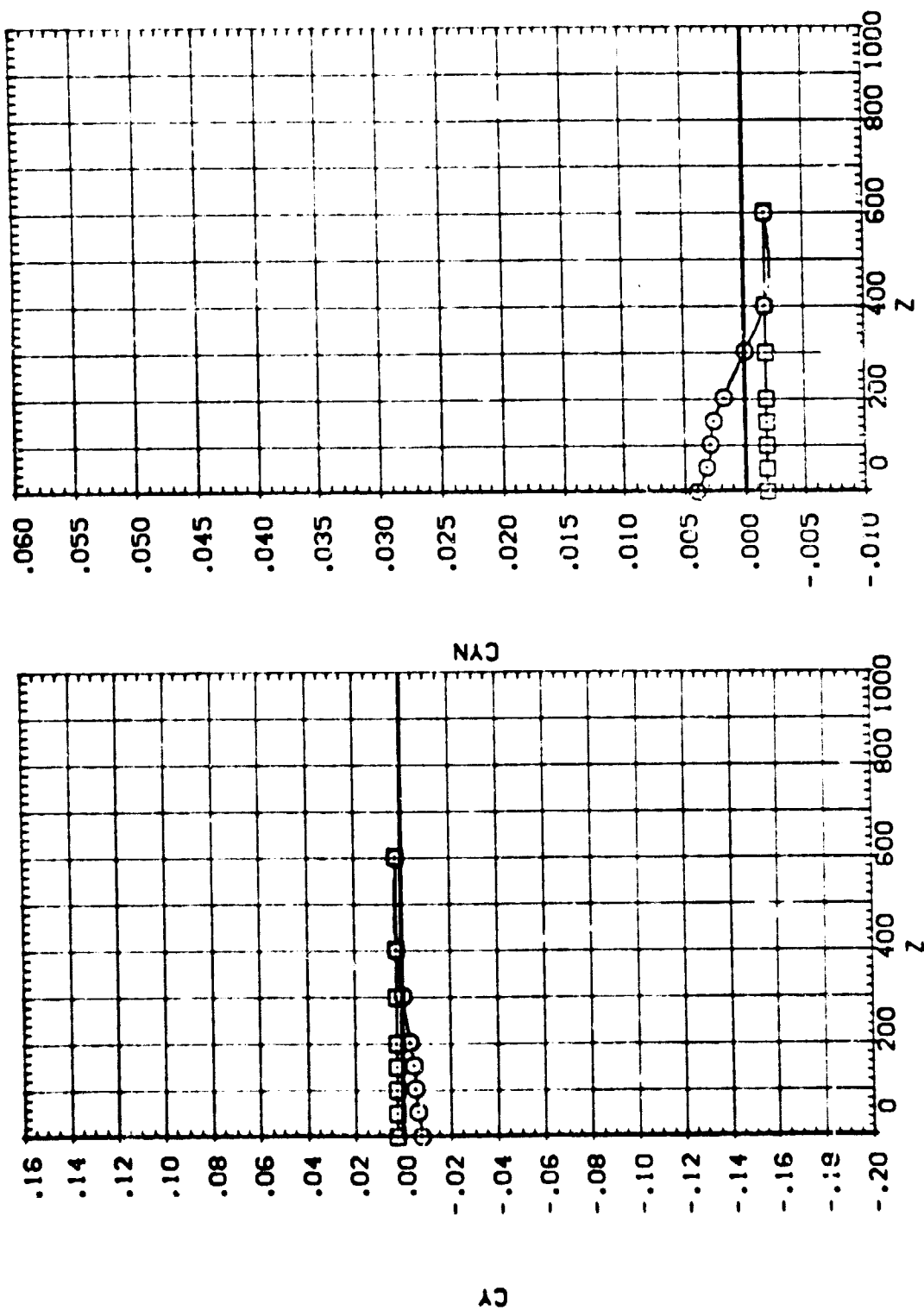

EFFECT OF SR8 W/O PLUMES SEPARATION ON ORB/ET AERODYNAMIC CHARACTERISTICS

IA13 SRB(S8) W/O PLUMES SEPARATING FROM 09T10 (RTJ175)

SEE THE ASSOCIATED DATA DOCUMENT FOR REFERENCE CHARACTERISTICS FOR INDIVIDUAL DATASETS

SYMBOL		PARAMETRIC VALUES	
○	x	MACH	4.530
□	900.730	ALPHA	.000
		DAUPHA	5.000
		Y	400.000
		PTOTAL	110.000
		BETA	.000
		DBETA	2.000
		PCFBR	.000

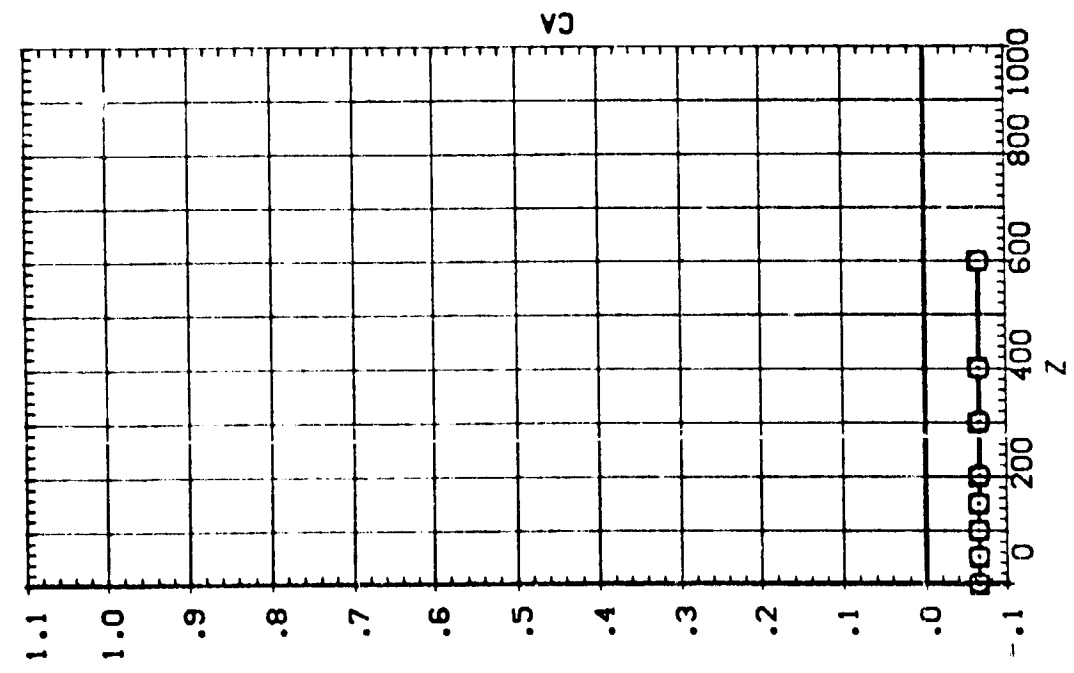
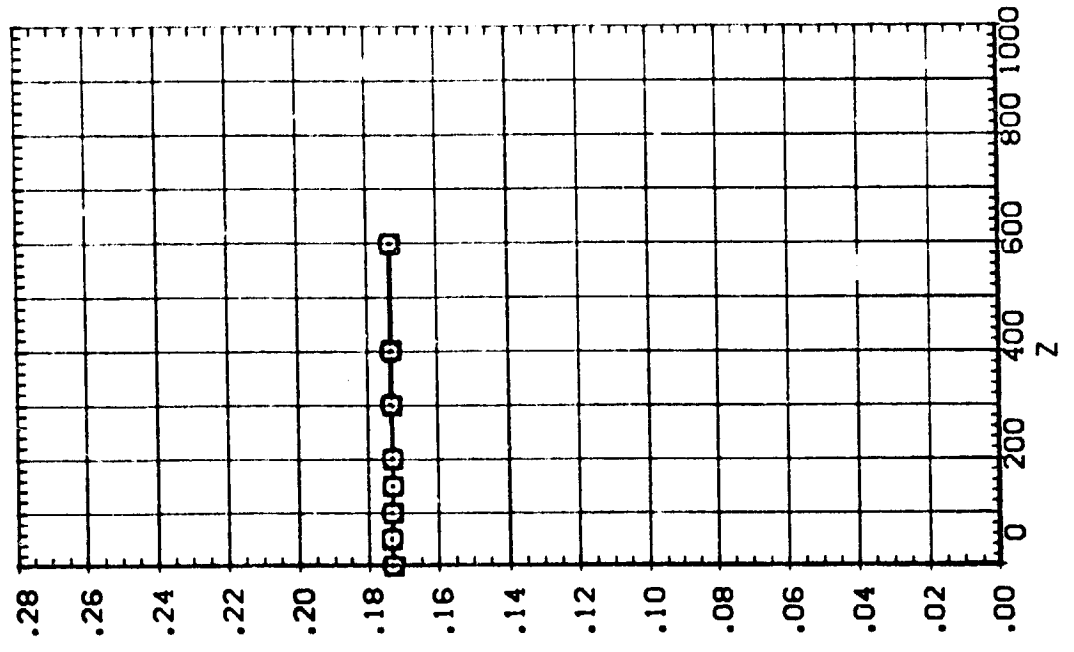

IA13 SR3(S8) W/O PLUMES SEPARATING FROM 09T10 (RTJ175)

SYMBOL X
 ○ 900.730
 □ 400.000

PARAMETRIC VALUES
 MACH 4.530 PTOTAL 110.000
 ALPHA .000 BETA .000
 DALPHA 5.000 DBETA 5.000
 Y 400.000 PC-MBR .000

SEE THE ASSOCIATED DATA DOCUMENT FOR REFERENCE CHARACTERISTICS FOR INDIVIDUAL DATASETS

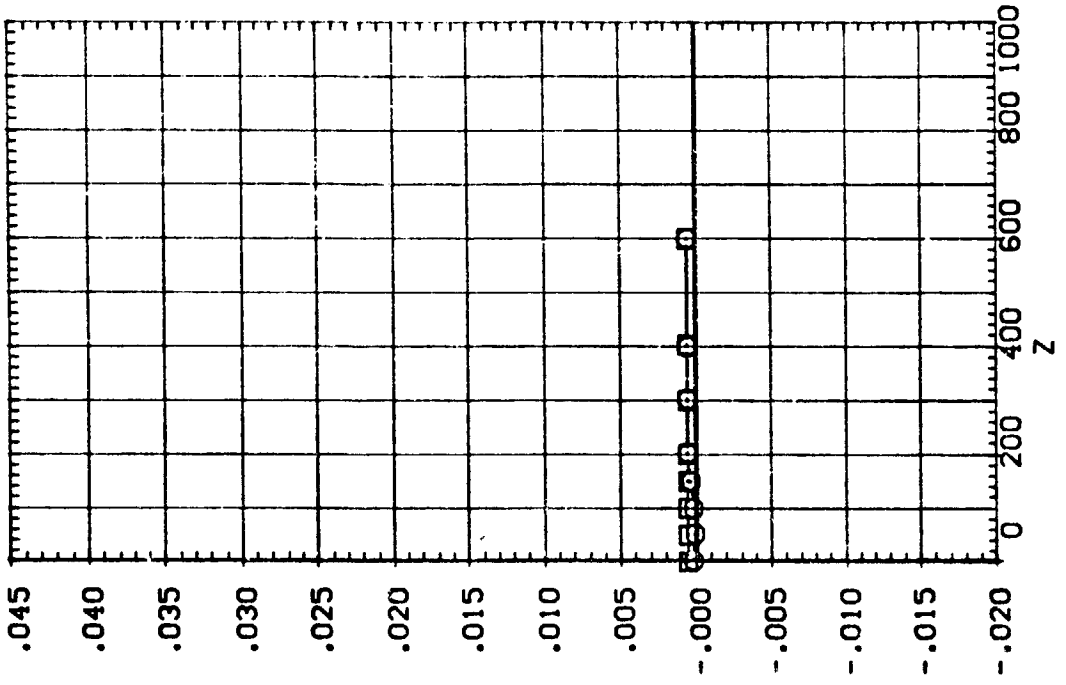
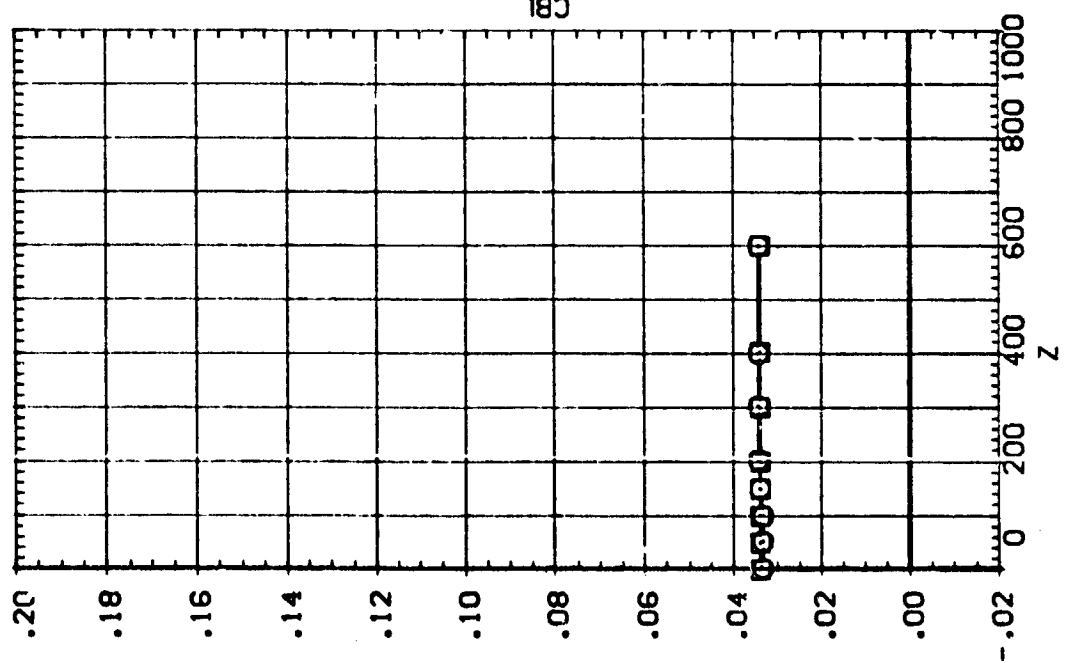

EFFECT OF SRB W/O PLUMES SEPARATION ON ORB/ET AERODYNAMIC CHARACTERISTICS

IA13 SRB(S8) W/O PLUMES SEPARATING FROM 09T10 (RTJ175)

SEE THE ASSOCIATED DATA DOCUMENT FOR REFERENCE CHARACTERISTICS FOR INDIVIDUAL DATASETS

SYMBOL		PARAMETRIC VALUES	
X	.183	MACH	4.530
	900.730	ALPHA	.000
		DALPHA	5.000
		BETA	.000
		DBETA	5.000
		PCHBER	.000

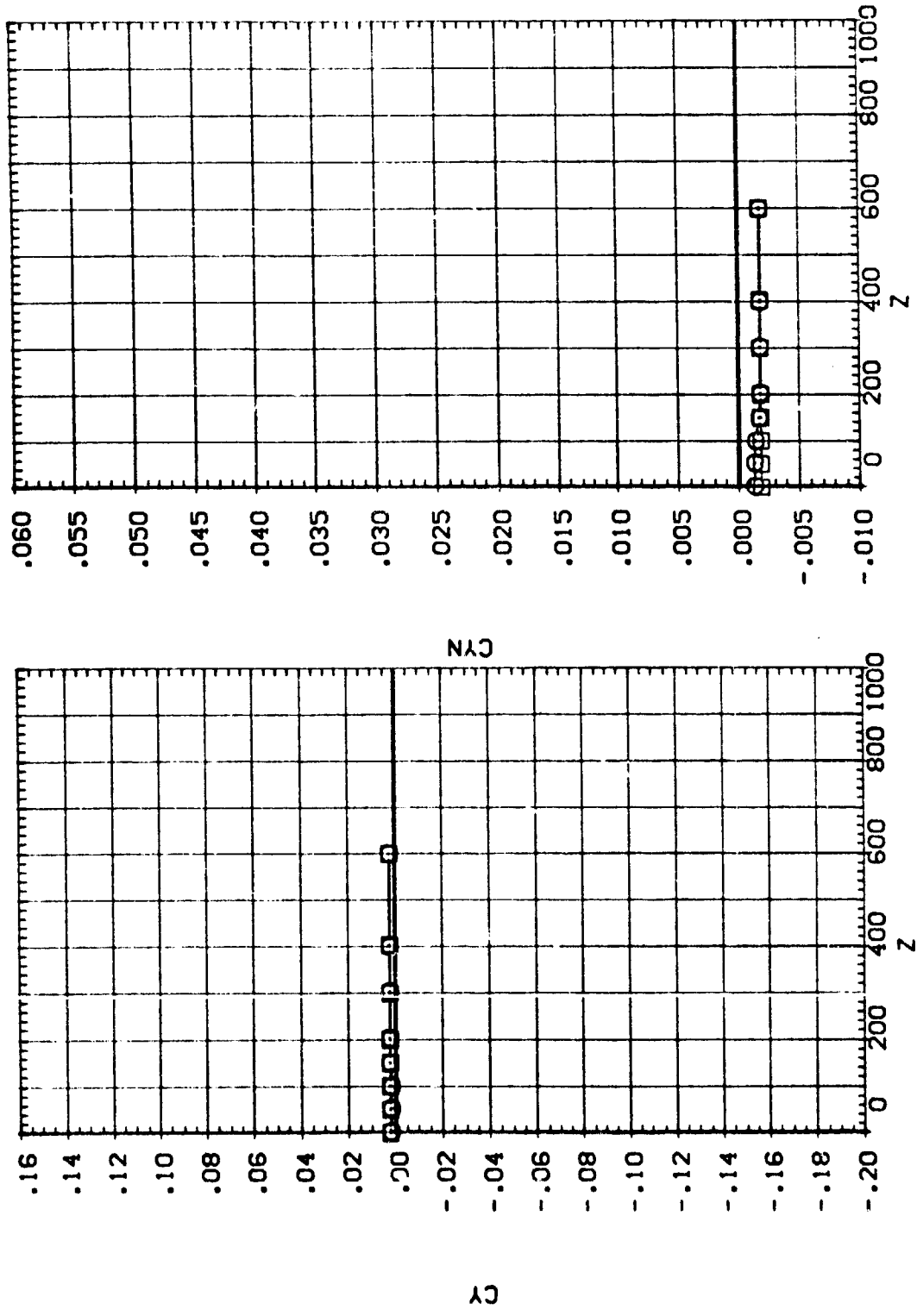

IA13 SRB(S8) W/O PLUMES SEPARATING FROM 09T10 (RTJ176)

SEE THE ASSOCIATED DATA DOCUMENT FOR REFERENCE CHARACTERISTICS FOR INDIVIDUAL DATASETS

SYMBOL		PARAMETRIC VALUES	
○	X	MACH	110.000
□	900.690	ALPHA	.000
		BETA	-5.000
		DBETA	.000
		PCMBR	.000

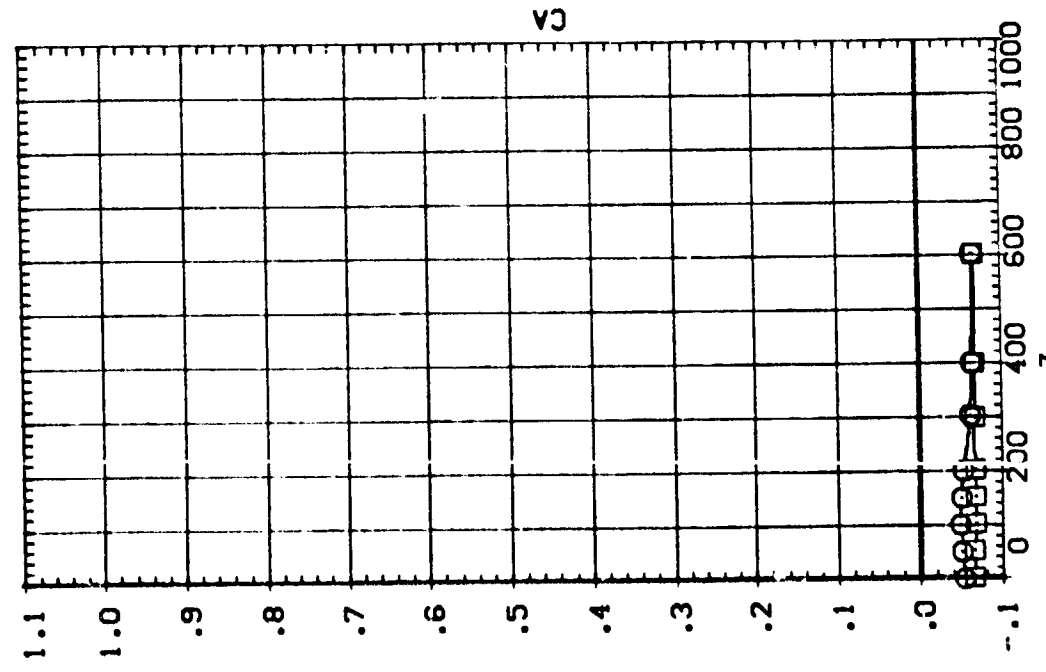
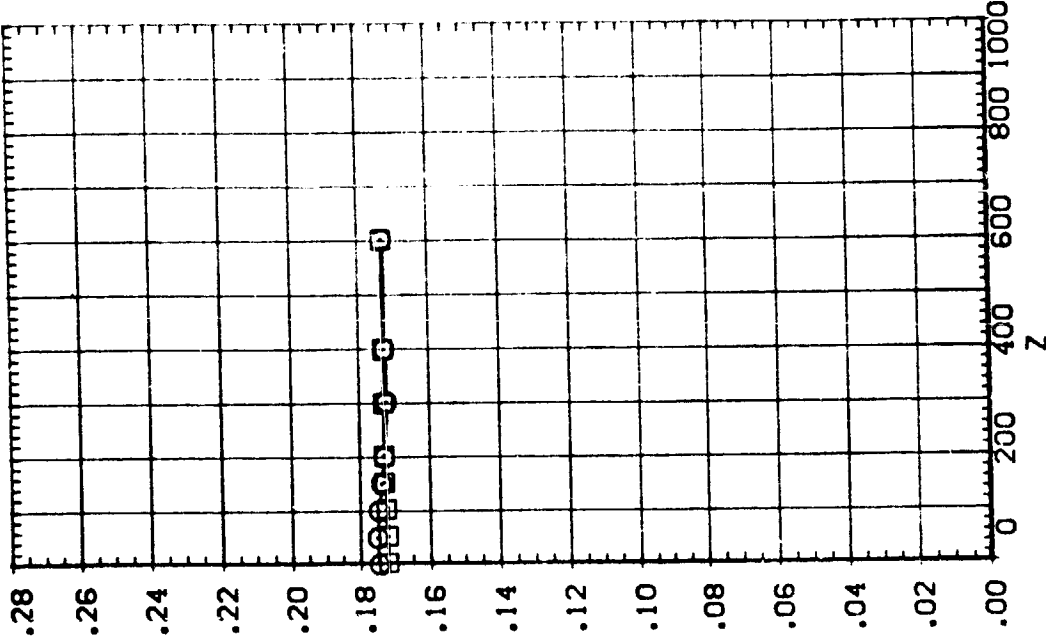

EFFECT OF SRB W/O PLUMES SEPARATION ON ORB/ET AERODYNAMIC CHARACTERISTICS

IA13 SRB(S&S) W/O PLUMES SEPARATING FROM 09T10 (RTJ176)

SEE THE ASSOCIATED DATA DOCUMENT FOR REFERENCE CHARACTERISTICS FOR INDIVIDUAL DATASETS

SYMBOL		PARAMETRIC VALUES			
X	.256	MACH	4.530	PTOTAL	110.000
	900.690	ALPHA	.000	BETA	.000
		DALPHA	5.000	DBETA	-5.000
Y		PC-MBR	.00.000	PC-HBR	.000

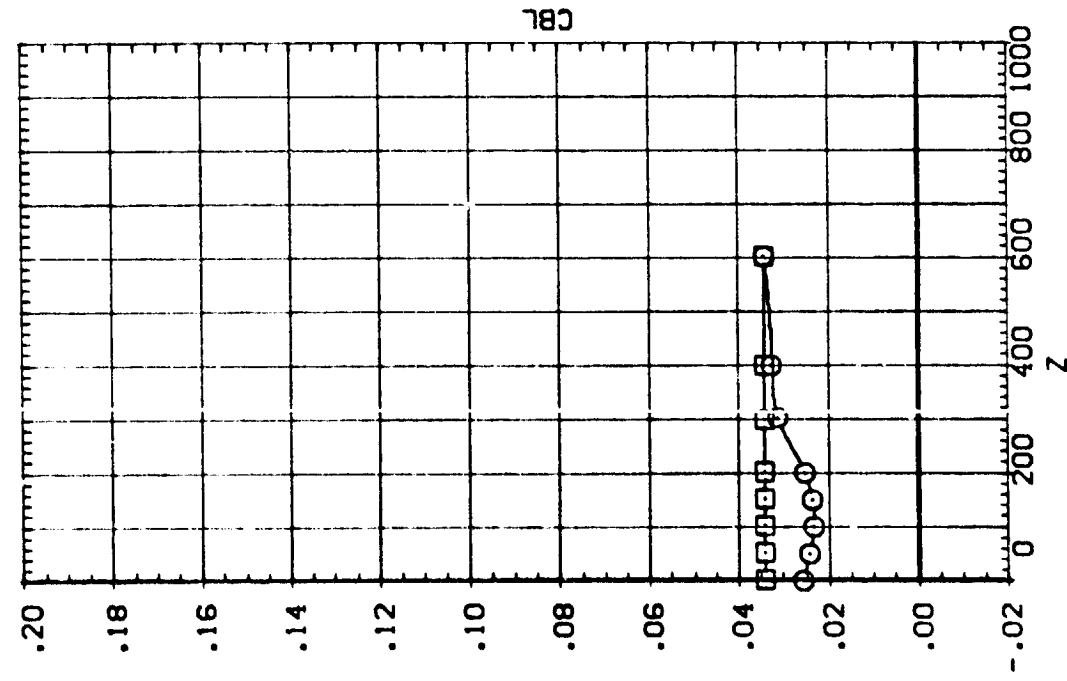
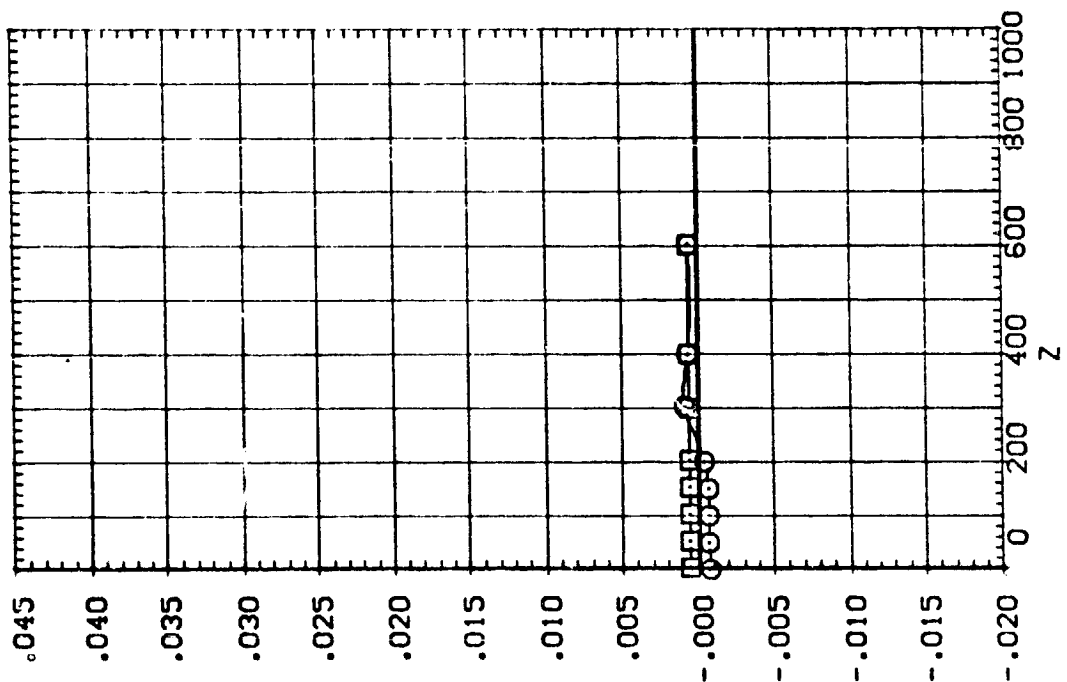

IA13 SRB(S8) W/O PLUMES SEPARATING FROM 09T10 (RTJ176)

SEE THE ASSOCIATED DATA DOCUMENT FOR REFERENCE CHARACTERISTICS FOR INDIVIDUAL DATASETS

SYMBOL		PARAMETRIC VALUES	
X	□	MACH	4.530
	○	PTOTAL	110.000
		BETA	.000
		DBETA	-5.000
		PC-MBR	.000
		ALPHA	.000
		DALPHA	5.000
		Y	200.000

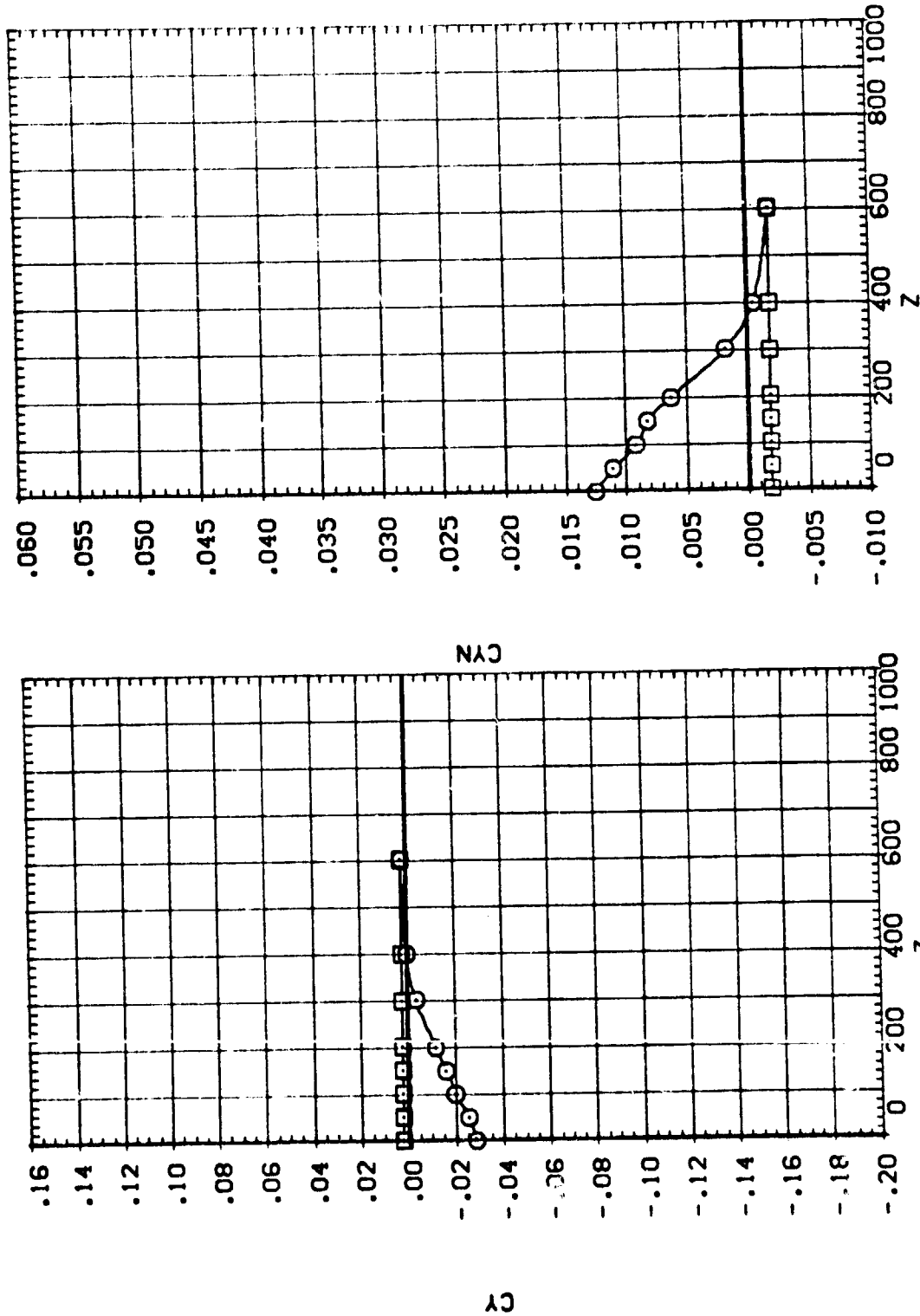

EFFECT OF SRB W/O PLUMES SEPARATION ON ORB/ET AERODYNAMIC CHARACTERISTICS

IA13 SRB(SH) W/O PLUMES SEPARATING FROM 09T10 (RTJ177)

SEE THE ASSOCIATED DATA DOCUMENT FOR REFERENCE CHARACTERISTICS FOR INDIVIDUAL DATASETS

SYMBOL		PARAMETRIC VALUES			
x	.369	MACH	4.530	PIOTAL	110.000
900.51C		ALPHA	.000	BETA	.000
		DALPHA	5.000	DBETA	-5.000
		Y	100.000	PC-PBR	.000

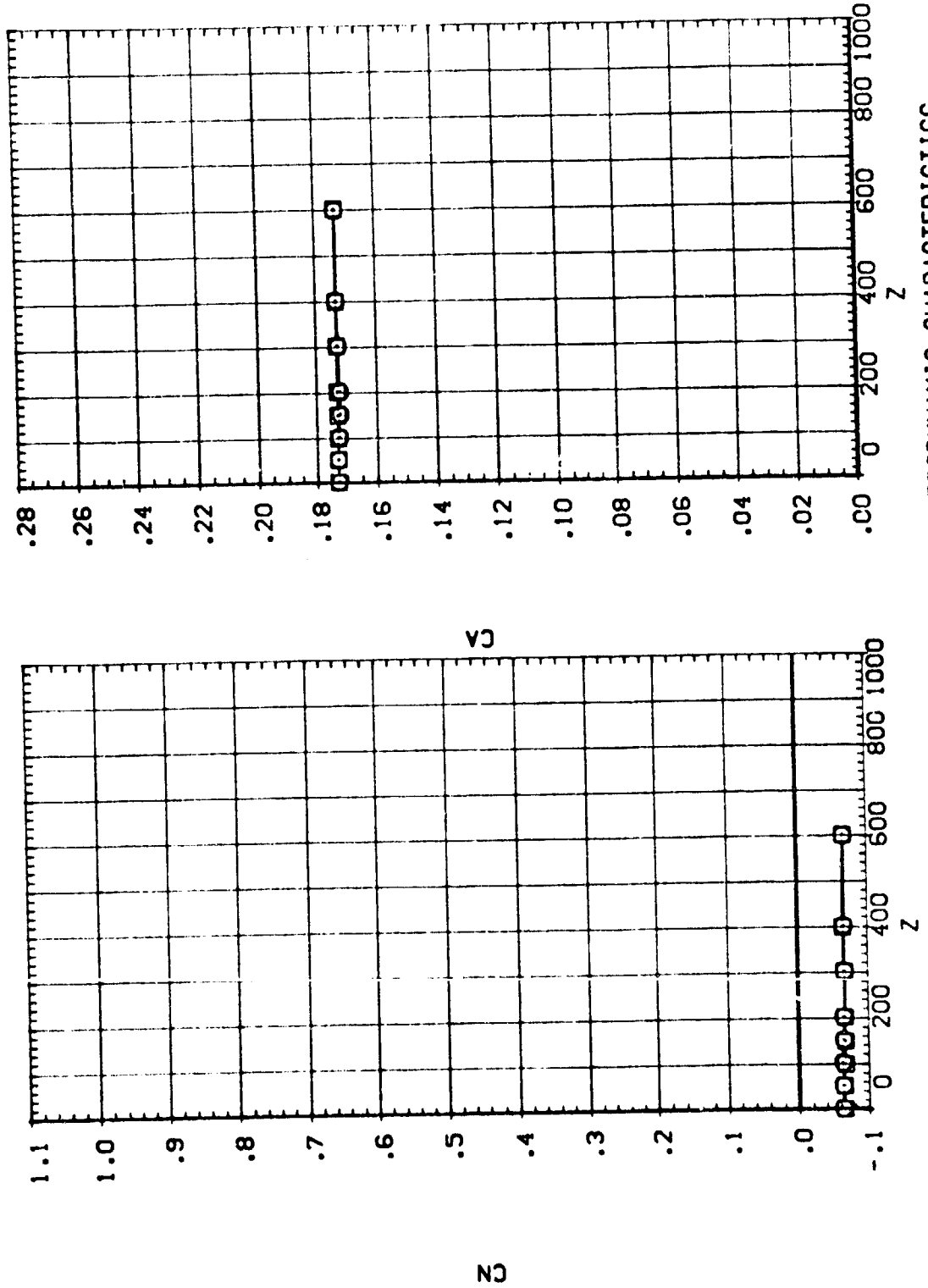

IA13 SRB(S8) W/O PLUMES SEPARATING FROM 09T10 (RTJ177)

SEE THE ASSOCIATED DATA DOCUMENT FOR REFERENCE CHARACTERISTICS FOR INDIVIDUAL DATASETS

X .369 MACH 4.530 PTOTAL 110.000
 900.510 ALPHA .000 BETA .000
 DALP-A 5.000 DBETA -5.000
 Y 400.000 PC-HBR .000

Symbol □
 □

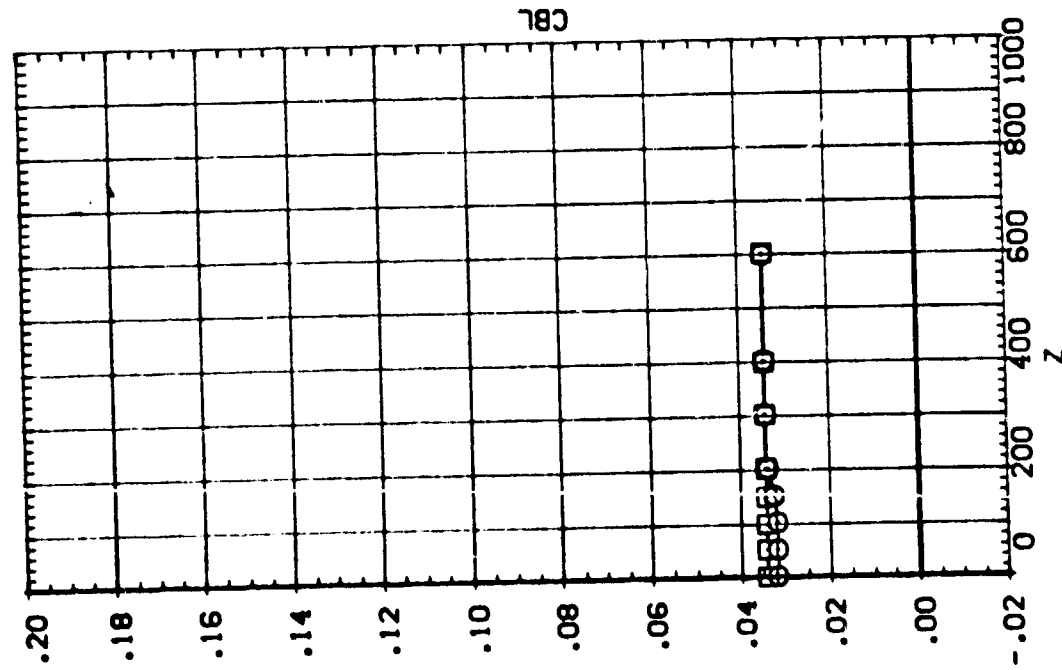
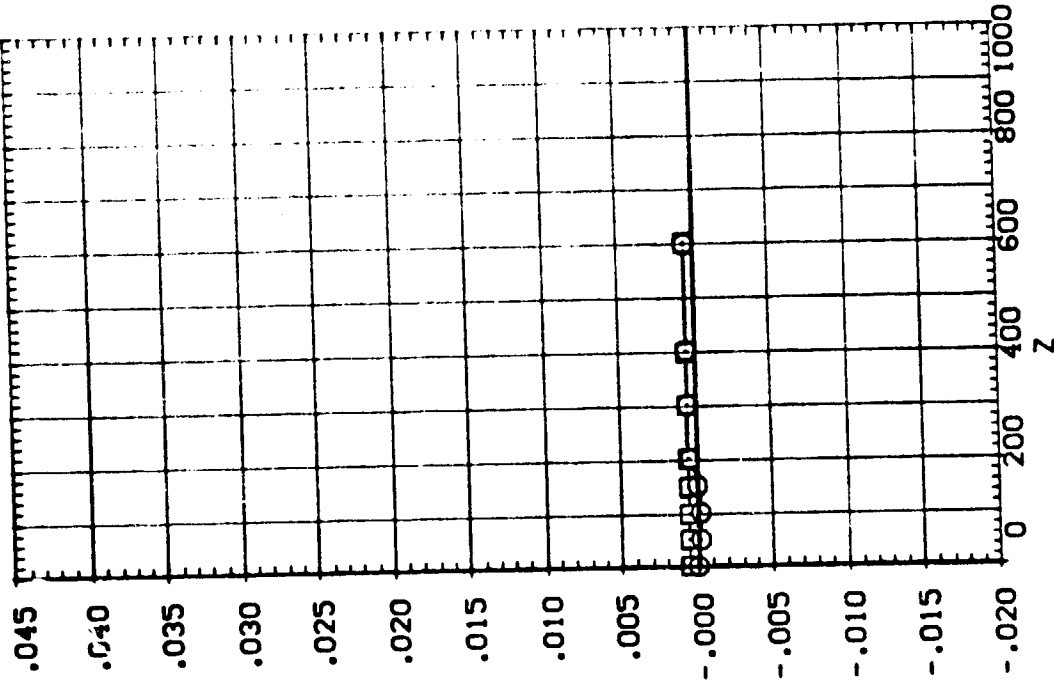

EFFECT OF S8 W/O PLUMES SEPARATION ON ORB/ET AERODYNAMIC CHARACTERISTICS

1A13 SRB(SB) W/O PLUMES SEPARATING FROM 09T10 (RTJ177)

SEE THE ASSOCIATED DATA DOCUMENT FOR REFERENCE CHARACTERISTICS FOR INDIVIDUAL DATASETS

SYMBOL		PARAMETRIC VALUES	
X	.369	MACH	4.530
	900.510	ALPHA	.000
		DELTA	5.000
		POMER	400.000
		PTOTAL	110.000
		BETA	.000
		DELTA	-5.000
		POMER	.000

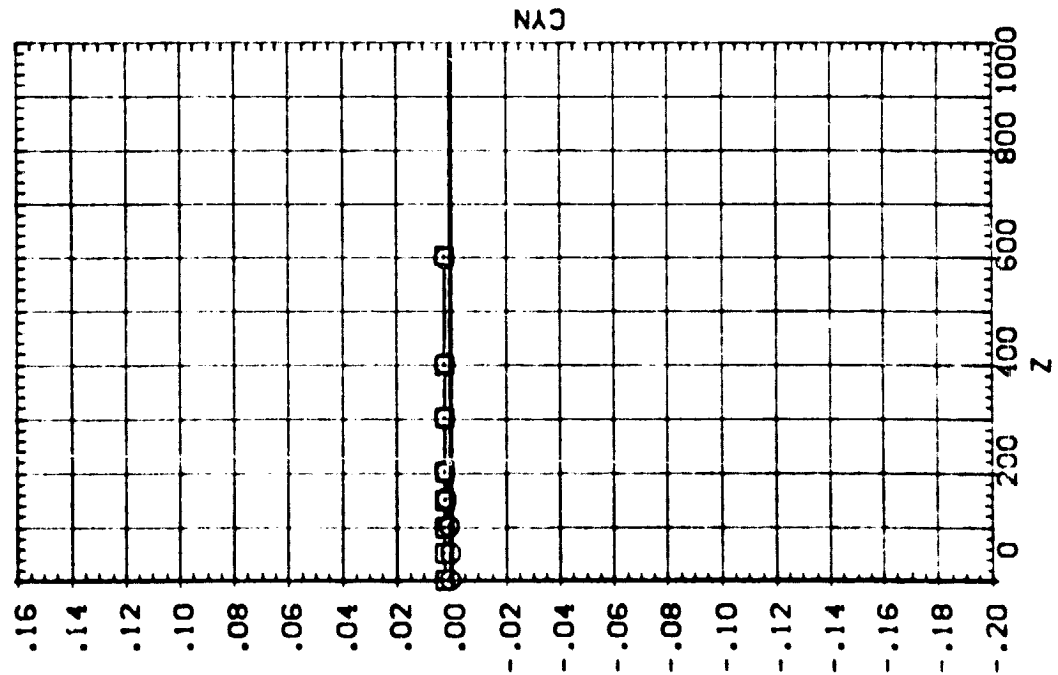
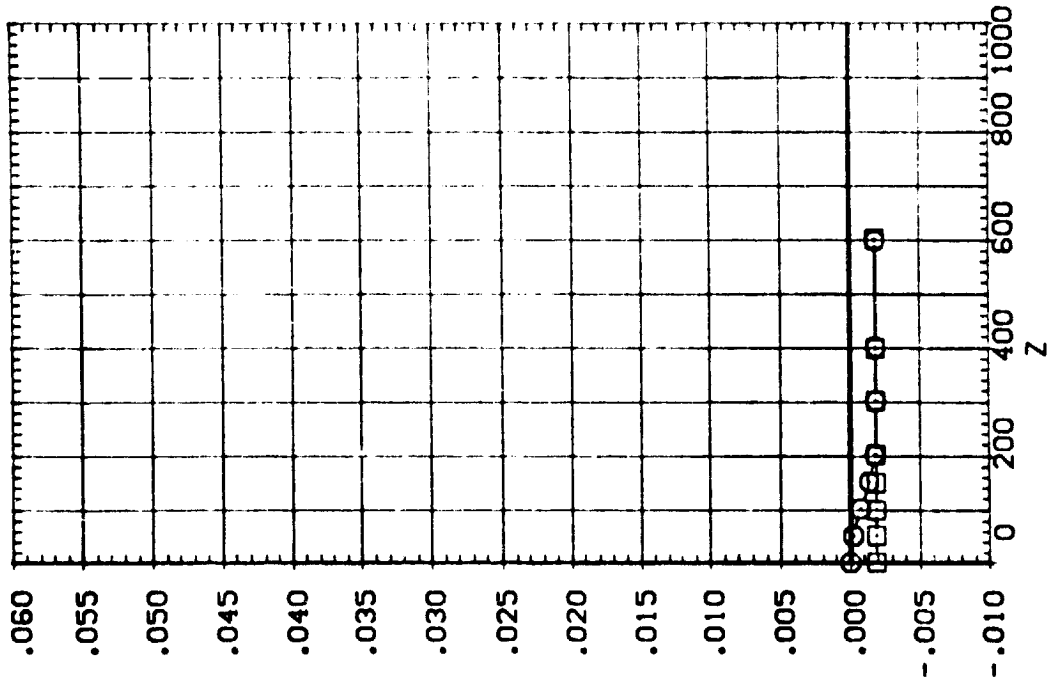

1A:3 SRB(SB) W/O PLUMES SEPARATING FROM 09T10 (RTJ178)

SEE THE ASSOCIATED DATA DOCUMENT FOR REFERENCE CHARACTERISTICS FOR INDIVIDUAL DATASETS

SYMBOL		PARAMETRIC VALUES			
□	X	MACH	4.530	PTOTAL	110.000
□	900.600	ALPHA	.000	BETA	.000
		DALPHA	5.000	DBETA	-5.000
		Y	.000	PCHNR	.000

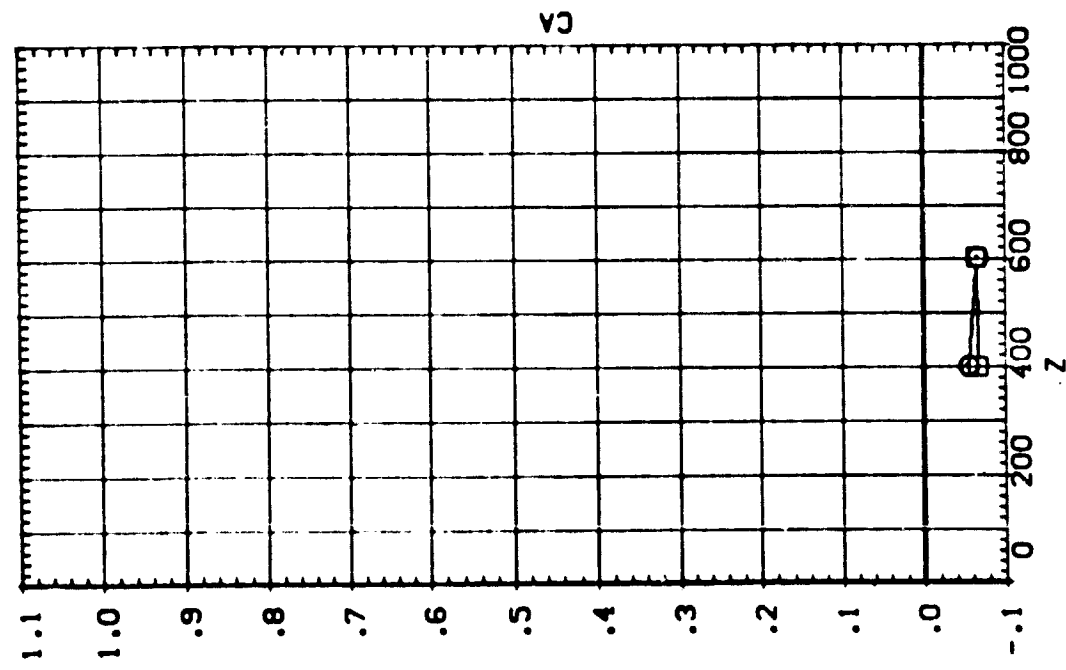
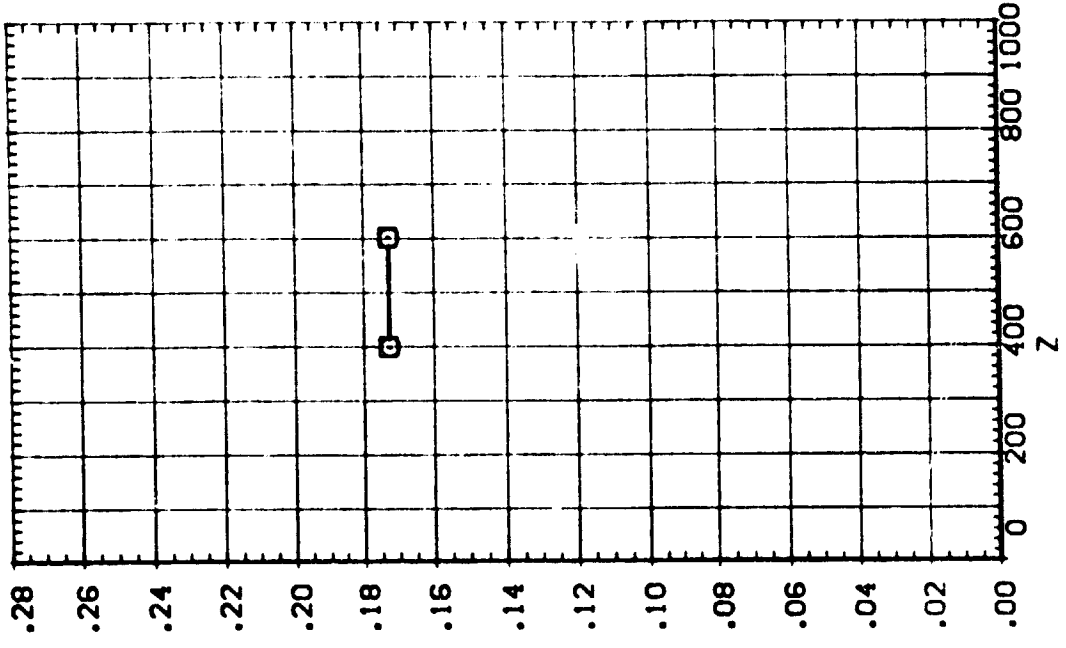

EFFECT OF SRB W/O PLUMES SEPARATION ON ORB/ET AERODYNAMIC CHARACTERISTICS

IA13 SRB(SB) W/O PLUMES SEPARATING FROM 09T10 (RTJ178)

SEE THE ASSOCIATED DATA DOCUMENT FOR REFERENCE CHARACTERISTICS FOR INDIVIDUAL DATASETS

SYMBOL		PARAMETRIC VALUES			
x	□	MACH	4.530	P TOTAL	110.000
	○	ALPHA	.000	BETA	.000
		DALPHA	5.000	DBETA	-5.000
		Y	.000	PCMPER	.000

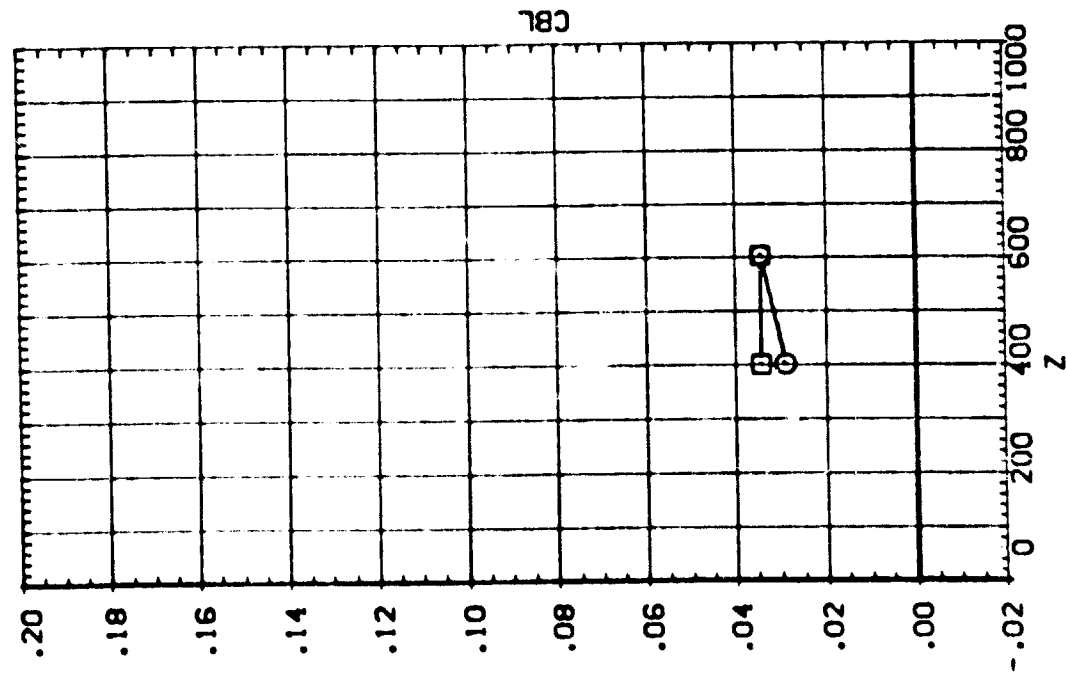
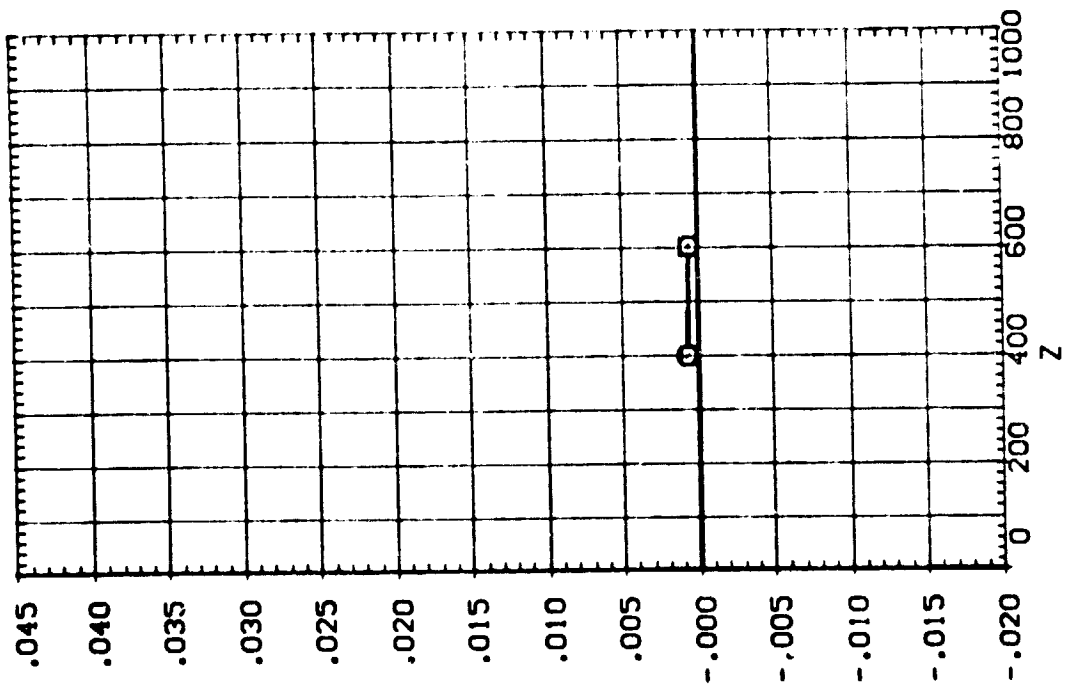

[A13 SRB(S8) W/O PLUMES SEPARATING FROM 09T10 (RTJ178)]

SEE THE ASSOCIATED DATA DOCUMENT FOR REFERENCE CHARACTERISTICS FOR INDIVIDUAL DATASETS

SYMBOL	K	PARAMETRIC VALUES			
		MACH	PTOTAL	BETA	OBETA
○	.307	4.530	110.000	.000	-5.000
□	900.600	.000	.000	.000	.000
		5.000			

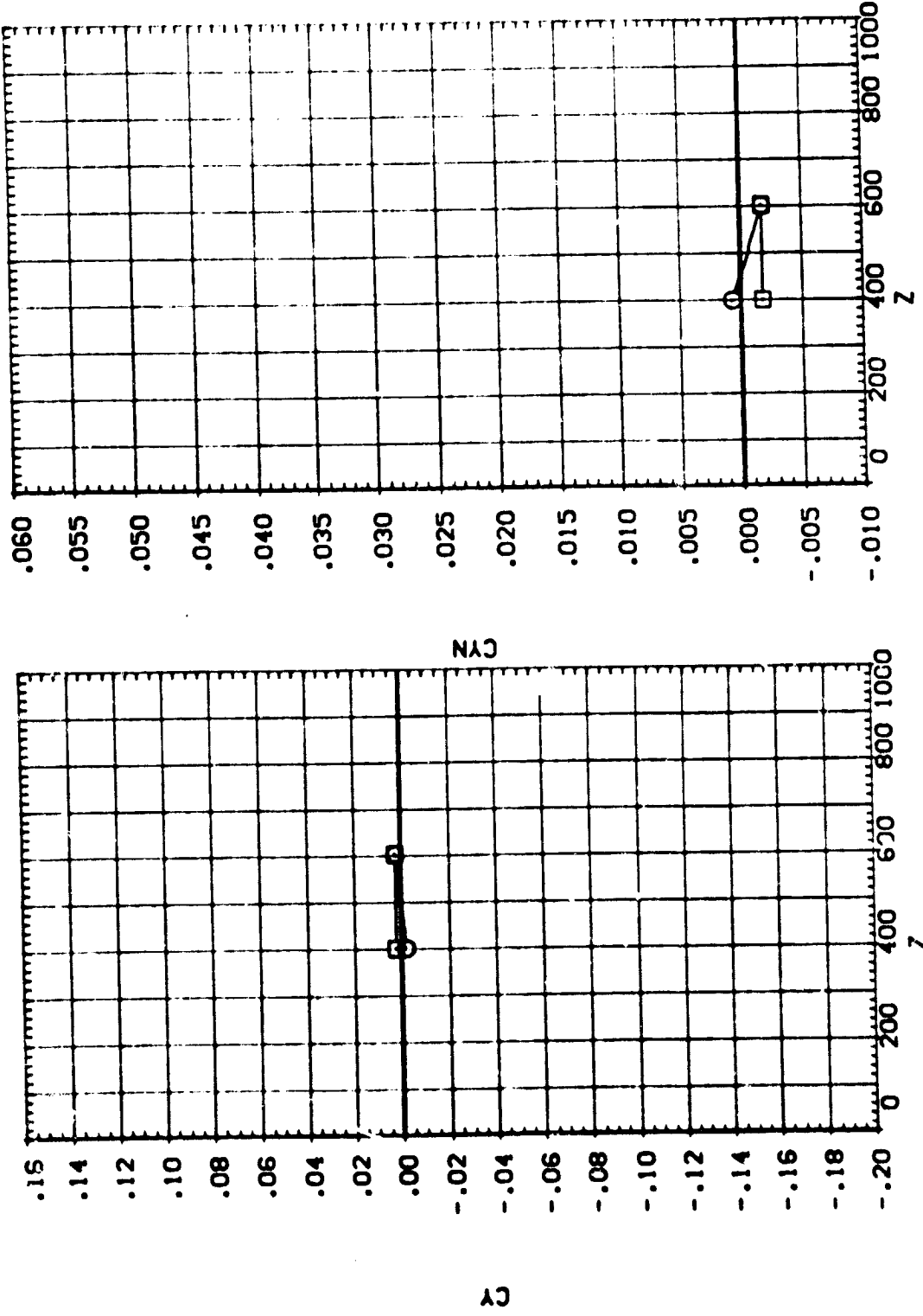

EFFECT OF SRB W/O PLUMES SEPARATION ON ORB/ET AERODYNAMIC CHARACTERISTICS

IAI SRB(SB) W/O PLUMES SEPARATING FROM 09T10 (RTJ179)

SEE THE ASSOCIATED DATA DOCUMENT FOR REFERENCE CHARACTERISTICS FOR INDIVIDUAL DATASETS

PARAMETRIC VALUES	
4.530	PTOTAL 110.000
.000	BETA .000
5.000	DBETA -10.000
400.000	POWER .000

900.520	MACH
.302	ALPHA
	DBLPHA
	Y

SYMBOL X

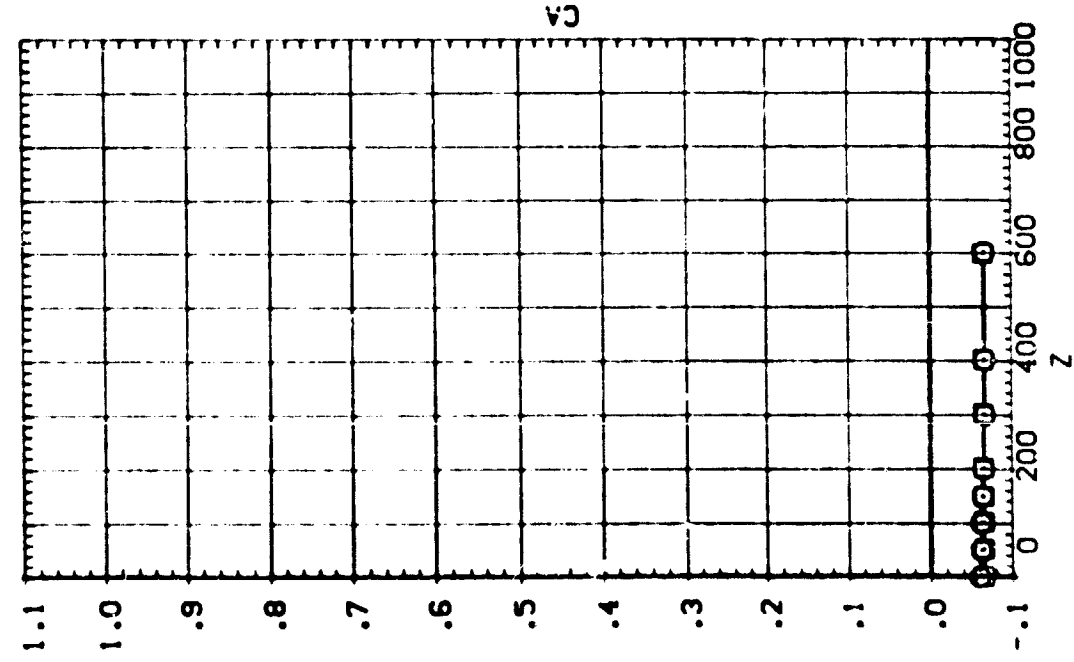
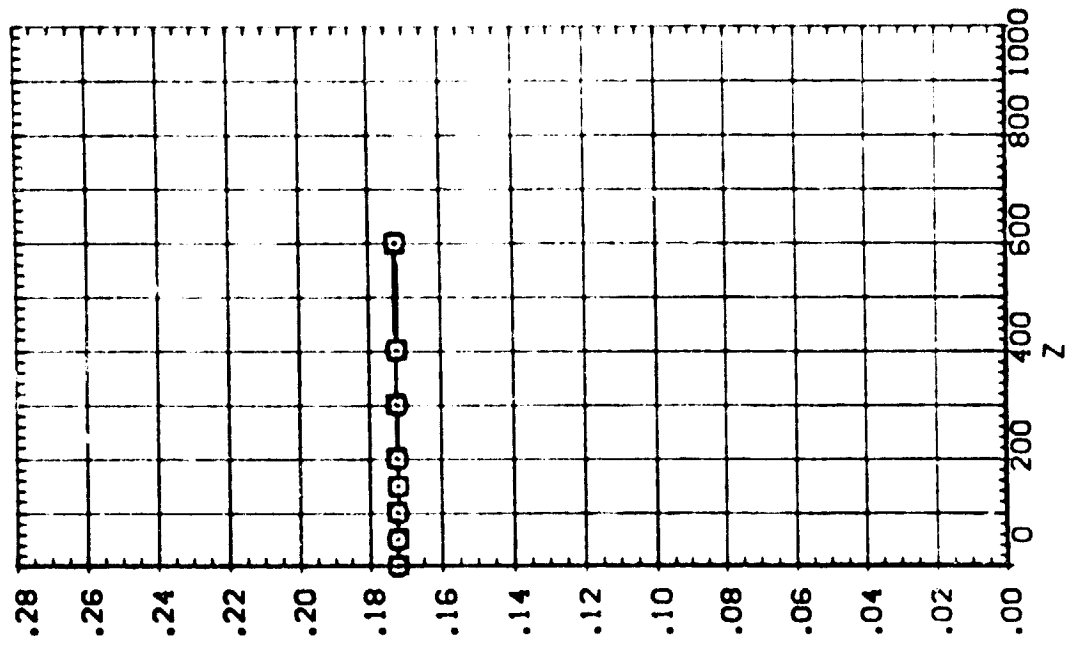

1A13 SRB(S8) W/O PLUMES SEPARATING FROM 09T10 (RTJ179)

SEE THE ASSOCIATED DATA DOCUMENT FOR REFERENCE CHARACTERISTICS FOR INDIVIDUAL DATASETS

SYMBOL X
 ○ 900.520
 □ .302

PARAMETRIC VALUES
 MACH 4.530
 ALPHA .000
 DALPHA 5.000
 Y 400.000

P/TOTAL 110.000
 BETA .000
 DBETA -10.000
 PC-MBR .000

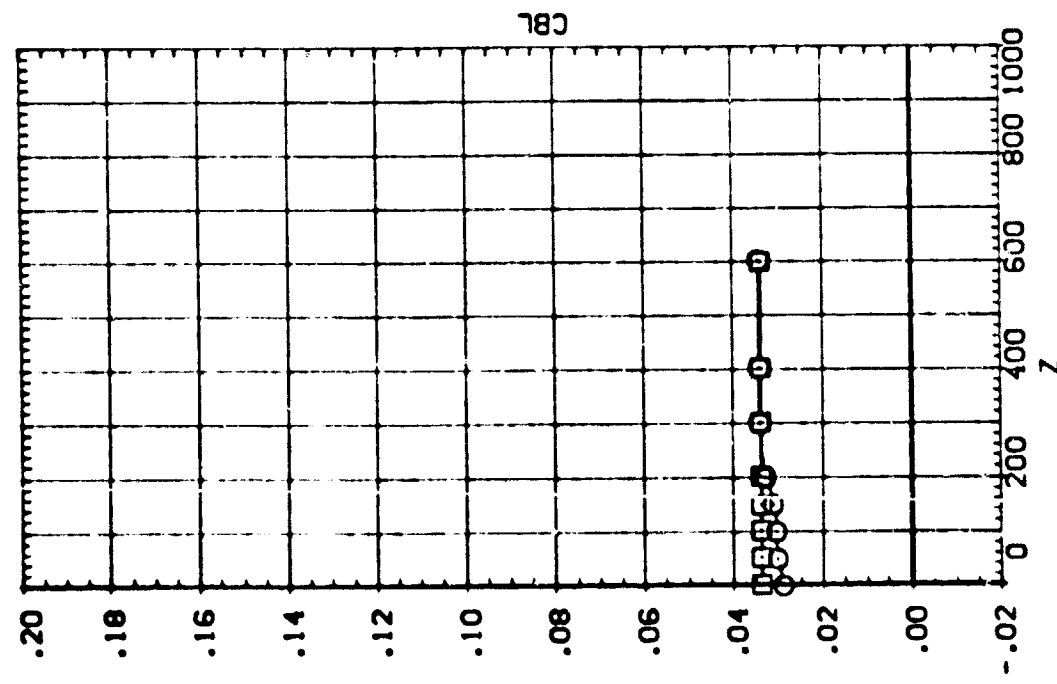
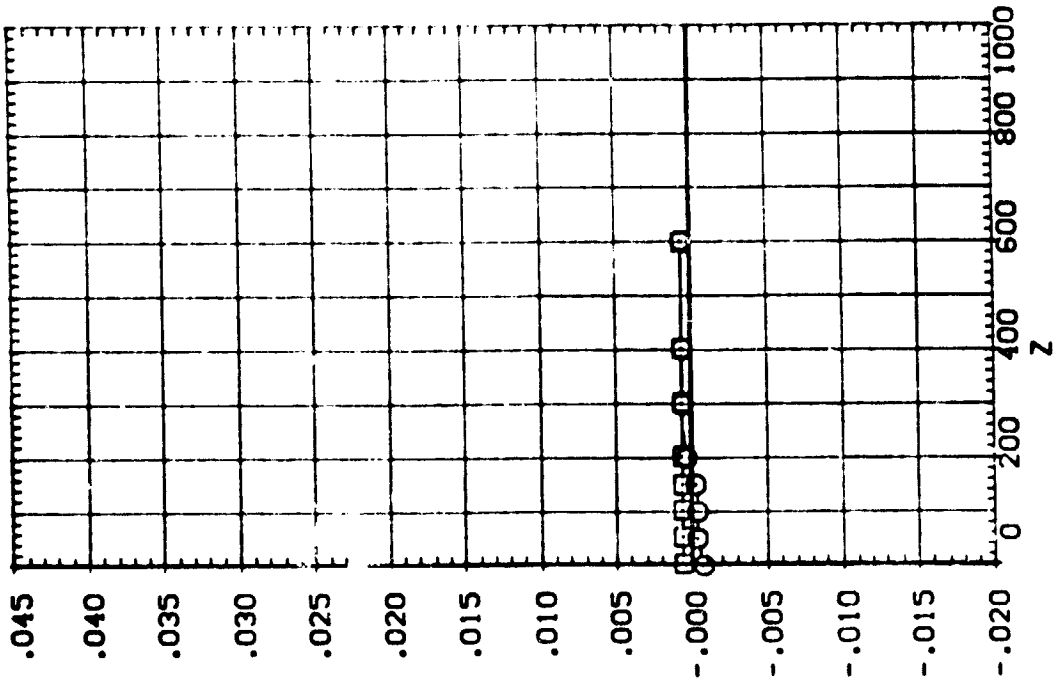

EFFECT OF SRB W/O PLUMES SEPARATION ON ORB/ET AERODYNAMIC CHARACTERISTICS

1A13 SRB(S8) W/O PLUMES SEPARATING FROM 09T10 (RTJ179)

SEE THE ASSOCIATED DATA DOCUMENT FOR REFERENCE CHARACTERISTICS FOR INDIVIDUAL DATASETS

SYMBOL X MACH ALPHA DALPHA Y PCHWER
 O .302 500.520 .000 5.000 400.000
 □ 110.000 .000 -10.000 .000

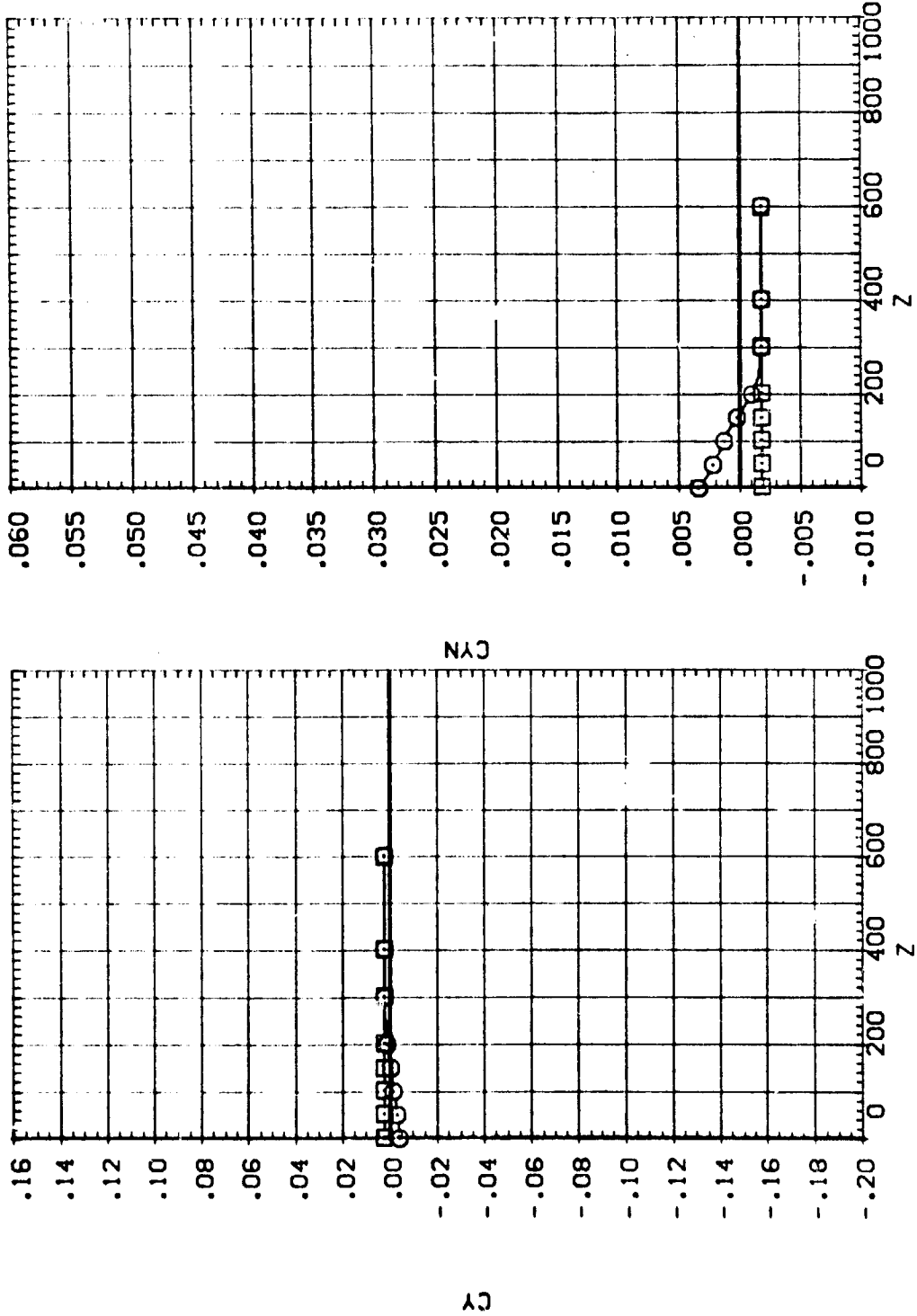

IA13 SRB(S8) W/O PLUMES SEPARATING FROM 09T10 (RTJ180)

SEE THE ASSOCIATED DATA DOCUMENT FOR REFERENCE CHARACTERISTICS FOR INDIVIDUAL DATASETS

SYMBOL	X	MACH	PARAMETRIC VALUES
○	900.670	.485	4.530 P/TOTAL 110.000
□		ALPHA	.000 BETA .000
		DALPHA	5.000 DBETA -10.000
		Y	200.000 PC+PER .000

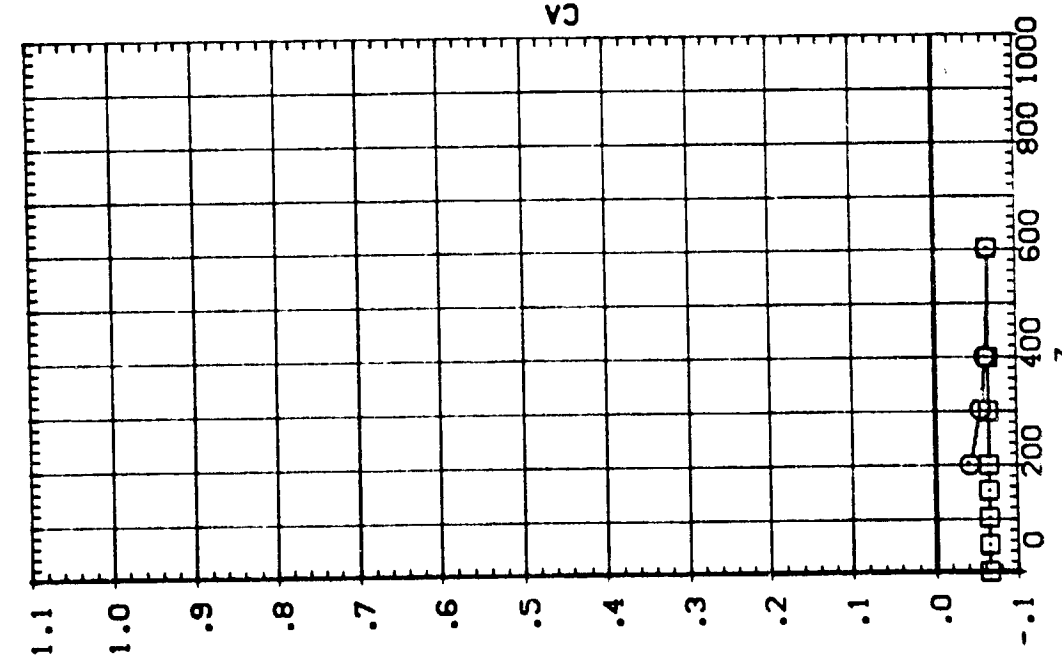
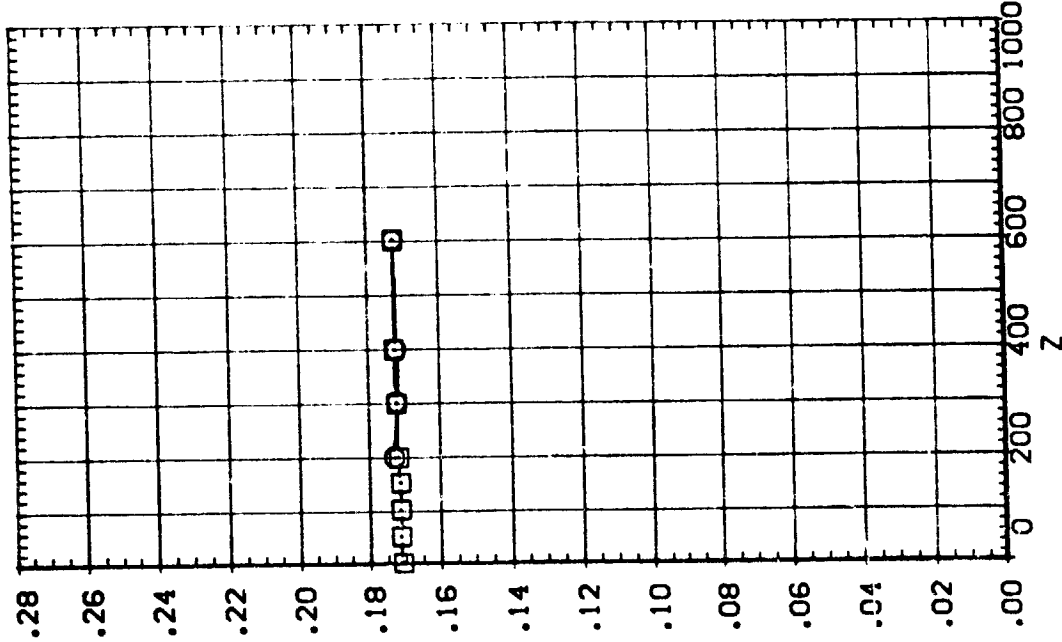

EFFECT OF SRB W/O PLUMES SEPARATION ON ORB/ET AERODYNAMIC CHARACTERISTICS

IA13 SRB(S8) W/O PLUMES SEPARATING FROM 09T10 (RTJ180)

SEE THE ASSOCIATED DATA DOCUMENT FOR REFERENCE CHARACTERISTICS FOR INDIVIDUAL DATASETS

SYMBOL	X	MACH	PARAMETRIC VALUES
○	.465	4.530	P/TOTAL 110.000
□	900.670	.000	BETA .000
		3.000	DBETA -10.000
		200.000	PCHMBR .000

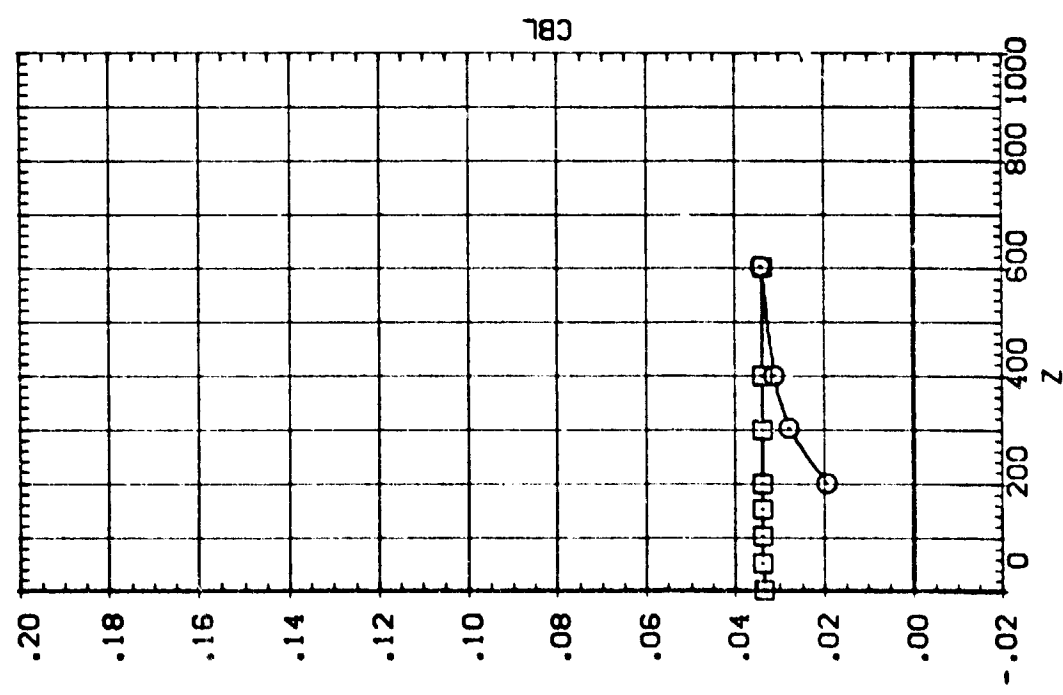
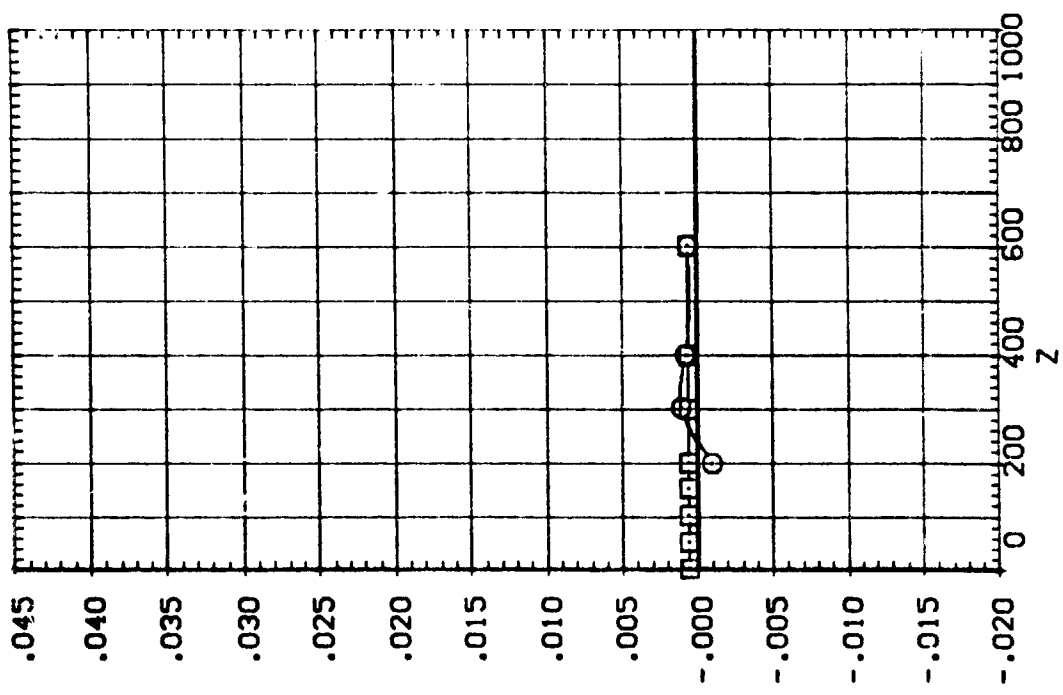

IA13 SRB(S8) W/O PLUMES SEPARATING FROM 09T10 (RTJ180)

SEE THE ASSOCIATED DATA DOCUMENT FOR REFERENCE CHARACTERISTICS FOR INDIVIDUAL DATASETS

SYMBOL X PARAMETRIC VALUES
 O MACH 4.530 PTOTAL 110.000
 □ ALPHA .000 BETA .000
 DALPHA 5.000 DBETA -10.000
 Y 200.000 PC-MER .000

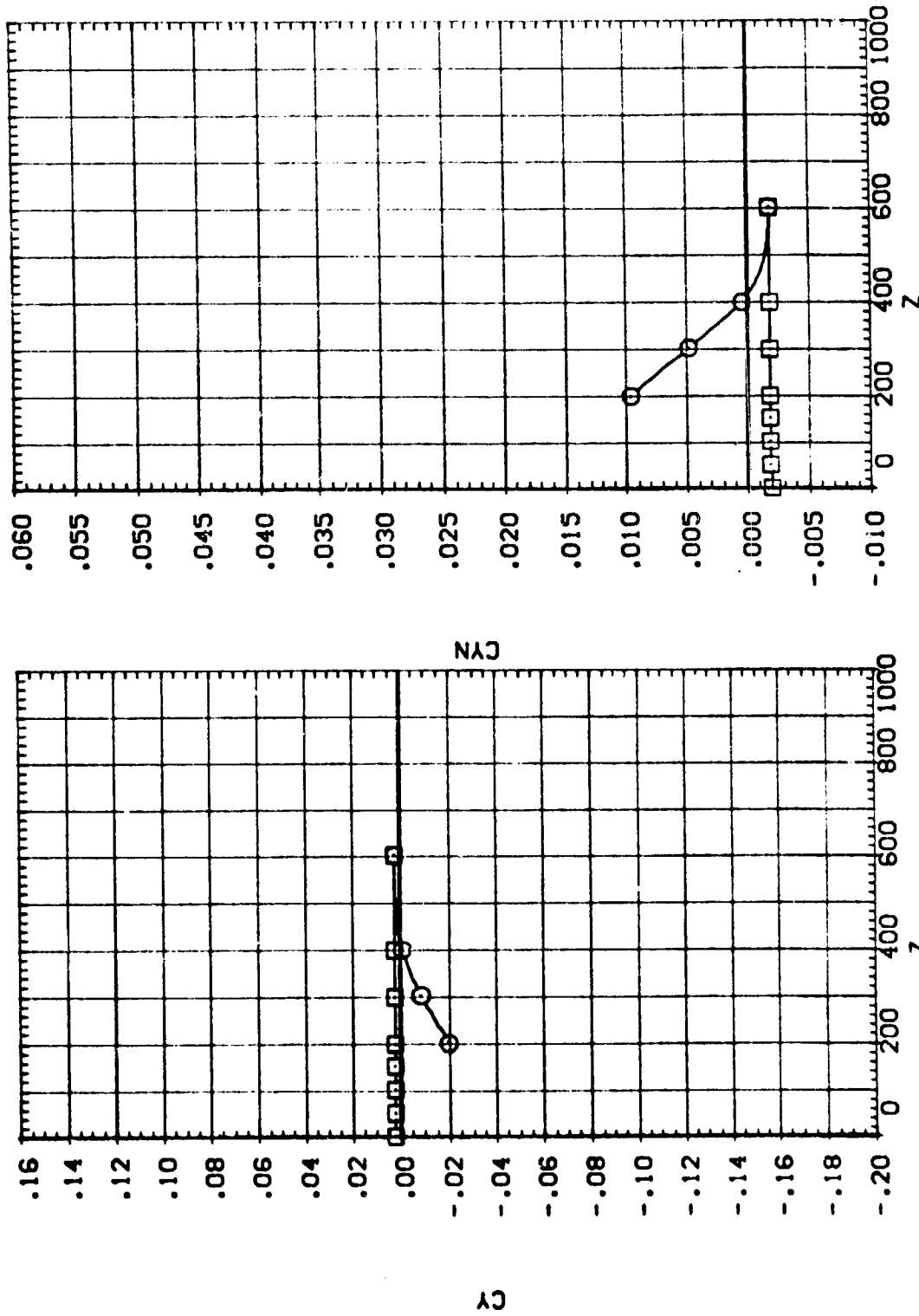

EFFECT OF SRB W/O PLUMES SEPARATION ON ORB/ET AERODYNAMIC CHARACTERISTICS

[A13 SRB(S8) W/O PLUMES SEPARATING FROM 09T10 (RTJ181)]

SEE THE ASSOCIATED DATA DOCUMENT FOR REFERENCE CHARACTERISTICS FOR INDIVIDUAL DATASETS

SYMBOL X .190 MACH 4.530 PTOTAL 110.000
 O 900.700 ALPHA .000 BETA .000
 □ 5.000 DBETA -10.000
 Y .000 PCMBR .000

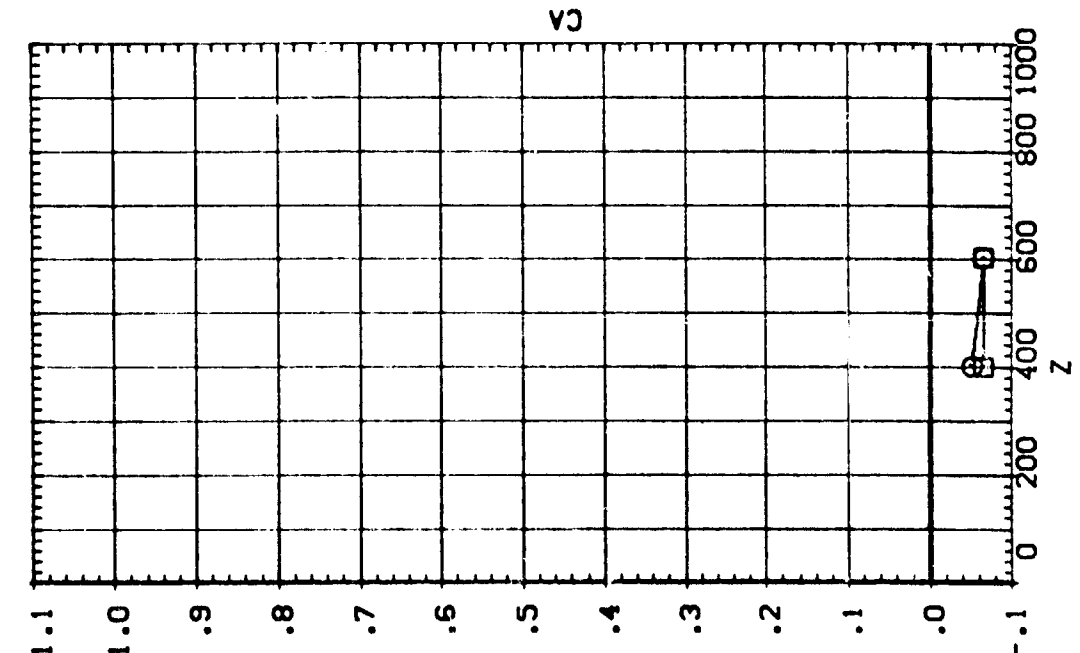
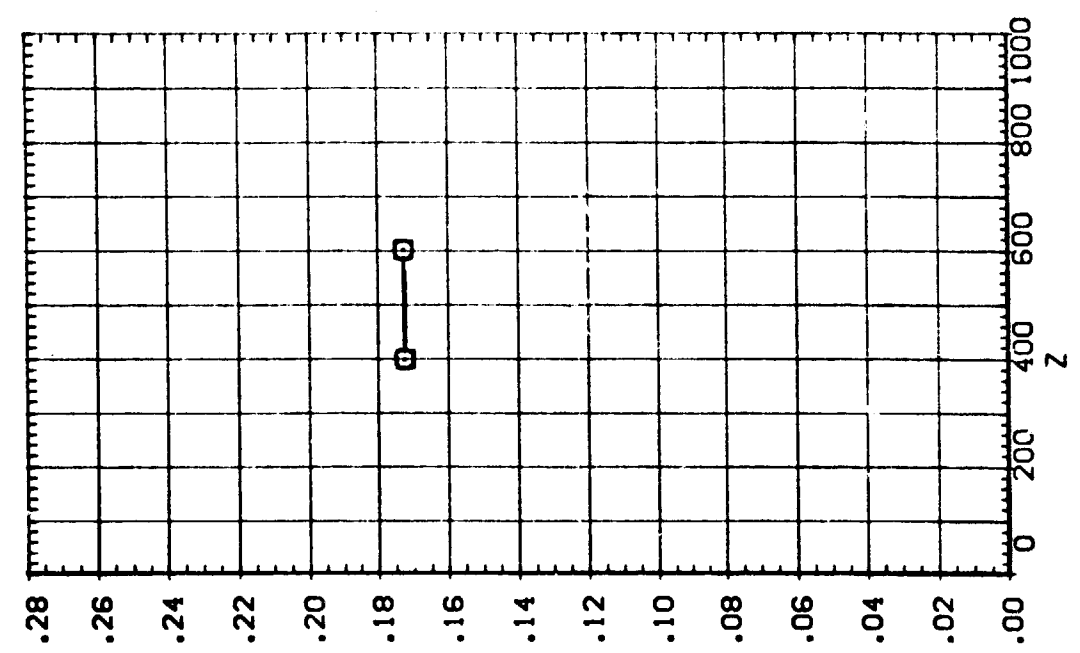

EFFECT OF SRB W/O PLUMES SEPARATION ON ORB/ET AERODYNAMIC CHARACTERISTICS

IA13 SRB(S8) W/O PLUMES SEPARATING FROM 09T10 (RTJ181)

SEE THE ASSOCIATED DATA DOCUMENT FOR REFERENCE CHARACTERISTICS FOR INDIVIDUAL DATASETS

SYMBOL		PARAMETRIC VALUES	
○	X	MACH	110.000
□	Y	ALPHA	.000
		BETA	-10.000
		DBETA	.000
		PO-MBR	.000

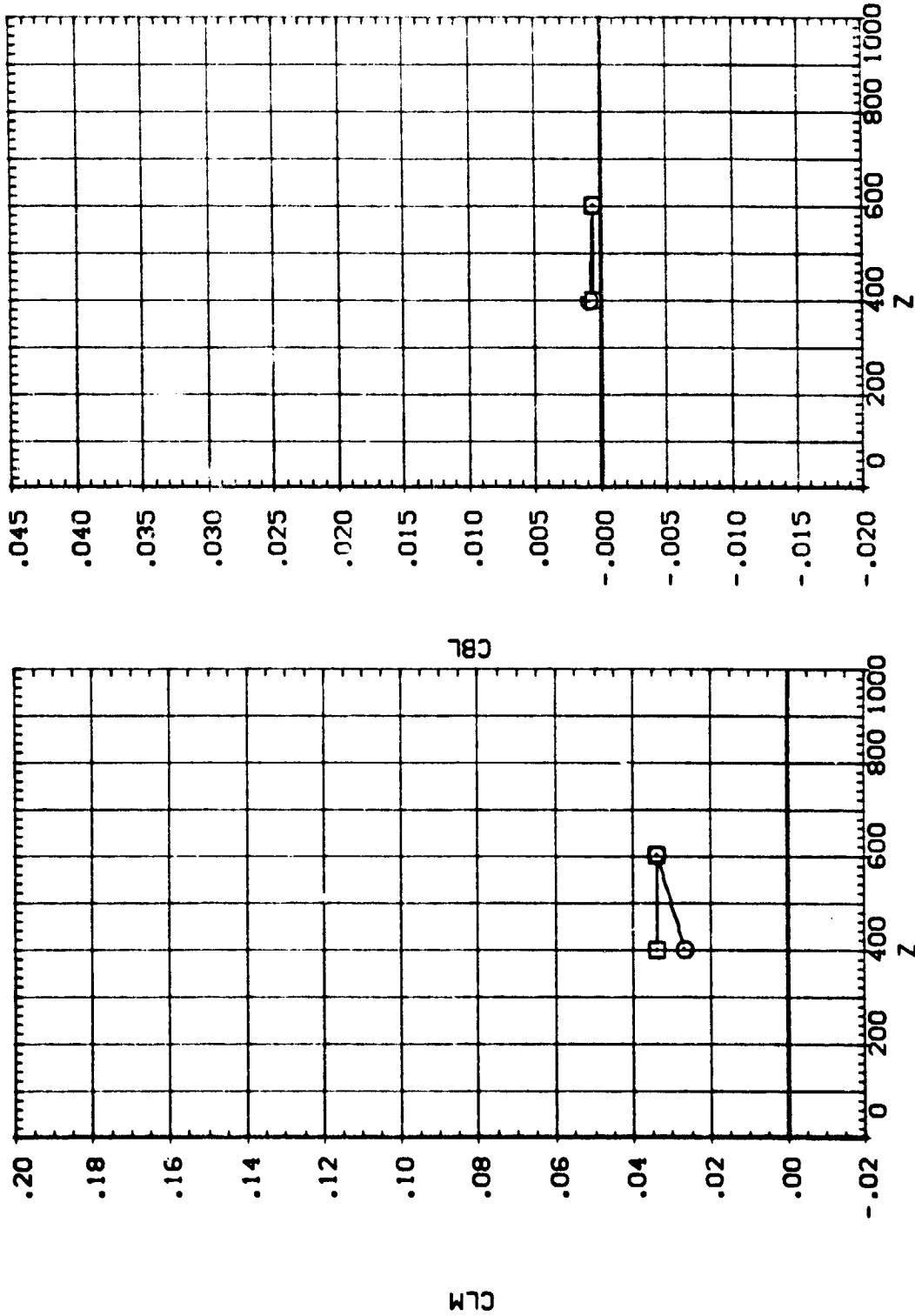

EFFECT OF SRB W/O PLUMES SEPARATION ON ORB/ET AERODYNAMIC CHARACTERISTICS

IA13 SRB(S8) W/O PLUMES SEPARATING FROM 09T10 (RTJ181)

SEE THE ASSOCIATED DATA DOCUMENT FOR REFERENCE CHARACTERISTICS FOR INDIVIDUAL DATASETS

SYMBOL X .190 MACH 4.530 P TOTAL 110.000
 O 900.700 ALPHA .000 BETA .000
 □ 5.000 DBETA -10.000
 Y .000 PC-MBR .000

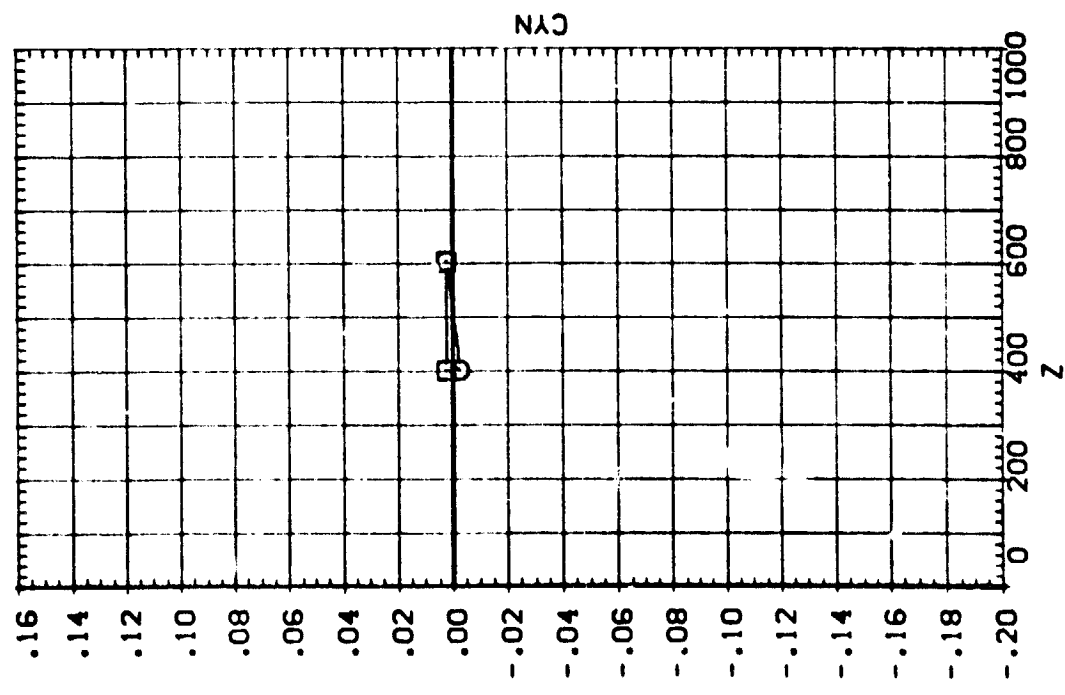
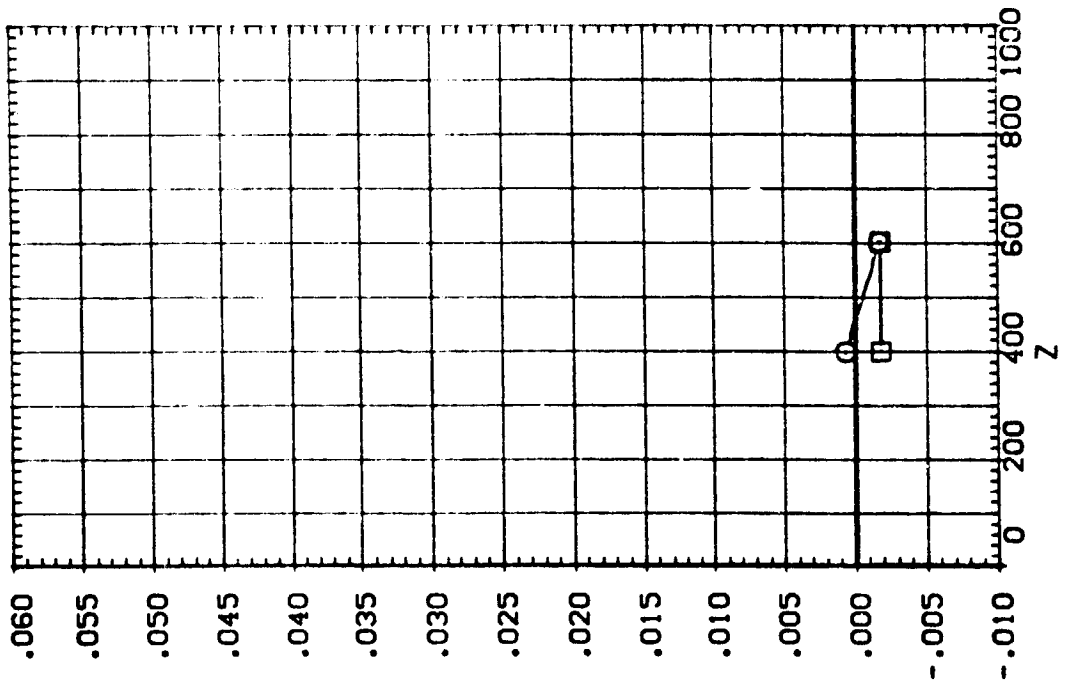

[A13 SRB(S8) W/O PLUMES SEPARATING FROM 09T10 (RTJ182)]

SEE THE ASSOCIATED DATA DOCUMENT FOR REFERENCE CHARACTERISTICS FOR INDIVIDUAL DATASETS

SYMBOL		PARAMETRIC VALUES	
○	X	4.530	PTOTAL
○	Y	200.000	PC+PR
○	ALPHA	.000	BETA
○	ALPHA	5.000	DBETA
○	Y	200.000	PC+PR
○	MACH	110.000	
○	ALPHA	.000	BETA
○	ALPHA	5.000	DBETA
○	Y	200.000	PC+PR

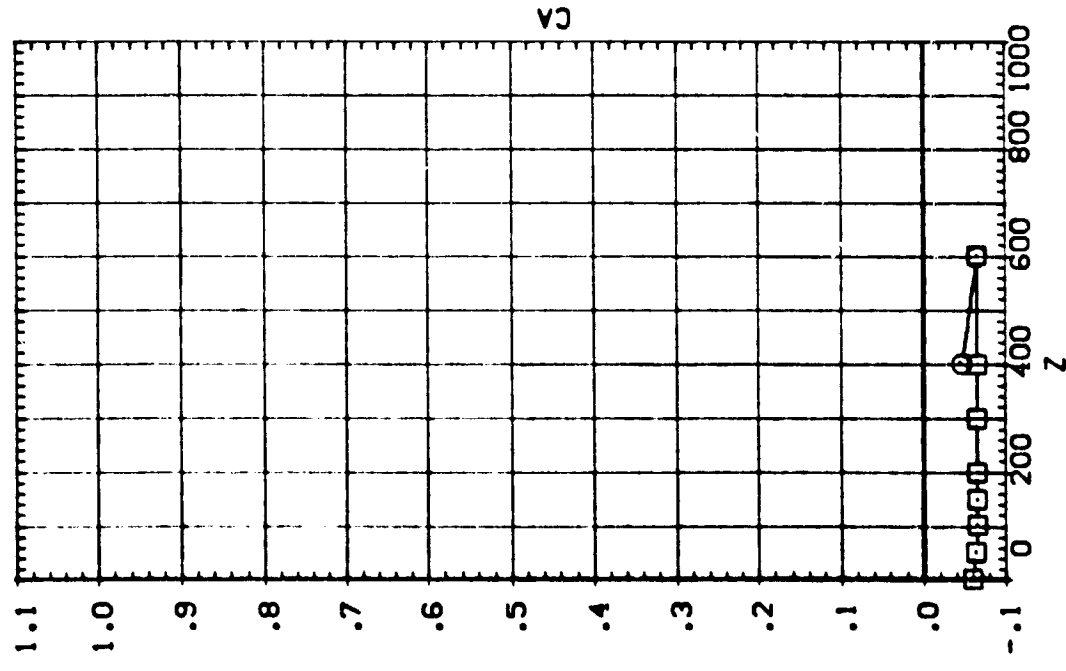
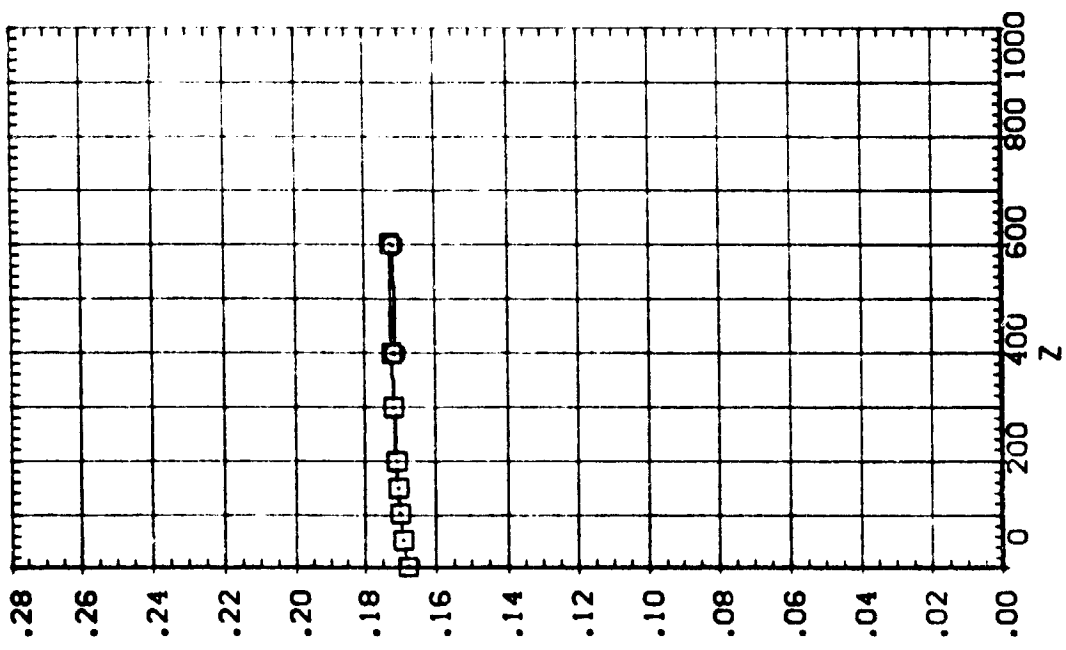

EFFECT OF SRB W/O PLUMES SEPARATION ON ORB/ET AERODYNAMIC CHARACTERISTICS

IA13 SRB(S8) W/O PLUMES SEPARATING FROM 09T10 (RTJ182)

SEE THE ASSOCIATED DATA DOCUMENT FOR REFERENCE CHARACTERISTICS FOR INDIVIDUAL DATASETS

SYMBOL X
 ○ □

PARAMETRIC VALUES
 .354 MACH 110.000
 900.370 ALPHA .000
 5.000 DELTA -20.000
 200.000 PO+PR .000

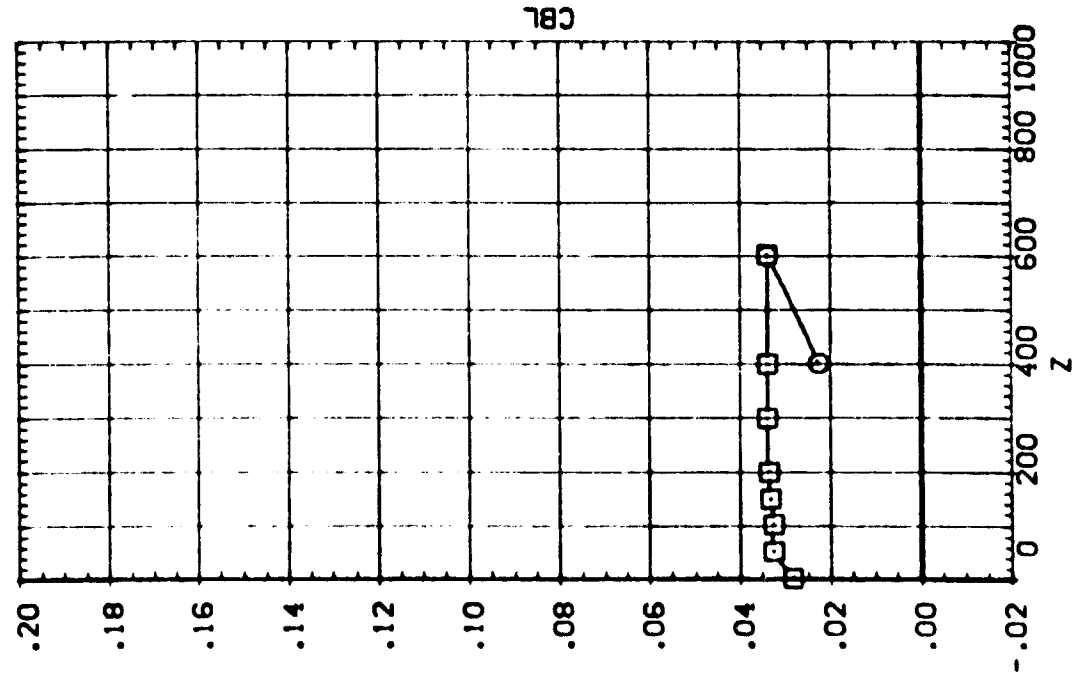
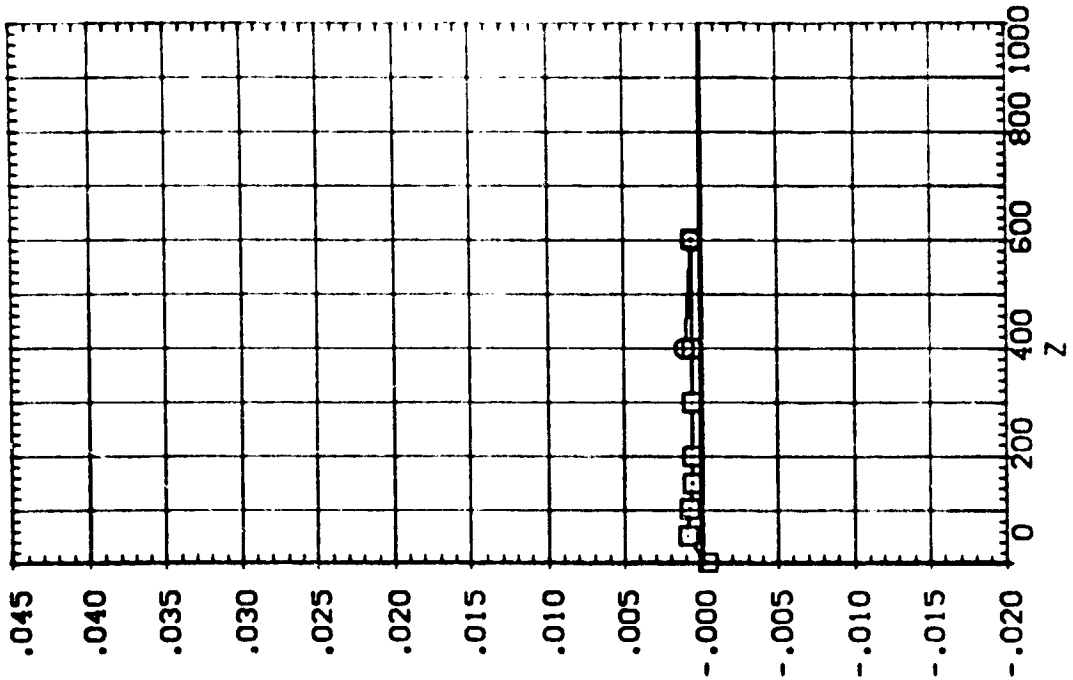

[A13 SRB(S8) W/O PLUMES SEPARATING FROM 09T10 (RTJ182)]

SYMBOL X
 ○
 □

PARAMETRIC VALUES
 MACH 4.530 PTOTAL 110.000
 ALPHA .000 BETA .000
 DALPHA 5.000 DBETA -20.000
 Y 200.000 PC+PR .000

SEE THE ASSOCIATED DATA DOCUMENT FOR REFERENCE CHARACTERISTICS FOR INDIVIDUAL DATASETS

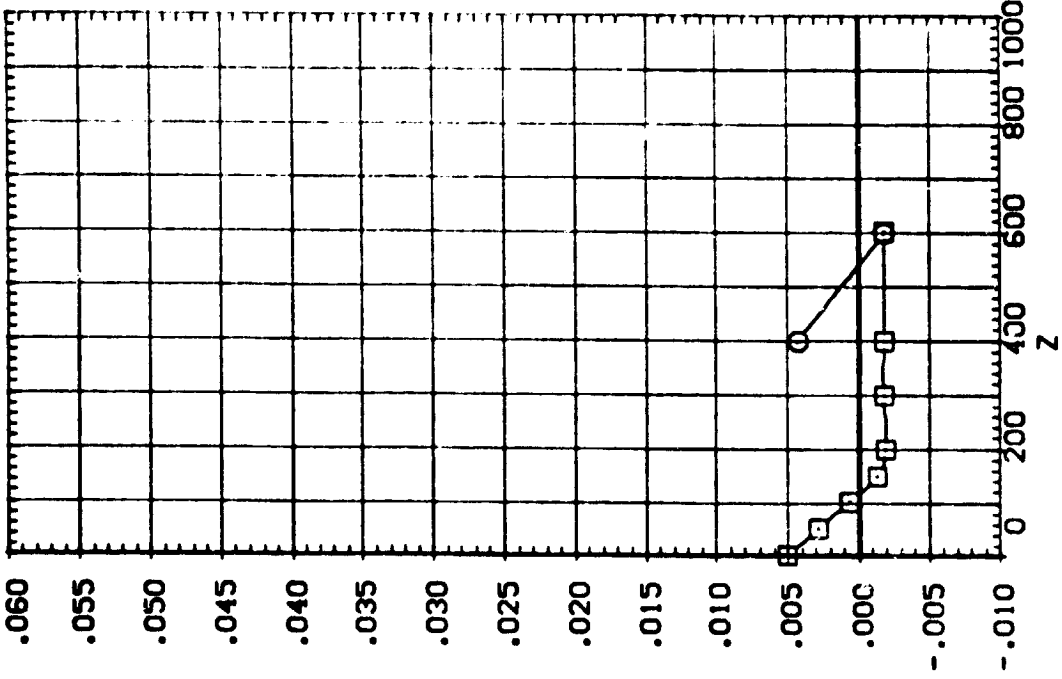
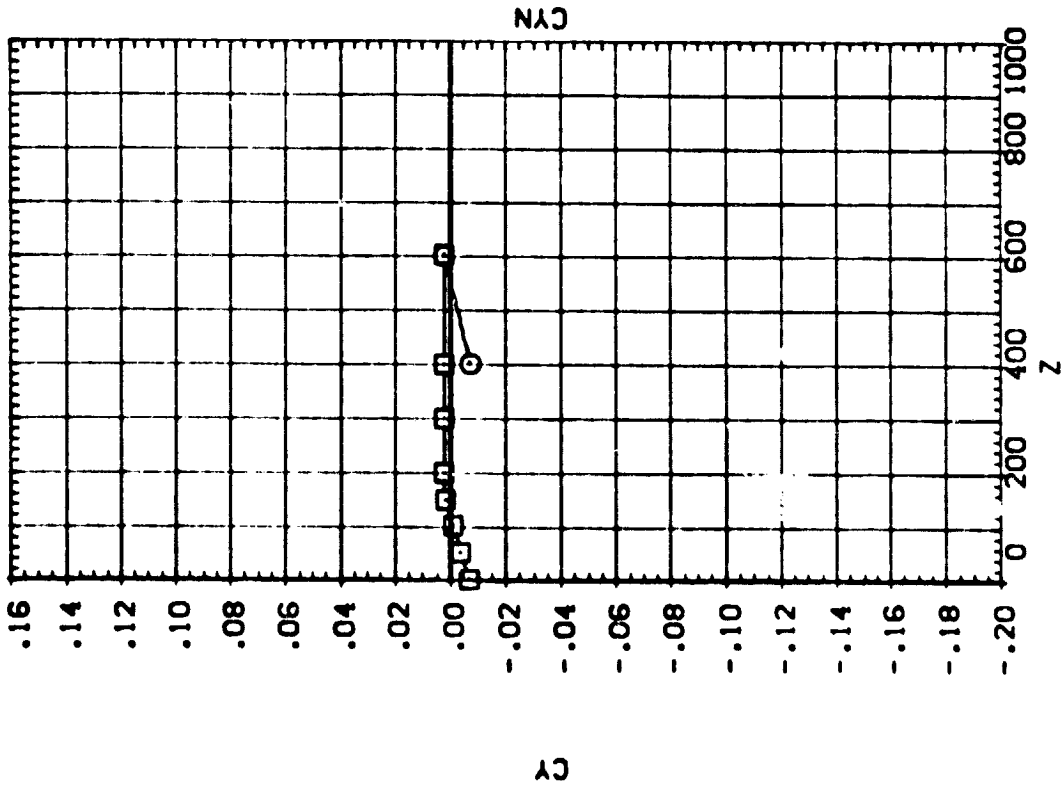

EFFECT OF SRB W/O PLUMES SEPARATION ON ORB/ET AERODYNAMIC CHARACTERISTICS

1A13 SRB(S8) W/O PLUMES SEPARATING FROM 09T10 (RTJ183)

SYMBOL
O

MACH	.538	PARAMETRIC VALUES
ALPHA	900.120	4.530
DALPHA	.000	P/TOTAL
Y	400.000	BETA
		DEBETA
		PC-MBR
		110.000
		.000
		-20.000
		.000

SEE THE ASSOCIATED DATA DOCUMENT FOR REFERENCE CHARACTERISTICS FOR INDIVIDUAL DATASETS

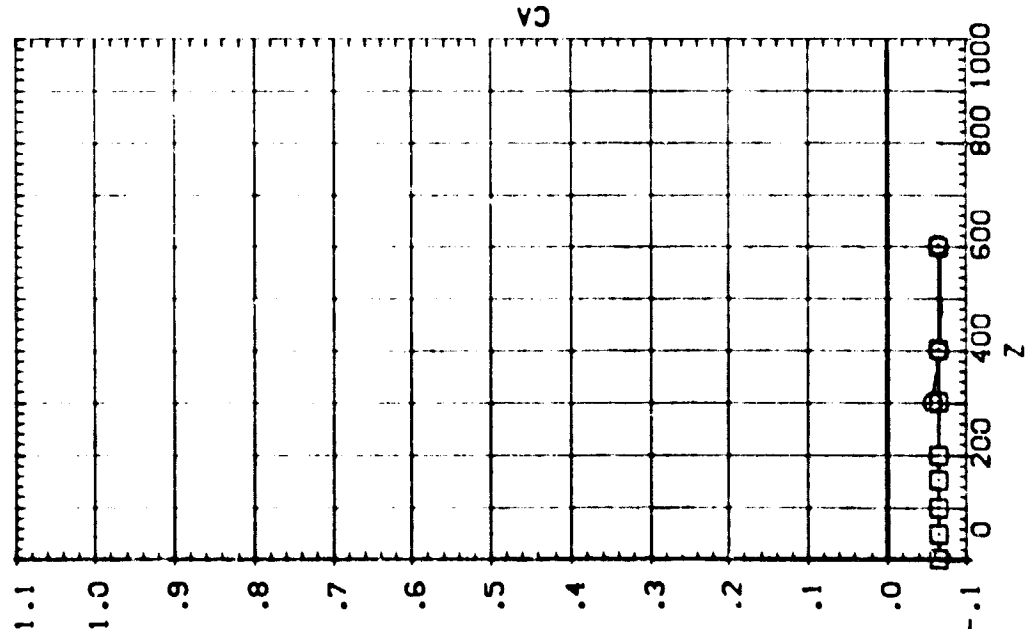

2

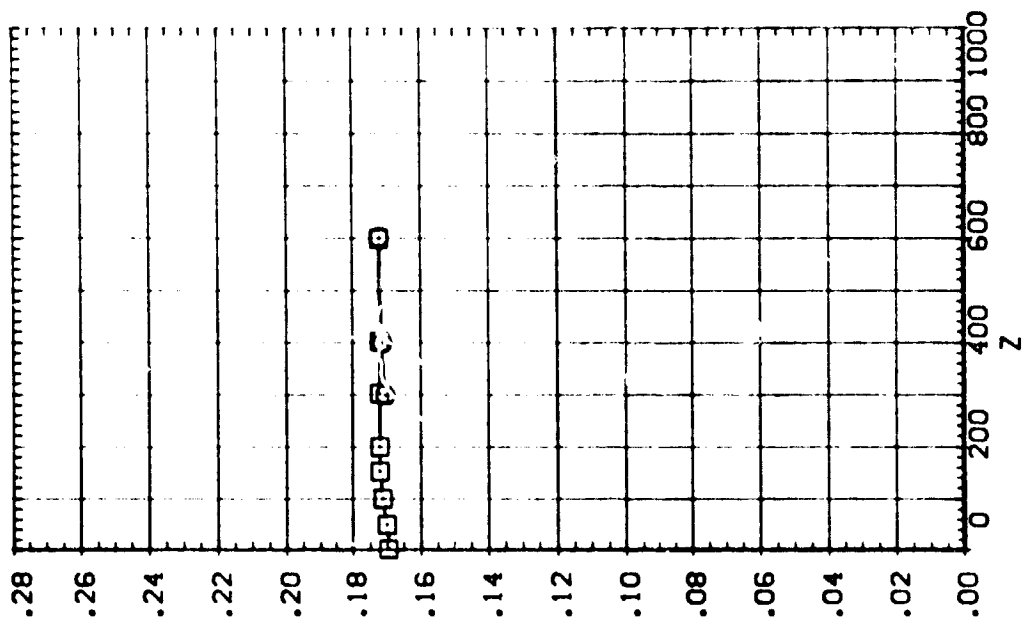

EFFECT OF SRB W/O PLUMES SEPARATION ON ORB/ET AERODYNAMIC CHARACTERISTICS

IA13 SRB(SB) W/O PLUMES SEPARATING FROM 09T10 (RTJ183)

SEE THE ASSOCIATED DATA DOCUMENT FOR REFERENCE CHARACTERISTICS FOR INDIVIDUAL DATASETS

SYMBOL X .538 MACH 4.530 P/TOTAL 110.000
 900.120 ALPHA .000 BETA .000
 DALPHA 5.000 DBETA -20.000
 Y 400.000 PC-MBR .000

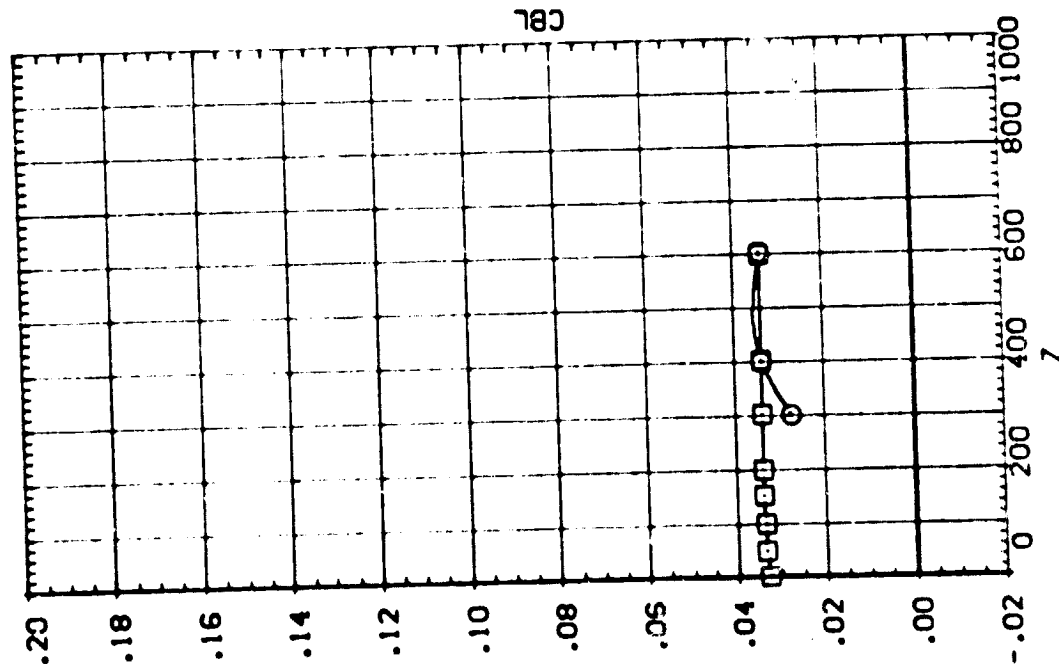
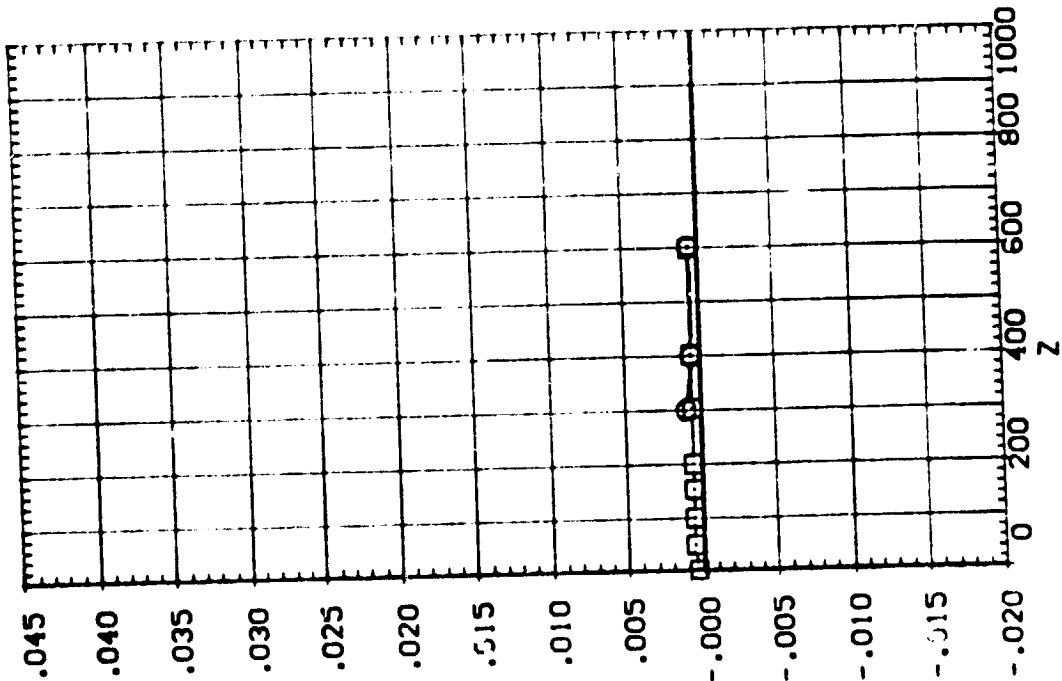

EFFECT OF SRB W/O PLUMES SEPARATION ON ORB/ET AERODYNAMIC CHARACTERISTICS

IA13 SRB(S8) W/O PLUMES SEPARATING FROM 09T10 (RTJ184)

SEE THE ASSOCIATED DATA DOCUMENT FOR REFERENCE CHARACTERISTICS FOR INDIVIDUAL DATASETS

SYMBOL		PARAMETRIC VALUES			
□	x	MACH	4.530	P/TOTAL	110.000
□	500.010	ALPHA	.000	BETA	.000
		DALPHA	5.000	DBETA	-20.000
		Y	.000	POWBR	.000

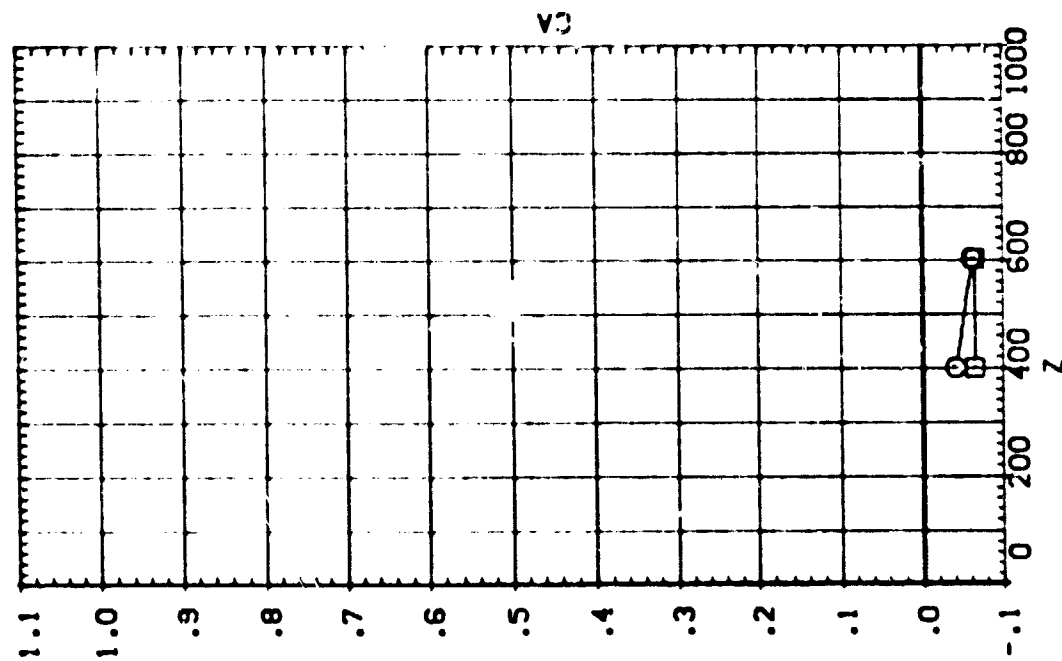
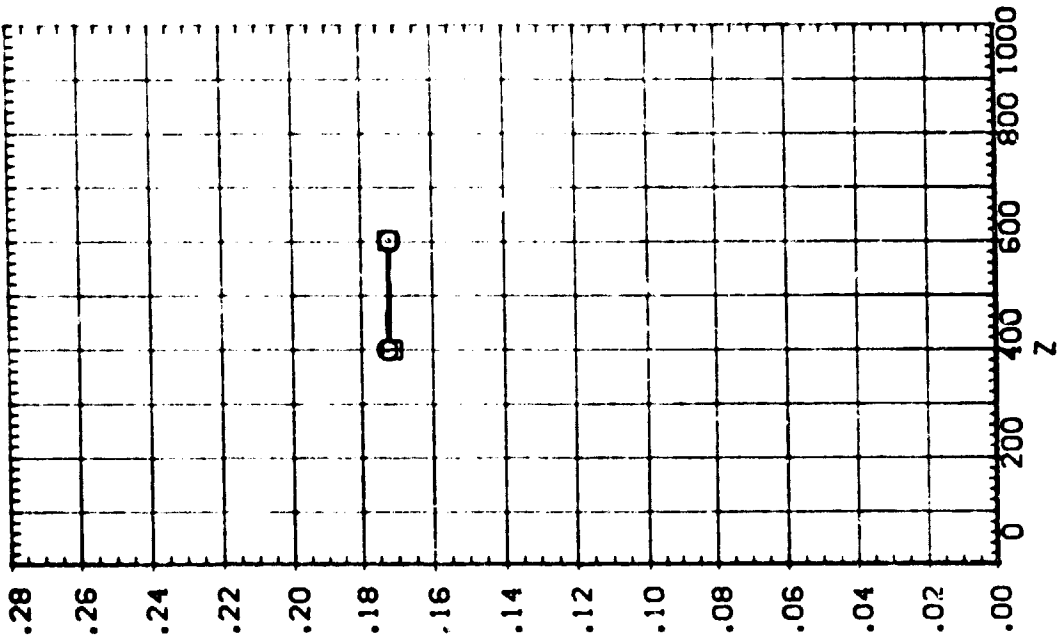

EFFECT OF SRB W/O PLUMES SEPARATION ON ORB/ET AERODYNAMIC CHARACTERISTICS

IA13 SRB(S8) W/O PLUMES SEPARATING FROM 09T10 (RTJ184)

SEE THE ASSOCIATED DATA DOCUMENT FOR REFERENCE CHARACTERISTICS FOR INDIVIDUAL DATASETS

SYMBOL	X	MACH	PARAMETRIC VALUES
○	.019	4.530	PTOTAL 110.000
□	900.810	.000	BETA .000
		5.000	DBETA -20.000
		.000	PCMBR .000
			Y

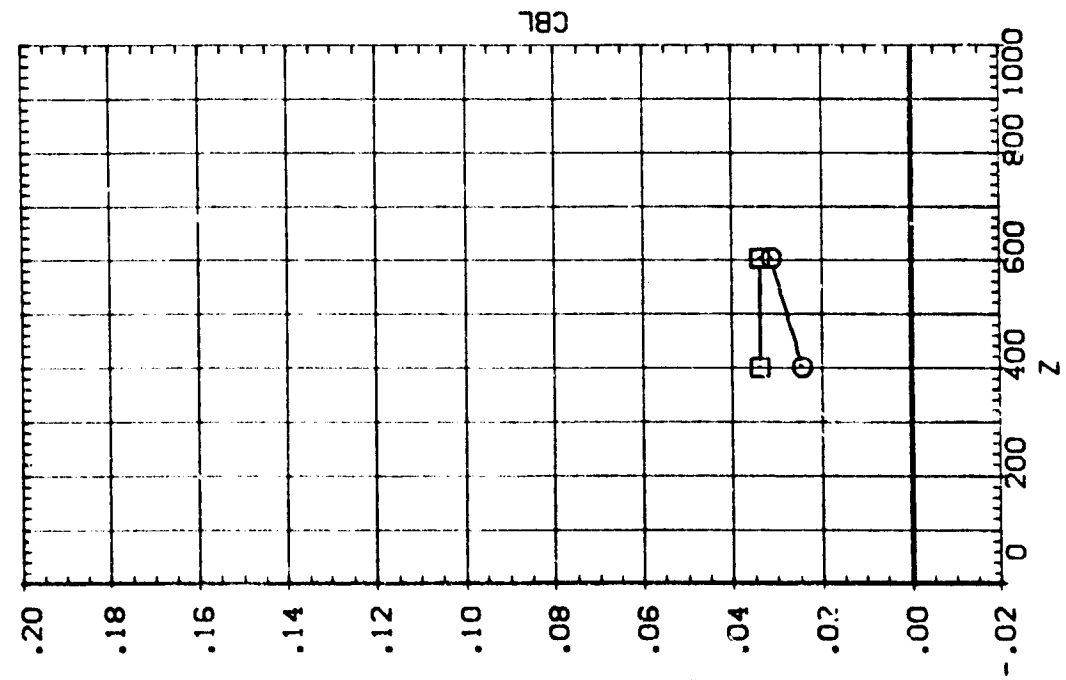
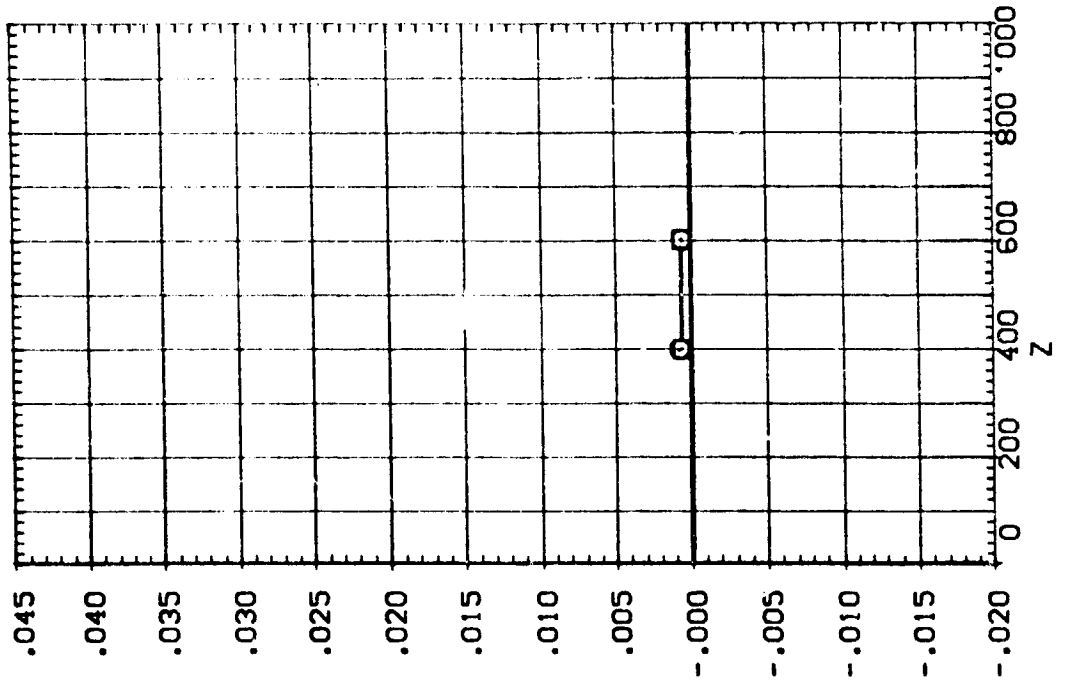

IA13 SRB(S8) W/O PLUMES SEPARATING FROM 09T10 (RTJ184)

SEE THE ASSOCIATED DATA DOCUMENT FOR REFERENCE CHARACTERISTICS FOR INDIVIDUAL DATASETS

SYMBOL		PARAMETRIC VALUES			
x	.019	MACH	4.530	PIOTAL	110.070
o	900.810	ALPHA	.000	BETA	.000
□		DALPHA	5.000	DBETA	-20.000
		Y	.000	PC-MBR	.000

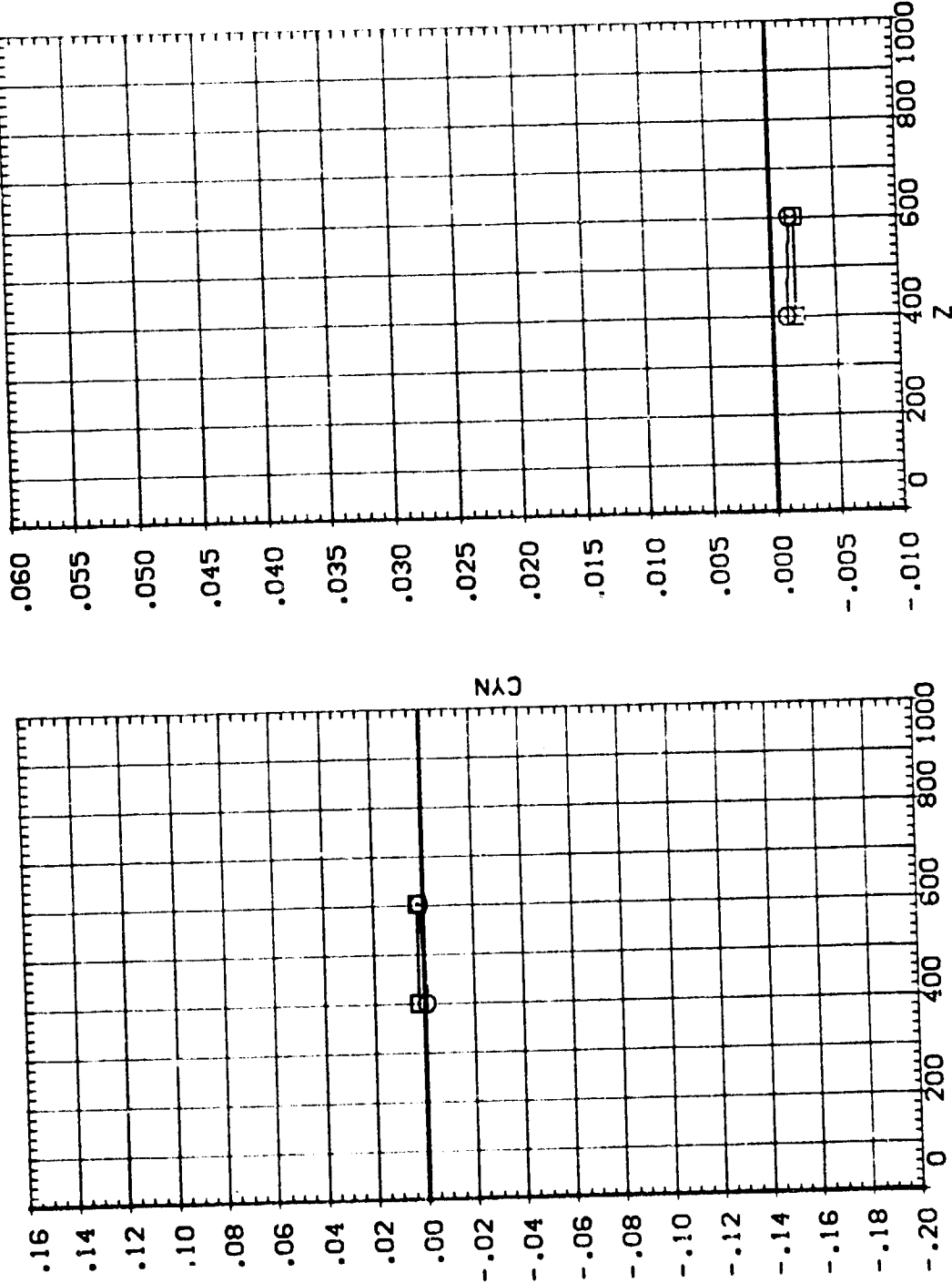

EFFECT OF SRB W/O PLUMES SEPARATION ON ORB/ET AERODYNAMIC CHARACTERISTICS

IA13 SRB(S8) W/O PLUMES SEPARATING FROM 09T10 (RTJ185)

SEE THE ASSOCIATED DATA DOCUMENT FOR REFERENCE CHARACTERISTICS FOR INDIVIDUAL DATASETS

SYMBOL		PARAMETRIC VALUES			
C	.237	MACH	4.530	PTOTAL	110.000
		ALPHA	.000	BETA	.000
		DALPHA	-5.000	DBETA	5.000
		Y	.000	PC#EBR	.000

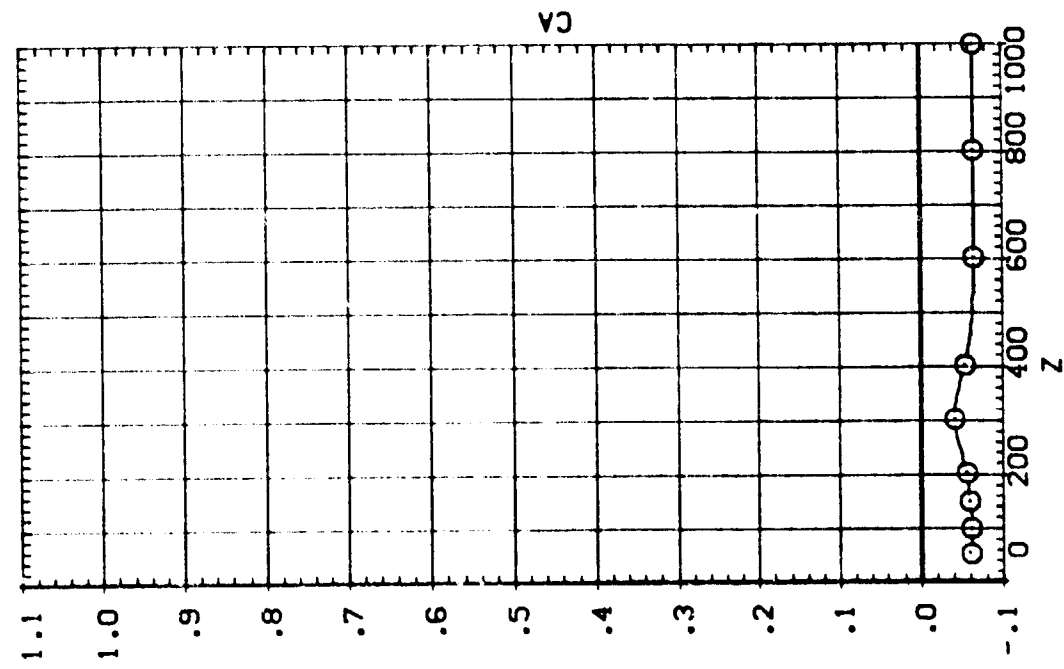
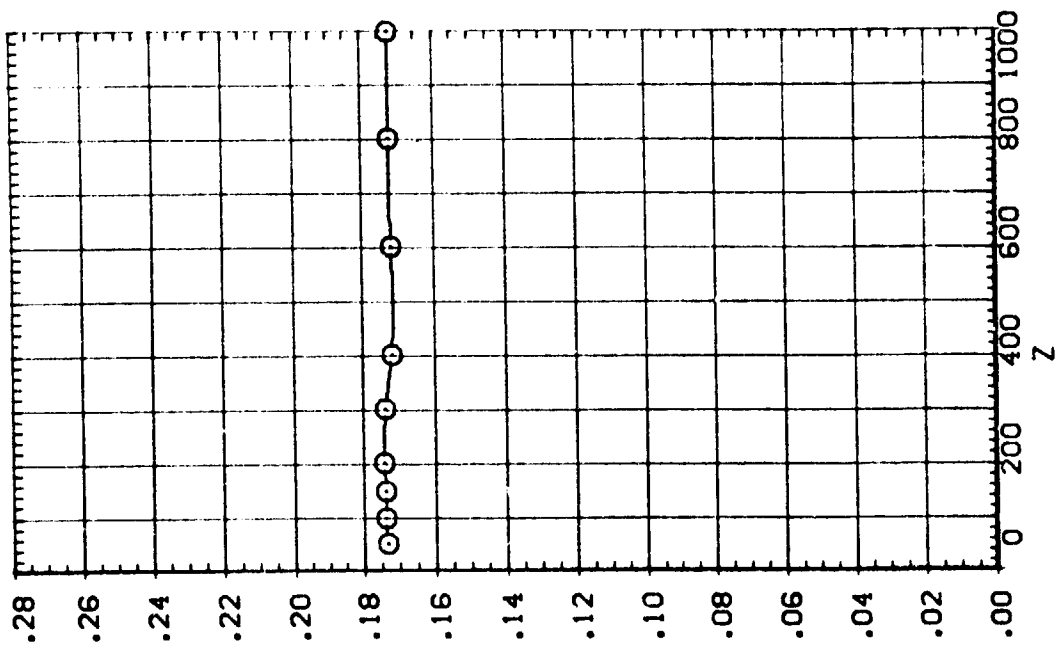

EFFECT OF SRB W/O PLUMES SEPARATION ON ORB/ET AERODYNAMIC CHARACTERISTICS

IA13 SRB(S8) W/O PLUMES SEPARATING FROM 09T10 (RTJ185)

SEE THE ASSOCIATED DATA DOCUMENT FOR REFERENCE CHARACTERISTICS FOR INDIVIDUAL DATASETS

SYMBOL		PARAMETRIC VALUES			
O	X	MACH	4.530	PITOTAL	110.000
		ALPHA	.000	BETA	.000
		DALPHA	-5.000	DBETA	5.000
		Y	.000	PCMBER	.000

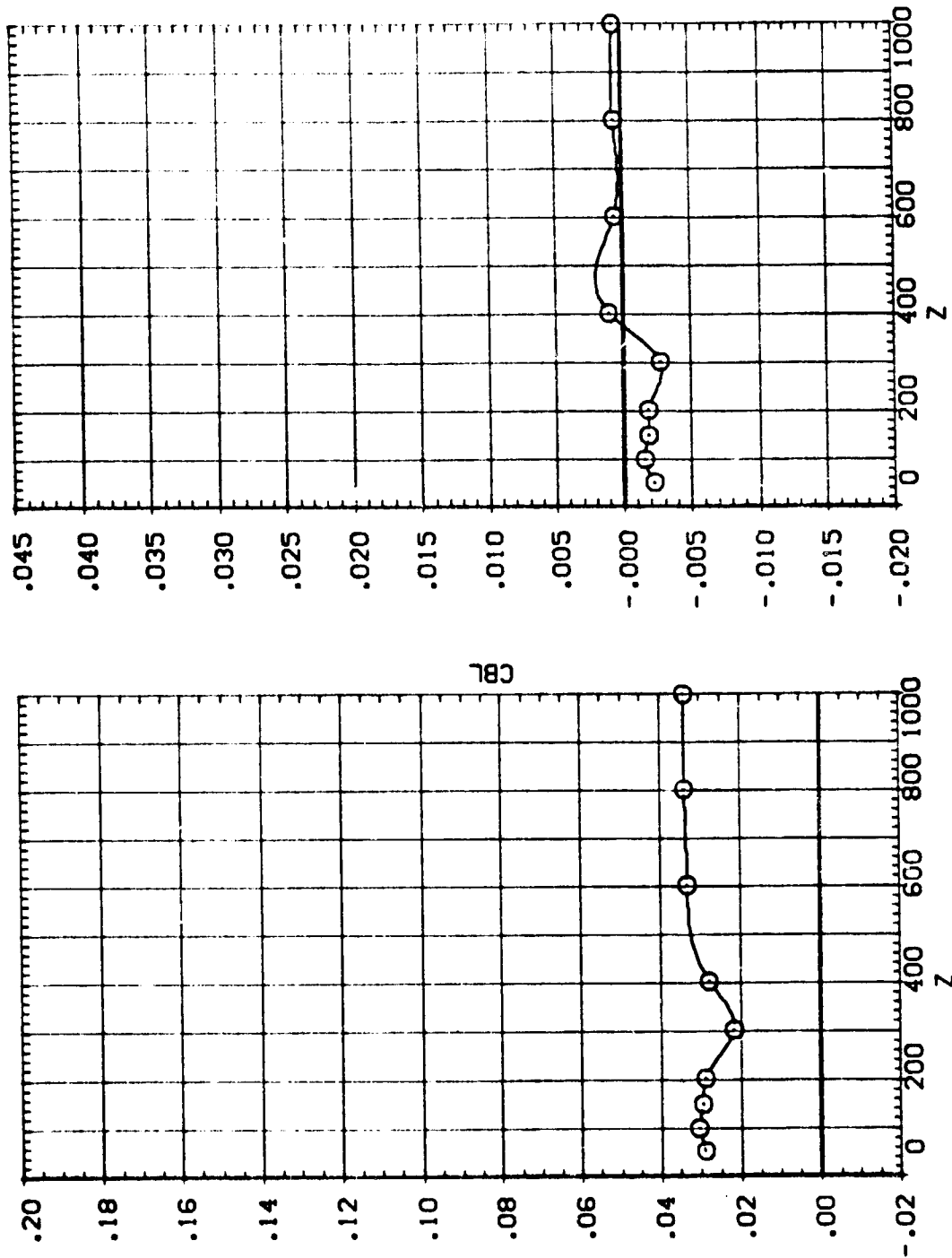

EFFECT OF SRB W/O PLUMES SEPARATION ON ORB/ET AERODYNAMIC CHARACTERISTICS

IA13 SRB(S8) W/O PLUMES SEPARATING FROM 09T10 (RTJ185)

S-HBDL X .237
 PARAMETRIC VALUES
 4.530 PTOTAL 110.000
 .000 ALPHA BETA .000
 -5.000 DALPHA DBETA 5.000
 .000 Y PC-HBR .000

SEE THE ASSOCIATED DATA DOCUMENT FOR REFERENCE CHARACTERISTICS FOR INDIVIDUAL DATASETS

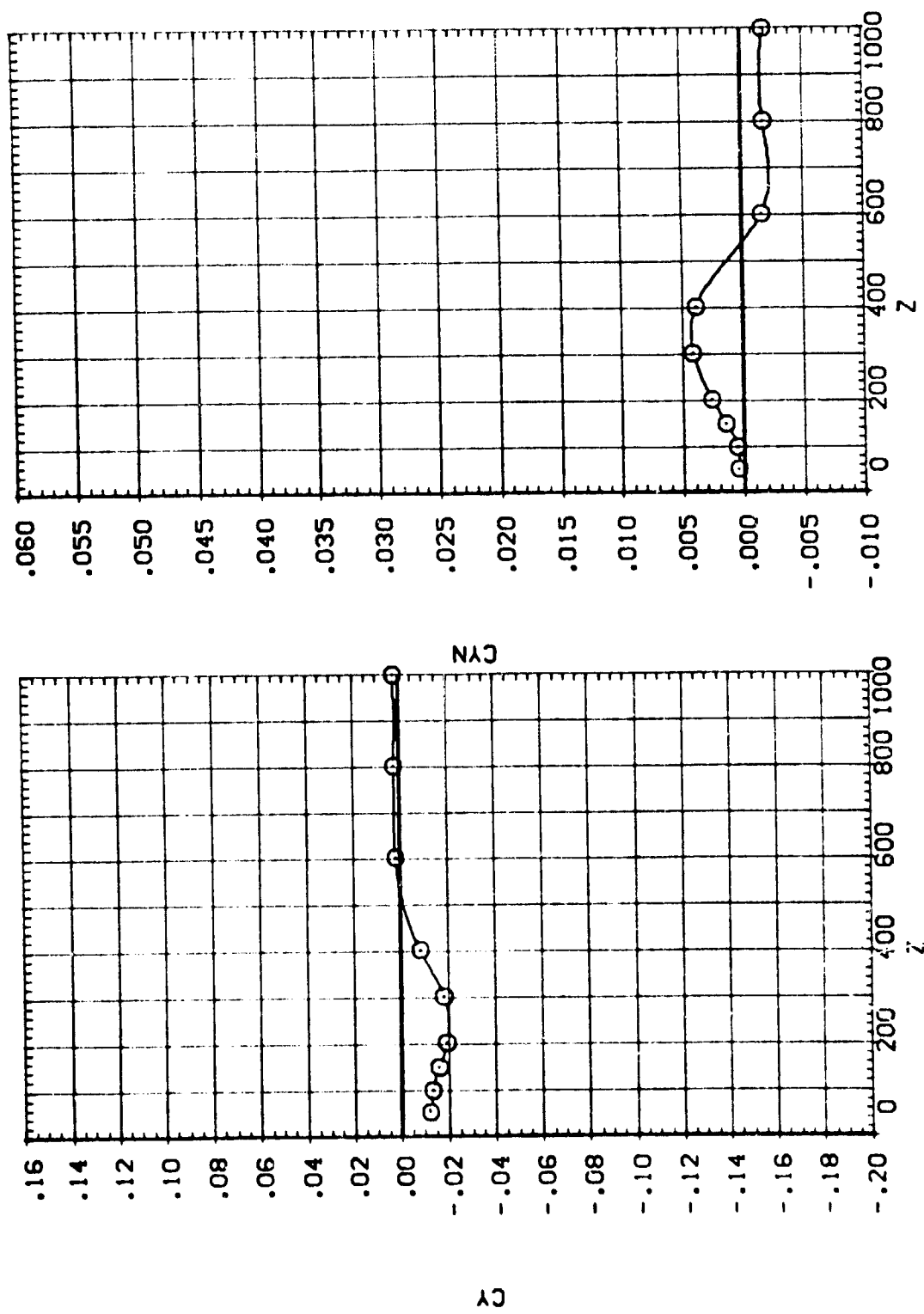

IA13 SRB(SB) W/O PLUMES SEPARATING FROM 09T10 (RTJ186)

SEE THE ASSOCIATED DATA DOCUMENT FOR REFERENCE CHARACTERISTICS FOR INDIVIDUAL DATASETS

PARAMETRIC VALUES
 MAC-1 4.530 P/TOTAL 110.000
 ALPHA .000 BETA .000
 DALPHA -5.000 DBETA 5.000
 Y 200.000 PC-MBR .000

SYMBOL x .216
 ○

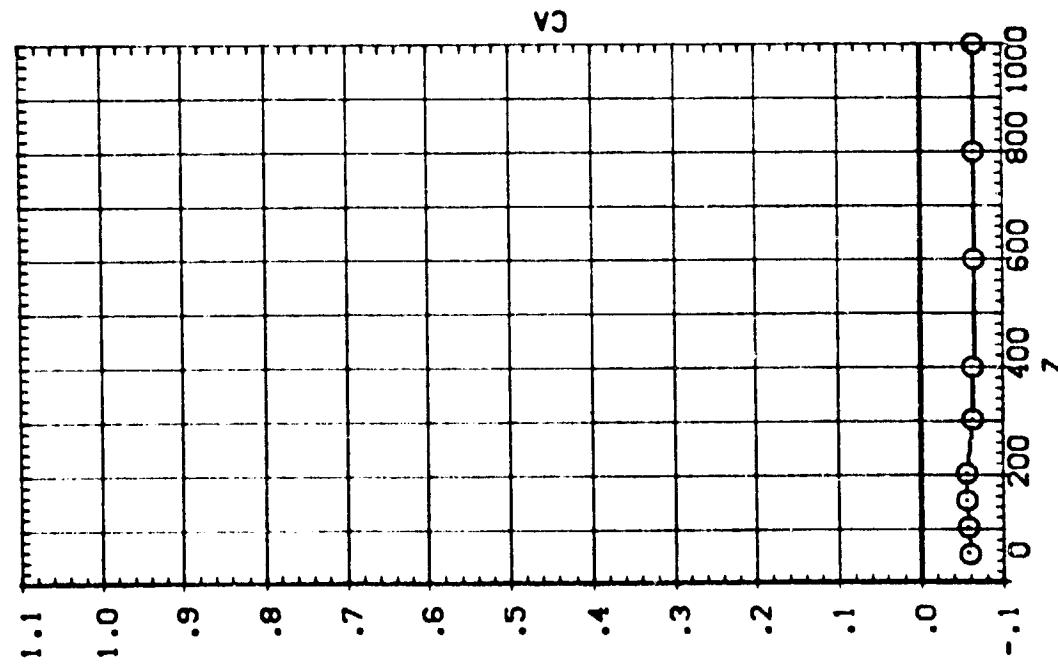
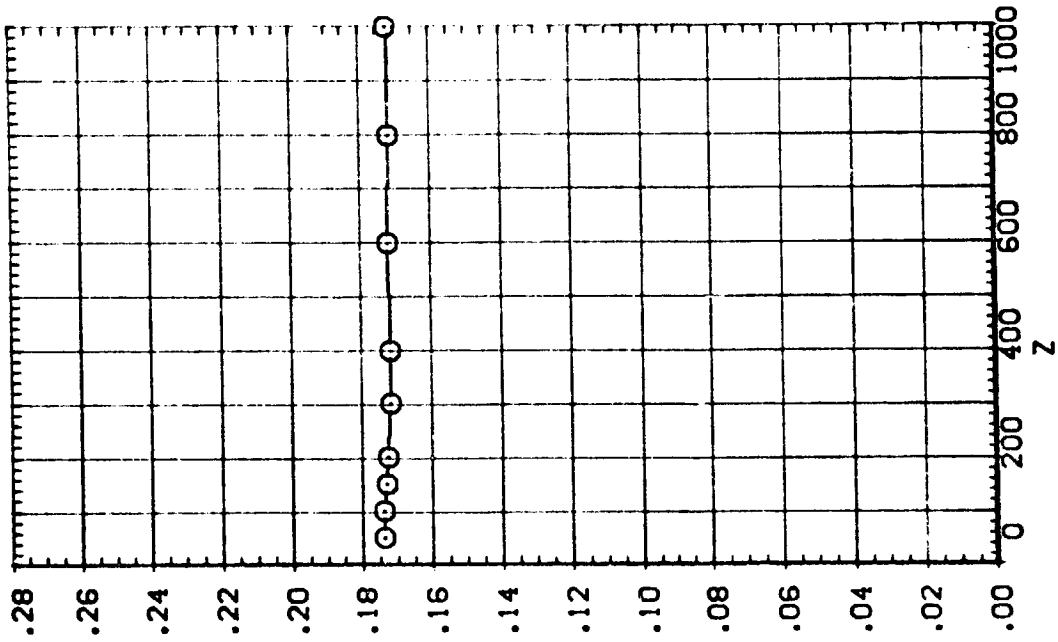

EFFECT OF SRB W/O PLUMES SEPARATION ON ORB/ET AERODYNAMIC CHARACTERISTICS

IA13 SRB(SB) W/O PLUMES SEPARATING FROM 09T10 (RTJ186)

SEE THE ASSOCIATED DATA DOCUMENT FOR REFERENCE CHARACTERISTICS FOR INDIVIDUAL DATASETS

SYMBOL	X	MACH	PARAMETRIC VALUES
○	.216	4.530	POTAL 110.000
		ALPHA .000	BETA .000
		DALPHA -5.000	DBETA 5.000
		Y 200.000	PC-MBR .000

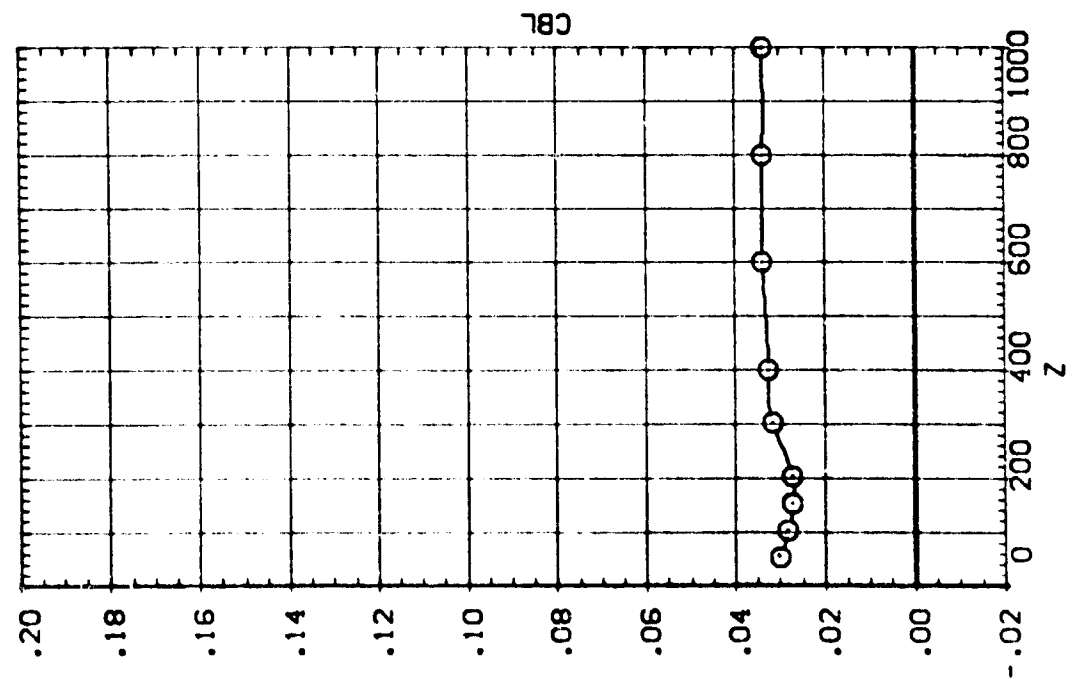
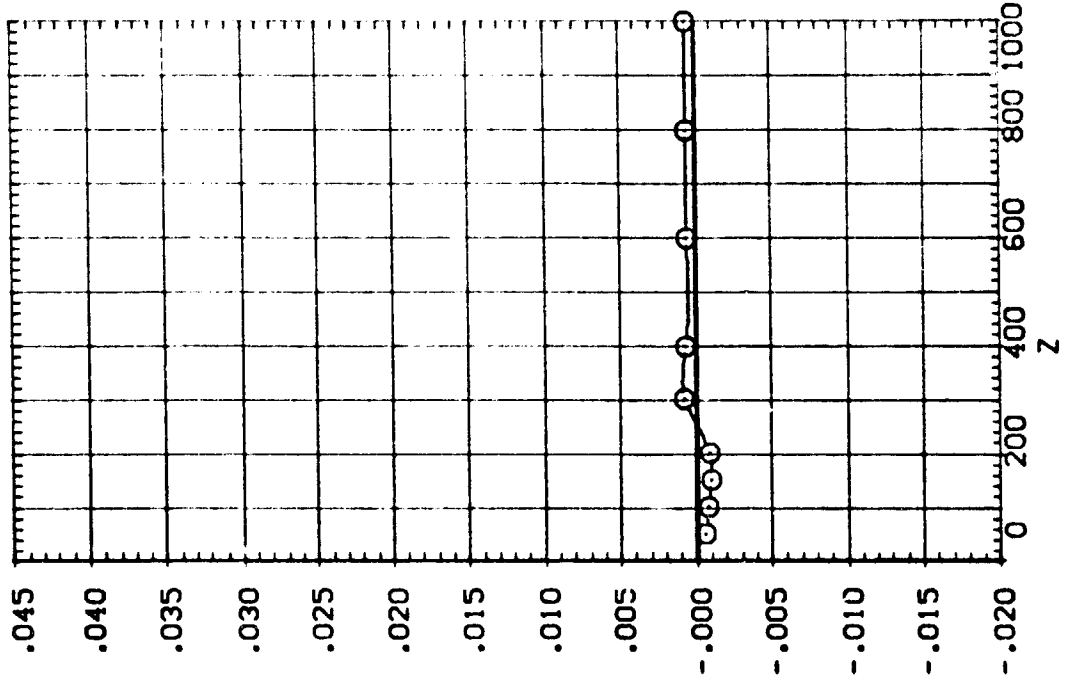

[A13 SRB(S8) W/O PLUMES SEPARATING FROM 09T10 (RTJ186)]

SEE THE ASSOCIATED DATA DOCUMENT FOR REFERENCE CHARACTERISTICS FOR INDIVIDUAL DATASETS

SYMBOL \circ .216 MACH .530 PTOTAL 110.000
 ALPHA .000 BETA .000
 DA/PHA -5.000 DBETA 5.000
 Y 200.000 PC+6R .000

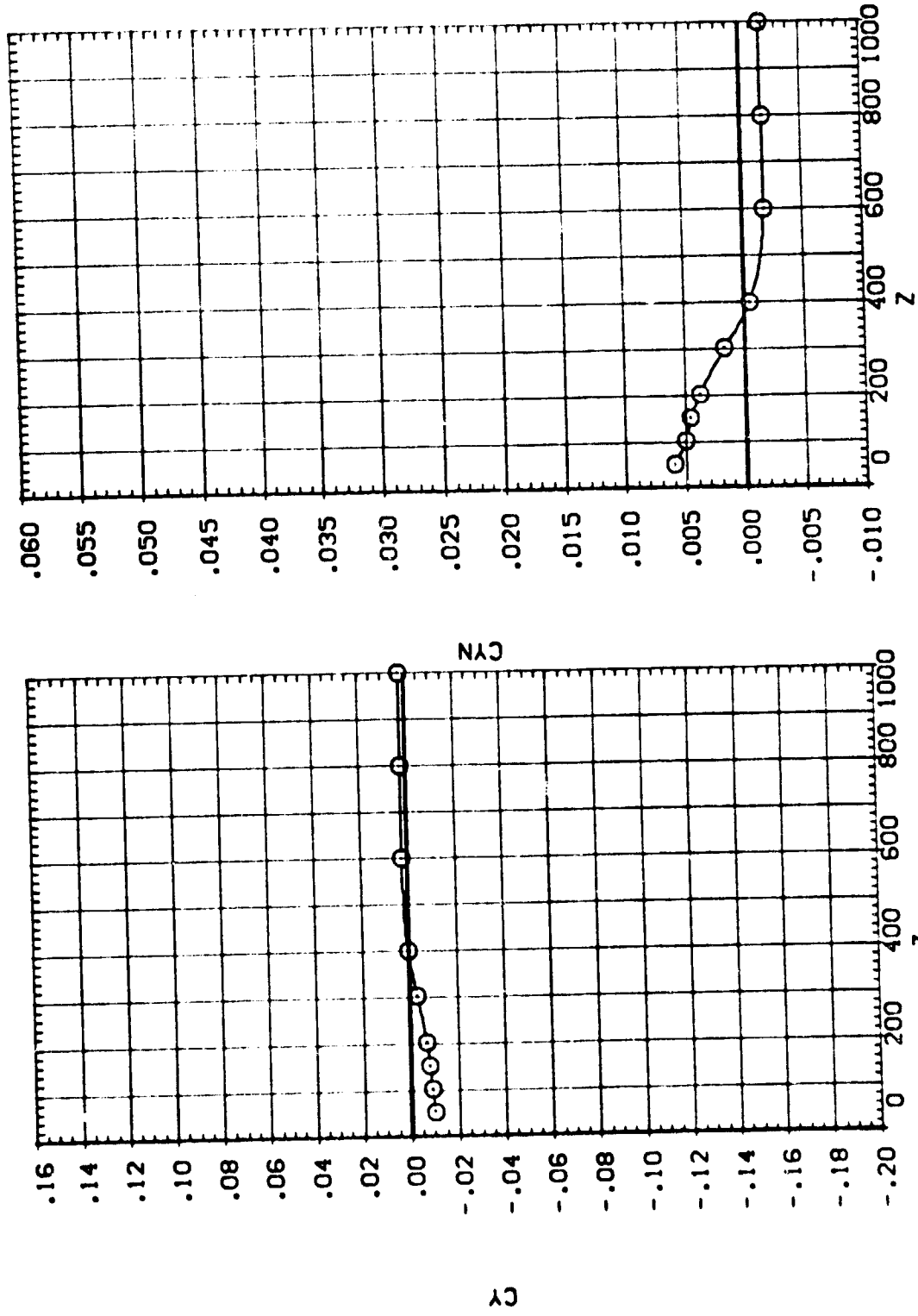

IA13 SRB(S8) W/O PLUMES SEPARATING FROM 09T10 (RTJ187)

SEE THE ASSOCIATED DATA DOCUMENT FOR REFERENCE CHARACTERISTICS FOR INDIVIDUAL DATASETS

SYMBOL		PARAMETRIC VALUES				
○	X	.013	MACH	4.530	PTOTAL	110.000
□	900.650	.000	ALPHA	.000	BETA	.000
		-5.000	DBETA	5.000	PC+PBR	.000
	Y	.000				

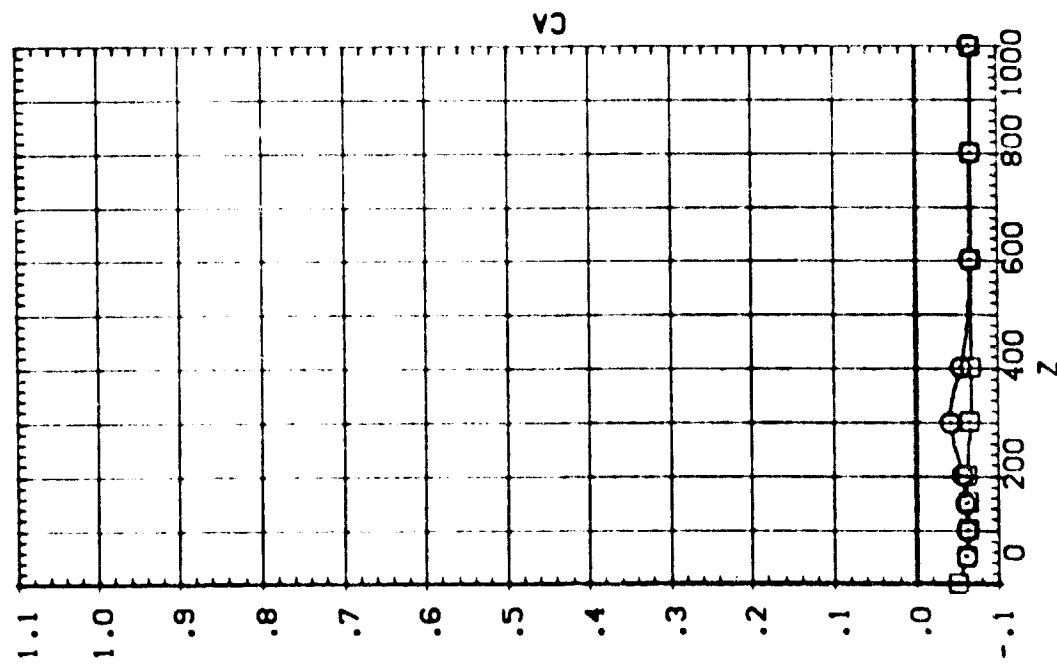
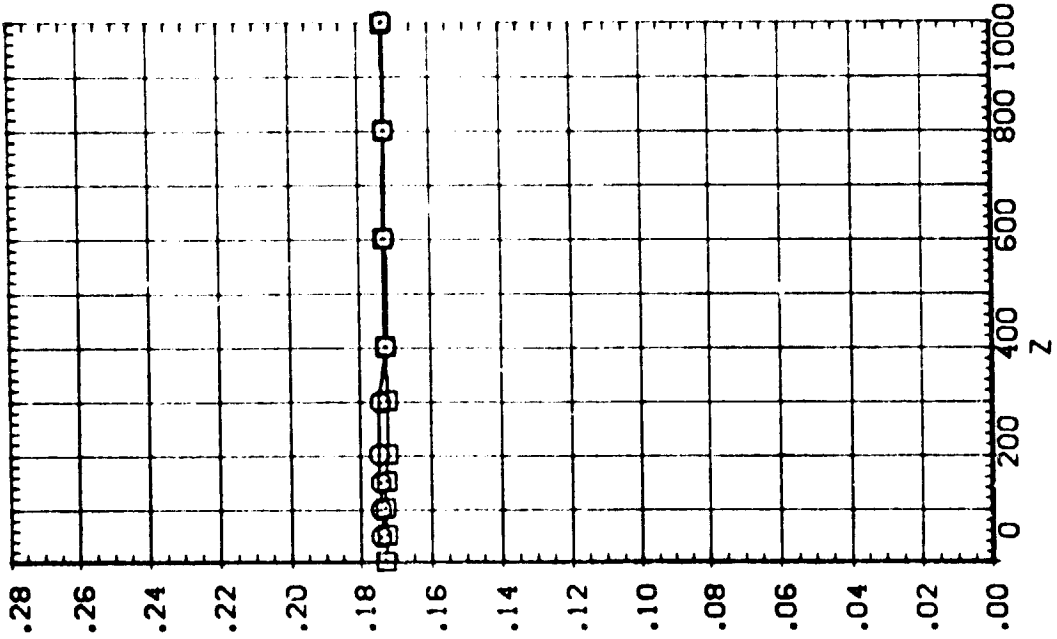

IA13 SRB(S8) W/O PLUMES SEPARATING FROM 09T10 (RTJ:187)

SEE THE ASSOCIATED DATA DOCUMENT FOR REFERENCE CHARACTERISTICS FOR INDIVIDUAL DATASETS

SYMBOL X
 ○
 □

PARAMETRIC VALUES
 MACH .013 PTOTAL 110.000
 ALPHA .000 BETA .000
 DALPHA -5.000 DBETA 5.000
 Y .000 PO-MBR .000

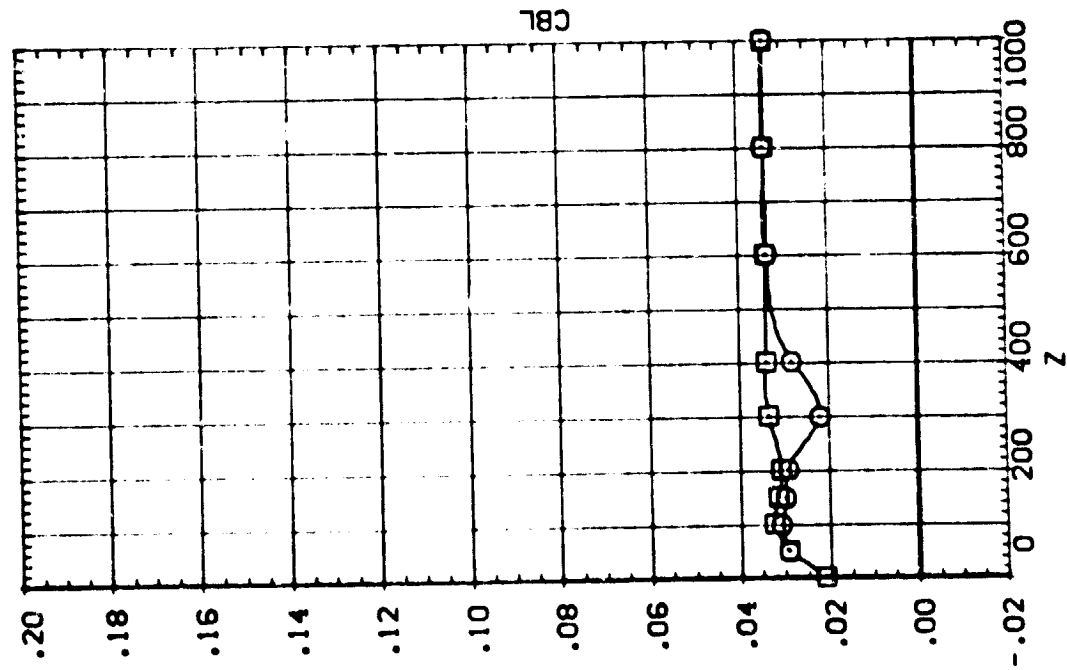
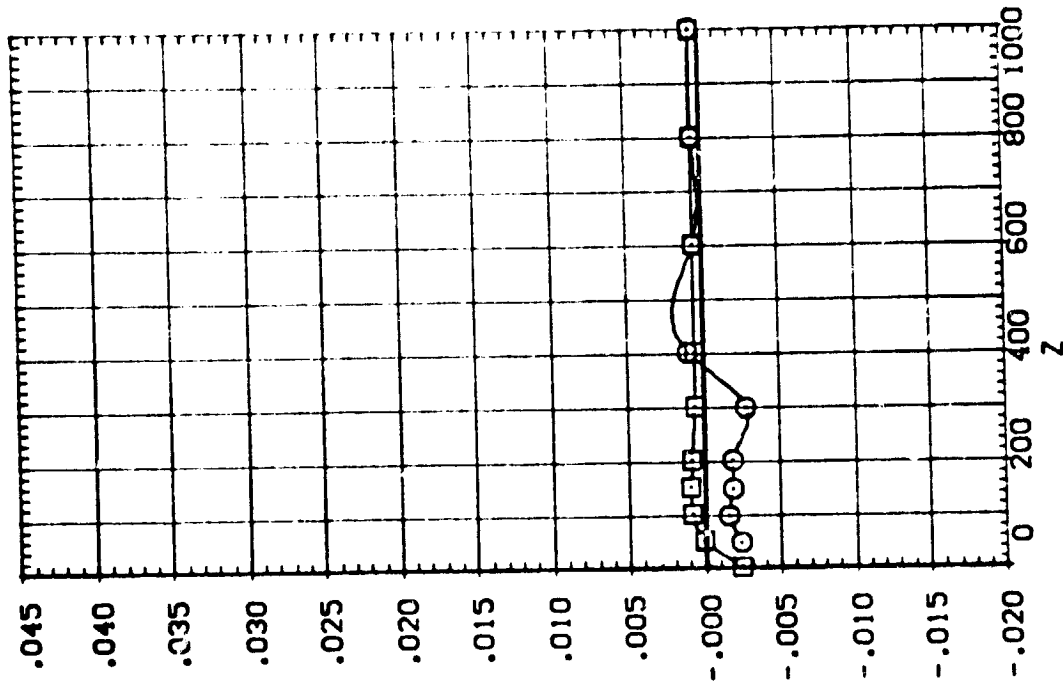

EFFECT OF SRB W/O PLUMES SEPARATION ON ORB/ET AERODYNAMIC CHARACTERISTICS

1A13 SRB(S8) W/O PLUMES SEPARATING FROM 09T10 (RTJ187)

SEE THE ASSOCIATED DATA DOCUMENT FOR REFERENCE CHARACTERISTICS FOR INDIVIDUAL DATASETS

SYMBOL		PARAMETRIC VALUES			
x	.013	MACH	4.530	P/TOTAL	110.000
o	900.650	ALPHA	.000	BETA	.000
□		DALPHA	5.000	DBETA	5.000
		Y	.000	PCMBR	.000

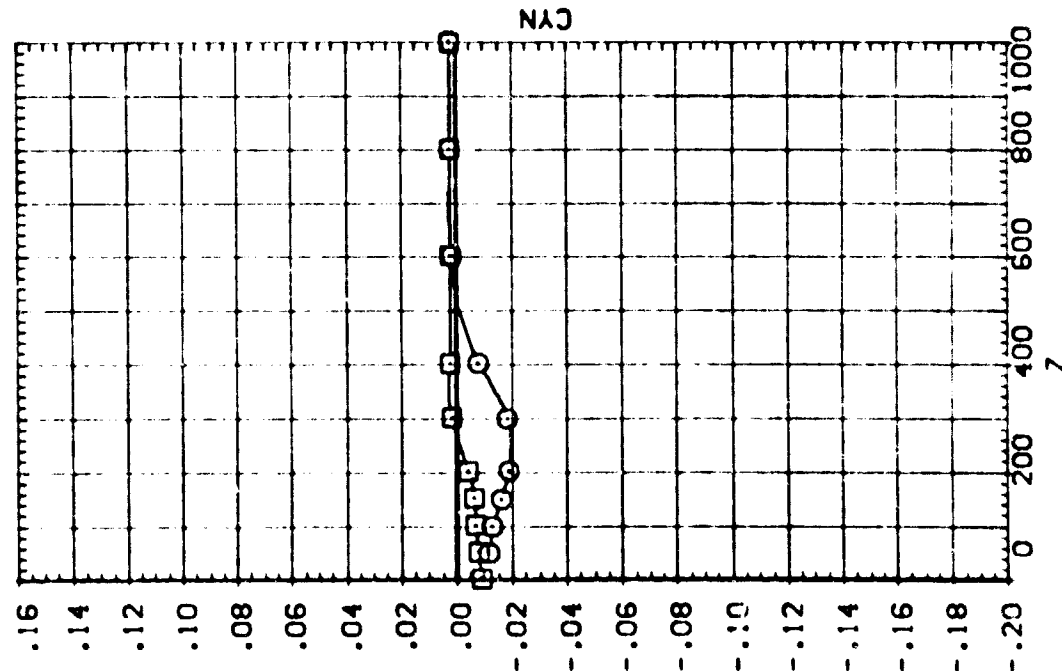
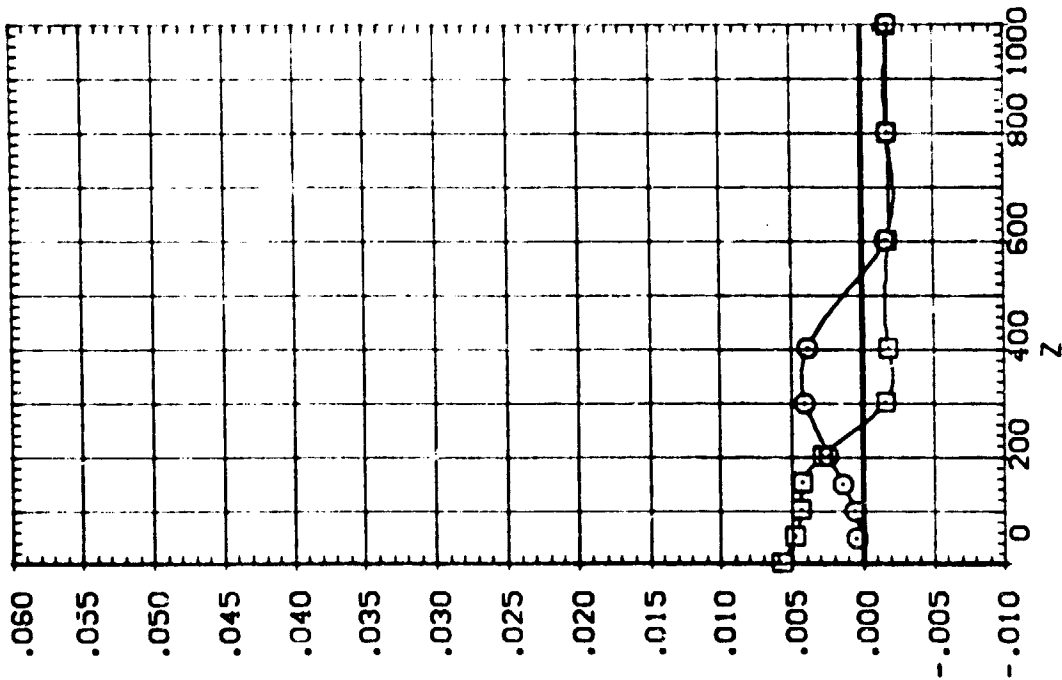

IA13 SRB(SB) W/O PLUMES SEPARATING FROM 09T10 (RTJ188)

SEE THE ASSOCIATED DATA DOCUMENT FOR REFERENCE CHARACTERISTICS FOR INDIVIDUAL DATASETS

PARAMETRIC VALUES
 4.530 PTOTAL 110.000
 .000 BETA .000
 -5.000 DBETA 5.000
 200.000 PC+SR .000

MACH .142
 ALPHA
 DALPHA
 Y

SYMBOL X
 ○
 □

900.58C

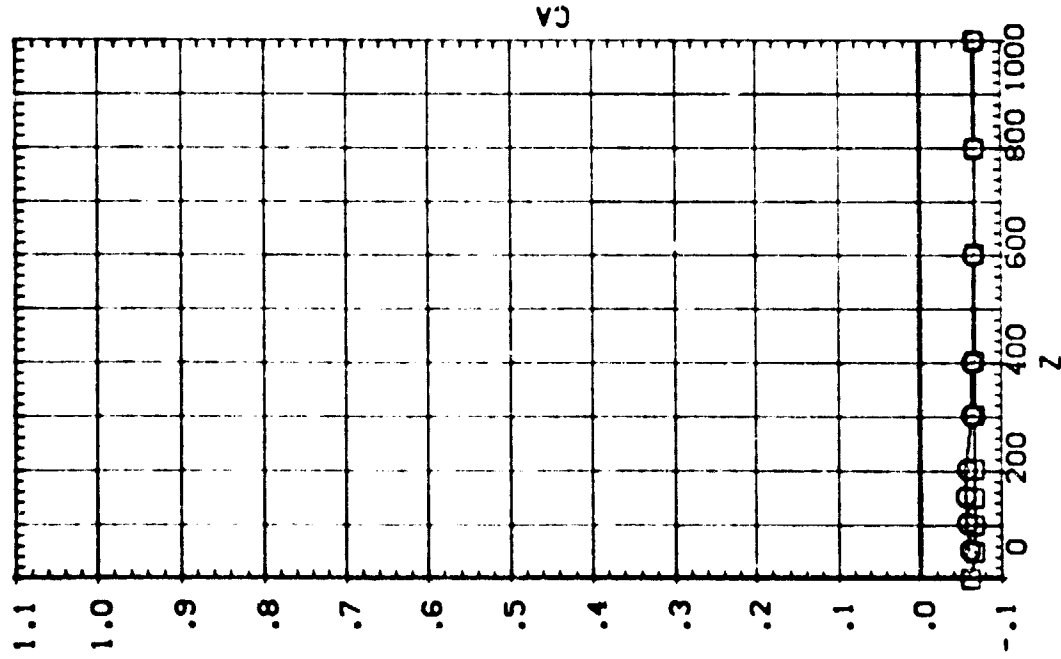
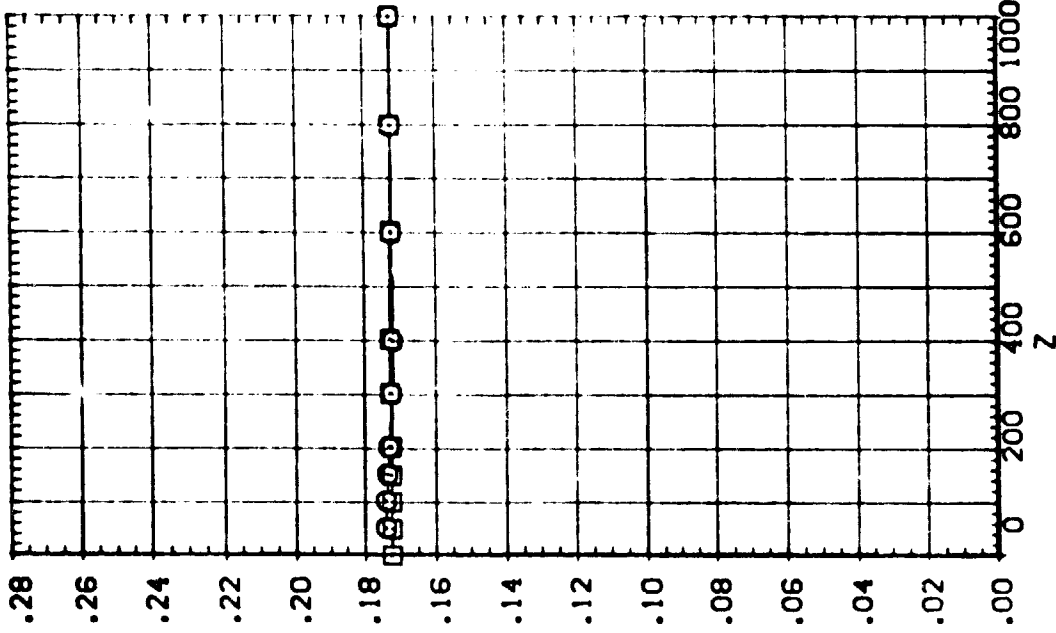

EFFECT OF SRB W/O PLUMES SEPARATION ON 09T10 AERODYNAMIC CHARACTERISTICS

1A13 SRB(SB) W/O PLUMES SEPARATING FROM 09T10 (RTJ188)

SYMBOL
 ○
 □

X	.142	MACH	4.530	PITOTAL	110.000
900.580	.000	ALPHA	-5.000	BETA	5.000
		DALPHA	200.000	PCMBR	.000
Y					

SEE THE ASSOCIATED DATA DOCUMENT FOR REFERENCE CHARACTERISTICS FOR INDIVIDUAL DATASETS

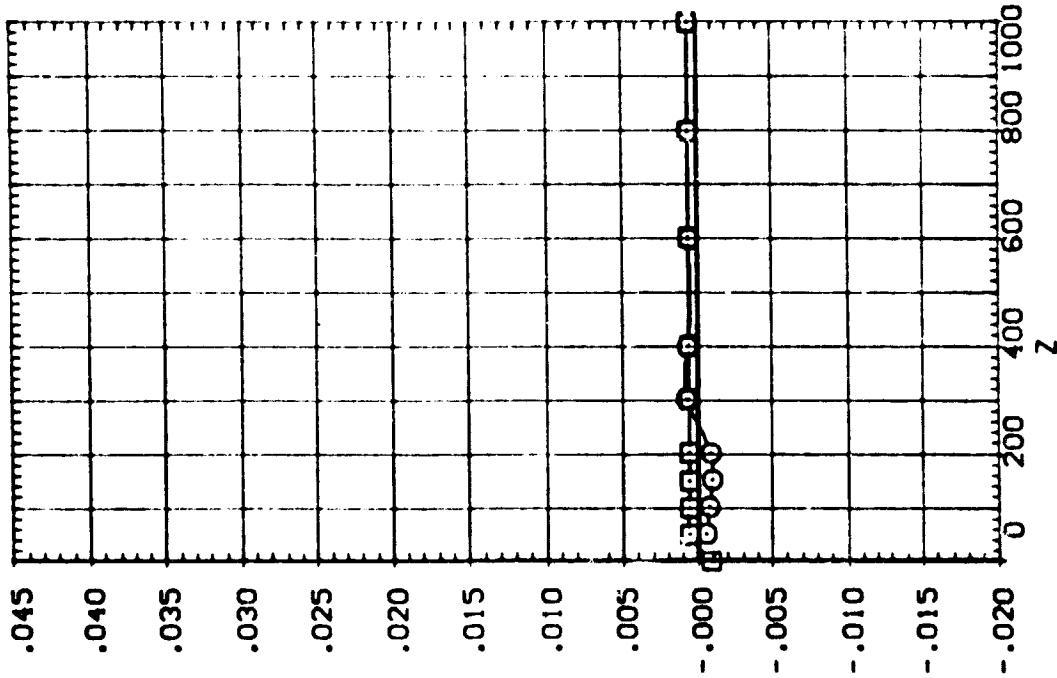
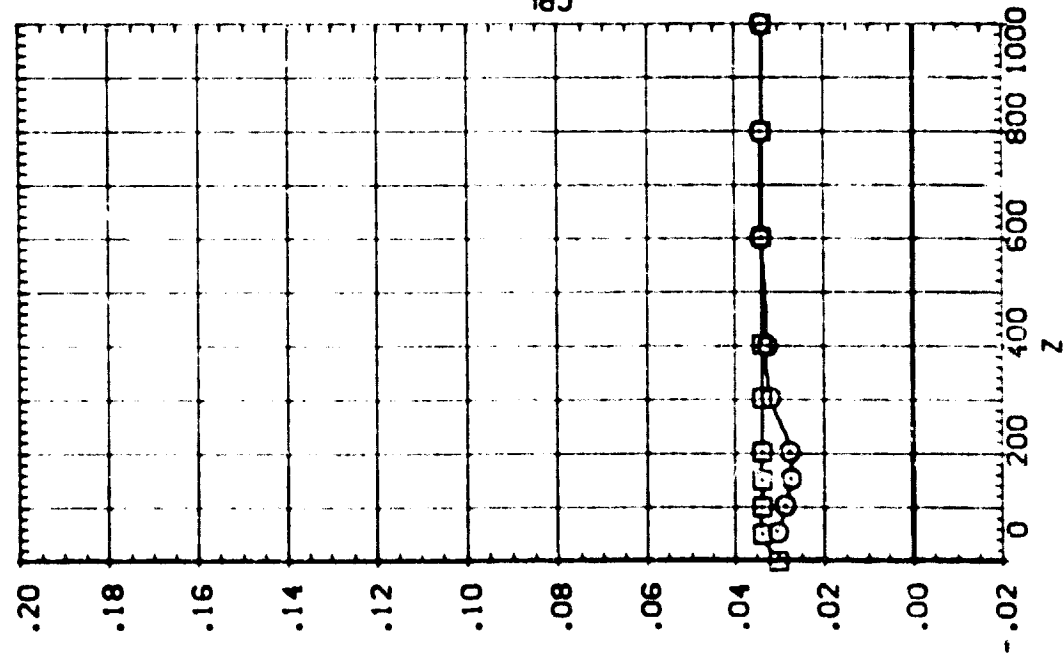

IA13 SRB(S9) W/O PLUMES SEPARATING FROM 09T10 (RTJ188)

SEE THE ASSOCIATED DATA DOCUMENT FOR REFERENCE CHARACTERISTICS FOR INDIVIDUAL DATASETS

SYMBOL	X	MACH	PARAMETRIC VALUES
○	.142	4.530	PTOTAL 110.000
□	500.580	.000	ALPHA .000
		-5.000	BETA 5.000
		250.000	POWER .000

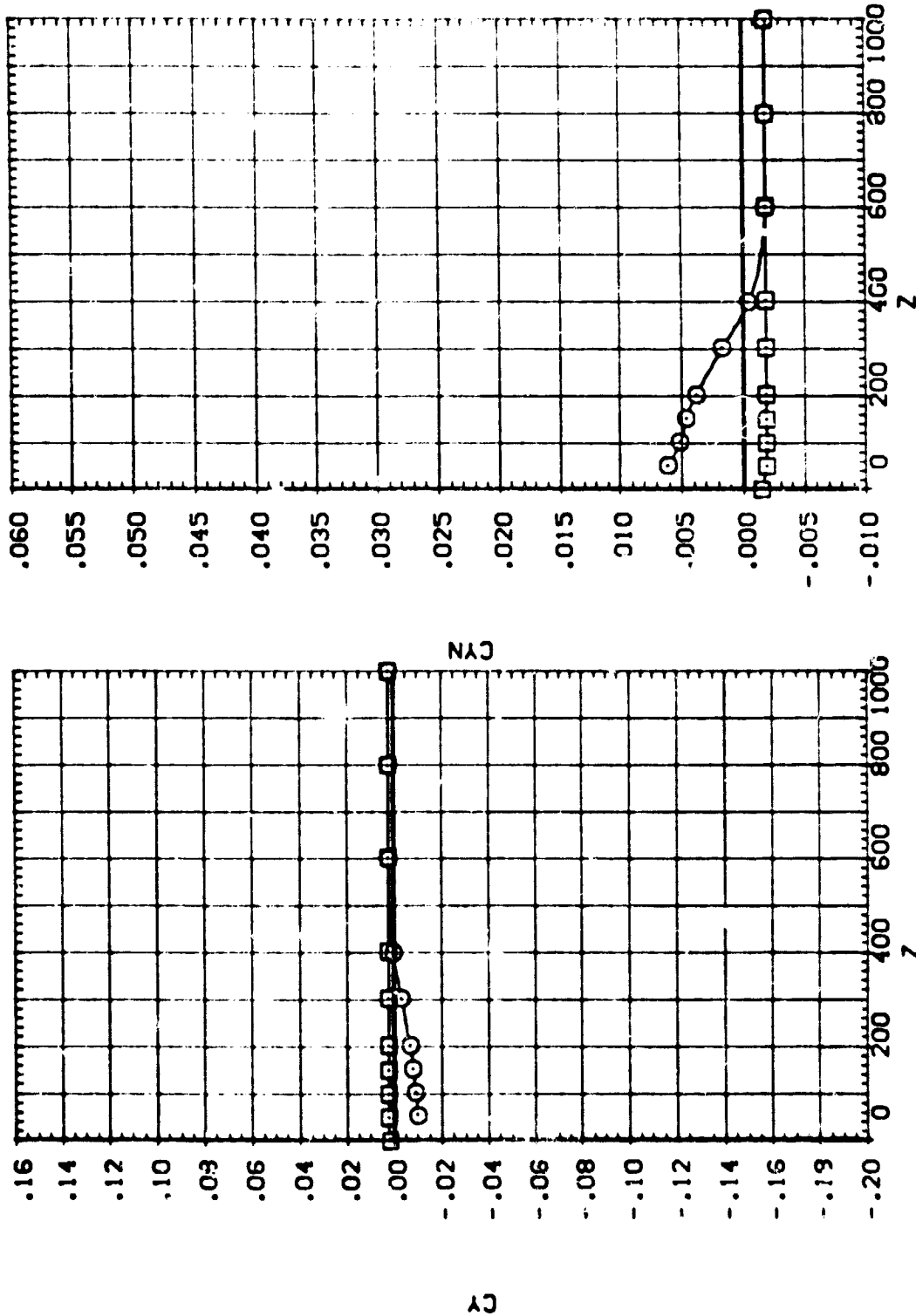

EFFECT OF SRB W/O PLUMES SEPARATION ON ORB/ET AERODYNAMIC CHARACTERISTICS

IA13 SRB(SB) W/O PLUMES SEPARATING FROM 09T10 (RTJ189)

SEE THE ASSOCIATED DATA DOCUMENT FOR REFERENCE CHARACTERISTICS FOR INDIVIDUAL DATASETS

SYMBOL	X	MACH	PARAMETRIC VALUES
○	.219	4.530	PISTAL 110.000
□	900.570	ALPHA .000	BETA .000
		DELTA -5.000	DBETA 5.000
		Y 400.000	PC-MBR .000

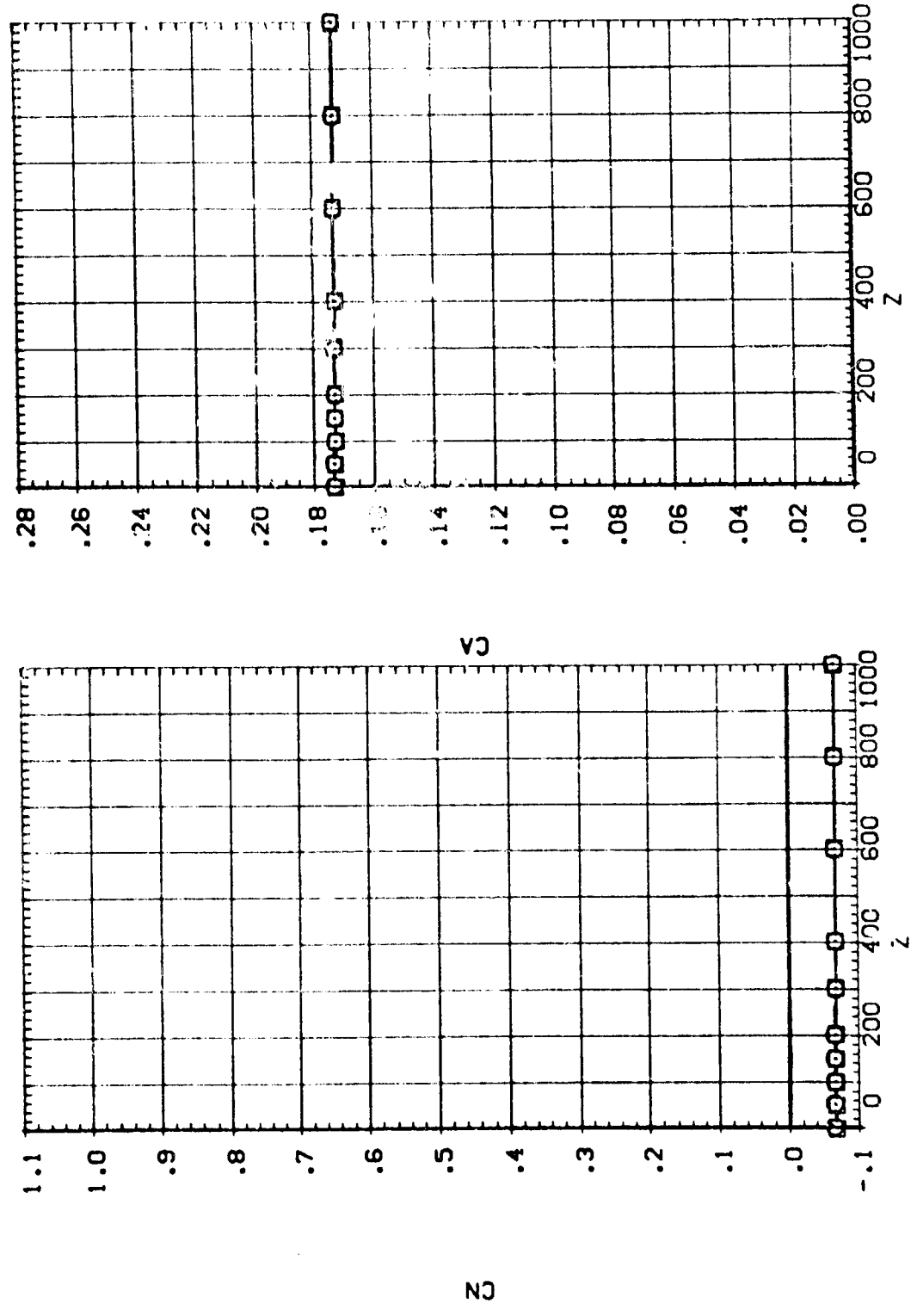

IA13 SRB(S8) W/O PLUMES SEPARATING FROM 09T10 (RTJ189)

SEE THE ASSOCIATED DATA DOCUMENT FOR REFERENCE CHARACTERISTICS FOR INDIVIDUAL DATASETS

PARAMETRIC VALUES
 MACH 4.530 P/TOTAL 110.000
 ALPHA .000 BETA .000
 DALPHA -5.000 DBETA 5.000
 Y 400.000 PC-MBR .000

SYMBOL X
 ○ .219
 □ 900.570

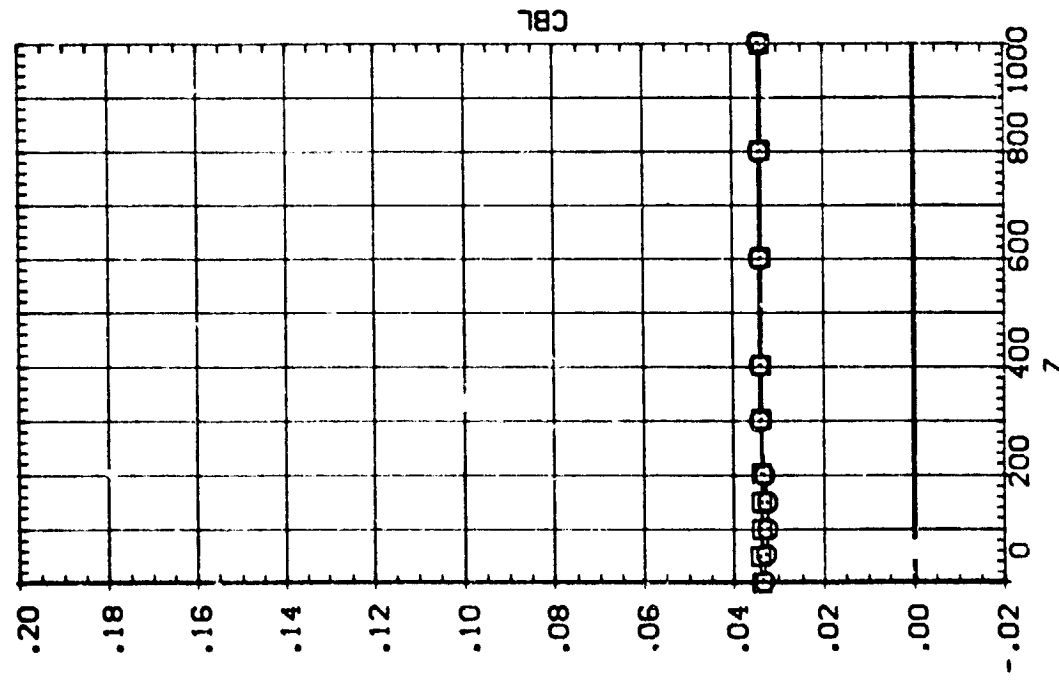
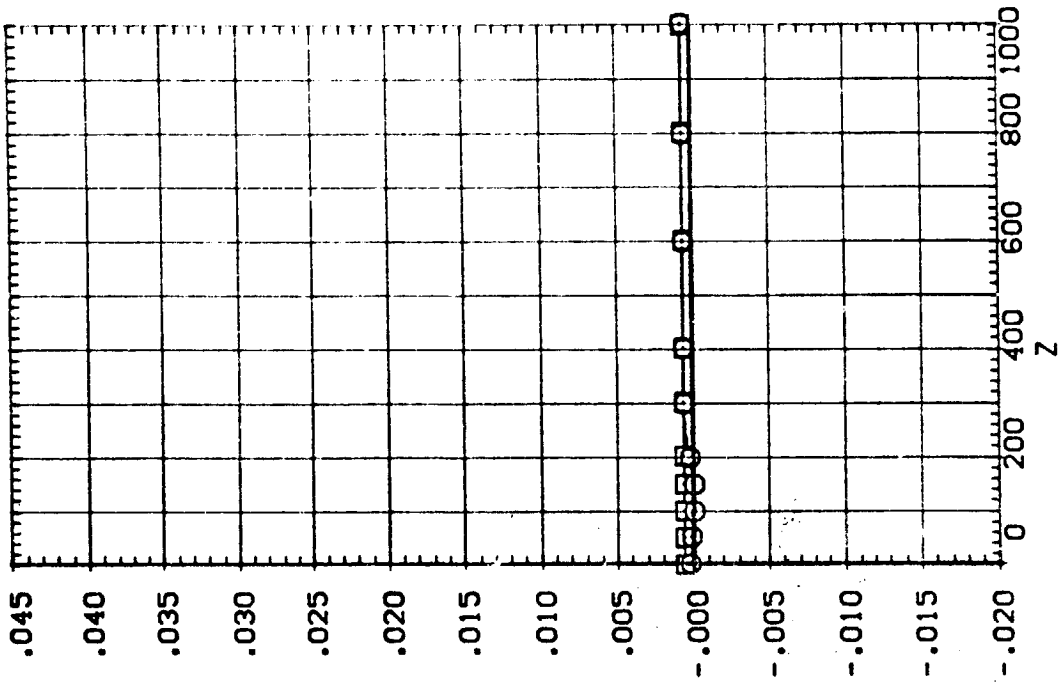

EFFECT OF SRB W/O PLUMES SEPARATION ON ORB/ET AERODYNAMIC CHARACTERISTICS

LA13 SRB(S8) W/O PLUMES SEPARATING FROM 09T10 (RTJ189)

SYMBOL

○ □

PARAMETRIC VALUES
 .219 MACH 4.530 PTCAL 110.000
 900.570 ALPHA .000 BETA .000
 DALPHA -5.000 DBETA 5.000
 Y 400.000 PCMBER .000

SEE THE ASSOCIATED DATA DOCUMENT FOR REFERENCE CHARACTERISTICS FOR INDIVIDUAL DATASETS

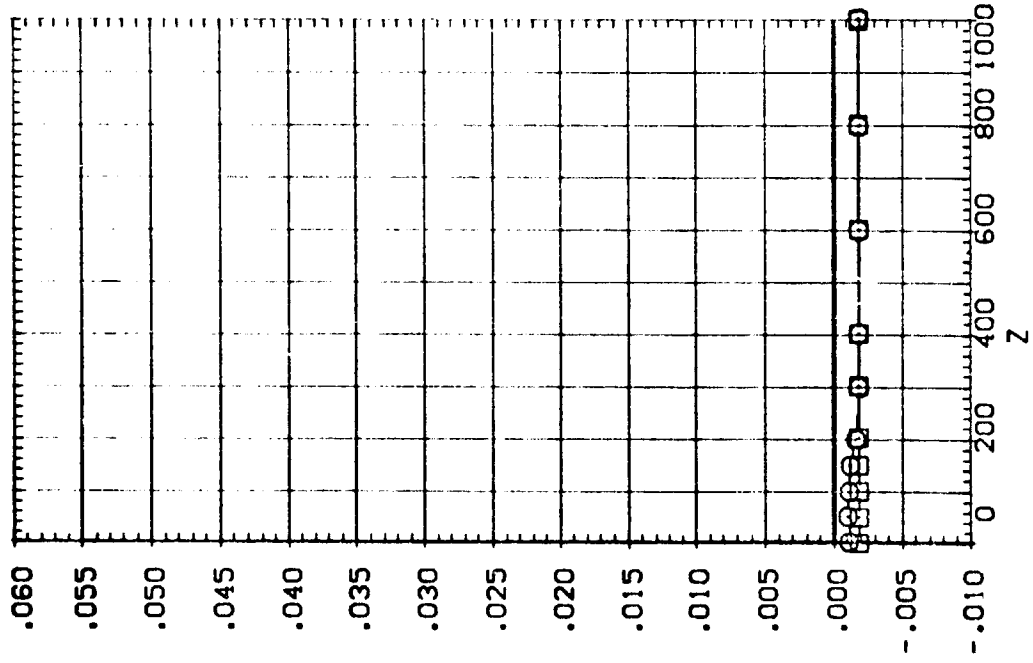
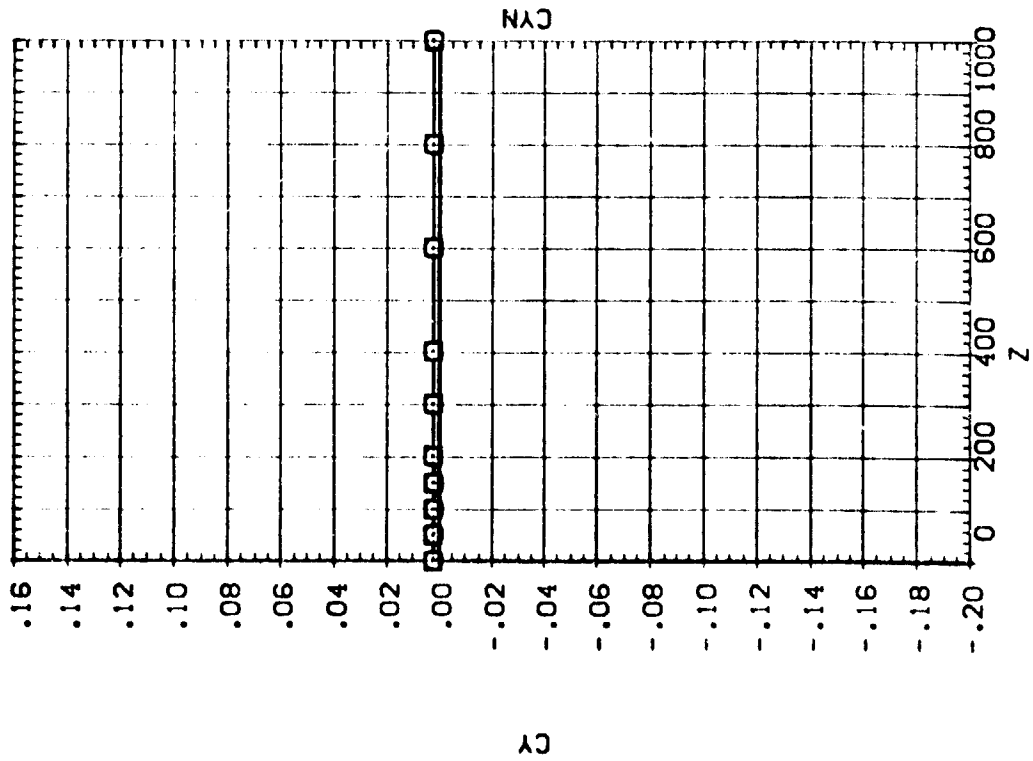

EFFECT OF SRB W/O PLUMES SEPARATION ON 09B/ET AERODYNAMIC CHARACTERISTICS

IA13 SRB(SB) W/O PLUMES SEPARATING FROM 09T10 (RTJ190)

SEE THE ASSOCIATED DATA DOCUMENT FOR REFERENCE CHARACTERISTICS FOR INDIVIDUAL DATASETS

SYMBOL	X	MACH	PARAMETRIC VALUES
○	.191	4.530	P TOTAL 110.000
□	300.330	.000	BETA .000
◇	600.560	-5.000	DBETA -5.000
△	900.500	.000	PC+PBR .000

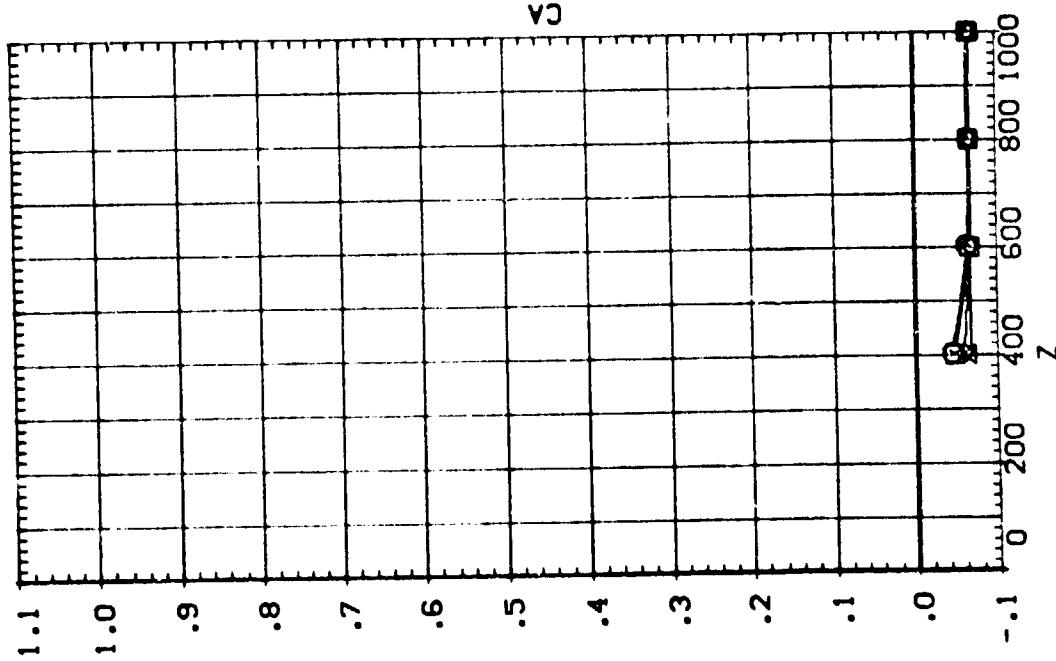
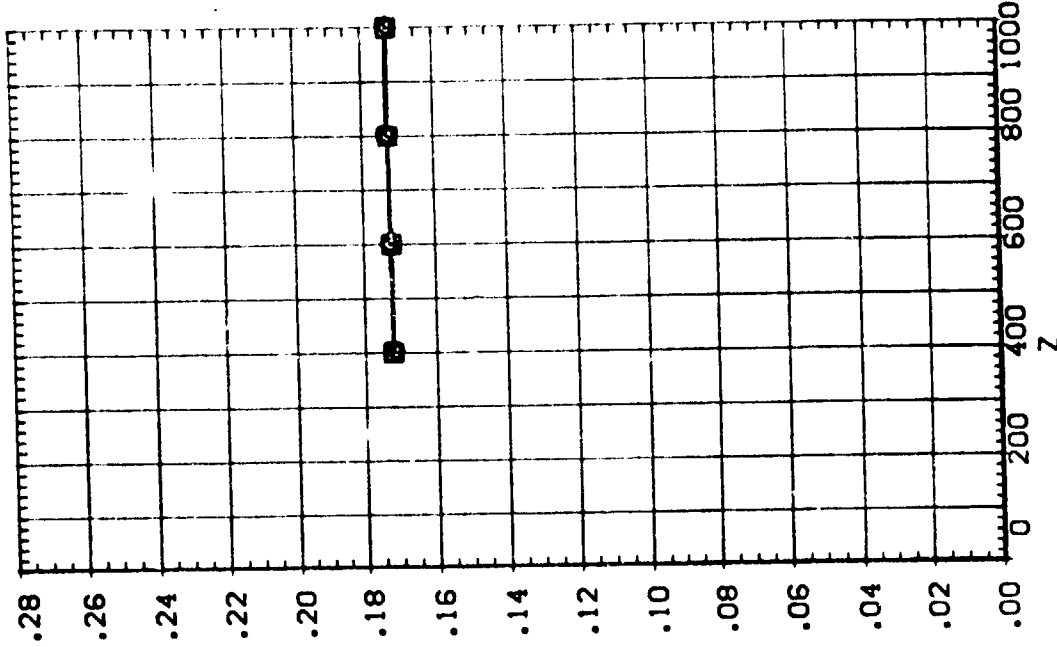

EFFECT OF SRB W/O PLUMES SEPARATION ON ORB/ET AERODYNAMIC CHARACTERISTICS

1:13 SRB(S8) W/O PLUMES SEPARATING FROM 09T10 (RTJ190)

SEE THE ASSOCIATED DATA DOCUMENT FOR REFERENCE CHARACTERISTICS FOR INDIVIDUAL DATASETS

SYMB.	X	MACH	PARAMETRIC VALUES
○	300.330	.491	4.530 P/TOTAL 110.000
□	600.560	.000	BETA .000
◇	900.500	.000	DBETA -5.000
△		.000	PC+PER .000

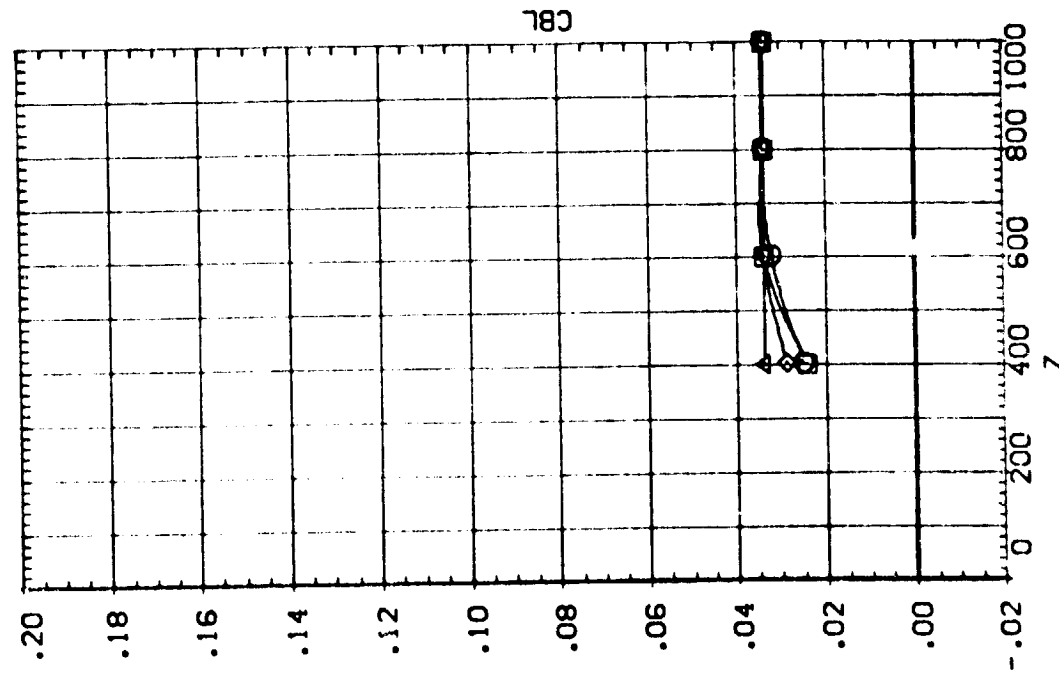
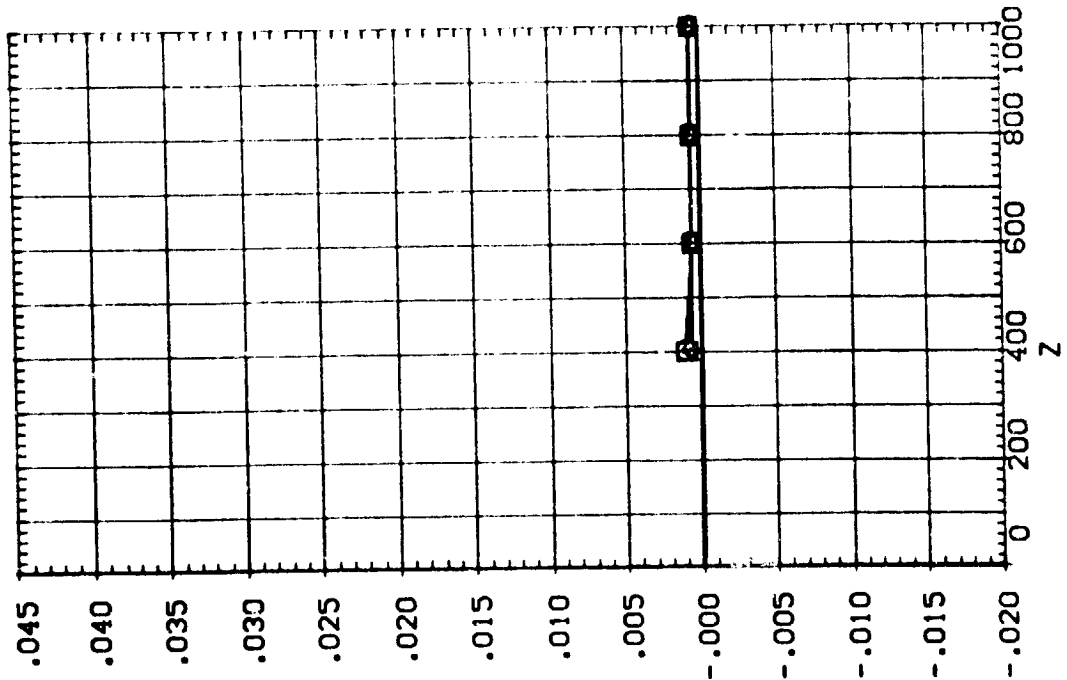

EFFECT OF SRB W/O PLUMES SEPARATION ON ORB/ET AERODYNAMIC CHARACTERISTICS

IA13 SRB(SB) W/O PLUMES SEPARATING FROM 09T10 (RTJ190)

SEE THE ASSOCIATED DATA DOCUMENT FOR REFERENCE CHARACTERISTICS FOR INDIVIDUAL DATASETS

SYMBOL		PARAMETRIC VALUES			
○	.491	MACH	4.530	PTOTAL	110.000
□	300.330	ALPHA	.000	BETA	.000
◇	600.560	DALPHA	-5.000	DBETA	-5.000
△	900.500	Y	.000	PC-MBR	.000

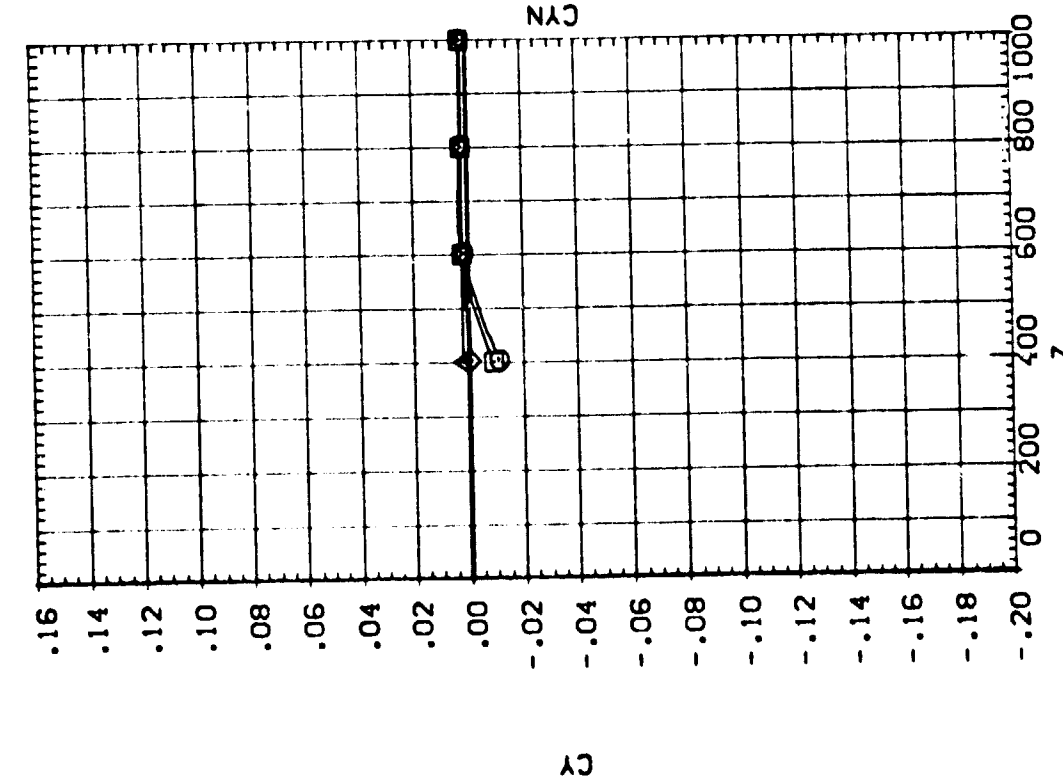
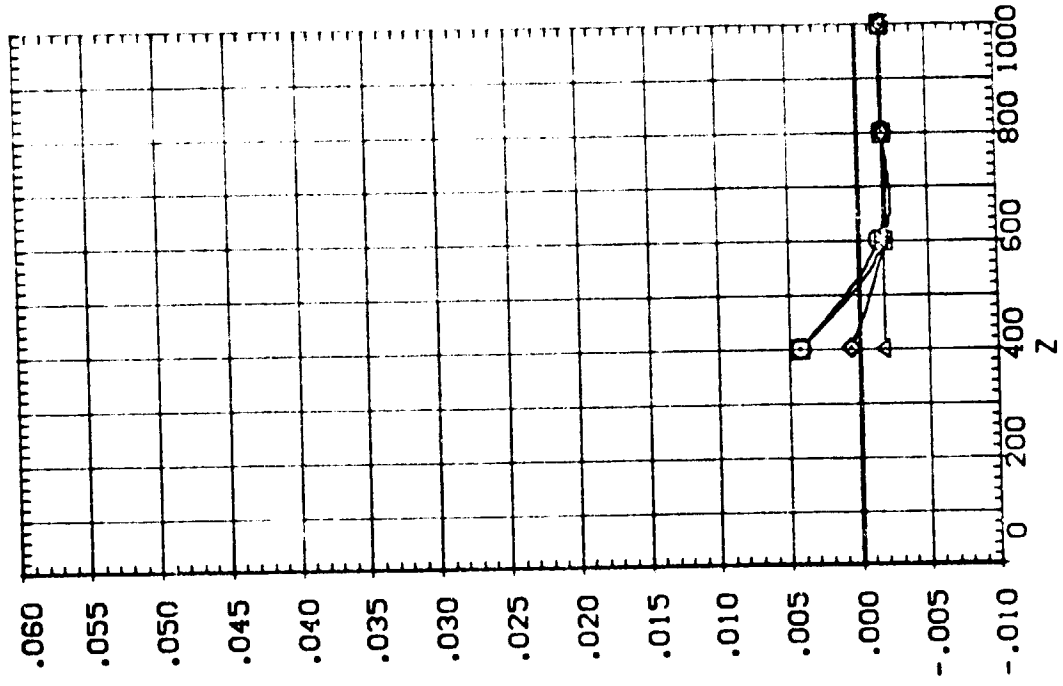

EFFECT OF SRB W/O PLUMES SEPARATION ON ORB/ET AERODYNAMIC CHARACTERISTICS

IA13 SRB(SB) W/O PLUMES SEPARATING FROM 09T10 (RTJ191)

SEE THE ASSOCIATED DATA DOCUMENT FOR REFERENCE CHARACTERISTICS FOR INDIVIDUAL DATASETS

SYMBD.	X	MACH	PARAMETRIC VALUES
○	.324	4.530	P TOTAL 110.000
□	300.230	.000	BETA .000
◇	600.570	-5.000	DBETA -5.000
△	900.600	200.000	PC+MR .000

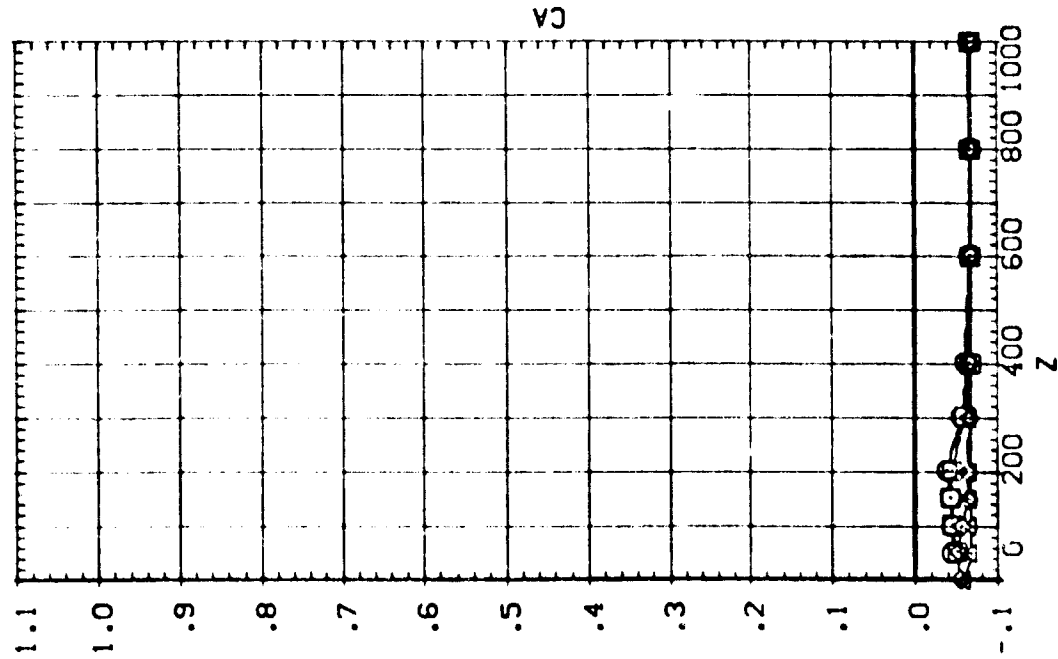
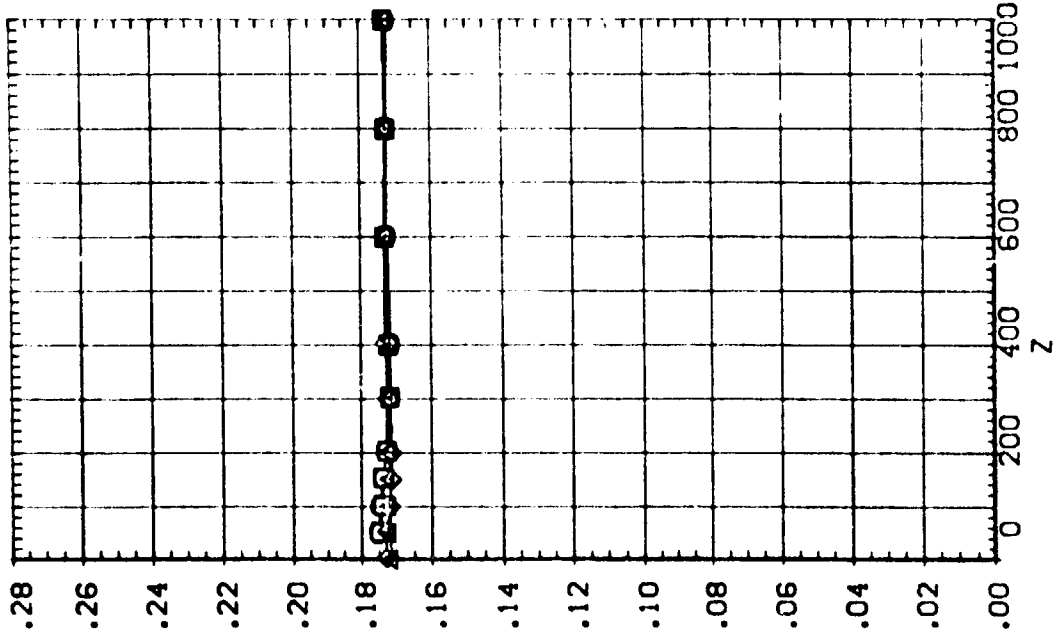

IA13 SRB(S8) W/O PLUMES SEPARATING FROM 09T10 (RTJ191)

SEE THE ASSOCIATED DATA DOCUMENT FOR REFERENCE CHARACTERISTICS FOR INDIVIDUAL DATASETS

SYMBOL	X	MACH	PARAMETRIC VALUES
○	.224	4.530	POTAL 110.000
□	300.230	.000	BETA .000
◇	600.570	-5.000	DBETA -5.000
△	900.600	200.000	PC-MBR .000

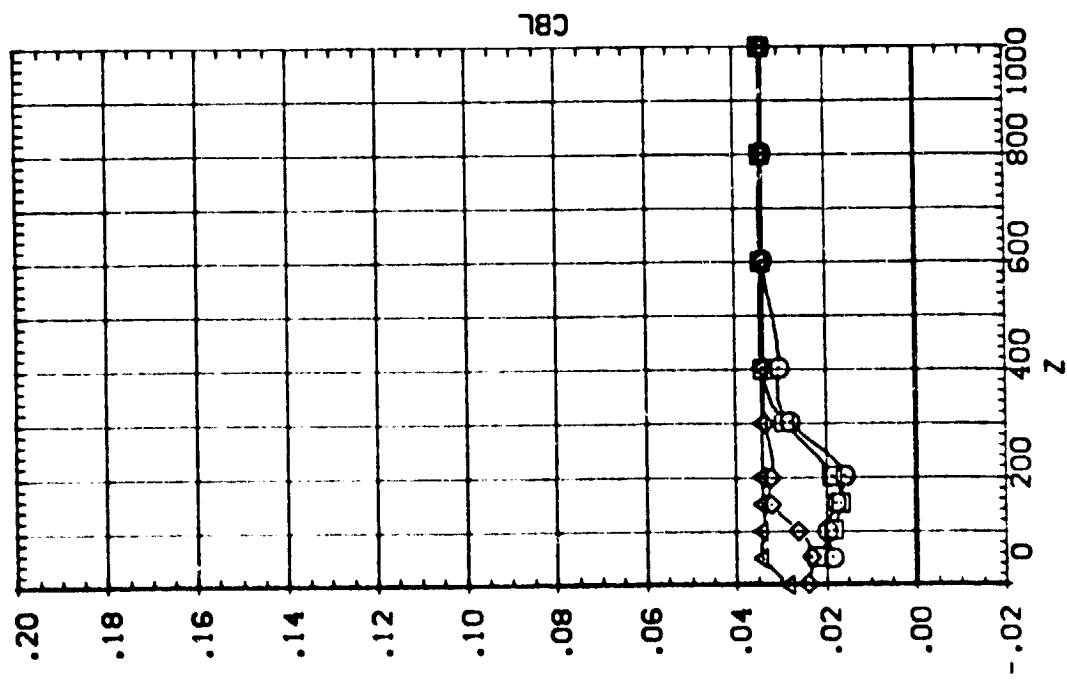
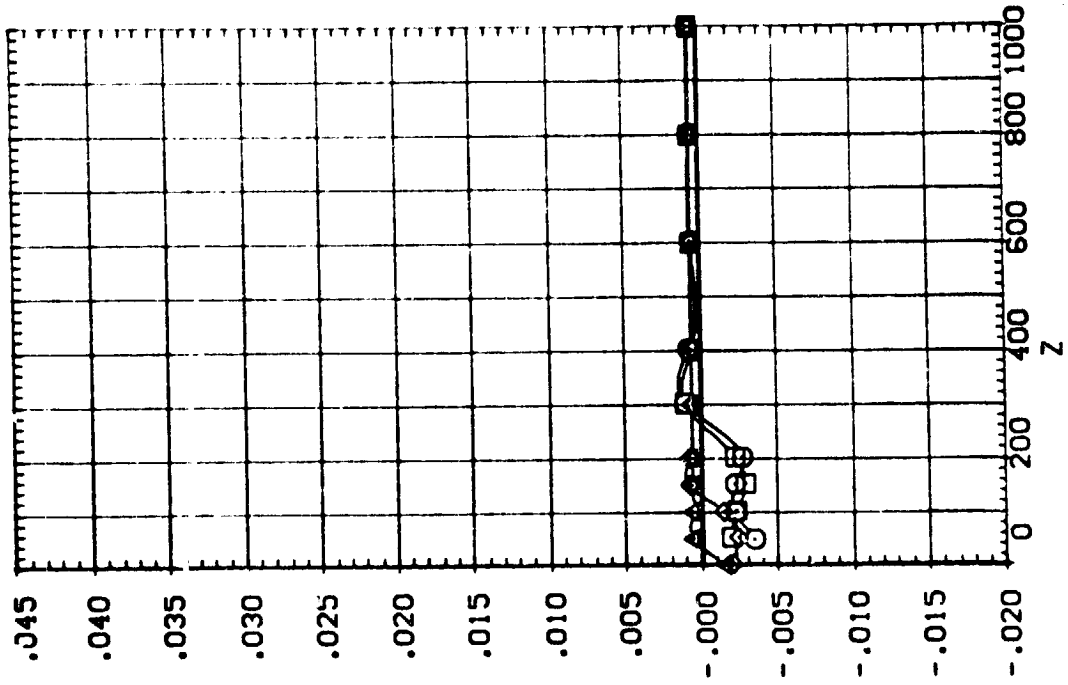

EFFECT OF SRB W/O PLUMES SEPARATION ON ORB/ET AERODYNAMIC CHARACTERISTICS

IA13 SRB(S8) W/O PLUMES SEPARATING FROM 09T10 (RTJ191)

SYMBOL

-
-
- ◇
- △

PARAMETRIC VALUES

MACH	4.530	PITOTAL	110.000
ALPHA	.000	BETA	.000
DALPHA	-5.000	DBETA	-5.000
Y	200.000	PC+PR	.000

SEE THE ASSOCIATED DATA DOCUMENT FOR REFERENCE CHARACTERISTICS FOR INDIVIDUAL DATASETS

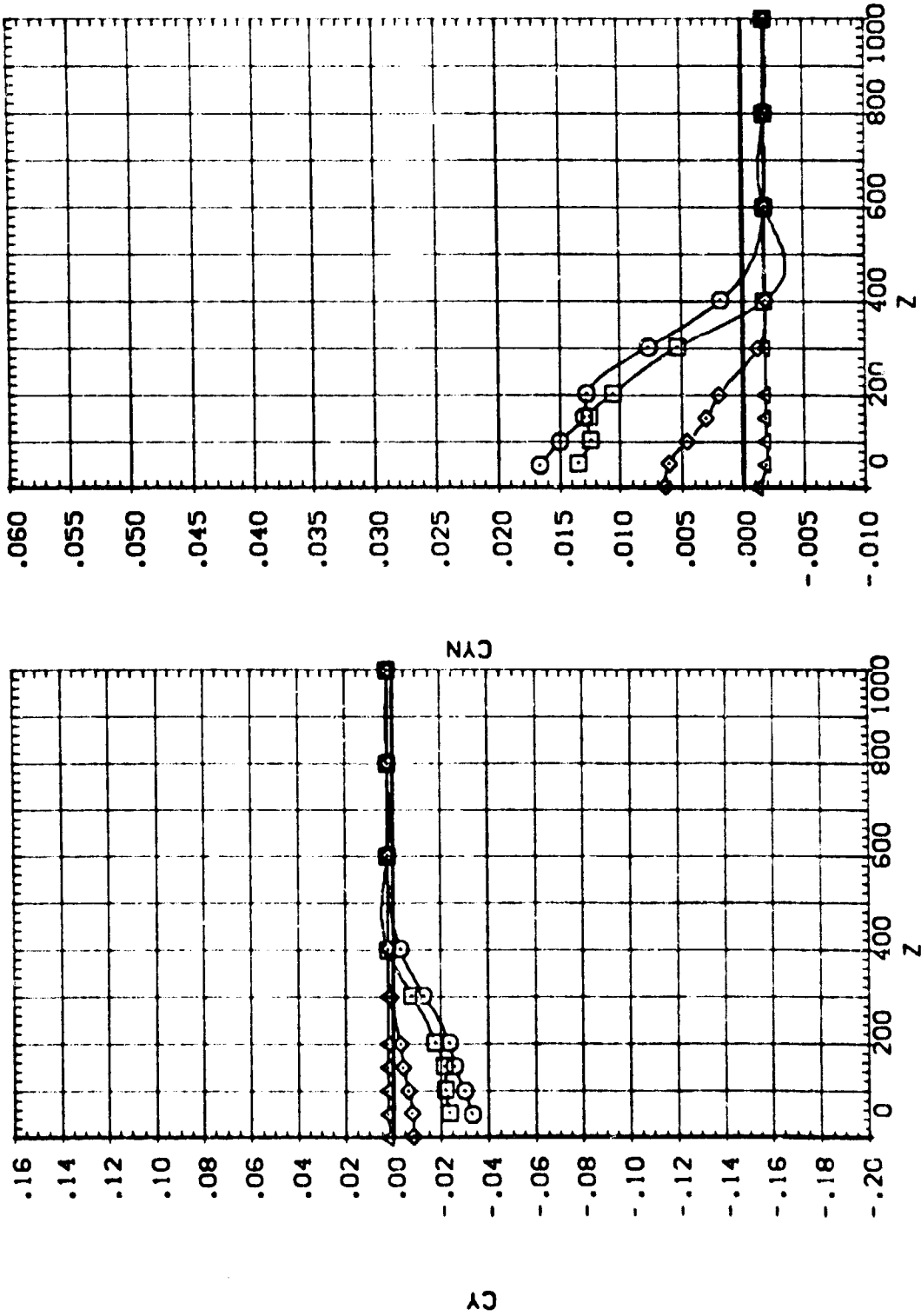

[A13 SRB(S8) W/O PLUMES SEPARATING FROM 09T10 (RTJ192)]

SEE THE ASSOCIATED DATA DOCUMENT FOR REFERENCE CHARACTERISTICS FOR INDIVIDUAL DATASETS

SYMBOL	X	MACH	PARAMETRIC VALUES
□	.375	4.530	P TOTAL 110.000
◇	0.490	.000	BETA .000
△	600.480	-5.000	DBETA -5.000
	900.610	400.000	PC-HBR .000

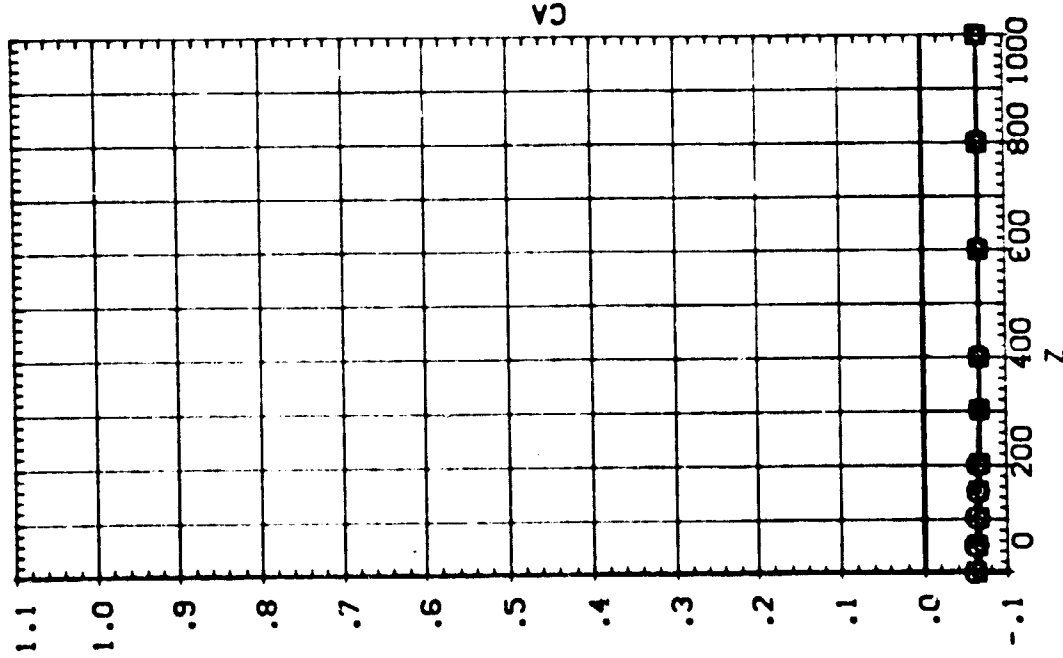
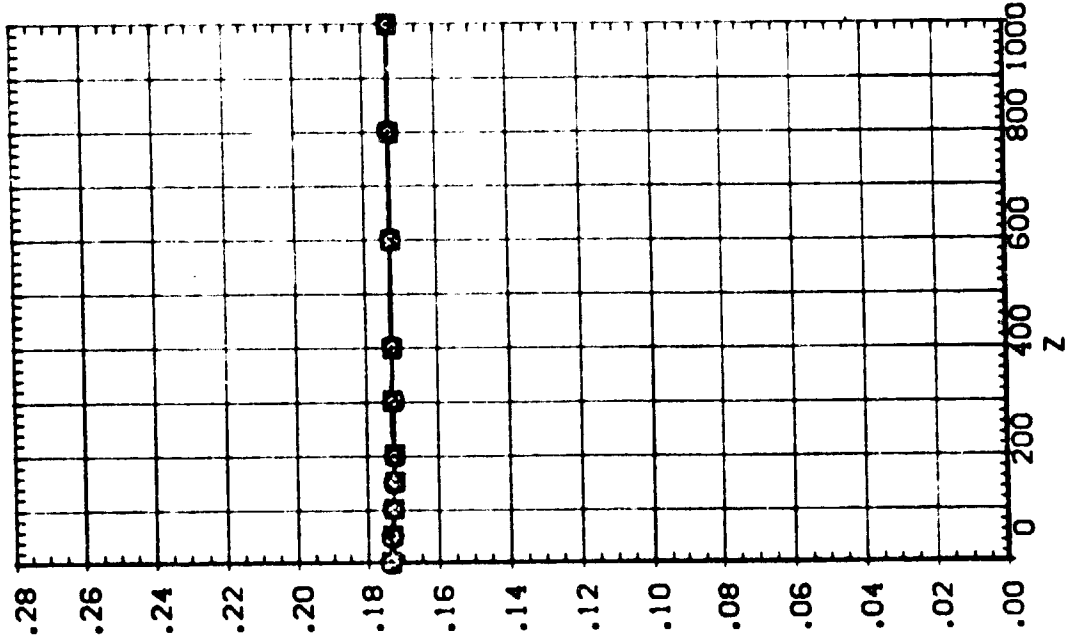

EFFECT OF SRB W/O PLUMES SEPARATION ON ORB/ET AERODYNAMIC CHARACTERISTICS

IA13 SRB(SB) W/O PLUMES SEPARATING FROM 09T10 (RTJ192)

SEE THE ASSOCIATED DATA DOCUMENT FOR REFERENCE CHARACTERISTICS FOR INDIVIDUAL DATASETS

SYMBOL	X	MACH	PARAMETRIC VALUES
○	.325		PITOTAL 110.000
□	300.490	ALPHA	BETA .000
◇	600.480	DALPHA	DBETA -5.000
△	900.610	Y	POWERR .000

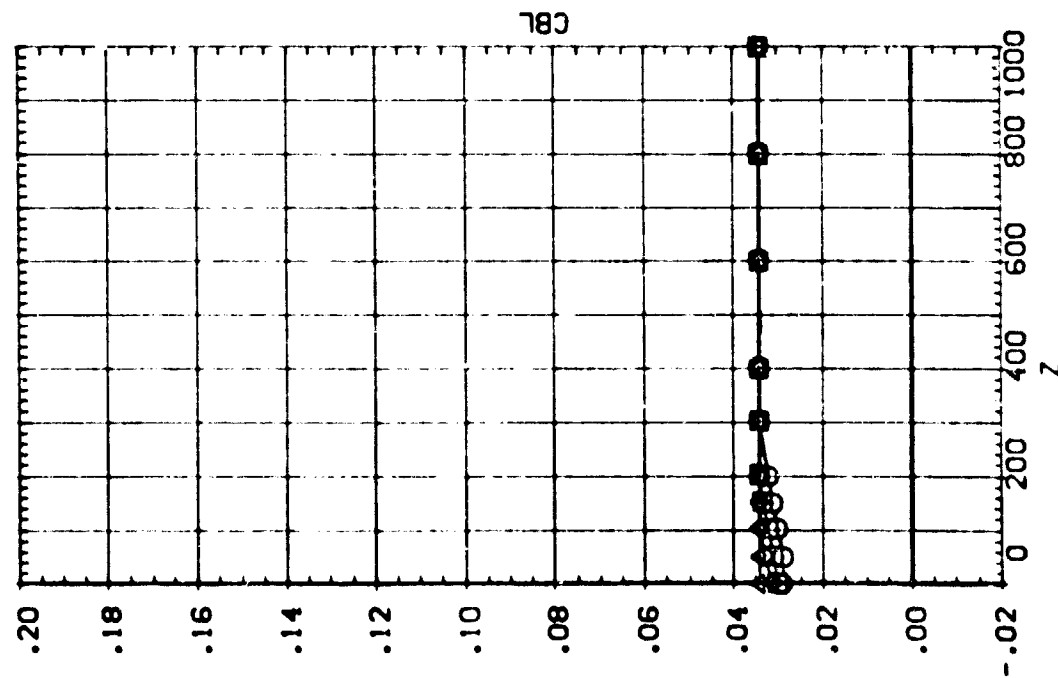
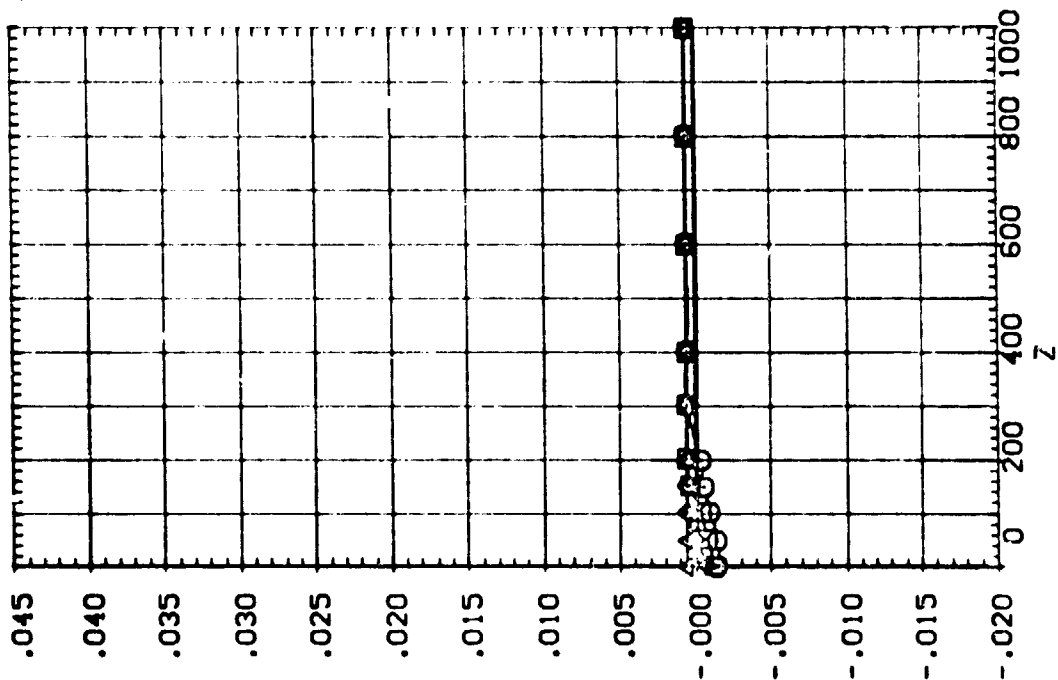

IA13 SRB(S8) W/O PLUMES SEPARATING FROM 09T10 (RTJ192)

SEE THE ASSOCIATED DATA DOCUMENT FOR REFERENCE CHARACTERISTICS FOR INDIVIDUAL DATASETS

SYMBOL	X	PARAMETRIC VALUES
○	.325	MACH
□	300.450	PTOTAL
◇	600.480	BETA
△	900.610	DEBETA
		PC+SR

	110.000
	.000
	-5.000
	.000

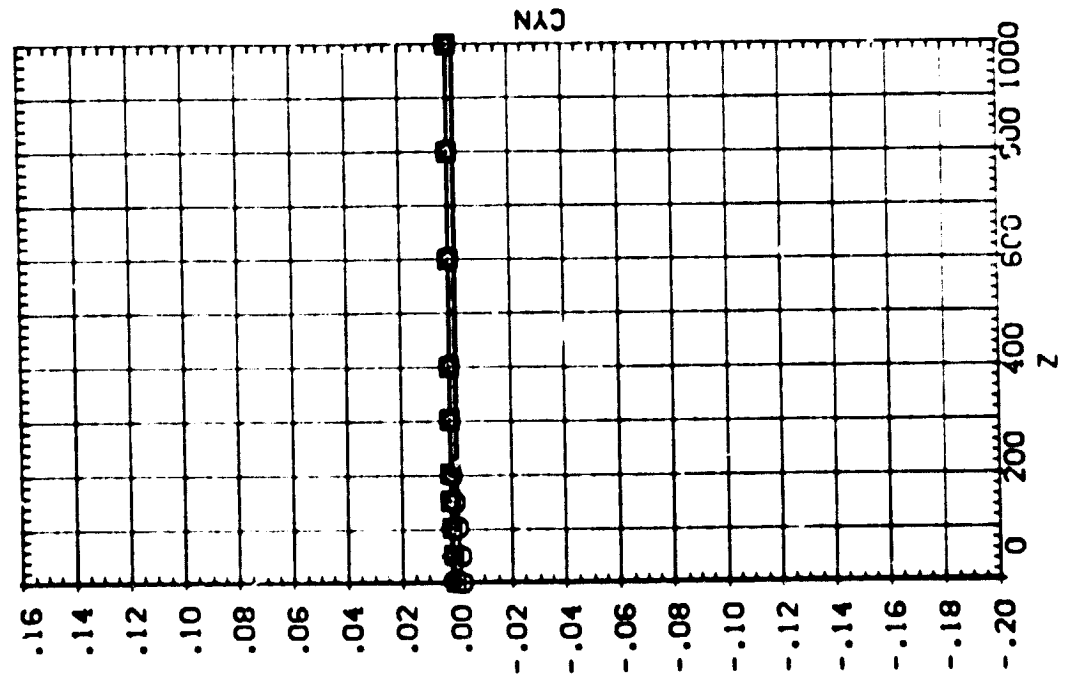
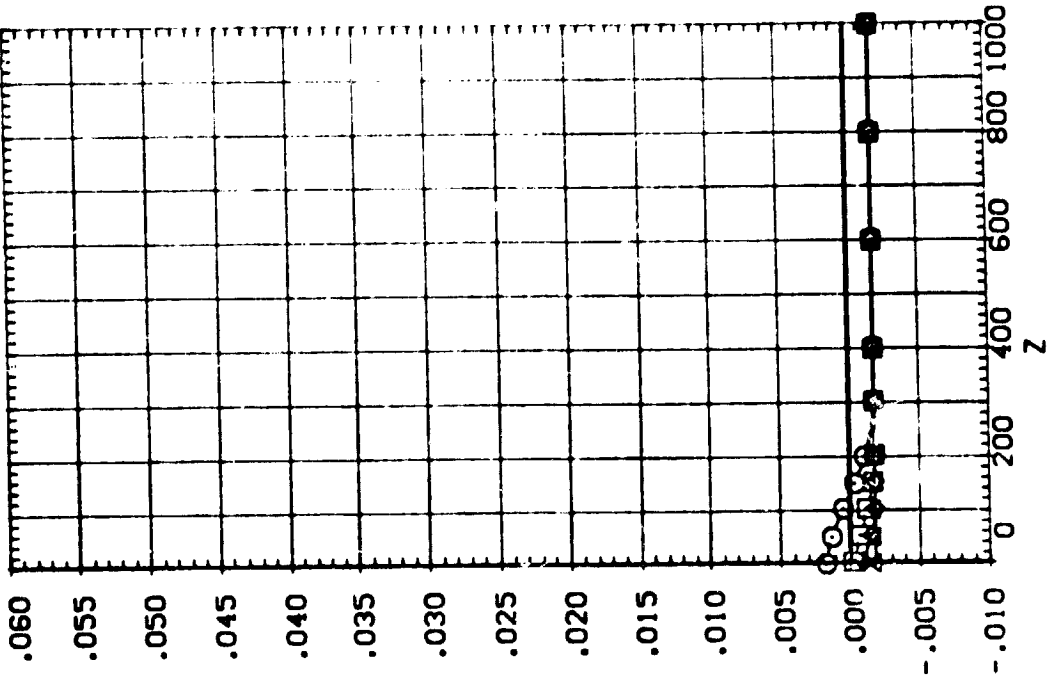

EFFECT OF SRB W/O PLUMES SEPARATION ON ORB/ET AERODYNAMIC CHARACTERISTICS

IA13 SRB(S8) W/O PLUMES SEPARATING FROM 09T10 (RTJ193)

SEE THE ASSOCIATED DATA DOCUMENT FOR REFERENCE CHARACTERISTICS FOR INDIVIDUAL DATASETS

SYMBOL		X		PARAMETRIC VALUES			
○		.375	MACH	4.500	P/TOTAL	110.000	
□		300.300	ALPHA	.000	BETA	.000	
◇		600.560	DALPHA	-5.000	DBETA	-5.000	
△		900.570	Y	800.000	PC-MBR	.000	

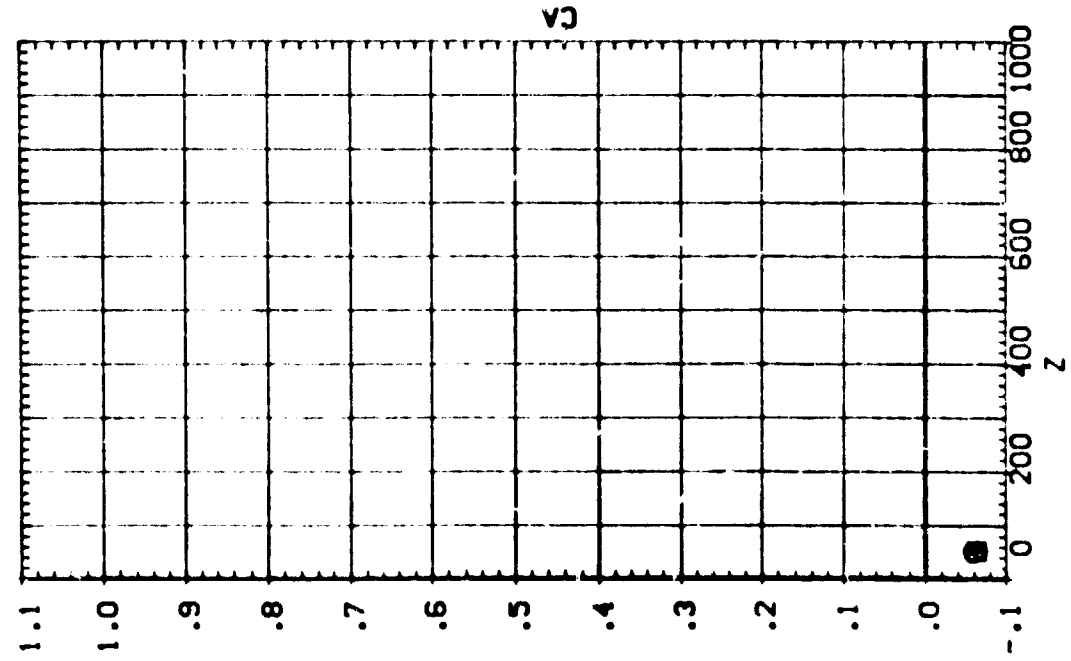
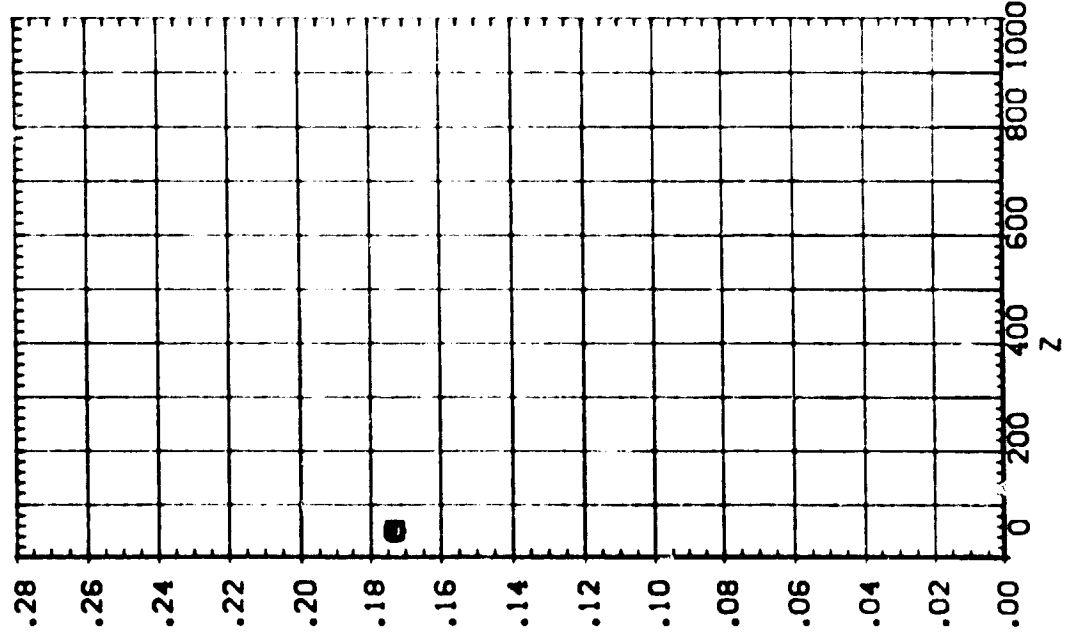

JA13 SRB(SB) W/O PLUMES SEPARATING FROM 09T10 (RTJ193)

SEE THE ASSOCIATED DATA DOCUMENT FOR REFERENCE CHARACTERISTICS FOR INDIVIDUAL DATASETS

SYMBOL	X	PARAMETRIC VALUES			
		MACH	P/TOTAL	BETA	PC-MFR
○	.375	4.530	110.000	.000	.000
□	300.300	.000	.000	-5.070	.000
◇	600.560	5.000	.000	.000	.000
△	900.570	800.000	.000	.000	.000

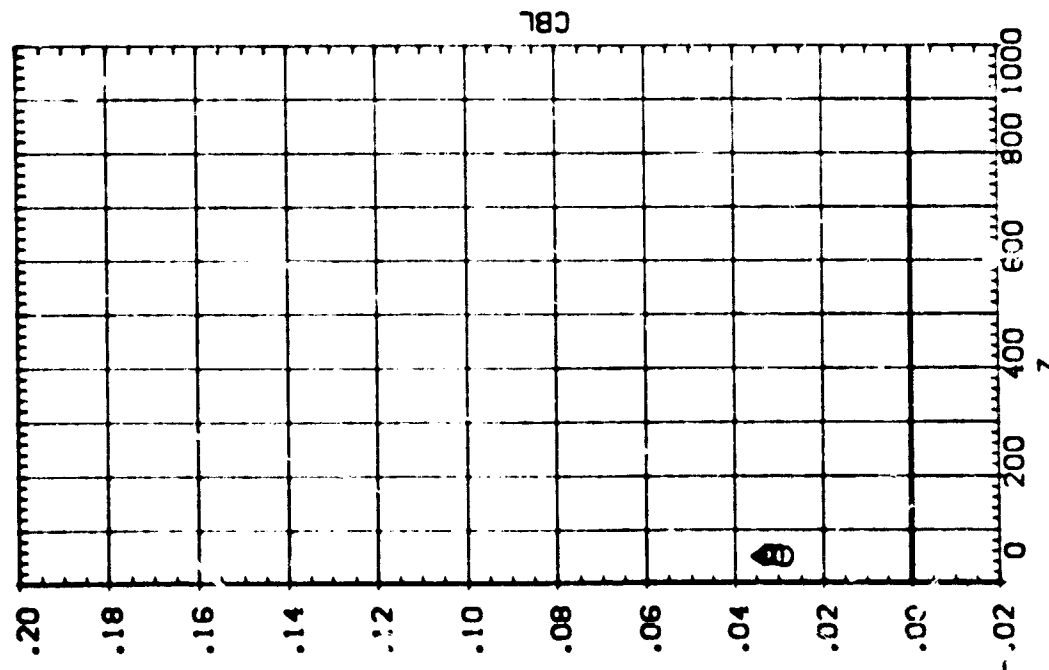
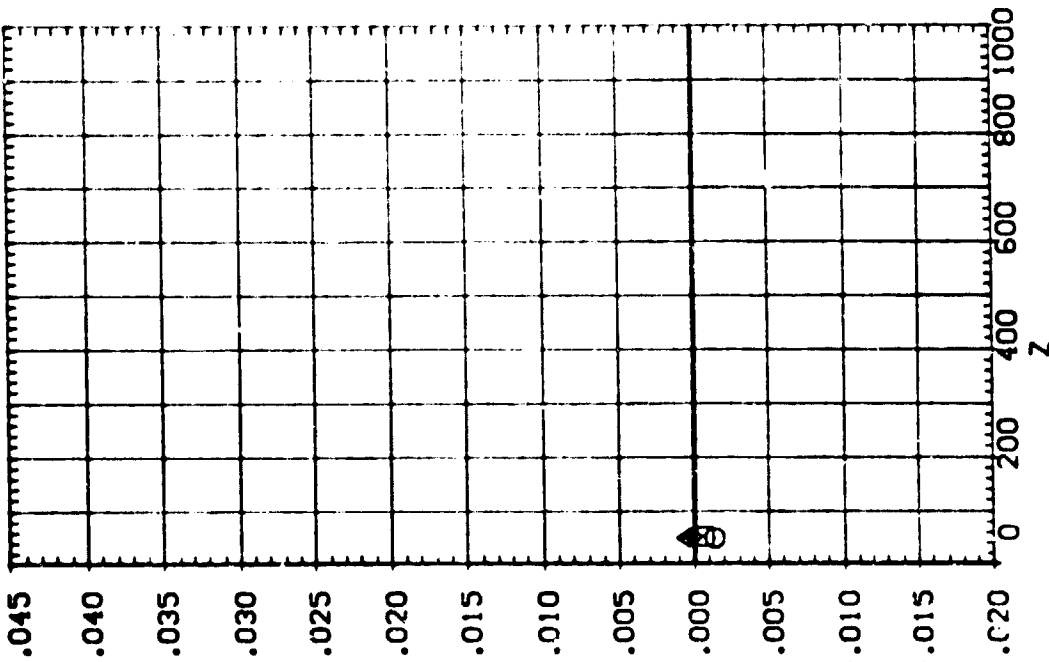

EFFECT OF SRB W/O PLUMES SEPARATION ON ORB/ET AERODYNAMIC CHARACTERISTICS

IA13 SRB(S8) W/O PLUMES SEPARATING FROM 09T10 (RTJ19S)

SEE THE ASSOCIATED DATA DOCUMENT FOR REFERENCE CHARACTERISTICS FOR INDIVIDUAL DATASETS

SYMBOL		PARAMETRIC VALUES			
○	X	MACH	4.530	PTOTAL	110.000
□	300.300	ALPHA	.000	BETA	.000
◇	600.560	DALPHA	-5.000	DBETA	-5.000
△	900.570	Y	800.000	PC-MBR	.000

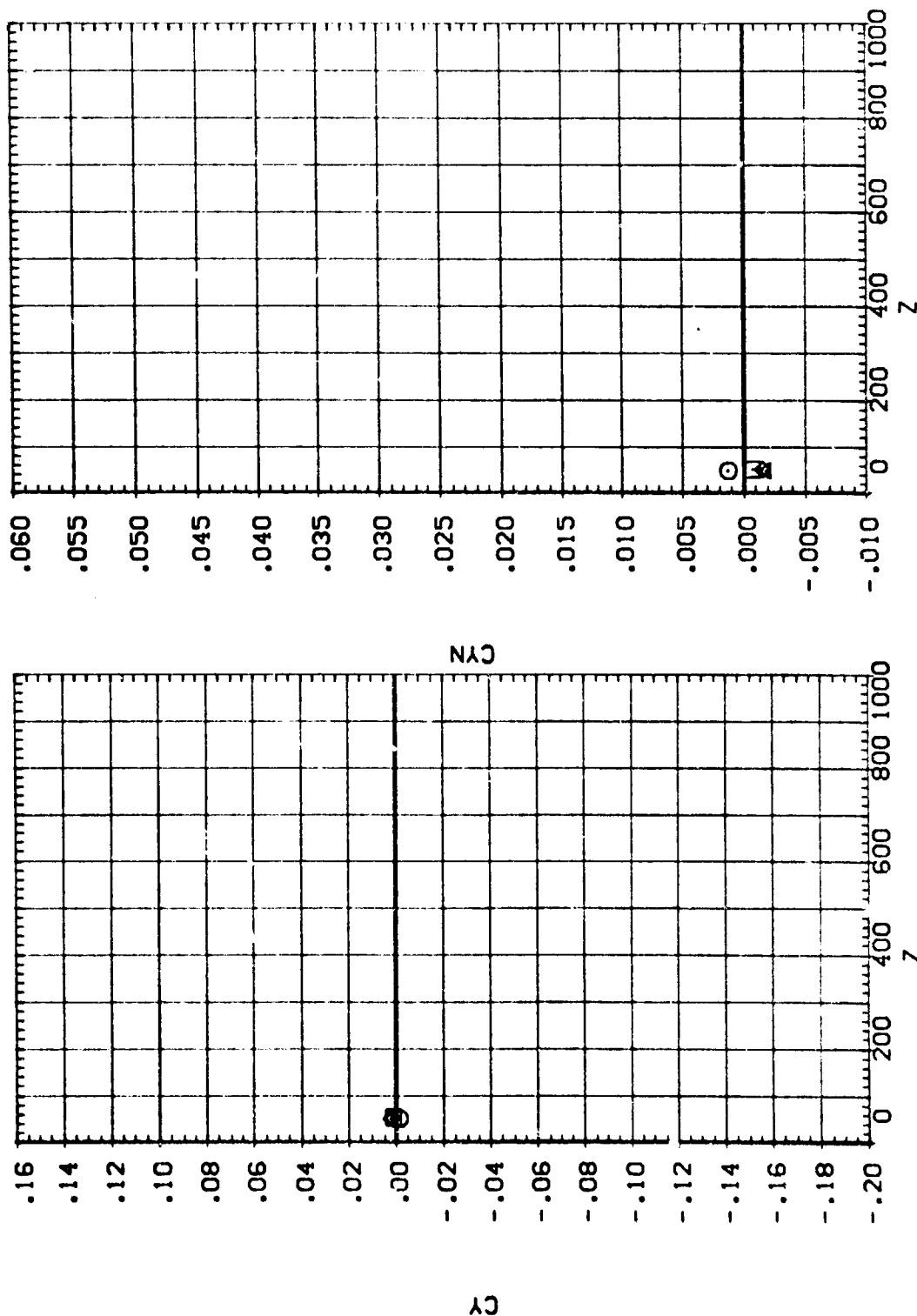

IA13 SRB(S8) W/O PLUMES SEPARATING FROM 09T10 (RTJ195)

SEE THE ASSOCIATED DATA DOCUMENT FOR REFERENCE CHARACTERISTICS FOR INDIVIDUAL DATASETS

SYMBOL		X		MACH		PARAMETRIC VALUES	
○	□	300	600	900	.202	4.530	110.000
◇	△	300	600	900	.410	.000	.000
		300	600	900	.650	-5.000	-10.000
		300	600	900	.650	400.000	PCHBR .000

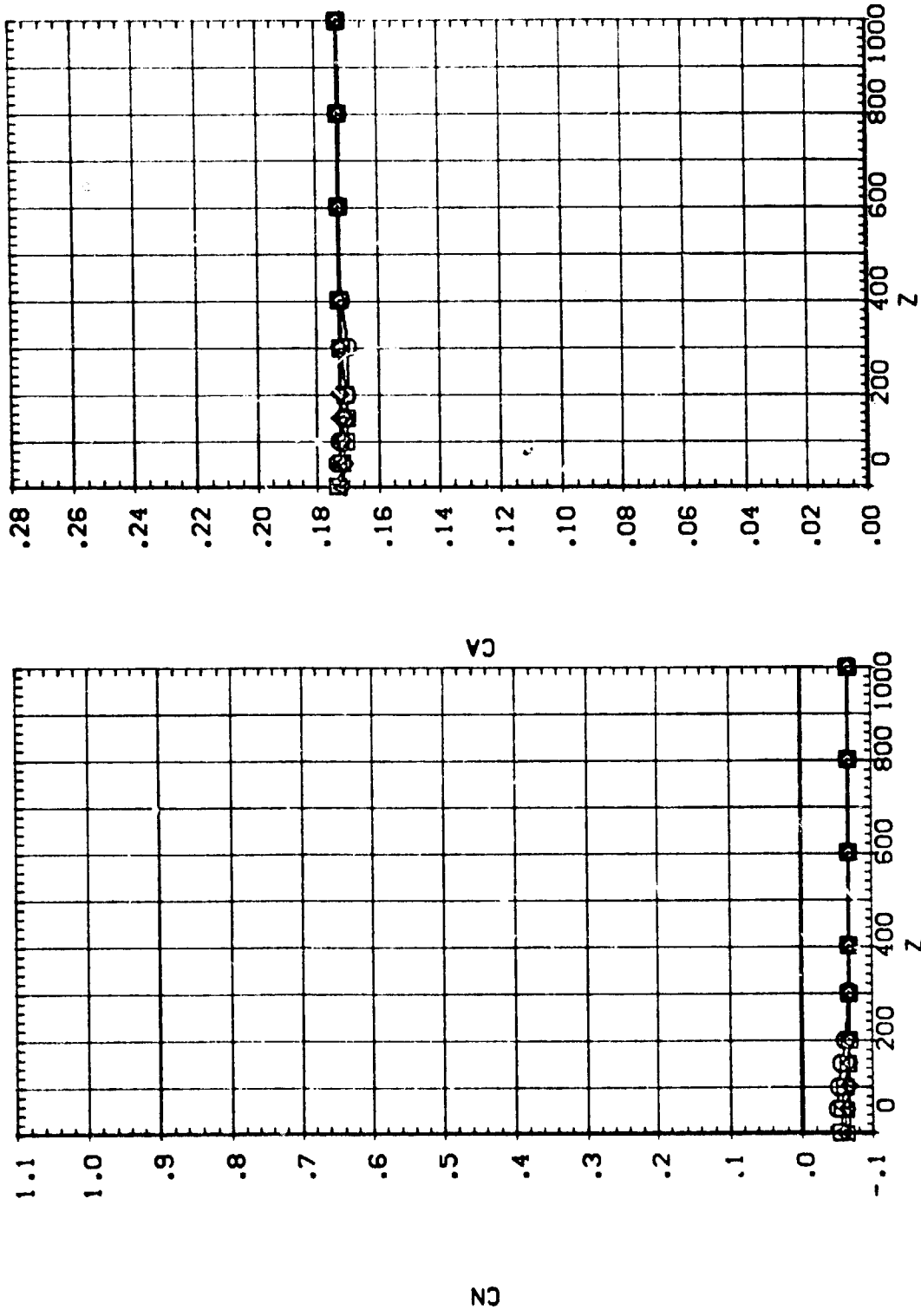

EFFECT OF SRB W/O PLUMES SEPARATION ON ORB/ET AERODYNAMIC CHARACTERISTICS

IA13 SRB(S8) W/O PLUMES SEPARATING FROM 09T10 (RTJ195)

SYMBOL X
 ○ □ ◇ △

PARAMETRIC VALUES
 MACH 4.530 PTOTAL 110.000
 ALPHA .000 BETA .000
 DALPHA -5.000 DBETA -10.000
 Y 400.000 PC-MER .000

SEE THE ASSOCIATED DATA DOCUMENT FOR REFERENCE CHARACTERISTICS FOR INDIVIDUAL DATASETS

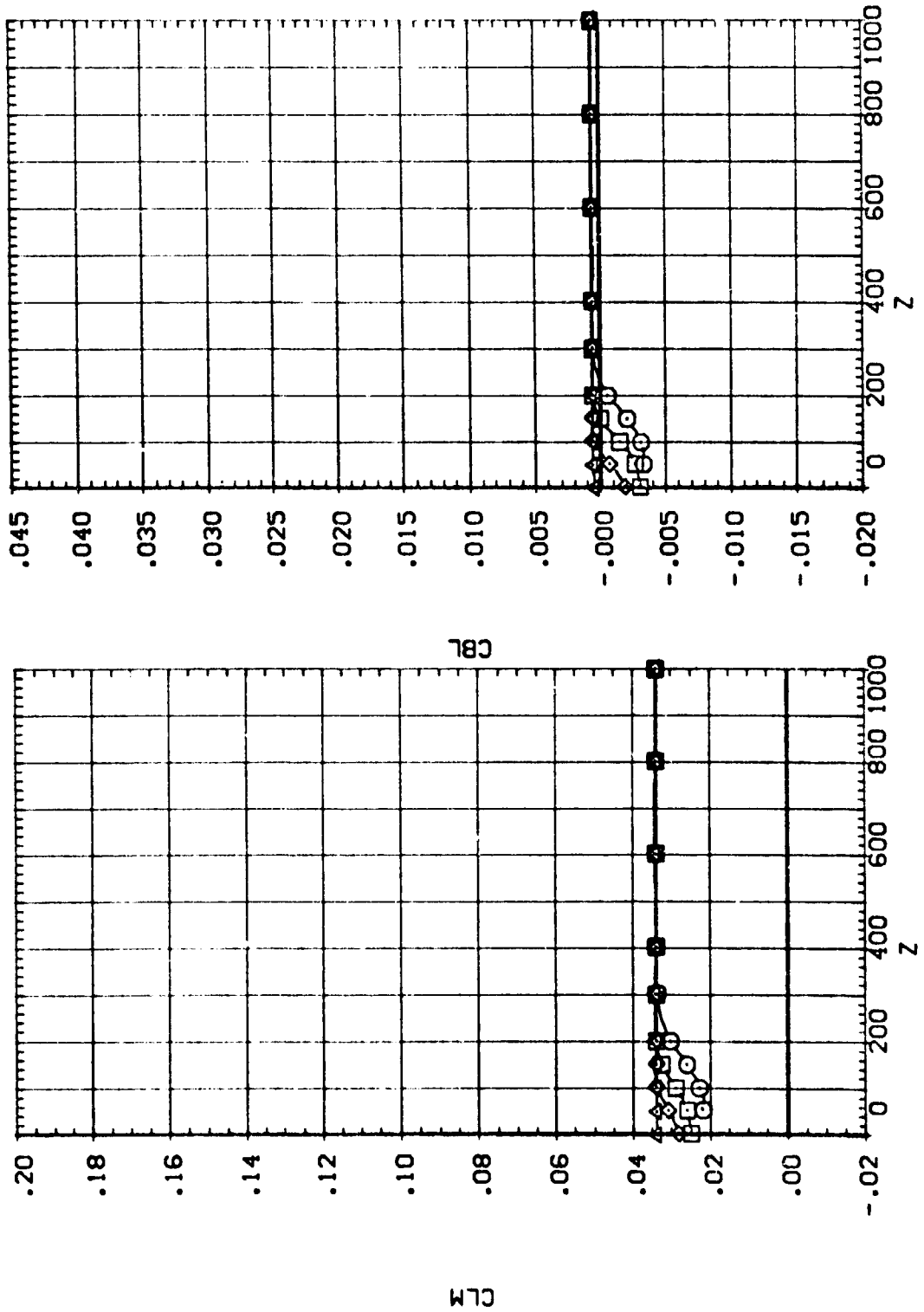

IA13 SRB(S8) W/O PLUMES SEPARATING FROM 09T10 (RTJ195)

SEE THE ASSOCIATED DATA DOCUMENT FOR REFERENCE CHARACTERISTICS FOR INDIVIDUAL DATASETS

SYMBOL X MACH ALPHA DALPHA Y PC-MBR
 O 300.410 .202 .000 -5.000 400.000
 □ 600.650 .000 .000 .000 110.000
 △ 900.650 .000 .000 -10.000 .000

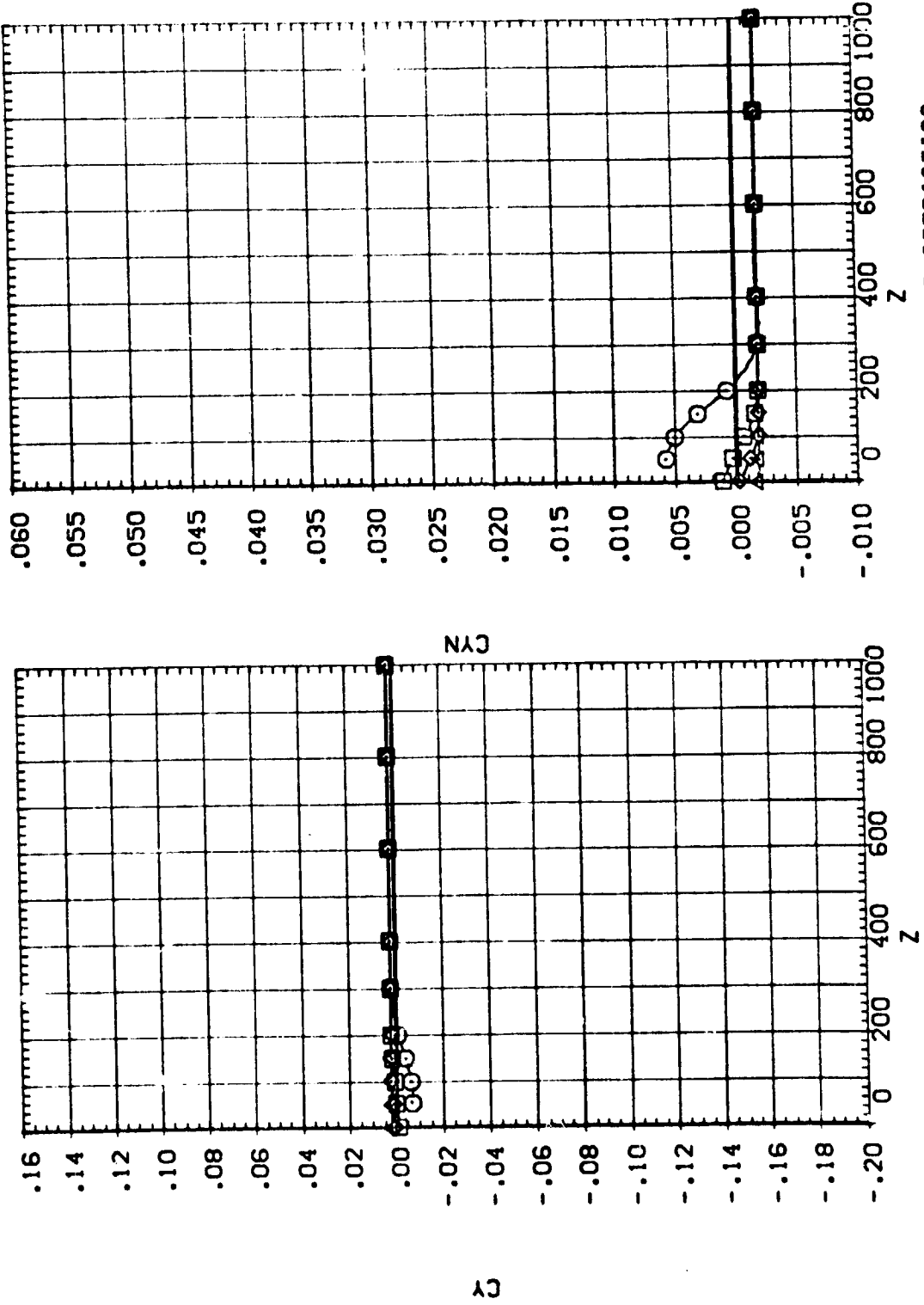

EFFECT OF SRB W/O PLUMES SEPARATION ON ORB/ET AERODYNAMIC CHARACTERISTICS

IA13 SRB(S8) W/O PLUMES SEPARATING FROM 09T10 (RTJ196)

SEE THE ASSOCIATED DATA DOCUMENT FOR REFERENCE CHARACTERISTICS FOR INDIVIDUAL DATASETS

SYMBOL	X	MACH	PARAMETRIC VALUES
○	.321		PTOTAL 110.000
□	300.410	ALPHA .000	BETA .000
◇	600.470	DALPHA -5.000	DBETA -10.000
△	900.250	Y 200.000	POWER .000

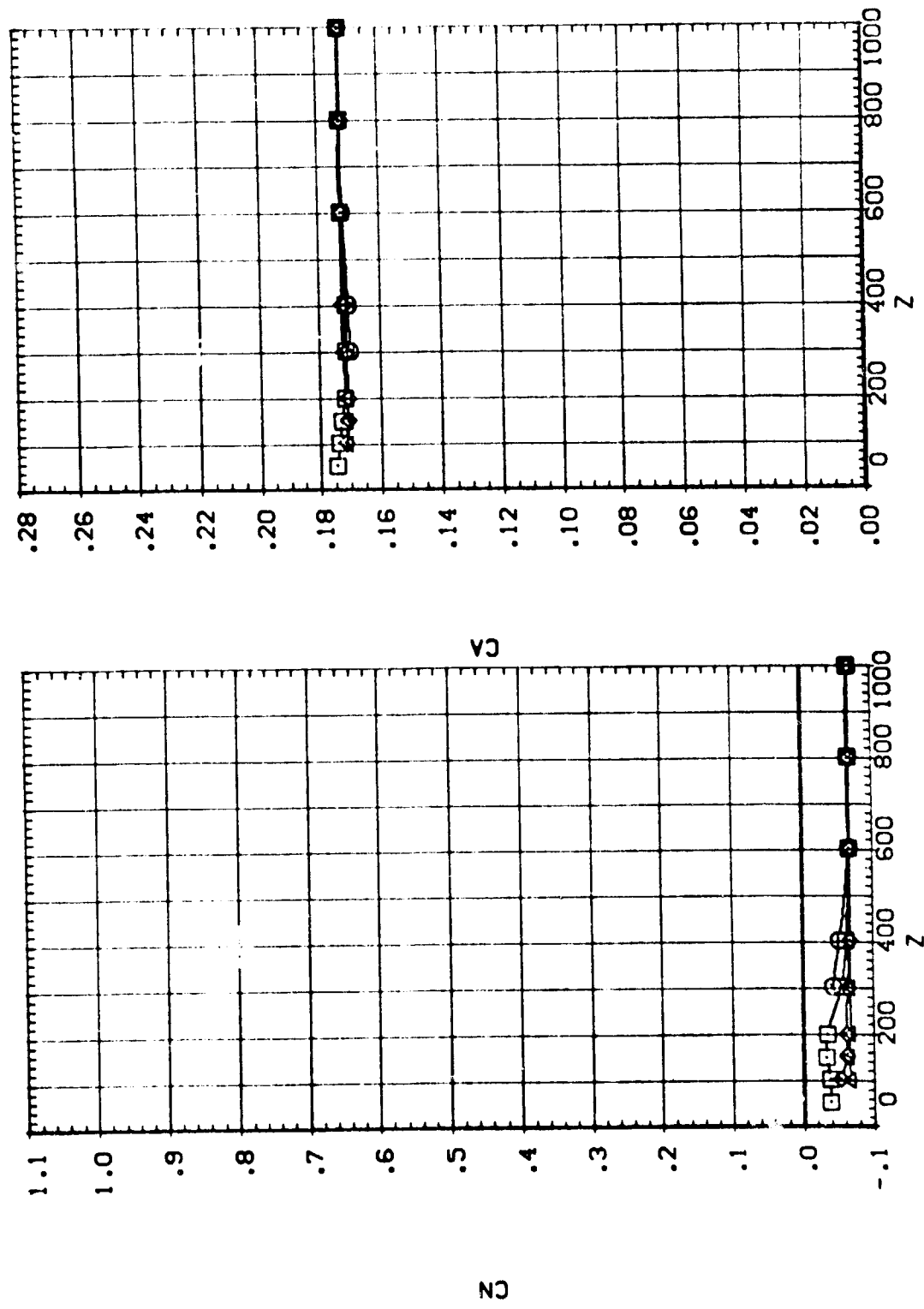

IA13 SRB(S8) W/O PLUMES SEPARATING FROM 09T10 (RTJ196)

SEE THE ASSOCIATED DATA DOCUMENT FOR REFERENCE CHARACTERISTICS FOR INDIVIDUAL DATASETS

SYMBOL	X	MACH	PARAMETRIC VALUES
○	.321	4.530	PTOTAL 110.000
□	300.410	.000	BETA .000
◇	600.470	-5.000	DBETA -10.000
△	900.250	200.000	PC-MBR .000

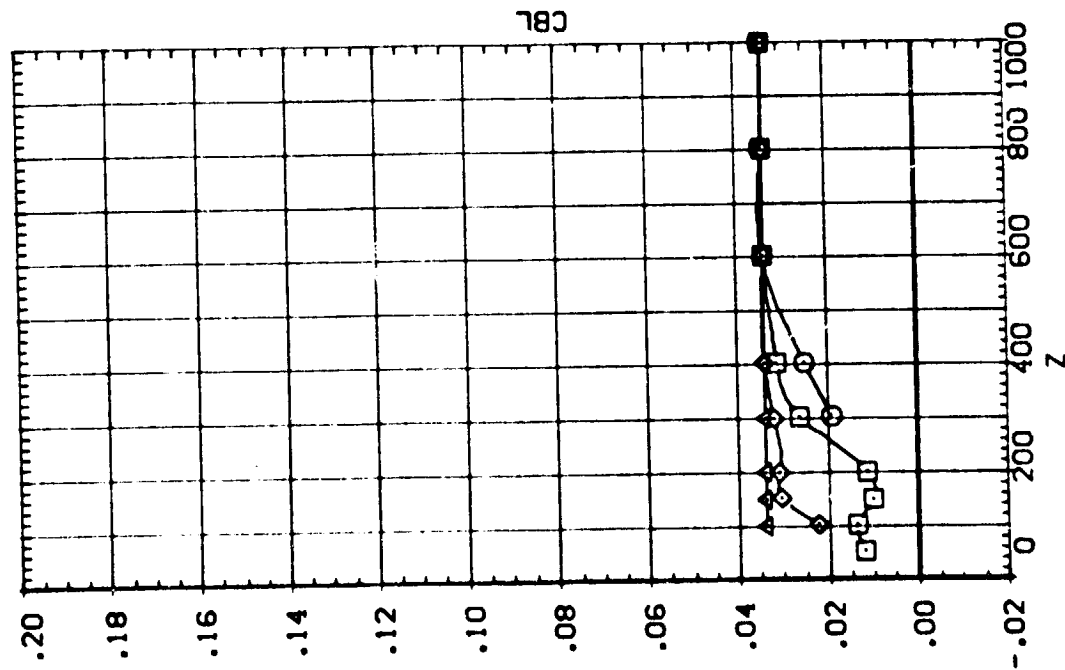
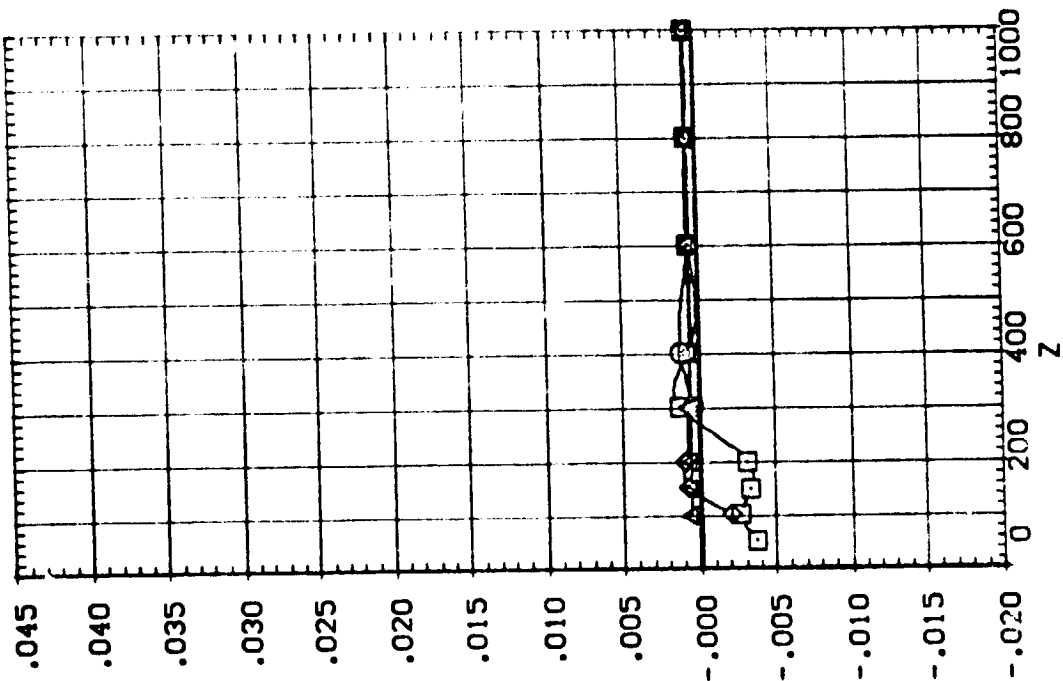

EFFECT OF SRB W/O PLUMES SEPARATION ON 09B/ET AERODYNAMIC CHARACTERISTICS

[A13 SRB(S8) W/O PLUMES SEPARATING FROM 09T10 (RTJ196)]

SYMBOL	X	PARAMETRIC VALUES			
		MACH	PIOTAL	BETA	PCMBR
○	300.410	4.530	110.000	.000	.000
◇	600.470	.000	.000	-10.000	.000
△	900.250	-5.000	200.000	-10.000	.000

SEE THE ASSOCIATED DATA DOCUMENT FOR REFERENCE CHARACTERISTICS FOR INDIVIDUAL DATASETS

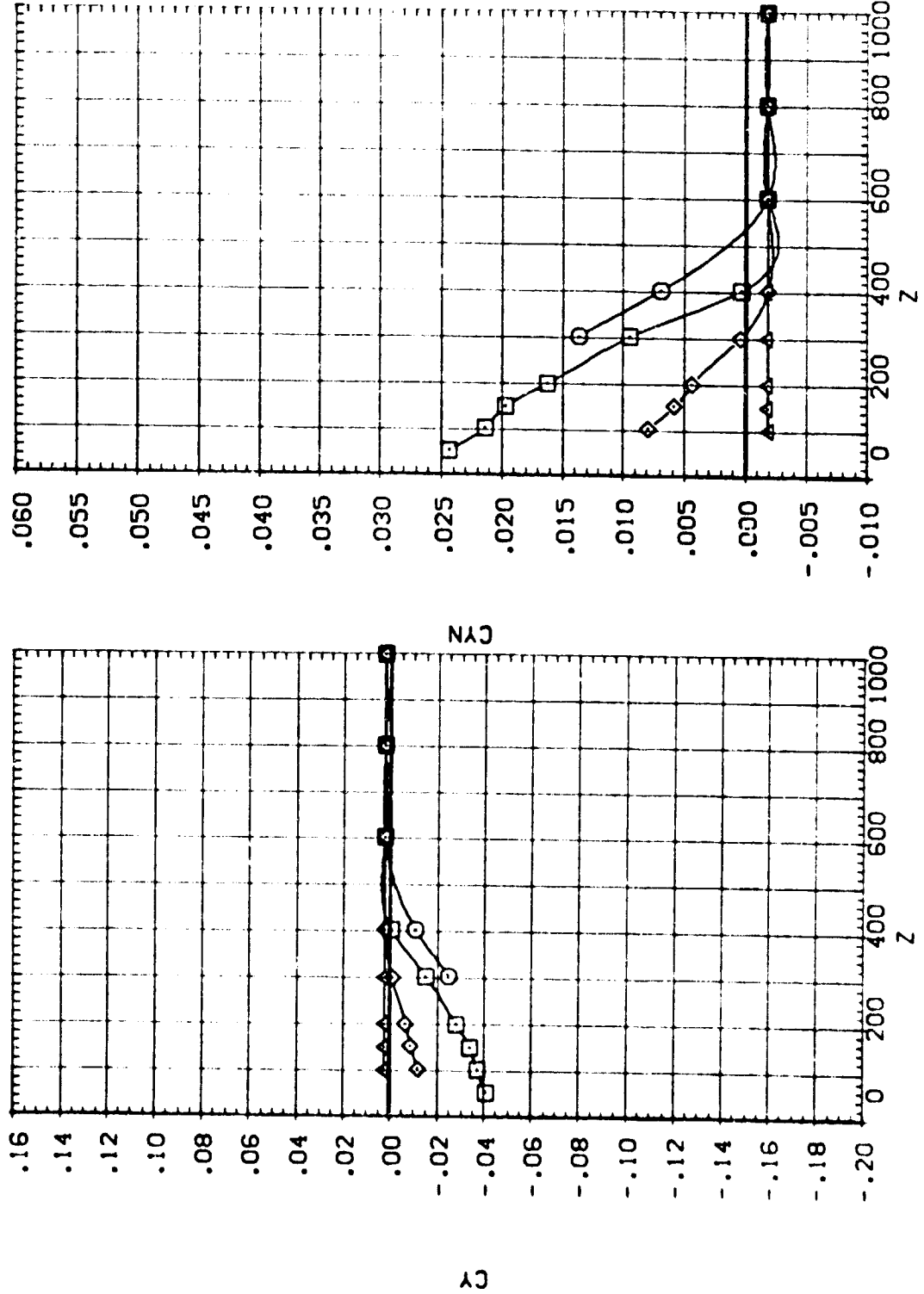

IA13 SRB(S8) W/O PLUMES SEPARATING FROM 09T10 (RTJ197)

SYMBOL X
 ○ □ ◇ △

PARAMETRIC VALUES
 MACH 4.530 PITCH 110.000
 ALPHA .000 BETA .000
 DALPHA -5.000 DBETA -10.000
 Y .000 PC-MFR .000

SEE THE ASSOCIATED DATA DOCUMENT FOR REFERENCE CHARACTERISTICS FOR INDIVIDUAL DATASETS

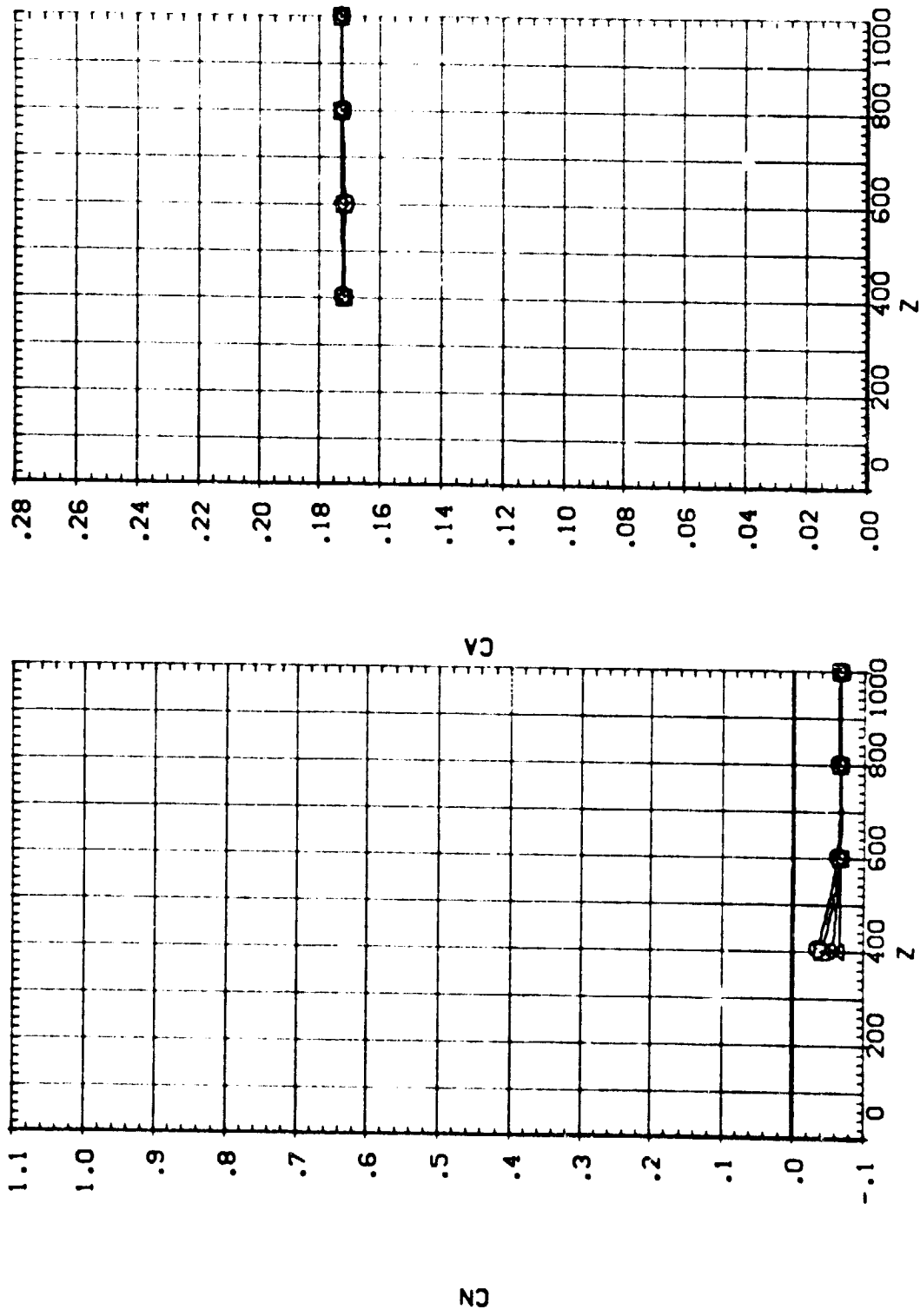

EFFECT OF SRB W/O PLUMES SEPARATION ON ORB/ET AERODYNAMIC CHARACTERISTICS

IA13 SRB(SB) W/O PLUMES SEPARATING FROM 09T10 (RTJ197)

SEE THE ASSOCIATED DATA DOCUMENT FOR REFERENCE CHARACTERISTICS FOR INDIVIDUAL DATASETS

SYMBOL		PARAMETRIC VALUES			
X	.559	MACH	4.530	P/TOTAL	110.000
○	300.050	ALPHA	.000	BETA	.000
□	600.550	DELTA	-5.000	DBETA	-10.000
△	900.440	Y	.000	PC+PGR	.000

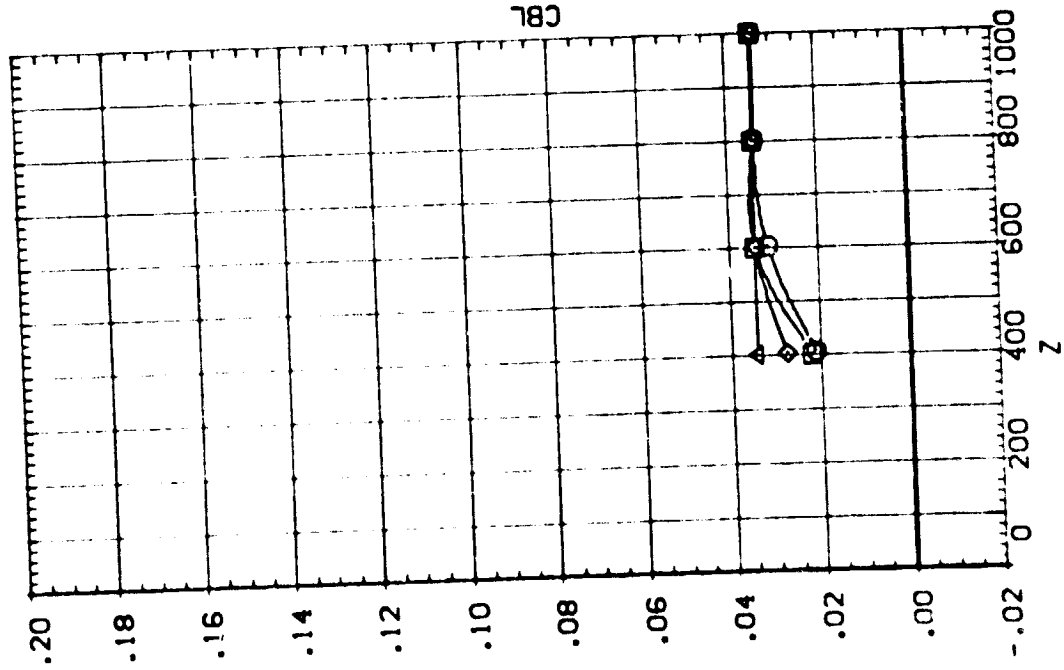
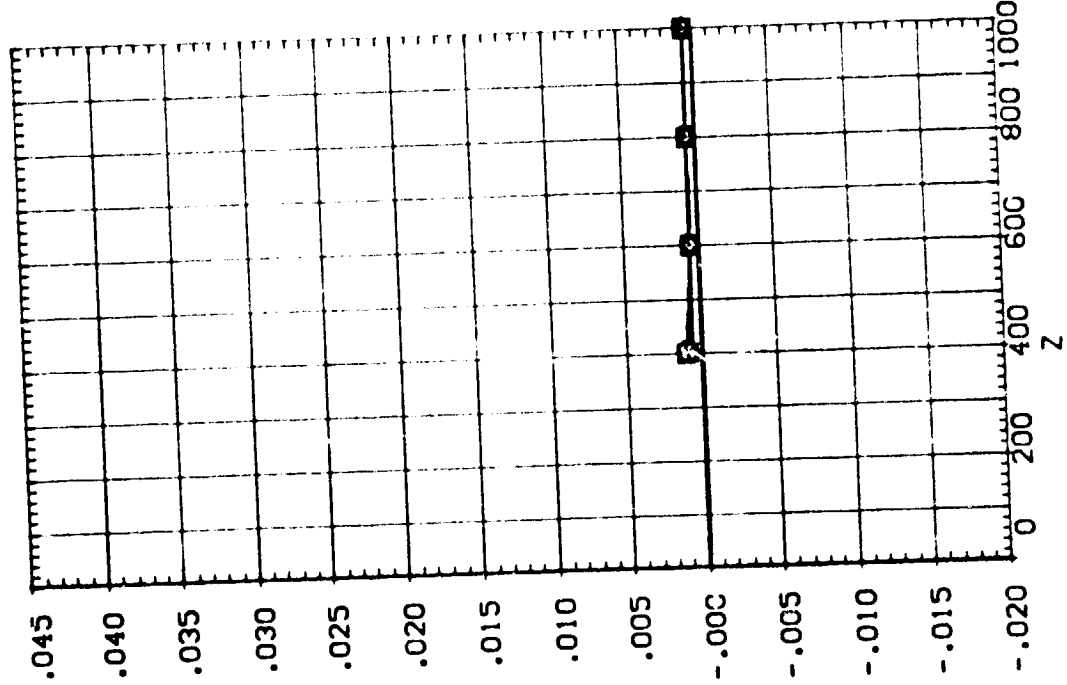

[A13 SRB(S8) W/O PLUMES SEPARATING FROM 09T10 (RTJ197)]

SEE THE ASSOCIATED DATA DOCUMENT FOR REFERENCE CHARACTERISTICS FOR INDIVIDUAL DATASETS

SYMBOL	X	MACH	PIOTAL	110.000
○	300.090	4.530	BETA	.000
□	600.550	4.530	DBETA	-10.000
◇	900.440	4.530	PC+R	.000

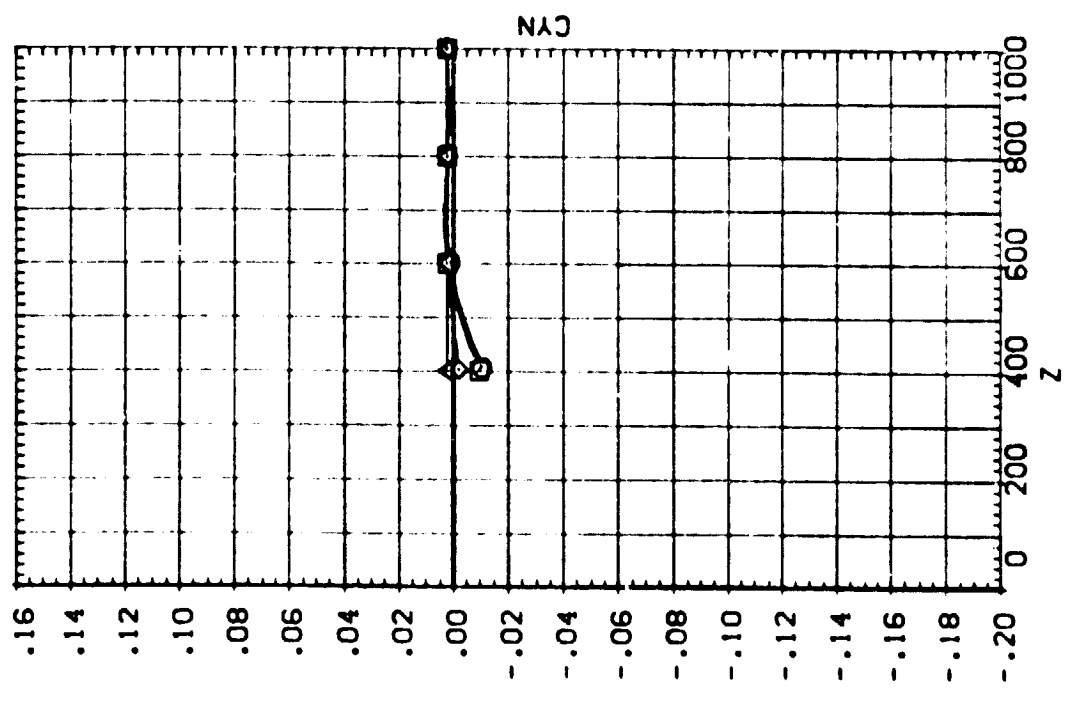
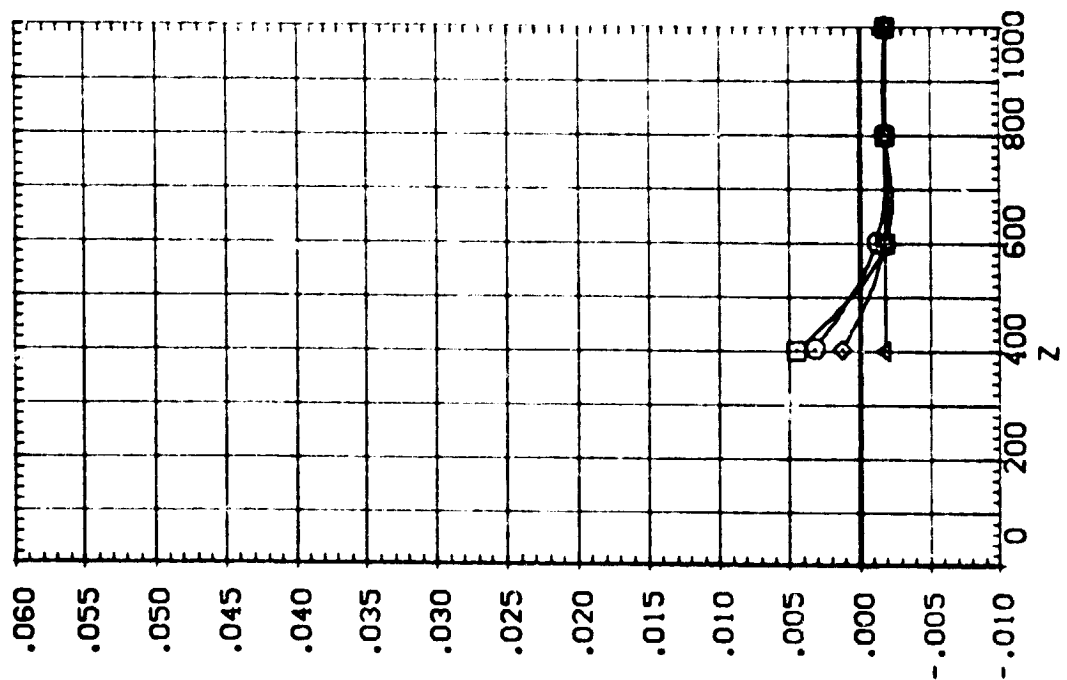

EFFECT OF SRB W/O PLUMES SEPARATION ON ORB/ET AERODYNAMIC CHARACTERISTICS

1A13 SRB(SB) W/O PLUMES SEPARATING FROM 09T10 (RTJ138)

SEE THE ASSOCIATED DATA DOCUMENT FOR REFERENCE CHARACTERISTICS FOR INDIVIDUAL DATASETS

SYMBOL		PARAMETRIC VALUES			
○	x	MACH	PTOTAL	110	.000
◇	300	ALPHA	BETA	.000	.000
△	600	DALPHA	DBETA	-20	.000
	900	Y	PC-HBR	.000	.000

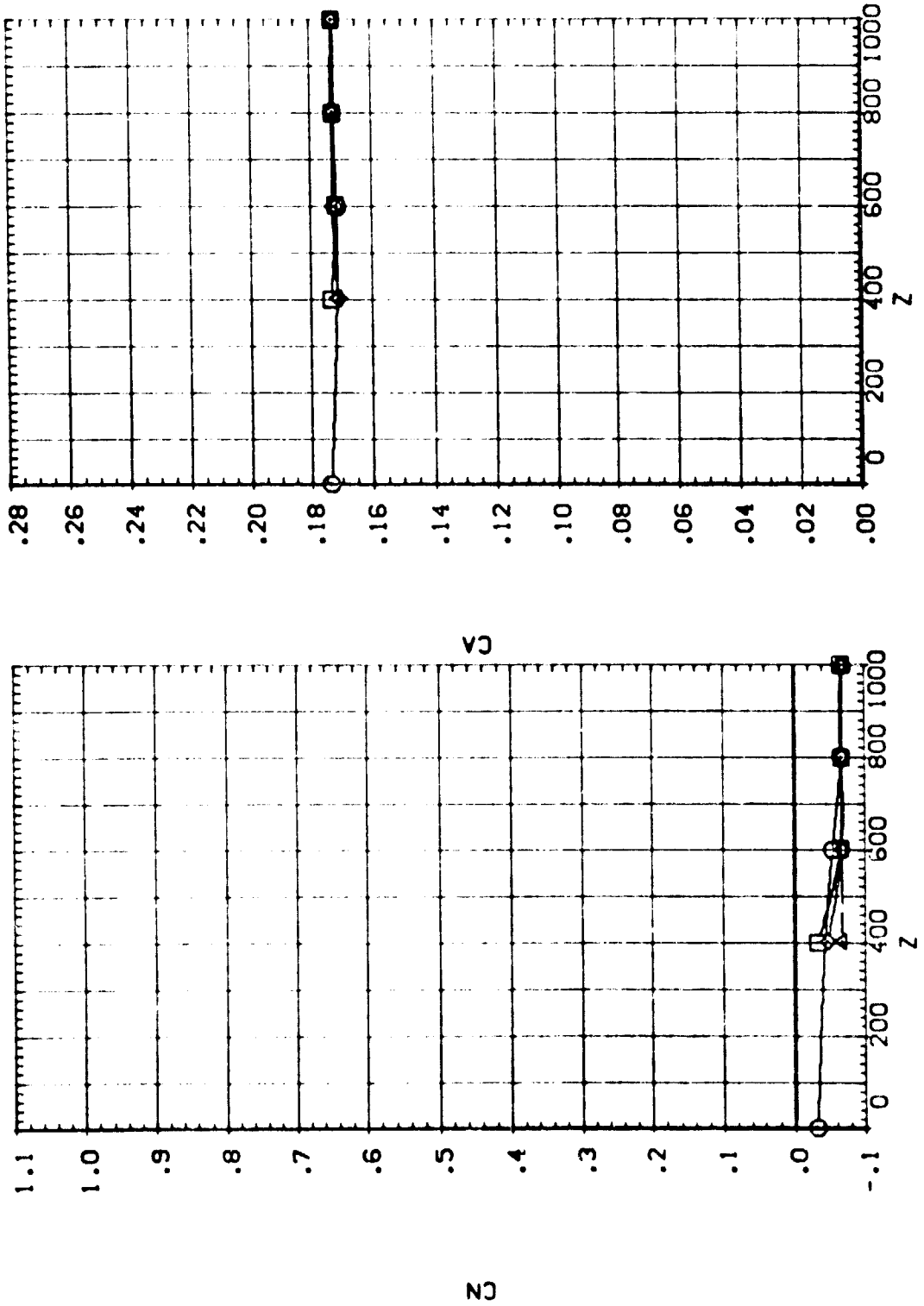

IA13 SRB(S8) W/O PLUMES SEPARATING FROM 09T10 (RTJ198)

SEE THE ASSOCIATED DATA DOCUMENT FOR REFERENCE CHARACTERISTICS FOR IDUAL DATASETS

SYMBOL		PARAMETRIC VALUES			
X	.000	MACH	4.530	PTOTAL	110.000
□	300.380	ALPHA	.000	BETA	.000
◇	600.820	DALPHA	-5.000	DBETA	-20.000
△	900.820	Y	.000	PC-MBR	.000

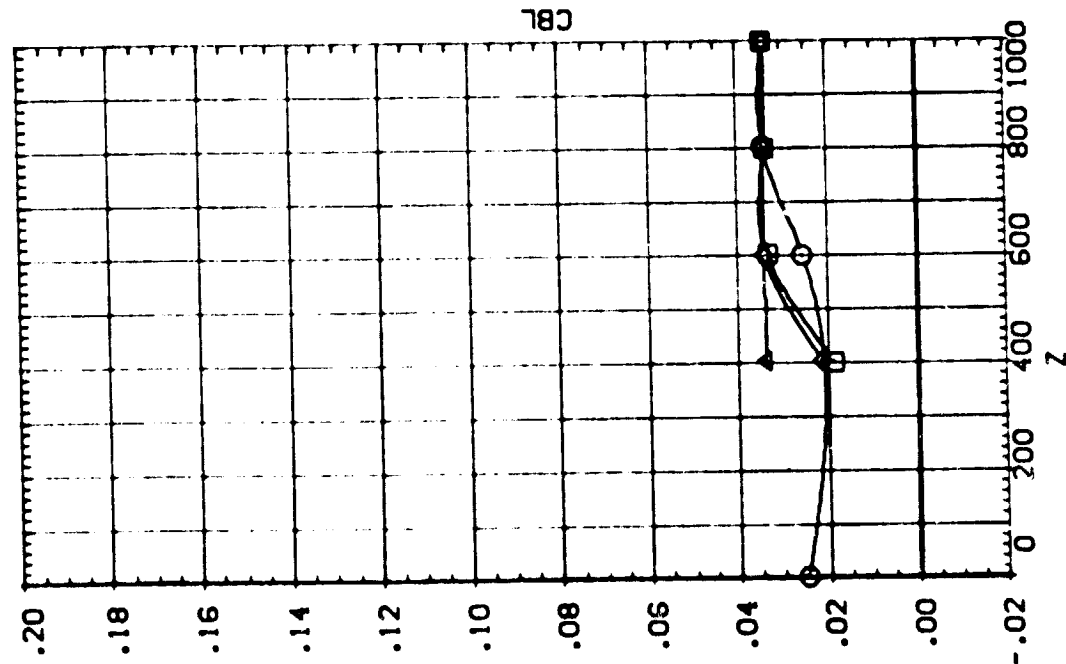

CLM

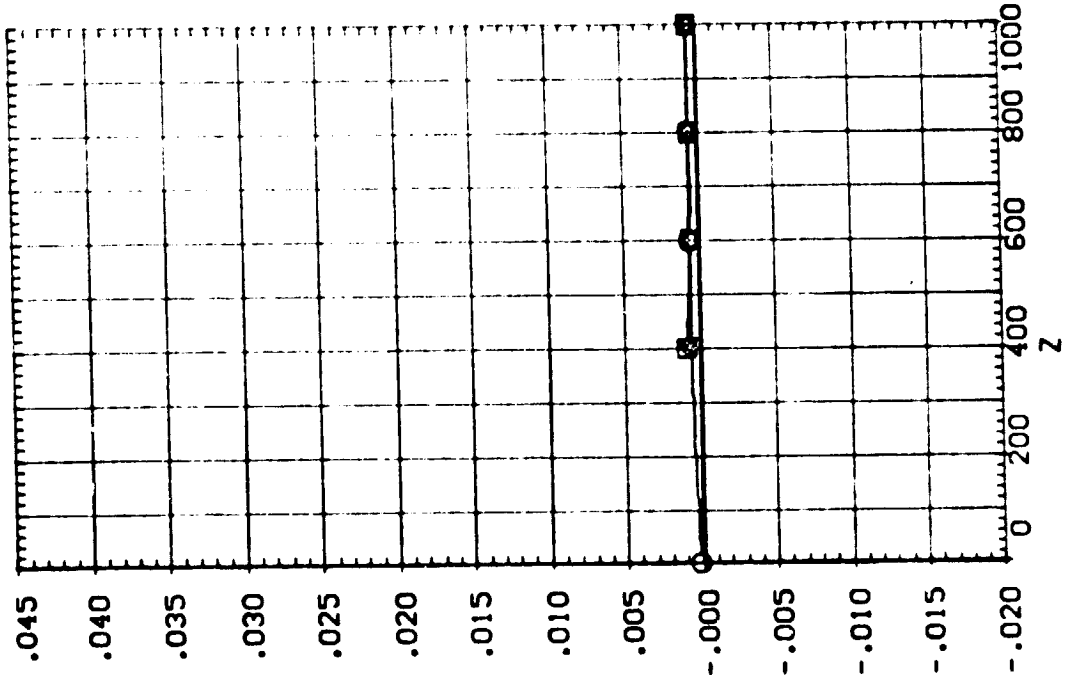

EFFECT OF SRB W/O PLUMES SEPARATION ON ORB/ET AERODYNAMIC CHARACTERISTICS

[A13 SRB(S8) W/O PLUMES SEPARATING FROM 09T10 (RTJ198)]

SEE THE ASSOCIATED DATA DOCUMENT FOR REFERENCE CHARACTERISTICS FOR INDIVIDUAL DATASETS

SYMB.		X		PARAMETRIC VALUES							
○	◇	300.380	600.870	MACH	ALPHA	DALPHA	Y	PTOTAL	BETA	DBETA	PC+PR
		.000	.000	4.530	.000	-5.000	.000	110.000	.000	-20.000	.000

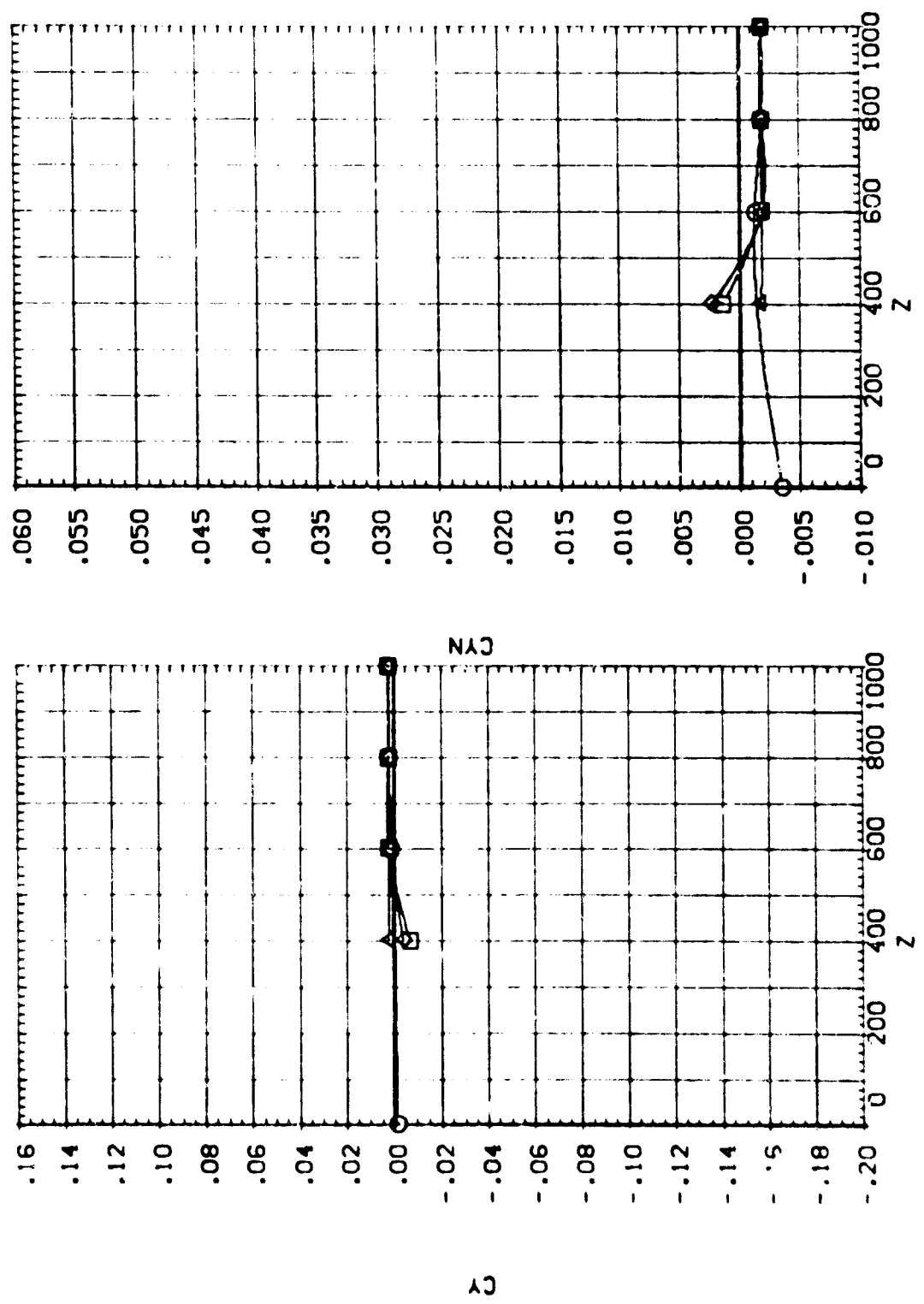

EFFECT OF SRB W/O PLUMES SEPARATION ON OR8/ET AERODYNAMIC CHARACTERISTICS

[A13 SRB(SB) W/O PLUMES SEPARATING FROM 09T10 (RTJ199)

SYMBOL	X	MACH	PARAMETRIC VALUES
○	.103	4.530	PTOTAL 110.000
□	300.790	.000	BETA .000
◇	600.660	-5.000	DBETA -20.000
△	900.550	200.000	PC+PR .000

SEE THE ASSOCIATED DATA DOCUMENT FOR REFERENCE CHARACTERISTICS FOR INDIVIDUAL DATASETS

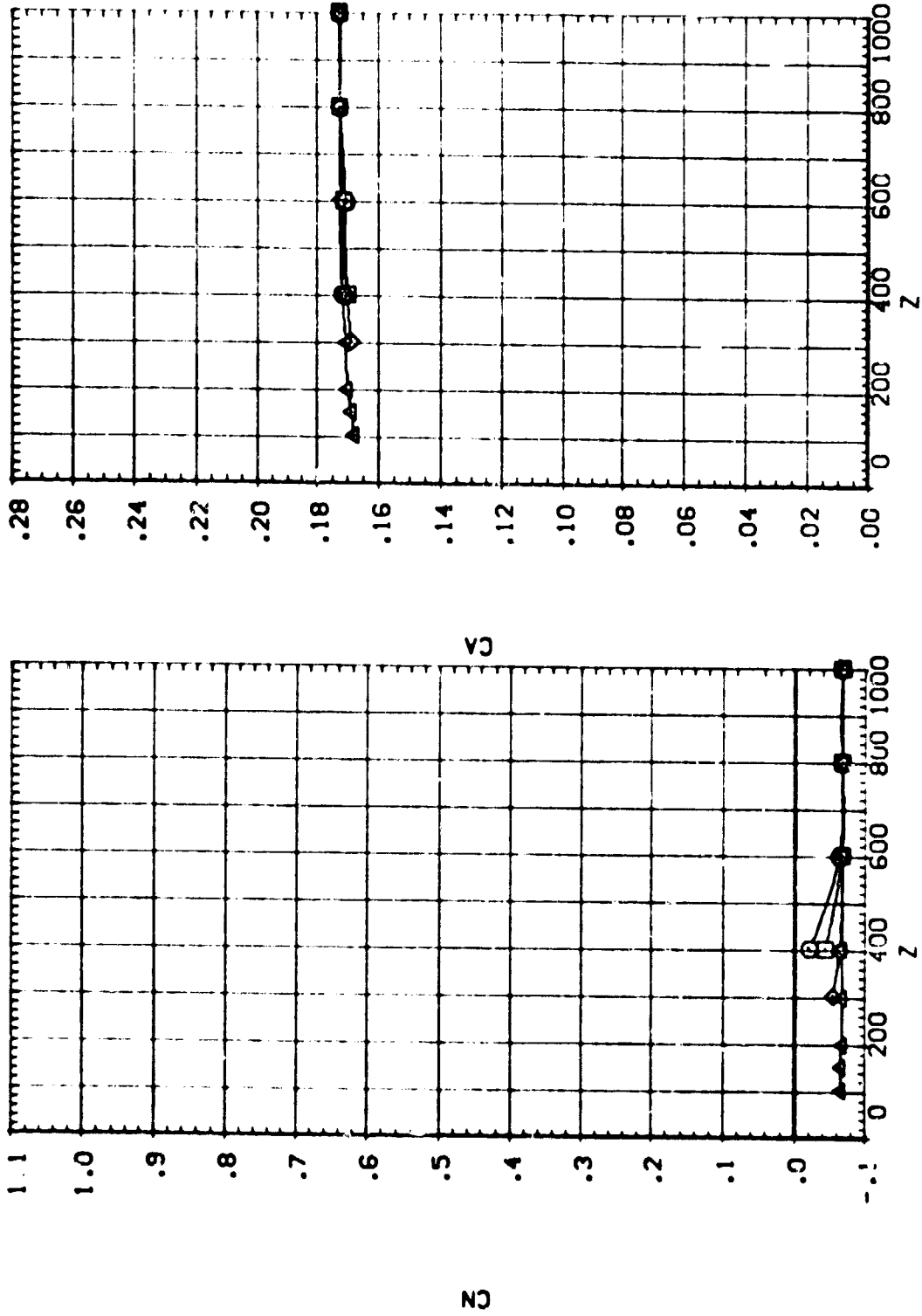

EFFECT OF SRB W/O PLUMES SEPARATION ON ORB/ET AERODYNAMIC CHARACTERISTICS

TAIS SRB(S8) W/O PLUMES SEPARATING FROM 09T10 (RTJ199)

SEE THE ASSOCIATED DATA DOCUMENT FOR REFERENCE CHARACTERISTICS FOR INDIVIDUAL DATASETS

SYMBOL	X	MACH	PARAMETRIC VALUES
○	.103	4.530	P/TOTAL 110.000
◇	300.290	.000	BETA .000
△	600.660	-5.000	DBETA -20.000
	900.550	200.000	PCHMBR .000

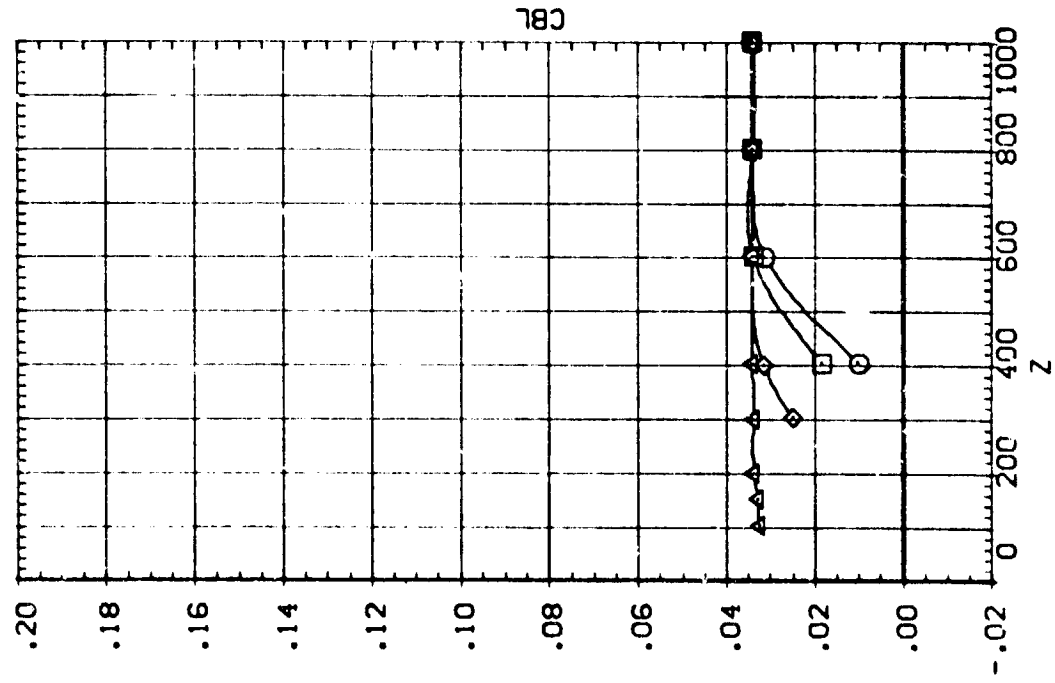
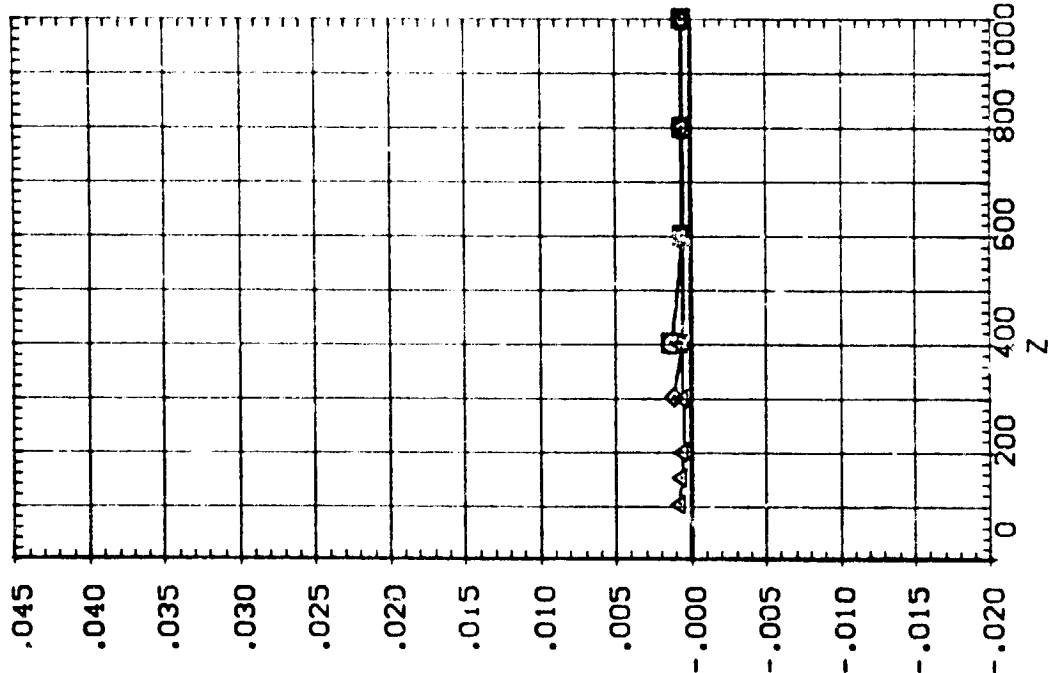

EFFECT OF SRB W/O PLUMES SEPARATION ON ORB/ET AERODYNAMIC CHARACTERISTICS

IA13 SRB(S8) W/O PLUMES SEPARATING FROM 09T10 (RTJ199)

SEE THE ASSOCIATED DATA DOCUMENT FOR REFERENCE CHARACTERISTICS FOR INDIVIDUAL DATASETS

SYMBOL		PARAMETRIC VALUES	
X	.103	MACH	4.530
	300.250	ALPHA	.000
	600.660	BETA	-5.000
	900.550	DETA	-20.000
		PC-PER	200.000
			110.000
			.000
			-20.000
			.000

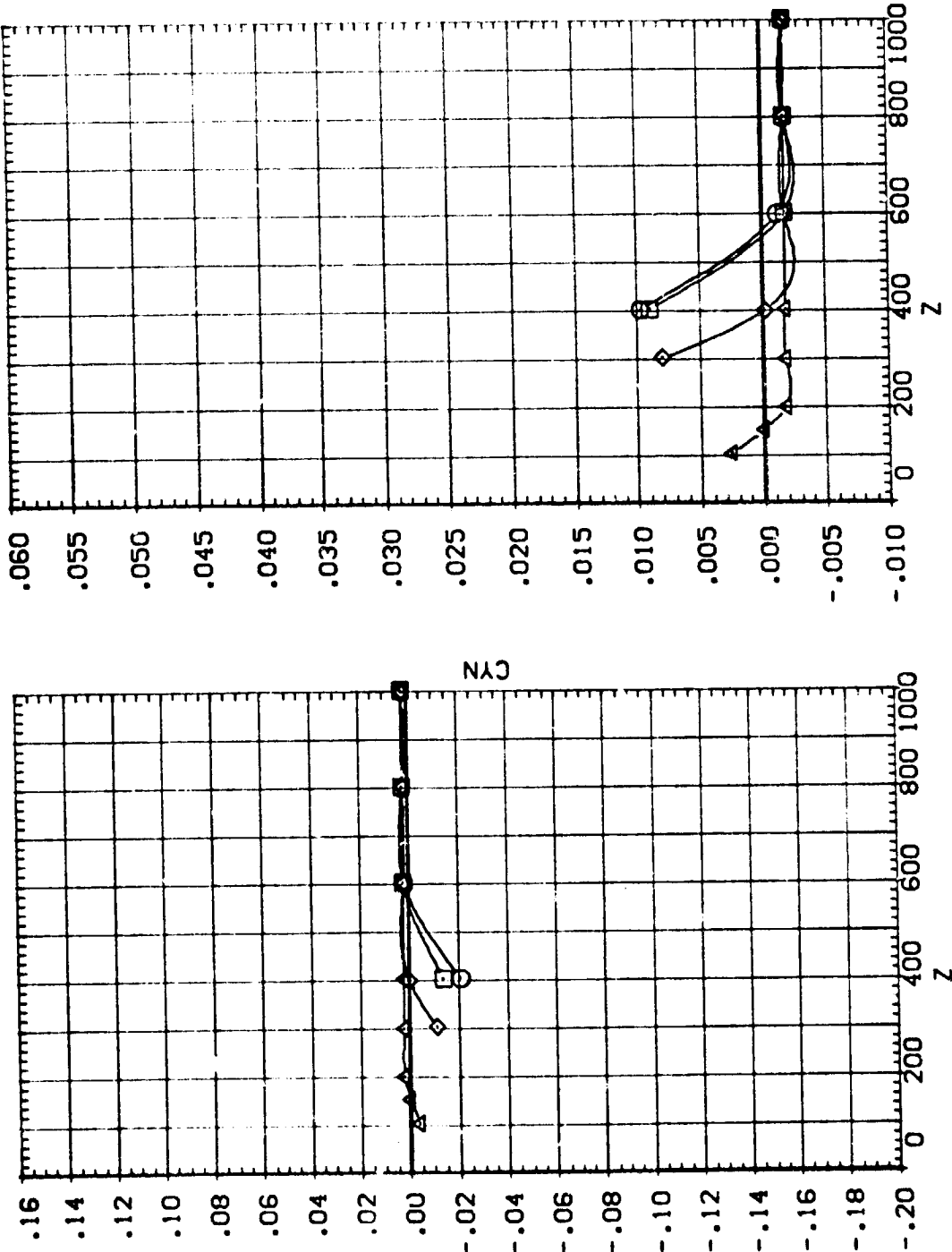

EFFECT OF SRB W/O PLUMES SEPARATION ON ORB/ET AERODYNAMIC CHARACTERISTICS

IA13 SRB(SB) W/O PLUMES SEPARATING FROM 09T10 (RTJ200)

SEE THE ASSOCIATED DATA DOCUMENT FOR REFERENCE CHARACTERISTICS FOR INDIVIDUAL DATASETS

SYMBOL		PARAMETRIC VALUES	
○	x	MACH	4.530
□		ALPHA	.000
◇		DALPHA	-5.000
△		BETA	-20.000
		DBETA	.000
		CHFR	.000

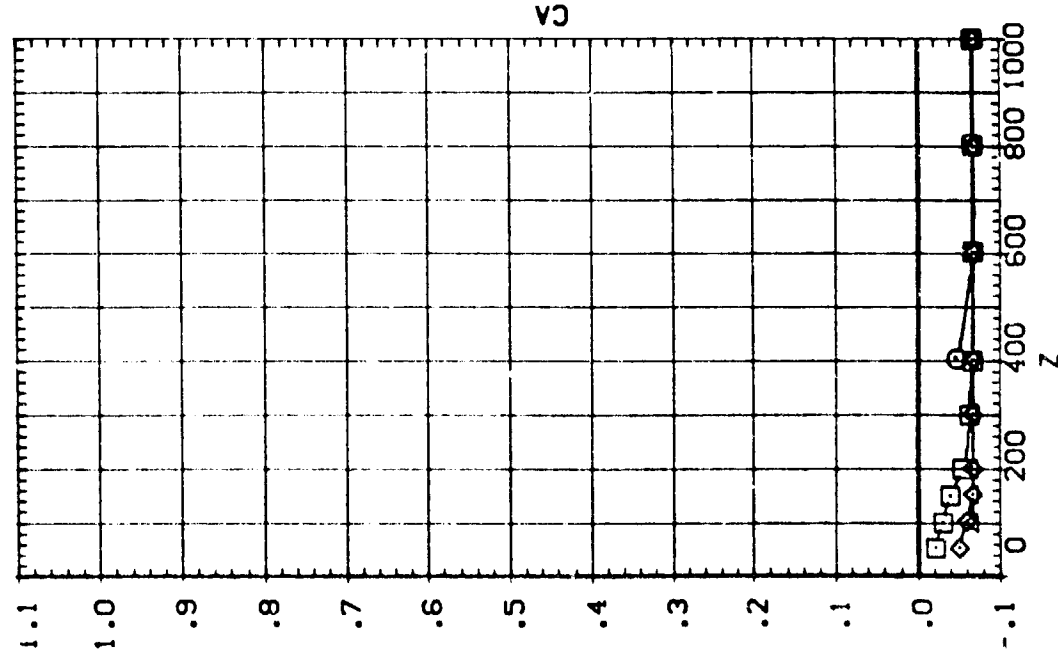
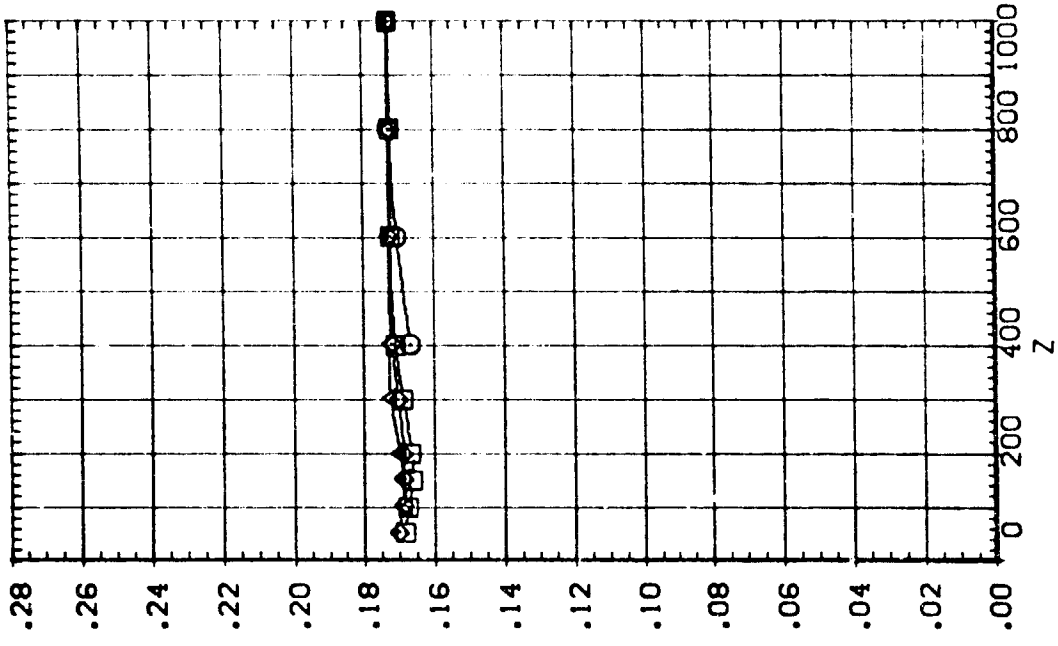

IA13 SRB(S8) W/O PLUMES SEPARATING FROM 09110 (RTJ200)

SEE THE ASSOCIATED DATA DOCUMENT FOR REFERENCE CHARACTERISTICS FOR INDIVIDUAL DATASETS

SYMBOL	X	MACH	PARAMETRIC VALUES
○	.250	4.530	PTOTAL 110.000
□	300.700	.000	BETA .000
◇	599.930	-5.000	DBETA -20.000
△	899.980	400.000	PCHGR .000

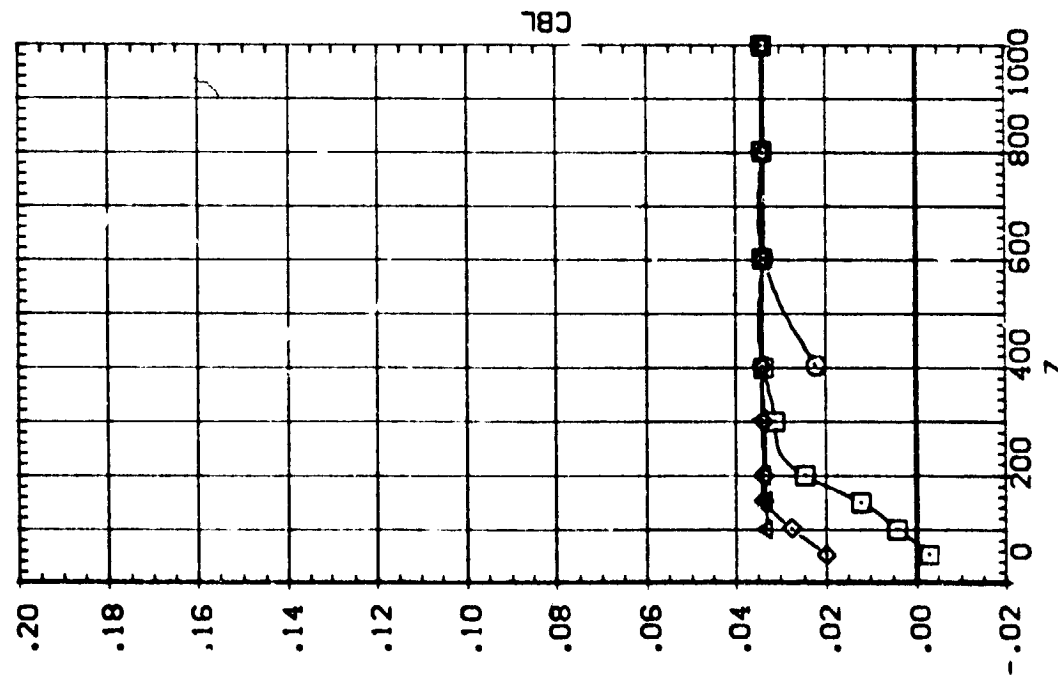
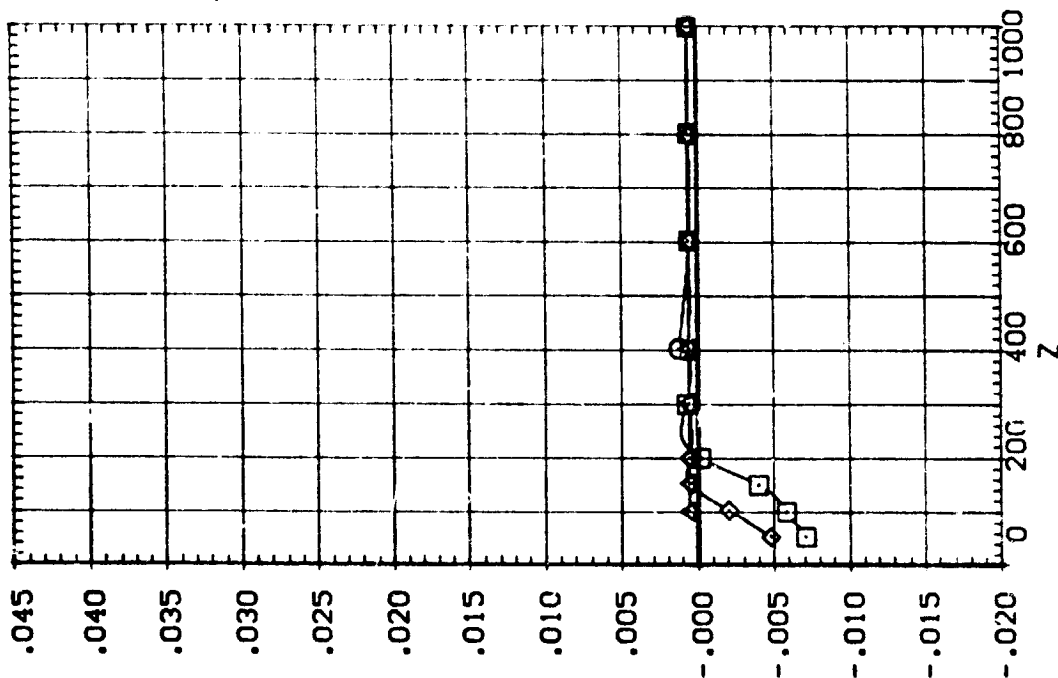

EFFECT OF SRB W/O PLUMES SEPARATION ON ORB/ET AERODYNAMIC CHARACTERISTICS

IA12 SRB(S8) W/O PLUMES SEPARATING FROM 09T10 (RTJ200)

SYMBOL X PARAMETRIC VALUES

□	.250	MACH	4.530	PTOTAL	110.000
◇	300.700	ALPHA	.000	BETA	.000
◇	599.930	DALPHA	-5.000	DBETA	-20.000
△	899.980	Y	400.000	PCHPBR	.000

SEE THE ASSOCIATED DATA DOCUMENT FOR REFERENCE CHARACTERISTICS FOR INDIVIDUAL DATASETS

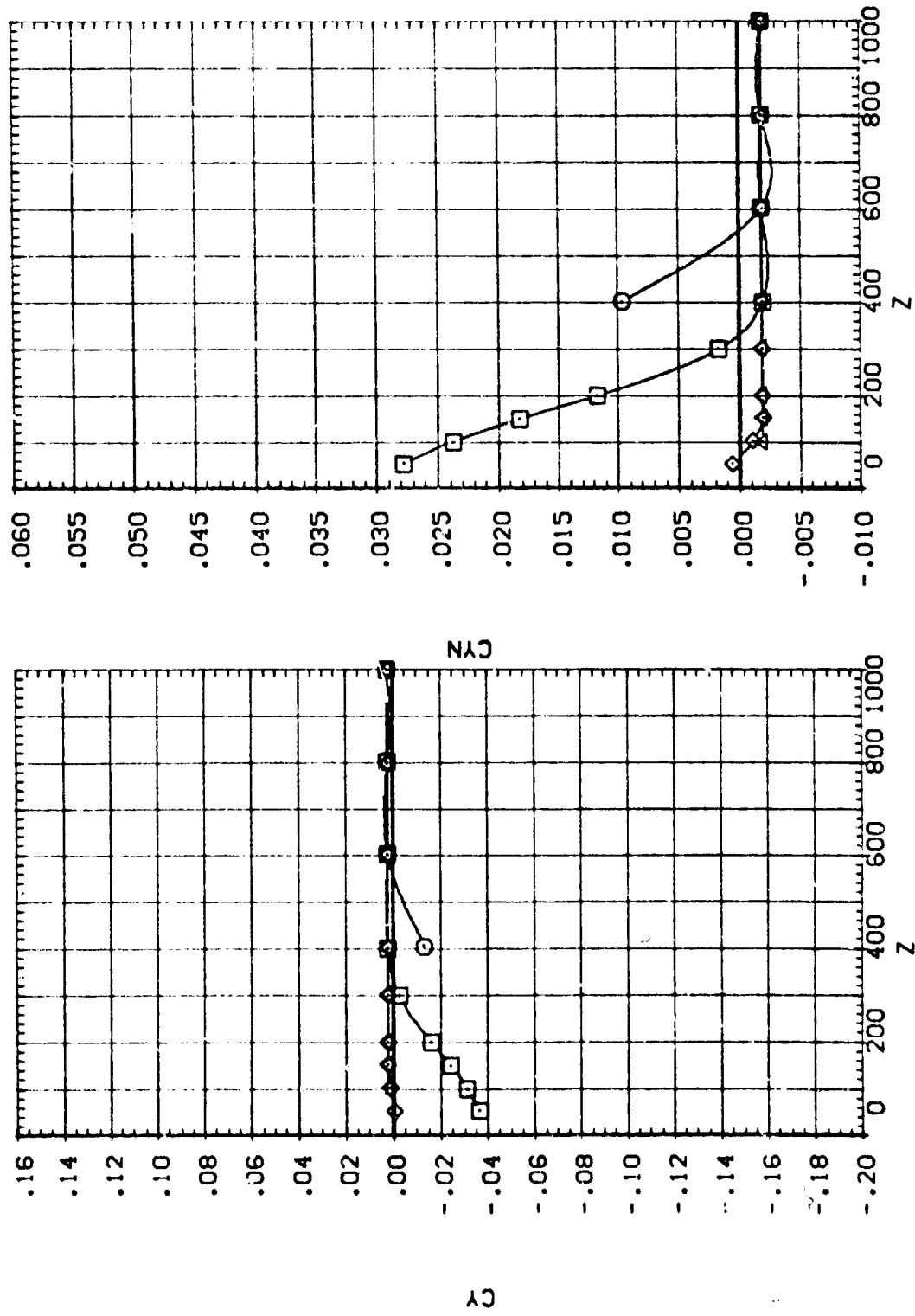

[A13 SRB(S8) W/O PLUMES SEPARATING FROM 09T10 (RTJ201)

SEE THE ASSOCIATED DATA DOCUMENT FOR REFERENCE CHARACTERISTICS FOR INDIVIDUAL DATASETS

SYMBOL	X	MACH	PARAMETRIC VALUES
○	.702	4.530	P TOTAL 110.000
□	300.510	.000	BETA .000
◇	600.100	-5.000	DBETA -20.000
△	900.630	Y	PC-MER .000

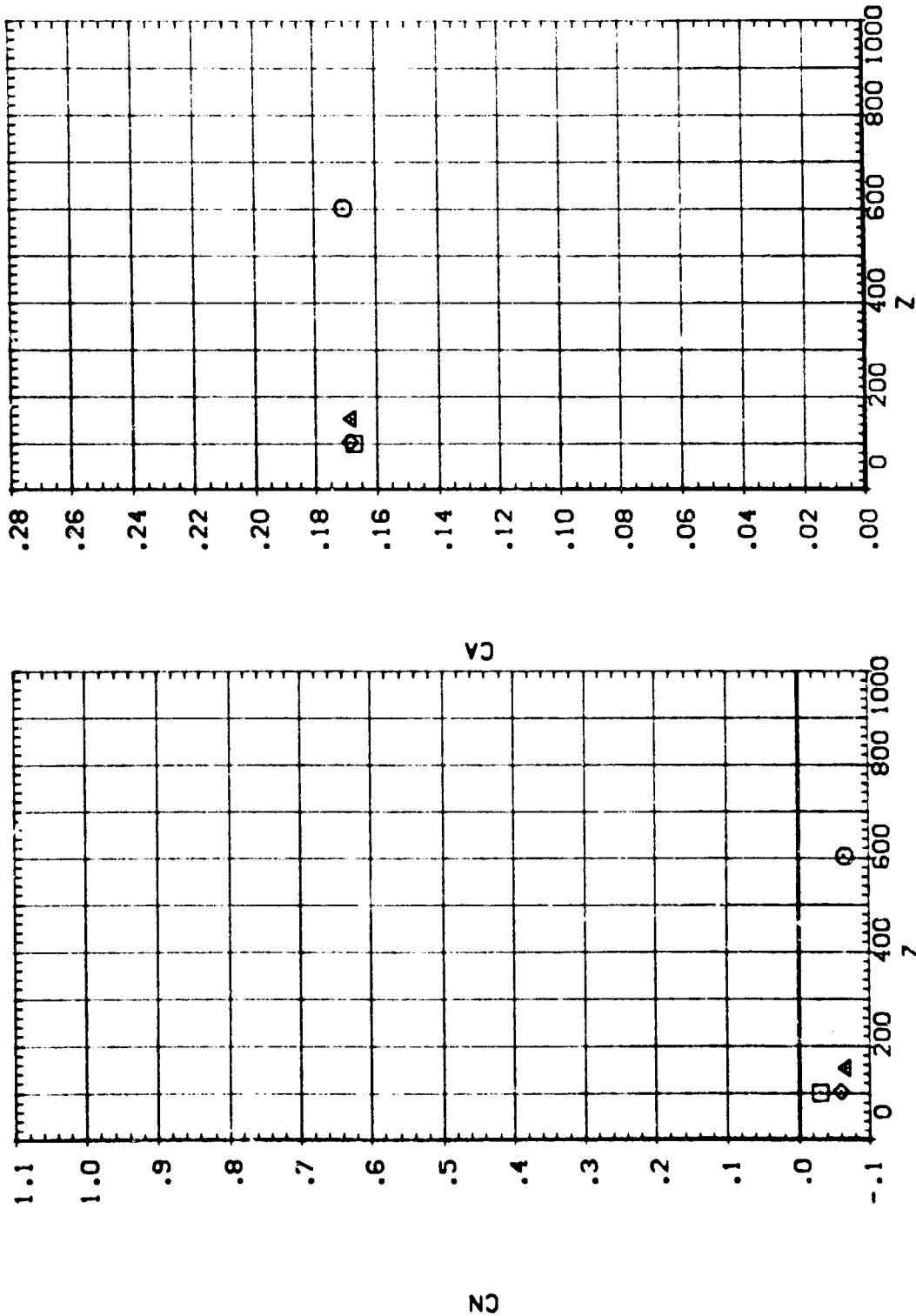

EFFECT OF SRB W/O PLUMES SEPARATION ON ORB/ET AERODYNAMIC CHARACTERISTICS

IA13 SRB(SB) W/O PLUMES SEPARATING FROM ORT10 (RTJ201)

SEE THE ASSOCIATED DATA DOCUMENT FOR REFERENCE CHARACTERISTICS FOR INDIVIDUAL DATASETS

PARAMETRIC VALUES

MACH	4.530	P/TOTAL	110.000
ALPHA	.000	BETA	.000
DELTA	-5.000	DBETA	-20.000
Y	800.000	PC-MBR	.000

SYMBOL X
 O
 □
 ◇
 △

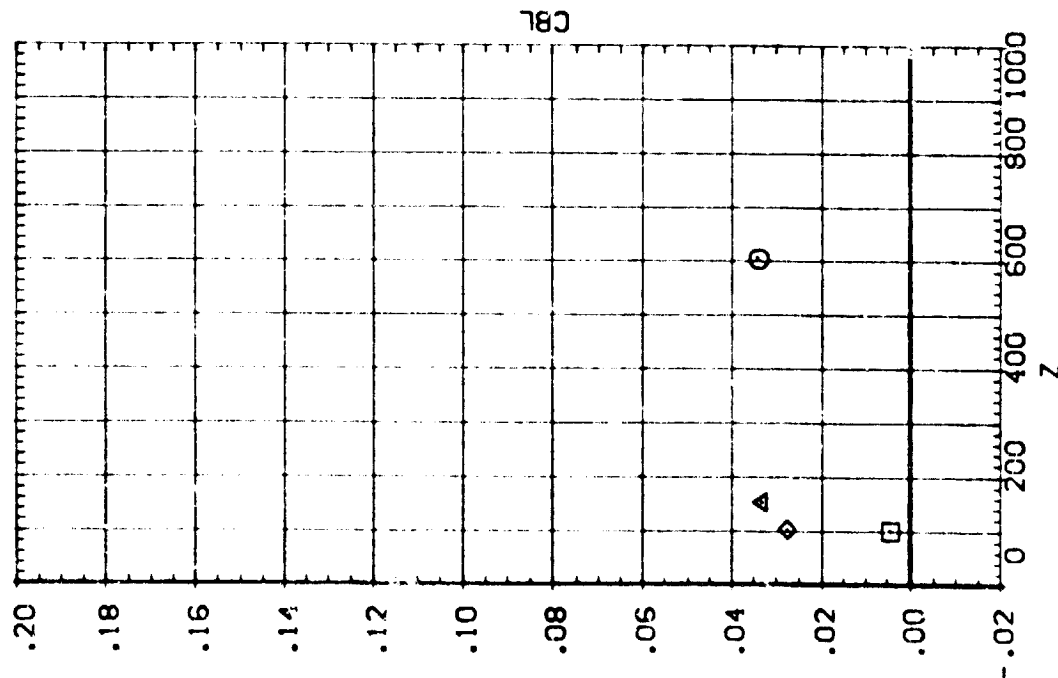
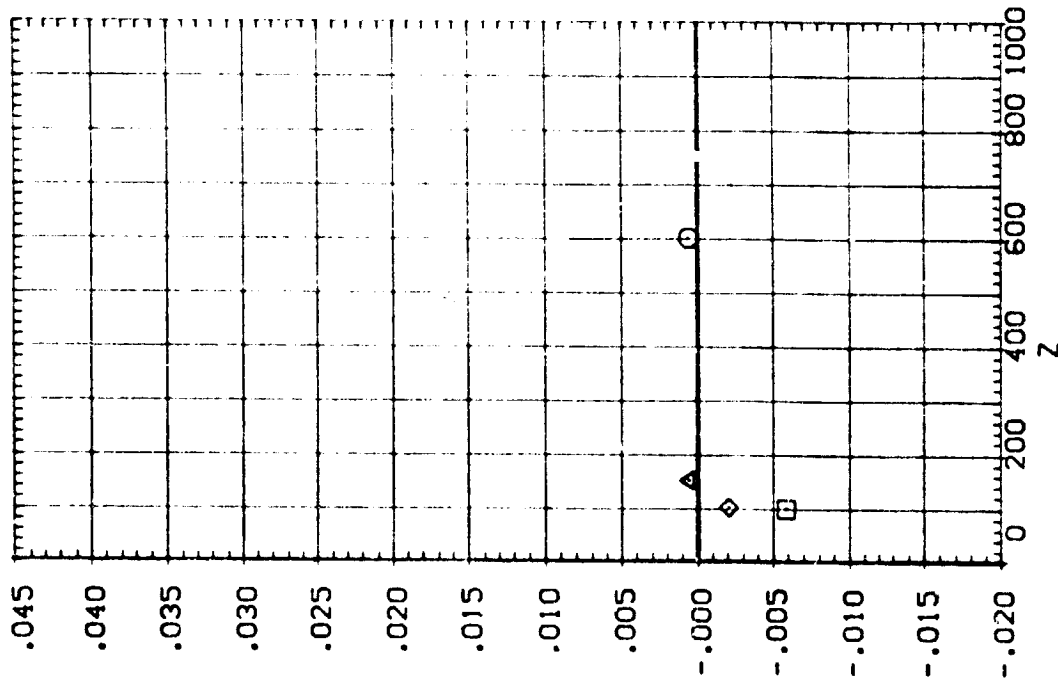

IA13 SR8(S8) W/O PLUMES SEPARATING FROM 09T10 (RTJ201)

SEE THE ASSOCIATED DATA DOCUMENT FOR REFERENCE CHARACTERISTICS FOR INDIVIDUAL DATASETS

SYMBOL		PARAMETRIC VALUES				
○	X	.702	MACH	4.530	PITOTAL	110.000
□	300.510	.000	ALPHA	.000	BETA	.000
◇	600.100	-5.000	DALPHA	-5.000	DBETA	-20.000
△	900.630	800.000	Y	800.000	PC-MFR	.000

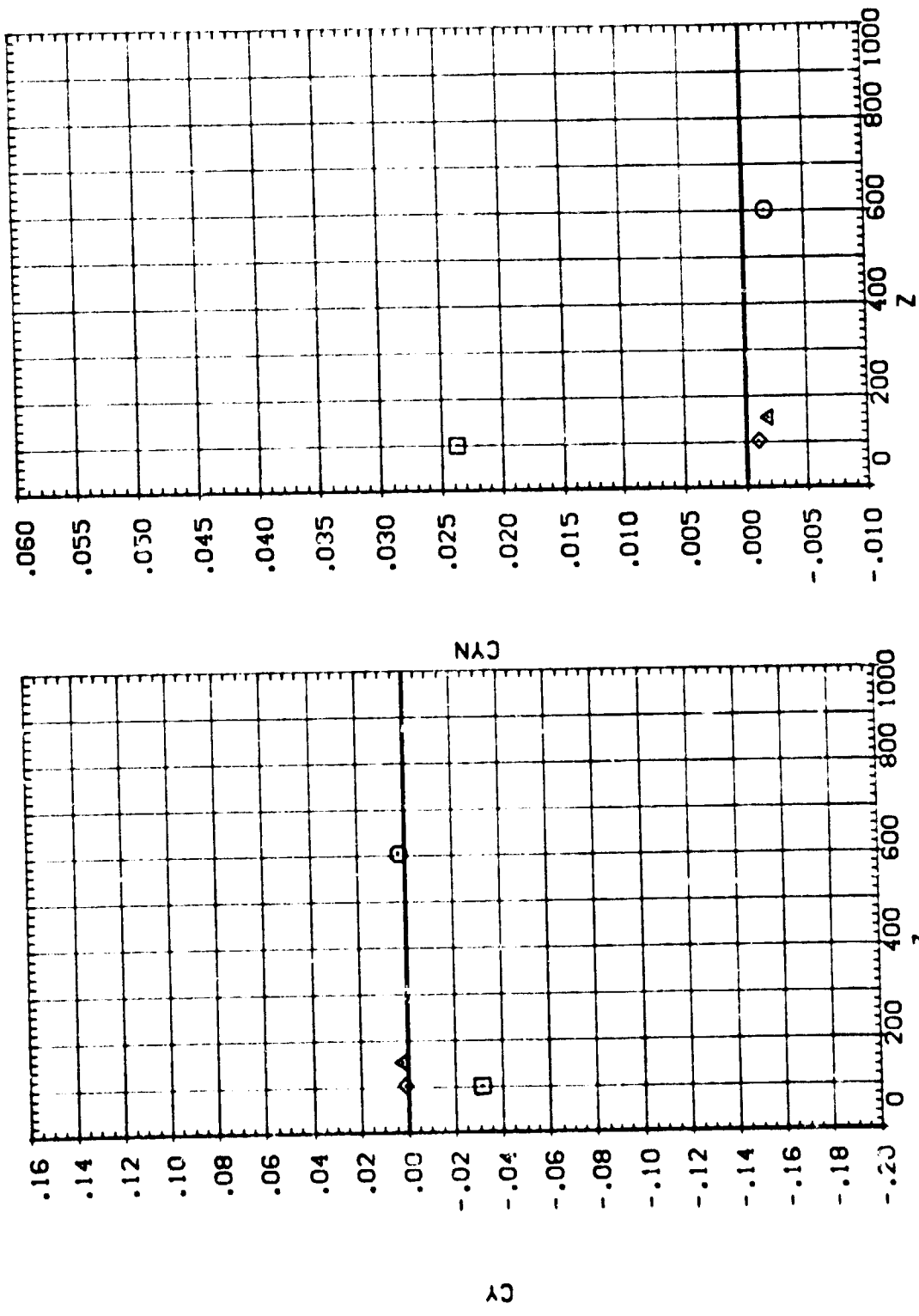

EFFECT OF SR8 W/O PLUMES SEPARATION ON ORB/ET AERODYNAMIC CHARACTERISTICS

IA13 SRB(SB) W/O PLUMES SEPARATING FROM 09T10 (RTJ202)

SEE THE ASSOCIATED DATA DOCUMENT FOR REFERENCE CHARACTERISTICS FOR INDIVIDUAL DATASETS

STATION	X	MACH	PARAMETRIC VALUES
900.690	.173	4.530	P TOTAL :10.000
		.000	BETA :.000
		-10.000	DBETA 5.000
		.000	PC-MBR :.000

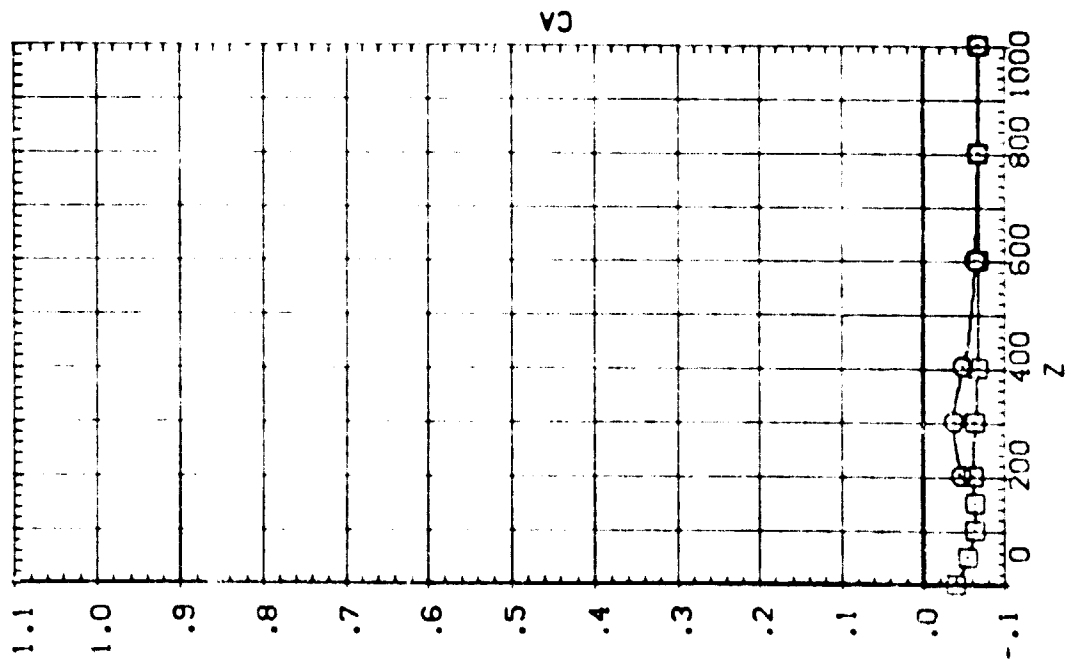
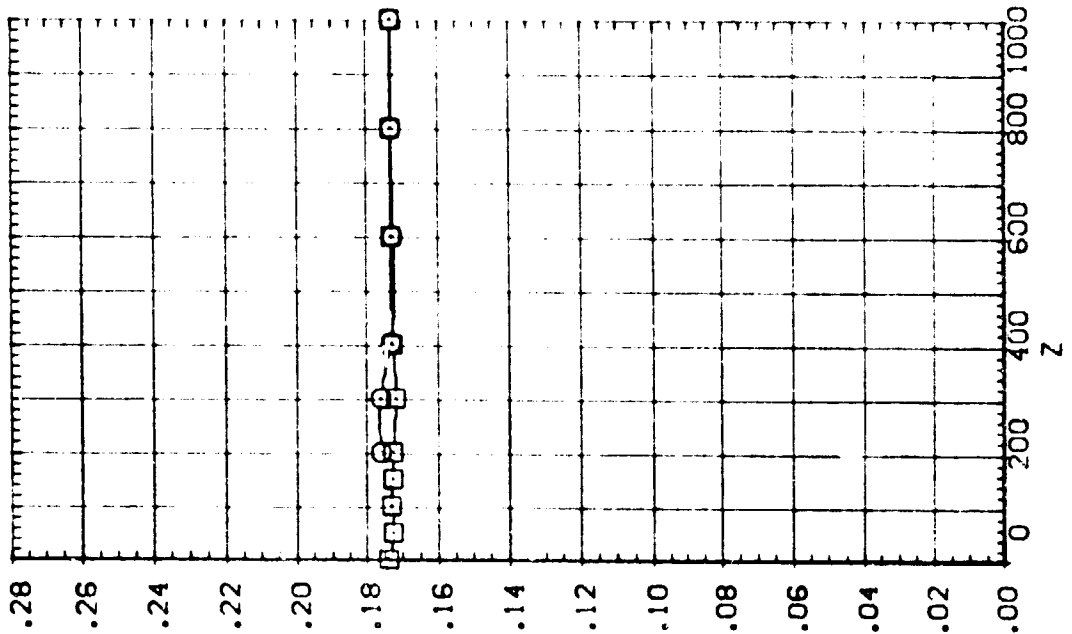

IA13 SRB(S8) W/O PLUMES SEPARATING FROM 09T10 (RTJ202)

SEE THE ASSOCIATED DATA DOCUMENT FOR REFERENCE CHARACTERISTICS FOR INDIVIDUAL DATASETS

SYMBOL	X	MACH	PARAMETRIC VALUES		
□	.173	4.530	PTOTAL	110.000	
○	900.690	ALPHA	BETA	.000	
		DALPHA	DBETA	5.000	
		Y	PC-MBR	.000	

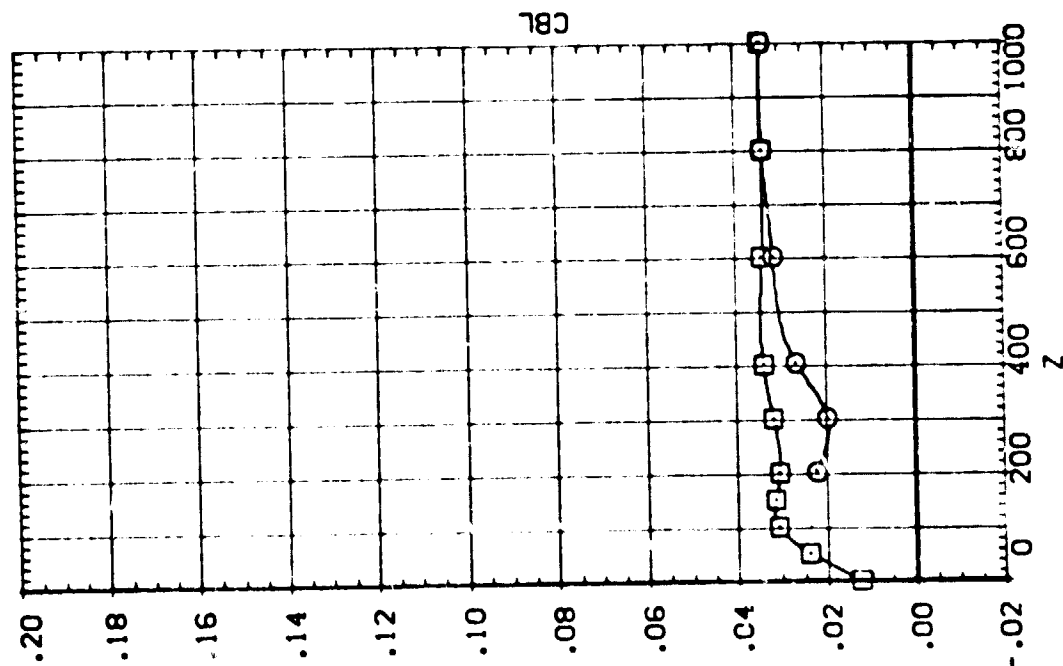
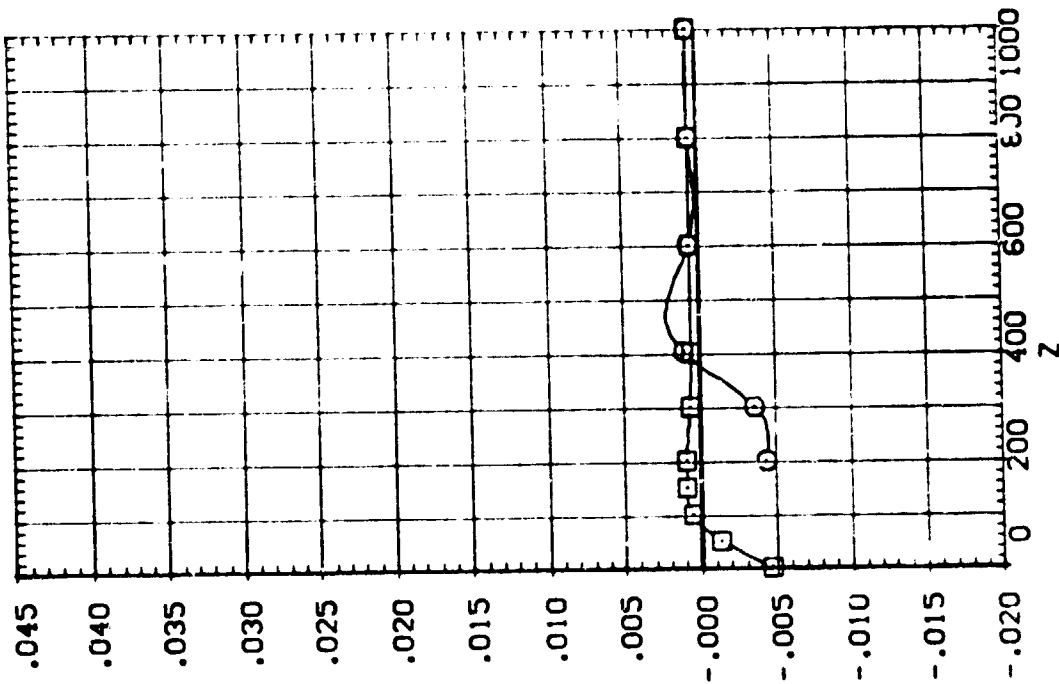

EFFECT OF SRB W/O PLUMES SEPARATION ON ORB/ET AERODYNAMIC CHARACTERISTICS

1A13 SRB(SB) W/O PLUMES SEPARATING FROM ORBIT (RTJ202)

SEE THE ASSOCIATED DATA DOCUMENT FOR REFERENCE CHARACTERISTICS FOR INDIVIDUAL DATA SETS

SYMBOL	PARAMETRIC VALUES
1	MACH 4.530 PTOTAL 110.000
2	ALPHA .000 BETA .000
3	DALPHA -10.000 DBETA 5.000
4	Y .000 PC-MBR .000

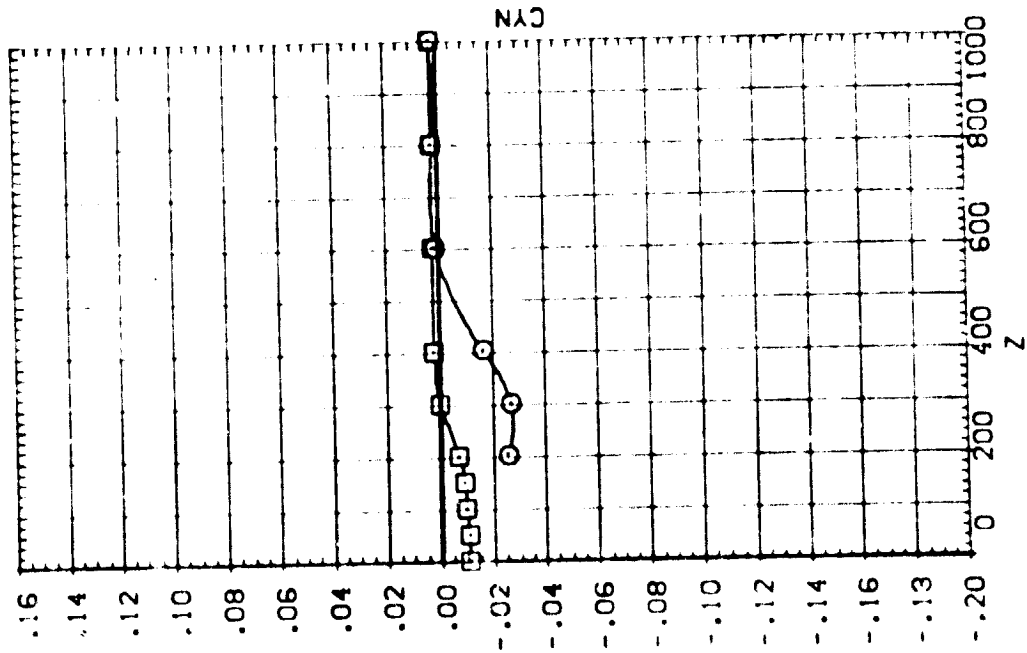
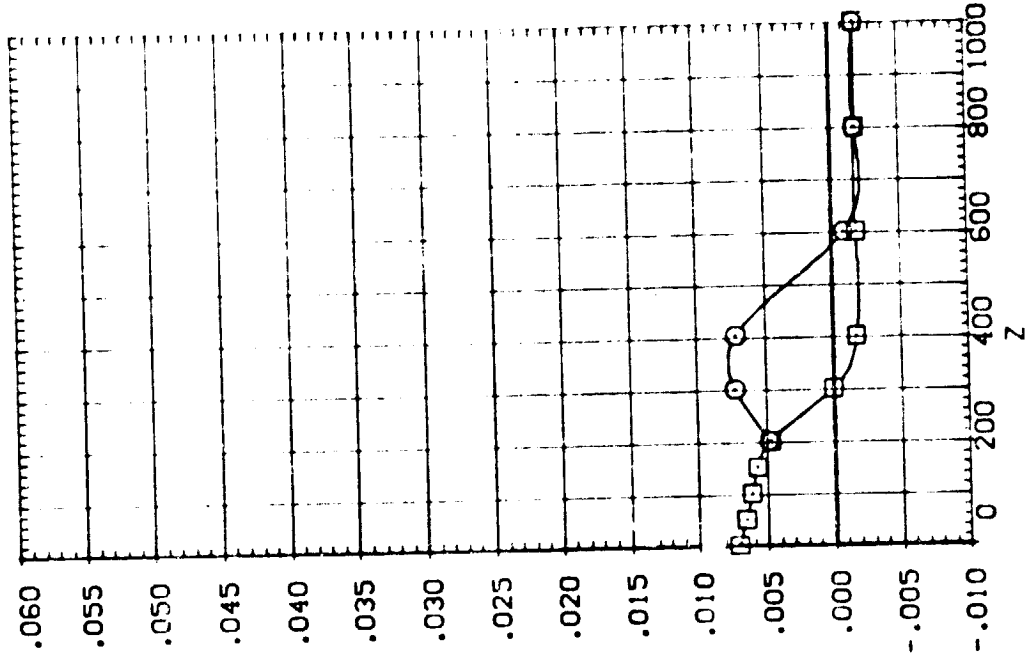

IA13 SRB(S8) W/O PLUMES SEPARATING FROM 09T10 (RTJ203)

SYMBOL X

○ □

PARAMETRIC VALUES

MACH	4.530	PITOTAL	110.000
ALPHA	.000	BETA	.000
DALPHA	-10.000	DBETA	5.000
V	200.000	PC-MBR	.000

SEE THE ASSOCIATED DATA DOCUMENT FOR REFERENCE CHARACTERISTICS FOR INDIVIDUAL DATASETS

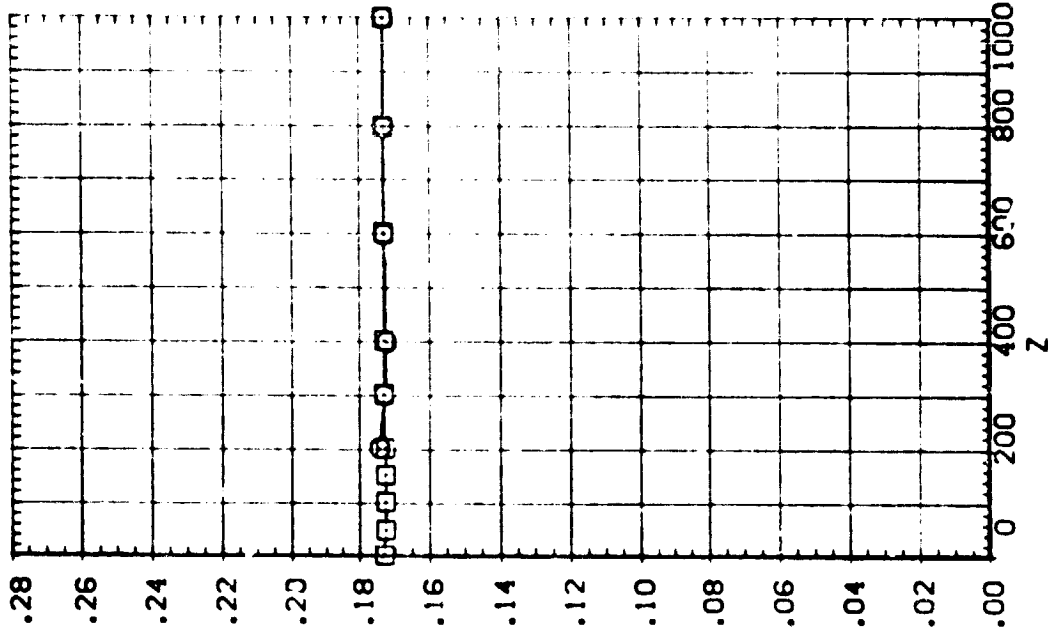
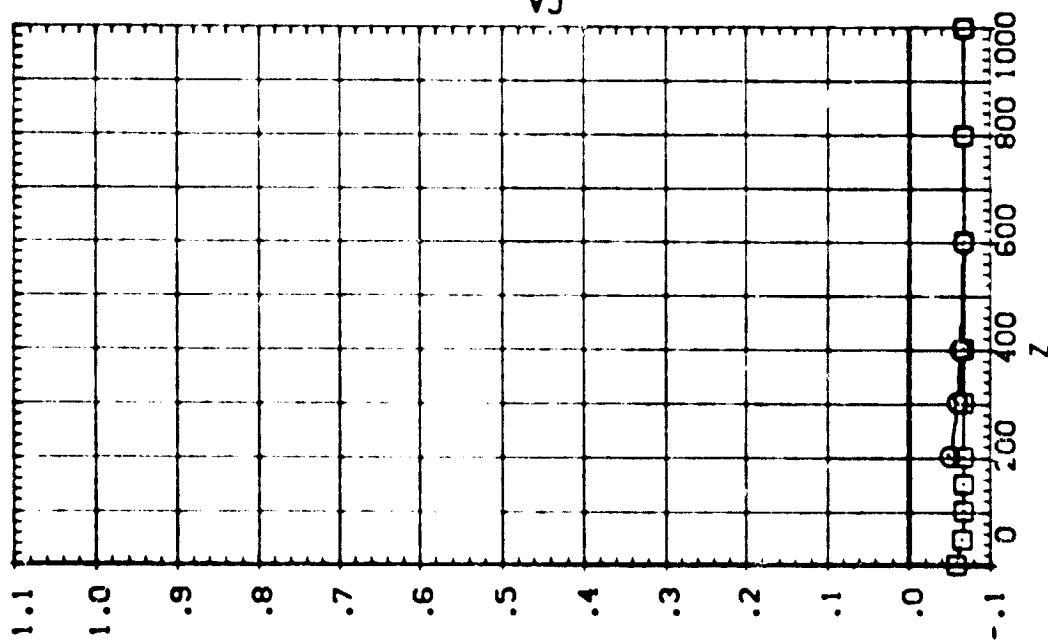

Z

EFFECT OF SRB W/O PLUMES SEPARATION ON ORB/ET AERODYNAMIC CHARACTERISTICS

1A13 SRB(S8) W/O PLUMES SEPARATING FROM 09T10 (RTJ203)

SEE THE ASSOCIATED DATA DOCUMENT FOR REFERENCE CHARACTERISTICS FOR INDIVIDUAL DATA SETS

SYMBOL X PARAMETRIC VALUES
 ○ .277 MACH TOTAL 110.000
 □ 500.600 ALPHA .000 BETA .000
 △ -10.000 DBETA 5.000
 ▽ 200.000 PCMBR .000

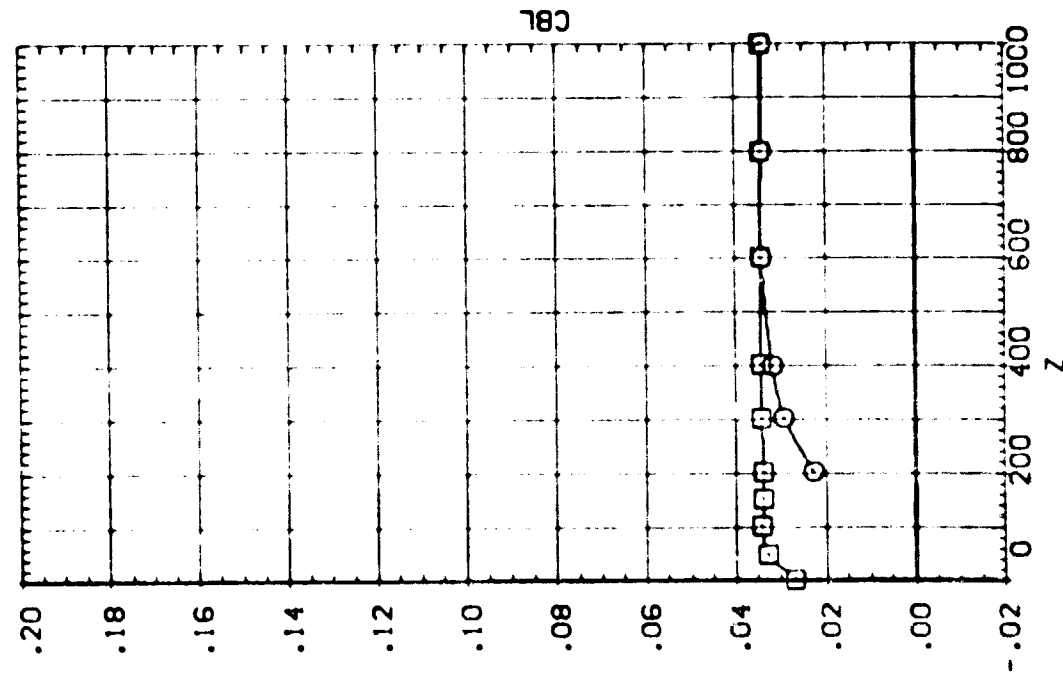
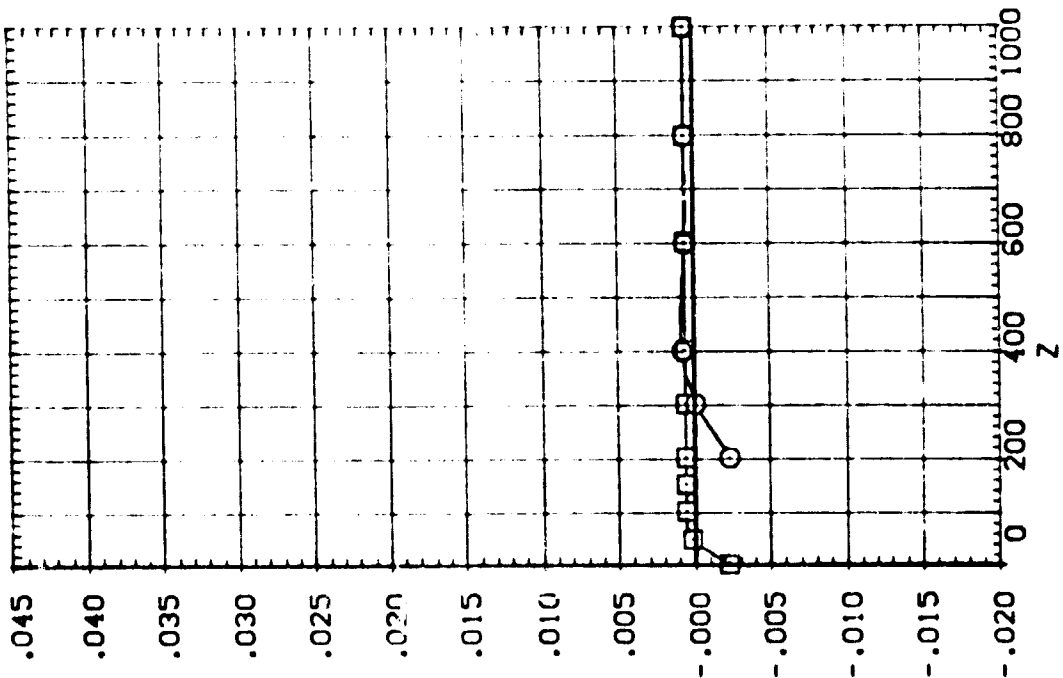

EFFECT OF SRB W/O PLUMES SEPARATION ON ORB/ET AERODYNAMIC CHARACTERISTICS

IA13 SRB(S8) W/O PLUMES SEPARATING FROM 09T10 (RTJ203)

SEE THE ASSOCIATED DATA DOCUMENT FOR REFERENCE CHARACTERISTICS FOR INDIVIDUAL DATASETS

SYMBOL		PARAMETRIC VALUES			
○	x	MACH	4.530	PTOTAL	110.000
□	900.600	ALPHA	.000	BETA	.000
		ALPHA	-10.000	BETA	5.000
		Y	200.000	PC-MFR	.000

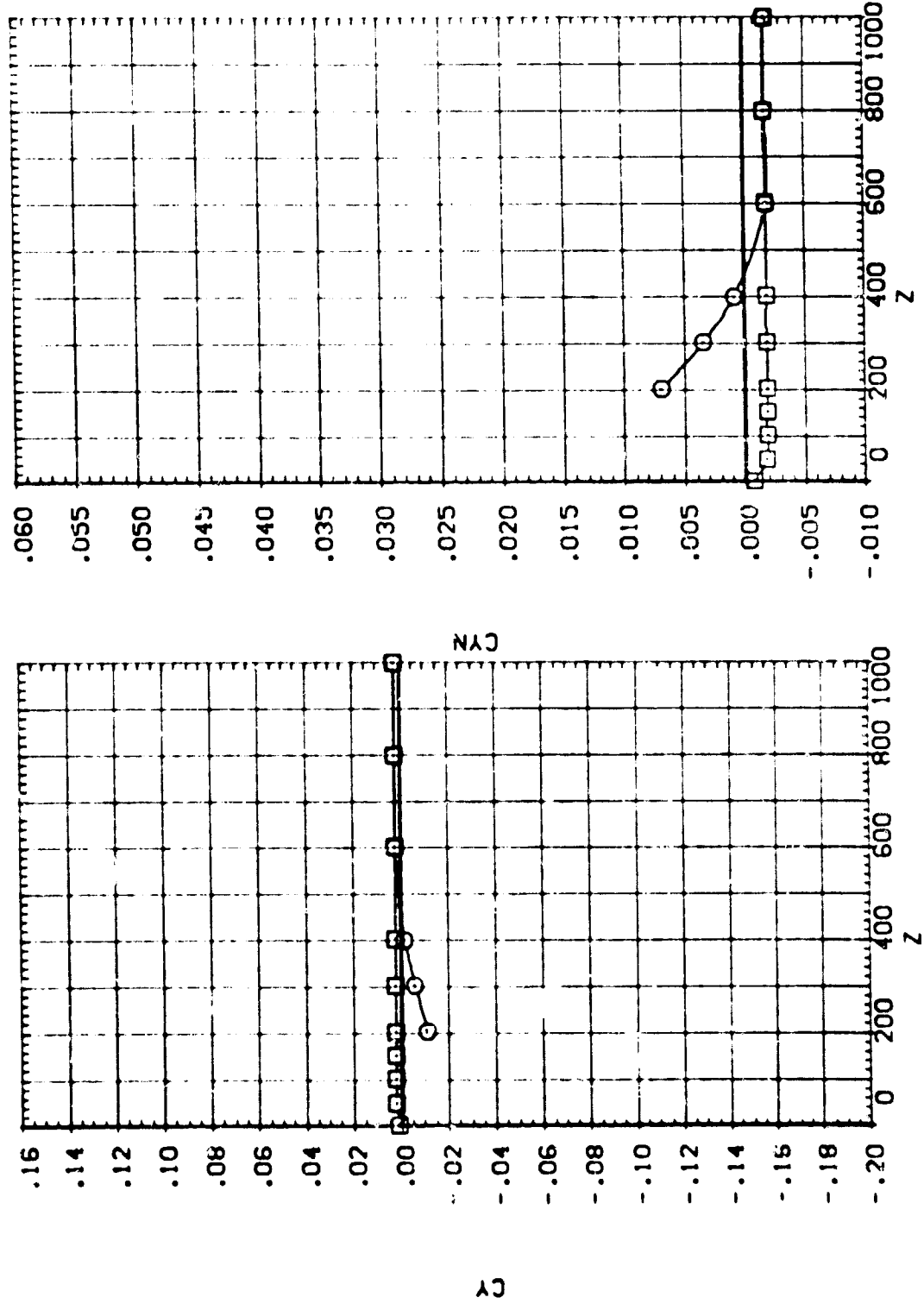

EFFECT OF SRB W/O PLUMES SEPARATION ON ORB/ET AERODYNAMIC CHARACTERISTICS

IA13 SRB(S8) W/O PLUMES SEPARATING FROM 09T10 (RTJ204)

SEE THE ASSOCIATED DATA DOCUMENT FOR REFERENCE CHARACTERISTICS FOR INDIVIDUAL DATASETS

SYMBOL	X	MACH	PARAMETRIC VALUES
○	.163	4.530	PITOTAL 110.000
□	900.370	.000	BETA .000
		-10.000	DBETA 5.000
		400.000	PC-MBR .000

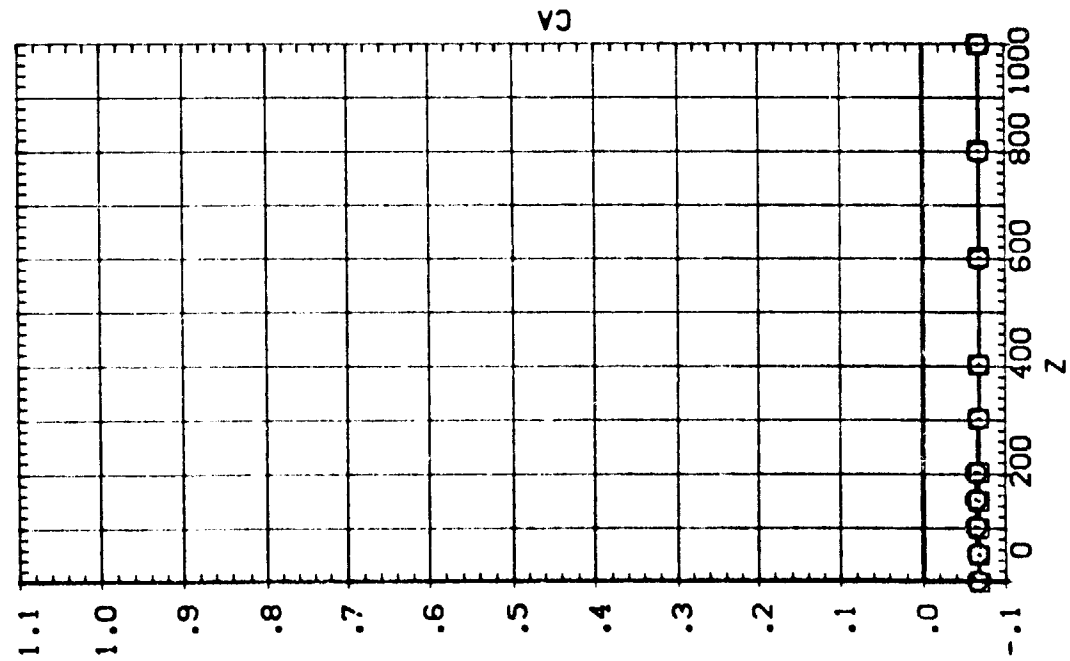
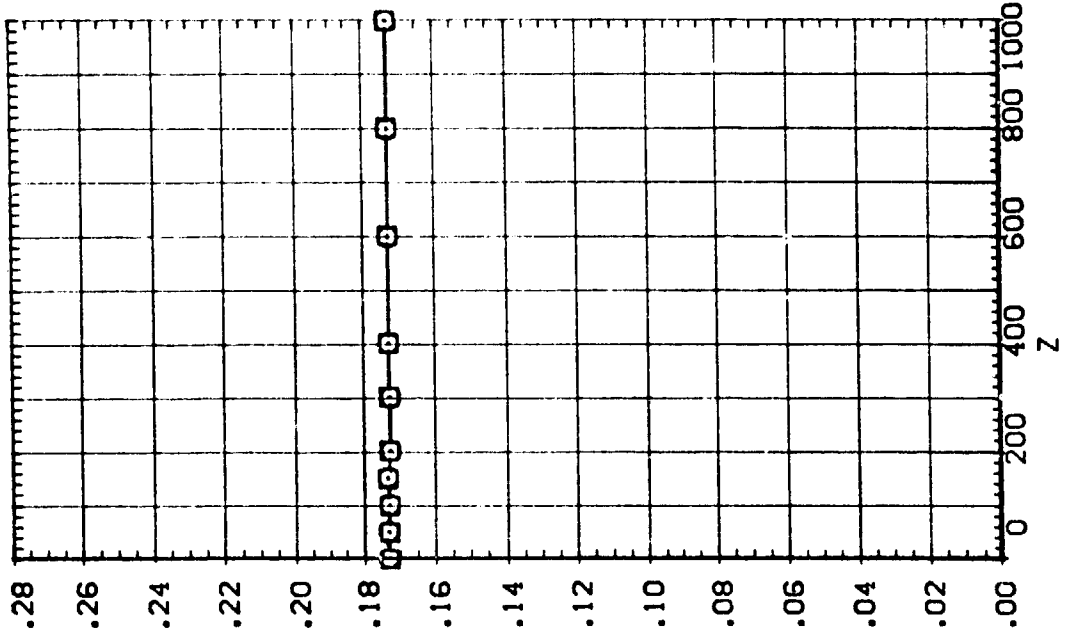

IA13 SRB(S8) W/O PLUMES SEPARATING FROM 09T10 (RTJ204)

SEE THE ASSOCIATED DATA DOCUMENT FOR REFERENCE CHARACTERISTICS FOR INDIVIDUAL DATASETS

PARAMETRIC VALUES
 MACH 4.530 P/TOTAL 110.000
 ALPHA .000 BETA .000
 DALPHA -10.000 DBETA 5.000
 Y 400.000 PC-MFR .000

SYMBOL X .163
 900.370

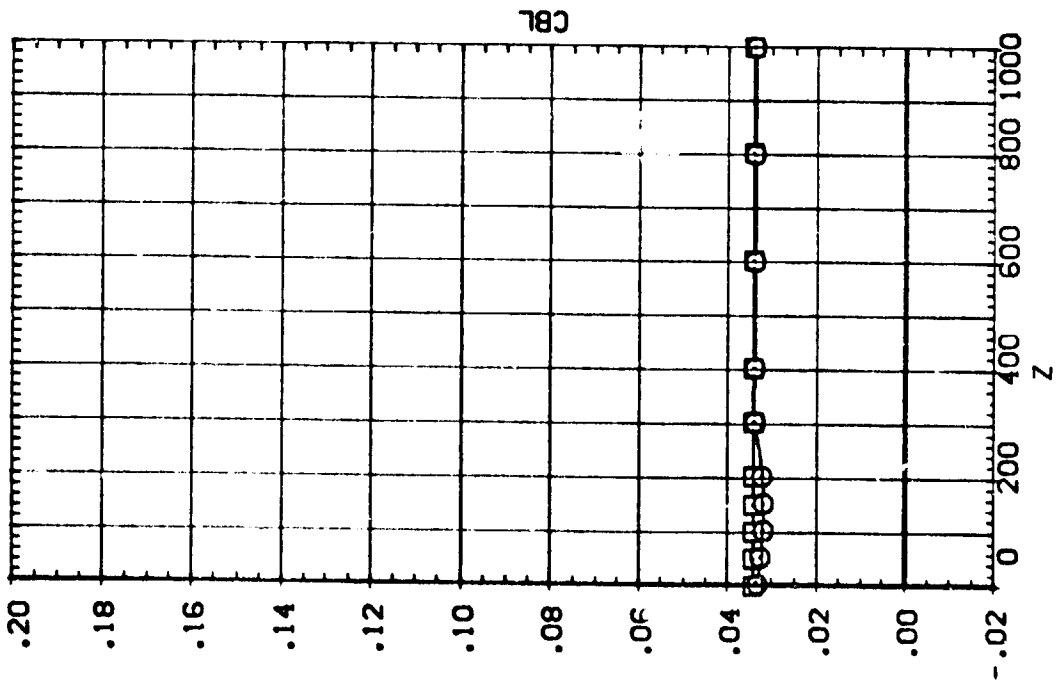
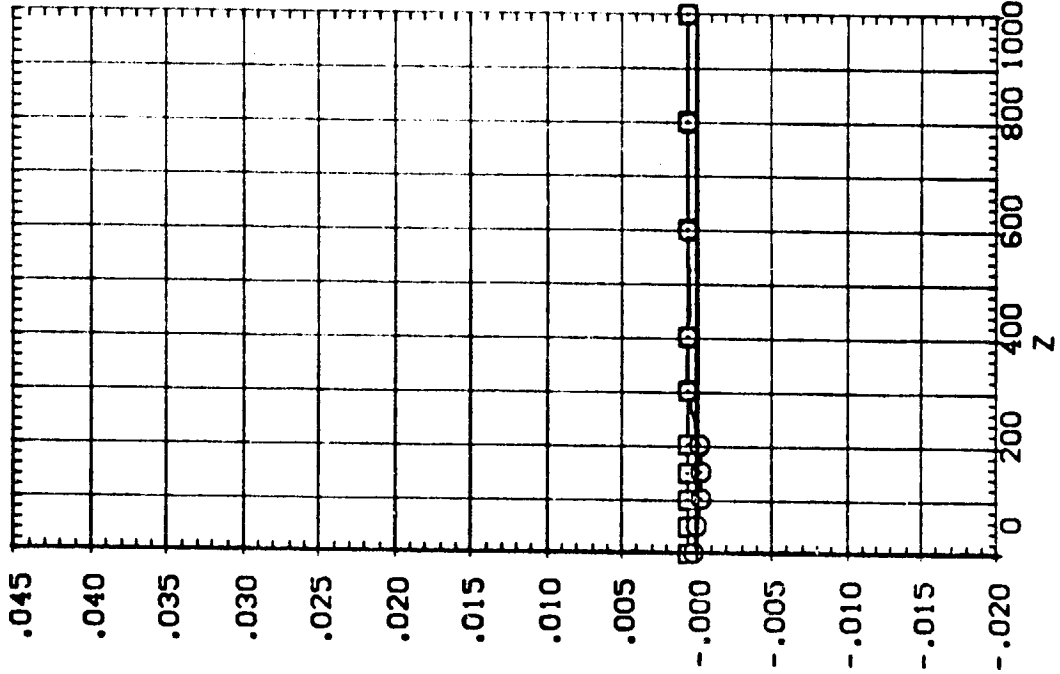

EFFECT OF SRB W/O PLUMES SEPARATION ON ORB/ET AERODYNAMIC CHARACTERISTICS

IA13 SRB(S8) W/O PLUMES SEPARATING FROM 09T10 (RTJ204)

SEE THE ASSOCIATED DATA DOCUMENT FOR REFERENCE CHARACTERISTICS FOR INDIVIDUAL DATASETS

SYMBOL		X	MACH	PARAMETRIC VALUES			
○		.161	4.530	PTOTAL	110.000		
□		900.373	.000	BETA	.000		
			-10.000	DBETA	5.000		
			400.000	PC-MFR	.000		

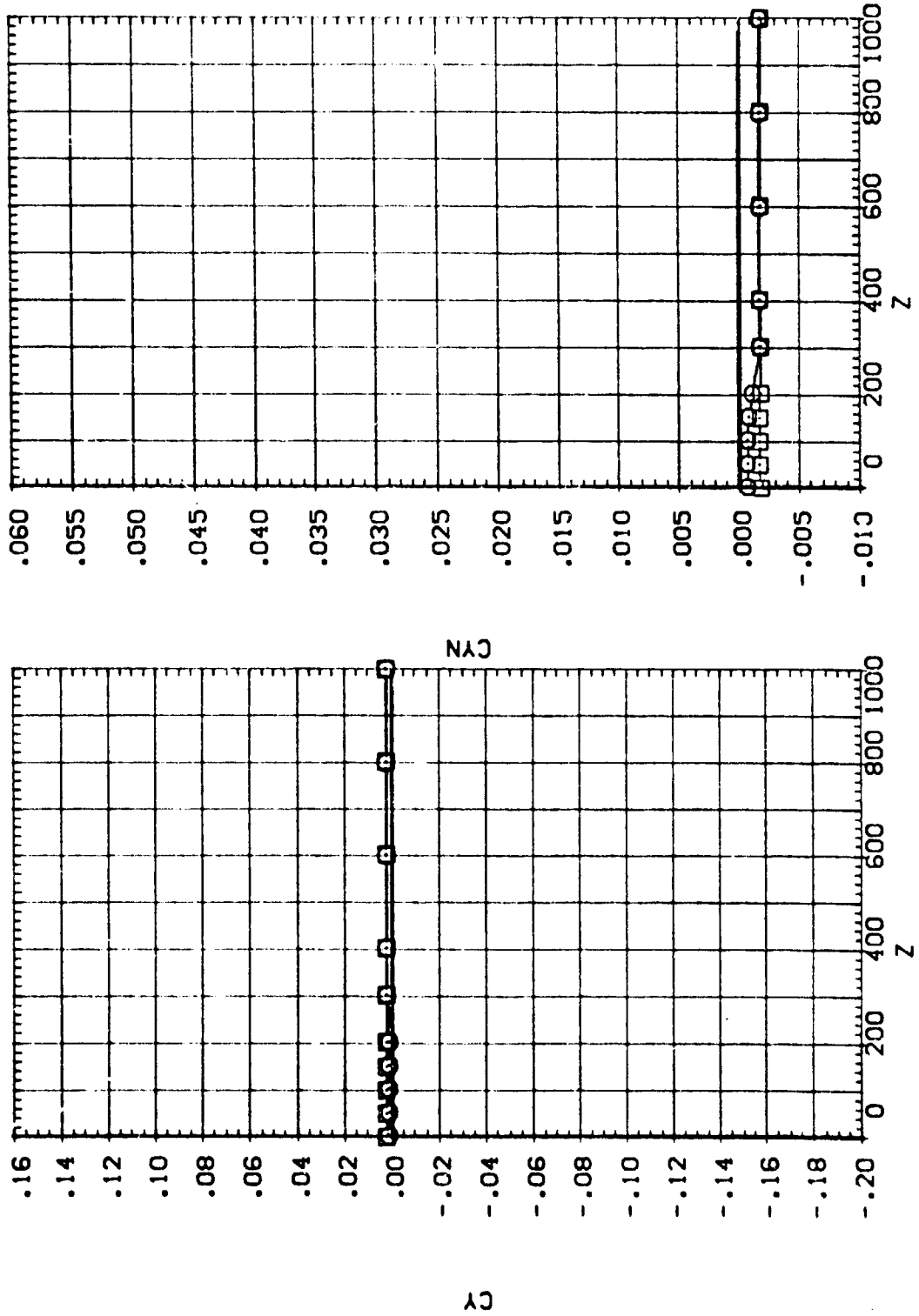

IA13 SRB(S8) W/O PLUMES SEPARATING FROM 09T10 (RTJ205)

SEE THE ASSOCIATED DATA DOCUMENT FOR REFERENCE CHARACTERISTICS FOR INDIVIDUAL DATASETS

SYMBOL		PARAMETRIC VALUES			
○	300.590	MACH	4.530	P/TOTAL	110.000
□	600.600	ALPHA	.000	BETA	.000
◇	900.340	DALPHA	-10.000	DBETA	-5.000
△		Y	.000	PC-MGR	.000

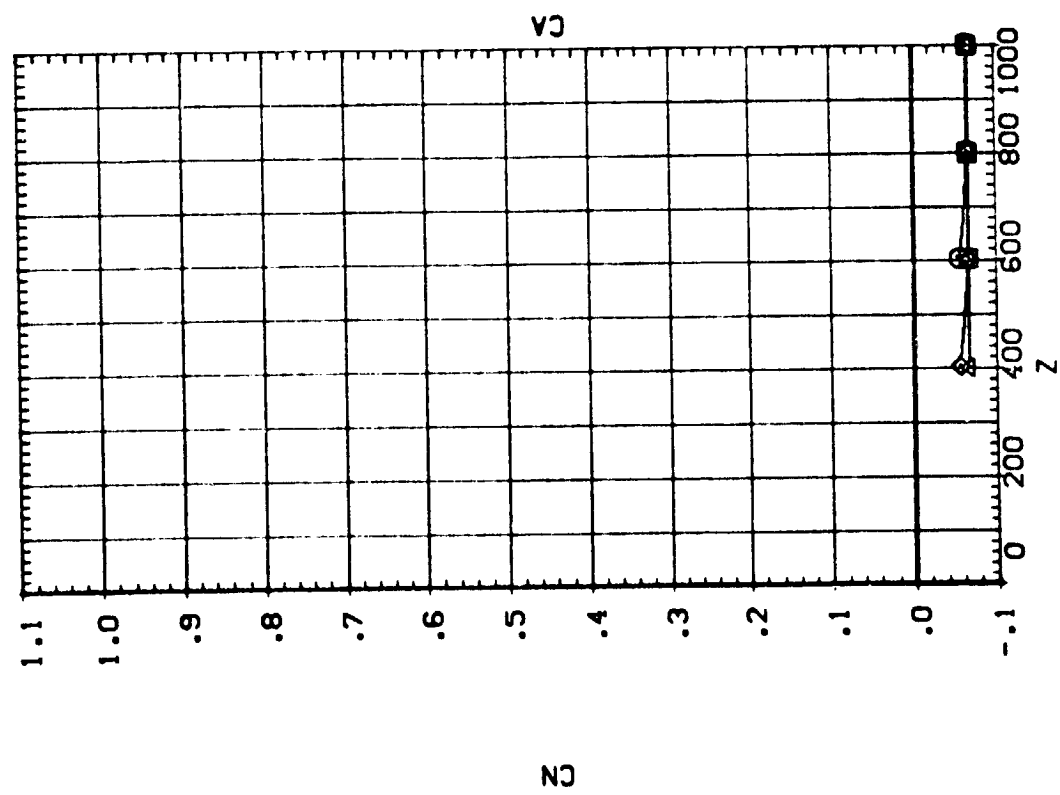
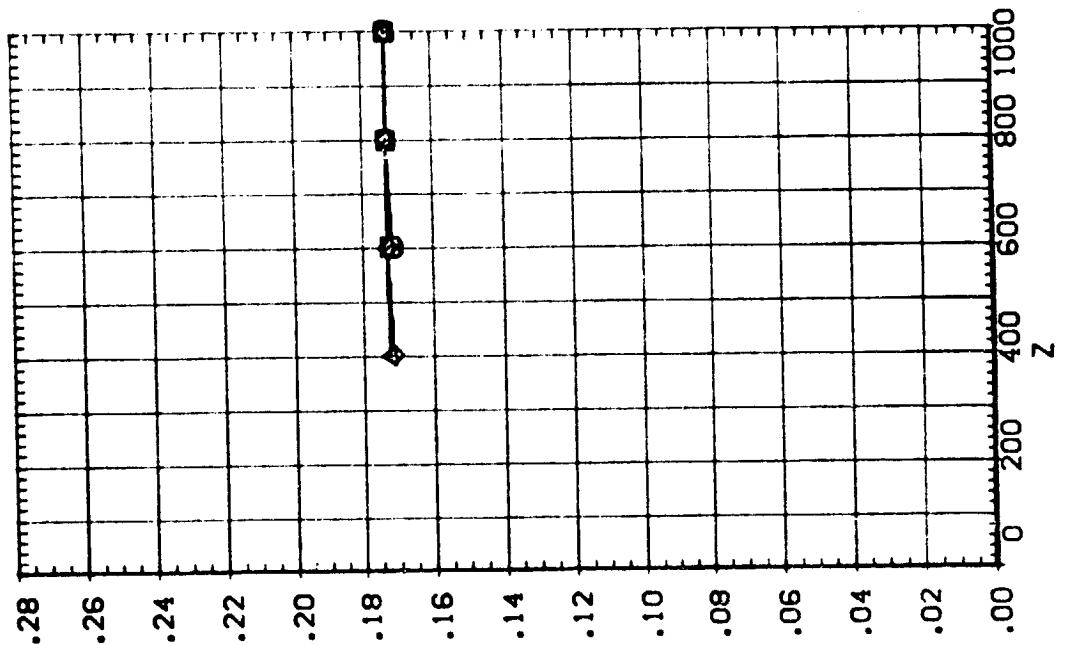

EFFECT OF SRB W/O PLUMES SEPARATION ON 09B/ET AERODYNAMIC CHARACTERISTICS

IA13 SRB(S8) W/O PLUMES SEPARATING FROM 09T10 (RTJ205)

SYMBOL X
 O
 □
 ◇
 △

PARAMETRIC VALUES

.469	MACH	4.530	P TOTAL	110.000
300.590	ALPHA	.000	BETA	.000
600.600	DALPHA	-10.000	DBETA	-5.000
900.340	Y	.000	PC+PB	.000

SEE THE ASSOCIATED DATA DOCUMENT FOR REFERENCE CHARACTERISTICS FOR INDIVIDUAL DATASETS

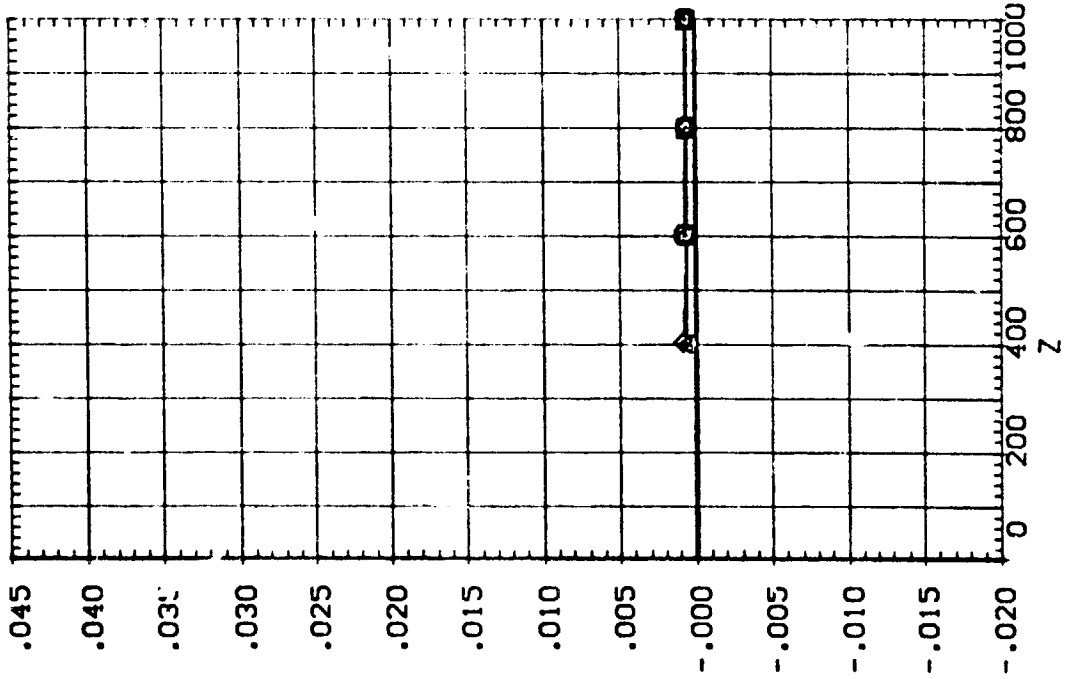
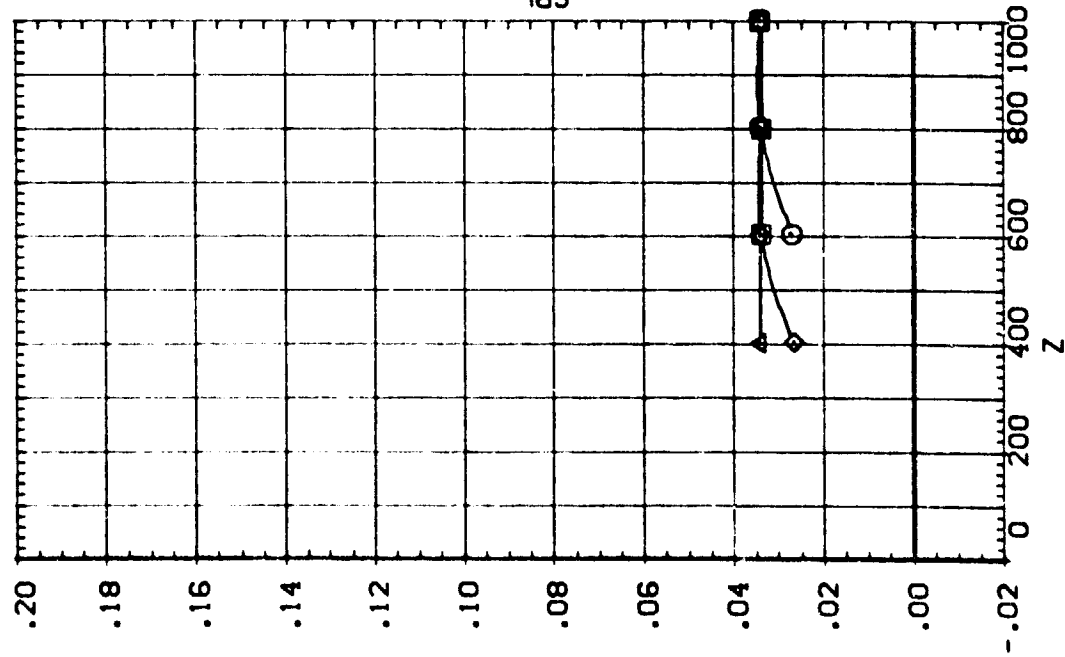

1A13 SRB(S8) W/O PLUMES SEPARATING FROM 09T10 (RTJ205)

SEE THE ASSOCIATED DATA DOCUMENT FOR REFERENCE CHARACTERISTICS FOR INDIVIDUAL DATASETS

SYMBOL	X	PARAMETRIC VALUES			
		MACH	PTOTAL	BETA	PCMBER
○	.469	4.530	110.000	.000	.000
□	300.590	.000	.000	-5.000	.000
◇	600.600	-10.000	.000	.000	.000
△	900.340	.000	.000	.000	.000

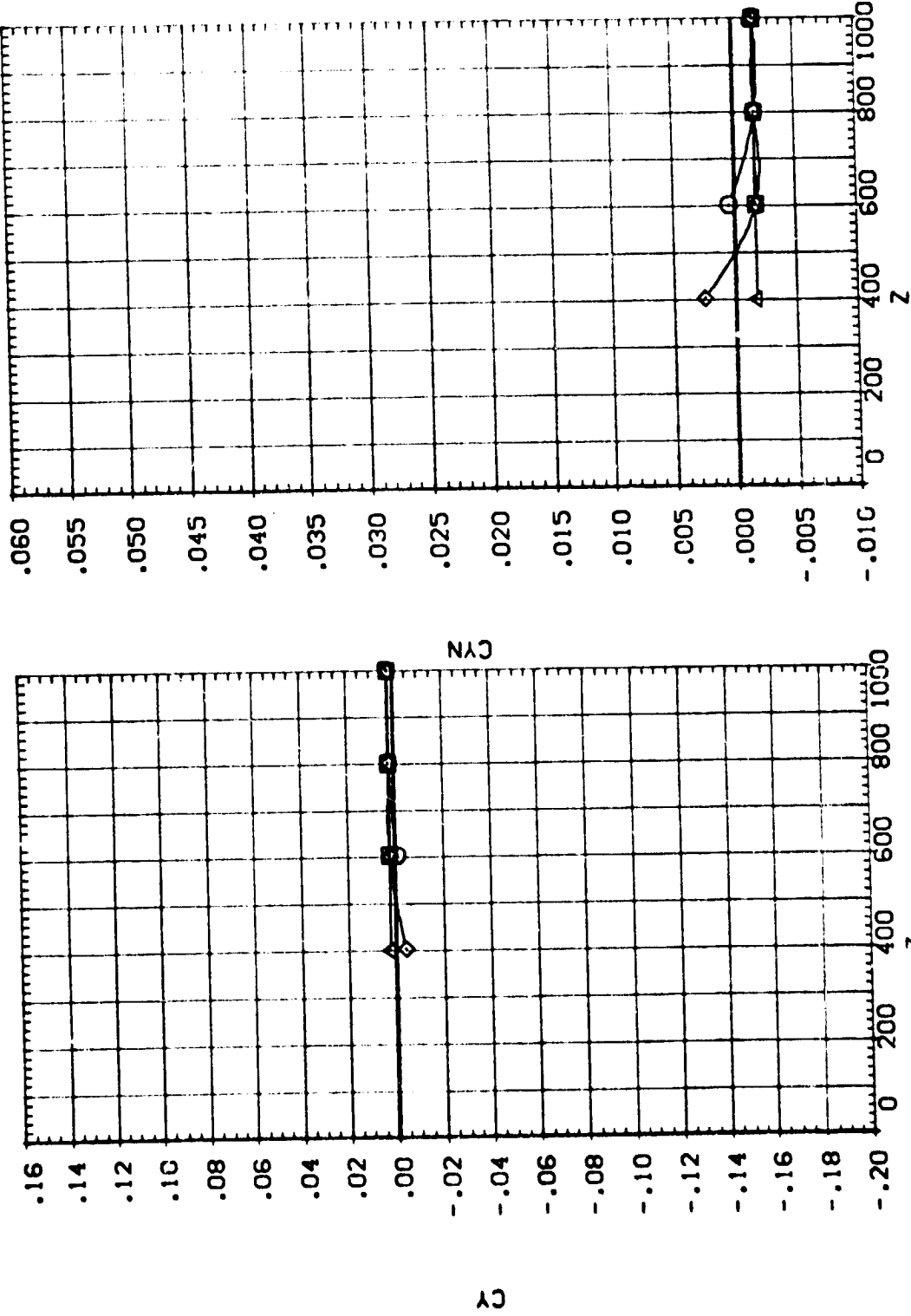

EFFECT OF SRB W/O PLUMES SEPARATION ON ORB/ET AERODYNAMIC CHARACTERISTICS

1.4:3 SRB(SB) W/O PLUMES SEPARATING FROM C9T10 (RTJ206)

SEE THE ASSOCIATED DATA DOCUMENT FOR REFERENCE CHARACTERISTICS FOR INDIVIDUAL DATA SETS

PARAMETER	PARAMETRIC VALUES
1	MACH 4.530 PITCH 110.000
2	ALPHA .000 SEPA .000
3	DELTA -10.000 BETA -5.000
4	Y 200.000 PC-MBR .000

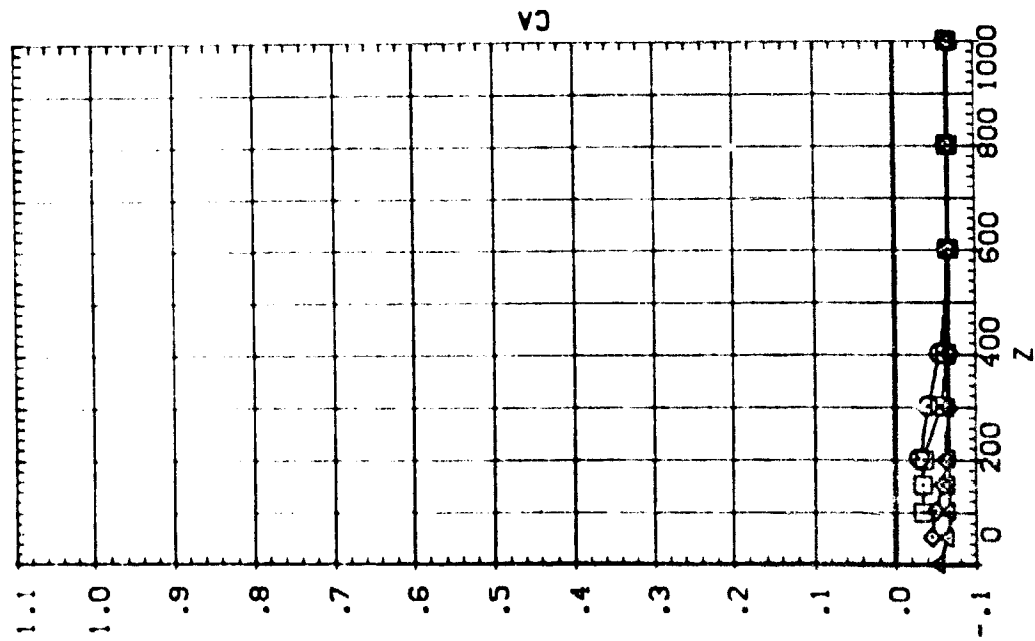
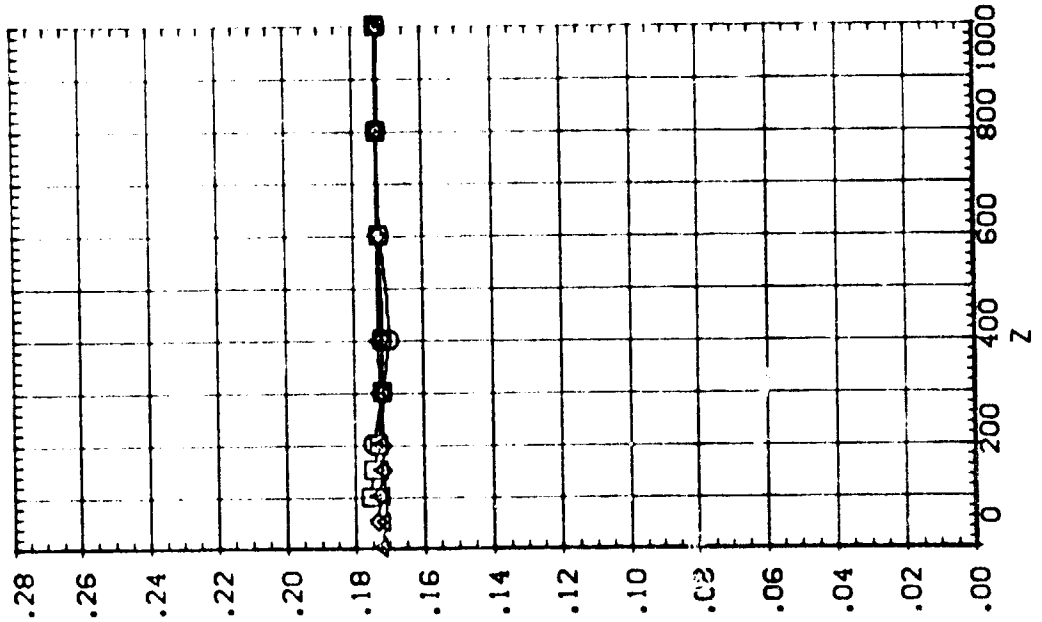

IA13 SRB(S8) W/O PLUMES SEPARATING FROM 09T10 (RTJ206)

SEE THE ASSOCIATED DATA DOCUMENT FOR REFERENCE CHARACTERISTICS FOR INDIVIDUAL DATASETS

SYMBOL	X	PARAMETRIC VALUES			
		MACH	PTOTAL	BETA	PC+PBR
○	300.360	.451	110.000	.000	.000
□	600.610	.000	-10.000	-5.000	.000
◇	900.830	.000	.000	.000	.000

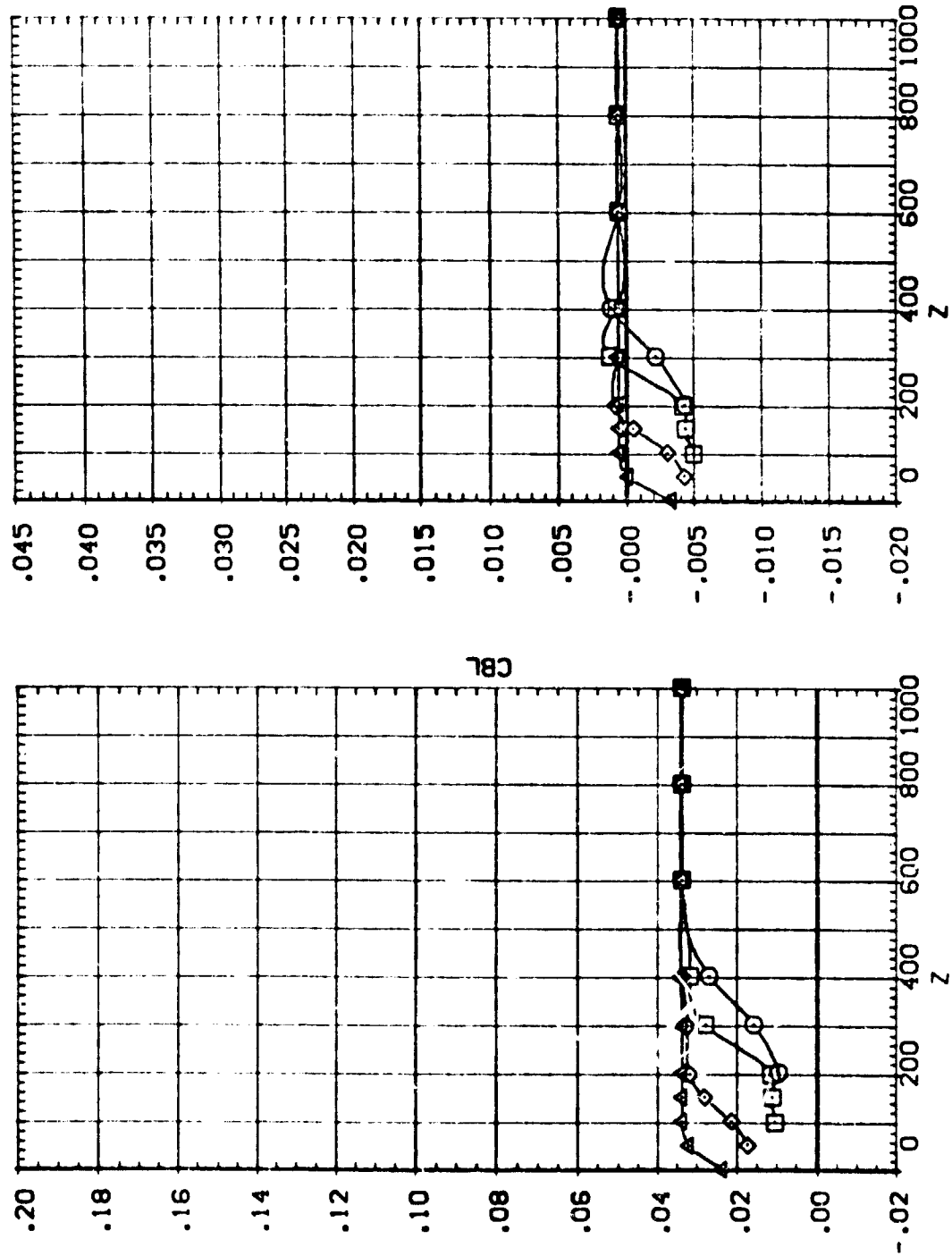

EFFECT OF SRB W/O PLUMES SEPARATION ON ORB/ET AERODYNAMIC CHARACTERISTICS

IA13 SRB(SB) W/O PLUMES SEPARATING FROM 09T10 (RTJ206)

SEE THE ASSOCIATED DATA DOCUMENT FOR REFERENCE CHARACTERISTICS FOR INDIVIDUAL DATASETS

SYMBOL		PARAMETRIC VALUES				
○	x	.451	MACH	4.530	P/DOTAL	110.000
□		300.360	ALPHA	.000	BETA	.000
◇		600.610	DALPHA	-10.000	DBETA	-5.000
△		900.830	Y	200.000	PC+PBR	.000

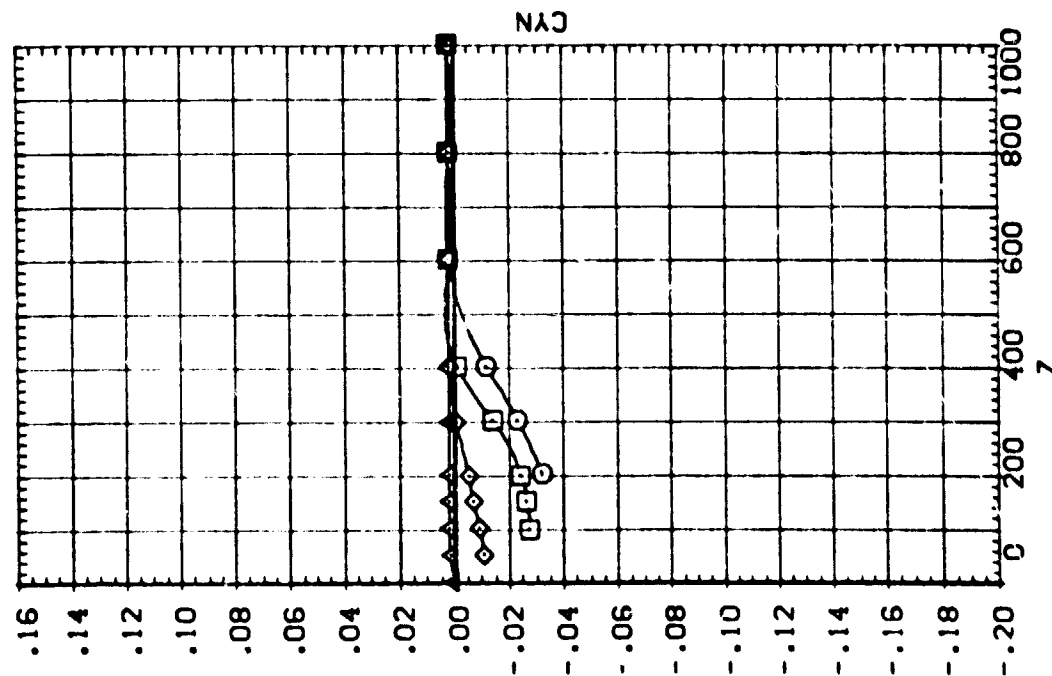
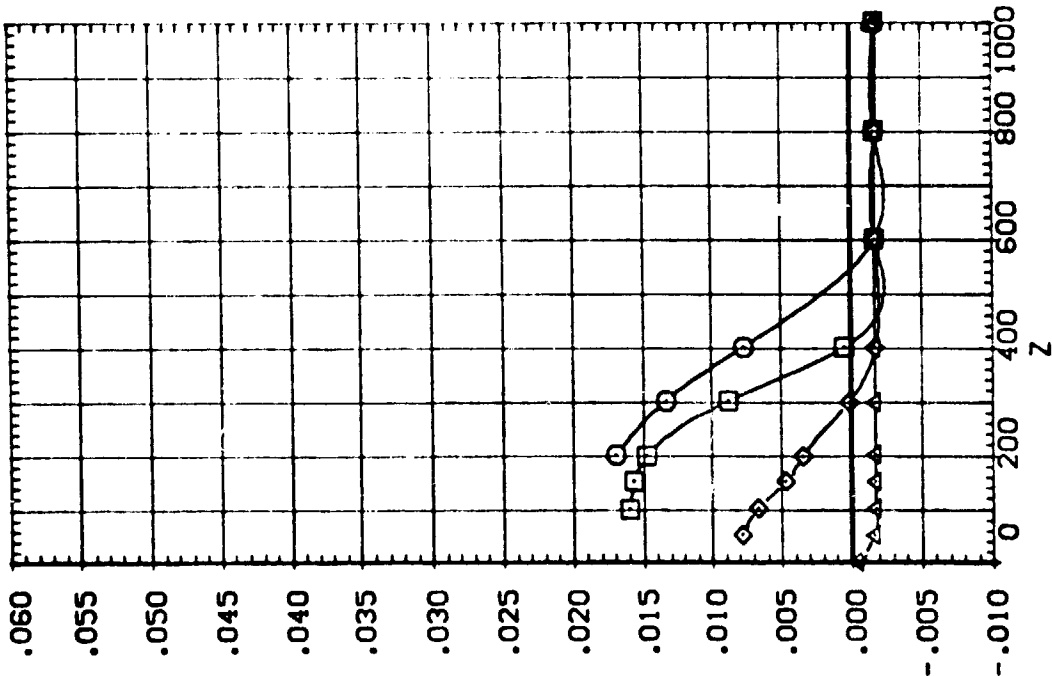

IA13 SRB(SB) W/O PLUMES SEPARATING FROM 09T10 (RTJ207)

SEE THE ASSOCIATED DATA DOCUMENT FOR REFERENCE CHARACTERISTICS FOR INDIVIDUAL DATASETS

SYMBOL	X	MAOH	PARAMETRIC VALUES
○	.256	4.530	PTOTAL 110.000
□	299.890	.000	BETA .000
◇	600.400	-10.000	DBETA -5.000
△	900.580	400.000	PO-PIBR .000

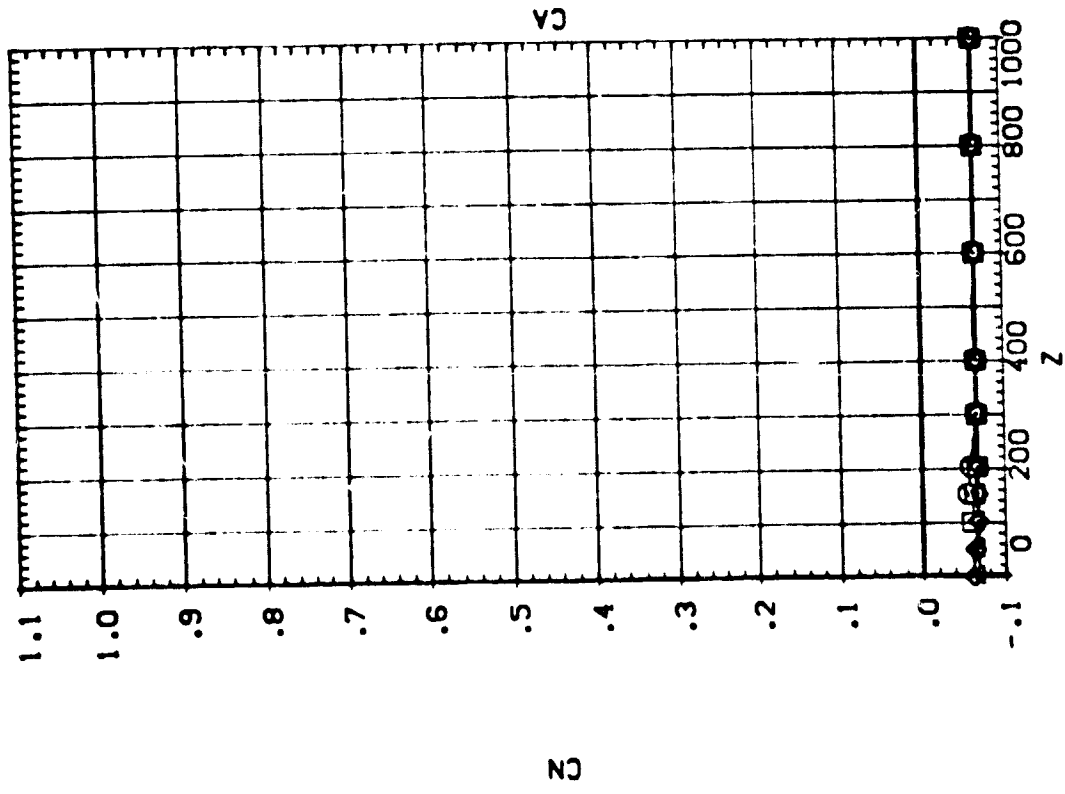
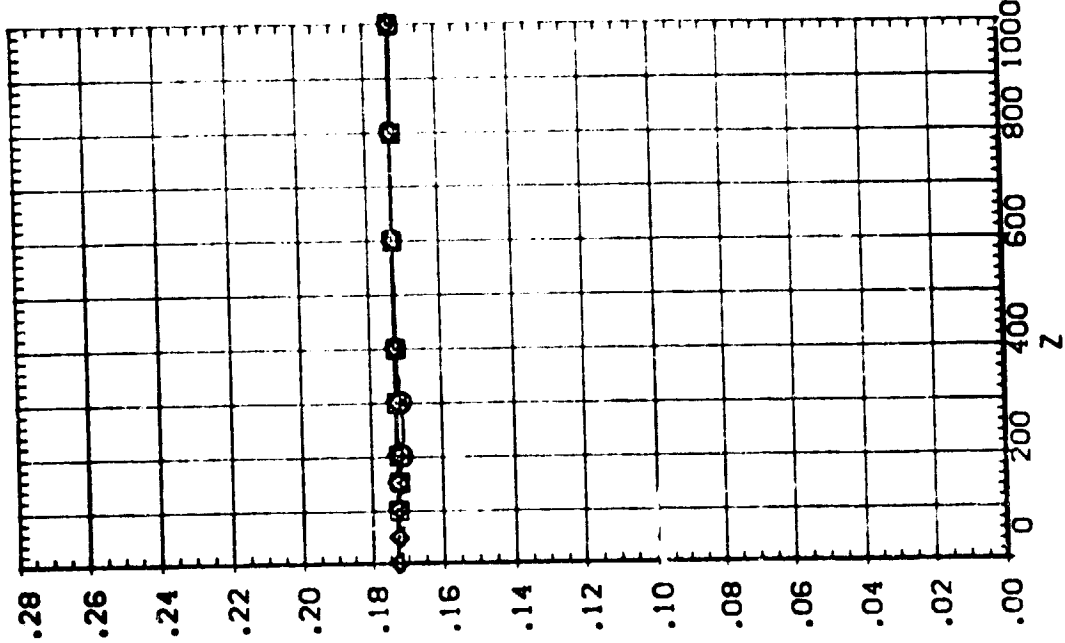

EFFECT OF SRB W/O PLUMES SEPARATION ON ORB/ET AERODYNAMIC CHARACTERISTICS PAGE 820

:A13 SRB(S8) W/O PLUMES SEPARATING FROM 09T10 (RTJ207)

SEE THE ASSOCIATED DATA DOCUMENT FOR REFERENCE CHARACTERISTICS FOR INDIVIDUAL DATASETS

SYMBOL	X	PARAMETRIC VALUES
○	.296	MACH
()	299.690	ALPHA
◇	600.400	DALPHA
△	900.580	Y
	4.530	P TOTAL
	.000	BETA
	-10.000	DBETA
	400.000	PC-MER
		110.000
		.000
		-5.000
		.000

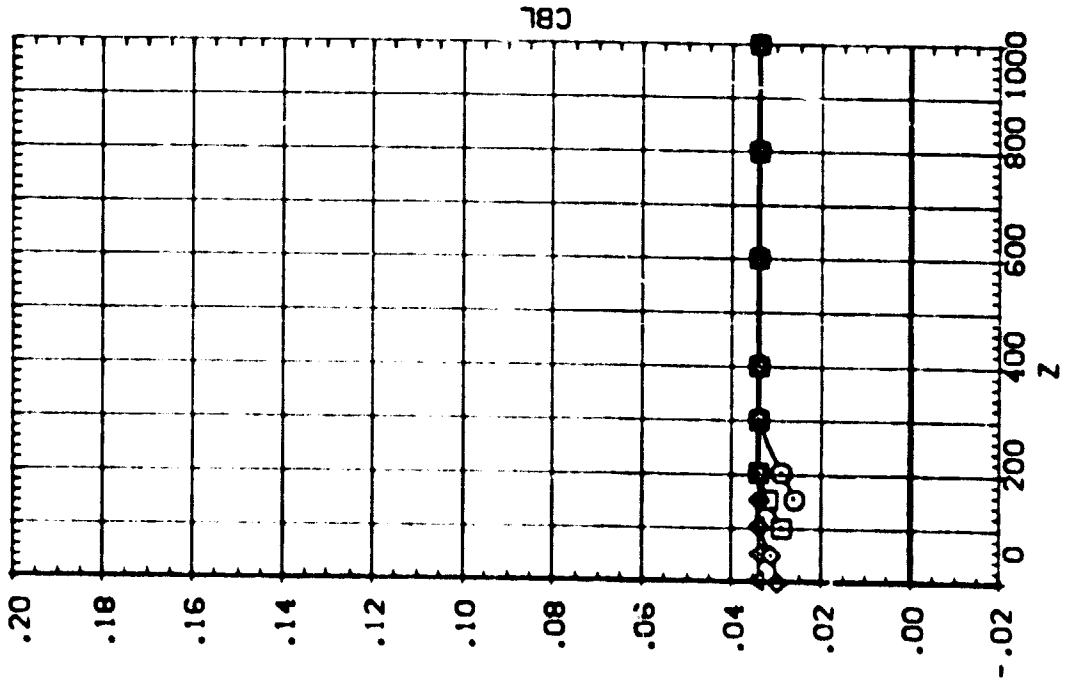
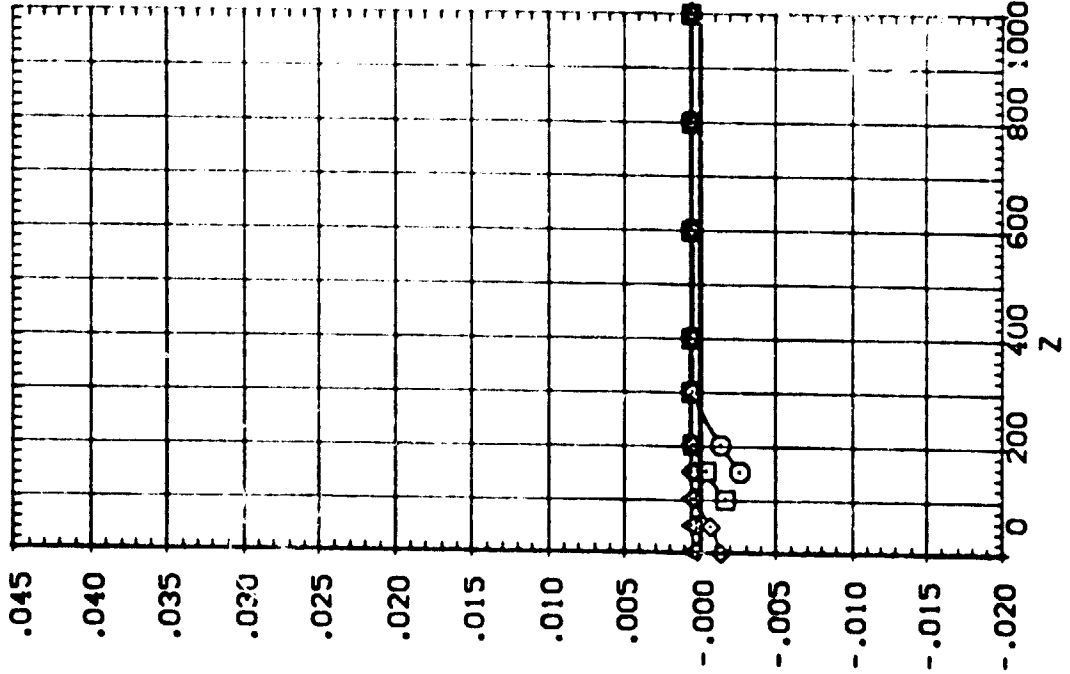

EFFECT OF SRB W/O PLUMES SEPARATION ON ORB/ET AERODYNAMIC CHARACTERISTICS

1A13 SRB(S8) W/O PLUMES SEPARATING FROM 09T10 (RTJ207)

SYMBOL
 ○ □ ◇ △

PARAMETRIC VALUES
 X .296 MACH 4.530 PTOTAL 110.000
 299.890 ALPHA .000 BETA .000
 600.400 DALPHA -10.000 DBETA -5.000
 900.560 Y 400.000 POWER .000

SEE THE ASSOCIATED DATA DOCUMENT FOR REFERENCE CHARACTERISTICS FOR INDIVIDUAL DATASETS

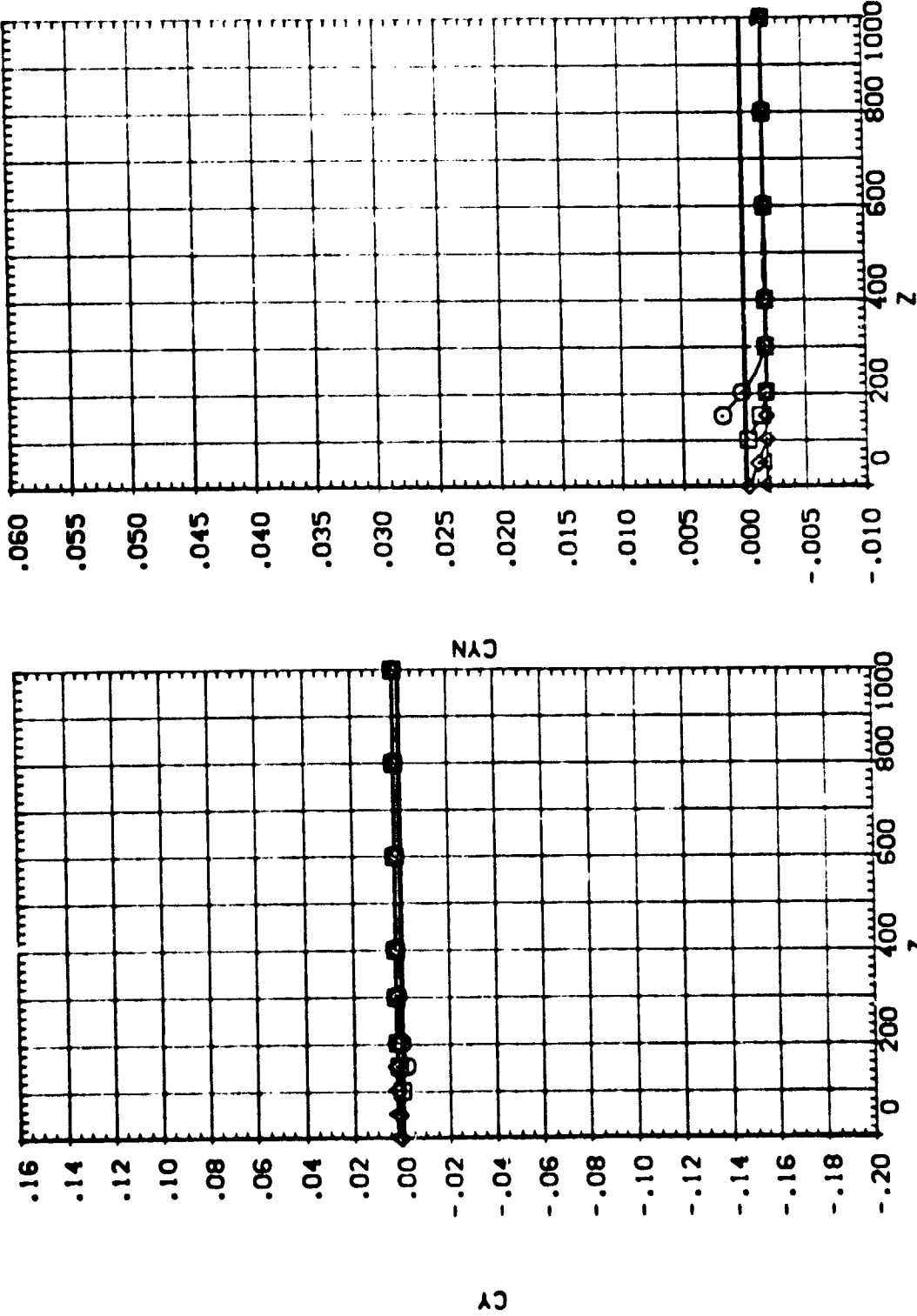

EFFECT OF SRB W/O PLUMES SEPARATION ON ORBIT AERODYNAMIC CHARACTERISTICS

1A13 SRB(S8) W/O PLUMES SEPARATING FROM 09T10 (RTJ208)

SEE THE ASSOCIATED DATA DOCUMENT FOR REFERENCE CHARACTERISTICS FOR INDIVIDUAL DATASETS

SYMBOL	X	PARAMETRIC VALUES			
		MACH	PTOTAL	110.000	
○	300.390	ALPHA	.000	BETA	.000
□	600.540	DALPHA	-10.000	DBETA	-5.000
◇	900.680	Y	800.000	PC+R	.000

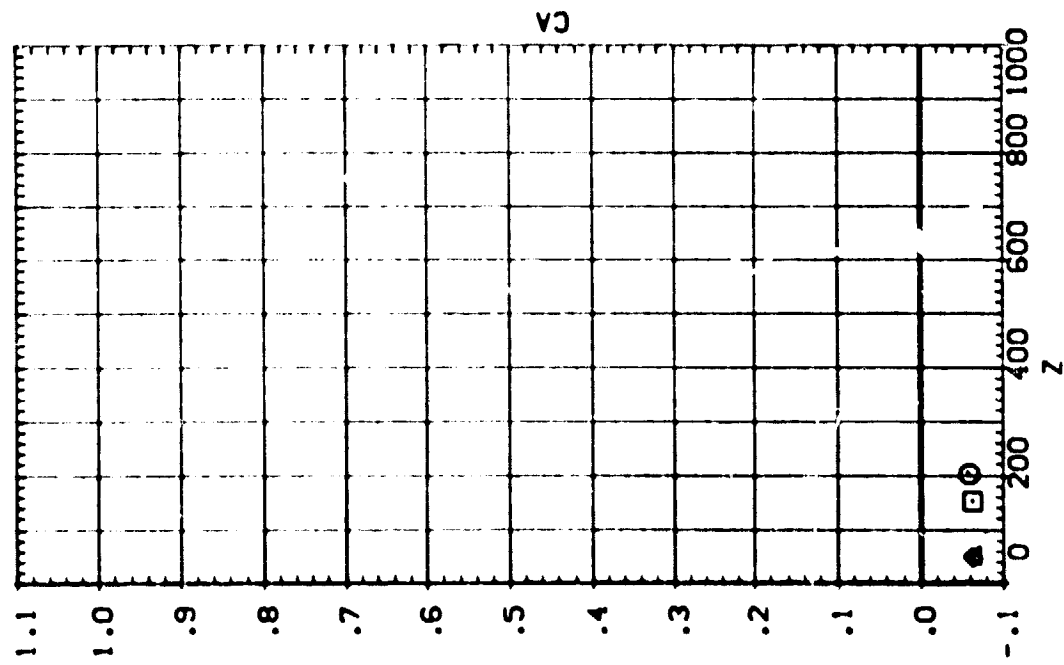
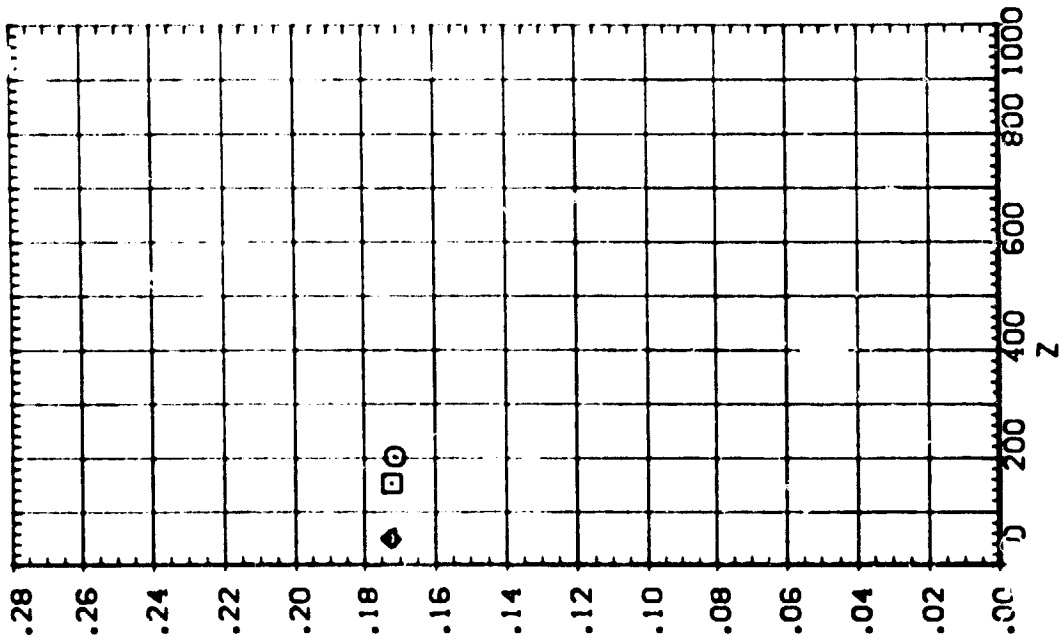

[A13 SRB(S8) W/O PLUMES SEPARATING FROM 09T10 (RTJ208)

SEE THE ASSOCIATED DATA DOCUMENT FOR REFERENCE CHARACTERISTICS FOR INDIVIDUAL DATASETS

SYMBOL	X	MACH	PARAMETRIC VALUES
○	.294	4.530	PTOTAL 110.000
□	300.350	ALPHA .000	BETA .000
◇	600.540	D/ALPHA -10.000	DBETA -5.000
△	900.680	Y 800.000	PC-MBR .000

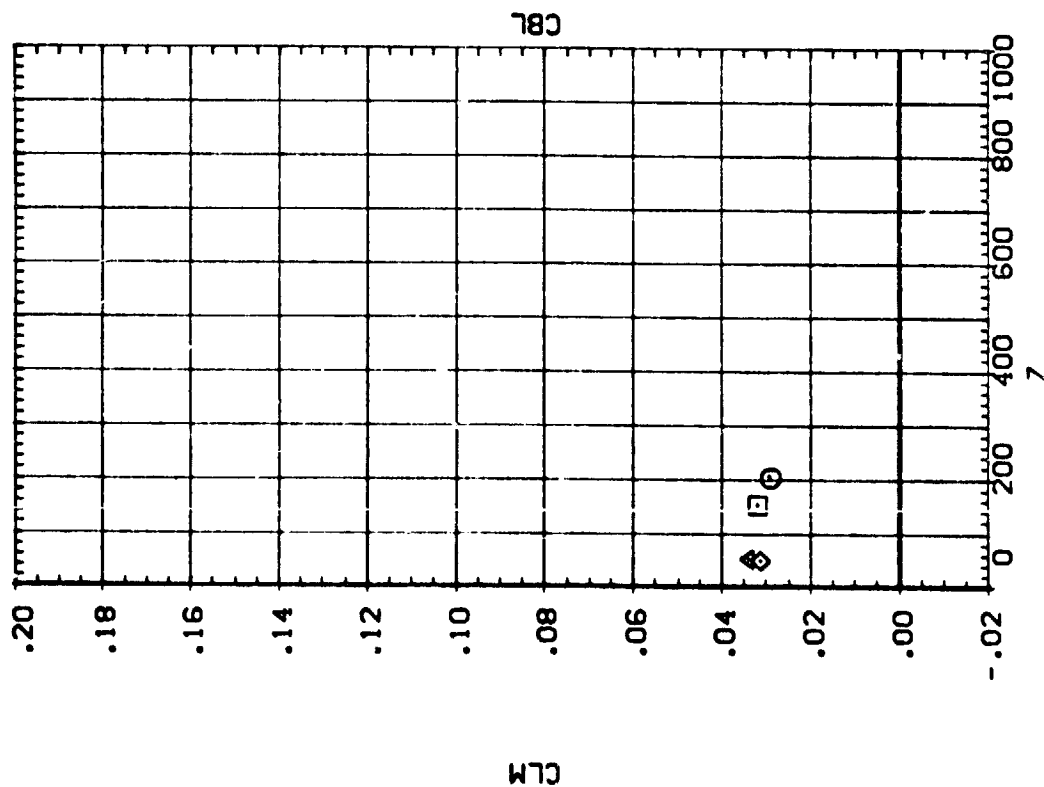
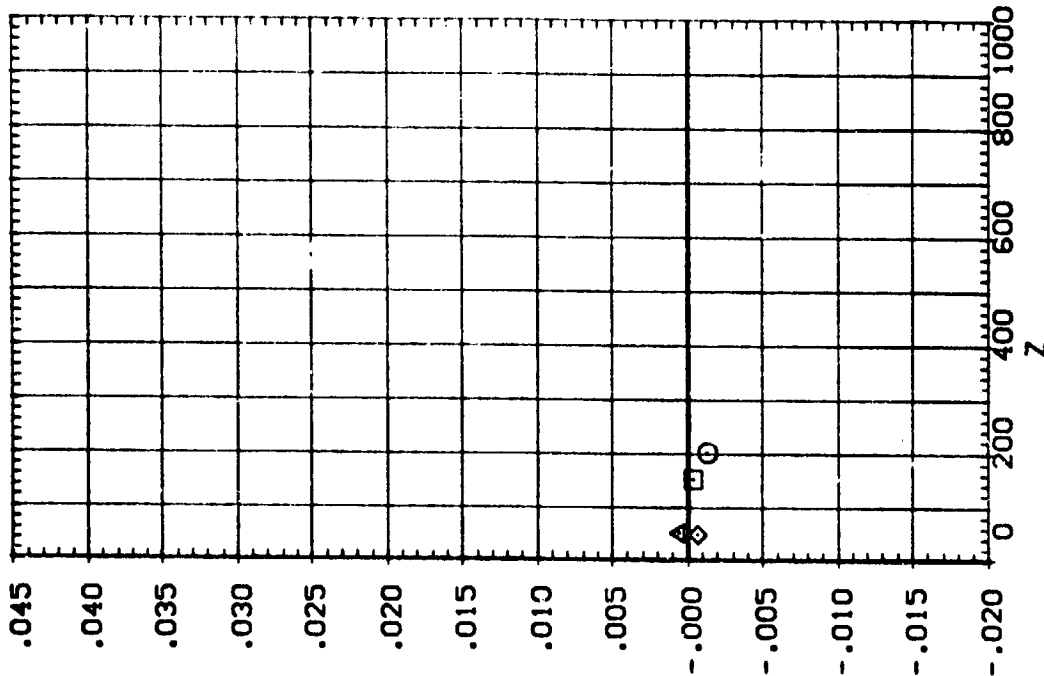

EFFECT OF SRB W/O PLUMES SEPARATION ON 09B/ET AERODYNAMIC CHARACTERISTICS

TA13 SRB(SB) W/O PLUMES SEPARATING FROM 09T10 (RTJ208)

SEE THE ASSOCIATED DATA DOCUMENT FOR REFERENCE CHARACTERISTICS FOR INDIVIDUAL DATASETS

SYMBOL	X	MACH	PARAMETRIC VALUES
□	.294	4.530	PTOTAL 110.000
◇	300.390	.000	BETA .000
△	600.540	-10.000	DBETA -5.000
	900.680	800.000	PC-MGR .000

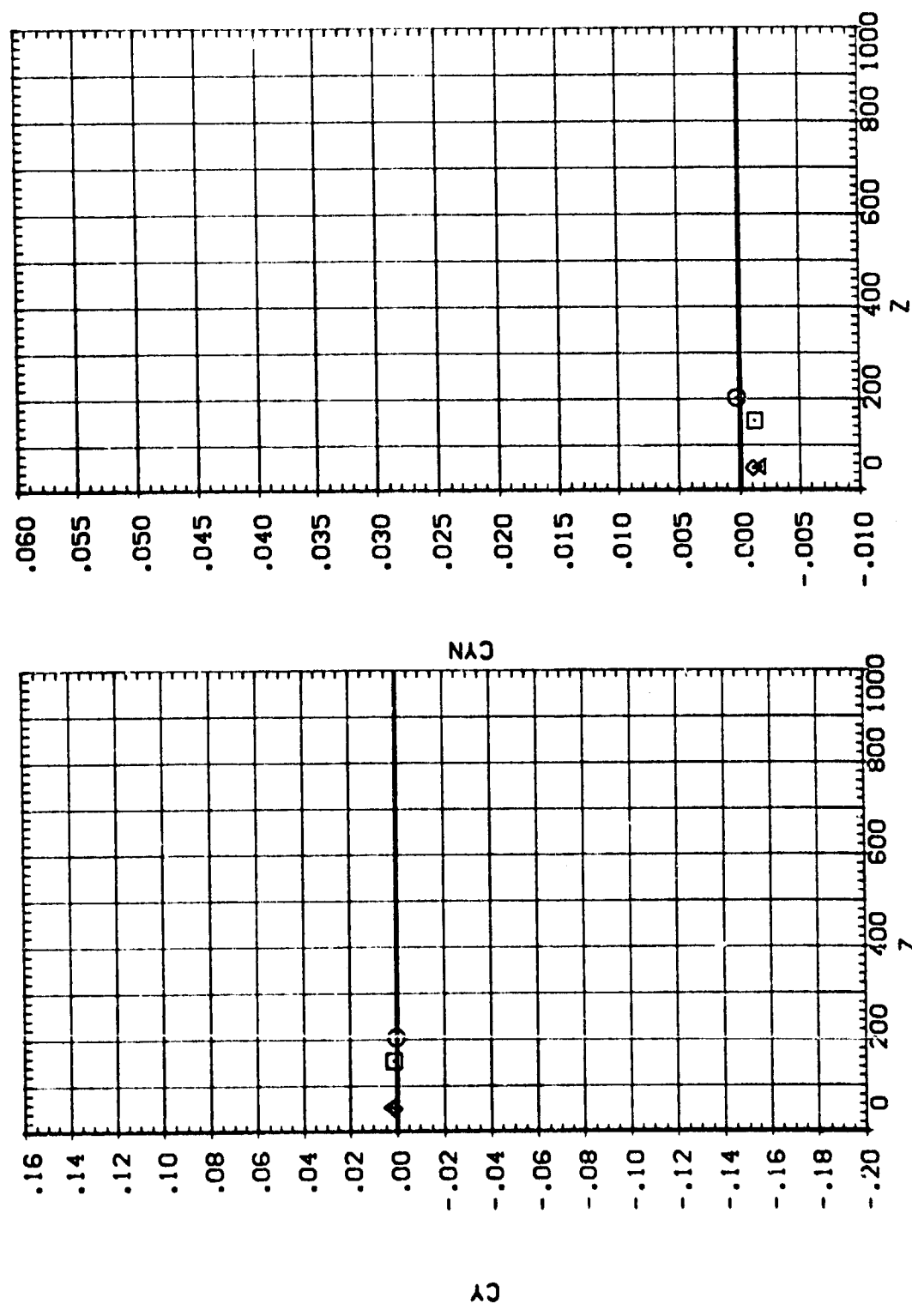

IA13 SRB(S8) W/O PLUMES SEPARATING FROM 09T10 (RTJ210)

SYMBOL X

-
-
- ◇
- △

PARAMETRIC VALUES

PARAMETER	VALUE
MACH	4.530
PIOTAL	110.000
ALPHA	.000
BETA	.000
DBETA	-10.000
Y	400.000
PC-MER	.000

SEE THE ASSOCIATED DATA DOCUMENT FOR REFERENCE CHARACTERISTICS FOR INDIVIDUAL DATASETS

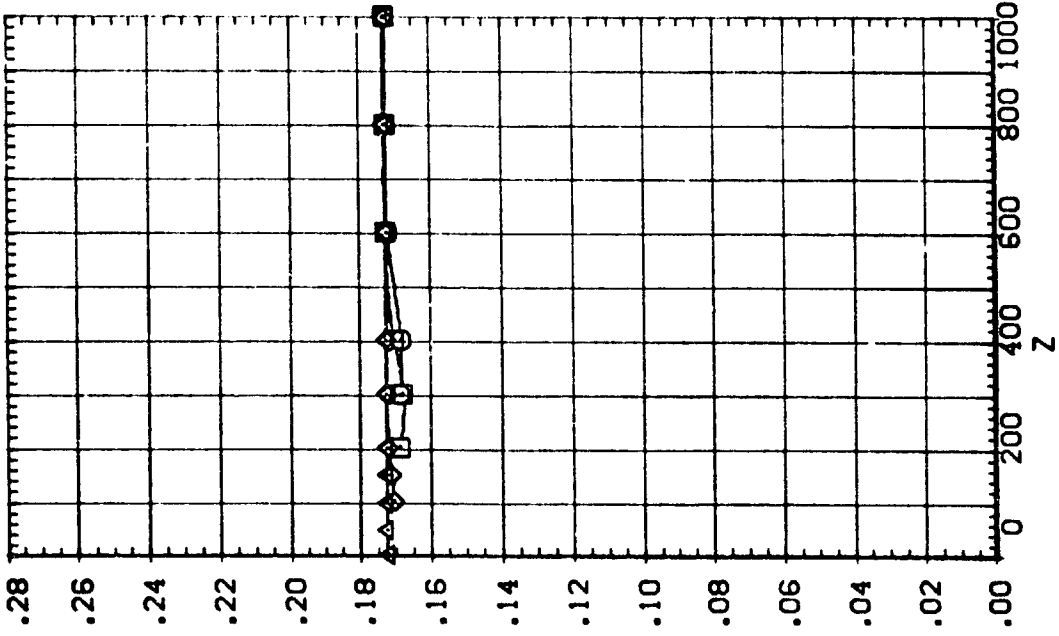
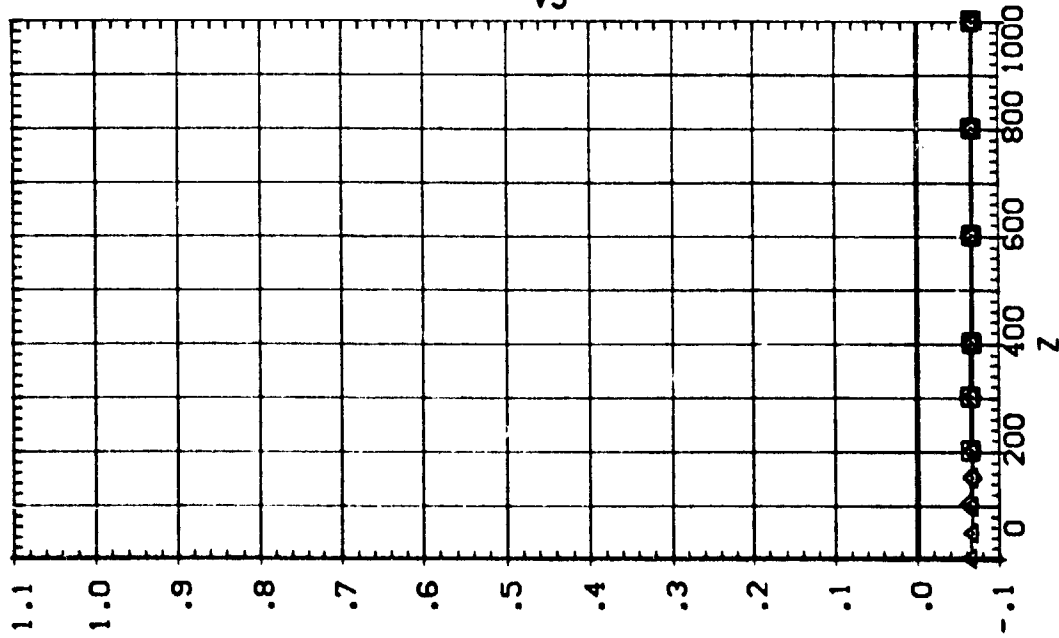

EFFECT OF SRB W/O PLUMES SEPARATION ON ORB/ET AERODYNAMIC CHARACTERISTICS

IA13 SRB(SB) W/O PLUMES SEPARATING FROM 09T10 (RTJ210)

SYMBOL X
 ○
 □
 ◇
 △

PARAMETRIC VALUES

MACH	4.530	P TOTAL	110.000
ALPHA	.000	BETA	.000
DALPHA	-10.000	DBETA	-10.000
Y	400.000	PC-MFR	.000

SEE THE ASSOCIATED DATA DOCUMENT FOR REFERENCE CHARACTERISTICS FOR INDIVIDUAL DATASETS

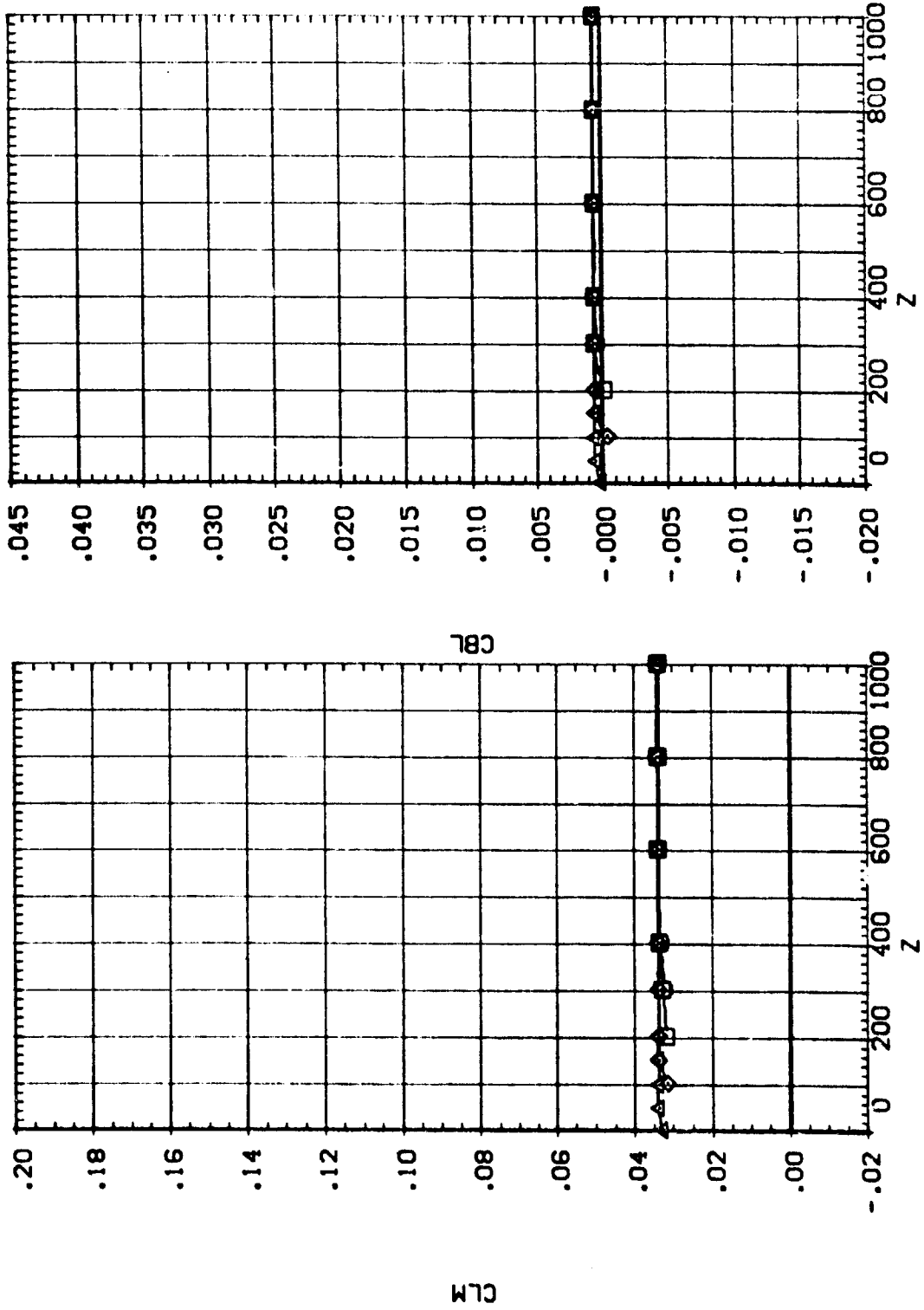

IA13 SRB(S8) W/O PLUMES SEPARATING FROM 09T10 (RTJ210)

SEE THE ASSOCIATED DATA DOCUMENT FOR REFERENCE CHARACTERISTICS FOR INDIVIDUAL DATASETS

SYMBOL	X	MACH	PARAMETRIC VALUES
○	300.600	.355	4.530 PTOTAL 110.000
□	600.430	.000	BETA .000
◇	900.530	.430	DALPHA -13.000
△		.530	PCHGR 400.000

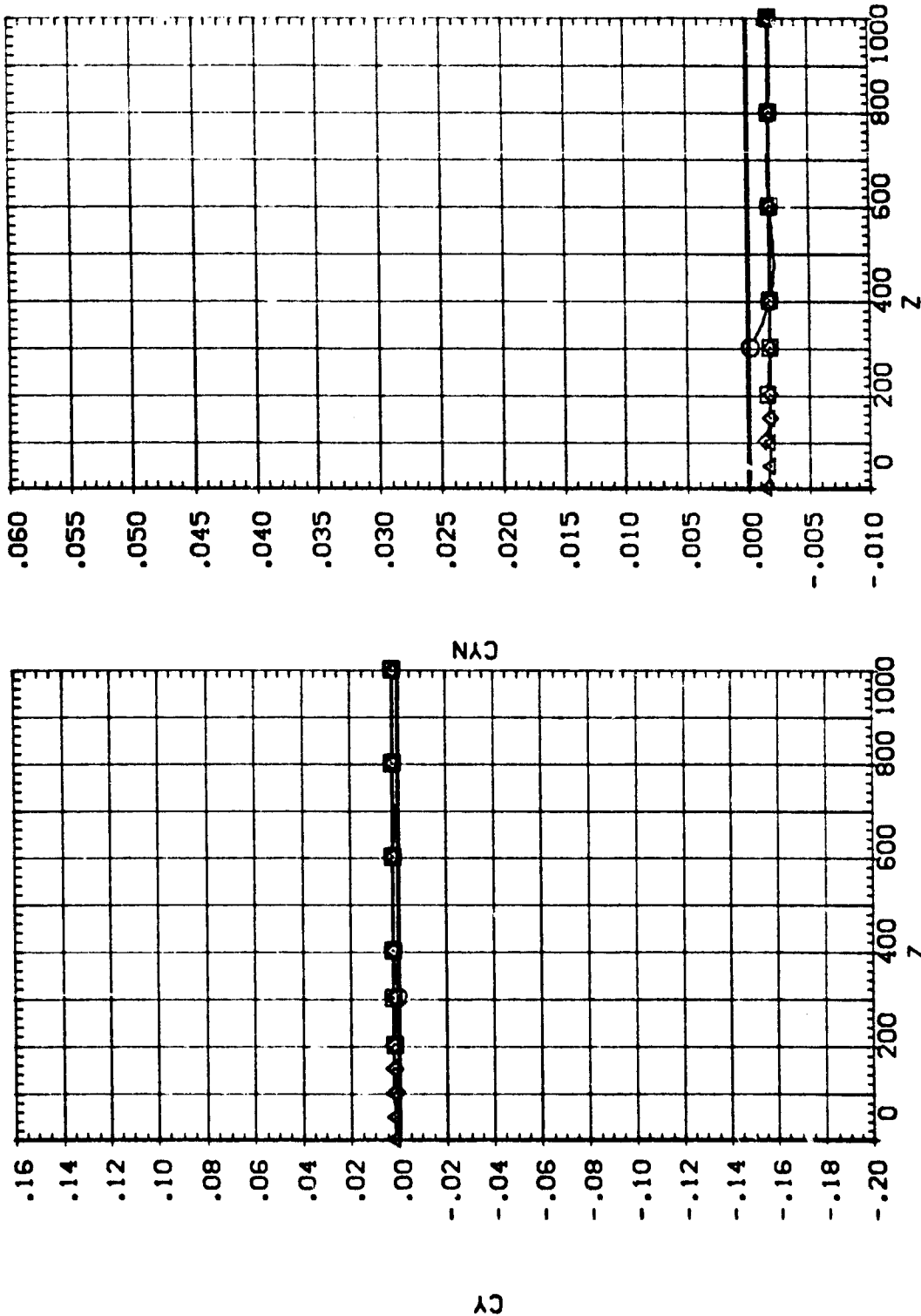

EFFECT OF SRB W/O PLUMES SEPARATION ON ORB/ET AERODYNAMIC CHARACTERISTICS

[A13 SRB(S8) W/O PLUMES SEPARATING FROM 09T10 (RTJ211)]

SEE THE ASSOCIATED DATA DOCUMENT FOR REFERENCE CHARACTERISTICS FOR INDIVIDUAL DATASETS

SYMBOL	X	MACH	PARAMETRIC VALUES
○	.553	4.530	PIOTAL 110.000
□	300.640	.000	BETA .000
◇	600.250	-10.000	DBETA -10.000
△	900.070	200.000	PC-MBR .000

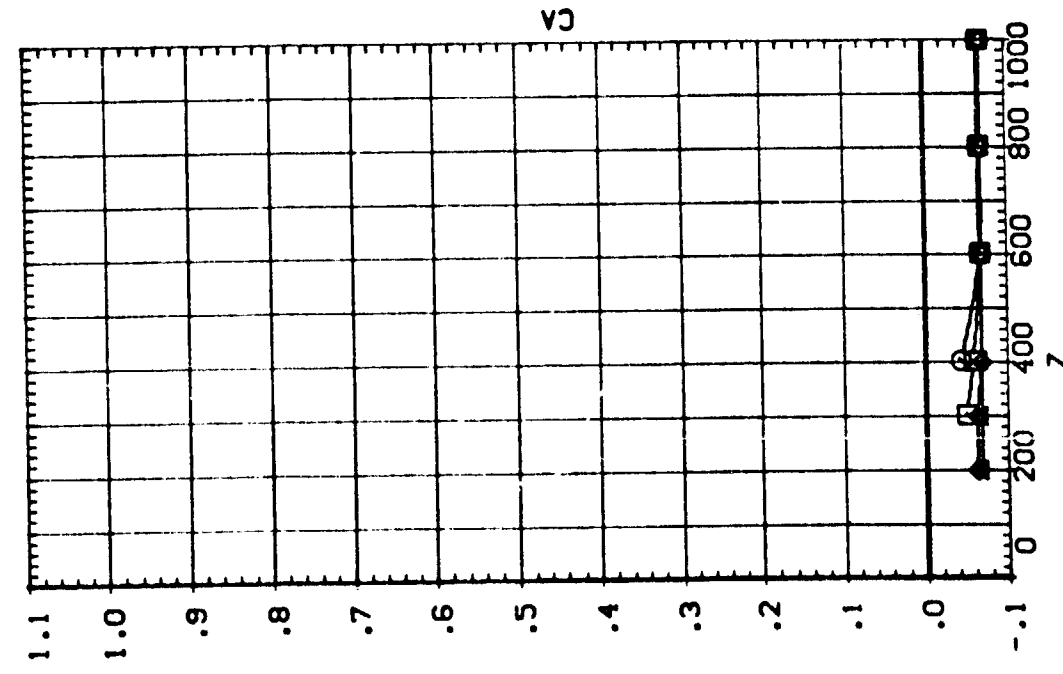
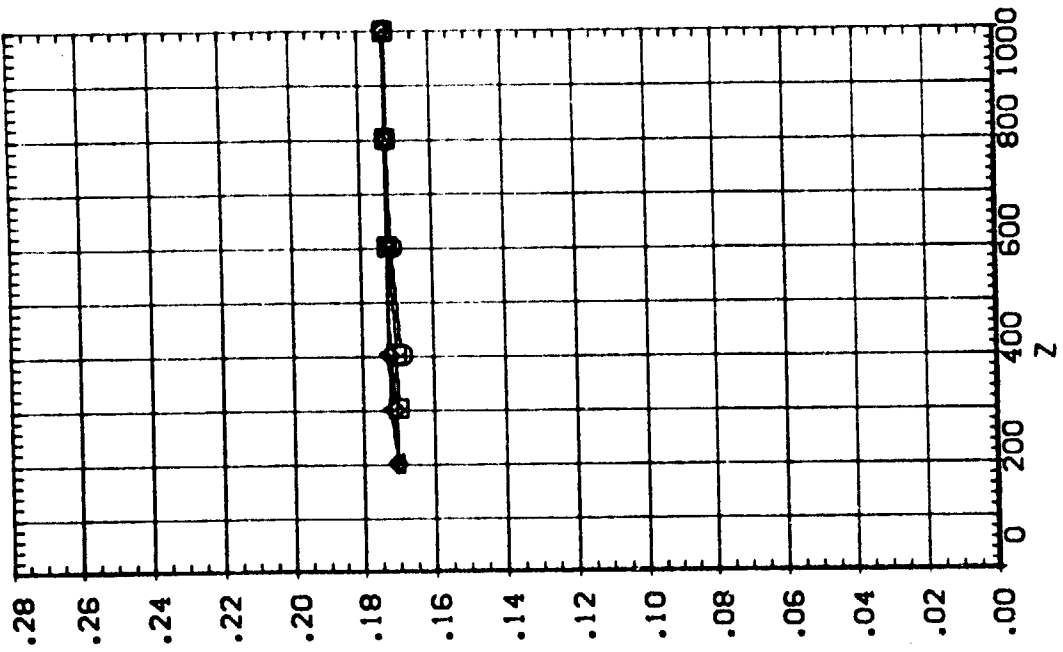

IA13 SRB(S8) W/O PLUMES SEPARATING FROM 09T10 (RTJ211)

SEE THE ASSOCIATED DATA DOCUMENT FOR REFERENCE CHARACTERISTICS FOR INDIVIDUAL DATASETS

SYMBOL	X	MACH	PARAMETRIC VALUES
○	.5F3	4.530	PTOTAL 110.000
□	300.F40	.000	BETA .000
◇	600.250	-10.000	DBETA -10.000
△	900.070	200.000	PC-MBR .000

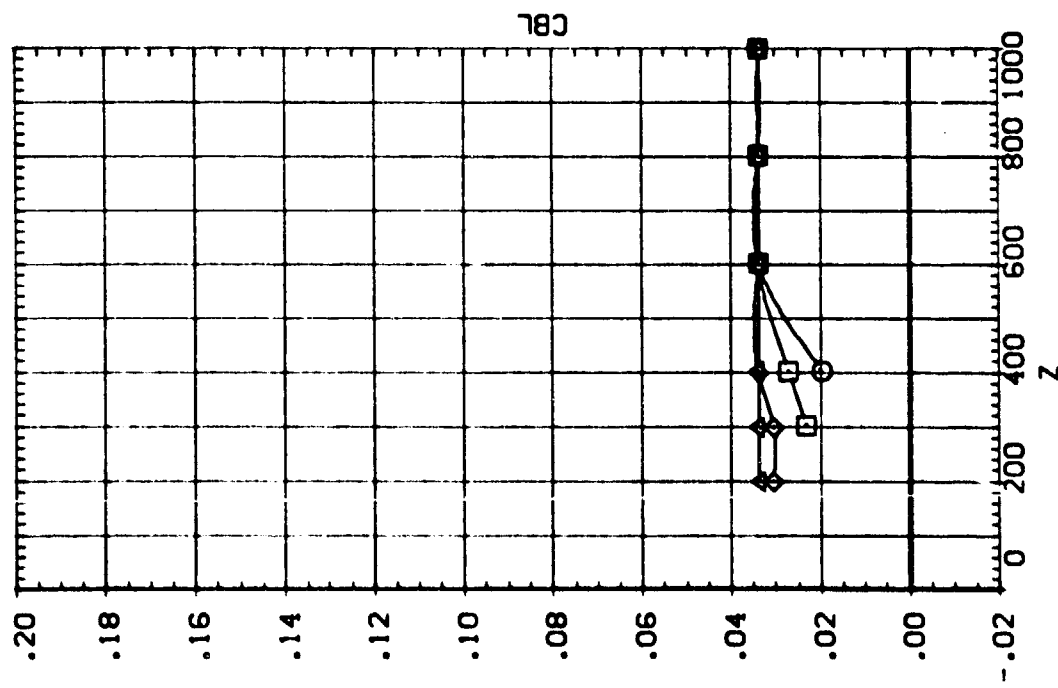
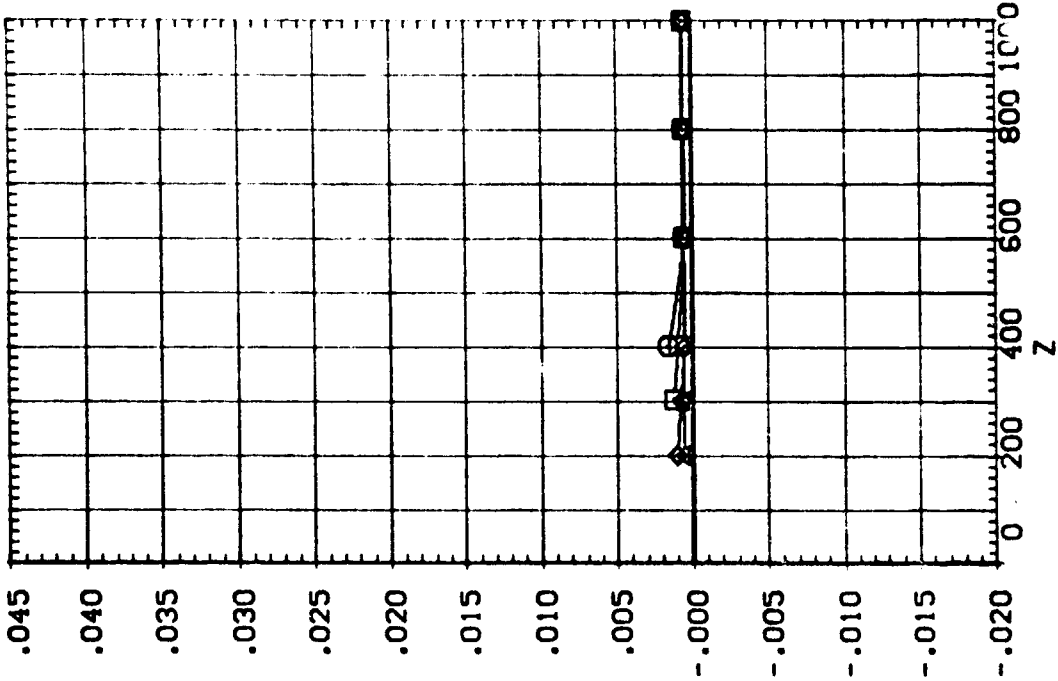

EFFECT OF SRB W/O PLUMES SEPARATION ON ORB/ET AERODYNAMIC CHARACTERISTICS

IA13 SRB(S8) W/O PLUMES SEPARATING FROM 09T10 (RTJ211)

SEE THE ASSOCIATED DATA DOCUMENT FOR REFERENCE CHARACTERISTICS FOR INDIVIDUAL DATASETS

SYMBOL	X	MACH	PARAMETRIC VALUES
○	.553	4.530	PTOTAL 110.000
□	300.640	.000	BETA .000
◇	600.250	-10.000	DBETA -10.000
△	900.070	200.000	PCHIBR .000

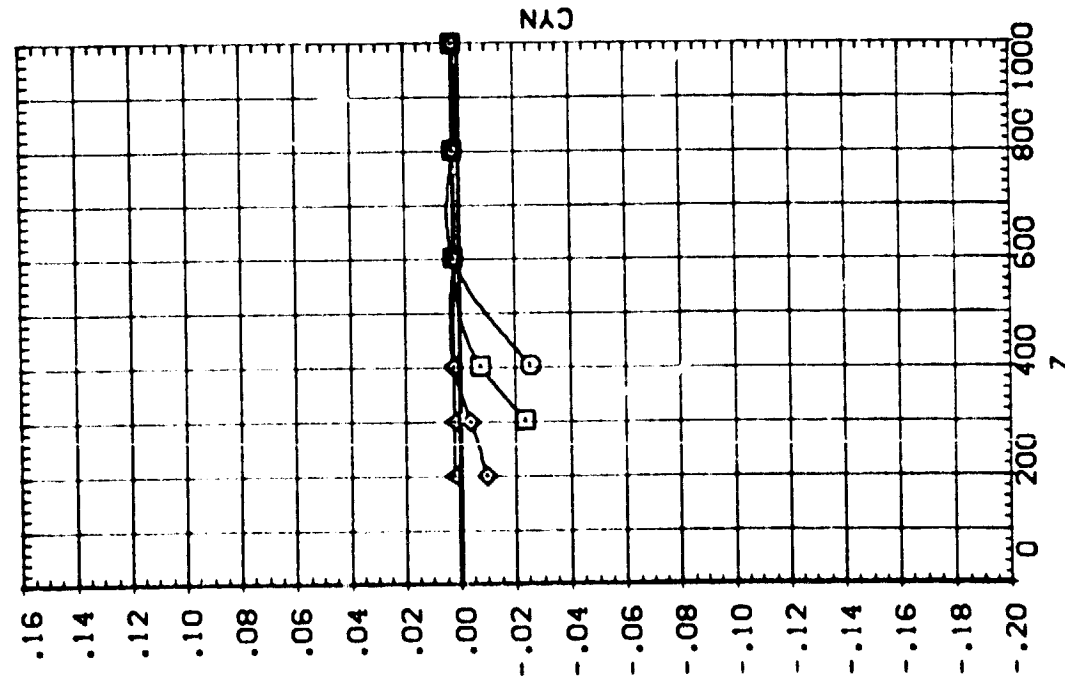
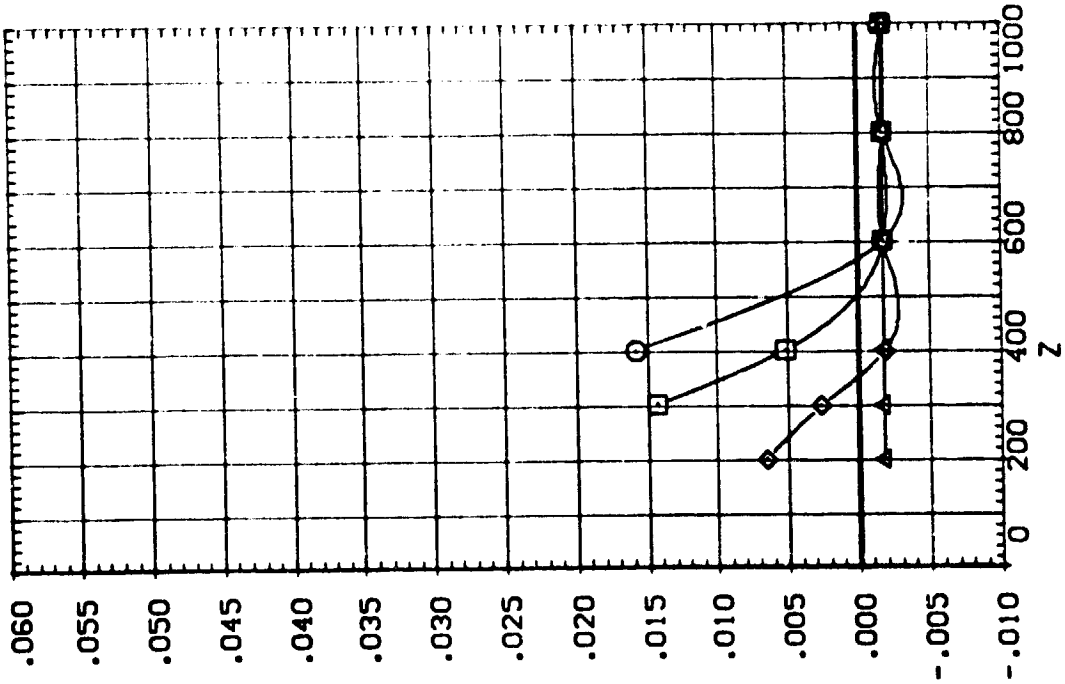

SEE THE ASSOCIATED DATA DOCUMENT FOR REFERENCE CHARACTERISTICS FOR INDIVIDUAL DATASETS

SYMBOL		PARAMETRIC VALUES	
○	X	MACH	4.530
□	300.470	ALPHA	.000
◇	600.710	DALPHA	-10.000
△	900.290	Y	.000
		PTOTAL	110.000
		BETA	.000
		DBETA	-10.000
		PC-MBR	.000

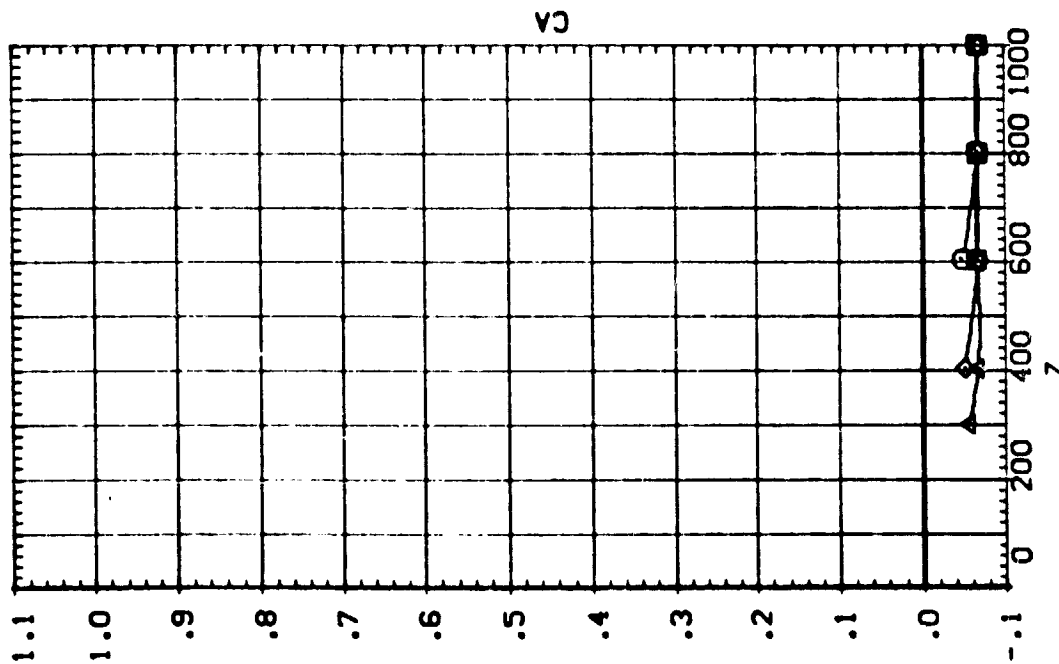
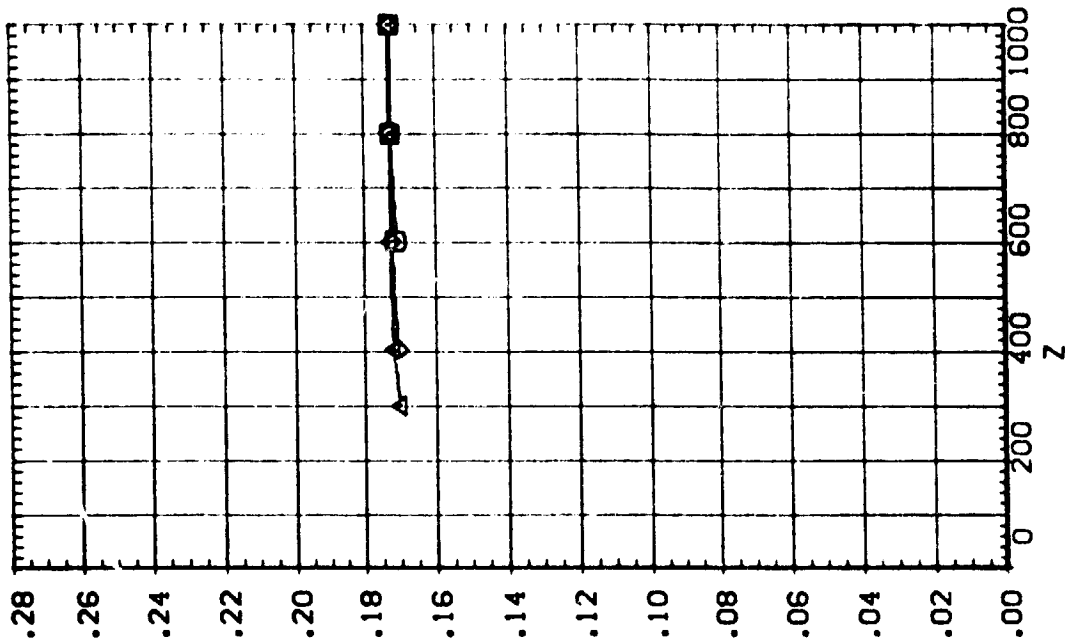

EFFECT OF SRB W/O PLUMES SEPARATION ON ORB/ET AERODYNAMIC CHARACTERISTICS

IA13 SRB(S8) W/O PLUMES SEPARATING FROM 09T10 (RTJ212)

SEE THE ASSOCIATED DATA DOCUMENT FOR REFERENCE CHARACTERISTICS FOR INDIVIDUAL DATASETS

SYMBOL X
 □
 ◇
 △

PARAMETRIC VALUES
 MACH 4.530 P/TOTAL 110.000
 ALPHA .000 BETA .000
 DALPHA -10.000 DBETA -10.000
 Y .000 PC-MER .000

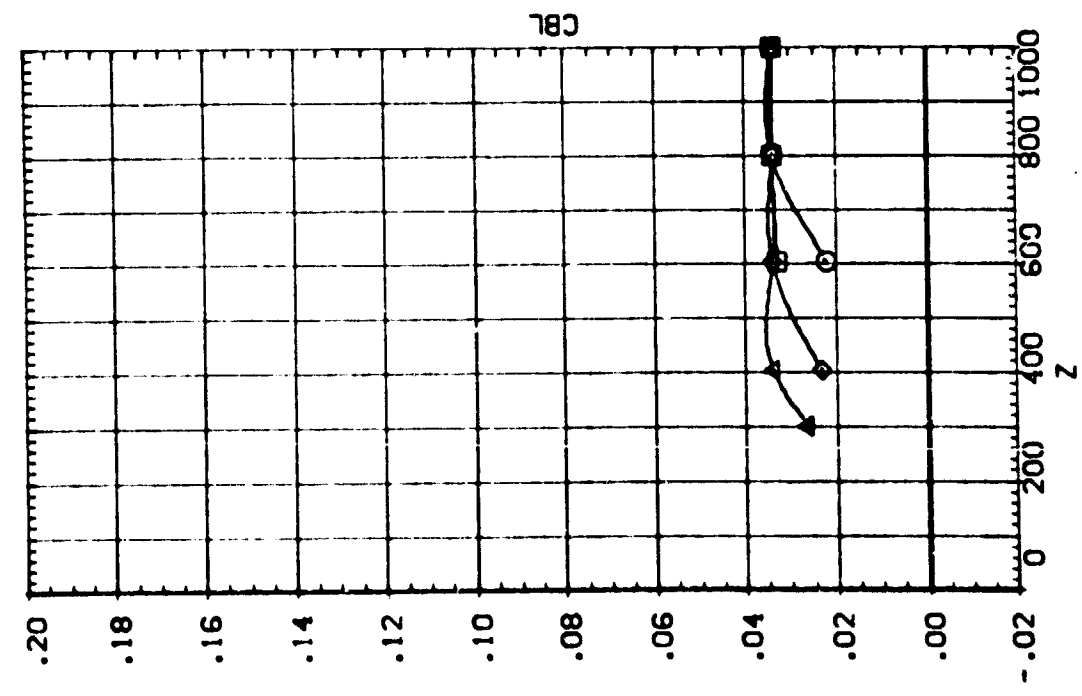
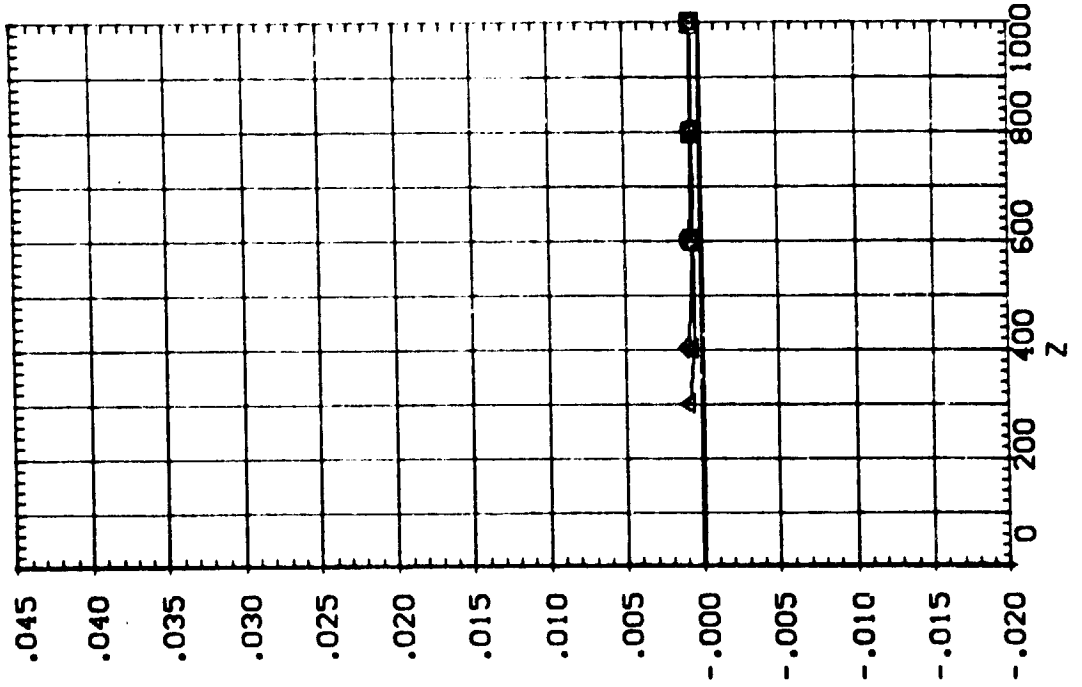

EFFECT OF SRB W/O PLUMES SEPARATION ON ORB/ET AERODYNAMIC CHARACTERISTICS

IA13 SRB(S8) W/O PLUMES SEPARATING FROM 09T10 (RTJ212)

SEE THE ASSOCIATED DATA DOCUMENT FOR REFERENCE CHARACTERISTICS FOR INDIVIDUAL DATASETS

SYMBOL	X	MACH	PARAMETRIC VALUES
○	300.470	4.530	P/TOTAL 110.000
□	600.710	.000	BETA .000
◇	900.290	-10.000	DBETA -10.000
△		.000	PC+6R .000

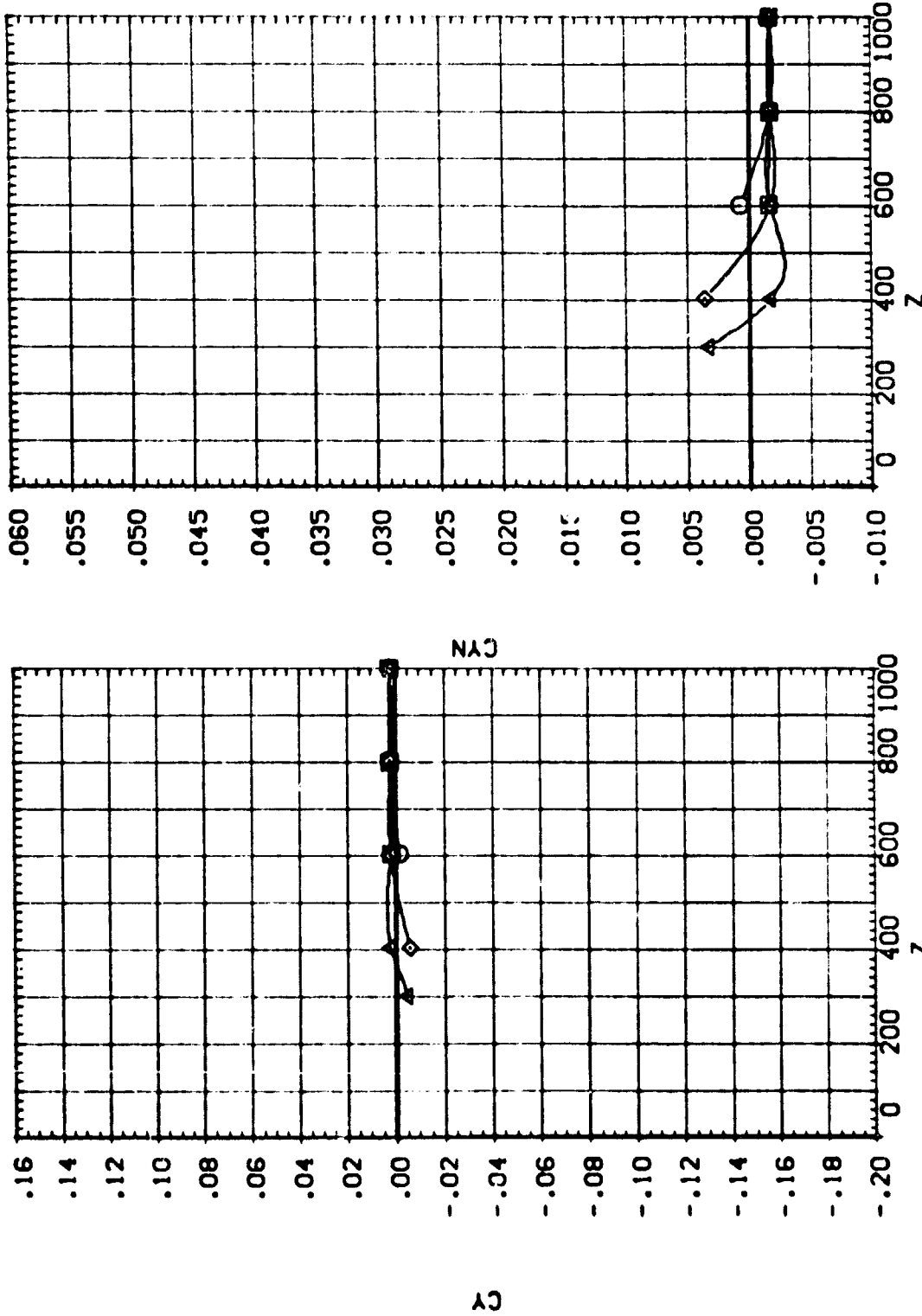

EFFECT OF SRB W/O PLUMES SEPARATION ON ORB/ET AERODYNAMIC CHARACTERISTICS

IA13 SRB(SB) W/O PLUMES SEPARATING FROM 79T10 (RTJ213)

SEE THE ASSOCIATED DATA DOCUMENT FOR REFERENCE CHARACTERISTICS FOR INDIVIDUAL DATASETS

SYMBOL		PARAMETRIC VALUES			
○	X	MACH	4.530	P/TOTAL	110.000
◇	300	ALPHA	.000	BETA	.000
◇	600	DALPHA	-10.000	DBETA	-20.000
△	899.950	γ	.000	PC-MBR	.000

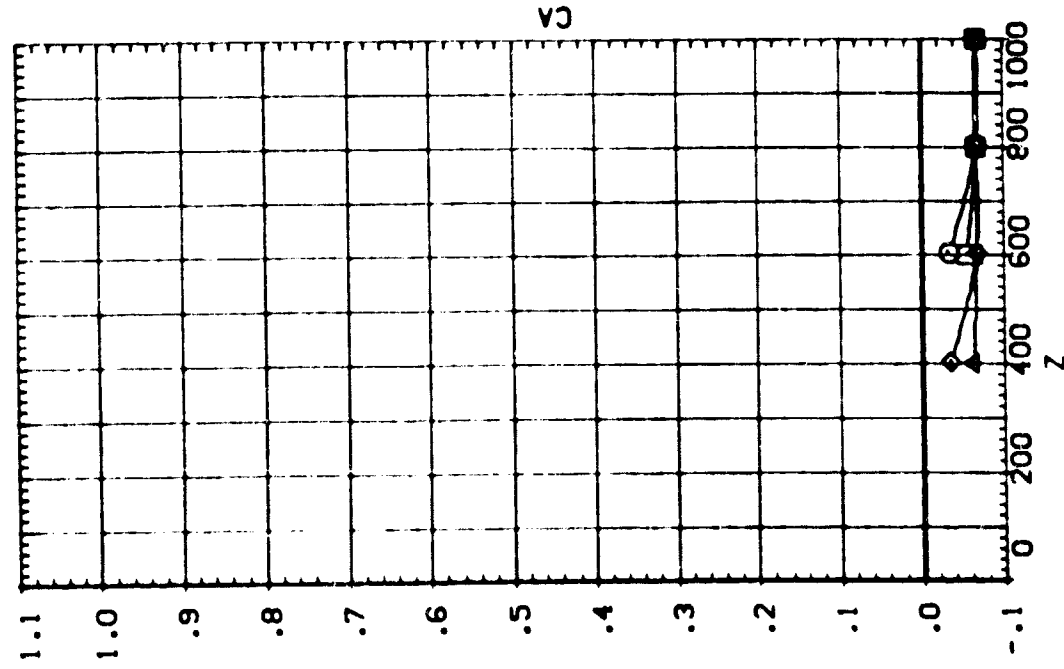
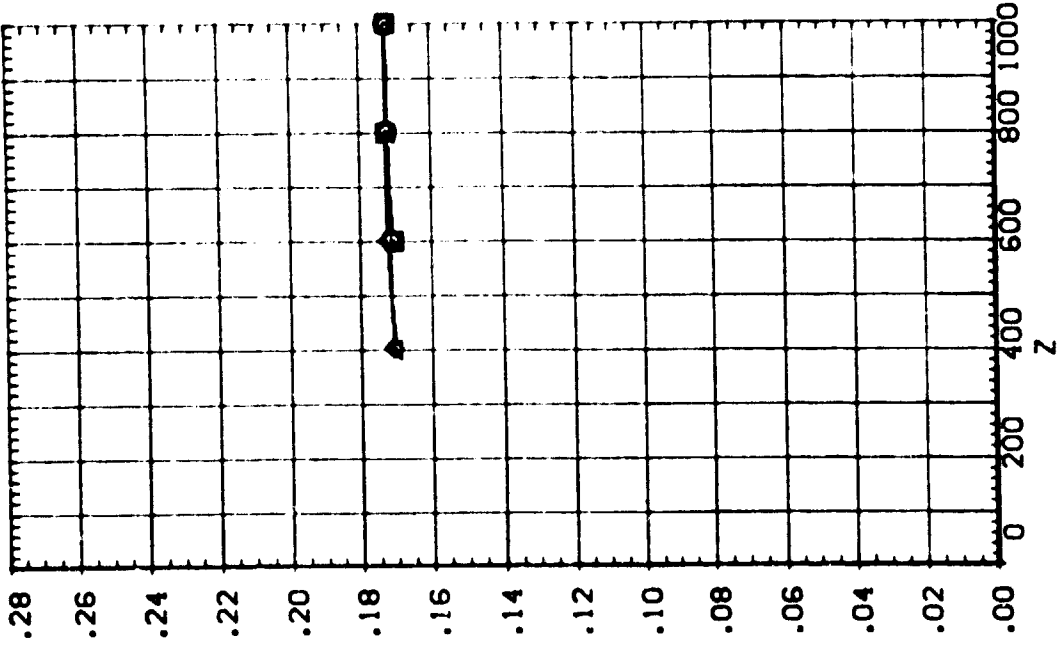

EFFECT OF SRB W/O PLUMES SEPARATION ON ORB/ET AERODYNAMIC CHARACTERISTICS

[A13 SRB(S8) W/O PLUMES SEPARATING FROM 09T10 (RTJ213)]

SEE THE ASSOCIATED DATA DOCUMENT FOR REFERENCE CHARACTERISTICS FOR INDIVIDUAL DATASETS

SYMBOL
 ○
 □
 ◇
 △

PARAMETRIC VALUES

X	.708	MACH	4.530	PITOTAL	110.000
300.430	.000	ALPHA	.000	BETA	.000
600.560	-10.000	DALPHA	.000	DBETA	-20.000
899.950	.000	Y	.000	POWER	.000

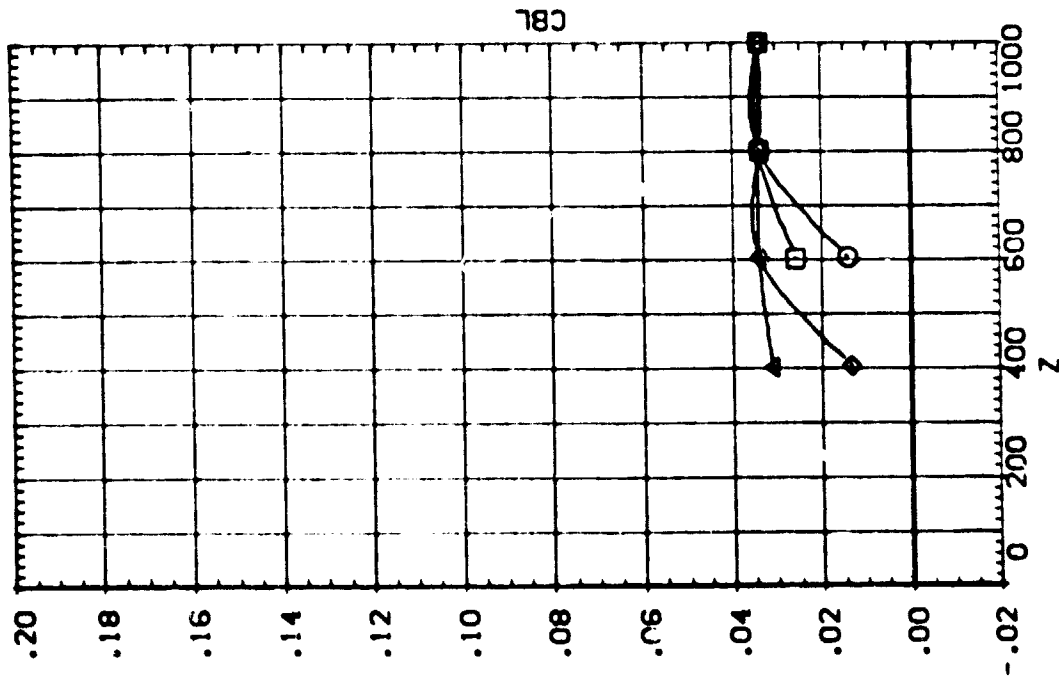
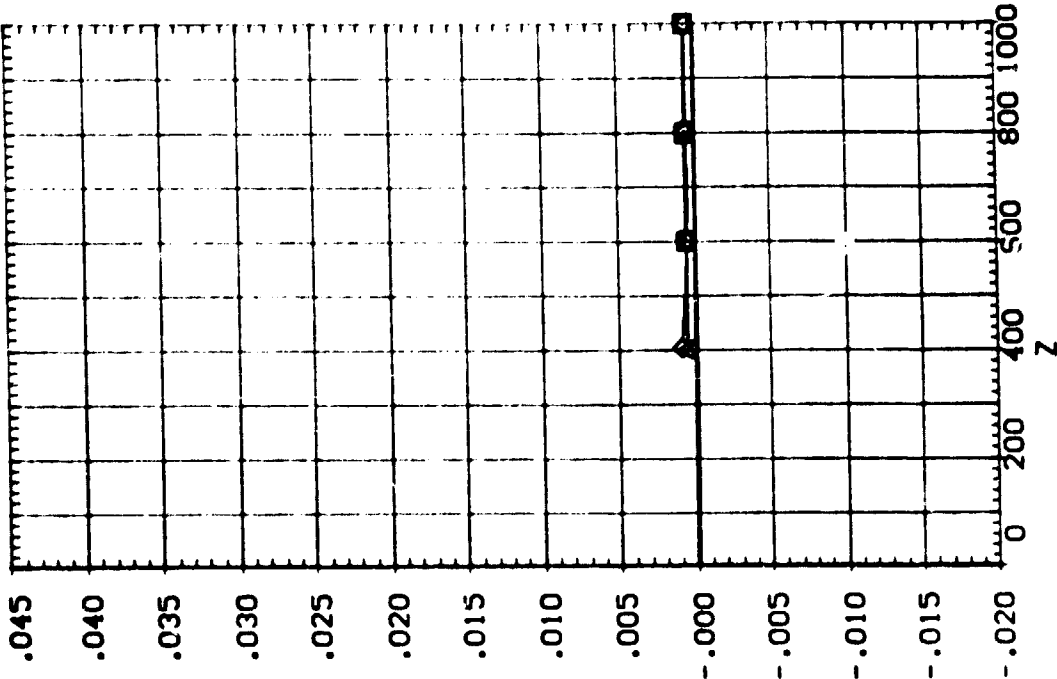

EFFECT OF SRB W/O PLUMES SEPARATION ON ORB/ET AERODYNAMIC CHARACTERISTICS

IA13 SRB(S8) W/O PLUMES SEPARATING FROM 09T10 (RTJ213)

SEE THE ASSOCIATED DATA DOCUMENT FOR REFERENCE CHARACTERISTICS FOR INDIVIDUAL DATASETS

SYMBOL	X	MACH	PARAMETRIC VALUES
○	.708	4.530	PITOT 110.000
□	300.430	.000	BETA .000
◇	600.563	-10.000	DBETA -20.000
△	699.950	.000	PC-MBR .000

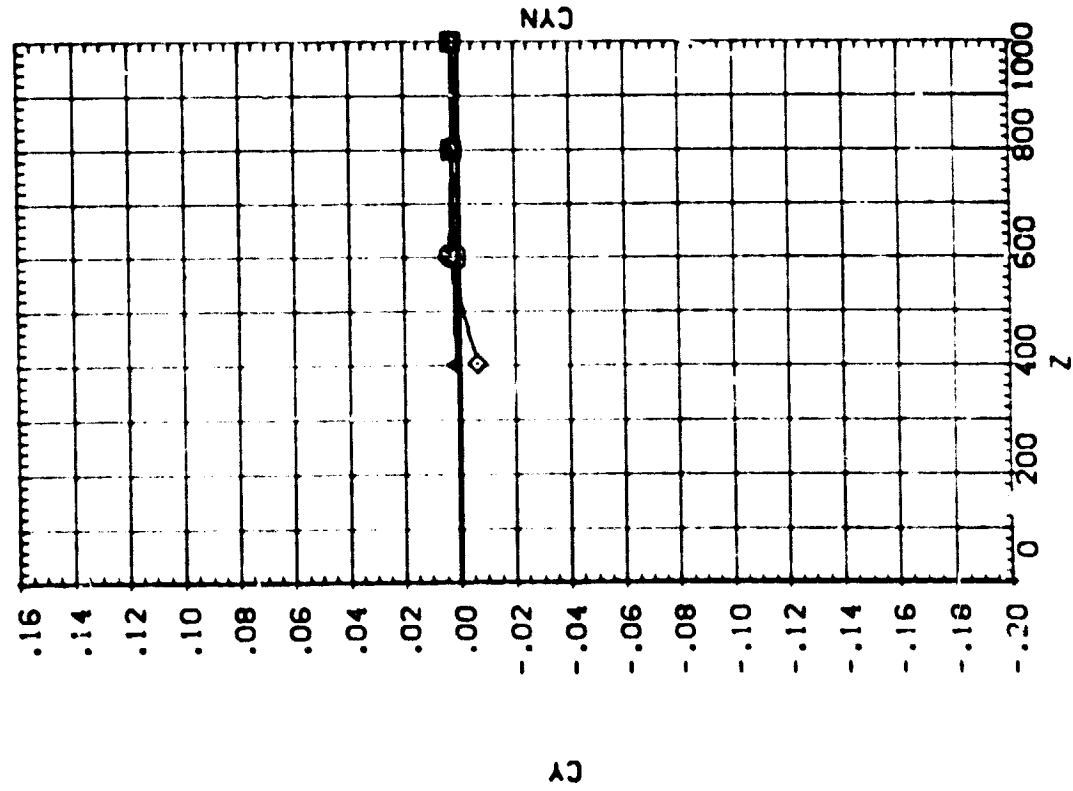
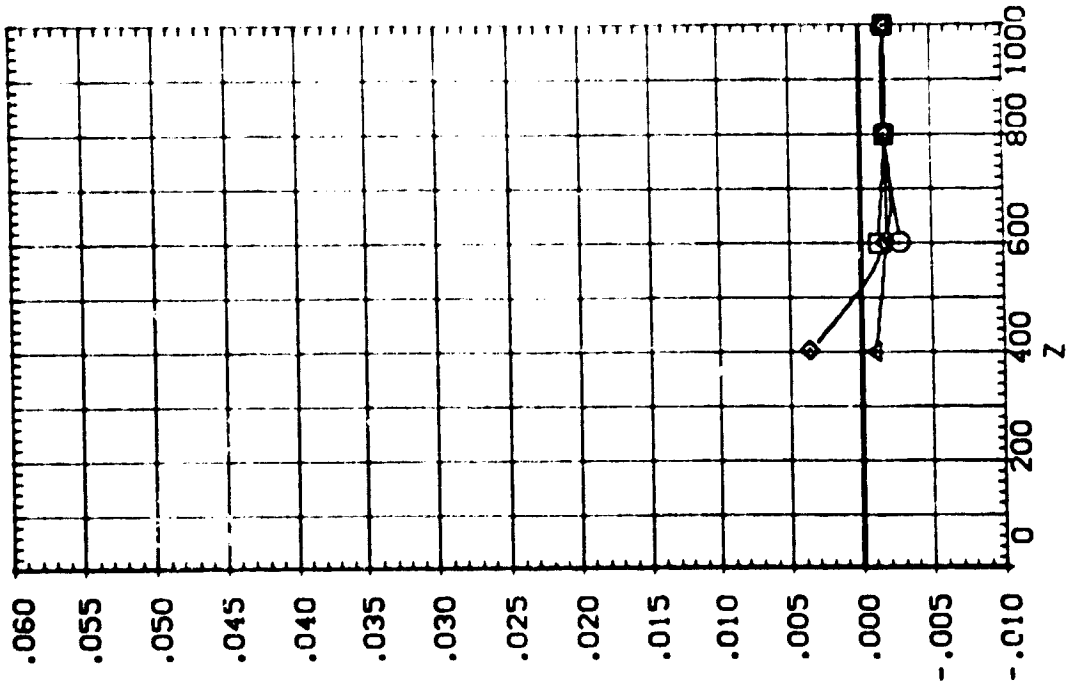

IA13 SRB(S8) W/O PLUMES SEPARATING FROM 09T10 (RTJ214)

SEE THE ASSOCIATED DATA DOCUMENT FOR REFERENCE CHARACTERISTICS FOR INDIVIDUAL DATASETS

SYMBOL		PARAMETRIC VALUES			
□	X	MACH	4.530	PTOTAL	110.000
◇	300.430	ALPHA	.000	BETA	.000
△	598.860	DALPHA	-10.000	DBETA	-20.000
	899.400	Y	200.000	PCMR	.000

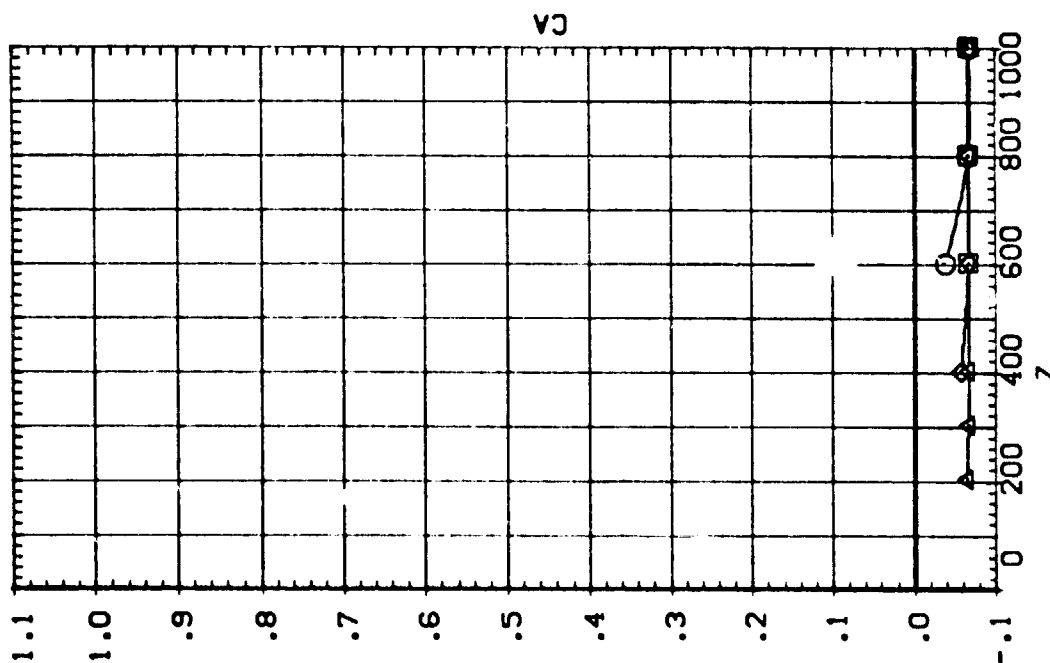
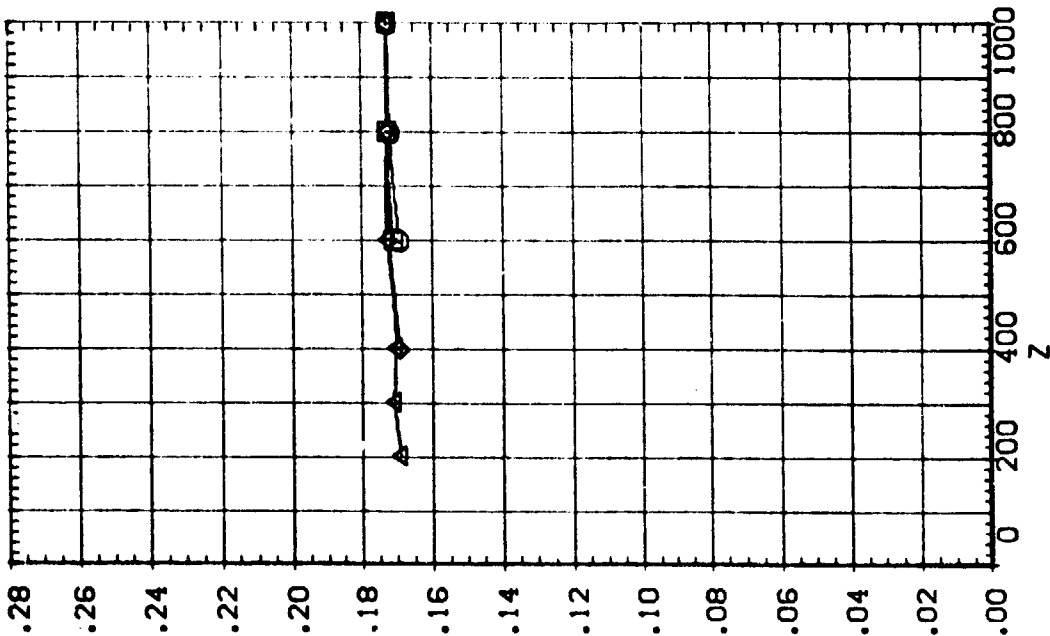

EFFECT OF SRB W/O PLUMES SEPARATION ON ORB/ET AERODYNAMIC CHARACTERISTICS

IA13 SRB(S8) W/O PLUMES SEPARATING FROM OST10 (RTJ214)

SEE THE ASSOCIATED DATA DOCUMENT FOR REFERENCE CHARACTERISTICS FOR INDIVIDUAL DATASETS

SYMBOL		PARAMETRIC VALUES			
x	- .101	MACH	4.530	PTOTAL	110.000
o	500.430	ALPHA	.000	BETA	.000
□	598.860	DALPHA	-10.000	DBETA	-20.000
◇	899.400	Y	200.000	PCMBER	.000

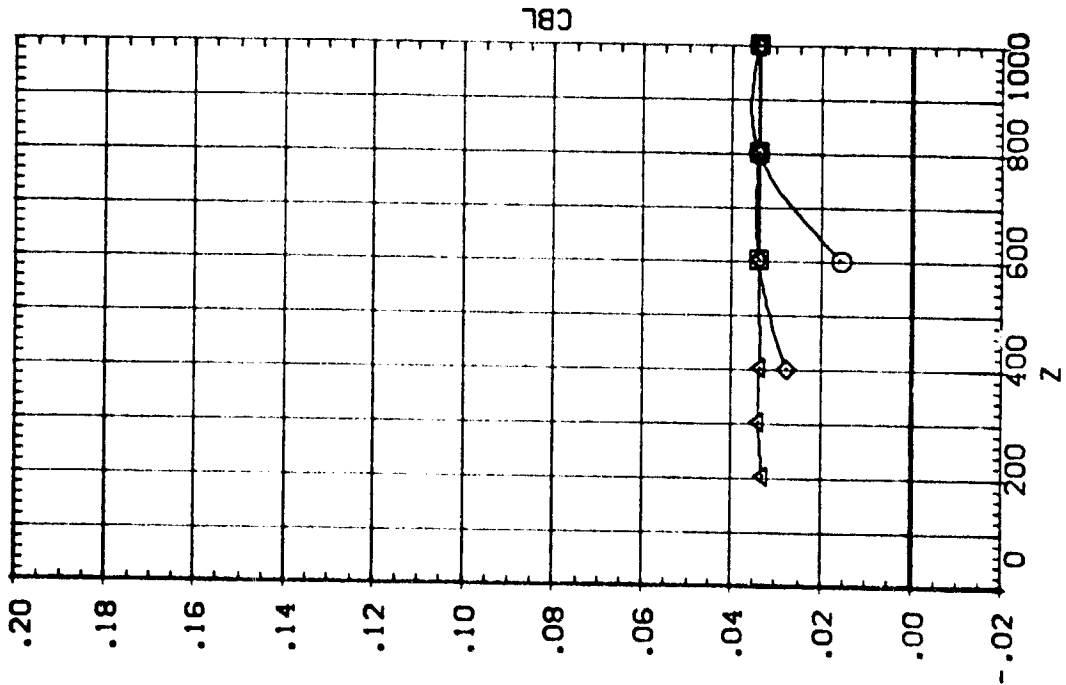
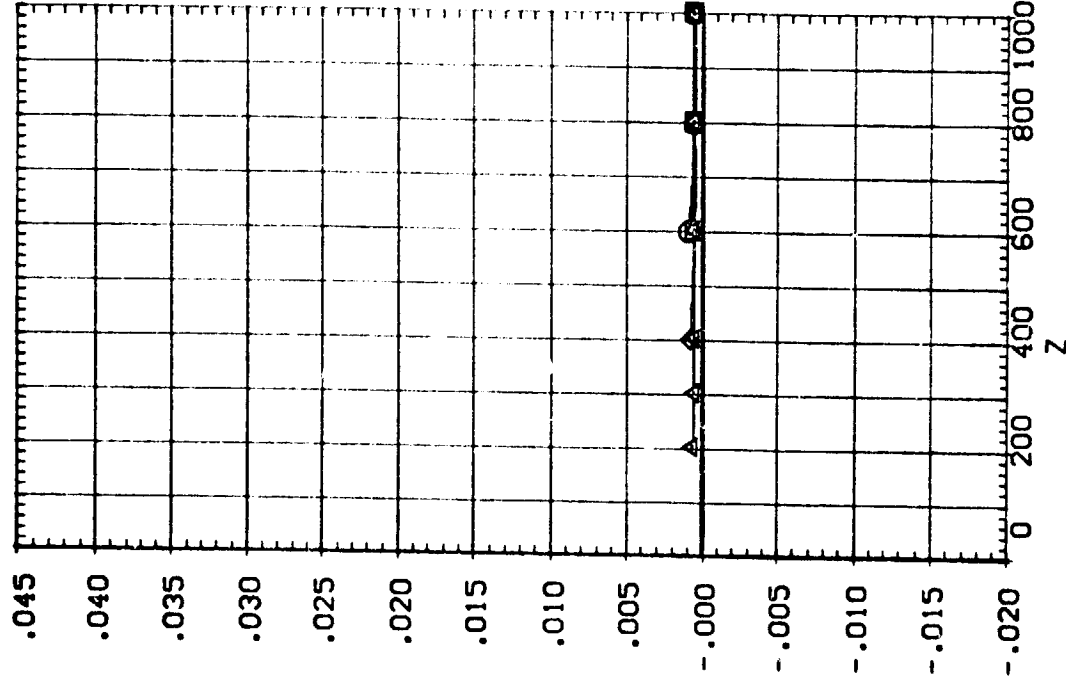

EFFECT OF SRB W/O PLUMES SEPARATION ON ORB/ET AERODYNAMIC CHARACTERISTICS

IA13 SRB(SB) W/O PLUMES SEPARATING FROM 09T10 (RTJ214)

SEE THE ASSOCIATED DATA DOCUMENT FOR REFERENCE CHARACTERISTICS FOR INDIVIDUAL DATASETS

SYMBOL		PARAMETRIC VALUES			
X	-0.101	MACH	4.530	POTAL	110.000
□	300.430	ALPHA	.000	BETA	.000
◇	598.850	DALPHA	-10.000	DBETA	-20.000
△	899.400	Y	200.000	PC-MBR	.000

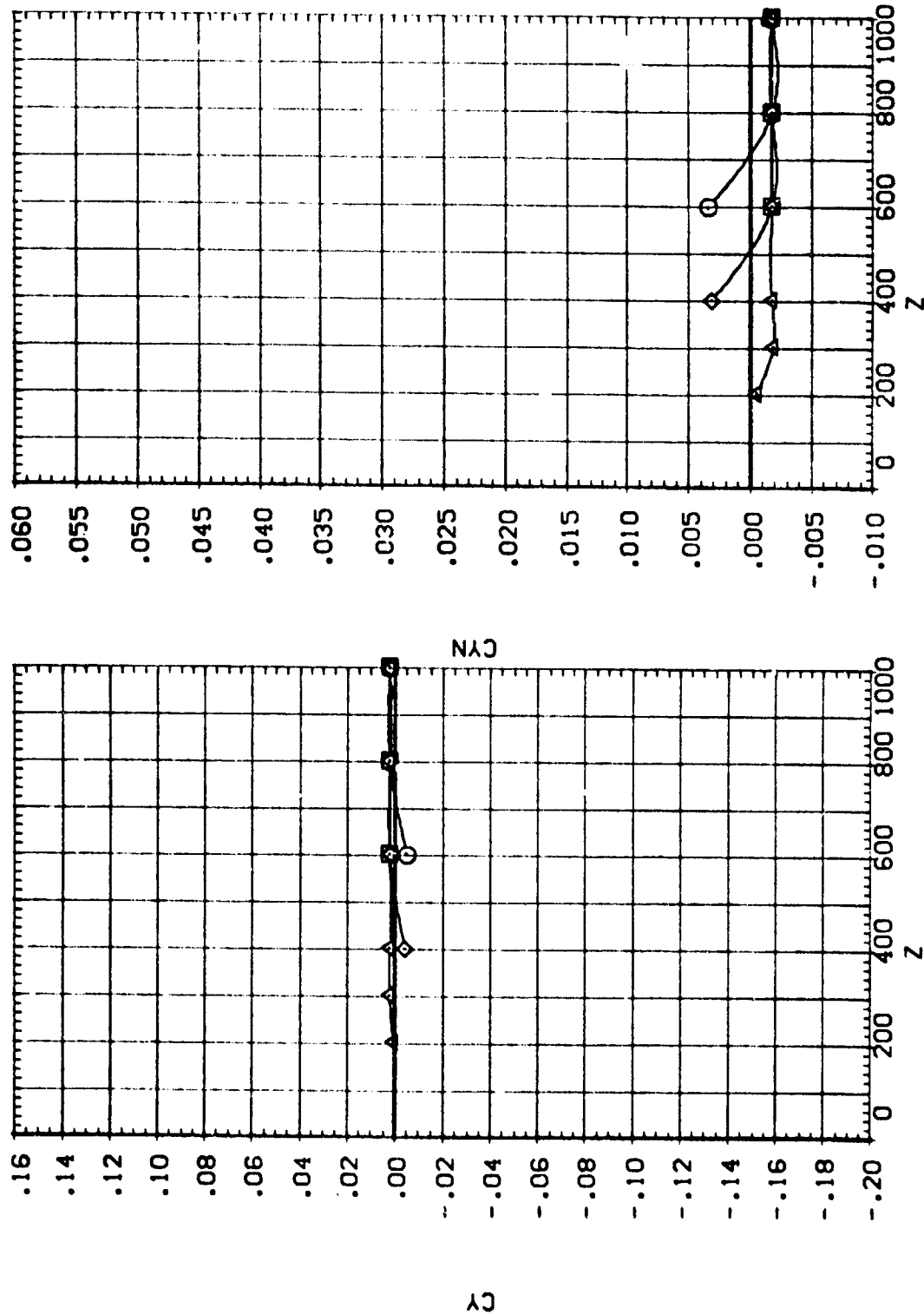

EFFECT OF SRB W/O PLUMES SEPARATION ON ORB/ET AERODYNAMIC CHARACTERISTICS

1A13 SRB(SB) W/O PLUMES SEPARATING FROM 09T10 (RTJ215)

SEE THE ASSOCIATED DATA DOCUMENT FOR REFERENCE CHARACTERISTICS FOR INDIVIDUAL DATASETS

SYMBOL		PARAMETRIC VALUES	
○	x	MACH	PTOTAL
□	299.860	ALPHA	BETA
◇	600.710	DALPHA	DBETA
△	899.920	Y	PC-MBR
			110.000
			.000
			-20.000
			.000

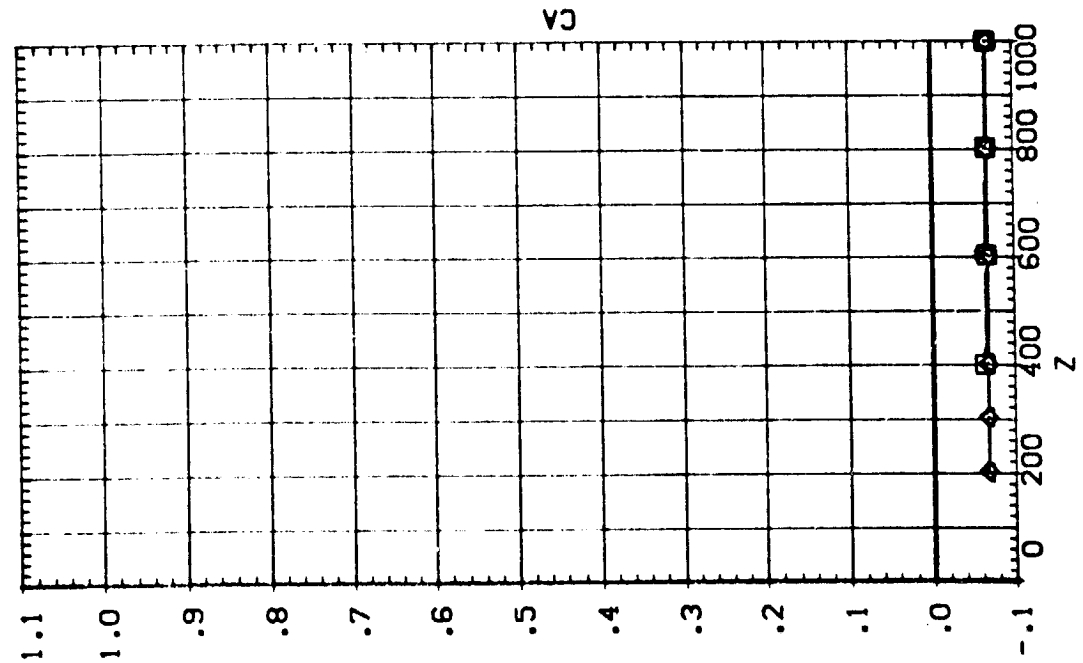
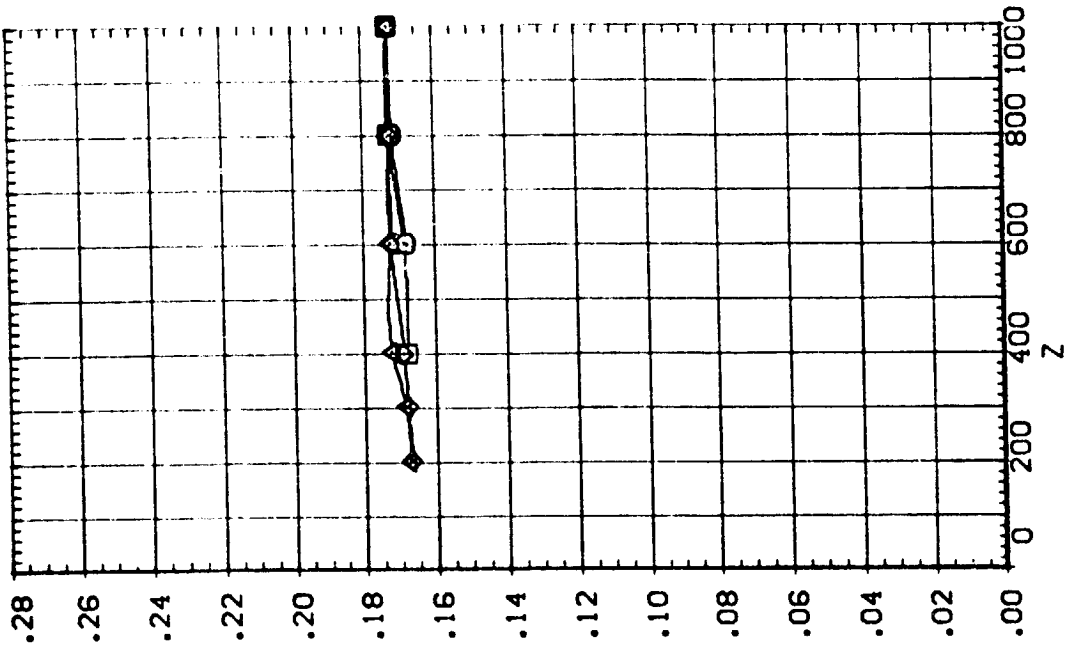

IA13 SRB(S8) W/O PLUMES SEPARATING FROM 09T10 (RTJ215)

SEE THE ASSOCIATED DATA DOCUMENT FOR REFERENCE CHARACTERISTICS FOR INDIVIDUAL DATASETS

SYMBOL		PARAMETRIC VALUES			
○	X	MACH	4.530	PIOTAL	110.000
□	299.860	ALPHA	.000	BETA	.000
◇	600.710	DALPHA	-10.000	DBETA	-20.000
△	899.920	Y	400.000	PCHMR	.000

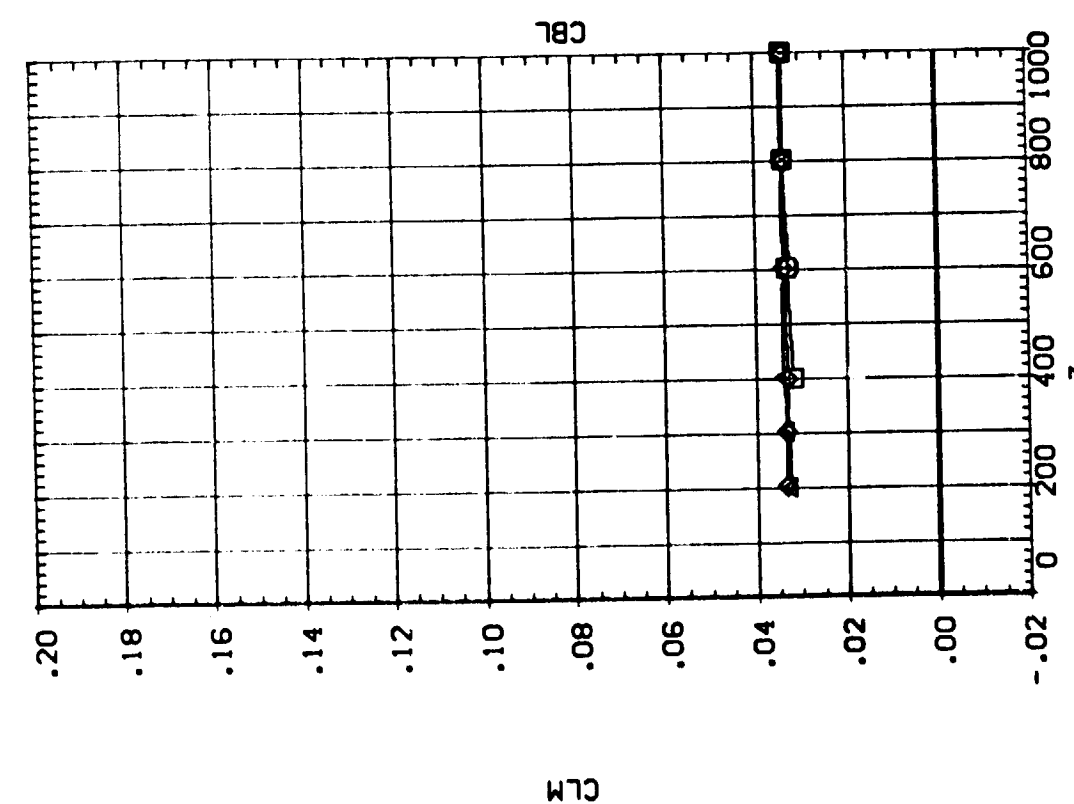
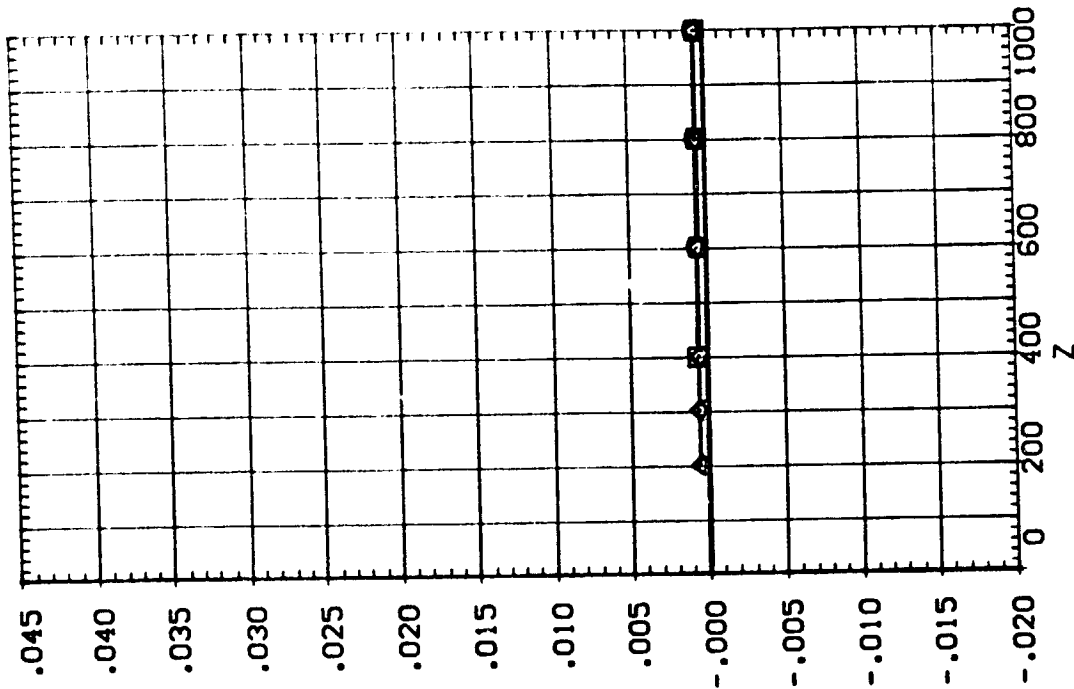

IA13 SRB(S8) W/O PLUMES SEPARATING FROM 09T10 (RTJ215)

SEE THE ASSOCIATED DATA DOCUMENT FOR REFERENCE CHARACTERISTICS FOR INDIVIDUAL DATASETS

PARAMETRIC VALUES	
MACH	4.530
PTOTAL	110.000
BETA	.000
DBETA	-20.000
PC+BR	.000
X	.398
Y	600.710
Z	899.920

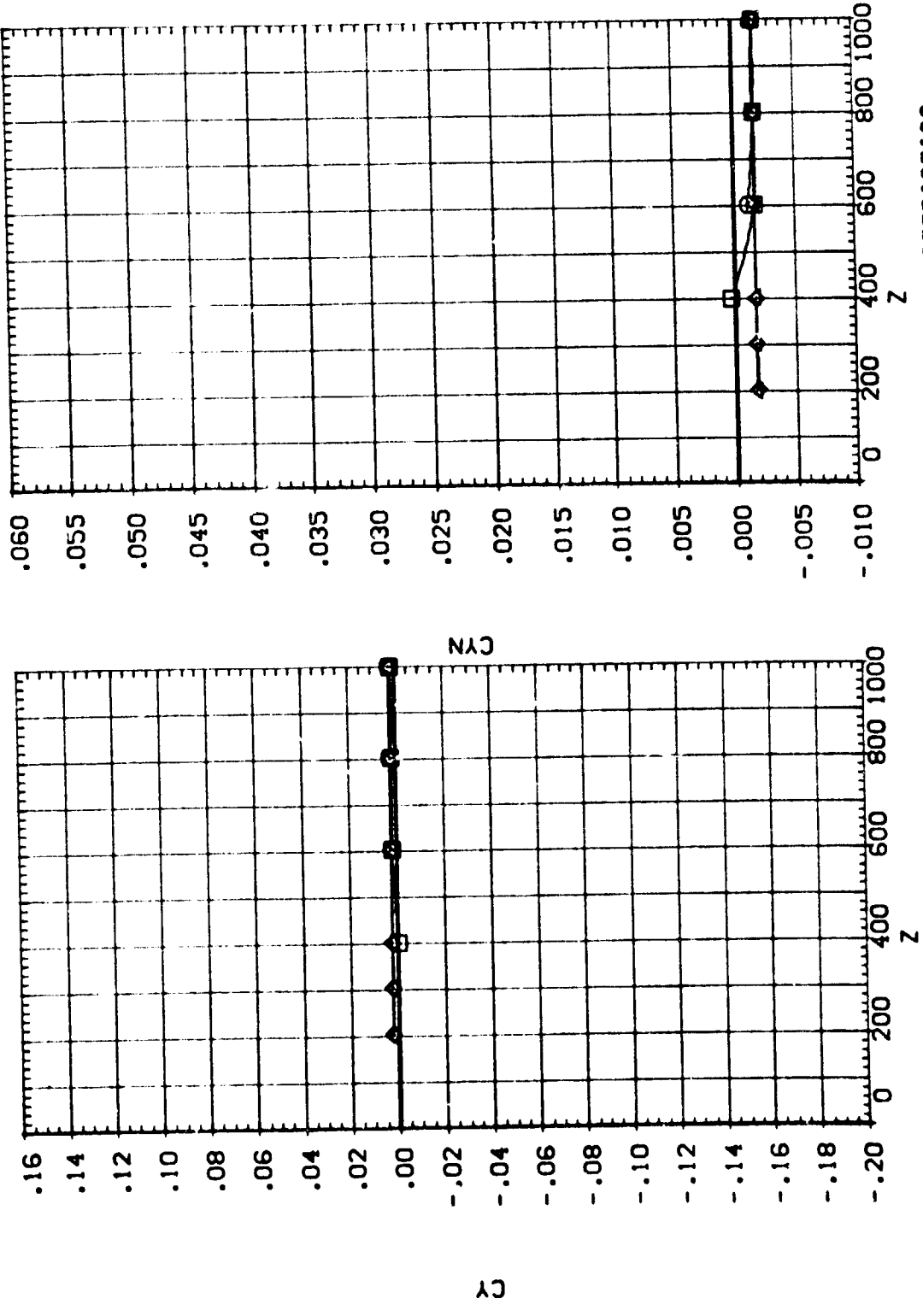

IA13 SRB(S8) W/O PLUMES SEPARATING FROM 09T10 (RTJ216)

SEE THE ASSOCIATED DATA DOCUMENT FOR REFERENCE CHARACTERISTICS FOR INDIVIDUAL DATASETS

PARAMETRIC VALUES	
MACH	4.530
PITOTAL	110.000
BETA	.000
DBETA	-20.000
PC-MBR	.000
X	-.656
Y	900.840
ALPHA	.000
DALPHA	-10.000

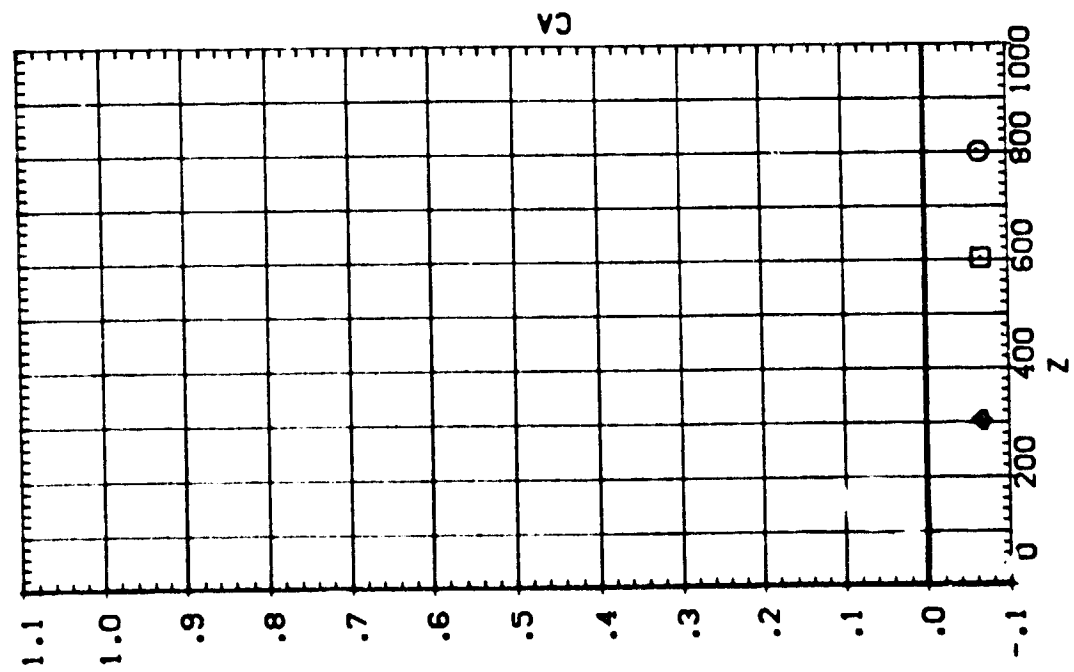
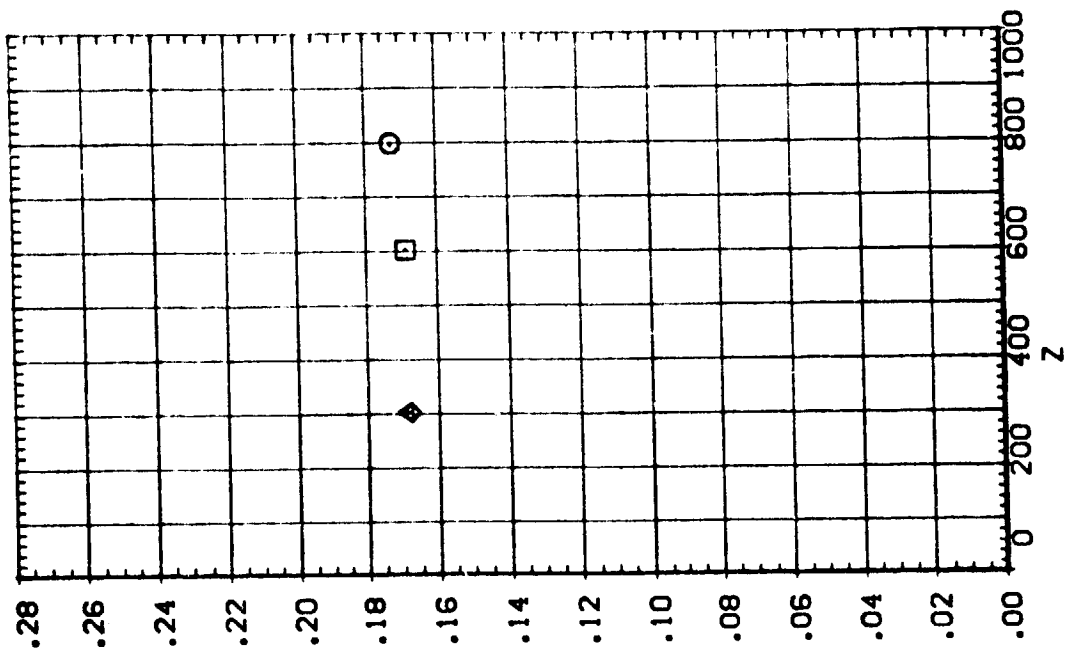

EFFECT OF SRB W/O PLUMES SEPARATION ON ORB/ET AERODYNAMIC CHARACTERISTICS

IA13 SRB(S8) W/O PLUMES SEPARATING FROM 09T10 (RTJ216)

SEE THE ASSOCIATED DATA DOCUMENT FOR REFERENCE CHARACTERISTICS FOR INDIVIDUAL DATASETS

PARAMETRIC VALUES	
X	-.656
MACH	4.530
PITOTAL	110.000
ALPHA	.000
BETA	.000
DELTA	-10.000
PC-MFR	800.000
Y	600.840
Z	20.000

SYMBOL
 ○
 □
 ◇
 △

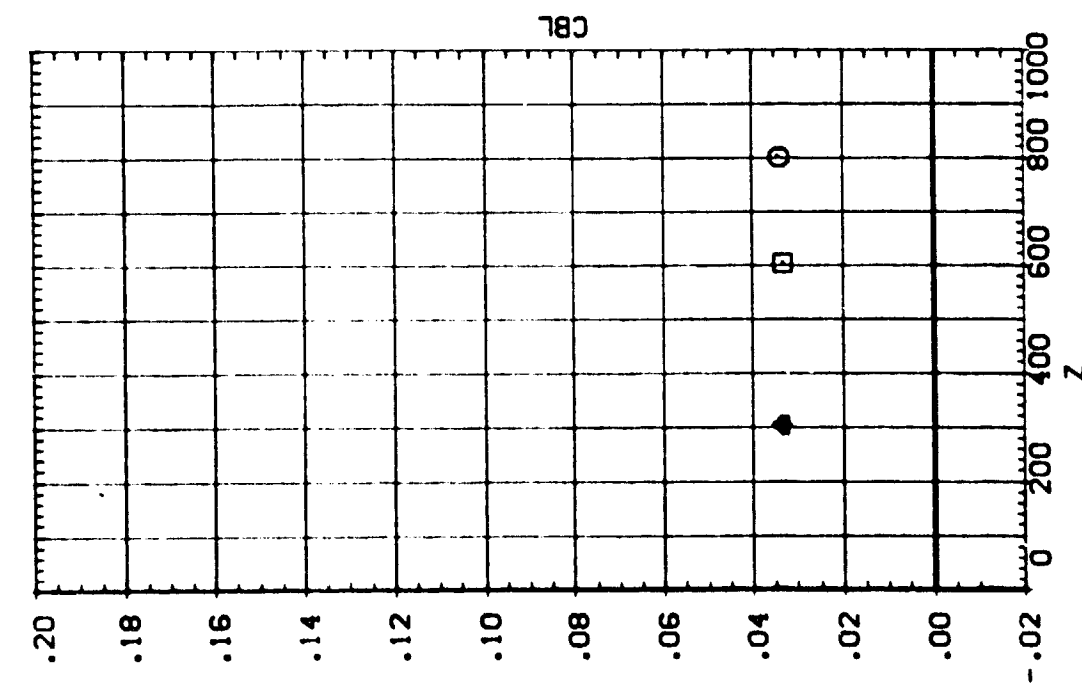
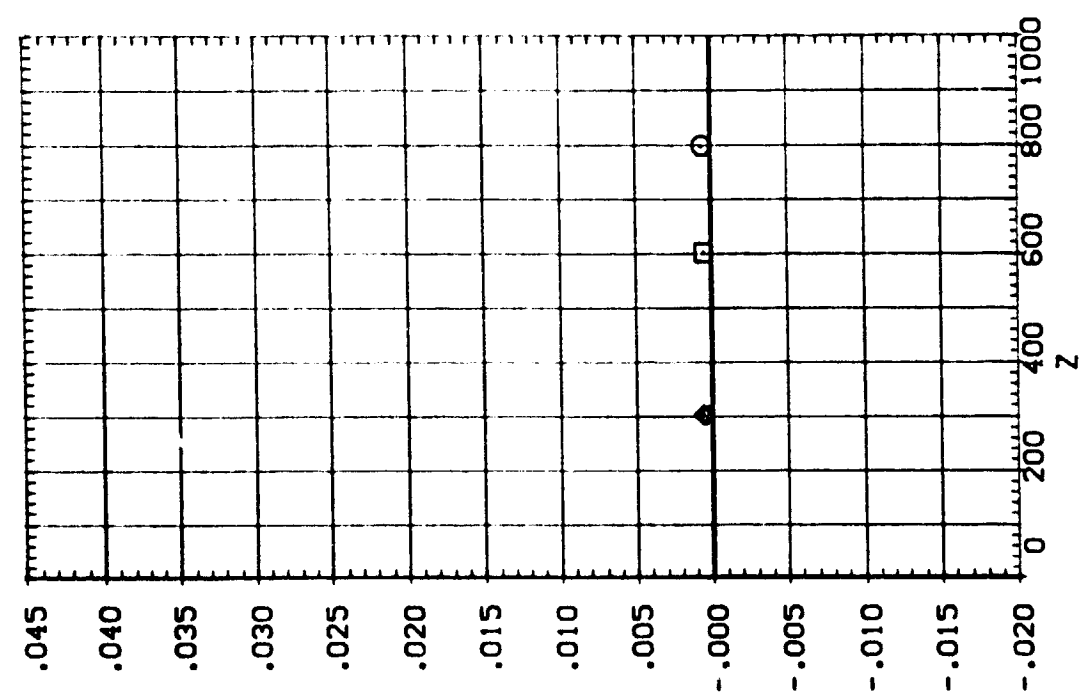

EFFECT OF SRB W/O PLUMES SEPARATION ON 08/ET AERODYNAMIC CHARACTERISTICS

SEE THE ASSOCIATED DATA DOCUMENT FOR REFERENCE CHARACTERISTICS FOR INDIVIDUAL DATASETS

SYMBOL		PARAMETRIC VALUES			
○	X	MACH	4.530	PIOTAL	110.000
□	300.470	ALPHA	.000	BETA	.000
◇	600.170	DALPHA	-10.000	DBETA	-20.000
△	900.840	Y	800.000	PC-MBR	.000

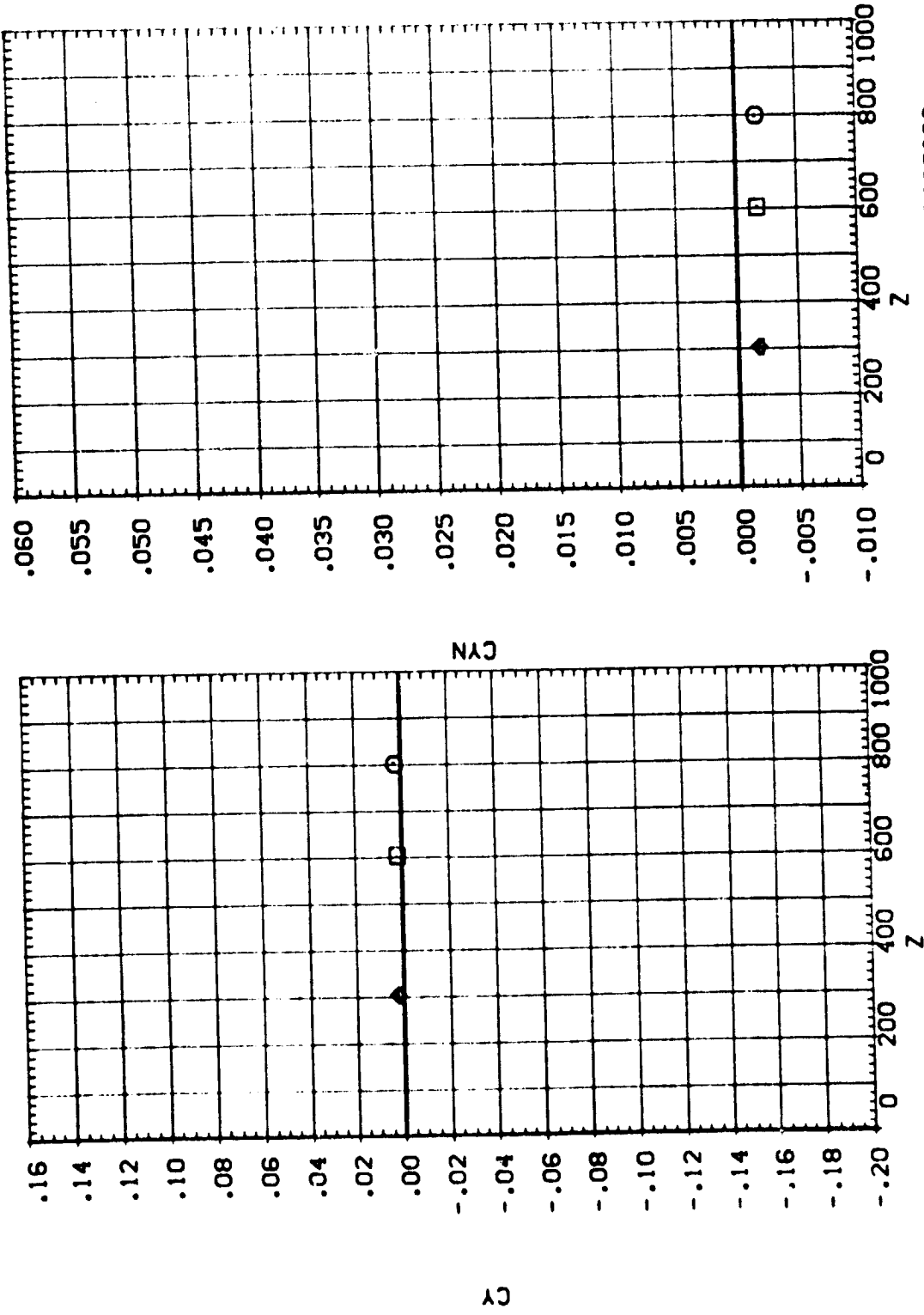

EFFECT OF SRB W/O PLUMES SEPARATION ON ORB/ET AERODYNAMIC CHARACTERISTICS

1A13 SRB(SB) W/O PLUMES SEPARATING FROM 09T10 (RTJ217)

SYMBOL

x

900.200

MACH

4.530

PARAMETRIC VALUES

PIDTAL

110.000

BETA

.000

DBETA

5.000

PC-MBR

.000

SEE THE ASSOCIATED DATA DOCUMENT FOR REFERENCE CHARACTERISTICS FOR INDIVIDUAL DATASETS

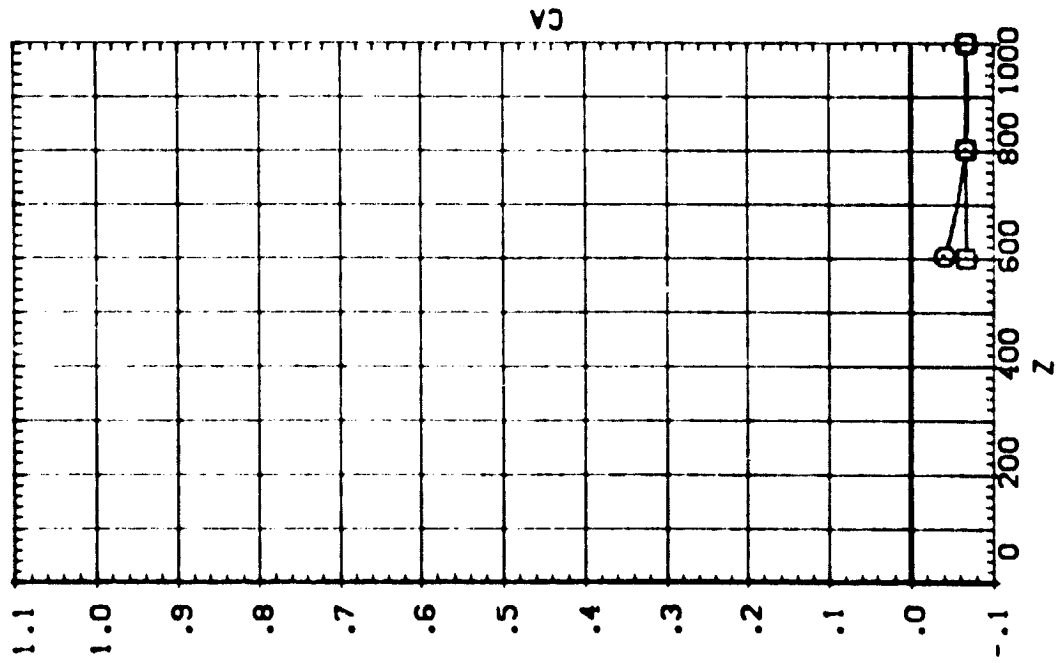
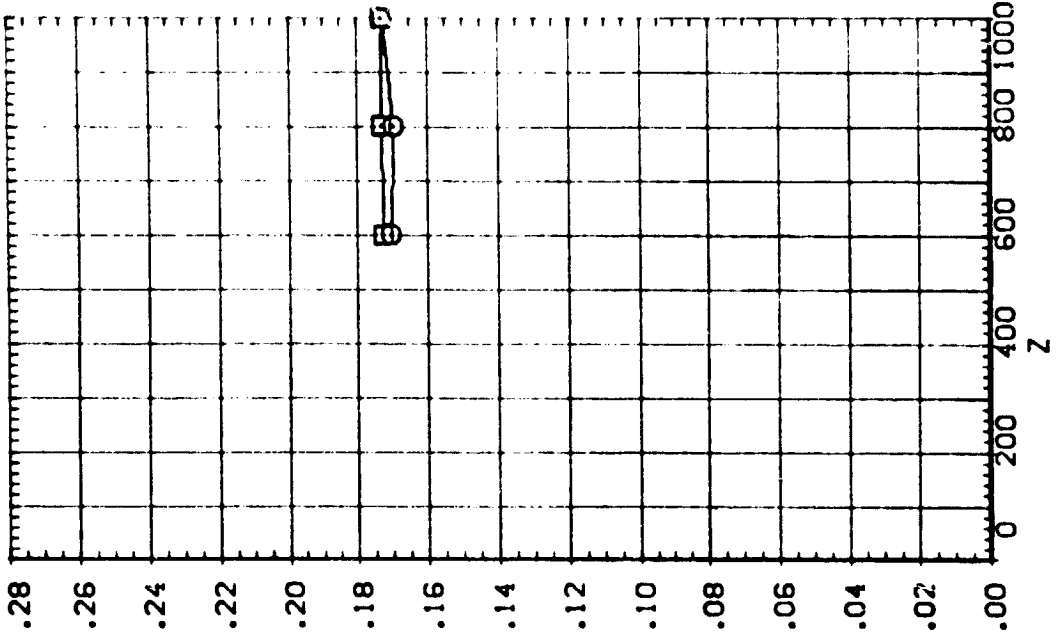

SEE THE ASSOCIATED DATA DOCUMENT FOR REFERENCE CHARACTERISTICS FOR INDIVIDUAL DATASETS

SYMBOL X .467 MACH .530 PTOTAL 110.000
 900.200 ALPHA .000 BETA .000
 DALPHA -20.000 DBETA 5.000
 V PC-MFR .000

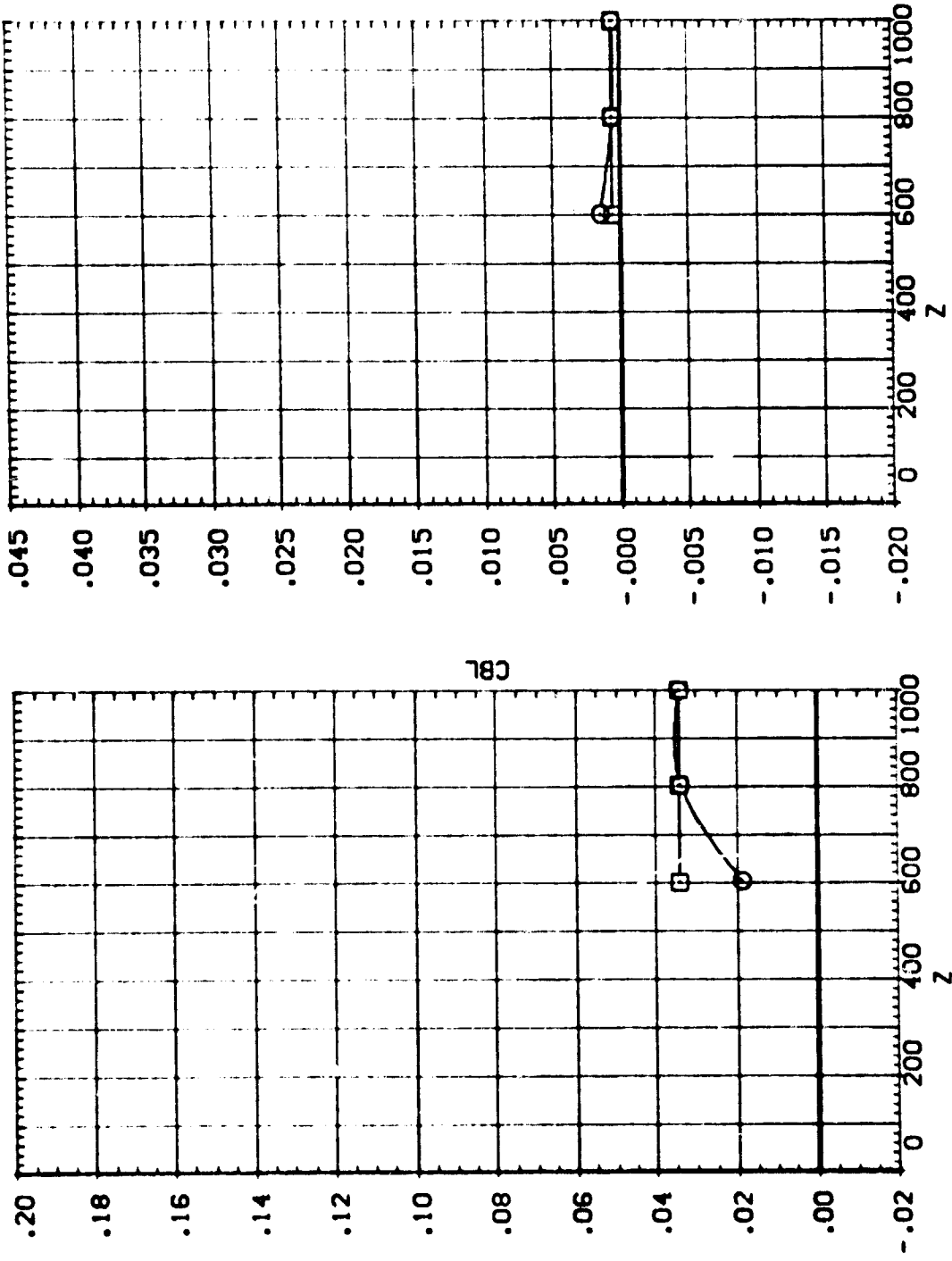

EFFECT OF SRB W/O PLUMES SEPARATION ON ORB/ET AERODYNAMIC CHARACTERISTICS

IA13 SRB(SB) W/O PLUMES SEPARATING FROM 09T10 (RTJ217)

SEE THE ASSOCIATED DATA DOCUMENT FOR REFERENCE CHARACTERISTICS FOR INDIVIDUAL DATASETS

SYMBOL X
 ○
 □

PARAMETRIC VALUES
 MACH: 4.530 PTOTAL 110.000
 ALPHA: .000 BETA .000
 DALPHA -20.000 DBETA 5.000
 Y .000 PCMBR .000

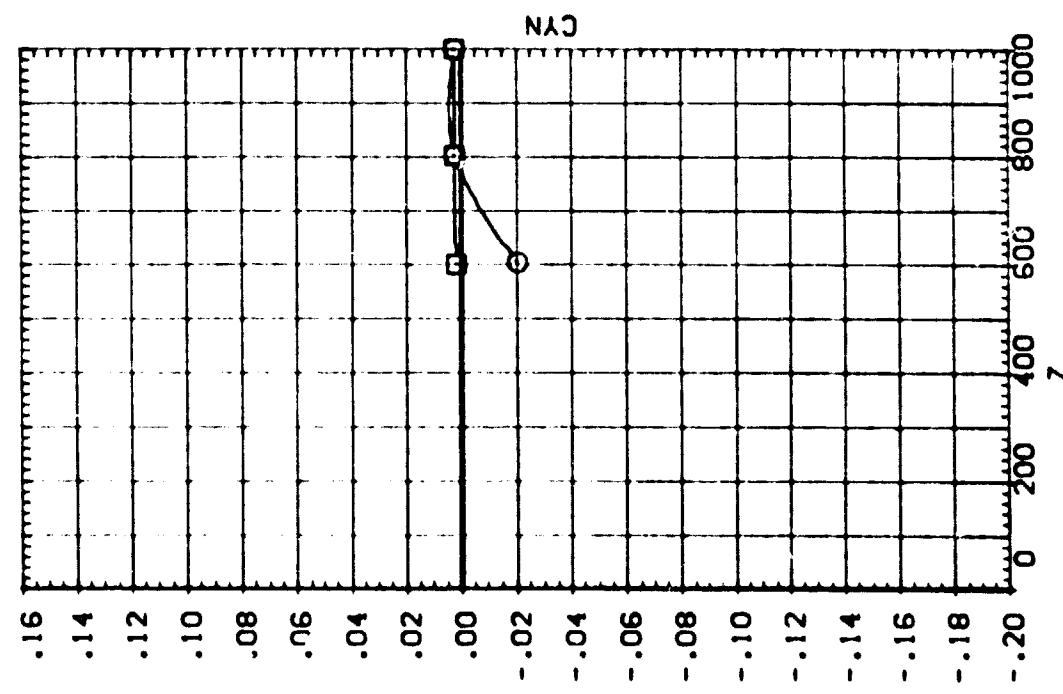
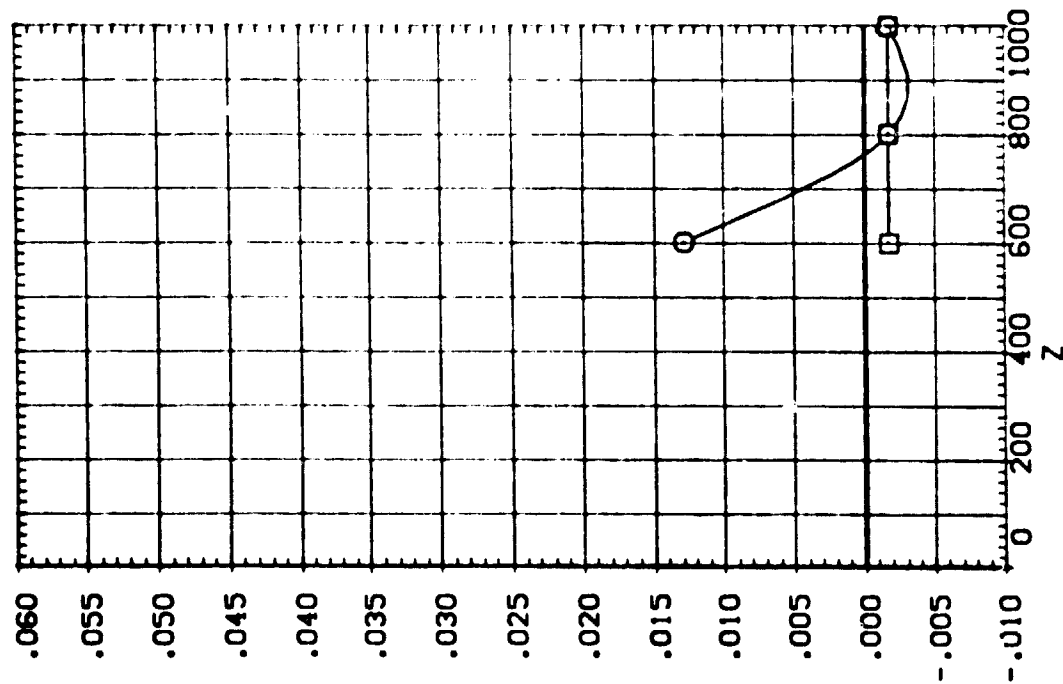

EFFECT OF SRB W/O PLUMES SEPARATION ON ORB/ET AERODYNAMIC CHARACTERISTICS

[A13 SRB(S8) W/O PLUMES SEPARATING FROM 09T10 (RTJ218)]

SEE THE ASSOCIATED DATA DOCUMENT FOR REFERENCE CHARACTERISTICS FOR INDIVIDUAL DATASETS

SYMBOL	X	MACH	PARAMETRIC VALUES
□	-.262	4.530	PISTAL 110.000
□	501.290	.000	BETA .000
		-20.000	DBETA 5.000
		200.000	PO-MFR .000

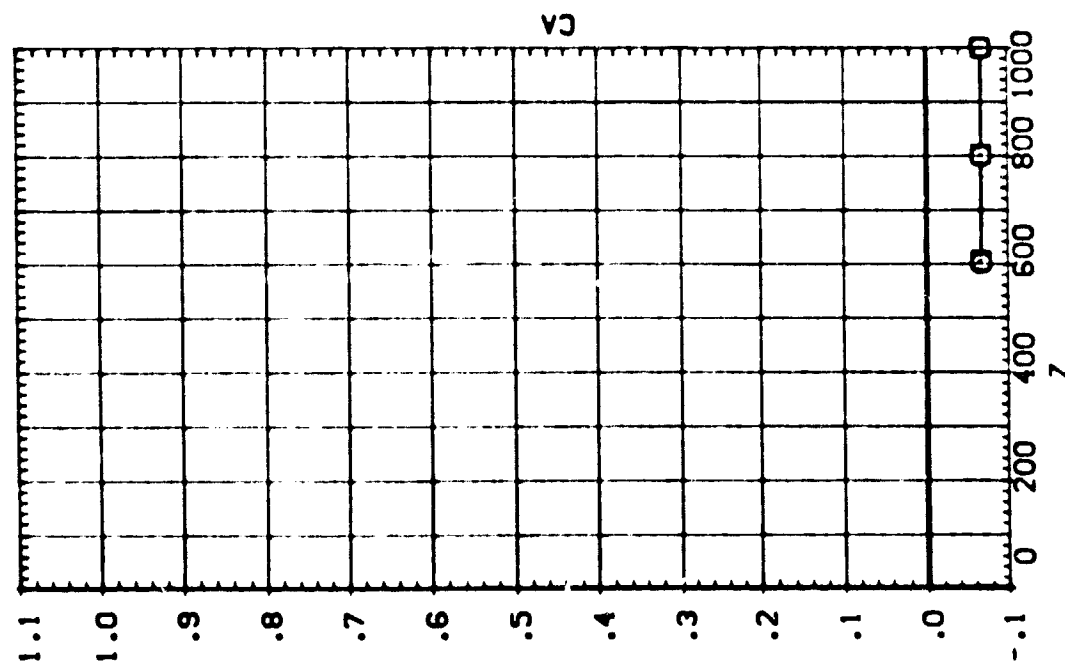
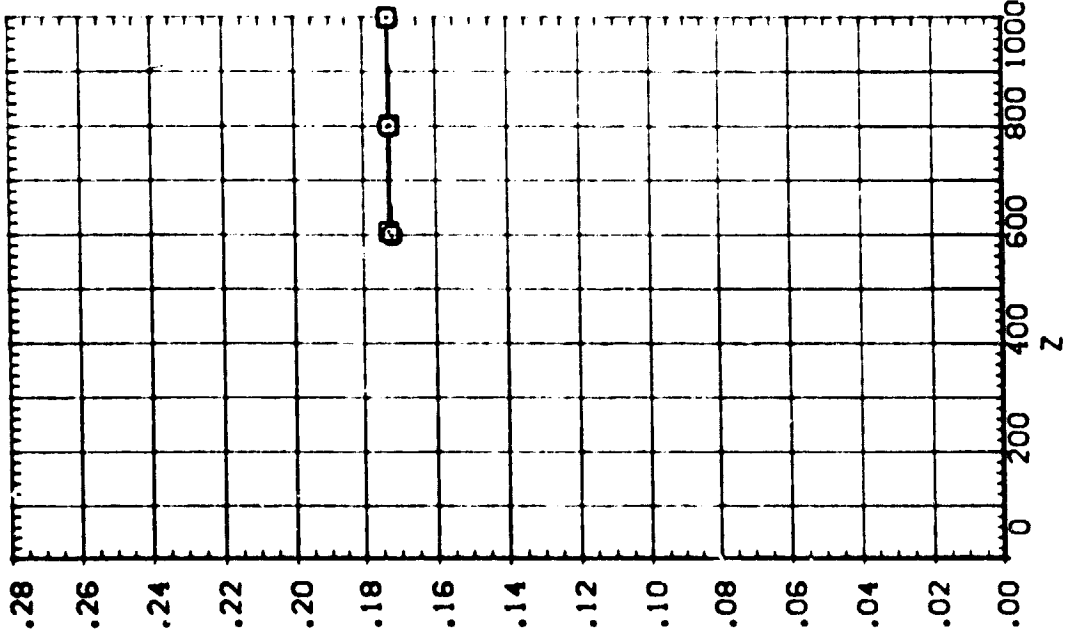

EFFECT OF SRB W/O PLUMES SEPARATION ON ORB/ET AERODYNAMIC CHARACTERISTICS

1A13 SRB(S6) W/O PLUMES SEPARATING FROM 09T10 (RTJ218)

SEE THE ASSOCIATED DATA DOCUMENT FOR REFERENCE CHARACTERISTICS FOR INDIVIDUAL DATASETS

SYMBOL		PARAMETRIC VALUES	
X	- .262	MACH	4.530
Y	901.280	PIOTAL	110.000
		ALPHA	.000
		BETA	5.000
		PC-MBR	.000

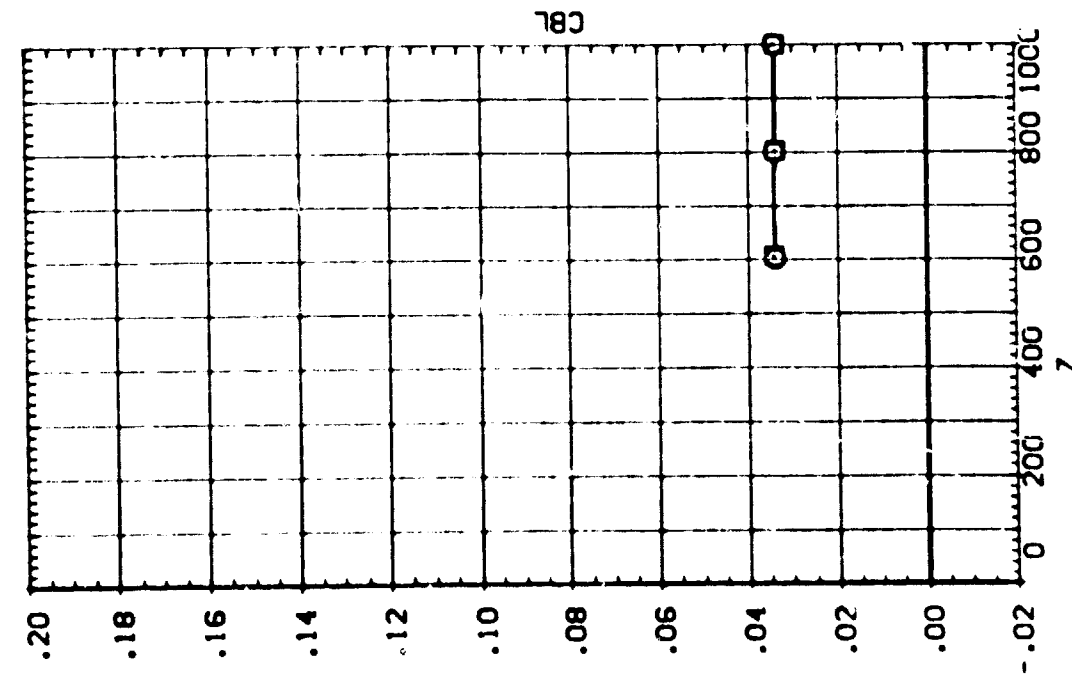
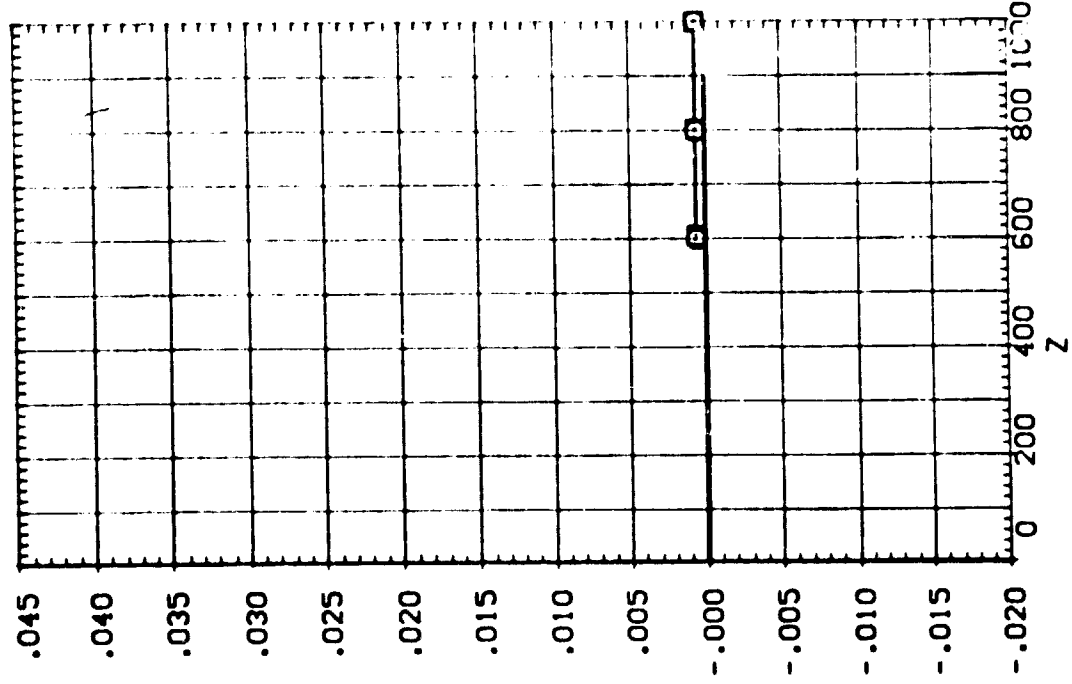

EFFECT OF SRB W/O PLUMES SEPARATION ON ORB/ET AERODYNAMIC CHARACTERISTICS

IA13 SRB(S8) W/O PLUMES SEPARATING FROM 09T10 (RTJ218)

SEE THE ASSOCIATED DATA DOCUMENT FOR REFERENCE CHARACTERISTICS FOR INDIVIDUAL DATASETS

SYMBOL		PARAMETRIC VALUES			
X	-0.262	MACH	4.530	P/TOTAL	110.000
□	901.260	ALPHA	.000	BETA	.000
		DALPHA	-20.000	DBETA	5.000
		Y	200.000	PC-MER	.000

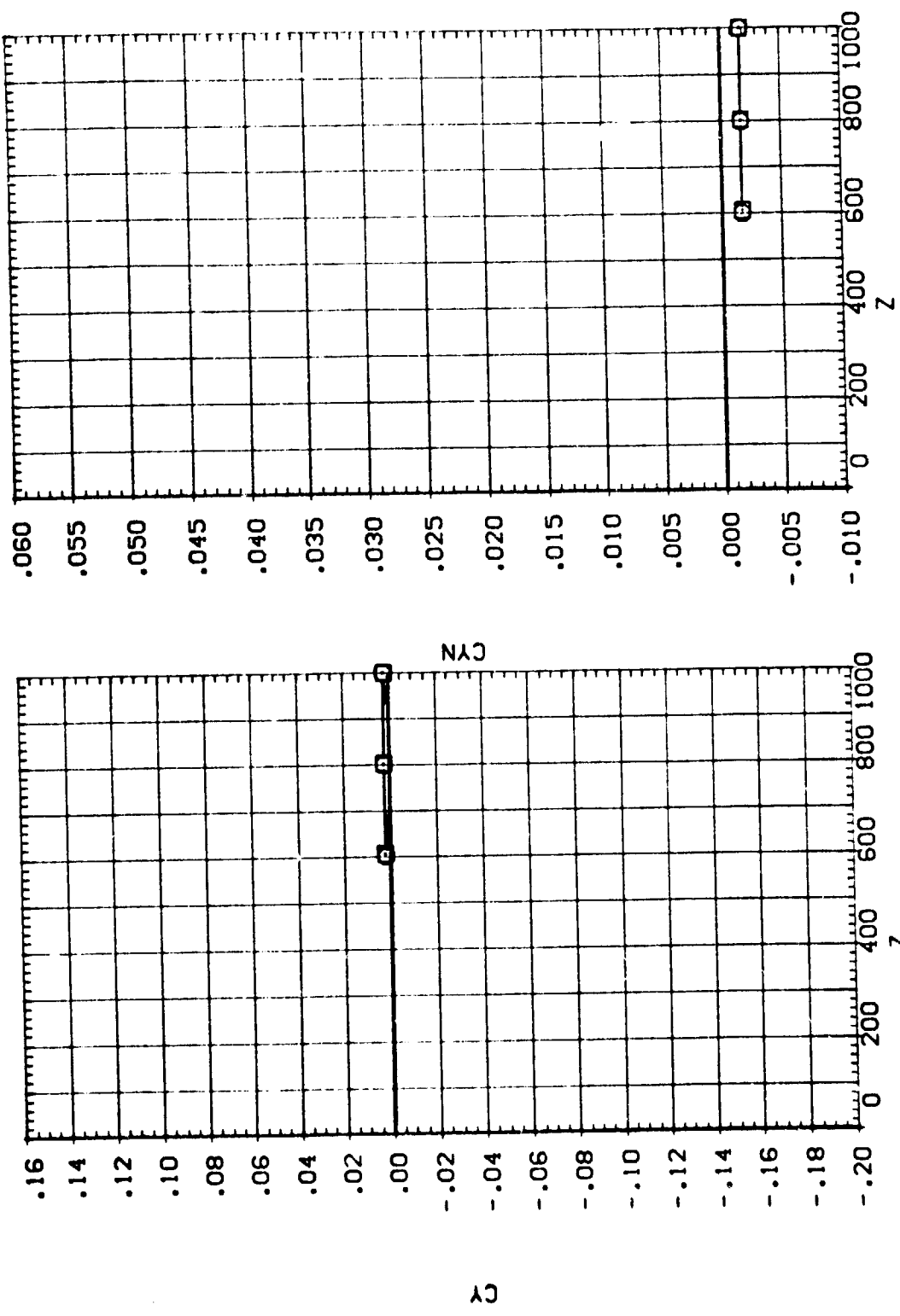

EFFECT OF SRB W/O PLUMES SEPARATION ON ORB/ET AERODYNAMIC CHARACTERISTICS

IA13 SRB(S8) W/O PLUMES SEPARATING FROM 09T10 (RTJ219)

SEE THE ASSOCIATED DATA DOCUMENT FOR REFERENCE CHARACTERISTICS FOR INDIVIDUAL DATASETS

PARAMETRIC VALUES

MACH	4.530	PIOTAL	110.000
ALPHA	.000	BETA	.000
DALPHA	-20.000	DBETA	5.000
Y	400.000	PC-MBR	.000

SYMB. X
 ○ 900.800
 □ 100.000

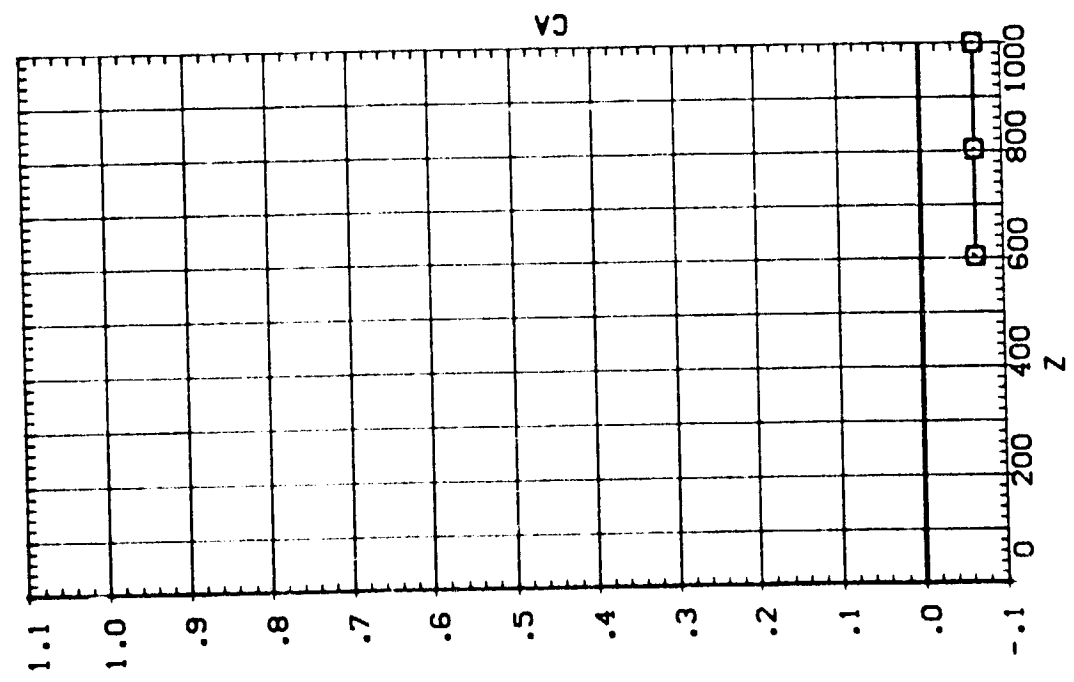
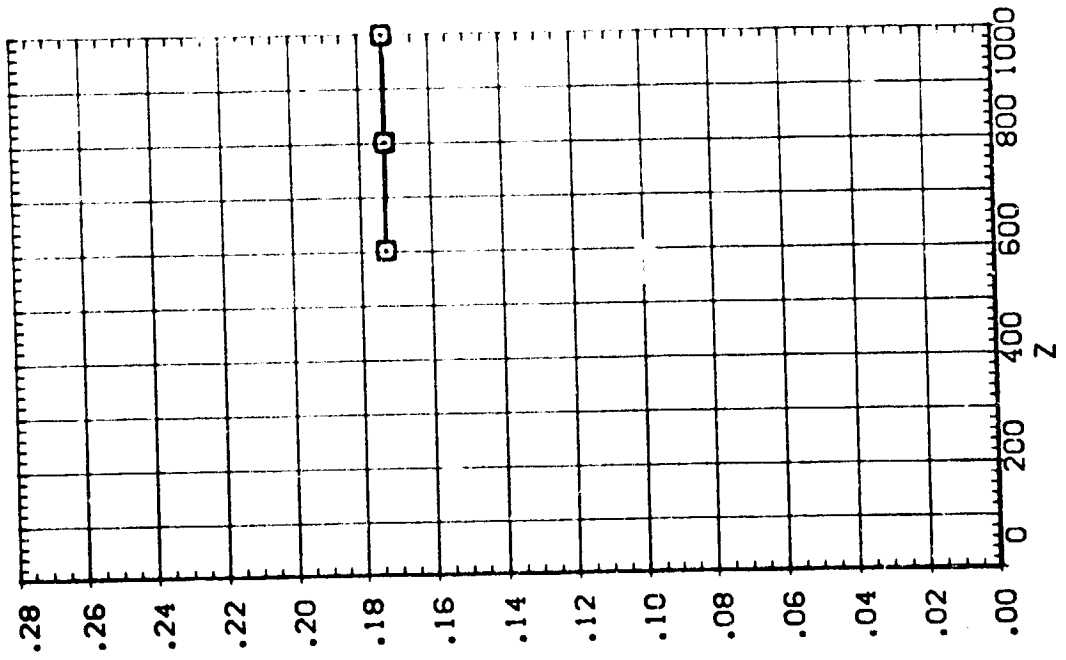

IA13 SRB(S8) W/O PLUMES SEPARATING FROM 09T10 (RTJ219)

SEE THE ASSOCIATED DATA DOCUMENT FOR REFERENCE CHARACTERISTICS FOR INDIVIDUAL DATASETS

SYMBOL	X	MACH	PARAMETRIC VALUES			
			PTOTAL	BETA	DBETA	PCHGR
○	.225	4.530	110.000	.000	.000	.000
□	900.800	.000	.000	5.000	.000	.000
		DALPHA				
		Y	-20.000			

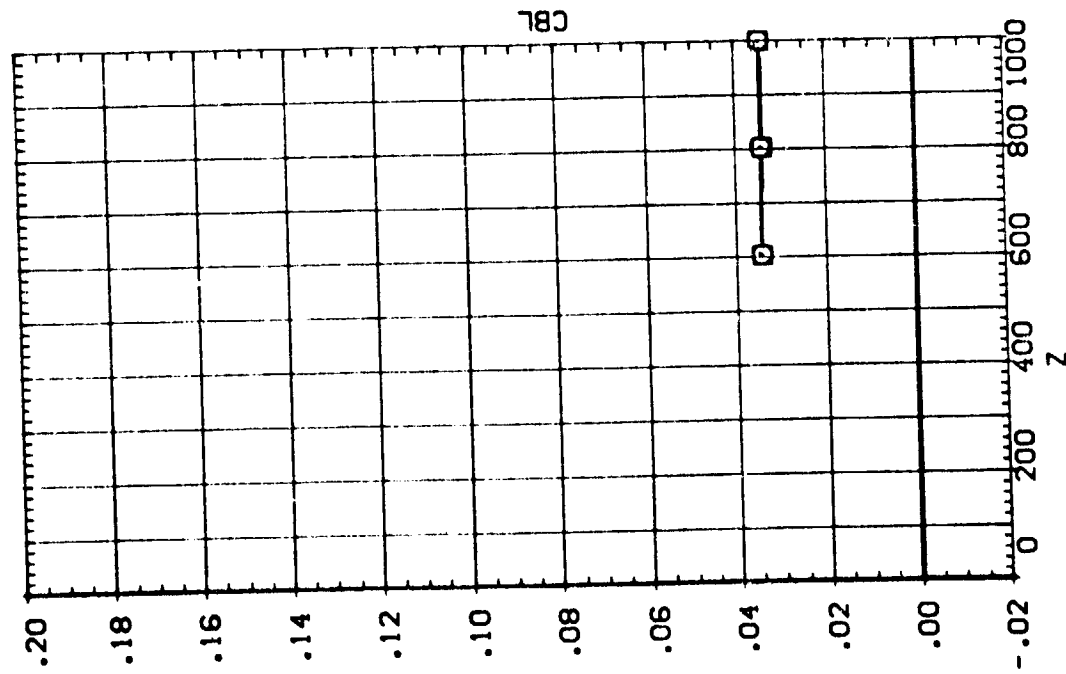
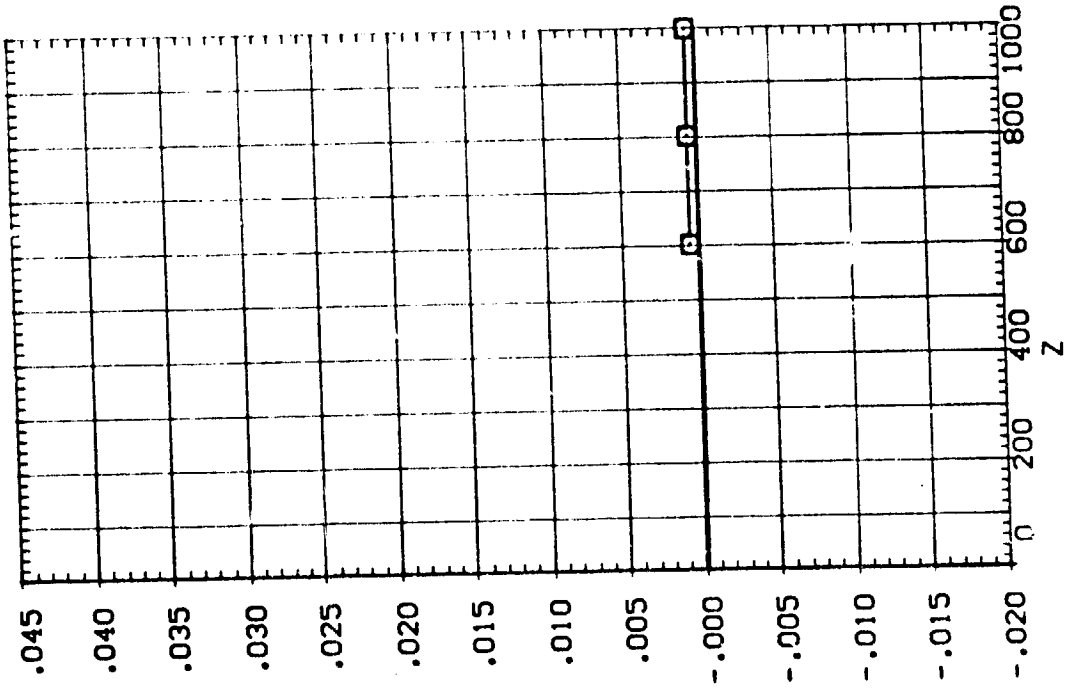

EFFECT OF SRB W/O PLUMES SEPARATION ON ORB/ET AERODYNAMIC CHARACTERISTICS

IA13 SRB(SB) W/O PLUMES SEPARATING FROM 09T10 (RTJ219)

SEE THE ASSOCIATED DATA DOCUMENT FOR REFERENCE CHARACTERISTICS FOR INDIVIDUAL DATASETS

SYMBOL		PARAMETRIC VALUES	
○	X	MACH	4.530
□	Y	ALPHA	.000
		BETA	.000
		DELTA	-20.000
		PCHGR	5.000
			400.000
			110.000
			.000
			.000

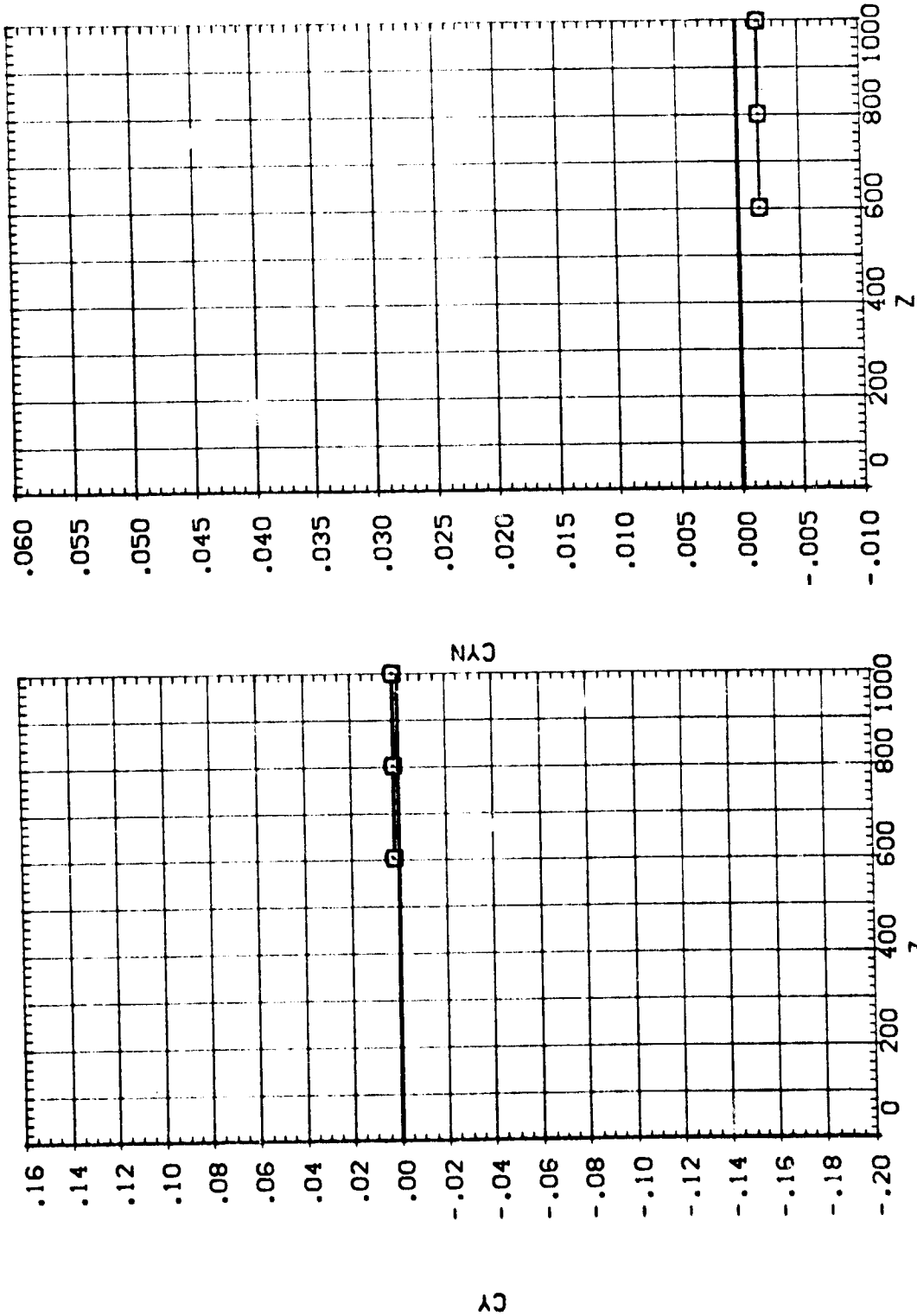

EFFECT OF SRB W/O PLUMES SEPARATION ON ORB/ET AERODYNAMIC CHARACTERISTICS

IA13 SRB(S8) W/O PLUMES SEPARATING FROM 09T10 (RTJ220)

SEE THE ASSOCIATED DATA DOCUMENT FOR REFERENCE CHARACTERISTICS FOR INDIVIDUAL DATASETS

SYMBOL	X	MACH	PARAMETRIC VALUES
○	.590	4.530	PTOTAL 110.000
□	300.870	.000	BETA .000
◇	600.220	-20.000	DBETA -5.000
△	900.630	.000	POWER .000

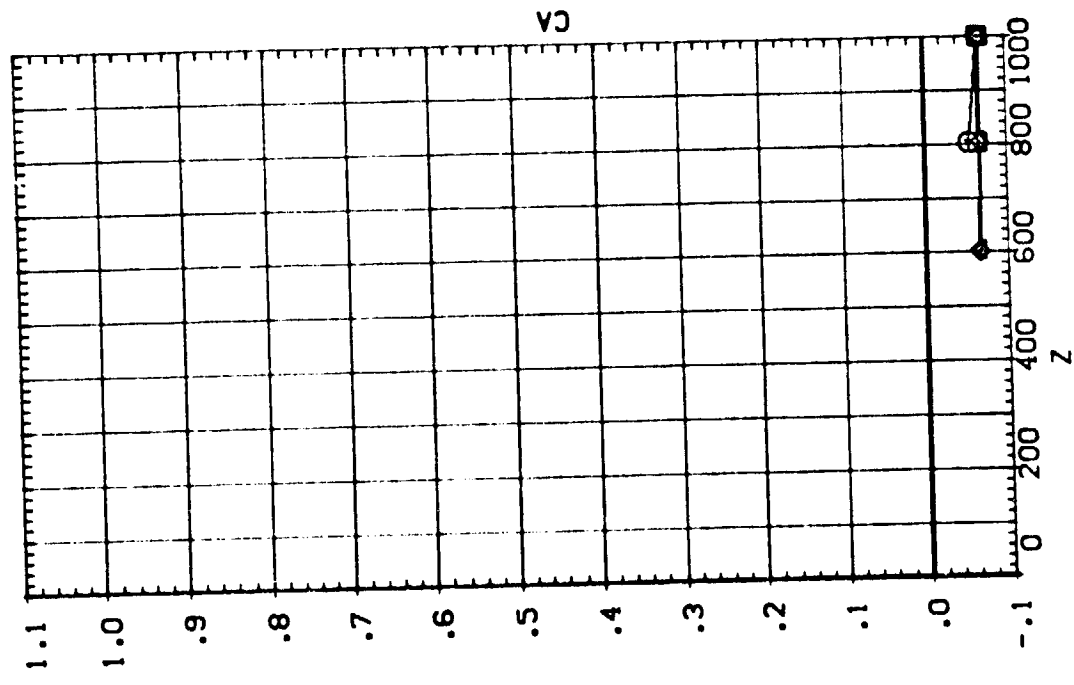
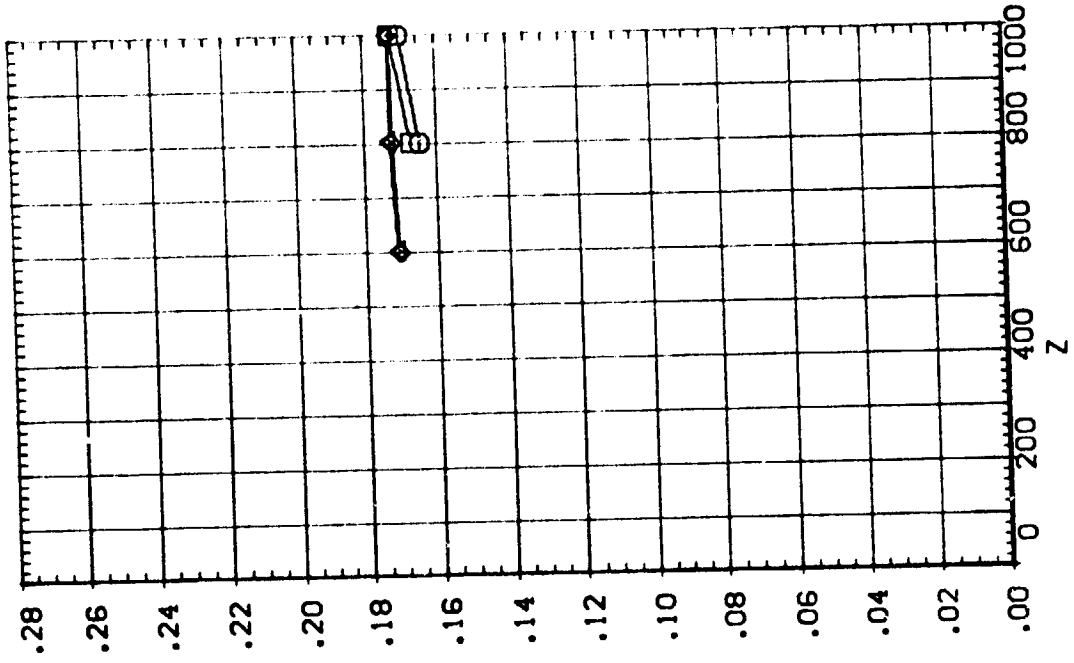

EFFECT OF SRB W/O PLUMES SEPARATION ON ORB/ET AERODYNAMIC CHARACTERISTICS

IA13 SRB(S8) W/O PLUMES SEPARATING FROM 09T10 (RTJ220)

SEE THE ASSOCIATED DATA DOCUMENT FOR REFERENCE CHARACTERISTICS FOR INDIVIDUAL DATASETS

SYMBOL		PARAMETRIC VALUES				
○	X	.590	MACH	4.530	P/TOTAL	110.000
□	300.870	.000	ALPHA	.000	BETA	.000
◇	600.220	-20.000	DALPHA	.000	DBETA	-5.000
△	900.630	.000	Y	.000	PO-MER	.000

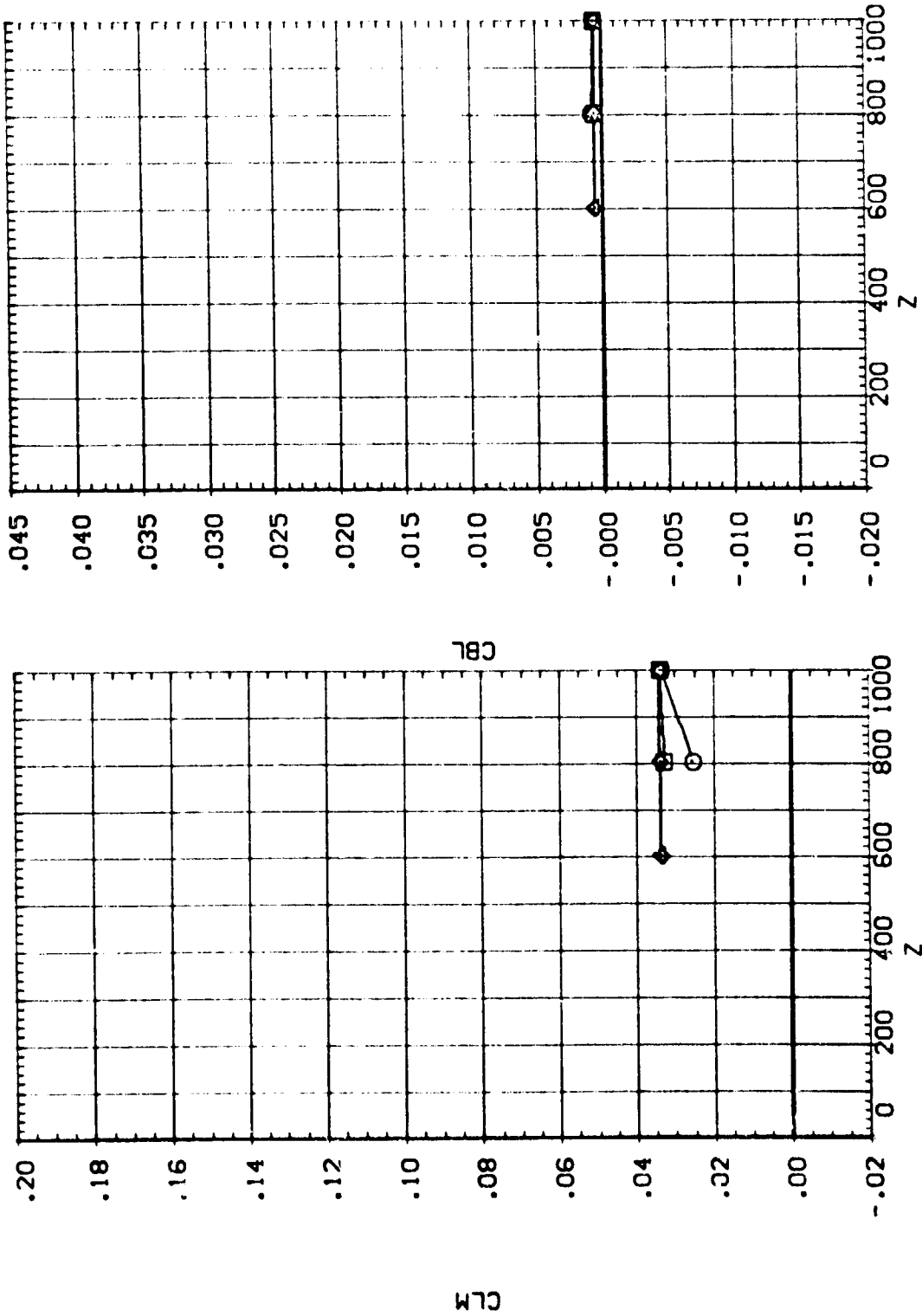

IA13 SRB(S8) W/O PLUMES SEPARATING FROM 09T10 (RTJ220)

SEE THE ASSOCIATED DATA DOCUMENT FOR REFERENCE CHARACTERISTICS FOR INDIVIDUAL DATASETS

SYMBOL		PARAMETRIC VALUES			
○	X	MACH	PTOTAL	BETA	PCHEBR
□	300.870	4.530	110.000	.000	.000
◇	600.220	.000	BETA	-5.000	.000
△	900.630	-20.000	DBETA	.000	.000

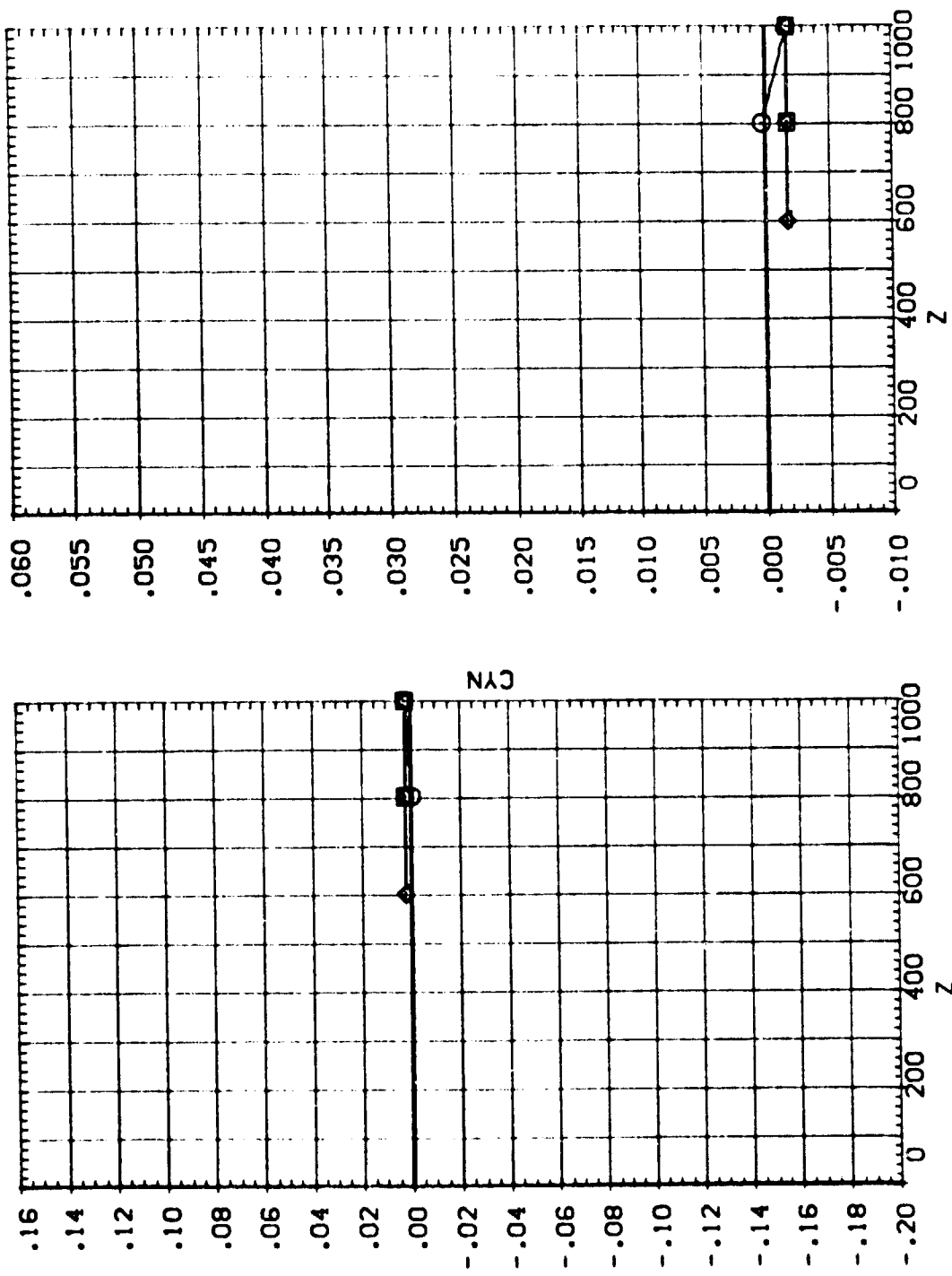

EFFECT OF SRB W/O PLUMES SEPARATION ON ORB/ET AERODYNAMIC CHARACTERISTICS

IA13 SRB(S8) W/O PLUMES SEPARATING FROM 09T10 (RTJ221)

SEE THE ASSOCIATED DATA DOCUMENT FOR REFERENCE CHARACTERISTICS FOR INDIVIDUAL DATASETS

SYMBOL	X	MACH	PARAMETRIC VALUES
○	.051	4.530	P TOTAL 110.000
□	300.670	.000	BETA .000
◇	600.280	-20.000	DBETA -5.000
△	900.900	200.000	PCMBR .000

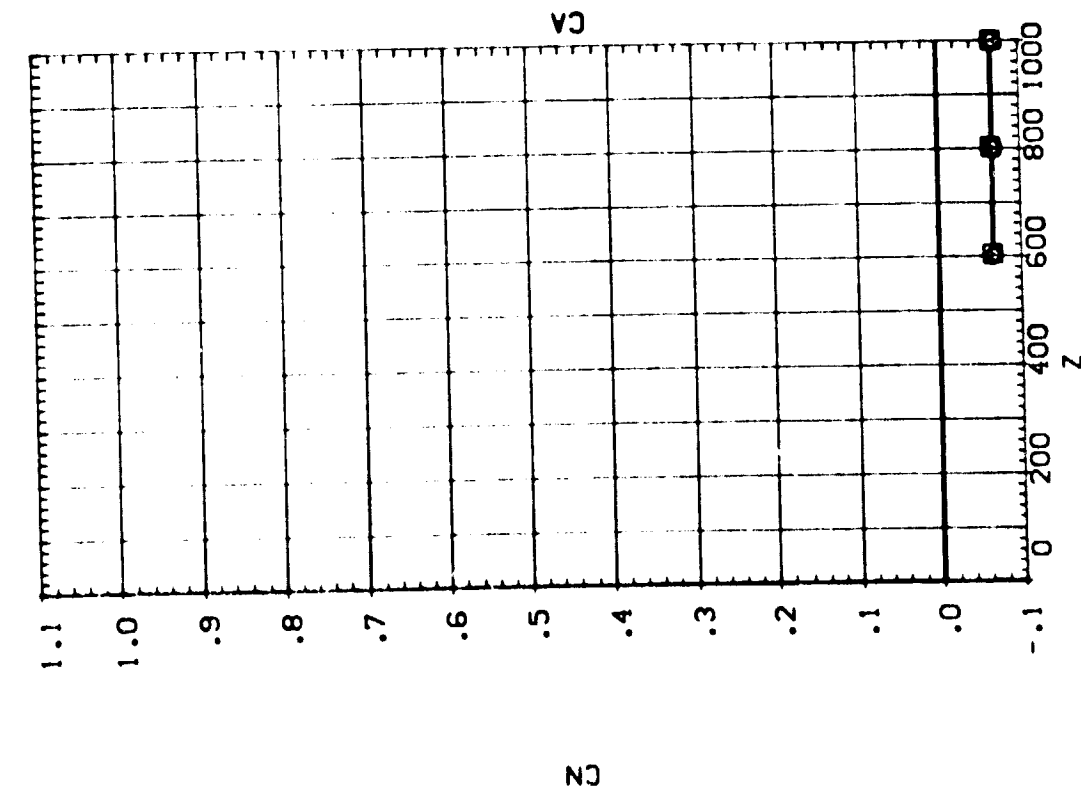
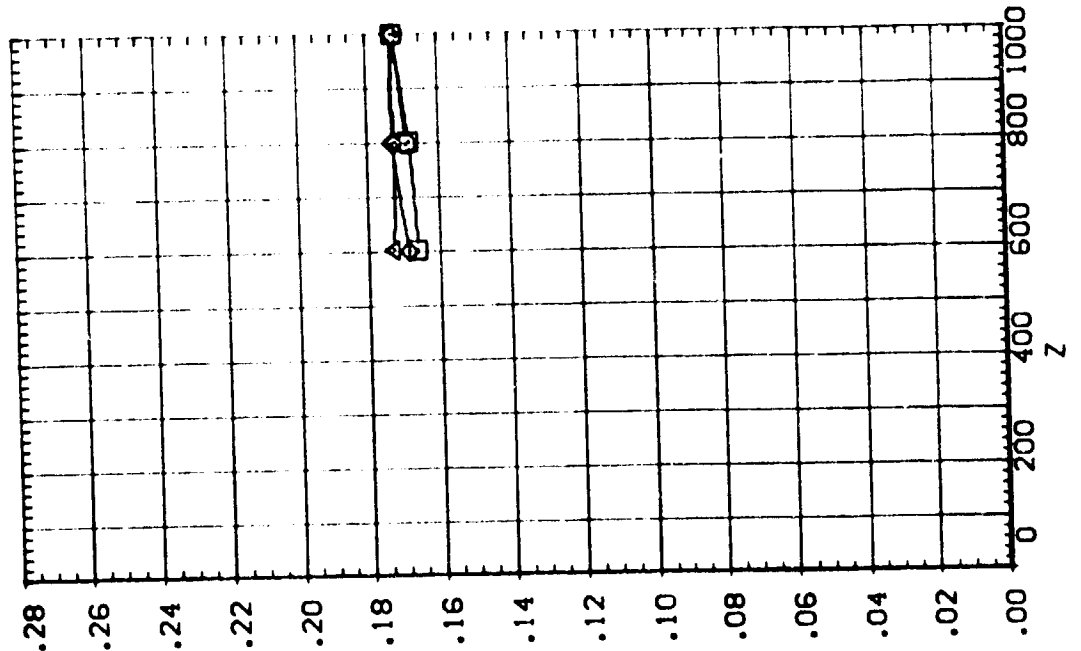

SEE THE ASSOCIATED DATA DOCUMENT FOR REFERENCE CHARACTERISTICS FOR INDIVIDUAL DATASETS

SYMBOL	○	MACH	PARAMETRIC VALUES			
	□		4.530	P TOTAL	110.000	
	◇	300.670	ALPHA	.000	BETA	.000
	△	600.280	C ALPHA	-20.000	DBETA	-5.000
		900.950	Y	200.000	PC+PBR	.000

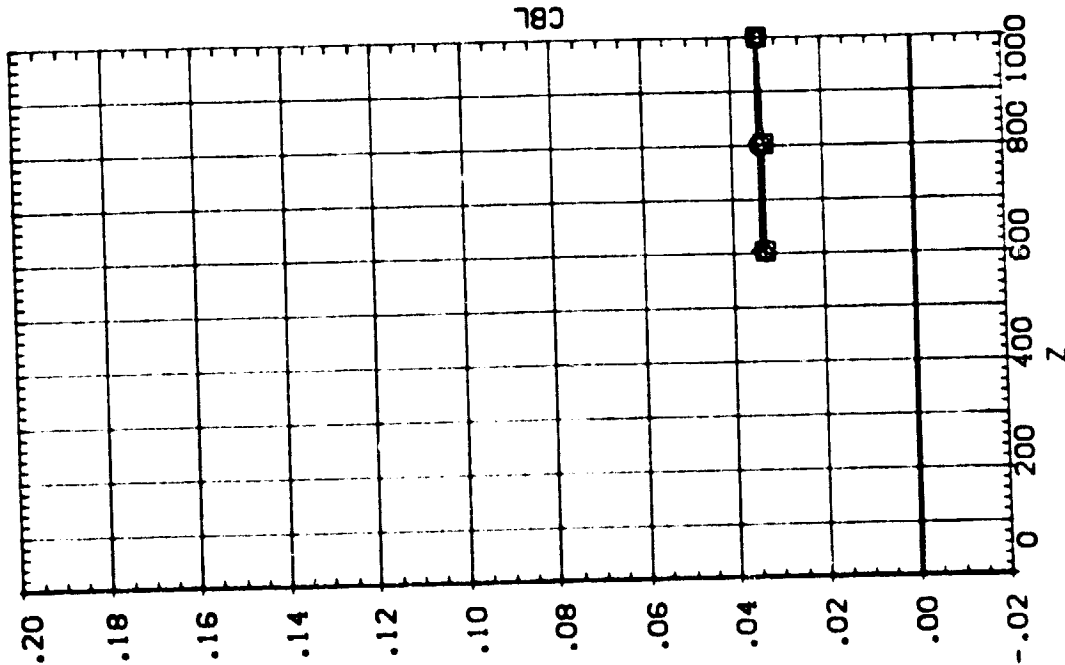
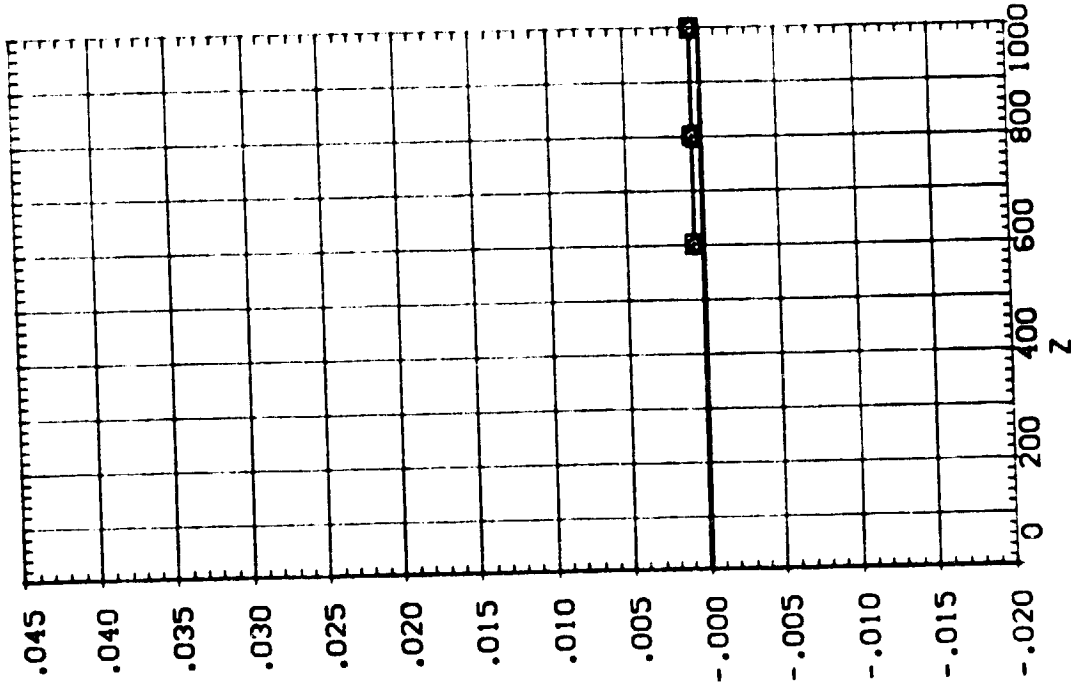

EFFECT OF SRB W/O PLUMES SEPARATION ON ORB/ET AERODYNAMIC CHARACTERISTICS

1A13 SRB(S8) W/O PLUMES SEPARATING FROM 09T10 (RTJ221)

SEE THE ASSOCIATED DATA DOCUMENT FOR REFERENCE CHARACTERISTICS FOR INDIVIDUAL DATASETS

SYMBOL		PARAMETRIC VALUES				
○	X	.051	MACH	4.530	PTOTAL	110.000
□	300.570	.000	ALPHA	-20.000	BETA	.000
◇	600.280	200.000	DALPHA	200.000	DBETA	-5.000
△	900.950		Y	PC+PR		.000

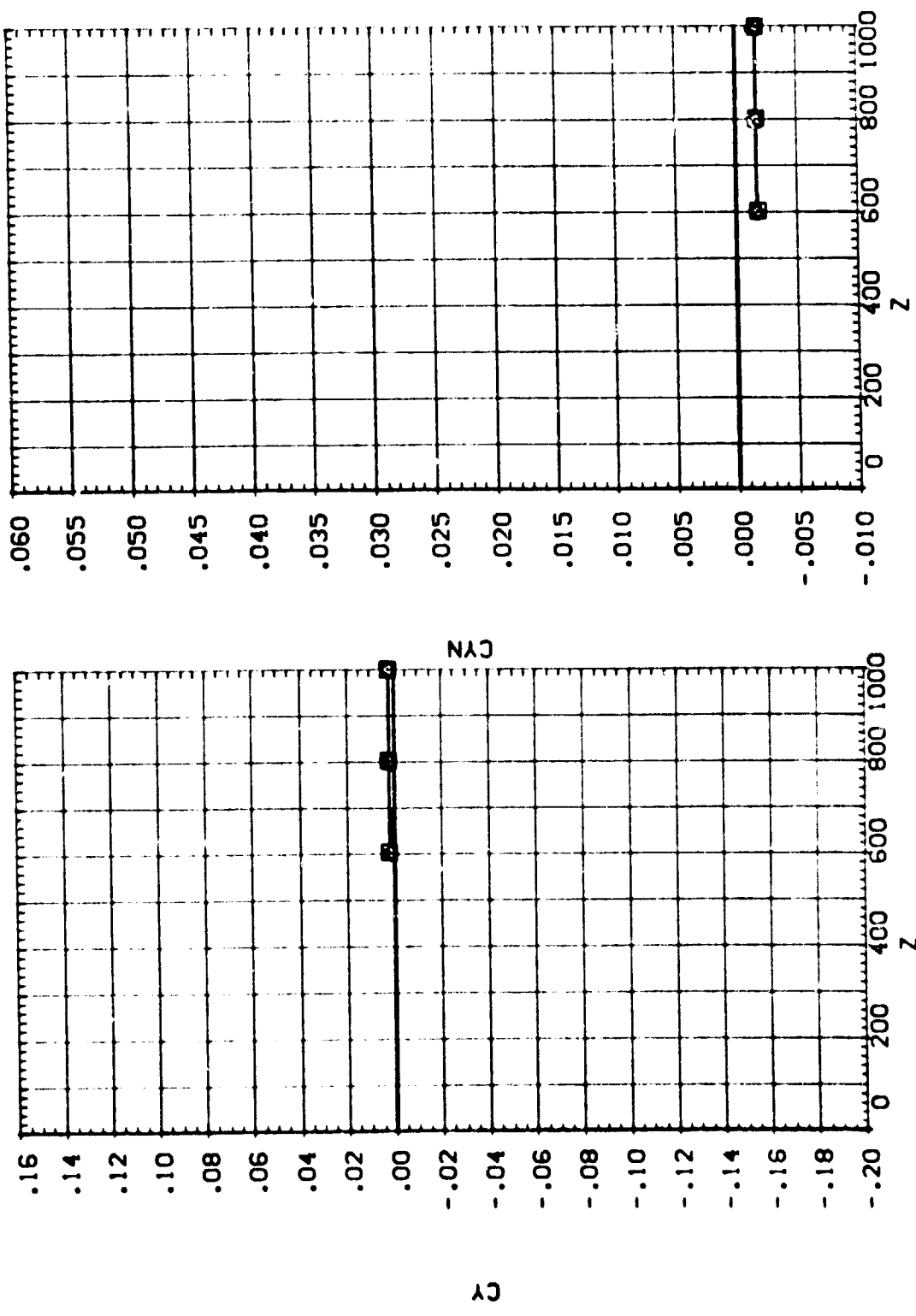

EFFECT OF SRB W/O PLUMES SEPARATION ON ORB/ET AERODYNAMIC CHARACTERISTICS

IA13 SRB(S8) W/O PLUMES SEPARATING FROM 09T10 (RTJ222)

SEE THE ASSOCIATED DATA DOCUMENT FOR REFERENCE CHARACTERISTICS FOR INDIVIDUAL DATASETS

SYMBOL		X	MACH	PARAMETRIC VALUES			
○		.238		4.530	P TOTAL	110.000	
□		300.020	ALPHA	.000	BETA	.000	
◇		600.770	DALPHA	-20.000	DBETA	-5.000	
△		900.750	Y	400.000	PC+PR	.000	

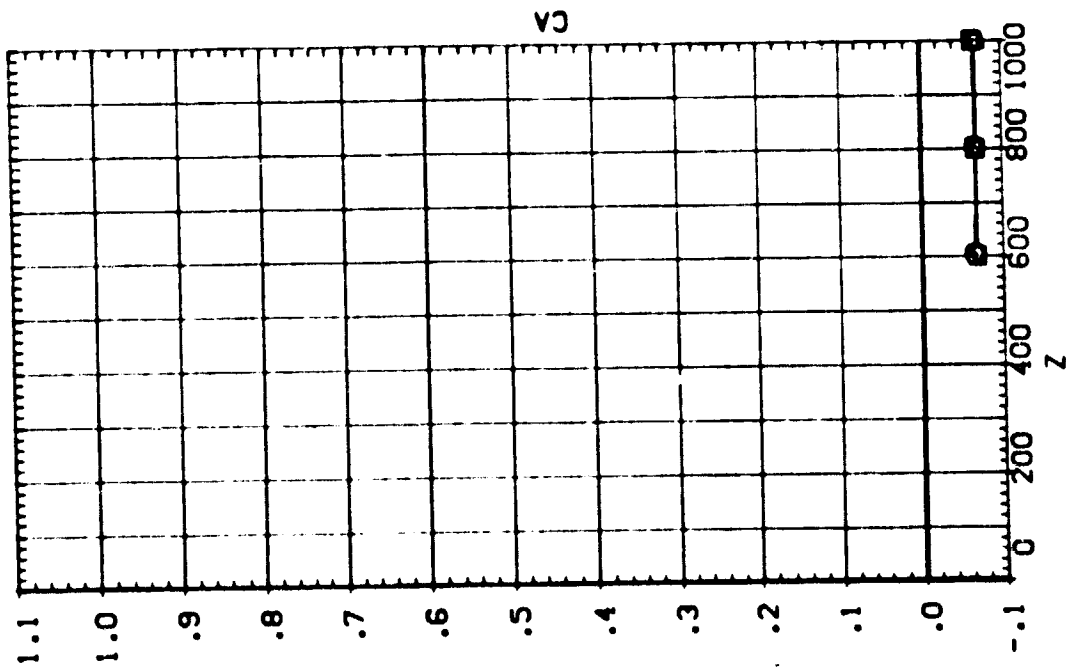
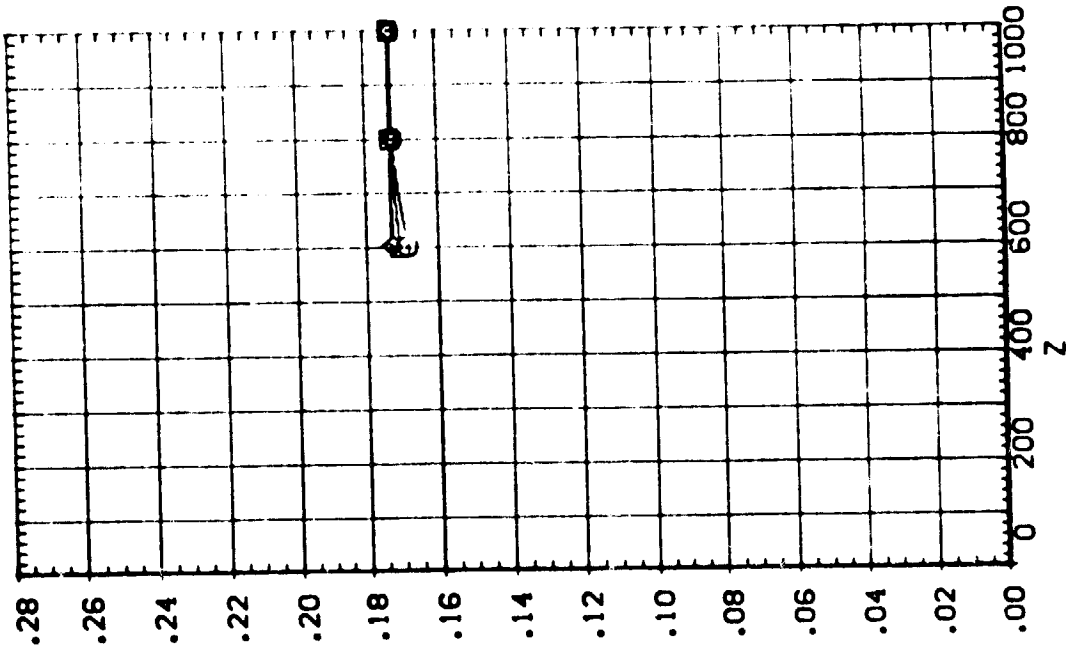

EFFECT OF SRB W/O PLUMES SEPARATION ON ORB/ET AERODYNAMIC CHARACTERISTICS

1A13 SRB(SB) W/O PLUMES SEPARATING FROM 09T10 (RTJ222)

SEE THE ASSOCIATED DATA DOCUMENT FOR REFERENCE CHARACTERISTICS FOR INDIVIDUAL DATASETS

SYMBOL		PARAMETRIC VALUES	
○	X	MACH	110.000
□	300.020	ALPHA	.000
◇	600.770	BETA	-5.000
△	900.750	DELTA	.000
		PC-MBR	.000

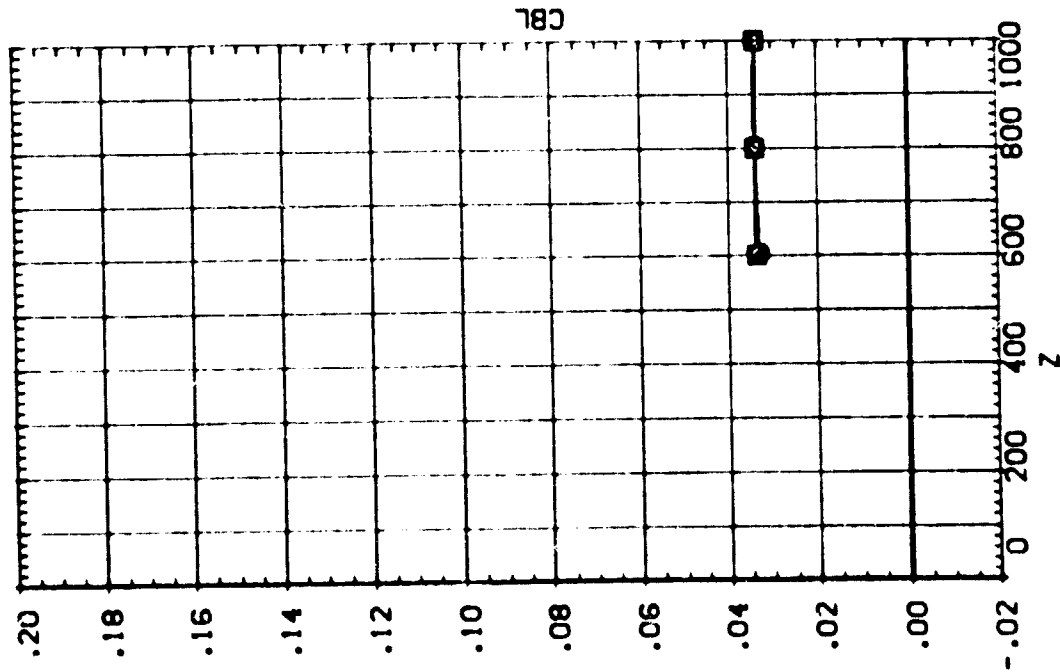
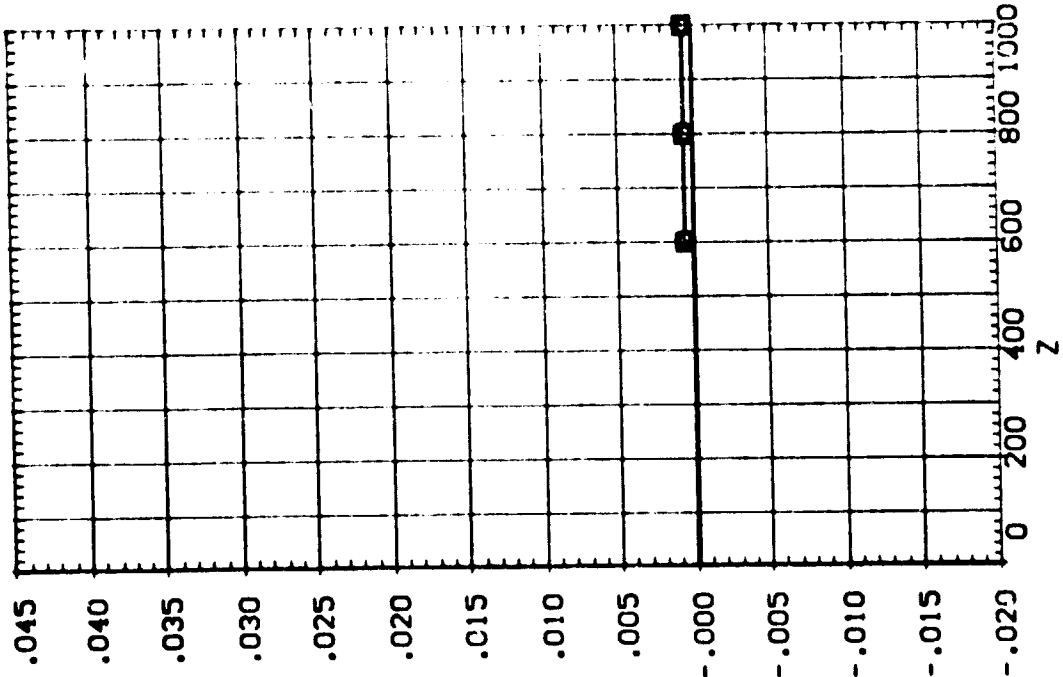

EFFECT OF SRB W/O PLUMES SEPARATION ON 09B/ET AERODYNAMIC CHARACTERISTICS

IA13 SRB(S8) W/O PLUMES SEPARATING FROM 09T10 (RTJ222)

SEE THE ASSOCIATED DATA DOCUMENT FOR REFERENCE CHARACTERISTICS FOR INDIVIDUAL DATASETS

SYMBOL		PARAMETRIC VALUES				
○	X	.279	MAOH	4.530	PTOTAL	110.000
□	300.020	.000	ALPHA	.000	BETA	.000
◇	600.770	-20.000	DALPHA	-20.000	DBETA	-5.000
△	900.750	400.000	Y	400.000	PC-MBR	.000

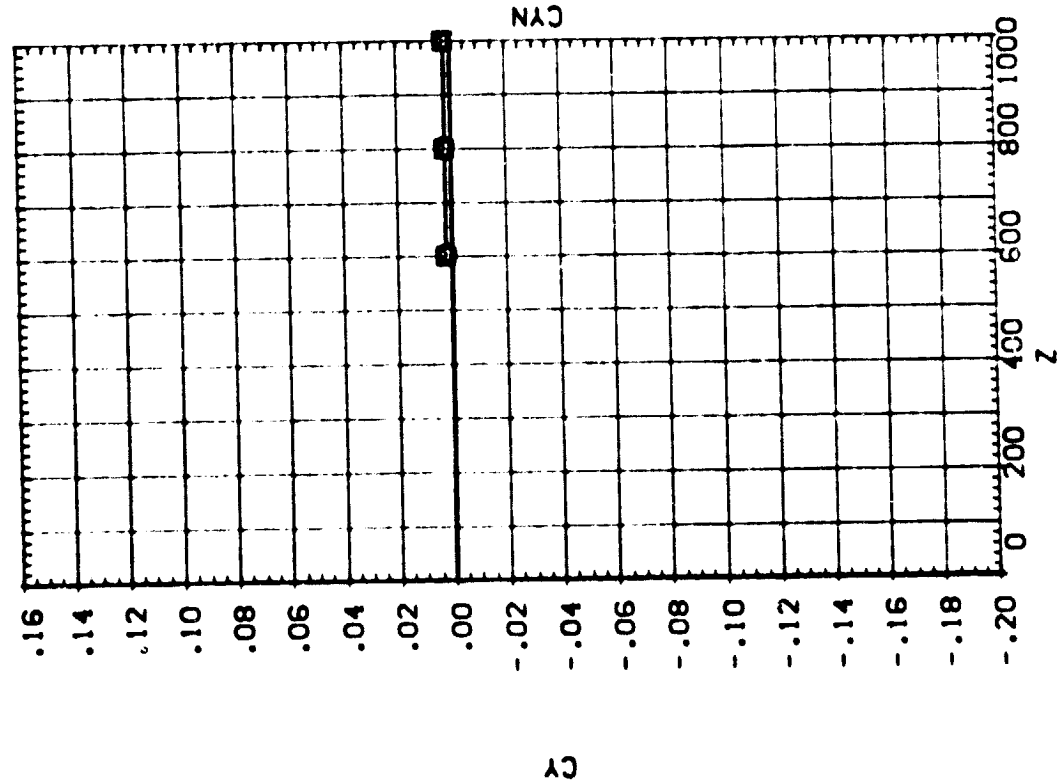
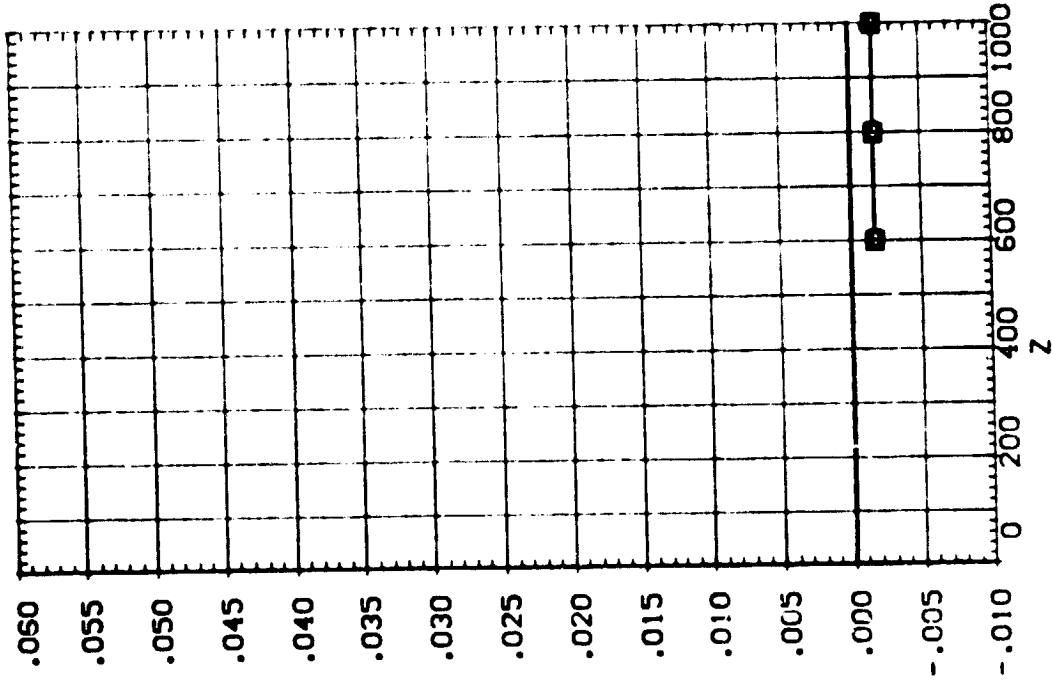

EFFECT OF SRB W/O PLUMES SEPARATION ON ORB/ET AERODYNAMIC CHARACTERISTICS

1: A:3 SRB(SB) W/O PLUMES SEPARATING FROM C9T10 (RTJ223)

SEE THE ASSOCIATED DATA DOCUMENT FOR REFERENCE CHARACTERISTICS FOR INDIVIDUAL DATASETS

SYMBOL		PARAMETRIC VALUES	
○	x	MACH	4.530
○	300.150	ALPHA	.000
○	500.630	DALPHA	-20.000
○	500.030	BETA	110.000
○		DBETA	-5.000
○		PC+RBR	.000

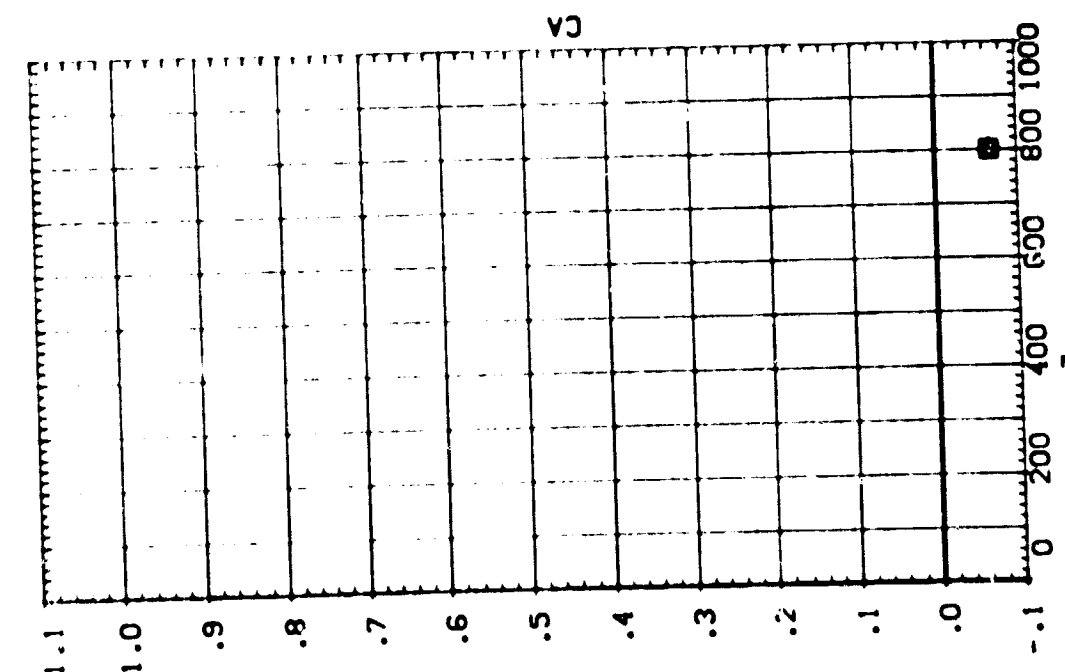
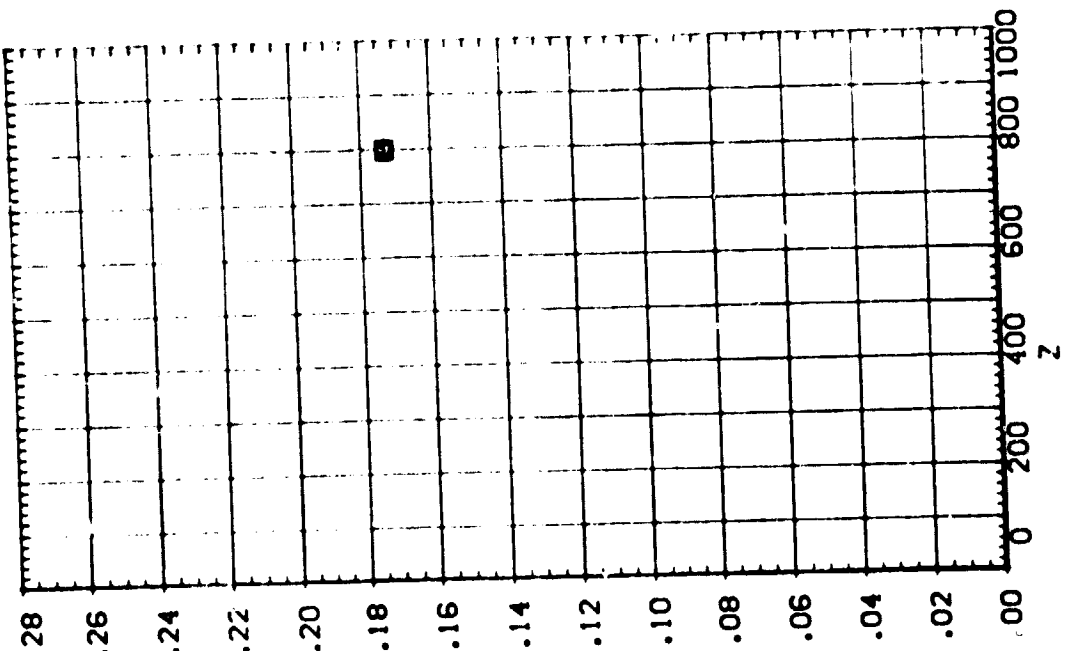

EFFECT OF SRB W/O PLUMES SEPARATION ON ORB/ET AERODYNAMIC CHARACTERISTICS

IA13 SRB(S8) W/O PLUMES SEPARATING FROM 09T10 (RTJ223)

SEE THE ASSOCIATED DATA DOCUMENT FOR REFERENCE CHARACTERISTICS FOR INDIVIDUAL DATASETS

SYMBOL		PARAMETRIC VALUES	
○	x	MACH	PTOTAL
□	300.150	ALPHA	BETA
◇	600.630	DALPHA	DBETA
△	900.030	Y	YCHGR
			110.000
			.000
			-5.000
			.000

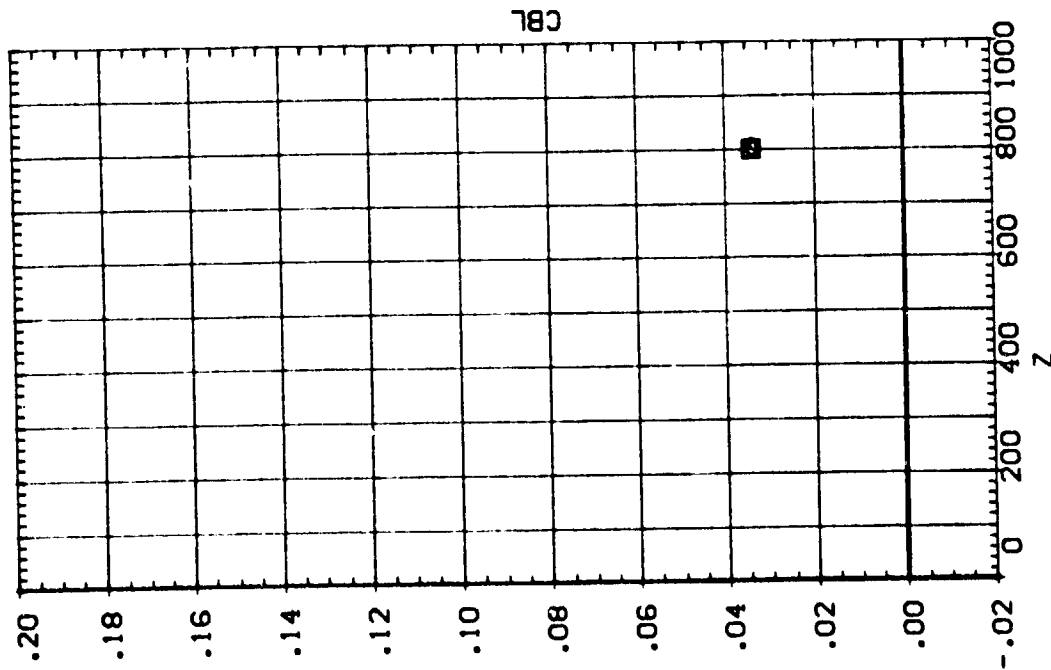
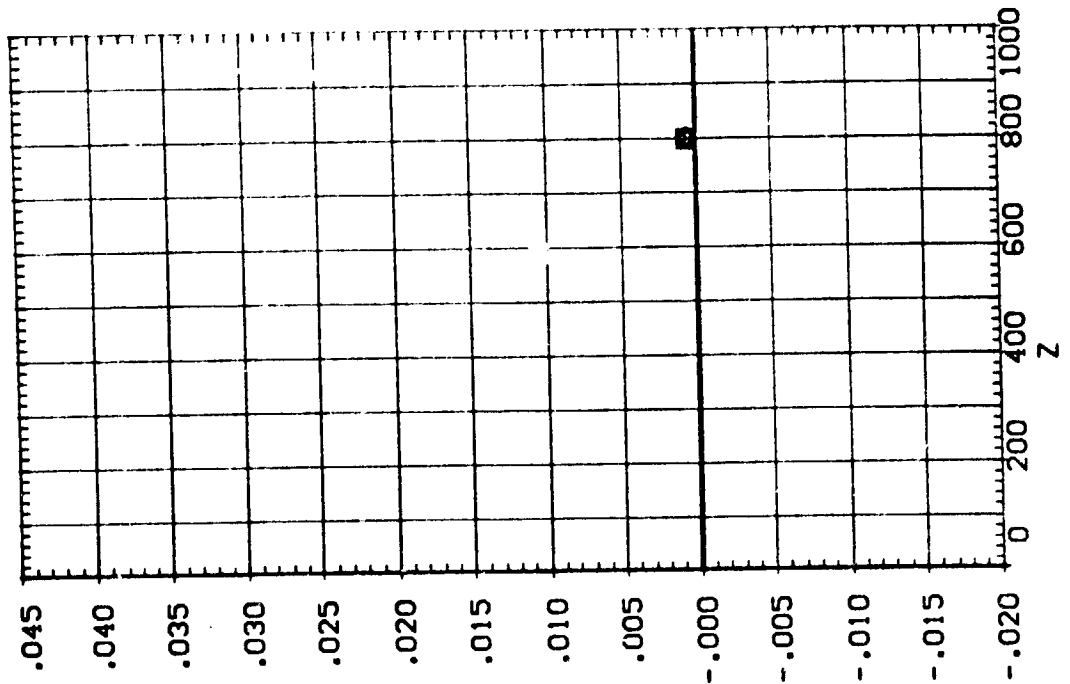

EFFECT OF SRB W/O PLUMES SEPARATION ON ORB/ET AERODYNAMIC CHARACTERISTICS

IA13 SRB(S8) W/O PLUMES SEPARATING FROM 09T10 (RTJ223)

SEE THE ASSOCIATED DATA DOCUMENT FOR REFERENCE CHARACTERISTICS FOR INDIVIDUAL DATASETS

SYMBOL	X	PARAMETRIC VALUES			
		MACH	PTOTAL	BETA	PCH#BR
○	300.150	4.530	110.000	.000	.000
□	600.630	20.000	-20.000	-5.000	.000
△	900.030	800.000	800.000	800.000	800.000

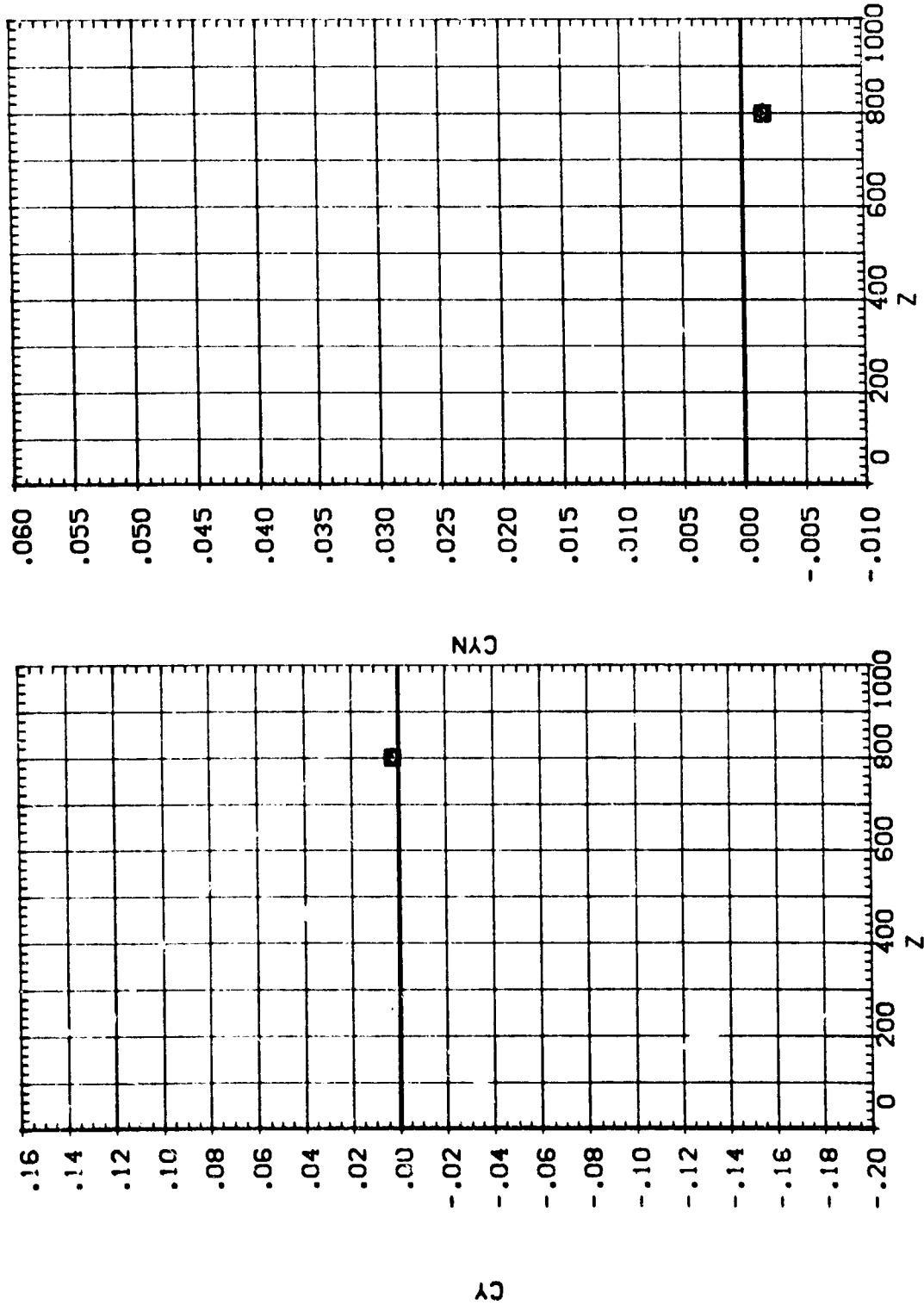

[A13 SRB(S8) W/O PLUMES SEPARATING FROM 09T10 (RTJ225)]

SEE THE ASSOCIATED DATA DOCUMENT FOR REFERENCE CHARACTERISTICS FOR INDIVIDUAL DATASETS

SYMBOL		PARAMETRIC VALUES				
○	X	.643	MACH	4.530	PITOTAL	110.000
□	300.660	ALPHA	.000	BETA	.000	
◇	599.870	DALPHA	-20.000	DBETA	-10.000	
△	900.580	Y	.000	PC-MBR	.000	

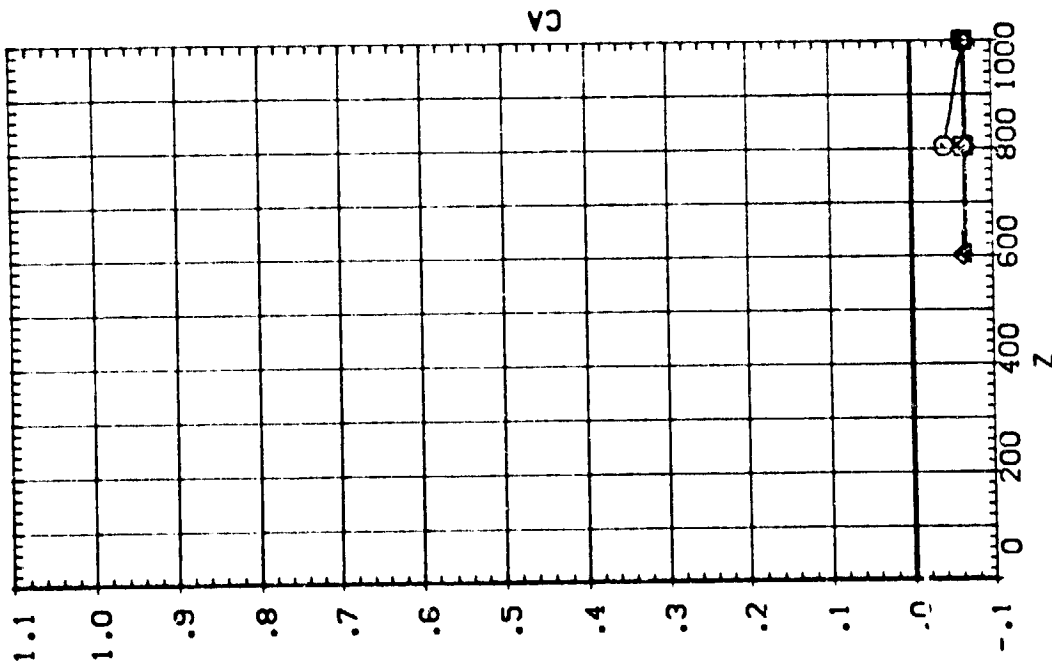
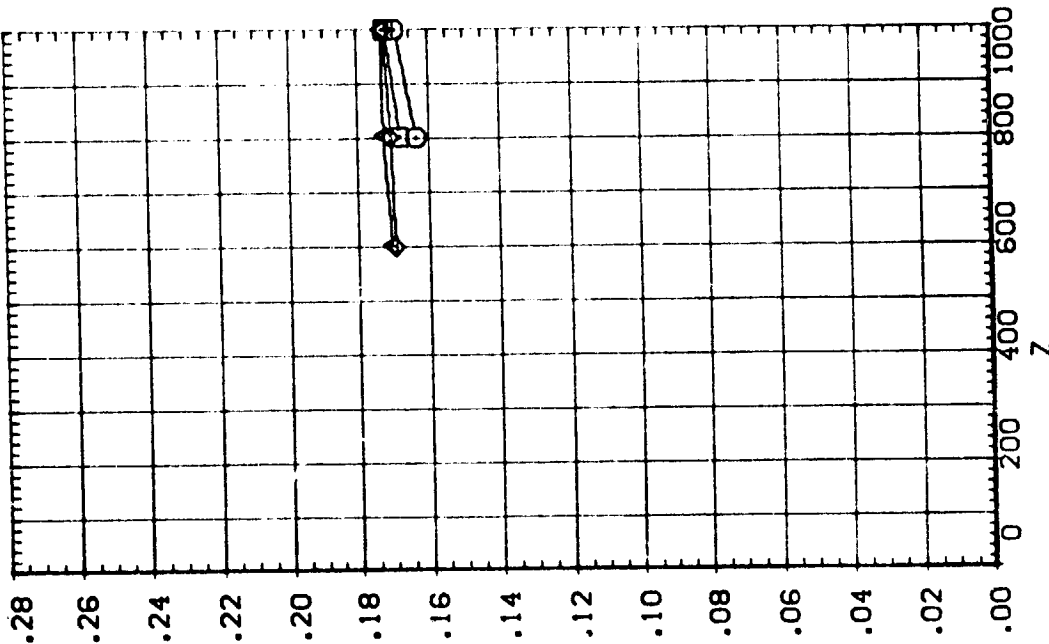

EFFECT OF SRB W/O PLUMES SEPARATION ON ORB/ET AERODYNAMIC CHARACTERISTICS

IA13 SRB(S8) W/O PLUMES SEPARATING FROM 09T10 (RTJ225)

SEE THE ASSOCIATED DATA DOCUMENT FOR REFERENCE CHARACTERISTICS FOR INDIVIDUAL DATASETS

SYMBOL		X		PARAMETRIC VALUES			
○		.643	MACH	4.530	PTOTAL	110.000	
□		300.660	ALPHA	.000	BETA	.000	
◇		599.870	DALPHA	-20.000	DBETA	-10.000	
△		900.580	Y	.000	PC-MBR	.000	

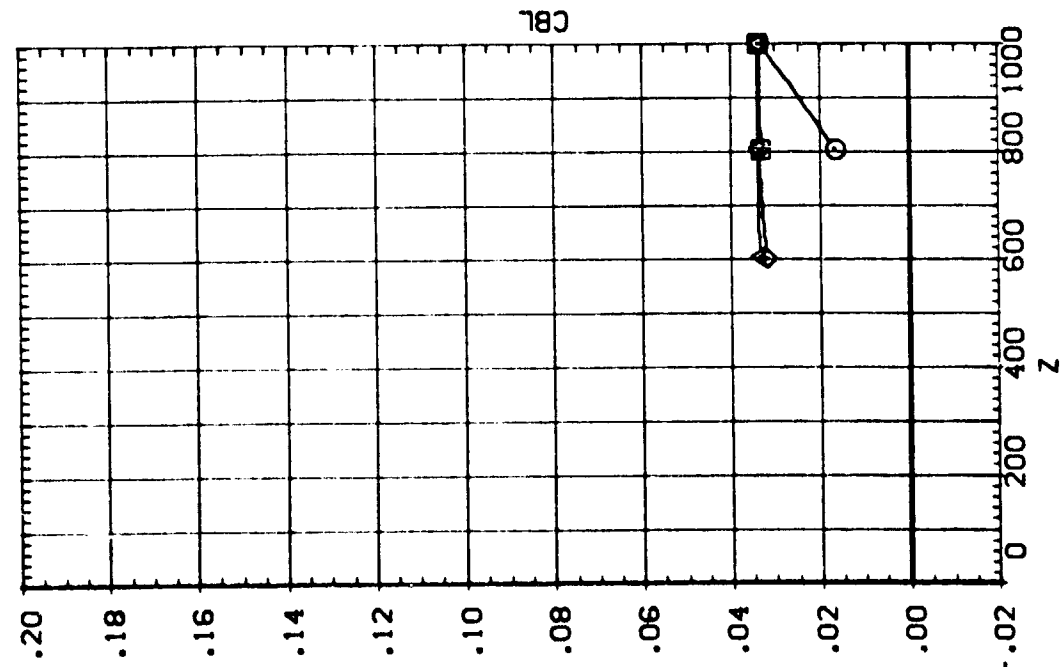
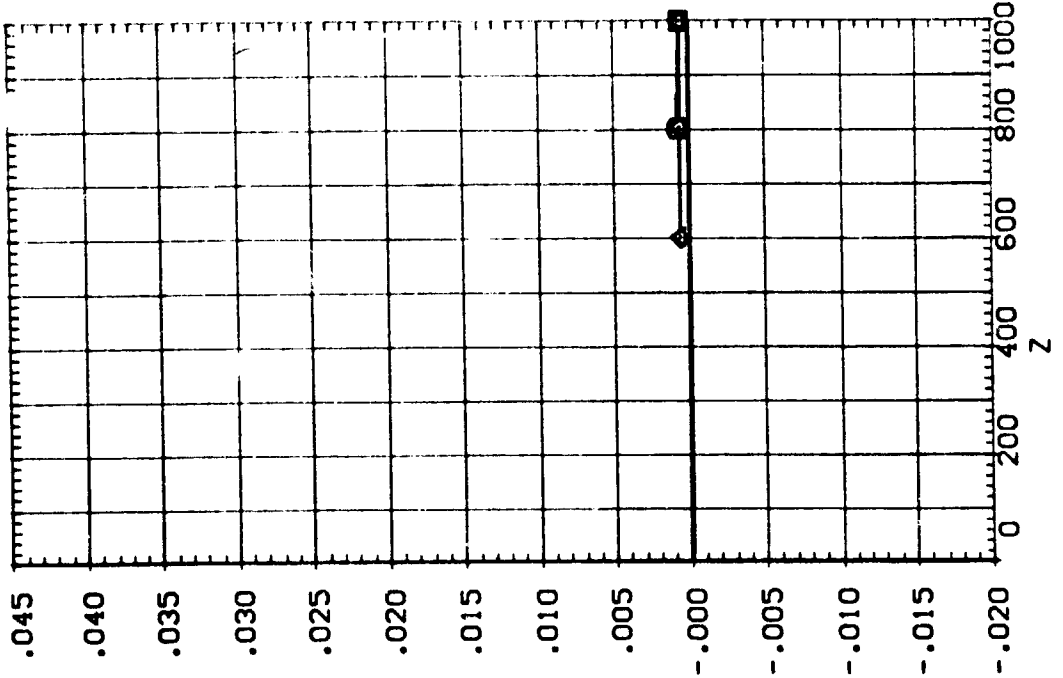

EFFECT OF SRB W/O PLUMES SEPARATION ON ORB/ET AERODYNAMIC CHARACTERISTICS

SEE THE ASSOCIATED DATA DOCUMENT FOR REFERENCE CHARACTERISTICS FOR INDIVIDUAL DATASETS

SYMBOL		PARAMETRIC VALUES	
○	X	MACH	110.000
□		PIOTAL	.000
◇		BETA	-10.000
△		DBETA	.000
		PC-MBR	.000

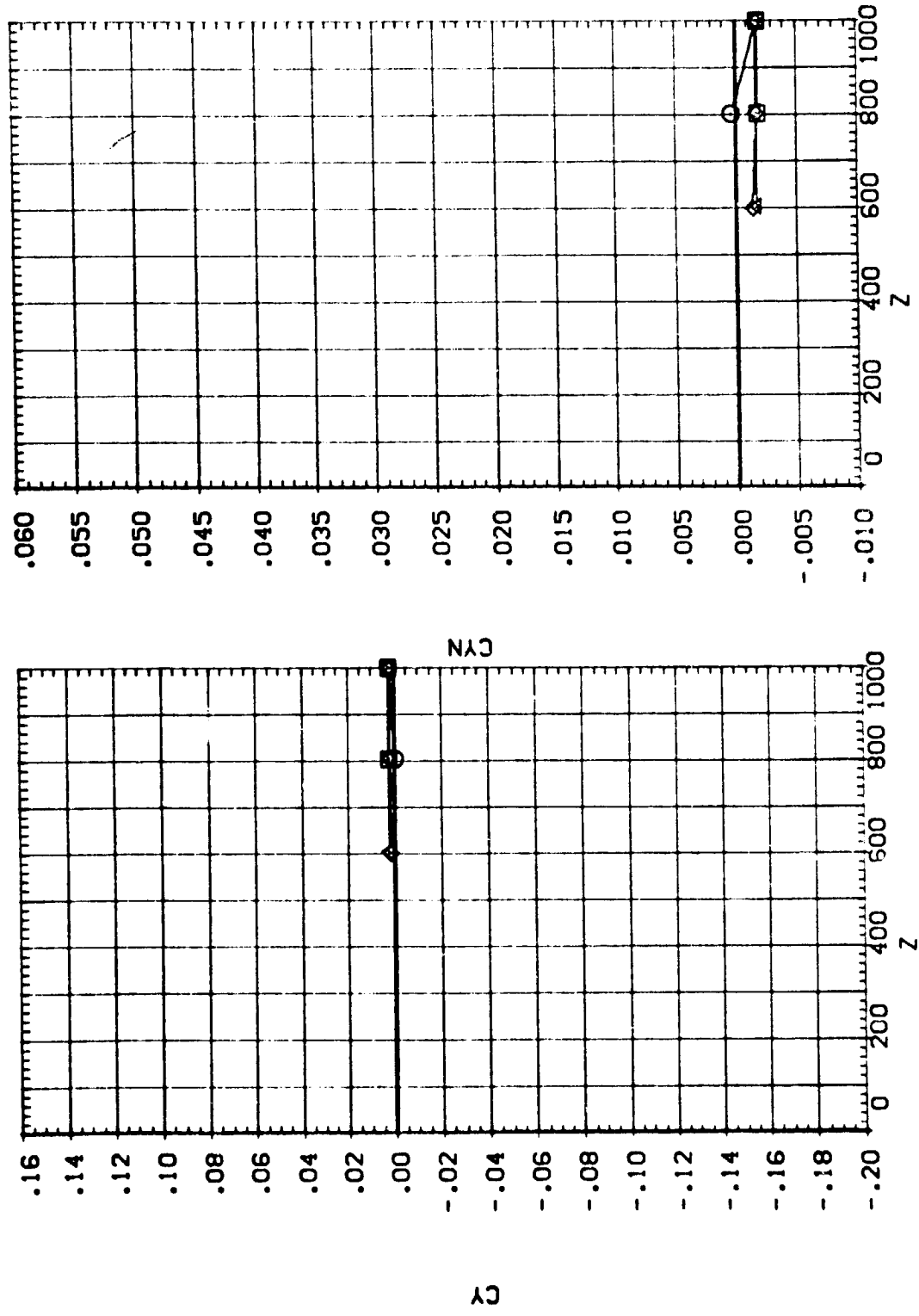

EFFECT OF SRB W/O PLUMES SEPARATION ON ORB/ET AERODYNAMIC CHARACTERISTICS

IA13 SRB(SB) W/O PLUMES SEPARATING FROM 09T10 (RTJ226)

SEE THE ASSOCIATED DATA DOCUMENT FOR REFERENCE CHARACTERISTICS FOR INDIVIDUAL DATASETS

SYMBOL	X	MACH	PARAMETRIC VALUES
○	.131	4.530	P/TOTAL 110.000
□	300.460	.000	BETA .000
◇	600.430	-20.000	DBETA -10.000
△	900.520	200.000	PC-MBR .000

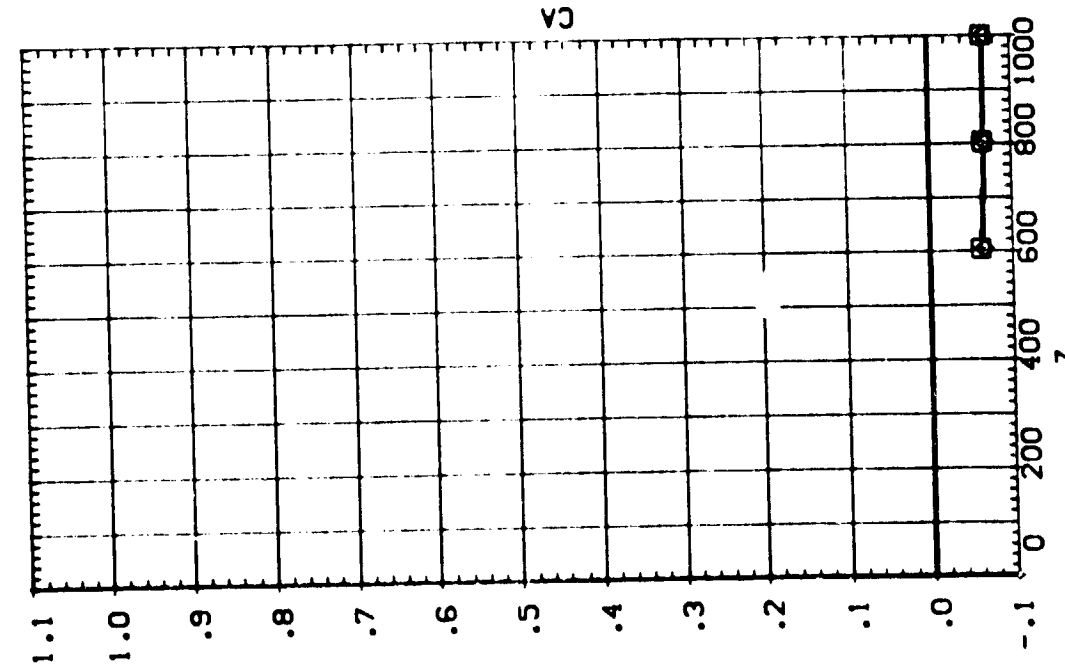
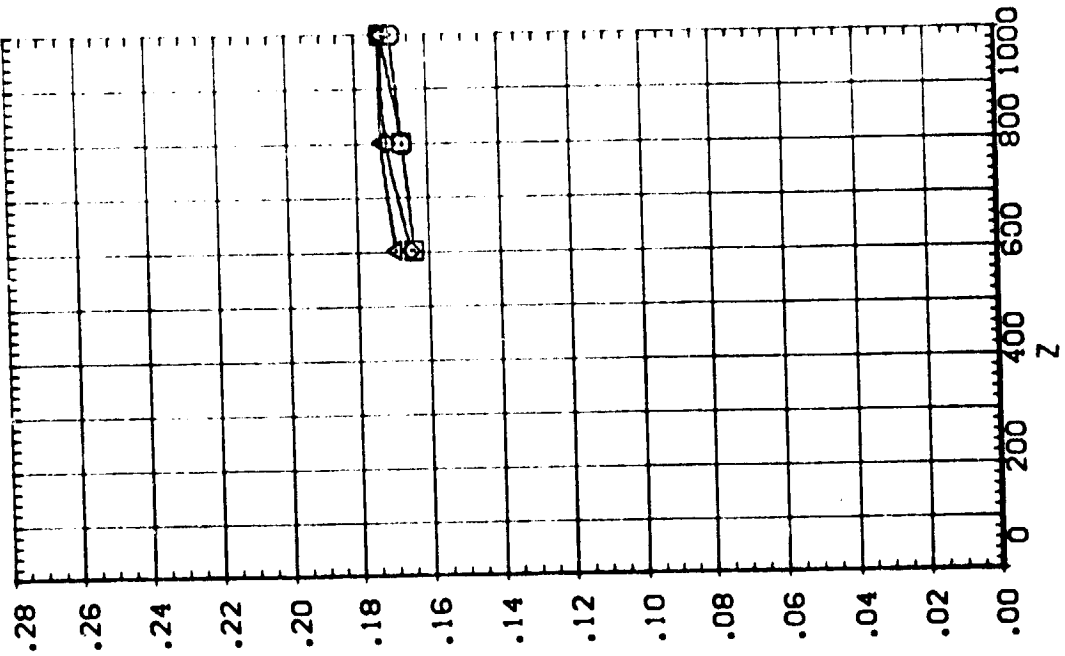

IA13 SRB(SB) W/O PLUMES SEPARATING FROM OYSTIO (RTJ226)

SEE THE ASSOCIATED DATA DOCUMENT FOR REFERENCE CHARACTERISTICS FOR INDIVIDUAL DATASETS

SYMBOL		PARAMETRIC VALUES	
○	X	MACH	110.000
□	300.460	ALPHA	.000
◇	600.430	DALPHA	-20.000
△	900.520	Y	200.000
		POTAL	.000
		BETA	.000
		DBETA	-10.000
		PC-MBR	.000

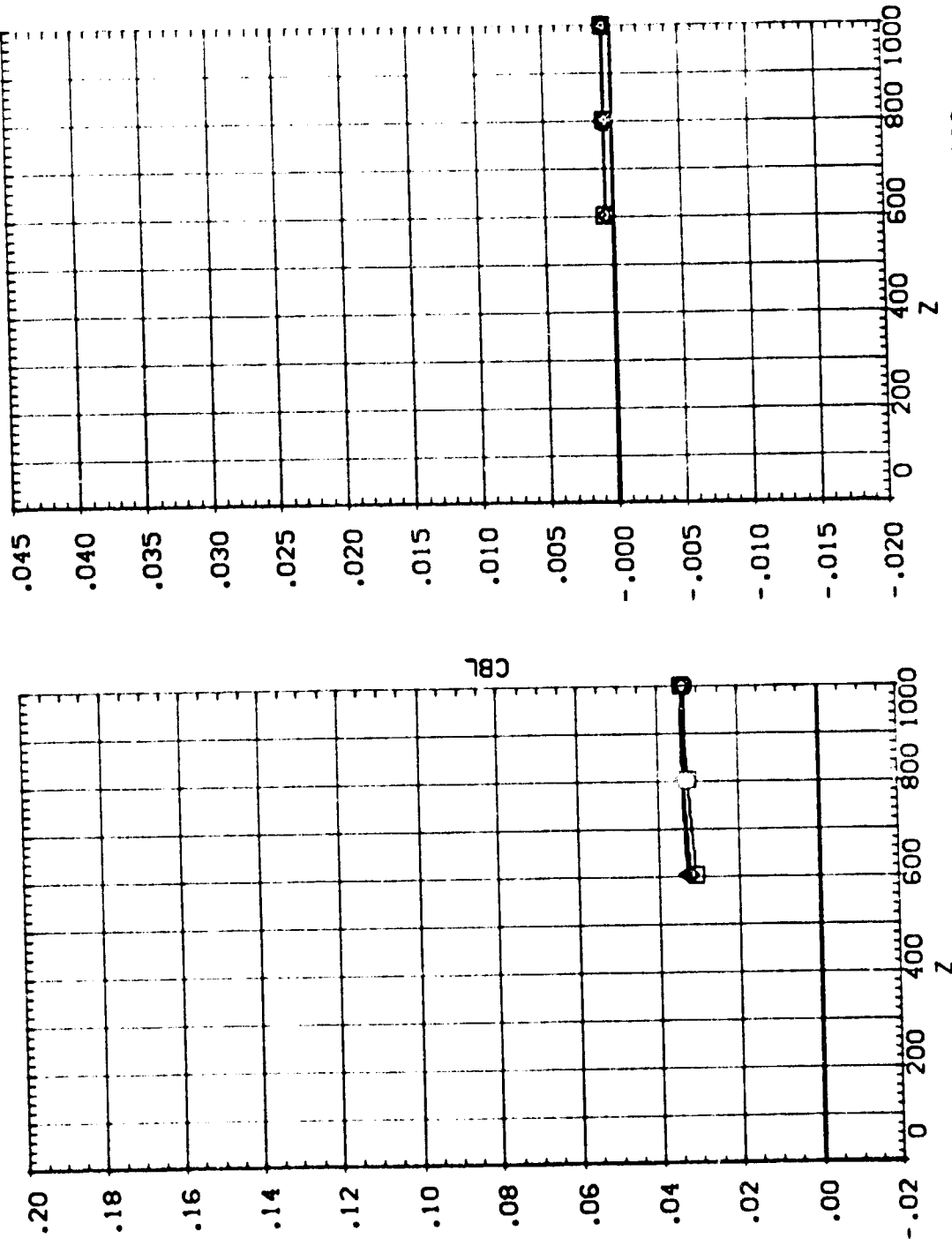

EFFECT OF SRB W/O PLUMES SEPARATION ON ORB/ET AERODYNAMIC CHARACTERISTICS

LA13 SRB(S8) W/O PLUMES SEPARATING FROM 09T10 (RTJ2226)

SEE THE ASSOCIATED DATA DOCUMENT FOR REFERENCE CHARACTERISTICS FOR INDIVIDUAL DATASETS

SYMBOL	X	MACH	PARAMETRIC VALUES
○	.131	4.530	PITOTAL 110.000
□	300.460	.000	BETA .000
◇	600.430	-20.000	DBETA -10.000
△	900.570	200.000	PCMBR .000

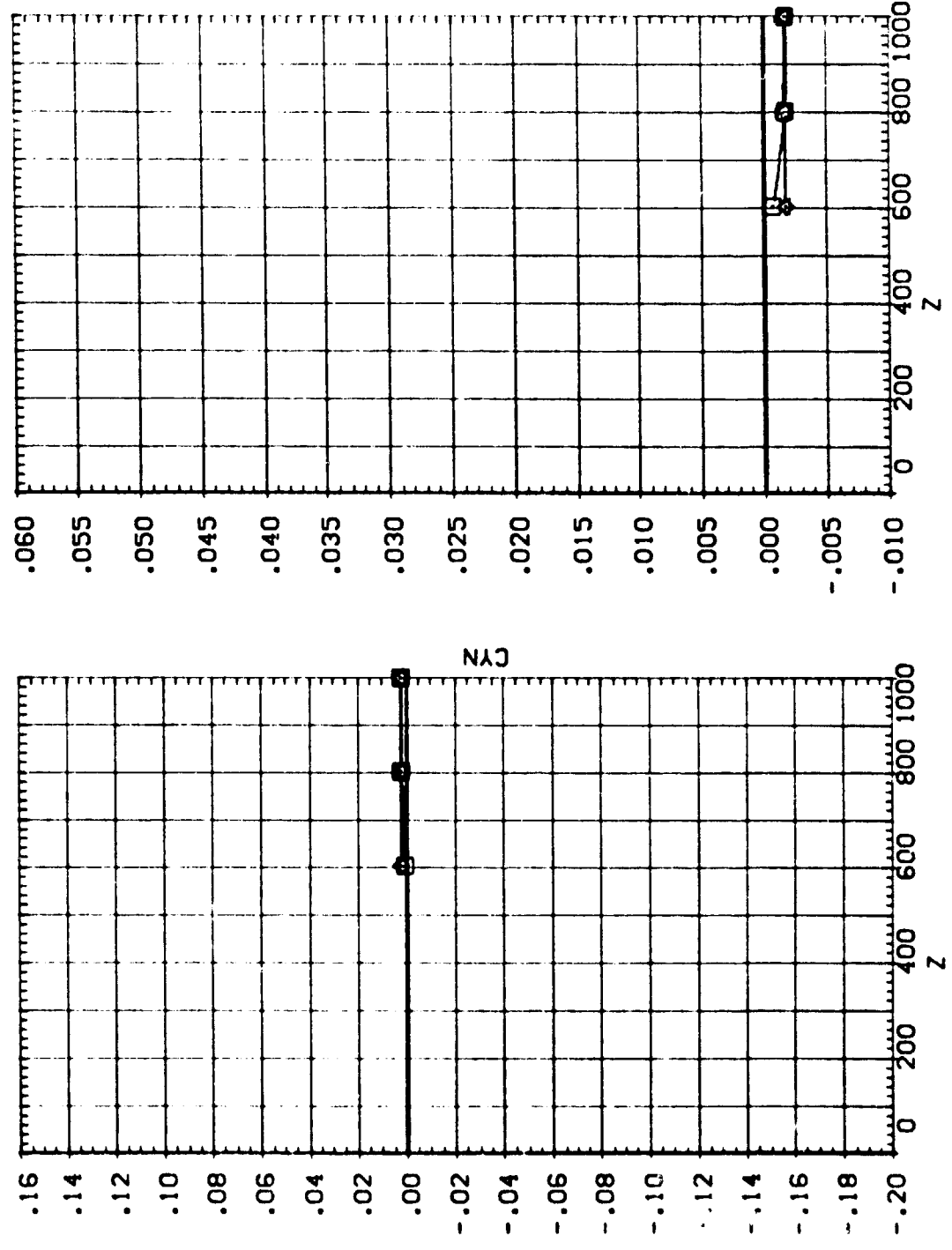

EFFECT OF SRB W/O PLUMES SEPARATION ON ORB/ET AERODYNAMIC CHARACTERISTICS

IA13 SRB(S8) W/O PLUMES SEPARATING FROM 09T10 (RTJ227)

SEE THE ASSOCIATED DATA DOCUMENT FOR REFERENCE CHARACTERISTICS FOR INDIVIDUAL DATASETS

SYMBOL		PARAMETRIC VALUES			
○	.595	MACH	4.530	PTOTAL	110.000
□	300.640	ALPHA	.000	BETA	.000
◇	600.750	DALPHA	-20.000	DBETA	-10.000
△	900.720	Y	400.000	PC+PBR	.000

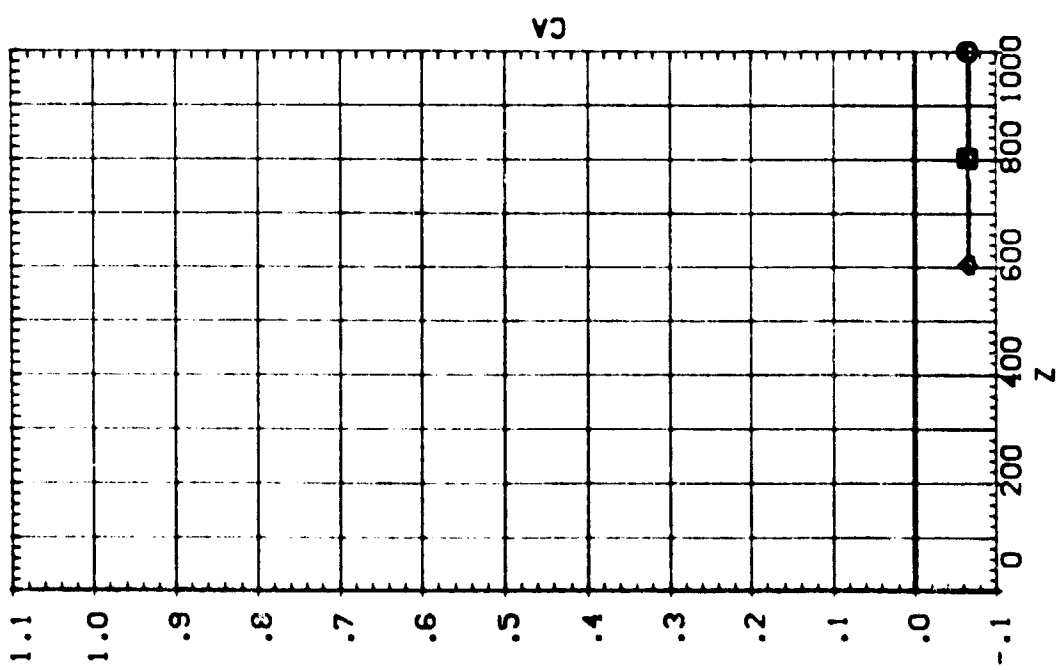
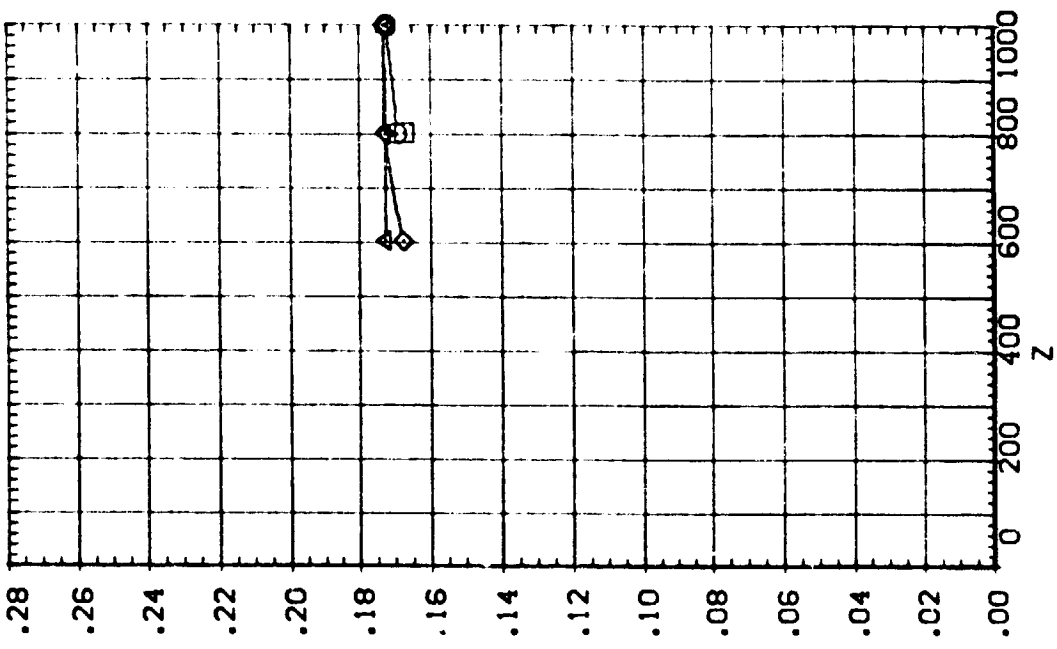

EFFECT OF SRB W/O PLUMES SEPARATION ON ORB/ET AERODYNAMIC CHARACTERISTICS

1A13 SRB(SB) W/O PLUMES SEPARATING FROM 09T10 (RTJ227)

SEE THE ASSOCIATED DATA DOCUMENT FOR REFERENCE CHARACTERISTICS FOR INDIVIDUAL DATASETS

SYMBOL X PARAMETRIC VALUES

○	.595	MACH	4.530	PTOTAL	110.000
□	300.640	ALPHA	.000	BETA	.000
◇	600.750	DALPHA	-20.000	DBETA	-10.000
△	900.720	Y	400.000	PCMBER	.000

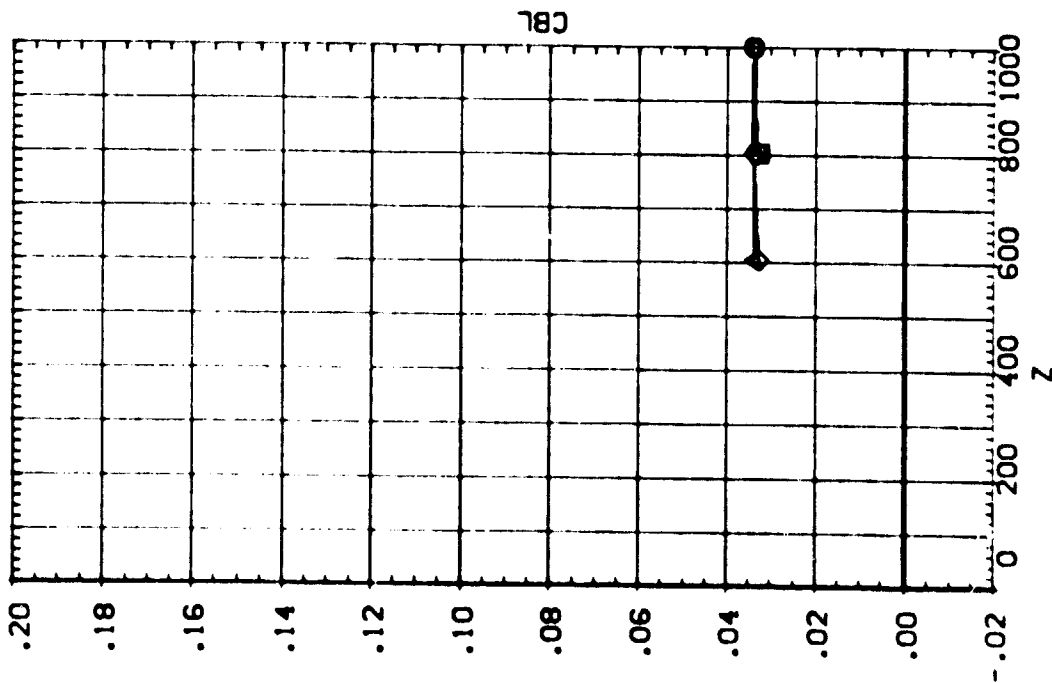
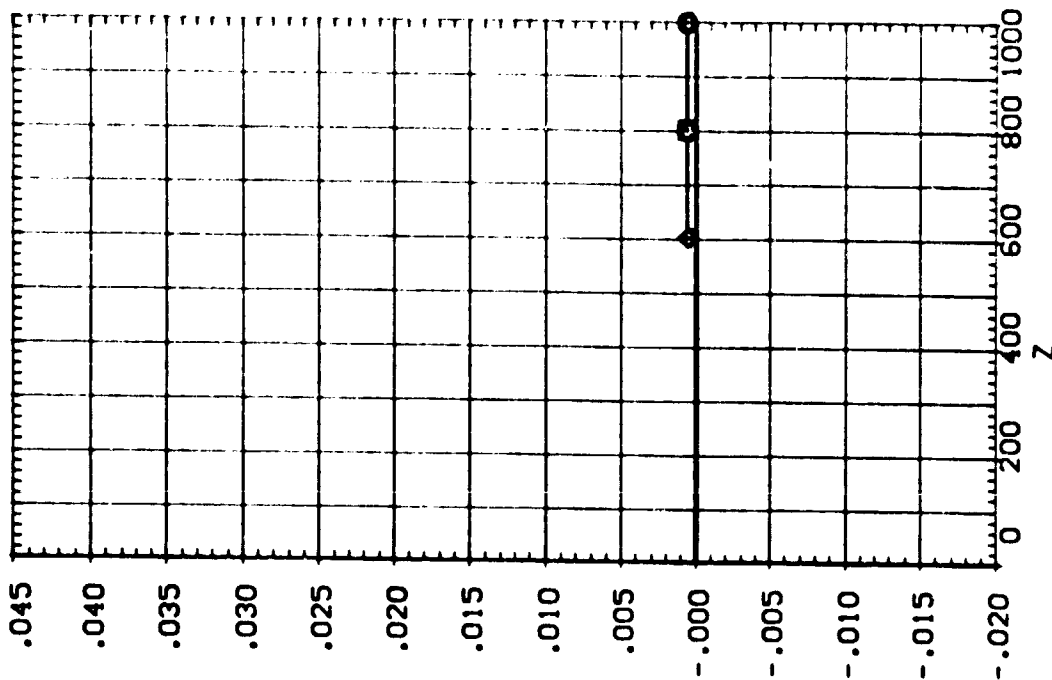

EFFECT OF SRB W/O PLUMES SEPARATION ON ORB/ET AERODYNAMIC CHARACTERISTICS

LA13 SRB(SB) W/O PLUMES SEPARATING FROM ORT:0 (RTJ227)

SEE THE ASSOCIATED DATA DOCUMENT FOR REFERENCE CHARACTERISTICS FOR INDIVIDUAL DATASETS

SYMBOL X MACH ALPHA D ALPHA Y PC+PR

○	.595	4.530	P TOTAL	110.000		
□	300.640	.000	BETA	.000		
◇	600.750	-20.000	DBETA	-10.000		
△	900.720	400.000	PC+PR	.000		

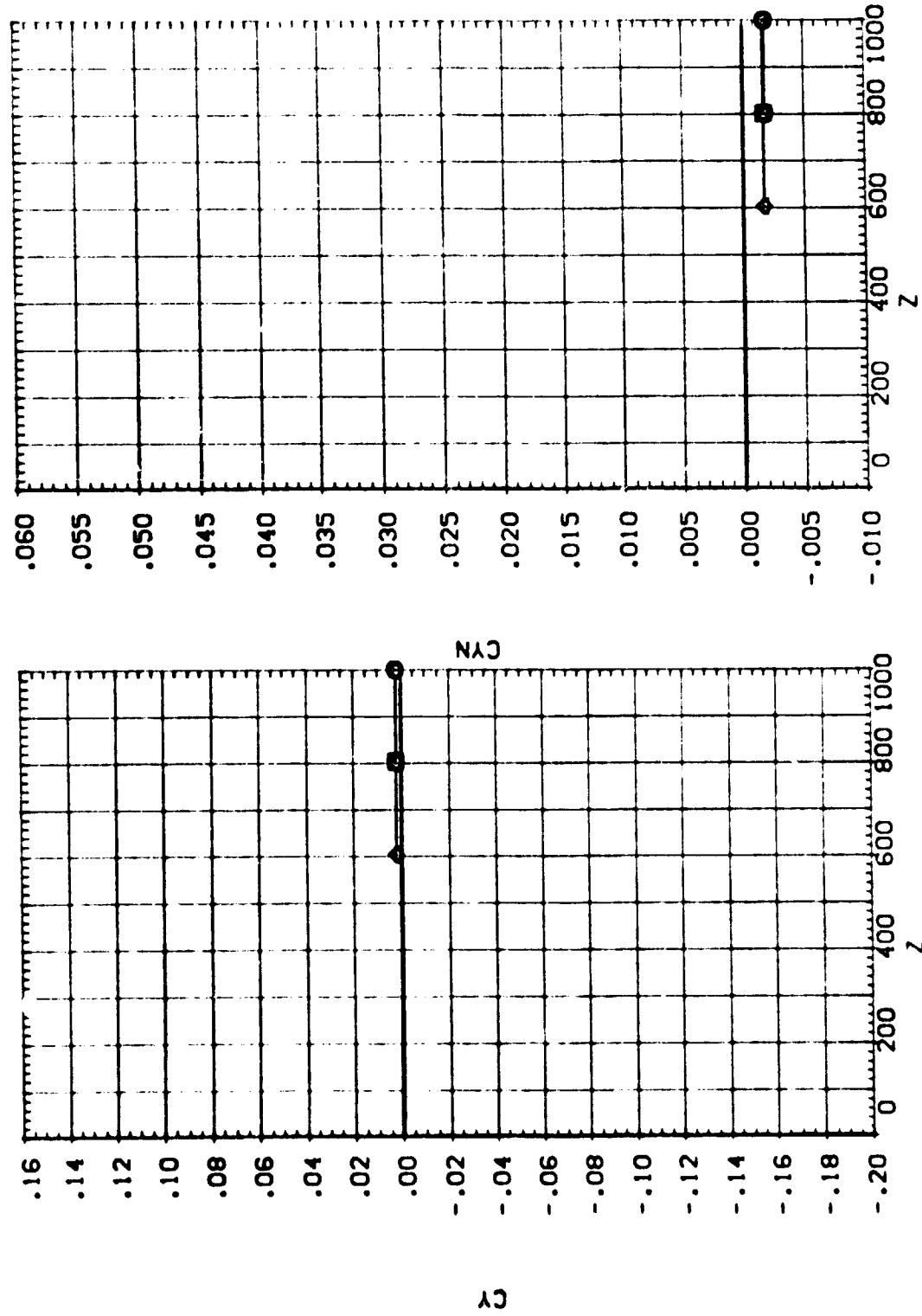

EFFECT OF SRB W/O PLUMES SEPARATION ON ORB/ET AERODYNAMIC CHARACTERISTICS

[A13 SRB(S8) W/O PLUMES SEPARATING FROM 09T10 (RTJ228)

SEE THE ASSOCIATED DATA DOCUMENT FOR REFERENCE CHARACTERISTICS FOR INDIVIDUAL DATASETS

SYMBOL	X	MACH	PARAMETRIC VALUES
○	.817	4.530	P TOTAL 110.000
□	300.300	.000	BETA .000
◇	600.930	-20.000	DBETA -20.000
△	900.570	.000	PC-MBR .000

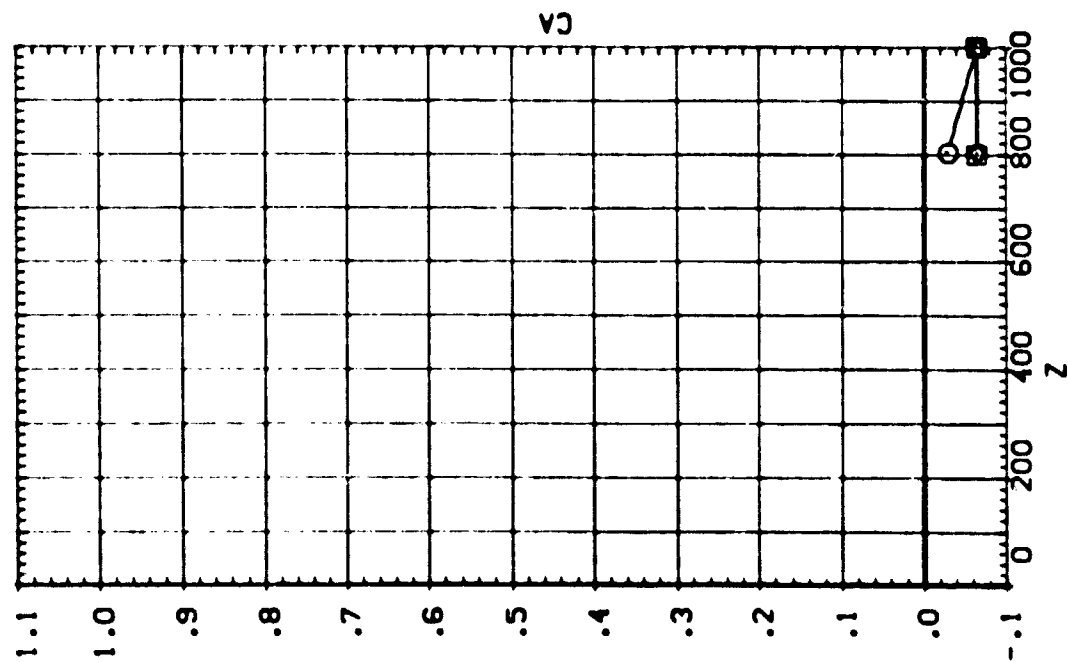
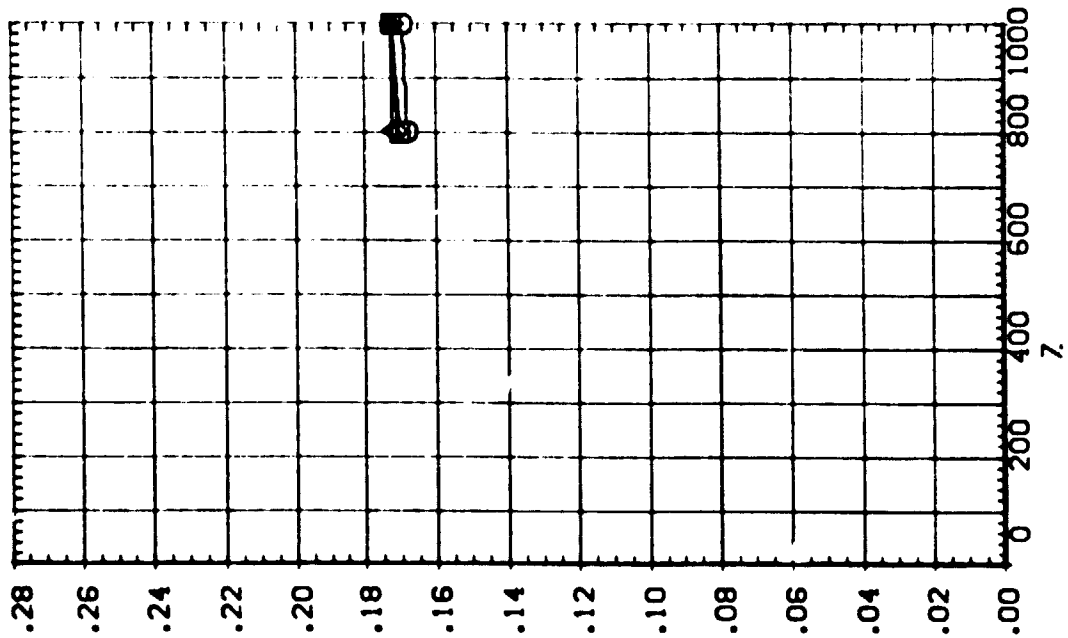

EFFECT OF SRB W/O PLUMES SEPARATION ON ORB/ET AERODYNAMIC CHARACTERISTICS

TA13 SR8(S8) W/O PLUMES SEPARATING FROM 09T10 (RTJ228)

SEE THE ASSOCIATED DATA DOCUMENT FOR REFERENCE CHARACTERISTICS FOR INDIVIDUAL DATASETS

SYMBL	X	PARAMETRIC VALUES			
		MACH	PIOTAL	BETA	PO-MBR
□	.817	4.530	110.000	.000	.000
○	300.300	.000	.000	-20.000	.000
◇	600.930	-20.000	.000	.000	.000
△	900.570	.000	.000	.000	.000

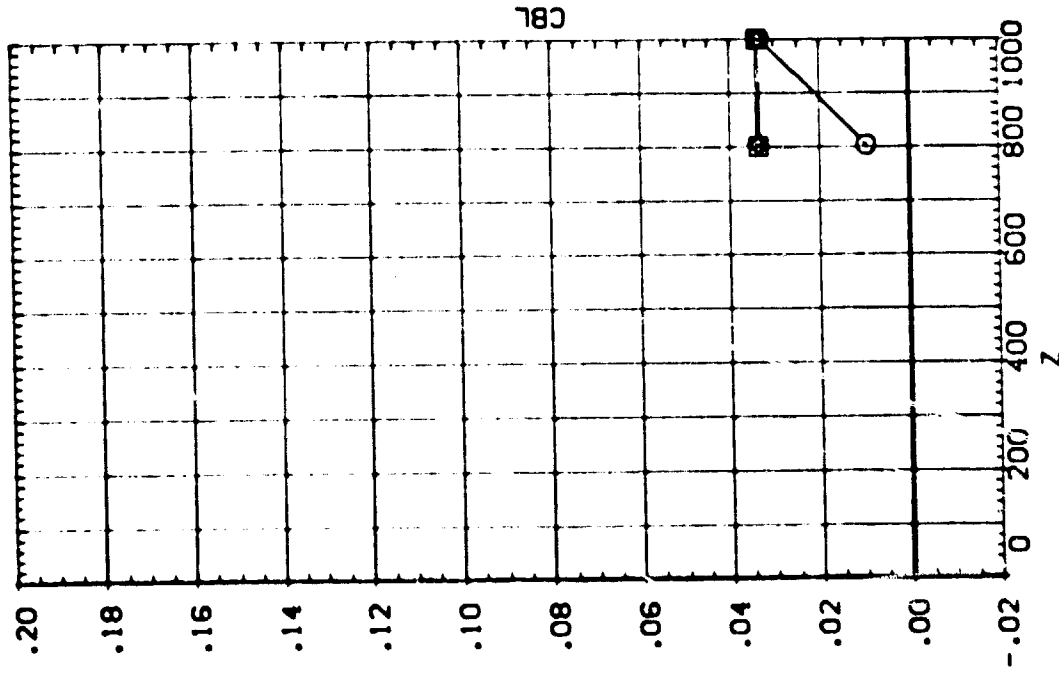
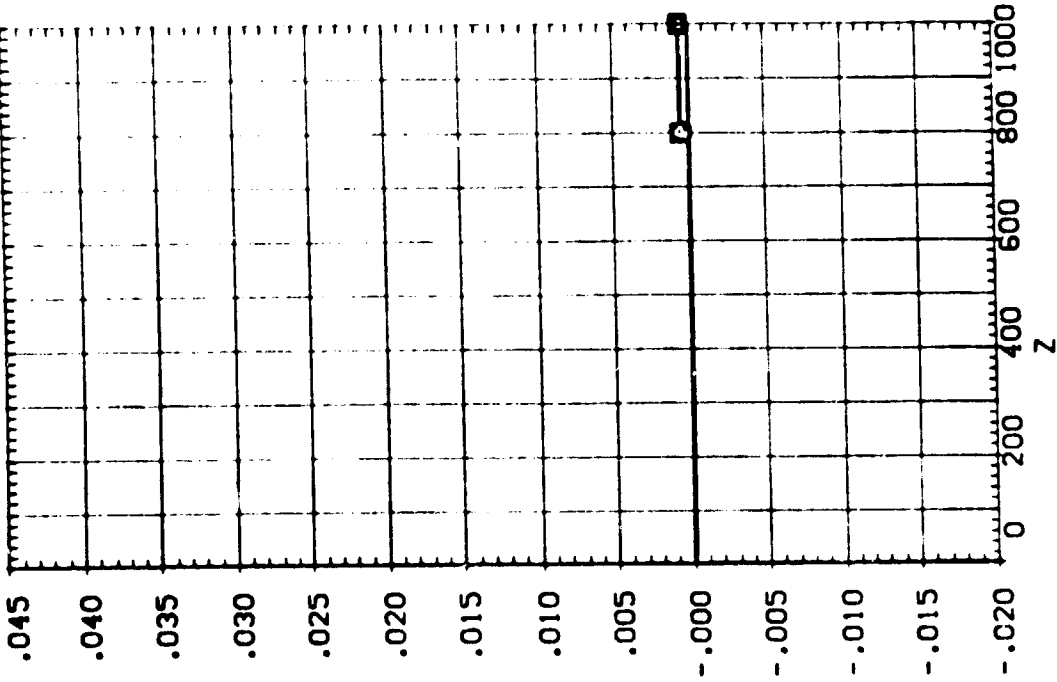

EFFECT OF SR8 W/O PLUMES SEPARATION ON CRB/ET AERODYNAMIC CHARACTERISTICS

IA13 SRB(SB) W/O PLUMES SEPARATING FROM 09T10 (RTJ228)

SEE THE ASSOCIATED DATA DOCUMENT FOR REFERENCE CHARACTERISTICS FOR INDIVIDUAL DATASETS

SYMBOL	X	MAOM	PARAMETRIC VALUES	PTOTAL
○	.017	4.530	BETA	110.000
□	300.300	.000	DBETA	.000
◇	600.930	-20.000	PC-MBR	-20.000
△	900.570	.000		.000

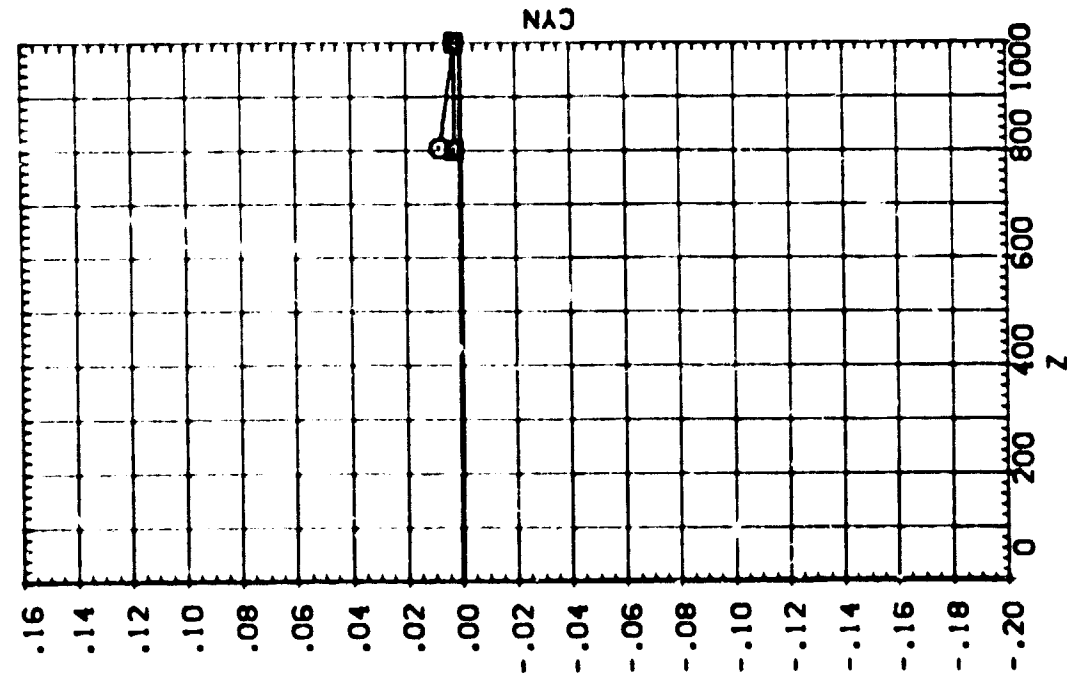
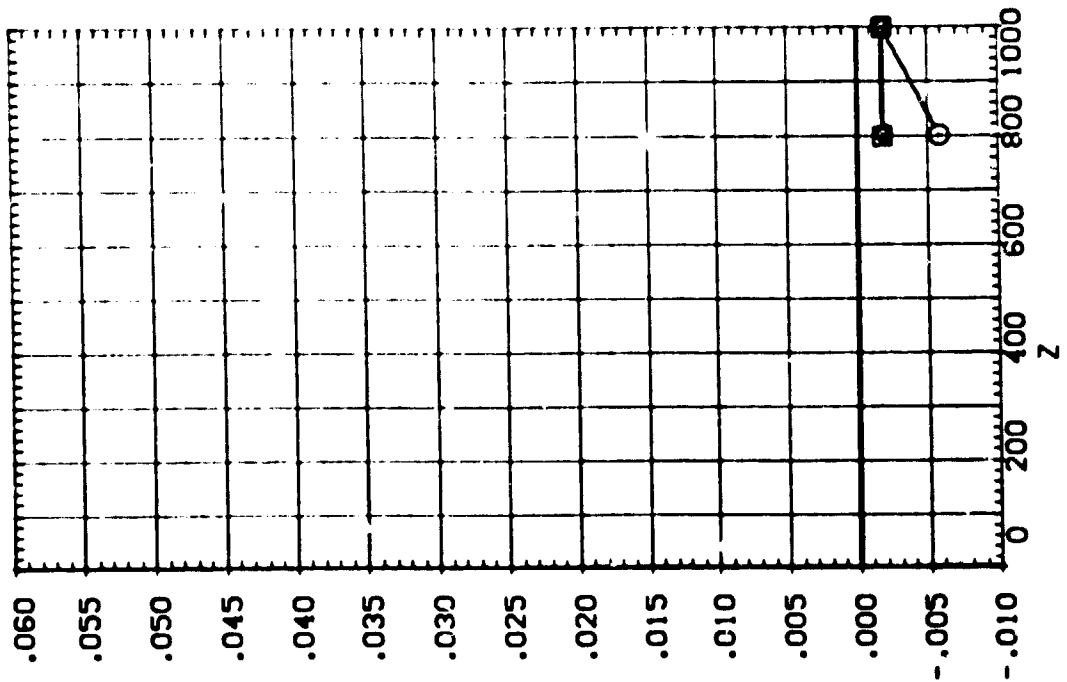

EFFECT OF SRB W/O PLUMES SEPARATION ON ORB/ET AERODYNAMIC CHARACTERISTICS

IA13 SRB(S8) W/O PLUMES SEPARATING FROM 09T10 (RTJ229)

SEE THE ASSOCIATED DATA DOCUMENT FOR REFERENCE CHARACTERISTICS FOR INDIVIDUAL DATASETS

SYMBOL		PARAMETRIC VALUES	
○	X	MACH	PTOTAL
□	300,660	4.530	110,000
◇	600,330	.000	BETA
△	900,330	-20,000	DBETA
		200,000	PCHGR
			.000

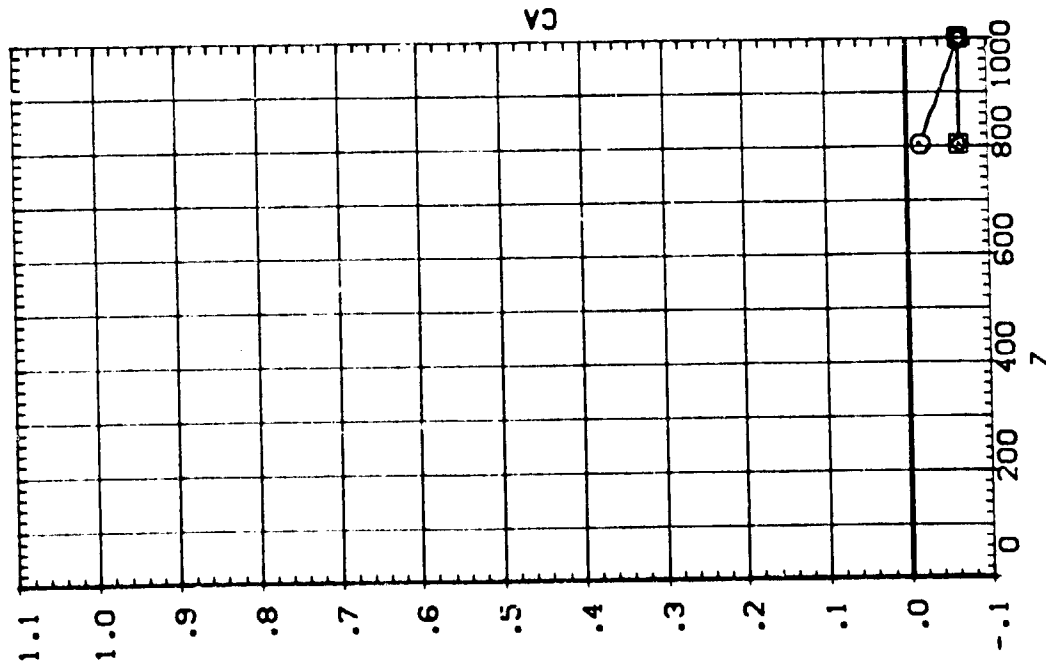
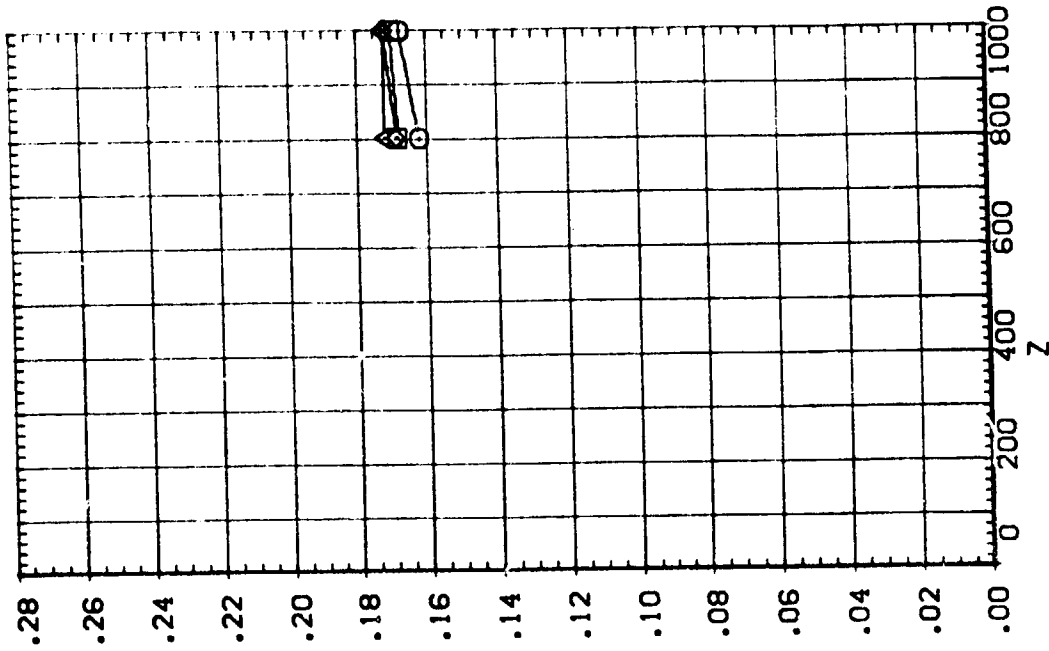

EFFECT OF SRB W/O PLUMES SEPARATION ON ORB/ET AERODYNAMIC CHARACTERISTICS

1A13 SRB(S8) W/O PLUMES SEPARATING FROM 09T10 (RTJ229)

SEE THE ASSOCIATED DATA DOCUMENT FOR REFERENCE CHARACTERISTICS FOR INDIVIDUAL DATASETS

SYMBOL		PARAMETRIC VALUES				
○	X	.291	MACH	4.530	PTOTAL	110.000
□		300.660	ALPHA	.000	BETA	.000
◇		600.330	DALPHA	-20.000	DBETA	-20.000
△		900.330	Y	200.000	PC-MBR	.000

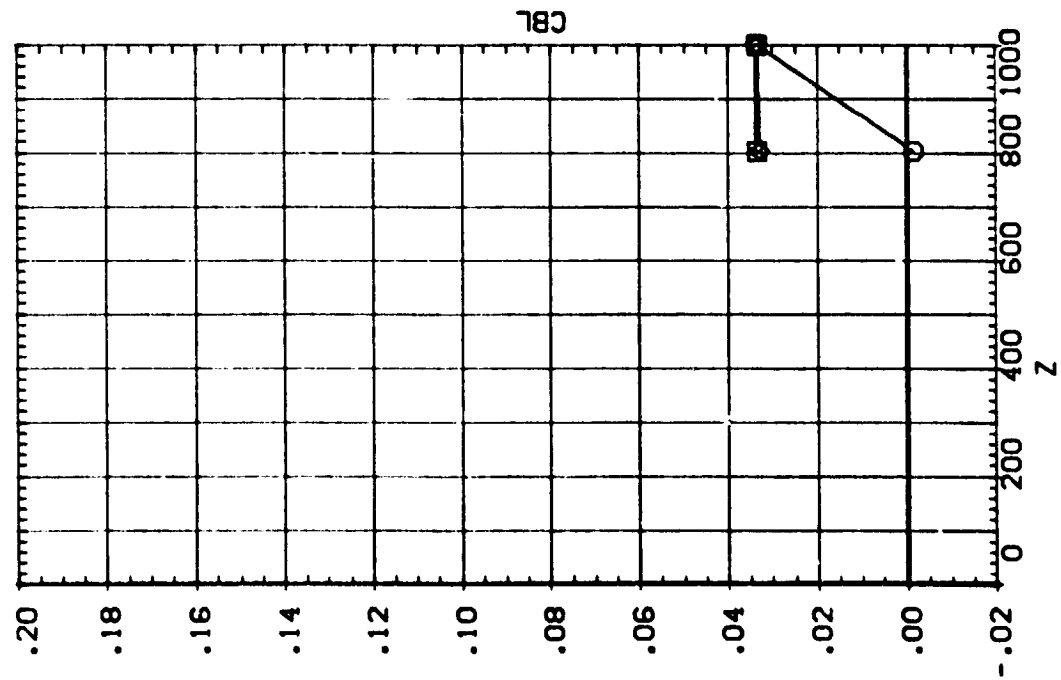
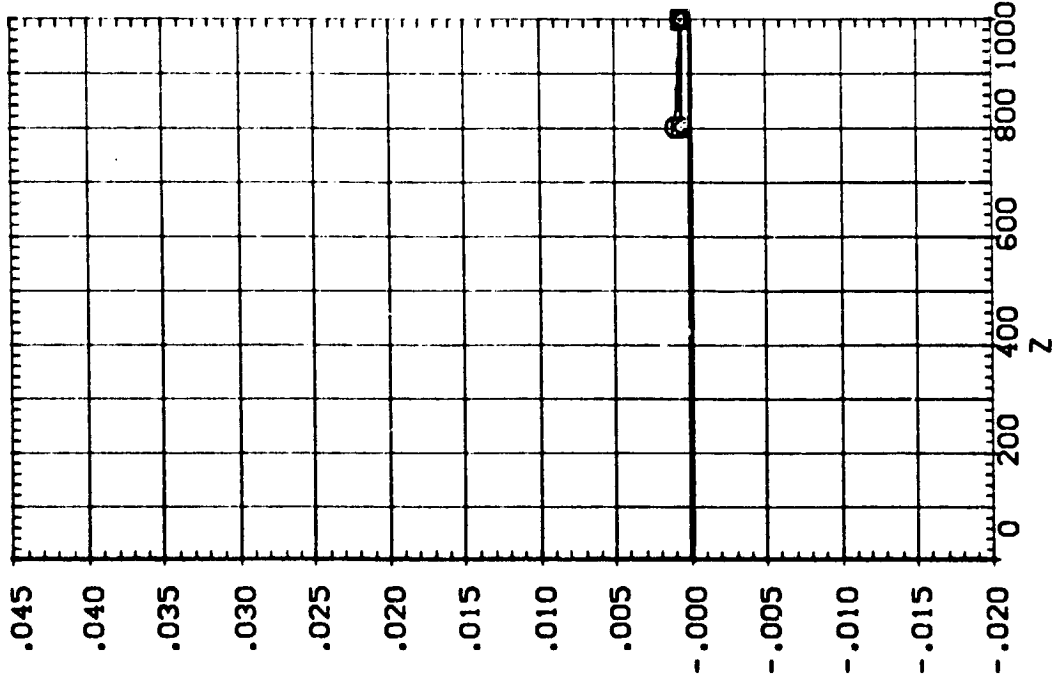

EFFECT OF SRB W/O PLUMES SEPARATION ON ORB/ET AERODYNAMIC CHARACTERISTICS

IA13 SRB(S8) W/O PLUMES SEPARATING FROM 09T10 (RTJ229)

SEE THE ASSOCIATED DATA DOCUMENT FOR REFERENCE CHARACTERISTICS FOR INDIVIDUAL DATASETS

SYMBOL	X	MACH	PARAMETRIC VALUES
○	.291	4.530	PTOTAL 110.000
□	300.660	.000	BETA .000
◇	600.330	-20.000	DBETA -20.000
△	900.330	200.000	PC-MBR .000

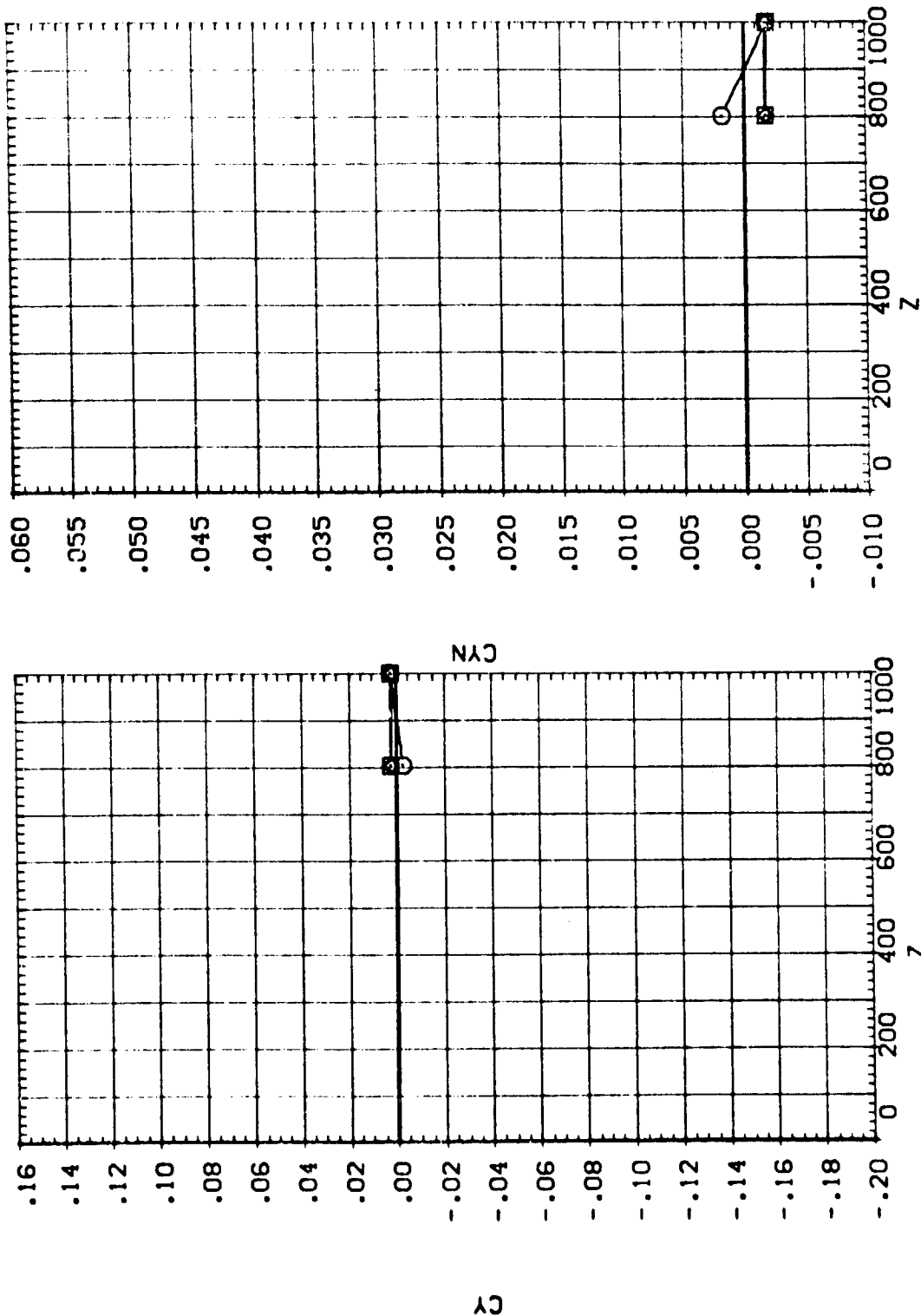

EFFECT OF SRB W/O PLUMES SEPARATION ON ORB/ET AERODYNAMIC CHARACTERISTICS

IA13 SRB(S8) W/O PLUMES SEPARATING FROM 09T10 (RTJ230)

SEE THE ASSOCIATED DATA DOCUMENT FOR REFERENCE CHARACTERISTICS FOR INDIVIDUAL DATASETS

SYMBOL	X	MACH	PARAMETRIC VALUES
○	.586	4.530	P/TOTAL 110.000
□	300.250	.000	BETA .000
◇	600.580	-20.000	DBETA -20.000
△	900.250	400.000	PC-MBR .000

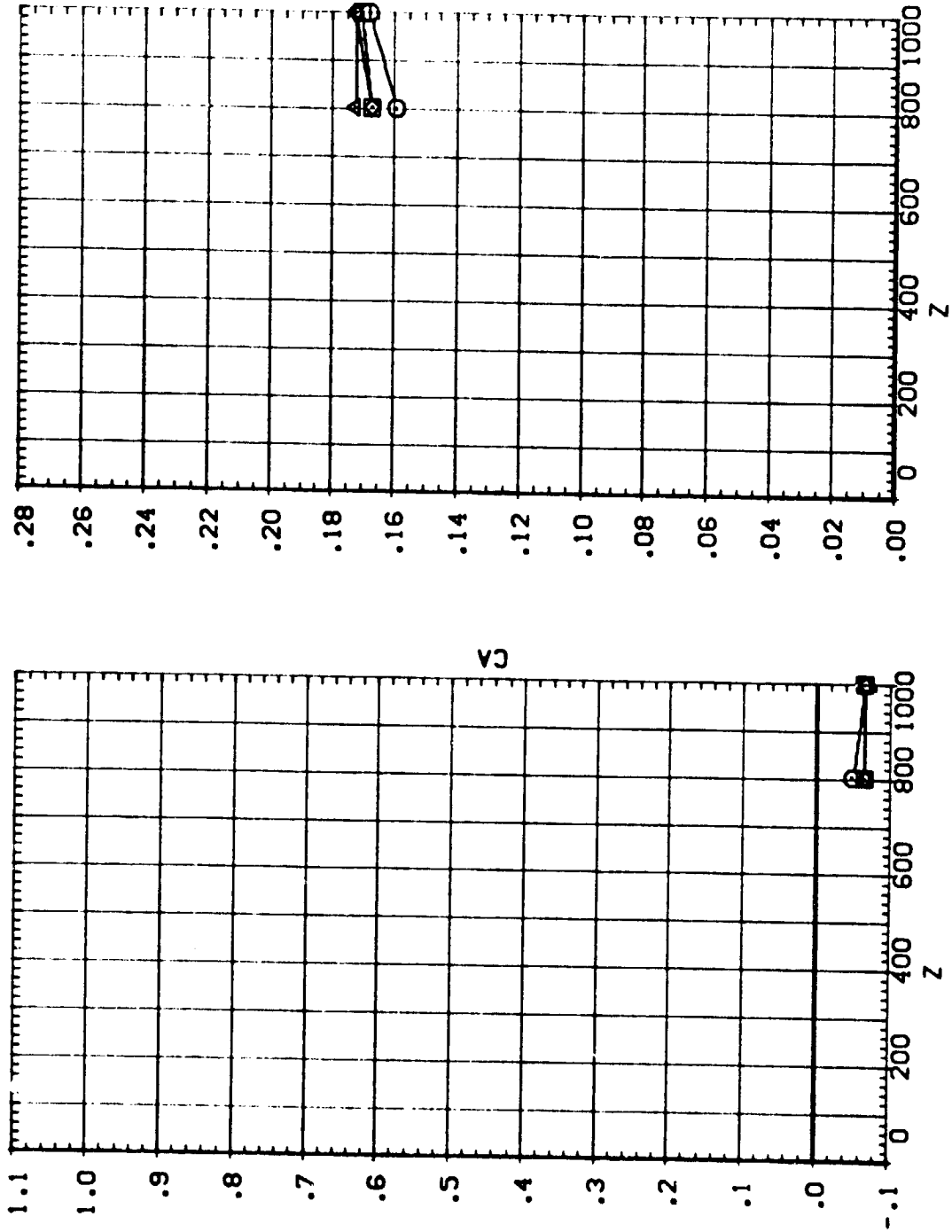

EFFECT OF SRB W/O PLUMES SEPARATION ON ORB/ET AERODYNAMIC CHARACTERISTICS

IA13 SRB(S8) W/O PLUMES SEPARATING FROM 09T10 (RTJ230)

SEE THE ASSOCIATED DATA DOCUMENT FOR REFERENCE CHARACTERISTICS FOR INDIVIDUAL DATA SETS

SYMBOL		X		MACH		PARAMETRIC VALUES	
○	□	300.250	.566	4.530	PITOTAL	110.000	
◇	△	600.580	ALPHA	.000	BETA	.000	
		900.290	DALPHA	-20.000	DBETA	-20.000	
			Y	400.000	PC-MBR	.000	

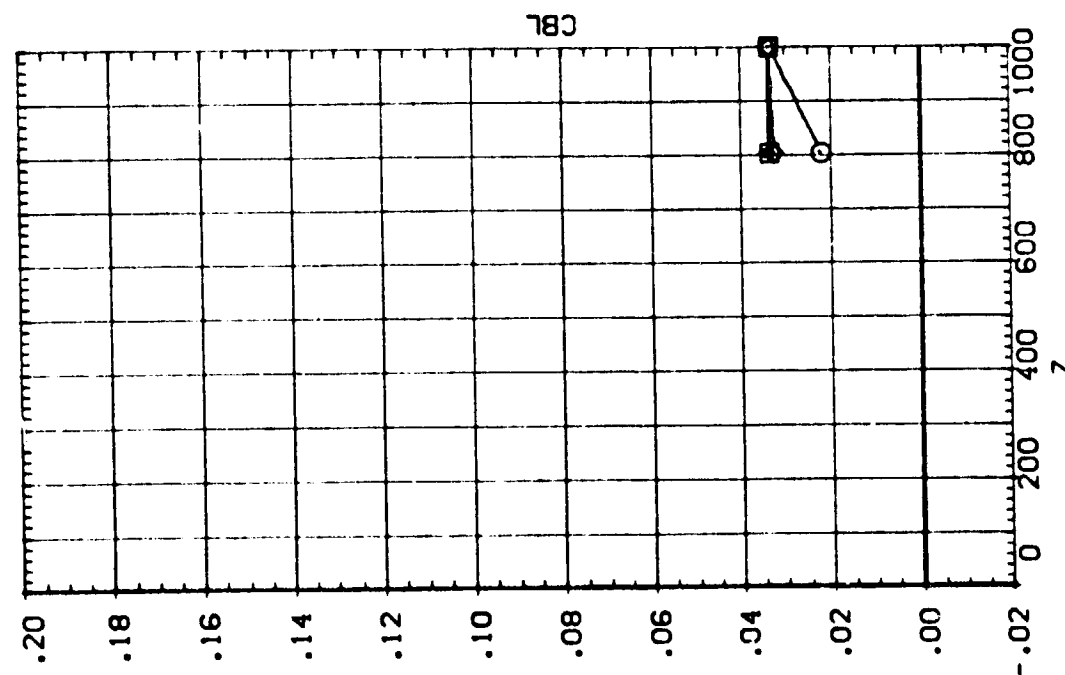
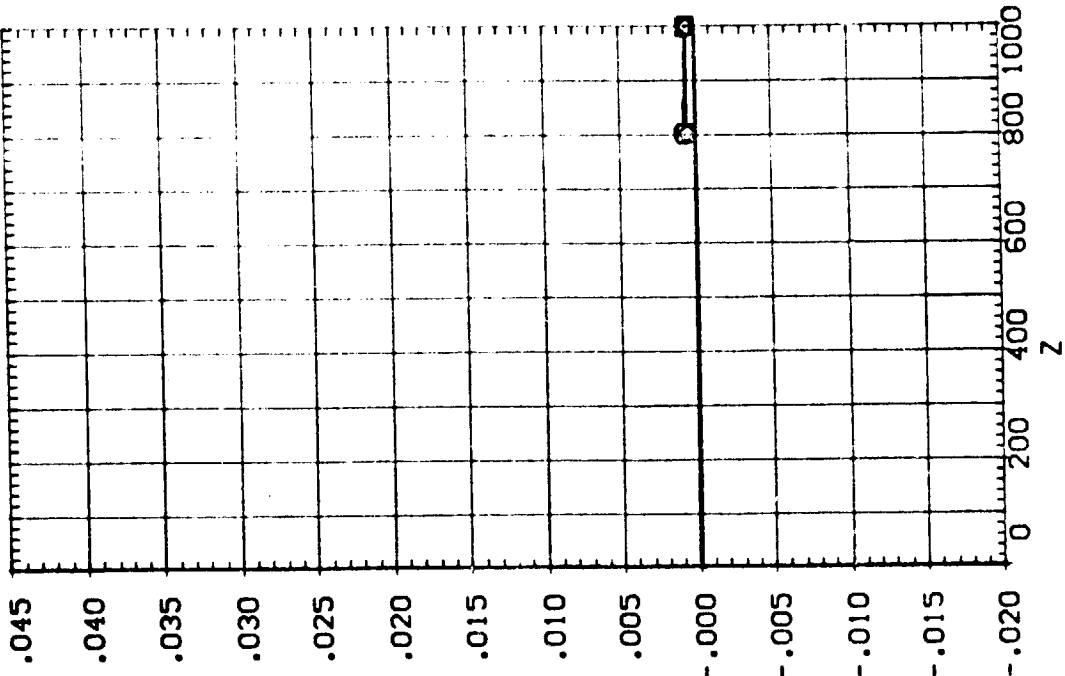

EFFECT OF SRB W/O PLUMES SEPARATION ON ORB/ET AERODYNAMIC CHARACTERISTICS

IA13 SRB(S8) W/O PLUMES SEPARATING FROM 09T10 (RTJ230)

SEE THE ASSOCIATED DATA DOCUMENT FOR REFERENCE CHARACTERISTICS FOR INDIVIDUAL DATASETS

SYMBOL	X	PARAMETRIC VALUES			
		MACH	PTOTAL	BETA	PC-MBR
○	.586	4.530	110.000	.000	.000
□	300.250	.000	.000	-20.000	.000
◇	600.580	-20.000	400.000	.000	.000
△	900.290	Y			

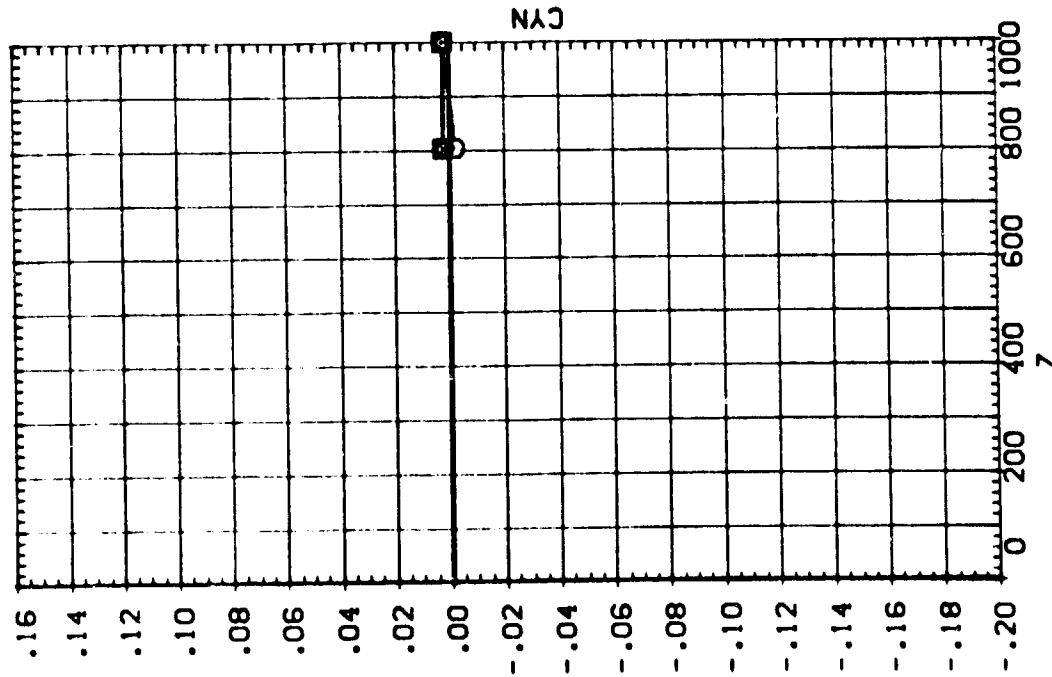
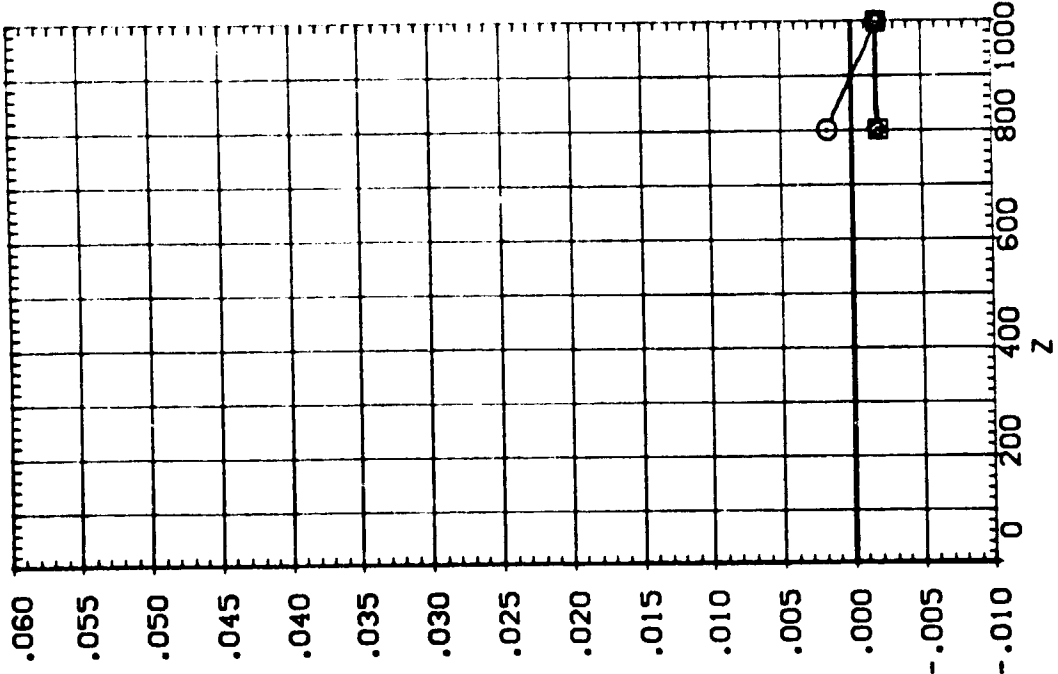

IA13 SRB(SB) W/O PLUMES SEPARATING FROM 09T10 (RTJ231)

SEE THE ASSOCIATED DATA DOCUMENT FOR REFERENCE CHARACTERISTICS FOR INDIVIDUAL DATASETS

SYMBOL	X	MACH	PARAMETRIC VALUES
○	-1.218	4.530	PITOTAL 110.000
□	300.610	.000	BETA .000
◇	600.610	-20.000	DBETA -20.000
△	900.560	800.000	PC+R .000

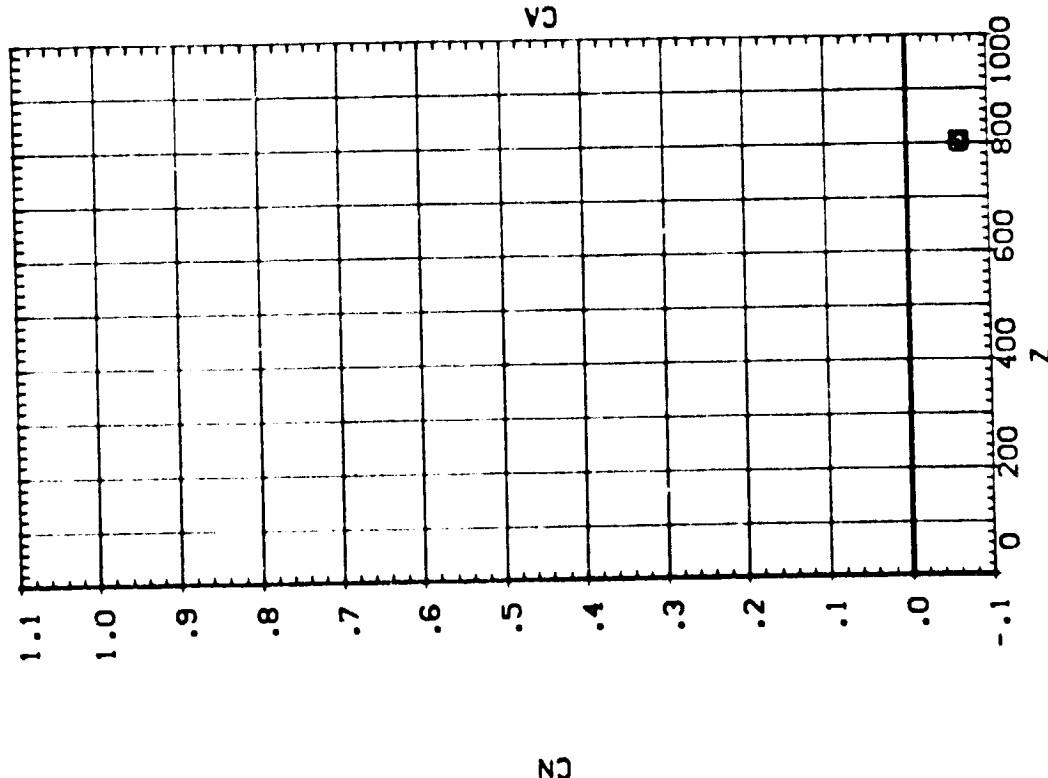
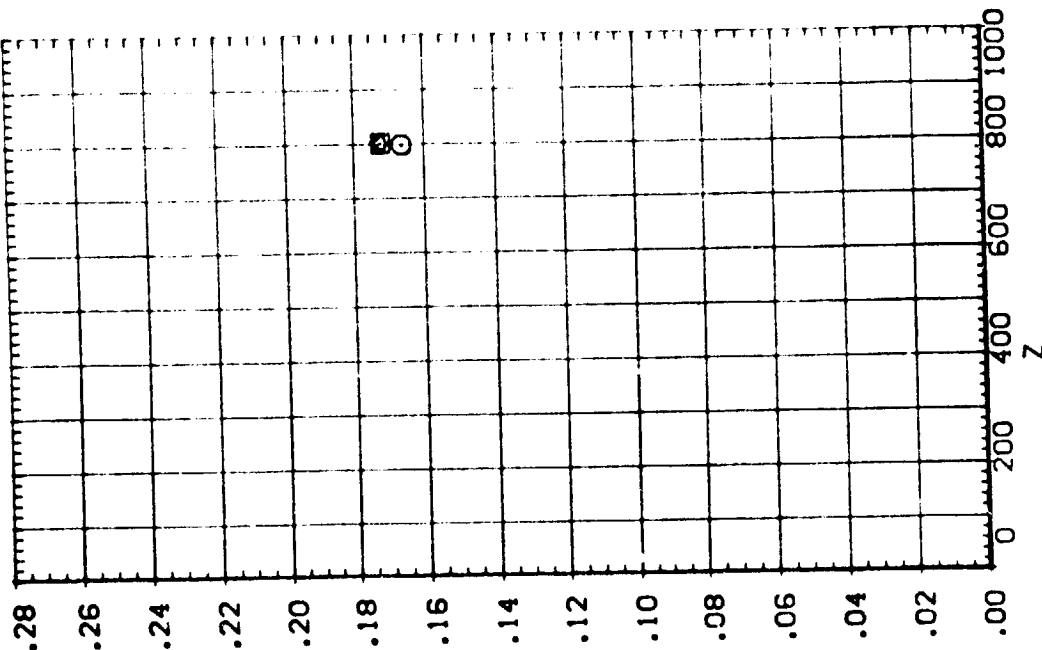

EFFECT OF SRB W/O PLUMES SEPARATION ON ORB/ET AERODYNAMIC CHARACTERISTICS

IA13 SRB(S8) W/O PLUMES SEPARATING FROM 09T10 (RTJ231)

SEE THE ASSOCIATED DATA DOCUMENT FOR REFERENCE CHARACTERISTICS FOR INDIVIDUAL DATASETS

SYMBOL		PARAMETRIC VALUES			
○	X	MACH	4.530	P/TOTAL	110.000
□	300.610	ALPHA	.000	BETA	.000
◇	600.610	DALPHA	-20.000	DBETA	-20.000
△	900.560	Y	800.000	PC-MFR	.000

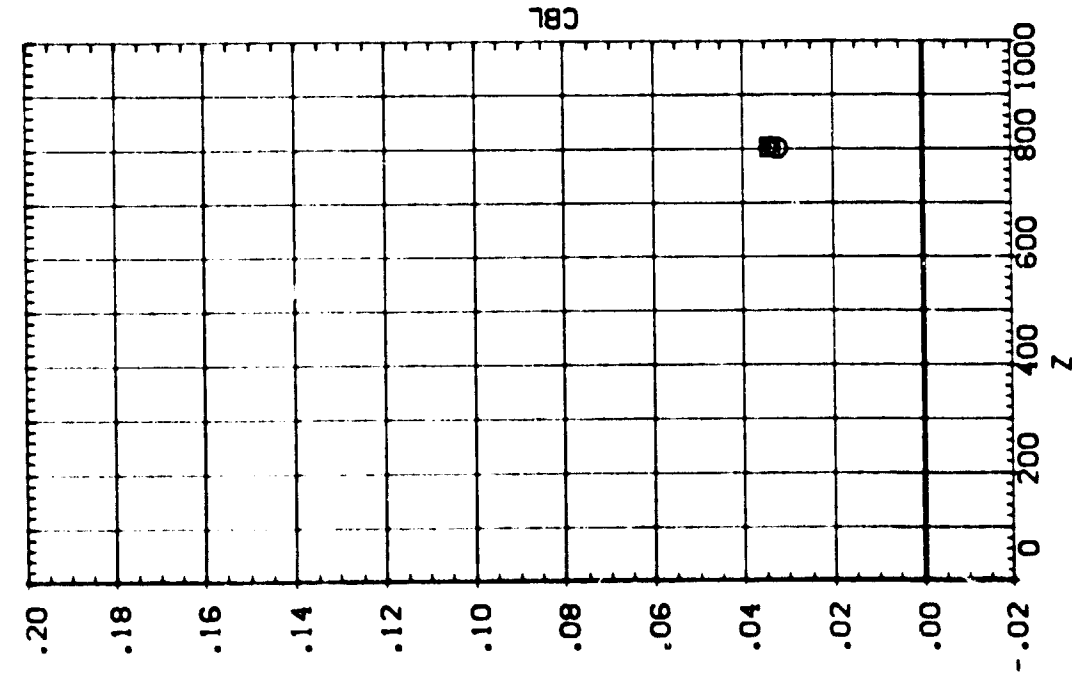
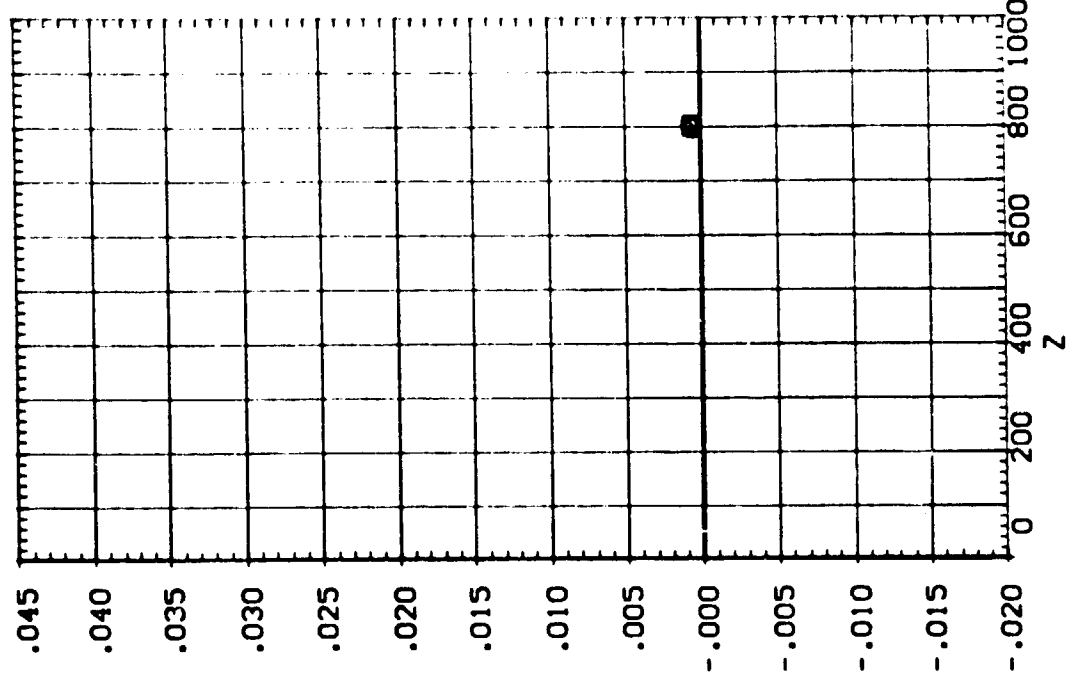

IA13 SRB(SB) W/O PLUMES SEPARATING FROM 09T10 (RTJ231)

SEE THE ASSOCIATED DATA DOCUMENT FOR REFERENCE CHARACTERISTICS FOR INDIVIDUAL DATASETS

SYMBOL	X	MACH	PARAMETRIC VALUES
○	-1.218	4.530	PISTAL 110.000
□	300.610	.000	BETA .000
◇	600.610	-20.000	DETA -20.000
△	900.560	800.000	PCHFR .000

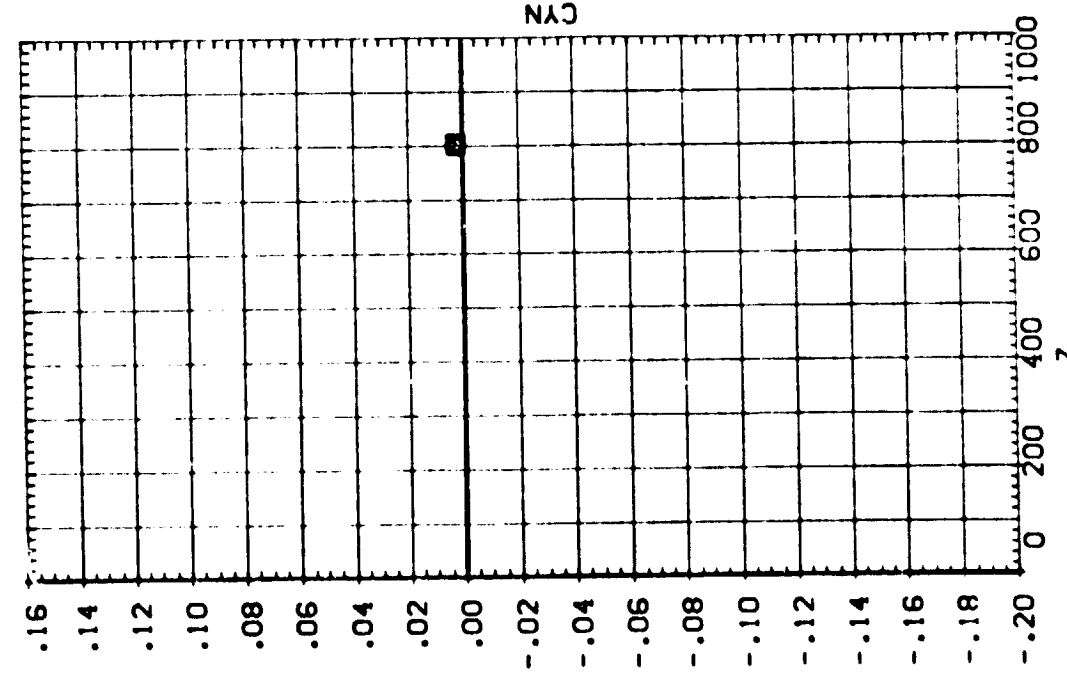
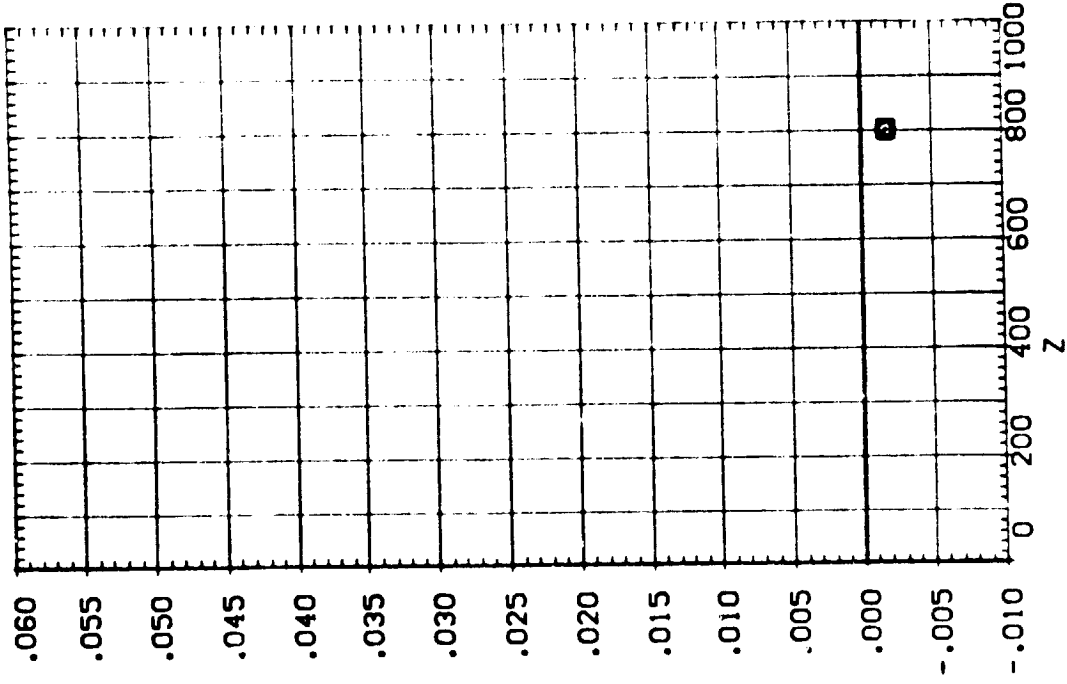

EFFECT OF SRB W/O PLUMES SEPARATION ON ORB/ET AERODYNAMIC CHARACTERISTICS

LA13 SRB(S8) W/O PLUMES SEPARATING FROM 09T10 (RTJ257)

SYMBOL

○

PARAMETRIC VALUES

Y	10.254	MACH	4.510	PTOTL	28.900
		ALPHA	.000	BETA	5.000
		DALPHA	.000	DBETA	.000
		X	.000	PCMB	.000

SEE THE ASSOCIATED DATA DOCUMENT FOR REFERENCE CHARACTERISTICS FOR INDIVIDUAL DATASETS

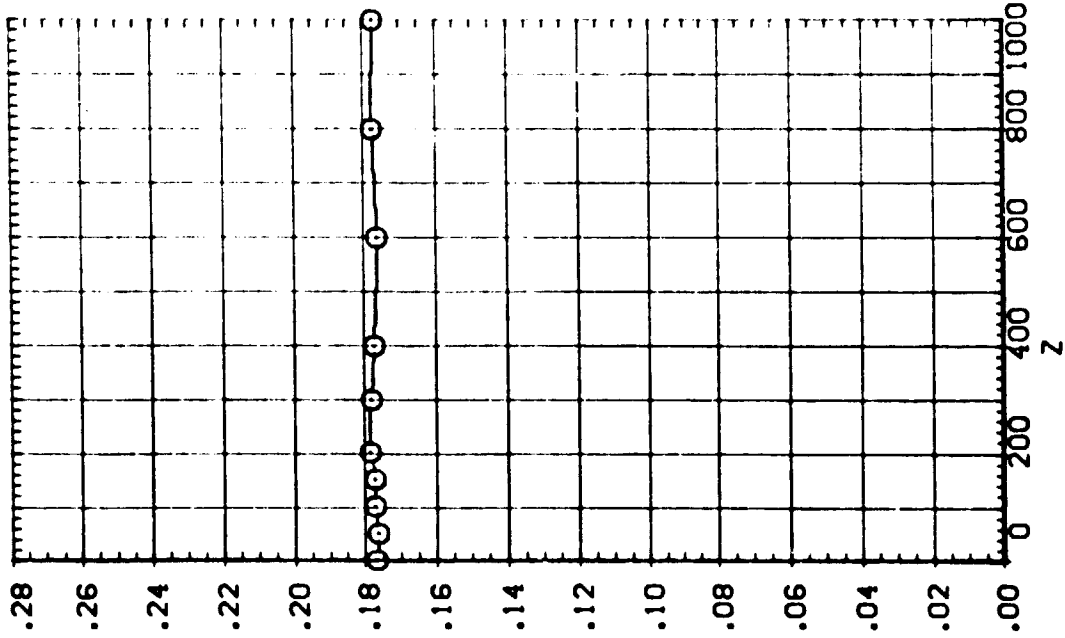
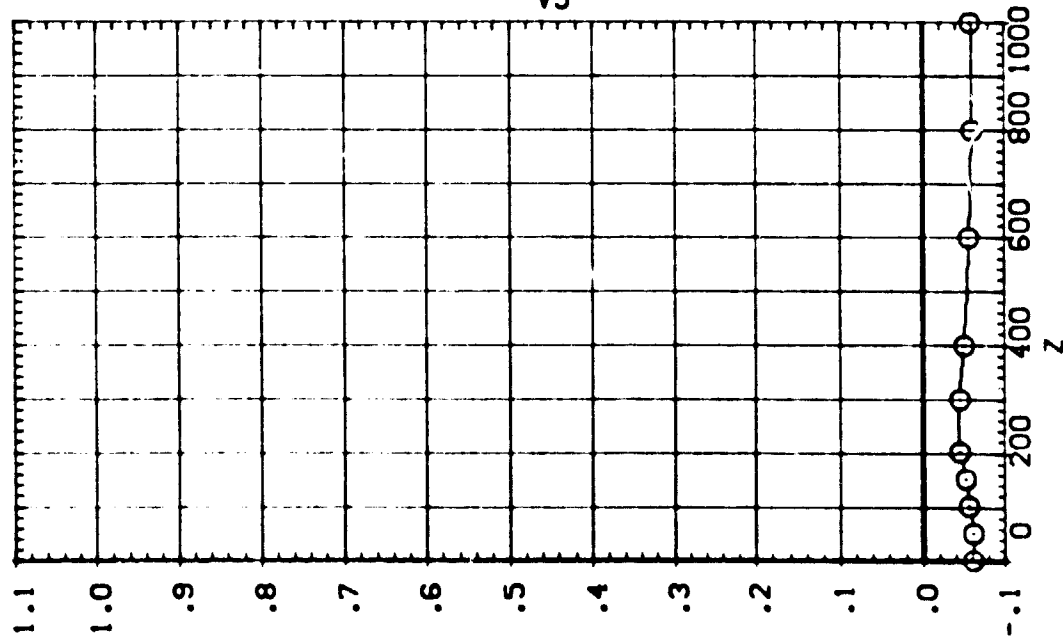

EFFECT OF SRB W/O PLUMES SEPARATION ON ORB/ET AERODYNAMIC CHARACTERISTICS

IA13 SRB(SB) W/O PLUMES SEPARATING FROM 09T10 (RTJ257)

SEE THE ASSOCIATED DATA DOCUMENT FOR REFERENCE CHARACTERISTICS FOR INDIVIDUAL DATASETS

SYMBOL		PARAMETRIC VALUES	
○	10.254	MACH	28.900
		ALPHA	5.000
		DBETA	.000
		PC-MB	.000

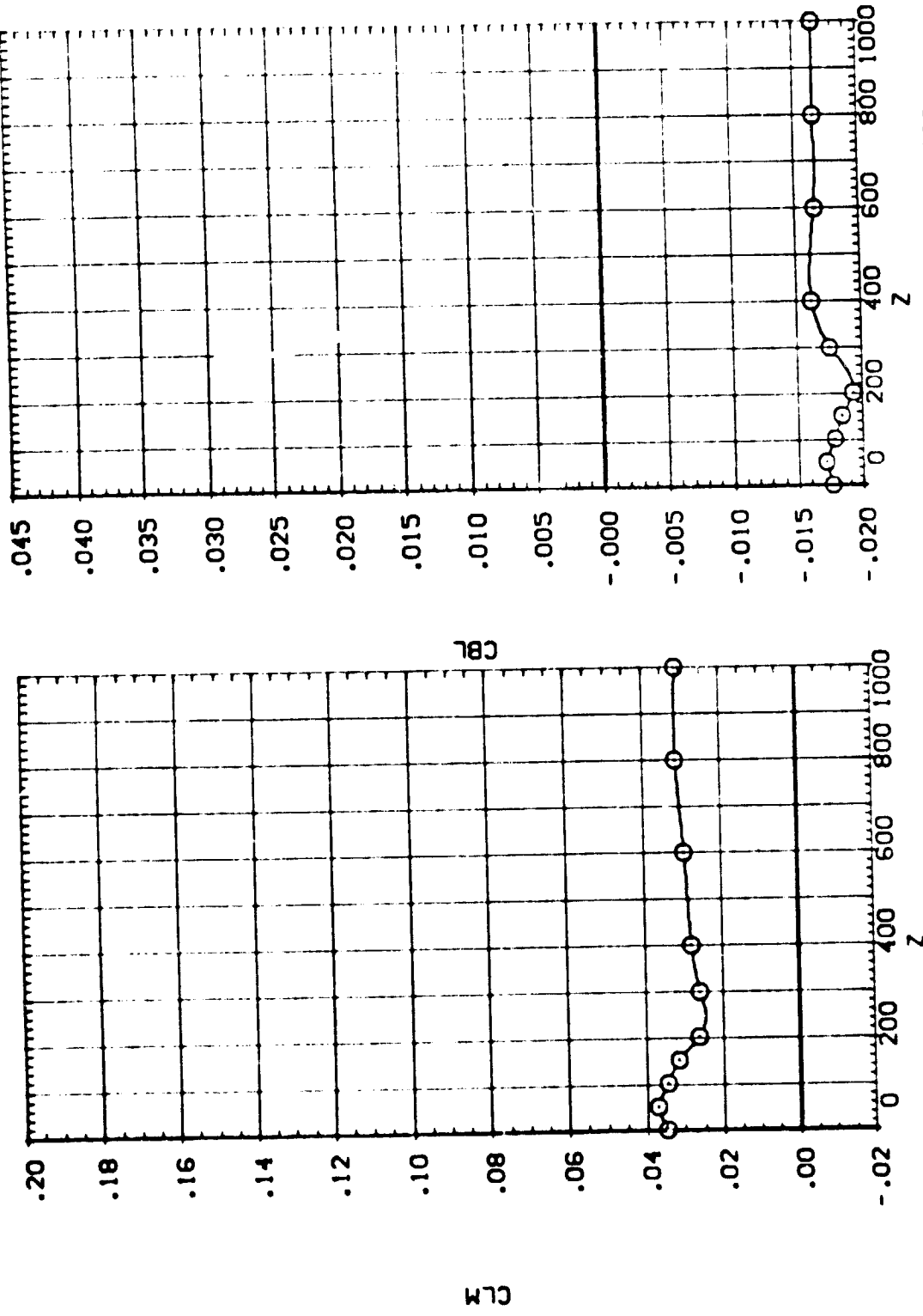

EFFECT OF SRB W/O PLUMES SEPARATION ON ORB/ET AERODYNAMIC CHARACTERISTICS

IA13 SRB(SB) W/O PLUMES SEPARATING FROM 09T10 (RTJ257)

SEE THE ASSOCIATED DATA DOCUMENT FOR REFERENCE CHARACTERISTICS FOR INDIVIDUAL DATASETS

SYMBOL		PARAMETRIC VALUES			
○	Y	MACH	4.510	PI/DTL	28.900
		ALPHA	.000	BETA	5.000
		DALPHA	.000	DBETA	.000
	X		.000	PCMB	.000

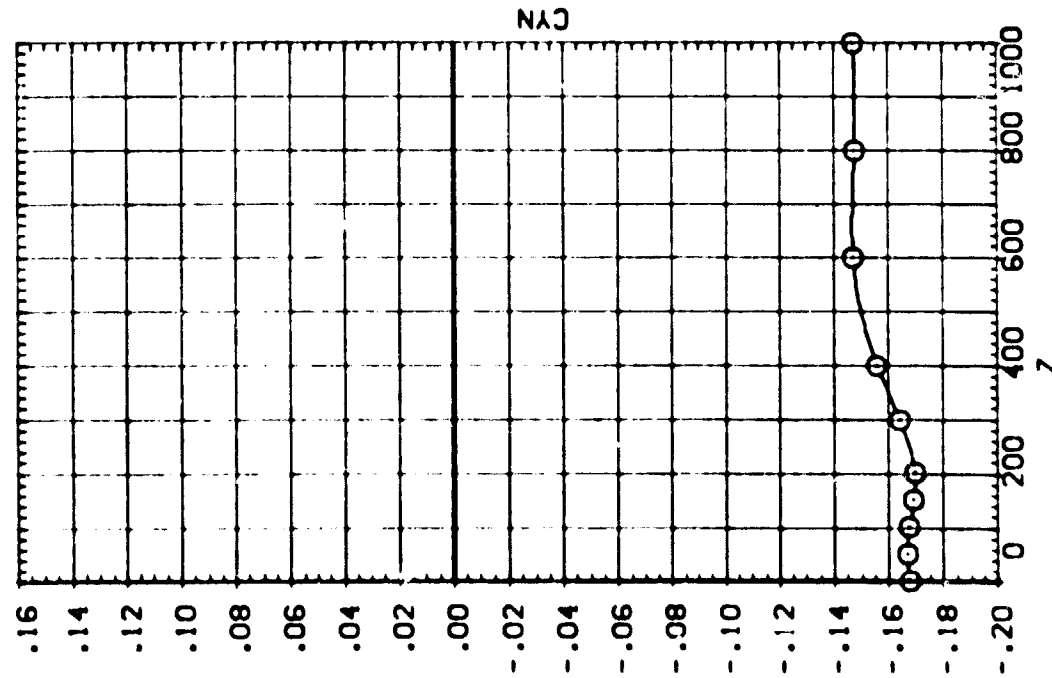
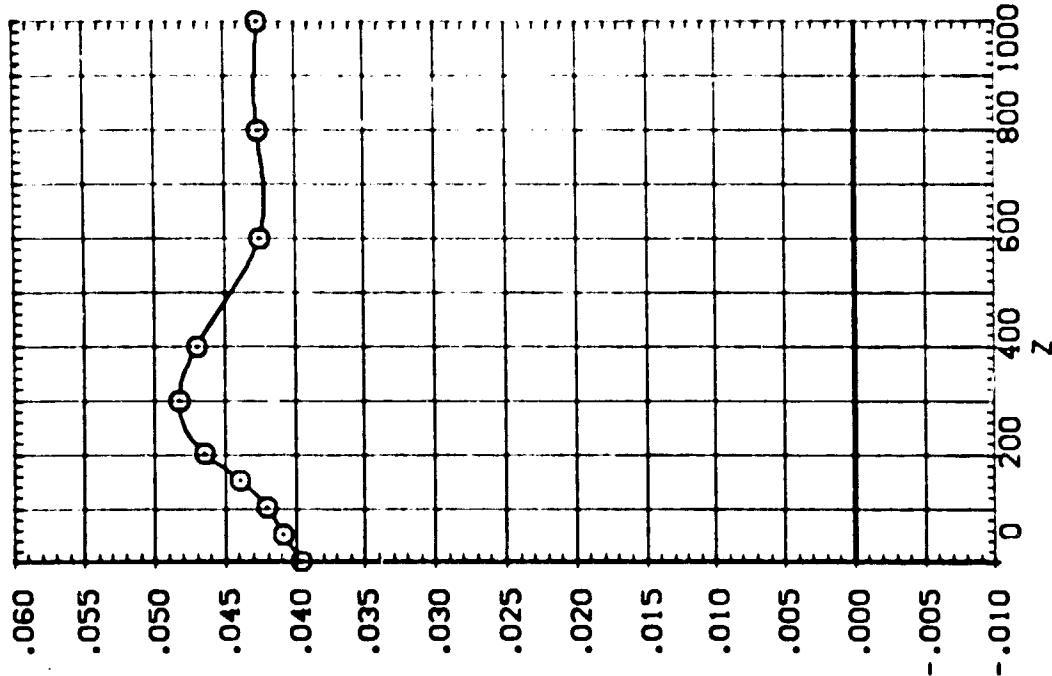

EFFECT OF SRB W/O PLUMES SEPARATION ON ORB/ET AERODYNAMIC CHARACTERISTICS

1A13 SRB(S8) W/O PLUMES SEPARATING FROM 09T10 (RTJ258)

SEE THE ASSOCIATED DATA DOCUMENT FOR REFERENCE CHARACTERISTICS FOR INDIVIDUAL DATASETS

SYMBOL		PARAMETRIC VALUES			
Y	.475	MACH	4.510	PICHL	28.900
O		ALPHA	.000	BETA	5.000
		DALPHA	.000	DBETA	5.000
		K	.000	PCMB	.000

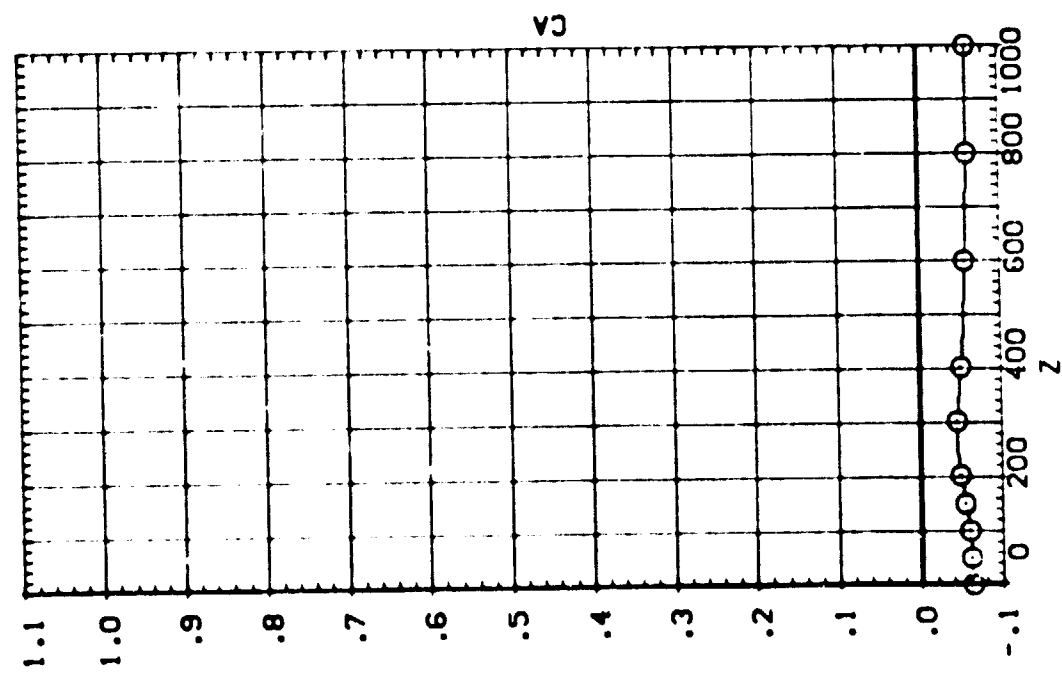
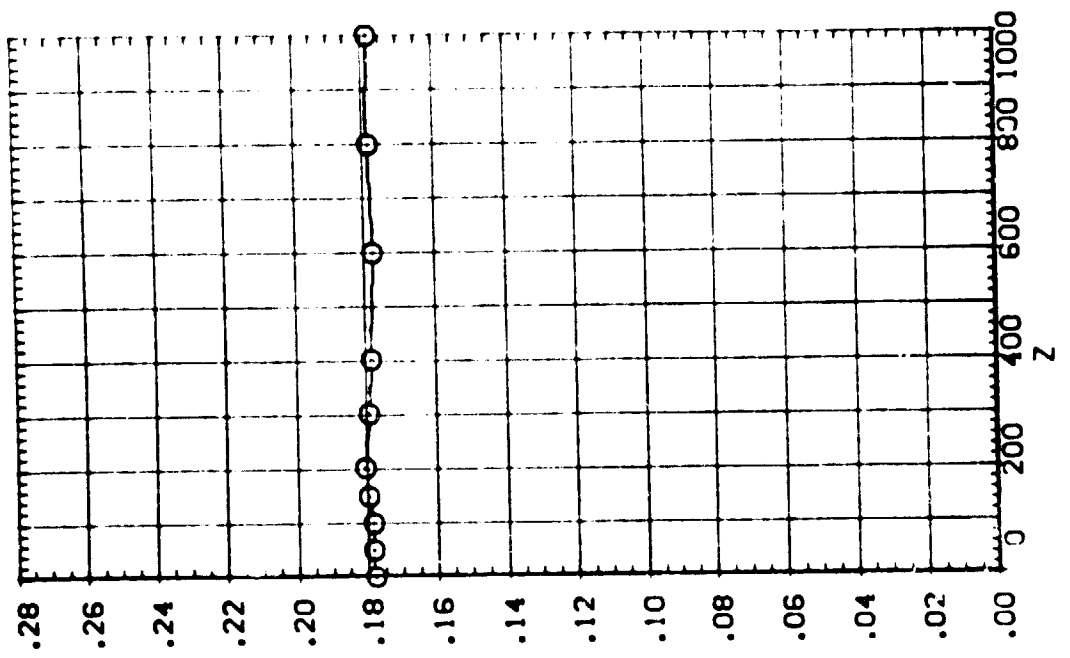

EFFECT OF SRB W/O PLUMES SEPARATION ON ORB/ET AERODYNAMIC CHARACTERISTICS



IA13 SRB(SB) W/O PLUMES SEPARATING FROM 09T10 (RTJ258)

SYMBOL



PARAMETRIC VALUES

MACH	4.510	P/TOTL	28.900
ALPHA	.000	BETA	5.000
DALPHA	.000	DBETA	5.000
K	.000	PCHWB	.000

SEE THE ASSOCIATED DATA DOCUMENT FOR REFERENCE CHARACTERISTICS FOR INDIVIDUAL DATASETS

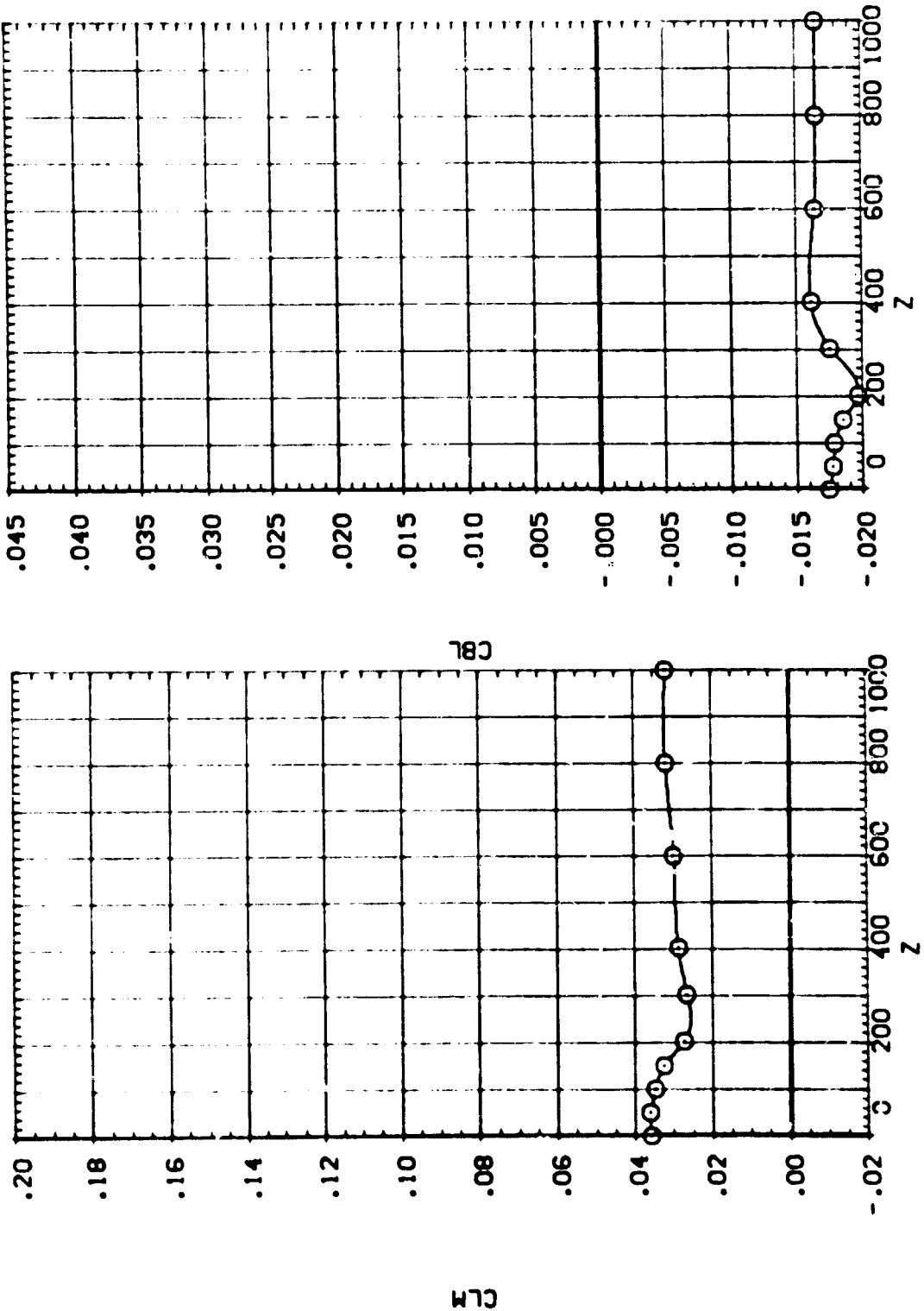

EFFECT OF SRB W/O PLUMES SEPARATION ON ORB/ET AERODYNAMIC CHARACTERISTICS

IA13 SRB(S8) W/O PLUMES SEPARATING FROM 09T10 (RTJ258)

SEE THE ASSOCIATED DATA DOCUMENT FOR REFERENCE CHARACTERISTICS FOR INDIVIDUAL DATASETS

SYMBOL	Y	.475	M'CH	PTOTL	28.900
○			ALPHA	BETA	5.000
			DALPHA	DBETA	5.000
			X	PCMB	.000

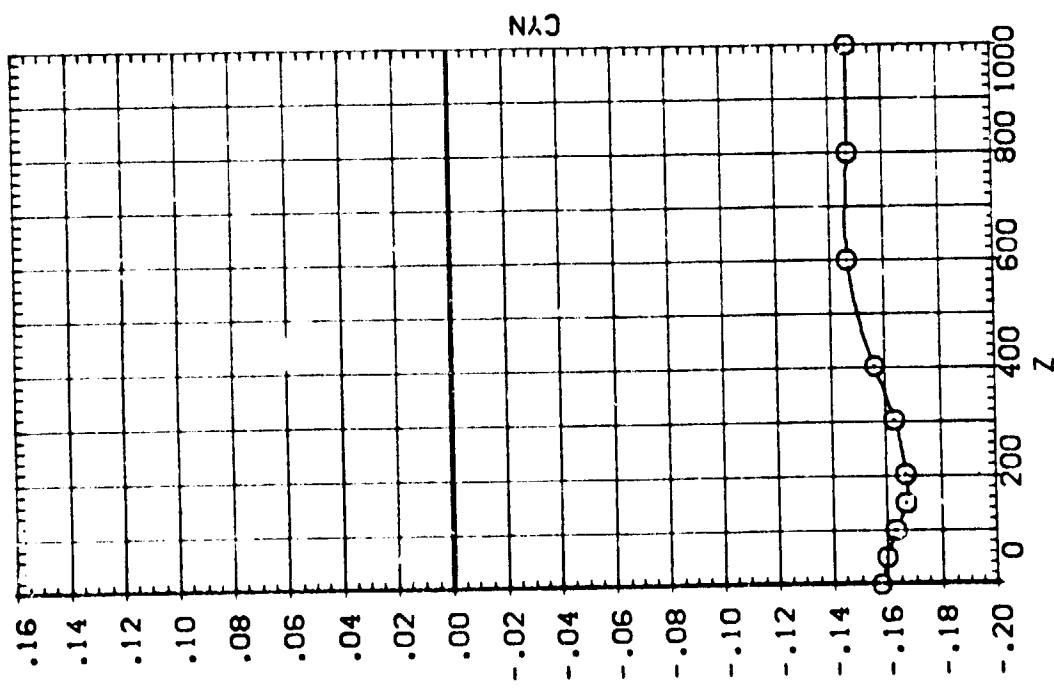
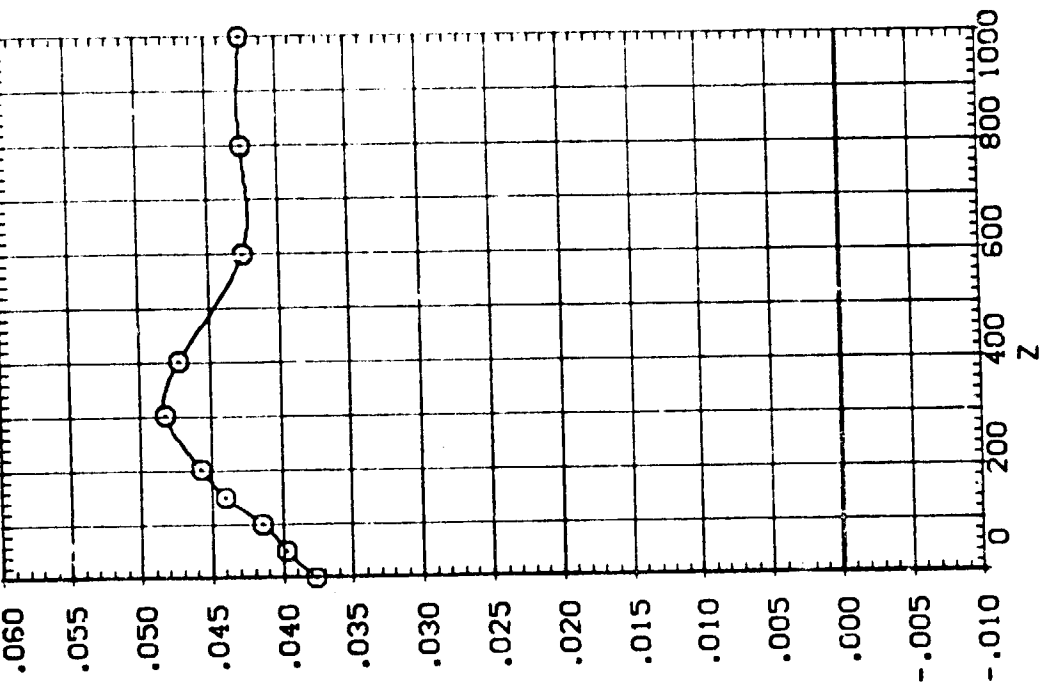

EFFECT OF SRB W/O PLUMES SEPARATION ON ORB/ET AERODYNAMIC CHARACTERISTICS