

THE DYN AIRSHIP

William McElwee Miller, Jr.*

ABSTRACT: A brief history of Aereon Corporation and its research and development of hybrid aircraft, with preliminary projections of the advantages represented by a deltoid aerobody configuration, the "Dynairship".

Aereon Corporation has invented an "aerobody" which is a blend of two concepts:

- A buoyant-lift airship,
- A dynamic-lift lifting-body.

Historically, Dr. Solomon Andrews coined the name "aereon" (air age). A New Jersey inventor, he built and flew America's first directionally maneuverable aircraft over 100 years ago. It was a 3-hulled balloon, propelled first by gravity and then by buoyancy as he alternated the inclination of the hulls together with changes in the buoyancy. He also flew a second one before the company failed in the 1860's.

The present company--founded in 1959--took the name--Aereon--and built Aereon III during the early 1960's. A 3-hulled rigid airship,

* President, Aereon Corporation, Princeton, New Jersey

PRECEDING PAGE BLANK NOT FILMED

85' long, this vehicle demonstrated simple ground-handling. It was dismantled in 1967 after studies indicated a deltoid aerobody would be a superior configuration for a hybrid vehicle. It is a "lifting-body-airship," which we call the Dynairship.

Aereon has been innovating--with private funds, in an abandoned sector of aeronautical research for 14 years--that of airship development.

THE CONCEPTUAL BASIS

If the abandonment and subsequent neglect of airships was in part due to poor economics and operational problems, then innovation would be required, in technology, to overcome these. A more efficient and competitive airship could be developed; specifically:

1. There would need to be an advance in economics by:
 - a) an increase in the productivity of the vehicle, in payload and in speed;
 - b) a decrease in the man-machine interfaces, with a resulting lower labor cost.
2. There would need to be advancement in the art of airship operations, in several areas:
 - a) (Easy) Ground maneuvering and docking.
 - b) (Internal) Loading of bulky cargo and container-freight.
 - c) (Compatible) Flight operations within the existing airport and airways system and facilities.
 - d) (Maneuverable) Flight activity under adverse weather conditions.

Others previously had done work in areas suggestive, especially Dr. Solomon Andrews 100 years before; and N.A.S.A. had developed lifting-bodies for reentry from space, very compact fast vehicles.

THE AEREON APPROACH

Aereon III (Fig. 1), built 10 years ago, was a very ambitious attempt to combine many innovations at once. No wind-tunnel tests were done. The goal was to demonstrate all the innovations in the belief that resulting publicity would bring desired support. An accident to the aircraft cut short these hopes; but already Aereon III was superseded.

Aereon 26 (Fig. 2 - 5), the first "aerobody," evolved by a different philosophy, one which sought to achieve modest and limited goals in a series of steps, so that the greatest risk was assumed at least cost. Progressively larger costs were incurred as more became known about the aerobody. This was the sequence:

1. Parameters for an optimum hybrid aircraft were selected.
2. An optimization computer-search was done, to define the "aerobody" geometry.
3. Research and development then began with the plan to

proceed in 2 stages, consecutively:

- a) aerodynamics
 - b) aerostatics.
4. Aerodynamic research has centered on a series of ever-larger models of the "aerobody" leading to the smallest feasible manned experimental aircraft: Aereon 26.
- a) A balsa and paper model with rubber-band (20 cm.) was flown in a hangar in January 1968; A series of gas-engine powered 4' long radio controlled models were built and tested from spring 1968-1969; 7' model (R.C.) was tested in mid 1970.
 - b) A series of Wind-Tunnel tests during 1968-late 1969; Analog-computer simulation of Aereon 26.
 - c) AEREON 26 - heli-arc welded aluminum structure, aircraft cloth, aluminum sheet, strength-analysis (simple).
 - d) In late 1970 and early 1971 we moved the experimental aerobody to National Aviation Facilities Experimental Center (NAFEC) in New Jersey. Manned flight tests were conducted to obtain--not demonstration; but documentation as to stability and control, and performance.

This program we called Project Tiger (Test Implementation Group Evaluation Report). It is the principal achievement of our company. It has been recorded accurately in "The Deltoid Pumpkin Seed"--a book which appeared first in New Yorker Magazine in 3 parts in February and which a large book club in the U.S. has recommended recently. This was the first public announcement of our flight tests. The book was not done for, or by, Aereon, however.

A 16mm. film of portions of these tests will be presented to this conference. It is the first such presentation to a professional audience. The exact data, however, is proprietary, and may not be released.

Significant findings include the following:

1. Performance was as had been predicted from previous analytical and experimental work. Phototheodolite recordings (at the National Aviation Facilities Experimental Center (NAFEC) a facility of the F.A.A.) verified performance.
2. Stability and control and handling qualities were good. A SFIM recorder on-board obtained precise data.
3. The pilot found the "aerobody" a docile and acceptable aircraft, within the limited scope of the tests.
4. In summary: --the "aerobody" is aerodynamically a feasible concept, and a basis exists for realistic studies of much larger such aircraft. The next step (and major milestone) will be the development of the Dynairship aerobody,

operationally to prove the concept of adding aerostatic lift to this aerodynamically proven configuration.

The final stage for translating the hybrid concept to reality will require the following general sequence, which Aereon is seeking to implement at this time.

1. Seek mission-definition for a (preferably) small hybrid aerobody, as a first step in a long-term plan to scale-up gradually (i.e.--in size of vehicle, cost incurred, development time) so as to control risk, gain from learning-curve benefits, and to develop economically the technology base for larger vehicles, and gradually to develop a market for hybrid aircraft generally.
2. Perform conceptual study of the suitability of the aircraft for performing a stipulated mission.
3. Analytical study of the structure weight and other questions basic to operating economics.
4. Design, build and test (evaluate) a prototype hybrid to determine operational suitability for the mission.

THE MAIN FEATURES OF THE DYNAIRSHIP

The Dynairship is half-way between the airplane and the airship (Fig. 6 - 10). It has much more aerodynamic lift than a comparable airship while, in exchange for this, it could not hover (by buoyant lift), which means it would operate from existing airfields normally and would be compatible with all (but high-speed) airplane traffic. Of course exceptionally large Dynairships (400 - 1,000' long) would require larger facilities. It would carry much more tonnage than the same-sized airship. Dynairship would be more maneuverable in air traffic and general operations including encounters with adverse weather. Dynairship would require smaller groundcrews and would land and taxi like an airplane. There would be a large gain in productivity over classical airship concepts for commerce of non-specialized loads. It would be less sensitive to wind-conditions for schedule-reliability and loading and unloading.

The Dynairship should be more energy-conservative than typical transport airplanes, with a lower ton-miles per hour productivity, but less thrust horse-power will be required and large cube-capacity for low-density cargoes or low-density fuels is available at no penalty to cargo space. Operating cost as well as acquisition-cost benefits may be realized were diesel engines to be made available.

In contrast to many airplanes, a hybrid aircraft offers a long-loiter capability at low fuel consumption while it could also have a top speed twice that of blimps. This combination is useful for patrol tasks, whether over cities or ocean spaces.

Aereon, lacking any widely-recognized criterion for estimation of airship structure weights (a basic element in cost estimates as well as operating economics), has assumed a structure-weight growth law following that of airplanes (Fig. 11). However, increases in size cause acquisition-cost benefits (Fig. 12) due to the growth of buoyant lift as a percentage of total lift and, at design-speeds of 150-200 mph, diesel engines substantially lower acquisition costs (theoretically). Such engines are not now in service.

Does the Dynairship configuration represent a specially effective design for a hybrid aircraft? Aereon's invention is based on the fact that it does. The significance is that the aerodynamic center occurs, in a highly-swept delta-body, near the 50% chord where the center of buoyancy also occurs, and where the "CG" is placed; and there is a minimum of trim control devices, therefore since there is a minimum disturbance to the stability of the deltoid Dynairship with speed changes, it is possible to carry a full range of tonnages at various speeds without major trim requirements. Maximum control authority is maintained under all normal flight maneuvers. Certain other planform shapes do not offer these inherent advantages but require energy-consuming, drag-creating means to provide trim. In sum, features of the Dynairship which represent capabilities of value are:

1. Improvement in performance over airships.
2. Improvement in energy-conservation over airplanes.
3. Potential benefits in acquisition cost.
4. Improvement in operational-efficiency over other hybrid concepts.

HYPOTHETICAL DYN AIRSHIPS (Fig. 13 - 14)

A Small Patrol Aircraft

Length: 50'	50 mph cruise; mission = 8 hour loiter with
Gross (N): 4,000 lb.	crew of 3 men and a speed range of 40 - 120
Power: 300 h.p.	mph for aerial observation at low noise level
	and low fuel consumption with high crew ef-
	ficiciency and stable flight.

A Medium-Size Cargo Aircraft*

Length: 200'	150 mph cruise: mission = 90 tons of freight
Gross (N): 270 T	for a 1000 mile range, using medium to small
#200 = \$3,000,000.	fields, at energy-conserving levels of oper-
	ation.

A Logistic Carrier*

Length: 1,000'

Gross: 4,200 T

#200 = \$65,000,000.

150 mph cruise; mission = 3,300 tons of bulk cargoes, or natural resources, from (or to) remote areas, under various weather conditions, to special airfields, where both large volumes and tonnages are required, at lowest effective acquisition cost per vehicle.

*Low confidence attached to preliminary estimates.

SUMMARY

With historical roots which are over 100 years old, Aereon Corporation, founded 14 years ago, has since then existed for the goal of developing aircraft which most effectively combine aerodynamic lift with aerostatic lift. Since 1967, the "aerobody" concept has been the means. (This could be described as an L.B.A.--a "Lifting Body Airship"--since it has no wings yet would develop substantial aerodynamic lift over the body.)

At first intuitively, then analytically and experimentally, the aerobody has been developed. Having determined--through a series of model tests and manned flight test--that it is aerodynamically and technically a feasible concept, the next major technical milestone is to develop and evaluate the aerobody in a larger size, in which buoyant lift would be significant.

Economic feasibility has not been established and must be investigated for a variety of missions, to which the capabilities of the conceptual aircraft-family may be suited. The helium-filled, delta aerobody we call the Dynairship, (or dynamic-lift airship). Its special features include:

1. Flight operations compatible with airplanes.
2. Economies in energy-consumption like airships.
3. Maneuverability improvement over airships and long-loiter improvement over airplanes.

Aereon's business is advanced airship-technology. We have, with our private funds, demonstrated our commitment. We have, alone in the world, flight-tested an optimized aerodynamic pre-prototype of the lifting-body-airship. Next, the Dynairship.

NOTE: All photographs and drawings copyrighted by Aereon, Inc. and may not be reproduced without permission.

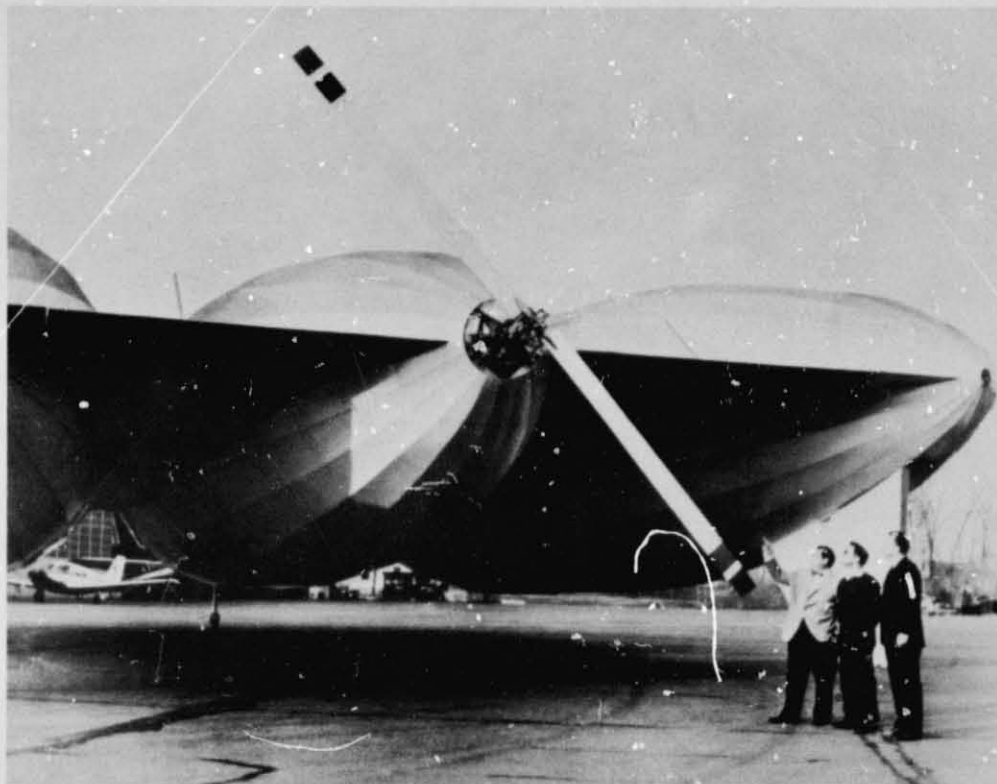

Figure 1. Aereon III, Mercer Co. Airport, Trenton, N. J.,
C. A. Beck, J. R. Fitzpatrick, M. Drew, Jr. (l.-r.), 1964

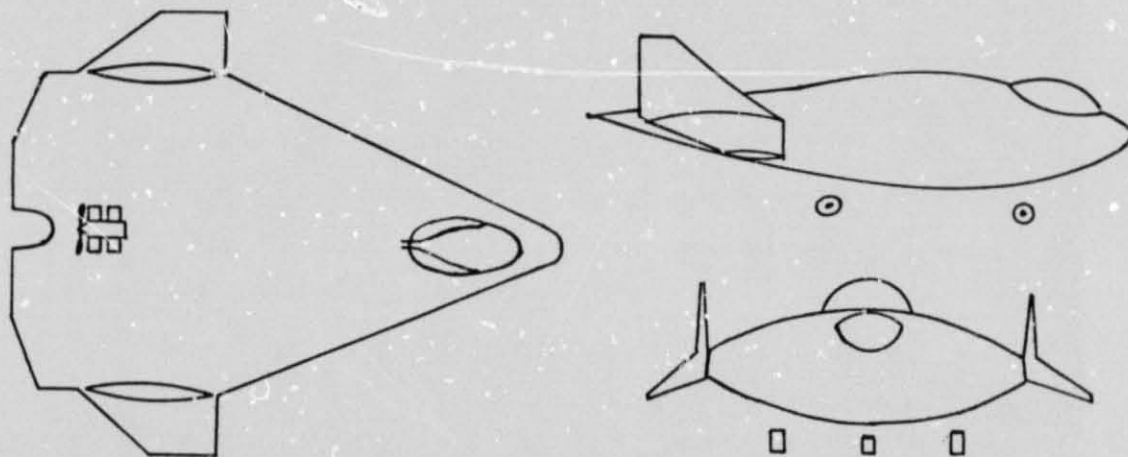

Figure 2. Aereon 26 Schematic



Figure 3. Aereon 26 During Ground Tests, Red Lion, N. J., 1969

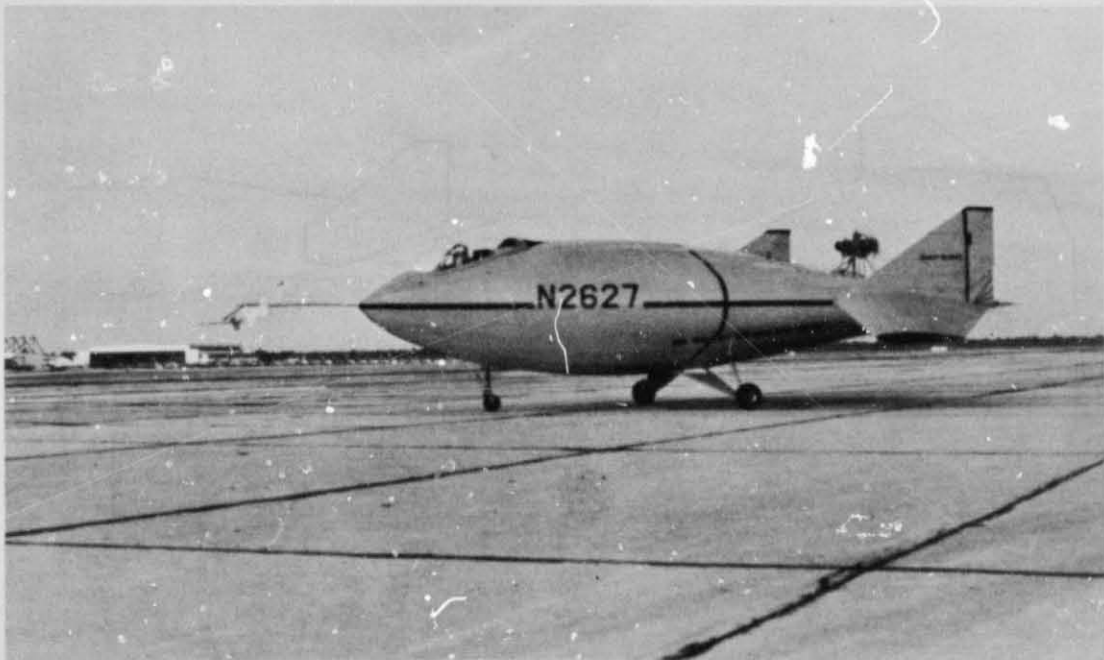

Figure 4. Aereon 26 Taxi Tests, NAFEC, Atlantic City, N.J., 1971

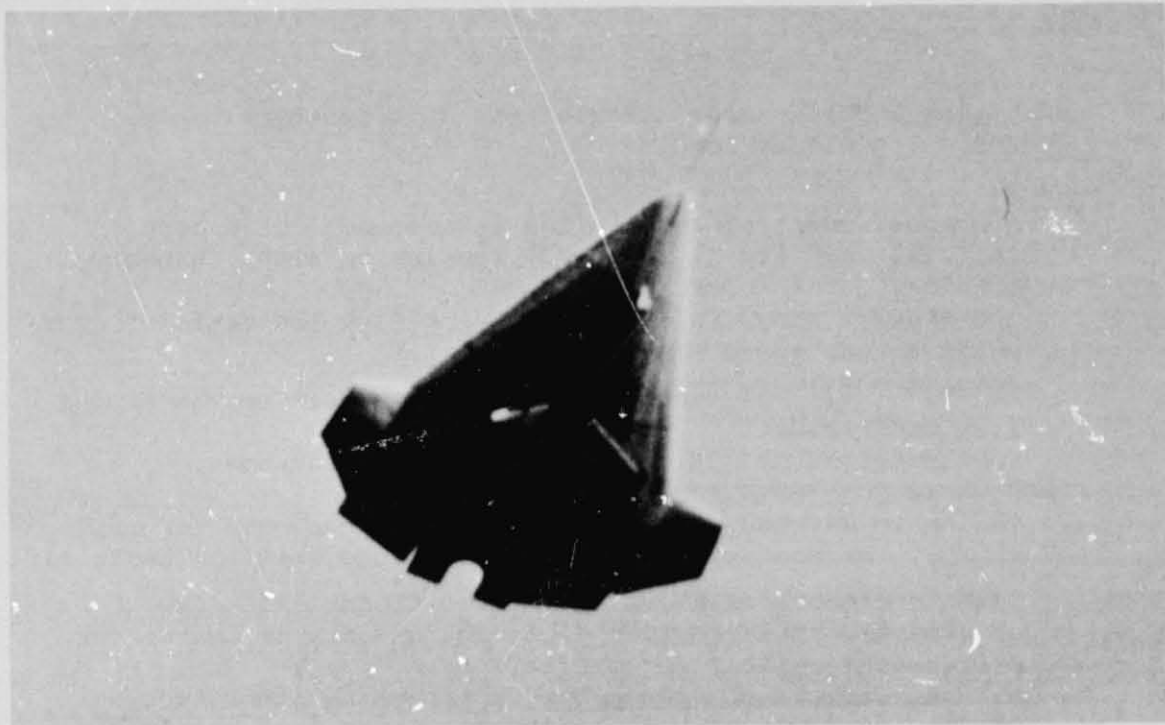

Figure 5. Aereon 26 in Flight, NAFEC, Atlantic City, N.J., 1971

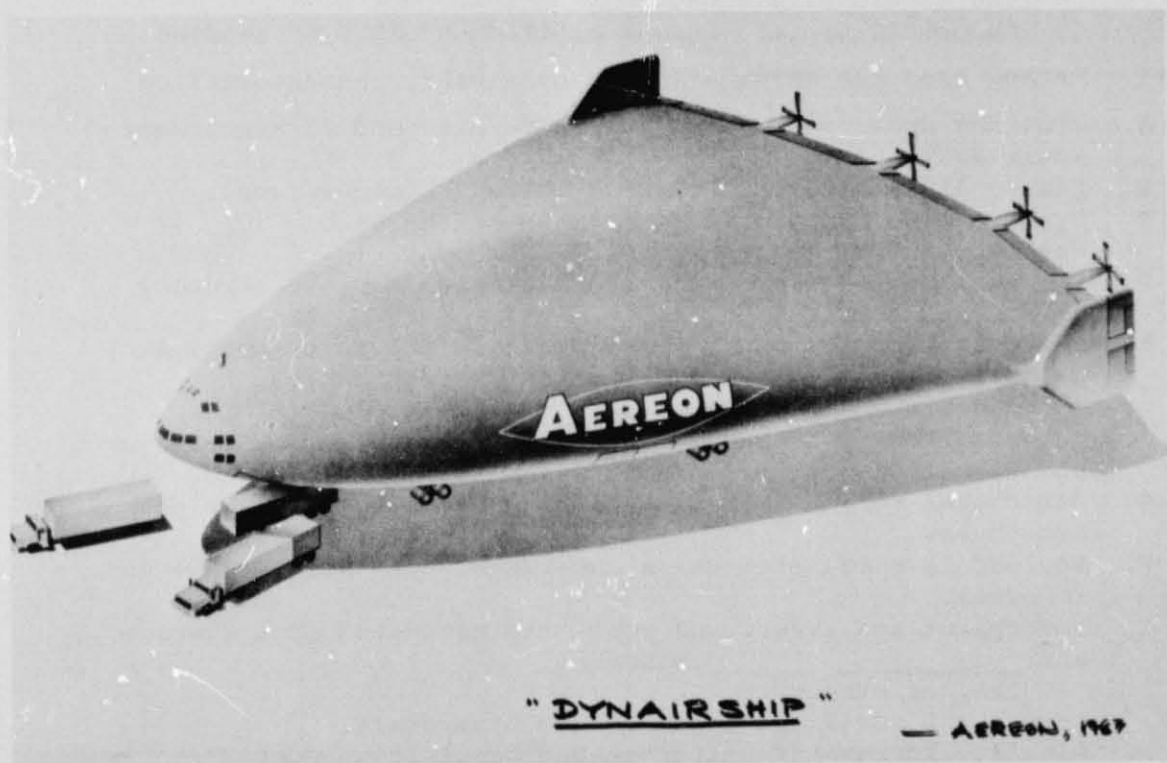

Figure 6. The Dynairship

THE APPROACH USED IN PREPARATION OF DISPLAYS
WHICH FOLLOW

- I. Assumptions made in range calculations of large Dynairships,
i.e. 200 - 1,000 feet long.
- A. RANGE:
1. A Breguet range of 1,000 miles is assumed. This means that the quantity $\frac{1}{SFC} (L_D/D)$ remains constant throughout mission.
 2. The Breguet range is optimized by setting the cruising speed equal to the speed for max (L_D/D) , i.e.
 $V_{cruise} = V_{(L_D/D) \text{ max.}}$ This assumption defines the cruise lift coefficient.
 3. Fuel reserves of 15% of required fuel are assumed.
- B. AERODYNAMIC CONFIGURATION:
1. The basic aerobody shape is (optimally) cambered for maximum (L_D/D) , the condition of optimality being that the basic lift (due to camber) is equal to the additional lift (due to angle of attack). This implies different amounts of camber for different dynamic lift coefficients.
 2. All the effects of the camber variation on items such as volume, wetted area and structural weight have been neglected as a first approximation.
 3. The static lift, L_S , is assumed constant during the mission.
The static lift equation is $2.26 \times 10^{-3} \times \rho^3$.
 4. An operating (mid-range) altitude of 10,000' assumed.
- II. Method used for calculation of Dynairship characteristics
- A. Cruising speed and overall size (V_{cruise} and ρ) are independently assigned.
 - B. Static lift is calculated from the size (and volume).
 - C. Dynamic lift is calculated from speed and size. (C_{L_D} is determined from assumption I, A, 2 above)
 - D. The required cruise HP is then estimated for the aerobody optimum (L_D/D) .
 - E. The weight of the power plants (diesel and turbo-prop) is calculated given average PowerPlant Weight ratios.
SHP Installed
 - F. The required fuel is calculated from the S.F.C. of turbo-prop and diesel powerplants.
 - G. Structural weight is evaluated from the Structural Weight Growth Law.
 - H. Payload is calculated using mid-range fuel (half fuel + 15% reserve).
 - I. Powerplant and structural costs are estimated from average $\frac{\$}{HP}$, and $\frac{\$}{\text{lbs. of structure}}$ ratios.
Structural costs are based on 200th aircraft.
 - J. Finally, Energy-Effectiveness and Acquisition-Cost Effectiveness are estimated for the Dynairship.

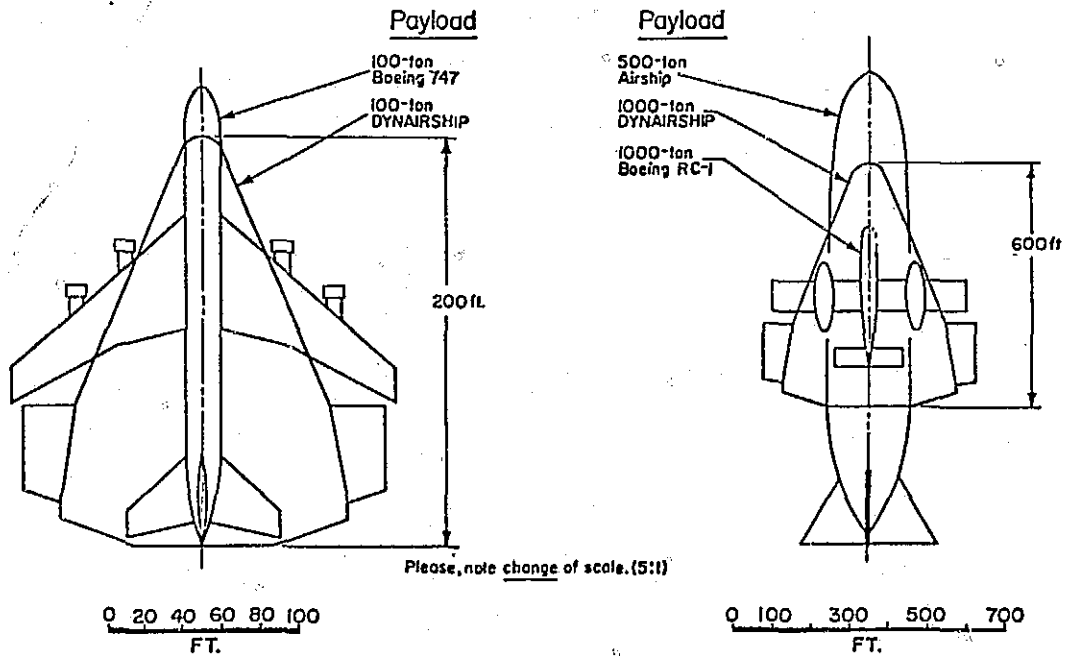

Figure 7. Dynairship Size and Payload Comparisons

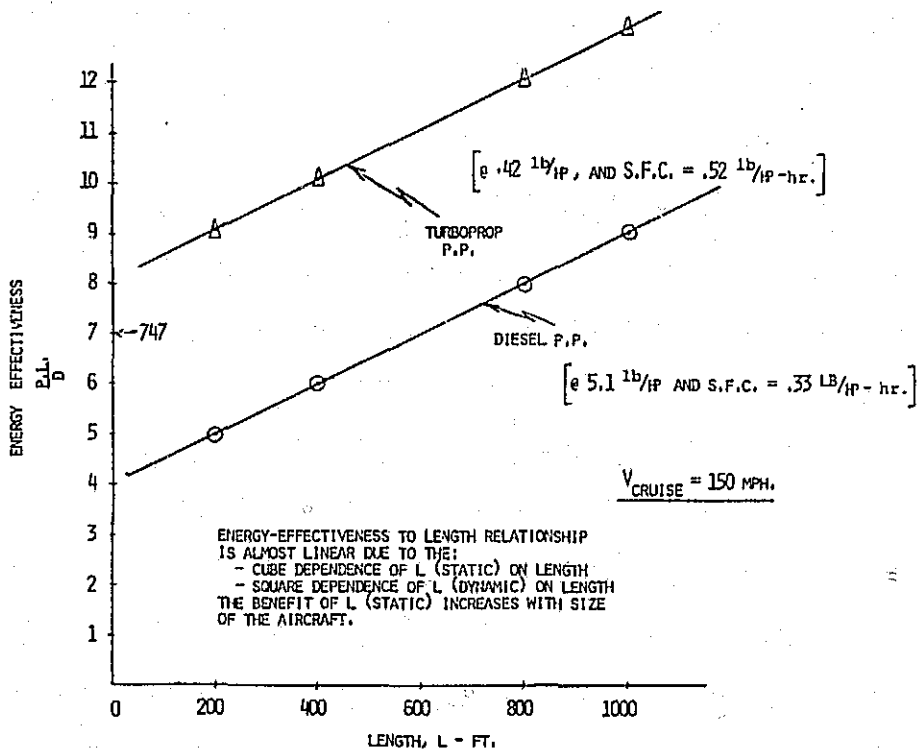

Figure 8. Dynairship Energy Effectiveness

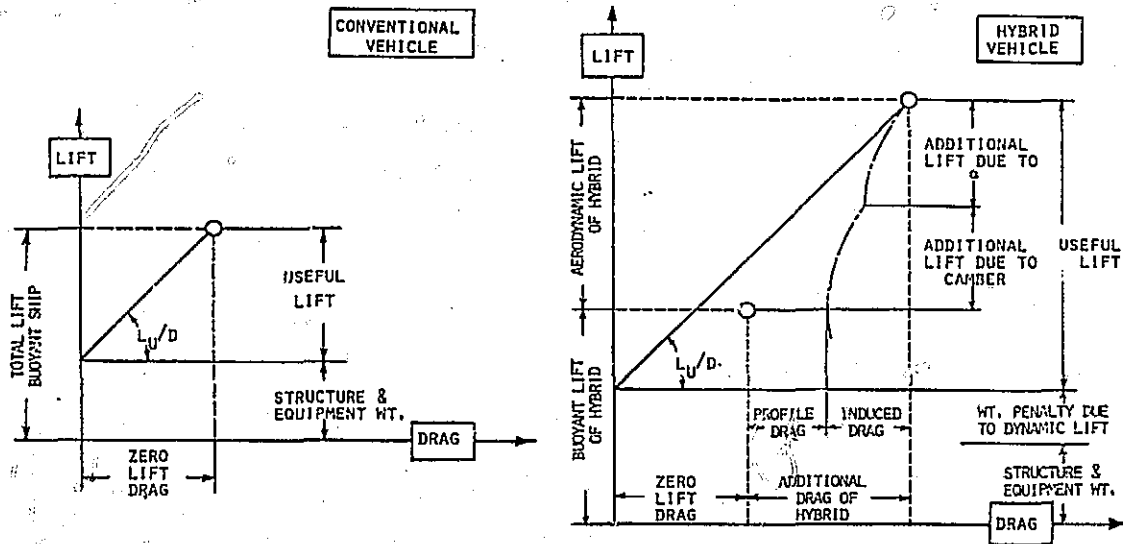

Figure 9. Useful Lift and Drag for Conventional and Hybrid Airships

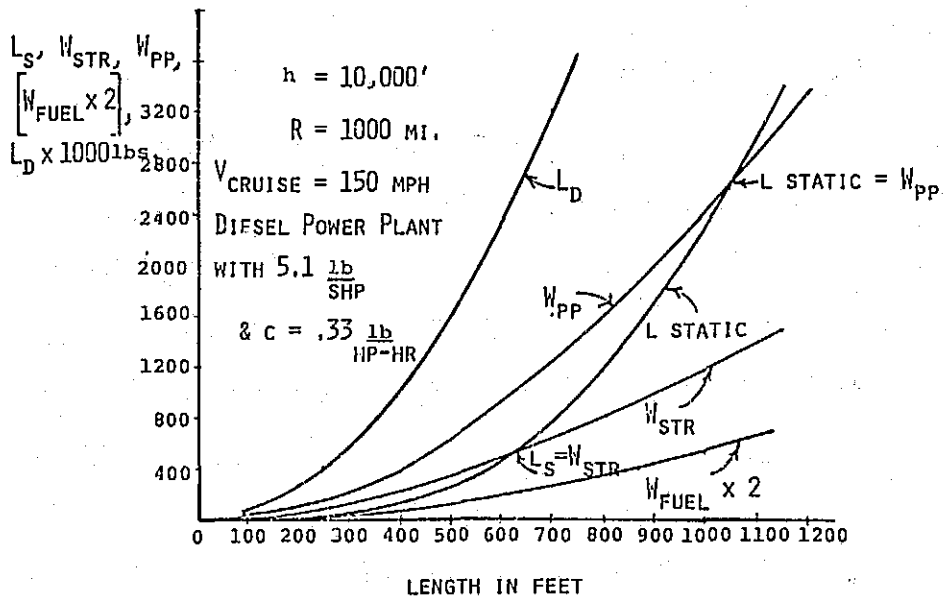

Figure 10. Dynairship Weights and Lifts vs. Size

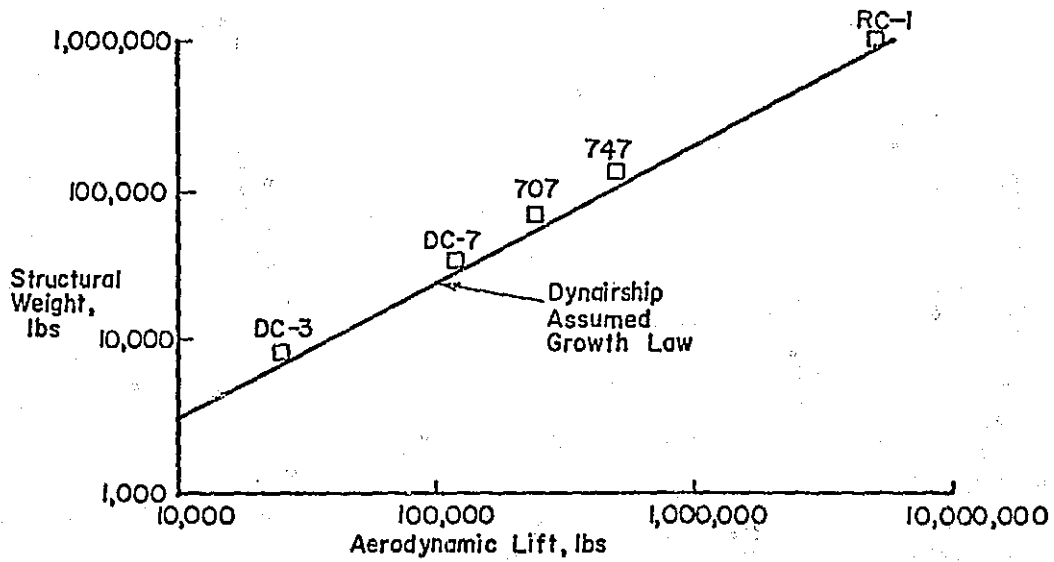

Figure 11. Structural Weight Growth Law

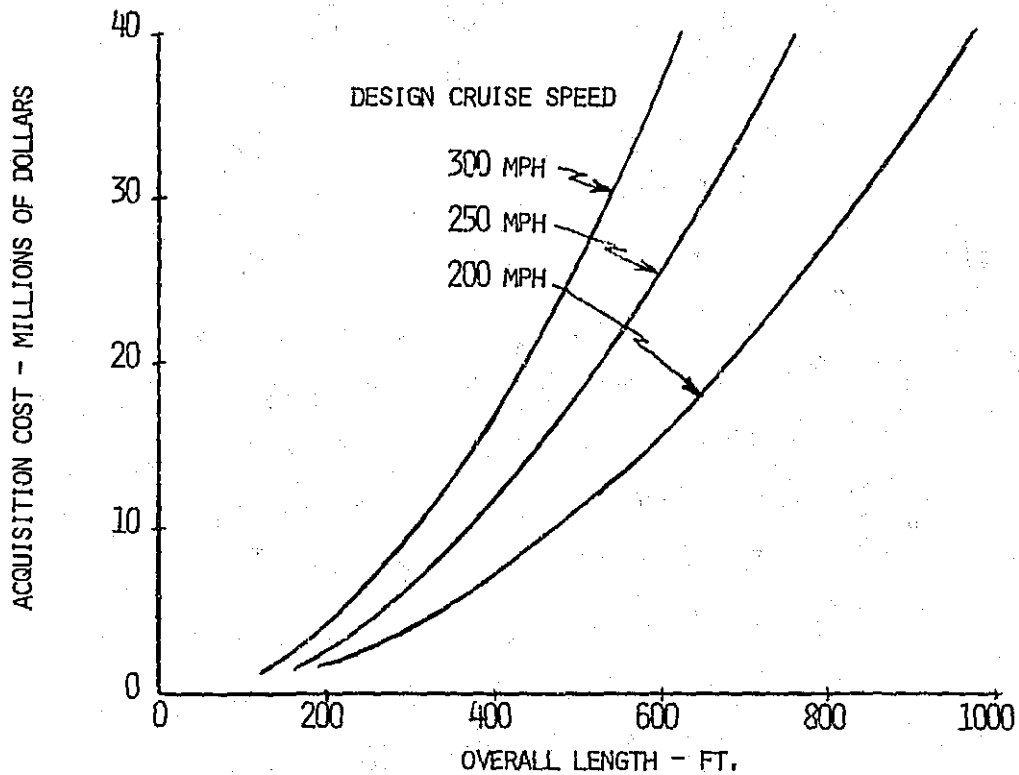

Figure 12. Dynairship Acquisition Cost (200th Aircraft)

PHASE I



PHASE III

REMOTE AREA LOGISTICS

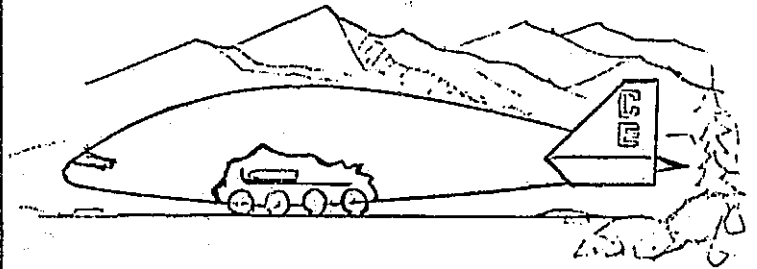

PHASE II

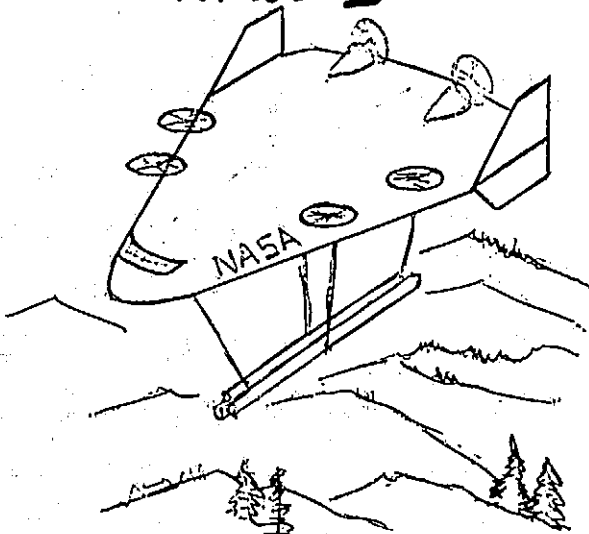

- RESEARCH
- SYSTEMS (V/STOL)
- ECONOMICS
- COMMERCE
- BULK LIFTER
- MASS TRANSPORT

OCEANIC SURVEILLANCE

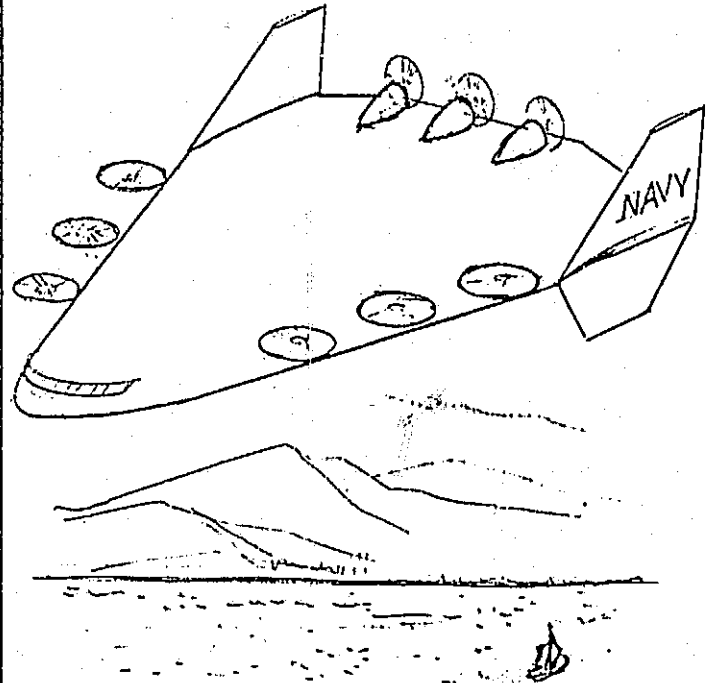

Figure 13. Phased Development for Dynairships

Figure 14
A PATROL AEROBODY

What is the 'aerobody' and how is it innovative?

1. A hybrid, a mix of aerostatic with aerodynamic lift, the 'aerobody' is a lifting-body of deltoid planform, elliptical cross-sections, and a fineness ratio of 4:5. Body geometry was derived from a computer-assisted optimization-search program. Several patents covering key aspects of this invention have been issued to Aereon both in the United States and abroad.
2. In operation, it is stable with acceptable handling qualities. Characterized by a low body-loading, it is capable of very low-speed flight and STOL. As a partially buoyant vehicle it is sure, however, to be much more maneuverable than a blimp. (It would require powered-lift for hover, at lower loadings than for heavier-than-air craft.) It would operate much like a STOL airplane in lower speed flight, but with considerably less fuel consumption, being capable of protracted loiter at speeds of 30 - 50 mph. Dash speeds comparable to or faster than helicopters now in service (reciprocating), and certainly faster than blimps, are normal expectations for the 'aerobody.' This combination of features would permit shorter response-time from its loitering station to any urgent call to counter a threat due to a high state of readiness. A loiter-time of 8 hours is assumed.
3. Below are presented two representative STOL 'aerobody' configurations, not the result of experimental work but based on the projections made from analytical and experimental test data. The aircraft are basic, not adorned with lift-augmenting refinements. Therefore feasibility and preliminary design studies are in order, fully to apply the 'aerobody' concept to Police missions.

	SMALL	LARGE
OVERALL LENGTH	- 50 ft.	100
OVERALL WIDTH	- 40 ft.	80
NORMAL GROSS WEIGHT ¹	- 3,990 lb.	7,610
CARGO AND CREW	- 1,600 lb.	3,700
LOITER SPEED	- 50 mph	30
MAX. LEVEL FLIGHT SPEED	- 130 mph	75
INSTALLED POWER	- 290 HP	210
TAKEOFF DISTANCE OVER 50'	- 770	300

¹Gross Wt. is defined as Gross Mass x g.