

APPLICATION OF THE CINGEN PROGRAM

A THERMAL NETWORK DATA GENERATOR

William E Schultz and Ronald P. Schmitz

Sperry Support Services

INTRODUCTION

Since the introduction of the digital computer, analytical simulation of complex physical systems has become a major vocational entity. Although computer speed now makes formerly impossible solutions easily accessible, there is rarely enough lead time between design and fabrication to do a thorough computer analysis. Sperry Support Services engineers have increased their efficiency in analysis of thermal and structural systems by developing computer programs which automatically develop the necessary data for computer simulation and provide visual output to aid the analyst in verification of the model. The primary program for discussion in this paper is entitled CINGEN (Ref. 1), a contraction of CINDA data GENERATOR, after the CINDA thermal analysis program (Ref. 2). Supporting programs, COON3D (Ref. 3) and GEOMPLT (Ref. 4) developed for structural analysis and adapted for use with CINGEN, will also be discussed.

CINGEN TECHNIQUE

Present state-of-the-art mathematical modeling techniques for evaluation of structural and thermal performance of physical systems are distinctly different. The leading method for structural analysis is the finite element approach. The finite differencing technique is most frequently used for thermal analysis. Although thermal problems can be solved by finite element analysis (See Refs. 5 and 6), present state-of-the-art finite element programs cannot compete in computer execution speed with conventional thermal programs using the finite differencing method. Frequently separate thermal and structural math models must be developed which have a one-to-one positional correspondence to allow thermal loads to be evaluated in the structural analysis (Ref. 7). The duplication of modeling effort can be quite costly, especially if large systems are involved. Avoidance of this duplication effort and a desire for a geometrical representation of the thermal model to reduce modeling errors were key factors which prompted the development of CINGEN.

The CINGEN program simplifies the thermal modeling process by performing all of the capacitance and conductance calculations normally done by the analyst. Each solid element is divided into five tetrahedrons, allowing the total volume to be calculated precisely. The thermal capacitance is then calculated as the product of volume, density and specific heat. The center of gravity of each element is calculated, and the thermal resistance is based on the distance between element centroids divided by the product of the element interface area

and the thermal conductivity. There is no problem with elements of dissimilar materials having a common interface, since the total conductance between the elements is the reciprocal of the sum of the thermal resistances for each node to the interface.

Mathematical modeling of thermal systems is somewhat of an art and reliability depends greatly on the principle of subdivision of the system. A thermal analyst can use CINGEN without prior experience with finite element modeling techniques and without the aid of supporting programs. He needs only to determine the physical location of desired coordinates for each desired element. The sample problem chosen includes both manually developed and automatically developed input for CINGEN.

SAMPLE PROBLEM

Figure 1 lists seven basic steps in the utilization of CINGEN, and supporting programs COON3D and GEOMPLT. COON3D was developed by Sperry Support Services to automatically generate a three-dimensional solid-element grid mesh of desired systems. The program has the ability to generate multilayer models as exhibited in the sample problem. Figure 2 is the COON3D input which describes the four bounding curves for each surface. Figure 3 contains the COON3D output and the manually developed input for CINGEN. For verification of the COON3D model, program GEOMPLT is used to display the model on the CRT graphics screen. Figure 4 contains the GEOMPLT user options as viewed on the CRT screen. Figure 5 displays the GEOMPLT user option of plotting NASTRAN bulk data which was generated by COON3D and by manual development, and the option to plot the thermal network created by CINGEN. Figure 6 contains a sketch of the actual hardware and a side view of the CINGEN model.

When the analyst is satisfied with the appearance of the COON3D generated model, CINGEN is executed. Figure 7 contains the CINGEN output which is a format acceptable to the thermal analyzers CINDA, SINDA, and MITAS (Refs. 2, 8, and 9). Data files are also created which allow the analyst to view the thermal network created by CINGEN. Figures 8(a) to 8(h) are a series of partial views of the thermal network displayed by GEOMPLT. If the analyst is satisfied with the model, he can use the Text Editor processor capability of UNIVAC 1100 series computers to input the system boundary conditions and then execute SINDA. The resulting SINDA solution can be viewed using the special purpose line printer plotter routine (Ref. 10) for X-Y plotting, Figure 9.

CONCLUDING REMARKS

With the aid of these analytical tools - CINGEN, COON3D, GEOMPLT - analysis cost and time can be drastically reduced from manual development of models. In addition, the visual verification of the models provides added confidence in the accuracy of the model. These tools will lead to reduced time between design, analysis, and fabrication and contribute to final development of the best design rather than one which is expedient.

REFERENCES

1. Schultz, W. E.: "Automated Data Generation for Thermal/Structural Models," Attachment 1. Sperry Support Services Memorandum, Huntsville, Alabama, October 17, 1974.
2. Gaski, J. D., Lewis, D. R., and Thompson, L. R.: "Chrysler Improved Numerical Differencing Analyzer for Third Generation Computers," TN-AP-67-287, October 20, 1967.
3. Chan, G. C.: "Automated Data Generation for Thermal/Structural Models," Attachment 2. Sperry Support Services Memorandum, Huntsville, Alabama, October 17, 1974.
4. Schmitz, Ronald P.: "GEOMPLT - Interactive Graphics Program for Finite Element and Thermal Network Models." Sperry Support Services, Huntsville, Alabama, November 30, 1974.
5. Zienkiewicz, O. C.: The Finite Element Method in Engineering Science, Second Edition, McGraw-Hill Pub., Ltd., Berkshire, England, 1971.
6. McCormick, C. W.: Editor. "The NASTRAN User's Manual," (Level 15.6). NASA SP-222(01), January 1975. (Revised by Sperry Support Services, Huntsville, Alabama.)
7. Loafman, J. W., Schmitz, R. P., and Eldrige, C. M.: "NASTRAN Thermo-structural Analysis of a High Energy Laser Mirror and Comparison with CINDA Thermal Analysis," Fifth Annual Navy-NASTRAN Colloquium." September 10, 1974.
8. Smith, J. P.: "SINDA User's Manual." NASA Contract 9-10435, TRW System Group, April 1971.
9. "Martin Interactive Thermal Analysis System." MDS-SPLPD-71-FD238, Martin Marietta Corporation Denver Data Center, Denver, Colorado, March 1971.
10. Schultz, W. E., and Stephen, L. A.: "A Self-Contained Line Printer Plotting Routine." Sperry Support Services Memorandum, Huntsville, Alabama, May 30, 1974.

STEPS	FUNCTION	HARDWARE	SOFTWARE
1	GENERATE FINITE ELEMENT MODEL	TTY	COON3D/MANUAL
2	DISPLAY MODEL	CRT	GEOMPLT/PLOT MODE
3	EDIT MODEL	CRT	GEOMPLT/EDIT MODE
4	GENERATE THERMAL NETWORK	TTY	CINGEN
5	DISPLAY THERMAL NETWORK	CRT	GEOMPLT/THERMAL NETWORK PLOT
6	SINDA DECK SET UP	TTY	FUR/PUR
7	SINDA ANALYSIS	TTY (BRKPT)	SINDA

Figure 1.- Basic steps in the use of CINGEN.

SPACE SHUTTLE HYDRAULIC ENGINE ACTUATOR INTERFACE RING

CURVE U 0			CURVE U 1			
X	Y	Z	X	Y	Z	
1	0.00000	2.30000+00	-6.50000+00	2.00000+00	0.00000	-6.50000+00
2	0.00000	3.30000+00	-6.50000+00	3.30000+00	0.00000	-6.50000+00
CURVE W 0			CURVE W 1			
X	Y	Z	X	Y	Z	
1	0.00000	2.00000+00	-6.50000+00	0.00000	3.30000+00	-6.50000+00
2	1.40000+00	1.40000+00	-6.50000+00	3.30000+00	2.30000+00	-6.50000+00
3	2.00000+00	0.00000	-6.50000+00	3.30000+00	0.00000	-6.50000+00

Figure 2.- Sample COON3D input data.

CIS30A	3004	5204	5203	5205	5206	5304	5303	5305	3004	} Manual
3004	5304									
CIS304	3005	5301	5302	5303	5304	5401	5402	5403	3005	
3005	5404									
CIS308	3006	5304	5303	5305	5306	5404	5403	5405	3006	
3006	5406									
CIS308	3007	5401	5402	5403	5404	5501	5502	5503	3007	
3007	5504									
CIS308	3008	5404	5403	5405	5406	5504	5503	5505	3008	} COON3D
3008	5506									
CIS308	10001	10001	10002	10005	10004	10101	10102	10105	10001	
10001	10104									
CIS308	10002	10002	10003	10006	10005	10102	10103	10106	10002	
10002	10105									
CIS308	10003	10004	10005	10008	10007	10104	10105	10108	10003	
10003	10107									
CIS308	10004	10005	10006	10009	10008	10105	10106	10109	10004	
10004	10108									
CIS308	10101	10101	10102	10105	10104	10201	10202	10205	10101	} COON3D
10101	10204									
GRID	5501		-.420	-.420	3.530					
GRID	5502		-.420	-.420	3.530					
GRID	5503		.420	.000	3.530					
GRID	5504		-.420	.000	3.530					
GRID	5505		.420	.420	3.530					
GRID	5506		-.420	-.420	3.530					
GRID	10001		.000	2.000	-6.500					
GRID	10002		1.400	1.400	-6.500					
GRID	10003		2.000	.000	-6.500					
GRID	10004		.000	2.000	-6.500					
GRID	10005		1.850	1.850	-6.500					
GRID	10006		2.650	.000	-6.500					

Figure 3.- Sample element and grid data automatically developed by COON3D and manually developed input for CINGEN.

OXQT GEOM MPA

```
  X X
  X X
 XX XX
XXXXX XXXXX
XXXXX XXXXX
  XX XX
  X X
  X X
```

```
XXXXXXXXXXXXXXXX XXXXX XXXXXXXXXXXXXXX X X
X X X X X X X X X X X X
XXXX XXXXX XXX XXXXX XXX XXX
  X X X X X X X
XXXX X XXXXX X XX XX X
```

INTERACTIVE GRAPHICS PROGRAM
GEOMPLT VERSION 3.0
GENERATED BY SPERRY SUPPORT SERVICES
NOV 74

DIFFERENTIAL TRANSDUCER MANUALLY DEVELOPED

```
** TYPE ( $INPUT (OPTIONS) $)
** NOTE- 1ST COLUMN IS IGNORED FOR NAMELIST INPUT.
**      (.) AS LAST CHARACTER TO CONTINUE ON NEXT LINE,
**      ($) AS LAST CHARACTER TERMINATES NAMELIST INPUT
=INPUT PROGRAM=3.NODENO=1.PU=1$
** TYPE ( $PVIEW JPU(1)= ,(ELEMENT NUMBERS) $)
** TO DEFINE PARTIAL VIEW

** NOTE - 1ST COLUMN IS IGNORED FOR NAMELIST INPUT.
**      (.) AS LAST CHARACTER TO CONTINUE ON NEXT LINE,
**      ($) AS LAST CHARACTER TERMINATES NAMELIST INPUT
**      (-@ OR 4HTRU) IS USED FOR CONSECUTIVE NUMBERS
**      EXAMPLE 1,-@,4= 1,2,3,4.
```

Figure 4.- GEOMPLT header page and typical user options.

TOTAL RESISTANCE NETWORK
** TYPE (C) TO CONTINUE

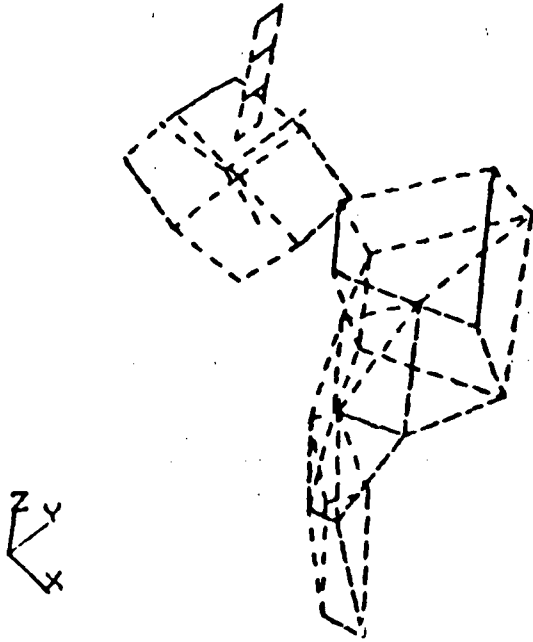

TOTAL RESISTANCE NETWORK
** TYPE (C) TO CONTINUE

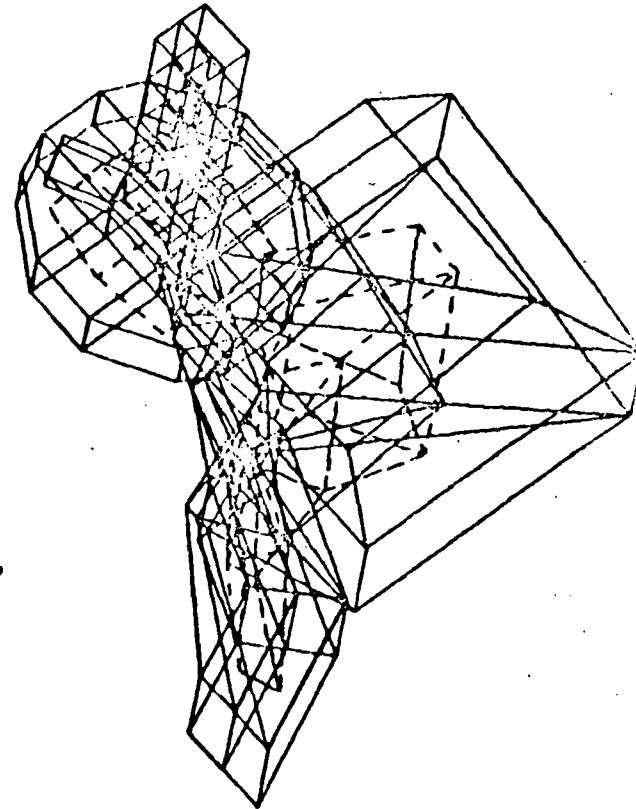

Figure 5.- Total model NASTRAN type bulk data and resistance network.

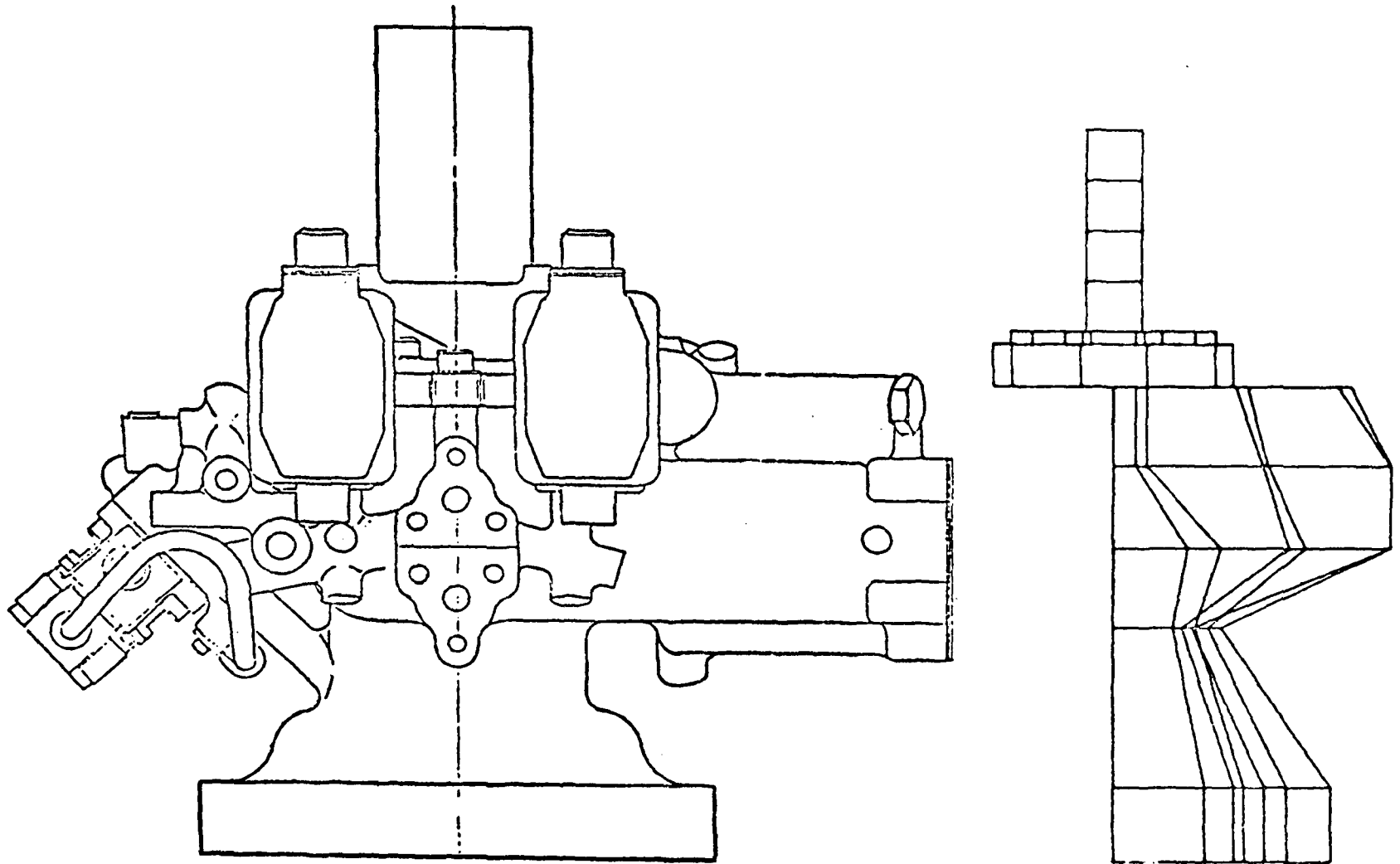

Figure 6.- Sketch of the actuator and the CINGEN model.

CINDA MODEL BEGINS WITH A BLANK CARD

```
BCD 3THERMAL SPCS
BCD 6TITLE= SPACE SHUTTLE HYDRAULIC ENGI
BCD 6NE ACTUATOR INTERFACE RING
END
BCD 3NODE DATA
1001,100., .01262
1002,100., .01666
1003,100., .01666
1004,100., .01666
1005,100., .01666
1006,100., .01383
1007,100., .01383
1008,100., .01383
1009,100., .01383
2001,100., .00287
2002,100., .00277
2003,100., .00230
2004,100., .00230
2005,100., .00227
3001,100., .00557
3002,100., .00557
3003,100., .00557
3004,100., .00557
3005,100., .00557
3006,100., .00557
3007,100., .00557
3008,100., .00557
10001,100., .02370
10002,100., .02370
10003,100., .03029
10004,100., .03029
10101,100., .02796
10102,100., .02919
10103,100., .03436
10104,100., .03655
10201,100., .04216
10202,100., .03919
10203,100., .06521
10204,100., .06513
10301,100., .06831
10302,100., .07844
10303,100., .17928
10304,100., .15652
10401,100., .06087
10402,100., .05647
10403,100., .14438
10404,100., .13388
END
```

Figure 7.- Computer printout of the model generated by CINGEN.

BCD 3CONDUCTOR DATA

1, 1001, 1002, 3.86207
2, 1001, 1003, 3.86207
3, 1001, 1004, 3.86207
4, 1001, 1005, 3.86207
5, 1002, 1006, 5.51663
6, 1002, 1009, 5.51663
7, 1003, 1007, 5.51663
8, 1003, 1008, 5.51663
9, 1004, 1008, 4.15913
10, 1004, 1009, 4.15913
11, 1005, 1006, 4.15913
12, 1005, 1007, 4.15913
13, 2001, 2002, 2.40120
14, 2001, 2003, .82993
15, 2001, 2004, .82993
16, 2007, 2005, 1.43174
17, 3001, 3002, 11.20000
18, 3001, 3003, 4.03200
19, 3002, 3004, 4.03200
20, 3003, 3004, 11.20000
21, 3003, 3005, 4.03200
22, 3004, 3006, 4.03200
23, 3005, 3006, 11.20000
24, 3005, 3007, 4.03200
25, 3006, 3008, 4.03200
26, 3007, 3008, 11.20000
27, 10001, 10002, 2.68636
28, 10001, 10003, 26.72456
29, 10001, 10101, 2.92444
30, 10002, 10004, 26.72456
31, 10002, 10102, 3.03076
32, 10003, 10004, 2.10140
33, 10003, 10103, 3.20498
34, 10004, 10104, 3.37718
35, 10101, 10102, 5.12264
36, 10101, 10103, 71.09416
37, 10101, 10201, 2.66558
38, 10102, 10104, 74.85917
39, 10102, 10202, 2.80583
40, 10103, 10104, 4.19219
41, 10103, 10203, 2.04396
42, 10104, 10204, 2.39383
43, 10201, 10207, 6.07447
44, 10201, 10203, 15.65426
45, 10201, 10301, 8.18221
46, 10202, 10204, 20.24132
47, 10207, 10302, 8.40394
48, 10203, 10204, 3.93730
49, 10203, 10303, 4.27694
50, 10204, 10304, 5.56573
51, 10301, 10302, 9.93401
52, 10301, 10303, 8.42990
53, 10301, 10401, 16.28932
54, 10302, 10304, 9.99392

Figure 7.- Continued.

```

55,10302,10402, 15.41091
56,10303,10304, 4.60041
57,10303,10403, 27.92661
58,10304,10404, 33.33628
59,10401,10402, 13.20353
60,10401,10403, 6.82662
61,10402,10404, 7.37689
62,10403,10404, 5.27584
END
BCD 3CONSTANTS DATA
TIMEND,0.01,OUTPUT,0.001,ITEST,0
END
BCD 3ARRAY DATA
-100,SPACE,100,END $ TIME ARRAY
-101,SPACE,100,END $ TEMP ARRAY
-102,SPACE,100,END $ TEMP ARRAY
200
BCD 6 TIME IN HOURS
BCD 6 ,END
201
BCD 6 TEMPERATURE -DEGREES F
BCD 6 ,END
202
BCD 6 LINE PRINTER PLOT OF SAMPLE PROBLEM
BCD 6 ,END
END
BCD 3EXECUTION
DIMENSION X(4000)
F NDI=4000
F NTH=0
CNFRWD
PLOTIT(0,2,40,70,ITEST,A100,A101,A202,A200,A201)
PLOTIT(1,2,40,70,ITEST,A100,A102,A202,A200,A201)
END
BCD 3VARIABLES 1
END
BCD 3VARIABLES 2
END
BCD 3OUTPUT CALLS
TPRINT
F ITEST=ITEST+1
STOARY(ITEST,TIMEN,A100) $ TIME
STOARY(ITEST,T10001,A101) $ RING
STOARY(ITEST,T10101,A102) $ CONE
END
BCD 3END OF DATA

```

Figure 7.- Concluded.

RVDT DIFFERENTIAL TRANSDUCER MANUALLY DEVELOPED

** TYPE (C) TO CONTINUE

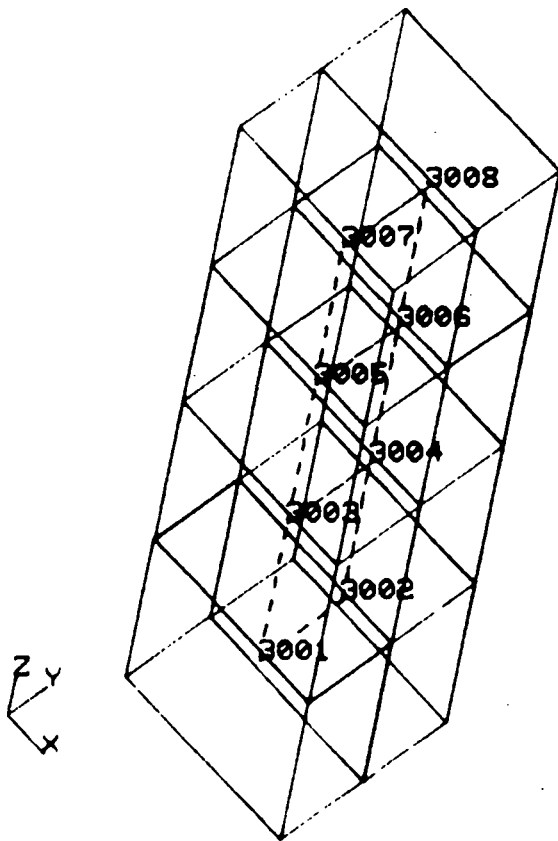

(a) Partial view of the RVDT.

Figure 8.- Resistance network.

MOUNTING BRACKET MANUALLY DEVELOPED

** TYPE (C) TO CONTINUE

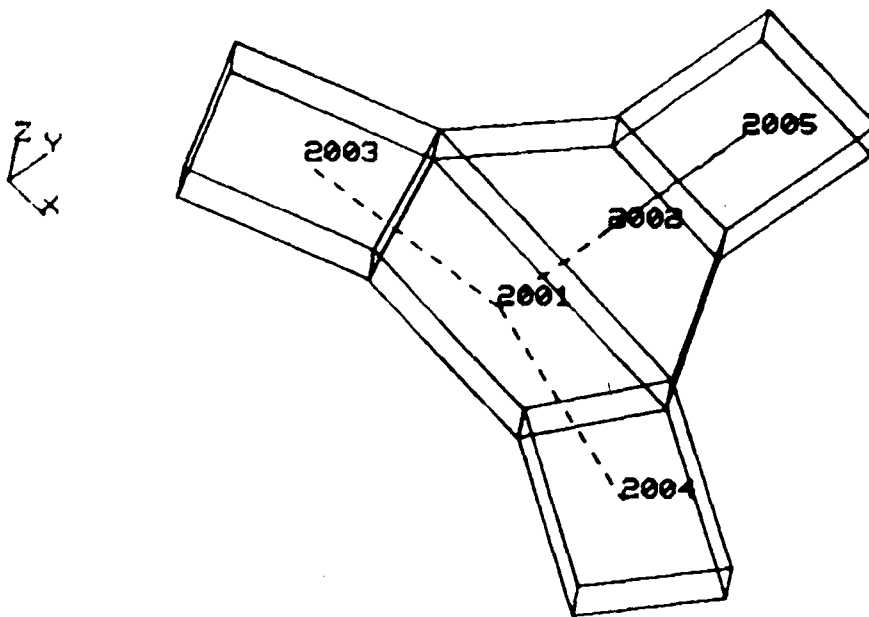

(b) Partial view of the mounting bracket.

Figure 8.- Continued.

TOP PLATE 360 DEGREE MANUALLY DEVELOPED GRID
** TYPE (C) TO CONTINUE

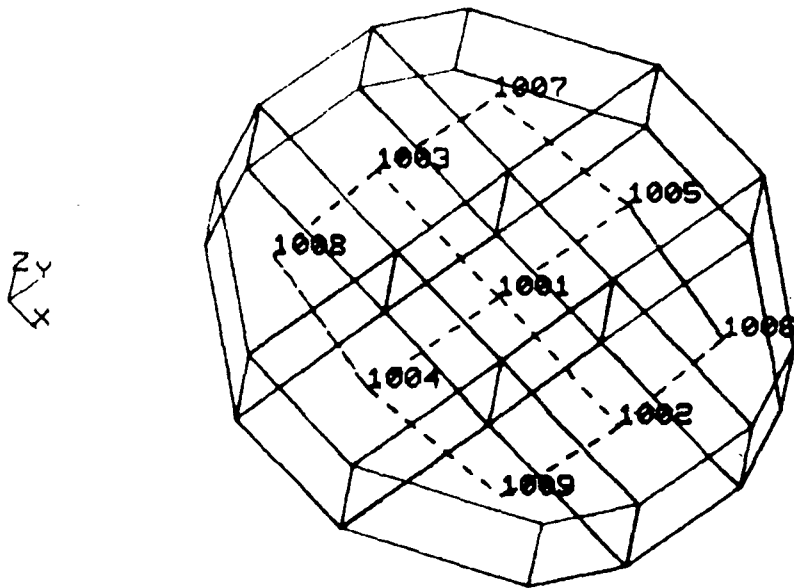

(c) Partial view of the top plate.

Figure 8.- Continued.

BODY SEGMENT NUMBER 3
** TYPE (C) TO CONTINUE

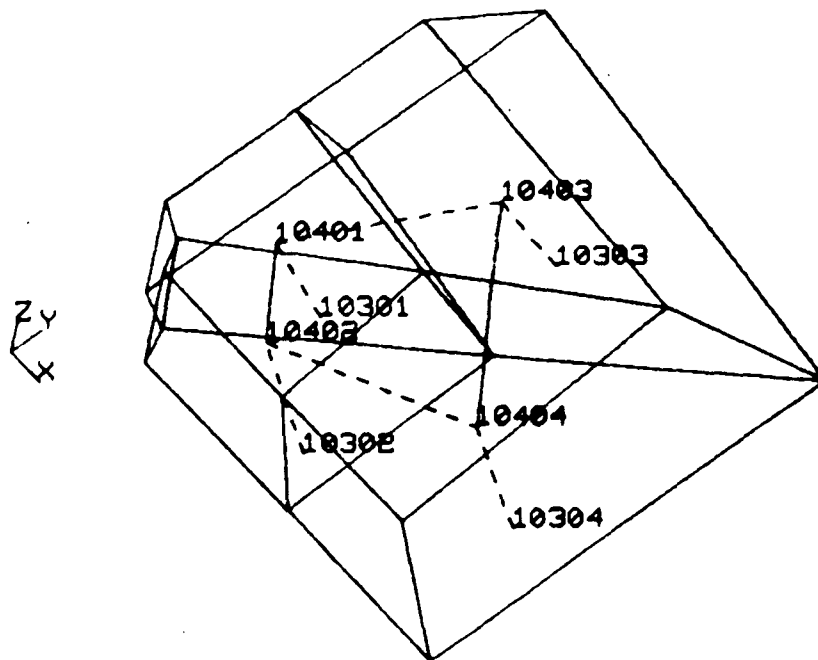

(d) Partial view of body segment 3.

Figure 8.- Continued.

BODY SEGMENT NUMBER 2
** TYPE (C) TO CONTINUE

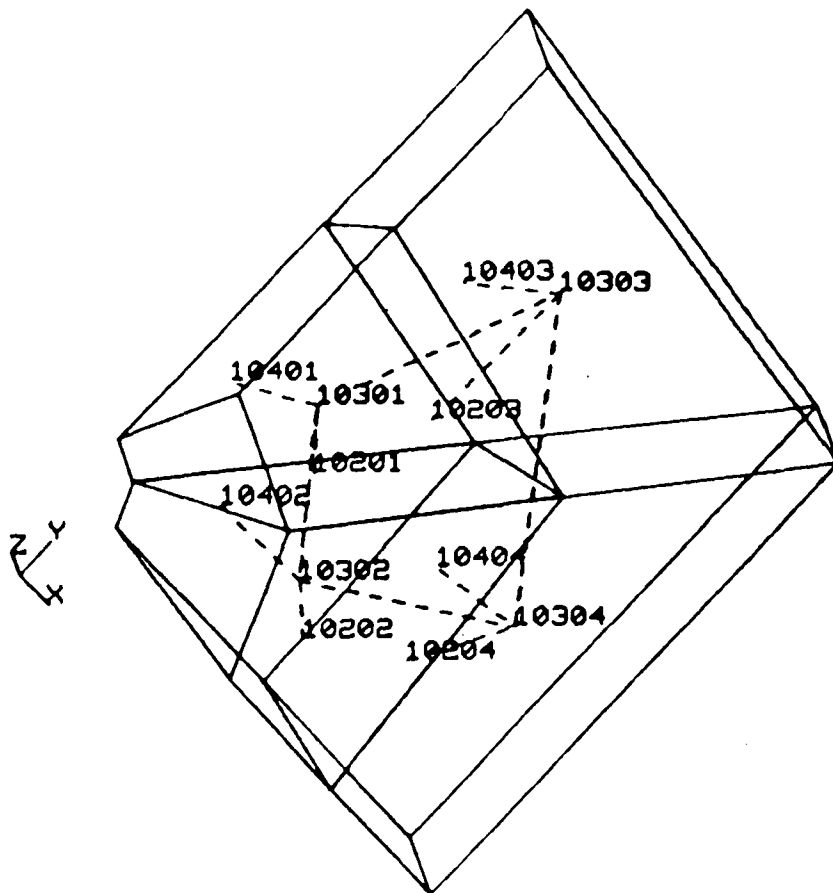

(e) Partial view of body segment 2.

Figure 8.- Continued.

BODY SEGMENT NUMBER 1
** TYPE (C) TO CONTINUE

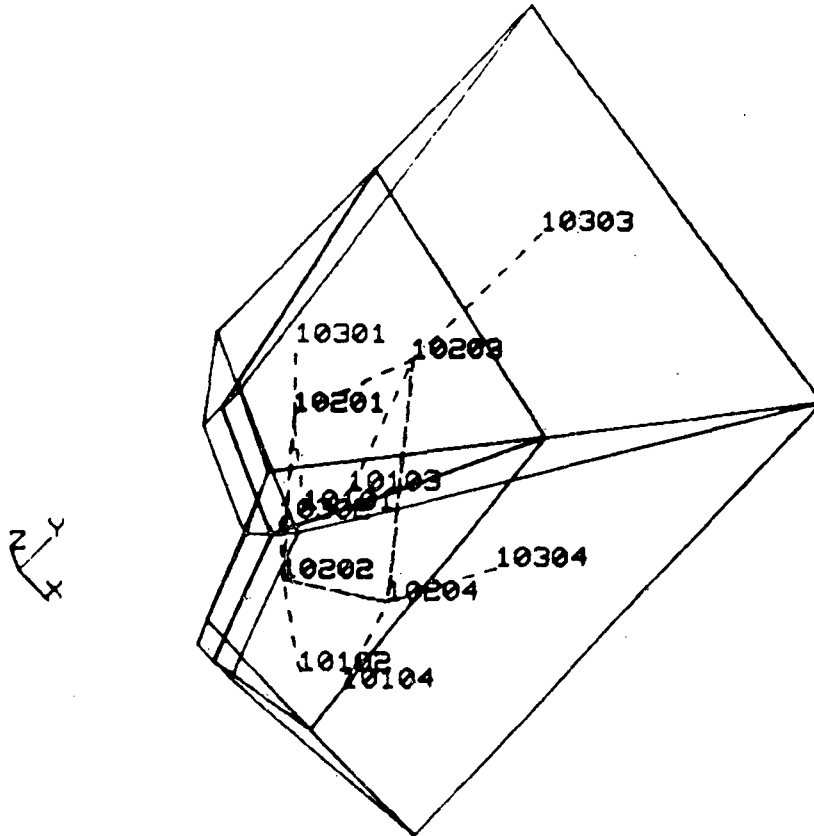

(f) Partial view of body segment 1.

Figure 8.- Continued.

PISTON CONE
" TYPE (C) TO CONTINUE

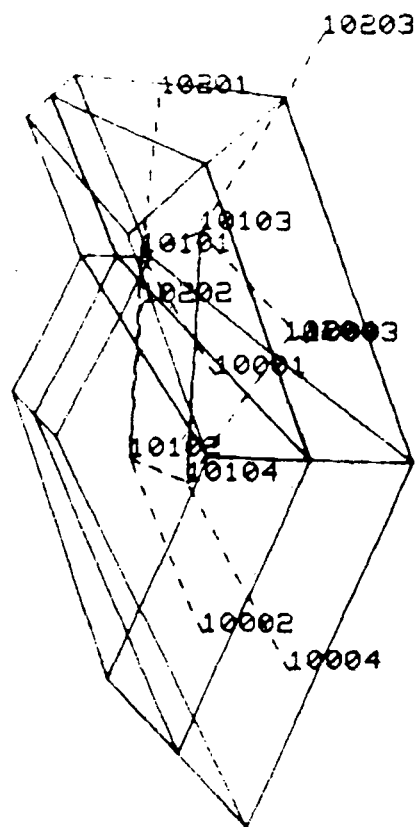

(g) Partial view of the piston cone.

Figure 8.- Continued.

INTERFACE RING RESISTANCE NETWORK
** TYPE (C) TO CONTINUE

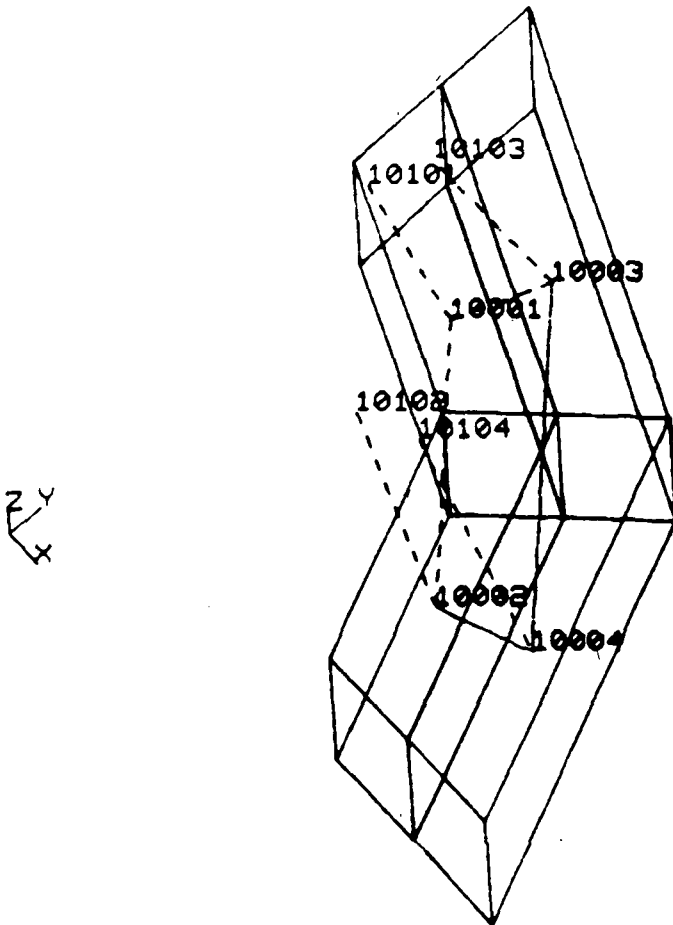

(h) Partial view of the interface ring.

Figure 8.- Concluded.

HYDRAULIC ACTUATOR FOR SSME MAIN ENGINE SAMPLE GRAPHICS PROBLEM

```

*****
TIME= 1.00000-02 DTIMEU= 5.38633-n5 CSGHINI 2005)= 1.04359-04 TEMPCCI 10003)= 5.81692-01 RELACCI 01= 0.00000
T 1001= 9.94835+01 T 1002= 9.94282+01 T 1003= 9.94282+01 T 1004= 9.94294+01 T 1005= 9.94294+01 T 1006= 9.94132+01
T 1007= 9.94132+01 T 1008= 9.94132+01 T 1009= 9.94132+01 T 2001= 9.97057+01 T 2002= 9.97080+01 T 2003= 9.97008+01
T 2004= 9.97333+01 T 2005= 9.97324+01 T 3001= 9.98782+01 T 3002= 9.98784+01 T 3003= 9.99465+01 T 3004= 9.99465+01
T 3005= 9.99766+01 T 3006= 9.99766+01 T 3007= 9.99777+01 T 3008= 9.99777+01 T 10001= 1.64322+02 T 10002= 1.64322+02
T 10003= 1.64242+02 T 10004= 1.64322+02 T 10101= 4.38727+00 T 10102= 4.55408+00 T 10103= 4.21714+00 T 10104= 4.29971+00
T 10201= 8.23650+01 T 10202= 8.23650+01 T 10203= 8.23650+01 T 10204= 8.23650+01 T 10301= 9.95150+01 T 10302= 9.95150+01
T 10303= 9.95150+01 T 10304= 9.95150+01 T 10401= 9.94782+01 T 10402= 9.94629+01 T 10403= 9.99069+01 T 10404= 9.95150+01
T 9999= -4.23000-02
    
```

LINE PRINTER PLOT OF SAMPLE PROBLEM

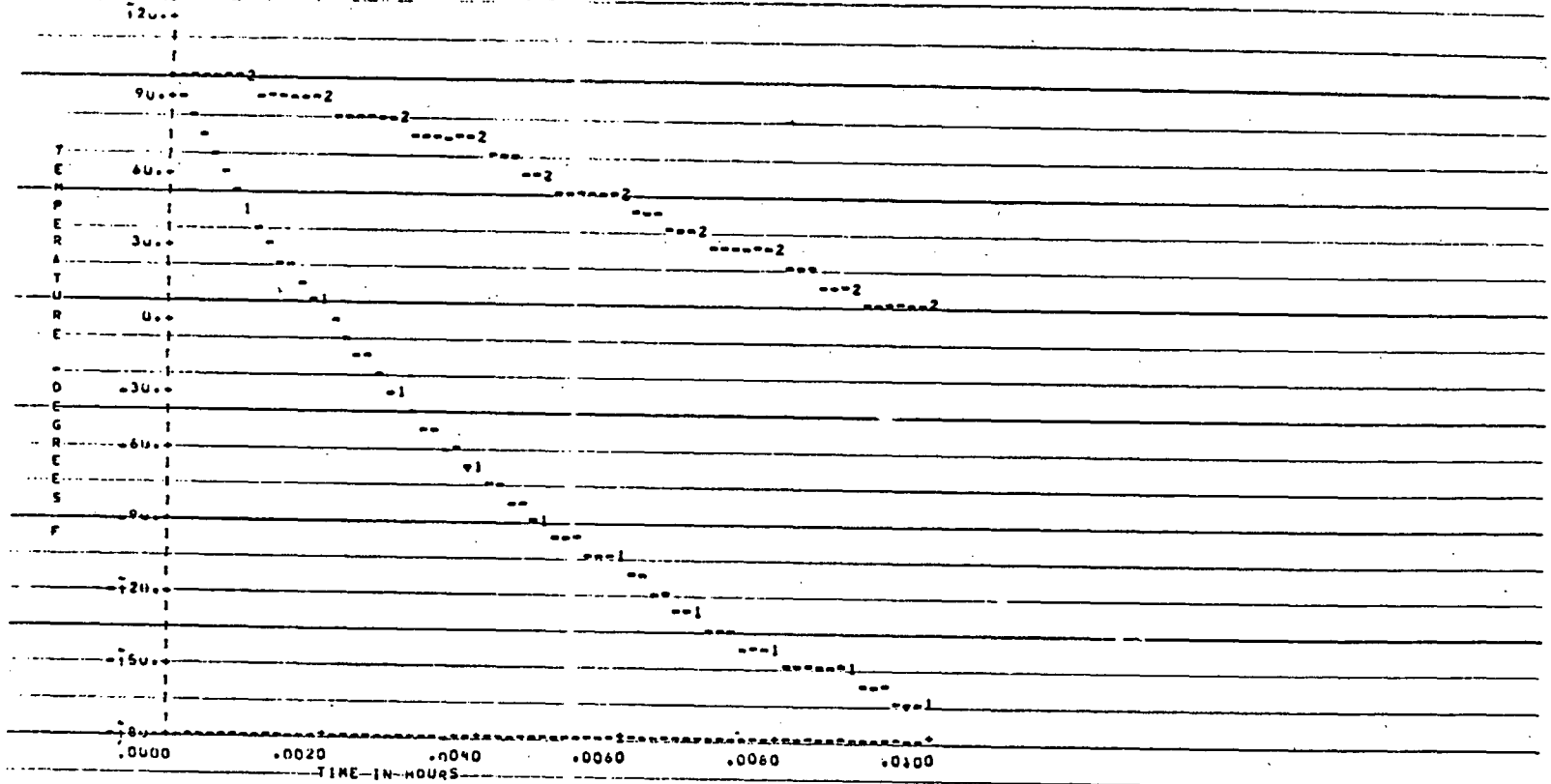

END OF DATA

Figure 9.- Sample SINDA output and line printer plots which can be viewed on the CRT.