

AN INTERACTIVE GRAPHICS PROGRAM TO RETRIEVE,  
DISPLAY, COMPARE, MANIPULATE, CURVE FIT,  
DIFFERENCE AND CROSS PLOT WIND TUNNEL DATA

Robert D. Elliott, Norbert M. Werner,  
and William M. Baker

Lockheed California Company

SUMMARY

The Aerodynamic Data Analysis and Integration System (ADAIS), developed at the Lockheed California Company, is a highly interactive computer graphics program capable of manipulating large quantities of data such that addressable elements of a data base can be called up for graphic display, compared, curve fit, stored, retrieved, differenced, cross plotted, and output for hardcopy plots. While the principle use of ADAIS thus far has been in the aerodynamic analysis of wind tunnel model force and moment data, the general nature of the system and its potential for broader application is evidenced by the fact that limited usage has already occurred with data bases consisting of thermodynamic, basic loads, and flight dynamics data. Productivity using ADAIS of five times that for conventional manual methods of wind tunnel data analysis is routinely achieved.

In using ADAIS for wind tunnel data analysis, data from one or more runs of a particular test may be called up and displayed along with data from one or more runs of a different test. By means of light pen detection, the principle mechanism of interaction with the program, the parameters for ordinate and abscissa are selected. Scaling of the axes to fit the data range is automatic, with an option for manual over-ride via the typewriter keyboard. Curves may be faired through the data points by any of four methods, including cubic spline and least squares polynomial fit up to seventh order. Improvement to visually unacceptable curve fits can be accomplished by deletion of certain data points from the curve fit while continuing to display the deleted points.

Another option permits weighting of selected data points by moving them up, down, right or left incrementally for curve fit purposes while observing the effect of each movement on the fairing with respect to the original data point positions. With practice, curve fits as good as those obtained manually can be achieved in a very short time, due to the interactive nature of the process.

Once a family of curves is defined mathematically by a visually acceptable fairing, increments between curves can be obtained, graphically displayed, and faired in the above manner. Each of these incremented curves may then be given an identifying numerical value corresponding to some physical parameter of the test. Upon specification of a few additional control items, a cross plot can then be obtained.

A request for hardcopy print, accomplished by light pen detection, results in generation of a magnetic tape from which a 35 mm negative is produced in an off line process. Hardcopy is made from the negative by an electrostatic process of photo enlargement. Grid spacing is one millimeter on metric plots and major and minor accented lines are shown, just as in commercially printed graph paper. Hardcopy quality is adequate for use in published reports and has been so used.

The data base is resident on a Disc Pack and occupies approximately 14 million bytes of storage. Presently the data base consists of five major data sets. Each data set includes an average of 120 runs. Each run consists of an average of 18 test points. For each test point there is provision for storing 12 elemental items of data such as lift coefficient, drag coefficient, etc. The result is an addressable data base of over 2.4 million elemental items of data with space available for up to 3.5 million items total.

Adding a new test to the data base is routinely accomplished within 24 hours of receipt of the wind tunnel test data tape and has been accomplished in as little as three hours elapsed time. Older tests are removed from the data base to off line storage from time to time to make way for new ones.

## INTRODUCTION

In conventional aerodynamic analysis of wind tunnel test data, both tabulated and automatically plotted aerodynamic coefficient data are available. Usually a magnetic tape or punched cards containing the same data is also available at the conclusion of the test. In a well run wind tunnel test, where a plotting schedule has been adequately pre-planned, automatically plotted data, available at the end or shortly after the end of the test, present different test runs logically grouped on particular plots so as to facilitate subsequent analysis. Faired curves through the data points are usually not included in these batch-generated plots, and when they are included they are often unacceptable to the aerodynamicist. Therefore, only symbolized data points are usually presented and curve fairing is accomplished manually on ozalid or vellum plots of the data.

The bulk of wind tunnel data analysis deals with evaluation of increments between runs rather than absolute levels of aerodynamic coefficients. Furthermore, there are almost always comparisons to be made with previous tests made with the same or slightly different models, possibly in a different tunnel. Therein lies a severe logistics problem. Previous test data are usually found in large bound volumes of 11 by 17 inch ozalid prints of plotted data. When these are located, the appropriate runs selected, and the corresponding plots located and removed from the bound volume, it is frequently discovered, in overlaying of old and new test plots on a light box, that differences in graph paper and stretch in the reproduction process are sufficiently large to preclude this method for assessing small differences between runs. What is almost always resorted to is a manual replotting of tabulated data from the separate tests on a clean piece of graph paper, a time consuming process.

Even for that portion of the analysis that is done within a single test, considerable hand plotting is unavoidable. Suppose it is desired to find the variation of incremental drag coefficient due to spoilers versus spoiler deflection at several specified values of angle of attack. Available is a batch-plotted display of data points of total drag coefficient versus angle of attack for several runs, each at a different spoiler deflection and including one at zero deflection. After fairing curves through the data points, increments between the zero deflection curve and each of the other curves must be developed and plotted as incremental drag versus angle of attack on a separate plot. This usually involves use of a pair of dividers. Once this intermediate plot is faired, the data can be manually cross plotted using dividers again, or manually digitized and replotted to obtain the desired final plot.

In 1970, Michael I. Grove, then of LCC's Commercial Engineering Aerodynamics, recognizing both the need to speed up the storage, retrieval, and analysis of wind tunnel data and the availability of computer graphics equipment, conceived an Aerodynamic Data Analysis and Integration System (ADAIS) to make use of available computer graphics equipment. Programming was initiated in June 1970 and by November 1970, ADAIS was developed to the point of productive use. By July 1971, at which point about two man years of programming effort had been expended, significant production use had been accumulated. An additional man year of effort was expended between July 1971 and June 1975 in continued improvement of the system.

The relatively general nature of the ADAIS system and its potential for wide application is evidenced by the fact that it has already been used on the following problems other than aerodynamic wind tunnel data:

- o Loads - Pressure distribution data set up in a data base, accessed, manipulated, and faired.
- o Flight Dynamics - Bode plot data for numerous servo system variations were stored, retrieved, compared, and plotted.
- o Thermodynamics - Using a data base consisting of batch program output of the variation of several thermodynamic system variables along an aircraft flight profile, selected variables such as temperature, inlet area, and ram airflow, were plotted versus altitude for the L-1011 Environmental Control System. Extensive use was also made of the zoom in/zoom out feature to "zero in on" and blow up certain areas of the flight profile history which were of particular interest.

#### NOTATION

|           |  |
|-----------|--|
| ADAIS     | Aerodynamic Data Analysis and Integration System |
| ALPH      | Angle of Attack, Alpha                           |
| CADAM     | Computer Augmented Design and Manufacturing      |
| CD        | Drag Coefficient                                 |
| CPU       | Central Processing Unit                          |
| DSP       | Incremental Spoiler Deflection                   |
| IBM       | International Business Machines                  |
| INCR      | Incrementation                                   |
| LCC       | Lockheed California Co.                          |
| LPD       | Light Pen Detect                                 |
| STC       | Storage Technology Corporation                   |
| <b>VG</b> | <b>Vector General</b>                            |

## COMPUTER ENVIRONMENT

The principal scientific computer complex at the Lockheed-California Company (LCC) is built around an IBM 360/91, shown in simplified schematic in figure 1. The three methods of communication with the computer are 1) graphics, which is direct access, on line, and interactive, 2) other direct access devices limited to remote job entry (RJE) and program and data edit, and 3) normal batch, usually input via punched cards.

Most graphic work is accomplished during day shift when the two million byte core of the IBM 360/91 is partitioned as shown in figure 2. Also shown are the relative priorities for access to the Central Processing Unit (CPU). ADAIS operates as an analytic graphics program which is third in access priority to the CPU and where each partition is devoted to only one graphic scope. Response times are typically under one half second which is usually faster than the user can supply the next instruction.

In addition to the digital computer, other hardware is necessary to process a magnetic tape to obtain 35 mm microfilm from which hardcopy plots are obtained by an electrostatic process. The entire process is shown schematically in figure 3.

Graphics consoles from two manufacturers, IBM and Vector General, are used interchangeably at LCC and are pictured in figures 4 and 5, respectively. Of the three means of direct communication with the computer: 1) light pen, 2) function keyboard, and 3) typewriter keyboard, the light pen is the principal one used with ADAIS. ADAIS also makes use of 17 function buttons on the function keyboard, as indicated in the function keyboard overlay template shown in figure 6.

The ADAIS source deck consists of about six boxes of cards containing 48 subroutines. Because it must operate in a 130K partition, it is tightly overlaid. Without overlay the program would occupy approximately 230K bytes of computer core. The main logic flow, shown in figure 7, gives an indication of the many program elements which must be interchanged within the partition.

## INTERACTIVE GRAPHIC UTILIZATION

The interactive use of ADAIS is explained in this section via a step-by-step treatment of a typical session at the graphics terminal. The session was designed to illustrate most of the main features available, such as combining data from different tests on the same plot, fairing, incrementing, and cross plotting. The figures used are either photographic reproductions of the screen display as seen by the user or photo enlargements of the 35 millimeter microfilm used in the generation of hardcopy. The user's view of the screen is of white lines on a dark blue background (IBM 2250) or green lines on a dark green background (Vector General DD2).

However, for clarity and reproducibility the photo negatives have been reversed to produce a black on white image.

### Selection of Data

Following entry of certain accounting information, the user is presented with a display listing the data sets currently stored on the data base (fig. 8) from which the appropriate data set is selected by light pen detection (LPD). (S-3A HIGH SPEED was selected for the example to follow.) This action results in the TABLE OF CONTENTS display of figure 9 where TEST TABLE is normally LPDed at this point. The resulting TEST TABLE (fig. 10) consists of a list of the wind tunnel tests contained in the data set selected from figure 8. Limited information about the test such as type, date, or test facility may be included in addition to the test number. LPD of one of the test numbers in figure 10 brings up a RUN SCHEDULE (fig. 11) displaying 20 runs at a time. This display may be rolled up or down by LPD to display desired runs. Runs to be plotted are singled out by LPD of their run number upon which a small arrow appears to the left of the word RUN (fig. 11). In the example problem, runs 6, 17, 33, and 48 from test N277 were required to be displayed on the same plot with certain runs from test N289.

When all the N277 runs had been selected TEST SCHEDULE was LPDed from the bottom menu (fig. 11) to return to the figure 10 display where N289 was detected. After the last run of those desired from N289 (7, 71, and 105) was selected (fig. 12), the word PLOT was LPDed in the lower menu to complete the process of selection of data to be plotted.

### Plotting and Fairing of Basic Data

The PARAMETER TABLE, figure 13, obtained in this example by LPD of PLOT in figure 12, allows the user to select the parameters to be plotted and the grid and size of paper to be used. The grid and paper size default to metric and  $8\frac{1}{2}$  by 11 inches unless overridden by LPD. While not readily apparent in figure 13, the METRIC GRID and A SIZE are brighter than the other options. If INCH GRID is detected, it then becomes the brighter display. The metric grid available for plotting is 16 centimeters horizontally and 20 centimeters vertically, and for B the horizontal size is 26 centimeters. The inch grid is 6 inches horizontally and 8 inches vertically for A size, and for B size the horizontal size is 10 inches. (1 in. = 2.54 cm.)

The parameter for the horizontal axis is selected first by LPD from the list displayed under PARAMETERS. Then the vertical axis parameter is LPDed. As each parameter is selected the center of the screen fills in to give further information, as shown in figure 14. In this example, angle of attack, ALPH, and drag coefficient, CD, have been selected for the horizontal and vertical axes, respectively.

During the parameter selection, the program has examined the range of variation of the data from each of the runs previously selected, compared this with the number of cycles of grid available on the paper selected, and computed a non-bastard scale factor (multiple of 1, 2, or  $4 \times 10^n$  UNITS/CYCLE where n is some positive or negative integer) which will display all the data within the grid boundaries. This process, referred to as AUTO SCALE, is automatic.

Figure 15 is the graphic display of basic data points for the runs selected and is the result of selecting PLOT DATA in the PARAMETER TABLE, figure 14. Due to display limitations and for clarity, fewer grid lines are shown on the graphic display than will be shown on the subsequent hardcopy. Grid lines are shown only for each cycle. Twenty times as many lines will be shown on the hardcopy. Axis labeling appears at every other cycle on the graphic display and some labels are in scientific notation. Hardcopy will be labeled at every cycle in engineering notation. Certain alphabetic letters are used as symbols in the graphic display. The corresponding hardcopy will utilize different symbols.

In addition to the curve symbol identification menu at the upper right and the three boxed menus at the bottom, there are four arrows at the lower right. These may be used to center the plotted points within the grid area. LPD of any of the arrows shifts the display by one half cycle in the direction of the arrow.

LPD of the word FAIRING in the lower center menu of figure 15 brings up the fairing menu shown at the bottom of figure 16. The LINEAR option connects each consecutive point with a straight line. The LEAST SQUARES option generates a least squares polynomial fit up to seventh order. The parameter on the vertical axis is the dependent variable, i.e., the sum of the squares of the vertical distances from the points to the curve are minimized. This is the most suitable and most used option for experimental data. The SPLINE FIT generates a chain cubic fit passing through every point. A different set of coefficients for the cubic are computed between each two points such that the first and second derivatives of adjacent equations have identical values at each data point. This option gives difficulty when two data points are very close, as is the case with "repeat points" which are often taken in each run of a wind tunnel test as a check for hysteresis. NEW METHOD is an option similar to SPLINE but is slightly better behaved.

If LEAST SQUARES is selected, as in this example, a further display permits selection of the degree of the polynomial to be used upon which the display is restored to that of figure 15, except that the word DRAW appears just below the upper right CURVES menu. LPD of DRAW, followed by LPD of any of the symbols under CURVES, results in a display of that curve's fairing. Alternatively, DRAW may be detected twice in succession to fair all of the displayed runs simultaneously (see figure 17).

If the fairings displayed are not visually satisfactory there are several methods for altering them, either individually or collectively. These are:

- o Change the order of the polynomial used for LEAST SQUARES FIT.
- o Change the type of fit.
- o Delete points from consideration in the fairing process.
- o Add points to the data. This is time consuming and seldom used.
- o Move selected points insofar as the curve fairing is concerned while retaining the ability to display the data points in either their original or altered positions.

When a satisfactory set of fairings has been obtained, a HARDCOPY may be LPDed in the lower center menu of figure 17 to produce microfilm resulting in a faired plot of the basic data, figure 18.

#### Incrementation

In ADAIS incrementation is defined as obtaining differences between the dependent values of one or more curves and a base curve at equally spaced intervals of the independent variable. In the example chosen, an S-3A Viking model was tested at several wing spoiler deflection angles in two different wind tunnel tests. In each test a base run was made at zero spoiler deflection. Determination of the incremental drag due to spoiler deflections ranging from 0 to 60 degrees was desired. This is obtained by finding the difference between each of the non-zero spoiler deflection runs and the one from the appropriate test having zero deflection. In ADAIS nomenclature the non-zero spoiler runs are designated NON BASE and the zero spoiler runs BASE runs. Through light pen interaction with a series of displays not shown, the BASE and NON BASE runs are identified, the incremental dependent variable ( $\Delta$  CD) is computed (NON BASE minus BASE) at equally spaced values of the independent variable (ALPH). Subtraction between two curves occurs at precisely the same value of the independent variable (ALPH) because the mathematical curve fits previously determined permit accurate interpolation. Figure 19 is the result of this incrementation process prior to fairing. Note that the data points representing the subtraction of RUN 7 from RUN 105, designated by the symbol A, are not completely displayed in figure 19. This is due to display buffer limitations which have been corrected since the photo was made. The undisplayed data are available on any hardcopy taken at this point. Note also that the data are not well centered on the plot in figure 19. This was easily corrected by LPD of the upper arrow in the lower right hand corner of the display. Four LPDs of the arrow resulted in figure 20 where the data is well centered.

Figures 21 and 22 compare least squares curve fits of the figure 20 data using fifth and third order, respectively, and figure 23 shows the hardcopy result from the third order fit of figure 22.



## Cross Plotting

To cross plot it is necessary to define a third variable, such as spoiler deflection angle in the example, a different value of which can be associated with each curve to be cross plotted. What this means in terms of figure 22 is that values of 0, 7.5, 15, 30, 45, and 60 degrees were assigned to the curves from bottom to top. Through a series of steps(not shown) involving use of both the light pen and typewriter keyboard the cross plot of figure 24 is produced. Figure 24 illustrates a fifth order least squares polynomial fit and figure 25 shows the same data fitted by third order, the fairing ultimately chosen. Figure 26 is the hardcopy resulting from figure 25. Figure 26 thus represents the incremental drag coefficient versus spoiler deflection for lines of constant angle of attack, ALPH. Each curve can be identified as to its ALPH value by correlating the curve symbol with the symbol key in the upper right corners of figures 25 or 26 where the ALPH value (0, 2, 4, 6, or 8) is shown below the symbol.

## IMPROVEMENT POTENTIAL

### Interfaces to Other Programs

Much of the data extracted from wind tunnel tests by the methods described above are destined to become input data for various performance or stability and control computer programs, some of which are also extant on analytic graphics. To conserve storage and speed computation many of these programs accept data in terms of coefficients for polynomial expressions. Presently in development is the capability to provide coefficients of the least squares polynomial fit equations by 1) visual display on the screen, 2) print output, 3) punch card output, and 4) a created data set accessible from other analytic programs.

The level of effort to process wind tunnel data into a format suitable for loading onto the data base is greatly reduced when there is coordination between the ADAIS programmer and those responsible for running the test prior to the test. Continued publicizing of this fact is expected to improve the interface between the wind tunnel data reduction programs and ADAIS.

### Utilization

Increased utilization of the program is desirable to amortize its development costs at an earlier date. To a large degree ADAIS utilization parallels the frequency of wind tunnel testing at LCC. Timing was such that ADAIS development occurred too late to have a significant impact on the relatively large wind tunnel test programs of the L-1011 Tristar and S-3A Viking. However, it is believed that better documentation of the

program might have improved recent ADAIS utilization. Accordingly, the authors developed a comprehensive 120 page users manual, published in August 1975, and distributed it widely among potential users. Its impact on utilization is still to be assessed.

Lack of advance preparation by the user has resulted in some sessions being less than cost effective. Warnings and admonitions in the above mentioned users manual are expected to alleviate this problem.

As a result of geographic moves of engineering personnel among various engineering buildings it has become necessary for many of the potential users to make a five to ten minute walk to a building containing a graphics terminal. Although the deterrent effect of this inconvenience has not been quantified, efforts continue to be made to locate graphics terminals in buildings where the bulk of the users are based.

Quality control of hardcopy and, to a lesser extent, microfilm quality have been continuing problems. Efforts are being made to justify in-house hardcopy generation capability which should provide more control over quality as well as possible reduction in elapsed time between the graphics session and receipt of hardcopy which is currently running between 24 and 48 hours. Equipment other than the Datagraphics 4060 is also being considered as a microfilm generator.

#### Expansion of Applications

Underway is the expansion of the ADAIS concept into a non-engineering area, namely that of financial forecasting. This application envisions a data base consisting of manpower and materials performance on previous projects which will be readily accessible and manipulatable for rapid response during bid and proposal activity. Plots suitable for direct inclusion in proposals are a desired result.

Use of ADAIS for analysis of pressure data obtained from wind tunnel testing is restricted by the limit of 12 variables per run, whereas 200 to 300 pressure values per test point are not uncommon for some pressure models. Hopefully, a potential user will be able to justify the cost of restructuring the data base to accommodate a variable number of parameters at each test point.

#### CONCLUSIONS

ADAIS is a highly interactive analytic graphics application program which utilizes the full capabilities of the graphics equipment. It has been human engineered to maximize use of the light pen in order to reduce the distractions from frequent shifts of attention to the typewriter or function keyboards.

Productivity using ADAIS of five times that for conventional manual methods of wind tunnel data analysis is routinely achieved. As many as 45 useful plots per hour have been produced by experienced users.

The broad applicability of the ADAIS system is demonstrated by prior use of thermodynamic, basic loads, and flight dynamics data bases as well as by projected development into non-engineering applications.

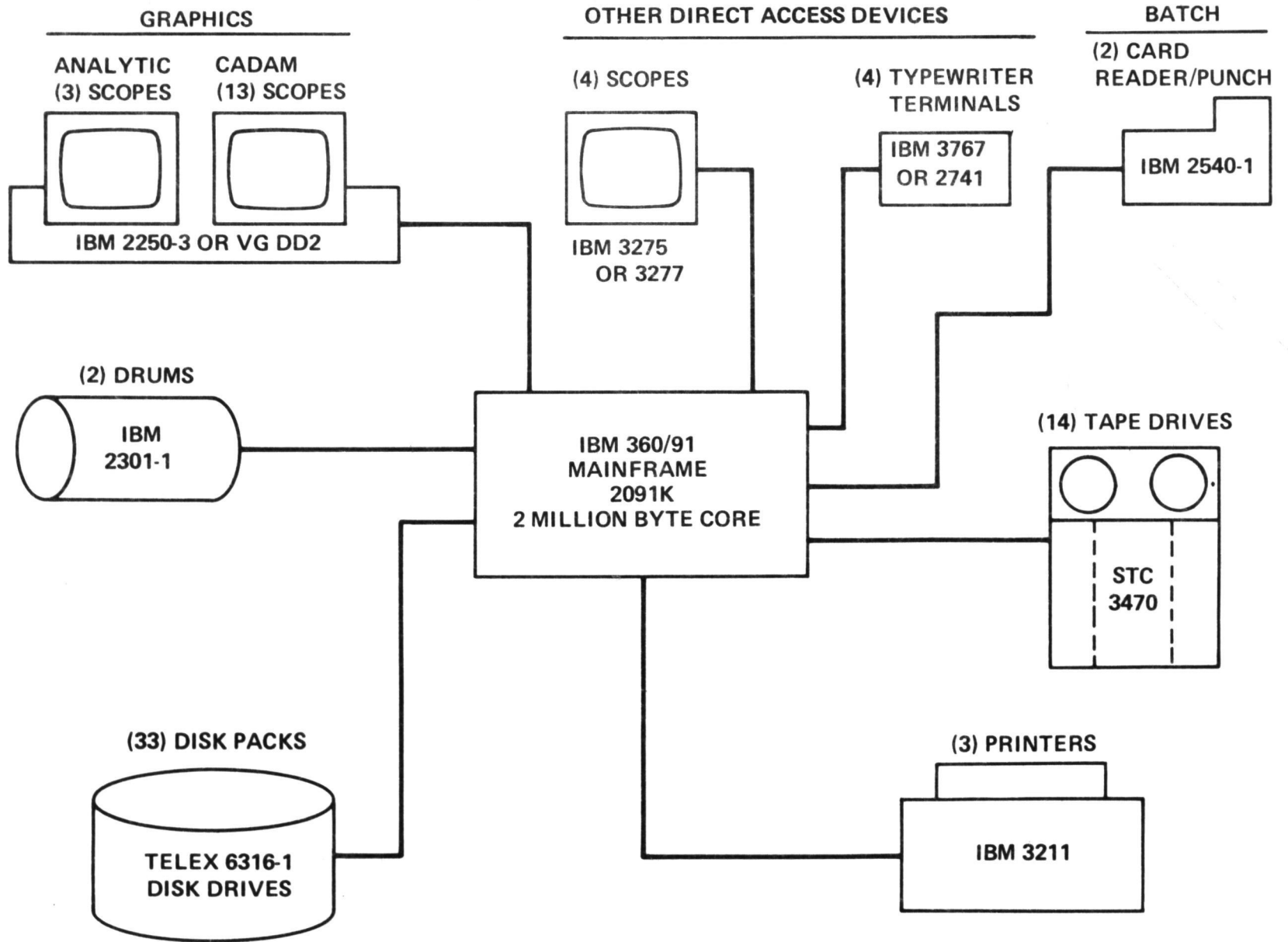

FIGURE 1. SCHEMATIC OF LOCKHEED-CALIFORNIA COMPANY IBM 360/91 INSTALLATION

CPU ACCESS HIERARCHY

BYTES

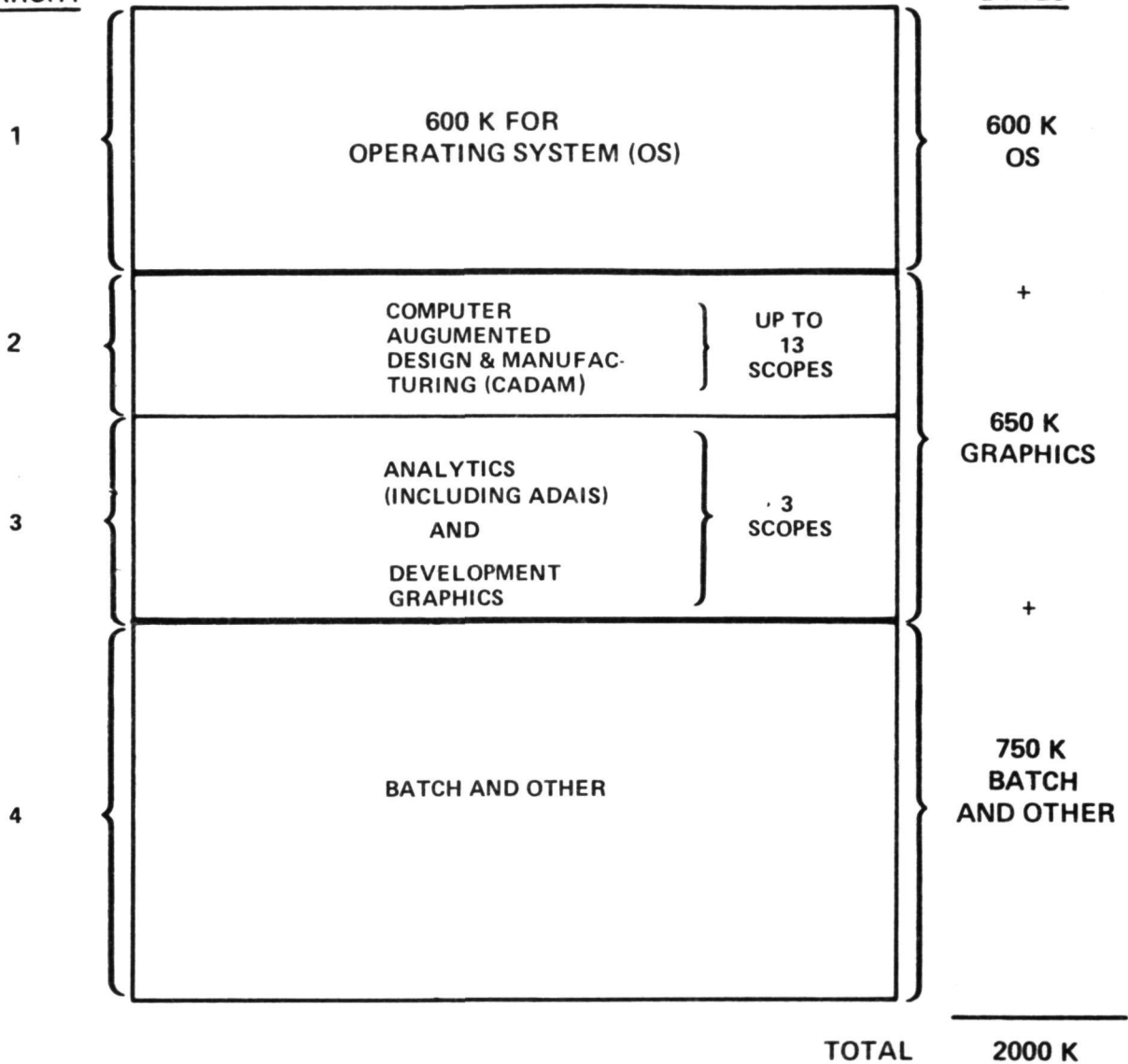

FIGURE 2. TYPICAL IBM 360/91 CORE PARTITIONING - DAY SHIFT

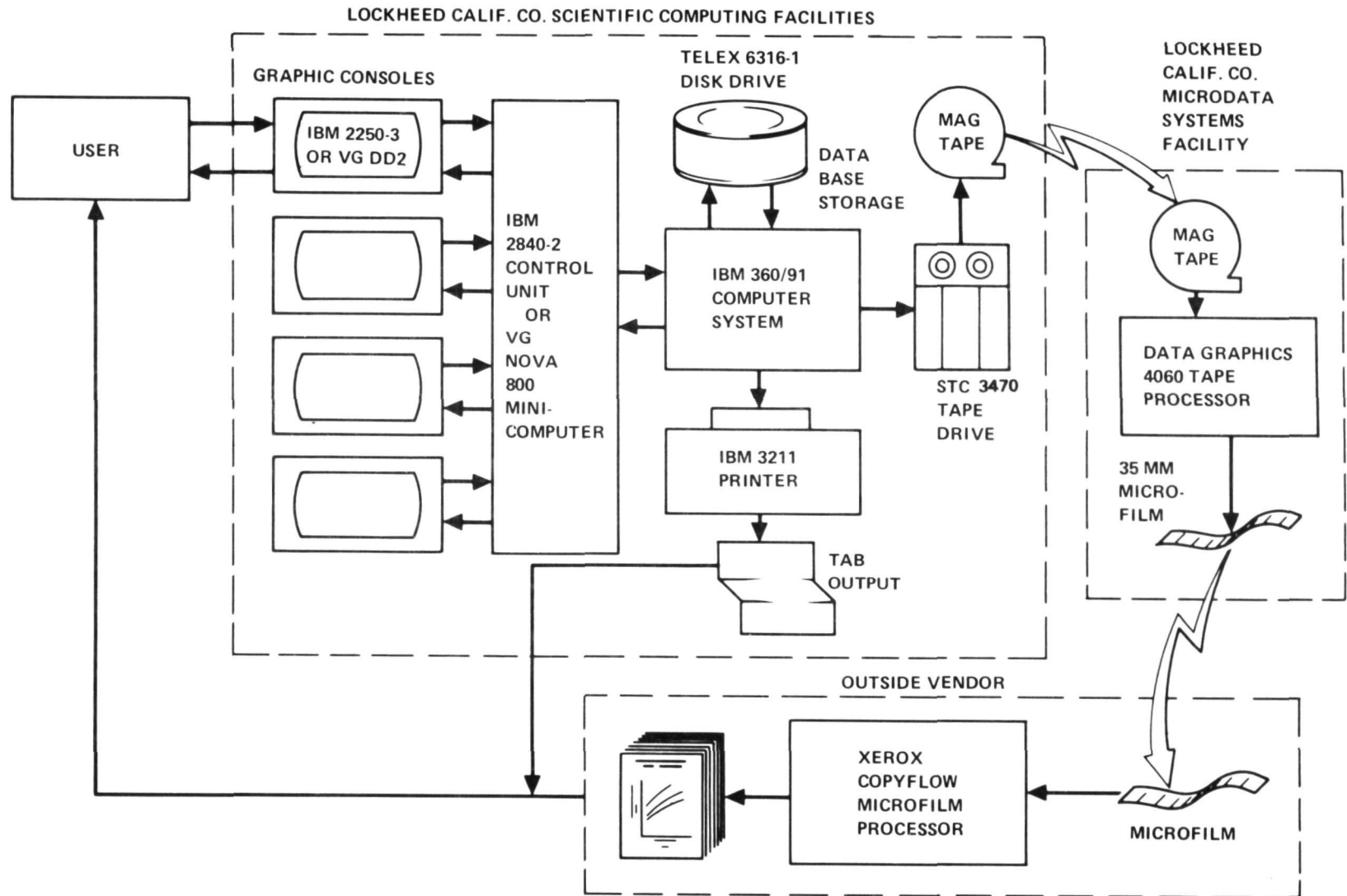

FIGURE 3. ADAIS HARDWARE ENVIRONMENT

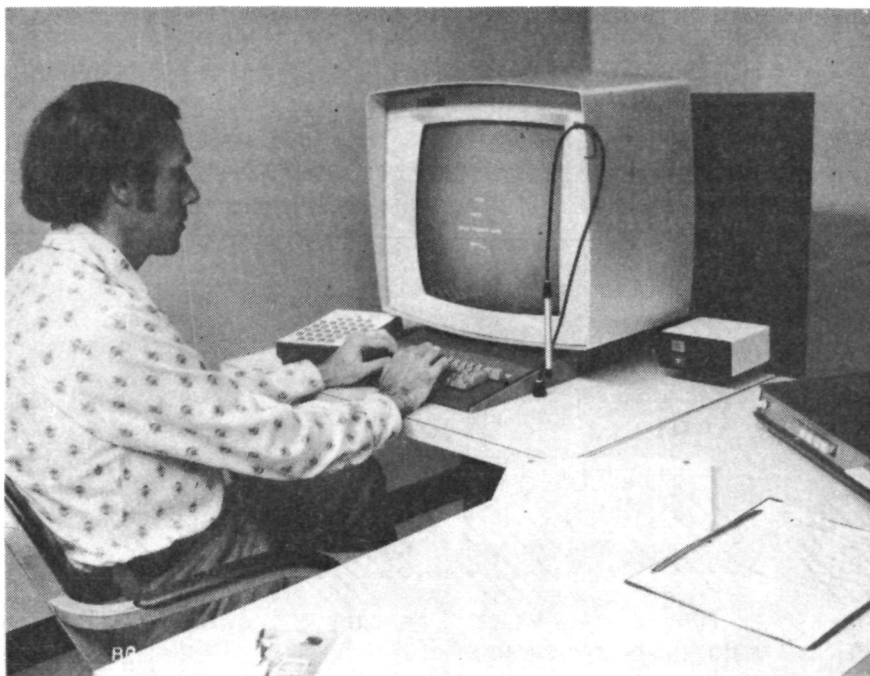

FIGURE 4. IBM 2250-3 DISPLAY CONSOLE

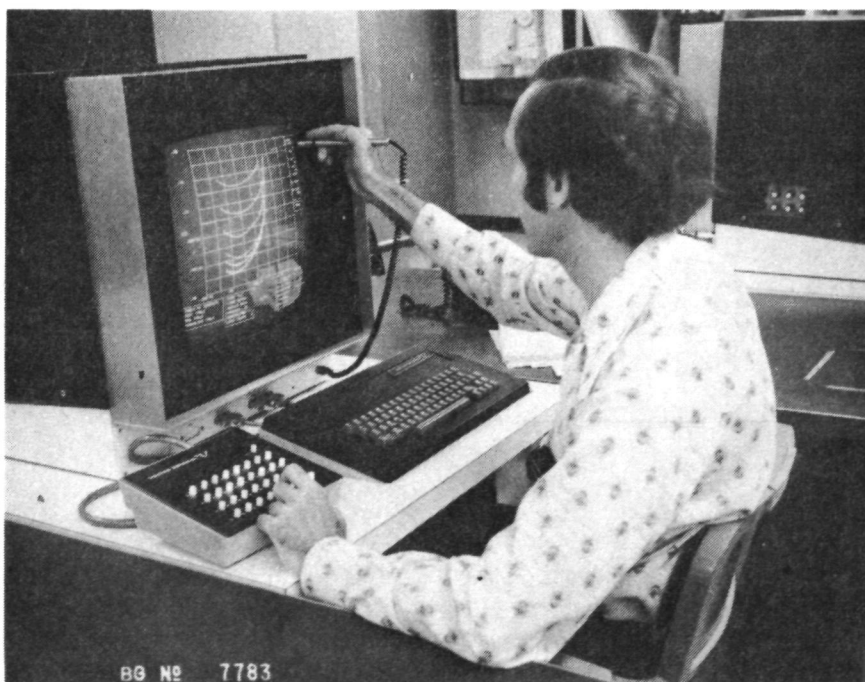

FIGURE 5. VECTOR GENERAL DD2 DISPLAY CONSOLE

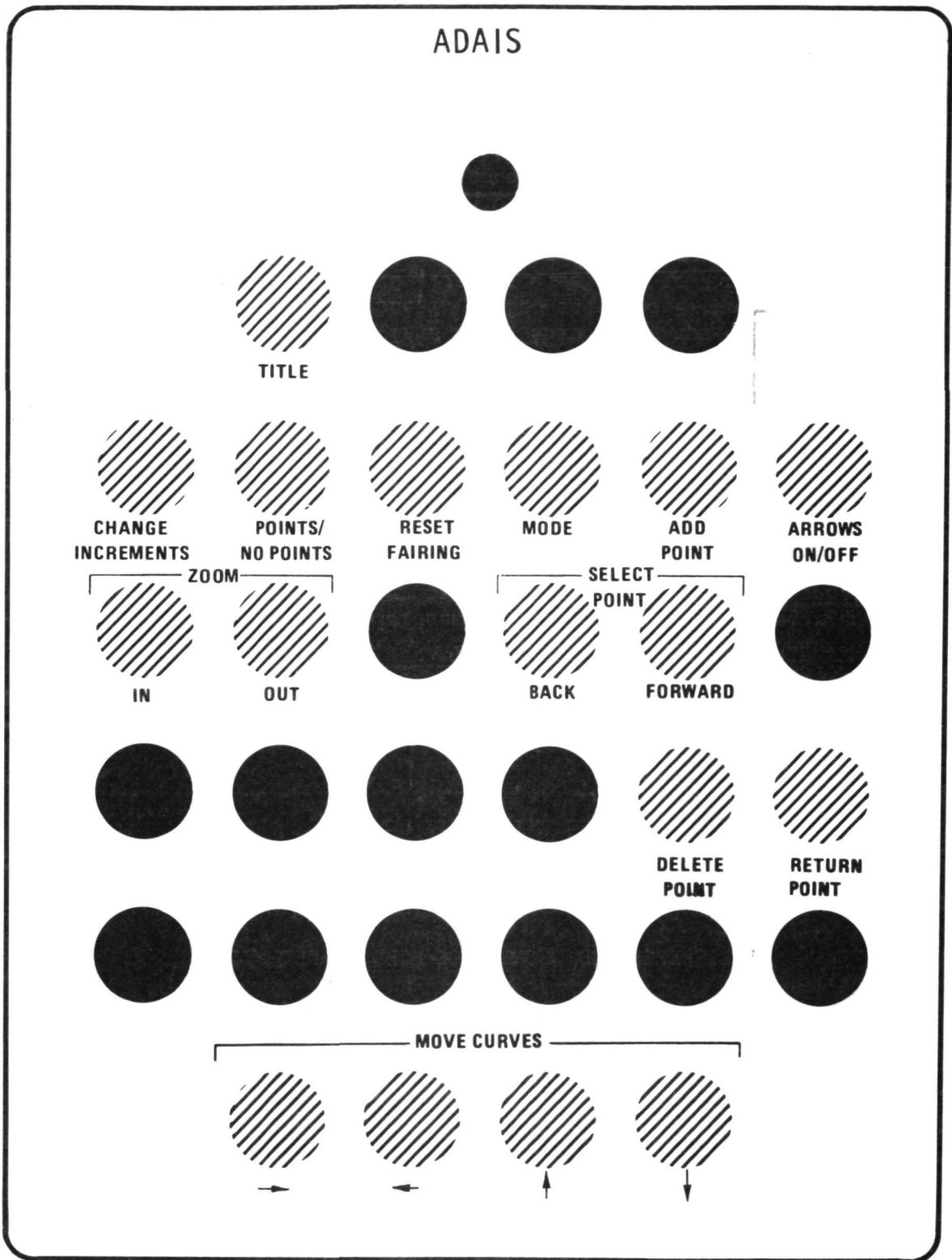

FIGURE 6. IBM ADAIS FUNCTION KEYBOARD OVERLAY TEMPLATE



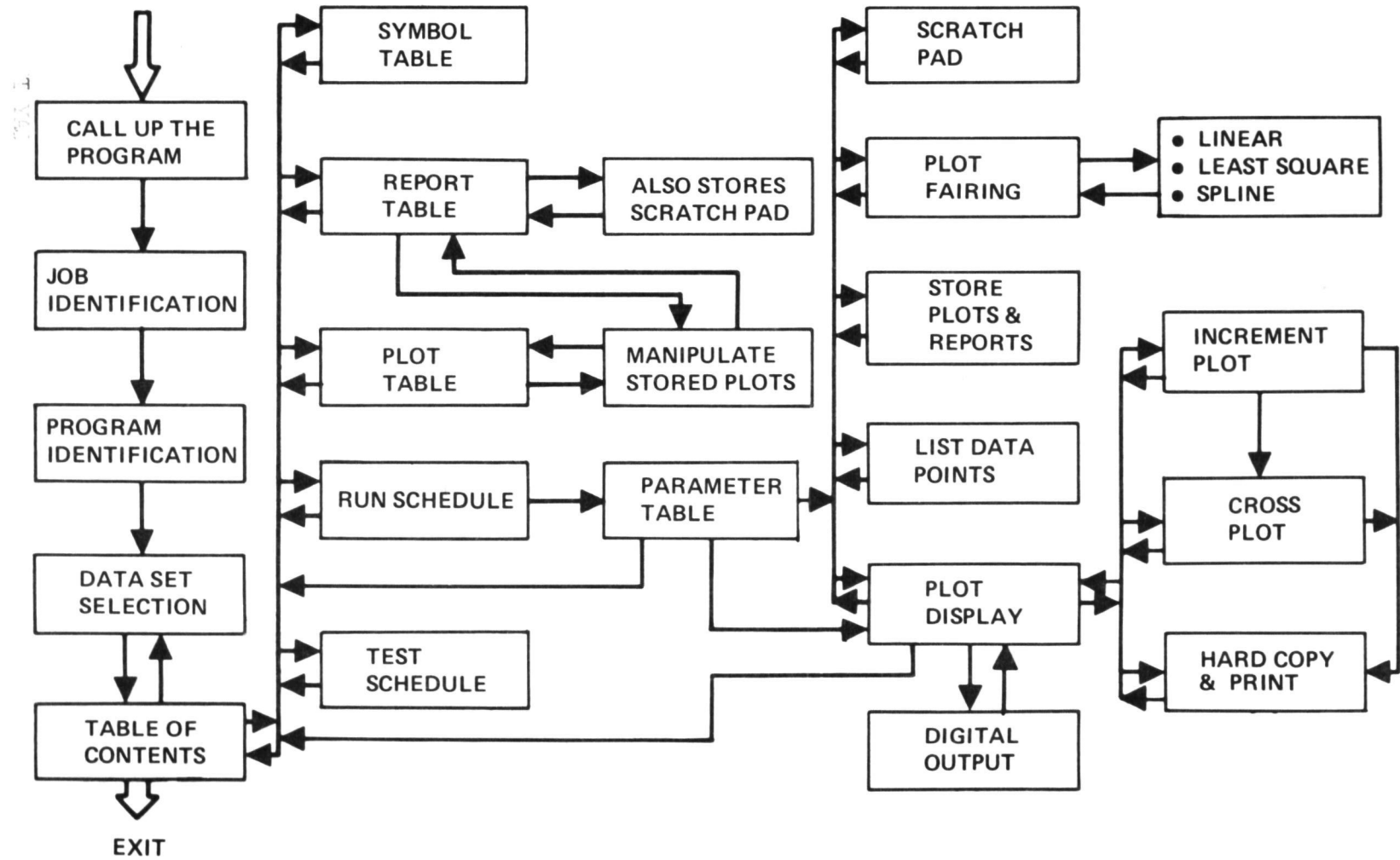

FIGURE 7. ADAIS MAIN LOGIC FLOW

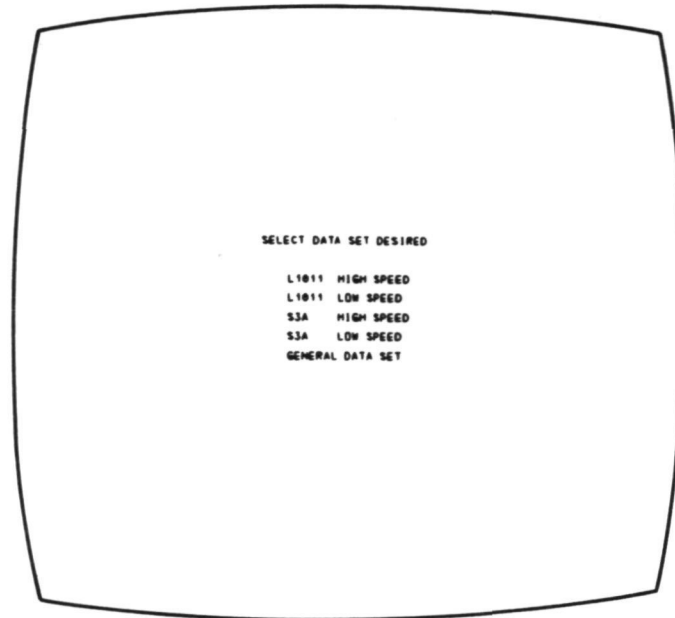

FIGURE 8. DATA TEST SELECTION

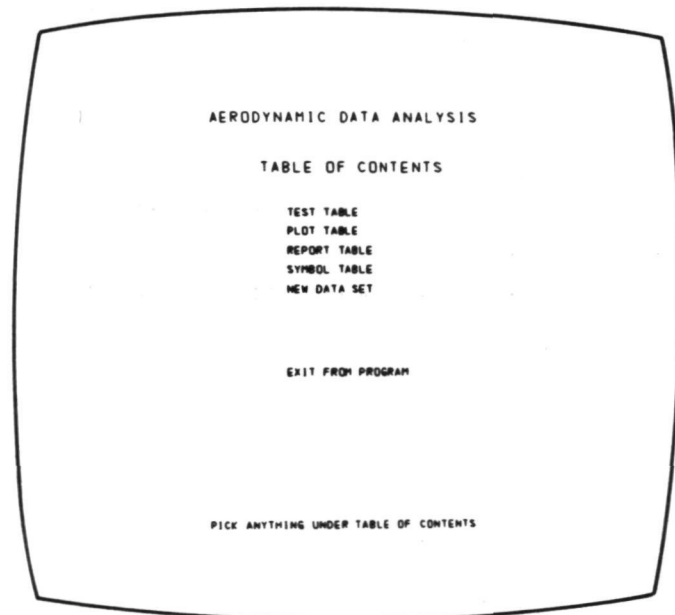

FIGURE 9. TABLE OF CONTENTS

TEST TABLE

| TEST | PLACE | DATE                          | TYPE |
|------|-------|-------------------------------|------|
| N249 | S-3A  | HIGH SPEED TEST(CORNELL)      |      |
| N254 | S-3A  | HIGH SPEED TEST(CORNELL)      |      |
| N281 | S-3A  | HIGH SPEED TEST(AMES)         |      |
| N261 | S-3A  | HIGH SPEED TEST(AMES) 12/5/69 |      |
| N242 | S-3A  | HIGH SPEED TEST(AMES) 2/18/70 |      |
| N274 | S-3A  | HIGH SPEED TEST(AMES) 5/12/70 |      |
| N284 | S-3A  | HIGH SPEED TEST(AMES) 9/3/70  |      |
| N277 | S-3A  | HIGH SPEED TEST(AMES) 7/10/70 |      |
| N230 | S-3A  | HIGH SPEED TEST(CORNELL)      |      |
| N252 | S-3A  | HIGH SPEED TEST(CORNELL)      |      |
| N243 | S-3A  | HIGH SPEED TEST(CORNELL)      |      |
| N244 | S-3A  | HIGH SPEED TEST(CORNELL)      |      |
| N250 | S-3A  | HIGH SPEED TEST(CORNELL)      |      |
| N278 | S-3A  | HIGH SPEED TEST (CORNELL)     |      |
| N229 | S-3A  | HIGH SPEED TEST (CORNELL)     |      |

TABLE OF CONTENTS

PICK ANY TEST TO DISPLAY TEST RUN SCHEDULE OR TABLE OF CONTENTS TO RETURN

FIGURE 10. TEST TABLE

RUN SCHEDULE OF TEST - N277

RUN CONFIGURATION MACH

|       |    |             |       |             |                |
|-------|----|-------------|-------|-------------|----------------|
| RUN   | 21 | CONFIG MACH | 0.652 | SWEEP ALPHA | 14 DATA POINTS |
| RUN   | 22 | CONFIG MACH | 0.852 | SWEEP ALPHA | 14 DATA POINTS |
| RUN   | 23 | CONFIG MACH | 0.801 | SWEEP ALPHA | 14 DATA POINTS |
| RUN   | 24 | CONFIG MACH | 0.751 | SWEEP ALPHA | 14 DATA POINTS |
| RUN   | 25 | CONFIG MACH | 0.702 | SWEEP ALPHA | 14 DATA POINTS |
| RUN   | 26 | CONFIG MACH | 0.652 | SWEEP ALPHA | 14 DATA POINTS |
| RUN   | 27 | CONFIG MACH | 0.501 | SWEEP ALPHA | 17 DATA POINTS |
| RUN   | 28 | CONFIG MACH | 0.850 | SWEEP ALPHA | 14 DATA POINTS |
| RUN   | 29 | CONFIG MACH | 0.802 | SWEEP ALPHA | 14 DATA POINTS |
| RUN   | 30 | CONFIG MACH | 0.751 | SWEEP ALPHA | 14 DATA POINTS |
| RUN   | 31 | CONFIG MACH | 0.701 | SWEEP ALPHA | 14 DATA POINTS |
| RUN   | 32 | CONFIG MACH | 0.651 | SWEEP ALPHA | 14 DATA POINTS |
| ->RUN | 33 | CONFIG MACH | 0.501 | SWEEP ALPHA | 17 DATA POINTS |
| RUN   | 34 | CONFIG MACH | 0.801 | SWEEP ALPHA | 14 DATA POINTS |
| RUN   | 35 | CONFIG MACH | 0.851 | SWEEP ALPHA | 14 DATA POINTS |
| RUN   | 36 | CONFIG MACH | 0.801 | SWEEP ALPHA | 14 DATA POINTS |
| RUN   | 37 | CONFIG MACH | 0.753 | SWEEP ALPHA | 14 DATA POINTS |
| RUN   | 38 | CONFIG MACH | 0.700 | SWEEP ALPHA | 14 DATA POINTS |
| RUN   | 39 | CONFIG MACH | 0.651 | SWEEP ALPHA | 14 DATA POINTS |
| RUN   | 40 | CONFIG MACH | 0.501 | SWEEP ALPHA | 18 DATA POINTS |

NO. OF CURVES = 3

ROLL UP/ ROLL DOWN/ TABLE OF CONTENTS/ TEST SCHEDULE/ PLOT / PRINT  
PICK RUN TO PLOT OR ITEM FROM MENU

FIGURE 11. RUN SCHEDULE - FIRST TEST

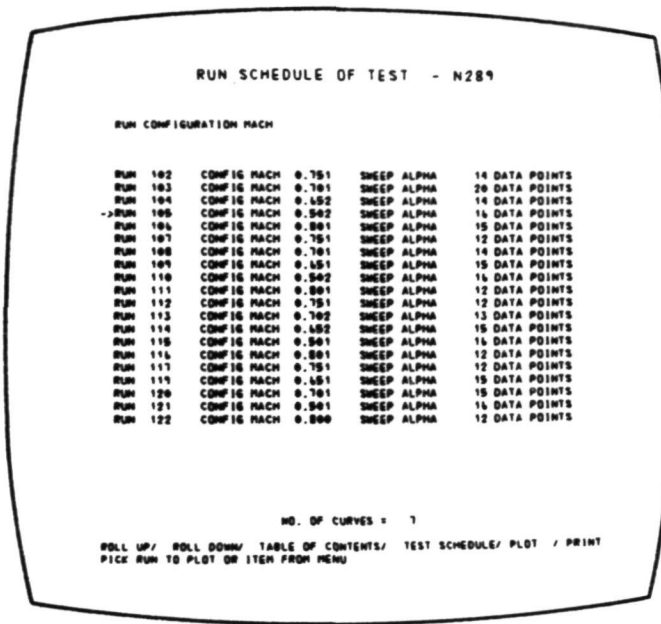

FIGURE 12. LAST RUN OF SECOND TEST DETECTED

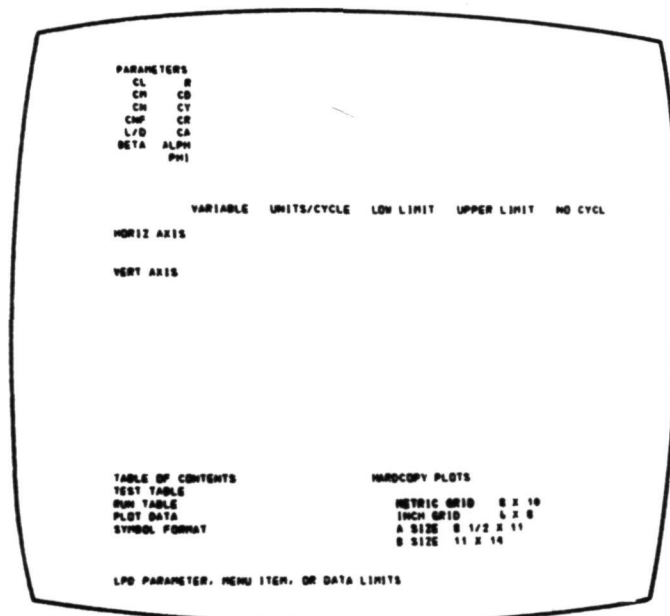

FIGURE 13. PARAMETER TABLE - INITIAL DISPLAY

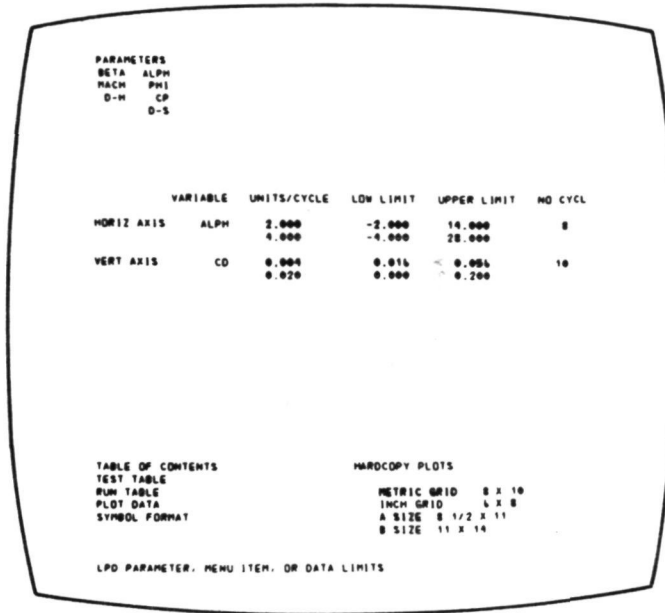

FIGURE 14. PARAMETER TABLE - PARAMETERS DETECTED

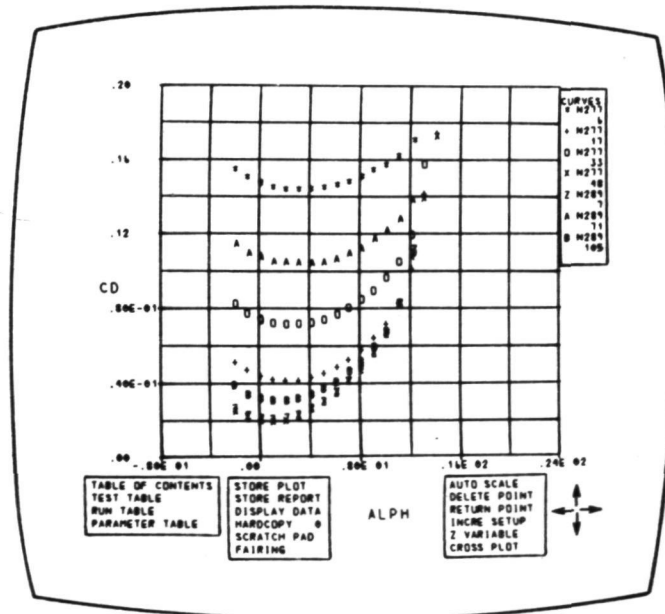

FIGURE 15. BASIC DATA POINT DISPLAY

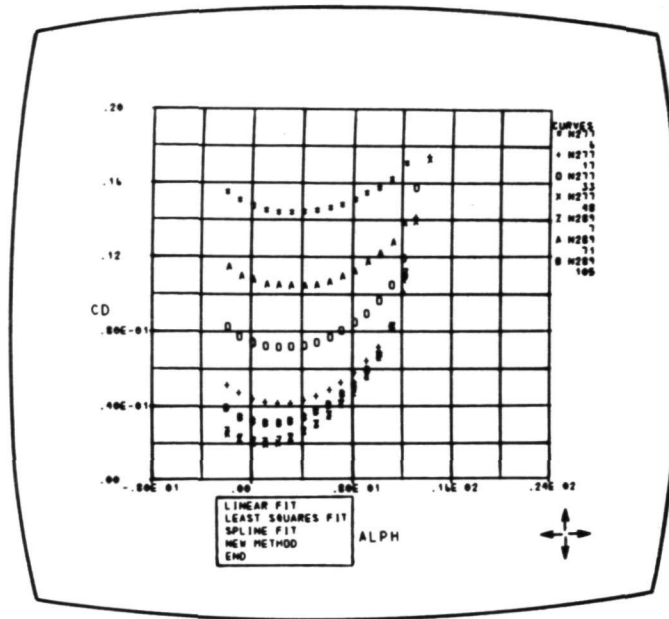

FIGURE 16. FAIRING MENU

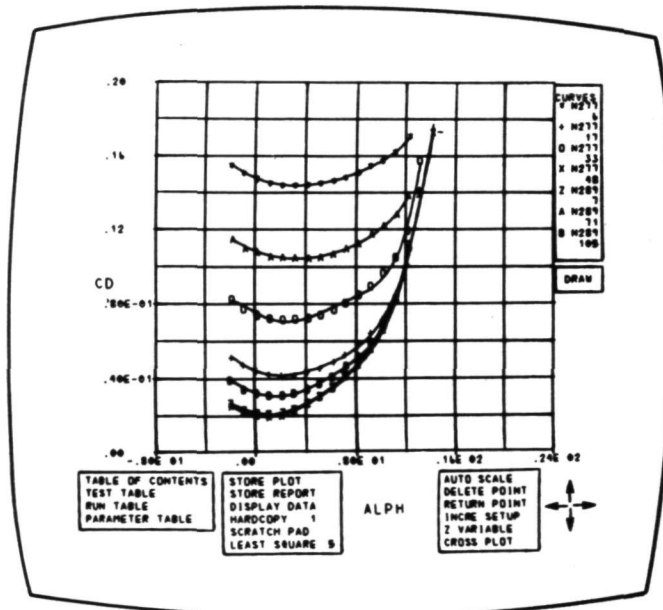

FIGURE 17. FIFTH ORDER FIT OF BASIC DATA

CURV

- 6
- N277
- ▲ 17
- N277
- 33
- N277
- 48
- N277
- 7
- N289
- ⊕ 71
- N289
- 105
- N289

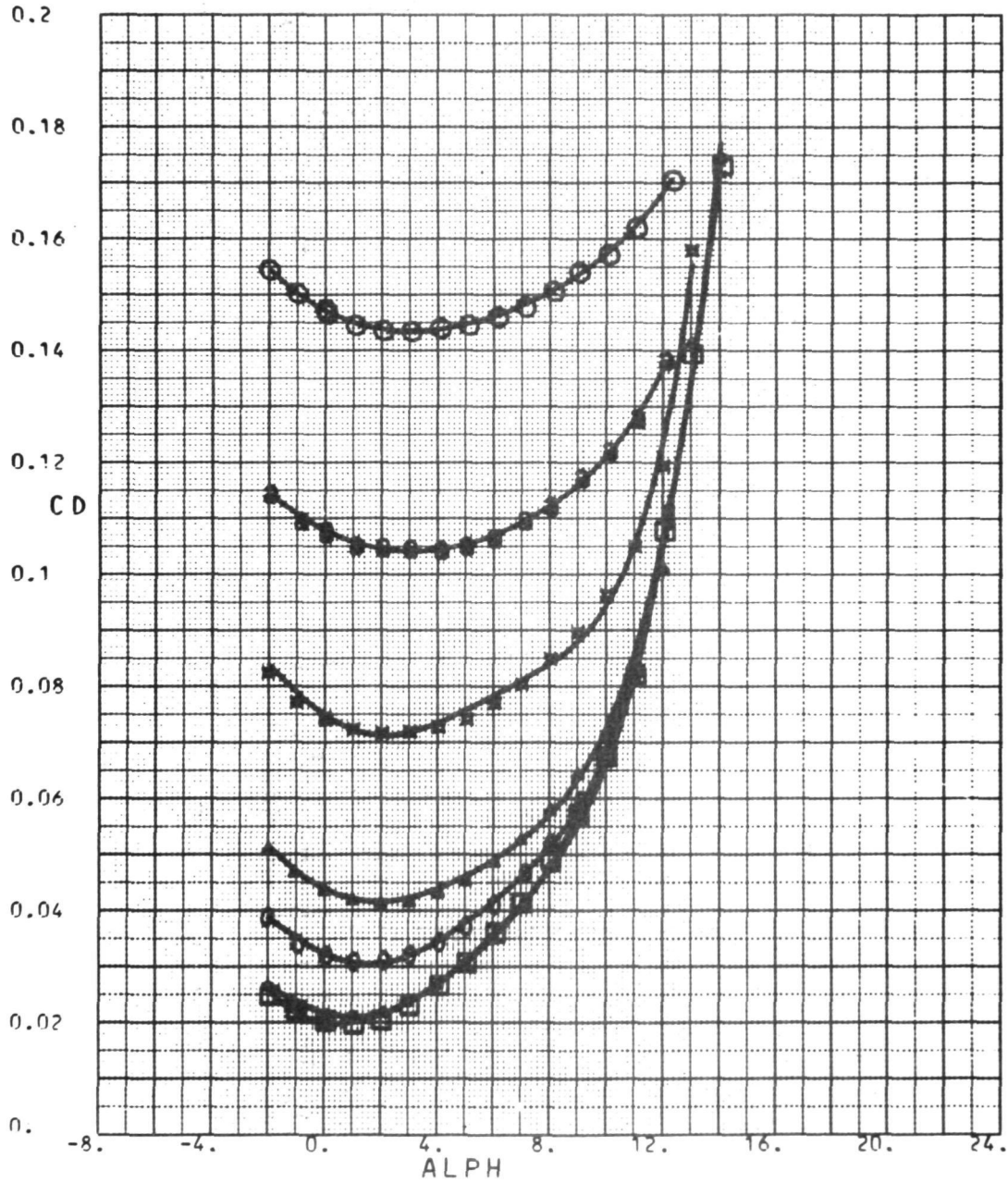

FIGURE 18. HARDCOPY OF FAIRED BASIC DATA

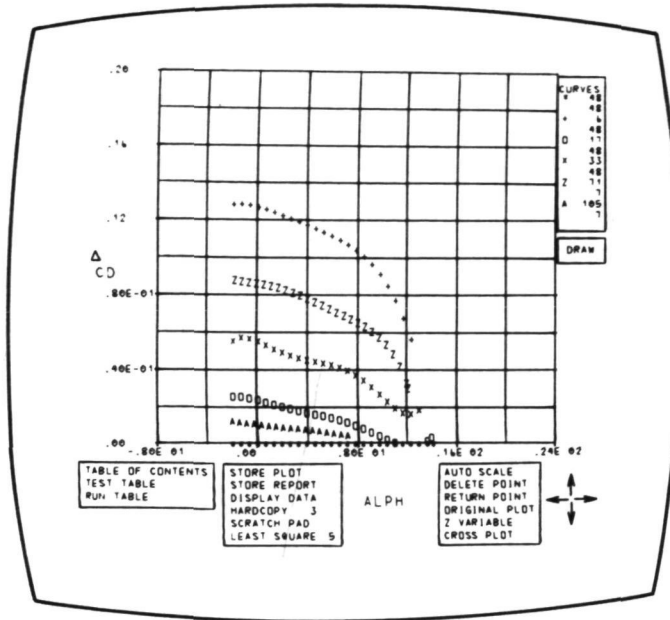

FIGURE 19. INCREMENT PLOT POINT DISPLAY, INITIAL POSITION

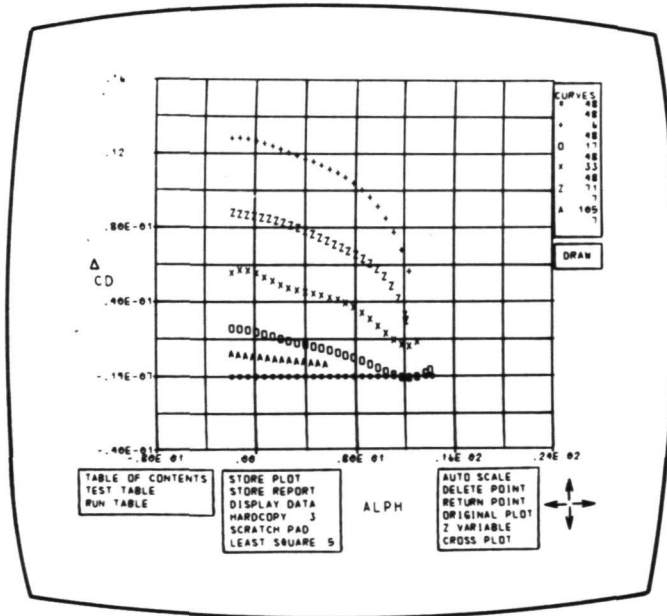

FIGURE 20. INCREMENT PLOT POINT DISPLAY, MOVED POSITION



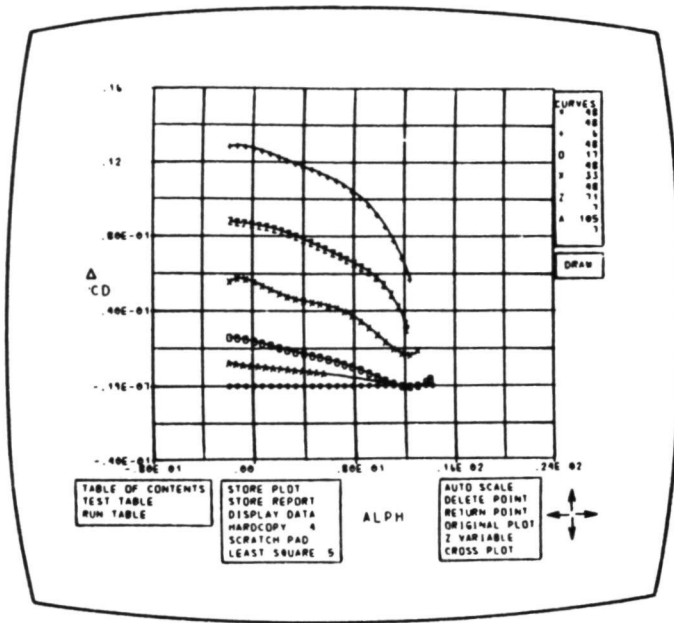

FIGURE 21. INITIAL FAIRING OF INCREMENT PLOT

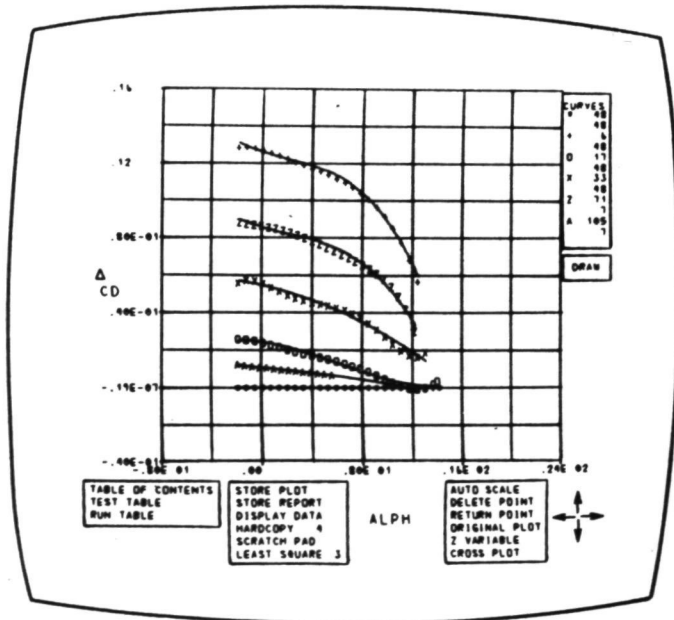

FIGURE 22. FINAL FAIRING OF INCREMENT PLOT

6

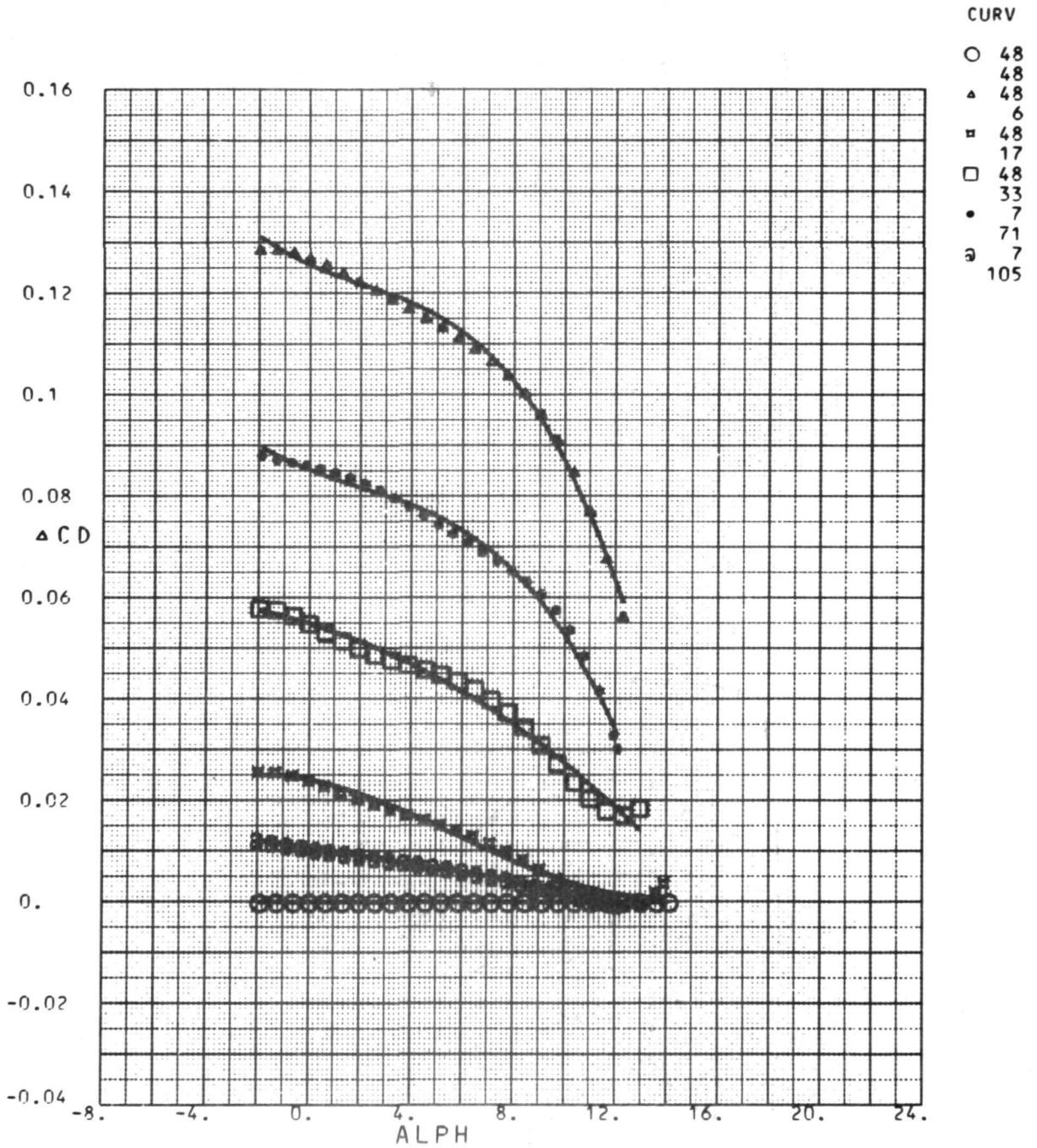

FIGURE 23. HARDCOPY RESULT FOR FIGURE 22

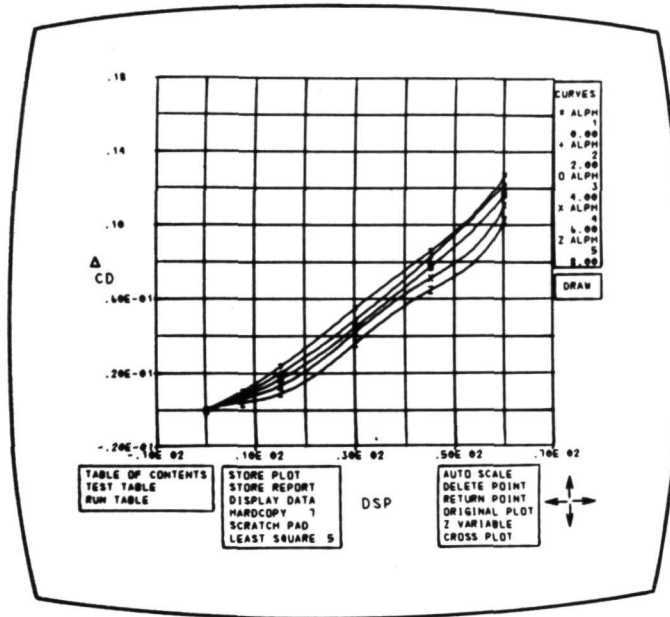

FIGURE 24. FAIRED CROSS PLOT, LEAST SQUARE 5

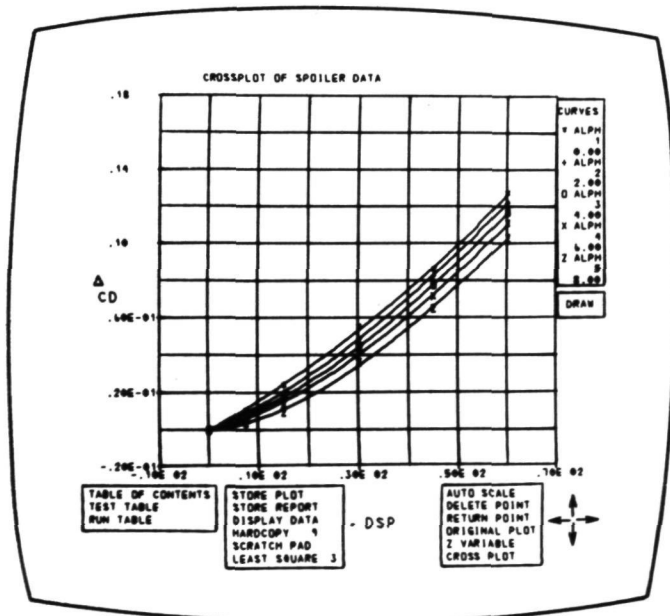

FIGURE 25. FAIRED CROSS PLOT, LEAST SQUARE 3

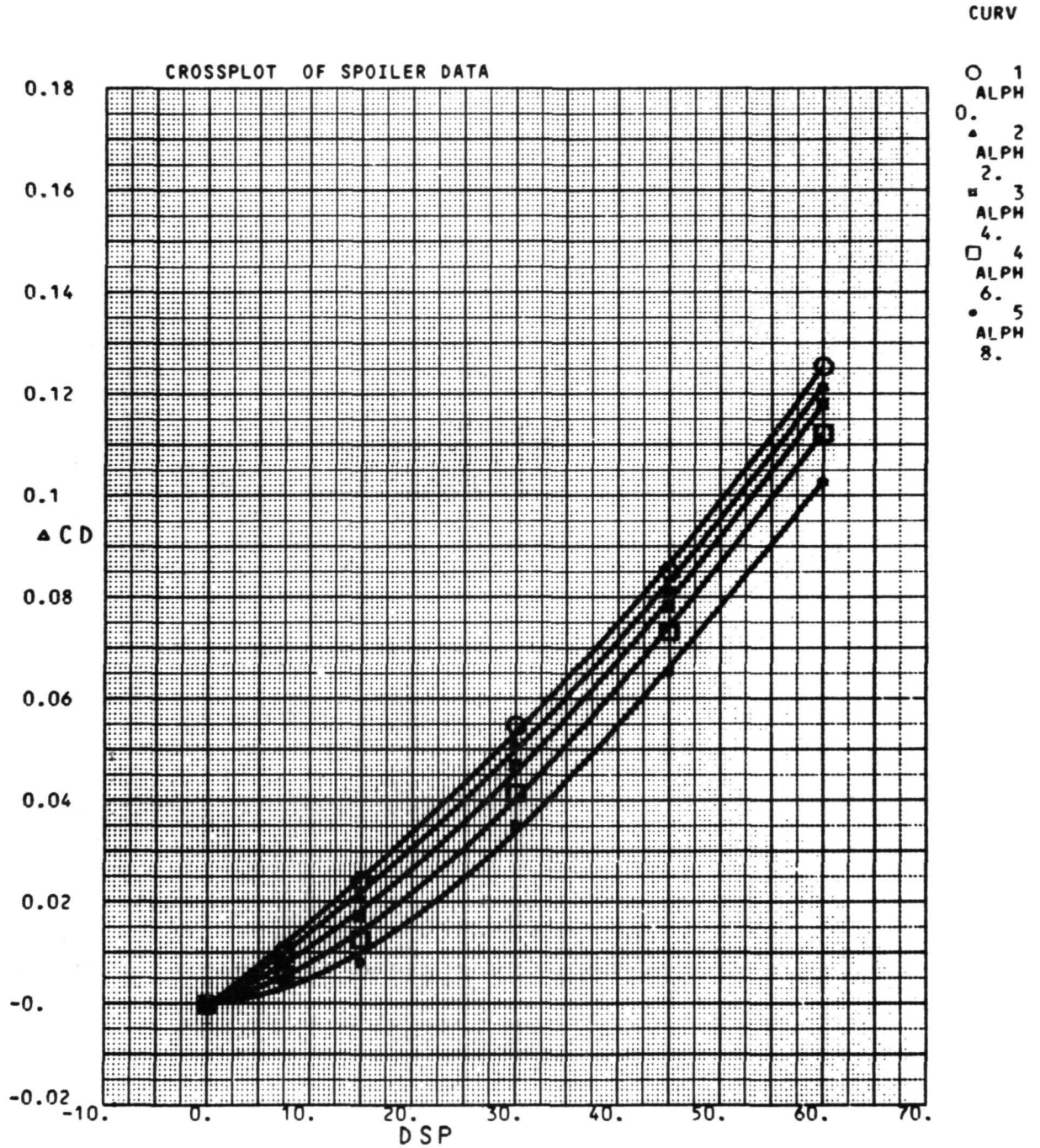

FIGURE 26. HARDCOPY OF FIGURE 25 CROSS PLOT