

General Disclaimer

One or more of the Following Statements may affect this Document

- This document has been reproduced from the best copy furnished by the organizational source. It is being released in the interest of making available as much information as possible.
- This document may contain data, which exceeds the sheet parameters. It was furnished in this condition by the organizational source and is the best copy available.
- This document may contain tone-on-tone or color graphs, charts and/or pictures, which have been reproduced in black and white.
- This document is paginated as submitted by the original source.
- Portions of this document are not fully legible due to the historical nature of some of the material. However, it is the best reproduction available from the original submission.

THE CURATORS OF THE UNIVERSITY OF MISSOURI
FOR

THE DALTON RESEARCH CENTER

(NASA-CR-146665) [STRESS, TEMPERATURE,
HEART RATE, AND HIBERNATING FACTORS IN
HAMSTERS] Annual Status Report (Missouri
Univ.) 109 p HC \$5.50

CSCI 06C

N76-20802

Unclas

G3/51 23888

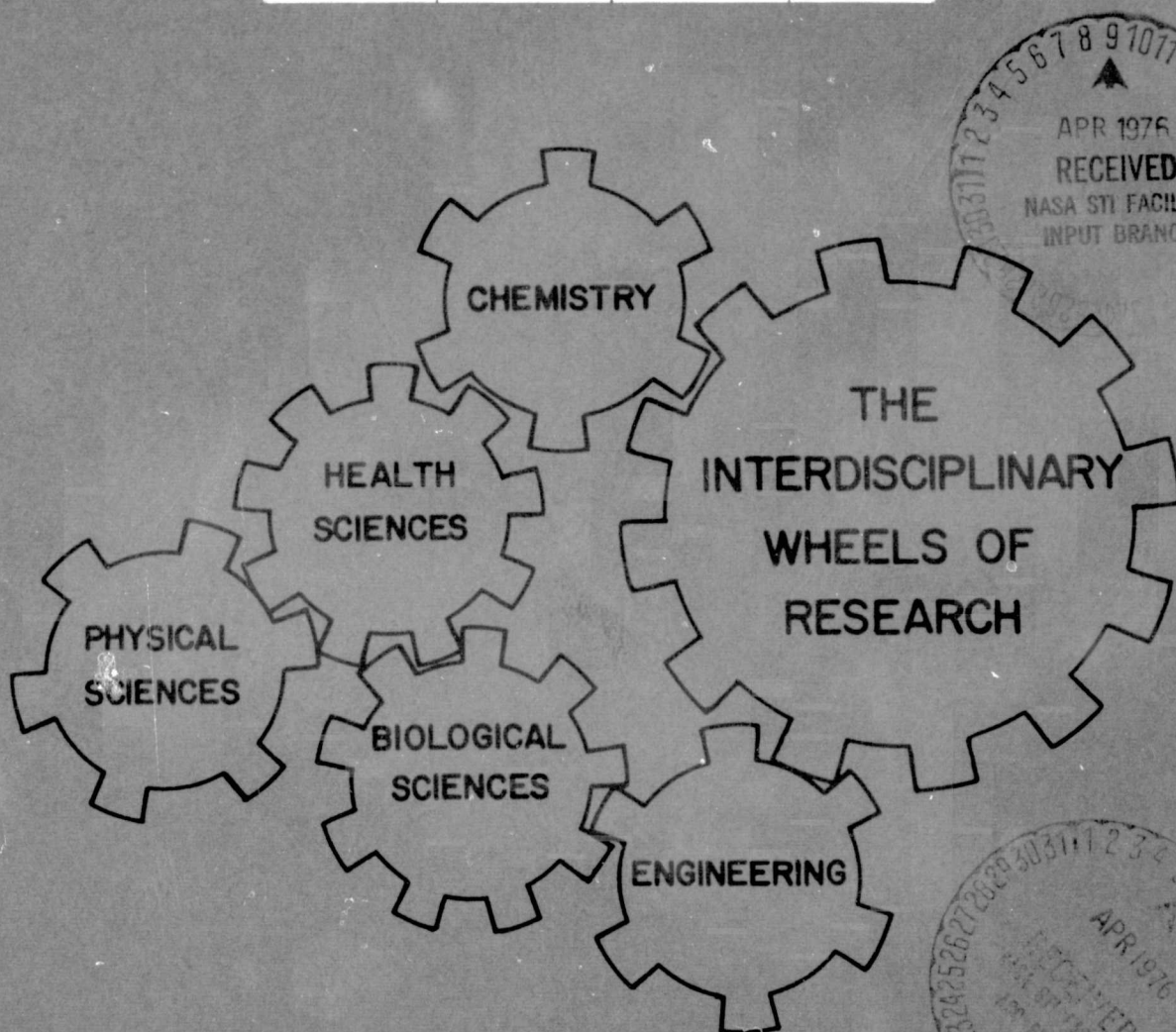
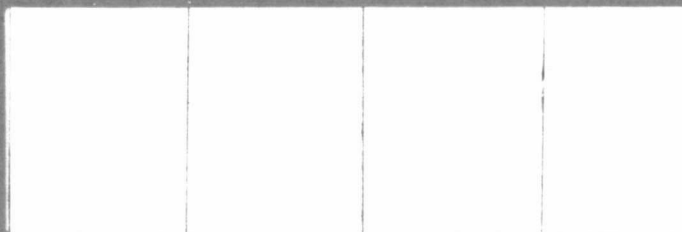

UNIVERSITY OF MISSOURI-COLUMBIA
COLUMBIA, MISSOURI

ANNUAL STATUS REPORT AND
REQUEST FOR CONTINUATION

NASA GRANT NGL 26-004-021

X. J. Musacchia, Ph.D.

(August 1974)

Table of Contents

I. Introduction and Background

II. Experimental Projects

1. Renal function in the hibernating and hypothermic hamster, Mesocricetus auratus. George E. Tempel and X. J. Musacchia
2. The effect of chronic heat stress on intestinal function in the hamster. Mecca Carpenter and X. J. Musacchia
3. Erythrocyte 2,3- diphosphoglycerate concentrations in hibernating, hypothermic, and rewarming hamsters. George E. Tempel and X. J. Musacchia
4. Temperature acclimation and norepinephrine turnover rates in the golden hamster. Stephen Jones and X. J. Musacchia
5. Telemetry system: body temperature and heart rate. George E. Tempel and X. J. Musacchia

III. Publications

1. Reprint: The effects of argon in the bioenergetics of the hamster and the rat. George E. Tempel and X. J. Musacchia
2. Preprint: Renal function in the hibernating and hypothermic hamster, Mesocricetus auratus. George E. Tempel and X. J. Musacchia
Indexed in Section II. Project 1.
3. Abstracts
 - 3.1 Renal function in hypothermic and hibernating golden hamster. George E. Tempel, Wynn Volkert and X. J. Musacchia
Fed. Proc. 33 (3): 423, 1974
 - 3.2 Turnover rates of norepinephrine in heart and other tissues of the golden hamster in heat and cold acclimation. S. B. Jones and X. J. Musacchia
Trans. Mo. Acad. of Sci. 1974
 - 3.3 Experimental hypothermia, a model for natural hibernation. X. J. Musacchia
Cryobiology (in press) 1974
 - 3.4 RBC 2,3- Diphosphoglycerate in hibernating, hypothermic and rewarming hamsters. George E. Tempel and X. J. Musacchia
The Physiologist (in press) 1974
 - 3.5 The effect of chronic heat stress on intestinal function in the rat. Mecca Carpenter and X. J. Musacchia
The Physiologist (in press) 1974
 - 3.6 Turnover rates of norepinephrine in heart, spleen, and brain tissues of the golden hamster in temperature acclimation. S. B. Jones and X. J. Musacchia
The Physiologist (in press) 1974

IV. Copy of Renewal Request

I INTRODUCTION AND BACKGROUND

Continued exploration of outer space and extra terrestrial environments will be an objective of the U.S., the U.S.S.R. and any other nation or groups of nations that have the capacity to place men and machines outside the earth's environmental envelope. It is also recognized that at the present time, there has been a lessening in the number of missions which directly include human space travelers. This situation may of itself be fortuitous since it can provide the experimental physiologists the opportunity to "catch up" and examine the pathophysiologic problems evident in both astronauts and cosmonauts. In short, it is well recognized that prolonged exposure to zero gravity, cabin constraint, altered ambient environment, whether it be noise, vibrations, high temperatures, or combinations of such factors, etc., have resulted in numerous pathophysiologic conditions. It is generally agreed that aberrations occur not only in overall metabolism but also in such systems as cardiovascular, including hematology, in mineral and hormonal metabolism, in vestibular function, etc. It is not my intent to itemize or list the numerous pathophysiologic conditions that both the Americans and the Russians have experienced.

It is my intent to argue that now is the time to utilize the expertise of the Consortium members, in particular, the Regulatory Biology group, to identify several areas where specific problems are known to exist, to plan experiments which test and analyze those problems and, based on the results, to plan projects which will alleviate malfunction or at least which will give us a way to understand and correct human problem areas. This Consortium should be planning projects which are supportive of manned programs. Ideally, our experiment should

precede the manned space flight projects. However, since there is now a bulk of information available which identifies problem areas, this laboratory proposes to investigate several areas, in concert with other laboratories in the Consortium.

Our areas of expertise include:

1. Thermoregulation and its role in reflecting stress and adaptation to the unique and challenging environment of the gravity free state and cabin confinement with its altered circadian forcings.
2. Renal function and its measurement in electrolyte distribution and blood flow dynamics.
3. Gastrointestinal function and an assessment of altered absorptive capacity in the intestinal mucosa.
4. Catecholamine metabolism in terms of distribution and turnover rates (e.g. N and NE, etc.) in specific tissues. These investigations are related to 1 and 2 above.

In the present report, the reader will note several project areas. The rationale for many of these projects has been provided in previous Annual and Semi-annual Reports and in the dozens of publications and reports credited to NASA grant NGL26-004-021. From the start this grant has supported a variety of projects all of which have been related to one or more NASA missions. Our techniques and methods are widely applicable to numerous animal species and only one example will be cited.

The study by Mecca Carpenter of intestinal function in heat stressed animals, has two salient features for the Regulatory Biology group. One feature is an identification of methods which can be used with a variety of small laboratory animals (rats, hamsters, mice, etc.) and even with larger subjects if biopsy samples are obtained. Clearly the absorptive capacity of the intestine, an undeniable basic function in man and one which responds readily to stressful insult, can be studied in animals subjected to extraterrestrial experimentation. Furthermore, the write-up, as it is presented, illustrates the basis for some original research which will be extended and continued during the forthcoming year. Mrs. Carpenter is a Ph.D. candidate in physiology. Incidentally, this NASA grant has been a supporting factor in several Ph.D. programs in this laboratory.

With continuing constraints on funding, it is herein proposed to concentrate our future efforts on the four areas described above. These are in keeping with discussions with other members of the Consortium. In addition, I firmly believe these are programs which are closely allied to the manned space flight programs. Our projects are aimed at experiments which will provide increased knowledge of the man's functional capacity to live and work for prolonged periods in the gravity-free orbital environment. Our projects are clearly allied to a better understanding of the pathophysiology of manned space flight and we refer to these projects as being supportive of manned programs.

Personnel and facilities in this laboratory in the Dalton Research Center are relatively unchanged. Various staff members are identified with each project, these include Dr. George Tempel, a research associate, Ms. Mecca Carpenter and Mr. Stephen Jones, both Ph.D. candidates, Mrs. Janet Burnett, a technician, and in addition, Dr. Wynn Volkert, Associate Professor of Radiology, who has been associated with these projects for several years. Dr. Garth Resch recently completed his Ph.D. and he now has a post-doctoral appointment in a NASA program in Gainesville, Florida. We lost one technician, Ms. Jane Roberts, she returned to graduate school. In all probability she will not be replaced on a full-time basis. The additional reductions in funding will not permit full salaries for Dr. Tempel and a technician.

We continued our research projects in tissue intermediary metabolism with Dr. Cecil Entenman and currently have two papers accepted for publication in Comparative Biochemistry and Physiology. Two additional manuscripts are in preparation.

Our funds have been expanded and are committed in accordance with provisions set forth in our proposal. The additional request for \$20,000 was submitted earlier and a copy is presented in the last section of this report.

RENAL FUNCTION IN THE HIBERNATING, AND
HYPOTHERMIC HAMSTER, MESOCRICETUS AURATUS *

George E. Tempeí and X. J. Musacchia

Dalton Research Center

and

Department of Physiology

University of Missouri

Columbia, Missouri 65201

Running Head: Hibernating, Hypothermic Hamster Kidney Function

- * This work has been submitted for publication to the American Foundation of Physiology and has been accepted for publication. The write-up presented herein as a portion of this annual report is in effect a pre-print of the paper. It is a copy of the manuscript accepted for publication.

Tempel, George E. and X. J. Musacchia. Renal function in the hibernating and hypothermic hamster (M. auratus). Plasma and urine concentrations of Na^+ , K^+ , and urea were examined in hibernating, hypothermic, and normothermic hamsters. Plasma Na^+ and K^+ appear unaffected by 48 hrs of hypothermia (T_{re} 7C); however, plasma Na^+ increased ($P < 0.05$) from control values of 125.8 ± 10.2 mEq/l to 173 ± 9.2 mEq/l in hibernators. Plasma K^+ of the hibernator increased to 9.6 ± 3.2 mEq/l from control values of 5.5 ± 0.8 mEq/l ($P < 0.05$). Plasma urea concentrations were increased ($P < 0.05$) in both metabolically depressed groups from a control value of $0.5 \pm .05$ to $0.8 \pm .16$ and 7.2 ± 2.8 mM/l in hypothermic and hibernating groups, respectively. Urine concentrations of solute for the hypothermic animals showed no detectable change from control values for Na^+ , and a decrease for both K^+ and urea. Concentrations from hibernators showed a decrease from control values for both Na^+ and K^+ with no detectable change in urea.

Renal tissue slice analysis demonstrated a marked cortico medullary solute gradient for Na^+ and urea in normothermic control animals which is eliminated in hamsters hypothermic for 48 hrs and reduced in animals hypothermic for 15 min. Rewarming animals did not show a return of the solute gradient at T_{re} 18C. However, animals which had rewarmed to T_{re} 37C demonstrated a complete return with no difference ($P > 0.05$) from control values. Hibernators showed a slight ($P < 0.05$) gradient for Na^+ , and no gradient for urea. Animals in all instances demonstrated a decrease in K^+ concentration from cortex to papilla. A greater concentration of K^+ was found in the renal cortex of animals hypothermic for 15 min, and in hibernators ($P < 0.05$).

INDEX TERMS:

hypothermia

hibernation

depressed metabolism

renal concentrating mechanisms

RENAL FUNCTION IN THE HIBERNATING &
HYPOTHERMIC HAMSTER (M. AURATUS)

Recent investigations have demonstrated the depression of a variety of renal functions in hibernating ground squirrels (8,13,14) and marmots (25). Additional studies have likewise shown a depression of kidney function in experimentally hypothermic dogs (5,9,15, 19), rabbits (1) and man (12,15). In these latter studies core temperatures were between 20C and 27C, considerably higher than the temperature of a hibernator.

Our interest in depressed metabolism has centered around investigations of the physiologic state of the hypothermic hamster. These studies have involved efforts to prolong survival time as well as to further characterize the physiologic state of the metabolically depressed animal. Our motivation has been that further characterization might enable use of the helium-cold hypothermic hamster as a model of natural hibernation, a model that would require neither time consuming preexposure to cold nor dependence on the season.

Since hibernation is a response not only to lowered ambient temperatures, but also to water deprivation (10), and since fluid intake by the hypothermic animal is also absent, it is likely that water conservation and electrolyte balance are of considerable importance in both metabolically depressed states. The present study was undertaken to examine renal function in an artificially hypothermic animal whose core temperature more closely approximated that of a hibernator, and to further characterize the physiologic state of the helium-cold

hypothermic hamster. A preliminary report of these results has appeared (22).

METHODS

Animal Protocol. Male and female golden hamsters from our closed colony weighing 100 to 130 g were employed in these investigations. They were maintained on a diet of Wayne Lab-Blox supplemented with fresh lettuce and water ad libitum. These animals were divided into 8 groups: hamsters from group one were taken directly from the animal quarters with no prior treatment; group two animals were deprived of water for 72 hrs prior to sacrifice; group three animals were given free access to food and water, and maintained in helium and oxygen 80:20 for 48 hrs prior to sacrifice. The hamsters from the experimental groups were made hypothermic with a rectal temperature (T_{re}) of 7C by exposure to gas mixtures containing 90% helium, 10% oxygen at an ambient temperature (T_a) of 7C, a modification of the technique described by Musacchia (1972). After reaching T_{re} 7C, the animals were kept at T_a 7C in room air. Group four hamsters were sacrificed after approximately 15 min at T_{re} 7C; group five animals were maintained at T_{re} 7C for 48 hrs prior to sacrifice; group six and seven animals, likewise hypothermic for 48 hrs were allowed to rewarm to T_{re} 18C (group 6) and T_{re} 37C (group 7) by placing the animal in a 22C environment. Group seven animals were normothermic for a two-hour period prior to sacrifice; group eight animals were induced to hibernate by exposure to T_a 7C environment for

a period of several weeks. The hibernating hamsters were sacrificed after approximately 48 hrs in hibernating torpor with $T_{re} \approx 7C$.

The hamsters were sacrificed by cervical transection, and the thorax and abdomen entered by means of a continuous midline incision. An average of 1 ml of blood was collected from the beating heart into a heparinized syringe using a 22 gauge needle and transferred to a centrifuge tube. After centrifugation at 7C for 20 min, the plasma was collected and stored frozen at -20C until analyses were performed. A urine sample, collected by direct puncture into the urinary bladder, was likewise frozen. A small section of the rectus abdominis (approximately 1 cm square) and the kidneys were removed. Blood and urine collection and the preparation of the renal tissue were carried out in less than 5 min following cervical fracture.

Renal Tissue Preparation and Analysis. The renal capsule was removed and the kidney sectioned as described by Moy (13). Upper and lower poles were removed with a scalpel or razor blade and cortical tissue of the anterior and posterior surfaces likewise removed to leave a mid saggital section which was immediately frozen in dry ice and acetone. The renal tissue and the section of the rectus abdominis were frozen and stored at -76C in a Revco ultra low refrigerator until subsequent analyses of tissue electrolyte and urea concentrations were performed.

The tissues were removed from storage and prepared for analysis in the following manner: the mid saggital section was sliced frozen into three readily distinguishable divisions: cortex; medulla; and papilla (Fig. 1). No distinction was made between the left and the right kidney.

The tissue slices were then weighed to the nearest 0.2 mg on a Roller-Smith Precision balance. Three ml sample cups were placed on a Sartorius analytical balance and approximately 200 μ l of ammonia-free distilled water were added to those cups which were to receive the cortical and medullary slices. To those cups which were to receive the smaller papilla, approximately 100 μ l were added. The sample cups were then reweighed, and the frozen tissue slices added. After being tightly sealed, the cups were heated at 80C for 5-10 min to denature the tissue enzymes. The samples were again weighed to make certain no evaporative water loss had occurred. The samples were then stored at 7C for 24 hrs before analysis to maximize the diffusion of solutes from the tissue residues into the solvent.

The dilution factor to correct for the addition of water was determined by the following formula:

$$\text{dilution factor} = \frac{\text{wt. of tissue water} + \text{diluent}}{\text{wt. of tissue water}}$$

Tissue water was estimated at 80% of the total tissue weights (18).

Solute Analysis. Tissue, plasma, and urine sodium and potassium were analyzed by flame photometry. Urea determinations were made spectrophotometrically by a modified Bertholet reaction (Sigma Chemical Co.), and standards were run with each group of unknowns.

Intergroup comparisons of plasma, and urine solutes, and corticomedullary gradients were made using the non-parametric Mann-Whitney test (11).

RESULTS

Plasma and urine sodium, potassium and urea levels were compared in normothermic, hypothermic and hibernating hamsters. The data for plasma and urine electrolyte and urea concentrations are summarized in Table 1.

Plasma. Plasma concentrations of electrolytes were compared in two groups of normothermic controls with two experimental groups with animals at reduced core temperatures. Sodium and potassium were 117.4 ± 7.0 and 6.5 ± 0.8 mEq/l respectively in the normothermic animals allowed access to water ad lib. Seventy-two hrs of water deprivation produced no significant changes ($P > 0.05$) with values of 125.8 ± 10.2 mEq/l for Na^+ and 5.5 ± 0.8 mEq/l for K^+ . Forty-eight hrs of hypothermia produced no significant change ($P > 0.05$) from control values in either Na^+ or K^+ which were 110.3 ± 12.6 and 5.5 ± 0.7 mEq/l respectively. Unlike the hypothermic and control animals, in the hibernating hamster plasma sodium increased significantly ($P < 0.05$) to 173.2 ± 9.2 mEq/l. Plasma potassium concentrations, comparable in normothermic water deprived, water ad lib, and hypothermic hamsters, increased in the hibernator to 9.6 ± 3.2 mEq/l, and the difference is significant at the .05 level.

Plasma urea concentrations demonstrated no effect relatable to water deprivation in the normothermic control group with means of 0.5 ± 0.05 mM/l in both the water ad lib and water deprived hamsters. By contrast, plasma urea concentration rose significantly ($P < 0.05$) above control values in metabolically depressed animals. In the helium-cold hypothermic hamster, plasma urea concentration increased

slightly to 0.8 ± 0.10 mM/l while that of the hibernators increased markedly to 7.2 ± 2.8 mM/l.

Urine. Urine samples from the normothermic hamsters provided, water, ad lib., showed a mean sodium concentration of 99.4 ± 45.4 mEq/l.

Hamsters deprived of water for 72 hrs and hamsters hypothermic for 48 hrs showed no significant differences in urine sodium concentration (115.7 ± 61.0 and 80.4 ± 37.7 mEq/l respectively) from control values. In contrast, urine sodium concentration, 24.3 ± 8.6 mEq/l, of the hibernating hamster showed a significant decrease ($P < 0.05$) from normothermic control values.

Urinary potassium concentrations of normothermic hamsters likewise showed little change due to water deprivation. The concentration for deprived animals was 206.6 ± 33.9 mEq/l while the value for hamsters given water ad lib was 299.2 ± 90.8 mEq/l. Urinary potassium concentrations of both hypothermic and hibernating hamsters 78.3 ± 45.9 mEq/l and 110.3 ± 38.0 mEq/l showed a significant decline ($P < 0.05$) from control values.

Urine concentrations of urea show no significant difference between normothermic hamsters provided water ad lib, water deprived and hibernating hamsters. However, in the hypothermic hamster, the urine urea concentrations were 1.8 ± 1.2 mM/l, a 50-fold decrease from control levels.

Renal Tissue Slices

Sodium Concentrations. The sodium concentration observed in the renal tissue slices from normothermic, water deprived hamsters are compared with those from hypothermic hamsters in the scatter diagram

(Fig. 2A). In order to quantitate the gradient for each tissue section as given in Figures 2 and 3, a mean and SD were calculated. Sodium concentrations in kidneys from normothermic water deprived hamsters were 64.4 ± 6.0 , 94.1 ± 17.2 , 136.6 ± 33.9 mEq/l in cortex, medulla, and papilla slices respectively. The sodium concentration gradient of the normothermic control hamsters given water ad lib did not differ significantly ($P > 0.05$) from either the water deprived animals or the helium-oxygen group (Fig. 2a,b,c). The gradient for sodium is, however, essentially eliminated in hamsters hypothermic for 72 hrs. The mean sodium concentrations were 55.4 ± 3.2 , 64.0 ± 11.3 , and 55.7 ± 9.8 mEq/l in the cortex, medulla and papilla respectively. Hamsters sacrificed immediately upon reaching T_{re} 7C showed a slight, although not statistically significant ($P = 0.18$) decrease in the renal cortico-medullary sodium gradient (Fig. 3a). Rewarming animals did not demonstrate a gradient at T_{re} 18C (e.g. values were 61.8 ± 9.0 , 62.4 ± 7.2 , and 64.7 ± 11.7 mEq/l for cortex, medulla, and papilla respectively). By contrast, hamsters which had rewarmed to T_{re} 37C, after 2 hrs showed a definite gradient: 64.2 ± 5.7 , 101.1 ± 17.9 , and 177.0 ± 17.4 mEq/l for cortex, medulla and papilla. This represents a notable return to levels comparable to control values (Fig. 3b). Unlike the hypothermic hamster, the hibernator kidney shows a slight although significant ($P < 0.05$) sodium gradient from cortex, 65.1 ± 16.2 mEq/l, to papilla 80.3 ± 10.5 mEq/l (Fig. 3c).

Tissue fluid (TF) to muscle (M) ratios of sodium were determined for cortex, medulla, and papilla in the normothermic, hypothermic, and hibernating hamsters. The data (Table 2) indicate a pronounced sodium

gradient in the normothermic hamster, which is eliminated in the hypothermic hamster, and reduced in the hibernator.

Potassium Concentrations. Potassium decreased in concentration from the cortex to the papilla (Figs. 2 and 3) in all groups examined. The slopes of the lines are the same for the normothermic groups and for the 48 hr hypothermic, and rewarming groups. There is, however, a significant ($P < 0.05$) increase in the negative slope in the animals sacrificed immediately after reaching a temperature of $T_{re} 7C$, and in the hibernating animals.

Urea Concentrations. Urea gradients reflect the trends observed in the sodium data. Urea concentrations in kidneys of normothermic water deprived hamsters increased from 25.6 ± 5.1 mM/l to 140.5 ± 88.1 mM/l, from the cortex to papilla respectively. This gradient does not exist in kidneys from hamsters hypothermic for 48 hrs, with values of 16.2 ± 2.8 , 16.1 ± 1.1 , and 12.9 ± 1.1 mM/l for cortex, medulla, and papilla respectively (Fig. 2a). The other groups of normothermic hamsters, i.e., those given water ad lib and the helium:oxygen group are comparable statistically (Fig. 2b,c).

Hamsters sacrificed upon reaching $T_{re} 7C$ demonstrated a gradient from cortex to papilla with values of 19.8 ± 2.9 and 55.7 ± 13.2 mM/l respectively; these values are significantly less ($P < 0.05$) than control values. Hamsters hypothermic for 48 hrs which had rewarmed to $T_{re} 18C$ showed no gradient; 16.1 ± 1.6 , 14.5 ± 2.2 , and 13.8 ± 2.3 mM/l for cortex, medulla, and papilla respectively. Animals which re-

warmed to T_{re} 37C, however, showed a return to control levels. Hibernating hamsters, like the helium-cold hypothermic hamster, demonstrated the absence of a gradient with values of 10.8 ± 3.9 , 9.4 ± 3.1 , and 8.5 ± 2.5 mM/l for cortex, medulla and papilla respectively.

TF to plasma (P) ratios of urea determined for all sections of the kidney likewise demonstrate a pronounced gradient in the normothermic animal which is absent in both the helium-cold, hypothermic hamster and the hibernating hamster.

DISCUSSION

The effect of hypothermia on the kidney may be viewed in terms of interactions of physical factors affecting filtration pressure such as blood pressure and renal vascular resistance, and active transport processes such as a sodium pump mechanism. In both hypothermia and hibernation there occurs a decrease in systemic blood pressure which results in a decreased filtered load presented to renal tubules and, in turn, a depression in their ability to transport filtered elements. Thus, at very low temperatures filtration and hence excretion might be expected to be eliminated. Indeed, the loss of fluids, electrolyte and other plasma constituents which might occur due to depressed tubular transport capacity at low temperatures is minimized by a concomitant reduction in filtration, and is of definite adaptive advantage (9).

The mechanisms responsible for the cortico-medullary concentration gradient are hypothesized to involve a counter-current system consisting

of the vasa recta and juxta medullary nephrons. Available evidence suggests that a countercurrent multiplier system consisting of the ascending and descending limbs of the loop of Henle establishes this gradient. Countercurrent flow in the vasa recta prevents the dissipation of this gradient once established. This increase in solute concentration from cortex to medulla could be altered by such factors as the redistribution of blood flow to the nephrons, by increased blood flow in the vasa recta, by a redirection in the reabsorption of solutes in the ascending thick limbs of the tubules, or by a reduction in the secretion of antidiuretic hormone. Although the alterations noted above are possible, the reduced concentration of urea in the urine of hypothermic animals would suggest a reduction or elimination of filtration greater than the reduction in tubular reabsorption. The reduction in nervous activity, which occurs in hypothermia and hibernation, would argue against blood flow changes while the hemoconcentration which occurs would suggest increased, not decreased levels of antidiuretic hormone. It is also inherent in the countercurrent hypothesis that in order for the gradient to exist, glomerular filtration is present, and that in the absence of filtration, equilibration between the renal interstitial fluid and plasma occurs (27). The depression of factors involving filtration pressure, and tubular transport mechanisms (23) coupled with observations of morphologic changes (26) would also suggest the absence of glomerular filtration in animals profoundly hypothermic. Our results, which demonstrate the absence of a solute gradient in the hypothermic, and a marked depression in the hibernating hamster, suggest the absence of filtration in the hypothermic

hamster and minimal, if any, in the hibernator. This study also demonstrates the absence of a corticomedullary solute gradient in animals rewarmed to T_{re} 18C. However, complete recovery is effected in the animal which has returned to normothermia T_{re} 37-38C. We also reasoned that urine samples obtained from metabolically depressed hamsters are, therefore, not a reflection of renal activity during either hypothermia or hibernation. They are rather likely a reflection of the time course of events, hypothermia being induced more rapidly than entry into hibernation.

Urine. Urine values of sodium in the hypothermic hamster demonstrated no significant change from control values which suggests a parallel reduction in filtration and tubular reabsorptive mechanisms. By contrast, the sodium concentration in the urine of hibernating hamsters showed approximately a four fold decrease from control values. This would suggest a more marked reduction in filtered load than in tubular transport prior to complete cessation of function. It is also possible that reduction in urine sodium concentration reflects the response of the renin-angiotension-aldosterone system. A decrease in systemic arterial pressure, through increased renin release results in increased angiotension (A II) levels. Such an increase in A II stimulates aldosterone secretion which results in greater Na^+ retention and lower urine Na^+ concentration.

Filtered potassium is largely or completely reabsorbed (2) and that potassium which appears in the urine is due to secretion. The depression in urine concentrations of potassium in both hypothermia (approximately 3-fold) and hibernation (over 2-fold) might well be ex-

plained in terms of a general metabolic depression of active tubular processes (7,19).

Urine urea concentrations although demonstrating no change in the hibernating hamster decreased approximately 50-fold in hypothermic hamsters. An explanation for this enhanced reabsorption prior to hypothermia with cessation of renal function may reside in a lower urea concentration in medullary tissue. This would increase the urea diffusion gradient and result in a decrease in excreted urea. That this does not occur in the hibernator may be a reflection of a reduction in the filtered load before the elimination of the gradient.

The Na^+ and K^+ values determined for normothermic animals compare favorably with values reported in the literature (17). However, reports for values for urine urea concentrations were lacking.

Plasma. Plasma concentrations of sodium and potassium were comparable in the control and hypothermic animals. The hibernating animals, however, demonstrated approximately 40% and 60% increases for Na^+ and K^+ respectively. Experiments using other laboratory species, generally conducted at higher temperatures, suggest a sodium decrease in hypothermia (2,12,20); while others report no change (6,21). Potassium data from the literature suggest little alteration in plasma K^+ from hibernating animals (24) although experiments on animals at more elevated temperatures suggest a decreased plasma K^+ due to hypothermia (9). In our study, plasma hemoglobin was not assessed. We recognize that hemolysis can contribute to a rise in plasma K^+ , however, care exercised to prevent lysis of the cells and visual inspection of the plasma argue against such an event. In our opinion the plasma K^+ values

reflect a true increase. Several tissues (erythrocytes, brain, kidney, diaphragm) are known to possess adaptations which minimize the loss of intracellular potassium at low temperatures in vitro (24). Although, perhaps functional in the hibernator, the extent to which intracellular K^+ loss may be prevented is questionable, in that plasma K^+ rose markedly in our animals. The loss of this important electrolyte in the urine may, however, be minimized due to its retention by the renal cortex. In both the hibernating and short-term hypothermic hamsters the concentration of potassium is higher in the renal cortex than in the normothermic control groups, accounting for the greater negative slope of the regression line.

Increases in plasma urea concentration are marked in both experimental groups and give some insight into the relative extent of metabolic activity in hypothermia in comparison with hibernation. With no urine formation in the helium cold hypothermic hamster and with minimum, if any, formation in the hibernator, increases in plasma urea may be regarded as a reflection of the extent of amino acid metabolism and liver function. Although ongoing in both the helium-cold and hibernating hamsters, the greater than 15-fold increase in comparison to controls observed in the hibernator would suggest a much greater degree of metabolic activity. In contrast, the helium-cold animal increased only 60% in comparison to controls.

Plasma values for these solutes agree favorably with reports in the literature (3).

In summary, the absence of a solute gradient in hypothermic hamsters suggests the absence of glomerular filtration. The marked de-

pression seen in the hibernator would also argue for marked reduction to minimal levels of glomerular function. Plasma data also suggest: a continued, though depressed, level of amino acid metabolism and liver function as well as a compensation for potassium loss through renal storage in both hibernating and hypothermic hamsters.

REFERENCES

1. Andersen, M. and K. C. Nielsen. Studies on the renal function under experimental hypothermy in rabbits. Acta. Med. Scand. 151:191-199, 1955.
2. Axelrod, D. R. and D. E. Bass. Electrolytes and acid-base balance in hypothermia. Am. J. Physiol. 186:31-34, 1956.
3. Beaton, J. R. Note on blood metabolite and electrolyte levels in the hypothermic hamster. Canad. J. Biochem. Physiol. 31:1207-1209, 1961.
4. Berliner, R. W., N. G. Levinsky, D. G. Davidson and M. Eden. Dilution and concentration of the urine and the action of antidiuretic hormone. Am. J. Med. 24:730-744, 1958.
5. Blatteis, C. M. and S. M. Horvath. Renal, cardiovascular and respiratory responses and their interrelations during hypothermia. Am. J. Physiol. 192:357-363, 1958.
6. Fleming, R. Acid-base balance of the blood in dogs at reduced body temperature. Arch. Surg. 68:145-152, 1954.
7. Harvey, R. B. Effect of temperature on function of isolated dog kidney. Am. J. Physiol. 197:181-186, 1959.

8. Hong, S. K. Renal function during hypothermia and hibernation. Am. J. Physiol. 188:137-150, 1957.
9. Kanter, G. S. Renal clearance of sodium and potassium in hypothermia. Can. J. Biochem. Physiol. 40:113-122, 1962.
10. Lyman, C. P. Hibernation in mammals and birds. Am. Scient. 51:127-138, 1963.
11. Mann, H. O. and D. R. Whitney. On a test of whether one of two random variables is stochastically larger than the other. Ann. Math. Statist. 18:50-60, 1947.
12. Morales, P., W. Carbery, A. Morello and G. Morales. Alterations in renal function during hypothermia in man. Ann. Surg. 145:488-499, 1957.
13. Moy, R. M. Renal function in the hibernating ground squirrel Spermophilus columbianus. Am. J. Physiol. 220:747-753, 1971.
14. Moy, R. M., R. W. Lesser and E. W. Pfeiffer. Urine concentrating ability of arousing and normothermic ground squirrels (Spermophilus columbianus). Comp. Biochem. Physiol. 41A:327-337, 1972.
15. Moyer, J. H., G. Morris, and M. E. DeBakey. Hypothermia: I. Effect on renal hemodynamics and on excretion of water and electrolytes in dog and man. Ann. Surg. 145:26-40, 1957.

16. Musacchia, X. J. Heat and cold acclimation in helium-cold hypothermia in the hamster. Am. J. Physiol. 222:495-498, 1972.
17. Robinson, P. F. in: The Golden Hamster, ed. by Hoffman, R. A., Robinson, P. F., and Magalhaes, H. Ames: Iowa State University Press, 1968, p. 112.
18. Schmidt-Nielsen, B. Urea excretion in mammals. Physiol. Rev. 38:139-168, 1958.
19. Segar, W. E. Effect of hypothermia on tubular transport mechanisms. Am. J. Physiol. 195:91-96, 1958.
20. Spurr, G. B. and G. Barlow. Plasma and erythrocyte Na, K, Cl and water in hypothermic and hyperthermic dogs. Am. J. Physiol. 197: 648-652, 1959.
21. Swan, H., I. Zeavin, J. H. Holmes and V. Montgomery. Cessation of circulation in general hypothermia I. physiologic changes and their control. Ann. Surg. 138:360-376, 1953.
22. Tempel, G. E. and X. J. Musacchia. Renal function in helium-cold hypothermic hamsters (M. auratus). Physiologist 16:468, 1973.
23. Willis, J. S. Cold adaptation of activities of tissues of hibernating mammals. In Mammalian Hibernation III ed. by Fisher, K. C. et al. New York: Elsevier, 1967, p. 356-381.

24. Willis, J. S., S. S. Goldman and R. F. Foster. Tissue K concentration in relation to the role of the kidney in hibernation and the cause of periodic arousal. Comp. Biochem. Physiol. 39A:437-445, 1971.

25. Zatzman, M. L. and F. E. South. Renal function of the awake and hibernating marmot. Marmota flaviventris. Am. J. Physiol. 222: 1035-1039, 1972.

26. Zimny, M. L. and E. Rigamer. Glomerular ultrastructure in the kidney of a hibernating animal. Anat. Rec. 154:87-94, 1966.

The authors wish to thank Jane R. Roberts for technical assistance and Drs. G. Anderson and R. Freeman for comments concerning the manuscript.

Research was supported by a Grant NGL 26-004-021, Supplements 9, 10, from the National Aeronautics and Space Administration and the Dalton Research Center.

Table 1. Plasma and Urine Sodium, Potassium, and Urea of Normothermic, Hypothermic and Hibernating Golden Hamsters*

	Na ⁺ (mEq/l)	K ⁺ (mEq/l)	Urea (mM/l)
<u>Plasma</u>			
Normothermic water <u>ad lib</u>	117.4 ± 7.0 (6)	6.5 ± 0.8 (6)	0.5 ± 0.05 (6)
Normothermic dehydrated 72 hr	125.8 ± 10.2 (6)	5.5 ± 0.8 (6)	0.5 ± 0.05 (6)
Hypothermic T _{re} = 7C for 48 hr	110.3 ± 12.6 (9)	5.5 ± 0.7 (9)	0.8 ± 0.10 (7)
Hibernator T _{re} = 7C for ≥ 48 hr	173.2 ± 9.2 (8)	9.6 ± 3.2 (5)	7.2 ± 2.8 (8)
<u>Urine</u>			
Normothermic water <u>ad lib</u>	99.4 ± 45.2 (10)	299.2 ± 90.8 (10)	98.1 ± 16.5 (7)
Normothermic dehydrated 72 hr	115.7 ± 61.8 (7)	206.6 ± 33.9 (7)	97.3 ± 17.7 (7)
Hypothermic T _{re} = 7C for 48 hr	80.4 ± 37.7 (9)	78.3 ± 45.9 (9)	1.8 ± 1.2 (7)
Hibernator T _{re} = 7C for ≥ 48 hr	24.3 ± 8.6 (8)	100.3 ± 38.0 (8)	114.7 ± 20.4 (8)

* Mean ± SD (N)

Table 2. Urea tissue fluid to plasma and sodium tissue fluid to muscle ratios from normothermic, hypothermic and hibernating hamsters.

Kidney Zone	Normothermic Water deprived		Hypothermic T_{re} 7°C for 48 hrs		Hibernating T_{re}	
	Na ⁺ TF/M	Urea TF/P	Na ⁺ TF/M	Urea TF/P	Na ⁺ TF/M	Urea TF/P
Cortex	0.5	51.2	1.8	20.3	1.2	1.5
Medulla	0.8	124.6	2.1	20.1	1.3	1.3
Papilla	1.1	381.0	1.8	16.1	1.5	1.2

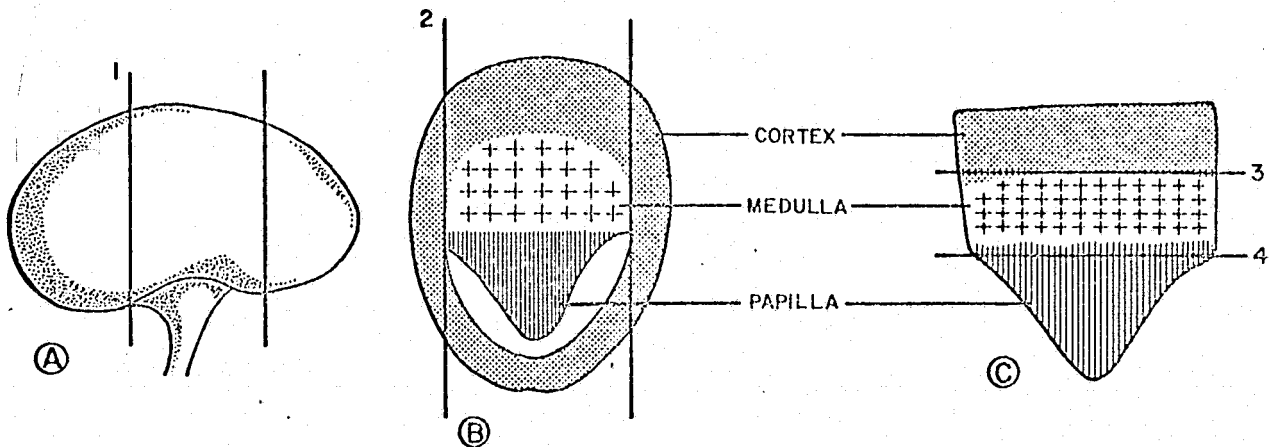

LATERAL VIEW OF KIDNEY
 LINES INDICATE CUTS TO
 REMOVE ANTERIOR AND
 POSTERIOR POLES

CROSS-SECTION OF
 KIDNEY AT 1

PARASAGGITAL VIEW
 SHOWING THE 3 ZONES
 USED IN ANALYSIS

FIG. 1. Views of the kidney indicating the location of cuts made to obtain tissue sections for gradient analysis. (A) First two cuts remove the anterior and posterior poles; (B) two cuts made to remove lateral cortical tissue; (C) last two cuts section the kidney slice into cortical, medullary and papillary divisions.

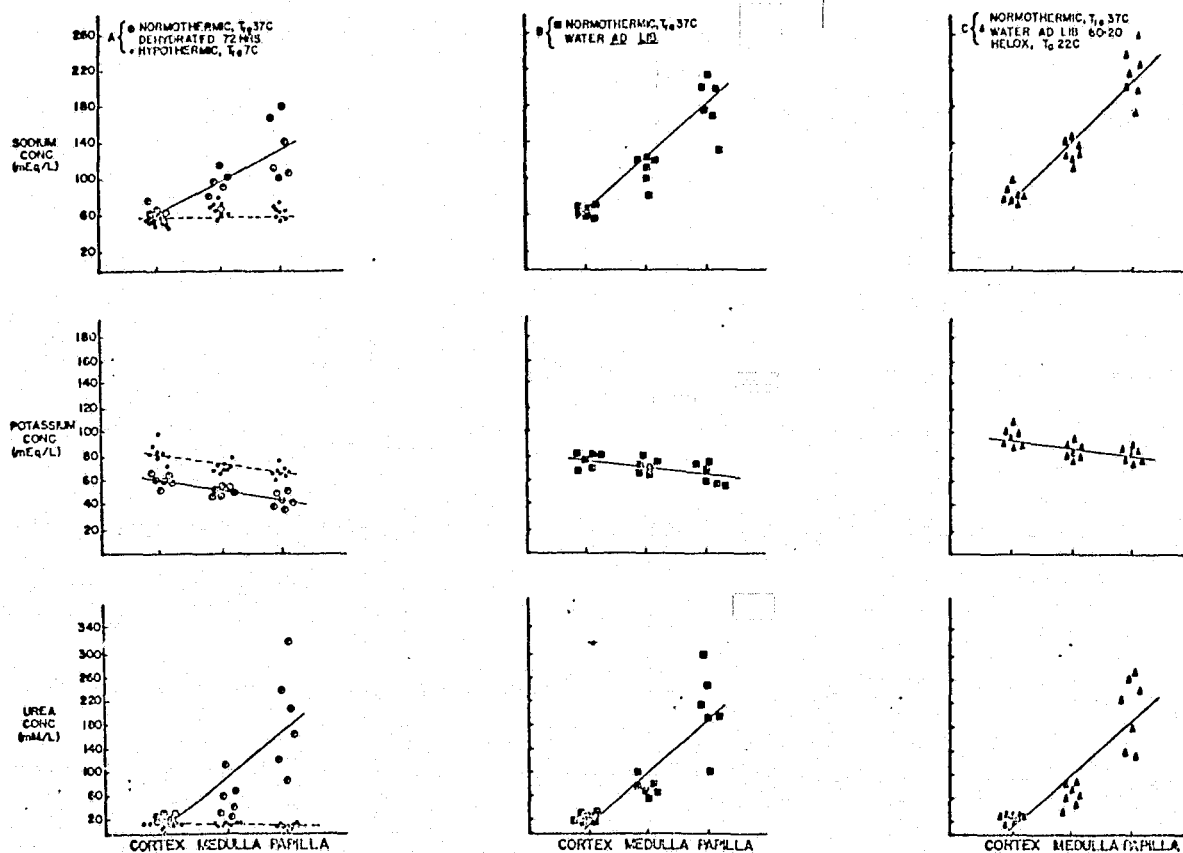

FIG. 2. Solute concentrations from renal tissue slices from normothermic hamsters. (A) water-deprived for 72 hrs (open circles) compared with hypothermic group (solid circles); (B) water ad libitum (black squares); (C) helium:oxygen, 80:20 controls at T_a $22 \pm 2C$ (black triangles).

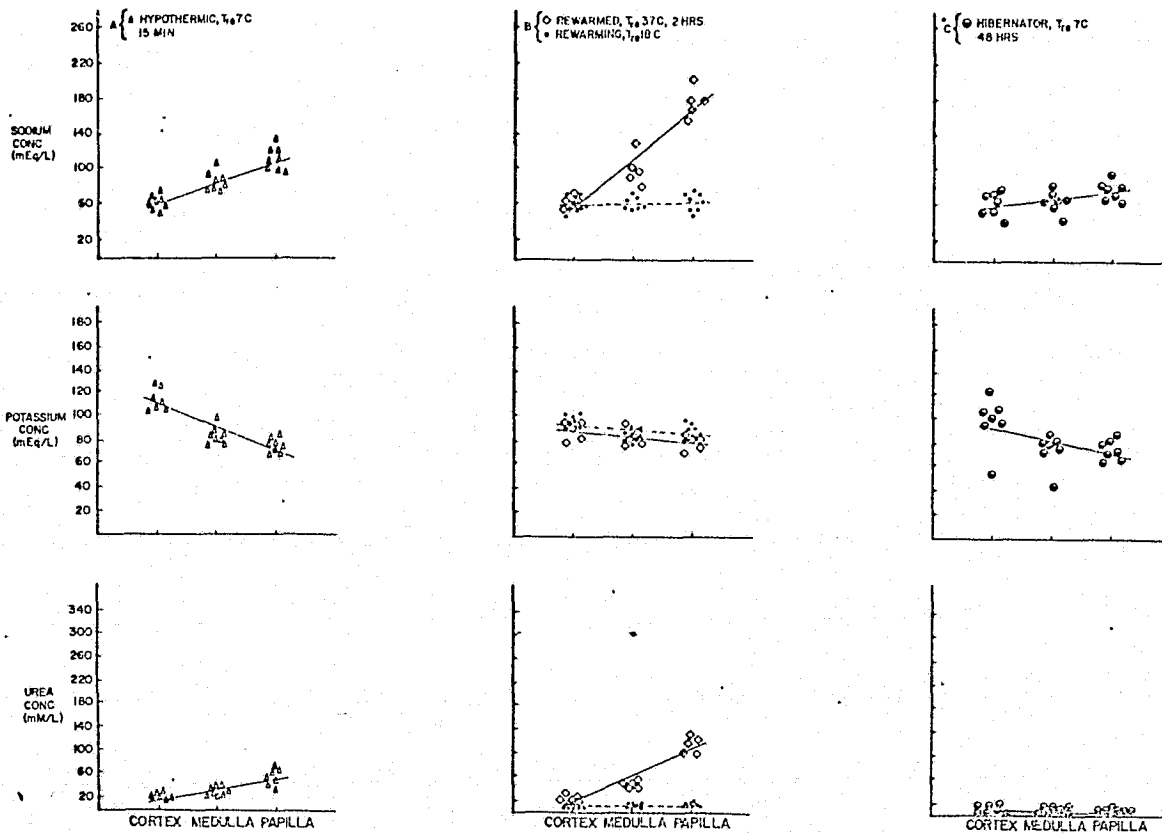

FIG. 3. Solute concentrations from renal tissue slices from hypothermic hamsters. (A) Hamsters which had just reached a rectal temperature of 7C (open triangles); (B) hamsters hypothermic for 48 hrs which had rewarmed to 37C (diamond) and 18C for 2 hrs (solid circles); (C) hibernating hamsters (half shaded circles).

THE EFFECT OF CHRONIC HEAT STRESS ON INTESTINAL FUNCTION IN THE HAMSTER

Previous work in our laboratory (Musacchia and Barr, 1969) indicated that intestinal function in hamsters was responsive to alteration in environmental temperature. Animals exposed to T_a 4-5°C for 1 to 10 weeks showed alteration in active transport of glucose. Preliminary work with hamsters (NASA semi-annual status report NGR January, 1970) chronically exposed to T_a 34°C suggested that intestinal function might also be altered with elevated temperatures. In vitro transport of glucose was depressed compared to control values for periods of 1-10 weeks. However, no change was observed in in vivo transport of glucose following the same exposure periods.

The purpose of this investigation was to continue the study of the response of the hamster intestine to chronic heat stress.

Materials & Methods

Intestinal function following chronic heat exposure was assessed in the transport of two substrates in vitro, glucose and 3-O methyl glucose in two series of experiments. In Series 1, the active transport of glucose was measured using everted sacs. In Series 2, uptake of 3-O methyl glucose by intestinal slices was determined.

Series 1: Female golden hamsters Mesocricetus auratus, 2-3 months old, were randomly divided into three groups: heat-exposed; pair-fed; and animals fed ad lib. The heat exposed animals were housed in a Hotpack walk-in chamber at T_a 34°C for periods of 1 to 8 weeks. Food (Wayne Lab Blox) and water were available ad lib for this group. Pair-fed control animals were housed at 22°C for the same periods in the animal quarters.

The everted sac method used in series 1 has been described earlier (Crane and Wilson, 1958; Musacchia and Barr, 1969; and Wurth and Musacchia, 1973). In brief, animals were fasted 24 hrs prior to use. The hamsters were killed by cervical dislocation, the abdomen opened and the small intestine was cut and dissected from the mesentery beginning at the ligament of Trietz. The intestine was flushed with chilled Krebs Ringer bicarbonate buffer (KRB) and everted on a stainless steel rod. The intestine was placed in a trough of cold KRB which had been gassed with 95% O_2 :5% CO_2 . Three sacs approximately 6mm in length were prepared and mounted on

glass cannulas. One ml of 100 mg% glucose in KRB was introduced into the serosal side of the sac and the sac suspended in 8 ml of the same solution. Sacs were incubated for 30 minutes at 37°C with continuous gassing of 95% O₂: 5% CO₂. Following incubation, the sacs were dried at 100°C for 24 hrs for a determination of dry weight. Unused portions of the gut were similarly dried.

Glucose concentrations in the serosal and mucosal fluids were determined by a modified ortho toluidine method ("Trucose," American Monitor) with a Technicon autoanalyzer. Analysis of Variance or Student's t test was performed on the transport data. Non-parametric Analysis of Variance was used on the intestinal mass data because of the small sample sizes.

Series 2: Male and female golden hamsters were randomly divided into a heat exposed and food restricted group. (Animals at T_a 34°C ate approximately 4.0 grams/day; animals at 22°C were allowed to eat only during daylight hours, and ate approximately 5.0 grams/day). Water was available ad lib. to both groups.

Uptake of 3-O methyl glucose was measured by the ring method of Crane and Mandelstam (1960). The intestine was removed and everted as described above. The entire length of intestine was cut into slices 1-5mm in length and returned to a continuously gassed beaker of chilled KRB for random mixing. Intestinal slices from one or two animals were used for each experiment.

Approximately 15 rings were blotted and placed into 25ml Erlenmeyer flasks containing 5 ml of 5 mM 3-O methyl glucose (Sigma Chemical Company) solution in oxygenated KRB or in control flasks with 5 ml of KRB alone. Flasks were gassed with 95% O₂:5% CO₂ for 30 seconds and stoppered with a rubber stopper. The flasks were put on a Dubnoff shaking incubator at 37°C, allowed to come to equilibrium for 2 minutes, and then incubated with shaking for 30 additional minutes. The reaction was stopped by pouring off the supernatant solution and rinsing the tissue in two 20 ml aliquots of ice cold KRB. The flasks were held in an ice bath until the tissue could be weighed. Wet weights were determined on a Sartorius balance. One sample from each series was dried at 100°C for 24 hrs for the determination of tissue water.

Tissue slices were homogenized for 30 seconds with a Polytron in 3 or 4 ml of water and TCA added to bring the concentration of TCA to 5%. The deproteinized mixture was centrifuged and the supernatant removed. The 3-O methyl glucose content of the supernatant and of the incubating medium was determined by "Trucose" method as described above. Endogenous glucose was also measured by this method in slices incubated in KRB alone.

Calculation of data: Data are expressed as uptake of 3-O methyl glucose in μ M per gram wet weight or as mM sugar in tissue water and in the medium. Seventeen samples gave an average dry weight of 17.5% of wet weight. Tissue water was approximated at

.8 wet weight in the following calculations. Uptake was calculated by the formula:

$$\frac{\text{vol supernatant} \times \text{mM concentration}}{\text{wet weight of tissue}} = \mu\text{M/gm}$$

All controls gave positive values from endogenous glucose even though animals had been fasted for 24 hrs. Since endogenous glucose could not be distinguished from 3-O methyl glucose by the Trucose method, control values were subtracted from experimental values for each series. Control values were frequently as high as 10% of the experimental value. Volume of the supernatant was determined as the sum of the homogenizing solution plus 80% of the tissue wet weight. Calculation of tissue concentration was done in a manner similar to Crane and Mandelstam (1960) with the exception that no attempt was made to correct for passive diffusion.

$$\text{mM (tissue)} = \frac{\text{mM (filtrate)} \times \text{homogenate vol}}{\text{wet weight} \times 0.8}$$

Tissue concentrations were also corrected for endogenous glucose. Tissue to final medium ratios were determined when possible. Statistical differences were determined by the Mann-Whitney non-parametric test.

Results

Mucosal uptake and serosal transfer of glucose following chronic heat exposure and in pair-fed and control animals are given in

Table 1. Intestinal mass data expressed as percent of body weight for the three groups is given in Table 2. Uptake of 3-O methyl glucose by intestinal slices from heat-exposed and food restricted hamsters is given in Table 3.

Table 1

ACTIVE TRANSPORT OF GLUCOSE IN VITRO IN HAMSTERS

CHRONICALLY EXPOSED TO T_a 34°C

Mucosal Uptake and Serosal Transfer in $\mu\text{M}/\text{ml}/\text{gm}$ Dry Wt

		Heat	Pair-Fed	Control
1 Week	Mucosal	393.3 \pm 33.5 (15)	411.9 \pm 30.7 (15)	409.2 \pm 34.4 (11)
	Serosal	134.0 \pm 18.2	107.2 \pm 11.5	123.5 \pm 19.0
2 Weeks	Mucosal	400.9 \pm 24.7 (14)	476.5 \pm 55.6 (12)	425.8 \pm 29.6 (15)
	Serosal	154.4 \pm 7.6	143.7 \pm 13.1	137.7 \pm 7.1
4 Weeks	Mucosal	397.4 \pm 31.8 (9)	396.9 \pm 24.1 (9)	391.2 \pm 27.9 (10)
	Serosal	159.1 \pm 24.1	109.7 \pm 10.1	120.1 \pm 16.0
8 Weeks	Mucosal	469.0 \pm 30.2 (20)		456.5 \pm 21.5 (20)
	Serosal	179.5 \pm 17.8*		131.4 \pm 11.4

* P < .05. Differences between all other groups are not significant. Number of sacs indicated in brackets.

Table 2

ALTERATIONS IN INTESTINAL MASS IN HAMSTERS

CHRONICALLY EXPOSED TO T_a 34°C

Dry Weight of Gut as Percent of Body Wt

	Heat	Pair-Fed	Control
1 Week*	.18 ± .006 (4)	.25 ± .007 (5)	.18 ± .013 (4)
2 Weeks**	.17 ± .015 (5)	.23 ± .005 (4)	.20 ± .008 (5)
4 Weeks**	.15 ± .007 (4)	.23 ± .017 (3)	.21 ± .015 (4)
8 Weeks*	.18 ± .019 (8)		.23 ± .007 (8)

* P < .05; ** P < .01. Number of animals indicated in brackets.

Table 3

Exposure Time	Uptake $\mu\text{M}/\text{gm}$	Concentration		
		Tissue	Medium	T/M
Two days (5)	11.462 \pm .221	14.509 \pm .125	3.98 \pm .025	3.65
Control (5)	10.871 \pm .226	13.628 \pm .341	3.86 \pm .042	3.53
One Week (5)	6.924 \pm .212*	No values		
Control (10)	10.468 \pm .240	13.097 \pm .302	3.71 \pm .048	3.53
Two weeks (8)	6.725 \pm .382*	8.424 \pm .478	4.43 \pm .04	1.90
Control (6)	10.120 \pm .432	No values		
Four weeks (9)	8.529 \pm .204*	10.691 \pm .257	4.21 \pm .03	2.53
Control (8)	9.736 \pm .392	12.164 \pm .493	3.95 \pm .03	3.07

Effect of heat exposure T_3 34°C on active transport of 3-O methyl glucose in the hamster intestine. In vitro tissue slices were incubated in 5mM 3-O methyl glucose for 30 minutes at 37°C. Number of flasks given in parentheses. Uptake given in $\mu\text{M} \pm$ standard error.

* Experimental groups differ significantly from controls $\alpha = .05$.

Discussion

Under conditions of chronic heat exposure many animals exhibit a decrease in food consumption and resting heat production. This is well established for a few species of rodents and has been reviewed by Hart (1971). In vitro oxygen consumption is reduced in the liver and other tissues in heat acclimated hamsters (Cassuto, 1965; Cassuto and Chaffee, 1965, 1966). Changes in oxidative enzymes of liver, kidney, heart, and muscle have also been reported for rats (Bedrak and Samiloff, 1967).

Total growth is depressed in rats following chronic heat exposure (Pennycuik, 1964; Roubicek et al., 1964). In addition, chronic heat exposure reduces the relative weight of heat producing organs such as the heart, kidney, and liver in hamsters (Cassuto, 1965), rats (Hale et al., 1959), and guinea pigs (Zeman and Wilber, 1966). Ray et al. (1968) examined a number of organs and glands following chronic heat exposure in the rat and found that all weights were depressed except for brain and reproductive organs.

Investigations of the effects of chronic exposure to elevated ambient temperatures on the gastrointestinal system have been limited mainly to its effect on gastric secretion and motility (Thomas, 1964). Related studies on the effects of heat stress on appetite and food intake have been reviewed by Collins and Weiner (1968). Recent work by Rakhimov and Korotina (1973) demonstrates that enzymes of the intestinal mucosa are altered following 24 days

exposure to T_a 34-36°C in the rat. Activities of invertase, dipeptidase, and alkaline phosphatase in the duodenal and jejunal mucosa are altered while glyceride lipase remains unchanged compared to ad lib. controls at T_a 23-25°C. Enzyme analyses on pair-fed animals show that while reduced food intake alters enzyme activity it does not produce identical changes to those of heat stress.

Our data (Table 1) shows that active uptake of glucose per gram dry weight does not appear to be altered in the hamster following chronic heat exposure. There is increased serosal transfer of glucose at eight weeks. This may be a reflection of the in vitro system in that increased thinning of the gut would present decreased resistance to diffusion into the serosal volume. Alternatively, increased serosal transfer would also result from a lessened utilization of glucose by the mucosal cells (i.e., depressed metabolism of the mucosa). The total capacity for glucose transfer is significantly depressed in the 34°C animals after two weeks exposure because gut size relative to total body mass is reduced (Table 2). Although both the experimental and control groups lost weight following their initial isolation from the colony, the pair-fed group shows hypertrophy of the intestine compared to the other two groups. This is possibly related to the artificially spaced feeding of the pair-fed animals. Periodic intake of large amounts of food causes enlargement of the digestive tract in a variety of animals (Fabry, 1967).

Although glucose and non-metabolizable 3-O methyl glucose are thought to enter the mucosal cell by the same mechanism (Czaky and Wilson, 1956; Wilson and Landau, 1960), 3-O methyl glucose uptake is depressed after one week heat exposure (Table 3) despite the apparent constancy of glucose transport. One explanation is that the metabolism of the mucosal cells following chronic heat exposure is depressed. If the availability of endogenous energy stores were lower under heat stress, less active transfer of 3-O methyl glucose would occur (Levin, 1969). This limitation would be minimized for a substance that could be metabolized as it is transferred. Further study of the metabolic capacity of intestinal tissue from heat stressed animals under in vitro conditions is suggested.

Conclusions

Glucose uptake in vitro by hamster intestinal tissue on a weight basis is unchanged following exposure of the animals to T_a 34°C for one to eight weeks. Serosal transfer of glucose is increased after eight weeks heat exposure. Total capacity for glucose transport is depressed in heat exposed animals after two weeks compared to pair-fed or ad lib. controls. In vitro transport of 3-O methyl glucose is depressed following heat exposures of one to four weeks. It is hypothesized that this depression reflects a depressed metabolism of the mucosal cell.

Bibliography

1. Bedrak, E. and V. Samorhoff (1967). Comparative effects of aldosterone and heat acclimation on oxidative enzymes in rat tissues. *Can. J. Physiol. Pharmacol.* 45:717-722.
2. Cassuto, Y. (1965). Energy metabolism of the heat acclimated hamster (Mesocricetus auratus). *Diss. Abstr.* 26:1226.
3. Cassuto, Y. and R. R. J. Chaffee (1965). The thermogenic role of the liver in the heat acclimated hamster (Mesocricetus auratus). *Can. J. Biochem. Physiol.* 41:1840-1842.
4. Cassuto, Y. and R. R. J. Chaffee (1966). Effects of prolonged heat exposure on the cellular metabolism of the hamster. *Amer. J. Physiol.* 210:423-426.
5. Collins, K. J. and J. S. Weiner (1968). Endocrinological aspects of exposures to high environmental temperatures. *Phys. Rev.* 48:785-833.
6. Crane, R. K. and P. Mandelstam (1960). The active transport of sugars by various preparations of hamster intestine. *Biochem. et Biophys. Acta* 45:460-476.

7. Crane, R. K. and T. H. Wilson (1958). In vitro method for the study of intestinal absorption of sugars. J. Appl. Physiol. 12:145-146.
8. Czaky, T. Z. and J. E. Wilson (1956). The fate of 3-O C¹⁴H₃ glucose in the rat. Biochim. Biophys. Acta 22:185-186.
9. Fabry, P. (1967). Metabolic consequences of the pattern of food intake. In: "Handbook of Physiology," Sec. 6, Alimentary Canal, Vol. 1 (C. F. Code and W. Heidel, eds.), p. 31-49. Am. Physiol. Soc., Washington, D.C.
10. Hale, H. B., R. B. Mifford, Jr., G. Vawter, G. E. Foerster and D. Criscuolo (1959). Influence of long-term exposure to adverse environments on organ weights and histology. Am. J. Physiol. 196:520-524.
11. Hart, J. S. (1971). Rodents. In: "Comparative Physiology of Thermoregulation" (G. C. Whittow, ed.), Vol. II, Mammals p. 1-149. Academic Press, New York.
12. Levin, R. J. (1969). The effects of hormones on the absorptive, metabolic, and digestive functions of the small intestine. J. Endocrinol. 45:315-348.

13. Musacchia, X. J. and R. E. Barr (1969). Cold exposure and intestinal absorption in the hamster. Fed. Proc. 28:969-973.
14. Pennycuik, P. R. (1964). The effects on rats of chronic exposure to 34°C. II. Growth. Aust. J. Biol. Sci. 17:220-235.
15. Rakhimov, K. and N. A. Korotina (1973). Enzyme activity of the small intestine in growing rats under the chronic influence of high temperatures. Bull. Eksp. Biol. Med. 75:21-23.
16. Ray, D. E., C. B. Roubicek, and M. Hamidi (1968). Organ and gland weights of rats chronically exposed to 22° and 35°C. Growth 32:1-12.
17. Roubicek, C. B., O. F. Pahnish, and R. L. Taylor (1964). Growth of rats at two temperatures. Growth 28:157-164.
18. Thomas, J. E. (1964). Organ systems in adaptation: The digestive system. In: "Handbook of Physiology," Sec. 4, Adaptation to the Environment (D. B. Dill, E. F. Adolph and C. G. Wilber, eds.), p. 193-224. American Physiological Society, Washington, D.C.

19. Wilson, T. H. and B. R. Landau (1960). Specificity of sugar transport by the intestine of the hamster. *Am. J. Physiol.* 198(1):99-102.

20. Wurth, M. A. and X. J. Musacchia (1973). Mechlorethamine effects on intestinal absorption in vitro and on cell proliferation. *Am. J. Physiol.* 225(1):73-80.

21. Zeman, F. J. and C. G. Wilber (1966). Influence of ascorbic acid and of thiamine on physiological responses of guinea pigs to high ambient temperatures. *Ohio J. Science* 66:474-487.

ERYTHROCYTE 2,3-DIPHOSPHOGLYCERATE CONCENTRATIONS IN
HIBERNATING, HYPOTHERMIC, AND REWARMING HAMSTERS *

George E. Tempel and X. J. Musacchia

Dalton Research Center

and

Department of Physiology

University of Missouri

Columbia, Missouri 65201

* This report is prepared in manuscript form and will be submitted for publication to either of two journals, Proceedings of the Society for Experimental Biology and Medicine or Comparative Biochemistry and Physiology.

Erythrocyte 2,3-Diphosphoglycerate Concentrations in Hibernating, Hypothermic, and Rewarming Hamsters

The major pathway of carbohydrate metabolism in mature mammalian erythrocytes has been shown to have a shunt for the production of 2,3-diphosphoglycerate (2,3-DPG), a pathway that does not yield ATP. 2,3-DPG has been shown to reduce the oxygen affinity of hemoglobin solutions (1,2), and hence, alter the position of the dissociation curve. This finding gave impetus to investigations which examined the adaptive significance of changes in 2,3-DPG concentration. For example, residents of high altitudes have higher 2,3-DPG concentrations than sea level counter parts, accounting for a reduced hemoglobin affinity for oxygen (3). Association of the functional state of the erythrocyte with its metabolic status as well as reported alterations in the dissociation curve from blood of hibernators (4) has prompted investigations in the area of depressed metabolism. In hibernating thirteen-lined and golden mantled ground squirrels, Burlington and Whitten (5) demonstrated a significant decrease in red cell 2,3-DPG content. They suggested that reduced 2,3-DPG levels play a role in periodic arousal, increasing the affinity of hemoglobin for oxygen. Such a shift in the oxygen dissociation curve might prove adaptive in a winter burrow where oxygen is limited (6).

The present study was undertaken to examine 2,3-DPG concentra-

tions in another species of hibernator, the hamster, Mesocricetus auratus. Alterations reported in the ground squirrel, if of adaptive significance, should also be found in another species of hibernator. In addition, the depression in 2,3-DPG concentration reported for the hibernator would have to persist in the rewarmed animal. The effect of alterations in 2,3-DPG concentration would be of greater functional significance in the aroused, normothermic animal than in the hibernator where the temperature effect on the affinity of hemoglobin for oxygen is greater. Accordingly, rewarmed animals were studied. Finally, helium-cold hypothermic animals were examined both to provide further information on this state of depressed metabolism as a model of hibernation, and also to gain insight into possible mechanisms underlying the depression in synthesis of 2,3-DPG.

Materials and Methods. Adult male and female golden hamsters weighing 100 to 140 g were used in this study. Normothermic control animals were taken directly from our closed colony, lightly anesthetized with halothane, and bled by transthoracic cardiac puncture. Hibernation was induced in an age-matched group by six to eight weeks of exposure to an ambient temperature (T_a) of 7°C. Hibernators were bled by cardiac puncture after approximately 48 hrs of hibernating torpor as determined by the placement of cedar chips on the dorsum of the animal. The hamster's rectal temperature was noted

at the time of sacrifice to ensure that all animals were truly hibernating, and not arousing. Deep hypothermia was induced in a third group by the helium-cold method of Fischer and Musacchia (7), and a modification thereof. In brief, the animals were exposed to one of two gas mixtures of helium and oxygen (helox) (80% He:20% O₂; or 90% He:10% O₂) at T_a 0C. After reaching a rectal temperature (T_{re}) of 6 to 8C, hamsters were removed from the helox environment and transferred to a room air environment at T_a 7C. After 12 to 24 hrs at T_{re} 7C, blood samples were obtained by cardiac puncture. Animals which were hibernating or hypothermic were rewarmed by placing them at T_a ~ 22C. Blood samples were obtained by cardiac puncture under light halothane anesthesia both immediately upon re-warming (T_{re} ~ 37C) and after approximately 2 hrs of normothermia.

The blood samples obtained from the various experimental groups were analyzed for hematocrit, hemoglobin, and 2,3-DPG. Hematocrits were determined by the micro method, and hemoglobin concentration was assessed as cyanmethemoglobin at 540 m μ using a Beckman Spectrophotometer, model DB-G. A protein-free filtrate was obtained by cold trichloroacetic acid precipitation, stored at 0C for one day, and analysis was made by the colorimetric determination of inorganic phosphate produced by the action of 2,3-DPG phosphatase (Sigma).

Intergroup comparisons of the data were made using the non-parametric Mann-Whitney test (8).

Results. The data comparing normothermic control, hibernating, and hypothermic hamsters are summarized in Figure 1. Hematocrits, although not significantly different ($P > 0.05$), reflect the alterations observed in hemoglobin concentration for hibernating, hypothermic and rewarming groups. In normothermic animals hemoglobin and 2,3-DPG values were 16.9 ± 1.2 g% and 19.2 ± 1.2 μ moles/g Hgb, respectively. Hypothermia of 12 hrs duration induced by exposure to 80:20 helox and cold did not significantly affect hemoglobin or 2,3-DPG concentrations ($P > 0.05$). By contrast, both hibernation for 48 hrs and hypothermia for 24 hrs induced by 90:10 helox and cold exposure effect a marked increase in hemoglobin as well as a marked decline in 2,3-DPG levels. Hemoglobin increased approximately 20% in both groups, to 20.7 ± 0.8 and 20.2 ± 1.0 g% for hibernators and hypothermic hamsters, respectively. The decrease in 2,3-DPG concentration in the hibernator to 11.7 ± 1.2 μ moles/g Hgb, was a 39.1% decrease from control values. The hypothermic hamsters demonstrated a 33.9% decrease to 13.5 ± 1.0 μ moles/g Hgb. Although both groups demonstrate the same trend, hamsters hypothermic for 24 hrs showed 2,3-DPG concentrations approximately 15% greater than the group hibernating for 48 hrs.

2,3-DPG levels were measured in rewarmed hibernating and hypothermic hamsters at various time periods after reaching normothermic body temperatures. These data are summarized in Table 1. Rewarming hibernators and hypothermic hamsters sacrificed immediately

upon reaching a stable core temperature did not differ significantly ($P > 0.05$). In both groups hemoglobin concentration had returned to control levels with values of 17.5 ± 1.5 (5) and 17.4 ± 1.0 (8) g% for rewarmed hibernating and hypothermic animals, respectively; erythrocyte 2,3-DPG concentrations increased to 17.2 ± 1.0 in the former, and 16.9 ± 0.8 $\mu\text{moles/g Hgb}$ in the latter. Although this represents a notable increase, these values remain about 10% less than those in the control animals. Rewarmed hypothermic hamsters sacrificed after 2 hrs at a stable core temperature demonstrated a 2,3-DPG concentration of 17.5 ± 1.3 $\mu\text{moles/g Hgb}$, a value not significantly different from the groups sacrificed immediately upon rewarming ($P > 0.05$).

Discussion. The data from this study reflects the hemoconcentration reported for the hibernating hamster (9,10,11) with approximately a 20% increase in hemoglobin concentration. Hamsters hypothermic for 24 hrs showed a similar increase while 12 hrs of hypothermia produced no detectable effect as had been previously reported (12).

2,3-DPG concentrations reported for control animals were consistently higher than values previously reported for the hamster (13). In the present experiments, standard determinations were run with each assay and the data are highly reproducible. We have no explanation for the difference between the values herein obtained and those of Meyerstein and Cassuto, op cit. However, the altera-

tions reported for the hamster parallel changes noted in the golden mantled ground squirrel by Burlington and Whitten (5).

In the regulation of oxygen transport and delivery to the tissue, 2,3-DPG interacts with several other variables. In the metabolically depressed animal ($T_{re} \approx 7C$), decreased temperature per se effects a marked leftward shift of the dissociation curve. This has been shown for the hibernating ground squirrel (14) and hedgehog (15), as well as for the helium-cold hypothermic hamster (12). The influence of temperature on the oxygen carrying capacity of the blood might therefore, be expected to play the predominant role in the animal with a reduced core temperature. However, a role for alterations in DPG has been suggested by Burlington and Whitten (5). These investigators suggest that the depression in 2,3-DPG observed in hibernating golden mantled and 13-lined ground squirrels plays a role in periodic arousals. In the aroused animal at $T_{re} = 37C$ a reduced 2,3-DPG concentration would increase the affinity of hemoglobin for oxygen in a burrow where the P_{O_2} may be reduced.

If alterations in 2,3-DPG concentration were of adaptive advantage to a hibernator, one might expect the 45.5% and 48.0% decrease reported in the hibernating golden-mantled and 13-lined ground squirrels respectively (5), both to occur in other species of hibernators as well as to persist in the aroused animal ($T_{re} 37C$) where the temperature effect on the affinity of hemoglobin for

oxygen does not predominate. This study has shown a similar decrease (29.1%) in 2,3-DPG concentration in the hibernating hamster, as well as a 32.9% decrease in the 24 hr hypothermic animal. It is noteworthy that the depression in 2,3-DP concentration persists for some 2 hrs in the aroused animal although rapid changes occur during arousal to values about 10% less than controls. It can be speculated that the reported 10% decrease in hamster 2,3-DPG would decrease the P_{50} by approximately 1 mm Hg, a possible adaptation to a reduced P_{O_2} environment.

A comparison of the 24 hr hypothermic hamster with the 48 hr hibernator shows a 15% greater concentration of 2,3-DPG in the former. In hibernation various changes occur in intermediary metabolism of adaptive significance. For example, the primary energy substrates during hibernation are lipids as shown by a respiratory quotient very close to 0.7 (16). A greater efficiency for some liver mitochondrial enzymes in cold exposed and hibernating hamsters has also been demonstrated (17). In an investigation of alterations in intermediary metabolism in hibernation, Brock (18) suggests that adaptive changes occur before or during hibernation which result in the maintenance of red cell high energy phosphates at low in vivo temperatures. Although metabolic adaptations undoubtedly exist in hibernators, comparison of the experimental hypothermic group with natural hibernators suggest a cold suppression of glycolysis. Thus, the higher concentration of 2,3-DPG reported for the hypothermic animals

may be explained by their shorter stay at a reduced body temperature (24 hrs compared to 48 hrs for the hibernator).

In both the hibernating and hypothermic animals, reduced levels of 2,3-DPG might be anticipated. Cold suppression of phosphoglyceromutase and diphosphoglycerate phosphatase, the enzymes involved in anabolism and catabolism respectively, would occur in both metabolically depressed groups. It is, however, possible that 2,3-DPG stores are reduced through the mainstream of glycolysis via the Rapoport-Lubering shunt as has been suggested by Larkin (19).

Summary. Hematocrit, hemoglobin and erythrocyte 2,3-DPG concentrations were examined in normothermic control, hibernating, and helium-cold hypothermic hamsters. Hematocrit was not significantly different ($P > 0.05$) between groups, but did reflect alterations reported for hemoglobin. Hemoglobin concentration did not change from control values during 12 hrs at $T_{re} 7C$; however, approximately a 20% decrease occurred in hibernators (48 hrs) and animals hypothermic (24 hrs). 2,3-DPG concentrations declined 39.1 and 33.9% from control values in the hibernating and 24 hrs hypothermic groups, respectively. No change was observed in animals hypothermic for 12 hrs. Both parameters were studied in the aroused animal. Hemoglobin returns to control values immediately after the animals reached a stable $T_{re} \approx 37C$. Although 2,3-DPG levels increased during arousal, they were still 10% lower than control values in both me-

metabolically depressed groups. 2,3-DPG remained approximately 10% less than controls in rewanned hypothermic animals studies 2 hrs after reaching stable $T_{re} \approx 37C$. The data are discussed in terms of cold depression of erythrocyte glycolysis.

Table 1

HEMATOCRIT, HEMOGLOBIN, AND ERYTHROCYTE 2,3-DPG OF REWARMING
HAMSTERS*

	Hematocrit %	Hemoglobin g%	2,3-DPG μ Moles/g Hgb
Hibernating; 48 hrs Normothermic 15 min	48.0 \pm 4.9 (5)	17.5 \pm 1.5 (5)	17.2 \pm 1.0 (5)
Hypothermic; 24 hrs Normothermic 15 min	49.8 \pm 2.3 (8)	17.4 \pm 1.0 (8)	16.9 \pm 0.8 (8)
Hypothermic; 24 hrs Normothermic 2 hrs	45.1 \pm 2.2 (8)	15.3 \pm 0.8 (8)	17.5 \pm 1.3 (8)

* Mean \pm S.D. (N)

Acknowledgement

The authors wish to thank Janet Burnett for her excellent technical assistance.

Research was supported by Grant NGL 26-004-021, Supplement 9,10, from the National Aeronautics and Space Administration, and the Dalton Research Center.

Figure Legend

Figure 1. Hematocrit, hemoglobin, and red cell 2,3-DPG of normo-thermic golden hamsters compared with hibernators, and hypo-thermic animals. Hypothermic hamsters were sampled after 12 and 24 hrs at T_{re} 7C. Hypothermia was induced in the former by 30:20 helox and cold, and in the latter by 90:10 helox and cold.

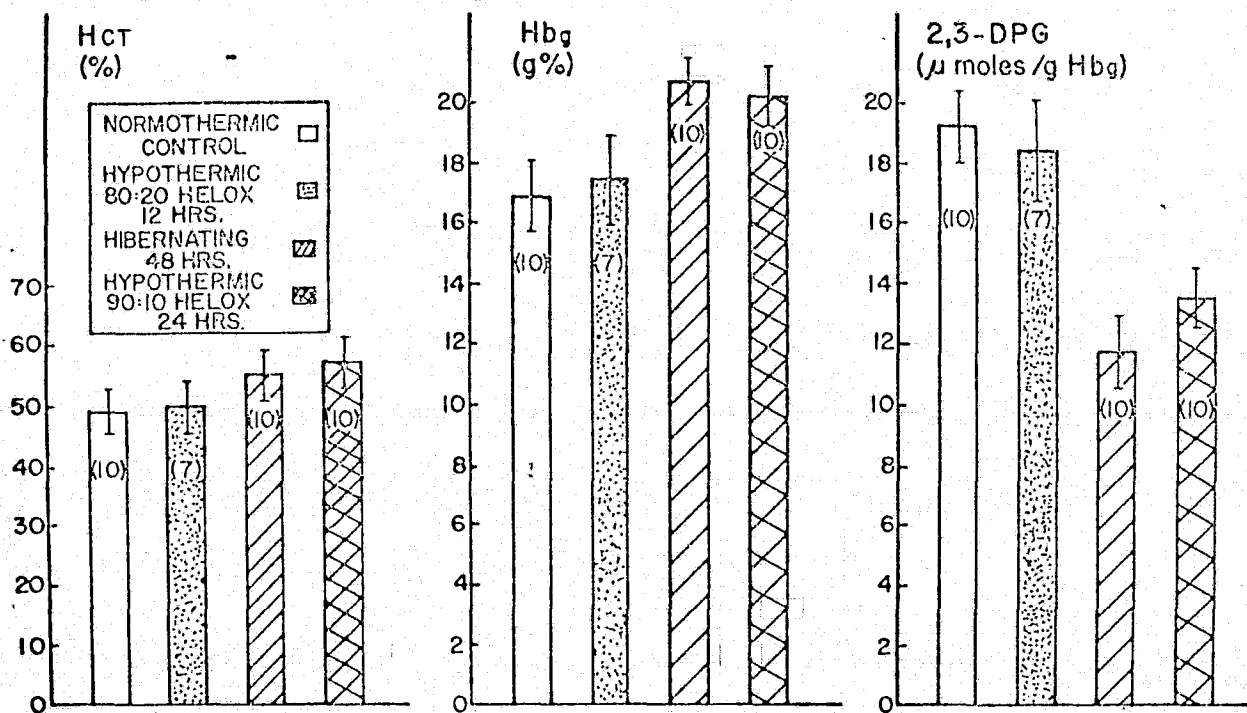

HEMATOCRIT, HEMOGLOBIN, AND RED CELL 2,3-DPG OF NORMOTHERMIC HYPOTHERMIC AND HIBERNATING HAMSTERS. MEAN ± 1SD. NO. ANIMALS IN (),

References

1. Chanutin, A. and Curnish, R. R., Arch. Biochem. Biophys. 121:96 (1967).
2. Benesch, R. and Benesch, R. E., Biochem. Biophys. Res. Commun. 26:162 (1967).
3. Eaton, J. W., Brewer, G. J. and Grover, R. F., J. Lab. Clin. Med. 73:603 (1969).
4. Bartels, H., Schmelzle, R. and Ulrich, S., Resp. Physiol. 7:278 (1969).
5. Burlington, R. F. and Whitten, B. K., Comp. Biochem. Physiol. 38A:469 (1971).
6. Studier, E. H. and Procter, J. W., J. Mammol. 52:631 (1971).
7. Fischer, B. A., and Musacchia, X. J., Am. J. Physiol. 215:1130 (1968).
8. Mann, H. O. and Whitney, D. R., Ann. Math. Statist. 18:50 (1947).
9. Suomalainen, P. and Granstrom, T., Exp. Cell. Res. Suppl. 3:335 (1955).

10. Lyman, C. P., Weiss, L. P., O'Brien, R. C., and Barbeau, A. A.,
J. Exp. Zool. 136:471 (1957).
11. South, F. E., and Jaffay, H., Proc. Soc. Exp. Biol. Med. 98:885
(1958).
12. Volkert, W. A., and Musacchia, X. J., Am. J. Physiol. 219:919
(1970).
13. Meyerstein, N., and Cassuto, Y., Comp. Biochem. Physiol. 41A:297
(1972).
14. Musacchia, X. J. and Volkert, W. A., Am. J. Physiol. 221:128
(1971).
15. Clausen, G. and Ersland, A., Resp. Physiol. 5:221 (1968).
16. Lyman, C. P. and Chatfield, P. O., Physiol. Rev. 35:403 (1955).
17. Chaffee, R. R., Thesis, Harvard University, 1957.
18. Brock, M. A., In: "Mammalian Hibernation III" (Fisher, K. C., Dawe,
A. R., Lyman, C. P., Schonbaum, E. and F. E. South, eds.), p. 409.
Oliver & Boyd, Edinburgh and London (1967).

19. Larkin, E. C., *Comp. Biochem. Physiol.* 45A:1 (1973).

TEMPERATURE ACCLIMATION AND NOREPINEPHRINE TURNOVER
RATES IN THE GOLDEN HAMSTER

Background and Rationale

The role of neurohumoral factors in stress and adaptation to new environments has been of widespread interest for over half a century. It is well recognized that the catecholamines play a significant role in maintenance of functional homeostasis. The literature is heavy with documentation and need not be reviewed at this time. What is of concern to us is that animal models are essential to further elucidate the actual physiological and biochemical responses to new and sometimes hostile environments such as heat or cold. In addition, extension of these findings are essential to further our understanding of human responses to stress and adaptation. A better understanding of man's ability to sudden or extended exposure of heat and cold is becoming increasingly important in a society keyed to technological expansion. Confinement in space vehicles, submarines, mines, industrial structures etc., rapid transportation from one environment to another, industrial accidents, military logistics, and maneuvers are only a few of the factors which can be cited as examples of man's potential exposure to unexpected and sometimes extended heat and/or cold. In our experiments we are using laboratory animals to learn about specific responses to temperatures outside the thermal neutral zone.

Pilot studies of the effects of temperature acclimation on tissue catecholamines have indicated that exposure to heat or cold for several weeks markedly alters heart and kidney levels of norepinephrine (NE) in

the hamster (Jones and Musacchia, 1973a). Further studies have shown that in heat exposure the observed alterations in heart norepinephrine are associated with a decreased ability to overcome inhibition of NE synthesis (Jones and Musacchia, 1973b). Interpretation of tissue catecholamine function based on tissue levels alone, is difficult due to the fact that inhibition of synthesis or degradation may alter tissue levels without altering the rate of utilization. The present study was designed (1) to confirm earlier reports that heat exposure elevates heart NE and cold exposure depresses these levels; and (2) to determine the turnover rate of NE in these and other tissues. In vivo methods for the determination of NE turnover rates utilized in these experiments were dependent upon a pharmacologic blocker of synthesis; α -methyl-p-tyrosine. The biosynthetic pathway of NE and E is demonstrated as follows:

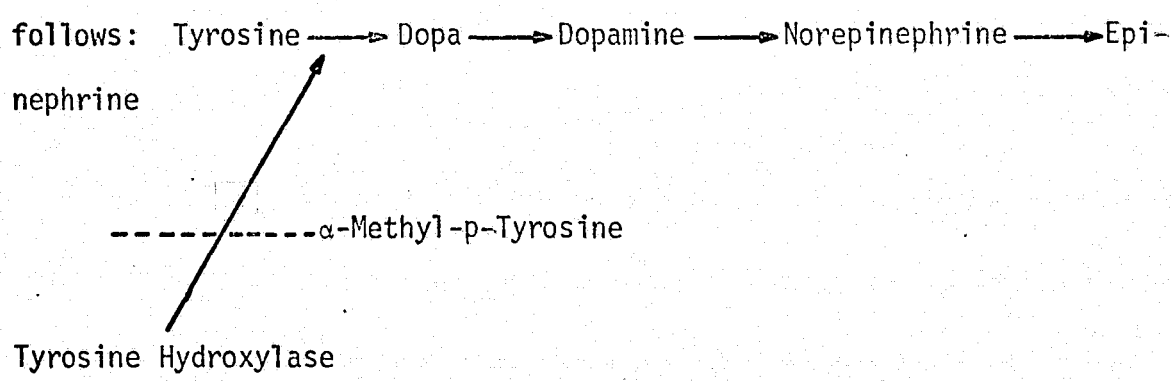

The rate-limiting enzyme of NE synthesis has been demonstrated to be tyrosine hydroxylase (Levitt et al., 1965). Therefore, blockade of this step will result in blockade of synthesis. A competitive inhibitor of tyrosine hydroxylase, α -methyl-p-tyrosine (Nagatsu et al., 1964), can be used to measure tissue utilization with time. In a steady state, the rate of decay of tissue NE will reflect a rate of utilization and

thus the rate of synthesis. This rate of endogenous NE decay is defined by Costa and Neff (1965) to be a single exponential, i.e., a semi-log plot of tissue level vs. time will result in a straight line with a negative slope.

Methods:

Male golden hamsters, Mesocricetus auratus, were selected from our closed colony and individually caged for the duration of the experiment. Animals were placed in 7,22 (which served as control), or 34°C chambers. All animals were followed for 5-8 weeks at these temperatures. Food and water were given ad lib. with a 12-12, light-dark cycle. At the end of the exposure period, animals were given an intraperitoneal injection of α -methyl-p-tyrosine (Sigma Chemical Co.) at a dose of 200 mg/kg body weight. At sequential time periods after drug administration, animals were sacrificed by cervical dislocation and heart, spleen, and whole brain were quickly removed and frozen in liquid nitrogen. Catecholamines were analyzed by the trihydroxyindolamine method.

Results:

The data are presented in a summarized fashion in Figures 1-4. Figure 1 shows the pattern of response to the inhibitor in heart tissue in animals acclimated to the three different temperatures. The fall in tissue NE with time in all three groups appears to be linear to the point of maximal tissue depression and thus behaves as an exponential decay. Rate of recovery follows closely the rate of depletion, i.e., rapid depletion and rapid recovery vs. slow depletion and slow recovery.

This is evidence that this technique is a measure of utilization as well as synthesis. Changes in tissue levels at the different acclimation temperatures reflect the same pattern as previously reported (Jones and Musacchia, 1973a), i.e., depressed in the cold and elevated in the heat. The most striking feature of this graph is that of the slopes of the decay lines. The most rapid decay is associated with cold exposure, and the least rapid decay is coincident with heat acclimation. Rectal temperatures of the three groups were not different at the end of the acclimation period.

Statistical quantitation and comparison of this data involved regression analysis. Data points were included to the point of maximal tissue depression. Figure 2 shows the regression analysis of the heart data and clearly indicates the changes in tissue levels at zero time as well as differences in the slopes. Figure 3 demonstrates these same measurements in spleen tissue. The very little difference between tissue levels at zero time would imply little or no change in NE utilization with these temperature treatments. However the slope of the 34°C group is significantly different from the control, $p < .001$, whereas the slope of the cold group line is not different from control. Thus, NE in spleen has a lower utilization and synthesis rate with heat acclimation than in cold or room temperature exposure. Figure 4 presents the rate of NE utilization in whole hamster brain. There are no differences in the tissue levels at zero time, whereas statistical tests of the slopes of the 34 and 22°C lines does indicate a significant difference, $p = .023$. Thus, in contrast to the other tissues with heat exposure, the brain appears to increase NE utilization and synthesis.

Since the form of all these data is that of an exponential decay, one is able to compute a rate constant for the decay of tissue NE with time. Multiplying the rate constant by the endogenous tissue levels at zero time, results in a turnover rate of tissue NE in $\mu\text{g/g/hr}$. Table I summarizes the three tissues at the different ambient temperatures in terms of (1) tissue level; (2) rate constant; and (3) turnover rate. Considering heart tissue, there is a lower tissue level with cold exposure and a higher tissue level with heat exposure when contrasted against tissue levels at 22°C . Rate constants derived from the slopes of the regression lines are expressed in terms of the standard error of sample regression. In heart tissue, these changes are significant: heat vs. control, $p < .001$; cold vs. control, $p = .017$. Turnover rates in $\mu\text{g/g/hr}$ reflect these changes of tissue levels and rate constants. With heat exposure heart turnover is approximately 2 times less than control, while in cold exposure turnover is approximately 37% greater than control. Thus, tissue level and turnover rate of NE are inversely related in hamster heart with temperature acclimation.

Spleen NE tissue levels are not significantly different as a result of temperature acclimation. The slope and rate constant of the 34°C line is significantly different from control; $p < .001$. Turnover rate in the control is 130% greater than with heat exposure. There is no difference in comparison of cold and control turnover rates.

Whole brain tissue NE levels do not vary with temperature acclimation treatments. The slopes of the decay lines and rate constants do differ in comparison of control and heat exposed groups; $p = .023$. Thus, the turnover rate of brain NE is highest with heat exposure whereas cold and control values are comparable.

Discussion

Udenfriend and Dairman (1970) have demonstrated that NE release varies with the degree of sympathetic nerve activity and that variations in biosynthesis following release are related to changes in tyrosine hydroxylase enzyme activity. It follows that sympathetic nerve activity causes NE release and biosynthesis. Thus, in a steady state different levels of sympathetic tone (impulses per second) will be related to tissue levels and turnover. Decreased tissue levels will follow heavy demand (increased turnover) and elevated levels will be associated with decreased demand (decreased turnover). Such inverse relationships of tissue levels and turnover rates on a more acute basis have been previously reported (Neff and Costa, 1968).

The functional advantage of altered tissue levels and/or turnover rates to the whole animal are not clear. Cassuto and Chaffee (1966) reported a 35% decrease in hamster myocardial mass with long term heat exposure and we have seen similar evidence of such changes in our own laboratory. To speculate that the heart is required to work less, or that it is more efficient in heat exposure, is limited by the lack of information regarding cardiac output in heat acclimated heart. Cold exposure, however, is known to increase cardiac output (Jansky and Hart, 1968). Feist (1970) has reported measurements of heart NE turnover in cold acclimated hamsters and finds no differences in NE tissue levels or turnover rates. These cold acclimated animals were reported to have hibernated, but were not hibernating at the time of use. Animals reported in our study were all naive, and the initiation of the cold exposure period marked their first entry into a cold environment. If

our animals would have first hibernated and were then used in the experiment, differences in the results, perhaps, would be minimal. NE turnover and tissue changes in the spleen, are not inversely related. However, the decrease in NE turnover in heat exposure was consistent with the finding of heart tissue levels. Both peripheral tissues are important components of circulatory control and the decrease in NE turnover rate with long term heat exposure implies that they both have depressed sympathetic tone.

Brain tissue turnover changes are the least definitive of those examined. However, the increase in NE turnover with heat exposure is in the opposite direction of that for heart and spleen. Present models of temperature regulation involving hypothalamic neuro-transmitters, depict NE as mediating heat dissipation. It is our view that the observed increase in whole brain NE turnover with heat acclimation may be a reflection of increased hypothalamic NE turnover. Although the hypothalamus weighs approximately 50 mg in comparison to 1,000 mg for the whole brain, a 20-fold difference, some evidence supports this reasoning. The work of Legrand (1969) describes a fall in hypothalamic norepinephrine levels and a rise in heart and adrenal NE levels with acute heat exposure. Simmons and Iverson, 1969, reported an increase in hypothalamic NE turnover in rats with acute exposure to heat. Thus, in an acute situation hypothalamic NE utilization appears to increase. Evidence in the present study suggest that chronic exposure may also result in a marked increase in hypothalamic NE turnover.

Peripheral tissue changes in NE turnover in heat exposure are notably in the opposite direction. Such a decrease in spleen and myo-

cardial NE utilization would also imply a decrease in peripheral vascular NE utilization. Body heat dissipation through prolonged peripheral vasodilatation would be advantageous to the animal confronted with a hot environment.

Summary and Conclusions:

1. Acclimation of the hamster to different environmental temperatures results in altered myocardial NE levels, but does not affect spleen or brain tissue levels.

2. Turnover rate measurements of NE were found to be inversely related to tissue levels in the heart with exposure to different environmental temperatures. Like the heart, spleen NE turnover was decreased in heat exposure. Brain NE turnover was not changed in cold exposure but was increased in heat exposure.

3. These data suggest that increased central nervous system NE turnover with heat exposure may be related to peripheral heat dissipation mechanism. The observed decreases in myocardial and spleen NE utilization in heat exposure would suggest a general decrease in peripheral sympathetic tone which could facilitate general vasodilatation. With increasing peripheral blood flow, a greater quantity of body heat could be dissipated. Mechanisms which may account for the observed tissue NE changes appear to be related to sympathetic nerve activity. The functional advantage of these changes to the whole animal is hypothesized to facilitate peripheral vasomotion which would aid in regulation of body temperature.

Figure 1

Hamster Heart Norepinephrine Response to Blockade of Synthesis with α -Methyl-p-tyrosine

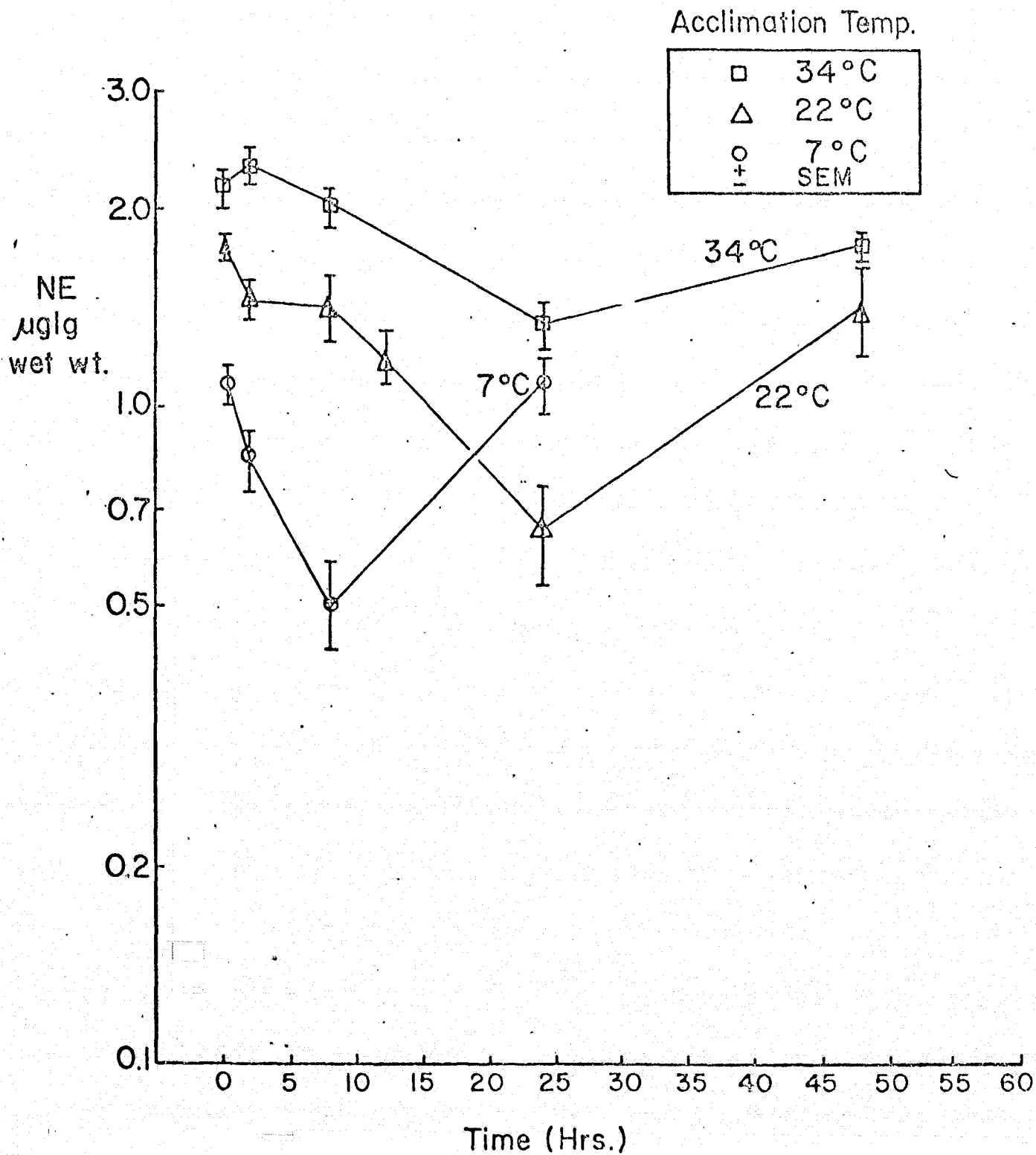

Figure 2

Norepinephrine Turnover Rates In Hamster Heart

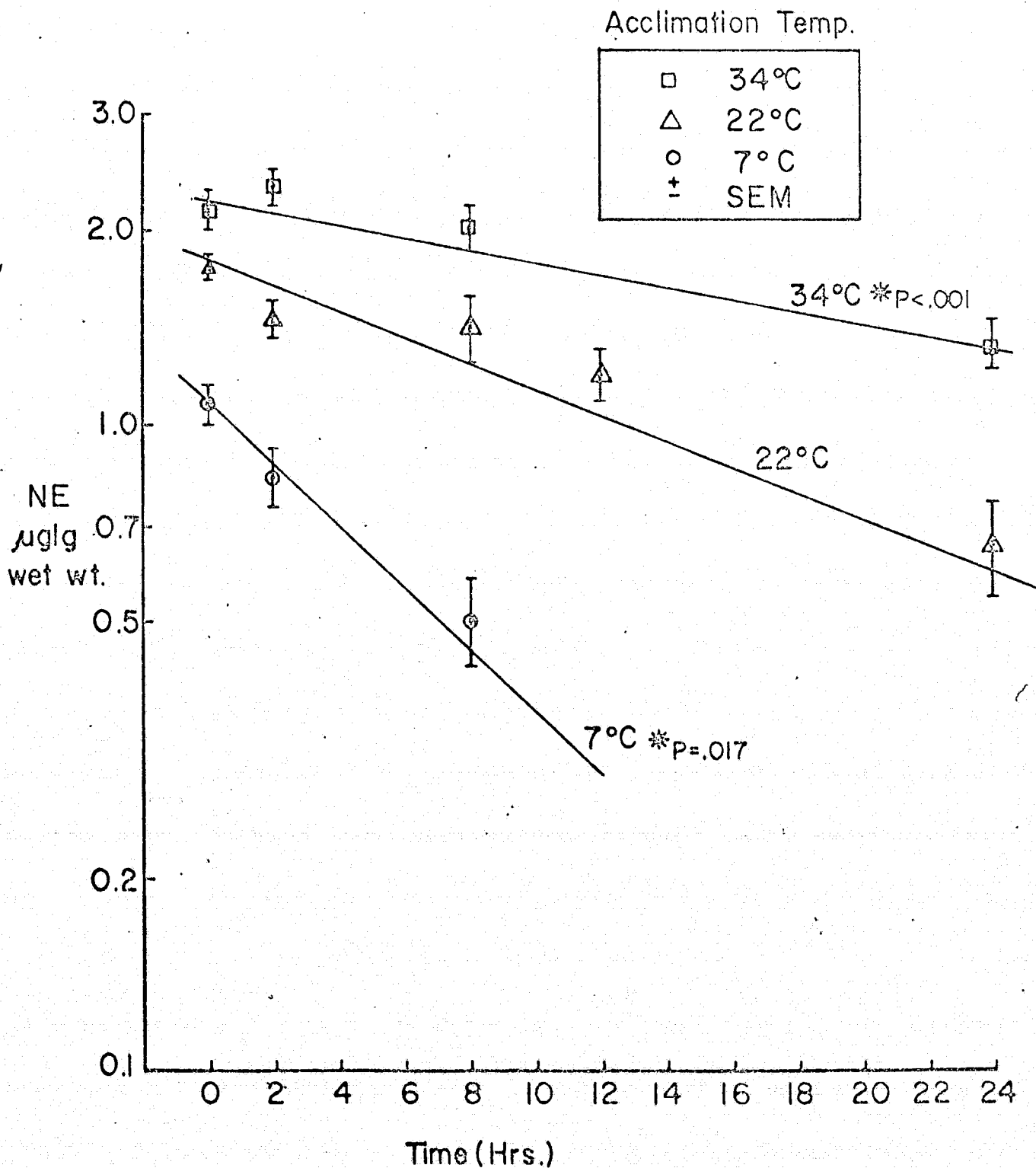

Figure 3

Norepinephrine Turnover Rates In Hamster Spleen

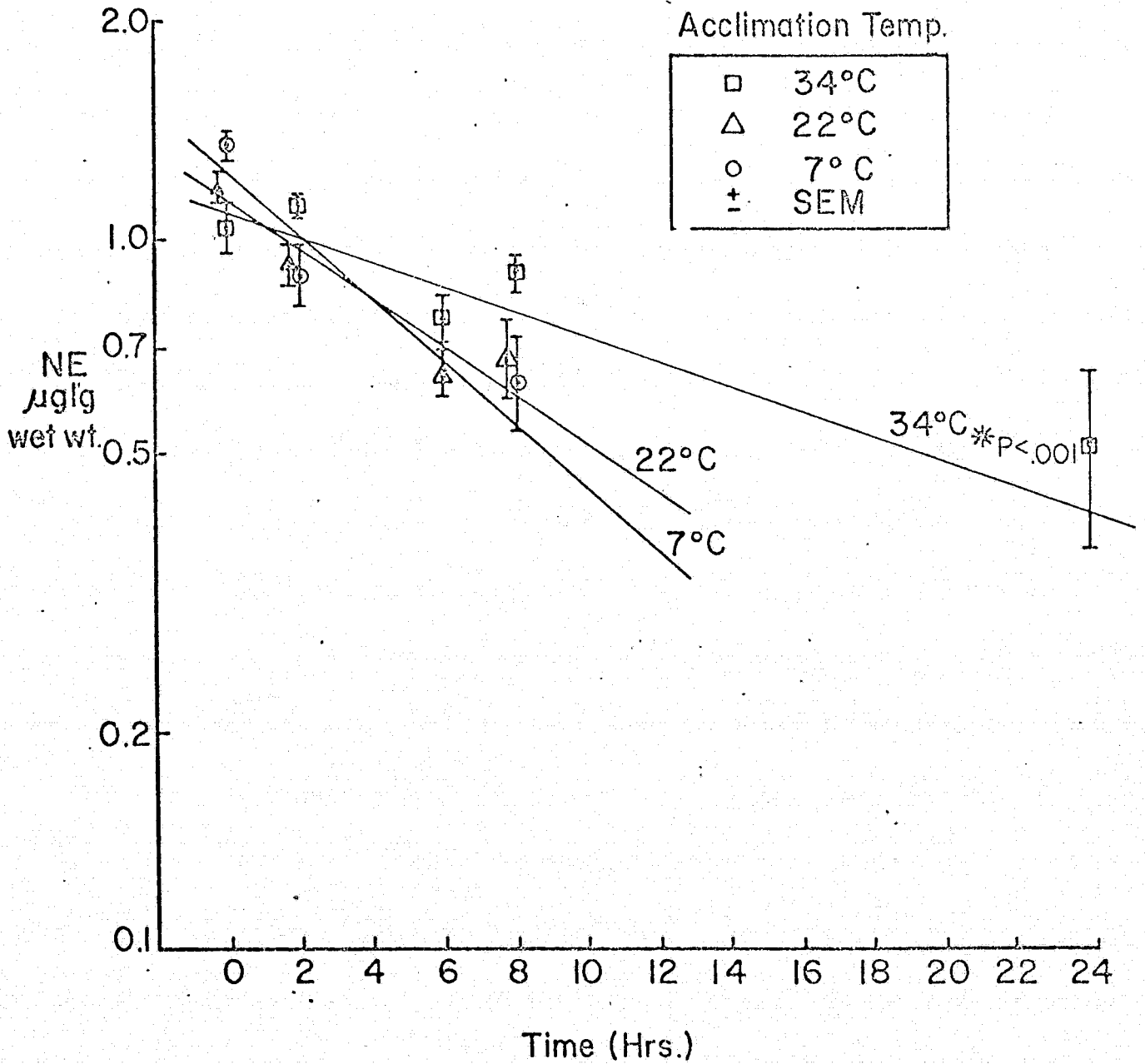

Figure 4

Norepinephrine Turnover Rates In Hamster Brain

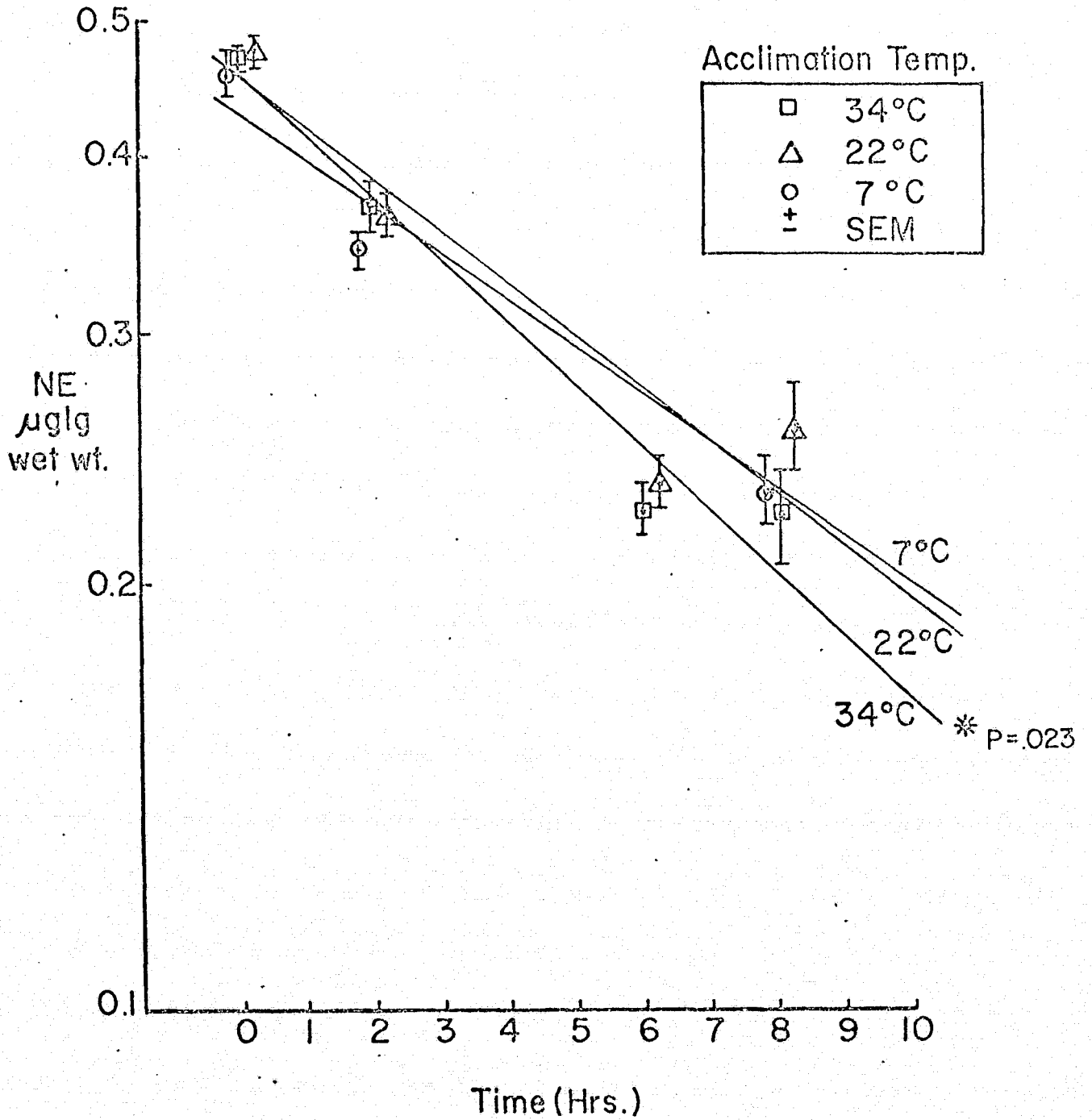

Table 1.

Norepinephrine Turnover Rate Data

	Acclimation Temp. °C	Endogenous Norepinephrine µg/g	Rate Constant h ⁻¹	Turnover Rate µg/g/hr.
Heart	34	2.140 ± .130	0.0218 ± .0018	0.047
	22	1.760 ± .040	0.0459 ± .0040	0.081
	7	1.084 ± .069	0.1027 ± .0095	0.111
Spleen	34	1.037 ± .087	0.0408 ± .0032	0.042
	22	1.218 ± .092	0.0790 ± .0055	0.096
	7	1.356 ± .044	0.1023 ± .0089	0.140
Brain	34	0.465 ± .006	0.1012 ± .0030	0.047
	22	0.473 ± .010	0.0844 ± .0040	0.040
	7	0.458 ± .016	0.0759 ± .0035	0.035

LITERATURE CITED

Cassuto, Y. and R. R. J. Chaffee, 1966. Effects of prolonged heat exposure on the cellular metabolism of the hamster. *Am. J. Physiol.* 210:423-26.

Costa, Erminio and Norton H. Neff, 1965. Isotopic and non-isotopic measurements of the rate of catecholamine biosynthesis, Biochemistry and Pharmacology of the Basal Ganglion (ed. by E. Costa, L. J. Côté and M. D. Yahn) Raven Press, New York. pp. 141-156.

Fiest, Dale D. 1970. Brown fat norepinephrine contents and turnover during cold acclimation and hibernation in the golden hamster (Mesocricetus auratus). *Comp. and Gen. Pharmacol.* 1(3):299-315.

Jansky, L. and J. S. Hart, 1968. Cardiac output and organ blood flow in warm and cold acclimated rats exposed to cold. *Can. J. Physiol. and Pharmacol.* 46:653-659.

Jones, S. B. and X. J. Musacchia, 1973a. Effects of temperature acclimation on endogenous tissue levels of catecholamines in the hamster. *Bull. Mo. Acad. Sci.* 1(5).

Jones, S. B. and X. J. Musacchia, 1973b. Effects of temperature acclimation on catecholamine tissue levels and sympathetic capacity in the hamster. *Physiologist* 16(3):355.

Legrand, Michele, 1969. Influence de l'hyperthermie sur les concentrations en noradrenaline de différentes aires cérébrales chez le rat. Variations concomitantes au niveau du cœur et des surrénales. *J. Physiol. (Paris)* 61:99-118.

Levitt, N., S. Spector, A. Sjoerdsma and S. Udenfriend, 1965. Elucidation of the rate-limiting step in norepinephrine biosynthesis in the perfused guinea pig heart. *J. Pharmacol. Exptl. Therap.* 148:1-8.

Nagatsu, Toshiharu, Morton Levitt and Sidney Udenfriend, 1964. Tyrosine hydroxylase, the initial step in norepinephrine biosynthesis. *J. Biol. Chem.* 239(9):2910-2917.

Neff, N. H. and E. Costa, 1968. Application of steady-state kinetics to the study of catecholamine turnover after monoamine oxidase inhibition or reserpine administration. *J. of Pharmacol. and Exptl. Therap.* 160(1):40-47.

Simmonds, M. A. and L. L. Iversen, 1969. Thermoregulation: effects of environmental temperature on turnover of hypothalamic norepinephrine. *Science* 163:473-474.

Udenfriend, Sidney and Wallace Dairman, 1970. Regulation of norepinephrine synthesis. *Adv. Enzyme Regul.* 9:145-185.

TELEMETRY SYSTEM: BODY TEMPERATURE AND HEART RATE

INTRODUCTION

One of the principle parameters used in ascertaining an understanding of metabolism in an animal is its body temperature. However, most of the techniques used in obtaining body temperature readings over extended periods of time or during repeated samplings require manual manipulation of the animal, for example, restraint and insertion of rectal probes. These procedures disturb the animal in question and often evoke a change in body temperature which can, unfortunately, result in questionable experimental data. In order to avoid these problems we are attempting to utilize a telemeter system based on existing NASA technology. In our experiments we plan to include an extension of the instrument so that we can monitor heart rate as well as body temperature.

THE TELEMETRY INSTRUMENTS

1. Transmitter EKG/Temperature: The transmitter was designed (NASA Technical Brief #72-10035) to produce a base pulse frequency which, by averaging the pulses per unit time, would have a direct relationship with temperature, and any rapid variation around this average would be heart rate. The circuit contains an oscillation and an amplifier-modulation. The oscillator produces the base pulse frequency which varies with temperature due to the action of a ther-

mistor, in this device a resistor that is highly affected by temperature. The EKG signal is amplified and applied to the oscillator in order to modulate the base frequency. Since the EKG signal is very rapid and only occurs at approximately 1/10 the rate of the base frequency, it is possible to average, over a long-term, the base frequency (temperature), and any rapid periodic changes in the base frequency would be heart rate. The transmitter range is approximately 2 feet and can be received on a standard A.M. radio. The temperature range of the transmitter is wide and can be selected by the various internal components, in order to insure maximum efficiency. A schematic figure is presented as follows:

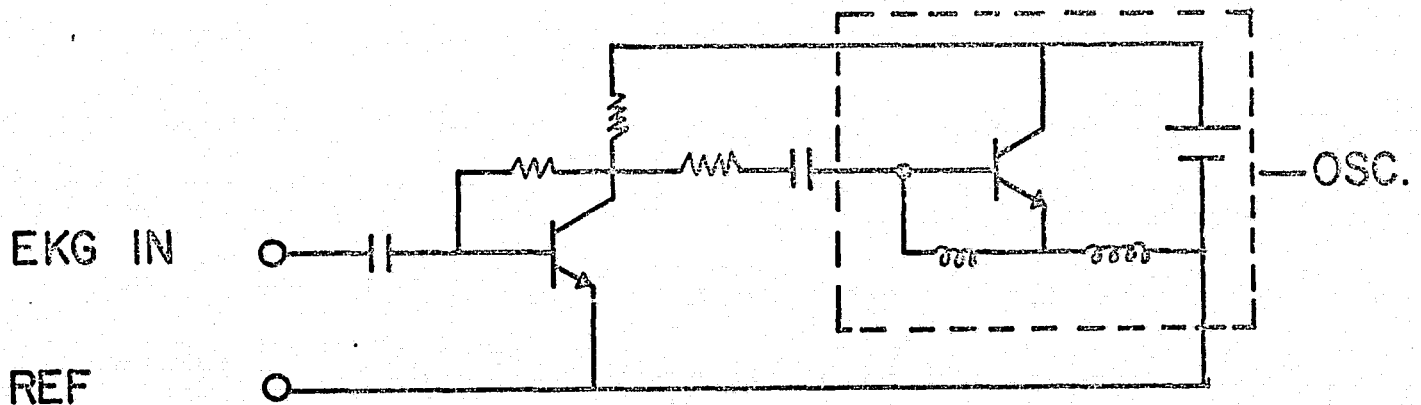

The size of the unit after construction is approximately 2 cm x 1.2 cm x 0.8 cm. A diagram of the unit is presented.

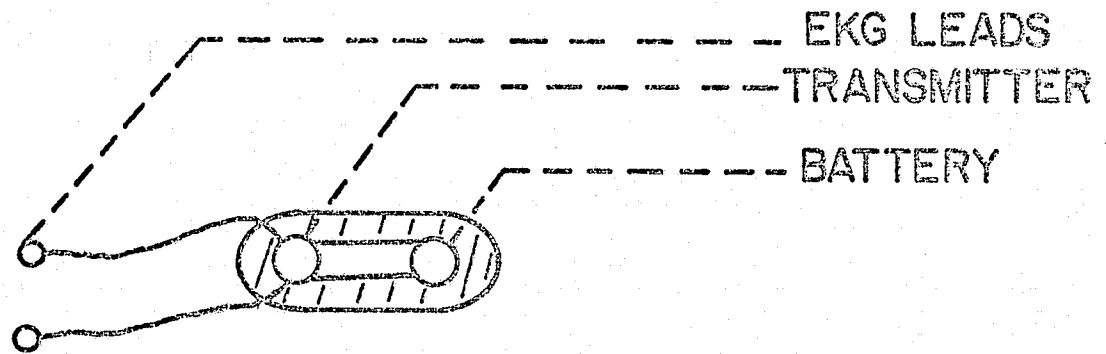

With the transmitter size being approximately 0.4 cm x 0.9 cm before assembly. The batteries used are hearing aid batteries, 312 or 212. Weight of complete unit is < 2.5 gm.

The transmitter is assembled and sealed in glue, then the battery is attached and the unit is sealed in a layer of wax. The unit is then sealed by epoxy followed by a coating of silicon.

The transmitter unit has an expectancy of one month, and at that time the batteries can be replaced.

2. Demodulator EKG/Temperature Transmitter: The signal (pulsed frequency) from the transmitter can be received with a standard A.M. radio. The output from the radio (taken from the speaker) is then applied to a wave shaping circuit, which converts the transmitter pulses to square wave pulses. The pulses, then averaged (converted

to a D.C. level), are proportional to temperature. This D.C. level (temperature pulse average) shifts slightly at the occurrence of a heart beat. The shift has very little effect on the overall temperature pulse average, and by applying the D.C. level to feather wave shaping and averaging circuits this slight shift can be converted to D.C. level which is proportional to heart rate. See figure as follows:

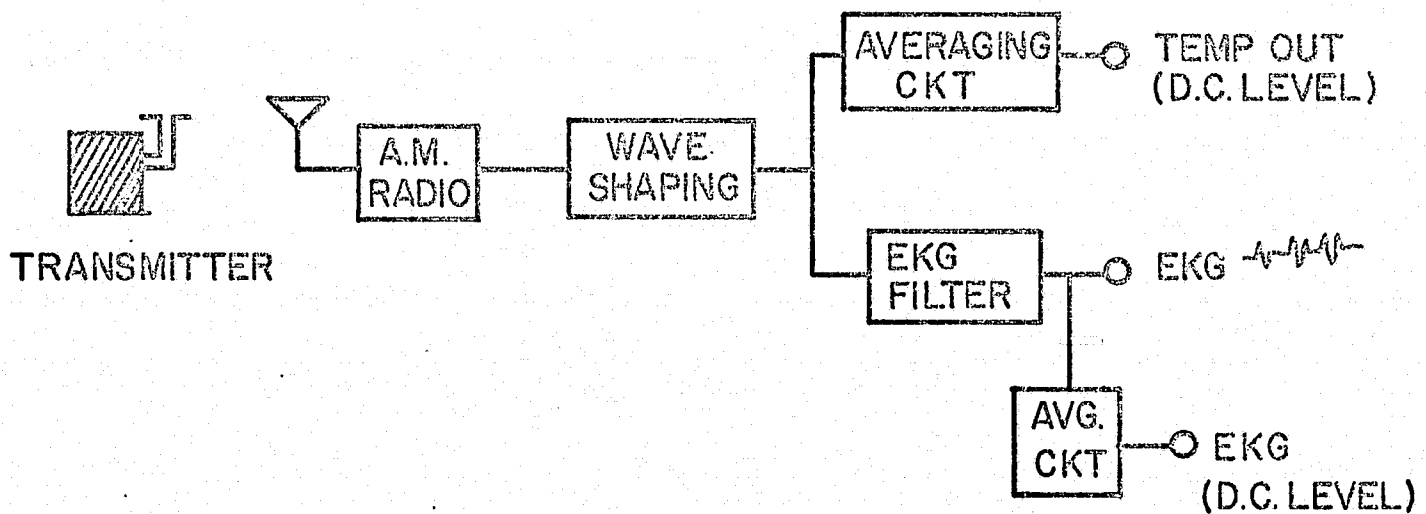

RESULTS

To date several hamsters have had transmitters implanted. The bio-materials have been found to be acceptable in the peritoneal

cavity. Surgical procedures have proven to be readily facilitated and the animals are resistant to infection. Transmitters have been implanted for periods of up to one month; the present limitations are the battery life. Post mortems indicate there are no adverse effects in the animals. EKG and temperature signals have been recorded. As many as three animals in plastic cages, side by side, within 8 inches of each other, have been tested and found free of signal interference.

CONCLUSION

The transmitter/telemetry system for body temperature and EKG is not only feasible but working models have been built and used on a limited basis. The cost of manufacture is principally one of labor, since parts for each device are minimal. This laboratory would be willing to explore a contract for manufacture of these instruments to be used by all members of the consortium.

REPRINT

The Effects of Argon in the Bioenergetics of the Hamster and the Rat¹ (37879)

GEORGE E. TEMPEL AND X. J. MUSACCHIA

Dalton Research Center and Department of Physiology, University of Missouri, Columbia, Missouri 65201

There has been a growing interest in the use of various inert gases in biomedical research in various mammalian species. Two gases in particular have attracted attention in light of their effects in altering metabolism, viz., helium and argon. Several investigators (1-6) have shown that in the presence of helium (even in a normoxic environment), there is a metabolic challenge to small mammals such as rats, mice, and hamsters. In general, exposure to helium results in increases in metabolism whether measured as increased oxygen consumption or increased rates of respiration (ventilation). These changes are credited, or at least relatable, to increased thermal conductivity. In contrast, Clarkson *et al.* (7) maintained that the metabolic rate of the rat exposed to helium-oxygen (80%, 20%) is reduced from control levels obtained in nitrogen-oxygen (80%, 20%), a depression that could not be explained by thermal factors alone. In their experiment, ambient temperatures were regulated to a thermal neutral temperature, an approach which differs markedly from that taken by others.

Investigations employing argon as a diluent gas have also yielded controversial results; however, this gas does not induce a thermal-related acceleration of metabolic rate to the same extent as helium. Early studies of divers (8) demonstrated a greater narcotic effect for argon at increased pressure (up to 10 atm) than for nitrogen at

similar pressure. No effect, however, was observed at atmospheric pressure. Cook (9), in an investigation of the effects of argon on metabolism and metamorphosis, reported that at atmospheric pressure, the substitution of argon for nitrogen accelerated the development of insects. Frankel and Schneiderman (10) in an attempt to confirm and extend these findings, concluded on the contrary that at atmospheric pressure, inert gases were without effect on the development of insects. Galvin *et al.* (11) and Schatte (12) have reported that compared with nitrogen, argon has a depressant effect on the oxygen consumption of rabbits and rats respectively. However, Hamilton *et al.* (13, 14) using a similar approach i.e., normoxic environments, failed to observe such an effect in either species.

These conflicting reports as well as our interest in depressed metabolic states prompted this study of the effect of normoxic mixtures of argon in the golden hamster (*Mesocricetus auratus*). It was hoped that an assessment of both the direction and the significance of the effects of exposure to argon might be made. In order to provide some basis for comparison with other workers, several experiments with Sprague-Dawley rats were also done. The effects of fasting and low ambient temperatures were also studied in order to further elucidate the role of argon, if any, in mammalian bioenergetics.

Materials and Methods. Hamsters, males and females (120-130 g), from our closed colony were used. Sprague-Dawley rats, males and females (130-140 g) purchased

¹ Supported by NASA Grant NGL 26-004-021 S7 and Dalton Research Center funds.

from Carworth Farms were also studied. The hamsters required no additional conditioning to the laboratory as they could be taken directly from the stock supply. Rats, on the other hand, were conditioned for 2 or more weeks in our animal room prior to experimentation. All animals were fed a diet of Wayne Lab-Blox and water *ad lib*. Hamsters were given weekly supplements of fresh lettuce.

Gas mixtures were 80% argon or nitrogen and 20% oxygen. Mixtures are accurate to within 1% and were prepared by Puritan Bennett Corp. The gas cylinders for room-temperature experiments were maintained at room temperature 22° (variation $\pm 2^\circ$) and those used in the low-temperature experiments were maintained at 7° (variation $\pm 1^\circ$).

Metabolism chambers were made of lucite cylinders with an approximate volume of 1,000 ml. In all experiments conducted, there was only one animal per chamber. The animal was isolated from laboratory disturbances by placing the metabolism chamber in a larger temperature-regulated and sound-insulated cabinet (a converted refrigerator equipped with inlet and outlet ports and a window). Room-temperature (22°) experiments were conducted in this manner while those at 7° carried out by isolating the chamber in a walk-in cold room (Forma Scientific, Inc.). Temperatures within the metabolism chamber, monitored in early experiments with thermocouples, showed approximately a 2° increase above ambient in both the 22 and 7° environments. Oxygen consumption (\dot{V}_{O_2}) was determined using a Beckman model G-2 paramagnetic oxygen analyzer which gave full-scale deflection for a 5% oxygen difference. Mean flow (\dot{V}_I) through the chamber was 118.9 and 192.4 ml/min for the 22 and 7° determinations, respectively. \dot{V}_{O_2} was calculated according to the following formula:

$$\dot{V}_{O_2} = \dot{V}_I \times 60 \frac{(F_{I_{O_2}} - F_{E_{O_2}})}{100} \times \frac{10^3}{wt} \text{ ml}(\text{kg}\cdot\text{hr})^{-1},$$

where \dot{V}_I is flow in ml/min, $(F_{I_{O_2}} - F_{E_{O_2}})$ is the percent change in oxygen content in the chamber air, and weight is animal weight in grams. Calibration of the instrument was accomplished with room air (20.39% O_2) as the zero gas and Puritan-Bennett primary standard (17.00% O_2) as the span gas. The 0.2% difference in O_2 concentration possible due to differences in diamagnetic properties of the diluent gases was considered negligible due to the fact that the determination involved assessment of Δ oxygen.

In each experiment, the animal served as its own control. A hamster or rat was individually placed in a metabolism chamber, containing cedar shavings which prevented direct contact with the floor. The animal was monitored as it respired a normoxic nitrogen mixture, and then switched to a normoxic argon mixture at comparable flow rates. Those animals which were fasted were deprived of food 16 hr prior to an experimental run. It must be noted, however, that all animals were essentially under conditions of fasting from the time they were placed in their individual metabolism chambers.

The experimental protocol consisted of three stages. During stage 1, which was a period of stabilization, the animal in the metabolism chamber respired a mixture of 80% N_2 and 20% O_2 , visual observations were made, and oxygen consumption was monitored. After stabilization, stage 2 was initiated, namely, the continual monitoring of oxygen consumption in the 80% N_2 and 20% O_2 environment. Data were recorded for periods of 4 or more hr. Stage 3 designates the last period, i.e., when the gas mixture was changed from 80% N_2 and 20% O_2 to 80% Ar and 20% O_2 . Oxygen consumption was monitored and recorded for an additional 4 or more hr. Overall, oxygen utilization was monitored for periods up to 16 hr. In general, determinations of oxygen consumption of the nitrogen-oxygen environment were made in the morning, while those in argon-oxygen were completed in the afternoon. The morning activity increase between the hours of 10 and 11 reported by Petrsek (15) was

TABLE I. Oxygen Consumption of the Golden Hamster and White Rat in Air and Argon.^a

Animal	Experimental conditions (1 atm)	Mean oxygen consumption ^b (ml(kg·hr) ⁻¹) ^c	
		Air	Argon
Hamster	Nonfasted, 22°	1070.2 ± 247.5 (6)	967.4 ± 137.0 (6)
	Fasted 16 hr, 22°	795.2 ± 139.3 (7)	749.1 ± 126.9 (7)
	Fasted 16 hr, 7°	1893.0 ± 291.8 (8)	1548.3 ± 249.2 (8)
Rat	Nonfasted, 22°	1250.6 ± 133.1 (6)	1136.0 ± 225.2 (6)
	Fasted 16 hr, 7°	1499.6 ± 170.5 (7)	1266.6 ± 115.4 (7)

^a Air = 80% N₂ + 20% O₂, Argon = 80% Ar + 20% O₂.

^b Volumes are for standard conditions of temperature and pressure.

^c Data are mean ± SD, number of animals in parentheses.

noted and corrected for by drawing the line of best fit through the data.

Intergroup comparisons of the data were made using the Wilcoxon signed ranks test for populations of small *n*.

Results. The data for both hamsters and rats are summarized in Table I and Fig. 1. At room temperature (T_a 22°), the substitution of argon for nitrogen appears to be without marked effect in unfasted hamsters. Although oxygen consumption is depressed in argon, 967.4 ± 137.0 from 1070.2 ± 247.5 ml (kg·hr)⁻¹ in air, the difference is indicative only of a trend and is not statistically significant. A significant ($P < 0.05$) change due to the calorific effect of food may be seen in a comparison of fasted and unfasted hamsters; nonfasted

hamster in air utilized oxygen at a mean rate of 1070.2 ± 147.5 ml (kg·hr)⁻¹ whereas the 16-hr-fasted animals under similar conditions consumed 795.2 ± 139.3 ml (kg·hr)⁻¹. Sixteen-hour-fasted hamsters exposed to 80% Ar, 20% O₂ demonstrated a similar decrease from a nonfasted mean of 967.4 ± 137.0 to 749.1 ± 126.9 ml (kg·hr)⁻¹. The oxygen consumption of fasted hamsters exposed to argon indicated a slight (5.8%) decrease from 795.2 ± 129.3 to 749.1 ± 126.9 ml (kg·hr)⁻¹ which was statistically significant at the 0.05 level.

During cold exposure (T_a 7°), hamsters increased their oxygen consumption in both air and argon to a level approximately double that of comparable animals at T_a 22°. There is, however, significantly ($P <$

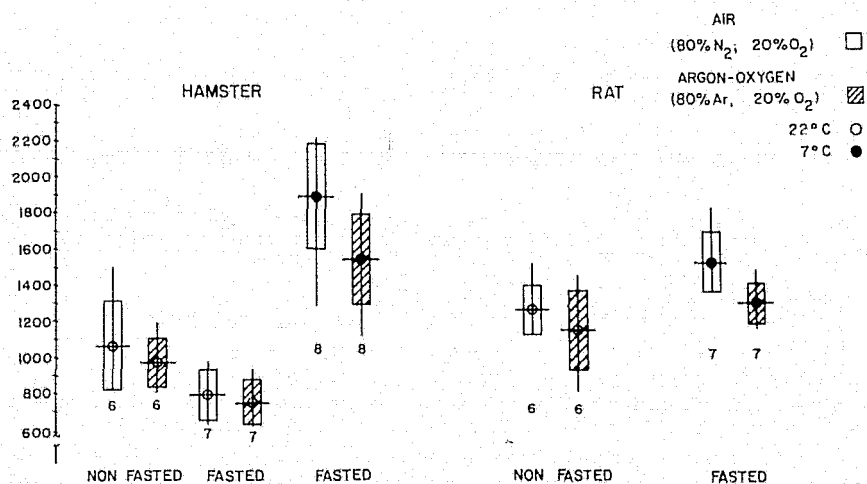

FIG. 1. Comparison of oxygen consumption in air (80% N₂:20% O₂) and in 80% Ar:20% O₂ of golden hamsters and white rats. (Vertical line indicates range; horizontal line represents mean; rectangles enclose mean ± SD, and number below is sample size.)

0.05) less oxygen consumption in the presence of argon (Table I). This difference, from 1893.0 ± 291.8 to 1548.3 ± 249.2 ml (kg·hr)⁻¹, represents a decrease of 18.2%.

The data obtained from rats are in many ways comparable to those from hamsters. At 22° the nonfasted rats had a mean oxygen consumption of 1250.6 ± 133.1 ml (kg·hr)⁻¹ in 80% N₂, 20% O₂ environment with no significant change during exposure to the 80% Ar, 20% O₂ environment. Fasted rats exposed to 7° temperature demonstrated an increased oxygen consumption in normoxic nitrogen, but not in normoxic argon. There is, therefore, a depression (15.5%) in the metabolic rate of fasted rats at 7° in the normoxic argon environment. This represents a significant ($P < 0.05$) decrease in oxygen consumption from a mean value of 1499.6 ± 170.5 to 1266.6 ± 115.4 ml (kg·hr)⁻¹ in air and argon, respectively.

Discussion. The resting oxygen consumption data from hamsters exposed to air (80% N₂, 20% O₂) are in reasonable agreement with previously reported values. The mean oxygen consumption of hamsters at $22 \pm 2^\circ$ was approximately 1070 ml (kg·hr)⁻¹. Hoffman (16) reported a range of oxygen consumption from 930 to 1014 ml (kg·hr)⁻¹ for resting hamsters at 28 to 34°. Although the value reported herein is greater than the upper limit of this range, it is likely due to the difference in thermal environments at which the experiments were carried out, or to seasonal differences.

To reduce the variable increase in energy metabolism following the ingestion of food,

groups of both hamsters and rats were fasted for 16 hr prior to the experiments. The result suggests that the elimination of the calorific effect of food significantly reduced the hamsters' oxygen consumption in both air and normoxic argon. Individual values (Fig. 1) are suggestive of metabolic depression when the animal finds itself in an 80% argon, 20% oxygen atmosphere. However, the large overlap in values between air and argon exposures suggests the lack of any marked difference between the two conditions.

The group of elements known as chemically inert or rare gases are characterized by the completeness of their outer electron shell, and consequently, little tendency to gain or lose electrons. This decreased ability to form bonds with biochemical elements of cells and tissues suggests that the effect of these gases on animal metabolism might relate to their physical properties. Some of those characteristics most frequently considered in terms of narcotic potency are listed in Table II. Examination of this table shows that the oil:water solubility ratios of nitrogen and argon are strikingly similar although they differ markedly in thermal conductivity. In order to assess the data in terms of thermal conductivity, it is necessary to consider the animal's other avenues of heat loss: radiation, convection, and evaporation.

Radiant heat loss varies directly with the temperature gradient between the body surface and the average ambient temperature. In both air and argon environments, the ambient temperature and hence heat loss by radiation were the same. Convective heat

TABLE II. Physical Properties of Inert Gases.

Inert gas	Helium	Nitrogen	Neon	Argon	Krypton	Xenon
Atomic number	2	7	10	18	36	54
Atomic weight	4.003	28.016 (N ₂)	20.183	39.944	83.80	131.30
Oil:water solubility ratio ^a	1.8	5.2	2.1	5.4	9.6	20.0
Thermal conductivity at 37.8° and 1 atm cal/(sec) (cm ²) (°/cm) × 10 ⁻⁴	368.63	64.06	118.19	41.22	23.56	12.1 ^b

^a Calculated from solubility data of Lawrence *et al.* (19).

^b Thermal conductivity of He, N₂, Ne, Ar, Kr at 37.8° from West (20); Xe thermal conductivity at 0° from Jenkins (21).

transfer likewise depends on a temperature gradient between the body surface and ambient air as seen in the following equation:

$$H_c = K_c A_c (T_b - T_a), \quad (17)$$

where H_c is heat transfer by convection, K_c is the convection coefficient, A_c the exposed body surface area, and $(T_b - T_a)$ the temperature gradient between body surface and ambient air. In these experiments, both the thermal gradient and exposed body surface area were probably the same in the two environments in that no postural changes were noted and the ambient temperature was not altered. Another influence in the transfer of heat by convection, as seen in the above equation, is the rate at which convective currents bring gas to the body surface to participate in heat exchange (K_c). Use of comparable flow rates in the two environments keeps this factor, and thus convective heat transfer, uniform in air and argon environments.

Finally, heat transfer by evaporation would be the same in both cases since the relative humidity is constant. Humidity, a function of the chamber size, rate of gas flow through the chamber, and evaporative water loss, remains stable as none of the preceding are varied upon changing the diluent gas from nitrogen to argon.

The effect of alteration of the thermal conductivity of the gaseous environment on heat transfer can be seen in the following equation of Hardy (18):

$$H_D = \frac{KA(T_2 - T_1)}{d} \times t,$$

where heat loss by conduction (H_D) is proportional to the area A , the thermal gradient $(T_2 - T_1)/d$, the time t , and the thermal conductivity K . With other factors constant between the two environments, an increase in the thermal conductivity would cause a proportionate increase in heat loss to the environment under these experimental conditions. Thus, the fact that oxygen consumption observed at T_a 7° is not as great in argon as in nitrogen may be due to the greater thermal conductivity of the latter. The effective cold stress imposed

upon the animal might then be greater in the nitrogen atmosphere as a consequence of increased heat loss. Moreover, it is conceivable that the lack of any marked effect of argon at $22 \pm 2^\circ$ is relatable to reduction in the thermal gradient between the hamster's surface temperature and the temperature of the gas.

Although these data do not permit absolute separation of the effects of argon into thermal and nonthermal components, they are consistent with the indirect or physical hypothesis for its effect on metabolism. Thus, at atmospheric pressure, the effects of argon are minimal unless superimposed on cold stress where the reduced thermal conductivity of argon might account for the observed "decrease" in metabolic rate.

Summary. Oxygen consumption was examined in hamsters and rats exposed to normoxic mixtures of argon at 1 atm. In fasted and nonfasted animals, no marked change in O_2 utilization was detectable at 22°. However, at 7° a significant decrease in oxygen consumption was observed where the animals were exposed in argon. The data are interpreted in terms of the greater thermal conductivity of nitrogen.

We thank Jane R. Utsler for technical assistance and Drs. Barbara Horwitz and J. P. Jordan for their suggestions in the preparation of this manuscript.

1. Leon, H. A., and Cook, S. F., *Amer. J. Physiol.* 199, 243 (1960).
2. Rhoades, R. A., Wright, R. A., Hiatt, E. P., and Weiss, H. S., *Amer. J. Physiol.* 213, 1009 (1967).
3. Fischer, B. A., and Musacchia, X. J., *Amer. J. Physiol.* 215, 1130 (1968).
4. Zimin, A. B., and Runkov, S. V., *Bull. Exp. Biol. Med.* 67, 364 (1969).
5. Musacchia, X. J., *Amer. J. Physiol.* 222, 495 (1972).
6. Troshikh, G. V., *Kosmich. Biol. Med.* 6, 84 (1972).
7. Clarkson, D. P., Shatte, C. L., and Jordan, J. P., *Amer. J. Physiol.* 222, 1494 (1972).
8. Behnke, A. R., and Yarbrough, O. D., *Amer. J. Physiol.* 126, 409 (1939).
9. Cook, S. F., *J. Cell. Comp. Physiol.* 36, 115 (1950).

10. Frankel, J., and Schneiderman, A., *J. Cell. Comp. Physiol.* **52**, 431 (1958).
11. Galvin, R. D., Peeler, D. J., and Albright, G. A., *Aerospace Med.* **37**, 278 (1966).
12. Shatte, C. L., Ph.D. Dissertation, Colorado State University, Fort Collins, Colorado (1971).
13. Hamilton, R. W., Doebbler, G. F., and Schreiner, H. R., *Spaces Life Sci.* **2**, 307 (1970).
14. Hamilton, R. W., Doebbler, G. F., and Schreiner, H. R., *Spaces Life Sci.* **2**, 407 (1971).
15. Petrasek, R., *Vestn. Cesk. Spol. Zool.* **21**, 300 (1957).
16. Hoffman, R. A., in "The Golden Hamster" (R. A. Hoffman, P. F. Robinson, and H. Magalhaes, eds.), Chap. 3, p. 28. Iowa State University Press, Ames (1968).
17. Adams, T., *J. Appl. Physiol.* **18**, 772 (1963).
18. Hardy, J. D., in "Physiology of Heat Regulation and the Science of Clothing" (Newburgh, L. H., ed.), p. 88. Saunders, Philadelphia (1949).
19. Lawrence, J. H., Loomis, W. F., Tobias, C. A., and Turpin, F. H., *J. Physiol.* **105**, 197 (1946).
20. Weast, R. C., ed., in "CRC Handbook of Chemistry and Physics," 52nd ed., Chemical Rubber Co., Cleveland (1971).
21. Jenkins, A. C., in "Argon, Helium, and the Rare Gases," Vol. 1, (Cook, G. A., ed.), Interscience Publishers, New York (1961).

Received June 1, 1973. P.S.E.B.M., 1974, Vol. 145.

PREPRINT: SEE SECTION II. PROJECT 1.

ABSTRACTS

RENAL FUNCTION IN HYPOTHERMIC AND HIBERNATING GOLDEN HAMSTER.
G.E. Tempel*, W. Volkert* and X.J. Musacchia, Dept. of Physiol.
Dalton Res. Ctr., Univ. of Missouri, Columbia, MO 65201.

Previous studies of the hypothermic hamster suggested the absence of glomerular function. The renal corticomedullary solute gradient was examined; radioisotope renograms and blood pressure determinations were made. Solute gradients were studied in (1) 80:20 helium:oxygen controls ($T_{re}37C$, T_a22C); (2) helium-cold hypothermic hamsters (5-15 min $T_{re}7C$, T_a7C); and (3) hibernating hamsters (48 hr, $T_{re}7C$, T_a7C). Na^+ in normothermic controls increased from 80.8 ± 9.3 to 217.8 ± 29.1 mEq/l. Urea also increased from 22.4 ± 3.8 to 202.8 ± 59.7 mM/l. Hypothermic hamsters showed gradients for both Na^+ and urea. Gradients for Na^+ , from 63.1 ± 8.0 to 112.6 ± 12.8 mEq/l, and for urea, from 19.8 ± 2.9 to 55.7 ± 13.2 mM/l, are significantly different from controls ($P < .01$). Hibernating hamsters showed no gradient for urea. However, Na^+ showed a slight gradient from 65.1 ± 16.2 to 80.3 ± 10.5 mEq/l. All groups showed a decrease in K^+ concentration from cortex to medulla. Technetium and iodohippurate ^{131}I renograms in rewarming hypothermic hamsters showed renal perfusion at 8C, but an absence of filtration until the T_{re} had risen to 10-12C. Blood pressure determinations suggest that renal perfusion occurs in the hypothermic hamster ($T_{re}7C$) at a mean aortic pressure some 40% less than control. Filtration, however, does not begin until blood pressure has increased to approximately 70 mm Hg at $T_{re}10-12C$. (Supported by NASA NGL 26-004-021 and Dalton Research Center)

TURNOVER RATES OF NOREPINEPHRINE IN HEART AND OTHER TISSUES OF THE GOLDEN HAMSTER IN HEAT AND COLD ACCLIMATION. S. B. Jones and X. J. Musacchia (Physiology and Dalton Research Center, Univ. Mo., Columbia). Tissue norepinephrine (NE) turnover rates were investigated in hamsters (Mesocricetus auratus) after 5-7 wk exposure to 7, 22 and 34°C. The drug α -methyl-p-tyrosine methyl ester, which competitively inhibits rate limiting biosynthetic enzyme of NE, was injected (ip 200 mg/kg). At sequential periods after administration animals were sacrificed by cervical dislocation, tissues removed and frozen. Decay constants, half-life and turnover rates were determined. Heart NE turnover was highest in cold acclimated and lowest in heat exposed animals (.110 and .045 $\mu\text{g/g/hr}$ respectively); control values being intermediate (.081 $\mu\text{g/g/hr}$). Turnover is inversely related to tissue levels at these temperatures. Spleen NE turnover was not different from that of heart, being lowest with heat and highest with cold exposure (34°C = .042 $\mu\text{g/g/hr}$, 22°C = .096 $\mu\text{g/g/hr}$, 7°C = .139 $\mu\text{g/g/hr}$). Brain NE turnover was not different with either heat or cold acclimation. Changes in peripheral organ turnover of NE are considered to be related to transynaptic induction of biosynthetic enzymes. Such transynaptic activity is reportedly mediated by peripheral sympathetic tone. Therefore, evidence reported herein suggests increased peripheral sympathetic tone with cold exposure and depressed peripheral tone with heat acclimation. Supported in part: NASA Grant NGL 26-004-021 S 8-9.

Transaction Missouri Academy of Sciences 1974

ORIGINAL PAGE IS
OF POOR QUALITY

EXPERIMENTAL HYPOTHERMIA, A MODEL FOR NATURAL HIBERNATION.

Musacchia, X. J. Dalton Research Center and Department of Physiology,
University of Missouri, Columbia, Missouri 65201, U.S.A.

The hamster, Mesocricetus auratus, was selected because of its ability to undergo hypothermia under controlled conditions, its ability to hibernate and its potential as a suitable model for experimental or "controlled" hibernation. The hamster is induced into deep hypothermia, $T_{re} 7^{\circ}\text{C}$, using the helium-cold method (exposure to $\text{He}:\text{O}_2$, 80:20 at $0-5^{\circ}\text{C}$). It does not awaken spontaneously as does the hibernating animal, however, exposure to room temperature, $T_a 22^{\circ}\text{C}$, elicits rewarming to normothermia. In hypothermia and hibernation oxygen consumption stabilizes, respectively, in $\text{ml}\cdot\text{kg}^{-1}\cdot\text{hr}^{-1}$ 37-40 (our data) and 60-80 (Lyman's data). In contrast, oxygen consumption in normothermic control animals is $1138 \pm 0.08 \text{ ml}\cdot\text{kg}^{-1}\cdot\text{hr}^{-1}$. The question remains as to whether the level of oxygen consumption is sufficient to meet metabolic requirements. Obviously in hibernation it does. Respiratory failure appears to be the limiting factor in hypothermia. The animal shows a gasping response prior to death, and survival can be prolonged with artificial respiration. In addition, hypoglycemia is characteristic of hypothermia; blood glucose values fall from about 100 mg% in normothermia to about 30 mg% during initial periods in hypothermia and 5-10 mg% at the onset of gasping, immediately before death. Considering also the role of glucose as a source of energy for the brain, a series of glucose infusion experiments were done. When glucose was infused, 2.7 mg/hr, and blood levels maintained at about 40 mg%, hypothermia was sustained for 4 and 5 days. These periods are comparable to periods of hibernation. Renal function, i.e. glomerular filtration, estimated from cortico-medullary concentration gradients of Na^+ , K^+ and urea, was absent in hypothermic and minimal in hibernating hamsters. Upon arousal from hibernation or hypothermia functional recovery occurred. To date, our results show that the helium-cold method for induction of hypothermia can serve as a model for controlled depressed metabolism. (Supported by NASA Grant, NGL 26-004-021, S10 and the Dalton Research Center. C. 2

RBC 2,3-DIPHOSPHOGLYCERATE IN HIBERNATING, HYPOTHERMIC, AND REWARMING HAMSTERS. George E. Tempel* and X. J. Musacchia, Dept. of Physiol., and Dalton Research Center, University of Missouri, Columbia, Mo. 65201.

Red cell 2,3-diphosphoglycerate (DPG) was investigated to provide information on the time course of recovery of DPG upon rewarming, and on mechanisms of DPG depression. Blood samples (cardiac puncture) were analyzed for hemoglobin (Hgb) and DPG in: control hamster (C), T_{re} 37°C at T_a $22 \pm 2^\circ\text{C}$; hibernators (H 48), T_{re} 7°C for 48 hr; rewarming hibernators (RH 48) bled after reaching stable T_{re} $36 \pm 2^\circ\text{C}$; hypothermic 12 hrs (Hy 12) induced with 80:20 cold He:O₂ and T_{re} 7°C; hypothermic 24 hrs (Hy 24) induced with 90:10 cold He:O₂ and T_{re} 7°C; recovered hypothermic (R₁Hy 24) bled after reaching stable T_{re} $36 \pm 2^\circ\text{C}$; recovered hypothermic (R₂Hy 24) bled 2 hrs after reaching stable T_{re} $36 \pm 2^\circ\text{C}$. Values for C were 16.9 ± 1.2 g% and 19.2 ± 1.1 $\mu\text{moles/g}$ Hgb for Hgb and 2,3-DPG respectively. Group H 48 showed a 22.5% increase in Hgb and decrease in DPG of 39.1%. By contrast the Hy 12 group did not differ from group C ($p > 0.05$). However, in group Hy 24 a 19.5% decrease in Hgb concentration to 16.9 ± 1.2 g% and a 33.9% decrease in DPG concentration to 12.7 ± 0.7 $\mu\text{moles/g}$ Hgb resulted. DPG concentration, although decreased in the hypothermic animal, is 15% greater than the concentration in the hibernator. RH 48 and R₁Hy 24 did not differ from each other ($p > 0.05$). Hgb returned to C values in both; however, DPG levels were approximately 10% less than C. R₂Hy 24 values for DPG were 17.5 ± 1.3 $\mu\text{moles/g}$ Hgb, 8.7% less than C values. DPG concentration decreases in both the hibernating and long term hypothermic hamsters. Differences between the two are slight

and may be attributed to the long term cold exposure of the latter.

(Supported by NASA NGL 26-004-021 S9 and 10, and Dalton Res. Center.)

The Physiologist (in press) 1974

THE EFFECT OF CHRONIC HEAT STRESS ON INTESTINAL FUNCTION IN THE RAT.
Mecca Carpenter* and X. J. Musacchia, Dept. of Physiol., and Dalton
Research Center, University of Missouri, Columbia, Mo. 65201.

Male rats exposed to T 34°C for two weeks show alteration in intestinal function compared^a to pair fed controls at T 22°C. Active transport was measured by an everted gut sac method^a using three jejunal locations. The initial concentration of glucose was 18 mM in a Krebs-Ringer Bicarbonate buffer at both the mucosal and serosal surfaces. Incubation time was 30 minutes. The total amount of glucose transported per sac was significantly less in heat stressed animals for each jejunal location. Proximal to distal values for glucose uptake following heat exposure were 49.8 ± 2.2 , 38.0 ± 3.4 , and 36.7 ± 2.6 μM . Control values were 57.1 ± 2.0 , 53.7 ± 4.3 , and 47.4 ± 4.0 μM . However, when transport of glucose is expressed as $\mu\text{moles/gm wet wt.}$, there was no significant difference between sacs from the same location in the two groups of animals. Intestinal mass per gram body weight was reduced in heat stressed rats. The total dry gut weight to body weight ratio after heat exposure was $.0033 \pm .0002$ compared to a control value of $.0043 \pm .0001$ ($p < .005$). With heat exposure, gut tissue water was also significantly reduced from control values. Reduction in total absorptive capacity while maintaining a stable active transport system may be one adaptation to reduced metabolic demands with an increased heat load in the rat. (Supported by NASA NGL 26-004-021-S10).

The Physiologist (in press) 1974

**ORIGINAL PAGE IS
OF POOR QUALITY**

TURNOVER RATES OF NOREPINEPHRINE IN HEART SPLEEN, AND BRAIN TISSUES OF THE GOLDEN HAMSTER IN TEMPERATURE ACCLIMATION. S. B. Jones* and X. J. Musacchia, Dept. of Physiol., and Dalton Research Center, University of Missouri, Columbia, Mo. 65201.

Tissue norepinephrine (NE) turnover rates were investigated in hamsters (Mesocricetus auratus) after 5-7 wk exposure to 7, 22 and 34°C. The drug α -methyl-p-tyrosine methyl ester, which competitively inhibits rate-limiting biosynthetic enzyme of NE, was injected (ip 200 mg/kg). At sequential periods after administration animals were sacrificed by cervical dislocation, tissues removed and frozen. Decay constants, half-life and turnover rates were determined. Heart NE turnover was highest in cold acclimated and lowest in heat exposed animals (.110 and .045 $\mu\text{g/g/hr}$, respectively); control values being intermediate (.081 $\mu\text{g/g/hr}$). Turnover is inversely related to tissue levels in these acclimated states. Spleen NE turnover was not different from that of heart, being lowest with heat and highest with cold exposure (34°C = .042 $\mu\text{g/g/hr}$, 22°C = .096 $\mu\text{g/g/hr}$, 7°C = .139 $\mu\text{g/g/hr}$). Brain NE turnover was not different with either 22 or 7°C acclimation, but was elevated with 34°C acclimation. Changes in peripheral organ turnover of NE are considered to be related to transynaptic induction of biosynthetic enzymes. Such transynaptic activity is reportedly mediated by peripheral sympathetic tone. Therefore, evidence reported herein suggests increased peripheral sympathetic tone with cold exposure and depressed peripheral tone with heat acclimation. (Supported in part: NASA NGL 26-004-021 S8-9.)

The Physiologist (in press) 1974

ORIGINAL PAGE IS
OF POOR QUALITY

University of Missouri - Columbia



Research Park
Columbia, Mo. 65201

JOHN M. DALTON RESEARCH CENTER
Office of the Director

Telephone
314-882-7586

August 2, 1974

Mr. Ray Sutton
Office of University Affairs
National Aeronautics and
Space Administration
NASA/Ames Research Center
Moffett Field, California 94035

Dear Mr. Sutton:

This letter is in regard to NASA Grant NGL 26-004-021. I have been advised by Dr. Emily Holton, my grant monitor, to submit this continuation request to your office. The amount requested is \$20,000 for the period 9/30/74 to 8/31/75.

The enclosures contain a listing of our current projects and a brief explanation of the continued policy of our research program. A detailed annual report is in preparation and will be forwarded to Dr. Holton and your office later, at a time closer to our anniversary date. In addition, facilities for research are unchanged and there are no new major items required. The budget allocations are for continued posted payments of salaries, expendable items, travel to meetings, and publications. Indirect costs are in accordance with university regulation.

Progress of our research is monitored by Dr. Emily Holton and full disclosure of information is available to NASA and in particular, members of the consortium.

If I can provide any additional information, please do not hesitate to let me know.

Sincerely,

A handwritten signature in cursive script, appearing to read 'X. J. Musacchia'.

X. J. Musacchia, Ph.D.
Professor of Physiology
Interim Director
Dalton Research Center

XJM/lw

enc.

cc Dr. Emily Holton

I. BACKGROUND AND OBJECTIVES

Our studies have been aimed at a better understanding of the physiology of depressed metabolic states; our interests can now be focused on research in metabolic alterations and functional responses due to effects of stressful environments. These areas readily include animal metabolism under gravity-free conditions or synergistic effect of gravity-free conditions, and extreme modifications of environmental temperatures, and/or prolonged confinement. In short, our area of expertise can be concentrated in studies of animal metabolism which can be related to human stresses and pathophysiologic responses experienced in space vehicles.

Functional alterations in cardiovascular and renal metabolism under conditions of temperature stress are under investigation and they will be continued. Conditions of stress, whether they be induced by temperature stress (e.g., as in our laboratory) or eventually by features of a gravity-free environment (e.g., as in future NASA projects) can be assumed to have relatable physiologic responses. The bridging of activities in our laboratory with projected interests in NASA biomedical objectives are readily ascertained.

Among examples of projects identified for the Skylab Program (Skylab Experiments, Volume 4, Life Sciences, NASA publications, 1973), the cardiovascular and energy expenditure projects appear

to be in keeping with the program currently operative in this laboratory. Problems of energy expenditure are currently designed to measure oxygen intake and carbon dioxide output, temperature measurements, and work load relationships. These projects have been designed for man experiments in other NASA research. Our experiments will be planned as correlaries and the experimental subjects are laboratory mammals (e.g.; rats, hamsters, mice). Parallel experimental procedures can be readily designed to include additional studies for the assessment of cellular metabolism. The experimental animals can be ultimately sacrificed and energy exchange at the cellular level can be assessed. Obviously, human experimentation is limited at the cellular level.

At this time, our studies are providing basic experimental protocol for small animal experimentation. In one project, development of a telemeter system implantable in small mammals can provide an additional base of information. Our system measures both heart rate and body temperature in 100 gm animals. The role of the cardiovascular system, with its principle function of transport, can also be examined in small animal models with even greater detail than in the human subject. We would propose to measure heart rate, blood pressure, and body temperature during the course of exposure to gravity-free environment, and in addition, include a series of experiments which would assess alteration of vaso-active

hormones (e.g., norepinephrine and epinephrine). This laboratory is currently measuring turnover rates of catecholamines in heat stressed hamsters. What we are learning from environmental heat stress will be applicable to other forms of stress (e.g., gravity-free conditions).

Recently, we developed some relatively easy methods to determine kidney glomerular function, utilizing cortico-medullary gradients for sodium, potassium, and urea. This approach provides an efficient, qualitative system for assessing kidney function.

Lastly, little or no attention has been given to gastrointestinal function in manned or animal experiments in the NASA program. We propose to measure intestinal absorption and active transport phenomena in animal subjects. We have had ample experience in measurements of intestinal active transport in heat and cold stressed animals, and foresee little or no difficulty in applying our method to animals subjected to other forms of stress..

In summary, we propose to do a variety of animal experiments which are supportive of human-oriented experiments, wherever possible, our animal model experiments will parallel the human-based experiments (e.g., whole animal metabolism, cardiovascular responses, and temperature regulation), and we will extend these studies to include renal function, gastro-intestinal function, and the role of catecholamines on the cardiovascular system. The latter experiments can only be done using animal models. The results of such

experiments could be interpreted with reference to human responses and human pathophysiology in NASA manned programs.

II. PROJECTS CURRENTLY IN PROGRESS

1. Bioenergetics of Altered Metabolic States

- 1.1 Metabolism in the hamster: A potential subject for space flight experiments.
- 1.2 Role of carbohydrate in long-term survival in depressed metabolic states.

2. Telemetry Miniaturization

- 2.1 Development of a small animal transmitter for temperature and heart rate measurements.

3. Intestinal Function and Stress

- 3.1 Alterations in intestinal absorption in response to heat stress.

4. Renal Function and Stress

- 4.1 Renal glomerular function in depressed metabolic states (DMS) and in recovery from DMS.
- 4.2 Renal electrolyte distribution in response to hyper-gravity (A progress report).
- 4.3 Development of renin-angiotensin methods for small mammal research.

5. Hematology

- 5.1 Scintigraphic studies of renal blood flow in response to temperature stress.
- 5.2 Comparative aspects of 2,3-DPG in experimental hypothermia.

6. Cardiovascular and Neurohumoral Responses

6.1 Catecholamine tissues in long-term heat expressed animals (heart and other tissues).

III. BUDGET

Salary

X. J. Musacchia, Principal Investigator
(5% FTE)
G. W. Tempel, Co-Investigator
(40% FTE) \$ 5,400

Fringe Benefits 756

TOTAL S&W \$ 6,156

Animal Care \$ 2,000

Expendable Reagents & Supplies \$ 6,903

Travel

One trip to Ames and one trip
to FASEB Meetings \$ 1,000

Publication \$ 800

\$16,859

Indirect Costs (58.17 S&W) \$ 3,141

TOTAL \$20,000